

I-*Intelligent Sensor* -SERIES

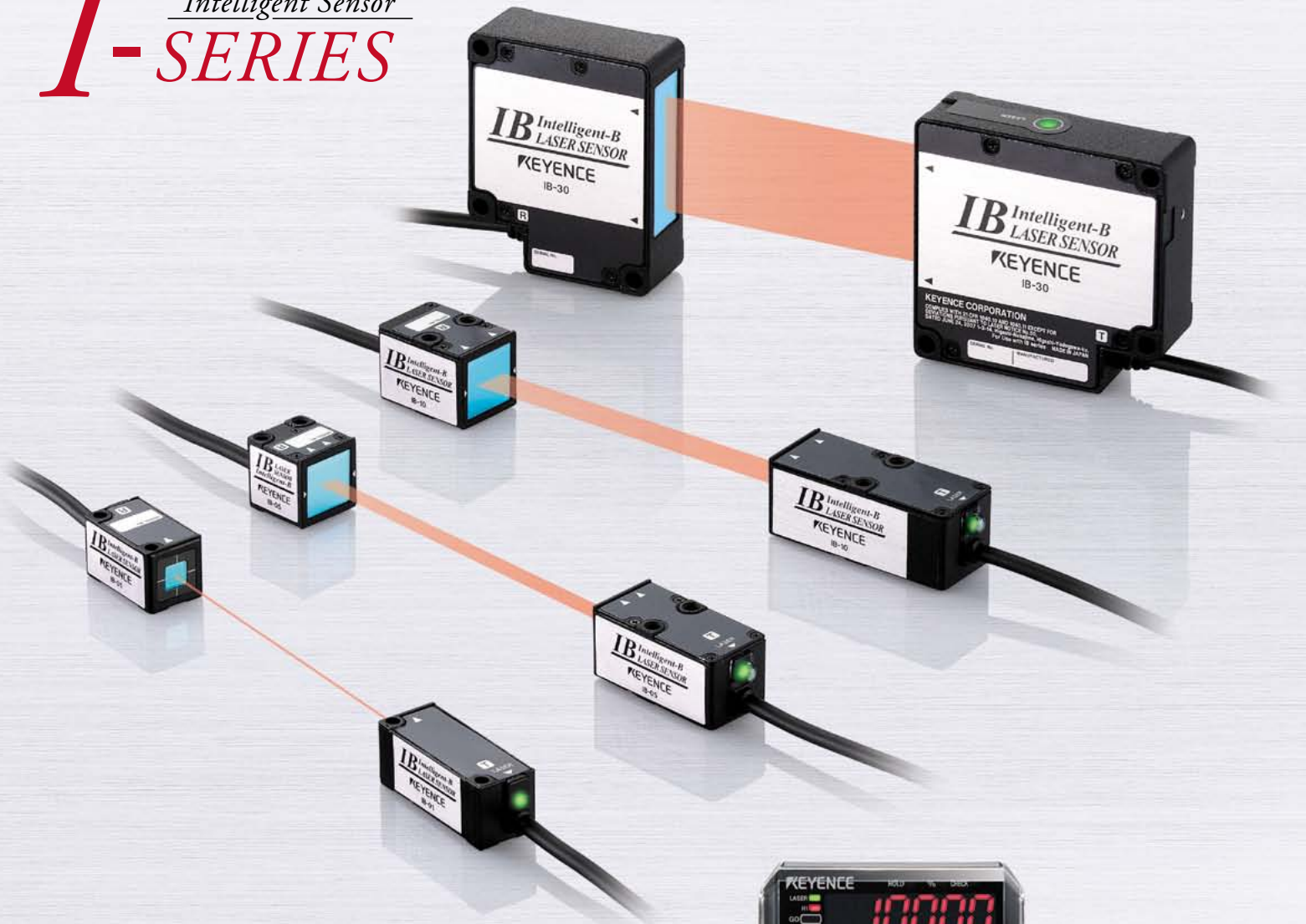

Make Sensing Easy:

FROM SIMPLE DIFFERENTIATION TO HIGH SPEED,
HIGHLY REPEATABLE DETECTION



Low-cost
High
Performance

A wide variety of applications are possible with the various sensor heads and the highly-functional amplifiers

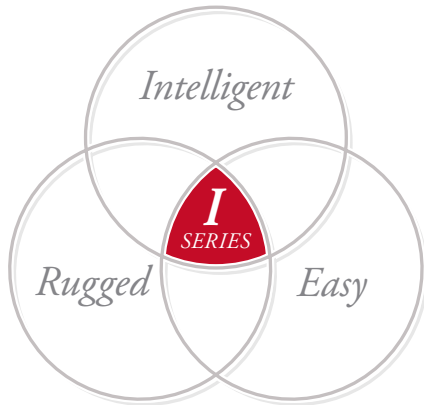

- High-speed sampling of 80 μ s
- High repeatability of 5 μ m (0.20 Mil)
- New function: Auto adjustment included

Highly repeatable detection even for transparent targets

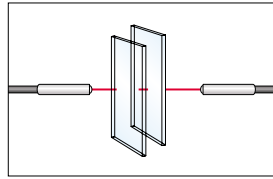

Not stable due to the subtle differences in received light volume



Definitive determination of even the most minute transmitted received light volume difference

Not influenced by passage position

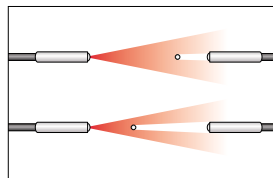

At the target gets closer to the transmitter or receiver, the received light volume changes.

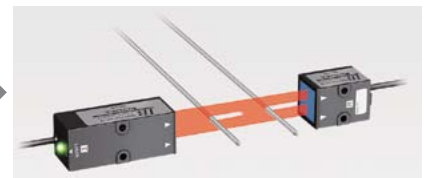

Regardless of position, the received light volume remains the same

Simple positioning using to the alignment LED

Easy to align the optical axis

As the optical axis of the laser aligns, the flash frequency of the laser transmitter indicator quickens. Even without looking at the amplifier unit, the optimum position can be achieved easily.

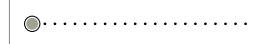

If the optical axis is not aligned the LED turns off



When the optical axis begins to align, the flashing frequency of the LED quickens



High-speed flashing when the optical axis is aligned

Maintenance-saving with the Auto adjustment function

Long-term, stable detection even in environments where the device becomes dirty easily

In the IB Series, should the received light volume decrease due to dirt on the front of the sensor head, by using the adjustment input, the new received light volume can be adjusted to compensate. In addition, when the Auto adjustment function recognizes no target in the beam path and the received light volume drops below 90%, the sensor compensates for the light loss automatically. Even when used in environments where the device becomes dirty easily, stable detection and a high degree of maintenance-saving has been made possible by the device automatically correcting itself.

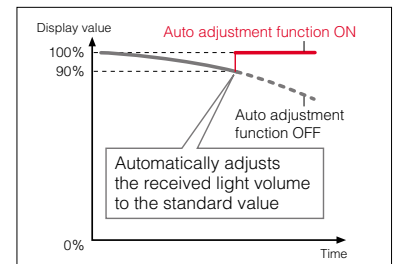

Metal Industry

Differentiation of different metal shafts



Plastics Industry

Differentiation of different films



Factories

Turbidity detection of factory waste water



Specifications



Sensor head

Model	IB-01	IB-05	IB-10	IB-30
Appearance				
Light source	Visible semiconductor laser Wavelength: 660 nm Class 1 (IEC60825-1, FDA (CDRH) Part 1040.10 ¹⁾)			
Mounting distance	0 to 2000 mm 0 to 78.74"		0 to 300 mm 0 to 11.81"	
Measurement range	Ø1 mm 0.04" (Installation distance 0 to 300 mm 11.81") Ø1 to 2.5 mm 0.04" to 0.10" (Installation distance 300 to 2000 mm 11.81" to 78.74")	5 mm 0.20"	10 mm 0.39"	30 mm 1.18"
Sampling rate	12,500 times/sec. (80 µs)			
Minimum detectable object ²	Ø8 µm 0.32 Mil (Installation distance 0 to 300 mm) Ø8 to 50 µm 0.32 Mil to 1.97 Mil (Installation distance 300 to 2000 mm 11.81" to 78.74")	Ø0.05 mm 0.002"	Ø0.1 mm 0.004"	Ø0.2 mm 0.008"
Repeatability ³	5 µm 0.20 Mil (distance 0 to 300 mm 11.81")	5 µm 0.20 Mil	5 µm 0.20 Mil	10 µm 0.39 Mil
Temperature characteristics ⁴	±0.2% of F.S./°C	±0.1% of F.S./°C (±5 µm ±0.20 Mil)	±0.1% of F.S./°C (±10 µm ±0.39 Mil)	±0.1% of F.S./°C (±30 µm ±1.18 Mil)
Operation indicator	Laser emission warning indicator: green LED			
Environmental resistance	Ambient luminance	Incandescent lamp: 5000 lux Solar light: 10000 lux	Incandescent lamp: 5000 lux Solar light: 5000 lux	Incandescent lamp: 10000 lux Solar light: 10000 lux
	Ambient temperature	0 to 40°C 0 to 104°F (no freezing)		
	Ambient humidity	35 to 85%RH (no condensation)		
	Vibration	10 to 55 Hz Double amplitude 1.5 mm 0.06" XYZ each axis: 2 hours		
Material	Case	PBT	Zinc die-cast	
	Lens cover	Glass		
	Cable	PVC		
Weight	Approx. 140 g	Approx. 180 g	Approx. 220 g	Approx. 510 g

- The classification for FDA (CDRH) is implemented based on IEC60825-1 in accordance with the requirements of Laser Notice No.50.
- Value when measuring the target (white diffuse object) at the middle of the transmitter and receiver position, and at the center of the measurement range.
- When distance between transmitter and receiver is set to 300 mm 11.81", and light is half-shielded at a position 150 mm 5.91" from receiver.
Deflection width (±2σ) when sampled for 30 seconds with an average number of times set to 64 times.
- When distance between transmitter and receiver is set to 100 mm 3.94" and full light is received.

Amplifier unit

Model	IB-1000	IB-1500	IB-1050	IB-1550
Appearance				
Amplifier type	DIN rail mount	Panel mount	DIN rail mount	Panel mount
Main unit/Expansion unit	Main unit		Expansion unit	
Head compatibility	Yes			
Display	Display resolution	0.01%, 0.1%, 1% (switchable)		
	Display range	-99.999 to 99.999, -99.99 to 99.99, -99.9 to 99.9, -99 to 99 (switchable)		
	Digital display method	Dual 7-segment display Upper level: 5 red digits Lower level: 5 green digits	Dual 7-segment display Upper level: 2-color (green/red) 5 digits Lower level: 5 green digits	Dual 7-segment display Upper level: 5 red digits Lower level: 5 green digits
Operation indicator	Judgment indicator: 2-color (green/red) LED (HI, GO, LO), Bank indicator: Green LED x 4, Laser emission warning indicator: Green LED, Others: Green LED x 8, red LED x 3			
Analog voltage output ¹	±5 V, 1 to 5 V, 0 to 5 V Output impedance 100Ω		N/A	
Analog current output ¹	4 to 20 mA Maximum load resistance 350Ω			
Control input ²	Bank switch input	Non-voltage input		
	Zero-shift input			
	Laser emission stop input			
	Timing input			
	Reset input			
	Adjust input			
Control output ³	Judgment output	Open collector (NPN/PNP switchable, N.O./N.C. switchable)		
	Check output			
Power supply	Power voltage	10 to 30 VDC, including ripple (P-P) 10% Class 2 or LPS		Supplied from main unit
	Power consumption ⁴	1950 mW or less (at 30 V, 65 mA max.)	2100 mW or less (at 30 V, 70 mA max.)	1950 mW or less (at 30 V, 65 mA max.) 2100 mW or less (at 30 V, 70 mA max.)
Environmental resistance	Ambient temperature	-10 to +50°C 14 to 122°F (No freezing)		
	Ambient humidity	35 to 85% RH (No condensation)		
	Vibration	10 to 55 Hz Double amplitude 1.5 mm 0.06" XYZ each axis: 2 hours		
	Pollution degree	2		
Material	Case/Front panel: polycarbonate, keytop: polyacetal, cable: PVC			
Weight (including supplied items)	Approx. 150 g	Approx. 170 g	Approx. 140 g	Approx. 165 g

- ±5 V, 1 to 5 V, 0 to 5 V, or 4 - 20 mA should be selected.
- The four external input wires are assigned with desired inputs.
Rated no-voltage input: ON voltage 2 V or less, OFF current 0.05 mA or less
Rated voltage input: Max. input rating 30 V or less, ON voltage 7.5 V or more, OFF current 0.05 mA or less
- Rated NPN open collector output: Max. 50 mA/ch (20 mA/ch when expansion units are connected), 30 V or less, residual voltage 1 V or less
Rated PNP open collector output: Max. 50 mA/ch (20 mA/ch when expansion units are connected), 30 V or less, residual voltage 2 V or less
- The power consumption with slave units installed is the total of each amplifier unit's power consumption.
Example: When using one master unit (IB-1000) with two slave units (IB-1050) (1950 mW X 1) + (1950 mW X 2) = 5850 mW

Dimensions

Unit : mm inch

IB Series Sensor head

IB-01

Receiver

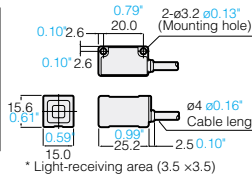

* Light-receiving area (3.5 x 3.5)

Transmitter

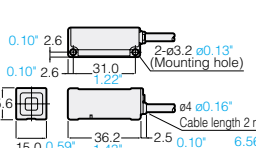

* Transmission spot (reference value)
When distance is 300 mm 11.81; approximately ø 1 mm 0.04"
When distance is 2000 mm 78.74; approximately ø 2.5 mm 0.10"

IB-05

Receiver

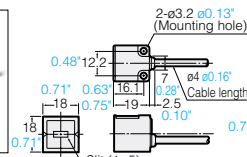

Transmitter

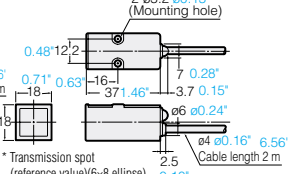

* Transmission spot (reference value)(6-8 ellipse)

IB-10

Receiver

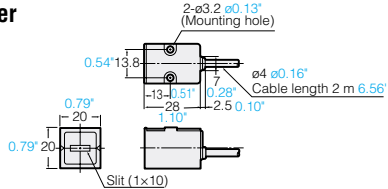

Transmitter

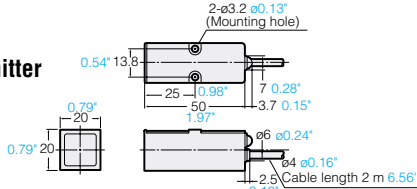

*Transmission spot (reference value)
(7x13 ellipse)

IB-30

Receiver

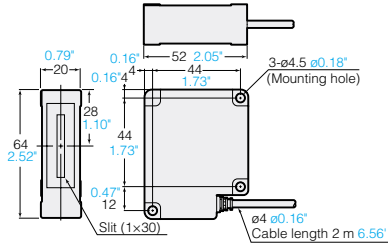

Transmitter

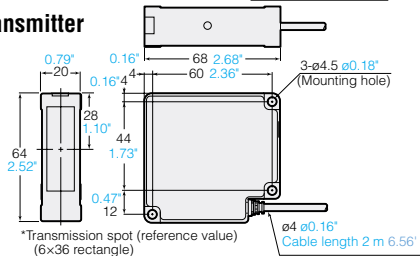

*Transmission spot (reference value)
(6x36 rectangle)

Sensor amplifier (DIN rail mount type)

IB-1000/IB-1050



IB-1000

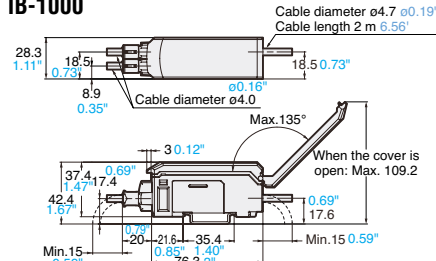

IB-1050

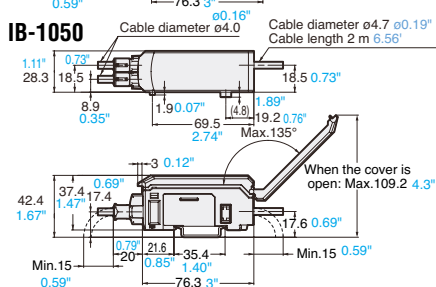

Sensor amplifier (Panel mount type)

IB-1500/IB-1550

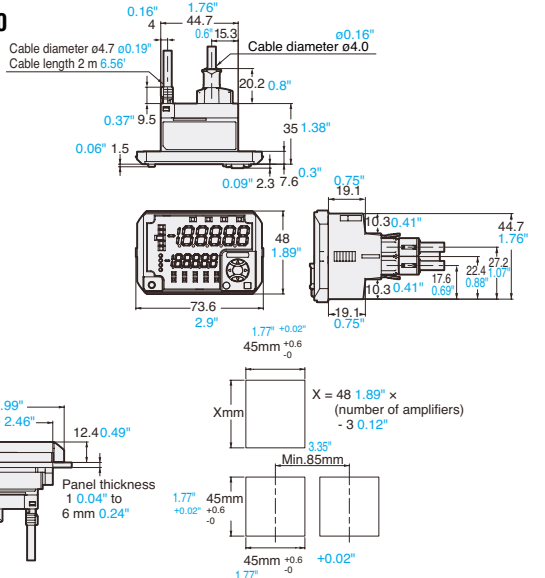

CALL TOLL FREE TO CONTACT YOUR LOCAL OFFICE
1-888-KEYENCE
1 - 8 8 8 - 5 3 9 - 3 6 2 3

www.keyence.com



SAFETY INFORMATION

Please read the instruction manual carefully in order to safely operate any KEYENCE product.

KEYENCE CORPORATION OF AMERICA

Corporate Office 669 River Drive, Suite 302, Elmwood Park, NJ 07407 PHONE: 888-539-3623 FAX: 855-539-0123 E-mail: keyence@keyence.com

Sales & Marketing Head Office 1100 North Arlington Heights Road, Suite 210, Itasca, IL 60143 PHONE: 888-539-3623 FAX: 855-539-0123

AL Birmingham	CO Denver	IN Indianapolis	MI Detroit	NJ Elmwood Park	OH Cincinnati	PA Pittsburgh	TX Austin	WI Milwaukee
AR Little Rock	FL Tampa	KS Kansas City	MI Grand Rapids	NY Rochester	OH Cleveland	SC Greenville	TX Dallas	
CA N. California	GA Atlanta	KY Louisville	MN Minneapolis	NC Charlotte	OR Portland	TN Knoxville	VA Richmond	
CA Los Angeles	IL Chicago	MA Boston	MO St. Louis	NC Raleigh	PA Philadelphia	TN Nashville	WA Seattle	

KEYENCE CANADA INC.

Head Office PHONE: 905-366-7655 FAX: 905-366-1122 E-mail: keyencecanada@keyence.com
Montreal PHONE: 514-694-4740 FAX: 514-694-3206 Windsor PHONE: 905-366-7655 FAX: 905-366-1122

KEYENCE MEXICO S.A. DE C.V.

PHONE: +52-81-8220-7900 FAX: +52-81-8220-9097
E-mail: keyencemexico@keyence.com

The information in this publication is based on KEYENCE's internal research/evaluation at the time of release and is subject to change without notice.
Copyright (c) 2010 KEYENCE CORPORATION. All rights reserved.

IB-KA-C-US 1025-3 [611446] Printed in Japan



KA1-1124