

**Montageanleitung**  
**Nebelscheinwerfer**

**Installation Instruction**  
**Fog lamps**

**Instructions de Montage**  
**Projecteur antibrouillard**

**Monteringsanvisning**  
**Dimsrårkastare**

**Montagehandleiding**  
**Mistlampen**

**Instrucciones de Montaje**  
**Faros antiniebla**

**Istruzioni di Montaggio**  
**Proiettori fendinebbia**

**Asennusohje**  
**Sumuvalonheittimet**

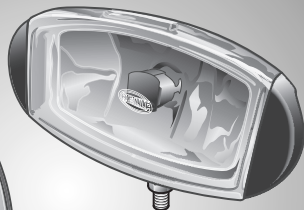

**Comet FF 450/500/550**



**DE** Technische Änderungen vorbehalten

**EN** Subject to alteration without notice

**FR** Sous réserve de modifications techniques

**SV** Vi reserverar oss för tekniska ändringar

**NL** Technische wijzigingen voorbehouden

**ES** Reservadas modificaciones técnicas

**IT** Con riserva di modifiche tecniche

**FI** Oikeus teknisiin muutoksiin pidätetään

**Zeichenerklärung**  
**Explanation of symbols**  
**Explication des symboles**

**Symbolförklaring**  
**Legenda**  
**Aclaración de símbolos**

**Legenda**  
**Piirroksen selitys**



- (DE)** Richtig
- (EN)** Correct
- (FR)** Correct
- (SV)** Rätt
- (NL)** Goed
- (ES)** Correcto
- (IT)** Giusto
- (FI)** Oikein



- (DE)** Falsch
- (EN)** Incorrect
- (FR)** Incorrect
- (SV)** Fel
- (NL)** Fout
- (ES)** Erróneo
- (IT)** Sbagliato
- (FI)** Väärin



- (DE)** Positionspfeil
- (EN)** Location/Position Arrow
- (FR)** Flèche de Position
- (SV)** Positionpil
- (NL)** Lokatie/Positie pijl
- (ES)** Flecha de posición
- (IT)** Freccia di posizione
- (FI)** Paikannusnuoli



- (DE)** Bewegungspfeil
- (EN)** Movement Arrow
- (FR)** Flèche indiquant sens du mouvement
- (SV)** Rörelsepil
- (NL)** Richtingspijl
- (ES)** Flecha de movimiento
- (IT)** Freccia di movimento
- (FI)** Liikesuuntanuoli



- (DE)** Achtung
- (EN)** Warning
- (FR)** Attention
- (SV)** Varning
- (NL)** Let op
- (ES)** Atención
- (IT)** Attenzione
- (FI)** Huomio

**Lieferumfang-Set**  
**Scope of supply kit**  
**Kit fourniture**

**Leveransomfattning-sats**  
**Leveringsomvangset**  
**Set volumen de entrega**

**Kit forniture**  
**Tomitüksensarja**



**Comet 450**  
**1NB 010 951-xxx**



**Comet 550**  
**1ND 010 953-xxx**



**Comet 500**  
**1N6 010 952-xxx**

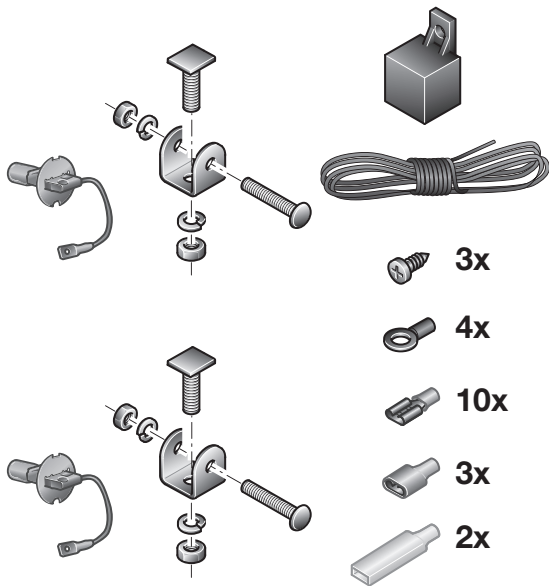

**Lieferumfang**  
**Scope of supply**  
**Furniture**

**Leveransomfattning**  
**Leveringsomvang**  
**Volumen de entrega**

**Fornitura**  
**Tomituxsen**

**Comet 450**



**1NB 010 951-xxx**

**Comet 500**



**1N6 010 952-xxx**

**Comet 550**



**1ND 010 953-xxx**

**Ersatzteile**  
**Spare parts**  
**Pièces de rechange**

**Reservdelar**  
**Reserveonderdelen**  
**Recambios**

**Ricambi**  
**Varaosat**

**Comet 450**



**ECE 1NB 187 883-101**

**Comet 500**



**ECE 1N6 187 887-101**

**Comet 550**



**ECE 1NB 187 888-101**

**Zubehör \***  
**Accessories \***  
**Accessories \***

**Tillbehör \***  
**Toebehoren \***  
**Accessorios \***

**Accessori \***  
**Lisätarvikkeet \***

**Comet 450**



**8XS 186 530-011**

**Comet 550**



**8XS 186 532-011**

**Comet 500**



**8XS 186 531-011**



**6EH 007 946-031**



**8KW 044 033-812**

**DE**

\* **ACHTUNG:** In einigen Ländern sind Schutzkappen gesetzlich nicht zugelassen. Vor einer Verwendung im öffentlichen Straßenverkehr erkundigen Sie sich bitte bei der zuständigen Stelle. Im öffentlichen Straßenverkehr in Deutschland müssen Scheinwerfer nach der StVZO ständig betriebsbereit sein. Ein Verstoß hiergegen stellt eine Ordnungswidrigkeit dar.

**EN**

\* **NOTE:** In some countries, protective caps are not permitted by law. Before use on public roads, please check with your competent government agency. On public roads in Germany, headlights must be functional at all times in accordance with the German Road Traffic Licensing Regulations (StVZO). Violation constitutes a misdemeanour.

**FR**

\* **ATTENTION :** les caches de protection sont interdits par la loi dans certains pays. Avant toute utilisation sur la voie publique, pensez à vous renseigner auprès des autorités compétentes. Tout manquement à cette règle mène à une infraction.

**SV**

\* **OBSERVERA:** I vissa länder är skyddskåpor för strålkastare inte tillåtna. Informera dig hos ansvarig myndighet innan du börjar köra på allmän väg. På allmän väg i Tyskland skall strålkastare alltid vara klara för användning enligt vägtrafikförordningen (StVZO). Brott mot detta leder till böter.



**NL**

\* **LET OP:** In sommige landen zijn beschermkappen wettelijk niet toegestaan. Voor gebruik in het openbaar verkeer adviseren wij om altijd inlichtingen bij de lokale overheid op te vragen. In het openbaar verkeer in Duitsland moeten aanbouwlampen volgens de StVZO steeds operationeel zijn. Een inbreuk hierop staat gelijk aan een overtreding.

**ES**

\* **ATENCIÓN:** En algunos países las tapas protectoras no están permitidas por ley. Antes de proceder a su uso en carreteras públicas, pida información a las autoridades competentes. En las carreteras públicas de Alemania, los faros deben estar siempre preparados para su uso, según la ley StVZO. En caso contrario, se estaría infringiendo la ley.

**IT**

\* **ATTENZIONE:** in alcuni Paesi le calotte protettive non sono consentite dalla legge. Prima di usarle per la circolazione su strade aperte al traffico, è consigliabile informarsi presso un ente competente. In Germania nella circolazione su strade aperte al traffico i proiettori devono essere sempre pronti all'uso secondo le norme StVZO (norme per l'omologazione dei veicoli). Una violazione del codice stradale costituisce un'infrazione.

**FI**

\* **HUOMIO:** Joissain maissa kivisuojat eivät ole lain mukaan sallittuja. Ennen kuin käytät niitä julkisessa tieliikenteessä, selvitä asia viranomaisilta.

**Benötigte Montagewerkzeuge**  
**Installation tools required**  
**Outillage de montage requis**

**Nödvändiga monteringsverktyg**  
**Benodigde montagewerktuigen**  
**Herramientas de montaje necesarias**

**Attrezzi necessari per il montaggio**  
**Tarvittavat asennustyökalut**

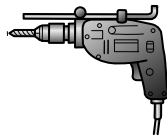
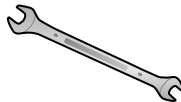

**SW 13, 17**



**Torx 20**

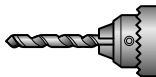
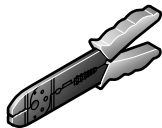

**3,5 mm**  
**10,5 mm**

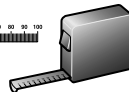

**Montage**  
**Mounting**  
**Montage Général**

**Montering**  
**Montage**  
**Montaje**

**Montaggio**  
**Asennus**

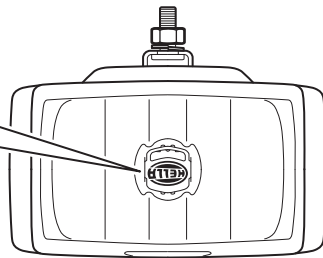
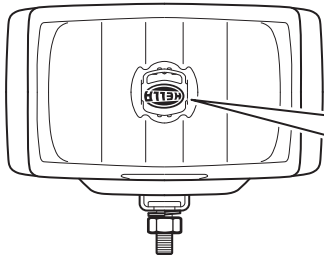
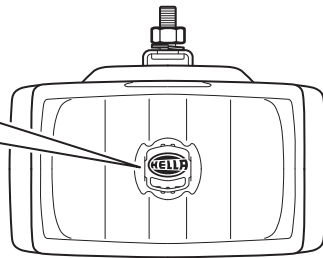
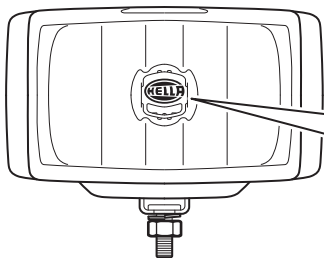

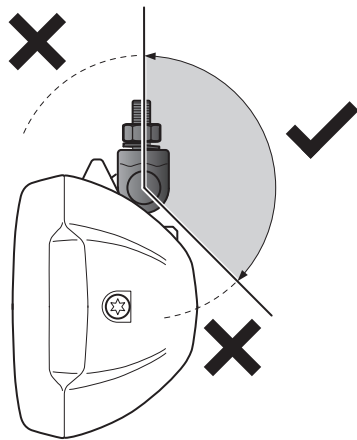
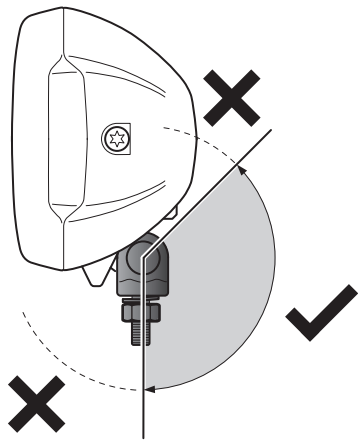

Comet 450, 550

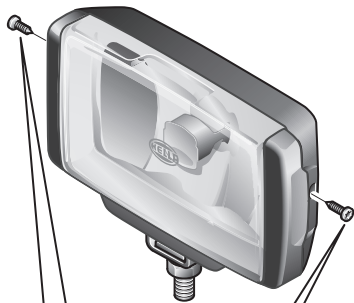

1



Torx 20

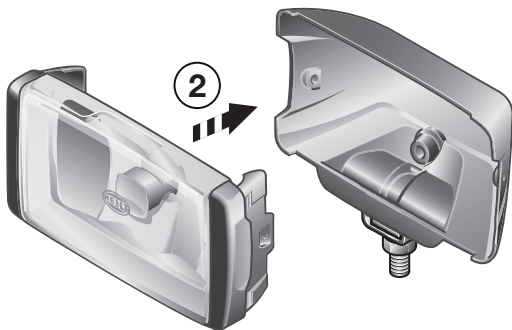

Comet 500



1



Torx 20

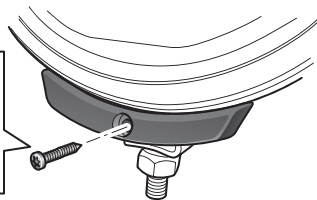

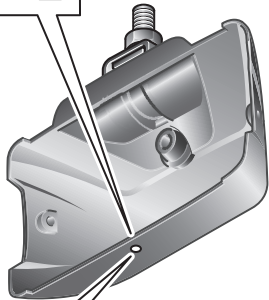
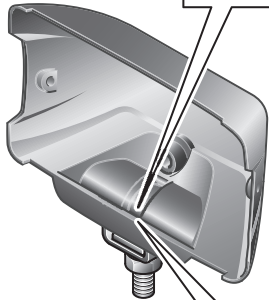
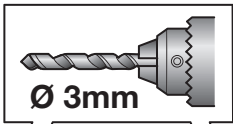

**Glühlampenmontage**  
**Bulb mounting**  
**Montage lampe**

**Montering glödlampor**  
**Montage gloeilampen**  
**Montage lámparas**

**Montaggio lampadine**  
**Asennus polttimot**

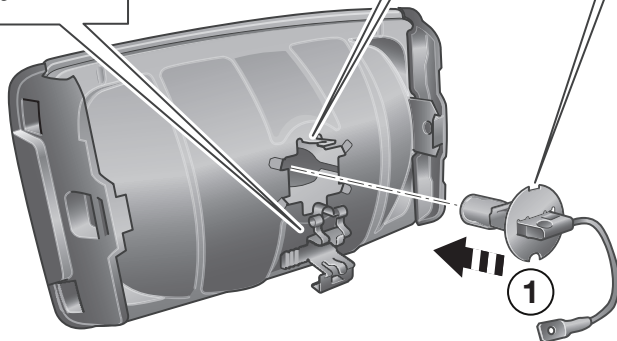
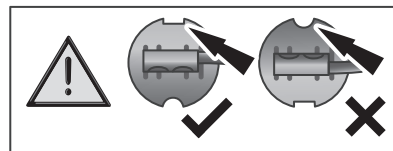
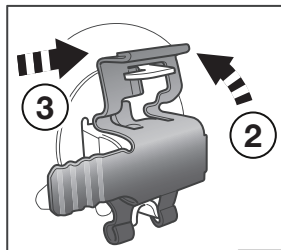

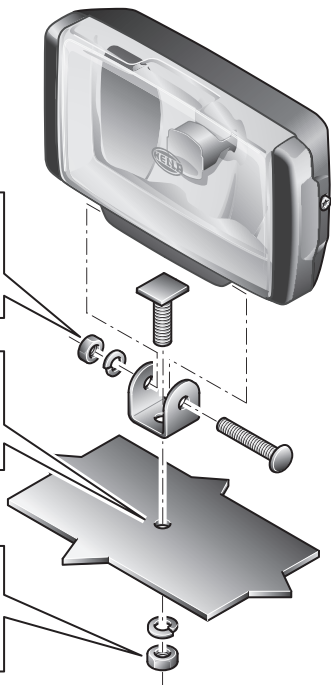
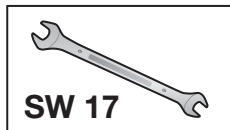
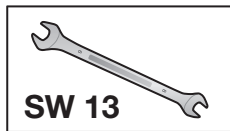
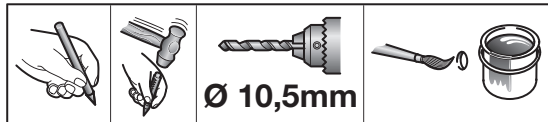



Lampenwechsel  
Bulb replacement  
Remplacement lampe

Lampbyte  
Lampvervanging  
Cambio de lámpara

Sostituzione delle lampadine  
Lampulla vaihto

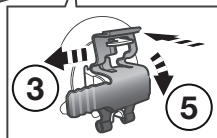
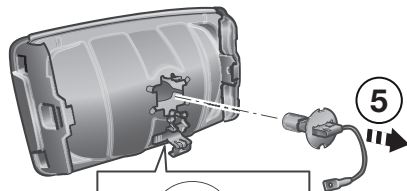
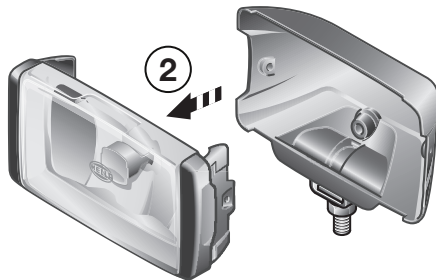

**Elektrischer Anschluss**  
**Electrical connection**  
**Branchement électrique**

**Elektrisk anslutning**  
**Elektrische aansluiting**  
**Conexión eléctrica**

**Collegamento elettrico**  
**Osaluettelo**

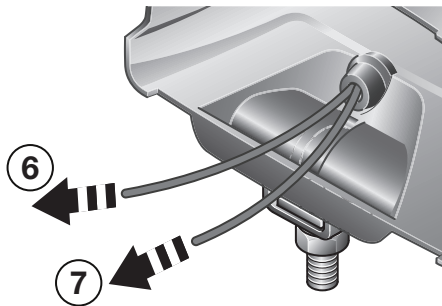
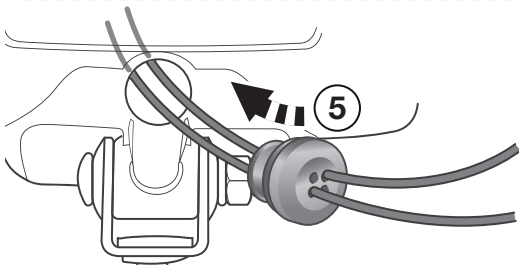
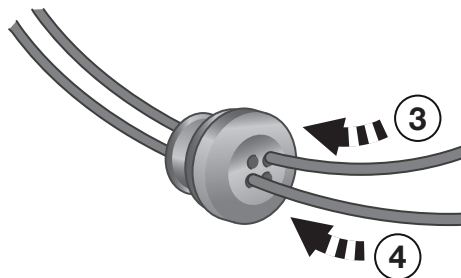
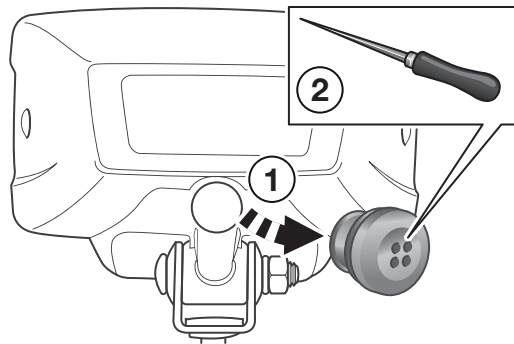

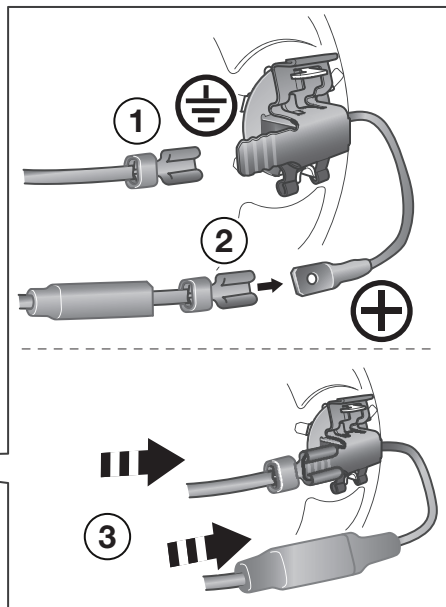
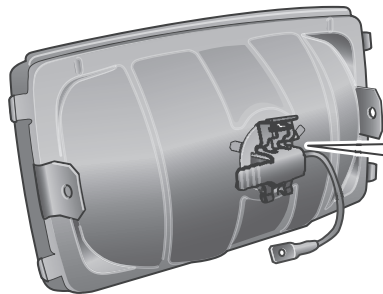
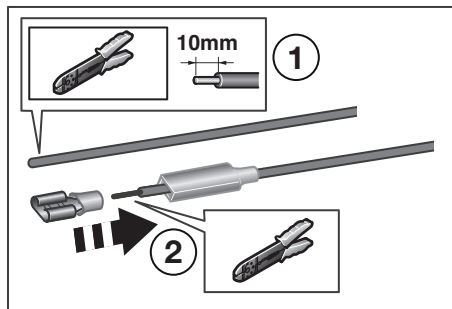

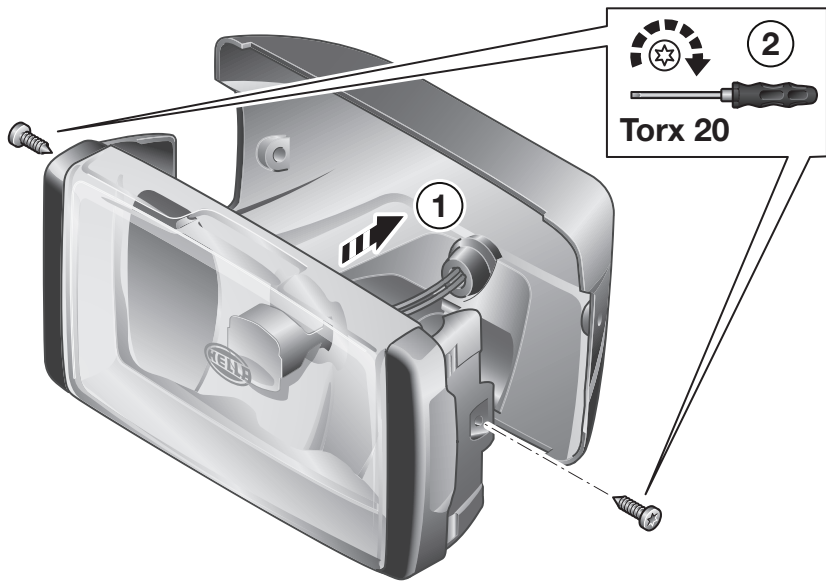



③① rot  
red  
rouge  
röd

rood  
rajo  
rosso  
punainen

⑧⑤ braun  
brown  
marron  
brun

bruin  
marrón  
marrone  
ruskea

⑧⑥ gelb/grau  
yellow/grey  
jaune/gris  
gul/grå

geel/grijs  
amarillo/grigio  
giallo/grigio  
keltainen/harmaa

⑧⑦ blau  
blue  
bleu  
blå

blauw  
azul  
blu  
sininen

— braun  
brown  
marron  
brun



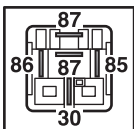
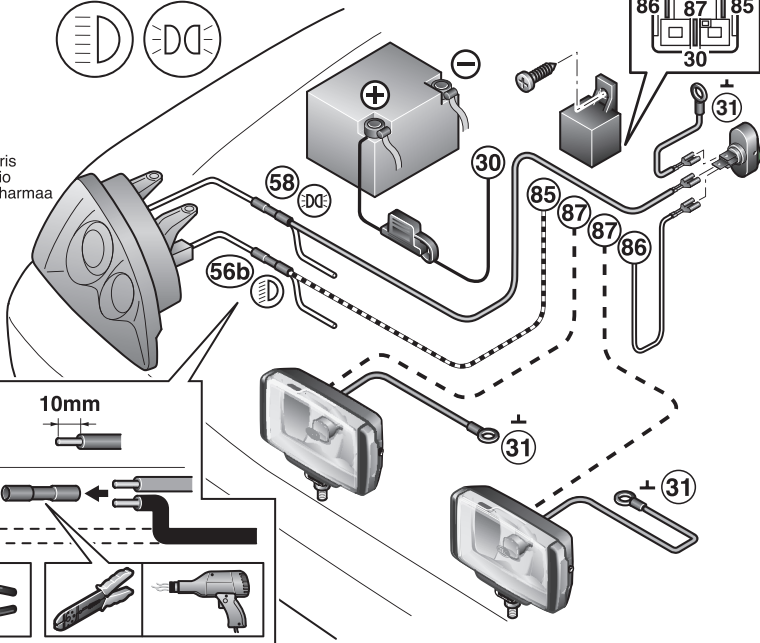

bruin  
marrón  
marrone  
ruskea

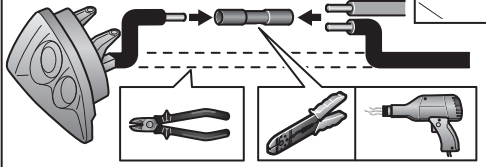

10mm





- |   |   |  |
|---|---|--|
| <b>30</b>  | rot<br>red<br>rouge<br>röd                        | rood<br>rajo<br>rosso<br>punainen                                  |
| <b>85</b>  | braun<br>brown<br>marron<br>brun                  | bruin<br>marrón<br>marrone<br>ruskea                               |
| <b>86</b>  | gelb/grau<br>yellow/grey<br>jaune/gris<br>gul/grå | geel/grijs<br>amarillo/grigio<br>giallo/grigio<br>keltainen/harmaa |
| <b>87</b>  | blau<br>blue<br>bleu<br>blå                       | blauw<br>azul<br>blu<br>sininen                                    |
|            | braun<br>brown<br>marron<br>brun                  | bruin<br>marrón<br>marrone<br>ruskea                               |

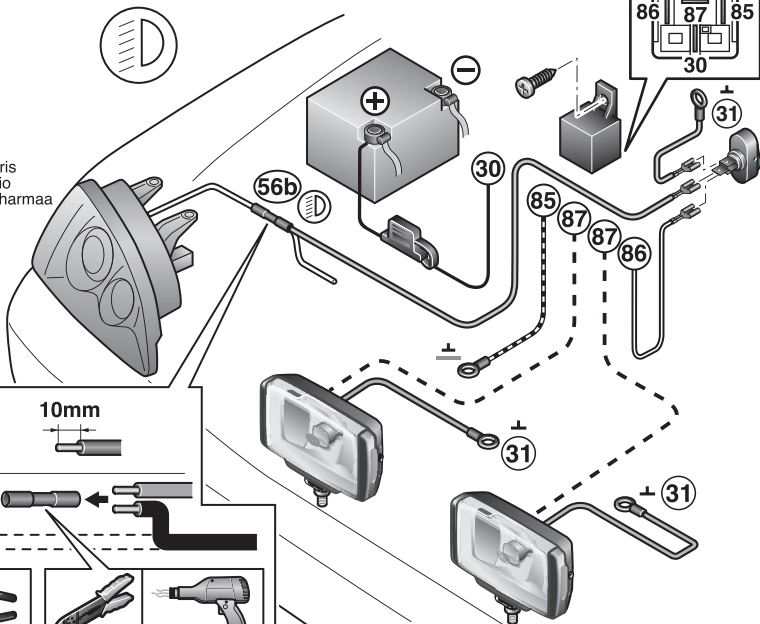

10mm



<b>DE</b>	Informationstext	26-27
<b>EN</b>	Information Text	28-29
<b>FR</b>	Texte d'information	30-31
<b>SV</b>	Informationstext	32-33
<b>NL</b>	Informatie tekst	34-35
<b>ES</b>	Texto informativo	36-37
<b>IT</b>	Informazioni	38-39
<b>FI</b>	Ohjetekstit	40-41

**Montage:**  
**Seite 11-16**

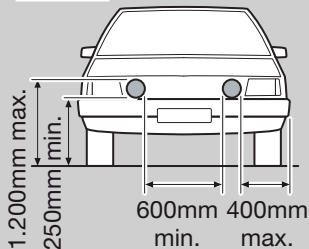

Die Montage der Scheinwerfer Comet 450 und 550 ist stehend oder hängend möglich. Der Comet 500 darf nur stehend angebaut werden. Die Scheinwerfer dürfen nicht vibrieren, über die Motorhaube ragen und müssen symmetrisch angebracht sein. Bei der Montage sind die Anbaumaße in der aufgeführten Zeichnung zu beachten. Montageposition festlegen

und Befestigungspunkte anzeichnen. Mit 3 mm Bohrer vorbohren und 8,5 mm aufbohren. Gebohrte Metallteile mit Rostschutz versiegeln. Scheinwerfer montieren und nach Zeichnung ausrichten. Befestigungsschrauben leicht anziehen. Nach dem elektrischen Anschluss die Scheinwerfer einstellen und Befestigungsschrauben fest anziehen. Lassen Sie die Nebelscheinwerfer bzw. Fernscheinwerfer in der Fachwerkstatt einstellen. Nur richtig eingestellte Scheinwerfer sorgen für eine optimale Ausleuchtung.

Leitungen nach einem der 4 Schaltpläne verlegen und anschließen. Mit welchen Lichtfunktionen Nebelscheinwerfer kombiniert werden dürfen, soll die nachstehende Tabelle, beispielhaft für drei Länder zeigen.

**Auf jeden Fall müssen aber die landesspezifischen Gesetze eingehalten werden.**

Lichtanlage prüfen, Anschlussleitungen sicher befestigen.

**Elektrischer Anschluss:**  
**Seite 18-24**





Relais mit Anschlussklemmen spritzwassergeschützt nach unten einbauen. Bei Bedarf und gesetzlicher Zulässigkeit Schalter ins Armaturenbrett einbauen.

**Glühlampenwechsel:**  
**Abb. Seite 17**

Glühlampe nach Zeichnung austauschen. Glühlampen nicht mit bloßen Fingern anfassen! Papiertuch oder ähnliches verwenden.

**Sicherheitshinweise:**

Scheinwerfer vor dem Lampenwechsel immer ausschalten und von der Versorgungsspannung trennen.

		<b>A</b>	<b>CH</b>	<b>D</b>
Abblendlicht				●
Abblend- und Standlicht		●	●	●
Standlicht			●	●
Fern- und Standlicht			●	

#### Noch ein Tipp:

- Halten Sie die Scheinwerfer-Streuscheiben stets sauber. Schmutz kann bis zu 80% der Lichtleistung schlucken. Sie fahren sicher, wenn Sie gut sehen und somit auch gut gesehen werden.

Haben Sie Ersatz-Lampen und Sicherungen im Wagen?

**Mounting steps:**  
**Page 11-16**

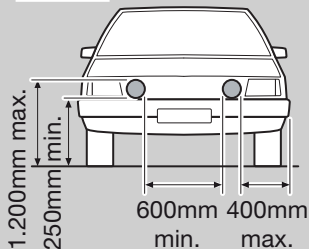

Installation of the Comet 450 and 550 headlamps is possible either in upright or pendant position. The Comet 500 may only be mounted in upright position. The headlamps may not vibrate, protrude beyond the bonnet and must be installed symmetrically. Upon installation, the mounting dimensions in the

stated drawing must be observed. Determine the mounting position and mark the fastening points. Start with a 3 mm drill and then drill an 8.5 mm hole. Seal drilled metal parts with rust protection. Install the headlamps and align in accordance with the drawing. Tighten the fastening screws slightly. After the electrical connection, adjust the headlamps and tighten the fastening screws firmly. Have the fog lamps and the high beam lamps adjusted at a specialist garage. Only correctly adjusted headlamps ensure optimum illumination.

Lay and connect the cables in accordance with one of the 4 circuit diagrams.

By way of example for three countries, the following table is intended to show with which lighting functions fog lights may be combined.

**It is however essential that country-specific laws are observed.**

Check the lighting system, fasten the connection cables securely.

**Electrical connection:**  
**From page 18-24**















Fit the relay with the connection terminals pointing downwards in a waterproof manner. If required and if legally permitted, fit a switch in the dashboard.

**Bulb replacement:**  
**From page 17**

Replace bulb in accordance with the drawing. Do not touch bulbs with bare fingers! Use a paper towel or similar.

**Safety notes:**

Always switch off headlights and disconnect the supply voltage prior to replacing a bulb.

				
Dipped beam				
Dipped beam and position light				
Position light				
Main beam and position light				

**Another tip:**

- Always keep the light lenses clean. Dirt can absorb more than 80% of the light output. You can drive safely if you can see well and therefore also be seen well.

Do you have spare bulbs and fuses in your car?

**Montage:**  
**Page 11-16**

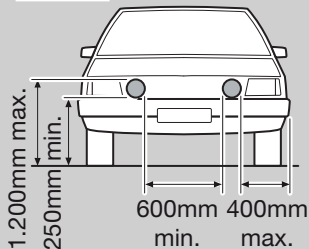

Les projecteurs Comet 450 et 550 peuvent être montés en position verticale ou suspendue. Le projecteur Comet 500 ne peut être monté qu'en position verticale. Les projecteurs doivent être fixés symétriquement et ne doivent pas vibrer, ni dépasser du capot. Observer lors du montage les dimensions pré-

sentées sur le schéma. Déterminer la position de montage et marquer les points de fixation. Pré-percer au moyen d'une perceuse à foret de 3 mm, puis percer des trous de 8,5 mm. Couvrir les parties métalliques percées d'une protection antirouille. Monter les projecteurs et les aligner comme indiqué sur le schéma. Serrer légèrement les vis de fixation. Après avoir effectué les branchements électriques, régler les projecteurs, puis serrer à fond les vis de fixation. Faire régler les projecteurs longue portée et antibrouillard dans un garage agréé. Seuls les projecteurs correctement réglés assurent un éclairage optimal.

Poser et raccorder les câbles suivant un des 4 schémas électriques.

Le tableau ci-après indique, avec l'exemple de trois pays à l'appui, avec quelles fonctions d'éclairage le projecteur antibrouillard peut être combiné.

**Dans tous les cas, la législation spécifique à chaque pays doit être respectée.**

Contrôler le système d'éclairage, fixer les câbles de connexion de

façon sûre.

**Faites régler vos projecteurs longue portée dans un garage spécialisé.**

**Branchement électrique:**  
**Page 18-24**









Monter le relais avec les bornes orientées vers le bas, afin de le protéger des projections d'eau. Si besoin et à condition que cela soit réglementaire, monter un commutateur dans la planche de bord.

**Remplacement des lampes:**  
**Figure page 17**

Remplacer les lampes suivant le plan. Ne pas prendre les lampes à mains nues ! Utiliser une serviette en papier ou autre semblable.

**Instructions de sécurité:**

Toujours éteindre les projecteurs et les mettre hors tension avant de remplacer les lampes.

				
Feux de croisement				●
Feux de croisement et de position	 	●	●	●
Feux de position			●	●
Feux de route et de position	 		●	

#### Derniers conseils:

- Les glaces des projecteurs doivent toujours être propres. Les salissures peuvent absorber jusqu'à 80% de la puissance lumineuse. Vous roulez en toute sécurité si votre visibilité est bonne et si les autres usagers de la route vous voient bien.

Avez-vous des lampes de rechange et des fusibles dans votre voiture?

## **Montering: Sidan 11-16**

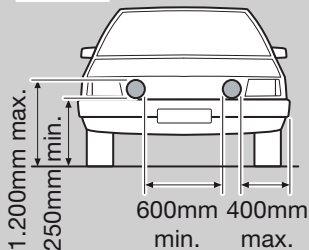

Strålkastarna Comet 450 och 550 kan monteras stående eller hängande. Comet 500 får bara sättas fast stående. Strålkastarna får inte vibrera eller sticka upp över motorhuvn och måste sättas fast symmetriskt. Vid montering ska

måtten i den medföljande ritningen respekteras. Bestäm monteringsposition och rita ut fästpunkter. Förborra med 3 mm-borr och bora ett hål på 8,5 mm. Förse borrade metalldelar med rostskydd. Montera strålkastarna och rikta dem i enlighet med teckningen. Dra åt fästskruvarna lätt. Anslut strålkastarna till en strömkälla och skruva sedan åt fästskruvarna hårt. Låt en verkstad ställa in dimstrålkastare respektive fjärrstrålkastare. Endast rätt inställda strålkastare ger optimal belysning.

Dra ledningarna enligt något av de fyra kopplingsscheman som finns och anslut dem. Nedanstående tabell visar exempel för tre olika länder på vilka ljusfunktioner som får kombineras.

### **Nationella lagar måste alltid följas.**

Testa ljussystemet. Fäst anslutningsledningarna på ett säkert sätt.

### **Låt en fackverkstad ställa in fjärrstrålkastaren.**

## **Elektrisk anslutning: Sidan 18-24**

Montera reläet med anslutningsklämmor nedtill så att det är skyddat mot stänkvatten. Montera en strömställare i instrumentpanelen om det behövs och är tillåtet enligt lag.





### **Byte av glödlampa: Bild på sidan 17**

Byt glödlampan enligt bilden. Ta inte i glödlampan med bara fingrar, använd en pappersduk eller liknande.

### **Säkerhetsanvisningar:**

Stäng alltid av strålkastaren innan lampan byts och koppla loss den från strömförsörjningen.



		<b>A</b>	<b>CH</b>	<b>D</b>
Halvljus				●
Halv- och parkeringsljus		●	●	●
Parkeringsljus			●	●
Fjärr- och parkeringsljus			●	

**Fler tips:**

- Håll alltid strålkastarglasen rena. Smuts kan ta bort upp till 80 % av ljuseffekten. Du kör säkert när du ser bra och syns bra.

Har du med dig reservlampor och säkringar i bilen?

## Montage: Pagina 11-16

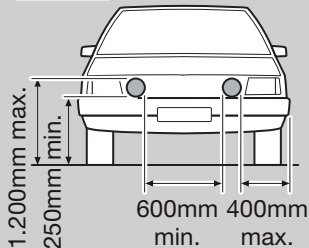

De koplampen Com 450 en 550 kunnen zowel staand als hangend worden gemonteerd. Comet 500 mag alleen staand worden ingebouwd. De koplampen mogen niet trillen of boven de motorkap uitsteken en moeten symmetrisch zijn aangebracht. Bij de montage moeten de

inbouwmaten van de genoemde tekening worden aangehouden. Montagepositie vastleggen en bevestigingspunten aangeven. Voorboren met een 3 mm boor, en 8,5 mm diep boren. Geboorde metalen delen met anti-roest afdichten. Koplampen monteren en volgens tekening uitrichten. Bevestigingsschroeven licht aandraaien. Na de elektrische aansluiting de koplampen instellen en de bevestigingsschroeven vast aandraaien. Laat de mistkoplampen en/of grootlicht in de gespecialiseerde werkplaats instellen. Alleen correct ingestelde koplampen zorgen voor een optimale belichting.

Leg de kabels en sluit ze aan zoals in een van de vier schakelschema's is aangegeven. Met welke lichtfuncties mistlampen mogen worden gecombineerd, wordt in de volgende tabel als voorbeeld voor drie landen aangegeven.

### **Houd u te allen tijde aan de ter plaatse geldende wetgeving.**

Verlichting controleren. Kabels goed bevestigen.

**Laat de vérstralers in de werkplaats afstellen.**

### **Elektrische aansluiting: Pagina 18-24**





Relais met aansluitklemmen spatwaterdicht omlaag gericht monteren. Monteer indien nodig en wettelijk toegestaan een schakelaar in het dashboard.

### **Gloeilamp vervangen: Afb. pagina 17**

Vervang de gloeilamp zoals in de tekening is aangegeven. Raak de gloeilamp niet met blote vingers aan! Gebruik een papieren doekje of iets dergelijks.

### **Veiligheidsvoorschriften:**

Schakel schijnwerpers voordat u een lamp vervangt altijd uit en ontkoppel de voeding.

		<b>A</b>	<b>CH</b>	<b>D</b>
Dimlicht				●
Dim- en parkeerlicht		●	●	●
Parkeerlicht			●	●
Groot- en parkeerlicht			●	

**Nog een tip:**

- Houd het lampglas van de schijnwerpers schoon. Vuil kan tot 80% van de lichtopbrengst absorberen. U rijdt veilig wanneer u goed kunt zien en daardoor ook goed gezien wordt.

Heeft u reservelampen en -zekeringen bij u in de auto?

## Conexión eléctrica:

Página 11-16

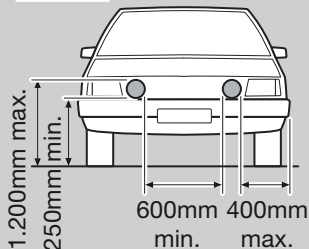

El montaje de los faros Comet 450 y 550 es sólo posible en vertical o de forma suspendida. El Comet 500 sólo se debe montar en vertical. Los faros no deben vibrar ni sobresalir del capó y deben ser montados de forma simétrica. Al montarlos se deben tener en cuenta las medidas de montaje representadas en el dibujo. Determinar la posición de montaje y marcar los puntos de fijación.

Pretaladrar con una broca de 3 mm y acabar el taladro con una broca de 8,5 mm. Sellar las piezas metálicas taladradas con protección anticorrosión. Montar los faros y orientar según dibujo. Apretar ligeramente los tornillos de fijación. Después de la conexión eléctrica ajustar los faros y apretar fijamente los tornillos de fijación. Deje ajustar en un taller especializado los faros antiniebla o los faros de luz larga. Sólo los faros ajustados de forma correcta garantizan una iluminación óptima.

Tender los cables según uno de los 4 esquemas de conexiones y realizar las conexiones.

La siguiente tabla muestra las funciones de iluminación con las que pueden combinarse los faros antiniebla, tomando tres países como ejemplo.

**En todos los casos deberán cumplirse las leyes específicas para cada país.**

Probar el funcionamiento del faro y fijar los cables de conexión de forma segura.

**Los faros de luz de carretera deberán ser ajustados por un taller**

especializado.

## Conexión eléctrica: Página 18-24





Montar el relé con los bornes de conexión mirando hacia abajo para que estén protegidos de las salpicaduras de agua. En caso necesario y siempre que la normativa lo permita, se puede montar un interruptor en el tablero de instrumentos.

## Cambio de lámparas: fig. página 17

Sustituir la lámpara según el dibujo. No tocar la lámpara directamente con las manos; utilizar un trozo de papel o algo similar.

## Indicaciones de seguridad:

Desconectar siempre los faros antes de proceder a la sustitución de las lámparas y separarlos de la tensión de alimentación.

		<b>A</b>	<b>CH</b>	<b>D</b>
Luz de cruce				●
Luz de cruce y de posición		●	●	●
Luz de posición			●	●
Luz de carretera y de posición			●	

### Un consejo más:

- Mantenga los cristales dispersores de los faros siempre limpios. La suciedad puede absorber hasta un 80% de la potencia luminosa. Conducirá de forma más segura si puede ver bien y también ser visto.

¿Lleva lámparas de repuesto y fusibles en su vehículo?

## Montaggio: Pagine 11-16

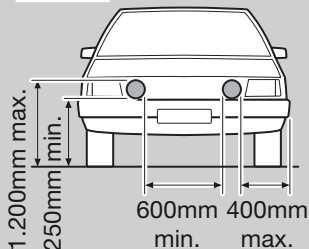

E' possibile montare i proiettori Come 450 e 550 sia in posizione ritta o sospesa. Il proiettore Comet 500 può essere montato solo in posizione verticale. I proiettori non devono vibrare, non devono sporgere oltre il cofano motore e devono essere posti simmetricamente. Durante il montaggio bisogna attenersi alle misure indicate

nel disegno. Posizionare la dima di montaggio e segnare i punti di foratura. Forare di grosso con una punta da trapano da 3 mm ed alesare con una punta da 8,5 mm. Sigillare le parti in metallo perforato con una protezione antiruggine. Montare il proiettore e regolare conformemente al disegno. Serrare leggermente le viti di fissaggio. Regolare i fari a seconda del collegamento elettrico e serrare a fondo le viti di fissaggio. Far montare i fendinebbia od i fari in un'officina specializzata. Solo fari correttamente regolati garantiscono un'illuminazione ottimale.

Montare e collegare i cavi in base a uno dei 4 schemi elettrici. La seguente tabella indica le funzioni luminose con cui possono essere combinati i proiettori fendinebbia, portando l'esempio di tre Paesi.

**In ogni caso bisogna rispettare le leggi specifiche del Paese.**

Controllare l'impianto d'illuminazione, fissare in modo sicuro i cavi di collegamento.

**Far regolare i proiettori abbaglianti presso un'officina specializzata.**

**Collegamento elettrico:  
Pagina 18-24**







Montare il relè con i morsetti di collegamento rivolto verso il basso per proteggerlo dagli spruzzi d'acqua. Se necessario e conforme alle richieste di legge, montare l'interruttore nel cruscotto.

**Sostituzione delle lampadine:  
Fig. pagina 17**

Sostituire la lampadina in base al disegno. Non toccare le lampadine direttamente con le dita! Utilizzare fazzoletti di carta o simili.

**Avvertenze di sicurezza:**

Prima di sostituire le lampadine, spegnere sempre il proiettore e staccarlo dalla tensione di alimentazione.

		<b>A</b>	<b>CH</b>	<b>D</b>
Luce anabbagliante				●
Luce anabbagliante e di posizione	 	●	●	●
Luce di posizione			●	●
Luce di profondità e di posizione	 		●	

#### Ancora un consiglio:

- Tenere sempre puliti i trasparenti dei proiettori. La sporcizia può ridurre la potenza luminosa fino all'80%. Si viaggia più sicuri se si vede bene e si è ben visti.

Avete lampadine e fusibili di ricambio in auto?

## **Asennus: Sivu 11-16**

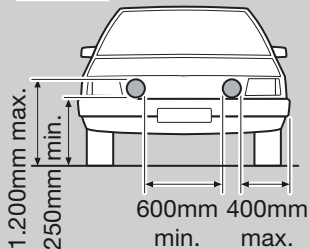

Ajovalot Comet 450 ja 550 voidaan asentaa pystyasentoon tai riippuvaan asentoon. Comet 500 voidaan asentaa ainoastaan pystyasentoon. Ajovalot eivät saa tärinä tai kohota konepellin yläpuolelle, ja valojen on oltava symmetrisesti asennettu. Asennuksessa on huomioitava esitetyn kuvan asennusmitat.

Määritä asennuskohta ja merkitse kiinnityskohdat. Esiporaa reiät 3 mm:n poranterällä ja avarra reiät 8,5 mm:iin. Käsittele poratut metalliosat ruosteestolla. Asenna ajovalot ja suuntaa ne kuvan mukaisesti. Kiristä kiinnitysruuvit kevyesti. Kun olet tehnyt sähköliitännän, säädä ajovalot ja kiristä kiinnitysruuvit tiukalle. Anna ammattikorjaamon säätää sumuvalojen tai kaukovalojen suuntaus. Vain oikein suunnatut ajovalot valaisevat optimaalisesti.

Valitse neljästä kytkentäkaaviosta oikea ja asenna johdot sen mukaan ja liitä.

Alla olevassa taulukossa on esitetty mitä valotoimintoja saa käyttää yhdessä sumuvalojen kanssa käyttämällä esimerkkinä kolmea eri maata.

### **Maakohtaisia lakeja on noudatettava joka tapauksessa.**

Testaa valolaitteisto. Kiinnitä liitosjohdot huolellisesti.

### **Säädä kaukovalot asiantuntijalla korjaamolla.**

## **Sähköinen liitäntä: Sivu 18-24**

Asenna releet liitospuristimilla alapuolelle siten, että ne ovat suojassa roiskevedeltä. Asenna katkaisija kojelautaan tarvittaessa ja lain salliessa.

## **Polttimonvaihto: Kuva sivu 17**





Vaihda polttimo piirroksen mukaan. Älä koske polttimoon paljain sormin! Käytä paperiliinaa tai muuta samantapaista.

## **Turvallisuusohjeita:**

Sammuta valonheittimet aina ennen lampun vaihtoa ja erota ne syöttöjännitteestä.

Anna lampun jäähtyä ensiksi. Käytä lampun vaihdon aikana suojalaseja ja suojakäsineitä.



		<b>A</b>	<b>CH</b>	<b>D</b>
Lähivalo				●
Lähi- ja seisontavalot		●	●	●
Seisontavalot			●	●
Kauko- ja seisontavalot			●	

**Ohje:**

- Pidä ajovalojen lasit puhtaina. Lika voi siemaista valotehosta jopa 80 %. Hyvä näkeminen ja näkyminen liikenteessä lisäävät turvallisuuttasi.

Onko ajoneuvossasi varalla poltti-  
moita ja sulakkeita?

**DE** Beleuchtungsanlage auf einwandfreie Funktion hin prüfen

**EN** Check that the lighting system is working perfectly

**FR** Contrôler le bon fonctionnement de l'installation d'éclairage

**SV** Kontrollera att ljussystemet fungerar felfritt

**NL** Controleer of de verlichting goed functioneert

**ES** Comprobar que el sistema de iluminación funciona impecablemente

**IT** Controllare la perfetta funzionalità dell'impianto di illuminazione

**FI** Tarkasta valaistusjärjestelmän toiminta

**DE** Bei Fragen oder Einbauproblemen, rufen Sie bitte den HELLA Kundendienst, Großhändler an oder wenden Sie sich an Ihre Werkstatt.

**EN** If you have questions or installation problems, please call the HELLA Service, wholesaler, or turn to your garage.

**FR** Pour toutes questions ou problèmes de montage, merci de contacter le service après-vente HELLA, votre distributeur ou votre garage.

**SV** Vid frågor eller monteringsproblem, kontakta Hella kundtjänst, återförsäljaren eller din verkstad.

**NL** In geval van vragen of montageproblemen verzoeken wij u contact met de HELLA-klantenservice, de groothandel of uw dealer op te nemen.

**ES** En caso de dudas o problemas de montaje, por favor, llame al Servicio postventa de Hella o al mayorista, o bien diríjase a su taller.

**IT** Per qualsiasi domanda o problemi di montaggio si prega di contattare il servizio assistenza o il proprio grossista HELLA oppure di rivolgersi alla propria officina.

**FI** Jos sinulla on kysymyksiä tai asennusongelmia, soita HELLA-asiakaspalvelulle tai tukkuliikkeelle tai käänny korjaamon puoleen.

