



Thank you for purchasing our Koso EX-02 Speedometer. Before operating the unit, please read the instruction thoroughly and keep it for future reference.

**Notice**

1. The meter requires DC 12V power only.
2. For installation, please follow the steps described below. Any damage caused by a wrong installation shall be imputed to the users.
3. To avoid short circuits, do not pull the wires off the connector when installing the unit. Do not break or modify the wire terminal.
4. Do not disassemble or change any parts.
5. Repair and maintenance should be executed by our professionals only.

**MARK MEANING:**

⚠ Some procedures must be followed to avoid damage caused by a wrong installation.

**WARNING!** Some procedures must be followed to avoid injuries.

**CAUTION!** Some procedures must be followed to avoid any damage to the vehicle.

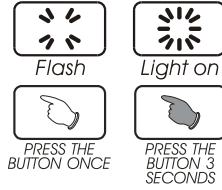

**1-1 Accessories**

<b>1</b> Meter X 1	<b>2</b> Speed sensor X 1	<b>3</b> M8/ S type speed sensor bracket X 1	<b>4</b> M10/ S type speed sensor bracket X 1
<b>5</b> M5X5L Hexagon socket screw X 2	<b>6</b> D6X5 mm magnet X6	<b>7</b> Meter bracket X 1 set	<b>8</b> M4 x 10 screw X2
<b>9</b> M5 x 15 screw X2	<b>10</b> M5 Washer X2	<b>11</b> 2.5 mm Allen key X 1	<b>12</b> 3 mm Allen key X1
<b>13</b> 4 mm Allen key X1	<b>14</b> Mid-way connector X8		

**NOTE** Please contact your local distributor if the items received are not the same as the above-listed ones.

**1-2 Option accessory**

<b>1</b> Reed Sensor	<b>2</b> External button
----------------------	--------------------------

**NOTE** Some optional accessories may not be sold in your area. For more details, please contact your local distributor.

**2-1 Wiring installation instruction**

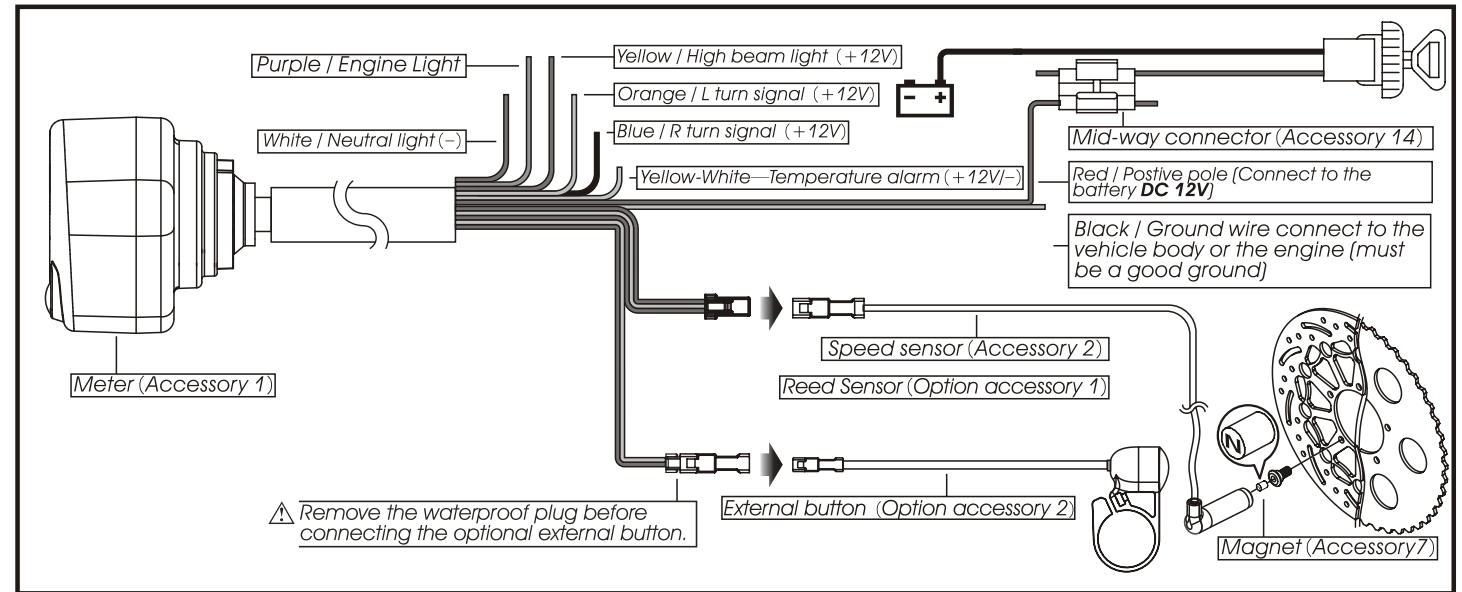

**MOTO / SCOOTER S type speed sensor bracket instruction**

- Loose the screw on the caliper
- Install the speed sensor (Accessory 2).
- Install the S type bracket on the caliper.
- Adjusting the distance between the sensor and screw to get the best speed signal. Please make sure the distance is under 2 mm to get the best signal.
- Please adjust the bracket to the proper angle and then screw it up. Please make sure the disc screw could pass the hole on the bracket for you to install the sensor into the same hole for catching the speed signal.

⚠ When using the electronic speed sensor (Hall Sensor), the meter must connect with DC12V battery instead of using inner battery from the meter.

⚠ When using Reed Sensor, the meter could function normally when using only the inner battery.

**2-2 Installation instruction**

**Follow this procedure for proper installation**

1. M5 X 15 screw X 2 (Accessory 9)
2. Meter bracket for handle bar (Accessory 7)
3. Fix the bracket on handle bar
4. Meter bracket clip (Accessory 7)
5. M4 x 10 screw X 2 (Accessory 8)
6. M5 Washer X 2 (Accessory 10)
7. Meter fixed board (Accessory 7)
8. Meter (Accessory 1)

**NOTE** Adjust the meter to the proper viewing angle before tightening the Allen screw.

**Special instruction for meter fix board.**

- A. Push meter bracket clip up to lock meter fix board (with meter) on bracket
- B. Push meter bracket clip down to release meter fix board (with meter) on bracket

## 2-3 Basic function instruction

### Speedometer

- Display range: 0~360km/h (0~225 MPH).
- Display unit: km/h (MPH).

### Indicator lights

- High beam light (Blue)
- Direction light (Green)
- Engine Light (Yellow)
- Neutral light (Green)
- Direction light (Green)
- Warning Light (Red)

### Odo meter

- Display range: 0~99999 km (mile), automatically reset after 99999 km (mile).
- Display unit: 1 km (mile).

### Trip meter

- Display range: 0~9999.9 km (mile), automatically reset after 9999.9 km (mile).
- Display unit: 0.1 km (mile).

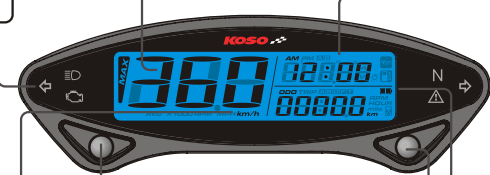

### Select button

- Press the Select button on the main screen to switch between 12 / 24 hour mode, speedometer record, stopwatch, and MAX record.

- Clock: 12 / 24 MODE
- Volt meter: DC 8~18 V
- Stopwatch function: can be either programmed for manual activation or by wheel activation
- MAX Record function: Average speed : 0~360 km/h (0~225 MPH) MAX Speed : 0~360 km/h (0~225 MPH) MAX voltage : DC 8~18 V

- Inner battery display range: 4 levels.

### Adjust button

- Press the Adjust button on the main screen to switch between ODO, TripA / B, Total Hour meter, Hour meter A / B.

## 2-4 Function specifications

<ul style="list-style-type: none"> <li>● Speedometer Display range : 0~360 km/h (0~225 MPH) Display unit : 1 km/h &amp; MPH for alternative</li> <li>○ Display internal &lt;0.5 second</li> <li>○ Odometer Display range : 0~99999 km (mile) Automatically reset after 99999km (mile) Display unit : 1 km (mile)</li> <li>○ Trip meter A / B Display range : 0~9999.9 km (mile), Automatically reset after 0~9999.9 km (mile) Display unit : 0.1 km (mile)</li> <li>● Hour meter Display range : 0~9999.9 hour Display unit : 0.1 hour</li> <li>○ Hour meter A / B Display range : 0~9999.9 hour, Automatically reset after 9999.9 hour Display unit : 0.1 hour</li> <li>● Clock Setting range : 12 / 24 hour Setting unit : 1 minute</li> <li>● Volt Display range : DC 8~18 V Display unit : 0.1V</li> </ul>	<ul style="list-style-type: none"> <li>● Stopwatch Display range : 0'00"00~9'59"99 Display unit : 0.01 sec.</li> <li>● Maintenance Mileage Setting range : 300~5,000 km Automatically reset after 5,000 km Setting unit : 1 km</li> <li>● MAX Record function Average speed : 0~360 km/h (0~225MPH) MAX Speed : 0~360 km/h (0~225 MPH) MAX voltage : DC 8~18 V</li> <li>● Inner Battery Level Display range : 4 levels</li> <li>● Effective temperature range -10~+60°C</li> <li>● Meter standard JIS D 0203 S2</li> <li>● Meter size 120 X 40 X 23 mm</li> <li>● Meter weight Around 127.3 g</li> <li>● Telltales High beam light (Blue) Neutral (Green) Direction light (Green) Warning Light (Red) Engine Light (Yellow)</li> </ul>
--	--

**NOTE** Design and specifications are subject to change without notice!

## 2-5 Battery replacement

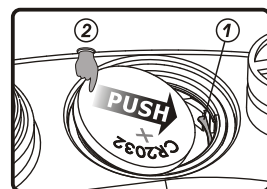
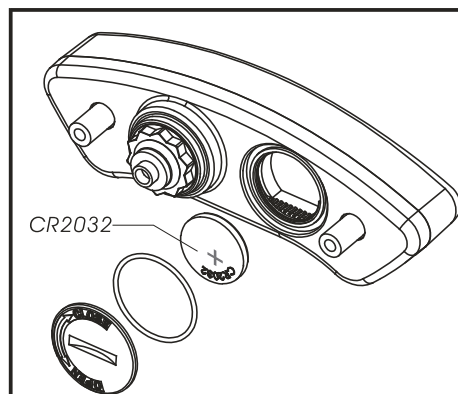

Figure A

### Follow this procedure for proper installation.

- The meter includes an internal battery (CR2032). This battery shall be replaced only when power runs out.
- In order to install the battery properly, push the battery as show on figure (A) to make sure the battery is placed underneath the metal tab (1).

**WARNING!** Not following this procedure could result in permanent damage to the meter.

## 3 Switch function instructions

### Instructions for select button



- Press the **Select button** while on main screen to switch from Clock to Stopwatch.

- Press and hold the **Select button** for 3 seconds to alternate 12/24hour modes.



**NOTE** If 24hour mode is chosen, then the AM/PM symbol will not be displayed.



- Press the **Select button** to switch from Stopwatch to Volt meter.

**NOTE** When the option for manually resetting the stopwatch is chosen, press Select button and hold for 6sec. to switch to Voltmeter.

- Press and hold the **Select button** for 3 seconds to reset the Stopwatch.

**NOTE** if the button setting is "ON", then press the **Select button** to start counting and press **Select button** again to stop.

**NOTE** If button setting is "OFF", then press the external button (optional) to start counting and press again to stop.

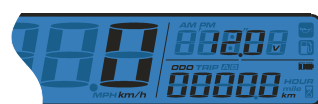

- Press the **Select button** to switch from Voltage to Speed Record.



**CAUTION** To switch from Stopwatch to Speed Record, you must have a record for the Stopwatch (please do not reset the Stopwatch). When Stopwatch is resetted, pressing the Select/External button will start the Stopwatch function again.



- Press the **Select button** to switch from Speed record to clock meter.

- Press and hold the **Select button** for 3 seconds to reset the Speed Record



**NOTE** When Maintenance Symbol is ON, please reset under this function screen.



- Back to clock screen.

### Instructions for adjust button



- While on main screen, press the **adjust button** once to switch the function from odometer to trip A.

- While on odometer screen, press and hold the **Adjust button** for 3 seconds to change the speed unit.



- Press the **Adjust button** to switch from trip A to trip B.

- Press and hold the **Adjust button** for 3 seconds to reset the trip A.



- Press the **Adjust button** to switch from trip B to total hour meter.

- Press and hold the **Adjust button** for 3 seconds to reset the trip B.



- Press the **Adjust button** to switch from total hour meter to hour meter A.



- Press the **Adjust button** to switch from hour meter A to hour meter B.



- Press the **Adjust button** to exit from Hour Meter B and to go back to odometer screen.



- Back to the odometer screen.

## 4 Setting Mode



- While on main screen, press the **Adjust+Select** 3 sec. to enter the tire circumference and sensing point settings (for setting a different tire size.)



- Use the **Adjust** button to set the proper tire circumference.

### ●4-1 The tire circumference and sensing point setting



- EX. The tire circumference is 1300 mm.
- Press the **Adjust** button to move to the digit you want to set.



#### NOTE

The tire circumference setting range is from 300 to 2500 mm.

NOTE Default setting : 1000mm

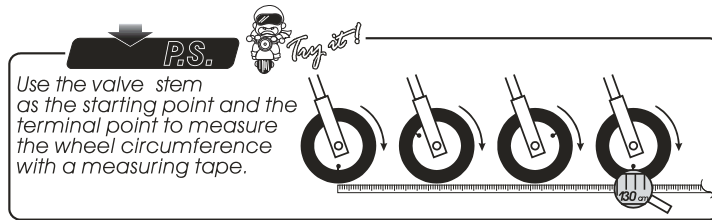

- EX. The tire circumference setting is changed from 1000 mm to 1300 mm.
- Press the **Select** button to change the setting.



- Press the **Adjust** button three times to enter the sensing point setting.

### ●4-2 Sensing point setting



- EX. To change the sensing point to 6.

NOTE The sensing point settings range from 1 to 6 points.

NOTE Default value: 1



- EX. the sensing point setting has been changed from 1 to 6.

- Press the **Select** button to choose the hour you want to set.



- Press **Adjust** button to go back to tire circumferences value & sensing point setting screen.

- From **a 1** switch to **a 2** screen.



- Press the **Select** button to enter the clock (Hour) setting

### ●4-3 The clock (Hour) setting



- EX: The hours have to be set to 14.
- Press the **Select** button to choose the hour you want to set.



NOTE Setting range: 0~24 H.



- EX. The hours have now been changed from 0:00 to 14:00.
- Press the **Adjust** button to enter the minute setting.

### ●4-4 The clock (minute) setting



- EX. To change the setting to 14:05.
- Press the **Select** Button to choose the minute to be set.



NOTE Setting range: 0~59 minutes.

- EX. The time is now changed to 14:05.

- Press **Adjust** button to go back to Clock setting screen.

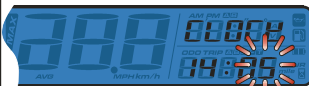

- From **a 2** switch to **a 3** screen.



- Press the **Select** button again to enter the Stopwatch Setup

### ●4-5 Stopwatch Setup



- Press **Adjust** button to choose between Auto mode (Stopwatch starts/stops according to the wheel rotation) and Manual mode (Stopwatch starts/stops by pressing the meter button of the optional thumb switch).

- If AUTO option is chosen, press **Adjust** button to exit the Stopwatch setup



NOTE Default value: AUTO

- If Manual mode "SW" (switch) option is chosen, press **Adjust** button to enter the menu then **Select** button to switch between "ON" (external button - optional) or "OFF" (meter button).



NOTE Default value: OFF

- Press the **Adjust** button to enter the ODO setting.

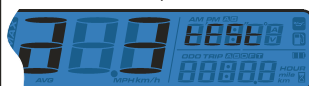

- From **a 3** switch to **a 4** screen.



- Press the **Adjust** button to enter the Maintenance Oil Light Setting.

### ●4-6 Maintenance Oil Light Setting



- Ex. Select ON/OFF to enable/disable the maintenance oil light function.
- If OFF is selected, then press the **Adjust** button once to exit the maintenance mileage setting.



NOTE Default value: OFF

- If ON is chosen, press **Adjust** button to enter the maintenance oil light setting
- Press the **Adjust** button to move the cursor to the digit to be set.



- If OFF is chosen, then press the **Adjust** button to exit the maintenance

oil light setting

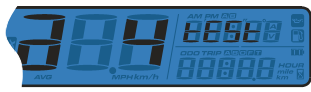

● From **a** 4 switch to **a** 5 screen.



● Press the **Adjust button** to enter the Backlight Brightness setting

#### ●4-7 Backlight brightness



●EX. To change the Backlight brightness setting to 1.  
● Press the **Select button** to adjust the brightness of the backlight



**NOTE** Adjustable Range: 1 ~ 5

**NOTE** Default value: 5



●EX. The Backlight brightness setting is changed from 5 to 1  
● Press the **Adjust button** to confirm and exit the backlight Brightness setting



● From **a** 5 switch to **a** 6 screen.



● Press the **Adjust button** to enter the ODO setting.

#### ●4-8 Warning Light signal



●EX. To set the signal type of the Warning Light (+12V = Hi; GND = Lo)  
● Press the **Select button** to choose the signal type



**NOTE** Warning Light Signal Type: Hi / Lo

**NOTE** Default: Lo



●EX. The Warning Light signal setting is changed from Lo to Hi  
● Press **Adjust button** to go back to Warning Light signal setting screen.



● From **a** 6 switch to **a** 7 screen.



Press the **Adjust button** to enter the ODO setting

#### ●4-9 ODO setting.



● Press the **Adjust button** again to view the actual meter mileage under TOTAL.

● EX. To set the customized mileage adjustment under USER.

● Press the **Select Button** to switch from Total ODO to User ODO setting.



● EX. To change the ODO setting of 5000 km.

● Press the **Adjust button** to enter the desired ODO value to be set.

● EX. The User ODO to be set is 3000 km.

● Press the **Adjust button** to move the cursor to the digit to be set.



**NOTE** Setting range : 00000~99999 km.  
Setting unit : 1 mm.

**NOTE** Default value: 0

● Press the **Select button** to choose the digit to be set.



● Press the **Adjust button** to go back to the ODO viewing display

● Then press and hold both the **Adjust and Select buttons** 3 sec. to exit and go back to the main screen.

● Back to the main screen.

## 5 Troubleshooting

The following situations do not necessarily indicate a malfunction to the meter. Please check the following before taking it in for repair.

Problem	Diagnosis
The meter doesn't work when the power is on.	<ul style="list-style-type: none"> <li>● The power is not supplied properly to the meter.               <ul style="list-style-type: none"> <li>→ Make sure the wiring is connected correctly. The wiring and fuse may be broken.</li> <li>→ The battery is too old to supply enough power to make the meter work.</li> </ul> </li> </ul>
The meter shows wrong information	<ul style="list-style-type: none"> <li>● Check the battery voltage and make sure that it supplies enough power.</li> </ul>
Speed does not appear or appear incorrectly.	<ul style="list-style-type: none"> <li>● Make sure that the speed sensor is connected properly.</li> <li>● Check the tire-size setting.               <ul style="list-style-type: none"> <li>→ refer to manual 4-1.</li> </ul> </li> </ul>

Problem	Diagnosis
Clock is incorrect	<ul style="list-style-type: none"> <li>● Check if the wire is connected properly               <ul style="list-style-type: none"> <li>→ Check if the positive wire (Red) is connected to the battery and the main switch positive wire (Brown) is connected to the main switch.</li> </ul> </li> </ul>
Battery power lower than level 1.	<ul style="list-style-type: none"> <li>● The problem may be caused by insufficient power.               <ul style="list-style-type: none"> <li>→ Replacement of the internal battery may be necessary.</li> </ul> </li> </ul>

※ If the problem can still not be solved according to the steps above, please contact your local distributor to get assistance.