

**FOR PUBLIC  
RELEASE**

Инструкция пользователя

OneDer V02 Bluetooth колонка СТЕРЕО, с информатором времени/будильник, модуль беспроводной зарядки, с сенсорным управлением, с аккумулятором для использования в помещении

Артикул: OneDer V02

Спасибо за совершенную покупку в нашем магазине

**FOR PUBLIC  
RELEASE**

**FOR PUBLIC  
RELEASE**

# V02

Wireless charger with speaker  
alarm ,clock, phone holder  
time display

## USER MANUAL

**4** IN 1  
Wireless charging  
Speaker  
Time Display  
Phone holder

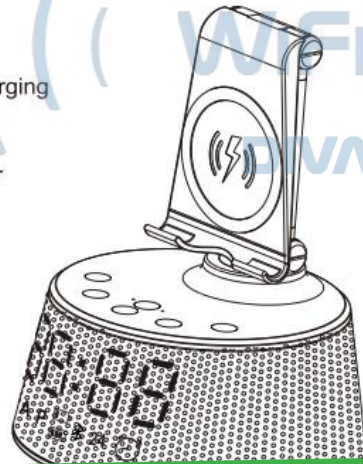

**FOR PUBLIC  
RELEASE**

### Packing information



1 Speaker



2 Charging cable



3 Manual

### Touch keys display

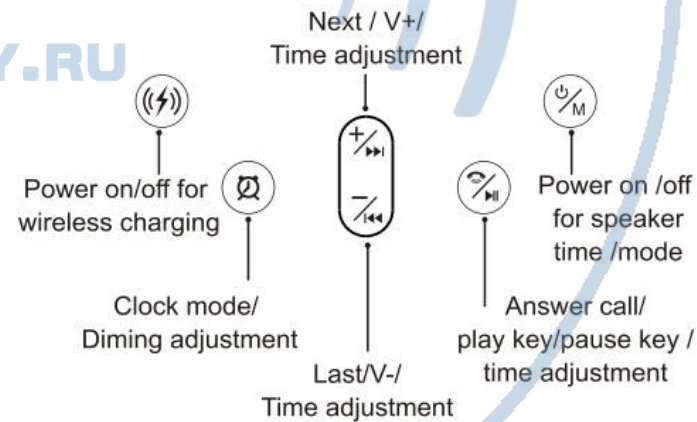

## Port display

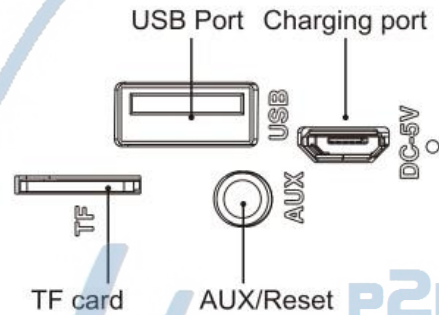

## Connect bluetooth pairing name

At first, please open your phone's bluetooth mode, then research the pairing name-V02, Once connected, you can play your music



Shortly press -/< key means V- ,  
long press -/< key means last song .

Shortly press +/> key means V+ ,  
long press +/> key means next song



AUX-IN function: when you find a AUX cable connect the speaker and your phone or computer , the speaker can play the music from your phone or computer

TF card function : you can find a TF card with music , inset the TF card port ,then the speaker can play the music

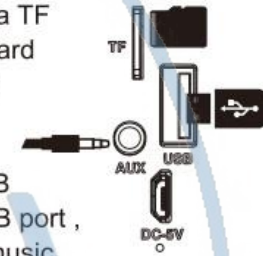
USB disk : when you find a USB with some music , inset the USB port , the speaker also can play the music



## Hands free function

Once the speaker connected the pairing name , at this time , someone call you , you can press  key to answer this call, then you press  this key again, it means you hang up , then you press  this key for two times , it means you can call the last number who call you



**FOR PUBLIC  
RELEASE**



## Wireless charging function

Touch one time this key (📶), the indication light will bright, then you take the phone (must support wireless charging function) put on the holder, then this speaker can charging your phone, you also can watch video from your phone, if the charging is full, you can press the (📶) key, close the charging function



Note : only the speaker connect the adapter, this speaker can charging for phone

## Clock function

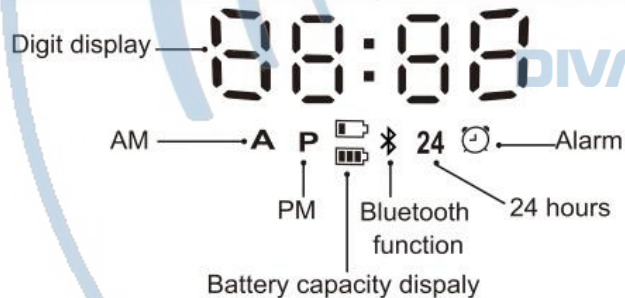

Touch the (🕒) key, you can open or close digit display, press again, you can adjust the brightness.

Long press (🕒) key, select either 12hour or 24 hour display

## Setting the time

long press (🕒) key, the clock will flash, you can press the v+/v- to adjust the hour, then you can touch the (🕒) key, the minute will flash, you can press the v+/v- to adjust the time, press (🕒) key again to confirm the time

## Setting the alarm

1 Long press (🕒) key, the hour digit will flash, press (🕒) key again, the minute digit will flash, at the same time, alarm will be appear on the bottom right side of the LED screen. touch the V+/V- to set the hour time, press set again, the minute digit will flash, then press the V+/V- to set the minute time.

After you chosen a time, touch V+/V- TO set, in the end, you touch the alarm key to confirm

2 when the alarm ring, press the alarm key, cancel alarm

## Technical parameters

Brightness: Dimming	Signal-to-noise ratio: ≥90dB
Distance :10m	Bluetooth version : 4.1 +EDR
Input : DC 5V ↔2A	Battery capacity : 3.7V.4400 mAH
Loudspeaker : ∅ 52mm,4ohm,5W X 2	Wireless charging output: DC 5V↔1A
Frequency response:90Hz-20KHz	Wireless charging input: DC 5V↔1A

**FOR PUBLIC  
RELEASE**

*Наслаждайтесь использованием.*