

EASYMNEMO

This document is not a user guide, but a set of explanations, tips, examples, answers to frequently asked questions.

24.05.2021

<http://www.easymnemo.com>

Contents

Introduction.....	2
Interface language.....	2
Editing.....	3
Pipes.....	7
Colors.....	14
Text.....	17
Comments.....	19
Specification.....	20
Models.....	21
Isometric projection.....	22
User panels.....	23
Export to bitmap files (BMP, GIF, JPEG, PNG, TIFF).....	25
Inserting bitmap files (BMP, GIF, JPEG, PNG, TIFF).....	25
Examples.....	25
Recommendations.....	25

Introduction

Easymnemo is vector graphics application to create diagrams, charts. You can use diagrams in your documents, presentations, promotional materials, business cards, etc. The program contains a large library of symbols and elements, including product images of popular manufacturers of equipment, image graphic symbols from GOST, ABOK. A lot of attention has been paid to the heat supply, water supply, gas supply, Automated Process Control System. The program gives the possibility to print prepared by the scheme, export them to bitmap files.

Installation kit contains the catalog of examples (schemes of measurement of heat energy, water, gas, heating, connection schemes of boiler equipment, switching schemes, structural schemes, schemes of computer networks, schemes of burglar fire alarm, advertising materials, business cards, etc.).

Easymnemo allows you to store text information in several languages for one scheme. User can easily change the color scheme, to choose volumetric or flat style of image, add shadows, etc. The Easymnemo Interface and most of the examples translated into Russian, English, Spanish, Italian and Czech languages.

Program is easy to use and intuitive. Nevertheless, there are not very obvious points that this document will help you clarify.

Interface language

Select a language from the list in the upper right corner of the window of the program:

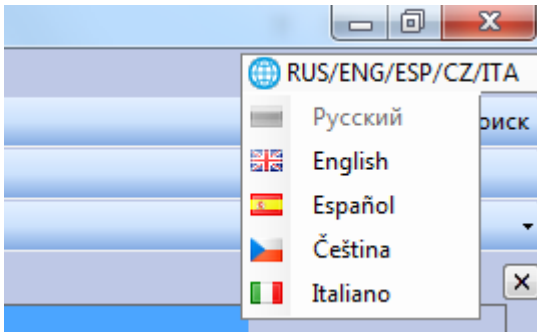

Note: All the examples included in the installation kit, translated into Russian and English languages, and many in Spanish and Czech. Changing the interface language will display examples in accordance with the established language (examples, which not translated into Spanish, Czech or Italian, will display at the English language).

Editing

After starting, the program is in *the selection mode*. The mouse pointer is in the form of a cursor. The left part of the program window contains the toolbox (collection of symbols). After clicking on the item icon, the program will enter *the mode of inserting a new object*. The mouse pointer will take the crosshair form.

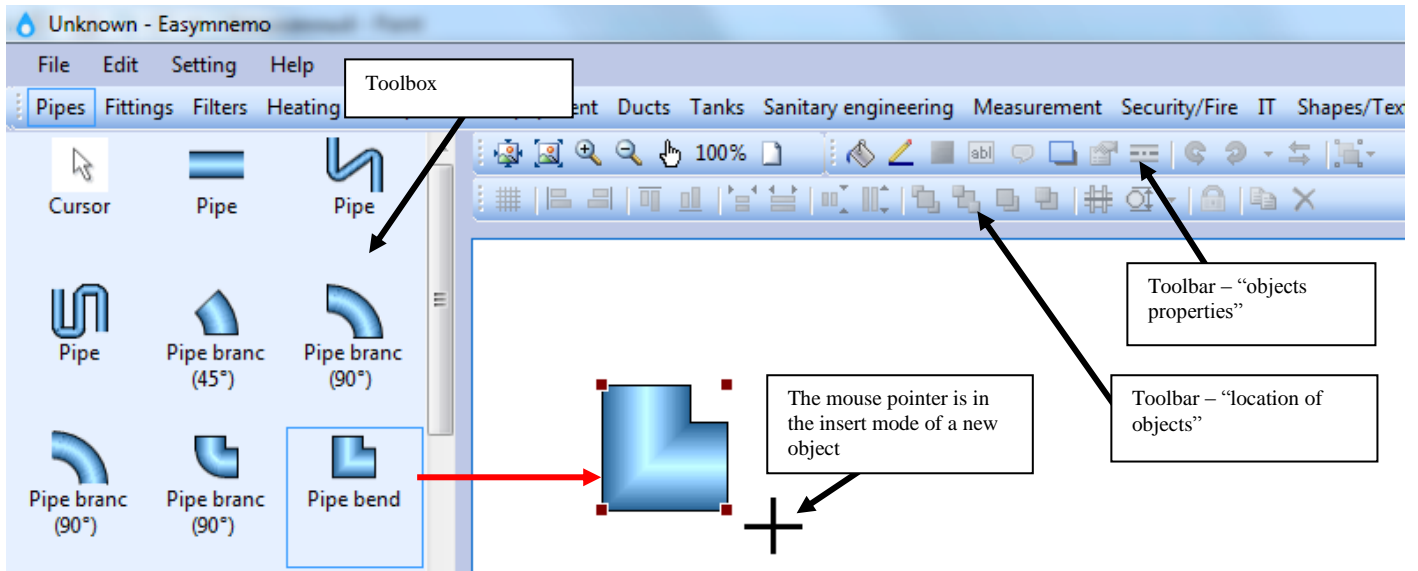

To add an object to the diagram, press the left mouse button on the diagram and drag the mouse pointer. After you release the left mouse button, the object will appear on the diagram. The program will remain in the insert mode of the new object (the mouse pointer will also remain in the crosshair form) and you can add the object again.

To return to the selection mode, click the *Cursor* icon or right mouse button or any key. The mouse pointer will take the cursor form. In the selection mode, you can edit the added objects.

► Starting from version 2.19.06.18, one more way to insert a new object is added - by double-clicking on the corresponding icon. For objects that can be placed on pipes (fittings, filters, flow meters, etc.), the initial dimensions of the created object will be set by the program based on the current diameter of the pipe. For other the initial dimensions will be set by the program based on the base size of the element. The original current pipe diameter and the base element size can be set in the in the *Picture properties* dialog box.

Note that the current diameter of the pipe can change when working with the scheme, for example, you have selected a different diameter pipe, and the program remembers this value. The base size of the element can be set in the *Picture properties* dialog box.

Comment. If the current pipe diameter is less than the minimum value (the default is 5 px; can be set in the *Picture Properties* dialog box), the pipe diameter for the object size calculation is assumed to be this minimum value.

To start editing an object, select the object by click the left mouse button on the object. After that, you will have access to the toolbar for editing the properties of objects (fill, lines, rotation, etc.) and the toolbar responsible for the position and alignment of objects.

Note 1: There are several ways to select multiple objects:

- Holding the *Shift key* click the left mouse button on the objects. If the object clicked on is not already selected, it will be selected. If it is already selected, it will be deselected;
- Press the left mouse button on the free space of the diagram and drag the cursor. Objects will be selected, that fall into the field of the displayed rectangle;
- You can select all objects by using *Edit > Select all* menu.

To move a object: position the pointer over the object. Hold down the left mouse button and drag the object. You can also move selected objects by using the *Shift / Arrow Keys*.

Note 2: After selecting an object, the program “remembers” some properties of the selected object: colors, border parameters, pipe diameter, etc. When you insert a new object, the program uses this data to give the new objects the appropriate properties. For example, if you select a pipe, a new pipe will be added with the same diameter, color, and thickness of the boundary lines as the selected pipe.

Note 3. ► Starting from version 2.20.05.15, a *layout grid* has been introduced (in 0.1 cm increments by default). When moving objects will coordinate their position with her. Namely: each object has a certain conditional center, which will be combined with the nearest node of the layout grid. You can change the properties of the layout grid and also discard it in the *Settings > Parameters* dialog box.

Toolbar “*Objects properties*”

- Fill
- Lines
- Additional color
- Text and text attributes (font, size, color, alignment)
- Text
- Comment
- Shadow
- Specification
- Centerline (dot-dashed line), Centerline color
- Flanges, connections, stoppers
- Nodes, diameter, insulation and section view of pipeline
- Line stoppers
- Properties of object *Table*
- Properties of object *Keys*
- Properties of object *Parallel lines*
- Properties of object *Frame*
- Anchor (binding of the extreme nodes of the tubes or lines to objects)
- Rotation:
 - Counterclockwise (default 15°) Clockwise (default 15°) At an arbitrary angle
 - Flip horizontally Flip vertically
 - Isometric projection
 - Group/Ungroup
 - Assemble model/Disassemble model

Toolbar “*Objects location*”

- Alignment of selected objects:
 - Align to layout grid
 - Left align
 - Right align
 - Top align
 - Bottom align
- Size alignment of selected objects:
 - Min width
 - Max width
 - Min height
 - Max height
- Order in which objects appear:
 - Bring to front
 - Send to back
 - Bring forward
 - Send backward
- Align to pipe and attach
- Set object size by pipe diameter
- Lock
- Format painter
- Clone
- Delete

The selected object has corner handles ■ (brown markers). Drag a corner handle until the object is the size you want.

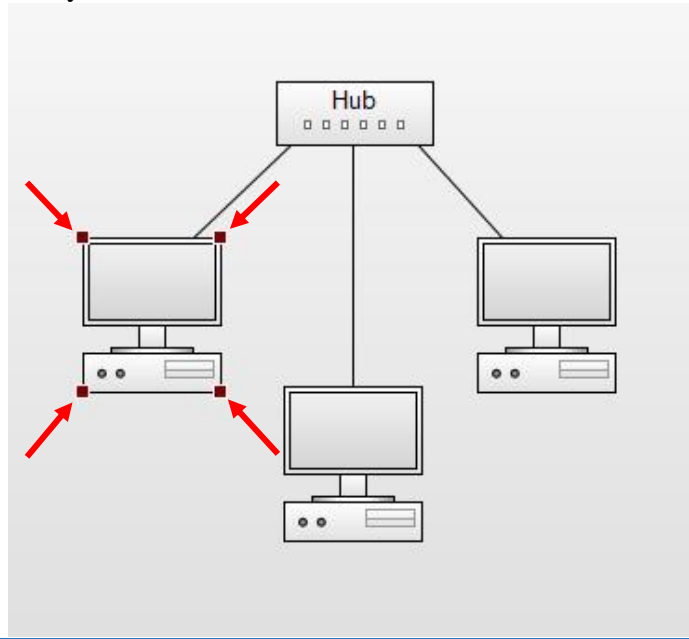

The group of selected objects has corner handles ■ (black markers). Drag a corner handle until the group is the size you want.

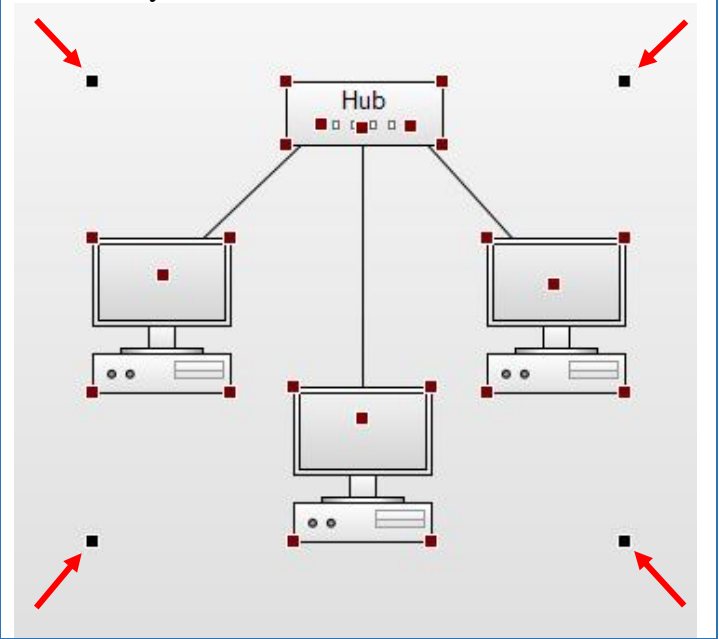

You can also change the size of the selected objects by using keyboard shortcuts:

Shift / + , *Shift / -* , *Shift / PageUp* , *Shift / PageDown*

Note 1: Some objects require a valid width to height ratio. For some objects, the height must be greater than the width (or part of it), for others, on the contrary, the width is greater than the height (or part of it). If you do not observe the "proportions" - a rectangle is drawn. The following picture shows what will happen to one of these objects if you constantly increase its width.

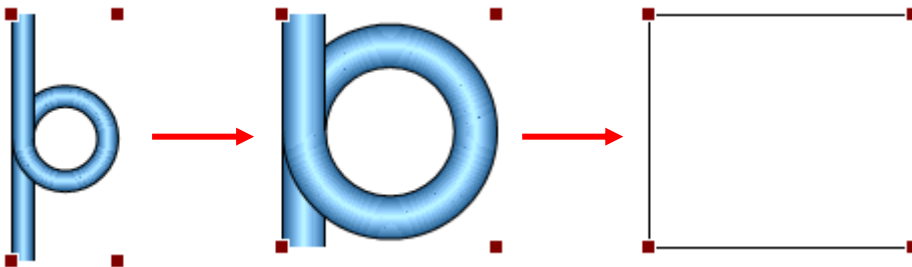

Note 2: When you resize selected object, if you hold *Shift* key, the selected object will be resized proportionally.

Note 3: For some objects, it is possible to change the "geometry" using special handles ■ (yellow markers):

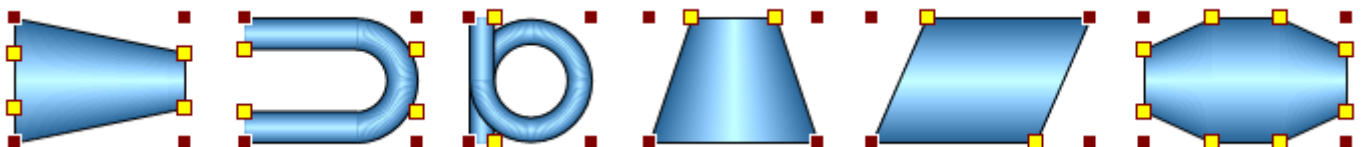

Drag a yellow handle until the object is the "geometry" you want. For example,

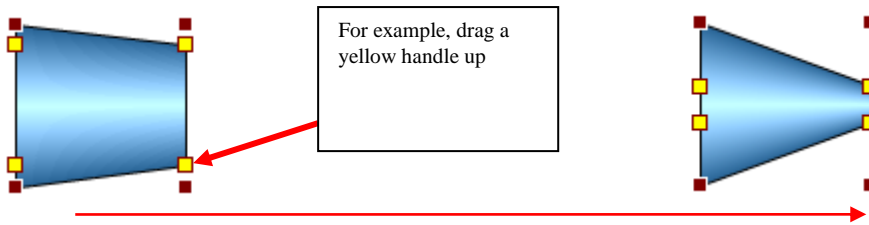

Pipes

The program provides two types of pipes (ducts): with diameter and without diameter. A pipe without a diameter is a polyline for which a dimension is specified that determines the height of the “pipe ends” and the elements that can be placed on the pipe. In this sense, the size plays the same role as the diameter of "ordinary" pipes.

1. To draw pipe with horizontal/vertical segments, click the "Right angles" flag on context menu.

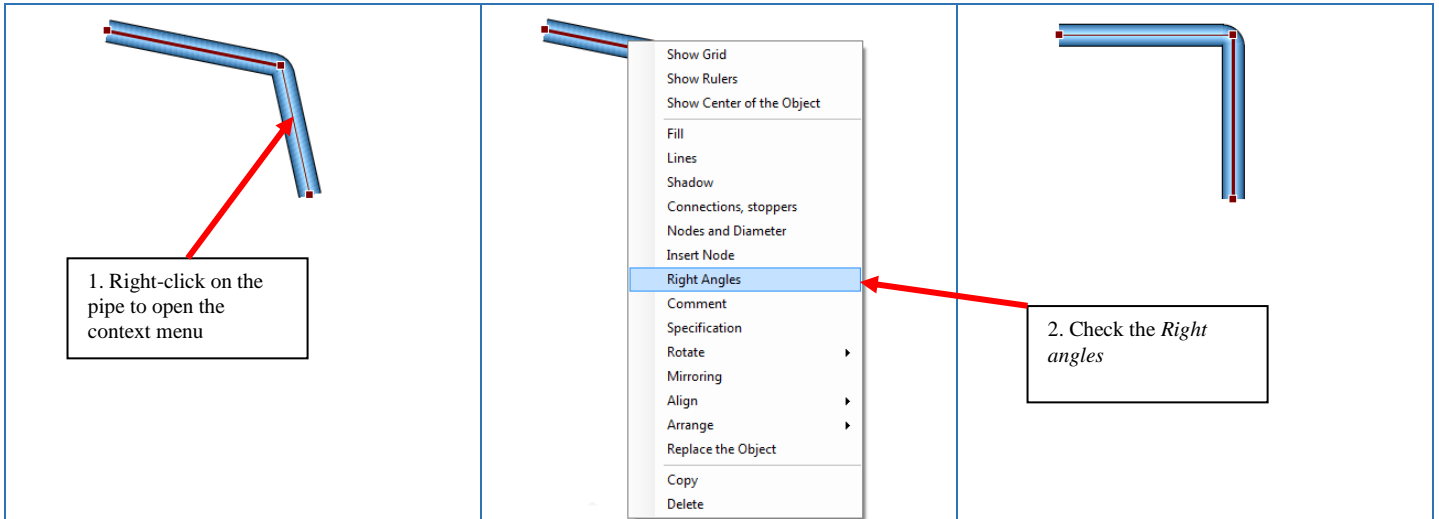

2. To add a new pipe segment, select the pipe node (click on the node - it will change color from brown to yellow) and press the *Insert* key (or select *Add node* on context menu).

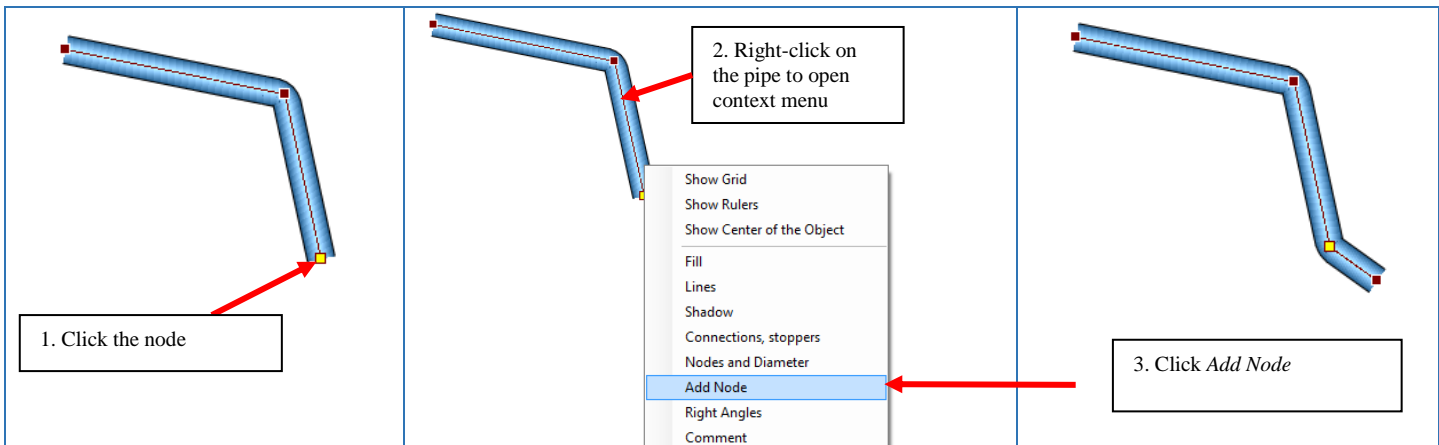

3. To delete a pipe segment, select the pipe node and press the *Delete* key (or click *Delete* on context menu).

4. To bind an extreme pipe node to an object: select the node, move the node on the object and click the button  (or set the *Anchor flag* on context menu).

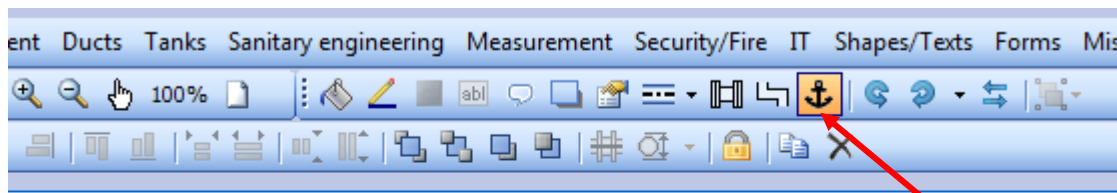

1. Click the pipe node

2. Click Anchor button

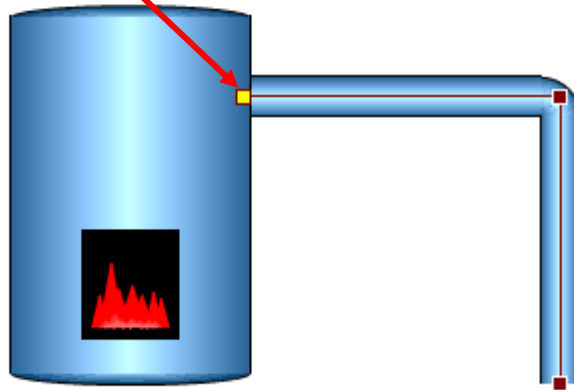

5. To change the diameter of the pipe, diameter, and color of individual segments of pipe and the type and size of pipe nodes click the button  (or click *Nodes and Diameter* on context menu). Set your desired pipe diameter, segment diameter, insulation, flanges and gaskets in the pop-up dialogue box.

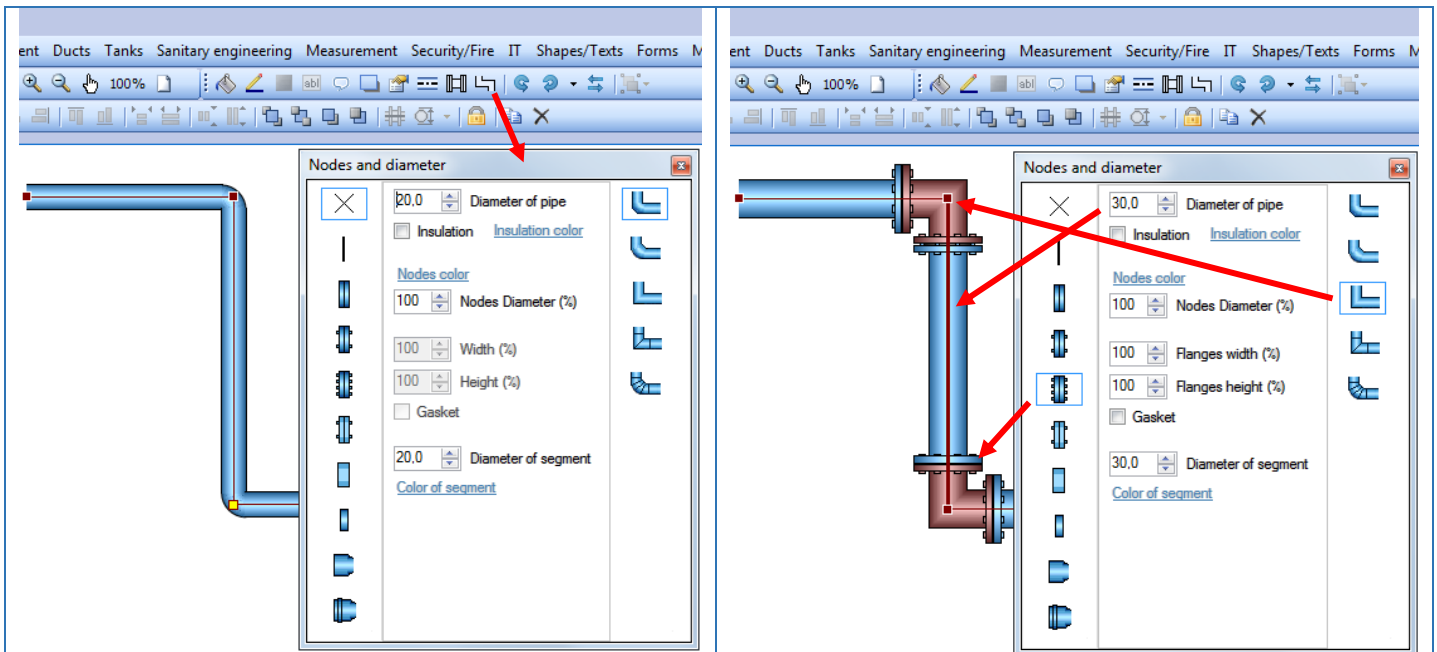

The following examples illustrate the results of the changes in the *Nodes and Diameter* dialogue box:

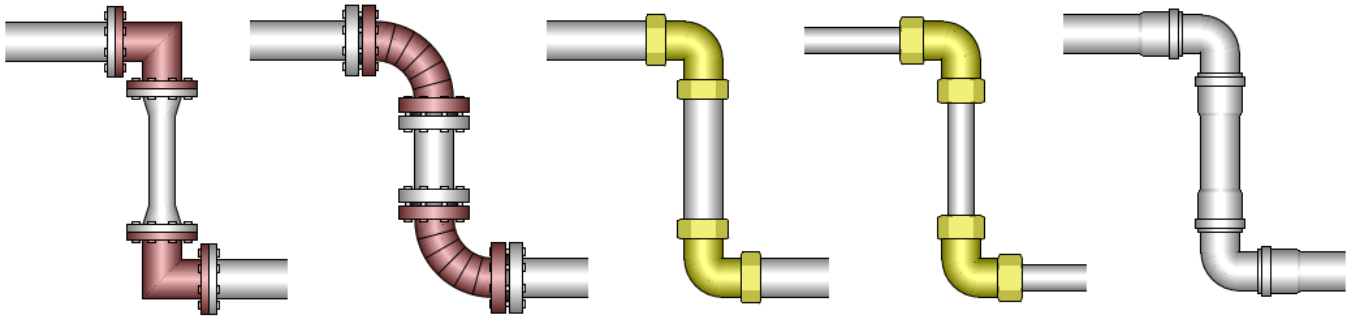

6. To change the pipe endings click the button  (or click *Connectors, stoppers* on context menu). Set your desired pipe endings in the *Connections, stoppers* dialog box.

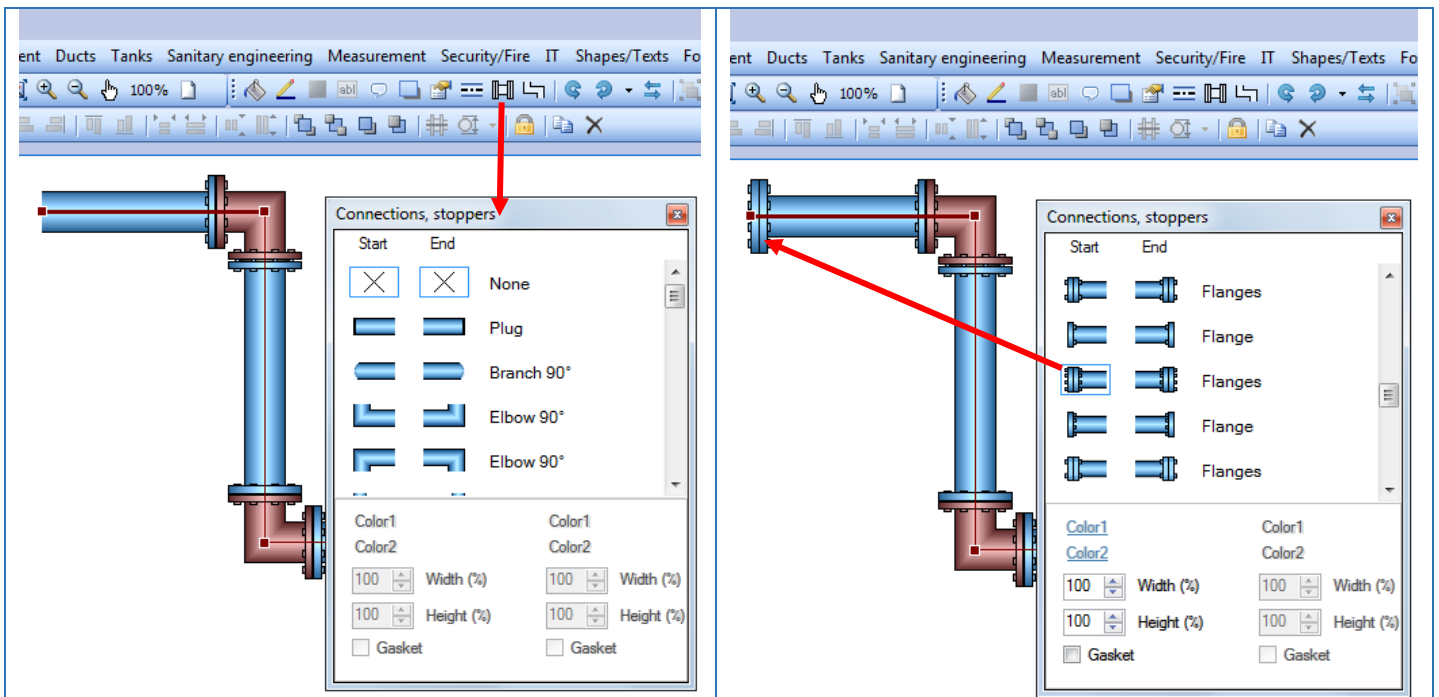

Examples:

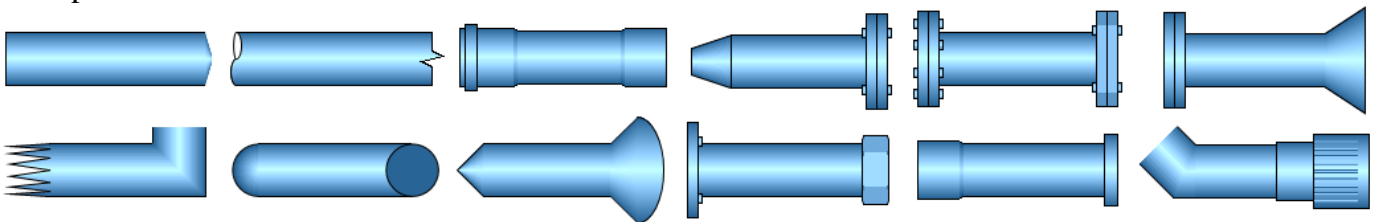

Using the pipes and settings in the *Connectors, stoppers* dialog box, you can easily create pipe elements. For example,

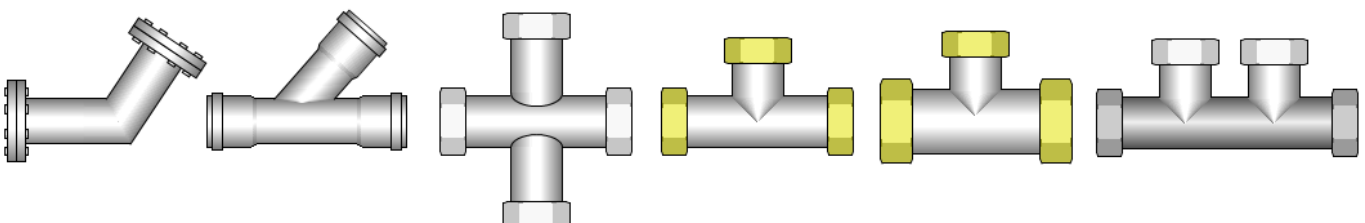

For pipe without diameter, the set of connectors and limiters is different. In the *Connectors, stoppers* dialog box, you can specify a size that determines the height of the constraints and the elements that can be placed on the pipe.

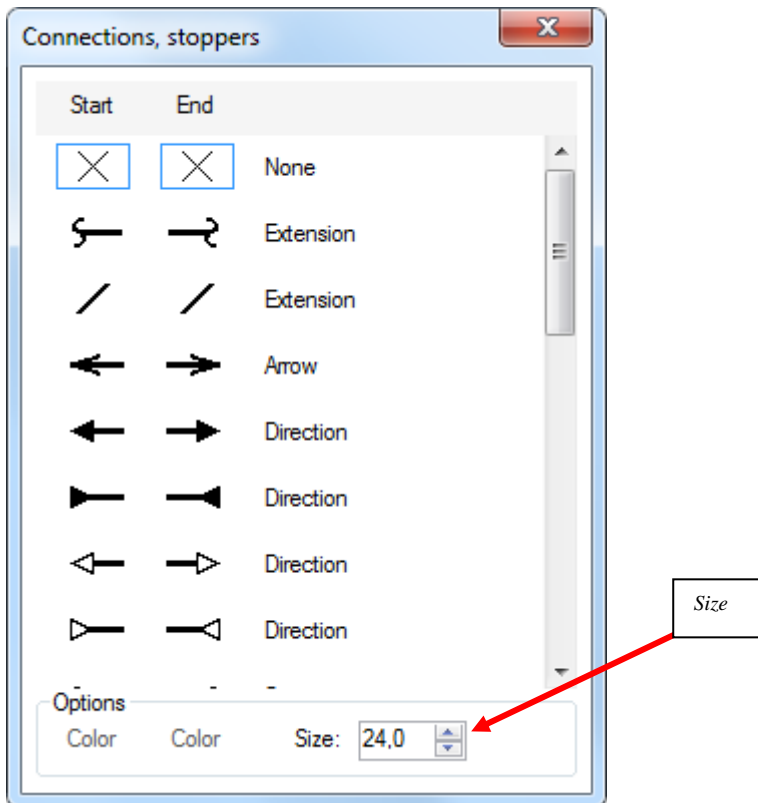

7. To center and bind the object located on the pipe to the pipe itself, click the button (or click *Align > Align to Pipe and Attach* on context menu).

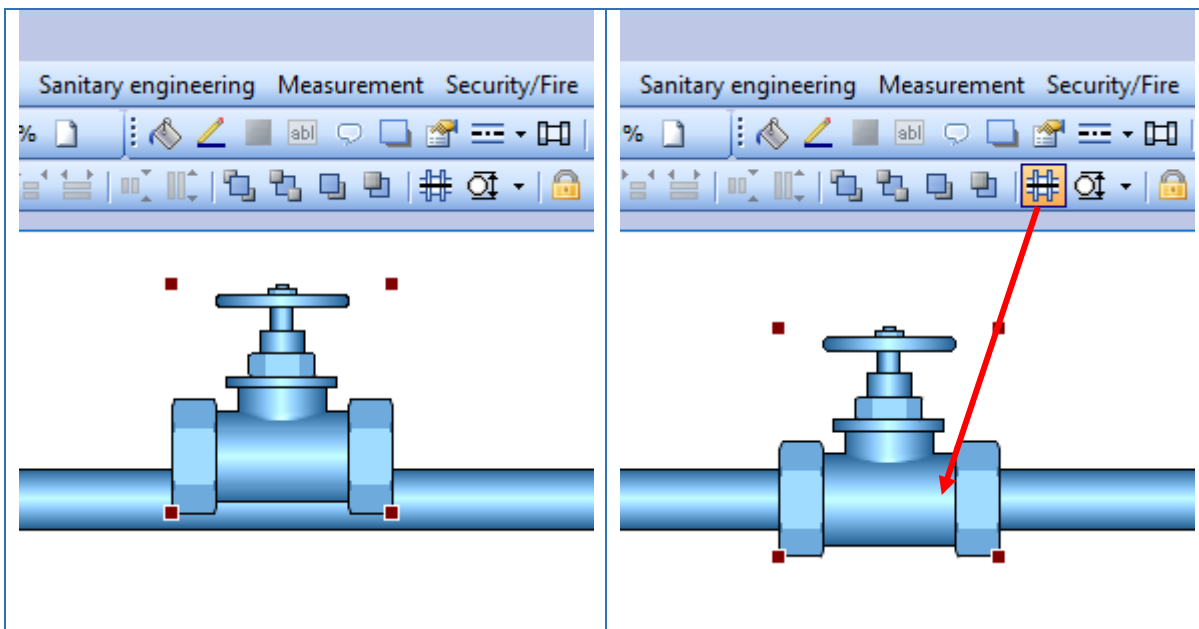

8. Some objects (for example, a pressure gauge or temperature sensor) can be tied to the border (surface) of the pipe. Click the button . To change the type of the mounting click the button (or click *Mounting* on context menu). Set your desired mounting in the *Mounting* dialog box.

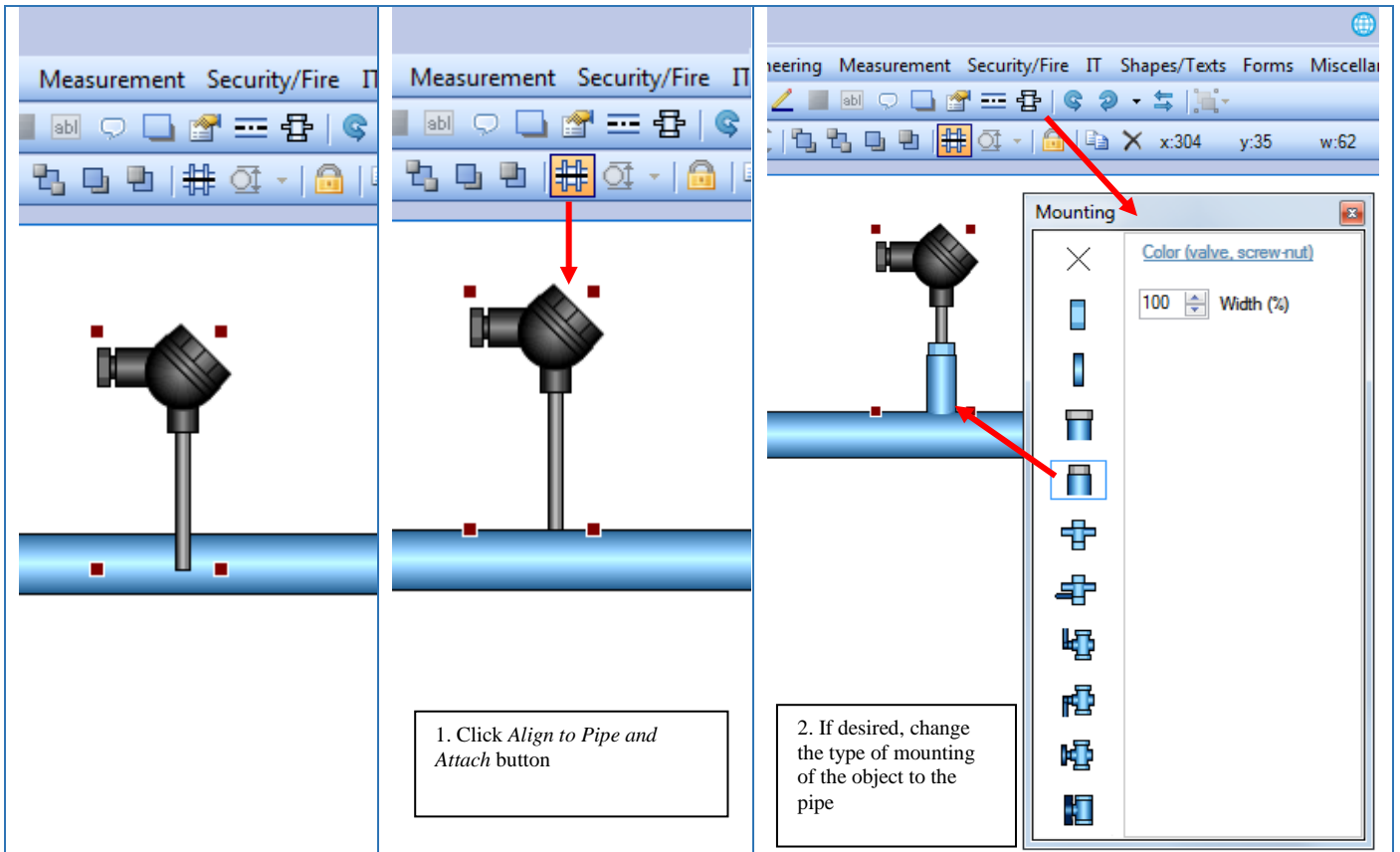

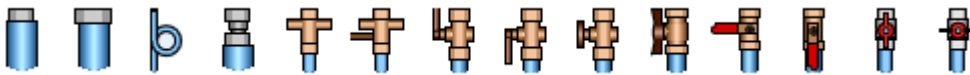

In addition, to visualize the installation there are special "mounting" elements. They are located in the *Measurement* section.

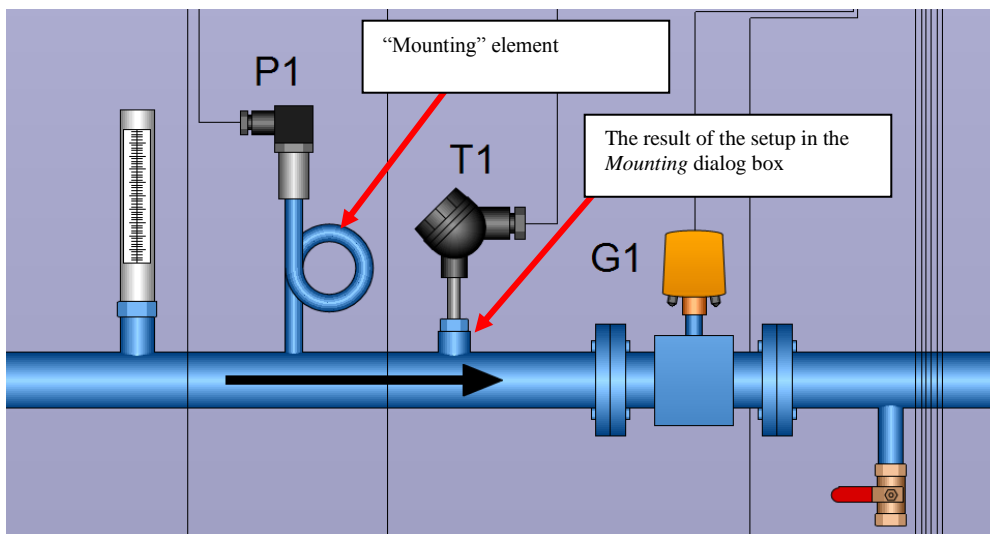

Below is an example of both methods for mounting sensors.



9. To set the object size by pipe diameter, click the button  (or click *Align > Set Object Size by Pipe Diameter* on context menu). You can also press the button  (located to the right of the button ) to set object size by pipe diameter with the multiplication factor.

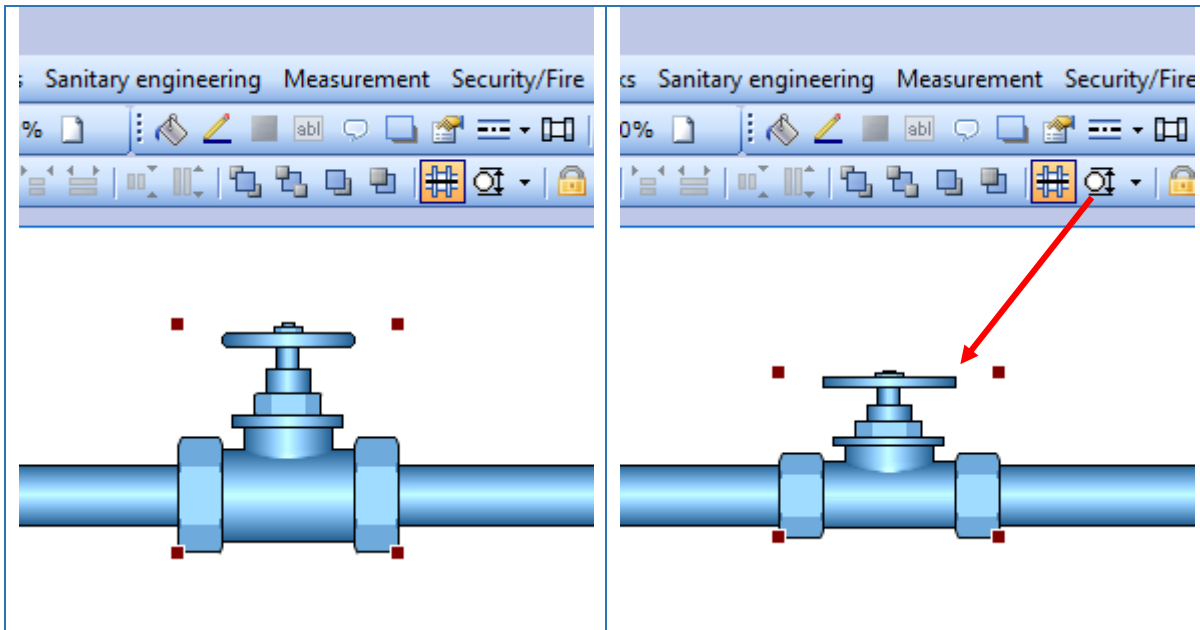

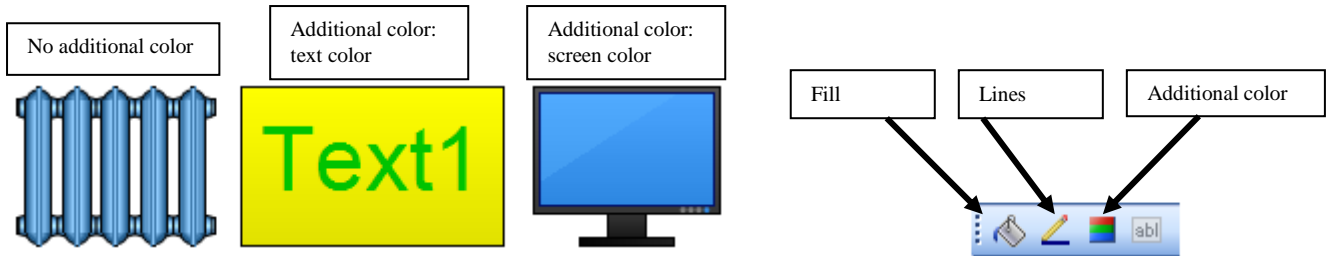

Colors

1. For most objects, you can set two or three primary colors: one for the fill, one for the border, and third (optional) color, depending on the object type. For example, you can only specify two colors for a heating radiator: fill color and border color. However, for example, you can set three colors for a rectangle with text: fill color, border color, and text color. You can also set three colors for the monitor: fill color, border color, and screen color.

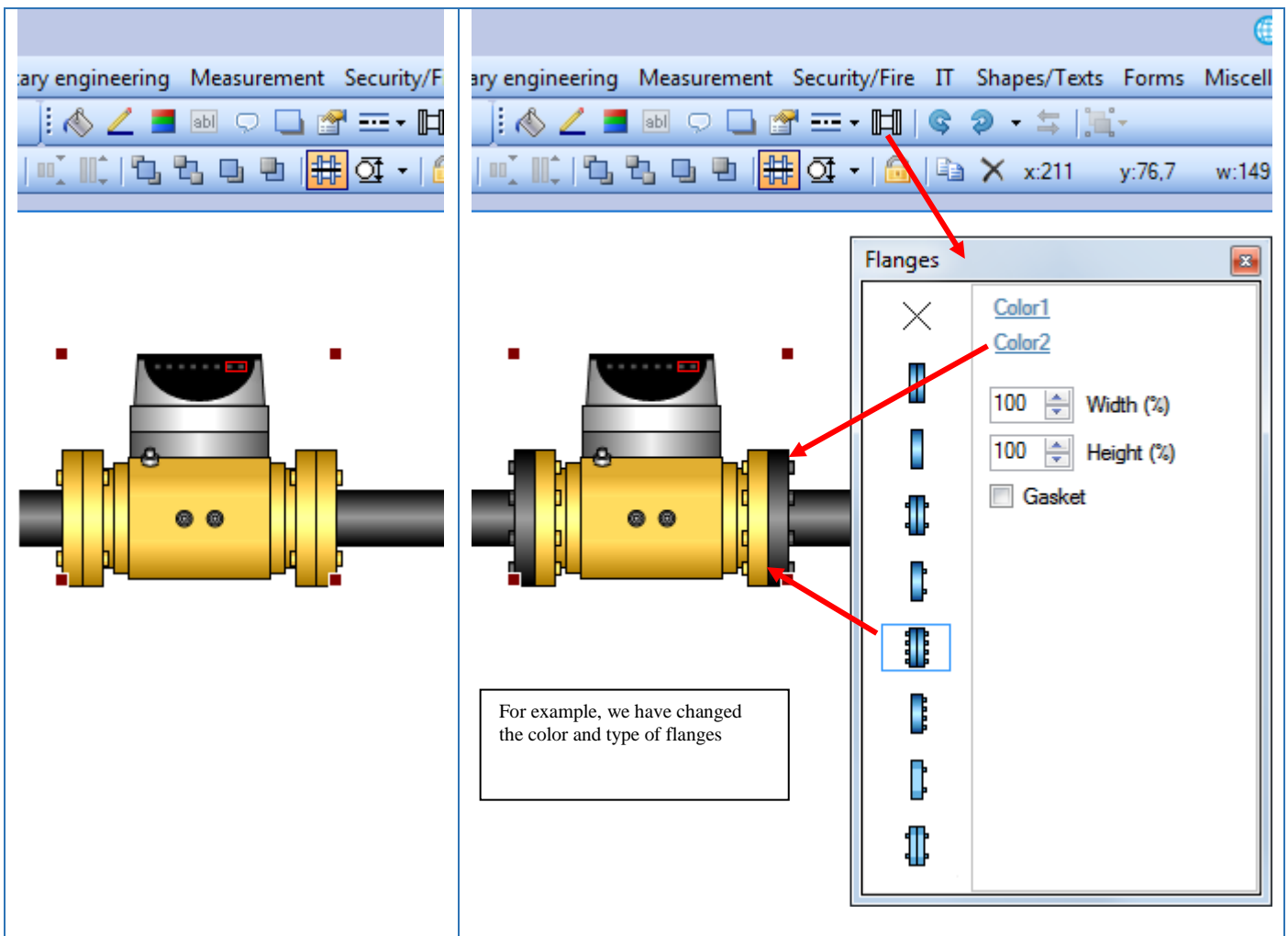

2. For objects that have flanges or screw-nuts, you can change the color of the flanges or screw-nuts. To change the color, type, width, height and gasket of flanges click the button . To change the color, type, width, height of flanges of screw-nuts click the button . Set your desired properties in the pop-up dialog box.





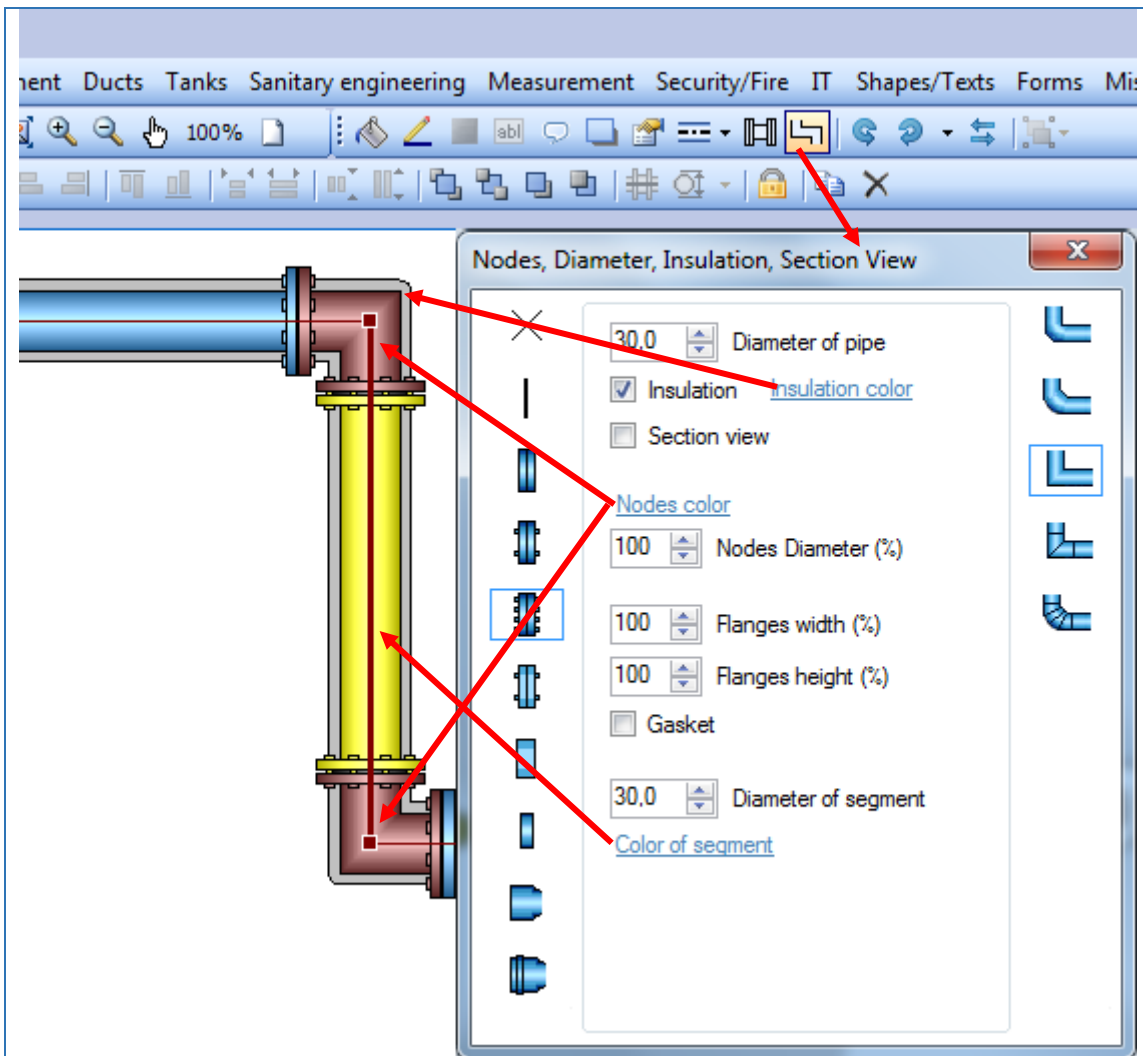



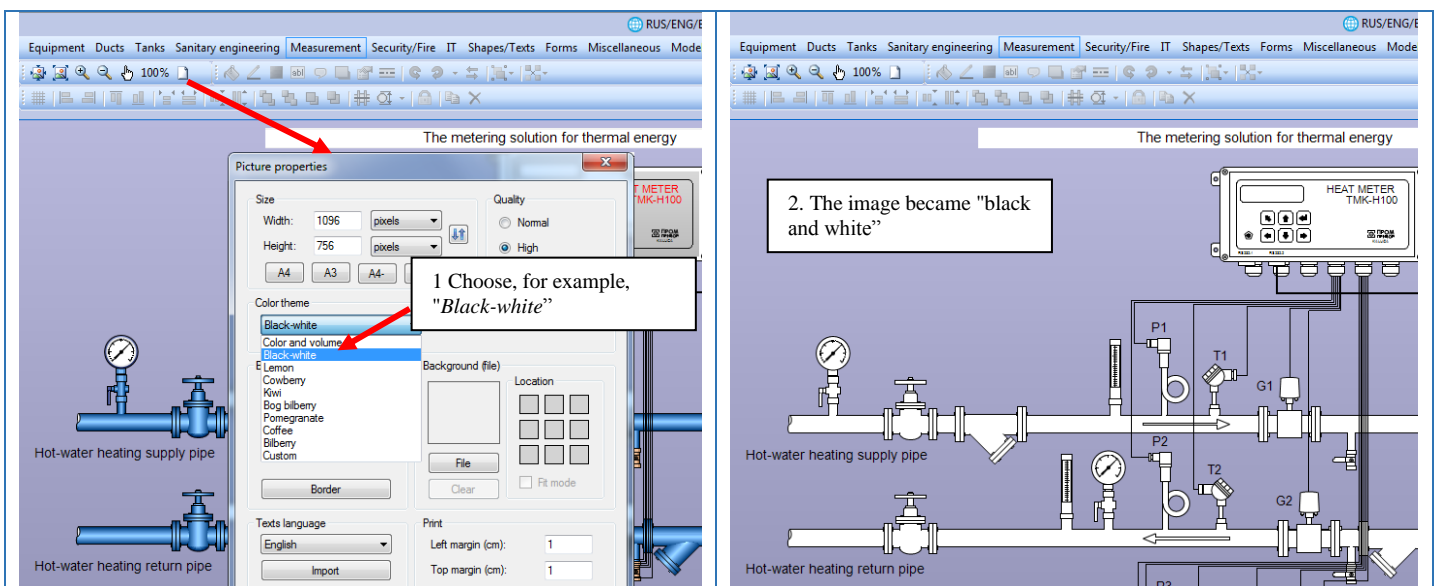

3. The color of individual pipe segments, the color of pipe nodes, the color of the insulation can be set in the *Nodes and diameter* dialog box. Click the button  (or click *Nodes, Diameter, Insulation, Section View* on context menu) to show the Node and diameter dialog box.

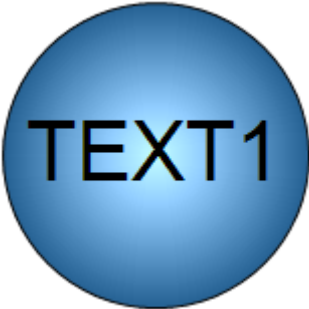
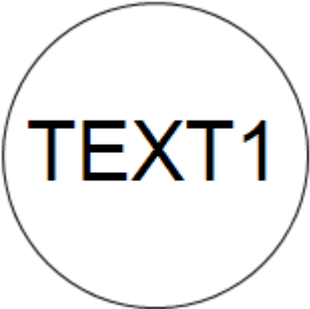







4. If you want to create a monochrome scheme, you do not need to change the colors of each object. Just select the color scheme in the *Picture properties* dialog box (click the button  to show the dialog box). In the same dialog box, you can set the background color.





The program contains 9 color themes that define the fill colors and lines of objects. In addition, the user can set his color theme. Themes, except “*Color and volume*”, are monochrome. Choice of the theme does not affect the background color.

 <p>Color and volume</p>	 <p>Black-white</p>	 <p>Lemon</p>
 <p>Cowberry</p>	 <p>Kiwi</p>	 <p>Bog bilberry</p>
 <p>Pomegranate</p>	 <p>Coffee</p>	 <p>Bilberry</p>

Text

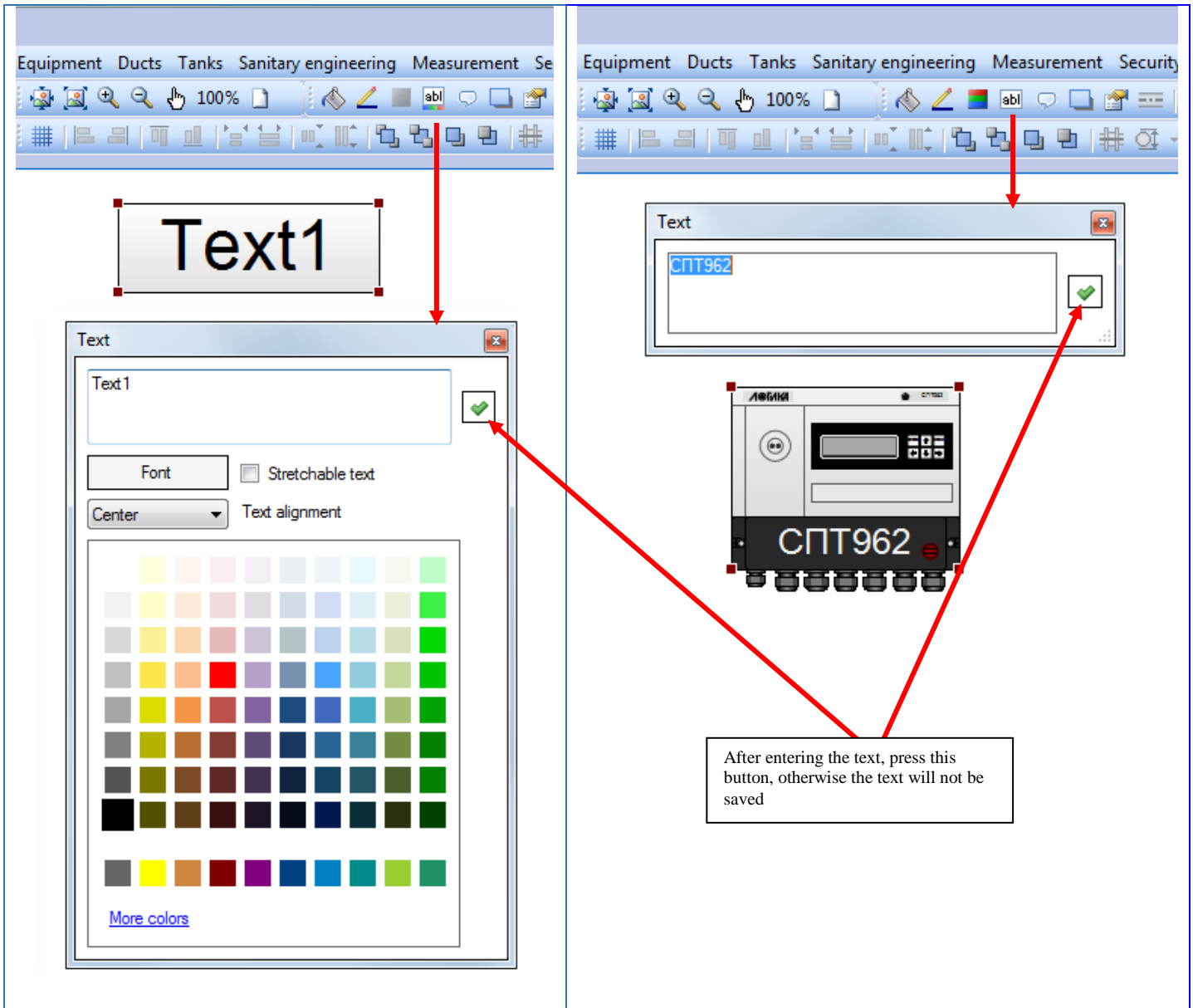
To enter the text for the selected object, click the button  or button  to display the corresponding dialog box. The buttons  and  cannot be on the screen at the same time. The button  is available for objects for which you can set text and attributes of text: font, size, alignment, color. The button  is available only for objects for which you can set only text.



After entering the text, be sure to click on the button , otherwise the text will not be saved. If the *Stretchable text* check box is selected, the font size does not matter, the text size will depend on the size of the object.

Each scheme in Easymnemo can contain 5 variants of text and comments. This feature is implemented in order to have the same scheme “in several languages”. Try to change the *Text and comments language* in some example Easymnemo, and there is an impression that the program itself has translated the scheme into another language.

The *Text and comments language* for the diagram can be set in the *Picture Properties* dialog box (click the button  to show the dialog box).

Note: The language settings for the scheme are conditional. For example, you can set *Text and comments language* to Spanish, but you can type text in English.

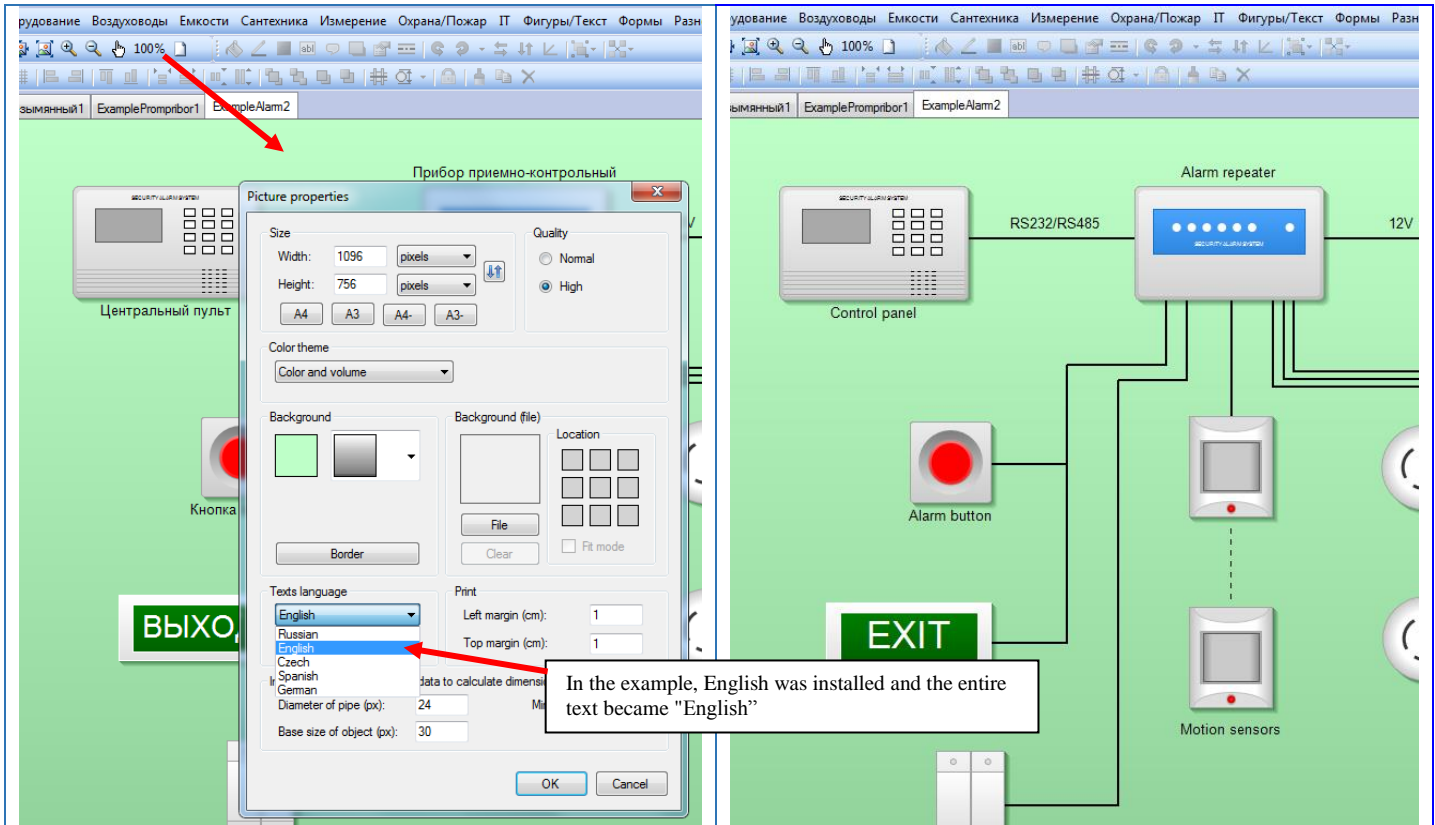

Note: For “*Meter reading device*” objects (*Figures/Text*) the text format is “*White Digits/Point/Red Digits*” and defines the appearance of the object. For example,

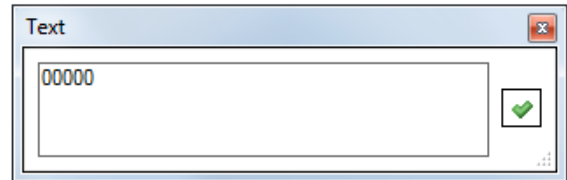
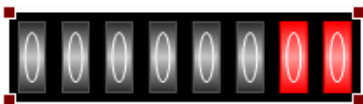
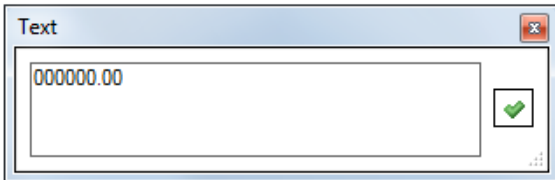

Comments

A comment is text that can be bound to any object and is displayed along one of the object's boundaries.

The text, font, color, position relative to the object, as well as the fill and border of the rectangle within which the comment is displayed can be set in the *Comment* dialog box. To open the dialog box, click the button  (or click *Comment* on context menu).

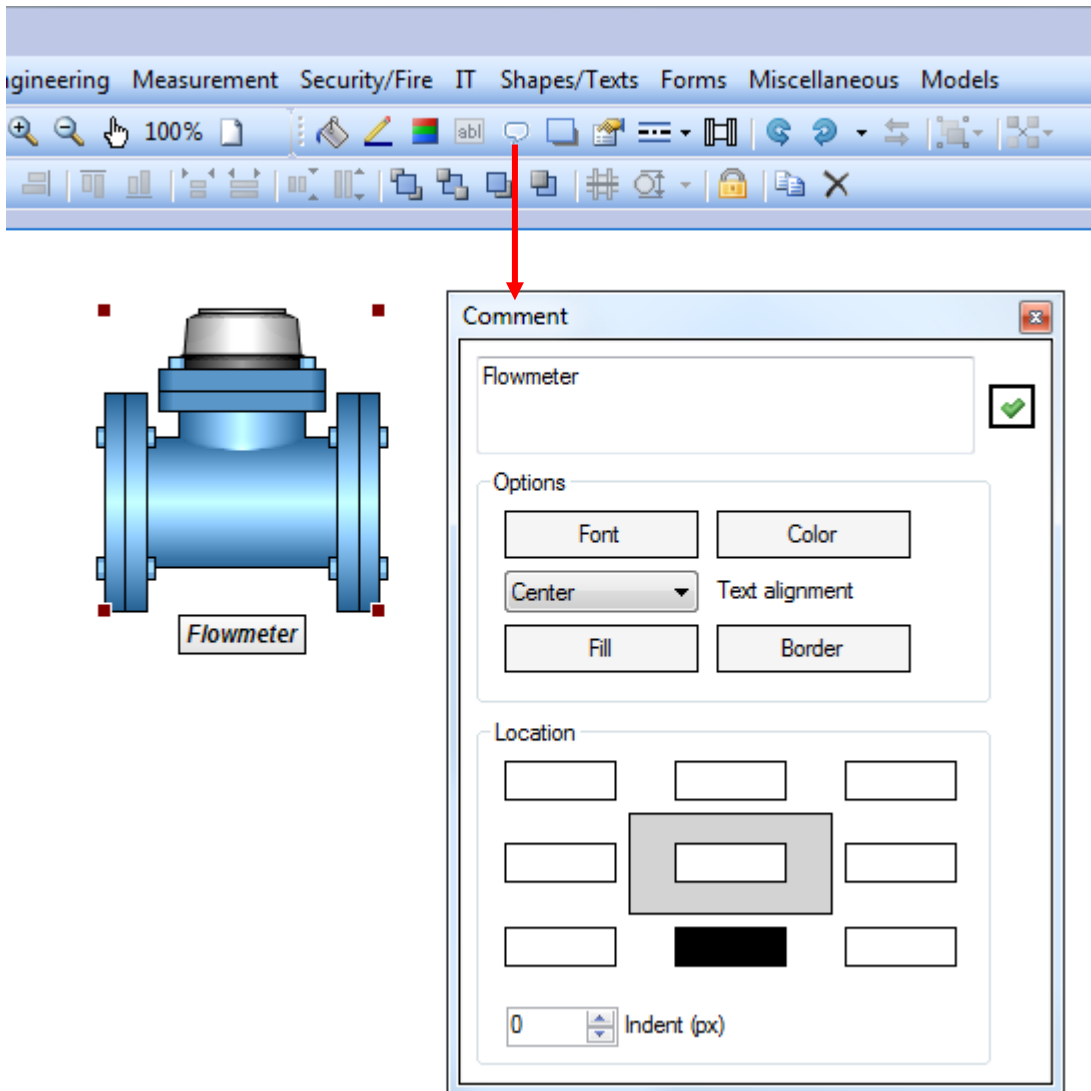

Note: When you change the size of the object, the font size does not change.

Specification

A specification is a summary table of the objects that you have drawn and that you would like to see in this table (or, most likely, a part of them) with automatic calculation of the number of identical objects. To do this, each object must be described in the *Specification* dialog box (to show dialog box click the button  or click *Specification* on context menu). For example,

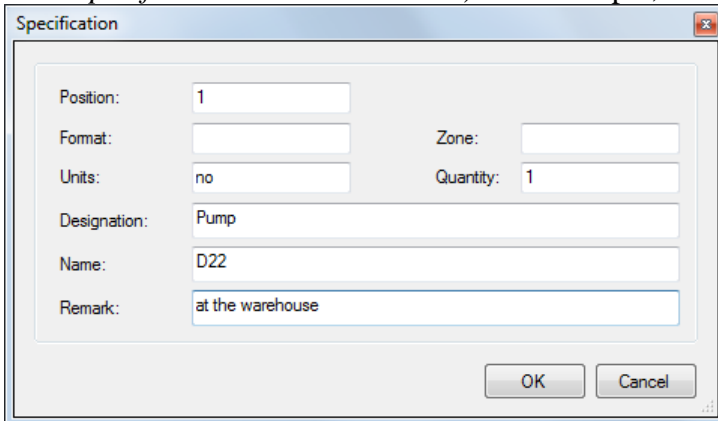



The *Specification* dialog box contains the following fields:

- Position: 1
- Format: (empty)
- Zone: (empty)
- Units: no
- Quantity: 1
- Designation: Pump
- Name: D22
- Remark: at the warehouse

Buttons: OK, Cancel

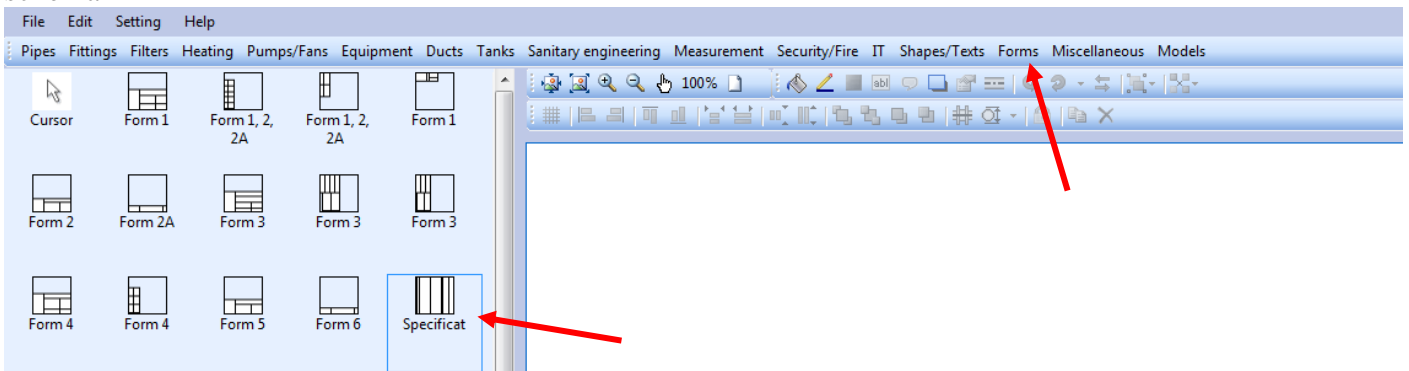
After you have set the specification of objects, add the *Specification* object (*Forms* section) to the schema



The fields of the summary table can be edit in the *Specification (Style)* dialog box (click the button  to show the dialog box)

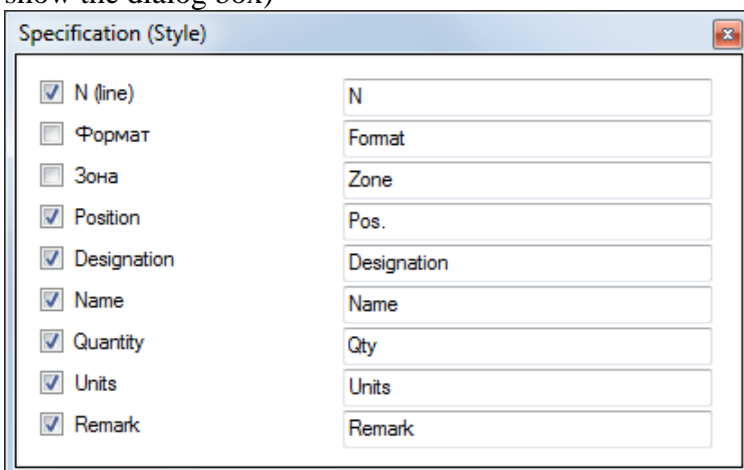

The *Specification (Style)* dialog box contains the following fields:

- N (line) N
- Формат Format
- Зона Zone
- Position Pos.
- Designation Designation
- Name Name
- Quantity Qty
- Units Units
- Remark Remark

You can save the specification to the file (for later usage, for example, in Excel) click *Export of specification to CSV* on context menu.

Note: Easymnemo contains a *Specification* example that will simplify the understanding of how to create specifications.

Models

Models are items that you can create yourself. When developing a model, you can use any elements from any section.

Note: To create models, the *Details* subsection have been added to the *Shapes/Text* section.

To create a model, follow these steps:

1. Add to the diagram the objects from which the model will be composed.
2. Set your desired properties (size, fill, border, text, etc) of objects.
3. Compose (place) objects to get the intended result.
4. Select objects and click the button -Assemble model (or click *Model* > *Assemble model* on context menu).

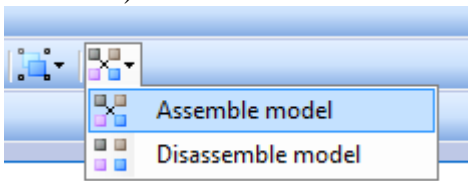

5. In the dialog box set the name of the model. After that, a new model will appear in the *Models* section.

Models are stored as separate files in the *Models* folder of the Easymnemo installation directory (by default *C:\Program Files (x86)\Easymnemo*). When you install Easymnemo on another computer, to transfer “your” models, just copy the *Models* folder. The file names are the same as the model names. Use menu *Help* > *Open folder with models* to open the *Models* folder

There are no restrictions to select objects. Generally speaking, you can make a model from the whole scheme. Click on context menu of the model button to rename, delete or preview model.

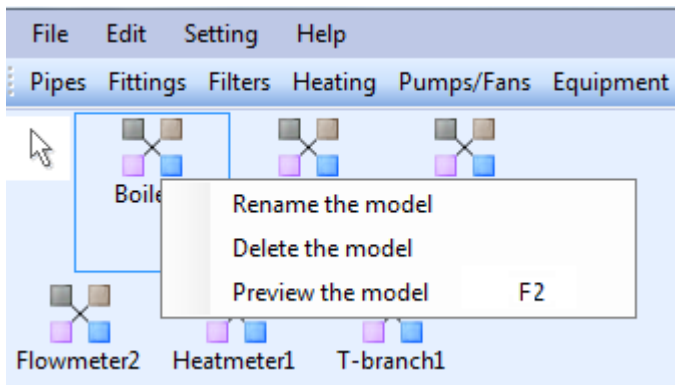

To edit the created model, you need to add the model to the diagram, disassemble it (-Disassemble the model), make changes and assemble again. Deleting or changing a model does not affect models already added to the schema. Starting from version 2.21.05.24, for models added to the diagram, the ability to edit the elements that make up the model is added without disassembling/assembling the model itself. Editing options include fill, color, line thickness, text, font, etc. (except for the size and position of the element).

Inserting an object from the *Model* panel is different from inserting objects from other panels. After activating the desired button on the *Model* panel, simply click the left mouse button on the diagram (you do not need to “pull” the mouse pointer). The object added to the diagram will have dimensions and position exactly the same as the model has when it is built. Therefore, the position of the cursor does not matter.

Note: Easymnemo contains examples that explain the process of creating the models:

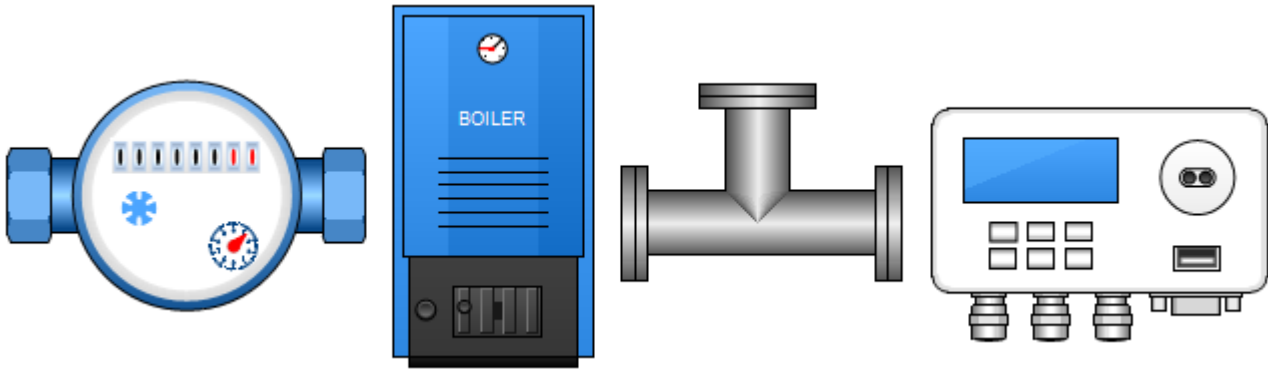

Isometric projection

Starting from version 2.19.08.22 Easymnemo can to draw objects in isometric projection. This possibility is provided for most of the objects of the technical standards (GOST, ABOK, etc.), buildings, doors, windows and the element *Interval*.

To create a geometric projection, select the object and click the button . Then set the *Projection angle* in the dialog box.

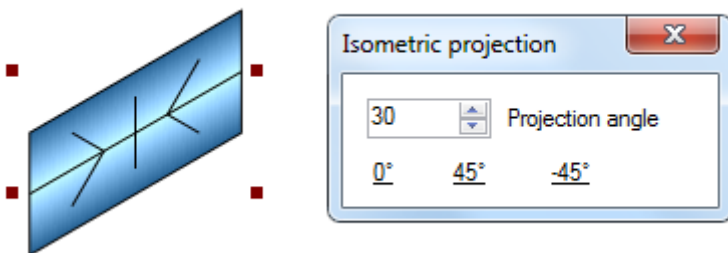

Note: It is possible that the binding to the pipes of such objects will not work or will not work correctly.

User panels

As the library of elements is constantly updated and it becomes more difficult to find the necessary element in the Easymnemo program there is an opportunity to the user to create the panels (to 5 panels) in which he can add any elements from other panels or from the ready diagram.

To add a new user panel, in the *Settings* menu click *Add User Panel*.



Then in the dialog box enter the name of the panel. For example, *Heat*:

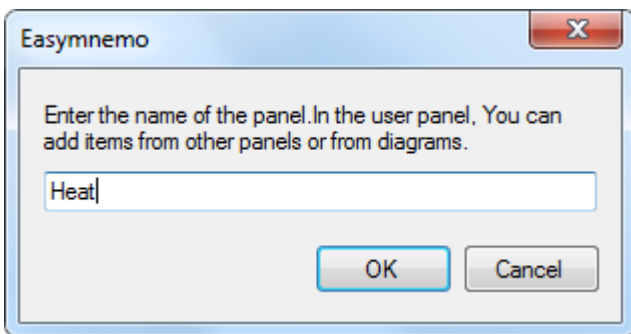

As a result, the panel name should appear to the right of the *Model* panel:

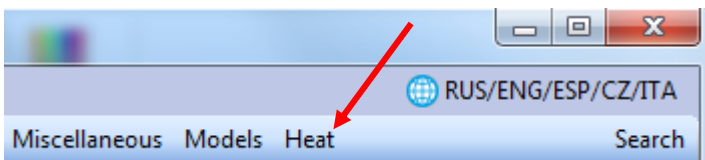

To change the name of the panel or delete the panel click the desired item on context menu:

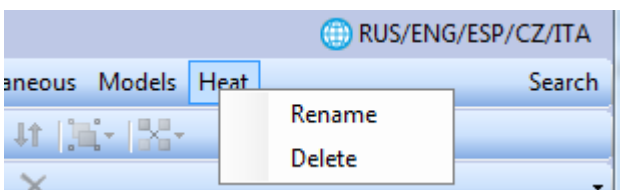

You can add an item to the user panel in one of two ways.

1. Select the desired element icon on one of the panels and then click "*Panel name*" on the context menu
Copy to the user panel:

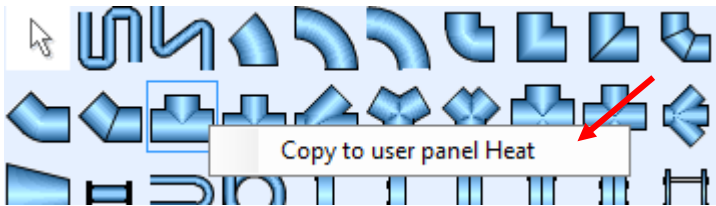

2. Select one or more objects in the diagram and click *Copy to User Panel* > "*Panel name*" on context menu:

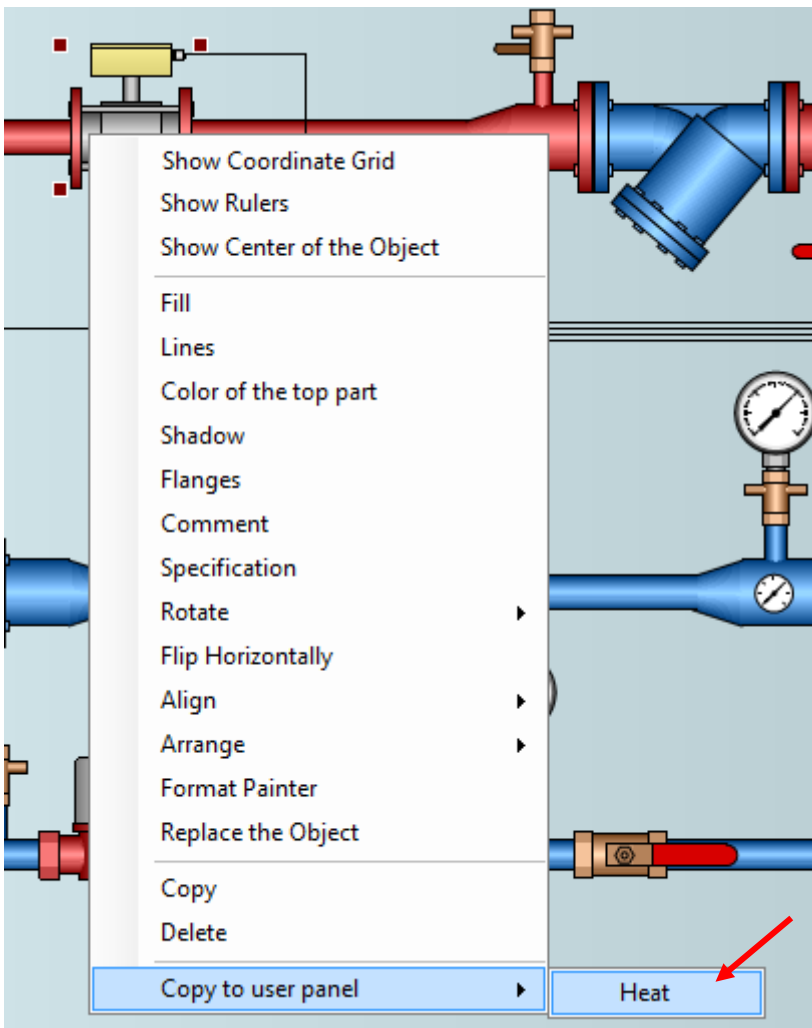

User panels are stored in the *User panels* folder of the Easymnemo installation directory (by default *C:\Program Files (x86)\Easymnemo*). When you install Easymnemo on another computer, to transfer “your” user panels, just copy the *User panels* folder.

Export to bitmap files (BMP, GIF, JPEG, PNG, TIFF)

In the *File* menu, click *Export*.

Inserting bitmap files (BMP, GIF, JPEG, PNG, TIFF)

To insert an image from a file, use the icon  (*Shapes/Text* section).

Examples

Easymnemo contains more than 100 examples. In the *File* menu, click *Examples* to open the *Examples* window.

Recommendations

1. By default, the line color is black and the thickness is 1 px. However, sometimes the image looks more attractive if the color of the lines for the object borders is set to the color of the object fill, and the thickness of the lines is set to less than 1 px (the latter is relevant for printing).

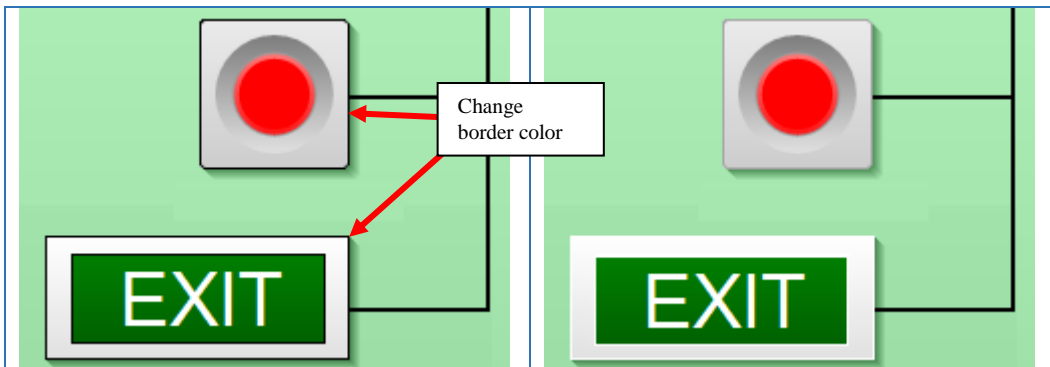

The color and thickness of the lines are set in the *Lines* dialog box. Click the button  (or click *Lines* on context menu) to open the *Lines* dialog box.

2. When resizing, hold down the *Shift* key to keep the proportions of the object.

3. To nudge a object exactly one pixel, hold down *Shift* key and press an arrow key. To resize a object exactly one pixel, hold down *Shift* and press + (to increase width) or – (to reduce width) or *PageUp* (to increase height) or *PageDown* (to reduce height).

4. To quickly copy the properties of one object to another, use the button -  *Format Painter*. Allows you to copy from one object to another the properties of the fill, borders, shadows, text and comment. For pipes also the diameter, properties of nodes and insulation.

5. Use the *Search* dialog box to search for an item (the *Search* menu at the top right of the program window). In the search bar, you can enter words from the descriptions of the item icons or enter a technical standard. For example,

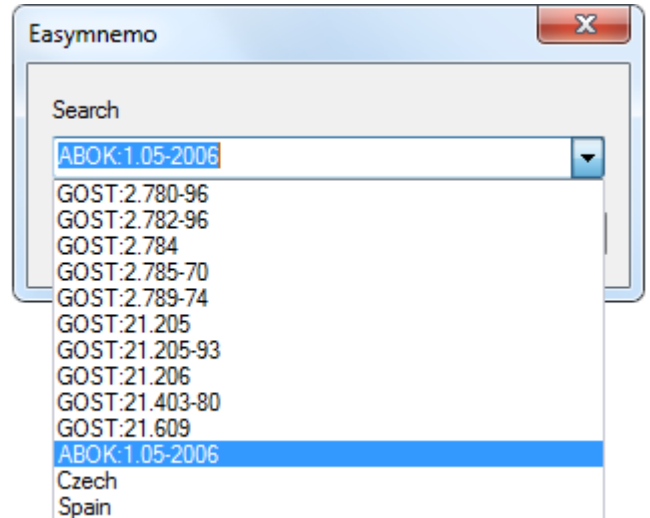
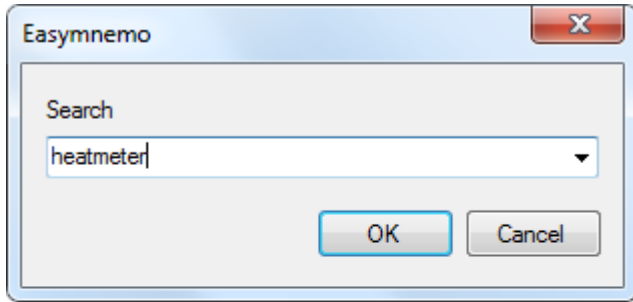

6. Double-click a polyline, pipe, or duct to align "not enough horizontal and vertical" segments. "Insufficient" means a deviation of less than 5 degrees from the horizontal or vertical. The picture below shows the result of this "trick".

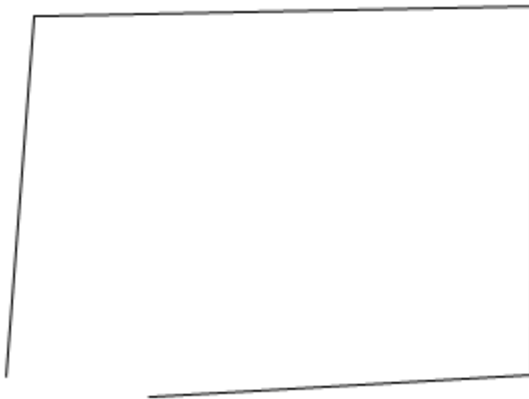

7. Two pipes or lines can be combined into one. To do this, select the desired pipes/lines and select *Merge Lines/Pipes* on context menu.

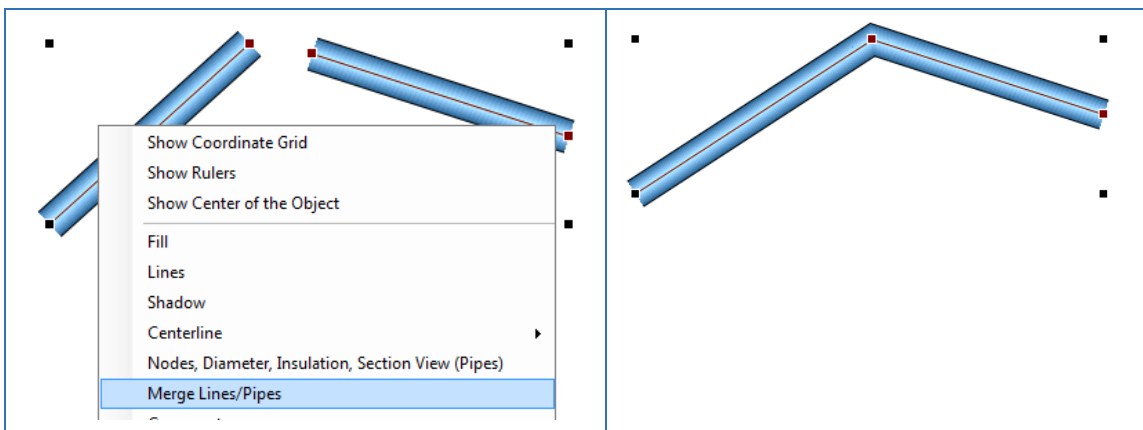

8. To place a text object along one of the page borders, use one of the context menu items:

Aligning>Text on the Top of the Page

Aligning>Text on the Left of the Page

Aligning>Text on the Bottom of the Page

Aligning>Text on the Right of the Page

For example,

