

PDS_848

CHAIN PLUG

**EN** CHAIN PLUG

- UNREMOVABLE AFTER ASSEMBLY

NL kettingplug

- onverwijderbaar na montage

FR bouchon de chaînes

- inviolable après montage

DE Kette Stecker

- nach der Montage unlösbar









ES tapón de cadena

- indesmontables después de montaje

PL wtyczka łańcucha

- części są nierozłączalne po montażu

PACKAGING

					
848.020.006.001	0,05 kg	10 x 100	38 x 34 x 21 cm	54 kg	
					
848.020.006.001	15		120 x 80 x 120 cm	810 kg	



MANUAL : -
 SALESSTATUS : STD
 PRODUCT DIMENSIONS : 20 x 20 x 30.5 mm

MATERIAL :





KBT nv
Hemelrijken 8
2890 Sint-Amands
Belgium

KBT Polska sp. z o.o.
ul. M. Konopnickiej 6
00-491 Warszawa
Poland

CHAIN PLUG

DRAWINGS:

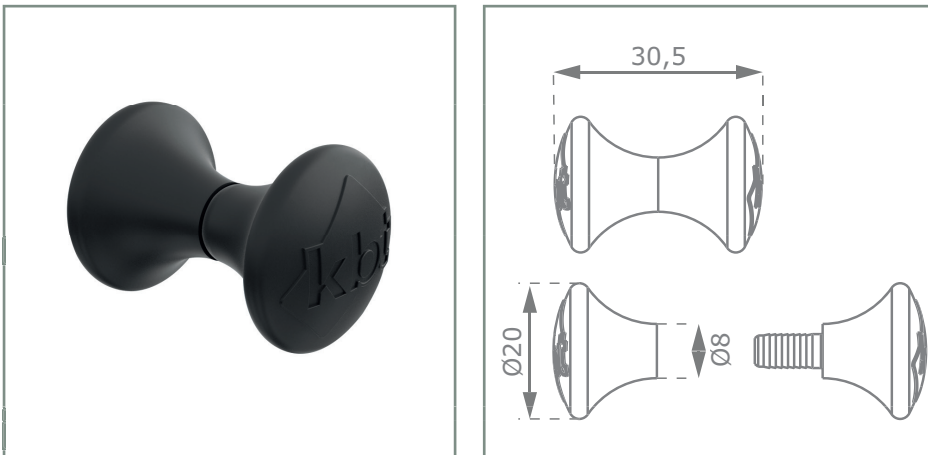

VARIATIONS :

■ 848.020.006.001 chain plug - two parts - black