

PDS_241.005

ZIP WIRE - CABLE HOLDER

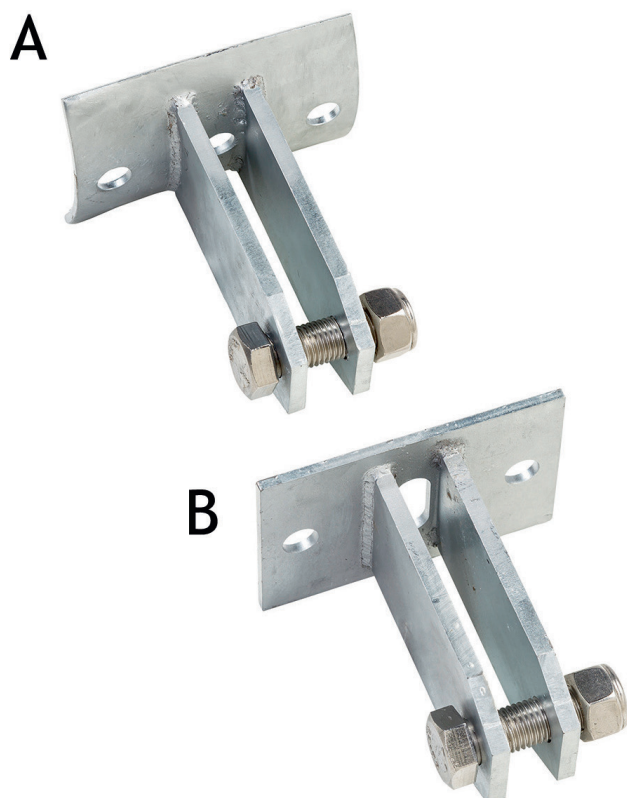

MANUAL :
SALESSTATUS :
PRODUCT DIMENSIONS :

MATERIAL :

EN CABLE HOLDING DEVICE

- galvanised
- A - round wood (161 x 140 x 70 mm)
- B - square wood (145 x 140 x 70 mm)

NL kabelhouder

- gegalvaniseerd
- A - rond hout (161 x 140 x 70 mm)
- B - vierkant hout (145 x 140 x 70 mm)

FR porte-câble

- galvanisé
- A - bois rond (161 x 140 x 70 mm)
- B - bois carré (145 x 140 x 70 mm)

DE Seilhalterung

- verzinkt
- A - Rundholz (161 x 140 x 70 mm)
- B - Kantholz (145 x 140 x 70 mm)











ES guardacabo

- galvanizado
- A - madera redonda (161 x 140 x 70 mm)
- B - madera cuadrada (145 x 140 x 70 mm)

PL urządzenie podtrzymujące kable

- galwanizowane
- A - drewno okrągłe (161 x 140 x 70 mm)
- B - drewno kwadratowe (145 x 140 x 70 mm)

PACKAGING



					
241005.	1,8 kg	8	43 x 33 x 23 cm		18 kg
					
241005.		30	120 x 80 x 135 cm		490 kg

ZIP WIRE - CABLE HOLDER

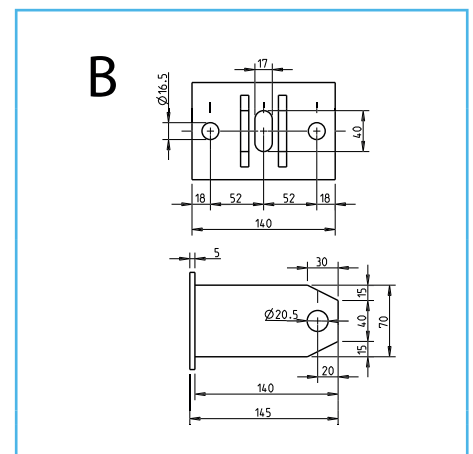
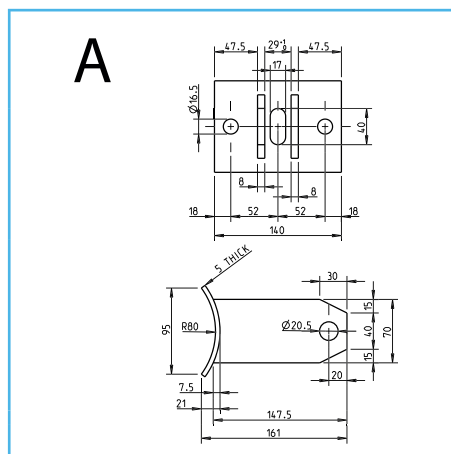
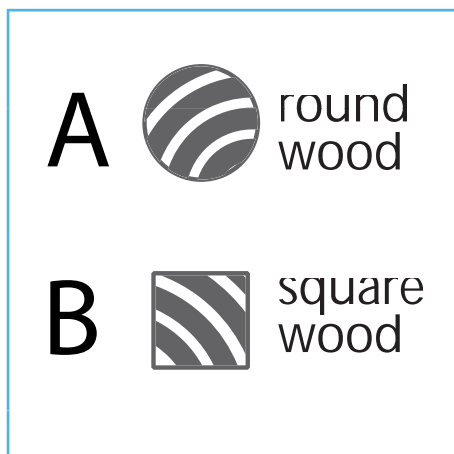
DRAWINGS:



VARIATIONS :

-  241.005.010.001 cable holding device - A - round wood 161 x 140 x 70 mm
-  241.005.020.001 cable holding device - B - square wood 145 x 140 x 70 mm