

PDS_261.020.010

HINGE FOR SEESAW



MANUAL : M26X
SALESSTATUS : STD
PRODUCT DIMENSIONS :

MATERIAL :

EN HINGE FOR SEESAW

• galvanised

NL scharnier voor wipplank

• gegalvaniseerd

FR charnière pour balançoire à bascule

• galvanisé

DE Scharnier für Wippe

• verzinkt











ES bisagra para balancín

• galvanizado

PL zawiasy do wałki

• galwanizowane

PACKAGING

| | | | | |
|--------------|---|---|---|---|
| |  pcs |  ? pcs |  ? |   |
| 261.020.010. | 7,7 kg | 1 | 51 x 26 x 8 cm | 8 kg |
| |  = ? pcs |  |  ? |   |
| 261.020.010. | 1 x 96 = 96 | | 120 x 80 x 143 cm | 760 kg |



KBT nv
Hemelrijken 8
2890 Sint-Amands
Belgium

KBT Polska sp. z o.o.
ul. M. Konopnickiej 6
00-491 Warszawa
Poland

HINGE FOR SEESAW

DRAWINGS:

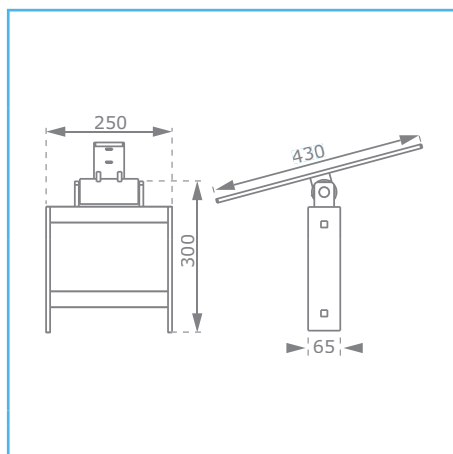

VARIATIONS :

-  261.020.010.009 hinge for seesaw
-  261.020.020.009 hinge for seesaw on rack