

anex

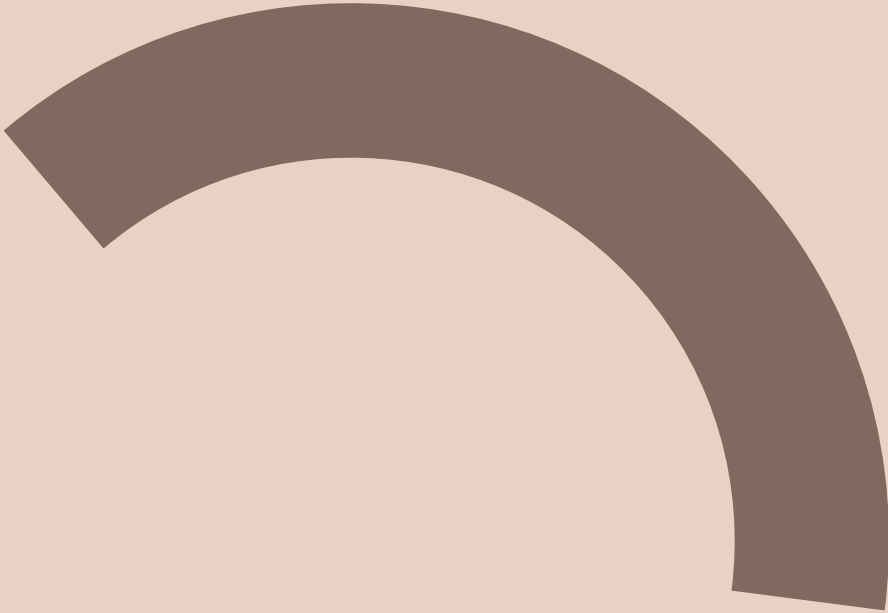

MAINTENANCE  
MANUAL

eli

1	Folding of the frame	5
2	Unfolding of the frame	6
3	Handle regulation	7
4	Attaching the shopping basket	8
5	Assembly and disassembly of the front wheel	9
6	Locking the front swivel wheels	10
7	Assembly and disassembly of the rear wheel	11
8	Brakes	12
9	Shock absorption	12
10	Attachment of the carrycot to the frame	13
11	Adjustment of the carrycot's hood	14
12	Ventilation of the carrycot's hood	15
13	Ventilation of the carrycot's bottom	16
14	Carrycot's foot cover	16
15	Cleaning the inside of the carrycot	16
16	Disassembly of the carrycot's hood	17
17	Attachment of the seat soft goods	18
18	Attachment of the seat unit	20
19	Folding the seat unit with the frame	21
20	Adjustment of the seat unit's hood	22
21	Ventilation of the seat unit's hood	23
22	Adjustment of the seat unit's backrest	24
23	Adjustment of the seat unit's footrest	25
24	Attachment of the seat unit's bumper	26
25	Safety belts buckle	27
26	Adjustment of the safety belts	28
27	Adapters for carrycot & seat unit	29
28	Carry handle	30
29	Backpack	30
30	Mosquito net	31
31	Rain cover	31

# FOLDING OF THE FRAME

1

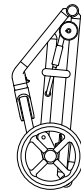
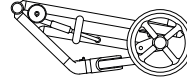
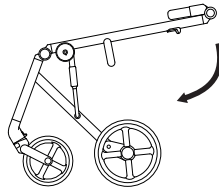
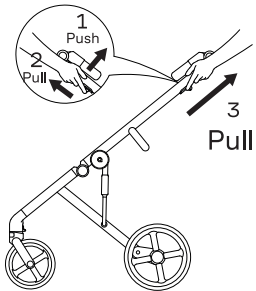
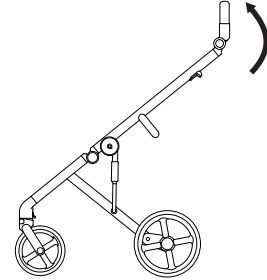
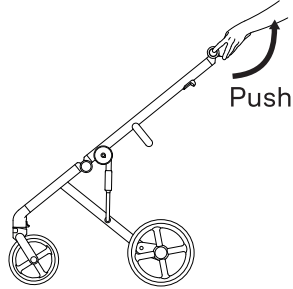
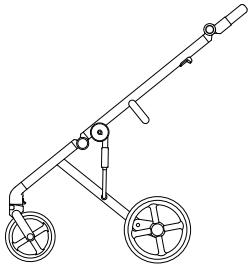

## UNFOLDING OF THE FRAME

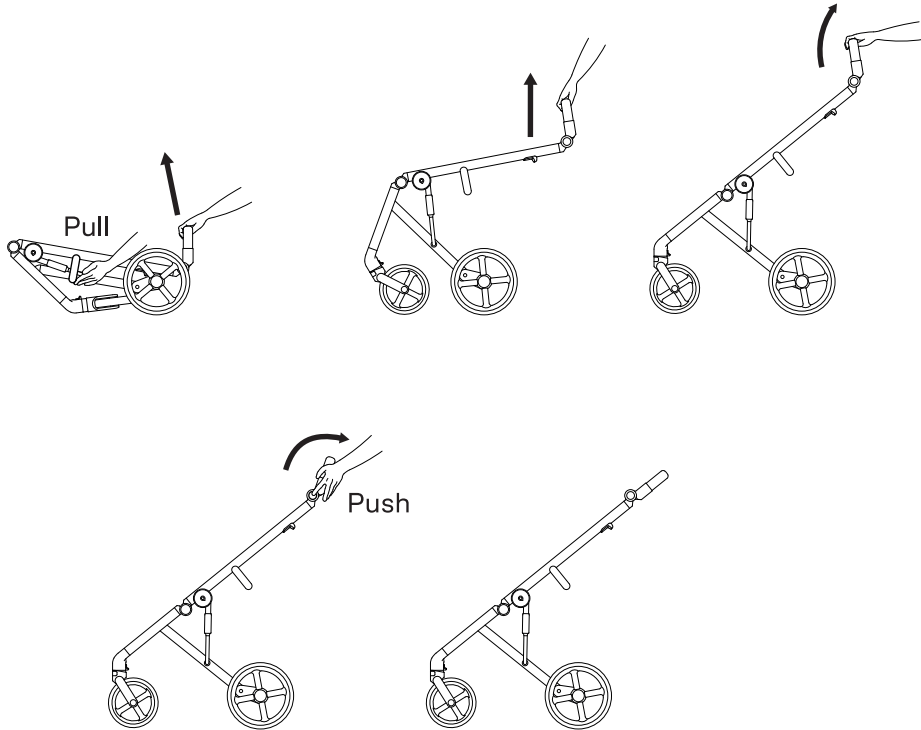

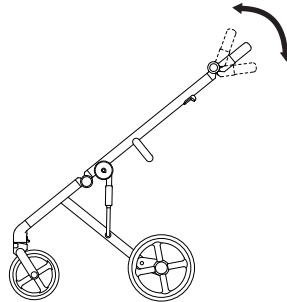
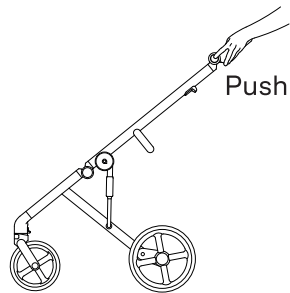

## ATTACHING THE SHOPPING BASKET

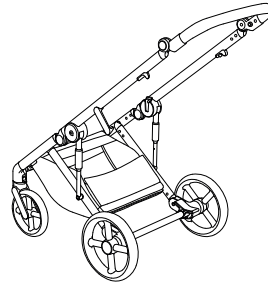
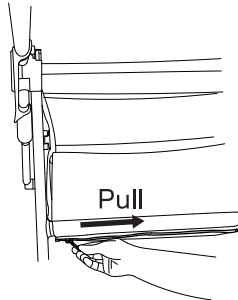
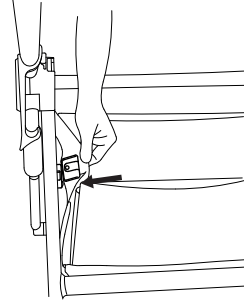
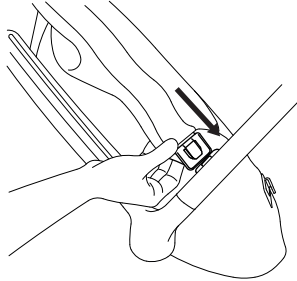

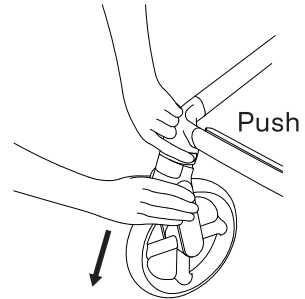
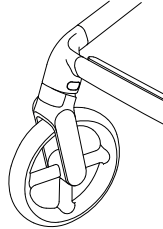
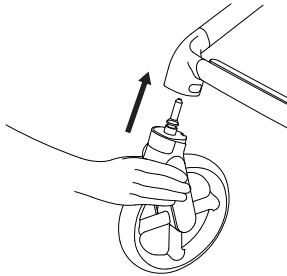

## LOCKING THE FRONT SWIVEL WHEELS

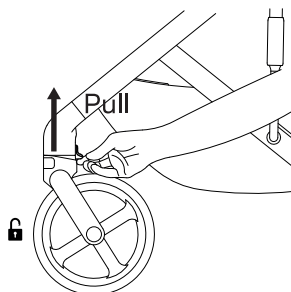
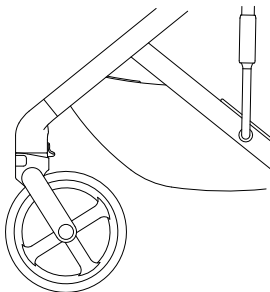
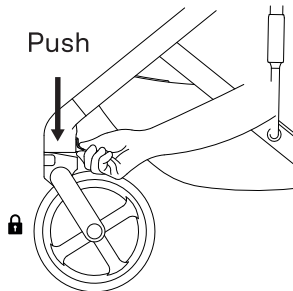
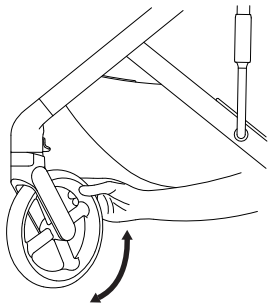



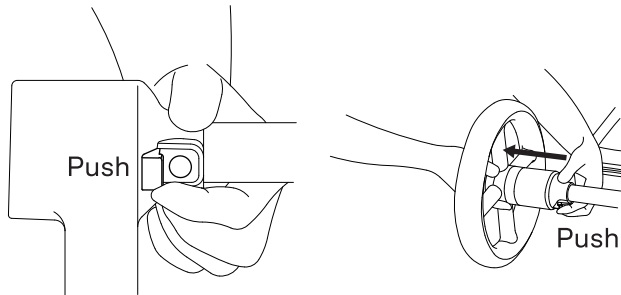
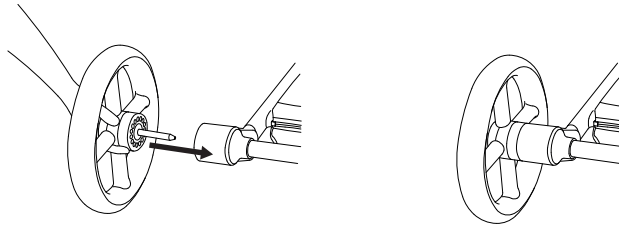

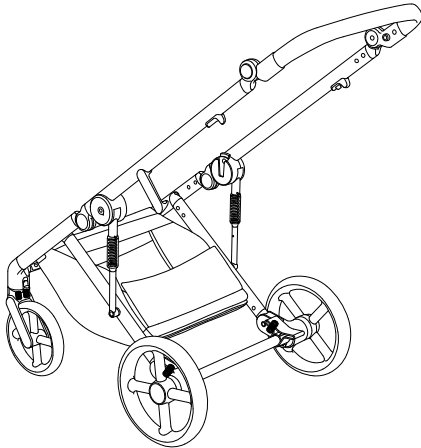
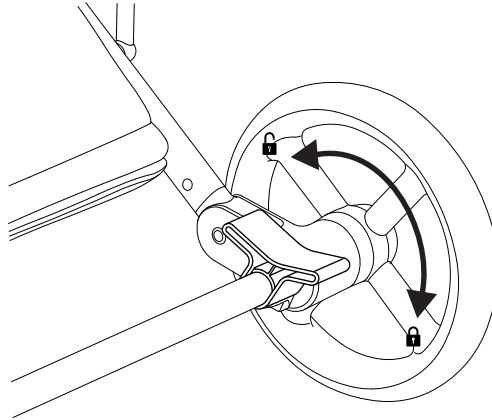

## ATTACHMENT OF THE CARRYCOT TO THE FRAME

10

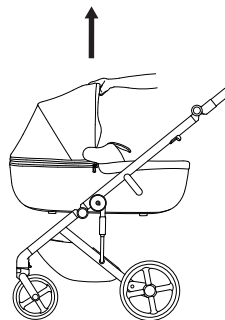
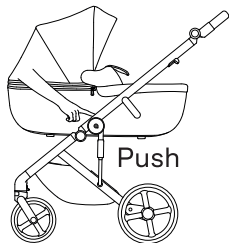
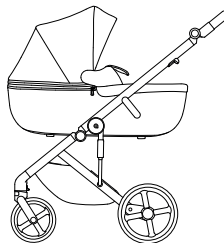
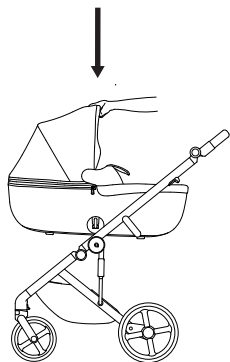

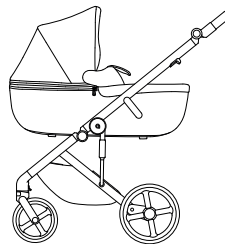
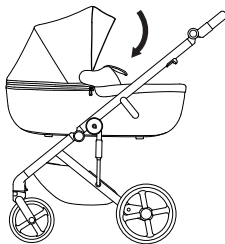
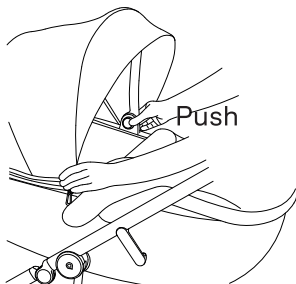
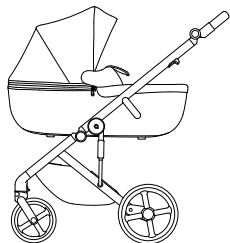

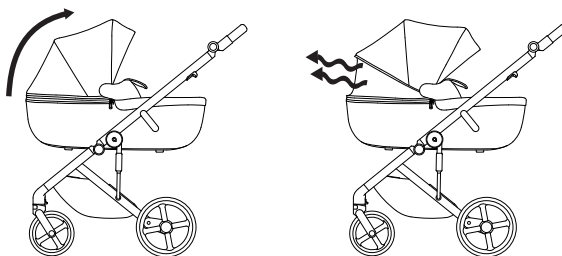
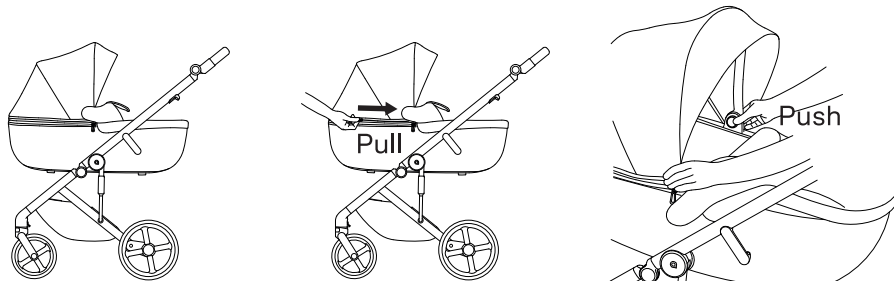

13

## VENTILATION OF THE CARRYCOT'S BOTTOM

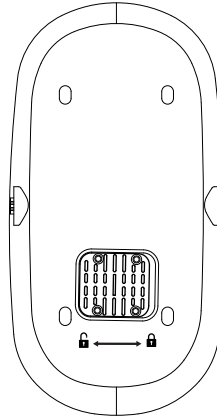

14

## CARRYCOT'S FOOT COVER

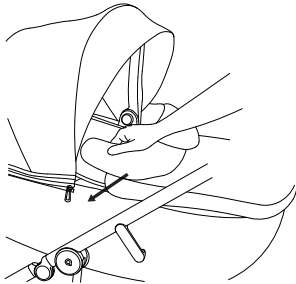

## CLEANING THE INSIDE OF THE CARRYCOT

15

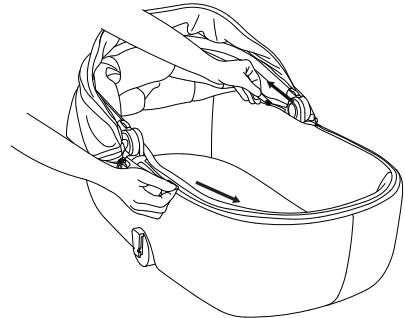

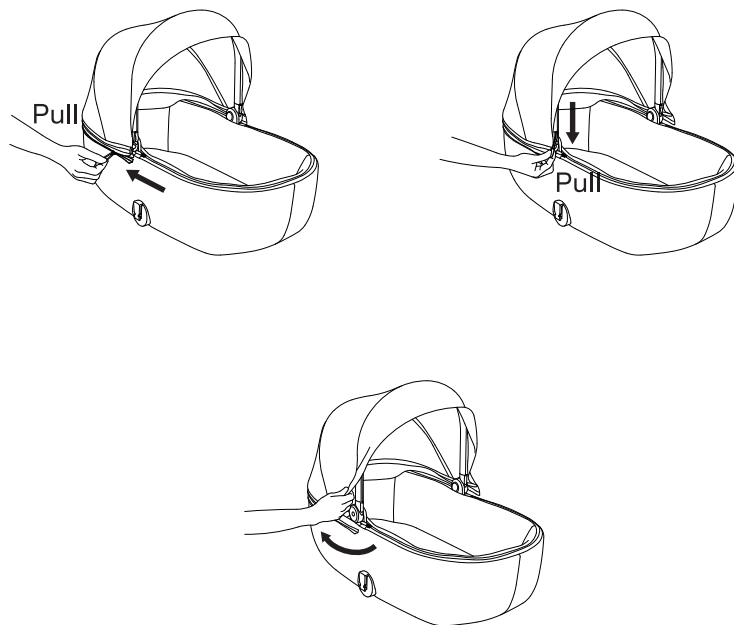

## ATTACHMENT OF THE SEAT SOFT GOODS

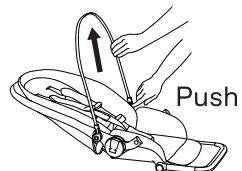
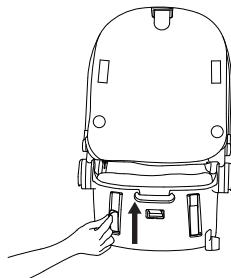
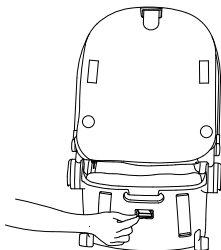
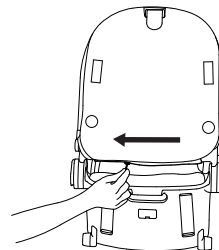
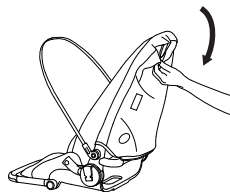
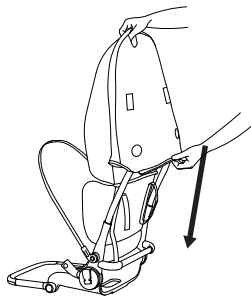



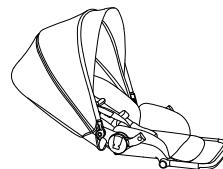
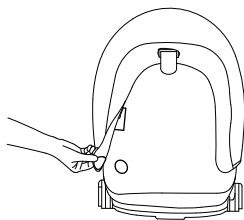
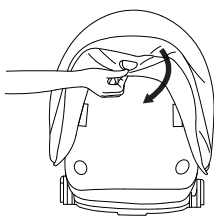
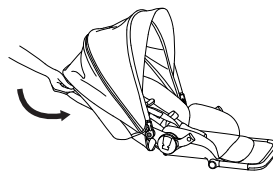
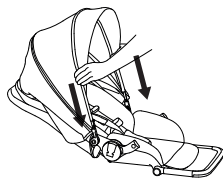
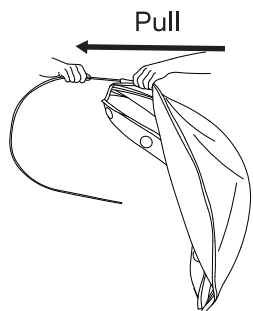

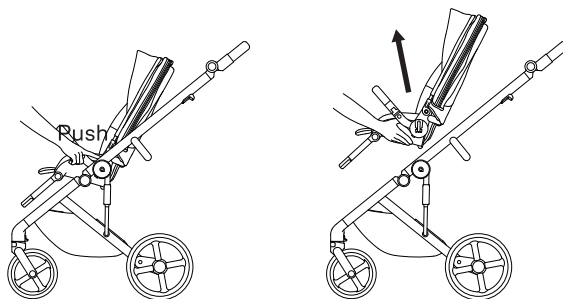

# FOLDING THE SEAT UNIT WITH THE FRAME

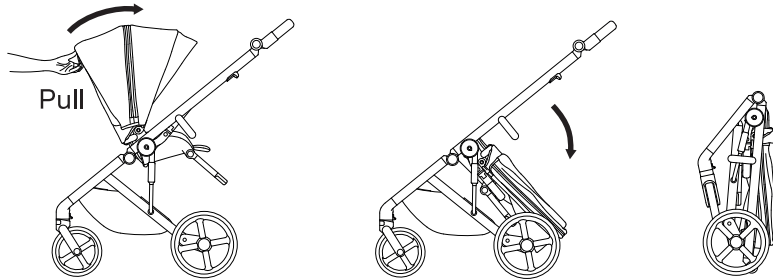
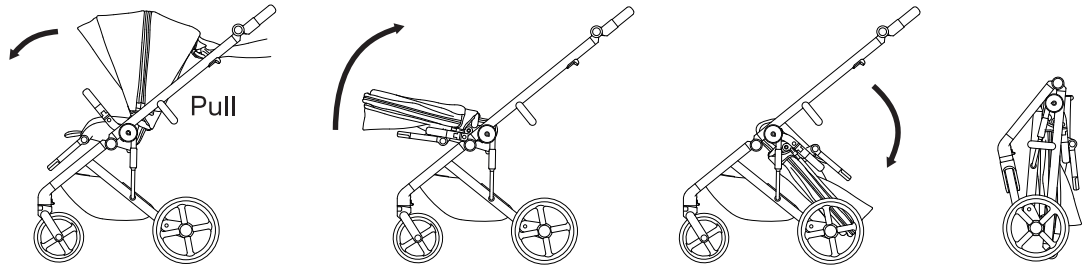

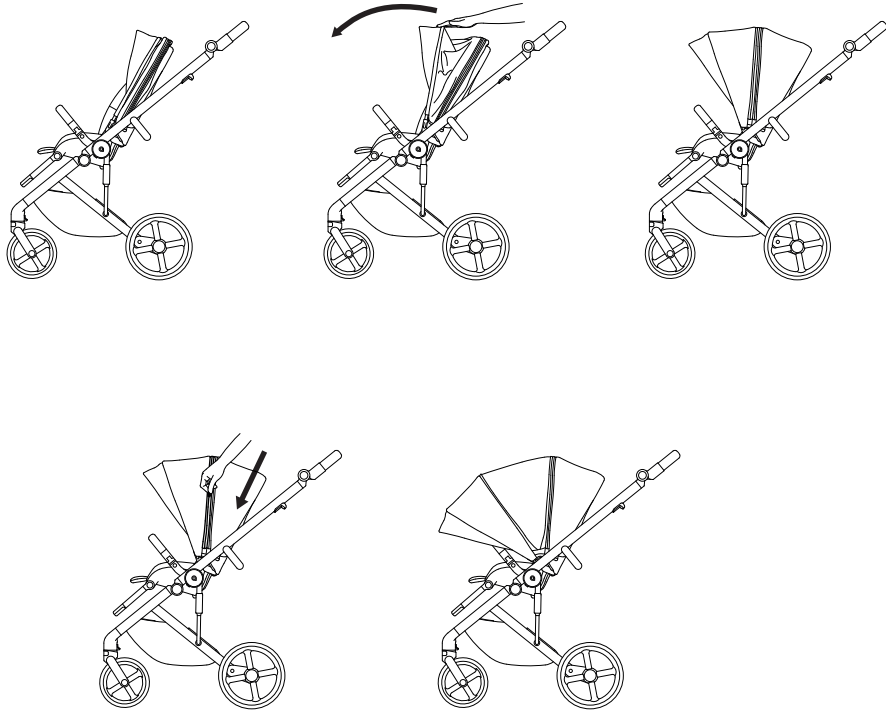

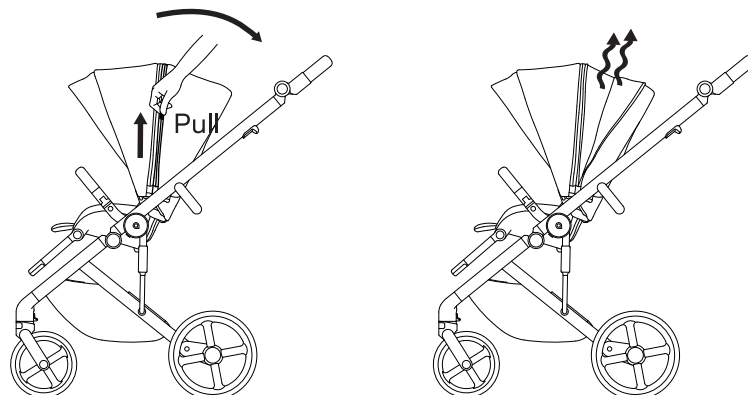

## ADJUSTMENT OF THE SEAT UNIT'S BACKREST

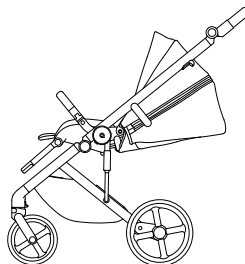
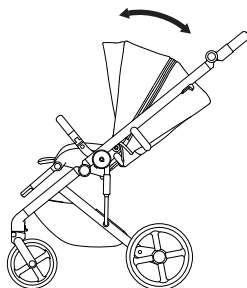
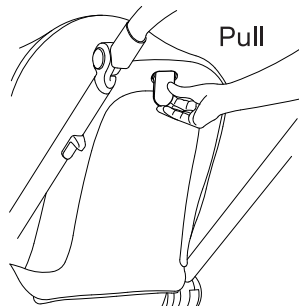
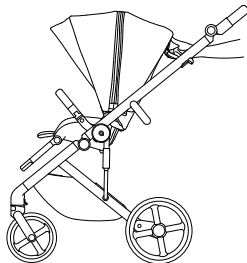

## ADJUSTMENT OF THE SEAT UNIT'S FOOTREST

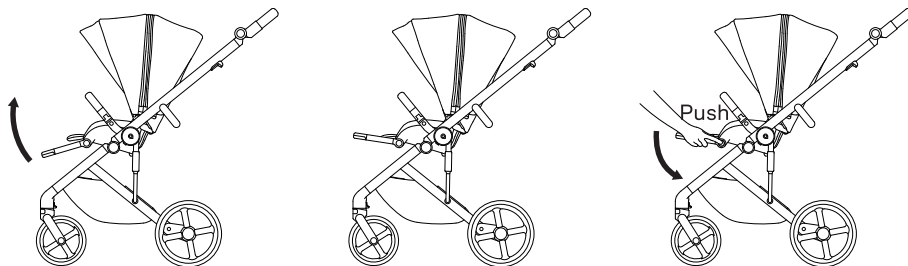
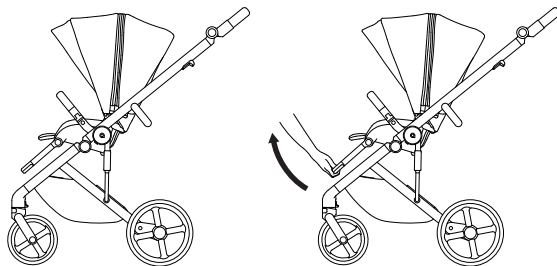

## ATTACHMENT OF THE SEAT UNIT'S BUMPER

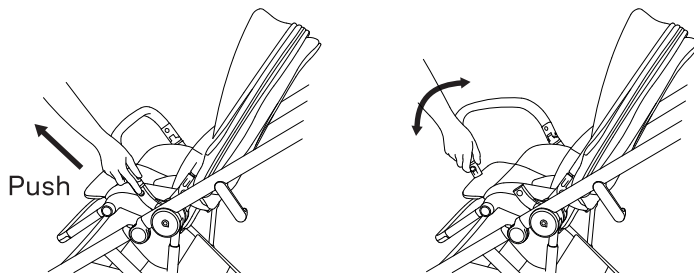
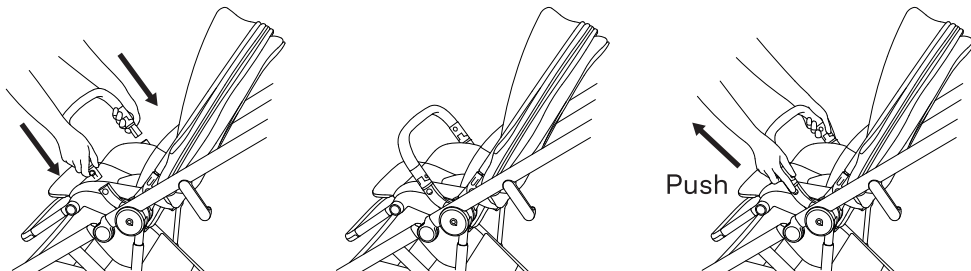



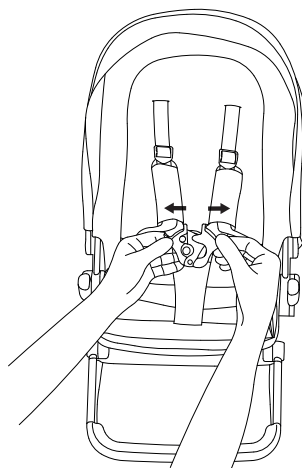
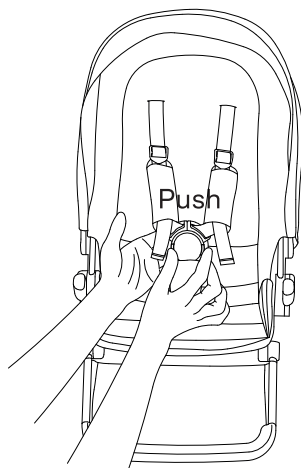

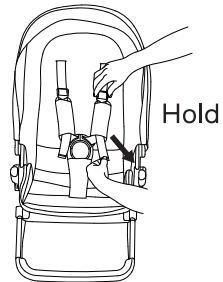
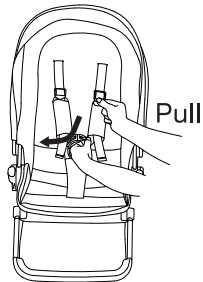
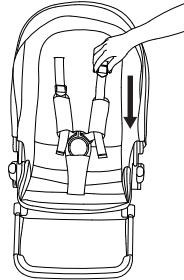
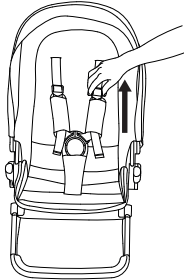

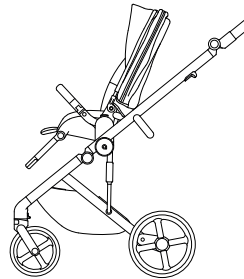
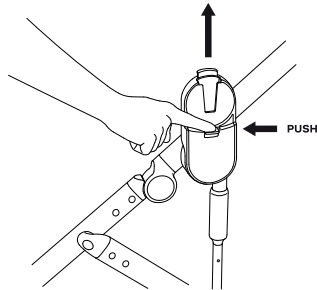
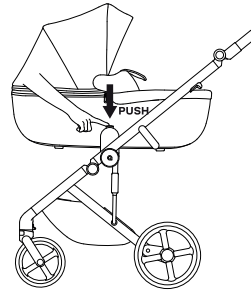
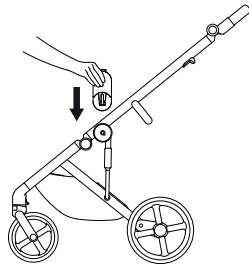

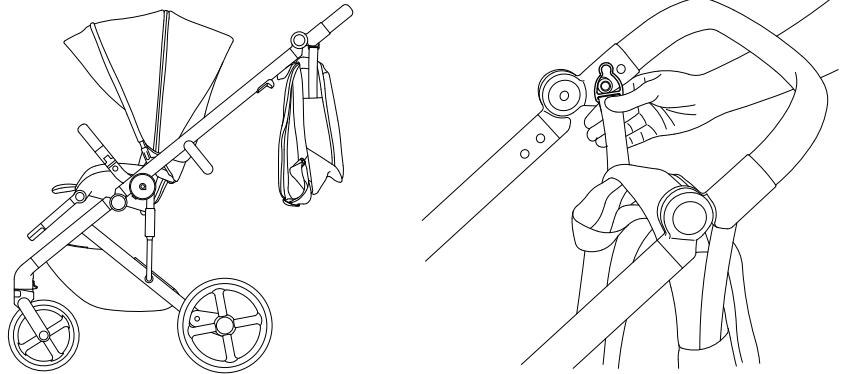
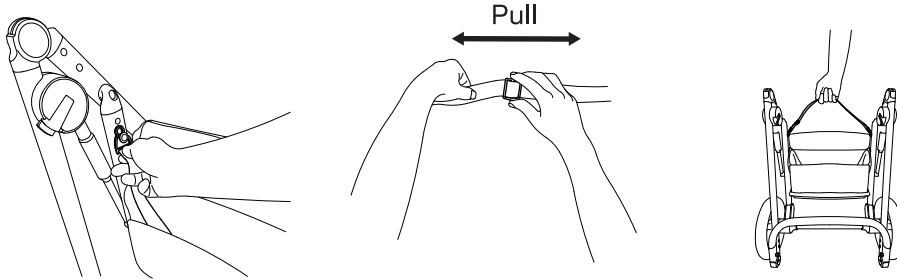

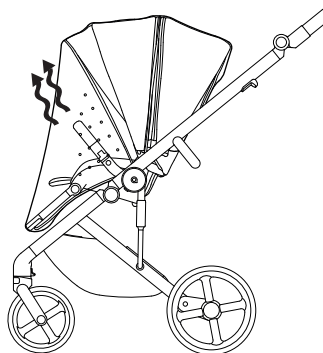
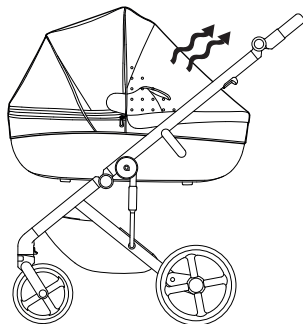
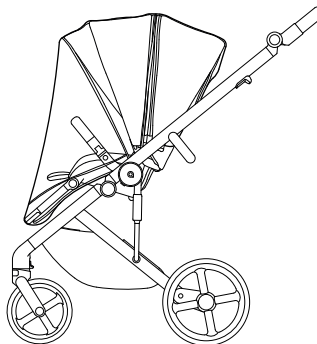
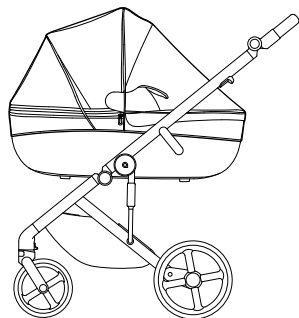

Check for the most recent manuals  
on our website: **[anexbaby.com](http://anexbaby.com)**

The information is subject to change without notice.  
Anex shall not be liable for technical errors or omissions  
contained in this manual. The purchased product may  
differ from the product as described in this manual.

**AVALEX PTE. LTD.,**

8 Eu Tong Sen Street #17-88, Central  
Office tower 2, Singapore, 059818  
+65 6221 5096  
[office@anexbaby.com](mailto:office@anexbaby.com)

