

Инструкция по установке

LADA Largus

(2012-)



Арт.: F.6017.005

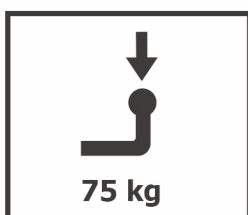
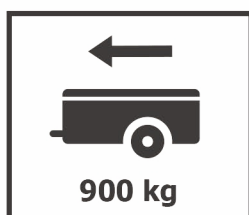

$D = 7,42 \text{ kN}$

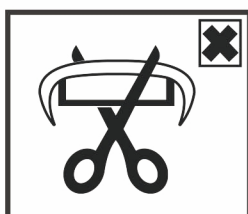

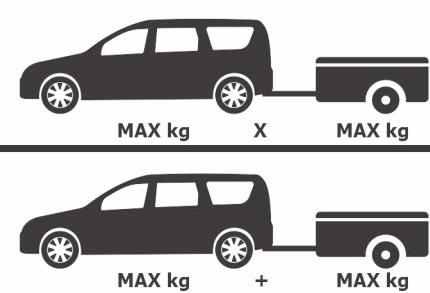
$$D \text{ (kN)} = \frac{\text{MAX kg} \times \text{MAX kg}}{\text{MAX kg} + \text{MAX kg}} \times 0,00981$$

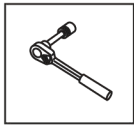

Вкрутить/выкрутить используя инструмент

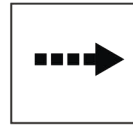

Движение

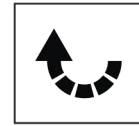

Поворот



Вкрутить/выкрутить не затягивая

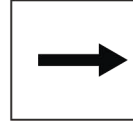





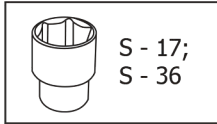
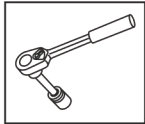



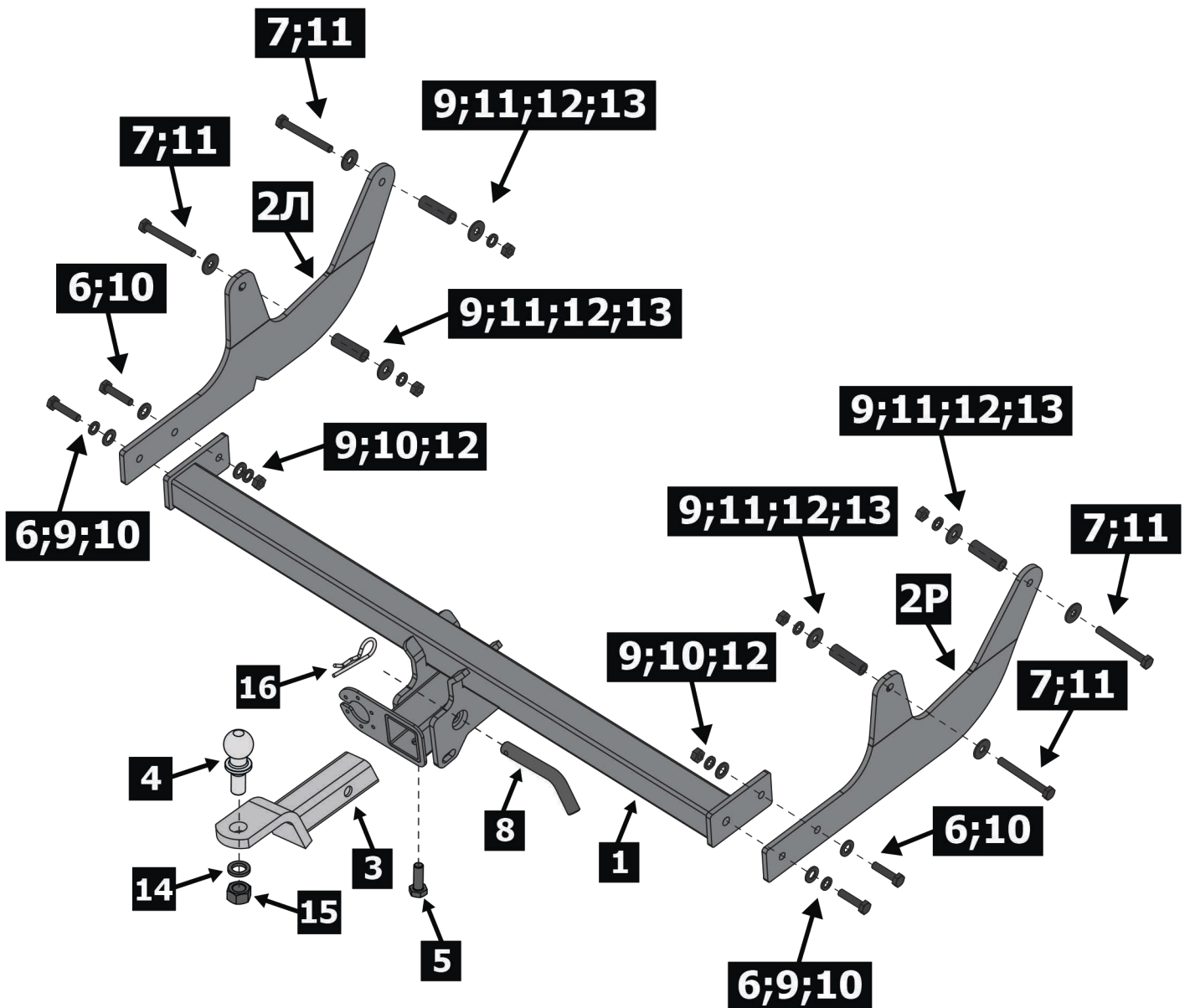

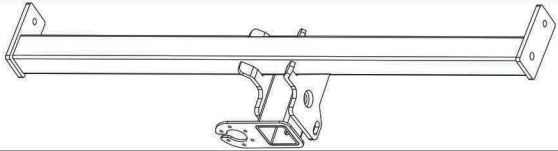
Расположение

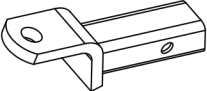
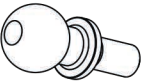
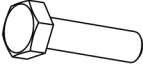
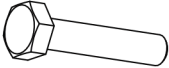
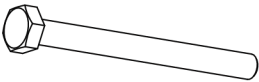
Используемый инструмент:



S - 17;
S - 36

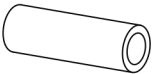

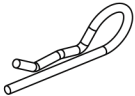
1	x1	Балка	
2Л	x1	Кронштейн левый	
2Р	x1	Кронштейн правый	
3	x1	Переходник	
4	x1	Шар	
5	x1	M10x20	
6	x4	M10x35	
7	x4	M10x90	
8	x1	Штифт	
9	x8	∅ 10	
10	x6	∅ 10	
11	x8	∅ 10	
12	x6	M10	
13	x4	Втулка	
14	x1	∅24	
15	x1	M24	
16	x1	Шплинт	

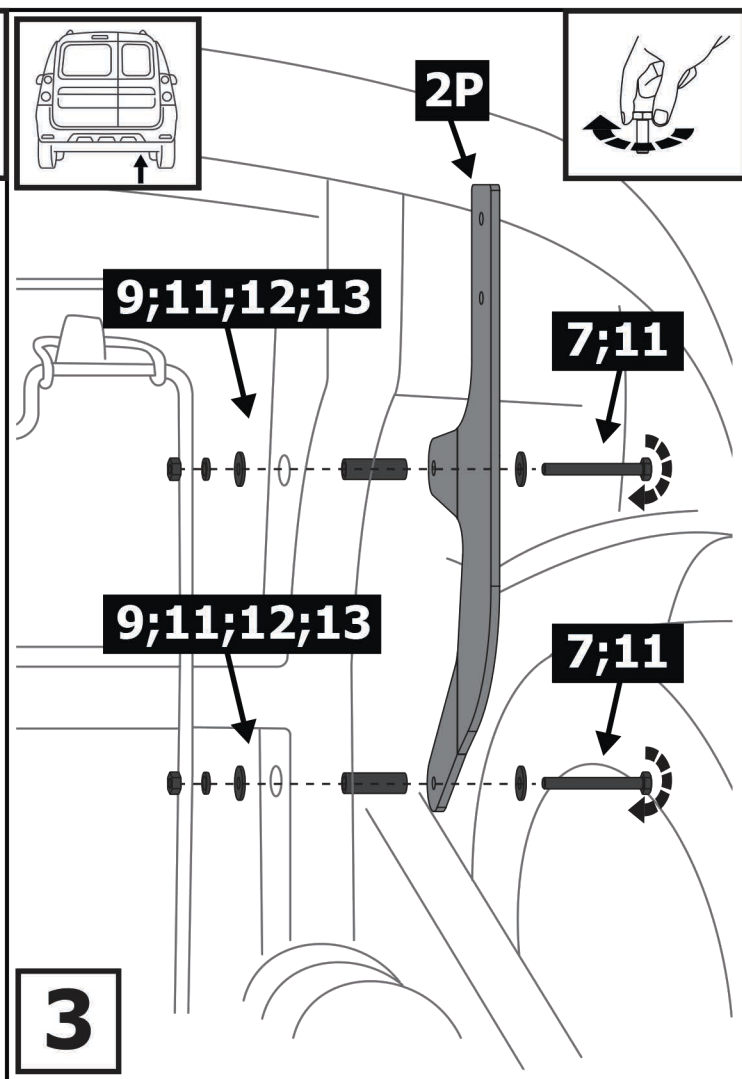
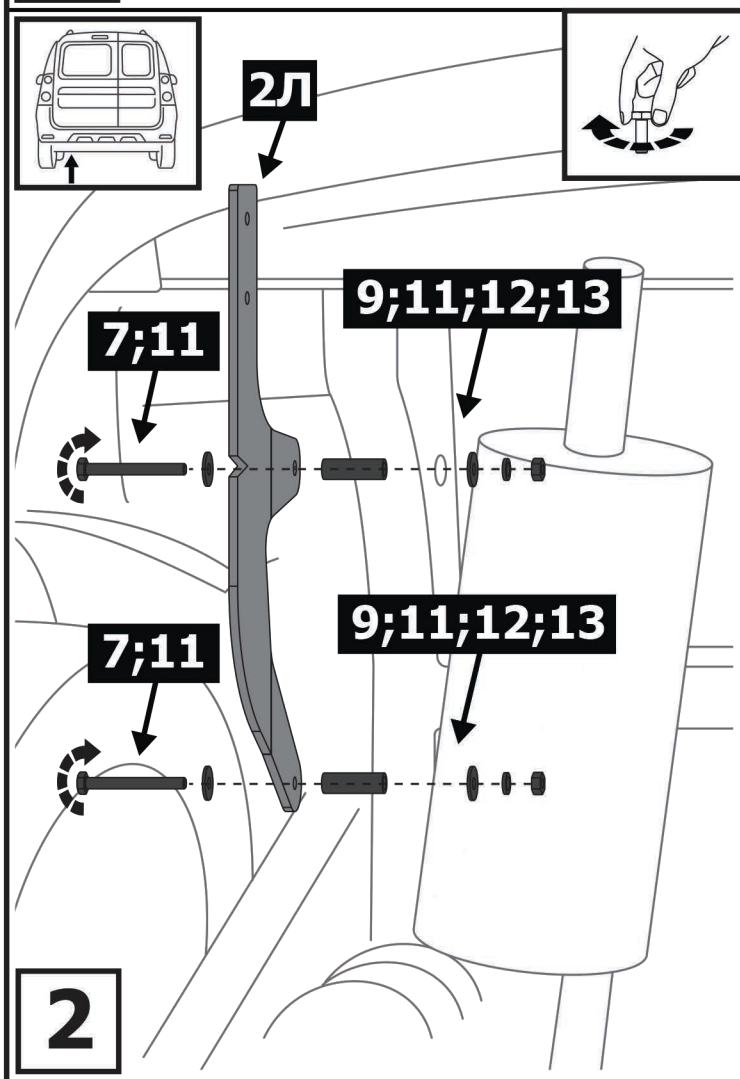
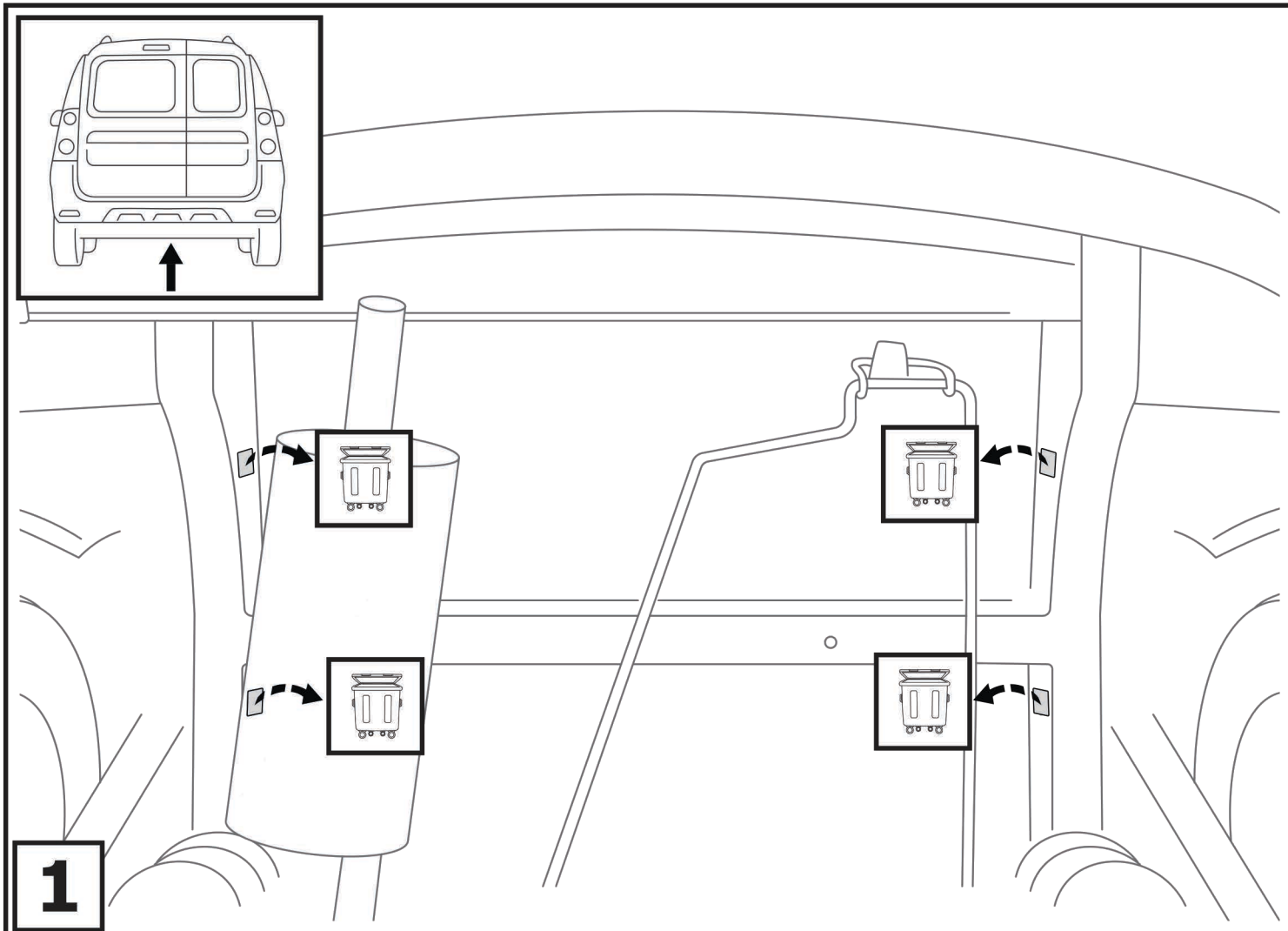

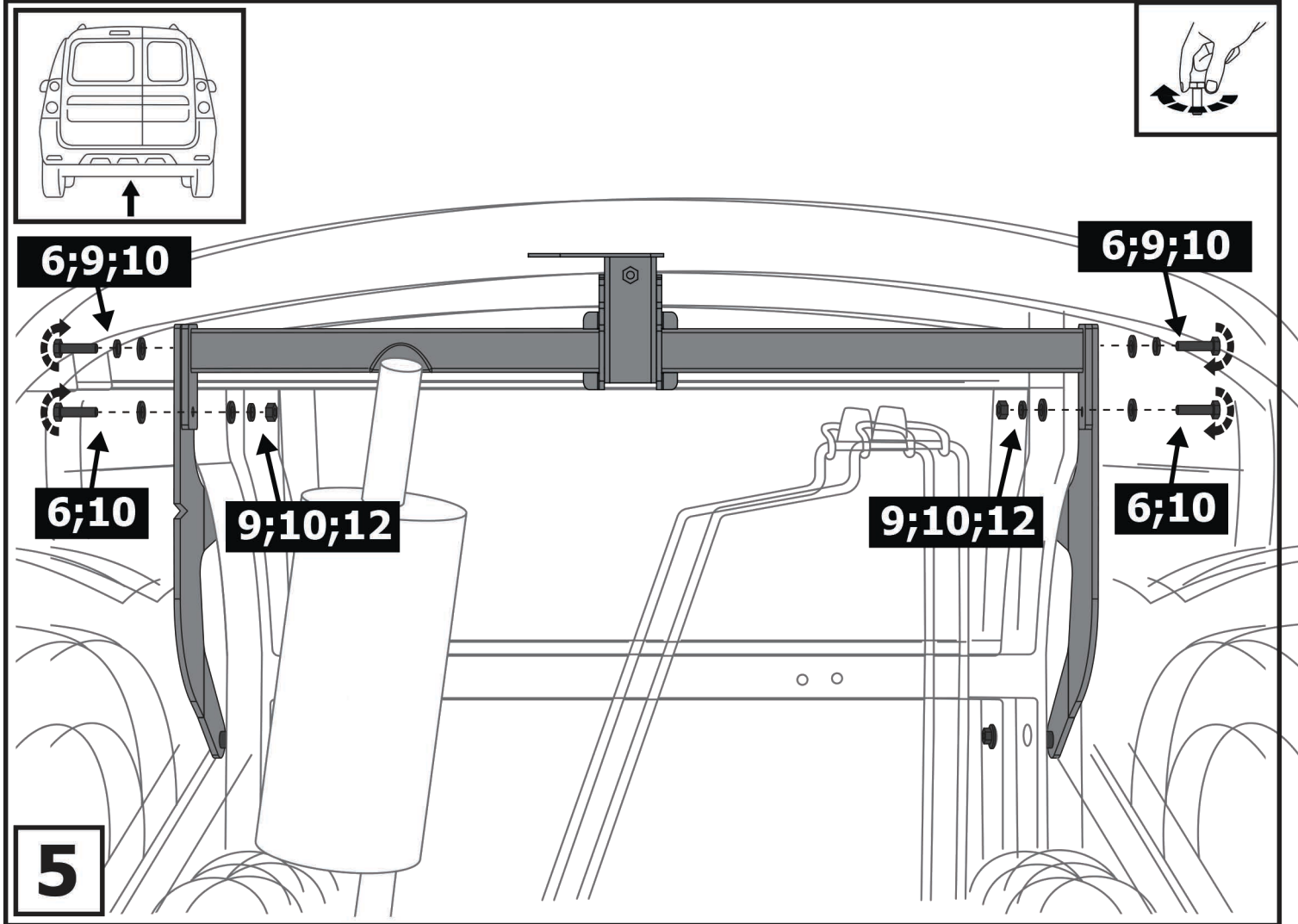
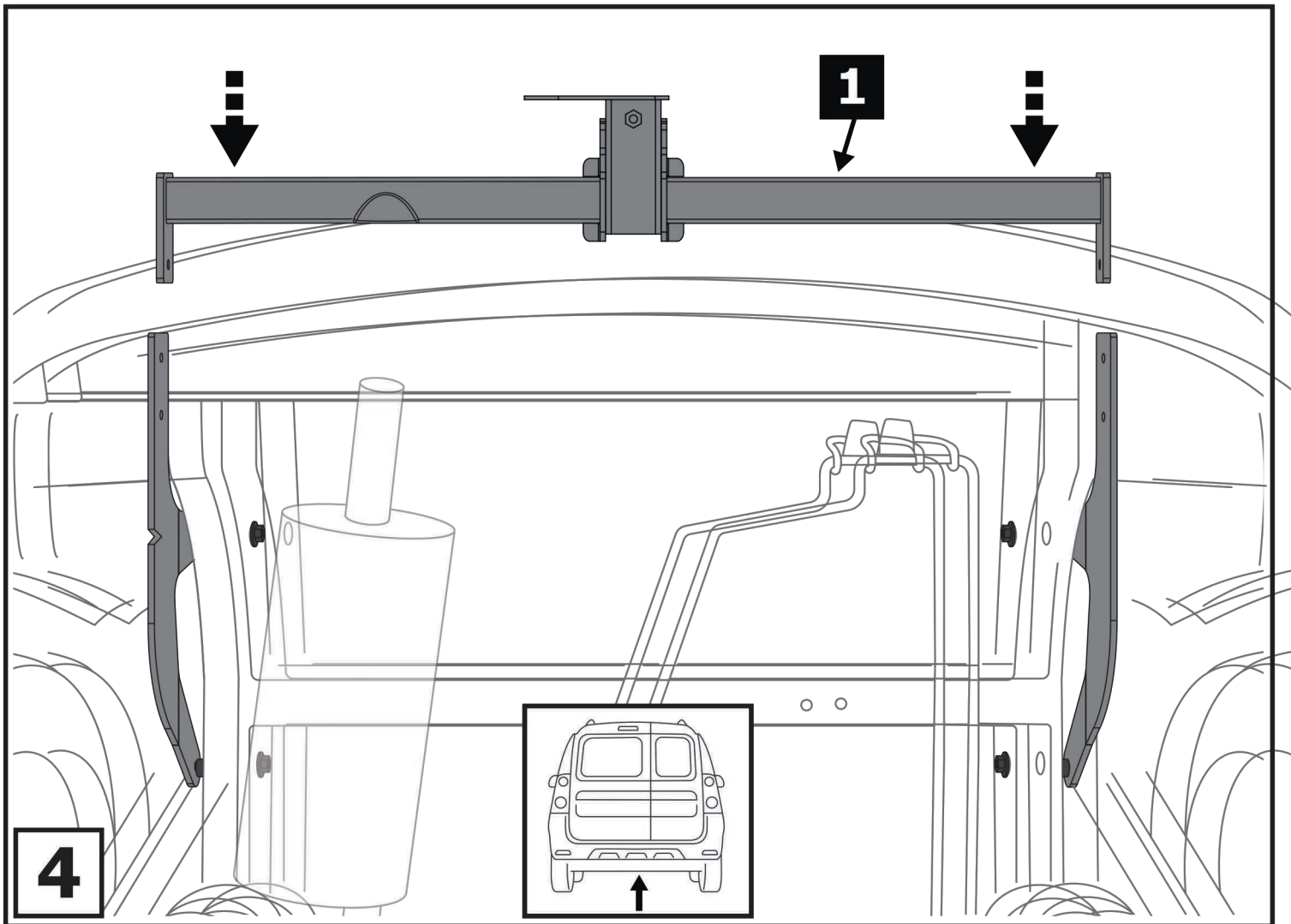

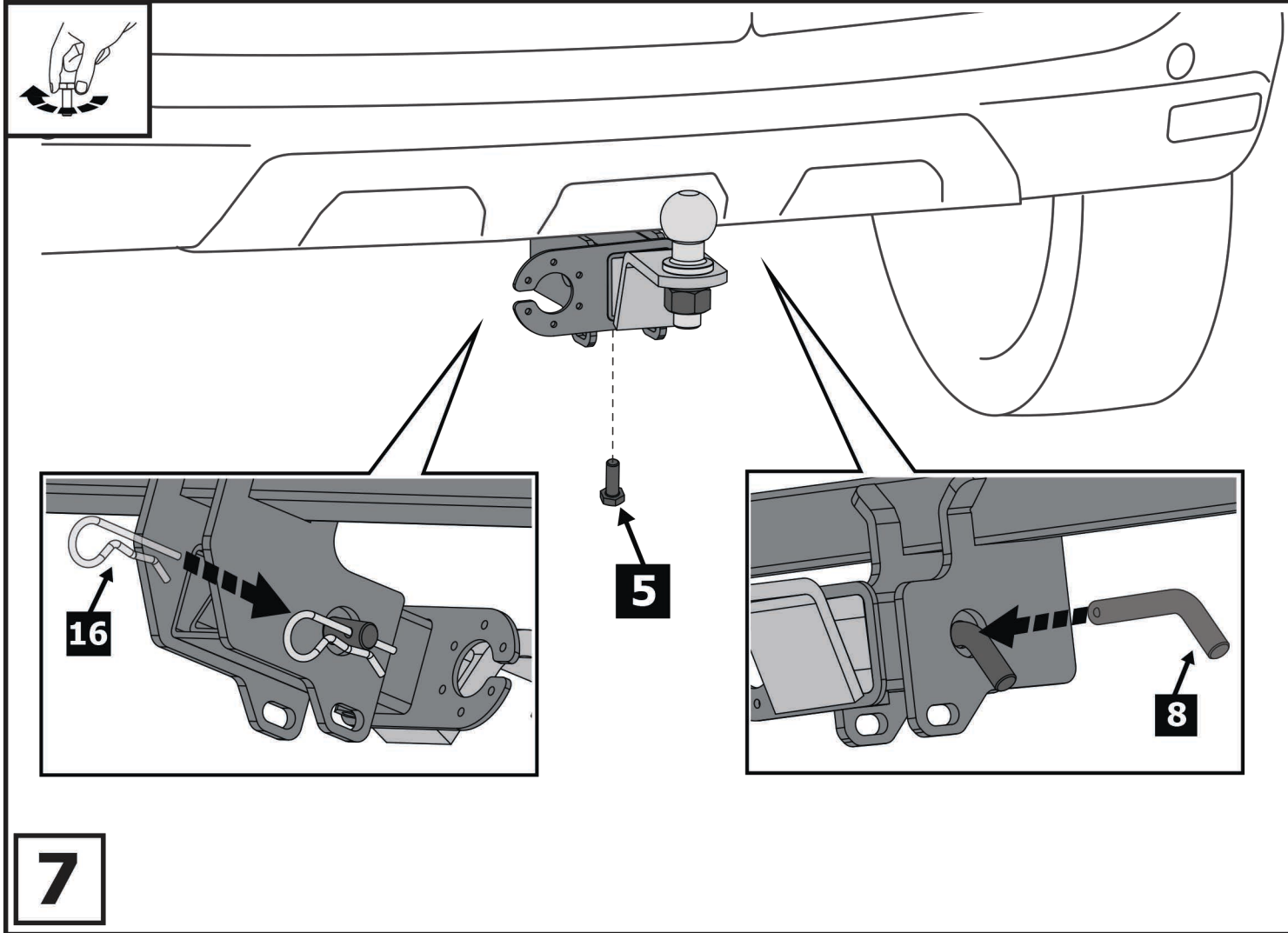
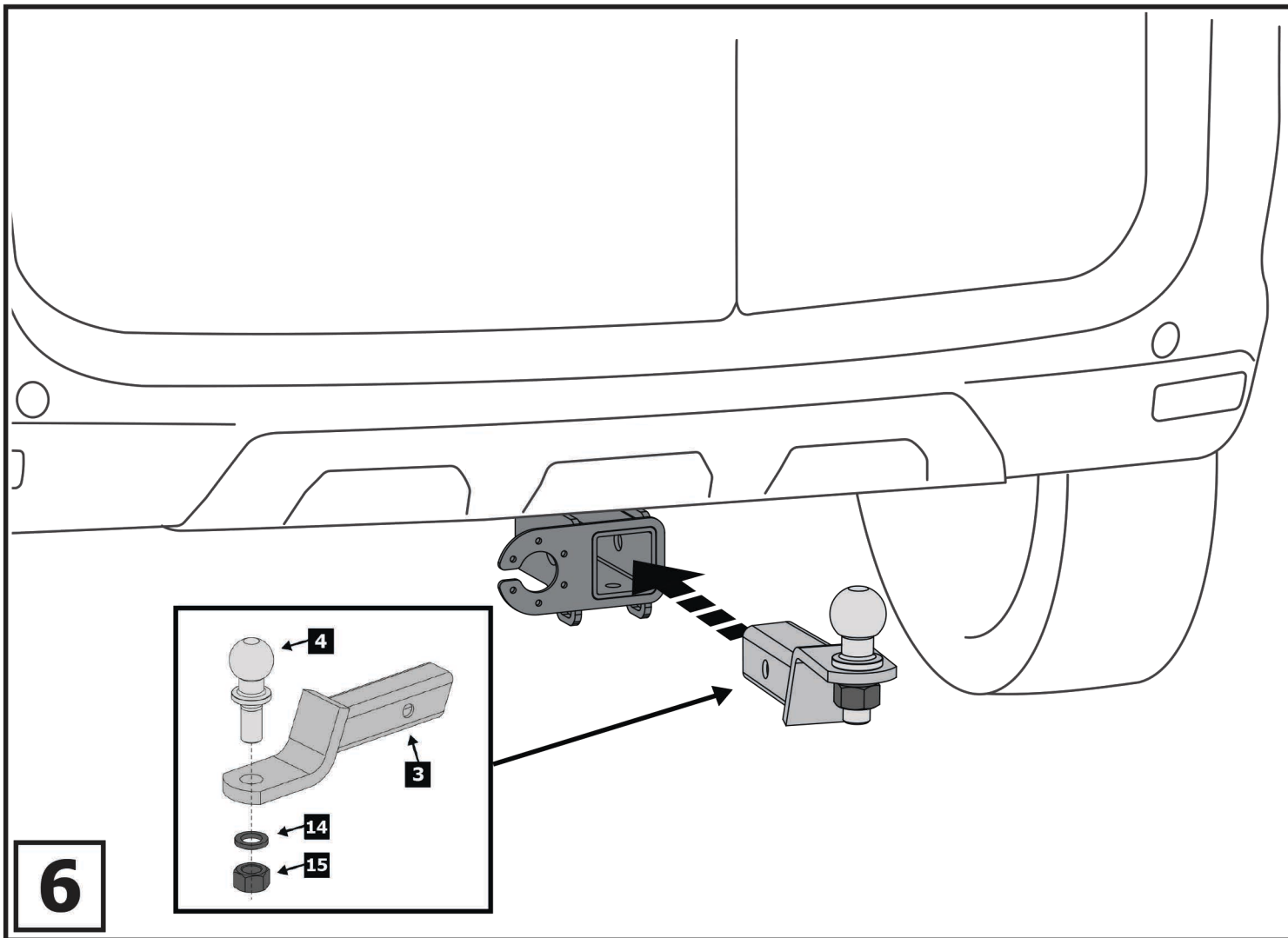

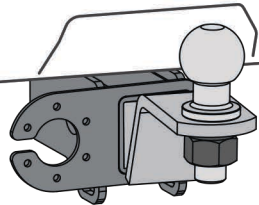

8

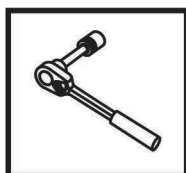

Затянуть все резьбовые соединения

M10 = 47 Nm M24 = 730 Nm