

Инструкция по установке Toyota Land Cruiser Prado 150

(2009-) кроме комплектации **Black Onyx**

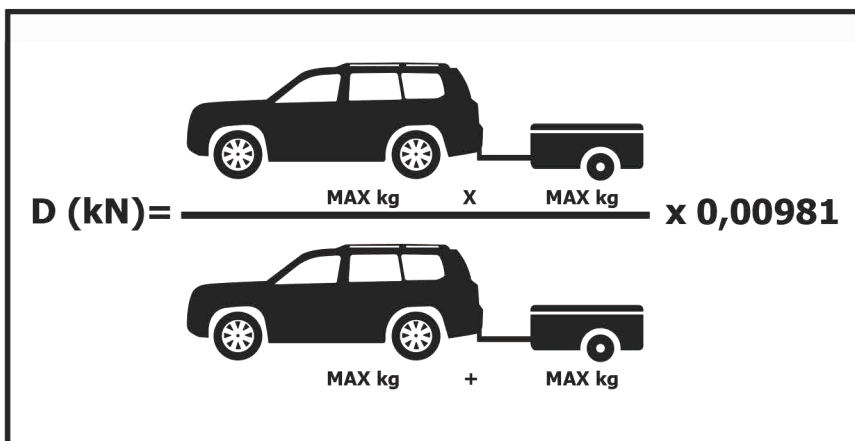

Арт.: F.5714.006

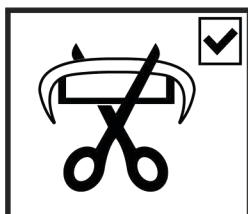
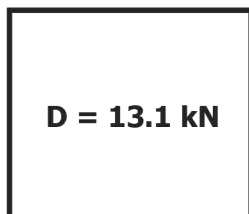
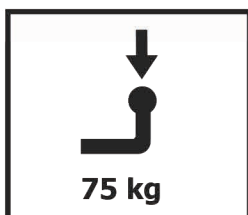
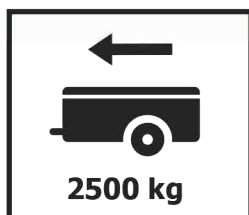

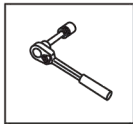

Вкрутить/выкрутить используя инструмент

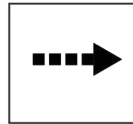

Движение



Поворот





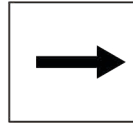



Вкрутить/выкрутить не затягивая

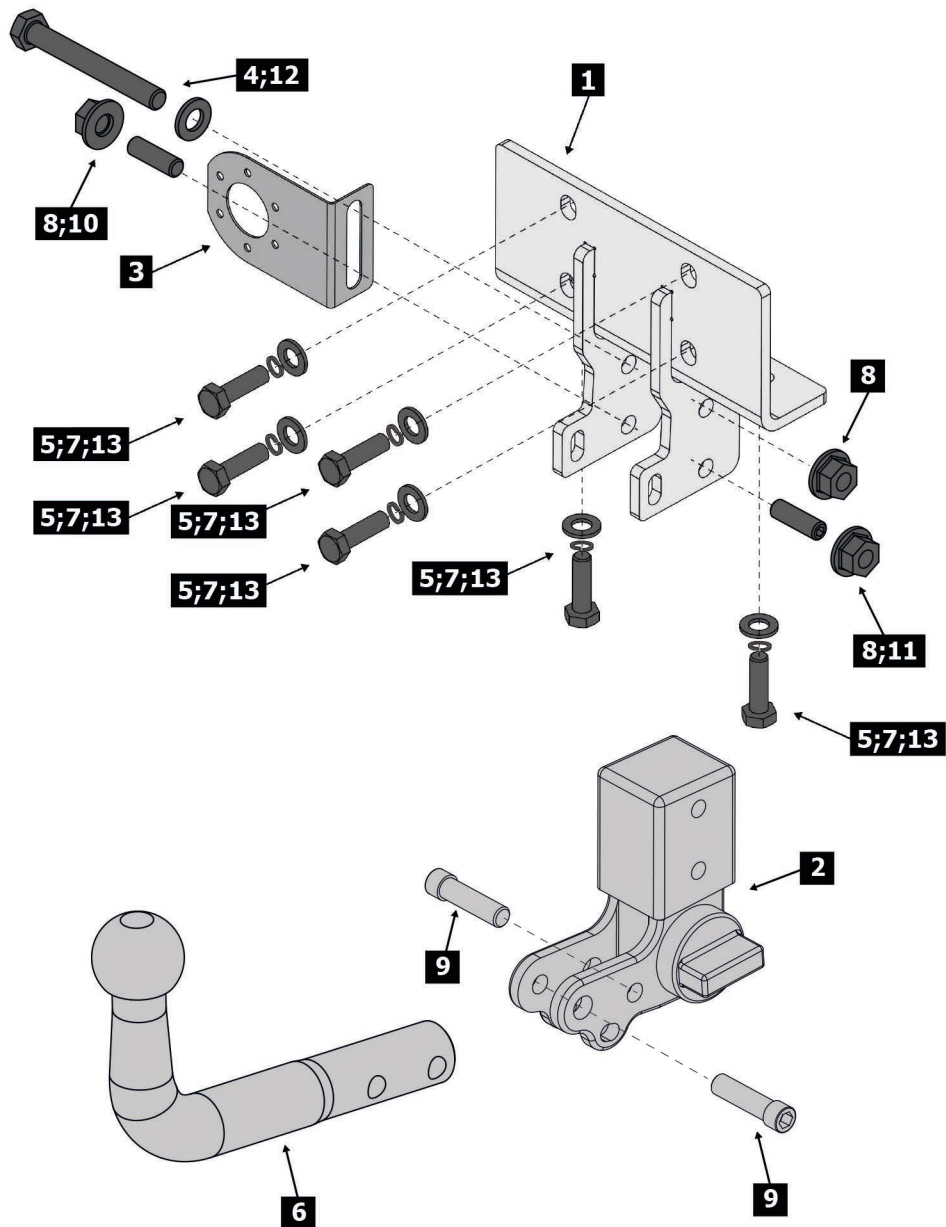
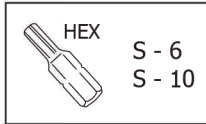
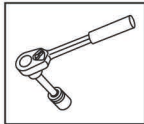

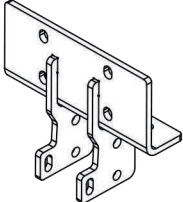
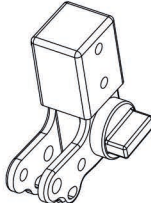
Расположение

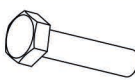
Используемый инструмент:

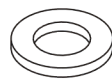
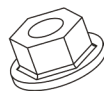
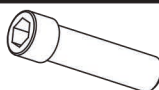
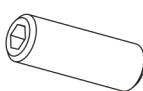
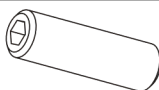
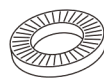

1	x1	Кронштейн	
2	x1	Быстросъём	
3	x1	Подрозетник	
4	x1	M12x100	
5	x6	M12x1.25x40	
6	x1	Крюк	
7	x6	Ø12	
8	x3	M12	
9	x2	M12x45	
10	x1	Шпилька M12x25	
11	x1	Шпилька M12x35	
12	x1	Ø12	
13	x6	Ø12	

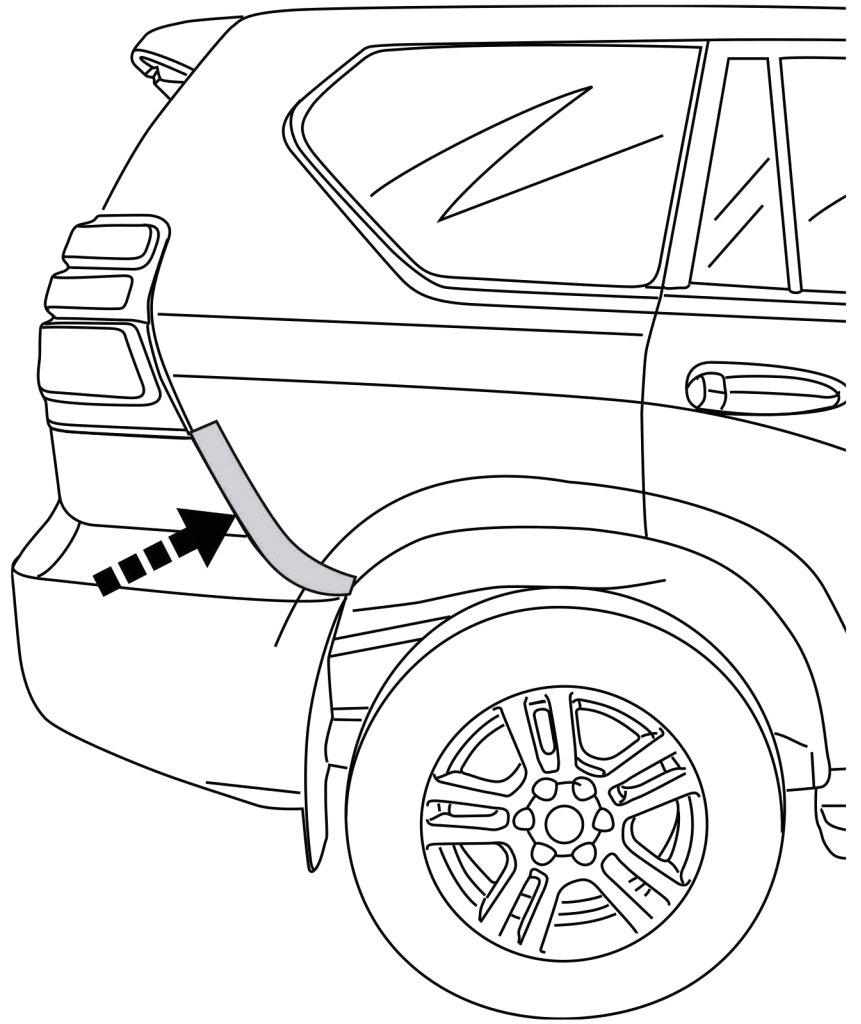
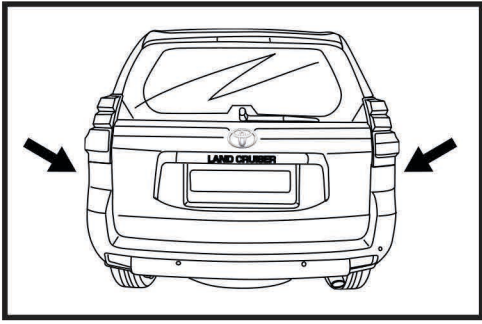

1

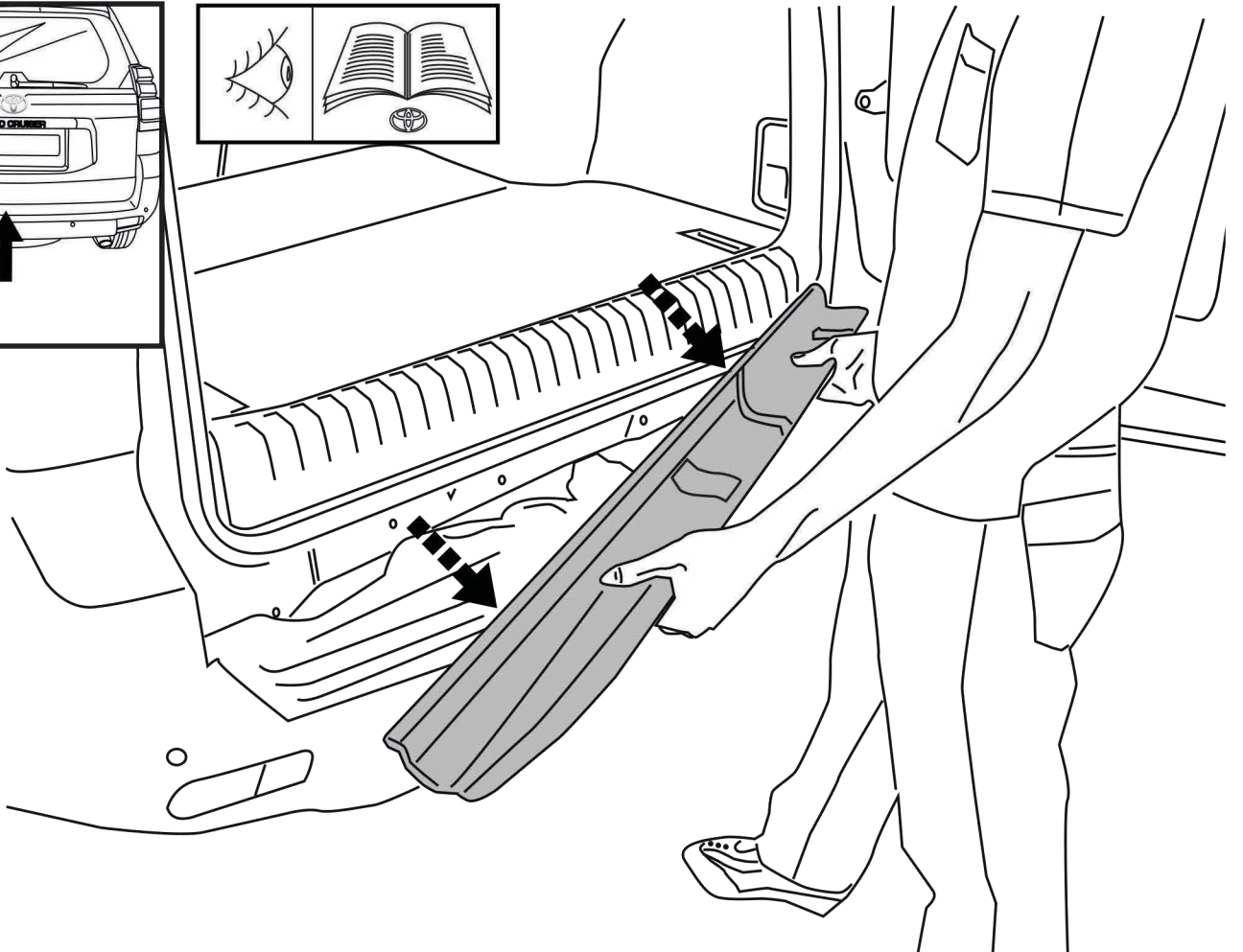
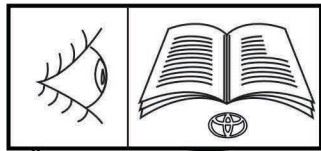
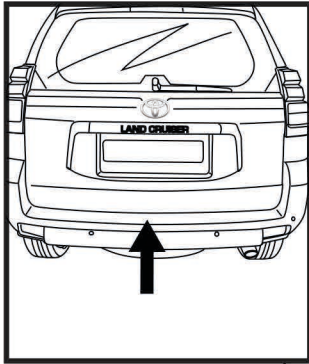

2

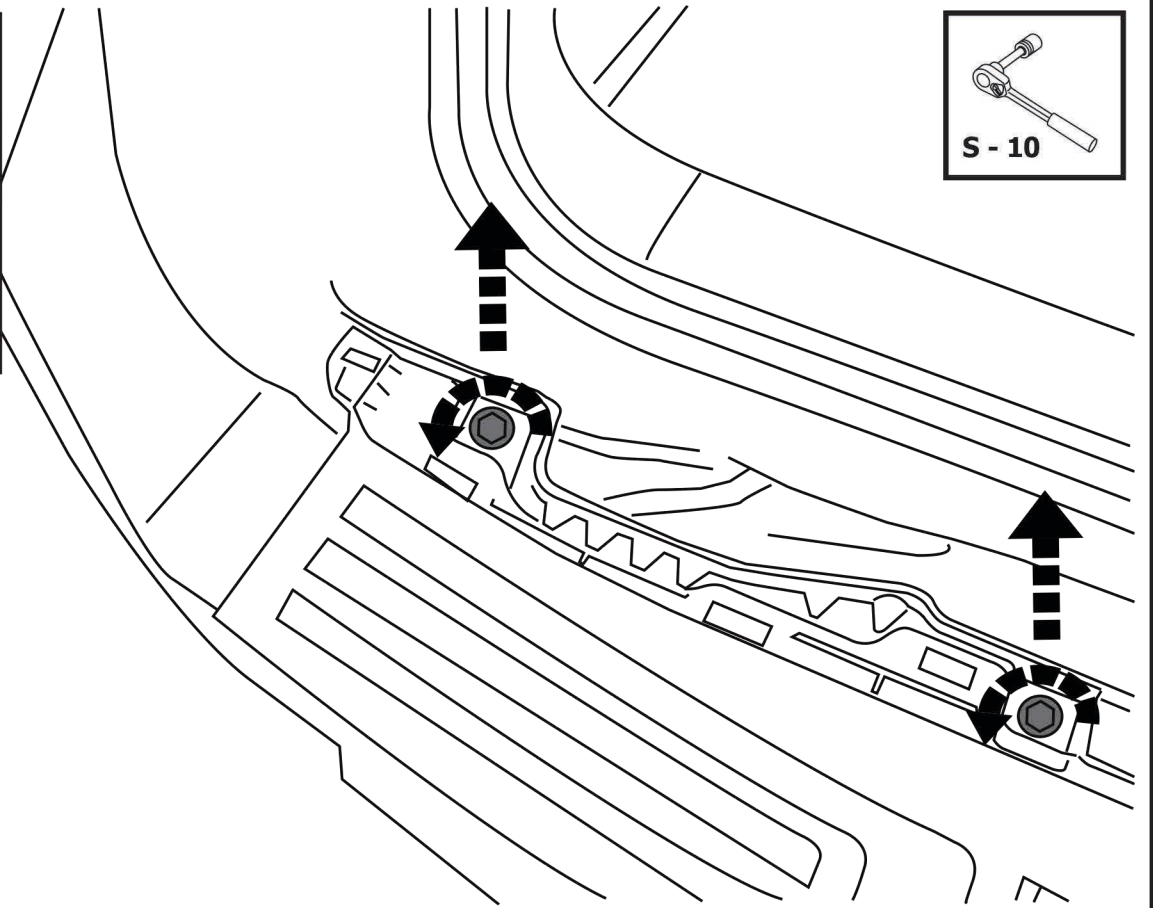
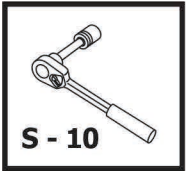
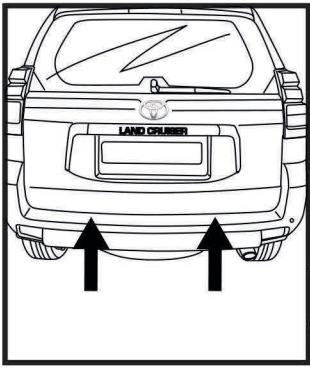

3

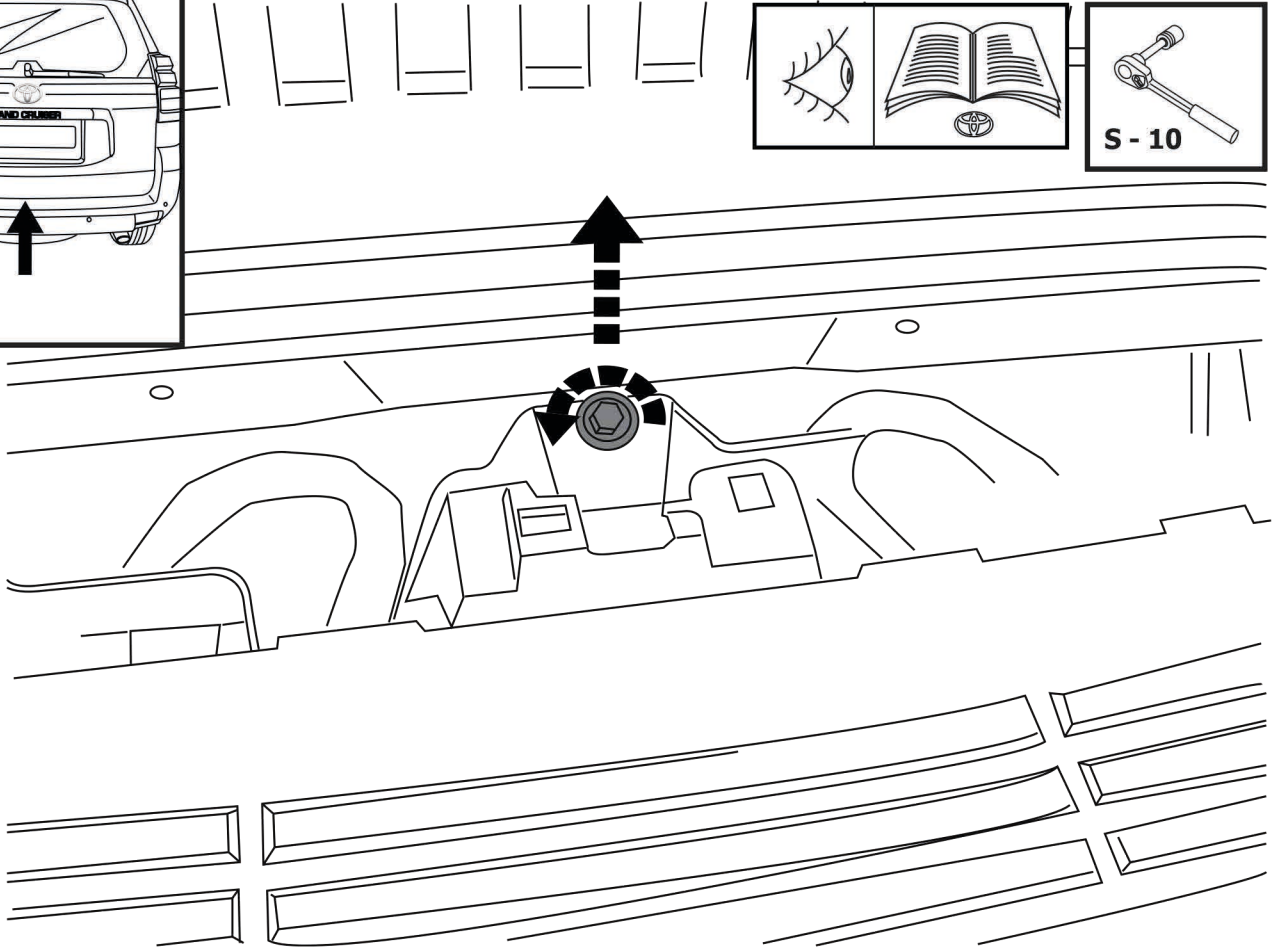
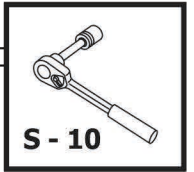
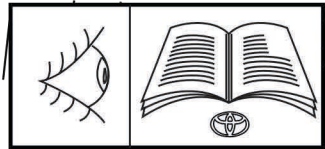
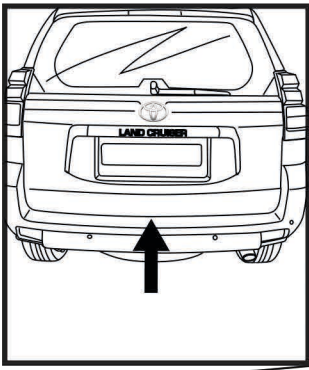

4

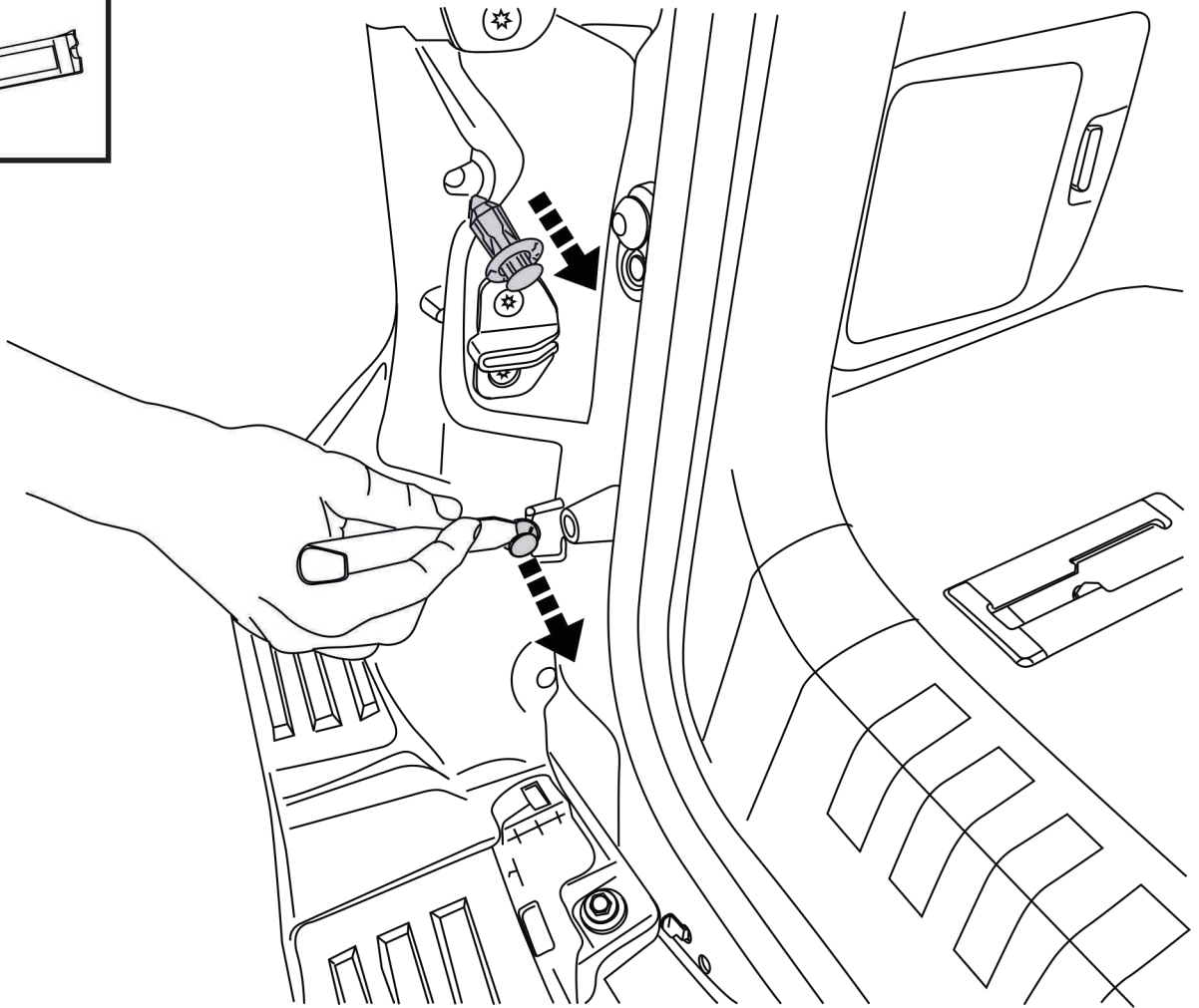
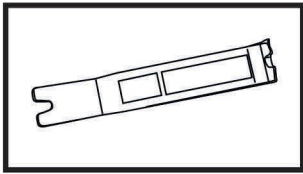

5

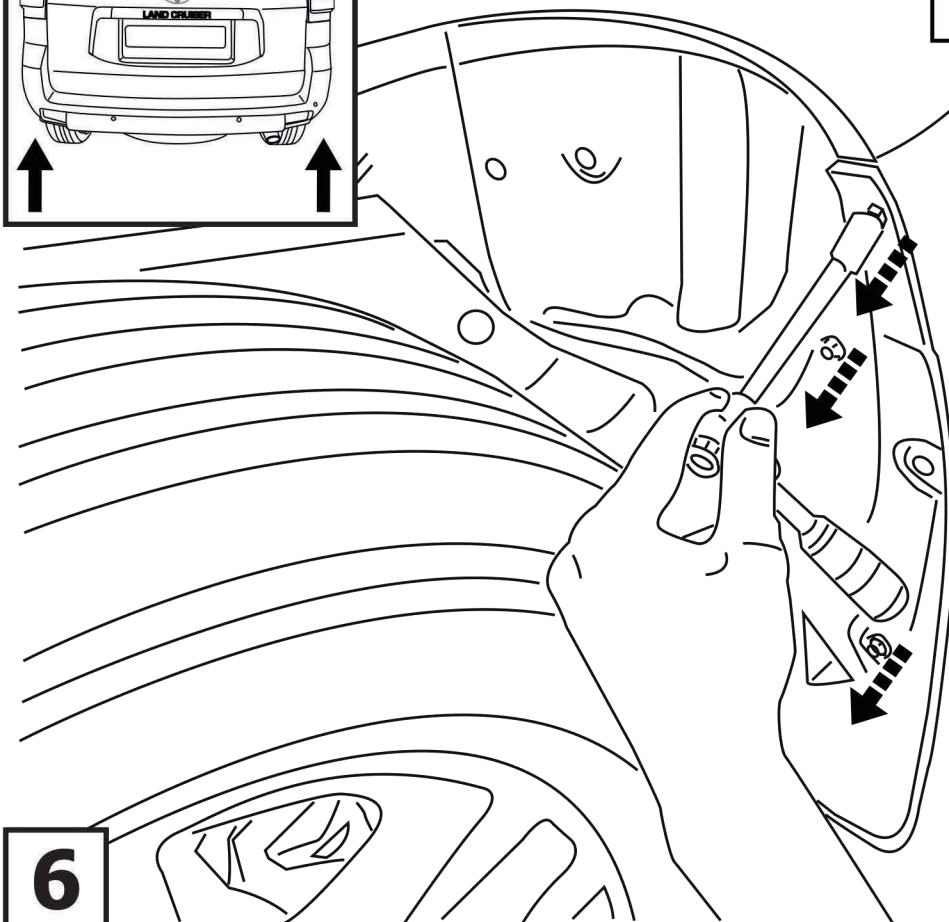
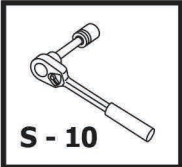
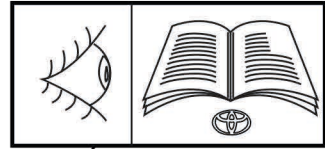
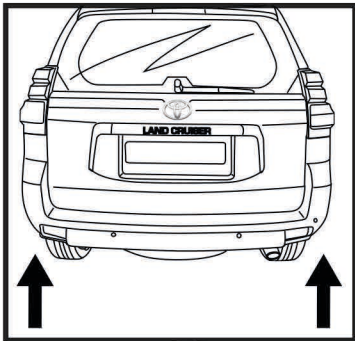

6

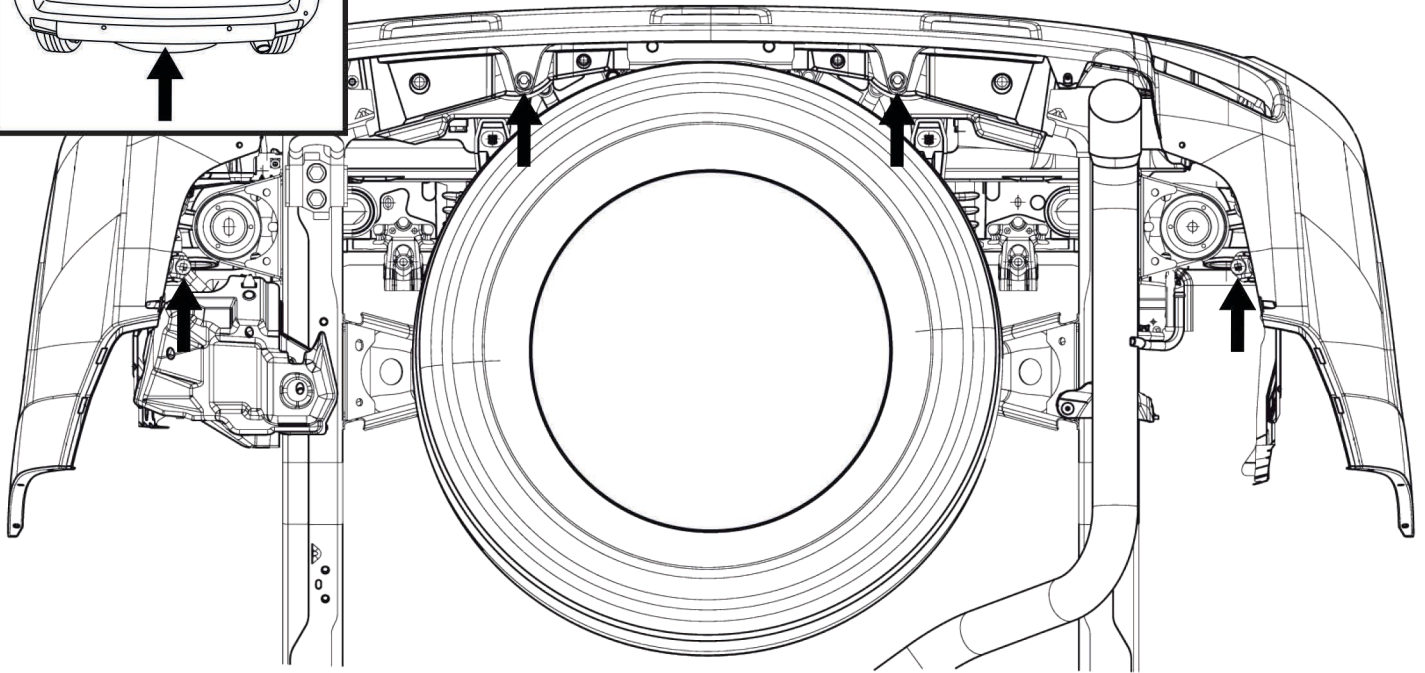
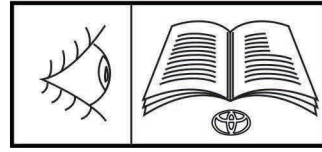
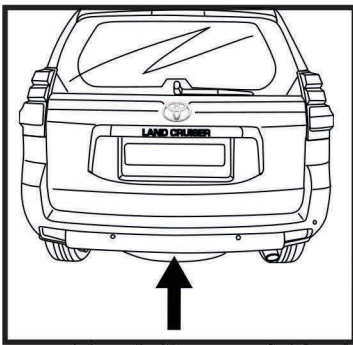

7

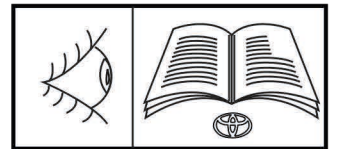
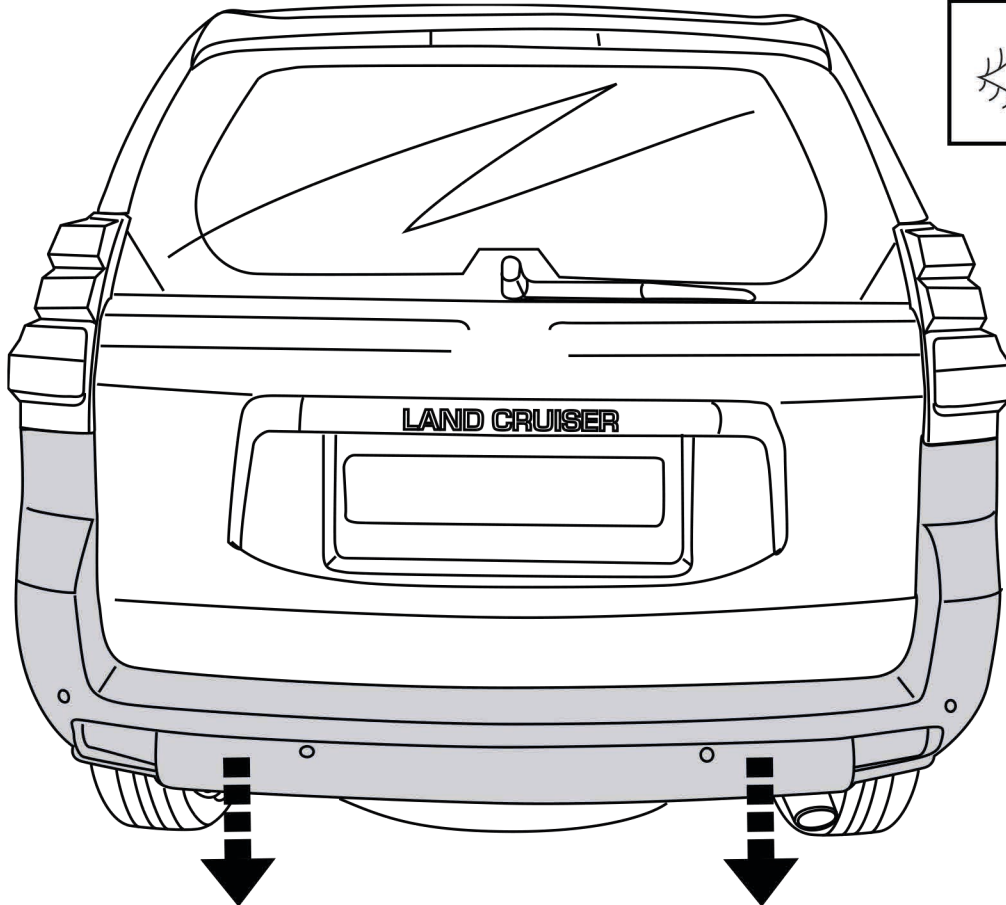

8

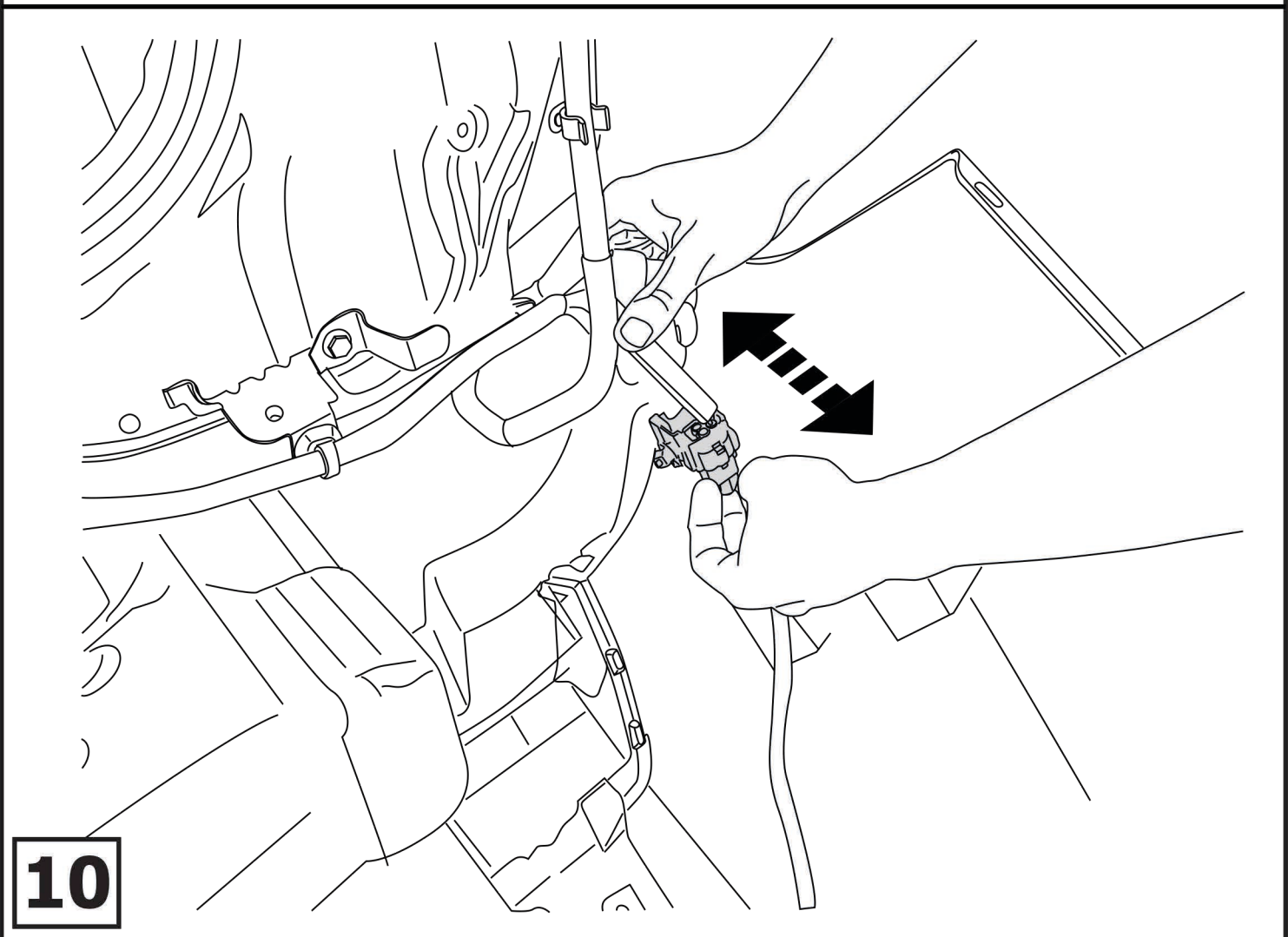
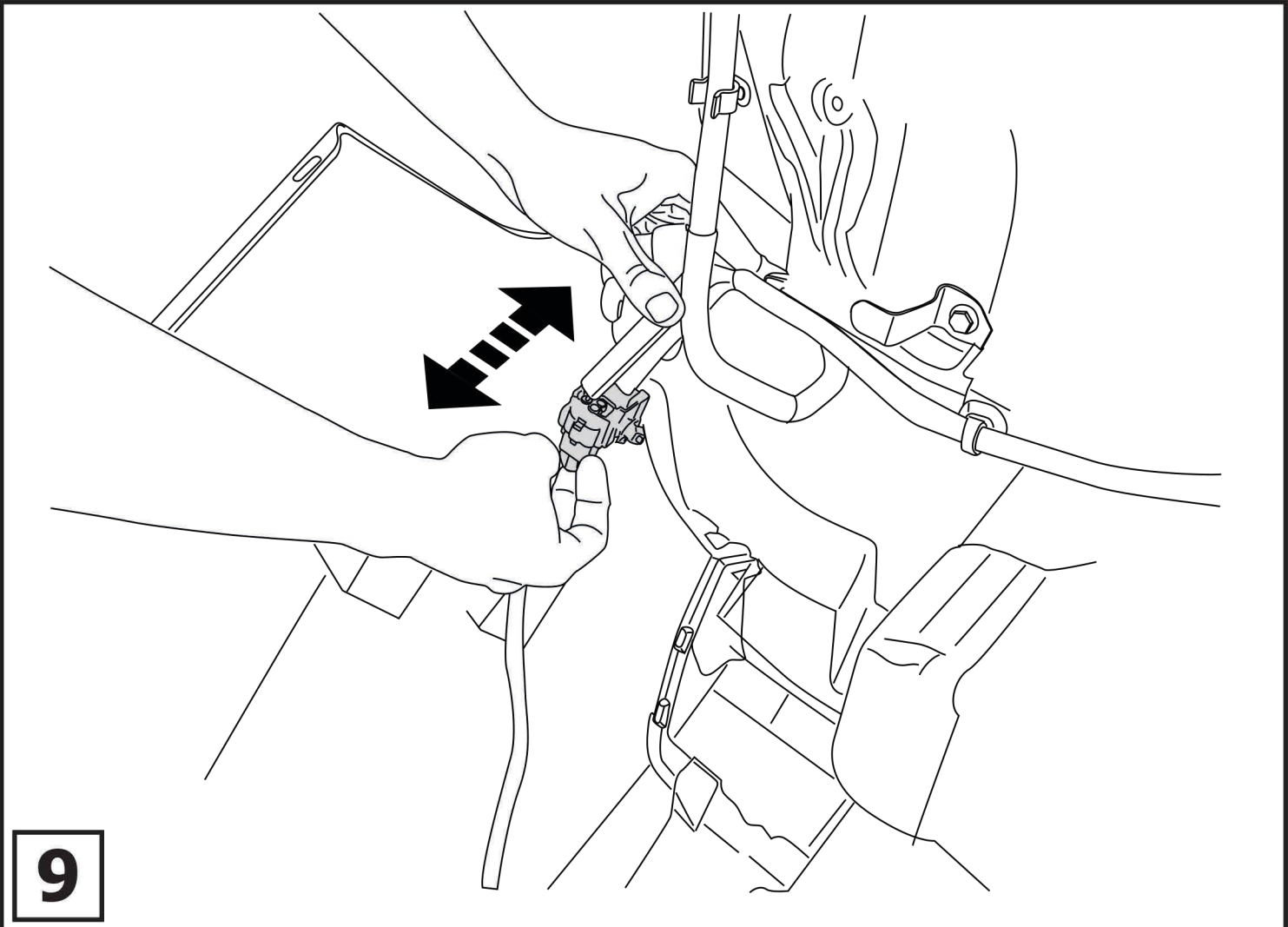

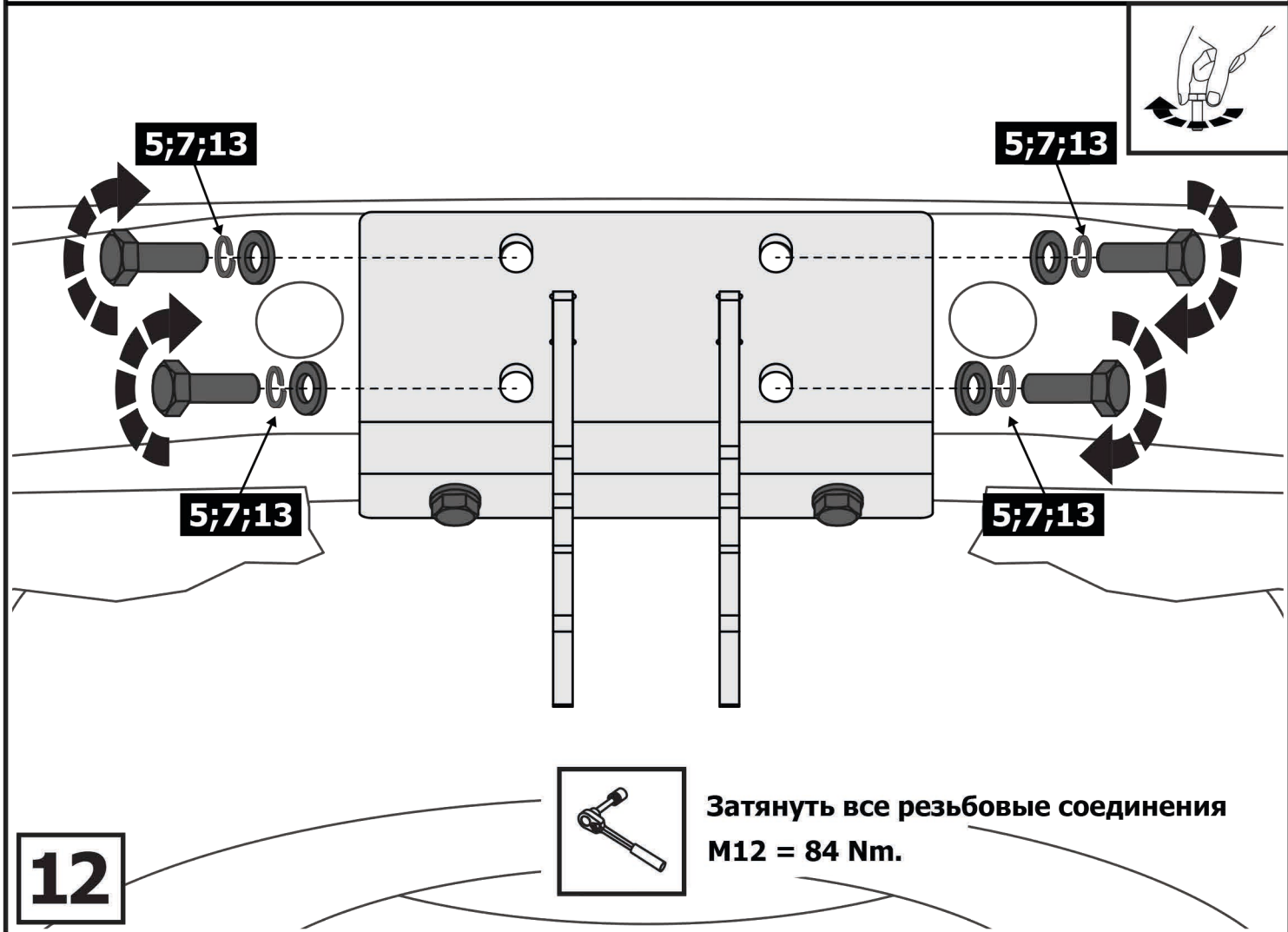
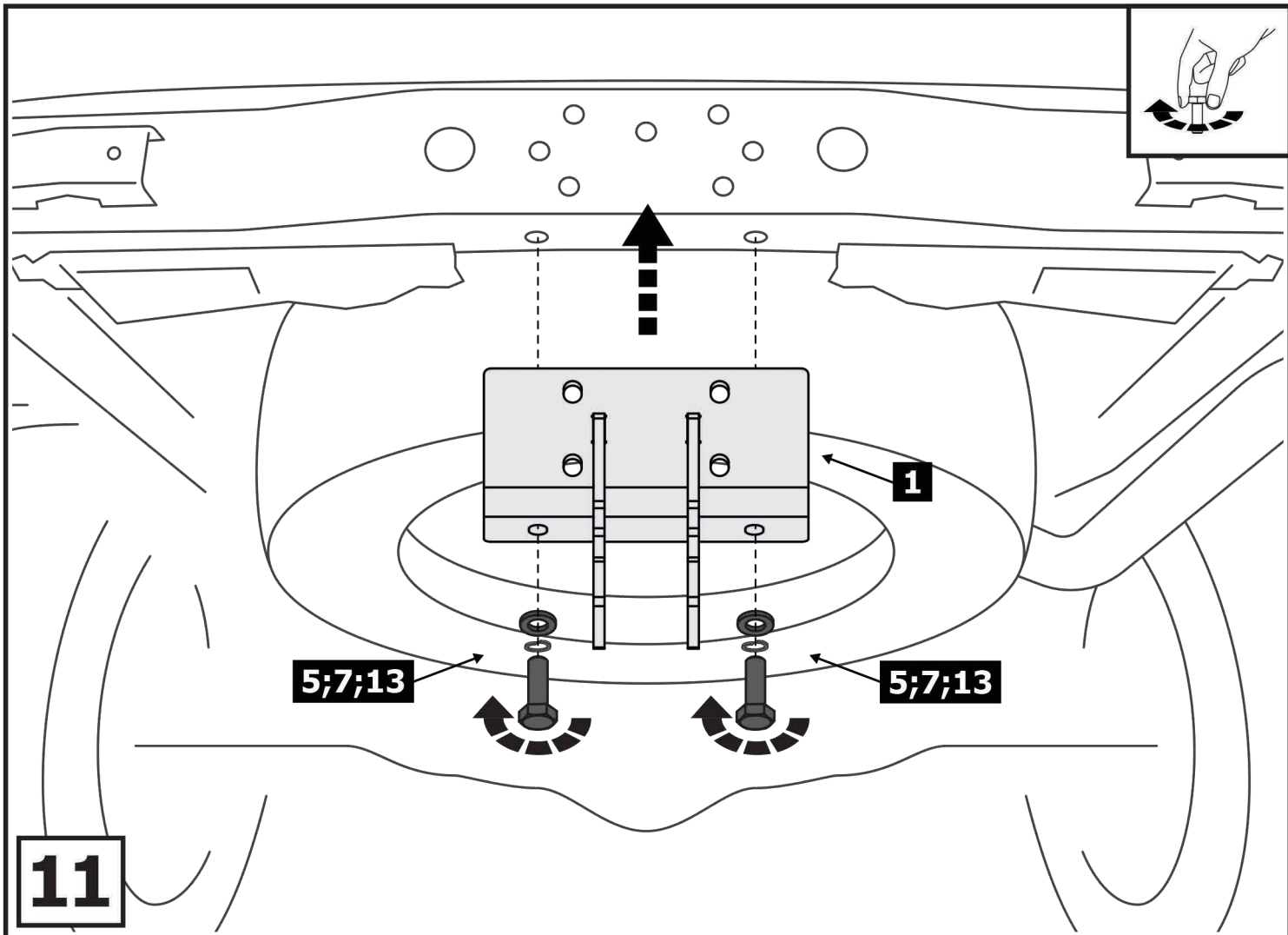

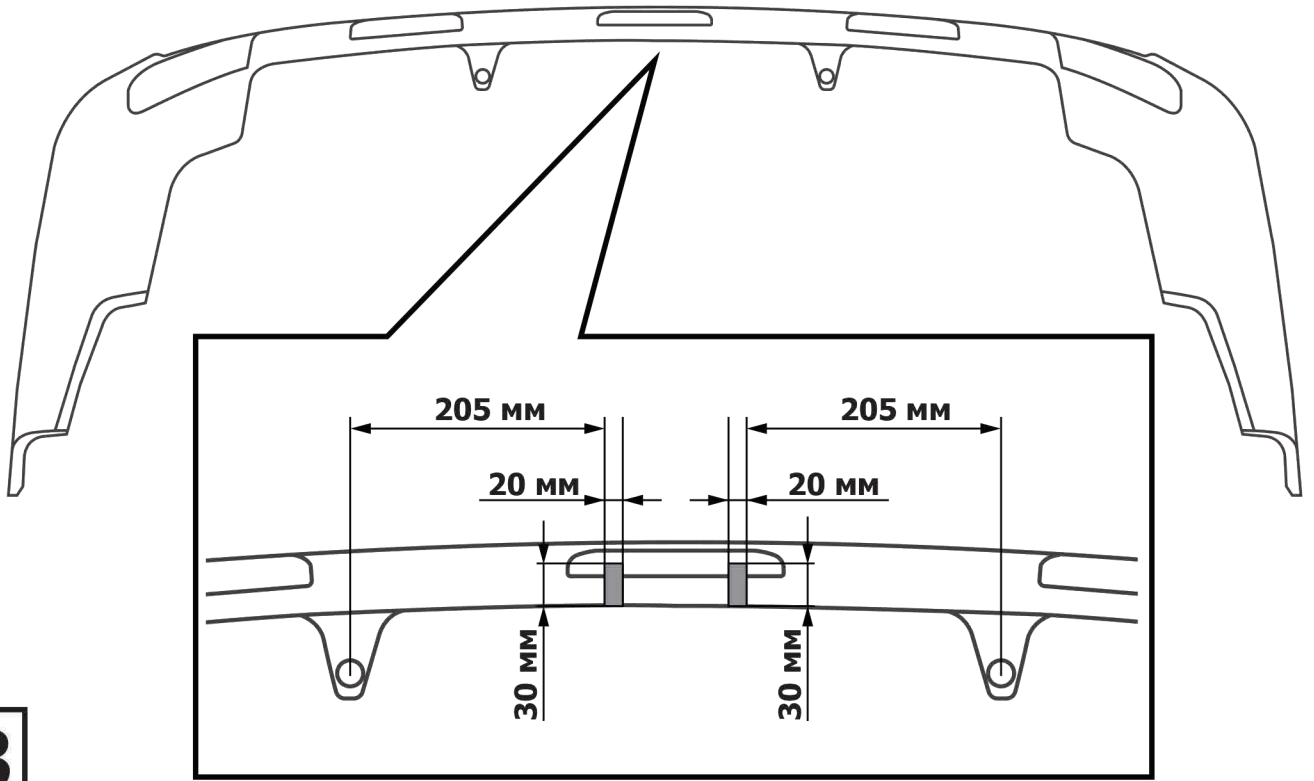
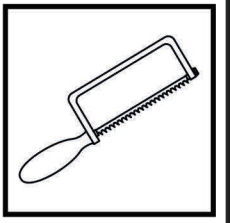
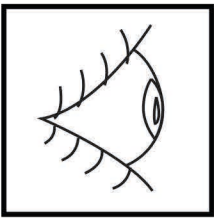

13

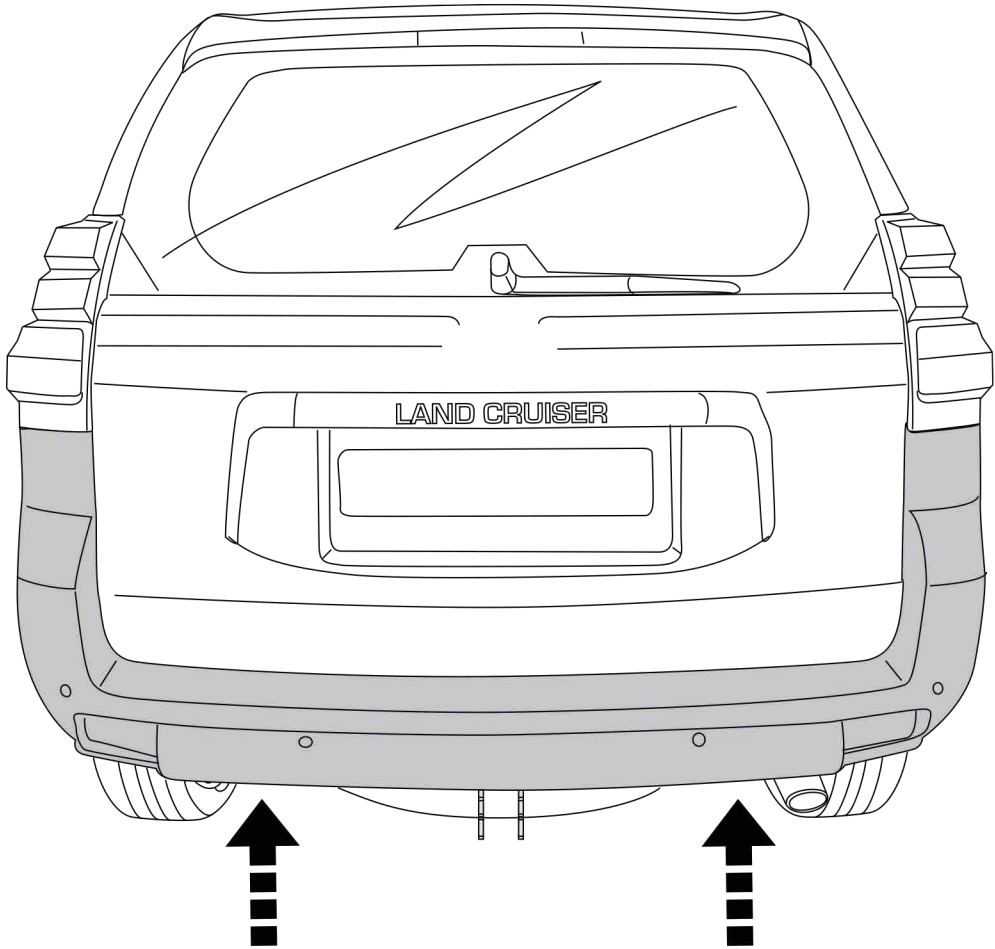

14

