

Инструкция по установке **KIA SELTOS** (2020-)

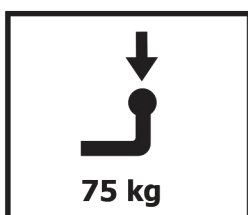

Арт.: F.2816.001

Тип шара - «А»

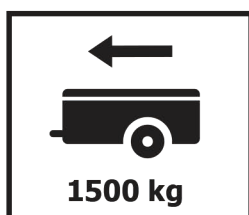

$D = 8.2 \text{ kN}$

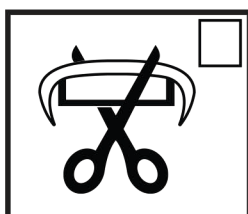

$$D \text{ (kN)} = \frac{\text{MAX kg} \times X}{\text{MAX kg} + \text{MAX kg}} \times 0,00981$$

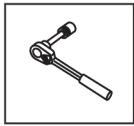

Вкрутить/выкрутить используя инструмент

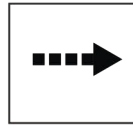

Движение



Поворот



Вкрутить/выкрутить не затягивая

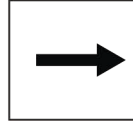





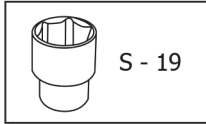
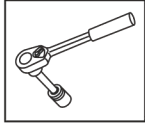

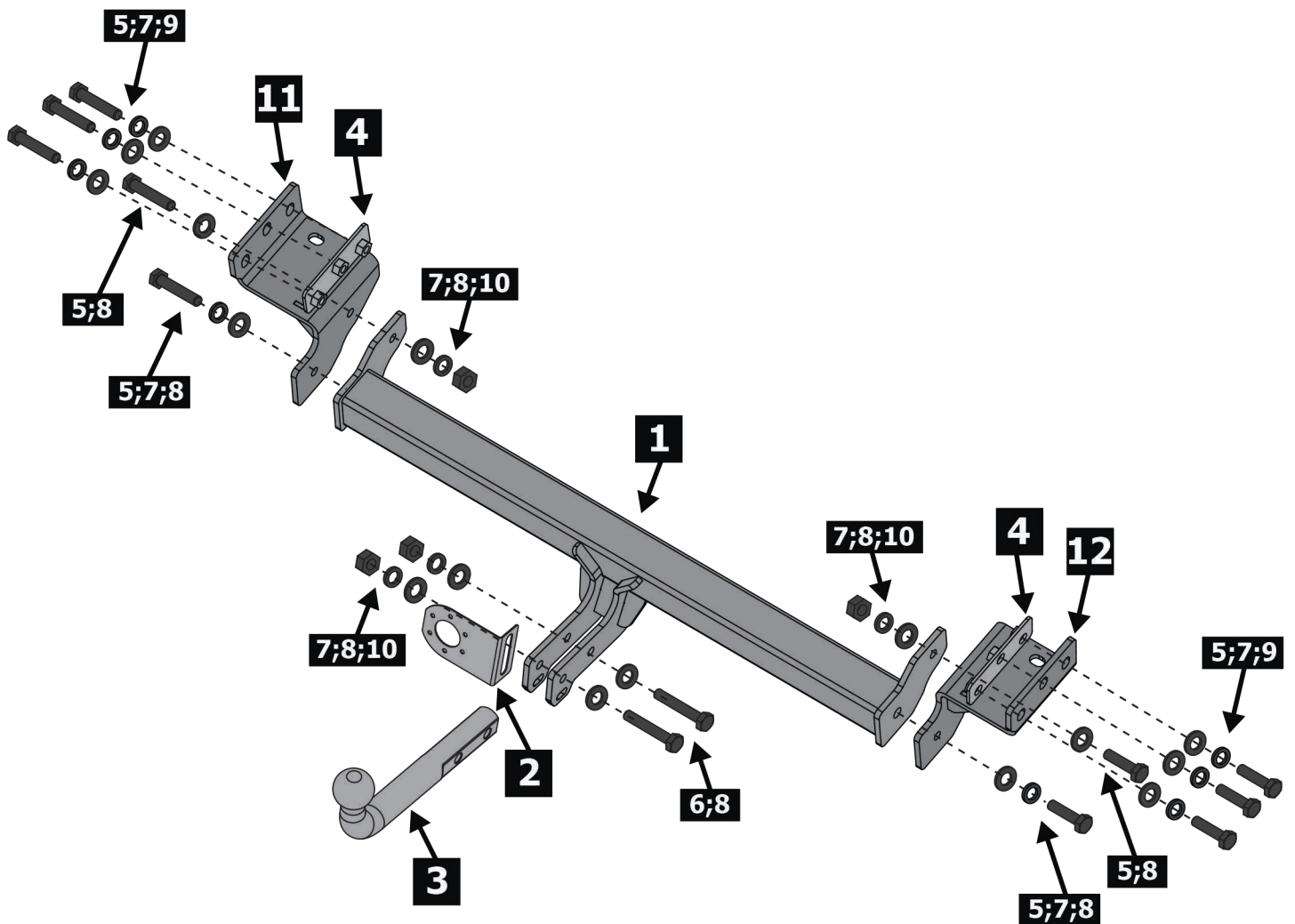

Расположение

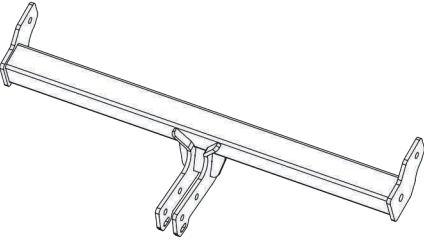
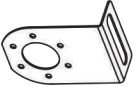
Используемый инструмент:

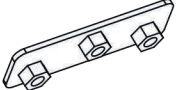
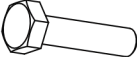

S - 19

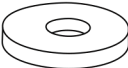

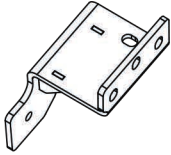
1	x1	Балка	
2	x1	Подрозетник	
3	x1	Крюк	
4	x2	Закладная пластина	
5	x10	M12x1,25x40	
6	x2	M12x1,25x70	
7	x12	∅ 12	
8	x10	∅ 12	
9	x6	∅ 12	
10	x4	M12x1,25	
11	x1	Кронштейн правый	
12	x1	Кронштейн левый	

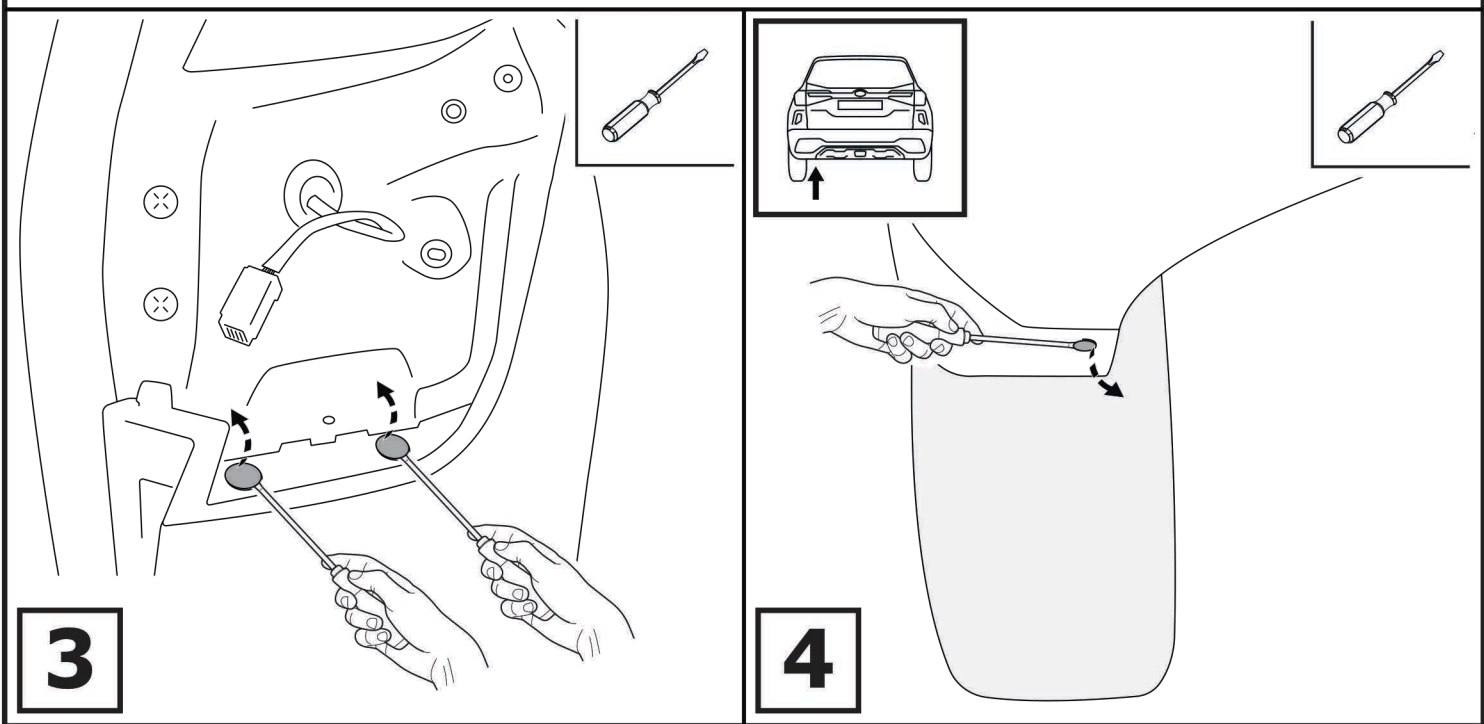
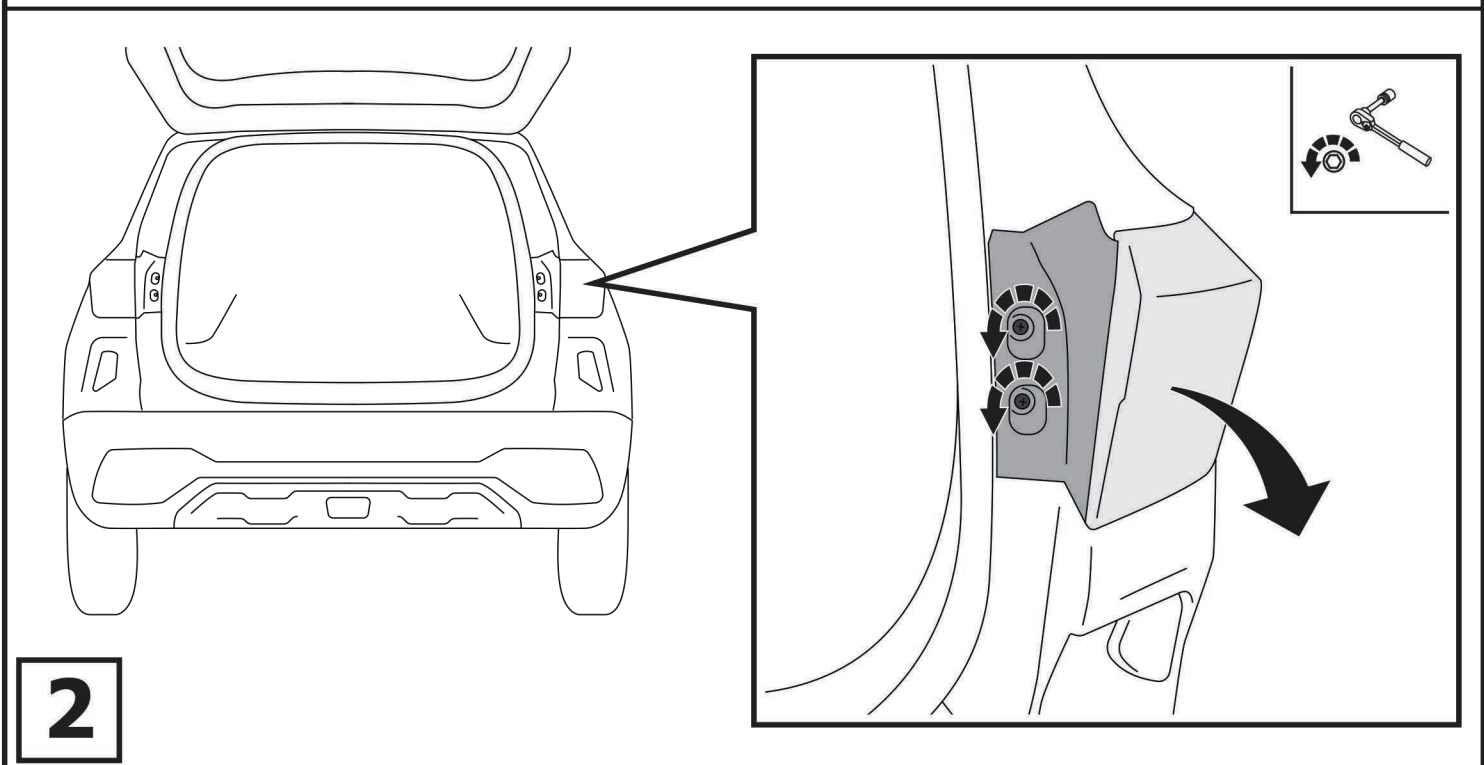
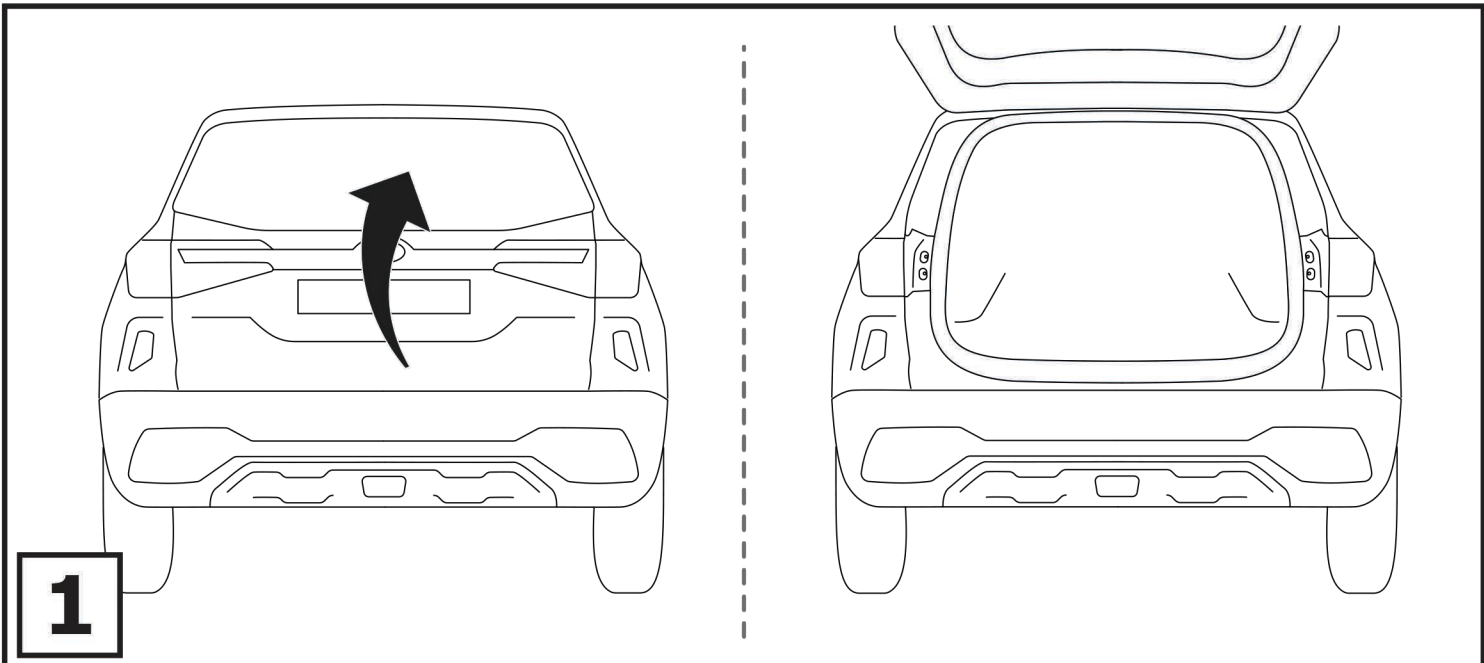

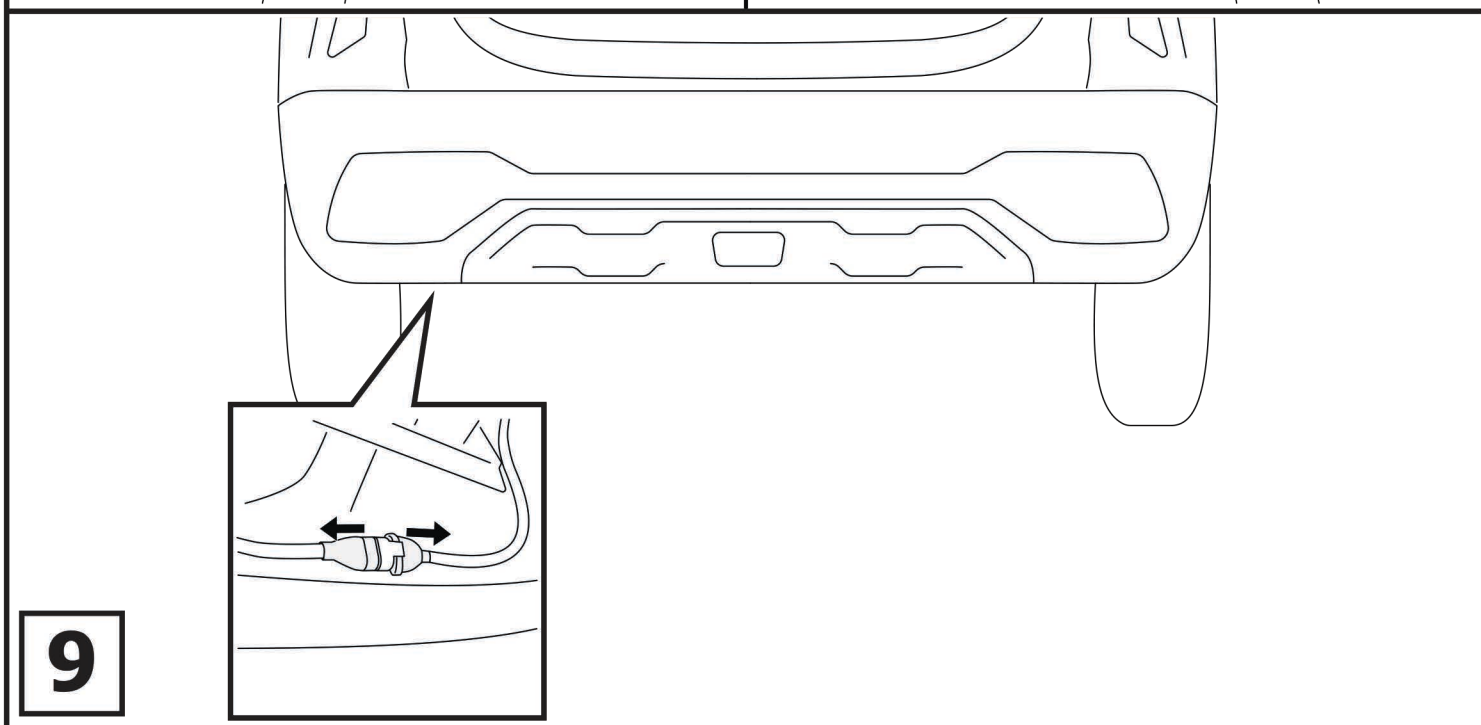
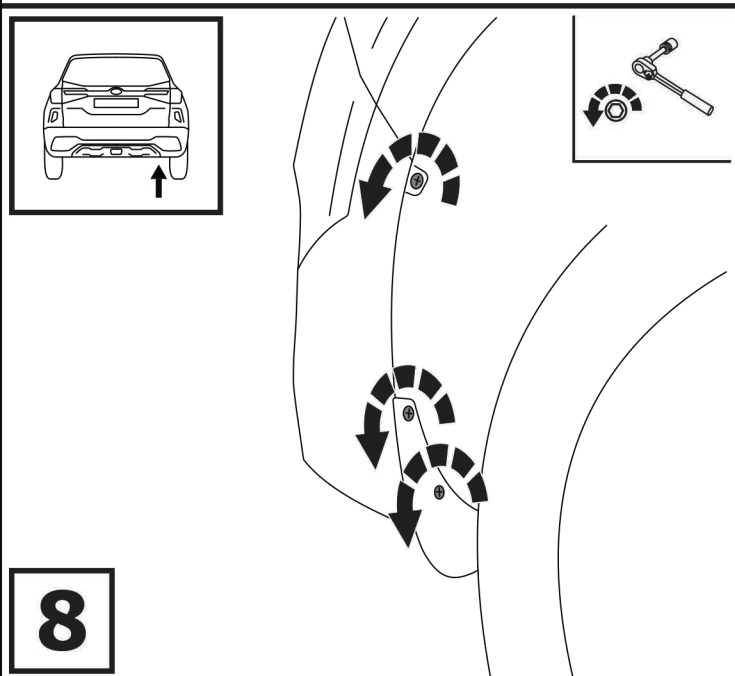
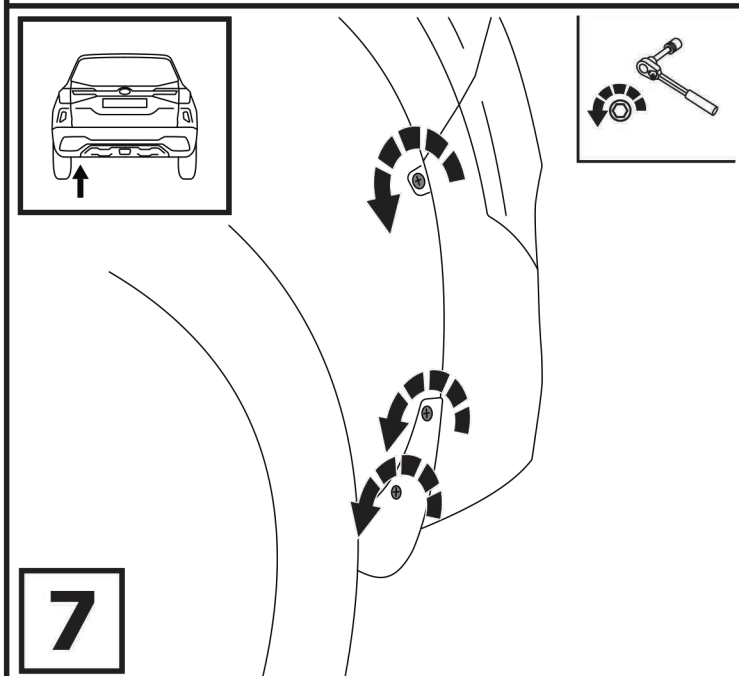
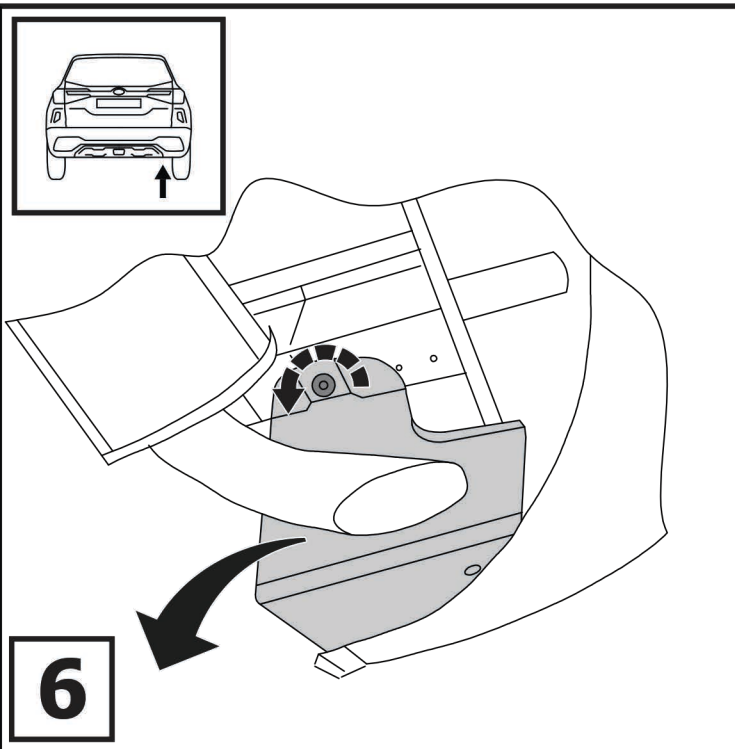
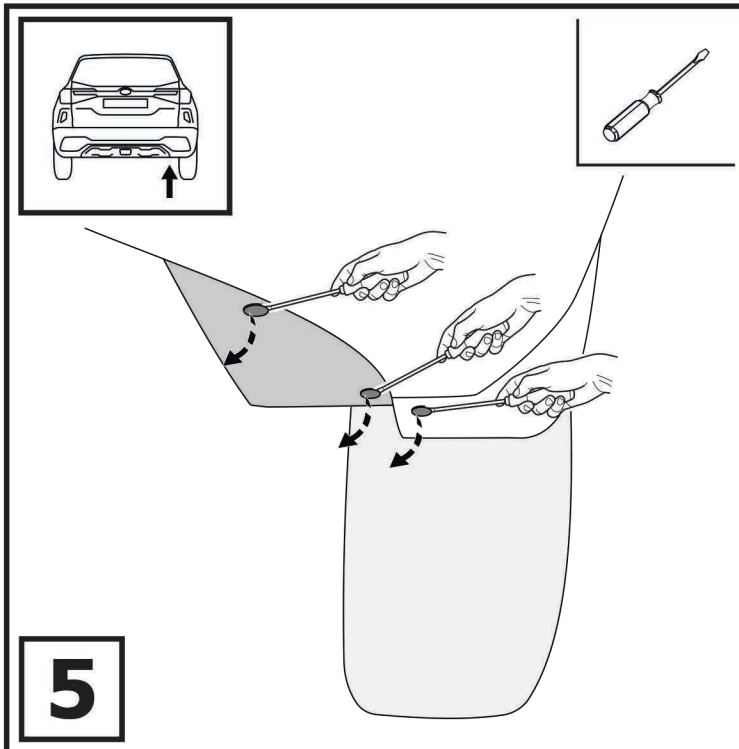

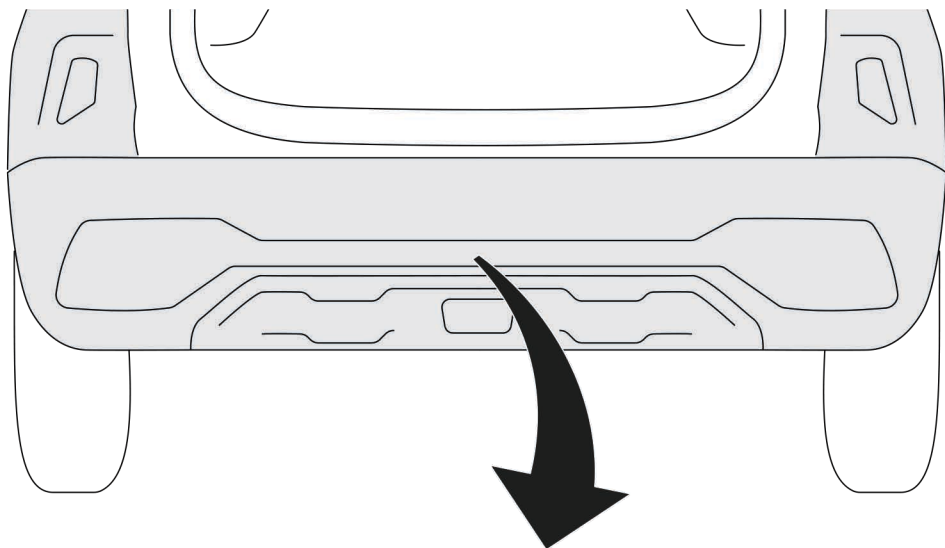
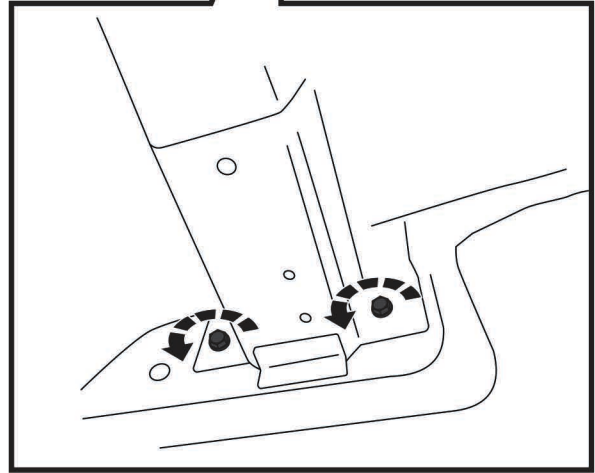
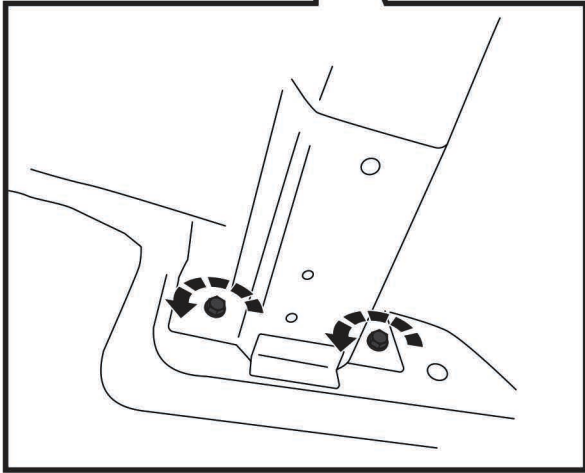
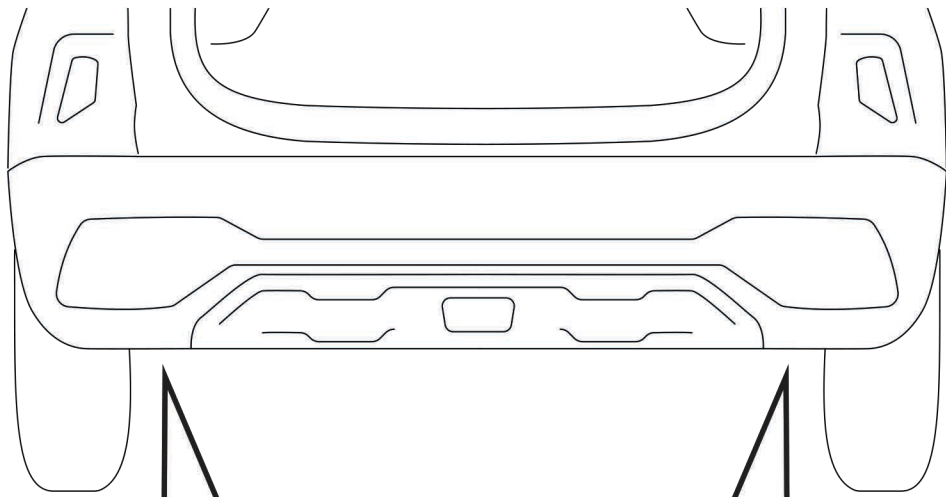

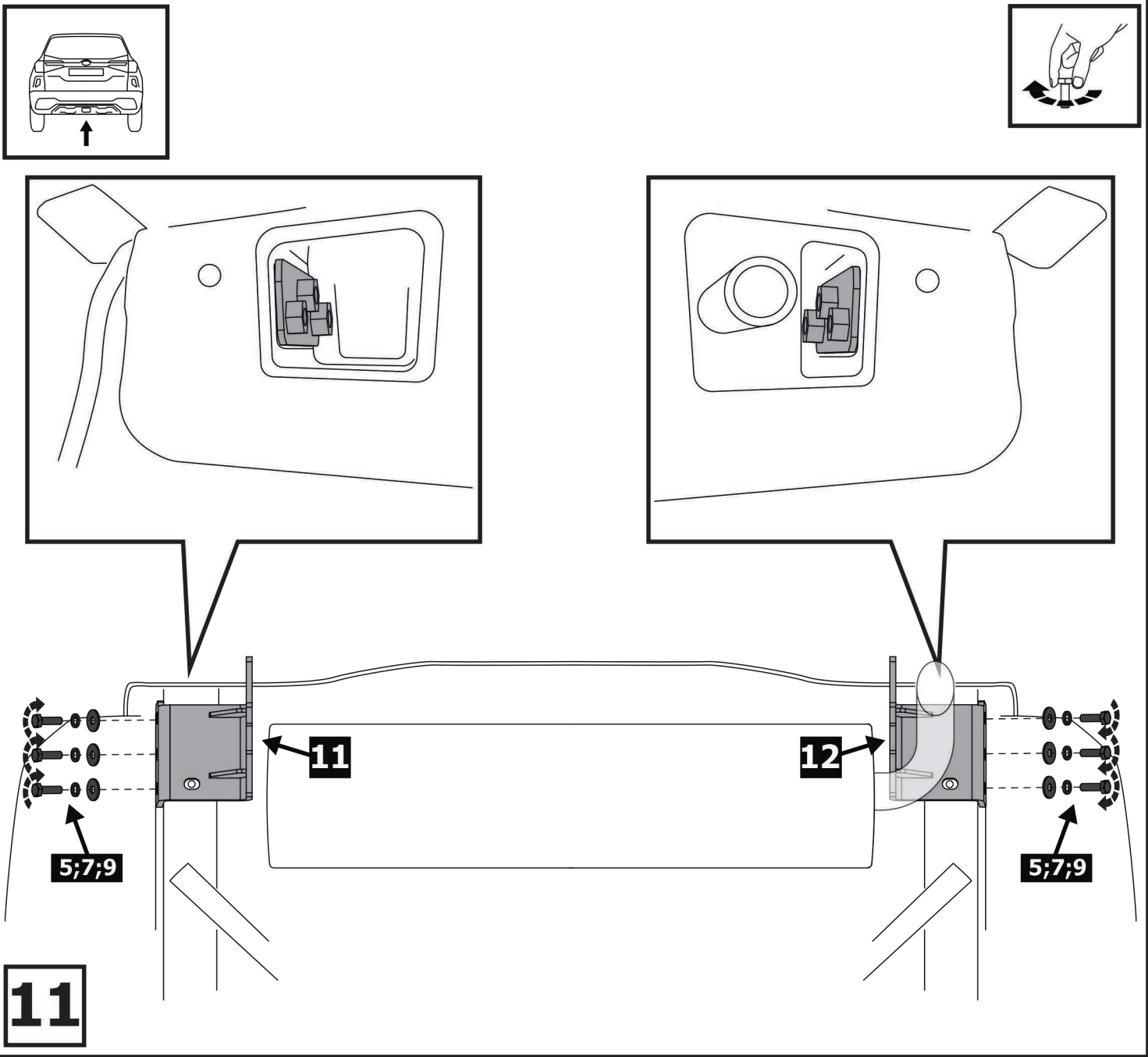
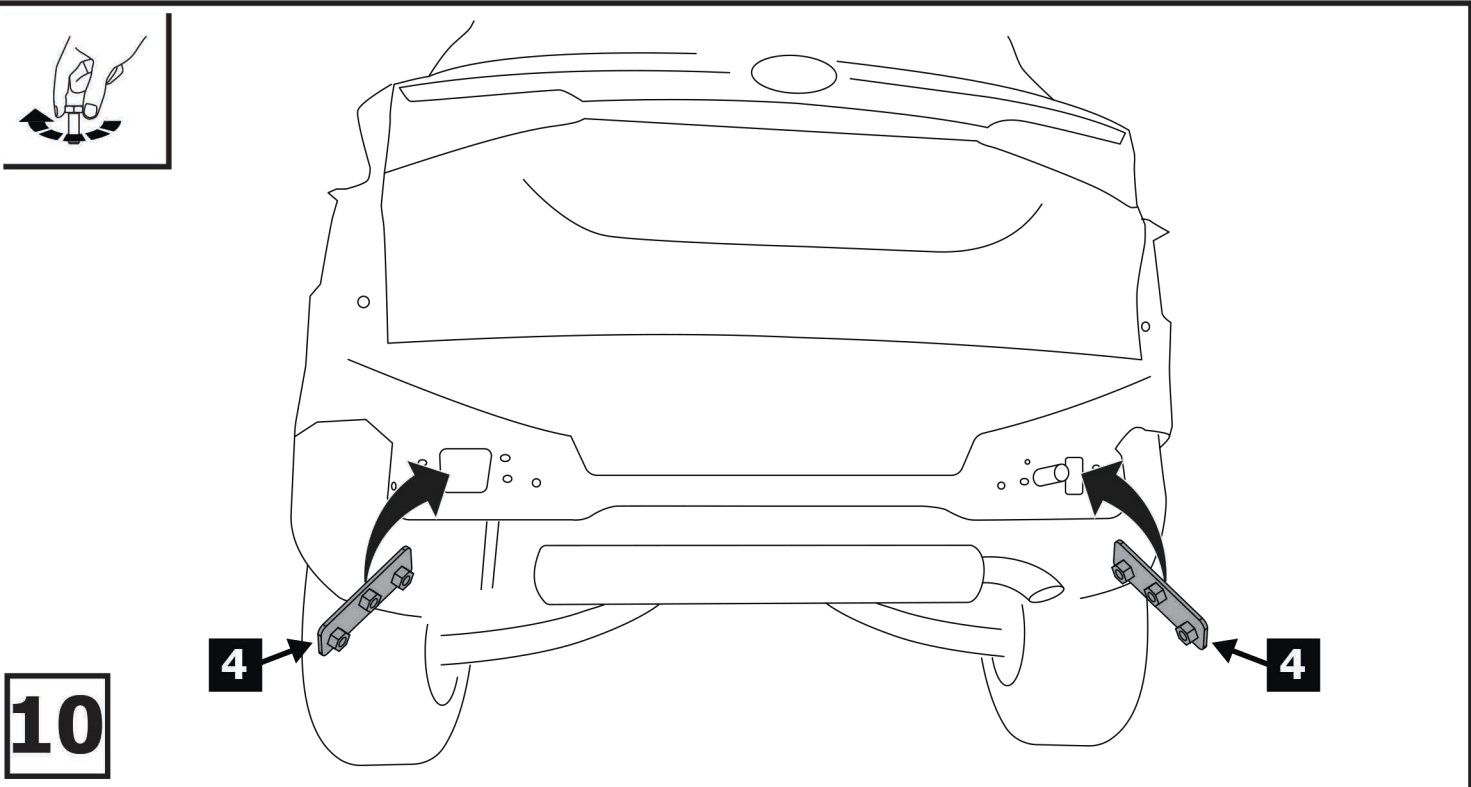

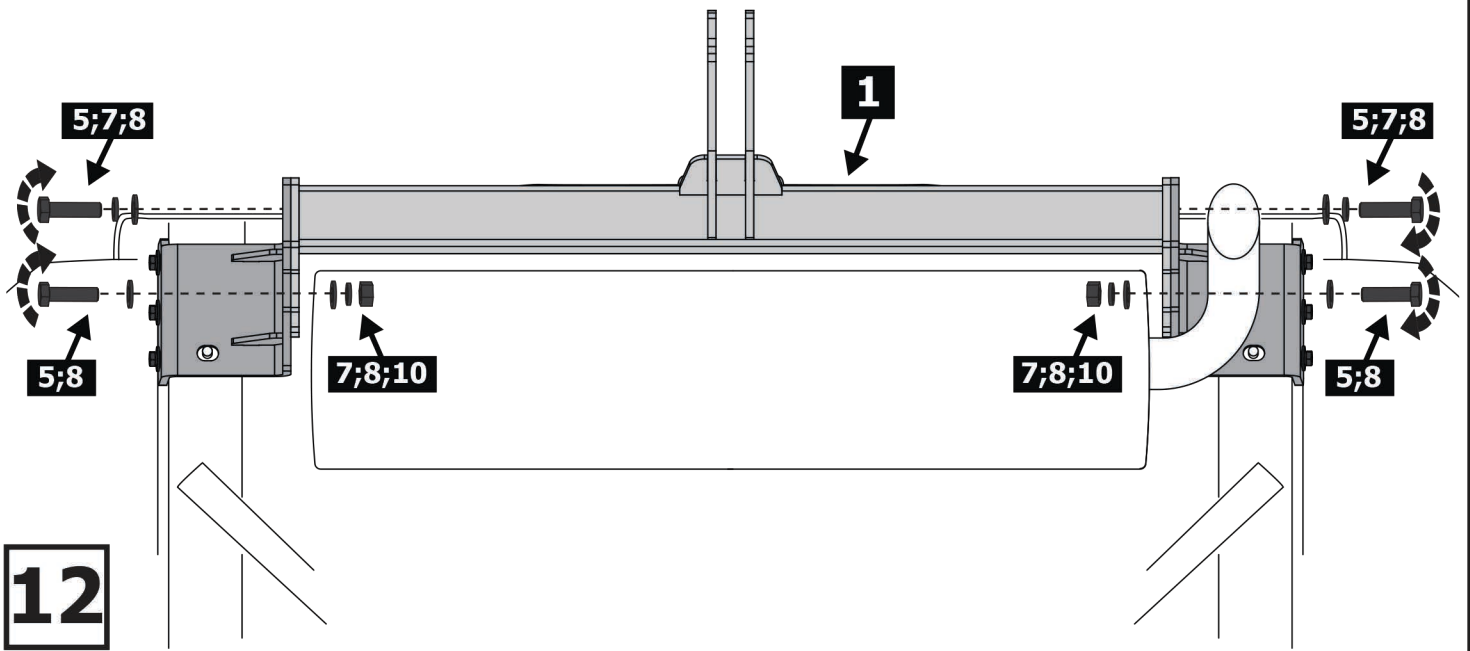
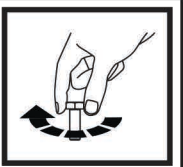
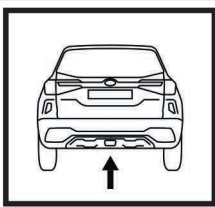

12

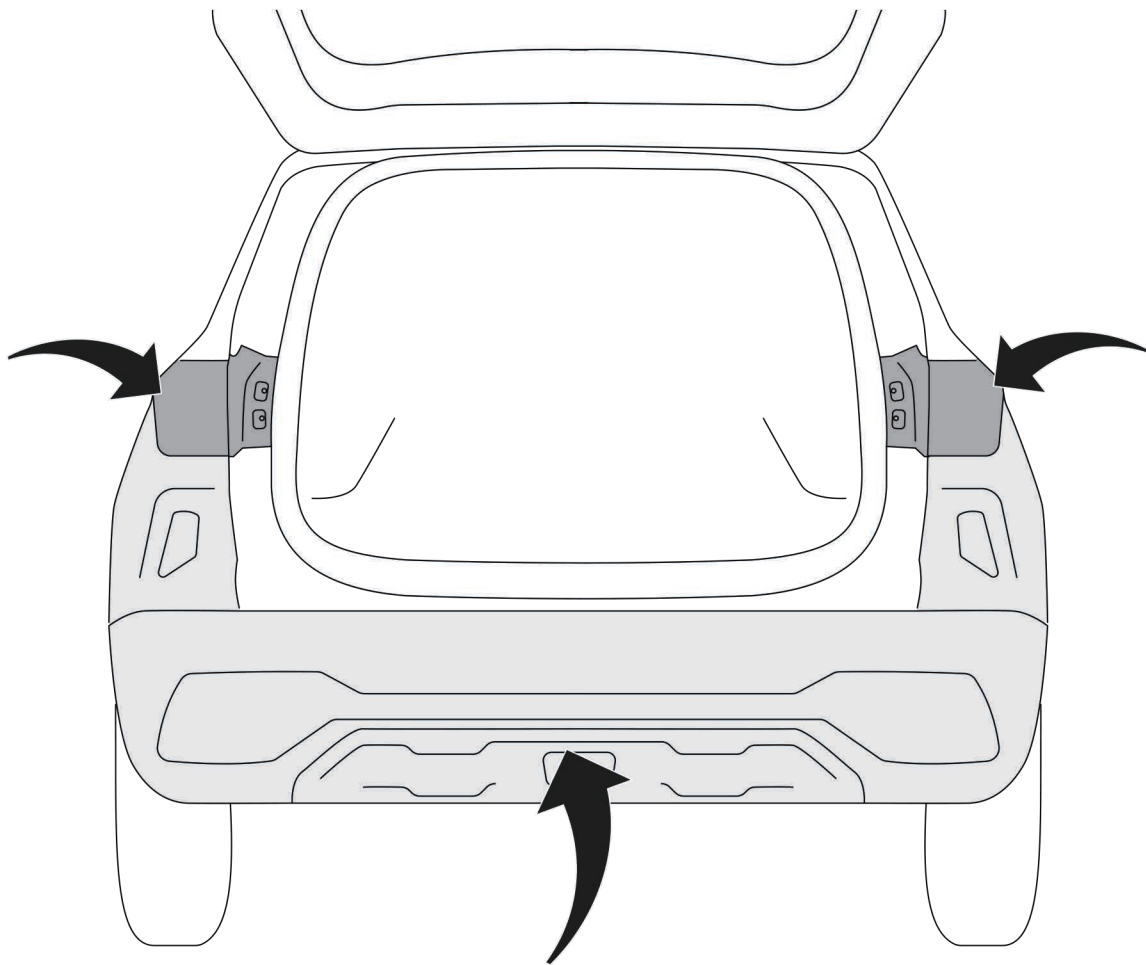

13

14

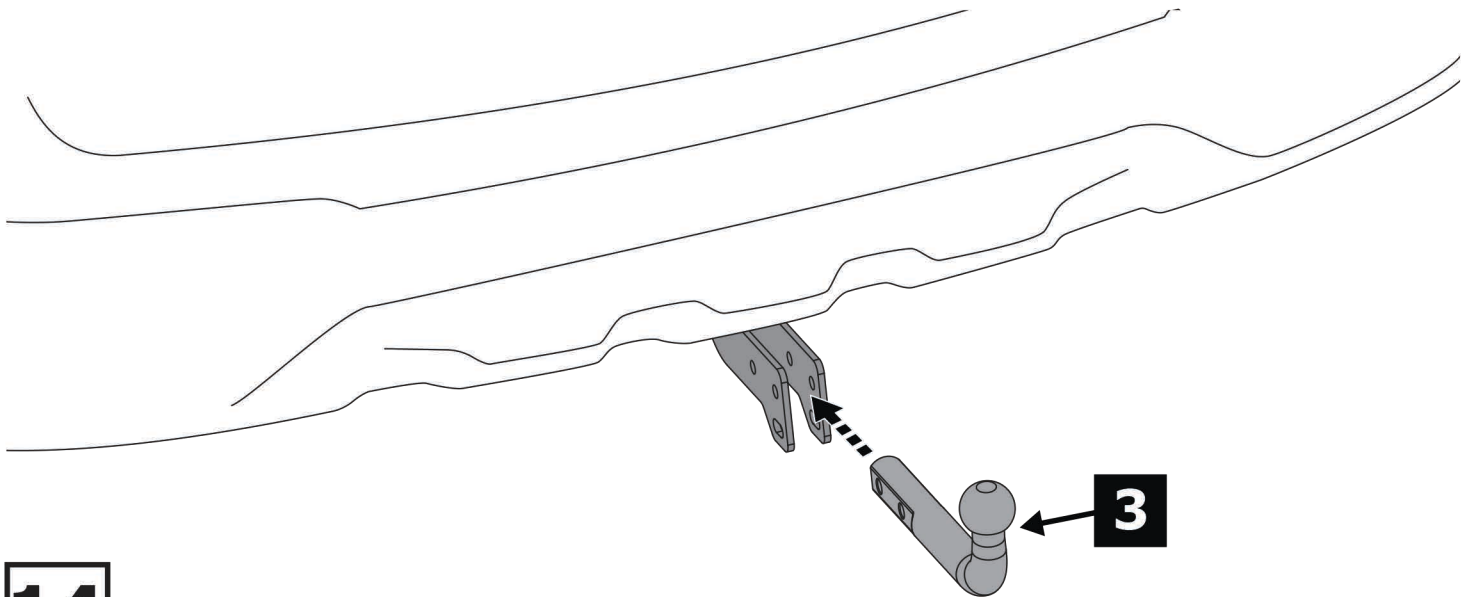

15

