



Инструкция по установке



Toyota RAV4

(2019-)

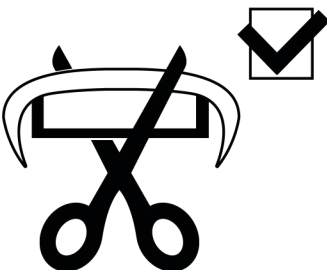

Арт.: F.5717.003

 2000 kg	 100 kg	D = 10,4 kN	
---	--	--------------------	---

D (kN) =	 MAX kg X MAX kg	x 0,00981
	 MAX kg + MAX kg	

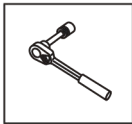

Вкрутить/выкрутить используя инструмент

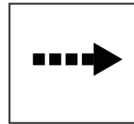

Движение

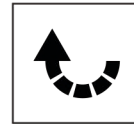

Поворот





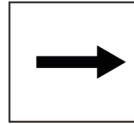





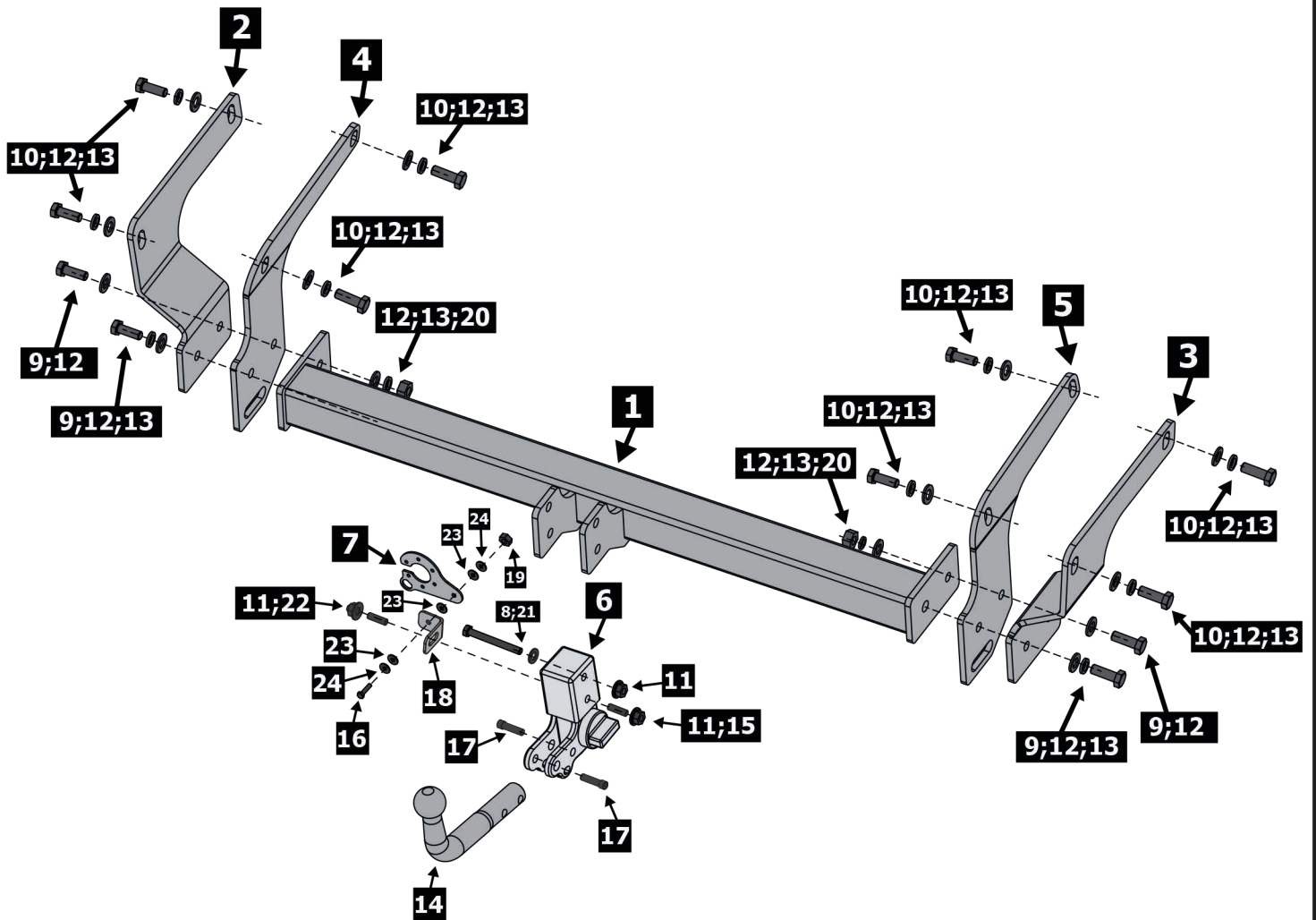
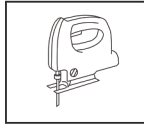
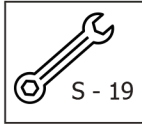
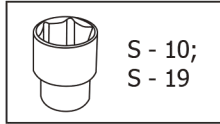
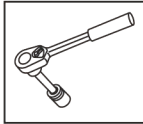

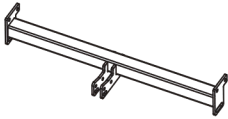
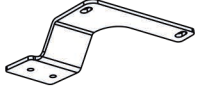

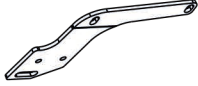
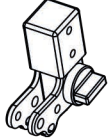

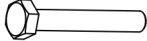





Вкрутить/выкрутить не затягивая

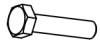
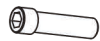

Расположение

Используемый инструмент:



1	x1	Балка	
2	x1	Кронштейн внешний левый	
3	x1	Кронштейн внешний правый	
4	x1	Кронштейн внутренний левый	
5	x1	Кронштейн внутренний правый	
6	x1	Быстросъемный крюк	
7	x1	Подрозетник	
8	x2	M12x100	
9	x4	M12x1.25x50	
10	x8	M12x1.25x35	
11	x3	M12	
12	x12	∅ 12	
13	x14	∅ 12	
14	x1	Крюк	
15	x1	Шпилька M12x35	
16	x1	M6x25	
17	x2	M12x45	
18	x1	Уголок	
19	x1	M6	
20	x2	M12x1.25	
21	x1	∅ 12	
22	x1	Шпилька M12x25	
23	x3	∅ 6 (полиамид)	
24	x2	∅ 6	

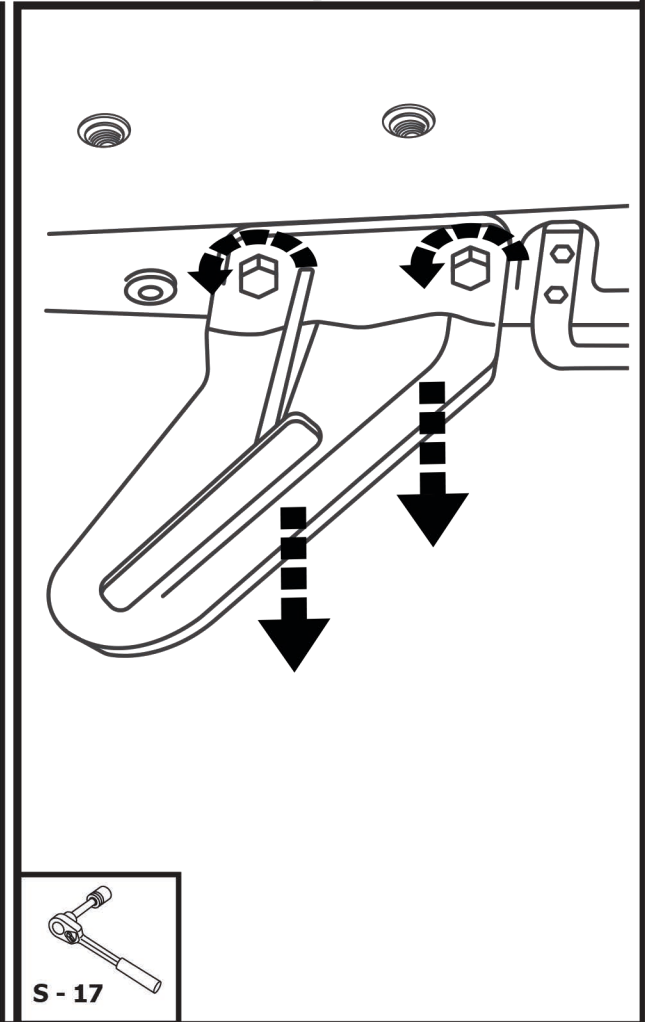
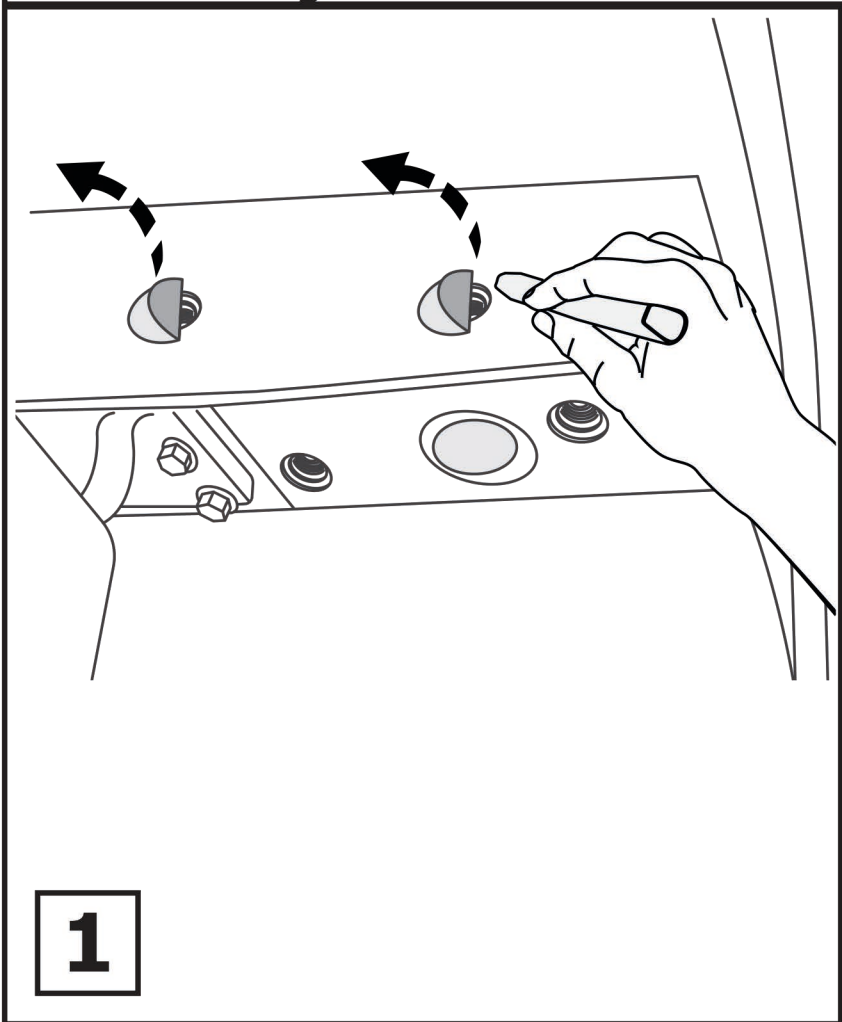
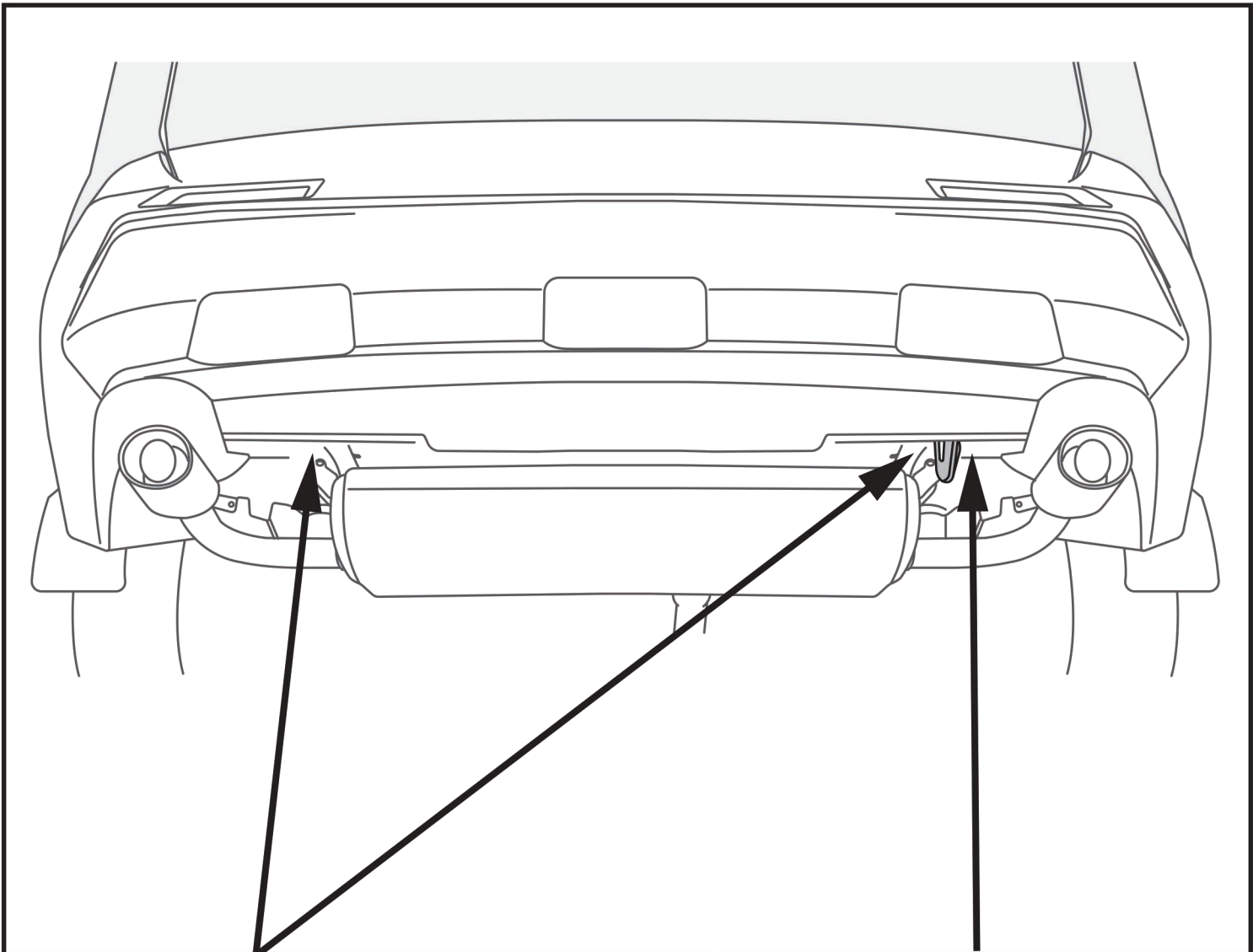

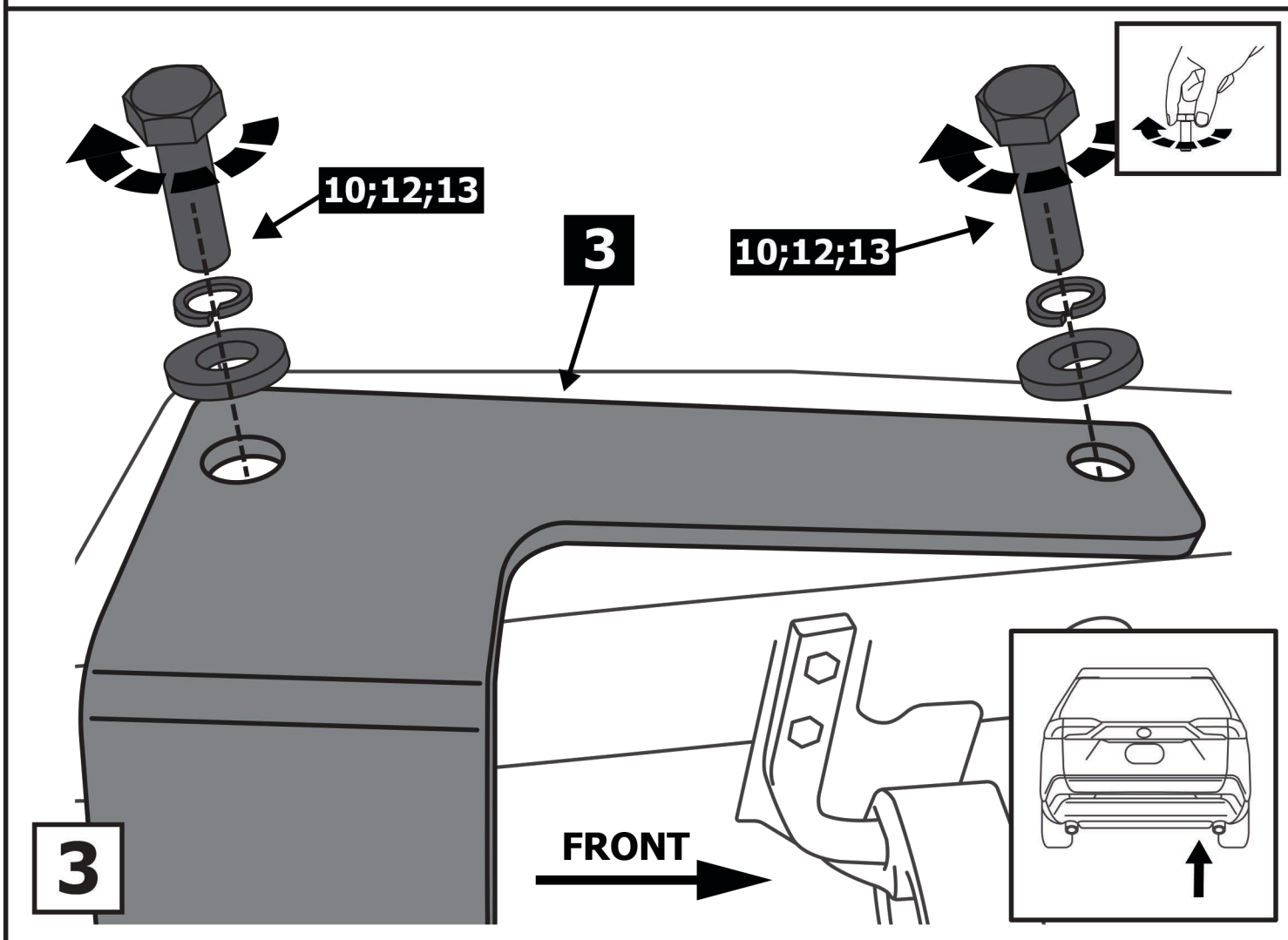
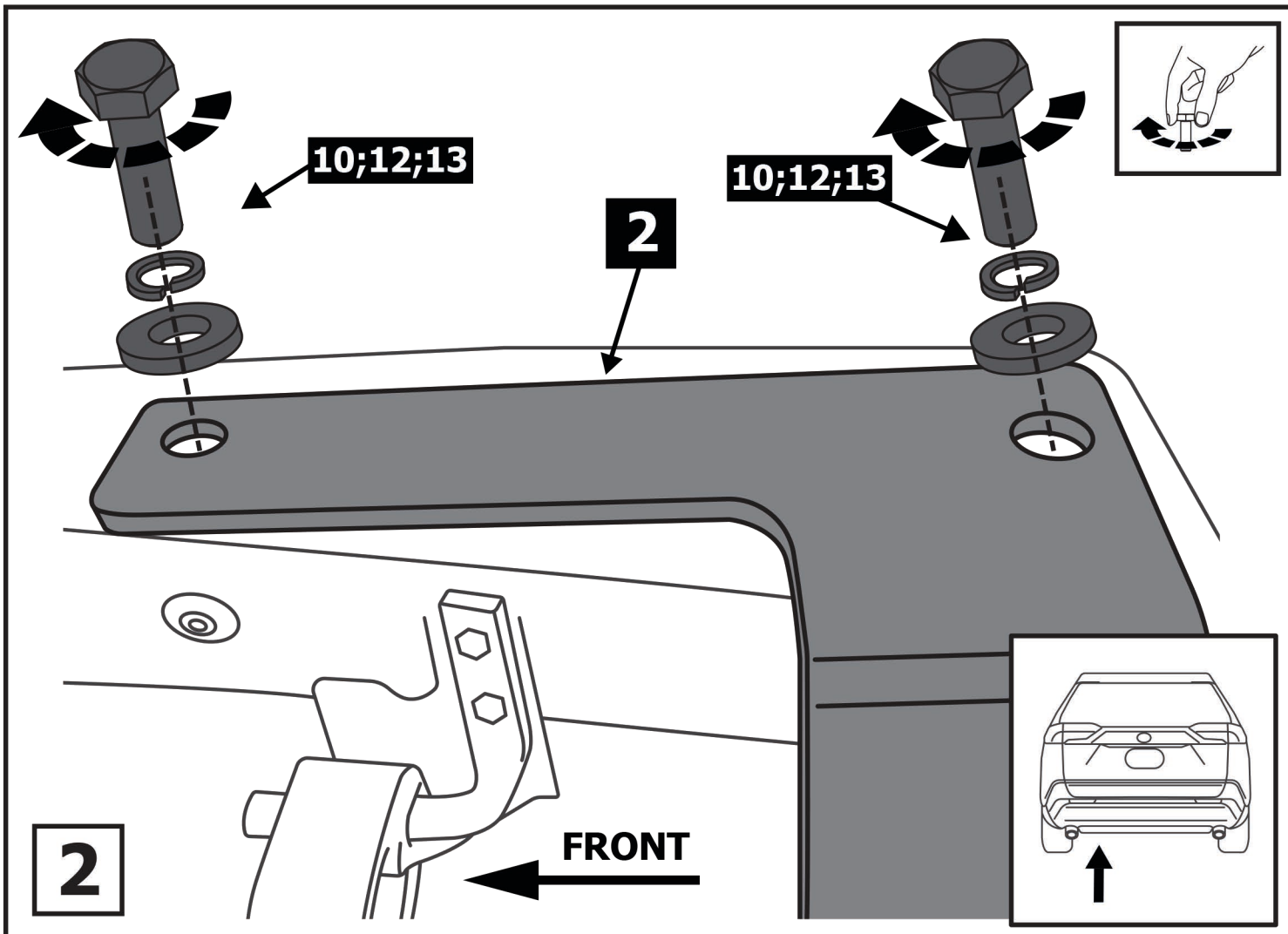

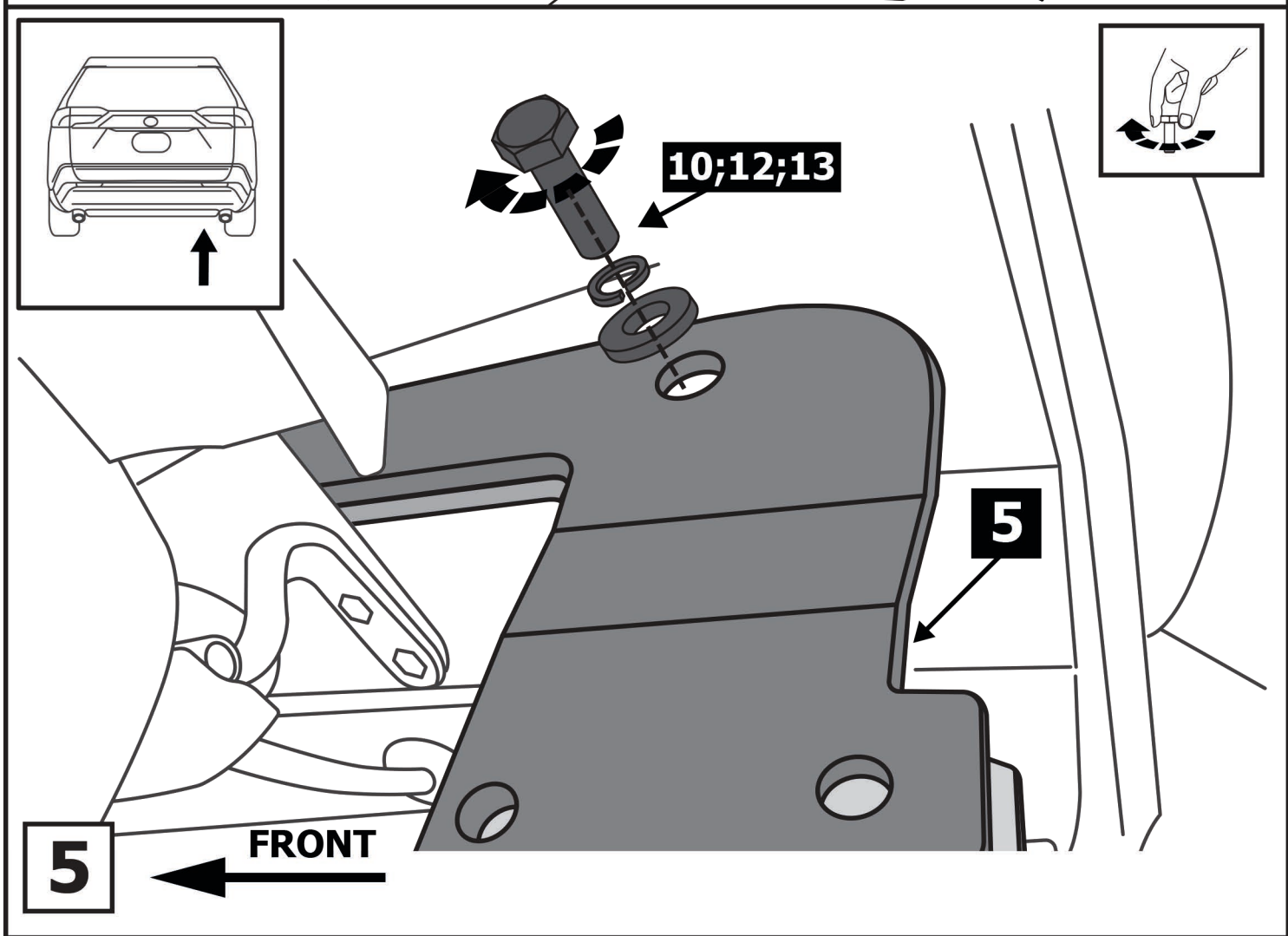
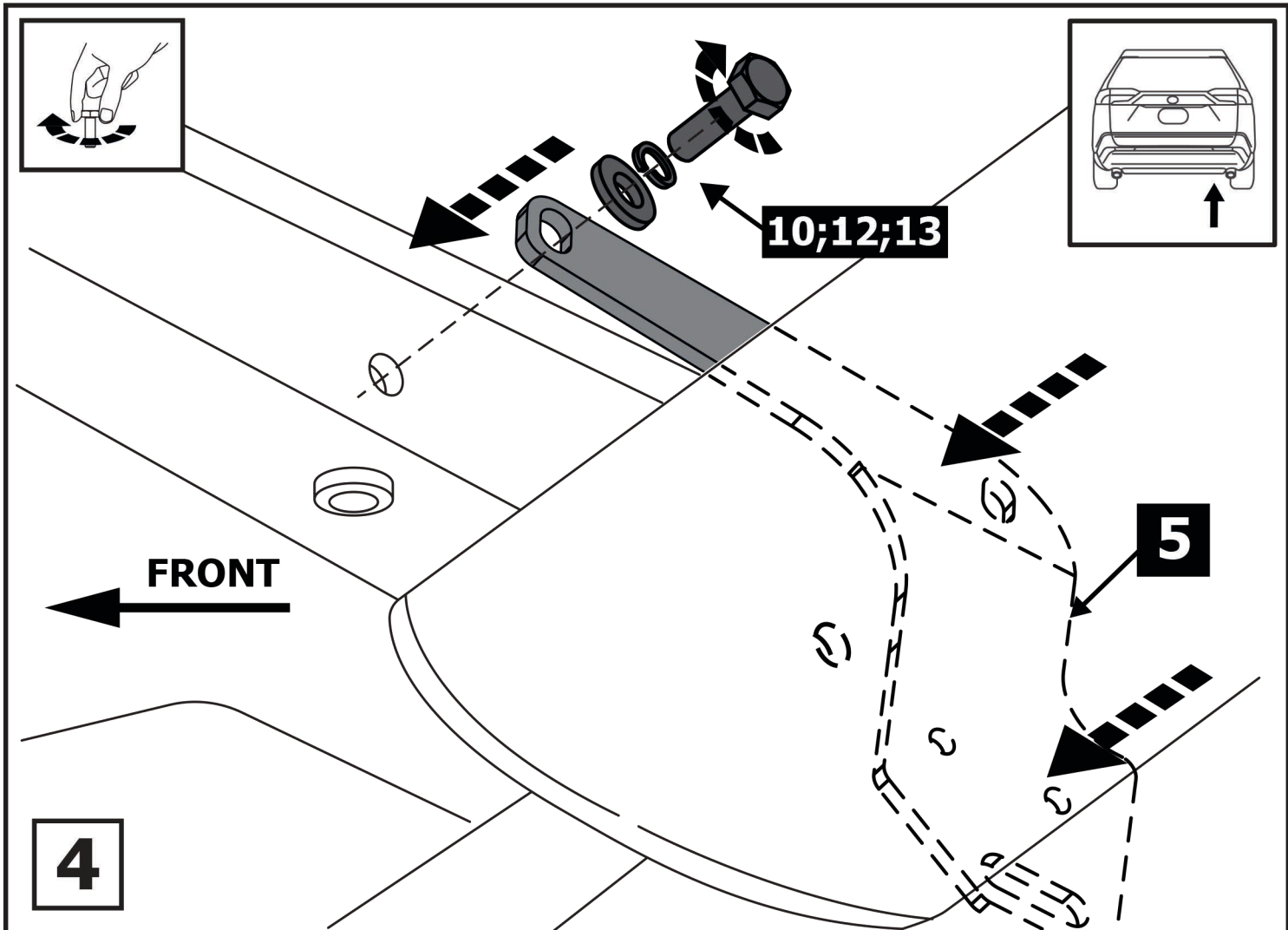

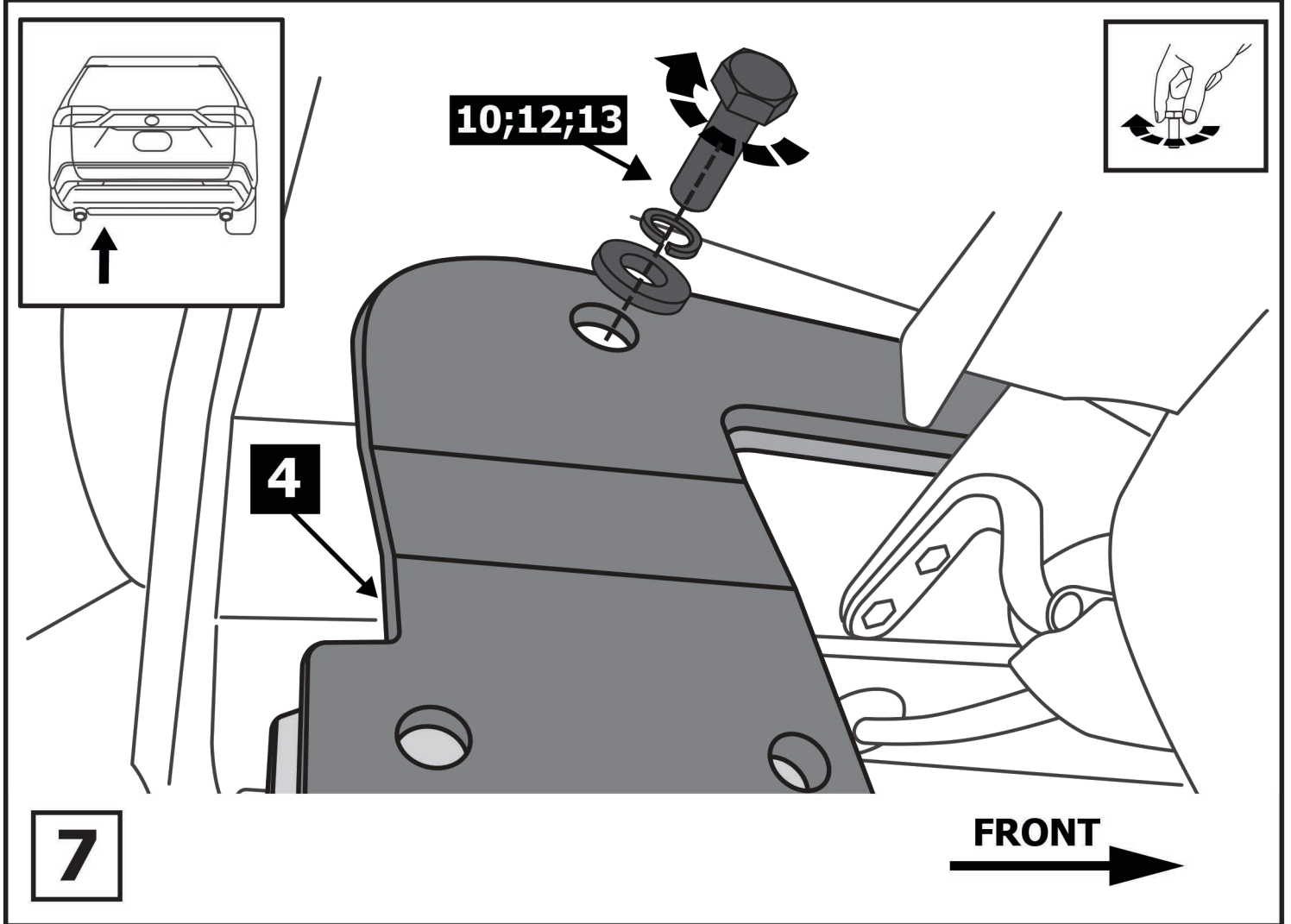
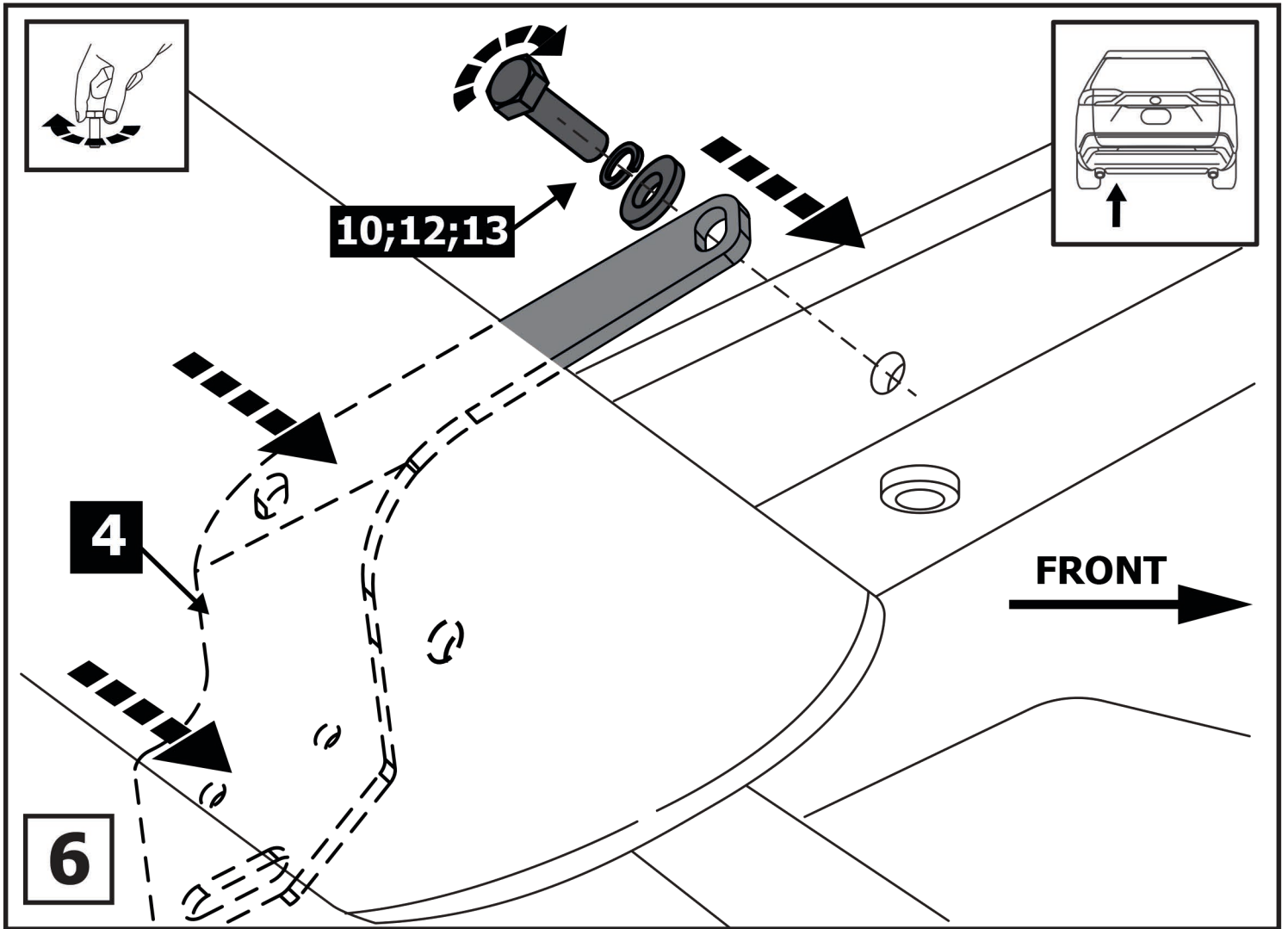

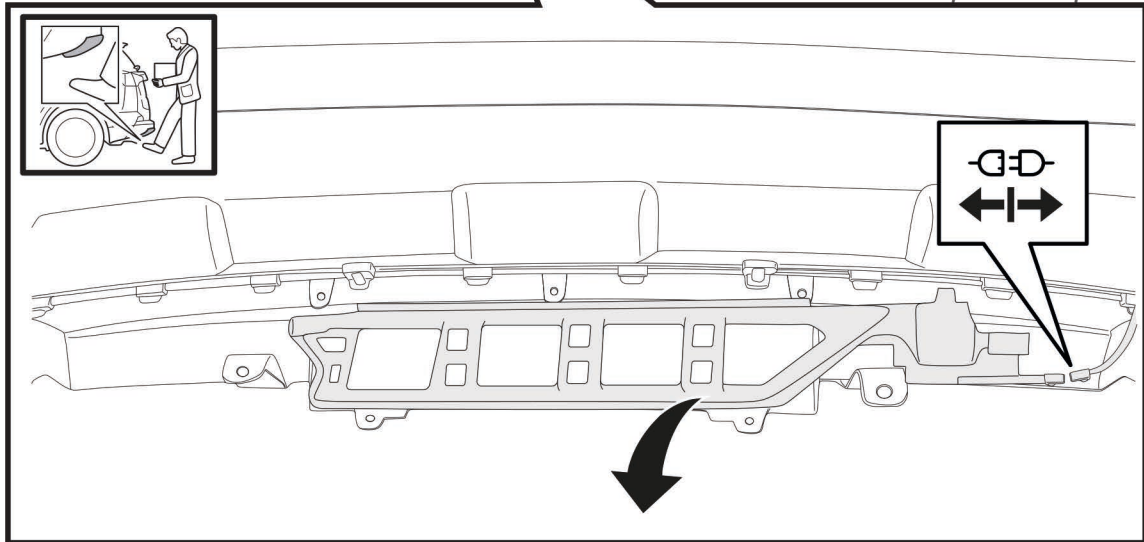
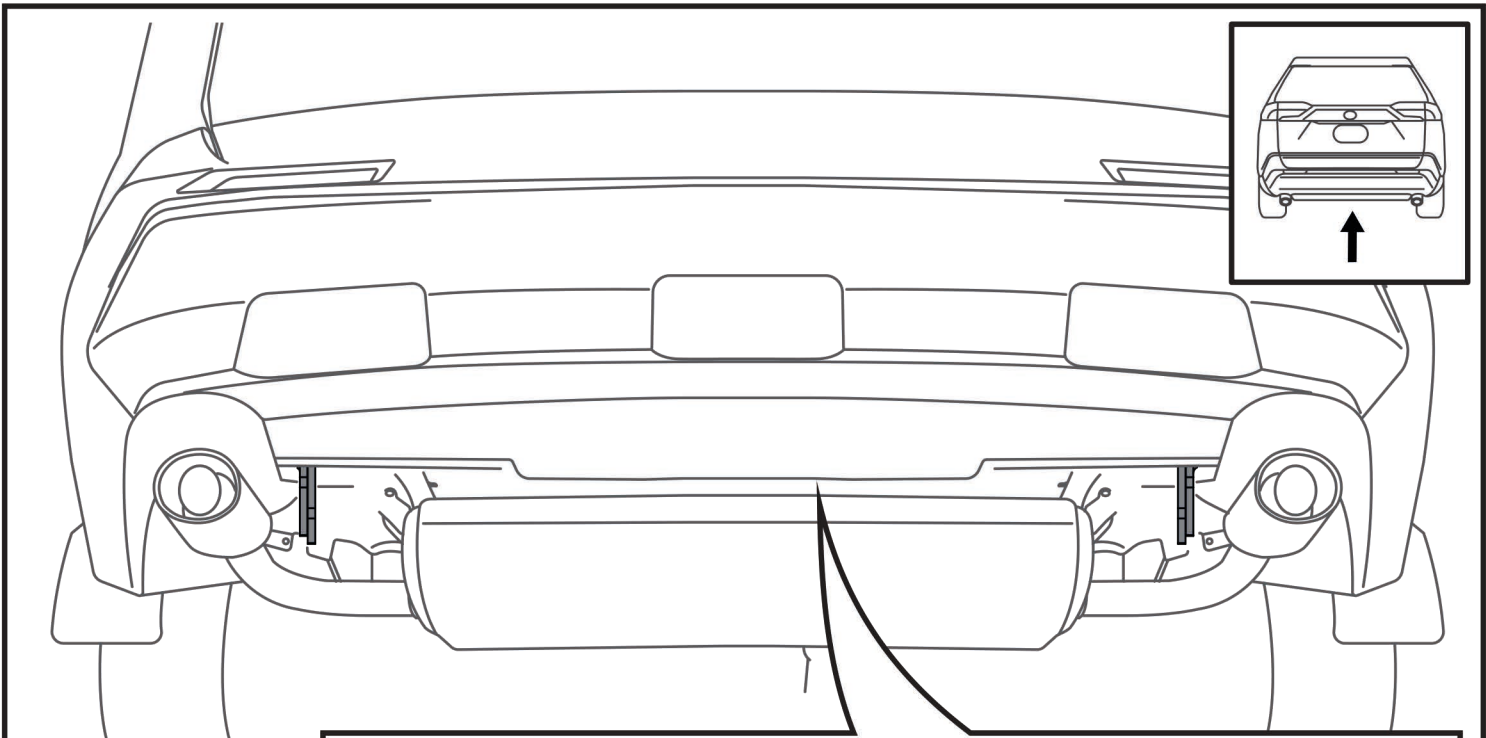

8

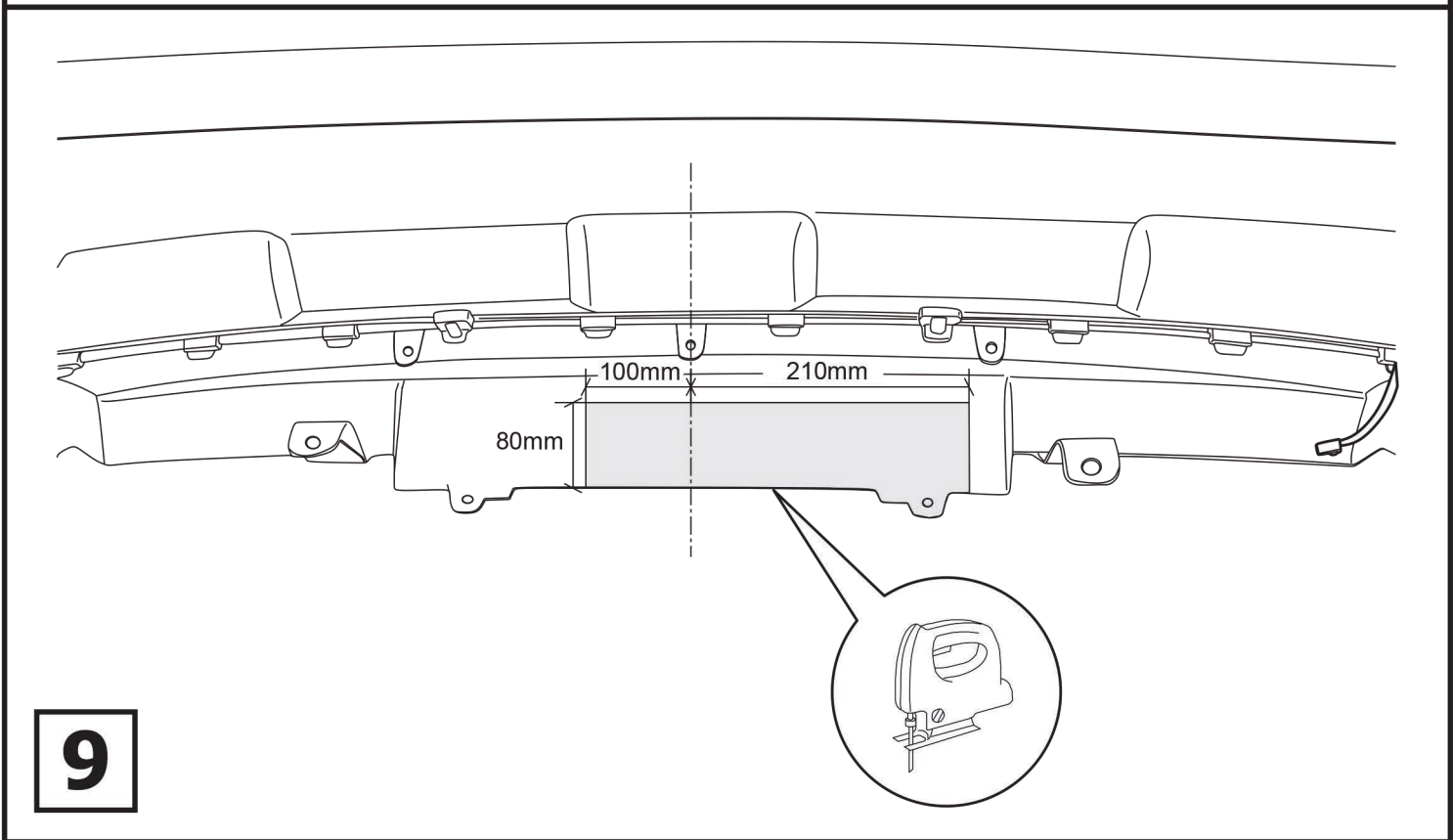

9

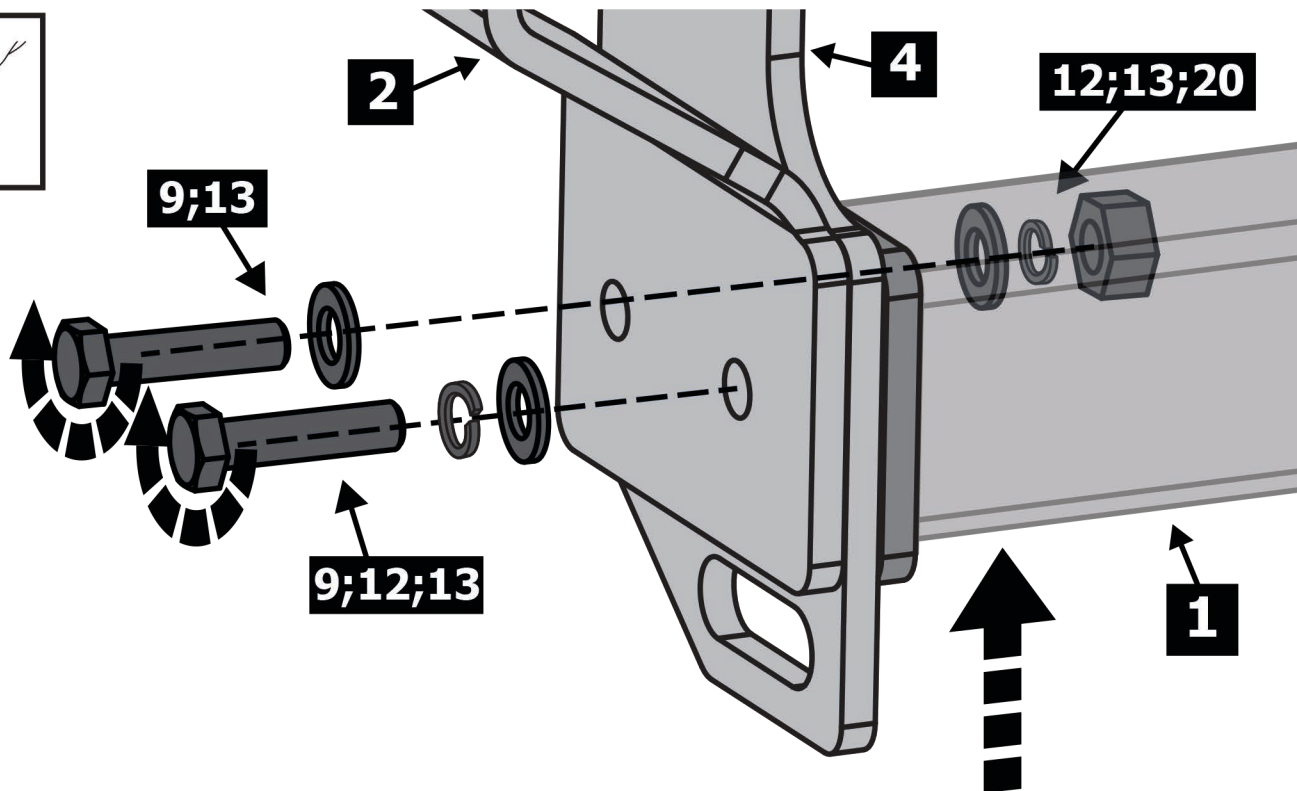
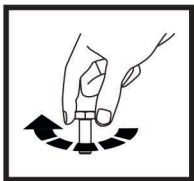

10

LEFT=RIGHT

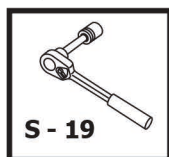
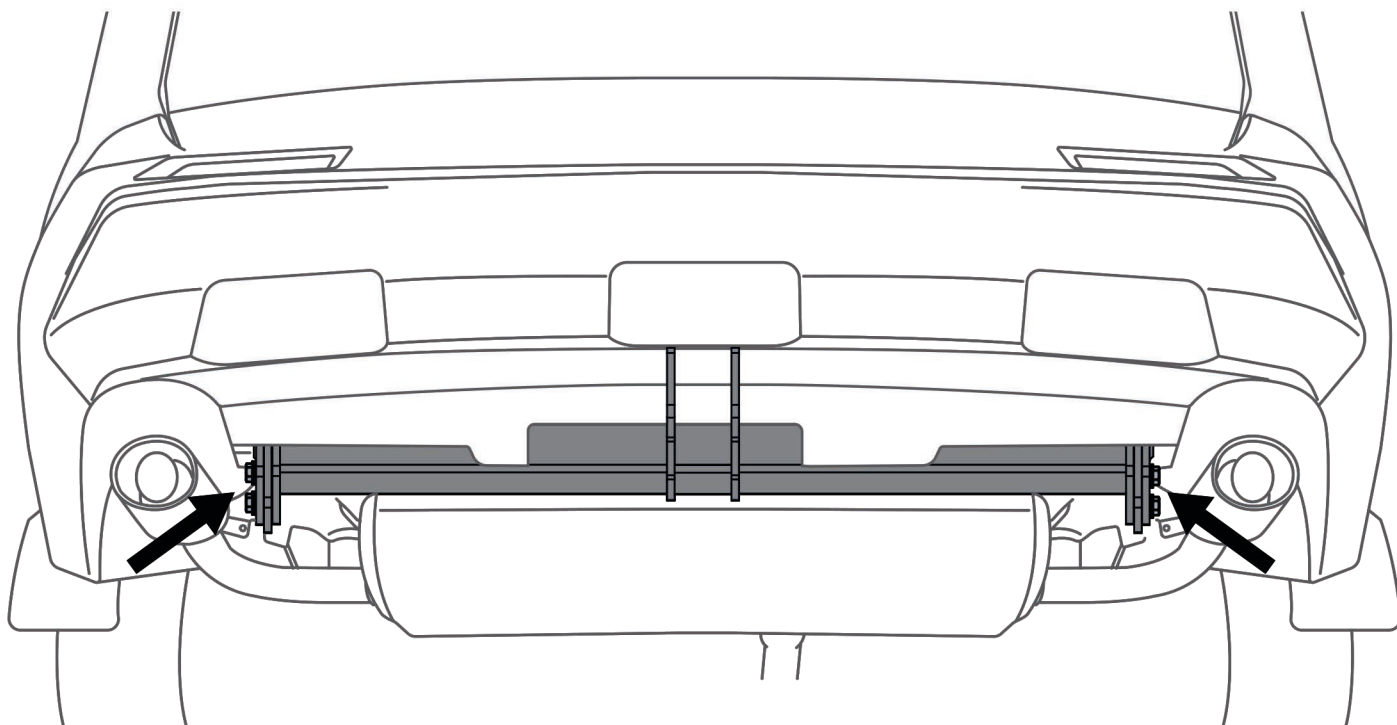

Затянуть резьбовые соединения балки с кронштейнами, затем кронштейнов с кузовом (M12=81 Nm)

11

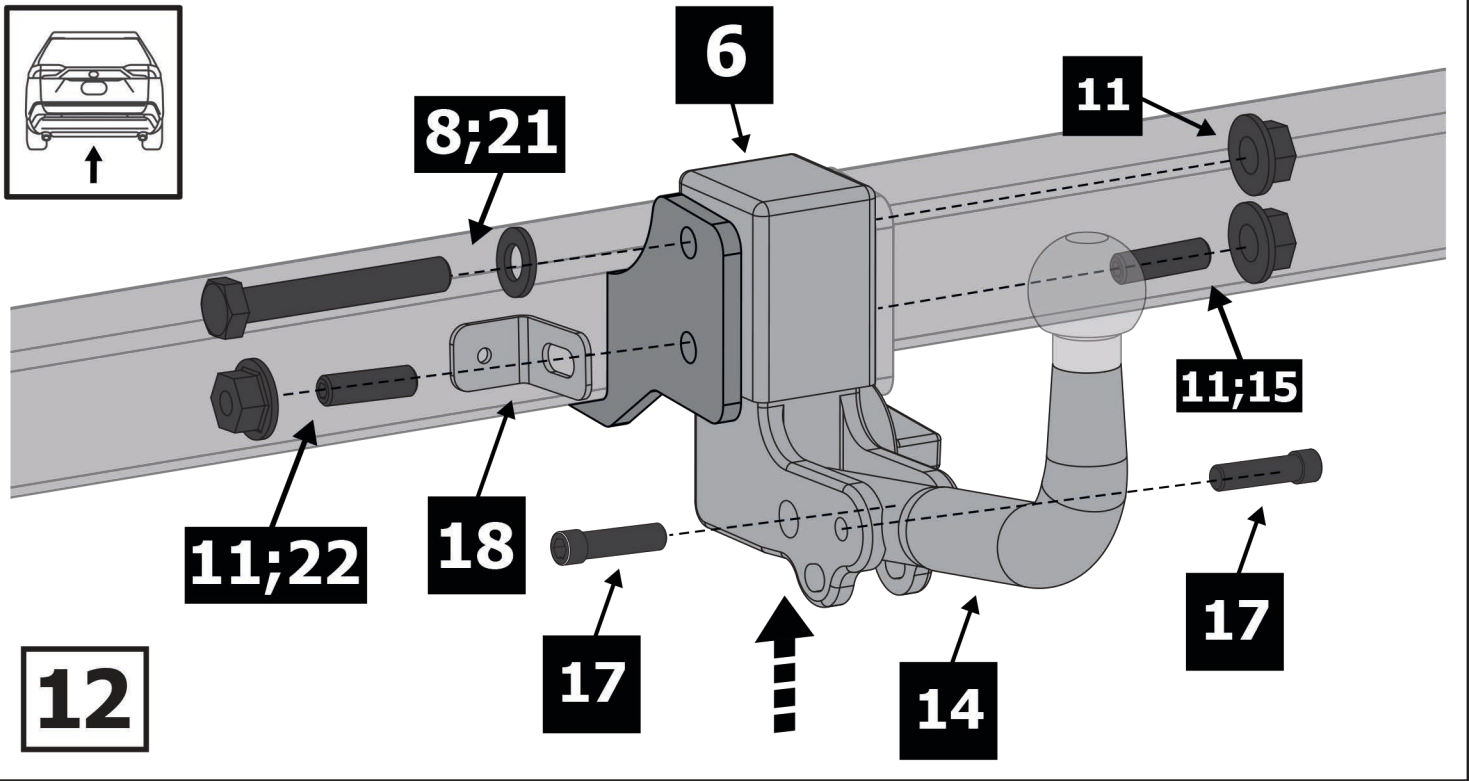

12

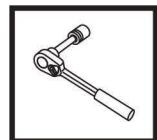
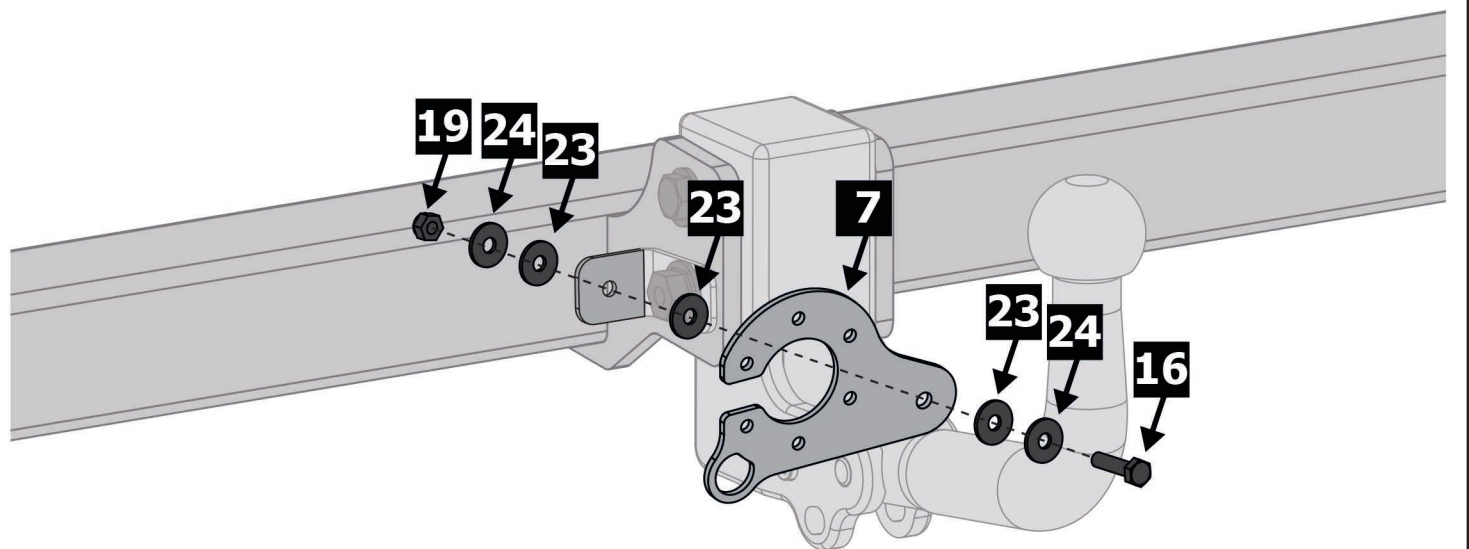

Затянуть все резьбовые соединения
M6 = 6 Nm M12 = 81 Nm

13