

5 YEAR WARRANTY



ORIGINE FRANCE GARANTIE
BY Cert. 6010761

V-INSP-L

Maturing cabinet

Built-in and Flush-fitted – Integrated glass door
1-temperature



Sliding shelf
(6 bottles)

ACMSIW / ACMSIB



Wine service area
(11 bottles)

ACMSERVW / ACMSERVB



Storage shelf
(up to 22 bottles)

AXIHW / AXIHB



Half shelf
(5 bottles)

ACMSI-DEMI

CONFIGURATIONS

Premium Pack bottle capacity ¹	Service Pack bottle capacity ¹	Access Pack bottle capacity ¹
89	88	89
14 sliding shelves (+grid)	12 sliding shelves 1 half shelf 1 Wine service area	3 sliding shelves 3 storage shelves (+grid)

TECHNICAL FEATURES

REGULATION

- On/Off/Standby of the display button
- Electronic regulation
- Temperature setting range between 5°C and 20°C
- Electronic external display and settings
- LED screen
- Backlit capacitive keys
- Visual and/or sound alarms in case of:
 - Temperature dysfunction (sound and visual)
 - Hygrometry dysfunction (visual)
 - Sensor fault (sound and visual)
 - Hygrometry limit (visual)
 - Open door (sound and visual)
 - Need to replace charcoal filter (visual)
- Automatic defrost
- Frost protection thermostat (double protection)

HOT – COLD – INSULATION TECHNOLOGIES

Cold production:	<ul style="list-style-type: none"> • Ventilated • Compressor R600a
Cords:	<ul style="list-style-type: none"> • CE/UK/AU/CH/US
Heat production:	<ul style="list-style-type: none"> • Heating element
Heat release:	<ul style="list-style-type: none"> • Automatic, adjustable threshold
Inner material:	<ul style="list-style-type: none"> • Stucco aluminum
Exterior coating material:	<ul style="list-style-type: none"> • HDF (High Density Fiber) melamine-faced panels
Insulation type:	<ul style="list-style-type: none"> • Injected polyurethane foam (59mm)

GENERAL FEATURES

	Integrated glass
Gross weight packaged (kg)	97,8
Empty net weight (kg) ²	86,8
Dimensions H x W x D (mm)	1820-1890 x 594 ³ x 597
Dimensions packaged H x W x D (mm)	1980 x 645 x 630

EQUIPMENT & ACCESSORIES

EQUIPEMENT

- Reversible Integrated glass door with soft close and door stop
- Max thickness of the door panel: 20 mm
- Max weight of the door panel: 12 kg
- Inner lighting : light strip and 2 LED (3 options: permanent, open door, disabled)
- Charcoal filter
- 4 adjustable feet
- Humidity cartridge

ACCESSORIES

- Sliding shelves with Mains du Sommelier, open / close locking notch, setting of the Main du Sommelier at the front of the shelf
- 6 removable bottles identifiers per sliding shelf
- 1 erasable felt-tip marker
- 1 microfiber cloth
- 1 EuroCave key ring

ENERGY EFFICIENCY & CONSUMPTION

Cords	230V-50Hz (R600a)
Type of door	Integrated glass
Energy efficiency class	A
Annual energy consumption Aec ⁴ (Kwh/year)	165
Useful volume (liters)	285
Sound emission (dB(A))	38
Ambient temperature range (°C)	12-35

¹ Traditional Bordeaux bottles

² Without cladding

³ Without fillers

⁴ Calculation based on the result obtained over 24 hrs in standard conditions (25°C / 77°F)

Dimensions of the decoration panel

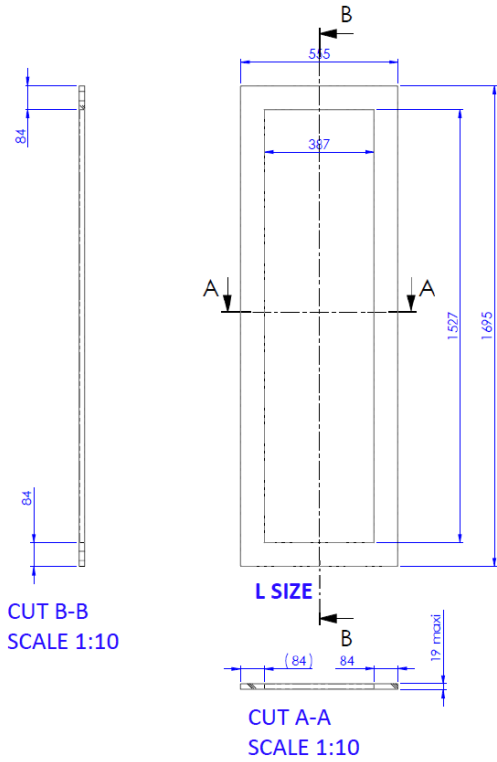

Storage layouts

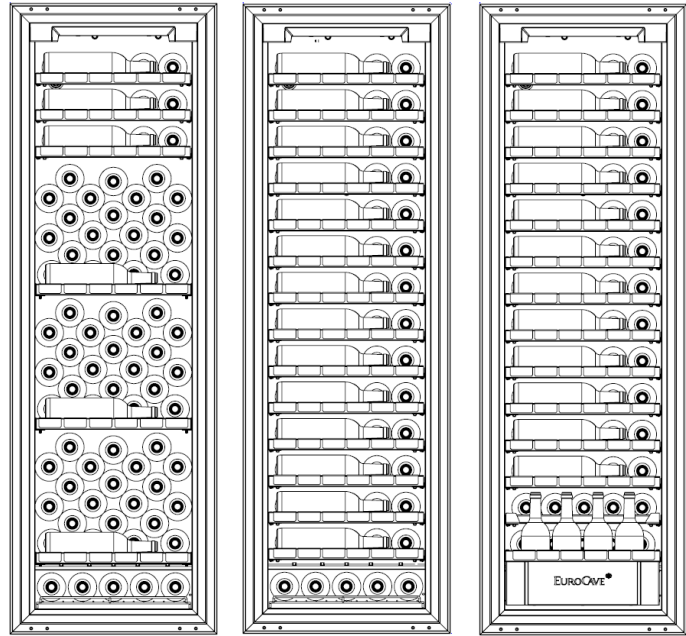

Access Pack

Premium Pack

Service Pack

Installation diagrams

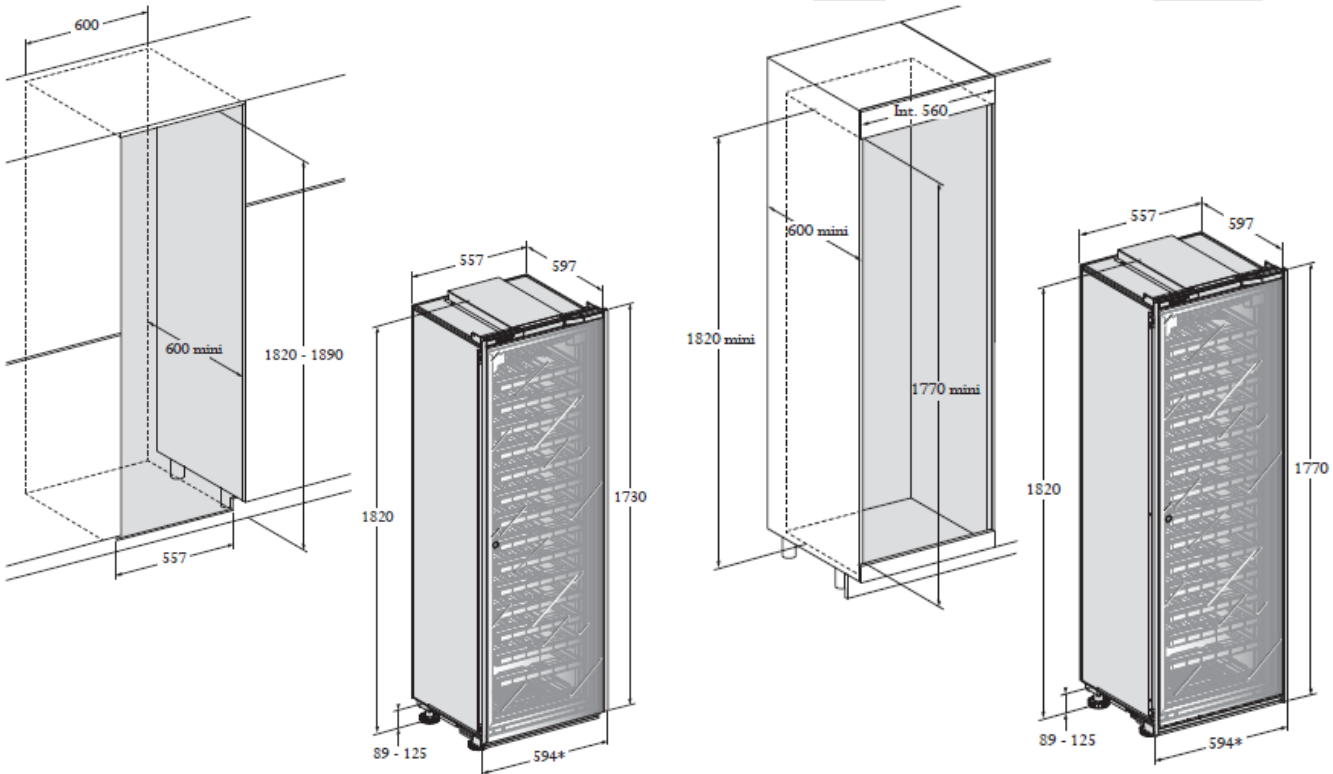

Built-in

Flush-fitted