

ТЕХНИЧЕСКИЙ ПАСПОРТ, ПРАВИЛА ЭКСПЛУАТАЦИИ
ИНСТРУКЦИЯ ПО СБОРКЕ, ГАРАНТИЙНЫЙ ТАЛОН

теплица
Польза-4

Усиленная



МЕТАЛЛИЧЕСКИЙ КАРКАС АРОЧНОГО ТИПА
ДЛЯ ПОКРЫТИЯ СОТОВЫМ ПОЛИКАРБОНАТОМ

1. Обвязка

1.1 Брус 100х150 мм/ 6 м

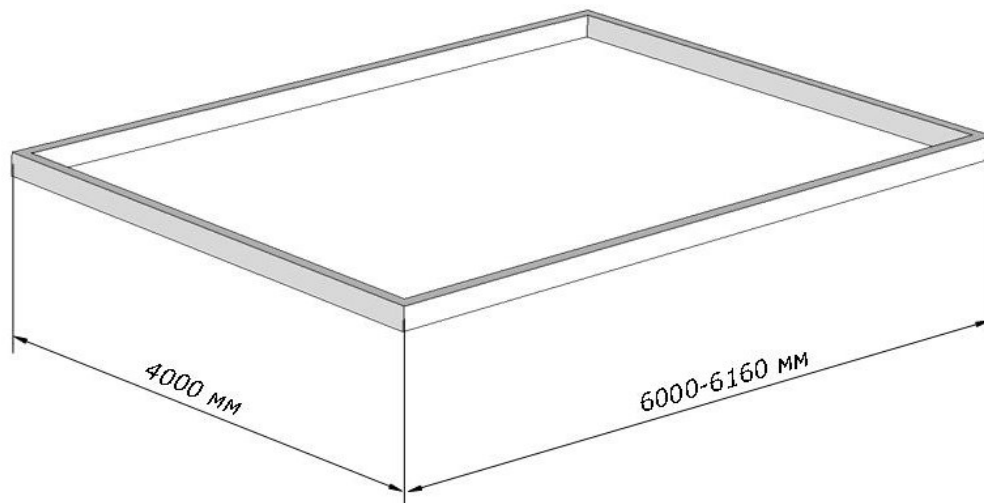

1.2 Брус 100х150 мм/ 8 м

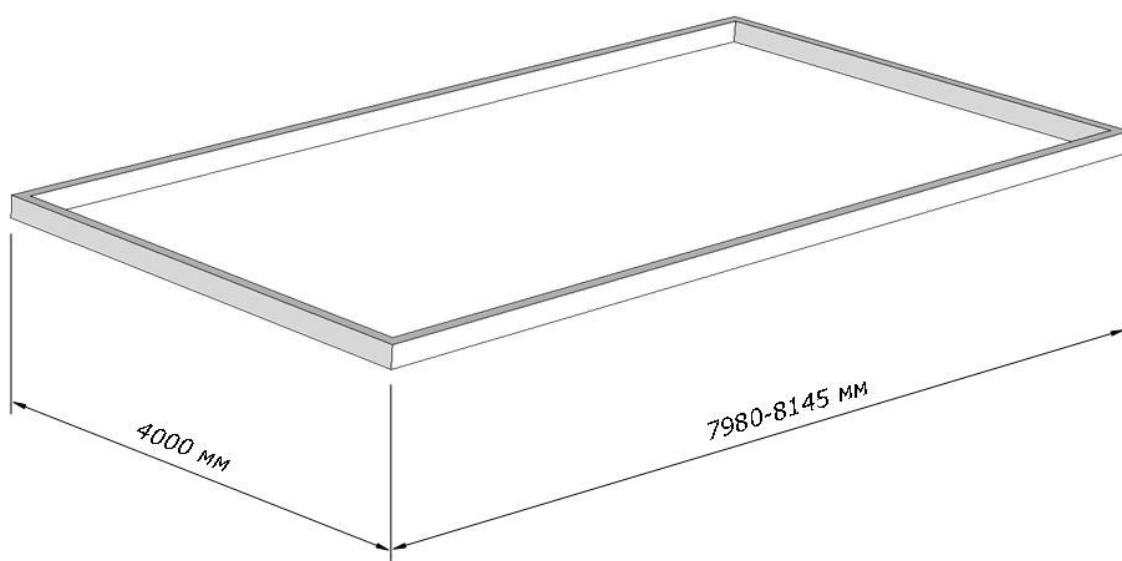

2. Каркас

2.1 Торец

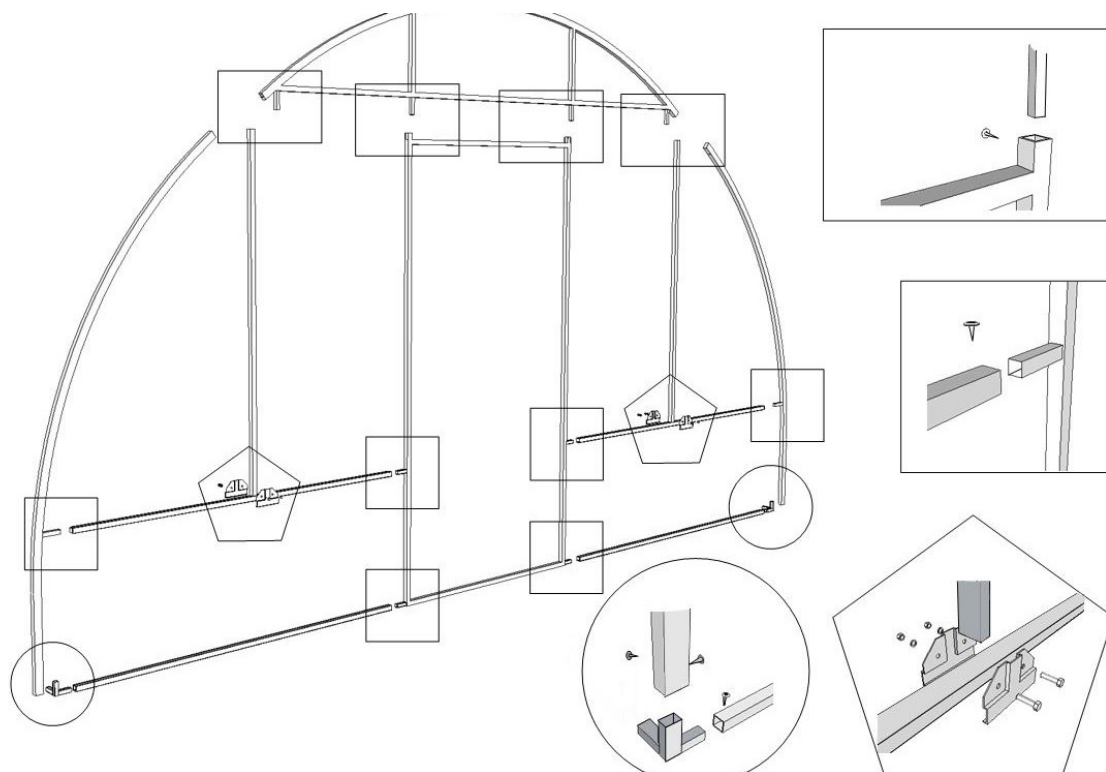

2.2 Дверь

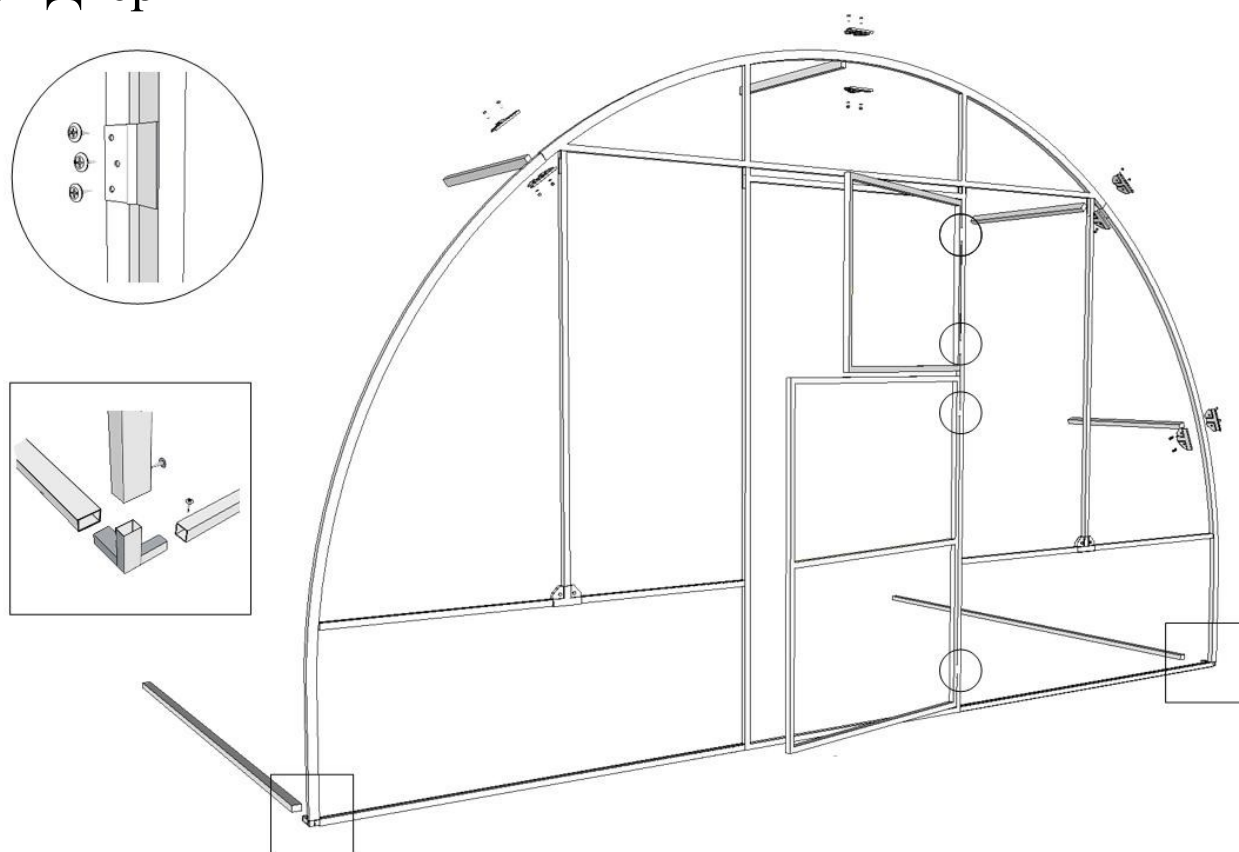

2.3 Туннель

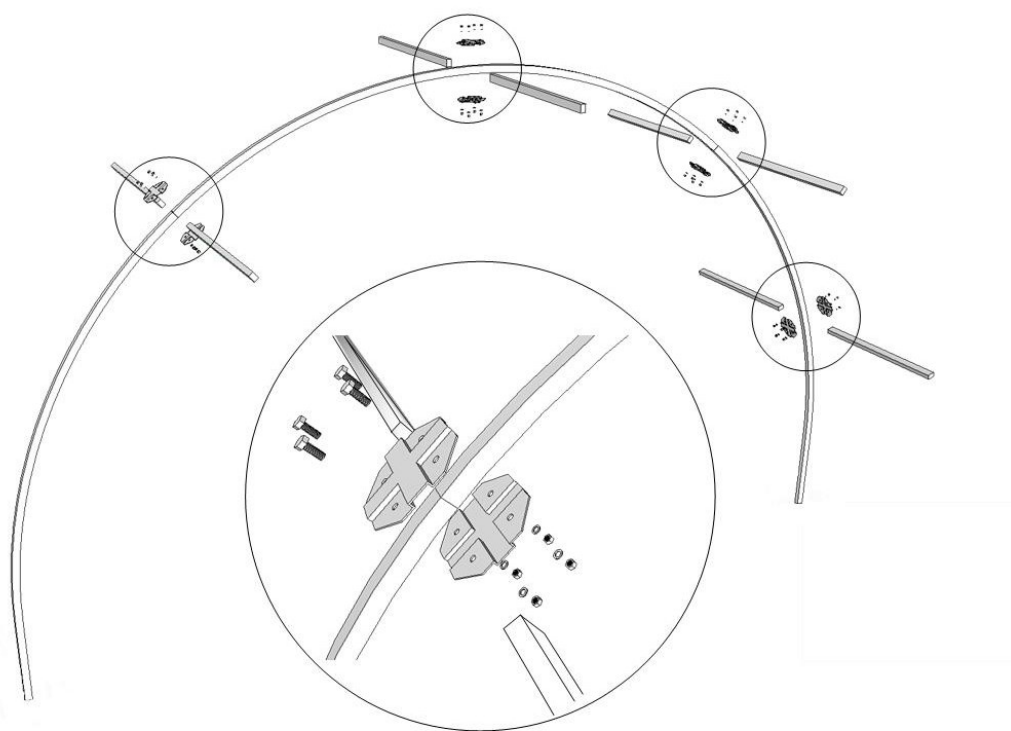

2.4 Вставка

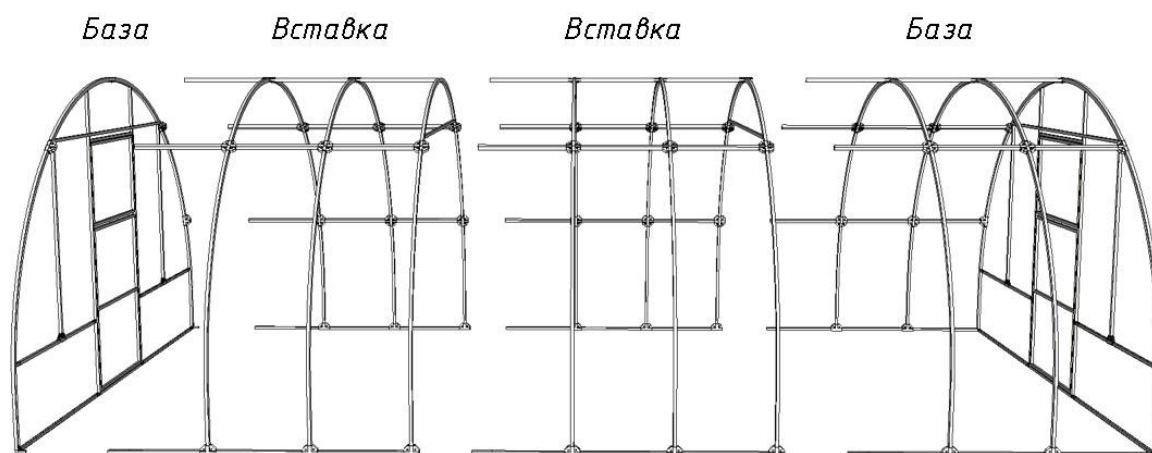

2.5 Соединительные элементы («хомуты»)

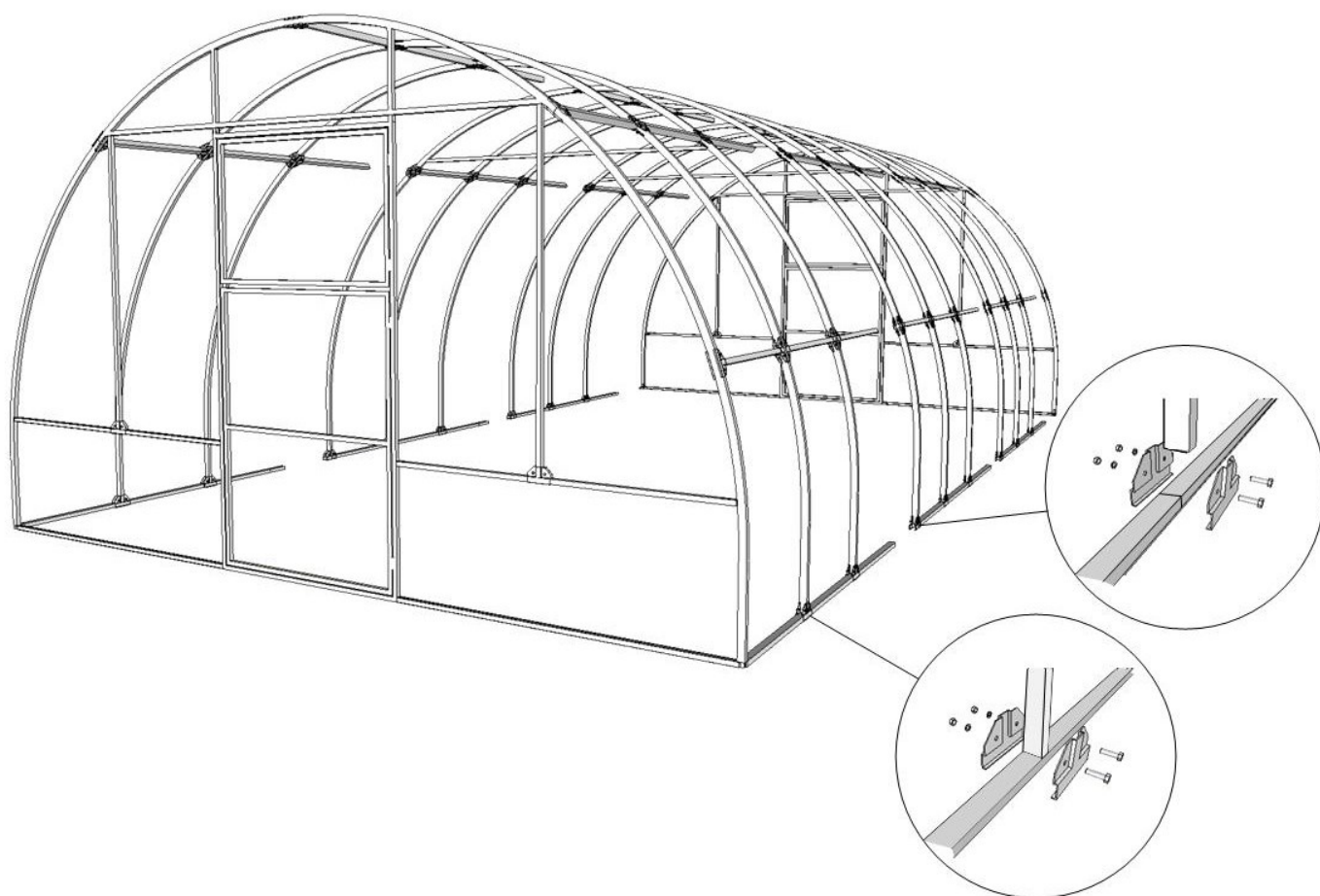

3. Установка каркаса на обвязку

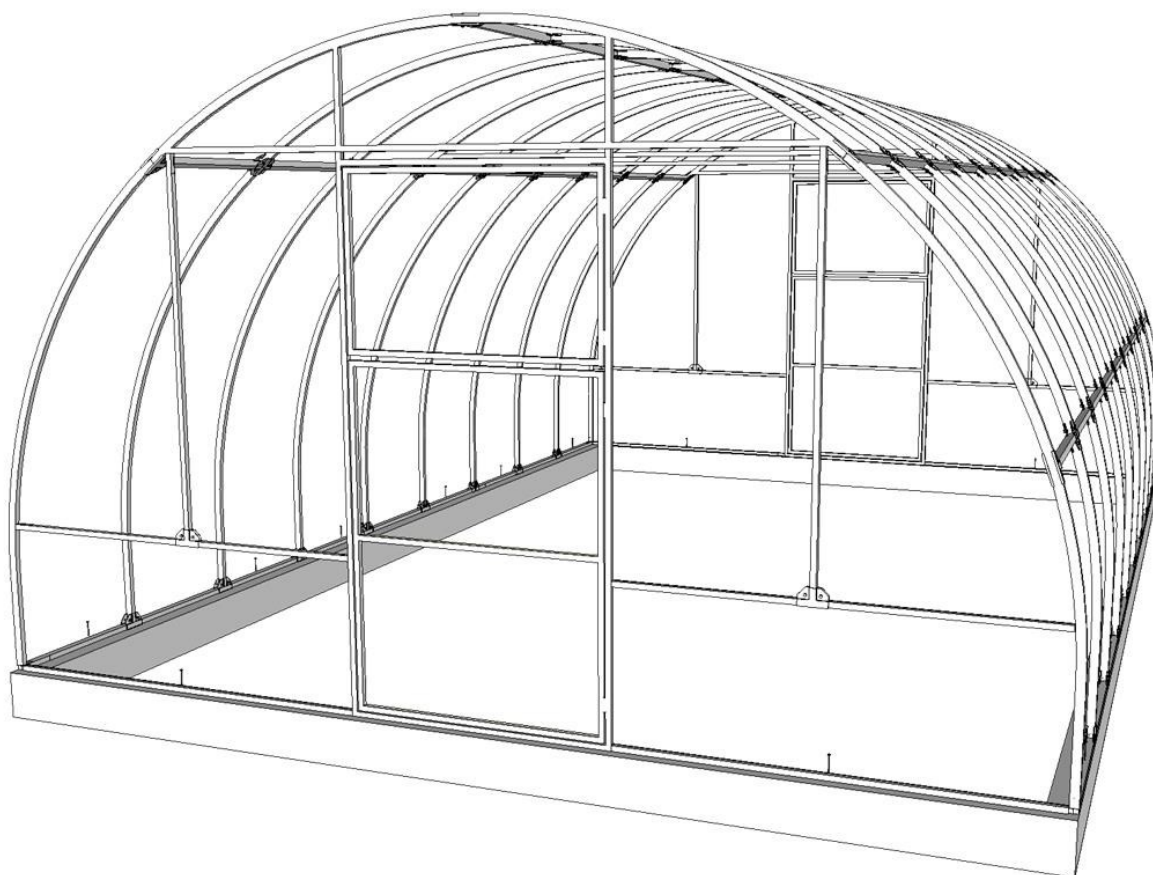

4. Форточка

4.1 Сборка

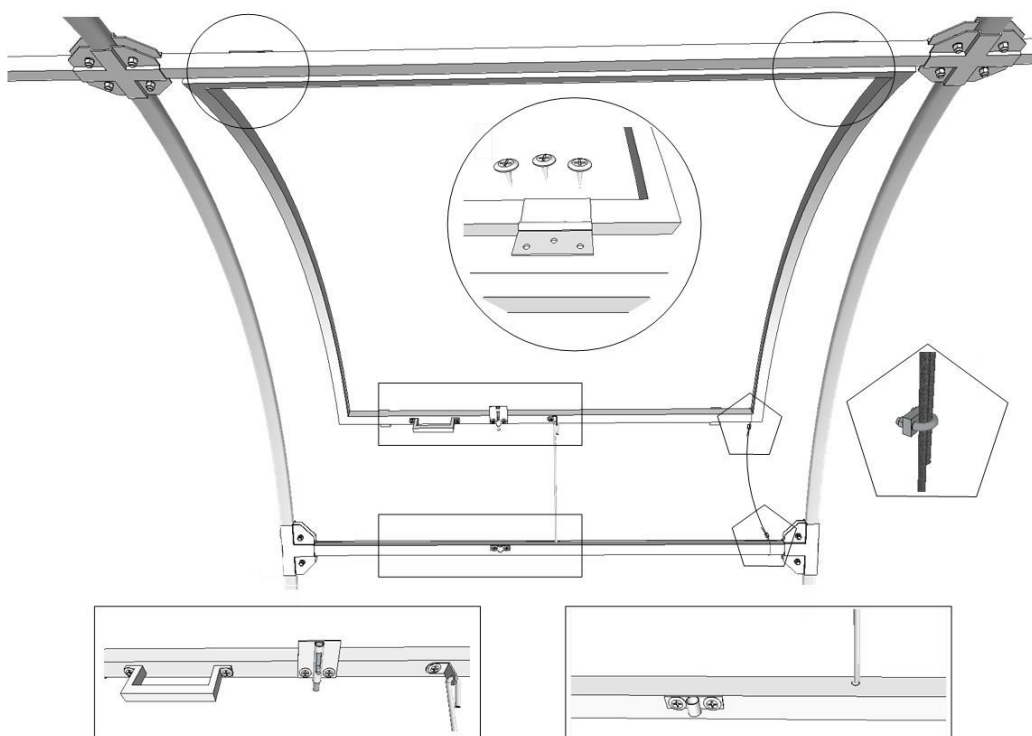

4.2 Установка термопривода

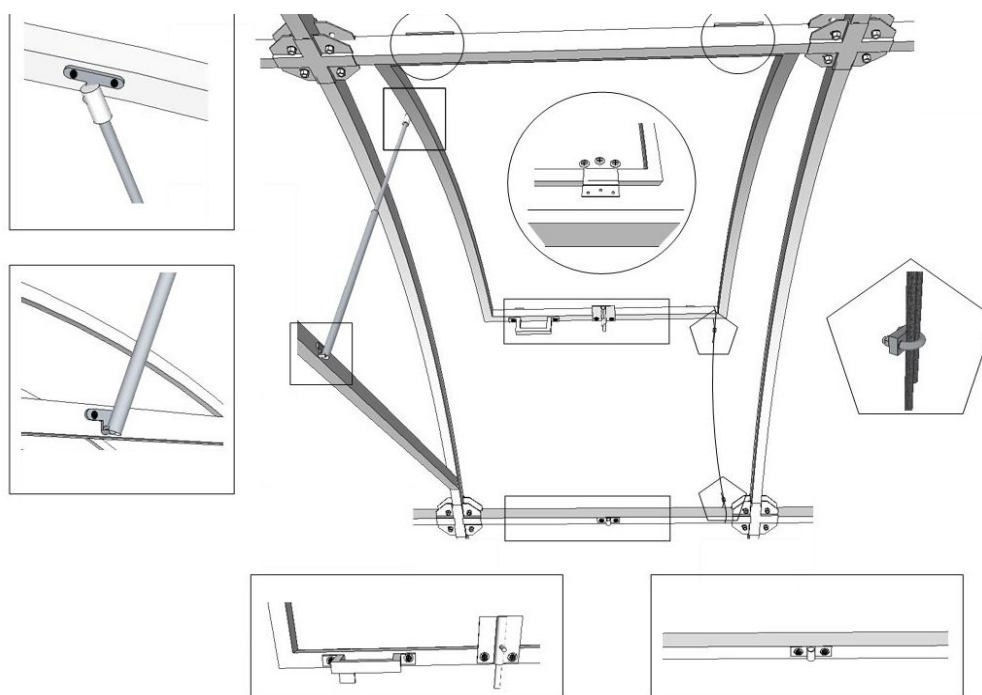

4.3 Установка

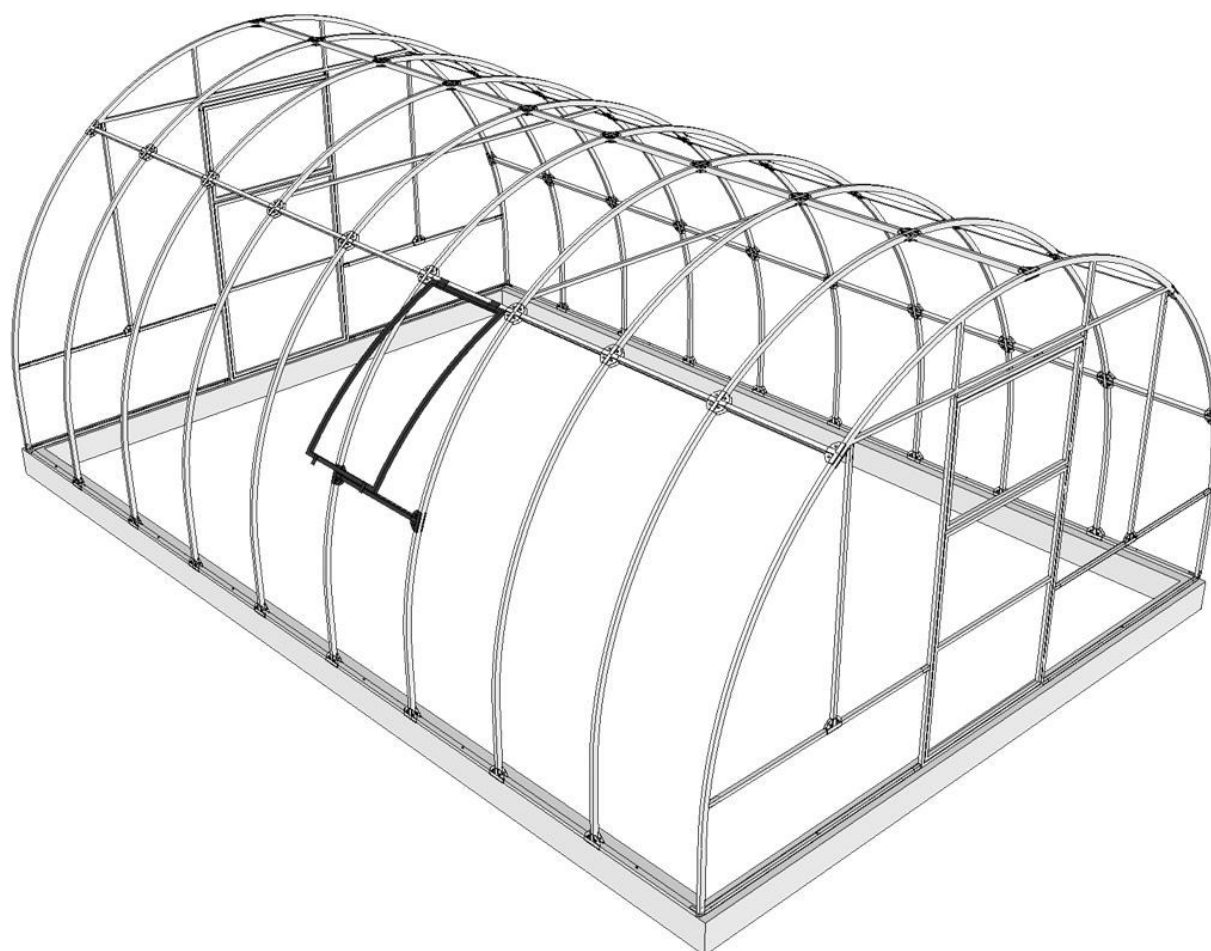

5. Раскрой поликарбоната

5.1 Туннель

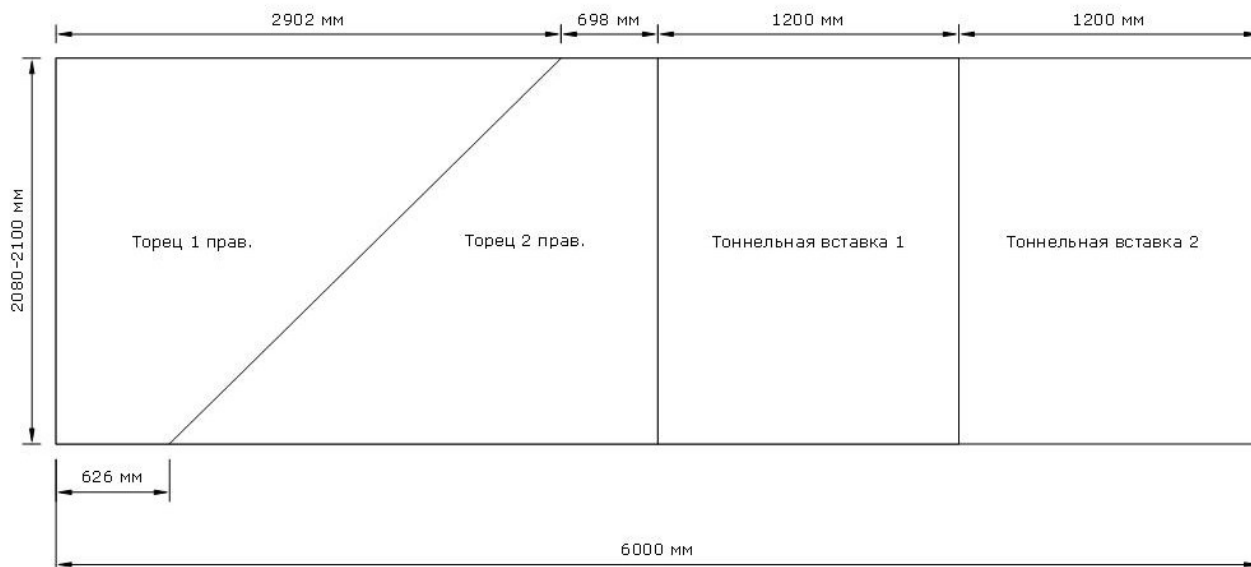
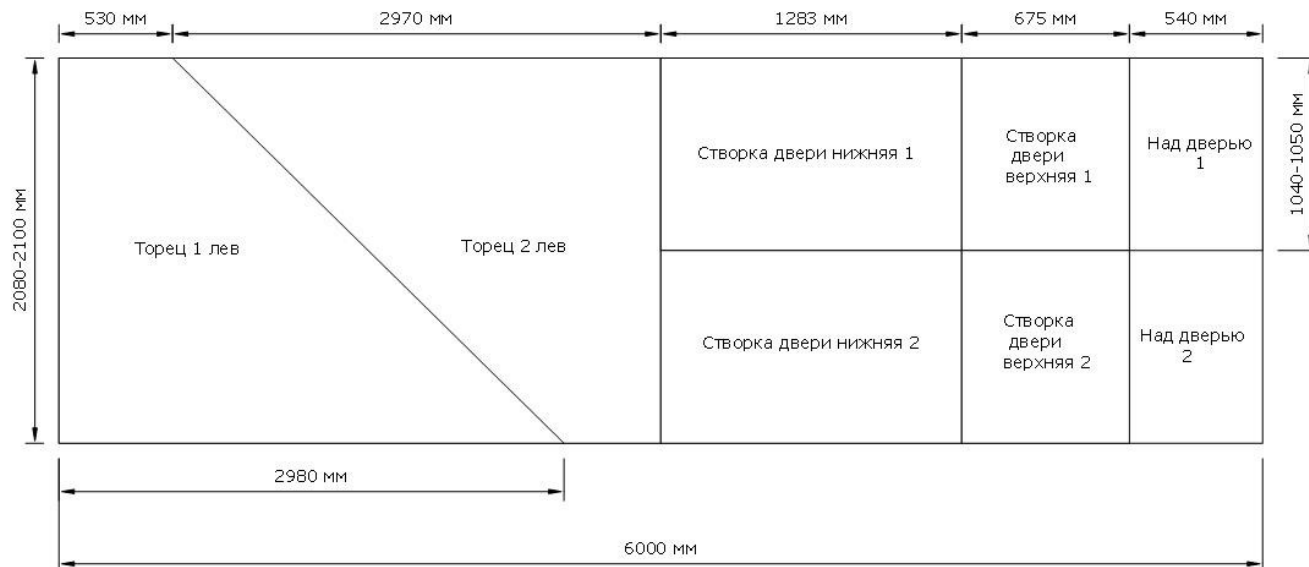

5.2 Форточка

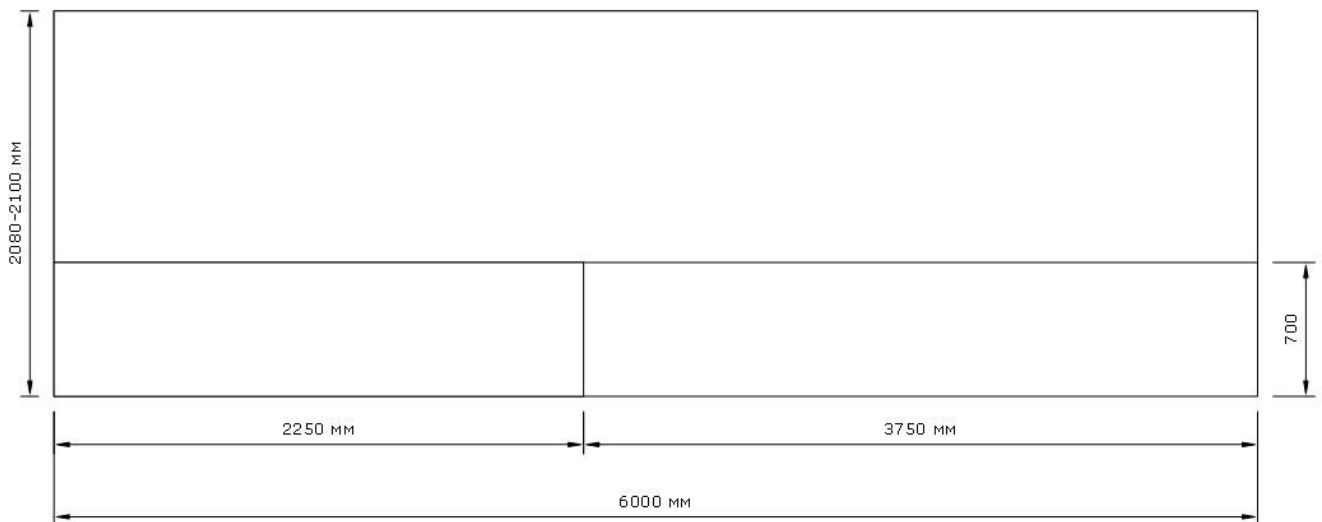
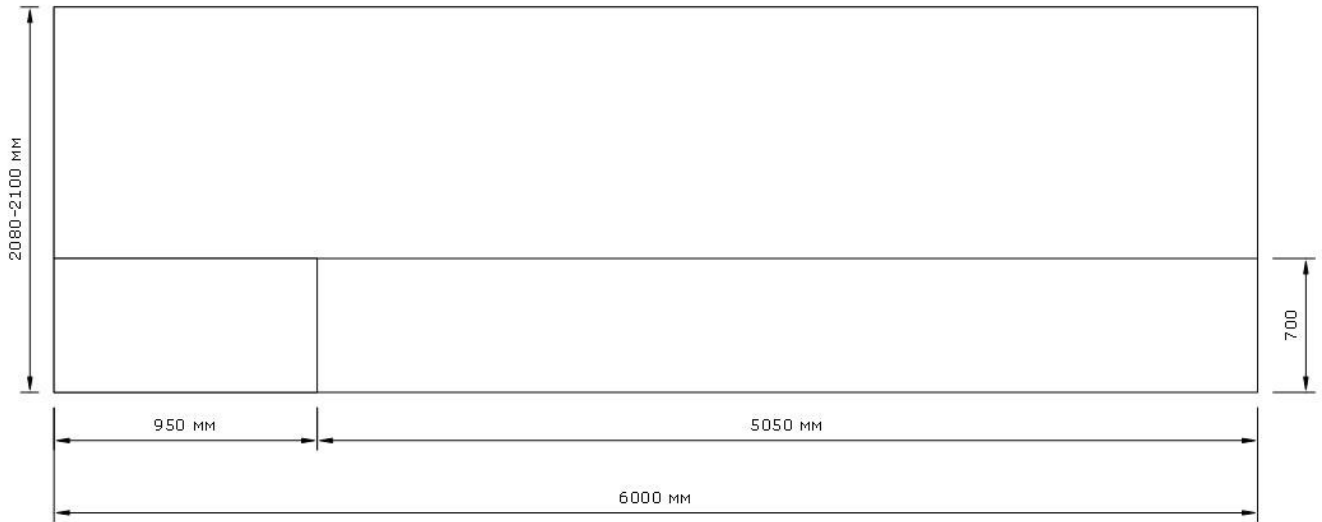

6. Монтаж поликарбоната

6.1 Торец

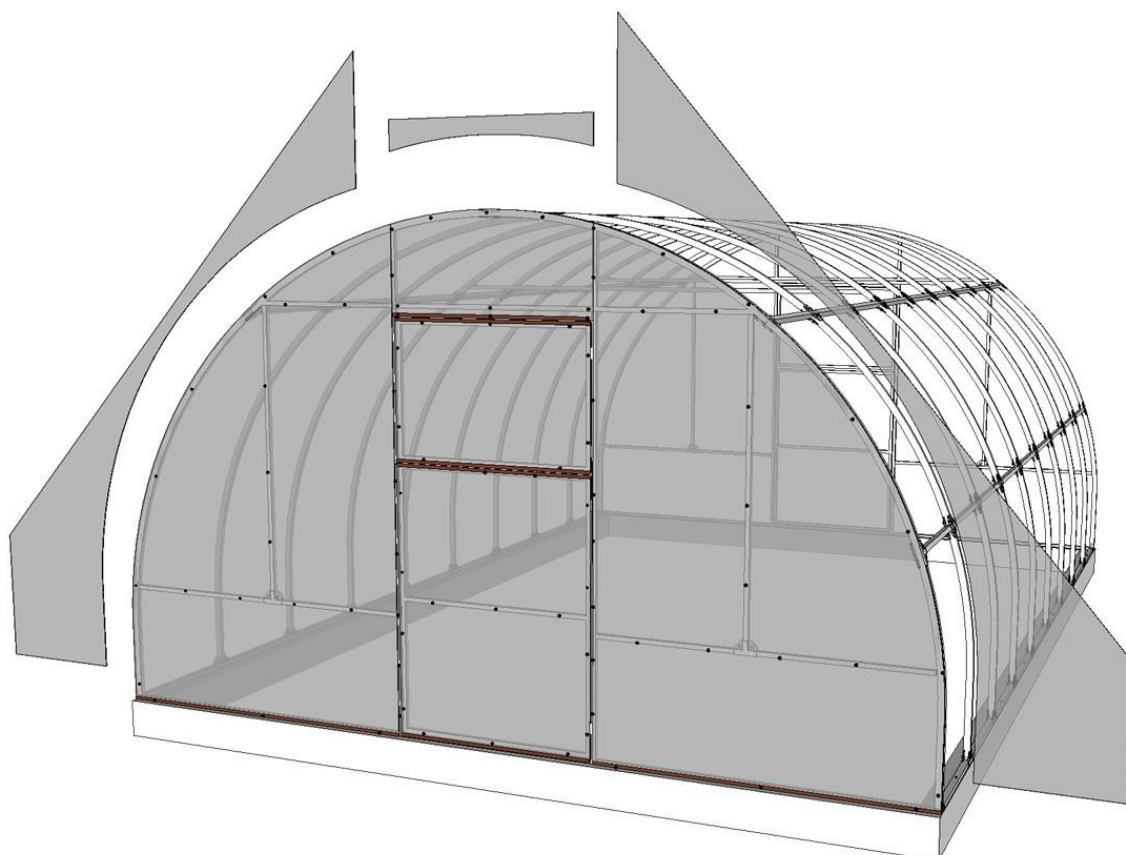
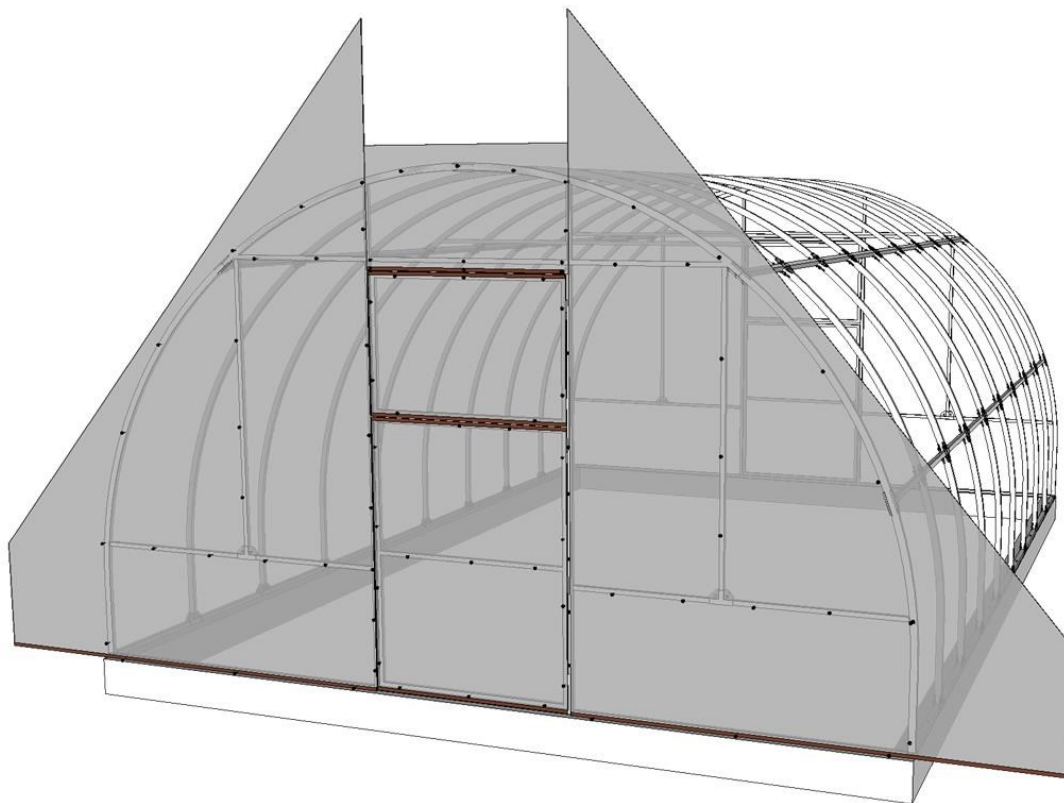

6.2 Туннель

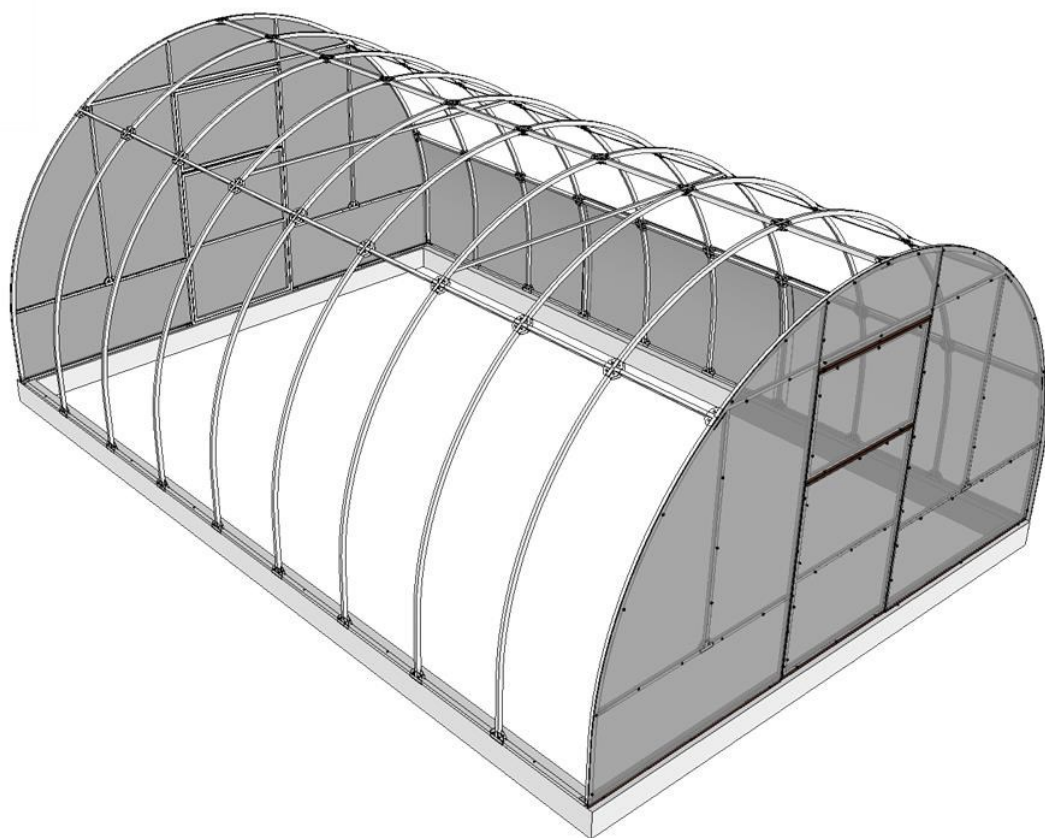
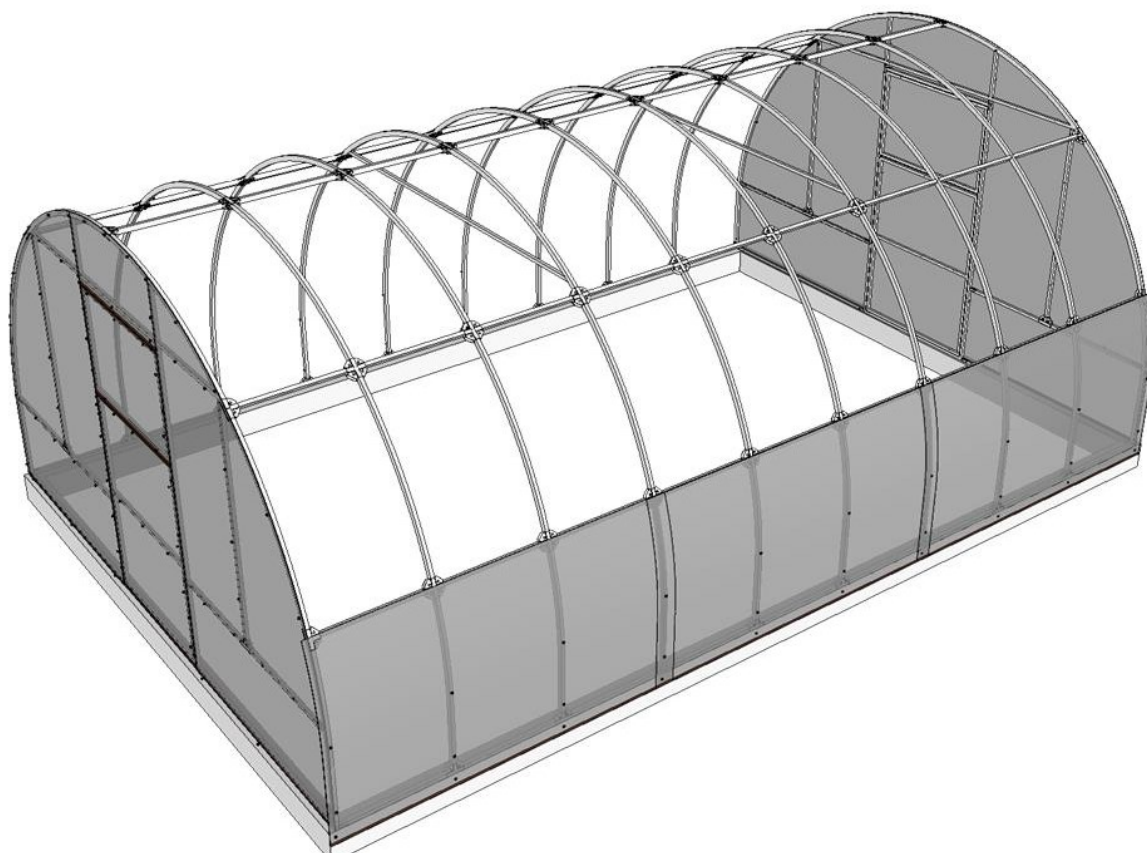

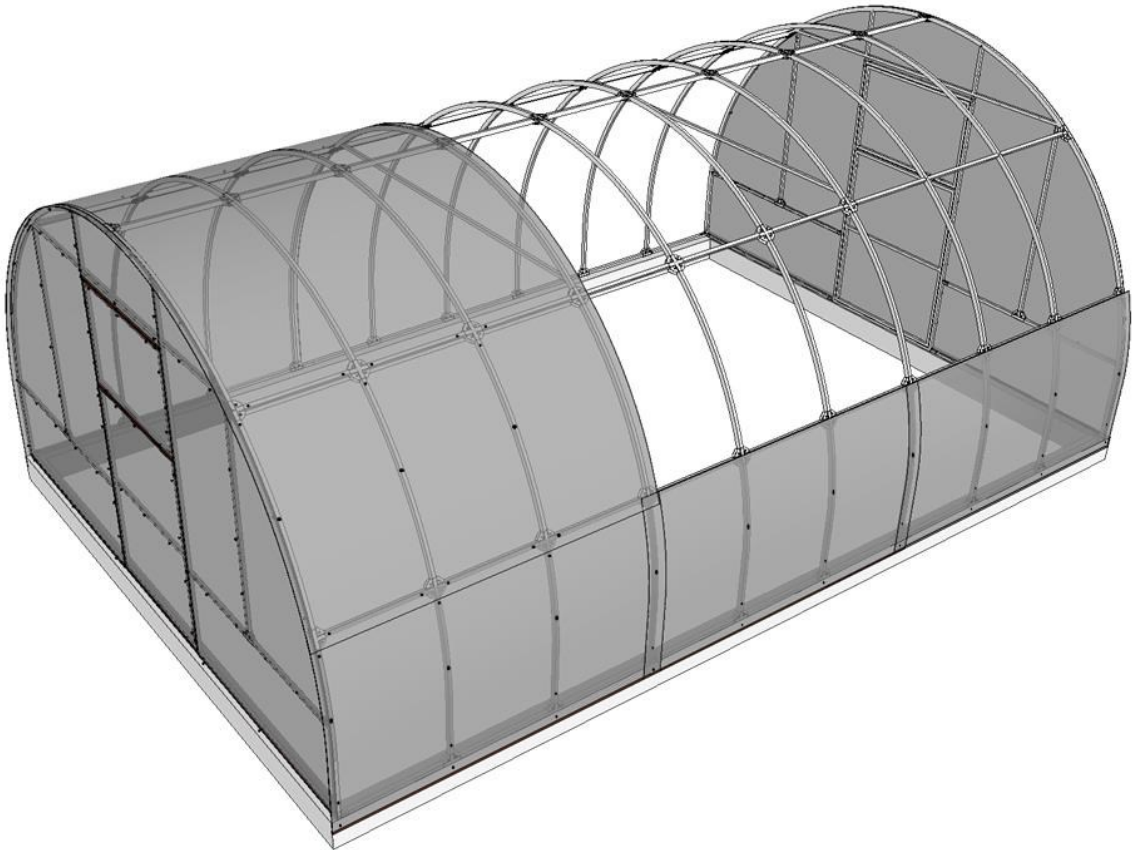
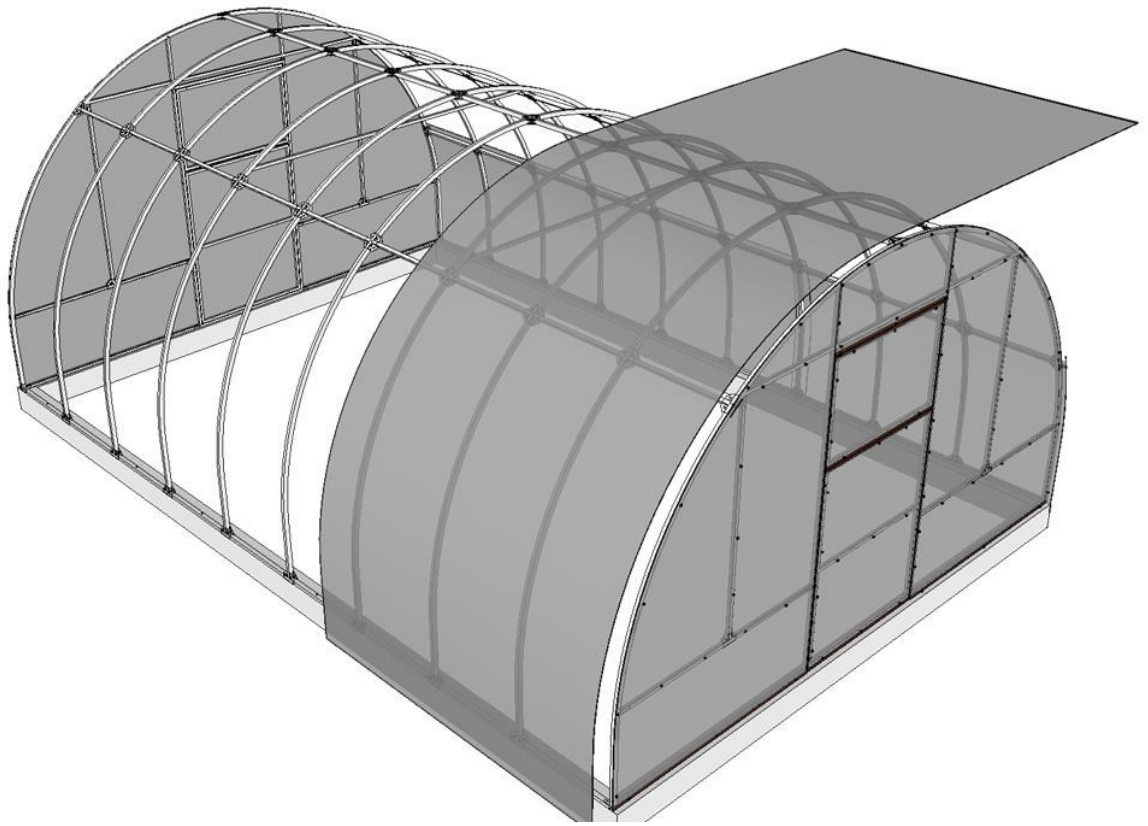

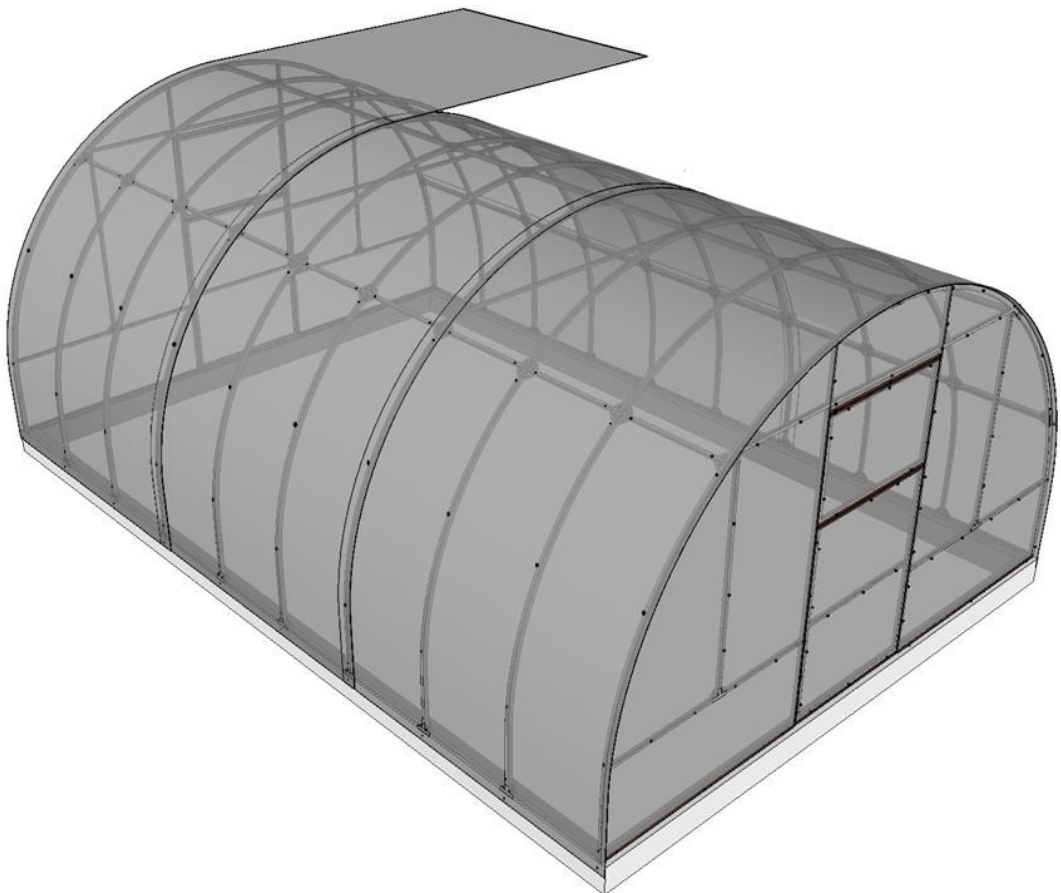
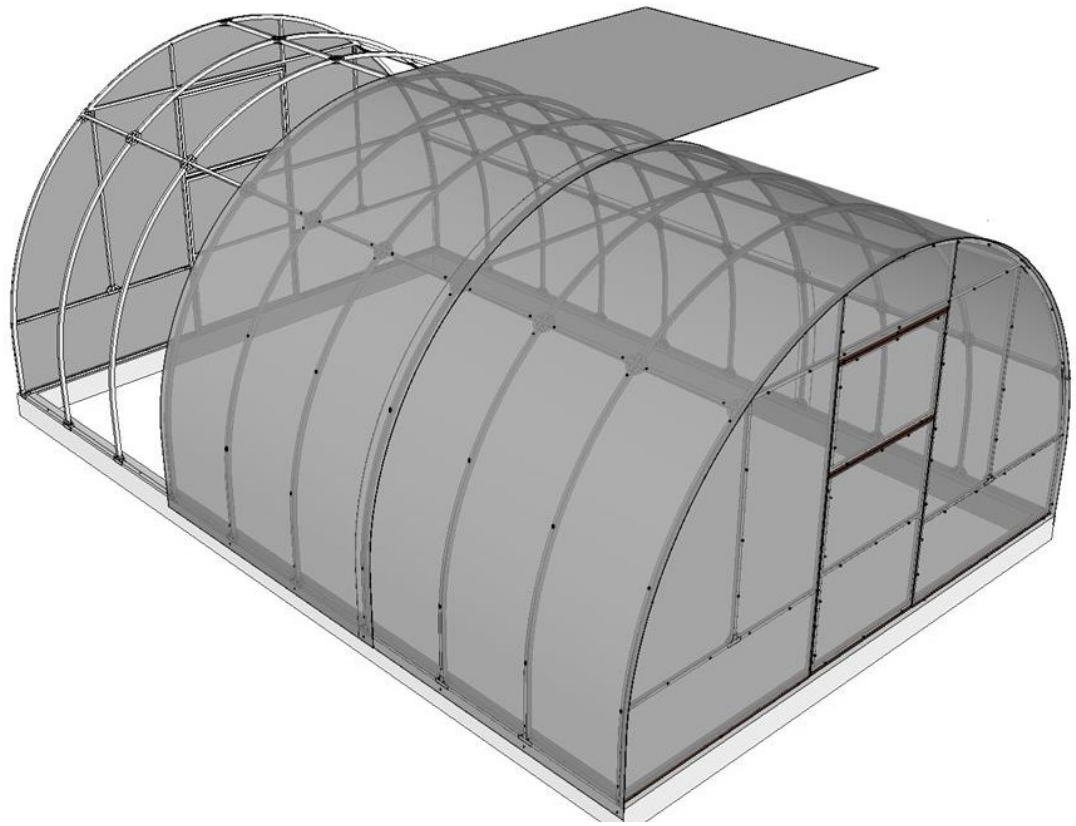

6.3 Боковая туннельная форточка

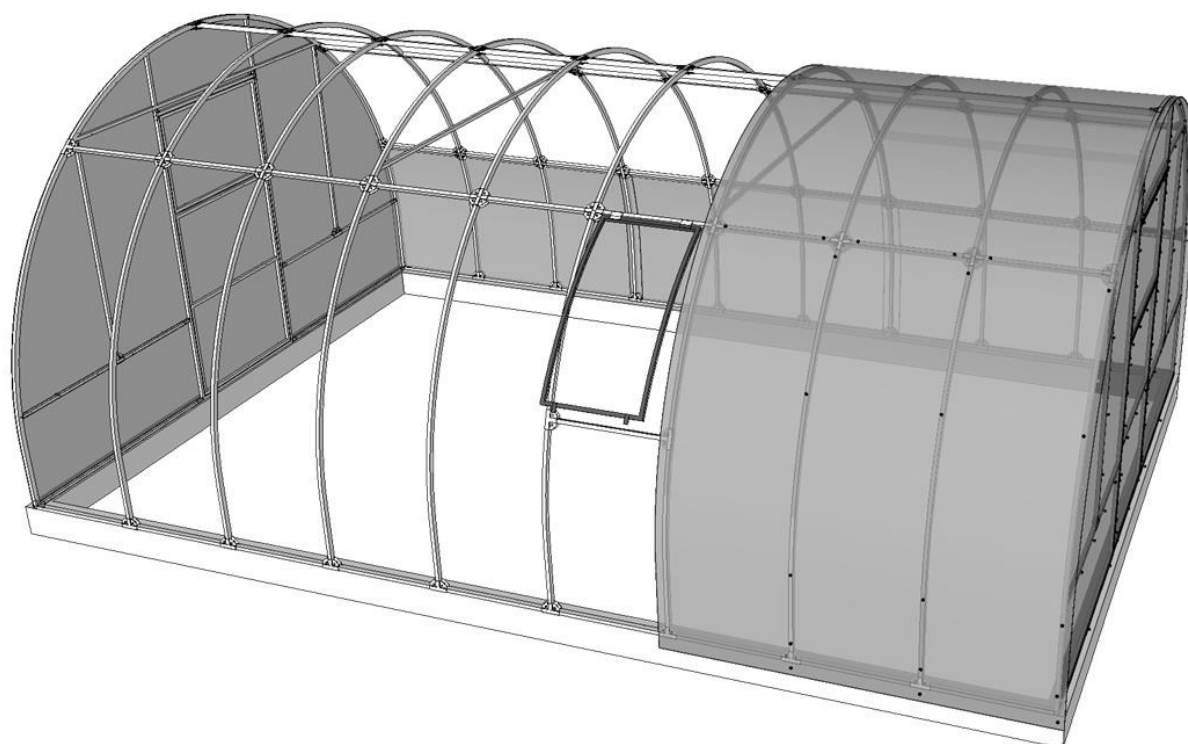
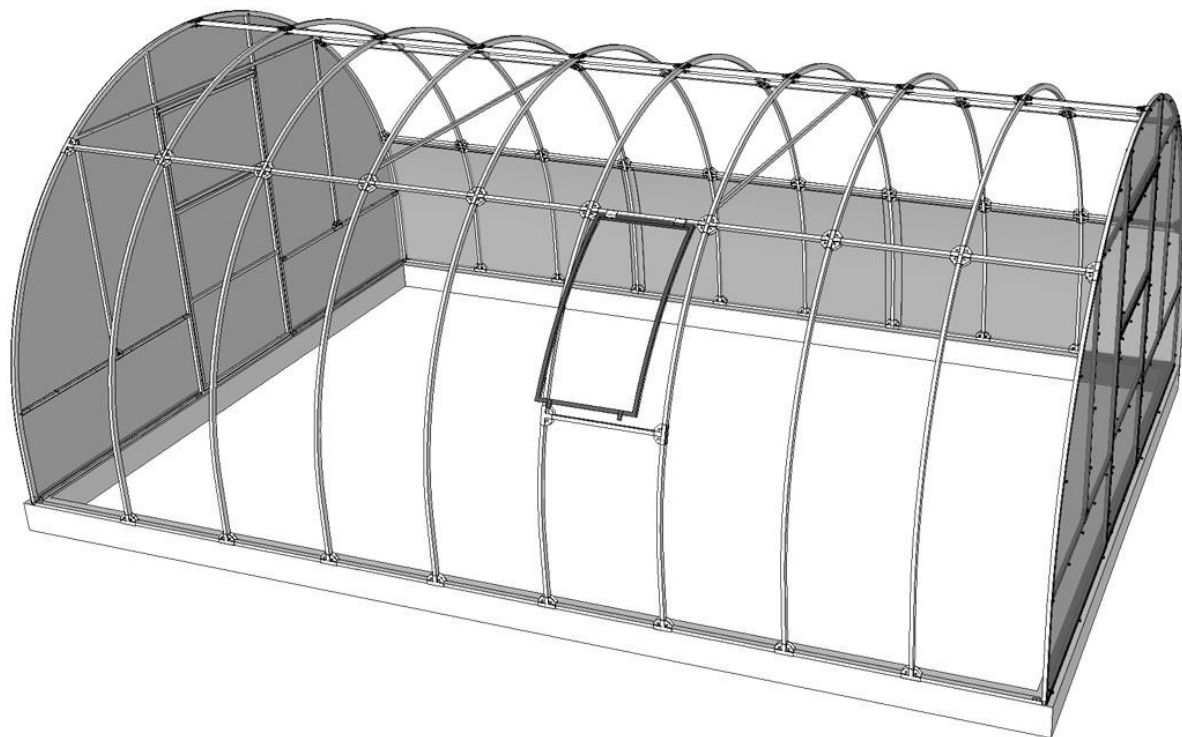

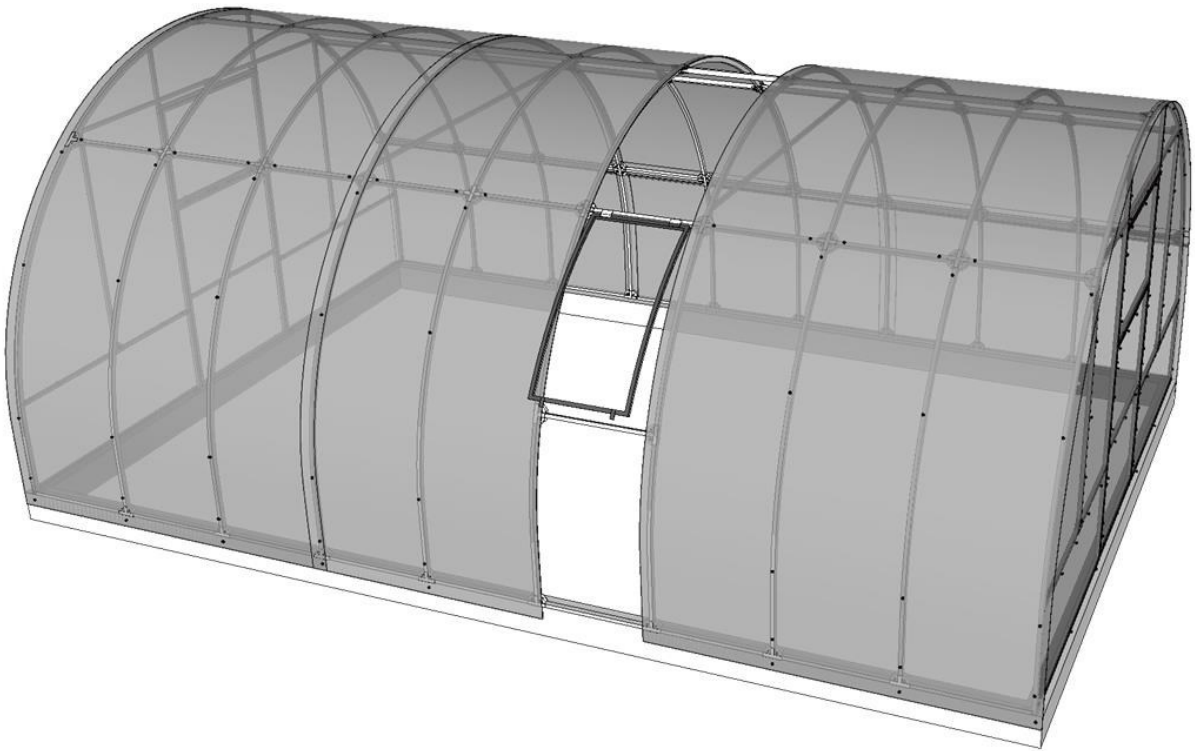
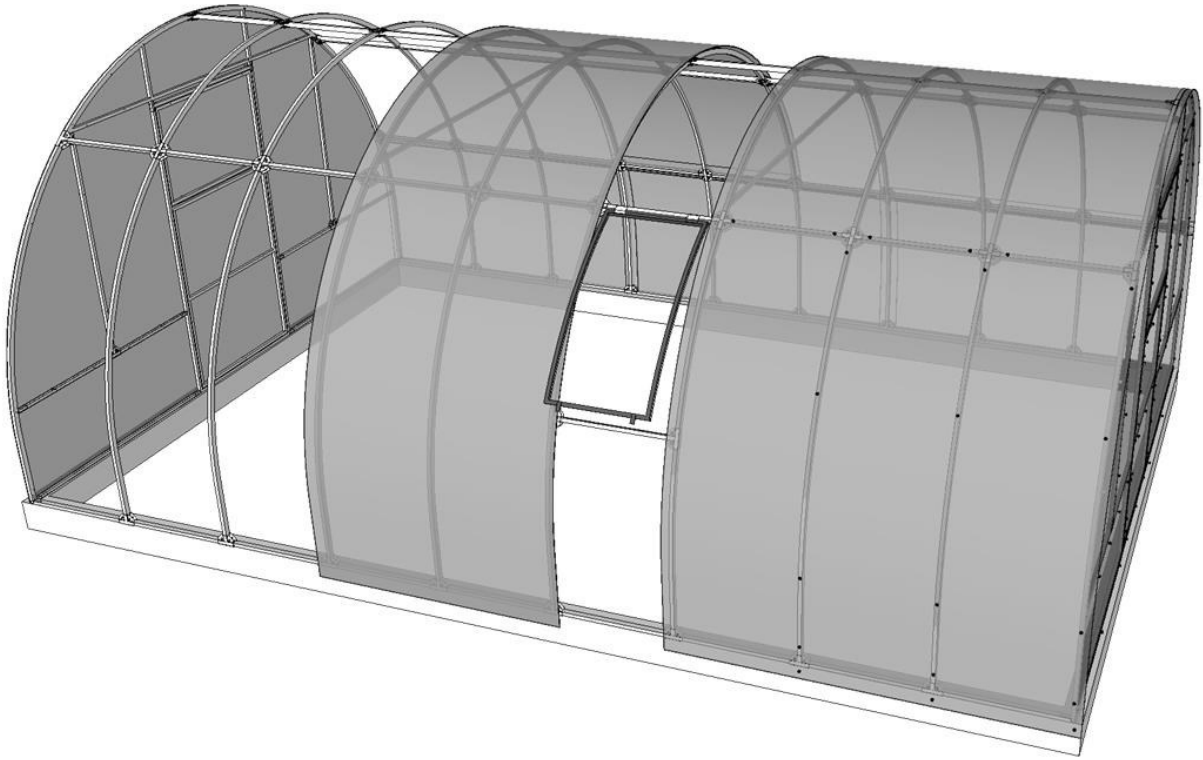

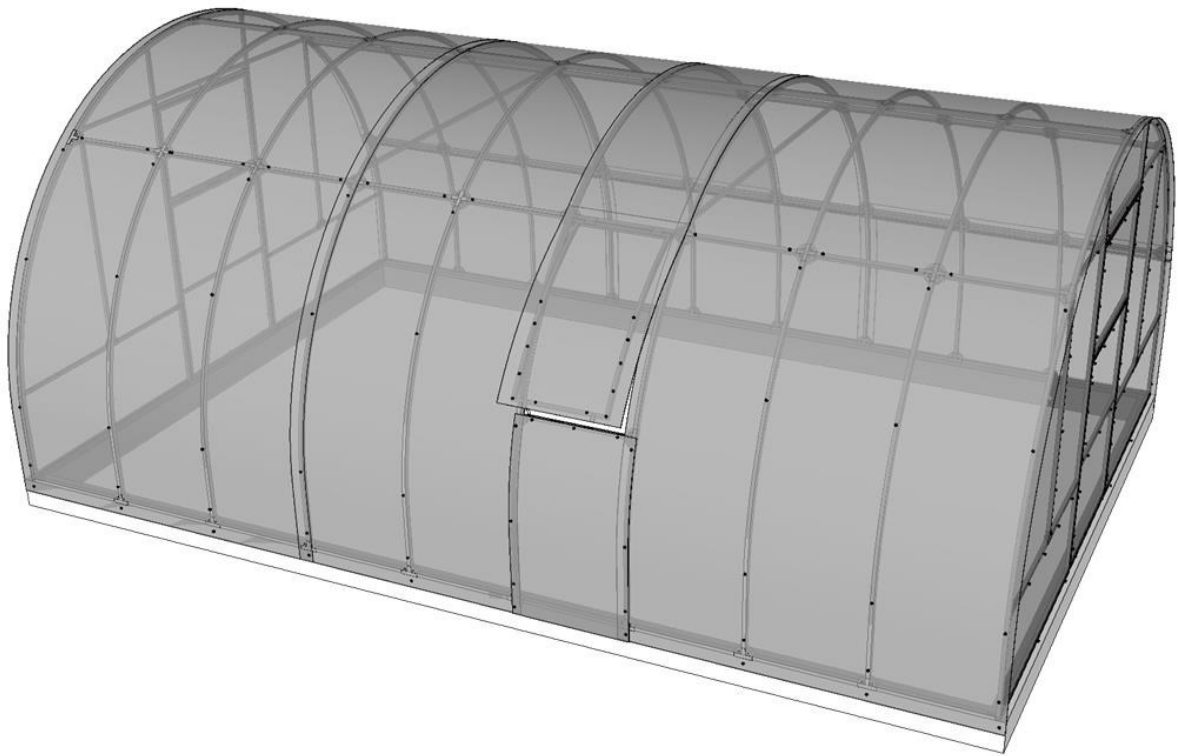
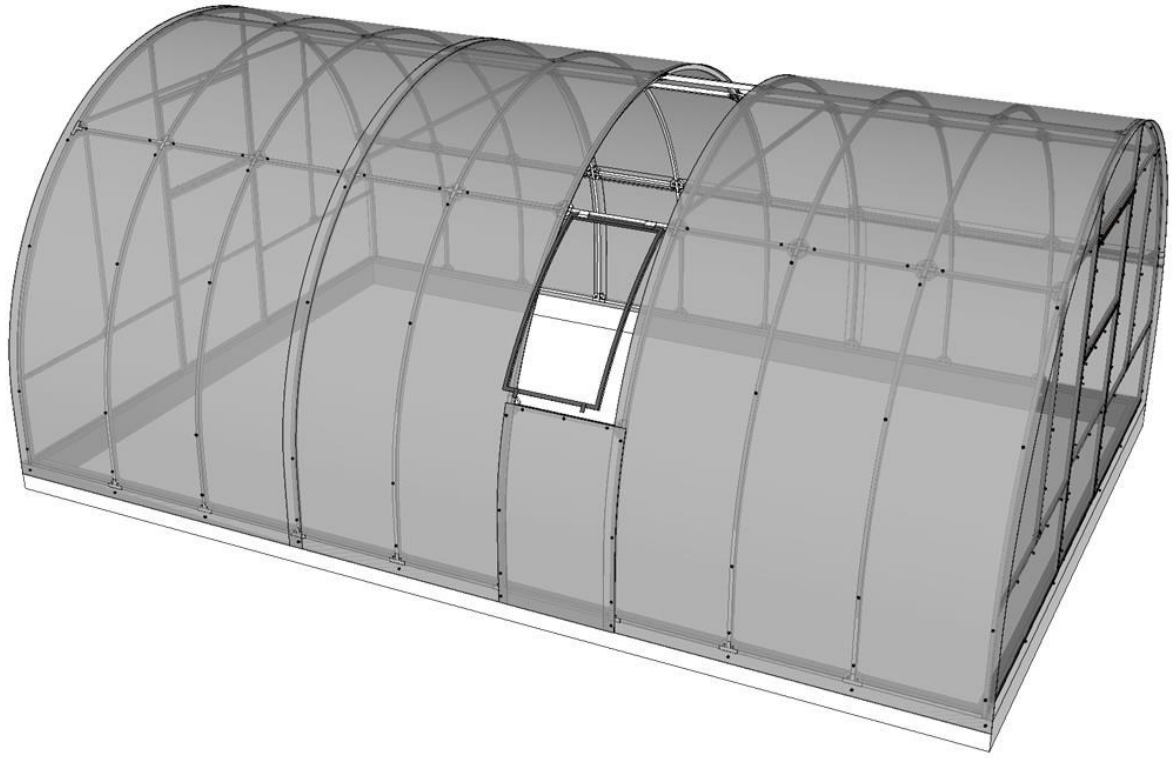

6.4 Верхняя туннельная форточка

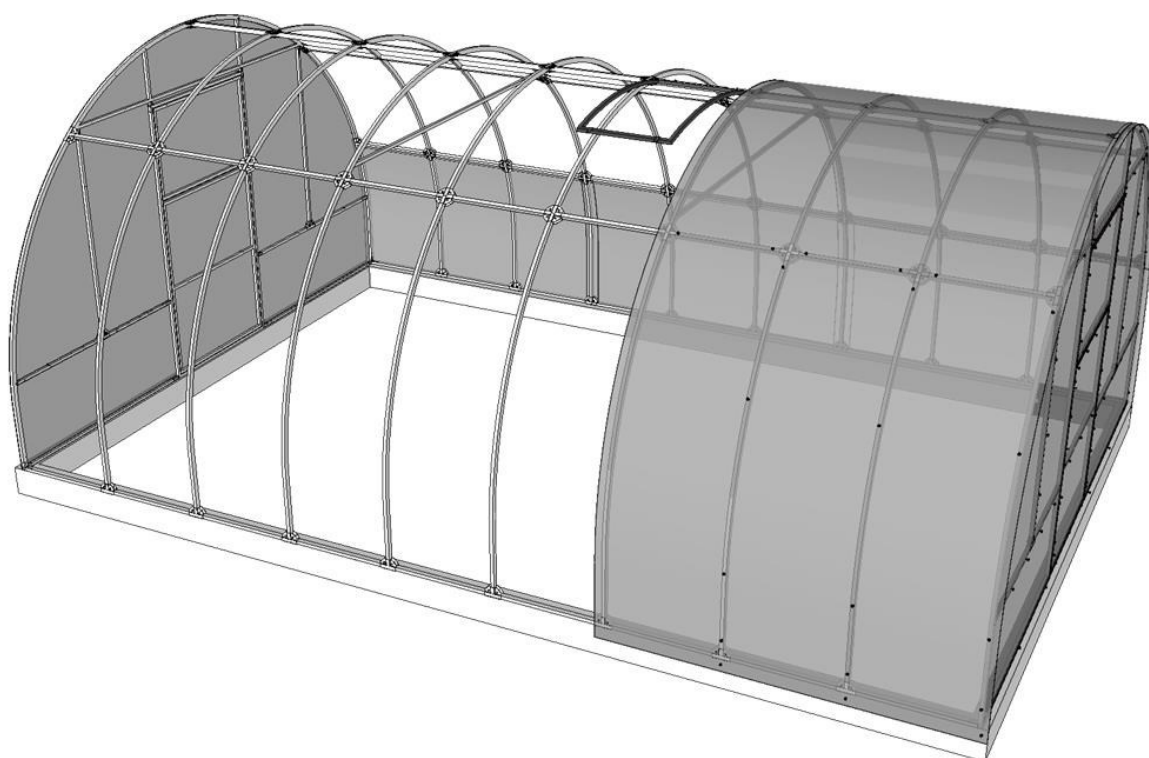
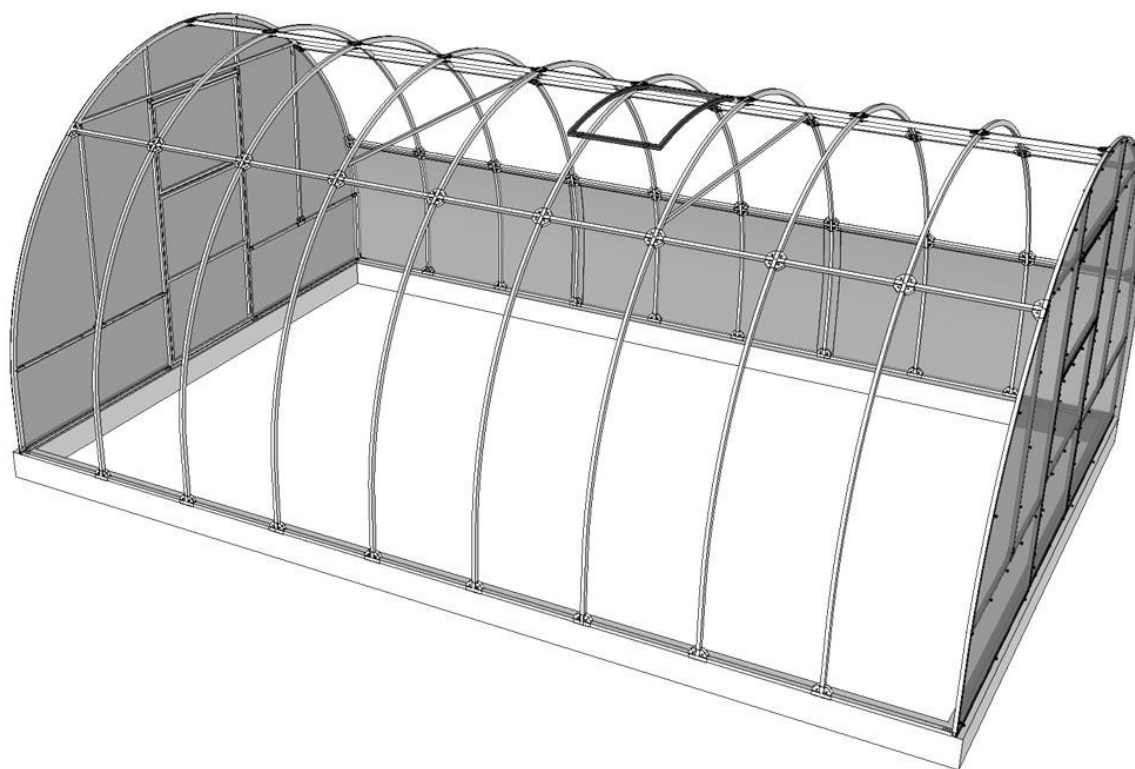

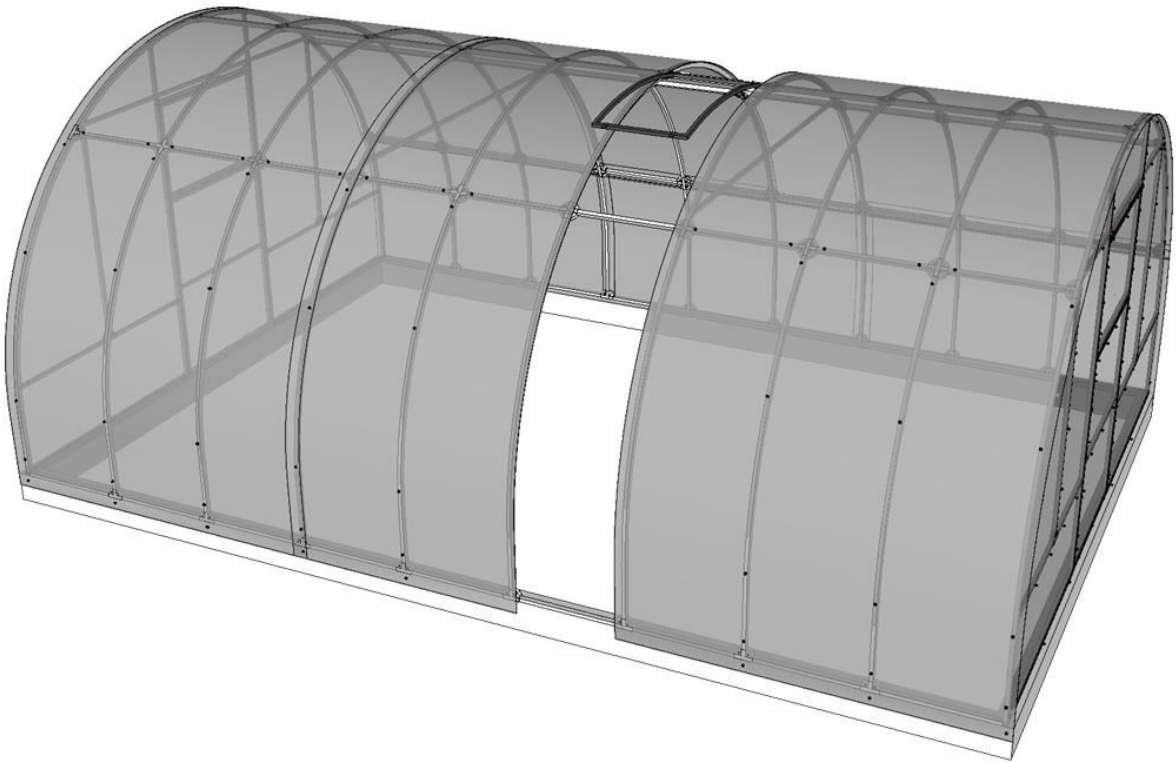
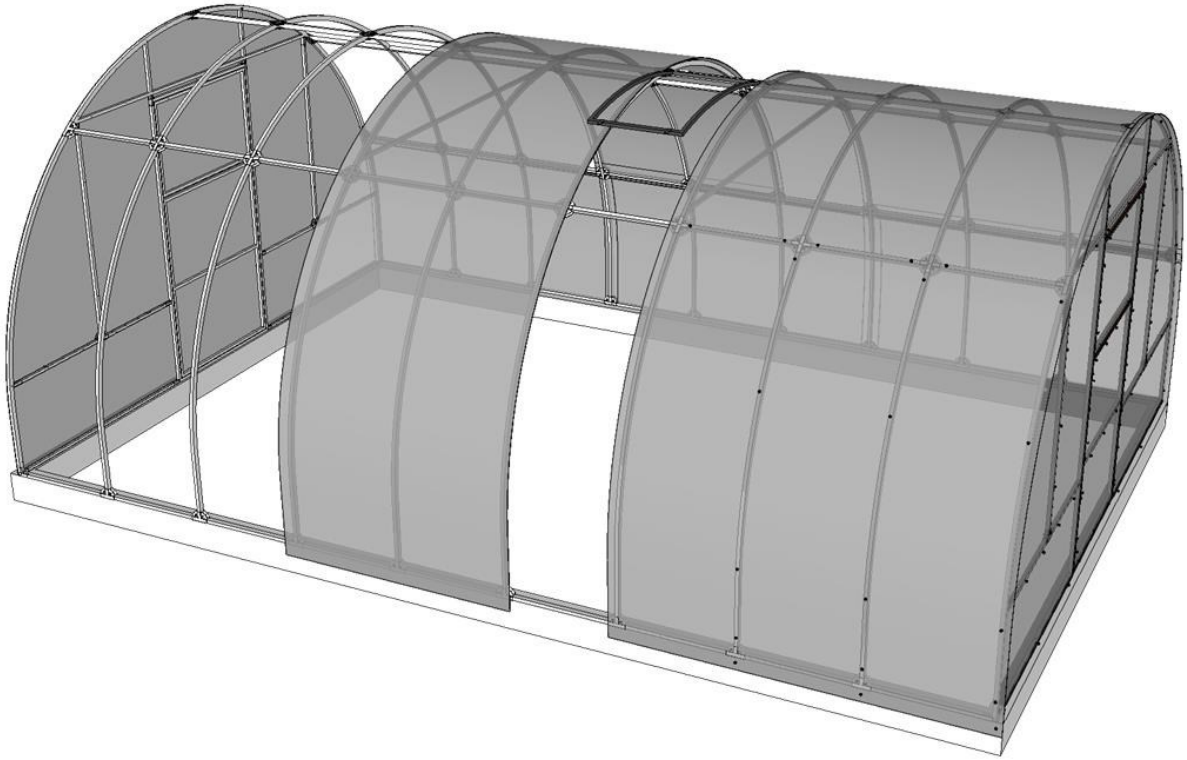

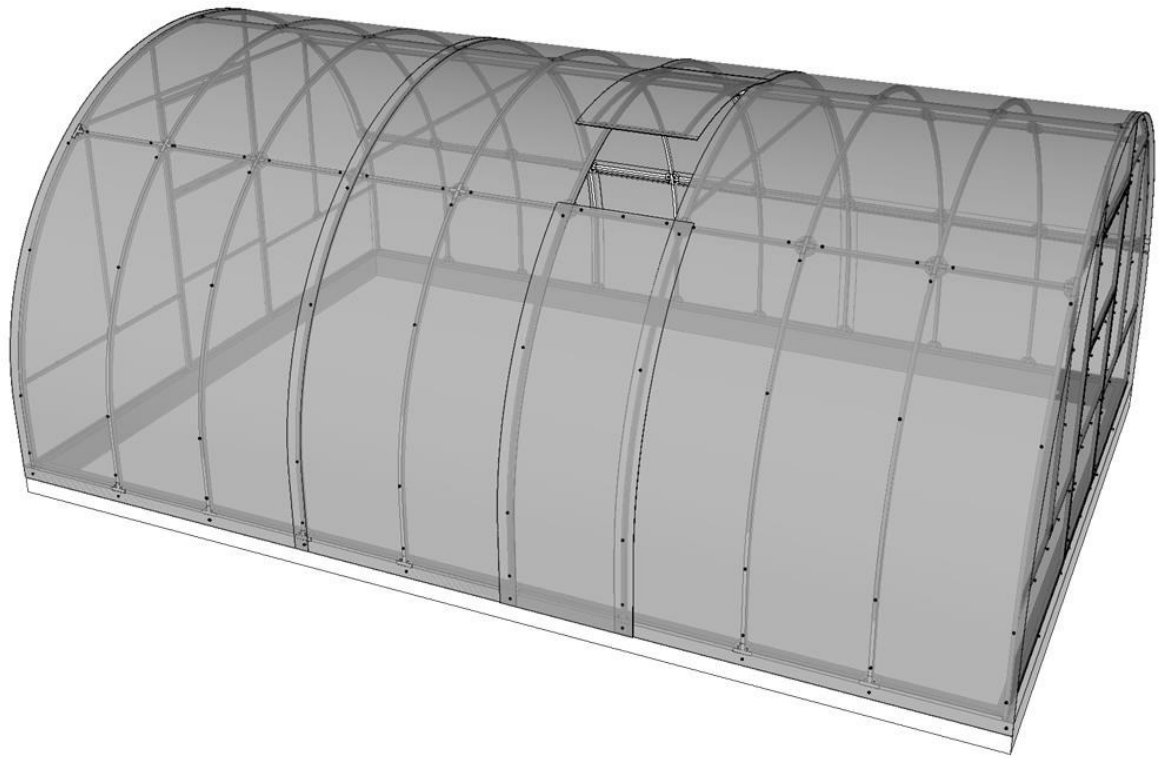
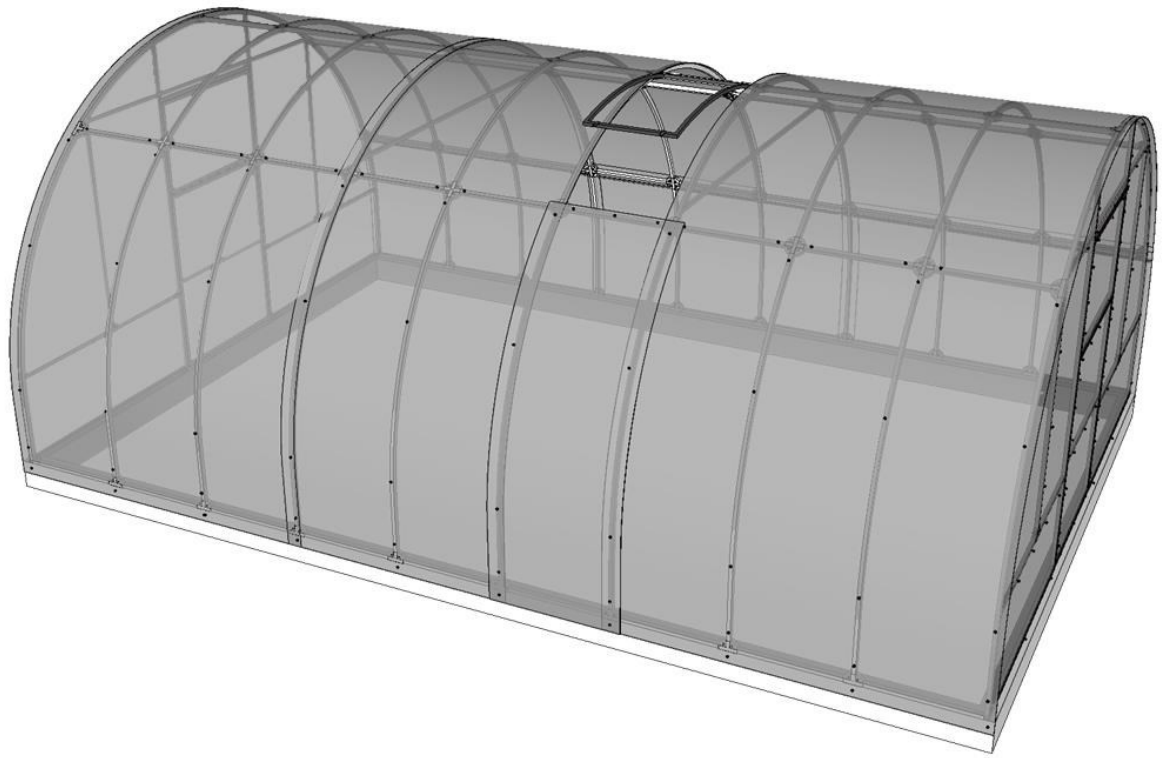

7. Установка фурнитуры

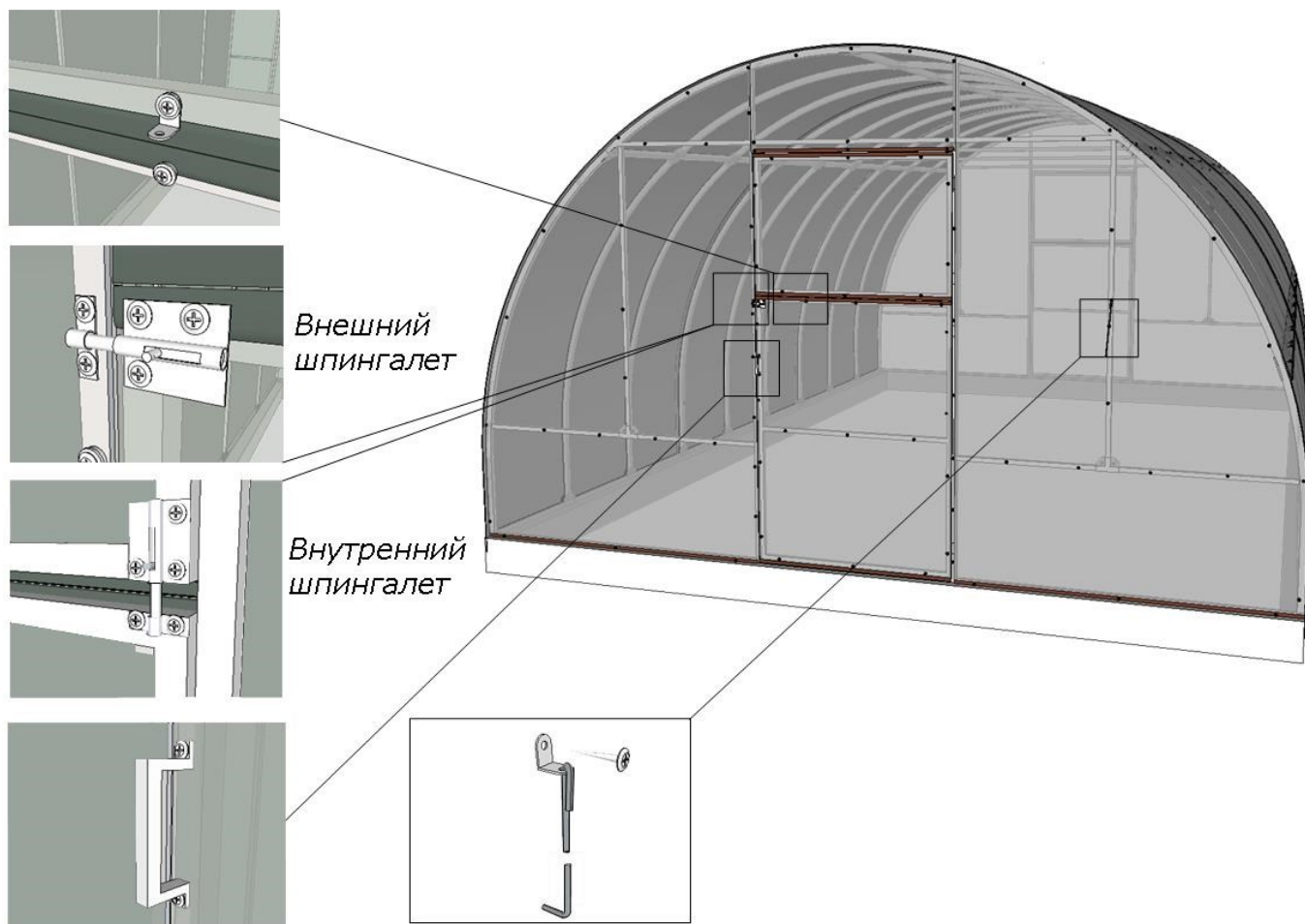

8. Готовая теплица

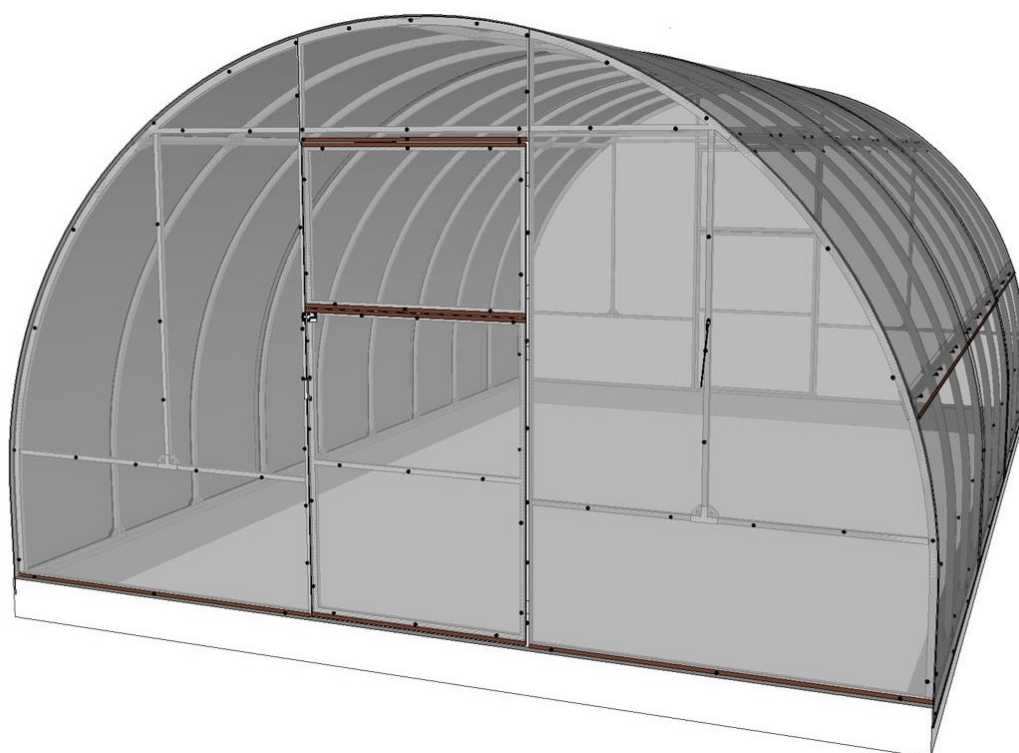



**Иркутск
2016**