

LOHKOKANSIKIVI

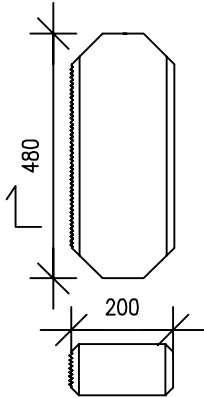

LOHKOMUURIKIVI

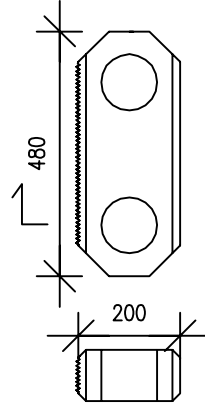

LOHKOMUURIKIVIPARI
Menekki 17,8 kiviparia/m2

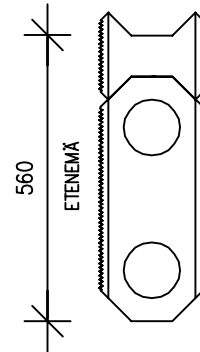

PÄÄTYKIVI "MUTTERI"

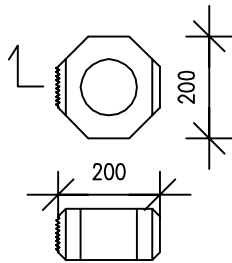

VÄLIKIVI "PERHONEN"

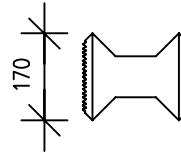

LOHKOMUURIKIVI- JA PÄÄTYKIVIPARI

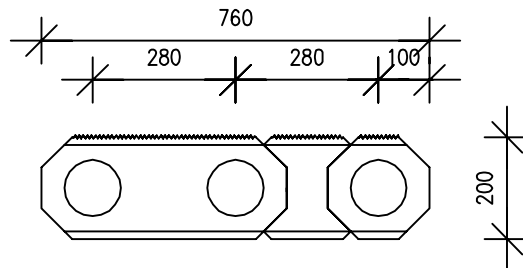

LOHKOMUURIKIVI ON VALMIIKSI LOHKAISTU.

KIVEN TOINEN PUOLI ON SILEÄ, JOLLOIN KUMPIKIN PUOLI ON JULKISIVUKELPOINEN.

RAKENNE VOIDAAN RAUDOITTA PYSTYSUUNTAAN, JOLLOIN PYSTYREIÄT VALETAAN BETONILLA KORKEISSA SEINÄMISSÄ.

SUORAKULMA TEHDÄÄN
LEIKKAAMALLA VÄLIKIVESTÄ
YKSI SAKARA POIS

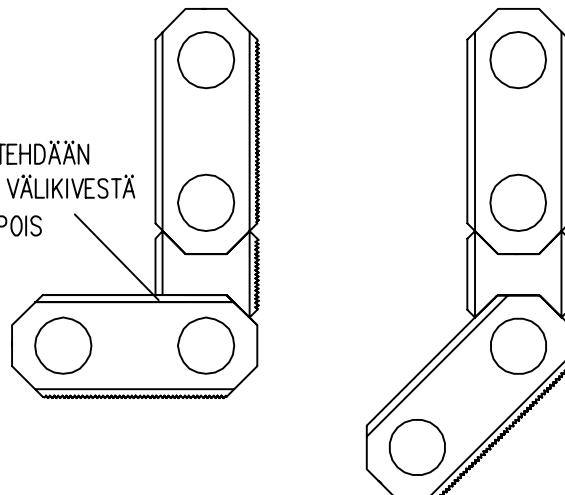



LADONTAMALLIT

LAKAN BETONI OY

1:50

LADONTAESIMERKKEJÄ

24.5.2016

LOHKOMUURIKIVI

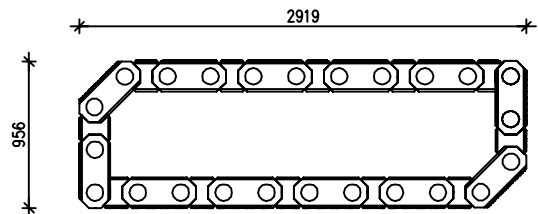
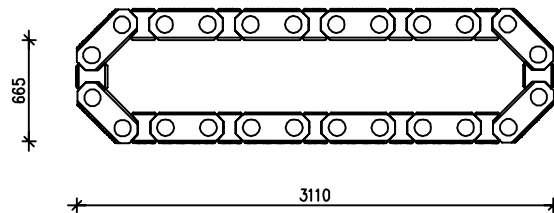
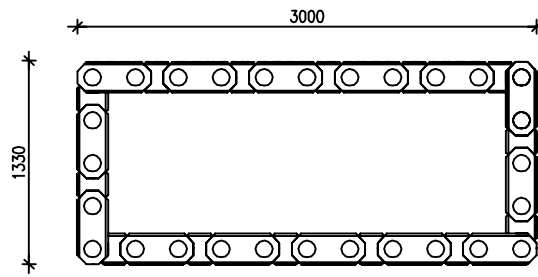
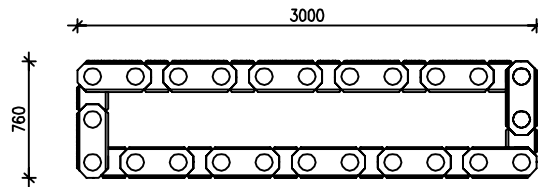

4 reikäkiparia

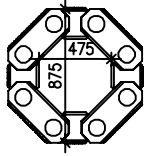

4 reikäkiparia

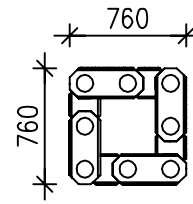

8 reikäkiparia

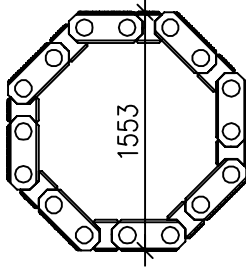

8 reikäkiparia

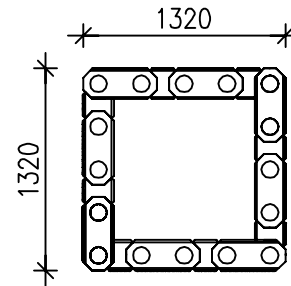

16 reikäkiparia

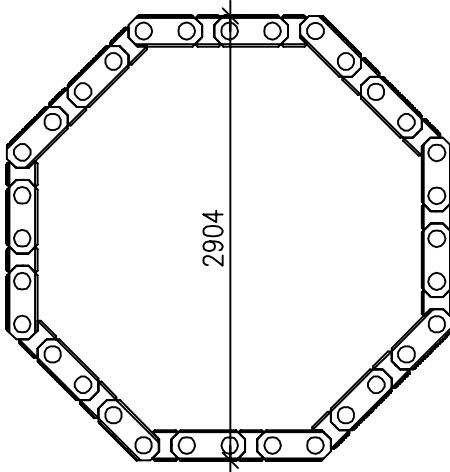

12 reikäkiparia

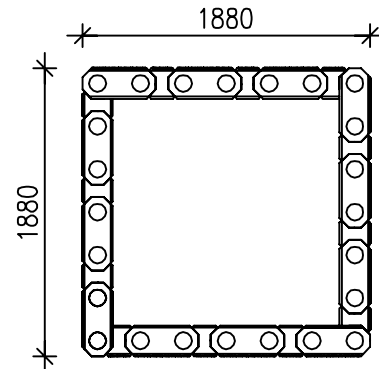

24 reikäkiparia

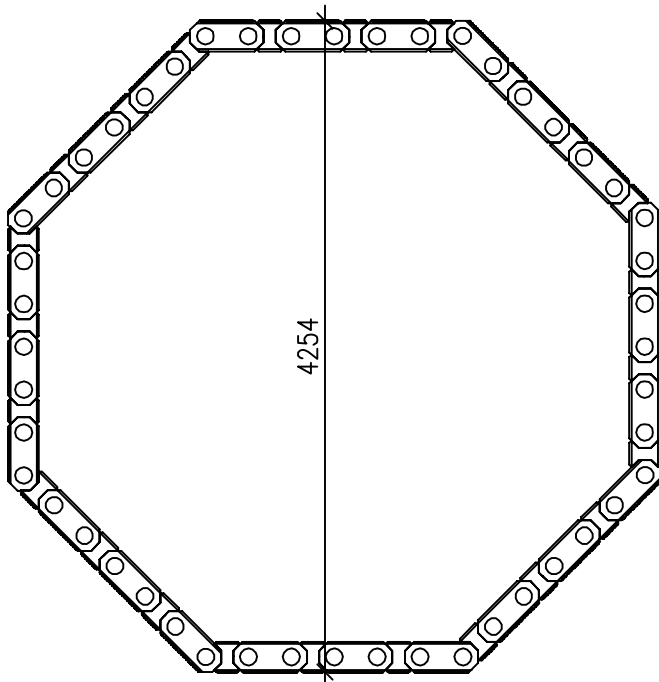

18 reikäkiparia

