

# The FIBERFIX System with ceramic CUPLOCKS

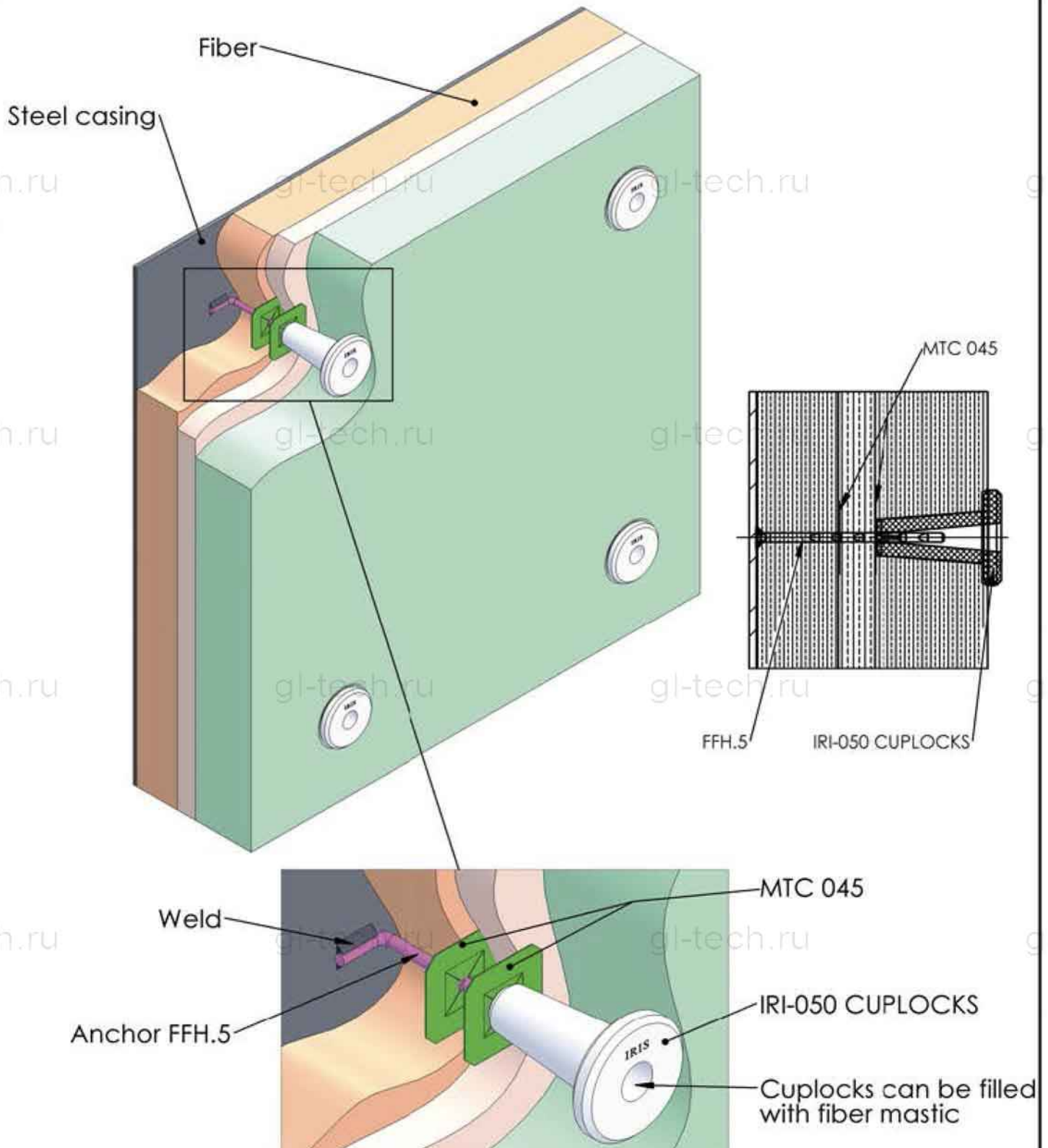

**IRIS - Industrial Refractories & Insulating Specialities**  
 Parc d'Activités Aérodrome Ouest - Rouvignies - F - 59328 VALENCIENNES Cedex (France)

Tél : +33 (0)3.27.21.52.80  
 E-mail: [contact@irisfrance.com](mailto:contact@irisfrance.com)

Fax : +33 (0)3.27.21.52.99  
 Web: [www.irisfrance.com](http://www.irisfrance.com)

This drawing is the property of IRIS. Unauthorised use of patented features and/or reproduction of this drawing is strictly prohibited

# The FIBERFIX System

## Application with fibre blankets.

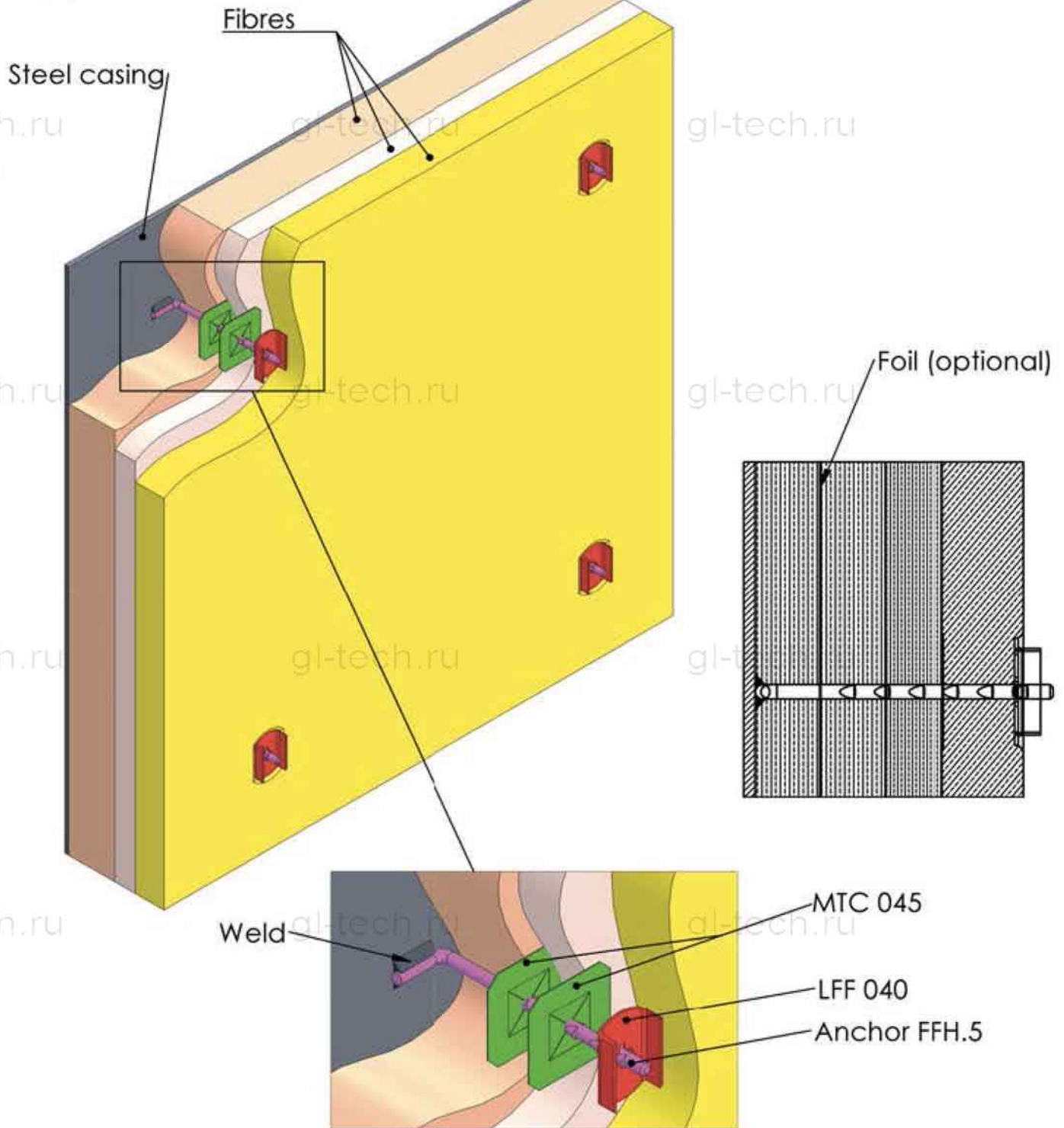

**IRIS - Industrial Refractories & Insulating Specialities**  
Parc d'Activités Aérodrome Ouest - Rouvignies - F - 59328 VALENCIENNES Cedex (France)

Tél : +33 (0)3.27.21.52.80  
E-mail: [contact@irisfrance.com](mailto:contact@irisfrance.com)

Fax : +33 (0)3.27.21.52.99  
Web: [www.irisfrance.com](http://www.irisfrance.com)

This drawing is the property of IRIS. Unauthorised use of patented features and/or reproduction of this drawing is strictly prohibited

# The FIBERFIX System

**FFS**

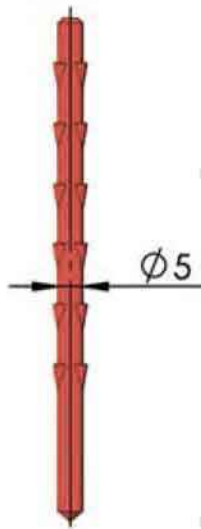

**FFH**

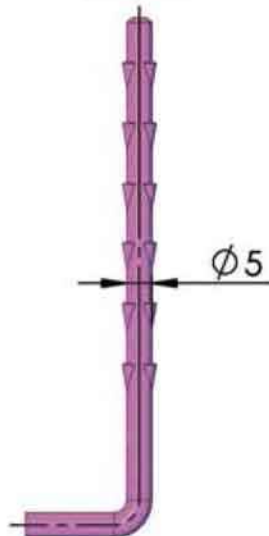

HAND WELD

**FFT**

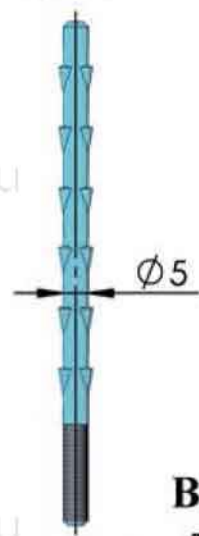

**ISA**



**BDB**



THREADED

**LFF 040**  
(Lockwasher 040)

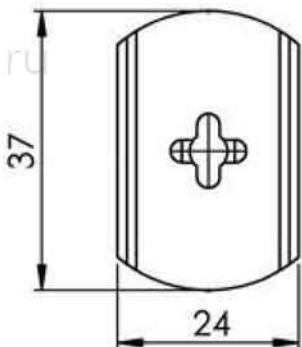
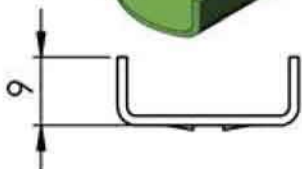

**LFF 060**  
(Lockwasher 060)

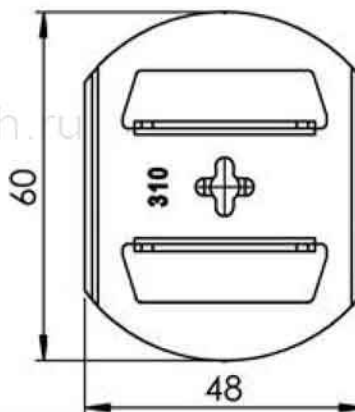
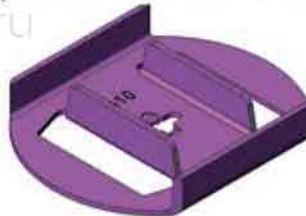

**MTC 045**  
(Mounting clip)

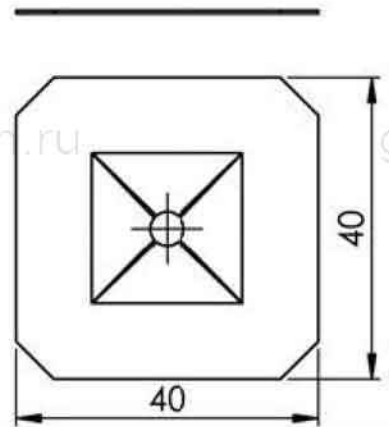
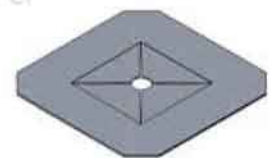

**IRIS - Industrial Refractories & Insulating Specialities**  
Parc d'Activités Aérodrome Ouest - Rouvignies - F - 59328 VALENCIENNES Cedex (France)

Tél : +33 (0)3.27.21.52.80  
E-mail: [contact@irisfrance.com](mailto:contact@irisfrance.com)

Fax : +33 (0)3.27.21.52.99  
Web: [www.irisfrance.com](http://www.irisfrance.com)

This drawing is the property of IRIS. Unauthorised use of patented features and/or reproduction of this drawing is strictly prohibited

### DESIGNATION EXAMPLE

# FFS.5 - 200 - 310

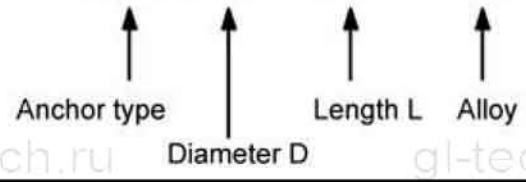

# FFS

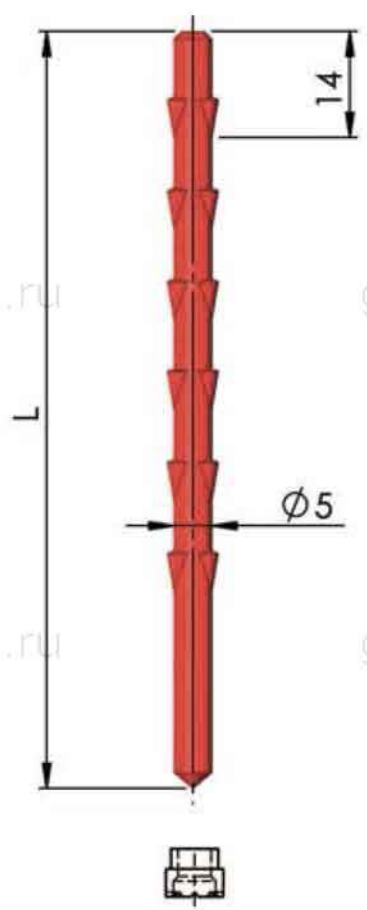

CERAMIC FERRULE: FER - 052  
FOR STUD WELDING



## OPTIONS

\*Sketch not contractual

**MTC Mounting Clip**

**MTC - 045 - 000**

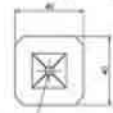
Mounting clip Diameter Alloy

000 = Spring carbon steel  
301 = 18% (0.4% C)

MTC-045 (d=4.5mm) for studs Ø5.0 - 6.0  
MTC-065 (d=6.5mm) for studs Ø7.0 - 8.0

**LFF 040**

**LFF - 040 - 310**

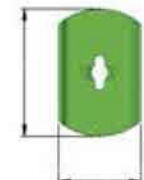
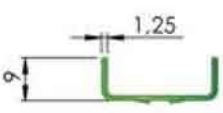

Lockwasher Thickness Alloy



1.25

**LFF 060**

Lockwasher 060

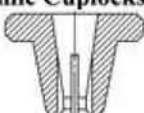

**IRI-025 Ceramic Cuplocks**



SECTION A-A

ONLY suitable for our Ø5 studs FIBERFIX (FFS - FFH - FFT)  
Other models on request.

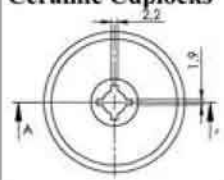
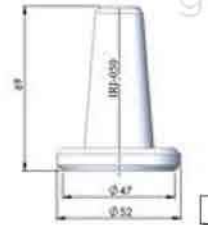
**IRI-050 Ceramic Cuplocks**



**IRI-100 Slotted Ceramic Rings**

SUITABLE FOR IRI-025 AND IRI-050  
THE SLOT IMPROVES TEMPERATURE CHANGE RESISTANCE AND LIFE TIME. 3  
NOT SLOTTED RINGS AVAILABLE ON REQUEST.

### DESIGNATION EXAMPLE

# FFH.5 - 200 - 304

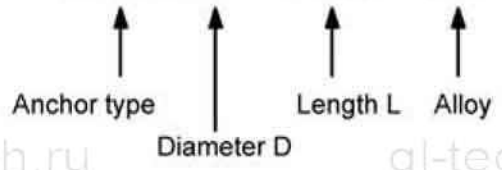

# FFH

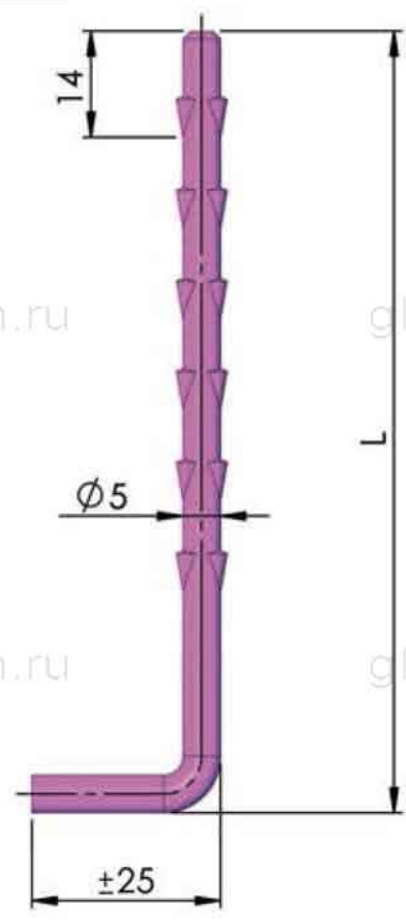

\*Sketch not contractual

## OPTIONS

**MTC Mounting Clip**

**MTC - 045 - 000**

Mounting clip      Diameter      Alloy

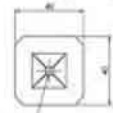

000 = Spring carbon steel  
301 = 18/8 (0.4% C)

MTC-045 (d=4.5mm) for studs Ø5.0 - 6.0  
MTC-065 (d=6.5mm) for studs Ø7.0 - 8.0

**LFF 040**

**LFF - 040 - 310**

Lockwasher      Thickness      Alloy

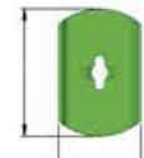

1.25

**LFF 060**

Lockwasher 060

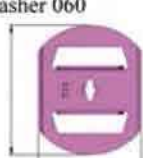

**IRI-025 Ceramic Cuplocks**

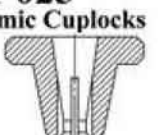

SECTION A-A

ONLY suitable for our Ø25 studs FIBERFIX (FFS - FFH - FFT)  
Other models on request.

**IRI-050 Ceramic Cuplocks**



IRI-050

**IRI-100 Slotted Ceramic Rings**



SUITABLE FOR IRI-025 AND IRI-050  
THE SLOT IMPROVES TEMPERATURE CHANGE RESISTANCE AND LIFE TIME. 3  
NOT SLOTTED RINGS AVAILABLE ON REQUEST.

### DESIGNATION EXAMPLE

# FFT.5.25 - 250 - 330

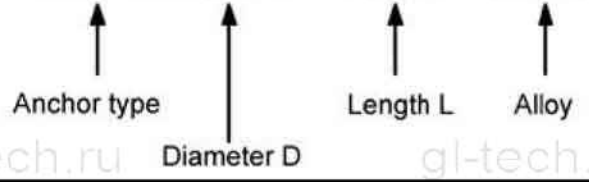

# FFT

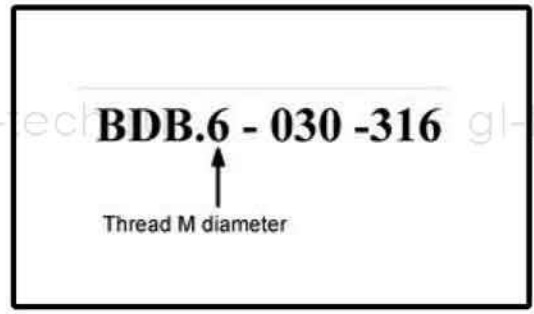

**NOTES :**  
- BDB dowels are only suitable for FFT.5.25

# BDB

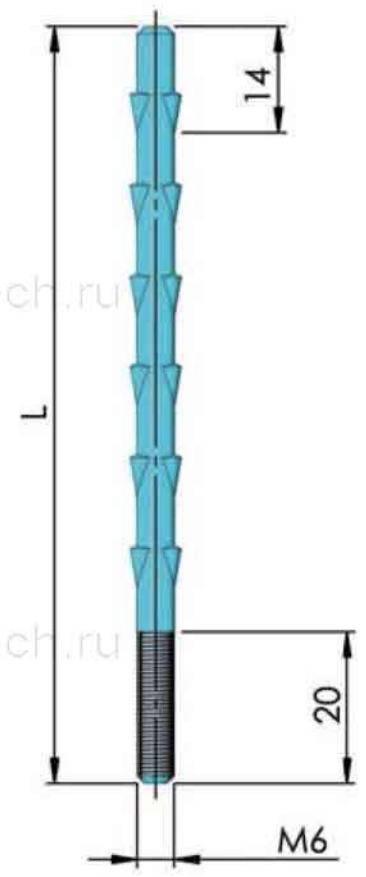
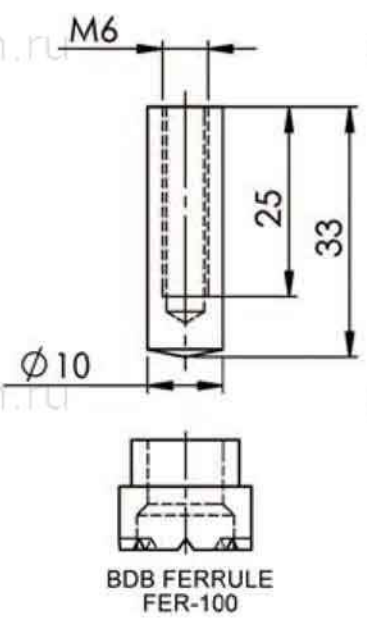

# OPTIONS

\*Sketch not contractual

**MTC Mounting Clip**

MTC - 045 - 000

Mounting clip      Diameter      Alloy

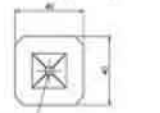

000 = Spring carbon steel  
301 = 18% (0.4% C)

MTC-045 (d=4.5mm) for studs Ø5.0 - 6.0  
MTC-065 (d=6.5mm) for studs Ø7.0 - 8.0

**LFF 040**

LFF - 040 - 310

Lockwasher      Thickness      Alloy

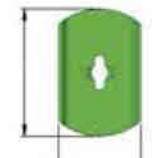

**LFF 060**

Lockwasher 060



**IRI-025 Ceramic Cuplocks**

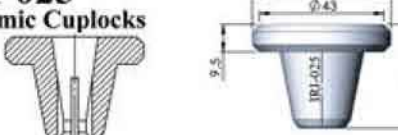

SECTION A-A  
ONLY suitable for our Ø25 studs FIBERFIX (FFS - FFH - FFT)  
Other models on request.

**IRI-050 Ceramic Cuplocks**

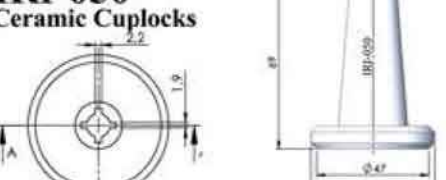

**IRI-100 Slotted Ceramic Rings**



SUITABLE FOR IRI-025 AND IRI-050  
THE SLOT IMPROVES TEMPERATURE CHANGES RESISTANCE AND LIFE TIME. 3  
NOT SLOTTED RINGS AVAILABLE ON REQUEST.