

iPECS

iPECS UCP

(Unified Communications Platform)

System DECT Installation Guide

Please read this manual carefully before operating System.
Retain it for future reference.

iPECS is an Ericsson-LG Brand



Regulatory Information

Before making connections to the telephone network, you may be required to notify your local serving telephone company of your intention to use "customer provided equipment." You may further be required to provide any or all of the following information:

PSTN line Telephone numbers to be connected to the system

Model name

iPECS UCP DECT

The required regulatory agency registration number is available from your local Ericsson-LG Enterprise representative.

This equipment complies with the following regulatory standards, EN 301, EN 406, TBR 10 and TBR 22. Also, this equipment complies with the safety requirements of EN 60950-1 and the EMC requirements of EN5022, EN5024, EN301 489-1 and EN 301 489-6.

GDC DECT Series has been designed to comply with the Hearing Aid Compatibility requirements as defined in Section 68.316 of Part 68 FCC Rules.

If the telephone company determines that customer provided equipment is faulty and may possibly cause harm or interruption in service to the telephone network, it should be disconnected until repair can be affected. If this is not done, the telephone company may temporarily disconnect your service.

The local telephone company may make changes in its communications facilities or procedures. If these changes could reasonably be expected to affect the use of **iPECS UCP** or compatibility with the network, the telephone company is required to give advanced written notice to the user, allowing the user to take appropriate steps to maintain telephone service.

iPECS UCP complies with rules regarding radiation and radio frequency emission as defined by local regulatory agencies. In accordance with these agencies, you may be required to provide information such as the following to the end user:



WARNING

“This equipment generates and uses R.F. energy, and if not installed and used in accordance with the Instruction Manual, it may cause interference to radio communications. It has been tested and found to comply with the appropriate limits for a telecommunication device. The limits are designed to provide reasonable protection against such interference, when operated in a commercial environment. Operation of this equipment in a residential area could cause interference, in which case the user, at his own expense, will be required to take whatever measures may be required to correct the interference.”

Revision History

SW version	ISSUE	DATE	CONTENTS OF CHANGES
	1.0	Mar., 2014	Initial Release
1.1.x	1.1	Feb., 2015	Update the contents according to SW integration.
1.2.x	1.2	July, 2015	Changed LG logo type and system connection diagram
2.0.x	1.3	Jan, 2016	Added GDC-480H and corrected the wrong operation in subscription and Attendant service

Copyright© 2014 Ericsson-LG Enterprise Co., Ltd. All Rights Reserved

This material is copyrighted by Ericsson-LG Enterprise Co., Ltd. (Ericsson-LG Enterprise). Any unauthorized reproductions, use or disclosure of this material, or any part thereof, is strictly prohibited and is a violation of Copyright Laws. Ericsson-LG Enterprise reserves the right to make changes in specifications at any time without notice. The information furnished by Ericsson-LG Enterprise in this material is believed to be accurate and reliable, but is not warranted to be true in all cases.

iPECS is trademarks of Ericsson-LG Enterprise Co., Ltd.

All other brand and product names are trademarks or registered trademarks of their respective companies.

Table of Contents

1. Introduction	1
2. System DECT Components & Specifications	2
2.1 GDC-600BE Specifications	3
2.2 GDC-450H/480H/500H Specifications	3
3. Installation	4
3.1 Installation Overview.....	4
3.2 Site Planning for Base Stations	4
3.2.1 Cell-coverage Region Survey (CRS).....	4
3.2.2 Preliminary Positions of Base Stations	5
3.2.3 General Procedure for CRS	8
3.2.3.1 Additional Tips for CRS	9
3.2.4 Base Station General Guidelines	10
3.3 WTIM4.....	13
3.4 WTIM8.....	15
3.5 WTIM Installation.....	17
3.6 Description and Installation of GDC-600BE.....	19
3.6.1 GDC-600E Description.....	19
3.6.2 Base Station Installation.....	19
3.6.2.1 Mounting Base Station	19
3.6.2.2 Mounting Base Station - 2 (Using Wedge)	20
3.6.2.3 LED Indications.....	21
3.6.2.4 Traffic Guidelines	21
3.7 Ferrite Core Installation and Wiring.....	22
3.8 User Subscription/Unsubscription	24
3.8.1 System ID	24
3.8.2 Authentication Code.....	25
3.8.3 User Subscription.....	26
3.8.4 User Unsubscription I.....	27
3.8.5 User Unsubscription II.....	28
3.8.6 RSSI Monitoring.....	29
4. Attendant Services	30
4.1 Enable Subscription.....	31
4.2 Terminate a Subscription	32

4.3 Authentication Code for DECT Subscription.....	33
4.4 Viewing the System ID (PARK code)	34
4.5 Authenticating a User	35
4.6 Modifying the System ID (PARK code).....	36
4.7 Deleting all Subscriptions	37
4.8 Deleting a Single Subscription.....	38
4.9 Registering to a Networked System	39
5. Troubleshooting	40

1. INTRODUCTION

iPECS System DECT (Digital Euro Cordless Technology) solution employs Ericsson-LG Enterprise DECT technology to provide convenience and enhanced productivity with increased office mobility. With the System DECT solution, any DECT Gap compatible handset such as Ericsson-LG Enterprise GDC-450H/480H/500H DECT handset can use wireless connectivity for accessing features and functions of the iPECS system. GDC-450H/480H/500H connect with Ericsson-LG Enterprise DECT Base Stations, providing a fixed radio coverage area or cell. Arranging multiple base stations with overlapping cells forms zones of transparent coverage. As the handset is moved within the zone, a Radio Frequency (RF) connection can be established with any Base station in the zone for transparent operation of the handset throughout the zone, using active call hand-off.

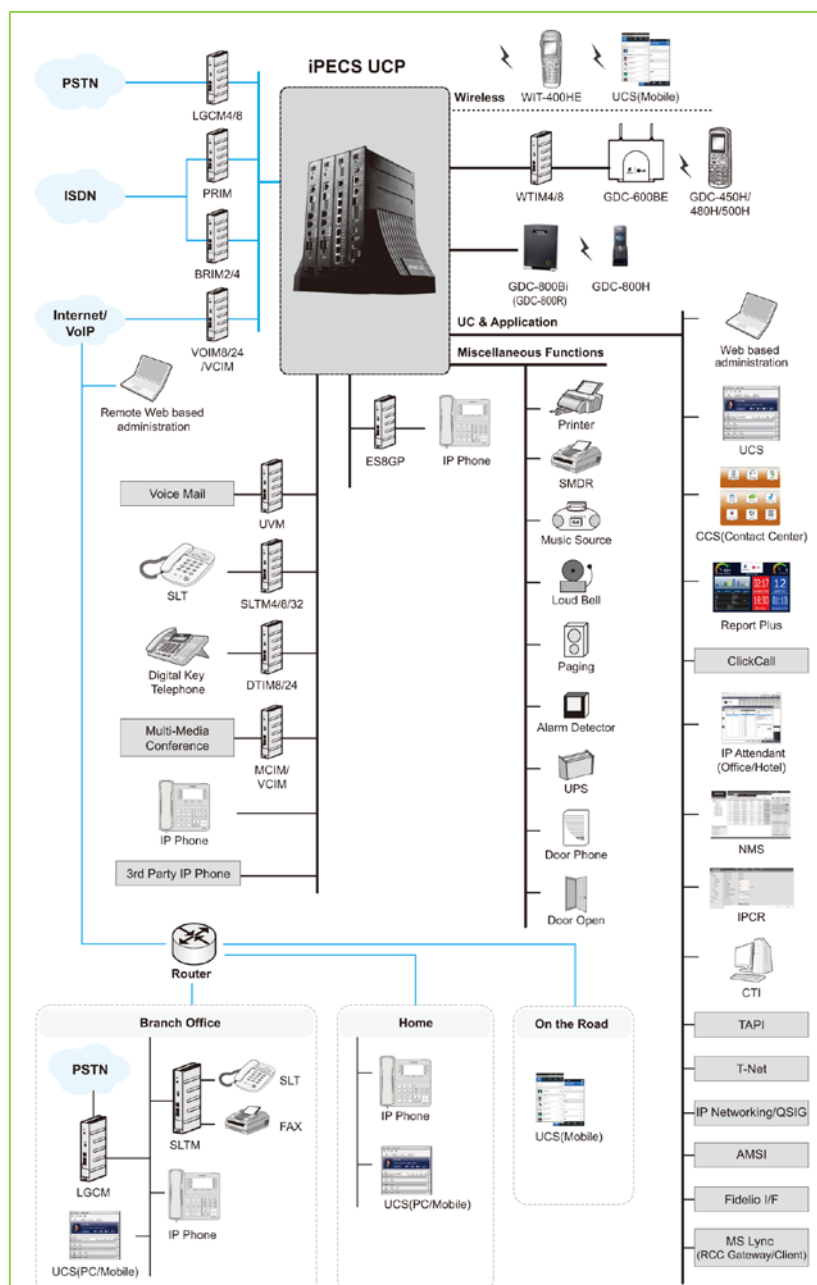

Figure 1.1-1 System Connection Diagram

2. SYSTEM DECT COMPONENTS & SPECIFICATIONS

The System DECT solution works well with iPECS UCP System which is comprised of WTIM4/8, Base Station (RFP), and DECT terminal. The next figure shows a general DECT reference model of Wireless Office Terminal System (WOTS).

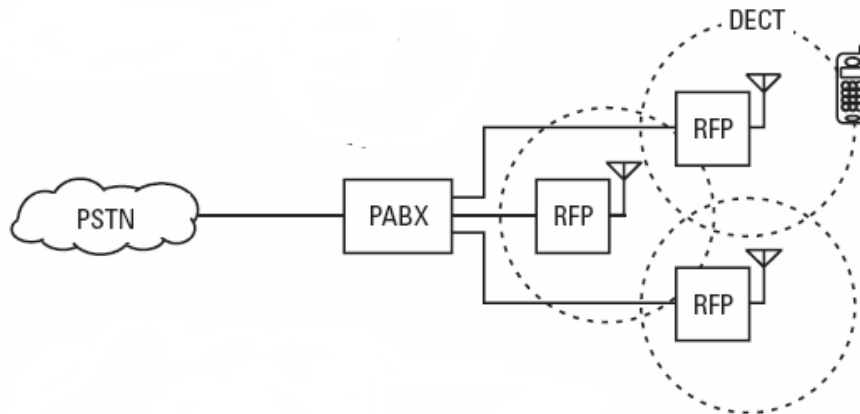

Figure 2.1 General DECT reference model of Wireless Office Terminal System

- **PABX** – Private Automatic Branch Exchange
- **RFP** – Radio Fixed Part (Base Station)
- **PSTN** – Public Switched Telephone Network

The following is needed to configure the System using DECT phones:

- **WTIM4 and WTIM8** – Up to three WTIM4s or WTIM8s can be connected to iPECS UCP System. Each WTIM4 and WTIM8 can support up to 4 or 8 Base Stations (respectively).
- **Base Station (GDC-600BE)** – The base station should be installed indoors and protected from surge because it is designed for indoor station.
Each base station provides similar coverage for a particular area call as a cell, and supports 6 simultaneous calls (6 traffic channels). However, since individual wireless terminals are not continuous in call, the system may support more than 6 wireless terminals.
- **Wireless Terminal (GDC-450H/480H/500H)** – UP to 192 wireless terminals can be registered.

2.1 GDC-600BE Specifications

2.1-1 Base Station Specifications

ITEM	SPECIFICATION
Power Feeding	+30V DC
Transmission Max Power	250mW
Access Method/Duplex	TDMA/TDD
Frequency Band	1,880 ~ 1,900MHz 1,920 ~ 1,930MHz (USA)
Channel Spacing	1.728MHz
Modulation	GFSK
Data rate	1.152Mbps
Max. Base Station distance from the WTIM	600m (Recommended CAT5 cable or CAT3 cable)

2.2 GDC-450H/480H/500H Specifications

Battery type, battery life, charger/base input voltage and current, charger output voltage and current, minimum receive power for operation, etc.

2.2-1 Wireless Terminal Specifications

ITEM	SPECIFICATION
Max. Transmission Power	250Mw 100mW(USA) maximum
Modulation Method	GFSK
Frequency Band	1,880MHz ~ 1,900MHz 1,920 ~ 1,930MHz (USA)

3. INSTALLATION

3.1 Installation Overview

The installation of System DECT begins with a Site Survey to establish a temporary site map including initial locations for Base Stations. After the site map is developed, the WTIM(s) is installed and iPECS is configured to support System DECT (refer to your system **iPECS Administration and Programming Manual** for establishing DECT data in Web Admin). Once configuration is complete, the Base Stations are mounted in their preliminary locations and an RF coverage survey is conducted to refine the Base Station locations. With the Base Stations placed and installed in their permanent locations, handsets can be registered to System DECT.

DECT employs RF signals to communicate between the handsets and Base Stations.

In order to address the variation in range, prior to installation, a site survey should be conducted to establish a map with the preliminary locations for the DECT Base Stations. After installation, the handset is employed in the Cell Tool mode to define the actual RF radiation pattern and Base Station locations can be adjusted to provide seamless coverage.

3.2 Site Planning for Base Stations

The purpose of Site Planning is to provide you with information and explain tasks that should be considered to ensure the best operation of the system. Read the following information before installing the unit.



CAUTION

The Base Station should be installed indoors and protected from surge because it is designed to be an indoor station.

3.2.1 Cell-coverage Region Survey (CRS)

In order to obtain the most complete coverage in your facility, this Section explains the measuring procedures using the Cell-coverage Region Survey (CRS) tool of GDC-600TBE. The temporary positions of Base Stations should be determined prior to this measurement according to instructions outlined in this section. The temporary positions will be adjusted according to the measurement findings, if necessary. Before reading this part, it is recommended to get used to the manipulation of the CRS tool. GDC-450H/480H/500H support CRS function.

3.2.2 Preliminary Positions of Base Stations

1. Obtain the plane drawings of the building.

First, understand the general constructing materials of the walls, doors, windows, etc. The materials of the building are the main factors of attenuation of the RF signals.

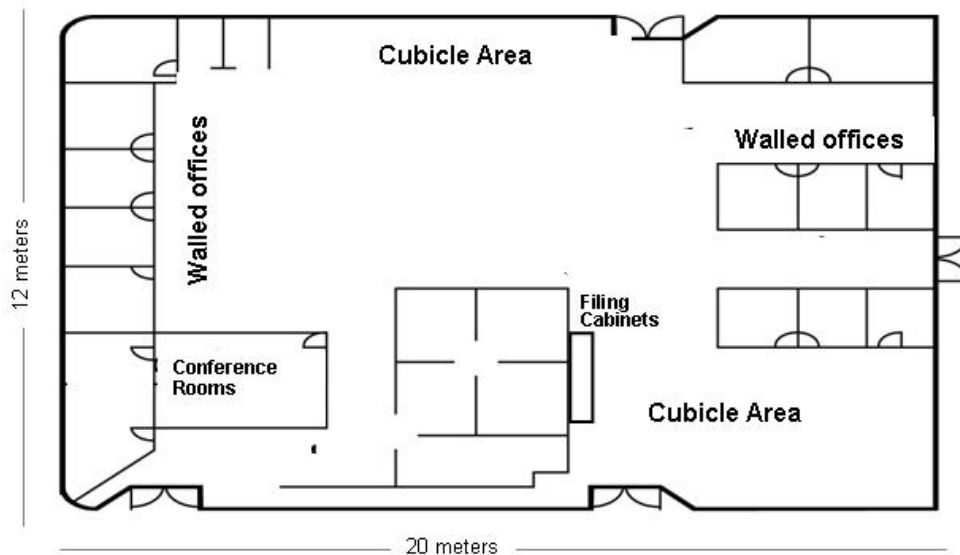

Figure 3.2.2-1 DECT Site Survey

As the Base Station or Handset RF signal propagates, it is subject to several characteristics that affect the ability to receive the signal in a useable form. Normal attenuation, reflection, and noise all contribute to signal degradation over distance. The Base Station and Handset transmit at about 10 dbm and can receive a signal of -70 dbm. In an open field with line-of-sight, the handset and Base station can have a separation of about 175 meters. The antenna radiation pattern is approximately circular in the horizontal plane (shown Figure 3.2.2-2). In an office environment, walls, doors, windows, etc. will further attenuate the RF signal to varying degrees (guidelines below), significantly reducing the coverage area.

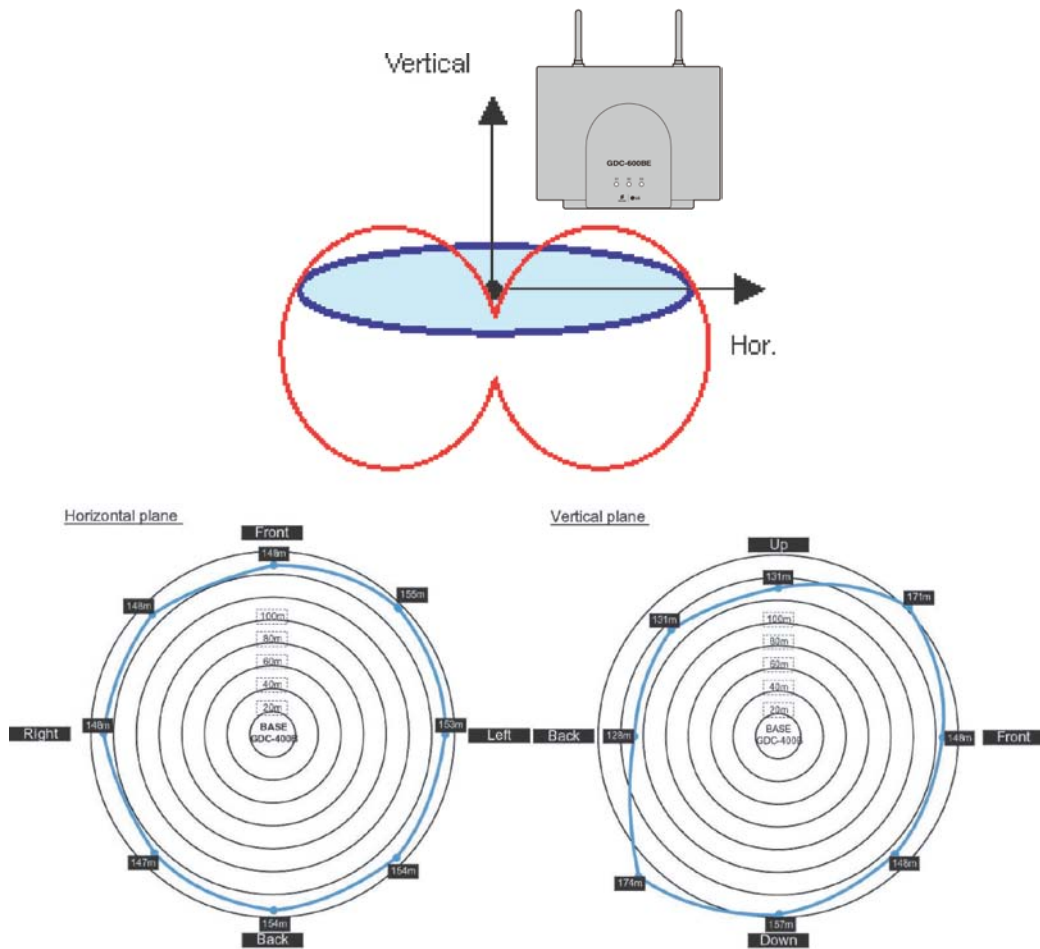

Figure 3.2.2-2 Antenna Radiation Pattern

Office furniture and structures such as filing cabinets, and certain windows and other surfaces can cause reflections of the original signal. Some materials cause significant reflections, which can reduce the received signal. GDC-600BE has two antennas to implement antenna diversity, which minimizes the affects of signal reflections. By employing the antenna with the best signal, the affects of reflected signals can be reduced. Although reflections cannot be eliminated in an office, consider locating the Base Stations away from cabinets and other tall furniture.

High noise levels affect the ability of the receiver to separate the desired signal from the general noise. Office and industrial equipments such as Fax machines, office electronics, welders, microwave ovens and even poorly maintained fluorescent lighting can generate high RF emissions, which appear as background RF noise. Also multiple reflections of the original signal can appear as noise. Again, although RF noise cannot be eliminated, noise can be reduced by locating Base stations away from nearby emitters.

2. Determine the broadcasting range of a Base Station.

In a typical office environment, the radius of the cell supported by a Base Station is approximately 15-30 meters. If it is an open area inside of a building, as in a factory, the signals may reach 20-50 meters. These figures however, are truly dependent on the office characteristics (ex., construction material of walls, placement of metallic objects, doors, windows, etc.); make sure to get to know the broadcast range in your environment taking each office characteristic into account (refer to Figure 3.2.2-3).

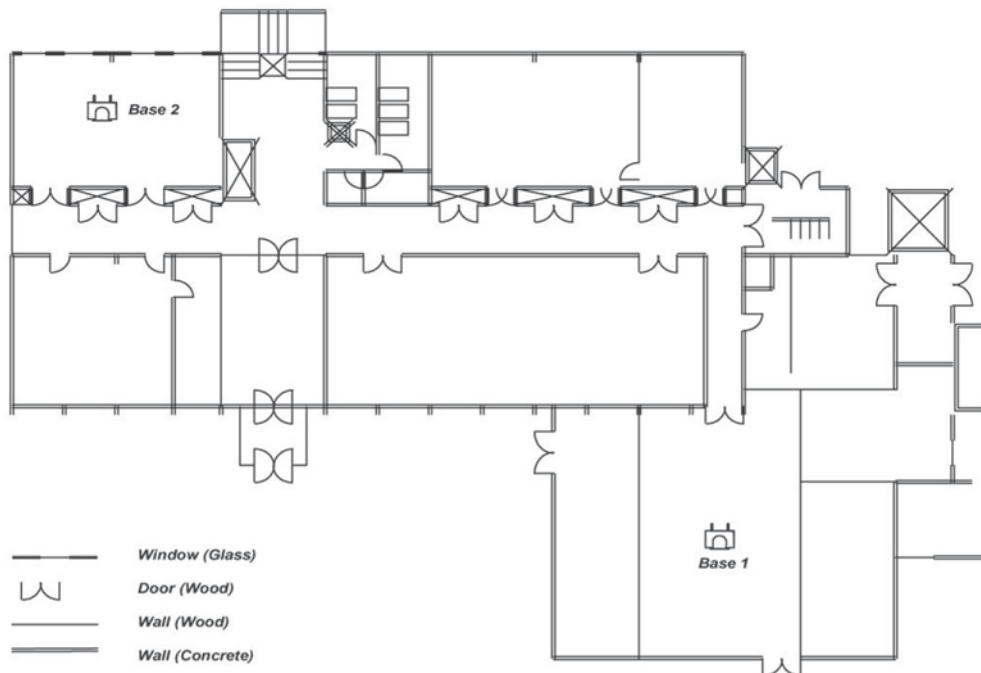

Figure 3.2.2-3 Sample Temporary Base Station Position

3. Mark the position of the offices where wireless handsets (450H/480H/500H) mainly will be used, and mark the places where high call demands would exist; these areas should be well covered by the Base Stations.
4. Roughly determine the number of Base Stations and the positions needed according to the above tips.

3.2.3 General Procedure for CRS

After getting well-acquainted with the operation of GDC-600TBE, and how the Base Stations work as applicable to your facility, the CRS can be conducted. Section 3.2.2, Preliminary Positions of Base Stations should already have been completed.

To conduct a CRS:

1. First, verify that other DECT Base Stations in the area are powered OFF; only the one you are working with currently should be ON.
2. Enter the same PARK ID in GDC-600TBE and GDC-450H/480H/500H.
3. Mount GDC-600TBE at the determined temporary position as high as possible; it is recommended to place the GDC-600TBE at higher than 2 meters.
4. Check the Remote System Service Indicator (RSSI) level in GDC-450H/480H/500H by walking around the area; decide the cell-coverage range temporarily using the pre-determined RSSI level.
5. Repeat CRS procedure from Step 1 at the next tentative Base Station position; it is likely and recommended that the cell-coverage will overlap a bit as shown:

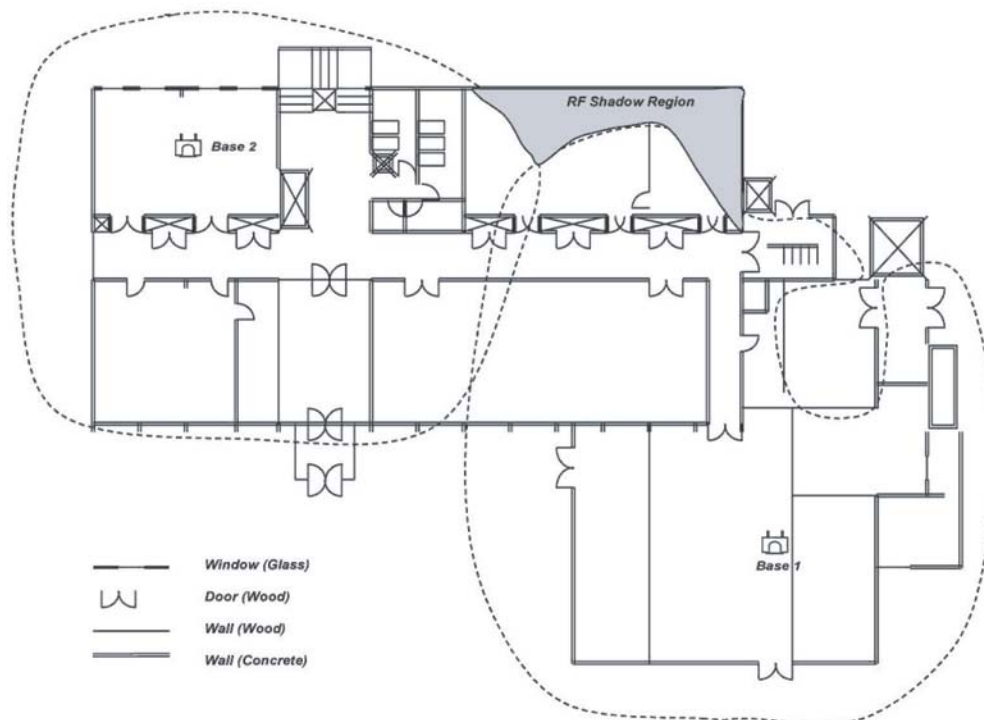

Figure 3.2.3-1 Cell Boundary Map with Base 1 and Base 2

6. If marked positions on the drawing need to be adjusted, move Base Station positions by checking shadow area on plan drawing, and adjusting the Cell-Coverage Regions (consider traffic of 6 calls per area, and add to plan) as shown:

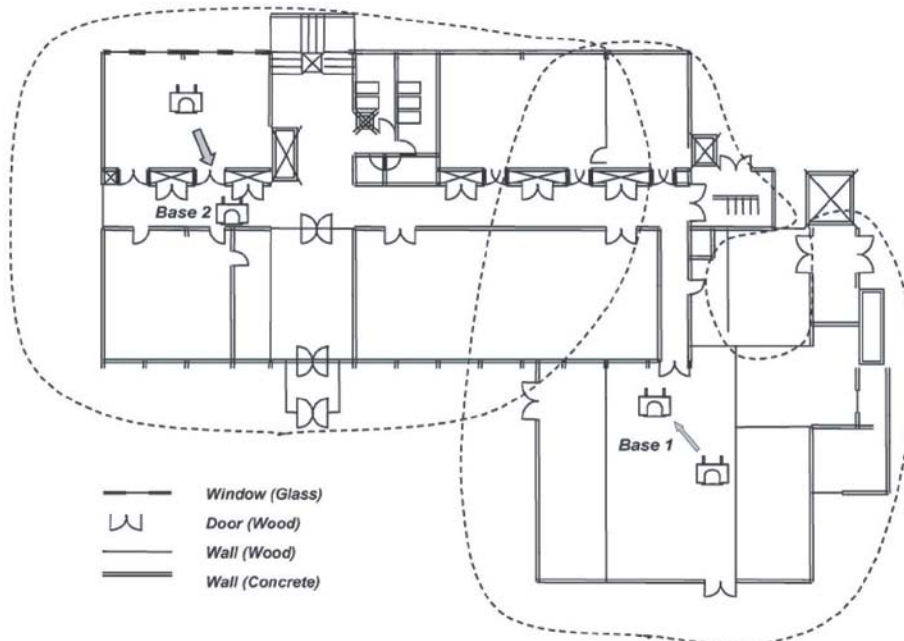

Figure 3.2.3-2 Adjusting Cell Boundary Positions for Base 1 and Base 2

7. After completing the CRS, install the Base Stations (GDC-600BE) in the optimal locations.
8. Finalize the Base Station position by performing a handover and call test with wireless terminals (ex., GDC-450H/480H/500H), by checking the cell coverage region with GDC-450H/480H/500H monitor RSSI level (recommended $-65 \pm 5\text{dBm}$, walk with 2 handsets and monitor for voice quality).

3.2.3.1 Additional Tips for CRS

The following lists what you should keep in mind during the CRS Test:

- Draw a cell-coverage region map for each Base Station temporary position.
- The height of a mounted Base Station highly affects the performance of Base Station; it is recommended Radio Fixed Parts (RFP) such as Base Stations, should be mounted as high as possible, and at least higher than 2 meters.
- It is good to locate the position of the RFP in order to secure as many line-of-sight paths as possible, no obstacles between the RFP and Handset (PP), and the path is direct; a line-of-sight path is a good travel way for Radio Frequency signal.
- All other DECT products should be powered-OFF, and GDC-600TBEs cannot work simultaneously.
- Testing during daytime in the real environment is more recommended, as the RSSI is very sensitive to environmental situations; testing at night when the interfering factors are minimized will bring quite different results from a real office environment. If there is fading due to metal material, the RSSI value can be varied over a wide range.
- Use a fully-charged battery pack.

3.2.4 Base Station General Guidelines

Using the guidelines and examples below, determine and indicate the approximate Base station locations on the drawing.

- Maximize line-of-sight
- Distance in open field 150 meters ~ -65 dbm
- Distance in-office 25 to 40 meters
- Distance in hallway or open factory floor 40 to 70 meters
- Locate Base stations to minimize obstructions (sprinklers, exit signs, etc.)
- Locate Base stations away from noise emitters (FAX machines, etc.)
- Locate Base stations away from metal objects (tall filing cabinets, security/fire doors, etc.)
- Locate Base stations near the center of the desired coverage area
- For proper handover, the coverage area of each Base station should overlap by 10 to 15 meters.

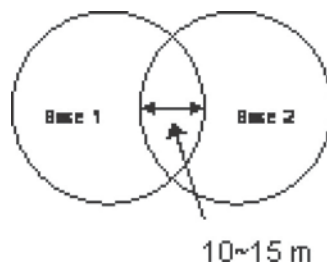

- Consider high traffic areas such as conference rooms and cafeterias.
- Each Base station supports four (6) simultaneous conversations.
- Multiple Base stations can be co-located with a minimum distance of 0.25 meters.
- For a multi-floor installation, plan coverage for each floor separately
- Attenuation approximations considering office equipment and materials:
 - Open field = 0.5 db/meter
 - Office environment = 2 to 3 db/meter (25 ~ 40 meters)
 - Hall or open factory floor = 1 to 2 db/meter (40 to 70 meters)
 - Concrete and masonry = 15 db/cm
 - Windows, clear glass = 5 dbWindows, mirrored glass = 15 db
 - Drywall, standard = 5 db
 - Drywall, metal backed = 12 db
 - Metal, 1.5 mm = > 20db

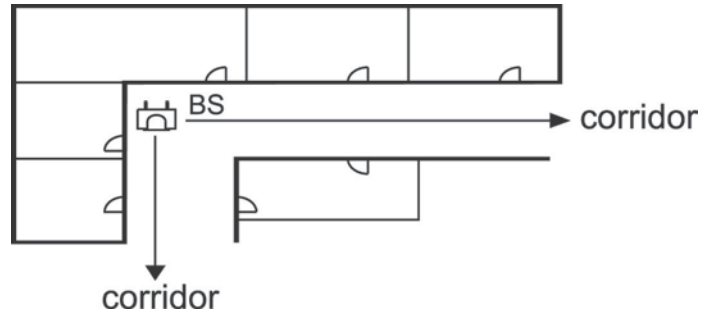

Figure 3.2.4-1 Hallway Placement

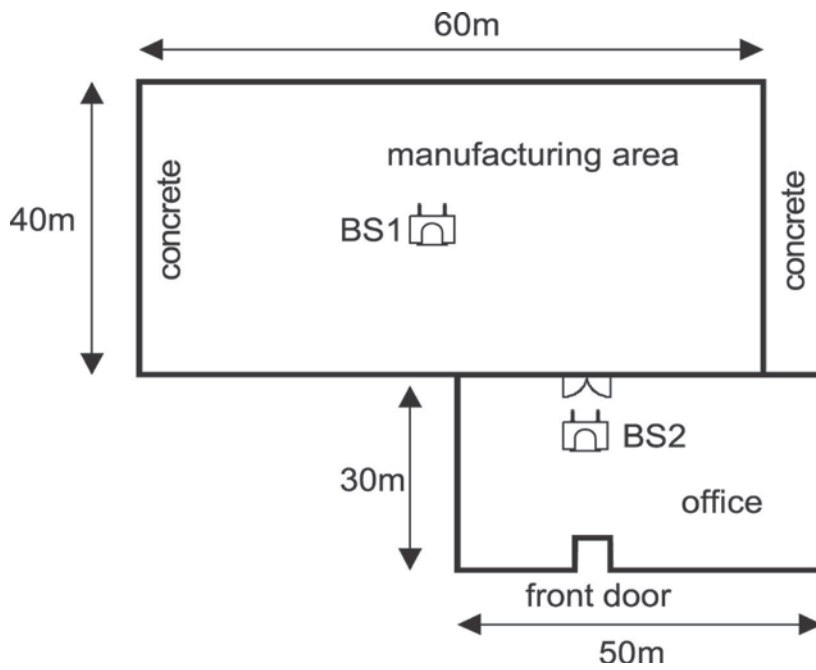

Figure 3.2.4-2 Centralized Base Station Placement

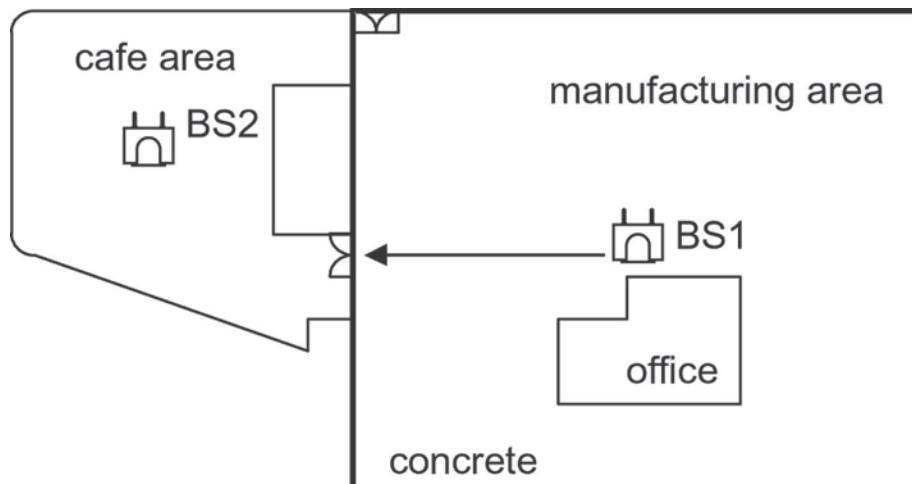

Figure 3.2.4-3 Base Station Aligned with Corridor to Adjoining Area

⚠ CAUTION

1. The appropriate position for a Base Station is no closer than 1.8m above the floor and 0.5m below the ceiling.
 - The best communication environment is when a Base Station and a user are of the same height. In an office environment, however, it is recommended to consider office furniture (especially iron desktops or cabinets) to minimize reflection, diffraction and scattering of DECT wave when you set the position of a Base Station.
2. Keep away from any electronic equipment such as copy machines, printers or computers.
3. The lower wall of a corridor where many people pass by, corner of a wall, and narrow indoors also should be avoided.
4. When you install a Base Station on the wall, it is better to include intervals.
 - DECT wave is attenuated by reflection indoors. In order to minimize attenuation, when you install a Base Station on the wall, give at least three-wave-length intervals. The intervals should be about 45cm because the wavelength is 15cm at DECT frequency.

In iPECS UCP System, WTIM4 and WTIM8 are both Base Station interface boards. iPECS UCP System can have up to three WTIM4 (up to 4 ports) or WTIM8 (up to 8 ports).

3.3 WTIM4

The four (4)-channel Wireless Terminal Interface gateway Module(WTIM4) provides 4 GDC-600BE interfaces. DECT handsets can be used if GDC-600BE is connected to the WTIM4 and the proper attendant programming is done. The WTIM4 contains a processor for IP to TDM and signaling conversion and DSP circuitry to provide trans-coding for each channel. GDC-600BE can be connected to the WTIM4 up to 600 meters from the gateway using 24 AWG twisted pair cabling. The WTIM4 includes the PHY and MAC for the 10/100 Base-T Ethernet interface as well as packet voice processing functions. The Ethernet port incorporates auto MDI, MDIX switching, therefore, both straight and cross cables can be used.

As shown in Figure 3.3-1, the front panel of the WTIM4 has:

- (1) Power jack for the AC/DC adapter supplied.
- (2) Power status LED.
- (3) Normal/Service switch – In Service mode, circuits in use are busied as they return to idle.
- (4) RJ-45 Female LAN connector with Speed and Link/Activity LEDs.

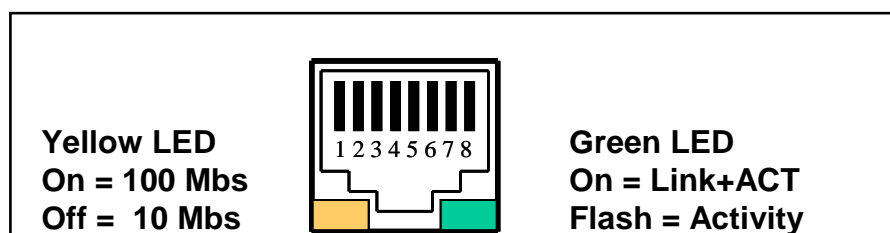

- (5) Function switch, SW4

SW	On	Off	Description	Default
SW1-1	TBR6 test mode	Normal	Reserved for test	OFF
SW1-2	Enable Echo-can.	Disable Echo-can.	Echo-canceller control	ON
SW1-3	Nios-II(FPGA) Serial Mode	Mindspeed Serial mode	Serial selection	ON
SW1-4	All base reset	One base reset	S/W debugging	OFF

- (6) Eight (8) WTIM4 status LEDs.

LED	Define	Label
1	When WTIM is connected with MFIM via LAN, LED1 is turned on.	LINK
2	Whenever WTIM receives/sends the message from/to MFIM, LED2 is toggled.	HBUS
3	Whenever WTIM receives/sends the message from/to BASE, LED3 is toggled.	E1
4	If WTIM is master, LED4 is always turn-on. If WTIM is 1 st slave, LED4 is blink for 1 sec period.	M/S

LED	Define	Label
	If WTIM is 2 nd slave, LED4 is always turn-off.	
5	When Mindspeed CPU is normal, LED5 is toggled.	CP1
6	When Nios-II CPU is normal, LED6 is toggled.	CP2
7	Whenever WTIM4/8 receives/sends the message from/to other WTIMs, LED7 is toggled.	WBUS
8	When more than one DECT channel is used, LED8 is turned on.	USE

- (7) DB-9 RS-232 connector.
- (8) Reset Switch.

On the rear panel, the WTIM4 has:

- (1) Four (4) RJ-45 female connectors.
- (2) Ground Lug.
- (3) Fifty (50)-pin back plane connector.
- (4) Two(2) WTIMⁱ link connectors(24 pins)
 - OUT: connected to the next slave WTIM with link cable
 - IN: connected to the previous WTIM with link cable

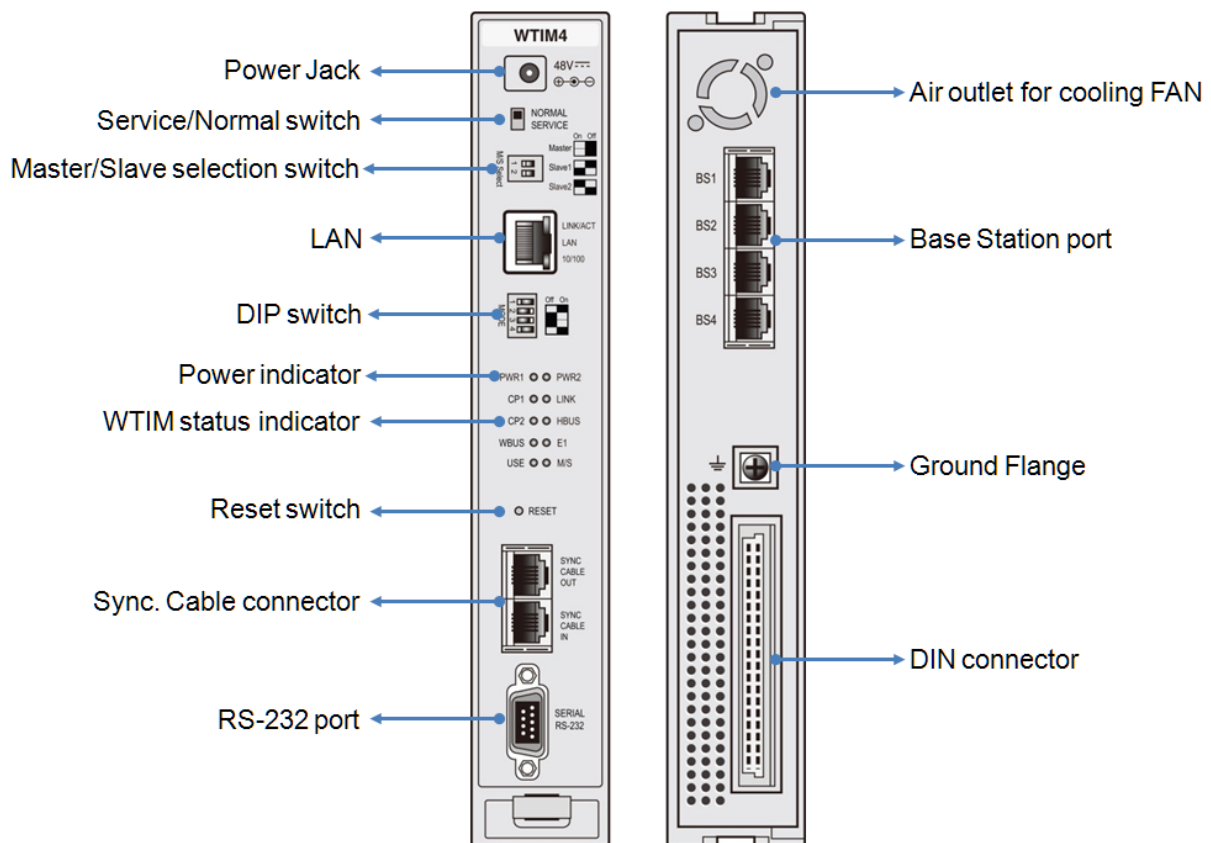

Figure 3.3-1 WTIM4 Front & Rear Panels

3.4 WTIM8

The eight (8)-channel Wireless Terminal Interface gateway Module(WTIM8) provides 8 GDC-600BE interfaces. DECT handsets can be used if GDC-600BE is connected to the WTIM8 and the proper attendant programming is done. The WTIM8 contains a processor for IP to TDM and signaling conversion and DSP circuitry to provide trans-coding for each channel. GDC-600BE can be connected to the WTIM8 up to 600 meters from the gateway using 24 AWG twisted pair cabling. The WTIM8 includes the PHY and MAC for the 10/100 Base-T Ethernet interface as well as packet voice processing functions. The Ethernet port incorporates auto MDI, MDIX switching, therefore, both straight and cross cables can be used.

As shown in Figure 3.4-1, the front panel of the WTIM8 has:

- (1) Power jack for the AC/DC adapter supplied.
- (2) Power status LED.
- (3) Normal/Service switch – In Service mode, circuits in use are busied as they return to idle.
- (4) RJ-45 Female LAN connector with Speed and Link/Activity LEDs.

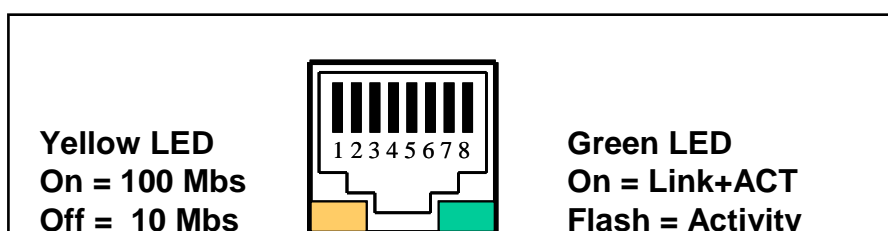

- (5) Function switch, SW4

SW	On	Off	Description	Default
SW1-1	TBR6 test mode	Normal	Reserved for test	OFF
SW1-2	Enable Echo-can.	Disable Echo-can.	Echo-canceller control	ON
SW1-3	NiosII(FPGA) Serial Mode	Mindspeed Serial mode	Serial selection	ON
SW1-4	All base reset	One base reset	S/W debugging	OFF

- (6) Eight (8) WTIM8 status LEDs.

LED	Define	Label
1	When WTIM is connected with MFIM via LAN, LED1 is turned on.	LINK
2	Whenever WTIM receives/sends the message from/to MFIM, LED2 is toggled.	HBUS
3	Whenever WTIM receives/sends the message from/to BASE, LED3 is toggled.	E1
4	If WTIM is master, LED4 is always turn-on. If WTIM is 1 st slave, LED4 is blink for 1 sec period. If WTIM is 2 nd slave, LED4 is always turn-off.	M/S
5	When Mindspeed CPU is normal, LED5 is toggled.	CP1

LED	Define	Label
6	When Nios-II CPU is normal, LED6 is toggled.	CP2
7	Whenever WTIM4/8 receives/sends the message from/to other WTIMs, LED7 is toggled.	WBUS
8	When more than one DECT channel is used, LED8 is turned on.	USE

- (7) DB-9 RS-232 connector.
- (8) Reset Switch.

On the rear panel, the WTIM8 has:

- (1) Eight (8) RJ-45 female connectors.
- (2) Ground Lug.
- (3) Fifty (50)-pin back plane connector.
- (4) Two(2) WTIM link connectors(24 pins).
 - OUT: connected to the next slave WTIM with link cable.
 - IN: connected to the previous WTIM with link cable.

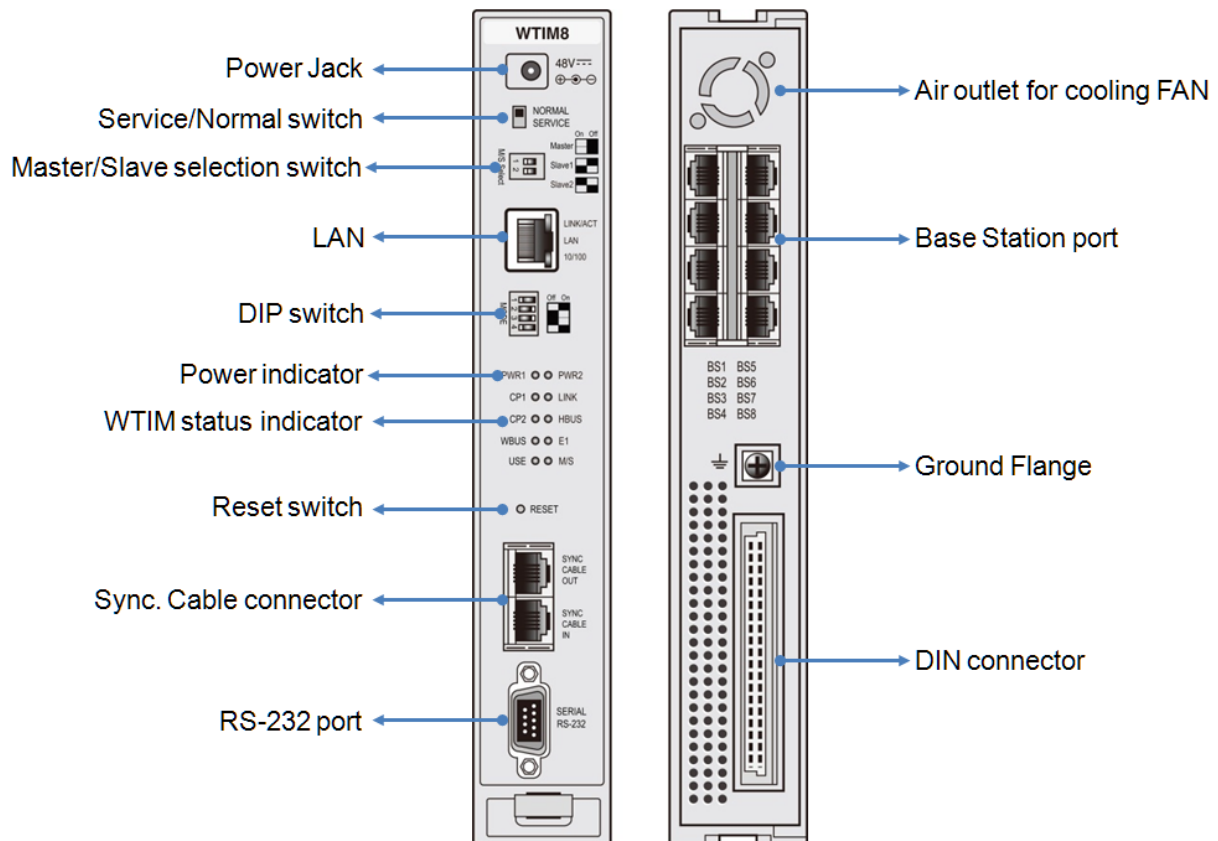

Figure 3.4-1 WTIM8 Front & Rear Panels

3.5 WTIM Installation

The WTIM may be installed in any slot of the Main Cabinet, or may be installed anywhere in the Desk Mount Holder. The WTIM provides a gateway between DECT handsets as like GDC-450H/480H/500H.

The WTIM4 can provides four (4) GDC-600BE interfaces.

The WTIM8 can provides eight (8) GDC-600BE interfaces.

LEDs

In addition to the Power and LAN LEDs, the WTIM has eight (8) status LEDs for each function(Refer to the LED definition for the detail).

Wiring Connectors

Before wiring any of the Modules, first connect the “” screw on the back of the Module to a known ground.

On the front of the WTIM is the RJ 45 type “LAN” connector. This connector should be wired to the appropriate LAN points.



- Wire “LAN” to a 10/100/1000 Base-T switch, ES8GP or ES8G can be used, to connect to LAN. Before connecting to the LAN X port of ES8G, the appropriate switch for DTE power must be in the “OFF” position.
- Tag or number wiring for maintenance.

Pin assignment

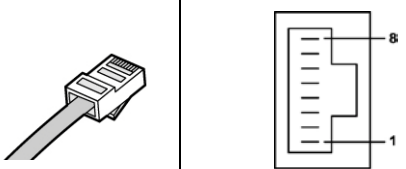
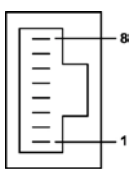
Connector	Pin Number	NO	SIGNAL NAME	FUNCTION
		1, 2, 7, 8	RESERVED	
		3	RX+(GND)	Receive Data
		4	TX-(+30V)	Transmit Data
		5	TX+(+30v)	Transmit Data
		6	RX-(GND)	Receive Data

The above table shows the pin assignment of each RJ45 on the rear panel of WTIM.

The pin number 3 and 6 of each base station port is connected to the circuit ground (GND) of WTIM, and the pin number 4 and 5 is connected to the DC power(+30V) of WTIM. So, the base station receives DC power from WTIM when the base station is connected to the base station port.

Category 5 cable should be used to connect between WTIM and GDC-600BE.

It is not possible to connect between WTIM and GDC-600BE through the Main Cabinet back-plane.

- Wire using another CAT5 cable between each RJ-45 on rear panel of WTIM and the termination point/MDF connected to GDC-600BE with CAT5 cable.
- Tag or number wiring for maintenance.

AC/DC Adapter

Assure the AC/DC Adapter is plugged into a live AC outlet and the Module Power jack.

WTIM cascading

WTIMs should be connected with link cable one another to make it possible to handover between GDC- 600BE connected to each WTIM. Cascading connection of up to three (3) WTIMs is possible irrespective of the kind of WTIM.

Note that hot plugging is not recommended when connecting between WTIM with link cable.

The next figure shows how to connect WTIMs for cascading WTIM.

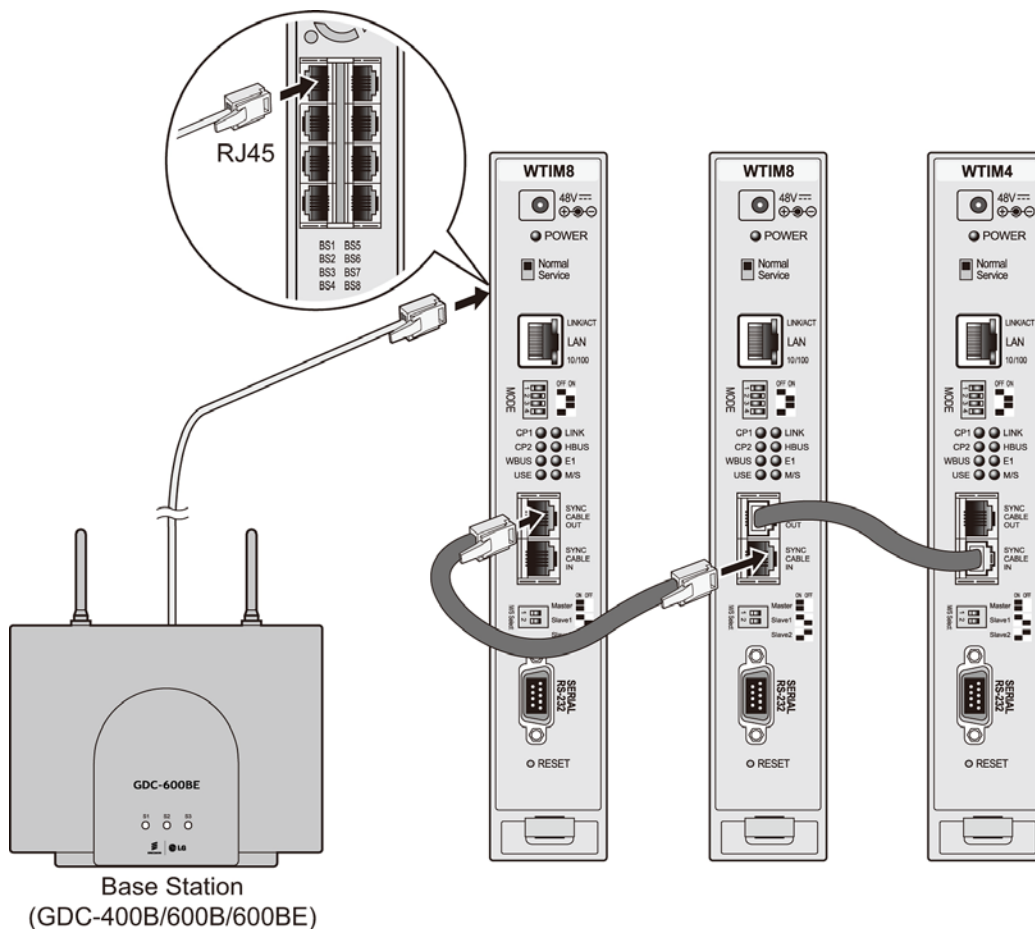

3.6 Description and Installation of GDC-600BE

3.6.1 GDC-600E Description

GDC-600BE Base station employs DECT technology to provide an RF link to any standard DECT GAP handset such as the GDC-450H/480H/500H. The Base Station connects to a WTIM4/8 for access to features and resources of iPECS with an RJ-11 4-wire connector on the left-side of the unit. In addition to providing the path for signaling and audio between the Base Station and the WTIM4/8, this connection provides power to GDC-600BE.

Two antennas provide antenna diversity to minimize the effects of RF signal reflection. The Base Station is meant for indoor wall mounting only. The Base Station is directly mounted on the wall using two (2) screws.

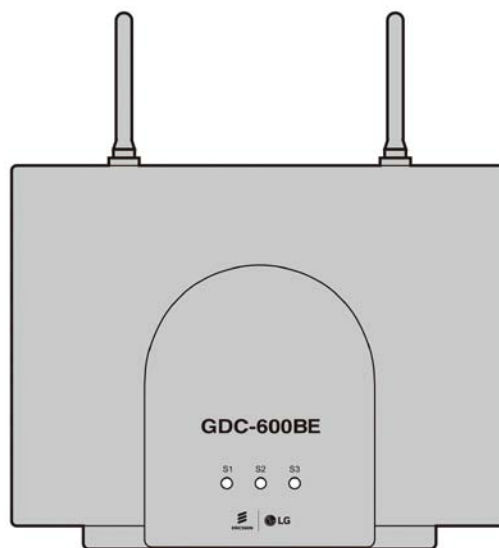

Figure 3.6.1-1 GDC-600BE DECT Base Station

3.6.2 Base Station Installation

As mentioned in previous sections in this chapter, before permanently mounting a Base Station, you should determine the most appropriate location for providing the best coverage. Base Stations may be mounted on wall or desktop up to 600m away from the WTIM4/8 using a twisted 2-pair unshielded cable (0.5 ϕ , AWG 24). They are remotely powered (DC 30 volts) by the WTIM4/8.

The number of Base Stations used in a system depends on the area to be covered and the traffic density. The typical in-house coverage is a 75m radius for GDC-600BE. In practice, the cell outdoor radius in free space may be up to 400m for GDC-600BE.

There are two ways to install the Base Station: mounting directly to wall surface, or mounting using a wedge, as described in the following Section.

3.6.2.1 Mounting Base Station

The weight of a Base Station is approximately 460g (1.2lb.), so it can be mounted on a masonry or dry-wall surface, wooden wall, or partition wall.

Before mounting Base Station permanently, you should determine locations that provide the

best coverage (refer to General Procedure for CRS). To wall mount the Base Station, perform the following Steps:

1. Drill two 3.5mm holes in a fixed wall; to properly position the holes, use the mounting template (last sheet of this manual) and copy it if necessary. The distance between mounting holes is 121mm as shown in the image.
2. Insert anchors into the drilled holes.
3. Insert screws in the anchors, leaving a 3mm gap between the wall and screw head.
4. Mount the Base Station eyelets on the screws.

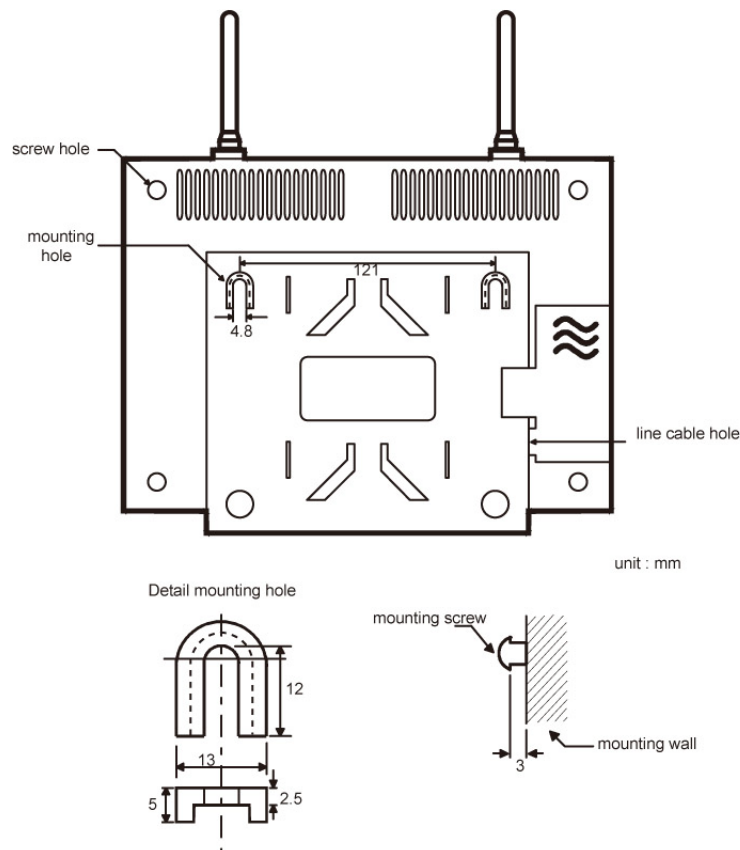

Figure 3.6.2.1-1 Back side of the GDC-600BE

Before mounting base station permanently, you should determine locations that provide the best coverage. The wall mounting procedure of a base station is as follows:

1. Drill two 3.5mm holes in a fixed wall. To properly position the holes, you can use mounting template that is the last sheet of this manual and copy it if necessary.
2. Insert anchors into the drilled holes. Then insert screws in the anchors, leaving a 3mm gap between the wall and screw head.
3. Mount the base station eyelets on the screws.

3.6.2.2 Mounting Base Station - 2 (Using Wedge)

To Install the Base Station using the wedge:

1. First determine the appropriate location on wall where the wedge will be mounted.
2. The wedge should be affixed to the wall using two screws; use the mounting template as in #1 of the previous procedure.
3. Attach the Base Station to the wedge by aligning the guides to the back the Base Station and pulling the Base Station down until it is secure on the wedge.

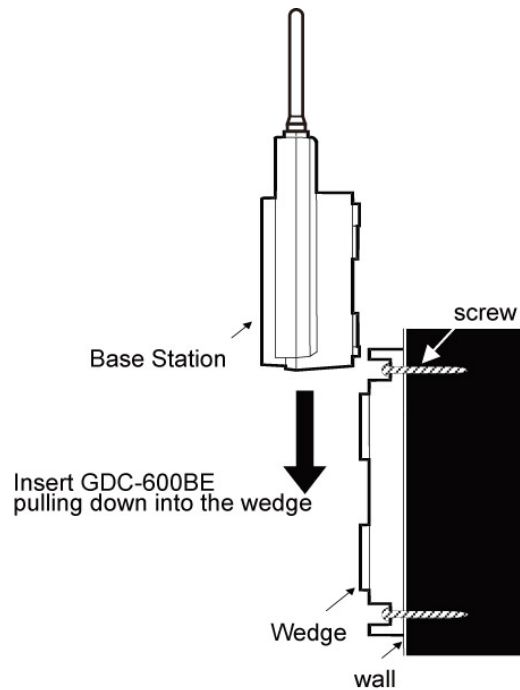

Figure 3.6.2.2-1 Side of GDC-600BE

3.6.2.3 LED Indications

3.6.2.3-1 GDC-600BE

LED	Description	Remark
LED 1	Normal operation of FPGA (U14). FPGA controls the Base Station including BMC	Blinking (Blue)
LED 2	Normal operation of BMC (U8). BMC controls DECT frame	Steady(5sec) _ON and OFF (Blue)
LED 4	PWR_ON	Steady _ON (Red)

3.6.2.4 Traffic Guidelines

Each GDC-600BE Base Station supports 6 simultaneous calls, but because all users are not usually simultaneously on calls, a Base Station can support a greater number of wireless terminal users in practice.

3.6.2.4-1 GDC-600BE

Number of CELL (Base Station)	Number of Wireless Terminal	Max. Number of simultaneous conversation
1	8-192 by 8 steps	6
2		12
3		18
4		24
23		138
24		144

3.7 Ferrite Core Installation and Wiring

Ferrite core is provided in the packaging of the Base Station for EMI. The Ferrite core should be installed when the WTIM4/8 is installed in the key telephone system. One Ferrite core is to be used with the line cord between the Base Station and each port of WTIM4/8 (as shown).

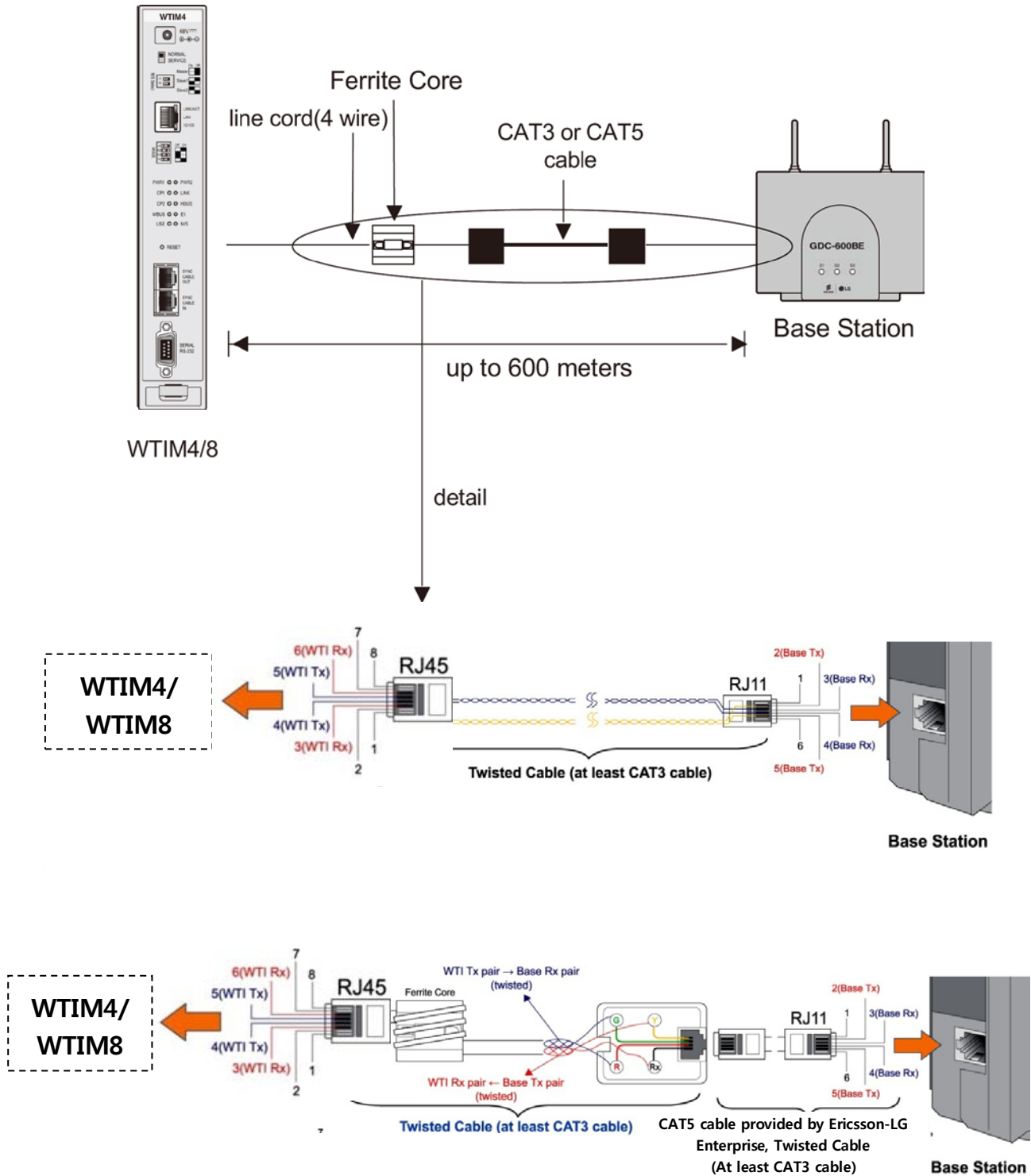
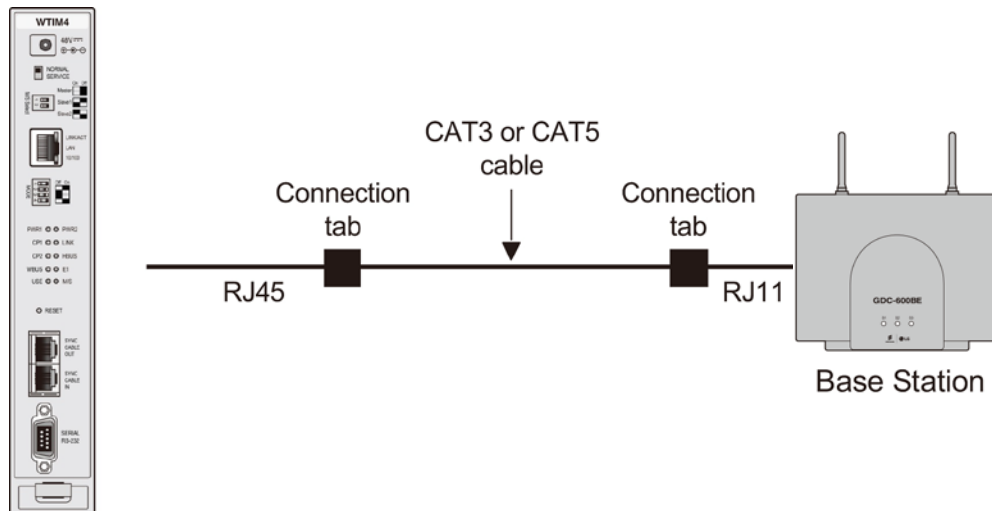
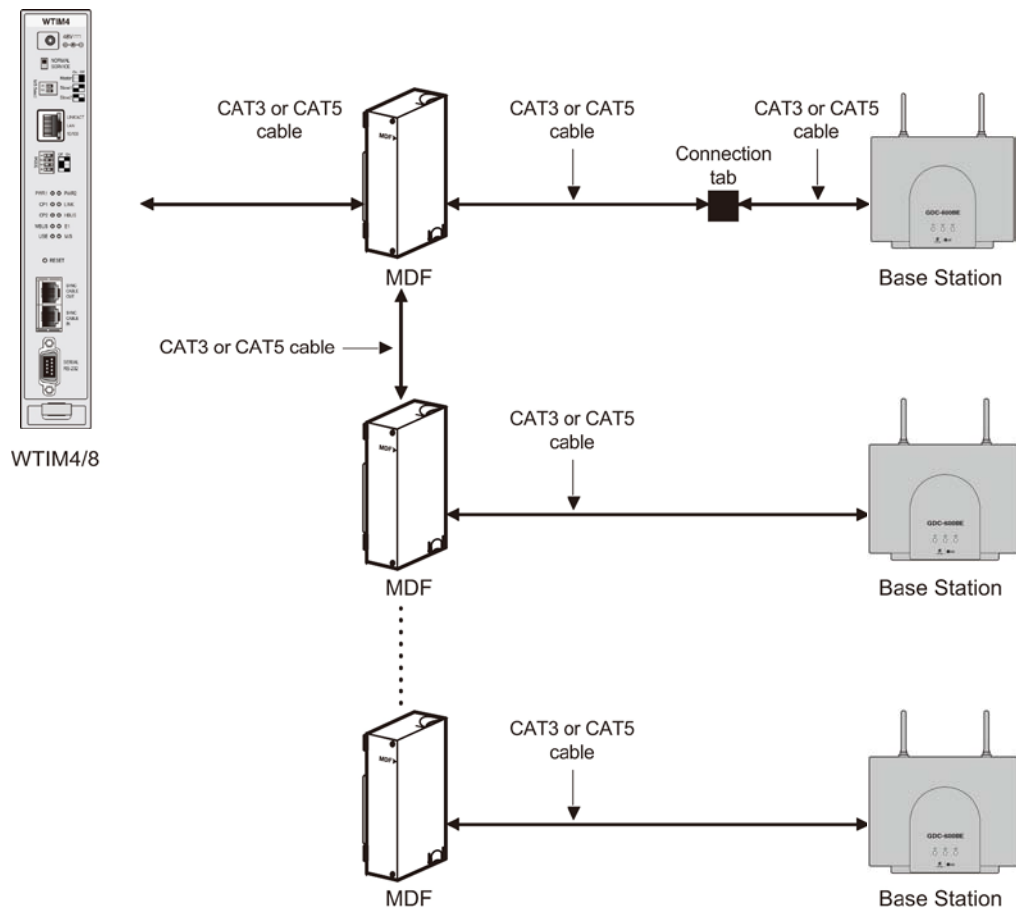

Figure 3.7-1 Cable connection with Ferrite Core between WTIM4/8 and Base Station



WTIM4/8

Figure 3.7-2 Wiring with connection tab between WTIM4/8 and Base Station



WTIM4/8

Figure 3.7-3 Wiring with MDF and connection tab between WTIM4/8 and Base Station

NOTE

- Even though there are connection points such as MDF or connection tab between WTIM4/8 and Base Station, the connection points should be connected with twisted-pair cable (at least CAT3 class) each other. For example, WTIM4/8 to MDF, MDF to MDF, MDF to connection tab, and connection tab to Base Station should be connected with twisted-pair cable

3.8 User Subscription/Unsubscription

3.8.1 System ID

A System ID is given to iPECS UCP system attached to the wireless GAP terminal for identification. System ID, which is the Potable Access Rights Key (PARK), is written on the UCP.

PARK: 31100013411741

The Authentication Code as well as System ID should be entered at only the Attendant Station, before Subscribing the wireless terminal (GAP) to iPECS UCP system.

To display the System ID, perform the following Steps:

1. From the Attendant station, press **[TRANS/PGM]** button.
2. Dial 0#.
3. Press the FLEX 4 button.

When modifying or entering the System ID:

1. From the Attendant Station, press **[TRANS/PGM]** button.
2. Dial 0#.
3. Press the FLEX 6 button.
4. Enter the System ID (PARK code, refer to key sequence description below).
5. When finished, press the **[HOLD/SAVE]** button; a confirmation tone will be heard.

CAUTION

Normally you should not change the system ID. If you should change it, please contact Ericsson-LG Enterprise or the local dealer in your country.

The key sequence of the PARK= LLP_____PC

- LL – Two digits decimal representation of PARK length (Bit count)
- P_____P – 11 heximal digits representation of PARK
- C – Check digit, calculated as the sum of each digit in the input stream multiplied by its position in the input stream, module of 11; if the result is 10, this is represented by *.

Conditions

1. The System ID must be programmed when the System is installed.
2. When System ID is programmed, all previously entered data related to wireless features will be erased.
3. The initial PARK value is 00000000000000; the value will display in LCD at first.

3.8.2 Authentication Code

The Authentication Code is entered at the Attendant station before subscribing a User wireless terminal (GAP) to iPECS UCP.

To display the Authentication Code, perform the following steps:

1. From the Attendant station, press **[TRANS/PGM]** button.
2. Press 0#.
3. Press the FLEX 3 button; the current AC code will display on the LCD.
4. If Authentication code is correct, exit the program mode.

If Authentication code is wrong, please follow the procedure:

1. From the Attendant station, press **[TRANS/PGM]** button.
2. Dial 0#.
3. Press the FLEX 3 button.
4. Enter the Authentication Code (up to 8 digits, refer to key sequence description below).
5. When finished, press **[HOLD/SAVE]**; a confirmation tone will be heard.

The key sequence of the AC code= D _____ D

- D _____ D – Up to 8 digits decimal representation.

Condition

1. AC code must be programmed for User Subscription.
2. AC code must be programmed after the system was installed; if AC code is changed while under system operation, it may not operate properly (ex., subscribed terminal may not receive incoming calls or not make an outgoing call).
3. If PARK value is changed, AC code must also be entered again.
4. The initial AC code is 000000.
5. AC code change will not affect the system operation except subscribing new wireless terminals.

3.8.3 User Subscription

This procedure is for subscribing the wireless terminal to iPECS UCP system.

To subscribe the wireless terminal to PECS UCP system at Attendant Station:

1. From the Attendant station, press **[TRANS/PGM]** button.
2. Dial 0#.
3. Press the FLEX 1 button.
4. Enter the appropriate Station Number.
5. Enter the phone type (2=Standard GAP, 3=GDC-40x/45xH, 5=GDC-480H/500H)
6. Press the **[HOLD/SAVE]** button; a confirmation tone is heard.
7. The Attendant Station LCD should display "SUBSCRIBED: SUCCESS"; if message is not received, perform Steps again from #1

To subscribe at the wireless terminal (e.g. GDC-480H/500H):

1. Press **[MENU]** button.
2. Select **[Phone Register]** menu.
3. Select **[Subscription]** menu.
4. Select the empty base number (1-4) using **[UP/DOWN]** button, and press **[OK]** button.
5. The wireless terminal will search for the register system and 'SEARCHING...X' is displayed on the LCD. After searching the register system, PARK value is displayed on the LCD.
 - If value displayed is correct, press **[OK]** button; confirmation tone will be heard and displayed at the Attendant Station and at the wireless terminal which will then return to an idle state displaying the appropriate station number.
 - If value is not correct, press the **[NO]** button; the terminal will retry the search and display 'SEARCHING...X' on the LCD.
6. Enter AC code (up to 8 digits decimal representation) and press **[OK]** button.
7. If search fails, repeat the above steps at the Attendant Station and Wireless Terminal.

Condition

1. Wireless terminal must be subscribed to system for normal service.
2. Only Attendant can subscribe the wireless terminals (GAP).
3. Attendant can subscribe another wireless terminal after one subscribing procedure.
4. An error tone will be heard if attendant attempts to subscribe a wireless terminal that was subscribed already.

3.8.4 User Unsubscription I

This procedure will disconnect a wireless terminal from the iPECS UCP system. To unsubscribe a wireless terminal, it should be in an idle state.

To unsubscribe a wireless terminal from the Attendant Station, perform the following:

1. At the Attendant station, press **[TRANS/PGM]** button.
2. Dial 0#.
3. Press the FLEX 2 button.
4. Enter the appropriate Station Number.
5. Press **[HOLD/SAVE]** button; a confirmation tone will be heard and displayed to the Attendant and the Wireless terminal.
 - If using GDC-480H/500H, It will attempt to synchronize the next registered system; if any available system doesn't exist, GDC-480H/500H displays "Not Subscribed" on LCD.
6. Power-Off the wireless terminal.

Condition

1. Only an Attendant can unsubscribe a wireless terminal.
2. Attendant can only unsubscribe wireless terminals that were subscribed already; if attendant attempts to unsubscribe an unsubscribed wireless terminal, an error tone will be heard.
3. Attendant can unsubscribe another wireless terminal after completing an unsubscribing procedure.
4. Attendant can perform unsubscribing procedure only when the wireless terminal is in an idle state.

3.8.5 User Unsubscription II

If you want to perform the unsubscription procedure at wireless terminal and Attendant station independently, follow the procedure described below.

To erase all subscriptions from the Attendant Station:

1. At the Attendant station, press **[TRANS/PGM]** button.
2. Dial 0#.
3. Press the FLEX 7 button.
4. Enter the appropriate password (147*).
5. Press the **[HOLD/SAVE]** button; a confirmation tone will be heard.

To erase one subscription from the wireless terminal:

1. From the wireless terminal, press the **[TRANS/PGM]** button.
2. Dial 0#.
3. Press the FLEX 8 button.
4. Enter the appropriate Station Number.
5. Press the **[HOLD/SAVE]** button; a confirmation tone will be heard.

Condition

1. Wireless terminal must be unsubscribed from the system for normal service.
2. Only an Attendant can unsubscribe a wireless terminal.
3. Attendant can unsubscribe another wireless terminal after completing the subscribing procedure; if attendant attempts to unsubscribe an unsubscribed wireless terminal, an error tone will be heard.

3.8.6 RSSI Monitoring

Received Signal Strength Indicator (RSSI) Monitoring is a way that the dealer can install Base Stations without using the CRS tool. The RSSI level of a Base Station to which the wireless terminal is locked is displayed as a "dBm" value on the LCD (up to 80dbm.); the value is updated periodically. The handset must be subscribed for this function to work.

To use RSSI Monitoring when using a GDC-480H/500H wireless terminal:

1. From the wireless terminal.
2. Press the **[Menu]** button.
3. Press the * key.
4. Enter the Technician menu by entering press PIN code (L G G A P = 5 4 4 2 7).
5. Press **[OK]** button.
6. Press the **[CELL TOOL]** mode to **YES** and press the **[OK]** button.
7. The RSSI value will display on LCD of wireless terminal (automatically updated periodically).

4. ATTENDANT SERVICES

The Attendant can manage User subscriptions to iPECS System DECT. The Attendant enables subscriptions, can unsubscribe User data, request authentication and register a User to another networked system. In addition, the Attendant can view and modify DECT-related codes (Authentication and PARK). It is recommended these codes not be changed as subscribed handsets may perform erratically. Subscription management and code control services are available under the Attendant DECT Data program.

To access the DECT Data program from the Attendant station, perform the following procedure:

1. Press the **[PGM]** button.



STATION 1000 (T)
04 SEP 01 02:49 PM

2. Dial 0 and #.
3. Press the desired Flex button (1-9),



WTU (UN)SUBSCRIBE
PRESS FLEX BUTTON

- Flex Button 1 – Enter the station number for subscription => 4.1 Enable Subscription
- Flex Button 2 – Enter the station number for un-subscription => 4.2 Terminate a Subscription
- Flex Button 3 – Enter Authentication Code for Wireless terminal => 4.3 Authentication Code for DECT subscription
- Flex Button 4 – View the system ID (PARK Code) => 4.4 Viewing System ID (PARK code)
- Flex Button 5 – Enter Authentication Code for Desk terminal => 4.5 Authenticating a user
- Flex Button 6 – Modify the system ID (PARK Code) => 4.6 Modifying the system ID (PARK code)
- Flex Button 7 – Delete all subscriber data => 4.7 Deleting all subscriptions
- Flex Button 8 – Delete each subscriber data => 4.8 Deleting a single subscription
- Flex Button 9 – DECT zone Mobility => 4.9 Registering to Networked systems

4.1 Enable Subscription

For security and control, handset subscription must be authorized, and enabled. Once enabled, the User can subscribe the DECT handset.

To enable a subscription from the Attendant, perform the following procedure:

1. Press the **[PGM]** button.

STATION 1000 (T)
04 SEP 01 02:49 PM

2. Dial 0 and #.
3. Press Flex button 1.

WTU (UN)SUBSCRIBE
PRESS FLEX BUTTON

4. Enter the Station number of the subscribing Station.

WTU SUBSCRIBE ENABLE
ENTER STA NO.

5. Enter the Type of Handset,

STATION : XXXX
ENTER PHONE TYPE

- 2 – Standard DECT GAP
 - 3 – GDC-400H/450H Handset
 - 5 – GDC-480H/500H
6. Press **[HOLD/SAVE]** button and await Success message.
 7. Press Speaker to return to idle.

4.2 Terminate a Subscription

For security and control, a subscription only can be terminated by the Attendant. Once the subscription is terminated, the wireless handset will no longer have access to iPECS services and will display an unregistered or not subscribed status. The handset must be idle to terminate the subscription.

To terminate a subscription from the Attendant, perform the following procedure:

1. Press the **[PGM]** button.

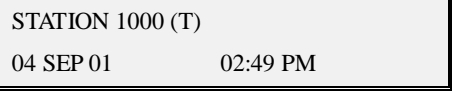

STATION 1000 (T)
04 SEP 01 02:49 PM

2. Dial 0 and #.
3. Press Flex button 2.



WTU (UN)SUBSCRIBE
PRESS FLEX BUTTON

4. Enter the Station number of the subscribing Station.

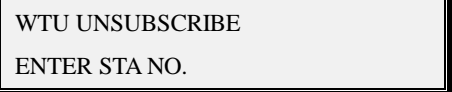

WTU UNSUBSCRIBE
ENTER STA NO.

5. Press **[HOLD/SAVE]** and await confirmation tone.
6. Press Speaker to return to idle.

4.3 Authentication Code for DECT Subscription

When a user subscribes to iPECS System DECT, entry of the DECT Authentication code is required. The Authentication Code entered by the User is compared to the code in the system to verify the User subscription.

To view or enter the Authentication code from the Attendant, perform the following procedure:

1. Press the **[PGM]** button.

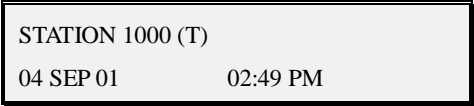

STATION 1000 (T)
04 SEP 01 02:49 PM

2. Dial 0 and #.
3. Press Flex button 3.



WTU (UN)SUBSCRIBE
PRESS FLEX BUTTON

4. Enter the new Authentication Code (up to 8 digits).



AC CODE: XXXXXXXX
ENTER DGT & HOLD BTN

5. Press **[HOLD/SAVE]** button and await confirmation tone.
6. Press Speaker to return to idle.

NOTE

- The Authentication Code must be assigned before a user can subscribe for services.
- Changing the Authentication Code after handsets have registered will cause improper operation, handsets may display erratic operation and may not be able to subscribe or de-subscribe. If the Authentication Code must be changed, first un-subscribe all handsets.
- If the system Id is changed, the Authentication Code must be reassigned.

4.4 Viewing the System ID (PARK code)

The system Id, also known as the PARK (Portable Access Rights Key) code, is used to identify the DECT system. During subscription, the user can verify the handset is subscribing to the correct DECT system. Each WTIM carries a label with the PARK code as shown in the example. In a cascade of WTIMs, the PARK code of the master WTIM is used for the system.

PARK: 31100013411741

To view the Id for the iPECS System DECT from the Attendant station, follow the procedure below.

1. Press the **[PGM]** button.

STATION 1000 (T)
04 SEP 01 02:49 PM

2. Dial 0 and #.
3. Press Flex button 4.

WTU (UN)SUBSCRIBE
PRESS FLEX BUTTON

4. The current System ID (PARK code) displays.

PARK: xxxxxxxxxxxxxx

5. Press **[HOLD/SAVE]** button.
6. Press Speaker to return to idle.

4.5 Authenticating a User

The Attendant can request a User verify their identification. The Attendant requests an authentication, and in response the handset displays a request for the user to enter their Personal ID Number (PIN). The user must enter their PIN in order to receive further services from System DECT.

The PIN, which may be up to five (5) digits is assigned in the handset by the user (refer to the GDC-480H/GDC-500H User Guide).

1. Press the **[PGM]** button.

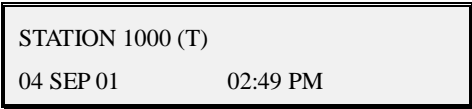

STATION 1000 (T)
04 SEP 01 02:49 PM

2. Dial 0 and #.
3. Press Flex button 5.



WTU (UN)SUBSCRIBE
PRESS FLEX BUTTON

4. Enter the desired Station number.

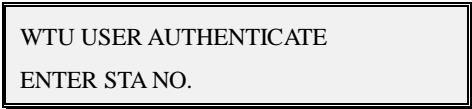

WTU USER AUTHENTICATE
ENTER STA NO.

5. Press **[HOLD/SAVE]**, and await Pass/Fail display on the Attendant phone LCD along with confirmation tone.
6. Press Speaker to return to idle.

4.6 Modifying the System ID (PARK code)

The System ID (PARK code) is a 14-digit number, which uniquely identifies the DECT system. Each DECT System must have a unique PARK code. Should a conflict occur between an iPECS System DECT and another DECT system, the System ID can be changed.

NOTE

- Changing the System ID of an operational iPECS System DECT will remove all subscription and Authentication Code data. It will be necessary to enter an Authentication Code and subscribe all wireless handsets to System DECT if the System ID is changed.

To modify System ID from the Attendant, perform the following procedure:

1. Press the **[PGM]** button.

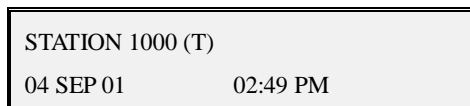

STATION 1000 (T)
04 SEP 01 02:49 PM

2. Dial 0 and #.
3. Press Flex button 6.



WTU (UN)SUBSCRIBE
PRESS FLEX BUTTON

4. The current System ID (PARK code) displays; enter the new PARK code.

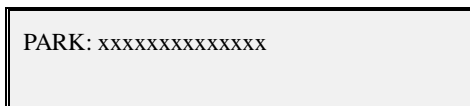

PARK: xxxxxxxxxxxxxx

5. Press **[HOLD/SAVE]** button.
6. Press Speaker to return to idle.

4.7 Deleting all Subscriptions

DECT handsets can be subscribed to an iPECS System DECT. In some situations, subscription data can be deleted from System DECT when moving a DECT Base station or iPECS. In this case, existing subscriptions are deleted and all handset subscriptions must be re-initialized for obtaining access to System DECT services:

1. Press the **[PGM]** button.

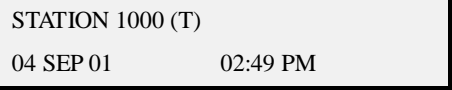

STATION 1000 (T)
04 SEP 01 02:49 PM

2. Dial 0 and #.
3. Press Flex button 7.



WTU (UN)SUBSCRIBE
PRESS FLEX BUTTON

4. Enter 147* (password).



WTU SUBS ALL DATA ERASE
PRESS PASSWD & HOLD

5. Press **[HOLD/SAVE]** button.
6. Press Speaker to return to idle.

4.8 Deleting a Single Subscription

DECT handsets can be subscribed to an iPECS System DECT. In some situations, subscription data for a handset can be deleted from System DECT when replacing a handset. When the subscription is deleted, the handset must be re-initialized for access to System DECT services:

1. Press the **[PGM]** button.

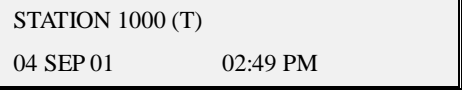

STATION 1000 (T)
04 SEP 01 02:49 PM

2. Dial 0 and #.
3. Press Flex button 8.



WTU (UN)SUBSCRIBE
PRESS FLEX BUTTON

4. Enter desired Station number.



WTU SUBSCRIPTION ERASE
ENTER STA NO.

5. Press **[HOLD/SAVE]** button.
6. Press Speaker to return to idle.

4.9 Registering to a Networked System

Handset can be subscribed to the System DECT of several iPECS Systems simultaneously. If the iPECS Systems are part of a network, the DECT handset can be assigned DECT Mobility and have calls to one iPECS routed over the network to the DECT handset location. To register a handset for DECT Mobility from the Attendant station, follow the procedure:

1. Press the **[PGM]** button.

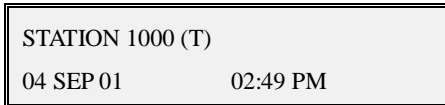

STATION 1000 (T)
04 SEP 01 02:49 PM

2. Dial 0 and #.
3. Press Flex button 9.

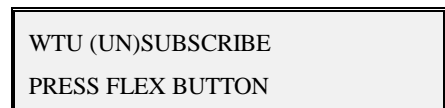

WTU (UN)SUBSCRIBE
PRESS FLEX BUTTON

4. Enter desired Station number.

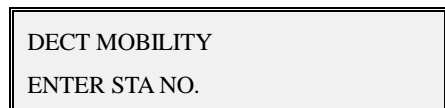

DECT MOBILITY
ENTER STA NO.

5. Enter 1 to enable Network Mobility.

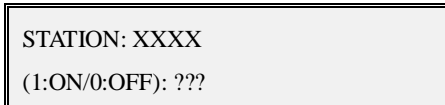

STATION: XXXX
(1:ON/0:OFF): ???

6. Press **[HOLD/SAVE]** button.
7. Press Speaker to return to idle.

5. TROUBLESHOOTING

PROBLEM	CAUSE/SYMPTOM	SOLUTION
User cannot place a call using DECT handset	WTIM issue	<ul style="list-style-type: none">- Please check at least one DECT base station is properly connected to WTIM.- Please check the WTIM is properly connected to the IP network via LAN cable.
	DECT Handset issue	<ul style="list-style-type: none">- Please check the DECT terminal is registered and subscription is completed.- Please check the DECT terminal user is located in the RF coverage area of the DECT base station.
DECT frequently drops calls	Base Station issue	<ul style="list-style-type: none">- Please check cell-planning of DECT base stations.- Please check the DECT terminal user is located in the RF coverage of DECT base stations.- Please check all WTIMs are installed on the same KSU when multiple WTIMs are used together.