

# MAVIC AIR

User Manual v1.0

2018.01

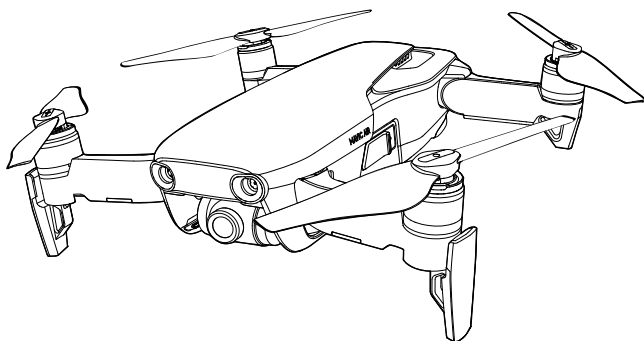

### Searching for Keywords

Search for keywords such as “battery” and “install” to find a topic. If you are using Adobe Acrobat Reader to read this document, press Ctrl+F on Windows or Command+F on Mac to begin a search.

### Navigating to a Topic

View a complete list of topics in the table of contents. Click on a topic to navigate to that section.

### Printing this Document

This document supports high resolution printing.

## Using This Manual

### Legend

 Warning

 Important

 Hints and Tips

 Reference

### Read Before the First Flight

Read the following documents before using the MAVIC™ Air:

1. *Mavic Air In the Box*
2. *Mavic Air User Manual*
3. *Mavic Air Quick Start Guide*
4. *Mavic Air Disclaimer and Safety Guidelines*
5. *Mavic Air Intelligent Flight Battery Safety Guidelines*

We recommend that you watch all tutorial videos on the official DJI™ website and read the *Mavic Air Disclaimer and Safety Guidelines* before you fly. Prepare for your first flight by reviewing the *Mavic Air Quick Start Guide* and refer to this *Mavic Air User Manual* for more details.

### Video Tutorials

Go to the address below or scan the QR code on the right to watch the Mavic Air tutorial videos, which demonstrate how to use the Mavic Air safely:

<http://www.dji.com/mavic-air/info#video>



### Download the DJI GO 4 App

Be sure to use the DJI GO™ 4 app during flight\*. Scan the QR code on the right to download the latest version. The Android version of DJI GO 4 is compatible with Android v4.4 and later. The iOS version of DJI GO 4 is compatible with iOS v9.0 and later.



\* For increased safety, flight is restricted to a height of 98.4 ft (30 m) and range of 164 ft (50 m) when not connected or logged into the app during flight. This applies to DJI GO 4 and all apps compatible with DJI aircraft.

### Download DJI Assistant 2

Download the DJI Assistant 2 at <http://www.dji.com/mavic-air/download>

# Contents

<b>Using This Manual</b>	2
Legend	2
Read Before the First Flight	2
Video Tutorials	2
Download the DJI GO 4 App	2
Download DJI Assistant 2	2
<b>Product Profile</b>	6
Introduction	6
Feature Highlights	6
Preparing the Mavic Air	6
Aircraft Diagram	8
Remote Controller Diagram	8
Activation	9
<b>Aircraft</b>	11
Flight Modes	11
Aircraft LEDs and Status Indicator	12
Return to Home	13
Vision Systems	16
Intelligent Flight Modes	19
Advanced Pilot Assistance Systems	27
Attaching and Detaching the Propellers	27
Intelligent Flight Battery	28
Gimbal and Camera	32
<b>Remote Controller</b>	35
Using the Remote Controller	35
Optimal Transmission Zone	38
Linking the Remote Controller	39
<b>DJI GO 4 App</b>	41
Equipment	41
Editor	43
SkyPixel	43
Me	43
Controlling the Aircraft with a Mobile Device	44

<b>Flight</b>	47
Flight Environment Requirements	47
Flight Limits and GEO Zones	47
Preflight Checklist	48
Auto Takeoff and Auto Landing	49
Starting/Stopping the Motors	49
Flight Test	50
<b>Appendix</b>	53
Specifications	53
Calibrating the Compass	55
Firmware Updates	57
After-Sales Information	57



## Product Profile

---

This section introduces the Mavic Air and lists the components of the aircraft and remote controller.

# Product Profile

## Introduction

The DJI Mavic Air features a new folding design and a fully stabilized 3-axis gimbal camera capable of shooting 4K video and 12 megapixel photos. DJI signature technologies such as Obstacle Avoidance and Intelligent Flight Modes like SmartCapture, 8K Panorama, Advanced Pilot Assistance Systems, QuickShots, ActiveTrack™, and TapFly™, make capturing complex shots easy. The Mavic Air boasts a maximum flight speed of 42.5 mph (68.4 kph) and a maximum flight time of 21 minutes\*.

## Feature Highlights

**Camera and Gimbal:** With the Mavic Air, you are able to shoot 4K video at up to 30 frames per second and capture 12 megapixel photos that look crisp and clear, all stabilized by the onboard 3-axis gimbal.

**Flight Controller:** The next-generation flight controller has been updated to provide a safer, more reliable flight experience. The aircraft is able to automatically return to its Home Point when the remote control signal is lost or the battery level is low. As well as being able to hover indoors at low altitudes, the aircraft can sense and avoid obstacles on its route, enhancing safety.

**HD Video Downlink:** DJI's enhanced Wi-Fi technology is built into the remote controller, offering a transmission range of up to 2.49 mi (4 km)\*\* and making it possible to stream 720p video to your mobile device.

## Preparing the Mavic Air

### Preparing the Aircraft

1. Remove the gimbal protector from the camera.
2. All aircraft arms are folded before the aircraft is packaged at the factory. First, unfold the rear arms, then unfold the front arms and the front landing gear.



\* Maximum flight time was tested in windless conditions flying at a consistent 15.5 mph (25 kph). This value should be taken for reference only.

\*\* The remote controller is able to reach its maximum transmission distance (FCC) in a wide open area with no electromagnetic interference and at an altitude of about 400 ft (120 m).

3. For safety reasons it is recommended that the propeller guards are mounted when flying in Beginner Mode or indoors. Refer to the *Mavic Air Propeller Guards User Guide* to learn more.



- It is recommended that the gimbal protector be attached when the aircraft is not in use. Make sure the gimbal is horizontal when mounting or removing the gimbal protector.
- Ensure the landing gear is properly unfolded before use. Otherwise, the built-in antennas may be affected causing serious problems to the video link.
- When putting the aircraft away after use, be sure to fold the landing gear first before folding the aircraft arms.

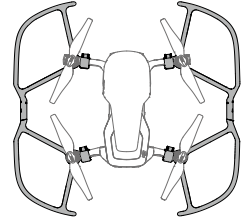

4. All Intelligent Flight Batteries are in Hibernation mode before shipment to ensure safety. Use the provided AC power adapter to charge and activate Intelligent Flight Batteries for the first time. Charging the Intelligent Flight Battery fully before each flight is recommended. To charge an Intelligent Flight Battery after flight, remove it from the aircraft and attach it to the AC power adapter.

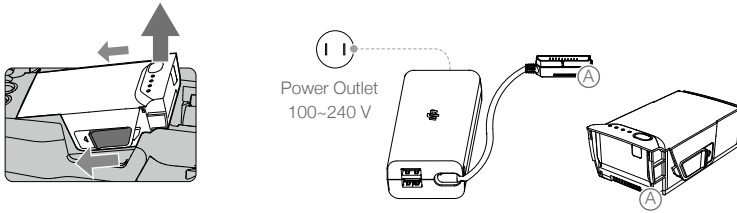

### Preparing the Remote Controller (RC)

1. Unfold the antennas and mobile device clamps.
2. Remove the control sticks from their storage slots on the remote controller and screw them into place.
3. Choose an appropriate RC cable based on the type of mobile device being used. A cable with a Lightning connector is connected by default, and Micro USB and USB-C cables are included in the packaging. Move the cable slider to the end of the slot in the left clamp and connect the end of the cable to your mobile device. Secure your mobile device by pushing both clamps inward.



- When using a tablet, use the USB port on the remote controller.
- Do not use the Micro USB and USB ports simultaneously for video linking. Disconnect all devices from one port before connecting a device to the other port for video linking.

## Aircraft Diagram

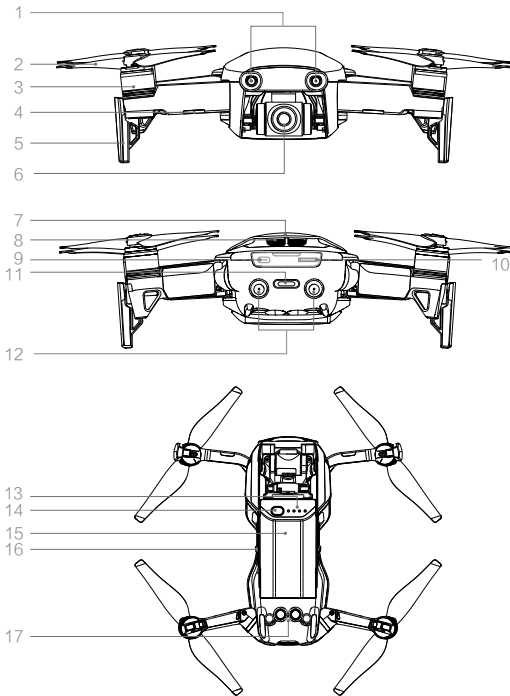

- 1. Forward Vision System
- 2. Propellers
- 3. Motors
- 4. Front LEDs
- 5. Landing Gear (with built-in antennas)
- 6. Gimbal and Camera
- 7. GPS Antennas
- 8. Vents
- 9. USB-C Port
- 10. Camera microSD Card Slot
- 11. Aircraft Status Indicator / Function Button
- 12. Backward Vision System
- 13. Battery Level LEDs
- 14. Power Button
- 15. Intelligent Flight Battery
- 16. Battery Latches
- 17. Downward Vision System

## Remote Controller Diagram

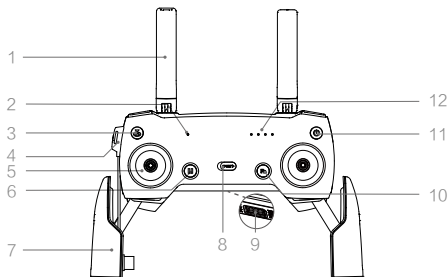

- 1. Antennas  
Relay aircraft control and video signals.
- 2. Status LED  
Displays the remote controller's system status.
- 3. Return to Home (RTH) Button  
Press and hold the button to initiate RTH. Press again to cancel RTH.
- 4. Charging / Main Video Link Port (Micro USB)  
Connect to the AC Power Adapter to charge the remote controller battery; connect to a mobile device for video linking via RC cable.

**5. Control Sticks**

Control the orientation and movement of the aircraft.

**6. Flight Pause Button**

Press once for emergency braking (when GPS or Vision System are available).

**7. Mobile Device Clamps**

Securely mount your mobile device onto the remote controller.

**8. Flight Mode Switch**

Switch between P-mode and S-mode.

**9. USB / Assistant Video Link Port**

Connect to a mobile device for video downlink via a standard USB cable.

**13. Gimbal Dial**

Controls the camera's tilt.

**14. Record Button**

Press to start recording video. Press again to stop recording.

**15. Customizable Button**

Performs various functions based on settings in the DJI GO 4 app.

**16. Shutter Button**

Press to take a photo. If Burst shooting mode is selected, a pre-set number of photos will be taken.

**10. Function Button**

Performs various functions based on settings in the DJI GO 4 app.

**11. Power Button**

Press once to check the current battery level. Press once, then again and hold to turn on/off the remote controller.

**12. Battery Level LEDs**

Display the remote controller's battery level.

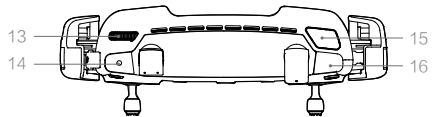

## Activation

The Mavic Air requires activation before first time use. Follow the steps below to activate the Mavic Air using the DJI GO 4 app:

1. Connect your mobile device to the remote controller and then launch DJI GO 4.
2. Log in to the app using your DJI account or register a new DJI account.
3. Power on the aircraft and remote controller.
4. Select "Mavic Air", select "Connect to the Aircraft's Wi-Fi" and "Wired Connection", and then follow the prompts to establish connection.
5. Tap "Activating Device" after connection is complete, and then follow the prompts to activate your Mavic Air.

# Aircraft

---

This section introduces the flight controller, Forward, Backward and Downward Vision Systems, and the Intelligent Flight Battery.

# Aircraft

The Mavic Air contains a flight controller, video downlink system, propulsion system, and an Intelligent Flight Battery. Refer to the aircraft diagram in the Product Profile section.

## Flight Modes

The Mavic Air has two flight modes that users can select, plus a third flight mode that the aircraft falls back to in certain circumstances:

**P-mode (Positioning):** P-mode works best when the GPS signal is strong. The aircraft utilizes GPS and the Vision Systems to locate itself, stabilize, and navigate between obstacles. Intelligent Flight Modes such as SmartCapture, QuickShots, TapFly and ActiveTrack are enabled in this mode.

When the Forward and Backward Vision Systems are enabled and lighting conditions are sufficient, the maximum flight attitude angle is 15° and the maximum flight speed is 17.9 mph (28.8 kph).

Note: P-mode requires larger stick movements to achieve high speeds.

**S-mode (Sport):** In S-mode the aircraft uses GPS only for positioning and the Forward and Backward Vision Systems are disabled. As such, the aircraft is not able to sense and avoid obstacles and Intelligent Flight Modes are not available.

Note: In S-mode aircraft responses are optimized for agility and speed making it more responsive to stick movements.

**ATTI mode:** The aircraft automatically changes to Attitude mode (ATTI mode) when the Vision Systems are unavailable and either the GPS signal is weak or the compass is experiencing interference. When the Vision Systems are unavailable the aircraft is not able to position itself or auto-brake, so potential flight hazards exist when flying in ATTI mode. In ATTI mode, the aircraft is easily affected by its surroundings. Environmental factors such as wind can result in horizontal shifting, which may present hazards, especially when flying in confined spaces.



- It is strongly recommended that you find a safe place to land as soon as possible if the aircraft enters ATTI mode. To reduce the likelihood of the aircraft entering ATTI mode and minimize hazards if it does enter ATTI mode, avoid flying in areas where the GPS signal is weak and avoid flying in confined spaces.
- The Forward and Backward Vision Systems are disabled in S-mode, which means the aircraft will not be able to automatically sense obstacles on its route.
- The aircraft's maximum speed and braking distance are significantly increased in S-mode. A minimum braking distance of 98.4 ft (30 m) is required in windless conditions.
- Descent speed is significantly increased in S-mode.
- The aircraft's responsiveness is significantly increased in S-mode, which means a small stick movement on the remote controller will translate into a large travel distance of the aircraft. Be vigilant and maintain adequate maneuvering space during flight.



- Enable "Multiple Flight Modes" in the DJI GO 4 app to allow switching between S-mode and P-mode.
  - Use the Flight Mode switch on the remote controller to switch between Flight Modes.
  - S-mode is only available with a Mavic Air remote controller. S-mode is disabled when flying with a mobile device.
-

## Aircraft LEDs and Status Indicator

The Mavic Air has Front LEDs and an Aircraft Status Indicator. The positions of these LEDs are shown in the figure below:

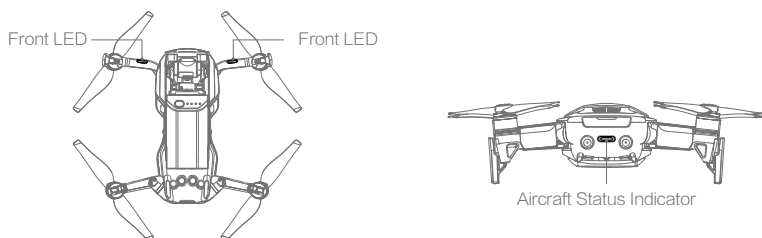

The Front LEDs show the orientation of the aircraft and the status of some of the functions (refer to the function sections for more details). The Front LEDs glow solid red when the aircraft is turned on to indicate the front of the aircraft.

The Aircraft Status Indicator communicates the statuses of the aircraft's flight control system and Intelligent Flight Battery. Refer to the table below for more information about the aircraft states indicated by the Aircraft Status Indicator. The Aircraft Status Indicator also flashes when the Home Point is being recorded, as described in the Return to Home section.



### Aircraft Status Indicator States

	Color	Blinking/Solid	Description of aircraft state
<b>Normal States</b>			
	Alternating red, green, and yellow	Blinking	Turning on and performing self-diagnostic tests
	Yellow	Blinks four times	Warming up
	Green	Blinking slowly	P-mode with GPS
	Green	Periodically blinks twice	P-mode with Forward and Downward Vision Systems
	Yellow	Blinking slowly	No GPS, Forward Vision System or Downward Vision System
	Green	Blinking quickly	Braking
<b>Warning States</b>			
	Yellow	Blinking quickly	Remote controller signal lost
	Red	Blinking slowly	Low battery
	Red	Blinking quickly	Critically low battery
	Red	Blinking	IMU error
	Red	Solid	Critical error
	Alternating red and yellow	Blinking quickly	Compass calibration required



## Return to Home

The Return to Home (RTH) function brings the aircraft back to the last recorded Home Point. There are three types of RTH: Smart RTH, Low Battery RTH, and Failsafe RTH. This section describes these three scenarios in detail.

	GPS	Description
Home Point		If a strong GPS signal was acquired before takeoff, the Home Point is the location from which the aircraft launched. The GPS signal strength is indicated by the GPS icon (  ). The Aircraft Status Indicator will blink green quickly when the Home Point is recorded.

### Smart RTH

If the GPS signal is sufficiently strong, Smart RTH can be used to bring the aircraft back to the Home Point. Smart RTH is initiated either by tapping  in the DJI GO 4 app (and following the on-screen instructions) or by pressing and holding the RTH button on the remote controller.

Smart RTH can be exited by tapping  in the DJI GO 4 app or by pressing the RTH button on the remote controller.

### Low Battery RTH

Low Battery RTH is triggered when the Intelligent Flight Battery is depleted to a point that may affect the safe return of the aircraft. Return home immediately or land the aircraft promptly when prompted. DJI GO 4 will display a warning when a low battery level warning is triggered. The aircraft will automatically return to the Home Point if no action is taken after a ten-second countdown. The user can cancel the RTH procedure by pressing the RTH button or Flight Pause button on the remote controller. The thresholds for the battery level warnings are automatically determined based on the aircraft's current altitude and distance from the Home Point. Low Battery RTH will only be triggered one time during each flight.

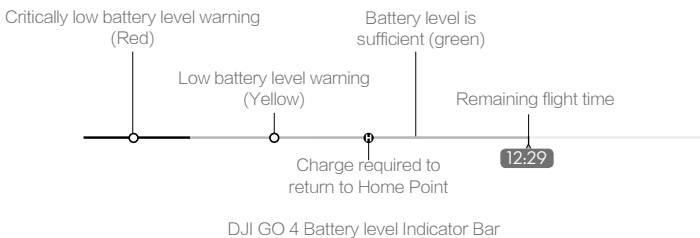

- The colored zones and markers on the DJI GO 4 battery level indicator bar reflect the estimated remaining flight time. They are automatically adjusted according to the aircraft's current location and status.
- If the current battery level can only support the aircraft long enough to descend from its current altitude a critically low battery level warning will be triggered and the aircraft will descend and land automatically. This procedure cannot be cancelled. If there is danger of collision occurring, push the throttle up and try to navigate away.
- If the battery level is sufficient the battery level indicator bar in the DJI GO 4 app displays the estimated remaining flight time based on current battery level.

If a battery level warning appears, take action as described in the table below.

### RTH and Battery Level Warnings

Warning	Aircraft Status Indicator	DJI GO 4 App	Remote Controller	Remarks/Instructions
Low Battery Level	Blinks red slowly	Tap "Go-home" to have the aircraft return to the Home Point automatically or "Cancel" to resume normal flight. If no action is taken, the aircraft will automatically fly home after 10 seconds.	Alarm sounds continuously	Battery level is low. Fly the aircraft back and land promptly, then stop the motors and replace the battery.
Critically Low Battery Level	Blinks red quickly	Display flashes red	Alarm sounds continuously	The aircraft will descend and land automatically. This procedure cannot be cancelled. If there is danger of collision occurring, push the throttle up and try to navigate away.

### Failsafe RTH

The Forward Vision System allows the aircraft to create a real-time map of its flight route as it flies. If the Home Point was successfully recorded and the compass is functioning normally, Failsafe RTH will be automatically activated if the remote control signal is lost for a specified amount of time (three seconds when using the remote controller and 20 seconds when flying with a mobile device). When Failsafe RTH is activated, the aircraft will retrace its original flight route home.

If the wireless control signal is re-established during the Failsafe RTH procedure, the aircraft will hover at its present location for 10 seconds and wait for pilot commands. The user may pull the control sticks to cancel Failsafe RTH and retake control. If no pilot command is given the aircraft will resume its flight home.

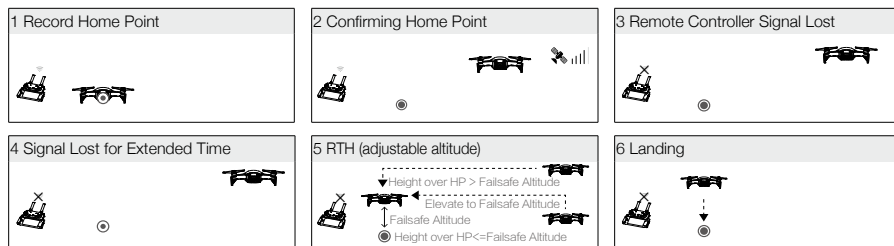

## RTH Procedure

Smart RTH, Low Battery RTH, and Failsafe RTH follow this procedure:

1. The aircraft adjusts its orientation.
2.
  - a. If the aircraft is further than 20 m from the Home Point it ascends to the pre-set RTH attitude and then flies to the Home Point.
  - b. If the aircraft is between 5 m and 20 m from the Home Point:
    - i. If the RTH at Current Altitude option is enabled (the default setting in DJI GO 4) the aircraft flies to the Home Point at the current altitude, unless the current altitude is less than 2.5 m, in which case the aircraft ascends to 2.5 m and then flies to the Home Point.
    - ii. If the RTH at Current Altitude option is disabled, the aircraft lands immediately.
  - c. If the aircraft is less than 5 m from the Home Point it lands immediately.
5. The aircraft lands and stops its motors once it reaches the Home Point.

## Obstacle Avoidance During RTH

The Mavic Air senses and actively attempts to avoid obstacles during RTH, provided that lighting conditions are sufficient for the Forward and Backward Vision Systems to operate. The obstacle avoidance procedure is as follows:

1. The aircraft decelerates when an obstacle is sensed.
2. The aircraft stops and hovers then starts flying backward and ascends vertically until no obstacle is sensed.
3. The RTH procedure resumes. The aircraft flies to the Home Point at the new altitude.

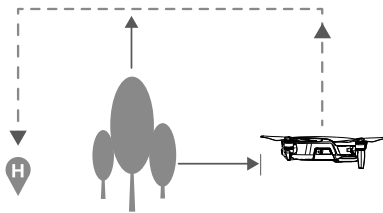

- The aircraft will not be able to return to the Home Point if the GPS signal is weak or if GPS is unavailable.
- In Smart RTH and Low Battery RTH, during the aircraft's ascent to its RTH altitude, the ascent is automatic until an altitude of 65 ft (20 m) is reached. Once the altitude is 65ft (20 m) or higher, moving the throttle stick commands the aircraft to stop ascending and to fly to the Home Point at its current altitude.
- The aircraft will not be able to avoid obstacles during Failsafe RTH if the Forward and Backward Vision Systems are unavailable. It is important to set a suitable RTH Altitude before each flight. Launch the DJI GO 4 app, tap  and then set the RTH Altitude.
- The aircraft cannot avoid obstacles above or beside the aircraft.
- During the RTH procedure the aircraft's speed and altitude can be controlled using the remote controller or the DJI GO 4 app, but its orientation and direction of flight are controlled by the flight controller.

## Landing Protection

Landing Protection will activate during Smart RTH.

1. When Landing Protection determines that the ground is suitable for landing, the Mavic Air will land gently.
2. If Landing Protection determines that the ground is not suitable for landing, the Mavic Air will hover and wait for pilot confirmation.
3. If Landing Protection is not operational, the DJI GO 4 app will display a landing prompt when the Mavic Air descends below 0.5 meters. Pull down on the throttle or use the auto landing slider to land.

## Precision Landing

The Mavic Air automatically scans and attempts to match the terrain features underneath during Return to Home. When the current terrain matches Home Point terrain, the Mavic Air will start landing. The DJI GO 4 app will show a terrain feature mismatch prompt if matching fails.



- Precision Landing performance is subject to the following conditions:
  - a. The Home Point must be recorded upon takeoff and must not be changed during flight, otherwise the aircraft will have no record of the Home Point's terrain features.
  - b. During takeoff the aircraft must ascend vertically 7 m before moving horizontally.
  - c. The Home Point terrain features must remain largely unchanged.
  - d. The Home Point terrain features must be sufficiently distinctive.
  - e. The lighting conditions must not be too light or too dark.
- The following actions are available during Precision Landing:
  - a. Throttle down to accelerate landing.
  - b. Move the control sticks in any other direction to stop Precision Landing. The Mavic Air will descend vertically after the control sticks are released.

## Vision Systems

The Mavic Air is equipped with Forward, Backward, and Downward Vision Systems that constantly scan for obstacles in front of and behind the aircraft, allowing it to avoid collisions by going around or hovering (if lighting conditions are adequate).

The main components of the Forward and Backward Vision Systems are four cameras located on the nose and the rear side of the aircraft.

The Downward Vision System helps the aircraft maintain its current position. With the help of the Downward Vision System, the Mavic Air can hover in place more precisely and fly indoors or in other environments where a GPS signal is unavailable. The main components of the Downward Vision System are two cameras and one 3D infrared module located on the underside of the aircraft.



Forward Vision System

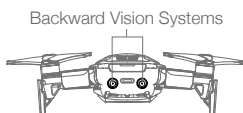

Backward Vision Systems

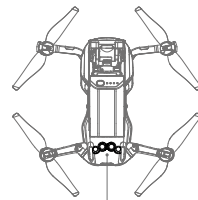

Downward Vision System

## Detection Fields

The detection fields of the Forward, Backward and Downward Vision Systems is depicted below. Note that the aircraft cannot sense or avoid obstacles that are not within the detection fields.

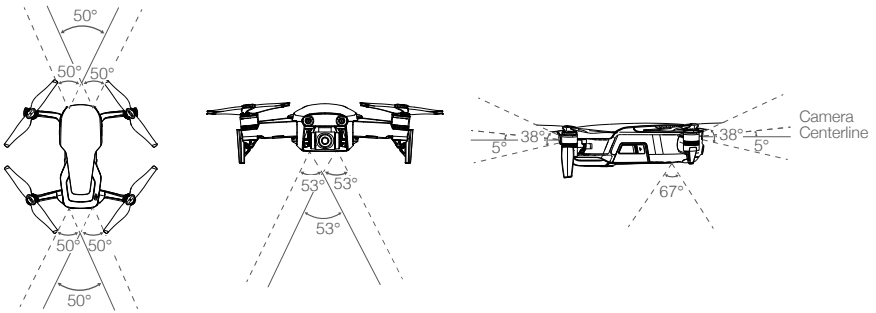

## Calibrating Vision System Cameras

The Forward, Backward, and Downward Vision System cameras installed on the aircraft are factory-calibrated, but may require calibration via DJI Assistant 2 or the DJI GO 4 app if the aircraft is subjected to an impact.

The most accurate way to calibrate the vision systems is by using DJI Assistant 2. Follow the steps below to calibrate the Forward Vision System cameras, then repeat the steps to calibrate the Backward and Downward Vision System cameras.

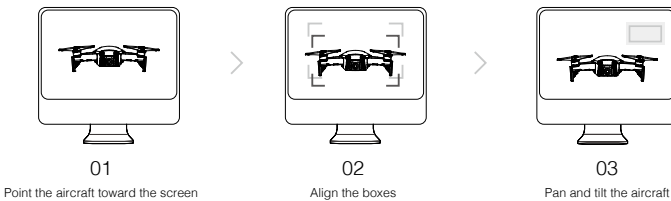

1. Point the aircraft toward the screen.
2. Move the aircraft to align the boxes shown on the screen.
3. Pan and tilt the aircraft as prompted.

When the DJI GO 4 app notifies that a vision system calibration is required but a computer is not nearby a quick calibration can be performed within the app. Tap through "Aircraft Status" > "Vision Sensors" to start quick calibration.



- Quick calibration is a quick fix to vision system issues. When possible, connecting the aircraft to a computer to carry out a full calibration using DJI Assistant 2 is recommended. Only calibrate when lighting conditions are adequate and on textured surfaces such as grass.
- Do not calibrate the aircraft on highly reflective surfaces such as marble or ceramic tiles.

## Using the Vision Systems

The Downward Vision System is activated automatically when the aircraft is turned on. No further action is required. Using the Downward Vision System, the aircraft can hover precisely even without GPS.

The Downward Vision System is typically used in indoor environments where GPS is unavailable. The Downward Vision System works best when the aircraft is at altitudes of 1.6 to 26 ft (0.5 to 8 m). If the aircraft's altitude is above 8 m the Vision Positioning function may be affected, so extra caution is required.

Follow the steps below to use the Downward Vision System:

1. Ensure the aircraft is in P-mode and place the aircraft on a flat surface. Note that the Downward Vision System cannot work properly on surfaces without clear pattern variations.
2. Turn on the aircraft. The aircraft will hover in place after takeoff. The Aircraft Status Indicator will flash green twice, which indicates the Downward Vision System is working.

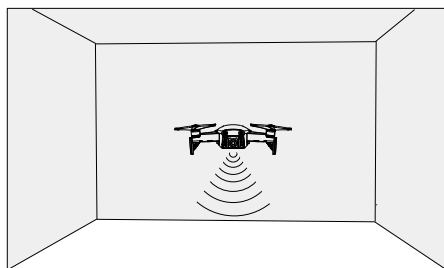

Using the Forward and Backward Vision Systems, the aircraft is able to actively brake when obstacles are detected in front. The Forward and Backward Vision Systems work best when lighting is adequate and obstacles are clearly marked or textured. The aircraft must fly at no more than 17.9 mph (22.8 kph) to allow for sufficient braking distance.

- 
- ⚠ • The performance of the Vision Systems are affected by the surface being flown over. The aircraft automatically switches from P-mode to ATTI mode when the Vision Systems are unavailable and either the GPS signal is weak or the compass is experiencing interference. Operate the aircraft with great caution in the following situations:
- a. Flying at high speeds below 1.6 ft (0.5 m).
  - b. Flying over monochrome surfaces (e.g. pure black, pure white, pure red, pure green).
  - c. Flying over highly reflective surfaces.
  - d. Flying over water or transparent surfaces.
  - e. Flying over moving surfaces or objects.
  - f. Flying in an area where the lighting changes frequently or drastically.
  - g. Flying over extremely dark (< 10 lux) or bright (> 100,000 lux) surfaces or towards bright sources of light (e.g. towards sunlight).
  - h. Flying over surfaces without clear patterns or texture.
  - i. Flying over surfaces with identical repeating patterns or textures (e.g. tiling).
  - j. Flying over small and fine objects (e.g. tree branches or power lines).
  - k. Flying at high speeds of over 11.2 mph (18 kph) at 3.3 ft (1 m).
-







- ☀️ • Keep the cameras and sensors clean at all times. Dirt or other debris may adversely affect their effectiveness.
- The Forward, Backward, and Downward Vision Systems may not be able to recognize patterns on the ground in very dark (< 100 lux) environments.

## Intelligent Flight Modes

The Mavic Air supports Intelligent Flight Modes including QuickShots, ActiveTrack, SmartCapture, Tripod mode, Cinematic mode, TapFly, and Point of Interest. Tap  in DJI GO 4 to select an Intelligent Flight Mode.

### QuickShots

QuickShots shooting modes include Dronie, Circle, Helix, Rocket, Boomerang, and Asteroid. The Mavic Air records a video according to the selected shooting mode and then automatically generates a 10-second video. The video can then be viewed, edited, or shared to social media from the playback menu.

-  **Dronie:** The aircraft flies backward and upward, with the camera locked on your subject.
-  **Circle:** The aircraft circles around your subject.
-  **Helix:** The aircraft flies upward, spiraling around your subject.
-  **Rocket:** The aircraft ascends with the camera pointing downward.
-  **Boomerang:** The aircraft flies backward around the subject in an oval path.
-  **Asteroid:** The aircraft flies backward and upward and then takes several photos, then flies back to its starting point. The video generated starts with a panorama of the highest position and then shows the descent.

### Using QuickShots

Ensure that the aircraft is in P-mode and that the Intelligent Flight Battery is sufficiently charged.

Follow the steps below to use QuickShots:

1. Take off and hover at least 6.6 ft (2 m) above the ground.

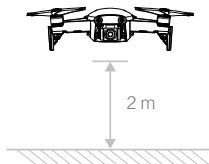

2. In DJI GO 4, tap , then select QuickShots and follow the prompts.

3. Select your target subject in Camera View (tap the circle on the subject or drag a box around the subject) and choose a shooting mode. Tap "GO" to begin recording. The aircraft will fly back to its original position once shooting is finished.



4. Tap to access the video.

- 
- ⚠ • QuickShots are only available when the GPS signal is strong.
  - When using QuickShots, the aircraft cannot avoid obstacles automatically. Only use QuickShots in wide open areas.
- 

### Exiting QuickShots

Tap in DJI GO 4 or toggle the Flight Mode switch to S-mode to exit QuickShots anytime during shooting. Press the Flight Pause button on the remote controller for emergency breaking.

### ActiveTrack

ActiveTrack allows you to mark and track several moving objects on your mobile device's screen. No external tracking device is required. Mavic Air can automatically identify and track people, vehicles and boats, and use different tracking strategies for each.

### Using ActiveTrack

Ensure that the aircraft is in P-mode and that the Intelligent Flight Battery is sufficiently charged. Follow the steps below to use ActiveTrack:

1. Take off and hover at least 6.6 ft (2 m) above the ground.

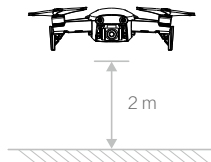

2. In DJI GO 4, tap , then select ActiveTrack.





3. Tap on the subject you want to track then tap to confirm your selection. If the subject is not automatically recognized, drag a box around it. The box will turn green when the subject has been recognized and tracking has begun. If the box turns red, the object could not be identified and you should try again.

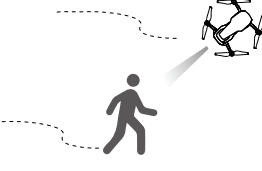
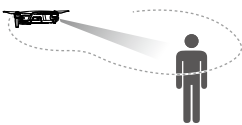

4. The aircraft will automatically avoid obstacles in its flight path. If the aircraft loses track of the subject because it is moving too fast or is obscured, re-select the subject to resume tracking.

ActiveTrack includes following sub-modes:

Trace	Profile	Spotlight
		
<p>The aircraft tracks the subject at a constant distance. Use the roll stick on the remote controller or the slider in DJI GO 4 to fly in a circle around the subject.</p>	<p>The aircraft tracks the subject at constant angle and distance from the side. Use the roll stick on the remote control to fly in a circle around the subject.</p>	<p>The aircraft will not trace a subject automatically, but it keeps the camera pointing at the subject during flight. The remote controller can be used to maneuver the aircraft, but orientation control is disabled. Using the left stick and gimbal dial will adjust subject framing.</p>

- ⚠ • DO NOT use ActiveTrack in areas with people, animals, small or fine objects (e.g. tree branches or power lines), or transparent objects (e.g. glass or water).
- Stay clear of obstacles near the flight path, especially obstacles to the left and right of the aircraft.
- Operate the aircraft manually (press the Flight Pause button or toggle the Flight Mode switch to S-mode on the remote controller) or tap  in DJI GO 4 in an emergency.
- Be extra vigilant when using ActiveTrack in any of the following situations:
  - a. The tracked subject is not moving on a level plane.
  - b. The tracked subject changes shape drastically while moving.
  - c. The tracked subject could be out of sight for a long time.
  - d. The tracked subject is moving on a snowy surface.
  - e. The tracked subject has a similar color or pattern to its surrounding environment.
  - f. Available light is too low (< 300 lux) or too high (> 10,000 lux).
- You must follow local privacy laws and regulations when using ActiveTrack.

### Exiting ActiveTrack

Tap the stop icon button  on the screen or toggle the Flight Mode switch to S-mode on the remote controller to exit ActiveTrack. After exiting ActiveTrack, the aircraft will hover in place, at which point you may choose to fly manually, track another subject, or return to home.

### SmartCapture

Deep learning gesture recognition allows you to take selfies, record videos, and control the aircraft using simple hand gestures. The Mavic Air features brand new modes like GestureLaunch, Follow, and GestureLand. (Note: Aircraft firmware v1.0.1.0 or higher is required to use SmartCapture.)

#### Activating FaceAware and PalmControl



To use SmartCapture first activate FaceAware and PalmControl:

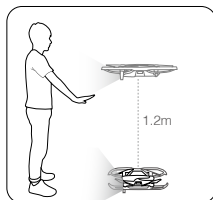





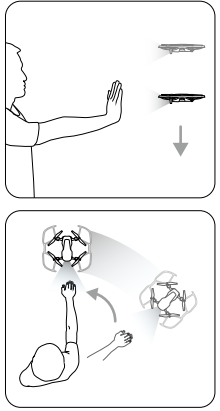

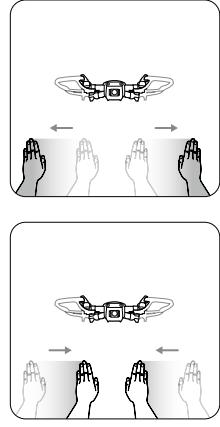
1. Tap  in the DJI GO 4 app and select SmartCapture. When FaceAware has activated the aircraft will beep twice and the Front LEDs will blink red slowly.
2. Next, use one of the following two methods to activate PalmControl:
  - a. GestureLaunch: If the aircraft is on the ground you can use GestureLaunch to command the aircraft to take off and activate PalmControl. Stand at a distance of 6.6 to 9.8 ft (2 to 3 m) in front of the aircraft with your palm in front of the aircraft's nose. Keep your palm open and your fingers close together. After about two seconds the aircraft will take off automatically and hover at a height of 3.9 ft (1.2 m). The Front LEDs will blink green slowly to indicate that PalmControl has been activated.

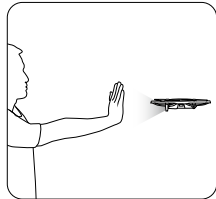

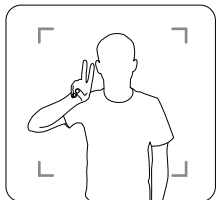
- b) If the aircraft is already airborne, raise and extend your arm and position your palm about 6.6 ft (2 m) in front of the aircraft's nose. Keep your palm open and your fingers close together. After about two seconds the Front LEDs will blink green slowly to indicate that PalmControl has been activated.

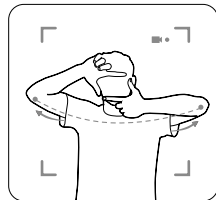
Once FaceAware and PalmControl have been activated you can control the aircraft in the following ways. (Stay within 23 ft (7 m) of the aircraft for your gestures to be recognized):

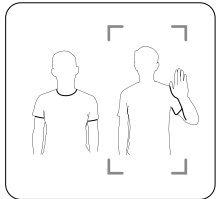
Control Position		
<p>Move your palm up or down slowly to control the aircraft's altitude. Move your arm left or right to control the aircraft's orientation. Move forward or backward to fly forward or backward.</p>	<p> Front LEDs blink green slowly</p>	
Control Distance		
<p>Raise and extend your other arm and hold your two palms close together. Move your hands apart and the aircraft will fly away from you, to a maximum distance of 19.7 ft (6 m). Move your hands together and the aircraft will fly towards you, to a minimum distance of 6.6 ft (2 m).</p>	<p> Front LEDs blink yellow slowly</p>	

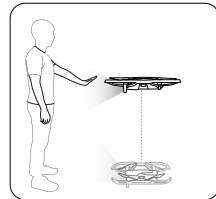
<b>Follow</b>		
<p>Drop your hand towards the floor to activate Follow. Once Follow is activated, the front LEDs will turn solid green. As you move your body, the aircraft will follow you automatically. Whilst Follow is active, you can raise your hand or hands again to use the other SmartCapture features.</p>	<p> Front LEDs solid green</p>	
<b>Selfie</b>		
<p>Make a V gesture with one hand. Once your selfie gesture has been recognized a three-second countdown will begin. With two seconds remaining the aircraft's Front LEDs will start to blink red slowly, then with one second remaining they will start to blink red quickly.</p>	<p> Front LEDs blink red quickly</p>	
<b>Record Videos</b>		
<p>Make a frame gesture with your fingers (ensuring at least one hand is above your nose). Once your frame gesture has been recognized the aircraft's Front LEDs will turn off and the camera will start recording. After five seconds or more have elapsed, making the frame gesture again will stop the recording.</p>	<p> Front LEDs Off</p>	
<b>Switching Control</b>		
<p>a. Drop your hand towards the floor. The Front LEDs will turn solid green.</p>	<p> Front LEDs solid green</p>	
<p>b. The person who would like to control the aircraft should raise their palm in front of the aircraft. Once the aircraft is under their control the Front LEDs will blink green slowly.</p>	<p> Front LEDs blink green slowly</p>	
<b>GestureLand</b>		
<p>Move your palm down slowly to make the aircraft descend. Continue until it has descended to its minimum altitude, then continue commanding it to descend for a further three seconds and it will land automatically and its motors will stop.</p>	<p> Front LEDs solid red</p>	

## Tripod Mode

Tap  in the DJI GO 4 app to select Tripod mode. In Tripod mode, the maximum flight speed is limited to 2.2 mph (3.6 kph). Responsiveness to stick movements is also reduced for smoother, more controlled movements.

 Only use Tripod mode where the GPS signal is strong or light conditions are ideal for the Vision Systems. If the GPS signal is lost and if the Vision Systems are disabled or unavailable, the aircraft will automatically switch to ATTI mode. In this case, flight speed will increase and the aircraft will not hover in place. Use Tripod mode carefully.

## Cinematic Mode

Tap  in the DJI GO 4 app to select Cinematic mode. In Cinematic mode, the aircraft's braking distance is extended and its rotation speed is reduced. The aircraft will slow down gently until it stops, keeping footage smooth and stable even if control inputs are choppy.

## TapFly

TapFly features four sub-modes, Forward, Backward, Free, and Coordinate. Provided that lighting conditions are suitable (between 300 and 10,000 lux), the aircraft will automatically avoid obstacles it senses.

**Forward:** The aircraft will fly towards the target with the Forward Vision System sensing obstacles.

**Backward:** The aircraft will fly in the opposite direction of the target with the Backward Vision System sensing obstacles..

**Free:** The aircraft will fly towards the target. The remote controller can be used to maneuver the orientation of the aircraft freely.

**Coordinate:** Tap a specific location on screen. The aircraft will travel to that point at its current altitude, then hover in place.

## Using TapFly

Ensure that the aircraft is in P-mode and that the Intelligent Flight Battery is sufficiently charged. Follow the steps below to use TapFly:

1. Take off and hover at least 3.3 ft (1 m) above the ground.

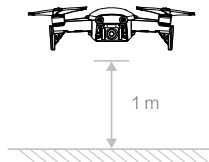



2. In DJI GO 4, tap , select TapFly, then select a sub-mode and follow the prompts.

3. Tap once on the target and wait for the “GO” button to appear. Tap the “GO” button to confirm the selection and the aircraft will fly to the target automatically. A prompt will appear if the target cannot be reached. If this is the case, select another target and try again. The target can be changed mid-flight by tapping the screen.



### Exiting TapFly

Press the Flight Pause button on the remote controller or pull a control stick in the direction opposite to the direction of flight and the aircraft will brake and hover in place. Tap the screen to resume TapFly. Tap  or toggle the Flight Mode switch to S-mode to exit TapFly.

-  • DO NOT use TapFly in areas with people, animals, small or fine objects (e.g. tree branches or power lines), or transparent objects (e.g. glass or water). TapFly Mode may not work properly when the aircraft is flying over water or snow covered areas.
- There may be deviations between expected and actual flight paths selected in TapFly.
- The selectable range for the target direction is limited. You cannot make a selection close to the upper or lower edges of the screen.

### Point of Interest

Select a subject, and set the circle radius, flight altitude, and flight speed, and the aircraft will fly around the subject according to these settings.

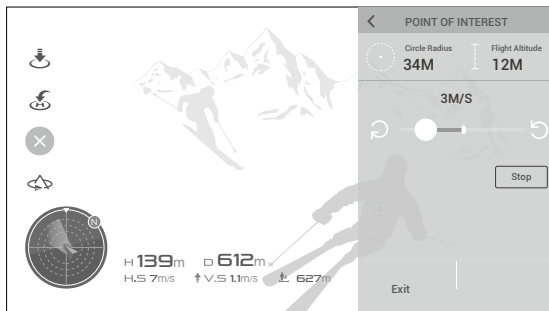

## Advanced Pilot Assistance Systems

The Advanced Pilot Assistance Systems (APAS) feature is available in P-mode. When APAS is enabled the aircraft continues to respond to user commands and plans its path according to both control stick inputs and the flight environment. APAS makes it easier to avoid obstacles and obtain smoother footage, and gives a better flying experience.

When APAS is enabled, pressing the Flight Pause button on the remote controller or tapping  in the DJI GO 4 app brings the aircraft to a stop. The aircraft will hover for three seconds and await pilot commands.

To enable APAS, tap  in the DJI GO 4 app.

-  • The APAS feature is automatically disabled when using Intelligent Flight Modes and will resume automatically after exiting from Intelligent Flight Modes.

## Flight Recorder

Flight data including flight telemetry, aircraft status information, and other parameters is automatically saved to the aircraft's internal data recorder. This data can be accessed using DJI Assistant 2.

## Attaching and Detaching the Propellers

The Mavic Air uses model 5332S propellers. There are two varieties of 5332S propellers, which are designed to spin in different directions. The presence or absence of white marks on the propellers indicates which type they are and therefore which motors they should be attached to.

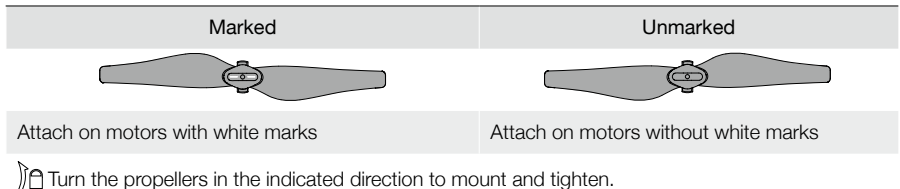

## Attaching the Propellers

Attach the propellers with the white marks to the motors with white marks. Press each propeller down onto the mounting plate and rotate in the lock direction until it is secured. Attach unmarked propellers to the motors without marks.

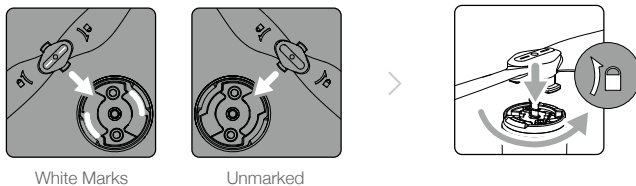

## Detaching the Propellers

Press the propellers down into the mounting plate and rotate them in the unlock direction.

---



- Propeller blades are sharp – handle with care.
  - Only use original DJI propellers and do not mix propeller types.
  - Ensure that all propellers are in good condition before each flight. Do not use aged, chipped, or broken propellers.
  - Ensure that the propellers and motors are installed firmly and correctly before each flight.
  - To avoid injury, stand clear of and do not touch propellers or motors when they are spinning.
  - Place the aircraft in the direction shown in the carrying case during transportation or storage to avoid damaging the propellers. Do not squeeze or bend the propellers. If propellers become distorted flight performance will be affected.
- 

## Intelligent Flight Battery

The Mavic Air Intelligent Flight Battery is an 11.55 V, 2375 mAh battery with smart charging/discharging functionality. It should only be charged using an appropriate DJI approved AC power adapter.

### Battery Features

1. Battery Level Display: The LED indicators display the current battery level.
  2. Auto-Discharging Function: To prevent swelling, the battery automatically discharges to below 65% of the maximum charge when it is idle for more than 10 days. It takes approximately one day to discharge the battery to 65%. It is normal to feel moderate heat being emitted from the battery during the discharging process.
  3. Balanced Charging: The voltages of the battery cells are automatically balanced during charging.
  4. Overcharge Protection: Charging automatically stops when the battery is fully charged.
  5. Temperature Detection: The battery will only charge when the temperature is between 41° and 104° F (5° and 40° C).
  6. Overcurrent Protection: The battery stops charging if an excessive current is detected.
  7. Overdischarge Protection: Discharging stops automatically to prevent excessive discharge.
  8. Short Circuit Protection: The power supply is cut automatically if a short circuit is detected.
  9. Battery Cell Damage Protection: The DJI GO 4 app displays a warning message when a damaged battery cell is detected.
  10. Hibernation Mode: The battery will cut the power supply and switch off after 20 minutes of inactivity to save power. To prevent over discharging the battery will enter Hibernation mode after six hours of inactivity if the battery level is less than 10%. In Hibernation mode the battery level indicators do not illuminate. Charging the battery will wake it from hibernation.
  11. Communication: Information pertaining to the battery's voltage, capacity, and current is transmitted to the aircraft.
- 



- Refer to the *Mavic Air Intelligent Flight Battery Safety Guidelines* before use. Users take full responsibility for all operations and usage.
- 



- Before carrying Intelligent Flight Batteries on an airline flight, they must be discharged to 30% or lower. This can be done by flying your Mavic Air outdoors until there is less than 30% charge left or until the Intelligent Flight Battery no longer turns on.
-



## Using the Battery

Press the Power button once, then press again and hold for two seconds to turn the battery on or off.

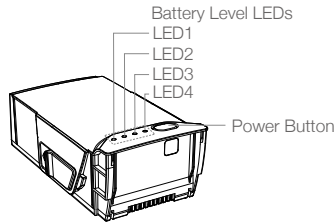

## Low Temperature Notice

1. Battery capacity is significantly reduced when flying in low temperature (14° to 41° F (-10° to 5° C)) environments.
2. Batteries cannot be used in extremely low temperature (< 14° F (-10° C)) environments.
3. End the flight as soon as the DJI GO 4 app displays the low battery level warning in low temperature environments.
4. To ensure optimal performance of the battery, keep the battery temperature above 68° F (20° C).
5. The reduced battery capacity in low temperature environments reduces the aircraft's wind speed resistance performance, so extra caution is required.

**⚠** In cold environments, insert the battery into the battery compartment and turn on the aircraft for approximately 1 to 2 minutes to warm up before taking off.

## Checking Battery Level

The battery level LEDs on the battery display how much charge remains. If the battery is turned off, press the Power button once and the battery level LEDs will light up to display the current battery level.

### Battery Level LEDs

○ : LED is on.      ◉ : LED is flashing.      ○ : LED is off.

LED1	LED2	LED3	LED4	Battery Level
○	○	○	○	88% - 100%
○	○	○	◉	75% - 88%
○	○	○	○	63% - 75%
○	○	◉	○	50% - 63%
○	○	○	○	38% - 50%
○	◉	○	○	25% - 38%
○	○	○	○	13% - 25%
◉	○	○	○	0% - 13%

## Charging the Battery

The Intelligent Flight Battery must be fully charged before using it for the first time:

1. Connect the AC power adapter to a power source (100 to 240 V, 50/60 Hz).
2. Attach the Intelligent Flight Battery to the AC power adapter using the battery charging cable with the battery powered off.
3. The battery level LEDs display the current battery level during charging. The Intelligent Flight Battery is fully charged when the battery level LEDs all turn off. Detach the AC power adapter when the battery is full charged.

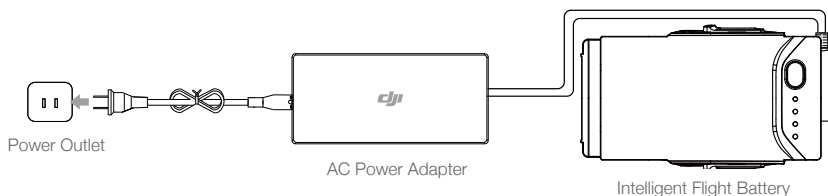

### Intelligent Flight Battery Charging Time

53 minutes in environments at temperatures between 59° and 104° F (15° and 40° C); 1 hour and 40 minutes in environments at temperatures between 41° and 59° F (5° and 15° C).

- ⚠ DO NOT charge an Intelligent Flight Battery immediately after flight, because its temperature may be too high. DO NOT charge an Intelligent Flight Battery until it cools down to near room temperature.
- The AC power adapter will stop charging the battery if the battery cell temperature is not within the operating range (41° to 104° F (5° to 40° C)). The ideal charging temperature is 71.6° to 82.4° F (22° to 28° C).
- The optional Battery Charging Hub can charge up to four batteries. Please visit the official DJI Online Store to learn more.

### Battery Level LEDs During Charging

● : LED is on.      ● (with radiating lines) : LED is flashing.      ○ : LED is off.

LED1	LED2	LED3	LED4	Battery Level
● (flashing)	● (flashing)	○	○	0% - 50%
● (flashing)	● (flashing)	● (flashing)	○	50% - 75%
● (flashing)	● (flashing)	● (flashing)	● (flashing)	75% - 100%
○	○	○	○	Fully Charged

## Battery Protection

The table below shows battery protection mechanisms and corresponding LED patterns.

Battery Protection Mechanisms					
LED1	LED2	LED3	LED4	Blinking Pattern	Battery Protection Item
○	☀	○	○	LED2 blinks twice per second	Overcurrent detected
○	☀	○	○	LED2 blinks three times per second	Short circuit detected
○	○	☀	○	LED3 blinks twice per second	Overcharge detected
○	○	☀	○	LED3 blinks three times per second	Over-voltage charger detected
○	○	○	☀	LED4 blinks twice per second	Charging temperature is too low
○	○	○	☀	LED4 blinks three times per second	Charging temperature is too high

In the event of charging temperature protection occurring the battery will resume charging once the temperature has returned to within the allowable range. If one of the other battery protection mechanisms activates, to resume charging once the issue has been resolved it is necessary to first press the Power button to turn the battery off, unplug the battery from the AC power adapter, and then plug it back in to resume charging.



- DJI does not take any responsibility for damage caused by third-party AC power adapters.

## Inserting the Intelligent Flight Battery

Insert the Intelligent Flight Battery into the aircraft's battery compartment, making sure that it is mounted firmly and that the battery latches have clicked into place.

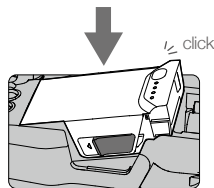

## Removing the Intelligent Flight Battery



Slide the battery latches on the sides of the Intelligent Flight Battery and it will pop out of the battery compartment.



- Never insert or remove the battery when it is turned on.
- Ensure the battery is mounted firmly. The aircraft will not take off if the battery is mounted incorrectly.

## Gimbal and Camera

### Gimbal

The Mavic Air's 3-axis gimbal provides stabilization for the camera, allowing you to capture clear, stable images and video. The gimbal has a tilt range of  $-90^\circ$  to  $+17^\circ$ . The tilt range is set to  $-90^\circ$  to  $0^\circ$  by default and can be adjusted in DJI GO 4 (tap  and select "Advanced Settings" > "Extend Gimbal Tilt Limit"). Other gimbal settings such as Gimbal Mode and Gimbal Auto Calibration can also be selecting by tapping .

Use the gimbal dial on the remote controller to control camera tilt. Alternatively, in DJI GO 4, go to Camera View, press and hold on the screen until a blue circle appears, and drag the circle up and down to control camera tilt. Dragging the circle left and right will control the aircraft's orientation.

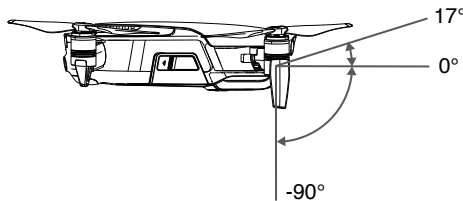

### Gimbal Operation Modes

Two gimbal operation modes are available. Switch between the different operation modes on the camera settings page of the DJI GO 4 app.

**Follow Mode:** The angle between the gimbal's orientation and aircraft's nose remains constant at all times.

**FPV Mode:** The gimbal will synchronize with the movement of the aircraft to provide a first-person perspective flying experience.



- Do not tap or knock the gimbal when the aircraft is powered on. To protect the gimbal during takeoff, always take off from flat, open ground.
- A gimbal motor error may occur in these situations:
  - a. The aircraft is placed on uneven ground or the gimbal's motion is obstructed.
  - b. The gimbal has been subjected to excessive external force, such as during a collision.
- Flying in heavy fog or clouds may make the gimbal wet, leading to temporary failure. The gimbal will recover full functionality once it dries.

## Camera

The onboard camera uses its 1/2.3" CMOS sensor to capture video at up to 4K at 30 fps and 12 megapixel stills. You can record video in either MOV or MP4 formats. Available picture shooting modes include Single Shot, Burst, Interval, HDR, and various Panorama modes. A live preview of what the camera is seeing can be monitored on a connected mobile device via the DJI GO 4 app.

### Camera microSD Card Slot

The Mavic Air comes with 8 GB of internal storage, and it also supports using a microSD card to store your photos and videos. A UHS-1 microSD card is required due to the fast read and write speeds required for high-resolution video data.

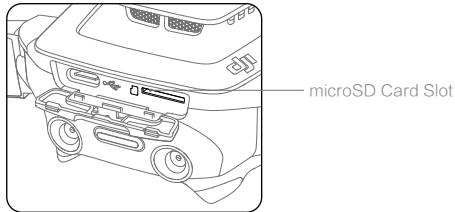

# Remote Controller

---

This section describes the features of the remote controller and includes instructions for controlling the aircraft and the camera.

# Remote Controller

Built into the remote controller is DJI's enhanced Wi-Fi technology, enabling a maximum transmission distance of 2.49 miles (4 km)\* and downlinking of 720p video from the aircraft to the DJI GO 4 app on your mobile device. The detachable control sticks make the remote controller easier to store. Maximum remote controller battery life is approximately 3 hours\*\*. Refer to the remote controller diagram in the Product Profile section.

## Using the Remote Controller

The remote controller is powered by a rechargeable battery that has a capacity of 2970 mAh. Press the Power button once to check the current battery level. Press once, then again and hold to turn the remote controller on or off.

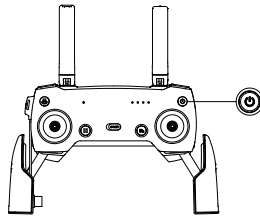

## Charging the Battery

Use a USB-C cable to connect the USB adapter to the AC power adapter, then plug the USB adapter into the Charging / Main Video Link port on the remote controller. It takes approximately two and a half hours to fully charge the remote controller battery.

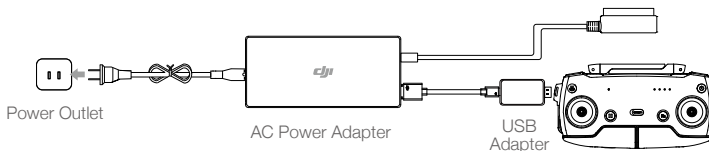

## Controlling the Camera

Shoot videos/photos and adjust the camera's tilt via the Shutter Button, Record Button, and Gimbal Dial on the remote controller.

\* The remote controller is able to reach its maximum transmission distance (FCC) in a wide open area with no electro-magnetic interference and at an altitude of about 400 ft (120 m).

\*\* Maximum battery life was tested under laboratory conditions using an iOS device. This value should be taken for reference only.

## Controlling the Aircraft

The remote controller's control sticks are used to control the aircraft's orientation (yaw), forward/backward movement (pitch), altitude (throttle), and left/right movement (roll). The function that each control stick movement performs is determined by the choice of control stick mode. Three pre-programmed modes (Mode 1, Mode 2, and Mode 3) are available and custom modes can be defined in the DJI GO 4 app. The default mode is Mode 2.

In each of the three pre-programmed modes the Mavic Air hovers in place at a constant orientation when both sticks are centered. Pushing a control stick away from the center position performs the functions show in the figure below.

### Mode 1

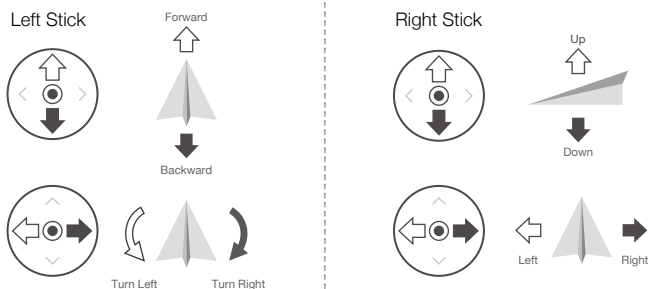

### Mode 2

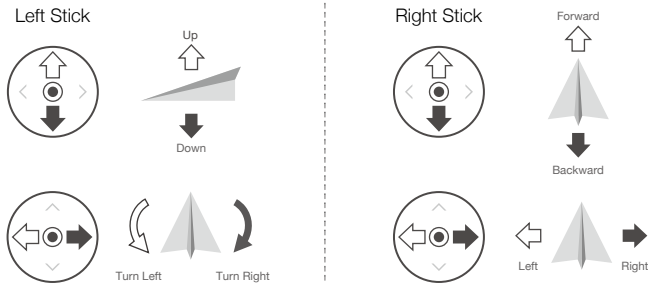



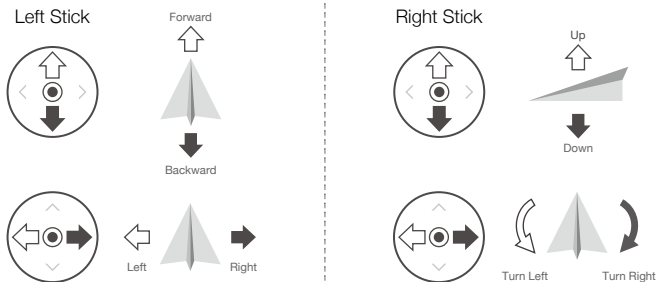



### Mode 3

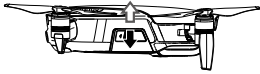

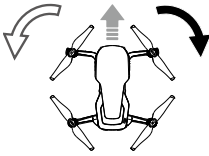

The figure below explains how to use each control stick, using Mode 2 as an example.

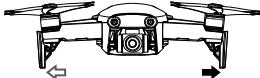

Remote Controller (Mode 2)	Aircraft (◀ Indicates Nose Direction)	Remarks
		Moving the left stick up or down changes the aircraft's altitude. Push the stick up to ascend and down to descend. The more the stick is pushed away from the center position, the faster the aircraft will change altitude. Always push the stick gently to prevent sudden and unexpected changes in altitude.
		Moving the left stick to the left or right controls the orientation of the aircraft. Push the stick left to rotate the aircraft counter-clockwise and right to rotate the aircraft clockwise. The more the stick is pushed away from the center position, the faster the aircraft will rotate.
		Moving the right stick up and down changes the aircraft's pitch. Push the stick up to fly forward and down to fly backward. The more the stick is pushed away from the center position, the faster the aircraft will move.
		Moving the right stick to the left or right changes the aircraft's roll. Push the stick left to fly left and right to fly right.



- Keep the remote controller away from magnetic materials to avoid it being affected by magnetic interference.
- It is recommended that the control sticks are removed and stored in their storage slots on the remote controller during transportation or storage to avoid them getting damaged.

### Flight Mode Switch

Toggle the switch to select the desired flight mode. Choose between P-mode and S-mode.

Position	Flight Mode
	P-mode
	S-mode

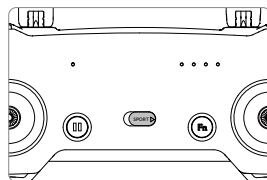

### RTH Button

Press and hold the RTH button to start the Return-to-Home (RTH) procedure. The aircraft will then return to the last recorded Home Point. Press this button again to cancel the RTH procedure and regain control of the aircraft. Refer to the Return to Home section for more information about RTH.

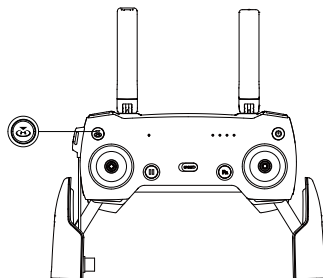

### Function Button and Customizable Button

The functions of the Function button and Customizable button are set in the DJI GO 4 app.

### Optimal Transmission Zone

The signal between the aircraft and the remote controller is most reliable when the antennas are positioned in relation to the aircraft as depicted below.

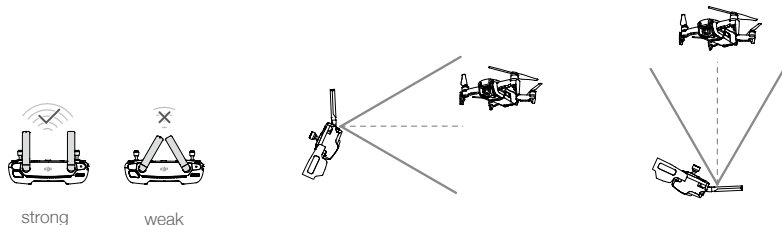

Ensure that the aircraft is flying within the optimal transmission zone. To maintain optimal transmission performance, adjust the remote controller and antennas according to the figure above.

---

## Linking the Remote Controller

Remote controllers that are bought together with a Mavic Air are linked before shipment. To link a remote controller to a Mavic Air, follow the instructions below:

1. Power on the aircraft and the remote controller.
2. Launch DJI GO 4.
3. Select "Connect to the Aircraft's Wi-Fi" and "Wired Connection". And then select "Linking the remote controller".
4. Press and hold the aircraft's Function button for two seconds. Release the button upon hearing a single beep.
5. When the status LED on the remote controller turns solid green, linking is complete.



- Ensure the remote controller is within 1.6 ft (0.5 m) of the aircraft during linking.
-

## DJI GO 4 App

---

This section introduces the main functions of the DJI GO 4 app.

# DJI GO 4 App

Use this app to control the gimbal, camera, and other aircraft functions. The app features Equipment, Editor, SkyPixel, and Me sections, which are used for configuring your aircraft, and editing and sharing your photos and videos with others.

## Equipment

Enter Camera View by tapping the “GO FLY” button on the Equipment screen with your mobile device connected to the aircraft.

### Camera View

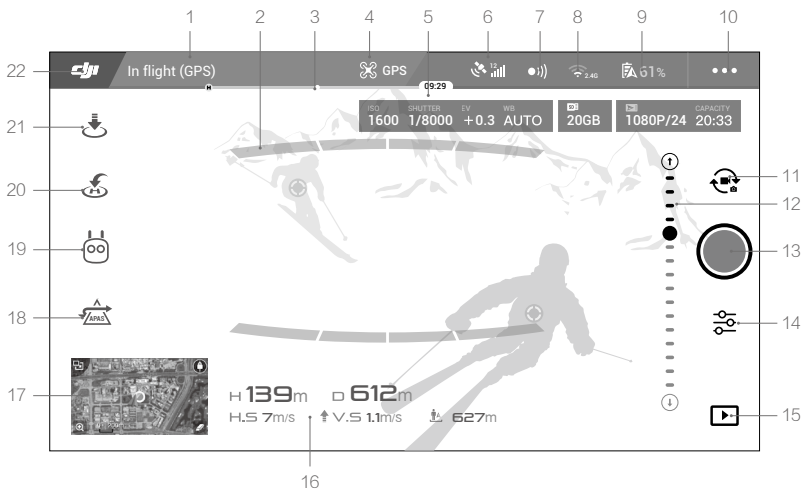

#### 1. System Status Bar

**READY TO GO (GPS)** : This icon indicates aircraft flight status and displays various warning messages.

#### 2. Obstacle Detection Status

**Red bars** : Red bars are displayed when obstacles are close to the aircraft. Orange bars are displayed when obstacles are in detection range.

#### 3. Battery Level Indicator Bar

**Colored zones** : The battery level indicator provides a dynamic display of the battery level. The colored zones on the battery level indicator represent the power levels needed to carry out different functions.

#### 4. Flight Mode

**GPS** : The text next to this icon indicates the current flight mode.

Tap to configure the Flight Controller settings. These settings allow you to modify flight limits and set gain values.

5. Camera Parameters

Displays camera parameters and the capacity of the internal storage and the microSD card.



6. GPS Signal Strength

: Shows the current GPS signal strength. White bars indicate adequate GPS strength.

7. Forward and Backward Vision Systems Status

: Tap into this button to enable or disable features provided by the Forward and Backward Vision Systems.

8. Wi-Fi Settings

<sub>2.4G</sub>: Tap to enter the Wi-Fi Settings menu.

9. Battery Level

**61%**: Shows the current battery level. Tap to view the battery information menu, set the various battery warning thresholds, and view the battery warning history.

10. General Settings

: Tap to enter the General Settings menu to set units of measurement, enable/disable livestream, and adjust flight route display settings.

11. Photo/Video Toggle

: Tap to switch between photo and video recording modes.

12. Gimbal Slider

: Displays the gimbal tilt angle.

13. Shoot / Record Button

: Tap to start shooting photos or recording video.

14. Camera Settings

: Tap to enter the Camera Settings menu.

Tap to set the camera's ISO, shutter, and auto exposure settings.

Tap to select picture shooting modes. The Mavic Air supports Single Shot, Burst Shot, Interval Shot, and various Panorama modes. Panorama supports four shooting sub-modes and can capture and generate 32 megapixel sphere panorama photos.

Tap to enter the General Camera Settings menu.

15. Playback

: Tap to enter the playback page and preview photos and videos as soon as they are captured.

## 16. Flight Telemetry

**D 30M**: Distance between the aircraft and the Home Point.

**H 10.0M** : Height from the Home Point.

**HS 10.0M/S** : Aircraft horizontal speed.

**VS 2.0M/S**: Aircraft vertical speed.

## 17. Map

Tap to view the map.



## 18. Advanced Pilot Assistance Systems

: Tap to enable/disable the APAS feature.

## 19. Intelligent Flight Mode

: Tap to select Intelligent Flight Modes.

## 20. Smart RTH

: Tap to initiate the Smart RTH procedure and have the aircraft return to the last recorded Home Point.

## 21. Auto Takeoff/Landing

: Tap to initiate auto takeoff or landing.

## 22. Back

: Tap to return to the main menu.

## Editor

An intelligent video editor is built into the DJI GO 4 app. After recording several video clips and downloading them to your mobile device, go to Editor on the home screen. You can then select a template and a specified number of clips which are automatically combined to create a short film that can be shared immediately.

## SkyPixel

View and share the photos and videos in the SkyPixel page.

## Me

If you already have a DJI account, you will be able to participate in forum discussions, and share your creation with the community.

## Controlling the Aircraft with a Mobile Device

You can connect a mobile device via Wi-Fi to control the aircraft with DJI GO 4:

1. Power on the aircraft.
2. Press and hold the Function button on the aircraft for four seconds until you hear a double beep, which indicates that the aircraft has switched to mobile device control.
3. Launch the DJI GO 4 app and tap the icon in the top right corner of the screen. Next, scan the Wi-Fi QR Code on the aircraft to start the connection procedure.
4. Tap the  icon to take off automatically. Put both your thumbs on screen and use the virtual joysticks to maneuver the aircraft.

- When flying with just a mobile device in a wide open area with no electromagnetic interference, the maximum transmission distance is approximately 262 ft (80 m) at an altitude of 164 ft (50 m).
- The Wi-Fi frequency can be set to 2.4 GHz (default) or 5 GHz. On supported mobile devices, set Wi-Fi to 5 GHz for less interference.
- Turn on your mobile device's Wi-Fi and enter the Wi-Fi password shown on the aircraft to connect to the Mavic Air network if for any reason you cannot scan the QR code.
- Linking is required when switching back to Remote Control mode.
- To reset the Wi-Fi SSID and password, and to reset the Wi-Fi frequency to 2.4 GHz, press and hold the aircraft's Function button for about 6 seconds, until you hear three beeps. Alternatively, tap "Help" in the DJI GO 4 app, then follow the instructions.
- Only fly with a mobile device in wide open areas with relatively little electromagnetic interference. If your connection is adversely affected by interference, fly with the remote controller instead, or move to an area with less interference.

### Using Virtual Joysticks

Ensure the mobile device has been connected to the aircraft before using the virtual joysticks. The illustrations below are based on Mode 2 (left stick controls throttle and yaw, right stick controls pitch and roll). Tap  to enable or disable the virtual joysticks.

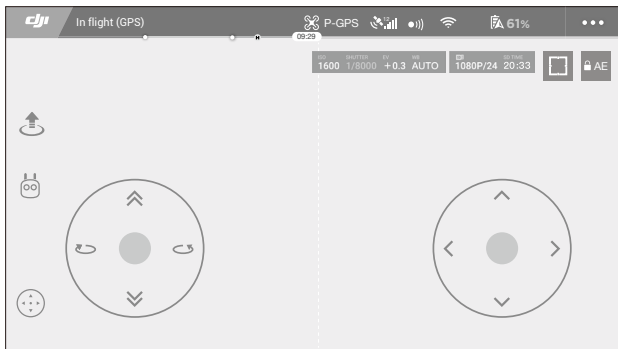

Virtual Joysticks



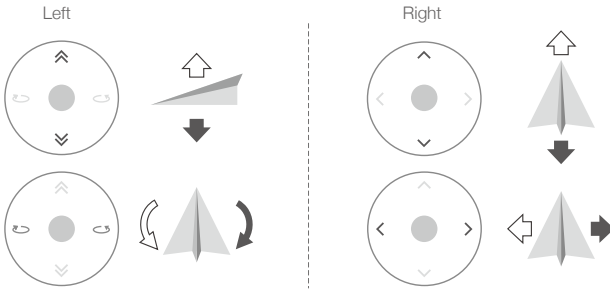

• The area beyond the white circles is also responsive to control commands.

# Flight

---

This section describes safe flight practices and flight restrictions.

# Flight

Once pre-flight preparation is complete, it is recommended that you use the flight simulator in the DJI GO 4 app to hone your flight skills and practice flying safely. Ensure that all flights are carried out in an open area. Refer to the Remote Controller and DJI GO 4 App sections for information about using the remote controller and the app to control the aircraft.

## Flight Environment Requirements

1. Do not use the aircraft in severe weather conditions. These include wind speeds exceeding 10 m/s, snow, rain, and fog.
2. Fly in open areas. Tall structures and large metal structures may affect the accuracy of the on-board compass and GPS system.
3. Avoid obstacles, crowds, high voltage power lines, trees, and bodies of water.
4. Minimize interference by avoiding areas with high levels of electromagnetism such as locations near power lines, base stations, electrical substations, and broadcasting towers.
5. Aircraft and battery performance is subject to environmental factors such as air density and temperature. Be very careful when flying 16404 ft (5000 m) or more above sea level, since battery and aircraft performance may be reduced.
6. The Mavic Air cannot use GPS within the polar areas. Use the Downward Vision System when flying in such locations.

## Flight Limits and GEO Zones



Abide by all laws and regulations when flying your Mavic Air. Flight limitations are applied by default in order to help users operate this product safely and legally. Flight limitations include altitude limits, distance limits, and GEO Zones.

When operating in P-mode, altitude limits, distance limits, and GEO Zones function concurrently to manage flight safety.

### Flight Altitude and Distance Limits

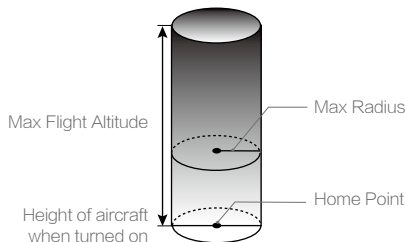
The flight altitude and distance limits may be changed in the DJI GO 4 app. The maximum flight altitude setting cannot exceed 1640 ft (500 m). Based on these settings, your Mavic Air will fly in a restricted cylinder, as shown below:



GPS Signal Strong  ..... Blinking Green			
	Flight Limits	DJI GO 4 App	Aircraft Status Indicator
Max Altitude	Aircraft's altitude cannot exceed the specified value.	Warning: Height limit reached.	N/A
Max Distance	Flight distance must be within the max radius.	Warning: Distance limit reached.	Blinking red quickly  when close to the max radius limit.

GPS Signal Weak  ..... Blinking Yellow			
	Flight Limits	DJI GO 4 App	Aircraft Status Indicator
Max Altitude	Height is restricted to 16 feet (5 meters) when the GPS signal is weak and Downward Vision System is activated. Height is restricted to 98 feet (30 meters) when the GPS signal is weak and Downward Vision System is inactivated.	Warning: Height limit reached.	N/A
Max Distance	No limit		

-  • If the aircraft reaches one of the limits, you can still control the aircraft, but you cannot fly it any farther.
- If the aircraft flies out of the max radius, it will fly back within range automatically when GPS signal is strong.
- For safety reasons, please do not fly close to airports, highways, railway stations, railway lines, city centers, or other sensitive areas. Fly the aircraft only within your line of sight.

### GEO Zones

All GEO Zones are listed on the DJI official website at <http://www.dji.com/flysafe>. GEO Zones are divided into different categories and include locations such as airports, flying fields where manned aircraft operate at low altitudes, borders between countries, and sensitive locations such as power plants.

### Preflight Checklist

1. Ensure the remote control device, smart device, and Intelligent Flight Battery are fully charged.
2. Ensure the Intelligent Flight Battery is mounted firmly.
3. Ensure the aircraft arms and landing gears are unfolded.
4. Ensure the propellers and propeller guards are in good condition and securely mounted and tightened.
5. Ensure that there is nothing obstructing the motors and that the motors are functioning normally. Ensure that the camera lens and Vision System sensors are clean.
6. Ensure the gimbal and camera are functioning normally.
7. Ensure that the DJI GO 4 app is successfully connected to the aircraft.

## Auto Takeoff and Auto Landing

### Auto Takeoff

Use auto takeoff only if the Aircraft Status Indicator is blinking green. Follow the steps below to use the auto takeoff feature:

1. Launch the DJI GO 4 app, and tap "GO FLY" to enter Camera View.
2. Complete all steps in the pre-flight checklist.
3. Tap .
4. If conditions are safe for takeoff slide the slider to confirm and the aircraft will take off and hover 3.9 ft (1.2 m) above the ground.

- 
-  • The Aircraft Status Indicator indicates whether the aircraft is using GPS and/or the Downward Vision System for flight control. Refer to the Aircraft LEDs and Status Indicator section for more information.
- It is recommended to wait until the GPS signal is strong before using the auto takeoff.
- 

### Auto Landing

Use auto landing only if the Aircraft Status Indicator is blinking green. Follow the steps below to use the auto landing feature:

1. Tap .
2. If conditions are safe for landing condition slide the slider to confirm and the aircraft will commence the auto landing procedure. Warnings will appear in the DJI GO 4 app if the aircraft detects that conditions are not suitable for landing. Be sure to respond promptly.

- 
-  During the auto landing procedure, auto landing can be aborted immediately by tapping  in the DJI GO 4 app.
- 

## Starting/Stopping the Motors

### Starting the Motors

A Combination Stick Command (CSC) is used to start the motors. Push both sticks to the bottom inner or outer corners to start the motors. Once the motors have started spinning, release both sticks simultaneously.

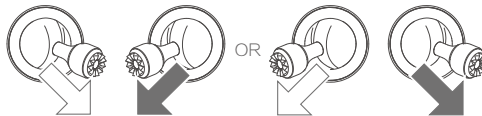

## Stopping the Motors

There are two methods to stop the motors.

1. Method 1: When the aircraft has landed, push and hold the left stick down. The motors will stop after three seconds.
2. Method 2: When aircraft has landed, push the left stick down, then conduct the same CSC that was used to start the motors, as described above. The motors will stop immediately. Release both sticks once the motors have stopped.

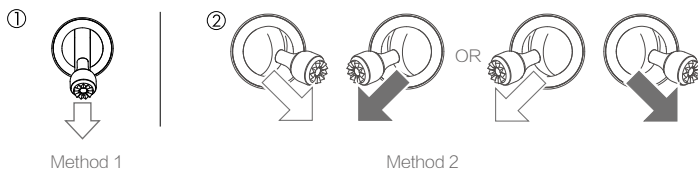

## Stopping Motors Mid-flight

Stopping motors mid-flight will cause the aircraft to crash. The motors should only be stopped mid-flight in an emergency situation such as if a collision has occurred or if the aircraft is out of control and is ascending/descending very quickly, rolling in the air, or if a motor has stalled. To stop the motors mid-flight use the same CSC that was used to start the motors.

## Flight Test

### Takeoff/Landing Procedures

1. Place the aircraft in an open, flat area with the battery level indicators facing towards you.
2. Turn on the aircraft and the remote controller.
3. Launch the DJI GO 4 app and enter Camera View.
4. Wait until the Aircraft Status Indicator blinks green quickly indicating that the Home Point has been recorded and it is now safe to fly.
5. Gently push the throttle stick to take off, or use auto takeoff.
6. Pull the throttle stick or use auto landing to land the aircraft.
7. Turn off the aircraft and remote controller.

- ⚠️ If the Aircraft Status Indicator blinks yellow quickly during flight, the remote control signal has been lost and the aircraft will activate Failsafe RTH. Refer to the Return to Home section for more information.
- If the Aircraft Status Indicator blinking red slowly or quickly during flight a low battery level warning or critically low battery level warning has occurred.
- Watch the Mavic Air video tutorials to learn more about takeoff/landing procedures.

## Video Suggestions and Tips

1. The pre-flight checklist is designed to help you fly safely and to ensure that you are able to shoot video during flight. Go through the full pre-flight checklist before each flight.
2. Select the desired gimbal operation mode in the DJI GO 4 app.
3. Only shoot video when flying in P-mode.

4. Always fly in good weather and avoid flying in rain or wind.
5. Choose the camera settings that suit your needs. Settings include photo format and exposure compensation.
6. Perform flight tests to establish flight routes and preview scenes.
7. Push the control sticks gently to keep the aircraft's movement smooth and stable.

# Appendix

---



# Appendix

## Specifications

Aircraft	
Weight	430 g
Dimensions (LxWxH)	Folded: 168x83x49 mm Unfolded: 168x184x64 mm
Diagonal Length	213 mm (excluding propellers)
Max Ascent Speed	2 m/s (P-mode with RC); 4 m/s (S - mode); 2 m/s (P-mode without RC)
Max Descent Speed	1.5 m/s (P-mode with RC); 3 m/s (S -mode); 1 m/s (P-mode without RC)
Max Speed (Near Sea Level, No Wind)	17.9 mph (28.8 km/h); P-mode with RC 42.5 mph (68.4 km/h); S-mode 17.9 mph (28.8 km/h); P-mode without RC
Max Service Ceiling Above Sea Level	5000 m
Max Flight Time	21 minutes (0 wind at a consistent 15.5 mph (25 kph))
Max Hovering Time	20 minutes (0 wind)
Max Flight Distance	10 km (0 wind)
Max Wind Speed Resistance	22 mph (10 m/s)
Max Tilt Angle	35° (S-mode); 25° (P-mode)
Max Angular Velocity	250°/s
Operating Temperature	32° to 104° F (0° to 40° C)
GNSS	GPS/GLONASS
Operating Frequency	2.4-2.4835 GHz; 5.725-5.850 GHz
Transmitter Power (EIRP)	2.4 GHz: FCC: < 28 dBm; CE: < 19 dBm; SRRC: < 19 dBm; MIC: < 19 dBm 5.8 GHz: FCC: < 31 dBm; CE: < 14 dBm; SRRC: < 27 dBm
GPS Hover Accuracy Range	Vertical: ±0.1 m (With Vision Positioning); ±0.5 m (With GPS Positioning) Horizontal: ±0.1 m (With Vision Positioning); ±1.5 m (With GPS Positioning)
Internal Storage	8 GB
Gimbal	
Stabilization	3-axis (tilt, roll, pan)
Max Control Speed (Tilt)	120°/s
Angular Vibration Range	±0.005°
Controllable Range	Tilt: -90° to +0° (default setting); -90° to +17° (extended)
Vision System	
Effective Sensing Speed	≤ 8 m/s
Altitude Range	0.3 to 26 ft (0.1 to 8 m)
Operating Range	1.6 to 98 ft (0.5 to 30 m)
Operating Environment	Surfaces with diffuse reflection material, size > 20x20 mm and reflectivity > 20% (such as wall, trees, humans), adequate lighting (> 15 lux)

Directions	Forward/Backward/Downward
FOV	Forward: Horizontal: 50°, Vertical: 38° Backward: Horizontal: 50°, Vertical: 38° Downward: Front and Back: 67°, Left and Right: 53°
Sensing Range	Forward: Precision Measurement Range: 0.5-12 m Detectable Range: 12-24 m Backward: Precision Measurement Range: 0.5-10 m Detectable Range: 10-20 m
Camera	
Sensor	1/2.3" CMOS; Effective pixels: 12 megapixels
Lens	85° FOV, 24 mm (35 mm format equivalent) f/2.8 Shooting Range: 0.5 m to infinity
ISO Range	Video: 100 to 1600 (Auto), 100-1600 (Manual) Photo: 100 to 1600 (Auto), 100 to 3200 (Manual)
Electronic Shutter Speed	8 to 1/8000 s
Max Image Size	4056x3040
Still Photography Modes	Single shot HDR Burst shooting: 3 frames Auto Exposure Bracketing (AEB): 3/5 bracketed frames at 0.7 EV Bias Interval (2/3/5/7/10/15/20/30/60 s) Pano: 3x1: 42°x78°, W: 2048xH:3712 3x3: 119°x78°, W: 4096xH:2688 180°: 251°x88°, W: 6144xH:2048 Sphere (3x8+1): 8192x4096
Video Recording Modes	4K Ultra HD: 3840x2160 24/25/30 p 2.7K: 2720x1530 24/25/30/48/50/60 p FHD: 1920x1080 24/25/30/48/50/60/120 p HD: 1280x720 24/25/30/48/50/60/120 p
Video Storage Bitrate	100 Mbps
Supported File System	FAT32
Photo	JPEG / DNG (RAW)
Video	MP4, MOV (MPEG-4 AVC/H.264)
Supported SD Cards	microSD (Class 10 or UHS-1 rating required)
Remote Controller	
Operating Frequencies	2.4-2.4835 GHz; 5.725-5.850 GHz
Max Transmission Distance (Unobstructed, free of interference)	2.4 GHz: FCC: 2.5 mi (4 km); CE/SRRC/MIC: 1.2 mi (2 km) 5.8 GHz: FCC: 2.5 mi (4 km); CE: 0.3 mi (0.5 km); SRRC: 1.6 mi (2.5 km)
Operating Temperature Range	32° to 104° F (0° to 40° C)

Transmitter Power (EIRP)	2.4 GHz: < 26 dBm (FCC), < 18 dBm (CE), < 18 dBm (SRRC), < 18 dBm (MIC) 5.8 GHz: < 30 dBm (FCC), < 14 dBm (CE), < 26 dBm (SRRC)
Built-in Battery	2970 mAh
Operating Current/Voltage	1400 mA = 3.7 V (Android) 750 mA = 3.7 V (iOS)
Supported Mobile Device Size	Thickness: 6.5 to 8.5 mm Max length: 160 mm
Supported USB port types	Lightning, Micro USB (Type-B), USB-C
<b>Power Adapter</b>	
Input	100 to 240 V, 50/60 Hz, 1.4 A
Output	Main: 13.2 V = 3.79 A USB: 5 V = 2 A
Voltage	13.2 V
Rated Power	50 W
<b>Intelligent Flight Battery</b>	
Capacity	2375 mAh
Voltage	11.55 V
Max Charging Voltage	13.2 V
Battery Type	LiPo 3S
Energy	27.43 Wh
Net Weight	Approx. 140 g
Charging Temperature Range	5°C to 40°C
Max Charging Power	60 W

## Calibrating the Compass

It is recommended that the compass is calibrated in any of the following situations when flying outdoors:

1. Flying at a location farther than 31 miles (50 km) away from the last flight location.
2. The aircraft has not been flown for more than 30 days.
3. A compass interference warning appears in the DJI GO 4 app and/or the Aircraft Status Indicator blinks alternating red and yellow quickly.



- DO NOT calibrate your compass where magnetic interference may occur, such as locations close to magnetite deposits or large metallic structures such as parking structures, steel-reinforced basements, bridges, cars, or scaffolding.
- DO NOT carry objects (such as cell phones) that contain ferromagnetic materials near the aircraft during calibration.
- It is not necessary to calibrate compass when flying indoors.

### Calibration Procedure

Choose an open area to carry out the following procedure.

1. Tap the System Status Bar in the DJI GO 4 app and select "Calibrate", then follow the on-screen instructions.
2. Hold the aircraft horizontally and rotate it 360 degrees. The Aircraft Status Indicator will turn solid green.

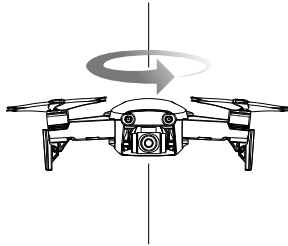

3. Hold the aircraft vertically, with its nose pointing downward, and rotate it 360 degrees around a vertical axis.

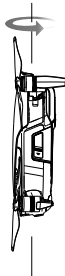

4. If the Aircraft Status Indicator blinks red the calibration has failed. Change your location and try the calibration procedure again.



- The aircraft is able to take off immediately once the calibration has completed successfully. If you do not take off within three minutes of completing the calibration it is possible that another compass interference warning will appear while the aircraft is on the ground. If this happens it indicates that the current location is not suitable for flying the aircraft, due to the level of magnetic interference.
-

## Firmware Updates

Use DJI GO 4 or DJI Assistant 2 to update aircraft firmware.

### Using DJI GO 4

When you connect the aircraft or remote controller to the DJI GO 4 app you will be notified if a new firmware update is available. To start updating, connect your mobile device to the Internet and follow the on-screen instructions. Note that you cannot update the firmware if the remote controller is not linked to the aircraft.

### Using DJI Assistant 2

The USB-C port is used when connecting the Mavic Air to a computer to update firmware.

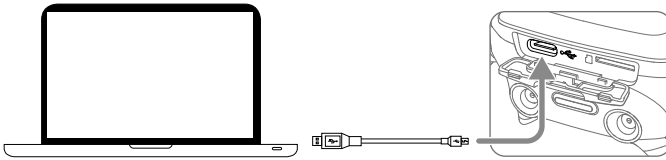

Follow the instructions below to update the firmware through DJI Assistant 2:

1. With the aircraft powered off, connect the aircraft to a computer via the Micro USB port using a Micro USB cable.
2. Power on the aircraft.
3. Launch DJI Assistant 2 and login with your DJI account.
4. Select "Mavic Air" and click on Firmware Updates on the left panel.
5. Select the firmware version that you wish to update to.
6. Wait for the firmware to be downloaded. The firmware update will start automatically.
7. Reboot the aircraft after the firmware update is complete.



- Ensure the aircraft is connected to the computer before powering on.
- The firmware update will take around 15 minutes. It is normal that the gimbal goes limp, aircraft status indicators blink, and the aircraft reboots. Please wait patiently until the update is complete.
- Ensure the computer has access to the Internet.
- Before performing an update ensure the Intelligent Flight Battery has at least 50% power and the remote controller has at least 30% power.
- Do not disconnect the aircraft from the computer during an update.

## After-Sales Information

Visit <https://www.dji.com/support> to learn more about after-sales service policies, repair services and support.

DJI Support  
<http://www.dji.com/support>

This content is subject to change.

**Download the latest version from**  
**<http://www.dji.com/mavic-air>**

If you have any questions about this document, please  
contact DJI by sending a message to **[DocSupport@dji.com](mailto:DocSupport@dji.com)**.

MAVIC is a trademark of DJI.  
Copyright © 2018 DJI All Rights Reserved.