

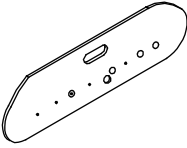

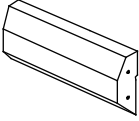

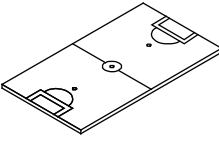











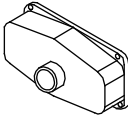
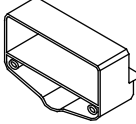
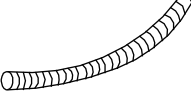

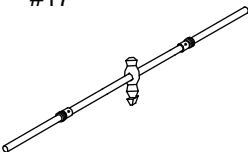
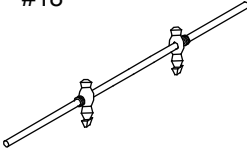
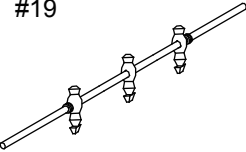
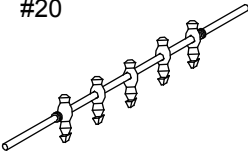

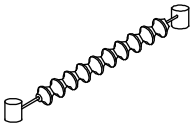
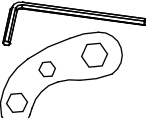

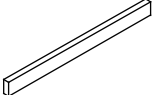

# Part List

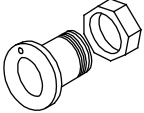
<p>#1</p>  <p>Long-side Boards 2PCS</p>	<p>#2</p>  <p>Short-side Boards 2PCS</p>	<p>#3</p>  <p>Playfield 1PC</p>	<p>#4</p>  <p>Long Legs 4PCS</p>	<p>#5</p>  <p>Leg Panels 2PCS</p>
<p>#6</p>  <p>P6*1-1/2" Bolts 8PCS</p>	<p>#7</p>  <p>F4*3/4"Screws 4PCS</p>	<p>#8</p>  <p>Rod Handles 8PCS</p>	<p>#9</p>  <p>F4*1"Screws 20PCS</p>	<p>#10</p>  <p>8#*2"Screws 8PCS</p>
<p>#11</p>  <p>T4*1/2" Screws 28PCS</p>	<p>#12</p>  <p>Ball Collectors 2PCS</p>	<p>#13</p>  <p>Ball Receivers 2PCS</p>	<p>#14</p>  <p>Ball Return Tubes 2PCS</p>	<p>#15</p>  <p>5/16**2-1/2"Bolts 12PCS</p>
<p>#16</p>  <p>5/16**19mm Washers 32PCS</p>	<p>#17</p>  <p>1Man Rods 2PCS</p>	<p>#18</p>  <p>2Man Rods 2PCS</p>	<p>#19</p>  <p>3Man Rods 2PCS</p>	<p>#20</p>  <p>5Man Rods 2PCS</p>
<p>#21</p>  <p>Ball cups 2PCS</p>	<p>#22</p>  <p>8#*5/8" Screws 6PCS</p>	<p>#23</p>  <p>Counters 2PCS</p>	<p>#24</p>  <p>Wrench 1SET</p>	<p>#25</p>  <p>Soccer Balls 4PCS</p>
<p>#26</p>  <p>Nuts 12PCS</p>	<p>#27</p>  <p>Abnormity steel 4PCS</p>	<p>#28</p>  <p>Support sticks 2PCS</p>	<p>#29</p>  <p>5/16**1-1/2"Bolts 8PCS</p>	<p>#30</p>  <p>Bearings 8PCS</p>
<p>#31</p>  <p>Bearing Sleeve 8PCS</p>	<p>#32</p>  <p>M6 Spring Washers 8PCS</p>	<p>#33</p>  <p>6.5*28mm Washers 16PCS</p>	<p>#34</p>  <p>M6 Lock Hexnuts 8PCS</p>	<p>#34</p>  <p>Lock Ring 8PCS</p>

# STEP 1

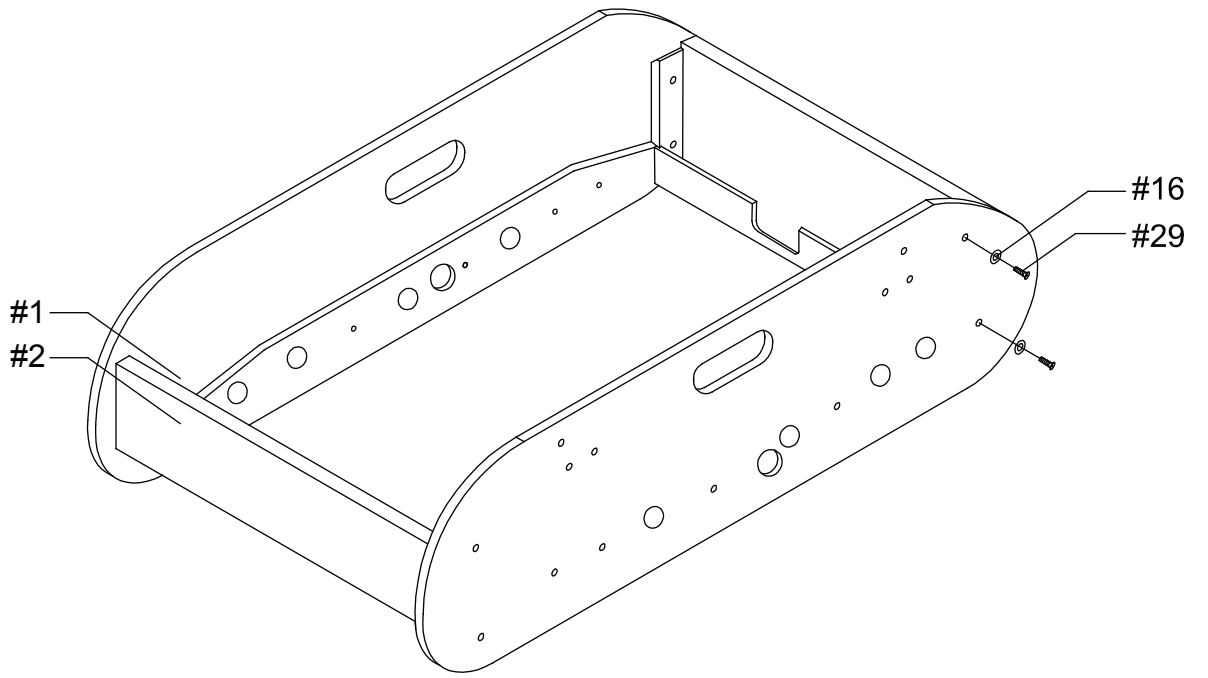

# STEP 2

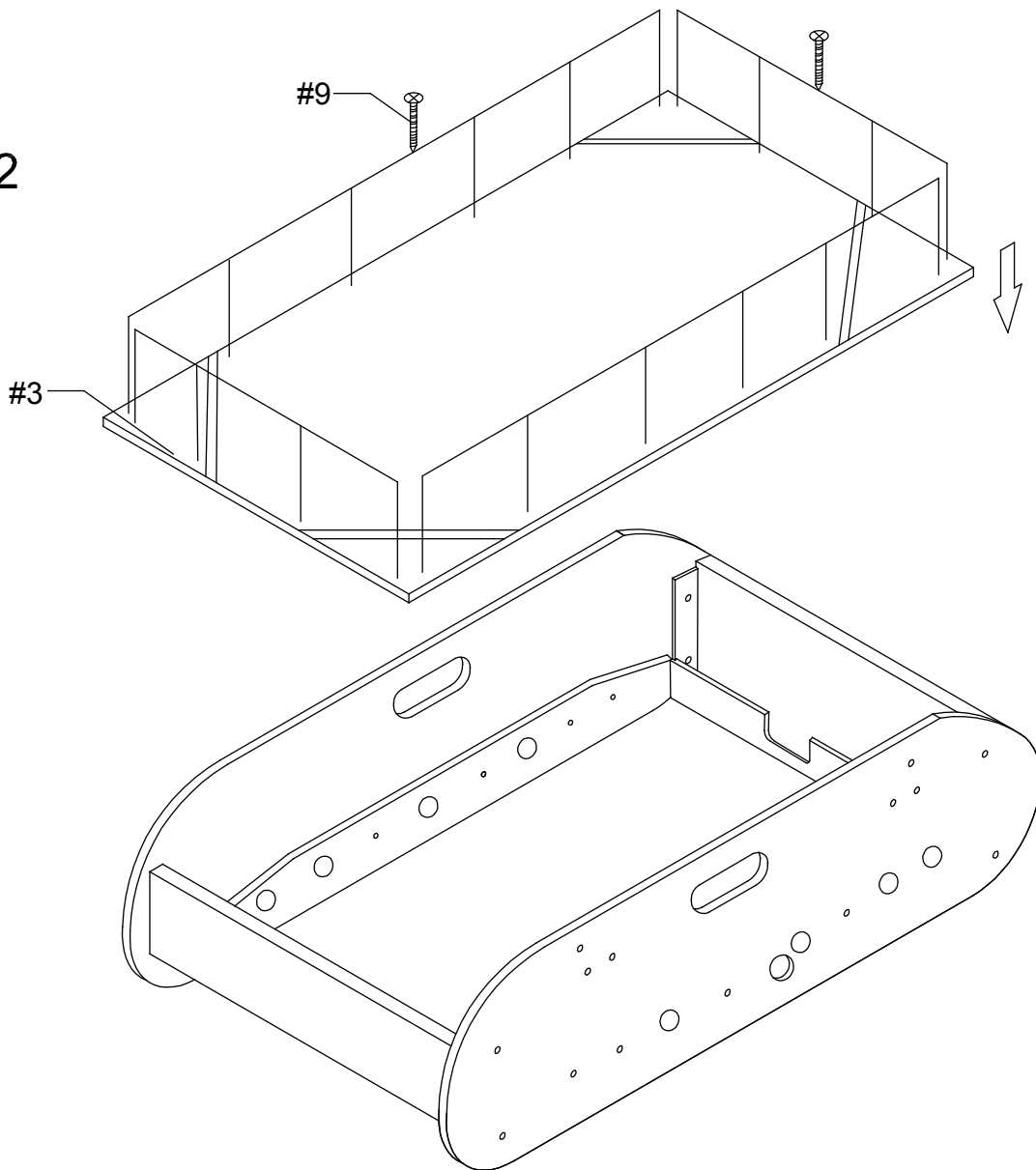

STEP 3

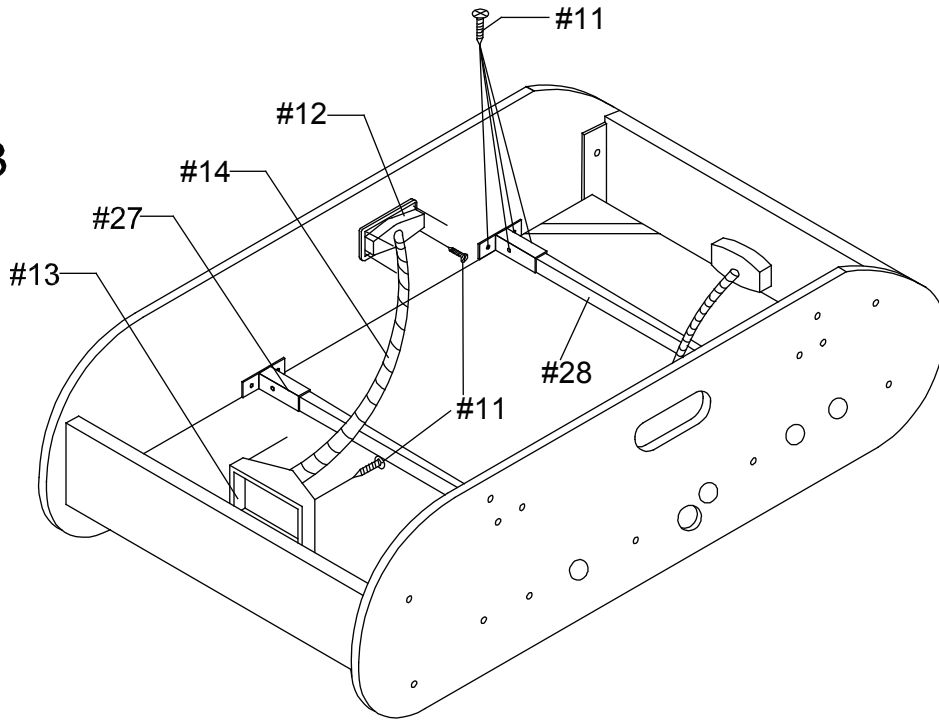

STEP 4

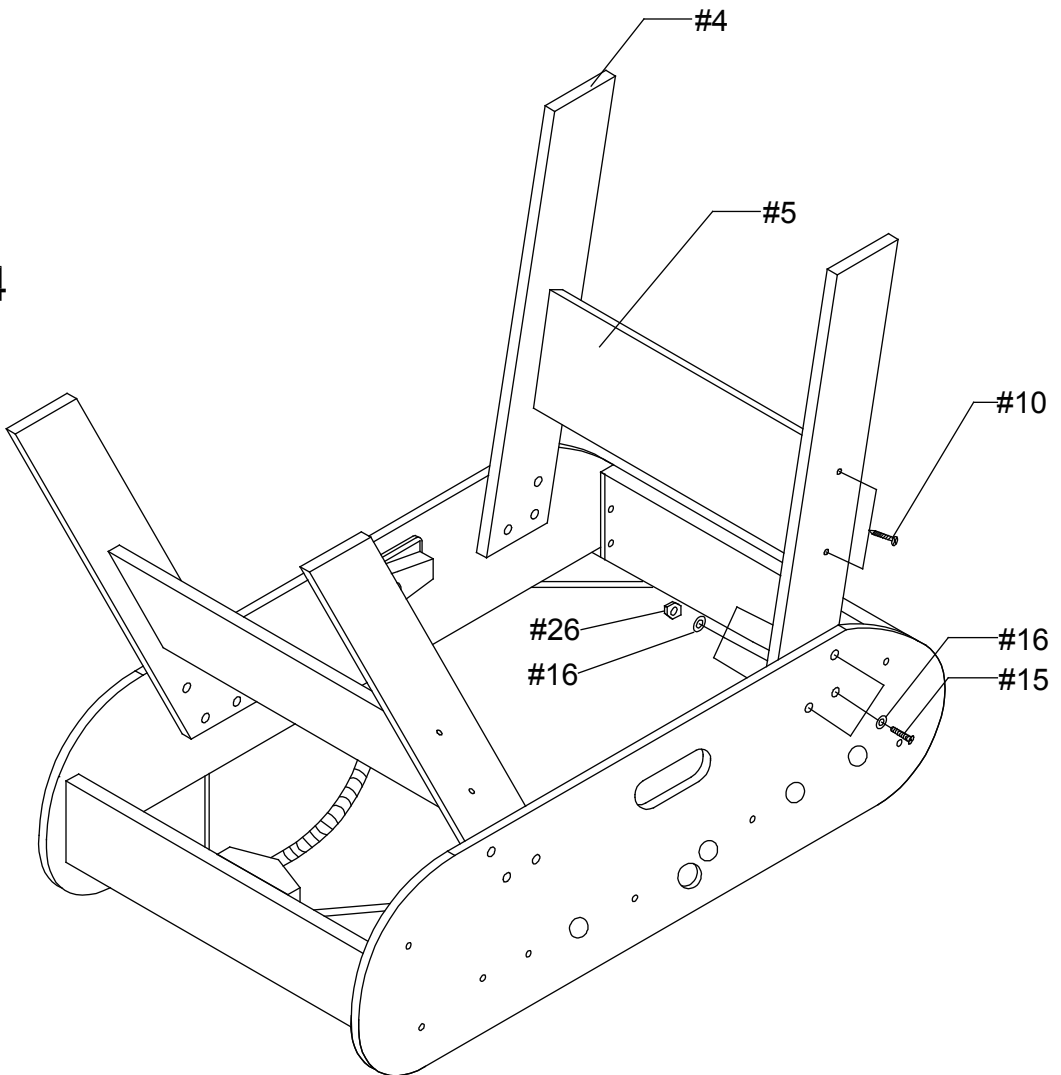

# STEP 5

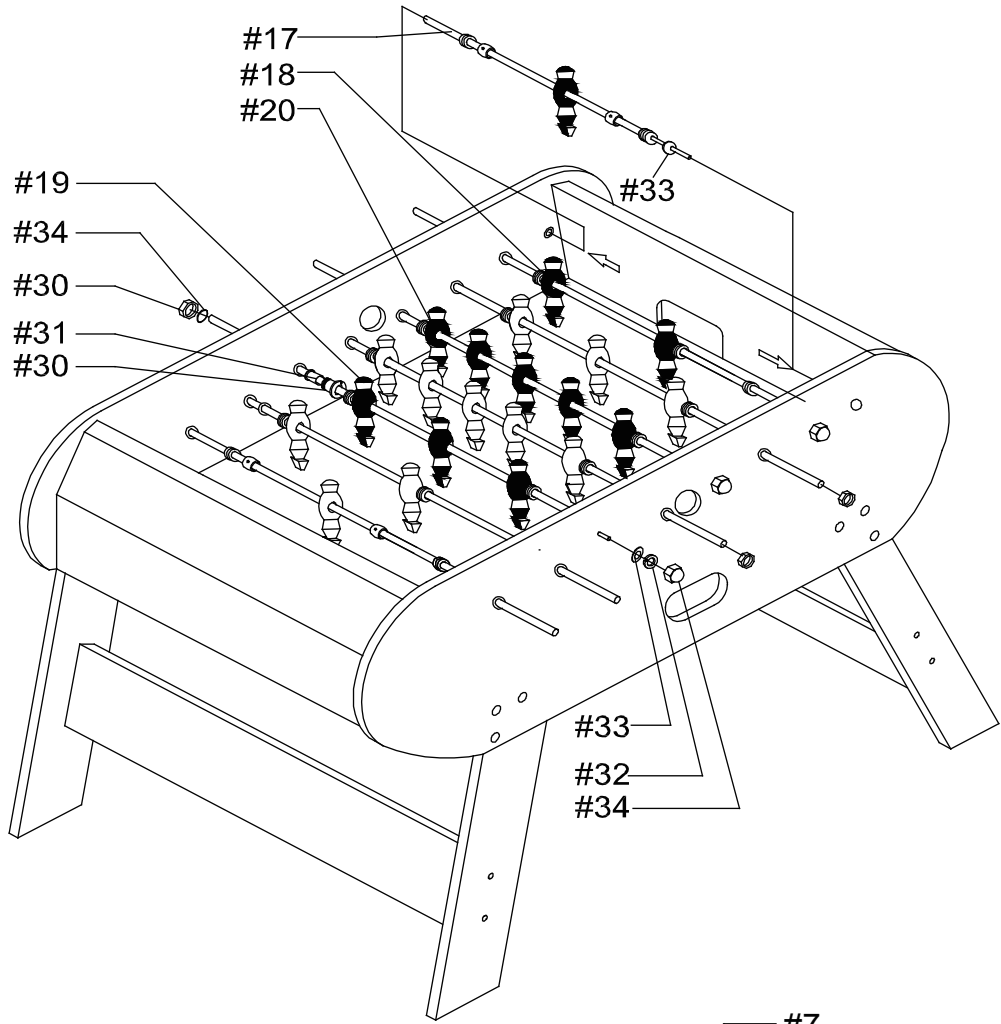

# STEP 6

