

Шкаф ШТВ-2-х.10.6 (Масштаб 1:10)

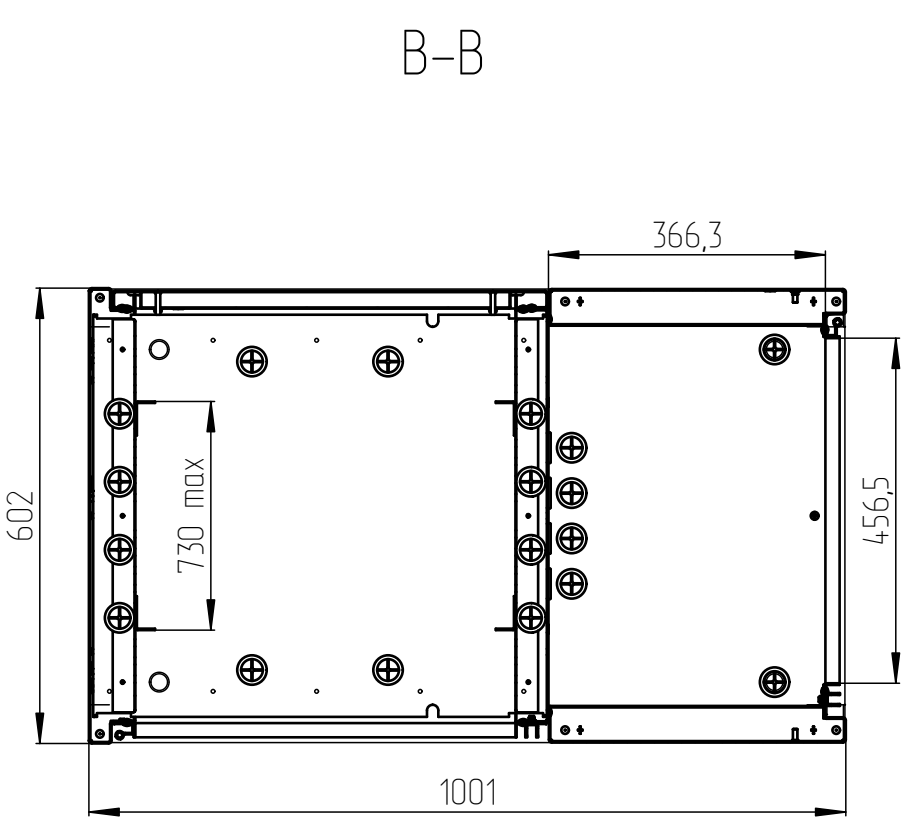

Дно каркаса

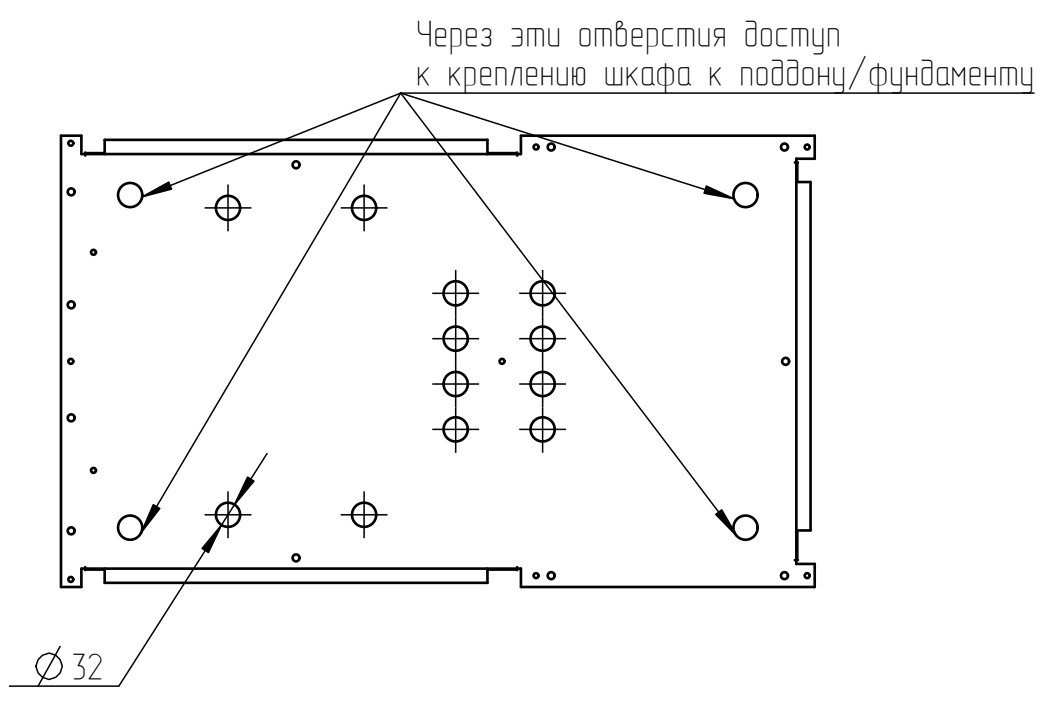

Основа

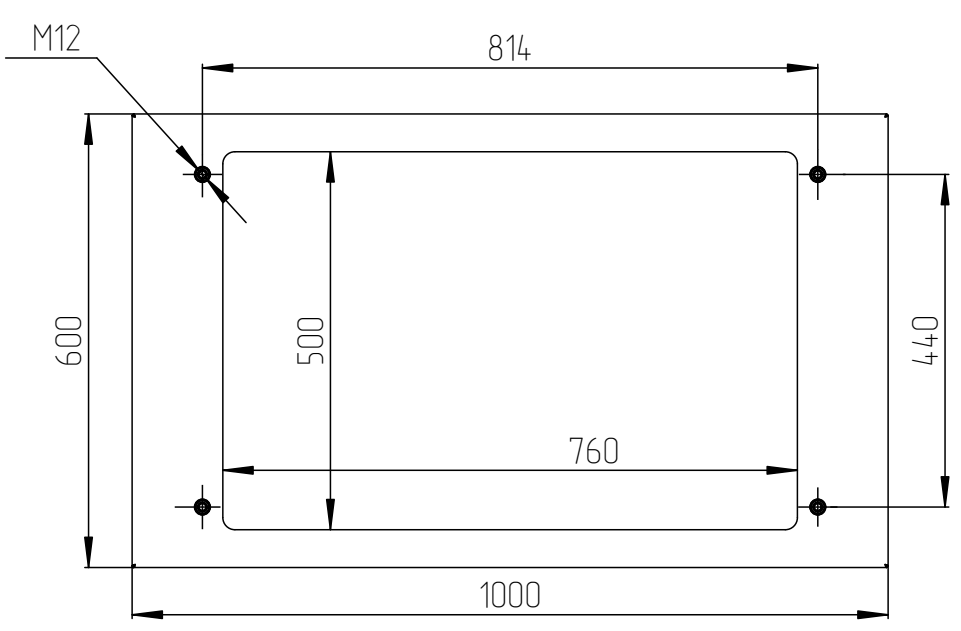

ШТВ-2-6U.10.6-4AA3

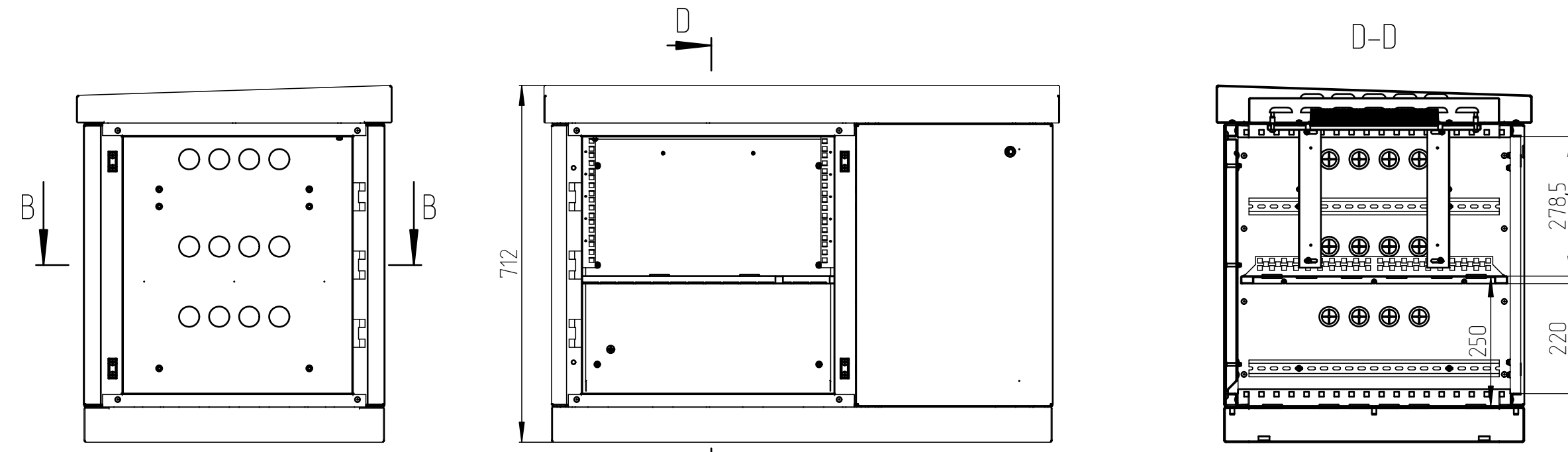

ШТВ-2-9U.10.6-4AA3

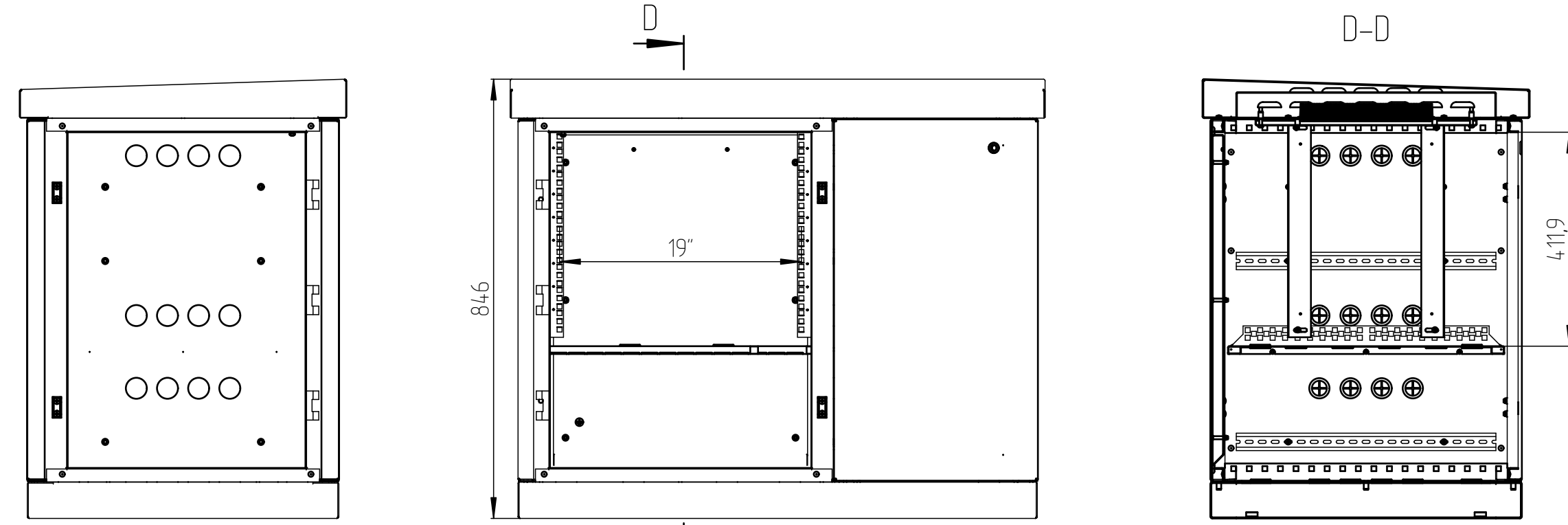

ШТВ-2-12U.10.6-4AA3

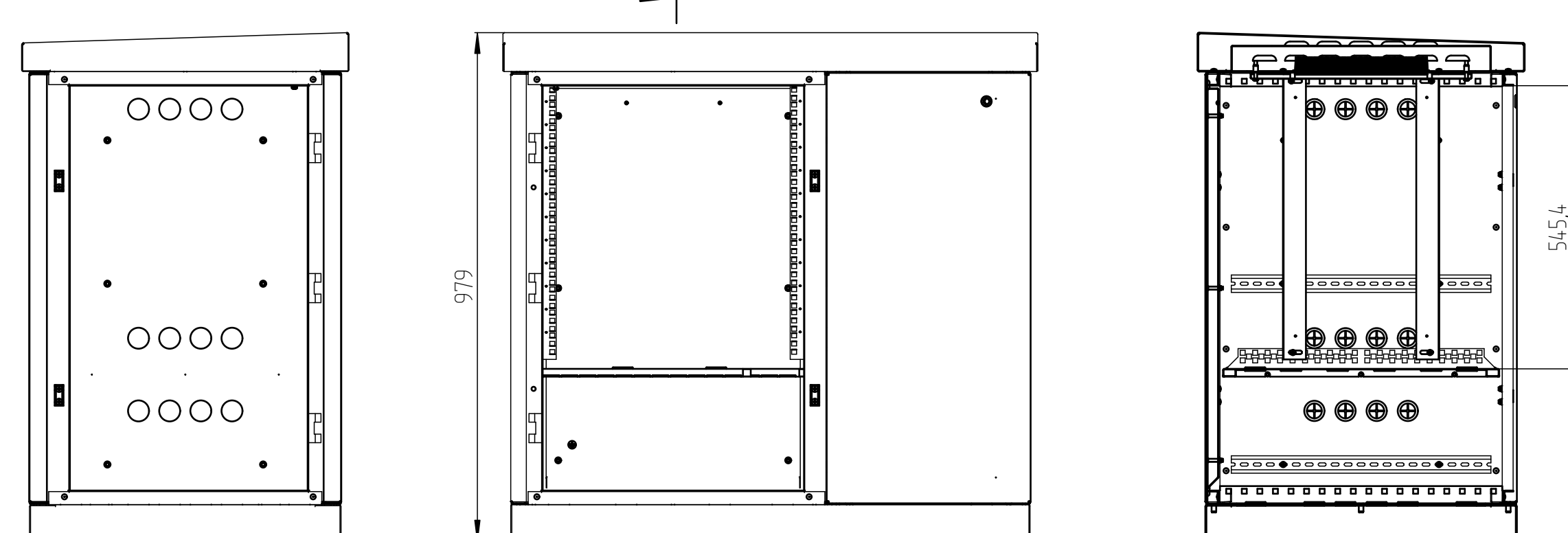

ШТВ-2-15U.10.6-4AA3

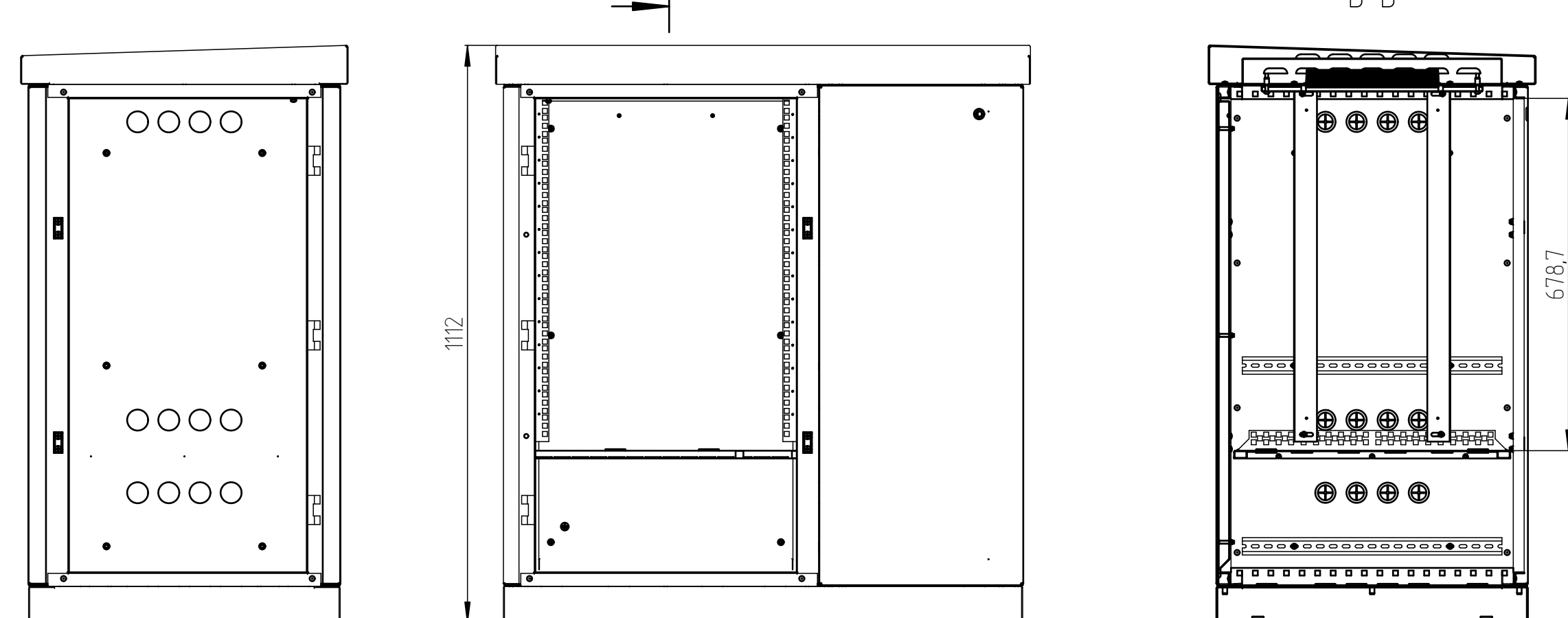

ШТВ-2-18U.10.6-4AA3

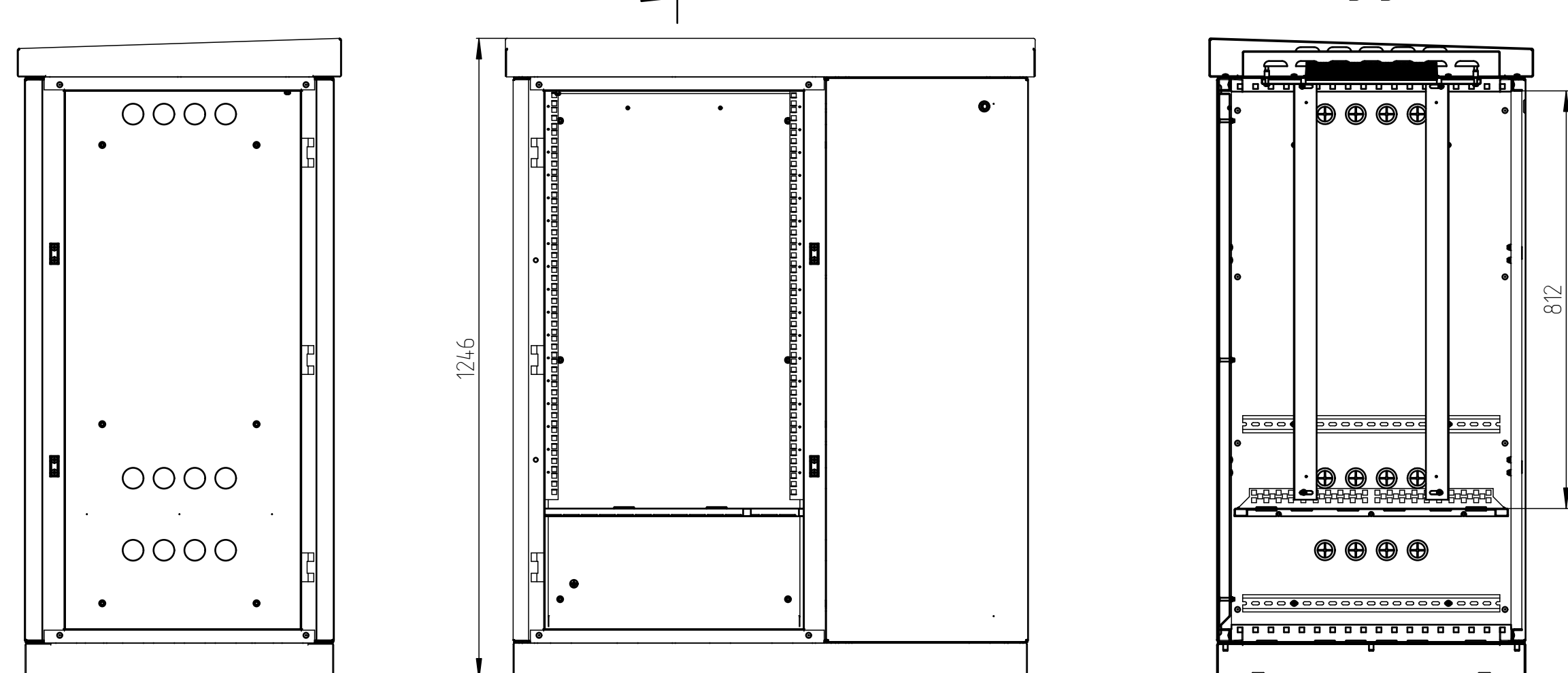

ШТВ-2-21U.10.6-4AA3

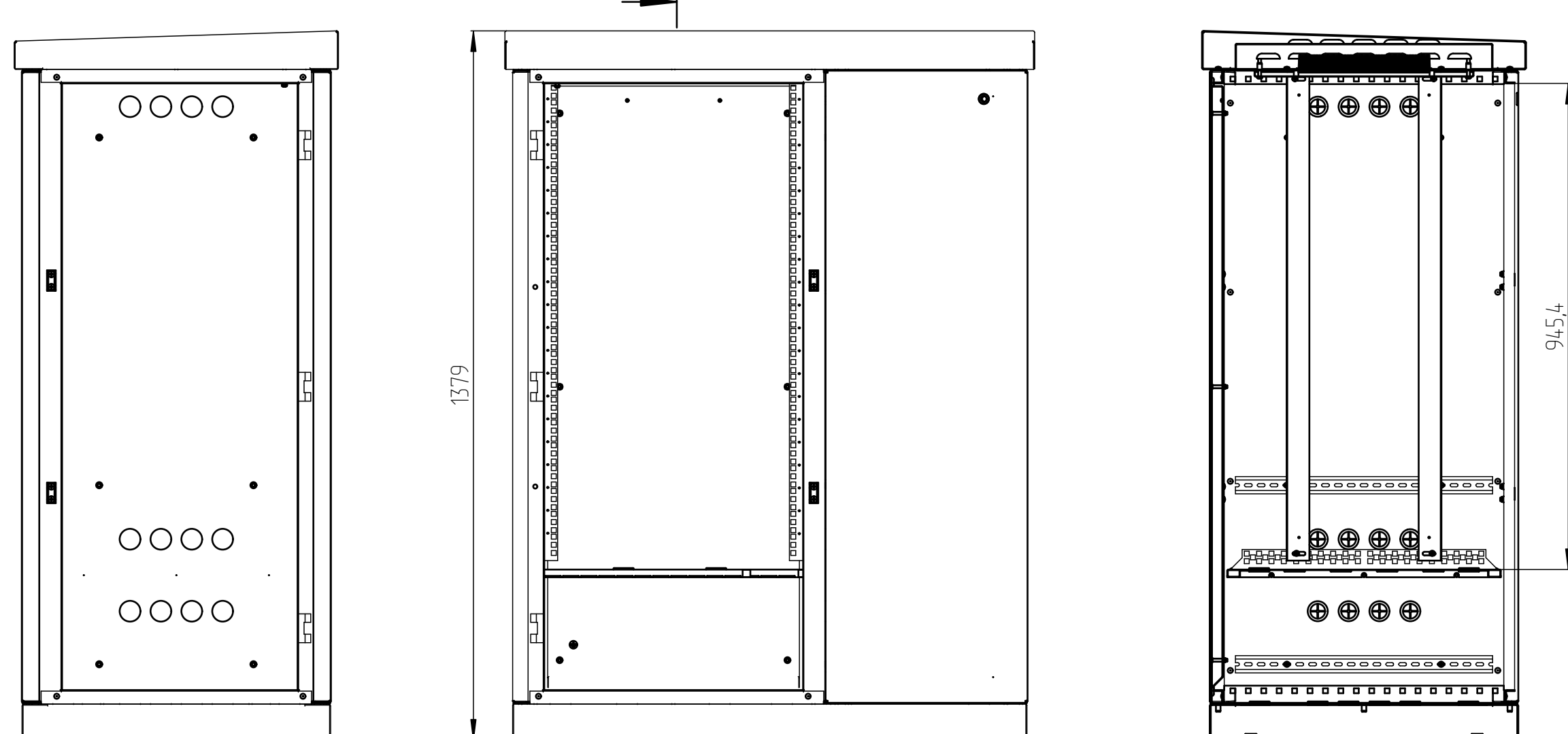

ШТВ-2-24U.10.6-4AA3

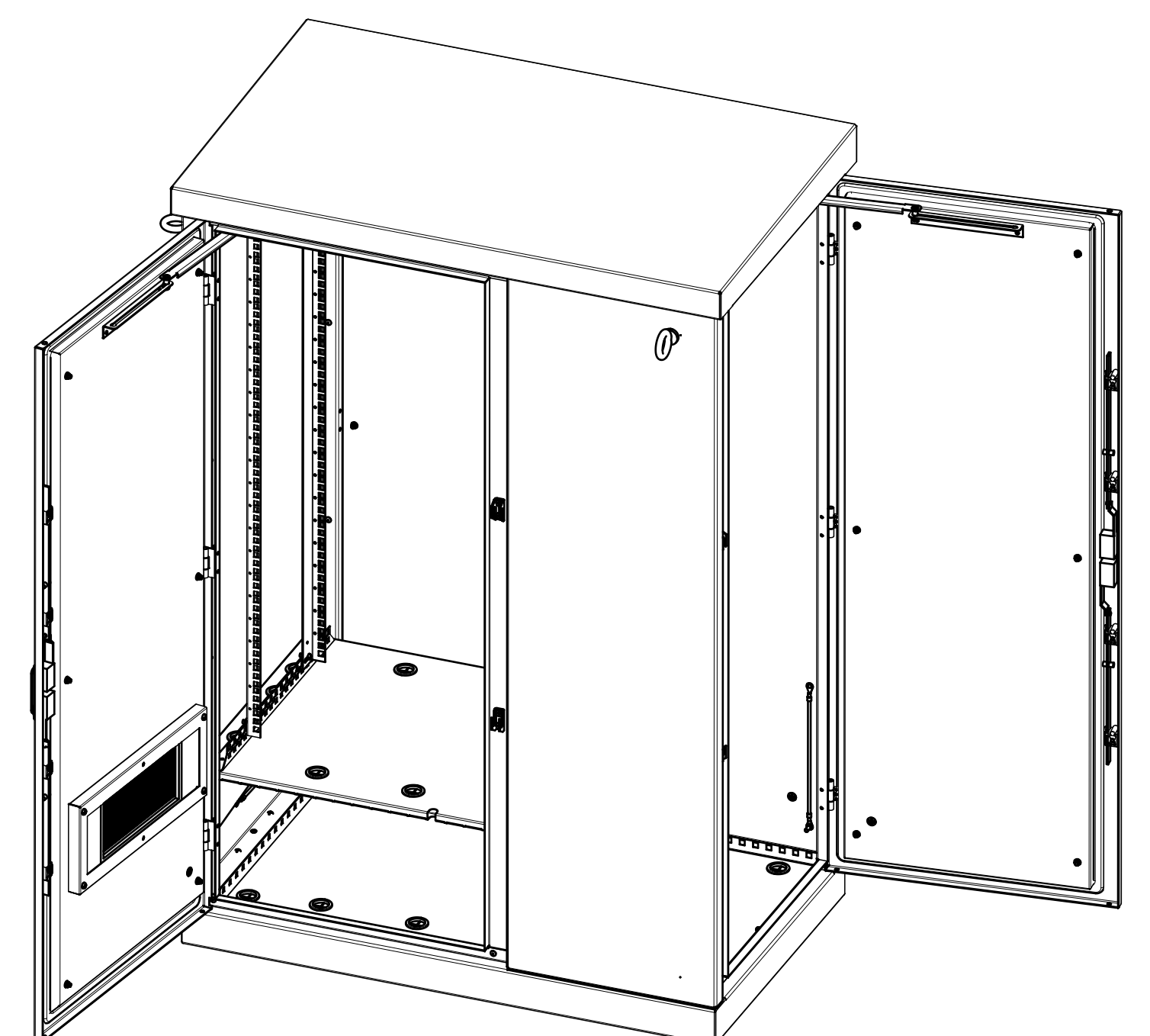
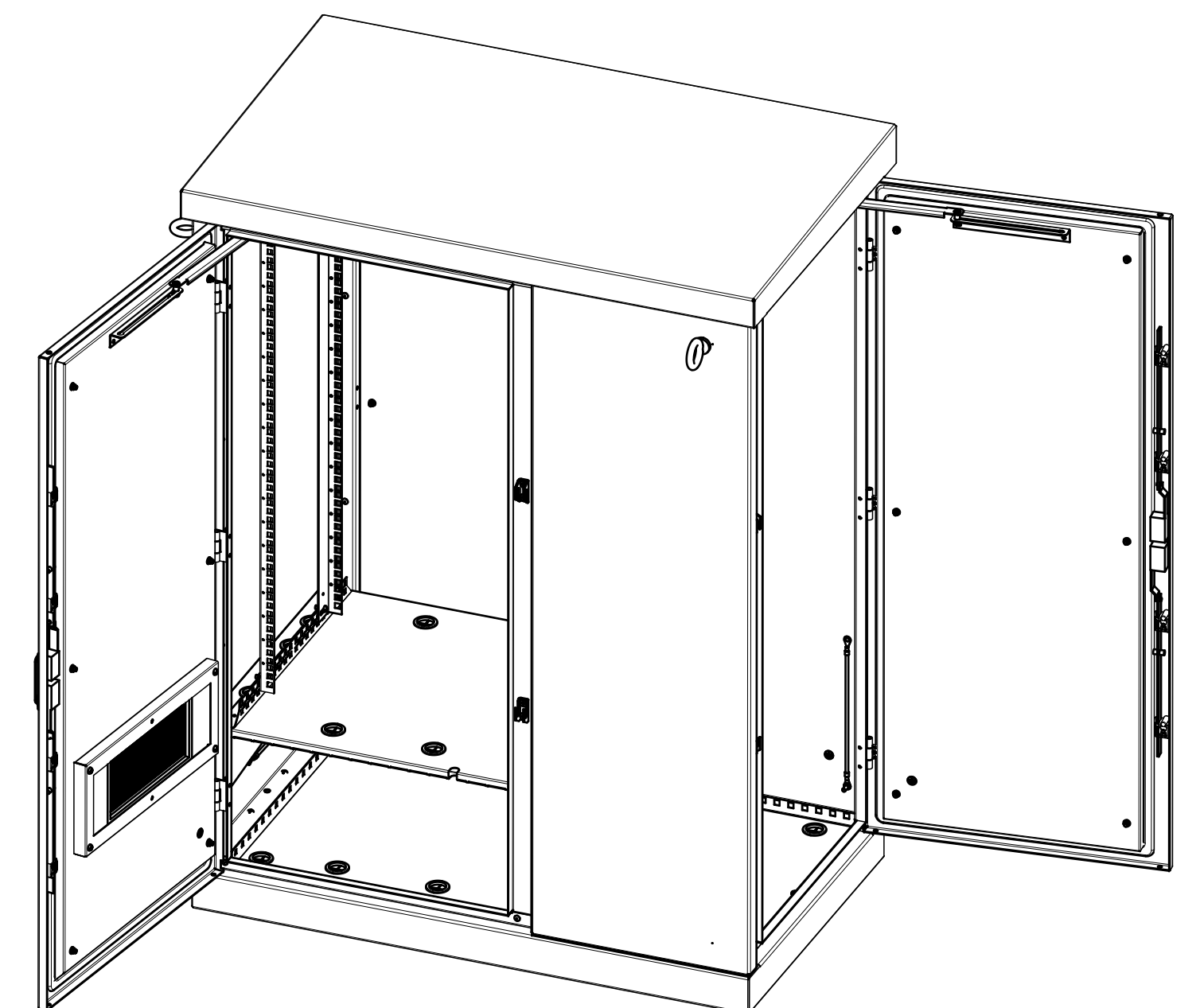
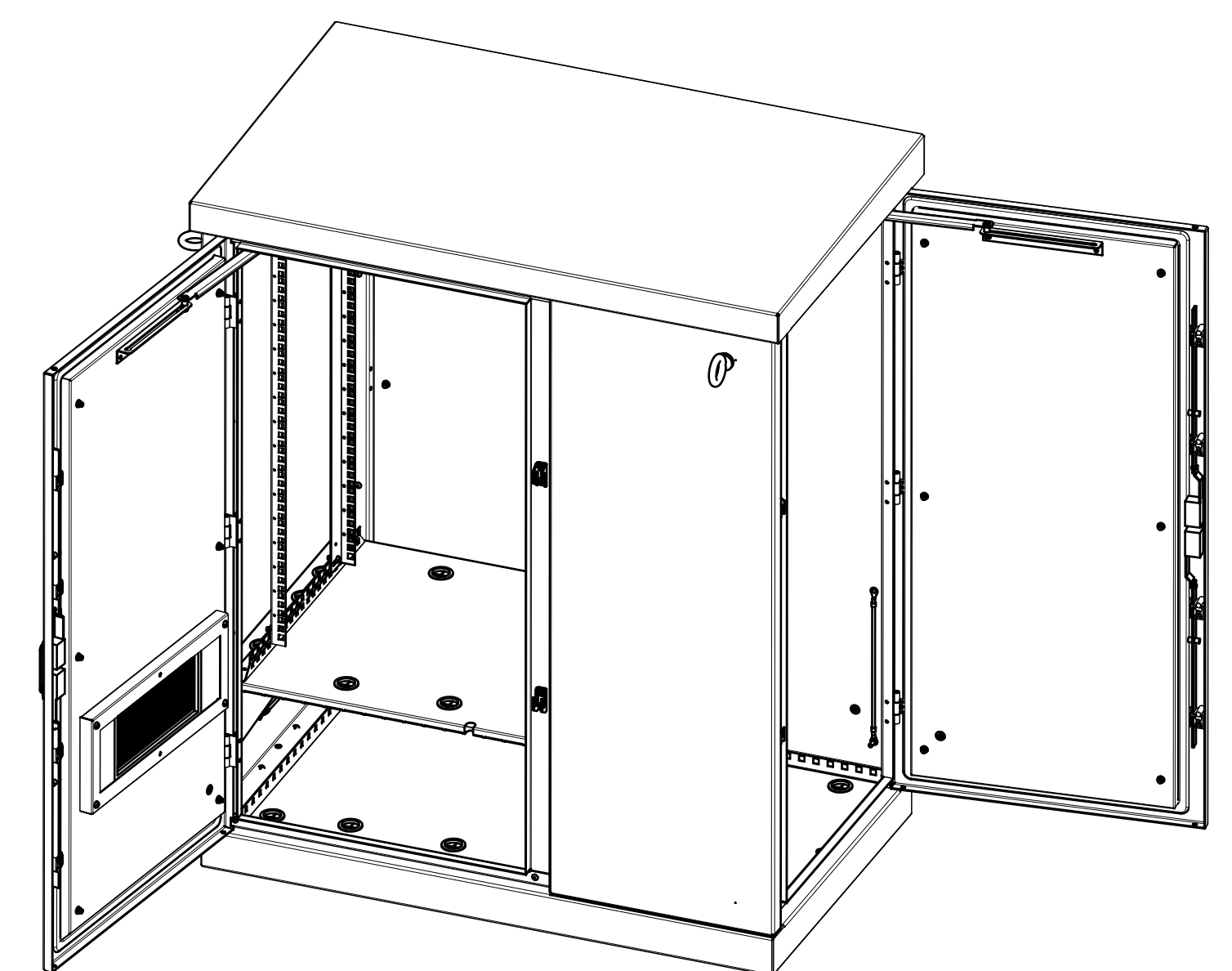
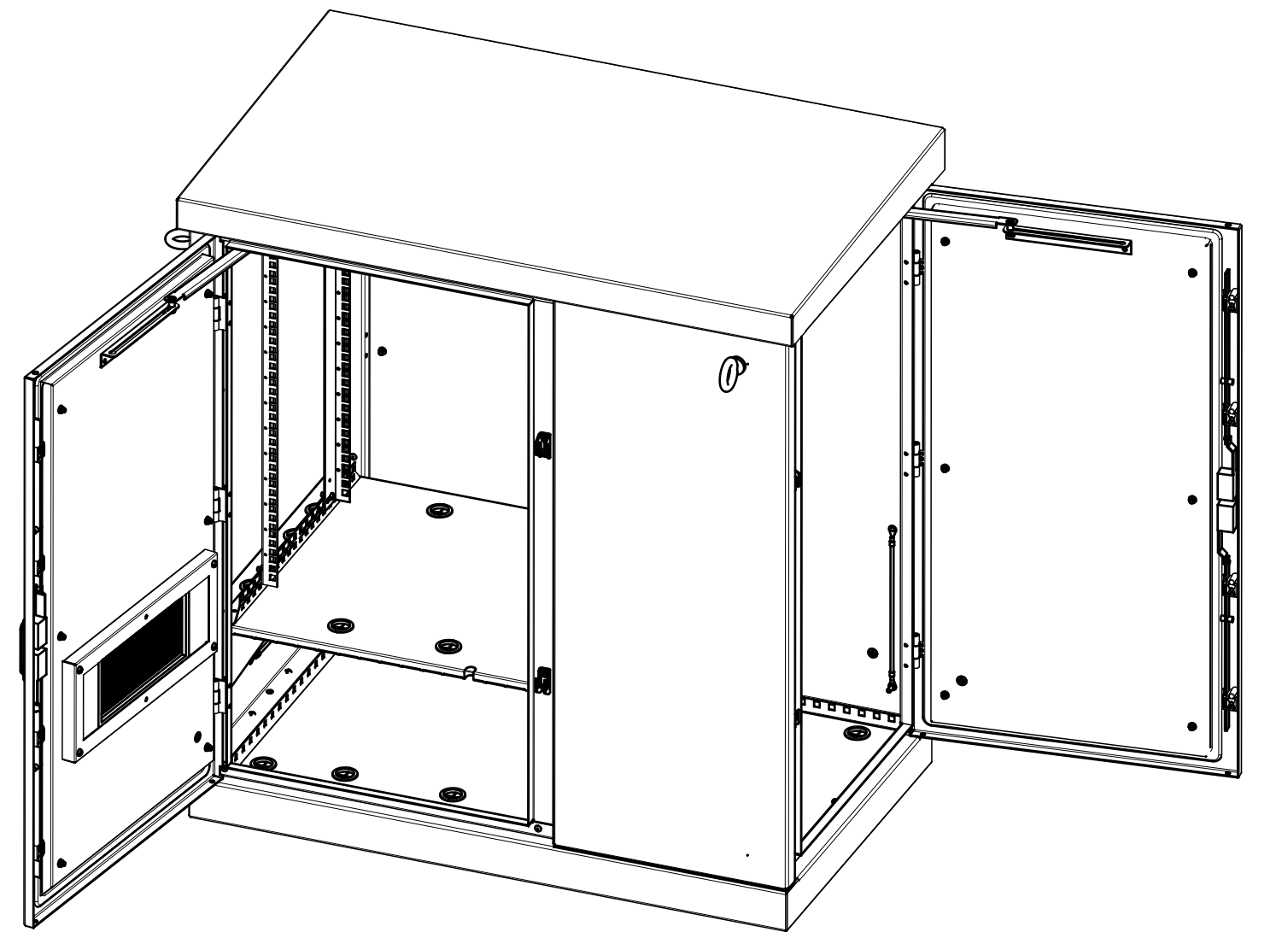
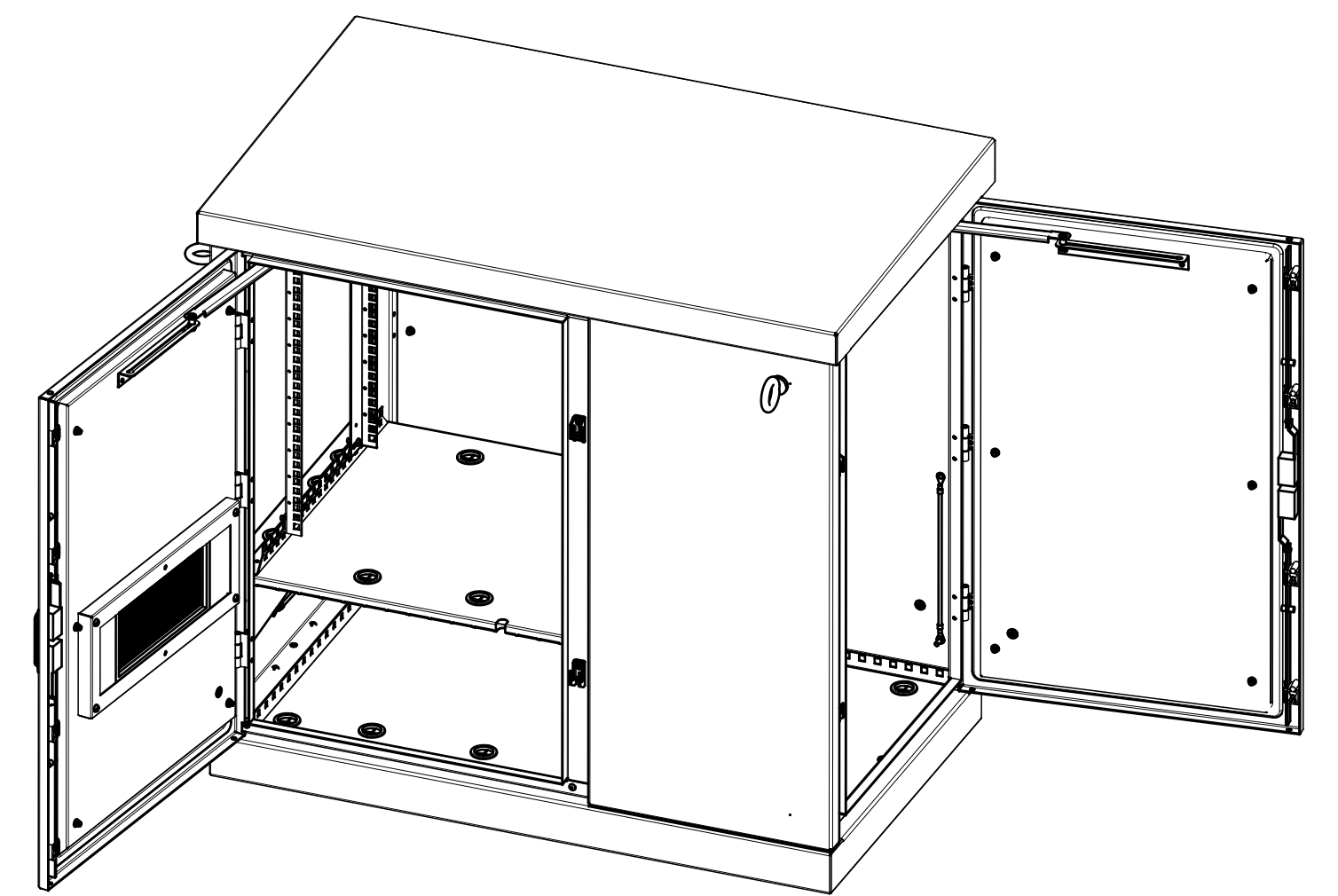
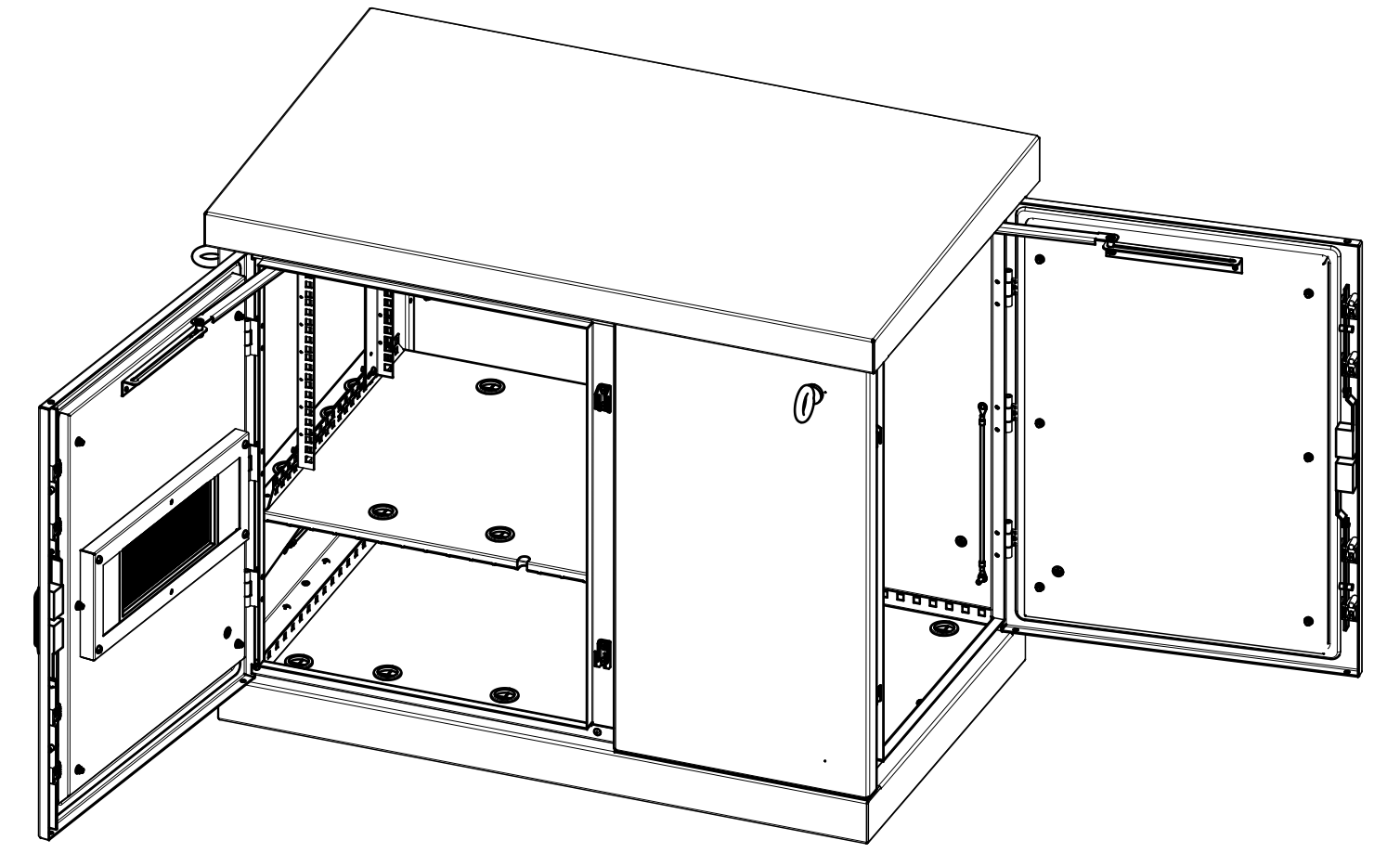
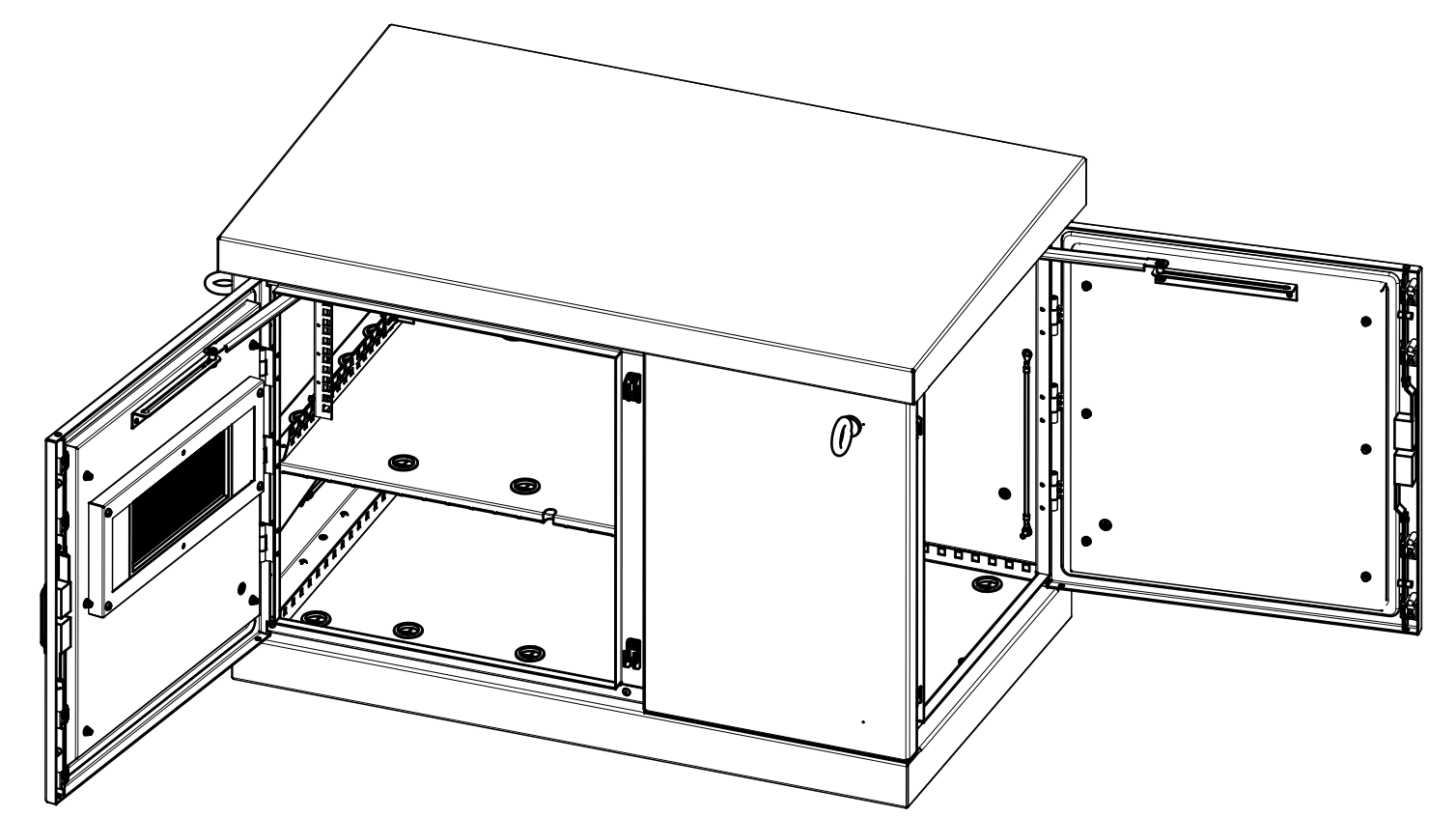
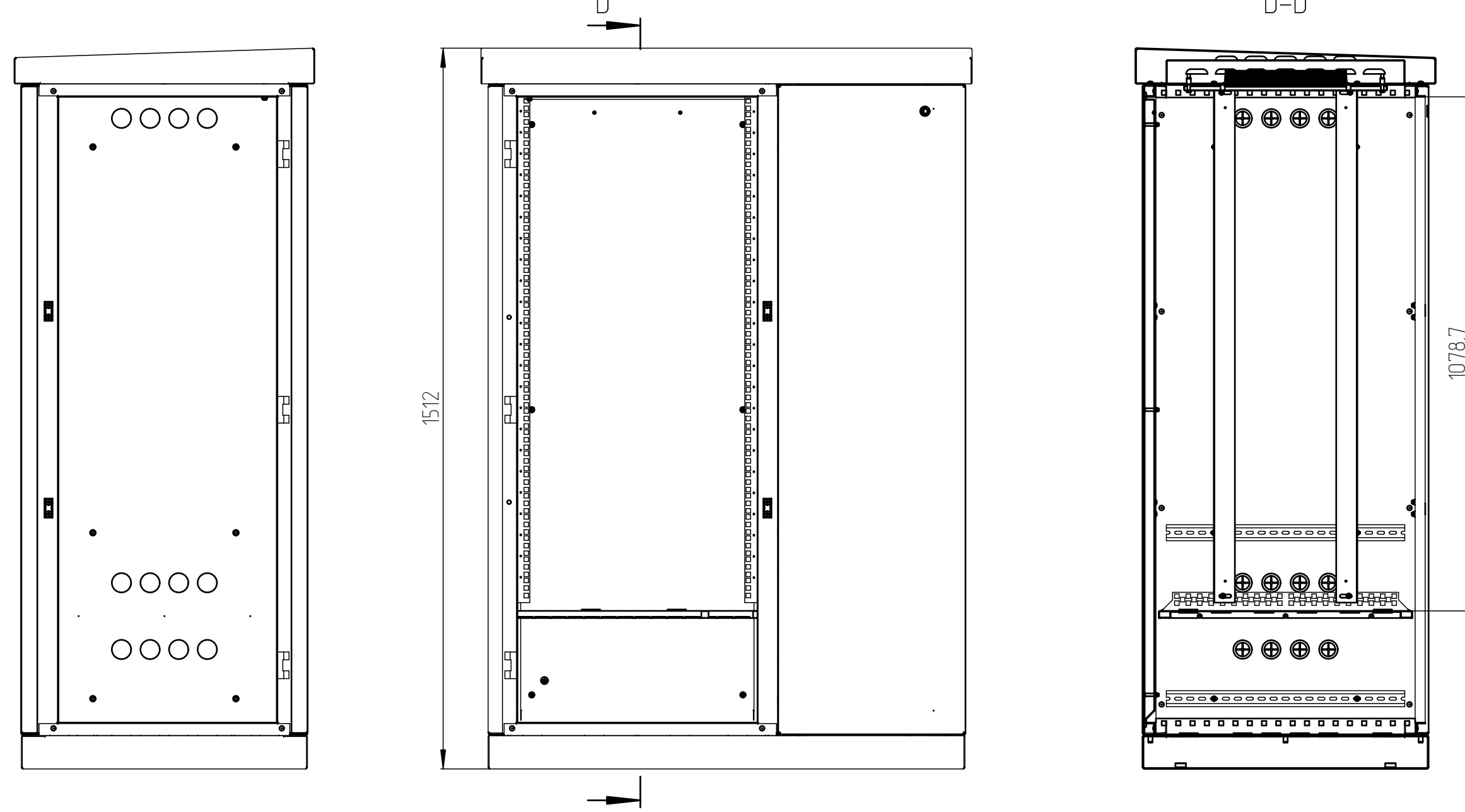

ЦМО

WWW.CMO.RU