

Шкаф ШТВ-2-х.8.6 (Масштаб 1:10)

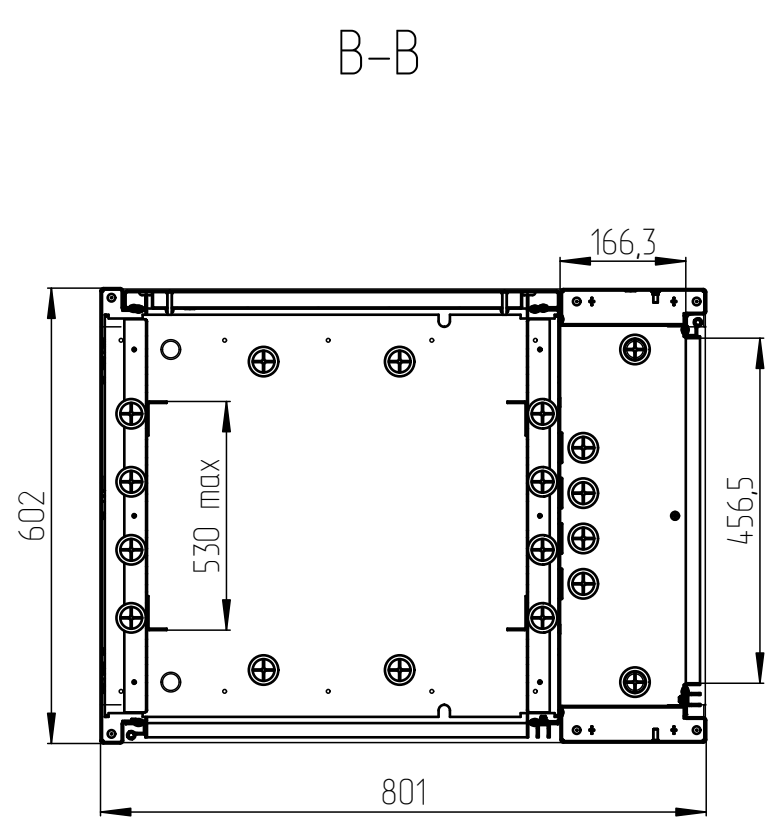

дно каркаса

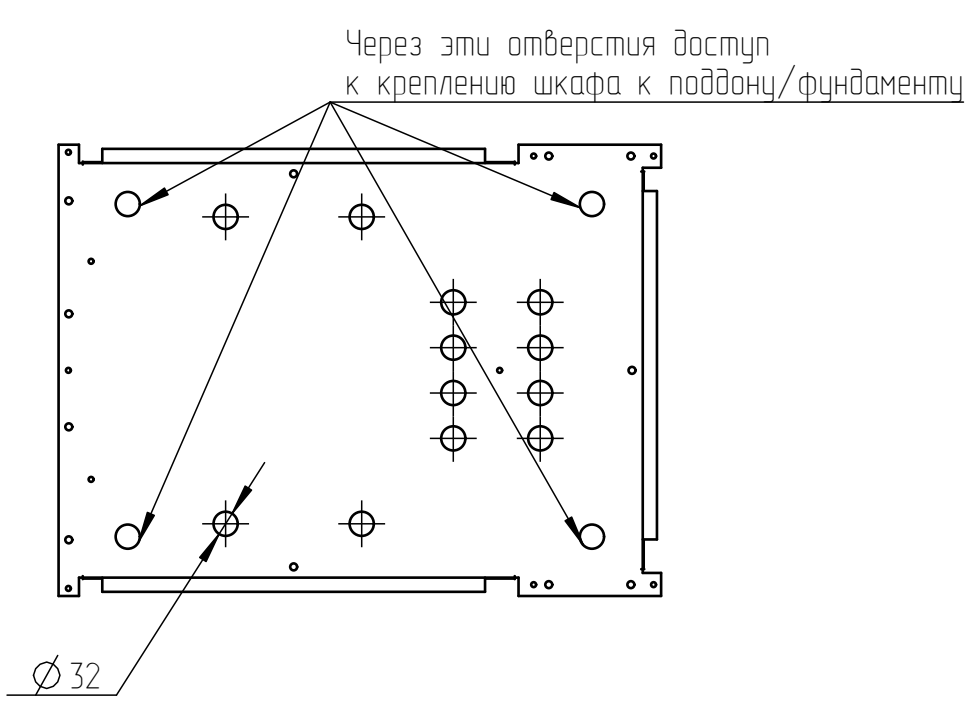

Основа

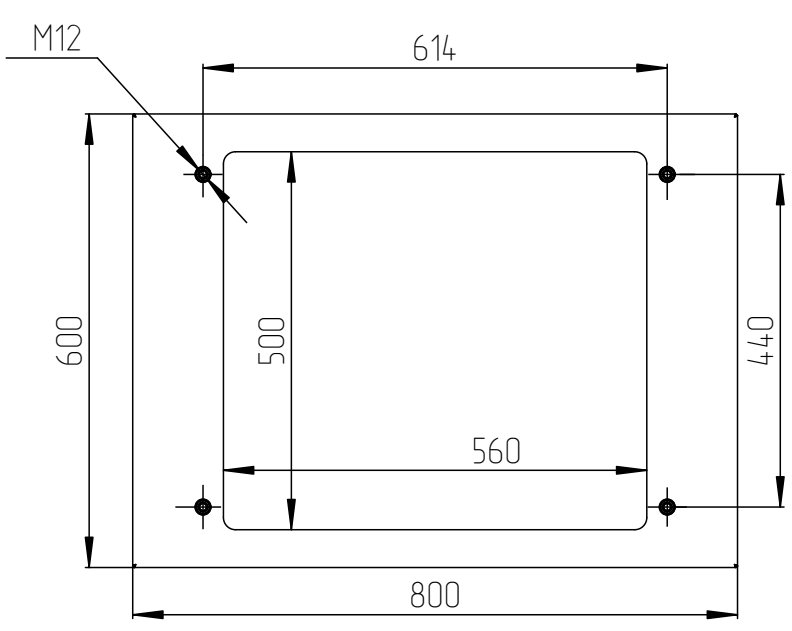

ШТВ-2-6U.8.6-4AA3

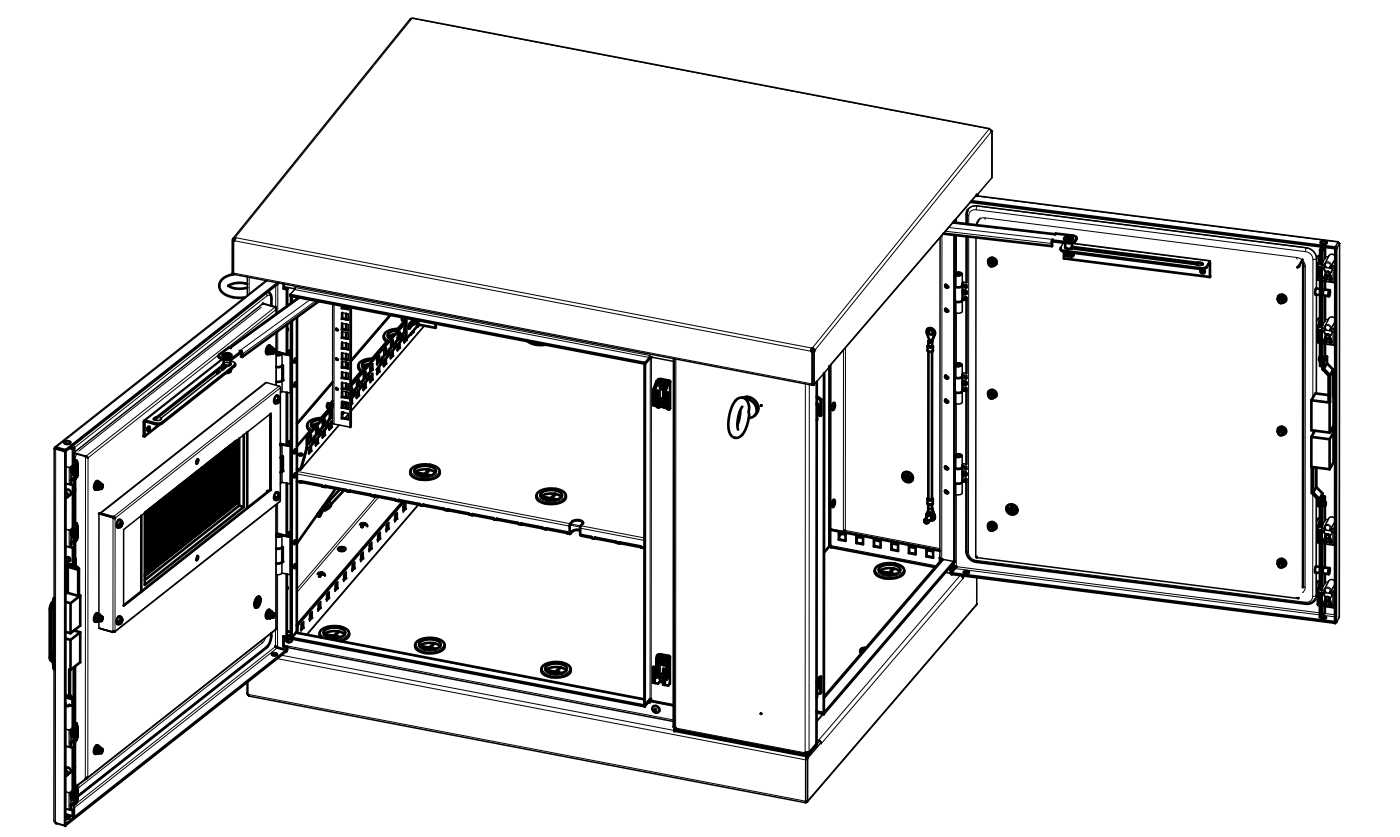
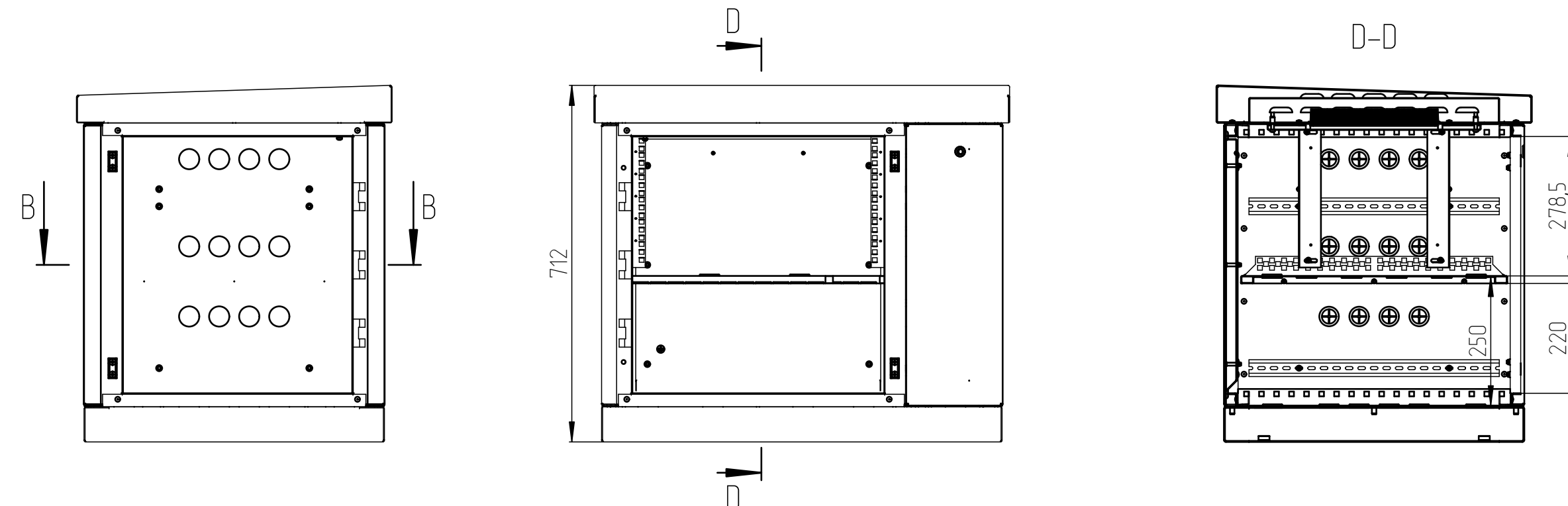

ШТВ-2-9U.8.6-4AA3

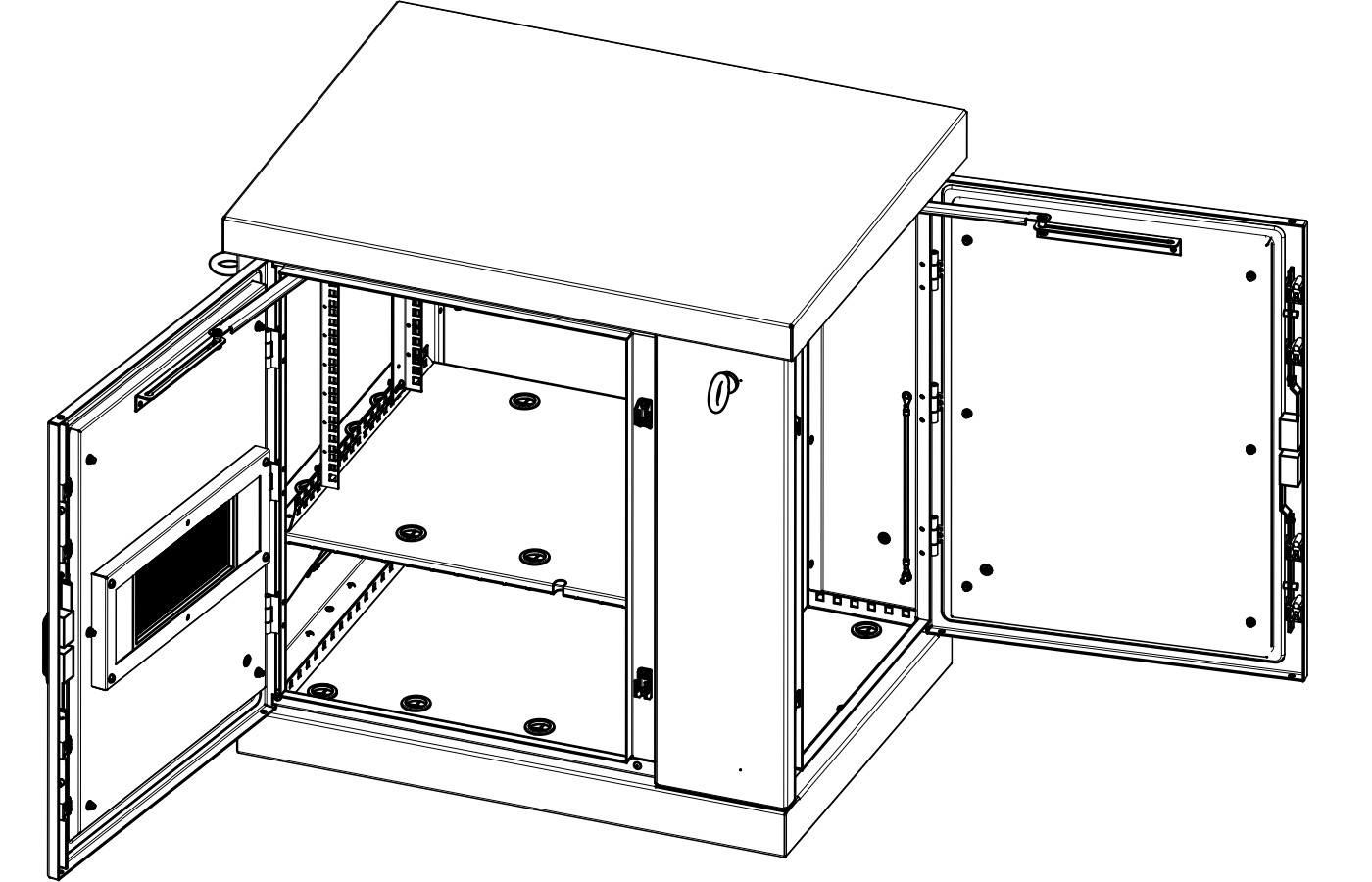
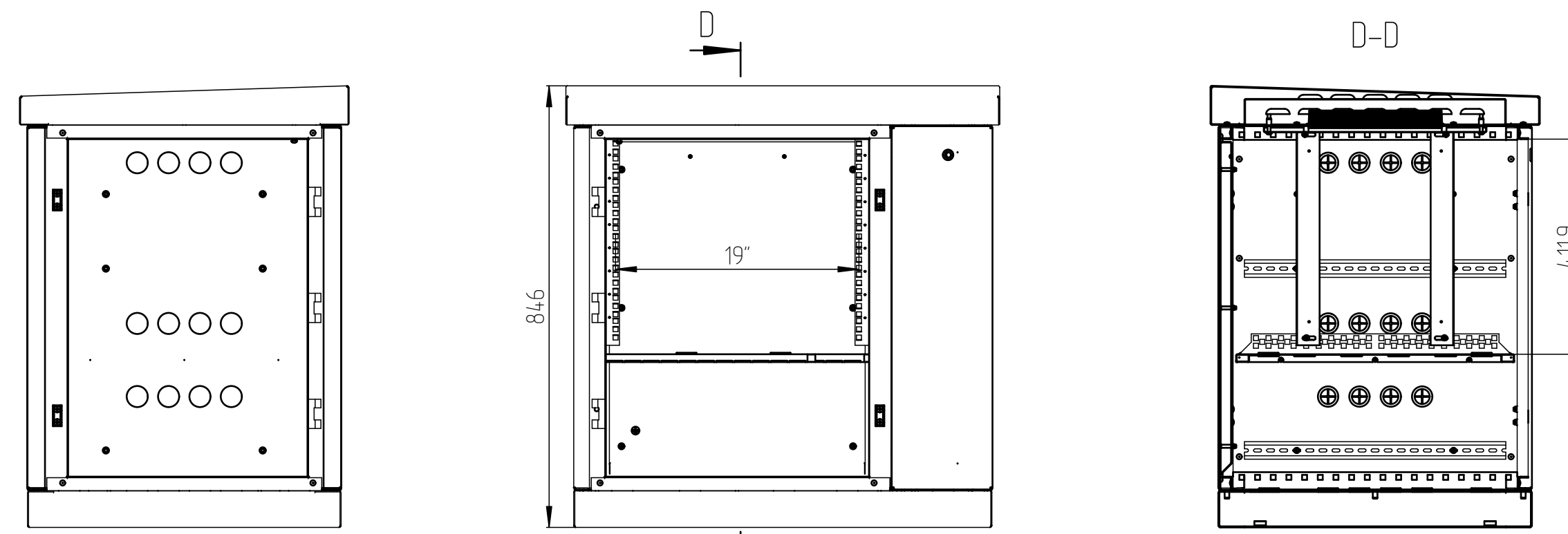

ШТВ-2-12U.8.6-4AA3

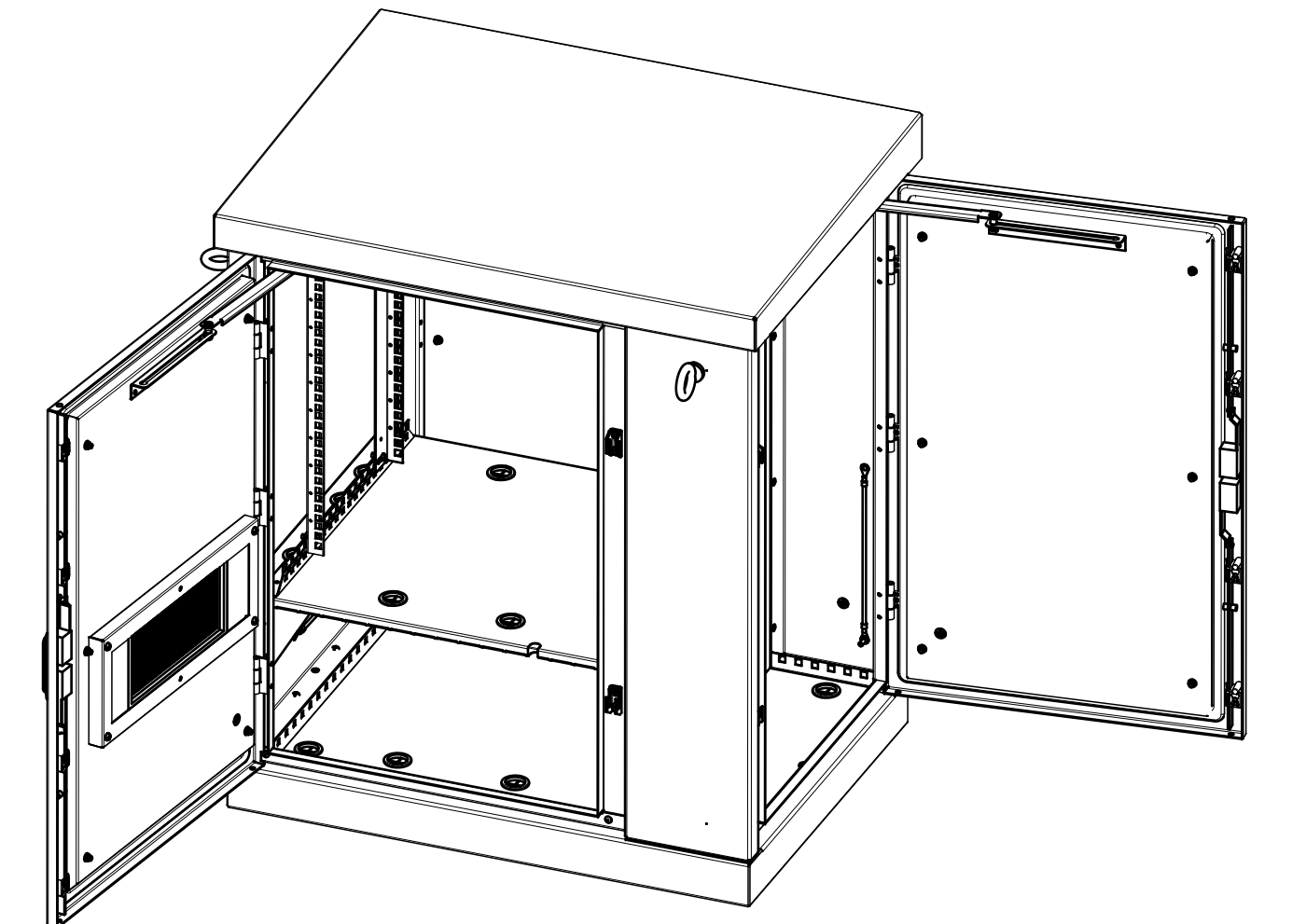
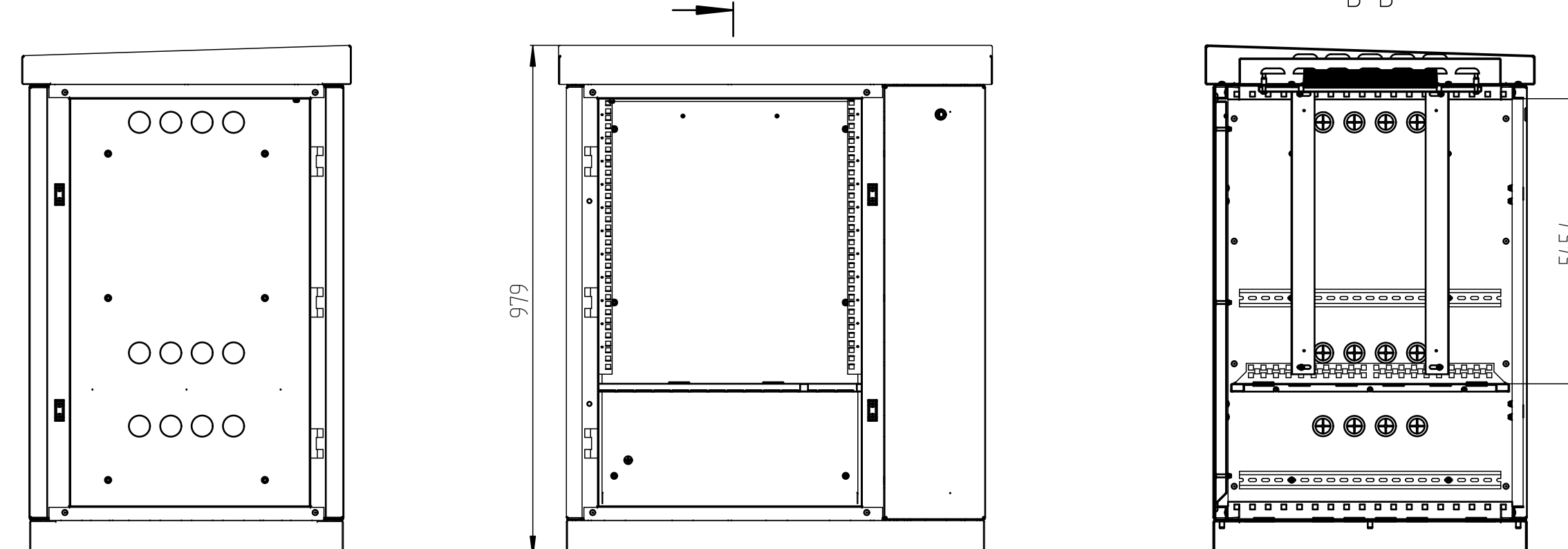

ШТВ-2-15U.8.6-4AA3

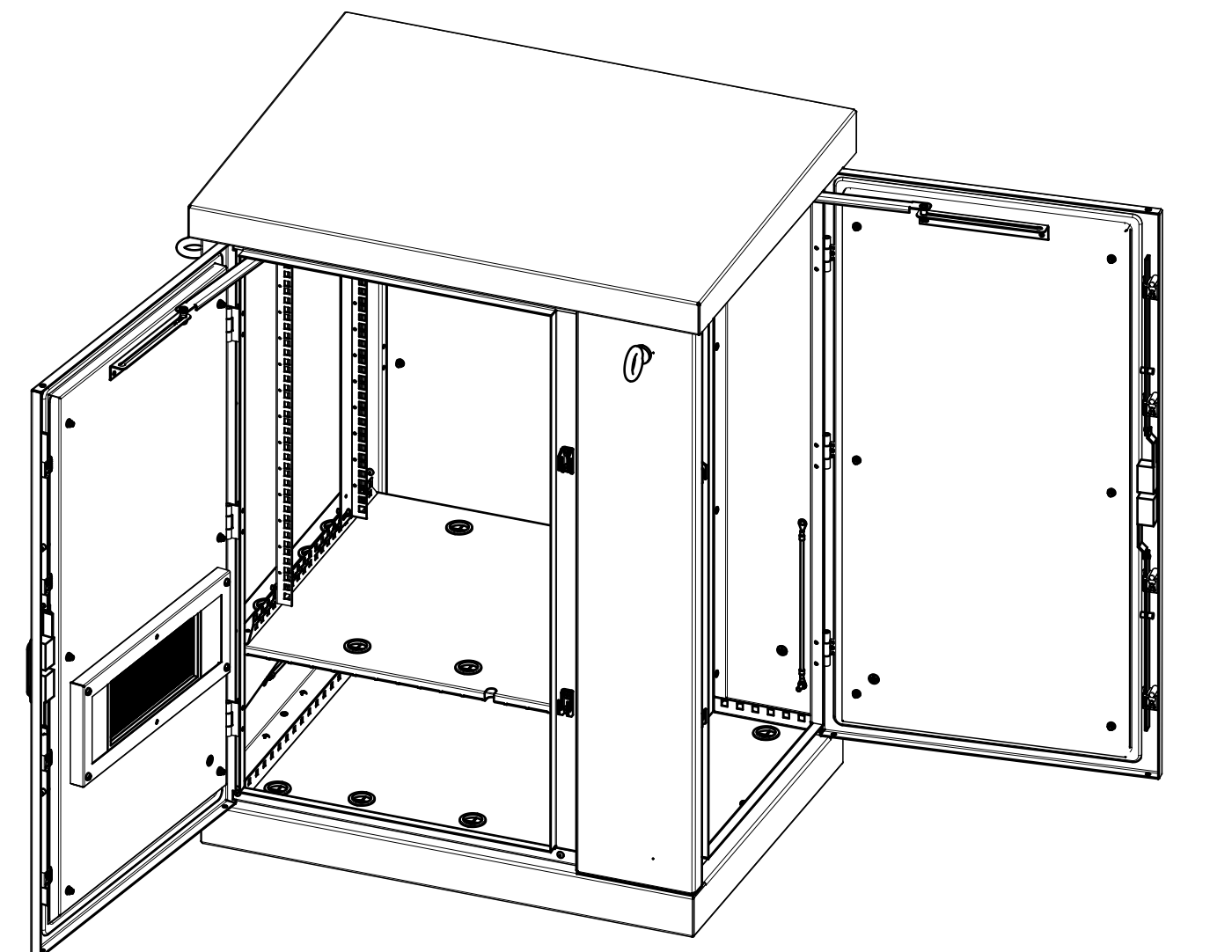
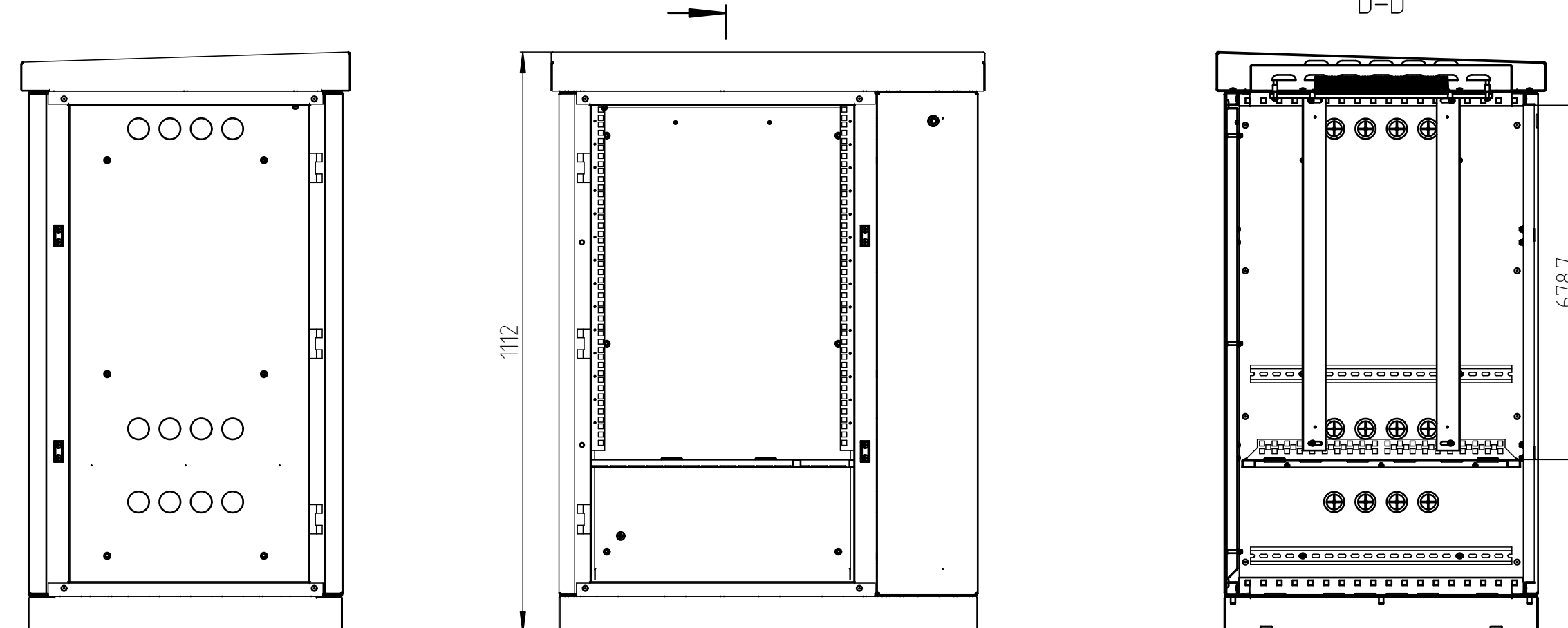

ШТВ-2-18U.8.6-4AA3

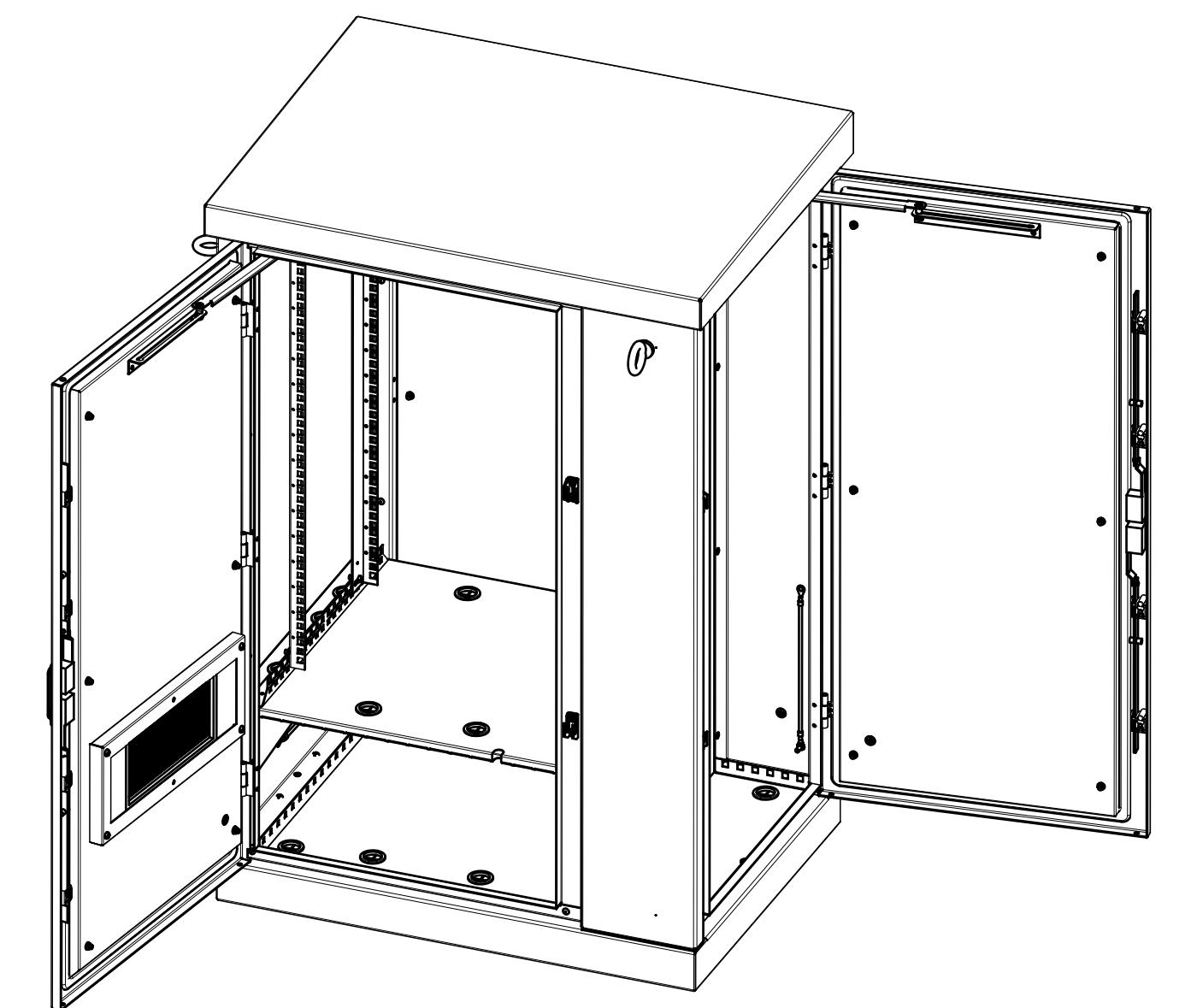
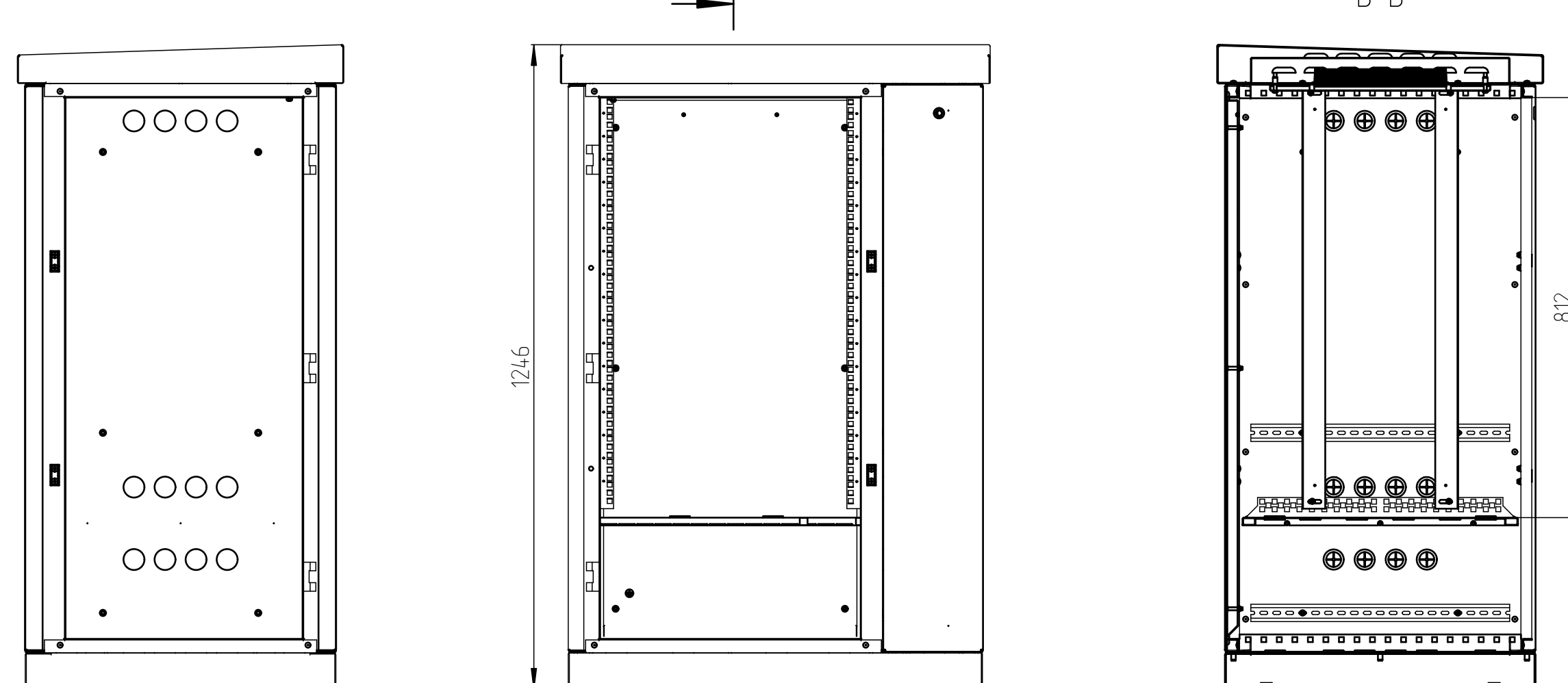

ШТВ-2-21U.8.6-4AA3

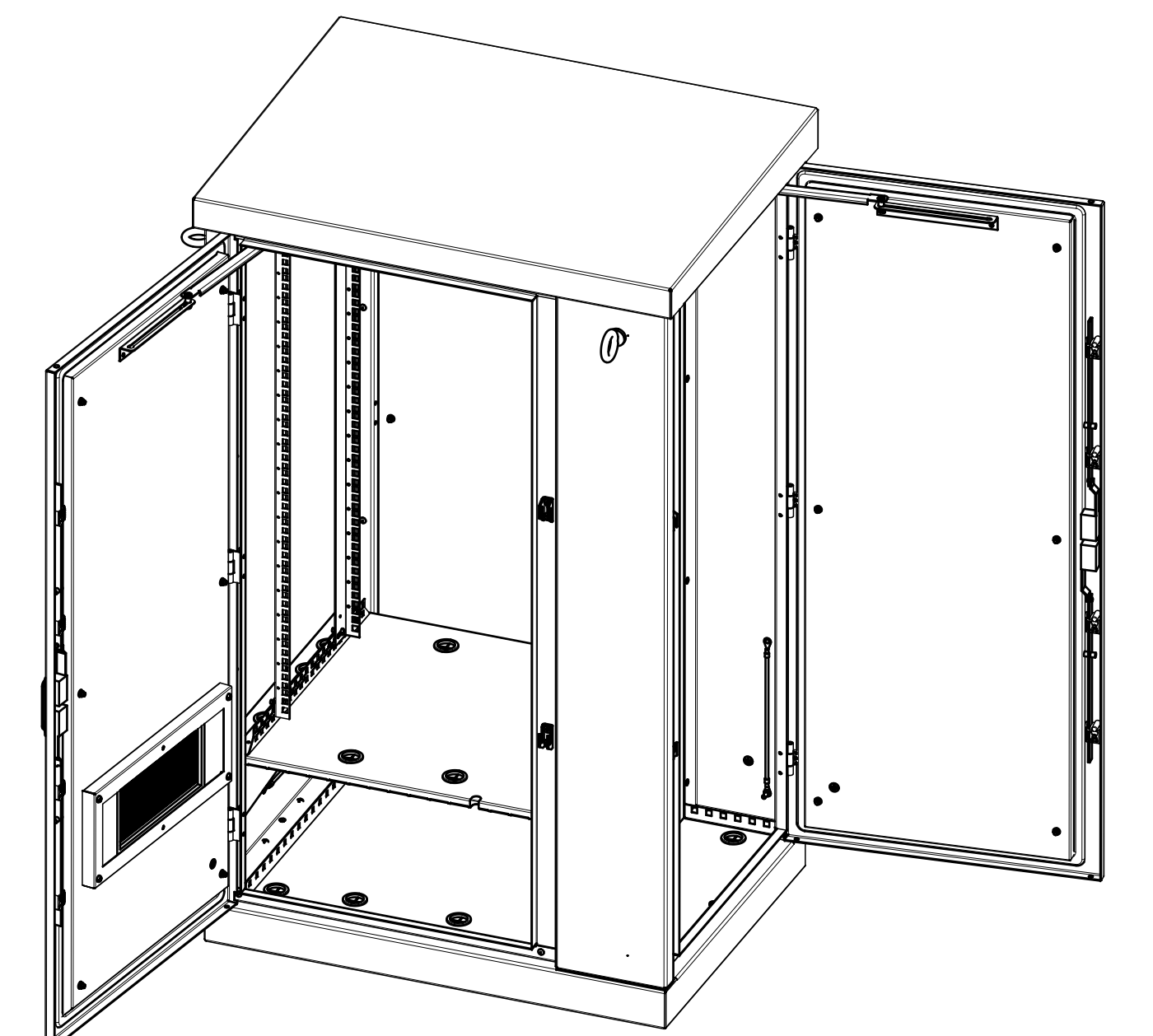
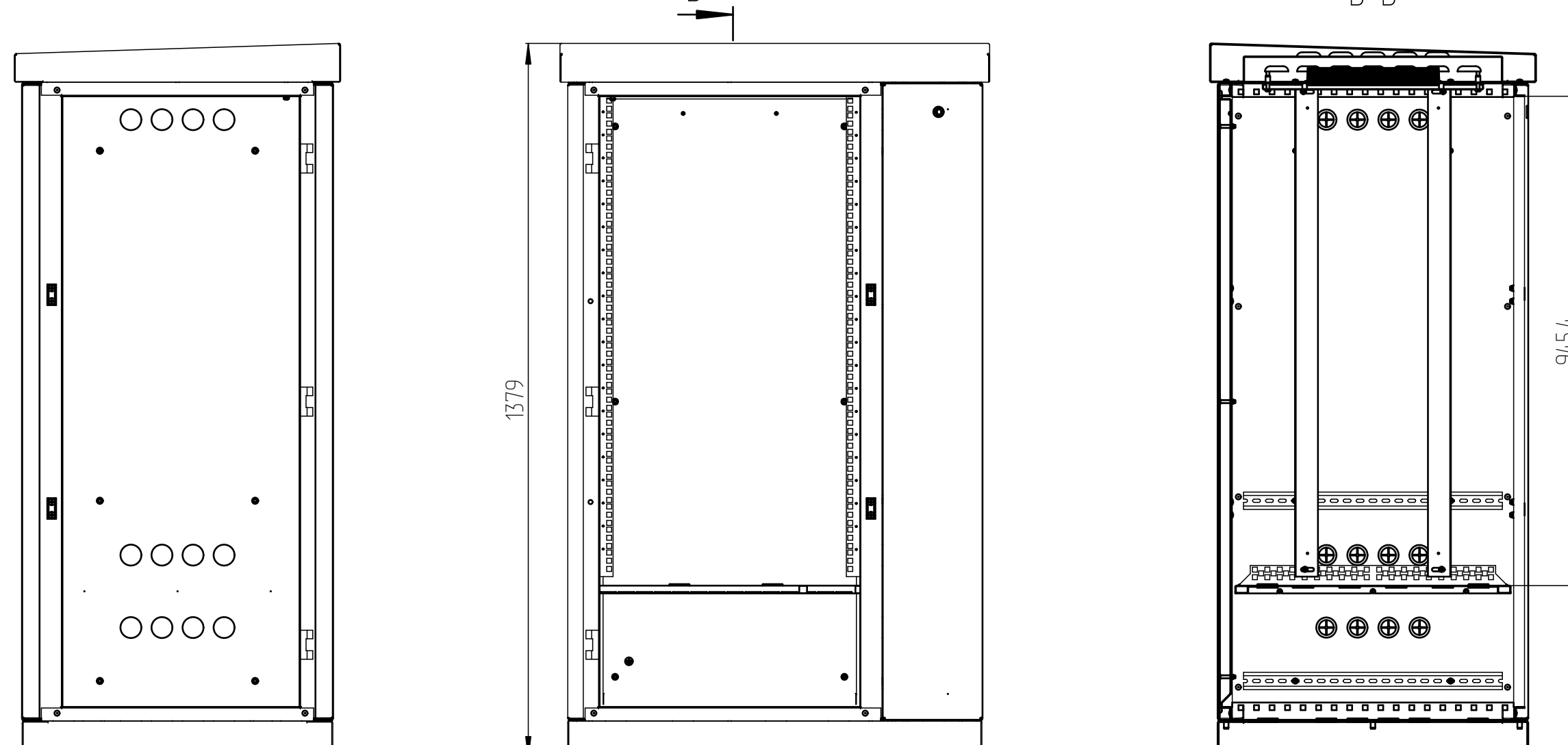

ШТВ-2-24U.8.6-4AA3

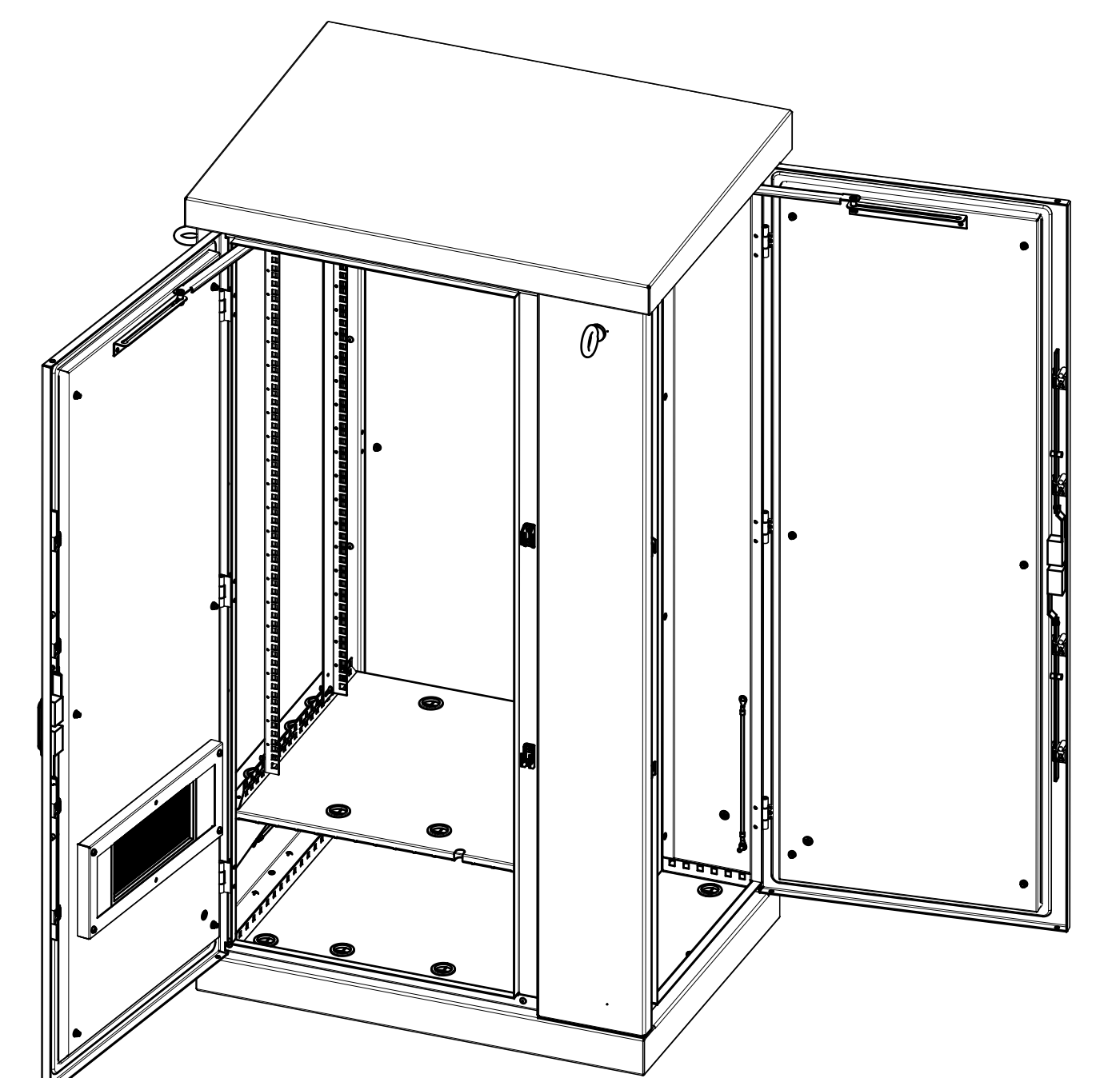
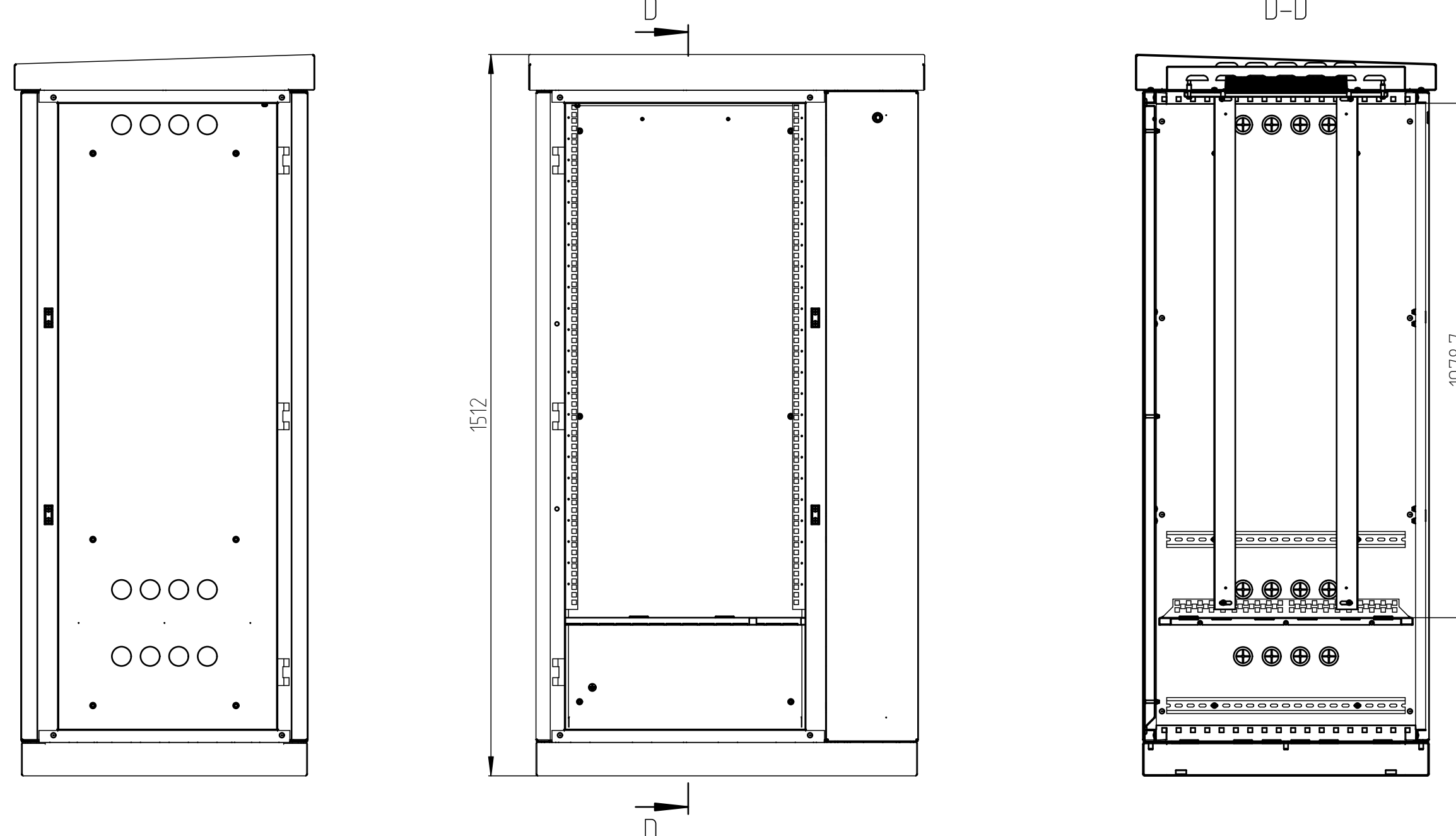

ЦМО

WWW.CMO.RU