

Kit 4018

PEUGEOT 508 SW, 5-dr Estate, 11-

This kit is only for vehicles with flush or integrated side railing.

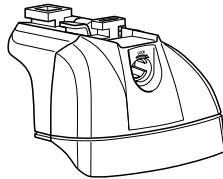

460R
753

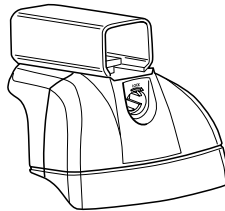
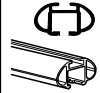

460

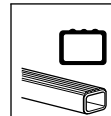

Kit

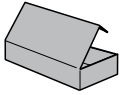

753

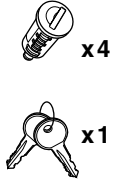
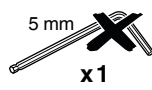
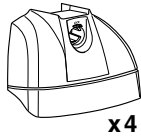
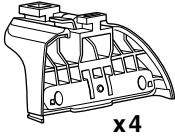

460R

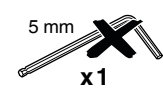
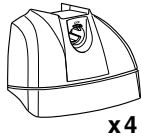
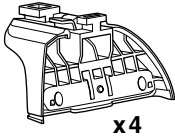

460

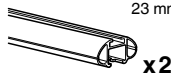
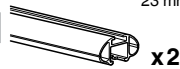
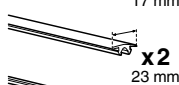
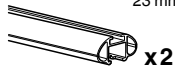
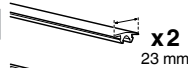
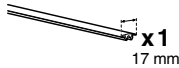
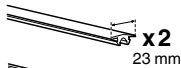
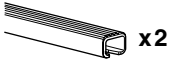
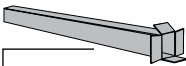
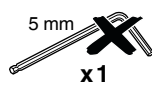
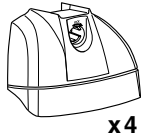
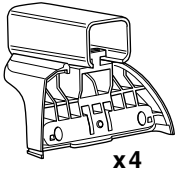

1

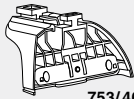

753/460R

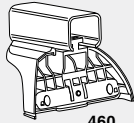

460

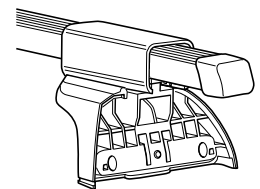
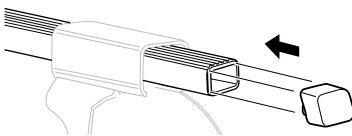
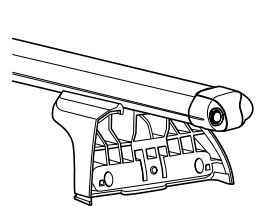
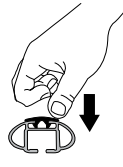
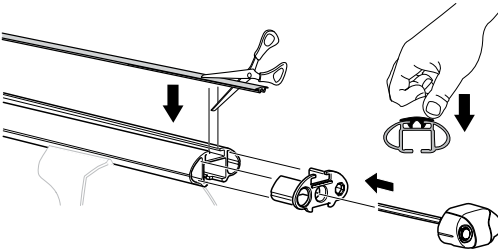
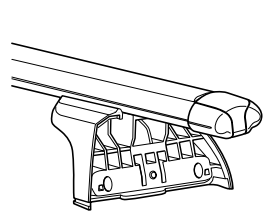
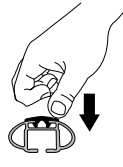
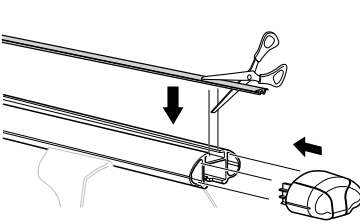
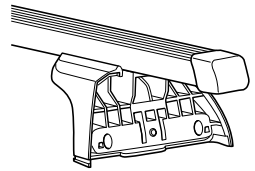
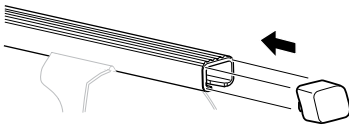
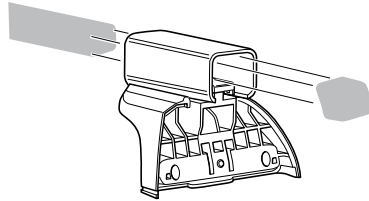
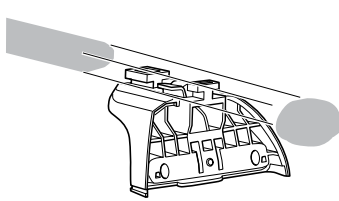

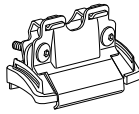
2**x 4****i**

GB	Only a few turns	EST	Ainult mõni pööre	HR	Samo nekoliko okreta
D	Nur wenige Umdrehungen	LAT	Tikai dažī apgriezieni	HU	Csak néhány fordítás
F	Quelques tours uniquement	LIT	Tik keli pasukimai	GR	Μόνο μερικές στροφές
NL	Slechts enkele slagen	PL	Wystarczy kilka obrotów	TR	Yalnız birkaç kez çevirm
I	Solo qualche giro	RU	Достаточно нескольких оборотов	中文	只有几个转向
E	Sólo algunas vueltas	CZ	Pouze několik otáček	한국어	두 세번만
PT	Noções básicas	SK	Len niekoľko otáčok	日本語	数回転のみ
S	Endast några varv	SLO	Le nekaj obratov	ไทย	หมุนเพียงไม่กี่รอบ
FIN	Vain muutama kierros				

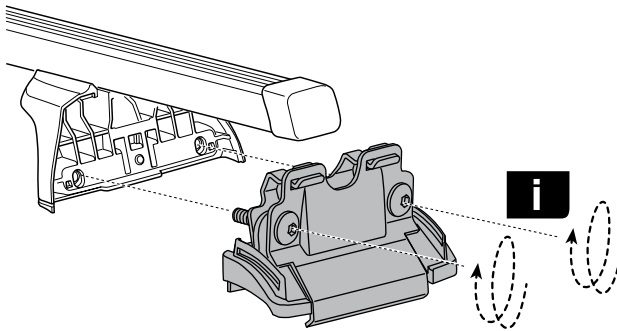
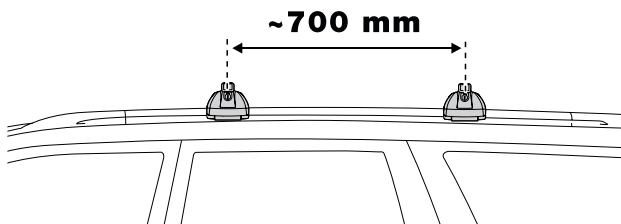
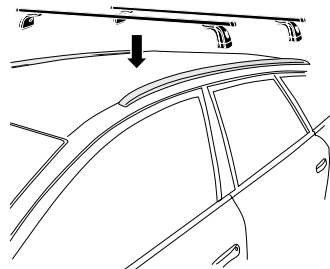
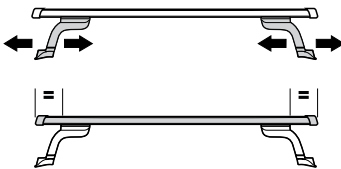
**3**

4

A

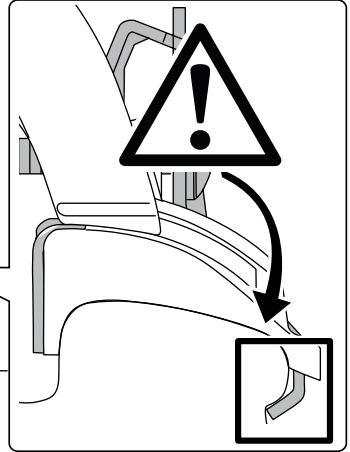
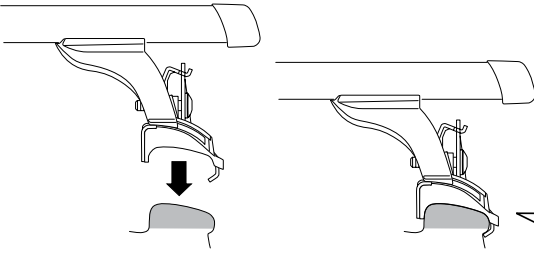

B

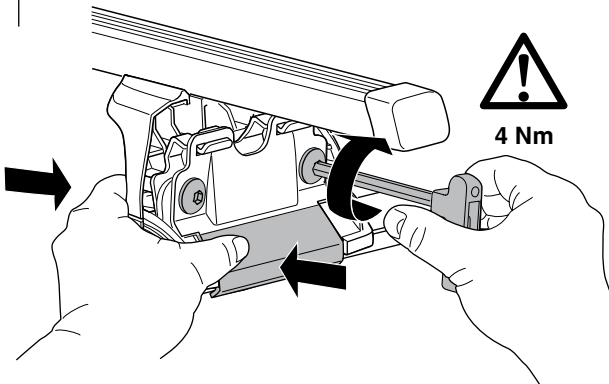
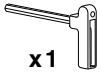

GB/US Tighten alternately
D Die Schrauben abwechselnd anziehen
F Serrer alternativement chaque côté
NL Afwisselend aan de linker- en de rechterkant aandraaien
I Alternare il serraggio delle viti
E Apretar alternativamente
PT Aperte alternadamente
S Dra åt växelvis
FIN Kierrä vuorotellen
EST Pinguldage vaheldumisi
LAT Pīvelciēt pamišus
LIT Užsukinėkite pakaitomis
PL Śruby dokręcaj naprzemiennie
RU Затягивайте попеременно

CZ Pokrétla багаžníka dokręcaj dokręcaj naprzemiennie.
SK Dotahujte striedavo
SLO Privijajte izmenično.
HR Naizmjenično zategnite
HU Egymástól függetlenül szorítandó
GR Σφιγγετε εναλλάξ
TR Dönüşümlü sıkın
中文 交替拧紧
한국어 번갈아 가며 조이십시오.
日本語 交互に締め付けてください。
ไทย ซึนในแบบสลับ

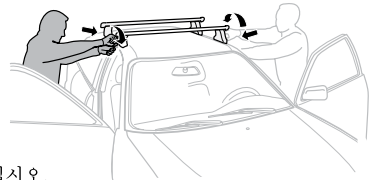

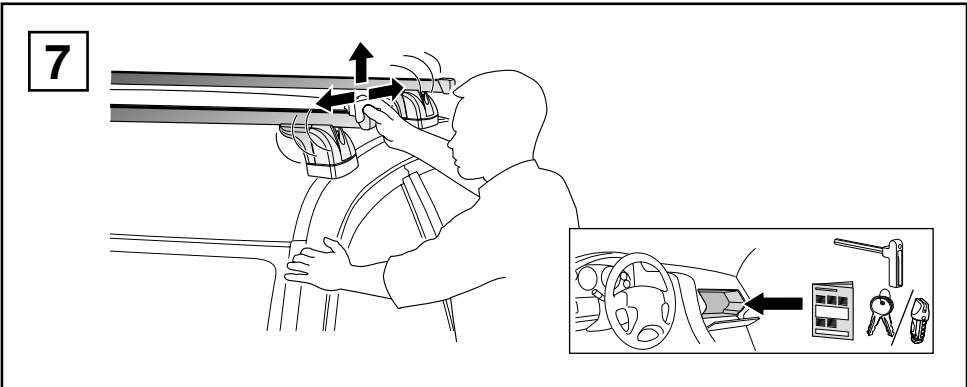
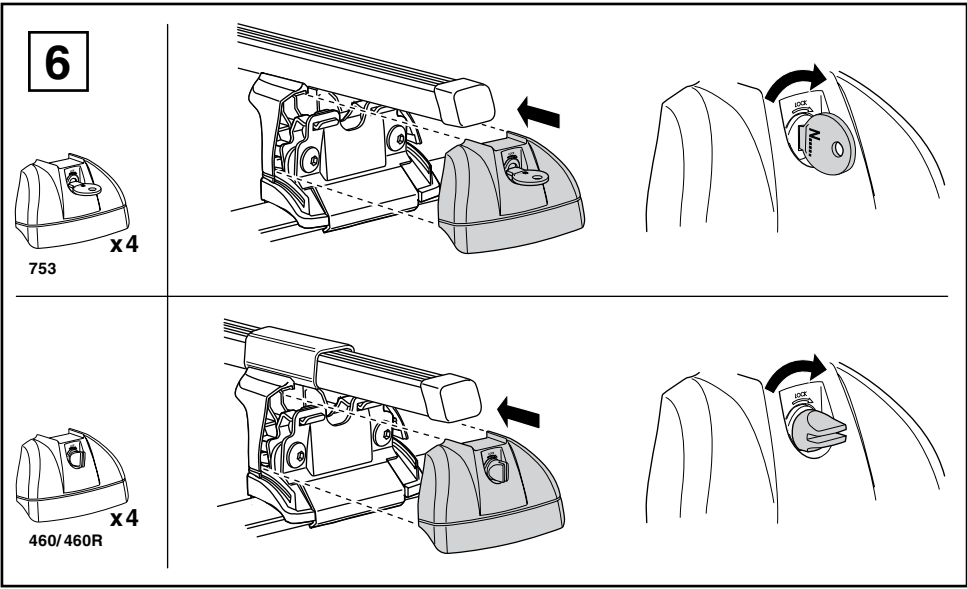
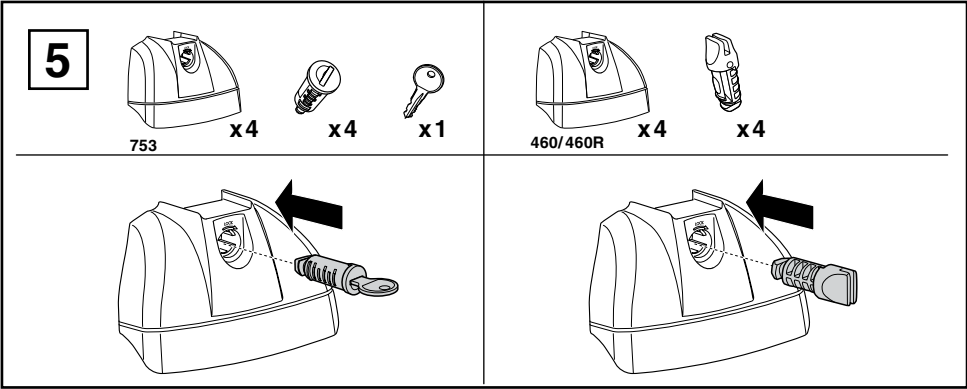

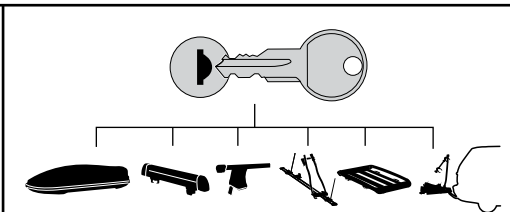
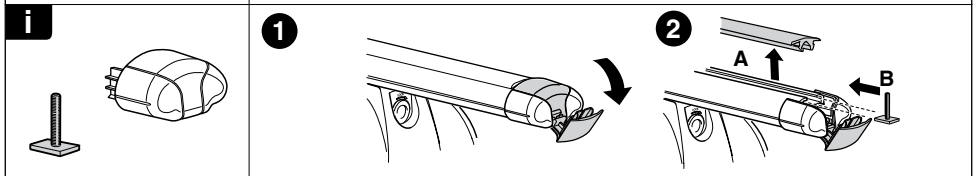
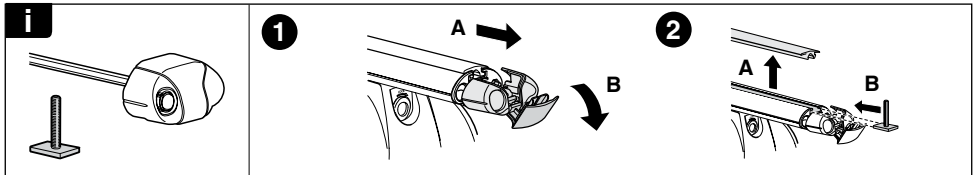
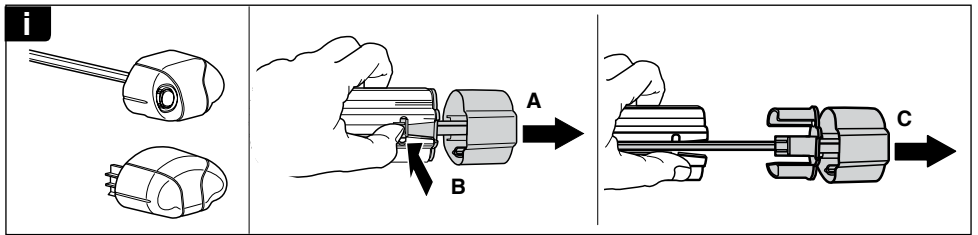
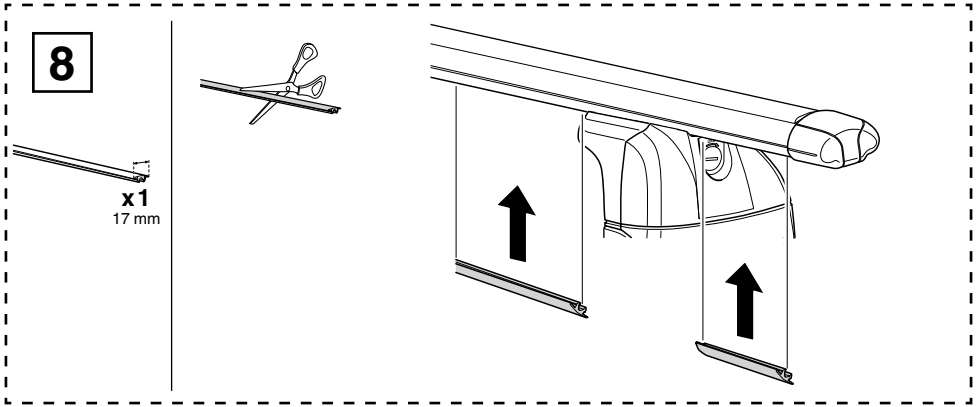

- 544 (x4)
- 596 (x6)
- 588 (x8)
- NA 510 (x10)
- EUR 452 (x12)

WW ▶ Thule Sweden AB, Box 69, 330 33 Hillerstorp, SWEDEN
 NA ▶ Thule Inc., 42 Silvermine Road, Seymour, Connecticut 06483, USA

info@thule.com
 customer.service@thule.com

www.thule.com