



Thule Rapid System Kit 4047

> Instructions

FORD Edge, 5-dr SUV, *15-

*North America

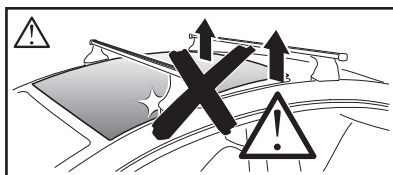

This kit is only for vehicles with flush or integrated side railing.

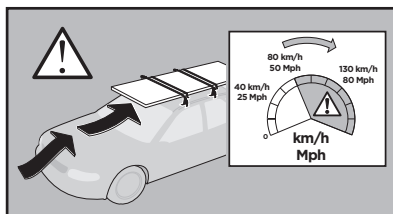
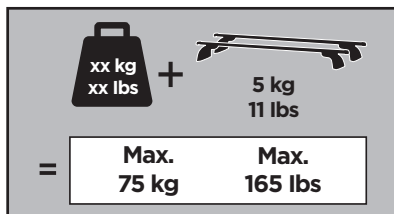
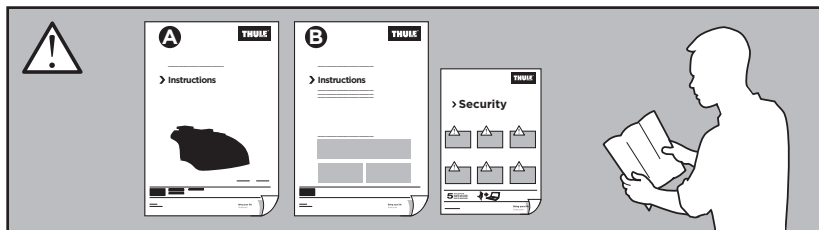

ISO 11154-E

184047

C.20140628
509-4047-01

Bring your life
thule.com

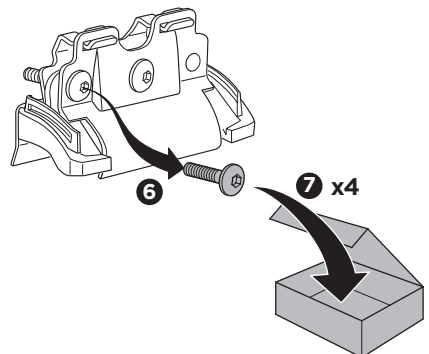
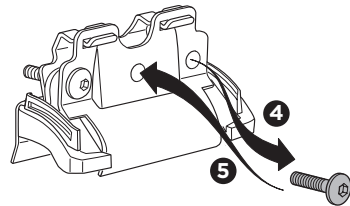
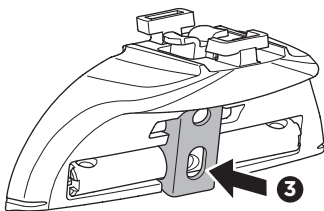
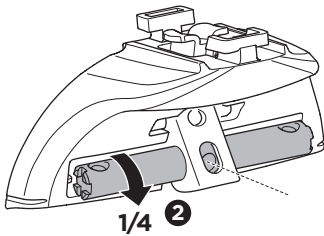
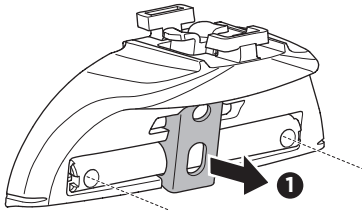
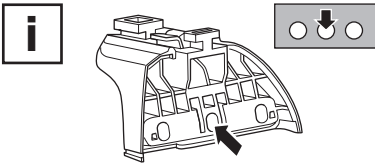
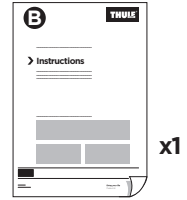
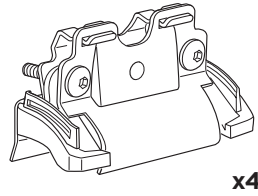
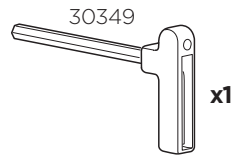
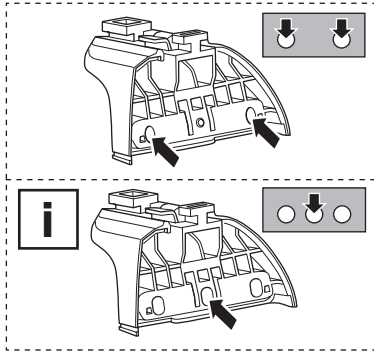

1

EN Only a few turns	ET Ainult mõni pööre	RO Doar câteva rotiri
DE Nur wenige Umdrehungen	LV Tikai daži apgriezieni	HU Csak néhány fordítás
FR Quelques tours uniquement	LT Tik keli pasukimai	EL Μόνο λίγες περιστροφές
NL Slechts enkele slagen	PL Wystarczy kilka obrotów	TR Yalnızca birkaç tur
IT Solo qualche giro	RU Только несколько оборотов	بعض دورات فقط AR
ES Sólo algunas vueltas	UK Лише декілька обертів	רק מספר סיבובים HE
PT Noções básicas	BG Само няколко завъртания	ZH 仅几圈
SV Endast några varv	CS Pouze několik otáček	JA 2～3回転のみ
DK Kun nogle få omgange	SK Len niekoľko otáčok	KO 몇 번만 돌리면 됨
NO Bare noen få omdreininger	SL Le nekaj obratov	TH เพียงสองสามรอบ
FI Vain muutama kierros	HR/BIH Samo nekoliko okreta	

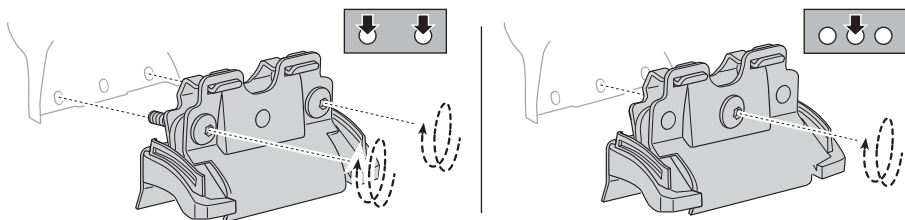
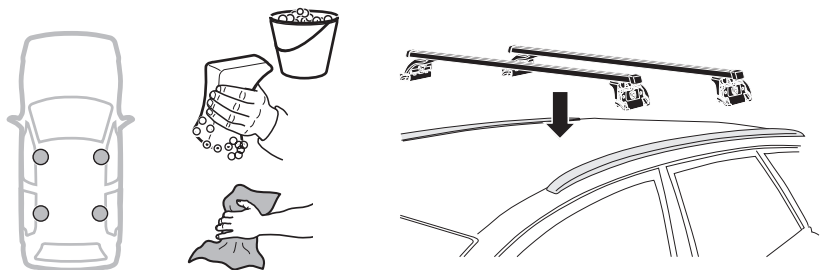
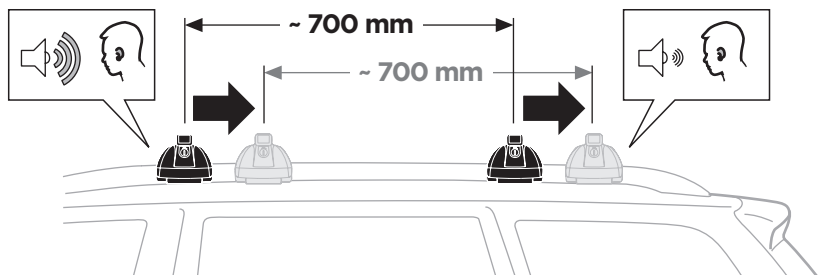
**i****2**

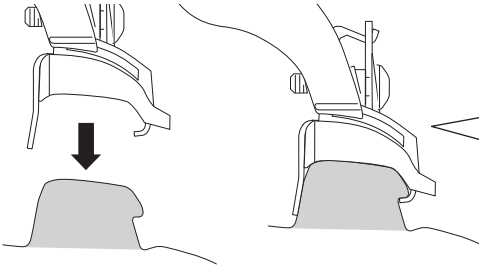
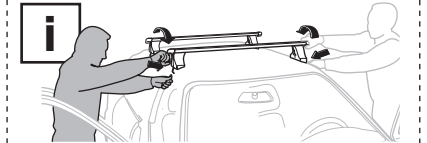
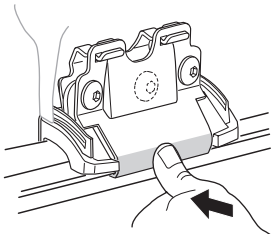
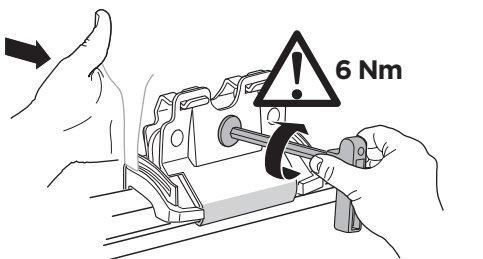
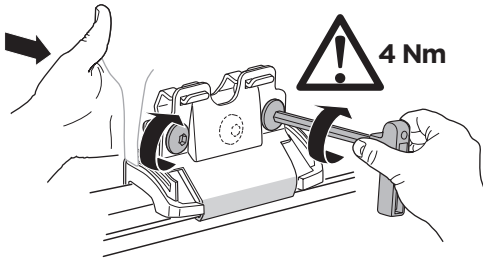
A**B****C**

EN Tighten alternately
DE Die Schrauben abwechselnd anziehen
FR Serrer alternativement chaque côté
NL Afwisselend aan de linker- en de rechterkant aandraaien

IT Alternare il serraggio delle viti

ES Apretar alternativamente

PT Aperte alternadamente

SV Dra åt växelvis

DK Spænd skiftevis

NO Trekk til vekselvis

FI Kierrä vuorotellen

ET Pinguldage vaheldumisi

LV Pievelciet pamšus

LT Užsukinėkite pakaitomis

PL Śruby dokręcaj naprzemiennie

RU Затягивайте попеременно

UK Затягти по чергово

BG Затегнете последователно

CS Pokręťte багаžníka dokręcaj dokręcaj naprzemiennie.

SK Doťahujte striedavo

SL Privijajte izmenično

HR/BiH Naizmjenično zategnite

RO Strângeți alternativ

HU Egymástól függetlenül szorítandó

EL Ζφίγγετε εναλλάξ

TR Dönüşümlü sıkın

AR إحكام الربط بالتناوب

HE חזק לסיבוב

ZH 交替拧紧

JA 自動固定

KO 번갈아 조이기

TH ซับนสลับกัน

