

Kit 3087

VOLKSWAGEN Amarok, 2-dr Single Cab, 10-
VOLKSWAGEN Amarok, 4-dr Double Cab, 10-

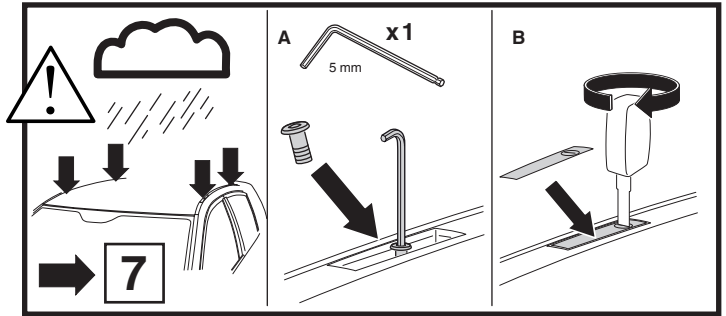

This Kit is only for vehicles with fixpoint mounting.

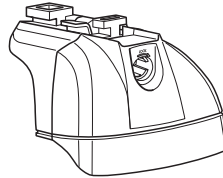

460R
753

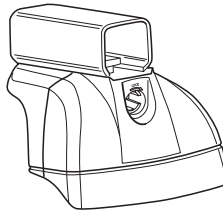
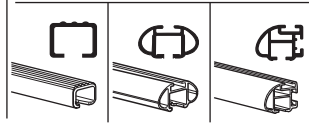

460

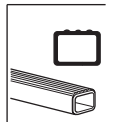

THULE[®]
SWEDEN

ISO 11154-E

- 21 x 1
- 22 x 1
- 23 x 2
- 17 x 4
- 005 x 1
- 006 x 1
- 013 x 1
- 014 x 1
- 50784 x 4
- 50786 x 4
- 50870 x 4
- 51294 3 mm x 1
- 50273 x 1

Kit

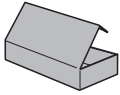

753

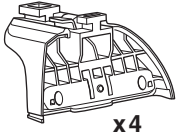

x4



x4



x4



x8



x1



x4



x1

460R

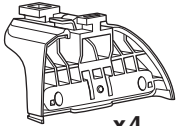

x4



x4



x4



x8



x1



x4

460

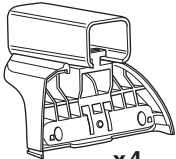

x4



x4



x4



x8



x1



x4

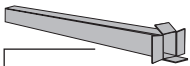

x2



x1



x2



x2



x2



x1

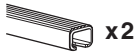

17 mm

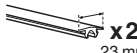

23 mm

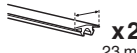

23 mm

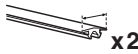

23 mm

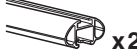

x2

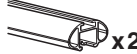

x2

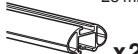

x2



x4



x4



x4

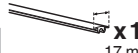

17 mm



x2



25 mm

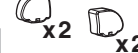

x2



x2

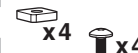

x4



x4



x1

5 mm

1

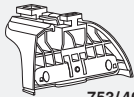

753/460R

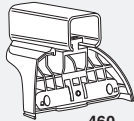

460

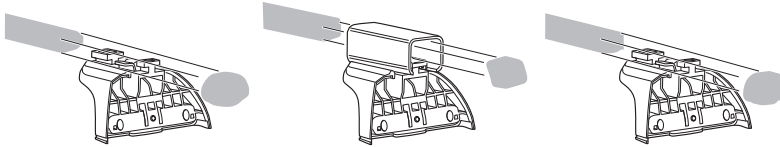

x4

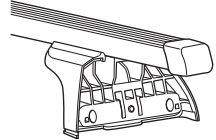
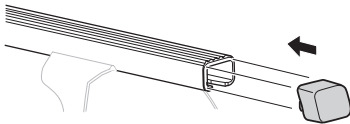

x4

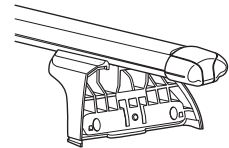
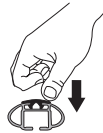
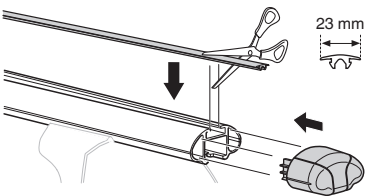

x4

x4

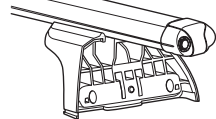
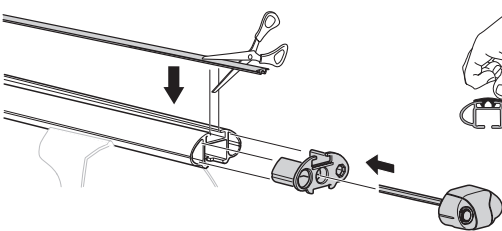

x4

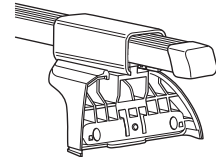
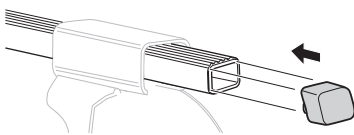

x2

x2

x4

x4

x1
5 mm

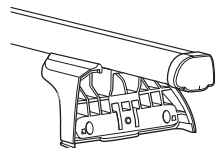
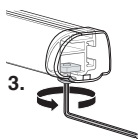
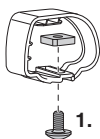
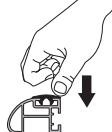
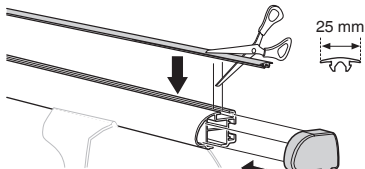

2

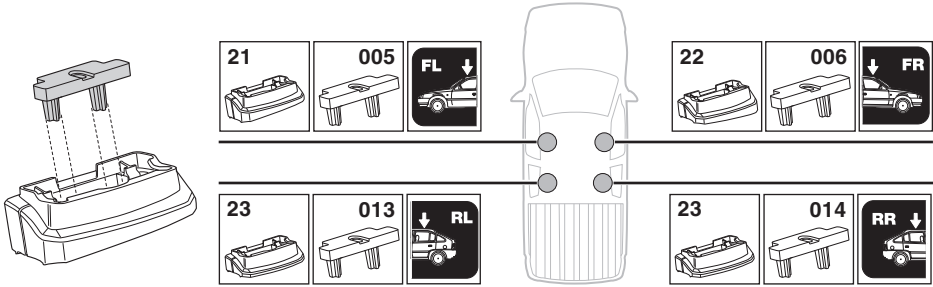
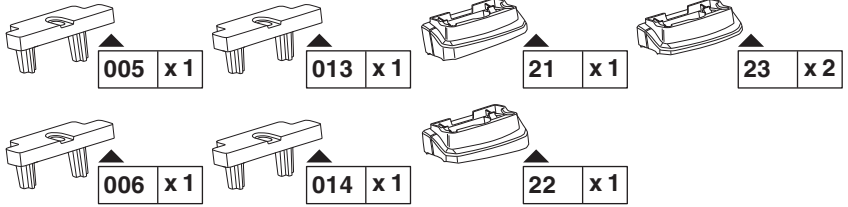

3

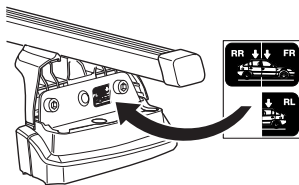
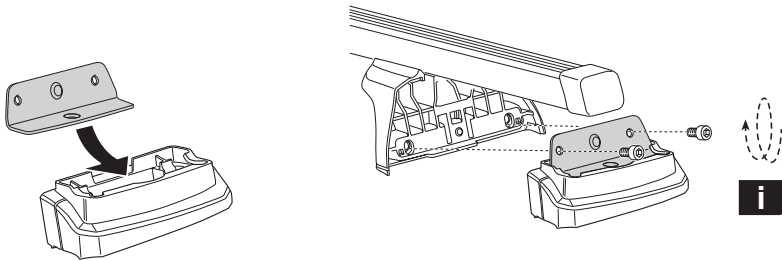

i		
GB	Only a few turns	RU Достаточно нескольких оборотов
D	Nur wenige Umdrehungen	CZ Pouze několik otáček
F	Quelques tours uniquement	SK Len niekoľko otáčok
NL	Slechts enkele slagen	SLO Le nekaj obratov
I	Solo qualche giro	HR Samo nekoliko okreta
E	Sólo algunas vueltas	HU Csak néhány fordítás
PT	Noções básicas	GR Μόνο μερικές στροφές
S	Endast några varv	TR Yalnız birkaç kez çevirm
FIN	Vain muutama kierros	中文 只有几个转向
EST	Ainult mõni pööre	한국어 두 세번만
LAT	Tikai dažī apgriezieni	日本語 数回転のみ
LIT	Tik keli pasukimai	ไทย หมุนเพียงไม่กี่รอบ
PL	Wystarczy kilka obrotów	

4

x 4

x 4

x 4

x 1

x 1

5 mm

3 mm

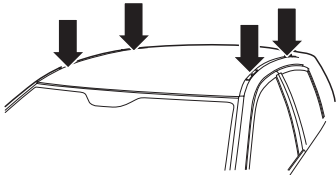
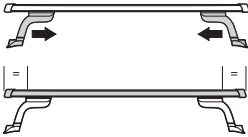
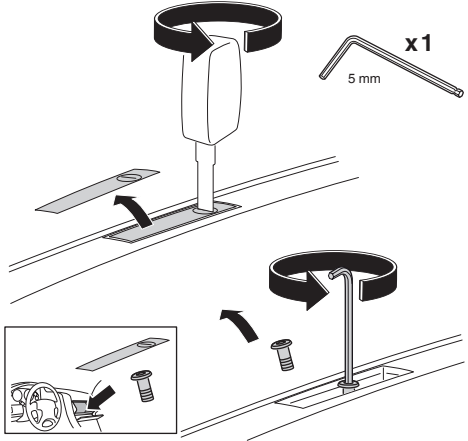
**A****B**

3 mm x 1

2 Nm

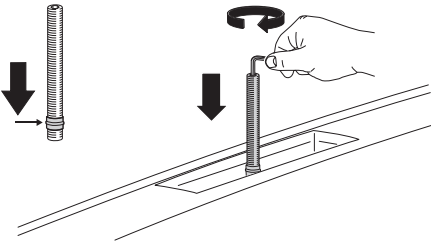
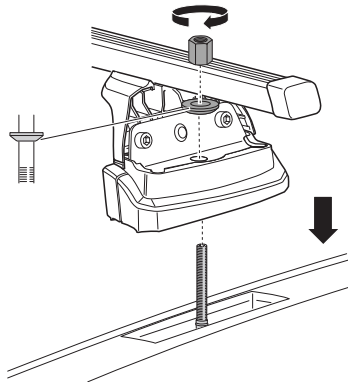
**C****D**

6 Nm

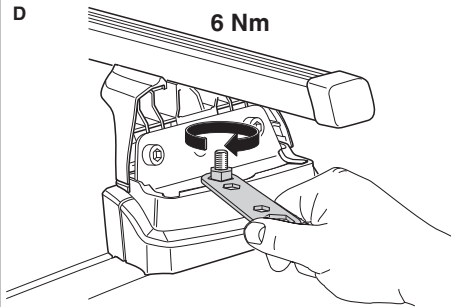
**E**

6 Nm

