

Thule Rapid System Kit 1619

> Instructions

NISSAN Juke, 5-dr SUV, 10-

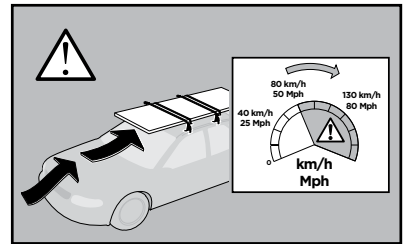
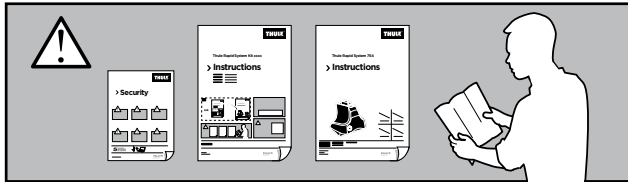
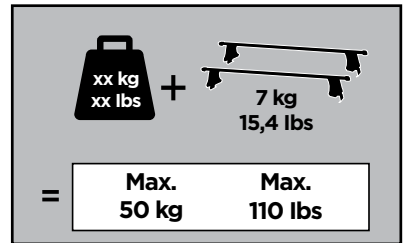
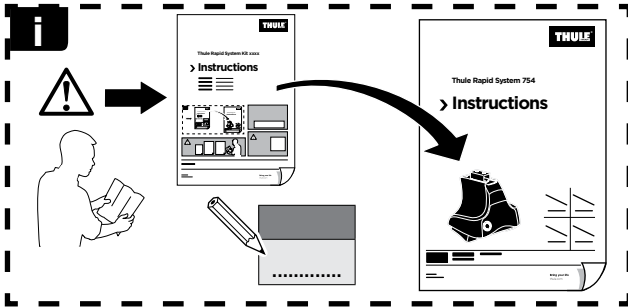

ISO 11154-E

141619

C.20120423
519-1619-01

Bring your life

thule.com



180 x2

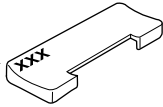

350 x2

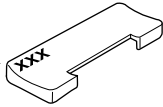

1126 x2



1127 x2



x1



x1

1

| | X (scale) | X (mm) | X (inch) |
|----------------------------|-----------|--------|----------|
| NISSAN Juke, 5-dr SUV, 10- | 33 | 980 | 38 5/8 |

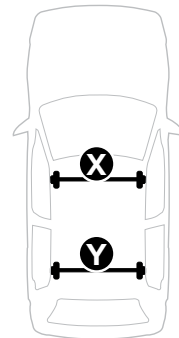
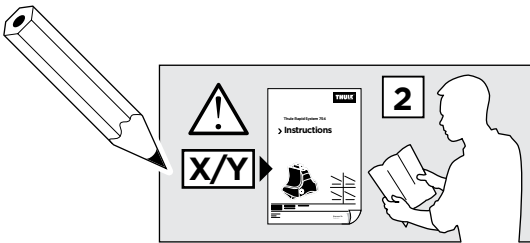

| | Y (scale) | Y (mm) | Y (inch) |
|----------------------------|-----------|--------|----------|
| NISSAN Juke, 5-dr SUV, 10- | 31 | 960 | 37 7/8 |

2

NISSAN Juke, 5-dr SUV, 10-

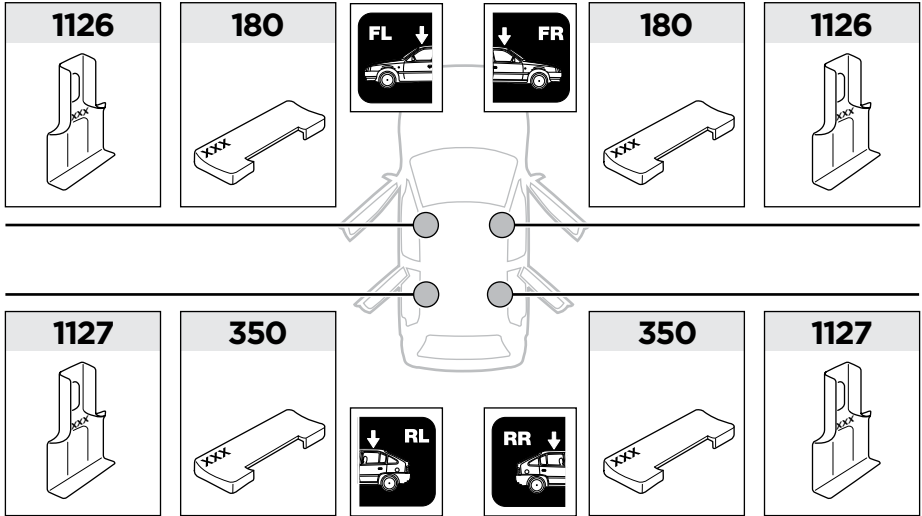

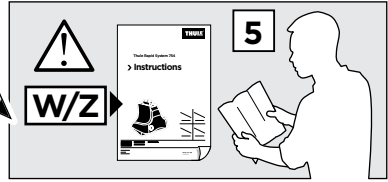
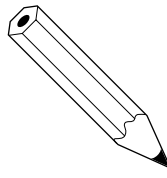
3

| | W (mm) | Z (mm) | W (inch) | Z (inch) |
|------------------------------------|------------|------------|-----------|-------------------------------------|
| NISSAN Juke , 5-dr SUV, 10- | 330 | 650 | 13 | 25 ⁵/₈ |

