



## Thule XT Kit 3175

# > Instructions

**CITROËN Berlingo**, 4-dr Van, 19-  
**OPEL Combo**, 4-dr Van, 19-  
**OPEL Combo Life**, 5-dr MPV, 19-  
**PEUGEOT Partner**, 4-dr Van, 19-  
**TOYOTA Proace City**, 4-dr Van, 20-  
**VAUXHALL Combo**, 4-dr Van, 19-  
**VAUXHALL Combo Life**, 5-dr MPV, 19-

This kit is only for vehicles with fixpoint mounting.

The diagram illustrates the kit's contents and usage. On the left, it shows the '751 FootPack' and '753 FootPack' (both with instructions) and a 'Security' page. In the center, two weight limit calculations are shown:  $xx \text{ kg} / xx \text{ lbs} + 6 \text{ kg} / 13 \text{ lbs} = \text{Max. } 100 \text{ kg} / 220 \text{ lbs}$  and  $xx \text{ kg} / xx \text{ lbs} + 9 \text{ kg} / 20 \text{ lbs} = \text{Max. } 150 \text{ kg} / 330 \text{ lbs}$ . On the right, two panels show the installation of the rack on a vehicle roof and a speed limit diagram. The speed limit diagram shows a speedometer with a warning triangle and arrows indicating that the rack is safe for speeds up to 80 km/h (50 Mph) and 130 km/h (80 Mph), but not for speeds above 40 km/h (25 Mph).

ISO 11154-E

183175

C.20200610  
5560249001

Bring your life  
thule.com

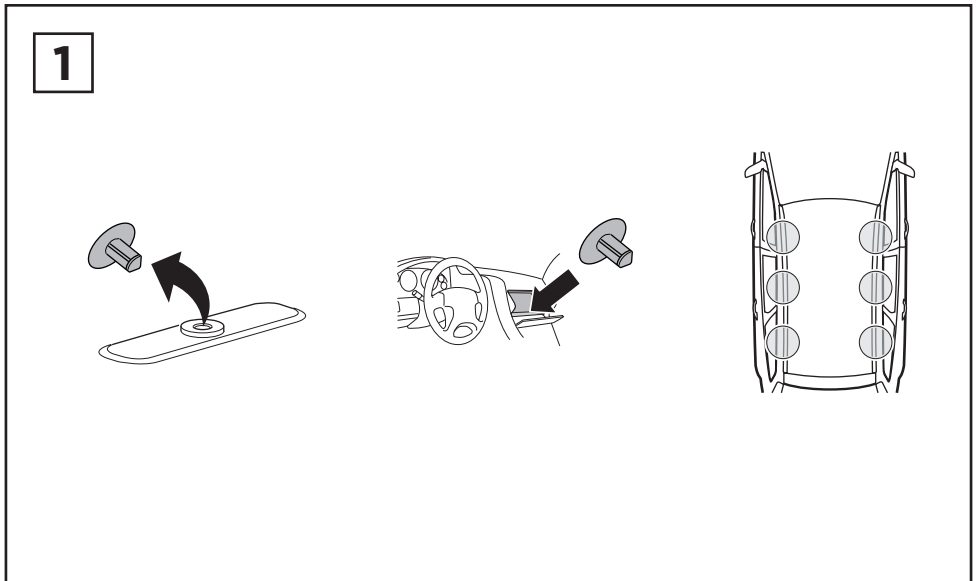
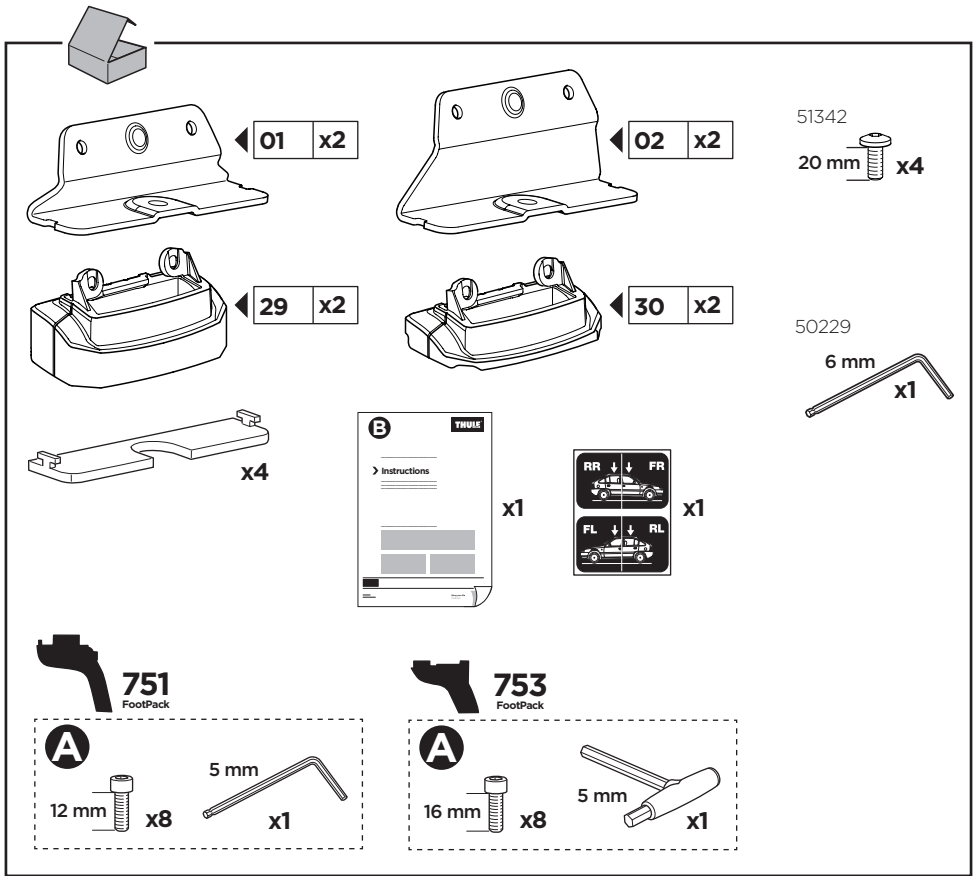

2

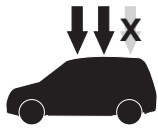
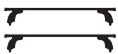

# 753

FootPack

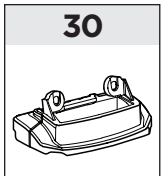
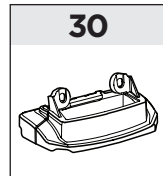
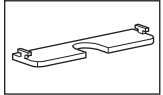
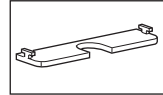
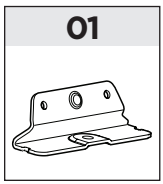
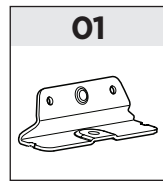
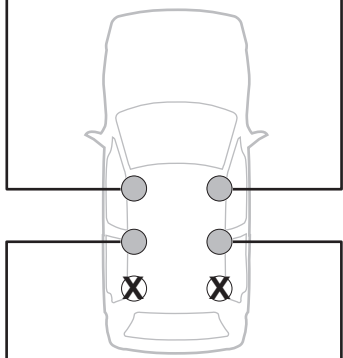
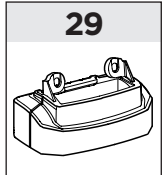
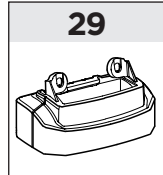
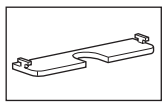
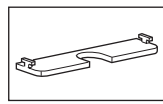
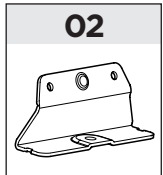
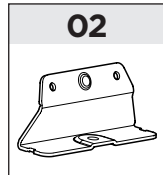

2

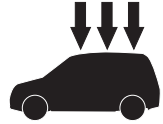

### 751 FootPack

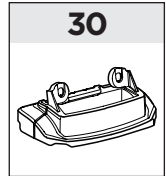
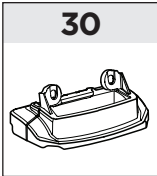
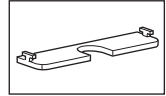
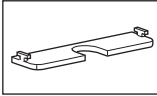
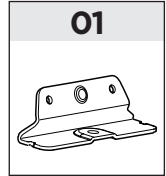
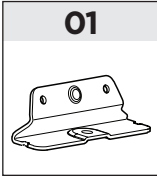

### 753 FootPack

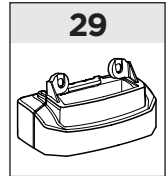
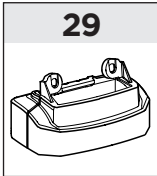
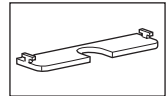
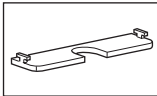
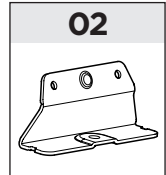
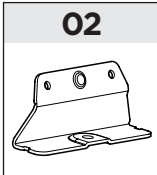

# 3 753 FootPack

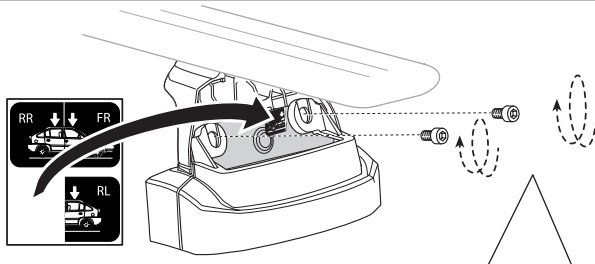
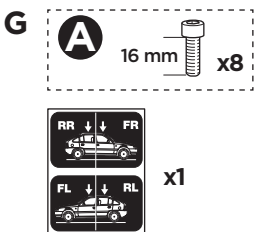
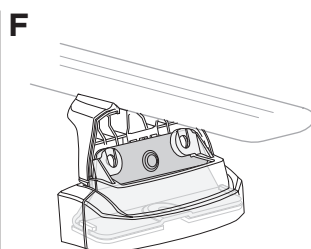
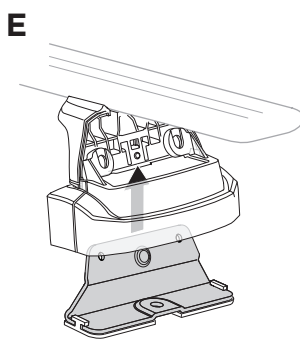
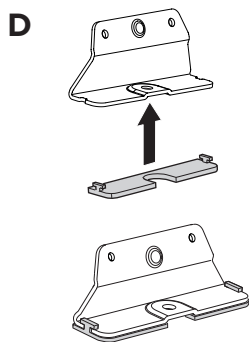
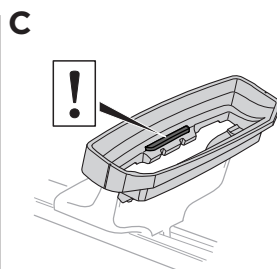
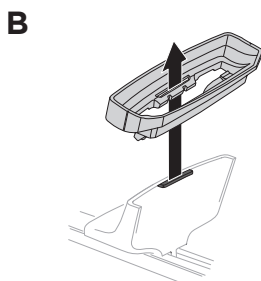
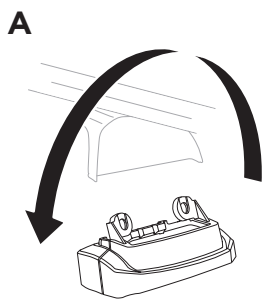

**EN** Only a few turns  
**DE** Nur wenige Umdrehungen  
**FR** Quelques tours uniquement  
**NL** Slechts enkele slagen  
**IT** Solo qualche giro  
**ES** Sólo algunas vueltas  
**PT** Noções básicas  
**SV** Endast några varv  
**DK** Kun nogle få omgange  
**NE** Bare noen få omdreinger  
**FI** Vain muutama kierros

**ET** Ainult mõni pööre  
**LV** Tikai dažī apgriezieni  
**LT** Tik keli pasukimai  
**PL** Wystarczy kilka obrotów  
**RU** Только несколько оборотов  
**UK** Лише декілька обертів  
**BG** Само няколко завъртания  
**CS** Pouze několik otáček  
**SK** Len niekoľko otáčok  
**SL** Le nekaj obratov  
**HR/BIH** Samo nekoliko okreta

**RO** Doar câteva rotiri  
**HU** Csak néhány fordítás  
**EL** Μόνο λίγες περιστροφές  
**TR** Yalnızca birkaç tur

بعض دورات فقط **AR**  
 רק מספר סיבובים **HE**  
**ZH** 仅几圈  
**JA** 2 ~ 3 回転のみ  
**KO** 몇 번만 돌리면 됨  
**TH** เพียงสองสามรอบ

3



751  
FootPack

A

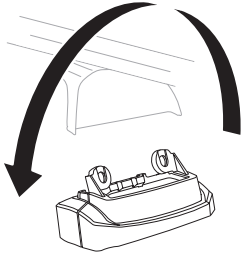

B

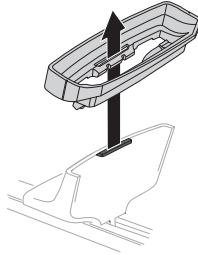

C

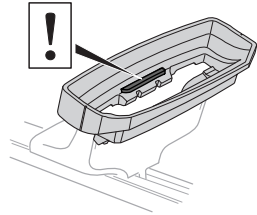

D

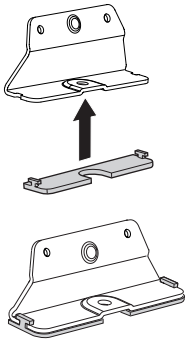

E

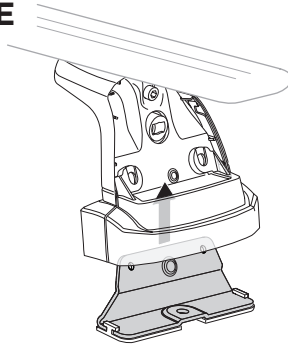

F

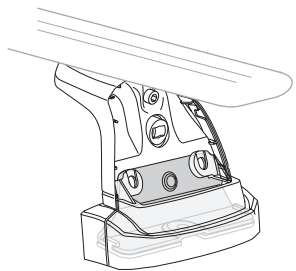

G

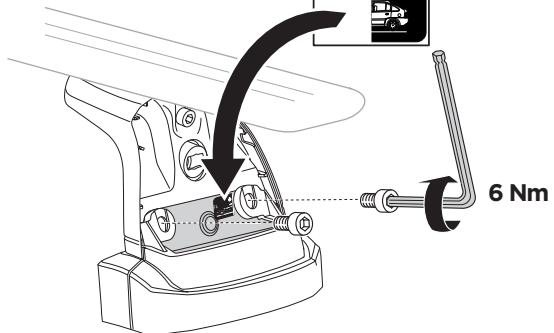
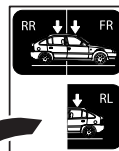
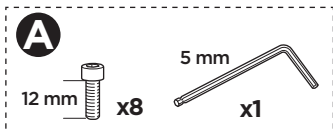

4

**753**  
FootPack

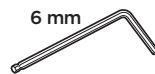
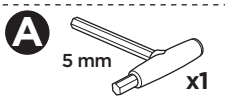

**A**

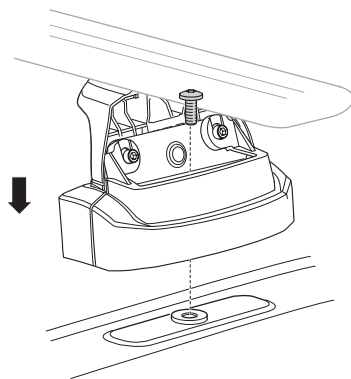

**B**

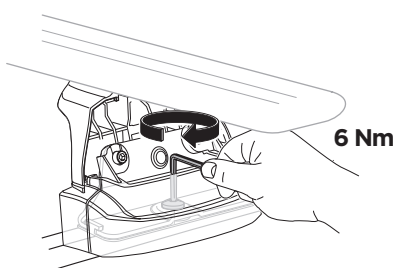
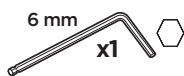

**C**

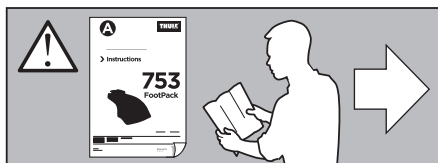
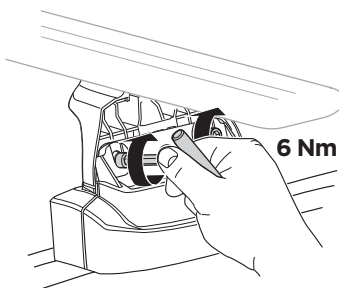
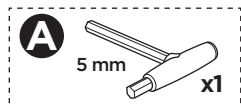

4



751  
FootPack

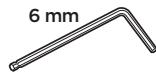
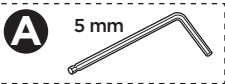

A

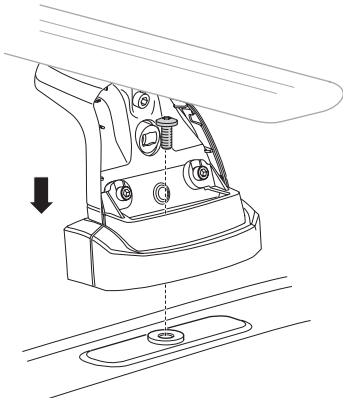

B

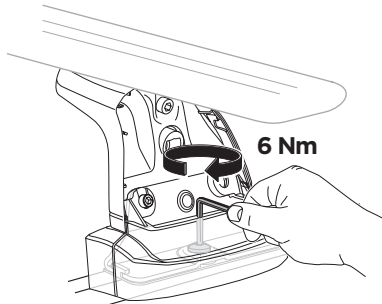
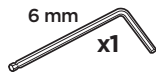

C

