

# Thule Rapid System Kit 1491

# > Instructions

**TOYOTA Alphard**, 5-dr MPV, 08-15

**TOYOTA Vellfire**, 5-dr MPV, 08-15

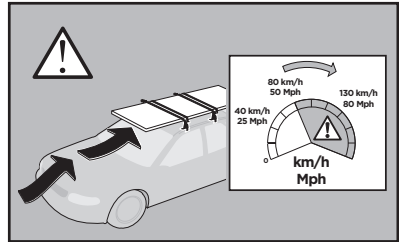
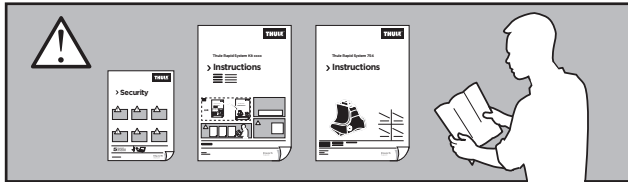
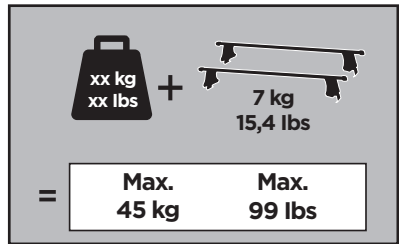
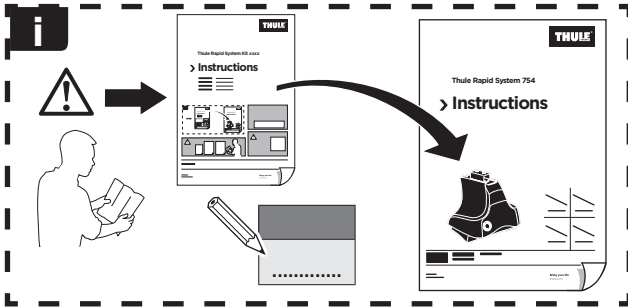

ISO 11154-E



172 x4

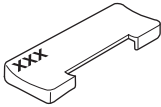

920 x4



x1



x1

1

|  | X (scale) | X (mm) | X (inch) |
|--|-----------|--------|----------|
| <b>TOYOTA Alphard</b> , 5-dr MPV, 08-15  | 58        | 1231   | 48 1/2   |
| <b>TOYOTA Vellfire</b> , 5-dr MPV, 08-15 | 58        | 1231   | 48 1/2   |

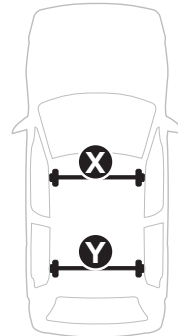
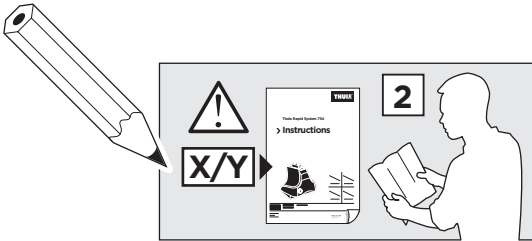

|  | Y (scale) | Y (mm) | Y (inch) |
|--|-----------|--------|----------|
| <b>TOYOTA Alphard</b> , 5-dr MPV, 08-15  | 57,5      | 1226   | 48 1/4   |
| <b>TOYOTA Vellfire</b> , 5-dr MPV, 08-15 | 57,5      | 1226   | 48 1/4   |

**2**

**TOYOTA Alphard**, 5-dr MPV, 08-15

**TOYOTA Vellfire**, 5-dr MPV, 08-15

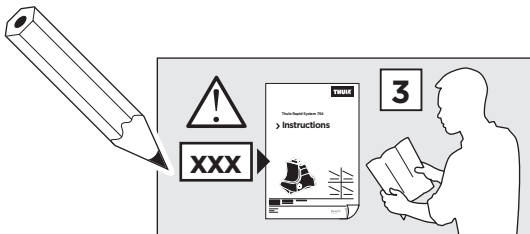
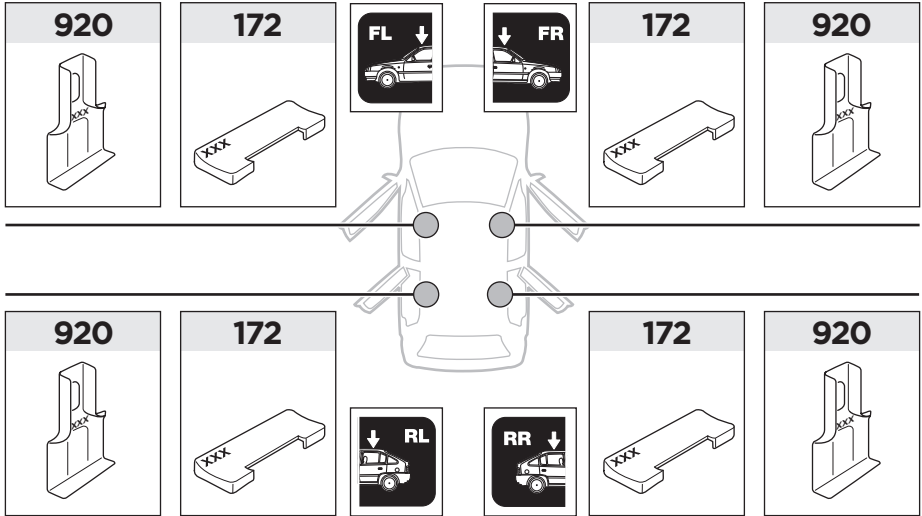

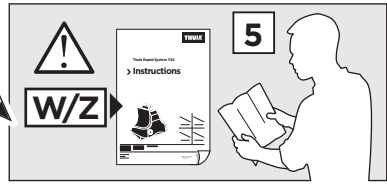
**3**

|  | W (mm)     | Z (mm)     | W (inch)      | Z (inch)      |
|--|------------|------------|---------------|---------------|
| <b>TOYOTA Alphard</b> , 5-dr MPV, 08-15  | <b>765</b> | <b>755</b> | <b>30 1/8</b> | <b>29 3/4</b> |
| <b>TOYOTA Vellfire</b> , 5-dr MPV, 08-15 | <b>765</b> | <b>755</b> | <b>30 1/8</b> | <b>29 3/4</b> |

