

2017

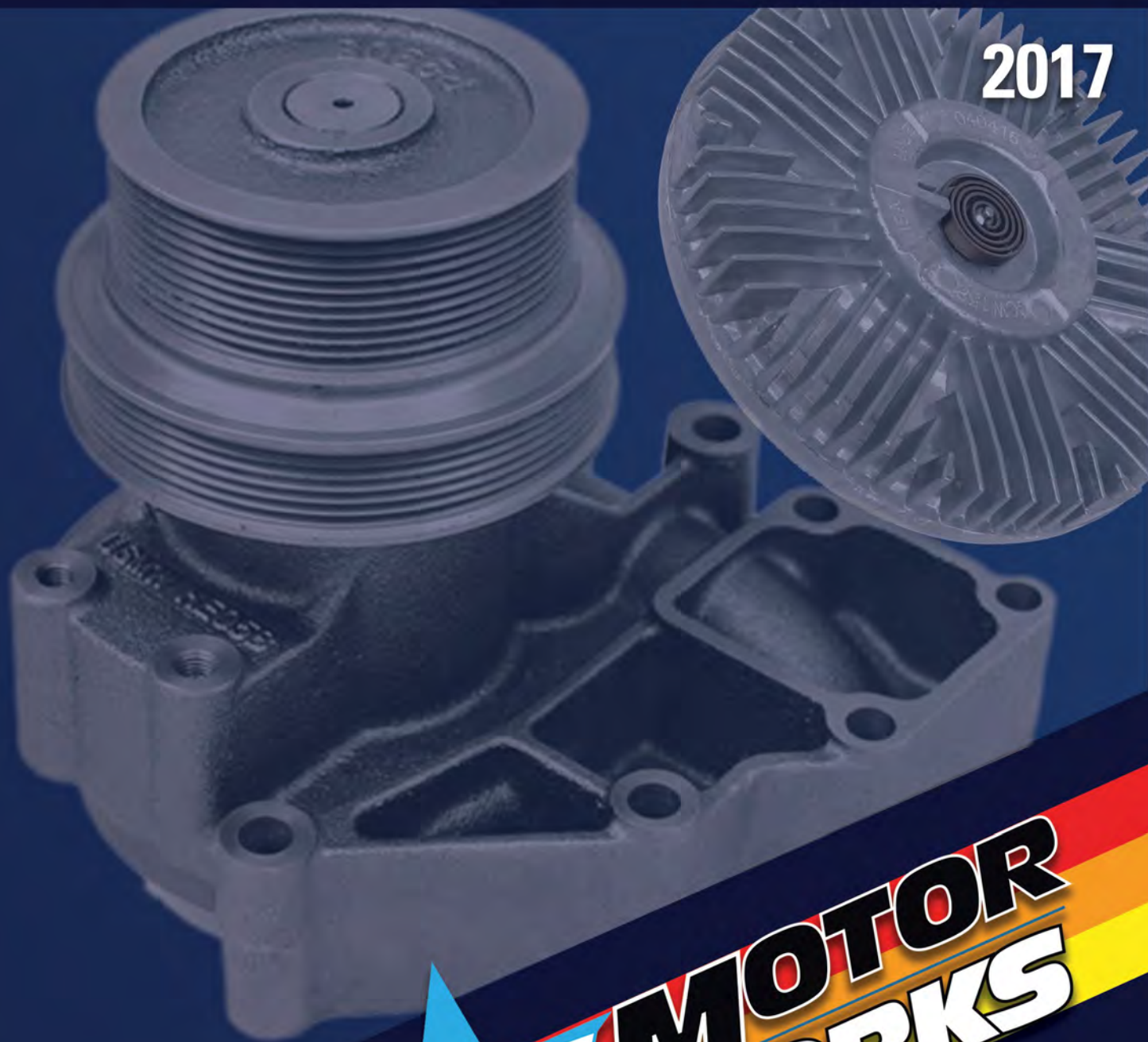

US MOTOR WORKS

HEAVY DUTY

**WATER PUMPS | FUEL PUMPS | OIL PUMPS
IDLERS | FAN CLUTCHES**

WARRANTY POLICY

US Motor Works, LLC

- USMW brand of US Motor Works, LLC products are warranted to be free from defects in material and manufacture, under normal use and service
- US Motor Works coverage will extend a full 12 months from the date of installation in an engine regardless of mileage or hours.
- US Motor Works will cover (replace free of charge or pay for) all labor and parts needed to repair the warrantable failure, including progressive damage to the engine concerned.

Conditions of the warranty are:

1. US Motor Works must be notified by the customer before filing a warranty claim.
2. All warranty claims must be in writing and US Motor Works reserves the right to examine every single engine or part subject to a claim under this warranty
3. Price of parts will be based on the US Motor Works current price list or other accepted suppliers at US Motor Work's option. Cost of labor will be of reasonable hourly flat rate (overtime or holiday rates are not accepted).

The warranty is also subject to the following limitations:

1. The provisions of this warranty shall not apply to any US Motor Works (USMW) brand part altered from its original specification (including but not limited to alterations in packaging and/or markings) or which has been misused, exposed to weather conditions, negligence or damage by accident.
2. The warranty shall be null and void, if the engine or vehicle is not maintained to the suggested OEM level. All receipts and record should be accounted for in the event it is requested for the warranty analysis.
3. This warranty is provided solely to direct customers of the US Motor Works and not any other party. It is the only agreement or obligation of US Motor Works. All other warranties, expressed or implied, including the warranties of merchantability and/or fitness for a particular purpose, are excluded.

US Motor Works, LLC

14722 Anson Ave.

Santa Fe Springs, CA 90670 USA

Tel (562) 404-0488 Fax (562) 404-8770

www.usmotorworks.com

HEAVY DUTY

USMW Heavy Duty Water Pumps are designed to the latest OE specifications. All product applications have been designed and tested to meet or exceed original equipment specifications. Our advanced research has implemented the use of the latest designed impellers, hubs, bearings and seals that will provide optimum cooling with performance and longevity. We use the highest quality material to create a stronger body design with less corrosion.

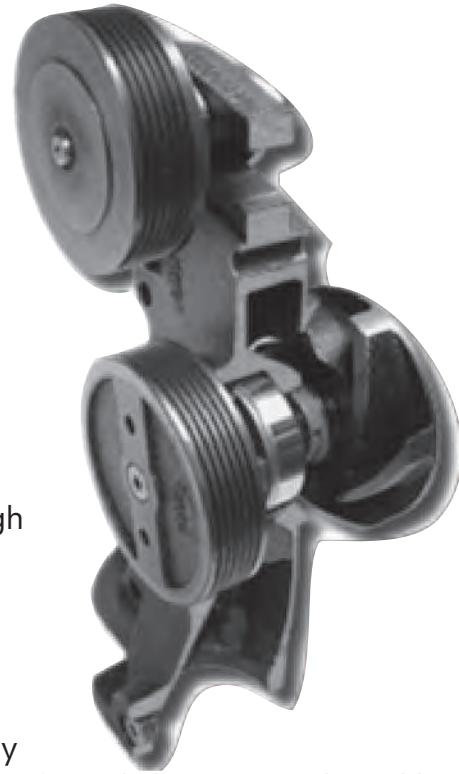

GENERAL FEATURES:

- * 100% Leak tested and hub-pull tested to our high quality standards.
- * Designed and manufactured with the best NEW unitized seals to ensure long, trouble-free performance.
- * Each unit uses bearings designed as specified by the original equipment manufacturer to meet specific radial torque and axial load requirements of each application to give long bearing life.
- * Every Water Pump is supplied with a quality mounting gasket and other accessories (seals/gaskets) necessary to properly complete the installation.
- * Manufactured to original casting specifications for proper fit, easy installation and proper water flow for maximum cooling.



TABLE OF CONTENTS

Application Guide	4
Quick Reference	39
Cross Reference	51
ISO 9001:2015 Certification	56

APPLICATIONS

QUICK REFERENCE

All Manufacturers names, numbers, symbols and descriptions are used for reference purposes only, and in no way does it imply that any parts listed in this catalog are the products of these manufacturers.



USMW 
Professional Series

CROSS REFERENCE

CASE	5
CATERPILLAR.....	5
CUMMINS	9
DAF.....	19
DETROIT DIESEL	19
FORD / INTERNATIONAL.....	21
GENERAL MOTORS.....	24
INTERNATIONAL / NAVISTAR.....	26
ISUZU NPR.....	29
JOHN DEERE.....	29
MACK.....	30
MAN	31
MERCEDES	32
PERKINS	34
SCANIA.....	36
THERMOKING	37
UNIVERSAL APPLICATIONS.....	37
VOLVO	37







ENGINE DESCRIPTION	USMW	REPLACES OEM	ILLUSTRATION
CASE			
WATER PUMP			
L4 200, 210, 300. 2.75" Impeller	US2014	G11596	
L4 3.1L, 188 3.4L 207, Forklift, Ag.	US2024	A146584	
CATERPILLAR			
BACK PLATE			
3406	BP2093	7C9222	
OIL PUMP			
3406	USOP0733	4N0733, 1614111 4N4295	
3116 / 3126	USOP8777	189-8777	
3304/3306	USOP2448	4W2448, 2P1785 6I1346, 4P4020	
3406E, C15	USOP8734	4N8734, 1614113	









ENGINE DESCRIPTION	USMW	REPLACES OEM	ILLUSTRATION
CATERPILLAR (CONT.)			
OIL PUMP			
C12	USOP5220	233-5220	
C13 (ACERT) High-Horsepower	USOP1608	223-1608, 10R2130	
WATER PUMP			
3066	US68	1252989	
3176	US71	1025844, 9Y4361	
3204	US1223	2W1223	
3114, 3116T	US4508	7C4508, 352-2151 1318238, 0R0104 1593137	
3116 4.37" Pulley	US74	4P3683, 4W0253 OR3007, 9V4879 OR1013, 4P3683	
3116, 3126	US6248	352-2149, 126-8277	

ENGINE DESCRIPTION	USMW	REPLACES OEM	ILLUSTRATION
CATERPILLAR (CONT.)			
WATER PUMP			
3126 3.75" Pulley	US75	1208402	
3208 with pulley	US2041	2W1225	
3208 With threaded pulley	US2043	2W1227	
3208 Without Pulley	US2041NP	9N6147	
3300 W/ Spline. Straight gear.	US7760	1727760, 1550061 4P9862, 0R0997	
3300 W/O Spline. Straight gear.	US7765	1727765, 1550066 1157560, 0R1002	
3304/3306 W/ spline. Out Ports 1.4 x 2.0 / 1.4 x 1.4 inch. Tapered Gear	US7766	1727766, 2W8002 1550067, 7C7967 7N5908, 9Y6435	
3304/3306 W/ spline. Out Ports 1.5 x 1.3 / 1.5 x 1.1 inch Tapered Gear	US7776	1727776, 2P0662	

ENGINE DESCRIPTION	USMW	REPLACES OEM	ILLUSTRATION
CATERPILLAR (CONT.)			
WATER PUMP			
3304/3306 W/O spline. Out Ports 1.4 x 2.0 / 1.4 x 1.4 inch Tapered Gear	US7767	1727767, 2W8001 1W3058, 1W3060 7N5909, 1550068	
3304/3306 W/O spline. Out Ports 1.5 x 1.3 / 1.5 x 1.1 inch Tapered Gear	US7775	1727775, 2P0661	
3406 B/C	US2035	7C4957, 7W7019 OR8217, 1354926	
3406E	US2093	6I3890, 10R0483 OR4120, OR8218 OR8330, 3520212	
C12	US70	1767000, OR0705	
C13 (ACERT)	US95	352-0206, 228-5811 10R2129	
C15	US6150	1615719, 10R0484 OR9869, 352-0211	
C15, C18 ACERT	US6342	336-2213, 2807374 3145155, 10R8660	







ENGINE DESCRIPTION	USMW	REPLACES OEM	ILLUSTRATION
CATERPILLAR (CONT.)			
WATER PUMP			
C7 On-highway	US92	352-2109, 10R5407 227-8843, 227-4299	
C7, 3126B	US91	352-2139, 236-4413 10R4429	
C9, 3126E	US90	352-2080, 10R5406 227-4298, 200-1212 260-1546, 227-4300	
CUMMINS			
FAN CLUTCH			
B Series (00-02 Dodge Ram Truck)	22616	5202 8894AA	
FUEL PUMP			
Diaphragm Fuel Pump	USFP0266	2830266, 84268475	
Diaphragm Fuel Pump	USFP4374	3904374, 5012 376AA 4429374, 4983584 3970080, 3966154 3928143, 3901425	
Fuel Transfer Pump	USFP4319	3918000, 3914319	

ENGINE DESCRIPTION	USMW	REPLACES OEM	ILLUSTRATION
CUMMINS (CONT.)			
FUEL PUMP			
Fuel Transfer Pump	USFP6316	3936316, 4988747 3925709, 3930134 3932224, 3933252 4944710	
Fuel Transfer Pump	USFP6317	3936317, 4988748	
Fuel Transfer Pump	USFP6318	3936318, 3917998 3917999, 4988749 4944712, 3933254 3632226, 3930201	
Fuel Transfer Pump	USFP6319	3936319, 4988750 4944713, 3933255 3932227, 3930202	
Fuel Transfer Pump	USFP6320	3936320, 4988751 4944714, 3933256 3932228, 3930349	
FUEL SOLENOID			
B Series 12V	USFS1167	3991167	
IDLER			
Big Cam	US2045	3064919, AR45189	
L10	US2602	3062602	

ENGINE DESCRIPTION	USMW	REPLACES OEM	ILLUSTRATION
CUMMINS (CONT.)			
IDLER			
N14	US2096	3066330	
NT88 (Ford)	US2064	3065000	
NT88 Big Cam IV	US2065	3062931, 3053537	
Small Cam	US2021	3064920, AR8851	
OIL PUMP			
4B	USOP0336	3930336, 3937027 3926202, 3924719 4939585	
4B helical	USOP9585	4939585, 3937027 3926202, 3924719	
4B spur	USOP9586	4939586, 3976087 5313086, 5273937	
6B	USOP0337	3930337, 3937404 3636203	









ENGINE DESCRIPTION	USMW	REPLACES OEM	ILLUSTRATION
CUMMINS (CONT.)			
OIL PUMP			
6B helical	USOP9587	4939587, 3937028 3932449	
6B spur	USOP9588	4939588, 3971544	
855 BIG CAM DFC	USOP1572	3821572, 3609837	
855 HIGH PRESSURE	USOP0172	AR10172	
B Series 6.7 Liter	USOP7481	4897481	
C Series 8.3L	USOP0338	3930338, 3800828 3926201, 3924644	
ISC	USOP6840	3966840	
ISL vented	USOP1464	4941464, 3991123	

ENGINE DESCRIPTION	USMW	REPLACES OEM	ILLUSTRATION
CUMMINS (CONT.)			
OIL PUMP			
ISX (Aluminum)	USOP1757	2881757, 4309500 4026691	
K Series	USOP7549	3047549	
M11, L10	USOP3950	4003950, 3401186 3895756, 3883910	
MY 03	USOP8801	4988801, 3973398 3957266, 3947308	
N14 Helical gear	USOP3369	3803369	
N14 straight gear	USOP3698	3803698	
REPAIR KIT			
ISX	KT6151	4090022	
SEAL KIT			
L10 Front gear cover - 5 Hole	USGK3894	3803894	







ENGINE DESCRIPTION	USMW	REPLACES OEM	ILLUSTRATION
CUMMINS (CONT.)			
SEAL KIT			
L10 Front gear cover - 6 Hole	USGK3573	3803573	
SHUTDOWN VALVE			
12 V	USSV5342	3035342, 143793	
24 V	USSV5344	3035344, 143795 3035362	
SOLENOID COIL			
12 V	USSC4808	4024808, 3054611 3054608, 3408421	
24 V	USSC4809	4024809, 134074 3054610, 3054609	
WATER PUMP			
4B 3.9L 6B 5.9L Series 94.25 MM pulley Gas	US88	2881688	
855 Small Cam FFC (2 Groove pulley)	US2000	3807784, 3000886 AR45080, 3801784 AR45090	

ENGINE DESCRIPTION	USMW	REPLACES OEM	ILLUSTRATION
CUMMINS (CONT.)			
WATER PUMP			
B Series New Style	US7145N	3286275	
B Series New Style Hardened Pulley	US7145HN	3286277, 3003749 3913432, 3802358 3802004, 3802970	
B Series New Style ISB Engine	US7123H	3286278, 3285410 3285414	
Big Cam 855 NTC 290, 350, 400 (Multi-Groove pulley)	US2001	3022474, 3801788 AR45184	
Big Cam III	US2060	3027174	
Big Cam III NTC300, 350, 400, Formula 300, 350, 400, 475	US2044	3004923	
Big Cam IV 855 (Multi-Groove pulley) Vented	US2032	3801708, 3049543 AR45217	
C Series Long Nose	US740N	3800974, 3926912 3923568, 3285323	

ENGINE DESCRIPTION	USMW	REPLACES OEM	ILLUSTRATION
CUMMINS (CONT.)			
WATER PUMP			
C Series Long Nose Hardened Pulley	US740HN	3800976, 3285324 3925540, 3926914	
C Series Long Nose Marine Engine	US740NM	3800975	
C Series Short Nose	US740	3913430	
C Series Short Nose Hardened Pulley	US740H	3806180, 3802081 3804883, F3HZ 8501-B	
Dina 155/210 Rear	US2054	34079-B05	
ISB Series	US6222	3800984, 4891252 2881804	
ISB Series (Bus)	US5394	4955394	
ISC / ISL	US69NX	4089647, 3286293 4309418, 3973114	

ENGINE DESCRIPTION	USMW	REPLACES OEM	ILLUSTRATION
CUMMINS (CONT.)			
WATER PUMP			
ISC, ISL, QSC, QSL 88.25MM Pulley	US94	4309417, 5291443	
ISM M11 & L10 Short shaft - Generator	US5708	4955708	
ISX (10 groove pulley)	US6151	4089908	
ISX (12 groove pulley)	US6344	4089910, 3684449	
ISX, ISZ (12 groove pulley) Pump only	US93	3684450, 3683651	
LTA10 Series (Before 1991, 4 hole mount)	US2202	3803402, 3801840 3925540	
M11 & L10 E Series (1991 and Later 3 hole mount)	US2203	3803403, 4955705 4003929, 3800737	
M11 & L10 Short shaft	US2204	3800745, 4955706	

ENGINE DESCRIPTION	USMW	REPLACES OEM	ILLUSTRATION
CUMMINS (CONT.)			
WATER PUMP			
N14	US2090	3803605, 3803361	
NH220	US2018	BM76506, 4919811	
NH230 Pancake 5-1/2" bore (With pulley)	US2042	AR4284, 4919813	
NH230 Pancake 5-1/2" bore (Without pulley)	US2002	AR4283, 4919814 196845	
NH250	US2033	AR51360, 4919815	
NHC250 Military (with Pulley)	US2033P	AR51333	
NT88 Big Cam IV - NTC300, 315, 350, 365, 400	US2062	3803138, 3803030 3062928, 3052386	
NTC 230	US2029	3801713, 3022471 4919820	





ENGINE DESCRIPTION	USMW	REPLACES OEM	ILLUSTRATION
CUMMINS (CONT.)			
WATER PUMP			
V8-210	US2048	AR61788, 4919812	
DAF			
WATER PUMP			
Model 85 CF, 95 XF XF 250 280 315	US16015	683386	
Model 86 WS 242 286 295	US16014	682968	
DETROIT DIESEL			
OIL PUMP			
Series 60	USOP5886	23505886	
Series 60 EGR	USOP7448	23527448	
REPAIR KIT			
Series 60 EGR	KT29-BP	23538693	
WATER PUMP			
53 Series (left hand)	US2603	23506003, 5144685	

ENGINE DESCRIPTION	USMW	REPLACES OEM	ILLUSTRATION
DETROIT DIESEL (CONT.)			
WATER PUMP			
53 Series (right hand)	US2607	23506007, 5144686	
53 Series Military Aluminum body	US2611	23506011, 5104392	
6 & 8V92	US2037	8922335	
8.2L (With heater outlet)	US2034	8928672	
DD13 DD15 (Mechanical)	US0401	EA 472 200 01 01, EA 472 200 04 01	
IL 71 LH	US1074	5149706, 23506723	
IL 71 LH HI-CAP	US2027	5149710, 23506704	
IL 71 RH	US1058	5149707, 23506735	







ENGINE DESCRIPTION	USMW	REPLACES OEM	ILLUSTRATION
DETROIT DIESEL (CONT.)			
WATER PUMP			
IL 71 RH HI-CAP	US2026	5149708, 23506711	
SERIES 60 - Late and Series 50	US60	23505895, 23520136 R3518216	
SERIES 60 - Late and Series 50 (Kangaroo Pouch)	US60P	23526039, 23522721 23522707	
Series 60 12.7L EGR	US2129	23532542, 23531257 23535017, 23530427	
Series 60 14.0L EGR	US2130	23532543, 23531258 23535018	
Series 60 14.0L EGR - Small Gear	US2636	23538636	
FORD / INTERNATIONAL			
EGR VALVE			
6.0L	USEGR60	5C3Z 9F452-AA , 4C3Z 9F452-A CX2056 , CX2020	

ENGINE DESCRIPTION	USMW	REPLACES OEM	ILLUSTRATION
FORD / INTERNATIONAL (CONT.)			
FAN CLUTCH			
83-96 6.9-7.3 diesel	22601	F2UZ 8A616-H,	
92-97 6.9-7.3 diesel NON D.I.	22607	F4TZ 8A616-B,	
94-98 7.3L D.I. Van Apps.	22609	F5TZ 8A616-KB,	
98-03 Van 7.3L D.I.	22612	F8UZ 8A616-AA,	
99-03 Excursion 7.3L D.I.	22611	F81Z 8A616-DA,	
WATER PUMP			
02-07 F650 - F750 6.0L Diesel VT365	US85	5C4Z 8501-AA, 4C4Z 8501-AARM 1845002C91	
11-12 F250, F350, F450, F550 6.7L Diesel	US77	BC3Z 8501-A,	
6.0L Turbo diesel. Power stroke 03-04	US61	3C3Z 8501-BA, 3C3Z 8501-ABRM	

ENGINE DESCRIPTION	USMW	REPLACES OEM	ILLUSTRATION
FORD / INTERNATIONAL (CONT.)			
WATER PUMP			
6.0L Turbo diesel. Power stroke 04-10	US67	4C3Z 8501-AB, 4C3Z 8501-ABRM F81Z 8501-ABRM	
6.1L, 7.0L B600, B700, C600, C700, F600, F700, F800, L800	US4037	D9HZ 8501-A, D9HZ 8501-B E2HZ 8501-B, E5HZ 8501-A	
6.4 Diesel F350/F450 2008 and up	US76	8C3Z 8501-B,	
6.6L & 7.8L Diesel	US4071	F1HZ 8501-C	
6.6L & 7.8L Diesel W/ Mounted fan.	US4072	F1HZ 8501-D	
6.6L Brazil	US4062	E8HZ 8501-B, E7HN 8A513 AB	
6.9l, 7.3L Diesel 94-96	US4096	F5TZ 8501-B, F5TZ 8501-C 1812313C93	

ENGINE DESCRIPTION	USMW	REPLACES OEM	ILLUSTRATION
FORD / INTERNATIONAL (CONT.)			
WATER PUMP			
6.9L, 7.3L Diesel Power Stroke Turbo D.I.	US4114	F7TZ 8501-C, F7TZ 8501-C 1831005C92, F6TZ 8501-AA F7TZ 8501-BRM, F81Z 8501-A F81Z 8501-B, F81Z 8501-CRM F81Z 8501F-A, F81Z 8501-ARM	
6.9L, 7.3L With 3/4" outlet	US4018	E9TZ 8501-B, E4TZ 8501-C	
7.3L Power Stroke	US66	1823669C92, 1831676C91 1831676C92, YC3Z 8501-AARM YC3Z 8501-CA	
GENERAL MOTORS			
FAN CLUTCH			
6.2L Diesel 82-93	22602	12517624	
6.5L Diesel 00-03	22614	15029405	

ENGINE DESCRIPTION	USMW	REPLACES OEM	ILLUSTRATION
GENERAL MOTORS (CONT.)			
FAN CLUTCH			
6.5L Diesel 92-93	22606	15671935	
6.5L Diesel 94-96	22605	15991496	
6.5L Diesel 97-99	22613	15022302	
6.6L Diesel Duramax	22617	15130067	
WATER PUMP			
366	US5084	14002440, 10074182	
6.0L School Bus 7.0L School Bus C5-7 50 60 70 Series	US5078	12551474, 12529192 12520263, 12512740 10140667	
6.2L	US5008	23500133, 12514269 15633465	
6.5L	US5062	12514574, 15633466 12534417, 23500138	

ENGINE DESCRIPTION	USMW	REPLACES OEM	ILLUSTRATION
GENERAL MOTORS (CONT.)			
WATER PUMP			
6.5L	US5074	88894036, 5744662 12530176, 12534772	
6.5L	US5086	88894035	
6.6L, (Duramax)	US63	97216136	
6.6L, (Duramax)	US72	97372515, 98031233	
7.4L School Bus Kodiak C6 C7 Bypass tube	US5094	12456328	
8.1L School Bus Kodiak 03-04 B7 01-02 C6, C7 C4500-8500	US5090	88893907	
INTERNATIONAL / NAVISTAR			
OIL COOLER			
DT466 15.4"	USOC5904	1815904C2	

ENGINE DESCRIPTION	USMW	REPLACES OEM	ILLUSTRATION
INTERNATIONAL / NAVISTAR (CONT.)			
OIL PUMP			
DT466 1" GEAR	USOP2666	1802666C92	
DT466 1.25" GEAR	USOP8832	1808832C92	
WATER PUMP			
3L Off-Highway 2.5L 155; 2.9 179	US2059	3136217R92	
5.6L GAS 78-94 1924, 1925, 1954, 2125	US1099	270918C93, 463365C91 861236R92,	
6.9L, 7.3L 1803276C95	US3705	1809374, 1809374C91 1805952C91,	
6.9L, 7.3L D.I. Turbo Desel	US4096	1812313C93, F5TZ 8501-B	
9.0L	US3702	1700594, 1700594C91 1700594C92	
DT-414, DT-436, DT-466 Agriculture	US3707	673162, 673162C92	

ENGINE DESCRIPTION	USMW	REPLACES OEM	ILLUSTRATION
INTERNATIONAL / NAVISTAR (CONT.)			
WATER PUMP			
DT-466 CONV Paystar, S-series	US3710	685155C92, 685155C91 685155C95, 735327C91	
DT-466 New Gen	US3713	1817687C95, 1817687C92 1817687C94, 1817687C96 1830606C93, 1830606C94 1830606C95	
DT-466 New Gen 04 +	US2128	1842664C91, 1842664C92 1830607C4, 1841764C2 1842665C93	
DT-466 Off-Highway - Tractor (Case IHC)	US3711	3136053, 3136053R93	
DT-466, Cargostar	US3709	680899C92	
DTA-360A & DT466 (left hand thread)	US3712	1815538, 1815538C91	
Maxxforce 7 6.4L	US98	1832498C91, 7081213C92	







ENGINE DESCRIPTION	USMW	REPLACES OEM	ILLUSTRATION
INTERNATIONAL / NAVISTAR (CONT.)			
WATER PUMP			
Maxxforce DT 9 & 10 2010+	US89	1889116C92	
VT365 Navistar V8 Diesel 02-07	US85	1845002C91, 5C4Z-8501-AA 4C4Z-8501-AARM	
ISUZU NPR			
WATER PUMP			
3.9L Diesel	US9302	8-97021-171-0, 2911463250	
96-99 5.7L Chevrolet engine	US5077	8-12532-528-0	
NPR, ELF, NKR, NPR, NKS, VKR	US8969	8-97073-951-0, 9-97109-676-0	
JOHN DEERE			
OIL PUMP			
Powertech 4.5L, 6.8L T, H High HP	USOP4914	RE504914	

ENGINE DESCRIPTION	USMW	REPLACES OEM	ILLUSTRATION
JOHN DEERE (CONT.)			
WATER PUMP			
Powertech 4 & 6 Cylinder	US5980	RE505980, RE500734 RE505981, RE500737	
Tractor 6105R 6115R 6125R 6105M 6115M 6125M 6140M +	US6918	RE546918, RE509813	
MACK			
WATER PUMP			
ASET - 12.0L Diesel 728 5.3" Pulley	US6659	316GC3193, 2143 7575	
ASET - 12.0L Diesel 728 5.9" Pulley	US6660	316GC3196, 2143 7577	
Econdyne	US2046	316GC1210A, 316GC4541A 316GC1219	
EM7, E7, 6 cyl, 12L - Short shaft - 6.34" 161 MM (No Pulley)	US3194	316GC3194	
END-T 675 / 676	US2004	316GC1211A, 316GC1211AX 316GC1184BX	

ENGINE DESCRIPTION	USMW	REPLACES OEM	ILLUSTRATION
MACK (CONT.)			
WATER PUMP			
END-T 675 / 676	US2006	316GCA184C, 316GCA184D 316GCA184E	
MP-7, MP-8, MP-10	US2304	21468472, 22197709	
MAN			
WATER PUMP			
Model D2865 LF24	US16008	51.06500.6546	
Model D2866 D2840 D2066	US16006	51.06500.6408	
Model D866	US16004	51.06500.6616	
Model D876	US16001	51.06500.7036	
Model F200 D2866 D2865 D2876	US16009	51.06500.9479	

ENGINE DESCRIPTION	USMW	REPLACES OEM	ILLUSTRATION
MAN (CONT.)			
WATER PUMP			
Model M2000 D0826	US16010	51.06500.6554	
Model 18.320, 18.350, 18.390, 18.430, TGA D2066	US16005	51.06500.7049	
Model F2000 D2865 D2866	US16007	51.06500.6547	
MERCEDES			
WATER PUMP			
2002-2003 Sprinter L5 2.7L	US6008	611 200 05 01, 611 200 11 01 5103 576AB, 5103 576AA	
2004-2007 Sprinter L5 2.7L	US6007	A642 200 13 01, 5138 057AA	
Actros 1831 1835 1840 1853 2035 OM541 OM542	US16011	541 200 01 01	
Actros 1843 1848 1853 1857 2035 OM541 OM542	US16012	542 200 17 01	

ENGINE DESCRIPTION	USMW	REPLACES OEM	ILLUSTRATION
MERCEDES (CONT.)			
WATER PUMP			
Atego OM904	US16013	904 200 04 01, 904 201 02 01 904 200 49 01, 904 200 06 01 904 200 08 01, 904 200 2601	
Bus/Truck OM366 1992-1986 OM256 OM366 (Short)	US2058	A366 200 0601	
DD13 DD15 (Mechanical)	US0401	EA 472 200 01 01, EA 472 200 04 01	
OM366 (Long) OM366 1991-1993 (No Back Plate)	US2067	A366 200 6801	
OM366 (Long) OM366 1991-1993 (With Back Plate)	US2067BP	A366 200 6801	
OM366 1979-1992 D-1521 Bus Marco-Polo	US2124	A390 200 01 01	
OM904 LA, OM906 LA, OM924 LA, OM926 LA	US16019	906 200 62 01, 906 200 55 01 906 200 37 01, 906 200 28 01	

ENGINE DESCRIPTION	USMW	REPLACES OEM	ILLUSTRATION
MERCEDES (CONT.)			
WATER PUMP			
OM906 LA, OM924 LA, OM926 LA	US16018	906 200 63 01, 906 200 40 01 906 200 51 01, 906 200 43 01	
U3000, U5000, OM900 OM906	US16000	A906 200 1401, 906 200 6101 906 200 1401, 906 200 2201 906 200 2911, 906 200 5401	
PERKINS			
OIL PUMP			
3.152	USOP4078	41314078, 41314178	
4.236	USOP4182	41314182, 41314054	
4.40T	USOP056	4131 F056, 4222282M91	
Phaser 1000 / 1006	USOP057	4131 F057, 4132 F023	
WATER PUMP			
1104C, 1104C.44T	US0194	U5MW0194, U5MW0206	

ENGINE DESCRIPTION	USMW	REPLACES OEM	ILLUSTRATION
PERKINS (CONT.)			
WATER PUMP			
236 431L Low Pump	US2056	236-57-31	
3A-153	US2019	41312159, 41312487	
4.401, T4.401, 4.421	US0193	U5MW0192, U5MW0193	
4-212, 4-236, 4-238	US2023	41312143, 41313201 21312201	
6-354 & 6-354T	US2022	41212691, 41313018	
L4 3.5L 212, 3.9L 236, 4.1L 248 Veh-Pulley	US2053	41312201, 41312320	
L6 5.8L Phase I and II - 4 Bolt Pulley	US2049	41311707, 41312479	
Phase IV - No Pulley	US2055	41313047	

ENGINE DESCRIPTION	USMW	REPLACES OEM	ILLUSTRATION
PERKINS (CONT.)			
WATER PUMP			
Phase IV, Turbo - No Pulley	US2057	41313048	
Phaser 135TI (AD) 1006-60TW (YK)	US0156	U5MW0156	
Phaser 4 cyl. 1004.1, 1006.6	US0159	U5MW0159, 41315020	
Phaser 6 CYL. 6.60 6.60CC 180 Diesel Dodge / Navistar	US2068	4131 E011, U5MW0092	
PJ - 1106D-E66TA; PK - 1106C-E66TA	US8947	U5MW0205, 4131 A131	
SCANIA			
WATER PUMP			
Model 114 124 DSC 11 DCS 12	US16016	1 057 0951, 1508533	
Model 114 DCS 14	US16017	1 057 0952, 1508534	

ENGINE DESCRIPTION	USMW	REPLACES OEM	ILLUSTRATION
THERMOKING			
WATER PUMP			
2.2L ISUZU - D.I.	US801	11-5252, 11-9356	
C201 Isuzu engine	US2039	11-4576	
VOLVO			
WATER PUMP			
D11 D13 D16	US2304	85142304, 85124621	
Model FL 12 D12 C	US16003	814 99 41	
Model FL10 FL 12 D12A	US16002	20 734 268	
UNIVERSAL APPLICATIONS			
FUEL PUMP			
Wide open LPH: 110. Max. output pressure: 2.5-4.5. Voltage: 12. Fuel: Diesel and gasoline. Type: Solenoid.	USEP12043	Universal	
Wide open LPH: 110. Max. output pressure: 2.5-4.5. Voltage: 12. Fuel: Diesel and gasoline. Type: Solenoid.	USEP8016S	Universal	

ENGINE DESCRIPTION	USMW	REPLACES OEM	ILLUSTRATION
UNIVERSAL APPLICATIONS (CONT.)			
FUEL PUMP			
Wide open LPH: 110. Max. output pressure: 5-9. Voltage: 12. Fuel: Diesel and gasoline. Type: Solenoid.	USEP12045	Universal	
Wide open LPH: 110. Max. output pressure: 5-9. Voltage: 12. Fuel: Diesel and gasoline. Type: Solenoid.	USEP8012S	Universal	
Wide open LPH: 120. Max. output pressure: 3-5. Voltage: 12. Fuel: Diesel and gasoline with up to 15% Ethanol. Type: Rotary-vane.	USEP8016HPT	Universal	
Wide open LPH: 120. Max. output pressure: 5-9. Voltage: 12. Fuel: Diesel and gasoline with up to 15% Ethanol. Type: Rotary-vane	USEP8012HPT	Universal	
Wide open LPH: 130. Max output pressure 4-7. Voltage: 12 Fuel: Diesel Type: Rotary vane	USEP12D	Universal	
Wide open LPH: 150. Max. output pressure: 4-5.75. Voltage: 12. Fuel: Diesel and gasoline. Type: Rotary vane.	USEP84070	Universal	
Wide open LPH: 90. Max. output pressure: 4-6. Voltage: 12. Fuel: Diesel and gasoline. Type: Solenoid.	USEP12005	Universal	

USMW #	MAKE	OE INTERCHANGE	PRODUCT TYPE
22601	Ford / International	F2UZ 8A616-H	Fan Clutch
22602	General Motors	12517624	Fan Clutch
22605	General Motors	15991496	Fan Clutch
22606	General Motors	15671935	Fan Clutch
22607	Ford / International	F4TZ 8A616-B	Fan Clutch
22609	Ford / International	F5TZ 8A616-KB	Fan Clutch
22611	Ford / International	F81Z 8A616-DA	Fan Clutch
22612	Ford / International	F8UZ 8A616-AA	Fan Clutch
22613	General Motors	15022302	Fan Clutch
22614	General Motors	15029405	Fan Clutch
22616	Cummins	5202 8894AA	Fan Clutch
22617	General Motors	15130067	Fan Clutch
BP2093	Caterpillar	7C9222	Back Plate
KT29-BP	Detroit Diesel	23538693	Repair Kit
KT6151	Cummins	4090022	Repair Kit
US0156	Perkins	U5MW0156	Water Pump
US0159	Perkins	U5MW0159	Water Pump
US0159	Perkins	41315020	Water Pump
US0159	Perkins	1309196	Water Pump
US0193	Perkins	U5MW0192	Water Pump
US0193	Perkins	U5MW0193	Water Pump
US0193	Perkins	U5MW0131	Water Pump
US0193	Perkins	1545442	Water Pump
US0194	Perkins	U5MW0194	Water Pump
US0194	Perkins	U5MW0206	Water Pump
US0401	Detroit Diesel	EA 472 200 01 01	Water Pump
US0401	Detroit Diesel	EA 472 200 01 01	Water Pump
US0401	Detroit Diesel	EA 472 200 04 01	Water Pump
US0401	Detroit Diesel	EA 472 200 04 01	Water Pump
US60	Detroit Diesel	23505895	Water Pump
US60	Detroit Diesel	23520136	Water Pump
US60	Detroit Diesel	R3518216	Water Pump
US60P	Detroit Diesel	23526039	Water Pump
US60P	Detroit Diesel	23522721	Water Pump
US60P	Detroit Diesel	23522707	Water Pump
US61	Ford / International	3C3Z 8501-BA	Water Pump
US61	Ford / International	3C3Z 8501-ABRM	Water Pump
US63	General Motors	97216136	Water Pump
US66	Ford / International	1823669C92	Water Pump
US66	Ford / International	1831676C91	Water Pump
US66	Ford / International	1831676C92	Water Pump
US66	Ford / International	YC3Z 8501-AARM	Water Pump
US66	Ford / International	YC3Z 8501-CA	Water Pump
US67	Ford / International	4C3Z 8501-AB	Water Pump
US67	Ford / International	4C3Z 8501-ABRM	Water Pump
US67	Ford / International	F81Z 8501-ABRM	Water Pump
US68	Caterpillar	1252989	Water Pump
US69NX	Cummins	4089647	Water Pump
US69NX	Cummins	3286293	Water Pump
US69NX	Cummins	4309418	Water Pump
US69NX	Cummins	3973114	Water Pump
US70	Caterpillar	1767000	Water Pump
US70	Caterpillar	OR0705	Water Pump

USMW #	MAKE	OE INTERCHANGE	PRODUCT TYPE
US71	Caterpillar	1025844	Water Pump
US71	Caterpillar	9Y4361	Water Pump
US72	General Motors	97372515	Water Pump
US72	General Motors	98031233	Water Pump
US74	Caterpillar	4P3683	Water Pump
US74	Caterpillar	4W0253	Water Pump
US74	Caterpillar	OR3007	Water Pump
US74	Caterpillar	9V4879	Water Pump
US74	Caterpillar	OR1013	Water Pump
US74	Caterpillar	4P3683	Water Pump
US75	Caterpillar	1208402	Water Pump
US76	Ford / International	8C3Z 8501-B	Water Pump
US77	Ford / International	BC3Z 8501-A	Water Pump
US85	International / Navistar	1845002C91	Water Pump
US85	International / Navistar	5C4Z 8501-AA	Water Pump
US85	International / Navistar	4C4Z 8501-AARM	Water Pump
US85	International / Navistar	5C4Z-8501-AA	Water Pump
US85	International / Navistar	1845002C91	Water Pump
US85	International / Navistar	4C4Z-8501-AARM	Water Pump
US88	Cummins	2881688	Water Pump
US89	International / Navistar	1889116C92	Water Pump
US90	Caterpillar	352-2080	Water Pump
US90	Caterpillar	10R5406	Water Pump
US90	Caterpillar	227-4298	Water Pump
US90	Caterpillar	200-1212	Water Pump
US90	Caterpillar	260-1546	Water Pump
US90	Caterpillar	227-4300	Water Pump
US91	Caterpillar	352-2139	Water Pump
US91	Caterpillar	236-4413	Water Pump
US91	Caterpillar	10R4429	Water Pump
US92	Caterpillar	352-2109	Water Pump
US92	Caterpillar	10R5407	Water Pump
US92	Caterpillar	227-8843	Water Pump
US92	Caterpillar	227-4299	Water Pump
US93	Cummins	3684450	Water Pump
US93	Cummins	3683651	Water Pump
US94	Cummins	4309417	Water Pump
US94	Cummins	5291443	Water Pump
US95	Caterpillar	352-0206	Water Pump
US95	Caterpillar	228-5811	Water Pump
US95	Caterpillar	10R2129	Water Pump
US98	International / Navistar	1832498C91	Water Pump
US98	International / Navistar	7081213C92	Water Pump
US740	Cummins	3913430	Water Pump
US740H	Cummins	3806180	Water Pump
US740H	Cummins	3802081	Water Pump
US740H	Cummins	3804883	Water Pump
US740H	Cummins	F3HZ 8501-B	Water Pump
US740HN	Cummins	3800976	Water Pump
US740HN	Cummins	3285324	Water Pump
US740HN	Cummins	3925540	Water Pump
US740HN	Cummins	3926914	Water Pump
US740N	Cummins	3800974	Water Pump

USMW #	MAKE	OE INTERCHANGE	PRODUCT TYPE
US740N	Cummins	3926912	Water Pump
US740N	Cummins	3923568	Water Pump
US740N	Cummins	3285323	Water Pump
US740NM	Cummins	3800975	Water Pump
US801	Thermoking	11-5252	Water Pump
US801	Thermoking	11-9356	Water Pump
US1058	Detroit Diesel	5149707	Water Pump
US1058	Detroit Diesel	23506735	Water Pump
US1074	Detroit Diesel	5149706	Water Pump
US1074	Detroit Diesel	23506723	Water Pump
US1099	International / Navistar	270918C93	Water Pump
US1099	International / Navistar	463365C91	Water Pump
US1099	International / Navistar	861236R92	Water Pump
US1223	Caterpillar	2W1223	Water Pump
US2000	Cummins	3807784	Water Pump
US2000	Cummins	3000886	Water Pump
US2000	Cummins	AR45080	Water Pump
US2000	Cummins	3801784	Water Pump
US2000	Cummins	AR45090	Water Pump
US2001	Cummins	3022474	Water Pump
US2001	Cummins	3801788	Water Pump
US2001	Cummins	AR45184	Water Pump
US2002	Cummins	AR4283	Water Pump
US2002	Cummins	4919814	Water Pump
US2002	Cummins	196845	Water Pump
US2004	Mack	316GC1211A	Water Pump
US2004	Mack	316GC1211AX	Water Pump
US2004	Mack	316GC1184BX	Water Pump
US2006	Mack	316GCA184C	Water Pump
US2006	Mack	316GCA184D	Water Pump
US2006	Mack	316GCA184E	Water Pump
US2014	Case	G11596	Water Pump
US2018	Cummins	BM76506	Water Pump
US2018	Cummins	4919811	Water Pump
US2019	Perkins	41312159	Water Pump
US2019	Perkins	41312487	Water Pump
US2021	Cummins	3064920	Idler
US2021	Cummins	AR8851	Idler
US2022	Perkins	41212691	Water Pump
US2022	Perkins	41313018	Water Pump
US2023	Perkins	41312143	Water Pump
US2023	Perkins	41313201	Water Pump
US2023	Perkins	12494050	Water Pump
US2023	Perkins	236-4-84	Water Pump
US2023	Perkins	21312201	Water Pump
US2024	Case	A146584	Water Pump
US2026	Detroit Diesel	5149708	Water Pump
US2026	Detroit Diesel	23506711	Water Pump
US2027	Detroit Diesel	5149710	Water Pump
US2027	Detroit Diesel	23506704	Water Pump
US2029	Cummins	3801713	Water Pump
US2029	Cummins	3022471	Water Pump
US2029	Cummins	4919820	Water Pump

QUICK REFERENCE

USMW #	MAKE	OE INTERCHANGE	PRODUCT TYPE
US2032	Cummins	3801708	Water Pump
US2032	Cummins	3049543	Water Pump
US2032	Cummins	AR45217	Water Pump
US2033	Cummins	AR51360	Water Pump
US2033	Cummins	4919815	Water Pump
US2033P	Cummins	AR51333	Water Pump
US2034	Detroit Diesel	8928672	Water Pump
US2035	Caterpillar	7C4957	Water Pump
US2035	Caterpillar	7W7019	Water Pump
US2035	Caterpillar	OR8217	Water Pump
US2035	Caterpillar	1354926	Water Pump
US2037	Detroit Diesel	8922335	Water Pump
US2039	Thermoking	11-4576	Water Pump
US2041	Caterpillar	2W1225	Water Pump
US2041NP	Caterpillar	9N6147	Water Pump
US2042	Cummins	AR4284	Water Pump
US2042	Cummins	4919813	Water Pump
US2043	Caterpillar	2W1227	Water Pump
US2044	Cummins	3004923	Water Pump
US2045	Cummins	3064919	Idler
US2045	Cummins	AR45189	Idler
US2046	Mack	316GC1210A	Water Pump
US2046	Mack	316GC4541A	Water Pump
US2046	Mack	316GC1219	Water Pump
US2048	Cummins	AR61788	Water Pump
US2048	Cummins	4919812	Water Pump
US2049	Perkins	41311707	Water Pump
US2049	Perkins	41312479	Water Pump
US2053	Perkins	41312201	Water Pump
US2053	Perkins	41312320	Water Pump
US2054	Cummins	34079-B05	Water Pump
US2055	Perkins	41313047	Water Pump
US2056	Perkins	236-57-31	Water Pump
US2057	Perkins	41313048	Water Pump
US2058	Mercedes	A366 200 0601	Water Pump
US2059	International / Navistar	3136217R92	Water Pump
US2060	Cummins	3027174	Water Pump
US2062	Cummins	3803138	Water Pump
US2062	Cummins	3803030	Water Pump
US2062	Cummins	3062928	Water Pump
US2062	Cummins	3052386	Water Pump
US2064	Cummins	3065000	Idler
US2065	Cummins	3062931	Idler
US2065	Cummins	3053537	Idler
US2067	Mercedes	A366 200 6801	Water Pump
US2067BP	Mercedes	A366 200 6801	Water Pump
US2068	Perkins	4131 E011	Water Pump
US2068	Perkins	U5MW0092	Water Pump
US2068	Perkins	U5MW0160	Water Pump
US2090	Cummins	3803605	Water Pump
US2090	Cummins	3803361	Water Pump
US2093	Caterpillar	6I3890	Water Pump
US2093	Caterpillar	10R0483	Water Pump

USMW #	MAKE	OE INTERCHANGE	PRODUCT TYPE
US2093	Caterpillar	OR4120	Water Pump
US2093	Caterpillar	OR8218	Water Pump
US2093	Caterpillar	OR8330	Water Pump
US2093	Caterpillar	3520212	Water Pump
US2096	Cummins	3066330	Idler
US2124	Mercedes	A390 200 01 01	Water Pump
US2128	International / Navistar	1842664C91	Water Pump
US2128	International / Navistar	1842664C92	Water Pump
US2128	International / Navistar	1830607C4	Water Pump
US2128	International / Navistar	1841764C2	Water Pump
US2128	International / Navistar	1842665C93	Water Pump
US2129	Detroit Diesel	23532542	Water Pump
US2129	Detroit Diesel	23531257	Water Pump
US2129	Detroit Diesel	23535017	Water Pump
US2129	Detroit Diesel	23530427	Water Pump
US2130	Detroit Diesel	23532543	Water Pump
US2130	Detroit Diesel	23531258	Water Pump
US2130	Detroit Diesel	23535018	Water Pump
US2202	Cummins	3803402	Water Pump
US2202	Cummins	3801840	Water Pump
US2202	Cummins	3925540	Water Pump
US2203	Cummins	3803403	Water Pump
US2203	Cummins	4955705	Water Pump
US2203	Cummins	4003929	Water Pump
US2203	Cummins	3800737	Water Pump
US2204	Cummins	3800745	Water Pump
US2204	Cummins	4955706	Water Pump
US2304	Mack	21468472	Water Pump
US2304	Mack	22197709	Water Pump
US2304	Volvo	85142304	Water Pump
US2304	Volvo	85124621	Water Pump
US2602	Cummins	3062602	Idler
US2603	Detroit Diesel	23506003	Water Pump
US2603	Detroit Diesel	5144685	Water Pump
US2607	Detroit Diesel	23506007	Water Pump
US2607	Detroit Diesel	5144686	Water Pump
US2611	Detroit Diesel	23506011	Water Pump
US2611	Detroit Diesel	5104392	Water Pump
US2636	Detroit Diesel	23538636	Water Pump
US3194	Mack	316GC3194	Water Pump
US3195	Mack	316GC3195	Water Pump
US3702	International / Navistar	1700594	Water Pump
US3702	International / Navistar	1700594C91	Water Pump
US3702	International / Navistar	1700594C92	Water Pump
US3705	International / Navistar	1809374	Water Pump
US3705	International / Navistar	1809374C91	Water Pump
US3705	International / Navistar	1805952C91	Water Pump
US3705	International / Navistar	1803276C95	Water Pump
US3707	International / Navistar	673162	Water Pump
US3707	International / Navistar	673162C92	Water Pump
US3709	International / Navistar	680899C92	Water Pump
US3710	International / Navistar	685155C92	Water Pump
US3710	International / Navistar	685155C91	Water Pump

QUICK REFERENCE

USMW #	MAKE	OE INTERCHANGE	PRODUCT TYPE
US3710	International / Navistar	685155C95	Water Pump
US3710	International / Navistar	735327C91	Water Pump
US3711	International / Navistar	3136053	Water Pump
US3711	International / Navistar	3136053R93	Water Pump
US3712	International / Navistar	1815538	Water Pump
US3712	International / Navistar	1815538C91	Water Pump
US3713	International / Navistar	1817687C95	Water Pump
US3713	International / Navistar	1817687C92	Water Pump
US3713	International / Navistar	1817687C94	Water Pump
US3713	International / Navistar	1817687C96	Water Pump
US3713	International / Navistar	1830606C93	Water Pump
US3713	International / Navistar	1830606C94	Water Pump
US3713	International / Navistar	1830606C95	Water Pump
US4018	Ford / International	E9TZ 8501-B	Water Pump
US4018	Ford / International	E4TZ 8501-C	Water Pump
US4037	Ford / International	D9HZ 8501-A	Water Pump
US4037	Ford / International	D9HZ 8501-B	Water Pump
US4037	Ford / International	E2HZ 8501-B	Water Pump
US4037	Ford / International	E5HZ 8501-A	Water Pump
US4062	Ford / International	E8HZ 8501-B	Water Pump
US4062	Ford / International	E7HN 8A513 AB	Water Pump
US4071	Ford / International	F1HZ 8501-C	Water Pump
US4072	Ford / International	F1HZ 8501-D	Water Pump
US4096	International / Navistar	1812313C93	Water Pump
US4096	International / Navistar	F5TZ 8501-B	Water Pump
US4096	International / Navistar	F5TZ 8501-B	Water Pump
US4096	International / Navistar	F5TZ 8501-C	Water Pump
US4096	International / Navistar	1812313C93	Water Pump
US4114	Ford / International	F7TZ 8501-C	Water Pump
US4114	Ford / International	F7TZ 8501-C	Water Pump
US4114	Ford / International	1831005C92	Water Pump
US4114	Ford / International	F6TZ 8501-AA	Water Pump
US4114	Ford / International	F7TZ 8501-BRM	Water Pump
US4114	Ford / International	F81Z 8501-A	Water Pump
US4114	Ford / International	F81Z 8501-B	Water Pump
US4114	Ford / International	F81Z 8501-CRM	Water Pump
US4114	Ford / International	F81Z 8501F-A	Water Pump
US4114	Ford / International	F81Z 8501-ARM	Water Pump
US4508	Caterpillar	7C4508	Water Pump
US4508	Caterpillar	352-2151	Water Pump
US4508	Caterpillar	1318238	Water Pump
US4508	Caterpillar	0R0104	Water Pump
US4508	Caterpillar	1593137	Water Pump
US5008	General Motors	23500133	Water Pump
US5008	General Motors	12514269	Water Pump
US5008	General Motors	15633465	Water Pump
US5062	General Motors	12514574	Water Pump
US5062	General Motors	15633466	Water Pump
US5062	General Motors	12534417	Water Pump
US5062	General Motors	23500138	Water Pump
US5074	General Motors	88894036	Water Pump
US5074	General Motors	5744662	Water Pump
US5074	General Motors	12530176	Water Pump

USMW #	MAKE	OE INTERCHANGE	PRODUCT TYPE
US5074	General Motors	12534772	Water Pump
US5077	Isuzu NPR	8-12532-528-0	Water Pump
US5078	General Motors	12551474	Water Pump
US5078	General Motors	12529192	Water Pump
US5078	General Motors	12520263	Water Pump
US5078	General Motors	12512740	Water Pump
US5078	General Motors	10140667	Water Pump
US5084	General Motors	14002440	Water Pump
US5084	General Motors	10074182	Water Pump
US5086	General Motors	88894035	Water Pump
US5090	General Motors	88893907	Water Pump
US5094	General Motors	12456328	Water Pump
US5394	Cummins	4955394	Water Pump
US5708	Cummins	4955708	Water Pump
US5980	John Deere	RE505980	Water Pump
US5980	John Deere	RE500734	Water Pump
US5980	John Deere	RE505981	Water Pump
US5980	John Deere	RE500737	Water Pump
US6007	Mercedes	A642 200 13 01	Water Pump
US6007	Mercedes	5138 057AA	Water Pump
US6007	Mercedes	647 200 01 01	Water Pump
US6008	Mercedes	611 200 05 01	Water Pump
US6008	Mercedes	611 200 11 01	Water Pump
US6008	Mercedes	611 220 01 10	Water Pump
US6008	Mercedes	A611 200 11 01	Water Pump
US6008	Mercedes	5103 576AB	Water Pump
US6008	Mercedes	5103 576AA	Water Pump
US6150	Caterpillar	1615719	Water Pump
US6150	Caterpillar	10R0484	Water Pump
US6150	Caterpillar	0R9869	Water Pump
US6150	Caterpillar	352-0211	Water Pump
US6151	Cummins	4089908	Water Pump
US6222	Cummins	3800984	Water Pump
US6222	Cummins	4891252	Water Pump
US6222	Cummins	2881804	Water Pump
US6248	Caterpillar	352-2149	Water Pump
US6248	Caterpillar	126-8277	Water Pump
US6342	Caterpillar	336-2213	Water Pump
US6342	Caterpillar	2807374	Water Pump
US6342	Caterpillar	3145155	Water Pump
US6342	Caterpillar	10R8660	Water Pump
US6344	Cummins	4089910	Water Pump
US6344	Cummins	3684449	Water Pump
US6659	Mack	316GC3193	Water Pump
US6659	Mack	2143 7575	Water Pump
US6660	Mack	316GC3196	Water Pump
US6660	Mack	2143 7577	Water Pump
US6918	John Deere	RE546918	Water Pump
US6918	John Deere	RE509813	Water Pump
US7123H	Cummins	3286278	Water Pump
US7123H	Cummins	3285410	Water Pump
US7123H	Cummins	3285414	Water Pump
US7145HN	Cummins	3286277	Water Pump

QUICK REFERENCE

USMW #	MAKE	OE INTERCHANGE	PRODUCT TYPE
US7145HN	Cummins	3003749	Water Pump
US7145HN	Cummins	3913432	Water Pump
US7145HN	Cummins	3802358	Water Pump
US7145HN	Cummins	3802004	Water Pump
US7145HN	Cummins	3802970	Water Pump
US7145N	Cummins	3286275	Water Pump
US7760	Caterpillar	1727760	Water Pump
US7760	Caterpillar	1550061	Water Pump
US7760	Caterpillar	4P9862	Water Pump
US7760	Caterpillar	0R0997	Water Pump
US7765	Caterpillar	1727765	Water Pump
US7765	Caterpillar	1550066	Water Pump
US7765	Caterpillar	1157560	Water Pump
US7765	Caterpillar	0R1002	Water Pump
US7766	Caterpillar	1727766	Water Pump
US7766	Caterpillar	2W8002	Water Pump
US7766	Caterpillar	1550067	Water Pump
US7766	Caterpillar	7C7967	Water Pump
US7766	Caterpillar	7N5908	Water Pump
US7766	Caterpillar	9Y6435	Water Pump
US7767	Caterpillar	1727767	Water Pump
US7767	Caterpillar	2W8001	Water Pump
US7767	Caterpillar	1W3058	Water Pump
US7767	Caterpillar	1W3060	Water Pump
US7767	Caterpillar	7N5909	Water Pump
US7767	Caterpillar	1550068	Water Pump
US7775	Caterpillar	1727775	Water Pump
US7775	Caterpillar	2P0661	Water Pump
US7776	Caterpillar	1727776	Water Pump
US7776	Caterpillar	2P0662	Water Pump
US8947	Perkins	U5MW0205	Water Pump
US8947	Perkins	4131 A131	Water Pump
US8969	Isuzu NPR	8-97073-951-0	Water Pump
US8969	Isuzu NPR	9-97109-676-0	Water Pump
US9302	Isuzu NPR	8-97021-171-0	Water Pump
US9302	Isuzu NPR	2911463250	Water Pump
US16000	Mercedes	A906 200 1401	Water Pump
US16000	Mercedes	906 200 6101	Water Pump
US16000	Mercedes	906 200 1401	Water Pump
US16000	Mercedes	906 200 2201	Water Pump
US16000	Mercedes	906 200 2911	Water Pump
US16000	Mercedes	906 200 5401	Water Pump
US16001	MAN	51.06500.7036	Water Pump
US16002	Volvo	20 734 268	Water Pump
US16003	Volvo	814 99 41	Water Pump
US16004	MAN	51.06500.6616	Water Pump
US16005	MAN	51.06500.7049	Water Pump
US16006	MAN	51.06500.6408	Water Pump
US16007	MAN	51.06500.6547	Water Pump
US16008	MAN	51.06500.6546	Water Pump
US16009	MAN	51.06500.9479	Water Pump
US16010	MAN	51.06500.6554	Water Pump
US16011	Mercedes	541 200 01 01	Water Pump

USMW #	MAKE	OE INTERCHANGE	PRODUCT TYPE
US16012	Mercedes	542 200 17 01	Water Pump
US16013	Mercedes	904 200 04 01	Water Pump
US16013	Mercedes	904 201 02 01	Water Pump
US16013	Mercedes	904 200 49 01	Water Pump
US16013	Mercedes	904 200 06 01	Water Pump
US16013	Mercedes	904 200 08 01	Water Pump
US16013	Mercedes	904 200 2601	Water Pump
US16014	DAF	682968	Water Pump
US16015	DAF	683386	Water Pump
US16016	Scania	1 057 0951	Water Pump
US16016	Scania	1508533	Water Pump
US16016	Scania	1353072	Water Pump
US16017	Scania	1 057 0952	Water Pump
US16017	Scania	1508534	Water Pump
US16017	Scania	1365841	Water Pump
US16018	Mercedes	906 200 63 01	Water Pump
US16018	Mercedes	906 200 40 01	Water Pump
US16018	Mercedes	906 200 51 01	Water Pump
US16018	Mercedes	906 200 43 01	Water Pump
US16019	Mercedes	906 200 62 01	Water Pump
US16019	Mercedes	906 200 55 01	Water Pump
US16019	Mercedes	906 200 37 01	Water Pump
US16019	Mercedes	906 200 28 01	Water Pump
USEGR60	Ford / International	5C3Z 9F452-AA	EGR Valve
USEGR60	Ford / International	4C3Z 9F452-A	EGR Valve
USEGR60	Ford / International	CX2056	EGR Valve
USEGR60	Ford / International	CX2020	EGR Valve
USFP0266	Cummins	2830266	Fuel Pump
USFP0266	Cummins	84268475	Fuel Pump
USFP4319	Cummins	3918000	Fuel Pump
USFP4319	Cummins	3914319	Fuel Pump
USFP4374	Cummins	3904374	Fuel Pump
USFP4374	Cummins	5012 376AA	Fuel Pump
USFP4374	Cummins	4429374	Fuel Pump
USFP4374	Cummins	4983584	Fuel Pump
USFP4374	Cummins	3970080	Fuel Pump
USFP4374	Cummins	3966154	Fuel Pump
USFP4374	Cummins	3928143	Fuel Pump
USFP4374	Cummins	3901425	Fuel Pump
USFP6316	Cummins	3936316	Fuel Pump
USFP6316	Cummins	4988747	Fuel Pump
USFP6316	Cummins	3925709	Fuel Pump
USFP6316	Cummins	3930134	Fuel Pump
USFP6316	Cummins	3932224	Fuel Pump
USFP6316	Cummins	3933252	Fuel Pump
USFP6316	Cummins	4944710	Fuel Pump
USFP6317	Cummins	3936317	Fuel Pump
USFP6317	Cummins	4988748	Fuel Pump
USFP6318	Cummins	3936318	Fuel Pump
USFP6318	Cummins	3917998	Fuel Pump
USFP6318	Cummins	3917999	Fuel Pump
USFP6318	Cummins	4988749	Fuel Pump
USFP6318	Cummins	4944712	Fuel Pump

QUICK REFERENCE



HEAVY DUTY QUICK REFERENCE GUIDE

USMW
Professional Series

USMW #	MAKE	OE INTERCHANGE	PRODUCT TYPE
USFP6318	Cummins	3933254	Fuel Pump
USFP6318	Cummins	3632226	Fuel Pump
USFP6318	Cummins	3930201	Fuel Pump
USFP6319	Cummins	3936319	Fuel Pump
USFP6319	Cummins	4988750	Fuel Pump
USFP6319	Cummins	4944713	Fuel Pump
USFP6319	Cummins	3933255	Fuel Pump
USFP6319	Cummins	3932227	Fuel Pump
USFP6319	Cummins	3930202	Fuel Pump
USFP6320	Cummins	3936320	Fuel Pump
USFP6320	Cummins	4988751	Fuel Pump
USFP6320	Cummins	4944714	Fuel Pump
USFP6320	Cummins	3933256	Fuel Pump
USFP6320	Cummins	3932228	Fuel Pump
USFP6320	Cummins	3930349	Fuel Pump
USFS1167	Cummins	3991167	Fuel Solenoid
USGK3573	Cummins	3803573	Seal Kit
USGK3894	Cummins	3803894	Seal Kit
USOC5904	International / Navistar	1815904C2	Oil Cooler
USOP0172	Cummins	AR10172	Oil Pump
USOP0336	Cummins	3930336	Oil Pump
USOP0336	Cummins	3937027	Oil Pump
USOP0336	Cummins	3926202	Oil Pump
USOP0336	Cummins	3924719	Oil Pump
USOP0336	Cummins	4939585	Oil Pump
USOP0337	Cummins	3930337	Oil Pump
USOP0337	Cummins	3937404	Oil Pump
USOP0337	Cummins	3636203	Oil Pump
USOP0338	Cummins	3930338	Oil Pump
USOP0338	Cummins	3800828	Oil Pump
USOP0338	Cummins	3926201	Oil Pump
USOP0338	Cummins	3924644	Oil Pump
USOP056	Perkins	4131 F056	Oil Pump
USOP056	Perkins	4222282M91	Oil Pump
USOP056	Perkins	6I0912	Oil Pump
USOP057	Perkins	4131 F057	Oil Pump
USOP057	Perkins	4132 F023	Oil Pump
USOP057	Perkins	4132 F029	Oil Pump
USOP0733	Caterpillar	4N0733	Oil Pump
USOP0733	Caterpillar	1614111	Oil Pump
USOP0733	Caterpillar	4N4295	Oil Pump
USOP1464	Cummins	4941464	Oil Pump
USOP1464	Cummins	3991123	Oil Pump
USOP1572	Cummins	3821572	Oil Pump
USOP1572	Cummins	3609837	Oil Pump
USOP1608	Caterpillar	223-1608	Oil Pump
USOP1608	Caterpillar	10R2130	Oil Pump
USOP1757	Cummins	2881757	Oil Pump
USOP1757	Cummins	4309500	Oil Pump
USOP1757	Cummins	4026691	Oil Pump
USOP2448	Caterpillar	4W2448	Oil Pump
USOP2448	Caterpillar	2P1785	Oil Pump
USOP2448	Caterpillar	6I1346	Oil Pump

USMW #	MAKE	OE INTERCHANGE	PRODUCT TYPE
USOP2448	Caterpillar	4P4020	Oil Pump
USOP2666	International / Navistar	1802666C92	Oil Pump
USOP3369	Cummins	3803369	Oil Pump
USOP3698	Cummins	3803698	Oil Pump
USOP3950	Cummins	4003950	Oil Pump
USOP3950	Cummins	3401186	Oil Pump
USOP3950	Cummins	3895756	Oil Pump
USOP3950	Cummins	3883910	Oil Pump
USOP4078	Perkins	41314078	Oil Pump
USOP4078	Perkins	41314178	Oil Pump
USOP4078	Perkins	41314187	Oil Pump
USOP4182	Perkins	41314182	Oil Pump
USOP4182	Perkins	41314054	Oil Pump
USOP4182	Perkins	41314061	Oil Pump
USOP4914	John Deere	RE504914	Oil Pump
USOP5220	Caterpillar	233-5220	Oil Pump
USOP5886	Detroit Diesel	23505886	Oil Pump
USOP6840	Cummins	3966840	Oil Pump
USOP7448	Detroit Diesel	23527448	Oil Pump
USOP7481	Cummins	4897481	Oil Pump
USOP7549	Cummins	3047549	Oil Pump
USOP8734	Caterpillar	4N8734	Oil Pump
USOP8734	Caterpillar	1614113	Oil Pump
USOP8777	Caterpillar	189-8777	Oil Pump
USOP8801	Cummins	4988801	Oil Pump
USOP8801	Cummins	3973398	Oil Pump
USOP8801	Cummins	3957266	Oil Pump
USOP8801	Cummins	3947308	Oil Pump
USOP8832	International / Navistar	1808832C92	Oil Pump
USOP9585	Cummins	4939585	Oil Pump
USOP9585	Cummins	3937027	Oil Pump
USOP9585	Cummins	3926202	Oil Pump
USOP9585	Cummins	3924719	Oil Pump
USOP9586	Cummins	4939586	Oil Pump
USOP9586	Cummins	3976087	Oil Pump
USOP9586	Cummins	5313086	Oil Pump
USOP9586	Cummins	5273937	Oil Pump
USOP9587	Cummins	4939587	Oil Pump
USOP9587	Cummins	3937028	Oil Pump
USOP9587	Cummins	3932449	Oil Pump
USOP9588	Cummins	4939588	Oil Pump
USOP9588	Cummins	3971544	Oil Pump
USSC4808	Cummins	4024808	Solenoid Coil
USSC4808	Cummins	3054611	Solenoid Coil
USSC4808	Cummins	3054608	Solenoid Coil
USSC4808	Cummins	3408421	Solenoid Coil
USSC4809	Cummins	4024809	Solenoid Coil
USSC4809	Cummins	134074	Solenoid Coil
USSC4809	Cummins	3054610	Solenoid Coil
USSC4809	Cummins	3054609	Solenoid Coil
USSV5342	Cummins	3035342	Shutdown Valve
USSV5342	Cummins	143793	Shutdown Valve
USSV5344	Cummins	3035344	Shutdown Valve

QUICK REFERENCE



HEAVY DUTY QUICK REFERENCE GUIDE

USMW
Professional Series

USMW #	MAKE	OE INTERCHANGE	PRODUCT TYPE
USSV5344	Cummins	143795	Shutdown Valve
USSV5344	Cummins	3035362	Shutdown Valve

CASE		2W1225	US2041	3970080	USFP4374
WATER PUMP		2W1227	US2043	4429374	USFP4374
A146584	US2024	2W8001	US7767	4944710	USFP6316
G11596	US2014	2W8002	US7766	4944712	USFP6318
CATERPILLAR		3145155	US6342	4944713	USFP6319
BACK PLATE		336-2213	US6342	4944714	USFP6320
7C9222	BP2093	352-0206	US95	4983584	USFP4374
OIL PUMP		352-0211	US6150	4988747	USFP6316
10R2130	USOP1608	3520212	US2093	4988748	USFP6317
1614111	USOP0733	352-2080	US90	4988749	USFP6318
1614113	USOP8734	352-2109	US92	4988750	USFP6319
189-8777	USOP8777	352-2139	US91	4988751	USFP6320
223-1608	USOP1608	352-2149	US6248	5012 376AA	USFP4374
233-5220	USOP5220	352-2151	US4508	84268475	USFP0266
2P1785	USOP2448	4P3683	US74	FUEL SOLENOID	
4N0733	USOP0733	4P3683	US74	3991167	USFS1167
4N4295	USOP0733	4P9862	US7760	IDLER	
4N8734	USOP8734	4W0253	US74	3053537	US2065
4P4020	USOP2448	6I3890	US2093	3062602	US2602
4W2448	USOP2448	7C4508	US4508	3062931	US2065
6I1346	USOP2448	7C4957	US2035	3064919	US2045
WATER PUMP		7C7967	US7766	3064920	US2021
0R0104	US4508	7N5908	US7766	3065000	US2064
0R0997	US7760	7N5909	US7767	3066330	US2096
0R1002	US7765	7W7019	US2035	AR45189	US2045
0R9869	US6150	9N6147	US2041NP	AR8851	US2021
1025844	US71	9V4879	US74	OIL PUMP	
10R0483	US2093	9Y4361	US71	2881757	USOP1757
10R0484	US6150	9Y6435	US7766	3047549	USOP7549
10R2129	US95	OR0705	US70	3401186	USOP3950
10R4429	US91	OR1013	US74	3609837	USOP1572
10R5406	US90	OR3007	US74	3636203	USOP0337
10R5407	US92	OR4120	US2093	3800828	USOP0338
10R8660	US6342	OR8217	US2035	3803369	USOP3369
1157560	US7765	OR8218	US2093	3803698	USOP3698
1208402	US75	OR8330	US2093	3821572	USOP1572
1252989	US68	CUMMINS		3883910	USOP3950
126-8277	US6248	FAN CLUTCH		3895756	USOP3950
1318238	US4508	5202 8894AA		3924644	USOP0338
1354926	US2035	FUEL PUMP		3924719	USOP0336
1550061	US7760	2830266	USFP0266	3924719	USOP9585
1550066	US7765	3632226	USFP6318	3926201	USOP0338
1550067	US7766	3901425	USFP4374	3926202	USOP0336
1550068	US7767	3904374	USFP4374	3926202	USOP9585
1593137	US4508	3914319	USFP4319	3930336	USOP0336
1615719	US6150	3917998	USFP6318	3930337	USOP0337
1727760	US7760	3917999	USFP6318	3930338	USOP0338
1727765	US7765	3918000	USFP4319	3932449	USOP9587
1727766	US7766	3925709	USFP6316	3937027	USOP0336
1727767	US7767	3928143	USFP4374	3937027	USOP9585
1727775	US7775	3930134	USFP6316	3937028	USOP9587
1727776	US7776	3930201	USFP6318	3937404	USOP0337
1767000	US70	3930202	USFP6319	3947308	USOP8801
1W3058	US7767	3930349	USFP6320	3957266	USOP8801
1W3060	US7767	3932224	USFP6316	3966840	USOP6840
200-1212	US90	3932227	USFP6319	3971544	USOP9588
227-4298	US90	3932228	USFP6320	3973398	USOP8801
227-4299	US92	3933252	USFP6316	3976087	USOP9586
227-4300	US90	3933254	USFP6318	3991123	USOP1464
227-8843	US92	3933255	USFP6319	4003950	USOP3950
228-5811	US95	3933256	USFP6320	4026691	USOP1757
236-4413	US91	3936316	USFP6316	4309500	USOP1757
260-1546	US90	3936317	USFP6317	4897481	USOP7481
2807374	US6342	3936318	USFP6318	4939585	USOP0336
2P0661	US7775	3936319	USFP6318	4939585	USOP9585
2P0662	US7776	3936320	USFP6319	4939586	USOP9586
2W1223	US1223	3966154	USFP4374	4939587	USOP9587
				4939588	USOP9588

CROSS REFERENCE

CUMMINS (CONT.)					
OIL PUMP (CONT.)					
4941464	USOP1464	3803030	US2062	23522721	US60P
4988801	USOP8801	3803138	US2062	23526039	US60P
5273937	USOP9586	3803361	US2090	23530427	US2129
5313086	USOP9586	3803402	US2202	23531257	US2129
AR10172	USOP0172	3803403	US2203	23531258	US2130
REPAIR KIT		3803605	US2090	23532542	US2129
4090022	KT6151	3804883	US740H	23532543	US2130
SEAL KIT		3806180	US740H	23535017	US2129
3803573	USGK3573	3807784	US2000	23535018	US2130
3803894	USGK3894	3913430	US740	23538636	US2636
SHUTDOWN VALVE		3913432	US7145HN	5104392	US2611
143793	USSV5342	3923568	US740N	5144685	US2603
143795	USSV5344	3925540	US2202	5144686	US2607
3035342	USSV5342	3925540	US740HN	5149706	US1074
3035344	USSV5344	3926912	US740N	5149707	US1058
3035362	USSV5344	3926914	US740HN	5149708	US2026
SOLENOID COIL		3973114	US69NX	5149710	US2027
134074	USSC4809	4003929	US2203	8922335	US2037
3054608	USSC4808	4089647	US69NX	8928672	US2034
3054609	USSC4809	4089908	US6151	EA 472 200 01 01	US0401
3054610	USSC4809	4089910	US6344	EA 472 200 01 01	US0401
3054611	USSC4808	4309417	US94	EA 472 200 04 01	US0401
3408421	USSC4808	4309418	US69NX	EA 472 200 04 01	US0401
4024808	USSC4808	4891252	US6222	R3518216	US60
4024809	USSC4809	4919811	US2018	FORD / INTERNATIONAL	
WATER PUMP		4919812	US2048	EGR VALVE	
196845	US2002	4919813	US2042	4C3Z 9F452-A	USEGR60
2881688	US88	4919814	US2002	5C3Z 9F452-AA	USEGR60
2881804	US6222	4919815	US2033	CX2020	USEGR60
3000886	US2000	4919820	US2029	CX2056	USEGR60
3003749	US7145HN	4955394	US5394	FAN CLUTCH	
3004923	US2044	4955705	US2203	F2UZ 8A616-H	22601
3022471	US2029	4955706	US2204	F4TZ 8A616-B	22607
3022474	US2001	4955708	US5708	F5TZ 8A616-KB	22609
3027174	US2060	5291443	US94	F81Z 8A616-DA	22611
3049543	US2032	AR4283	US2002	F8UZ 8A616-AA	22612
3052386	US2062	AR4284	US2042	WATER PUMP	
3062928	US2062	AR45080	US2000	1823669C92	US66
3285323	US740N	AR45090	US2000	1831676C91	US66
3285324	US740HN	AR45184	US2001	1831676C92	US66
3285410	US7123H	AR45217	US2032	3C3Z 8501-ABRM	US61
3285414	US7123H	AR51333	US2033P	3C3Z 8501-BA	US61
3286275	US7145N	AR51360	US2033	4C3Z 8501-AB	US67
3286277	US7145HN	AR61788	US2048	4C3Z 8501-ABRM	US67
3286278	US7123H	BM76506	US2018	8C3Z 8501-B	US76
3286293	US69NX	F3HZ 8501-B	US740H	BC3Z 8501-A	US77
34079-B05	US2054	DAF		D9HZ 8501-A	US4037
3683651	US93	WATER PUMP		D9HZ 8501-B	US4037
3684449	US6344	682968	US16014	E2HZ 8501-B	US4037
3684450	US93	683386	US16015	E4TZ 8501-C	US4018
3800737	US2203	DETROIT DIESEL		E5HZ 8501-A	US4037
3800745	US2204	OIL PUMP		E7HN 8A513 AB	US4062
3800974	US740N	23505886	USOP5886	E8HZ 8501-B	US4062
3800975	US740NM	23527448	USOP7448	E9TZ 8501-B	US4018
3800976	US740HN	REPAIR KIT		F1HZ 8501-C	US4071
3800984	US6222	23538693	KT29-BP	F1HZ 8501-D	US4072
3801708	US2032	WATER PUMP		F6TZ 8501-AA	US4114
3801713	US2029	23505895	US60	F7TZ 8501-BRM	US4114
3801784	US2000	23506003	US2603	F7TZ 8501-C	US4114
3801788	US2001	23506007	US2607	F7TZ 8501-C	US4114
3801840	US2202	23506011	US2611	F81Z 8501-A	US4114
3802004	US7145HN	23506704	US2027	F81Z 8501-ABRM	US67
3802081	US740H	23506711	US2026	F81Z 8501-ARM	US4114
3802358	US7145HN	23506723	US1074	F81Z 8501-B	US4114
3802970	US7145HN	23506735	US1058	F81Z 8501-CRM	US4114
		23520136	US60	F81Z 8501F-A	US4114
		23522707	US60P	YC3Z 8501-AARM	US66

FORD/INTERNATIONAL (CONT)

WATER PUMP
YC3Z 8501-CA US66

GENERAL MOTORS

FAN CLUTCH
12517624 22602
15022302 22613
15029405 22614
15130067 22617
15671935 22606
15991496 22605

WATER PUMP

10074182 US5084
10140667 US5078
12456328 US5094
12512740 US5078
12514269 US5008
12514574 US5062
12520263 US5078
12529192 US5078
12530176 US5074
12534417 US5062
12534772 US5074
12551474 US5078
14002440 US5084
15633465 US5008
15633466 US5062
23500133 US5008
23500138 US5062
5744662 US5074
88893907 US5090
88894035 US5086
88894036 US5074
97216136 US63
97372515 US72
98031233 US72

INTERNATIONAL / NAVISTAR

OIL COOLER
1815904C2 USOC5904

OIL PUMP

1802666C92 USOP2666
1808832C92 USOP8832

WATER PUMP

1700594 US3702
1700594C91 US3702
1700594C92 US3702
1803276C95 US3705
1805952C91 US3705
1809374 US3705
1809374C91 US3705
1812313C93 US4096
1812313C93 US4096
1815538 US3712
1815538C91 US3712
1817687C92 US3713
1817687C94 US3713
1817687C95 US3713
1817687C96 US3713
1830606C93 US3713
1830606C94 US3713
1830606C95 US3713
1830607C4 US2128
1832498C91 US98
1841764C2 US2128
1842664C91 US2128
1842664C92 US2128

1842665C93 US2128
1845002C91 US85
1845002C91 US85
1889116C92 US89
270918C93 US1099
3136053 US3711
3136053R93 US3711
3136217R92 US2059
463365C91 US1099
4C4Z 8501-AARM US85
4C4Z-8501-AARM US85
5C4Z 8501-AA US85
5C4Z-8501-AA US85
673162 US3707
673162C92 US3707
680899C92 US3709
685155C91 US3710
685155C92 US3710
685155C95 US3710
7081213C92 US98
735327C91 US3710
861236R92 US1099
F5TZ 8501-B US4096
F5TZ 8501-B US4096
F5TZ 8501-C US4096

ISUZU NPR

WATER PUMP

2911463250 US9302
8-12532-528-0 US5077
8-97021-171-0 US9302
8-97073-951-0 US8969
9-97109-676-0 US8969

JOHN DEERE

OIL PUMP

RE504914 USOP4914

WATER PUMP

RE500734 US5980
RE500737 US5980
RE505980 US5980
RE505981 US5980
RE509813 US6918
RE546918 US6918

MACK

WATER PUMP

2143 7575 US6659
2143 7577 US6660
21468472 US2304
22197709 US2304
316GC1184BX US2004
316GC1210A US2046
316GC1211A US2004
316GC1211AX US2004
316GC1219 US2046
316GC3193 US6659
316GC3194 US3194
316GC3196 US6660
316GC4541A US2046
316GCA184C US2006
316GCA184D US2006
316GCA184E US2006

MAN

WATER PUMP

51.06500.6408 US16006
51.06500.6546 US16008
51.06500.6547 US16007
51.06500.6554 US16010

51.06500.6616 US16004
51.06500.7036 US16001
51.06500.7049 US16005
51.06500.9479 US16009

MERCEDES

WATER PUMP

5103 576AA US6008
5103 576AB US6008
5138 057AA US6007
541 200 01 01 US16011
542 200 17 01 US16012
611 200 05 01 US6008
611 200 11 01 US6008
611 220 01 10 US6008
647 200 01 01 US6007
904 200 04 01 US16013
904 200 06 01 US16013
904 200 08 01 US16013
904 200 2601 US16013
904 200 49 01 US16013
904 201 02 01 US16013
906 200 1401 US16000
906 200 2201 US16000
906 200 28 01 US16019
906 200 2911 US16000
906 200 37 01 US16019
906 200 40 01 US16018
906 200 43 01 US16018
906 200 51 01 US16018
906 200 5401 US16000
906 200 55 01 US16019
906 200 6101 US16000
906 200 62 01 US16019
906 200 63 01 US16018
A366 200 0601 US2058
A366 200 6801 US2067
A366 200 6801 US2067BP
A390 200 01 01 US2124
A611 200 11 01 US6008
A642 200 13 01 US6007
A906 200 1401 US16000

PERKINS

OIL PUMP

4131 F056 USOP056
4131 F057 USOP057
41314054 USOP4182
41314061 USOP4182
41314078 USOP4078
41314178 USOP4078
41314182 USOP4182
41314187 USOP4078
4132 F023 USOP057
4132 F029 USOP057
4222282M91 USOP056
6I0912 USOP056

WATER PUMP

12494050 US2023
1309196 US0159
1545442 US0193
21312201 US2023
236-4-84 US2023
236-57-31 US2056
41212691 US2022
4131 A131 US8947
4131 E011 US2068
41311707 US2049
41312143 US2023



HEAVY DUTY CROSS REFERENCE GUIDE

USMW
Professional Series

PERKINS (CONT.)

WATER PUMP

41312159	US2019
41312201	US2053
41312320	US2053
41312479	US2049
41312487	US2019
41313018	US2022
41313047	US2055
41313048	US2057
41313201	US2023
41315020	US0159
U5MW0092	US2068
U5MW0131	US0193
U5MW0156	US0156
U5MW0159	US0159
U5MW0160	US2068
U5MW0192	US0193
U5MW0193	US0193
U5MW0194	US0194
U5MW0205	US8947
U5MW0206	US0194

SCANIA

WATER PUMP

1 057 0951	US16016
1 057 0952	US16017
1353072	US16016
1365841	US16017
1508533	US16016
1508534	US16017

THERMOKING

WATER PUMP

11-4576	US2039
11-5252	US801
11-9356	US801

VOLVO

WATER PUMP

20 734 268	US16002
814 99 41	US16003
85124621	US2304
85142304	US2304

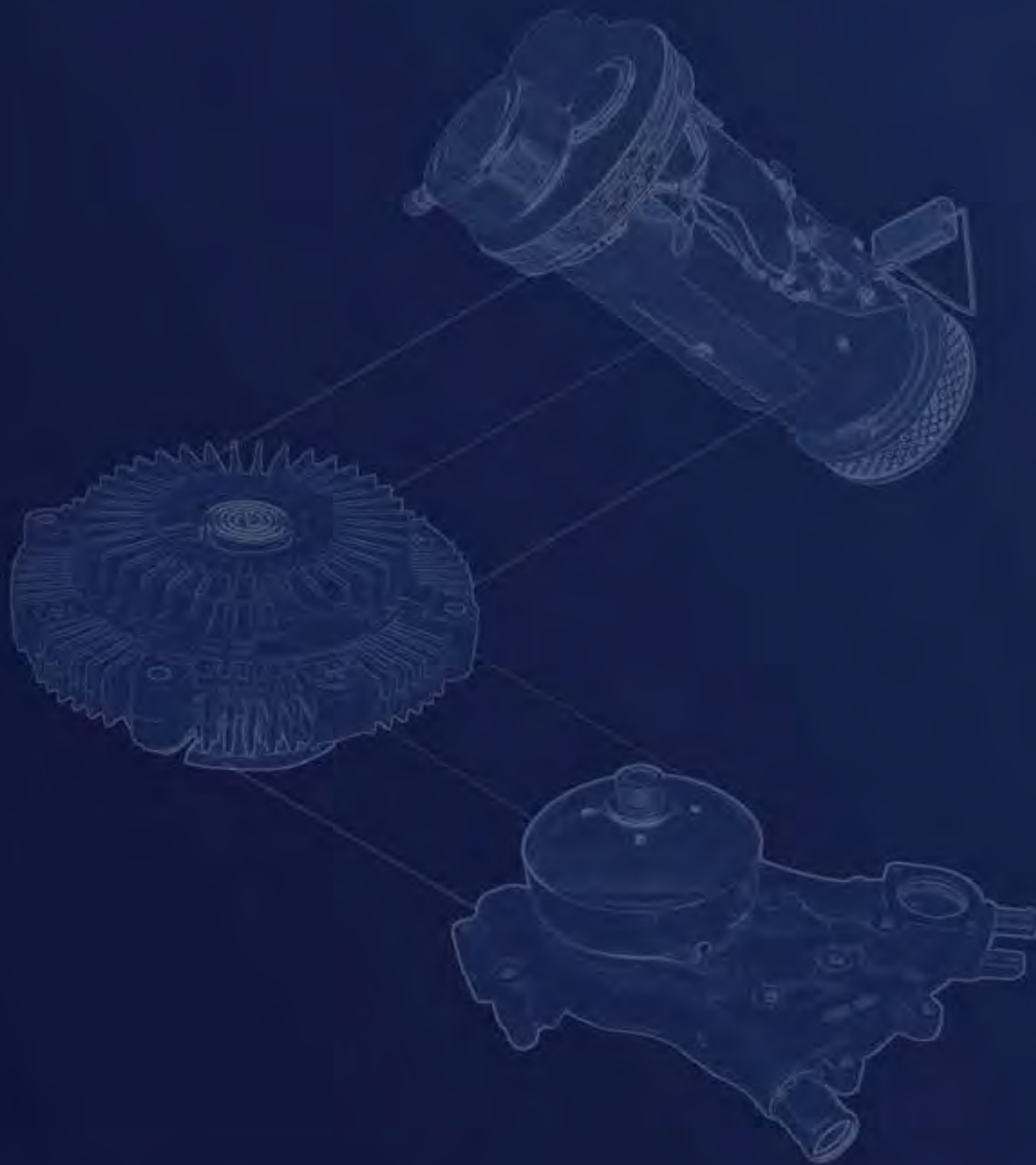

US MOTOR WORKS, LLC
14722 ANSON AVE
SANTA FE SPRINGS, CA 90670
TEL: +1 (562) 404 - 0488
FAX: +1 (562) 404 - 8770
www.usmotorworks.com