

See You.
More light, better visibility,
added safety

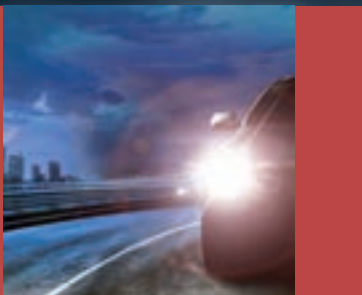

Automotive bulbs

2015 | 2016



BOSCH

See You.

Bosch automotive bulbs



Bosch is full of bright new ideas and product highlights for the automotive bulbs market.

- ▶ A variety of product lines: Comprehensive range for more or less every vehicle and all applications
- ▶ For all headlamps and lights: Appropriate bulbs with 6 V / 12 V / 24 V electrical system voltage.
- ▶ Workshop and self-service ranges: Two tailor-made product lines to achieve optimum sales results through all distribution channels
- ▶ Packaging design: Our practical workshop packaging and attractive self-service packaging have been optimized for the market requirements.

Contents

Offer

- A2** More safety with Bosch
- A4** Basic lighting terms
- A6** The automotive lamps range
- A8** The new Bosch packaging
- A9** Bulb packaging
- A10** Workshop packaging
- A12** Blister pack
- A14** Special packaging
- A15** LED retrofit lamps
- A16** Gas discharge lamps
- A17** Xenon
- A18** Pure Light range
- A20** Plus 30 and Plus 50/60 ranges
- A21** Plus 90 range
- A22** Gigalight Plus 120
- A24** Xenon Blue range
- A25** Xenon Silver range
- A26** Longlife Daytime range
- A27** Rallye range
- A28** Trucklight/Trucklight Maxlife range
- A30** Automotive lamp boxes
- A31** Sales support
- A32** Product range according to application
- A46** Base types
- A50** Workshop program
- A53** Self-service program
- A58** Product range according to bulb type

Cross-reference

- C1** Competitors Bosch



See you. Highly visible. Automotive bulbs from Bosch.



Bosch quality for added road safety

Bosch automotive bulbs meet the most stringent quality standards, because when it comes to repairs we believe a properly functioning lighting system is a top priority – using the famous Bosch quality. As well as our customers' requirements, we are guided by statutory regulations. In terms of service life, Bosch automotive bulbs far surpass legal requirements.

Bosch automotive bulbs stand for reliability and durability. They enhance road safety and improve driving comfort by providing excellent road illumination without dazzling oncoming traffic.

ECE guidelines

The ECE (Economic Commission for Europe) guidelines ensure added safety on public roads. All replaceable automotive bulbs for the vehicle exterior must be approved in accordance with these guidelines. As well as headlamps, this applies to signal lamps, for instance turn-signal lamps, stop lamps, tail lamps, fog warning lamps, side-marker lamps, backup lamps as well as license-plate lighting. The standards are defined in ECE Directive R 37 for automotive bulbs. Xenon HID automotive bulbs are subject to ECE Directive R 99. The aims of this standardization are to enable replacement across manufacturers on the one hand, while at the same time ruling out confusion with other bulb types.

UV-Cut

For technical and design reasons, the outer lenses on modern vehicles' headlamps are made of plastic. The UV radiation from a bulb causes plastics to gradually turn yellow and become brittle over time. Therefore, all Bosch main headlamps are equipped with UV-Cut, which reduces the harmful UV components of the light.

Safety and transparency for the consumer

To increase safety for the consumer, we provide product instructions on our bulb packaging or package inserts. This meets the requirements of the EU directives. To ensure that the information is understood internationally, pictograms are used.





Sustainability

Environmental and resource conservation

Ecological globalization demands sparing use of resources on all continents and avoiding burdens on the environment. For us, this means: Ecological thinking calls for technical action.

Materials

The EC directive 2002/95/EC limiting the use of defined hazardous substances in electrical and electronic equipment, governs the use of hazardous substances in equipment and components. As you would expect, we comply with this directive; in fact, we exceed the requirements it sets out.

Packaging

Bosch uses only packaging which is environmentally compatible and easy to dispose of. We supply our workshop bulbs in recyclable single-material, solid cardboard packaging. For blister packaging we use environmentally compatible, easy-to-separate dual-material packaging.

Quality and environmental awareness – always a matter of course for Bosch.



Basic lighting-technology terms

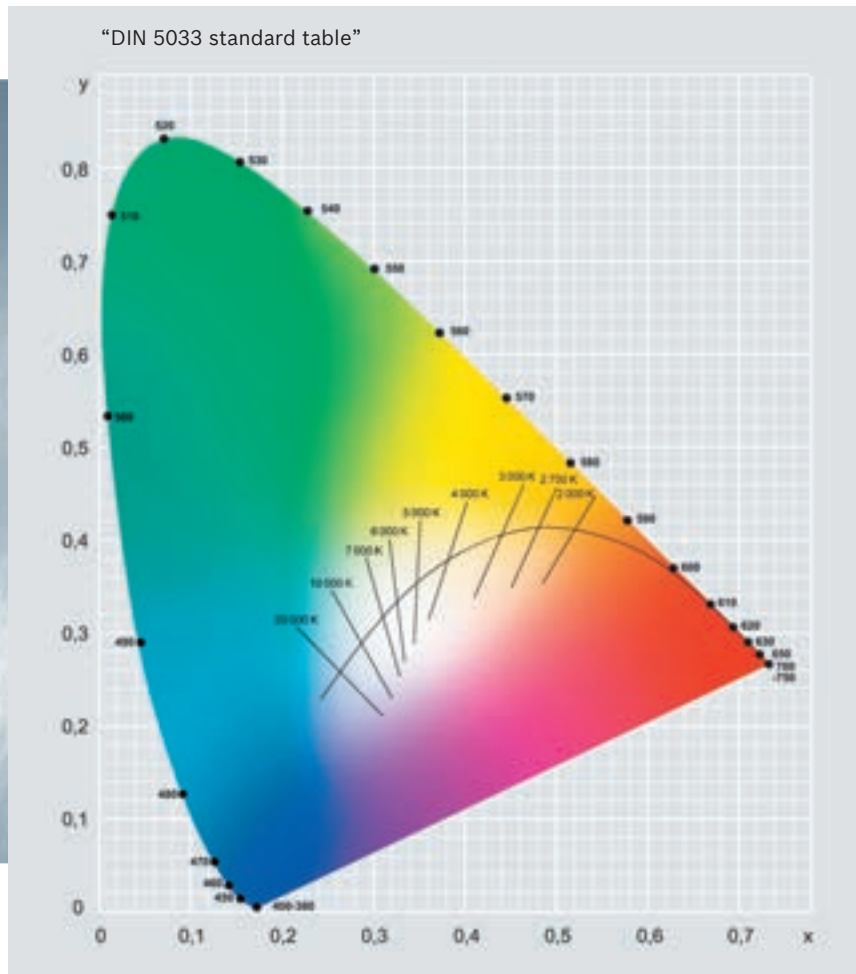

Below, we outline some of the basic principles of lighting technology, the “tool” used to create light.

Light

Light is propagated in the form of an electromagnetic wave. The human eye can only recognize a limited range (wavelength 380 to 780 nm) of these waves as light beams. The wavelength of the radiation determines the color of the light, from violet (380 nm) to red (780 nm) with the intermediate colors blue, green, yellow and orange, as can be seen in a rainbow.

Luminous flux

Luminous flux is the term used for the total radiant power emitted by the light source in the wavelength range of visible light, irrespective of the emission direction.
Unit: Lumen [lm].

Illumination

The illumination is the amount of light that is beamed in a particular spatial direction. It is made up of the ratio of the luminous-flux component and the associated solid-angle component.
Unit: Candela [cd].

Luminance

The luminance of a light source or an illuminated surface is a measure of the “apparent brightness”. It is the luminous flux relative to a particular surface area. The human eye perceives differences in luminance as differences in brightness. The brightness of a candle is approximately 1 cd (Candela). Automotive bulbs are in the magnitude of 10 cd for tail lamps, 100 cd for stop lamps, 200 cd for fog warning lamps and more than 200,000 cd for headlamps.
Unit: Candela per square meter [cd/m²].

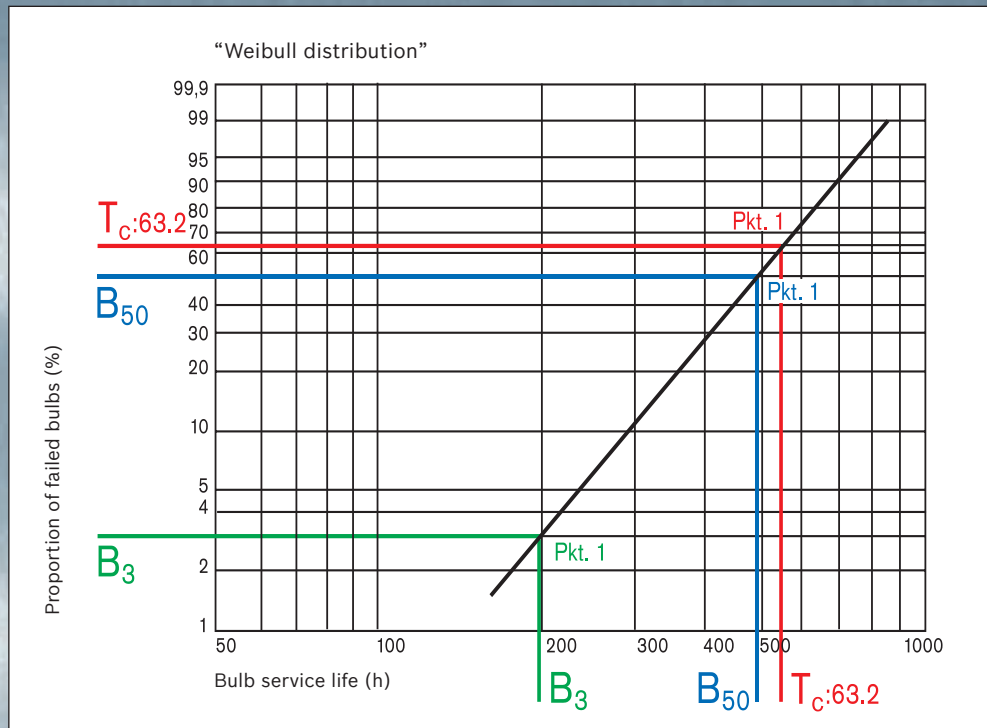

Luminous efficiency

Luminous efficiency is a measure of the efficiency of the process of converting electrical energy into light energy. The luminous efficiency of a halogen bulb is approx. 22–30 lm/W (efficiency below 10%), while that of a gas-discharge bulb is approx. 90 lm/W.

Unit: Lumens per watt [lm/W].

Color temperature

The color temperature specifies the shade of a light source (see Fig. DIN 5033 standard color table). The reference object used is a black solid, which glows in different light colors as heating increases. The emitted light changes from red to yellow and white through to blue. For example, a bulb with warm white light has a color temperature of approx. 2,700 Kelvin, a gas-discharge bulb with light similar to daylight approx. 4,000 Kelvin.

Unit: Kelvin [K].

Service life

The Weibull distribution has become established as the standard for analyzing the service life of technical products. This shows the failure rate in % over the entire service life of the bulb.

B₃ value: Represents the early-failure rate of bulbs. 3% of all bulbs tested had failed at this burning time.

T_c value: Represents the characteristic failure rate of 63.2% of bulbs.

B₅₀ value: Reflects the mean service life of the bulbs. The failure rate is 50%.

The Bosch automotive bulbs range



The right vehicle lamp for every application!

- ▶ A wide variety: Suitable for more than 98% of all vehicles in Europe.
- ▶ Workshop and self-service ranges: Two tailor-made product groups to achieve optimum sales results through all distribution channels
- ▶ Wide choice of product lines concentrating on different areas: The right bulb for every application.
- ▶ Bulb range for 6 V / 12 V / 24 V electrical system voltage

Xenon



Xenon

High luminous efficiency, better visibility, lower energy consumption and longer service life – all possible thanks to the modern technology in gas-discharge bulbs.

Halogen 12 V



Pure Light

The standard complete range in OEM quality with all standard bulbs for headlamps and other lamps (12 V and 6 V versions).

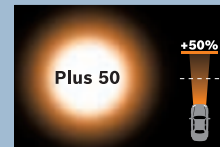

Plus 50

Up to 50% more light on the road* and up to 20 m longer range. For increased safety on the road.

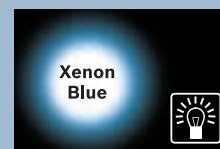

Xenon Blue

Blue/white light color, full-strength cool light over entire service life. Xenon look for halogen headlamps.

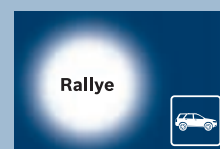

Rallye

Special high-performance bulbs for halogen headlamps. These bulbs are not approved for use on public roads. Only for use on roads not subject to road-traffic regulations.

**Longlife Daytime**

Up to 3 times longer service life and up to 10% more light*. Also ideal as daytime driving-light thanks to long-life technology.

**Plus 30**

Up to 30% more light*. For added safety and better road illumination.

Halogen 24 V**Trucklight**

Full 24 V range for commercial vehicles to original equipment standard.

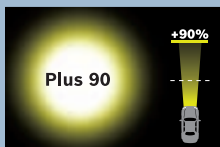
**Plus 90**

Up to 90% greater illumination of the road* with white light color. Safe and relaxed, stress-free driving.

**Gigalight Plus 120**

The bright halogen car lamp:
Up to 120% more illumination on the road*. Maximum safety and visibility even during long journeys and in all weather conditions.

**Trucklight Maxlife**

The combination of high resistance to vibration and a long service life helps to keep commercial vehicle downtimes to a minimum. Particularly suitable for regular long-distance driving or demanding road conditions.

**Xenon Silver**

White light similar to daylight, plus up to 50% more light on the road*. See and be seen more clearly and over a longer distance. For halogen headlamps.

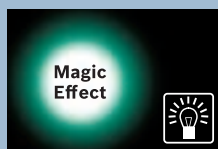
**Magic Effect**

Thanks to the special coating, the Magic Effect turn-signal bulb is practically colorless when switched off. It only turns orange when switched on. This bulb is ideal for clear-lens headlamps, and in comparison to standard turn-signal bulbs features twice the service life



* Compared to standard halogen bulbs

The new Bosch packaging and product properties



The new Bosch packaging

- ▶ attractive sales-enhancing design
- ▶ the globally recognizable Bosch packaging represents
- ▶ a multiple-line approach for different specifications to address the customer's specific needs

Blue packaging

- ▶ Main line
- ▶ high performance for quality-conscious customers

Black packaging

- ▶ Upgrade line
- ▶ Top-class performance to match all customer's needs and demands



The right lamp for all needs

	 Pure Light	 Longlife Daytime	 Plus 30	 Rallye	 Magic Effect
Service life	★ ★ ★	★ ★ ★ ★ ★	★ ★ ★	★ ★ ★	★ ★ ★ ★
Headlamp range	★ ★ ★	★ ★ ★	★ ★ ★ ★	★ ★ ★ ★ ★	★ ★ ★
Brightness	★ ★ ★	★ ★ ★	★ ★ ★	★ ★ ★ ★ ★	★ ★ ★ ★ ★
	 Xenon Blue	 Xenon Silver	 Plus 50	 Plus 90	 Gigalight Plus 120
Service life	★ ★ ★	★ ★	★ ★	★ ★	★ ★
Headlamp range	★ ★ ★	★ ★ ★ ★	★ ★ ★ ★	★ ★ ★ ★ ★	★ ★ ★ ★ ★
Brightness	★ ★ ★ ★	★ ★ ★ ★ ★	★ ★ ★ ★	★ ★ ★ ★	★ ★ ★ ★ ★

Bulb packaging

The right packaging for all needs:

Self-explanatory, attractive packaging for customer use.



Product line	Service center	Blister	Double pack	Individual pack	Use	Miscellaneous
Gigalight Plus 120 ¹⁾	●	●	●	●		Ready Shelf Display
Plus 90 ¹⁾	●	●	●	●		
Plus 50 ¹⁾	●	●		●		
Xenon Silver ¹⁾		●	●			
Xenon Blue ¹⁾	●	●				
Magic Effect ¹⁾		●				
Pure Light ¹⁾	●	●	●			PCB-Box ³⁾ Ready Shelf Display
Longlife Daytime ¹⁾	●	●				
Rallye ¹⁾	●					
Trucklight Maxlife ¹⁾	●					
Trucklight ¹⁾	●					PCB-Box ³⁾
Xenon HID ²⁾	●					

● Black packaging line – peak performance: the most powerful product to meet customer demands.

● Blue packaging line – high performance: for quality-conscious customers

¹⁾ Halogen lamp

²⁾ Xenon lamp

³⁾ Miniature lamp box for the workshop

Workshop packaging



New Bosch workshop packaging offers you a range of benefits

- ▶ Boxed packaging, practical and stackable
- ▶ All important information clearly visible at a glance
- ▶ Pack of 1 for headlamp bulbs and pack of 10 for auxiliary lamp bulbs

The complete workshop packaging range

- ▶ 6 V bulbs for older vehicles and special applications
- ▶ 12 V bulbs for all current vehicle types. Impressive product range: Pure Light, Plus 30, Plus 50, Plus 90, Gigalight Plus 120, Xenon Blue, Xenon Silver, Longlife Daytime, Rallye
- ▶ 24 V bulbs for tough applications in commercial vehicles: Trucklight, Trucklight Maxlife
- ▶ Gas-discharge lamps

“Informative” order-number system

All Bosch workshop bulbs start with the same seven digits: 1 987 302 xxx.

Number of bulbs you order using the part number

- Each part number corresponds to 1 workshop pack.
- ▶ Workshop pack with 1 bulb: Part number corresponds to 1 workshop pack with 1 bulb
 - ▶ Workshop pack with 10 bulbs: Part number corresponds to 1 bulb (1 workshop pack contains 10 bulbs)



Product line and important technical data are also displayed on packaging. Product data is clearly visible both horizontally and vertically.

Lamp type drawing and socket specification for easy identification

Overview relevant information: Homologation and competitor numbers

Part number and EAN code at a glance

Additional information on installation, applications and material properties

Safety symbols on the packaging flaps

Emphasis of the Bosch brand – the brand for optimum quality, competence and innovation

Product line and quantities

Easy and quick guide: The most important technical data is clearly highlighted on the front in a circular white space.

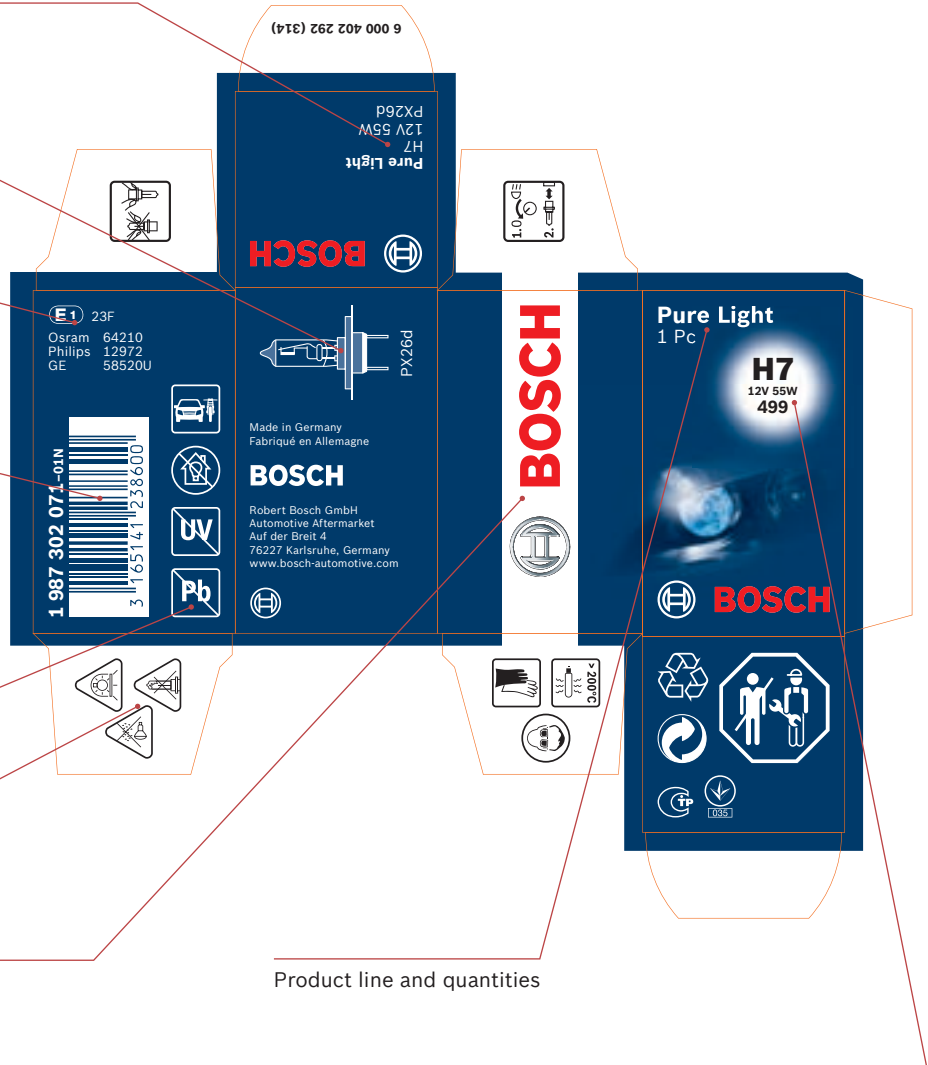

Blister packaging



High-turnover bulbs focused on the end customer in the self-service range

- ▶ 12 V bulbs for all current vehicle types
- ▶ Product range that is aimed at end customers: Pure Light, Plus 30, Plus 50, Plus 90, Gigalight Plus 120, Xenon Blue, Xenon Silver, Longlife Daytime, Magic Effect

New Bosch blister packs: Attractive and impressive

- ▶ High-quality, appealing packaging
- ▶ Clear instructions at point of sale using multi-line concept and self explanatory icons
- ▶ High-quality material
- ▶ Dynamic, expressive motif
- ▶ Bulb is visible under firm plastic cover
- ▶ All important information clearly visible at a glance and easy to read
- ▶ Product description in 11 languages
- ▶ Environmentally compatible, easy-to-separate two-material packaging
- ▶ Technical specification as customer search number (low risk of incorrect purchases)

“Informative” order number system

All self-service bulbs, Miniboxes and Maxiboxes start with the same seven digits: 1 987 301 xxx.

Number of bulbs you order using the part number

- Each part number corresponds to 1 blister pack.
- ▶ Blister pack with 1 bulb: Part number corresponds to 1 blister pack with 1 bulb
 - ▶ Blister pack with 2 bulbs: Part number corresponds to 1 blister pack with 2 bulbs



Name of product line and important product data



Attractive color coding for each product line

The most important technical data easily identifiable in the white space: Type of lamp, volts, watts, UK short code

Modern, appealing design

White stripe with Bosch logo as unmistakable hallmark of premium Bosch quality

Name of product line and important technical data



GTÜ quality symbol (independent German testing institute)

Drawing of the lamp type with socket specification and illustration of the purpose/ installation location of the lamp

Explanation of bulb characteristics and added value in 11 languages

Part number and EAN code

Overview area with additional information: Safety symbols, purpose, Material properties,...

Special packaging



„Double and individual pack“ with viewing window:

attractive to retail customers.

The Bosch double pack is available for lamps with high sales-volume, since lamps should always be replaced in pairs.

Attractive individual packs have been newly introduced for selected product lines.



Advantages

- ▶ High-quality, appealing packaging
- ▶ High-quality material
- ▶ Dynamic, expressive design
- ▶ Bulbs are visible thanks to transparent plastic-film window
- ▶ All important information clearly visible at a glance and easy to read
- ▶ Product description in 11 languages
- ▶ Environmentally compatible, easy-to-separate two-material packaging
- ▶ For the Pure Light and Gigalight Plus 120, retail packing is also available with an attractive counter display for better visibility at the POS
- ▶ The boxes of two are suitable for standing or hanging, making them equally interesting for workshops and large-scale retail displays

Automotive bulb kits: Everything you need

With a choice of the small and handy Mini-box, or the Maxibox containing almost all types of replacement car bulbs, drivers can always feel safe. Whenever a bulb fails, it can be replaced right away. In some countries, carrying a replacement set of bulbs is a legal requirement.

“Informative” order-number system

All self-service bulbs, Miniboxes and Maxiboxes start with the same seven digits: 1 987 301 xxx.

Number of bulbs you order using the part number

Each part number corresponds to 1 pack.

- ▶ Box of two: Part number corresponds to 1 box of two with 2 bulbs
- ▶ Individual pack: Part number corresponds to 1 individual pack with 1 lamp
- ▶ Minibox and Maxibox: Part number corresponds to 1 box with all the bulbs it contains



LED retrofit lamps

The new highlight from Bosch: LED retrofits for interior lighting

- ▶ Extremely powerful
- ▶ Stylish and modern
- ▶ Energy efficient
- ▶ Very long service life



LED retrofit lamps:

Improved style for car and driver

Bosch LED lamps provide modern and elegant lighting. The color temperature is considerably different compared to halogen lamps, due to the high Kelvin number.

Due to this, LED lamps achieve lighting effects ranging from bright white to blue Xenon look. Ideal for car drivers who want to travel in a modern and stylish manner.

High efficiency:

LED lamps are not only very powerful but also very energy efficient and economical. Despite considerably higher light intensity compared to standard interior lighting, LED lamps consume considerably less energy, and have an exceptionally long life.

High light output:

Bosch LED retrofits illuminate the interior of the vehicle. The LED provides an exceptional light output giving a prestige effect.

		ECE	$\frac{U}{V}$	$\frac{P}{W}$	
--	--	------------	---------------	---------------	--

LED retrofit lamps

-	1 987 301 501	C5W*	12 V	1 W	SV8,5-8
-	1 987 301 505	W5W*	12 V	1 W	W2,1x9,5d

*Area of application: Interior lighting

Gas-discharge lamps

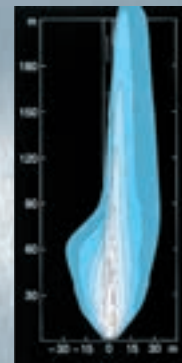
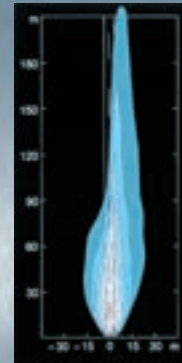
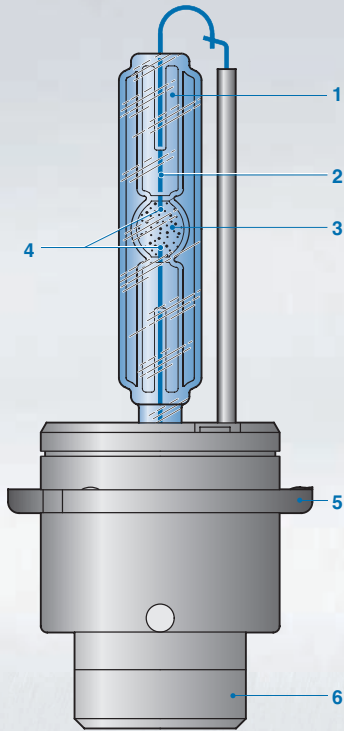

Gas-discharge lamps generate light using an arc

The glass bulb is filled with the noble gas Xenon and a mixture of metal halides. The very high voltage causes the gas to ionize between the electrodes and it begins to glow. Complete ionization of the particles normally takes several seconds. To achieve the full brightness immediately when starting, an electric ballast unit supplies an increased “starting current” to accelerate the particle ionization. Once the full light output is reached, the bulb current is restricted.

Better visibility

Gas-discharge lamps generate 2.5x more light than conventional bulbs. Because of this increased light emission, they also illuminate those parts of the road that cannot be lit by halogen bulbs. The light is so bright that it is comparable to genuine daylight. This means that the driver can see road markings and signs much earlier, while the Xenon light is very comfortable for the eyes.

Reduced energy consumption

Thanks to their lower energy consumption (35 W instead of 55 W), less fuel is required than for conventional bulbs. This benefits the environment and is something you will notice at the gas station.

Longer service life

Modern gas discharge lamp technology provides the longest possible service life. Gas discharge lamps do not require a filament, thus making them more durable and reliable.

- 1 UV inert-gas bulb
- 2 Electrical penetration
- 3 Discharge chamber
- 4 Electrodes
- 5 Lamp base
- 6 Electrical lead-through

D2S = Gas-discharge lamp (arc)
 H7 = Halogen lamp (filament)

Xenon

Gas-discharge bulbs generate light as bright as daylight using an arc

- ▶ Extremely good visibility due to high light yield
- ▶ Lower energy consumption than with conventional bulbs, benefits both the environment and your pocket
- ▶ Long service life – often the entire service life of a vehicle
- ▶ For both cars and commercial vehicles



ECE

 $\frac{U}{V}$
 $\frac{P}{W}$

Xenon

1 987 302 903	–	D2R	–	35 W	P32d-3
1 987 302 904	–	D2S	–	35 W	P32d-2
1 987 302 905	–	D1S	–	35 W	PK32d-2
1 987 302 906	–	D4S	–	35 W	P32d-5
1 987 302 907	–	D3S	–	35 W	PK32d-5

Pure Light



Standard automotive bulbs in OEM quality

- ▶ 12 V bulbs for all current headlamps and lights
- ▶ Full range for all lighting in and around the vehicle
- ▶ 6 V bulbs for older vehicles and special applications



ECE

 $\frac{U}{V}$
 $\frac{P}{W}$

Pure Light

1 987 302 011	1 987 301 005	H1	12 V	55 W	P14,5s
1 987 302 021	1 987 301 021	R2 Halogen	12 V	45/40 W	P45t
1 987 302 023	–	R2	12 V	45/40 W	P45t
1 987 302 024	–	H27W/1 (880)	12 V	27 W	PG13
1 987 302 026	–	HIR2 (9012)	12 V	55 W	PX22d
1 987 302 031	1 987 301 006	H3	12 V	55 W	PK22s
1 987 302 041	1 987 301 001	H4	12 V	60/55 W	P43t
1 987 302 071	1 987 301 012	H7	12 V	55 W	PX26d
1 987 302 081	–	H8	12 V	35 W	PGJ19-1
1 987 302 082	–	H9	12 V	65 W	PGJ19-5
1 987 302 083	–	H10	12 V	42 W	PY20d
1 987 302 084	–	H11	12 V	55 W	PGJ19-2
1 987 302 104	–	HS1	12 V	35/35 W	PX43t
1 987 302 105	–	S2	12 V	35/35 W	BA20d
1 987 302 106	–	S1	12 V	25/25 W	BA20d
1 987 302 152	1 987 301 062	HB3	12 V	60 W	P20d
1 987 302 153	1 987 301 063	HB4	12 V	51 W	P22d
1 987 302 201	1 987 301 017	P21W	12 V	21 W	BA15s
1 987 302 202	1 987 301 016	P21/5W	12 V	21/5 W	BAY15d
1 987 302 203	1 987 301 019	R10W	12 V	10 W	BA15s
1 987 302 204	1 987 301 022	R5W	12 V	5 W	BA15s
1 987 302 205	1 987 301 049	W16W	12 V	16 W	W2,1x9,5d
1 987 302 206	1 987 301 026	W5W	12 V	5 W	W2,1x9,5d
1 987 302 207	1 987 301 023	T4W	12 V	4 W	BA9s
1 987 302 208	1 987 301 024	–	12 V	1,2 W	W2x4,6d
1 987 302 210	1 987 301 014	–	12 V	10 W	SV8,5-8
1 987 302 211	1 987 301 004	C5W	12 V	5 W	SV8,5-8
1 987 302 212	–	–	12 V	2 W	BA9s
1 987 302 213	1 987 301 018	PY21W	12 V	21 W	BAU15s
1 987 302 214	–	–	12 V	18 W	BA15s
1 987 302 215	1 987 301 015	P21/4W	12 V	21/4 W	BAZ15d
1 987 302 217	1 987 301 028	W3W	12 V	3 W	W2,1x9,5d
1 987 302 218	–	–	12 V	2 W	W2x4,6d

		ECE	$\frac{U}{V}$	$\frac{P}{W}$	
---	---	-----	---------------	---------------	---

Pure Light

1 987 302 219	-	-	12 V	1,2 W	B8,5d
1 987 302 222	-	WY21W	12 V	21 W	W3x16d
1 987 302 223	-	-	12 V	2 W	W2,1x9,5d
1 987 302 224	-	-	12 V	2 W	BA7s
1 987 302 225	-	-	12 V	5 W	SV8,5-8
1 987 302 226	-	-	12 V	3 W	SV7-8
1 987 302 227	-	-	12 V	10 W	SV8,5-8
1 987 302 228	-	-	12 V	10 W	SV8 5-8
1 987 302 229	-	-	12 V	18 W	SV8,5-8
1 987 302 230	-	C21W	12 V	21 W	SV8,5-8
1 987 302 231	-	-	12 V	5 W	BA9s
1 987 302 232	1 987 301 035	H6W	12 V	6 W	BAX9s
1 987 302 233	-	-	12 V	10 W	BA9s
1 987 302 235	-	-	12 V	1,2 W	BX8,4d
1 987 302 236	-	-	12 V	2 W	BX8,4d
1 987 302 237	-	R5W	12 V	5 W	BA15d
1 987 302 238	-	-	12 V	15 W	SV8,5-8
1 987 302 239	-	21W amber	12 V	21 W	BA15s
1 987 302 240	-	W2,3W	12 V	2,3 W	W2x4,6d
1 987 302 241	-	WY5W	12 V	5 W	W2,1x9,5d
1 987 302 243	-	-	12 V	1,1 W	BX8,4d
1 987 302 249	-	-	12 V	21 W	W2,1x9,5d
1 987 302 251	-	W21W	12 V	21 W	W3x16d
1 987 302 252	1 987 301 079	W21/5W	12 V	21/5 W	W3x16q
1 987 302 255	-	-	12 V	1,5 W	BX8,4d
1 987 302 261	-	P21W	12 V	21 W	BA15d
1 987 302 262	-	21W red	12 V	21 W	BA15s
1 987 302 263	-	-	12 V	24 W	BA15d
1 987 302 264	-	H21W	12 V	21 W	BAY9s
1 987 302 265	-	P13W	12 V	13 W	PG18,5d-1
1 987 302 266	-	PS19W	12 V	19 W	PG20-1
1 987 302 267	-	PSY24W	12 V	24 W	PG20-4
1 987 302 603	-	T4W	6 V	4 W	BA9s
1 987 302 604	-	R10W	6 V	10 W	BA15s
1 987 302 605	-	R5W	6 V	5 W	BA15s
1 987 302 606	-	S3	6 V	15 W	P26s
1 987 302 607	-	P21W	6 V	21 W	BA15s
1 987 302 612	-	-	6 V	10 W	SV8,5-8

Pure Light in box of two

-	1 987 301 404	H1	12 V	55 W	P14,5s
-	1 987 301 405	H4	12 V	60/55 W	P43t
-	1 987 301 406	H7	12 V	55 W	PX26d

New



Plus 30 and Plus 50



Better visibility thanks to 50% more light*

- ▶ Improved illumination and orientation
- ▶ Increased safety
- ▶ Significant gains in driving safety and enjoyment
- ▶ Hazards, obstructions and road markings can be seen more quickly



		ECE	$\frac{U}{V}$	$\frac{P}{W}$	
--	--	-----	---------------	---------------	--

Plus 30

1 987 302 012	1 987 301 003	H1	12 V	55 W	P14,5s
1 987 302 042	1 987 301 002	H4	12 V	60/55 W	P43t

Plus 50

1 987 302 019	1 987 301 041	H1	12 V	55 W	P14,5s
1 987 302 049	1 987 301 040	H4	12 V	60/55 W	P43t
1 987 302 079	1 987 301 042	H7	12 V	55 W	PX26d

Plus 50 in individual pack

-	1 987 301 840	H1	12 V	55 W	P14,5s
-	1 987 301 850	H4	12 V	60/55 W	P43t
-	1 987 301 860	H7	12 V	55 W	PX26d



* Compared to standard halogen bulbs

Plus 90

Vehicle lamps with intense brightness:

- ▶ Up to 90% greater illumination of the road* for maximum driving safety
- ▶ Intense white light* for easy, relaxed and less tiring vision even on long journeys
- ▶ Better visibility whatever the weather, particularly at night
- ▶ Longer light beam provides a greater range of vision, giving you more time to react
- ▶ Exclusive design featuring silver top (H4 and H7) and blue sectors



ECE

 $\frac{U}{V}$
 $\frac{P}{W}$

Plus 90

1 987 302 114	1 987 301 076	H1	12 V	55 W	P14,5s
1 987 302 144	1 987 301 077	H4	12 V	60/55 W	P43t
1 987 302 174	1 987 301 078	H7	12 V	55 W	PX26d

Plus 90 in individual pack

-	1 987 301 730	H1	12 V	55 W	P14,5s
-	1 987 301 740	H4	12 V	60/55 W	P43t
-	1 987 301 750	H7	12 V	55 W	PX26d

Plus 90 in box of two

-	1 987 301 073	H1	12 V	55 W	P14,5s
-	1 987 301 074	H4	12 V	60/55 W	P43t
-	1 987 301 075	H7	12 V	55 W	PX26d

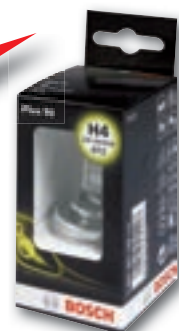
New

* Compared to standard halogen bulbs

Gigalight Plus 120



- ① **120 % more light ***
due to the use of xenon gas
- ② **Excellent light performance**
thanks to optimized filament size
- ③ **Extremely white light**
due to blue special coating
- ④ **Modern look**
thanks to noble silver top
- ⑤ **Reduced risk of accidents**
due to increased light intensity



Visibly safer:

- ▶ Up to 120 % more light on the road *
- ▶ Brightest bulb for headlamps within the Bosch range
- ▶ Reduced risk of accidents due to increased light intensity



Seeing and being seen is always crucial for survival in road traffic – at all seasons. Innovative Bosch automotive bulbs such as the automotive halogen bulb Gigalight Plus 120 increase the visual range thanks to an increased light beam. In this manner, they provide increased safety both for you and for other road users.

The Gigalight Plus 120 automotive halogen bulb provides up to 120 % more light on the road than standard halogen bulbs. This results in a longer light beam of the headlamp – and in an increased visual range. Potential hazards can be recognized earlier – even in case of bad weather conditions. This gives you more time to react. In addition, improved visibility also leads to more relaxed driving. Have a good journey!

* in comparison with standard halogen bulbs

Power lamps for highest brightness



		ECE	$\frac{U}{V}$	$\frac{P}{W}$	
Gigalight Plus 120					
1 987 302 110	1 987 301 108	H1	12 V	55 W	P14,5s
1 987 302 140	1 987 301 109	H4	12 V	60/55 W	P43t
1 987 302 170	1 987 301 110	H7	12 V	55 W	PX26d
Gigalight Plus 120 in individual pack					
-	1 987 301 150	H1	12 V	55 W	P14,5s
-	1 987 301 160	H4	12 V	60/55 W	P43t
-	1 987 301 170	H7	12 V	55 W	PX26d
Gigalight Plus 120 in box of two					
-	1 987 301 105	H1	12 V	55 W	P14,5s
-	1 987 301 106	H4	12 V	60/55 W	P43t
-	1 987 301 107	H7	12 V	55 W	PX26d

Xenon Blue



Blue/white light color, full-strength cool light over entire service life

- ▶ Stylish appearance
- ▶ Powerful bluish-white light similar to xenon light, for halogen headlamps
- ▶ Better reflection of road signs and markings, obstructions (pedestrians, cyclists, animals, etc.) are seen sooner and more clearly
- ▶ More comfortable for the eyes than light from conventional halogen headlamps



ECE

$\frac{U}{V}$

$\frac{P}{W}$



Xenon Blue

1 987 302 015	1 987 301 011	H1	12 V	55 W	P14,5s
1 987 302 035	1 987 301 007	H3	12 V	55 W	PK22s
1 987 302 045	1 987 301 010	H4	12 V	60/55 W	P43t
1 987 302 075	1 987 301 013	H7	12 V	55 W	PX26d
1 987 302 154		HB3	12 V	60 W	P20d
1 987 302 155		HB4	12 V	51 W	P22d
	1 987 301 034	T4W	12 V	4 W	BA9s
	1 987 301 033	W5W	12 V	5 W	W2,1x9,5d

Xenon Silver

Ahead of its time with extremely white halogen light

Added light and brightness:

- ▶ White light, similar to daylight
- ▶ Up to 50% greater illumination of the road*
- ▶ Premium Design



ECE

 $\frac{U}{V}$
 $\frac{P}{W}$

Xenon Silver

-	1 987 301 067	H1	12 V	55 W	P14,5s
-	1 987 301 068	H4	12 V	60/55 W	P43t
-	1 987 301 069	H7	12 V	55 W	PX26d

Xenon Silver in box of two

-	1 987 301 080	H1	12 V	55 W	P14,5s
-	1 987 301 081	H4	12 V	60/55 W	P43t
-	1 987 301 087	H7	12 V	55 W	PX26d

Magic Effect

-	1 987 301 025	PY21W	12 V	21 W	BAU15s
---	----------------------	-------	------	------	--------

Magic Effect

Only lights up orange when turned on

- ▶ Magic Effect: Thanks to a special coating, the Magic Effect turn-signal lamp appears almost colorless when off and only turns orange when it is switched on. Ideal for clear-glass headlamps.
- ▶ It also has twice the service life of standard turn-signal bulbs.



* Compared to standard halogen bulbs

Longlife Daytime



The bulb with stamina

- ▶ Up to three times the service life*
- ▶ Up to 10% more light* (H1, H3, H4, H7)
- ▶ Ideal for high-mileage drivers
- ▶ Ideal for drivers who drive with lights during the day

Note: The daytime driving-light regulations differ greatly among European countries. Please ensure that you observe the applicable legal regulations.



		ECE	$\frac{U}{V}$	$\frac{P}{W}$	
--	--	------------	---------------	---------------	--

Longlife Daytime

1 987 302 281	1 987 301 060	C5W	12 V	5 W	SV8,5-8
1 987 302 018	1 987 301 051	H1	12 V	55 W	P14,5s
1 987 302 038	1 987 301 053	H3	12 V	55 W	PK22s
1 987 302 048	1 987 301 054	H4	12 V	60/55 W	P43t
-	1 987 301 061	H6W	12 V	6 W	BAX9s
1 987 302 078	1 987 301 057	H7	12 V	55 W	PX26d
1 987 302 085	1 987 301 340	H11	12 V	55 W	PGJ19-2
1 987 302 282	1 987 301 055	P21/5W	12 V	21/5 W	BAY15d
1 987 302 280	1 987 301 050	P21W	12 V	21 W	BA15s
-	1 987 301 059	R10W	12 V	10 W	BA15s
1 987 302 284	1 987 301 058	R5W	12 V	5 W	BA15s
1 987 302 287	1 987 301 056	T4W	12 V	4 W	BA9s
1 987 302 286	1 987 301 052	W5W	12 V	5 W	W2,1x9,5d

* Compared to standard halogen bulbs

Rallye

Bulbs without ECE approval for off-road use

- ▶ Exceptionally light output for extremely tough applications, e.g. in agriculture and forestry, off-road competitions and racing, etc.
- ▶ Only for use where road-traffic regulations do not apply, use on public roads is not permitted



ECE

 $\frac{U}{V}$
 $\frac{P}{W}$

Rallye

1 987 302 016	–	H1*	12 V	100 W ¹⁾	P14,5s
1 987 302 036	–	H3*	12 V	100 W ¹⁾	PK22s
1 987 302 046	–	H4*	12 V	100/80 W ¹⁾	P43t

* Not allowed on public roads

¹⁾ Not allowed in the scope of ECE



Bosch technology:

The tungsten filament has an optimized material structure thanks to high-temperature treatment

Enhanced filler gas composition and higher filler gas pressure

Greater filament stability

Area of application: Commercial vehicles

No doubt about it: Commercial vehicles need particularly powerful lights. Bosch supply a comprehensive range of 24 V automotive bulbs. Two product lines cover all requirements and areas of application.

Bosch Trucklight

High-grade materials and precision manufacturing guarantee consistent quality and maximum reliability – bulb for bulb. In contrast to 12 V halogen bulbs, 24 V truck bulbs have a doubly wound filament for optimum adaptation to commercial vehicle requirements. Automotive bulbs from Bosch are constantly checked under realistic conditions. This ensures that Bosch Trucklight bulbs fully conform to original equipment standards. The comprehensive Bosch Trucklight range has just the right bulb for practically every application.

Bosch Trucklight Maxlife

Bosch have always been pioneers in the field of vehicle lighting technology. The Trucklight Maxlife range from Bosch is a good example of the continuous quality enhancement and development process. A long service life and robust design make Trucklight Maxlife from Bosch the professionals' choice of automotive bulb for all sorts of requirements: It is just as ideal for the everyday long motorway journeys of trucks and buses as it is for all commercial vehicles facing the toughest conditions in off-road use.

The Trucklight Maxlife range combines all the essential features for satisfying the most exacting demands:

- Long service life
- Reliability
- High light efficiency
- Robust construction

The special design, high-grade materials, excellent workmanship and stringent quality controls all form the basis for this.

Comprehensive range of 24 V bulbs for commercial vehicles

The Trucklight range from Bosch is available for practically all types of commercial vehicle and covers all requirements and areas of application.

Trucklight:

- ▶ Top quality and reliability – conforming to original equipment standards

Trucklight Maxlife:

- ▶ Durable and robust for off-road and motorway driving – reliable lighting even under the most challenging usage and road conditions
- ▶ Outstanding shock and vibration resistance for a long service life and greater economy



ECE

 $\frac{U}{V}$
 $\frac{P}{W}$

ECE

 $\frac{U}{V}$
 $\frac{P}{W}$

Trucklight

1 987 302 411	H1	24 V	70 W	P14,5s
1 987 302 421	R2	24 V	55/50 W	P45t
1 987 302 431	H3	24 V	70 W	PK22s
1 987 302 441	H4	24 V	75/70 W	P43t
1 987 302 471	H7	24 V	70 W	PX26d
1 987 302 481	H11	24 V	70 W	PGJ19-2
1 987 302 501	P21W	24 V	21 W	BA15s
1 987 302 504	–	24 V	1,2 W	W2x4,6d
1 987 302 505	R10W	24 V	10 W	BA15s
1 987 302 507	C5W	24 V	5 W	SV8,5-8
1 987 302 508	–	24 V	2 W	BA9s
1 987 302 510	R5W	24 V	5 W	BA15s
1 987 302 527	R5W	24 V	5 W	BA15d
1 987 302 512	T4W	24 V	4 W	BA9s
1 987 302 514	–	24 V	1,2 W	B8,5d
1 987 302 515	–	24 V	1,2 W	B8,3d
1 987 302 516	–	24 V	2 W	W2,1x9,5d
1 987 302 517	W3W	24 V	3 W	W2,1x9,5d
1 987 302 518	W5W	24 V	5 W	W2,1x9,5d
1 987 302 519	–	24 V	3 W	BA7s
1 987 302 520	–	24 V	5 W	SV8,5-8
1 987 302 521	–	24 V	10 W	SV8,5-8
1 987 302 523	–	24 V	18 W	BA15s
1 987 302 524	P21/5W	24 V	21/5 W	BAY15d
1 987 302 526	–	24 V	15 W	BA15s
1 987 302 528	–	24 V	3 W	SV7-8

Trucklight

1 987 302 532	P21W	24 V	21 W	BA15d
1 987 302 533	H21W	24 V	21 W	BAY9s
1 987 302 535	–	28 V	7 W	BA15s

Trucklight Maxlife

1 987 302 701	P21W	24 V	21 W	BA15s
1 987 302 702	P21W	24 V	21 W	BA15d
1 987 302 703	PY21W	24 V	21 W	BAU15s
1 987 302 704	R5W	24 V	5 W	BA15s
1 987 302 705	R5W	24 V	5 W	BA15d
1 987 302 706	R10W	24 V	10 W	BA15s
1 987 302 707	T4W	24 V	4 W	BA9s
1 987 302 712	H1	24 V	70 W	P14,5s
1 987 302 732	H3	24 V	70 W	PK22s
1 987 302 742	H4	24 V	75/70 W	P43t
1 987 302 772	H7	24 V	70 W	PX26d

Automotive bulb kits *

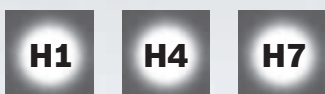

Minibox – small and handy, ideal for the glove compartment

Size (H x W x D) 112x63x52 mm

Includes bulbs for

- ▶ Headlamp
- ▶ Side-marker lamp
- ▶ Tail lamp
- ▶ Stop lamp / turn-signal lamp
- ▶ 3 fuses

Minibox contents

- ▶ H1, H4 or H7
- ▶ P21W, R5W, T4W
- ▶ 3 fuses
(1 x 10A, 1 x 15A, 1 x 20A)

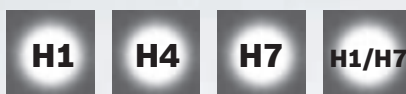

Maxibox – emergency spares for almost all automotive bulbs

Size (H x W x D) 113x90x53 mm

Includes bulbs for

- ▶ Headlamp
- ▶ Side-marker lamp
- ▶ Tail lamp
- ▶ Stop lamp / turn-signal lamp
- ▶ Backup lamp
- ▶ Fog warning lamp
- ▶ License-plate lamp
- ▶ 4 fuses

Maxibox contents

- ▶ H1, H4, H7 or H1 and H7
- ▶ P21W, PY21W, R5W, T4W, P21/5W, W5W, C5W
- ▶ 4 fuses
(2 x 10A, 1 x 15A, 1 x 20A)



Comprehensive range of miniwatt bulbs for 12 V vehicles.



Comprehensive range of miniwatt bulbs for 24 V vehicles.



ECE

$\frac{U}{V}$



Automotive bulb kits (Minibox)

-	1 987 301 102	H1, ...	12 V
-	1 987 301 101	H4, ...	12 V
-	1 987 301 103	H7, ...	12 V

Automotive bulb kits (Maxibox)

-	1 987 301 112	H1, ...	12 V
-	1 987 301 111	H4, ...	12 V
-	1 987 301 113	H7, ...	12 V
-	1 987 301 120	H1/H7	12 V

PCB - Miniwatt bulbs for interior lighting

1 987 302 301	-	PCB	12 V
1 987 302 302	-	PCB	24 V

* Must be carried as a legal requirement in many European countries: Replacement bulbs – in the practical Bosch box set, along with standard replacement fuses.

Sales support



Attractive product presentation

Some of our sales support tools are given below:

Counter display for boxes of two

Additional selling points for Additional revenues through sales-friendly counter displays.

- ▶ Direct at the POS, where they will be seen by your customers
- ▶ Space-saving and attention-grabbing
- ▶ Product-specific displays: Plus 90 and Gigalight Plus 120. Other models upon request
- ▶ Contents: 10 double packs

Gigalight Plus 120	H4	1 987 301 124
Gigalight Plus 120	H7	1 987 301 125
Pure Light	H4	1 987 301 127
Pure Light	H7	1 987 301 128



Also available upon request: LED posters, shelf hanger, desk pad etc.

Please contact your sales organization.



Bulb sales cabinet

For clearly laid out storage and presentation of workshop bulbs, we offer a cabinet with transparent doors.

An integrated portable tester makes it possible to check the proper operation of all automotive bulbs.

Size (HxWxD): 600x520x170 mm

 **1 987 301 202**

de

Scheinwerfer-
lampen

en

Headlamp
bulbs

fr

Lampes
pour projecteurs

it

Lampadine
per fari
principali

es

Lámparas
para faros



Fig.

ECE



$\frac{U}{V}$

$\frac{P}{W}$



D1

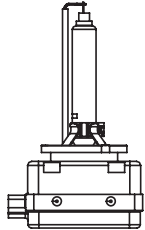

D1S	Xenon	-	35 W	PK32d-2	1 987 302 905

D2

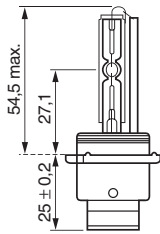

D2R	Xenon	-	35 W ¹⁾	P32d-3	1 987 302 903
D2S	Xenon	-	35 W ¹⁾	P32d-2	1 987 302 904

D3

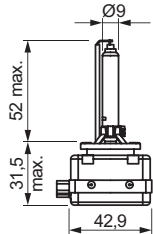

D3S	Xenon	-	35 W	PK32d-5	1 987 302 907

D4

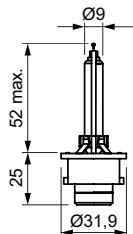

D4S	Xenon	-	35 W	P32d-5	1 987 302 906

Fig.

ECE

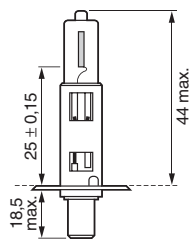

 $\frac{U}{V}$
 $\frac{P}{W}$

H1

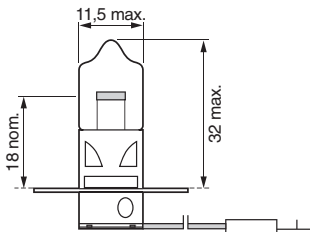

H1	Pure Light	12 V	55 W	P14,5s	1 987 302 011	1 987 301 005
H1	Longlife Daytime	12 V	55 W	P14,5s	1 987 302 018	1 987 301 051
H1	Gigalight Plus 120	12 V	55 W	P14,5s	1 987 302 110	1 987 301 108
H1	Gigalight Plus 120	12 V	55 W	P14,5s		1 987 301 150⁵⁾
H1	Gigalight Plus 120	12 V	55 W	P14,5s		1 987 301 105⁴⁾
H1	Plus 90	12 V	55 W	P14,5s	1 987 302 114	1 987 301 076
H1	Plus 90	12 V	55 W	P14,5s		1 987 301 073⁵⁾
H1	Plus 90	12 V	55 W	P14,5s		1 987 301 730⁴⁾
H1	Plus 50	12 V	55 W	P14,5s	1 987 302 019	1 987 301 041
H1	Plus 50	12 V	55 W	P14,5s		1 987 301 840⁴⁾
H1	Plus 30	12 V	55 W	P14,5s	1 987 302 012	1 987 301 003
H1	Xenon Silver	12 V	55 W	P14,5s		1 987 301 067
H1	Xenon Silver	12 V	55 W	P14,5s		1 987 301 080⁵⁾
H1	Xenon Blue	12 V	55 W	P14,5s	1 987 302 015	1 987 301 011
H1 ²⁾	Rallye	12 V	100 W ³⁾	P14,5s	1 987 302 016	
H1	Trucklight Maxlife	24 V	70 W	P14,5s	1 987 302 712	
H1	Trucklight	24 V	70 W	P14,5s	1 987 302 411	

H3



H3	Pure Light	12 V	55 W	PK22s	1 987 302 031	1 987 301 006
H3	Longlife Daytime	12 V	55 W	PK22s	1 987 302 038	1 987 301 053
H3	Xenon Blue	12 V	55 W	PK22s	1 987 302 035	1 987 301 007
H3 ¹⁾	Rallye	12 V	100 W ³⁾	PK22s	1 987 302 036	
H3	Trucklight Maxlife	24 V	70 W	PK22s	1 987 302 732	
H3	Trucklight	24 V	70 W	PK22s	1 987 302 431	

- ¹⁾ Betrieb nur mit geeignetem elektronischen Vorschaltgerät. / Operation only with suitable electronic ballast unit. / Utilisation uniquement avec module électronique de commande adéquat. / Funzionamento soltanto con l'apposito stabilizzatore elettronico. / Funciona solo con la unidad de control electrónica apropiada.
- ²⁾ Nicht im öffentlichen Straßenverkehr zulässig. / Not permitted where road traffic regulation applies. / N'est pas homologué par le Code de la Route. / Non ammesso in ambito di codice stradale. / No autorizada dentro del ámbito del código de circulación.
- ³⁾ Nicht im Geltungsbereich von ECE zulässig. / Not permitted where ECE applies. / N'est pas homologué par ECE. / Non ammesso in ambito di ECE. / No autorizada dentro del ámbito del ECE.
- ⁴⁾ Einzelschachtel – geeignet für SB und WS. / Individual pack – Suitable for workshop and self-service packagin. / Carton individuel – Pour emballage atelier et libre-service. / Scatola singola – Adatto per confezioni da officina e self-service. / Caja individual – Adecuado para talleres y envase de autoservicio.
- ⁵⁾ Doppelschachtel – geeignet für SB und WS. / Double carton – Suitable for workshop and self-service packagin. / Boîte de deux – Pour emballage atelier et libre-service. / Confezione doppia – Adatto per confezioni da officina e self-service. / Caja doble – Adecuado para talleres y envase de autoservicio.

de

Scheinwerferlampen
(Fortsetzung)

en

Headlamp bulbs
(continued)

fr

Lampes pour projecteurs
(suite)

it

Lampadine per fari principali
(seguito)

es

Lámparas para faros
(continuación)



Fig.

ECE



$\frac{U}{V}$

$\frac{P}{W}$



H4

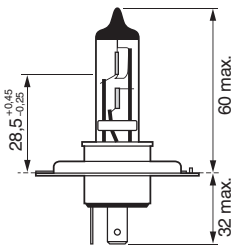

H4	Pure Light	12 V	60/55 W	P43t	1 987 302 041	1 987 301 001
H4	Longlife Daytime	12 V	60/55 W	P43t	1 987 302 048	1 987 301 054
H4	Gigalight Plus 120	12 V	60/55 W	P43t	1 987 302 140	1 987 301 109
H4	Gigalight Plus 120	12 V	60/55 W	P43t		1 987 301 160
H4	Gigalight Plus 120	12 V	60/55 W	P43t		1 987 301 106⁴⁾
H4	Plus 90	12 V	60/55 W	P43t	1 987 302 144	1 987 301 077
H4	Plus 90	12 V	60/55 W	P43t		1 987 301 074⁵⁾
H4	Plus 90	12 V	60/55 W	P43t		1 987 301 740⁴⁾
H4	Plus 50	12 V	60/55 W	P43t	1 987 302 049	1 987 301 040
H4	Plus 50	12 V	60/55 W	P43t		1 987 301 850⁴⁾
H4	Plus 30	12 V	60/55 W	P43t	1 987 302 042	1 987 301 002
H4	Xenon Silver	12 V	60/55 W	P43t		1 987 301 068
H4	Xenon Silver	12 V	60/55 W	P43t		1 987 301 081⁵⁾
H4	Xenon Blue	12 V	60/55 W	P43t	1 987 302 045	1 987 301 010
H4 ¹⁾	Rallye	12 V	100/80 W ³⁾	P43t	1 987 302 046	
H4	Trucklight Maxlife	24 V	75/70 W	P43t	1 987 302 742	
H4	Trucklight	24 V	75/70 W	P43t	1 987 302 441	

H7

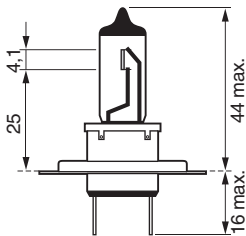

H7	Pure Light	12 V	55 W	PX26d	1 987 302 071	1 987 301 012
H7	Longlife Daytime	12 V	55 W	PX26d	1 987 302 078	1 987 301 057
H7	Gigalight Plus 120	12 V	55 W	PX26d	1 987 302 170	1 987 301 110
H7	Gigalight Plus 120	12 V	55 W	PX26d		1 987 301 170
H7	Gigalight Plus 120	12 V	55 W	PX26d		1 987 301 107⁴⁾
H7	Plus 90	12 V	55 W	PX26d	1 987 302 174	1 987 301 078
H7	Plus 90	12 V	55 W	PX26d		1 987 301 075⁵⁾
H7	Plus 90	12 V	55 W	PX26d		1 987 301 750⁴⁾
H7	Plus 50	12 V	55 W	PX26d	1 987 302 079	1 987 301 042
H7	Plus 50	12 V	55 W	PX26d		1 987 301 860⁴⁾
H7	Xenon Silver	12 V	55 W	PX26d		1 987 301 069
H7	Xenon Silver	12 V	55 W	PX26d		1 987 301 087⁵⁾
H7	Xenon Blue	12 V	55 W	PX26d	1 987 302 075	1 987 301 013
H7	Trucklight Maxlife	24 V	70 W	PX26d	1 987 302 772	
H7	Trucklight	24 V	70 W	PX26d	1 987 302 471	

H8

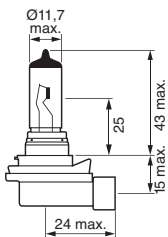

H8	Pure Light	12 V	35 W	PGJ19-1	1 987 302 081	

Fig.

ECE



$\frac{U}{V}$

$\frac{P}{W}$



H9

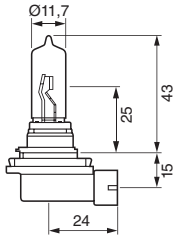

H9	Pure Light	12 V	65 W	PGJ19-5	1 987 302 082

H10

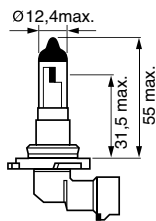

H10	Pure Light	12 V	42 W	PY20d	1 987 302 083

H11

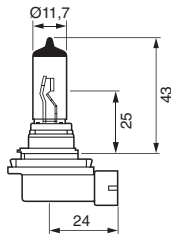

H11	Pure Light	12 V	55 W	PGJ19-2	1 987 302 084
H11	Longlife Daytime	12 V	55 W	PGJ19-2	1 987 302 085 1 987 301 339
H11	Trucklight	24 V	70 W	PGJ19-2	1 987 302 481 1 987 301 340

H27W/1 (880)

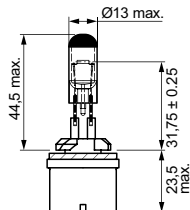

H27W/1	Pure Light	12 V	27 W	PG13	1 987 302 024

- 1) Betrieb nur mit geeignetem elektronischen Vorschaltgerät. / Operation only with suitable electronic ballast unit. / Utilisation uniquement avec module électronique de commande adéquat. / Funzionamento soltanto con l'apposito stabilizzatore elettronico. / Funciona solo con la unidad de control electrónica apropiada.
- 3) Nicht im Geltungsbereich von ECE zulässig. / Not permitted where ECE applies. / N'est pas homologué par ECE. / Non ammesso in ambito di ECE. / No autorizada dentro del ámbito del ECE.
- 4) Einzelschachtel – geeignet für SB und WS. / Individual pack – Suitable for workshop and self-service packagin. / Carton individuel – Pour emballage atelier et libre-service. / Scatola singola – Adatto per confezioni da officina e self-service. / Caja individual – Adecuado para talleres y envase de autoservicio.
- 5) Doppelschachtel – geeignet für SB und WS. / Double carton – Suitable for workshop and self-service packagin. / Boîte de deux – Pour emballage atelier et libre-service. / Confezione doppia – Adatto per confezioni da officina e self-service. / Caja doble – Adecuado para talleres y envase de autoservicio.

de

Scheinwerferlampen
(Fortsetzung)

en

Headlamp bulbs
(continued)

fr

Lampes pour projecteurs
(suite)

it

Lampadine per fari principali
(seguito)

es

Lámparas para faros
(continuación)



Fig.

ECE



$\frac{U}{V}$

$\frac{P}{W}$



HIR2 (9012)

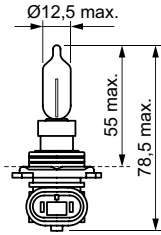

HIR2(9012)	Pure Light	12 V	55 W	PX22d	1 987 302 026

R2

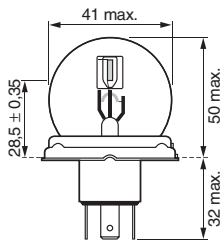

R2	Pure Light	12 V	45/40 W	P45t	1 987 302 023
R2	Trucklight	24 V	55/50 W	P45t	1 987 302 421

R2 Halogen

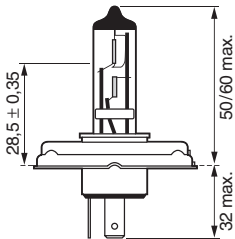

R2 Halogen	Pure Light	12 V	45/40 W	P45t	1 987 302 021	1 987 301 021

HB3/HB4

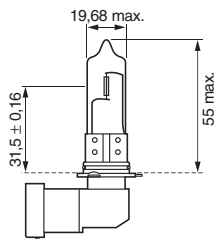

HB3	Pure Light	12 V	60 W	P20d	1 987 302 152	1 987 301 062
HB4	Pure Light	12 V	51 W	P22d	1 987 302 153	1 987 301 063
HB3	Xenon Blue	12 V	60 W	P20d	1 987 302 154	
HB4	Xenon Blue	12 V	51 W	P22d	1 987 302 155	

Fig.

ECE



$\frac{U}{V}$

$\frac{P}{W}$



P13W

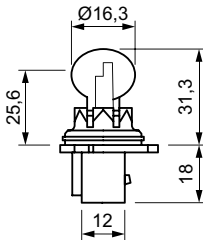

P13W	Pure Light	12 V	13 W	PG18,5d-1	1 987 302 265

de
Stopplichtlampen
Blinklichtlampen
Schlusslichtlampen

en
Stop-lamp/
turn-signal-lamp
bulbs
Tail-lamps

fr
Lampes pour feux
de stop/et clignotants
Lampes pour feux
arrière

it
Lampadine per
stop, indicatori
di direzione,
luci posteriori

es
Lámparas para
luces de freno
e intermitentes
Lámparas para
pilotos



Fig.

ECE



$\frac{U}{V}$

$\frac{P}{W}$

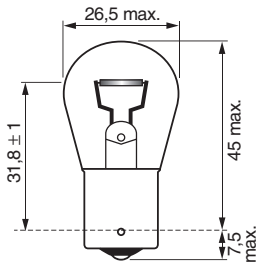

P21W	Pure Light	12 V	21 W	BA15s	1 987 302 201	1 987 301 017
21W amber	Pure Light	12 V	21 W	BA15s	1 987 302 239	
21W red	Pure Light	12 V	21 W	BA15s	1 987 302 262	
P21W	Pure Light	12 V	21 W	BA15d	1 987 302 261	
P21W	Pure Light	6 V	21 W	BA15s	1 987 302 607	
PY21W	Pure Light	12 V	21 W	BAU15s	1 987 302 213	1 987 301 018
P21W	Longlife Daytime	12 V	21 W	BA15s	1 987 302 280	1 987 301 050
PY21W	Magic Effect	12 V	21 W	BAU15s		1 987 301 025
P21W	Trucklight Maxlife	24 V	21 W	BA15s	1 987 302 701	
P21W	Trucklight Maxlife	24 V	21 W	BA15d	1 987 302 702	
PY21W	Trucklight Maxlife	24 V	21 W	BAU15s	1 987 302 703	
P21W	Trucklight	24 V	21 W	BA15s	1 987 302 501	
P21W	Trucklight	24 V	21 W	BA15d	1 987 302 532	

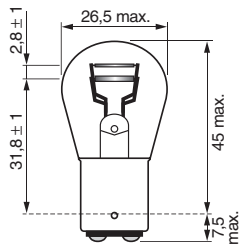

P21/4W	Pure Light	12 V	21/4 W	BAZ15d	1 987 302 215	1 987 301 015
P21/5W	Pure Light	12 V	21/5 W	BAY15d	1 987 302 202	1 987 301 016
P21/5W	Longlife Daytime	12 V	21/5 W	BAY15d	1 987 302 282	1 987 301 055
P21/5W	Trucklight	24 V	21/5 W	BAY15d	1 987 302 524	

R5W/R10W version 1

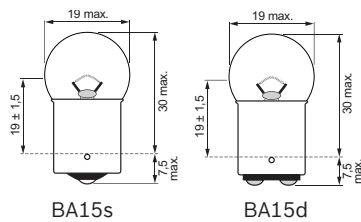

R5W	Pure Light	12 V	5 W	BA15s	1 987 302 204	
R5W	Pure Light	12 V	5 W	BA15d	1 987 302 237	
R5W	Pure Light	6 V	5 W	BA15s	1 987 302 605	
R10W	Pure Light	12 V	10 W	BA15s	1 987 302 203	1 987 301 019
R10W	Pure Light	6 V	10 W	BA15s	1 987 302 604	
R5W	Longlife Daytime	12 V	5 W	BA15s	1 987 302 284	1 987 301 058
R10W	Longlife Daytime	12 V	10 W	BA15s		1 987 301 059
-	Trucklight	28 V	7 W	BA15s	1 987 302 535	

R5W/R10W version 2

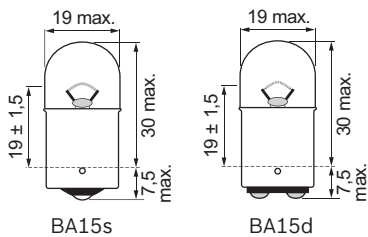

R5W	Pure Light	12 V	5 W	BA15s		1 987 301 022
R5W	Trucklight Maxlife	24 V	5 W	BA15s	1 987 302 704	
R5W	Trucklight Maxlife	24 V	5 W	BA15d	1 987 302 705	
R10W	Trucklight Maxlife	24 V	10 W	BA15s	1 987 302 706	
R10W	Trucklight	24 V	10 W	BA15s	1 987 302 505	
R5W	Trucklight	24 V	5 W	BA15s	1 987 302 510	
R5W	Trucklight	24 V	5 W	BA15d	1 987 302 527	

Fig.

ECE



$\frac{U}{V}$

$\frac{P}{W}$

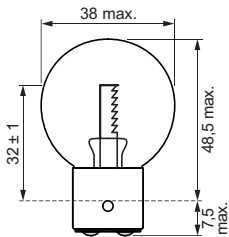

-	Pure Light	12 V	24 W	BA15d	1 987 302 263

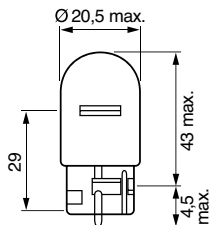

W21W	Pure Light	12 V	21 W	W3x16d	1 987 302 251
WY21W	Pure Light	12 V	21 W	W3x16d	1 987 302 222

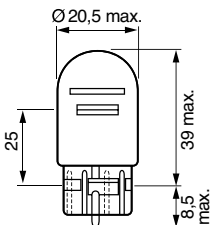

W21/5W	Pure Light	12 V	21/5 W	W3x16q	1 987 302 252	1 987 301 079

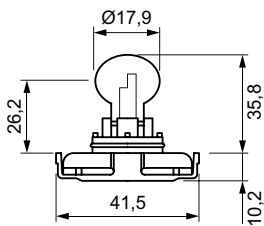

PS19W	Pure Light	12 V	19 W	PG20-1	1 987 302 266
PSY24W	Pure Light	12 V	24 W	PG20-4	1 987 302 267

de

Mini-Halogen-lampen, Glassockellampen

en

Mini halogen lamps, wedge base lamps

fr

Lampes halogène mini, lampes »wedge base«

it

Lampadine mini alogene, lampadine con attacco vetro

es

Lámparas halógenas mini, lámparas con casquillo de vidrio



Fig.

ECE



U
V

P
W

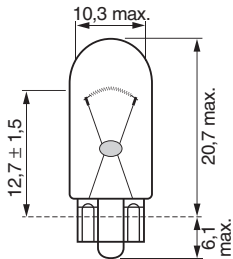

W3W	Pure Light	12 V	3 W	W2,1x9,5d	1 987 302 217	1 987 301 028
W5W	Pure Light	12 V	5 W	W2,1x9,5d	1 987 302 206	1 987 301 026
WY5W	Pure Light	12 V	5 W	W2,1x9,5d	1 987 302 241	
-	Pure Light	12 V	2 W	W2,1x9,5d	1 987 302 223	
W5W	Longlife Daytime	12 V	5 W	W2,1x9,5d	1 987 302 286	1 987 301 052
W5W	Xenon Blue	12 V	5 W	W2,1x9,5d		1 987 301 033
W3W	Trucklight	24 V	3 W	W2,1x9,5d	1 987 302 517	
W5W	Trucklight	24 V	5 W	W2,1x9,5d	1 987 302 518	
-	Trucklight	24 V	2 W	W2,1x9,5d	1 987 302 516	

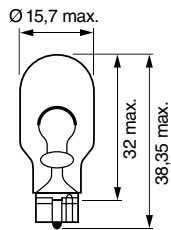

W16W	Pure Light	12 V	16 W	W2,1x9,5d	1 987 302 205	1 987 301 049
-	Pure Light	12 V	21 W	W2,1x9,5d	1 987 302 249	

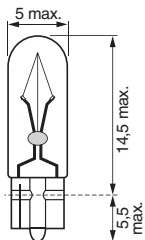

W2,3W	Pure Light	12 V	2,3 W	W2x4,6d	1 987 302 240	
-	Pure Light	12 V	1,2 W	W2x4,6d	1 987 302 208	1 987 301 024
-	Pure Light	12 V	2 W	W2x4,6d	1 987 302 218	
-	Trucklight	24 V	1,2 W	W2x4,6d	1 987 302 504	

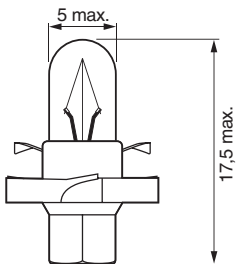

-	Pure Light	12 V	1,2 W	BX8,4d	1 987 302 243	
-	Pure Light	12 V	1,2 W	BX8,4d	1 987 302 235	
-	Pure Light	12 V	1,5 W	BX8,4d	1 987 302 255	
-	Pure Light	12 V	2 W	BX8,4d	1 987 302 236	

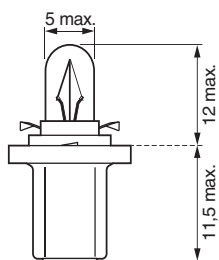

-	Pure Light	12 V	1,2 W	B8,5d	1 987 302 219	
-	Trucklight	24 V	1,2 W	B8,5d	1 987 302 514	

Fig.

ECE



$\frac{U}{V}$

$\frac{P}{W}$

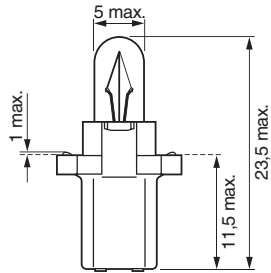

-	Trucklight	24 V	1,2 W	B8,3d	1 987 302 515

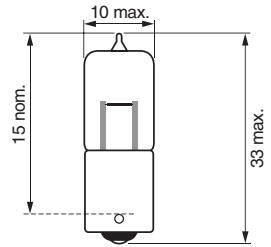

-	Pure Light	12 V	5 W	BA9s	1 987 302 231
-	Pure Light	12 V	10 W	BA9s	1 987 302 233

de

Standlicht-/
Anzeigenlampen

en

Parking-light/
indicator lamps

fr

Lampes pour
feux de position/
témoin

it

Lampadine per
luci di posizione
e di direzione

es

Lámparas para
luz de posición
e indicaciones



Fig.

ECE



$\frac{U}{V}$

$\frac{P}{W}$

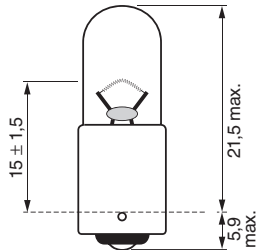

T4W	Pure Light	12 V	4 W	BA9s	1 987 302 207	1 987 301 023
T4W	Pure Light	6 V	4 W	BA9s	1 987 302 603	
T4W	Trucklight Maxlife	24 V	4 W	BA9s	1 987 302 707	
T4W	Trucklight	24 V	4 W	BA9s	1 987 302 512	

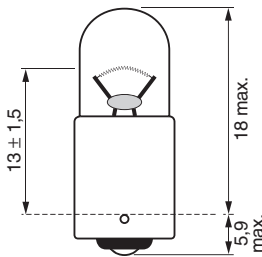

-	Pure Light	12 V	2 W	BA9s	1 987 302 212	
-	Trucklight	24 V	2 W	BA9s	1 987 302 508	

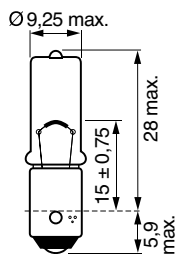

H6W	Pure Light	12 V	6 W	BAX9s	1 987 302 232	1 987 301 035
H6W	Longlife Daytime	12 V	6 W	BAX9s		1 987 301 061

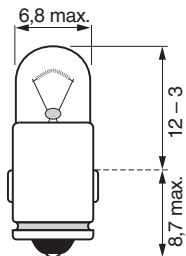

-	Pure Light	12 V	2 W	BA7s	1 987 302 224	
-	Trucklight	24 V	3 W	BA7s	1 987 302 519	

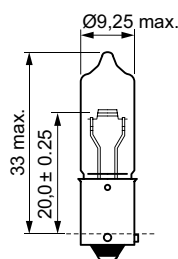

H21W	Pure Light	12 V	21 W	BAY9s	1 987 302 264	
H21W	Trucklight	24 V	21 W	BAY9s	1 987 302 533	

de

Soffittenlampen

en

Festoon bulbs

fr

Lampes navettes

it

Lampadine siluro

es

Lámparas de neón

Fig.

ECE



$\frac{U}{V}$

$\frac{P}{W}$

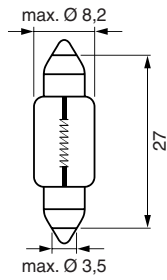

-	Pure Light	12 V	3 W	SV7-8	1 987 302 226	
-	Trucklight	24 V	3 W	SV7-8	1 987 302 528	

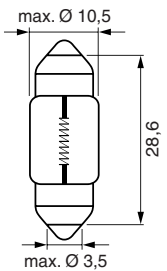

-	Pure Light	12 V	10 W	SV8,5-8	1 987 302 227	

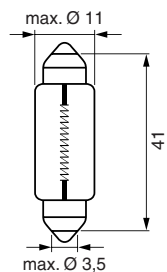

-	Pure Light	12 V	5 W	SV8,5-8	1 987 302 225	
-	Pure Light	12 V	10 W	SV8,5-8	1 987 302 210	1 987 301 014
-	Pure Light	6 V	10 W	SV8,5-8	1 987 302 612	
-	Trucklight	24 V	5 W	SV8,5-8	1 987 302 520	
-	Trucklight	24 V	10 W	SV8,5-8	1 987 302 521	

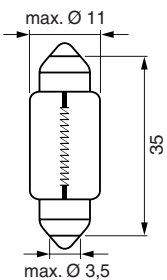

C5W	Pure Light	12 V	5 W	SV8,5-8	1 987 302 211	1 987 301 004
-	Pure Light	12 V	10 W	SV8,5-8	1 987 302 228	
C5W	Longlife Daytime	12 V	5 W	SV8,5-8	1 987 302 281	1 987 301 060
C5W	Trucklight	24 V	5 W	SV8,5-8	1 987 302 507	

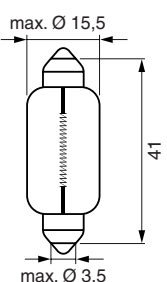

C21W	Pure Light		21 W	SV8,5-8	1 987 302 230	
-	Pure Light		15 W	SV8,5-8	1 987 302 238	
-	Pure Light		18 W	SV8,5-8	1 987 302 229	

de
**Moped-/
 Fahrradlampen**

en
**Moped/
 bicycle-lamp
 bulbs**

fr
**Lampes pour
 cyclomoteurs/
 bicyclettes**

it
**Lampadine
 per moto
 e ciclomotori**

es
**Lámparas para
 motocicletas
 y bicicletas**



Fig.

ECE



$\frac{U}{V}$

$\frac{P}{W}$



HS1

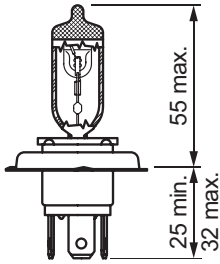

HS1	Pure Light	12 V	35/35 W	PX43t	1 987 302 104

S1, S2

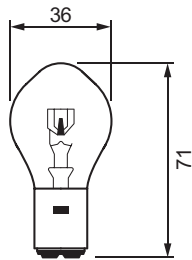

S1	Pure Light	12 V	25/25 W	BA20d	1 987 302 106
S2	Pure Light	12 V	35/35 W	BA20d	1 987 302 105

S3

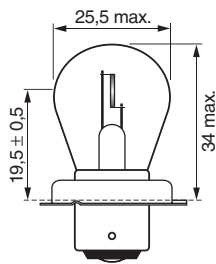

S3	Pure Light	6 V	15 W	P26s	1 987 302 606

de
LED-Retrofit-Lampen

en
LED retrofit lamps

fr
Lampes LED de substitution

it
Lampade LED Retrofit

es
Lámparas LED Retrofit

Fig. ECE  $\frac{U}{V}$ $\frac{P}{W}$   

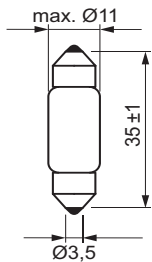

C5W ⁷⁾	LED retrofit lamps	12 V	1 W	SV8,5-8	1 987 301 501

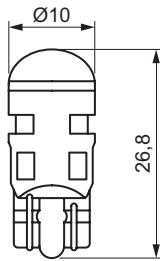

W5W ⁷⁾	LED retrofit lamps	12 V	1 W	W2,1x9,5d	1 987 301 505

⁷⁾ Anwendungsbereich: Innenraumbelichtung / Area of application: Interior lighting / Domaine d'application : éclairage d'habitacle / Campo d'uso: illuminazione abitacolo / Ámbito de aplicación: iluminación interior

de
Sockelbauarten

en
Base types

fr
Types de culots

it
Tavola degli
attacchi

es
Tipo de
casquillos



B8,3d

B8,5d

BA7s

BA9s

BA15d

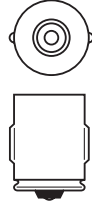

BA20d

BA15s

BAU15s

BAX9s

BAY9s

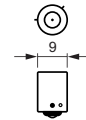
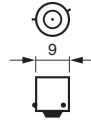

BAY15d

BAZ15d

BX8,4d

E10

EP10



P14.5s

P20d

P22d

P26s

P32d-2

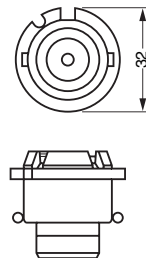
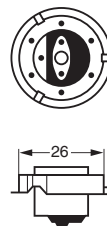
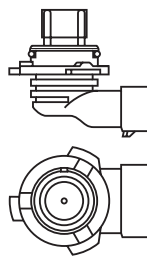
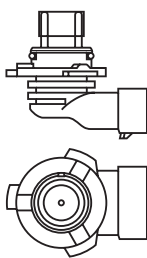
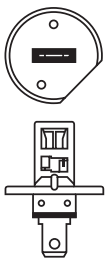



P32d-3

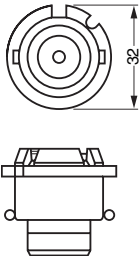

P32d-5

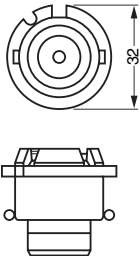

P43t

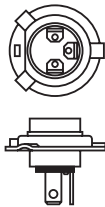

P45t



PG13

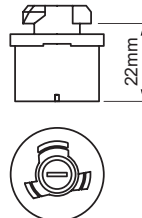

PG18,5d-1

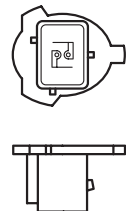

PG20-1

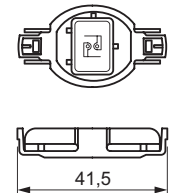

PG20-4

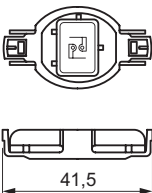

PGJ19-1

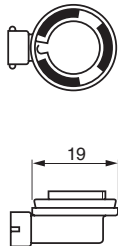

PGJ19-2

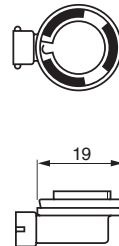

PGJ19-5

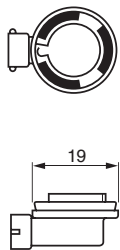

PK22s

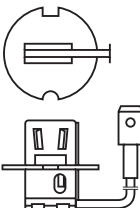

PK32d-5

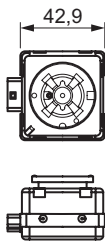

PY20d

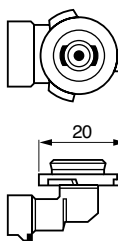

PX22d

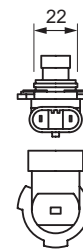

PX26d

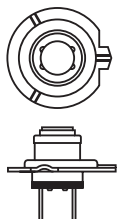

PX43t

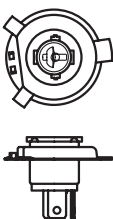

SV7-8

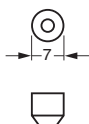

SV8,5-8

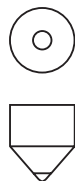

W2x4,6d



A48

de

Socketbauarten
(Fortsetzung)

en

Base types
(continued)

fr

Types de culots
(suite)

it

**Tavola degli
attacchi**
(seguito)

es

**Tipo de
casquillos**
(continuación)



W2,1x9,5d

W3x16d

W3x16q

X511

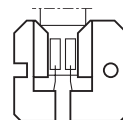

de

**Werkstatt-
Programm**nach Bestellnummern
sortiert

en

**Workshop
program**by part number
in ascending order

fr

Gamme atelierpar ordre croissant
des références

it

**Programma
per l'officina**ordinato per codice
di ordinazione

es

**Programa
de taller**ordenada por referencia
de pedido

ECE



 $\frac{P}{W}$ **12 Volt**

1 987 302 011	H1	Pure Light	55 W	P14,5s
1 987 302 012	H1	Plus 30	55 W	P14,5s
1 987 302 015	H1	Xenon Blue	55 W	P14,5s
1 987 302 016	H1 ⁶⁾	Rallye	100 W	P14,5s
1 987 302 018	H1	Longlife Daytime	55 W	P14,5s
1 987 302 019	H1	Plus 50	55 W	P14,5s
1 987 302 021	R2 Halogen	Pure Light	45/40 W	P45t
1 987 302 023	R2	Pure Light	45/40 W	P45t
1 987 302 024	H27W/1 (880)	Pure Light	27 W	PG13
1 987 302 026	HIR2 (9012)	Pure Light	55 W	PX22d
1 987 302 031	H3	Pure Light	55 W	PK22s
1 987 302 035	H3	Xenon Blue	55 W	PK22s
1 987 302 036	H3 ⁶⁾	Rallye	100 W	PK22s
1 987 302 038	H3	Longlife Daytime	55 W	PK22s
1 987 302 041	H4	Pure Light	60/55 W	P43t
1 987 302 042	H4	Plus 30	60/55 W	P43t
1 987 302 045	H4	Xenon Blue	60/55 W	P43t
1 987 302 046	H4 ⁶⁾	Rallye	100/80 W	P43t
1 987 302 048	H4	Longlife Daytime	60/55 W	P43t
1 987 302 049	H4	Plus 60	60/55 W	P43t
1 987 302 071	H7	Pure Light	55 W	PX26d
1 987 302 075	H7	Xenon Blue	55 W	PX26d
1 987 302 078	H7	Longlife Daytime	55 W	PX26d
1 987 302 079	H7	Plus 50	55 W	PX26d
1 987 302 081	H8	Pure Light	35 W	PGJ19-1
1 987 302 082	H9	Pure Light	65 W	PGJ19-5
1 987 302 083	H10	Pure Light	42 W	PY20d
1 987 302 084	H11	Pure Light	55 W	PGJ19-2
1 987 302 085	H11	Longlife Daytime	55 W	PGJ19-2
1 987 302 104	HS1	Pure Light	35/35 W	PX43t
1 987 302 105	S2	Pure Light	35/35 W	BA20d
1 987 302 106	S1	Pure Light	25/25 W	BA20d
1 987 302 110	H1	Gigalight Plus 120	55 W	P14,5s
1 987 302 114	H1	Plus 90	55 W	P14,5s
1 987 302 140	H4	Gigalight Plus 120	60/55 W	P43t
1 987 302 144	H4	Plus 90	60/55 W	P43t
1 987 302 152	HB3	Pure Light	60 W	P20d
1 987 302 153	HB4	Pure Light	51 W	P22d
1 987 302 154	HB3	Xenon Blue	60 W	P20d
1 987 302 155	HB4	Xenon Blue	51 W	P22d
1 987 302 170	H7	Gigalight Plus 120	55 W	PX26d
1 987 302 174	H7	Plus 90	55 W	PX26d
1 987 302 201	P21W	Pure Light	21 W	BA15s
1 987 302 202	P21/5W	Pure Light	21/5 W	BAY15d
1 987 302 203	R10W	Pure Light	10 W	BA15s
1 987 302 204	R5W	Pure Light	5 W	BA15s
1 987 302 205	W16W	Pure Light	16 W	W2,1x9,5d
1 987 302 206	W5W	Pure Light	5 W	W2,1x9,5d
1 987 302 207	T4W	Pure Light	4 W	BA9s

6) Nicht im öffentlichen Straßenverkehr zulässig. / Not permitted where road traffic regulation applies. /

N'est pas homologué par le Code de la Route. / Non ammesso in ambito di codice stradale.

No autorizada dentro del ámbito del código de circulación.

	ECE		$\frac{P}{W}$	
1 987 302 208	–	Pure Light	1,2 W	W2x4,6d
1 987 302 210	–	Pure Light	10 W	SV8,5-8
1 987 302 211	C5W	Pure Light	5 W	SV8,5-8
1 987 302 212	–	Pure Light	2 W	BA9s
1 987 302 213	PY21W	Pure Light	21 W	BAU15s
1 987 302 214	–	Pure Light	18 W	BA15s
1 987 302 215	P21/4W	Pure Light	21/4 W	BAZ15d
1 987 302 217	W3W	Pure Light	3 W	W2,1x9,5d
1 987 302 218	–	Pure Light	2 W	W2x4,6d
1 987 302 219	–	Pure Light	1,2 W	B8,5d
1 987 302 222	WY21W	Pure Light	21 W	W3x16d
1 987 302 223	–	Pure Light	2 W	W2,1x9,5d
1 987 302 224	–	Pure Light	2 W	BA7s
1 987 302 225	–	Pure Light	5 W	SV8,5-8
1 987 302 226	–	Pure Light	3 W	SV7-8
1 987 302 227	–	Pure Light	10 W	SV8,5-8
1 987 302 228	–	Pure Light	10 W	SV8,5-8
1 987 302 229	–	Pure Light	18 W	SV8,5-8
1 987 302 230	C21W	Pure Light	21 W	SV8,5-8
1 987 302 231	–	Pure Light	5 W	BA9s
1 987 302 232	H6W	Pure Light	6 W	BAX9s
1 987 302 233	–	Pure Light	10 W	BA9s
1 987 302 235	–	Pure Light	1,2 W	BX8,4d
1 987 302 236	–	Pure Light	2 W	BX8,4d
1 987 302 237	R5W	Pure Light	5 W	BA15d
1 987 302 238	–	Pure Light	15 W	SV8,5-8
1 987 302 239	21W amber	Pure Light	21 W	BA15s
1 987 302 240	W2,3W	Pure Light	2,3 W	W2x4,6d
1 987 302 241	WY5W	Pure Light	5 W	W2,1x9,5d
1 987 302 243	–	Pure Light	1,1 W	BX8,4d
1 987 302 249	–	Pure Light	21 W	W2,1x9,5d
1 987 302 251	W21W	Pure Light	21 W	W3x16d
1 987 302 252	W21/5W	Pure Light	21/5 W	W3x16q
1 987 302 255	–	Pure Light	1,5 W	BX8,4d
1 987 302 261	P21W	Pure Light	21 W	BA15d
1 987 302 262	21W red	Pure Light	21 W	BA15s
1 987 302 263	–	Pure Light	24 W	BA15d
1 987 302 264	H21W	Pure Light	21 W	BA9s
1 987 302 265	P13W	Pure Light	13 W	PG18,5d-1
1 987 302 266	PS19W	Pure Light	19 W	PG20-1
1 987 302 267	PSY24W	Pure Light	24 W	PG20-4
1 987 302 280	P21W	Longlife Daytime	21 W	BA15s
1 987 302 281	C5W	Longlife Daytime	5 W	SV8,5-8
1 987 302 282	P21/5W	Longlife Daytime	21/5 W	BAY15d
1 987 302 284	R5W	Longlife Daytime	5 W	BA15s
1 987 302 286	W5W	Longlife Daytime	5 W	W2,1x9,5d

24 Volt

1 987 302 411	H1	Trucklight	70 W	P14,5s
1 987 302 421	R2	Trucklight	55/50 W	P45t
1 987 302 431	H3	Trucklight	70 W	PK22s
1 987 302 441	H4	Trucklight	75/70 W	P43t
1 987 302 471	H7	Trucklight	70 W	PX26d
1 987 302 481	H11	Trucklight	70 W	PGJ19-2

de

**Werkstatt-
Programm**nach Bestellnummern
sortiert
(Fortsetzung)

en

**Workshop
program**by part number
in ascending order
(continued)

fr

Gamme atelierpar ordre croissant
des références
(suite)

it

**Programma
per l'officina**ordinato per codice
di ordinazione
(seguito)

es

**Programa
de taller**ordenada por referencia
de pedido
(continuación)

ECE

 $\frac{P}{W}$ 

	ECE		$\frac{P}{W}$	
1 987 302 501	P21W	Trucklight	21 W	BA15s
1 987 302 504	–	Trucklight	1,2 W	W2x4,6d
1 987 302 505	R10W	Trucklight	10 W	BA15s
1 987 302 507	C5W	Trucklight	5 W	SV8,5-8
1 987 302 508	–	Trucklight	2 W	BA9s
1 987 302 510	R5W	Trucklight	5 W	BA15s
1 987 302 512	T4W	Trucklight	4 W	BA9s
1 987 302 514	–	Trucklight	1,2 W	B8,5d
1 987 302 515	–	Trucklight	1,2 W	B8,3d
1 987 302 516	–	Trucklight	2 W	W2,1x9,5d
1 987 302 517	W3W	Trucklight	3 W	W2,1x9,5d
1 987 302 518	W5W	Trucklight	5 W	W2,1x9,5d
1 987 302 519	–	Trucklight	3 W	BA7s
1 987 302 520	–	Trucklight	5 W	SV8,5-8
1 987 302 521	–	Trucklight	10 W	SV8,5-8
1 987 302 523	–	Trucklight	18 W	BA15s
1 987 302 524	P21/5W	Trucklight	21/5 W	BAY15d
1 987 302 526	–	Trucklight	15 W	BA15s
1 987 302 527	R5W	Trucklight	5 W	BA15d
1 987 302 528	–	Trucklight	3 W	SV7-8
1 987 302 532	P21W	Trucklight	21 W	BA15d
1 987 302 533	H21W	Trucklight	21 W	BAY9s
1 987 302 701	P21W	Trucklight Maxlife	21 W	BA15s
1 987 302 702	P21W	Trucklight Maxlife	21 W	BA15d
1 987 302 703	PY21W	Trucklight Maxlife	21 W	BAU15s
1 987 302 704	R5W	Trucklight Maxlife	5 W	BA15s
1 987 302 705	R5W	Trucklight Maxlife	5 W	BA15d
1 987 302 706	R10W	Trucklight Maxlife	10 W	BA15s
1 987 302 707	T4W	Trucklight Maxlife	4 W	BA9s
1 987 302 712	H1	Trucklight Maxlife	70 W	P14,5s
1 987 302 732	H3	Trucklight Maxlife	70 W	PK22s
1 987 302 742	H4	Trucklight Maxlife	75/70 W	P43t
1 987 302 772	H7	Trucklight Maxlife	70 W	PX26d

6 Volt

1 987 302 603	T4W	Pure Light	4 W	BA9s
1 987 302 604	R10W	Pure Light	10 W	BA15s
1 987 302 605	R5W	Pure Light	5 W	BA15s
1 987 302 606	S3	Pure Light	15 W	P26s
1 987 302 607	P21W	Pure Light	21 W	BA15s
1 987 302 612	–	Pure Light	10 W	SV8,5-8

Gasentladungslampen ¹⁾

1 987 302 903	D2R	Xenon	35 W	P32d-3
1 987 302 904	D2S	Xenon	35 W	P32d-2
1 987 302 905	D1S	Xenon	35 W	PK32d-2
1 987 302 906	D4S	Xenon	35 W	P32d-5
1 987 302 907	D3S	Xenon	35 W	PK32d-5

¹⁾ Betrieb nur mit geeignetem elektronischen Vorschaltgerät. / Operation only with suitable electronic ballast unit. /

Utilisation uniquement avec module électronique de commande adéquat. / Funzionamento soltanto con l'apposito stabilizzatore elettronico. / Funciona solo con la unidad de control electrónica apropiada.

de

SB-Programmnach Bestellnummern
sortiert

en

**Self-service
program**by part number
in ascending order

fr





**Gamme
libre-service**par ordre croissant
des références

it

**Programma
self-service**ordinato per codice
di ordinazione

es

**Programa
de autoservicio**ordenada por referencia
de pedido

	ECE		$\frac{U}{V}$	$\frac{P}{W}$		
1 987 301 001	H4	Pure Light	12 V	60/55 W	P43t	1
1 987 301 002	H4	Plus 30	12 V	60/55 W	P43t	1
1 987 301 003	H1	Plus 30	12 V	55 W	P14,5s	1
1 987 301 004	C5W	Pure Light	12 V	5 W	SV8,5-8	2
1 987 301 005	H1	Pure Light	12 V	55 W	P14,5s	1
1 987 301 006	H3	Pure Light	12 V	55 W	PK22s	1
1 987 301 007	H3	Xenon Blue	12 V	55 W	PK22s	1
1 987 301 010	H4	Xenon Blue	12 V	60/55 W	P43t	1
1 987 301 011	H1	Xenon Blue	12 V	55 W	P14,5s	1
1 987 301 012	H7	Pure Light	12 V	55 W	PX26d	1
1 987 301 013	H7	Xenon Blue	12 V	55 W	PX26d	1
1 987 301 014	-	Pure Light	12 V	10 W	SV8,5-8	2
1 987 301 015	P21/4W	Pure Light	12 V	21/4 W	BAZ15d	2
1 987 301 016	P21/5W	Pure Light	12 V	21/5 W	BAY15d	2
1 987 301 017	P21W	Pure Light	12 V	21 W	BA15s	2
1 987 301 018	PY21W	Pure Light	12 V	21 W	BAU15s	2
1 987 301 019	R10W	Pure Light	12 V	10 W	BA15s	2
1 987 301 021	R2 Halogen	Pure Light	12 V	45/40 W	P45t	1
1 987 301 022	R5W	Pure Light	12 V	5 W	BA15s	2
1 987 301 023	T4W	Pure Light	12 V	4 W	BA9s	2
1 987 301 024	-	Pure Light	12 V	1,2 W	W2x4,6d	2
1 987 301 025	PY21W	Magic Effect	12 V	21 W	BAU15s	2
1 987 301 026	W5W	Pure Light	12 V	5 W	W2,1x9,5d	2
1 987 301 028	W3W	Pure Light	12 V	3 W	W2,1x9,5d	2
1 987 301 033	W5W	Xenon Blue	12 V	5 W	W2,1x9,5d	2
1 987 301 035	H6W	Pure Light	12 V	6 W	BAX9s	2
1 987 301 040	H4	Plus 60	12 V	60/55 W	P43t	1
1 987 301 041	H1	Plus 50	12 V	55 W	P14,5s	1
1 987 301 042	H7	Plus 50	12 V	55 W	PX26d	1
1 987 301 049	W16W	Pure Light	12 V	16 W	W2,1x9,5d	2
1 987 301 050	P21W	Longlife Daytime	12 V	21 W	BA15s	2
1 987 301 051	H1	Longlife Daytime	12 V	55 W	P14,5s	1
1 987 301 052	W5W	Longlife Daytime	12 V	5 W	W2,1x9,5d	2
1 987 301 053	H3	Longlife Daytime	12 V	55 W	PK22s	1
1 987 301 054	H4	Longlife Daytime	12 V	60/55 W	P43t	1
1 987 301 055	P21/5W	Longlife Daytime	12 V	21/5 W	BAY15d	2
1 987 301 057	H7	Longlife Daytime	12 V	55 W	PX26d	1
1 987 301 058	R5W	Longlife Daytime	12 V	5 W	BA15s	2
1 987 301 059	R10W	Longlife Daytime	12 V	10 W	BA15s	2
1 987 301 060	C5W	Longlife Daytime	12 V	5 W	SV8,5-8	2
1 987 301 061	H6W	Longlife Daytime	12 V	6 W	BAX9s	2
1 987 301 062	HB3	Pure Light	12 V	60 W	P20d	1
1 987 301 063	HB4	Pure Light	12 V	51 W	P22d	1
1 987 301 067	H1	Xenon Silver	12 V	55 W	P14,5s	1
1 987 301 068	H4	Xenon Silver	12 V	60/55 W	P43t	1
1 987 301 069	H7	Xenon Silver	12 V	55 W	PX26d	1
1 987 301 073 ⁵⁾	H1	Plus 90	12 V	55 W	P14,5s	2
1 987 301 074 ⁵⁾	H4	Plus 90	12 V	60/55 W	P43t	2
1 987 301 075 ⁵⁾	H7	Plus 90	12 V	55 W	PX26d	2
1 987 301 076	H1	Plus 90	12 V	55 W	P14,5s	1
1 987 301 077	H4	Plus 90	12 V	60/55 W	P43t	1

⁵⁾ Doppelschachtel – geeignet für SB und WS. / Double carton – Suitable for workshop and self-service packagin. /

Boîte de deux – Pour emballage atelier et libre-service. / Confezione doppia – Adatto per confezioni da officina e self-service. /

Caja doble – Adecuado para talleres y envase de autoservicio.

de

SB-Programmnach Bestellnummern
sortiert

en

**Self-service
program**by part number
in ascending order

fr

**Gamme
libre-service**par ordre croissant
des références

it

**Programma
self-service**ordinato per codice
di ordinazione

es

**Programa
de autoservicio**ordenada por referencia
de pedido

	ECE		$\frac{U}{V}$	$\frac{P}{W}$		
1 987 301 078	H7	Plus 90	12 V	55 W	PX26d	1
1 987 301 079	W16W	Pure Light	12 V	21,5 W	W3x16q	2
1 987 301 080 ⁵⁾	H1	Xenon Silver	12 V	55 W	P14,5s	2
1 987 301 081 ⁵⁾	H4	Xenon Silver	12 V	60/55 W	P43t	2
1 987 301 087 ⁵⁾	H7	Xenon Silver	12 V	55 W	PX26d	2
1 987 301 105	H1	Gigalight Plus 120	12 V	55 W	P14,5s	2
1 987 301 106	H4	Gigalight Plus 120	12 V	60/55 W	P43t	2
1 987 301 107	H7	Gigalight Plus 120	12 V	55 W	PX26d	2
1 987 301 108	H1	Gigalight Plus 120	12 V	55 W	P14,5s	1
1 987 301 109	H4	Gigalight Plus 120	12 V	60/55 W	P43t	1
1 987 301 110	H7	Gigalight Plus 120	12 V	55 W	PX26d	1
1 987 301 150 ⁴⁾	H1	Gigalight Plus 120	12 V	55 W	P14,5s	1
1 987 301 160 ⁴⁾	H4	Gigalight Plus 120	12 V	60/55 W	P43t	1
1 987 301 170 ⁴⁾	H7	Gigalight Plus 120	12 V	55 W	PX26d	1
1 987 301 339	H11	Pure Light	12 V	55 W	PGJ19-2	1
1 987 301 340	H11	Longlife Daytime	12 V	55 W	PGJ19-2	1
1 987 301 404 ⁵⁾	H1	Pure Light	12 V	55 W	P14,5s	2
1 987 301 405 ⁵⁾	H4	Pure Light	12 V	60/55 W	P43t	2
1 987 301 406 ⁵⁾	H7	Pure Light	12 V	55 W	PX26d	2
1 987 301 501	C5W ⁷⁾	LED Retrofit	12 V	1 W	SV8,5-8	2
1 987 301 505	W5W ⁷⁾	LED Retrofit	12 V	1 W	W2,1x9,5d	2
1 987 301 730 ⁴⁾	H1	Plus 90	12 V	55 W	P14,5s	1
1 987 301 740 ⁴⁾	H4	Plus 90	12 V	60/55 W	P43t	1
1 987 301 750 ⁴⁾	H7	Plus 90	12 V	55 W	PX26d	1
1 987 301 840 ⁴⁾	H1	Plus 50	12 V	55 W	P14,5s	1
1 987 301 850 ⁴⁾	H4	Plus 50	12 V	60/55 W	P43t	1
1 987 301 860 ⁴⁾	H7	Plus 50	12 V	55 W	PX26d	1

⁴⁾ Einzelschachtel – geeignet für SB und WS. / Individual pack – Suitable for workshop and self-service packagin. /
Carton individuel – Pour emballage atelier et libre-service. / Scatola singola – Adatto per confezioni da officina e self-service. /
Caja individual – Adecuado para talleres y envase de autoservicio.

⁵⁾ Doppelschachtel – geeignet für SB und WS. / Double carton – Suitable for workshop and self-service packagin. /
Boîte de deux – Pour emballage atelier et libre-service. / Confezione doppia – Adatto per confezioni da officina e self-service. /
Caja doble – Adecuado para talleres y envase de autoservicio.

⁷⁾ Anwendungsbereich: Innenraumbelichtung / Area of application: Interior lighting / Domaine d'application : éclairage d'habitable /
Campo d'uso: illuminazione abitacolo / Ámbito de aplicación: iluminación interior

de

SB-Programmnach Produktlinie
sortiert

en

**Self-service
program**by product line
in ascending order

fr

**Gamme
libre-service**par ordre croissant
des lignes produit

it

**Programma
self-service**ordinato per linea
di prodotto

es

**Programa
de autoservicio**ordenada por linea
de producto

ECE

 $\frac{U}{V}$ $\frac{P}{W}$ 

EAN

**Pure Light**

C5W	12 V	5 W	SV8,5-8	1 987 301 004	2	3 165141 22871 7	1,1 x 9,5 x 13,5
H1	12 V	55 W	P14,5s	1 987 301 005	1	3 165141 22872 4	3,0 x 9,5 x 13,5
H3	12 V	55 W	PK22s	1 987 301 006	1	3 165141 22873 1	2,0 x 9,5 x 13,5
H4	12 V	60/55 W	P43t	1 987 301 001	1	3 165141 22867 0	5,0 x 9,5 x 13,5
H6W	12 V	6 W	BAX9s	1 987 301 035	2	3 165143 23488 4	1,1 x 9,5 x 13,5
H7	12 V	55 W	PX26d	1 987 301 012	1	3 165141 22879 3	3,5 x 9,5 x 13,5
HB3	12 V	60 W	P20d	1 987 301 062	1	3 165143 98579 3	3,5 x 9,5 x 13,5
HB4	12 V	51 W	P22d	1 987 301 063	1	3 165143 98580 9	3,5 x 9,5 x 13,5
P21W	12 V	21 W	BA15s	1 987 301 017	2	3 165141 22884 7	2,6 x 9,5 x 13,5
P21/4W	12 V	21/4 W	BAZ15d	1 987 301 015	2	3 165141 22882 3	2,6 x 9,5 x 13,5
P21/5W	12 V	21/5 W	BAY15d	1 987 301 016	2	3 165141 22883 0	2,6 x 9,5 x 13,5
PY21W	12 V	21 W	BAU15s	1 987 301 018	2	3 165141 22885 4	2,6 x 9,5 x 13,5
PY21W Magic Effect	12 V	21 W	BAU15s	1 987 301 025	2	3 165143 47617 8	2,6 x 9,5 x 13,5
R2 Halogen	12 V	45/40 W	P45t	1 987 301 021	1	3 165141 22888 5	5,0 x 9,5 x 13,5
R5W	12 V	5 W	BA15s	1 987 301 022	2	3 165141 22889 2	2,0 x 9,5 x 13,5
R10W	12 V	10 W	BA15s	1 987 301 019	2	3 165141 22886 1	2,0 x 9,5 x 13,5
T4W	12 V	4 W	BA9s	1 987 301 023	2	3 165141 22890 8	6,0 x 9,5 x 13,5
W3W	12 V	3 W	W2,1x9,5d	1 987 301 028	2	3 165141 65008 2	6,0 x 9,5 x 13,5
W5W	12 V	5 W	W2,1x9,5d	1 987 301 026	2	3 165141 22893 9	6,0 x 9,5 x 13,5
-	12 V	10 W	SV8,5-8	1 987 301 014	2	3 165141 22881 6	1,1 x 9,5 x 13,5
-	12 V	1,2 W	W2x4,6d	1 987 301 024	2	3 165141 22891 5	6,0 x 9,5 x 13,5
W16W	12 V	16 W	W2,1x9,5d	1 987 301 049	2	4 047024 92073 6	2,2 x 9,5 x 13,5
W21/5W	12 V	21/5 W	W3x16q	1 987 301 079	2	4 047024 92080 4	2,2 x 9,5 x 13,5
H11	12 V	55 W	PGJ19-2	1 987 301 339	1	4 047025 25176 1	3,5 x 9,5 x 13,5
H1	12 V	55 W	P14,5s	1 987 301 404 ⁵⁾	2	4 047025 25167 9	3,0 x 9,5 x 13,5
H4	12 V	60/55 W	P43t	1 987 301 405 ⁵⁾	2	4 047025 25168 6	5,0 x 9,5 x 13,5
H7	12 V	55 W	PX26d	1 987 301 406 ⁵⁾	2	4 047025 25169 3	3,5 x 9,5 x 13,5

Longlife Daytime

C5W	12 V	5 W	SV8,5-8	1 987 301 060	2	3 165143 48212 4	1,1 x 9,5 x 13,5
H1	12 V	55 W	P14,5s	1 987 301 051	1	3 165143 48203 2	3,0 x 9,5 x 13,5
H3	12 V	55 W	PK22s	1 987 301 053	1	3 165143 48205 6	2,0 x 9,5 x 13,5
H4	12 V	60/55 W	P43t	1 987 301 054	1	3 165143 48206 3	5,0 x 9,5 x 13,5
H6W	12 V	6 W	BAX9s	1 987 301 061	2	3 165143 48213 1	1,1 x 9,5 x 13,5
H7	12 V	55 W	PX26d	1 987 301 057	1	3 165143 48209 4	3,5 x 9,5 x 13,5
P21W	12 V	21 W	BA15s	1 987 301 050	2	3 165143 48202 5	2,6 x 9,5 x 13,5
P21/5W	12 V	21/5 W	BAY15d	1 987 301 055	2	3 165143 48207 0	2,6 x 9,5 x 13,5
R5W	12 V	5 W	BA15s	1 987 301 058	2	3 165143 48210 0	2,0 x 9,5 x 13,5
R10W	12 V	10 W	BA15s	1 987 301 059	2	3 165143 48211 7	2,0 x 9,5 x 13,5
W5W	12 V	5 W	W2,1x9,5d	1 987 301 052	2	3 165143 48204 9	6,0 x 9,5 x 13,5
H11	12 V	55 W	PGJ19-2	1 987 301 340	1	4 047025 44118 6	3,5 x 9,5 x 13,5

5) Doppelschachtel – geeignet für SB und WS. / Double carton – Suitable for workshop and self-service packagin. /
Boîte de deux – Pour emballage atelier et libre-service. / Confezione doppia – Adatto per confezioni da officina e self-service. /
Caja doble – Adecuado para talleres y envase de autoservicio.

de

SB-Programmnach Produktlinie
sortiert
(Fortsetzung)

en

**Self-service
program**by product line
in ascending order
(continued)

fr

**Gamme
libre-service**par ordre croissant
des lignes produit
(suite)

it

**Programma
self-service**ordinato per linea
di prodotto
(seguito)

es

**Programa
de autoservicio**ordenada por linea
de producto
(continuación)

ECE

 $\frac{U}{V}$ $\frac{P}{W}$ 

EAN

**Gigalight Plus 120**

H1	12 V	55 W	P14,5s	1 987 301 105	2	4 047025 25164 8	3,0 x 9,5 x 13,5
H4	12 V	60/55 W	P43t	1 987 301 106	2	4 047025 25165 5	5,0 x 9,5 x 13,5
H7	12 V	55 W	PX26d	1 987 301 107	2	4 047025 25166 2	3,5 x 9,5 x 13,5
H1	12 V	55 W	P14,5s	1 987 301 108	1	4 047025 26016 9	3,0 x 9,5 x 13,5
H4	12 V	60/55 W	P43t	1 987 301 109	1	4 047025 26017 6	5,0 x 9,5 x 13,5
H7	12 V	55 W	PX26d	1 987 301 110	1	4 047025 26018 3	3,5 x 9,5 x 13,5
H1	12 V	55 W	P14,5s	1 987 301 150	1	4 047025 25186 0	3,0 x 9,5 x 13,5
H4	12 V	60/55 W	P43t	1 987 301 160	1	4 047025 25187 7	5,0 x 9,5 x 13,5
H7	12 V	55 W	PX26d	1 987 301 170	1	4 047025 25188 4	3,5 x 9,5 x 13,5

Plus 90

H1	12 V	55 W	P14,5s	1 987 301 076	1	4 047024 44809 4	3,0 x 9,5 x 13,5
H1	12 V	55 W	P14,5s	1 987 301 073 ⁵⁾	2	4 047024 44812 4	5,2 x 9,5 x 12,3
H4	12 V	60/55 W	P43t	1 987 301 077	1	4 047024 44811 7	5,0 x 9,5 x 13,5
H4	12 V	60/55 W	P43t	1 987 301 074 ⁵⁾	2	4 047024 44813 1	5,2 x 9,5 x 12,3
H7	12 V	55 W	PX26d	1 987 301 078	1	4 047024 44810 0	3,5 x 9,5 x 13,5
H7	12 V	55 W	PX26d	1 987 301 075 ⁵⁾	2	4 047024 44814 8	5,2 x 9,5 x 12,3
H1	12 V	55 W	P14,5s	1 987 301 730	1	4 047025 25189 1	3,0 x 9,5 x 13,5
H4	12 V	60/55 W	P43t	1 987 301 740	1	4 047025 25190 7	5,0 x 9,5 x 13,5
H7	12 V	55 W	PX26d	1 987 301 750	1	4 047025 25191 4	3,5 x 9,5 x 13,5

Plus 50

H1	12 V	55 W	P14,5s	1 987 301 041	1	3 165143 31998 7	3,0 x 9,5 x 13,5
H4	12 V	60/55 W	P43t	1 987 301 040	1	3 165143 28238 0	5,0 x 9,5 x 13,5
H7	12 V	55 W	PX26d	1 987 301 042	1	3 165143 35528 2	3,5 x 9,5 x 13,5
H1	12 V	55 W	P14,5s	1 987 301 840	1	4 047025 25192 1	3,0 x 9,5 x 13,5
H4	12 V	60/55 W	P43t	1 987 301 850	1	4 047025 25193 8	5,0 x 9,5 x 13,5
H7	12 V	55 W	PX26d	1 987 301 860	1	4 047025 25194 5	3,5 x 9,5 x 13,5

Plus 30

H1	12 V	55 W	P14,5s	1 987 301 003	1	3 165141 22869 4	3,0 x 9,5 x 13,5
H4	12 V	60/55 W	P43t	1 987 301 002	1	3 165141 22868 7	5,0 x 9,5 x 13,5

Xenon Silver

H1	12 V	55 W	P14,5s	1 987 301 067	1	4 047024 28820 1	3,0 x 9,5 x 13,5
H1	12 V	55 W	P14,5s	1 987 301 080 ⁵⁾	2	4 047024 28932 1	5,2 x 9,5 x 12,3
H4	12 V	60/55 W	P43t	1 987 301 068	1	4 047024 28821 8	5,0 x 9,5 x 13,5
H4	12 V	60/55 W	P43t	1 987 301 081 ⁵⁾	2	4 047024 28933 8	5,2 x 9,5 x 12,3
H7	12 V	55 W	PX26d	1 987 301 069	1	4 047024 28822 5	3,5 x 9,5 x 13,5
H7	12 V	55 W	PX26d	1 987 301 087 ⁵⁾	2	4 047024 29187 4	5,2 x 9,5 x 12,3

Xenon Blue

H1	12 V	55 W	P14,5s	1 987 301 011	1	3 165141 22878 6	3,0 x 9,5 x 13,5
H3	12 V	55 W	PK22s	1 987 301 007	1	3 165143 17972 7	2,0 x 9,5 x 13,5
H4	12 V	60/55 W	P43t	1 987 301 010	1	3 165141 22877 9	5,0 x 9,5 x 13,5
H7	12 V	55 W	PX26d	1 987 301 013	1	3 165141 22880 9	3,5 x 9,5 x 13,5
W5W	12 V	5 W	W2,1x9,5d	1 987 301 033	2	3 165143 23490 7	6,0 x 9,5 x 13,5

5) Doppelschachtel – geeignet für SB und WS. / Double carton – Suitable for workshop and self-service packagin. /

Boîte de deux – Pour emballage atelier et libre-service. / Confezione doppia – Adatto per confezioni da officina e self-service. /

Caja doble – Adecuado para talleres y envase de autoservicio.

ECE

 $\frac{U}{V}$ $\frac{P}{W}$ 

EAN

**LED-Retrofit-Lampen / LED retrofit lamps / Lampes LED de substitution /
Lampade LED Retrofit / Lámparas LED Retrofit**

C5W ⁷⁾	12 V	1 W	SV8,5-8	1 987 301 501	2	4 047025 44119 3	1,1 x 9,5 x 13,5
W5W ⁷⁾	12 V	1 W	W2,1x9,5d	1 987 301 505	2	4 047025 44120 9	6,0 x 9,5 x 13,5

**Ersatzlampenbox / Spare lamps boxes / Coffrets de lampes à rechange /
Box per lampade di ricambio / Estuchos de lamparas de recambio**

H1 Minibox	12 V	-	-	1 987 301 102	4	3 165141 23285 1	5,2 x 6,3 x 11,2
H4 Minibox	12 V	-	-	1 987 301 101	4	3 165141 22870 0	5,2 x 6,3 x 11,2
H7 Minibox	12 V	-	-	1 987 301 103	4	3 165141 23286 8	5,2 x 6,3 x 11,2
H1 Maxibox	12 V	-	-	1 987 301 112	8	3 165141 24859 3	5,3 x 9,0 x 11,3
H4 Maxibox	12 V	-	-	1 987 301 111	8	3 165141 24858 6	5,3 x 9,0 x 11,3
H7 Maxibox	12 V	-	-	1 987 301 113	8	3 165141 24860 9	5,3 x 9,0 x 11,3
H1/H7 Maxibox	12 V	-	-	1 987 301 120	9	3 165141 33433 3	5,3 x 9,0 x 11,3
PCB - Miniwatt	12 V	-	-	1 987 302 301	59	4 047024 93868 7	4,5 x 21,5 x 14
PCB - Miniwatt	24 V	-	-	1 987 302 302	172	4 047024 92645 5	4,5 x 21,5 x 14

⁷⁾ Anwendungsbereich: Innenraumbeleuchtung / Area of application: Interior lighting / Domaine d'application : éclairage d'habitable /
Campo d'uso: illuminazione abitacolo / Ámbito de aplicación: iluminación interior

de	en	fr	it	es
Programm- übersicht	Programm overview	Aperçude la gamme	Panoramica del programma	Relación programa
nach Lampentyp	in lamptype order	par ordre types de lampes	ordinate per tipi	ordenato por tipo



ECE

 $\frac{U}{V}$ $\frac{P}{W}$ **C ...**

C5W	Pure Light	12 V	5 W	SV8,5-8	1 987 302 211	1 987 301 004
C5W	Longlife Daytime	12 V	5 W	SV8,5-8	1 987 302 281	1 987 301 060
C5W	Trucklight	24 V	5 W	SV8,5-8	1 987 302 507	-
C21W	Pure Light	12 V	21 W	SV8,5-8	1 987 302 230	-
C5W ⁷⁾	LED-Retrofit-Lampen	12 V	1 W	SV8,5-8	-	1 987 301 501

D ...

D1S	Xenon	-	35 W	PK32d-2	1 987 302 905	-
D2R	Xenon	-	35 W	P32d-3	1 987 302 903	-
D2S	Xenon	-	35 W	P32d-2	1 987 302 904	-
D4S	Xenon	-	35 W	P32d-5	1 987 302 906	-
D3S	Xenon	-	35 W	PK32d-5	1 987 302 907	-

H1 ...

H1	Pure Light	12 V	55 W	P14,5s	1 987 302 011	1 987 301 005
H1	Plus 30	12 V	55 W	P14,5s	1 987 302 012	1 987 301 003
H1	Plus 50	12 V	55 W	P14,5s	1 987 302 019	1 987 301 041
H1	Plus 90	12 V	55 W	P14,5s	1 987 302 114	1 987 301 076
H1	Plus 90	12 V	55 W	P14,5s	-	1 987 301 073 ⁵⁾
H1	Longlife Daytime	12 V	55 W	P14,5s	1 987 302 018	1 987 301 051
H1	Rallye	12 V	100 W	P14,5s	1 987 302 016 ³⁾	-
H1	Xenon Blue	12 V	55 W	P14,5s	1 987 302 015	1 987 301 011
H1	Xenon Silver	12 V	55 W	P14,5s	-	1 987 301 067
H1	Xenon Silver	12 V	55 W	P14,5s	-	1 987 301 080 ⁵⁾
H1	Trucklight	24 V	70 W	P14,5s	1 987 302 411	-
H1	Trucklight Maxlife	24 V	70 W	P14,5s	1 987 302 712	-
H1	Gigalight Plus 120	12 V	55 W	P14,5s	1 987 302 110	1 987 301 108
H1	Gigalight Plus 120	12 V	55 W	P14,5s	-	1 987 301 105 ⁵⁾
H1	Gigalight Plus 120	12 V	55 W	P14,5s	-	1 987 301 150 ⁴⁾
H1	Plus 50	12 V	55 W	P14,5s	-	1 987 301 840 ⁴⁾
H1	Plus 90	12 V	55 W	P14,5s	-	1 987 301 730 ⁴⁾
H1	Pure Light	12 V	55 W	P14,5s	-	1 987 301 404 ⁵⁾

H21W ...

H21W	Pure Light	12 V	21 W	BAY9s	1 987 302 264	-
------	------------	------	------	-------	----------------------	---

H27W/1 (880) ...

H27W/1 (880)	Pure Light	12 V	27 W	PG13	1 987 302 024	-
--------------	------------	------	------	------	----------------------	---

H3 ...

H3	Pure Light	12 V	55 W	PK22s	1 987 302 031	1 987 301 006
H3	Longlife Daytime	12 V	55 W	PK22s	1 987 302 038	1 987 301 053
H3	Rallye	12 V	100 W	PK22s	1 987 302 036 ³⁾	-
H3	Xenon Blue	12 V	55 W	PK22s	1 987 302 035	1 987 301 007
H3	Trucklight	24 V	70 W	PK22s	1 987 302 431	-
H3	Trucklight Maxlife	24 V	70 W	PK22s	1 987 302 732	-

ECE

 $\frac{U}{V}$
 $\frac{P}{W}$

H4 ...

H4	Pure Light	12 V	60/55 W	P43t	1 987 302 041	1 987 301 001
H4	Plus 30	12 V	60/55 W	P43t	1 987 302 042	1 987 301 002
H4	Plus 50	12 V	60/55 W	P43t	1 987 302 049	1 987 301 040
H4	Plus 90	12 V	60/55 W	P43t	1 987 302 144	1 987 301 077
H4	Plus 90	12 V	60/55 W	P43t	–	1 987 301 074 ⁵⁾
H4	Longlife Daytime	12 V	60/55 W	P43t	1 987 302 048	1 987 301 054
H4	Rallye	12 V	100/80 W	P43t	1 987 302 046 ³⁾	–
H4	Xenon Blue	12 V	60/55 W	P43t	1 987 302 045	1 987 301 010
H4	Xenon Silver	12 V	60/55 W	P43t	–	1 987 301 068
H4	Xenon Silver	12 V	60/55 W	P43t	–	1 987 301 081 ⁵⁾
H4	Trucklight	24 V	75/70 W	P43t	1 987 302 441	–
H4	Trucklight Maxlife	24 V	75/70 W	P43t	1 987 302 742	–
H4	Gigalight Plus 120	12 V	60/55 W	P43t	1 987 302 140	1 987 301 109
H4	Gigalight Plus 120	12 V	60/55 W	P43t	–	1 987 301 106 ⁵⁾
H4	Gigalight Plus 120	12 V	60/55 W	P43t	–	1 987 301 160 ⁴⁾
H4	Plus 50	12 V	60/55 W	P43t	–	1 987 301 850 ⁴⁾
H4	Plus 50	12 V	60/55 W	P43t	–	1 987 301 740 ⁴⁾
H4	Plus 50	12 V	60/55 W	P43t	–	1 987 301 405 ⁵⁾

H6 ...

H6W	Pure Light	12 V	6 W	BAX9s	1 987 302 232	1 987 301 035
H6W	Longlife Daytime	12 V	6 W	BAX9s	–	1 987 301 061

H7 ...

H7	Pure Light	12 V	55 W	PX26d	1 987 302 071	1 987 301 012
H7	Plus 50	12 V	55 W	PX26d	1 987 302 079	1 987 301 042
H7	Plus 90	12 V	55 W	PX26d	1 987 302 174	1 987 301 078
H7	Plus 90	12 V	55 W	PX26d	–	1 987 301 075 ⁵⁾
H7	Longlife Daytime	12 V	55 W	PX26d	1 987 302 078	1 987 301 057
H7	Xenon Blue	12 V	55 W	PX26d	1 987 302 075	1 987 301 013
H7	Xenon Silver	12 V	55 W	PX26d	–	1 987 301 069
H7	Xenon Silver	12 V	55 W	PX26d	–	1 987 301 087 ⁵⁾
H7	Trucklight	24 V	70 W	PX26d	1 987 302 471	–
H7	Trucklight Maxlife	24 V	70 W	PX26d	1 987 302 772	–
H7	Gigalight Plus 120	12 V	55 W	PX26d	1 987 302 170	1 987 301 110
H7	Gigalight Plus 120	12 V	55 W	PX26d	–	1 987 301 107 ⁵⁾
H7	Gigalight Plus 120	12 V	55 W	PX26d	–	1 987 301 170 ⁴⁾
H7	Plus 50	12 V	55 W	PX26d	–	1 987 301 860 ⁴⁾
H7	Plus 50	12 V	55 W	PX26d	–	1 987 301 750 ⁴⁾
H7	Pure Light	12 V	55 W	PX26d	–	1 987 301 406 ⁵⁾

³⁾ Nicht im Geltungsbereich von ECE zulässig. / Not permitted where ECE applies. / N'est pas homologué par ECE. / Non ammesso in ambito di ECE. / No autorizada dentro del ámbito del ECE.

⁴⁾ Einzelschachtel – geeignet für SB und WS. / Individual pack – Suitable for workshop and self-service packagin. / Carton individuel – Pour emballage atelier et libre-service. / Scatola singola – Adatto per confezioni da officina e self-service. / Caja individual – Adecuado para talleres y envase de autoservicio.

⁵⁾ Doppelschachtel – geeignet für SB und WS. / Double carton – Suitable for workshop and self-service packagin. / Boîte de deux – Pour emballage atelier et libre-service. / Confezione doppia – Adatto per confezioni da officina e self-service. / Caja doble – Adecuado para talleres y envase de autoservicio.

⁷⁾ Anwendungsbereich: Innenraumbeleuchtung / Area of application: Interior lighting / Domaine d'application : éclairage d'habitacle / Campo d'uso: illuminazione abitacolo / Ámbito de aplicación: iluminación interior

de

**Programm-
übersicht**nach Lampentyp
(Fortsetzung)

en

**Programm
overview**in lamptype order
(continued)

fr

**Apercu
de la gamme**par ordre types
de lampes
(suite)

it

**Panoramica
del programma**ordinate per tipi
(seguito)

es

**Relación
programa**ordenato por tipo
(continuación)

ECE

 $\frac{U}{V}$ $\frac{P}{W}$ **H8 ...**

H8	Pure Light	12 V	35 W	PGJ19-1	1 987 302 081	-
----	------------	------	------	---------	----------------------	---

H9 ...

H9	Pure Light	12 V	65 W	PGJ19-5	1 987 302 082	-
----	------------	------	------	---------	----------------------	---

H10 ...

H10	Pure Light	12 V	42 W	PY20d	1 987 302 083	-
-----	------------	------	------	-------	----------------------	---

H11 ...

H11	Pure Light	12 V	55 W	PGJ19-2	1 987 302 084	1 987 301 339
H11	Longlife Daytime	12 V	55 W	PGJ19-2	1 987 302 085	1 987 301 340
H11	Trucklight	24 V	70 W	PGJ19-2	1 987 302 481	-

HB ...

HB3	Pure Light	12 V	60 W	P20d	1 987 302 152	1 987 301 062
HB3	Xenon Blue	12 V	60 W	P20d	1 987 302 154	-
HB4	Pure Light	12 V	51 W	P22d	1 987 302 153	1 987 301 063
HB4	Xenon Blue	12 V	51 W	P22d	1 987 302 155	-

HIR2 (9012) ...

HIR2 (9012)	Pure Light	12 V	55 W	PX22d	1 987 302 026	-
-------------	------------	------	------	-------	----------------------	---

HS1

HS1	Pure Light	12 V	35/35 W	PX43t	1 987 302 104	-
-----	------------	------	---------	-------	----------------------	---

P ...

P13W	Pure Light	12 V	13 W	PG18,5d-1	1 987 302 265	-
PS19W	Pure Light	12 V	19 W	PG20-1	1 987 302 266	-
P21W	Pure Light	12 V	21 W	BA15s	1 987 302 201	1 987 301 017
P21W	Pure Light	12 V	21 W	BA15d	1 987 302 261	-
P21W	Longlife Daytime	12 V	21 W	BA15s	1 987 302 280	1 987 301 050
P21W	Trucklight	12 V	21 W	BA15s	1 987 302 501	-
P21W	Trucklight	24 V	21 W	BA15d	1 987 302 532	-
P21W	Trucklight Maxlife	24 V	21 W	BA15s	1 987 302 701	-
P21W	Trucklight Maxlife	24 V	21 W	BA15d	1 987 302 702	-
P21W	Pure Light	6 V	21 W	BA15s	1 987 302 607	-
P21/4W	Pure Light	12 V	21/4 W	BAZ15d	1 987 302 215	1 987 301 015
P21/5W	Pure Light	12 V	21/5 W	BAY15d	1 987 302 202	1 987 301 016
P21/5W	Longlife Daytime	12 V	21/5 W	BAY15d	1 987 302 282	1 987 301 055
P21/5W	Trucklight	24 V	21/5 W	BAY15d	1 987 302 524	-
PY21W	Pure Light	12 V	21 W	BAU15s	1 987 302 213	1 987 301 018
PY21W	Magic Effect	12 V	21 W	BAU15s	-	1 987 301 025
PY21W	Trucklight Maxlife	24 V	21 W	BAU15s	1 987 302 703	-
PSY24W	Pure Light	12 V	24 W	PG20-4	1 987 302 267	-

ECE

 $\frac{U}{V}$ $\frac{P}{W}$ **R ...**

R2	Pure Light	12 V	45/40 W	P45t	1 987 302 023	-
R2	Trucklight	24 V	55/50 W	P45t	1 987 302 421	-
R2 Halogen	Pure Light	12 V	45/40 W	P45t	1 987 302 021	1 987 301 021
R5W	Pure Light	12 V	5 W	BA15s	1 987 302 204	1 987 301 022
R5W	Pure Light	12 V	5 W	BA15d	1 987 302 237	-
R5W	Pure Light	6 V	5 W	BA15s	1 987 302 605	-
R5W	Longlife Daytime	12 V	5 W	BA15s	1 987 302 284	1 987 301 058
R5W	Trucklight	24 V	5 W	BA15s	1 987 302 510	-
R5W	Trucklight	24 V	5 W	BA15d	1 987 302 527	-
R5W	Trucklight Maxlife	24 V	5 W	BA15s	1 987 302 704	-
R5W	Trucklight Maxlife	24 V	5 W	BA15d	1 987 302 705	-
R10W	Pure Light	12 V	10 W	BA15s	1 987 302 203	1 987 301 019
R10W	Longlife Daytime	12 V	10 W	BA15s	-	1 987 301 059
R10W	Trucklight	24 V	10 W	BA15s	1 987 302 505	-
R10W	Trucklight Maxlife	24 V	10 W	BA15s	1 987 302 706	-
R10W	Pure Light	6 V	10 W	BA15s	1 987 302 604	-

S ...

S1	Pure Light	12 V	25/25 W	BA20d	1 987 302 106	-
S2	Pure Light	12 V	35/35 W	BA20d	1 987 302 105	-
S3	Pure Light	6 V	15 W	P26s	1 987 302 606	-

T ...

T4W	Pure Light	12 V	4 W	BA9s	1 987 302 207	1 987 301 023
T4W	Trucklight	24 V	4 W	BA9s	1 987 302 512	-
T4W	Trucklight Maxlife	24 V	4 W	BA9s	1 987 302 707	-
T4W	Pure Light	6 V	4 W	BA9s	1 987 302 603	-

W ...

W2,3W	Pure Light	12 V	2,3 W	W2x4,6d	1 987 302 240	-
W3W	Pure Light	12 V	3 W	W2,1x9,5d	1 987 302 217	1 987 301 028
W3W	Trucklight	24 V	3 W	W2,1x9,5d	1 987 302 517	-
W5W	Pure Light	12 V	5 W	W2,1x9,5d	1 987 302 206	1 987 301 026
W5W	Longlife Daytime	12 V	5 W	W2,1x9,5d	1 987 302 286	1 987 301 052
W5W	Xenon Blue	12 V	5 W	W2,1x9,5d	-	1 987 301 033
W5W	Trucklight	24 V	5 W	W2,1x9,5d	1 987 302 518	-
W5W 7)	LED-Retrofit-Lampen	12 V	1 W	W2,1x9,5d	-	1 987 301 505
W16W	Pure Light	12 V	16 W	W2,1x9,5d	1 987 302 205	1 987 301 049
W21W	Pure Light	12 V	21 W	W3x16d	1 987 302 251	-
W21/5W	Pure Light	12 V	21/5 W	W3x16q	1 987 302 252	1 987 301 079
WY5W	Pure Light	12 V	5 W	W2,1x9,5d	1 987 302 241	-
WY21W	Pure Light	12 V	21 W	W3x16d	1 987 302 222	-

7) Anwendungsbereich: Innenraumbelichtung / Area of application: Interior lighting / Domaine d'application : éclairage d'habitacle / Campo d'uso: illuminazione abitacolo / Ámbito de aplicación: iluminación interior

de

**Programm-
übersicht**nach Lampentyp
(Fortsetzung)

en

**Programm
overview**in lamptype order
(continued)

fr

**Apercu
de la gamme**par ordre types
de lampes
(suite)

it

**Panoramica
del programma**ordinate per tipi
(seguito)

es

**Relación
programa**ordenato por tipo
(continuación)

ECE

 $\frac{U}{V}$ $\frac{P}{W}$ 

- ...

-	Pure Light	12 V	1,1 W	BX8,4d	1 987 302 243	-
-	Pure Light	12 V	1,2 W	W2x4,6d	1 987 302 208	1 987 301 024
-	Pure Light	12 V	1,2 W	B8,5d	1 987 302 219	-
-	Pure Light	12 V	1,2 W	BX8,4d	1 987 302 235	-
-	Pure Light	12 V	1,5 W	BX8,4d	1 987 302 255	-
-	Pure Light	12 V	2 W	BA9s	1 987 302 212	-
-	Pure Light	12 V	2 W	W2x4,6d	1 987 302 218	-
-	Pure Light	12 V	2 W	W2,1x9,5d	1 987 302 223	-
-	Pure Light	12 V	2 W	BA7s	1 987 302 224	-
-	Pure Light	12 V	2 W	BX8,4d	1 987 302 236	-
-	Pure Light	12 V	3 W	SV7-8	1 987 302 226	-
-	Pure Light	12 V	5 W	SV8,5-8	1 987 302 225	-
-	Pure Light	12 V	5 W	BA9s	1 987 302 231	-
-	Pure Light	12 V	10 W	SV8,5-8	1 987 302 210	1 987 301 014
-	Pure Light	12 V	10 W	SV8,5-8	1 987 302 227	-
-	Pure Light	12 V	10 W	SV8,5-8	1 987 302 228	-
-	Pure Light	12 V	10 W	BA9s	1 987 302 233	-
-	Pure Light	12 V	15 W	SV8,5-8	1 987 302 238	-
-	Pure Light	12 V	18 W	BA15s	1 987 302 214	-
-	Pure Light	12 V	18 W	SV8,5-8	1 987 302 229	-
21 W amber	Pure Light	12 V	21 W	BA15s	1 987 302 239	-
-	Pure Light	12 V	21 W	W2,1x9,5d	1 987 302 249	-
21 W red	Pure Light	12 V	21 W	BA15s	1 987 302 262	-
-	Pure Light	12 V	24 W	BA15d	1 987 302 263	-
-	Trucklight	24 V	1,2 W	W2x4,6d	1 987 302 504	-
-	Trucklight	24 V	1,2 W	B8,5d	1 987 302 514	-
-	Trucklight	24 V	1,2 W	B8,3d	1 987 302 515	-
-	Trucklight	24 V	2 W	BA9s	1 987 302 508	-
-	Trucklight	24 V	2 W	W2,1x9,5d	1 987 302 516	-
-	Trucklight	24 V	3 W	BA7s	1 987 302 519	-
-	Trucklight	24 V	3 W	SV7-8	1 987 302 528	-
-	Trucklight	24 V	5 W	SV8,5-8	1 987 302 520	-
-	Trucklight	24 V	10 W	SV8,5-8	1 987 302 521	-
-	Trucklight	24 V	18 W	BA15s	1 987 302 523	-
-	Trucklight	24 V	15 W	BA15s	1 987 302 526	-
-	Trucklight	28 V	7 W	BA15s	1 987 302 535	-
-	Pure Light	6 V	10 W	SV8,5-8	1 987 302 612	-

en

Cross-reference

Non-Bosch

→ Bosch

GE	Bosch	GE	Bosch	GE	Bosch	GE	Bosch
1...		2663	1 987 302 508	53110U	1 987 302 084	91622	1 987 302 518
1053	1 987 302 607	2692	1 987 302 519	53500U	1 987 302 904	91641PS	1 987 302 235
1056	1 987 302 213	2696	1 987 302 224	53510U	1 987 302 903	91645PS	1 987 302 236
1057	1 987 302 201			53620	1 987 302 905	91715	1 987 302 228
				53660	1 987 302 907	91735	1 987 302 227
1057D	1 987 302 280	5...		53670	1 987 302 906	91761	1 987 302 230
1058	1 987 302 261	501A	1 987 302 241	53800SPU	1 987 302 148	921	1 987 302 205
1059	1 987 302 214	50310/1U	1 987 302 011	53990	1 987 302 264		
1060	1 987 302 501	50310MU	1 987 302 012	58320SPU	1 987 302 178		
1060HDL	1 987 302 701			58520U	1 987 302 071		
1061	1 987 302 532	50310BU	1 987 302 015	58520BU	1 987 302 075	TU...	
1061HDL	1 987 302 702	50310DPU	1 987 302 018	58520DPU	1 987 302 078	TU930FD	1 987 302 286
1073NAHDL	1 987 302 703	50310NHSU	1 987 302 118	58520MPU	1 987 302 079		
1077	1 987 302 202	50310MPU	1 987 302 019	58520SNU	1 987 302 170		
1077LFD	1 987 302 282	50310NU	1 987 302 110	58520SXU	1 987 302 174		
1078	1 987 302 524	50310XU	1 987 302 114	58521U	1 987 302 471		
1115	1 987 302 526	50320/1U	1 987 302 411	58521HDLU	1 987 302 772		
1117	1 987 302 523	50320/1U_HDL	1 987 302 712	58540U	1 987 302 231		
1122	1 987 302 215	50340U	1 987 302 031	58560	1 987 302 233		
1931	1 987 302 023	50340BU	1 987 302 035				
1937	1 987 302 421	50340DPU	1 987 302 038	7...			
		50350U	1 987 302 431	7440	1 987 302 251		
		50350U_HDL	1 987 302 732	7440NA	1 987 302 222		
		50440U	1 987 302 041	7443	1 987 302 252		
		50440MU	1 987 302 042				
		50440BU	1 987 302 045	7546	1 987 302 211		
2...		50440DPU	1 987 302 048	7546LFD	1 987 302 281		
2615	1 987 302 605	50440MPU	1 987 302 049	7552	1 987 302 507		
2618	1 987 302 237	50440SNU	1 987 302 140	7575	1 987 302 225		
2619	1 987 302 204	50440SXU	1 987 302 144	7576	1 987 302 210		
2619LFD	1 987 302 284						
2626	1 987 302 527	50450U	1 987 302 441	7579	1 987 302 520		
2626HDL	1 987 302 705	50450HDLU	1 987 302 742	7580	1 987 302 521		
2627	1 987 302 510	52100U	1 987 302 046	7592	1 987 302 238		
2627HDL	1 987 302 704	52130U	1 987 302 036	7593	1 987 302 229		
		52140/1U	1 987 302 016				
2639	1 987 302 604	52830U	1 987 302 232	9...			
2641	1 987 302 203	52950U	1 987 302 021	9005	1 987 302 152		
2641LFD	1 987 302 283	5301	1 987 302 208	9005BU	1 987 302 154		
2643	1 987 302 505	5301PS	1 987 302 219	9006	1 987 302 153		
2643HDL	1 987 302 706	5302PS	1 987 302 514				
2659	1 987 302 603			9006BU	1 987 302 155		
2660	1 987 302 212	5304	1 987 302 217	9145	1 987 302 083		
2661	1 987 302 512	5305	1 987 302 517	91364	1 987 302 606		
2661HDL	1 987 302 707	5307	1 987 302 206	91602	1 987 302 504		
2662	1 987 302 207	53090U	1 987 302 081	91605	1 987 302 218		
		53100U	1 987 302 082				

Cross-reference

Non-Bosch

→ Bosch

(continued)

Osram	Bosch	Osram	Bosch	Osram	Bosch	Osram	Bosch
2...		5627	1 987 302 510	64210	1 987 302 071	7510LTS	1 987 302 703
2351MFX6	1 987 302 235	5627LTS	1 987 302 704	64210NBP	1 987 302 174	7511	1 987 302 501
2352MFX6	1 987 302 236	5637	1 987 302 505	64210NBU	1 987 302 170	7511LTS	1 987 302 701
2452MFX6	1 987 302 255	5637LTS	1 987 302 706	64210SVS	1 987 302 178	7515	1 987 302 252
				64217	1 987 302 072	7527	1 987 302 214
2473MFX6	1 987 302 243	6...		64210CB	1 987 302 075	7528	1 987 302 202
2721	1 987 302 208	62200	1 987 302 016	64210ULT	1 987 302 078	7528ULT	1 987 302 282
2721MF	1 987 302 219	62201	1 987 302 036	64210SVS	1 987 302 079	7529	1 987 302 526
2722	1 987 302 218	62203	1 987 302 046	64211	1 987 302 084	7535	1 987 302 523
2723	1 987 302 240	6411	1 987 302 210	64212	1 987 302 081	7537	1 987 302 524
2741	1 987 302 504	64111	1 987 302 231	64213	1 987 302 082	7951	1 987 302 023
2741MF	1 987 302 514	6413	1 987 302 225	64215	1 987 302 471	7952	1 987 302 421
2741MF8	1 987 302 515	64113	1 987 302 233	64215LTS	1 987 302 772		
2820	1 987 302 223	64132	1 987 302 232	6423	1 987 302 507		
2821	1 987 302 217	64136	1 987 302 264	6424	1 987 302 520		
2825	1 987 302 206	64138	1 987 302 533	6428	1 987 302 226	8...	
2825ULT	1 987 302 286	64150	1 987 302 011	6429	1 987 302 521	880	1 987 302 024
2827	1 987 302 241	64150CB	1 987 302 015	6430	1 987 302 528		
2840	1 987 302 516	64150NBP	1 987 302 114	64326	1 987 302 106		
2841	1 987 302 517	64150NBU	1 987 302 110	64327	1 987 302 105		
2845	1 987 302 518	64150SUP	1 987 302 012	6438	1 987 302 227	9...	
2850CW-02B	1 987 301 505	64150SVS	1 987 302 118	6450	1 987 302 612	9005	1 987 302 152
		64150ULT	1 987 302 018	6451	1 987 302 238	9005CB	1 987 302 154
		64150SVS	1 987 302 019	6461	1 987 302 228	9006	1 987 302 153
		64151	1 987 302 031	6475	1 987 302 229		
3...		64151CB	1 987 302 035	6476	1 987 302 230	9006CB	1 987 302 155
3796	1 987 302 212	64155	1 987 302 411	6498CW-01B	1 987 301 501	9145	1 987 302 083
3797	1 987 302 508	64155LTS	1 987 302 712	66144	1 987 302 905	921	1 987 302 205
3892	1 987 302 603	64156	1 987 302 431	66240	1 987 302 904		
3893	1 987 302 207	64156LTS	1 987 302 732	66250	1 987 302 903		
3898	1 987 302 224	6418	1 987 302 211	66340CBI	1 987 302 907		
3899	1 987 302 519	64185	1 987 302 104	66440CBI	1 987 302 906		
3930	1 987 302 512	6418ULT	1 987 302 281				
3930LTS	1 987 302 707	64183	1 987 302 021				
		64193	1 987 302 041	7...			
		64193CB	1 987 302 045	7130	1 987 302 606		
		64193NBP	1 987 302 144	7225	1 987 302 215		
		64193NBU	1 987 302 140	7501	1 987 302 607		
		64193SUP	1 987 302 042				
		64193SVS	1 987 302 148	7504	1 987 302 222		
		64193ULT	1 987 302 048	7505	1 987 302 251		
		64193SVS	1 987 302 049	7506	1 987 302 201		
		64196	1 987 302 441	7506ULT	1 987 302 280		
		64196LTS	1 987 302 742	7507	1 987 302 213		
5001	1 987 302 604						
5006	1 987 302 605						
5007	1 987 302 204						
5007ULT	1 987 302 284						
5008	1 987 302 203						
5008ULT	1 987 302 283						
5407	1 987 302 237						
5626	1 987 302 527						

Philips	Bosch	Philips	Bosch	Philips	Bosch	Philips	Bosch
1...		12505	1 987 302 218	13516	1 987 302 504	9...	
12023	1 987 302 231	12516	1 987 302 208	13620B1	1 987 302 421	9005	1 987 302 152
12024	1 987 302 233	12569RA	1 987 302 046	13814	1 987 302 505	9005BV+B1	1 987 302 154
12036	1 987 302 232	12594	1 987 302 215	13821	1 987 302 510	9006	1 987 302 153
12059C1	1 987 302 024	12620	1 987 302 023	13822	1 987 302 527	9006 BV+B1	1 987 302 155
12061	1 987 302 240	12624	1 987 302 243	13829	1 987 302 519		
12065	1 987 302 251	12625	1 987 302 235	13844	1 987 302 507		
12066	1 987 302 252	12626	1 987 302 236	13864	1 987 302 520		
12067	1 987 302 205	12627	1 987 302 255	13866	1 987 302 521		
12071B2	1 987 302 222	12636BW	1 987 302 104	13913	1 987 302 508		
12188NAC1	1 987 302 267	12728BW	1 987 302 105	13929	1 987 302 512		
12256	1 987 302 217	127996000KX2	1 987 301 505	13961	1 987 302 518		
12258	1 987 302 011	12803	1 987 302 230	13972	1 987 302 471		
12258BVUB1	1 987 302 015	12807	1 987 302 229				
12258PRB1	1 987 302 012	12814	1 987 302 203				
12258LLB1	1 987 302 018	12821	1 987 302 204	2...			
12258XVB1	1 987 302 110	12821LLB2	1 987 302 284	24356CP	1 987 302 533		
12258XVB1	1 987 302 114	12822	1 987 302 237	24362MDC1	1 987 302 481		
12258VPB1	1 987 302 019	12829	1 987 302 224				
12277C1	1 987 302 265	12844	1 987 302 211				
12336	1 987 302 031	12844LLCP	1 987 302 281	4...			
12336BVUB1	1 987 302 035	12850	1 987 302 238	42402VIC1	1 987 302 906		
12336LLC1	1 987 302 038	12854	1 987 302 228	42403VIC1	1 987 302 907		
12342	1 987 302 041	12864	1 987 302 225				
12342BVUB1	1 987 302 045	12866	1 987 302 210				
12342LLB1	1 987 302 048	12913	1 987 302 212	6...			
12342PRB1	1 987 302 042	12929	1 987 302 207	6498	1 987 302 607		
12342VPB1	1 987 302 049	129466000KX1	1 987 301 501	6814	1 987 302 604		
12342XVB1	1 987 302 140	12961	1 987 302 206	6821	1 987 302 605		
12342XVB1	1 987 302 144	12961LLB2	1 987 302 286	6929	1 987 302 603		
12356CP	1 987 302 264	12972	1 987 302 071				
12360	1 987 302 081	12972BVUB1	1 987 302 075				
12361	1 987 302 082	12972LLB1	1 987 302 078				
12362	1 987 302 084	12972VPB1	1 987 302 079				
12396	1 987 302 241	12972XVB1	1 987 302 170				
12445	1 987 302 214	12972XVB1	1 987 302 174	7...			
12454RA	1 987 302 016	13256	1 987 302 517	7008	1 987 302 606		
12455RA	1 987 302 036	13258	1 987 302 411	7778	1 987 302 223		
12475	1 987 302 021	13336	1 987 302 431	7779	1 987 302 516		
12496NA	1 987 302 213	13342	1 987 302 441				
12498	1 987 302 201	13401	1 987 302 526	8...			
12498LLB2	1 987 302 280	13445	1 987 302 523	85122	1 987 302 904		
12499	1 987 302 202	13496	1 987 302 703	85126	1 987 302 903		
12499LLB2	1 987 302 282	13498	1 987 302 501	85410	1 987 302 905		
		13499	1 987 302 524				

	Passenger cars		EAN code		Reversing lamp
	Commercial vehicles		No UV		Fog warning lamp
	Auto lamp		Lead free		Brake light
	Motorcycle		Attention: Hot!		Tail lamp
	Passenger cars		Wear protective gloves		Rear indicator
	Commercial vehicles		Workshop pack		Side-marker lamp
	SUV		Self-service pack		Qty. per self-service pack
	ECE		Rated voltage in Volts		Lamp on
	Not suitable for household use		Rated power in watts		Long service life
	Do not use damaged lights		Base type		Triple service life
	Light in protective cover		Dimensions		
	Lamp off the mount		Cross-reference		
	Touch lamp at its base only, never at the glass bulb		Front/ Side indicator		
	Wear eye protection		Position lamp		
	protect against splash water		Interior light		
	Only to be installed by specialist personnel		License plate light		
	Information/Explanations		Fog lamps		
	Page reference		Low beam		
	Illustration		Driving lamp		



Automotive bulbs usage overview

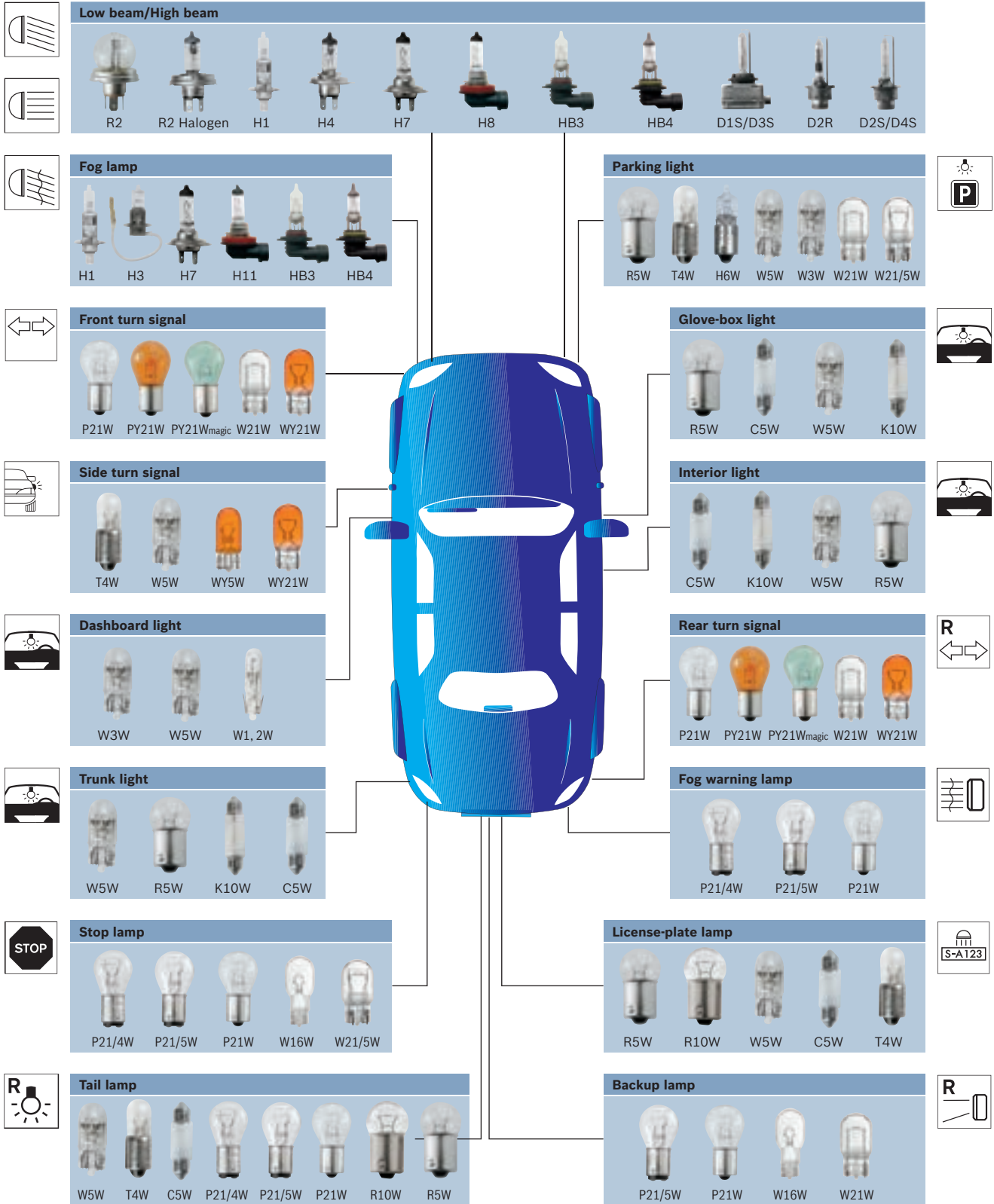



Bosch lighting technology

Bosch can provide you with the most suitable product for almost any application. As well as automotive bulbs, we can supply you with auxiliary lamps and beacons. And because we are a complete supplier working constantly on new technologies, our product range also includes testers and diagnostic software.



Bosch parts fast and easy on:
www.bosch-automotive-catalog.com



BOSCH

1 987 721 222/201506

AA/MK12 – 06.2015 – en

© 2015 Robert Bosch GmbH
Automotive Aftermarket
Postfach 41 09 60
76225 Karlsruhe

Token fee: € 5,00

www.bosch.de/aa

Editorial closing: 15. 04. 2015

Subject to change without notice.
Please direct questions and
comments to our Authorized
Representative in your country.
This edition supersedes all
previous editions.

