

Mini

Spare parts for passenger cars



DRIVER'S BEST FRIEND

MEYLE

Sophisticated technology - considerably longer service life.



The MEYLE range of products features a wide variety of components. Spare parts from A to Z, from Alfa Romeo to Volvo, from minicars to top-of-the-range luxury models.



Steering & suspension

Control arms, Stabilizer links, Tie rod assemblies, and many more



Brakes

Brake discs, MEYLE PD, Brake pad sets, Brake drums, and many more



Drive components

C.V. joint kits, Wheel bearings, Belt drives, and many more



Damping parts

Shock absorbers, Strut mounts, Coil springs, and many more



Filters

Oil filters, Air filters, Cabin air filters, Fuel filters, and many more



Cooling components

Water pumps, Expansion tanks, Radiator hoses, and many more



Rubber-to-metal parts

Flex discs, Cardan shaft bearings, Engine mounts, and many more



Electrics and sensors

Crank position sensor, Control units, Glow plugs, and many more



Engine and transmission parts

Oil change kits, V-ribbed belts, Idlers/guide pulleys, and many more



Fluids

Coolant additives, Hydraulic oil, Engine oil, and many more



Complementary product range

Wiper blades, Gas springs, Window lifters, and many more

ORIGINAL, PD and HD – The MEYLE product lines



MEYLE-ORIGINAL: Fit as snugly as the original.

More than 21,000 spare parts for passenger cars, vans and trucks, quality-tested, robust, durable and tried and tested a thousand times over on the roads across the world – that's MEYLE-ORIGINAL. Relying on our comprehensive product portfolio – offering everything from A for axial joint to Z for zinc-coated screw – customers can be sure that they will always have safety on their side.

MEYLE-PD: Safety to the power of two.

Thinking outside the box to make our products better: MEYLE-PD stands for brake discs and pads delivering maximum braking performance and setting new standards in terms of durability, comfort, aesthetics, and ease of installation. Look for the „/PD“ part number extension.

MEYLE-HD: Better than originals.

MEYLE-HD parts simply last longer. Their technically optimised and reinforced designs make them more durable and reliable than OE components. So it is only natural for us to offer extended warranty protection for our MEYLE-HD parts: All parts of the HD range come with a full four-year guarantee. Look for the „/HD“ part number extension.



4-year guarantee on all MEYLE-HD parts!

Robust, high mileage, reliable and better than the original. MEYLE-HD parts simply last longer!

Our three success factors.

The success of the MEYLE brand is based on competence, quality and service.

The development of quality-approved automotive spare parts for the independent aftermarket is our trademark. And MEYLE-HD parts are our specialty: improved parts, developed by our team of engineers at our headquarters in Hamburg. We give a 4-year guarantee on our MEYLE-HD parts which have a far longer service life. Based on information from TÜV (Technical control board), from recall statistics as well as media and market information from workshops and other technical partners, MEYLE engineers identify parts in vehicles which become conspicuous on account of frequent, early wear. On the basis of their findings, they develop technical improvements for the respective weakness. In the end, this work is a

large benefit for all MEYLE parts. Something all reputable automotive manufacturers highly appreciate: MEYLE also develops customized products, for example for Morgan, the legendary sports car manufacturer.

Passing on our know-how to staff and customers is just as much a part of our service as high parts availability and swift delivery. Modern warehouse logistics with space covering 29,000 m² and 56,000 pallet places ensure the reliable supply of our partners.

We have now won the "Top Job Employer" award for the fifth time which confirms our outstanding internal business approach and excellent Human Resources policy. We have been one of Germany's leading SME employers for many years.

MEYLE

Guarantee certificate



A distinguishing feature of MEYLE is our high level of precision, achieved by the application of the most modern manufacturing methods. Our MEYLE articles meet highest quality standards and our supply plants are certified in accordance with ISO 9001:2008 and ISO/TS 16949.

We guarantee perfect material and faultless processing of all our MEYLE articles for a period of 24 months as of the date of installation. For MEYLE-HD articles, this guarantee applies for 48 months as of the date of installation.

Complementing this guarantee, we give an additional 100,000 miles (160,934 kilometres) performance guarantee against defects of material and workmanship for MEYLE passenger car water pumps purchased from 01 May 2016. The guarantee given for MEYLE passenger car water pumps terminates upon expiration of the guarantee period or the guaranteed mileage, whichever occurs later: if the guaranteed mileage has not been reached at the end of the guarantee period of 24 or 48 months respectively, the performance guarantee continues to be valid. Respectively, the guarantee period of 24 or 48 months continues to be valid also in any case where the guaranteed mileage was already exceeded.

During the guarantee period, we perform repair work on claimed MEYLE articles or provide a replacement. The MEYLE guarantee does not apply for normal wear and damage caused by inappropriate handling or inappropriate installation. The guarantee expires if the respective part is modified by third parties or via installation of parts from third parties, or if the part, or vehicle, is used in excess of the appropriate use and purpose. The MEYLE guarantee also expires if MEYLE instructions or vehicle manufacturer instructions, e.g. concerning maintenance and replacement intervals, are not observed. The guarantee only applies for MEYLE water pumps, if the cooling circuit has been flushed prior to installation of the MEYLE water pump. Rights granted by law continue to apply unrestrictedly, irrespective of this guarantee.

The customer must submit a written guarantee claim immediately, or at the latest 30 days after identifying an error in material or processing. This claim is to be submitted to the dealer from which he acquired the MEYLE article part. The customer should return the article, carefully packed. He must enclose the original sales receipt and a description of the error. The customer must also verify the date of installation and the mileage of the vehicle by means of respective documents.

Last amended January 2017

A handwritten signature in white ink, appearing to read 'M. Wunder', set against a dark blue background.

Director Quality Assurance
Manfred Wunder

Body/Cabin 1

Body, Interior fittings

| | |
|------------------|-----------------------|
| Cabin air filter | Trunk-/tailgate shock |
| Hood shock | Wiper Blade |

Brakes 7

Disc brake, Hydraulics

| | |
|------------|---------------------------------|
| Brake disc | Brake pad set |
| Brake hose | Guide sleeve kit, brake caliper |

Drive train/Transmission 19

Drive shafts, Joints, Transmission

| | | |
|----------------------|---------------------------|---|
| Boot kit, C.V. joint | Hydraulic filter kit, A/T | Mount, manual transmission |
| C.V. joint kit | Hydraulic filter, A/T | Parts kit, automatic transm. oil change |

Electrics 24

Body, Brakes, Engine, Lighting

| | | |
|-----------------------|---------------------------|-----------------------------|
| ABS wheel sensor | Glow plug | Sensor, outdoor temperature |
| Back up light switch | Ignition coil | Wear sensor |
| Crank position sensor | Sensor, camshaft position | |

Engine/Cooling/Clutch 31

Belt drive / Engine control, Cooling system, Fuel system, Lubrication system, Mounts

| | | |
|--------------------|-------------------------------|--------------------|
| A/T oil pan gasket | Fuel filter | Timing belt roller |
| Air filter | Oil filter | V-ribbed belt |
| Engine mount | Radiator hose | Water pump |
| Expansion tank | Tensioner pulley, timing belt | |
| Expansion tank cap | Timing belt kit | |

Steering 49

Hydraulics, Mounting parts, Tie rod assemblies

| | | |
|-----------|-------------------|-------------|
| Axial rod | Steering boot kit | Tie rod end |
| P/S hose | Tie rod assembly | |

Suspension 57

Control arms, Stabilizer, Suspension / damping, Wheel hubs / Wheel bearings

| | | |
|--------------------------------|-------------------------|-----------------|
| Ball joint | Mount, control arm | Shock absorber |
| Control arm | Mount, stabilizer | Stabilizer link |
| Control arm set | Rod/strut, suspension | Strut mount |
| Dust cover kit, shock absorber | Rubber stop, suspension | Wheel hub |

Hood shock
340 910 0021 | MHS0071
Notes

 Length [mm] 575
 Force output F [N] 270

References

 51 23 7 066 566 51 23 7 175 020
 51 23 7 160 818

Application info

Mini I [06/01-11/07]

Trunk-/tailgate shock
340 910 0022 | MTS0263
Notes

 Length [mm] 500
 Force output F [N] 310
 Left and right
 Rear

References

41 62 6 801 258

Application info

Mini I [06/01-11/07]

Trunk-/tailgate shock
340 910 0012 | MTS0431
Notes

 Length [mm] 495
 Force output F [N] 370

References

51 24 7 148 902

Application info

Mini I [06/01-11/07]

Mini II [10/06-07/10]

029 280 1212 | MBL0046

Wiper Blade



Notes

Length [in]
Length [mm]

Flat bar wiper blade
Flat wiper blade
12
280
Rear

Application info

Paceman [04/12--]

029 290 1110 | MBL0001

Wiper Blade



Notes

Length [in]
Length [mm]

Flat bar wiper blade
Flat wiper blade
11
290
Rear

Application info

Mini II [10/06-07/10]

029 290 1111 | MBL0062

Wiper Blade



Notes

Length [in]
Length [mm]

Beam wiper blade
Bracket wiper blade
11.5
290
Rear

References

61 62 7 129 280

Application info

Mini I [06/01-11/07]

Wiper Blade

029 300 1210 | MBL0003

Notes

Length [in]
Length [mm]

Bracket wiper blade
Beam wiper blade
12
300
Rear



Application info

Mini I [06/01-11/07]

Wiper Blade

029 450 1800 | MBL0027

Notes

Observe service information
Length [in]
Length [mm]

Flat wiper blade
Flat bar wiper blade
18
450
Front



Application info

Mini I [06/01-11/07]
Mini II [10/06-07/10]

Mini III [12/13--]

Wiper Blade

029 475 1900 | MBL0028

Notes

Observe service information
Length [in]
Length [mm]

Flat bar wiper blade
Flat wiper blade
19
475
Front



Application info

Countryman I [06/10--]
Mini II [10/06-07/10]

Mini III [12/13--]
Paceman [04/12--]

029 500 2000 | MBL0029

Wiper Blade



Notes

Observe service information
Length [in]
Length [mm]

Flat bar wiper blade
Flat wiper blade
20
500
Front

Application info

Countryman I (06/10--)
Mini II (10/06-07/10)

Mini III (12/13--)
Paceman (04/12--)

029 550 2200 | MBL0032

Wiper Blade



Notes

Observe service information
Length [in]
Length [mm]

Flat bar wiper blade
Flat wiper blade
22
550
Front

Application info

Mini III (12/13--)

312 320 0025/S | MCF0451

Cabin air filter



Notes

Height [mm]
Width [mm]
Length [mm]

Kit
33
115
233
Activated Carbon Filter

References

64 11 9 321 875

Application info

Mini III (12/13--)

Cabin air filter
312 319 0024 | MCF0465
Notes

| | |
|-------------|--------------------|
| Height [mm] | Set |
| Width [mm] | 31 |
| Length [mm] | 115 |
| | 234 |
| | Particulate Filter |

References

64 31 6 835 404

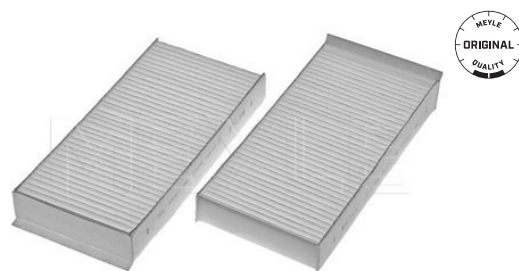
Application info

Mini III [12/13--]

Cabin air filter
312 320 0024 | MCF0466
Notes

| | |
|-------------|-------------------------|
| Height [mm] | Set |
| Width [mm] | 31 |
| Length [mm] | 115 |
| | 234 |
| | Activated Carbon Filter |

References

64 31 6 835 405

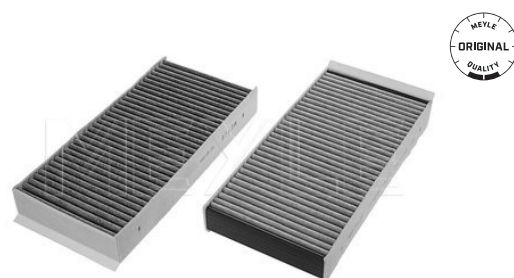
Application info

Mini III [12/13--]

Cabin air filter
312 319 0009 | MCF0239
Notes

| | |
|-------------|--------------------|
| Height [mm] | 32 |
| Width [mm] | 120 |
| Length [mm] | 449 |
| | Filter Insert |
| | Particulate Filter |

References

64 11 3 422 664

64 31 9 127 515

Application info

 Countryman I [06/10--]
 Mini I [06/01-11/07]

Mini II [10/06-07/10]

312 320 0009 | MCF0255

Cabin air filter



Notes

| | |
|-------------|-------------------------|
| Height [mm] | 32 |
| Width [mm] | 120 |
| Length [mm] | 449 |
| | Filter Insert |
| | Activated Carbon Filter |

References

| | |
|-----------------|-----------------|
| 64 11 3 422 665 | 64 31 9 127 516 |
| 64 31 1 496 711 | 64 31 9 257 505 |

Application info

Countryman I [06/10--]
Mini I [06/01-11/07]

Mini II [10/06-07/10]

Brake disc
315 521 0024 | MBD1901
Notes

| | |
|---------------------------|------------|
| Wheel Bolt Bore Ø [mm] | 14.7 |
| | Vented |
| Centering Diameter [mm] | 64.2 |
| Minimum thickness [mm] | 19 |
| Outer diameter [mm] | 276 |
| Height [mm] | 44.2 |
| Bolt Hole Circle Ø [mm] | 100 |
| Brake Disc Thickness [mm] | 22 |
| Required quantity | 2 |
| Number of Holes | 4 |
| | Front Axle |

References

| | |
|-----------------|-----------------|
| 34 11 1 502 891 | 34 11 6 774 984 |
|-----------------|-----------------|

Application info

Mini I (06/01-11/07)

Brake disc
315 521 0024/PD | MBD1901PD
Notes

| | |
|---------------------------|-------------------|
| Wheel Bolt Bore Ø [mm] | 14.7 |
| | Zink flake coated |
| | Vented |
| Centering Diameter [mm] | 64.2 |
| Minimum thickness [mm] | 19 |
| Outer diameter [mm] | 276 |
| Height [mm] | 44.2 |
| Bolt Hole Circle Ø [mm] | 100 |
| | with screws |
| Brake Disc Thickness [mm] | 22 |
| Required quantity | 2 |
| Number of Holes | 4 |
| | Front Axle |

References

| | |
|-----------------|-----------------|
| 34 11 1 502 891 | 34 11 6 774 984 |
|-----------------|-----------------|

Application info

Mini I (06/01-11/07)

383 521 0382/PD | MBD1573PD

Brake disc



Notes

| | |
|---------------------------|-------------------|
| Wheel Bolt Bore Ø [mm] | 16.2 |
| | Zink flake coated |
| | High-carbon |
| | Vented |
| Centering Diameter [mm] | 64.2 |
| Minimum thickness [mm] | 20.4 |
| Outer diameter [mm] | 280 |
| Height [mm] | 44.2 |
| Bolt Hole Circle Ø [mm] | 100 |
| | with screws |
| Brake Disc Thickness [mm] | 22 |
| Required quantity | 2 |
| Number of Holes | 4 |
| | Front Axle |

References

| | |
|-----------------|-----------------|
| 34 11 6 774 985 | 34 11 6 858 651 |
|-----------------|-----------------|

Application info

Mini II [10/06-07/10]

383 521 0007/PD | MBD1568PD

Brake disc



Notes

| | |
|---------------------------|-------------------|
| Wheel Bolt Bore Ø [mm] | 16.2 |
| | Zink flake coated |
| | High-carbon |
| | Vented |
| Centering Diameter [mm] | 64.2 |
| Minimum thickness [mm] | 20.4 |
| Outer diameter [mm] | 294 |
| Height [mm] | 44.2 |
| Bolt Hole Circle Ø [mm] | 100 |
| | with screws |
| Brake Disc Thickness [mm] | 22 |
| Required quantity | 2 |
| Number of Holes | 4 |
| | Front Axle |

References

| | |
|-----------------|-----------------|
| 34 11 6 774 986 | 34 11 6 858 652 |
|-----------------|-----------------|

Application info

Mini I [06/01-11/07]

Mini II [10/06-07/10]

Brake disc
315 521 0020/PD | MBD1897PD
Notes

| | |
|---------------------------|-------------------|
| Wheel Bolt Bore Ø [mm] | 16.5 |
| | Zink flake coated |
| | Vented |
| Centering Diameter [mm] | 79 |
| Minimum thickness [mm] | 20.4 |
| Outer diameter [mm] | 294 |
| Height [mm] | 45.2 |
| Bolt Hole Circle Ø [mm] | 120 |
| | with screws |
| Brake Disc Thickness [mm] | 22 |
| Required quantity | 2 |
| Number of Holes | 5 |
| | Front Axle |

References

| | |
|-----------------|-----------------|
| 34 11 9 804 828 | 34 11 9 811 537 |
|-----------------|-----------------|

Application info

Countryman I [06/10--]

Paceman [04/12--]

Brake disc
315 521 0021/PD | MBD1898PD
Notes

| | |
|---------------------------|-------------------|
| Wheel Bolt Bore Ø [mm] | 16.5 |
| | Zink flake coated |
| | Vented |
| Centering Diameter [mm] | 79 |
| Minimum thickness [mm] | 22.4 |
| Outer diameter [mm] | 307 |
| Height [mm] | 45.2 |
| Bolt Hole Circle Ø [mm] | 120 |
| | with screws |
| Brake Disc Thickness [mm] | 24 |
| Required quantity | 2 |
| Number of Holes | 5 |
| | Front Axle |

References

| | |
|-----------------|-----------------|
| 34 11 9 804 829 | 34 11 9 811 538 |
|-----------------|-----------------|

Application info

Countryman I [06/10--]

Paceman [04/12--]

315 523 0035 | MBD1918

Brake disc

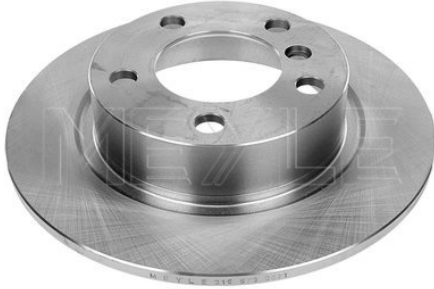

Notes

| | |
|---------------------------|-----------|
| Wheel Bolt Bore Ø [mm] | 16.5 |
| | Solid |
| Centering Diameter [mm] | 79 |
| Minimum thickness [mm] | 8.4 |
| Outer diameter [mm] | 280 |
| Height [mm] | 50.2 |
| Bolt Hole Circle Ø [mm] | 120 |
| Brake Disc Thickness [mm] | 10 |
| Required quantity | 2 |
| Number of Holes | 5 |
| | Rear Axle |

References

| | |
|-----------------|-----------------|
| 34 20 9 804 830 | 34 21 9 811 539 |
|-----------------|-----------------|

Application info

Countryman I [06/10--]

Paceman [04/12--]

315 523 0060 | MBD1943

Brake disc



Notes

| | |
|---------------------------|-----------|
| Wheel Bolt Bore Ø [mm] | 16 |
| | Solid |
| Centering Diameter [mm] | 64.2 |
| Minimum thickness [mm] | 8.4 |
| Outer diameter [mm] | 259 |
| Height [mm] | 44.1 |
| Bolt Hole Circle Ø [mm] | 100 |
| Brake Disc Thickness [mm] | 10 |
| Required quantity | 2 |
| Number of Holes | 4 |
| | Rear Axle |

References

| | |
|-----------------|-----------------|
| 34 21 1 503 070 | 34 21 6 774 987 |
|-----------------|-----------------|

Application info

Mini I [06/01-11/07]

Mini II [10/06-07/10]



Brake disc

315 523 0060/PD | MBD1943PD

Notes

| | |
|---------------------------|-------------------|
| Wheel Bolt Bore Ø [mm] | 16 |
| | Zink flake coated |
| | Solid |
| Centering Diameter [mm] | 64.2 |
| Minimum thickness [mm] | 8.4 |
| Outer diameter [mm] | 259 |
| Height [mm] | 44.1 |
| Bolt Hole Circle Ø [mm] | 100 |
| | with screws |
| Brake Disc Thickness [mm] | 10 |
| Required quantity | 2 |
| Number of Holes | 4 |
| | Rear Axle |



References

| | |
|----------------|----------------|
| 34 211 503 070 | 34 216 774 987 |
|----------------|----------------|

Application info

Mini I [06/01-11/07]

Mini II [10/06-07/10]

Brake disc

315 523 0035/PD | MBD1918PD

Notes

| | |
|---------------------------|-------------------|
| Wheel Bolt Bore Ø [mm] | 16.5 |
| | Zink flake coated |
| | Solid |
| Centering Diameter [mm] | 79 |
| Minimum thickness [mm] | 8.4 |
| Outer diameter [mm] | 280 |
| Height [mm] | 50.2 |
| Bolt Hole Circle Ø [mm] | 120 |
| | with screws |
| Brake Disc Thickness [mm] | 10 |
| Required quantity | 2 |
| Number of Holes | 5 |
| | Rear Axle |



References

| | |
|----------------|----------------|
| 34 209 804 830 | 34 219 811 539 |
|----------------|----------------|

Application info

Countryman I [06/10--]

Paceman [04/12--]

2

315 521 0028/PD | MBD1905PD

Brake disc



Notes

| | |
|---------------------------|-------------------|
| Wheel Bolt Bore Ø [mm] | 14.7 |
| | Zink flake coated |
| | Vented |
| Centering Diameter [mm] | 64.2 |
| Minimum thickness [mm] | 20.4 |
| Outer diameter [mm] | 294 |
| Height [mm] | 44.2 |
| Bolt Hole Circle Ø [mm] | 100 |
| Brake Disc Thickness [mm] | 22 |
| Required quantity | 2 |
| Number of Holes | 4 |
| | Front Axle |

Application info

Mini I [06/01-11/07]

025 243 1617 | MBP0568

Brake pad set

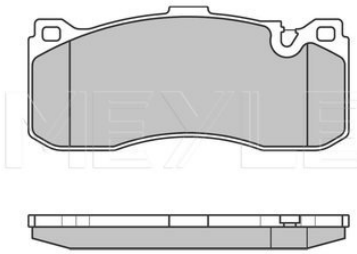

Notes

| | |
|----------------|------------------------|
| Thickness [mm] | 17 |
| Height [mm] | 73.5 |
| Width [mm] | 164.8 |
| Brake System | BREMBO |
| | with anti-squeak plate |
| | Front Axle |

References

34 10 6 860 642

Application info

Mini II [10/06-07/10]

025 243 1617/PD | MBP0568PD

Brake pad set



Notes

| | |
|----------------|------------------------|
| Quality | PREMIUM |
| Thickness [mm] | 17 |
| Height [mm] | 73.5 |
| Width [mm] | 164.8 |
| Brake System | BREMBO |
| | with anti-squeak plate |
| | Front Axle |

References

34 10 6 860 642

Application info

Mini II [10/06-07/10]

Brake pad set
025 232 8118 | MBP0311
Notes

| | |
|----------------|-----------------------------|
| Thickness [mm] | prepared for wear indicator |
| Height 2 [mm] | 18 |
| Height 1 [mm] | 59.7 |
| Width [mm] | 59.4 |
| Brake System | 140.3 |
| | ATE |
| | with anti-squeak plate |
| | Front Axle |

References

| | |
|-----------------|-----------------|
| 34 11 1503 076 | 34 11 6 765 446 |
| 34 11 6 761 287 | 34 11 6 770 332 |

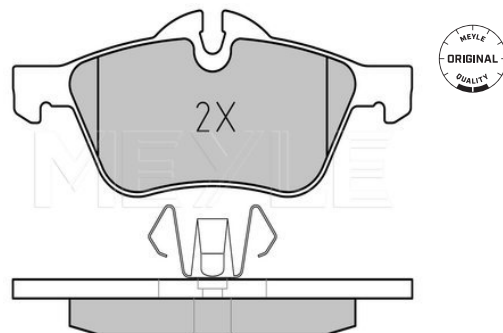
Application info

Mini I [06/01-11/07]

Brake pad set
025 239 1517 | MBP0471
Notes

| | |
|----------------|-----------------------------|
| Thickness [mm] | prepared for wear indicator |
| Height 2 [mm] | 17.4 |
| Height 1 [mm] | 53.8 |
| Width [mm] | 65 |
| Brake System | 131.4 |
| | TRW |
| | with anti-squeak plate |
| | Front Axle |

References

| | |
|-----------------|-----------------|
| 34 11 6 772 892 | 34 11 6 860 016 |
| 34 11 6 794 056 | |

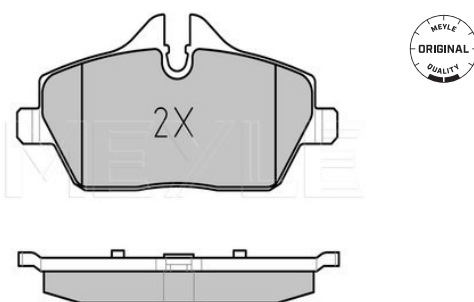
Application info

Mini II [10/06-07/10]

Mini III [12/13--]

Brake pad set
025 239 8418 | MBP0495
Notes

| | |
|----------------|-----------------------------|
| Thickness [mm] | prepared for wear indicator |
| Height 2 [mm] | 18 |
| Height 1 [mm] | 62.5 |
| Width [mm] | 71.4 |
| Brake System | 131.6 |
| | TRW |
| | with anti-squeak plate |
| | Front Axle |

References

| | |
|-----------------|-----------------|
| 34 11 6 770 251 | 34 11 9 804 735 |
| 34 11 6 778 320 | |

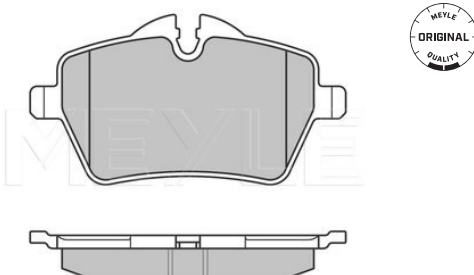

025 239 8418 | MBP0495

Brake pad set

Application info

Countryman I [06/10--]
Mini I [06/01-11/07]

Mini II [10/06-07/10]
Paceman [04/12--]

025 244 7814 | MBP0601

Brake pad set

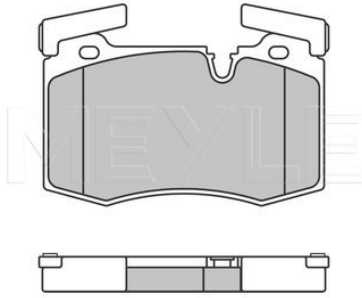

Notes

Thickness [mm]
Height [mm]
Width [mm]
Brake System

prepared for wear indicator
14.8
75.5
120.7
Brembo
with anti-squeak plate
Front Axle

References

34 11 6 778 719
34 11 6 784 726

34 11 6 789 157

Application info

Mini I [06/01-11/07]

Mini II [10/06-07/10]

025 237 1616 | MBP0429

Brake pad set

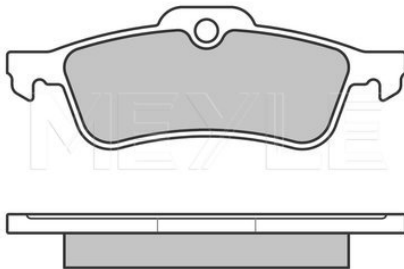

Notes

Thickness [mm]
Height [mm]
Width [mm]
Brake System

prepared for wear indicator
16.3
43.8
123.2
ATE
with anti-squeak plate
Rear Axle

References

34 21 1 503 077
34 21 6 761 288

34 21 6 762 871
34 21 6 770 252

Application info

Mini I [06/01-11/07]

Brake pad set
025 237 1616/PD | MBP0429PD
Notes

| | |
|----------------|-----------------------------|
| Quality | prepared for wear indicator |
| Thickness [mm] | PREMIUM |
| Height [mm] | 16.3 |
| Width [mm] | 43.8 |
| Brake System | 123.2 |
| | ATE |
| | with anti-squeak plate |
| | Rear Axle |

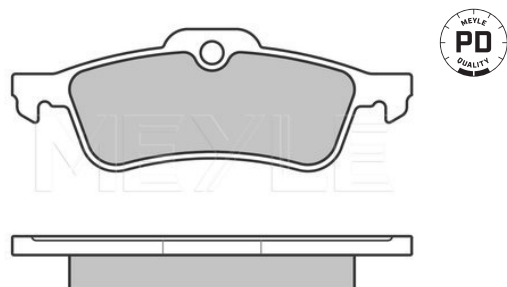
References

| | |
|----------------|----------------|
| 34 211 503 077 | 34 216 762 871 |
| 34 216 761 288 | 34 216 770 252 |

Application info

Mini I [06/01-11/07]

Brake pad set
025 242 8917 | MBP0557
Notes

| | |
|----------------|-----------------------------|
| Thickness [mm] | prepared for wear indicator |
| Height 2 [mm] | 17 |
| Height 1 [mm] | 39 |
| Width [mm] | 49 |
| Brake System | 95.4 |
| | TRW |
| | with anti-squeak plate |
| | Rear Axle |

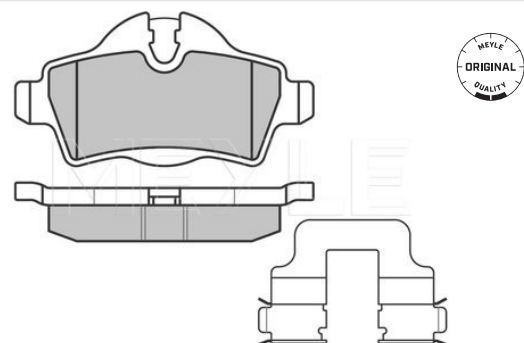
References

| | |
|----------------|----------------|
| 34 216 772 894 | 34 216 778 327 |
| 34 216 778 325 | 34 216 794 059 |
| 34 216 778 326 | |

Application info

Mini I [06/01-11/07]

Mini II [10/06-07/10]

Brake pad set
025 259 8016 | MBP1703
Notes

| | |
|----------------|-----------------------------|
| Thickness [mm] | prepared for wear indicator |
| Height 2 [mm] | 16 |
| Height 1 [mm] | 38.1 |
| Height [mm] | 45.5 |
| Width [mm] | 45.5 |
| | 100 |
| | with anti-squeak plate |
| | Rear Axle |

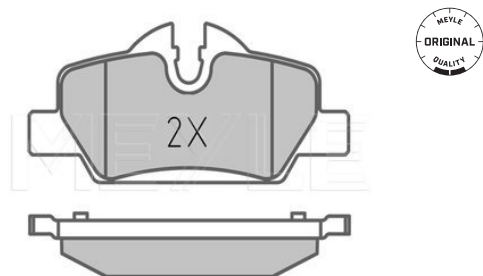
References

34 216 861 641



025 259 8016 | MBP1703

Brake pad set

Application info

Mini III (12/13--)

025 259 8016/PD | MBP1703PD

Brake pad set

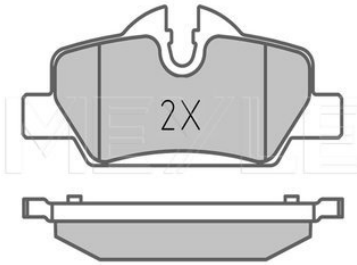

Notes

Quality
Thickness [mm]
Height 2 [mm]
Height 1 [mm]
Height [mm]
Width [mm]

prepared for wear indicator
Disc Brake
PREMIUM
16
38.1
45.5
45.5
100
with anti-squeak plate
Rear Axle

References

34 21 6 861 641

Application info

Mini III (12/13--)

025 236 2316 | MBP0408

Brake pad set

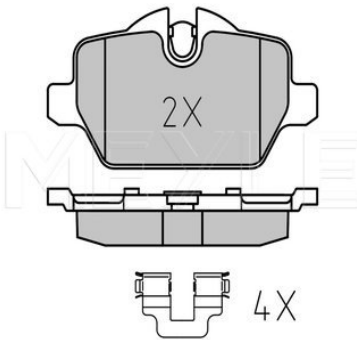

Notes

Thickness [mm]
Height 2 [mm]
Height 1 [mm]
Width [mm]
Brake System

prepared for wear indicator
17.2
51.4
45
95.3
TRW
with anti-squeak plate
Rear Axle

References

34 21 9 804 739

34 21 9 808 172

Application info

Countryman I (06/10--)

Paceman (04/12--)



Brake pad set

025 236 2316/PD | MBP0408PD

Notes

| | |
|----------------|-----------------------------|
| Quality | prepared for wear indicator |
| Thickness [mm] | PREMIUM |
| Height 2 [mm] | 17.2 |
| Height 1 [mm] | 51.4 |
| Height 1 [mm] | 45 |
| Width [mm] | 95.3 |
| Brake System | TRW |
| | with anti-squeak plate |
| | Rear Axle |



References

| | |
|-----------------|-----------------|
| 34 21 9 804 739 | 34 21 9 808 172 |
|-----------------|-----------------|

Application info

Countryman I [06/10--]

Paceman [04/12--]

Guide sleeve kit, brake caliper

014 698 0006 | MBX0010

Notes

| | |
|--------------|---------------------|
| Brake System | without guide bolts |
| | ATE |
| | Front Axle |



Application info

Mini I [06/01-11/07]

Guide sleeve kit, brake caliper

014 698 0006/S | MBX0011

Notes

| | |
|--------------|----------------|
| Brake System | with guide pin |
| | ATE |
| | Front Axle |



Parts list

| | |
|------------------------|---------------------------------|
| 014 698 0006 MBX0010 | Guide sleeve kit, brake caliper |
| 100 698 0008 MBX0156 | Guide bolt, brake caliper |



Application info

Mini I [06/01-11/07]

2

300 525 0001 | MBH0333

Brake hose



Notes

Inner thread [mm]
Length [mm]

M10x1
580
Front Axle

References

34 10 6 779 817
34 30 6 794 002

34 32 1 503 079

Application info

Mini I [06/01-11/07]

Mini II [10/06-07/10]

300 525 0009 | MBH0341

Brake hose



Notes

Inner thread [mm]
Connector type
Length [mm]
Required quantity

M10x1
Banjo fitting
430
2
Rear Axle

References

34 30 6 755 398

34 30 6 760 221

Application info

Mini I [06/01-11/07]

300 525 0010 | MBH0342

Brake hose



Notes

Inner thread [mm]
Outer thread [mm]
Length [mm]
Required quantity

M10x1
M10x1
443
2
Rear Axle

References

34 30 6 763 682
34 30 6 772 556

34 30 6 781 667
34 30 6 788 443

Application info

Mini I [06/01-11/07]

Mini II [10/06-07/10]



Boot kit, C.V. joint

314 495 0009 | MBK0188

Notes

Inner diameter 2 [mm]
Inner diameter 1 [mm]
Length [mm]

Elastomer
85
21
83
Transmission End



Application info

Mini I [06/01-11/07]

Boot kit, C.V. joint

314 495 0010 | MBK0189

Notes

Inner diameter 2 [mm]
Inner diameter 1 [mm]
Length [mm]

Thermoplast
81.6
24.5
119.5
Wheel Side



Application info

Mini I [06/01-11/07]

C.V. joint kit

314 498 0001 | MCV0219

Notes

Seal Diameter [mm]
Outer diameter [mm]
Length [mm]
Internal Teeth, wheel side
Outer gearing wheel side

CV Joint
without ABS ring
53.5
75.5
137
21
26
Wheel Side



References

31 60 7 518 248

Application info

Mini I [06/01-11/07]

3

314 498 0002 | MCV0220

C.V. joint kit



Notes

Seal Diameter [mm]
Length [mm]
Internal Teeth, wheel side
Outer gearing wheel side

CV Joint
without ABS ring
53.5
137.5
23
26
Wheel Side

References

31 60 7 518 261

Application info

Mini I [06/01-11/07]

314 137 0004/S | MHK0039

Hydraulic filter kit, A/T



Notes

Transmission Type

Kit
with seal
GACTV16Z
CVT (Stepless)

References

24 11 7 518 741

Parts list

314 137 0004 | MHF0039

Hydraulic filter, A/T

Application info

Mini I [06/01-11/07]

314 137 0007/S | MHK0042

Hydraulic filter kit, A/T



Notes

Transmission Type

Manufacturer Restriction

Kit
with seal
GA6F21WA
Automatic Transmission,
6-speed
Meyle: ACM gasket

References

24 34 7 551 087

Parts list

100 139 0002 | MMX0431
314 136 0007 | MHF0037

A/T oil pan gasket
Hydraulic filter, A/T

Application info

Mini I [06/01-11/07]

Hydraulic filter kit, A/T

314 137 0006/S | MHK0041

Notes

| | |
|--------------------------|-------------------------|
| Number of mounting bores | 8 |
| Kit | |
| Transmission Type | TF-60SN |
| Transmission Type | GABF21WA |
| | Automatic Transmission, |
| | 6-speed |
| Manufacturer Restriction | AISIN WARNER |

References

24 34 7 566 358



Application info

Countryman I [06/10--]
Mini II [10/06-07/10]

Paceman [04/12--]

Hydraulic filter, A/T

314 137 0004 | MHF0039

Notes

| | |
|-------------------|-----------------------------|
| Transmission Type | Piece without gasket / seal |
| | GACVT16Z |
| | CVT [Stepless] |

References

21 11 7 518 741 24 11 7 518 741



Application info

Mini I [06/01-11/07]

Hydraulic filter, A/T

314 136 0007 | MHF0037

Notes

| | |
|-------------------|-----------------------------|
| Transmission Type | Piece without gasket / seal |
| Transmission Type | GABF21WA |
| | TF-60SN |
| | Automatic Transmission, |
| | 6-speed |

References

24 34 7 551 087



Application info

Mini I [06/01-11/07]

300 221 2100 | MTM0045

Mount, manual transmission



Notes

Rubber-metal Bearing
Transmission End

Application info

Mini I [06/01-11/07]

300 135 0307 | MOK0031

Parts kit, automatic transm. oil change



Notes

Transmission Type

Manufacturer Restriction

Kit
with accessories
GABF21WA
Automatic Transmission,
6-speed
AISIN

References

24 34 7 551 087

Parts list

014 019 2300 | MAX0015
314 137 0007/S | MHK0042

Transmission fluid
Hydraulic filter kit, A/T

Application info

Mini I [06/01-11/07]

300 135 0305 | MOK0029

Parts kit, automatic transm. oil change



Notes

Transmission Type
Transmission Type

Manufacturer Restriction

Kit
with accessories
GACVT16Z
VT1-27T
CVT [Stepless]
ZF

Parts list

014 019 3000 | MAX0036
314 137 0004/S | MHK0039

Transmission fluid
Hydraulic filter kit, A/T



Parts kit, automatic transm. oil change

300 135 0305 | MOK0029

Application info

Mini I [06/01-11/07]

Parts kit, automatic transm. oil change

300 135 0306 | MOK0030

Notes

Transmission Type

Kit
with accessories
GA6F21WA
Automatic Transmission,
6-speed
AISIN

Manufacturer Restriction

Parts list

014 019 2300 | MAX0015
100 139 0002 | MMX0431
314 137 0006/S | MHK0041

Transmission fluid
A/T oil pan gasket
Hydraulic filter kit, A/T



Application info

Countryman I [06/10--]
Mini II [10/06-07/10]

Paceman [04/12--]

3

300 919 0001 | MEX0378

Sensor, outdoor temperature



Notes

Operating voltage [V]
Number of Poles

NTC Sensor
12
2
without cable

References

65 81 6 905 133

Application info

Countryman I [06/10--]
Mini I [06/01-11/07]

Mini II [10/06-07/10]
Paceman [04/12--]

314 800 0040 | MAS0154

ABS wheel sensor



Notes

Cable Length [mm]
Operating voltage [V]
Number of Poles
Required quantity

Hall Sensor
815
12
2
2
Rear Axle left and right

References

34 52 6 756 385

Application info

Mini I [06/01-11/07]

314 356 0004 | MWS0060

Wear sensor



Notes

Warning Contact Length [mm]
Required quantity

Disc Brake
1095
1
Rear Axle

References

34 35 6 761 448

Application info

Mini I [06/01-11/07]

Wear sensor
314 356 0003 | MWS0059
Notes

| | |
|-----------------------------|------------|
| Warning Contact Length [mm] | Disc Brake |
| Required quantity | 885 |
| | 1 |
| | Front Axle |

References

| | |
|-----------------|-----------------|
| 34 35 6 761 447 | 34 35 6 778 175 |
|-----------------|-----------------|

Application info

Mini I [06/01-11/07]

Wear sensor
314 527 0005 | MWS0068
Notes

| | |
|-----------------------------|------------|
| Warning Contact Length [mm] | Disc Brake |
| Required quantity | 805 |
| | 1 |
| | Front Axle |

References

| | |
|-----------------|-----------------|
| 34 35 6 773 017 | 34 35 6 789 329 |
| 34 35 6 783 230 | |

Application info

Mini II [10/06-07/10]

Wear sensor
314 527 0002 | MWS0065
Notes

| | |
|-----------------------------|------------|
| Warning Contact Length [mm] | Disc Brake |
| Required quantity | 1125 |
| | 1 |
| | Rear Axle |

References

| | |
|-----------------|-----------------|
| 34 35 6 773 018 | 34 35 6 789 330 |
| 34 35 6 783 772 | |



Application info

Mini II [10/06-07/10]

4

314 527 0023 | MWS0112

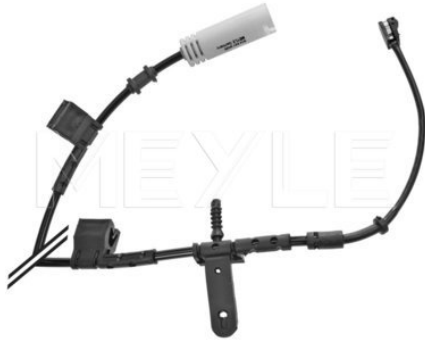
Wear sensor



Notes

Warning Contact Length [mm]
Required quantity

Disc Brake
808
1
Front Axle

References

34 35 6 792 572

Application info

Mini II [10/06-07/10]

314 527 0030 | MWS0116

Wear sensor



Notes

Warning Contact Length [mm]
Required quantity

Disc Brake
1141
1
Rear Axle

References

34 35 6 792 573

Application info

Mini II [10/06-07/10]

314 527 0037 | MWS0128

Wear sensor



Notes

Warning Contact Length [mm]
Required quantity

Disc Brake
665
1
Front Axle Left

References

34 35 6 799 735

34 35 6 865 611

Application info

Mini III [12/13--]



Wear sensor

314 527 0018 | MWS0081

Notes

Warning Contact Length [mm]
Required quantity

Disc Brake
957
1
Rear Axle

References

34 35 9 804 834



Application info

Countryman I (06/10--)

Wear sensor

314 527 0014 | MWS0077

Notes

Warning Contact Length [mm]
Required quantity

Disc Brake
910
1
Front Axle



Application info

Countryman I (06/10--)

Crank position sensor

40-14 800 0004 | MPS0049

Notes

Operating voltage [V]
Number of Poles

Black
Active sensor
12
3
without cable

References

13 62 7 805 004



Application info

Mini II (10/06-07/10)

4

30-14 860 0005 | MGP0047

Glow plug



Notes

| | |
|---------------------|---|
| Rated current [A] | 10 after-glow capable Pencil-type Glow Plug |
| Spanner Size | 12 |
| Diameter [mm] | 4 |
| Thread Size | M10 x 1,25 |
| Overall Length [mm] | 160 |
| Cone Pitch | 93° |
| Fitting Depth [mm] | 36 |
| Connector type | M4 |
| Voltage [V] | 11 |

References

12 23 7 791 101

Application info

Mini I [06/01-11/07]

314 860 0004 | MGP0113

Glow plug



Notes

| | |
|---------------------|--|
| Rated current [A] | 8.5 after-glow capable Pencil-type Glow Plug |
| Spanner Size | 10 |
| Diameter [mm] | 4 |
| Thread Size | M10 x 1 |
| Overall Length [mm] | 134 |
| Connector type | Ø 4 mm |
| Cone Pitch | 63° |
| Fitting Depth [mm] | 29 |
| Voltage [V] | 4.4 |

References

12 23 7 798 001

Application info

Countryman I [06/10--]

Mini II [10/06-07/10]

Paceman [04/12--]

Glow plug
11-14 860 0001 | MGP0025
Notes

| | |
|---------------------|---|
| Rated current [A] | 10 after-glow capable Pencil-type Glow Plug |
| Spanner Size | 8 |
| Diameter [mm] | 4.4 |
| Thread Size | M8 x 1 |
| Overall Length [mm] | 124 |
| Cone Pitch | 123° |
| Fitting Depth [mm] | 28 |
| Connector type | Ø 4 mm |
| Voltage [V] | 11 |

References

12 23 7 806 041

Application info

Mini II (10/06-07/10)

Ignition coil
314 885 0005 | MIC0120
Notes

| | |
|-----------------------|--|
| Operating voltage [V] | for fully electronic ignition (FI) 12 |
| Number of Poles | Coupling Type SAE 3 |

References

12 13 7 575 010

Application info

 Countryman I (06/10--)
Mini II (10/06-07/10)

Paceman (04/12--)

Sensor, camshaft position
214 800 0002 | MEX0376
Notes

| | |
|-----------------------|---------------------------------|
| Fitting Depth [mm] | Black Active sensor 24 |
| Operating voltage [V] | 12 |
| Number of Poles | 3 with seal without cable |

References

13 62 7 791 127



214 800 0002 | MEX0376

Sensor, camshaft position

Application info

Mini I [06/01-11/07]

40-14 800 0005 | MPS0050

Sensor, camshaft position



Notes

Operating voltage [V]
Fitting Depth [mm]
Number of Poles

Grey
Active sensor
12
22
3
without cable

References

13 62 7 805 005

Application info

Mini II [10/06-07/10]

614 123 0001 | MEX0438

Back up light switch



Notes

Thread Size
Number of Poles

Lock
M12 x 1,5
2

References

23 11 7 518 648
23 11 7 527 716

23 14 1 482 377

Application info

Mini I [06/01-11/07]



Tensioner pulley, timing belt

11-51 902 1011 | MMX1600

Notes

| | |
|---------------------|----|
| Inner diameter [mm] | 8 |
| Outer diameter [mm] | 60 |
| Width [mm] | 29 |

References

11317805960



Application info

Mini II (10/06-07/10)

Timing belt kit

11-51 049 0016 | MMX0520

Notes

| | |
|-------------------|------|
| Number of belts | 1 |
| Width [mm] | 25 |
| Pulleys contained | 2 |
| Length [mm] | 1305 |
| Number of Teeth | 137 |

Parts list

| | |
|--------------------------|-------------------------------|
| 11-51 902 1011 MMX1600 | Tensioner pulley, timing belt |
| 11-51 902 2001 MMX1608 | Timing belt roller |



Application info

Mini II (10/06-07/10)

Timing belt roller

11-51 902 2001 | MMX1608

Notes

| | |
|---------------------|----|
| Inner diameter [mm] | 10 |
| Outer diameter [mm] | 60 |
| Width [mm] | 30 |

References

11 31 7 805 961



Application info

Mini II (10/06-07/10)

5

050 006 0890 | MRB0325

V-ribbed belt

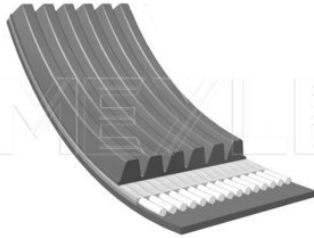

Notes

| | |
|----------------|-----|
| Number of Ribs | 6 |
| Length [mm] | 890 |

References

11 28 7 526 363

Application info

Mini I [06/01-11/07]

050 006 1055 | MRB0349

V-ribbed belt

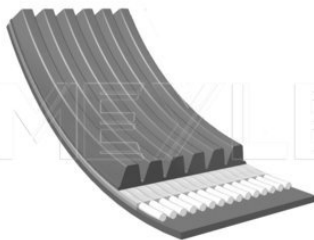

Notes

| | |
|----------------|------|
| Number of Ribs | 6 |
| Length [mm] | 1055 |

References

| | |
|-----------------|-----------------|
| 11 28 1 497 435 | 11 28 7 526 364 |
| 11 28 7 518 251 | |

Application info

Mini I [06/01-11/07]

050 006 0875 | MRB0322

V-ribbed belt

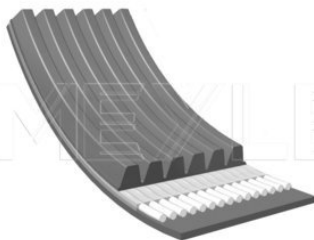

Notes

| | |
|----------------|-----|
| Number of Ribs | 6 |
| Length [mm] | 875 |

References

11 28 7 534 703

Application info

Mini I [06/01-11/07]



V-ribbed belt

050 006 1374 | MRB0407

Notes

Number of Ribs 6
Length [mm] 1374

References

11 28 0 300 802 11 28 7 545 120

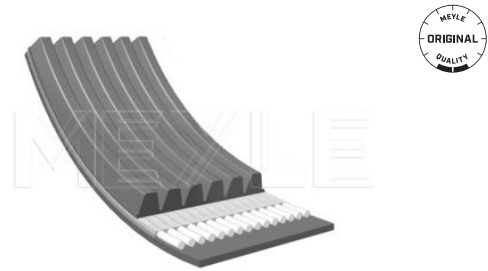

Application info

Mini I [06/01-11/07]

V-ribbed belt

050 006 0894 | MRB0326

Notes

Number of Ribs 6
Length [mm] 894

References

11 28 1 505 672 11 28 7 526 363
11 28 7 518 249 11 28 7 604 014

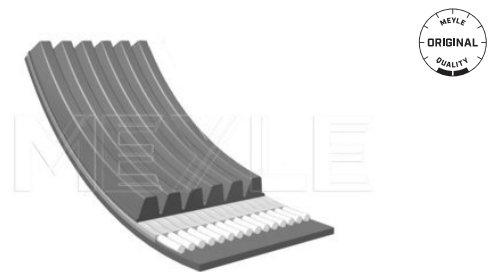

Application info

Countryman I [06/10--]
Mini II [10/06-07/10]

Paceman [04/12--]

V-ribbed belt

050 003 0885/E | MRB0729

Notes

Number of Ribs 3
Length [mm] 885
Permanently elastic

References

11287790919

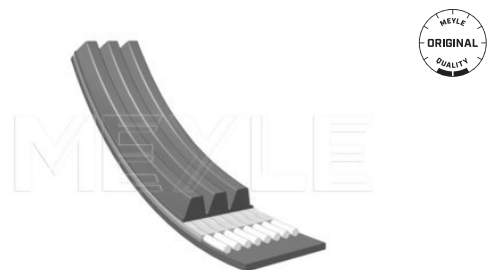

Application info

Mini I [06/01-11/07]

050 006 0800 | MRB0310

V-ribbed belt

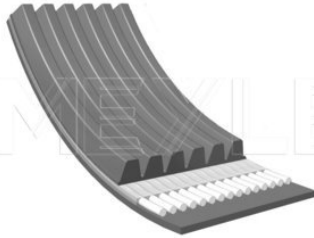

Notes

| | |
|----------------|-----|
| Number of Ribs | 6 |
| Length [mm] | 800 |

References

11 28 7 795 036

Application info

Mini II [10/06-07/10]

050 006 0976 | MRB0336

V-ribbed belt

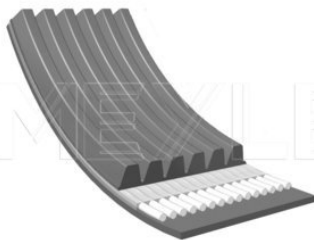

Notes

| | |
|----------------|-----|
| Number of Ribs | 6 |
| Length [mm] | 976 |

References

11 28 7 798 112

Application info

Mini II [10/06-07/10]

050 007 1173 | MRB0588

V-ribbed belt

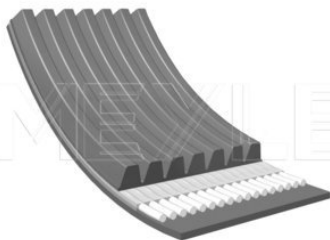

Notes

| | |
|----------------|------|
| Number of Ribs | 7 |
| Length [mm] | 1173 |

References

| | |
|-----------------|-----------------|
| 11 28 7 789 074 | 11 28 7 801 391 |
| 11 28 7 791 336 | |

Application info

Mini I [06/01-11/07]



V-ribbed belt

050 005 1105 | MRB0232

Notes

Number of Ribs 5
Length [mm] 1105

References

8511920 11288511920

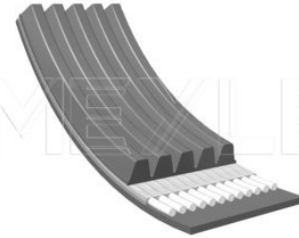

Application info

Countryman I [06/10--]
Mini II [10/06-07/10]

Paceman [04/12--]

Expansion tank

314 223 0012 | MET0061

References

17 10 7 509 071



Application info

Mini I [06/01-11/07]

Expansion tank

314 223 0010 | MET0076

References

17 13 7 529 273



Application info

Mini I [06/01-11/07]

314 223 0011 | MET0060

Expansion tank



References

17 13 7 823 626

Application info

Countryman I [06/10--]
Mini II [10/06-07/10]

Paceman [04/12--]

314 238 0005 | MMX1516

Expansion tank cap



Notes

Pressure [bar]

with seal
1.4

References

17 11 7 639 024

17 13 2 754 264

Application info

Countryman I [06/10--]
Mini II [10/06-07/10]

Mini III [12/13--]
Paceman [04/12--]

319 222 0001 | MRH0272

Radiator hose



Notes

from expansion tank to en-
gine cooler

References

17 12 1 475 561

Application info

Mini I [06/01-11/07]

Mini II [10/06-07/10]

Radiator hose

319 222 0002 | MRH0273

Notes

from expansion tank to engine cooler

References

17 12 7 515 489

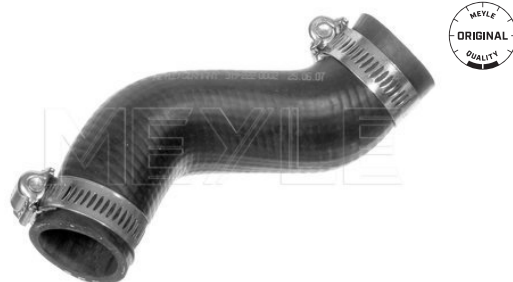

Application info

Mini I [06/01-11/07]

Radiator hose

319 222 0003 | MRH0274

Notes

from radiator to intermediate piece
Upper

References

17 12 7 515 500



Application info

Mini I [06/01-11/07]

Mini II [10/06-07/10]

Radiator hose

319 222 0004 | MRH0275

Notes

Upper

References

17 12 7 515 501



Application info

Mini I [06/01-11/07]

Mini II [10/06-07/10]

5

319 222 0005 | MRH0276

Radiator hose



Notes

from expansion tank to engine cooler

References

17 12 7 515 989

Application info

Mini I [06/01-11/07]

Mini II [10/06-07/10]

319 222 0006 | MRH0277

Radiator hose



Notes

from expansion tank to distributor

References

17 12 7 526 414

Application info

Mini I [06/01-11/07]

Mini II [10/06-07/10]

319 222 0007 | MRH0278

Radiator hose



Notes

Upper

References

17 12 7 556 614

Application info

Mini I [06/01-11/07]

Mini II [10/06-07/10]



Water pump

313 220 0003 | MWP0332

Notes

Quality
Number of Ribs

for v-ribbed belt use
with seal
Sealed with SiC/SiC
6

References

11 51 7 510 803

11 51 7 513 062

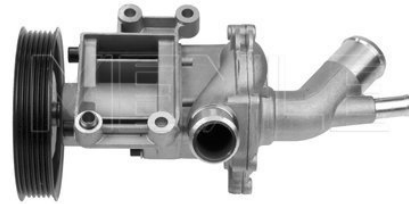

Application info

Mini I [06/01-11/07]

Water pump

313 220 0013 | MWP0341

Notes

Quality

with seal
with housing
Sealed with SiC/SiC

References

11 51 7 520 123



Application info

Mini I [06/01-11/07]

Water pump

11-13 220 0020 | MWP0093

Notes

Quality

with seal
Sealed with SiC/SiC

References

11 51 7 550 484
11 51 7 648 827

11 51 8 604 888



Application info

Countryman I [06/10--]
Mini II [10/06-07/10]

Paceman [04/12--]

313 220 0010 | MWP0338

Water pump



Notes

Number of Thread Bores 4
with seal

References

11 51 7 790 871

Application info

Mini I [06/01-11/07]

11-13 220 0004 | MWP0082

Water pump



Notes

Quality
Number of Teeth

for toothed belt drive
with seal
Sealed with SiC/SiC
19

References

11 51 7 805 992

Application info

Mini II [10/06-07/10]

11-13 220 0004/HD | MWP0082HD

Water pump



Notes

Quality
Number of Teeth

for toothed belt drive
with seal
Sealed with SiC/SiC
19

References

11 51 7 805 992

Application info

Mini II [10/06-07/10]



Air filter

11-12 321 0013 | MAF0101

Notes

| | |
|-------------|---------------|
| Height [mm] | 56 |
| Width [mm] | 85 |
| Length [mm] | 494 |
| | Filter Insert |

References

13 71 7 534 825



Application info

Countryman I (06/10--)

Mini II (10/06-07/10)

Air filter

11-12 321 0007 | MAF0095

Notes

| | |
|-------------|---------------|
| Height [mm] | 42 |
| Width [mm] | 147 |
| Length [mm] | 360 |
| | Filter Insert |

References

13 71 7 534 845



Application info

Mini II (10/06-07/10)

Air filter

312 321 0010 | MAF0424

Notes

| | |
|-------------|---------------|
| Height [mm] | 50 |
| Width [mm] | 131 |
| Length [mm] | 366 |
| | Filter Insert |

References

13 71 7 561 235



Application info

Mini II (10/06-07/10)

11-12 321 0027 | MAF0115

Air filter



Notes

| | |
|-------------|---------------|
| Height [mm] | 42 |
| Width [mm] | 147 |
| Length [mm] | 359 |
| | Filter Insert |

References

13 71 7 568 728

Application info

Countryman I [06/10--]
Mini I [06/01-11/07]

Mini II [10/06-07/10]

11-12 321 0022 | MAF0110

Air filter



Notes

| | |
|-------------|---------------|
| Height [mm] | 63 |
| Width [mm] | 132.5 |
| Length [mm] | 249 |
| | Filter Insert |

References

13 71 7 806 046

Application info

Mini II [10/06-07/10]

312 321 0032 | MAF0440

Air filter



Notes

| | |
|---------------------|---------------|
| Inner diameter [mm] | 77 |
| Outer diameter [mm] | 132 |
| Height [mm] | 234 |
| | Filter Insert |

References

13 71 8 509 032

Application info

Countryman I [06/10--]
Mini II [10/06-07/10]

Paceman [04/12--]



Air filter

312 321 0039 | MAF0675

Notes

| | |
|-------------|---------------|
| Height [mm] | 54 |
| Width [mm] | 292 |
| Length [mm] | 211 |
| | Filter Insert |

References

13 71 8 513 944

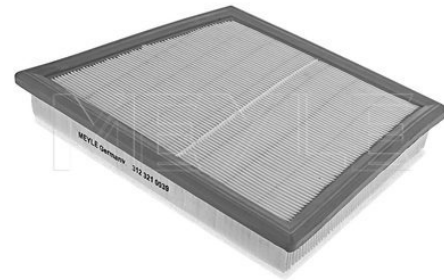

Application info

Mini III (12/13--)

Air filter

712 114 0000 | MAF0623

Notes

| | |
|-------------|---------------|
| Height [mm] | 32 |
| Width [mm] | 166 |
| Length [mm] | 216 |
| | Filter Insert |

References

13 72 1 477 840



Application info

Mini I (06/01-11/07)

Air filter

312 137 2015 | MAF0412

Notes

| | |
|-------------|---------------|
| Height [mm] | 34 |
| Width [mm] | 168 |
| Length [mm] | 276 |
| | Filter Insert |

References

13 72 1 491 749

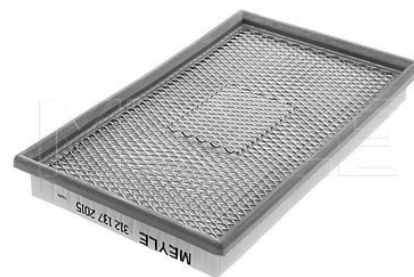

Application info

Mini I (06/01-11/07)

312 321 0014 | MAF0427

Air filter

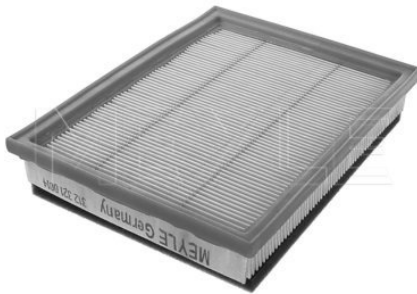

Notes

| | |
|-------------|---------------|
| Height [mm] | 42 |
| Width [mm] | 166 |
| Length [mm] | 216 |
| | Filter Insert |

References

| | |
|-----------------|-----------------|
| 13 71 7 520 855 | 13 72 7 520 855 |
|-----------------|-----------------|

Application info

Mini I [06/01-11/07]

312 321 0019 | MAF0430

Air filter

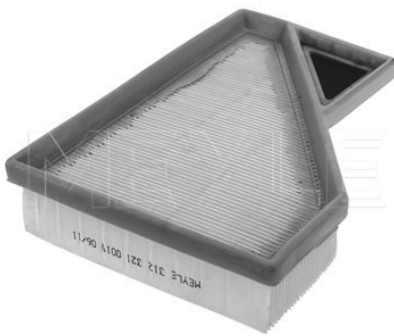

Notes

| | |
|-------------|---------------|
| Height [mm] | 46 |
| Width [mm] | 165 |
| Length [mm] | 215 |
| | Filter Insert |

References

13 72 7 529 261

Application info

Mini I [06/01-11/07]

314 323 0012 | MFF0157

Fuel filter



Notes

| | |
|---------------------|----------------|
| Outer diameter [mm] | Metal |
| Height [mm] | 55 |
| | 274 |
| | In-Line Filter |

References

| | |
|-----------------|-----------------|
| 13 32 7 787 477 | 13 32 7 794 590 |
| 13 32 7 791 034 | |

Application info

Mini I [06/01-11/07]



Fuel filter

314 323 0011 | MFF0156

Notes

Diameter [mm]
Height [mm]

Aluminium
55
250
In-Line Filter

References

13 32 7 811 227



Application info

Countryman I [06/10--]

Mini II [10/06-07/10]

Fuel filter

314 323 0013 | MFF0241

Notes

Diameter [mm]
Height [mm]

Metal
55
256.1
In-Line Filter

References

13 32 8 572 522



Application info

Countryman I [06/10--]

Paceman [04/12--]

A/T oil pan gasket

100 139 0002 | MMX0431

Notes

No. of holes 1

Transmission Type
Transmission Type
Transmission Type

Manufacturer Restriction

8
Piece
Elastomer
TF-60SN
AQ250
09G
Automatic Transmission,
6-speed
AISIN WARNER

References

24 11 7 566 356



Application info

Countryman I [06/10--]
Mini II [10/06-07/10]

Paceman [04/12--]

300 000 0001 | MOF0110

Oil filter



Notes

| | |
|-----------------------|---------------|
| Inner diameter 2 [mm] | with seal |
| Inner diameter 1 [mm] | 32 |
| Outer diameter [mm] | 22 |
| Height [mm] | 72 |
| | 83 |
| | Filter Insert |

References

| | |
|-----------------|-----------------|
| 11 42 0 026 787 | 11 42 7 512 446 |
| 11 42 7 509 208 | |

Application info

Mini I [06/01-11/07]

714 322 0011 | MOF0205

Oil filter



Notes

| | |
|---------------------|---------------|
| Inner diameter [mm] | with seal |
| Outer diameter [mm] | 24 |
| Height [mm] | 65 |
| | 69 |
| | Filter Insert |

References

| | |
|-----------------|-----------------|
| 11 42 7 557 012 | 11 42 7 622 446 |
|-----------------|-----------------|

Application info

Countryman I [06/10--]
Mini I [06/01-11/07]

Mini II [10/06-07/10]
Paceman [04/12--]

30-14 322 0004 | MOF0101

Oil filter



Notes

| | |
|-------------------------------------|----------------------------|
| Bypass Valve Opening Pressure [bar] | 1 |
| Diameter 1 [mm] | 74 |
| Diameter [mm] | 76.7 |
| Height 1 [mm] | 84.5 |
| Height [mm] | 86 |
| Thread Size | 3/4"-16 UNF |
| | Screw-on Filter |
| | with one anti-return valve |

References

| |
|-----------------|
| 11 42 7 791 059 |
|-----------------|

Application info

Mini I [06/01-11/07]

Oil filter
714 322 0007 | MOF0201
Notes

| | |
|---------------------|---------------|
| Inner diameter [mm] | with seal |
| Outer diameter [mm] | 25.7 |
| Height [mm] | 65.5 |
| | 83.5 |
| | Filter Insert |

References

11 42 7 805 978

Application info

Mini II [10/06-07/10]

Oil filter
314 322 0006 | MOF0234
Notes

| | |
|---------------------|--------------------|
| Inner diameter [mm] | with gaskets/seals |
| Outer diameter [mm] | 23 |
| Height [mm] | 53 |
| | 124.8 |
| | Filter Insert |

References

11 42 8 570 590

Application info

Mini III [12/13--]

Engine mount
300 221 2000 | MEM0427
Notes

 Rubber-metal Bearing
 Rear

References

22 11 6 756 406

Application info

Mini I [06/01-11/07]



300 221 2004 | MEM0828

Engine mount



Notes

Rubber-metal Bearing
Rear

References

22 11 4 052 474
22 11 6 772 040

22 11 6 783 094

Application info

Mini I [06/01-11/07]

Mini II [10/06-07/10]



P/S hose

359 202 0039 | MHH0075

Notes

for foreflow
from expansion tank to hy-
draulic pump

References

32 41 6 754 498

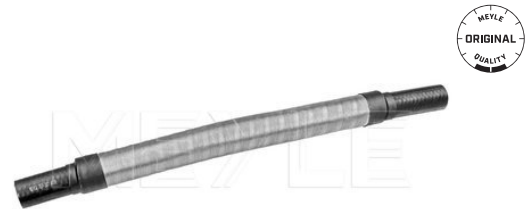

Application info

Mini I [06/01-11/07]

P/S hose

359 202 0009 | MHH0054

Notes

for foreflow

References

32 41 6 754 463

32 41 6 781 751



Application info

Mini I [06/01-11/07]

Steering boot kit

314 620 0007 | MSK0113

Notes

Inner diameter 2 [mm]
Inner diameter 1 [mm]
Height [mm]

with accessories
51
14
153
Front Axle Left
Front Axle Right

References

32 10 6 778 560



Application info

Countryman I [06/10--]
Mini II [10/06-07/10]

Paceman [04/12--]

314 620 0006 | MSK0112

Steering boot kit



Notes

Inner diameter 2 [mm]
Inner diameter 1 [mm]
Height [mm]

with accessories
51.5
13.5
187
Front Axle Left
Front Axle Right

References

32 10 6 865 380

Application info

Countryman II [10/16--]

Mini III [12/13--]

314 620 0000 | MSK0020

Steering boot kit



Notes

Inner diameter 2 [mm]
Inner diameter 1 [mm]
Height [mm]

with accessories
Thermoplast
47
14
162
Front Axle Left
Front Axle Right

References

32 13 6 756 757

Application info

Mini I [06/01-11/07]

316 031 0006 | MAR0212

Axial rod



Notes

Thread Measurement 2
Thread Measurement 1
Length [mm]

M14x1,5
M14x1,5
196
Front Axle Right
Front Axle Left

References

32 10 6 778 547*
32 10 6 778 548*

32 10 9 803 321*
32 10 9 803 322*

Application info

Countryman I [06/10--]

Mini II [10/06-07/10]



Axial rod

316 031 0020/HD | MAR0546HD

Notes

Thread Measurement 2
Thread Measurement 1
Length [mm]

M14X1,5
M14x1,5
190
Front Axle Left
Front Axle Right

Reinforced Version

References

32 10 6 854 733

32 10 6 854 736



Application info

Mini III [12/13--]

Axial rod

316 031 0019/HD | MAR0545HD

Notes

Thread Measurement 2
Thread Measurement 1
Length [mm]

M14X1,5
M14x1,5
221
Front Axle Left
Front Axle Right

Reinforced Version

References

32 10 6 867 404

32 10 6 867 405



Application info

Countryman II [10/16--]

Mini III [12/13--]

Axial rod

316 031 0000 | MAR0208

Notes

Thread Measurement 2
Thread Measurement 1
Length [mm]

M14X1,5
M16x1,5
184
Front Axle Right
Front Axle Left

References

32 11 6 754 563*
32 11 6 754 564*

32 11 6 780 785*
32 11 6 780 786*



Application info

Mini I [06/01-11/07]

316 030 0020 | MTA0164

Tie rod assembly



Notes

Thread Measurement 2
Thread Measurement 1

M16x1,5
M10x1,25
Front Axle Right

References

32 10 6 777 522

32 11 6 761 558

Parts list

316 031 0000 | MAR0208
316 020 0018 | MTE0342

Axial rod
Tie rod end

Counterpart

316 030 0019 | MTA0163

Application info

Mini I [06/01-11/07]

316 030 0022 | MTA0166

Tie rod assembly



Notes

Thread Measurement 2
Thread Measurement 1

M14x1,5
M12x1,5
Front Axle Left

References

32 10 6 778 547

Parts list

316 031 0006 | MAR0212
316 020 0022 | MTE0346

Axial rod
Tie rod end

Counterpart

316 030 0023 | MTA0167

Application info

Mini II [10/06-07/10]

316 030 0023 | MTA0167

Tie rod assembly



Notes

Thread Measurement 2
Thread Measurement 1

M14x1,5
M12x1,5
Front Axle Right

References

32 10 6 778 548

Parts list

316 031 0006 | MAR0212
316 020 0021 | MTE0345

Axial rod
Tie rod end

Counterpart

316 030 0022 | MTA0166

Tie rod assembly
316 030 0023 | MTA0167
Application info

Mini II [10/06-07/10]

Tie rod assembly
316 030 0019 | MTA0163
Notes

| | |
|----------------------|-----------------|
| Thread Measurement 2 | M16x1,5 |
| Thread Measurement 1 | M10x1,25 |
| | Front Axle Left |

References

| | |
|-----------------|-----------------|
| 32 11 6 761 557 | 32 11 6 777 521 |
|-----------------|-----------------|

Parts list

| | |
|------------------------|-------------|
| 316 031 0000 MAR0208 | Axial rod |
| 316 020 0019 MTE0343 | Tie rod end |

Counterpart

316 030 0020 | MTA0164

Application info

Mini I [06/01-11/07]

Tie rod end
316 020 0022 | MTE0346
Notes

| | |
|----------------------|-----------------|
| Thread Measurement 2 | M14x1,5 |
| Thread Measurement 1 | M12x1,5 |
| Length [mm] | 237 |
| | Front Axle Left |

References

32 10 6 778 437

Counterpart

316 020 0021 | MTE0345

Application info

Mini II [10/06-07/10]

316 020 0021 | MTE0345

Tie rod end



Notes

Thread Measurement 2
Thread Measurement 1
Length [mm]

M14x1,5
M12x1,5
237
Front Axle Right

References

32 10 6 778 438

Counterpart

316 020 0022 | MTE0346

Application info

Mini II (10/06-07/10)

316 020 0037/HD | MTE0755HD

Tie rod end



Notes

Thread Measurement 2
Thread Measurement 1
Length [mm]

M14x1,5
M14x1,5
221
Front Axle Left

Reinforced Version

References

32 10 6 854 734

Counterpart

316 020 0036/HD | MTE0754HD

Application info

Mini III (12/13--)

316 020 0036/HD | MTE0754HD

Tie rod end



Notes

Thread Measurement 2
Thread Measurement 1
Length [mm]

M14x1,5
M14x1,5
221
Front Axle Right

Reinforced Version

References

32 10 6 854 737

Counterpart

316 020 0037/HD | MTE0755HD

Application info

Mini III (12/13--)



Tie rod end

316 020 0031 | MTE0559

Notes

| | |
|----------------------|-----------------|
| Thread Measurement 2 | M14x1,5 |
| Thread Measurement 1 | M12 x 1,5 |
| Length [mm] | 269 |
| | Front Axle Left |

References

| | |
|-----------------|-----------------|
| 32 10 9 805 551 | 32 10 9 808 839 |
|-----------------|-----------------|

Counterpart

316 020 0030 | MTE0558



Application info

Countryman I (06/10--)

Paceman (04/12--)

Tie rod end

316 020 0030 | MTE0558

Notes

| | |
|----------------------|------------------|
| Thread Measurement 2 | M14x1,5 |
| Thread Measurement 1 | M12 x 1,5 |
| Length [mm] | 269 |
| | Front Axle Right |

References

| | |
|-----------------|-----------------|
| 32 10 9 805 552 | 32 10 9 808 840 |
|-----------------|-----------------|

Counterpart

316 020 0031 | MTE0559

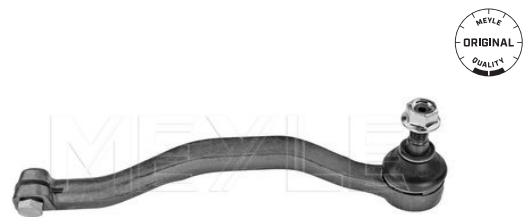

Application info

Countryman I (06/10--)

Paceman (04/12--)

Tie rod end

316 020 0018 | MTE0342

Notes

| | |
|----------------------|------------------|
| Thread Measurement 2 | M14x1,5 |
| Thread Measurement 1 | M10x1,25 |
| Length [mm] | 233 |
| | Front Axle Right |

References

32 11 6 761 560

Counterpart

316 020 0019 | MTE0343



Application info

Mini I (06/01-11/07)

316 020 0019 | MTE0343

Tie rod end



Notes

Thread Measurement 2
Thread Measurement 1
Length [mm]

M14x1,5
M10x1,25
233
Front Axle Left

References

32 13 6 761 559

Counterpart

316 020 0018 | MTE0342

Application info

Mini I [06/01-11/07]

316 020 0004 | MTE0332

Tie rod end



Notes

Thread Measurement 2
Thread Measurement 1
Length [mm]

M14x1,5
M10x1,25
230
Front Axle Left

References

32 21 6 754 565

Counterpart

316 020 0000 | MTE0329

Application info

Mini I [06/01-11/07]

316 020 0000 | MTE0329

Tie rod end



Notes

Thread Measurement 2
Thread Measurement 1
Length [mm]

M14x1,5
M10x1,25
230
Front Axle Right

References

32 21 6 754 566

Counterpart

316 020 0004 | MTE0332

Application info

Mini I [06/01-11/07]



Ball joint

316 010 0005 | MBJ0180

Notes

Thread Size M14x1,5
inner
Front Axle Left

References

31 10 6 779 437 31 12 6 753 991

Counterpart

316 010 0006 | MBJ0181



Application info

Mini I [06/01-11/07]

Ball joint

316 010 0006 | MBJ0181

Notes

Thread Size M14x1,5
inner
Front Axle Right

References

31 10 6 779 438 31 12 6 753 992

Counterpart

316 010 0005 | MBJ0180



Application info

Mini I [06/01-11/07]

Ball joint

316 010 0013 | MBJ0392

Notes

Thread Size with accessories
M14x1,5
Outer
Front Axle Right
Front Axle Left

References

31 10 9 803 662



Application info

Countryman I [06/10--]

Paceman [04/12--]

7

316 010 0010 | MBJ0185

Ball joint



Notes

Thread Size

with accessories
M12x1,5
Front Axle Left

References

31 12 4 048 629

31 12 6 772 303

Counterpart

316 010 0009 | MBJ0184

Application info

Mini II [10/06-07/10]

316 010 0009 | MBJ0184

Ball joint



Notes

Thread Size

with accessories
M12x1,5
Front Axle Right

References

31 12 4 048 630

31 12 6 772 304

Counterpart

316 010 0010 | MBJ0185

Application info

Mini II [10/06-07/10]

316 010 0007 | MBJ0182

Ball joint



Notes

Thread Size

with accessories
M12x1,5
Outer
Front Axle Right
Front Axle Left

References

31 12 2 167 245
31 12 6 756 309

31 12 6 783 443

Application info

Mini I [06/01-11/07]

7



Control arm

316 050 0005 | MCA0438

Notes

Sheet Steel
Control Arm
Lower
Front Axle Left

References

31 12 4 015 707

31 12 6 761 409

Counterpart

316 050 0006 | MCA0439



Application info

Mini I [06/01-11/07]

Control arm

316 050 0006 | MCA0439

Notes

Sheet Steel
Control Arm
Lower
Front Axle Right

References

31 12 4 015 708

31 12 6 761 410

Counterpart

316 050 0005 | MCA0438



Application info

Mini I [06/01-11/07]

Control arm

316 050 0081 | MCA0764

Notes

Thread Size

Sheet Steel
M14x1,5
Control Arm
Front Axle Left

References

31 12 4 048 627

31 12 6 772 301

Counterpart

316 050 0082 | MCA0765



Application info

Mini II [10/06-07/10]

7

316 050 0082 | MCA0765

Control arm



Notes

Thread Size

Sheet Steel
M14x1,5
Control Arm
Front Axle Right

References

31 12 4 048 628

31 12 6 772 302

Counterpart

316 050 0081 | MCA0764

Application info

Mini II [10/06-07/10]

316 050 0070/HD | MCK0017HD

Control arm set



Notes

Reinforced Version

with accessories
Front Axle Right
Front Axle Left

References

31 12 4 015 707

31 12 6 761 409

31 12 4 015 708

31 12 6 761 410

Parts list

316 010 0005 | MBJ0180

Ball joint

316 010 0006 | MBJ0181

Ball joint

316 010 0007 | MBJ0182

Ball joint

314 610 0002/HD | MCM0072HD

Mount, control arm

314 610 0003/HD | MCM0073HD

Mount, control arm

316 050 0005 | MCA0438

Control arm

316 050 0006 | MCA0439

Control arm

Application info

Mini I [06/01-11/07]

314 311 0000/HD | MCM0071HD

Mount, control arm



Notes

Inner diameter [mm]

22

Outer diameter [mm]

66

Height [mm]

61

Lower

Front Axle Right

Front Axle Left

Reinforced Version

References

31 12 4 012 193

31 12 6 767 530

31 12 6 757 551

31 12 6 783 185



Mount, control arm

314 311 0000/HD | MCM0071HD

Application info

Mini I [06/01-11/07]

Mini II [10/06-07/10]

Mount, control arm

314 610 0002/HD | MCM0072HD

Notes

Inner diameter [mm] 20
Reinforced Version Front Axle Left

References

31 12 6 757 561

Parts list

314 311 0000/HD | MCM0071HD Mount, control arm

Counterpart

314 610 0003/HD | MCM0073HD



Application info

Mini I [06/01-11/07]

Mount, control arm

314 610 0003/HD | MCM0073HD

Notes

Inner diameter [mm] 20
Reinforced Version Front Axle Right

References

31 12 6 757 562

Parts list

314 311 0000/HD | MCM0071HD Mount, control arm

Counterpart

314 610 0002/HD | MCM0072HD



Application info

Mini I [06/01-11/07]

314 610 0010/HD | MCM0118HD

Mount, control arm



Notes

Inner diameter [mm] 20
Front Axle Left

Reinforced Version

References

31 12 6 772 235

Parts list

314 311 0000/HD | MCM0071HD Mount, control arm

Counterpart

314 610 0009/HD | MCM0117HD

Application info

Mini II (10/06-07/10)

314 610 0009/HD | MCM0117HD

Mount, control arm



Notes

Inner diameter [mm] 20
Front Axle Right

Reinforced Version

References

31 12 6 772 236

Parts list

314 311 0000/HD | MCM0071HD Mount, control arm

Counterpart

314 610 0010/HD | MCM0118HD

Application info

Mini II (10/06-07/10)

316 035 0012 | MSR0085

Rod/strut, suspension



Notes

Length [mm] Guide Rod
Sheet Steel
535
Lower
Upper
Rear Axle Right
Rear Axle Left

References

33 32 6 768 724 33 32 6 769 020
33 32 6 768 726 33 32 6 769 023

Rod/strut, suspension
316 035 0012 | MSR0085
Application info

 Countryman I [06/10--]
 Mini I [06/01-11/07]

Mini II [10/06-07/10]

Mount, stabilizer
314 615 0000 | MSB0370
Notes

 Inner diameter [mm] 16
 Front Axle Left
 Front Axle Right

References

31 35 6 757 069

Application info

Mini I [06/01-11/07]

Mount, stabilizer
314 615 0022 | MSB0372
Notes

 Inner diameter [mm] 22.5
 Front Axle Left
 Front Axle Right

References

31 35 6 757 146

Application info

Mini I [06/01-11/07]

Mini II [10/06-07/10]

Mount, stabilizer
314 615 0020 | MSB0275
Notes

 Inner diameter [mm] 21
 Front Axle Right
 Front Axle Left

References

31 35 6 772 843



7

314 615 0020 | MSB0275

Mount, stabilizer

Application info
Mini II (10/06-07/10)

314 615 0030 | MSB0437

Mount, stabilizer



Notes

| | |
|---------------------|------------------|
| Inner diameter [mm] | 23.5 |
| Required quantity | 2 |
| | Front Axle Left |
| | Front Axle Right |

References

31 35 6 772 844

Application info
Mini II (10/06-07/10)

314 715 0002 | MSB0438

Mount, stabilizer



Notes

| | |
|---------------------|-----------------|
| Inner diameter [mm] | 16 |
| Required quantity | 2 |
| | Rear Axle Left |
| | Rear Axle Right |

References

| | |
|-----------------|-----------------|
| 33 55 1 508 001 | 33 55 6 754 823 |
|-----------------|-----------------|

Application info
Countryman I (06/10--)
Mini II (10/06-07/10)

Paceman (04/12--)

314 715 0020 | MSB0450

Mount, stabilizer



Notes

| | |
|---------------------|-----------------|
| Inner diameter [mm] | 16.5 |
| Required quantity | 2 |
| | Rear Axle Left |
| | Rear Axle Right |

References

33 55 6 756 151



Mount, stabilizer

314 715 0020 | MSB0450

Application info

Countryman I [06/10--]
Mini II [10/06-07/10]

Paceman [04/12--]

Mount, stabilizer

314 715 0021 | MSB0374

Notes

Inner diameter [mm] 18
Rear Axle Left
Rear Axle Right



References

33 55 6 772 788

Application info

Mini II [10/06-07/10]

Stabilizer link

316 060 0092/HD | MSL0909HD

Notes

with spanner attachment
Coupling Rod
Thread Measurement 2 M10X15
Thread Measurement 1 M10x15
Length [mm] 320
Front Axle Left
Front Axle Right

Reinforced Version

References

31 30 6 862 864



Application info

Mini III [12/13--]

7

316 060 0021/HD | MSL0325HD

Stabilizer link



Notes

Thread Measurement 2
Thread Measurement 1
Length [mm]

Reinforced Version

References

31 35 1 507 989

with spanner attachment
Coupling Rod
M10x1,5
M10x1,5
331
Front Axle Right
Front Axle Left

Application info

Mini I [06/01-11/07]

316 060 0022/HD | MSL0326HD

Stabilizer link



Notes

Thread Measurement 2
Thread Measurement 1
Length [mm]

Reinforced Version

References

31 35 6 759 537

Coupling Rod
M10x1,5
M10x1,5
300
Front Axle Right
Front Axle Left

31 35 6 778 831

Application info

Mini I [06/01-11/07]

Mini II [10/06-07/10]

316 060 0078 | MSL0823

Stabilizer link



Notes

Thread Measurement 2
Thread Measurement 1
Length [mm]

References

31 35 6 759 537

Coupling Rod
M10x1,5
M10x1,5
300
Front Axle Right
Front Axle Left

31 35 6 778 831

Application info

Mini I [06/01-11/07]

Mini II [10/06-07/10]



Stabilizer link

316 060 0044/HD | MSL0571HD

Notes

Thread Size
Length [mm]

Reinforced Version

with spanner attachment
Coupling Rod
M10x1,5
292
Front Axle Left

References

31 35 9 806 351

Counterpart

316 060 0045/HD | MSL0572HD

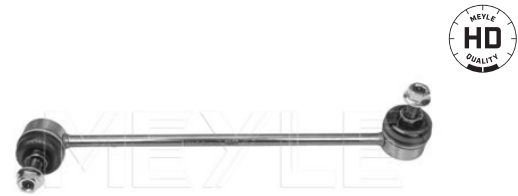

Application info

Countryman I [06/10--]

Paceman [04/12--]

Stabilizer link

316 060 0045/HD | MSL0572HD

Notes

Thread Size
Length [mm]

Reinforced Version

with spanner attachment
Coupling Rod
M10x1,5
292
Front Axle Right

References

31 35 9 806 352

Counterpart

316 060 0044/HD | MSL0571HD



Application info

Countryman I [06/10--]

Paceman [04/12--]

Stabilizer link

316 060 0060/HD | MSL0706HD

Notes

Thread Measurement 2
Thread Measurement 1
Length [mm]

Reinforced Version

with spanner attachment
Coupling Rod
M10x1,5
M10x1,5
233
Rear Axle Right
Rear Axle Left

References

33 50 6 772 789
33 50 6 781 133

33 55 1 507 999



7



316 060 0060/HD | MSL0706HD

Stabilizer link

Application info

Mini I [06/01-11/07]

Mini II [10/06-07/10]

314 640 0006 | MSC0059

Dust cover kit, shock absorber



Notes

Kit
Front Axle

Application info

Mini I [06/01-11/07]

Mini II [10/06-07/10]

314 740 0013 | MSC0073

Dust cover kit, shock absorber



Notes

Kit
Rear Axle

Application info

Mini I [06/01-11/07]

Mini II [10/06-07/10]

314 642 0008 | MRS0142

Rubber stop, suspension



Notes

Height [mm] 60
Required quantity 2
Front Axle

References

31 30 6 777 049

Rubber stop, suspension

314 642 0008 | MRS0142

Application info

Mini I [06/01-11/07]

Mini II [10/06-07/10]

Shock absorber

326 623 0015 | MSA0294

Notes

Suspension Strut
Gas Pressure
Twin-Tube
Front Axle Left

References

31 30 6 764 915
31 30 6 764 917
31 30 6 764 919
31 31 6 759 419
31 31 6 763 131
31 31 6 764 915
31 31 6 764 917

31 31 6 768 409
31 31 6 780 465
31 31 6 780 467
31 31 6 780 469
31 31 6 780 471
31 31 6 780 473
31 31 6 780 521

Counterpart

326 623 0021 | MSA0300



Application info

Mini I [06/01-11/07]

Shock absorber

326 623 0021 | MSA0300

Notes

Suspension Strut
Gas Pressure
Twin-Tube
Front Axle Right

References

31 30 6 764 916
31 30 6 764 918
31 30 6 764 920
31 31 6 759 420
31 31 6 763 132
31 31 6 764 916
31 31 6 764 918

31 31 6 768 410
31 31 6 780 466
31 31 6 780 468
31 31 6 780 470
31 31 6 780 472
31 31 6 780 474
31 31 6 780 522

Counterpart

326 623 0015 | MSA0294



Application info

Mini I [06/01-11/07]

326 623 0036 | MSA0307

Shock absorber



Notes

Suspension Strut
Gas Pressure
Twin-Tube
Front Axle Left

References

| | |
|-----------------|-----------------|
| 31 31 6 772 730 | 31 31 6 782 209 |
| 31 31 6 777 139 | 31 31 6 784 513 |
| 31 31 6 777 141 | 31 31 6 789 551 |
| 31 31 6 781 904 | 31 31 6 789 553 |
| 31 31 6 782 207 | |

Counterpart

326 623 0037 | MSA0308

Application info

Mini I [06/01-11/07]

Mini II [10/06-07/10]

326 623 0037 | MSA0308

Shock absorber



Notes

Suspension Strut
Gas Pressure
Twin-Tube
Front Axle Right

References

| | |
|-----------------|-----------------|
| 31 31 6 772 729 | 31 31 6 782 210 |
| 31 31 6 777 140 | 31 31 6 784 514 |
| 31 31 6 781 903 | 31 31 6 789 552 |
| 31 31 6 782 208 | 31 31 6 789 554 |

Counterpart

326 623 0036 | MSA0307

Application info

Mini I [06/01-11/07]

Mini II [10/06-07/10]

326 725 0011 | MSA0332

Shock absorber



Notes

Suspension Strut
Gas Pressure
Twin-Tube
Rear Axle

References

| | |
|-----------------|-----------------|
| 31 30 6 764 912 | 33 50 6 764 913 |
|-----------------|-----------------|

Shock absorber

326 725 0011 | MSA0332

Application info

Mini I [06/01-11/07]

Shock absorber

326 723 0000 | MSA0324

Notes

Bottom eye
Top pin
Gas Pressure
Twin-Tube
Rear Axle

References

| | |
|-----------------|-----------------|
| 33 52 6 777 143 | 33 52 6 784 520 |
| 33 52 6 778 565 | 33 52 6 789 557 |
| 33 52 6 778 566 | 33 52 6 789 558 |
| 33 52 6 778 575 | 33 52 6 789 559 |
| 33 52 6 778 576 | 33 52 6 789 560 |
| 33 52 6 781 909 | 33 52 6 853 963 |
| 33 52 6 781 910 | 33 52 6 853 964 |
| 33 52 6 782 213 | 33 52 6 853 965 |
| 33 52 6 782 214 | 33 52 6 853 967 |
| 33 52 6 782 215 | 33 52 6 853 969 |
| 33 52 6 782 216 | 33 52 6 853 970 |
| 33 52 6 784 519 | |



Application info

Mini I [06/01-11/07]

Mini II [10/06-07/10]

Strut mount

314 641 0004 | MSM0202

Notes

with ball bearing
Front Axle

References

31 30 6 772 749



Application info

Countryman I [06/10--]
Mini I [06/01-11/07]

Mini II [10/06-07/10]
Paceman [04/12--]

7

314 641 0002 | MSM0136

Strut mount



Notes

with ball bearing
Front Axle

References

31 30 6 764 884
31 30 6 769 741

31 30 6 778 833
31 33 6 759 498

Application info

Mini I [06/01-11/07]

314 641 1002 | MSM0242

Strut mount



Notes

Piece
Rubber-metal Bearing
with ball bearing
Front Axle left and right

References

31 30 6 778 833

Application info

Mini I [06/01-11/07]

Mini II [10/06-07/10]

300 312 1105 | MWH0111

Wheel hub



Notes

Outer diameter [mm]
Bolt Hole Circle Ø [mm]
Thread Size
Rim Hole Number

with add-on material
137

100
M14x1,25
4

Four-point mounting
with integrated wheel bearing
Front Axle left and right

References

31 22 6 776 162

31 22 6 776 671

Application info

Mini I [06/01-11/07]

Mini II [10/06-07/10]

7

Wheel hub
300 343 1102 | MWH0124
Notes

Number of Teeth, ABS ring
 Inner diameter [mm]
 Outer diameter [mm]
 Bolt Hole Circle Ø [mm]
 Thread Size
 Rim Hole Number

with add-on material
 50
 82
 137
 100
 M12x1,5
 4
 Four-point mounting
 with integrated sensor ring
 with integrated wheel bearing
 Rear Axle left and right

References

33 41 6 756 830

Application info

Mini I [06/01-11/07]

Wheel hub
300 343 1103 | MWH0125
Notes

Inner diameter [mm]
 Outer diameter [mm]
 Bolt Hole Circle Ø [mm]
 Thread Size
 Rim Hole Number

with add-on material
 82
 134
 100
 M14x1,25
 4
 Four-point mounting
 with fastening material
 with integrated wheel bearing
 Rear Axle left and right

References

 33 41 6 774 944
 3 341 6 786 552

33 41 6 786 620

Application info

Mini I [06/01-11/07]

Mini II [10/06-07/10]

300 312 1104 | MWH0110

Wheel hub



Notes

Inner diameter [mm]
Outer diameter [mm]
Bolt Hole Circle Ø [mm]
Thread Size
Rim Hole Number

without add-on material

70

137

100

M12x1,5

4

Four-point mounting
with integrated sensor ring
with wheel bearing
Front Axle left and right

References

31 22 6 756 889

Application info

Mini I [06/01-11/07]

| MEYLE no. | Ref. no. | Page |
|-----------------|---|------|
| Mini | | |
| 014 698 0006 | - | 17 |
| 014 698 0006/S | - | 17 |
| 025 232 8118 | 34 11 1 503 076 34 11 6 761 287 34 11 6 765 446 34 11 6 770 332 | 13 |
| 025 236 2316 | 34 21 9 804 739 34 21 9 808 172 | 16 |
| 025 236 2316/PD | 34 21 9 804 739 34 21 9 808 172 | 17 |
| 025 237 1616 | 34 21 1 503 077 34 21 6 761 288 34 21 6 762 871 34 21 6 770 252 | 14 |
| 025 237 1616/PD | 34 21 1 503 077 34 21 6 761 288 34 21 6 762 871 34 21 6 770 252 | 15 |
| 025 239 1517 | 34 11 6 772 892 34 11 6 794 056 34 11 6 860 016 | 13 |
| 025 239 8418 | 34 11 6 770 251 34 11 6 778 320 34 11 9 804 735 | 13 |
| 025 242 8917 | 34 21 6 772 894 34 21 6 778 325 34 21 6 778 326 34 21 6 778 327 34 21 6 794 059 | 15 |
| 025 243 1617 | 34 10 6 860 642 | 12 |
| 025 243 1617/PD | 34 10 6 860 642 | 12 |
| 025 244 7814 | 34 11 6 778 719 34 11 6 784 726 34 11 6 789 157 | 14 |
| 025 259 8016 | 34 21 6 861 641 | 15 |
| 025 259 8016/PD | 34 21 6 861 641 | 16 |
| 029 280 1212 | - | 2 |
| 029 290 1110 | - | 2 |
| 029 290 1111 | 61 62 7 129 280 | 2 |
| 029 300 1210 | - | 3 |
| 029 450 1800 | - | 3 |
| 029 475 1900 | - | 3 |
| 029 500 2000 | - | 4 |
| 029 550 2200 | - | 4 |
| 050 003 0885/E | 11287790919 | 33 |
| 050 005 1105 | 8511920 | 35 |

| MEYLE no. | Ref. no. | Page |
|-------------------|--|------|
| Mini | | |
| | 11288511920 | |
| 050 006 0800 | 11 28 7 795 036 | 34 |
| 050 006 0875 | 11 28 7 534 703 | 32 |
| 050 006 0890 | 11 28 7 526 363 | 32 |
| 050 006 0894 | 11 28 1 505 672 11 28 7 518 249 11 28 7 526 363 11 28 7 604 014 | 33 |
| 050 006 0976 | 11 28 7 798 112 | 34 |
| 050 006 1055 | 11 28 1 497 435 11 28 7 518 251 11 28 7 526 364 | 32 |
| 050 006 1374 | 11 28 0 300 802 11 28 7 545 120 | 33 |
| 050 007 1173 | 11 28 7 789 074 11 28 7 791 336 11 28 7 801 391 | 34 |
| 100 139 0002 | 24 11 7 566 356 | 45 |
| 11-12 321 0007 | 13 71 7 534 845 | 41 |
| 11-12 321 0013 | 13 71 7 534 825 | 41 |
| 11-12 321 0022 | 13 71 7 806 046 | 42 |
| 11-12 321 0027 | 13 71 7 568 728 | 42 |
| 11-13 220 0004 | 11 51 7 805 992 | 40 |
| 11-13 220 0004/HD | 11 51 7 805 992 | 40 |
| 11-13 220 0020 | 11 51 7 550 484 11 51 7 648 827 11 51 8 604 888 | 39 |
| 11-14 860 0001 | 12 23 7 806 041 | 29 |
| 11-51 049 0016 | - | 31 |
| 11-51 902 1011 | 11317805960 | 31 |
| 11-51 902 2001 | 11 31 7 805 961 | 31 |
| 214 800 0002 | 13 62 7 791 127 | 29 |
| 30-14 322 0004 | 11 42 7 791 059 | 46 |
| 30-14 860 0005 | 12 23 7 791 101 | 28 |
| 300 000 0001 | 11 42 0 026 787 11 42 7 509 208 11 42 7 512 446 | 46 |
| 300 135 0305 | - | 22 |
| 300 135 0306 | - | 23 |
| 300 135 0307 | 24 34 7 551 087 | 22 |
| 300 221 2000 | 22 11 6 756 406 | 47 |
| 300 221 2004 | 22 11 4 052 474 22 11 6 772 040 22 11 6 783 094 | 48 |
| 300 221 2100 | - | 22 |
| 300 312 1104 | 31 22 6 756 889 | 74 |

| MEYLE no. | Ref. no. | Page |
|----------------|-----------------|------|
| Mini | | |
| 300 312 1105 | 31 22 6 776 162 | 72 |
| | 31 22 6 776 671 | |
| 300 343 1102 | 33 41 6 756 830 | 73 |
| 300 343 1103 | 33 41 6 774 944 | 73 |
| | 3 341 6 786 552 | |
| | 33 41 6 786 620 | |
| 300 525 0001 | 34 10 6 779 817 | 18 |
| | 34 30 6 794 002 | |
| | 34 32 1 503 079 | |
| 300 525 0009 | 34 30 6 755 398 | 18 |
| | 34 30 6 760 221 | |
| 300 525 0010 | 34 30 6 763 682 | 18 |
| | 34 30 6 772 556 | |
| | 34 30 6 781 667 | |
| | 34 30 6 788 443 | |
| 300 919 0001 | 65 81 6 905 133 | 24 |
| 312 137 2015 | 13 72 1 491 749 | 43 |
| 312 319 0009 | 64 11 3 422 664 | 5 |
| | 64 31 9 127 515 | |
| 312 319 0024 | 64 31 6 835 404 | 5 |
| 312 320 0009 | 64 11 3 422 665 | 6 |
| | 64 31 1 496 711 | |
| | 64 31 9 127 516 | |
| | 64 31 9 257 505 | |
| 312 320 0024 | 64 31 6 835 405 | 5 |
| 312 320 0025/S | 64 11 9 321 875 | 4 |
| 312 321 0010 | 13 71 7 561 235 | 41 |
| 312 321 0014 | 13 71 7 520 855 | 44 |
| | 13 72 7 520 855 | |
| 312 321 0019 | 13 72 7 529 261 | 44 |
| 312 321 0032 | 13 71 8 509 032 | 42 |
| 312 321 0039 | 13 71 8 513 944 | 43 |
| 313 220 0003 | 11 51 7 510 803 | 39 |
| | 11 51 7 513 062 | |
| 313 220 0010 | 11 51 7 790 871 | 40 |
| 313 220 0013 | 11 51 7 520 123 | 39 |
| 314 136 0007 | 24 34 7 551 087 | 21 |
| 314 137 0004 | 21 11 7 518 741 | 21 |
| | 24 11 7 518 741 | |
| 314 137 0004/S | 24 11 7 518 741 | 20 |
| 314 137 0006/S | 24 34 7 566 358 | 21 |
| 314 137 0007/S | 24 34 7 551 087 | 20 |
| 314 223 0010 | 17 13 7 529 273 | 35 |
| 314 223 0011 | 17 13 7 823 626 | 36 |
| 314 223 0012 | 17 10 7 509 071 | 35 |
| 314 238 0005 | 17 11 7 639 024 | 36 |

| MEYLE no. | Ref. no. | Page |
|-----------------|-----------------|------|
| Mini | | |
| | 17 13 2 754 264 | |
| 314 311 0000/HD | 31 12 4 012 193 | 60 |
| | 31 12 6 757 551 | |
| | 31 12 6 767 530 | |
| | 31 12 6 783 185 | |
| 314 322 0006 | 11 42 8 570 590 | 47 |
| 314 323 0011 | 13 32 7 811 227 | 45 |
| 314 323 0012 | 13 32 7 787 477 | 44 |
| | 13 32 7 791 034 | |
| | 13 32 7 794 590 | |
| 314 323 0013 | 13 32 8 572 522 | 45 |
| 314 356 0003 | 34 35 6 761 447 | 25 |
| | 34 35 6 778 175 | |
| 314 356 0004 | 34 35 6 761 448 | 24 |
| 314 495 0009 | - | 19 |
| 314 495 0010 | - | 19 |
| 314 498 0001 | 31 60 7 518 248 | 19 |
| 314 498 0002 | 31 60 7 518 261 | 20 |
| 314 527 0002 | 34 35 6 773 018 | 25 |
| | 34 35 6 783 772 | |
| | 34 35 6 789 330 | |
| 314 527 0005 | 34 35 6 773 017 | 25 |
| | 34 35 6 783 230 | |
| | 34 35 6 789 329 | |
| 314 527 0014 | - | 27 |
| 314 527 0018 | 34 35 9 804 834 | 27 |
| 314 527 0023 | 34 35 6 792 572 | 26 |
| 314 527 0030 | 34 35 6 792 573 | 26 |
| 314 527 0037 | 34 35 6 799 735 | 26 |
| | 34 35 6 865 611 | |
| 314 610 0002/HD | 31 12 6 757 561 | 61 |
| 314 610 0003/HD | 31 12 6 757 562 | 61 |
| 314 610 0009/HD | 31 12 6 772 236 | 62 |
| 314 610 0010/HD | 31 12 6 772 235 | 62 |
| 314 615 0000 | 31 35 6 757 069 | 63 |
| 314 615 0020 | 31 35 6 772 843 | 63 |
| 314 615 0022 | 31 35 6 757 146 | 63 |
| 314 615 0030 | 31 35 6 772 844 | 64 |
| 314 620 0000 | 32 13 6 756 757 | 50 |
| 314 620 0006 | 32 10 6 865 380 | 50 |
| 314 620 0007 | 32 10 6 778 560 | 49 |
| 314 640 0006 | - | 68 |
| 314 641 0002 | 31 30 6 764 884 | 72 |
| | 31 30 6 769 741 | |
| | 31 30 6 778 833 | |
| | 31 33 6 759 498 | |

| MEYLE no. | Ref. no. | Page |
|-----------------|---|------|
| Mini | | |
| 314 641 0004 | 31 30 6 772 749 | 71 |
| 314 641 1002 | 31 30 6 778 833 | 72 |
| 314 642 0008 | 31 30 6 777 049 | 68 |
| 314 715 0002 | 33 55 1 508 001 33 55 6 754 823 | 64 |
| 314 715 0020 | 33 55 6 756 151 | 64 |
| 314 715 0021 | 33 55 6 772 788 | 65 |
| 314 740 0013 | - | 68 |
| 314 800 0040 | 34 52 6 756 385 | 24 |
| 314 860 0004 | 12 23 7 798 001 | 28 |
| 314 885 0005 | 12 13 7 575 010 | 29 |
| 315 521 0020/PD | 34 11 9 804 828 34 11 9 811 537 | 9 |
| 315 521 0021/PD | 34 11 9 804 829 34 11 9 811 538 | 9 |
| 315 521 0024 | 34 11 1 502 891 34 11 6 774 984 | 7 |
| 315 521 0024/PD | 34 11 1 502 891 34 11 6 774 984 | 7 |
| 315 521 0028/PD | - | 12 |
| 315 523 0035 | 34 20 9 804 830 34 21 9 811 539 | 10 |
| 315 523 0035/PD | 34 20 9 804 830 34 21 9 811 539 | 11 |
| 315 523 0060 | 34 21 1 503 070 34 21 6 774 987 | 10 |
| 315 523 0060/PD | 34 21 1 503 070 34 21 6 774 987 | 11 |
| 316 010 0005 | 31 10 6 779 437 31 12 6 753 991 | 57 |
| 316 010 0006 | 31 10 6 779 438 31 12 6 753 992 | 57 |
| 316 010 0007 | 31 12 2 167 245 31 12 6 756 309 31 12 6 783 443 | 58 |
| 316 010 0009 | 31 12 4 048 630 31 12 6 772 304 | 58 |
| 316 010 0010 | 31 12 4 048 629 31 12 6 772 303 | 58 |
| 316 010 0013 | 31 10 9 803 662 | 57 |
| 316 020 0000 | 32 21 6 754 566 | 56 |
| 316 020 0004 | 32 21 6 754 565 | 56 |
| 316 020 0018 | 32 11 6 761 560 | 55 |
| 316 020 0019 | 32 13 6 761 559 | 56 |
| 316 020 0021 | 32 10 6 778 438 | 54 |
| 316 020 0022 | 32 10 6 778 437 | 53 |

| MEYLE no. | Ref. no. | Page |
|-----------------|--|------|
| Mini | | |
| 316 020 0030 | 32 10 9 805 552 32 10 9 808 840 | 55 |
| 316 020 0031 | 32 10 9 805 551 32 10 9 808 839 | 55 |
| 316 020 0036/HD | 32 10 6 854 737 | 54 |
| 316 020 0037/HD | 32 10 6 854 734 | 54 |
| 316 030 0019 | 32 11 6 761 557 32 11 6 777 521 | 53 |
| 316 030 0020 | 32 10 6 777 522 32 11 6 761 558 | 52 |
| 316 030 0022 | 32 10 6 778 547 | 52 |
| 316 030 0023 | 32 10 6 778 548 | 52 |
| 316 031 0000 | 32 11 6 754 563* 32 11 6 754 564* 32 11 6 780 785* 32 11 6 780 786* | 51 |
| 316 031 0006 | 32 10 6 778 547* 32 10 6 778 548* 32 10 9 803 321* 32 10 9 803 322* | 50 |
| 316 031 0019/HD | 32 10 6 867 404 32 10 6 867 405 | 51 |
| 316 031 0020/HD | 32 10 6 854 733 32 10 6 854 736 | 51 |
| 316 035 0012 | 33 32 6 768 724 33 32 6 768 726 33 32 6 769 020 33 32 6 769 023 | 62 |
| 316 050 0005 | 31 12 4 015 707 31 12 6 761 409 | 59 |
| 316 050 0006 | 31 12 4 015 708 31 12 6 761 410 | 59 |
| 316 050 0070/HD | 31 12 4 015 707 31 12 4 015 708 31 12 6 761 409 31 12 6 761 410 | 60 |
| 316 050 0081 | 31 12 4 048 627 31 12 6 772 301 | 59 |
| 316 050 0082 | 31 12 4 048 628 31 12 6 772 302 | 60 |
| 316 060 0021/HD | 31 35 1 507 989 | 66 |
| 316 060 0022/HD | 31 35 6 759 537 31 35 6 778 831 | 66 |
| 316 060 0044/HD | 31 35 9 806 351 | 67 |
| 316 060 0045/HD | 31 35 9 806 352 | 67 |
| 316 060 0060/HD | 33 50 6 772 789 | 67 |

| MEYLE no. | Ref. no. | Page |
|-----------------|--|------|
| Mini | | |
| | 33 50 6 781 133 33 55 1 507 999 | |
| 316 060 0078 | 31 35 6 759 537 31 35 6 778 831 | 66 |
| 316 060 0092/HD | 31 30 6 862 864 | 65 |
| 319 222 0001 | 17 12 1 475 561 | 36 |
| 319 222 0002 | 17 12 7 515 489 | 37 |
| 319 222 0003 | 17 12 7 515 500 | 37 |
| 319 222 0004 | 17 12 7 515 501 | 37 |
| 319 222 0005 | 17 12 7 515 989 | 38 |
| 319 222 0006 | 17 12 7 526 414 | 38 |
| 319 222 0007 | 17 12 7 556 614 | 38 |
| 326 623 0015 | 31 30 6 764 915 31 30 6 764 917 31 30 6 764 919 31 31 6 759 419 31 31 6 763 131 31 31 6 764 915 31 31 6 764 917 31 31 6 768 409 31 31 6 780 465 31 31 6 780 467 31 31 6 780 469 31 31 6 780 471 31 31 6 780 473 31 31 6 780 521 | 69 |
| 326 623 0021 | 31 30 6 764 916 31 30 6 764 918 31 30 6 764 920 31 31 6 759 420 31 31 6 763 132 31 31 6 764 916 31 31 6 764 918 31 31 6 768 410 31 31 6 780 466 31 31 6 780 468 31 31 6 780 470 31 31 6 780 472 31 31 6 780 474 31 31 6 780 522 | 69 |
| 326 623 0036 | 31 31 6 772 730 31 31 6 777 139 31 31 6 777 141 31 31 6 781 904 31 31 6 782 207 31 31 6 782 209 | 70 |

| MEYLE no. | Ref. no. | Page |
|-----------------|---|------|
| Mini | | |
| | 31 31 6 784 513 31 31 6 789 551 31 31 6 789 553 | |
| 326 623 0037 | 31 31 6 772 729 31 31 6 777 140 31 31 6 781 903 31 31 6 782 208 31 31 6 782 210 31 31 6 784 514 31 31 6 789 552 31 31 6 789 554 | 70 |
| 326 723 0000 | 33 52 6 777 143 33 52 6 778 565 33 52 6 778 566 33 52 6 778 575 33 52 6 778 576 33 52 6 781 909 33 52 6 781 910 33 52 6 782 213 33 52 6 782 214 33 52 6 782 215 33 52 6 782 216 33 52 6 784 519 33 52 6 784 520 33 52 6 789 557 33 52 6 789 558 33 52 6 789 559 33 52 6 789 560 33 52 6 853 963 33 52 6 853 964 33 52 6 853 965 33 52 6 853 967 33 52 6 853 969 33 52 6 853 970 | 71 |
| 326 725 0011 | 31 30 6 764 912 33 50 6 764 913 | 70 |
| 340 910 0012 | 51 24 7 148 902 | 1 |
| 340 910 0021 | 51 23 7 066 566 51 23 7 160 818 51 23 7 175 020 | 1 |
| 340 910 0022 | 41 62 6 801 258 | 1 |
| 359 202 0009 | 32 41 6 754 463 32 41 6 781 751 | 49 |
| 359 202 0039 | 32 41 6 754 498 | 49 |
| 383 521 0007/PD | 34 11 6 774 986 34 11 6 858 652 | 8 |

| MEYLE no. | Ref. no. | Page |
|-----------------|---|------|
| Mini | | |
| 383 521 0382/PD | 34 11 6 774 985 34 11 6 858 651 | 8 |
| 40-14 800 0004 | 13 62 7 805 004 | 27 |
| 40-14 800 0005 | 13 62 7 805 005 | 30 |
| 614 123 0001 | 23 11 7 518 648 23 11 7 527 716 23 14 1 482 377 | 30 |
| 712 114 0000 | 13 72 1 477 840 | 43 |
| 714 322 0007 | 11 42 7 805 978 | 47 |
| 714 322 0011 | 11 42 7 557 012 11 42 7 622 446 | 46 |



| Ref. no. | MEYLE no. | Page |
|-----------------|-------------------------------------|-------|
| Mini | | |
| 8511920 | 050 005 1105 | 35 |
| 11 28 0 300 802 | 050 006 1374 | 33 |
| 11 28 1 497 435 | 050 006 1055 | 32 |
| 11 28 1 505 672 | 050 006 0894 | 33 |
| 11 28 7 518 249 | 050 006 0894 | 33 |
| 11 28 7 518 251 | 050 006 1055 | 32 |
| 11 28 7 526 363 | 050 006 0890 050 006 0894 | 32-33 |
| 11 28 7 526 364 | 050 006 1055 | 32 |
| 11 28 7 534 703 | 050 006 0875 | 32 |
| 11 28 7 545 120 | 050 006 1374 | 33 |
| 11 28 7 604 014 | 050 006 0894 | 33 |
| 11 28 7 789 074 | 050 007 1173 | 34 |
| 11287790919 | 050 003 0885/E | 33 |
| 11 28 7 791 336 | 050 007 1173 | 34 |
| 11 28 7 795 036 | 050 006 0800 | 34 |
| 11 28 7 798 112 | 050 006 0976 | 34 |
| 11 28 7 801 391 | 050 007 1173 | 34 |
| 11288511920 | 050 005 1105 | 35 |
| 11317805960 | 11-51 902 1011 | 31 |
| 11 31 7 805 961 | 11-51 902 2001 | 31 |
| 11 42 0 026 787 | 300 000 0001 | 46 |
| 11 42 7 509 208 | 300 000 0001 | 46 |
| 11 42 7 512 446 | 300 000 0001 | 46 |
| 11 42 7 557 012 | 714 322 0011 | 46 |
| 11 42 7 622 446 | 714 322 0011 | 46 |
| 11 42 7 791 059 | 30-14 322 0004 | 46 |
| 11 42 7 805 978 | 714 322 0007 | 47 |
| 11 42 8 570 590 | 314 322 0006 | 47 |
| 11 51 7 510 803 | 313 220 0003 | 39 |
| 11 51 7 513 062 | 313 220 0003 | 39 |
| 11 51 7 520 123 | 313 220 0013 | 39 |
| 11 51 7 550 484 | 11-13 220 0020 | 39 |
| 11 51 7 648 827 | 11-13 220 0020 | 39 |
| 11 51 7 790 871 | 313 220 0010 | 40 |
| 11 51 7 805 992 | 11-13 220 0004 11-13 220 0004/HD | 40 |
| 11 51 8 604 888 | 11-13 220 0020 | 39 |
| 12 13 7 575 010 | 314 885 0005 | 29 |
| 12 23 7 791 101 | 30-14 860 0005 | 28 |
| 12 23 7 798 001 | 314 860 0004 | 28 |
| 12 23 7 806 041 | 11-14 860 0001 | 29 |
| 13 32 7 787 477 | 314 323 0012 | 44 |
| 13 32 7 791 034 | 314 323 0012 | 44 |
| 13 32 7 794 590 | 314 323 0012 | 44 |
| 13 32 7 811 227 | 314 323 0011 | 45 |

| Ref. no. | MEYLE no. | Page |
|-----------------|--|-------|
| Mini | | |
| 13 32 8 572 522 | 314 323 0013 | 45 |
| 13 62 7 791 127 | 214 800 0002 | 29 |
| 13 62 7 805 004 | 40-14 800 0004 | 27 |
| 13 62 7 805 005 | 40-14 800 0005 | 30 |
| 13 71 7 520 855 | 312 321 0014 | 44 |
| 13 71 7 534 825 | 11-12 321 0013 | 41 |
| 13 71 7 534 845 | 11-12 321 0007 | 41 |
| 13 71 7 561 235 | 312 321 0010 | 41 |
| 13 71 7 568 728 | 11-12 321 0027 | 42 |
| 13 71 7 806 046 | 11-12 321 0022 | 42 |
| 13 71 8 509 032 | 312 321 0032 | 42 |
| 13 71 8 513 944 | 312 321 0039 | 43 |
| 13 72 1 477 840 | 712 114 0000 | 43 |
| 13 72 1 491 749 | 312 137 2015 | 43 |
| 13 72 7 520 855 | 312 321 0014 | 44 |
| 13 72 7 529 261 | 312 321 0019 | 44 |
| 17 10 7 509 071 | 314 223 0012 | 35 |
| 17 11 7 639 024 | 314 238 0005 | 36 |
| 17 12 1 475 561 | 319 222 0001 | 36 |
| 17 12 7 515 489 | 319 222 0002 | 37 |
| 17 12 7 515 500 | 319 222 0003 | 37 |
| 17 12 7 515 501 | 319 222 0004 | 37 |
| 17 12 7 515 989 | 319 222 0005 | 38 |
| 17 12 7 526 414 | 319 222 0006 | 38 |
| 17 12 7 556 614 | 319 222 0007 | 38 |
| 17 13 2 754 264 | 314 238 0005 | 36 |
| 17 13 7 529 273 | 314 223 0010 | 35 |
| 17 13 7 823 626 | 314 223 0011 | 36 |
| 21 11 7 518 741 | 314 137 0004 | 21 |
| 22 11 4 052 474 | 300 221 2004 | 48 |
| 22 11 6 756 406 | 300 221 2000 | 47 |
| 22 11 6 772 040 | 300 221 2004 | 48 |
| 22 11 6 783 094 | 300 221 2004 | 48 |
| 23 11 7 518 648 | 614 123 0001 | 30 |
| 23 11 7 527 716 | 614 123 0001 | 30 |
| 23 14 1 482 377 | 614 123 0001 | 30 |
| 24 11 7 518 741 | 314 137 0004 314 137 0004/S | 20-21 |
| 24 11 7 566 356 | 100 139 0002 | 45 |
| 24 34 7 551 087 | 300 135 0307 314 136 0007 314 137 0007/S | 20-22 |
| 24 34 7 566 358 | 314 137 0006/S | 21 |
| 31 10 6 779 437 | 316 010 0005 | 57 |
| 31 10 6 779 438 | 316 010 0006 | 57 |
| 31 10 9 803 662 | 316 010 0013 | 57 |

| Ref. no. | MEYLE no. | Page |
|-----------------|---------------------------------|-------|
| Mini | | |
| 31 12 2 167 245 | 316 010 0007 | 58 |
| 31 12 4 012 193 | 314 311 0000/HD | 60 |
| 31 12 4 015 707 | 316 050 0005 316 050 0070/HD | 59-60 |
| 31 12 4 015 708 | 316 050 0006 316 050 0070/HD | 59-60 |
| 31 12 4 048 627 | 316 050 0081 | 59 |
| 31 12 4 048 628 | 316 050 0082 | 60 |
| 31 12 4 048 629 | 316 010 0010 | 58 |
| 31 12 4 048 630 | 316 010 0009 | 58 |
| 31 12 6 753 991 | 316 010 0005 | 57 |
| 31 12 6 753 992 | 316 010 0006 | 57 |
| 31 12 6 756 309 | 316 010 0007 | 58 |
| 31 12 6 757 551 | 314 311 0000/HD | 60 |
| 31 12 6 757 561 | 314 610 0002/HD | 61 |
| 31 12 6 757 562 | 314 610 0003/HD | 61 |
| 31 12 6 761 409 | 316 050 0005 316 050 0070/HD | 59-60 |
| 31 12 6 761 410 | 316 050 0006 316 050 0070/HD | 59-60 |
| 31 12 6 767 530 | 314 311 0000/HD | 60 |
| 31 12 6 772 235 | 314 610 0010/HD | 62 |
| 31 12 6 772 236 | 314 610 0009/HD | 62 |
| 31 12 6 772 301 | 316 050 0081 | 59 |
| 31 12 6 772 302 | 316 050 0082 | 60 |
| 31 12 6 772 303 | 316 010 0010 | 58 |
| 31 12 6 772 304 | 316 010 0009 | 58 |
| 31 12 6 783 185 | 314 311 0000/HD | 60 |
| 31 12 6 783 443 | 316 010 0007 | 58 |
| 31 22 6 756 889 | 300 312 1104 | 74 |
| 31 22 6 776 162 | 300 312 1105 | 72 |
| 31 22 6 776 671 | 300 312 1105 | 72 |
| 31 30 6 764 884 | 314 641 0002 | 72 |
| 31 30 6 764 912 | 326 725 0011 | 70 |
| 31 30 6 764 915 | 326 623 0015 | 69 |
| 31 30 6 764 916 | 326 623 0021 | 69 |
| 31 30 6 764 917 | 326 623 0015 | 69 |
| 31 30 6 764 918 | 326 623 0021 | 69 |
| 31 30 6 764 919 | 326 623 0015 | 69 |
| 31 30 6 764 920 | 326 623 0021 | 69 |
| 31 30 6 769 741 | 314 641 0002 | 72 |
| 31 30 6 772 749 | 314 641 0004 | 71 |
| 31 30 6 777 049 | 314 642 0008 | 68 |
| 31 30 6 778 833 | 314 641 0002 314 641 1002 | 72 |
| 31 30 6 862 864 | 316 060 0092/HD | 65 |

| Ref. no. | MEYLE no. | Page |
|-----------------|---------------------------------|------|
| Mini | | |
| 31 31 6 759 419 | 326 623 0015 | 69 |
| 31 31 6 759 420 | 326 623 0021 | 69 |
| 31 31 6 763 131 | 326 623 0015 | 69 |
| 31 31 6 763 132 | 326 623 0021 | 69 |
| 31 31 6 764 915 | 326 623 0015 | 69 |
| 31 31 6 764 916 | 326 623 0021 | 69 |
| 31 31 6 764 917 | 326 623 0015 | 69 |
| 31 31 6 764 918 | 326 623 0021 | 69 |
| 31 31 6 768 409 | 326 623 0015 | 69 |
| 31 31 6 768 410 | 326 623 0021 | 69 |
| 31 31 6 772 729 | 326 623 0037 | 70 |
| 31 31 6 772 730 | 326 623 0036 | 70 |
| 31 31 6 777 139 | 326 623 0036 | 70 |
| 31 31 6 777 140 | 326 623 0037 | 70 |
| 31 31 6 777 141 | 326 623 0036 | 70 |
| 31 31 6 780 465 | 326 623 0015 | 69 |
| 31 31 6 780 466 | 326 623 0021 | 69 |
| 31 31 6 780 467 | 326 623 0015 | 69 |
| 31 31 6 780 468 | 326 623 0021 | 69 |
| 31 31 6 780 469 | 326 623 0015 | 69 |
| 31 31 6 780 470 | 326 623 0021 | 69 |
| 31 31 6 780 471 | 326 623 0015 | 69 |
| 31 31 6 780 472 | 326 623 0021 | 69 |
| 31 31 6 780 473 | 326 623 0015 | 69 |
| 31 31 6 780 474 | 326 623 0021 | 69 |
| 31 31 6 780 521 | 326 623 0015 | 69 |
| 31 31 6 780 522 | 326 623 0021 | 69 |
| 31 31 6 781 903 | 326 623 0037 | 70 |
| 31 31 6 781 904 | 326 623 0036 | 70 |
| 31 31 6 782 207 | 326 623 0036 | 70 |
| 31 31 6 782 208 | 326 623 0037 | 70 |
| 31 31 6 782 209 | 326 623 0036 | 70 |
| 31 31 6 782 210 | 326 623 0037 | 70 |
| 31 31 6 784 513 | 326 623 0036 | 70 |
| 31 31 6 784 514 | 326 623 0037 | 70 |
| 31 31 6 789 551 | 326 623 0036 | 70 |
| 31 31 6 789 552 | 326 623 0037 | 70 |
| 31 31 6 789 553 | 326 623 0036 | 70 |
| 31 31 6 789 554 | 326 623 0037 | 70 |
| 31 33 6 759 498 | 314 641 0002 | 72 |
| 31 35 1 507 989 | 316 060 0021/HD | 66 |
| 31 35 6 757 069 | 314 615 0000 | 63 |
| 31 35 6 757 146 | 314 615 0022 | 63 |
| 31 35 6 759 537 | 316 060 0022/HD 316 060 0078 | 66 |
| 31 35 6 772 843 | 314 615 0020 | 63 |

| Ref. no. | MEYLE no. | Page |
|------------------|---------------------------------|--------|
| Mini | | |
| 31 35 6 772 844 | 314 615 0030 | 64 |
| 31 35 6 778 831 | 316 060 0022/HD 316 060 0078 | 66 |
| 31 35 9 806 351 | 316 060 0044/HD | 67 |
| 31 35 9 806 352 | 316 060 0045/HD | 67 |
| 31 60 7 518 248 | 314 498 0001 | 19 |
| 31 60 7 518 261 | 314 498 0002 | 20 |
| 32 10 6 777 522 | 316 030 0020 | 52 |
| 32 10 6 778 437 | 316 020 0022 | 53 |
| 32 10 6 778 438 | 316 020 0021 | 54 |
| 32 10 6 778 547 | 316 030 0022 | 50, 52 |
| 32 10 6 778 547* | 316 031 0006 | 50, 52 |
| 32 10 6 778 548 | 316 030 0023 | 50, 52 |
| 32 10 6 778 548* | 316 031 0006 | 50, 52 |
| 32 10 6 778 560 | 314 620 0007 | 49 |
| 32 10 6 854 733 | 316 031 0020/HD | 51 |
| 32 10 6 854 734 | 316 020 0037/HD | 54 |
| 32 10 6 854 736 | 316 031 0020/HD | 51 |
| 32 10 6 854 737 | 316 020 0036/HD | 54 |
| 32 10 6 865 380 | 314 620 0006 | 50 |
| 32 10 6 867 404 | 316 031 0019/HD | 51 |
| 32 10 6 867 405 | 316 031 0019/HD | 51 |
| 32 10 9 803 321* | 316 031 0006 | 50 |
| 32 10 9 803 322* | 316 031 0006 | 50 |
| 32 10 9 805 551 | 316 020 0031 | 55 |
| 32 10 9 805 552 | 316 020 0030 | 55 |
| 32 10 9 808 839 | 316 020 0031 | 55 |
| 32 10 9 808 840 | 316 020 0030 | 55 |
| 32 11 6 754 563* | 316 031 0000 | 51 |
| 32 11 6 754 564* | 316 031 0000 | 51 |
| 32 11 6 761 557 | 316 030 0019 | 53 |
| 32 11 6 761 558 | 316 030 0020 | 52 |
| 32 11 6 761 560 | 316 020 0018 | 55 |
| 32 11 6 777 521 | 316 030 0019 | 53 |
| 32 11 6 780 785* | 316 031 0000 | 51 |
| 32 11 6 780 786* | 316 031 0000 | 51 |
| 32 13 6 756 757 | 314 620 0000 | 50 |
| 32 13 6 761 559 | 316 020 0019 | 56 |
| 32 21 6 754 565 | 316 020 0004 | 56 |
| 32 21 6 754 566 | 316 020 0000 | 56 |
| 32 41 6 754 463 | 359 202 0009 | 49 |
| 32 41 6 754 498 | 359 202 0039 | 49 |
| 32 41 6 781 751 | 359 202 0009 | 49 |
| 33 32 6 768 724 | 316 035 0012 | 62 |
| 33 32 6 768 726 | 316 035 0012 | 62 |
| 33 32 6 769 020 | 316 035 0012 | 62 |

| Ref. no. | MEYLE no. | Page |
|-----------------|---------------------------------|------|
| Mini | | |
| 33 32 6 769 023 | 316 035 0012 | 62 |
| 33 41 6 756 830 | 300 343 1102 | 73 |
| 33 41 6 774 944 | 300 343 1103 | 73 |
| 3 341 6 786 552 | 300 343 1103 | 73 |
| 33 41 6 786 620 | 300 343 1103 | 73 |
| 33 50 6 764 913 | 326 725 0011 | 70 |
| 33 50 6 772 789 | 316 060 0060/HD | 67 |
| 33 50 6 781 133 | 316 060 0060/HD | 67 |
| 33 52 6 777 143 | 326 723 0000 | 71 |
| 33 52 6 778 565 | 326 723 0000 | 71 |
| 33 52 6 778 566 | 326 723 0000 | 71 |
| 33 52 6 778 575 | 326 723 0000 | 71 |
| 33 52 6 778 576 | 326 723 0000 | 71 |
| 33 52 6 781 909 | 326 723 0000 | 71 |
| 33 52 6 781 910 | 326 723 0000 | 71 |
| 33 52 6 782 213 | 326 723 0000 | 71 |
| 33 52 6 782 214 | 326 723 0000 | 71 |
| 33 52 6 782 215 | 326 723 0000 | 71 |
| 33 52 6 782 216 | 326 723 0000 | 71 |
| 33 52 6 784 519 | 326 723 0000 | 71 |
| 33 52 6 784 520 | 326 723 0000 | 71 |
| 33 52 6 789 557 | 326 723 0000 | 71 |
| 33 52 6 789 558 | 326 723 0000 | 71 |
| 33 52 6 789 559 | 326 723 0000 | 71 |
| 33 52 6 789 560 | 326 723 0000 | 71 |
| 33 52 6 853 963 | 326 723 0000 | 71 |
| 33 52 6 853 964 | 326 723 0000 | 71 |
| 33 52 6 853 965 | 326 723 0000 | 71 |
| 33 52 6 853 967 | 326 723 0000 | 71 |
| 33 52 6 853 969 | 326 723 0000 | 71 |
| 33 52 6 853 970 | 326 723 0000 | 71 |
| 33 55 1 507 999 | 316 060 0060/HD | 67 |
| 33 55 1 508 001 | 314 715 0002 | 64 |
| 33 55 6 754 823 | 314 715 0002 | 64 |
| 33 55 6 756 151 | 314 715 0020 | 64 |
| 33 55 6 772 788 | 314 715 0021 | 65 |
| 34 10 6 779 817 | 300 525 0001 | 18 |
| 34 10 6 860 642 | 025 243 1617 025 243 1617/PD | 12 |
| 34 11 1 502 891 | 315 521 0024 315 521 0024/PD | 7 |
| 34 11 1 503 076 | 025 232 8118 | 13 |
| 34 11 6 761 287 | 025 232 8118 | 13 |
| 34 11 6 765 446 | 025 232 8118 | 13 |
| 34 11 6 770 251 | 025 239 8418 | 13 |
| 34 11 6 770 332 | 025 232 8118 | 13 |

| Ref. no. | MEYLE no. | Page |
|-----------------|---------------------------------|-------|
| Mini | | |
| 34 11 6 772 892 | 025 239 1517 | 13 |
| 34 11 6 774 984 | 315 521 0024 315 521 0024/PD | 7 |
| 34 11 6 774 985 | 383 521 0382/PD | 8 |
| 34 11 6 774 986 | 383 521 0007/PD | 8 |
| 34 11 6 778 320 | 025 239 8418 | 13 |
| 34 11 6 778 719 | 025 244 7814 | 14 |
| 34 11 6 784 726 | 025 244 7814 | 14 |
| 34 11 6 789 157 | 025 244 7814 | 14 |
| 34 11 6 794 056 | 025 239 1517 | 13 |
| 34 11 6 858 651 | 383 521 0382/PD | 8 |
| 34 11 6 858 652 | 383 521 0007/PD | 8 |
| 34 11 6 860 016 | 025 239 1517 | 13 |
| 34 11 9 804 735 | 025 239 8418 | 13 |
| 34 11 9 804 828 | 315 521 0020/PD | 9 |
| 34 11 9 804 829 | 315 521 0021/PD | 9 |
| 34 11 9 811 537 | 315 521 0020/PD | 9 |
| 34 11 9 811 538 | 315 521 0021/PD | 9 |
| 34 20 9 804 830 | 315 523 0035 315 523 0035/PD | 10-11 |
| 34 21 1 503 070 | 315 523 0060 315 523 0060/PD | 10-11 |
| 34 21 1 503 077 | 025 237 1616 025 237 1616/PD | 14-15 |
| 34 21 6 761 288 | 025 237 1616 025 237 1616/PD | 14-15 |
| 34 21 6 762 871 | 025 237 1616 025 237 1616/PD | 14-15 |
| 34 21 6 770 252 | 025 237 1616 025 237 1616/PD | 14-15 |
| 34 21 6 772 894 | 025 242 8917 | 15 |
| 34 21 6 774 987 | 315 523 0060 315 523 0060/PD | 10-11 |
| 34 21 6 778 325 | 025 242 8917 | 15 |
| 34 21 6 778 326 | 025 242 8917 | 15 |
| 34 21 6 778 327 | 025 242 8917 | 15 |
| 34 21 6 794 059 | 025 242 8917 | 15 |
| 34 21 6 861 641 | 025 259 8016 025 259 8016/PD | 15-16 |
| 34 21 9 804 739 | 025 236 2316 025 236 2316/PD | 16-17 |
| 34 21 9 808 172 | 025 236 2316 025 236 2316/PD | 16-17 |
| 34 21 9 811 539 | 315 523 0035 315 523 0035/PD | 10-11 |
| 34 30 6 755 398 | 300 525 0009 | 18 |

| Ref. no. | MEYLE no. | Page |
|-----------------|----------------|------|
| Mini | | |
| 34 30 6 760 221 | 300 525 0009 | 18 |
| 34 30 6 763 682 | 300 525 0010 | 18 |
| 34 30 6 772 556 | 300 525 0010 | 18 |
| 34 30 6 781 667 | 300 525 0010 | 18 |
| 34 30 6 788 443 | 300 525 0010 | 18 |
| 34 30 6 794 002 | 300 525 0001 | 18 |
| 34 32 1 503 079 | 300 525 0001 | 18 |
| 34 35 6 761 447 | 314 356 0003 | 25 |
| 34 35 6 761 448 | 314 356 0004 | 24 |
| 34 35 6 773 017 | 314 527 0005 | 25 |
| 34 35 6 773 018 | 314 527 0002 | 25 |
| 34 35 6 778 175 | 314 356 0003 | 25 |
| 34 35 6 783 230 | 314 527 0005 | 25 |
| 34 35 6 783 772 | 314 527 0002 | 25 |
| 34 35 6 789 329 | 314 527 0005 | 25 |
| 34 35 6 789 330 | 314 527 0002 | 25 |
| 34 35 6 792 572 | 314 527 0023 | 26 |
| 34 35 6 792 573 | 314 527 0030 | 26 |
| 34 35 6 799 735 | 314 527 0037 | 26 |
| 34 35 6 865 611 | 314 527 0037 | 26 |
| 34 35 9 804 834 | 314 527 0018 | 27 |
| 34 52 6 756 385 | 314 800 0040 | 24 |
| 41 62 6 801 258 | 340 910 0022 | 1 |
| 51 23 7 066 566 | 340 910 0021 | 1 |
| 51 23 7 160 818 | 340 910 0021 | 1 |
| 51 23 7 175 020 | 340 910 0021 | 1 |
| 51 24 7 148 902 | 340 910 0012 | 1 |
| 61 62 7 129 280 | 029 290 1111 | 2 |
| 64 11 3 422 664 | 312 319 0009 | 5 |
| 64 11 3 422 665 | 312 320 0009 | 6 |
| 64 11 9 321 875 | 312 320 0025/S | 4 |
| 64 31 1 496 711 | 312 320 0009 | 6 |
| 64 31 6 835 404 | 312 319 0024 | 5 |
| 64 31 6 835 405 | 312 320 0024 | 5 |
| 64 31 9 127 515 | 312 319 0009 | 5 |
| 64 31 9 127 516 | 312 320 0009 | 6 |
| 64 31 9 257 505 | 312 320 0009 | 6 |
| 65 81 6 905 133 | 300 919 0001 | 24 |

| Short no. | MEYLE no. | Page |
|-------------|-----------------|------|
| Mini | | |
| MAF0095 | 11-12 321 0007 | 41 |
| MAF0101 | 11-12 321 0013 | 41 |
| MAF0110 | 11-12 321 0022 | 42 |
| MAF0115 | 11-12 321 0027 | 42 |
| MAF0412 | 312 137 2015 | 43 |
| MAF0424 | 312 321 0010 | 41 |
| MAF0427 | 312 321 0014 | 44 |
| MAF0430 | 312 321 0019 | 44 |
| MAF0440 | 312 321 0032 | 42 |
| MAF0623 | 712 114 0000 | 43 |
| MAF0675 | 312 321 0039 | 43 |
| MAR0208 | 316 031 0000 | 51 |
| MAR0212 | 316 031 0006 | 50 |
| MAR0545HD | 316 031 0019/HD | 51 |
| MAR0546HD | 316 031 0020/HD | 51 |
| MAS0154 | 314 800 0040 | 24 |
| MBD1568PD | 383 521 0007/PD | 8 |
| MBD1573PD | 383 521 0382/PD | 8 |
| MBD1897PD | 315 521 0020/PD | 9 |
| MBD1898PD | 315 521 0021/PD | 9 |
| MBD1901 | 315 521 0024 | 7 |
| MBD1901PD | 315 521 0024/PD | 7 |
| MBD1905PD | 315 521 0028/PD | 12 |
| MBD1918 | 315 523 0035 | 10 |
| MBD1918PD | 315 523 0035/PD | 11 |
| MBD1943 | 315 523 0060 | 10 |
| MBD1943PD | 315 523 0060/PD | 11 |
| MBH0333 | 300 525 0001 | 18 |
| MBH0341 | 300 525 0009 | 18 |
| MBH0342 | 300 525 0010 | 18 |
| MBJ0180 | 316 010 0005 | 57 |
| MBJ0181 | 316 010 0006 | 57 |
| MBJ0182 | 316 010 0007 | 58 |
| MBJ0184 | 316 010 0009 | 58 |
| MBJ0185 | 316 010 0010 | 58 |
| MBJ0392 | 316 010 0013 | 57 |
| MBK0188 | 314 495 0009 | 19 |
| MBK0189 | 314 495 0010 | 19 |
| MBL0001 | 029 290 1110 | 2 |
| MBL0003 | 029 300 1210 | 3 |
| MBL0027 | 029 450 1800 | 3 |
| MBL0028 | 029 475 1900 | 3 |
| MBL0029 | 029 500 2000 | 4 |
| MBL0032 | 029 550 2200 | 4 |
| MBL0046 | 029 280 1212 | 2 |
| MBL0062 | 029 290 1111 | 2 |

| Short no. | MEYLE no. | Page |
|-------------|-----------------|------|
| Mini | | |
| MBP0311 | 025 232 8118 | 13 |
| MBP0408 | 025 236 2316 | 16 |
| MBP0408PD | 025 236 2316/PD | 17 |
| MBP0429 | 025 237 1616 | 14 |
| MBP0429PD | 025 237 1616/PD | 15 |
| MBP0471 | 025 239 1517 | 13 |
| MBP0495 | 025 239 8418 | 13 |
| MBP0557 | 025 242 8917 | 15 |
| MBP0568 | 025 243 1617 | 12 |
| MBP0568PD | 025 243 1617/PD | 12 |
| MBP0601 | 025 244 7814 | 14 |
| MBP1703 | 025 259 8016 | 15 |
| MBP1703PD | 025 259 8016/PD | 16 |
| MBX0010 | 014 698 0006 | 17 |
| MBX0011 | 014 698 0006/S | 17 |
| MCA0438 | 316 050 0005 | 59 |
| MCA0439 | 316 050 0006 | 59 |
| MCA0764 | 316 050 0081 | 59 |
| MCA0765 | 316 050 0082 | 60 |
| MCF0239 | 312 319 0009 | 5 |
| MCF0255 | 312 320 0009 | 6 |
| MCF0451 | 312 320 0025/S | 4 |
| MCF0465 | 312 319 0024 | 5 |
| MCF0466 | 312 320 0024 | 5 |
| MCK0017HD | 316 050 0070/HD | 60 |
| MCM0071HD | 314 311 0000/HD | 60 |
| MCM0072HD | 314 610 0002/HD | 61 |
| MCM0073HD | 314 610 0003/HD | 61 |
| MCM0117HD | 314 610 0009/HD | 62 |
| MCM0118HD | 314 610 0010/HD | 62 |
| MCV0219 | 314 498 0001 | 19 |
| MCV0220 | 314 498 0002 | 20 |
| MEM0427 | 300 221 2000 | 47 |
| MEM0828 | 300 221 2004 | 48 |
| MET0060 | 314 223 0011 | 36 |
| MET0061 | 314 223 0012 | 35 |
| MET0076 | 314 223 0010 | 35 |
| MEX0376 | 214 800 0002 | 29 |
| MEX0378 | 300 919 0001 | 24 |
| MEX0438 | 614 123 0001 | 30 |
| MFF0156 | 314 323 0011 | 45 |
| MFF0157 | 314 323 0012 | 44 |
| MFF0241 | 314 323 0013 | 45 |
| MGP0025 | 11-14 860 0001 | 29 |
| MGP0047 | 30-14 860 0005 | 28 |
| MGP0113 | 314 860 0004 | 28 |

| Short no. | MEYLE no. | Page |
|-------------|----------------|------|
| Mini | | |
| MHF0037 | 314 136 0007 | 21 |
| MHF0039 | 314 137 0004 | 21 |
| MHH0054 | 359 202 0009 | 49 |
| MHH0075 | 359 202 0039 | 49 |
| MHK0039 | 314 137 0004/S | 20 |
| MHK0041 | 314 137 0006/S | 21 |
| MHK0042 | 314 137 0007/S | 20 |
| MHS0071 | 340 910 0021 | 1 |
| MIC0120 | 314 885 0005 | 29 |
| MMX0431 | 100 139 0002 | 45 |
| MMX0520 | 11-51 049 0016 | 31 |
| MMX1516 | 314 238 0005 | 36 |
| MMX1600 | 11-51 902 1011 | 31 |
| MMX1608 | 11-51 902 2001 | 31 |
| MOF0101 | 30-14 322 0004 | 46 |
| MOF0110 | 300 000 0001 | 46 |
| MOF0201 | 714 322 0007 | 47 |
| MOF0205 | 714 322 0011 | 46 |
| MOF0234 | 314 322 0006 | 47 |
| MOK0029 | 300 135 0305 | 22 |
| MOK0030 | 300 135 0306 | 23 |
| MOK0031 | 300 135 0307 | 22 |
| MPS0049 | 40-14 800 0004 | 27 |
| MPS0050 | 40-14 800 0005 | 30 |
| MRB0232 | 050 005 1105 | 35 |
| MRB0310 | 050 006 0800 | 34 |
| MRB0322 | 050 006 0875 | 32 |
| MRB0325 | 050 006 0890 | 32 |
| MRB0326 | 050 006 0894 | 33 |
| MRB0336 | 050 006 0976 | 34 |
| MRB0349 | 050 006 1055 | 32 |
| MRB0407 | 050 006 1374 | 33 |
| MRB0588 | 050 007 1173 | 34 |
| MRB0729 | 050 003 0885/E | 33 |
| MRH0272 | 319 222 0001 | 36 |
| MRH0273 | 319 222 0002 | 37 |
| MRH0274 | 319 222 0003 | 37 |
| MRH0275 | 319 222 0004 | 37 |
| MRH0276 | 319 222 0005 | 38 |
| MRH0277 | 319 222 0006 | 38 |
| MRH0278 | 319 222 0007 | 38 |
| MRS0142 | 314 642 0008 | 68 |
| MSA0294 | 326 623 0015 | 69 |
| MSA0300 | 326 623 0021 | 69 |
| MSA0307 | 326 623 0036 | 70 |
| MSA0308 | 326 623 0037 | 70 |

| Short no. | MEYLE no. | Page |
|-------------|-----------------|------|
| Mini | | |
| MSA0324 | 326 723 0000 | 71 |
| MSA0332 | 326 725 0011 | 70 |
| MSB0275 | 314 615 0020 | 63 |
| MSB0370 | 314 615 0000 | 63 |
| MSB0372 | 314 615 0022 | 63 |
| MSB0374 | 314 715 0021 | 65 |
| MSB0437 | 314 615 0030 | 64 |
| MSB0438 | 314 715 0002 | 64 |
| MSB0450 | 314 715 0020 | 64 |
| MSC0059 | 314 640 0006 | 68 |
| MSC0073 | 314 740 0013 | 68 |
| MSK0020 | 314 620 0000 | 50 |
| MSK0112 | 314 620 0006 | 50 |
| MSK0113 | 314 620 0007 | 49 |
| MSL0325HD | 316 060 0021/HD | 66 |
| MSL0326HD | 316 060 0022/HD | 66 |
| MSL0571HD | 316 060 0044/HD | 67 |
| MSL0572HD | 316 060 0045/HD | 67 |
| MSL0706HD | 316 060 0060/HD | 67 |
| MSL0823 | 316 060 0078 | 66 |
| MSL0909HD | 316 060 0092/HD | 65 |
| MSM0136 | 314 641 0002 | 72 |
| MSM0202 | 314 641 0004 | 71 |
| MSM0242 | 314 641 1002 | 72 |
| MSR0085 | 316 035 0012 | 62 |
| MTA0163 | 316 030 0019 | 53 |
| MTA0164 | 316 030 0020 | 52 |
| MTA0166 | 316 030 0022 | 52 |
| MTA0167 | 316 030 0023 | 52 |
| MTE0329 | 316 020 0000 | 56 |
| MTE0332 | 316 020 0004 | 56 |
| MTE0342 | 316 020 0018 | 55 |
| MTE0343 | 316 020 0019 | 56 |
| MTE0345 | 316 020 0021 | 54 |
| MTE0346 | 316 020 0022 | 53 |
| MTE0558 | 316 020 0030 | 55 |
| MTE0559 | 316 020 0031 | 55 |
| MTE0754HD | 316 020 0036/HD | 54 |
| MTE0755HD | 316 020 0037/HD | 54 |
| MTM0045 | 300 221 2100 | 22 |
| MTS0263 | 340 910 0022 | 1 |
| MTS0431 | 340 910 0012 | 1 |
| MWH0110 | 300 312 1104 | 74 |
| MWH0111 | 300 312 1105 | 72 |
| MWH0124 | 300 343 1102 | 73 |
| MWH0125 | 300 343 1103 | 73 |



| Short no. | MEYLE no. | Page |
|-------------|-------------------|------|
| Mini | | |
| MWP0082 | 11-13 220 0004 | 40 |
| MWP0082HD | 11-13 220 0004/HD | 40 |
| MWP0093 | 11-13 220 0020 | 39 |
| MWP0332 | 313 220 0003 | 39 |
| MWP0338 | 313 220 0010 | 40 |
| MWP0341 | 313 220 0013 | 39 |
| MWS0059 | 314 356 0003 | 25 |
| MWS0060 | 314 356 0004 | 24 |
| MWS0065 | 314 527 0002 | 25 |
| MWS0068 | 314 527 0005 | 25 |
| MWS0077 | 314 527 0014 | 27 |
| MWS0081 | 314 527 0018 | 27 |
| MWS0112 | 314 527 0023 | 26 |
| MWS0116 | 314 527 0030 | 26 |
| MWS0128 | 314 527 0037 | 26 |





MEYLE

You see the pretty
curves, underneath
is what counts.



The MEYLE brand supplies its customers with more than 21,000 extremely reliable and durable spare parts manufactured at our own production facilities or by trusted production partners. MEYLE boasts a highly diversified product range.

Whether steering and suspension components, rubber-to-metal parts, brakes, damping components, cooling systems, filters, drive components, electric and sensors MEYLE is synonymous with top-grade quality-tested spare parts.

Notes

This catalogue is protected by copyright. Reproduction of text, graphic elements, photographs and/or data, even in part, is prohibited. MEYLE, **MEYLE**, or parts thereof, are registered trademarks of MEYLE AG.

All supplies and services are subject to our General Terms and Conditions. The original spare part numbers shown in this catalogue are for cross-reference purposes only and shall not be disclosed to third parties on invoices and delivery notes. While the information in this catalogue was compiled and edited with utmost care we do not assume responsibility or accept claims arising from errors or inconsistencies. Subject to technical and/or design changes.

This issue of the catalogue supersedes all previous issues.
All rights reserved. © 2017 MEYLE AG



MEYLE parts are available through:

MEYLE AG

Merkurring 111, 22143 Hamburg, Germany
Tel. +49 40 67506 510, Fax +49 40 67506 506
contact@meyle.com

www.meyle.com

MEYLE