



Automotive Lighting

Catalog 2016-2017



Which lighting solution do you need?

12V halogen solutions



Replacement	Durability	Better vision		Styling		
Standard Value for money 	Long Life Double lifetime 	Range Power 50+ Up to 50% more vision 	Range Power 110 Up to 110% more vision 	Range Power Blue+ Up to 50% more vision Stylish white 	Range Power White 4 500 K Xenon white 	Rallye Extreme brightness 
Available in H1, H2, H3, H4, H7, H8, H9, H10, H13, H15, R2, H27W, S2, HB1, HB2, HB3, HB4, HB5	Available in H1, H4, H7, H11, H6W, 862	Available in H1, H3, H4, H7	Available in H4, H7	Available in H1, H3, H4, H7, HB2, HB3, HB4, HB5	Available in H1, H3, H4, H7, HB3, HB4, W5W kits	Available in H1, H2, H3, H4, H7, HB1, HB3, HB4, HB5

Xenon solutions



High Intensity Discharge lamps

HID technology



D1S



D1R



D2S



D2R



D3S



D4S

*Important Products that do not carry the ECE certification logo are not homologated and cannot be sold in Europe.



24V halogen solutions



Replacement

Standard

Value for money



Available in
 H1, H2, H3, H4, H7, R2, R2 halogen

Durability

Heavy Duty

Resists all vibrations



Available in
 H1, H3, H4, H7

Styling

Rallye

Extreme brightness



Non-ECE-homologated*

Available in
 H1, H3, H4

LED solutions



Reliability

LED Interior lighting

LED



Available in T10 and Festoon



LED Inspection lamps

Cordless with magnet

SLID10

LED



Rechargeable with magnet

FLEX10

LED



Table of contents



12V Halogen solutions

HEADLAMPS

■ **Replacement**

10 | Standard

■ **Durability**

12 | Long Life

■ **Better vision**

13 | Range Power 50+

13 | Range Power 110

■ **Styling**

14 | Range Power Blue+

15 | Range Power White

16 | Rallye

17 | **American types**

SIGNALING AND INTERIOR LIGHTING

■ **Replacement**

20 | Signaling lamps

22 | Halogen miniature lamps

22 | Wedge base lamps

24 | Festoon lamps

25 | Plastic base lamps (Bax)

■ **Styling**

27 | Range Power Blue+

27 | **American types**

28 | **Which 12V lamp type do you need?**

SPARE KITS AND SALES TOOLS

30 | Spare kits

31 | Range Power White kit

32 | Bax box

32 | Sales tools

12V LED Interior lighting

33 | **LED types**

Xenon solutions

35 | **NARVA HID headlamps**

24V Halogen solutions

HEADLAMPS

■ **Replacement**

36 | Standard

■ **Durability**

37 | Heavy Duty

■ **Styling**

37 | Rallye

SIGNALING AND INTERIOR LIGHTING

■ **Replacement**

38 | Signaling lamps

39 | Halogen miniature lamps

40 | Wedge base lamps

40 | Festoon lamps

41 | Plastic base lamps (Bax)

■ **Durability**

42 | Heavy Duty

43 | **Which 24V lamp type do you need?**

SPARE KITS AND SALES TOOLS

44 | Spare kits

45 | Sales tools

Two-wheeler lighting

HEADLAMPS

■ **Replacement**

46 | Standard

48 | **Which two-wheeler lamp type do you need?**

LED inspection lamps

49 | High-quality LED inspection lamps

NARVA

the automotive lighting experts

Our customers come first

At NARVA, customer satisfaction is our number one priority. NARVA delivers high-quality automotive lighting products so that professionals can fully satisfy their customers' needs. With NARVA, garages and shops are able to deliver reliable products and quality service at an affordable price. NARVA has developed a comprehensive product portfolio in order to meet the needs of professionals all around the world. Dedicated NARVA teams and distributors are committed to serving and informing our customers worldwide. We strive to efficiently and effectively meet all customer and market demands in all areas of our business.

Our sales offices, together with a central warehouse, provide attentive customer care and an efficient delivery service.

Dedicated NARVA teams and distributors are committed to providing outstanding customer service in all areas of our business.

Caring for our customers begins with providing a **quality product** at an **affordable price**.

As today's roads become more congested, we believe it's necessary for all drivers to be able to afford a high-quality and reliable lighting solution for increased safety and visibility.

Quality lighting at an affordable price, now available to everyone.



Our affordable quality

NARVA products: consistent quality and dependable reliability

- NARVA, more than 65 years of automotive lighting experience
- Comprehensive testing throughout the entire production process
- Constant quality control of every lamp
- Compliance testing and international certification processes, including ISO/TS 16949, DIN EN ISO 14001, ECE R37, ECE R87
- Ongoing investment in product innovation and new processes

The quality of NARVA products and production processes are regularly controlled. Our products adhere to ECE* regulations and other legal requirements. (See *Which lighting solution do you need* on page 2 to discover all ECE certified lighting products.)

NARVA production, as well as marketing and logistics processes, are regularly controlled with the help of today's international ISO** engineering standards. The ECE created international guidelines for the automotive industry and its suppliers in order to reduce trade barriers and increase traffic safety. Products that do not conform to ECE regulations cannot be sold in Europe. NARVA products adhere to ECE regulations 37 and 99 that provide guidelines for filament lamps, including measurements, luminous flux and power. The ISO/TS 16949 is our proof of strong integration of safety and stability in our production, marketing and logistics.

Over 65 years of experience and know-how define all NARVA lighting solutions. NARVA performs ongoing tests on its automotive lighting products in order to enhance and assure constant quality. The adherence to all quality tests guarantees the reliability of all NARVA products.



Accredited management system
 DIN ISO/TS 16949
 DIN EN ISO 9001
 for sales and manufacturing
 DIN EN ISO 14001



*ECE = Economic Commission for Europe
 **ISO = International Organization for Standardization

For more information about NARVA, please visit our website at www.narva-light.com

12V Halogen solutions

NARVA is renowned for manufacturing quality lighting solutions that are durable, reliable and provide greater visibility and greater safety in all driving conditions.

Discover our complete range of automotive lighting, including our LED interior lighting.

■ Replacement

Standard

NARVA Standard represents the best value, combining reliability with economy.

For drivers seeking the greatest price/performance ratio without sacrificing safety, NARVA Standard is the right choice.



Read more about Standard

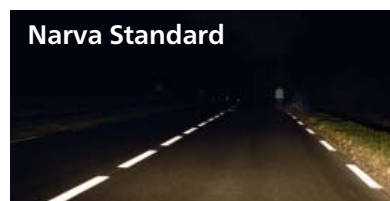
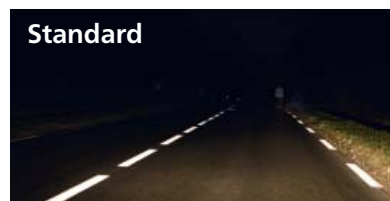

■ Durability

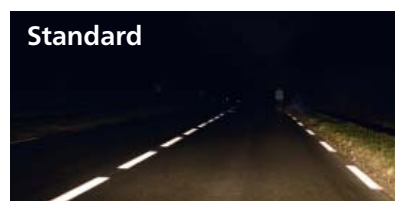

Long Life

Our green range has been especially engineered for long lifetime. Lasting twice as long as standard lamps, these long-lasting lamps will not have to be replaced as often which results in less maintenance combined with a minimal impact on the environment.



Read more about Long Life



■ Better vision

Range Power 50+

Offering 50% up to 50% more vision than a standard lamp, our Range Power 50+ delivers a longer light beam for even greater brightness. It's engineered for drivers to see farther and more clearly for greater safety.



Read more about Range Power 50+

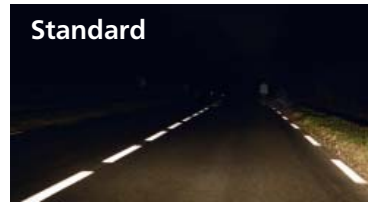

Standard



Standard



Range Power 110

Range Power 110

The new Range Power 110 delivers up to 110% more vision. The powerful light beam allows drivers to see farther. A special burner design creates a higher lumen output for increased safety and greater performance.



Read more about Range Power 110



■ Styling

Range Power Blue+

Offering up to 50% more vision and up to 30% stylish, cooler light, our Range Power Blue+ is engineered for drivers to see farther and more clearly for greater visibility and safety. The stylish blue effect will make any car stand out from the crowd.



Read more about Range Power Blue+



Standard

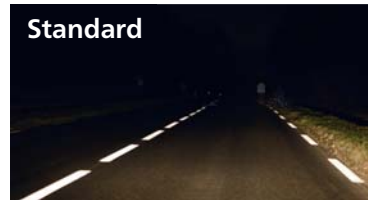

Range Power Blue+

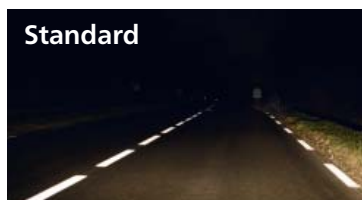

Standard



Range Power White

Range Power White*

NARVA Range Power White offers a bright and stylish white light. The stylish xenon effect obtained by the 4 500 K color temperature offers your car an eye-catching look close to daylight. Range Power White is the choice for those who seek to stand out from the crowd.



Read more about Range Power White



*Non-ECE-homologated. Cannot be sold or used in Europe.



12V Headlamps



The **Standard Replacement** lamp is perfect for drivers seeking to replace a burned out lamp.

For those looking for a more environmentally friendly lamp, our **Long Life** range offers double lifetime.

For demanding drivers seeking a high-performance lamp, discover our **Range Power 50+**, featuring up to 50% more vision.





The new **Range Power 110** delivers up to 110% more vision. The powerful light beam allows drivers to see farther.

NARVA **Range Power Blue+** combines a bright white light with a blue effect for stylish performance.

Replacement

STANDARD

Value for money

	ECE	Ref. No	V	W	Base	Pieces/PU	Packaging
	H1	483203000	12	55	P14,5s	100	C1
		483204000	12	55	P14,5s	10	B1
	H2	484203000	12	55	X511	100	C1
	H3	483213000	12	55	PK22s	100	C1
		483214000	12	55	PK22s	10	B1
	H4	488813000	12	60/55	P43t	100	C1
		488814000	12	60/55	P43t-38	10	B1
	H7	483283000	12	55	PX26d	100	C1
		483284000	12	55	PX26d	10	B1



ECE	Ref. No	V	W	Base	Pieces/PU	Packaging
H8	48076 3000	12	35	PGJ19-1	100	C1



ECE	Ref. No	V	W	Base	Pieces/PU	Packaging
H9	48077 3000	12	65	PGJ19-5	100	C1



ECE	Ref. No	V	W	Base	Pieces/PU	Packaging
H10 (9145)	48095 3000	12	42	PY20d	100	C1



ECE	Ref. No	V	W	Base	Pieces/PU	Packaging
H13 (9008)	48092 3000	12	60/55	P26,4t	100	C1



ECE	Ref. No	V	W	Base	Pieces/PU	Packaging
H15	48070 3000	12	15/55	PGJ23t-1	100	C1



ECE	Ref. No	V	W	Base	Pieces/PU	Packaging
R2 Halogen	48121 3000	12	45/40	P45t-41	100	C1



ECE	Ref. No	V	W	Base	Pieces/PU	Packaging
R2	49211 3000	12	45/40	P45t	100	C1



ECE	Ref. No	V	W	Base	Pieces/PU	Packaging
H27W/1	48041 3000	12	27	PG13	100	C1



ECE	Ref. No	V	W	Base	Pieces/PU	Packaging
H27W/2	48042 3000	12	27	PGJ13	100	C1



ECE	Ref. No	V	W	Base	Pieces/PU	Packaging
S2	49531 3000	12	35/35	BA20d	200	C1





ECE	Ref. No	V	W	Base	Pieces/PU	Packaging
HB1	480043000	12	65/45	P29t	100	CP



ECE	Ref. No	V	W	Base	Pieces/PU	Packaging
HB2	488823000	12	67/60	P43t-38	100	C1



ECE	Ref. No	V	W	Base	Pieces/PU	Packaging
HB3	480053000	12	60	P20d	100	C1
	480054000	12	60	P20d	10	B1



ECE	Ref. No	V	W	Base	Pieces/PU	Packaging
HB4	480063000	12	51	P22d	100	C1
	480064000	12	51	P22d	10	B1



ECE	Ref. No	V	W	Base	Pieces/PU	Packaging
HB5	480073000	12	65/55	PX29t	100	C1

Durability

LONG LIFE

Double lifetime



ECE	Ref. No	V	W	Base	Pieces/PU	Packaging
H1 LL	483223000	12	55	P14,5s	100	C1



ECE	Ref. No	V	W	Base	Pieces/PU	Packaging
H4 LL	488893000	12	60/55	P43t-38	100	C1



ECE	Ref. No	V	W	Base	Pieces/PU	Packaging
H7 LL	483293000	12	55	PX26d	100	C1



ECE	Ref. No	V	W	Base	Pieces/PU	Packaging
H11 LL	480783000	12	55	PGJ19-2	100	C1



ECE	Ref. No	V	W	Base	Pieces/PU	Packaging
862 LL	480595000	12	37.5	PGJ13	300	CP

Better vision

RANGE POWER 50+

Up to 50% more vision



ECE	Ref. No	V	W	Base	Pieces/PU	Packaging
H1 RP50+	48334 3000	12	55	P14,5s	100	C1
	48334 4000	12	55	P14,5s	10	B1
	48334 2100	12	55	P14,5s	10	S2



ECE	Ref. No	V	W	Base	Pieces/PU	Packaging
H3 RP50+	48335 3000	12	55	PK22s	100	C1



ECE	Ref. No	V	W	Base	Pieces/PU	Packaging
H4 RP50+	48861 3000	12	60/55	P43t-38	100	C1
	48861 4000	12	60/55	P43t-38	10	B1
	48861 2100	12	60/55	P43t-38	10	S2



ECE	Ref. No	V	W	Base	Pieces/PU	Packaging
H7 RP50+	48339 3000	12	55	PX26d	100	C1
	48339 4000	12	55	PX26d	10	B1
	48339 2100	12	55	PX26d	10	S2

RANGE POWER 110

Up to 110% more vision



ECE	Ref. No	V	W	Base	Pieces/PU	Packaging
H4 RP110	48061 3000	12	60/55	P43t-38	100	C1
	48061 2100	12	60/55	P43t-38	10	S2



ECE	Ref. No	V	W	Base	Pieces/PU	Packaging
H7 RP110	48062 3000	12	55	PX26d	100	C1
	48062 2100	12	55	PX26d	10	S2



Styling

RANGE POWER BLUE+

Up to 50% more vision, stylish white



ECE	Ref. No	V	W	Base	Pieces/PU	Packaging
H1 RPB+	48630 3000	12	55	P14,5s	100	C1
	48630 4000	12	55	P14,5s	10	B1
	48630 2100	12	55	P14,5s	10	S2



ECE	Ref. No	V	W	Base	Pieces/PU	Packaging
H3 RPB+	48633 3000	12	55	PK22s	100	C1



ECE	Ref. No	V	W	Base	Pieces/PU	Packaging
H4 RPB+	48677 3000	12	60/55	P43t-38	100	C1
	48677 4000	12	60/55	P43t-38	10	B1
	48677 2100	12	60/55	P43t-38	10	S2



ECE	Ref. No	V	W	Base	Pieces/PU	Packaging
H7 RPB+	48638 3000	12	55	PX26d	100	C1
	48638 4000	12	55	PX26d	10	B1
	48638 2100	12	55	PX26d	10	S2



ECE	Ref. No	V	W	Base	Pieces/PU	Packaging
HB2 RPB+	48676 3000	12	67/60	P43t-38	100	C1



ECE	Ref. No	V	W	Base	Pieces/PU	Packaging
HB3 RPB+	48616 3000	12	60	P20d	100	C1



ECE	Ref. No	V	W	Base	Pieces/PU	Packaging
HB4 RPB+	48613 3000	12	51	P22d	100	C1











ECE	Ref. No	V	W	Base	Pieces/PU	Packaging
HB5 RPB+	48629 3000	12	65/55	PX29t	100	C1

Styling

RANGE POWER WHITE*

4500 K xenon white

	H1 RPW	Ref. No 486412100	V 12	W 55	Base P14,5s	Pieces/PU 10	Packaging S2
	H3 RPW	Ref. No 486022100	V 12	W 55	Base PK22s	Pieces/PU 10	Packaging S2
	H4 RPW	Ref. No 486802100	V 12	W 60/55	Base P43t-38	Pieces/PU 10	Packaging S2
	H7 RPW	Ref. No 486072100	V 12	W 55	Base PX26d	Pieces/PU 10	Packaging S2
	HB3 (9005) RPW	Ref. No 486252100	V 12	W 65	Base P20d	Pieces/PU 10	Packaging S2
	HB4 (9006) RPW	Ref. No 486262100	V 12	W 55	Base P22d	Pieces/PU 10	Packaging S2
	H1/W5W RPW kit	Ref. No 980142100	Content	W	Base	N° of pieces	
			H1	85	P14,5s	2	
			W5W	5	W2,1x9,5d	2	
	H4/W5W RPW kit	Ref. No 980152100	Content	W	Base	N° of pieces	
			H4	100/90	P43t	2	
			W5W	5	W2,1x9,5d	2	
	H7/W5W RPW kit	Ref. No 980162100	Content	W	Base	N° of pieces	
			H7	85	PX26d	2	
			W5W	5	W2,1x9,5d	2	

*Important Products that do not carry the ECE certification logo are not homologated and cannot be sold in Europe.





Styling

RALLYE*

Extreme brightness (for off-road only)

	Ref. No	V	W	Base	Pieces/PU	Packaging
 H1 Rallye	48350 3000	12	100	P14,5s	100	C1
	48380 3000	12	130	P14,5s	100	C1

	Ref. No	V	W	Base	Pieces/PU	Packaging
 H2 Rallye	48450 3000	12	100	X511	100	C1

	Ref. No	V	W	Base	Pieces/PU	Packaging
 H3 Rallye	48351 3000	12	100	PK22s	100	C1
	48381 3000	12	130	PK22s	100	C1

	Ref. No	V	W	Base	Pieces/PU	Packaging
 H4 Rallye P43t	48901 3000	12	100/90	P43t-38	100	C1
	48901 4000	12	100/90	P43t-38	10	B1
	48911 3000	12	100/55	P43t-38	100	C1
	48951 3000	12	130/100	P43t	100	C1

	Ref. No	V	W	Base	Pieces/PU	Packaging
 H4 Rallye P45t	48884 3000	12	60/55	P45t	100	C1
	48904 3000	12	100/90	P45t-41	100	C1

	Ref. No	V	W	Base	Pieces/PU	Packaging
 H7 Rallye	48358 3000	12	80	PX26d	100	C1

	Ref. No	V	W	Base	Pieces/PU	Packaging
 HB1 Rallye	48034 3000	12	100/80	P29t	100	C1

	Ref. No	V	W	Base	Pieces/PU	Packaging
 HB3 Rallye	48025 3000	12	100	P20d	100	C1

	Ref. No	V	W	Base	Pieces/PU	Packaging
 HB4 Rallye	48026 3000	12	70	P22d	100	C1

***Important** Products that do not carry the ECE certification logo are not homologated and cannot be sold in Europe.



**HB5
Rallye**

Ref. No	V	W	Base	Pieces/PU	Packaging
480313000	12	100/80	PX29t	100	C1

*Important Products that do not carry the ECE certification logo are not homologated and cannot be sold in Europe.

American types



**9004
(HB1)**

US Type	Ref. No	V	W	Base	Pieces/PU	Packaging
9004 (HB1)	480043000	12	65/45	P29t	100	CP



**9003
(HB2)**

US Type	Ref. No	V	W	Base	Pieces/PU	Packaging
9003 (HB2)	488823000	12	67/60	P43t-38	100	C1



**9005
(HB3)**

US Type	Ref. No	V	W	Base	Pieces/PU	Packaging
9005 (HB3)	480053000	12	60	P20d	100	C1
	480054000	12	60	P20d	10	B1



**9006
(HB4)**

US Type	Ref. No	V	W	Base	Pieces/PU	Packaging
9006 (HB4)	480063000	12	51	P22d	100	C1
	480064000	12	51	P22d	10	B1



**9007
(HB5)**

US Type	Ref. No	V	W	Base	Pieces/PU	Packaging
9007 (HB5)	480073000	12	65/55	PX29t	100	C1



**9008
(H13)**

US Type	Ref. No	V	W	Base	Pieces/PU	Packaging
9008 (H13)	480923000	12	60/55	P26,4t	100	C1



**9145
(H10)**

US Type	Ref. No	V	W	Base	Pieces/PU	Packaging
9145 (H10)	480953000	12	42	PY20d	100	C1







US Type	Ref. No	V	W	Base	Pieces/PU	Packaging
880	480393000	12.8	27	PG13	100	C1



US Type	Ref. No	V	W	Base	Pieces/PU	Packaging
881	480403000	12.8	27	PGJ13	100	C1



US Type	Ref. No	V	W	Base	Pieces/PU	Packaging
885	480553000	12.8	50	PG13	100	C1



US Type	Ref. No	V	W	Base	Pieces/PU	Packaging
886	480563000	12.8	50	PGJ13	100	C1



US Type	Ref. No	V	W	Base	Pieces/PU	Packaging
889	480453000	12.8	27	PGJ13	100	C1



US Type	Ref. No	V	W	Base	Pieces/PU	Packaging
890	480463000	12.8	27	PG13	100	C1



US Type	Ref. No	V	W	Base	Pieces/PU	Packaging
893	480513000	12.8	37.5	PG13	100	C1



US Type	Ref. No	V	W	Base	Pieces/PU	Packaging
894	480543000	12.8	37.5	PGJ13	100	C1



US Type	Ref. No	V	W	Base	Pieces/PU	Packaging
896	480523000	12.8	37.5	PGJ13	100	C1





12V Signaling and interior lighting

NARVA offers a full range of 12V signaling lamps designed to replace standard bulbs, including our LED signaling lamps, engineered for improved visibility and safety (see page 33).





Replacement

SIGNALING LAMPS

ECE	Ref. No	V	W	Base	Pieces/PU	Packaging
 (Stop P22)	174113000	12	15	BA15s	200	CP

ECE	Ref. No	V	W	Base	Pieces/PU	Packaging
 (Stop P25) BA15s	175113000	12	18	BA15s	200	CP

ECE	Ref. No	V	W	Base	Pieces/PU	Packaging
 P21W	176353000	12	21	BA15s	200	CP
	176354000	12	21	BA15s	10	B2
	176403000	12	21	BAU15s	200	CP

ECE	Ref. No	V	W	Base	Pieces/PU	Packaging
 PY21W Amber	176383000	12	21	BAU15s	200	CP
	176384000	12	21	BAU15s	10	B2

ECE	Ref. No	V	W	Base	Pieces/PU	Packaging
 P21/4W	178813000	12	21/4	BAZ15d	200	CP
	178814000	12	21/4	BAZ15d	10	B2



ECE	Ref. No	V	W	Base	Pieces/PU	Packaging
P21/5W	179163000	12	21/5	BAY15d	200	CP
	179164000	12	21/5	BAY15d	10	B2



ECE	Ref. No	V	W	Base	Pieces/PU	Packaging
(Stop P25) BA15d	179183000	12	21/5	BA15d	200	CP



ECE	Ref. No	V	W	Base	Pieces/PU	Packaging
R5W BA15s	171713000	12	5	BA15s	200	CP
	171714000	12	5	BA15s	10	B2



ECE	Ref. No	V	W	Base	Pieces/PU	Packaging
R5W BA15d	171723000	12	5	BA15d	200	CP



ECE	Ref. No	V	W	Base	Pieces/PU	Packaging
R10W	173113000	12	10	BA15s	200	CP
	173114000	12	10	BA15s	10	B2



ECE	Ref. No	V	W	Base	Pieces/PU	Packaging
RY10W	173173000	12	10	BAU15s	200	CP



ECE	Ref. No	V	W	Base	Pieces/PU	Packaging
	170513000	12	2	BA7s	200	CP









ECE	Ref. No	V	W	Base	Pieces/PU	Packaging
	170533000	12	2	BA9s	200	CP





ECE	Ref. No	V	W	Base	Pieces/PU	Packaging
T4W	171313000	12	4	BA9s	200	CP



HALOGEN MINIATURE LAMPS

	ECE (H5W)	Ref. No 17830 3000	V 12	W 5	Base BA9s	Pieces/PU 200	Packaging CP
	ECE H6W	Ref. No 68161 3000	V 12	W 6	Base BAX9s	Pieces/PU 200	Packaging CP
	ECE H6W LL	Ref. No 68162 3000	V 12	W 6	Base BAX9s	Pieces/PU 200	Packaging CP
	ECE (H10W)	Ref. No 17833 3000	V 12	W 10	Base BA9s	Pieces/PU 200	Packaging CP
	ECE (H20W)	Ref. No 17835 3000	V 12	W 20	Base BA9s	Pieces/PU 200	Packaging CP
	ECE H21W	Ref. No 68191 3000	V 12	W 21	Base BAY9s	Pieces/PU 200	Packaging CP
	ECE (W1,2W)	Ref. No 70761 3000	V 12	W 10	Base W2,1x9,5d	Pieces/PU 200	Packaging CP

WEDGE BASE LAMPS

	ECE (W1,2W) Frosted	Ref. No 17032 3000	V 12	W 1.2	Base W2x4,6d	Pieces/PU 200	Packaging CP
	ECE (W1,2W)	Ref. No 17037 3000	V 12	W 1.2	Base W2x4,6d	Pieces/PU 200	Packaging CP



ECE	Ref. No	V	W	Base	Pieces/PU	Packaging
(W2,2W)	17059 3000	12	2.2	W2,1x9,5d	200	CP



ECE	Ref. No	V	W	Base	Pieces/PU	Packaging
W2,3W	17073 3000	12	2.3	W2x4,6d	200	CP



ECE	Ref. No	V	W	Base	Pieces/PU	Packaging
W3W	17097 3000	12	3	W2,1x9,5d	200	CP



ECE	Ref. No	V	W	Base	Pieces/PU	Packaging
W5W	17177 3000	12	5	W2,1x9,5d	200	CP
	17177 4000	12	5	W2,1x9,5d	10	B2



ECE	Ref. No	V	W	Base	Pieces/PU	Packaging
WY5W	17169 3000	12	5	W2,1x9,5d	200	CP



ECE	Ref. No	V	W	Base	Pieces/PU	Packaging
W16W	17631 3000	12	16	W2,1x9,5d	200	CP



ECE	Ref. No	V	W	Base	Pieces/PU	Packaging
W21W	17632 3000	12	21	W3x16d	200	CP











ECE	Ref. No	V	W	Base	Pieces/PU	Packaging
WY21W	17629 3000	12	21	WX3x16d	200	CP











ECE	Ref. No	V	W	Base	Pieces/PU	Packaging
W21/5W	17919 3000	12	21/5	W3x16q	200	CP











FESTOON LAMPS

	ECE T8.2x30	Ref. No 170943000	V 12	W 3	Base SV7,5	Pieces/PU 200	Packaging CP
	ECE C5W	Ref. No 171253000	V 12	W 5	Base SV8,5	Pieces/PU 200	Packaging CP
		Ref. No 171254000	V 12	W 5	Base SV8,5	Pieces/PU 10	Packaging B2
	ECE T10.5x43	Ref. No 171753000	V 12	W 5	Base SV8,5	Pieces/PU 200	Packaging CP
	ECE T10.5x43	Ref. No 173143000	V 12	W 10	Base SV8,5	Pieces/PU 200	Packaging CP
	ECE T10.5x30	Ref. No 173153000	V 12	W 10	Base SV8,5	Pieces/PU 200	Packaging CP
	ECE T10.5x38	Ref. No 173163000	V 12	W 10	Base SV8,5	Pieces/PU 200	Packaging CP
	ECE T15x43	Ref. No 175123000	V 12	W 18	Base SV8,5	Pieces/PU 200	Packaging CP
	ECE C21W	Ref. No 176343000	V 12	W 21	Base SV8,5	Pieces/PU 200	Packaging CP

PLASTIC BASE LAMPS (BAX)

	ECE	Ref. No	V	W	Base	Pieces/PU	Packaging
		17006 3000	12	0.4	Bax 8,5d blue violet	200	CP
	ECE	Ref. No	V	W	Base	Pieces/PU	Packaging
		17019 3000	12	1	Bax 8,5d orange	200	CP
	ECE	Ref. No	V	W	Base	Pieces/PU	Packaging
		17027 3000	12	1.2	Bax 8,4d light blue	200	CP
	ECE	Ref. No	V	W	Base	Pieces/PU	Packaging
		17028 3000	12	1.2	Bax 8,4d black	200	CP
	ECE	Ref. No	V	W	Base	Pieces/PU	Packaging
		17029 3000	12	1.2	Bax 8,5d blue	200	CP
	ECE	Ref. No	V	W	Base	Pieces/PU	Packaging
		17035 3000	12	1.2	Bax 8,5d black	200	CP
	ECE	Ref. No	V	W	Base	Pieces/PU	Packaging
		17036 3000	12	1.2	Bax 8,3d black	200	CP
	ECE	Ref. No	V	W	Base	Pieces/PU	Packaging
		17046 3000	12	1.1	Bax 8,4d orange	200	CP
	ECE	Ref. No	V	W	Base	Pieces/PU	Packaging
		17047 3000	12	1.3	Bax 8,4d olive green	200	CP



	ECE	Ref. No	V	W	Base	Pieces/PU	Packaging
		170483000	12	1.5	Bax 8,4d beige	200	CP
	ECE	Ref. No	V	W	Base	Pieces/PU	Packaging
		170493000	12	1.5	Bax 8,5d beige	200	CP
	ECE	Ref. No	V	W	Base	Pieces/PU	Packaging
		170503000	12	1.5	Bax 8,5d yellow	200	CP
	ECE	Ref. No	V	W	Base	Pieces/PU	Packaging
		170523000	12	2	Bax 8,5d light green	200	CP
	ECE	Ref. No	V	W	Base	Pieces/PU	Packaging
		170543000	12	2	Bax 8,4d light green	200	CP
	ECE	Ref. No	V	W	Base	Pieces/PU	Packaging
		170573000	12	2	Bax 8,5d green	200	CP
	ECE	Ref. No	V	W	Base	Pieces/PU	Packaging
		170583000	12	2	Bax 8,3d blue	200	CP
	ECE	Ref. No	V	W	Base	Pieces/PU	Packaging
		170603000	12	1.8	Bax 8,4d beige	200	CP
	ECE	Ref. No	V	W	Base	Pieces/PU	Packaging
		171633000	12	5	Bax 10d black	100	C1

Styling

RANGE POWER BLUE+

Up to 50% more vision, stylish white

ECE	Ref. No	V	W	Base	Pieces/PU	Packaging
 T4W RPB+	17137 3000	12	4	BA9s	200	CP

ECE	Ref. No	V	W	Base	Pieces/PU	Packaging
 W5W RPB+	17189 3000	12	5	W2,1x9,5d	200	CP

ECE	Ref. No	V	W	Base	Pieces/PU	Packaging
 H6W RPB+	68163 3000	12	6	BAX9s	200	CP

American types

US Type	Ref. No	V	W	Base	Pieces/PU	Packaging
 3156	17941 3000	12.8	32CP	W2,5x16d	200	CP

US Type	Ref. No	V	W	Base	Pieces/PU	Packaging
 3157	17945 3000	12.8/14	32/3CP	W2,5x16q	200	CP

US Type	Ref. No	V	W	Base	Pieces/PU	Packaging
 3157 NA	17948 3000	12.8/14	24/2.2CP	W2,5x16q	200	CP



Which 12V lamp type do you need?



Low beam - High beam - Daytime Running Lights



Interior lights



Dashboard lights



Side indicators

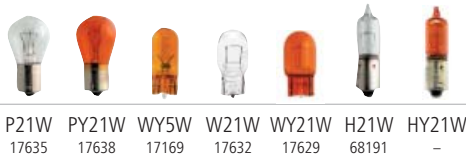

Front indicators



Front fog lights



Front parking lights





Standard

Replacement



Long Life

Durability



Range Power 50+

Better vision



Range Power 110



Range Power Blue+

Styling



Range Power White



Rallye



3rd stop light



Reversing light



Trunk lights



Rear indicators



Glove compartment light



Rear parking lights



License plate lights



Rear fog lights



Stop lights





12V Spare kits and sales tools

In many European countries it's compulsory or recommended to have a spare kit in the vehicle. Our Spare kits provide drivers with the safety they need while on the road or traveling.



SPARE KITS

ECE	Ref. No	Content	W	Base	N° of pieces
	98004 3010	H4	60/55	P43t	1
		P21W	21	BA15s	1
		R5W	5	BA15s	1
		W5W	5	W2,1x9,5d	1
		Flat fuse			2
		Packing quantity			20

ECE	Ref. No	Content	W	Base	N° of pieces
	98400 3010	H4	60/55	P43t	1
		P21/5W	21/5	BAY15d	1
		P21W	21	BA15s	1
		R5W	5	BA15s	1
		C5W	5	SV8,5	1
		W5W	5	W2,1x9,5d	1
		Flat fuse			4
		Packing quantity			20

ECE	Ref. No	Content	W	Base	N° of pieces	
	Spare kit H7/H1	984353010	H7	55	PX26d	1
		H1	55	P14,5s	1	
		P21/5W	21/5	BAY15d	1	
		P21W	21	BA15s	1	
		PY21W	21	BAU15s	1	
		C5W	5	SV8,5	1	
		W5W	5	W2,1x9,5d	1	
		Flat fuse			4	
		Packing quantity			20	

RANGE POWER WHITE KITS*

	Ref. No	Content	W	Base	N° of pieces	
	RPW kit H1/W5W	980142100	H1	85	P14,5s	2
		W5W	5	W2,1x9,5d	2	
		Packing quantity			10	

	Ref. No	Content	W	Base	N° of pieces	
	RPW kit H4/W5W	980152100	H4	100/90	P43t	2
		W5W	5	W2,1x9,5d	2	
		Packing quantity			10	

	Ref. No	Content	W	Base	N° of pieces	
	RPW kit H7/W5W	980162100	H7	85	PX26d	2
		W5W	5	W2,1x9,5d	2	
		Packing quantity			10	

*Important Products that do not carry the ECE certification logo are not homologated and cannot be sold in Europe.



BAX BOX

ECE	Ref. No	Content	W	Base	N° of pieces
Bax set 12V	987503000	Bax	1.2	Bax 8,3d black	10
		Bax	2	Bax 8,3d blue	10
		Bax	1.2	Bax 8,5d black	10
		Bax	2	Bax 8,5d green	10
		Bax	1.5	Bax 8,5d blue violet	10
		Bax	0.4	Bax 8,5d beige	10
		Bax	1	Bax 8,5d blue violet	10
		Bax	1.2	Bax 8,5d blue	10
		Bax	2	Bax 8,5d light green	10
		Bax	1.1	Bax 8,4d orange	10
		Bax	1.2	Bax 8,4d black	10
		Bax	1.3	Bax 8,4d olive green	10
		Bax	1.5	Bax 8,4d beige	10
		Bax	1.8	Bax 8,4d beige	10
Bax	2	Bax 8,4d light green	10		
Packing quantity					5



SALES TOOLS



Counter display

GOC: 80277000

Delivered with

- 20x H7 Standard
- 10x H4 Standard



Floor display

GOC: 90267000

Durable cardboard floor display, delivered empty.

- 12 hooks
- Interchangeable header



Wall dispenser

GOC (empty): 80173000

GOC (filled): 80223000

Delivered empty or filled with lamps (see composition below).

- Resistant metallic housing
- Compact size: 37 x 17.6 x 59.5 cm
- Lockable

Delivered with

- | | | |
|--------------|------------|---------------------|
| ■ 10x H1 | ■ 30x P21W | ■ 20x Fest T10,5x43 |
| ■ 10x H3 | ■ 30x R5W | ■ 20x W1,2W |
| ■ 30x H4 | ■ 30x R10W | ■ 20x W3W |
| ■ 50x H7 | ■ 30x T4W | ■ 30x W5W |
| ■ 30x P21/5W | ■ 30x C5W | |

 LED

12V LED Interior lighting

NARVA LED interior lighting illuminates the car interior with cool white light that lets the passengers read, work or go about their activities without blinding the driver. The LED interior lamps use less energy while producing more powerful lighting. It's the long-lasting lighting choice for any interior.



LED TYPES



ECE	Ref. No	V	W	Base	Pieces/PU	Packaging
WB T10	180014000	12	0.35	W2,1x9,5d	10	B2



ECE	Ref. No	V	W	Base	Pieces/PU	Packaging
Festoon 10,5x38	180104000	12	0.35	SV8,5	10	B2

LED interior lighting is not available in all countries.



Xenon solutions



Producing a brilliant, white light and a precise beam, the NARVA xenon range offers greater visibility for greater safety. NARVA xenon technology means longer lifetime and up to 3x more vision compared to a standard halogen lamp. Featuring a special UV-blocking quartz glass, this lighting solution provides maximum safety by allowing drivers to see even farther.



UNDERSTANDING XENON LIGHTING SYSTEMS

Xenon HID

(High Intensity Discharge) lamp

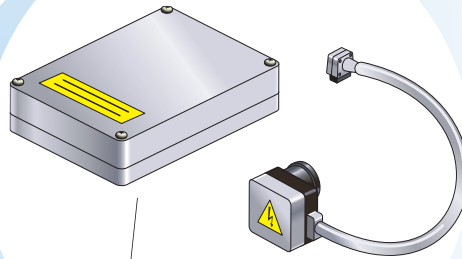

Electronic ballast and high-voltage starter

Main benefits

- Brilliant and powerful light projection on the road
- Light color and intensity close to daylight
- Extra-long lifetime
- Low power consumption

Complex optical system with automatic level control and power-wash system

NARVA HID HEADLAMPS



ECE	Ref. No	V	W	Base	Pieces/PU	Packaging
D1S	84010 3000	85	35	PK32d-2	10	C1



ECE	Ref. No	V	W	Base	Pieces/PU	Packaging
D1R	84011 3000	85	35	PK32d-3	10	C1



ECE	Ref. No	V	W	Base	Pieces/PU	Packaging
D2S	84002 3000	85	35	P32d-2	20	C1



ECE	Ref. No	V	W	Base	Pieces/PU	Packaging
D2R	84006 3000	85	35	P32d-3	20	C1



ECE	Ref. No	V	W	Base	Pieces/PU	Packaging
D3S	84032 3000	42	35	PK32d-5	10	C1



ECE	Ref. No	V	W	Base	Pieces/PU	Packaging
D4S	84042 3000	42	35	P32d-5	20	C1





24V Halogen solutions Headlamps







Combining vibration resistance with high quality, our **24V Standard** and **Heavy Duty** lighting ranges are robust and dependable for today's trucks and other heavy-duty vehicles. NARVA truck headlamps feature vibration resistance and superior quality. Check out our Standard lamps or our Heavy Duty range when greater strength and durability are required.



Replacement

STANDARD

Value for money

	ECE	Ref. No	V	W	Base	Pieces/PU	Packaging
	H1	487023000	24	70	P14,5s	100	C1
		487024000	24	70	P14,5s	10	B1
	H2	487203000	24	70	X511	100	C1
	H3	487003000	24	70	PK22s	100	C1
	H4	488923000	24	75/70	P43t	100	C1
		488924000	24	75/70	P43t-38	10	B1
	H7	487283000	24	70	PX26d	100	C1
		487284000	24	70	PX26d	10	B1
	R2 Halogen	481323000	24	55/50	P45t-41	100	C1



ECE	Ref. No	V	W	Base	Pieces/PU	Packaging
R2	493213000	24	55/50	P45t	100	C1

Durability

HEAVY DUTY

Resists all vibrations



ECE	Ref. No	V	W	Base	Pieces/PU	Packaging
H1 HD	487083000	24	70	P14,5s	100	C1



ECE	Ref. No	V	W	Base	Pieces/PU	Packaging
H3 HD	487093000	24	70	PK22s	100	C1



ECE	Ref. No	V	W	Base	Pieces/PU	Packaging
H4 HD	488983000	24	75/70	P43t-38	100	C1



ECE	Ref. No	V	W	Base	Pieces/PU	Packaging
H7 HD	487293000	24	70	PX26d	100	C1

Styling

RALLYE*

Extreme brightness (for off-road only)



ECE	Ref. No	V	W	Base	Pieces/PU	Packaging
H1 Rallye	487503000	24	100	P14,5s	100	C1



ECE	Ref. No	V	W	Base	Pieces/PU	Packaging
H3 Rallye	487513000	24	100	PK22s	100	C1



ECE	Ref. No	V	W	Base	Pieces/PU	Packaging
H4 Rallye P43t	489913000	24	100/90	P43t-38	100	C1



ECE	Ref. No	V	W	Base	Pieces/PU	Packaging
H4 Rallye P45t	488943000	24	75/70	P45t-41	100	C1
	489943000	24	100/90	P45t-41	100	C1

*Important Products that do not carry the ECE certification logo are not homologated and cannot be sold in Europe.







24V Signaling and interior lighting

NARVA offers a full range of signaling and interior lighting for today's trucks and heavy-duty vehicles. Designed for robustness and durability, discover our 24V signaling and interior lighting.





Replacement

SIGNALING LAMPS

	ECE	Ref. No	V	W	Base	Pieces/PU	Packaging
		179273000	24	21/5	BA15d	200	CP
	ECE	Ref. No	V	W	Base	Pieces/PU	Packaging
P21W		176433000	24	21	BA15s	200	CP
		176434000	24	21	BA15s	10	B2
	ECE	Ref. No	V	W	Base	Pieces/PU	Packaging
P21/4W		178823000	24	21/4	BAZ15d	200	CP
	ECE	Ref. No	V	W	Base	Pieces/PU	Packaging
P21/5W		179253000	24	21/5	BAY15d	200	CP
	ECE	Ref. No	V	W	Base	Pieces/PU	Packaging
Stop P22		174213000	24	15	BA15s	200	CP

ECE	Ref. No	V	W	Base	Pieces/PU	Packaging
 R5W BA15s	17181 3000	24	5	BA15s	200	CP
	17181 4000	24	5	BA15s	10	B2

ECE	Ref. No	V	W	Base	Pieces/PU	Packaging
 R5W	17182 3000	24	5	BA15d	200	CP

ECE	Ref. No	V	W	Base	Pieces/PU	Packaging
 (R10W)	17322 3000	24	10	BA15d	200	CP

ECE	Ref. No	V	W	Base	Pieces/PU	Packaging
 17061 3000	17061 3000	24	3	BA7s	200	CP

ECE	Ref. No	V	W	Base	Pieces/PU	Packaging
 17063 3000	17063 3000	24	2	BA9s	200	CP

ECE	Ref. No	V	W	Base	Pieces/PU	Packaging
 T4W	17141 3000	24	4	BA9s	200	CP

HALOGEN MINIATURE LAMPS

ECE	Ref. No	V	W	Base	Pieces/PU	Packaging
 H21W	68196 3000	24	21	BAY9s	200	CP



WEDGE BASE LAMPS

ECE	Ref. No	V	W	Base	Pieces/PU	Packaging
 W1,2W	170403000	24	1.2	W2x4,6d	200	CP

ECE	Ref. No	V	W	Base	Pieces/PU	Packaging
 W3W	171093000	24	3	W2,1x9,5d	200	CP

ECE	Ref. No	V	W	Base	Pieces/PU	Packaging
 W5W	171973000	24	5	W2,1x9,5d	200	CP

FESTOON LAMPS

ECE	Ref. No	V	W	Base	Pieces/PU	Packaging
 T8.2x30	171043000	24	3	SV7,5	200	CP











ECE	Ref. No	V	W	Base	Pieces/PU	Packaging
 C5W	171363000	24	5	SV8,5	200	CP

ECE	Ref. No	V	W	Base	Pieces/PU	Packaging
 T10.5x43	171853000	24	5	SV8,5	200	CP

ECE	Ref. No	V	W	Base	Pieces/PU	Packaging
 T10.5x43	173273000	24	10	SV8,5	200	CP

ECE	Ref. No	V	W	Base	Pieces/PU	Packaging
 T15x43	175223000	24	18	SV8,5	200	CP

PLASTIC BASE LAMPS (BAX)

	ECE	Ref. No	V	W	Base	Pieces/PU	Packaging
		17022 3000	24	1.2	EBS-R4 yellow	200	CP
	ECE	Ref. No	V	W	Base	Pieces/PU	Packaging
		17038 3000	24	1.2	Bax 8,3d grey	200	CP
	ECE	Ref. No	V	W	Base	Pieces/PU	Packaging
		17039 3000	24	1.2	Bax 8,5d grey	200	CP
	ECE	Ref. No	V	W	Base	Pieces/PU	Packaging
		17067 3000	24	1.8	Bax 8,4d blue	200	CP
	ECE	Ref. No	V	W	Base	Pieces/PU	Packaging
		17076 3000	24	1.2	Bax 8,5d brown	200	CP
	ECE	Ref. No	V	W	Base	Pieces/PU	Packaging
		17081 3000	24	1.4	REF29 white	200	CP
	ECE	Ref. No	V	W	Base	Pieces/PU	Packaging
		17082 3000	24	1.4	Bax 8,4d light green	200	CP
	ECE	Ref. No	V	W	Base	Pieces/PU	Packaging
		17102 3000	24	1.2	EBS-R6 brown	200	CP
	ECE	Ref. No	V	W	Base	Pieces/PU	Packaging
		17103 3000	24	1.2	EBS-R white 1,25 mm FR	200	CP
	ECE	Ref. No	V	W	Base	Pieces/PU	Packaging
		17072 3000	24	1.2	EBS-R white frosted	200	CP



Durability

HEAVY DUTY

Resists all vibrations



ECE	Ref. No	V	W	Base	Pieces/PU	Packaging
P21W HD	17644 3000	24	21	BA15s	200	CP



ECE	Ref. No	V	W	Base	Pieces/PU	Packaging
PY21W HD	17649 3000	24	21	BAU15s	200	CP



ECE	Ref. No	V	W	Base	Pieces/PU	Packaging
T4W HD	17143 3000	24	4	BA9s	200	CP



ECE	Ref. No	V	W	Base	Pieces/PU	Packaging
R5W HD	17186 3000	24	5	BA15s	200	CP



ECE	Ref. No	V	W	Base	Pieces/PU	Packaging
R10W HD	17328 3000	24	10	BA15s	200	CP

Which 24V lamp type do you need?





24V Spare kits and sales tools

In many European countries it's compulsory or recommended to have a spare kit in the vehicle. Our Spare kits provide drivers with the safety they need while on the road or traveling.



SPARE KITS



ECE	Ref. No	Content	W	Base	N° of pieces
Spare kit H4	986143010	H4	75/70	P43t	2
		P21W	21	BA15s	6
		R10W	10	BA15s	2
		C10W	10	SV8,5	2
		W5W	5	W2,1x9,5d	2
		Flat fuse			8
		Packing quantity			



ECE	Ref. No	Content	W	Base	N° of pieces
Spare kit H7	986303010	H7	70	PX26d	2
		P21W	21	BA15s	4
		PY21W	21	BA15s	2
		R10W	10	BA15s	2
		C10W	10	SV8,5	2
		W5W	5	W2,1x9,5d	2
		Flat fuse			3
Packing quantity				20	

SALES TOOLS



Wall dispenser

GOC (filled): 90287000

Delivered filled with lamps
(see composition below).

- Resistant metallic housing
- Compact size: 37 x 17.6 x 59.5 cm
- Lockable

Delivered with

- | | | |
|------------|----------------|------------|
| ■ 15x H1 | ■ 10x PY21W HD | ■ 10x W5W |
| ■ 15x H3 | ■ 10x R5W | ■ 10x W12W |
| ■ 10x H4 | ■ 10x R10W | ■ 10x C5W |
| ■ 20x H7 | ■ 10x T4W | |
| ■ 10x P21W | ■ 10x W3W | |



Counter display

GOC: 80287000

Delivered with

- 20x H7 Standard
- 10x H4 Standard



Two-wheeler lighting Headlamps

NARVA offers the motorcycle lighting for today's demanding riding conditions. Our motorcycle lamps provide the visibility and safety the bike riders need.



Replacement

STANDARD

Value for money



ECE	Ref. No	V	W	Base	Pieces/PU	Packaging
H51	482203000	12	35/35	PX43t	100	C1



ECE	Ref. No	V	W	Base	Pieces/PU	Packaging
H3	483013000	6	55	PK22s	100	C1



ECE	Ref. No	V	W	Base	Pieces/PU	Packaging
H4 Rallye	482223000	12	35/35	P43t-38	100	C1



ECE	Ref. No	V	W	Base	Pieces/PU	Packaging
F2	490723000	12	35	BA20s	200	C1



ECE	Ref. No	V	W	Base	Pieces/PU	Packaging
S3	49014 3000	12	15	P26s	200	CP
	49004 3000	6	15	P26s	200	CP



ECE	Ref. No	V	W	Base	Pieces/PU	Packaging
(M5) P15d-25-1	42007 3000	12	35/35	P15d-25-1	100	C1
	42005 3000	12	25/25	P15d-25-1	100	C1
	42001 3000	12	18/18	P15d-25-1	100	C1



ECE	Ref. No	V	W	Base	Pieces/PU	Packaging
(M5) P15d-25-3	42017 3000	12	35/35	P15d-25-3	100	C1
	42015 3000	12	25/25	P15d-25-3	100	C1



ECE	Ref. No	V	W	Base	Pieces/PU	Packaging
(M5) BA20d	42027 3000	12	35/35	BA20d	100	C1
	42025 3000	12	25/25	BA20d	100	C1



Which two-wheeler lamp type do you need?



H1	H3 (6v)	H4	H7	H8	H9	H11	HB3	HB4	HS1	HS3	HR2 P45t	S1	S2	S3	M5	M5	M5	F2	R2
48320	48301	48222	48328	48076	48077	48078	48005	48006	48220	-	-	-	49531	49014	P15d-25-1 42007	P15d-25-3 42017	BA20d 42027	49072	49211

Low beam - high beam



W5W	W16W	W21W	WY21W	WY5W	H21W
17177	17631	17632	17629	17169	68191



R5W	R10W	RY10W	P21W	P21/5W	PY21W
17171	17311	17317	17635	17916	17638

Front indicators



W3W	W5W	W16W	T2W	T4W
17097	17177	17631	-	17131



T5W	H6W	R5W	R10W
-	68161	17171	17311

Front parking lights



R5W	R10W	T4W	H6W	W3W	W5W	W21/5W	P21W	P21/5W
17171	17311	17131	68161	17097	17177	17919	17635	17916

Rear parking lights



P21W	P21/5W	R10W	RY10W	W16W	C5W
17635	17916	17311	17317	17631	17125

Stop lights



W16W	W21W	WY21W	R5W	R10W
17631	17632	17629	17171	17311



RY10W	PY21W	T3W	H6W
17317	17638	-	68161

Rear indicators



R5W	R10W	T4W	W3W	W5W	H6W	C5W
17171	17311	17131	17097	17177	68161	17125

License plate lights

LED

LED inspection lamps

For more than 65 years NARVA has been delivering quality products that are reliable and dependable. Now discover our new range of Professional LED inspection lamps. Featuring powerful LEDs, these rugged work lights provide bright light where you need it most!



HIGH-QUALITY LED LIGHTS

Get the job done with quality LED light



ECE	Ref. No	V	Plug	Pieces/PU	Packaging
FLEX10 LED Lamp	900034000	3,7	EU	6	B1

Rechargeable LED tool for every day

With its multi-directional LED light and rechargeable battery convenience Narva FLEX10 provides optimal illumination to fight any shadow.

- 250 lumens for perfect work space illumination
- 100° wide beam angle
- 180° lamp flexibility thanks to bendable magnetic base
- High-capacity Li-ion battery for durable service
- Hands-free light with 360° rotation hook and magnet
- IP rating - IP20



ECE	Ref. No	Pieces/PU	Packaging
SLID10 LED Lamp	900024000	6	B1

Your cordless LED tool for every day

With its functional slide-out design and 2 light modes Narva SLID10 provides optimal illumination to fight any shadow.

- 200 lumens of main light for homogeneous illumination
- 80 lumens of LED spot light for dark cavities
- 120° wide beam angle
- Lamp rotation thanks to magnet and hook
- IP rating - IP20
- IK rating - IK06

Technical illustrations

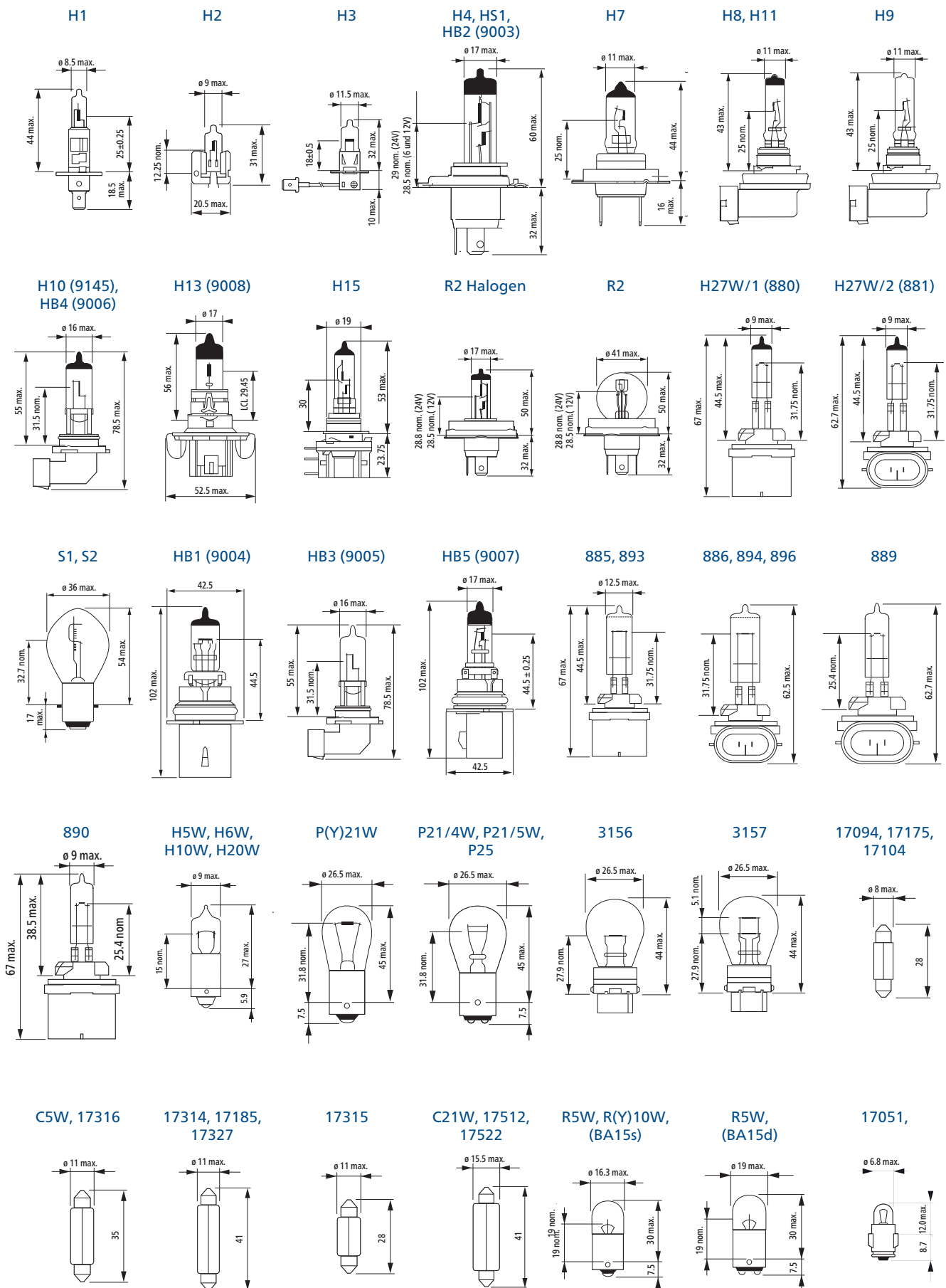

17053, 17063

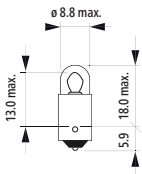

T4W

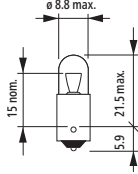

W1,2W, W2,3W

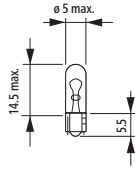

W2,2W, W3W, W(Y)5W

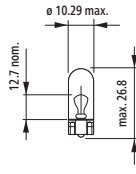

W16W

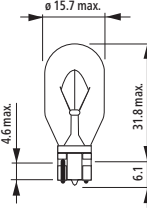

W(Y)21W

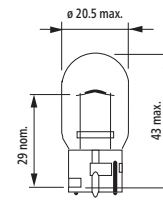

W21/5W

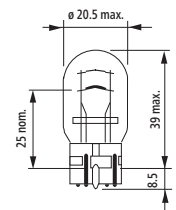

H21W

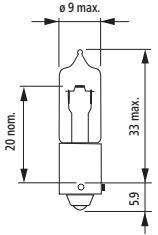

70761

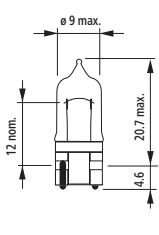

Bax 8,3d

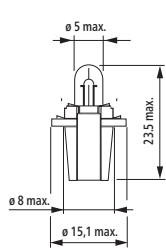

Bax 8,4d

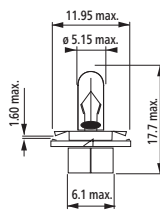

Bax 8,5d

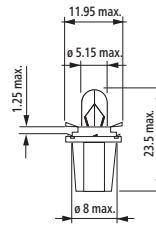

Bax 10d

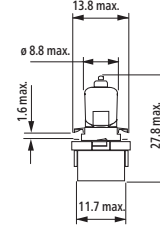

Bax EBS-R

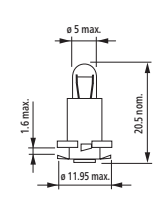

Bax REF29

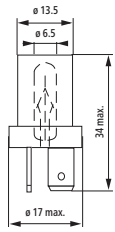

WB T10 LED

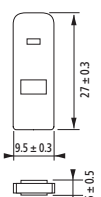

D1S, D3S

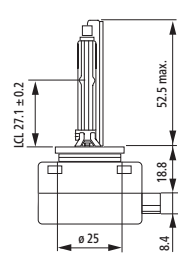

D1R

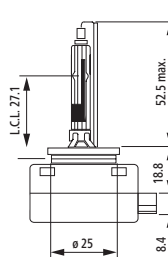

D2S, D4S

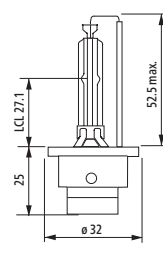

D2R

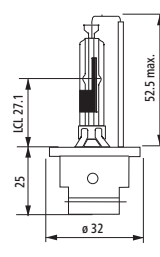

F

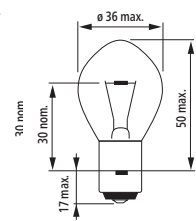

S3

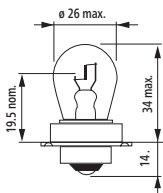

M5 (P15d-25-1)

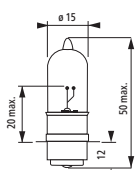

M5 (P15d-25-3)

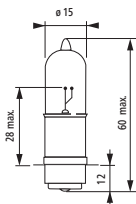

M5 (BA20d)

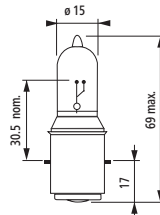

Bases (IEC 60061-1)

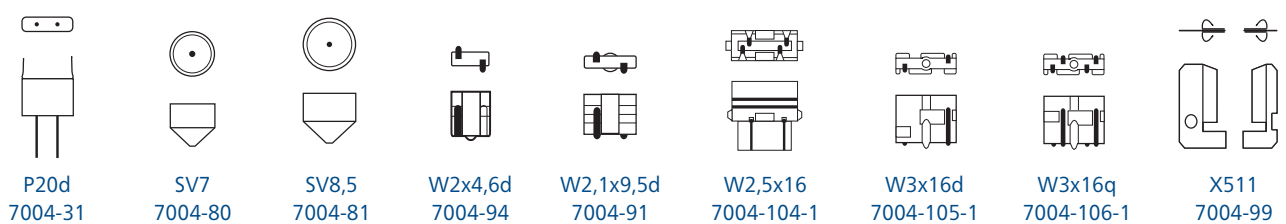
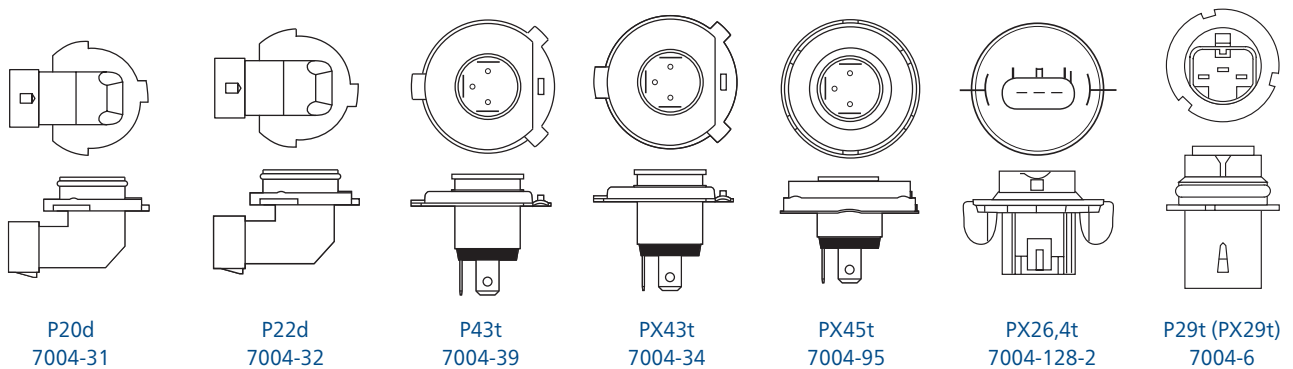
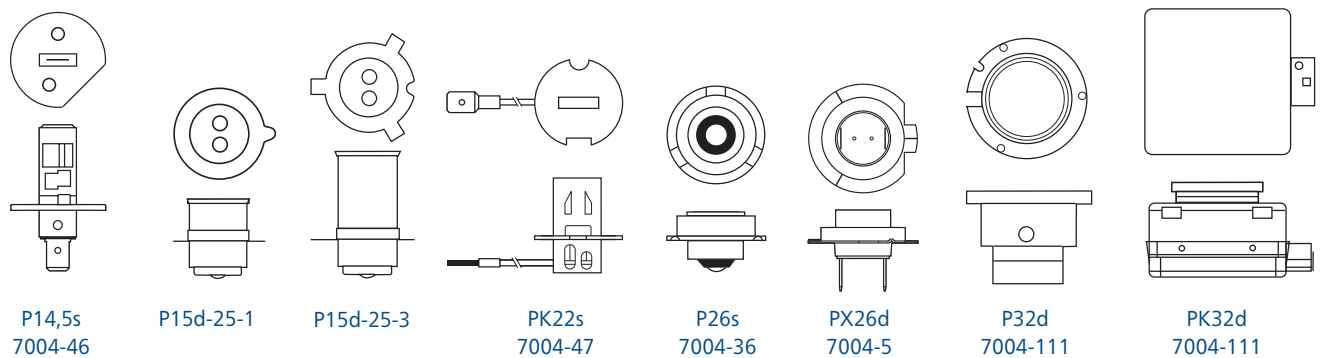
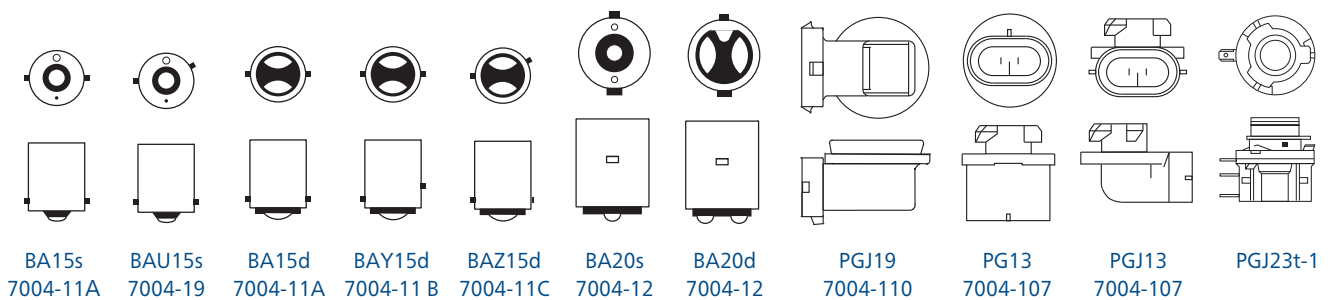
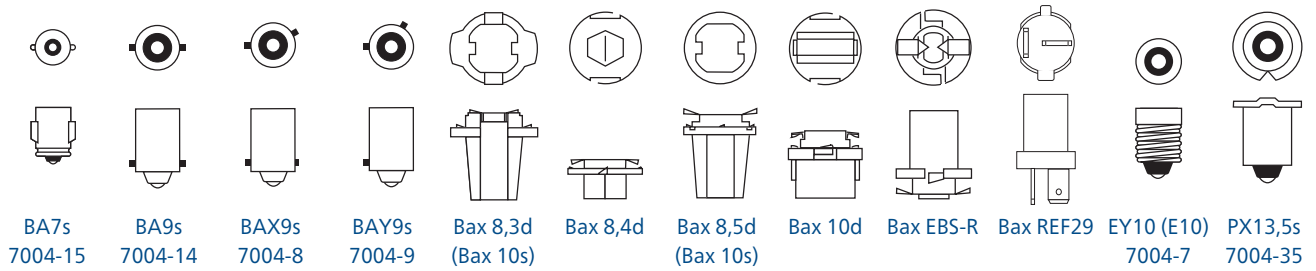

Packaging

New Narva Special packaging

Our new packaging may be used for both Special double packs as well as for Spare kits. Product information is simply and clearly displayed on the back to help consumers make an informed decision.



The attractive packaging design provides a clear view of the products inside and its robust construction protects the content during shipping as well as in-store.

- Economical
- Reduces waste
- Clear information
- Robust construction



Commercial pack



Spare kits



Blisters

Bax set



Understanding the NARVA ordering code

Packaging abbreviations and packaging type codes



C1/CP
Commercial pack
3000



S2/SM
Special double pack
2100



B1/B2
Single blister / Double blister
4000

Abbreviations for range names

- HD** Heavy Duty
Resists all vibrations
- LL** Long Life
Double lifetime
- RA** Rallye*
Extreme brightness
- RP50+** Range Power 50+
Up to 50% more vision
- RP110** Range Power 110
Up to 110% more vision
- RPB+** Range Power Blue+
Up to 50% more vision, stylish white
- RPW** Range Power White*
4 500 K Xenon white

***Important** Products that do not carry the ECE certification logo are not homologated and cannot be sold in Europe.



Lumileds Germany GmbH

Philipsstraße 8
52068 Aachen
Germany

Tel. +49 241 539 3030
E-mail: info@narva-light.com
www.narva-light.com

© 2016 Lumileds Holding B.V.

EN-CE · Printed in Germany 08.16 · Created by ASET France

Member of **NARVA e.V. Germany** ///