

DAF

Spare parts for commercial vehicles

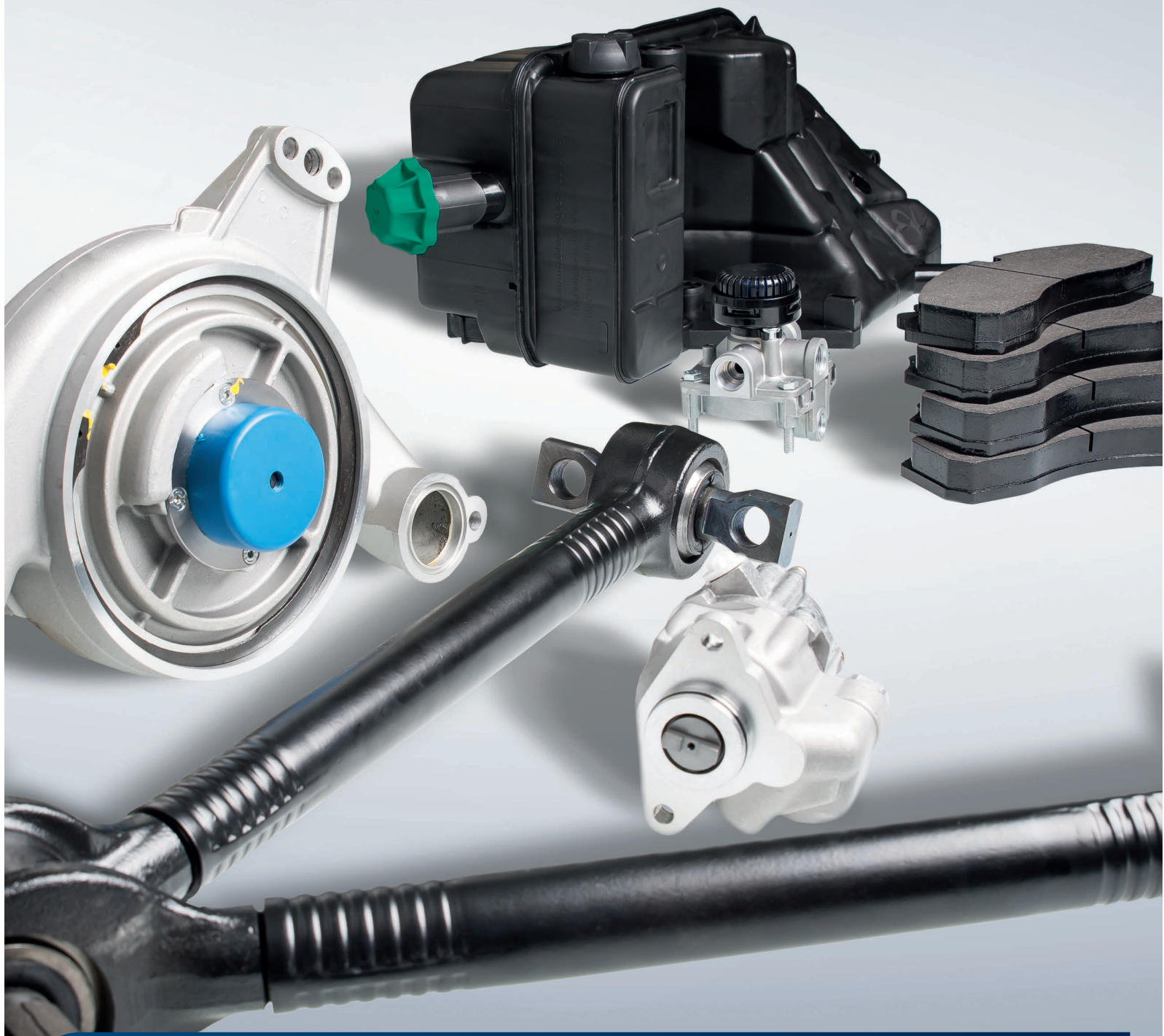

DRIVER'S BEST FRIEND

MEYLE

Robust and reliable components – simply longer on the road.



Trucks are subject to extreme use and require reliable, durable spare parts. MEYLE parts provide outstanding services on roads all over the world, especially for trucks of MAN, Mercedes-Benz, DAF, Volvo, Scania, Renault and Iveco as well as for bus and trailer applications.



Steering & suspension

King pins, Tie rods/tie rod ends, Drag links, and many more



Brakes

Brake discs, Brake pads, Wear indicators, and many more



Drive, clutch and gearbox parts

Clutch discs, Release bearings, Release forks, and many more



Filters

Air filters, Oil filters, Hydraulic oil filters, Cabin air filters, and many more



Engine and cooling parts

Engine mounts, Oil cooler, Fuel pumps, Belt tensioners, and many more



Electrics and sensors

Steering-column switch, ABS sensors, and many more



Cabin and body parts

Cabin tilt pumps, Cabin tilt cylinders, Door handles, and many more

ORIGINAL, PD and HD – The MEYLE product lines



MEYLE-ORIGINAL: Fit as snugly as the original.

More than 21,000 spare parts for passenger cars, vans and trucks, quality-tested, robust, durable and tried and tested a thousand times over on the roads across the world – that's MEYLE-ORIGINAL. Relying on our comprehensive product portfolio – offering everything from A for axial joint to Z for zinc-coated screw – customers can be sure that they will always have safety on their side.

MEYLE-PD: Safety to the power of two.

Thinking outside the box to make our products better: MEYLE-PD stands for brake discs and pads delivering maximum braking performance and setting new standards in terms of durability, comfort, aesthetics, and ease of installation. Look for the „/PD“ part number extension.

MEYLE-HD: Better than originals.

MEYLE-HD parts simply last longer. Their technically optimised and reinforced designs make them more durable and reliable than OE components. So it is only natural for us to offer extended warranty protection for our MEYLE-HD parts: All parts of the HD range come with a full four-year guarantee. Look for the „/HD“ part number extension.



4-year guarantee on all MEYLE-HD parts!

Robust, high mileage, reliable and better than the original. MEYLE-HD parts simply last longer!

Our three success factors.

The success of the MEYLE brand is based on competence, quality and service.

The development of quality-approved automotive spare parts for the independent aftermarket is our trademark. And MEYLE-HD parts are our specialty: improved parts, developed by our team of engineers at our headquarters in Hamburg. We give a 4-year guarantee on our MEYLE-HD parts which have a far longer service life. Based on information from TÜV (Technical control board), from recall statistics as well as media and market information from workshops and other technical partners, MEYLE engineers identify parts in vehicles which become conspicuous on account of frequent, early wear. On the basis of their findings, they develop technical improvements for the respective weakness. In the end, this work is a

large benefit for all MEYLE parts. Something all reputable automotive manufacturers highly appreciate: MEYLE also develops customized products, for example for Morgan, the legendary sports car manufacturer.

Passing on our know-how to staff and customers is just as much a part of our service as high parts availability and swift delivery. Modern warehouse logistics with space covering 29,000 m² and 56,000 pallet places ensure the reliable supply of our partners.

We have now won the "Top Job Employer" award for the fifth time which confirms our outstanding internal business approach and excellent Human Resources policy. We have been one of Germany's leading SME employers for many years.

MEYLE

Guarantee certificate



A distinguishing feature of MEYLE is our high level of precision, achieved by the application of the most modern manufacturing methods. Our MEYLE articles meet highest quality standards and our supply plants are certified in accordance with ISO 9001:2008 and ISO/TS 16949.

We guarantee perfect material and faultless processing of all our MEYLE articles for a period of 24 months as of the date of installation. For MEYLE-HD articles, this guarantee applies for 48 months as of the date of installation.

Complementing this guarantee, we give an additional 100,000 miles (160,934 kilometres) performance guarantee against defects of material and workmanship for MEYLE passenger car water pumps purchased from 01 May 2016. The guarantee given for MEYLE passenger car water pumps terminates upon expiration of the guarantee period or the guaranteed mileage, whichever occurs later: if the guaranteed mileage has not been reached at the end of the guarantee period of 24 or 48 months respectively, the performance guarantee continues to be valid. Respectively, the guarantee period of 24 or 48 months continues to be valid also in any case where the guaranteed mileage was already exceeded.

During the guarantee period, we perform repair work on claimed MEYLE articles or provide a replacement. The MEYLE guarantee does not apply for normal wear and damage caused by inappropriate handling or inappropriate installation. The guarantee expires if the respective part is modified by third parties or via installation of parts from third parties, or if the part, or vehicle, is used in excess of the appropriate use and purpose. The MEYLE guarantee also expires if MEYLE instructions or vehicle manufacturer instructions, e.g. concerning maintenance and replacement intervals, are not observed. The guarantee only applies for MEYLE water pumps, if the cooling circuit has been flushed prior to installation of the MEYLE water pump. Rights granted by law continue to apply unrestrictedly, irrespective of this guarantee.

The customer must submit a written guarantee claim immediately, or at the latest 30 days after identifying an error in material or processing. This claim is to be submitted to the dealer from which he acquired the MEYLE article part. The customer should return the article, carefully packed. He must enclose the original sales receipt and a description of the error. The customer must also verify the date of installation and the mileage of the vehicle by means of respective documents.

Last amended January 2017

Director Quality Assurance
Manfred Wunder

Engine/Cooling

1

Belt drive / Engine control, Cooling system, Crankshaft drive, Cylinder head, Engine, Exhaust system, Fuel system, Lubrication system

Air filter	Gasket set, crankcase	Repair kit, fuel pump
Belt tensioner	Gasket set, cylinder head	Sensor, boost pressure
Cylinder head gasket	Gasket, exhaust manifold	Sensor, coolant level
Expansion tank	Gasket, exhaust pipe	Tension roller, ribbed belt
Expansion tank cap	Gasket, oil pan	V-belt
Fan blade	Hand primer pump	Voltage regulator
Fan clutch	Oil filter	V-ribbed belt
Fuel filter	Radiator fan motor	Water pump

Brakes

31

Air system, Brakes, Disc brake

ABS wheel sensor	Check valve	Relay valve
Air dryer cartridge	Control valve, trailer	Repair kit, brake caliper
Air suspension valve	Cylinder head, compressor	Sensor, pneumatic suspension level
Brake disc	Diaphragm, brake cylinder	Slave cylinder
Brake line coupling	Line filter, compressor system	Valve, compressor system
Brake pad set	Multiway valve	

Drive train/Transmission/Clutch

46

Axle shafts, Clutch, Transmission

Clutch booster	Neutral safety switch	Switch, splitter gearbox
Joint, propeller shaft	Shift rod connector	

Suspension

51

Control arms, Stabilizer, Stub axle, Suspension / damping, Wheel hubs / Wheel bearings

Bushing, leaf spring	Mount, stabilizer	Rod/strut, suspension
Bushing, stabilizer	Repair kit, control arm	Rubber stop, suspension
Control arm	Repair kit, kingpin	Wheel bearing
Mount, leaf spring	Repair kit, stabilizer bushing	Wheel bearing kit

Steering

68

Hydraulics, Tie rod assemblies

Drag link	Hydraulic pump, P/S	Tie rod end
Hydraulic filter, steering system	Tie rod assembly	

Body/Cabin

78

Body, Cabin, Interior fittings

Bushing, driver cab suspension	Ignition lock cylinder	Tilt cylinder, driver cab
Cabin air filter	Repair kit, driver cab mounting	Tilt pump, driver cab
Gear shift knob	Spacer, driver cab stabiliser	Wiper Blade

Gasket set, cylinder head

16-34 900 0008 | MMX1591

Notes

without valve stem seals
Cast Aluminium

References

0683 373 683373

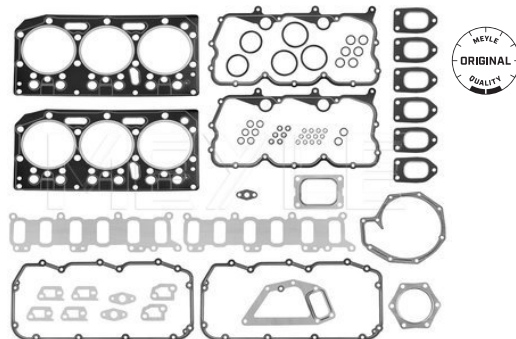

Application info

85 CF [02/98-12/00]
95 XF [01/97-09/02]

XF 95 [09/02-12/06]

Gasket set, cylinder head

14-34 001 0003 | MMX1493

Notes

without valve stem seals
Steel

References

0683494 683532
683494 0683532

Parts list

14-34 001 0004 | MMX1589 Cylinder head gasket

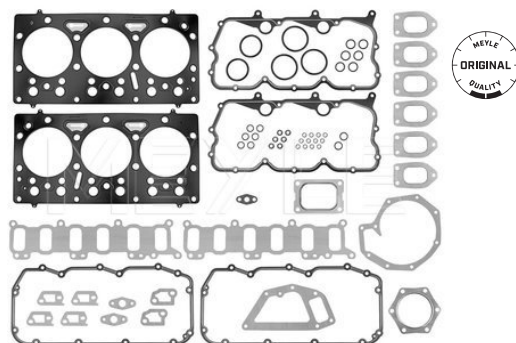

Application info

95 XF [01/97-09/02]
CF 85 [01/01--]

XF 95 [09/02-12/06]

Cylinder head gasket

14-34 001 0002 | MMX1486

References

0376 729 1298 923
376 729 1320 372
1283 752 1366 063

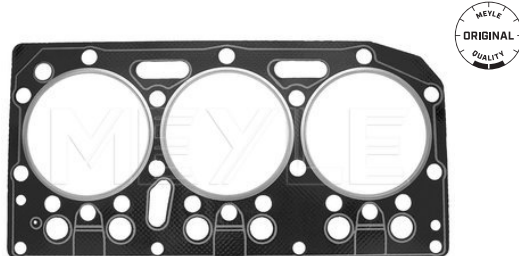

14-34 001 0002 | MMX1486

Cylinder head gasket

Application info

65 CF (02/98-12/00)
75 CF (02/98-12/00)
85 (07/92-02/98)
85 CF (02/98-12/00)
95 (09/87-01/98)

95 XF (01/97-09/02)
CF 65 (01/01--)
CF 75 (01/01--)
CF 85 (01/01--)

14-34 001 0004 | MMX1589

Cylinder head gasket

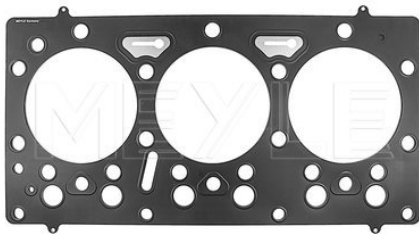

Notes

Thickness [mm]
Width [mm]
Length [mm]

Sheet Steel
3
26
475

References

1445 893
1693 518

1699 517

Application info

95 XF (01/97-09/02)
CF 85 (01/01--)

XF 95 (09/02-12/06)

14-34 900 0005 | MMX1590

Gasket set, crankcase

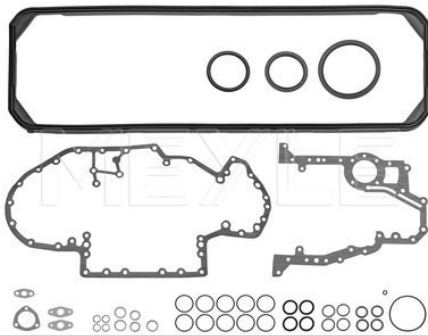

References

0683 191

683191

Application info

85 CF (02/98-12/00)
95 XF (01/97-09/02)

CF 85 (01/01--)
XF 95 (09/02-12/06)

Voltage regulator
034 015 0005 | MEX0143
Notes

 Number of Poles 2
 Voltage [V] 28

References

 0068 499 68499
 068499

Application info

85 [07/92-02/98]

95 [09/87-01/98]

Sensor, boost pressure
12-34 899 0004 | MEX0474
Notes

 Operating voltage [V] Piezoelectric Sensor 24
 Number of Poles 4

References

1697 325

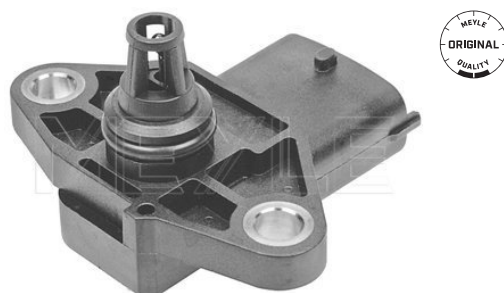
Application info

 95 XF [01/97-09/02]
 CF 75 [01/01--]

CF 85 [01/01--]

Gasket, oil pan
14-34 038 0001 | MMX1487
References

1315 381 1458 701

Application info

 85 CF [02/98-12/00]
 95 XF [01/97-09/02]

 CF 85 [01/01--]
 XF 95 [09/02-12/06]

14-34 018 0001 | MOF0069

Oil filter



Notes

Inner diameter [mm]
Outer diameter [mm]
Height [mm]

with seal
56
112.5
150
Filter Insert

References

1397 764

Application info

CF 75 [01/01--]
CF 85 [01/01--]

XF 95 [09/02-12/06]

14-34 018 0007 | MOF0070

Oil filter



Notes

Inner diameter [mm]
Outer diameter [mm]
Height [mm]
Thread Size

with seal
62
93.5
174
M27x2
Screw-on Filter

References

1399 494

Application info

CF 65 [01/01--]
LF 45 [01/01--]

LF 55 [01/01--]

14-34 018 0013 | MOF0074

Oil filter



Notes

Inner diameter [mm]
Outer diameter [mm]
Height [mm]

with seal
56
113
220
Filter Insert

References

1629 393
1643 070
1948 921

1643 070G
1948 921G

Application info

CF 85 [01/01--]

XF 105 [10/05--]

Air filter
812 321 0001 | MAF0649
Notes

Inner diameter [mm]	190.5
Outer diameter [mm]	302
Height [mm]	365
	Filter Insert

References

0667 078	1207 748
667078	

Application info

85 (07/92-02/98)
 85 CF (02/98-12/00)
 95 (09/87-01/98)

95 XF (01/97-09/02)
 F 2900 (01/90-10/93)
 F 3200 (01/90-10/93)

Air filter
14-34 321 0006 | MAF0217
Notes

Inner diameter [mm]	124
Outer diameter [mm]	214
Height [mm]	417
	Filter Insert

References

1433 697	1672 464
1644 641	APUC944
1668 000	

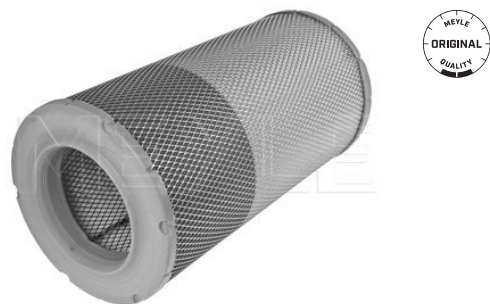
Application info

LF 45 (01/01--)

LF 55 (01/01--)

Air filter
14-12 321 0001 | MAF0209
Notes

Inner diameter [mm]	147
Outer diameter [mm]	281
Height [mm]	510
	Filter Insert

References

1638 054

Application info

XF 105 (10/05--)

14-12 321 0007 | MAF0210

Air filter

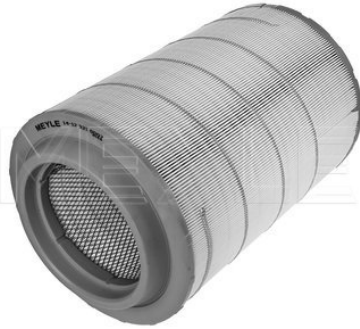

Notes

Inner diameter [mm]	170
Outer diameter [mm]	267
Height [mm]	420
	Filter Insert

References

1363 023	1657 522
1363 025	1726 061
1638 026	1789 292
1640 920	

Application info

CF 65 (01/01--)

CF 75 (01/01--)

14-34 321 0004 | MAF0215

Air filter

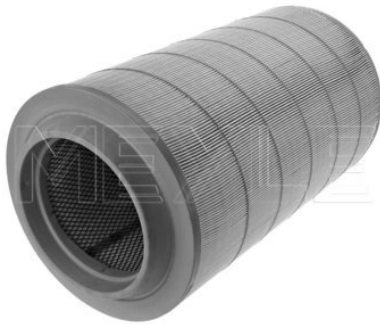

Notes

Inner diameter [mm]	160
Outer diameter [mm]	267
Height [mm]	480
	Filter Insert

References

1363 024	1657 523
1638 006	1726 060
1640 921	1921 967
1656 513	1933 740

Application info

65 CF (02/98-12/00)
85 CF (02/98-12/00)

CF 85 (01/01--)

14-34 321 0001 | MAF0213

Air filter



Notes

Inner diameter [mm]	147
Outer diameter [mm]	281
Height [mm]	508
	Filter Insert

References

1295 090	1529 631
1353 115	1664 524
1500 399	1664 525

Application info

95 XF (01/97-09/02)

Air filter
14-34 321 0011 | MAF0693
Notes

Inner diameter 2 [mm]	72
Inner diameter 1 [mm]	62
Outer diameter [mm]	77
Height [mm]	120
	Screw-on Filter

References

1686 587

Application info

CF 75 (01/01--)	XF 95 (09/02-12/06)
XF 105 (10/05--)	

Hand primer pump
034 009 0015 | MMX0197
Notes

Outer thread [mm]	M16x1,5
	Manual

References

0194 194	1311 608
194194	

Application info

65 CF (02/98-12/00)	F 2500 (02/82-08/91)
75 CF (02/98-12/00)	F 2700 (01/90-10/93)
85 CF (02/98-12/00)	F 2900 (01/90-10/93)
95 (09/87-01/98)	F 3200 (01/90-10/93)
95 XF (01/97-09/02)	F 3300 (06/81-09/91)
F 2100 (07/78-08/91)	F 3600 (06/85-09/91)
F 2300 (07/78-10/93)	

Repair kit, fuel pump
034 009 0013 | MMX0196
Notes

	Kit with seal
	Plastic
Inner diameter [mm]	23.4
Outer diameter [mm]	50.4
Height [mm]	41.3
	with pre-filter

References

1438 836	1683 353
1604 476	



034 009 0013 | MMX0196

Repair kit, fuel pump

Application info

95 XF (01/97-09/02)

12-34 323 0008 | MFF0232

Fuel filter



Notes

Outer diameter [mm]
Height [mm]
Thread Size

with seal
109
146
1 1/4"-UNS-2B
Screw-on Filter

References

1296 851

Application info

95 XF (01/97-09/02)
CF 65 (01/01--)
CF 75 (01/01--)

CF 85 (01/01--)
XF 105 (10/05--)

034 009 0003 | MFF0023

Fuel filter



Notes

Diameter [mm]
Height [mm]
Connecting thread

Plastic
36
52
M20x1,5
Pre-filter

References

1315 514

Application info

45 (05/91-12/00)
55 (11/95-12/00)
65 (03/93-02/98)
75 (07/92-02/98)
95 (09/87-01/98)
F 1000 (12/86-12/92)
F 1100 (01/78-11/90)
F 1200 (01/69-12/81)
F 1300 (07/78-12/92)
F 1400 (02/72-12/81)
F 1500 (--08/91)
F 1600 (01/70-08/91)
F 1700 (12/86-02/95)
F 1800 (01/70-08/91)
F 1900 (12/86-09/93)
F 2000 (01/70-12/79)
F 2100 (07/78-08/91)

F 2200 (01/71-11/80)
F 2300 (07/78-10/93)
F 2500 (02/82-08/91)
F 2600 (02/72-12/73)
F 2700 (01/90-10/93)
F 2800 (01/74-09/91)
F 2900 (01/90-10/93)
F 3200 (01/90-10/93)
F 3300 (06/81-09/91)
F 3600 (06/85-09/91)
F 500 (12/77-12/79)
F 600 (12/86-12/92)
F 700 (12/75-12/79)
F 800 (12/86-08/91)
F 900 (01/75-11/88)
SB [---]

Fuel filter

14-34 009 0002 | MFF0084

Notes

Outer diameter [mm]	with seal
Height [mm]	95
Thread Size	144
	M16x1,5
	Screw-on Filter

References

0247 138	0247 139
247138	1318 695
247139	



Application info

65 [03/93-02/98]	F 1300 [07/78-12/92]
65 CF [02/98-12/00]	F 2100 [07/78-08/91]
75 [07/92-02/98]	F 2300 [07/78-10/93]
85 [07/92-02/98]	F 2500 [02/82-08/91]
85 CF [02/98-12/00]	F 2700 [01/90-10/93]
95 [09/87-01/98]	F 2800 [01/74-09/91]
95 XF [01/97-09/02]	F 3300 [06/81-09/91]
CF 75 [01/01--]	F 3600 [06/85-09/91]
F 1100 [01/78-11/90]	

Fuel filter

14-34 018 0004 | MFF0086

Notes

Diameter [mm]	with seal
Outer diameter [mm]	62
Height [mm]	93
Thread Size	144
	M22x1,5
	Screw-on Filter

References

1345 335



Application info

75 CF [02/98-12/00]	95 XF [01/97-09/02]
85 CF [02/98-12/00]	

Fuel filter

14-34 018 0002 | MFF0085

Notes

Diameter 2 [mm]	46
Diameter 1 [mm]	14
Outer diameter [mm]	105
Height [mm]	202
	Filter Insert

References

1397 766	1784 782
----------	----------



14-34 018 0002 | MFF0085

Fuel filter

Application info

CF 75 [01/01--]
CF 85 [01/01--]

XF 95 [09/02-12/06]

14-34 018 0008 | MFF0087

Fuel filter



Notes

Outer diameter [mm]
Height [mm]
Thread Size

with seal
93
209
M20x1,5
Screw-on Filter

References

1399 760

Application info

CF 65 [01/01--]
LF 45 [01/01--]

LF 55 [01/01--]

14-34 018 0016 | MFF0265

Fuel filter



Notes

Outer diameter [mm]
Height [mm]
Thread Size

with seal
108
231
1-14 UNS -1B
Screw-on Filter

References

1433 649

Application info

95 XF [01/97-09/02]
CF 75 [01/01--]
CF 85 [01/01--]

XF 105 [10/05--]
XF 95 [09/02-12/06]

Radiator fan motor
14-34 234 0012 | MRM0075
Notes

 Number of Wings 8
 Outer diameter [mm] 205

References

1372 386

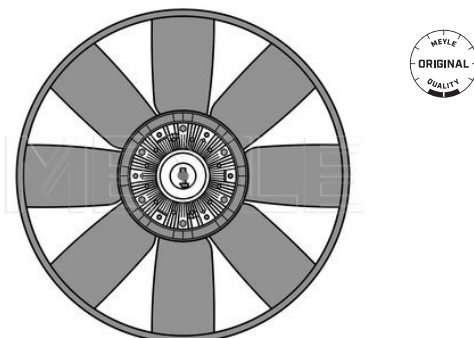
Application info

CF 75 [01/01--]

Fan clutch
14-34 234 0008 | MFC0077
Notes

 Number of mounting bores 4
 Outer diameter [mm] 163
 Depth [mm] 141

References

1259 622 1307 823

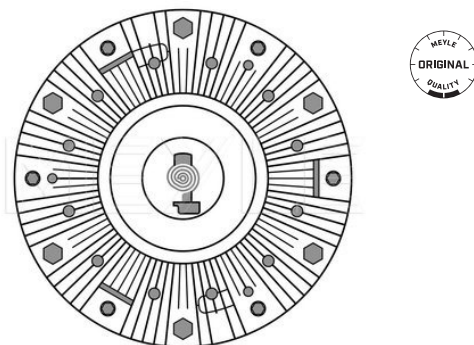
Application info

65 CF [02/98-12/00]

CF 85 [01/01--]

Fan clutch
14-34 234 0016 | MFC0084
Notes

 Number of mounting bores 6
 Outer diameter [mm] 205
 Depth [mm] 136

References

1372 387

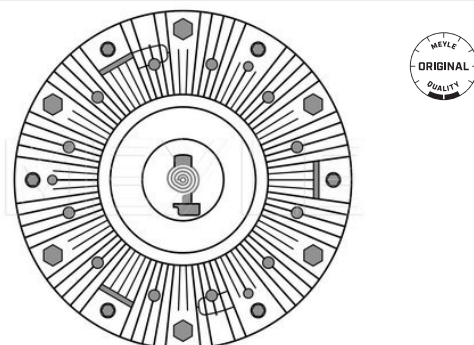

Application info

85 CF [02/98-12/00]

CF 85 [01/01--]

14-34 234 0010 | MFC0079

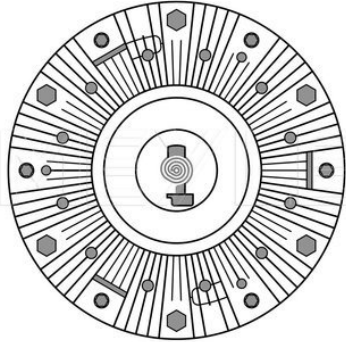
Fan clutch



Notes

Number of mounting bores	6
Outer diameter [mm]	Thermic 205
Depth [mm]	171

References

1398 793

Application info

CF 75 [01/01--]

CF 85 [01/01--]

14-34 234 0018 | MFC0086

Fan clutch

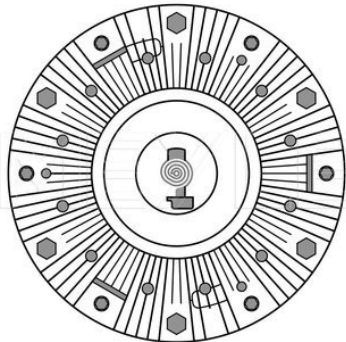

Notes

Number of mounting bores	5
Outer diameter [mm]	Thermic 205
Depth [mm]	106

References

1402 415	APUB185
1408 555	APUC331

Application info

LF 45 [01/01--]

LF 55 [01/01--]

14-34 234 0004 | MFC0073

Fan clutch



Notes

Number of mounting bores	6
Outer diameter [mm]	Electric 233
Depth [mm]	154
Number of Poles	5

References

1427 573	1680 935
1666 098	

Application info

XF 95 [09/02-12/06]

Fan clutch
14-34 234 0005 | MFC0074
Notes

Number of mounting bores	6
	Electric
Outer diameter [mm]	260
Depth [mm]	150
Number of Poles	5

References

1441 770	1666 156
1441 773	1666 157
1441 774	1680 937
1449 676	1680 938
1449 677	

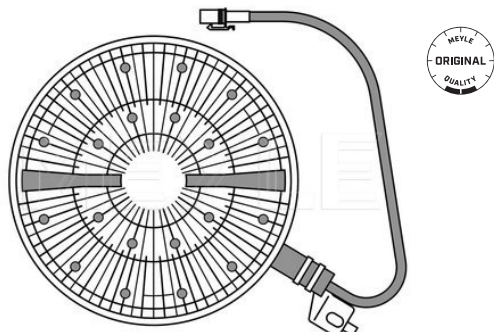
Application info

85 CF (02/98-12/00)

CF 85 (01/01--)

Fan clutch
14-34 234 0001 | MFC0070
Notes

Number of mounting bores	6
	Thermic
Outer diameter [mm]	233
Depth [mm]	171

References

1449 678	1449 679
----------	----------

Application info

CF 75 (01/01--)

Fan clutch
14-34 234 0003 | MFC0072
Notes

Number of mounting bores	6
	Electric
Outer diameter [mm]	275
Depth [mm]	152
Number of Poles	5

References

1677 080	1732 274
1693 441	1806 712
1697 677	1916 597
1732 273	

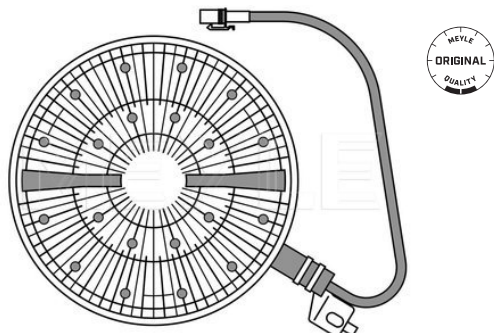

Application info

CF 85 (01/01--)

XF 105 (10/05--)

14-34 234 0002 | MFC0071

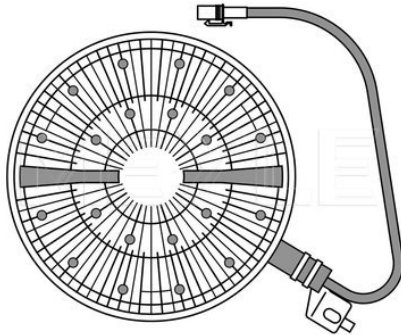
Fan clutch



Notes

Number of mounting bores	4
Outer diameter [mm]	275
Number of Poles	2

References

1737 460	1806 713
1742 083	1916 598

Application info

CF 85 [01/01--]

XF 105 [10/05--]

14-34 232 0008 | MMX1357

Fan blade

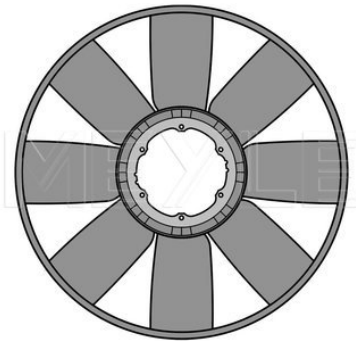

Notes

Number of Wings	8
Outer diameter [mm]	203

References

1236 096

Application info

95 XF [01/97-09/02]

14-34 232 0011 | MMX1360

Fan blade

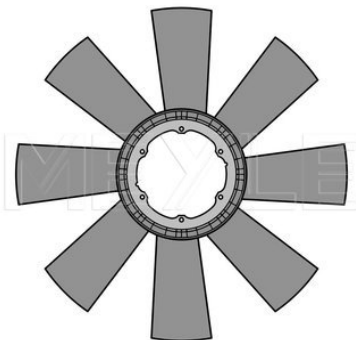

Notes

Number of Wings	10
Diameter [mm]	510

References

1282 146	1403 238
----------	----------

Application info

LF 55 [01/01--]

Fan blade

14-34 232 0005 | MMX1354

Notes

Number of Wings 8

References

1291 218

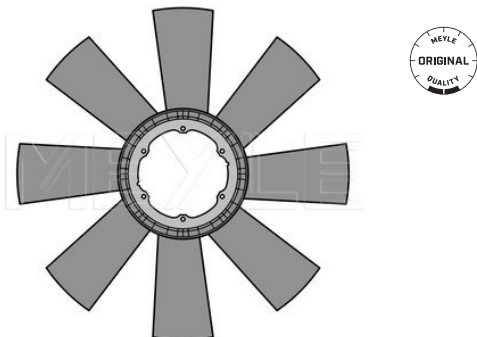

Application info

75 CF [02/98-12/00]

CF 75 [01/01--]

Fan blade

14-34 232 0007 | MMX1356

Notes

Number of Wings 8
Outer diameter [mm] 720

References

1293 812

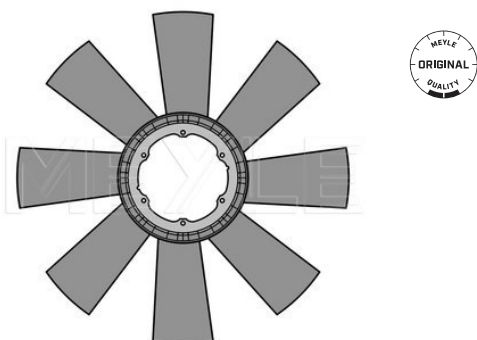

Application info

95 [09/87-01/98]

95 XF [01/97-09/02]

Fan blade

14-34 232 0002 | MMX1351

Notes

Number of Wings 8
Outer diameter [mm] 704

References

1308 285 1448 197
1399 180 1733 234

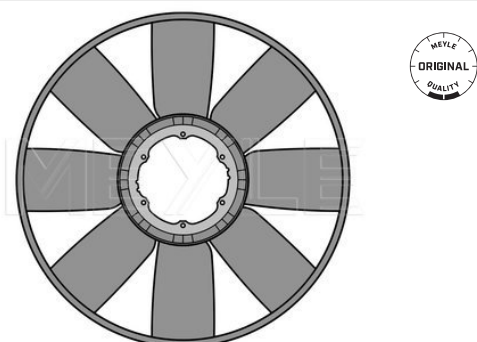

Application info

65 CF [02/98-12/00]
75 CF [02/98-12/00]
85 CF [02/98-12/00]

CF 75 [01/01--]
CF 85 [01/01--]

14-34 232 0009 | MMX1358

Fan blade

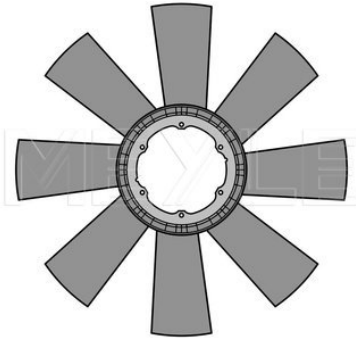

Notes

Number of Wings	8
Outer diameter [mm]	720

References

1338 736

Application info

95 XF [01/97-09/02]

XF 95 [09/02-12/06]

14-34 232 0006 | MMX1355

Fan blade

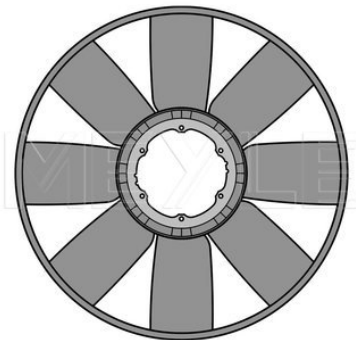

Notes

Number of Wings	8
Outer diameter [mm]	725

References

1376 260

Application info

CF 75 [01/01--]

14-34 232 0012 | MMX1361

Fan blade

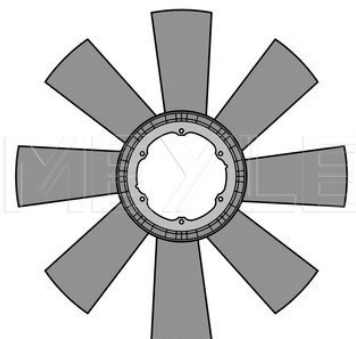

Notes

Number of Wings	7
Outer diameter [mm]	720

References

1399 819

Application info

XF 105 [10/05--]

XF 95 [09/02-12/06]



Fan blade

14-34 232 0010 | MMX1359

Notes

Number of Wings 9

References

1402 417 1403 248

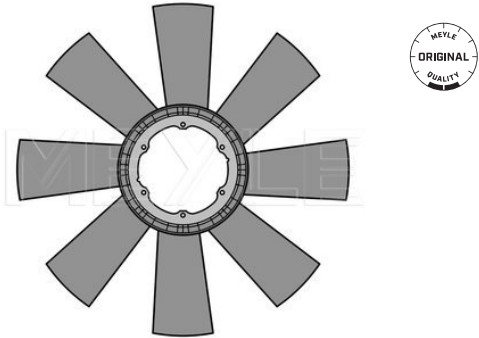

Application info

LF 45 [01/01--]

LF 55 [01/01--]

Water pump

14-33 220 0003 | MWP0546

Notes

Weight [kg] 10.5
with seal

References

0683 579 1609 853
683 579 0683 579 R
1399 150 683 579 R



Application info

85 CF [02/98-12/00]
95 XF [01/97-09/02]

CF 85 [01/01--]

Water pump

14-33 220 0002 | MWP0183

Notes

Weight [kg] 3.05
with seal
1-part housing
with v-ribbed belt pulley
with seal

References

1664 762 1778 280
1738 991 1828 162



Application info

CF 85 [01/01--]
XF 105 [10/05--]

XF 95 [09/02-12/06]

14-34 223 0001 | MET0042

Expansion tank



Notes

Opening Pressure [bar]	Black 1
Width [mm]	PP (Polypropylene) 337
Depth [mm]	104
Length [mm]	547
Capacity [Litre]	11.8 without sensor without filler cap Front

References

1295 910	1607 794
----------	----------

Parts list

14-34 223 0003 MEX0582	Sensor, coolant level
14-34 238 0002 MMX1457	Expansion tank cap
14-34 238 0003 MMX1452	Expansion tank cap

Application info

95 XF [01/97-09/02]

XF 95 [09/02-12/06]

14-34 223 0005 | MET0043

Expansion tank



Notes

Opening Pressure [bar]	Black 1
Width [mm]	PP (Polypropylene) 345
Depth [mm]	105
Length [mm]	555
Capacity [Litre]	6.7 without sensor without filler cap Front

References

1626 237

Parts list

14-34 238 0002 MMX1457	Expansion tank cap
14-34 238 0003 MMX1452	Expansion tank cap

Application info

XF 105 [10/05--]

Expansion tank

14-34 223 0006 | MET0075

Notes

Opening Pressure [bar]	Black 1
Width [mm]	PP (Polypropylene) 337
Depth [mm]	104
Length [mm]	547
Capacity [Litre]	11.8 without sensor without filler cap Front



References

1684 655

Parts list

14-34 238 0002 MMX1457	Expansion tank cap
14-34 238 0003 MMX1452	Expansion tank cap

Application info

XF 95 (09/02-12/06)

Expansion tank

16-34 223 0001 | MET0087

Notes

Opening Pressure [bar]	Transparent 0.7
Pressure [bar]	PP (Polypropylene) 0.7
Width [mm]	380
Depth [mm]	146
Length [mm]	619
Capacity [Litre]	11 with sensor with filler cap Front



References

1404 524	1702 252
1700 772	

Parts list

039 238 0001 MMX0290	Expansion tank cap
------------------------	--------------------

Application info

LF 45 (01/01--)

LF 55 (01/01--)

14-34 223 0004 | MET0079

Expansion tank



Notes

Opening Pressure [bar]	Black/White 1.2 PP (Polypropylene)
Width [mm]	382
Depth [mm]	293
Length [mm]	594 with sensor with filler cap Front

References

1371 329	1871 493
1660 859	

Parts list

14-34 899 0001 MEX0562	Sensor, coolant level
14-34 238 0001 MMX1439	Expansion tank cap

Application info

75 CF (02/98-12/00)
85 (07/92-02/98)
85 CF (02/98-12/00)

CF 65 (01/01--)
CF 75 (01/01--)
CF 85 (01/01--)

14-34 223 0002 | MEX0581

Sensor, coolant level



Notes

Operating voltage [V]	Piezoelectric Sensor 24
Length [mm]	138
Number of Poles	3

References

1320 045	1624 782
1327 199	

Application info

75 CF (02/98-12/00)
85 CF (02/98-12/00)

95 XF (01/97-09/02)

14-34 223 0003 | MEX0582

Sensor, coolant level



Notes

Operating voltage [V]	Blade Terminal Piezoelectric Sensor 24
Length [mm]	138
Number of Poles	3

References

1453 046	1624 784
----------	----------

Sensor, coolant level

14-34 223 0003 | MEX0582

Application info

75 CF [02/98-12/00]
85 CF [02/98-12/00]

95 XF [01/97-09/02]

Sensor, coolant level

14-34 899 0001 | MEX0562

Notes

Operating voltage [V]	Active sensor
Fitting Depth [mm]	24
Length [mm]	290
Number of Poles	325
	2

References

1371 332	1740 758
1624 783	



Application info

75 CF [02/98-12/00]
85 CF [02/98-12/00]

CF 75 [01/01--]
CF 85 [01/01--]

Expansion tank cap

14-34 238 0003 | MMX1452

Notes

Pressure [bar]	Black
	Round
	1

References

1399 820



Application info

95 XF [01/97-09/02]
CF 85 [01/01--]

XF 105 [10/05--]
XF 95 [09/02-12/06]

14-34 238 0002 | MMX1457

Expansion tank cap



Notes

Diameter [mm]

Black
Round
81

References

1685 352

Application info

85 CF (02/98-12/00)
95 XF (01/97-09/02)

XF 105 (10/05--)
XF 95 (09/02-12/06)

14-34 238 0001 | MMX1439

Expansion tank cap



Notes

Pressure [bar]
Diameter [mm]

Black
Round
1.45
67

References

1371 331
1615 509
1657 336

1743 703
1867 861

Application info

65 (03/93-02/98)
75 CF (02/98-12/00)
85 CF (02/98-12/00)

CF 75 (01/01--)
CF 85 (01/01--)

14-34 000 0002 | MBT0071

Belt tensioner

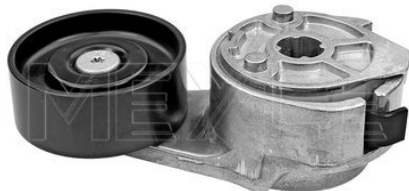

Notes

Outer diameter [mm]
Width [mm]

85
32

References

1406 486

1702 525

Application info

CF 65 (01/01--)
LF 45 (01/01--)

LF 55 (01/01--)



Belt tensioner

14-34 000 0003 | MBT0061

References

1627 625	1695 242
1694 953	

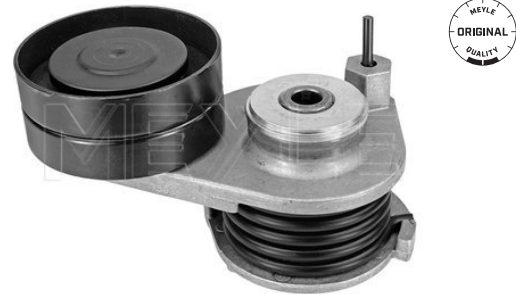

Application info

CF 85 [01/01--]	XF 105 [10/05--]
-----------------	------------------

Belt tensioner

14-34 000 0001 | MBT0070

Notes

Belt Pulley Ø [mm]	77
Height [mm]	103

References

1398 620	1614 978
1458 764	1628 148



Application info

95 XF [01/97-09/02] CF 85 [01/01--]	XF 95 [09/02-12/06]
--	---------------------

Tension roller, ribbed belt

14-34 000 0004 | MTR0040

Notes

Outer diameter [mm]	78
Width [mm]	38

References

1638 696	1699 240
1687 821	1811 819



Application info

CF 85 [01/01--]	XF 105 [10/05--]
-----------------	------------------

Ø52 Ø13 1600 | MVB0228

V-belt

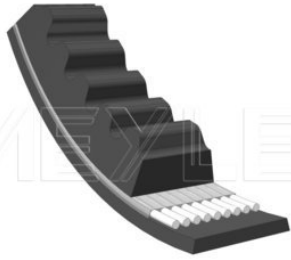

Notes

Width [mm] 13
Length [mm] 1600

References

Ø067 681 67681
Ø67681

Application info

F 2300 [07/78-10/93]

F 2500 [02/82-08/91]

Ø52 Ø13 1675 | MVB0231

V-belt

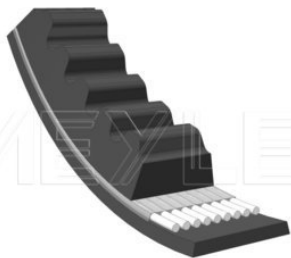

Notes

Width [mm] 13
Length [mm] 1675

References

238670

Application info

F 2800 [01/74-09/91]

F 3200 [01/90-10/93]

F 3300 [06/81-09/91]

F 3600 [06/85-09/91]

Ø52 Ø13 1050 | MVB0188

V-belt

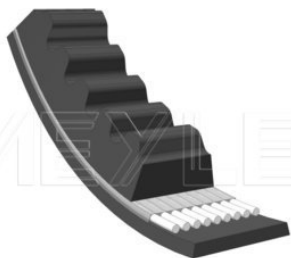

Notes

Width [mm] 13
Length [mm] 1050

References

Ø296 961 296961

Application info

F 2500 [02/82-08/91]

V-belt
Ø52 Ø13 1475 | MVBØ222
Notes

 Width [mm] 13
 Length [mm] 1475

References

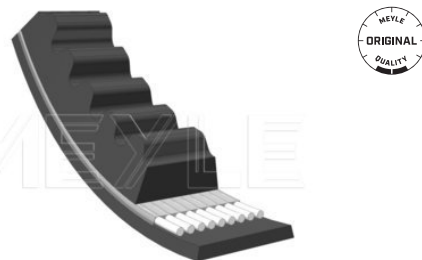
 Ø238 770 655043
 238770 0655 043

Application info

 65 (03/93-02/98)
 CF 65 (01/01--)

F 2100 (07/78-08/91)

V-belt
Ø52 Ø10 0975 | MVBØ063
Notes

 Width [mm] 10
 Length [mm] 975

References

Ø679 733 679733

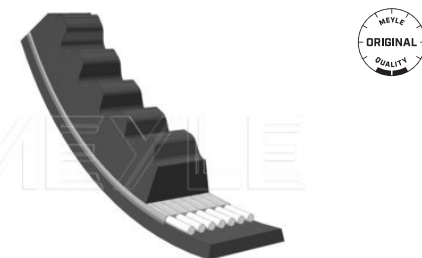
Application info

 F 2300 (07/78-10/93)
 F 2500 (02/82-08/91)

F 2700 (01/90-10/93)

V-belt
Ø52 Ø13 1525 | MVBØ224
Notes

 Width [mm] 13
 Length [mm] 1525

References

248761 1265 398

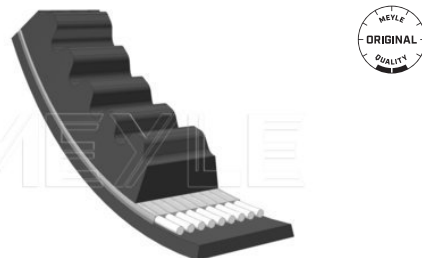
Application info

F 1600 (01/70-08/91)

052 013 1000 | MVB0183

V-belt

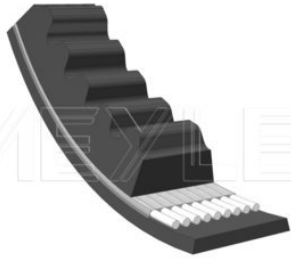

Notes

Width [mm] 13
Length [mm] 1000

References

1425 709

Application info

85 CF [02/98-12/00]
95 XF [01/97-09/02]

CF 85 [01/01--]

052 013 1535 | MVB0225

V-belt

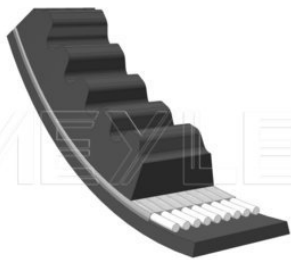

Notes

Width [mm] 13
Length [mm] 1535

Application info

F 1600 [01/70-08/91]

050 008 1398 | MRB0657

V-ribbed belt

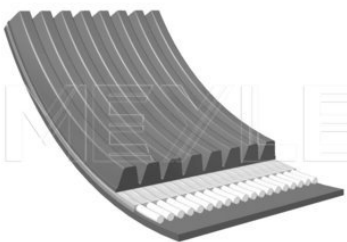

Notes

Width [mm] 28
Number of Ribs 8
Length [mm] 1398
One-sided
EPDM [ethylene propylene diene Monomer (M-class) rubber]

References

0067 690 0490 269
067690 CBU1182
67690 CBU1532
490269

Application info

45 [05/91-12/00]
F 1000 [12/86-12/92]

F 600 [12/86-12/92]

F 800 [12/86-08/91]



V-ribbed belt

050 008 1915 | MRB0678

Notes

Width [mm]
Number of Ribs
Length [mm]

EPDM (ethylene propylene diene Monomer [M-class] rubber)
28
8
1915
One-sided

References

1152 425 1372 669

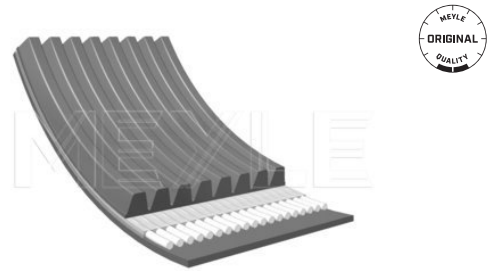

Application info

XF 105 [10/05--]

XF 95 [09/02-12/06]

V-ribbed belt

050 008 1525 | MRB0664

Notes

Width [mm]
Number of Ribs
Length [mm]

EPDM (ethylene propylene diene Monomer [M-class] rubber)
28
8
1525
One-sided

References

1388 161 1702 605

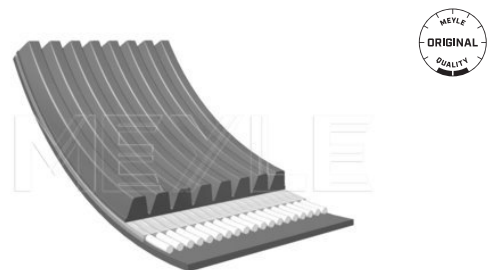

Application info

CF 65 [01/01--]
LF 45 [01/01--]

LF 55 [01/01--]

V-ribbed belt

050 008 2050 | MRB0685

Notes

Width [mm]
Number of Ribs
Length [mm]

EPDM (ethylene propylene diene Monomer [M-class] rubber)
28
8
2050
One-sided

References

1393 280

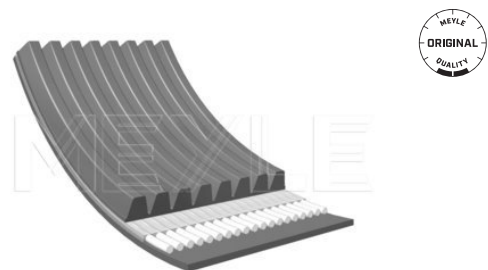

Application info

CF 85 [01/01--]

050 008 1215 | MRB0651

V-ribbed belt

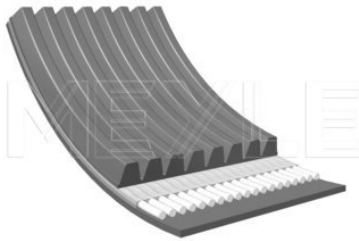

Notes

Width [mm]
Number of Ribs
Length [mm]

EPDM (ethylene propylene diene Monomer [M-class] rubber)
28
8
1215
One-sided

References

1393 344

Application info

CF 65 [01/01--]
LF 45 [01/01--]

LF 55 [01/01--]

050 008 1720 | MRB0672

V-ribbed belt

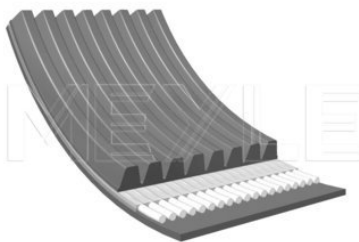

Notes

Width [mm]
Number of Ribs
Length [mm]

EPDM (ethylene propylene diene Monomer [M-class] rubber)
28
8
1720
One-sided

References

1393 365

Application info

CF 85 [01/01--]

050 008 2380 | MRB0693

V-ribbed belt

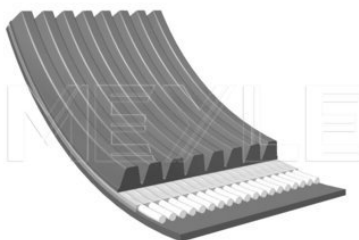

Notes

Width [mm]
Number of Ribs
Length [mm]

EPDM (ethylene propylene diene Monomer [M-class] rubber)
28
8
2380
One-sided

References

1398 637

Application info

75 CF [02/98-12/00]

CF 75 [01/01--]



V-ribbed belt

050 008 2120 | MRB0762

Notes

Width [mm]
Number of Ribs
Length [mm]

EPDM (ethylene propylene diene Monomer [M-class] rubber)
28
8
2120
One-sided

References

1444 203

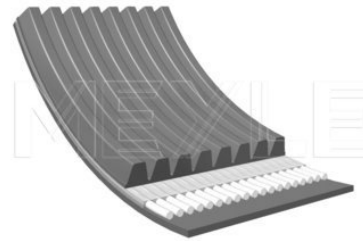

Application info

85 CF (02/98-12/00)

V-ribbed belt

050 007 1750 | MRB0613

Notes

Width [mm]
Number of Ribs
Length [mm]

EPDM (ethylene propylene diene Monomer [M-class] rubber)
24
7
1750
One-sided

References

1638 698

1812 162

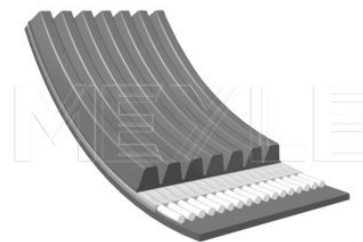

Application info

CF 85 (01/01--)

V-ribbed belt

050 009 1380 | MRB0698

Notes

Width [mm]
Number of Ribs
Length [mm]

EPDM (ethylene propylene diene Monomer [M-class] rubber)
32
9
1380
One-sided

References

1654 398

1661 948

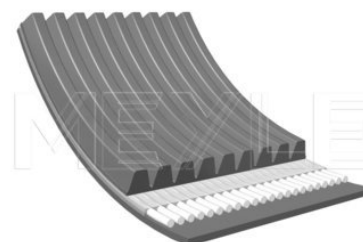

Application info

CF 85 (01/01--)

050 009 1424 | MRB0750

V-ribbed belt

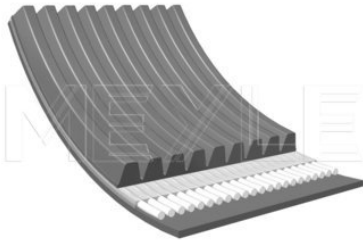

Notes

Width [mm]
Number of Ribs
Length [mm]

EPDM (ethylene propylene diene Monomer [M-class] rubber)
32
9
1424
One-sided

References

1661 949

1661 954

Application info

CF 85 [01/01--]

14-34 900 0001 | MMX1488

Gasket, exhaust manifold



References

1639810

Application info

CF 85 [01/01--]

14-34 900 0002 | MMX1489

Gasket, exhaust pipe



Notes

Hole Arrangement / Number

3

References

1316772

Application info

75 CF [02/98-12/00]
85 CF [02/98-12/00]
95 XF [01/97-09/02]

CF 75 [01/01--]
CF 85 [01/01--]
XF 95 [09/02-12/06]

Repair kit, brake caliper

12-34 042 0010 | MBX0163

Notes

Front Axle

References

1142 142
1198 153

1198 154
1448 915



Application info

65 CF [02/98-12/00]
75 CF [02/98-12/00]
85 CF [02/98-12/00]
95 XF [01/97-09/02]

CF 65 [01/01--]
CF 75 [01/01--]
CF 85 [01/01--]
LF 55 [01/01--]

Brake disc

14-35 521 0004 | MBD1470

Notes

Centering Diameter [mm] 155
Minimum thickness [mm] 40
Outer diameter [mm] 375
Height [mm] 128
Brake System WABCO 1600-V-G
Brake Disc Thickness [mm] 44
Required quantity 2
Number of Holes 10
Front Axle



References

AMPA014
AMPB481

AMPB860
NJK2785

Application info

55 [11/95-12/00]

Brake pad set

025 290 8730 | MBP0710

Notes

Thickness [mm] 30
Height [mm] 109.5
Width [mm] 247.3
Brake System KNORR SB 6/7
Rear Axle
Front Axle

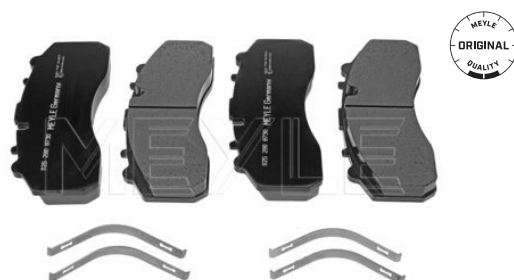

References

1439 324
1617 343

1797 053
1878 030

025 290 8730 | MBP0710

Brake pad set

Application info

CF 65 [01/01--]
CF 75 [01/01--]

CF 85 [01/01--]
XF 95 [09/02-12/06]

025 290 8730/S | MBP0711

Brake pad set

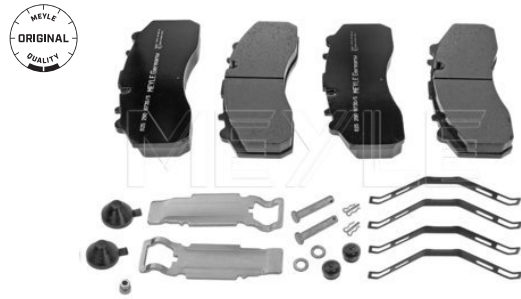

Notes

Thickness [mm]
Height [mm]
Width [mm]
Brake System

with accessories
prepared for wear indicator
30
109.5
247.3
Knorr
Rear Axle
Front Axle

References

1439 324

Application info

CF 65 [01/01--]
CF 75 [01/01--]

CF 85 [01/01--]
XF 95 [09/02-12/06]

14-34 533 0004 | MAS0112

ABS wheel sensor



Notes

Cable Length [mm]
Operating voltage [V]
Length [mm]
Number of Poles
Required quantity
Resistance [Ohm]

with accessories
Inductive Sensor
for vehicles with ABS
220
24
300
2
2
1150
Rear Axle
Front Axle

References

1230 594	1361 393
1238 561	1778 553
1315 691	1778 554

Application info

65 [03/93-02/98]
65 CF [02/98-12/00]
75 [07/92-02/98]
75 CF [02/98-12/00]
85 [07/92-02/98]
85 CF [02/98-12/00]

95 [09/87-01/98]
95 XF [01/97-09/02]
CF 65 [01/01--]
CF 75 [01/01--]
CF 85 [01/01--]



ABS wheel sensor

034 533 0017 | MAS0015

Notes

	with accessories
	Inductive Sensor
	for vehicles with ABS
Cable Length [mm]	325
Operating voltage [V]	24
Length [mm]	400
Number of Poles	2
Required quantity	2
Resistance [Ohm]	1150
	Rear Axle left and right



References

1315 898	1504 951
----------	----------

Application info

65 CF (02/98-12/00)
 75 (07/92-02/98)
 75 CF (02/98-12/00)
 85 (07/92-02/98)
 85 CF (02/98-12/00)

95 (09/87-01/98)
 95 XF (01/97-09/02)
 CF 65 (01/01--)
 CF 75 (01/01--)
 CF 85 (01/01--)

ABS wheel sensor

534 003 0001 | MAS0193

Notes

	with accessories
	Inductive Sensor
Cable Length [mm]	1700
Operating voltage [V]	24
Length [mm]	1840
Number of Poles	2
Required quantity	2
Resistance [Ohm]	1150
	Rear Axle
	Front Axle



References

1400 071	1525 416
1506 149	

Application info

LF 45 (01/01--)

LF 55 (01/01--)

14-34 533 0017 | MAS0308

ABS wheel sensor



Notes

Operating voltage [V]
Cable Length [mm]
Length [mm]
Number of Poles
Required quantity
Resistance [Ohm]

with accessories
Inductive Sensor
24
925
1025
2
2
1150
Front Axle

References

1504 930

1505 215

Application info

85 CF [02/98-12/00]

14-34 533 0016 | MAS0389

ABS wheel sensor



Notes

Operating voltage [V]
Number of Poles
Required quantity
Resistance [Ohm]

Inductive Sensor
24
2
2
1150
Left and right

References

1505211

Application info

CF 75 [01/01--]

14-34 533 0010 | MAS0113

ABS wheel sensor



Notes

Cable Length [mm]
Operating voltage [V]
Length [mm]
Number of Poles
Required quantity
Resistance [Ohm]

with accessories
Inductive Sensor
for vehicles with ABS
2050
24
2000
2
2
1150
Rear Axle
Front Axle

References

1505 212



ABS wheel sensor

14-34 533 0010 | MAS0113

Application info

CF 65 (01/01--)
CF 75 (01/01--)

CF 85 (01/01--)

ABS wheel sensor

14-34 533 0001 | MAS0111

Notes

Cable Length [mm]
Operating voltage [V]
Length [mm]
Number of Poles
Required quantity
Resistance [Ohm]

with accessories
Inductive Sensor
for vehicles with ABS
990
24
1070
2
2
1150
Front Axle



References

1506 003

Application info

95 XF (01/97-09/02)

ABS wheel sensor

14-34 533 0018 | MAS0309

Notes

Operating voltage [V]
Cable Length [mm]
Length [mm]
Number of Poles
Required quantity
Resistance [Ohm]

Inductive Sensor
24
3605
3555
2
2
1150
Rear Axle



References

1518 010

Application info

CF 65 (01/01--)

034 533 0035 | MAS0033

ABS wheel sensor



Notes

Cable Length [mm]
Operating voltage [V]
Length [mm]
Number of Poles
Required quantity
Resistance [Ohm]

with accessories
Inductive Sensor
for vehicles with ABS
2150
24
2200
2
2
1150
Rear Axle
Front Axle

References

1518 311

Application info

75 CF (02/98-12/00)

034 013 0006 | MBX0018

Cylinder head, compressor



References

1517 929

BBU5510

Application info

F 1900 (12/86-09/93)

14-34 042 0005 | MBX0198

Air dryer cartridge



Notes

Inner thread [mm]
Outer diameter [mm]
Height [mm]

M41x1,5
141
135

References

1391 510

Air dryer cartridge

14-34 042 0005 | MBX0198

Application info

CF 65 (01/01--)
CF 75 (01/01--)

CF 85 (01/01--)
LF 45 (01/01--)

Air suspension valve

12-34 032 0000 | MBX0162

Notes

Left and right

References

0759 050
759050
1341 990

1445 900
1600 489



Application info

75 CF (02/98-12/00)
85 CF (02/98-12/00)
95 (09/87-01/98)
95 XF (01/97-09/02)
CF 65 (01/01--)

CF 75 (01/01--)
CF 85 (01/01--)
F 1600 (01/70-08/91)
F 1800 (01/70-08/91)

Sensor, pneumatic suspension level

834 533 0004 | MEX0477

References

1305 844

1505 287



Application info

65 CF (02/98-12/00)
75 CF (02/98-12/00)
85 CF (02/98-12/00)
95 XF (01/97-09/02)
CF 75 (01/01--)
CF 85 (01/01--)

F 2100 (07/78-08/91)
F 2300 (07/78-10/93)
F 2500 (02/82-08/91)
LF 45 (01/01--)
LF 55 (01/01--)

034 042 0034 | MBX0068

Brake line coupling



Notes

Number of connectors	Yellow
Connecting thread	1
Operating Pressure [bar]	M22x1,5
	8

References

0109 916	109916
----------	--------

Counterpart

034 042 0033 | MBX0067

Application info

CF 75 [01/01--]

034 042 0033 | MBX0067

Brake line coupling



Notes

Number of connectors	Red
Connecting thread	1
Operating Pressure [bar]	M22x1,5
	8.2

References

1427 369

Counterpart

034 042 0034 | MBX0068

Application info

75 [07/92-02/98]

034 042 0038 | MBX0072

Brake line coupling



Notes

Number of connectors	Red
Connecting thread	1
Operating Pressure [bar]	M16x1,5
	8.1

References

1504 961

Counterpart

034 042 0039 | MBX0073

Application info

75 [07/92-02/98]

F 1100 [01/78-11/90]

Brake line coupling
034 042 0039 | MBX0073
Notes

Number of connectors	Yellow
Connecting thread	1
Operating Pressure [bar]	M16x1,5
	8.1

References

1519 232

Counterpart

034 042 0038 | MBX0072

Application info

75 [07/92-02/98]

F 1100 [01/78-11/90]

Line filter, compressor system
034 042 0024 | MBX0063
Notes

Pressure [bar]	8
----------------	---

References

0587 805	123 8508
587805	

Application info

F 2300 [07/78-10/93]

LF 45 [01/01--]

LF 55 [01/01--]

Slave cylinder
034 043 0005 | MBX0090
Notes

Diameter [mm]	Black
Thread Size	35
	M18x1

References

1505 023

Application info

75 CF [02/98-12/00]

85 CF [02/98-12/00]

034 042 0051 | MBX0082

Check valve



Notes

Non-return Valve

References

0288 495
288495
307475
0307 475

0507 808
507808
587808
0587 808

Application info

F 2300 (07/78-10/93)

F 2500 (02/82-08/91)

034 043 0039 | MBX0103

Control valve, trailer



Notes

Thread Size
Operating Pressure [bar]

M16x1,5
10

References

0167 846

167846

Application info

F 2100 (07/78-08/91)

F 2300 (07/78-10/93)

034 042 0001 | MBX0052

Diaphragm, brake cylinder



Notes

Equipment Variant

T24
Rubber with textile reinforcement
24"

Diameter [in]

References

0501 182
501182
706123

0706 123
FB08648

Application info

45 (05/91-12/00)

55 (11/95-12/00)

Diaphragm, brake cylinder
034 042 0062 | MBX0088
Notes

Equipment Variant T20L
 Rubber with textile reinforcement
 Diameter [in] 20"

References

0689 366 689366

Application info

55 [11/95-12/00]

Diaphragm, brake cylinder
034 042 0061 | MBX0087
Notes

Equipment Variant T16L
 Rubber with textile reinforcement
 Diameter [in] 16"

References

0689 511 FB09614
 689511

Application info

75 [07/92-02/98]

Diaphragm, brake cylinder
034 042 0002 | MBX0053
Notes

Equipment Variant T30L
 Rubber with textile reinforcement
 Diameter [in] 30"

References

0691 602 694277
 691602 0694 277

Application info

F 1000 [12/86-12/92]

034 042 0043 | MBX0075

Diaphragm, brake cylinder



Notes

Equipment Variant

T24L
Rubber with textile reinforcement
24"

Diameter [in]

References

0895 751

895751

Application info

F 2200 [01/71-11/80]

034 042 0003 | MBX0054

Diaphragm, brake cylinder



Notes

Equipment Variant

T30
Rubber with textile reinforcement
30"

Diameter [in]

References

0305 049
305049
533891

0533 891
0706 128
706128

Application info

F 1800 [01/70-08/91]

034 043 0002 | MBX0089

Diaphragm, brake cylinder



Notes

Equipment Variant

T20
Rubber with textile reinforcement
20"

Diameter [in]

References

0303 055
303055

1325 345

Application info

65 [03/93-02/98]

Valve, compressor system

034 026 0027 | MBX0038

Notes

Relay Valve

References

0069 237
069237
69237

692183
0692 183



Application info

F 2100 (07/78-08/91)
F 2300 (07/78-10/93)
F 2500 (02/82-08/91)
F 2800 (01/74-09/91)
F 2900 (01/90-10/93)

F 3200 (01/90-10/93)
F 3300 (06/81-09/91)
F 3600 (06/85-09/91)
SB [---]

Valve, compressor system

12-34 026 0002 | MBX0161

Notes

Multiport Valve

References

1300 662

1374 724



Application info

75 CF (02/98-12/00)
85 CF (02/98-12/00)

95 XF (01/97-09/02)

Relay valve

034 043 0073 | MBX0118

Notes

Pressure [bar] 8
Thread Size M24x1,5
Number of Inlets / Outlets 2

References

1304 635

1505 210



034 043 0073 | MBX0118

Relay valve

Application info

75 [07/92-02/98]
75 CF [02/98-12/00]
85 [07/92-02/98]
85 CF [02/98-12/00]
95 [09/87-01/98]
95 XF [01/97-09/02]

CF 65 [01/01--]
CF 75 [01/01--]
CF 85 [01/01--]
LF 45 [01/01--]
LF 55 [01/01--]

034 043 0069 | MBX0116

Relay valve



Notes

Pressure [bar]	8.1
Thread Size	M22x1,5
Thread Size	M16x1,5
Number of Inlets / Outlets	5

References

1302 103	1506 488
----------	----------

Application info

75 [07/92-02/98]
75 CF [02/98-12/00]
85 [07/92-02/98]

85 CF [02/98-12/00]
95 [09/87-01/98]
95 XF [01/97-09/02]

034 026 0030 | MBX0039

Multiway valve



Notes

Pressure [bar]	8.1
----------------	-----

References

0262 633	262633
----------	--------

Application info

F 2700 [01/90-10/93]



Multiway valve

034 026 0026 | MBX0037

Notes

Pressure [bar] 8

References

0609 715 609715



Application info

F 1700 (12/86-02/95)
 F 1900 (12/86-09/93)
 F 2100 (07/78-08/91)

F 2300 (07/78-10/93)
 F 2500 (02/82-08/91)
 F 2700 (01/90-10/93)

2

034 026 0017 | MTX0022

Shift rod connector



Notes

Thread Measurement 2	with left-hand thread
Thread Measurement 1	M12x1,75
Length [mm]	M10x1,5
Cone Size [mm]	55
	12.8

References

0592 106	0656 084
592106	1249 088
656084	

Counterpart

034 026 0018 | MTX0023

Application info

75 [07/92-02/98]
75 CF [02/98-12/00]
85 [07/92-02/98]

85 CF [02/98-12/00]
95 [09/87-01/98]
95 XF [01/97-09/02]

034 026 0018 | MTX0023

Shift rod connector



Notes

Thread Measurement 2	with right-hand thread
Thread Measurement 1	M12x1,75
Length [mm]	M10x1,5
Cone Size [mm]	55
	10.8

References

0589 333	0656 085
589333	1249 129
656085	

Counterpart

034 026 0017 | MTX0022

Application info

75 [07/92-02/98]
75 CF [02/98-12/00]
85 [07/92-02/98]

85 CF [02/98-12/00]
95 [09/87-01/98]
95 XF [01/97-09/02]

14-34 043 0001 | MEX0567

Switch, splitter gearbox



References

1297 004	1787556
1374 723	

Switch, splitter gearbox

14-34 043 0001 | MEX0567

Application info

75 CF [02/98-12/00]
85 CF [02/98-12/00]
95 XF [01/97-09/02]

CF 75 [01/01--]
CF 85 [01/01--]

Switch, splitter gearbox

14-34 154 0001 | MEX0367

Notes

Number of connectors 4
with threaded coupling
Voltage [V] 24

References

1303 948 1457 275
1379 772



Application info

75 CF [02/98-12/00]
85 CF [02/98-12/00]

95 XF [01/97-09/02]

Switch, splitter gearbox

14-34 154 0002 | MEX0368

Notes

Number of connectors 4
Voltage [V] 24

References

1457 276



Application info

95 XF [01/97-09/02]
CF 65 [01/01--]

CF 75 [01/01--]
CF 85 [01/01--]

3

034 026 0025 | MEX0148

Neutral safety switch



Notes

Operating Pressure [bar] Pneumatic 8

References

0106 321 106321

Application info

F 1700 [12/86-02/95]
F 1900 [12/86-09/93]
F 2100 [07/78-08/91]

F 2300 [07/78-10/93]
F 2500 [02/82-08/91]
F 2800 [01/74-09/91]

034 026 0014 | MEX0146

Neutral safety switch



Notes

Operating Pressure [bar] Pneumatic 8

References

1517 945

Application info

75 CF [02/98-12/00]

85 CF [02/98-12/00]

12-34 126 6017 | MPJ0071

Joint, propeller shaft



Notes

Outer diameter [mm] 57
Length [mm] 144
Centre Piece with add-on material Universal Joint

References

0505 698 0689 962
505698 1252 350
689962

Application info

F 2300 [07/78-10/93]
F 2800 [01/74-09/91]

F 3300 [06/81-09/91]
F 3600 [06/85-09/91]



Clutch booster

834 029 0003 | MBX0210

Notes

Force output F [N]
Stroke [mm]

Brake Fluid
4000
80

References

1504 842



Application info

F 1100 (01/78-11/90)

3

Clutch booster

034 029 0026 | MBX0043

Notes

Force output F [N]
Operating Pressure [bar]
Stroke [mm]

Brake Fluid
6200
10
85

References

1506 468



Application info

XF 95 (09/02-12/06)

Clutch booster

034 042 0016 | MBX0060

Notes

Force output F [N]
Operating Pressure [bar]
Stroke [mm]

Brake Fluid
6000
10
58

References

1518 244



Application info

F 1000 (12/86-12/92)

034 029 0025 | MBX0042

Clutch booster



Notes

Pressure [bar]
Force output F [N]
Stroke [mm]

Brake Fluid
10
6000
50

References

1518 252

Application info

F 2900 [01/90-10/93]

3

Repair kit, kingpin
14-34 068 1706 | MCX0252
Notes

Outer diameter [mm]	Disc Brake
Outer diameter [mm]	31.5
Length [mm]	50
	270
	with ball bearing
	Left and right

References

0681 706	681706
----------	--------

Application info

75 (07/92-02/98)
 75 CF (02/98-12/00)
 85 (07/92-02/98)

85 CF (02/98-12/00)
 95 (09/87-01/98)
 95 XF (01/97-09/02)

Rubber stop, suspension
14-34 162 0001 | MRS0188
Notes

Outer diameter [mm]	Steel Elastomer
Height [mm]	74
	11
	Left and right

References

0361 477	1676 777
361477	

Application info

65 CF (02/98-12/00)
 75 CF (02/98-12/00)

85 CF (02/98-12/00)
 95 XF (01/97-09/02)

Bushing, leaf spring
14-34 032 0001 | MCX0399
Notes

Inner diameter [mm]	24.2
Outer diameter [mm]	63
Height [mm]	86
	Front Axle

References

1357 764



14-34 032 0001 | MCX0399

Bushing, leaf spring

Application info

65 CF (02/98-12/00)
75 CF (02/98-12/00)
85 CF (02/98-12/00)
CF 65 (01/01--)

CF 75 (01/01--)
CF 85 (01/01--)
LF 55 (01/01--)

14-34 032 0002 | MCX0400

Bushing, leaf spring



Notes

Inner diameter [mm]	24
Outer diameter [mm]	63
Height [mm]	106
	Rear Axle
	Front Axle

References

1368 283

Application info

65 CF (02/98-12/00)
75 CF (02/98-12/00)
85 CF (02/98-12/00)

CF 65 (01/01--)
CF 75 (01/01--)
CF 85 (01/01--)

14-34 032 0003 | MCX0401

Bushing, leaf spring



Notes

Inner diameter [mm]	24
Outer diameter [mm]	61
Height [mm]	86
	Rear Axle
	Front Axle

References

1671 219

Application info

85 CF (02/98-12/00)
95 XF (01/97-09/02)

CF 75 (01/01--)
CF 85 (01/01--)

Mount, leaf spring
14-34 742 0001 | MCX0384
Notes

Height [mm]	Rubber-metal Bearing
Width [mm]	205
Length [mm]	135
	220
	Left and right

References

1699 564	1779 767
----------	----------

Application info

 75 CF (02/98-12/00)
 85 CF (02/98-12/00)
 95 XF (01/97-09/02)

 CF 75 (01/01--)
 CF 85 (01/01--)
Control arm
14-36 050 0002 | MCA0243
Notes

Hole Pitch 1/ Hole Pitch 2	Steel
Bore Ø [mm]	152mm/152mm
Pipe Ø [mm]	23
Length [mm]	48
	609
	Wishbone (CV)
	Rear Axle

References

0080 521	1793 875
80521	1817 808
1361 651	1892 482
1368 270	1892 492
1390 932	2001 492
1617 096	

Application info

 65 CF (02/98-12/00)
 75 CF (02/98-12/00)

 85 CF (02/98-12/00)
 95 XF (01/97-09/02)
Rod/strut, suspension
14-36 050 0009 | MSR0105
Notes

Bore Ø 1 [mm]	17
Bore Ø 2 [mm]	17
	Guide Rod
Hole Pitch 1/ Hole Pitch 2	115mm/115mm
Pipe Ø [mm]	46
Length [mm]	665
	Left and right

References

0099 990	99990
099 990	

Parts list

12-34 230 6051 MCX0221	Repair kit, control arm
--------------------------	-------------------------



14-36 050 0009 | MSR0105

Rod/strut, suspension

Application info

75 CF [02/98-12/00]
85 CF [02/98-12/00]
CF 75 [01/01--]

CF 85 [01/01--]
XF 105 [10/05--]
XF 95 [09/02-12/06]

14-36 050 0004 | MSR0107

Rod/strut, suspension



Notes

Bore Ø 1 [mm]	19
Bore Ø 2 [mm]	21
Guide Rod	
Hole Pitch 1/ Hole Pitch 2	130mm/152mm
Pipe Ø [mm]	50
Length [mm]	390
	Left and right

References

1261 101

Parts list

12-34 220 6108 | MCX0219 Repair kit, control arm

Application info

CF 75 [01/01--]
CF 85 [01/01--]

XF 105 [10/05--]
XF 95 [09/02-12/06]

14-34 035 0001 | MSR0076

Rod/strut, suspension



Notes

Bore Ø 1 [mm]	21
Bore Ø 2 [mm]	21
Push Rod	
Molecular Bearing	
Hole Pitch 1/ Hole Pitch 2	130mm/130mm
Pipe Ø [mm]	48
Length [mm]	611
	Rear Axle left and right

References

0267 743	1656 428
1361 649	1817 809
1361 650	

Application info

85 [07/92-02/98]
95 [09/87-01/98]
95 XF [01/97-09/02]
CF 65 [01/01--]
CF 75 [01/01--]

CF 85 [01/01--]
LF 55 [01/01--]
XF 105 [10/05--]
XF 95 [09/02-12/06]

Repair kit, control arm
14-36 035 0003 | MCX0492
Notes

Hole Pitch 1/ Hole Pitch 2	130
Thickness [mm]	30
	for drag link
	Rear Axle

References

0513 757	691 709
513 757	0691 709

Application info

95 XF (01/97-09/02)
 CF 65 (01/01--)
 CF 75 (01/01--)
 CF 85 (01/01--)

LF 55 (01/01--)
 XF 105 (10/05--)
 XF 95 (09/02-12/06)

Repair kit, control arm
12-34 230 6051 | MCX0221
Notes

Hole Pitch 1/ Hole Pitch 2	115
Bore Ø [mm]	17
Thickness [mm]	24
Outer diameter [mm]	75
Length [mm]	150
	for drag link
	Rear Axle

References

0689 748	689748
----------	--------

Application info

75 CF (02/98-12/00)
 85 CF (02/98-12/00)

95 (09/87-01/98)
 95 XF (01/97-09/02)

Repair kit, control arm
034 035 0028 | MCX0088
Notes

Bore Ø [mm]	21
Thickness [mm]	24
Outer diameter [mm]	85
Length [mm]	152
	for wishbone [CV]
	Front and Rear
	Rear Axle

References

0691 703	691703
----------	--------



034 035 0028 | MCX0088

Repair kit, control arm

Application info

F 2100 (07/78-08/91)
F 2200 (01/71-11/80)
F 2300 (07/78-10/93)
F 2500 (02/82-08/91)
F 2600 (02/72-12/73)
F 2700 (01/90-10/93)

F 2800 (01/74-09/91)
F 2900 (01/90-10/93)
F 3200 (01/90-10/93)
F 3300 (06/81-09/91)
F 3600 (06/85-09/91)

034 058 0019 | MCX0104

Repair kit, control arm



Notes

Hole Pitch 1/ Hole Pitch 2	152
Bore Ø [mm]	21
	without bolts for wishbone [CV]
	Rear Axle

References

0693 778	693778
----------	--------

Application info

95 (09/87-01/98)

95 XF (01/97-09/02)

14-34 032 0004 | MCX0504

Bushing, stabilizer



Notes

Inner diameter [mm]	25
Outer diameter [mm]	35
Height [mm]	23
Required quantity	2
	Left and right

References

0268 043	268043
----------	--------

Application info

75 CF (02/98-12/00)

85 CF (02/98-12/00)

Bushing, stabilizer
14-36 010 0028 | MCX0410
Notes

Inner diameter [mm]	26.5
Outer diameter [mm]	52.5
Height [mm]	63
	Left and right

References

1402 562

Application info

CF 75 (01/01--)

Mount, stabilizer
14-36 010 0029 | MSB0295
Notes

Inner diameter [mm]	17
Outer diameter [mm]	55
Height [mm]	130
	Front Axle

References

0082 522	82522
082522	

Application info

SB (---)

Mount, stabilizer
14-36 010 0010 | MSB0342
Notes

Inner diameter [mm]	55
Outer diameter [mm]	84
Outer diameter [mm]	70
Height [mm]	75
	Rear

References

0268 044	268044
----------	--------

Application info

95 (09/87-01/98)

4

14-36 010 0011 | MSB0286

Mount, stabilizer



Notes

Inner diameter [mm]	50
Inner diameter [mm]	82.5
Outer diameter [mm]	70
Height [mm]	75
	Rear

References

0268 045	268045
----------	--------

Application info

95 (09/87-01/98)
F 2100 (07/78-08/91)
F 2300 (07/78-10/93)

F 2500 (02/82-08/91)
F 2800 (01/74-09/91)
F 3300 (06/81-09/91)

14-36 010 0002 | MSB0281

Mount, stabilizer



Notes

Inner diameter [mm]	40
Outer diameter [mm]	60
Height [mm]	23.5
Required quantity	2
	Outer Front Axle

References

0274 650	274650
----------	--------

Application info

75 (07/92-02/98)
85 (07/92-02/98)
95 (09/87-01/98)
F 1100 (01/78-11/90)

F 1300 (07/78-12/92)
F 1700 (12/86-02/95)
F 1900 (12/86-09/93)

14-36 010 0003 | MSB0282

Mount, stabilizer



Notes

Inner diameter [mm]	50
Outer diameter [mm]	70
Outer diameter [mm]	59
Height [mm]	23.5
Required quantity	2
	Rear

References

0274 651	274651
----------	--------

Mount, stabilizer

14-36 010 0003 | MSB0282

Application info

65 CF (02/98-12/00)
75 CF (02/98-12/00)
85 (07/92-02/98)
85 CF (02/98-12/00)
95 (09/87-01/98)
95 XF (01/97-09/02)

F 1700 (12/86-02/95)
F 1900 (12/86-09/93)
F 2100 (07/78-08/91)
F 2300 (07/78-10/93)
F 2500 (02/82-08/91)
F 2700 (01/90-10/93)

Mount, stabilizer

14-36 010 0004 | MSB0283

Notes

Inner diameter [mm]	30
Outer diameter [mm]	55
Height [mm]	60
	Rear
	Front

References

0259 524	0290 825
259524	0299 106
290825	299106



Application info

65 CF (02/98-12/00)
75 CF (02/98-12/00)
85 CF (02/98-12/00)
95 XF (01/97-09/02)
F 1700 (12/86-02/95)

F 1900 (12/86-09/93)
F 2100 (07/78-08/91)
F 2300 (07/78-10/93)
F 2500 (02/82-08/91)
F 2700 (01/90-10/93)

Mount, stabilizer

14-36 010 0005 | MSB0284

Notes

Inner diameter [mm]	20
Outer diameter [mm]	55
Height [mm]	56
	Rear
	Rear Axle

References

0295 726	295726
----------	--------



Application info

65 (03/93-02/98)
75 (07/92-02/98)

85 (07/92-02/98)

4

14-36 010 0021 | MSB0294

Mount, stabilizer



Notes

Inner diameter [mm]	62
Outer diameter [mm]	93
Height [mm]	70
Required quantity	2
	Front Axle

References

0298 498	298498
----------	--------

Application info

75 CF [02/98-12/00]
85 CF [02/98-12/00]

95 [09/87-01/98]

14-36 010 0013 | MSB0331

Mount, stabilizer



Notes

Inner diameter [mm]	65
Outer diameter [mm]	84
Height [mm]	60
	Rear

References

0366 351	366351
----------	--------

Application info

95 [09/87-01/98]

95 XF [01/97-09/02]

14-36 010 0001 | MSB0280

Mount, stabilizer



Notes

Inner diameter [mm]	42
Outer diameter [mm]	84
Outer diameter [mm]	74
Height [mm]	60
	Rear
	Front

References

0538 329	538329
----------	--------

Application info

95 [09/87-01/98]

Mount, stabilizer
14-36 010 0014 | MSB0287
Notes

Inner diameter [mm]	57
Outer diameter [mm]	85
Height [mm]	60.5
	Rear
	Front

References

0558 864	558864
----------	--------

Application info

 65 CF [02/98-12/00]
 75 CF [02/98-12/00]
 85 CF [02/98-12/00]

 95 XF [01/97-09/02]
 F 2300 [07/78-10/93]
 F 2700 [01/90-10/93]

Mount, stabilizer
14-36 010 0016 | MSB0289
Notes

Inner diameter 1 [mm]	51
Inner diameter [mm]	51
Outer diameter 2 [mm]	85
Outer diameter 1 [mm]	74
Height [mm]	60
Required quantity	2
	Rear
	Front

References

0763 523	763523
----------	--------

Application info

 75 CF [02/98-12/00]
 85 CF [02/98-12/00]
 95 XF [01/97-09/02]
 CF 75 [01/01--]

 CF 85 [01/01--]
 F 1700 [12/86-02/95]
 F 1900 [12/86-09/93]

Mount, stabilizer
14-36 010 0007 | MSB0285
Notes

Inner diameter [mm]	20
Outer diameter [mm]	60
Height [mm]	60
	Outer
	Rear Axle

References

1283 618



14-36 010 0007 | MSB0285

Mount, stabilizer

Application info

85 CF (02/98-12/00)

95 XF (01/97-09/02)

14-36 010 0015 | MSB0288

Mount, stabilizer



Notes

Inner diameter [mm]	49
Outer diameter [mm]	93.5
Outer diameter [mm]	83
Height [mm]	61
	Rear
	Rear Axle

References

1323 838

Application info

65 CF (02/98-12/00)
75 CF (02/98-12/00)
85 CF (02/98-12/00)
95 XF (01/97-09/02)

CF 65 (01/01--)
CF 75 (01/01--)
CF 85 (01/01--)

14-36 010 0020 | MSB0293

Mount, stabilizer



Notes

Inner diameter [mm]	55
Outer diameter [mm]	83
Height [mm]	60
	Rear Axle

References

1323 839

Application info

75 CF (02/98-12/00)

Mount, stabilizer
14-36 010 0019 | MSB0292
Notes

Inner diameter [mm]	33.5
Outer diameter 2 [mm]	57.5
Outer diameter 1 [mm]	53
Height [mm]	62.5
	Front Axle

References

1400 147

Application info

 75 CF [02/98-12/00]
 85 CF [02/98-12/00]

95 XF [01/97-09/02]

Mount, stabilizer
14-36 010 0023 | MSB0256
Notes

Inner diameter [mm]	46
Required quantity	2
	Front Axle

References

1402 587

Application info

75 CF [02/98-12/00]

Mount, stabilizer
14-36 010 0022 | MSB0255
Notes

Inner diameter [mm]	48
Required quantity	2
	Front Axle

References

1402 590

Application info

75 CF [02/98-12/00]

4

14-36 010 0018 | MSB0291

Mount, stabilizer



Notes

Inner diameter [mm]	39
Outer diameter 2 [mm]	71
Outer diameter 1 [mm]	63
Height [mm]	60
	Front Axle

References

1288 000	1732 886
----------	----------

Application info

65 CF (02/98-12/00)
75 CF (02/98-12/00)
85 CF (02/98-12/00)

95 XF (01/97-09/02)
CF 75 (01/01--)
CF 85 (01/01--)

14-36 010 0017 | MSB0290

Mount, stabilizer



Notes

Inner diameter [mm]	42.5
Outer diameter [mm]	60
Height [mm]	60
	Front Axle

References

1291 233	1732 887
----------	----------

Application info

75 CF (02/98-12/00)
85 CF (02/98-12/00)
95 XF (01/97-09/02)

CF 75 (01/01--)
CF 85 (01/01--)
LF 45 (01/01--)

14-36 010 0027 | MCX0409

Repair kit, stabilizer bushing



Notes

Inner diameter [mm]	50
Outer diameter [mm]	60
Height [mm]	23.5
	Rear Axle
	Front Axle

References

0274 651	274651
----------	--------

Application info

75 CF (02/98-12/00)
85 CF (02/98-12/00)

95 XF (01/97-09/02)



Repair kit, stabilizer bushing

14-34 032 0006 | MCX0476

Notes

Inner diameter [mm]	65
Outer diameter [mm]	84
Height [mm]	50
	Rear Axle

References

0286 369	0366 351
286369	366351
311049	1283 618
0311 049	

Parts list

14-36 010 0013 | MSB0331 Mount, stabilizer



Application info

95 (09/87-01/98)

95 XF (01/97-09/02)

Repair kit, stabilizer bushing

14-36 010 0025 | MCX0408

Notes

Inner diameter [mm]	20
Outer diameter [mm]	60
Height [mm]	59.5
	Rear Axle

References

1283 618

Parts list

14-36 010 0007 | MSB0285 Mount, stabilizer



Application info

65 CF (02/98-12/00)
 75 CF (02/98-12/00)
 85 CF (02/98-12/00)
 95 XF (01/97-09/02)

CF 75 (01/01--)
 CF 85 (01/01--)
 LF 55 (01/01--)

Wheel bearing kit

14-34 650 0001 | MWK0105

Notes

	with add-on material
Inner diameter [mm]	70
Outer diameter [mm]	125
Height [mm]	114
	Front Axle left and right

References

1801 592



4



14-34 650 0001 | MWK0105

Wheel bearing kit

Application info

75 CF (02/98-12/00)
85 CF (02/98-12/00)
CF 65 (01/01--)
CF 75 (01/01--)

CF 85 (01/01--)
LF 55 (01/01--)
XF 105 (10/05--)
XF 95 (09/02-12/06)

034 650 0001 | MWB0016

Wheel bearing



Notes

Inner diameter [mm]	50
Outer diameter [mm]	110
Height [mm]	42.25
DIN / ISO	32310 A
	Tapered Roller Bearing
	Outer
	Rear Axle left and right
	Front Axle left and right

References

0556 289	626875
556289	0626 875

Application info

75 (07/92-02/98)
75 CF (02/98-12/00)
85 (07/92-02/98)
85 CF (02/98-12/00)
95 (09/87-01/98)
95 XF (01/97-09/02)
F 1600 (01/70-08/91)

F 2100 (07/78-08/91)
F 2300 (07/78-10/93)
F 2500 (02/82-08/91)
F 2800 (01/74-09/91)
F 3300 (06/81-09/91)
F 3600 (06/85-09/91)

12-14 650 0005 | MWB0049

Wheel bearing



Notes

Inner diameter [mm]	45
Outer diameter [mm]	85
Height [mm]	32.2
	Tapered Roller Bearing
	Outer
	Front Axle

References

0636 820	636820
----------	--------

Application info

F 600 (12/86-12/92)
F 800 (12/86-08/91)

LF 55 (01/01--)



Wheel bearing

14-34 650 0002 | MWB0058

Notes

Inner diameter [mm]	90
Outer diameter [mm]	160
Height [mm]	125
	Rear Axle

References

1400 291	1705 686
1408 086	



Application info

LF 55 (01/01--)

Wheel bearing

16-34 650 0001 | MWB0059

Notes

Inner diameter [mm]	93.8
Outer diameter [mm]	148
Height [mm]	135
	Rear Axle



Application info

XF 105 (10/05--)

4

14-36 020 0019 | MTA0222

Tie rod assembly



Notes

Pipe Ø [mm]

Thread Measurement 2

Thread Measurement 1

Length [mm]

Cone Size [mm]

Guide Rod
Nut with lateral notches
52
with metric thread
M30x1,5
M30x1,5
1522
26
Front Axle

References

1297 572

1361 155

Parts list

12-36 020 0039 | MTE0655

Tie rod end

Application info

95 XF [01/97-09/02]

CF 75 [01/01--]

CF 85 [01/01--]

XF 105 [10/05--]

XF 95 [09/02-12/06]

14-36 040 0017 | MDL0097

Drag link



Notes

Pipe Ø [mm]

Thread Measurement 2

Thread Measurement 1

Length [mm]

Cone Size [mm]

Push Rod
50
with right-hand thread
M30x1,5
M24x1,5
991
for right-hand drive vehicles
30
Front Axle

References

1395 994

Parts list

036 020 0004 | MTE0047

Tie rod end

Application info

CF 85 [01/01--]

XF 105 [10/05--]

XF 95 [09/02-12/06]

Tie rod end

14-36 040 0003 | MTE0543

Notes

Thread Measurement 2
Thread Measurement 1
Length [mm]

Cone Size [mm]

Nut with lateral notches
with left-hand thread
M48x1,5
M24x1,5
133
for left-/right-hand traffic
30
Front Axle

References

0067 303
067303

67303

Counterpart

14-36 040 0004 | MTE0174



Application info

75 (07/92-02/98)
75 CF (02/98-12/00)
85 (07/92-02/98)

85 CF (02/98-12/00)
95 (09/87-01/98)
95 XF (01/97-09/02)

Tie rod end

14-36 040 0004 | MTE0174

Notes

Thread Measurement 2
Thread Measurement 1
Length [mm]

Cone Size [mm]

Nut with lateral notches
with right-hand thread
M48x1,5
M24x1,5
133
for left-/right-hand traffic
30
Front Axle

References

0067 389
067389

67389

Counterpart

14-36 040 0003 | MTE0543



Application info

75 (07/92-02/98)
75 CF (02/98-12/00)
85 (07/92-02/98)

85 CF (02/98-12/00)
95 (09/87-01/98)
95 XF (01/97-09/02)

036 020 0016 | MTE0059

Tie rod end



Notes

Thread Measurement 2
Thread Measurement 1
Length [mm]

Cone Size [mm]

References

0608 530

Nut with lateral notches
with right-hand thread
M24x1,5
M16x1,5
104
for left-/right-hand traffic
20
Front Axle

608530

Counterpart

036 020 0015 | MTE0058

Application info

75 CF [02/98-12/00]
85 CF [02/98-12/00]

95 [09/87-01/98]
95 XF [01/97-09/02]

12-36 020 0007 | MTE0170

Tie rod end



Notes

Thread Measurement 2
Thread Measurement 1
Length [mm]

Cone Size [mm]

References

0069 867
069867
69867
161376
0161 376

Nut with lateral notches
with right-hand thread
M30x1,5
M20x1,5
126
for left-/right-hand traffic
26
Front Axle

0608 000
608000
1142 173
1326 866

Application info

F 1600 [01/70-08/91]

F 1800 [01/70-08/91]

Tie rod end
036 020 0003 | MTE0046
Notes

Thread Measurement 2
Thread Measurement 1
Length [mm]

Cone Size [mm]

Nut with lateral notches
with right-hand thread
M28x1,5
M18x1,5
106
for left-/right-hand traffic
22
Front Axle

References

0100 197
100197
110197
0110 197
0607 451
607451

607453
0607 453
1228 114
1326 864
1373 135
ACU9242

Counterpart

036 020 0008 | MTE0051

Application info

F 1200 [01/69-12/81]
F 1700 [12/86-02/95]

F 1900 [12/86-09/93]

Tie rod end
036 020 0005 | MTE0048
Notes

Thread Measurement 2
Thread Measurement 1
Length [mm]

Cone Size [mm]

Nut with lateral notches
with left-hand thread
M30x1,5
M24x1,5
125
for left-/right-hand traffic
30
Front Axle

References

0607 053
607053
696205

0696 205
1228 115

Counterpart

036 020 0004 | MTE0047

Application info

75 [07/92-02/98]
75 CF [02/98-12/00]
85 [07/92-02/98]
85 CF [02/98-12/00]
95 [09/87-01/98]
95 XF [01/97-09/02]

F 1600 [01/70-08/91]
F 1700 [12/86-02/95]
F 1900 [12/86-09/93]
F 2000 [01/70-12/79]
F 2100 [07/78-08/91]

036 020 0005/HD | MTE0048HD

Tie rod end



Notes

Thread Measurement 2
Thread Measurement 1
Length [mm]

Cone Size [mm]

Reinforced Version

Nut with lateral notches
with left-hand thread
M30x1,5
M24x1,5
125
for left-/right-hand traffic
30
Front Axle

References

0607 053	0696 225
607053	696225
696205	1228 115
0696 205	

Counterpart

036 020 0004/HD | MTE0047HD

Application info

75 (07/92-02/98)
75 CF (02/98-12/00)
85 (07/92-02/98)
85 CF (02/98-12/00)
95 (09/87-01/98)

F 1600 (01/70-08/91)
F 1700 (12/86-02/95)
F 1900 (12/86-09/93)
F 2000 (01/70-12/79)
F 2100 (07/78-08/91)

036 020 0004/HD | MTE0047HD

Tie rod end



Notes

Thread Measurement 2
Thread Measurement 1
Length [mm]

Cone Size [mm]

Reinforced Version

Nut with lateral notches
with right-hand thread
M30x1,5
M24x1,5
125
for left-/right-hand traffic
30
Front Axle

References

0607 981	0698 450
607981	698450
696226	1257 890
0696 226	1603 789

Counterpart

036 020 0005/HD | MTE0048HD

Application info

85 (07/92-02/98)

95 (09/87-01/98)



Tie rod end

036 020 0002 | MTE0045

Notes

Thread Measurement 2
Thread Measurement 1
Length [mm]

Cone Size [mm]

Nut with lateral notches
with left-hand thread
M30x1,5
M20x1,5
114
for left-/right-hand traffic
26
Front Axle

References

0311 300
311300
607998
0607 998
1315 447
1319 838

1338 714
1689 604
1892 666
1923 863
AMPA346

Counterpart

036 020 0001 | MTE0044



Application info

75 CF [02/98-12/00]
F 1300 [07/78-12/92]
F 1400 [02/72-12/81]
F 1500 [--08/91]

F 1600 [01/70-08/91]
F 1700 [12/86-02/95]
F 1800 [01/70-08/91]
F 1900 [12/86-09/93]

Tie rod end

036 020 0001 | MTE0044

Notes

Thread Measurement 2
Thread Measurement 1
Length [mm]

Cone Size [mm]

Nut with lateral notches
with right-hand thread
M30x1,5
M20x1,5
114
for left-/right-hand traffic
26
Front Axle

References

0586 753
586753
0607 999
0694 298
694298
694360

0694 360
0698 609
698609
1229 944
1326 896
1331 925

Counterpart

036 020 0002 | MTE0045



Application info

75 CF [02/98-12/00]

036 020 0008 | MTE0051

Tie rod end



Notes

Thread Measurement 2
Thread Measurement 1
Length [mm]

Cone Size [mm]

Nut with lateral notches
with left-hand thread
M28x1,5L
M18x1,5
106
for left-/right-hand traffic
22
Front Axle

References

Ø110 196
110196
Ø607 452

607452
1373 137
ACU9241

Counterpart

036 020 0003 | MTE0046

Application info

F 1200 [01/69-12/81]
F 1700 [12/86-02/95]

F 1900 [12/86-09/93]

12-36 020 0039 | MTE0655

Tie rod end



Notes

Thread Measurement 2
Thread Measurement 1
Length [mm]

Cone Size [mm]

Nut with lateral notches
with right-hand thread
M24x1,5
M30x1,5
141
for left-/right-hand traffic
26
Front Axle

References

1 389 190

Application info

65 CF [02/98-12/00]
75 CF [02/98-12/00]
85 CF [02/98-12/00]
95 XF [01/97-09/02]

CF 75 [01/01--]
CF 85 [01/01--]
XF 105 [10/05--]
XF 95 [09/02-12/06]

14-36 020 0027 | MTE0739

Tie rod end



Notes

Thread Measurement 2
Thread Measurement 1
Length [mm]
Cone Size [mm]

Self-locking
with left-hand thread
M30x1,5
M18x1,5
120
22
Front Axle

References

1401 942

AFRA635

Tie rod end

14-36 020 0027 | MTE0739

Application info

LF 45 (01/01--)

Tie rod end

036 020 0004 | MTE0047

Notes

Thread Measurement 2
Thread Measurement 1
Length [mm]

Cone Size [mm]

Nut with lateral notches
with right-hand thread
M30x1,5
M24x1,5
125
for left-/right-hand traffic
30
Front Axle

References

0607 981
607981
696226
0696 226

0698 450
698450
1257 890
1603 789

Counterpart

036 020 0005 | MTE0048



Application info

85 (07/92-02/98)
95 (09/87-01/98)

95 XF (01/97-09/02)

Tie rod end

836 020 0006 | MTE0728

Notes

Thread Measurement 2
Thread Measurement 1
Length [mm]

Cone Size [mm]

Nut with lateral notches
with right-hand thread
M30x1,5
M24x1,5
141
for left-/right-hand traffic
30
Front Axle

References

1685 552



Application info

85 CF (02/98-12/00)
95 XF (01/97-09/02)
CF 75 (01/01--)

CF 85 (01/01--)
XF 105 (10/05--)
XF 95 (09/02-12/06)

036 020 0015 | MTE0058

Tie rod end



Notes

Thread Measurement 2
Thread Measurement 1
Length [mm]

Cone Size [mm]

Counterpart

036 020 0016 | MTE0059

Nut with lateral notches
with left-hand thread
M24x1,5
M16x1,5
104
for left-/right-hand traffic
20
Front Axle

Application info

75 CF [02/98-12/00]
85 CF [02/98-12/00]

95 [09/87-01/98]
95 XF [01/97-09/02]

14-36 631 0001 | MHP0058

Hydraulic pump, P/S



Notes

Thread Measurement 2
Number of connectors
Thread Measurement 1
Operating Pressure [bar]

References

052663
0526 63R
1239 411

Hydraulic
Cast Aluminium
M26x1,5
2
M16x1,5
150
Anti-clockwise rotation

Application info

75 [07/92-02/98]
75 CF [02/98-12/00]
85 [07/92-02/98]

85 CF [02/98-12/00]
95 [09/87-01/98]
95 XF [01/97-09/02]

14-34 631 0004 | MHP0057

Hydraulic pump, P/S

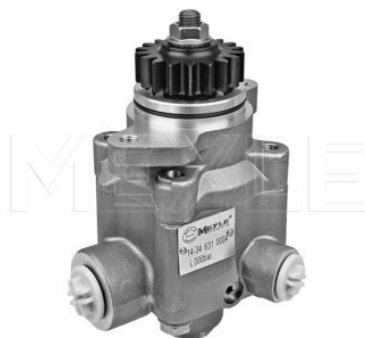

Notes

Thread Measurement 2
Number of connectors
Thread Measurement 1

References

1375 507

Hydraulic
Steel
M26X1
2
M18x1,5
Anti-clockwise rotation



Hydraulic pump, P/S

14-34 631 0004 | MHP0057**Application info**75 CF (02/98-12/00)
85 CF (02/98-12/00)CF 75 (01/01--)
CF 85 (01/01--)

Hydraulic filter, steering system

034 046 0000 | MSX0026**Notes**

Thickness [mm]	100
Inner diameter [mm]	17.1
Outer diameter [mm]	59

References

0229 348 229348

**Application info**

75 (07/92-02/98)
 75 CF (02/98-12/00)
 85 (07/92-02/98)
 85 CF (02/98-12/00)
 95 (09/87-01/98)
 95 XF (01/97-09/02)
 CF 65 (01/01--)
 CF 75 (01/01--)
 CF 85 (01/01--)
 F 1100 (01/78-11/90)
 F 1200 (01/69-12/81)
 F 1300 (07/78-12/92)
 F 1400 (02/72-12/81)
 F 1500 (--08/91)
 F 1600 (01/70-08/91)
 F 1700 (12/86-02/95)
 F 1800 (01/70-08/91)
 F 1900 (12/86-09/93)
 F 2000 (01/70-12/79)

F 2100 (07/78-08/91)
 F 2200 (01/71-11/80)
 F 2300 (07/78-10/93)
 F 2500 (02/82-08/91)
 F 2600 (02/72-12/73)
 F 2700 (01/90-10/93)
 F 2800 (01/74-09/91)
 F 2900 (01/90-10/93)
 F 3200 (01/90-10/93)
 F 3300 (06/81-09/91)
 F 3600 (06/85-09/91)
 F 800 (12/86-08/91)
 F 900 (01/75-11/88)
 LF 45 (01/01--)
 LF 55 (01/01--)
 N 2800 (01/81-09/91)
 XF 105 (10/05--)
 XF 95 (09/02-12/06)

5

14-34 026 0003 | MIX0312

Gear shift knob



Notes

Outer thread [mm]	M42x1,5
Number of connectors	3
Length [mm]	155

References

1285 258	1833 030
----------	----------

Application info

75 CF (02/98-12/00)
85 CF (02/98-12/00)
95 XF (01/97-09/02)

CF 75 (01/01--)
CF 85 (01/01--)

14-34 026 0001 | MIX0321

Gear shift knob



Notes

Outer thread [mm]	M42x1,5
Number of connectors	4
Length [mm]	156

References

1285 260

Application info

75 CF (02/98-12/00)
85 CF (02/98-12/00)
95 XF (01/97-09/02)

CF 75 (01/01--)
CF 85 (01/01--)

14-12 319 0001 | MCF0120

Cabin air filter

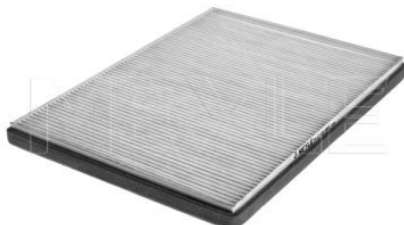

Notes

Height [mm]	23.5
Width [mm]	224
Length [mm]	338
	Filter Insert
	Particulate Filter

References

1322 255	1658 991
----------	----------

Application info

95 XF (01/97-09/02)

Cabin air filter

14-12 319 0005 | MCF0123

Notes

Height [mm] 38
Width [mm] 164
Length [mm] 260
Filter Insert
Particulate Filter

References

1362 124 1791 192



Application info

CF 65 (01/01--) CF 85 (01/01--)
CF 75 (01/01--)

Cabin air filter

14-12 319 0004 | MCF0122

Notes

Height [mm] 20
Width [mm] 105
Length [mm] 230
Filter Insert
Particulate Filter

References

1600 428



Application info

LF 45 (01/01--) LF 55 (01/01--)

Cabin air filter

14-12 319 0000 | MCF0119

Notes

Height [mm] 23.5
Width [mm] 169
Length [mm] 432
Filter Insert
Particulate Filter

References

1322 259 1825 428
1659 691



Application info

75 CF (02/98-12/00) CF 65 (01/01--)
85 CF (02/98-12/00) CF 75 (01/01--)

6

14-12 319 0007 | MCF0455

Cabin air filter



Notes

Height [mm]	10
Width [mm]	94
Length [mm]	205
	Particulate Filter

References

182 9399	195 0785
----------	----------

Application info

LF 45 [01/01--]

LF 55 [01/01--]

14-34 089 0011 | MIX0282

Spacer, driver cab stabiliser



References

1271 385	1399 159
----------	----------

Application info

65 CF [02/98-12/00]
75 CF [02/98-12/00]
85 CF [02/98-12/00]

95 [09/87-01/98]
95 XF [01/97-09/02]
CF 85 [01/01--]

14-34 089 0010 | MIX0259

Bushing, driver cab suspension



Notes

Inner diameter 1 [mm]	25
Outer diameter 2 [mm]	51
Outer diameter 1 [mm]	30
Height 1 [mm]	20.3
	Front

References

1266 426	1656 266
1399 160	

Application info

CF 85 [01/01--]



Bushing, driver cab suspension

14-34 089 0003 | MIX0258

Notes

Inner diameter 1 [mm]	20
Outer diameter 1 [mm]	60
Height 2 [mm]	48
Height 1 [mm]	39
	Front

References

1290 794



Application info

95 [09/87-01/98]

95 XF [01/97-09/02]

Bushing, driver cab suspension

14-34 089 0001 | MIX0297

Notes

Inner diameter 1 [mm]	20
Outer diameter 1 [mm]	90
Height 1 [mm]	70

References

1314 545



Application info

95 [09/87-01/98]

95 XF [01/97-09/02]

Bushing, driver cab suspension

14-34 089 0005 | MIX0303

Notes

Inner diameter 1 [mm]	20
Outer diameter 2 [mm]	83
Outer diameter 1 [mm]	60
Height 1 [mm]	24
	Rear

References

1298 675
1396 202

1438 837

Parts list

14-34 089 0009 | MIX0304

Repair kit, driver cab mounting



Application info

65 CF [02/98-12/00]
75 CF [02/98-12/00]

85 CF [02/98-12/00]

14-34 089 0008 | MIX0268

Bushing, driver cab suspension



Notes

Inner diameter 1 [mm]	30
Outer diameter 1 [mm]	55
Height 1 [mm]	25
	Left and right

References

1694 967

Application info

XF 95 (09/02-12/06)

14-34 089 0008/S | MIX0269

Repair kit, driver cab mounting



References

1243 049	1964 968
1694 967	1964 969
1699 375	

Parts list

14-34 089 0008 MIX0268	Bushing, driver cab suspension
--------------------------	--------------------------------

Application info

XF 105 (10/05--)

XF 95 (09/02-12/06)

14-34 032 0009 | MIX0308

Repair kit, driver cab mounting



References

1314 545

Parts list

14-34 089 0001 MIX0297	Bushing, driver cab suspension
--------------------------	--------------------------------

Application info

95 (09/87-01/98)

95 XF (01/97-09/02)



Repair kit, driver cab mounting

14-34 032 0010 | MIX0296

References

1314 545

Parts list

14-34 089 0001 | MIX0297

Bushing, driver cab suspension



Application info

95 [09/87-01/98]

95 XF [01/97-09/02]

Repair kit, driver cab mounting

14-34 089 0009 | MIX0304

References

1298 675
1396 202

1438 837



Application info

65 CF [02/98-12/00]
75 CF [02/98-12/00]

85 CF [02/98-12/00]

Tilt pump, driver cab

14-34 910 0100 | MIX0241

Notes

for left-hand drive vehicles

References

1315 942



Application info

95 XF [01/97-09/02]

14-34 910 0101 | MIX0242

Tilt pump, driver cab



Notes

for right-hand drive vehicles

References

1382 282
1450 902

1914 281

Application info

65 CF [02/98-12/00]
75 CF [02/98-12/00]
85 CF [02/98-12/00]
CF 75 [01/01--]
CF 85 [01/01--]
F 1100 [01/78-11/90]
F 1300 [07/78-12/92]

F 1600 [01/70-08/91]
F 1900 [12/86-09/93]
F 2100 [07/78-08/91]
F 2300 [07/78-10/93]
F 2500 [02/82-08/91]
LF 55 [01/01--]

14-34 910 1002 | MIX0243

Tilt cylinder, driver cab



Notes

Outer thread [mm]	M14x1,5
Outer thread [mm]	M12x1,5
Pressure [bar]	250
Outer diameter [mm]	50
Length 2 [mm]	1386
Length 1 [mm]	862
Stroke [mm]	524

References

1308 300

1346 200

Application info

75 CF [02/98-12/00]
85 CF [02/98-12/00]

95 XF [01/97-09/02]
LF 45 [01/01--]

14-34 910 0001 | MIX0187

Ignition lock cylinder



References

1277 475

1336 529

Ignition lock cylinder

14-34 910 0001 | MIX0187

Application info

65 CF (02/98-12/00)
75 CF (02/98-12/00)
85 CF (02/98-12/00)

95 XF (01/97-09/02)
CF 65 (01/01--)
CF 75 (01/01--)

Wiper Blade

029 600 2470 | MBL0035

Notes

Length [in]
Length [mm]

Bracket wiper blade
Beam wiper blade
24
600
Front

References

1260 954

1260954G



Application info

65 (03/93-02/98)
65 CF (02/98-12/00)
75 (07/92-02/98)
75 CF (02/98-12/00)
85 (07/92-02/98)
85 CF (02/98-12/00)
CF 65 (01/01--)
CF 75 (01/01--)
CF 85 (01/01--)
F 1100 (01/78-11/90)

F 1500 (--08/91)
F 2600 (02/72-12/73)
F 500 (12/77-12/79)
F 600 (12/86-12/92)
F 700 (12/75-12/79)
F 800 (12/86-08/91)
F 900 (01/75-11/88)
N 2800 (01/81-09/91)
N 3300 (01/81-09/91)

Wiper Blade

029 500 2070/S | MBL0060

Notes

Observe service information

Length [in]
Length [mm]

Beam wiper blade
Bracket wiper blade
Set
20
500
Front

References

513952

1517 862



Application info

55 (11/95-12/00)

029 600 2471 | MBL0071

Wiper Blade



Notes

Observe service information

Length [in]
Length [mm]

Beam wiper blade
Bracket wiper blade

Set
24
600
with pipe connector
with integrated washer-fluid
jet
Front

References

1401 103
1405 387

1408 385
1954 744

Application info

LF 45 [01/01--]

LF 55 [01/01--]

MEYLE no.	Ref. no.	Page
DAF		
025 290 8730	1439 324	31
	1617 343	
	1797 053	
	1878 030	
025 290 8730/S	1439 324	32
029 500 2070/S	513952	85
	1517 862	
029 600 2470	1260 954	85
	12609546	
029 600 2471	1401 103	86
	1405 387	
	1408 385	
	1954 744	
034 009 0003	1315 514	8
034 009 0013	1438 836	7
	1604 476	
	1683 353	
034 009 0015	0194 194	7
	194194	
	1311 608	
034 013 0006	1517 929	36
	BBU5510	
034 015 0005	0068 499	3
	068499	
	68499	
034 026 0014	1517 945	48
034 026 0017	0592 106	46
	592106	
	656084	
	0656 084 1249 088	
034 026 0018	0589 333	46
	589333	
	656085	
	0656 085 1249 129	
034 026 0025	0106 321	48
	106321	
034 026 0026	0609 715	45
	609715	
034 026 0027	0069 237	43
	069237	
	69237	
	692183 0692 183	
034 026 0030	0262 633	44

MEYLE no.	Ref. no.	Page
DAF		
	262633	
034 029 0025	1518 252	50
034 029 0026	1506 468	49
034 035 0028	0691 703	55
	691703	
034 042 0001	0501 182	40
	501182	
	706123	
	0706 123 FBU8648	
034 042 0002	0691 602	41
	691602	
	694277	
	0694 277	
034 042 0003	0305 049	42
	305049	
	533891	
	0533 891 0706 128 706128	
034 042 0016	1518 244	49
034 042 0024	0587 805	39
	587805	
	123 8508	
034 042 0033	1427 369	38
034 042 0034	0109 916 109916	38
034 042 0038	1504 961	38
034 042 0039	1519 232	39
034 042 0043	0695 751	42
	695751	
034 042 0051	0288 495	40
	288495	
	307475	
	0307 475	
	0507 808	
	507808	
	587808 0587 808	
034 042 0061	0689 511	41
	689511	
	FBU9614	
034 042 0062	0689 366 689366	41
034 043 0002	0303 055 303055	42

MEYLE no.	Ref. no.	Page
DAF		
	1325 345	
034 043 0005	1505 023	39
034 043 0039	0167 846 167846	40
034 043 0069	1302 103 1506 488	44
034 043 0073	1304 635 1505 210	43
034 046 0000	0229 348 229348	77
034 058 0019	0693 778 693778	56
034 533 0017	1315 698 1504 951	33
034 533 0035	1518 311	36
034 650 0001	0556 289 556289 626875 0626 875	66
036 020 0001	0586 753 586753 0607 999 0694 298 694298 694360 0694 360 0698 609 698609 1229 944 1326 896 1331 925	73
036 020 0002	0311 300 311300 607998 0607 998 1315 447 1319 838 1338 714 1689 604 1892 666 1923 963 AMPA346	73
036 020 0003	0100 197 100197 110197 0110 197	71

MEYLE no.	Ref. no.	Page
DAF		
	0607 451 607451 607453 0607 453 1228 114 1326 864 1373 135 ACU9242	
036 020 0004	0607 981 607981 696226 0696 226 0698 450 698450 1257 890 1603 789	75
036 020 0004/HD	0607 981 607981 696226 0696 226 0698 450 698450 1257 890 1603 789	72
036 020 0005	0607 053 607053 696205 0696 205 1228 115	71
036 020 0005/HD	0607 053 607053 696205 0696 205 696225 1228 115	72
036 020 0008	0110 196 110196 0607 452 607452 1373 137 ACU9241	74
036 020 0015	-	76
036 020 0016	0608 530 608530	70
050 007 1750	1638 698	29

MEYLE no.	Ref. no.	Page
DAF		
	1812 162	
050 008 1215	1393 344	28
050 008 1398	0067 690 067690 67690 490269 0490 269 CBU1182 CBU1532	26
050 008 1525	1388 161 1702 605	27
050 008 1720	1393 365	28
050 008 1915	1152 425 1372 669	27
050 008 2050	1393 280	27
050 008 2120	1444 203	29
050 008 2380	1398 637	28
050 009 1380	1654 398 1661 948	29
050 009 1424	1661 949 1661 954	30
052 010 0975	0679 733 679733	25
052 013 1000	1425 709	26
052 013 1050	0296 961 296961	24
052 013 1475	0238 770 238770 655043 0655 043	25
052 013 1525	248761 1265 398	25
052 013 1535	-	26
052 013 1600	0067 681 067681 67681	24
052 013 1675	238670	24
12-14 650 0005	0636 820 636820	66
12-34 026 0002	1300 662 1374 724	43
12-34 032 0000	0759 050 759050 1341 990 1445 900 1600 469	37

MEYLE no.	Ref. no.	Page
DAF		
12-34 042 0010	1142 142 1198 153 1198 154 1448 915	31
12-34 126 6017	0505 698 505698 689962 0689 962 1252 350	48
12-34 230 6051	0689 748 689748	55
12-34 323 0008	1296 851	8
12-34 899 0004	1697 325	3
12-36 020 0007	0069 867 069867 69867 161376 0161 376 0608 000 608000 1142 173 1326 866	70
12-36 020 0039	1 389 190	74
14-12 319 0000	1322 259 1659 691 1825 428	79
14-12 319 0001	1322 255 1658 991	78
14-12 319 0004	1600 428	79
14-12 319 0005	1362 124 1791 192	79
14-12 319 0007	182 9399 195 0785	80
14-12 321 0001	1638 054	5
14-12 321 0007	1363 023 1363 025 1638 026 1640 920 1657 522 1726 061 1789 292	6
14-33 220 0002	1664 762 1738 991 1778 280 1828 162	17
14-33 220 0003	0683 579	17

MEYLE no.	Ref. no.	Page
DAF		
	683 579 1399 150 1609 853 0683 579 R 683 579 R	
14-34 000 0001	1398 620 1458 764 1614 978 1628 148	23
14-34 000 0002	1406 486 1702 525	22
14-34 000 0003	1627 625 1694 953 1695 242	23
14-34 000 0004	1638 696 1687 821 1699 240 1811 819	23
14-34 001 0002	0376 729 376 729 1283 752 1298 923 1320 372 1366 063	1
14-34 001 0003	0683494 683494 683532 0683532	1
14-34 001 0004	1445 893 1693 518 1699 517	2
14-34 009 0002	0247 138 247138 247139 0247 139 1318 695	9
14-34 018 0001	1397 764	4
14-34 018 0002	1397 766 1784 782	9
14-34 018 0004	1345 335	9
14-34 018 0007	1399 494	4
14-34 018 0008	1399 760	10
14-34 018 0013	1629 393 1643 070 1948 921 1643 070G	4

MEYLE no.	Ref. no.	Page
DAF		
	1948 921G	
14-34 018 0016	1433 649	10
14-34 026 0001	1285 260	78
14-34 026 0003	1285 258 1833 030	78
14-34 032 0001	1357 764	51
14-34 032 0002	1368 283	52
14-34 032 0003	1671 219	52
14-34 032 0004	0268 043 268043	56
14-34 032 0006	0286 369 286369 311049 0311 049 0366 351 366351 1283 618	65
14-34 032 0009	1314 545	82
14-34 032 0010	1314 545	83
14-34 035 0001	0267 743 1361 649 1361 650 1656 428 1817 809	54
14-34 038 0001	1315 381 1458 701	3
14-34 042 0005	1391 510	36
14-34 043 0001	1297 004 1374 723 1787556	46
14-34 068 1706	0681 706 681706	51
14-34 089 0001	1314 545	81
14-34 089 0003	1290 794	81
14-34 089 0005	1298 675 1396 202 1438 837	81
14-34 089 0008	1694 967	82
14-34 089 0008/S	1243 049 1694 967 1699 375 1964 968 1964 969	82
14-34 089 0009	1298 675 1396 202 1438 837	83

MEYLE no.	Ref. no.	Page
DAF		
14-34 089 0010	1266 426	80
	1399 160	
	1656 266	
14-34 089 0011	1271 385	80
	1399 159	
14-34 154 0001	1303 948	47
	1379 772	
	1457 275	
14-34 154 0002	1457 276	47
14-34 162 0001	0361 477	51
	361477	
	1676 777	
14-34 223 0001	1295 910	18
	1607 794	
14-34 223 0002	1320 045	20
	1327 199	
	1624 782	
14-34 223 0003	1453 046	20
	1624 784	
14-34 223 0004	1371 329	20
	1660 859	
	1871 493	
14-34 223 0005	1626 237	18
14-34 223 0006	1684 655	19
14-34 232 0002	1308 285	15
	1399 180	
	1448 197	
	1733 234	
14-34 232 0005	1291 218	15
14-34 232 0006	1376 260	16
14-34 232 0007	1293 812	15
14-34 232 0008	1236 096	14
14-34 232 0009	1338 736	16
	1402 417	
14-34 232 0010	1403 248	17
	1402 417	
14-34 232 0011	1282 146	14
	1403 238	
14-34 232 0012	1399 819	16
14-34 234 0001	1449 678	13
	1449 679	
14-34 234 0002	1737 460	14
	1742 083	
	1806 713	
	1916 598	
14-34 234 0003	1677 080	13
	1693 441	

MEYLE no.	Ref. no.	Page
DAF		
	1697 677	
	1732 273	
	1732 274	
	1806 712	
	1916 597	
14-34 234 0004	1427 573	12
	1666 098	
	1680 935	
14-34 234 0005	1441 770	13
	1441 773	
	1441 774	
	1449 676	
	1449 677	
	1666 156	
	1666 157	
	1680 937	
1680 938		
14-34 234 0008	1259 622	11
	1307 823	
14-34 234 0010	1398 793	12
14-34 234 0012	1372 386	11
14-34 234 0016	1372 387	11
14-34 234 0018	1402 415	12
	1408 555	
	APUB185 APUC331	
14-34 238 0001	1371 331	22
	1615 509	
	1657 336	
	1743 703	
	1867 861	
14-34 238 0002	1685 352	22
14-34 238 0003	1399 820	21
14-34 321 0001	1295 090	6
	1353 115	
	1500 399	
	1529 631	
	1664 524	
14-34 321 0004	1664 525	6
	1363 024	
	1638 006	
	1640 921	
	1656 513	
	1657 523	
	1726 060	
	1921 967	

MEYLE no.	Ref. no.	Page
DAF		
	1933 740	
14-34 321 0006	1433 697 1644 641 1668 000 1672 464 APUC944	5
14-34 321 0011	1686 587	7
14-34 533 0001	1506 003	35
14-34 533 0004	1230 594 1238 561 1315 691 1361 393 1778 553 1778 554	32
14-34 533 0010	1505 212	34
14-34 533 0016	1505211	34
14-34 533 0017	1504 930 1505 215	34
14-34 533 0018	1518 010	35
14-34 631 0004	1375 507	76
14-34 650 0001	1801 592	65
14-34 650 0002	1400 291 1408 086 1705 686	67
14-34 742 0001	1699 564 1779 767	53
14-34 899 0001	1371 332 1624 783 1740 758	21
14-34 900 0001	1639810	30
14-34 900 0002	1316772	30
14-34 900 0005	0683 191 683191	2
14-34 910 0001	1277 475 1336 529	84
14-34 910 0100	1315 942	83
14-34 910 0101	1382 282 1450 902 1914 281	84
14-34 910 1002	1308 300 1346 200	84
14-35 521 0004	AMPA014 AMPB481 AMPB860 NJK2785	31
14-36 010 0001	0538 329	60

MEYLE no.	Ref. no.	Page
DAF		
	538329	
14-36 010 0002	0274 650 274650	58
14-36 010 0003	0274 651 274651	58
14-36 010 0004	0259 524 259524 290825 0290 825 0299 106 299106	59
14-36 010 0005	0295 726 295726	59
14-36 010 0007	1283 618	61
14-36 010 0010	0268 044 268044	57
14-36 010 0011	0268 045 268045	58
14-36 010 0013	0366 351 366351	60
14-36 010 0014	0558 864 558864	61
14-36 010 0015	1323 838	62
14-36 010 0016	0763 523 763523	61
14-36 010 0017	1291 233 1732 887	64
14-36 010 0018	1288 000 1732 886	64
14-36 010 0019	1400 147	63
14-36 010 0020	1323 839	62
14-36 010 0021	0298 498 298498	60
14-36 010 0022	1402 590	63
14-36 010 0023	1402 587	63
14-36 010 0025	1283 618	65
14-36 010 0027	0274 651 274651	64
14-36 010 0028	1402 562	57
14-36 010 0029	0082 522 082522 82522	57
14-36 020 0019	1297 572 1361 155	68
14-36 020 0027	1401 942 AFRA635	74

MEYLE no.	Ref. no.	Page
DAF		
14-36 035 0003	0513 757 513 757 691 709 0691 709	55
14-36 040 0003	0067 303 067303 67303	69
14-36 040 0004	0067 389 067389 67389	69
14-36 040 0017	1395 994	68
14-36 050 0002	0080 521 80521 1361 651 1368 270 1390 932 1617 096 1793 875 1817 808 1892 482 1892 492 2001 492	53
14-36 050 0004	1261 101	54
14-36 050 0009	0099 990 099 990 99990	53
14-36 631 0001	052663 0526 63R 1239 411 1291 227 1 239 411R	76
16-34 223 0001	1404 524 1700 772 1702 252	19
16-34 650 0001	-	67
16-34 900 0008	0683 373 683373	1
534 003 0001	1400 071 1506 149 1525 416	33
812 321 0001	0667 078 667078 1207 748	5
834 029 0003	1504 842	49
834 533 0004	1305 844 1505 287	37

MEYLE no.	Ref. no.	Page
DAF		
836 020 0006	1 685 552	75



Ref. no.	MEYLE no.	Page
DAF		
052663	14-36 631 0001	76
0067 303	14-36 040 0003	69
067303	14-36 040 0003	69
67303	14-36 040 0003	69
0067 389	14-36 040 0004	69
067389	14-36 040 0004	69
67389	14-36 040 0004	69
0067 681	052 013 1600	24
067681	052 013 1600	24
67681	052 013 1600	24
0067 690	050 008 1398	26
067690	050 008 1398	26
67690	050 008 1398	26
0068 499	034 015 0005	3
068499	034 015 0005	3
68499	034 015 0005	3
0069 237	034 026 0027	43
069237	034 026 0027	43
69237	034 026 0027	43
0069 867	12-36 020 0007	70
069867	12-36 020 0007	70
69867	12-36 020 0007	70
0080 521	14-36 050 0002	53
80521	14-36 050 0002	53
0082 522	14-36 010 0029	57
082522	14-36 010 0029	57
82522	14-36 010 0029	57
0099 990	14-36 050 0009	53
099 990	14-36 050 0009	53
99990	14-36 050 0009	53
0100 197	036 020 0003	71
100197	036 020 0003	71
0106 321	034 026 0025	48
106321	034 026 0025	48
0109 916	034 042 0034	38
109916	034 042 0034	38
0110 196	036 020 0008	74
110196	036 020 0008	74
0110 197	036 020 0003	71
110197	036 020 0003	71
0161 376	12-36 020 0007	70
161376	12-36 020 0007	70
0167 846	034 043 0039	40
167846	034 043 0039	40
0194 194	034 009 0015	7
194194	034 009 0015	7

Ref. no.	MEYLE no.	Page
DAF		
0229 348	034 046 0000	77
229348	034 046 0000	77
238670	052 013 1675	24
0238 770	052 013 1475	25
238770	052 013 1475	25
0247 138	14-34 009 0002	9
247138	14-34 009 0002	9
0247 139	14-34 009 0002	9
247139	14-34 009 0002	9
248761	052 013 1525	25
0259 524	14-36 010 0004	59
259524	14-36 010 0004	59
0262 633	034 026 0030	44
262633	034 026 0030	44
0267 743	14-34 035 0001	54
0268 043	14-34 032 0004	56
268043	14-34 032 0004	56
0268 044	14-36 010 0010	57
268044	14-36 010 0010	57
0268 045	14-36 010 0011	58
268045	14-36 010 0011	58
0274 650	14-36 010 0002	58
274650	14-36 010 0002	58
0274 651	14-36 010 0003 14-36 010 0027	58, 64
274651	14-36 010 0003 14-36 010 0027	58, 64
0286 369	14-34 032 0006	65
286369	14-34 032 0006	65
0288 495	034 042 0051	40
288495	034 042 0051	40
0290 825	14-36 010 0004	59
290825	14-36 010 0004	59
0295 726	14-36 010 0005	59
295726	14-36 010 0005	59
0296 961	052 013 1050	24
296961	052 013 1050	24
0298 498	14-36 010 0021	60
298498	14-36 010 0021	60
0299 106	14-36 010 0004	59
299106	14-36 010 0004	59
0303 055	034 043 0002	42
303055	034 043 0002	42
0305 049	034 042 0003	42
305049	034 042 0003	42
0307 475	034 042 0051	40

Ref. no.	MEYLE no.	Page
DAF		
307475	034 042 0051	40
0311 049	14-34 032 0006	65
311049	14-34 032 0006	65
0311 300	036 020 0002	73
311300	036 020 0002	73
0361 477	14-34 162 0001	51
361477	14-34 162 0001	51
0366 351	14-34 032 0006 14-36 010 0013	60, 65
366351	14-34 032 0006 14-36 010 0013	60, 65
0376 729	14-34 001 0002	1
376 729	14-34 001 0002	1
0490 269	050 008 1398	26
490269	050 008 1398	26
0501 182	034 042 0001	40
501182	034 042 0001	40
0505 698	12-34 126 6017	48
505698	12-34 126 6017	48
0507 808	034 042 0051	40
507808	034 042 0051	40
0513 757	14-36 035 0003	55
513 757	14-36 035 0003	55
513952	029 500 2070/S	85
0526 63R	14-36 631 0001	76
0533 891	034 042 0003	42
533891	034 042 0003	42
0538 329	14-36 010 0001	60
538329	14-36 010 0001	60
0556 289	034 650 0001	66
556289	034 650 0001	66
0558 864	14-36 010 0014	61
558864	14-36 010 0014	61
0586 753	036 020 0001	73
586753	036 020 0001	73
0587 805	034 042 0024	39
587805	034 042 0024	39
0587 808	034 042 0051	40
587808	034 042 0051	40
0589 333	034 026 0018	46
589333	034 026 0018	46
0592 106	034 026 0017	46
592106	034 026 0017	46
0607 053	036 020 0005 036 020 0005/HD	71-72
607053	036 020 0005	71-72

Ref. no.	MEYLE no.	Page
DAF		
	036 020 0005/HD	
0607 451	036 020 0003	71
607451	036 020 0003	71
0607 452	036 020 0008	74
607452	036 020 0008	74
0607 453	036 020 0003	71
607453	036 020 0003	71
0607 981	036 020 0004 036 020 0004/HD	72, 75
607981	036 020 0004 036 020 0004/HD	72, 75
0607 998	036 020 0002	73
607998	036 020 0002	73
0607 999	036 020 0001	73
0608 000	12-36 020 0007	70
608000	12-36 020 0007	70
0608 530	036 020 0016	70
608530	036 020 0016	70
0609 715	034 026 0026	45
609715	034 026 0026	45
0626 875	034 650 0001	66
626875	034 650 0001	66
0636 820	12-14 650 0005	66
636820	12-14 650 0005	66
0655 043	052 013 1475	25
655043	052 013 1475	25
0656 084	034 026 0017	46
656084	034 026 0017	46
0656 085	034 026 0018	46
656085	034 026 0018	46
0667 078	812 321 0001	5
667078	812 321 0001	5
0679 733	052 010 0975	25
679733	052 010 0975	25
0681 706	14-34 068 1706	51
681706	14-34 068 1706	51
0683 191	14-34 900 0005	2
683191	14-34 900 0005	2
0683 373	16-34 900 0008	1
683373	16-34 900 0008	1
0683494	14-34 001 0003	1
683494	14-34 001 0003	1
0683532	14-34 001 0003	1
683532	14-34 001 0003	1
0683 579	14-33 220 0003	17
683 579	14-33 220 0003	17

Ref. no.	MEYLE no.	Page
DAF		
0689 366	034 042 0062	41
689366	034 042 0062	41
0689 511	034 042 0061	41
689511	034 042 0061	41
0689 748	12-34 230 6051	55
689748	12-34 230 6051	55
0689 962	12-34 126 6017	48
689962	12-34 126 6017	48
0691 602	034 042 0002	41
691602	034 042 0002	41
0691 703	034 035 0028	55
691703	034 035 0028	55
0691 709	14-36 035 0003	55
691709	14-36 035 0003	55
0692 183	034 026 0027	43
692183	034 026 0027	43
0693 778	034 058 0019	56
693778	034 058 0019	56
0694 277	034 042 0002	41
694277	034 042 0002	41
0694 298	036 020 0001	73
694298	036 020 0001	73
0694 360	036 020 0001	73
694360	036 020 0001	73
0695 751	034 042 0043	42
695751	034 042 0043	42
0696 205	036 020 0005 036 020 0005/HD	71-72
696205	036 020 0005 036 020 0005/HD	71-72
0696 225	036 020 0005/HD	72
696225	036 020 0005/HD	72
0696 226	036 020 0004 036 020 0004/HD	72, 75
696226	036 020 0004 036 020 0004/HD	72, 75
0698 450	036 020 0004 036 020 0004/HD	72, 75
698450	036 020 0004 036 020 0004/HD	72, 75
0698 609	036 020 0001	73
698609	036 020 0001	73
0706 123	034 042 0001	40
706123	034 042 0001	40
0706 128	034 042 0003	42
706128	034 042 0003	42

Ref. no.	MEYLE no.	Page
DAF		
0759 050	12-34 032 0000	37
759050	12-34 032 0000	37
0763 523	14-36 010 0016	61
763523	14-36 010 0016	61
1142 142	12-34 042 0010	31
1142 173	12-36 020 0007	70
1152 425	050 008 1915	27
1198 153	12-34 042 0010	31
1198 154	12-34 042 0010	31
1207 748	812 321 0001	5
1228 114	036 020 0003	71
1228 115	036 020 0005 036 020 0005/HD	71-72
1229 944	036 020 0001	73
1230 594	14-34 533 0004	32
1236 096	14-34 232 0008	14
123 8508	034 042 0024	39
1238 561	14-34 533 0004	32
1239 411	14-36 631 0001	76
1243 049	14-34 089 0008/S	82
1249 088	034 026 0017	46
1249 129	034 026 0018	46
1252 350	12-34 126 6017	48
1257 890	036 020 0004 036 020 0004/HD	72, 75
1259 622	14-34 234 0008	11
1260 954	029 600 2470	85
1261 101	14-36 050 0004	54
1265 398	052 013 1525	25
1266 426	14-34 089 0010	80
1271 385	14-34 089 0011	80
1277 475	14-34 910 0001	84
1282 146	14-34 232 0011	14
1283 618	14-34 032 0006 14-36 010 0007 14-36 010 0025	61, 65
1283 752	14-34 001 0002	1
1285 258	14-34 026 0003	78
1285 260	14-34 026 0001	78
1288 000	14-36 010 0018	64
1290 794	14-34 089 0003	81
1291 218	14-34 232 0005	15
1291 227	14-36 631 0001	76
1291 233	14-36 010 0017	64
1293 812	14-34 232 0007	15
1295 090	14-34 321 0001	6

Ref. no.	MEYLE no.	Page
DAF		
1295 910	14-34 223 0001	18
1296 851	12-34 323 0008	8
1297 004	14-34 043 0001	46
1297 572	14-36 020 0019	68
1298 675	14-34 089 0005 14-34 089 0009	81, 83
1298 923	14-34 001 0002	1
1300 662	12-34 026 0002	43
1302 103	034 043 0069	44
1303 948	14-34 154 0001	47
1304 635	034 043 0073	43
1305 844	834 533 0004	37
1307 823	14-34 234 0008	11
1308 285	14-34 232 0002	15
1308 300	14-34 910 1002	84
1311 608	034 009 0015	7
1314 545	14-34 032 0009 14-34 032 0010 14-34 089 0001	81-83
1315 381	14-34 038 0001	3
1315 447	036 020 0002	73
1315 514	034 009 0003	8
1315 691	14-34 533 0004	32
1315 698	034 533 0017	33
1315 942	14-34 910 0100	83
1316772	14-34 900 0002	30
1318 695	14-34 009 0002	9
1319 838	036 020 0002	73
1320 045	14-34 223 0002	20
1320 372	14-34 001 0002	1
1322 255	14-12 319 0001	78
1322 259	14-12 319 0000	79
1323 838	14-36 010 0015	62
1323 839	14-36 010 0020	62
1325 345	034 043 0002	42
1326 864	036 020 0003	71
1326 866	12-36 020 0007	70
1326 896	036 020 0001	73
1327 199	14-34 223 0002	20
1331 925	036 020 0001	73
1336 529	14-34 910 0001	84
1338 714	036 020 0002	73
1338 736	14-34 232 0009	16
1341 990	12-34 032 0000	37
1345 335	14-34 018 0004	9
1346 200	14-34 910 1002	84

Ref. no.	MEYLE no.	Page
DAF		
1353 115	14-34 321 0001	6
1357 764	14-34 032 0001	51
1361 155	14-36 020 0019	68
1361 393	14-34 533 0004	32
1361 649	14-34 035 0001	54
1361 650	14-34 035 0001	54
1361 651	14-36 050 0002	53
1362 124	14-12 319 0005	79
1363 023	14-12 321 0007	6
1363 024	14-34 321 0004	6
1363 025	14-12 321 0007	6
1366 063	14-34 001 0002	1
1366 270	14-36 050 0002	53
1366 283	14-34 032 0002	52
1371 329	14-34 223 0004	20
1371 331	14-34 238 0001	22
1371 332	14-34 899 0001	21
1372 386	14-34 234 0012	11
1372 387	14-34 234 0016	11
1372 669	050 008 1915	27
1373 135	036 020 0003	71
1373 137	036 020 0008	74
1374 723	14-34 043 0001	46
1374 724	12-34 026 0002	43
1375 507	14-34 631 0004	76
1376 260	14-34 232 0006	16
1379 772	14-34 154 0001	47
1382 282	14-34 910 0101	84
1388 161	050 008 1525	27
1389 190	12-36 020 0039	74
1390 932	14-36 050 0002	53
1391 510	14-34 042 0005	36
1393 280	050 008 2050	27
1393 344	050 008 1215	28
1393 365	050 008 1720	28
1395 994	14-36 040 0017	68
1396 202	14-34 089 0005 14-34 089 0009	81, 83
1397 764	14-34 018 0001	4
1397 766	14-34 018 0002	9
1398 620	14-34 000 0001	23
1398 637	050 008 2380	28
1398 793	14-34 234 0010	12
1399 150	14-33 220 0003	17
1399 159	14-34 089 0011	80
1399 160	14-34 089 0010	80

Ref. no.	MEYLE no.	Page
DAF		
1399 180	14-34 232 0002	15
1399 494	14-34 018 0007	4
1399 760	14-34 018 0008	10
1399 819	14-34 232 0012	16
1399 820	14-34 238 0003	21
1400 071	534 003 0001	33
1400 147	14-36 010 0019	63
1400 291	14-34 650 0002	67
1401 103	029 600 2471	86
1401 942	14-36 020 0027	74
1402 415	14-34 234 0018	12
1402 417	14-34 232 0010	17
1402 562	14-36 010 0028	57
1402 587	14-36 010 0023	63
1402 590	14-36 010 0022	63
1403 238	14-34 232 0011	14
1403 248	14-34 232 0010	17
1404 524	16-34 223 0001	19
1405 387	029 600 2471	86
1406 486	14-34 000 0002	22
1408 086	14-34 650 0002	67
1408 385	029 600 2471	86
1408 555	14-34 234 0018	12
1425 709	052 013 1000	26
1427 369	034 042 0033	38
1427 573	14-34 234 0004	12
1433 649	14-34 018 0016	10
1433 697	14-34 321 0006	5
1438 836	034 009 0013	7
1438 837	14-34 089 0005 14-34 089 0009	81, 83
1439 324	025 290 8730 025 290 8730/S	31-32
1441 770	14-34 234 0005	13
1441 773	14-34 234 0005	13
1441 774	14-34 234 0005	13
1444 203	050 008 2120	29
1445 893	14-34 001 0004	2
1445 900	12-34 032 0000	37
1448 197	14-34 232 0002	15
1448 915	12-34 042 0010	31
1449 676	14-34 234 0005	13
1449 677	14-34 234 0005	13
1449 678	14-34 234 0001	13
1449 679	14-34 234 0001	13
1450 902	14-34 910 0101	84

Ref. no.	MEYLE no.	Page
DAF		
1453 046	14-34 223 0003	20
1457 275	14-34 154 0001	47
1457 276	14-34 154 0002	47
1458 701	14-34 038 0001	3
1458 764	14-34 000 0001	23
1500 399	14-34 321 0001	6
1504 842	834 029 0003	49
1504 930	14-34 533 0017	34
1504 951	034 533 0017	33
1504 961	034 042 0038	38
1505 023	034 043 0005	39
1505 210	034 043 0073	43
1505211	14-34 533 0016	34
1505 212	14-34 533 0010	34
1505 215	14-34 533 0017	34
1505 287	834 533 0004	37
1506 003	14-34 533 0001	35
1506 149	534 003 0001	33
1506 468	034 029 0026	49
1506 488	034 043 0069	44
1517 862	029 500 2070/S	85
1517 929	034 013 0006	36
1517 945	034 026 0014	48
1518 010	14-34 533 0018	35
1518 244	034 042 0016	49
1518 252	034 029 0025	50
1518 311	034 533 0035	36
1519 232	034 042 0039	39
1525 416	534 003 0001	33
1529 631	14-34 321 0001	6
1600 428	14-12 319 0004	79
1600 469	12-34 032 0000	37
1603 789	036 020 0004 036 020 0004/HD	72, 75
1604 476	034 009 0013	7
1607 794	14-34 223 0001	18
1609 853	14-33 220 0003	17
1614 978	14-34 000 0001	23
1615 509	14-34 238 0001	22
1617 096	14-36 050 0002	53
1617 343	025 290 8730	31
1624 782	14-34 223 0002	20
1624 783	14-34 899 0001	21
1624 784	14-34 223 0003	20
1626 237	14-34 223 0005	18
1627 625	14-34 000 0003	23

Ref. no.	MEYLE no.	Page
DAF		
1628 148	14-34 000 0001	23
1629 393	14-34 018 0013	4
1638 006	14-34 321 0004	6
1638 026	14-12 321 0007	6
1638 054	14-12 321 0001	5
1638 696	14-34 000 0004	23
1638 698	050 007 1750	29
1639810	14-34 900 0001	30
1640 920	14-12 321 0007	6
1640 921	14-34 321 0004	6
1643 070	14-34 018 0013	4
1644 641	14-34 321 0006	5
1654 398	050 009 1380	29
1656 266	14-34 089 0010	80
1656 428	14-34 035 0001	54
1656 513	14-34 321 0004	6
1657 336	14-34 238 0001	22
1657 522	14-12 321 0007	6
1657 523	14-34 321 0004	6
1658 991	14-12 319 0001	78
1659 691	14-12 319 0000	79
1660 859	14-34 223 0004	20
1661 948	050 009 1380	29
1661 949	050 009 1424	30
1661 954	050 009 1424	30
1664 524	14-34 321 0001	6
1664 525	14-34 321 0001	6
1664 762	14-33 220 0002	17
1666 098	14-34 234 0004	12
1666 156	14-34 234 0005	13
1666 157	14-34 234 0005	13
1668 000	14-34 321 0006	5
1671 219	14-34 032 0003	52
1672 464	14-34 321 0006	5
1676 777	14-34 162 0001	51
1677 080	14-34 234 0003	13
1680 935	14-34 234 0004	12
1680 937	14-34 234 0005	13
1680 938	14-34 234 0005	13
1683 353	034 009 0013	7
1684 655	14-34 223 0006	19
1685 352	14-34 238 0002	22
1685 552	836 020 0006	75
1686 587	14-34 321 0011	7
1687 821	14-34 000 0004	23
1689 604	036 020 0002	73

Ref. no.	MEYLE no.	Page
DAF		
1693 441	14-34 234 0003	13
1693 518	14-34 001 0004	2
1694 953	14-34 000 0003	23
1694 967	14-34 089 0008 14-34 089 0008/S	82
1695 242	14-34 000 0003	23
1697 325	12-34 899 0004	3
1697 677	14-34 234 0003	13
1699 240	14-34 000 0004	23
1699 375	14-34 089 0008/S	82
1699 517	14-34 001 0004	2
1699 564	14-34 742 0001	53
1700 772	16-34 223 0001	19
1702 252	16-34 223 0001	19
1702 525	14-34 000 0002	22
1702 605	050 008 1525	27
1705 686	14-34 650 0002	67
1726 060	14-34 321 0004	6
1726 061	14-12 321 0007	6
1732 273	14-34 234 0003	13
1732 274	14-34 234 0003	13
1732 886	14-36 010 0018	64
1732 887	14-36 010 0017	64
1733 234	14-34 232 0002	15
1737 460	14-34 234 0002	14
1738 991	14-33 220 0002	17
1740 758	14-34 899 0001	21
1742 083	14-34 234 0002	14
1743 703	14-34 238 0001	22
1778 280	14-33 220 0002	17
1778 553	14-34 533 0004	32
1778 554	14-34 533 0004	32
1779 767	14-34 742 0001	53
1784 782	14-34 018 0002	9
1787556	14-34 043 0001	46
1789 292	14-12 321 0007	6
1791 192	14-12 319 0005	79
1793 875	14-36 050 0002	53
1797 053	025 290 8730	31
1801 592	14-34 650 0001	65
1806 712	14-34 234 0003	13
1806 713	14-34 234 0002	14
1811 819	14-34 000 0004	23
1812 162	050 007 1750	29
1817 808	14-36 050 0002	53
1817 809	14-34 035 0001	54

Ref. no.	MEYLE no.	Page
DAF		
1825 428	14-12 319 0000	79
1828 162	14-33 220 0002	17
182 9399	14-12 319 0007	80
1833 030	14-34 026 0003	78
1867 861	14-34 238 0001	22
1871 493	14-34 223 0004	20
1878 030	025 290 8730	31
1892 482	14-36 050 0002	53
1892 492	14-36 050 0002	53
1892 666	036 020 0002	73
1914 281	14-34 910 0101	84
1916 597	14-34 234 0003	13
1916 598	14-34 234 0002	14
1921 967	14-34 321 0004	6
1923 963	036 020 0002	73
1933 740	14-34 321 0004	6
1948 921	14-34 018 0013	4
195 0785	14-12 319 0007	80
1954 744	029 600 2471	86
1964 968	14-34 089 0008/S	82
1964 969	14-34 089 0008/S	82
2001 492	14-36 050 0002	53
0683 579 R	14-33 220 0003	17
683 579 R	14-33 220 0003	17
ACU9241	036 020 0008	74
ACU9242	036 020 0003	71
AFRA635	14-36 020 0027	74
AMPA014	14-35 521 0004	31
AMPA346	036 020 0002	73
AMPB481	14-35 521 0004	31
AMPB860	14-35 521 0004	31
APUB185	14-34 234 0018	12
APUC331	14-34 234 0018	12
APUC944	14-34 321 0006	5
BBU5510	034 013 0006	36
CBU1182	050 008 1398	26
CBU1532	050 008 1398	26
FBU8648	034 042 0001	40
FBU9614	034 042 0061	41
NJK2785	14-35 521 0004	31
1 239 411R	14-36 631 0001	76
12609546	029 600 2470	85
1643 0706	14-34 018 0013	4
1948 921G	14-34 018 0013	4

Short no.	MEYLE no.	Page
DAF		
MAF0209	14-12 321 0001	5
MAF0210	14-12 321 0007	6
MAF0213	14-34 321 0001	6
MAF0215	14-34 321 0004	6
MAF0217	14-34 321 0006	5
MAF0649	812 321 0001	5
MAF0693	14-34 321 0011	7
MAS0015	034 533 0017	33
MAS0033	034 533 0035	36
MAS0111	14-34 533 0001	35
MAS0112	14-34 533 0004	32
MAS0113	14-34 533 0010	34
MAS0193	534 003 0001	33
MAS0308	14-34 533 0017	34
MAS0309	14-34 533 0018	35
MAS0389	14-34 533 0016	34
MBD1470	14-35 521 0004	31
MBL0035	029 600 2470	85
MBL0060	029 500 2070/S	85
MBL0071	029 600 2471	86
MBP0710	025 290 8730	31
MBP0711	025 290 8730/S	32
MBT0061	14-34 000 0003	23
MBT0070	14-34 000 0001	23
MBT0071	14-34 000 0002	22
MBX0018	034 013 0006	36
MBX0037	034 026 0026	45
MBX0038	034 026 0027	43
MBX0039	034 026 0030	44
MBX0042	034 029 0025	50
MBX0043	034 029 0026	49
MBX0052	034 042 0001	40
MBX0053	034 042 0002	41
MBX0054	034 042 0003	42
MBX0060	034 042 0016	49
MBX0063	034 042 0024	39
MBX0067	034 042 0033	38
MBX0068	034 042 0034	38
MBX0072	034 042 0038	38
MBX0073	034 042 0039	39
MBX0075	034 042 0043	42
MBX0082	034 042 0051	40
MBX0087	034 042 0061	41
MBX0088	034 042 0062	41
MBX0089	034 043 0002	42
MBX0090	034 043 0005	39

Short no.	MEYLE no.	Page
DAF		
MBX0103	034 043 0039	40
MBX0116	034 043 0069	44
MBX0118	034 043 0073	43
MBX0161	12-34 026 0002	43
MBX0162	12-34 032 0000	37
MBX0163	12-34 042 0010	31
MBX0198	14-34 042 0005	36
MBX0210	834 029 0003	49
MCA0243	14-36 050 0002	53
MCF0119	14-12 319 0000	79
MCF0120	14-12 319 0001	78
MCF0122	14-12 319 0004	79
MCF0123	14-12 319 0005	79
MCF0455	14-12 319 0007	80
MCX0088	034 035 0028	55
MCX0104	034 058 0019	56
MCX0221	12-34 230 6051	55
MCX0252	14-34 068 1706	51
MCX0384	14-34 742 0001	53
MCX0399	14-34 032 0001	51
MCX0400	14-34 032 0002	52
MCX0401	14-34 032 0003	52
MCX0408	14-36 010 0025	65
MCX0409	14-36 010 0027	64
MCX0410	14-36 010 0028	57
MCX0476	14-34 032 0006	65
MCX0492	14-36 035 0003	55
MCX0504	14-34 032 0004	56
MDL0097	14-36 040 0017	68
MET0042	14-34 223 0001	18
MET0043	14-34 223 0005	18
MET0075	14-34 223 0006	19
MET0079	14-34 223 0004	20
MET0087	16-34 223 0001	19
MEX0143	034 015 0005	3
MEX0146	034 026 0014	48
MEX0148	034 026 0025	48
MEX0367	14-34 154 0001	47
MEX0368	14-34 154 0002	47
MEX0474	12-34 899 0004	3
MEX0477	834 533 0004	37
MEX0562	14-34 899 0001	21
MEX0567	14-34 043 0001	46
MEX0581	14-34 223 0002	20
MEX0582	14-34 223 0003	20
MFC0070	14-34 234 0001	13

Short no.	MEYLE no.	Page
DAF		
MFC0071	14-34 234 0002	14
MFC0072	14-34 234 0003	13
MFC0073	14-34 234 0004	12
MFC0074	14-34 234 0005	13
MFC0077	14-34 234 0008	11
MFC0079	14-34 234 0010	12
MFC0084	14-34 234 0016	11
MFC0086	14-34 234 0018	12
MFF0023	034 009 0003	8
MFF0084	14-34 009 0002	9
MFF0085	14-34 018 0002	9
MFF0086	14-34 018 0004	9
MFF0087	14-34 018 0008	10
MFF0232	12-34 323 0008	8
MFF0265	14-34 018 0016	10
MHP0057	14-34 631 0004	76
MHP0058	14-36 631 0001	76
MIX0187	14-34 910 0001	84
MIX0241	14-34 910 0100	83
MIX0242	14-34 910 0101	84
MIX0243	14-34 910 1002	84
MIX0258	14-34 089 0003	81
MIX0259	14-34 089 0010	80
MIX0268	14-34 089 0008	82
MIX0269	14-34 089 0008/S	82
MIX0282	14-34 089 0011	80
MIX0296	14-34 032 0010	83
MIX0297	14-34 089 0001	81
MIX0303	14-34 089 0005	81
MIX0304	14-34 089 0009	83
MIX0308	14-34 032 0009	82
MIX0312	14-34 026 0003	78
MIX0321	14-34 026 0001	78
MMX0196	034 009 0013	7
MMX0197	034 009 0015	7
MMX1351	14-34 232 0002	15
MMX1354	14-34 232 0005	15
MMX1355	14-34 232 0006	16
MMX1356	14-34 232 0007	15
MMX1357	14-34 232 0008	14
MMX1358	14-34 232 0009	16
MMX1359	14-34 232 0010	17
MMX1360	14-34 232 0011	14
MMX1361	14-34 232 0012	16
MMX1439	14-34 238 0001	22
MMX1452	14-34 238 0003	21

Short no.	MEYLE no.	Page
DAF		
MMX1457	14-34 238 0002	22
MMX1486	14-34 001 0002	1
MMX1487	14-34 038 0001	3
MMX1488	14-34 900 0001	30
MMX1489	14-34 900 0002	30
MMX1493	14-34 001 0003	1
MMX1589	14-34 001 0004	2
MMX1590	14-34 900 0005	2
MMX1591	16-34 900 0008	1
MOF0069	14-34 018 0001	4
MOF0070	14-34 018 0007	4
MOF0074	14-34 018 0013	4
MPJ0071	12-34 126 6017	48
MRB0613	050 007 1750	29
MRB0651	050 008 1215	28
MRB0657	050 008 1398	26
MRB0664	050 008 1525	27
MRB0672	050 008 1720	28
MRB0678	050 008 1915	27
MRB0685	050 008 2050	27
MRB0693	050 008 2380	28
MRB0698	050 009 1380	29
MRB0750	050 009 1424	30
MRB0762	050 008 2120	29
MRM0075	14-34 234 0012	11
MRS0188	14-34 162 0001	51
MSB0255	14-36 010 0022	63
MSB0256	14-36 010 0023	63
MSB0280	14-36 010 0001	60
MSB0281	14-36 010 0002	58
MSB0282	14-36 010 0003	58
MSB0283	14-36 010 0004	59
MSB0284	14-36 010 0005	59
MSB0285	14-36 010 0007	61
MSB0286	14-36 010 0011	58
MSB0287	14-36 010 0014	61
MSB0288	14-36 010 0015	62
MSB0289	14-36 010 0016	61
MSB0290	14-36 010 0017	64
MSB0291	14-36 010 0018	64
MSB0292	14-36 010 0019	63
MSB0293	14-36 010 0020	62
MSB0294	14-36 010 0021	60
MSB0295	14-36 010 0029	57
MSB0331	14-36 010 0013	60
MSB0342	14-36 010 0010	57

Short no.	MEYLE no.	Page
DAF		
MSR0076	14-34 035 0001	54
MSR0105	14-36 050 0009	53
MSR0107	14-36 050 0004	54
MSX0026	034 046 0000	77
MTA0222	14-36 020 0019	68
MTE0044	036 020 0001	73
MTE0045	036 020 0002	73
MTE0046	036 020 0003	71
MTE0047	036 020 0004	75
MTE0047HD	036 020 0004/HD	72
MTE0048	036 020 0005	71
MTE0048HD	036 020 0005/HD	72
MTE0051	036 020 0008	74
MTE0058	036 020 0015	76
MTE0059	036 020 0016	70
MTE0170	12-36 020 0007	70
MTE0174	14-36 040 0004	69
MTE0543	14-36 040 0003	69
MTE0655	12-36 020 0039	74
MTE0728	836 020 0006	75
MTE0739	14-36 020 0027	74
MTR0040	14-34 000 0004	23
MTX0022	034 026 0017	46
MTX0023	034 026 0018	46
MVB0063	052 010 0975	25
MVB0183	052 013 1000	26
MVB0188	052 013 1050	24
MVB0222	052 013 1475	25
MVB0224	052 013 1525	25
MVB0225	052 013 1535	26
MVB0228	052 013 1600	24
MVB0231	052 013 1675	24
MWB0016	034 650 0001	66
MWB0049	12-14 650 0005	66
MWB0058	14-34 650 0002	67
MWB0059	16-34 650 0001	67
MWK0105	14-34 650 0001	65
MWP0183	14-33 220 0002	17
MWP0546	14-33 220 0003	17





MEYLE

**My longest relationship?
The one with my truck.**



The MEYLE brand supplies its customers with more than 21,000 extremely reliable and durable spare parts manufactured at our own production facilities or by trusted production partners. MEYLE boasts a highly diversified product range.

Whether steering and suspension components, rubber-to-metal parts, brakes, damping components, cooling systems, filters, drive components, electric and sensors MEYLE is synonymous with top-grade quality-tested spare parts.

Notes

This catalogue is protected by copyright. Reproduction of text, graphic elements, photographs and/or data, even in part, is prohibited. MEYLE, **MEYLE**, or parts thereof, are registered trademarks of MEYLE AG.

All supplies and services are subject to our General Terms and Conditions. The original spare part numbers shown in this catalogue are for cross-reference purposes only and shall not be disclosed to third parties on invoices and delivery notes. While the information in this catalogue was compiled and edited with utmost care we do not assume responsibility or accept claims arising from errors or inconsistencies. Subject to technical and/or design changes.

This issue of the catalogue supersedes all previous issues.
All rights reserved. © 2017 MEYLE AG



MEYLE parts are available through:

MEYLE AG

Merkurring 111, 22143 Hamburg, Germany
Tel. +49 40 67506 510, Fax +49 40 67506 506
contact@meyle.com

www.meyle.com

MEYLE