

Gasdruckfedern
Ressort pneumatique
Molle pressione gas
газовые пружины



Gas Pressure Springs



Edition
2013/2014

ALLEINE STARK, IM TEAM UNSCHLAGBAR

Die bilstein group ist eine familiengeführte, konzernunabhängige Unternehmensgruppe, unter deren starkem Dach die renommierten Produktmarken febi, SWAG und Blue Print vereint werden.

Als führender Spezialist im weltweiten Automotive Aftermarket bietet die bilstein group Verschleißteile und Reparaturlösungen für alle gängigen Fahrzeugtypen der Bereiche PKW und NKW.

Das in Breite und Tiefe außergewöhnliche Sortiment umfasst rund 47.000 verschiedene Produkte und wird durch praxisorientierte Serviceleistungen ergänzt. Damit wird die bilstein group selbst höchsten Ansprüchen gerecht.

Weitere Informationen erhalten Sie unter:
www.bilsteingroup.com

INDIVIDUALLY STRONG, UNBEATABLE AS A TEAM

The bilstein group is a family-run, independent group of companies providing a single strong umbrella under which the prestigious product brands febi, SWAG and Blue Print are united.

As a leading specialist in the global automotive aftermarket, the bilstein group offers spare parts and repair solutions to fit all popular makes of cars and commercial vehicles.

The range, which is exceptional in its breadth and depth, comprises approximately 47,000 different products and is supplemented by practice-oriented services. The bilstein group can therefore meet even the highest requirements.

Get more information at: www.bilsteingroup.com

Best Choice for Spare Parts



Best Choice for Spare Parts

We are committed to this motto to your benefit, because SWAG stands for over 14,000 popular parts for all German and European vehicle types, for the product groups engine, steering, chassis and brake technology as well as electrics and SWAG Extra. We offer an always up-to-date range of professional vehicle repair products for all popular vehicle types. Of course in original equipment quality!

More than 55 years of experience

SWAG is one of the leading global partners to the wholesale with manufacturing competence for automotive spare parts in the independent aftermarket. SWAG has been a synonym for high quality with extremely short delivery times since 1954. The company, which is located in Germany, is a strategic partner of leading manufacturers of the automotive supplier industry as well as a distributor of high-quality spare parts for motor vehicles.

Planning for the future

As a supplier of spare parts we are also member of a German manufacturing group with the Know-how acquired over many years and state-of-the-art manufacturing technologies. In order to meet the growing expectations of the market at all times, the group is continually investing in the expansion of production, testing equipment and machinery.

SWAG advantages at a glance

- Original equipment quality
- Variety in range
- Manufacturing expertise
- Triple-Checking-System
- A strong brand
- Just in time delivery in 140 countries



Best Choice for Spare Parts

Dieses Motto ist für uns eine Verpflichtung und Ihr Vorteil. Denn SWAG steht für über 14.000 gängige Verschleißteile für alle deutschen und europäischen Fahrzeugtypen, aus den Produktgruppen Motor-, Lenkungs-, Fahrwerks- und Bremstechnik sowie Elektrik und SWAG Extra. Ein stets aktuelles Programm für die professionelle Fahrzeugreparatur aller gängigen Modelle! Natürlich in Erstausrüsterqualität.

Über 55 Jahre automobile Erfahrung

SWAG gehört zu den weltweit führenden Großhandelspartnern mit Herstellerkompetenz für automotive Verschleißteile im freien Ersatzteilmarkt. Bereits seit 1954 steht SWAG für hochwertige Qualität bei kürzesten Lieferzeiten. Wir sind strategischer Partner führender Hersteller der Automobilzulieferindustrie und Distributor hochwertiger Ersatzteile für Kraftfahrzeuge.

Zukunft im Blick

Als Lieferant von Autoersatzteilen gehören wir zu einer deutschen Herstellergruppe mit langjährigem Know-how und modernster Fertigungstechnik. Um den steigenden Erwartungen des Marktes jederzeit zu entsprechen, investiert die Gruppe kontinuierlich in den Ausbau der Fertigung, in Prüfeinrichtungen und Maschinenparks.

SWAG Vorteile auf einen Blick

- Erstausrüstungsqualität
- Produktvielfalt
- Herstellerkompetenz
- Triple-Checking-System
- Eine starke Marke
- Lieferung „Just in time“ in 140 Länder



Best Choice for Spare Parts

Cette devise constitue pour nous un engagement – et votre avantage. Car SWAG est synonyme de plus de 14 000 pièces d'usure courantes pour tous les modèles de véhicules allemands et européens dans les catégories de produits moteur, direction, train de roulement et frein ainsi qu'électrique et SWAG Extra. Une gamme sans cesse réactualisée pour la réparation professionnelle de véhicules de tous les modèles courants! Et naturellement en qualité de premier équipementier.

Plus de 55 ans d'expérience dans le secteur automobile

SWAG est un des partenaires de commerce en gros leaders dans le monde entier et compétent en matière de fabrication de pièces d'usure automobiles sur le marché libre des pièces de rechange. Depuis 1954, la société SWAG est réputée pour sa qualité haut de gamme avec de brefs délais de livraison. Nous sommes le partenaire stratégique pour les fabricants leaders dans le secteur de l'industrie des matériels automobiles additionnels et le distributeur de pièces de rechange de qualité élevée pour automobiles.

Regard vers l'avenir

En notre qualité de fournisseur de pièces détachées automobiles nous appartenons à un groupe de constructeurs allemands disposant d'un vaste savoir-faire et d'une technique de production ultra-moderne. Pour se conformer en permanence aux exigences croissantes du marché, nous investissons continuellement dans la modernisation de la production, dans les équipements de contrôle et dans le parc de machines.

Avantages SWAG en bref.

- Qualité de premier équipementier
- Multiplicité des produits
- Compétence de constructeur
- Le système Triple-Checking
- Une enseigne de renom
- Livraison „just-in-time“ dans 140 pays



Best Choice for Spare Parts

– Este lema es nuestra obligación... y su ventaja. SWAG ofrece más de 14.000 piezas de desgaste convencionales para todo tipo de vehículos alemanes y europeos, procedentes de los grupos de productos tecnología de motor, dirección, rodaje y frenado, más electricidad y SWAG Extra. Un programa en continua actualización para la reparación profesional de vehículos de todos los modelos convencionales. Y, por supuesto, con calidad de equipo original.

Más de 55 años de experiencia en el sector del automóvil

SWAG es uno de los mayoristas líderes a escala internacional de piezas de desgaste para el automóvil dentro del mercado libre de las piezas de repuesto. Además, su grado de competencia y conocimientos es igual al de los propios fabricantes. Ya desde 1954, SWAG es símbolo de alta calidad con reducidos plazos de entrega. Somos socios estratégicos de los fabricantes líderes del sector de suministros para el automóvil y distribuidores de piezas de repuesto de alta calidad para automóviles.

Futuro a la vista

Como proveedor de repuestos para automóviles, pertenecemos a un grupo de productores alemanes con una larga experiencia y la tecnología de fabricación más innovadora. Para poder cumplir en todo momento las crecientes expectativas del mercado, invertimos constantemente en la ampliación de la producción, equipos de ensayo y parques de máquinas.

Ventajas de SWAG en un vistazo

- Calidad de equipo original
- Gran variedad de productos
- Competencia de fabricación
- Triple Checking System
- Marca potente
- Suministro „justo a tiempo“ a 140 países



Лучший выбор запасных частей

– Для нас этот девиз – обязательство, для Вас – преимущество. Ведь марка SWAG – это синоним более 14000 наиболее распространённых расходных деталей для всех типов немецких и европейских транспортных средств с распределением по следующим товарным группам: двигатель, система управления, ходовая часть, тормозная система, а также электрика и детали категории SWAG Extra. Постоянно обновляемая

программа для профессионального ремонта автомобилей всех основных моделей! Только настоящее заводское качество.

Более чем 55-летний опыт в автомобильной промышленности

SWAG – один из мировых лидеров в области оптовой торговли с опытом производства изнашиваемых автомобильных запасных частей на свободном рынке запасных деталей. С 1954 SWAG ручается за высокое качество при кратчайших сроках поставки. Мы являемся стратегическим партнером ведущих производителей индустрии автомобильных комплектующих и дистрибьютором высококачественных запасных частей для автомобилей.

Курс на будущее

Являясь поставщиком запасных частей для автомобилей, мы принадлежим к немецкой группе производителей, обладающей с многолетним „ноу-хау“ и современной производственной технологией. Для того чтобы соответствовать постоянно растущим требованиям современных рынков, наша компания осуществляет последовательные инвестиции в расширение производственных мощностей, а также в испытательное оборудование и машинный парк.

Преимущества компании SWAG:

- Заводское качество
- Разнообразный ассортимент
- Компетентность производителя
- Тройная система контроля
- Сильная марка
- Поставки „Just in time“ в 140 стран

Catalogue Guide

Katalogleitfaden Manuel du catalogue Guía del catálogo Руководство по работе с каталогом



Find every part:
quick and convenient

You know the vehicle type and the
vehicle manufacturer's reference number:

Reference number -> SWAG number
-> Page number

The positioning of the reference numbers
corresponds to the vehicle manufactur-
ers' sorting sequence.

SWAG number -> Reference number
-> Page number

This list is sorted by SWAG number in
ascending order.

Note: On the catalogue cover, you
will find a list of symbols and abbrevi-
ations with explanations in different
languages.



Ersatzteile finden:
komfortabel und schnell

Sie kennen den Fahrzeugtyp und haben
eine Referenznummer des Fahrzeugher-
stellers:

Referenz-Nr. -> SWAG-Nr.
-> Seitenzahl

Die Anordnung der Referenznummern
entspricht der Sortierreihenfolge der
Fahrzeughersteller.

SWAG-Nr. -> Referenz-Nr.
->Seitenzahl

Diese Liste ist nach SWAG-Nr. aufstei-
gend sortiert.

Hinweis: Eine Liste der Symbole und
Abkürzungen mit Erklärungen in ver-
schiedenen Sprachen finden Sie auf
den letzten Katalogseiten.

Ref. - No.



SWAG
GERMANY

Ref. - No.

SWAG
GERMANY



SWAG
GERMANY

passend für / to fit

ALFA ROMEO

46739202	74 92 8013	1, 2
46771551	74 93 3060	1
50500057	74 93 3060	1
50508010	74 93 3062	1
50508060	74 93 3063	2
50508706	74 93 3064	2
50508742	74 93 3064	2

passend für / to fit

AUDI

059 145 294	30 92 7604	95
059 145 294 B	30 92 7604	95
046 145 299	32 92 8550	95
440 425 021	30 92 7606	130, 131, 132
4D0 425 021	30 92 7611	131, 132
4D0 425 021 A	30 92 7611	131, 132
4D0 425 021 B	30 92 7611	131, 132
4D0 425 021 C	30 92 7611	131, 132
4D0 425 021 D	30 92 7611	131, 132
8A1 425 021	30 92 7613	130, 131
4A9 827 552 C	30 92 7692	4, 6, 7
4B9 827 552 N	30 92 7674	7
443 823 359 B	30 92 7678	3, 4, 9
443 823 359 D	30 91 0013	3, 4
4A0 823 359	30 91 0026	6, 7
4A0 823 359 B	30 92 7677	3, 4
4A0 823 359 C	30 91 0026	6, 7
4D0 823 359 F	30 92 7675	8
4E0 823 359 C	30 93 1637	8
4E0 823 359 D	30 93 1637	8
4F0 823 359 A	30 93 1636	7, 8
4L0 823 359	30 93 1639	10
8A0 823 359 B	30 93 9261	9
8D0 823 359	30 92 8350	5

passend für / to fit

ALFA ROMEO

482 8350	5
482 7690	5, 6
482 7690	5, 6
30 92 7695	6
30 92 9433	9
30 91 0050	4
30 92 9445	9
30 93 1634	4, 5
30 93 1634	4, 5
30 93 1638	9
30 93 1635	5, 6
30 92 8556	3, 8
32 92 3398	5
30 93 1679	6
30 92 7894	9
30 92 8348	8
30 92 8348	8
30 93 1678	8
30 93 1679	8
30 93 1679	8
30 91 0025	3, 6
99 91 7800	4, 7
32 92 3378	7
32 92 3378	7
32 92 3378	7
30 92 8327	5, 7
30 92 8327	5, 7
30 92 8346	7
30 92 8346	7
30 92 8346	7
30 92 8346	7
30 92 8346	7
30 93 1680	8
30 93 1680	8
30 93 1672	7
30 93 1673	7
30 93 1674	7, 8
30 93 1677	7, 8
30 93 1676	7
30 93 1677	7, 8
30 93 1674	7, 8
30 93 1684	10



Trouvez vos pièces facilement et rapidement

Vous connaissez le type du véhicule et avez la référence de son constructeur:

Référence → N° SWAG → Numéro de page

Le classement des références correspond à l'ordre de classement du constructeur de véhicules.

N° SWAG → Référence → Numéro de page

Cette liste est triée par référence SWAG, en ordre croissant.

Note: Sur la dernière page de catalogue, vous trouverez la liste des symboles et des abréviations avec les explications dans différentes langues.



Búsqueda de cualquier recambio: rápida y cómoda

Sabe usted cuál es el tipo de vehículo y tiene un número de referencia del fabricante del vehículo:

N° de referencia → N° de SWAG → N° de página

La clasificación de los números de referencia corresponden al orden de clasificación de los fabricantes de vehículos.

N° de SWAG → N° de referencia → N° de página

En esta lista se indican las referencias de SWAG en orden ascendente.

Nota: En la última página del catálogo usted encuentra un listado de todos los símbolos y las abreviaciones respectivamente, en los idiomas.



Поиск запасных частей: комфорт и скорость

Вы знаете тип транспортного средства и референсный номер автопроизводителя:

Референс-№ → SWAG-№ → Число страниц

Структура референсных номеров соответствует сортировочной последовательности автопроизводителей.

SWAG-№ → Референс-№ → Число страниц

Данный перечень рассортирован по номерам SWAG возрастающим порядком.

Указание: перечень символов и сокращений с объяснениями на различных языках Вы найдёте на странице обложки каталога.

Catalogue Guide

Katalogleitfaden Manuel du catalogue Guía del catálogo Руководство по работе с каталогом



User notes: clear and simple

The SWAG catalogue contains the following information:

- 1 Vehicle type (alphabetical order)
- 2 Model (alphabetical order)
- 3 Model year
- 4 SWAG No.
- 5 Restrictions and exceptions (the parts illustrated are essentially valid for all engine and equipment variations; exceptions are listed in this column a list of abbreviations can be found on the last page of the catalogue)



Benutzerhinweise: übersichtlich und einfach

Im SWAG Katalog befinden sich folgende Angaben:

- 1 Fahrzeugtyp (alphabetische Reihenfolge)
- 2 Modell (alphabetisch aufsteigend sortiert)
- 3 Modelljahr
- 4 SWAG-Nr.
- 5 Abgrenzungen und Ausnahmen (grundsätzlich gelten die abgebildeten Teile für alle Motor- und Ausstattungsvarianten. Ausnahmen werden in dieser Spalte hervorgehoben; eine Liste der Abkürzungen finden Sie auf der letzten Katalogseite)

SWAG GERMANY		MERCEDES-BENZ	
C-Klasse (BM 203) (00 → 07)			
	←	10 92 4733	-
	→	10 92 4739	-
(CL203)	←	10 92 4733	10 92 7739
(CL203)	→	10 92 4739	10 92 7739
		10 92 4733	10 92 4327
C-Klasse (BM 204) (07 →)			
	←	10 93 0880	-
	→	10 93 0881	-
(ex.)		-	10 93 0882
		-	10 93 0883
CL (BM 215) (99 → 06)			
(ch.)	← A 006189	10 92 7731	-
(ch.)	→ A 006189	10 92 7731	-
(ch.)	A 006190 →	10 92 7731	-
(ch.)	A 006190 →	10 92 7731	-

Die Einbaue darf nur durch geschultes Fachpersonal erfolgen. / The installation may exclusively be performed by trained specialist staff.

41

**Information
utilisateur: claire et simple**

Les indications suivantes se trouvent dans le catalogue SWAG:

- 1 Type de véhicule (ordre alphabétique)
- 2 Modèle (ordre alphabétique)
- 3 Année-modèle
- 4 N° SWAG
- 5 Limitations et exceptions (de principe, les pièces représentées sont applicables à toutes les variantes de moteur et d'équipement; les exceptions sont identifiées dans cette colonne; vous trouverez une liste abrégées à la dernière page du catalogue)

**Para el usuario:
claro y simple**

En el catálogo SWAG se encuentran los siguientes datos:

- 1 tipos de vehículos (orden alfabético)
- 2 modelo (orden alfabético)
- 3 año del modelo
- 4 N° SWAG
- 5 Delimitaciones y excepciones (generalmente, las piezas visualizadas son válidas para las variantes de motor y equipamiento; las excepciones están resaltadas en esta lista)

**Указания для
пользователя отличаются
ясностью и простотой**

В каталоге SWAG содержатся следующие данные:

- 1 марка автомобиля (расположение в алфавитном порядке по возрастанию)
- 2 модель (расположение в алфавитном порядке по возрастанию)
- 3 год выпуска
- 4 SWAG-N°
- 5 Ограничения и исключения (в основном все представляемые запасные части действительны для любых моторов и различных соотношений; исключения будут показаны в этой колонке; перечень сокращений Вы найдёте на последней странице каталога).

Page Overview

to fit / passend für:

ALFA-ROMEO



145 (930)	1	-	-
146 (930)	1	-	-
147 (937)	1	-	-
156 (932)	1	-	-
156 Sportwagon	1	-	-
159	1	-	-
159 Sportwagon	1	-	-
Brera	1	-	-
GT	2	-	-
Mito	2	-	-
Spider	2	-	-

to fit / passend für:

AUDI

80/90/quattro (89/8A)	3	-	132
80/90/Avantquattro (8C/B4)	3	-	132
80/90/Avant/quattro (8C/B4)	3	-	132
100 (44/C3)	3	-	132
100 Avant (44/C3)	3	-	132
100 (4A/C4)	3	-	132
100 Avant (4A/C4)	4	-	132
200/Avant (44/44Q)	4	-	132
A1 (8x1/8xA)	4	-	-
A2 (8Z0)	4	-	-
A3/quattro (8L1)	4	95	-
A3/quattro/S3 (8P)	4	-	-
A3 Cabriolet	5	-	-
A4/S4/quattro (8D2/B5)	5	-	-
A4 Avant/RS4/quattro (8D5/B5)	5	-	-
A4/S4/quattro (8E2/B6)	5	-	-
A4 Avant/S4 Avant/quattro (8E2/B6)	5	-	-
A4/S4/Avant/quattro (8K)	5	-	-
A4 Avant/S4 Avant/quattro (8K)	5	-	-
A4/RS4/quattro (8EC)	5	95	-
A4 / Avant (8D_)	-	95	-
A4 Avant/S4+RS4 Avant/quattro (8ED)	6	95	-
A4 Cabrio/S4+RS4 Cabrio/quattro (8H7/8HE)	6	-	-
A4 Allroad	6	-	-
A5 Coupé/Sportback/Cabriolet	6	-	-
A6/S6/quattro (4A/C4)	6	-	-
A6 Avant/S6 Avant/quattro (4A/C4)	7	-	-
A6/S6/RS6/quattro (4B/C5)	7	-	-
A6 Avant/S6+RS6 Avant/quattro (4B/C5)	7	-	-
A6/S6/RS6 Avant/quattro (4F)	7	-	-
A6 Allroad quattro (4BH)	7	-	-

to fit / passend für:

AUDI



A6 Allroad	8	-	-
A8/S8/quattro (4D2/4D8)	8	-	-
A8/S8/quattro (4E)	8	-	-
Cabriolet (8G7/B4)	8	-	-
Coupé/quattro (81/85)	8	-	-
Coupé (89/8B)	8	-	-
TT Coupé (8N3)	9	-	-
TT Coupé (8J3)	9	-	-
TT Roadster (8N9)	9	-	-
TT Roadster (8J9)	9	-	-
V8 (44/4C)	9	-	-
Q3 (8U)	9	-	-
Q5 (8R)	9	-	-
Q7 (4L)	10	-	-
Quattro/Sport quattro (85)	10	-	-

to fit / passend für:

BMW

1'er (E81/82/87/LCI/88)	11	-	-
3'er (E30)	11	-	-
3'er (E36)	11	96	-
3'er (E46)	12	96	-
3'er / LCI (E90)	12	-	-
3'er Touring (E91/LCI)	12	-	-
3'er / LCI (E92)	12	-	-
3'er (E93/LCI)	12	-	-
5'er (E28)	13	-	-
5'er (E34)	13	97	-
5'er (E39)	13	97	-
5'er (E60/LCI)	13	98	-
5'er Touring (E61/LCI)	13	98	-
6'er (E24)	13	-	-
7'er (E23)	14	-	-
7'er (E32)	14	98	-
7'er (E38)	14	98	-
7'er (E65/66)	14	-	-
7'er (F01/F02/F04)	14	-	-
8'er (E31)	-	99	-
X1 (E84)	14	-	-
X3 I (E83/LCI)	14	100	-
X5 I (E53)	14	100	-
X5 (E70/LCI)	15	-	-
X6 (E71/72)	15	-	-
Z3	-	101	-
Z3 Roadster (E36/7)	15	-	-
Z3 Coupé (E36)	15	-	-
Z4 (E85)	15	-	-

to fit / passend für:

CITROËN

C1	16	-	-
C2	16	-	-

to fit / passend für:

CITROËN



C3	16	-	-
C3 Picasso	16	-	-
C4	16	-	-
C4 Picasso	16	-	-
C4 Grand Picasso	17	-	-
C5 I+II+III	17	102	-
C6	18	102	-
C8	18	102	-
C-Crosser	18	-	-
Berlingo I+II (M49/M59)	18	102	-
Berlingo III (B9)	18	-	-
Evasion	18	103	-
Jumpy I+II	-	103	-
Jumpy III	19	-	-
Nemo Kombi / Kasten	19	-	-
Saxo	19	-	-
Xantia I (X1)	19	103	-
Xantia II (X2)	19	103	-
XM (Y3)	-	103	-
XM (Y4)	-	103	-
Xsara I	19	104	-
Xsara II	19	-	-
Xsara Picasso	20	-	-
ZX	20	104	-

to fit / passend für:

FIAT

500	21	-	-
Brava (182)	21	-	-
Bravo (182)	21	-	-
Bravo II Nuova (182)	21	-	-
Cinquecento (170)	21	-	-
Croma (194)	21	-	-
Fiorino Nuovo/Qubo Nuovo (225)	21	-	-
Idea	21	-	-
Linea (323)	22	-	-
Marea Weekend (185)	22	-	-
Multipla (186)	22	-	-
Panda (169) II Nuova	22	-	-
Punto (176)	22	-	-
Punto (188)	22	-	-
Grande Punto (199)	22	-	-
Punto EVO	23	-	-
Scudo (220P/L)	-	105	-
Scudo Nuovo (270)	23	-	-
Stilo (192)	23	-	-
Sedici	23	-	-
Seicento (187)	23	-	-
Ulysse (220)	23	105	-
Ulysse II Nuovo (179AX)	-	105	-

to fit / passend für:

FORD



Escort 81	24	-	-
Escort 86	24	-	-
Escort 91	24	-	-
Escort 95	24	-	-
Fiesta 89	24-25	-	-
Fiesta 96	25	-	-
Fiesta 02	25	-	-
Fiesta 08	25	-	-
Fiesta 13	25	-	-
Focus 98	26	-	-
Focus 04	26	-	-
Focus C-MAX 03	26	-	-
Focus C-MAX 07	27	-	-
Focus 08 Turnier	27	-	-
Fusion 02	27	-	-
Galaxy 95	27	-	-
Galaxy 00	27	-	-
Galaxy 06	27	-	-
KA 97	27	-	-
KA 08	27	-	-
Kuga 08	28	-	-
Mondeo 93	28	-	-
Mondeo 97	28	-	-
Mondeo 00	29	-	-
Mondeo 07	29	-	-
Puma 97	29	-	-
Scorpio 95	-	106	-
S-Max 06	30	-	-
Tourneo Connect 02	30	-	-
Transit 86	30	-	-
Transit 92	30	-	-
Transit 95	30	-	-
Transit 00	30	-	-
Transit 06	30	-	-
Transit Connect 02	31	-	-

to fit / passend für:

HONDA

Civic V	32	-	-
Civic VII	32	-	-
CRV III	32	-	-

to fit / passend für:

HYUNDAI

i10	33	-	-
i20	33	-	-
Accent (LC)	33	-	-
Atos (MX)	33	-	-
Atos Prime (MX)	33	-	-
Coupé (RD/GK)	33	-	-
Elantra (XD)	33	-	-
Getz (TB)	33	-	-

Page Overview

to fit / passend für:

HYUNDAI



Lantra II Wagon (J2)	34	-	-
Matrix (FC)	34	-	-
Santa Fé (SM)	34	-	-
Sonata V	34	-	-
Sonata IV	34	-	-
Trajet	34	-	-
Tucson (JM)	34	-	-
Verna (LC)	35	-	-
XG 350	35	-	-

to fit / passend für:

KIA

Carens II	36	-	-
Carnival II	36	-	-
Sorento	36	-	-

to fit / passend für:

LANCIA

Musa (350)	37	-	-
Phedra (179)	-	107	-
Zeta (220)	37	-	-

to fit / passend für:

LEXUS

GS	38	-	-
IS	38	-	-

to fit / passend für:

MAZDA

121 (JASM/JBSM)	39	-	-
626 (GE)	39	-	-
Mazda 6 (GG)	39	-	-
Mazda 6 (GY)	39	-	-
MX-5 (NC)	39	-	-

to fit / passend für:

MERCEDES-BENZ

BM 110/111	-	-	135
BM 114/115	-	-	135
BM 123	40	-	135
BM 124	40	108 - 110	135
190 (BM 201)	40	110 - 111	135
A-Klasse (BM 168)	40	-	-
A-Klasse (BM 169)	40	-	-
B-Klasse (BM 245)	40	-	-
C-Klasse (BM 202)	40	112	136
C-Klasse (BM 203)	41	113	-
C-Klasse (BM 204)	41	113	-
CL (BM 215)	41	113	-
CL (BM 216)	42	-	-
CLK (BM 208)	42	113	136
CLK (BM 209)	42	113	-
CLS (BM 219)	42	114	-
E-Klasse (BM 210)	43	114	-
E-Klasse (BM 211)	43	115	-

to fit / passend für:

MERCEDES-BENZ



E-Klasse (BM 212)	43	-	-
G-Klasse (BM 460/461)	-	115	136
G-Klasse (BM 463)	-	115 - 116	136
GL- Klasse (BM 164)	44	-	-
GLK-Klasse (BM 204)	44	-	-
M-Klasse (BM 163)	44	116	-
M-Klasse (BM 164)	44	116	-
R-Klasse (BM 251)	45	117	-
S-Klasse (BM 108/109)	-	-	136
S-Klasse (BM 116)	-	-	136
S-Klasse (BM 126)	-	117	137
S-Klasse (BM 140)	45	117	137
S-Klasse (BM 220)	45	117 - 118	-
S-Klasse (BM 221)	45	-	-
SL (BM 113)	-	-	137
SL (BM 107)	-	118	137
SL (BM 129)	45	118	137
SL (BM 230)	46	119	-
SLK (BM 170)	46	119	137
SLK (BM 171)	46	119	-
Sprinter I (BM 901/902/903/904)	-	120	-
Sprinter II (BM 906)	-	120	-
Vaneo (BM 414)	46	-	-
V-Klasse/Vito (BM 638)	46	-	-
Viano/Vito (BM 639)	46	-	-
Vito / V-Klasse (BM 638)	-	120	-

to fit / passend für:

MINI

Mini One / One D / Cooper / Cooper S (R50/R53)	47	-	-
Mini Cabriolet One / Cooper / Cooper S (R52)	47	-	-
Mini Clubman / LCI (R55)	47	-	-
Mini Coupé / LCI (R56)	47	-	-
Mini Cabrio / LCI (R57)	47	-	-
Mini Coupé (R58)	47	-	-
Mini Roadster (R59)	47	-	-

to fit / passend für:

MITSUBISHI

Carisma	48	-	-
Outlander II	48	-	-
Space Star	48	-	-

to fit / passend für:

NISSAN

Almera II (N16)	49	-	-
Kubistar (X76)	49	-	-
Micra (K11)	49	-	-
Micra (K12E)	49	-	-
Primera (P11/WP11)	49	-	-

to fit / passend für:

NISSAN



X-Trail (T30)	49	-	-
---------------	----	---	---

to fit / passend für:

OPEL

Agila A	50	-	-
Astra F	51	-	-
Astra G	51	121	-
Astra H	51	-	-
Astra J	52	-	-
Calibra	52	-	-
Corsa B	52	-	-
Corsa C	52	-	-
Corsa C Combo	52	-	-
Corsa D	52	-	-
Frontera B	-	121	-
Insignia	53	-	-
Kadett E	53	-	-
Meriva A	53	-	-
Omega A	53	-	-
Omega B	53	121	-
Signum	53	121	-
Sintra	-	121	-
Vectra A	53	-	-
Vectra B	53	122	-
Vectra C	54	122	-
Vivaro	54	-	-
Zafira A	54	122	-
Zafira B	54	-	-

to fit / passend für:

PEUGEOT

106 I	55	-	-
107	55	-	-
205 I	55	-	-
205 II	55	-	-
206	55	206	-
206 CC	55	-	-
206 SW	55	-	-
207	56	-	-
306	56	123	-
306 Restyling	56	-	-
307	56	-	-
307 SW	56	-	-
308	57	-	-
406	57	123	-
407	57	123	-
605	-	123	-
607	58	124	-
806	58	124	-
807	58	124	-
3008	58	-	-

to fit / passend für:

PEUGEOT



4007	58	-	-
Bipper Kombi / Kasten	58	-	-
Expert III	58	-	-
Partner / Partner Kasten (B9)	59	-	-
Partner I (M49)	59	-	-
Partner II (M59)	59	-	-
Expert I+II	-	124	-
Partner I+II (M49/M59)	-	124	-

to fit / passend für:

PORSCHE

911/Cabriolet (964)	60	-	-
911/Cabriolet (993)	60	-	-
911/Cabriolet (996)	60	-	-
911/Cabriolet (997)	60	-	-
924	60	-	-
944	60	-	-
Boxster (986)	60	-	-
Boxster (987)	61	-	-
Cayenne (955)	61	-	-
Cayman (987)	61	-	-

to fit / passend für:

RENAULT

Clio I	62	-	-
Clio II	62	-	-
Clio III	62	-	-
Dacia Duster	62	-	-
Dacia Sandero	62	-	-
Espace II	62	-	-
Espace III	62	-	-
Espace IV	62	-	-
Kangoo I	63	-	-
Laguna I	63	-	-
Laguna II	63	-	-
Laguna III	63	-	-
Megane I	63	-	-
Megane II	64	-	-
Megane II CC	64	-	-
Megane III	64	-	-
Modus	64	-	-
Rapid	64	-	-
Scenic I	65	-	-
Scenic II	65	-	-
Scenic III	65	-	-
Grand Scenic III	65	-	-
Twingo I	65	-	-
Twingo II	65	-	-

to fit / passend für:

ROVER

75	66	-	-
----	----	---	---

Page Overview

to fit / passend für:

SAAB



900 I	67	-	-
900 II	67	-	-
9000	67	-	-
9-3 I	67	-	-
9-3 II	68	-	-
9-5 I	68	-	-
9000	-	125	-

to fit / passend für:

SEAT

Alhambra (7V8/7V9)	69	-	-
Alhambra (710)	69	-	-
Cardoba II (6K2)	-	126	-
Cordoba Vario (6K5)	69	-	-
Exeo ST	69	-	-
Golf Plus (5M1/521)	69	-	-
Ibiza (6K1)	69	-	-
Ibiza (6L1)	69	-	-
Ibiza (6J1)	70	-	-
Ibiza II (6K1)	-	126	-
Leon/4x4 (1M1)	70	126	-
Leon (1P1)	70	-	-
Toledo (1L2)	70	-	-
Toledo (1M2)	70	-	-
Toledo (5P2)	70	-	-
Toledo II (1M2)	-	126	-

to fit / passend für:

SKODA

Fabia (6Y2/6Y3/6Y5)	71	-	-
Fabia (5J2)	71	-	-
Fabia (5J5)	71	-	-
Felicia (6U1/6U5)	71	-	-
Octavia/4x4 (1U1/1U5)	71	-	-
Octavia (1U_/1Z_)	-	127	-
Octavia (1Z3/1Z5)	72	-	-
Roomster (5J)	72	-	-
Superb (3U4)	72	127	-
Superb (3T4/3T5)	72	-	-

to fit / passend für:

SMART

Smart (BM450)	73	-	-
Fortwo (BM451)	73	-	-
City Coupé (BM 450)	-	-	138

to fit / passend für:

SUZUKI

Wagon R+	74	-	-
----------	----	---	---

to fit / passend für:

TOYOTA

Avensis (T22)	75	-	-
Avensis (T25)	75	-	-
Aygo	75	-	-

to fit / passend für:

TOYOTA



Carina E	75	-	-
Corolla (E10)	75	-	-
Corolla (E11)	75	-	-
Corolla (E12)	75	-	-
Corolla Verso	75	-	-
Prius	76	-	-
Yaris	76	-	-

to fit / passend für:

VAUXHALL

Agila A	77	-	-
Astra Mk II	77	-	-
Astra Mk III	77	-	-
Astra Mk IV	77	128	-
Astra Mk V	78	-	-
Astra Mk VI	78	-	-
Calibra	78	-	-
Carlton Mk III	78	-	-
Cavalier Mk III	78	-	-
Corsa	79	-	-
Corsa Mk II	79	-	-
Corsa Mk III	79	-	-
Corsa C Combo	79	-	-
Frontera Mk II	-	128	-
Insignia	79	-	-
Meriva MK I	79	-	-
Omega	80	128	-
Signum	80	128	-
Sintra	-	128	-
Vectra	80	129	-
Vectra MK I	80	-	-
Vectra MK II	81	129	-
Vivaro	81	-	-
Zafira	-	129	-
Zafira MK I	81	-	-
Zafira MK II	81	-	-

to fit / passend für:

VOLKSWAGEN

Bora/4motion (1J2)	82	-	-
Bora / Variant (1J2/5)	-	130	-
Bora Variant/4motion (1J6)	82	-	-
Caddy III (2K)	82	-	-
Caddy 4/4motion/Caddy Maxi (2CA/2CB/2CH/2CJ)	82	-	-
Fox/Crossfox (5Z1)	82	-	-
Crosstoura/Touran (1T)	82	-	-
Crosstouran (1T)	82	-	-
EOS	83	-	-
Golf 2/Syncro (19E/1G1)	83	-	-
Golf 3/Syncro (1H1)	83	-	-
Golf 3 Variant/Syncro (1H5)	83	-	-

to fit / passend für:

VOLKSWAGEN



Golf 3 Cabriolet (1E7)	83	-	-
Golf 4/Variant/4motion (1J1)	83	-	-
Golf 4 Cabriolet (1E7)	83	-	-
Golf 5/4motion (1K1)	84	-	-
Golf IV / Variant (1J1/5)	-	130	-
Golf VI (5K)	84	-	-
Golf VI/Variant/4motion	84	-	-
Golf 6 Cabrio	84	-	-
Jetta (1K2)	84	-	-
Lupo (6X1/6E1)	84	-	-
New Beetle (9C1/1C1)	84	130	-
New Beetle Cabrio (1Y7)	84	-	-
Passat Variant (32B)	85	-	-
Passat Variant (3A2/35I)	85	-	-
Passat / Variant (3B_)	-	130	-
Passat/Variant (3B2/3B5)	-	-	139
Passat/4motion (3B2)	85	-	-
Passat/Variant 4motion (3B2/3B5)	-	-	139
Passat Variant/4motion (3B5)	85	-	-
Passat/4motion (3B3)	85	-	-
Passat Variant/4motion (3B6)	85	-	-
Passat Variant/4motion (3C)	86	-	-
Passat/4motion(3C2)	86	-	-
Passat CC/4motion	86	-	-
Passat 6/4motion	86	-	-
Passat 6/Variant+Variant 4motion+Alltrack+Alltrack 4motion	86	-	-
Polo (6N1/6N2)	86	-	-
Polo (9N)	86	-	-
Polo Classic Avant (6KV2)	86	-	-
Polo Classic / Variant (6KV2/5)	-	131	-
Polo (6R)	87	-	-
Scirocco (137)	87	-	-
Sharan (7M6/7M8/7M9)	87	-	-
Sharan /4motion (7N1)	87	-	-
Tiguan (5N)	87	-	-
Touareg (7LA/7L6/7L7)	87	-	-
Touran (1T1/1T2)	87	-	-
Touran (GP2)	88	-	-
Transporter (T4)	-	-	139
Transporter/Syncro (T3)	88	-	-
Transporter/Syncro (T4) (ch.) → 70-N-151781	88	-	-
Transporter/Syncro (T4) (ch.) → 70-N-151782	89	-	-
Transporter/4motion (T5)	89	-	-
Transporter T5/4motion+T5 Multivan/4motion	89	-	-

to fit / passend für:

VOLKSWAGEN



up! (CHYA/CHYB/CPGA)	90	-	-
Vento (1H2)	90	-	-

to fit / passend für:

VOLVO

740	91	-	-
760	91	-	-
850	91	-	-
940 I / II	91	-	-
960 I	91	-	-
960 II	91	-	-
C 30	92	-	-
C 70 II	92	-	-
S 40 I	92	-	-
S 40 II	92	-	-
S 60 I	92	-	-
S 70	92	-	-
S 80 I	92	-	-
S 80 II	92	-	-
S 90	93	-	-
V 40 I	93	-	-
V 50	93	-	-
V 70 I	93	-	-
V 70 II	93	-	-
V 70 III	93	-	-
V 90	94	-	-
XC 60	94	-	-
XC 70 III	94	-	-
XC 70 Cross Country II	94	-	-

Catalogues, Flyers and more



Axle and Steering Boots

Achs- und Lenkmanschetten
Soufflets de Cardan et de Direction
Manguitos Guardapolvo y de Dirección
Осевые манжеты и манжеты рулевого управления

98 00 1019



Propeller Shaft Accessories

Kardanwellenzubehör
Accessoires de Transmission
Accesorios para los Árboles de Cardán
Арматура карданного Вала

8 00 1017



Gas Pressure Springs

Gasdruckfedern
Ressort pneumatique
Molle pressione gas
газовые пружины

8 00 1054

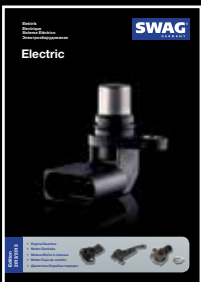

Electric Engine / transmission

Elektrik Motor / Getriebe
Electrique moteur / boîte de vitesse
Sistema Eléctrico motor / Caja de cambio
Электрооборудование двигатель / коробка передач

8 00 1050



Electric Heater / climate control

Elektrik Heizung / Klima
Electrique chauffage / climatisation
Sistema Eléctrico calefacción / climatización
Электрооборудование система отопления / Кондиционер

8 00 1051

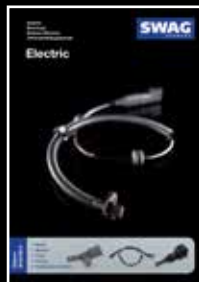

Electric Brake

Elektrik Bremse
Electrique frein
Sistema Eléctrico frenos
Электрооборудование тормозная система

8 00 1052



Electric Body

Elektrik Karosserie
Electrique carrosserie
Sistema Eléctrico carrocería
Электрооборудование кузов

8 00 1053



Engine Timing for diesel engines

Motorsteuerung für Dieselmotoren
Distribution pour moteurs diesel
Distribución del Motor para motores diesel
Детали привода механизма газораспределения и вспомогательных агрегатов Для дизельных двигателей

8 00 1012

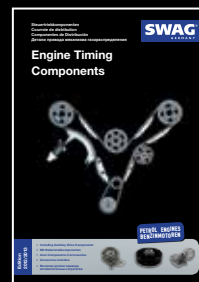

Engine Timing for petrol engines

Motorsteuerung für Benzinmotoren
Distribution pour véhicules Essence
Distribución del Motor para motores gasoline
Детали привода механизма газораспределения и вспомогательных агрегатов Для бензиновых двигателей

8 00 1014

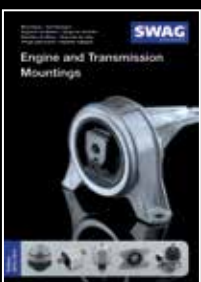

Engine and Transmission Mountings

Motorlager/ Getriebelager
Support de Moteur/ Support de Boîte
Soportes de Motor/ Soportes de Caja
Опора двигателя/ коробки передач

8 00 1007



Brake Pad/ Brake Disc

Bremsklotz/ Bremsscheibe
Plaquette de Frein/ Disque de Frein
Pastillas de Freno/ Disco de Freno
Тормозная Колодка/ Тормозной Диск

98 00 1038



Cylinder Head Components

Zylinderkopfkomponenten
Composants de Culasse
Componentes de Culata
Компоненты головки блока цилиндра

98 00 1025

Line Catalogues/
Linienkataloge



**Rubber-Metal-Parts
for Suspension**

Gummimetallteile
für Fahrwerke
Pièces Caoutchouc-
Métal pour Suspension
Piezas de Caucho-
Metal para Chasis
Резинометаллические
детали для ходовой
части

8 00 1066



**Steering and
Suspension**

Lenkung und
Aufhängung
Direction et
Suspension
Dirección y
Suspension
Рулевое управление
и подвеска

8 00 1013



Pulleys

Riemenscheiben
Poulies
Poleas
Ременной шкив
8 00 1066

Type Catalogues/
Typenkataloge

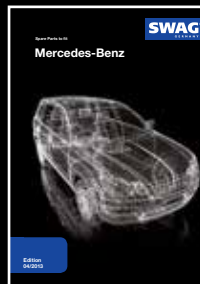

**Spare Parts
to fit Mercedes-
Benz**

8 00 1036



**Spare Parts
to fit Ford**

98 00 1063



**Spare Parts
to fit VW**

98 00 1035

SWAG Extra



SWAG Extra

8 00 1032

DVD



DVD

8 00 1060

Brochures/Broschüren



Fluids

8 00 1040

Технологические
жидкости

8 00 1042



Wheel Fastening

Radbefestigung
Fixation de Roue
Fissaggio Ruota
Fijación de Ruedas
Колесное крепление

8 00 1037



Cabin Air Filters

Innenraumluftfilter
Filtres à air d'habitacle
Filtri abitacolo
Filtros de aire del habitáculo
внутренний воздушный фильтр

8 00 1043



Glow Plugs

Glühkerzen
Bougies de Préchauffage
Candelette ad
Incandescenza

Bujía de Encendido
Свечи накаливания
98 00 1021



Your advantages at a glance

Our special catalogue service for you!

- Simple to find parts thanks to grouping of sections.
- Gas springs and dampers in one catalogue.
- Easy reference thanks to use of symbols.

Ihre Vorteile auf einen Blick

Unser spezieller Katalog-Service für Sie!

- Einfache Teilefindung durch Kapitelgliederung.
- Gasfedern und Dämpfer in einem Katalog.
- Übersichtlich durch Verwendung von Symbolen

Vos avantages en un coup d'œil

Notre catalogue: conçu spécialement pour vous

- Découverte simple des diverses parties par chapitres.
- Ressorts à gaz et amortisseurs dans un même catalogue.
- Clair et pratique par l'emploi de symboles.

Sus ventajas en un solo vistazo

¡Nuestro servicio de catálogo especial para usted!

- Encontrar piezas de modo sencillo por división en capítulos.
- Resortes de gas y amortiguadores en un catálogo.
- Claro por el uso de símbolos.

Все Ваши преимущества здесь и сейчас

Наш специальный сервис каталогов для Вас!

- Простота поиска деталей благодаря разделению по главам.
- Амортизаторы багажника/капота и демпферы в одном каталоге.
- Наглядность благодаря использованию символов.

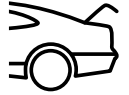

145 (930)

(94 → 00)

-

74 92 8017

146 (930)

(95 → 00)

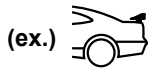

-

74 92 8014

147 (937)

(00 → 10)

74 92 8013

74 93 3060

156 (932)

(97 → 05)

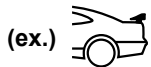

74 92 8016

74 92 8018

156 Sportwagon

(00 → 06)

74 92 8016

74 92 8015

159

(05 → 11)

74 93 3059

74 93 3061

159 Sportwagon

(05 → 11)

-

74 93 3062

Brera

(06 → 10)

74 93 3059

-

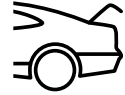
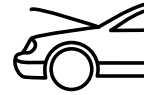

GT

(03 → 10)

74 92 8013

74 93 3063

Mito

(08 →)

-

74 93 3064

Spider

(06 → 12)

74 93 3059

-



80/90/quattro (89/8A)

(86 → 92)

-

30 51 0019

80/90/quattro (8C/B4)

(92 → 96)

30 92 8556

30 92 8345

80/90/Avant/quattro (8C/B4)

(92 → 96)



30 92 8556

30 92 7691



30 92 8556

30 92 7696

100 (44/C3)

(82 → 91)



(ch.) → 44-F-115150

30 51 0013

-



(ch.) 44-F-115151 →

30 92 7678

-

100 Avant (44/C3)

(82 → 91)

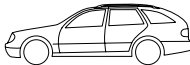

(ch.) → 44-F-115150

30 51 0013

-

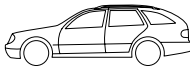

(ch.) 44-F-115151 →

30 92 7678

-

100 (4A/C4)

(91 → 94)



30 92 7677

30 51 0025

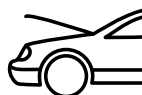

100 Avant (4A/C4)

(91 → 94)



30 92 7677

99 91 7880



30 92 7677

30 92 7692

200/Avant (44/44Q)

(83 → 91)

(ch.) → 44-F-115150

30 51 0013

-

(ch.) 44-F-115151 →

30 92 7678

-

A1 (8x1/8xA)

(10 →)



-

30 93 9259



-

30 93 9260

A2 (8Z0)

(00 → 05)

(ch.) 8Z0-1-055001 →

-

30 92 7678

A3/quattro (8L1)

(96 → 03)

(ch.) → 8L-2-090000

30 51 0050

32 92 3394

(ch.) 8L-2-090001 →

30 51 0050

30 92 7682

A3/quattro/S3 (8P)

(03 → 12)



30 93 1634

30 93 1663



30 93 1634

30 93 1662

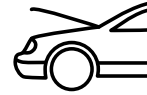

A3 Cabriolet (08 →)



30 93 1634

30 93 1664

A4/S4/quattro (8D2/B5) (95 → 01)



30 92 8350

32 92 3398

A4 Avant/RS4/quattro (8D5/B5) (95 → 01)

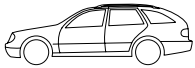

30 92 8350

32 92 3394

A4/S4/quattro (8E2/B6) (01 → 05)



(ch.) 8E-1-000001 → 8E-5-400000

30 92 7690

30 92 8327

A4 Avant/S4 Avant/quattro (8E2/B6) (01 → 05)

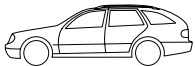

(ch.) 8E-1-000001 → 8E-5-400000

30 92 7690

30 92 9428

A4/S4/Avant/quattro (8K) (07 →)

*10 →

30 93 1635

30 93 7483*

A4 Avant/S4 Avant/quattro (8K) (08 →)



-

30 93 1667



-

30 93 1666

A4/RS4/quattro (8EC) (05 →)



*(ex.) 2,0 TFSI / 1,9 TDI

30 92 7690*

30 92 9429

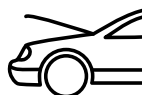

A4 Avant/S4+RS4 Avant/quattro (8ED)

(05 →)

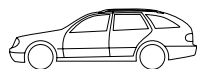

*(ex.) 2,0 TFSI / 1,9 TDI

30 92 7690*

30 92 9430

A4 Cabrio/S4+RS4Cabrio/quattro (8H7/8HE)

(03 →)

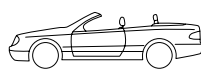

→ 06

30 92 7695

30 92 8343

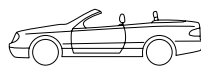

07 →

30 92 7690

30 92 8343

A4 Allroad

(09 →)

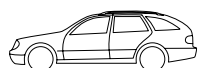

10 →

30 93 1635

30 93 1667

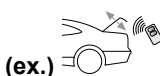
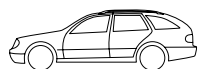

(ex.)

30 93 1635

30 93 1666

A5 Coupe/Sportback/Cabriolet

(07 →)

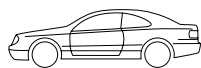

30 93 1635

30 93 7491



5

*(PR-5NC)

30 93 1635

30 93 7492*



30 93 1635

30 93 1670

A6/S6/quattro (4A/C4)

(95 → 97)



4

30 51 0026

30 51 0025



A6 Avant/S6 Avant/quattro (4A/C4)

(95 → 97)



30 51 0026

99 91 7880

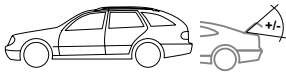

30 51 0026

30 92 7692

A6/S6/RS6/quattro (4B/C5)

(97 → 05)



(ch.) → 4B-Y-130134

30 92 7693

32 92 3378



(ch.) 4B-Y-130135 →

30 92 7693

30 92 8327

A6 Avant/S6+RS6 Avant/quattro (4B/C5)

(97 → 05)

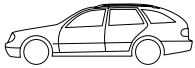

30 92 7693

30 92 8346

A6/S6/RS6 Avant/quattro (4F)

(04 →)

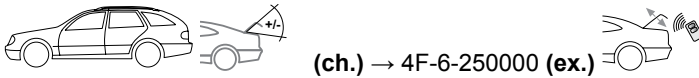

(ch.) → 4F-6-250000 (ex.)

30 93 1636

30 93 1676

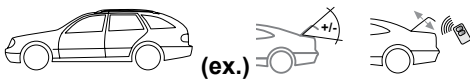

(ex.)

30 93 1636

30 93 1677



30 93 1636

30 93 1674

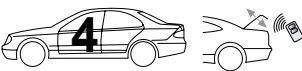

30 93 1636

30 93 1672

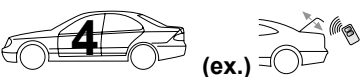

(ex.)

30 93 1636

30 93 1673

A6 Allroad Quattro (4BH)

(00 → 05)

30 92 7693

30 92 7674

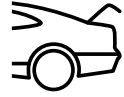
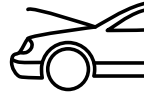

A6 Allroad
(05 →)

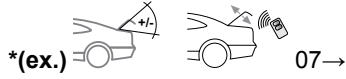

30 93 1636

30 93 1677*



30 93 1636

30 93 1674

A8/S8/quattro (4D2/4D8)
(94 → 03)

30 92 7675

30 92 8348

A8/S8/quattro (4E)
(04 →)

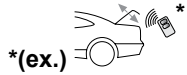

30 93 1637

30 93 1678*



30 93 1637

30 93 1679



30 93 1637

30 93 1680

Cabriolet (8G7/B4)
(92 → 00)



30 92 8556

30 92 9431

Coupe/quattro (81/85)
(81 → 88)

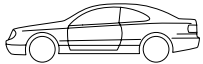

-

30 93 1466

Coupe (89/8B)
(89 → 96)

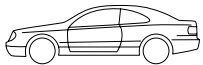

30 92 8556

30 92 9432



TT Coupe (8N3)

(98 → 06)



(ch.) → 8N-1-010000

30 92 9445

30 92 7172

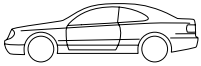

(ch.) 8N-1-010001 → 8N-3-050000

30 92 9445

30 92 7683

TT Coupe (8J3)

(06 →)

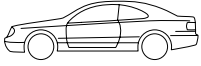

30 92 9433

30 92 7172

TT Roadster (8N9)

(02 → 06)

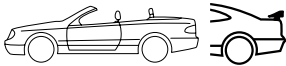

(ch.) 8N-2-026001→

30 92 9445

30 92 7684

TT Roadster (8J9)

(06 →)

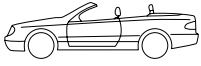

30 92 9433

30 92 7172

V8 (44/4C)

(88 → 94)

30 92 7678

30 92 7694

Q3 (8U)

(11 →)

30 93 9261

30 93 9262

Q5 (8R)

(08 →)

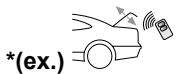

*(ex.)

30 93 1637

30 93 1681*

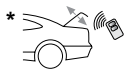

*

30 93 1637

30 93 1831*



Q7 (4L)
(06 →)

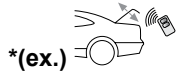

30 93 1639

30 93 1683*

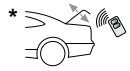

30 93 1639

30 93 1684*

Quattro/Sport quattro (85)
(80 →91)

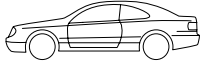

-

30 93 1466

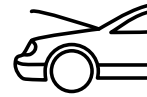

1'er (E81/82/87/LCI/88)

(04 →)

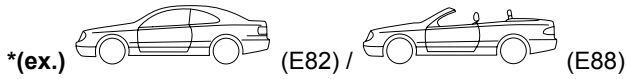

20 92 7586

20 92 9259*

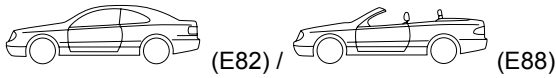

20 92 7586

20 93 4505

3'er (E30)

(82 → 94)



20 51 0003

-

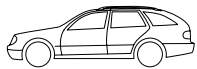

20 51 0003

20 93 1025

3'er (E36)

(90 → 99)

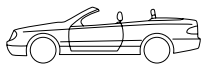

20 51 0020

20 51 0025

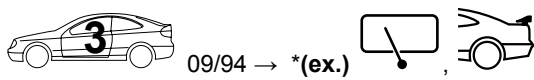

20 51 0014

20 92 7585*

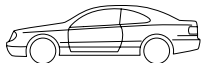

20 51 0020

20 51 0027



20 51 0014

20 51 0027

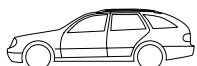

20 51 0014

20 92 7601

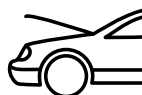

3`er (E46)

(98 → 05)

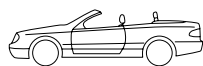

20 51 0045

20 92 7587



20 51 0045

20 93 8231

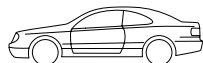

20 51 0045

20 51 0043



20 51 0045

20 51 0043

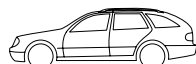

20 51 0045

20 92 7590

3`er / LCI (E90)

(05 → 12)

20 92 7599

20 93 4200

3`er Touring (E91/LCI)

(05 → 12)

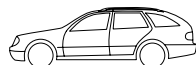

20 92 7599

20 93 4506

3`er / LCI (E92)

(06 →)

-

20 93 4200

3`er (E93/LCI)

(06 →)

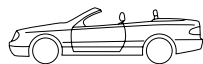

-

20 93 4508

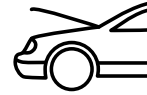

5'er (E28)

(81 → 87)



20 51 0001

-

5'er (E34)

(88 → 97)



20 51 0004

20 51 0007



20 51 0004

20 92 9263



20 51 0004

20 92 9264

5'er (E39)

(95 → 04)



20 51 0032

20 92 7602



20 51 0032

20 92 9364



20 51 0032

20 92 7597

5'er (E60/LCI)

(04 → 10)



20 92 6057

-

5'er Touring (E61/LCI)

(04 → 11)

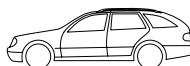

20 92 6057

-

6'er (E24)

(76 → 89)

20 51 0002

-

**7'er (E23)**

(77 → 86)



20 51 0002

-

7'er (E32)

(86 → 94)



20 51 0005

20 51 0006

7'er (E38)

(94 → 01)



20 51 0024

20 92 7596

7'er (E65/66)

(01 →)



20 92 3649

-

7'er (F01/F02/F04)

(08 →)

Mit aktiver Motorhaube / with active engine hood

20 93 4510

-

(ex.) aktiver Motorhaube / (ex.) active engine hood

20 93 4512

-

X1 (E84)

(09 →)

20 93 6960

-

X3 I (E83/LCI)

(04 → 10)

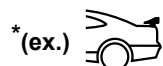

20 92 7591

20 92 7588*

X5 I (E53)

(00 → 07)

20 92 7595

20 92 7594

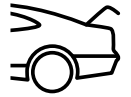
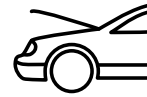
X5 (E70/LCI)
 (07 →)

20 93 4514

-

X6 (E71/72)
 (08 →)

20 93 4514

-

Z3 Roadster (E36/7)
 (95 → 03)

* 10/95 → 04/99

20 93 3538

20 93 0233

* 04/99 → 01/03

20 93 3538

20 93 0234

Z3 Coupe (E36)
 (97 → 03)

20 93 3538

-

Z4 (E85)
 (03 →)

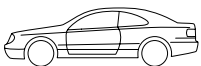

20 92 7593

20 92 7600

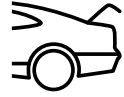
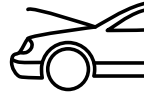

20 92 7593

-



C1 (05 →)

-	64 92 8002
---	------------

C2 (03 →)

-	64 92 8003
---	------------

C3 (02 → 09)

(ex.) Pluriel

-	64 92 8004
---	------------

C3 Picasso (09 →)

-	64 93 4449
---	------------

C4 (04 →)

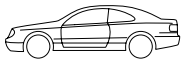

-	64 93 4447
---	------------

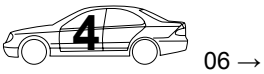

-	64 93 4448
---	------------



-	64 93 4446
---	------------

C4 Picasso (07 →)

-	62 93 4445
---	------------

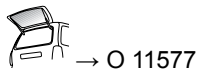

-	62 93 4444
---	------------

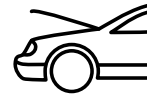

C4 Grand Picasso

(06 →)



-

64 93 1411

-

62 93 4441



-

64 93 4442

C5 I

(01 → 04)



-

64 93 4440



-

64 92 8005



-

64 92 9260

C5 II

(04 → 08)



-

64 93 4439



-

64 92 8005



-

64 92 9260

C5 III

(08 →)



-

64 93 4438



-

64 93 4437

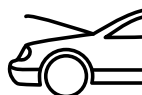

C6

(05 →)

-

64 93 4436

C8

(02 →)

-

64 93 4434

C-Crosser

(07 →)

-

80 93 3393

Berlingo I+II (M49/M59)

(96 → 08)

-

64 93 4433

Berlingo III (B9)

(08 →)

*O → 11829

-

64 93 4430*

*O 11830 →

-

64 93 4424*



-

64 93 4425*



-

64 93 4431*

Evasion

(94 → 02)

O 6945 → 7632

-

64 51 0014

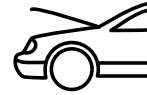

Jumpy III

(07 →)

-

64 93 4429

Nemo Kombi / Kasten

(08 →)

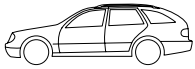

-

64 93 4428

Saxo

(96 → 03)

-

64 92 9197

Xantia I (X1)

(93 → 98)

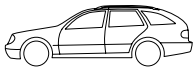

-

64 92 8006

Xantia II (X2)

(98 → 03)

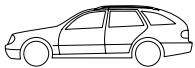

-

64 92 8006

Xsara I

(97 → 00)



64 92 8010

64 92 8007

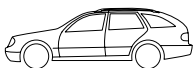

64 92 8010

64 92 8008

Xsara II

(00 → 05)



64 92 8011

64 92 8007

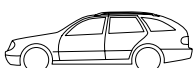

64 92 8011

64 92 8008

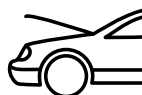

Xsara Picasso

(99 →)

O 09842 →
mit Lift-O-Mat Gasfeder/with Lift-O-Mat gas spring

-

64 93 4427

ZX

(91 → 98)

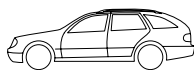

-

64 92 8009



500
(07 → 12)

-

70 93 3347

Brava (182)
(95 → 01)

-

70 92 8041

Bravo (182)
(98 → 05)

-

70 92 8042

Bravo II Nuova (198)
(07 →)

-

70 93 3339

Cinquecento (170)
(91 → 99)

-

70 93 1084

Croma (194)
(05 → 10)

-

70 93 3344

Fiorino Nuovo / Qubo Nuovo (225)
(08 →)

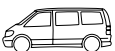

-

64 93 4428

Idea
(03 → 12)

-

70 93 3338

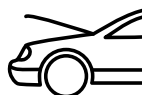

Linea (323)

(07 →)

-

70 93 3343

Marea Weekend (185)

(97 → 05)

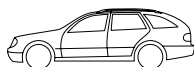

-

70 51 0018

Multipla (186)

(98 → 02)



-

70 92 8040

Panda (169) II Nuova

(03 → 09)

-

70 93 3337

Punto (176)

(93 → 99)

-

70 51 0014

Punto (188)

(99 → 05)



-

70 92 8037



-

70 92 8036

Grande Punto (199)

(05 → 12)

-

70 93 3346



Punto EVO

(09 → 11)

-

70 93 3346

Scudo Nuovo (270)

(07 →)

-

64 93 4429

Stilo (192)

(01 → 07)



-

70 92 8038



-

70 92 8039



*(ex.)

-

70 93 3340*

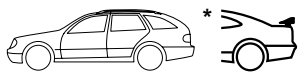

*

-

70 93 3341*



*

-

70 93 3342*

Sedici

(06 → 11)

-

70 93 3345

Seicento (187)

(98 → 10)

-

70 93 1084

Ulysse (220)

(94 → 02)

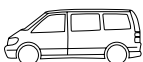

-

64 51 0014

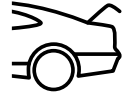

Escort 81 (83 → 85)

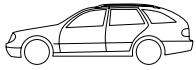

05/83 → 12/85 (ex.)



-

50 51 0025

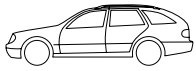

05/83 → 12/85



-

50 51 0025

Escort 86 (86 → 90)

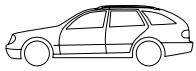

01/86 → 07/90 (ex.)



-

50 51 0025

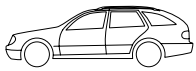

01/86 → 07/90



-

50 51 0025

Escort 91 (90 → 95)



08/92 → 01/95 (ex.)



-

50 51 0028



08/92 → 01/95



-

50 51 0029

Escort 95 (95 → 98)



01/95 → 10/98 (ex.)



-

50 51 0028



01/95 → 10/98



-

50 51 0029

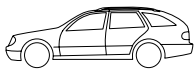

01/95 → 03/99

-

50 92 7761

Fiesta 89 (89 → 95)



03/89 → 03/93 (ex.)



-

50 92 7786



03/89 → 03/93



-

50 92 7759



Fiesta 89

(89 → 95)



04/93 → 12/95 (ex.)



-

50 92 7782

Fiesta 96

(95 → 02)



11/95 → 01/02 (ex.)



-

50 92 7774



11/95 → 01/02



-

50 51 0049

Fiesta 02

(01 → 08)



11/01 →

-

50 92 7784



11/01 →

-

50 92 7757

Fiesta 08

(08 → 13)

07/08 →

-

50 93 8234

Fiesta 13

(08 → 13)

-

50 93 8234

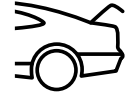

Focus 98 (98 → 04)

	08/98 → 12/00	-	50 92 7773
	12/00 → 12/02	-	50 92 7776
	12/02 → 07/04	-	50 92 7776
	12/02 → 07/04	-	50 92 7777
	02/99 → 11/04	-	50 92 7777
	11/98 → 02/01	-	10 92 7758
	02/01 → 12/02	-	50 92 7778

Focus 04 (04 → 08)

	07/04 → 11/07	-	50 92 7768
	07/04 → 11/07	-	50 92 7770
	07/04 → 11/07	-	50 92 7767

Focus C-MAX 03 (03 → 07)

	06/03 → 02/07	-	50 92 7766
--	---------------	---	------------



Focus C-MAX 07

(07 → 11)

02/07 →

-

50 92 7766

Focus 08 Turnier

(08 → 11)

→ 03/08

-

50 92 7767

03/08 →

-

50 93 1947

Fusion 02

(02 →)

06/02 →

-

50 92 7787

Galaxy 95

(95 → 00)

11/95 → 03/00

-

32 92 3390

Galaxy 00

(00 → 06)

04/00 → 08/06

30 92 7664

32 92 3390

Galaxy 06

(06 →)

04/06 →

-

50 93 1949

KA 97

(97 → 08)

09/96 →

-

50 51 0034

KA 08

(08 →)

09/08 →

-



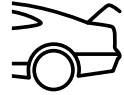





50 93 1950









Kuga 08 (08 → 13)

02/08 →	-	50 93 1956
 03/08 →	-	50 93 1946

Mondeo 93 (93 → 96)

 01/93 → 07/96 (ex.) 	-	50 51 0040
 01/93 → 07/96 	-	50 51 0043
 01/93 → 07/96 (ex.) 	-	50 51 0044
 01/93 → 07/96 	-	50 51 0045
 01/93 → 07/96	-	50 51 0046

Mondeo 97 (96 → 00)

 08/96 → 09/00 (ex.) 	-	50 51 0040
 08/96 → 09/00 	-	50 51 0043
 08/96 → 09/00 (ex.) 	-	50 51 0044
 08/96 → 09/00 	-	50 51 0045
 08/96 → 09/00	-	50 51 0046



Mondeo 00

(00 → 07)



10/00 → 01/07 (ex.)



50 92 7771

50 92 7781



10/00 → 01/07



50 92 7771

50 92 7781



10/00 → 01/07

50 92 7771

50 92 7760



10/02 → 01/07

50 92 7771

50 92 7762

Mondeo 07

(07 →)

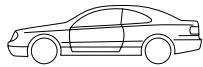

08/07 →

-

50 93 1954



02/07 → 07/08

-

50 93 1951



07/08 →

-

50 93 1952

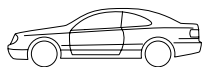

03/07 → 07/08

-

50 93 1953

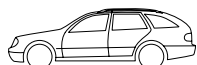

03/07 →

-

50 93 1955

Puma 97

(97 → 01)

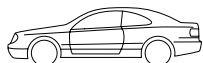

06/97 → 06/00



-

50 92 7789

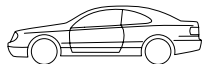

06/00 → 12/01



-

50 92 7789

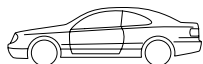

06/00 → 12/01



-

50 92 7769

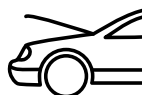

S-Max 06

(06 →)

03/06 →	-	50 93 1948
---------	---	------------

Tourneo Connect 02

(02 →)

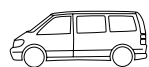

06/02 →

-	50 93 4507
---	------------

Transit 86

(85 → 91)

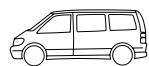

11/85 → 07/91 (ex.)



-	50 51 0053
---	------------

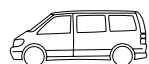

11/85 → 07/91



-	50 51 0035
---	------------

Transit 92

(91 → 94)

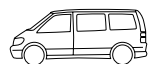

08/91 → 07/94 (ex.)



-	50 51 0053
---	------------

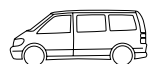

08/91 → 07/94



-	50 51 0035
---	------------

Transit 95

(94 → 99)



08/94 → 12/99 (ex.)



-	50 51 0053
---	------------

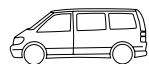

08/94 → 12/99



-	50 51 0035
---	------------

Transit 00

(00 → 06)

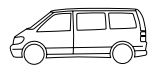

01/00 → 04/06

-	50 92 7772
---	------------

Transit 06

(06 →)

04/06 →	-	50 92 7772
---------	---	------------



Transit Connect 02
(02 →)

06/02 →

-

50 93 4507

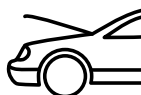

Civic V

(95 → 01)



-

85 92 8043

Civic VII

(06 →)

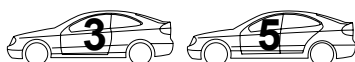

-

85 93 1049

CRV III

(07 →)

-

85 93 1050



i10

(10/07 →)

-

90 93 3560

i20

(08/08 →)

-

90 93 3561

Accent (LC)

(99 → 05)

-

90 92 9405

Atos (MX)

(98 →)

-

81 92 8087

Atos Prime (MX)

(99 →)

-

90 92 9294

Coupe (RD/GK)

(96 →)

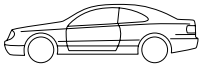

90 92 9295

90 92 9300

Elantra (XD)

(00 → 06)

-

90 92 9284

Getz (TB)

(02 → 07)

-

90 92 7939

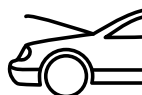

Lantra II Wagon (J2)

(02/96 → 07/00)

-

90 93 3562

Matrix (FC)

(01 →)

-

90 92 7938

Santa Fé (SM)

(00 → 06)



90 92 7936

90 92 7921



90 92 7936

90 92 7937

Sonata V

(11/04 →)

90 93 3562

90 93 3564

Sonata IV

(01 → 04)

90 92 9296

90 93 3847

Trajjet

(01/00 → 12/06)

-

90 93 3565

Tucson (JM)

(04 → 10)



-

90 92 9297



-

90 92 9298

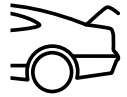

Verna (LC)
(99 → 05)

-

90 92 9405

XG 350
(03 →)

-

90 92 9299

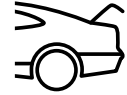

Carenus II
(02 →)

-

91 92 8065

Carnival II
(01 →)

07/02 → 09/05

91 92 8064

91 92 8063

Sorento
(02 →)



91 92 8062

91 92 8060



91 92 8062

91 92 8061

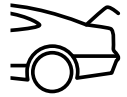
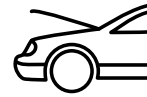

Musa (350)
(04 → 07)

-

70 93 3338

Zeta (220)
(94 → 02)

-

64 51 0014

passend für / to fit

LEXUS

SWAG[®]
GERMANY

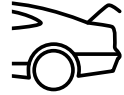

GS

(05 →)



GS 300 / 350 / 430 / 450H / 460

81 92 9285

81 92 8089

IS

(05 →)



IS 250 / 300 / 350

81 92 9286

-



121 (JASM/JBSM)

(95 → 02)

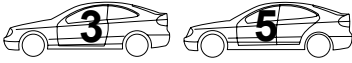

-

50 51 0049

626 (GE)

(92 → 98)



-

83 91 7055

Mazda 6 (GG)

(02 → 07)



-

83 92 9401



-

83 92 9402

Mazda 6 (GY)

(02 → 07)

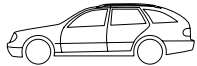

-

83 92 9404

MX-5 (NC)

(05 →)

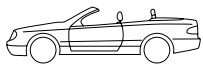

-

83 92 9403



BM 123 (77 → 85)

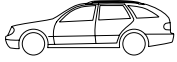

-

10 51 0001

BM 124 Cabriolet (91 → 98)



(ch.) → C 018272

-

10 92 7741

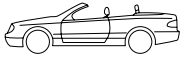

(ch.) C 018273 →

-

10 92 8561

BM 124 (85 → 96)

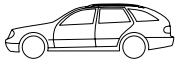

-

10 51 0008

190 (BM 201) (82 → 91)



10 51 0002

-

A-Klasse (BM 168) (97 → 04)

-

10 92 4707

A-Klasse (BM 169) (04 →)

-

10 92 4711

B-Klasse (BM 245) (05 →)



-

10 92 7736

C-Klasse (BM 202) (93 → 00)



10 51 0009

-

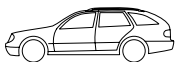

10 51 0009

10 93 0439

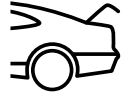

C-Klasse (BM 203) (00 → 07)



10 92 4733

-



10 92 4739

-



10 92 4733

10 92 7739

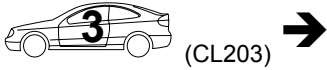

10 92 4739

10 92 7739

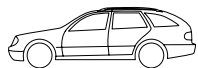

10 92 4733

10 92 4327

C-Klasse (BM 204) (07 →)



10 93 0880

-



10 93 0881

-



-

10 93 0882



-

10 93 0883

CL (BM 215) (99 → 06)

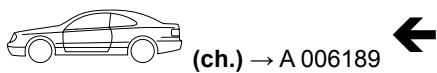

10 92 7731

-

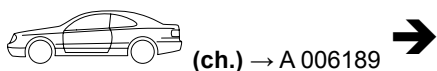

10 92 7731

-

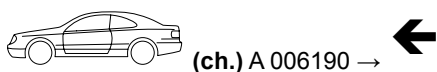

10 92 7731

-

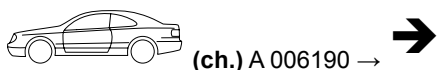

10 92 7731

-

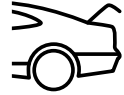

CL (BM 216) (06 →)

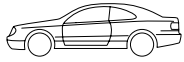

10 92 7733

-

CLK (BM 208) (97 → 02)

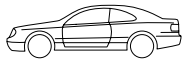

10 92 7737

-



10 92 7737

10 92 7738

CLK (BM 209) (02 →)

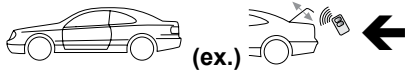

10 92 4733

-

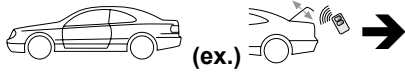

10 92 4739

-

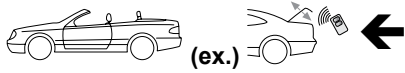

10 92 4733

10 92 7832

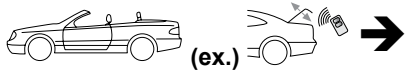

10 92 4739

10 92 7832

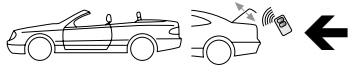

10 92 4733

10 92 7746

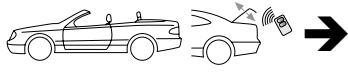

10 92 4739

10 92 7746



*für Kofferraumabdeckung/removable interior trunk lid/
cubierta de maleta del coche/recouvrement de coffre à bagages/
per cuffia vano bagagli/voor kofferruimtebedekking/
dla pokrywy bagażnika/для крышки багажника

-

10 93 7274*

CLS (BM 219) (04 →)

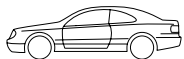

10 92 7743

-

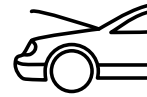

E-Klasse (BM 210)

(95 → 02)



10 51 0017

-

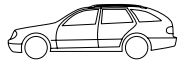

10 51 0017

10 51 0022

E-Klasse (BM 211)

(02 → 08)



10 92 7743

-



10 92 7743

10 92 7011



10 92 7743

10 92 7011

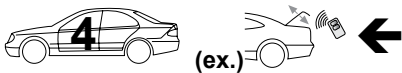

-

10 93 2045

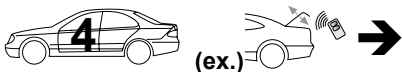

-

10 93 2046

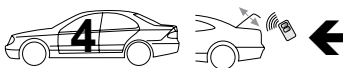

-

10 93 2047

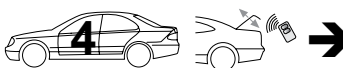

-

10 93 2048

E-Klasse (BM 212)

(09 →)

20 93 0849

-

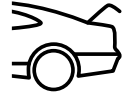

GL-Klasse (BM 164) (06 →)

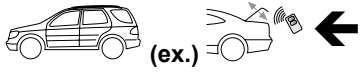

-

10 92 9336

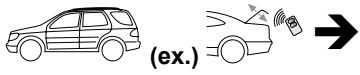

-

10 92 9336



-

10 92 9338



-

10 92 9339

GLK-Klasse (BM 204) (08 →)

10 93 7085

-

M-Klasse (BM 163) (98 → 05)



10 97 2622

10 92 2621

M-Klasse (BM 164) (05 →)

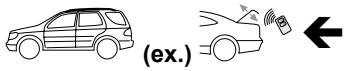

10 92 4737

10 92 8562

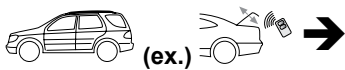

10 92 4731

10 92 8563



10 92 4737

10 92 9334



10 92 4731

10 92 9334



R-Klasse (BM 251)

(06 →)



(ch.) → A 114965

10 92 4738

-



-

10 92 4709



-

10 92 4718

S-Klasse (BM 140)

(91 → 98)



BM 140.051,057 500SEL/S500, 600SEL/S600

10 51 0002

-

S-Klasse (BM 220)

(98 → 05)



(ch.) → A 097774



10 92 4713

-



(ch.) → A 097774



10 92 4713

-



(ch.) A 097775 →



10 92 4713

-



(ch.) A 097775 →



10 92 4713

-

S-Klasse (BM 221)

(05 →)



10 92 7733

10 92 7747

SL (BM 129)

(89 → 01)

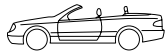

(ch.) → F 018805

-

10 92 7742



(ch.) F 018806 →

-

10 92 7734

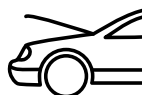

SL (BM 230)

(01 →)

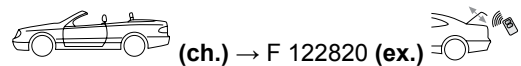

10 92 7745

10 92 7744

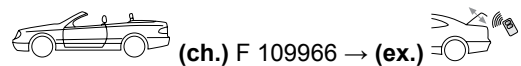

10 92 7745

10 92 7830

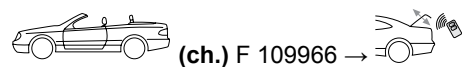

10 92 7745

10 92 7831

SLK (BM 170)

(96 → 04)



10 92 4735

-

-

10 93 4112

SLK (BM 171)

(04 →)



10 92 4710

-



10 92 4719

-

-

10 92 8559

Vaneo (BM 414)

(04 →)



-

10 92 7740

V-Klasse/Vito (BM 638)

(04 →)

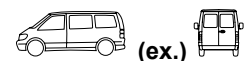

-

10 51 0021

Viano/Vito (BM 639)

(04 →)

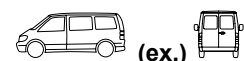

-

10 92 7748



-

10 92 4712



Mini One / One D / Cooper / Cooper S (R50/R53)

(01 → 06)

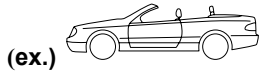

11 92 7598

11 92 7598

Mini Cabriolet One / Cooper / Cooper S (R52)

(04 → 06)

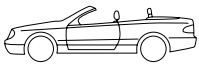

11 92 7598

-

Mini Clubman / LCI (R55)

(07 →)

11 93 4517

-

Mini Coupe / LCI (R56)

(06 →)

11 93 4517

11 93 4518

Mini Cabrio / LCI (R57)

(07 →)

11 93 4517

-

Mini Coupe (R58)

(11 →)

11 93 4517

-

Mini Roadster (R59)

(11 →)

11 93 4517

-

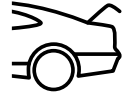

Carisma

(95 → 06)



-

80 92 9291

Outlander II

(06 →)

-

80 93 3393

Space Star

(98 → 04)

-

80 92 9293



Almera II (N16)

(00 →)

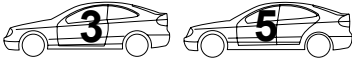

-

82 92 7886

Kubistar (X76)

(03 →)

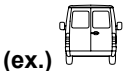

-

60 92 7903

Micra (K11)

(92 → 03)

-

82 92 9977

Micra (K12E)

(03 →)

-

82 92 7909

Primera (P11/WP11)

(96 → 02)



-

82 92 7890

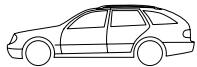

-

82 92 7896

X-Trail (T30)

(01 →)

-

82 92 7911

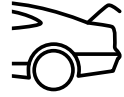

Agila A (00 → 07)

-	84 92 9198
---	------------

Astra F (91 → 98)

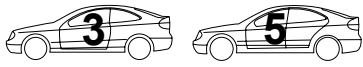

-	40 92 7644
---	------------

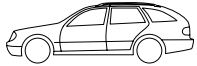

-	40 92 7645
---	------------



-	40 51 0045
---	------------

Astra G (98 → 05)

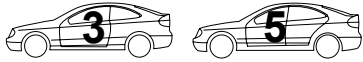

-	40 92 7614
---	------------

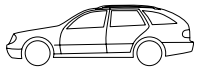

-	40 92 7641
---	------------



-	40 93 4509
---	------------

Astra H (05 →)



40 92 7603	40 92 7619
------------	------------



40 92 7603	40 92 7605
------------	------------

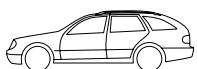

40 92 7603	40 92 7607
------------	------------

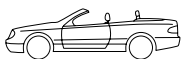

40 92 7603	40 92 7625
------------	------------

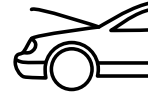

Astra J

(09 →)



-

40 93 6220

Calibra

(90 → 97)

-

40 92 7643

Corso B

(93 → 00)



-

40 92 7647



(ch.) 2R000001 →

-

40 92 7646

Corso C

(00 → 06)



-

40 92 7626

Corso C Combo

(06 → 10)

-

40 93 3974

Corso D

(06 →)



-

40 92 7621



-

40 92 7622

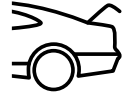

Insignia
(08 →)



-

40 93 6248

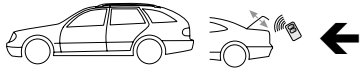

-

40 93 6249



-

40 93 6250

Kadett E
(84 → 91)



-

40 51 0014

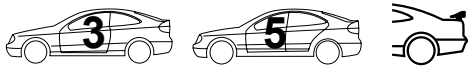

-

40 51 0015

Meriva A
(03 → 10)

-

40 92 7646

Omega A
(86 → 94)



-

40 92 7648

Omega B
(94 → 03)



40 92 7627

40 51 0038

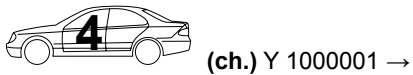

40 92 7610

40 51 0038

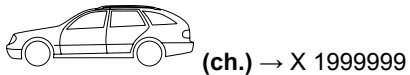

40 92 7627

40 51 0037

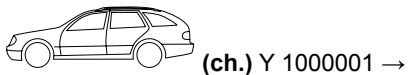

40 92 7610

40 51 0037



Signum

(03 → 08)

(ch.) → 5 1999999

40 92 7617

40 92 9281

(ch.) 6 1000001 →

-

40 92 9281

Vectra A

(88 → 95)



-

40 92 7649

Vectra B

(95 → 03)



(ch.) → W 5999999/W 7999999

40 92 7616

40 92 7609



(ch.) X 7000001 →

40 92 7616

40 92 7609

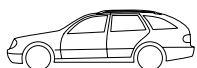

40 92 7616

40 92 7628

(ch.) X 1000001 →

-

40 93 4443

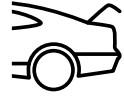

Vectra C

(03 → 08)



(ch.) → 5 1999999/5 8999999

40 92 7617

-



(ch.) → 5 1999999/5 8999999

40 92 7617

40 92 7629



(ch.) 6 1000001 →

-

40 92 7629

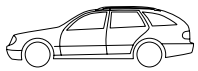

(ch.) → 5 1999999/5 8999999 (ex.)



40 92 7617

40 92 7623

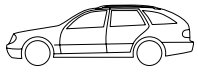

(ch.) 6 1000001 → (ex.)



-

40 92 7623

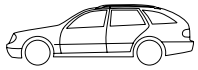

(ch.) → 5 1999999/5 8999999



40 92 7617

-

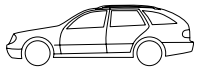

(ch.) → 5 1999999/5 8999999



40 92 7617

-

Vivaro

(01 →)

-

40 93 4515

Zafira A

(98 → 05)

-

40 92 7608

Zafira B

(05 → 11)

-

40 92 7620



106 I

(91 → 96)

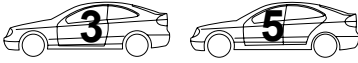

-

62 51 0022

107

(05 →)

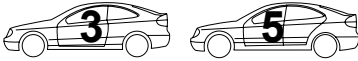

-

64 92 8002

205 I

(83 → 87)

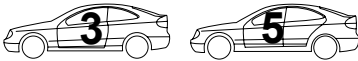

-

62 51 0013

205 II

(87 → 98)

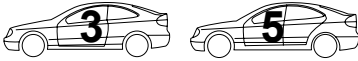

-

62 51 0013

206

(98 →)

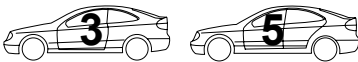

-

62 91 8563

206 CC

(00 →)

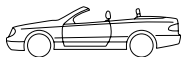

-

62 92 7905

206 SW

(02 →)



-

62 92 9262



-

62 92 9261

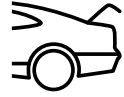
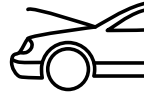

207

(06 →)

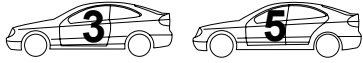

-

62 93 4421

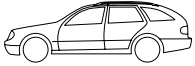

-

62 93 4435

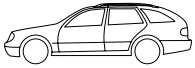

-

62 93 4420



-

62 93 4422

306

(94 → 02)

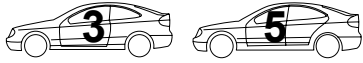

62 92 8027

62 51 0013

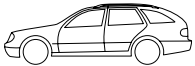

62 92 8027

62 92 8026



04/93 → 04/97

-

62 93 8235

306 Restyling

(05/97 → 05/01)



-

62 93 8235

307

(03 →)

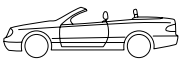

-

62 93 4419

307 SW

(07 →)

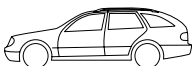

-

62 92 8028



308

(07 →)

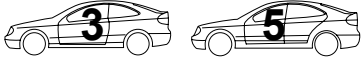

-

62 93 4417

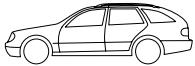

-

62 93 4414



-

62 93 4415



-

62 93 4416



-

62 93 4418

406

(95 → 04)

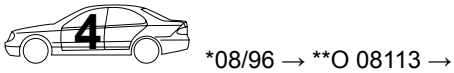

*08/96 → **O 08113 →

62 92 8031*

62 92 8030**

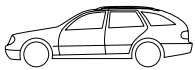

62 92 8031

62 92 8029

407

(04 →)



-

62 92 8032



-

62 92 8033



-

62 92 8034

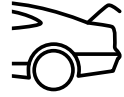

607

(00 →)



-

62 93 4411

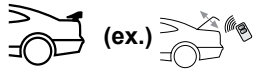

-

62 93 4412

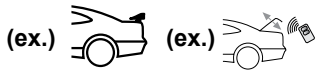

-

62 93 4413

806

(94 → 02)



-

64 51 0014

807

(02 →)

-

64 93 4434

3008

(09 →)

-

62 93 4410

4007

(07 →)

-

80 93 3393

Bipper Kombi / Kasten

(08 →)

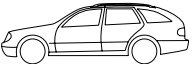

-

64 93 4428

Expert III

(07 →)

-

64 93 4429



Partner / Partner Kasten (B9)

(08 →)



-

64 93 4425



-

64 93 4431

O 11830 →

-

64 93 4424

O 11829 →

-

64 93 4430

Partner I (M49)

(96 → 03)

-

64 93 4433

Partner II (M59)

(03 → 08)

-

64 93 4433

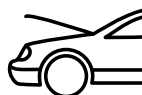

911/Cabriolet (964)

(89 → 94)

38 92 7915

-

911/Cabriolet (993)

(94 → 98)

38 92 7915

-

911/Cabriolet (996)

(98 → 05)

38 92 7884

-

911/Cabriolet (997)

(05 →)

(ex.) GT3/Turbo

38 92 7902

38 92 7899

GT3/Turbo

38 92 7902

-

924

(80 → 88)

38 51 0003

-

944

(81 → 91)

38 51 0003

-

Boxster (986)

(97 → 04)

38 92 7884

38 92 7898

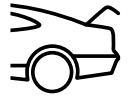
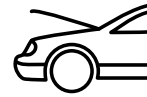

Boxster (987)
(05 →)

38 92 7902

38 92 7907

Cayenne (955)
(03 →)



38 92 9267

38 92 9269



38 92 9267

38 92 9268

Cayman (987)
(05 →)

-

38 93 2984

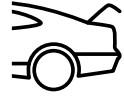

Clio I (90 → 98)

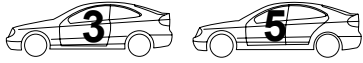

-

60 51 0007

Clio II (98 → 05)

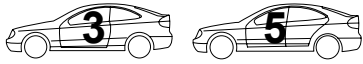

-

60 92 7885

Clio III (05 →)

-

60 93 2896

Dacia Duster (10 →)

60 93 8232

60 93 8233

Dacia Sandero (08 →)

-

60 93 1438

Espace II (91 → 96)

-

60 93 1029

Espace III (96 → 02)



-

60 92 7910

Espace IV (02 →)

*→ 16/07/2004

60 93 2892*

60 93 2897

*17/07/2004 →

60 93 2893*

60 93 2898

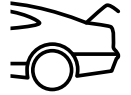
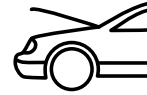

Kangoo I

(98 → 08)

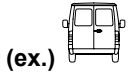

-

60 92 7903

Laguna I

(93 → 01)



-

60 92 9444

Laguna II

(01 → 07)



-

60 93 2899

Laguna III

(07 →)



-

60 93 2900

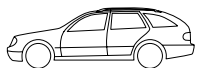

-

60 93 2901

Megane I

(96 → 03)



-

60 92 7906

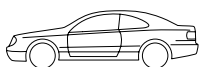

-

60 92 7904



-

60 93 0095



Megane II (02 → 08)



-

60 92 7914



-

60 92 7895

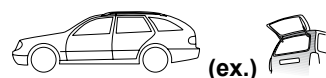

-

60 92 7893



-

60 92 7894



-

60 92 7891

Megane II CC (03 → 10)

-

60 93 8236

Megane III (08 →)



60 93 2894

60 93 2902*

Modus (04 →)

-

60 93 2903

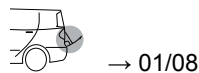

-

60 93 2904

Rapid (85 → 98)

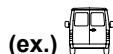

-

60 92 9895



Scenic I

(96 → 03)

(ex.)  / 4X4	-	82 92 7887
 (ex.) 4X4	-	60 92 7888
 (ex.) 4X4	-	60 92 7889

Scenic II

(03 →)

(ex.) 	-	60 92 7919
	-	60 92 7920
	-	60 92 7892

Scenic III

(09 →)

60 93 2895	60 93 2906
------------	------------

Grand Scenic III

(09 →)

-	60 93 2907
---	------------

Twingo I

(93 → 07)

-	60 92 7901
---	------------

Twingo II

(07 →)

-	60 93 2908
---	------------

passend für / to fit

ROVER



75

(99 → 05)

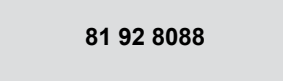

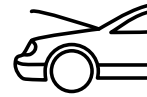

900 I

(78 → 94)

-

57 92 9935

900 II

(95 → 98)



(3D)



(5D)

57 92 7654

57 92 7655

9000

(85 → 98)



(4D) (ch.) J1024929 →

-

57 92 9256



CS (5D)

-

57 92 9256

9-3 I

(98 → 02)



(3D)



(5D) (ch.) → 1424174

57 92 7654

57 92 7653



(3D)



(5D) (ch.) 1424175 →

57 92 9204

57 92 7653

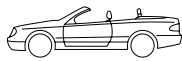

(CV) (ch.) → 1424174

57 92 7654

57 92 7650



(CV) (ch.) 1424175 →

57 92 9204

57 92 7650



9-3 II

(02 →)



(4D)

57 92 9257

-

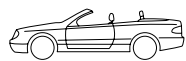

(CV)

57 92 9257

-

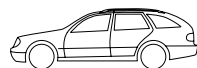

(5D)

57 92 9257

57 92 9258

9-5 I

(97 → 10)



(4D) → 05

57 92 7651

57 92 7652

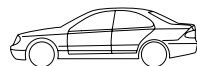

(4D) 05 →

-

57 92 7652

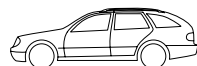

(5D) → 05

57 92 7651

57 92 9205

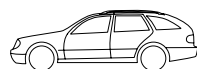

(5D) 05 →

-

57 92 9205

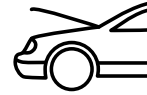

Alhambra (7V8/7V9)

(96 → 10)

30 92 7664

32 92 3390

Alhambra (710)

(10 →)

*PR-4E0

30 93 8188

30 93 8189*

Cordoba Vario (6K5)

(97 → 02)

-

30 93 1028

Exeo ST

(09 →)

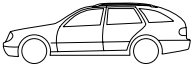

-

30 93 1648

Ibiza (6K1)

(93 → 02)

-

30 92 7709

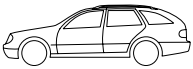

(97 → 99)

-

30 93 1028

Ibiza (6L1)

(02 → 09)

-

30 92 7710

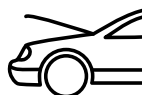

Ibiza (6J1)

(08 →)



3

-

30 93 1649



5

-

30 93 1650

Leon/4x4 (1M1)

(99 → 06)

30 92 7705

30 92 7708

Leon (1P1)

(05 →)

-

30 93 4113

Toledo (1L2)

(91 → 99)

-

30 92 7707

Toledo (1M2)

(99 → 04)

30 92 7705

30 92 7706

Toledo (5P2)

(04 → 09)

-

30 93 1651



Fabia (6Y2/6Y3/6Y5)

(99 → 08)

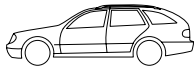

-

30 93 1652

-

30 93 1652

-

30 93 1653

Fabia (5J2)

(06 →)

-

30 93 1654

Fabia (5J5)

(07 →)

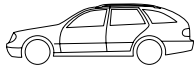

-

30 93 1654

Felicia (6U1/6U5)

(94 → 01)

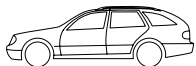

-

30 92 9320

-

30 92 9320

Octavia/4x4 (1U1/1U5)

(97 → 08)



(ex.) RS



RS

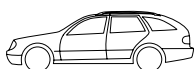

-

30 92 7713

-

30 92 7715

-

30 92 7712

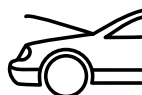

Octavia (1Z3/1Z5)

(04 →)



-

30 93 1656

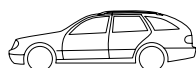

-

30 93 1657

Roomster (5J)

(06 →)

-

30 93 1658

Superb (3U4)

(02 → 08)



30 92 7711

30 92 9436



-

30 92 9435

Superb (3T4/3T5)

(08 →)



30 93 1633

30 93 1659

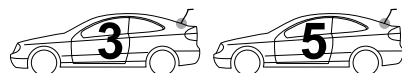

30 93 1633

30 93 1660

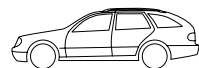

30 93 1633

30 93 8237

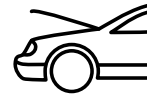

Smart (BM450)
(98 → 04)

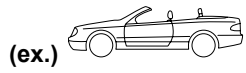

-

10 92 7732

FORTWO (BM451)
(07 →)

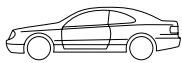

-

12 93 0351

passend für / to fit

SUZUKI



Wagon R+
(00 →)

02 →

-

84 92 9198

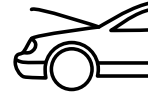

Avensis (T22)

(97 → 03)



-

81 92 8078

Avensis (T25)

(03 → 08)

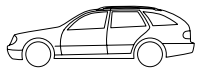

-

81 92 8080

Aygo

(05 →)

-

64 92 8002

Carina E

(92 → 96)



-

81 92 8077

Corolla (E10)

(92 → 97)



-

81 92 6270

Corolla (E11)

(97 → 02)

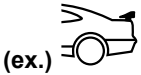

-

81 92 9978



-

81 92 9979

Corolla (E12)

(02 →)

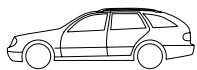

-

81 92 8085

Corolla Verso

(04 → 09)

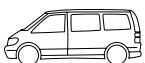

-

81 92 8084

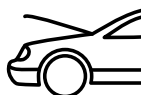

Prius (03 → 05)



-

81 92 9290

Yaris (99 → 05)



-

81 92 6268

Yaris (05 →)

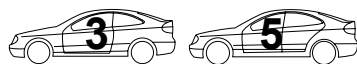

-

81 92 8081



Agila A (00 → 07)

-

84 92 9198

Astra Mk II (84 → 91)



-

40 51 0014



-

40 51 0015

Astra Mk III (91 → 98)

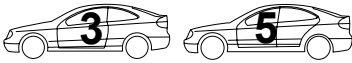

-

40 92 7644

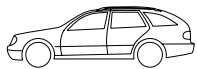

-

40 92 7645



-

40 51 0045

Astra Mk IV (98 → 05)



-

40 92 7614

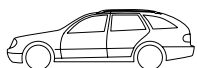

-

40 92 7641

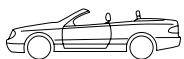

-

40 93 4509

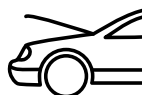

Astra Mk V

(05 →)



40 92 7603

40 92 7619



40 92 7603

40 92 7605

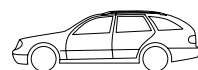

40 92 7603

40 92 7607



40 92 7603

40 92 7625

Astra Mk VI

(09 →)



-

40 93 6220

Calibra

(90 → 97)

-

40 92 7643

Carlton Mk III

(86 → 94)

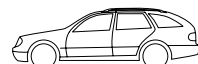

-

40 92 7648

Cavalier Mk III

(88 → 95)



-

40 92 7649



Corsa

(93 → 00)



(ex.)



-

40 92 7647



(ch.) 2R000001 →

-

40 92 7646

Corsa Mk II

(00 → 06)



-

40 92 7626

Corsa Mk III

(06 →)



-

40 92 7621



-

40 92 7622

Corsa C Combo

(06 → 10)

-

40 93 3974

Insignia

(08 →)



-

40 93 6248

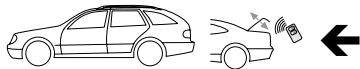

-

40 93 6249



-

40 93 6250

Meriva MK I

(03 →10)

-

40 92 7646

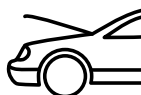

Omega

(94 → 03)



(ch.) → X 1999999

40 92 7627

40 51 0037



(ch.) Y 1000001 →

40 92 7610

40 51 0037

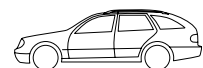

(ch.) → X 1999999

40 92 7627

40 51 0038

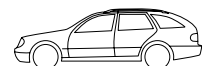

(ch.) Y 1000001 →

40 92 7610

40 51 0038

Signum

(03 → 08)

(ch.) → 5 1999999

40 92 7617

40 92 9281

(ch.) 6 1000001 →

-

40 92 9281

Vectra

(95 → 03)



(ch.) → W 5999999/W 7999999

40 92 7616

40 92 7609



(ch.) X 7000001 →

40 92 7616

40 92 7609

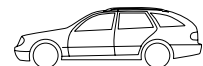

40 92 7616

40 92 7628

Vectra MK I

(96 → 02)

(ch.) X 1000001 →

-

40 93 4443

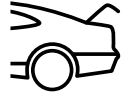

Vectra Mk II

(03 → 08)



(ch.) → 5 1999999/5 8999999

40 92 7617

-



(ch.) → 5 1999999/5 8999999

40 92 7617

40 92 7629



(ch.) 6 1000001 →

-

40 92 7629

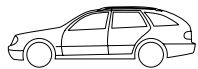

(ch.) → 5 1999999/5 8999999 (ex.)



40 92 7617

40 92 7623

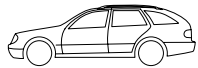

(ch.) 6 1000001 → (ex.)



-

40 92 7623

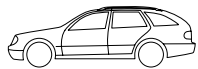

(ch.) → 5 1999999/5 8999999



40 92 7617

-

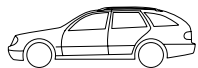

(ch.) → 5 1999999/5 8999999



40 92 7617

-

Vivaro

(01 →)

-

40 93 4515

Zafira MK I

(98 → 05)

-

40 92 7608

Zafira Mk II

(05 → 11)

-

40 92 7620

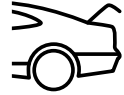

Bora/4motion (1J2)

(98 → 05)



(ch.) → 1J-1-560000

32 92 3386

-



(ch.) 1J-1-560001 → / *00→05

32 92 3386

30 92 9435*

Bora Variant/4motion (1J6)

(98 → 05)

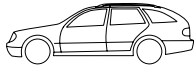

(ch.) → 1J-1-560000

32 92 3386

32 92 3380

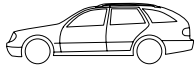

(ch.) 1J-1-560001 →

32 92 3386

32 92 3388

Caddy III (2K)

(04 →)

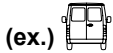

(ex.)

-

30 93 1645

Caddy 4/4motion/Caddy Maxi (2CA/2CB/2CH/2CJ)

(10 →)

30 93 8190

-

Fox/Crossfox (5Z1)

(03 →)



-

30 93 8192



05 →

-

30 93 8192

Crosstouran/Touran (1T)

(03 →)

-

30 93 7482

Crosstouran (1T)

(07 →)

*(PR-6P1)

30 93 8190

30 93 8191*

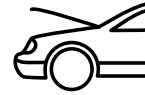

EOS

(06 →)

30 93 1632

30 93 1646

Golf 2/Syncro (19E/1G1)

(83 → 92)



(ch.) 19-E-780001 →

-

30 51 0018

Golf 3/Syncro (1H1)

(91 → 97)



-

30 51 0031

Golf 3 Variant/Syncro (1H5)

(93 → 99)

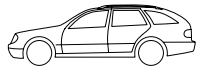

-

30 51 0060

Golf 3 Cabriolet (1E7)

(94 → 98)

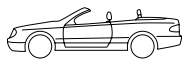

-

30 92 7659

Golf 4/Variant/4motion (1J1)

(97 → 05)

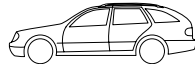

(ch.) → 1J-1-560000

30 51 0050

32 92 3380

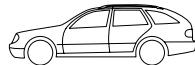

(ch.) 1J-1-560001 →

32 92 3386

32 92 3388

Golf 4 Cabriolet (1E7)

(98 → 02)



32 92 3386

30 92 7659

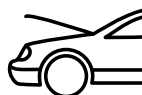

Golf 5/4motion (1K1)

(04 →)

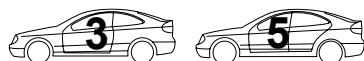

30 92 9434

30 92 7666

Golf VI (5K)

(08 →)

(ex.) Japan

30 93 1631

30 93 1644

Golf VI/Variant/4motion

(08 →)

30 93 1631

-

Golf 6 Cabrio

(11 →)

30 93 1631

30 93 7495

Jetta (1K2)

(05 → 10)

30 92 9434

30 93 7501

Lupo (6X1/6E1)

(98 → 05)

30 92 9275

30 51 0050

New Beetle (9C1/1C1)

(98 →)

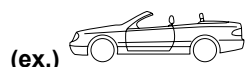

30 92 9395

30 92 9274

New Beetle Cabrio (1Y7)

(03 →)



30 92 9395

-



Passat Variant (32B)

(80 → 88)

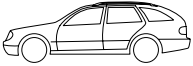

-

30 51 0030

Passat Variant (3A2/35I)

(88 → 97)

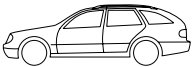

-

30 51 0064

Passat/4motion (3B2)

(97 → 00)



(ex.)



32 92 3382

32 92 3398



32 92 3382

-

Passat Variant/4motion (3B5)

(97 → 00)

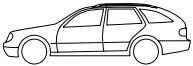

32 92 3382

32 92 3384

Passat/4motion (3B3)

(00 → 05)



(ch.) → 3B-4-080000 / *(ex.) W8

30 92 7693*

30 92 9435



(ch.) 3B-4-080001 → / *(ex.) W8

30 92 7693*

30 92 9436

Passat Variant/4motion (3B6)

(00 → 05)



(ch.) → 3B-4-080000

30 92 7693

32 92 3388

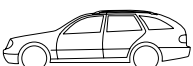

(ch.) 3B-4-080001 → *(ex.) W8

30 92 7693*

32 92 3380

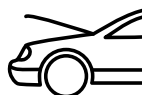
Passat Variant/4motion (3C)

(05 →)

30 93 1629

30 93 1641

Passat/4motion (3C2)

(05 →)

30 93 1629

30 93 1640

Passat CC/4motion

(08 →)

30 93 1630

-

Passat 6/4motion

(10 →)

30 93 7480

30 93 7479

Passat 6/Variant+Variant 4motion+Alltrack+Alltrack 4motion

(10 →)

*(PR-4E2)

30 93 7480

30 93 7481*

Polo (6N1/6N2)

(95 → 02)

-

30 92 8557

Polo (9N)

(02 →)

30 92 9438

30 92 7665

Polo Classic Avant (6KV2)

(97 → 02)

-

30 93 1028

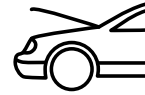

Polo (6R)

(09 →)

-

30 93 1642

Scirocco (137)

(08 →)

-

30 93 1647

Sharan (7M6/7M8/7M9)

(95 →)

30 92 7664

32 92 3390

Sharan/4 motion (7N1)

(10 →)

*(PR-4E0+6P1/6P5)

30 93 8188

30 93 8189*

Tiguan (5N)

(07 →)

(ex.) Japan

-

30 93 1643

Touareg (7LA/7L6/7L7)

(02 →)



30 92 7663

30 92 9439



30 92 7663

30 92 7667

Touran (1T1/1T2)

(03 →)

*03 → 06

30 92 9440

30 92 7673*

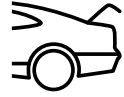
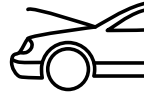

Touran (GP2) (10 →)

*(PR-6P1)

30 93 8190

30 93 8191*

Transporter/Syncro (T3) (79 → 92)

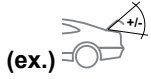

-

30 51 0010



(ch.) 25-C-102001 →

-

30 92 7661



(ch.) 25-C-102001 →

-

30 92 7660

Transporter/Syncro (T4) (ch.) → 70-N-151781 (90 → 03)

*LHD VR6(150kW)/TDI(110kW) ** (ex.)

30 92 7668*

30 92 8555**

*LHD VR6(150kW)/TDI(110kW) ** (ex.)

30 92 7668*

30 92 7669**

*LHD VR6(150kW)/TDI(110kW) ** (ex.)

30 92 7668*

30 92 8552**

*LHD VR6(150kW)/TDI(110kW) **

30 92 7668*

30 92 3396**

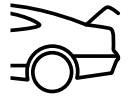

Transporter/Syncro (T4) (ch.) 70-N-151782 → (90 → 03)

*LHD VR6(150kW)/TDI(110kW) ** (ex.)	30 92 7668*	30 92 8554**
*LHD VR6(150kW)/TDI(110kW) ** (ex.)	30 92 7668*	30 92 7671**
*LHD VR6(150kW)/TDI(110kW) ** (ex.)	30 92 7668*	30 92 7672**
*LHD VR6(150kW)/TDI(110kW) ** (ex.)	30 92 7668*	30 92 8553**
*LHD VR6(150kW)/TDI(110kW) **	30 92 7668*	30 92 7658**

Transporter/4motion (T5) (03 →)

03 → 09 (PR-K4A/K4B/K4J/5NC/5NJ)	30 92 9441	32 92 3392
Multivan/Caravelle	-	30 92 9442

Transporter T5/4motion+T5 Multivan/4motion (09 →)

(ex.) (PR-A8E/A8Z/A9W/A9X/A9Y/QL0/QL4))	-	32 92 3392
--	---	------------

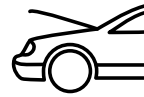

up! (CHYA/CHYB/CPGA)

(11 →)

10/2011 →

-

30 93 8187

CPGA 12 →

-

30 93 8187

Vento (1H2)

(91 → 98)



-

30 92 8558



740

(85 → 92)

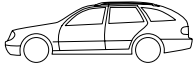

-

55 51 0005

760

(86 → 92)

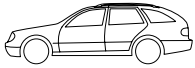

-

55 51 0005

850

(91 → 97)



-

55 92 2717



-

55 51 0016

940 I / II

(90 → 98)

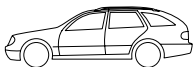

-

55 51 0005

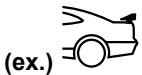

-

55 92 2716

960 I

(90 → 94)

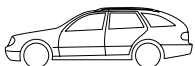

55 92 7634

55 51 0005

960 II

(94 → 96)

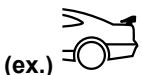

-

55 92 2716

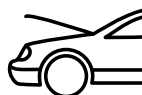

C 30

(06 →)

55 93 6214

-

C 70 II

(06 →)

55 93 6214

-

S 40 I

(95 → 03)

55 92 2718

55 92 7630

S 40 II

(04 → 12)

55 93 6214

55 93 6210

S 60 I

(00 → 11)

*→ (ch.) 470971

55 92 7636*

55 92 7632

S 70

(96 → 00)

-

55 92 7631

S 80 I

(98 → 06)

*→ 03

55 92 7636

55 92 7635*

S 80 II

(06 →)

55 93 6208

55 93 6207



S 90

(97 → 98)

55 92 7634

-

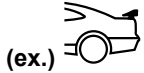

-

55 92 2716

V 40 I

(95 → 04)

55 92 2718

55 51 0024

V 50

(04 → 12)

*(ch.) → 479981

55 93 6214

55 93 6219*

*(ch.) 479982 →

55 93 6214

55 93 6206*

V 70 I

(97 → 00)

-

55 51 0016

V 70 II

(00 → 07)

*(ch.) → FC1 669226

(ch.) → FC2 667581

55 92 7636*

55 92 7633

V 70 III

(07 →)



55 93 6208

55 93 6209*



55 93 6208

55 93 6747*

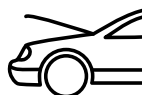

V 90
(97 → 98)

55 92 7634

55 51 0005

XC 60
(2010 →)



55 93 6211

55 93 6212*

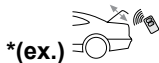

55 93 6211

55 93 6213*

XC 70 III
(07 →)

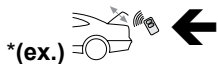

55 93 6208

55 93 6747*

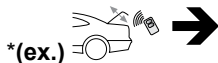

55 93 6208

55 93 6209*

XC 70 Cross Country II
(00 → 07)

*→ (ch.) 283695

55 92 7636*

55 92 7633

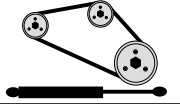
**A3 (8L1)**
(98 → 03)

1.9 TDI (mot.) AHF / AGR / ALH / ASV

30 92 1690

A4 / Avant (8D_/8E_)
(98 → 07)

2.5 TDI (mot.) AFB / AKE / AKN / AYM / BAU / BCZ / BDG / BDH / BFC

30 92 7604

A6 / Avant / Allroad (4A/4B)
(98 → 05)

2.5 TDI (mot.) AFB / AKE / AKN / AYM / BAU / BCZ / BDG / BDH / BFC

30 92 7604

2.5 TDI (mot.) AAT / AEL

32 92 8550

A8 (4D_)
(94 → 03)

2.5 TDI (mot.) AFB / AKE / AKN / AYM / BAU / BCZ / BDG / BDH / BFC

30 92 7604

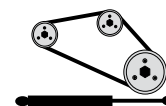

3`er (E 36)
(93 → 00)

316 i / 318 i (mot.) M43

→ 09/95

20 52 0009
20 91 8485

318 iS (mot.) M42 / M44

20 52 0009
20 91 8485

318 tds / 325 td/tds (mot.) M41 / M51

20 52 0007

320 i / 325 i / 328 i (mot.) M50 / M52

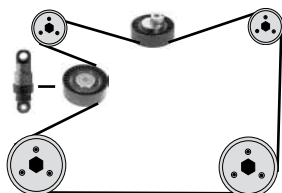

20 52 0004
20 91 8483

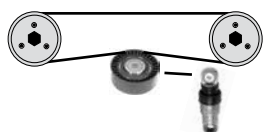

AC

20 52 0005
20 91 8484

3`er (E 46)
(98 → 05)

318 d / 320 d (mot.) M47

20 52 0017

320 i → 330 i (mot.) M52 / M54

20 52 0004
20 91 8483

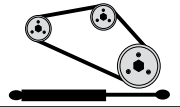

5`er (E 34) (88 → 95)

518 i (mot.) M43

20 52 0009
20 91 8485

520 i / 525 i (mot.) M50

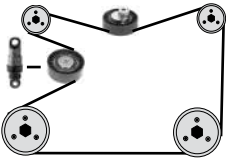

20 52 0004
20 91 8483

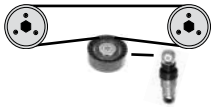

AC

20 52 0005
20 91 8484

525 td/tds (mot.) M51

20 52 0007

5`er (E 39) (95 → 03)

520 i → 530 i (mot.) M52 / M54

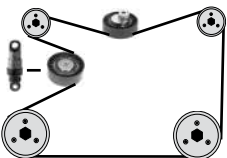

20 52 0004
20 91 8483

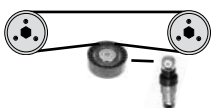

AC

20 52 0005
20 91 8484

520 d (mot.) M47

20 52 0017

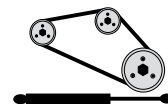

525 td/tds (mot.) M51

20 52 0007

535 i / 540 i (mot.) M62

09/97 →



20 52 0016
20 92 7561

09/97 →



20 52 0015
20 92 7560

5`er (E 60/61)
(03 →)

520 i / 525 i / 530 i (mot.) M54

20 52 0004
20 91 8483

7`er (E 32)
(86 → 94)

750 i/iL (mot.) M70

20 52 0006

7`er (E 38)
(94 → 01)

725 tds (mot.) M51

20 52 0007

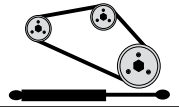

728 i/iL (mot.) M52

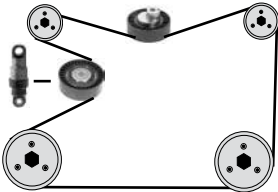

20 52 0004
20 91 8483

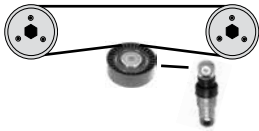

AC

20 52 0005
20 91 8484

735 i/iL / 740 i/iL (mot.) M62

09/97 →



20 52 0016
20 92 7561

09/97 →



20 52 0015
20 92 7560

8'er (E 31)

(93 → 96)

840 Ci (mot.) M62

09/97 →



20 52 0016
20 92 7561

09/97 →



20 52 0015
20 92 7560

850 i (mot.) M70

20 52 0006

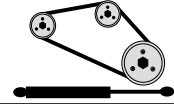

X 3 (E 83)

(03 →)

2.5 / 3.0 (mot.) M54

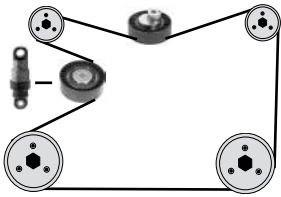

20 52 0004
20 91 8483

X 5 (E 53)

(00 → 07)

3.0 (mot.) M54

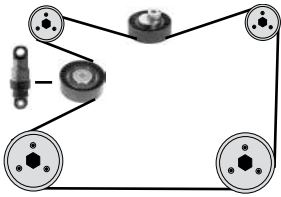

20 52 0004
20 91 8483

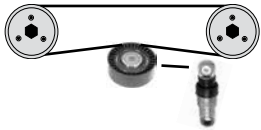

AC

20 52 0005
20 91 8484

4.4 / 4.6 (mot.) M62

09/97 →



20 52 0016
20 92 7561

09/97 →



20 52 0015
20 92 7560

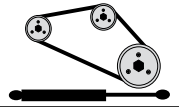

Z 3

(95 → 03)

2.0 (mot.) M54

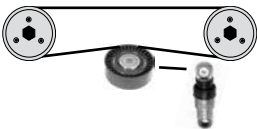

AC

20 52 0005
20 91 8484

2.8 (mot.) M52

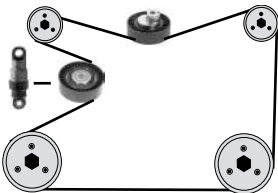

20 52 0004
20 91 8483

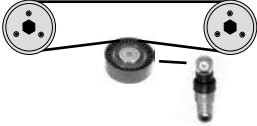

AC

20 52 0005
20 91 8484

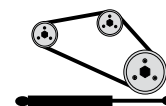

Berlingo I+II (M49/M59)

(96 → 08)

1.9 D (mot.) DW8 / DW8B / XUD

AC servo 

62 91 9072

C5 I

(01 → 04)

3.0 V6 (mot.) ES9J4S

62 92 8278

C5 II

(04 → 08)

3.0 V6 (mot.) ES9A

62 92 8278

C5 III

(08 →)

3.0 V6 (mot.) ES9A

62 92 8278

C6

(05 →)

3.0 V6 (mot.) ES9A

62 92 8278

C8

(02 →)

3.0 V6 (mot.) ES9J4S

62 92 8278

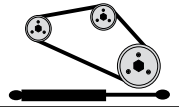
**Evasion**

(94 → 02)

1.9 TD / 2.1 TD (mot.) XUD**AC** servo **62 91 9072****Jumpy I+II**

(94 → 07)

1.9 D / 1.9 TD (mot.) DW8 / DW8B / XUD**AC** servo **62 91 9072****Xantia (X1)**

(93 → 01)

1.9 D / 1.9 TD / 2.1 TD (mot.) XUD**AC** servo **62 91 9072****Xantia (X2)**

(97 → 03)

3.0 V6 (mot.) ES9J4**62 92 8278****XM (Y3)**

(89 → 00)

1.9 D / 1.9 TD / 2.1 TD (mot.) XUD**AC** servo

O 06779 →

62 91 9072**XM (Y4)**

(97 → 00)

3.0 V6 (mot.) ES9J4**62 92 8278**

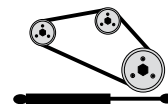

Xsara (N1)

(97 → 05)

1.9 D (mot.) DW8B

AC servo 

62 91 9072

ZX (N2)

(91 → 97)

1.9 D / 1.9 TD (mot.) XUD

AC servo 

0 06629 →

62 91 9072

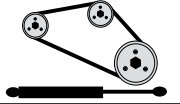
**Scudo (220P/L)**
(96 → 07)

1.9 D / 1.9 TD (mot.) DW8 / XUD

AC servo 

62 91 9072

Ulysse (220)
(94 → 02)

1.9 TD / 2.1 TD (mot.) XUD

AC servo 

62 91 9072

Ulysse II Nuovo (179AX)
(02 → 10)

3,0 V6

62 92 8278

passend für / to fit

FORD

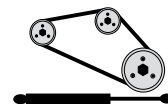

Scorpio 95

(10/94 → 06/98)

2,5 Turbo Diesel

14 92 8261

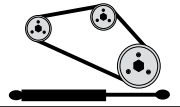

Phedra (179)
(02 → 10)

3,0 V6

62 92 8278

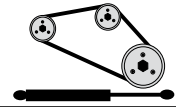

BM 124 (E-Klasse) (85 → 95)

200 / 200 E / 200 T / 200 TE / 230 E / 230 TE / 230 CE (mot.) M 102.922, 963, 982



(mot.) 102.922 (mot. no.) 000935 → 054114
 (mot.) 102.963 (mot. no.) 000001 → 006316
 (mot.) 102.982 (mot. no.) 000996 → 086551

10 52 0019



(mot.) 102.922 (mot. no.) 054115 →
 (mot.) 102.963 (mot. no.) 006317 →
 (mot.) 102.982 (mot. no.) 086552 →

10 52 0015



(mot.) 102.922 (mot. no.) 000255 → 021733
 (mot.) 102.963 (mot. no.) 000001 → 000335
 (mot.) 102.982 (mot. no.) 000659 → 083196

10 52 0019



(mot.) 102.922 (mot. no.) 021734 →
 (mot.) 102.963 (mot. no.) 000336 →
 (mot.) 102.982 (mot. no.) 083197 →

10 52 0015

200 / 200 CE / 200 TE / E 200 (mot.) M 111.940

10 91 9995

200 D / 200 TD / E 200 D (mot.) OM 601.912

10 52 0023

220 / 220 CE / 220 TE / E 220 (mot.) M 111.960

10 91 9995

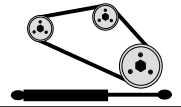

250 D / 250 TD / E 250/T D (mot.) OM 605.911

10 52 0023

250 D Turbodiesel / 250 TD Turbodiesel / E 250/T Turbo-D (mot.) OM 602.962

10 52 0012

260 E (mot.) M 103.940

(mot. no.) 027640 →

10 52 0012

280 E / 280 TE / E 280 (mot.) M 104.942



(mot. no.) → 005789

10 52 0012



(mot. no.) → 048696

10 52 0012

300 E / 300 CE / 300 TE (mot.) M 103.980, 983



(mot.) 103.983 (mot. no.) 032928 →

10 52 0012

300 E-24 / 300 CE-24 / 300 TE-24 (mot.) M 104.980

10 52 0012

300 D / 300 TD (mot.) OM 603.912

10 52 0018

E 300 D Turbo / E 300 TD Turbo (mot.) OM 606.910

10 52 0023

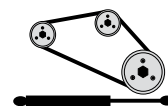
BM 124 (E-Klasse)

(85 → 95)

300 D / 300 TD / 300 TD Turbo / E 300 TD Turbo (mot.) OM 603.960

(mot. no.) → 049508

10 52 0018

(mot. no.) 049509 →

10 52 0023

320 E / 320 CE / 320 TE / E 320 / E 36 AMG (mot.) M 104.992

(mot. no.) → 004356

10 52 0012

BM 201 (190)

(83 → 92)

190 (mot.) M 102.924

(mot. no.) → 040718

10 52 0015



(mot. no.) → 010273

10 52 0015

190 D (mot.) OM 601.911

10 52 0018

190 D 2.5 / 2.5 D-Turbo (mot.) OM 602.911, 961

10 52 0018

190 E 1.8 (mot.) M 102.910, 919

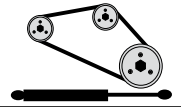

10 52 0015



190 E 2.0 / 2.3 (mot.) M 102.962, 985

	(mot.) 102.962	(mot. no.) 159206 →	10 52 0015
	(mot.) 102.962	(mot. no.) 080537 →	10 52 0015
	(mot.) 102.985	(mot. no.) 020298 →	10 52 0015
	(mot.) 102.985	(mot. no.) 064022 →	10 52 0015

190 E 2.3 16V (mot.) M 102.983

		(mot. no.) 006950 →	10 52 0019
		(mot. no.) 000003 →	10 52 0019

190 E 2.5 16V (mot.) M 102.990, 991, 992

10 52 0019

190 E 2.6 (mot.) M 103.942

10 52 0012

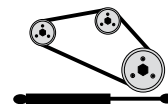
**C-Klasse (BM 202)**

(92 → 01)

C 180 / C 180 T / C200 / C200 T (mot.) M 111.920, 921, 941, 945

10 91 9995

C200 Kompressor / C200 T Kompressor (mot.) M 111.944, 961

10 91 9995

C 200 D / C 200 T D (mot.) OM 601.913

10 52 0023

C 200 TD / C 220 D / C 220 T D (mot.) OM 604.910, 915

10 52 0023

C230 / C 230 T / C 230 Kompressor / C 230 T Kompressor (mot.) M 111.974, 975

10 91 9995

C240 / C 240 T / C 280 / C 280 T / C 43 / C 43 T (mot.) M 112.910, 915, 920, 944

10 52 0025

C 250 D / C 250 T D / C 250 D-Turbo (mot.) OM 605.910, 960

10 52 0023

C280 / C 280 T / C 36 AMG / C 36 T AMG (mot.) M 104.941

(mot. no.) → 004058

10 52 0012



(mot. no.) → 034966

10 52 0012

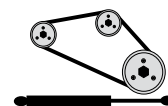
**C-Klasse (BM 203)**

(00 → 07)

C 230/T / C 280/T / C 350/T (mot.) M 272.920, 940, 941, 970**10 92 7454****C 240 / C 240 T / C 320 / C 320 T (mot.) M 112.912, 946****10 52 0025****C-Klasse (BM 204)**

(07 →)

C 230/T / C 280/T / C 350/T (mot.) M 272.911, 921, 947, 948, 960, 961, 971**10 92 7454****CL (BM 215)**

(99 → 06)

CL 500 (mot.) M 113.960**10 52 0025****CLK (BM 208)**

(97 → 02)

CLK 200 / CLK 200 Kompressor / CLK 230 Kompressor (mot.) M 111.944, 945, 975**10 91 9995****CLK (BM 209)**

(02 →)

CLK 280 / CLK 350 (mot.) M 272.940, 960**10 92 7454**

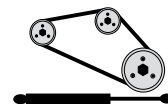
**CLS (BM 219)**

(04 →)

CLS 280 / CLS 350 / CLS 350 CGI (mot.) M 272.943, 964, 985

10 92 7454

E-Klasse (BM 210)

(95 → 03)

E 200 / E 200 T / E 200 Kompressor / E 200 T Kompressor (mot.) M 111.942, 947

10 91 9995

E 200 D / E 220 T D / E 220 D / E 220 T D (mot.) OM 604.912, 917

10 52 0023

E 240 / E 240 T (mot.) M 112.911, 914

10 52 0025

E 250 D / E 250 T D / E 250 D-Turbo / E 250 T D-Turbo (mot.) OM 605.912, 962

10 52 0023

E 280 / E 280 T (mot.) M 112.921

10 52 0025

E 290 Turbodiesel / E 290 T Turbodiesel (mot.) OM 602.982

10 52 0023

E 300 D / E 300 T D / E 300 D-Turbo / E 300 T D-Turbo (mot.) OM 606.912, 962

10 52 0023

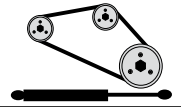

E 430 / E 430 T / E 55 AMG / E 55 T AMG (mot.) M 113.940, 980

10 52 0025

E-Klasse (BM 211)
(03 →)

E 230/T / E 280/T / E 350/T / E 350/T CGI (mot.) M 272.922, 943, 944, 964, 972, 985

10 92 7454

G-Klasse (BM 460/461)
(79 →)

250 GD / 290 GD / 290 GD-Turbo (mot.) OM 602.930, 939, 983

10 52 0023

250 GD / 290 GD / 290 GD-Turbo (mot.) OM 602.938, 946

10 52 0018

G-Klasse (BM 463)
(89 →)

200 GE / 230 GE (mot.) M 102.965, 989

→ 93

10 52 0015

250 GD (mot.) OM 602.931

10 52 0018

300 GE / G 300 (mot.) M 103.987

→ 93

10 52 0015

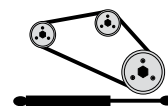
**G-Klasse (BM 463)**

(89 →)

300 GD / G 300 D (mot.) OM 603.931

→ 93

10 52 0018**350 GD-Turbo (mot.) OM 603.972**

→ 93

10 52 0018**G 300 D-Turbo (mot.) OM 606.964**

→ 93

10 52 0023**G 320 (mot.) M 112.945**

93 →

10 52 0025**G 500 / G 55 AMG (mot.) M 113.962**

93 →

10 52 0025**M-Klasse (BM 163)**

(98 → 05)

ML 230 (mot.) M 111.977**10 91 9995****M-Klasse (BM 164)**

(05 →)

ML 350 (mot.) M 272.967**10 92 7454**

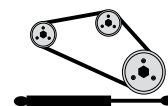

R-Klasse (BM 251)

(05 →)

R 280 / R 350 (mot.) M 272.945, 967

10 92 7454

S-Klasse (BM 126)

(80 → 90)

260 SE (mot.) M 103.941 / 300 SE (mot.) M 103.981

10 52 0018

S-Klasse (BM 140)

(91 → 99)

300 SE / SEL / S 320 (mot.) M 104.990, 944, 994



(mot.) 104.944

(mot. no.) → 007447

10 52 0012



(mot.) 104.994

(mot. no.) → 031209

10 52 0012

300 SD Turbo / S 350 D Turbo (mot.) OM 603.971

10 52 0023

S 300 D Turbo (mot.) OM 606.961

10 52 0023

S-Klasse (BM 220)

(98 → 05)

S 280 / S 350 (mot.) M 272.946, 965, 975

10 92 7454

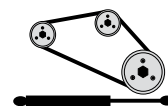

S-Klasse (BM 220)

(98 → 05)

S 430 / S 500 (mot.) M 113.941, 960

10 52 0025

SL (BM 107)

(71 → 89)

SL 300 (mot.) M 103.982

10 52 0012

SL (BM 129)

(89 → 01)

SL 280 (mot.) M 104.943

10 52 0012

SL 280 (mot.) M 112.923

10 52 0025

SL 300 (mot.) M 103.984

10 52 0018

SL 300-24 (mot.) M 104.981

10 52 0012

SL 320 (mot.) M 104.991



(mot. no.) → 009985

10 52 0012

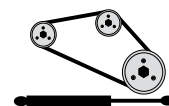
**SL 320 (mot.) M 112.943****10 52 0025****SL (BM 230)**

(01 →)

SL 350 (mot.) M 272.966**10 92 7454****SL 350 / SL 500 / SL 55 AMG (mot.) M 112.973 / M 113.993, 992****10 52 0025****SLK (BM 170)**

(96 → 04)

SLK 200 (mot.) M 111.943, 946**10 91 9995****SLK 230 Kompressor (mot.) M 111.973****10 91 9995****SLK 320 (mot.) M 112.947****10 52 0025****SLK (BM 171)**

(04 →)

SLK 280 / SLK 350 (mot.) M 272.942, 963**10 92 7454**

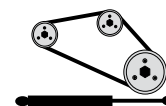

Sprinter I (BM 901/902/903/904)

(95 → 06)

208 D → 408 D (mot.) OM 601.943 / 210 D, 412 D OM 602.980

10 52 0023

214 / 314 / 414 (mot.) M 111.979, 984

10 91 9995

Sprinter II (BM 906)

(06 →)

209 CDI → 509 CDI

211 CDI → 511 CDI

215 CDI → 515 CDI

218 CDI → 518 CDI

(mot.) M 272.979

10 92 7454

Vito / V-Klasse (BM 638)

(95 → 04)

108 D / 110 D / 230 TD (mot.) OM 601.942, 970

10 91 9995

113 / 114 (mot.) M 111.948, 950, 978, 980

10 91 9995

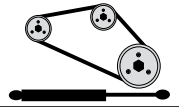
**Astra G**

(98 → 04)

2.0 TD / 2.2 TD (mot.) X20DTH / X20DTL / Y20DTH / Y22DTR

40 03 0023

Frontera B

(98 → 02)

2.2 TD (mot.) X22DTH / Y22DTH

40 03 0023

Omega B

(94 → 03)

2.0 TD / 2.2 TD (mot.) X20DTH / Y22DTH

40 03 0023

2.5 TD (mot.) U25TD / X25TD

20 52 0007

Signum

(03 → 08)

2.0 TD / 2.2 TD (mot.) Y20DTH / Y22DTR

40 03 0023

Sintra

(97 → 99)

2.2 TD (mot.) X22DTH

40 03 0023

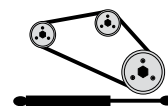

Vectra B

(96 → 02)

2.0 TD / 2.2 TD (mot.) X20DTH / X20DTL / Y20DTH / Y22DTR

40 03 0023

Vectra C

(02 → 08)

2.0 TD / 2.2 TD (mot.) Y20DTH / Y22DTR

40 03 0023

Zafira A

(98 → 05)

2.0 TD / 2.2 TD (mot.) X20DTH / X20DTL / Y20DTH / Y22DTR

40 03 0023

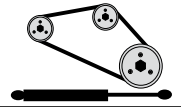
**206**
(98 →)**1.9 D (mot.) DW8****AC** servo **62 91 9072****306**
(94 → 02)**1.9 D / 1.9 TD (mot.) DW8 / DW8B / XUD****AC** servo **62 91 9072****406**
(95 → 04)**1.9 TD (mot.) XUD****AC** servo **62 91 9072****3.0 V6 / 24V (mot.) ES9J4 / ES9J4S****62 92 8278****407**
(04 →)**3.0 V6 / 24V (mot.) ES9A****62 92 8278****605**
(89 → 99)**2.1 TD (mot.) XUD****AC** servo **62 91 9072****3.0 V6 / 24V (mot.) ES9J4****62 92 8278**

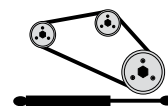
**607**

(00 →)

3.0 V6 / 24V (mot.) ES9J4S

62 92 8278

806

(94 → 02)

1.9 TD / 2.1 TD (mot.) XUD**AC** servo 

62 91 9072

807

(02 →)

3.0 V6 / 24V (mot.) ES9J4S

62 92 8278

Expert I+II

(95 → 07)

1.9 D / 1.9 TD (mot.) XUD**AC** servo 

62 91 9072

Partner I+II (M49/M59)

(96 → 08)

1.9 D (mot.) DW8 / DW8B / XUD**AC** servo 

62 91 9072

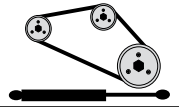

9000

(94 → 98)

2.0-16 / 2.0-16 Turbo

57 52 0001

2.3-16 / 2.3-16 Turbo

57 52 0001

9-3 II

(02 →)

2.2 TD (mot.) X22DTH

40 03 0023

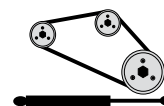

Cordoba II (6K2)

(99 → 02)

1.9 TDI (mot.) AGR / ALH / ASV

30 92 1690

Ibiza II (6K1)

(99 → 02)

1.9 TDI (mot.) AGR / ALH / ASV

30 92 1690

Leon (1M1)

(00 → 06)

1.9 TDI (mot.) AHF / AGR / ALH / ASV

30 92 1690

Toledo II (1M2)

(99 → 05)

1.9 TDI (mot.) AHF / AGR / ALH / ASV

30 92 1690

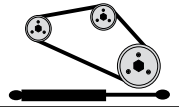

Octavia (1U_/1Z_)
(98 →)

1.9 SDI (mot.) AQM

30 92 1690

1.9 TDI (mot.) AHF / AGR / ALH / ASV

30 92 1690

Superb (3U4)
(02 →)

2.5 TDI (mot.) AYM / BDG

30 92 7604

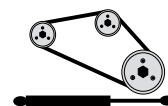

Astra Mk IV

(98 → 04)

2.0 TD / 2.2 TD (mot.) X20DTH / X20DTL / Y20DTH / Y22DTR

40 03 0023

Frontera Mk II

(98 → 02)

2.2 TD (mot.) X22DTH / Y22DTH

40 03 0023

Omega

(94 → 03)

2.0 TD / 2.2 TD (mot.) X20DTH / Y22DTH

40 03 0023

2.5 TD (mot.) U25TD / X25TD

20 52 0007

Signum

(03 → 08)

2.0 TD / 2.2 TD (mot.) Y20DTH / Y22DTR

40 03 0023

Sintra

(97 → 99)

2.2 TD (mot.) X22DTH

40 03 0023

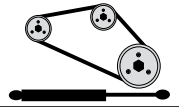

Vectra

(96 → 02)

2.0 TD / 2.2 TD (mot.) X20DTH / X20DTL / Y20DTH / Y22DTR

40 03 0023

Vectra Mk II

(02 → 08)

2.0 TD / 2.2 TD (mot.) Y20DTH / Y22DTR

40 03 0023

Zafira

(98 → 05)

2.0 TD / 2.2 TD (mot.) X20DTH / X20DTL / Y20DTH / Y22DTR

40 03 0023

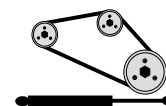

Bora / Variant (1J2/5)

(98 → 05)

1.9 SDI (mot.) AGP / AQM

30 92 1690

1.9 TDI (mot.) AHF / AGR / ALH / ASV

30 92 1690

Golf IV / Variant (1J1/5)

(98 → 05)

1.9 SDI (mot.) AGP / AQM

30 92 1690

1.9 TDI (mot.) AHF / AGR / ALH / ASV

30 92 1690

New Beetle (9C1/1C1)

(98 →)

1.9 TDI (mot.) ALH

30 92 1690

Passat / Variant (3B_)

(96 → 05)

2.5 TDI (mot.) AFB / AKN / BAU / BDG / BDH

30 92 7604

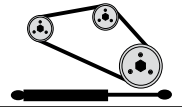

Polo Classic / Variant (6KV2/5)
(95 → 02)

1.9 TDI (mot.) AGR / ALH / ASV

00 → 02

30 92 1690

**80/90 (89/8A)**

(86 → 92)

LHD servo 

(ch.) 89-H-300000 →

2.3 (mot.) 7A

30 92 7613

80/90 quattro (89/8A)

(86 → 92)

LHD

30 92 7613

80/90/Avant (8C/B4)

(92 → 96)

LHD servo 2.6 (mot.) AAH
2.8 (mot.) ABC/ACZ

30 92 7613

80/90/Avant quattro (8C/B4)

(92 → 96)

2.0 (mot.) 6A/ABK/ACE/ADW
2.3 (mot.) ABY/NG
2.6/2.8 (mot.) AAH/ABC/ACZ

30 92 7691

100/Avant/quattro (44/C3)

(82 → 91)

30 92 7606

100/Avant quattro (4A/C4)

(91 → 94)

servo 2.2 (mot.) AAN
4.2 (mot.) ABH

30 92 7606

200/Avant quattro (44/44Q)

(88 → 91)

30 92 7606



A4/S4/Avant/quattro (8D2/B5)

(95 → 01)

95 → 98 **servo**  **1.8 (mot.) AJL**
2.4 (mot.) ALF/AGA/AJG
2.5 TDI (mot.) AFB
2.7 (mot.) AGB
2.8 (mot.) ACK/ALG **30 92 7611**

99 **LHD servo**  **1.8 (mot.) AJL**
2.4 (mot.) ALF/AGA/AJG
2.5 TDI (mot.) AFB
2.7 (mot.) AGB
2.8 (mot.) ACK/ALG **30 92 7611**
 (ch.) → 8D-X-303809

99 → 00 **RHD servo**  **1.8 (mot.) AJL**
2.4 (mot.) ALF/AGA/AJG
2.5 TDI (mot.) AFB
2.7 (mot.) AGB
2.8 (mot.) ACK/ALG **30 92 7611**
 (ch.) 8D-X-303810 → 8D-Y-005048

A6/S6/Avant quattro (4A/C4)

(95 → 97)

servo  **2.2 (mot.) AAN**
4.2 (mot.) AEC **30 92 7606**

A6/Avant (4B/C5)

(97 → 05)

servo  (ch.) → 4B-X-09000 **30 92 7611**

A6/S6/Avant quattro (4B/C5)

(97 → 05)

servo  (ch.) → 4B-X-065000 **30 92 7611**

A8/S8 quattro (4D2/4D8)

(94 → 03)

→ 99 **servo**  **30 92 7611**

Cabriolet (8G7/B4)

(92 → 00)

LHD servo  **2.6/2.8 (mot.) AAH/ABC/ACZ** **30 92 7613**



Coupe (89/8B)

(89 → 96)

→ 94

LHD servo

2.3 (mot.) 7A
2.6 (mot.) AAH
2.8 (mot.) ABC/ACZ

30 92 7611

95 →

LHD

2.6 (mot.) AAH
2.8 (mot.) ABC

30 92 7611

Coupe quattro (89/8B)

(89 → 96)

LHD

30 92 7611

V8 (44/4C)

(88 → 94)

servo

Hydraulikpumpe / hydraulic pump / pompe hydraulique / bomba de hid-
ráulica / pompa idraulica / hydraulische pomp / Pompa hydrauliczna /
гидравлический насос / hidraulična pumpa

30 92 7606



BM 110/111

(59 → 68)

10 52 0008

BM 114/115

(68 → 77)

10 52 0008

BM 123

(77 → 85)

10 52 0008

BM 123

(77 → 85)

10 52 0008

BM 124

(84 → 93)

(ex.) 4matic

10 52 0008

4matic

10 93 7868

190 (BM 201)

(82 → 93)

10 52 0003



C-Klasse (BM 202)

(93 → 01)

10 52 0003

CLK (BM 208)

(97 → 02)

10 52 0003

G-Klasse (BM 460)

(89 →)

10 93 1450

G-Klasse (BM 461/463)

(89 →)

ØA 50 mm

10 93 1449

ØA 39 mm

10 93 1450

S-Klasse (BM 108/109)

(66 → 72)

10 52 0008

S-Klasse (BM 116)

(72 → 80)

10 52 0008

**S-Klasse (BM 126)**

(79 → 91)

10 52 0008

S-Klasse (BM 140)

(91 → 98)

10 52 0008

SL (BM 107)

(71 → 89)

10 92 7572

SL (BM 113)

(63 → 71)

10 52 0008

SL (BM 129)

(89 → 01)

10 52 0003

SLK (BM 170)

(96 → 04)

10 52 0003

passend für / to fit

SMART



City Coupe (BM 450)
(98 → 04)

12 92 7569



Passat/Variant (3B2/3B5)

(97 → 00)

LHD servo 

(ch.) → 3B-YE014881 **2.3 (mot.) AGZ**
 (ch.) → 3B-YD050000 **2.5 TDI (mot.) AFB/AKN**
 (ch.) → 3B-YP044943 **2.8 (mot.) ACK/AHA/ALG/APR/ATX/ATQ/AQD**

30 92 7611

RHD servo 

(ch.) → 3B-YE072038 **2.3 (mot.) AGZ**
 (ch.) → 3B-YD092138 **2.5 TDI (mot.) AFB/AKN**
 (ch.) → 3B-YP038674 **2.8 (mot.) ACK/AHA/ALG/APR/ATX/ATQ/AQD**

30 92 7611

Passat/Variant 4motion (3B2/3B5)

(97 → 00)

LHD servo 

(ch.) → 3B-YE014881 **1.8 (mot.) ADR/APT**
 (ch.) → 3B-YD050000 **1.9 TDI (mot.) AFN/AHU/ATJ/AVG**
 (ch.) → 3B-YP044943 **2.3 (mot.) AGZ**
2.5 TDI (mot.) AFB/AKN
2.8 (mot.) ACK/AHA/ALG/APR/ATQ/AQD

30 92 7611

RHD servo 

(ch.) → 3B-YE072038 **2.3 (mot.) AGZ**
 (ch.) → 3B-YD092138 **2.5 TDI (mot.) AFB/AKN**
 (ch.) → 3B-YP038674 **2.8 (mot.) ACK/AHA/ALG/APR/ATQ/AQD**

30 92 7611

Transporter (T4)

(91 → 96)

(ch.) → 70-T-199000

30 92 7612

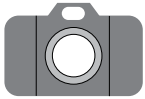

SWAG 10 51 0001



SWAG 10 51 0002



SWAG 10 51 0008



SWAG 10 51 0009



SWAG 10 51 0017



SWAG 10 51 0021



SWAG 10 51 0022



SWAG 10 52 0003



SWAG 10 52 0008



SWAG 10 52 0012



SWAG 10 52 0015



SWAG 10 52 0018



SWAG 10 52 0019



SWAG 10 52 0023



SWAG 10 52 0025

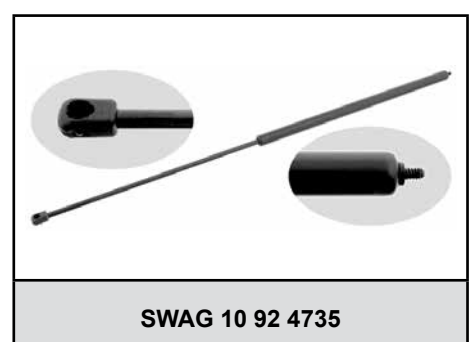
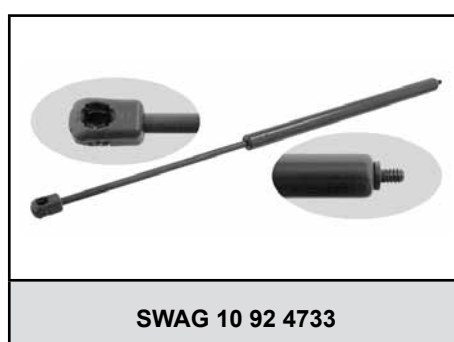
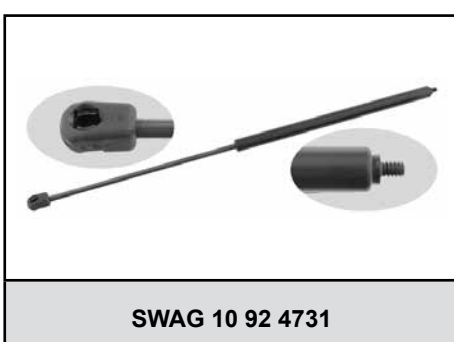
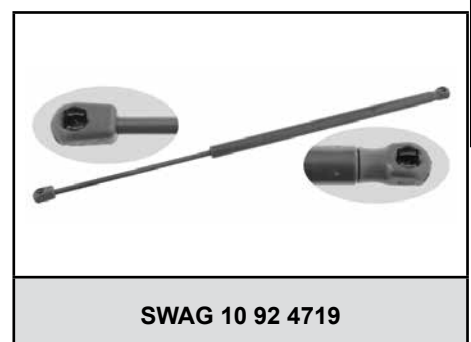
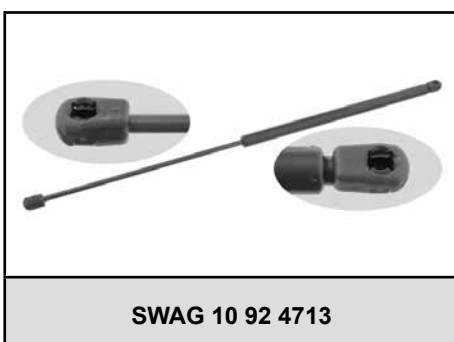
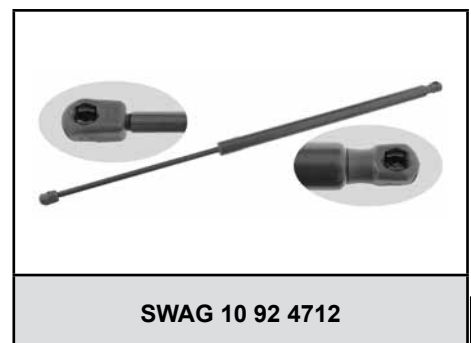
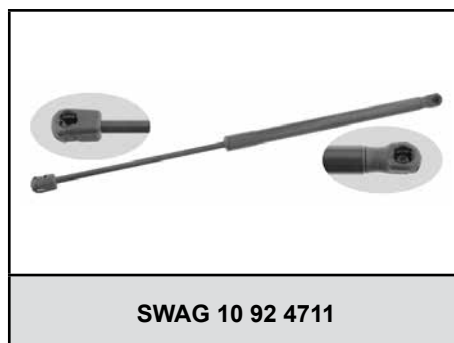
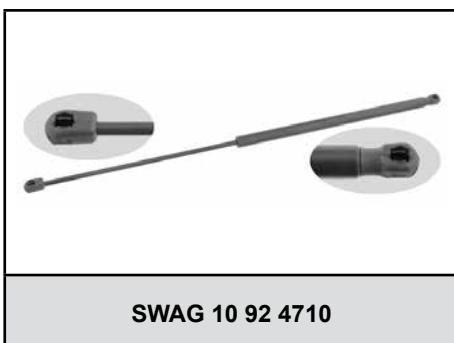
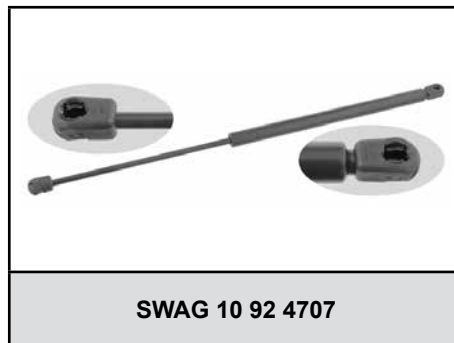
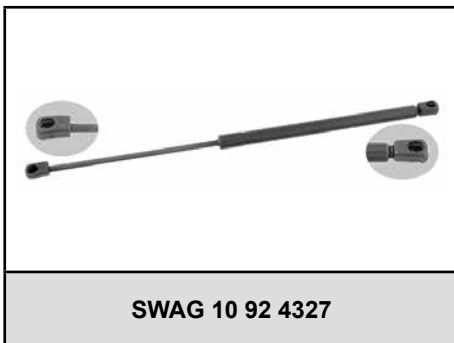
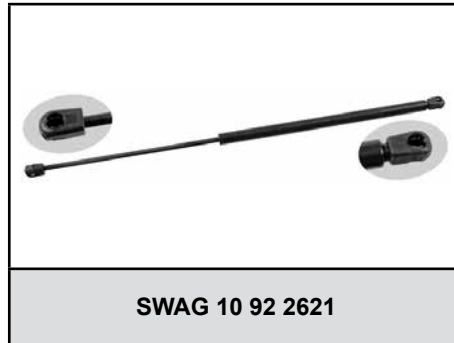
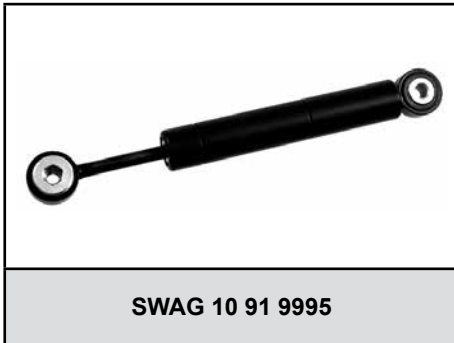
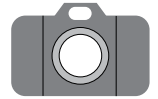

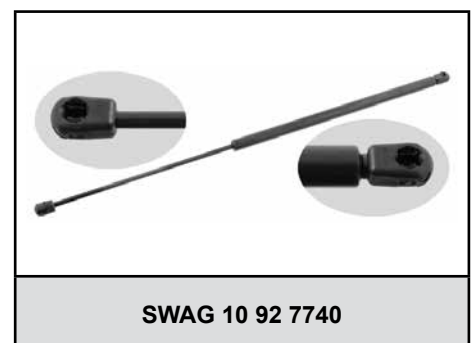
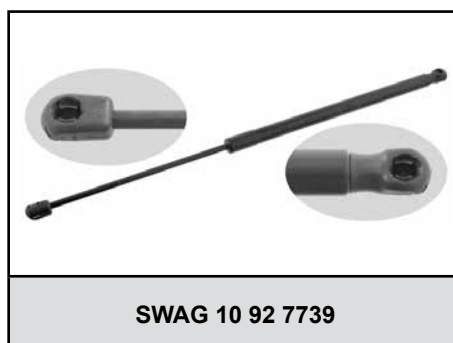
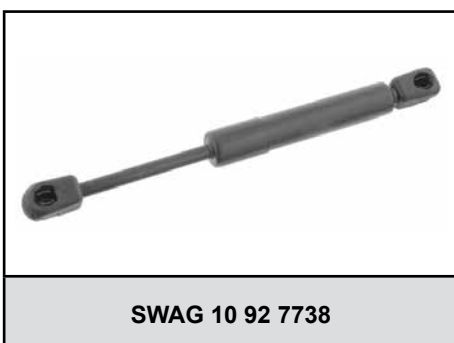
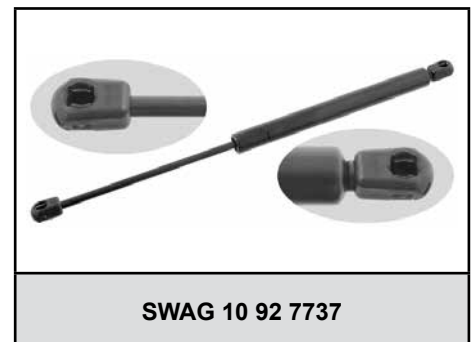
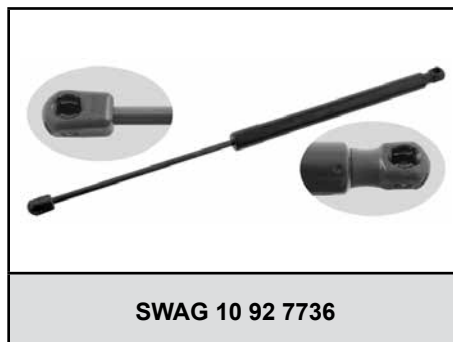
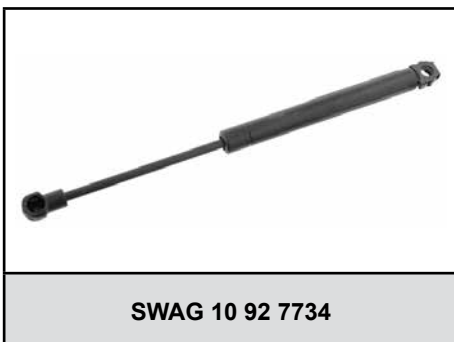
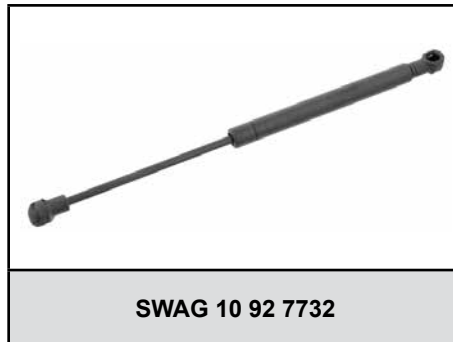
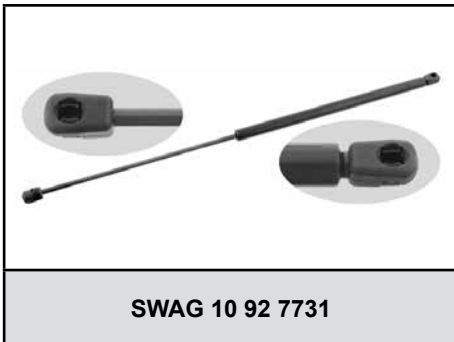
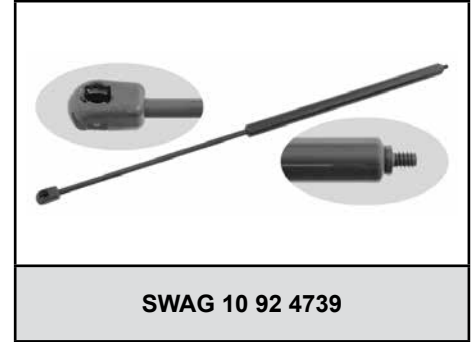
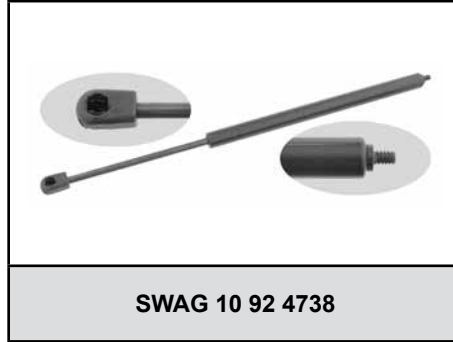
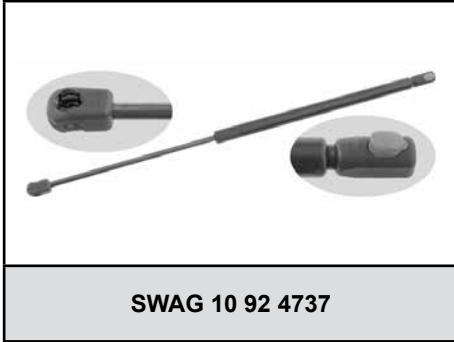
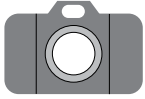

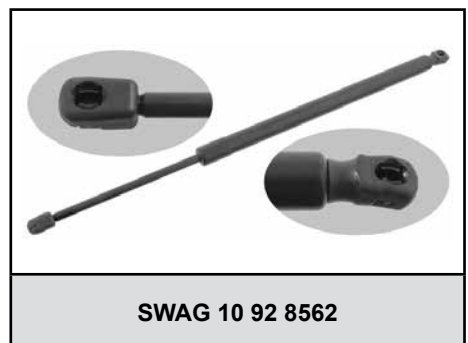
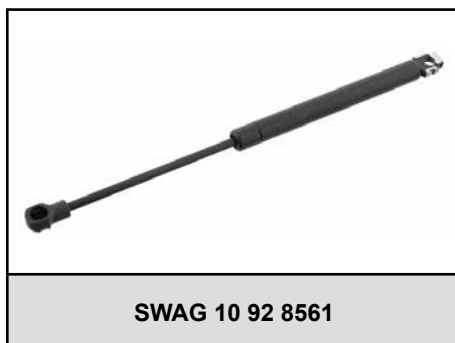
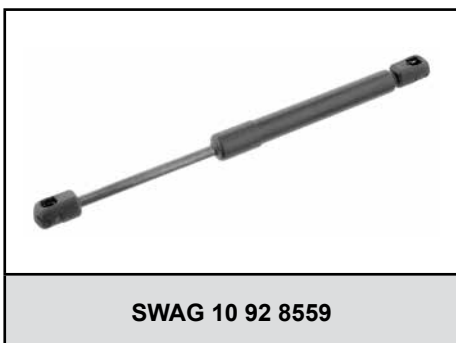
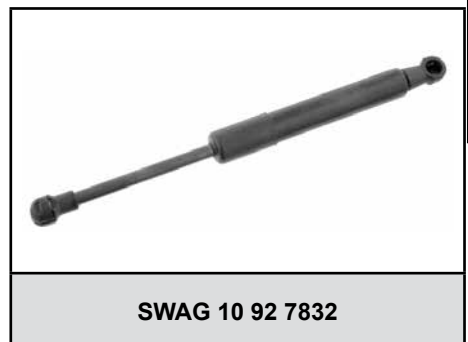
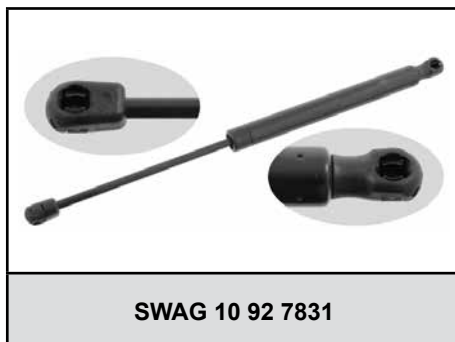
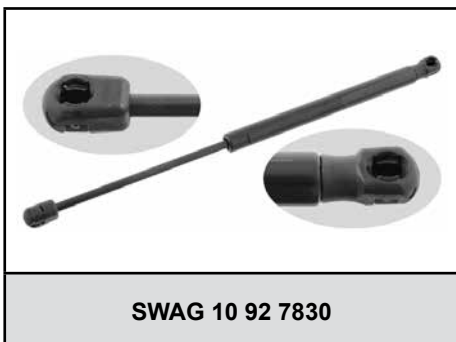
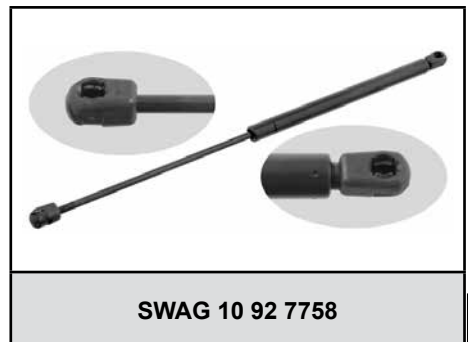
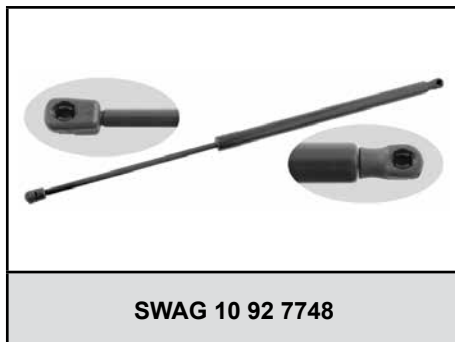
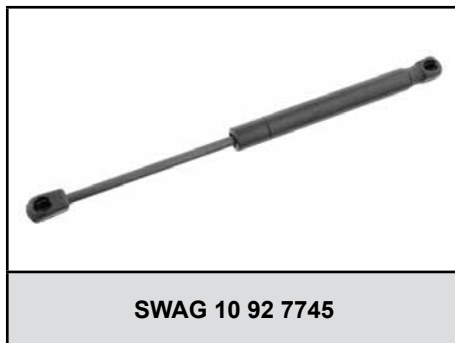
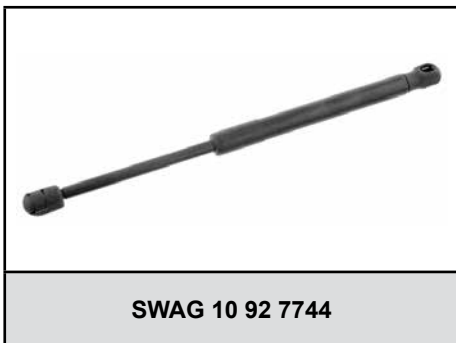
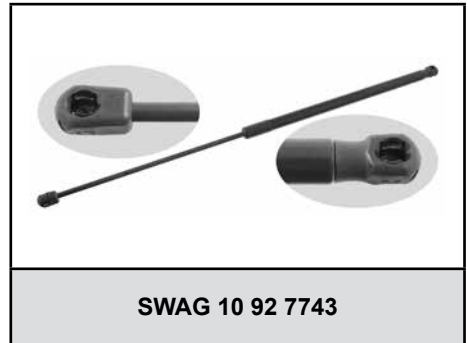
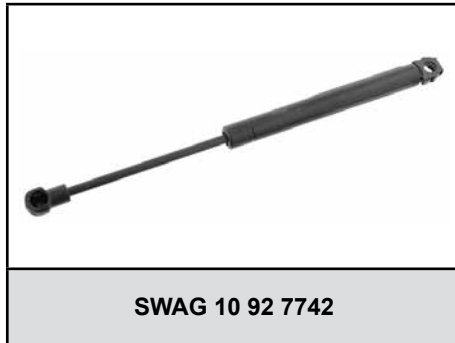
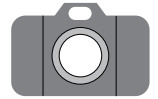

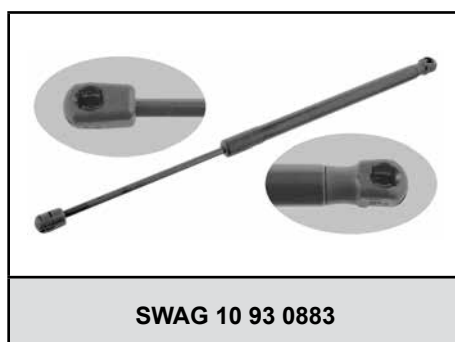
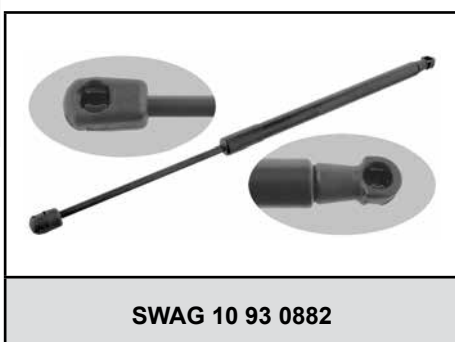
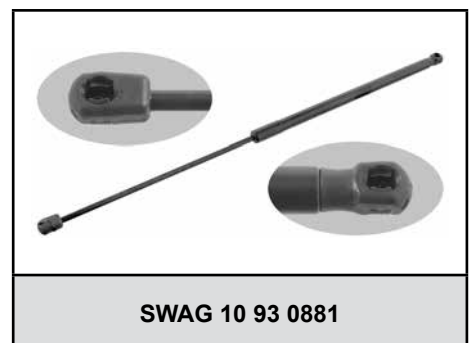
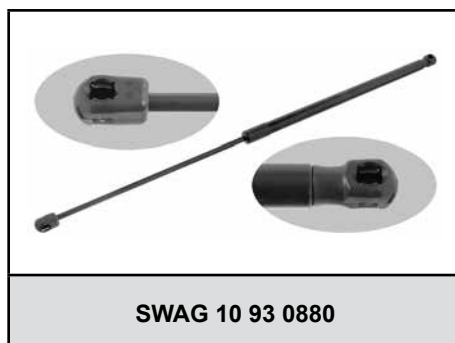
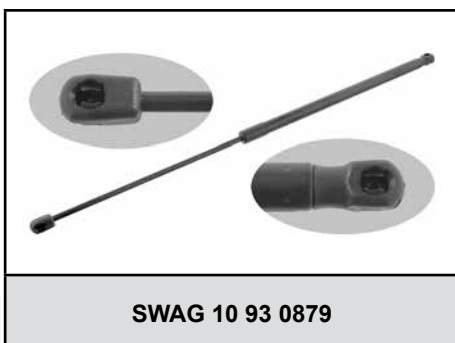
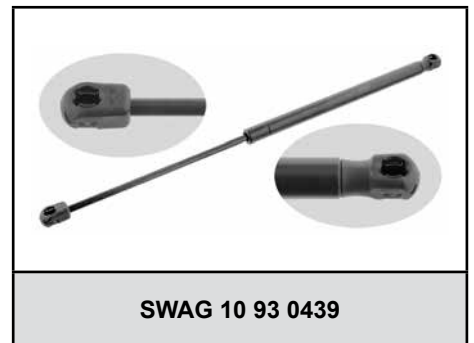
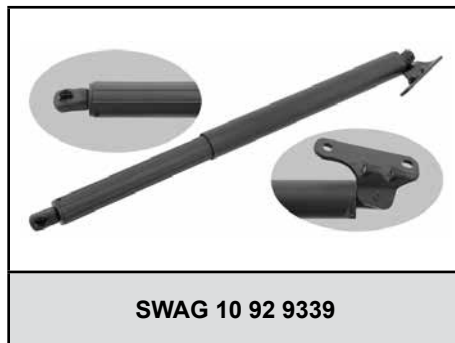
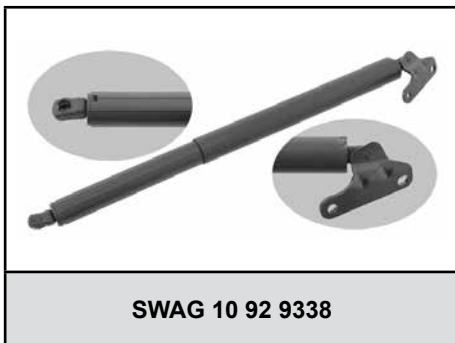
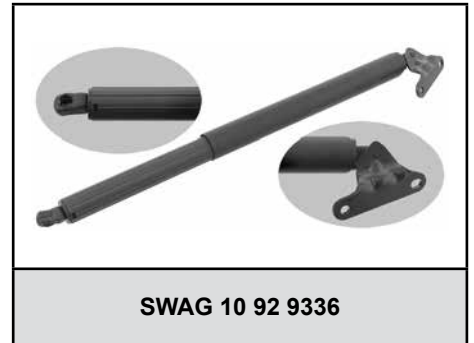
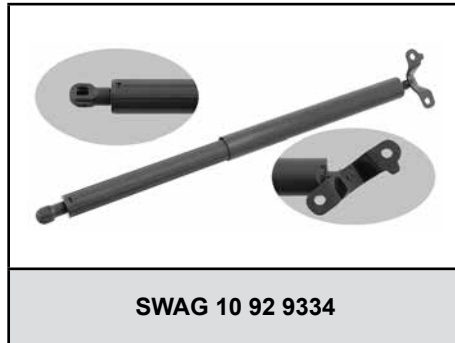
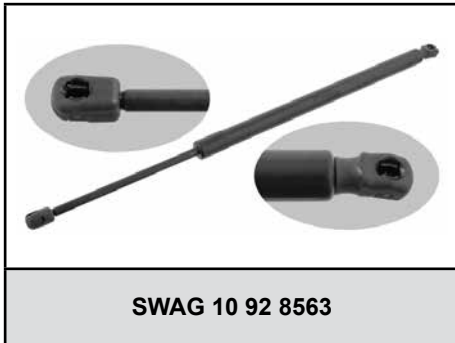
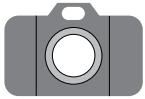

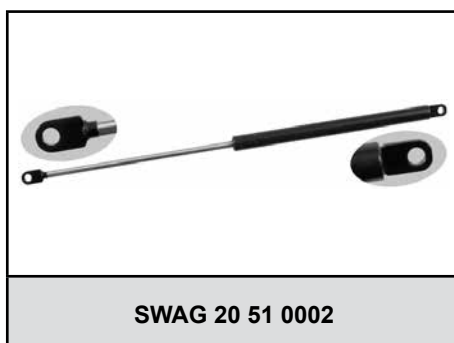
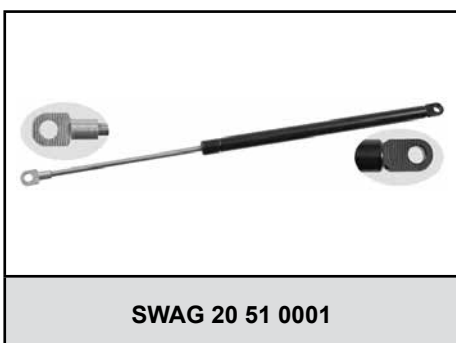
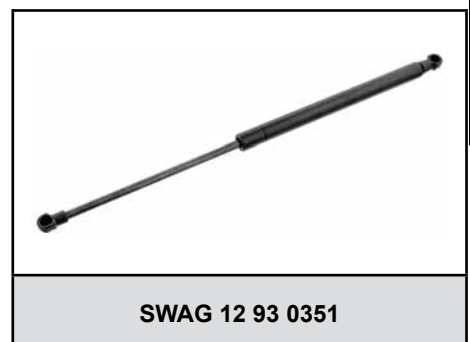
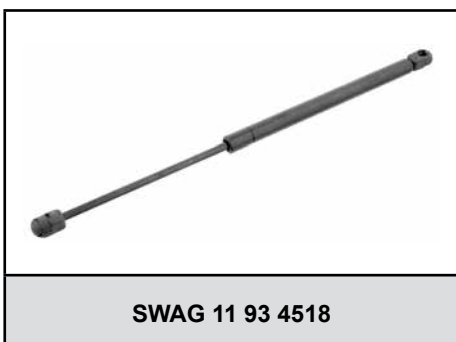
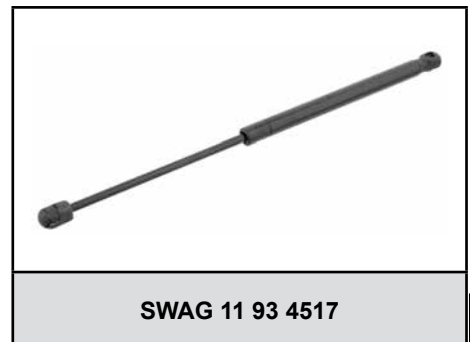
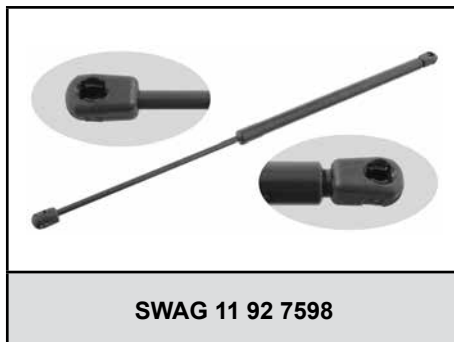
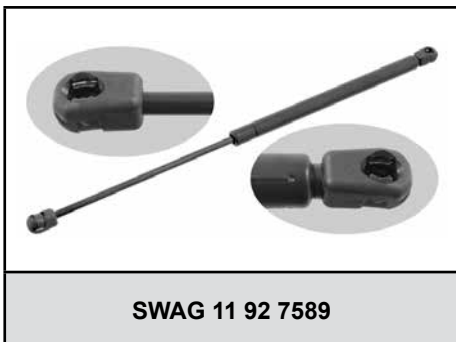
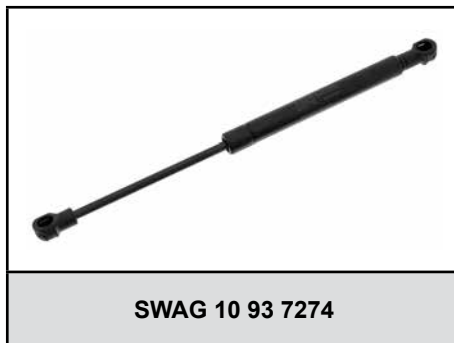
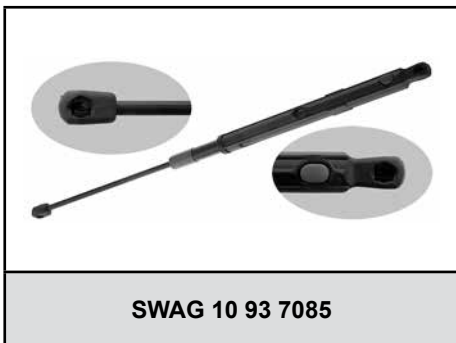
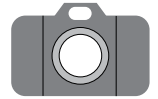

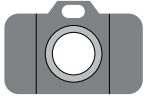

SWAG 20 51 0004



SWAG 20 51 0005



SWAG 20 51 0006



SWAG 20 51 0007



SWAG 20 51 0014



SWAG 20 51 0020



SWAG 20 51 0024



SWAG 20 51 0025



SWAG 20 51 0027



SWAG 20 51 0032



SWAG 20 51 0043



SWAG 20 51 0045



SWAG 20 52 0004



SWAG 20 52 0005

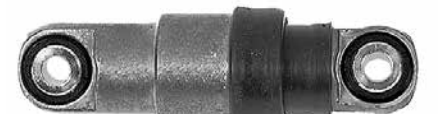

SWAG 20 52 0006

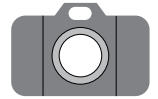

SWAG 20 52 0007



SWAG 20 52 0009



SWAG 20 52 0015



SWAG 20 52 0016



SWAG 20 52 0017



SWAG 20 91 8483



SWAG 20 91 8484



SWAG 20 91 8485



SWAG 20 92 3649



SWAG 20 92 6057



SWAG 20 92 7560



SWAG 20 92 7561

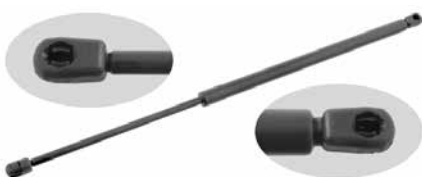

SWAG 20 92 7585



SWAG 20 92 7586



SWAG 20 92 7587

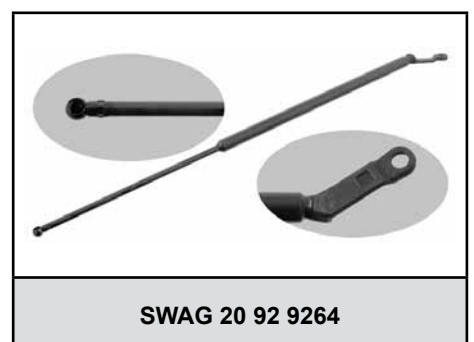
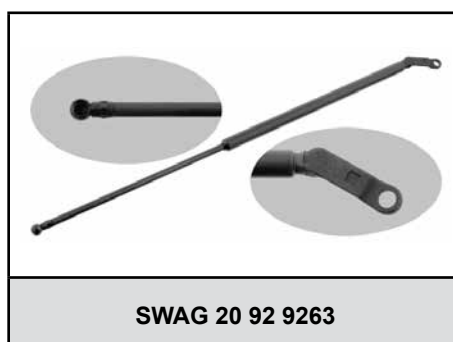
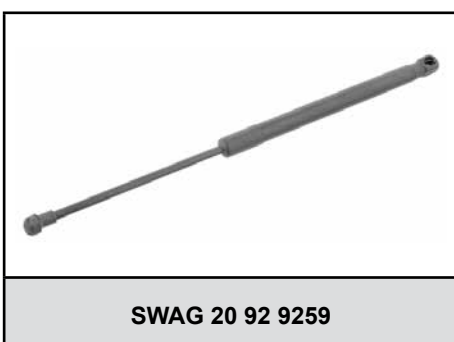
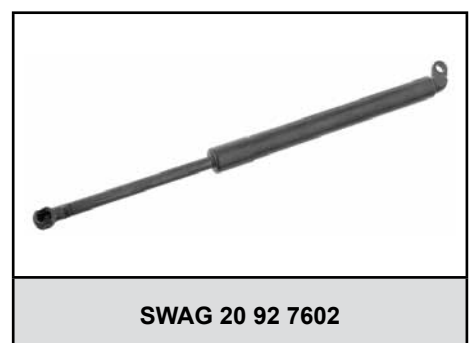
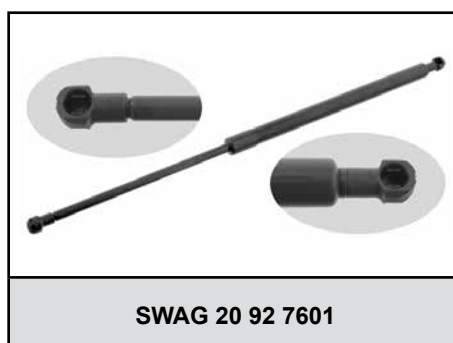
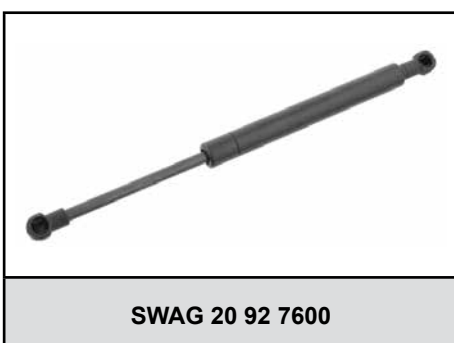
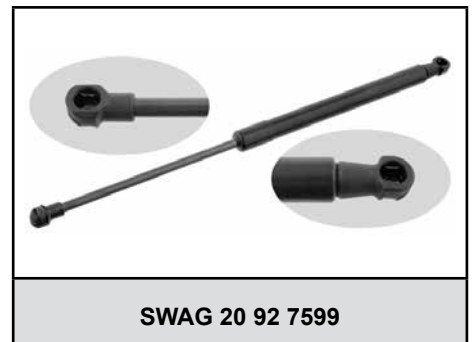
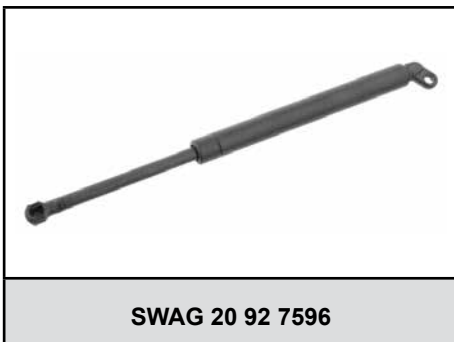
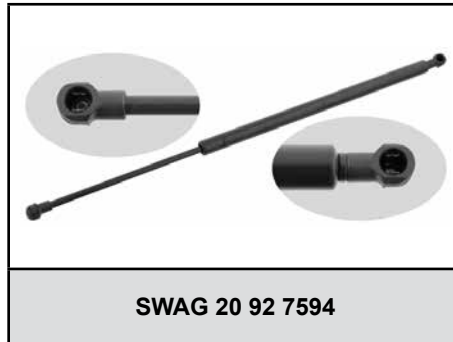
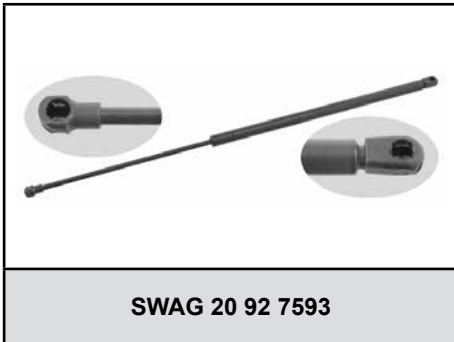
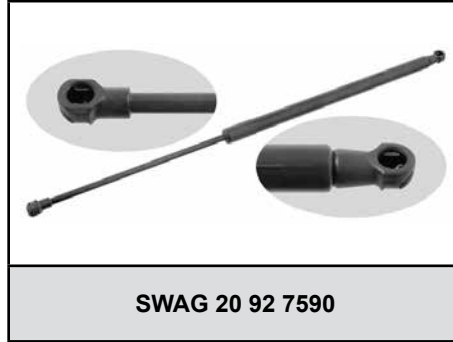
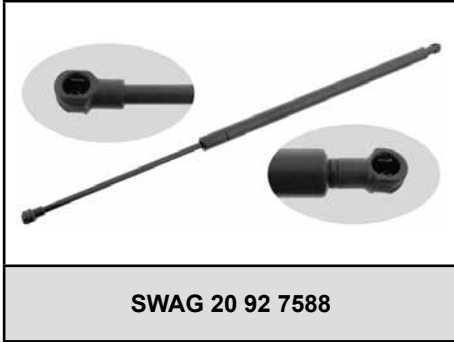
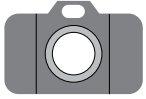

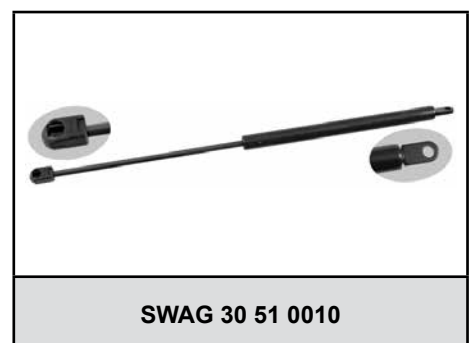
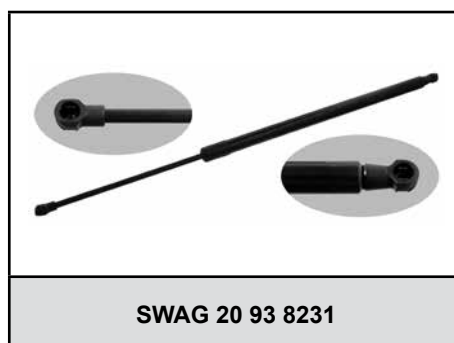
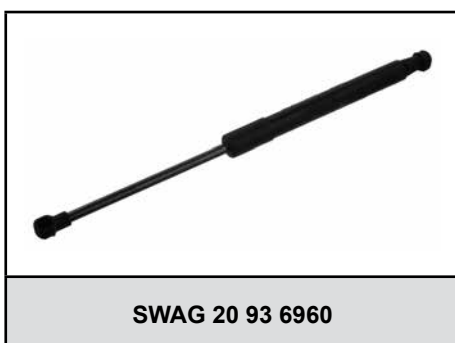
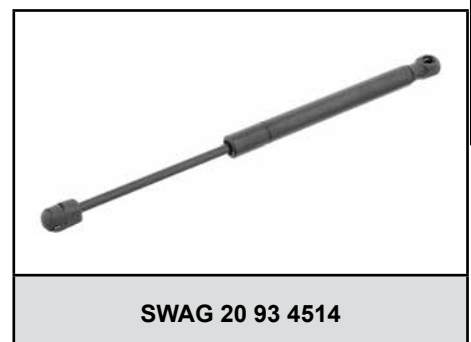
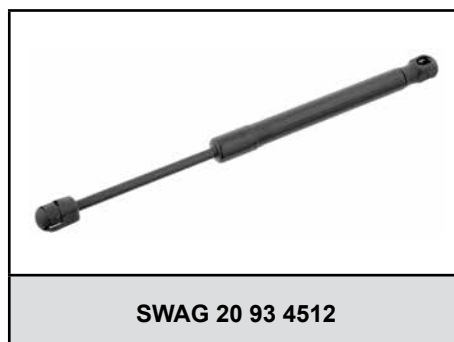
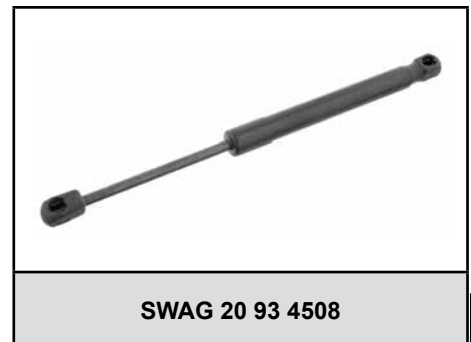
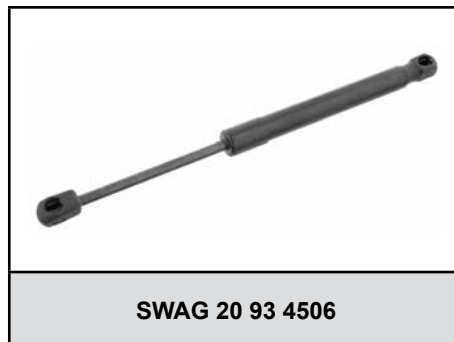
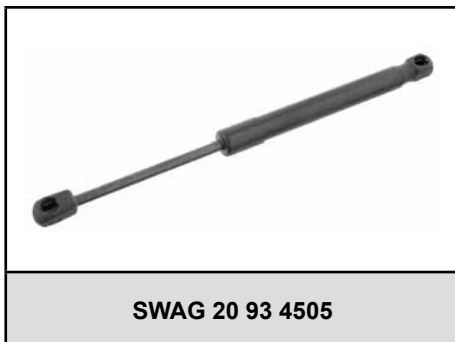
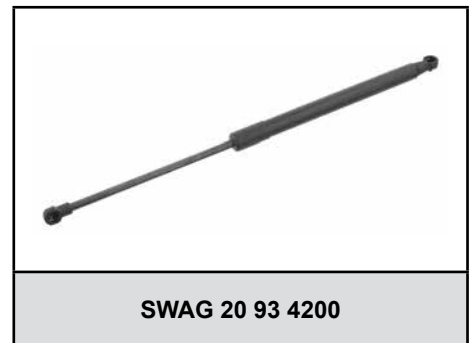
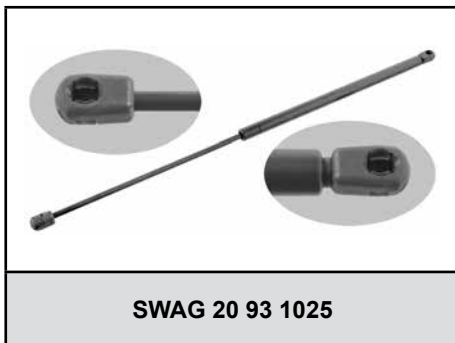
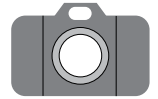

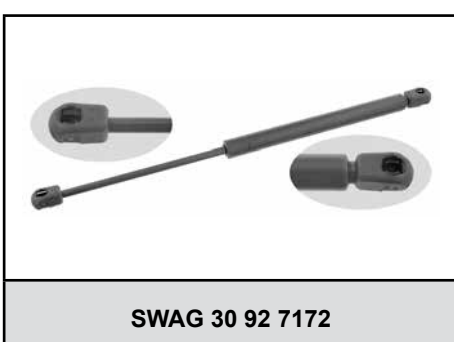
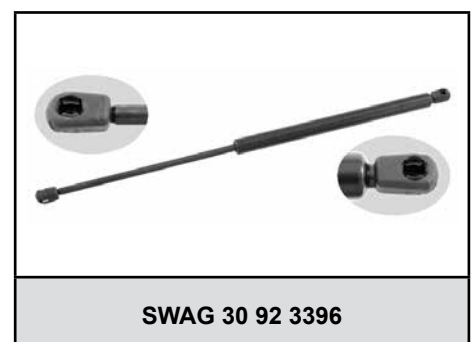
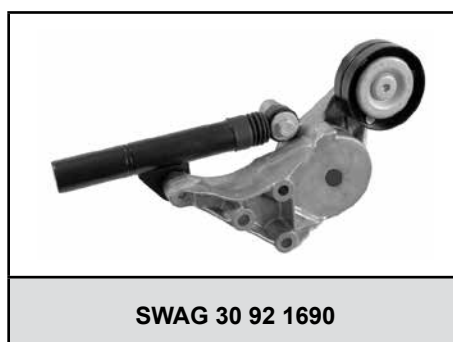
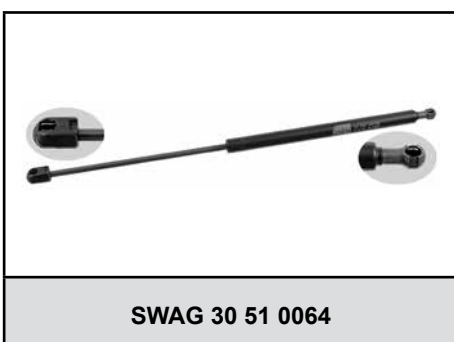
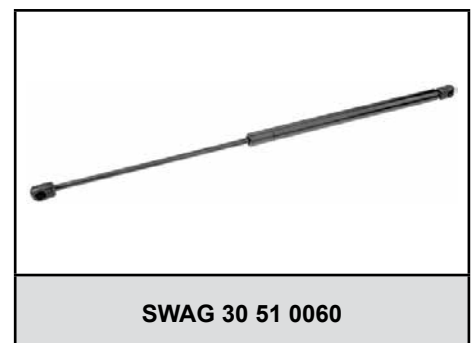
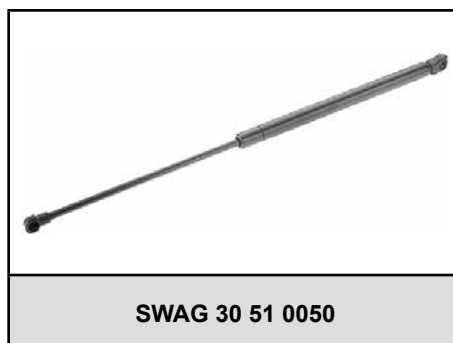
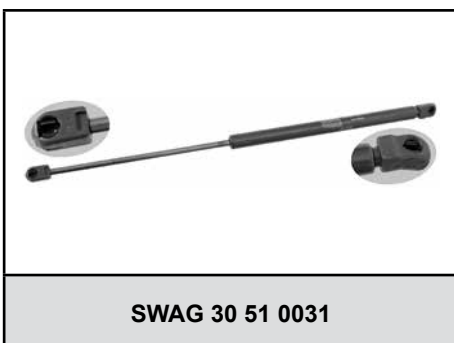
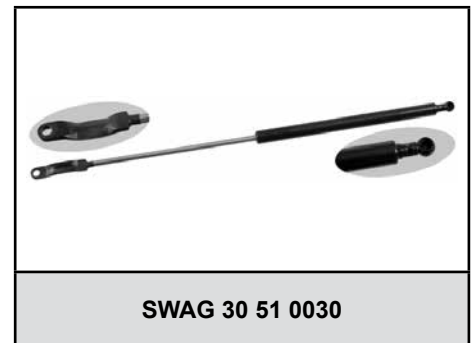
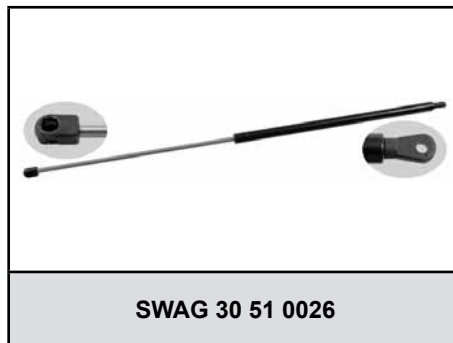
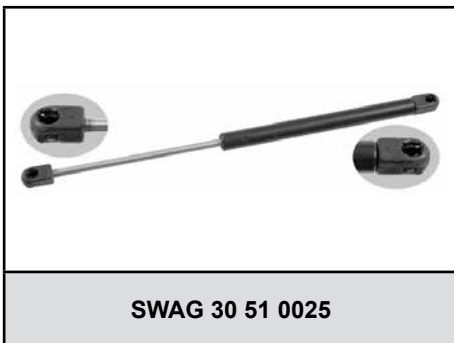
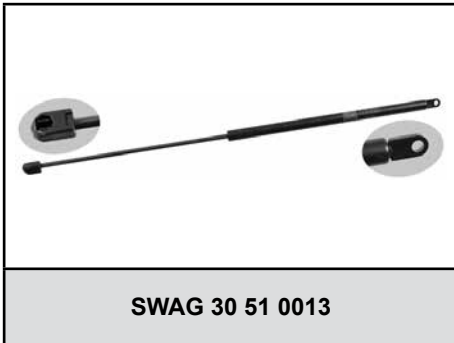
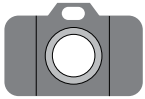

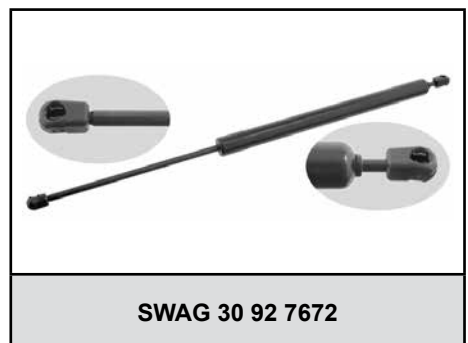
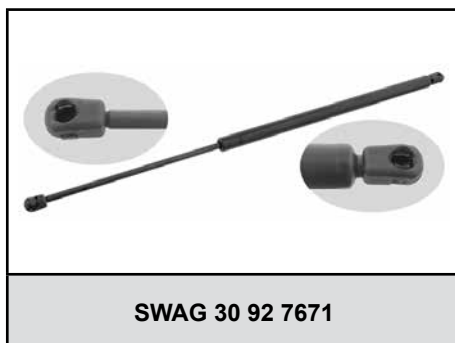
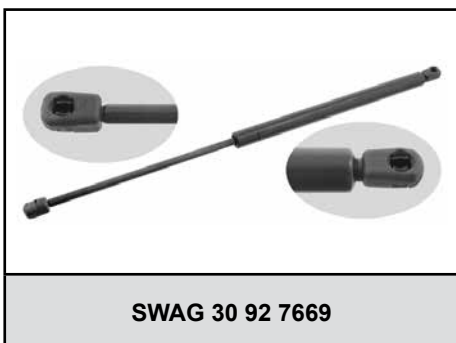
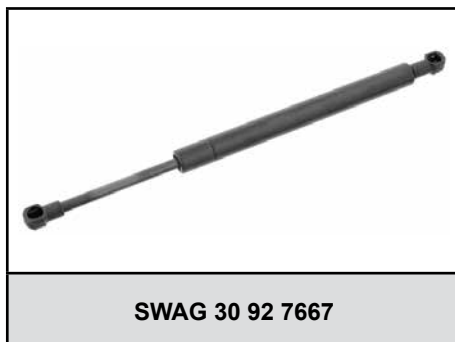
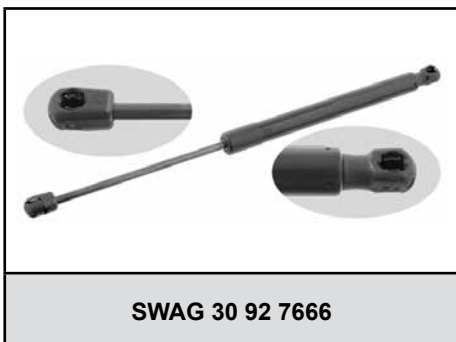
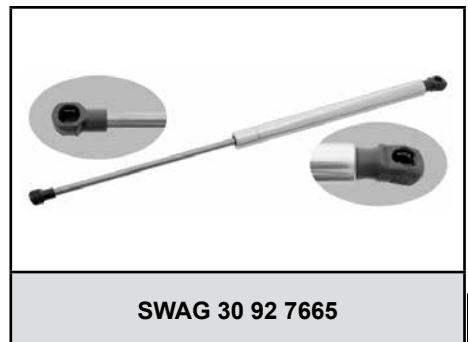
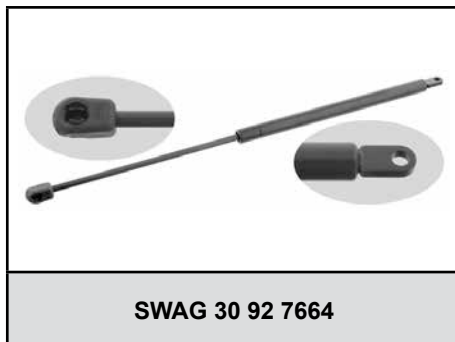
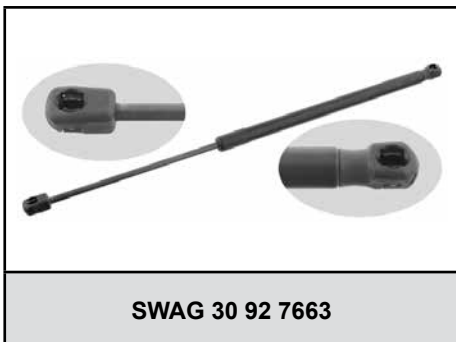
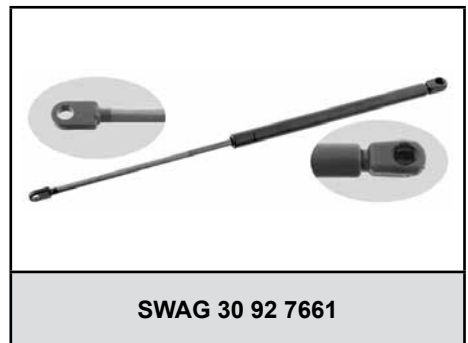
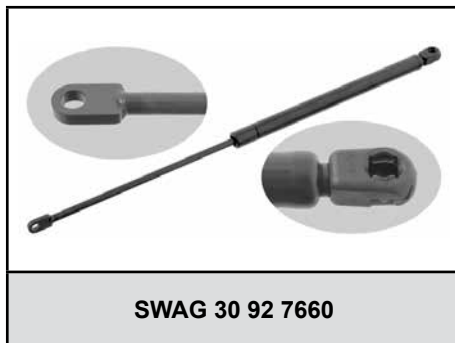
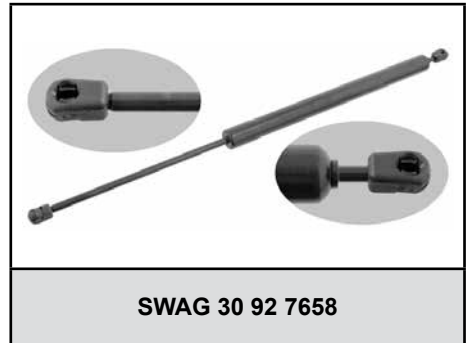
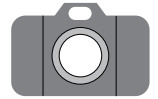

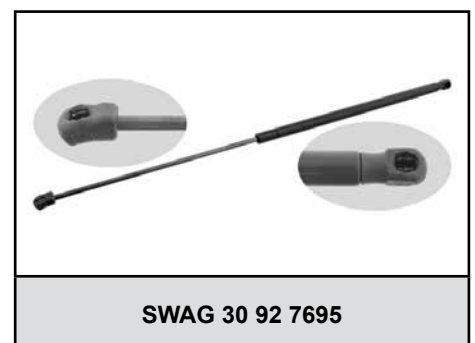
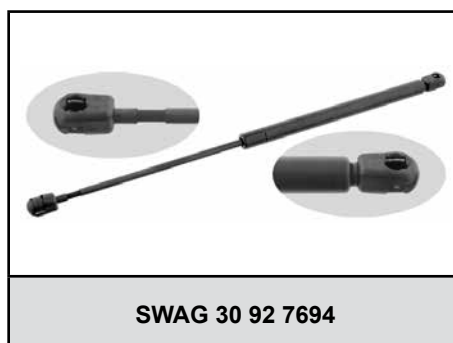
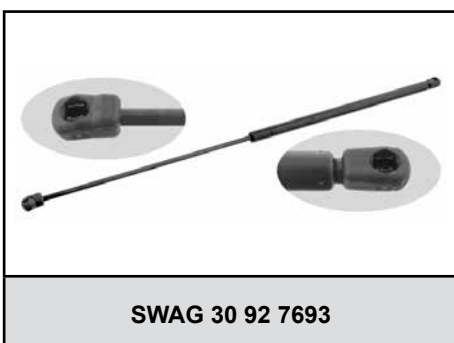
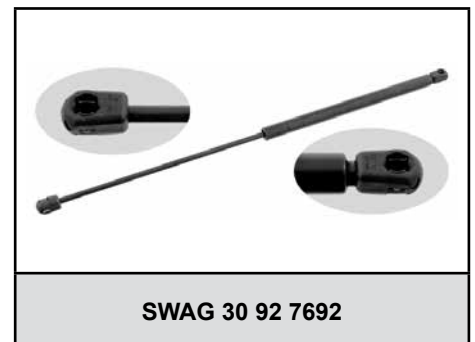
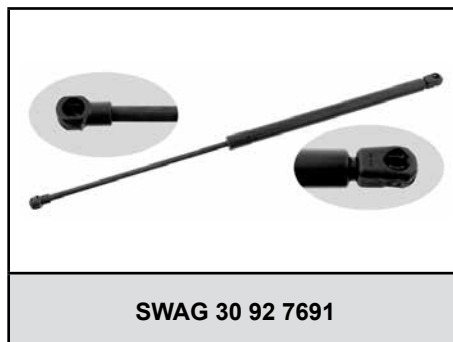
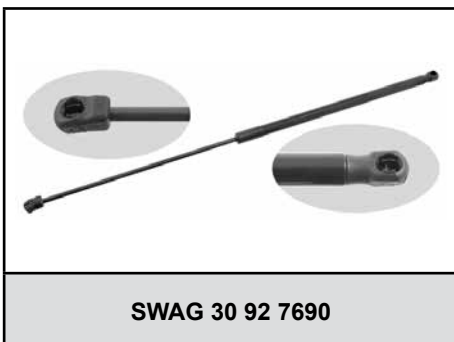
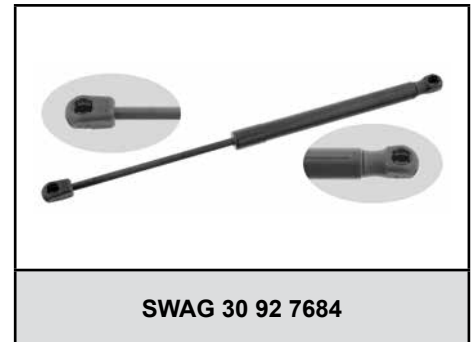
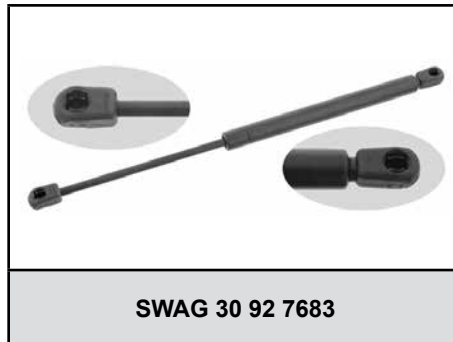
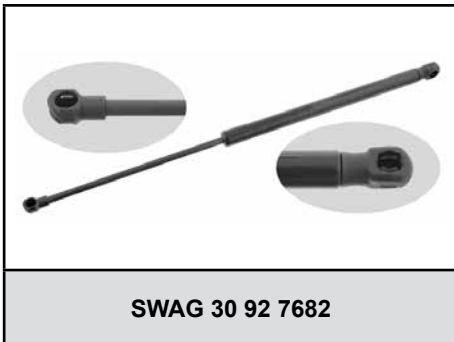
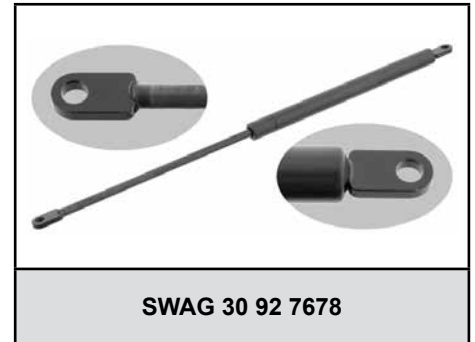
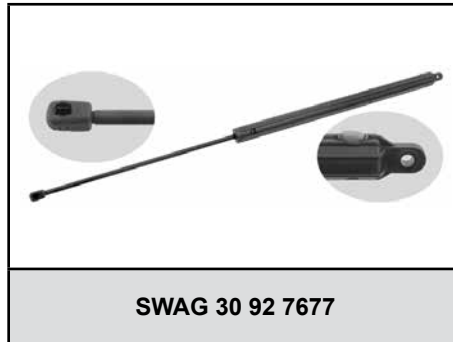
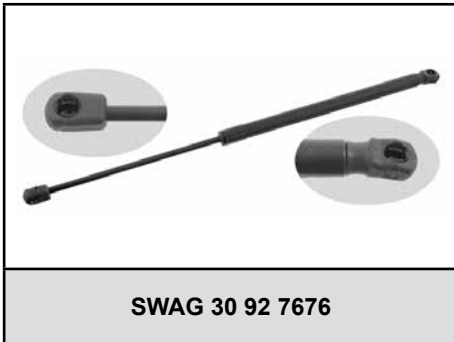
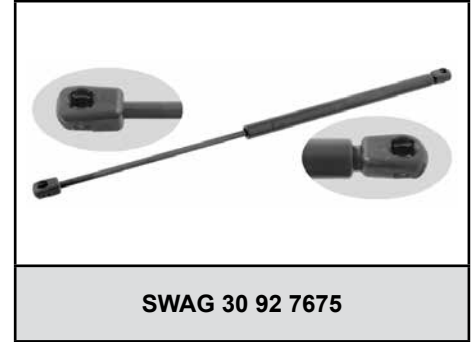
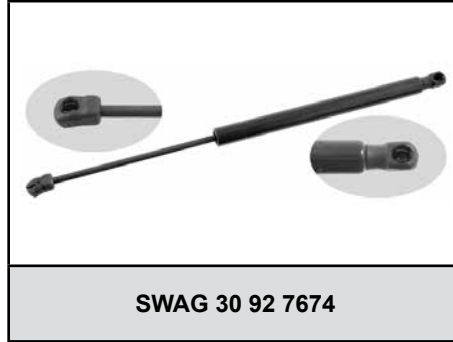
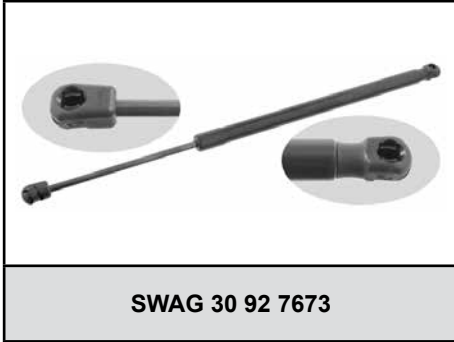
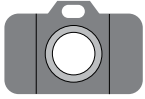

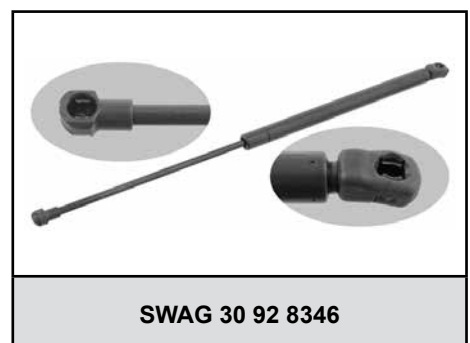
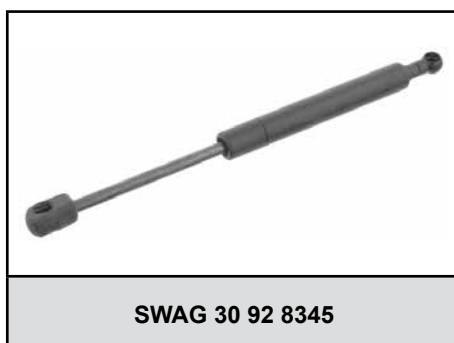
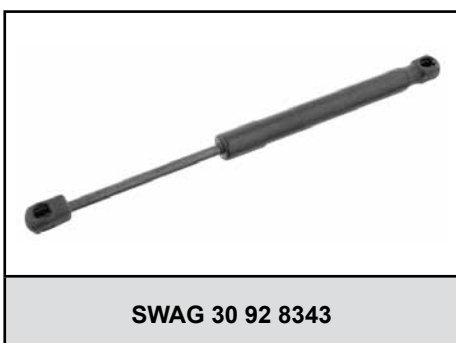
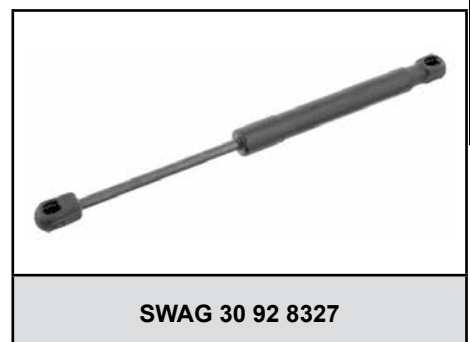
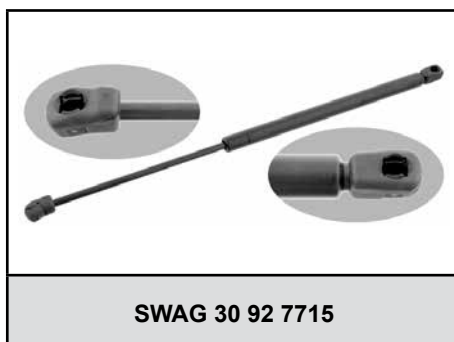
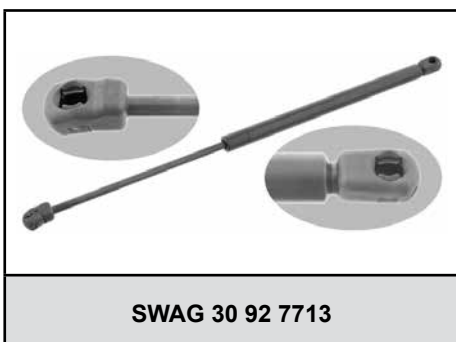
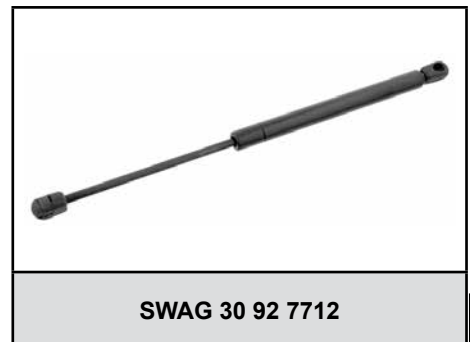
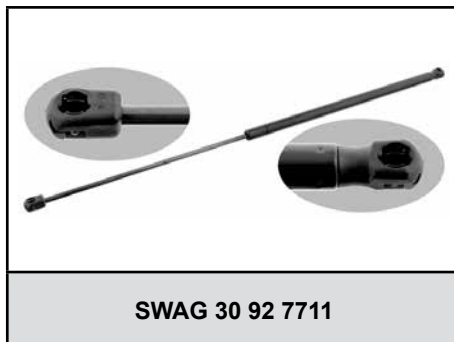
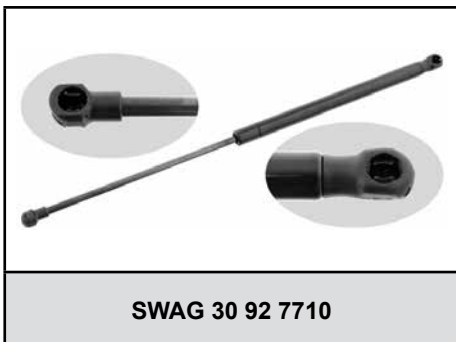
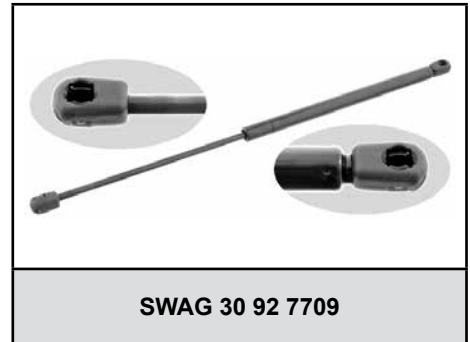
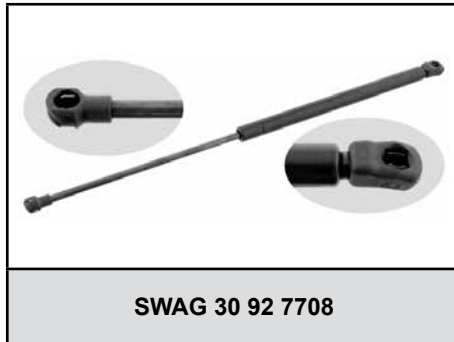
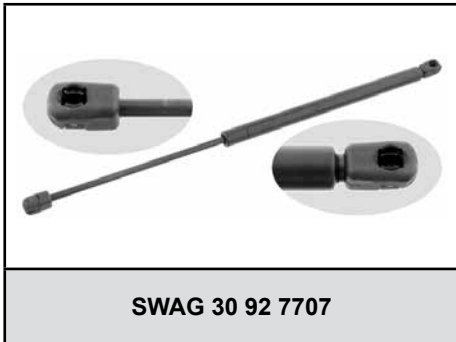
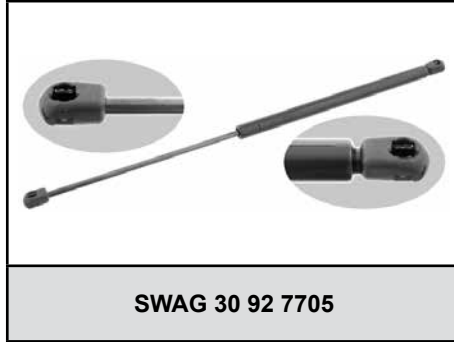
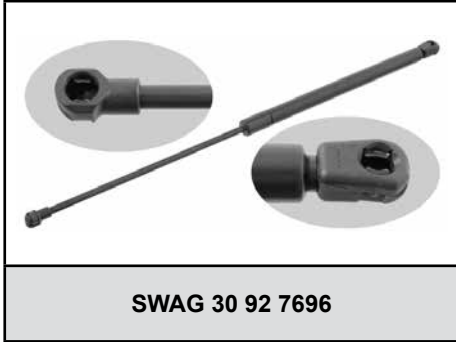
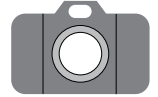

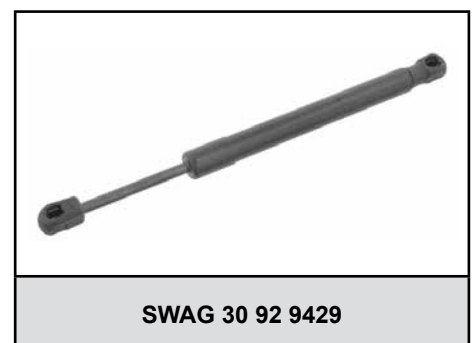
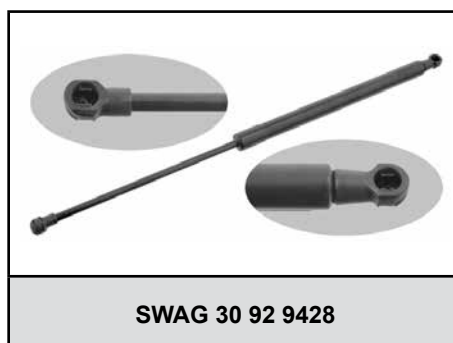
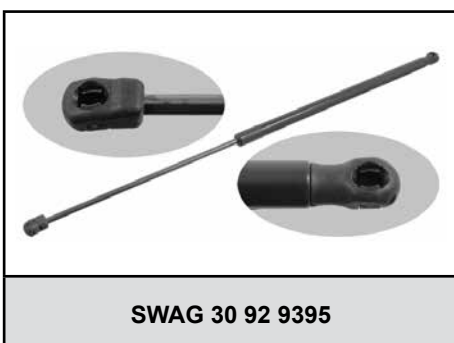
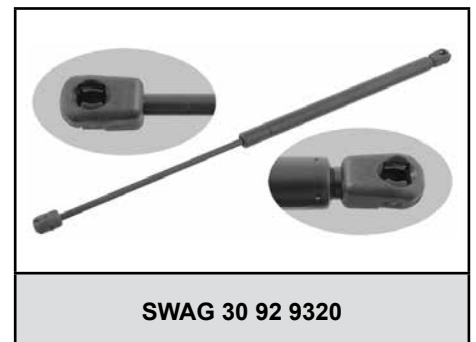
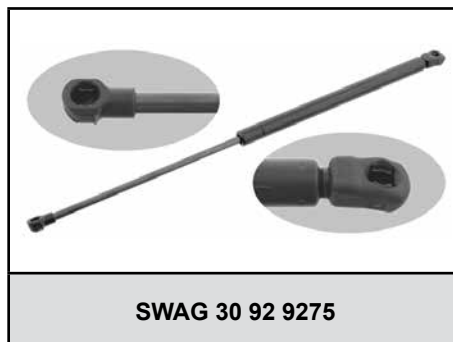
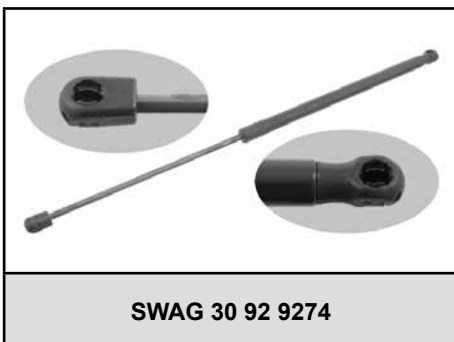
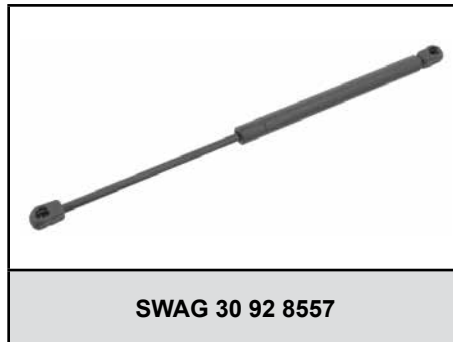
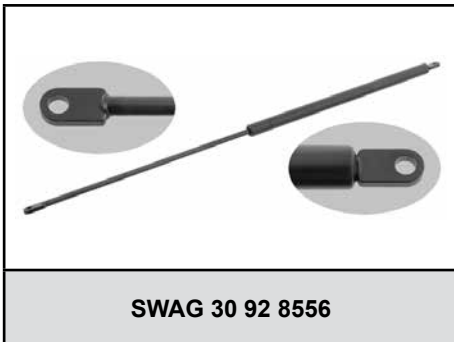
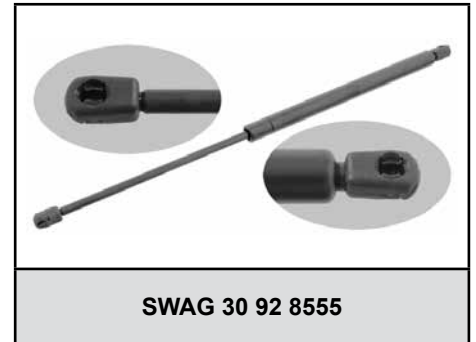
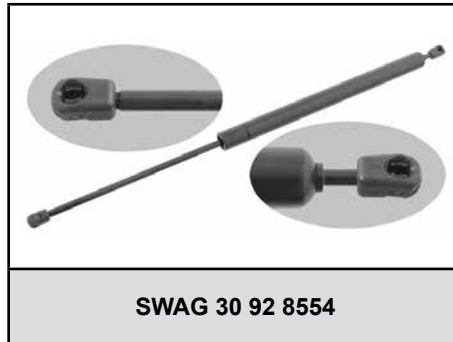
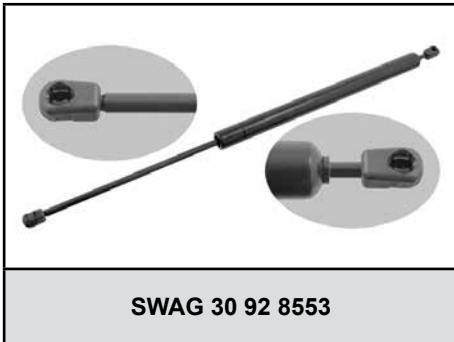
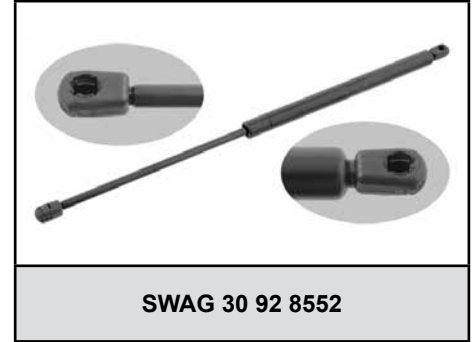
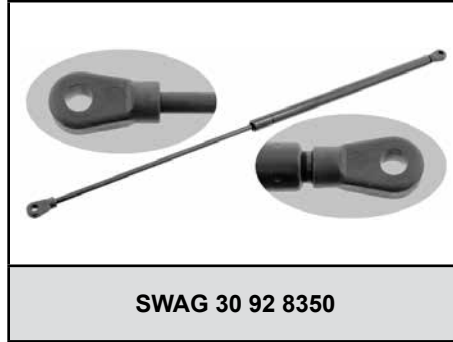
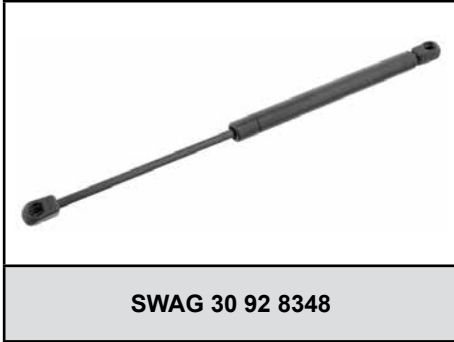
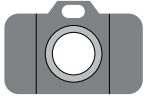

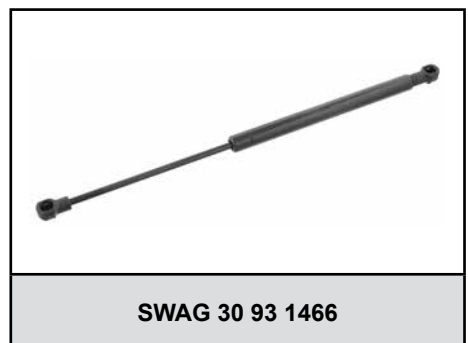
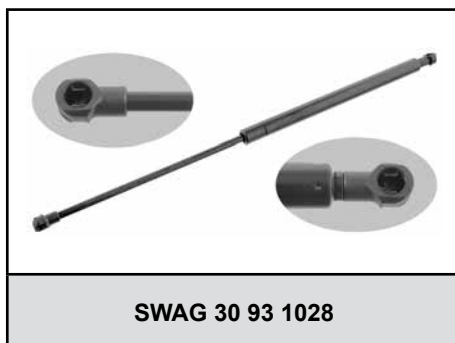
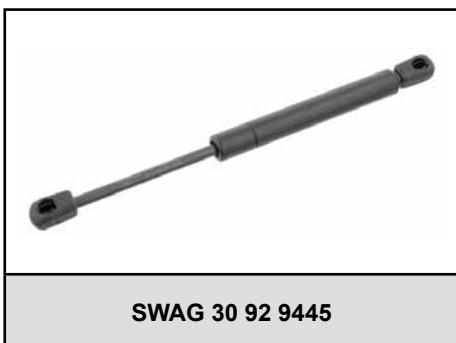
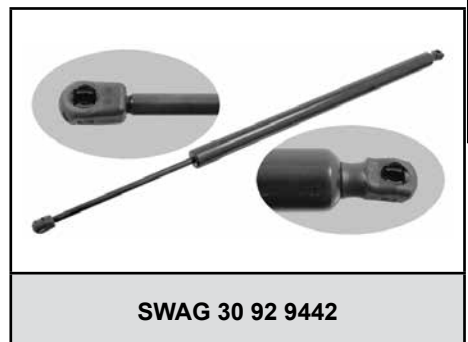
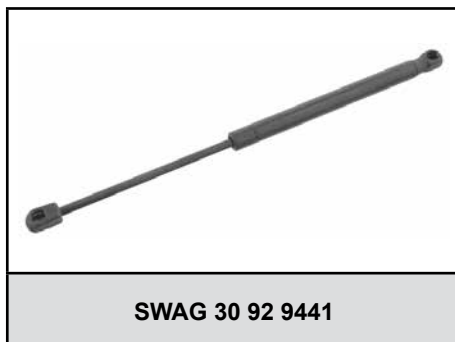
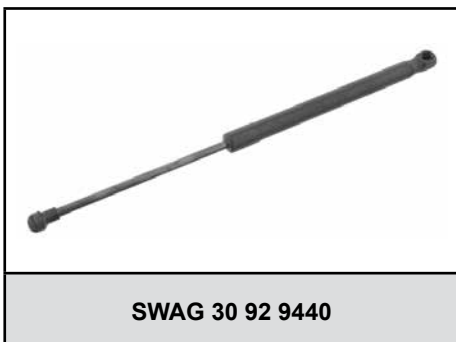
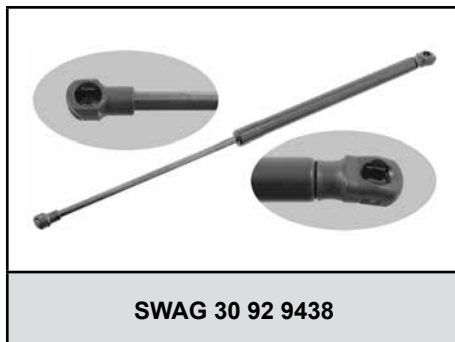
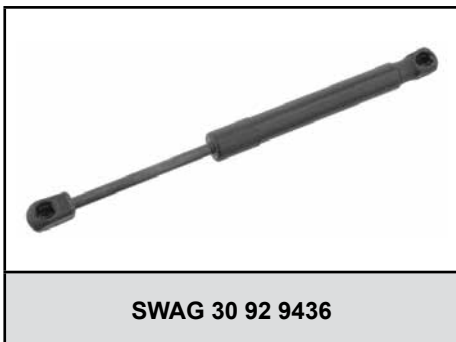
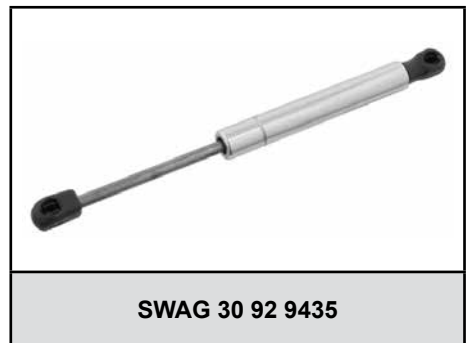
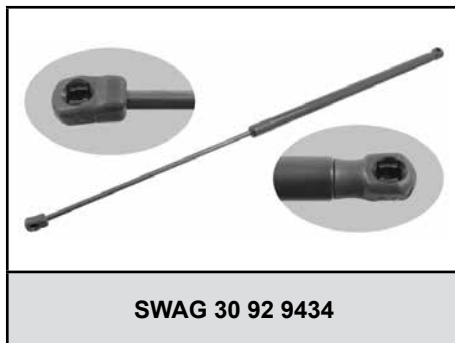
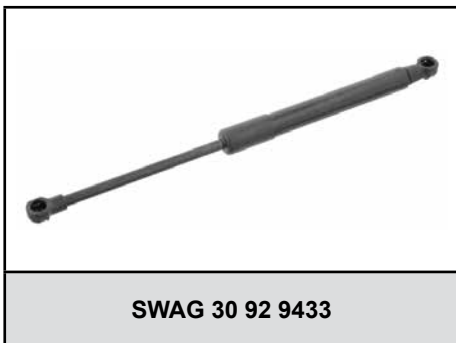
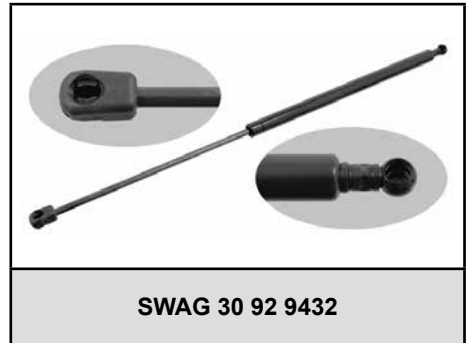
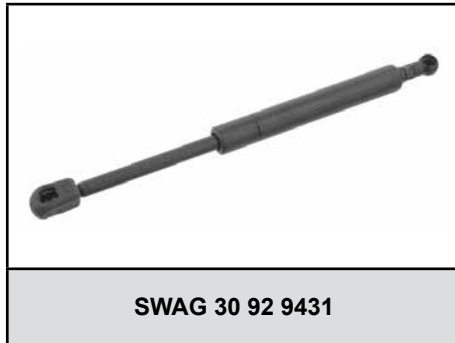
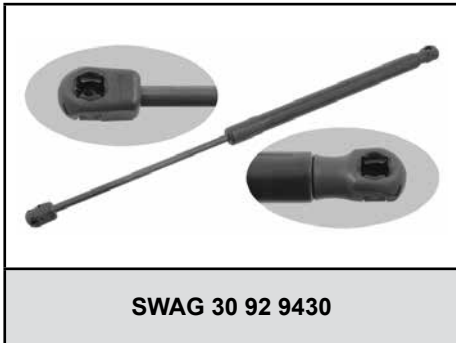
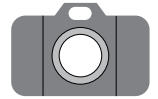

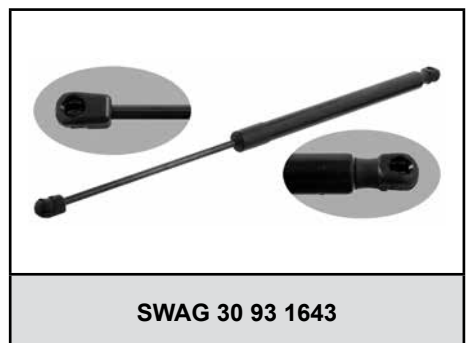
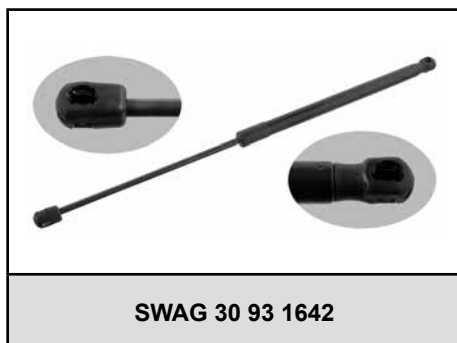
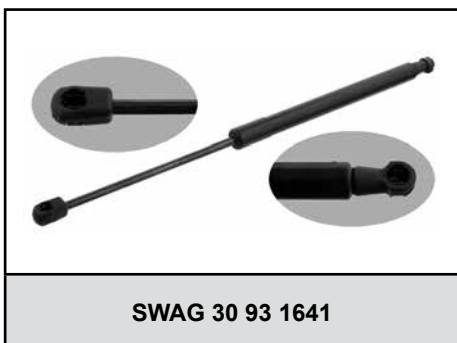
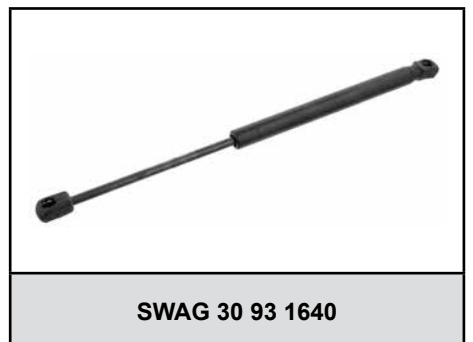
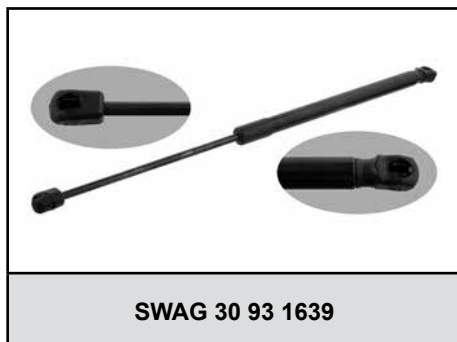
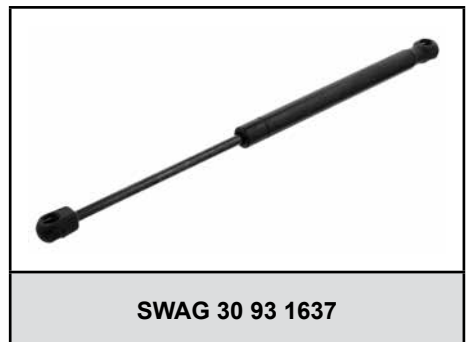
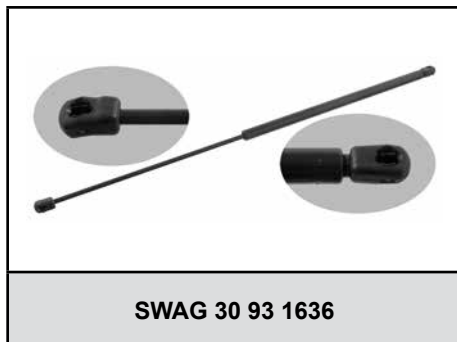
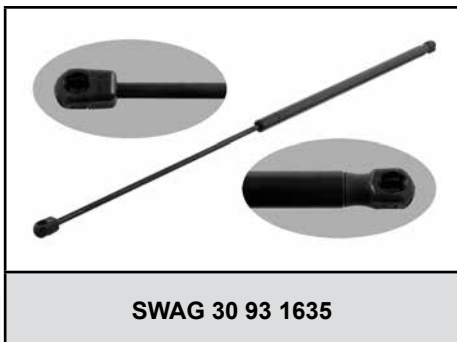
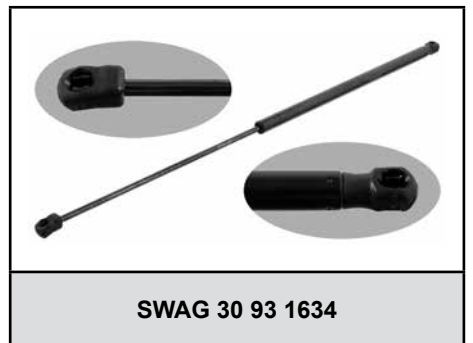
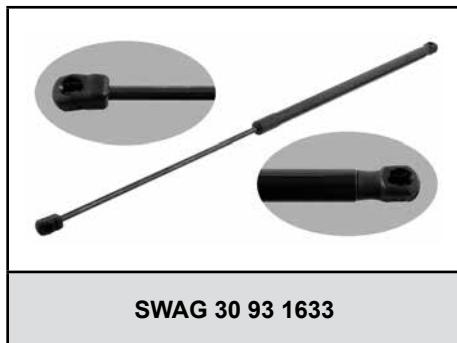
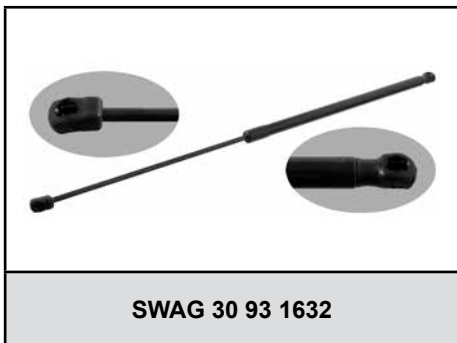
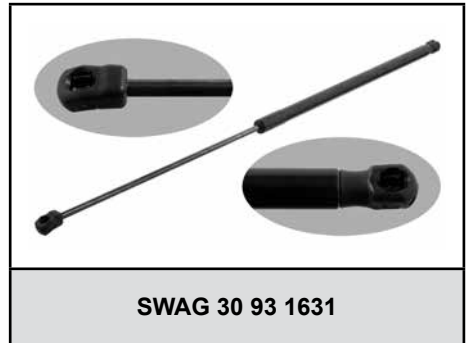
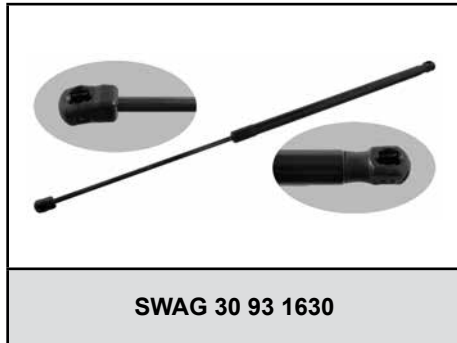
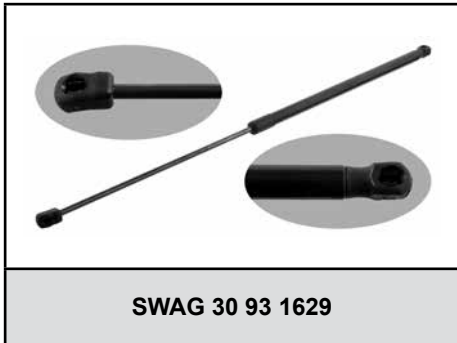
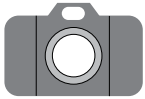

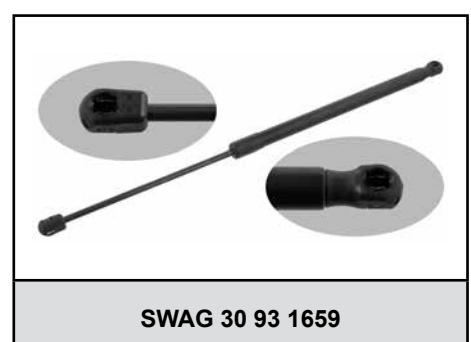
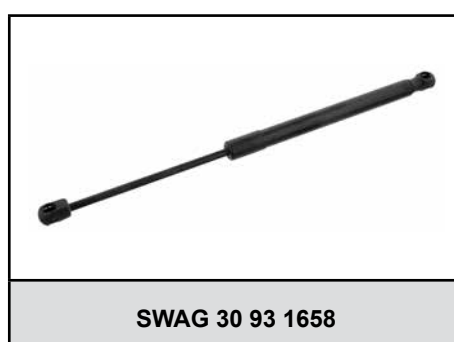
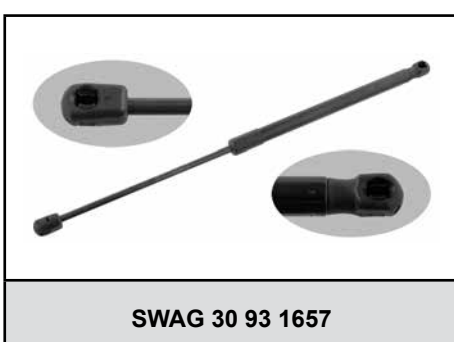
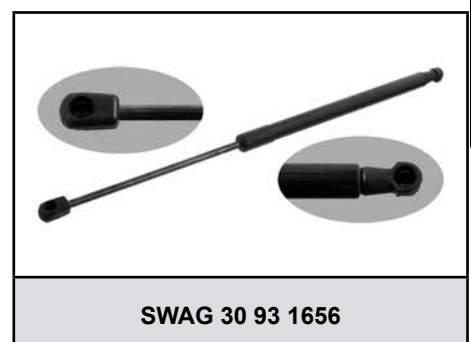
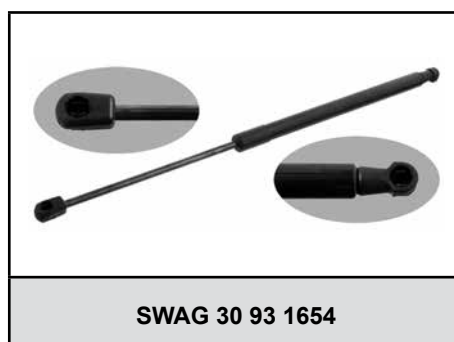
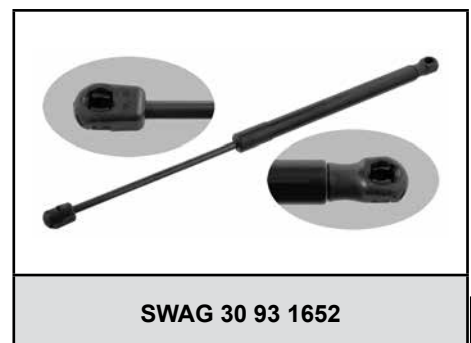
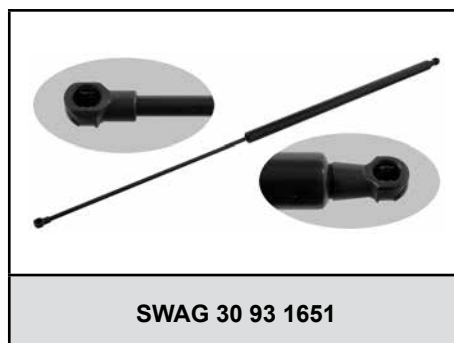
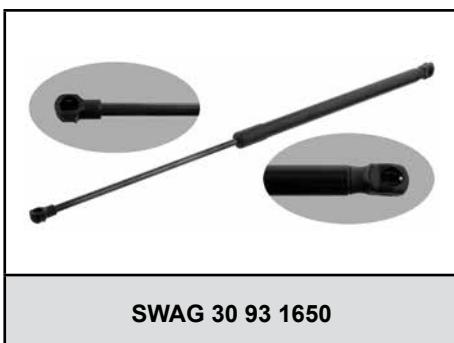
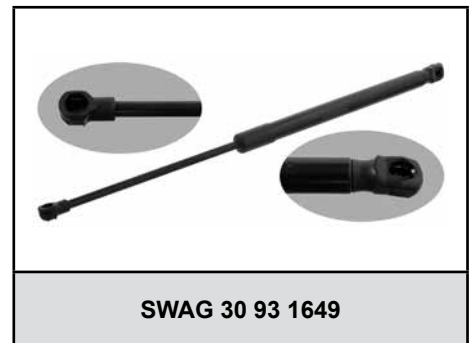
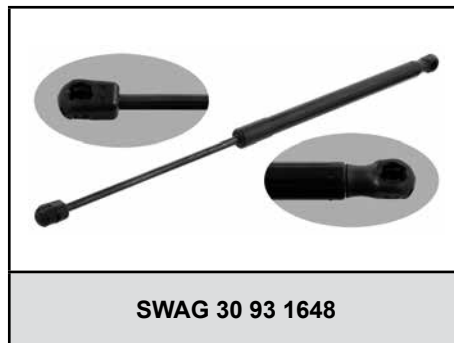
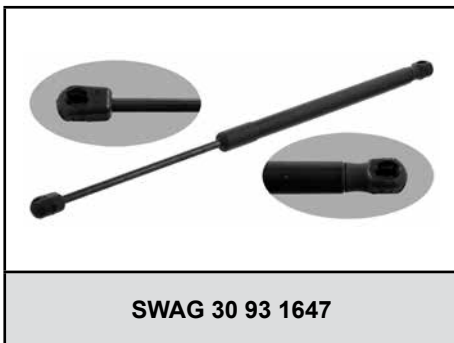
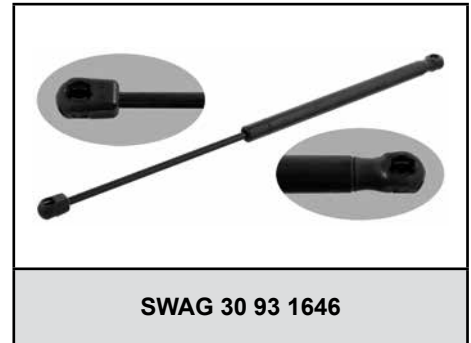
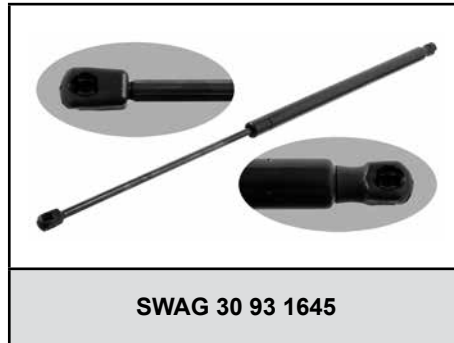
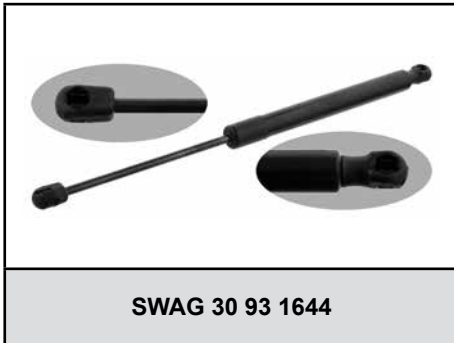
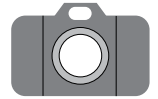

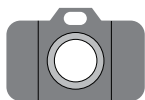

SWAG 30 93 1660



SWAG 30 93 1662



SWAG 30 93 1663



SWAG 30 93 1664

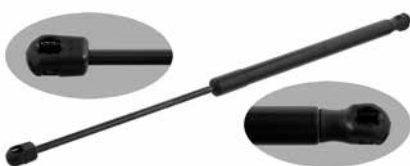

SWAG 30 93 1666



SWAG 30 93 1667



SWAG 30 93 1670



SWAG 30 93 1672



SWAG 30 93 1673

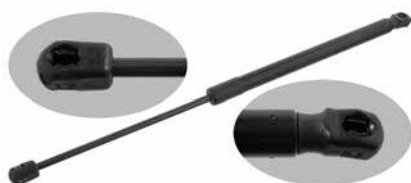

SWAG 30 93 1674



SWAG 30 93 1676



SWAG 30 93 1677



SWAG 30 93 1678



SWAG 30 93 1679



SWAG 30 93 1680

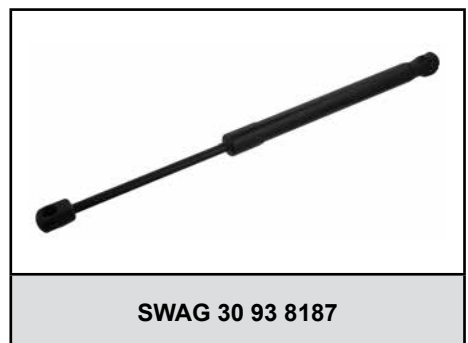
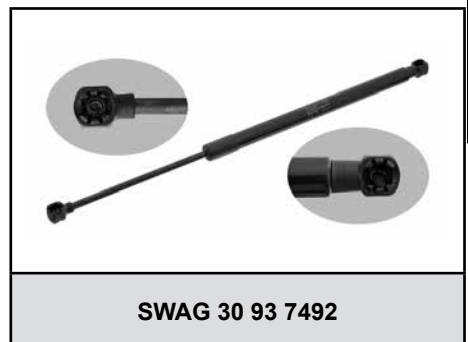
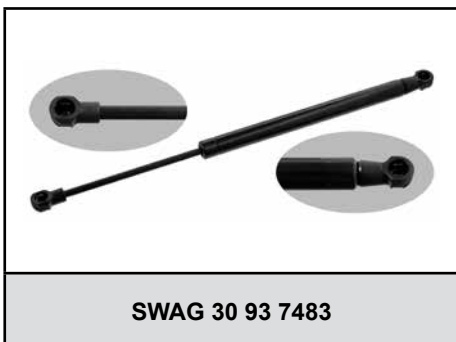
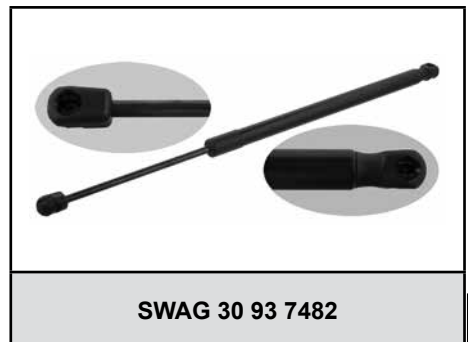
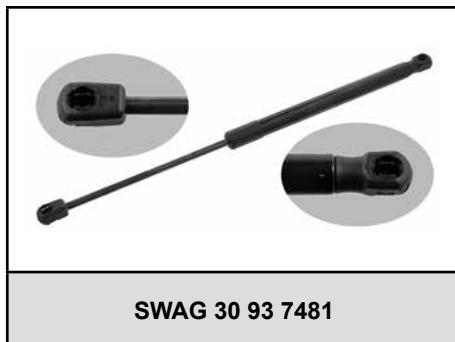
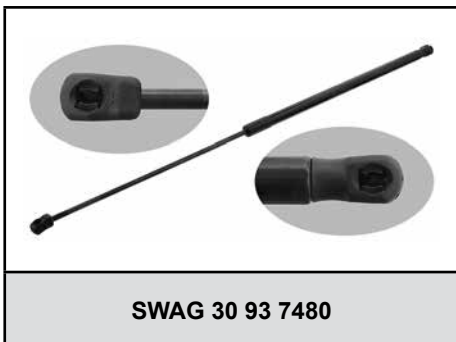
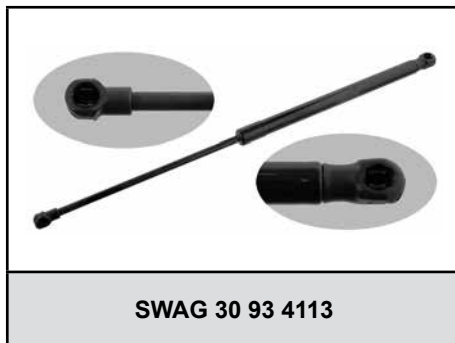
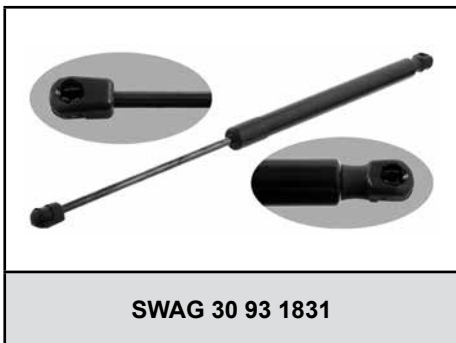
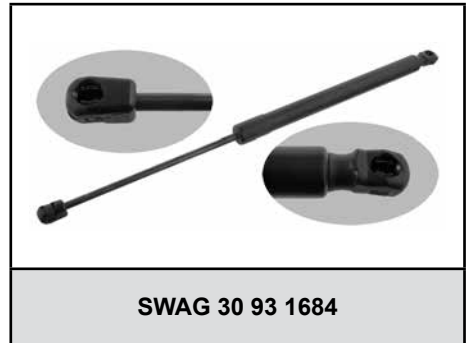
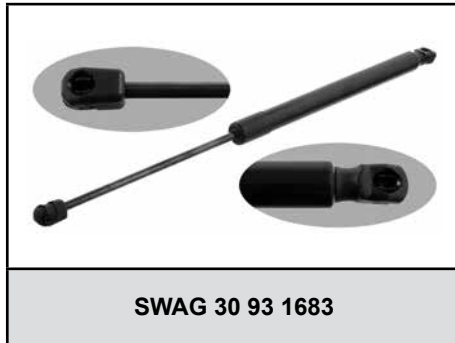
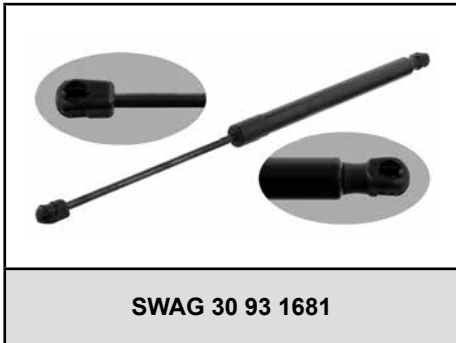
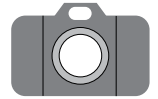

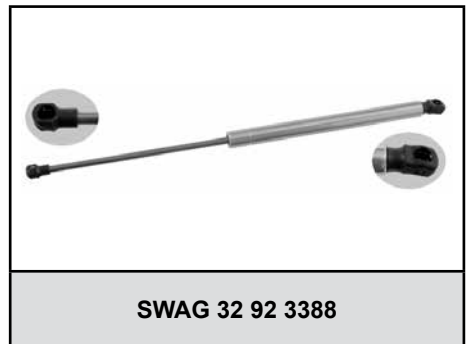
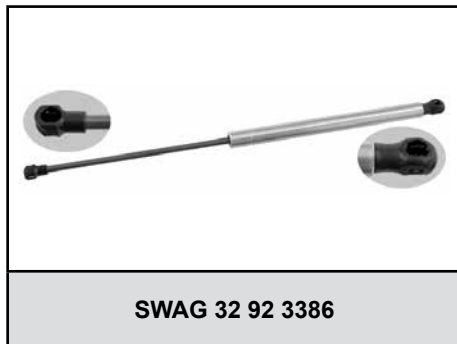
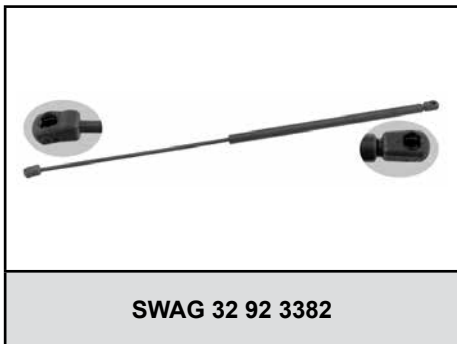
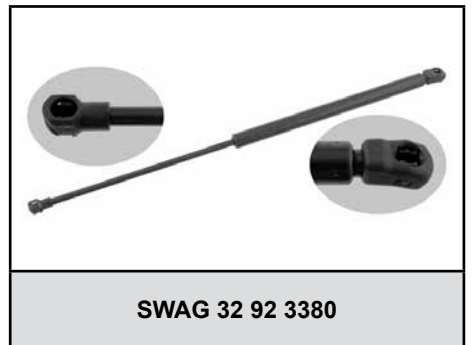
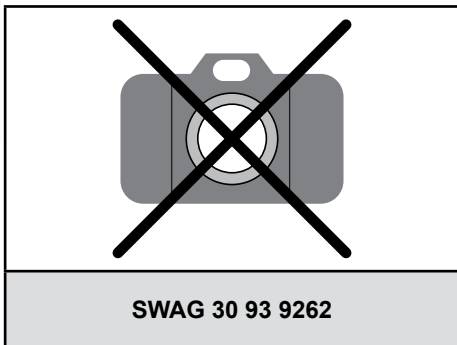
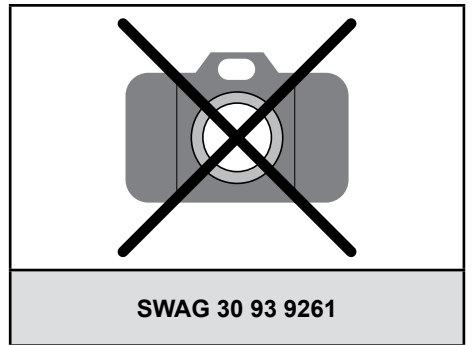
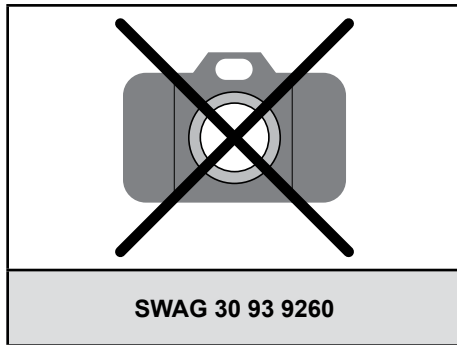
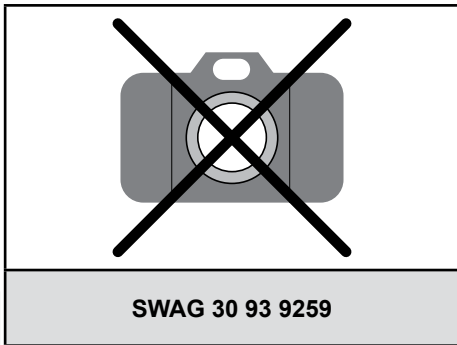
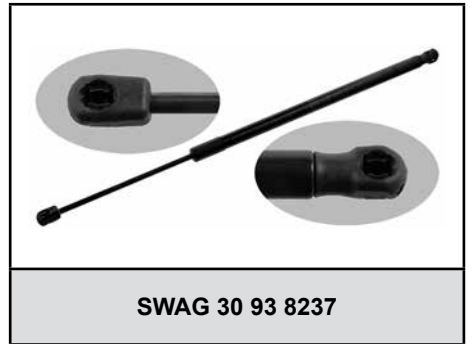
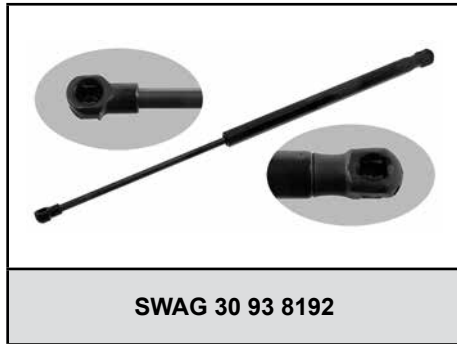
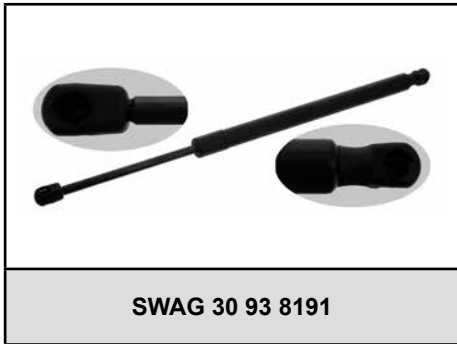
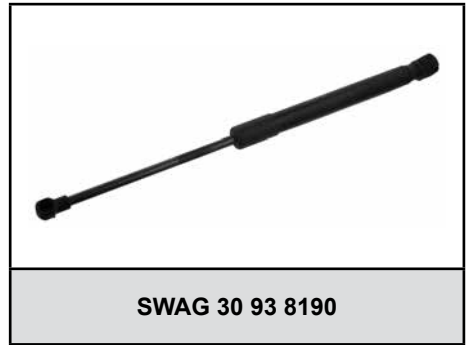
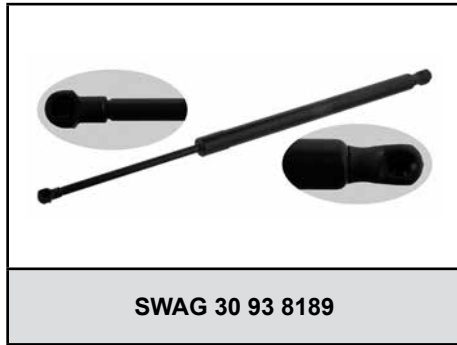
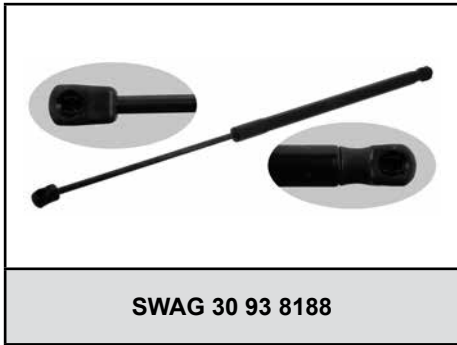
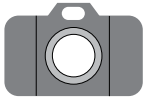

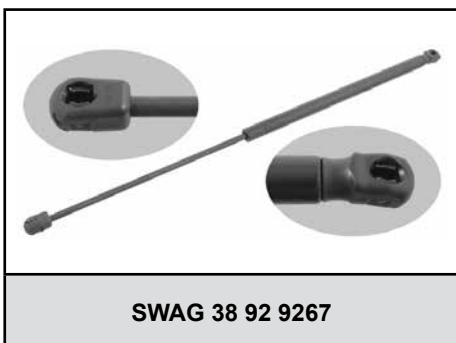
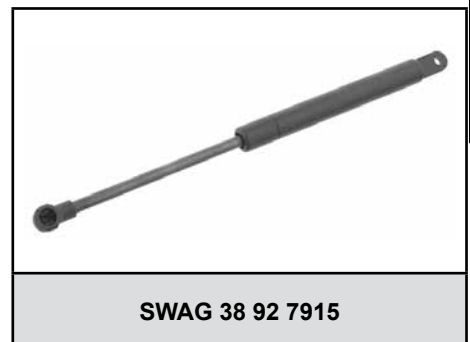
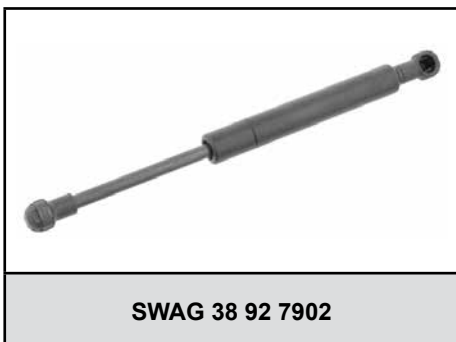
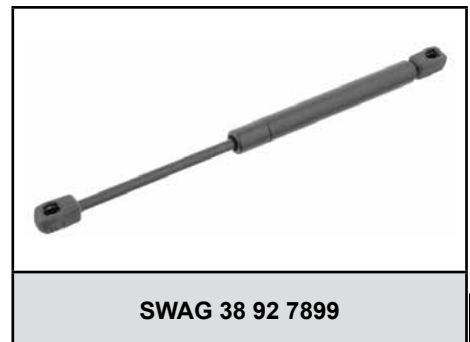
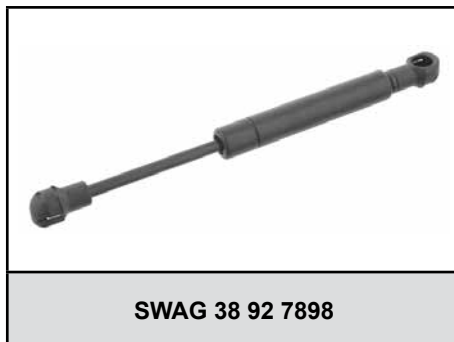
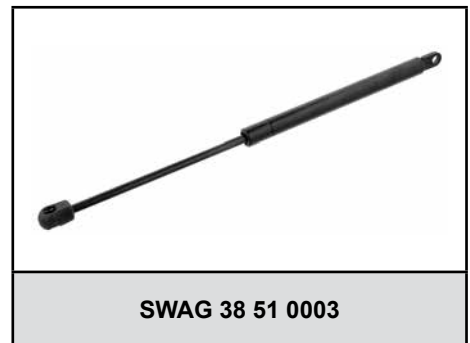
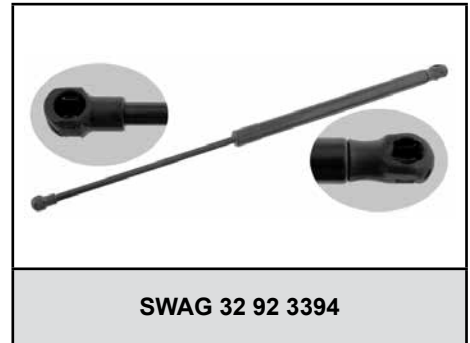
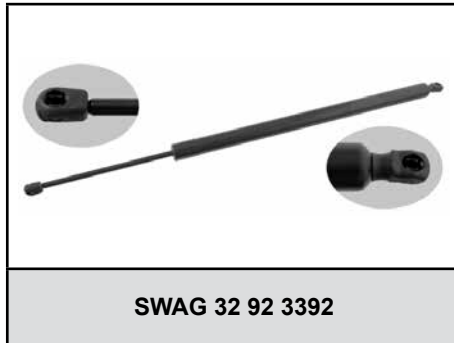
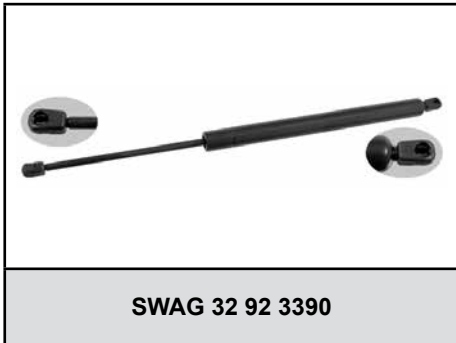
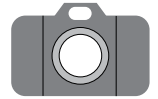

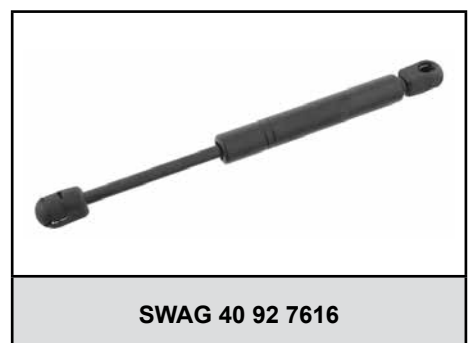
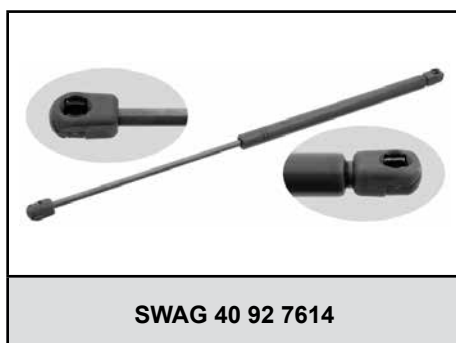
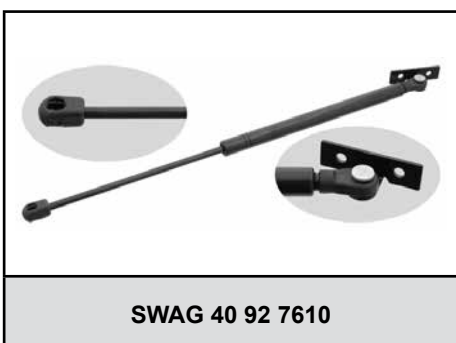
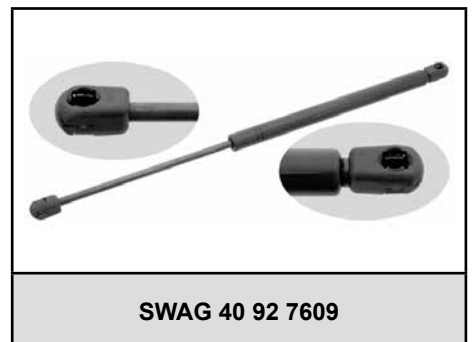
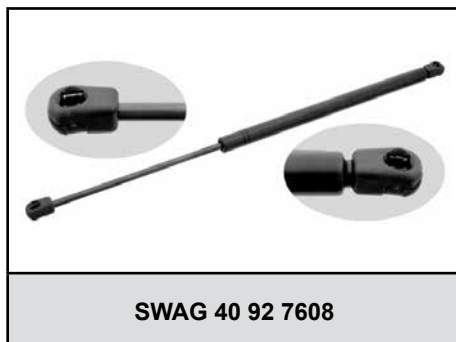
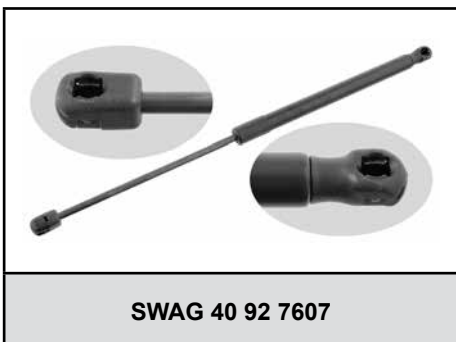
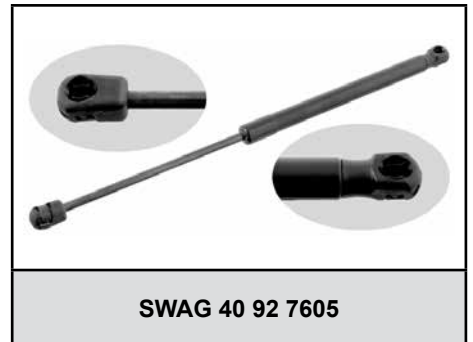
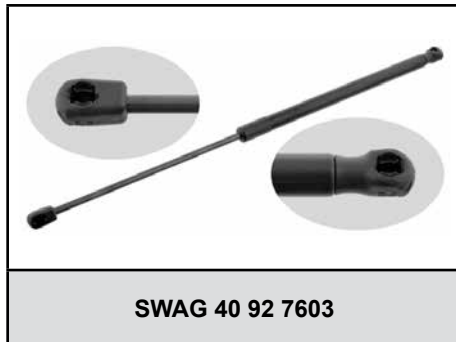
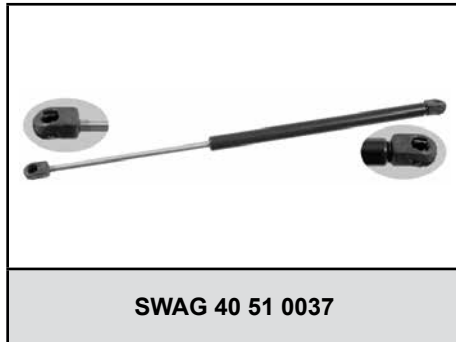
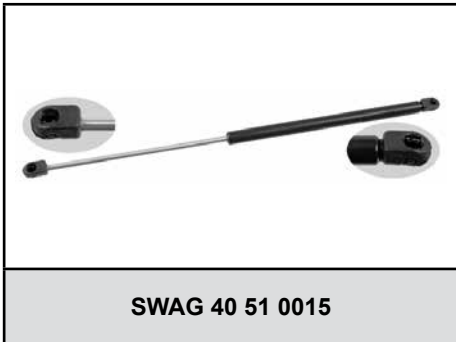
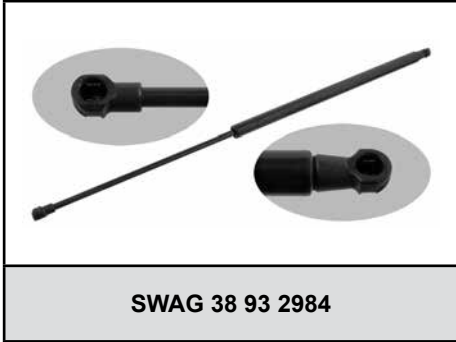
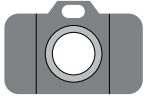

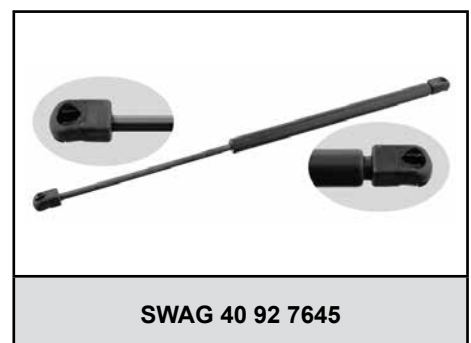
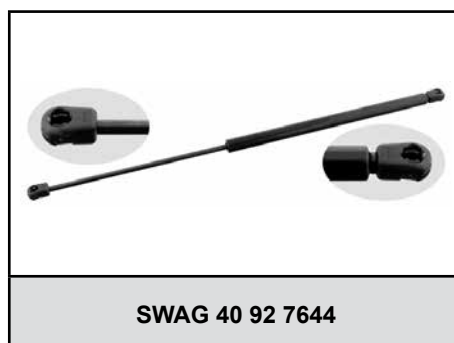
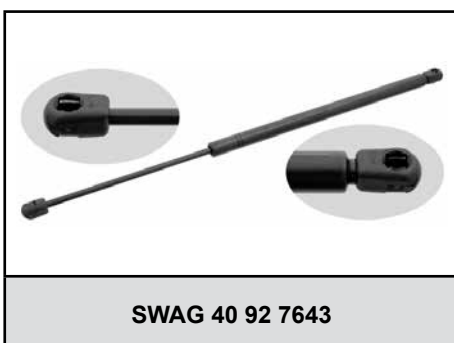
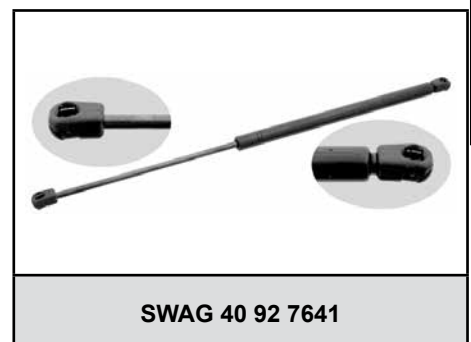
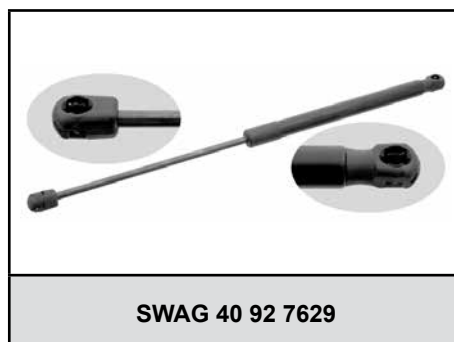
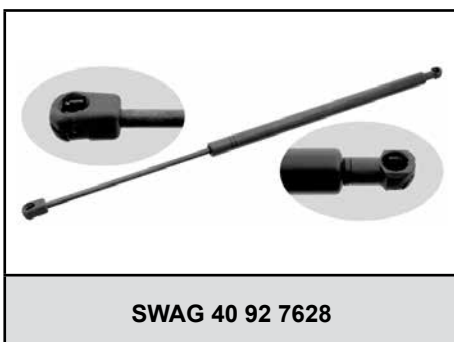
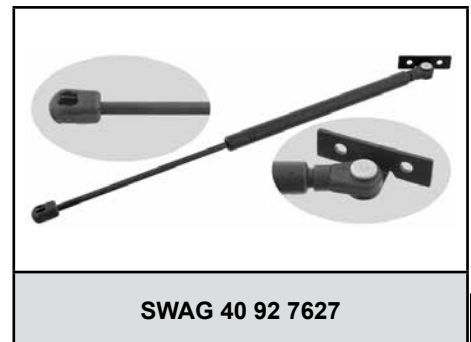
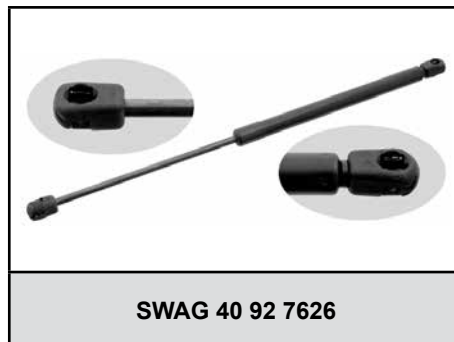
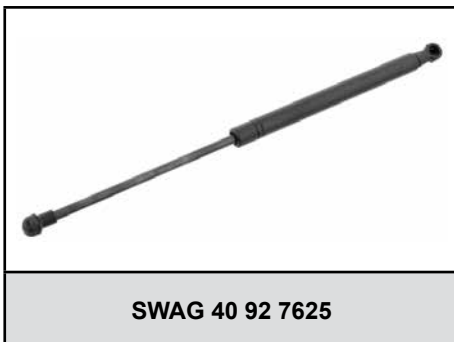
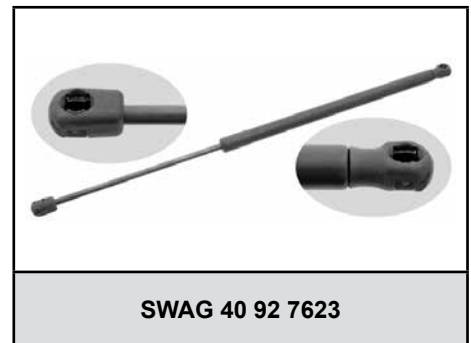
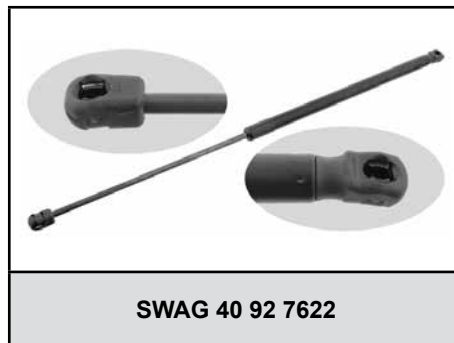
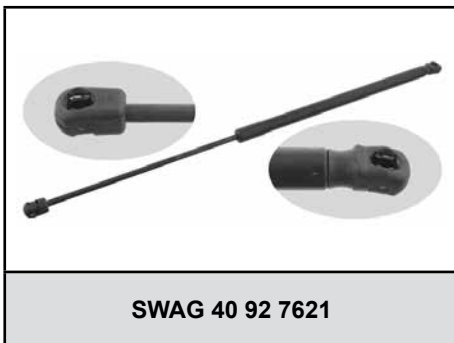
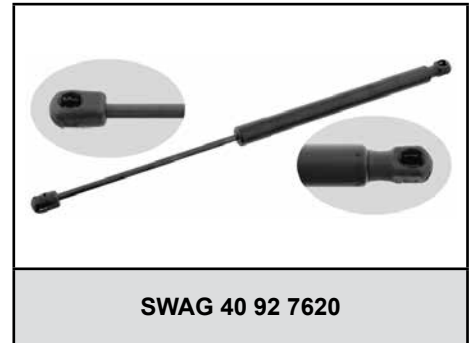
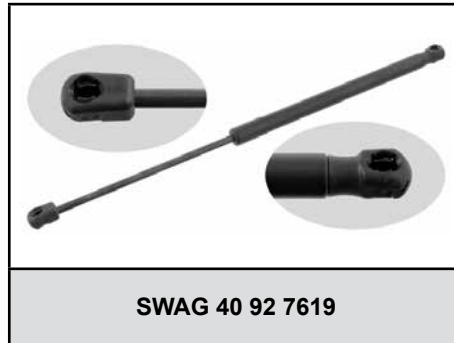
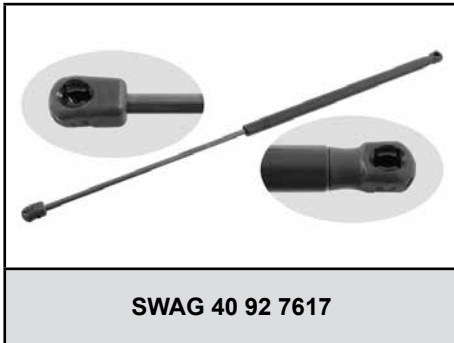
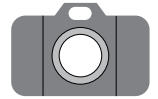

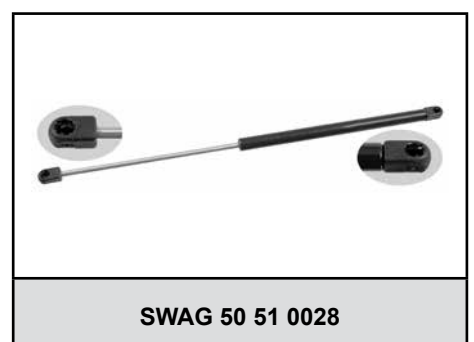
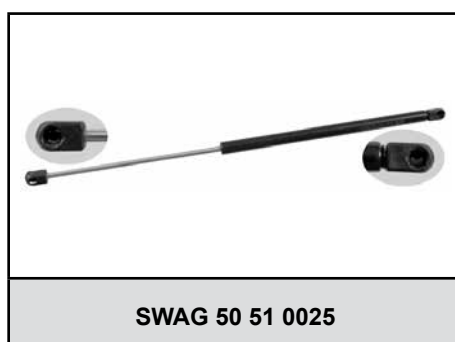
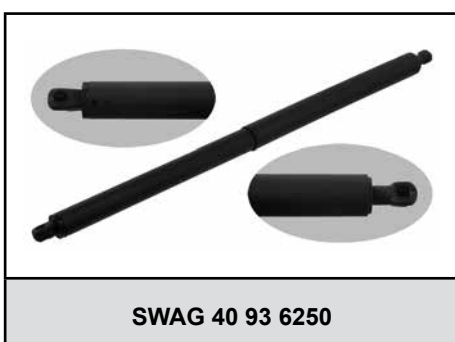
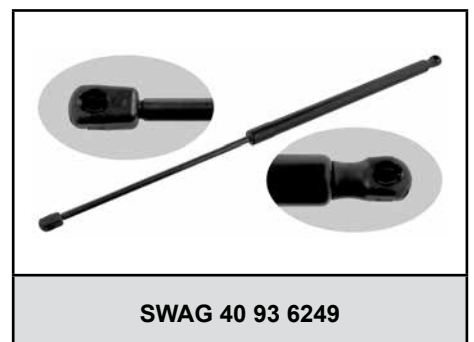
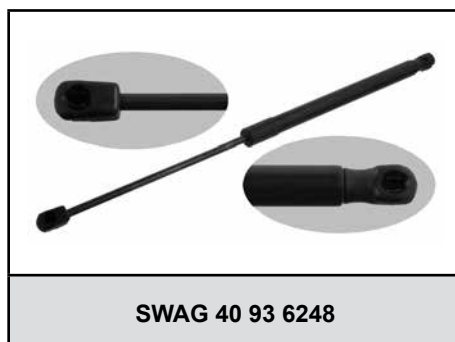
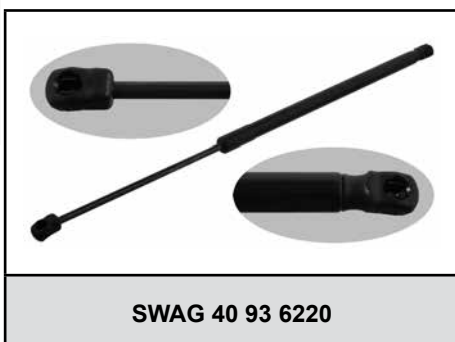
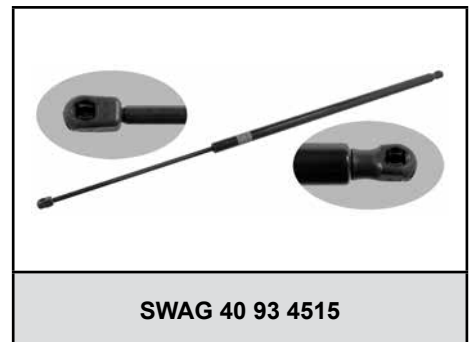
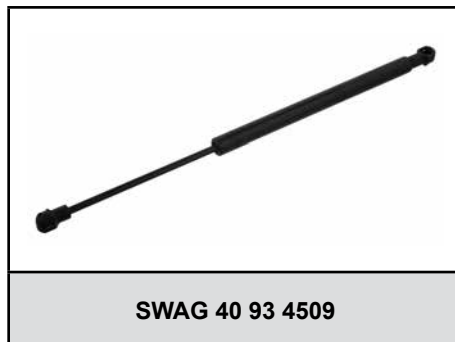
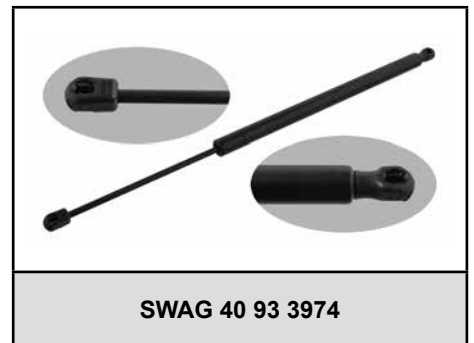
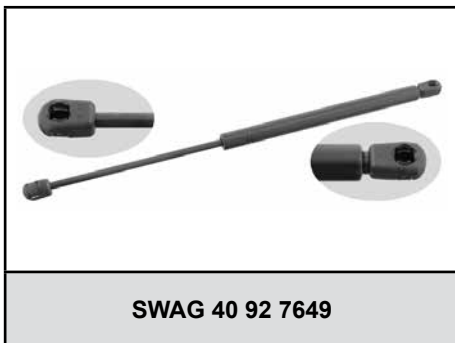
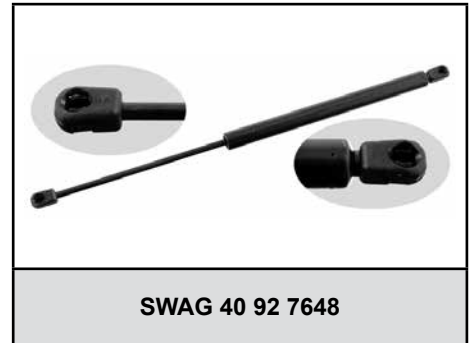
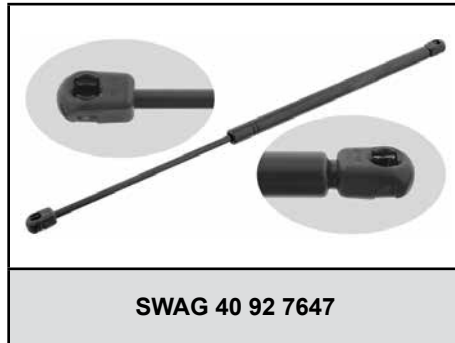
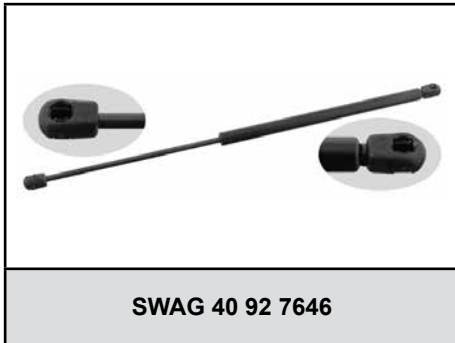
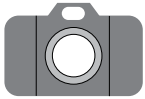

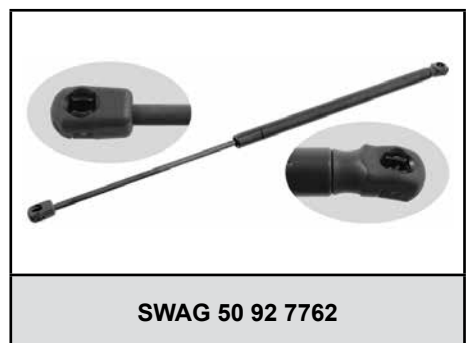
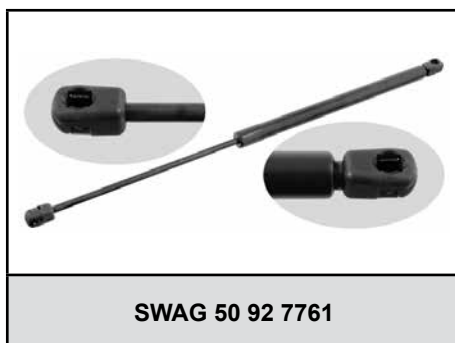
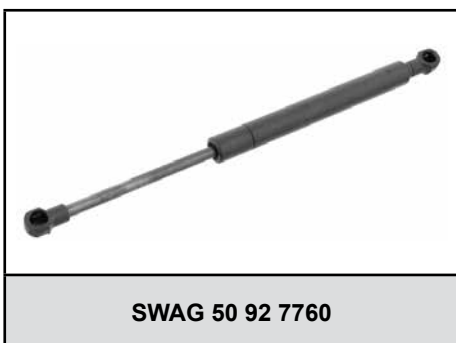
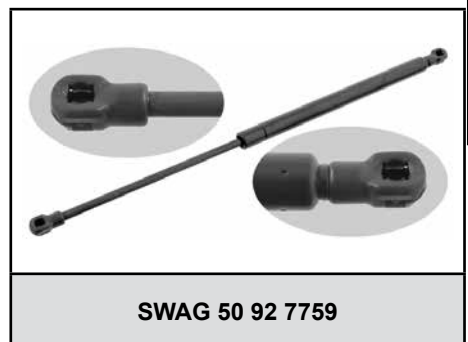
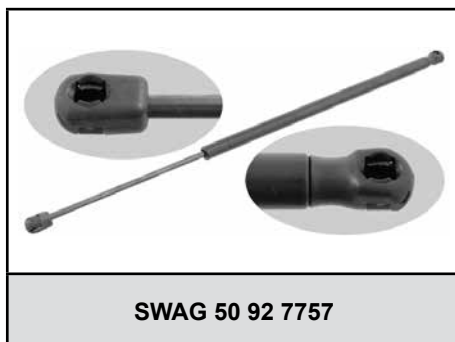
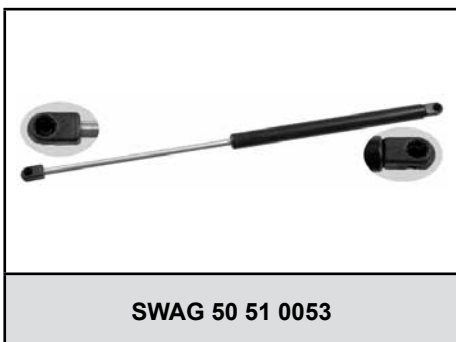
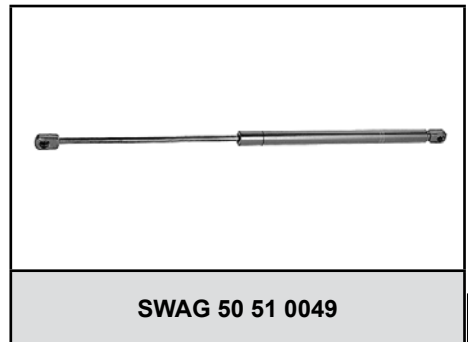
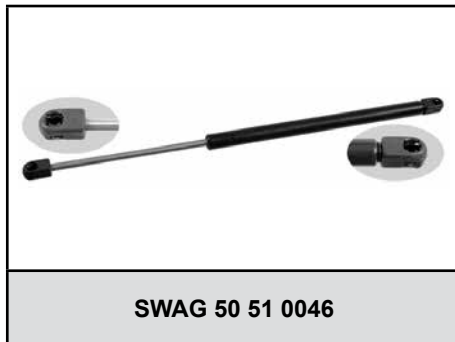
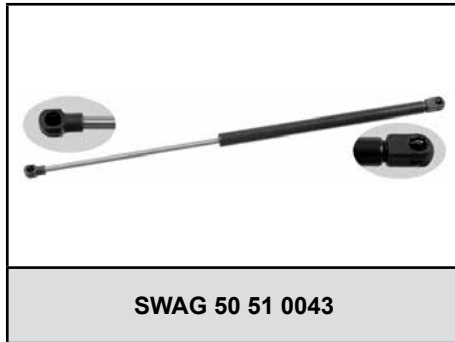
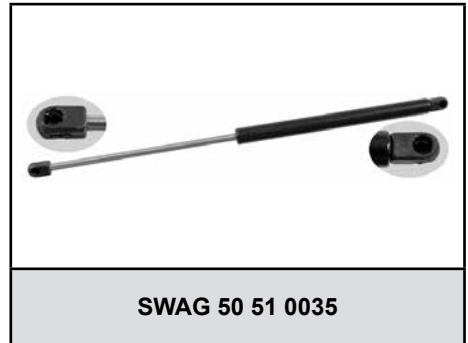
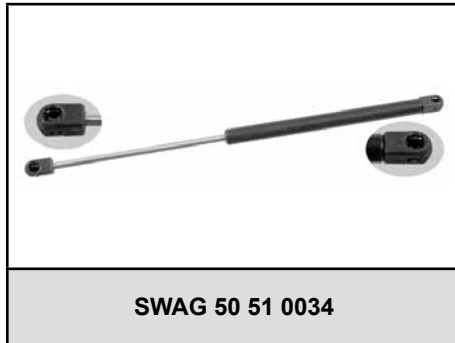
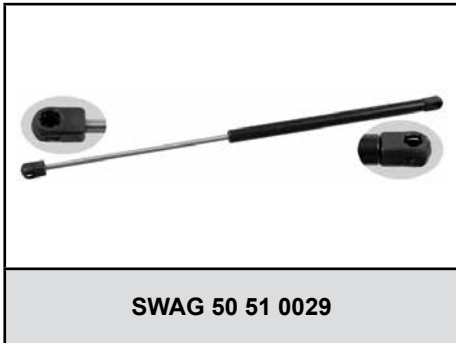
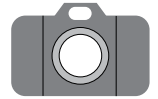

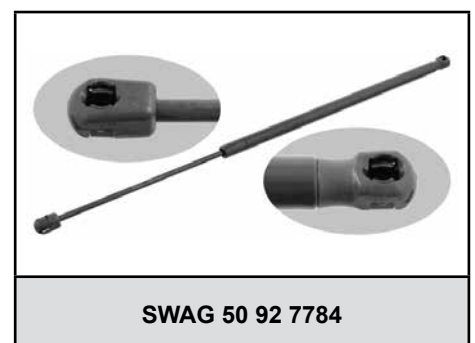
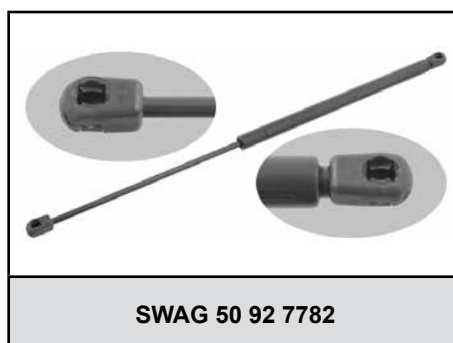
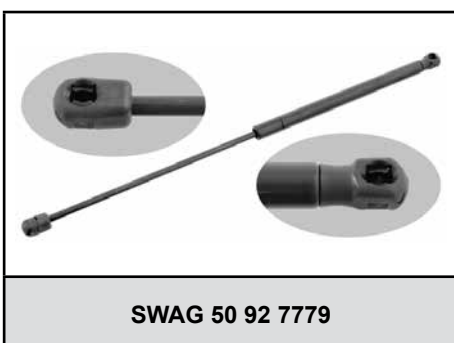
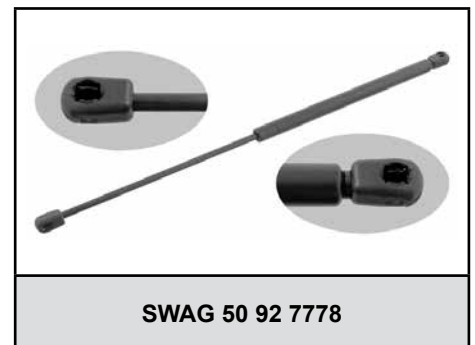
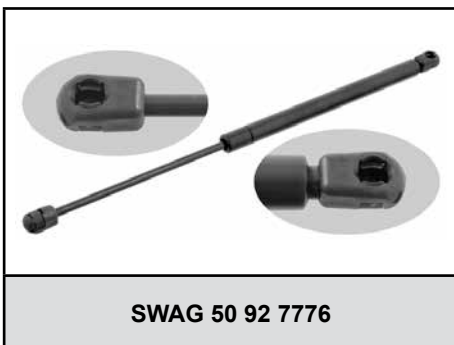
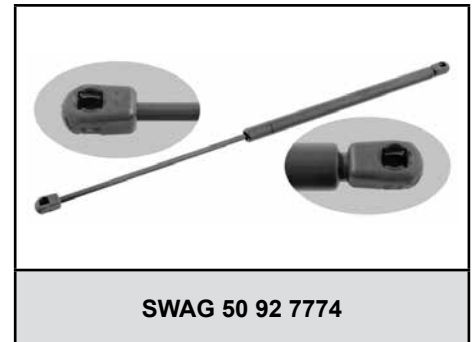
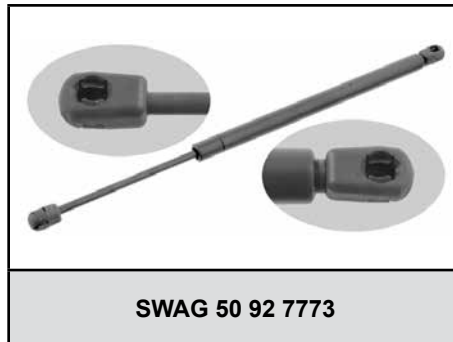
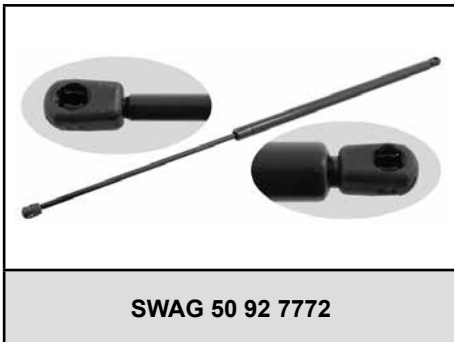
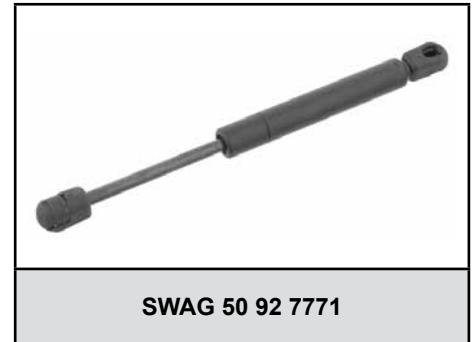
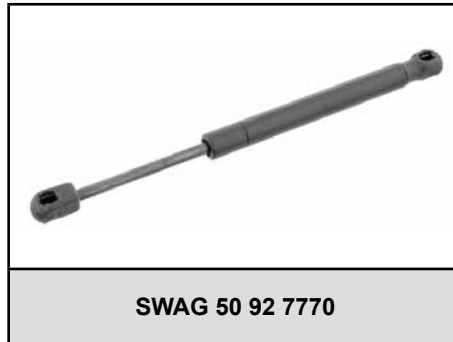
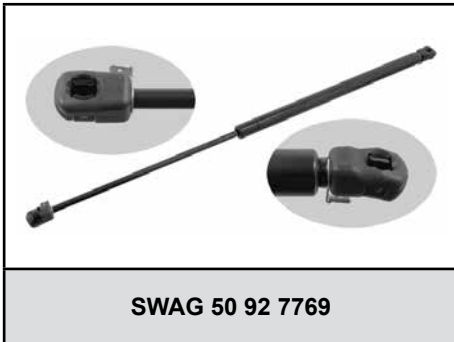
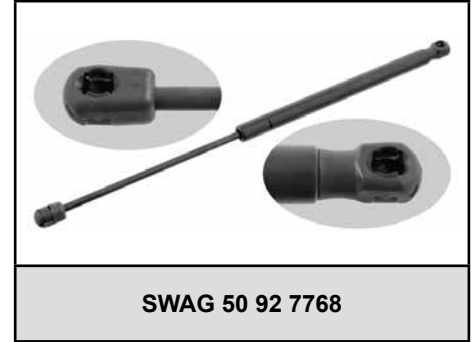
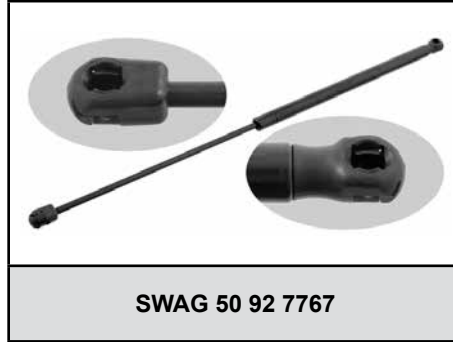
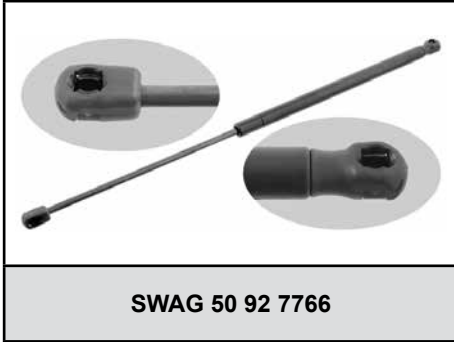
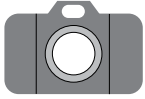

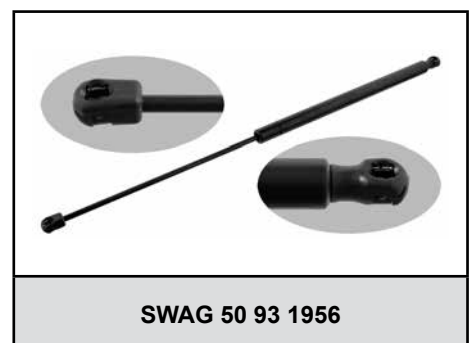
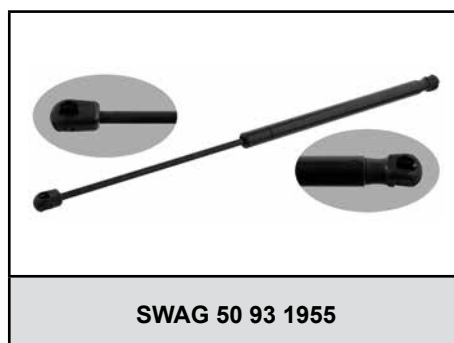
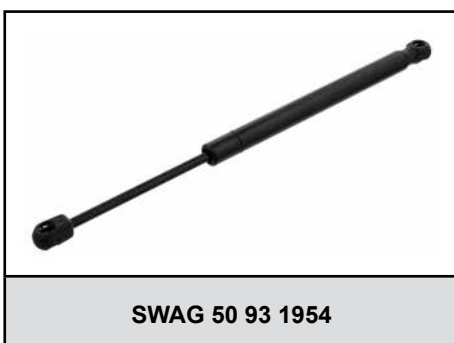
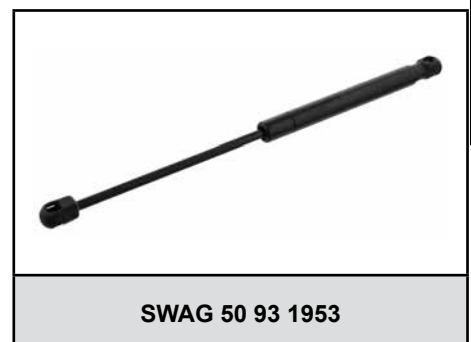
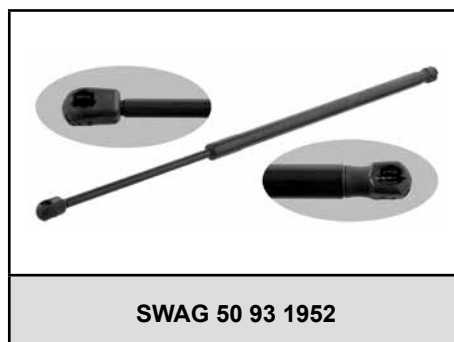
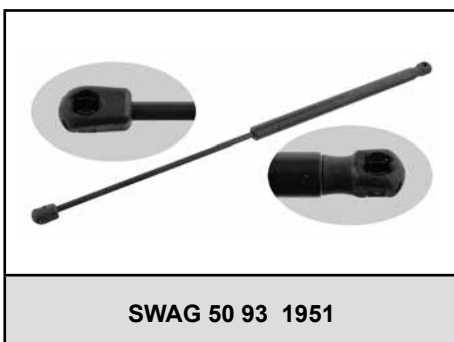
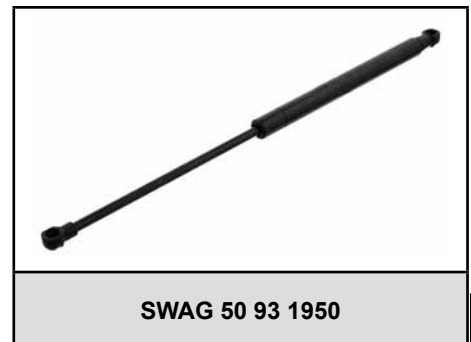
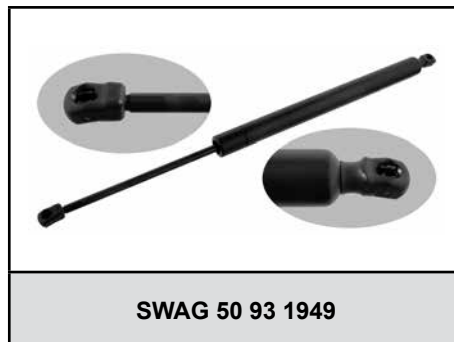
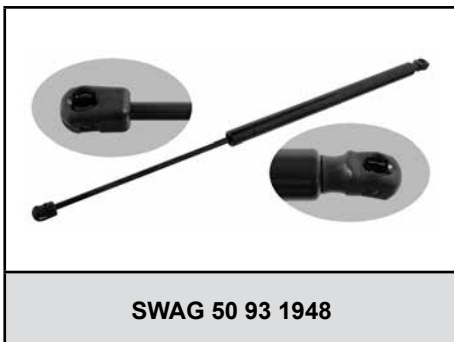
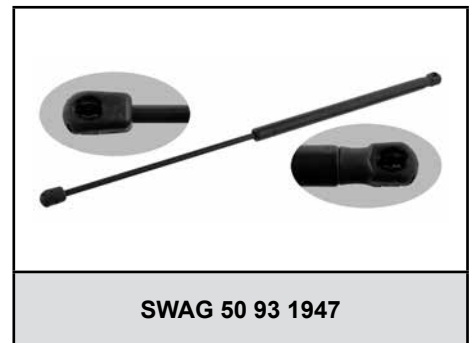
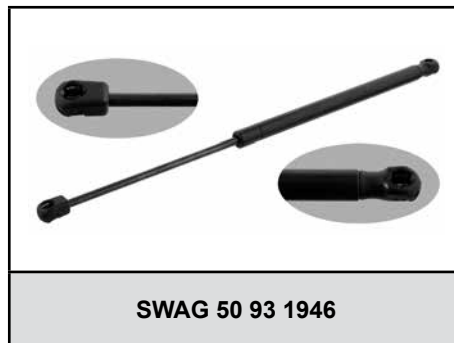
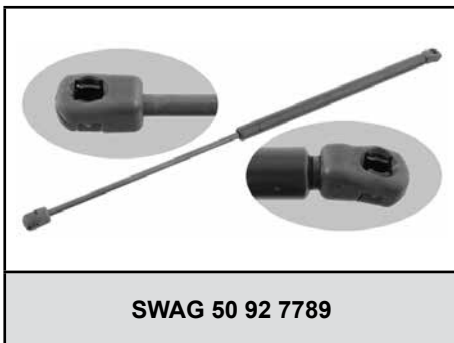
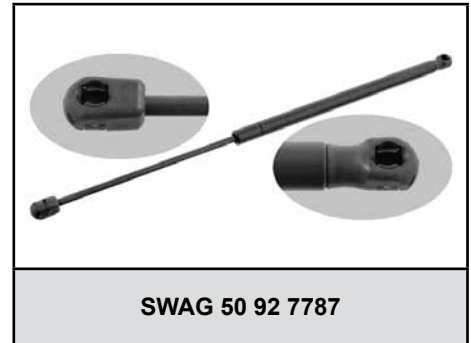
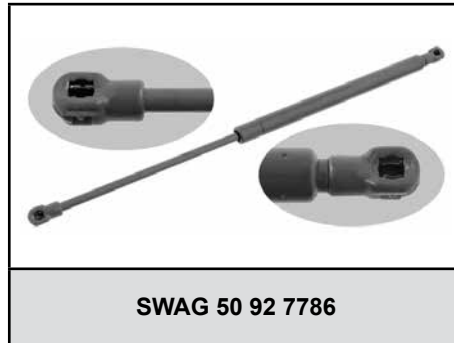
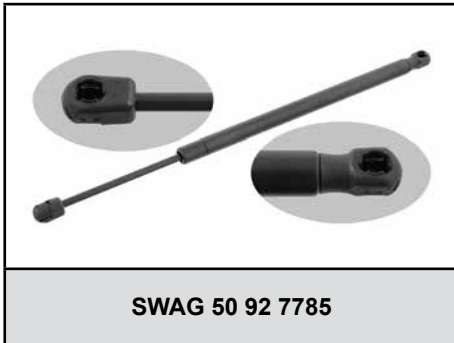
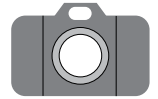

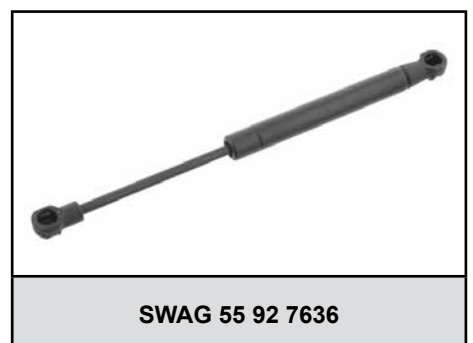
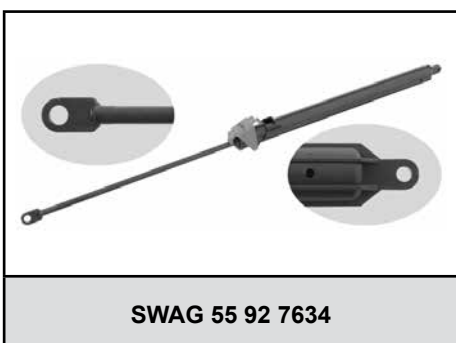
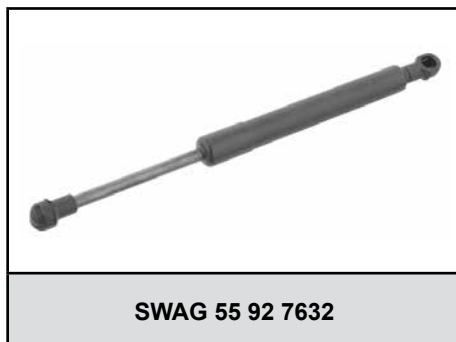
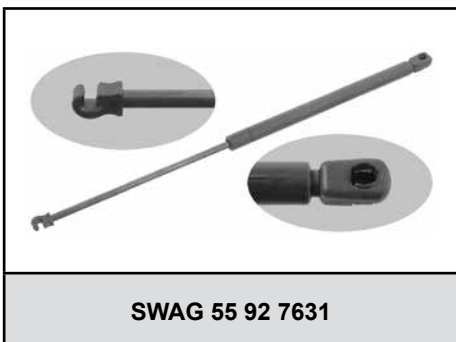
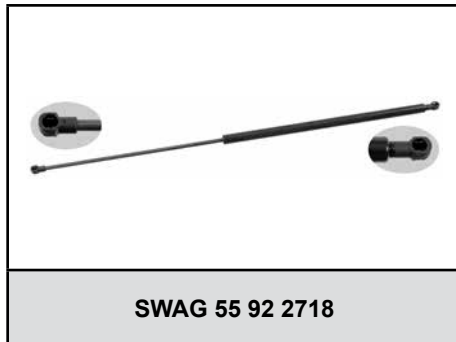
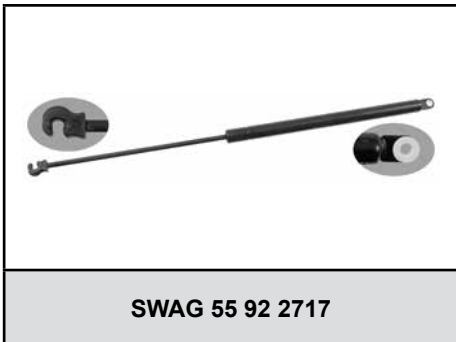
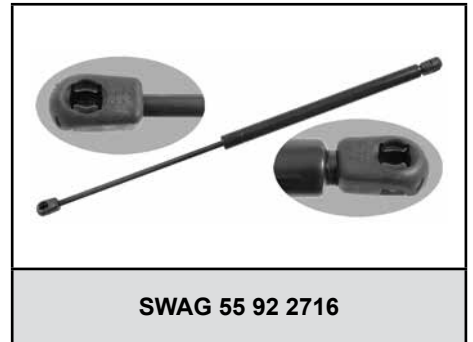
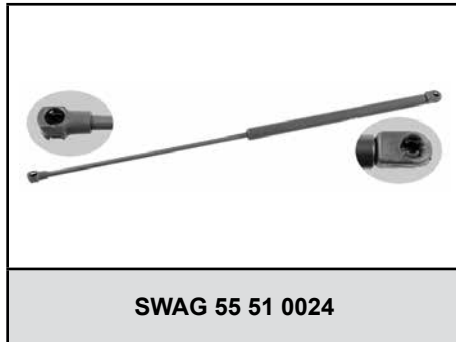
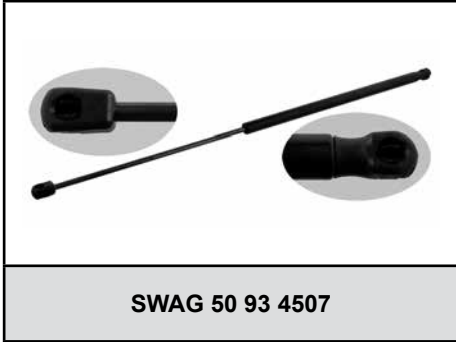
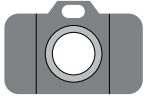

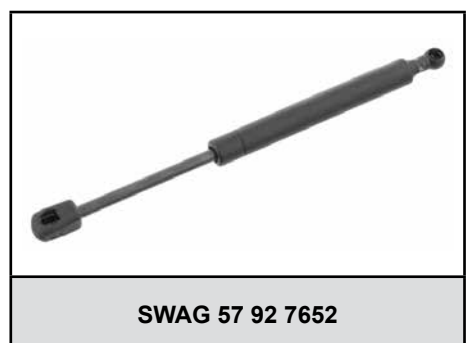
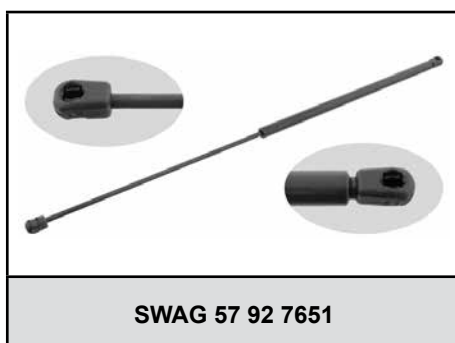
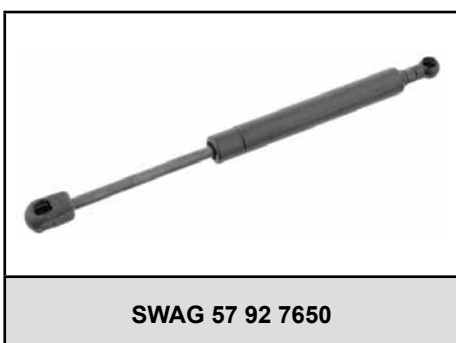
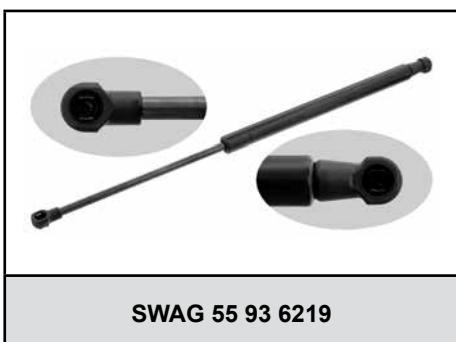
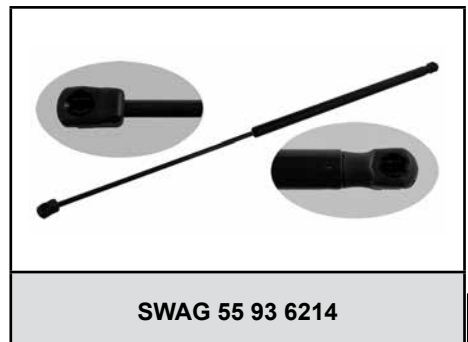
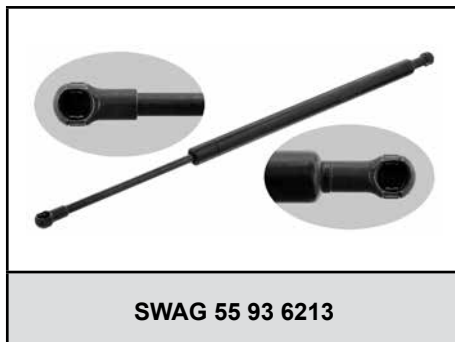
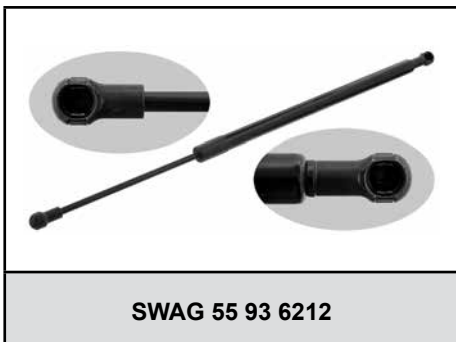
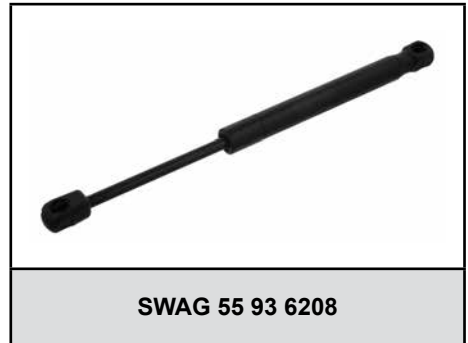
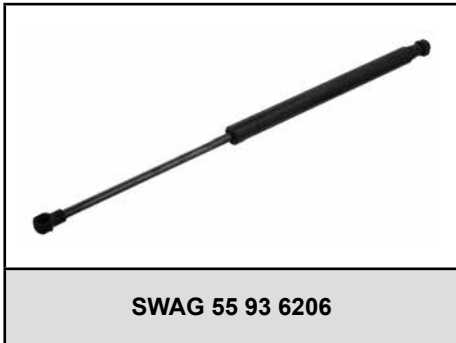
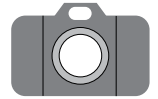

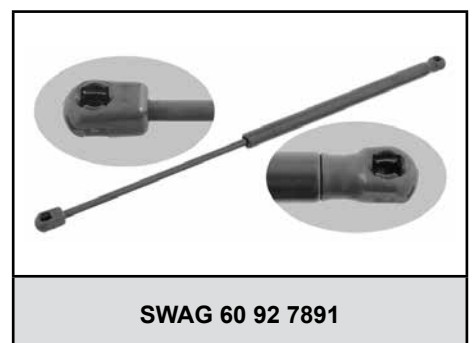
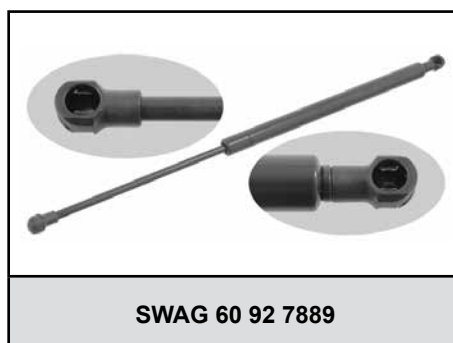
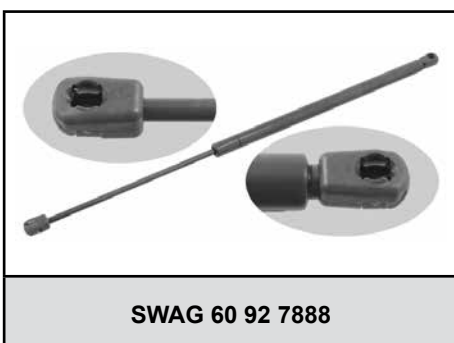
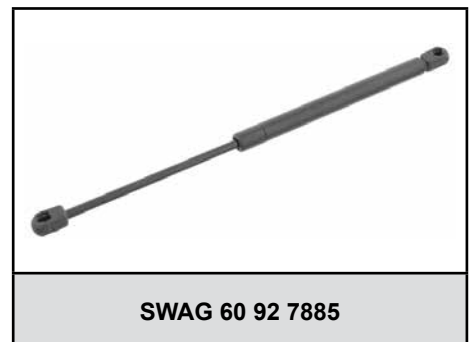
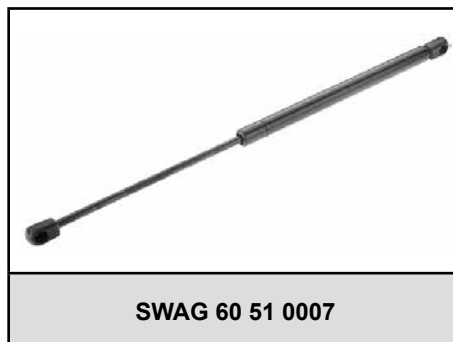
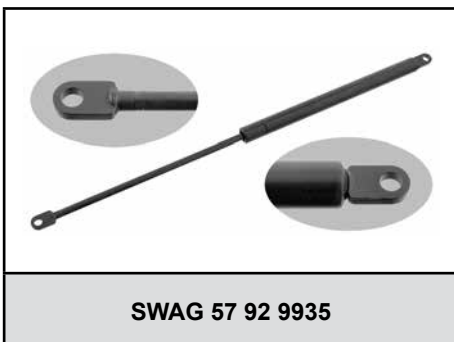
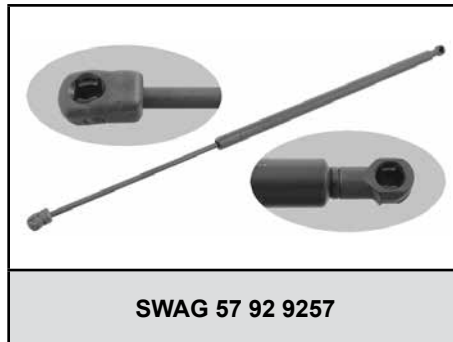
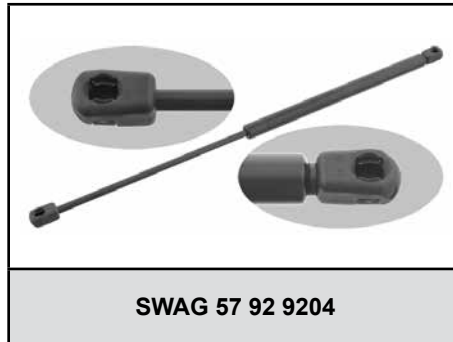
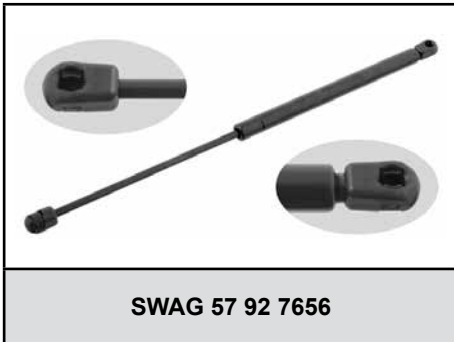
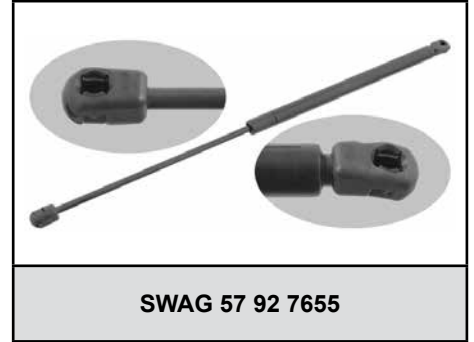
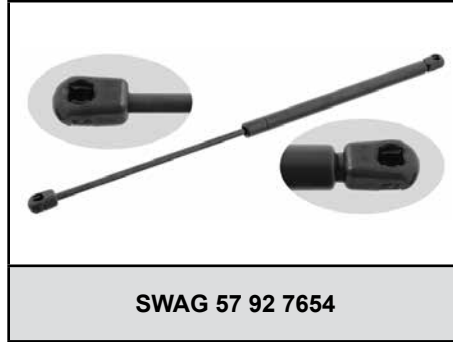
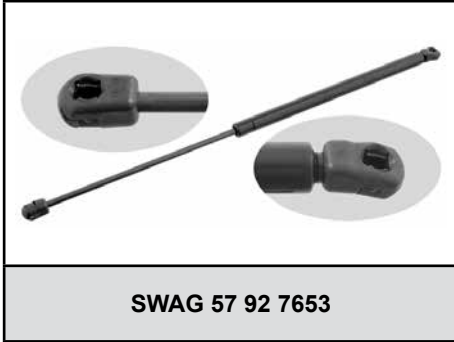
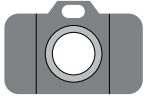

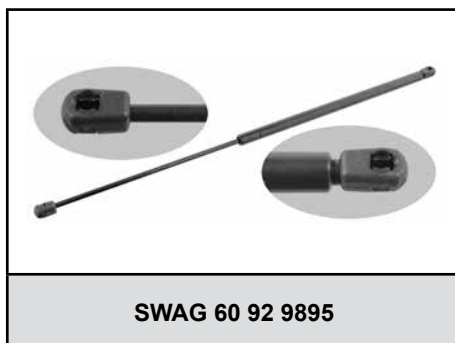
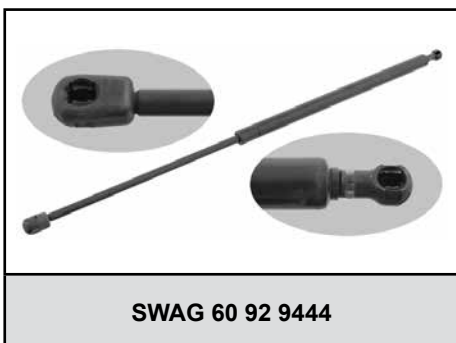
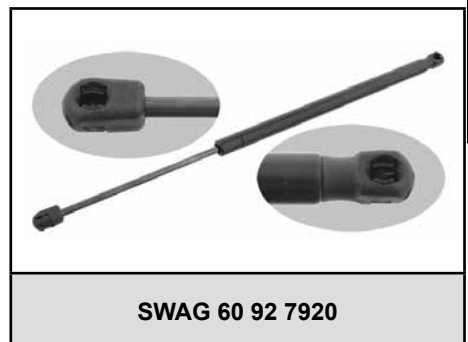
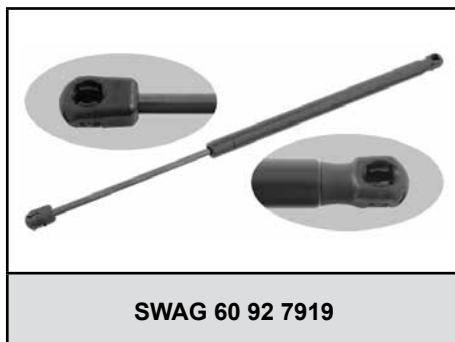
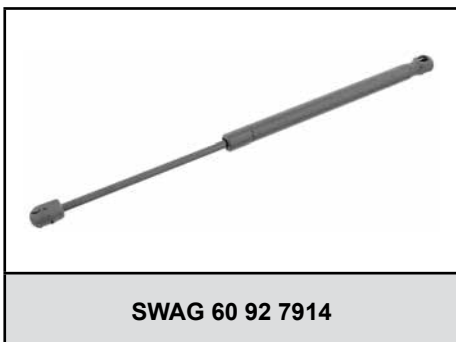
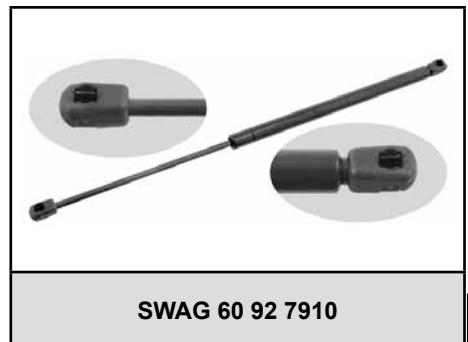
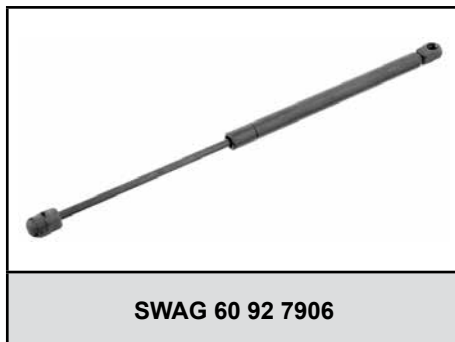
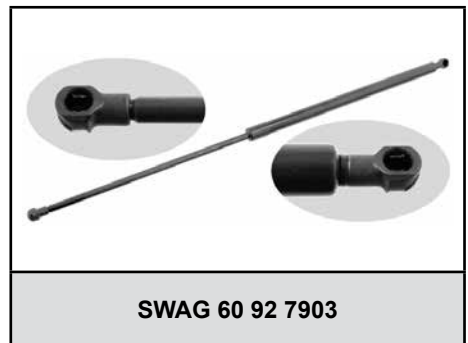
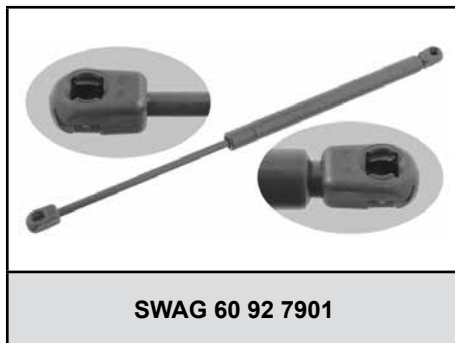
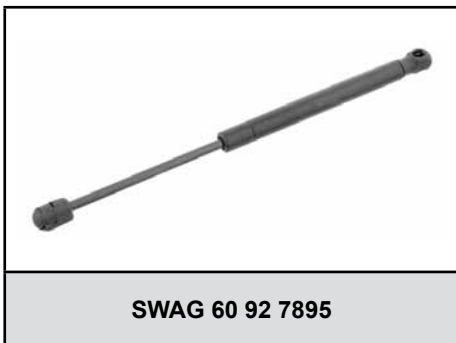
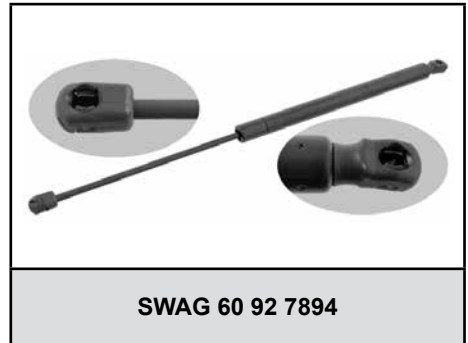
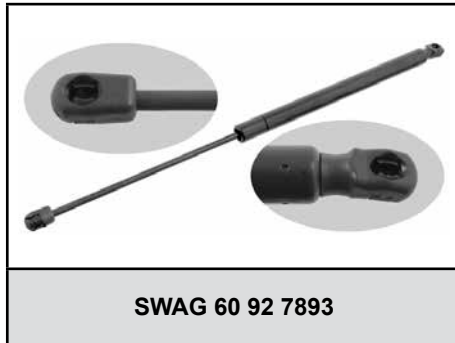
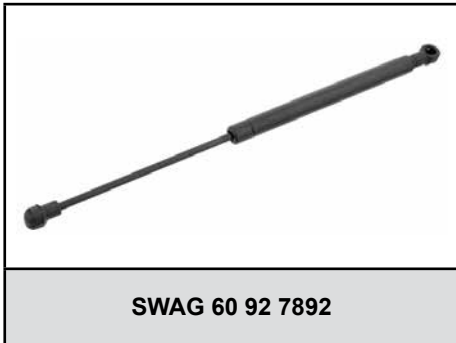
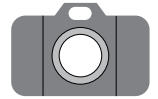

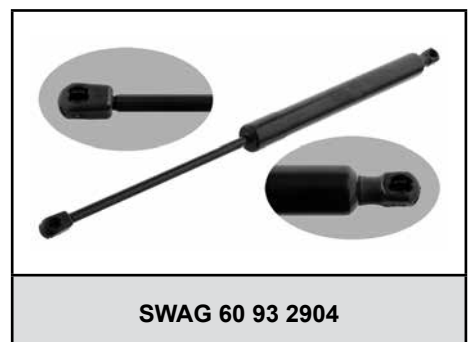
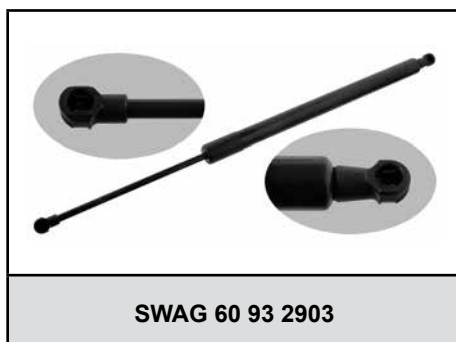
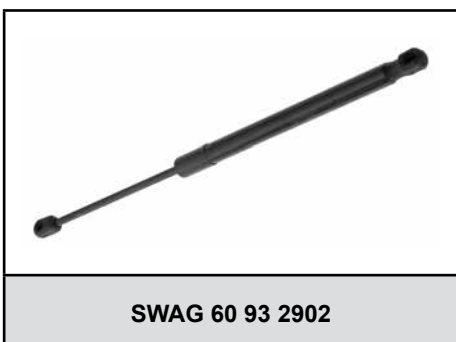
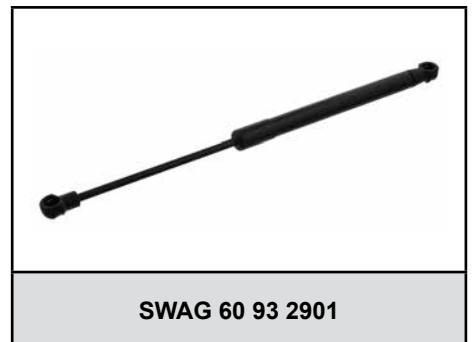
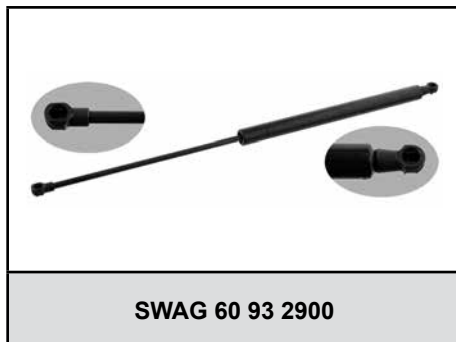
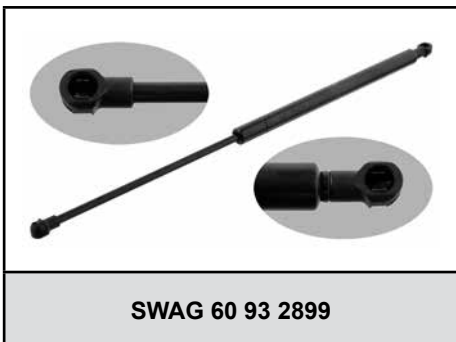
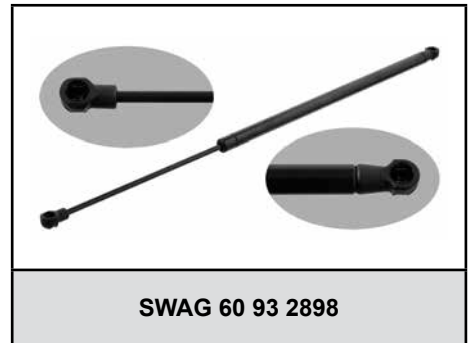
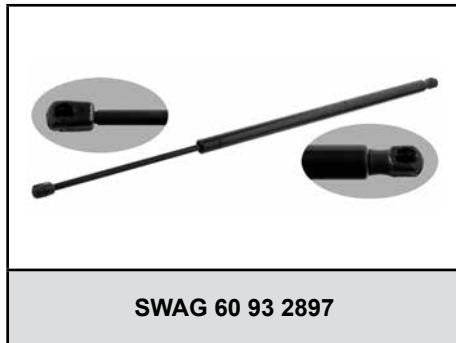
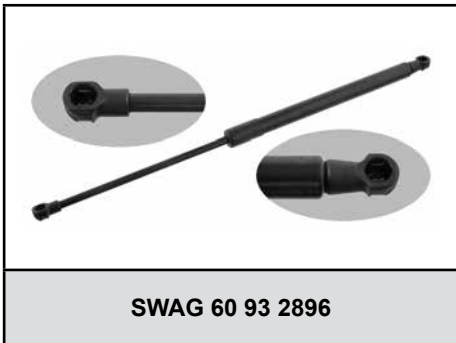
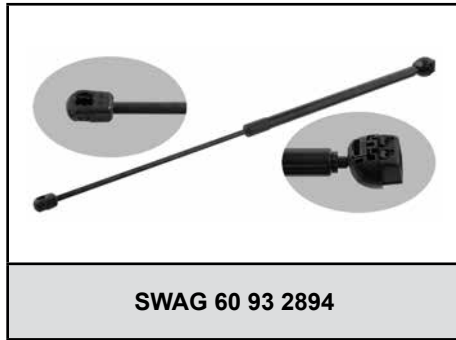
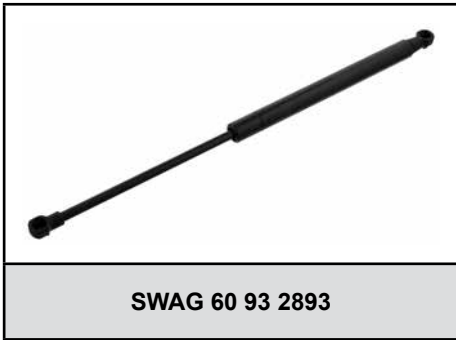
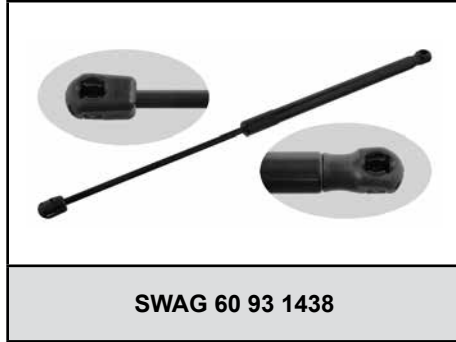
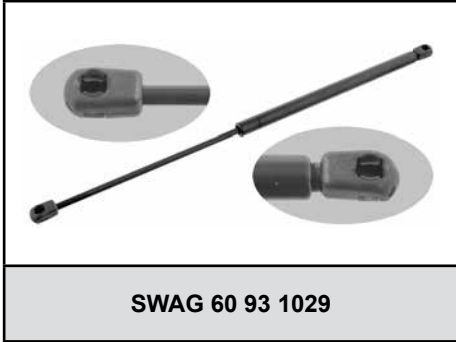
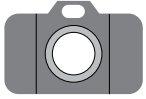

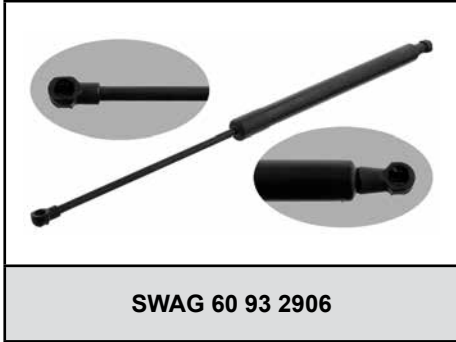
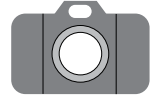

SWAG 60 93 2906

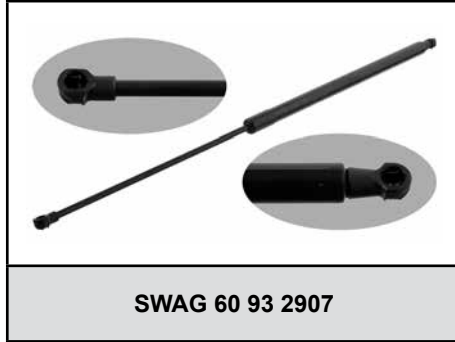

SWAG 60 93 2907

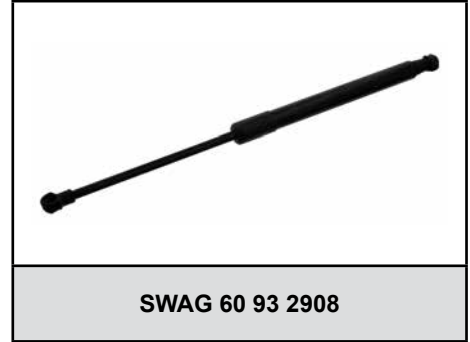

SWAG 60 93 2908

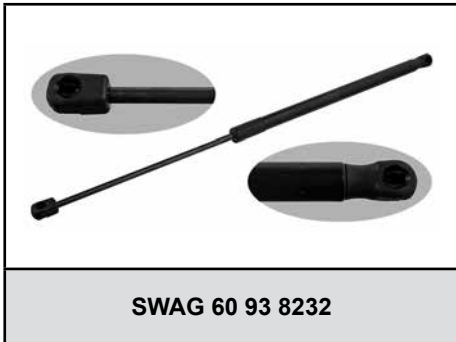

SWAG 60 93 8232

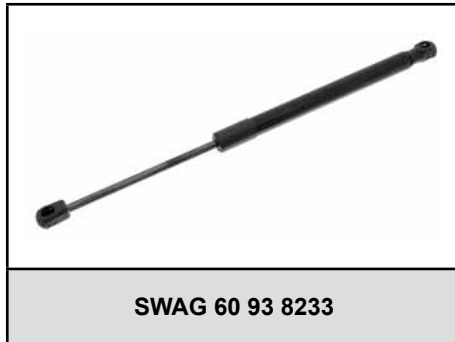

SWAG 60 93 8233

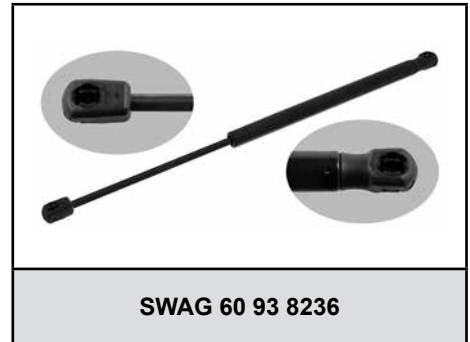

SWAG 60 93 8236

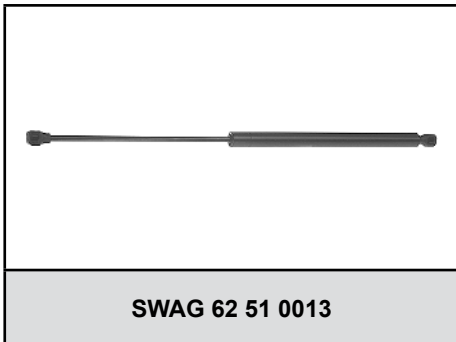

SWAG 62 51 0013

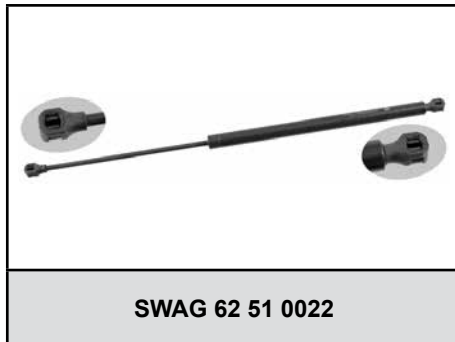

SWAG 62 51 0022

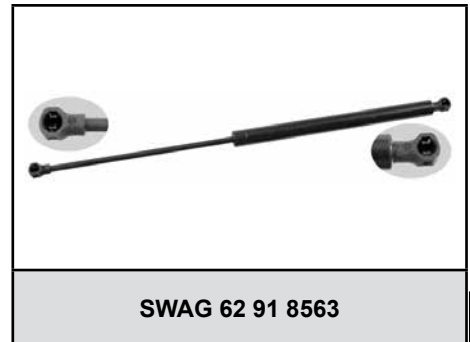

SWAG 62 91 8563



SWAG 62 91 9072

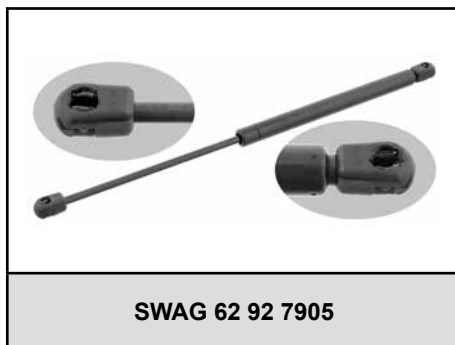

SWAG 62 92 7905

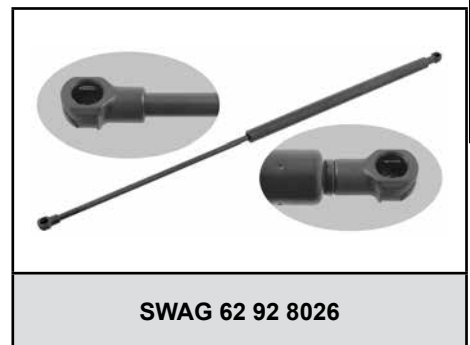

SWAG 62 92 8026

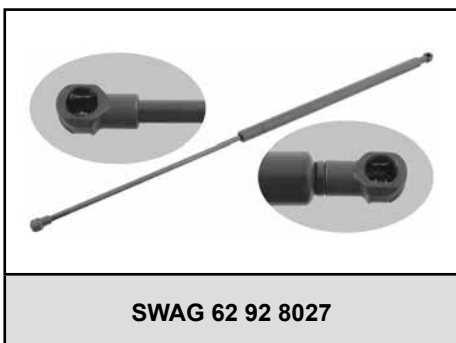

SWAG 62 92 8027

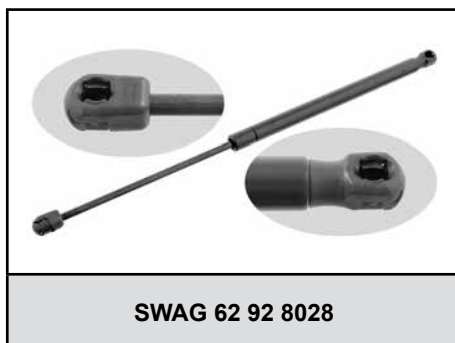

SWAG 62 92 8028

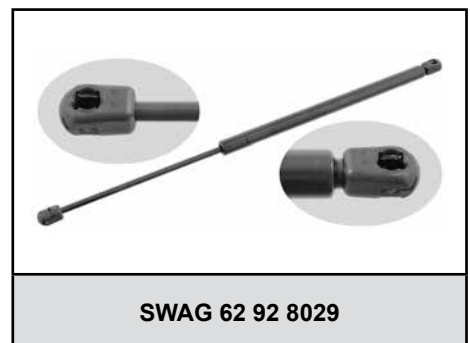

SWAG 62 92 8029

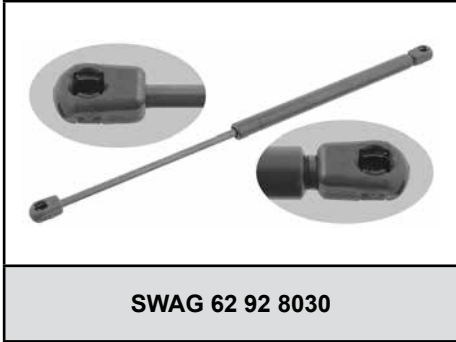
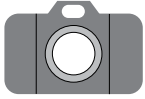

SWAG 62 92 8030

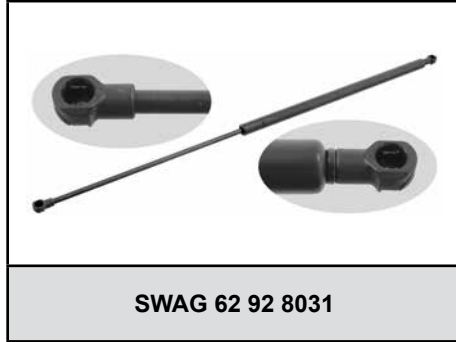

SWAG 62 92 8031

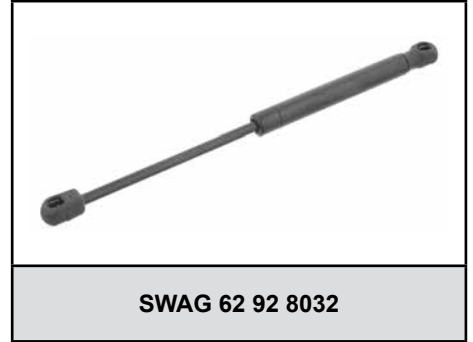

SWAG 62 92 8032

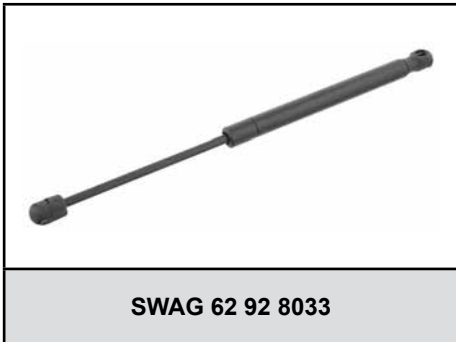

SWAG 62 92 8033

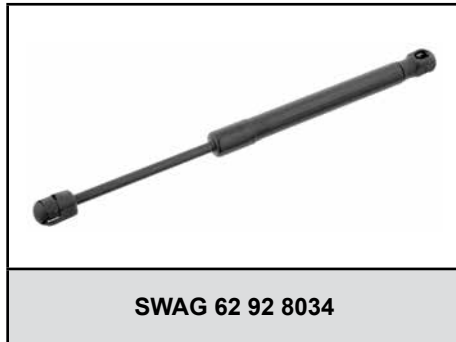

SWAG 62 92 8034



SWAG 62 92 8278

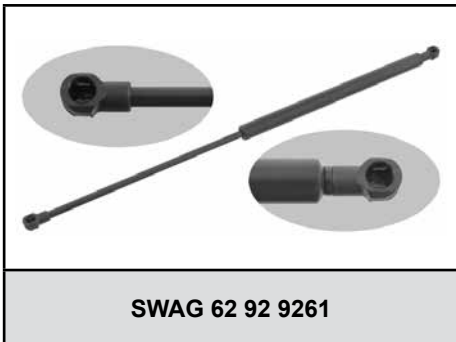

SWAG 62 92 9261

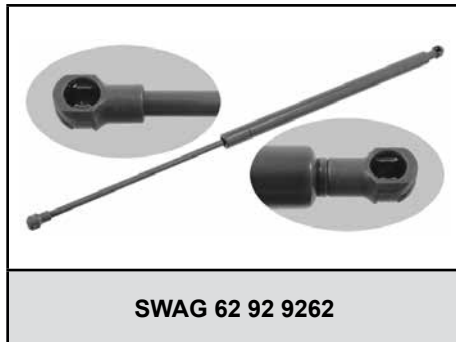

SWAG 62 92 9262

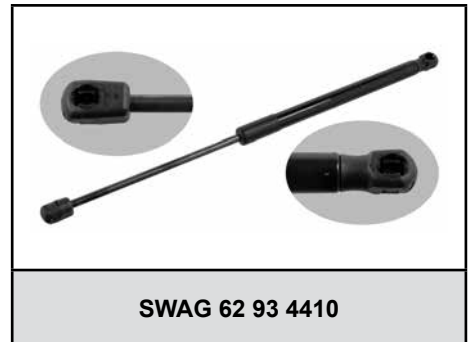

SWAG 62 93 4410

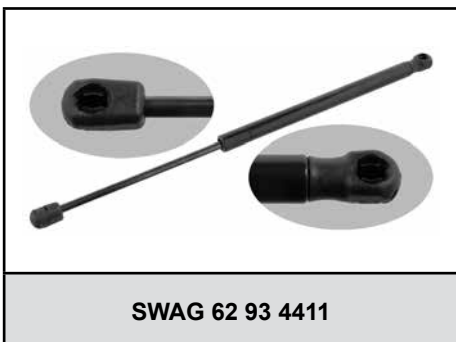

SWAG 62 93 4411

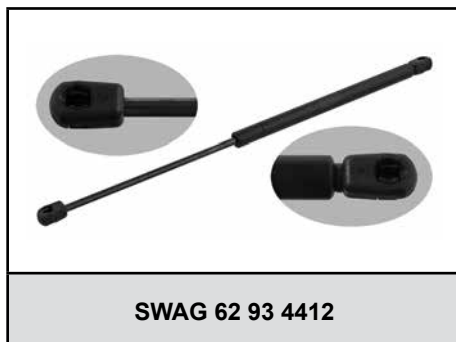

SWAG 62 93 4412

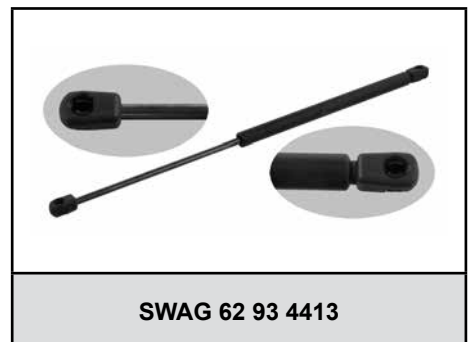

SWAG 62 93 4413

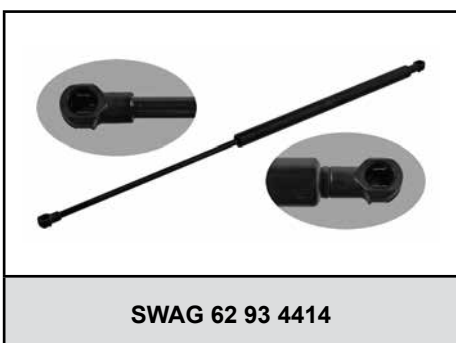

SWAG 62 93 4414



SWAG 62 93 4415

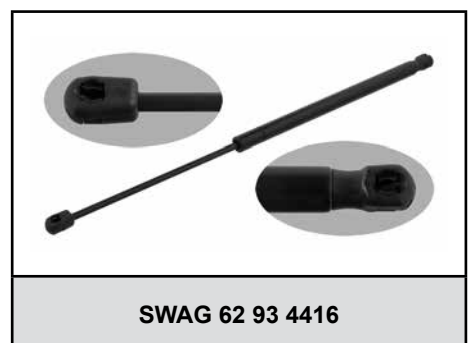

SWAG 62 93 4416

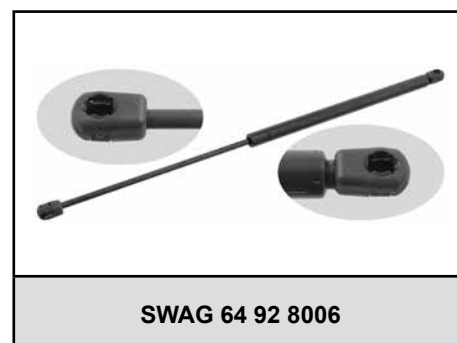
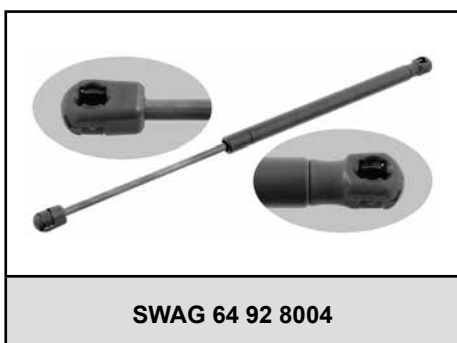
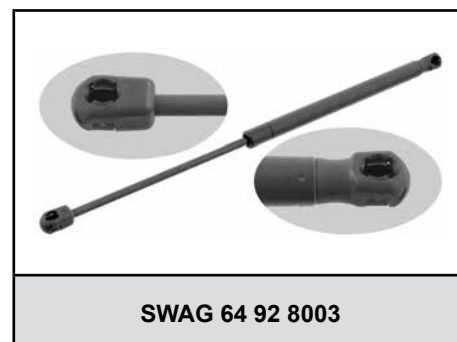
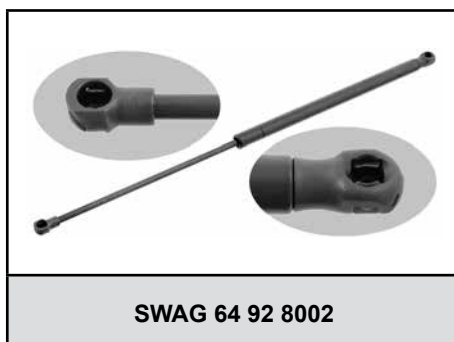
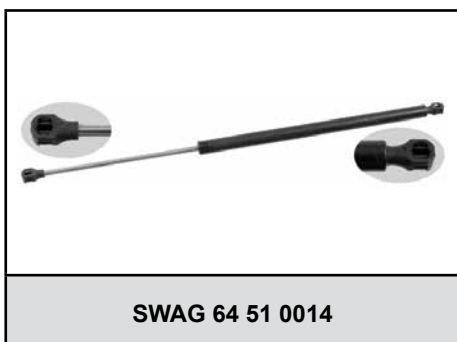
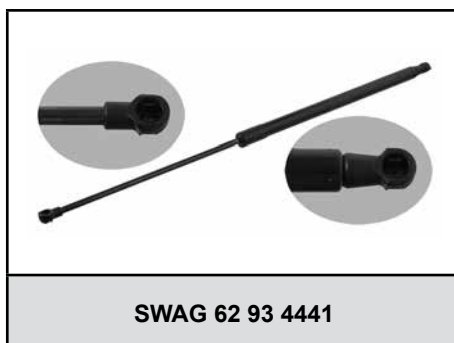
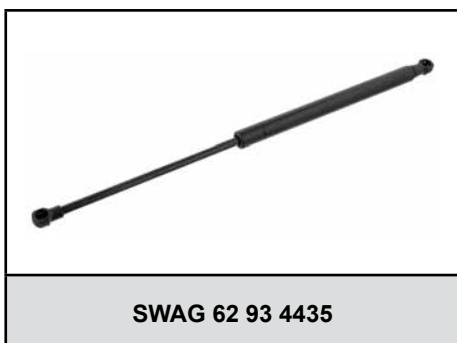
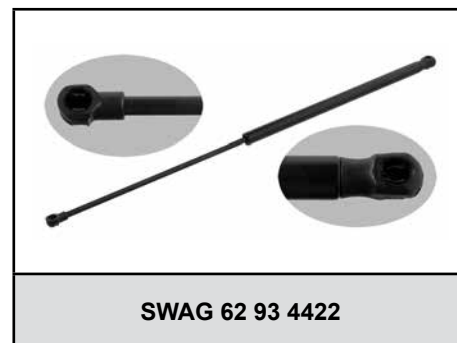
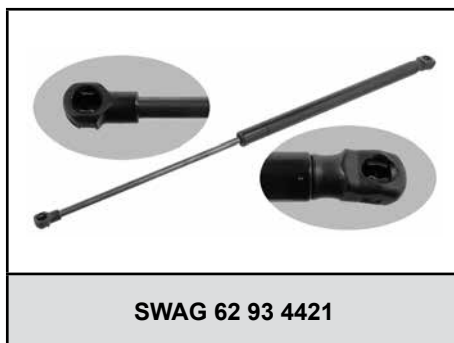
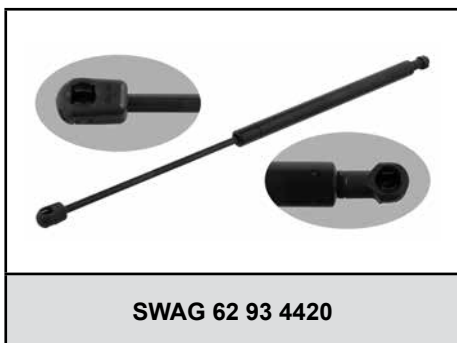
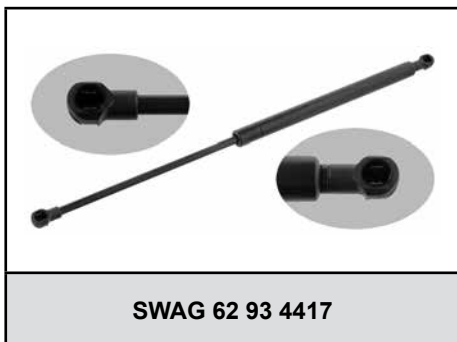

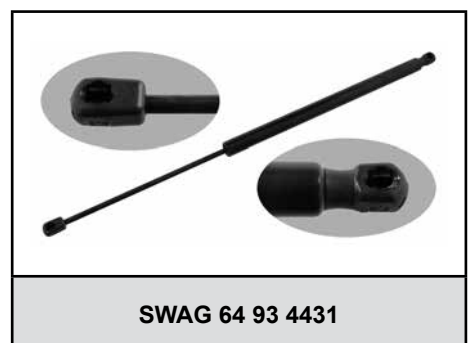
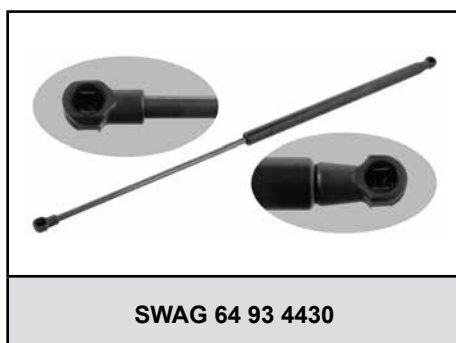
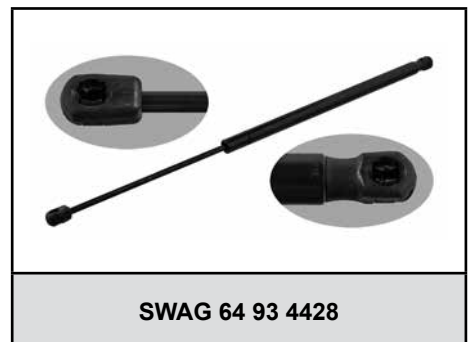
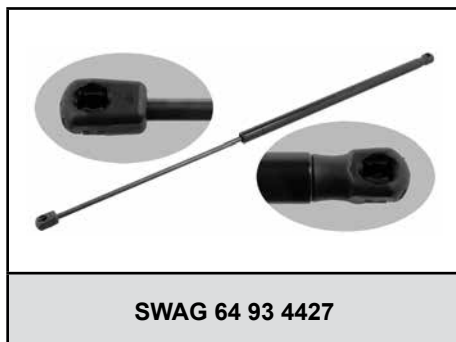
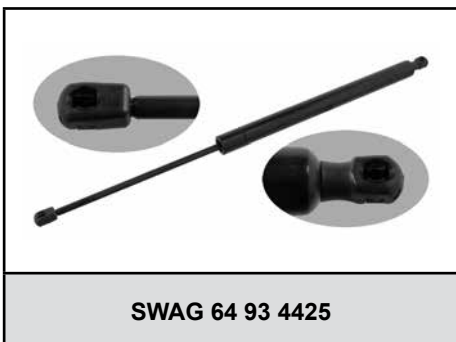
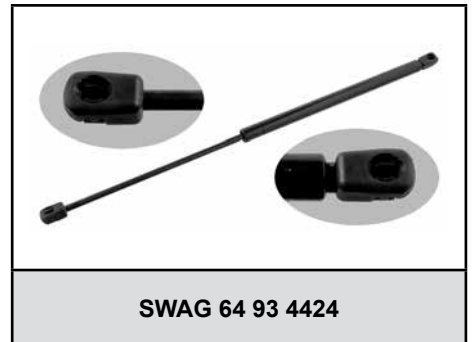
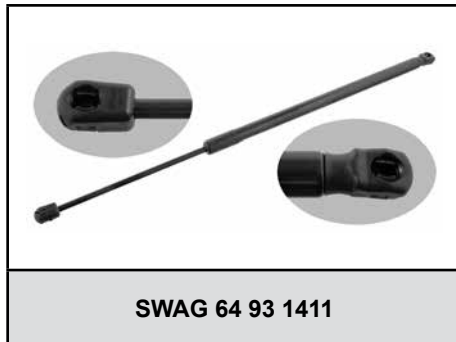
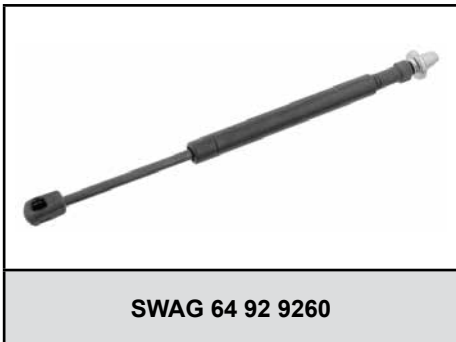
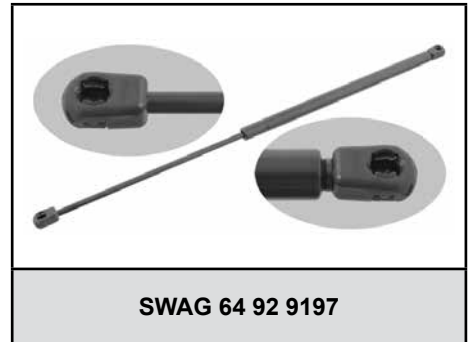
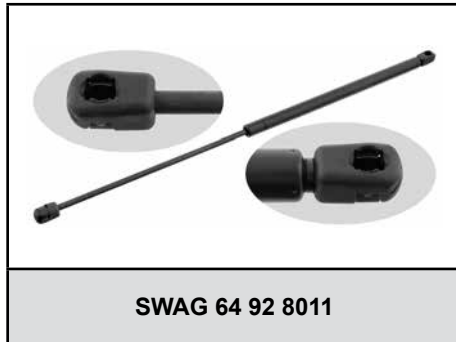
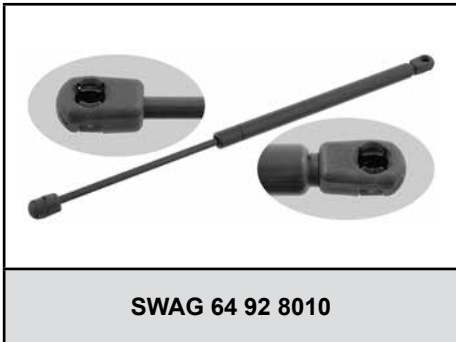
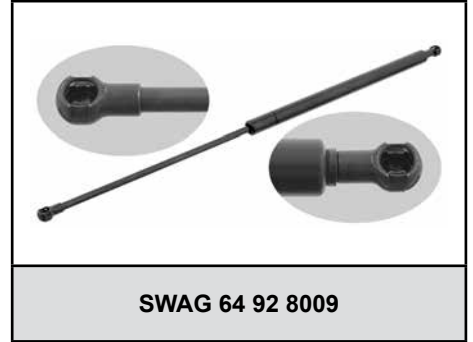
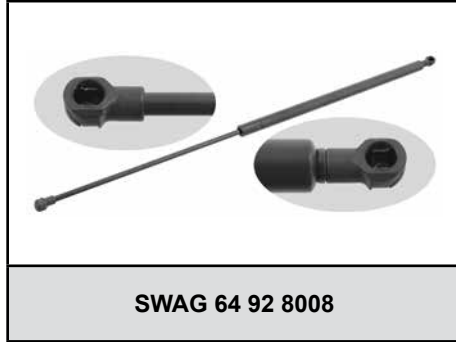
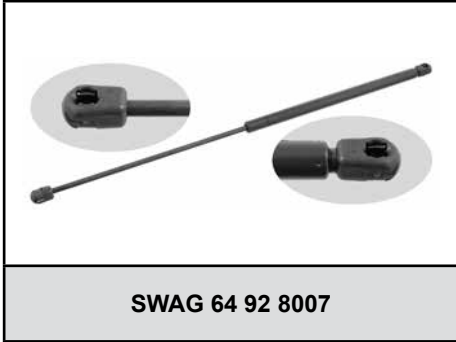
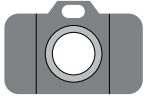

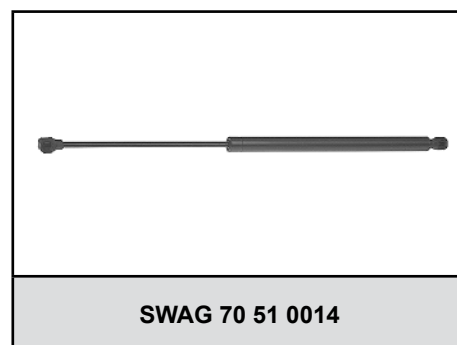
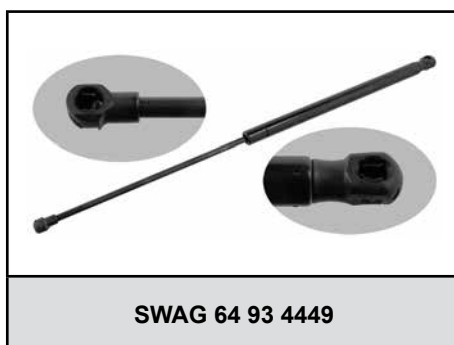
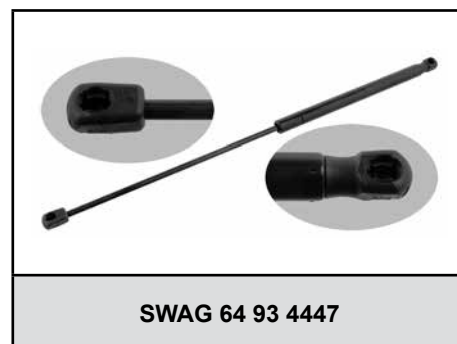
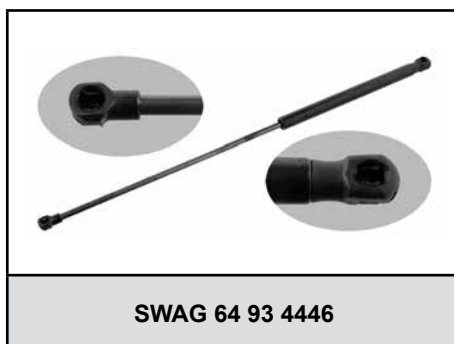
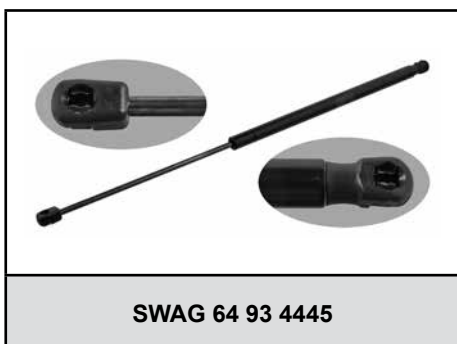
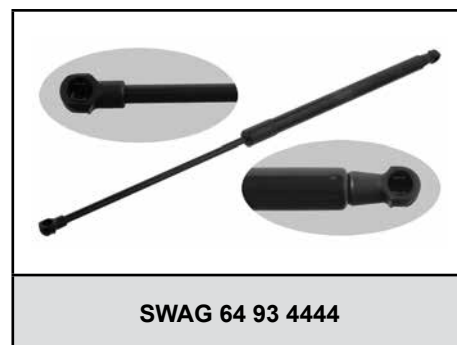
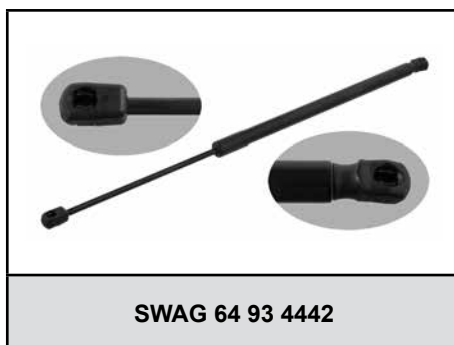
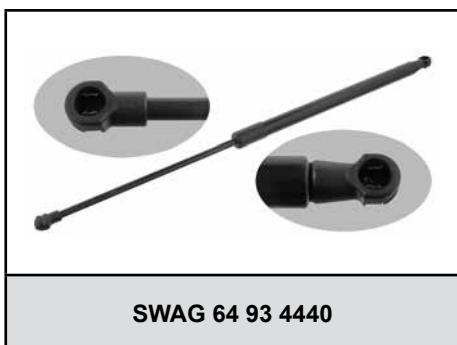
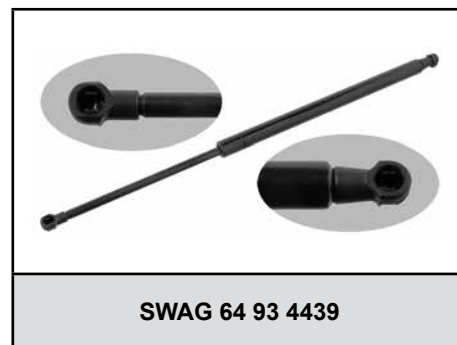
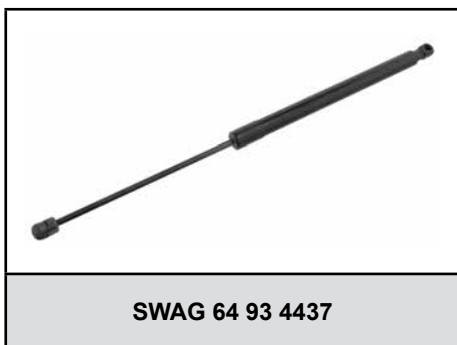
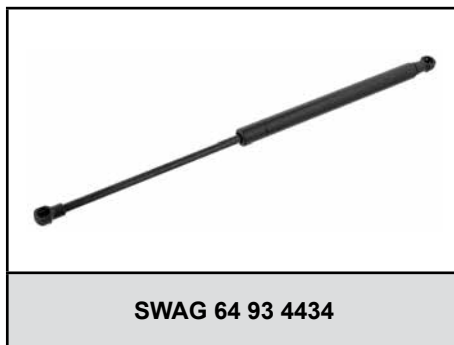
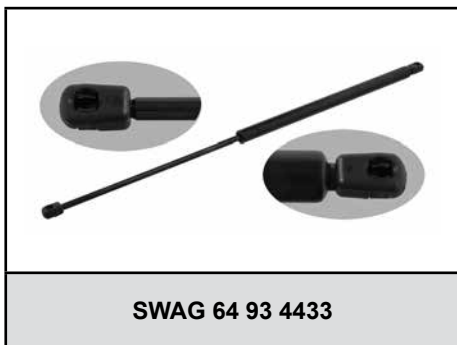

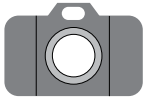

SWAG 70 51 0018



SWAG 70 92 8036



SWAG 70 92 8037



SWAG 70 92 8038



SWAG 70 92 8039



SWAG 70 92 8040



SWAG 70 92 8041



SWAG 70 92 8042



SWAG 70 93 1084



SWAG 70 93 3337



SWAG 70 93 3338

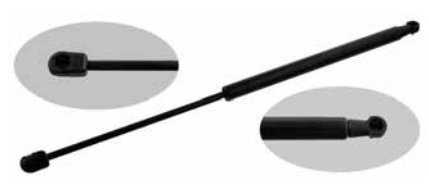

SWAG 70 93 3339

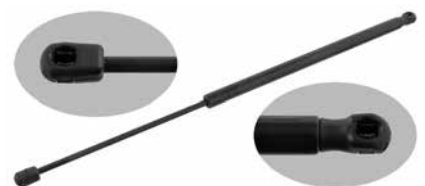

SWAG 70 93 3340

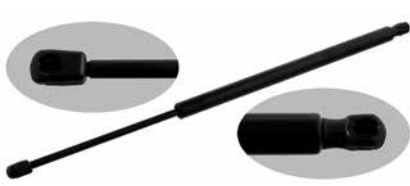

SWAG 70 93 3341



SWAG 70 93 3342

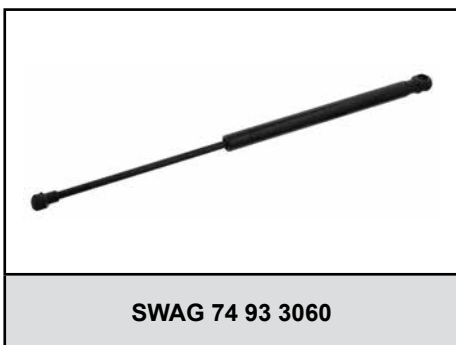
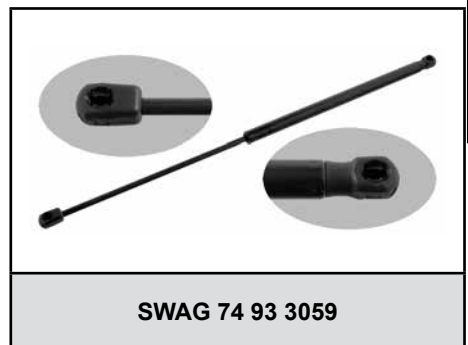
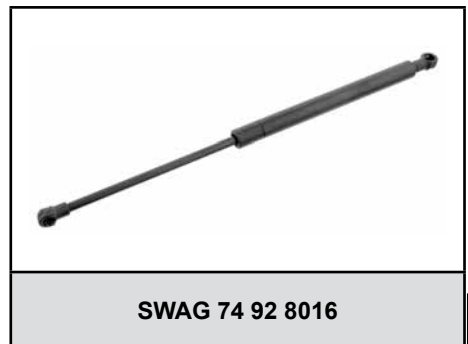
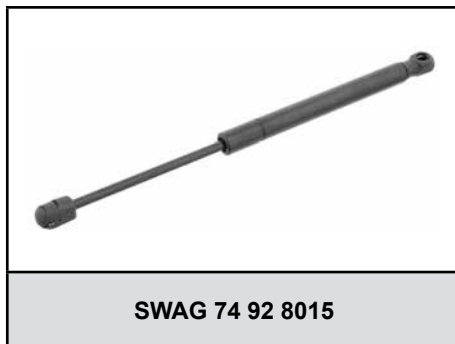
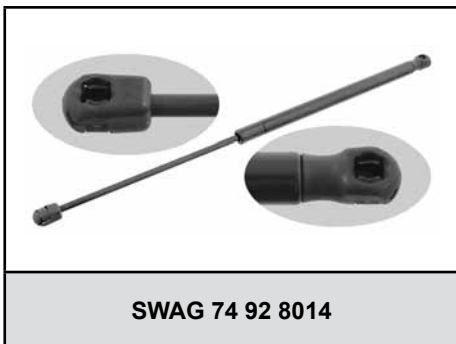
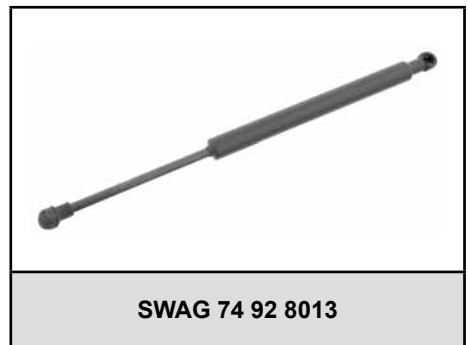
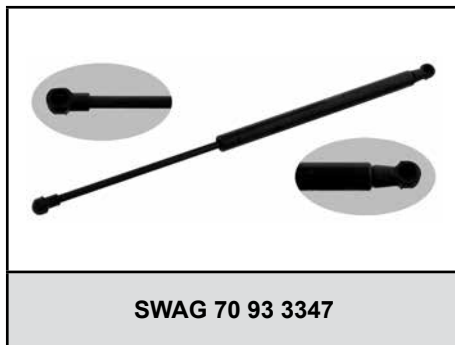
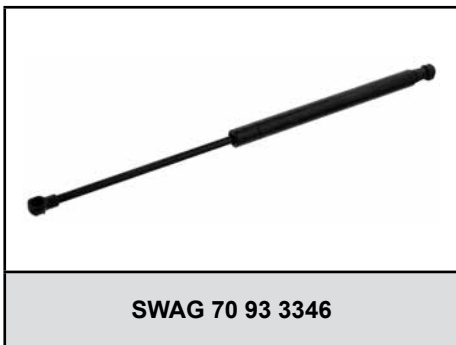
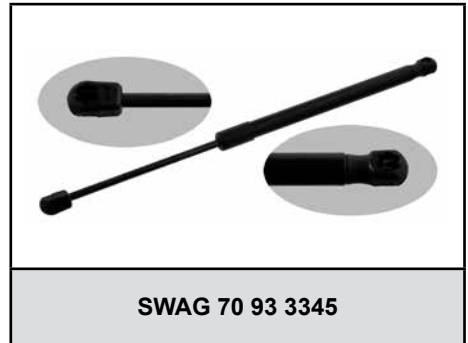
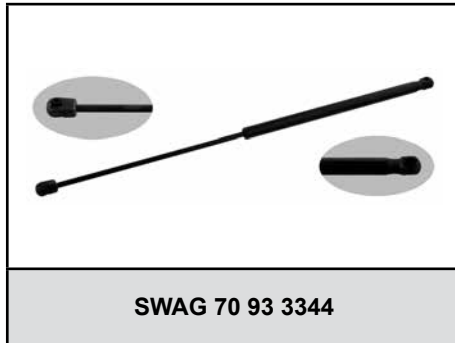
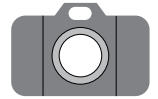

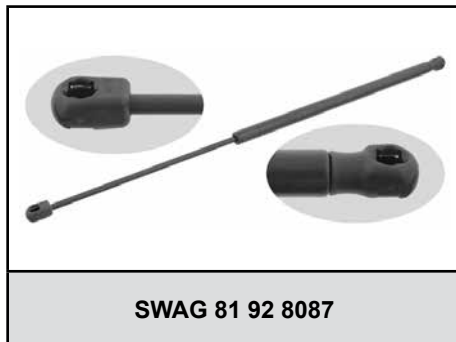
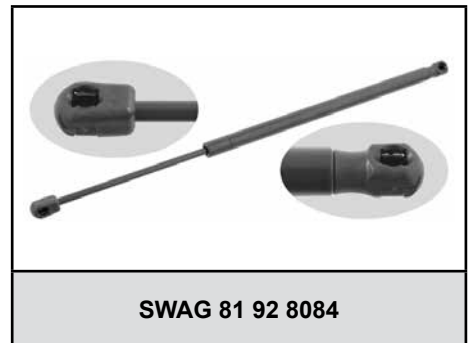
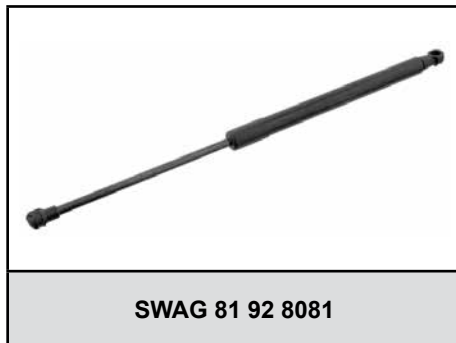
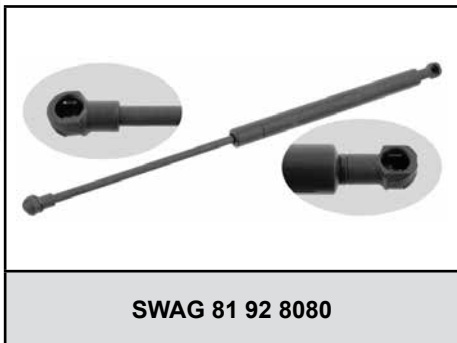
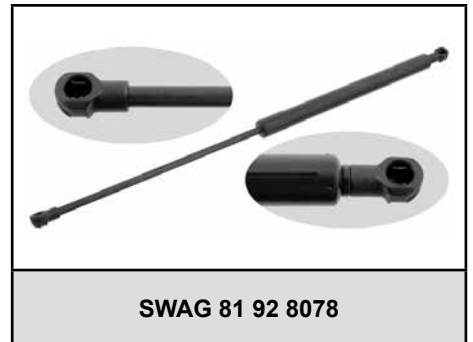
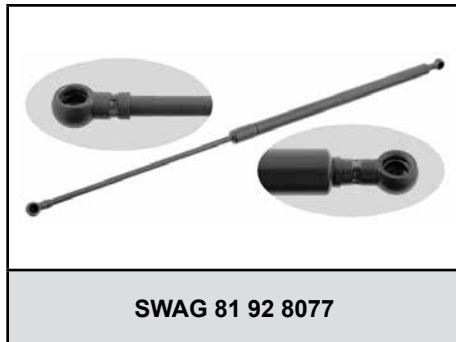
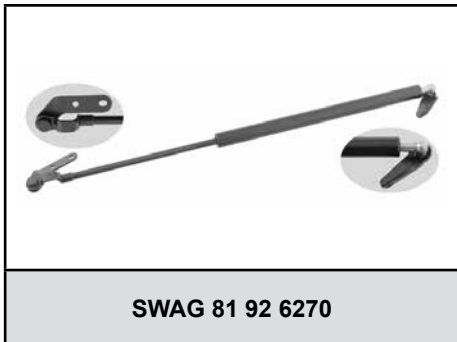
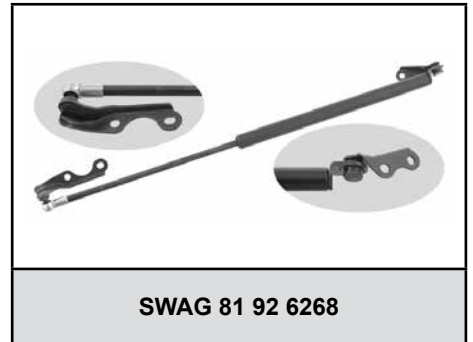
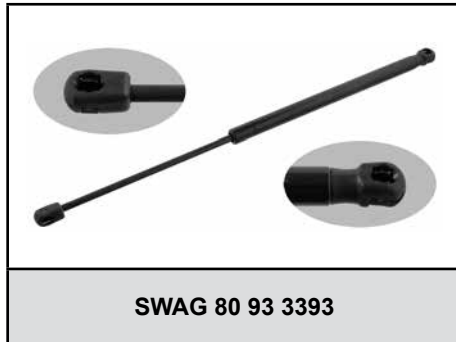
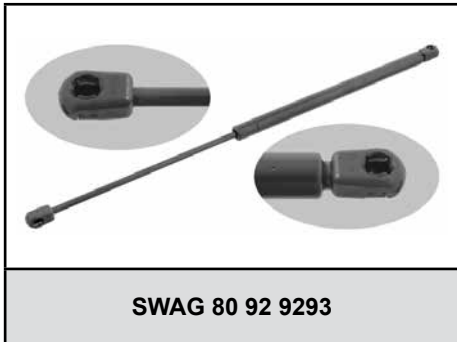
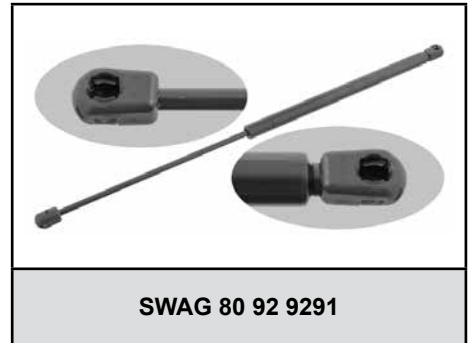
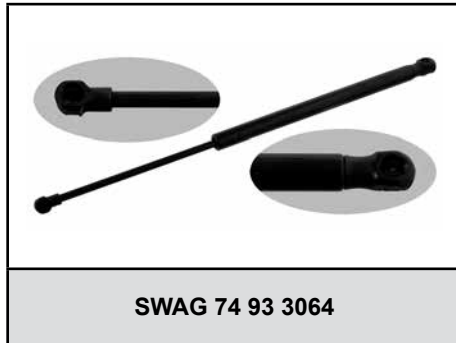
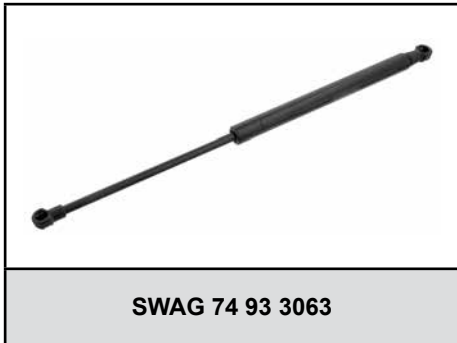
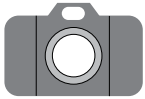

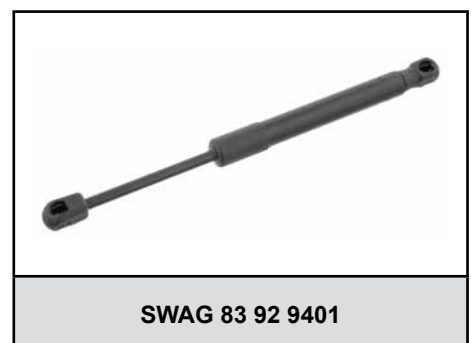
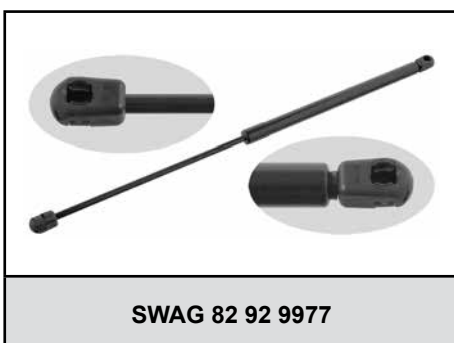
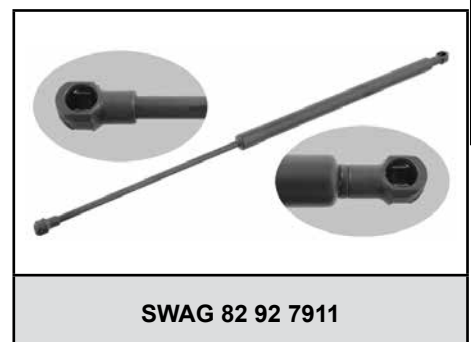
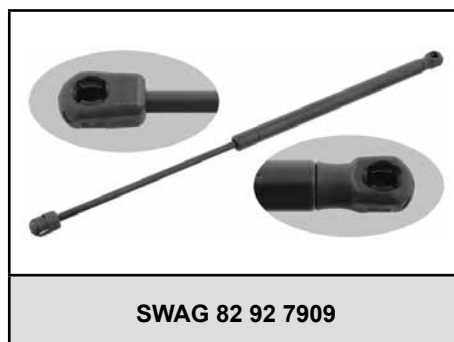
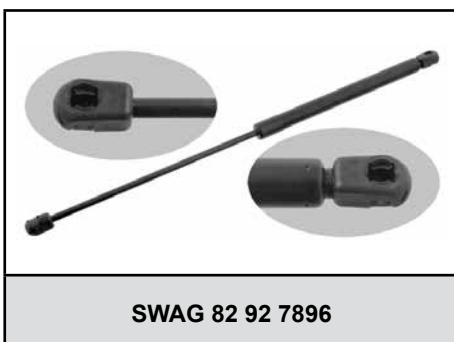
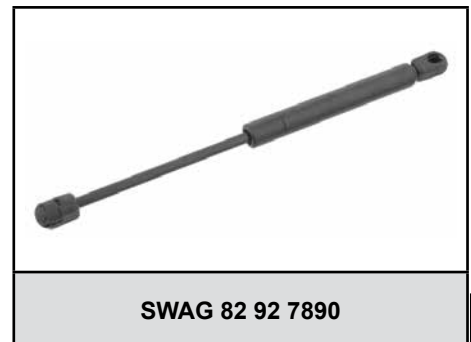
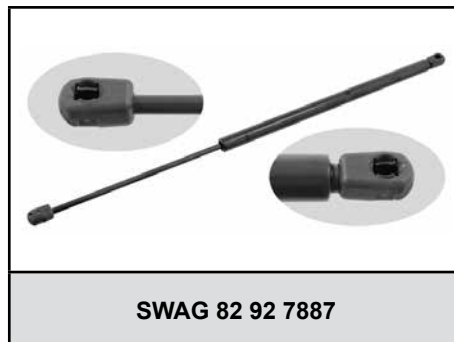
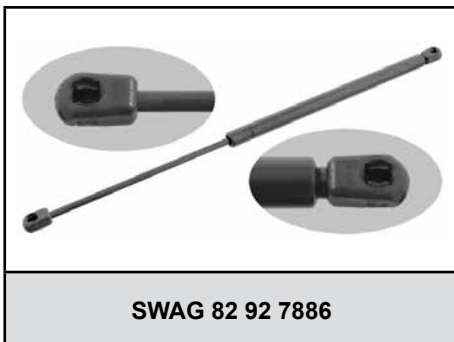
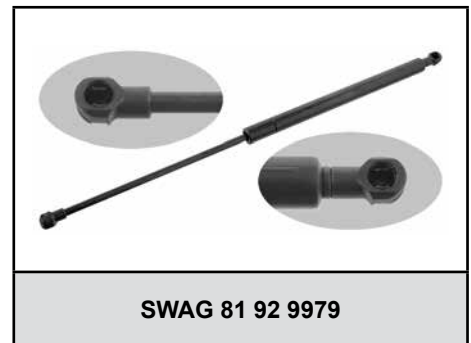
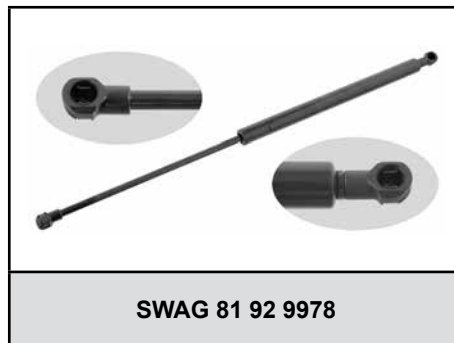
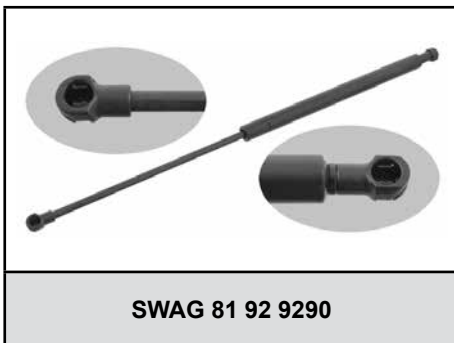
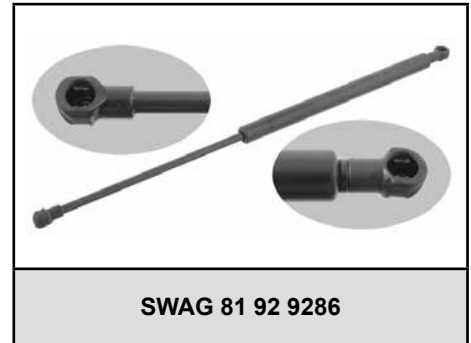
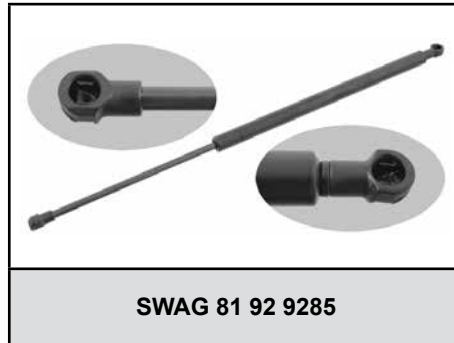
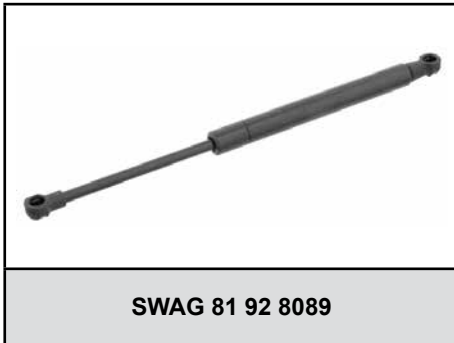
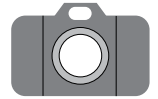

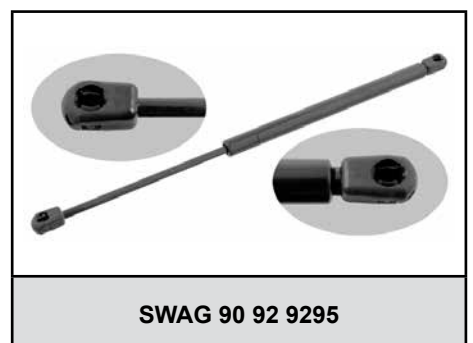
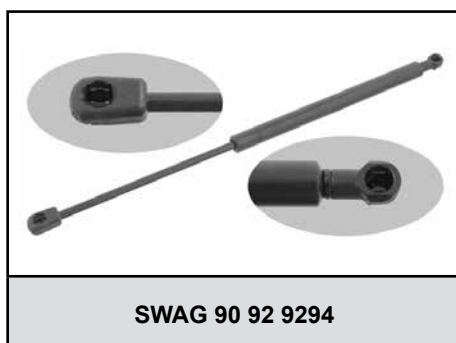
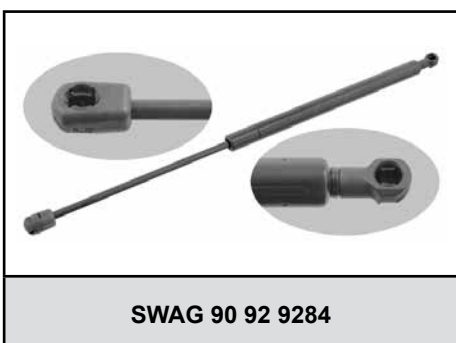
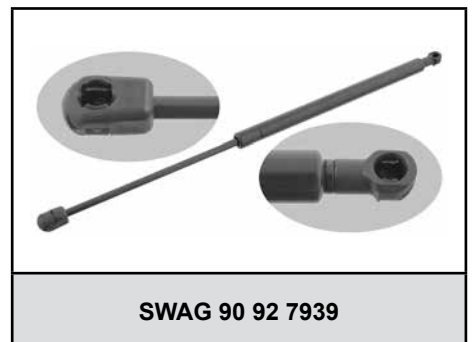
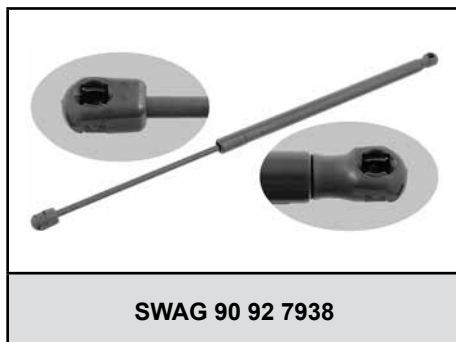
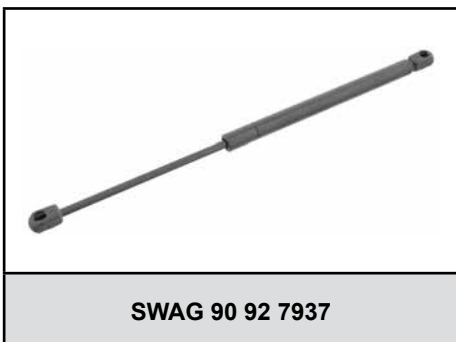
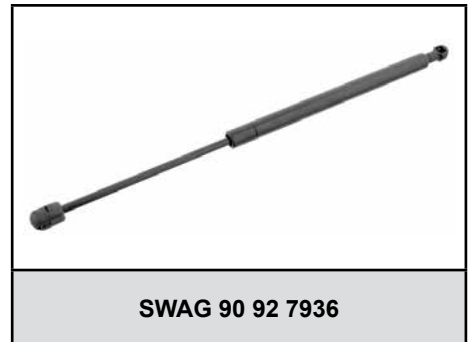
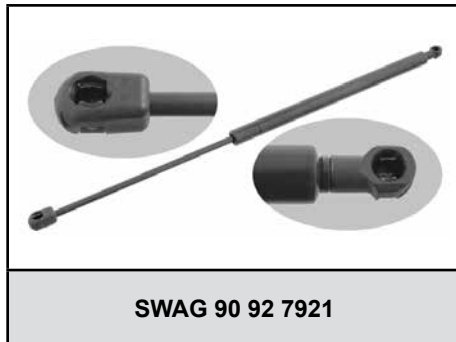
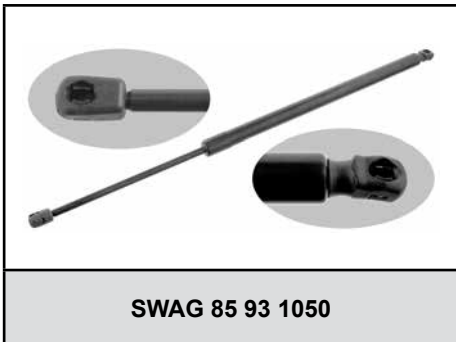
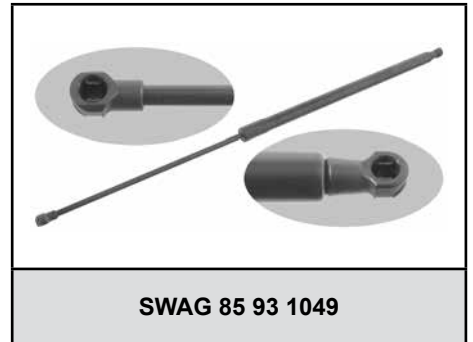
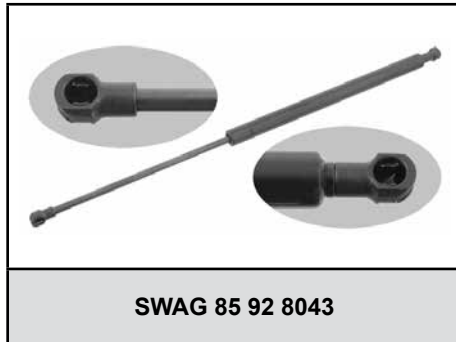
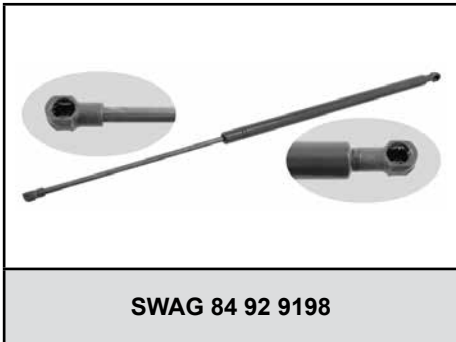
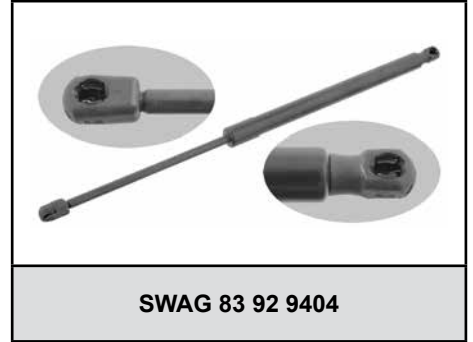
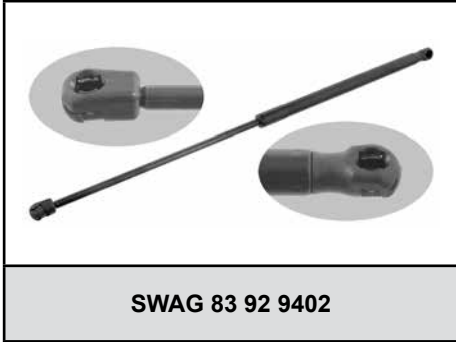
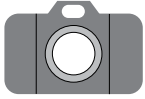

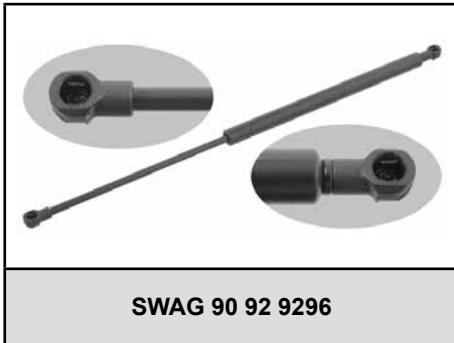
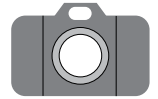

SWAG 90 92 9296

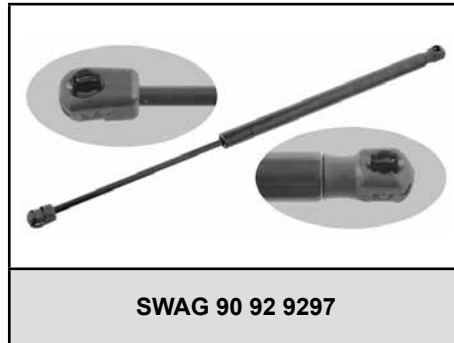

SWAG 90 92 9297

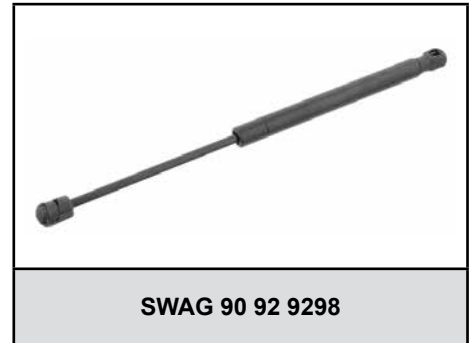

SWAG 90 92 9298

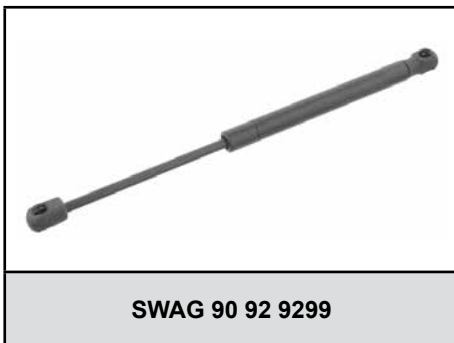

SWAG 90 92 9299

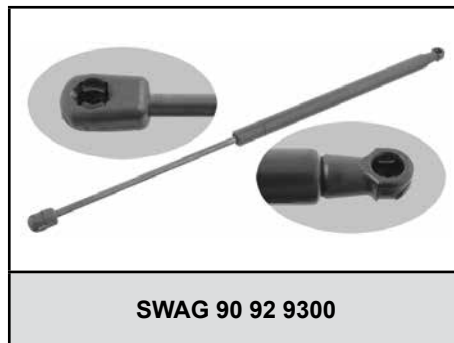

SWAG 90 92 9300

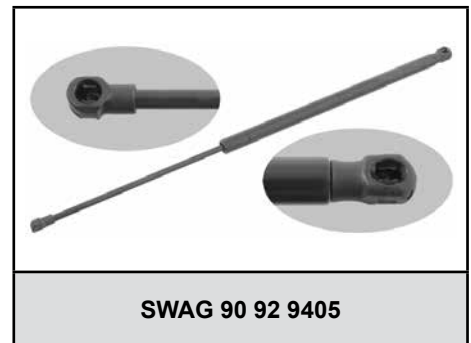

SWAG 90 92 9405

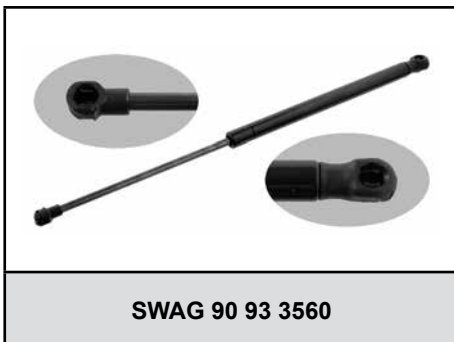

SWAG 90 93 3560

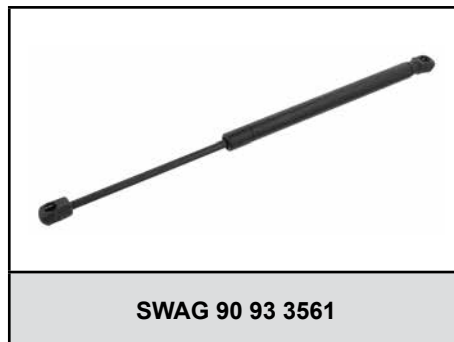

SWAG 90 93 3561

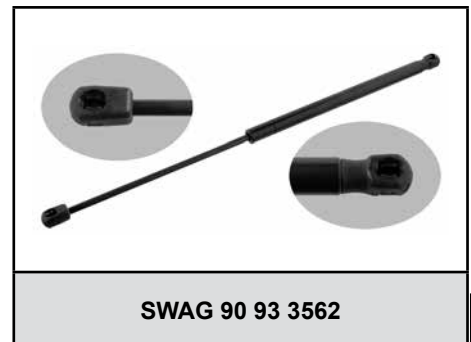

SWAG 90 93 3562

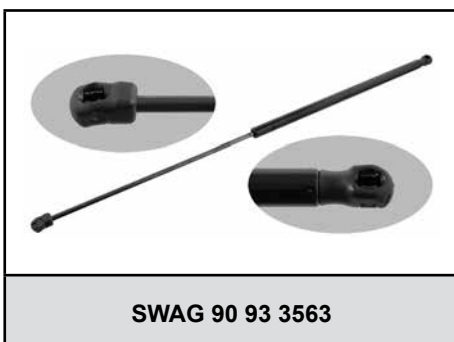

SWAG 90 93 3563



SWAG 90 93 3564

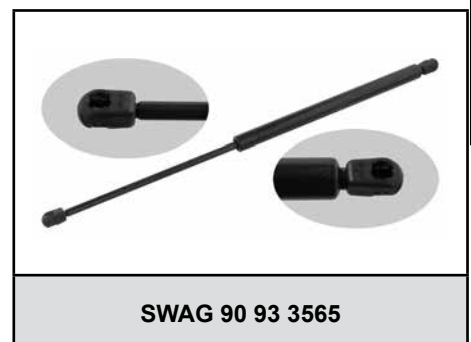

SWAG 90 93 3565



SWAG 90 93 3847

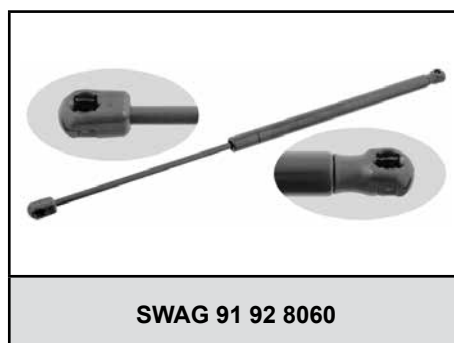

SWAG 91 92 8060

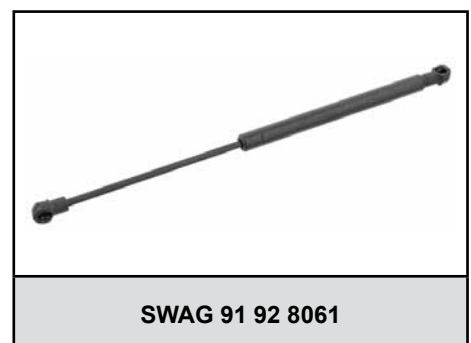

SWAG 91 92 8061

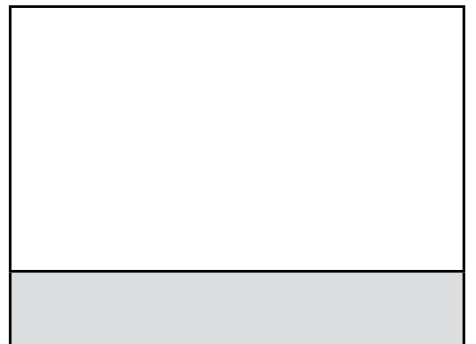
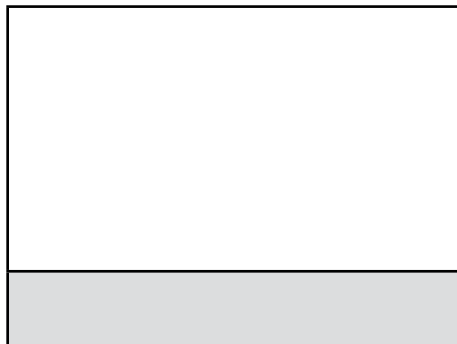
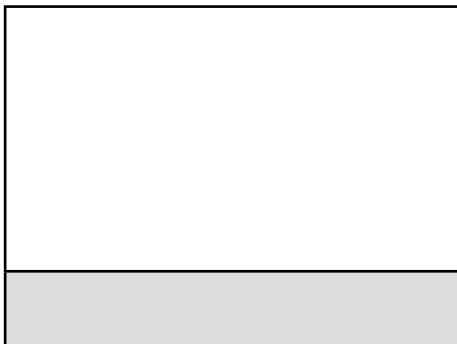
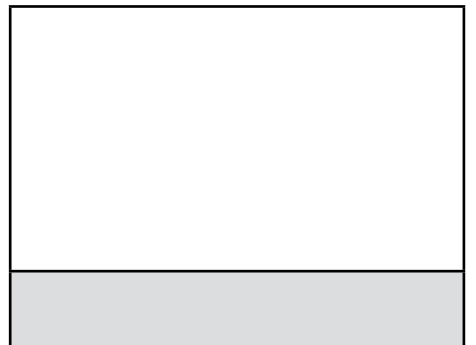
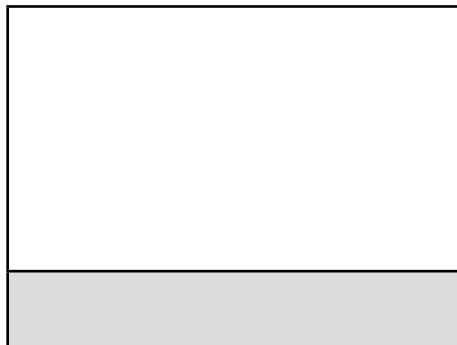
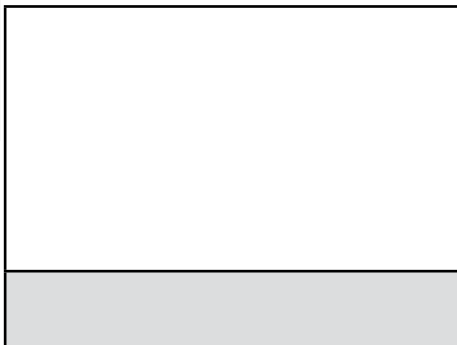
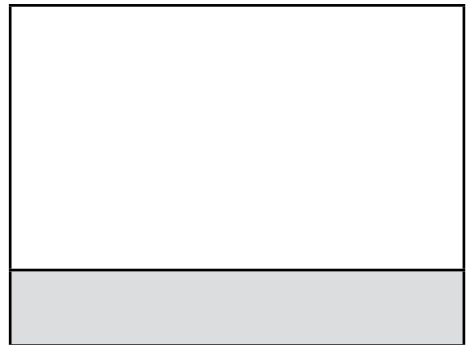
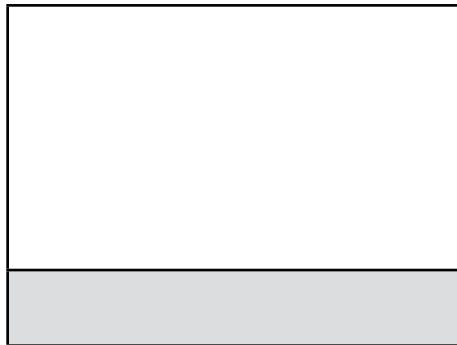
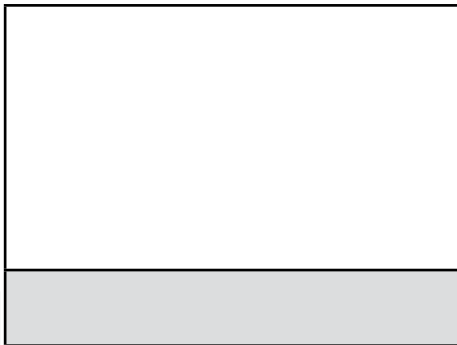
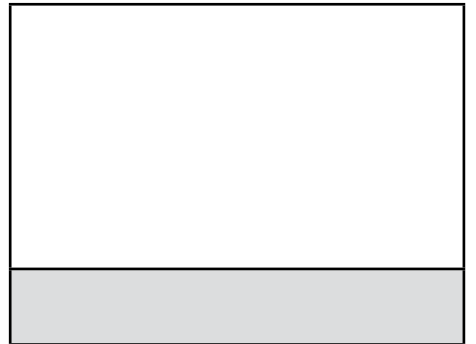
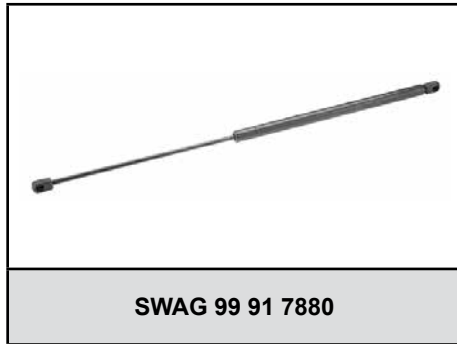
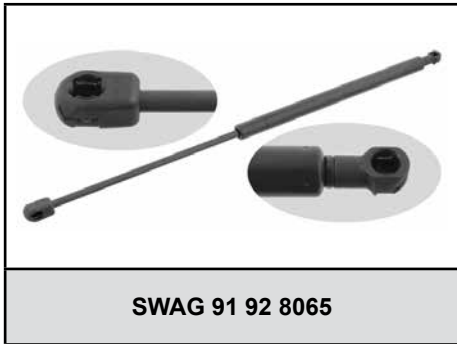
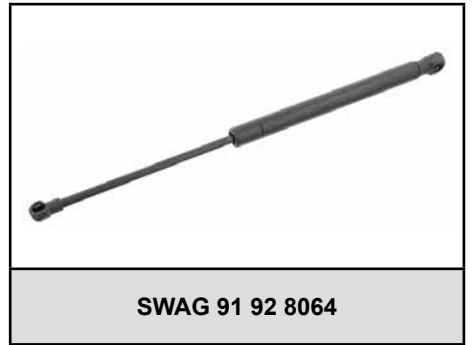
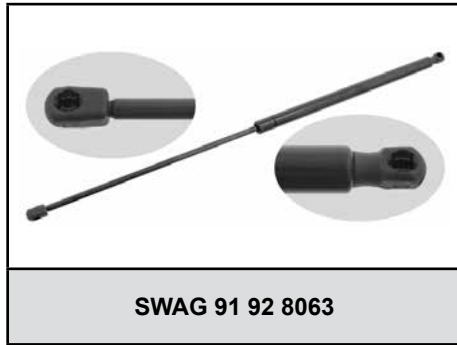
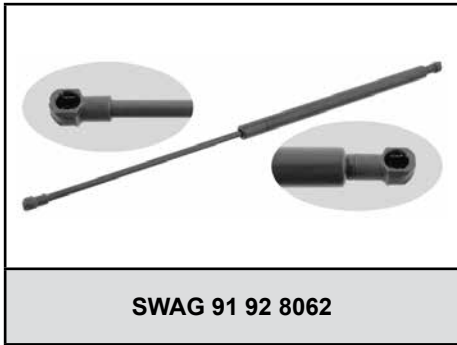
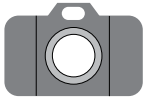



Ref. - No.



passend für / to fit

ALFA ROMEO

46739202	74 92 8013	1, 2
46771551	74 93 3060	1
50500057	74 93 3060	1
50508010	74 93 3062	1
50508060	74 93 3063	2
50508706	74 93 3064	2
50515442	74 93 3064	2
60567794	74 92 8017	1
60604823	74 92 8014	1
60651067	74 92 8018	1
60654724	74 92 8016	1
60664833	74 92 8015	1
60680087	74 93 3061	1
60683933	74 93 3062	1
60688574	74 93 3059	1, 2

passend für / to fit

AUDI

059 145 284	30 92 7604	95
059 145 284 B	30 92 7604	95
046 145 299	32 92 8550	95
4A0 425 021	30 92 7606	130, 131, 132
4D0 425 021	30 92 7611	131, 132
4D0 425 021 A	30 92 7611	131, 132
4D0 425 021 B	30 92 7611	131, 132
4D0 425 021 C	30 92 7611	131, 132
4D0 425 021 D	30 92 7611	131, 132
8A1 425 021	30 92 7613	130, 131
4A9 827 552 C	30 92 7692	4, 6, 7
4B9 827 552 N	30 92 7674	7
443 823 359 B	30 92 7678	3, 4, 9
443 823 359 D	30 51 0013	3, 4
4A0 823 359	30 51 0026	6, 7
4A0 823 359 B	30 92 7677	3, 4
4A0 823 359 C	30 51 0026	6, 7
4D0 823 359 F	30 92 7675	8
4E0 823 359 C	30 93 1637	8
4E0 823 359 D	30 93 1637	8
4F0 823 359 A	30 93 1636	7, 8
4L0 823 359	30 93 1639	10
8A0 823 359 B	30 93 9261	9
8D0 823 359	30 92 8350	5

Ref. - No.



8D0 823 359 B	30 92 8350	5
8E0 823 359	30 92 7690	5, 6
8E0 823 359 A	30 92 7690	5, 6
8H0 823 359	30 92 7695	6
8J0 823 359 C	30 92 9433	9
8L0 823 359	30 51 0050	4
8N0 823 359	30 92 9445	9
8P0 823 359	30 93 1634	4, 5
8P0 823 359 B	30 93 1634	4, 5
8R0 823 359 A	30 93 1638	9
8T0 823 359	30 93 1635	5, 6
8A0 823 360 A	30 92 8556	3, 8
3B5 827 550	32 92 3398	5
8F0 827 550 A	30 93 1670	6
441 827 551	30 92 7694	9
4D0 827 551 A	30 92 8348	8
4D0 827 551 B	30 92 8348	8
4E0 827 551 A	30 93 1678	8
4E0 827 551 B	30 93 1679	8
4E0 827 551 C	30 93 1679	8
4A5 827 552	30 51 0025	3, 6
4A9 827 552	99 91 7880	4, 7
4B5 827 552 A	32 92 3378	7
4B5 827 552 C	32 92 3378	7
4B5 827 552 D	32 92 3378	7
4B5 827 552 F	30 92 8327	5, 7
4B5 827 552 G	30 92 8327	5, 7
4B9 827 552 A	30 92 8346	7
4B9 827 552 C	30 92 8346	7
4B9 827 552 G	30 92 8346	7
4B9 827 552 J	30 92 8346	7
4B9 827 552 L	30 92 8346	7
4B9 827 552 M	30 92 8346	7
4E0 827 552 B	30 93 1680	8
4E0 827 552 C	30 93 1680	8
4F5 827 552	30 93 1672	7
4F5 827 552 B	30 93 1673	7
4F9 827 552 A	30 93 1674	7, 8
4F9 827 552 B	30 93 1677	7, 8
4F9 827 552 C	30 93 1676	7
4F9 827 552 D	30 93 1677	7, 8
4F9 827 552 E	30 93 1674	7, 8
4L0 827 552 C	30 93 1684	10

Ref. - No.

**SWAG**
GERMANY**SWAG**
GERMANY

Ref. - No.

SWAG
GERMANY

Ref. - No.

SWAG
GERMANY

4L0 827 552 E	30 93 1683	10
4L0 827 552 F	30 93 1684	10
855 827 552 G	30 93 1466	8, 10
893 827 552	30 51 0019	3
895 827 552 A	30 92 9432	8
8A5 827 552	30 92 8345	3
8A5 827 552 A	30 92 8345	3
8A9 827 552 A	30 92 7691	3, 130
8A9 827 552 C	30 92 7696	3
8D5 827 552 B	32 92 3398	5
8D5 827 552 C	32 92 3398	5
8D5 827 552 F	32 92 3398	5
8D9 827 552	32 92 3394	4, 5
8D9 827 552 F	32 92 3394	4, 5
8E5 827 552 B	30 92 8327	5, 7
8E5 827 552 C	30 92 9429	5
8E5 827 552 J	30 92 9429	5
8E9 827 552 E	30 92 9428	5
8E9 827 552 K	30 92 9430	6
8G0 827 552 C	30 92 9431	8
8H0 827 552 A	30 92 8343	6
8H0 827 552 B	30 92 8343	6
8K9 827 552	30 93 1666	5, 6
8K9 827 552 A	30 93 1667	5, 6
8K9 827 552 B	30 93 1666	5, 6
8N7 827 552 C	30 92 7684	9
8N8 827 552	30 92 7172	9
8N8 827 552 A	30 92 7172	9
8N8 827 552 B	30 92 7683	9
8P3 827 552 B	30 93 1662	4
8P3 827 552 C	30 93 1662	4
8P4 827 552 B	30 93 1663	4
8P7 827 552	30 93 1664	5
8P7 827 552 A	30 93 1664	5
8P7 827 552 C	30 93 1664	5
8P7 827 552 D	30 93 1664	5
8R0 827 552	30 93 1681	9
8R0 827 552 A	30 93 1831	9
8T8 827 552	30 93 7492	6
8T8 827 552 B	30 93 7492	6
8U0 827 552 A	30 93 9262	9
8X3 827 552	30 93 9259	4
8X4 827 552	30 93 9260	4

8Z0 827 552 B	30 92 7676	4
8K5 827 919	30 93 7483	5
8K5 827 919 A	30 93 7483	5
8T0 827 919	30 93 7491	6
8Z0 898 552	30 92 7676	4
8A9 827 552 D	30 92 7691	3, 130
8D9 827 552 H	30 92 7682	4
8N7827552A	30 92 7684	9
046 903 133 B	32 92 8550	95
038 903 315 C	30 92 1690	95

passend für / to fit

BMW

11 28 1 247 051	20 52 0009	96, 97
11 28 1 247 051 S1	20 91 8485	96, 97
11 28 1 247 052	20 91 8485	96, 97
11 28 1 709 613	20 52 0016	98, 99, 100
11 28 1 709 613 KPL	20 92 7561	98, 99, 100
11 28 1 715 626	20 52 0006	98, 99
11 28 1 717 188	20 52 0004	96, 97, 98, 99, 100, 101
11 28 1 717 188 S1	20 91 8483	96, 97, 98, 99, 100, 101
11 28 1 717 210	20 52 0005	96, 97, 99, 100, 101
11 28 1 717 210 S1	20 91 8484	96, 97, 99, 100, 101
11 28 1 722 789	20 91 8483	96, 97, 98, 99, 100, 101
11 28 1 726 773	20 91 8483	96, 97, 98, 99, 100, 101
11 28 1 726 774	20 91 8483	96, 97, 98, 99, 100, 101
11 28 1 742 858 KPL	20 92 7561	98, 99, 100
11 28 1 742 859 KPL	20 92 7560	98, 99, 100
11 28 1 745 545	20 52 0015	98, 99, 100
11 28 1 745 545 KPL	20 92 7560	98, 99, 100
11 28 1 745 546	20 92 7561	98, 99, 100
11 28 1 745 547	20 92 7560	98, 99, 100
11 28 1 745 904 KPL	20 92 7561	98, 99, 100
11 28 1 747 459 KPL	20 92 7560	98, 99, 100
11 28 2 243 510	20 52 0007	96, 97, 98
11 28 2 244 424	20 52 0007	96, 97, 98
11 28 2 246 769	20 52 0007	96, 97, 98
11 28 2 247 226	20 52 0017	96, 97
11 28 2 248 168	20 52 0007	96, 97, 98



Ref. - No.



11 28 2 248 169	20 52 0017	96, 97
11 28 7 838 797	20 91 8483	96, 97, 98, 99, 100, 101
41 61 2 990 344	20 93 6960	14
41 62 7 166 758	20 93 4505	11
51 23 1 129 190	20 92 7599	12
51 23 1 868 555	20 51 0001	13
51 23 1 869 147	20 51 0002	13, 14
51 23 1 906 286	20 51 0003	11
51 23 1 907 962	20 51 0001	13
51 23 1 908 465	20 51 0005	14
51 23 1 927 129	20 51 0001	13
51 23 1 944 119	20 51 0004	13
51 23 1 960 852	20 51 0014	11
51 23 3 400 352	20 92 7591	14
51 23 7 008 745	20 92 6057	13
51 23 7 016 178	20 92 7593	15
51 23 7 060 550	20 92 7599	12
51 23 7 118 370	20 92 7586	11
51 23 7 148 346	20 93 4514	15
51 23 7 183 741	20 93 4510	14
51 23 7 185 032	20 93 4512	14
51 23 8 119 558	20 51 0020	11
51 23 8 150 077	20 51 0024	14
51 23 8 174 866	20 51 0032	13
51 23 8 202 688	20 51 0045	12
51 23 8 240 596	20 92 3649	14
51 23 8 397 401	20 93 3538	15
51 23 8 402 551	20 92 7595	14
51 24 1 908 431	20 51 0006	14
51 24 1 934 270	20 51 0007	13
51 24 1 947 096	20 93 1025	11
51 24 1 960 862	20 51 0027	11
51 24 3 400 379	20 92 7588	14
51 24 3 414 711	20 92 7588	14
51 24 4 212 802	20 51 0043	12
51 24 4 365 788	20 93 4200	12
51 24 4 394 052	20 93 4200	12
51 24 7 016 186	20 92 7600	15
51 24 7 060 622	20 92 9259	11
51 24 7 060 623	20 93 4200	12
51 24 7 118 885	20 93 8231	12
51 24 7 127 875	20 93 4506	12

Ref. - No.



51 24 7 129 194	20 93 4200	12
51 24 7 129 215	20 93 4508	12
51 24 7 250 308	20 93 4200	12
51 24 8 110 327	20 51 0007	13
51 24 8 149 327	20 92 9263	13
51 24 8 149 328	20 92 9264	13
51 24 8 151 579	20 51 0025	11
51 24 8 171 158	20 92 7601	11
51 24 8 171 480	20 92 7596	14
51 24 8 190 688	20 92 7597	13
51 24 8 206 652	20 92 7585	11
51 24 8 220 072	20 92 9364	13
51 24 8 220 075	20 51 0043	12
51 24 8 222 913	20 92 7602	13
51 24 8 227 895	20 92 7587	12
51 24 8 230 070	20 92 7585	11
51 24 8 232 873	20 92 7590	12
51 24 8 245 031	20 92 7601	11
51 24 8 254 281	20 51 0043	12
51 24 8 399 087	20 93 0233	15
51 24 8 402 405	20 92 7594	14
51 24 8 410 755	20 93 0234	15
51 24 9 067 135	20 51 0025	11

passend für / to fit

CITROËN

5751.41	62 92 8278	102, 103
5751.44	62 91 9072	102, 103, 104
5751.81	62 91 9072	102, 103, 104
7925.11	64 92 8010	19
7925.13	64 92 8011	19
8731.94	64 92 8009	20
8731.A8	64 92 8006	19
8731.C0	64 92 9197	19
8731.C1	64 51 0014	18
8731.E0	64 93 4433	18
8731.E3	64 92 8007	19
8731.E4	64 92 8008	19
8731.E7	64 92 9197	19
8731.F4	64 92 8005	17
8731.F5	64 93 4440	17
8731.F6	64 93 4440	17
8731.F7	64 92 9260	17
8731.G3	64 92 8004	16

Ref. - No.

**SWAG**
GERMANY**SWAG**
GERMANY

Ref. - No.

SWAG
GERMANY

Ref. - No.

SWAG
GERMANY

8731.G6	64 93 4434	18
8731.H8	64 92 8003	16
8731.H9	64 93 4427	20
8731.J8	64 93 4446	16
8731.J9	64 93 4447	16
8731.K0	64 93 4447	16
8731.K1	64 93 4439	17
8731.K2	64 93 4439	17
8731.K8	64 93 4436	18
8731.L0	64 92 8002	16
8731.L8	64 93 4427	20
8731.L9	64 93 4448	16
8731.N8	62 93 4441	17
8731.N9	64 93 1411	17
8731.P0	64 93 4442	17
8731.P1	64 93 4444	16
8731.P2	64 93 4445	16
8731.P4	64 93 4445	16
8731.P5	64 93 4429	19
8731.P6	64 93 4433	18
8731.Q1	80 93 3393	18
8731.Q2	80 93 3393	18
8731.Q9	64 93 4429	19
8731.R6	64 93 4437	17
8731.R7	64 93 4438	17
8731.R8	64 93 4430	18
8731.R9	64 93 4431	18
8731.S0	64 93 4425	18
8731.S8	64 93 4449	16
8731.T0	64 93 4445	16
8731.T1	64 93 4445	16
8731.V0	64 93 4428	19
8731.V6	64 93 4424	18

passend für / to fit

FIAT

7634947	70 93 1084	21, 23
7686794	70 93 1084	21, 23
7734566	70 51 0014	22
7774707	70 92 8042	21
1354844080	64 93 4428	21
1498071080	64 93 4429	23
46420780	70 51 0018	22
46453503	70 93 1084	21, 23

46514867	70 92 8040	22
46524678	70 92 8036	22
46744596	70 92 8037	22
46762434	70 93 3340	23
46783650	70 92 8041	21
46784994	70 92 8038	23
46784995	70 92 8039	23
46812168	70 93 3342	23
46827091	70 93 3337	22
46830389	70 93 3338	21
46835404	70 93 1084	21, 23
51702090	70 93 3346	22, 23
51709681	70 93 3340	23
51716995	70 93 3341	23
51734960	70 93 3344	21
51736743	70 93 3340	23
51736744	70 93 3340	23
51736745	70 93 3341	23
51736746	70 93 3341	23
51778432	70 93 3346	22, 23
51785412	70 93 3347	21
51794446	70 92 8040	22
51801718	70 93 3343	22
51812267	70 93 3339	21
71743352	70 93 3345	23
71743353	70 93 3345	23
9405751819	62 91 9072	105
9620038880	62 92 8278	105
9622553680	64 51 0014	23
9623659880	62 91 9072	105
9626493880	64 51 0014	23
9632155180	62 91 9072	105
9633056680	62 91 9072	105

passend für / to fit

FORD

1 008 276	50 92 7774	25
1 008 277	50 51 0049	25
1 009 060	32 92 3390	27
1 020 155	50 51 0040	28
1 020 156	50 51 0043	28
1 025 425	50 51 0034	27
1 034 930	50 92 7789	29
1 047 212	32 92 3390	27



Ref. - No.



1 072 394	50 92 7777	26
1 074 368	50 92 7773	26
1 075 742	50 92 7761	24
1 079 800	10 92 7758	26
1 088 369	50 92 7789	29
1 092 108	50 92 7777	26
1 093 705	10 92 7758	26
1 094 814	32 92 3390	27
1 117 046	50 92 7779	29
1 117 246	50 92 7760	29
1 117 394	50 92 7762	29
1 119 688	50 92 7779	29
1 120 611	50 92 7779	29
1 120 812	50 92 7771	29
1 121 248	50 92 7769	29
1 124 003	50 92 7777	26
1 133 865	30 92 7664	27
1 136 483	50 92 7778	26
1 141 159	50 92 7757	25
1 146 649	50 92 7778	26
1 150 277	50 92 7776	26
1 211 497	50 92 7787	27
1 224 731	50 92 7757	25
1 229 461	50 92 7785	26
1 232 189	50 92 7762	29
1 251 915	50 92 7784	25
1 252 377	50 92 7766	26, 27
1 313 218	50 92 7785	26
1 321 021	50 92 7768	26
1 336 159	50 92 7770	26
1 336 230	50 92 7767	26, 27
1 349 309	50 92 7767	26, 27
1 376 673	50 92 7770	26
1 434 296	50 93 1948	30
1 434 313	50 93 1949	27
1 436 155	50 92 7787	27
1 460 415	50 92 7784	25
1 477 578	50 93 1951	29
1 477 988	50 93 1955	29
1 481 998	50 93 1948	30
1 484 158	50 93 1953	29
1 484 371	50 93 1951	29
1 492 389	50 93 1952	29

Ref. - No.



1 495 030	50 93 1953	29
1 496 865	50 93 1954	29
1 502 096	50 92 7768	26
1 514 965	50 93 8234	25
1 520 777	50 93 1946	28
1 523 356	50 93 8234	25
1 537 538	50 93 1956	28
1 539 291	50 93 1947	27
1 542 413	50 93 1950	27
1 549 615	50 93 1951	29
1 553 003	50 93 1948	30
1 553 975	50 93 1952	29
1 592 821	50 93 1955	29
1 608 113	50 93 1948	30
1 650 686	50 51 0025	24
1 650 687	50 51 0025	24
1 666 068	50 93 8234	25
1 684 313	50 93 1946	28
1 684 709	50 93 1956	28
1 708 365	50 93 1946	28
1 729 322	50 93 1956	28
4 134 632	50 92 7772	30
4 134 633	50 92 7772	30
4 378 216	50 93 4507	30, 31
6 142 657	50 51 0053	30
6 142 658	50 51 0035	30
6 734 732	50 92 7786	24
6 734 734	50 92 7759	24
6 789 158	50 51 0044	28
6 844 981	50 51 0045	28
6 885 988	50 92 7761	24
6 900 216	50 51 0028	24
6 900 217	50 51 0029	24
6 934 502	50 51 0046	28
6 965 594	50 92 7782	25
6 965 595	50 92 7774	25
7 020 592	50 51 0040	28
passend für / to fit		
HONDA		
74820-SMG-E01	85 93 1049	32
74820-SMG-E02	85 93 1049	32
74820-SMG-E03	85 93 1049	32
74820-ST3-E01	85 92 8043	32

Ref. - No.

**SWAG**
GERMANY**SWAG**
GERMANY

Ref. - No.

SWAG
GERMANY

Ref. - No.

SWAG
GERMANY

74820-ST3-E02	85 92 8043	32
74820-ST3-E51	85 92 8043	32
74820-ST3-E52	85 92 8043	32
74820-SWA-A01	85 93 1050	32
74870-SWA-A01	85 93 1050	32

passend für / to fit

HYUNDAI

81161-26000	90 92 7936	34
81161-26001	90 92 7936	34
81161-2C000	90 92 9295	33
81161-2C001	90 92 9295	33
81161-3D000	90 92 9296	34
81161-3D001	90 92 9296	34
81161-3K000	90 93 3563	34
81770-02030	81 92 8087	33
81770-02031	81 92 8087	33
81770-02040	81 92 8087	33
81770-02041	81 92 8087	33
81770-06010	90 92 9294	33
81770-06011	90 92 9294	33
81770-0X000	90 93 3560	33
81770-17010	90 92 7938	34
81770-17011	90 92 7938	34
81770-17030	90 92 7938	34
81770-17031	90 92 7938	34
81770-1C000	90 92 7939	33
81770-1C001	90 92 7939	33
81770-1J000	90 93 3561	33
81770-1J010	90 93 3561	33
81770-25220	90 92 9405	33, 35
81770-25230	90 92 9405	33, 35
81771-26010	90 92 7921	34
81771-26011	90 92 7921	34
81771-29200	90 93 3562	34
81771-29220	90 93 3562	34
81771-29221	90 93 3562	34
81771-2C020	90 92 9300	33
81771-2D210	90 92 9284	33
81771-2D211	90 92 9284	33
81771-2D220	90 92 9284	33
81771-2D720	90 92 9284	33
81771-2E000	90 92 9297	34
81771-38500	90 92 9299	35

81771-39501	90 92 9299	35
81771-3A000	90 93 3565	34
81771-3A001	90 93 3565	34
81771-3D000	90 93 3847	34
81771-3D001	90 93 3847	34
81771-3D002	90 93 3847	34
81771-3K000	90 93 3564	34
81771-3K001	90 93 3564	34
81780-02030	81 92 8087	33
81780-02031	81 92 8087	33
81780-02040	81 92 8087	33
81780-02041	81 92 8087	33
81780-1J000	90 93 3561	33
81780-1J010	90 93 3561	33
81780-25220	90 92 9405	33, 35
81780-25230	90 92 9405	33, 35
87170-26010	90 92 7937	34
87170-26011	90 92 7937	34
87170-2E020	90 92 9298	34

passend für / to fit

KIA

OK2FB-62-620	91 92 8065	36
OK2FB-62-620A	91 92 8065	36
OK2FB-62-620B	91 92 8065	36
OK2FB-63-620	91 92 8065	36
OK2FB-63-620A	91 92 8065	36
OK2FB-63-620B	91 92 8065	36
OK53Y-56-620	91 92 8064	36
OK53Y-56-630	91 92 8064	36
OK53Y-62-620	91 92 8063	36
OK53Y-63-620	91 92 8063	36
OK53Z-56-620	91 92 8064	36
OK53Z-56-620A	91 92 8064	36
OK53Z-56-630	91 92 8064	36
OK53Z-56-630A	91 92 8064	36
OK53Z-62-620	91 92 8063	36
OK53Z-62-620A	91 92 8063	36
OK53Z-63-620	91 92 8063	36
OK53Z-63-620A	91 92 8063	36
81181-3E000	91 92 8062	36
81181-3E001	91 92 8062	36
81181-3E010	91 92 8062	36
81181-3E011	91 92 8062	36



Ref. - No.



81771-3E010	91 92 8060	36
81771-3E011	91 92 8060	36
81771-3E020	91 92 8060	36
81771-3E021	91 92 8060	36
81781-3E010	91 92 8060	36
81781-3E011	91 92 8060	36
81781-3E020	91 92 8060	36
81781-3E021	91 92 8060	36
87170-3E000	91 92 8061	31
87170-3E010	91 92 8061	31
87180-3E000	91 92 8061	31
87180-3E010	91 92 8061	31

passend für / to fit

LANCIA

46830389	70 93 3338	37
9622553680	64 51 0014	37
9626493880	64 51 0014	37

passend für / to fit

LEXUS

53440-0W090	81 92 9285	38
53440-0W091	81 92 9285	38
53440-0W100	81 92 9286	38
53440-0W101	81 92 9286	38
53450-0W070	81 92 9285	38
53450-0W071	81 92 9285	38
53450-0W080	81 92 9286	38
53450-0W081	81 92 9286	38
64530-0W090	81 92 8089	38
64530-0W091	81 92 8089	38

passend für / to fit

MAZDA

1E00-62-620	50 51 0049	39
G21B-62-620	83 92 9404	39
G21B-63-620	83 92 9404	39
GD8V-63-620B	83 91 7055	39
GJ6A-56-930	83 92 9401	39
GJ6E-56-930	83 92 9401	39
GJ6J-62-620	83 92 9402	39
GJ6J-63-620	83 92 9402	39
GJ6L-62-620	83 92 9402	39
GJ6L-63-620	83 92 9402	39
NF79-56-930B	83 92 9403	32
NF80-56-930B	83 92 9403	32

Ref. - No.



passend für / to fit

MERCEDES-BENZ

102 200 04 14	10 52 0019	106, 109
102 200 07 14	10 52 0019	106, 109
102 200 08 14	10 52 0015	106, 108, 109, 113
102 200 12 14	10 52 0015	106, 108, 109, 113
102 200 14 14	10 52 0015	106, 108, 109, 113
102 200 15 14	10 52 0019	106, 109
103 200 01 14	10 52 0012	107, 108, 109, 110, 115, 116
111 200 04 14	10 91 9995	106, 110, 111, 112, 114, 117, 118
112 200 00 14	10 52 0025	110, 111, 112, 113, 114, 116, 117
272 200 01 14	10 92 7454	111, 112, 113, 114, 115, 117, 118
601 200 03 14	10 52 0018	107, 108, 113, 114, 115, 116
601 200 05 14	10 52 0018	107, 108, 113, 114, 115, 116
603 200 01 14	10 52 0018	107, 108, 113, 114, 115, 116
603 200 03 14	10 52 0018	107, 108, 113, 114, 115, 116
604 200 01 14	10 52 0018	107, 108, 113, 114, 115, 116
604 200 02 14	10 52 0023	106, 107, 108, 110, 112, 113, 114, 115, 118
604 200 03 14	10 52 0018	107, 108, 113, 114, 115, 116
000 463 43 32	10 52 0008	133, 134, 135
000 463 48 32	10 52 0008	133, 134, 135
000 463 51 32	10 52 0008	133, 134, 135
000 463 53 32	10 52 0003	131, 133, 134, 135
000 463 56 32	10 93 1450	134
000 463 60 32	10 93 1450	134
000 463 63 32	10 93 7868	133
000 463 66 32	10 93 1449	134
124 463 04 32	10 52 0003	131, 133, 134, 135
124 463 05 32	10 93 7868	133
140 463 01 32	10 92 7572	135
140 463 03 32	10 92 7572	135

Ref. - No.

**SWAG**
GERMANY**SWAG**
GERMANY

Ref. - No.

SWAG
GERMANY

Ref. - No.

SWAG
GERMANY

193 463 00 32	10 52 0008	133, 134, 135
209 690 00 59	10 93 7274	42
163 740 00 45	10 92 2621	44
163 740 03 45 S1	10 92 2621	44
163 740 03 45	10 92 2621	44
164 740 01 45	10 92 8562	44
164 740 02 45	10 92 8563	44
164 740 03 45	10 92 9334	44
164 740 04 45	10 92 9334	44
164 740 05 45	10 92 9338	44
164 740 06 45	10 92 9339	44
169 740 00 45	10 92 4711	40
203 740 00 45	10 92 4327	41
204 740 01 45	10 93 0883	41
251 740 00 45	10 92 4709	45
251 740 02 45	10 92 4718	45
124 750 04 36	10 92 7741	40
124 750 06 36	10 92 8561	40
170 750 00 36	10 93 4112	46
171 750 00 36	10 92 8559	46
208 750 00 36	10 92 7738	42
208 750 03 36	10 92 7738	42
221 750 02 36	10 92 7747	45
230 750 00 36	10 92 7744	46
163 880 00 29	10 92 2622	44
164 880 00 29	10 92 4737	44
164 880 01 29	10 92 4731	44
170 880 02 29 S1	10 92 4735	46
171 880 01 29	10 92 4710	46
201 880 02 29	10 51 0002	40, 45
201 880 03 29	10 51 0002	40, 45
202 880 00 29	10 51 0009	40
203 880 00 29	10 92 4739	41, 42
203 880 04 29	10 92 4733	41, 42
204 880 00 29	10 93 0879	43
208 880 00 29	10 92 7737	42
208 880 01 29	10 92 7737	42
210 880 02 29	10 51 0017	43
210 880 04 29	10 51 0017	43
211 880 00 29	10 92 7743	42, 43
211 880 03 29	10 92 7743	42, 43
215 880 00 29	10 92 7731	41
220 880 03 29	10 92 4713	45

221 880 03 29	10 92 7733	42, 45
230 880 00 29	10 92 7745	46
251 880 01 29	10 92 4738	45
251 880 02 29	10 92 4738	45
000 980 24 64	10 51 0002	40, 45
000 980 25 64	10 51 0002	40, 45
000 980 37 64	10 51 0002	40, 45
001 980 80 64	10 51 0022	43
123 980 00 64	10 51 0001	40
123 980 01 64	10 51 0001	40
124 980 01 64	10 51 0008	40
124 980 02 64	10 51 0008	40
129 980 05 64	10 92 7742	45
129 980 06 64	10 92 7734	45
164 980 01 64	10 92 9336	44
164 980 02 64	10 92 9336	44
168 980 01 64	10 92 4707	40
168 980 09 64	10 92 4707	40
168 980 11 64	10 92 4707	40
168 980 12 64	10 92 4707	40
169 980 08 64	10 92 7736	40
171 980 01 64	10 92 4719	46
202 980 03 64	10 93 0439	40
203 980 01 64	10 92 7739	41
203 980 03 64	10 92 4327	41
204 980 00 64	10 93 0880	41
204 980 05 64	10 93 7085	44
204 980 09 64	10 93 0881	41
204 980 11 64	10 93 0882	41
209 980 00 64	10 92 7832	42
209 980 01 64	10 92 7746	42
209 980 03 64	10 92 7832	42
209 980 04 64	10 92 7832	42
209 980 05 64	10 92 7832	42
211 980 03 64	10 92 7011	43
211 980 04 64	10 92 7011	43
211 980 07 64	10 93 2046	43
211 980 11 64	10 93 2045	43
211 980 13 64	10 93 2047	43
211 980 14 64	10 93 2048	43
211 980 15 64	10 93 2045	43
211 980 16 64	10 93 2046	43
211 980 17 64	10 93 2045	43



Ref. - No.



211 980 18 64	10 93 2046	43
211 980 19 64	10 93 2045	43
211 980 20 64	10 93 2046	43
211 980 21 64	10 93 2045	43
211 980 22 64	10 93 2046	43
230 980 01 64	10 92 7830	46
230 980 02 64	10 92 7831	46
414 980 00 64	10 92 7740	46
638 980 03 64	10 51 0021	46
639 980 01 64	10 92 4712	46
639 980 03 64	10 92 7748	46

passend für / to fit

MINI

41 61 6 801 259	11 92 7598	47
41 62 6 801 258	11 92 7589	47
51 23 4 360 740	11 92 7598	47
51 23 7 066 566	11 92 7598	47
51 23 7 148 864	11 93 4517	47
51 23 7 160 818	11 92 7598	47
51 23 7 175 020	11 92 7598	47
51 24 7 148 902	11 93 4518	47

passend für / to fit

MITSUBISHI

5802A007	80 93 3393	48
5802A008	80 93 3393	48
MB927791	80 92 9291	48
MR101555	80 92 9291	48
MR248939	80 92 9293	48
MR248940	80 92 9293	48

passend für / to fit

NISSAN

84430-2F000	82 92 7890	49
84430-2F010	82 92 7890	49
90450-00QAA	60 92 7903	49
90450-4F110	82 92 9977	49
90450-4F111	82 92 9977	49
90450-8H31A	82 92 7911	42
90450-AX000	82 92 7909	49
90450-AX610	82 92 7909	49
90450-AX61B	82 92 7909	49
90450-BM400	82 92 7886	49
90450-EQ30A	82 92 7911	42
90451-4F110	82 92 9977	49

Ref. - No.



90451-4F111	82 92 9977	49
90451-8H31A	82 92 7911	42
90451-AX000	82 92 7909	49
90451-EQ30A	82 92 7911	42
90452-2F725	82 92 7896	49
90452-6F100	82 92 7896	49

passend für / to fit

OPEL

0132 016	40 93 6220	51
0132 020	40 93 6249	52
0132 531	40 93 4509	50
0132 532	40 92 7619	50
0132 670	40 92 7626	51
0132 675	40 51 0037	52
0132 677	40 92 7614	50
0132 681	40 92 7609	53
0132 691	40 92 7623	54
0132 702	40 51 0014	52
0132 703	40 51 0015	52
0132 704	40 51 0014	52
0132 708	40 92 7648	52
0132 709	40 92 7648	52
0132 715	40 92 7649	53
0132 716	40 92 7649	53
0132 717	40 92 7643	51
0132 718	40 92 7647	51
0132 719	40 92 7645	50
0132 720	40 92 7645	50
0132 721	40 92 7644	50
0132 724	40 92 7647	51
0132 725	40 92 7646	51, 52
0132 731	40 92 7628	53
0132 739	40 92 7641	50
0132 742	40 92 7608	54
0132 743	40 92 7605	50
0132 749	40 92 7620	54
0132 757	40 92 7607	50
0132 865	40 92 9281	53
0176 105	40 93 6248	52
0176 124	40 93 6248	52
0176 387	40 93 4443	53
0176 413	40 92 7622	51
0176 414	40 92 7621	51

Ref. - No.

**SWAG**
GERMANY**SWAG**
GERMANY

Ref. - No.

SWAG
GERMANY

Ref. - No.

SWAG
GERMANY

0176 537	40 92 7623	54
0176 538	40 92 9281	53
0176 541	40 93 6249	52
0176 541	40 93 6250	52
0176 604	40 51 0045	50
0176 605	40 51 0038	52
0176 608	40 92 7629	54
0176 609	40 92 9281	53
0176 674	40 93 6248	52
0176 676	40 93 6250	52
0176 725	40 92 7629	54
1178 224	40 92 7617	53, 54
1180 401	40 92 7627	52
1180 402	40 92 7616	53
1180 403	40 92 7610	52
1180 405	40 92 7603	50
1340 530	40 03 0023	119, 120
1340 538	20 52 0007	119
1340 545	40 03 0023	119, 120
1340 548	40 03 0023	119, 120
1340 549	40 03 0023	119, 120
1340 552	20 52 0007	119
1340 653	20 52 0007	119
4414 419	40 93 4515	54
4705 684 SK	84 92 9198	50
4705 685 SK	84 92 9198	50
4706 265 SK	84 92 9198	50
4706 266 SK	84 92 9198	50
5132 267	40 93 3974	51
5176 765	40 92 7625	50

passend für / to fit

PEUGEOT

5751.41	62 92 8278	121, 122
5751.44	62 91 9072	121, 122
5751.81	62 91 9072	121, 122
7925.08	62 92 8031	57
7925.09	62 92 8027	56
7925.10	62 92 8031	57
7925.18	62 93 4419	56
7925.22	62 93 4418	57
7925.23	62 93 4418	57
8731.85	62 51 0022	55
8731.86	62 51 0022	55

8731.93	62 51 0013	55, 56
8731.A2	62 93 8235	56
8731.C1	64 51 0014	58
8731.C5	62 92 8029	57
8731.E0	64 93 4433	59
8731.E1	62 92 8026	56
8731.E2	62 51 0013	55, 56
8731.E6	62 91 8563	55
8731.F0	62 92 8030	57
8731.F2	62 92 7905	55
8731.F8	62 92 8028	56
8731.G4	62 92 9261	55
8731.G5	62 92 9262	55
8731.G6	64 93 4434	58
8731.G9	62 93 4413	58
8731.H4	62 93 4411	58
8731.H6	62 93 4411	58
8731.J3	64 92 8002	55
8731.J6	62 92 8033	57
8731.K4	62 92 8032	57
8731.K5	62 92 8034	57
8731.L0	64 92 8002	55
8731.L7	62 93 4421	56
8731.N6	62 93 4422	56
8731.P5	64 93 4429	58
8731.P6	64 93 4433	59
8731.P8	62 93 4435	56
8731.P9	62 93 4420	56
8731.Q0	62 93 4420	56
8731.Q1	80 93 3393	58
8731.Q2	80 93 3393	58
8731.Q5	62 93 4415	57
8731.Q6	62 93 4417	57
8731.Q7	62 93 4416	57
8731.Q8	62 93 4414	57
8731.Q9	64 93 4429	58
8731.R8	64 93 4430	59
8731.R9	64 93 4431	59
8731.S0	64 93 4425	59
8731.S7	62 93 4422	56
8731.T3	62 92 8034	57
8731.T4	62 93 4410	58
8731.V0	64 93 4428	58



Ref. - No.



8731.V6	64 93 4424	59
9614.V4	62 93 4412	58
96 200 388 80	62 92 8278	121, 122
96 523 712 80	62 93 4419	56

passend für / to fit

PORSCHE

964 511 331 00	38 92 7915	60
993 511 331 00	38 92 7915	60
944 511 351 00	38 51 0003	60
944 511 351 01	38 51 0003	60
955 511 359 00	38 92 9267	61
955 511 359 00	38 92 9269	61
955 512 528 00	38 92 9268	61
955 512 550 01	38 92 9269	61
955 512 550 02	38 92 9269	61
955 512 550 03	38 92 9269	61
955 512 550 04	38 92 9269	61
955 512 550 05	38 92 9269	61
955 512 550 06	38 92 9269	61
955 512 550 07	38 92 9269	61
986 512 551 01	38 92 7898	60
987 512 551 01	38 92 7907	61
987 512 551 03	38 93 2984	61
987 512 551 04	38 93 2984	61
987 512 551 05	38 92 7907	61
996 511 551 01	38 92 7884	60
997 511 551 01	38 92 7902	60, 61
997 512 551 00	38 92 7899	60

passend für / to fit

RENAULT

60 25 106 762	60 93 1029	62
60 25 300 735	60 92 7910	62
65 47 000 08R	60 93 2895	65
65 47 100 03R	60 93 2894	64
65 47 129 43R	60 93 8232	62
77 00 303 139	60 92 7903	63
77 00 303 186	60 92 7903	63
77 00 430 022	60 92 7889	65
77 00 434 465	82 92 7887	65
77 00 800 311	60 51 0007	62
77 00 807 057	60 92 9895	64
77 00 815 135	60 92 7901	65
77 00 828 451	60 92 7906	63

Ref. - No.



77 00 828 454	60 92 7888	65
77 00 838 487	60 92 7904	63
77 00 838 612	60 93 0095	63
77 00 842 152	60 92 9444	63
77 00 842 153	60 92 9444	63
77 00 842 256	60 92 7885	62
77 00 843 698	60 92 7906	63
77 00 846 772	60 92 9444	63
77 00 846 773	60 92 9444	63
77 01 057 303	60 93 8236	64
82 00 000 902	60 93 2899	63
82 00 003 020	60 93 2899	63
82 00 021 974	60 93 2897	62
82 00 021 975	60 93 2897	62
82 00 025 105	60 93 2898	62
82 00 051 750	60 92 7914	64
82 00 091 749	60 93 2892	62
82 00 119 497	60 92 7895	64
82 00 119 498	60 92 7893	64
82 00 119 500	60 92 7920	65
82 00 130 187	60 92 7892	65
82 00 135 264	60 92 7891	64
82 00 174 571	60 92 7919	65
82 00 212 598	60 92 7894	64
82 00 219 322	60 93 2903	64
82 00 219 323	60 93 2904	64
82 00 299 546	60 93 2896	62
82 00 362 400	60 93 2893	62
82 00 377 199	60 92 7919	65
82 00 377 789	60 92 7920	65
82 00 385 560	60 93 2908	65
82 00 461 349	60 93 2904	64
82 00 735 264	60 93 1438	62
84 43 000 04R	60 93 2900	63
84 43 100 02R	60 93 2900	63
90 45 000 04R	60 93 2906	65
90 45 100 01R	60 93 2902	64
90 45 100 05R	60 93 2907	65
90 45 200 04R	60 93 8233	62
90 46 000 01R	60 93 2901	63

passend für / to fit

ROVER

BMH 500010	81 92 8088	61
------------	------------	----

Ref. - No.

**SWAG**
GERMANY**SWAG**
GERMANY

Ref. - No.

SWAG
GERMANY

Ref. - No.

SWAG
GERMANY

passend für / to fit

SAAB

12 768 264	57 92 9205	68
12 785 021	57 92 9257	68
12 797 509	57 92 9258	68
30 586 552	57 92 9204	67
40 06 060	57 92 7656	67
40 28 064	57 52 0001	123
43 06 411	57 92 7656	67
43 23 994	57 92 7654	67
43 24 307	57 92 7655	67
43 26 468	57 92 7655	67
45 75 478	40 03 0023	123
46 99 260	57 92 9205	68
48 54 717	57 92 7653	67
48 54 733	57 92 7653	67
48 54 741	57 92 7650	67
48 54 758	57 92 7650	67
48 55 094	57 92 7652	68
48 55 128	57 92 7651	68
49 01 419	57 52 0001	123
50 22 082	57 92 7653	67
51 17 015	57 92 7652	68
51 83 017	57 92 9204	67
53 60 821	57 92 7651	68
53 60 839	57 92 7652	68
69 76 369	57 92 9256	67
91 80 809	40 03 0023	123
92 93 580	57 92 9935	67

passend für / to fit

SEAT

1M0 823 359 A	30 92 7705	70
7M3 823 359	30 92 7664	69
7M3 823 359 A	30 92 7664	69
7M3 823 359 B	30 92 7664	69
7N0 823 359	30 93 8188	69
1L0 827 550	30 92 7707	70
1L0 827 550 A	30 92 7707	70
1M5 827 550 B	30 92 7706	70
1M6 827 550 A	30 92 7708	70
1P0 827 550	30 93 4113	70
1P0 827 550 A	30 93 4113	70
1P9 827 550	30 93 4113	70

3R9 827 550	30 93 1648	69
5P5 827 550 A	30 93 1651	70
6J3 827 550	30 93 1649	70
6J4 827 550 B	30 93 1650	70
6K0 827 550	30 93 1028	69
6K0 827 550 A	30 93 1028	69
6K6 827 550	30 92 7709	69
6K6 827 550 A	30 92 7709	69
6L6 827 550 B	30 92 7710	69
7M0 827 550 D	32 92 3390	69
7M0 827 550 F	32 92 3390	69
7M0 827 550 G	32 92 3390	69
7N0 827 550	30 93 8189	69
038 903 315 C	30 92 1690	124

passend für / to fit

SKODA

059 145 284	30 92 7604	121
059 145 284 B	30 92 7604	121
3T0 823 359	30 93 1633	72
3U0 823 359	30 92 7711	72
1U6 827 550 E	30 92 7713	71
1U6 827 550 F	30 92 7713	71
1U6 827 550 H	30 92 7715	71
1U9 827 550 B	30 92 7712	71
1Z5 827 550	30 93 1656	72
1Z5 827 550 B	30 93 1656	72
1Z5 827 550 C	30 93 1656	72
1Z5 827 550 D	30 93 1656	72
1Z5 827 550 E	30 93 1656	72
1Z9 827 550	30 93 1657	72
3B5 827 550 E	30 92 9435	72
3T5 827 550	30 93 1659	72
3T9 827 550	30 93 8237	72
5J6 827 550 B	30 93 1654	71
5J7 827 550	30 93 1658	72
6Y0 827 550 C	30 93 1652	71
6Y5 827 550 A	30 93 1653	71
6U0 827 551	30 92 9320	71
6U0 827 551 B	30 92 9320	71
3T5 827 552	30 93 1660	72
038 903 315 C	30 92 1690	125



Ref. - No.



passend für / to fit

SMART

0000618V007000000	10 92 7732	73
0004873V002	12 92 7569	131
0004873V002000000	12 92 7569	131
451 988 00 04	12 93 0351	73

passend für / to fit

SUZUKI

81850-84E00-000 SK	84 92 9198	71
81860-84E00-000 SK	84 92 9198	71

passend für / to fit

TOYOTA

68950-02020	81 92 9978	75
68950-02030	81 92 9979	75
68950-02080	81 92 8085	75
68950-02081	81 92 8085	75
68950-09080	81 92 8078	75
68950-09090	81 92 9978	75
68950-09100	81 92 9979	75
68950-09150	81 92 8080	75
68950-09320	81 92 8080	75
68950-09340	81 92 8080	75
68950-09341	81 92 8080	75
68950-0D020	81 92 8081	71
68950-0D021	81 92 8081	71
68950-0D022	81 92 8081	71
68950-0F010	81 92 8084	75
68950-0F011	81 92 8084	75
68950-0F012	81 92 8084	75
68950-0H010	64 92 8002	75
68950-0W250	81 92 9290	76
68950-0W251	81 92 9290	76
68950-0W252	81 92 9290	76
68950-80020	81 92 8077	75
68960-02010	81 92 9978	75
68960-02020	81 92 9979	75
68960-02070	81 92 8085	75
68960-02071	81 92 8085	75
68960-09050	81 92 8078	75
68960-09060	81 92 9978	75
68960-09070	81 92 9979	75
68960-09100	81 92 8080	75
68960-09250	81 92 8080	75

Ref. - No.



68960-09260	81 92 8080	75
68960-09261	81 92 8080	75
68960-0D010	81 92 8081	71
68960-0D011	81 92 8081	71
68960-0D012	81 92 8081	71
68960-0F010	81 92 8084	75
68960-0F011	81 92 8084	75
68960-0F012	81 92 8084	75
68960-0W240	81 92 9290	76
68960-0W241	81 92 9290	76
68960-0W242	81 92 9290	76
68960-19525	81 92 6270	75
68960-59025	81 92 6268	76
68960-59026	81 92 6268	76

passend für / to fit

VAUXHALL

9114311	40 92 7626	79
9118848	20 52 0007	126
9146281	40 92 7610	80
9152393	40 92 7609	80
9180255	40 92 7629	81
9180256	40 92 9281	80
9180809	40 03 0023	121, 126, 127
09210307 SK	84 92 9198	77
09210308 SK	84 92 9198	77
09212659 SK	84 92 9198	77
09212660 SK	84 92 9198	77
13101335	40 92 7623	81
13122695	40 92 7607	78
13128759	40 92 7620	81
13182309	40 92 7622	79
13182537	40 92 7621	79
13191401	40 92 9281	80
13220159	40 92 7619	78
13241974	40 92 7629	81
13243589	40 92 7625	78
13246577	40 93 6248	79
13247867	40 92 7623	81
13247868	40 92 9281	80
13247949	40 93 6250	79
13258179	40 93 6220	78
13278257	40 93 6249	79
13321298	40 93 6248	79

Ref. - No.

**SWAG**
GERMANY**SWAG**
GERMANY

Ref. - No.

SWAG
GERMANY

Ref. - No.

SWAG
GERMANY

13332570	40 93 6248	79
13332885	40 93 6249	79
24454473	40 92 7617	80, 81
24463829	40 92 7605	78
24465295	40 92 7603	78
90159607	40 51 0014	77
90191627	40 51 0015	77
90191920	40 51 0014	77
90227934	40 92 7649	78
90227936	40 92 7649	78
90246620	40 92 7648	78
90246621	40 92 7648	78
90341282	40 92 7644	77
90341377	40 92 7645	77
90341378	40 92 7645	77
90346469	40 92 7643	78
90379025	40 92 7627	80
90379054	40 51 0038	80
90379081	40 51 0037	80
90388707	40 92 7646	79
90463253	40 93 4443	80
90463721	40 92 7616	80
90463781	40 92 7628	80
90481269	40 92 7647	79
90481270	40 92 7647	79
90486893	40 51 0045	77
90502421	40 03 0023	121, 126, 127
90509168	20 52 0007	126
90521517	40 92 7614	77
90542637	40 03 0023	121, 126, 127
90542638	40 03 0023	121, 126, 127
90543873	20 52 0007	126
90559245	40 92 7641	77
90579440	40 92 7608	81
91163328	40 93 3974	79
91166378	40 93 4515	81
91168256	40 93 4515	81
9199 932	40 93 4509	77

passend für / to fit

VOLKSWAGEN

059 145 284	30 92 7604	128
059 145 284 B	30 92 7604	128
1C0 823 359 A	30 92 9395	84

1C0 823 359 B	30 92 9395	84
1C0 823 359 C	30 92 9395	84
1C0 823 359 D	30 92 9395	84
1C0 823 359 E	30 92 9395	84
1J0 823 359 C	32 92 3386	82, 83
1J0 823 359 D	32 92 3386	82, 83
1K0 823 359 A	30 92 9434	84
1Q0 823 359	30 93 1632	83
1T0 823 359	30 92 9440	87
1T0 823 359 A	30 92 9440	87
1T0 823 359 C	30 92 9440	87
1T0 823 359 D	30 93 8190	82, 88
3AA 823 359 A	30 93 7480	86
3B0 823 359 A	32 92 3382	85
3B0 823 359 B	32 92 3382	85
3B0 823 359 C	30 92 7693	85
3B0 823 359 D	30 92 7693	85
3C0 823 359 A	30 93 1629	86
3C8 823 359	30 93 1630	86
4B0 823 359 B	30 92 7693	85
4B0 823 359 C	30 92 7693	85
5K0 823 359 B	30 93 1631	84
5K0 823 359 C	30 93 1631	84
5K0 823 359 D	30 93 1631	84
6E0 823 359 C	30 92 9275	84
6Q0 823 359	30 92 9438	86
6Q0 823 359 A	30 92 9438	86
6Q0 823 359 C	30 92 9438	86
6X0 823 359	30 92 9275	84
6X0 823 359 A	30 92 9275	84
7D0 823 359 A	30 92 7668	88, 89
7H0 823 359 A	30 92 9441	89
7H0 823 359 B	30 92 9441	89
7H0 823 359 C	30 92 9441	89
7L6 823 359 A	30 92 7663	87
7L6 823 359 B	30 92 7663	87
7M3 823 359	30 92 7664	87
7M3 823 359 A	30 92 7664	87
7M3 823 359 B	30 92 7664	87
7N0 823 359	30 93 8188	87
8L0 823 359	32 92 3386	82, 83
8L0 823 359	30 51 0050	83, 84
1J0 827 359 A	32 92 3386	82, 83



Ref. - No.



191 827 550	30 51 0018	83
191 827 550 B	30 51 0018	83
1C0 827 550 A	30 92 9274	84
1C0 827 550 B	30 92 9274	84
1C0 827 550 C	30 92 9274	84
1C0 827 550 D	30 92 9274	84
1C0 827 550 E	30 92 9274	84
1C0 827 550 F	30 92 9274	84
1E0 827 550	30 92 7659	83
1E0 827 550 A	30 92 7659	83
1E0 827 550 B	30 92 7659	83
1H5 827 550 A	30 92 8558	90
1H5 827 550 B	30 92 8558	90
1H6 827 550	30 51 0031	83
1H6 827 550 A	30 51 0031	83
1H9 827 550 A	30 51 0060	83
1J6 827 550	32 92 3380	82, 83, 85
1J6 827 550 C	32 92 3388	82, 83, 85
1J6 827 550 E	32 92 3380	82, 83, 85
1J9 827 550	32 92 3380	82, 83, 85
1K5 827 550 C	30 93 7501	84
1K6 827 550 D	30 92 7666	84
1K6 827 550 E	30 92 7666	84
1K6 827 550 F	30 92 7666	84
1K8 827 550 A	30 93 1647	87
1Q0 827 550 B	30 93 1646	83
1S6 827 550 D	30 93 8187	90
1T0 827 550 A	30 92 7673	87
1T0 827 550 B	30 92 7673	87
1T0 827 550 C	30 92 7673	87
1T0 827 550 E	30 93 7482	82
1T0 827 550 H	30 93 8191	82, 88
2K0 827 550	30 93 1645	82
2K0 827 550 A	30 93 1645	82
331 827 550 C	30 51 0030	85
333 827 550	30 51 0064	85
3A9 827 550	30 51 0064	85
3AE 827 550 A	30 93 7479	86
3AF 827 550 B	30 93 7481	86
3B5 827 550	32 92 3398	85
3B5 827 550 A	32 92 3398	85
3B5 827 550 E	30 92 9435	82, 85
3B5 827 550 G	30 92 9436	85

Ref. - No.



3B9 827 550	32 92 3380	82, 83, 85
3C5 827 550 A	30 93 1640	86
3C5 827 550 B	30 93 1640	86
3C5 827 550 C	30 93 1640	86
3C9 827 550 A	30 93 1641	86
5K6 827 550 B	30 93 1644	84
5K7 827 550 A	30 93 7495	84
5K7 827 550 B	30 93 7495	84
5N0 827 550	30 93 1643	87
5Z6 827 550 B	30 93 8192	82
6E0 827 550 A	30 92 9275	84
6E0 827 550 C	30 92 9275	84
6K0 827 550	30 93 1028	86
6K0 827 550 A	30 93 1028	86
6N0 827 550 A	30 92 8557	86
6Q6 827 550	30 92 7665	86
6Q6 827 550 C	30 92 7665	86
6R6 827 550 A	30 93 1642	87
7H0 827 550	32 92 3392	89
7H0 827 550 C	30 92 9442	89
7L6 827 550 A	30 92 9439	87
7L6 827 550 D	30 92 9439	87
7L6 827 550 K	30 92 9439	87
7L6 827 550 P	30 92 9439	87
7M0 827 550 D	32 92 3390	87
7M0 827 550 F	32 92 3390	87
7M0 827 550 G	32 92 3390	87
7N0 827 550	30 93 8189	87
8D5 827 552 B	32 92 3398	85
8D5 827 552 C	32 92 3398	85
8D5 827 552 F	32 92 3398	85
251 829 331 A	30 51 0010	88
251 829 331 B	30 92 7661	88
701 829 331 AB	30 92 7658	89
701 829 331 F	30 92 8555	88
701 829 331 G	30 92 8552	88
701 829 331 H	30 92 3396	88
701 829 331 J	30 92 7669	88
701 829 331 Q	30 92 8554	89
701 829 331 R	30 92 8553	89
701 829 331 S	30 92 7672	89
701 829 331 T	30 92 7671	89
7D0 829 331 D	30 92 8554	89



10 51 0001	123 980 01 64	40
10 51 0002	201 880 03 29	40, 45
10 51 0008	124 980 01 64	40
10 51 0009	202 880 00 29	40
10 51 0017	210 880 04 29	43
10 51 0021	638 980 03 64	46
10 51 0022	001 980 80 64	43
10 52 0003	124 463 04 32	131, 133, 134, 135
10 52 0008	000 463 51 32	133, 134, 135
10 52 0012	103 200 01 14	107, 108, 109, 110, 115, 116
10 52 0015	102 200 14 14	106, 108, 109, 113
10 52 0018	604 200 03 14	107, 108, 113, 114, 115, 116
10 52 0019	102 200 15 14	106, 109
10 52 0023	604 200 02 14	106, 107, 108, 110, 112, 113, 114, 115, 118
10 52 0025	112 200 00 14	110, 111, 112, 113, 114, 116, 117
10 91 9995	111 200 04 14	106, 110, 111, 112, 114, 117, 118
10 92 2621	163 740 03 45 S1	44
10 92 2622	163 880 00 29	44
10 92 4327	203 740 00 45	41
10 92 4707	168 980 12 64	40
10 92 4709	251 740 00 45	45
10 92 4710	171 880 01 29	46
10 92 4711	169 740 00 45	40
10 92 4712	639 980 01 64	46
10 92 4713	220 880 03 29	45
10 92 4718	251 740 02 45	45
10 92 4719	171 980 01 64	46
10 92 4731	164 880 01 29	44
10 92 4733	203 880 04 29	41, 42
10 92 4735	170 880 02 29 S1	46
10 92 4737	164 880 00 29	44
10 92 4738	251 880 02 29	45
10 92 4739	203 880 00 29	41, 42
10 92 7011	211 980 03 64	43
10 92 7454	272 200 01 14	111, 112, 113, 114, 115, 117, 118



10 92 7572	140 463 03 32	135
10 92 7731	215 880 00 29	41
10 92 7732	0000618V007000000	73
10 92 7733	221 880 03 29	42, 45
10 92 7734	129 980 06 64	45
10 92 7736	169 980 08 64	40
10 92 7737	208 880 00 29	42
10 92 7738	208 750 03 36	42
10 92 7739	203 980 01 64	41
10 92 7740	414 980 00 64	46
10 92 7741	124 750 04 36	40
10 92 7742	129 980 05 64	45
10 92 7743	211 880 00 29	42, 43
10 92 7744	230 750 00 36	46
10 92 7745	230 880 00 29	46
10 92 7746	209 980 01 64	42
10 92 7747	221 750 02 36	45
10 92 7748	639 980 03 64	46
10 92 7758	1 093 705	26
10 92 7830	230 980 01 64	46
10 92 7831	230 980 02 64	46
10 92 7832	209 980 05 64	42
10 92 8559	171 750 00 36	46
10 92 8561	124 750 06 36	40
10 92 8562	164 740 01 45	44
10 92 8563	164 740 02 45	44
10 92 9334	164 740 03 45	44
10 92 9336	164 980 01 64	44
10 92 9338	164 740 05 45	44
10 92 9339	164 740 06 45	44
10 93 0439	202 980 03 64	40
10 93 0879	204 880 00 29	43
10 93 0880	204 980 00 64	41
10 93 0881	204 980 09 64	41
10 93 0882	204 980 11 64	41
10 93 0883	204 740 01 45	41
10 93 1449	000 463 66 32	134
10 93 1450	000 463 60 32	134
10 93 2045	211 980 19 64	43
10 93 2046	211 980 20 64	43
10 93 2047	211 980 13 64	43
10 93 2048	211 980 14 64	43
10 93 4112	170 750 00 36	46



10 93 7085	204 980 05 64	44
10 93 7274	209 690 00 59	42
10 93 7868	124 463 05 32	133
11 92 7589	41 62 6 801 258	47
11 92 7598	41 61 6 801 259	47
11 92 7598	51 23 4 360 740	47
11 92 7598	51 23 7 066 566	47
11 92 7598	51 23 7 160 818	47
11 92 7598	51 23 7 175 020	47
11 93 4517	51 23 7 148 864	47
11 93 4518	51 24 7 148 902	47
12 92 7569	0004873V002000000	131
12 93 0351	451 988 00 04	73
20 51 0001	51 23 1 927 129	13
20 51 0002	51 23 1 869 147	13, 14
20 51 0003	51 23 1 906 286	11
20 51 0004	51 23 1 944 119	13
20 51 0005	51 23 1 908 465	14
20 51 0006	51 24 1 908 431	14
20 51 0007	51 24 8 110 327	13
20 51 0014	51 23 1 960 852	11
20 51 0020	51 23 8 119 558	11
20 51 0024	51 23 8 150 077	14
20 51 0025	51 24 8 151 579	11
20 51 0027	51 24 1 960 862	11
20 51 0032	51 23 8 174 866	13
20 51 0043	51 24 8 254 281	12
20 51 0045	51 23 8 202 688	12
20 52 0004	11 28 1 717 188	96, 97, 98, 99, 100, 101
20 52 0005	11 28 1 717 210	96, 97, 99, 100, 101
20 52 0006	11 28 1 715 626	98, 99
20 52 0007	11 28 2 248 168	96, 97, 98
20 52 0007	9118848	126
20 52 0007	1340 653	119
20 52 0009	11 28 1 247 051	96, 97
20 52 0015	11 28 1 745 545	98, 99, 100
20 52 0016	11 28 1 709 613	98, 99, 100
20 52 0017	11 28 2 248 169	96, 97
20 91 8483	11 28 7 838 797	96, 97, 98, 99, 100, 101
20 91 8484	11 28 1 717 210 S1	96, 97, 99, 100, 101
20 91 8485	11 28 1 247 051 S1	96, 97

20 92 3649	51 23 8 240 596	14
20 92 6057	51 23 7 008 745	13
20 92 7560	11 28 1 745 547	98, 99, 100
20 92 7561	11 28 1 745 546	98, 99, 100
20 92 7585	51 24 8 206 652	11
20 92 7586	51 23 7 118 370	11
20 92 7587	51 24 8 227 895	12
20 92 7588	51 24 3 400 379	14
20 92 7590	51 24 8 232 873	12
20 92 7591	51 23 3 400 352	14
20 92 7593	51 23 7 016 178	15
20 92 7594	51 24 8 402 405	14
20 92 7595	51 23 8 402 551	14
20 92 7596	51 24 8 171 480	14
20 92 7597	51 24 8 190 688	13
20 92 7599	51 23 7 060 550	12
20 92 7600	51 24 7 016 186	15
20 92 7601	51 24 8 245 031	11
20 92 7602	51 24 8 222 913	13
20 92 9259	51 24 7 060 622	11
20 92 9263	51 24 8 149 327	13
20 92 9264	51 24 8 149 328	13
20 92 9364	51 24 8 220 072	13
20 93 0233	51 24 8 399 087	15
20 93 0234	51 24 8 410 755	15
20 93 1025	51 24 1 947 096	11
20 93 3538	51 23 8 397 401	15
20 93 4200	51 24 7 250 308	12
20 93 4505	41 62 7 166 758	11
20 93 4506	51 24 7 127 875	12
20 93 4508	51 24 7 129 215	12
20 93 4510	51 23 7 183 741	14
20 93 4512	51 23 7 185 032	14
20 93 4514	51 23 7 148 346	15
20 93 6960	41 61 2 990 344	14
20 93 8231	51 24 7 118 885	12
30 51 0010	251 829 331 A	88
30 51 0013	443 823 359 D	3, 4
30 51 0018	191 827 550 B	83
30 51 0019	893 827 552	3
30 51 0025	4A5 827 552	3, 6
30 51 0026	4A0 823 359 C	6, 7
30 51 0030	331 827 550 C	85



30 51 0031	1H6 827 550 A	83
30 51 0050	8L0 823 359	4
30 51 0050	8L0 823 359	83, 84
30 51 0060	1H9 827 550 A	83
30 51 0064	3A9 827 550	85
30 92 1690	038 903 315 C	95
30 92 1690	038 903 315 C	128, 129
30 92 1690	038 903 315 C	125
30 92 1690	038 903 315 C	124
30 92 3396	701 829 331 H	88
30 92 7172	8N8 827 552 A	9
30 92 7604	059 145 284 B	95
30 92 7604	059 145 284 B	128
30 92 7604	059 145 284 B	121
30 92 7606	4A0 425 021	130, 131, 132
30 92 7611	4D0 425 021 D	131, 132
30 92 7613	8A1 425 021	130, 131
30 92 7658	7D0 829 331 G	89
30 92 7659	1E0 827 550 B	83
30 92 7660	251 829 332	88
30 92 7661	251 829 331 B	88
30 92 7663	7L6 823 359 B	87
30 92 7664	1 133 865	27
30 92 7664	7M3 823 359 A	87
30 92 7664	7M3 823 359 A	69
30 92 7665	6Q6 827 550	86
30 92 7666	1K6 827 550 F	84
30 92 7667	7L6 845 587 A	87
30 92 7668	7D0 823 359 A	88, 89
30 92 7669	701 829 331 J	88
30 92 7671	701 829 331 T	89
30 92 7672	7D0 829 331 F	89
30 92 7673	1T0 827 550 C	87
30 92 7674	4B9 827 552 N	7
30 92 7675	4D0 823 359 F	8
30 92 7676	8Z0 898 552	4
30 92 7677	4A0 823 359 B	3, 4
30 92 7678	443 823 359 B	3, 4, 9
30 92 7682	8D9 827 552 H	4
30 92 7683	8N8 827 552 B	9
30 92 7684	8N7 827 552 C	9
30 92 7690	8E0 823 359 A	5, 6
30 92 7691	8A9 827 552 D	3, 130



30 92 7692	4A9 827 552 C	4, 6, 7
30 92 7693	3B0 823 359 D	85
30 92 7694	441 827 551	9
30 92 7695	8H0 823 359	6
30 92 7696	8A9 827 552 C	3
30 92 7705	1M0 823 359 A	70
30 92 7706	1M5 827 550 B	70
30 92 7707	1L0 827 550	70
30 92 7708	1M6 827 550 A	70
30 92 7709	6K6 827 550	69
30 92 7710	6L6 827 550 B	69
30 92 7711	3U0 823 359	72
30 92 7712	1U9 827 550 B	71
30 92 7713	1U6 827 550 F	71
30 92 7715	1U6 827 550 H	71
30 92 8327	4B5 827 552 G	5, 7
30 92 8343	8H0 827 552 B	6
30 92 8345	8A5 827 552 A	3
30 92 8346	4B9 827 552 M	7
30 92 8348	4D0 827 551 B	8
30 92 8350	8D0 823 359 B	5
30 92 8552	701 829 331 G	88
30 92 8553	7D0 829 331 E	89
30 92 8554	7D0 829 331 D	89
30 92 8555	701 829 331 F	88
30 92 8556	8A0 823 360 A	3, 8
30 92 8557	6N0 827 550 A	86
30 92 8558	1H5 827 550 B	90
30 92 9274	1C0 827 550 E	84
30 92 9275	6E0 823 359 C	84
30 92 9320	6U0 827 551 B	71
30 92 9395	1C0 823 359 E	84
30 92 9428	8E9 827 552 E	5
30 92 9429	8E5 827 552 J	5
30 92 9430	8E9 827 552 K	6
30 92 9431	8G0 827 552 C	8
30 92 9432	895 827 552 A	8
30 92 9433	8J0 823 359 C	9
30 92 9434	1K0 823 359 A	84
30 92 9435	3B5 827 550 E	82, 85
30 92 9435	3B5 827 550 E	72
30 92 9436	3B5 827 550 G	85
30 92 9438	6Q0 823 359 C	86



30 92 9439	7L6 827 550 P	87
30 92 9440	1T0 823 359 A	87
30 92 9441	7H0 823 359 C	89
30 92 9442	7H0 827 550 C	89
30 92 9445	8N0 823 359	9
30 93 1028	6K0 827 550	86
30 93 1028	6K0 827 550	69
30 93 1466	855 827 552 G	8, 10
30 93 1629	3C0 823 359 A	86
30 93 1630	3C8 823 359	86
30 93 1631	5K0 823 359 D	84
30 93 1632	1Q0 823 359	83
30 93 1633	3T0 823 359	72
30 93 1634	8P0 823 359 B	4, 5
30 93 1635	8T0 823 359	5, 6
30 93 1636	4F0 823 359 A	7, 8
30 93 1637	4E0 823 359 D	8
30 93 1638	8R0 823 359 A	9
30 93 1639	4L0 823 359	10
30 93 1640	3C5 827 550 C	86
30 93 1641	3C9 827 550 A	86
30 93 1642	6R6 827 550 A	87
30 93 1643	5N0 827 550	87
30 93 1644	5K6 827 550 B	84
30 93 1645	2K0 827 550 A	82
30 93 1646	1Q0 827 550 B	83
30 93 1647	1K8 827 550 A	87
30 93 1648	3R9 827 550	69
30 93 1649	6J3 827 550	70
30 93 1650	6J4 827 550 B	70
30 93 1651	5P5 827 550 A	70
30 93 1652	6Y0 827 550 C	71
30 93 1653	6Y5 827 550 A	71
30 93 1654	5J6 827 550 B	71
30 93 1656	1Z5 827 550 E	72
30 93 1657	1Z9 827 550	72
30 93 1658	5J7 827 550	72
30 93 1659	3T5 827 550	72
30 93 1660	3T5 827 552	72
30 93 1662	8P3 827 552 C	4
30 93 1663	8P4 827 552 B	4
30 93 1664	8P7 827 552 D	5
30 93 1666	8K9 827 552 B	5, 6

30 93 1667	8K9 827 552 A	5, 6
30 93 1670	8F0 827 550 A	6
30 93 1672	4F5 827 552	7
30 93 1673	4F5 827 552 B	7
30 93 1674	4F9 827 552 E	7, 8
30 93 1676	4F9 827 552 C	7
30 93 1677	4F9 827 552 D	7, 8
30 93 1678	4E0 827 551 A	8
30 93 1679	4E0 827 551 C	8
30 93 1680	4E0 827 552 C	8
30 93 1681	8R0 827 552	9
30 93 1683	4L0 827 552 E	10
30 93 1684	4L0 827 552 F	10
30 93 1831	8R0 827 552 A	9
30 93 4113	1P0 827 550 A	70
30 93 7479	3AE 827 550 A	86
30 93 7480	3AA 823 359 A	86
30 93 7481	3AF 827 550 B	86
30 93 7482	1T0 827 550 E	82
30 93 7483	8K5 827 919 A	5
30 93 7491	8T0 827 919	6
30 93 7492	8T8 827 552 B	6
30 93 7495	5K7 827 550 A	84
30 93 7501	1K5 827 550 C	84
30 93 8187	1S6 827 550 D	90
30 93 8188	7N0 823 359	87
30 93 8188	7N0 823 359	69
30 93 8189	7N0 827 550	87
30 93 8189	7N0 827 550	69
30 93 8190	1T0 823 359 D	82, 88
30 93 8191	1T0 827 550 H	82, 88
30 93 8192	5Z6 827 550 B	82
30 93 8237	3T9 827 550	72
30 93 9259	8X3 827 552	4
30 93 9260	8X4 827 552	4
30 93 9261	8A0 823 359 B	9
30 93 9262	8U0 827 552 A	9
32 92 3378	4B5 827 552 D	7
32 92 3380	1J6 827 550 E	82, 83, 85
32 92 3382	3B0 823 359 B	85
32 92 3386	1J0 823 359 D	82, 83
32 92 3388	1J6 827 550 C	82, 83, 85
32 92 3390	1 094 814	27



32 92 3390	7M0 827 550 G	87
32 92 3390	7M0 827 550 G	69
32 92 3392	7H0 827 550	89
32 92 3394	8D9 827 552 F	4, 5
32 92 3398	8D5 827 552 F	5
32 92 3398	8D5 827 552 F	85
32 92 8550	046 145 299	95
38 51 0003	944 511 351 01	60
38 92 7884	996 511 551 01	60
38 92 7898	986 512 551 01	60
38 92 7899	997 512 551 00	60
38 92 7902	997 511 551 01	60, 61
38 92 7907	987 512 551 05	61
38 92 7915	993 511 331 00	60
38 92 9267	955 511 359 00	61
38 92 9268	955 512 528 00	61
38 92 9269	955 512 550 06	61
38 93 2984	987 512 551 04	61
40 03 0023	9180809	121, 126, 127
40 03 0023	91 80 809	123
40 03 0023	1340 530	119, 120
40 51 0014	90159607	77
40 51 0014	0132 704	52
40 51 0015	90191627	77
40 51 0015	0132 703	52
40 51 0037	90379081	80
40 51 0037	0132 675	52
40 51 0038	90379054	80
40 51 0038	0176 605	52
40 51 0045	90486893	77
40 51 0045	0176 604	50
40 92 7603	24465295	78
40 92 7603	1180 405	50
40 92 7605	24463829	78
40 92 7605	0132 743	50
40 92 7607	13122695	78
40 92 7607	0132 757	50
40 92 7608	90579440	81
40 92 7608	0132 742	54
40 92 7609	9152393	80
40 92 7609	0132 681	53
40 92 7610	9146281	80
40 92 7610	1180 403	52



40 92 7614	90521517	77
40 92 7614	0132 677	50
40 92 7616	90463721	80
40 92 7616	1180 402	53
40 92 7617	24454473	80, 81
40 92 7617	1178 224	53, 54
40 92 7619	13220159	78
40 92 7619	0132 532	50
40 92 7620	13128759	81
40 92 7620	0132 749	54
40 92 7621	13182537	79
40 92 7621	0176 414	51
40 92 7622	13182309	79
40 92 7622	0176 413	51
40 92 7623	13247867	81
40 92 7623	0176 537	54
40 92 7625	13243589	78
40 92 7625	5176 765	50
40 92 7626	9114311	79
40 92 7626	0132 670	51
40 92 7627	90379025	80
40 92 7627	1180 401	52
40 92 7628	90463781	80
40 92 7628	0132 731	53
40 92 7629	13241974	81
40 92 7629	0176 725	54
40 92 7641	90559245	77
40 92 7641	0132 739	50
40 92 7643	90346469	78
40 92 7643	0132 717	51
40 92 7644	90341282	77
40 92 7644	0132 721	50
40 92 7645	90341378	77
40 92 7645	0132 719	50
40 92 7646	90388707	79
40 92 7646	0132 725	51, 52
40 92 7647	90481269	79
40 92 7647	0132 718	51
40 92 7648	90246621	78
40 92 7648	0132 709	52
40 92 7649	90227936	78
40 92 7649	0132 715	53
40 92 9281	13247868	80



40 92 9281	0176 538	53
40 93 3974	91163328	79
40 93 3974	5132 267	51
40 93 4443	90463253	80
40 93 4443	0176 387	53
40 93 4509	9199 932	77
40 93 4509	0132 531	50
40 93 4515	91168256	81
40 93 4515	4414 419	54
40 93 6220	13258179	78
40 93 6220	0132 016	51
40 93 6248	13332570	79
40 93 6248	0176 124	52
40 93 6249	13332885	79
40 93 6249	0132 020	52
40 93 6250	13247949	79
40 93 6250	0176 676	52
50 51 0025	1 650 687	24
50 51 0028	6 900 216	24
50 51 0029	6 900 217	24
50 51 0034	1 025 425	27
50 51 0035	6 142 658	30
50 51 0040	1 020 155	28
50 51 0043	1 020 156	28
50 51 0044	6 789 158	28
50 51 0045	6 844 981	28
50 51 0046	6 934 502	28
50 51 0049	1 008 277	25
50 51 0049	1E00-62-620	39
50 51 0053	6 142 657	30
50 92 7757	1 141 159	25
50 92 7759	6 734 734	24
50 92 7760	1 117 246	29
50 92 7761	1 075 742	24
50 92 7762	1 232 189	29
50 92 7766	1 252 377	26, 27
50 92 7767	1 349 309	26, 27
50 92 7768	1 321 021	26
50 92 7769	1 121 248	29
50 92 7770	1 376 673	26
50 92 7771	1 120 812	29
50 92 7772	4 134 633	30
50 92 7773	1 074 368	26

50 92 7774	1 008 276	25
50 92 7776	1 150 277	26
50 92 7777	1 124 003	26
50 92 7778	1 146 649	26
50 92 7779	1 119 688	29
50 92 7782	6 965 594	25
50 92 7784	1 251 915	25
50 92 7785	1 313 218	26
50 92 7786	6 734 732	24
50 92 7787	1 436 155	27
50 92 7789	1 088 369	29
50 93 1946	1 708 365	28
50 93 1947	1 539 291	27
50 93 1948	1 434 296	30
50 93 1949	1 434 313	27
50 93 1950	1 542 413	27
50 93 1951	1 484 371	29
50 93 1952	1 492 389	29
50 93 1953	1 495 030	29
50 93 1954	1 496 865	29
50 93 1955	1 477 988	29
50 93 1956	1 729 322	28
50 93 4507	4 378 216	30, 31
50 93 8234	1 666 068	25
55 51 0005	1355263	91, 94
55 51 0005	6846014	91, 94
55 51 0005	9463056	91, 94
55 51 0016	3509482	91, 93
55 51 0016	9187315	91, 93
55 51 0016	9485548	91, 93
55 51 0024	30803472	93
55 92 2716	3526575	91, 93
55 92 2717	3509350	91
55 92 2717	3512998	91
55 92 2718	30819865	92, 93
55 92 7630	30852059	92
55 92 7630	30852060	92
55 92 7631	9159604	92
55 92 7631	9187795	92
55 92 7631	9187796	92
55 92 7631	9485546	92
55 92 7631	9485547	92
55 92 7632	30716057	92



55 92 7632	30799160	92
55 92 7632	31278321	92
55 92 7632	8650233	92
55 92 7632	8652462	92
55 92 7633	30674494	93
55 92 7633	30799161	93
55 92 7633	8643038	93
55 92 7634	3526163	91, 93, 94
55 92 7635	9483297	92
55 92 7636	9154605	92, 93, 94
55 93 6206	31276851	93
55 93 6207	30649836	92
55 93 6207	30779837	92
55 93 6208	30649516	92, 93, 94
55 93 6209	31217640	93, 94
55 93 6210	30674203	92
55 93 6210	30674971	92
55 93 6210	30799158	92
55 93 6210	31218465	92
55 93 6210	31297829	92
55 93 6211	30784935	94
55 93 6212	30779343	94
55 93 6212	31297524	94
55 93 6213	31297156	94
55 93 6213	31335392	94
55 93 6214	31218478	92, 93
55 93 6214	9483570	92, 93
55 93 6219	30674718	93
55 93 6219	30716189	93
55 93 6219	30799159	93
55 93 6219	30799188	93
55 93 6219	31278322	93
55 93 6747	31298337	93, 94
55 93 6747	31335344	93, 94
55 93 6747	31335795	93, 94
57 52 0001	49 01 419	123
57 92 7650	48 54 758	67
57 92 7651	53 60 821	68
57 92 7652	53 60 839	68
57 92 7653	50 22 082	67
57 92 7654	43 23 994	67
57 92 7655	43 24 307	67
57 92 7656	43 06 411	67



57 92 9204	30 586 552	67
57 92 9205	12 768 264	68
57 92 9256	69 76 369	67
57 92 9257	12 785 021	68
57 92 9258	12 797 509	68
57 92 9935	92 93 580	67
60 51 0007	77 00 800 311	62
60 92 7885	77 00 842 256	62
60 92 7888	77 00 828 454	65
60 92 7889	77 00 430 022	65
60 92 7891	82 00 135 264	64
60 92 7892	82 00 130 187	65
60 92 7893	82 00 119 498	64
60 92 7894	82 00 212 598	64
60 92 7895	82 00 119 497	64
60 92 7901	77 00 815 135	65
60 92 7903	77 00 303 186	63
60 92 7903	90450-00QAA	49
60 92 7904	77 00 838 487	63
60 92 7906	77 00 843 698	63
60 92 7910	60 25 300 735	62
60 92 7914	82 00 051 750	64
60 92 7919	82 00 377 199	65
60 92 7920	82 00 377 789	65
60 92 9444	77 00 846 772	63
60 92 9895	77 00 807 057	64
60 93 0095	77 00 838 612	63
60 93 1029	60 25 106 762	62
60 93 1438	82 00 735 264	62
60 93 2892	82 00 091 749	62
60 93 2893	82 00 362 400	62
60 93 2894	65 47 100 03R	64
60 93 2895	65 47 000 08R	65
60 93 2896	82 00 299 546	62
60 93 2897	82 00 021 974	62
60 93 2898	82 00 025 105	62
60 93 2899	82 00 000 902	63
60 93 2900	84 43 000 04R	63
60 93 2901	90 46 000 01R	63
60 93 2902	90 45 100 01R	64
60 93 2903	82 00 219 322	64
60 93 2904	82 00 461 349	64
60 93 2906	90 45 000 04R	65



60 93 2907	90 45 100 05R	65
60 93 2908	82 00 385 560	65
60 93 8232	65 47 129 43R	62
60 93 8233	90 45 200 04R	62
60 93 8236	77 01 057 303	64
62 51 0013	8731.93	55, 56
62 51 0022	8731.85	55
62 91 8563	8731.E6	55
62 91 9072	9405751819	105
62 91 9072	5751.81	102, 103, 104
62 91 9072	5751.81	121, 122
62 92 7905	8731.F2	55
62 92 8026	8731.E1	56
62 92 8027	7925.09	56
62 92 8028	8731.F8	56
62 92 8029	8731.C5	57
62 92 8030	8731.F0	57
62 92 8031	7925.10	57
62 92 8032	8731.K4	57
62 92 8033	8731.J6	57
62 92 8034	8731.T3	57
62 92 8278	9620038880	105
62 92 8278	5751.41	102, 103
62 92 8278	5751.41	121, 122
62 92 9261	8731.G4	55
62 92 9262	8731.G5	55
62 93 4410	8731.T4	58
62 93 4411	8731.H4	58
62 93 4412	9614.V4	58
62 93 4413	8731.G9	58
62 93 4414	8731.Q8	57
62 93 4415	8731.Q5	57
62 93 4416	8731.Q7	57
62 93 4417	8731.Q6	57
62 93 4418	7925.23	57
62 93 4419	7925.18	56
62 93 4420	8731.P9	56
62 93 4421	8731.L7	56
62 93 4422	8731.S7	56
62 93 4435	8731.P8	56
62 93 4441	8731.N8	17
62 93 8235	8731.A2	56
64 51 0014	9626493880	23

64 51 0014	8731.C1	18
64 51 0014	8731.C1	58
64 51 0014	9626493880	37
64 92 8002	8731.L0	16
64 92 8002	68950-0H010	75
64 92 8002	8731.L0	55
64 92 8003	8731.H8	16
64 92 8004	8731.G3	16
64 92 8005	8731.F4	17
64 92 8006	8731.A8	19
64 92 8007	8731.E3	19
64 92 8008	8731.E4	19
64 92 8009	8731.94	20
64 92 8010	7925.11	19
64 92 8011	7925.13	19
64 92 9197	8731.C0	19
64 92 9260	8731.F7	17
64 93 1411	8731.N9	17
64 93 4424	8731.V6	18
64 93 4424	8731.V6	59
64 93 4425	8731.S0	18
64 93 4425	8731.S0	59
64 93 4427	8731.L8	20
64 93 4428	1354844080	21
64 93 4428	8731.V0	19
64 93 4428	8731.V0	58
64 93 4429	1498071080	23
64 93 4429	8731.P5	19
64 93 4429	8731.P5	58
64 93 4430	8731.R8	18
64 93 4430	8731.R8	59
64 93 4431	8731.R9	18
64 93 4431	8731.R9	59
64 93 4433	8731.E0	18
64 93 4433	8731.E0	59
64 93 4434	8731.G6	18
64 93 4434	8731.G6	58
64 93 4436	8731.K8	18
64 93 4437	8731.R6	17
64 93 4438	8731.R7	17
64 93 4439	8731.K1	17
64 93 4440	8731.F6	17
64 93 4442	8731.P0	17













64 93 4444	8731.P1	16
64 93 4445	8731.TO	16
64 93 4446	8731.J8	16
64 93 4447	8731.J9	16
64 93 4448	8731.L9	16
64 93 4449	8731.S8	16
70 51 0014	7734566	22
70 51 0018	46420780	22
70 92 8036	46524678	22
70 92 8037	46744596	22
70 92 8038	46784994	23
70 92 8039	46784995	23
70 92 8040	51794446	22
70 92 8041	46783650	21
70 92 8042	7774707	21
70 93 1084	46835404	21, 23
70 93 3337	46827091	22
70 93 3338	46830389	21
70 93 3338	46830389	37
70 93 3339	51812267	21
70 93 3340	51736744	23
70 93 3341	51736745	23
70 93 3342	46812168	23
70 93 3343	51801718	22
70 93 3344	51734960	21
70 93 3345	71743352	23
70 93 3346	51778432	22, 23
70 93 3347	51785412	21
74 92 8013	46739202	1, 2
74 92 8014	60604823	1
74 92 8015	60664833	1
74 92 8016	60654724	1
74 92 8017	60567794	1
74 92 8018	60651067	1
74 93 3059	60688574	1, 2
74 93 3060	50500057	1
74 93 3061	60680087	1
74 93 3062	50508010	1
74 93 3063	50508060	2
74 93 3064	50515442	2
80 92 9291	MB927791	48
80 92 9291	MR101555	48
80 92 9293	MR248939	48













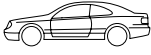



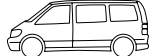



80 92 9293	MR248940	48
80 93 3393	8731.Q1	18
80 93 3393	8731.Q1	58
80 93 3393	5802A007	48
80 93 3393	5802A008	48
81 92 6268	68960-59026	76
81 92 6270	68960-19525	75
81 92 8077	68950-80020	75
81 92 8078	68960-09050	75
81 92 8080	68950-09341	75
81 92 8081	68960-0D012	71
81 92 8084	68950-0F010	75
81 92 8085	68960-02070	75
81 92 8087	81770-02041	33
81 92 8088	BMH 500010	61
81 92 8089	64530-0W091	38
81 92 9285	53450-0W071	38
81 92 9286	53450-0W081	38
81 92 9290	68960-0W242	76
81 92 9978	68960-02010	75
81 92 9979	68960-02020	75
82 92 7886	90450-BM400	49
82 92 7887	77 00 434 465	65
82 92 7890	84430-2F010	49
82 92 7896	90452-6F100	49
82 92 7909	90450-AX61B	49
82 92 7911	90450-EQ30A	42
82 92 9977	90450-4F111	49
83 91 7055	GD8V-63-620B	39
83 92 9401	GJ6E-56-930	39
83 92 9402	GJ6J-62-620	39
83 92 9403	NF79-56-930B	32
83 92 9404	G21B-62-620	39
84 92 9198	81850-84E00-000 SK	71
84 92 9198	4706 265 SK	50
85 92 8043	74820-ST3-E52	32
85 93 1049	74820-SMG-E03	32
85 93 1050	74820-SWA-A01	32
90 92 7921	81771-26011	34
90 92 7936	81161-26001	34
90 92 7937	87170-26011	34
90 92 7938	81770-17010	34
90 92 7939	81770-1C000	33



	deutsch	english	español	français
	SWAG-Nr.	SWAG-no.	n° de SWAG	n° SWAG
Ref. No.	Referenznummer	reference number	número de referencia	référence
	Motorhaube	engine hood	capot moteur	capot de motor
	Heckklappe	hatchback	hayon arrière	capot de portaequipajes
	Koffer-/Laderaumklappe	box-/ Tailboard	maleta-/ Compuerta de carga	Coffret-/ Clapet de chargement
	(ex.) Ladeklappe	(ex.) Tailgate	(ex.) Compuerta de carga	(ex.) Volet de chargement
	Lenkungsämpfer	steering-damper	amortisseur de direction	amortiguador de dirección
	Riementrieb	Belt Drive	Commande à courroie	Accionamiento de correa
(ex.)	außer	except / excluding	sauf	excepto
(ch.)	Fahrgestellnummer	chassis number	n° de châssis	n° de chasis
(mot.)	Motorcode	engine code	code moteur	código del motor
(mot. no.)	Motornummer	Engine Number	Numéro de moteur	Número de motor
LHD	LHD	left-hand drive	conduite á gauche	conduccion lado izquierdo
RHD	RHD	right - hand drive	conduite à droite	conducción a lado derecho
AC	Klima	air conditioning	climatisation	aire acondicionado
servo 	Servo	power steering	direction assistée	servodirección
	Schaltgetriebe	manual transmission	boîte de vitesses manuelle	caja de cambios manual
	Automatikgetriebe	automatic transmission	transmission automatique	transmisión automática
	links	left	gauche	izquierdo
	rechts	right	droite	derecha

italiano	nederlands	polski	русский
no SWAG	SWAG-nr.	Nr SWAG	SWAG-N°
n. di riferimento	referentienummer	Numer referencyjny	оригинальный номер
coperchio vano motore	motorkap	Maska	Капот двигателя
portellone posteriore	achterklep	Kłapa bagażnika	Задняя дверь
valigia-/ Portello di carico	Koffer-/ Kofferruimteklep	Kufer-/ kłapa załadunkowa	кузов-фургон-/ багажная дверь
(ex.) Sportello cofano bag./ vano carico	(ex.) Kofferruimteklep	(ex.) Pokrywa bagażnika	(ex.) Заслонка багажника / помещения для груза
ammortizzatore sterzo	stuurdemper	Tłumik drgań kierownicy	амортизатор рулевого управления
Trasmissione a cinghie	Riemaandrijving	Napęd pasowy	Ременный привод
eccetto	behalve	poza	кроме
nr. telaio	chassisnummer	Numer podwozia	номер ходовой части
numero motore	motorcode	Kod silnika	код двигателя
nr. motore	Motornummer	Numer silnika	Номер двигателя
guida a sinistra	linkse besturing	Układ kierowniczy z kierownicą po lewej stronie	левое рулевое управление
guida a destra	rechtse besturing	Układ kierowniczy z kierownicą z prawej strony	правое рулевое управление
aria condizionata	airconditioning	Klimatyzacja	Кондиционер
servo sterzo	servobesturing	Układ kierowniczy ze wspomaganiam	рулевое управление с гидроусилителем
cambio manuale	Handgeschakelde versnellingsbak	przek³adnia mechaniczna	механическая коробка передач
cambio automatico	automatische aandrijving	przek³adnia automatyczna	Автоматическая коробка передач
sx	links	po lewej	слева
dx	rechts	z prawej strony	справа

	deutsch	english	español	français
	oben	upper	haut	arriba
	unten	lower	bas	abajo
	Limousine 4-türig	sedan 4-door	limousine 4-portes	limusina 4-puertas
	Coupe	coupe	coupé	coupé
	Cabrio	convertible	décapotable	descapotable
	Schrägheck 3-türig	hatchback 3-door	fastback 3-portes	fastback 3-puertas
	Schrägheck 5-türig	hatchback 5-door	fastback 5-portes	fastback 5-puertas
	Kombi	estate	break	ranchera familiar
	Van	MPV	monospace	limusina
	Flügeltüren	Wing-door	Porte papillon	Puerta de batientes
	variabler Öffnungswinkel	variable opening angle	angle d'ouverture variable	variables ángulo de abertura
	für Heckklappe mit loser Scheibe	for rear lid with detachable screen	pour capot arrière avec rondelle amovible	para tapa del maletero con luna suelta
	Heckscheibe	rear-window	lunette arrière	ventanilla trasera
	FernschlieÙung	for tailgate with remote closing	pour capot arrière avec fermeture à distance	para tapa del maletero con cierre por sistema remoto
	Warndreieck	Emergency Triangle	Triangle de signalisation	Triángulo de aviso
	Verkleidung	Panelling	Garniture	Revestimiento
	Heckwischer	rear-window wiper	essuie-glace arrière	limpialuna trasero
	Spoiler	rear spoiler	spoiler à l'arrière	aerodinámico de popa
	gesamte Heckklappe	Overall hatchback	Portón trasero completo	Hayon complet
	untere Heckklappe	Lower hatchback door	Portón trasero inferior	Hayon inférieur

italiano	nederlands	polski	русский
superiore	boven	na górze	сверху
inferiore	onder	na dole	снизу
berlina 4-porte	limousine met 4 deuren	Limuzyna 4-Drzwi	седан 4-дверный
coupé	coupé	coupe	купе
cabriolet	cabriolet	kabriolet	кабрио
coda spiovente 3-porte	hatchback met 3 deuren	hatchback 3-Drzwi	Наклонная задняя часть 3-дверный
coda spiovente 5-porte	hatchback met 5 deuren	hatchback 5-Drzwi	Наклонная задняя часть 5-дверный
familiare	stationwagen	kombi	универсал
van /limousine d. ampio spazio	MPV	nadwozie wielkopojemne (MPV)	вэн
Porta a battente	Vleugeldeur	Drzwi skrzydłowe	Распашная дверь
angolo di apertura variabile	variabele openingshoek	dla tylnej pokrywy ze zmiennym kątem otworu	для задней двери с различным углом открытия
per portellone posteriore senza vetro fisso	voor achterklep met los ruit	dla pokrywy tylnej ze zdejmowalną szybą	для задней двери со свободным стеклом
lunotto posteriore	achterruit	Szyba tylna	Заднее окно
per portellone posteriore con chiusura a distanza	voor achterklep met sluiting op afstand	do tylnej pokrywy ze zdalnie sterowanym zamknięciem	для задней двери с дистанционным закрытием
Triangolo di avvertimento	Gevarendriehoek	Trójkąt ostrzegawczy	Знак аварийной остановки
Copertura / Rivestimento	Bekleding	Poszycie	Обшивка
tergicristallo del lunotto	achterruitwisser	tylnej wycieraczki	заднего омывателя
alettone posteriore	spoiler achteraan	Spojlery	Спойлер
portellone posteriore intero	-	cała kłapa bagażnika (tylna)	вся крышка багажника
portello posteriore inferiore	-	dolna kłapa bagażnika	нижняя крышка багажника