

Weatherly No. 432  
Catalog No. 431-2086  
Edition 2013  
Supersedes 431-2086HD [2005]



## MEDIUM + HEAVY DUTY TRUCK WATER PUMPS

Includes All Applications

# POWERCLEAN™ Flush Tool

Cooling systems can be difficult to flush completely due to accumulated debris. Inadequate flushing can ruin a newly installed water pump and result in warranty problems and frustrated customers. Make sure you perform a complete cooling system flush by using clean water and compressed air. The Power Clean Flush Tool “water hammers” accumulated sludge and scale deposits without the use of harsh chemicals or solvents. It cleans radiators, heat exchangers, hoses and engine blocks more effectively than conventional flushes, maintains system integrity and ensures warranty coverage on replacement parts, including water pumps. The Gates Power Clean Flush Tool patented process uses fixed dimensional control of the air and liquid flow paths. The process allows air to pressurize the cleaning fluid to scrub deep into corners and crevices, eliminating trapped debris. Part No. 91002.

Watch a video on the  
Gates Power Clean Flush Tool.



**POWERING PROGRESS™**

# Table of Contents

---

<b>Professional-Grade Tools</b> .....	A2
<b>Heavy-Duty Automatic Belt Tensioners</b> .....	A3
<b>Gates Performance Center</b> .....	A4
<b>Model and Manufacturer Index</b> .....	B1 - B5
<b>Abbreviations</b> .....	B6
<b>Water Pump Applications</b> .....	1 - 36
<b>Manufacturers Part Numbers</b> .....	37
<b>Changeover Listing</b> .....	38 - 40
<b>HD Water Pump Numerical Listings</b> .....	41 - 46

**Weatherly No.** 432  
**Catalog No.** 431-2086  
**Edition** 2013  
**Supersedes** 431-2086HD [2005]

## Warning

Be safe! Do not use Gates belts, pulleys or sprockets on any aircraft propeller or rotor drive systems or in-flight accessory drives. Those Gates products are not designed or intended for aircraft use.

## Caution

Use Gates products only on applications specified in Gates literature. Install and maintain products according to the vehicle manufacturers' recommended procedures and with recommended tools. Failure to follow these instructions could result in injury or property damage. Gates disclaims all liability due to failure to follow these instructions.

## Limited Warranty

Gates Heavy Duty Water Pumps carry a warranty of 18 months or 150,000 miles / 5,400 hours whichever comes first. Gates will replace or repair, at its option, any Goods proved defective in material or workmanship during the warranty period. This is the sole remedy for breach of warranty. Color fade and color difference is not warranted. This warranty is void if the defect is caused by improper installation, use or maintenance of the Goods, or used for racing or competition. Goods are not warranted to comply with laws that may apply to uses of the Goods not stated in related materials, e.g., use in manned or unmanned aviation or life support applications.

ALL OTHER WARRANTIES, EXPRESS OR IMPLIED, INCLUDING, BUT NOT LIMITED TO WARRANTIES OF MERCHANTABILITY AND FITNESS FOR A PARTICULAR PURPOSE, ARE EXPRESSLY DISCLAIMED. FAILURE TO REPLACE TIMING BELTS OR OTHER GATES PRODUCTS AS SPECIFIED MAY RESULT IN CATASTROPHIC ENGINE OR EQUIPMENT DAMAGE FOR WHICH GATES DISCLAIMS ALL RESPONSIBILITY, TO THE EXTENT PERMITTED BY APPLICABLE LAW.

We hereby certify that the goods will be produced in compliance with requirements of Sections 6 and 7 of the Fair Labor Standards Act of 1938, as amended, and of regulations and orders of the U.S. Department of Labor issued under Section 14 thereof.

Seller does not agree to any terms and conditions except those set forth herein and in its current price schedules and in its quotation, if any shipment of any merchandise by Seller will be on said terms and conditions, and no modification shall be affected by the acknowledgement or acceptance of any purchase order forms containing different terms and conditions from those set forth herein.

This publication contains the latest information available to our engineers. If you require additional application or part number information, contact the Automotive Product Application Tech Line at 303-744-5651.

## Professional-Grade Tools

### POWERCLEAN™ Flush Tool

Cooling systems can be difficult to flush completely due to accumulated debris. Inadequate flushing can ruin a newly installed water pump and result in warranty problems and frustrated customers. Make sure you perform a complete cooling system flush by using clean water and compressed air. The Power Clean™ Flush Tool “water hammers” accumulated sludge and scale deposits without the use of harsh chemicals or solvents. It cleans radiators, heat exchangers, hoses and engine blocks more effectively than conventional flushes, maintains system integrity and ensures warranty coverage on replacement parts, including water pumps. The Power Clean™ Flush Tool patented process uses fixed dimensional control of the air and liquid flow paths. The process allows air to pressurize the cleaning fluid to scrub deep into corners and crevices, eliminating trapped debris. Part No. 91002.



- Pulsating gun assembly with pre-set regulator.
- Water line backflow preventer.
- Large rubber tip for radiator necks and direct flushing of the engine block.
- Small rubber tip on whip hose for direct access to heater core tube stubs.
- 5/8" And 3/4" heater hose barbs for flushing heater cores or engine blocks.
- Durable protective storage case with room for additional items.

Back by popular demand:

### 2012 Gates Master Products Catalog

The 2012 Gates Master Products Catalog contains product pictures, sizing charts, SAE specifications, new products and educational information, and much more.

This full color, 96 page guide has been designed to be your one-stop shop for the rich product information detailing what separates Gates from the competition. Whether it is Automotive or Industrial - belts, hose, tensioners or hydraulics - it is our hope that this guide will prove to be beneficial in your future selling endeavors.



Master Product Catalog

## The longest lasting belt tensioners in the industry.

Engineered to exceed demanding OEM requirements.

Today heavy duty engines are more demanding than ever before, and the parts that keep them running require more strength, stability, exibility, wearability and load carrying capability. Diesel engines, with their extreme shaking and vibration, are inherently harsh on automatic tensioners. Gates manufactures the longest running, longest lasting heavy duty tensioners and pulleys in the industry to keep you and your fleet on the road longer.

In laboratory tests, under extreme peak-to-peak vibration and contamination tests, DriveAlign® heavy-duty tensioners lasted up to three times longer than competitive aftermarket tensioners.

- Labyrinth Seal – prevents contamination of internal parts for maximum durability and service life.
- Machined Steel Pulley – reduces surface wear while shielding internal bearing from outside contaminants.
- Double Row Bearings – twin rows of bearings carry more load and last up to three times longer than two individual bearings.
- Optimized Components – engineered for maximum strength and durability.
- Patented Design – provides superior belt alignment and tension for improved drive efficiency and life.
- Round Spring Wire – includes chrome-silicone torsion spring for less flex-fatigue than flat-wire designs.
- Patented Damping Mechanism – provides maximum stability, reducing vibration and increasing the life of belt, tensioner and other accessory drive components.

Scan code to learn more about Gates  
Heavy Duty Tensioners and Pulleys.



## Heavy-Duty Automatic Belt Tensioners



## Gates Performance Center



### Accelerate Your Automotive Knowledge

The Gates Performance Center is your source for FREE interactive, self-directed training courses and videos available any time of day.

Register today by logging onto: [Gates.com/AutoTraining](http://Gates.com/AutoTraining)

- Take Courses On**
- > Automotive and Heavy - Duty Accessory Belt Drive Systems
  - > Timing Systems
  - > Hydraulics
  - > And more!

- Learn By Watching Videos**
- > Accessory Belt Drive System Preventive Maintenance
  - > How to install a Decoupler Pulley
  - > How to flush a coolant system
  - > And more!

Track your training progress and print certificates upon completion of courses.



Scan code to access Gates Training.



## Model and Manufacturer Index

Model	Manufacturer	Model	Manufacturer	Model	Manufacturer
<b>1</b>		<b>2 - Continued</b>		<b>3 - Continued</b>	
10 Series.....	Divco	232.....	F.W.D.	350 Series.....	GMC
11 Series.....	Divco	233D.....	F.W.D.	351.....	Peterbilt
12 Series.....	Divco	244 Series.....	Divco	352.....	Peterbilt
13 Series.....	Divco	257.....	Brockway	353.....	Peterbilt
14 Series.....	Divco	258.....	Brockway	354.....	F.W.D.
15 Series.....	Divco	260.....	Brockway	355.....	F.W.D.
19 Series.....	Reo	264.....	F.W.D.	358.....	Brockway
100 Series.....	Divco	265.....	F.W.D.	359.....	Brockway
110.....	Iveco	281.....	Peterbilt	359.....	Peterbilt
114 Series.....	Divco	282.....	Peterbilt	360.....	Brockway
120 Series.....	Reo	284.....	F.W.D.	361.....	Brockway
120TA.....	Iveco	284D.....	F.W.D.	362.....	Peterbilt
122 Series.....	Reo	285.....	F.W.D.	364 Series.....	Divco
124 Series.....	Divco	285D.....	F.W.D.	364D.....	F.W.D.
134 Series.....	Divco	286.....	F.W.D.	364HD Series.....	Divco
140.....	F.W.D.	289.....	Peterbilt	365D.....	F.W.D.
154 Series.....	Divco	2050A.....	International/Navistar	366.....	F.W.D.
160A11.....	Magirus	2114.....	F.W.D.	367.....	F.W.D.
160A13.....	Magirus	2115.....	F.W.D.	368D.....	F.W.D.
170.....	F.W.D.	2116.....	F.W.D.	370 Series.....	GMC
171.....	F.W.D.	2117.....	F.W.D.	374 Series.....	Divco
181.....	F.W.D.	2125.....	International/Navistar	387.....	Peterbilt
182.....	F.W.D.	2155.....	International/Navistar	3000 Series.....	White
191.....	F.W.D.	2161.....	F.W.D.	3115.....	F.W.D.
192.....	F.W.D.	2173.....	F.W.D.	3116.....	F.W.D.
196.....	F.W.D.	2175.....	International/Navistar	3117.....	F.W.D.
1013.....	Mercedes-Benz	2216.....	F.W.D.	3161.....	F.W.D.
1113.....	Mercedes-Benz	2217.....	F.W.D.	3173.....	F.W.D.
1115.....	F.W.D.	2272.....	F.W.D.	3216.....	F.W.D.
1116.....	Mercedes-Benz	2275.....	International/Navistar	3217.....	F.W.D.
1117.....	Mercedes-Benz	2276.....	F.W.D.	3272.....	F.W.D.
1200 Series.....	White	2276.....	International/Navistar	3276.....	F.W.D.
1316.....	Mercedes-Benz	2300 Series.....	White	3316.....	F.W.D.
1317.....	Mercedes-Benz	2316.....	F.W.D.	3317.....	F.W.D.
1500 Series.....	White	2317.....	F.W.D.	3361.....	F.W.D.
1500A.....	International/Navistar	2375.....	International/Navistar	3377.....	F.W.D.
1500B.....	International/Navistar	2377.....	F.W.D.		
1500C.....	International/Navistar	2524.....	International/Navistar	<b>4</b>	
1500D.....	International/Navistar	2554.....	International/Navistar	40 Series.....	Divco
1624.....	International/Navistar	2574.....	International/Navistar	41 Series.....	Divco
1654.....	International/Navistar	2575.....	International/Navistar	42 Series.....	Divco
1724.....	International/Navistar	2624.....	International/Navistar	43 Series.....	Divco
1754.....	International/Navistar	2654.....	International/Navistar	44 Series.....	Divco
1824.....	International/Navistar	2674.....	International/Navistar	45 Series.....	Divco
1854.....	International/Navistar			46 Series.....	Divco
1924.....	International/Navistar	<b>3</b>		400 Series.....	GMC
1925.....	International/Navistar	3R14.....	Studebaker	406D.....	F.W.D.
1954.....	International/Navistar	3R15.....	Studebaker	407.....	F.W.D.
1955.....	International/Navistar	3R16.....	Studebaker	409D.....	F.W.D.
10000 Series.....	Chevrolet	3R17.....	Studebaker	410 Series.....	GMC
		30 Series.....	Reo	431 Series.....	Reo
		31 Series.....	Divco	450.....	Brockway
		33 Series.....	Divco	450 Series.....	GMC
		34 Series.....	Divco	456D.....	F.W.D.
		36 Series.....	Divco	457.....	F.W.D.
		37 Series.....	Divco	459.....	Brockway
		300.....	Peterbilt	459D.....	F.W.D.
		300 Series.....	Divco	466D.....	F.W.D.
		300 Series.....	GMC	469D.....	F.W.D.
		306 Series.....	Divco	486D.....	F.W.D.
		310.....	Peterbilt	487.....	F.W.D.
		324D.....	F.W.D.	489D.....	F.W.D.
		325D.....	F.W.D.	4000 Series.....	Chevrolet
		326.....	F.W.D.	4000 Series.....	White
		327.....	F.W.D.	4116.....	F.W.D.
		327D.....	F.W.D.	4117.....	F.W.D.
		332.....	F.W.D.	4161.....	F.W.D.
		334 Series.....	Divco	4173.....	F.W.D.
		336.....	F.W.D.	4217.....	F.W.D.
		340 Series.....	GMC	4276.....	F.W.D.
		340T.....	Iveco	4317.....	F.W.D.
		344 Series.....	Divco	4377.....	F.W.D.
		348.....	Peterbilt	4800 Series.....	Western Star
		349.....	Peterbilt	4900 Series.....	Western Star



## Model and Manufacturer Index

Model	Manufacturer	Model	Manufacturer	Model	Manufacturer
<b>5</b>		<b>7 - Continued</b>		<b>C - Continued</b>	
50 Series.....	Divco	740 Series.....	GMC	C3G.....	Dodge
50 Series.....	Reo	750.....	F.W.D.	C3H.....	Dodge
51 Series.....	Divco	750 Series.....	GMC	C3HH.....	Dodge
52 Series.....	Divco	758.....	Brockway	C3J.....	Dodge
53 Series.....	Divco	760.....	Brockway	C3K.....	Dodge
54 Series.....	Divco	761.....	Brockway	C3R.....	Dodge
54F.....	Marmon	762.....	Brockway	C3T.....	Dodge
54P.....	Marmon	7000 Series.....	Chevrolet	C3V.....	Dodge
55 Series.....	Divco	7000 Series.....	White	C6-2138.....	F.W.D.
56 Series.....	Divco	<b>8</b>		C8-2148.....	F.W.D.
57 Series.....	Divco	8MC.....	Marmon	C40.....	Chevrolet
57L.....	Marmon	8MC2.....	Marmon	C50.....	Chevrolet
57P.....	Marmon	800.....	Kenworth	C60.....	Chevrolet
58 Series.....	Divco	800 Series.....	GMC	C70.....	Chevrolet
500 Series.....	GMC	820 Series.....	GMC	C80.....	Chevrolet
506 Series.....	Reo	830 Series.....	Reo	C90.....	Diamond Reo
507.....	F.W.D.	860 Series.....	GMC	C92.....	Diamond Reo
521.....	F.W.D.	8000 Series.....	Chevrolet	C101.....	Diamond Reo
532 Series.....	Reo	<b>9</b>		C114.....	Diamond Reo
550 Series.....	GMC	900.....	Kenworth	C116.....	Diamond Reo
5000 Series.....	Chevrolet	920 Series.....	GMC	C119.....	Diamond Reo
5000 Series.....	White	930 Series.....	GMC	C500.....	Dodge
5117.....	F.W.D.	950 Series.....	GMC	C500.....	Ford
5161.....	F.W.D.	970 Series.....	GMC	C500.....	Kenworth
5173.....	F.W.D.	980 Series.....	GMC	C550.....	Ford
5217.....	F.W.D.	9000 Series.....	Chevrolet	C600.....	Dodge
5276.....	F.W.D.	9000 Series.....	White	C600.....	Ford
5317.....	F.W.D.	9370.....	International/Navistar	C700.....	Dodge
5377.....	F.W.D.	A60.....	Chevrolet	C700.....	Ford
<b>6</b>		A80.....	Chevrolet	C750.....	Ford
6M104.....	Marmon	A Series.....	Autocar	C800.....	Dodge
6M254.....	Marmon	A Series.....	International/Navistar	C800.....	Ford
6M354.....	Marmon	A Series.....	Reo	C850.....	Dodge
6M504.....	Marmon	AC Series.....	Reo	C850.....	Ford
6PM354.....	Marmon	ACO Series.....	International/Navistar	C900.....	Dodge
6PM504.....	Marmon	AEB.....	Walter	C900.....	Ford
64C.....	Marmon	AGB.....	Walter	C950.....	Ford
64D-1234.....	Oshkosh	AGR.....	Walter	C1000.....	Dodge
64D-1634.....	Oshkosh	AM Series.....	International/Navistar	C1000.....	Ford
64D-1638.....	Oshkosh	Astro.....	GMC	C1100.....	Ford
64D-1644.....	Oshkosh	AT Series.....	Autocar	C1704.....	Marmon
64D-1660.....	Oshkosh	<b>B</b>		C1804.....	Marmon
65C.....	Marmon	B Series.....	International/Navistar	C1854.....	Marmon
66C.....	Marmon	B Series.....	Mack	C2044.....	Oshkosh
600 Series.....	GMC	B Series.....	Oshkosh	C2056.....	Oshkosh
606D.....	F.W.D.	B Series.....	Reo	C5000.....	GMC
607.....	F.W.D.	B Series.....	Walter	C6000.....	Ford
609D.....	F.W.D.	B, D & M Series.....	Crane Carrier Company	C6000.....	GMC
620 Series.....	GMC	Binder Series.....	International/Navistar	C6500.....	GMC
630 Series.....	GMC	Bison.....	Chevrolet	C7000.....	Ford
630 Series.....	Reo	Brigadier.....	GMC	C7000.....	GMC
650 Series.....	GMC	Bruin.....	Chevrolet	C8000.....	Ford
660 Series.....	GMC	Brute.....	Kenworth	C11004.....	Marmon
662 Series.....	Reo	<b>C</b>		C Series.....	Autocar
6000 Series.....	Chevrolet	C1F.....	Dodge	C Series.....	F.W.D.
6000 Series.....	White	C1G.....	Dodge	C Series.....	Ford
6217.....	F.W.D.	C1H.....	Dodge	C Series.....	International/Navistar
6277.....	F.W.D.	C1J.....	Dodge	C Series.....	Reo
6317.....	F.W.D.	C1K.....	Dodge	CargoStar Series.....	International/Navistar
6379.....	F.W.D.	C1R.....	Dodge	CD50.....	Chevrolet
<b>7</b>		C1T.....	Dodge	CD60.....	Chevrolet
70 Series.....	Divco	C1V.....	Dodge	CE40.....	Chevrolet
71 Series.....	Divco	C3A.....	Dodge	CE50.....	Chevrolet
72 Series.....	Divco	C3AK.....	Dodge	CE60.....	Chevrolet
73 Series.....	Divco	C3AKM.....	Dodge	CE4500.....	GMC
74 Series.....	Divco	C3AT.....	Dodge	CE5500.....	GMC
75 Series.....	Divco	C3ATAS.....	Dodge	CE9500.....	GMC
76 Series.....	Divco	C3AY.....	Dodge	CF65.....	Diamond Reo
703 Series.....	Reo	C3F.....	Dodge	CF68.....	Diamond Reo
707.....	F.W.D.			CG50.....	Chevrolet
720 Series.....	Reo			CG60.....	Chevrolet
730 Series.....	Reo			CG5500.....	GMC
				CH9500.....	GMC
				CHDT.....	Marmon





## Model and Manufacturer Index

Model	Manufacturer	Model	Manufacturer	Model	Manufacturer
<b>C - Continued</b>		<b>D - Continued</b>		<b>F - Continued</b>	
CI9500.....	GMC	DCL Series.....	Reo	F Series.....	Crane Carrier Company
CJ9500.....	GMC	DE9500.....	GMC	F Series.....	Ford
CL9000.....	Ford	DF Series.....	Reo	F Series.....	Mack
CL Series.....	Autocar	DH5000.....	GMC	F Series.....	Oshkosh
CLT9000.....	Ford	DJ9500.....	GMC	FE17.....	Hino
CM60.....	Chevrolet	DL4000.....	GMC	FE9500.....	GMC
CM504.....	Marmon	DLH5000.....	GMC	FF17.....	Hino
CM604.....	Marmon	DM Series.....	Mack	FFB.....	Walter
CM704.....	Marmon	DMM Series.....	Mack	FFBL.....	Walter
CM754.....	Marmon	DS4000.....	GMC	FFK.....	Walter
CM804.....	Marmon	DW5000.....	GMC	Fire Truck.....	Hendrickson
CM904.....	Marmon	DW9500.....	GMC	Fire Truck.....	Ward La France
CM5500.....	GMC	<b>E</b>		FJ9500.....	GMC
CM6500.....	GMC	E13.....	Studebaker	FL Series.....	Mack
CMM5.....	Marmon	E14.....	Studebaker	FLC.....	Freightliner
CMM5T.....	Marmon	E15.....	Studebaker	FleetStar A Series.....	International/Navistar
CMM6.....	Marmon	E16.....	Studebaker	FleetStar D Series.....	International/Navistar
CMM6T.....	Marmon	E17.....	Studebaker	FLT.....	Freightliner
CN800.....	Dodge	E25.....	Studebaker	Forward W7.....	GMC
CN900.....	Dodge	E28.....	Studebaker	FS Series.....	Mack
CN950.....	Dodge	E35.....	Studebaker	FT800.....	Ford
CNT800.....	Dodge	E38.....	Studebaker	FT900.....	Ford
CNT900.....	Dodge	E40.....	Studebaker	FT8000.....	Ford
CNT950.....	Dodge	E45.....	Studebaker	FW9500.....	GMC
CO50.....	Diamond Reo	E80.....	Chevrolet	FYM.....	Walter
CO54.....	Diamond Reo	E Series.....	Reo	FZM.....	Walter
CO78.....	Diamond Reo	EG4500.....	GMC	<b>G</b>	
CO88.....	Diamond Reo	EG5500.....	GMC	General.....	GMC
CO180 Series.....	International/Navistar	EG6500.....	GMC	GR.....	Duplex
CO190.....	International/Navistar	EM4500.....	GMC	GR6.....	Duplex
CO200.....	International/Navistar	EM5500.....	GMC	<b>H</b>	
CO220.....	International/Navistar	EM6500.....	GMC	H.....	F.W.D.
CO4000 Series.....	International/Navistar	ES4500.....	GMC	H.....	Hendrickson
CO9670.....	International/Navistar	ETG70.....	Chevrolet	H1.....	Hendrickson
CO LoadStar Series.....	International/Navistar	<b>F</b>		H3.....	Hendrickson
CO TranStar II Series.....	International/Navistar	F6.....	Volvo	H70.....	Chevrolet
CO TranStar Series.....	International/Navistar	F7.....	Volvo	H80.....	Chevrolet
COF5870.....	International/Navistar	F86.....	Volvo	H90.....	Chevrolet
COF9670.....	International/Navistar	F500.....	Ford	H7500.....	GMC
Construcktor 2 Series.....	Autocar	F600.....	Ford	H9500.....	GMC
Construcktor Series.....	White	F700.....	Ford	H Series.....	Ford
CS50.....	Chevrolet	F750.....	Ford	HA.....	F.W.D.
CS60.....	Chevrolet	F800.....	Ford	HC9500.....	GMC
CS4500.....	GMC	F850.....	Ford	HDT.....	Marmon
CS5500.....	GMC	F880.....	Ford	HE90.....	Chevrolet
CT700.....	Dodge	F950.....	Ford	HE9500.....	GMC
CT700.....	Ford	F1504.....	Marmon	HG.....	F.W.D.
CT750.....	Ford	F1604.....	Marmon	HG70.....	Chevrolet
CT800.....	Dodge	F1704.....	Marmon	HG7500.....	GMC
CT800.....	Ford	F1754.....	Marmon	HH9500.....	GMC
CT850.....	Ford	F1834.....	Oshkosh	HI9500.....	GMC
CT900.....	Dodge	F1854.....	Marmon	HJ70.....	Chevrolet
CT900.....	Ford	F1924.....	International/Navistar	HJ7500.....	GMC
CT950.....	Ford	F1954.....	International/Navistar	HJ9500.....	GMC
CT8000.....	Ford	F1954.....	Marmon	HM70.....	Chevrolet
<b>D</b>		F2050A.....	International/Navistar	HM80.....	Chevrolet
D50.....	Chevrolet	F2125.....	International/Navistar	HM5500.....	GMC
D60.....	Chevrolet	F2275.....	International/Navistar	HM7500.....	GMC
D400.....	Dodge	F2276.....	International/Navistar	HM8500.....	GMC
D450.....	Dodge	F2375.....	International/Navistar	HN90.....	Chevrolet
D500.....	Dodge	F2524.....	International/Navistar	HN9500.....	GMC
D600.....	Dodge	F2554.....	International/Navistar	HR.....	F.W.D.
D700.....	Dodge	F2574.....	International/Navistar	HRT.....	F.W.D.
D800.....	Dodge	F2575.....	International/Navistar	HRU.....	F.W.D.
D900.....	Dodge	F2624.....	International/Navistar	Hustler.....	Kenworth
D1500.....	International/Navistar	F2654.....	International/Navistar	HV70.....	Chevrolet
D3500.....	GMC	F2674.....	International/Navistar	HV7500.....	GMC
D4000.....	GMC	F6000.....	Ford	<b>J</b>	
D Series.....	Reo	F7000.....	Ford	J70.....	Chevrolet
DB4000.....	GMC	F8000.....	Ford	J80.....	Chevrolet
DBH5000.....	GMC	F9370.....	International/Navistar	J90.....	Chevrolet
DC101.....	Diamond Reo	F11004.....	Marmon		
DC Series.....	Autocar				



## Model and Manufacturer Index

Model	Manufacturer	Model	Manufacturer	Model	Manufacturer
<b>J - Continued</b>		<b>L - Continued</b>		<b>N</b>	
J7500.....	GMC	LS8000.....	Ford	N10.....	Volvo
J8500.....	GMC	LS9000.....	Ford	N12.....	Volvo
J9500.....	GMC	LT800.....	Ford	N50.....	Chevrolet
JC90.....	Chevrolet	LT880.....	Ford	N60.....	Chevrolet
JC9500.....	GMC	LT900.....	Ford	N80.....	Chevrolet
JE90.....	Chevrolet	LT1000.....	Dodge	N Series.....	Ford
JE9500.....	GMC	LT8000.....	Ford	NPR.....	Isuzu
JG70.....	Chevrolet	LT9000.....	Ford	<b>O</b>	
JG7500.....	GMC	LTL9000.....	Ford	OT5.....	Marmon
JH9500.....	GMC	LTS800.....	Ford	<b>P</b>	
JI9500.....	GMC	LTS900.....	Ford	P4T042.....	Chevrolet
JJ70.....	Chevrolet	LTS8000.....	Ford	P4T042.....	GMC
JJ7500.....	GMC	LTS9000.....	Ford	P6T042.....	Chevrolet
JJ9500.....	GMC	<b>M</b>		P6T042.....	GMC
JM70.....	Chevrolet	M6.....	F.W.D.	P30.....	Chevrolet
JM80.....	Chevrolet	M15.....	Studebaker	P40.....	Chevrolet
JM7500.....	GMC	M15A.....	Studebaker	P50.....	Chevrolet
JM8500.....	GMC	M16.....	Studebaker	P400.....	Dodge
JN90.....	Chevrolet	M17.....	Studebaker	P3500.....	GMC
JN9500.....	GMC	M18-34.....	Oshkosh	P Series.....	Ford
JV70.....	Chevrolet	M18-38.....	Oshkosh	P Series.....	Oshkosh
JV80.....	Chevrolet	M18-44.....	Oshkosh	PayStar Series.....	International/Navistar
JV7500.....	GMC	M20-48.....	Oshkosh	PC500.....	Dodge
<b>K</b>		M34-34.....	Oshkosh	PC600.....	Dodge
K.....	Duplex	M50-50.....	Oshkosh	PD200.....	Kenworth
K100.....	Kenworth	M65.....	Chevrolet	PD500.....	Dodge
K501.....	Duplex	M70.....	Chevrolet	PD600.....	Dodge
KM Series.....	Autocar	M80.....	Chevrolet	PS40.....	Chevrolet
KS.....	Isuzu	M90.....	Chevrolet	PS4500.....	GMC
<b>L</b>		M104.....	Marmon	<b>Q</b>	
L.....	Duplex	M254.....	Marmon	Q50.....	Chevrolet
L6.....	Duplex	M354.....	Marmon	Q60.....	Chevrolet
L50.....	Chevrolet	M400.....	Dodge	Q80.....	Chevrolet
L60.....	Chevrolet	M500.....	Dodge	<b>R</b>	
L80.....	Chevrolet	M504.....	Marmon	R.....	Duplex
L600.....	Dodge	M600.....	Dodge	R4.....	Marmon
L700.....	Dodge	M604.....	Marmon	R5.....	Marmon
L700.....	Kenworth	M704.....	Marmon	R6.....	Marmon
L800.....	Ford	M754.....	Marmon	R450.....	Duplex
L880.....	Ford	M804.....	Marmon	R Series.....	International/Navistar
L900.....	Ford	M904.....	Marmon	R Series.....	Mack
L4000.....	GMC	M2208.....	Oshkosh	R Series.....	Oshkosh
L5000.....	GMC	M2209.....	Oshkosh	RD.....	Duplex
L5500.....	GMC	M4616.....	Oshkosh	RD Series.....	Mack
L6602.....	Duplex	M4817.....	Oshkosh	RL Series.....	Mack
L8000.....	Ford	M4906.....	Oshkosh	RM400.....	Dodge
L9000.....	Ford	M5817.....	Oshkosh	RM Series.....	Mack
LC600.....	Duplex	M5906.....	Oshkosh	Road Boss.....	White
LD.....	F.W.D.	M6500.....	GMC	Road Boss 2.....	White
LD6.....	Marmon	M9500.....	GMC	Road Commander.....	White
LD6P.....	Marmon	M Series.....	International/Navistar	Road Commander 2.....	White
LD7-4.....	Marmon	MB60.....	Chevrolet	Road Xpeditor.....	White
LE Series.....	Crane Carrier Company	MB400.....	Dodge	Road Xpeditor 2.....	White
LET Series.....	Crane Carrier Company	MB Series.....	Mack	RS Series.....	Mack
LL9000.....	Ford	MC9500.....	GMC	RU.....	F.W.D.
LN500.....	Ford	MC Series.....	Mack	RW Series.....	Mack
LN600.....	Ford	ME9500.....	GMC	RWL Series.....	Mack
LN700.....	Ford	Metro Series.....	International/Navistar	RWS Series.....	Mack
LN750.....	Ford	MH440.....	Marmon	<b>S</b>	
LN800.....	Ford	MH555.....	Marmon	S Series.....	Autocar
LN900.....	Ford	MH610.....	Marmon	S Series.....	International/Navistar
LN900.....	Ford	MH615.....	Marmon	S Series.....	Oshkosh
LN6000.....	Ford	MH620.....	Marmon	Seagrave.....	Seagrave
LN7000.....	Ford	MH625.....	Marmon	SM Series.....	International/Navistar
LN8000.....	Ford	MH630.....	Marmon	SU.....	F.W.D.
LN9000.....	Ford	MH9500.....	GMC	<b>T</b>	
LNT800.....	Ford	MH Series.....	Mack	T40.....	Chevrolet
LNT880.....	Ford	MI90.....	Chevrolet		
LNT900.....	Ford	MI9500.....	GMC		
LNT8000.....	Ford	MJ9500.....	GMC		
LNT9000.....	Ford	MR Series.....	Mack		
LoadStar Series.....	International/Navistar	MS1510.....	International/Navistar		
LS1000.....	Dodge	MS Series.....	Mack		



## Model and Manufacturer Index

Model	Manufacturer	Model	Manufacturer	Model	Manufacturer
<b>T - Continued</b>		<b>T - Continued</b>		<b>W - Continued</b>	
T50.....	Chevrolet	TranStar 400 Series ....	International/Navistar	W1600.....	Oshkosh
T60.....	Chevrolet	TranStar Series .....	International/Navistar	W2200.....	Oshkosh
T65.....	Chevrolet	TS5500.....	GMC	W7500.....	GMC
T70.....	Chevrolet	TV70.....	Chevrolet	W9000.....	Ford
T80.....	Chevrolet	TV7500.....	GMC	W Series .....	Ford
T90.....	Chevrolet	TW9500.....	GMC	WCL.....	White
T308.....	Duplex			WCM.....	White
T700.....	Dodge	<b>U</b>		WCS.....	White
T800.....	Dodge	U80 .....	Chevrolet	WE9500.....	GMC
T900.....	Dodge	U Series.....	Mack	Western Star Series ....	White
T6000.....	GMC	U Series.....	Walter	WFC.....	Freightliner
T6500.....	GMC	ULM Series.....	Divco	WFHD.....	Freightliner
T Series .....	Ford	UM Series.....	Divco	WFT.....	Freightliner
TD50 .....	Chevrolet	<b>V</b>		WHL.....	White
TD60 .....	Chevrolet	V5-4 .....	Marmon	WHM.....	White
TE50.....	Chevrolet	V60.....	Chevrolet	WHS.....	White
TE60.....	Chevrolet	V80.....	Chevrolet	WIL.....	White
TE65.....	Chevrolet	V Series .....	International/Navistar	WIM.....	White
TE90.....	Chevrolet	VC0405 Series.....	International/Navistar	WJ9500.....	GMC
TE5500.....	GMC	VCO Series.....	International/Navistar	WL Series .....	Mack
TE6500.....	GMC	<b>W</b>		WM80.....	Chevrolet
TE9500.....	GMC	W6.....	Chevrolet	WM7500.....	GMC
TG50 .....	Chevrolet	W6.....	GMC	WM8500.....	GMC
TG60 .....	Chevrolet	W7.....	Chevrolet	WS Series.....	Mack
TG70 .....	Chevrolet	W7.....	GMC	WSH Series.....	Western Star
TG5500 .....	GMC	W7.....	GMC	WT9000.....	Ford
TG7500 .....	GMC	W70.....	Chevrolet	WV7500.....	GMC
Tiltmaster W7 .....	Chevrolet	W80.....	Chevrolet	WW90.....	Chevrolet
Titan.....	Chevrolet	W316.....	Oshkosh	WW9500.....	GMC
TJ70.....	Chevrolet	W500.....	Dodge	WX.....	White
TJ7500.....	GMC	W600.....	Dodge	Y80.....	Chevrolet
TJ9500.....	GMC	W715.....	Oshkosh	YU.....	F.W.D.
TM65.....	Chevrolet	W816.....	Oshkosh	<b>Z</b>	
TM70.....	Chevrolet	W826.....	Oshkosh	Z100.....	Iveco
TM80.....	Chevrolet	W900.....	Kenworth	Z120TA.....	Iveco
TM5500.....	GMC	W900.....	Oshkosh	Z Series .....	Walter
TM6500.....	GMC	W909.....	Oshkosh	ZU.....	F.W.D.
TM7500.....	GMC				
TM8500.....	GMC				









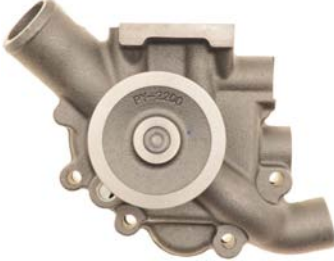

## Abbreviations







A.	Amperes	Frt.	Front	OEM	Original Equipment Manufacturer
A. Clnr.	Air Cleaner	Ft.	Foot (Feet)	OHC	Overhead Cam
A.C.	Air Conditioning	Fwd. Cont.	Forward Control	OHV	Overhead Valve
A.I.R.	Air Injector Reactor	G.V.W.	Gross Vehicle Weight	Opt.	Optional
A.P.	Air Pump	Gal.	Gallon	P.S.	Power Steering
A.T.	Automatic Transmission	Gas	Gasoline	P.T.O.	Power Take-Off
A.T.F.	Automatic Transmission Fluid	Gen.	Generator	Pass.	Passenger
AC	Allis Chalmers	GM	General Motors	Perf.	Performance
Accy.	Accessory	GMC	General Motors Corporation	Pkg.	Package
Adj.	Adjustable	Gov.	Governor	Prod.	Production
Adjmt.	Adjustment	H.D.	Heavy Duty	Pt. No.	Part Number
Air-Hyd.	Air Over Hydraulic	H.O.	High Output	Pcv	Positive Crankcase Ventilation
Almnm.	Aluminum	H.P.	Horsepower	Pwr.	Power
Alt.	Alternator	Hemi.	Hemispherical	R.H.	Right Hand
Assy.	Assembly	Herc.	Hercules	R.H.D.	Right Hand Drive
Auto.	Automatic	Hi Cap.	High Capacity	R.P.M.	Revolutions per Minute
Aux.	Auxiliary	Hi Perf.	High Performance	Rad. (Rads.)	Radiator(s)
B-W	Bendix Westinghouse	Horiz.	Horizontal	Reg.	Regular
B.B.C.	Bumper To Back Of Cab	HP	Horsepower	Repl.	Replacement
B.P.	By Pass	HR	Heater Return	Rr.	Rear
Bbl.	Barrel	Htr.	Heater	Rt.	Right
BP	By Pass	Hyd.	Hydraulic	S.P.	Steering Pump
Brkt	Bracket	Hydra.	Hydramatic	S.R.W.	Single Rear Wheels
C.I.D.	Cubic Inch Displacement	I.C.	Inside Circumference	Sch. Bus	School Bus
C.O.E.	Cab Over Engine	I.D.	Inside Diameter	Ser.	Serial
C.S.	Crankshaft	I.H.C.	International Harvester Company	SOHC	Single Overhead Cam
Calif.	California	IHC	International Harvester Company	Spec.	Special
Cam.	Camshaft	In.	Inch (Inches)	Sq.	Square
Carb.	Carburetor	Inc.	Increased	Sta. Wagon	Station Wagon
Cat.	Caterpillar	Incl.	Includes	Std.	Standard
CC (cc)	Cubic Centimeter(s)	Inj.	Injection	Stg.	Steering
CDC	Consolidated Diesel Corporation	Inst.	Installed	Strt.	Straight
CIH	Case IH	Install.	Installation	Susp.	Suspension
Chry.	Chrysler	J.S.	Jack Shaft	Svt	Special Vehicle Teams
Circ.	Circumference	JD	John Deere	T.W.	Top Width
CJ	Cobra Jet	L	Litre	T'Glide	Turboglide
Cng	Compressed Natural Gas	L-Hd.	L-Head	Tec.	Tecumseh
Co.	Company	L-N	Leece Neville	Th.	Thick, Thickness
Comm.	Commercial	L.C.F.	Low Cab Forward	Torq.	Torqmatic
Compr.	Compressor	L.C.I.	Low Cut-In	Trac. Pac.	Tractor Package
Cond.	Conditioning(er)	L.D.	Light Duty	Trans.	Transmission
Cont.	Continental	L.H.	Left Hand	Trlr.	Trailer
Conv.	Conventional	L.H.D.	Left Hand Drive	Trk.	Truck
Convert.	Convertible	Lb. (Lbs.)	Pound(s)	Turbo	Turbocharged
Cool.	Cooling	LPG	Liquid Petroleum Gas	U	Upper
Corp.	Corporation	Lt.	Left	Univ.	Universal
Cu.	Cubic	Lyc.	Lycoming	V.	Volts
Cum.	Cummins	M.H.C.	Motorhome Chassis	V.P.	Vacuum Pump
Cust.	Custom	Mach.	Machine	Vac.	Vacuum
CVT	Continuously Variable Transmission	Man.	Manual	Vent.	Ventilator
Cyl.	Cylinder	Max.	Maximum	Vert.	Vertical
D.R.W.	Dual Rear Wheels	Mfg.	Manufacturing	W/	With
Deg.	Degree	Mfr.	Manufacturer	W/O	Without
Det. Diesel	Detroit Diesel	Mech.	Mechanical	W.	Watts
Dia.	Diameter	Min.	Minimum	W.B.	Wheelbase
Dir.	Dealer	mm	Millimeter	W.P.	Water Pump
DOHC	Dual Overhead Cam	Mtd.	Mounted	Wauk.	Waukesha
E.E.C.	Evaporative Emission Control	Mtr.	Motor	Westh.	Westinghouse
E.G.R.	Exhaust Gas Recirculation	No.	Number	Wgn.	Wagon
Elec.	Electric	Nom.	Nominal	Wisc.	Wisconsin
Eng.	Engine	O & HR	Oil & Heat Resistant	X.C. (XC)	Extra Cooling
Equip.	Equipped, Equipment	O.C.	Outside Circumference	&	And
Exc.	Except	O.D.	Outside Diameter	2WD	2 Wheel Drive
Exch.	Exchanger	O.E.M.	Original Equipment Manufacturer	4WD	4 Wheel Drive
Ext.	External	O.H.C.	Overhead Cam	4WS	4 Wheel Steering
Fed.	Federal	O.H.V.	Overhead Valve		







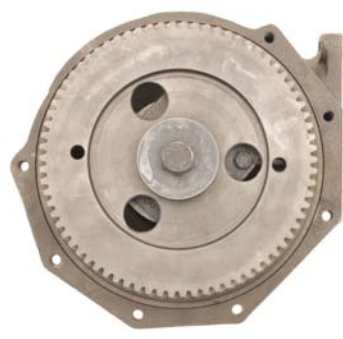

# Water Pump Applications - Medium/Heavy Duty Trucks

Application	Manufacturer PN	Part No.
<b>Caterpillar</b>		
Caterpillar 3126 Diesel 2004	OR1013	43554HD
		
Caterpillar 3208 Diesel 1991-1971; W/O Pulley	9N6147	42351HD
		
Caterpillar 3208 Diesel 1991-1971; W/Threaded Pulley	2W1227	43059HD
		
Caterpillar 3208 Diesel 1991-1971; W/Non-Threaded Pulley	2W1225	43233HD
		

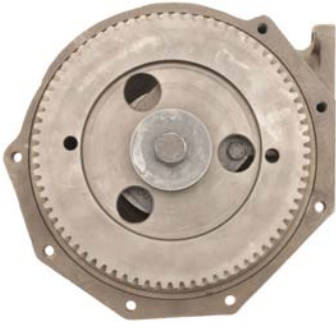



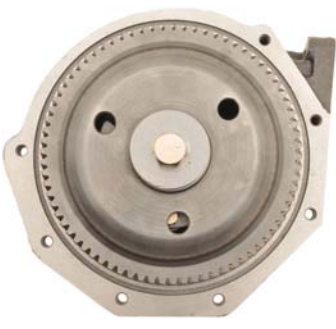





# Water Pump Applications - Medium/Heavy Duty Trucks

Application	Manufacturer PN	Part No.
<b>Caterpillar - Continued</b>		
Caterpillar 3406 Diesel 2003-1990	613890	44054HD
		
Caterpillar 3406 Diesel 2002-1989; W/Dished Gear	613890	44054HD
		
Caterpillar 3406 Diesel 1996-1973	7C9222	44600HDBP
		
Caterpillar 3406 Diesel 1996-1973; W/Flat Gear	7C4957	45009HD
		

## Water Pump Applications - Medium/Heavy Duty Trucks







Application	Manufacturer PN	Part No.
<b>Caterpillar - Continued</b>		
Caterpillar 3406 Diesel 1986	7C4957	45009HD
		
Caterpillar C10 Diesel 1997; Idler Pulley	3062602	41175HD
		
Caterpillar C15 Diesel 2000	10R0483	44054HD
		
<b>Cummins</b>		
Cummins 6-Cyl. 14.0 L Diesel 1992-1986; W/6-Ribbed Belt	3801708	44092HD
		

## Water Pump Applications - Medium/Heavy Duty Trucks









Application	Manufacturer PN	Part No.
<b>Cummins - Continued</b>		
Cummins 6-Cyl. 14.0 L Diesel 1992-1986; W/V-Belt Drive	3803138	44084HD
		
Cummins 6-Cyl. 14.0 L Diesel 1991-1990	3803605	44052HD
		
Cummins 6-Cyl. 14.0 L Diesel 1990-1984; Idler Pulley; W/Flat Idler Pulley	3065000	41173HD
		
Cummins 6-Cyl. 14.0 L Diesel 1990-1984; Idler Pulley; W/V-Ribbed Belt	3062931	41174HD
		
Cummins 6-Cyl. 14.0 L Diesel 1986-1981	3004923	44055HD
		











## Water Pump Applications - Medium/Heavy Duty Trucks

Application	Manufacturer PN	Part No.
<b>Cummins - Continued</b>		
Cummins 6-Cyl. 14.0 L Diesel 1985-1984; Tensioner Pulley; W/Big Cam III Eng.; W/V-Ribbed Belt	3064919	41111HD
		
Cummins 6-Cyl. 14.0 L Diesel 1985-1984; W/Big Cam IV Eng.; W/6-Ribbed Belt	3801708	44092HD
		
Cummins 6-Cyl. 14.0 L Diesel 1985-1984; W/Big Cam IV Eng.; W/V-Belt Drive	3803138	44084HD
		
Cummins 6-Cyl. 14.0 L Diesel 1984-1978	3022474	44086HD
		
Cummins 6-Cyl. 14.0 L Diesel 1983; W/Big Cam I & II Eng.	3022474	44086HD
		
Cummins 6-Cyl. 14.0 L Diesel 1983; W/Big Cam III Eng.	3004923	44055HD
		





## Water Pump Applications - Medium/Heavy Duty Trucks

Application	Manufacturer PN	Part No.
<b>Cummins - Continued</b>		
Cummins 6-Cyl. 14.0 L Diesel 1981-1978; Tensioner Pulley; W/V-Ribbed Belt	3064919	41111HD
		
Cummins 6-Cyl. 14.0 L Diesel 1979-1971; Idler Pulley; W/2-Groove Pulley	3064920	41129HD
		
Cummins 6-Cyl. 14.0 L Diesel 1979-1971; W/Full Flow Cool.	3807784	44064HD
		
Cummins 6-Cyl. 855 Diesel 1979-1971; Idler Pulley; W/2-Groove Pulley	3064920	41129HD
		









# Water Pump Applications - Medium/Heavy Duty Trucks

Application	Manufacturer PN	Part No.
<b>Cummins - Continued</b>		
Cummins 6-Cyl. 855 Diesel 1979-1971; W/Full Flow Cool.	3807784	44064HD
<div style="display: flex; justify-content: space-around;">   </div>		
Cummins C Series 8.3 L Diesel 1997-1960; W/Short Nose W.P.	3806180	42352HD
<div style="display: flex; justify-content: space-around;">   </div>		
Cummins C Series 8.3 L Diesel 1997-1960; W/Long Nose W.P.; W/O Hardened Pulley	3800974	43320HD
<div style="display: flex; justify-content: space-around;">   </div>		
Cummins C Series 8.3 L Diesel 1997-1960; W/Long Nose W.P.; W/Hardened Pulley	3800976	43321HD
<div style="display: flex; justify-content: space-around;">   </div>		









# Water Pump Applications - Medium/Heavy Duty Trucks

Application	Manufacturer PN	Part No.
<b>Cummins - Continued</b>		
Cummins C160 Diesel 1967-1959; W/Short Nose W.P.	3806180	42352HD
		
Cummins C160 Diesel 1967-1959; W/Long Nose W.P.; W/O Hardened Pulley	3800974	43320HD
		
Cummins C160 Diesel 1967-1959; W/Long Nose W.P.; W/Hardened Pulley	3800976	43321HD
		
Cummins C175 Diesel 1967-1959; W/Short Nose W.P.	3806180	42352HD
		









# Water Pump Applications - Medium/Heavy Duty Trucks

Application	Manufacturer PN	Part No.
<b>Cummins - Continued</b>		
Cummins C175 Diesel 1967-1959; W/Long Nose W.P.; W/O Hardened Pulley	3800974	43320HD
		
Cummins C175 Diesel 1967-1959; W/Long Nose W.P.; W/Hardened Pulley	3800976	43321HD
		
Cummins C180 Diesel 1967-1957; W/Short Nose W.P.	3806180	42352HD
		
Cummins C180 Diesel 1967-1957; W/Long Nose W.P.; W/O Hardened Pulley	3800974	43320HD
		







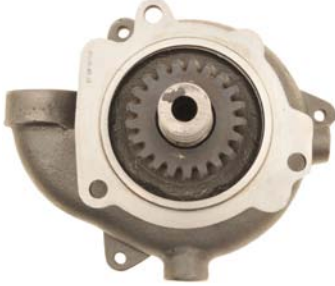

## Water Pump Applications - Medium/Heavy Duty Trucks

Application	Manufacturer PN	Part No.
<b>Cummins - Continued</b>		
Cummins C180 Diesel 1967-1957; W/Long Nose W.P.; W/Hardened Pulley	3800976	43321HD
		
Cummins CF160 Diesel 1967-1958; W/Short Nose W.P.	3806180	42352HD
		
Cummins CF160 Diesel 1967-1958; W/Long Nose W.P.; W/O Hardened Pulley	3800974	43320HD
		
Cummins CF160 Diesel 1967-1958; W/Long Nose W.P.; W/Hardened Pulley	3800976	43321HD
		

## Water Pump Applications - Medium/Heavy Duty Trucks



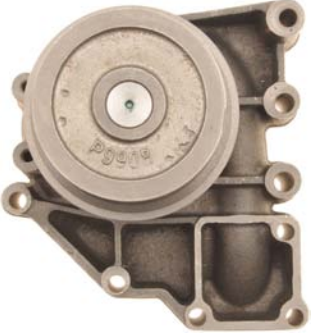





Application	Manufacturer PN	Part No.
<b>Cummins - Continued</b>		
Cummins ISC Diesel 2008-1997	4089647	42146HD
		
Cummins ISL Diesel 2009-2000	4089647	42146HD
		
Cummins ISL Diesel 2006-2005	4089647NX	42146HD
		
Cummins ISM Diesel 2008-1998	3803403RX	43307HD
		

# Water Pump Applications - Medium/Heavy Duty Trucks









Application	Manufacturer PN	Part No.
<b>Cummins - Continued</b>		
Cummins ISM Diesel 2001-1998	3803403	43307HD
		
Cummins ISX Diesel 2007-2003	4089910	45054HD
		
Cummins ISX Diesel 2007-2003	4089910RX	45054HD
		
Cummins ISX Diesel 2006	4089908NX	45051HD
		







## Water Pump Applications - Medium/Heavy Duty Trucks

Application	Manufacturer PN	Part No.
<b>Cummins - Continued</b>		
Cummins L10 Diesel 1998-1988; Idler Pulley	3062602	41175HD
		
Cummins L10 Diesel 1998-1988	3803403	43307HD
		
Cummins L10 Diesel 1991-1983	3803402	44094HD
		
Cummins M11 Diesel 1999-1992	3803403	43307HD
		









## Water Pump Applications - Medium/Heavy Duty Trucks

Application	Manufacturer PN	Part No.
<b>Cummins - Continued</b>		
Cummins M11 Diesel 1995; Idler Pulley	3062602	41175HD
		
Cummins N14 Diesel 2003-1988	3803605	44052HD
		
Cummins NH220 Diesel 1972-1968	BM76506	43229HD
		
Cummins NH230 Diesel 1979-1968; W/Pulley	AR4284	43238HD
		





## Water Pump Applications - Medium/Heavy Duty Trucks

Application	Manufacturer PN	Part No.
<b>Cummins - Continued</b>		
Cummins NH250 Diesel 1975-1973; W/Military Spec. Pulley	AR51333	43209HD
		
Cummins NH250 Diesel 1975-1973; W/O Pulley	AR51360	43258HD
		
Cummins NHC250 Diesel 1974-1968; W/Pulley	AR4284	43238HD
		
Cummins NHC250 Diesel 1973-1965; W/O Pulley	AR51360	43258HD
		

## Water Pump Applications - Medium/Heavy Duty Trucks

Application	Manufacturer PN	Part No.
<b>Cummins - Continued</b>		
Cummins NHC250 Diesel 1973-1965; W/Military Spec. Pulley	AR51333	43209HD
		
Cummins NHD230 Diesel 1974-1972; W/Pulley	AR4284	43238HD
		
Cummins NT Diesel 1973-1971; Idler Pulley; W/2-Groove Pulley	3064920	41129HD
		
Cummins NT Diesel 1973-1971; W/Full Flow Cool.	3807784	44064HD
		

## Water Pump Applications - Medium/Heavy Duty Trucks

Application	Manufacturer PN	Part No.
<b>Cummins - Continued</b>		
Cummins NTC230 Diesel 1979; W/2-Groove Pulley	3022471	43253HD
		
Cummins NTC250 Diesel 1976; W/Military Spec. Pulley	AR51333	43209HD
		
Cummins NTC250 Diesel 1976; W/O Pulley	AR51360	43258HD
		
Cummins V-8 210 Diesel 1973-1970	AR61788	44093HD
		

## Water Pump Applications - Medium/Heavy Duty Trucks

Application	Manufacturer PN	Part No.
<b>Detroit Diesel</b>		
Detroit Diesel 3-53 Diesel 1968-1962; W/Counterclockwise Eng. Rotation	23506003	43309HD
		
Detroit Diesel 3-53 Diesel 1968-1962; W/Clockwise Eng. Rotation	23506007	43310HD
		
Detroit Diesel 3-71 Diesel 1980-1976; W/O Turbo; W/Standard Rotation	5149707	42102HD
		
Detroit Diesel 3-71 Diesel 1980-1976; W/Turbo; W/Standard Rotation	5149708	42321HD
		

## Water Pump Applications - Medium/Heavy Duty Trucks











Application	Manufacturer PN	Part No.
<b>Detroit Diesel - Continued</b>		
Detroit Diesel 3-71 Diesel 1980-1976; W/Turbo; W/Reverse Rotation	5149710	42322HD
		
Detroit Diesel 3-71 Diesel 1980-1976; W/O Turbo; W/Reverse Rotation	5149706	42344HD
		
Detroit Diesel 4-53 Diesel 1981-1962; W/Counterclockwise Eng. Rotation	23506003	43309HD
		
Detroit Diesel 4-53 Diesel 1981-1962; W/Clockwise Eng. Rotation	23506007	43310HD
		

## Water Pump Applications - Medium/Heavy Duty Trucks













Application	Manufacturer PN	Part No.
<b>Detroit Diesel - Continued</b>		
Detroit Diesel 4-71 Diesel 1961-1952; W/O Turbo; W/Standard Rotation	5149707	42102HD
		
Detroit Diesel 4-71 Diesel 1961-1952; W/Turbo; W/Standard Rotation	5149708	42321HD
		
Detroit Diesel 4-71 Diesel 1961-1952; W/Turbo; W/Reverse Rotation	5149710	42322HD
		
Detroit Diesel 4-71 Diesel 1961-1952; W/O Turbo; W/Reverse Rotation	5149706	42344HD
		
Detroit Diesel 6-71 Diesel 1989-1952; W/O Turbo; W/Standard Rotation	5149707	42102HD
		











## Water Pump Applications - Medium/Heavy Duty Trucks

Application	Manufacturer PN	Part No.
<b>Detroit Diesel - Continued</b>		
Detroit Diesel 6-71 Diesel 1989-1952; W/Turbo; W/Standard Rotation	5149708	42321HD
		
Detroit Diesel 6-71 Diesel 1989-1952; W/Turbo; W/Reverse Rotation	5149710	42322HD
		
Detroit Diesel 6-71 Diesel 1989-1952; W/O Turbo; W/Reverse Rotation	5149706	42344HD
		
Detroit Diesel 6-71 Diesel 1983-1965; W/Reverse Rotation	5149706	42344HD
		
Detroit Diesel 6-71 Diesel 1983-1965; W/Standard Rotation	5149707	42102HD
		

## Water Pump Applications - Medium/Heavy Duty Trucks

Application	Manufacturer PN	Part No.
<b>Detroit Diesel - Continued</b>		
Detroit Diesel 6-71 Diesel 1982; W/Standard Rotation	5149708	42321HD
		
Detroit Diesel 6-71 Diesel 1982; W/Reverse Rotation	5149710	42322HD
		
Detroit Diesel 6-Cyl. 11.1 L Diesel 2003-1989	23535018	44066HD
		
Detroit Diesel 6-Cyl. 11.1 L Diesel 2000	-	44066HD
		
Detroit Diesel 6-Cyl. 12.7 L Diesel 2009-1988	23535018	44066HD
		
Detroit Diesel 6-Cyl. 12.7 L Diesel 2007	23535017	46003HD
		











## Water Pump Applications - Medium/Heavy Duty Trucks

Application	Manufacturer PN	Part No.
<b>Detroit Diesel - Continued</b>		
Detroit Diesel 6-Cyl. 12.7 L Diesel 2001	23526039	46002HD
		
Detroit Diesel 6-Cyl. 12.7 L Diesel 2000	-	44066HD
		
Detroit Diesel 6-Cyl. 14.0 L Diesel 2007-2001	23535018	44066HD
		
Detroit Diesel 6-Cyl. 14.0 L Diesel 2007; W/O E.G.R.	23535017	46003HD
		
Detroit Diesel 6-Cyl. 14.0 L Diesel 2007; W/E.G.R.	-	46004HD
No Image		













## Water Pump Applications - Medium/Heavy Duty Trucks

Application	Manufacturer PN	Part No.
<b>Detroit Diesel - Continued</b>		
Detroit Diesel 6V-53 Diesel 1985-1954; W/Counterclockwise Eng. Rotation	23506003	43309HD
		
Detroit Diesel 6V-53 Diesel 1985-1954; W/Clockwise Eng. Rotation	23506007	43310HD
		
Detroit Diesel 6V-71 Diesel 1978-1966; Standing Pump (2 outlets pointing straight down)	5149328	44075HD
		
Detroit Diesel 6V-92 Diesel 1989-1973; Walking Pump (1 outlet pointing straight down & 1 outlet at 45 deg. angle)	8922336	44097HD
		
Detroit Diesel 6V-92 Diesel 1983; W/O Turbo; W/Standard Rotation	5149707	42102HD
		

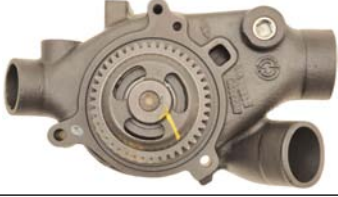







## Water Pump Applications - Medium/Heavy Duty Trucks

Application	Manufacturer PN	Part No.
<b>Detroit Diesel - Continued</b>		
Detroit Diesel 6V-92 Diesel 1983; W/Turbo; W/Standard Rotation	5149708	42321HD
		
Detroit Diesel 6V-92 Diesel 1983; W/Turbo; W/Reverse Rotation	5149710	42322HD
		
Detroit Diesel 6V-92 Diesel 1983; W/O Turbo; W/Reverse Rotation	5149706	42344HD
		
Detroit Diesel 8V-71 Diesel 1986-1957	5149328	44075HD
		
Detroit Diesel 8V-71 Diesel 1979-1966; Standing Pump (2 outlets pointing straight down)	5149328	44075HD
		

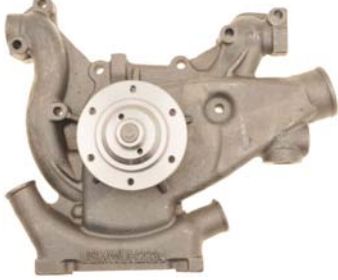



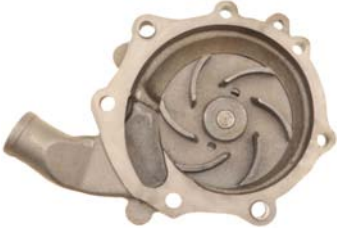

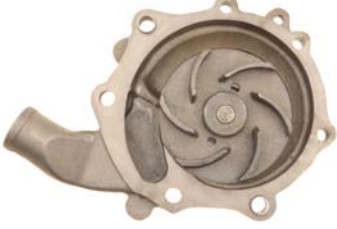
## Water Pump Applications - Medium/Heavy Duty Trucks

Application	Manufacturer PN	Part No.
<b>Detroit Diesel - Continued</b>		
Detroit Diesel 8V-71 Diesel 1973	AR61788	44093HD
		
Detroit Diesel 8V-71N Diesel 1974-1970	5149328	44075HD
		
Detroit Diesel 8V-71T Diesel 1974-1971	5149328	44075HD
		
Detroit Diesel 8V-92 Diesel 1988-1974; Walking Pump (1 outlet pointing straight down & 1 outlet at 45 deg. angle)	8922336	44097HD
		
Detroit Diesel Series 50 Diesel 2001-1994	23535018	44066HD
		
Detroit Diesel Series 55 Diesel 1998-1996	23535018	44066HD
		

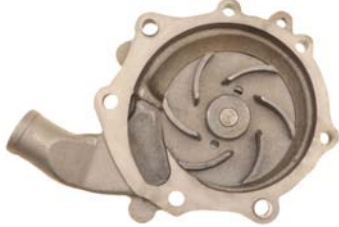
## Water Pump Applications - Medium/Heavy Duty Trucks

Application	Manufacturer PN	Part No.
<b>Detroit Diesel - Continued</b>		
Detroit Diesel Series 60 Diesel 2001-1991	23535018	44066HD
		
Detroit Diesel V-8 8.2 L Diesel 1990-1980; W/Heater Outlet	8928672	46001HD
		
<b>Ford</b>		
Ford 6-Cyl. 6.6 L Diesel 1994-1991; W/High Mount Fan	F1HZ 8501 C	43021HD
		
Ford 6-Cyl. 6.6 L Diesel 1994-1991; W/Low Mount Fan	F1HZ 8501 D	43125HD
		
Ford 6-Cyl. 6.6 L Diesel 1993-1991	F1HZ 8501 D	43125HD
		

## Water Pump Applications - Medium/Heavy Duty Trucks

Application	Manufacturer PN	Part No.
<b>Ford - Continued</b>		
Ford 6-Cyl. 7.8 L Diesel 1994-1991	F1HZ 8501 D	43125HD
		
Ford 6-Cyl. 7.8 L Diesel 1993-1991; W/Low Mount Fan	F1HZ 8501 D	43125HD
		
Ford 6-Cyl. 7.8 L Diesel 1993-1991; W/High Mount Fan	F1HZ 8501 C	43021HD
		
<b>International/Navistar</b>		
International/Navistar 530 Diesel 2000	1830606C94	42318HD
		











## Water Pump Applications - Medium/Heavy Duty Trucks

Application	Manufacturer PN	Part No.
<b>International/Navistar - Continued</b>		
International/Navistar 530 Diesel 1997-1994	1817687C94	42318HD
		
International/Navistar DT360 Diesel 1993	1815538	44059HD
		
International/Navistar DT408 Diesel 1994	1830606C94	42318HD
		
International/Navistar DT466 Diesel 2008-2004	1842665C93	43325HD
		









## Water Pump Applications - Medium/Heavy Duty Trucks

Application	Manufacturer PN	Part No.
<b>International/Navistar - Continued</b>		
International/Navistar DT466 Diesel 1996-1995	1817687C93	42318HD
		
International/Navistar DT466 Diesel 1996	1817687C94	42318HD
		
International/Navistar DT466 Diesel 1995-1992	1815538C91	44059HD
		
International/Navistar DT466 Diesel 1993; W/Low Mount Fan	1815538C91	44059HD
		









## Water Pump Applications - Medium/Heavy Duty Trucks

Application	Manufacturer PN	Part No.
<b>International/Navistar - Continued</b>		
International/Navistar DT466 Diesel 1992-1986	685155C91	44058HD
		
International/Navistar DT466 Diesel 1992; W/Low Mount Fan	685155C91	44058HD
		
International/Navistar DT466 Diesel 1986-1980	680899C93	44104HD
		
International/Navistar MaxxForce 10 Diesel 2008	1842665C93	43325HD
		







## Water Pump Applications - Medium/Heavy Duty Trucks

Application	Manufacturer PN	Part No.
<b>International/Navistar - Continued</b>		
International/Navistar MaxxForce DT Diesel 2012-2010	1842665C93	43325HD
		
International/Navistar MaxxForce DT Diesel 2009-2008	1842664C92	43325HD
		
International/Navistar T444 Diesel 2003-1997	1823669C92	43545HD
		
International/Navistar T444 Diesel 1994-1991	1809374	44053HD
		









## Water Pump Applications - Medium/Heavy Duty Trucks

Application	Manufacturer PN	Part No.
<b>International/Navistar - Continued</b>		
International/Navistar V345 1984-1978	-	42111HD
		
International/Navistar V345 1975-1973; W/O Fan Clutch	-	42111HD
		
International/Navistar V537 1981-1978	448087C92	43443HD
		
International/Navistar V-8 6.9 L Diesel 1988-1983	1809374	44053HD
		



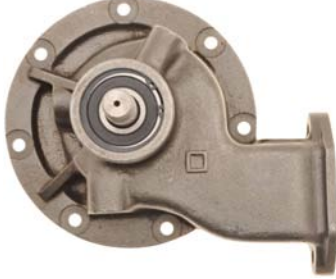
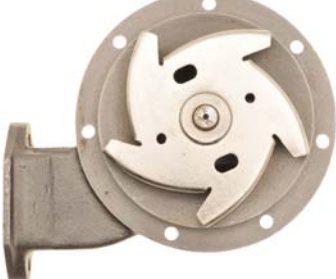



## Water Pump Applications - Medium/Heavy Duty Trucks

Application	Manufacturer PN	Part No.
<b>International/Navistar - Continued</b>		
International/Navistar V-8 7.3 L Diesel 1993-1988	1809374	44053HD
		
International/Navistar V-8 9.0 L Diesel 1988-1980	1700594	42114HD
		
<b>Mack</b>		
Mack 6-Cyl. 11.0 L Diesel 1991-1989	316GC-1210A	43240HD
		
Mack 6-Cyl. 11.0 L Diesel 1982-1980	316GCA-1211	43225HD
		
Mack 6-Cyl. 12.0 L Diesel 2003-1989	316GC-1210A	43240HD
		

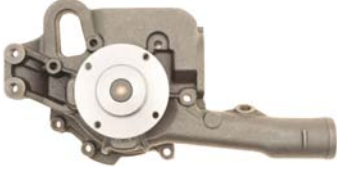
## Water Pump Applications - Medium/Heavy Duty Trucks

Application	Manufacturer PN	Part No.
<b>Mack - Continued</b>		
Mack 6-Cyl. 12.0 L Diesel 2002-2001	316GC-1219A	43240HD
		
Mack 6-Cyl. 672 Diesel 1979-1974	316GCA-1211	43225HD
		
Mack 6-Cyl. 672 Diesel 1973-1968	316GCA184CDE	43226HD
		
Mack E3 Diesel 1993-1990	500.338.059	43312HD
		
Mack E5 Diesel 1990-1987	500.338.059	43312HD
		

## Water Pump Applications - Medium/Heavy Duty Trucks

Application	Manufacturer PN	Part No.
<b>Mercedes-Benz</b>		
Mercedes-Benz MBE 900 Diesel 2005-2000	9042004901	45053HD
		
Mercedes-Benz MBE 900 Diesel 2003	9062006201	45050HD
		
Mercedes-Benz OM366 Diesel 1991	A3662000601	44080HD
		





## Manufacturer's Part Numbers

Manufacturer No.	Gates No.	Manufacturer No.	Gates No.	Manufacturer No.	Gates No.	Manufacturer No.	Gates No.
1072A734	43233HD	23535017	46003HD	4026702	45051HD	685155C94	44058HD
10R0483	44054HD	23535018	44066HD	4089647	42146HD	685155C95	44058HD
10R482	45009HD	2356027	42102HD	4089647NX	42146HD	6I3890	44054HD
11.4576	43313HD	270918C93	42111HD	4089908	45051HD	735036-M91	43232HD
11.5858	42342HD	2W1225	43233HD	4089908NX	45051HD	735327C91	44058HD
1208402	43554HD	2W1227	43059HD	4089910	45054HD	7C4957	45009HD
12528816	43256HD	3000886	44064HD	4089910RX	45054HD	7C9222	44600HDBP
132423	43229HD	3004923	44055HD	4131018	43243HD	7W7019	45009HD
1354926	45009HD	3022471	43253HD	41312159	43232HD	861236R92	42111HD
151203R1	42111HD	3022474	44086HD	41312487	43232HD	8920915	42322HD
1700594	42114HD	3027174	44078HD	41312756	43246HD	8920916M	42321HD
1700594C91	42114HD	3035157	44094HD	41312918	43247HD	8922336	44097HD
1700594C92	42114HD	3039182	44094HD	41313018	44069HD	8928672	46001HD
1805951C91	44053HD	3045943	44092HD	41313047	43441HD	9042004901	45053HD
1805952C91	44053HD	3053538	44084HD	41313048	43250HD	9062006201	45050HD
1809374	44053HD	3062602	41175HD	41313201	42311HD	93432783	43256HD
1809374C91	44053HD	3062931	41174HD	446430C	44053HD	93432783	43256HD
1809374C93	44053HD	3064201R	41174HD	446430C3	44053HD	9N1249	43233HD
1809374C94	44053HD	3064919	41111HD	446430C4	44053HD	9N1949	43233HD
1815538	44059HD	3064920	41129HD	448087C92	43443HD	9N6147	42351HD
1815538C91	44059HD	3065000	41173HD	463365C91	42111HD	A34079A05	44093HD
1817687C92	42318HD	3081234	41174HD	489173C1	42114HD	A3662000601	44080HD
1817687C93	42318HD	3136053	43322HD	4920465	45054HD	A3662006801	43251HD
1817687C94	42318HD	3136053R92	43322HD	4P2383	44600HDBP	A3902000101	44601HD
1817687C95	42318HD	316GC-1184BX	43225HD	500.338.059	43312HD	AR-04283	43242HD
1817687C96	42318HD	316GC-1210A	43240HD	5104392	43311HD	AR-04283	43242HD
1817687C97	42318HD	316GC-1210A	43240HD	510616C	44075HD	AR4283	43242HD
1817687C98	42318HD	316GC-1210AX	43240HD	5135595	42344HD	AR4284	43238HD
1821935C1	42318HD	316GC-1211AX	43225HD	5135596	42102HD	AR45073	43253HD
1821935C3	42318HD	316GC-1219	43240HD	5135596	42102HD	AR45090	44064HD
1821935C4	42318HD	316GC-1219A	43240HD	5135596	42102HD	AR45090RX	44064HD
1822325	44097HD	316GC-552M2X	43240HD	5135602	42102HD	AR45184	44086HD
1823669C91	43545HD	316GCA-1211	43225HD	5135602	42102HD	AR45184RX	44086HD
1823669C92	43545HD	316GCA-1211A	43225HD	5135602	42102HD	AR45189	41111HD
1830606C94	42318HD	316GCA-184C,D	43226HD	5149328	44075HD	AR51333	43209HD
1831676C91	43545HD	316GCA184CDE	43226HD	5149372	42102HD	AR51360	43258HD
1831676C92	43545HD	316GCA-184E,F	43226HD	5149706	42344HD	AR61788	44093HD
1831676C93	43545HD	316GCA-184G	43226HD	5149707	42102HD	AR8851	41129HD
1842664C92	43325HD	360GB325A	43226HD	5149708	42321HD	BM-50446	43229HD
1842665C93	43325HD	360GB4431	43225HD	5149710	42322HD	BM76506	43229HD
1889249C91	43545HD	3682311	45054HD	5159059	42344HD	BM-76506	43229HD
196845	43242HD	37711330B	43232HD	5159060	42102HD	C5NN 8501 A	43073HD
218274	44086HD	37711330B	43232HD	5159060	42102HD	D5NN 8501 E	43042HD
219040	44064HD	3800974	43320HD	5178318	42102HD	D5NN 8505 A	43042HD
23505019	46005HD	3800975	43319HD	5186574	42102HD	D8NN 8501 UA	43042HD
23506003	43309HD	3800976	43321HD	5186575	42344HD	E8HN 8508 AB	43125HD
23506007	43310HD	3801708	44092HD	5186576	42102HD	FOHN 8508 AA	43021HD
23506011	43311HD	3801713	43253HD	5186576	42102HD	F1HZ 8501 C	43021HD
23506602	44097HD	3801788	44086HD	613890	44054HD	F1HZ 8501 CRM	43021HD
23506704	42322HD	3802081	42352HD	673162	44101HD	F1HZ 8501 D	43125HD
23506711	42321HD	3803030	44084HD	673162C93	44101HD	F1HZ 8501 DRM	43125HD
23506723	42344HD	3803138	44084HD	673162C94	44101HD	OR1013	43554HD
23506735	42102HD	3803402	44094HD	675806C3	44104HD	R23531246	44066HD
23506790	44075HD	3803402RX	44094HD	677856C2	44058HD	R23531258	44066HD
23509067	46005HD	3803403	43307HD	680155C92	44058HD	R23535018	44066HD
23526039	46002HD	3803403RX	43307HD	680899C91	44104HD	TK4576	43313HD
23531246	44066HD	3803605	44052HD	680899C92	44104HD	U5MWW0092	43254HD
23531257	46003HD	3804927	42146HD	680899C93	44104HD		
23532542	46003HD	3806180	42352HD	685155C91	44058HD		
23532543	46004HD	3807784	44064HD	685155C92	44058HD		









# HD Water Pump Numerical Listings

Use as a Guide Only. Alphabetical Listing provides more detail.

<p style="text-align: center;"><b>41111HD</b></p> <p>Autocar; Cummins 6-Cyl. 14.0 L Diesel; 1985-1980            Chevrolet; Cummins 6-Cyl. 14.0 L Diesel; 1980            Ford; Cummins 6-Cyl. 14.0 L Diesel; 1985-1980            Freightliner; Cummins 6-Cyl. 14.0 L Diesel; 1985-1980            GMC; Cummins 6-Cyl. 14.0 L Diesel; 1985-1980            International/Navistar; Cummins 6-Cyl. 14.0 L Diesel; 1985-1980            Kenworth; Cummins 6-Cyl. 14.0 L Diesel; 1985-1980            Mack; Cummins 6-Cyl. 14.0 L Diesel; 1985-1980            Marmon; Cummins 6-Cyl. 14.0 L Diesel; 1985-1980            Peterbilt; Cummins 6-Cyl. 14.0 L Diesel; 1985-1980            Western Star; Cummins 6-Cyl. 14.0 L Diesel; 1985-1978            White; Cummins 6-Cyl. 14.0 L Diesel; 1985-1980</p> <p style="text-align: center;"><b>41129HD</b></p> <p>Autocar; Cummins 6-Cyl. 14.0 L Diesel; 1979-1974            Brockway; Cummins 6-Cyl. 14.0 L Diesel; 1977-1973            Chevrolet; Cummins 6-Cyl. 14.0 L Diesel; 1979-1971            Dodge; Cummins 6-Cyl. 14.0 L Diesel; 1974-1973            Ford; Cummins 6-Cyl. 14.0 L Diesel; 1979-1971            Freightliner; Cummins 6-Cyl. 855 Diesel; 1979-1974            Freightliner; Cummins NT Diesel; 1973-1971            Hendrickson; Cummins 6-Cyl. 14.0 L Diesel; 1973            International/Navistar; Cummins 6-Cyl. 14.0 L Diesel; 1979-1973            Kenworth; Cummins 6-Cyl. 855 Diesel; 1979-1971            Mack; Cummins 6-Cyl. 855 Diesel; 1979-1971            Mack; Cummins NT Diesel; 1972-1971            Marmon; Cummins 6-Cyl. 14.0 L Diesel; 1979-1973            Peterbilt; Cummins 6-Cyl. 14.0 L Diesel; 1979-1971            White; Cummins 6-Cyl. 14.0 L Diesel; 1979-1971</p> <p style="text-align: center;"><b>41173HD</b></p> <p>Autocar; Cummins 6-Cyl. 14.0 L Diesel; 1988-1985            Ford; Cummins 6-Cyl. 14.0 L Diesel; 1990-1985            Freightliner; Cummins 6-Cyl. 14.0 L Diesel; 1990-1985            GMC; Cummins 6-Cyl. 14.0 L Diesel; 1988-1985            International/Navistar; Cummins 6-Cyl. 14.0 L Diesel; 1990-1985            Kenworth; Cummins 6-Cyl. 14.0 L Diesel; 1990-1985            Mack; Cummins 6-Cyl. 14.0 L Diesel; 1990-1985            Marmon; Cummins 6-Cyl. 14.0 L Diesel; 1990-1985            Peterbilt; Cummins 6-Cyl. 14.0 L Diesel; 1990-1984            Volvo; Cummins 6-Cyl. 14.0 L Diesel; 1990            Western Star; Cummins 6-Cyl. 14.0 L Diesel; 1990-1985            White; Cummins 6-Cyl. 14.0 L Diesel; 1988-1984            White GMC; Cummins 6-Cyl. 14.0 L Diesel; 1990-1988</p> <p style="text-align: center;"><b>41174HD</b></p> <p>Autocar; Cummins 6-Cyl. 14.0 L Diesel; 1988-1985            Ford; Cummins 6-Cyl. 14.0 L Diesel; 1990-1985            Freightliner; Cummins 6-Cyl. 14.0 L Diesel; 1990-1985            GMC; Cummins 6-Cyl. 14.0 L Diesel; 1988-1985            International/Navistar; Cummins 6-Cyl. 14.0 L Diesel; 1990-1985            Kenworth; Cummins 6-Cyl. 14.0 L Diesel; 1990-1985            Mack; Cummins 6-Cyl. 14.0 L Diesel; 1990-1985            Marmon; Cummins 6-Cyl. 14.0 L Diesel; 1990-1985            Peterbilt; Cummins 6-Cyl. 14.0 L Diesel; 1990-1984            Volvo; Cummins 6-Cyl. 14.0 L Diesel; 1990            Western Star; Cummins 6-Cyl. 14.0 L Diesel; 1990-1985            White; Cummins 6-Cyl. 14.0 L Diesel; 1988-1984            White GMC; Cummins 6-Cyl. 14.0 L Diesel; 1990-1988</p> <p style="text-align: center;"><b>41175HD</b></p> <p>Autocar; Cummins L10 Diesel; 1995-1991            Ford; Caterpillar C10 Diesel; 1997</p>	<p style="text-align: center;"><b>41175HD - Continued</b></p> <p>Ford; Cummins L10 Diesel; 1997-1991            Freightliner; Cummins L10 Diesel; 1996-1989            International/Navistar; Cummins L10 Diesel; 1998-1991            International/Navistar; Cummins M11 Diesel; 1995            Kenworth; Cummins L10 Diesel; 1997-1991            Peterbilt; Cummins L10 Diesel; 1997-1988</p> <p style="text-align: center;"><b>42102HD</b></p> <p>Autocar; Detroit Diesel 6-71 Diesel; 1981-1972            Brockway; Detroit Diesel 6-71 Diesel; 1975-1973            Chevrolet; Detroit Diesel 6-71 Diesel; 1980-1966            Diamond Reo; Detroit Diesel 6-71 Diesel; 1974-1967            Dodge; Detroit Diesel 6-71 Diesel; 1974-1969            F.W.D.; Detroit Diesel 3-71 Diesel; 1980-1976            F.W.D.; Detroit Diesel 4-71 Diesel; 1961-1955            F.W.D.; Detroit Diesel 6-71 Diesel; 1988-1955            Ford; Detroit Diesel 6-71 Diesel; 1986-1967            GMC; Detroit Diesel 3-71 Diesel; 1978            GMC; Detroit Diesel 4-71 Diesel; 1959-1952            GMC; Detroit Diesel 6-71 Diesel; 1988-1952            Hendrickson; Detroit Diesel 6-71 Diesel; 1973            International/Navistar; Detroit Diesel 6-71 Diesel; 1987-1972            Kenworth; Detroit Diesel 6-71 Diesel; 1986-1973            Mack; Detroit Diesel 6V-92 Diesel; 1983            Peterbilt; Detroit Diesel 6-71 Diesel; 1986-1965            Reo; Detroit Diesel 6-71 Diesel; 1967-1954            Western Star; Detroit Diesel 6-71 Diesel; 1988-1979            White; Detroit Diesel 6-71 Diesel; 1988-1968            White GMC; Detroit Diesel 6-71 Diesel; 1989-1988</p> <p style="text-align: center;"><b>42111HD</b></p> <p>International/Navistar; International/Navistar V345; 1984-1973</p> <p style="text-align: center;"><b>42114HD</b></p> <p>International/Navistar; International/Navistar V-8 9.0 L Diesel; 1988-1980</p> <p style="text-align: center;"><b>42146HD</b></p> <p>Autocar; Cummins ISC Diesel; 2006-2002            Autocar; Cummins ISL Diesel; 2006            Freightliner; Cummins ISC Diesel; 2008-1998            Freightliner; Cummins ISL Diesel; 2005-2001            Kenworth; Cummins ISC Diesel; 2008-1998            Kenworth; Cummins ISL Diesel; 2009-2001            Mack; Cummins ISL Diesel; 2002            Peterbilt; Cummins ISC Diesel; 2007-1997            Peterbilt; Cummins ISL Diesel; 2008-2000            Sterling; Cummins ISC Diesel; 2008-1998            Sterling; Cummins ISL Diesel; 2007-2001            Volvo; Cummins ISL Diesel; 2005-2004</p> <p style="text-align: center;"><b>42318HD</b></p> <p>International/Navistar; International/Navistar 530 Diesel; 2000-1994            International/Navistar; International/Navistar DT408 Diesel; 1994            International/Navistar; International/Navistar DT466 Diesel; 1996-1995</p> <p style="text-align: center;"><b>42321HD</b></p> <p>Autocar; Detroit Diesel 6-71 Diesel; 1981-1972            Brockway; Detroit Diesel 6-71 Diesel; 1975-1973            Chevrolet; Detroit Diesel 6-71 Diesel; 1980-1966            Diamond Reo; Detroit Diesel 6-71 Diesel; 1974-1967            Dodge; Detroit Diesel 6-71 Diesel; 1974-1973            F.W.D.; Detroit Diesel 3-71 Diesel; 1980-1976            F.W.D.; Detroit Diesel 4-71 Diesel; 1961-1955            F.W.D.; Detroit Diesel 6-71 Diesel; 1988-1955</p>
--	--

## HD Water Pump Numerical Listings

Use as a Guide Only. Alphabetical Listing provides more detail.

42321HD - Continued	42351HD - Continued
Ford; Detroit Diesel 6-71 Diesel; 1986-1967 GMC; Detroit Diesel 3-71 Diesel; 1978 GMC; Detroit Diesel 4-71 Diesel; 1959-1952 GMC; Detroit Diesel 6-71 Diesel; 1988-1952 Hendrickson; Detroit Diesel 6-71 Diesel; 1973 International/Navistar; Detroit Diesel 6-71 Diesel; 1987-1972 Kenworth; Detroit Diesel 6-71 Diesel; 1986-1973 Mack; Detroit Diesel 6V-92 Diesel; 1983 Peterbilt; Detroit Diesel 6-71 Diesel; 1986-1972 Reo; Detroit Diesel 6-71 Diesel; 1966-1954 Western Star; Detroit Diesel 6-71 Diesel; 1988-1979 White; Detroit Diesel 6-71 Diesel; 1988-1968 White GMC; Detroit Diesel 6-71 Diesel; 1989-1988	Ford; Caterpillar 3208 Diesel; 1990-1971 GMC; Caterpillar 3208 Diesel; 1990-1976 International/Navistar; Caterpillar 3208 Diesel; 1990-1974 Mack; Caterpillar 3208 Diesel; 1982-1974 Peterbilt; Caterpillar 3208 Diesel; 1985-1977 Volvo; Caterpillar 3208 Diesel; 1990 White; Caterpillar 3208 Diesel; 1988-1975 White GMC; Caterpillar 3208 Diesel; 1991-1988
42322HD	42352HD
Autocar; Detroit Diesel 6-71 Diesel; 1981-1972 Brockway; Detroit Diesel 6-71 Diesel; 1975-1973 Chevrolet; Detroit Diesel 6-71 Diesel; 1980-1966 Diamond Reo; Detroit Diesel 6-71 Diesel; 1974-1967 Dodge; Detroit Diesel 6-71 Diesel; 1974-1973 F.W.D.; Detroit Diesel 3-71 Diesel; 1980-1976 F.W.D.; Detroit Diesel 4-71 Diesel; 1961-1955 F.W.D.; Detroit Diesel 6-71 Diesel; 1988-1955 Ford; Detroit Diesel 6-71 Diesel; 1986-1967 GMC; Detroit Diesel 3-71 Diesel; 1978 GMC; Detroit Diesel 4-71 Diesel; 1959-1952 GMC; Detroit Diesel 6-71 Diesel; 1988-1952 Hendrickson; Detroit Diesel 6-71 Diesel; 1973 International/Navistar; Detroit Diesel 6-71 Diesel; 1987-1972 Kenworth; Detroit Diesel 6-71 Diesel; 1986-1973 Mack; Detroit Diesel 6V-92 Diesel; 1983 Peterbilt; Detroit Diesel 6-71 Diesel; 1986-1972 Reo; Detroit Diesel 6-71 Diesel; 1966-1954 Western Star; Detroit Diesel 6-71 Diesel; 1988-1979 White; Detroit Diesel 6-71 Diesel; 1988-1968 White GMC; Detroit Diesel 6-71 Diesel; 1989-1988	Diamond Reo; Cummins C Series 8.3 L Diesel; 1969-1968 Dodge; Cummins C175 Diesel; 1966-1960 F.W.D.; Cummins C Series 8.3 L Diesel; 1965-1963 Ford; Cummins C Series 8.3 L Diesel; 1997-1993 Freightliner; Cummins C Series 8.3 L Diesel; 1996-1994 Kenworth; Cummins C Series 8.3 L Diesel; 1997-1987 Mack; Cummins C Series 8.3 L Diesel; 1992-1991 Oshkosh; Cummins C Series 8.3 L Diesel; 1966-1960 Peterbilt; Cummins C Series 8.3 L Diesel; 1997-1987 Reo; Cummins C160 Diesel; 1967-1959 Reo; Cummins C175 Diesel; 1967-1959 Reo; Cummins C180 Diesel; 1967-1957 Reo; Cummins CF160 Diesel; 1967-1958 Volvo; Cummins C Series 8.3 L Diesel; 1997-1996 Western Star; Cummins C Series 8.3 L Diesel; 1990-1989 White; Cummins C Series 8.3 L Diesel; 1972-1969 White GMC; Cummins C Series 8.3 L Diesel; 1995-1991
42344HD	43021HD
Autocar; Detroit Diesel 6-71 Diesel; 1981-1972 Brockway; Detroit Diesel 6-71 Diesel; 1975-1973 Chevrolet; Detroit Diesel 6-71 Diesel; 1980-1966 Diamond Reo; Detroit Diesel 6-71 Diesel; 1974-1967 Dodge; Detroit Diesel 6-71 Diesel; 1974-1969 F.W.D.; Detroit Diesel 3-71 Diesel; 1980-1976 F.W.D.; Detroit Diesel 4-71 Diesel; 1961-1955 F.W.D.; Detroit Diesel 6-71 Diesel; 1988-1955 Ford; Detroit Diesel 6-71 Diesel; 1986-1967 GMC; Detroit Diesel 3-71 Diesel; 1978 GMC; Detroit Diesel 4-71 Diesel; 1959-1952 GMC; Detroit Diesel 6-71 Diesel; 1988-1952 Hendrickson; Detroit Diesel 6-71 Diesel; 1973 International/Navistar; Detroit Diesel 6-71 Diesel; 1987-1972 Kenworth; Detroit Diesel 6-71 Diesel; 1986-1973 Mack; Detroit Diesel 6V-92 Diesel; 1983 Peterbilt; Detroit Diesel 6-71 Diesel; 1986-1965 Reo; Detroit Diesel 6-71 Diesel; 1967-1954 Western Star; Detroit Diesel 6-71 Diesel; 1988-1979 White; Detroit Diesel 6-71 Diesel; 1988-1968 White GMC; Detroit Diesel 6-71 Diesel; 1989-1988	Ford; Ford 6-Cyl. 6.6 L Diesel; 1994-1991 Ford; Ford 6-Cyl. 7.8 L Diesel; 1993-1991
42351HD	43059HD
Autocar; Caterpillar 3208 Diesel; 1980-1979 Chevrolet; Caterpillar 3208 Diesel; 1990-1976	Autocar; Caterpillar 3208 Diesel; 1980-1979 Chevrolet; Caterpillar 3208 Diesel; 1990-1976 Ford; Caterpillar 3208 Diesel; 1990-1971 GMC; Caterpillar 3208 Diesel; 1990-1976 International/Navistar; Caterpillar 3208 Diesel; 1990-1974 Mack; Caterpillar 3208 Diesel; 1982-1974 Peterbilt; Caterpillar 3208 Diesel; 1985-1977 Volvo; Caterpillar 3208 Diesel; 1990 White; Caterpillar 3208 Diesel; 1988-1975 White GMC; Caterpillar 3208 Diesel; 1991-1988
42351HD	43125HD
Autocar; Caterpillar 3208 Diesel; 1980-1979 Chevrolet; Caterpillar 3208 Diesel; 1990-1976	Ford; Ford 6-Cyl. 6.6 L Diesel; 1994-1991 Ford; Ford 6-Cyl. 7.8 L Diesel; 1994-1991
42351HD	43209HD
Autocar; Caterpillar 3208 Diesel; 1980-1979 Chevrolet; Caterpillar 3208 Diesel; 1990-1976	Brockway; Cummins NH250 Diesel; 1975-1973 F.W.D.; Cummins NTC250 Diesel; 1976 Mack; Cummins NHC250 Diesel; 1972-1970 Peterbilt; Cummins NHC250 Diesel; 1973-1965
42351HD	43225HD
Autocar; Caterpillar 3208 Diesel; 1980-1979 Chevrolet; Caterpillar 3208 Diesel; 1990-1976	Mack; Mack 6-Cyl. 11.0 L Diesel; 1982-1980 Mack; Mack 6-Cyl. 672 Diesel; 1979-1974
42351HD	43226HD
Autocar; Caterpillar 3208 Diesel; 1980-1979 Chevrolet; Caterpillar 3208 Diesel; 1990-1976	Mack; Mack 6-Cyl. 672 Diesel; 1973-1968
42351HD	43229HD
Autocar; Caterpillar 3208 Diesel; 1980-1979 Chevrolet; Caterpillar 3208 Diesel; 1990-1976	Marmon; Cummins NH220 Diesel; 1972-1968

# HD Water Pump Numerical Listings

Use as a Guide Only. Alphabetical Listing provides more detail.

<p style="text-align: center;"><b>43233HD</b></p> <p>Autocar; Caterpillar 3208 Diesel; 1980-1979            Chevrolet; Caterpillar 3208 Diesel; 1990-1976            Ford; Caterpillar 3208 Diesel; 1990-1971            GMC; Caterpillar 3208 Diesel; 1990-1976            International/Navistar; Caterpillar 3208 Diesel; 1990-1974            Mack; Caterpillar 3208 Diesel; 1982-1974            Peterbilt; Caterpillar 3208 Diesel; 1985-1977            Volvo; Caterpillar 3208 Diesel; 1990            White; Caterpillar 3208 Diesel; 1988-1975            White GMC; Caterpillar 3208 Diesel; 1991-1988</p>	<p style="text-align: center;"><b>43309HD - Continued</b></p> <p>Ford; Detroit Diesel 6V-53 Diesel; 1972-1969            Freightliner; Detroit Diesel 6V-53 Diesel; 1970-1968            GMC; Detroit Diesel 4-53 Diesel; 1981-1977            GMC; Detroit Diesel 6V-53 Diesel; 1985-1966            Hendrickson; Detroit Diesel 6V-53 Diesel; 1973            International/Navistar; Detroit Diesel 6V-53 Diesel; 1979-1966            Kenworth; Detroit Diesel 6V-53 Diesel; 1974-1972            Mack; Detroit Diesel 6V-53 Diesel; 1974            Peterbilt; Detroit Diesel 6V-53 Diesel; 1974-1972            Reo; Detroit Diesel 6V-53 Diesel; 1967-1954            Studebaker; Detroit Diesel 3-53 Diesel; 1964-1963            Studebaker; Detroit Diesel 4-53 Diesel; 1964-1962            White; Detroit Diesel 6V-53 Diesel; 1975-1969</p>
<p style="text-align: center;"><b>43238HD</b></p> <p>Brockway; Cummins NH230 Diesel; 1975-1973            International/Navistar; Cummins NH230 Diesel; 1979-1970            White; Cummins NH230 Diesel; 1977-1968            White; Cummins NHC250 Diesel; 1974-1968            White; Cummins NHD230 Diesel; 1974-1972</p>	<p style="text-align: center;"><b>43310HD</b></p> <p>Chevrolet; Detroit Diesel 3-53 Diesel; 1968-1962            Chevrolet; Detroit Diesel 4-53 Diesel; 1981-1962            Chevrolet; Detroit Diesel 6V-53 Diesel; 1980-1962            Diamond Reo; Detroit Diesel 6V-53 Diesel; 1974            F.W.D.; Detroit Diesel 6V-53 Diesel; 1976-1962            Ford; Detroit Diesel 6V-53 Diesel; 1972-1969            Freightliner; Detroit Diesel 6V-53 Diesel; 1970-1968            GMC; Detroit Diesel 4-53 Diesel; 1981-1977            GMC; Detroit Diesel 6V-53 Diesel; 1985-1966            Hendrickson; Detroit Diesel 6V-53 Diesel; 1973            International/Navistar; Detroit Diesel 6V-53 Diesel; 1979-1966            Kenworth; Detroit Diesel 6V-53 Diesel; 1974-1972            Mack; Detroit Diesel 6V-53 Diesel; 1974            Peterbilt; Detroit Diesel 6V-53 Diesel; 1974-1972            Reo; Detroit Diesel 6V-53 Diesel; 1967-1954            Studebaker; Detroit Diesel 3-53 Diesel; 1964-1963            Studebaker; Detroit Diesel 4-53 Diesel; 1964-1962            White; Detroit Diesel 6V-53 Diesel; 1975-1969</p>
<p style="text-align: center;"><b>43240HD</b></p> <p>Mack; Mack 6-Cyl. 11.0 L Diesel; 1991-1989            Mack; Mack 6-Cyl. 12.0 L Diesel; 2003-1989</p>	<p style="text-align: center;"><b>43312HD</b></p> <p>Mack; Mack E3 Diesel; 1993-1990            Mack; Mack E5 Diesel; 1990-1987</p>
<p style="text-align: center;"><b>43251HD</b></p> <p>Mercedes-Benz; Mercedes-Benz OM366 Diesel; 1990-1987</p>	<p style="text-align: center;"><b>43320HD</b></p> <p>Diamond Reo; Cummins C Series 8.3 L Diesel; 1969-1968            Dodge; Cummins C175 Diesel; 1966-1960            F.W.D.; Cummins C Series 8.3 L Diesel; 1965-1963            Ford; Cummins C Series 8.3 L Diesel; 1997-1993            Freightliner; Cummins C Series 8.3 L Diesel; 1996-1994            Kenworth; Cummins C Series 8.3 L Diesel; 1997-1987            Mack; Cummins C Series 8.3 L Diesel; 1992-1991            Oshkosh; Cummins C Series 8.3 L Diesel; 1966-1960            Peterbilt; Cummins C Series 8.3 L Diesel; 1997-1987            Reo; Cummins C160 Diesel; 1967-1959            Reo; Cummins C175 Diesel; 1967-1959            Reo; Cummins C180 Diesel; 1967-1957            Reo; Cummins CF160 Diesel; 1967-1958            Volvo; Cummins C Series 8.3 L Diesel; 1997-1996            Western Star; Cummins C Series 8.3 L Diesel; 1990-1989            White; Cummins C Series 8.3 L Diesel; 1972-1969            White GMC; Cummins C Series 8.3 L Diesel; 1995-1991</p>
<p style="text-align: center;"><b>43253HD</b></p> <p>Kenworth; Cummins NTC230 Diesel; 1979</p>	<p style="text-align: center;"><b>43321HD</b></p> <p>Diamond Reo; Cummins C Series 8.3 L Diesel; 1969-1968            Dodge; Cummins C175 Diesel; 1966-1960            F.W.D.; Cummins C Series 8.3 L Diesel; 1965-1963            Ford; Cummins C Series 8.3 L Diesel; 1997-1993            Freightliner; Cummins C Series 8.3 L Diesel; 1996-1994            Kenworth; Cummins C Series 8.3 L Diesel; 1997-1987            Mack; Cummins C Series 8.3 L Diesel; 1992-1991            Oshkosh; Cummins C Series 8.3 L Diesel; 1966-1960            Peterbilt; Cummins C Series 8.3 L Diesel; 1997-1987            Reo; Cummins C160 Diesel; 1967-1959            Reo; Cummins C175 Diesel; 1967-1959            Reo; Cummins C180 Diesel; 1967-1957            Reo; Cummins CF160 Diesel; 1967-1958            Volvo; Cummins C Series 8.3 L Diesel; 1997-1996            Western Star; Cummins C Series 8.3 L Diesel; 1990-1989            White; Cummins C Series 8.3 L Diesel; 1972-1969            White GMC; Cummins C Series 8.3 L Diesel; 1995-1991</p>
<p style="text-align: center;"><b>43258HD</b></p> <p>Brockway; Cummins NH250 Diesel; 1975-1973            F.W.D.; Cummins NTC250 Diesel; 1976            Mack; Cummins NHC250 Diesel; 1972-1970            Peterbilt; Cummins NHC250 Diesel; 1973-1965</p>	<p style="text-align: center;"><b>43307HD</b></p> <p>Autocar; Cummins L10 Diesel; 1995-1991            Autocar; Cummins M11 Diesel; 1995-1994            Ford; Cummins L10 Diesel; 1997-1991            Ford; Cummins M11 Diesel; 1997-1995            Freightliner; Cummins L10 Diesel; 1996-1989            Freightliner; Cummins M11 Diesel; 1998-1994            International/Navistar; Cummins ISM Diesel; 2008-1998            International/Navistar; Cummins L10 Diesel; 1998-1991            International/Navistar; Cummins M11 Diesel; 1999-1994            Kenworth; Cummins ISM Diesel; 2000-1999            Kenworth; Cummins L10 Diesel; 1997-1991            Kenworth; Cummins M11 Diesel; 1998-1995            Peterbilt; Cummins ISM Diesel; 1998            Peterbilt; Cummins L10 Diesel; 1997-1988            Peterbilt; Cummins M11 Diesel; 1997-1994            Sterling; Cummins M11 Diesel; 1998            Volvo; Cummins L10 Diesel; 1998-1991            Volvo; Cummins M11 Diesel; 1998-1996            Western Star; Cummins L10 Diesel; 1996-1991            Western Star; Cummins M11 Diesel; 1997-1992            White GMC; Cummins L10 Diesel; 1995-1991            White GMC; Cummins M11 Diesel; 1995-1994</p>
<p style="text-align: center;"><b>43309HD</b></p> <p>Chevrolet; Detroit Diesel 3-53 Diesel; 1968-1962            Chevrolet; Detroit Diesel 4-53 Diesel; 1981-1962            Chevrolet; Detroit Diesel 6V-53 Diesel; 1980-1962            Diamond Reo; Detroit Diesel 6V-53 Diesel; 1974            F.W.D.; Detroit Diesel 6V-53 Diesel; 1976-1962</p>	<p style="text-align: center;"><b>43309HD</b></p> <p>Chevrolet; Detroit Diesel 3-53 Diesel; 1968-1962            Chevrolet; Detroit Diesel 4-53 Diesel; 1981-1962            Chevrolet; Detroit Diesel 6V-53 Diesel; 1980-1962            Diamond Reo; Detroit Diesel 6V-53 Diesel; 1974            F.W.D.; Detroit Diesel 6V-53 Diesel; 1976-1962</p>

## HD Water Pump Numerical Listings

Use as a Guide Only. Alphabetical Listing provides more detail.

43321HD - Continued	44054HD - Continued
Kenworth; Cummins C Series 8.3 L Diesel; 1997-1987 Mack; Cummins C Series 8.3 L Diesel; 1992-1991 Oshkosh; Cummins C Series 8.3 L Diesel; 1966-1960 Peterbilt; Cummins C Series 8.3 L Diesel; 1997-1987 Reo; Cummins C160 Diesel; 1967-1959 Reo; Cummins C175 Diesel; 1967-1959 Reo; Cummins C180 Diesel; 1967-1957 Reo; Cummins CF160 Diesel; 1967-1958 Volvo; Cummins C Series 8.3 L Diesel; 1997-1996 Western Star; Cummins C Series 8.3 L Diesel; 1990-1989 White; Cummins C Series 8.3 L Diesel; 1972-1969 White GMC; Cummins C Series 8.3 L Diesel; 1995-1991	Peterbilt; Caterpillar C15 Diesel; 2000 Sterling; Caterpillar 3406 Diesel; 2001-1998 Volvo; Caterpillar 3406 Diesel; 1999-1996 Western Star; Caterpillar 3406 Diesel; 2003-1990 White GMC; Caterpillar 3406 Diesel; 1995-1989
43325HD	44055HD
International/Navistar; International/Navistar DT466 Diesel; 2008-2004 International/Navistar; International/Navistar MaxxForce 10 Diesel; 2008 International/Navistar; International/Navistar MaxxForce DT Diesel; 2012-2008	Autocar; Cummins 6-Cyl. 14.0 L Diesel; 1984-1983 Ford; Cummins 6-Cyl. 14.0 L Diesel; 1984-1983 Freightliner; Cummins 6-Cyl. 14.0 L Diesel; 1984-1983 GMC; Cummins 6-Cyl. 14.0 L Diesel; 1984-1983 International/Navistar; Cummins 6-Cyl. 14.0 L Diesel; 1984-1983 Kenworth; Cummins 6-Cyl. 14.0 L Diesel; 1985-1983 Mack; Cummins 6-Cyl. 14.0 L Diesel; 1985-1983 Marmon; Cummins 6-Cyl. 14.0 L Diesel; 1984-1983 Peterbilt; Cummins 6-Cyl. 14.0 L Diesel; 1986-1983 Western Star; Cummins 6-Cyl. 14.0 L Diesel; 1984-1983 White; Cummins 6-Cyl. 14.0 L Diesel; 1984-1981
43443HD	44058HD
International/Navistar; International/Navistar V537; 1981-1978	International/Navistar; International/Navistar DT466 Diesel; 1992-1986
43545HD	44059HD
International/Navistar; International/Navistar T444 Diesel; 2003-1997	International/Navistar; International/Navistar DT360 Diesel; 1993 International/Navistar; International/Navistar DT466 Diesel; 1995-1992
43554HD	44064HD
Freightliner; Caterpillar 3126 Diesel; 2004	Autocar; Cummins 6-Cyl. 14.0 L Diesel; 1979-1974 Brockway; Cummins 6-Cyl. 14.0 L Diesel; 1977-1973 Chevrolet; Cummins 6-Cyl. 14.0 L Diesel; 1979-1971 Dodge; Cummins 6-Cyl. 14.0 L Diesel; 1974-1973 Ford; Cummins 6-Cyl. 14.0 L Diesel; 1979-1971 Freightliner; Cummins 6-Cyl. 855 Diesel; 1979-1974 Freightliner; Cummins NT Diesel; 1973-1971 Hendrickson; Cummins 6-Cyl. 14.0 L Diesel; 1973 International/Navistar; Cummins 6-Cyl. 14.0 L Diesel; 1979-1973 Kenworth; Cummins 6-Cyl. 855 Diesel; 1979-1971 Mack; Cummins 6-Cyl. 855 Diesel; 1979-1971 Mack; Cummins NT Diesel; 1972-1971 Marmon; Cummins 6-Cyl. 14.0 L Diesel; 1979-1973 Peterbilt; Cummins 6-Cyl. 14.0 L Diesel; 1979-1971 White; Cummins 6-Cyl. 14.0 L Diesel; 1979-1971
44052HD	44066HD
Autocar; Cummins N14 Diesel; 1995-1988 Ford; Cummins 6-Cyl. 14.0 L Diesel; 1990 Ford; Cummins N14 Diesel; 1998-1991 Freightliner; Cummins 6-Cyl. 14.0 L Diesel; 1990 Freightliner; Cummins N14 Diesel; 2003-1991 International/Navistar; Cummins 6-Cyl. 14.0 L Diesel; 1990 International/Navistar; Cummins N14 Diesel; 2003-1991 Kenworth; Cummins 6-Cyl. 14.0 L Diesel; 1991-1990 Kenworth; Cummins N14 Diesel; 2003-1992 Mack; Cummins 6-Cyl. 14.0 L Diesel; 1991-1990 Mack; Cummins N14 Diesel; 1993-1992 Marmon; Cummins 6-Cyl. 14.0 L Diesel; 1990 Peterbilt; Cummins 6-Cyl. 14.0 L Diesel; 1991-1990 Peterbilt; Cummins N14 Diesel; 2003-1992 Sterling; Cummins N14 Diesel; 2003-1998 Volvo; Cummins 6-Cyl. 14.0 L Diesel; 1990 Volvo; Cummins N14 Diesel; 2003-1991 Western Star; Cummins N14 Diesel; 2001-1993 White GMC; Cummins 6-Cyl. 14.0 L Diesel; 1990 White GMC; Cummins N14 Diesel; 1995-1989	American LaFrance; Detroit Diesel 6-Cyl. 11.1 L Diesel; 1998 American LaFrance; Detroit Diesel 6-Cyl. 12.7 L Diesel; 1998 Autocar; Detroit Diesel 6-Cyl. 11.1 L Diesel; 1995-1991 Autocar; Detroit Diesel 6-Cyl. 12.7 L Diesel; 1995-1991 Ford; Detroit Diesel 6-Cyl. 11.1 L Diesel; 1997-1994 Ford; Detroit Diesel 6-Cyl. 12.7 L Diesel; 1996-1995 Ford; Detroit Diesel Series 60 Diesel; 1998-1991 Freightliner; Detroit Diesel 6-Cyl. 11.1 L Diesel; 2003-1991 Freightliner; Detroit Diesel 6-Cyl. 12.7 L Diesel; 2009-1990 Freightliner; Detroit Diesel 6-Cyl. 14.0 L Diesel; 2007-2001 Freightliner; Detroit Diesel Series 50 Diesel; 2001-1994 Freightliner; Detroit Diesel Series 55 Diesel; 1998-1996 International/Navistar; Detroit Diesel 6-Cyl. 11.1 L Diesel; 1998-1991 International/Navistar; Detroit Diesel 6-Cyl. 12.7 L Diesel; 2003-1991 International/Navistar; Detroit Diesel Series 50 Diesel; 1998-1994 International/Navistar; Detroit Diesel Series 60 Diesel; 2000-1992 Kenworth; Detroit Diesel 6-Cyl. 11.1 L Diesel; 2001-1991 Kenworth; Detroit Diesel 6-Cyl. 12.7 L Diesel; 2001-1991 Mack; Detroit Diesel 6-Cyl. 12.7 L Diesel; 1999-1992
44053HD	44054HD
International/Navistar; International/Navistar T444 Diesel; 1994-1991 International/Navistar; International/Navistar V-8 6.9 L Diesel; 1988-1983 International/Navistar; International/Navistar V-8 7.3 L Diesel; 1993-1988	Autocar; Caterpillar 3406 Diesel; 1995-1994 Ford; Caterpillar 3406 Diesel; 1998-1994 Freightliner; Caterpillar 3406 Diesel; 2002-1993 International/Navistar; Caterpillar 3406 Diesel; 2003-1993 Kenworth; Caterpillar 3406 Diesel; 2000-1993 Mack; Caterpillar 3406 Diesel; 1999-1995 Marmon; Caterpillar 3406 Diesel; 1996-1993 Peterbilt; Caterpillar 3406 Diesel; 2000-1993



# HD Water Pump Numerical Listings

Use as a Guide Only. Alphabetical Listing provides more detail.

44066HD - Continued	44086HD - Continued
<p>Marmon; Detroit Diesel Series 60 Diesel; 1992-1991                      Peterbilt; Detroit Diesel 6-Cyl. 11.1 L Diesel; 2001-1989                      Peterbilt; Detroit Diesel 6-Cyl. 12.7 L Diesel; 2001-1988                      Sterling; Detroit Diesel 6-Cyl. 11.1 L Diesel; 2002-1998                      Sterling; Detroit Diesel 6-Cyl. 12.7 L Diesel; 2007-1998                      Sterling; Detroit Diesel 6-Cyl. 14.0 L Diesel; 2007-2003                      Volvo; Detroit Diesel 6-Cyl. 11.1 L Diesel; 2001-1996                      Volvo; Detroit Diesel 6-Cyl. 12.7 L Diesel; 2001-1996                      Volvo; Detroit Diesel Series 60 Diesel; 2001-1991                      Western Star; Detroit Diesel 6-Cyl. 11.1 L Diesel; 2001-1991                      Western Star; Detroit Diesel 6-Cyl. 12.7 L Diesel; 2007-1989                      Western Star; Detroit Diesel 6-Cyl. 14.0 L Diesel; 2007-2003                      White GMC; Detroit Diesel 6-Cyl. 11.1 L Diesel; 1995-1990                      White GMC; Detroit Diesel 6-Cyl. 12.7 L Diesel; 1995-1990</p>	<p>GMC; Cummins 6-Cyl. 14.0 L Diesel; 1983-1980                      International/Navistar; Cummins 6-Cyl. 14.0 L Diesel; 1983-1980                      Kenworth; Cummins 6-Cyl. 14.0 L Diesel; 1983-1980                      Mack; Cummins 6-Cyl. 14.0 L Diesel; 1983-1980                      Marmon; Cummins 6-Cyl. 14.0 L Diesel; 1983-1980                      Peterbilt; Cummins 6-Cyl. 14.0 L Diesel; 1984-1980                      Western Star; Cummins 6-Cyl. 14.0 L Diesel; 1983-1978                      White; Cummins 6-Cyl. 14.0 L Diesel; 1983-1980</p>
44075HD	44092HD
<p>Autocar; Detroit Diesel 8V-71 Diesel; 1985-1965                      Brockway; Detroit Diesel 8V-71 Diesel; 1975-1957                      Chevrolet; Detroit Diesel 6V-71 Diesel; 1974-1966                      Chevrolet; Detroit Diesel 8V-71 Diesel; 1980-1966                      Diamond Reo; Detroit Diesel 8V-71 Diesel; 1975-1967                      Dodge; Detroit Diesel 8V-71 Diesel; 1975-1972                      F.W.D.; Detroit Diesel 6V-71 Diesel; 1978-1972                      Ford; Detroit Diesel 8V-71 Diesel; 1986-1966                      Ford; Detroit Diesel 8V-71N Diesel; 1974-1970                      Ford; Detroit Diesel 8V-71T Diesel; 1974-1971                      Freightliner; Detroit Diesel 8V-71 Diesel; 1977-1969                      GMC; Detroit Diesel 6V-71 Diesel; 1967-1966                      GMC; Detroit Diesel 8V-71 Diesel; 1983-1966                      Hendrickson; Detroit Diesel 8V-71 Diesel; 1977-1969                      International/Navistar; Detroit Diesel 8V-71 Diesel; 1985-1974                      Kenworth; Detroit Diesel 6V-71 Diesel; 1978-1973                      Kenworth; Detroit Diesel 8V-71 Diesel; 1980-1969                      Mack; Detroit Diesel 6V-71 Diesel; 1978-1975                      Mack; Detroit Diesel 8V-71 Diesel; 1975-1970                      Peterbilt; Detroit Diesel 6V-71 Diesel; 1976                      Peterbilt; Detroit Diesel 8V-71 Diesel; 1983-1966                      Western Star; Detroit Diesel 8V-71 Diesel; 1986-1979                      White; Detroit Diesel 8V-71 Diesel; 1980-1968</p>	<p>Autocar; Cummins 6-Cyl. 14.0 L Diesel; 1988-1985                      Ford; Cummins 6-Cyl. 14.0 L Diesel; 1989-1985                      Freightliner; Cummins 6-Cyl. 14.0 L Diesel; 1989-1985                      Giant Trucks; Cummins 6-Cyl. 14.0 L Diesel; 1989-1987                      GMC; Cummins 6-Cyl. 14.0 L Diesel; 1988-1985                      International/Navistar; Cummins 6-Cyl. 14.0 L Diesel; 1989-1985                      Kenworth; Cummins 6-Cyl. 14.0 L Diesel; 1989-1985                      Mack; Cummins 6-Cyl. 14.0 L Diesel; 1989-1985                      Marmon; Cummins 6-Cyl. 14.0 L Diesel; 1989-1985                      Peterbilt; Cummins 6-Cyl. 14.0 L Diesel; 1989-1984                      Western Star; Cummins 6-Cyl. 14.0 L Diesel; 1992-1985                      White; Cummins 6-Cyl. 14.0 L Diesel; 1988-1984                      White GMC; Cummins 6-Cyl. 14.0 L Diesel; 1989-1988</p>
44080HD	44093HD
<p>Mercedes-Benz; Mercedes-Benz OM366 Diesel; 1991</p>	<p>Diamond Reo; Cummins V-8 210 Diesel; 1973-1972                      Diamond Reo; Detroit Diesel 8V-71 Diesel; 1973                      Dodge; Cummins V-8 210 Diesel; 1973-1970                      Kenworth; Cummins V-8 210 Diesel; 1972-1971                      Mack; Cummins V-8 210 Diesel; 1973</p>
44084HD	44094HD
<p>Autocar; Cummins 6-Cyl. 14.0 L Diesel; 1988-1985                      Ford; Cummins 6-Cyl. 14.0 L Diesel; 1989-1985                      Freightliner; Cummins 6-Cyl. 14.0 L Diesel; 1989-1985                      Giant Trucks; Cummins 6-Cyl. 14.0 L Diesel; 1989-1987                      GMC; Cummins 6-Cyl. 14.0 L Diesel; 1988-1985                      International/Navistar; Cummins 6-Cyl. 14.0 L Diesel; 1989-1985                      Kenworth; Cummins 6-Cyl. 14.0 L Diesel; 1989-1985                      Mack; Cummins 6-Cyl. 14.0 L Diesel; 1989-1985                      Marmon; Cummins 6-Cyl. 14.0 L Diesel; 1989-1985                      Peterbilt; Cummins 6-Cyl. 14.0 L Diesel; 1989-1984                      Western Star; Cummins 6-Cyl. 14.0 L Diesel; 1992-1985                      White; Cummins 6-Cyl. 14.0 L Diesel; 1988-1984                      White GMC; Cummins 6-Cyl. 14.0 L Diesel; 1989-1988</p>	<p>Autocar; Cummins L10 Diesel; 1990-1986                      Ford; Cummins L10 Diesel; 1990-1984                      Freightliner; Cummins L10 Diesel; 1990-1983                      GMC; Cummins L10 Diesel; 1988-1983                      International/Navistar; Cummins L10 Diesel; 1990-1983                      Kenworth; Cummins L10 Diesel; 1990-1984                      Mack; Cummins L10 Diesel; 1984                      Marmon; Cummins L10 Diesel; 1990-1986                      Peterbilt; Cummins L10 Diesel; 1991-1984                      Volvo; Cummins L10 Diesel; 1990                      Western Star; Cummins L10 Diesel; 1990-1986                      White; Cummins L10 Diesel; 1988-1984                      White GMC; Cummins L10 Diesel; 1990-1988</p>
44086HD	44097HD
<p>Autocar; Cummins 6-Cyl. 14.0 L Diesel; 1983-1980                      Chevrolet; Cummins 6-Cyl. 14.0 L Diesel; 1980                      Ford; Cummins 6-Cyl. 14.0 L Diesel; 1983-1980                      Freightliner; Cummins 6-Cyl. 14.0 L Diesel; 1983-1980</p>	<p>Autocar; Detroit Diesel 8V-92 Diesel; 1981                      Chevrolet; Detroit Diesel 6V-92 Diesel; 1980-1977                      Chevrolet; Detroit Diesel 8V-92 Diesel; 1980-1977                      Ford; Detroit Diesel 6V-92 Diesel; 1986-1977                      Ford; Detroit Diesel 8V-92 Diesel; 1986-1978                      Freightliner; Detroit Diesel 6V-92 Diesel; 1988-1977                      Freightliner; Detroit Diesel 8V-92 Diesel; 1982-1974                      GMC; Detroit Diesel 6V-92 Diesel; 1988-1973                      GMC; Detroit Diesel 8V-92 Diesel; 1988-1975                      International/Navistar; Detroit Diesel 6V-92 Diesel; 1988-1976                      International/Navistar; Detroit Diesel 8V-92 Diesel; 1988-1974                      Kenworth; Detroit Diesel 6V-92 Diesel; 1982-1976                      Kenworth; Detroit Diesel 8V-92 Diesel; 1988-1974                      Mack; Detroit Diesel 6V-92 Diesel; 1985-1978                      Mack; Detroit Diesel 8V-92 Diesel; 1982-1978                      Peterbilt; Detroit Diesel 6V-92 Diesel; 1986-1976</p>

## HD Water Pump Numerical Listings

Use as a Guide Only. Alphabetical Listing provides more detail.

<b>44097HD - Continued</b>
Peterbilt; Detroit Diesel 8V-92 Diesel; 1988-1974 Western Star; Detroit Diesel 6V-92 Diesel; 1989-1979 White; Detroit Diesel 6V-92 Diesel; 1988-1973 White; Detroit Diesel 8V-92 Diesel; 1987-1976 White GMC; Detroit Diesel 6V-92 Diesel; 1989-1988
<b>44104HD</b>
International/Navistar; International/Navistar DT466 Diesel; 1986-1980
<b>44600HDBP</b>
Autocar; Caterpillar 3406 Diesel; 1995-1974 Chevrolet; Caterpillar 3406 Diesel; 1980-1979 Ford; Caterpillar 3406 Diesel; 1995-1975 Freightliner; Caterpillar 3406 Diesel; 1996-1975 GMC; Caterpillar 3406 Diesel; 1988-1979 International/Navistar; Caterpillar 3406 Diesel; 1996-1973 Kenworth; Caterpillar 3406 Diesel; 1995-1975 Mack; Caterpillar 3406 Diesel; 1996-1979 Marmon; Caterpillar 3406 Diesel; 1995-1986 Peterbilt; Caterpillar 3406 Diesel; 1995-1974 Western Star; Caterpillar 3406 Diesel; 1990-1979 White; Caterpillar 3406 Diesel; 1988-1981 White GMC; Caterpillar 3406 Diesel; 1995-1989
<b>45009HD</b>
Autocar; Caterpillar 3406 Diesel; 1995-1974 Chevrolet; Caterpillar 3406 Diesel; 1980-1979 Ford; Caterpillar 3406 Diesel; 1995-1975 Freightliner; Caterpillar 3406 Diesel; 1996-1975 GMC; Caterpillar 3406 Diesel; 1988-1979 International/Navistar; Caterpillar 3406 Diesel; 1996-1973 Kenworth; Caterpillar 3406 Diesel; 1995-1975 Mack; Caterpillar 3406 Diesel; 1996-1979 Marmon; Caterpillar 3406 Diesel; 1995-1986 Peterbilt; Caterpillar 3406 Diesel; 1995-1974 Western Star; Caterpillar 3406 Diesel; 1990-1979 White; Caterpillar 3406 Diesel; 1988-1981 White GMC; Caterpillar 3406 Diesel; 1995-1989
<b>45050HD</b>
Freightliner; Mercedes-Benz MBE 900 Diesel; 2003
<b>45051HD</b>
Peterbilt; Cummins ISX Diesel; 2006
<b>45053HD</b>
Freightliner; Mercedes-Benz MBE 900 Diesel; 2005-2000
<b>45054HD</b>
International/Navistar; Cummins ISX Diesel; 2007-2003 Kenworth; Cummins ISX Diesel; 2007-2004
<b>46001HD</b>
Chevrolet; Detroit Diesel V-8 8.2 L Diesel; 1990-1980 Ford; Detroit Diesel V-8 8.2 L Diesel; 1989-1980 GMC; Detroit Diesel V-8 8.2 L Diesel; 1990-1980
<b>46002HD</b>
Kenworth; Detroit Diesel 6-Cyl. 12.7 L Diesel; 2001
<b>46003HD</b>
Freightliner; Detroit Diesel 6-Cyl. 12.7 L Diesel; 2007 Freightliner; Detroit Diesel 6-Cyl. 14.0 L Diesel; 2007
<b>46004HD</b>
Freightliner; Detroit Diesel 6-Cyl. 14.0 L Diesel; 2007

# Complete Product Line at Competitive Pricing.

**NEW PUMPS MANUFACTURED TO ISO/TS STANDARDS.**

**85 SKUs For Virtually Any Heavy-Duty/Fleet Application.**

Gates new Heavy-Duty Water Pump product line offers high quality pumps at competitive pricing, with full coverage, so you can be sure to get the parts you need. Gates Water Pumps are constructed with premium alloy materials, computer-tooled, and fitted with a precisely balanced impeller to ensure OE fit and function. Each pump undergoes a 100% functional test of seals and bearings, and a 100% leakage test for both the casting and assembled water pump.

You can confidently install Gates Heavy-Duty Water Pumps and focus on keeping your fleet on the road and out of the shop. As with all our Heavy-Duty products, you can count on high-quality, reliable parts that will deliver worry-free operation for the life of the vehicle. For more information about Gates Heavy-Duty Water Pumps please contact your Gates Sales Representative.



**HEAVY-DUTY WATER PUMPS**



Manufacturing Facilities, Distribution Centers, Technical Centers, and Sales/Service Centers Worldwide



**POWERING PROGRESS™**

**GATES CORPORATION - WORLD HEADQUARTERS**

1551 Wewatta Street / P.O. Box 5887  
Denver, Colorado 80217, U.S.A.  
800.366.3128 / Fax 303.744.4499  
[Gates.com](http://Gates.com)

**431-2086**

2013



Please recycle this catalog!

Printed in the U.S.A.