

# R.V.I.

Spare parts for commercial vehicles



DRIVER'S BEST FRIEND

**MEYLE**

## Robust and reliable components – simply longer on the road.



Trucks are subject to extreme use and require reliable, durable spare parts. MEYLE parts provide outstanding services on roads all over the world, especially for trucks of MAN, Mercedes-Benz, DAF, Volvo, Scania, Renault and Iveco as well as for bus and trailer applications.



### Steering & suspension

King pins, Tie rods/tie rod ends, Drag links, and many more



### Brakes

Brake discs, Brake pads, Wear indicators, and many more



### Drive, clutch and gearbox parts

Clutch discs, Release bearings, Release forks, and many more



### Filters

Air filters, Oil filters, Hydraulic oil filters, Cabin air filters, and many more



### Engine and cooling parts

Engine mounts, Oil cooler, Fuel pumps, Belt tensioners, and many more



### Electrics and sensors

Steering-column switch, ABS sensors, and many more



### Cabin and body parts

Cabin tilt pumps, Cabin tilt cylinders, Door handles, and many more

# ORIGINAL, PD and HD – The MEYLE product lines



## **MEYLE-ORIGINAL: Fit as snugly as the original.**

More than 21,000 spare parts for passenger cars, vans and trucks, quality-tested, robust, durable and tried and tested a thousand times over on the roads across the world – that's MEYLE-ORIGINAL. Relying on our comprehensive product portfolio – offering everything from A for axial joint to Z for zinc-coated screw – customers can be sure that they will always have safety on their side.

## **MEYLE-PD: Safety to the power of two.**

Thinking outside the box to make our products better: MEYLE-PD stands for brake discs and pads delivering maximum braking performance and setting new standards in terms of durability, comfort, aesthetics, and ease of installation. Look for the „/PD“ part number extension.

## **MEYLE-HD: Better than originals.**

MEYLE-HD parts simply last longer. Their technically optimised and reinforced designs make them more durable and reliable than OE components. So it is only natural for us to offer extended warranty protection for our MEYLE-HD parts: All parts of the HD range come with a full four-year guarantee. Look for the „/HD“ part number extension.



**4-year guarantee on all MEYLE-HD parts!**

Robust, high mileage, reliable and better than the original. MEYLE-HD parts simply last longer!

## Our three success factors.

### **The success of the MEYLE brand is based on competence, quality and service.**

The development of quality-approved automotive spare parts for the independent aftermarket is our trademark. And MEYLE-HD parts are our specialty: improved parts, developed by our team of engineers at our headquarters in Hamburg. We give a 4-year guarantee on our MEYLE-HD parts which have a far longer service life. Based on information from TÜV (Technical control board), from recall statistics as well as media and market information from workshops and other technical partners, MEYLE engineers identify parts in vehicles which become conspicuous on account of frequent, early wear. On the basis of their findings, they develop technical improvements for the respective weakness. In the end, this work is a

large benefit for all MEYLE parts. Something all reputable automotive manufacturers highly appreciate: MEYLE also develops customized products, for example for Morgan, the legendary sports car manufacturer.

Passing on our know-how to staff and customers is just as much a part of our service as high parts availability and swift delivery. Modern warehouse logistics with space covering 29,000 m<sup>2</sup> and 56,000 pallet places ensure the reliable supply of our partners.

We have now won the "Top Job Employer" award for the fifth time which confirms our outstanding internal business approach and excellent Human Resources policy. We have been one of Germany's leading SME employers for many years.

# MEYLE

## Guarantee certificate



A distinguishing feature of MEYLE is our high level of precision, achieved by the application of the most modern manufacturing methods. Our MEYLE articles meet highest quality standards and our supply plants are certified in accordance with ISO 9001:2008 and ISO/TS 16949.

We guarantee perfect material and faultless processing of all our MEYLE articles for a period of 24 months as of the date of installation. For MEYLE-HD articles, this guarantee applies for 48 months as of the date of installation.

Complementing this guarantee, we give an additional 100,000 miles (160,934 kilometres) performance guarantee against defects of material and workmanship for MEYLE passenger car water pumps purchased from 01 May 2016. The guarantee given for MEYLE passenger car water pumps terminates upon expiration of the guarantee period or the guaranteed mileage, whichever occurs later: if the guaranteed mileage has not been reached at the end of the guarantee period of 24 or 48 months respectively, the performance guarantee continues to be valid. Respectively, the guarantee period of 24 or 48 months continues to be valid also in any case where the guaranteed mileage was already exceeded.

During the guarantee period, we perform repair work on claimed MEYLE articles or provide a replacement. The MEYLE guarantee does not apply for normal wear and damage caused by inappropriate handling or inappropriate installation. The guarantee expires if the respective part is modified by third parties or via installation of parts from third parties, or if the part, or vehicle, is used in excess of the appropriate use and purpose. The MEYLE guarantee also expires if MEYLE instructions or vehicle manufacturer instructions, e.g. concerning maintenance and replacement intervals, are not observed. The guarantee only applies for MEYLE water pumps, if the cooling circuit has been flushed prior to installation of the MEYLE water pump. Rights granted by law continue to apply unrestrictedly, irrespective of this guarantee.

The customer must submit a written guarantee claim immediately, or at the latest 30 days after identifying an error in material or processing. This claim is to be submitted to the dealer from which he acquired the MEYLE article part. The customer should return the article, carefully packed. He must enclose the original sales receipt and a description of the error. The customer must also verify the date of installation and the mileage of the vehicle by means of respective documents.

Last amended January 2017

Director Quality Assurance  
Manfred Wunder





## Engine/Cooling

1

**Belt drive / Engine control, Cooling system, Crankshaft drive, Cylinder head, Engine, Exhaust system, Fuel system, Lubrication system, Mounts**

Air filter	Fuel pump	Sensor, boost pressure
Belt tensioner	Gasket set, crankcase	Sensor, coolant level
Crankshaft seal	Gasket set, cylinder head	Tension roller, ribbed belt
Cylinder head gasket	Gasket, exhaust manifold	Thermostat
Engine mount	Gasket, exhaust pipe	Valve cover gasket
Expansion tank	Gasket, oil pan	V-belt
Expansion tank cap	Oil filter	Voltage regulator
Fan blade	Radiator fan motor	V-ribbed belt
Fan clutch	Sender unit, coolant temperature	Water pump
Fuel filter	Sender, oil pressure	

## Brakes

39

**Air system, Brakes, Disc brake**

ABS wheel sensor	Brake line coupling	Pressure limiting valve
Air dryer cartridge	Brake pad set	Quick release valve
Air suspension valve	Control valve, trailer	Valve, compressor system
Brake disc	Diaphragm, brake cylinder	Wear sensor

## Drive train/Transmission/Clutch

60

**Axle shafts, Clutch, Transmission**

Clutch booster	Joint, propeller shaft	Switch, differential lock
Hydraulic filter, A/T	Release bearing	Switch, splitter gearbox

## Suspension

63

**Control arms, Stabilizer, Stub axle, Suspension / damping, Wheel hubs / Wheel bearings**

Bushing, leaf spring	Repair kit, control arm	Rubber stop, suspension
Bushing, stabilizer	Repair kit, kingpin	Shaft seal, wheel hub
Control arm	Repair kit, spring bolt	Wheel bearing
Mount, leaf spring	Repair kit, stabilizer bushing	
Mount, stabilizer	Rod/strut, suspension	

## Steering

80

**Hydraulics, Tie rod assemblies**

Drag link	Hydraulic pump, P/S	Tie rod end
Hydraulic filter, steering system	Tie rod assembly	

## Body/Cabin

87

**Body, Cabin, Interior fittings**

Bushing, driver cab suspension	Repair kit, driver cab mounting	Tilt pump, driver cab
Cabin air filter	Rubber stop, cabin	Windshield washer pump
Lock cylinder set	Spacer, driver cab stabiliser	Wiper Blade





**Gasket set, cylinder head**

**16-34 900 0002 | MMX1552**

**Notes**

without valve stem seals  
Steel

**References**

50 01 830 802

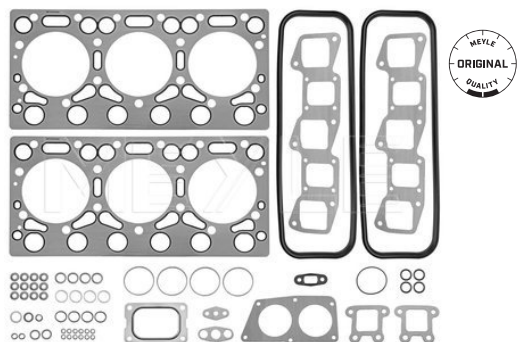

**Application info**

C [10/82-10/98]  
Magnum [09/90-04/06]

Major [05/91-10/96]

**Gasket set, cylinder head**

**16-34 001 0006 | MMX1336**

**References**

50 01 834 578

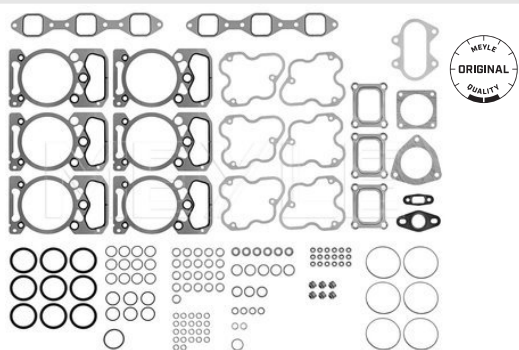

**Application info**

Agora [01/96--]  
Iliade [01/97--]  
Kerax [06/97-01/01]

Maxter [10/92-06/97]  
Premium [04/96--]

**Cylinder head gasket**

**16-34 900 0009 | MMX1570**

**References**

50 00 678 639

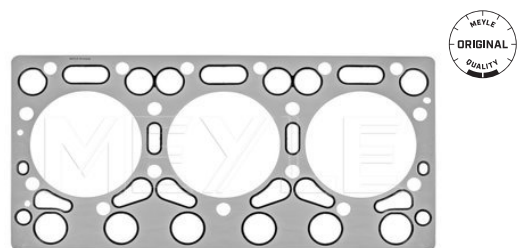

**Application info**

C [10/82-10/98]  
Magnum [09/90-04/06]

Major [05/91-10/96]

16-34 001 0005 | MMX1490

Cylinder head gasket

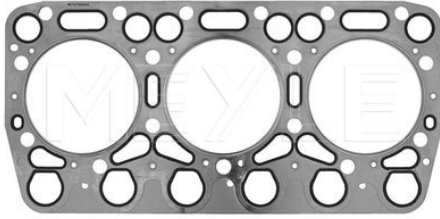

References

50 00 866 061

50 01 847 781

Application info

C [10/82-10/98]  
Major [05/91-10/96]

R [10/80-10/91]

16-34 900 0001 | MMX1316

Cylinder head gasket

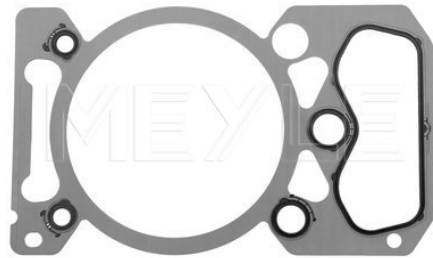

References

00 00 771 149  
50 00 670 202

50 10 295 726

Application info

C [10/82-10/98]  
G [10/82-03/93]  
Kerax [06/97-01/01]

Premium [04/96--]  
Premium 2 [10/05--]  
R [10/80-10/91]

16-34 001 0003 | MMX1334

Cylinder head gasket

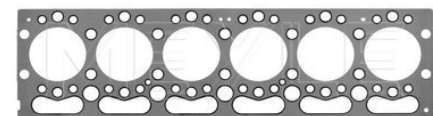

References

50 10 477 117

Application info

Kerax [06/97-01/01]

Premium [04/96--]

**Cylinder head gasket**
**16-34 900 0004 | MMX1517**
**Notes**

Thickness [mm]	Metal
Width [mm]	1.2
Length [mm]	240
	1054

**References**

74 03 099 100

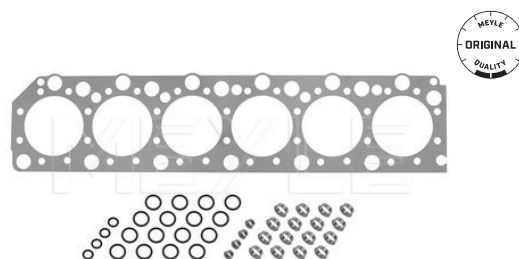
**Application info**

Magnum [09/90-04/06]

**Cylinder head gasket**
**16-34 001 0004 | MMX1335**
**Notes**

Thickness [mm]	Metal
Width [mm]	1.2
Length [mm]	226
	960

**References**

74 20 495 935

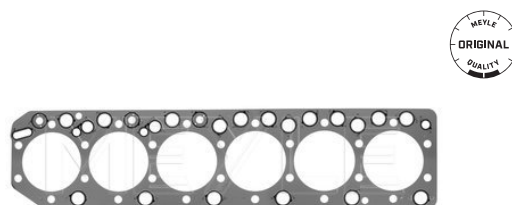
**Application info**

Kerax [06/97-01/01]

Premium 2 [10/05--]

**Valve cover gasket**
**16-34 900 0003 | MMX1553**
**Notes**

Thickness [mm]	2
----------------	---

**References**

00 00 771 684	50 00 694 271
---------------	---------------

**Application info**

C [10/82-10/98]
G [10/82-03/93]
Kerax [06/97-01/01]
Major [05/91-10/96]

Manager [09/91-10/96]
Maxter [10/92-06/97]
Premium [04/96--]
R [10/80-10/91]

534 001 0005 | MMX1587

Valve cover gasket



Notes

Required quantity

ACM (Polyacrylate)  
1

References

74 20 538 793

Application info

Kerax [06/97-01/01]

Magnum [09/90-04/06]

16-34 099 0005 | MMX1339

Crankshaft seal



Notes

Inner diameter [mm]  
Outer diameter [mm]  
Height [mm]

Left-hand Twist  
130  
150  
13  
Transmission End

References

50 03 087 026

Application info

C [10/82-10/98]  
Magnum [09/90-04/06]

Major [05/91-10/96]  
R [10/80-10/91]

16-34 753 0003 | MMX1341

Crankshaft seal



Notes

Inner diameter [mm]  
Outer diameter [mm]  
Height [mm]

Left-hand Twist  
160  
190  
13  
Transmission End

References

50 03 087 028

50 10 295 831

Application info

Kerax [06/97-01/01]

## Crankshaft seal

12-34 099 0005 | MMX0601

### Notes

Inner diameter [mm]  
Outer diameter [mm]  
Height [mm]

Left-hand Twist  
110  
130  
13  
Timing End

### References

50 10 339 723



### Application info

C (10/82-10/98)  
G (10/82-03/93)  
Manager (09/91-10/96)  
Maxter (10/92-06/97)

Midliner (10/82-01/00)  
Midlum (01/00--)  
Premium (04/96--)

## Crankshaft seal

16-34 099 0003 | MMX1337

### Notes

Inner diameter [mm]  
Outer diameter [mm]  
Height [mm]

Right-hand Twist  
90  
110  
11  
Timing End

### References

50 00 694 668  
50 03 087 031

50 10 359 806



### Application info

Agora (01/96--)  
Ares (---)  
C (10/82-10/98)  
G (10/82-03/93)  
Kerax (06/97-01/01)  
Magnum (09/90-04/06)

Major (05/91-10/96)  
Manager (09/91-10/96)  
Maxter (10/92-06/97)  
Premium (04/96--)  
R (10/80-10/91)

## Crankshaft seal

16-34 099 0004 | MMX1338

### Notes

Inner diameter [mm]  
Outer diameter [mm]  
Height [mm]

Left-hand Twist  
150  
172  
13  
Transmission End

### References

50 03 087 029

50 10 359 807



16-34 099 0004 | MMX1338

Crankshaft seal

Application info

C [10/82-10/98]  
G [10/82-03/93]  
Kerax [06/97-01/01]  
Manager [09/91-10/96]

Maxter [10/92-06/97]  
Premium [04/96--]  
R [10/80-10/91]

16-34 099 0001 | MMX0721

Crankshaft seal



Notes

Inner diameter [mm]  
Outer diameter [mm]  
Height [mm]

Left-hand Twist  
150  
180  
15  
Timing End

References

74 08 148 259

Application info

Kerax [06/97-01/01]  
Magnum [09/90-04/06]

Premium 2 [10/05--]

16-34 099 0006 | MMX1340

Crankshaft seal



Notes

Inner diameter [mm]  
Outer diameter [mm]  
Height [mm]

81  
104  
11  
Transmission End

References

74 20 412 568

74 21 486 081

Application info

Midlum [01/00--]

Premium 2 [10/05--]

**Crankshaft seal**

**16-34 099 0002 | MMX0722**

**Notes**

Inner diameter [mm]  
Outer diameter [mm]  
Height [mm]

Right-hand Twist  
136  
159  
13  
Timing End

**References**

74 85 108 423



**Application info**

Kerax [06/97-01/01]  
Magnum [09/90-04/06]

Premium 2 [10/05--]

**Gasket set, crankcase**

**16-34 001 0007 | MMX1550**

**References**

50 01 834 579

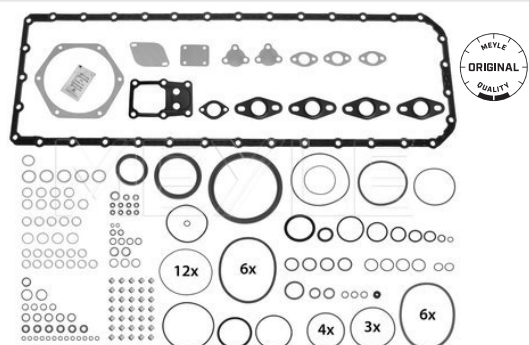

**Application info**

Kerax [06/97-01/01]

Premium [04/96--]

**Voltage regulator**

**034 015 0005 | MEX0143**

**Notes**

Number of Poles  
Voltage [V]

2  
28

**References**

50 00 820 871



**Application info**

C [10/82-10/98]

534 820 0002 | MEX0580

Sender, oil pressure



Notes

Spanner Size	19
Thread Size	M16x1,5
Operating voltage [V]	24
Number of Poles	3

References

74 20 514 065	74 20 803 650
---------------	---------------

Application info

Magnum [09/90-04/06]  
Midlum [01/00--]

Premium 2 [10/05--]

534 820 0001 | MEX0579

Sender, oil pressure



Notes

Spanner Size	17
Thread Size	M18x1,5
Operating voltage [V]	24
Number of Poles	4

References

74 20 484 678	74 21 302 639
74 20 796 740	74 21 540 602
74 20 898 038	74 21 634 021

Application info

Magnum [09/90-04/06]  
Premium [04/96--]

Premium 2 [10/05--]

534 899 0014 | MEX0601

Sensor, boost pressure



Notes

Operating voltage [V]	24
Number of Poles	4

References

50 10 437 653	74 20 524 936
---------------	---------------

Application info

Kerax [06/97-01/01]  
Midlum [01/00--]

Premium [04/96--]



## Gasket, oil pan

16-34 038 0002 | MMX1699

### References

50 10 550 818



### Application info

Kerax [06/97-01/01]

Premium [04/96--]

## Oil filter

814 013 0000 | MOF0209

### Notes

Inner diameter [mm]  
Outer diameter [mm]  
Height [mm]  
Thread Size

with seal  
93  
108  
260  
1 1/8-16 UN  
Screw-on Filter

### References

50 01 846 641  
50 01 846 642  
74 20 709 459

74 21 561 278  
74 21 700 201



### Application info

C [10/82-10/98]  
Kerax [06/97-01/01]  
Magnum [09/90-04/06]  
Major [05/91-10/96]  
Manager [09/91-10/96]  
Maxter [10/92-06/97]

Midliner [10/82-01/00]  
Midlum [01/00--]  
Premium [04/96--]  
Premium 2 [10/05--]  
R [10/80-10/91]

## Oil filter

36-14 322 0003 | MOF0156

### Notes

Bypass Valve Opening Pressure [bar]  
Diameter [mm]  
Height [mm]  
Thread Size

1  
94  
94  
3/4"-16 UNF  
Screw-on Filter  
with one anti-return valve

### References

50 01 869 771



36-14 322 0003 | MOF0156

Oil filter

Application info

Maxity [03/07--]

16-34 322 0001 | MOF0083

Oil filter



Notes

Inner diameter [mm]	with seal
Outer diameter [mm]	93
Height [mm]	107
Thread Size	260
	1 3/8x16
	Screw-on Filter

References

50 00 812 484	74 20 541 379
50 01 846 647	74 21 561 284
74 20 430 751	

Application info

Kerax [06/97-01/01]  
Magnum [09/90-04/06]

Premium [04/96--]  
Premium 2 [10/05--]

16-34 322 0002 | MOF0220

Oil filter



Notes

Inner diameter [mm]	with seal
Inner diameter [mm]	103
Outer diameter [mm]	93
Height [mm]	108
Thread Size	260
	1 1/8-16U
	Screw-on Filter

References

50 01 846 642	74 20 709 459
74 20 708 907	

Application info

Kerax [06/97-01/01]  
Magnum [09/90-04/06]

Premium 2 [10/05--]

**Oil filter**
**16-34 322 0004 | MOF0229**
**Notes**

Inner diameter [mm]	without gasket / seal
Outer diameter [mm]	31
Height [mm]	63.5
	150
	Filter Insert

**References**

74 20 779 040	74 21 990 552
---------------	---------------

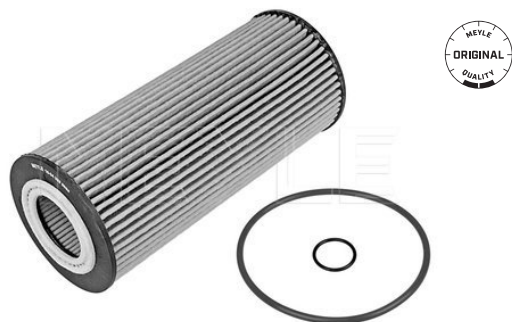
**Application info**

 Kerax [06/97-01/01]  
 Magnum [09/90-04/06]

Premium 2 [10/05--]

**Oil filter**
**534 323 0002 | MOF0174**
**Notes**

Inner diameter [mm]	with seal
Inner diameter [mm]	56
Outer diameter [mm]	14
Height [mm]	120
	204.5
	Filter Insert

**References**

74 20 796 782	74 20 998 809
---------------	---------------

**Application info**

Midlum [01/00--]

Premium 2 [10/05--]

**Oil filter**
**16-14 322 0006 | MOF0079**
**Notes**

Inner diameter [mm]	with seal
Outer diameter [mm]	29
Height [mm]	82
	105
	Filter Insert

**References**

50 01 869 773	77 01 057 828
---------------	---------------

**Application info**

Maxity [03/07--]

12-34 321 0010 | MAF0199

Air filter



Notes

Inner diameter [mm]	191
Inner diameter [mm]	11
Outer diameter [mm]	302
Height [mm]	473
	Filter Insert

References

50 00 806 317

Application info

Manager [09/91-10/96]

Maxter [10/92-06/97]

16-34 321 0003 | MAF0241

Air filter



Notes

Inner diameter [mm]	186
Outer diameter [mm]	312
Height [mm]	465.5
	Filter Insert

References

50 01 865 723

50 10 230 841

Application info

Magnum [09/90-04/06]  
Midlum [01/00--]

Premium [04/96--]

16-34 321 0002 | MAF0240

Air filter



Notes

Inner diameter [mm]	178
Outer diameter [mm]	313
Height [mm]	557
	Filter Insert

References

50 01 865 725

50 10 230 916

Application info

Ares [---]  
Iliade [01/97--]

Kerax [06/97-01/01]  
Premium [04/96--]

**Air filter**
**16-34 321 0006 | MAF0244**
**Notes**

Inner diameter [mm]	147
Outer diameter [mm]	176
Height [mm]	535
	Fine Filter
	Filter Insert

**References**

50 10 269 584

**Application info**

Kerax [06/97-01/01]

Premium [04/96--]

**Air filter**
**16-34 321 0007 | MAF0245**
**Notes**

Inner diameter [mm]	127.5
Outer diameter [mm]	245
Height [mm]	371.5
	Filter Insert

**References**

50 01 865 724

50 10 315 990

**Application info**

Midlum [01/00--]

**Air filter**
**16-34 321 0018 | MAF0256**
**Notes**

Inner diameter [mm]	143
Outer diameter [mm]	179
Height [mm]	445
	Filter Insert

**References**

50 10 317 187

**Application info**

 Magnum [09/90-04/06]  
 Midlum [01/00--]

Premium 2 [10/05--]

214 321 0001 | MAF0295

Air filter



Notes

Inner diameter [mm]	91
Outer diameter [mm]	165
Height [mm]	354
	Filter Insert

References

60 05 011 111

Application info

Agora [01/96--]

534 009 0001 | MFP0042

Fuel pump



Notes

Pressure [bar]	Diesel Mechanical 9.5
----------------	-----------------------------

References

74 20 997 341

74 85 103 778

Application info

G [10/82-03/93]

114 323 0001 | MFF0073

Fuel filter



Notes

Diameter [mm]	Steel 77
Height [mm]	122
Connecting thread	M16x1,5 Screw-on Filter

References

50 00 686 589  
50 00 686 590  
50 00 790 570  
50 00 814 227

77 01 015 820  
77 01 017 322  
77 01 017 732

Application info

C [10/82-10/98]  
G [10/82-03/93]

Maxter [10/92-06/97]

**Fuel filter**
**034 323 0003 | MFF0245**
**References**

50 01 833 651

**Application info**

 G [10/82-03/93]  
 Kerax [06/97-01/01]  
 Magnum [09/90-04/06]  
 Major [05/91-10/96]

 Manager [09/91-10/96]  
 Maxter [10/92-06/97]  
 Premium [04/96--]

**Fuel filter**
**034 009 0003 | MFF0023**
**Notes**

 Diameter [mm]  
 Height [mm]  
 Connecting thread

 Plastic  
 36  
 52  
 M20x1,5  
 Pre-filter

**References**

50 01 833 652

**Application info**

 R [10/80-10/91]  
 TBH [01/77-06/80]

 TR [05/71-12/81]  
 Tracer [01/91--]

**Fuel filter**
**16-34 323 0008 | MFF0100**
**Notes**

 Outer diameter [mm]  
 Height [mm]  
 Thread Size

 93  
 147  
 M18x1,5  
 Screw-on Filter

**References**

 50 01 853 860  
 50 10 412 350  
 50 10 450 824

 50 10 477 855  
 50 10 505 337

**Application info**

 Kerax [06/97-01/01]  
 Magnum [09/90-04/06]

 Midlum [01/00--]  
 Premium [04/96--]

16-34 323 0004 | MFF0271

Fuel filter



Notes

Outer diameter [mm]	93
Height [mm]	140
Connecting thread	1-14UNS-2B Screw-on Filter

References

74 20 514 654	74 20 998 634
74 20 541 383	

Application info

Magnum [09/90-04/06]  
Premium [04/96--]

Premium 2 [10/05--]

16-34 323 0003 | MFF0098

Fuel filter



Notes

Outer diameter [mm]	108
Height [mm]	262.5
Thread Size	M32x1,5 Screw-on Filter

References

74 20 541 381	74 85 116 634
74 20 976 001	

Application info

Kerax [06/97-01/01]  
Magnum [09/90-04/06]

Premium [04/96--]  
Premium 2 [10/05--]

16-34 323 0006 | MFF0272

Fuel filter



Notes

Outer diameter [mm]	108
Height [mm]	158
Thread Size	1-14 UNS Screw-on Filter

References

74 20 745 605	74 21 380 483
74 20 998 349	

Application info

Kerax [06/97-01/01]

Magnum [09/90-04/06]



**Fuel filter**
**16-34 323 0001 | MFF0250**
**Notes**

Diameter [mm]	Steel
Height [mm]	108
Connecting thread	263
	M32x1,5
	Screw-on Filter

**References**

74 20 875 666	74 20 972 291
---------------	---------------

**Application info**

 Kerax [06/97-01/01]  
 Magnum [09/90-04/06]

Premium 2 [10/05--]

**Fuel filter**
**534 323 0001 | MFF0261**
**Notes**

Outer diameter [mm]	94.5
Height [mm]	163
	Filter Insert

**References**

74 20 796 772	74 20 998 806
---------------	---------------

**Application info**

Midlum [01/00--]

Premium 2 [10/05--]

**Engine mount**
**16-34 030 0006 | MEM0640**
**Notes**

	Rubber-metal Bearing
	Steel Elastomer
Bore Ø [mm]	20
Outer diameter [mm]	110
Height [mm]	106
Required quantity	1
	Left

**References**

50 10 316 521

**Counterpart**

16-34 030 0007 | MEM0702

**Application info**

Kerax [06/97-01/01]

16-34 030 0007 | MEM0702

Engine mount



Notes

Bore Ø [mm]  
Outer diameter [mm]  
Height [mm]  
Required quantity

Rubber-metal Bearing  
Steel Elastomer  
20  
110  
106  
1  
Right

References

50 10 316 522

Counterpart

16-34 030 0006 | MEM0640

Application info

Kerax (06/97-01/01)

16-34 030 0003 | MEM0638

Engine mount



Notes

Bore Ø [mm]  
Height [mm]  
Required quantity

Rubber-metal Bearing  
Steel Elastomer  
20  
106  
1  
Left Front

References

50 10 316 591

Counterpart

16-34 030 0004 | MEM0639

Application info

Premium (04/96--)

Premium 2 (10/05--)

16-34 030 0004 | MEM0639

Engine mount



Notes

Bore Ø [mm]  
Height [mm]  
Required quantity

Rubber-metal Bearing  
Steel Elastomer  
20  
106  
1  
Right Front

References

50 10 316 592

Counterpart

16-34 030 0003 | MEM0638

**Engine mount**

**16-34 030 0004 | MEM0639**

**Application info**

Premium [04/96--]

Premium 2 [10/05--]

**Engine mount**

**534 030 0001 | MEM0641**

**Notes**

	Rubber-metal Bearing
	Steel Elastomer
Bore Ø [mm]	14
Height [mm]	130
Width [mm]	210
Length [mm]	250
Required quantity	2
	Rear
	Left and right

**References**

74 20 499 470

74 20 796 970



**Application info**

Kerax [06/97-01/01]

**Engine mount**

**16-34 030 0005 | MEM0788**

**Notes**

	Rubber-metal Bearing
	Steel Elastomer
Height [mm]	130
Width [mm]	220
Length [mm]	240
Required quantity	2
	Left and right
	Rear

**References**

74 20 499 469

74 20 499 472



**Application info**

Kerax [06/97-01/01]  
Magnum [09/90-04/06]

Premium [04/96--]  
Premium 2 [10/05--]

16-34 234 0002 | MRM0072

Radiator fan motor

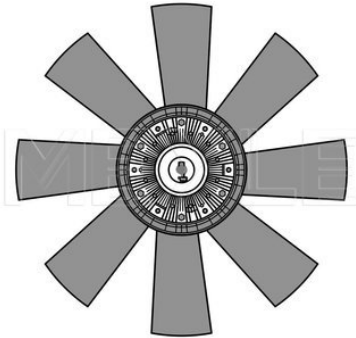

Notes

Number of Wings	9
Outer diameter [mm]	Thermic 720

References

50 10 269 869

Application info

Kerax [06/97-01/01]

Premium [04/96--]

16-34 234 0003 | MRM0073

Radiator fan motor



Notes

Number of Wings	9
Outer diameter [mm]	Thermic 680

References

50 10 315 427

Application info

Premium [04/96--]

534 234 0021 | MRM0122

Radiator fan motor

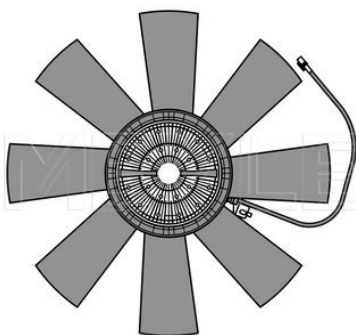

Notes

Number of Wings	11
Outer diameter [mm]	Electric 680

References

74 21 012 697

Application info

Kerax [06/97-01/01]

**Fan clutch**

**16-34 234 0004 | MFC0051**

**Notes**

Diameter [mm]                      Thermic  
233

**References**

50 10 269 871



**Application info**

Kerax [06/97-01/01]

Premium [04/96--]

**Fan clutch**

**16-34 234 0006 | MFC0053**

**Notes**

Number of mounting bores                      6  
Electronic  
Outer diameter [mm]                      260  
Hole Arrangement / Number                      6  
Depth [mm]                      150  
Number of Poles                      5

**References**

50 10 315 994

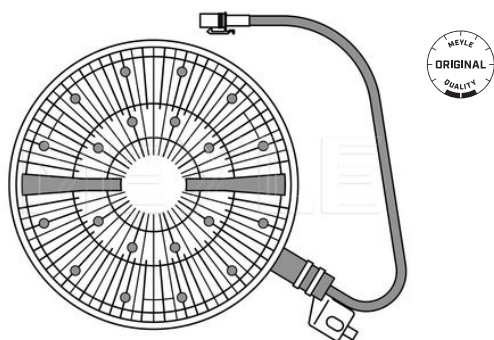

**Application info**

Kerax [06/97-01/01]

Premium [04/96--]

**Fan clutch**

**16-34 234 0005 | MFC0052**

**Notes**

Number of mounting bores                      6  
Thermic  
Outer diameter [mm]                      203  
Depth [mm]                      47  
Hole Arrangement / Number                      6

**References**

50 10 514 014

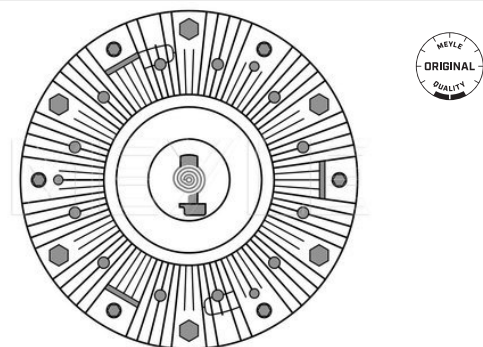

**Application info**

Midlum [01/00--]

Premium [04/96--]

16-33 234 0001 | MFC0087

Fan clutch

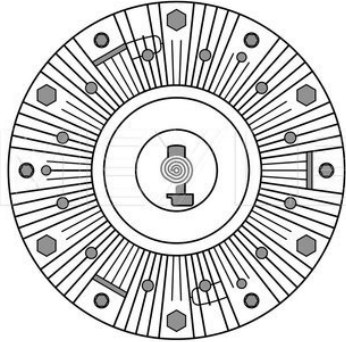

Notes

Number of mounting bores	6
	Thermic
Outer diameter [mm]	210
Depth [mm]	100
Hole Arrangement / Number	1

References

50 10 140 460	50 10 375 179
50 10 315 180	50 10 514 058
50 10 315 182	

Application info

Midlum [01/00--]  
Premium [04/96--]

Premium 2 [10/05--]

16-34 020 0001 | MFC0047

Fan clutch



Notes

Number of mounting bores	6
	Electronic
Outer diameter [mm]	260
Hole Arrangement / Number	4
Depth [mm]	158
Number of Poles	5

References

74 20 880 406	74 20 993 866
---------------	---------------

Application info

Kerax [06/97-01/01]

Premium 2 [10/05--]

16-34 232 0024 | MMX1319

Fan blade

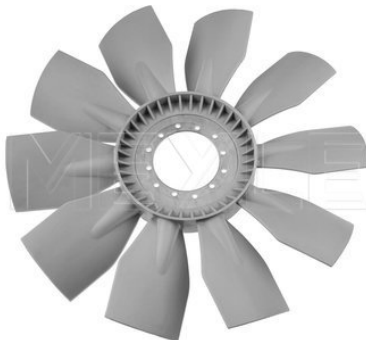

Notes

Number of Wings	10
	Plastic

References

50 10 140 298
---------------

Application info

Kerax [06/97-01/01]

**Fan blade**

**16-34 232 0003 | MMX1405**

**References**

50 10 269 159

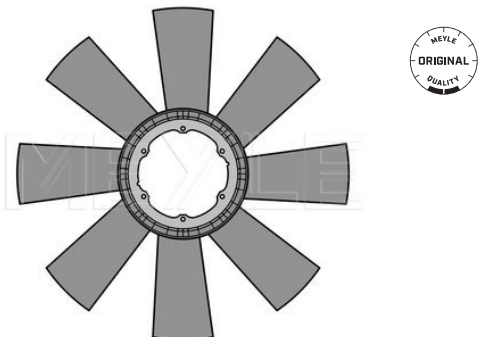

**Application info**

Midlum [01/00--]

**Fan blade**

**16-34 232 0012 | MMX1414**

**Notes**

Number of Wings

9

Outer diameter [mm]

Plastic  
720

**References**

50 10 269 870

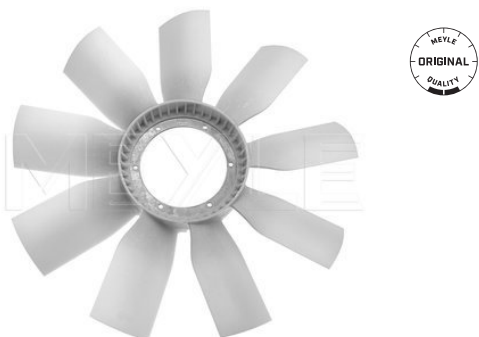

**Application info**

Kerax [06/97-01/01]

Premium [04/96--]

**Fan blade**

**16-34 232 0023 | MMX1425**

**Notes**

Number of Wings

9

Outer diameter [mm]

Plastic  
680

**References**

50 10 315 557

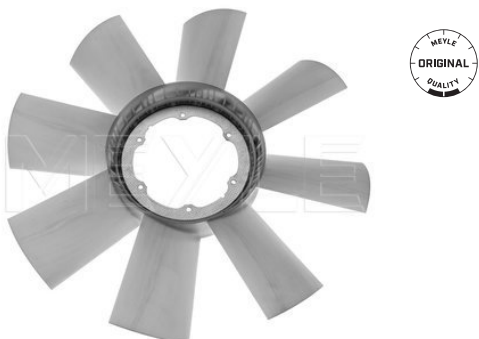

**Application info**

Premium [04/96--]

16-34 020 0002 | MMX1317

Fan blade

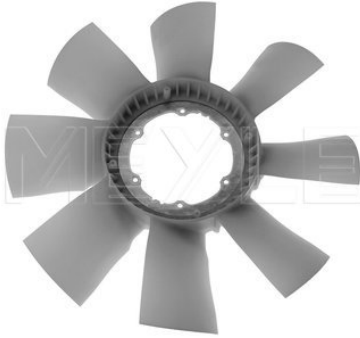

Notes

Number of Wings	8
Diameter [mm]	680

References

50 10 315 993

Application info

Kerax [06/97-01/01]

Premium [04/96--]

16-34 232 0011 | MMX1413

Fan blade

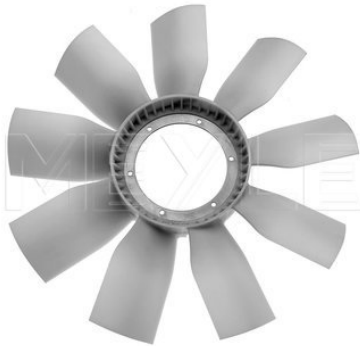

Notes

Number of Wings	9
Outer diameter [mm]	Plastic 680

References

50 10 514 839

Application info

Kerax [06/97-01/01]

16-34 232 0022 | MMX1424

Fan blade



Notes

Number of Wings	8
	Plastic

References

50 10 597 547

Application info

Premium [04/96--]



**Water pump**

**16-33 220 0001 | MWP0218**

**Notes**

Weight [kg] 3.4  
with seal

**References**

50 00 670 157 50 01 837 298



**Application info**

C [10/82-10/98]  
G [10/82-03/93]  
Major [05/91-10/96]

Manager [09/91-10/96]  
Maxter [10/92-06/97]

**Water pump**

**16-33 220 0005 | MWP0222**

**Notes**

Impeller Diameter [mm] 124  
Weight [kg] 2.1  
with seal  
1-part housing  
Metal impeller  
without belt pulley

**References**

50 01 857 427 50 01 858 484



**Application info**

Agora [01/96--]  
Kerax [06/97-01/01]

Maxter [10/92-06/97]  
Premium [04/96--]

**Water pump**

**16-33 220 0002 | MWP0219**

**Notes**

Weight [kg] 3.8  
with seal

**References**

50 10 330 029



**Application info**

Kerax [06/97-01/01]  
Manager [09/91-10/96]

Maxter [10/92-06/97]  
Premium [04/96--]

16-33 220 0004 | MWP0221

Water pump



Notes

Weight [kg] 4.7  
with gaskets/seals

References

50 01 866 278 74 20 734 268

Application info

Magnum [09/90-04/06]

533 220 0004 | MWP0553

Water pump



Notes

Impeller Diameter [mm] 130  
Weight [kg] 5.5  
Number of Wings 16  
with seal  
1-part housing  
Electric  
with v-ribbed belt pulley  
Belt Pulley Ø [mm] 155  
Height [mm] 110  
Number of connectors 1  
Number of Holes 6

References

74 21 959 184 74 21 960 480

Application info

Kerax [06/97-01/01]

Magnum [09/90-04/06]

533 220 0001 | MWP0439

Water pump



Notes

Weight [kg] 2.8  
with seal

References

74 20 744 939 74 85 000 763  
74 20 744 940 74 85 000 963  
74 21 615 952 74 85 013 068  
74 22 167 707

**Water pump**

**533 220 0001 | MWP0439**

**Application info**

Kerax [06/97-01/01]  
Magnum [09/90-04/06]

Premium [04/96--]  
Premium 2 [10/05--]

**Thermostat**

**16-28 283 0001 | MTH0113**

**Notes**

Diameter [mm]  
Opening Temperature [°C]

Thermic  
84.9  
83

**References**

50 10 295 225



**Application info**

Kerax [06/97-01/01]

**Thermostat**

**16-28 282 0001 | MTH0112**

**Notes**

Opening Temperature [°C]

with seal  
1-part housing  
82

**References**

74 20 560 249  
74 21 237 213

74 21 412 639



**Application info**

Kerax [06/97-01/01]  
Magnum [09/90-04/06]

Premium 2 [10/05--]

**Expansion tank**

**16-34 223 0003 | MET0080**

**Notes**

Opening Pressure [bar]

Transparent  
1.1  
PP (Polypropylene)  
with sensor  
with filler cap  
Rear

**References**

74 20 828 416  
74 21 055 339

74 55 064 150



16-34 223 0003 | MET0080

Expansion tank

Application info

Kerax [06/97-01/01]

16-34 223 0004 | MET0088

Expansion tank

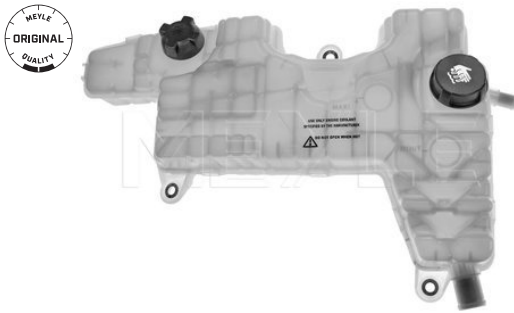

Notes

Opening Pressure [bar]	Transparent 0.9
Pressure [bar]	PP (Polypropylene) 0.9
Width [mm]	381
Depth [mm]	146
Length [mm]	619
Capacity [Litre]	11
	with sensor
	with filler cap
	Front

References

50 10 263 004	74 20 828 448
74 20 783 901	74 82 582 816

Application info

Midlum [01/00--]

16-34 223 0002 | MET0045

Expansion tank



Notes

Opening Pressure [bar]	Transparent 0.7
Pressure [bar]	PP (Polypropylene) 0.7
Width [mm]	380
Depth [mm]	145
Length [mm]	470
Capacity [Litre]	11.5
	with sensor
	with filler cap
	Front

References

50 10 141 465	74 21 017 015
50 10 514 340	74 22 064 150
74 20 783 159	74 85 132 205
74 20 983 308	

Application info

Kerax [06/97-01/01]  
Premium [04/96--]

Premium 2 [10/05--]

**Sender unit, coolant temperature**
**614 899 0038 | MEX0453**
**Notes**

	Grey
	NTC Sensor
Spanner Size	19
Thread Size	M12 x 1,5
Operating voltage [V]	12
Switch Point [°C]	150
Switch Point [°C]	-40
Number of Poles	2

**References**

50 10 412 450	74 85 137 860
74 20 513 340	

**Application info**

 Kerax [06/97-01/01]  
 Midlum [01/00--]

Premium [04/96--]

**Sensor, coolant level**
**16-34 223 0005 | MEX0583**
**Notes**

	Black
	Passive sensor
Cable Length [mm]	200
Operating voltage [V]	24
Fitting Depth [mm]	80
Length [mm]	390
Number of Poles	2

**References**

74 20 783 896	74 20 983 314
74 20 783 898	74 21 017 010

**Application info**

Kerax [06/97-01/01]

Premium [04/96--]

**Expansion tank cap**
**14-34 238 0002 | MMX1457**
**Notes**

	Black
	Round
Diameter [mm]	81

**References**

55 16 031 803

**Application info**

Magnum [09/90-04/06]

16-34 000 0005 | MBT0075

Belt tensioner



Notes

Outer diameter [mm] 74  
Width [mm] 46.3

References

50 10 284 807 50 10 553 993

Application info

Magnum [09/90-04/06]

16-34 000 0003 | MBT0062

Belt tensioner



Notes

Outer diameter [mm] 80  
Width [mm] 35

References

50 10 412 956

Application info

Kerax [06/97-01/01]

Premium [04/96--]

16-34 000 0008 | MBT0063

Belt tensioner



Notes

Outer diameter [mm] 74  
Width [mm] 38

References

50 10 550 335

Application info

Kerax [06/97-01/01]

Premium [04/96--]

**Belt tensioner**
**16-34 000 0001 | MBT0034**
**Notes**

Belt Pulley Ø [mm]	74
Height [mm]	58.5
Width [mm]	38

**References**

74 03 979 979

**Application info**

Magnum [09/90-04/06]

**Belt tensioner**
**534 000 0005 | MBT0045**
**Notes**

Belt Pulley Ø [mm]	74
--------------------	----

**References**

74 08 149 855

**Application info**

Magnum [09/90-04/06]

**Belt tensioner**
**16-34 000 0002 | MBT0035**
**Notes**

Weight [kg]	1.38
Height [mm]	69.2

**References**

74 20 487 079

**Application info**

 Magnum [09/90-04/06]  
 Premium [04/96--]

Premium 2 [10/05--]

534 000 0006 | MBT0046

Belt tensioner



Notes

Belt Pulley Ø [mm]	74
Height [mm]	87.5

References

74 20 739 751	74 21 819 687
74 20 935 521	

Application info

Magnum [09/90-04/06]

534 000 0011 | MBT0073

Belt tensioner



Notes

Outer diameter [mm]	70
Width [mm]	38

References

74 20 939 284	74 21 500 149
---------------	---------------

Application info

Midlum [01/00--]

Premium 2 [10/05--]

534 000 0010 | MBT0072

Belt tensioner



Notes

Outer diameter [mm]	73.8
Width [mm]	38.3

References

74 21 479 276
---------------

Application info

Kerax [06/97-01/01]

Magnum [09/90-04/06]



**Tension roller, ribbed belt**
**16-34 000 0007 | MTR0044**
**Notes**

Inner diameter [mm]	17
Outer diameter [mm]	72
Height [mm]	36.5

**References**

74 08 086 970

**Application info**

Kerax [06/97-01/01]

Premium 2 [10/05--]

**Tension roller, ribbed belt**
**534 000 0008 | MTR0034**
**Notes**

Inner diameter [mm]	20
Outer diameter [mm]	74
Width [mm]	38

**References**

74 20 747 516

**Application info**

 Kerax [06/97-01/01]  
 Premium [04/96--]

Premium 2 [10/05--]

**V-belt**
**052 010 0975 | MVB0063**
**Notes**

Width [mm]	10
Length [mm]	975

**References**

50 00 182 327	50 00 788 120
50 00 663 785	50 00 831 564

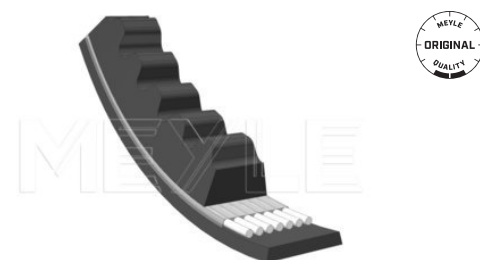
**Application info**

R [10/80-10/91]

052 013 1550 | MVB0226

V-belt

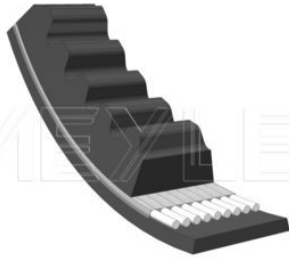

Notes

Width [mm] 13  
Length [mm] 1550

References

50 00 786 246 50 00 787 739  
50 00 786 359 50 00 789 954

Application info

C [10/82-10/98]

Magnum [09/90-04/06]

052 010 1575 | MVB0116

V-belt

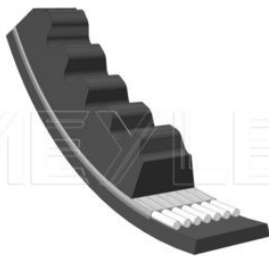

Notes

Width [mm] 10  
Length [mm] 1575

References

5000 790 821

Application info

C [10/82-10/98]

R [10/80-10/91]

052 010 1250 | MVB0097

V-belt

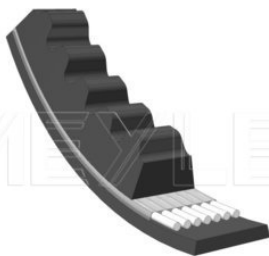

Notes

Width [mm] 10  
Length [mm] 1250

References

77 00 268 230 77 00 854 083  
77 00 268 232 77 01 029 704  
77 00 268 754

Application info

Midliner [10/82-01/00]

Premium [04/96--]



## V-ribbed belt

050 005 1010 | MRB0218

### Notes

Width [mm]  
Number of Ribs  
Length [mm]

EPDM (ethylene propylene diene Monomer [M-class] rubber)  
18  
5  
1010  
One-sided

### References

50 00 670 728

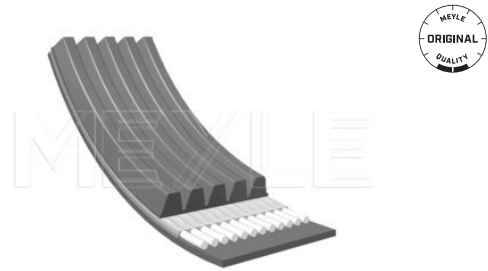

### Application info

Premium [04/96--]

## V-ribbed belt

050 010 1460 | MRB0755

### Notes

Width [mm]  
Number of Ribs  
Length [mm]

EPDM (ethylene propylene diene Monomer [M-class] rubber)  
35  
10  
1460  
One-sided

### References

50 10 437 603

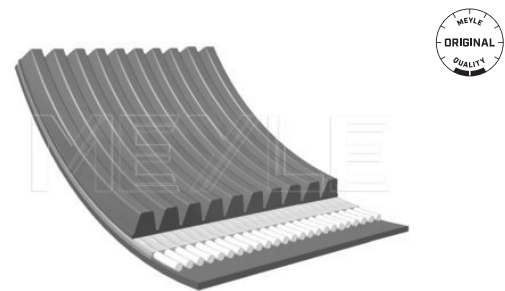

### Application info

Magnum [09/90-04/06]

## V-ribbed belt

050 009 1690 | MRB0754

### Notes

Width [mm]  
Number of Ribs  
Length [mm]

EPDM (ethylene propylene diene Monomer [M-class] rubber)  
32  
9  
1690  
One-sided

### References

50 10 477 838

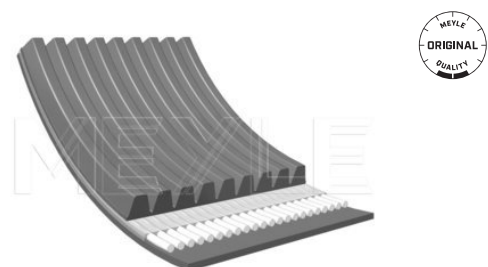

### Application info

Kerax [06/97-01/01]

Premium [04/96--]

**Ø50 008 1435 | MRB0659**

**V-ribbed belt**

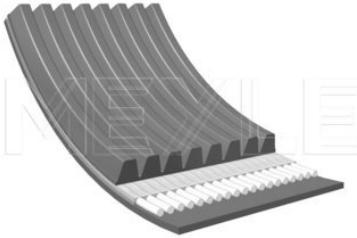

**Notes**

Width [mm]  
Number of Ribs  
Length [mm]

EPDM (ethylene propylene diene Monomer [M-class] rubber)  
28  
8  
1435  
One-sided

**References**

74 20 543 484

74 22 100 457

**Application info**

Kerax [06/97-01/01]

Premium 2 [10/05--]

**Ø50 010 1487 | MRB0756**

**V-ribbed belt**

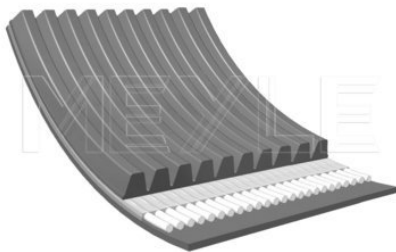

**Notes**

Width [mm]  
Number of Ribs  
Length [mm]

EPDM (ethylene propylene diene Monomer [M-class] rubber)  
35  
10  
1487  
One-sided

**References**

74 20 724 776

**Application info**

Magnum [09/90-04/06]

**Ø50 010 1512 | MRB0718**

**V-ribbed belt**

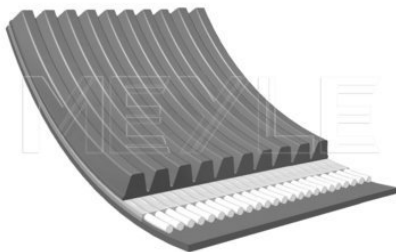

**Notes**

Width [mm]  
Number of Ribs  
Length [mm]

EPDM (ethylene propylene diene Monomer [M-class] rubber)  
35  
10  
1512  
One-sided

**References**

74 20 725 565

**Application info**

Magnum [09/90-04/06]



## V-ribbed belt

050 010 1342 | MRB0748

### Notes

Width [mm]  
Number of Ribs  
Length [mm]

EPDM (ethylene propylene diene Monomer [M-class] rubber)  
35  
10  
1342  
One-sided

### References

74 21 190 824                      74 22 100 459

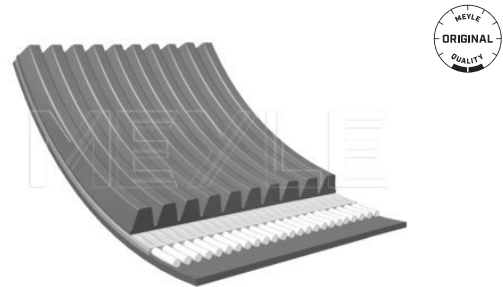

### Application info

Kerax [06/97-01/01]

## V-ribbed belt

050 005 1530 | MRB0275

### Notes

Width [mm]  
Number of Ribs  
Length [mm]

EPDM (ethylene propylene diene Monomer [M-class] rubber)  
18  
5  
1530  
One-sided

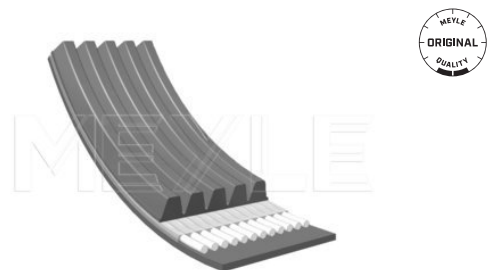

### Application info

C [10/82-10/98]  
Magnum [09/90-04/06]

Major [05/91-10/96]

## Gasket, exhaust manifold

16-34 900 0007 | MMX1569

### References

50 10 295 218

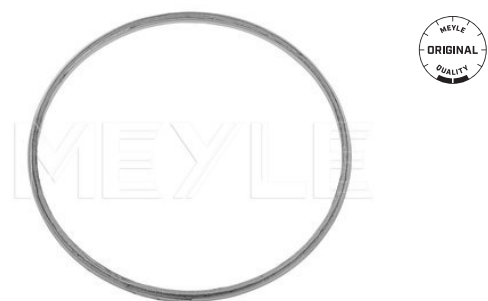

### Application info

Kerax [06/97-01/01]  
Manager [09/91-10/96]

Maxter [10/92-06/97]  
Premium [04/96--]

16-34 900 0005 | MMX1554

Gasket, exhaust manifold



References

74 08 170 959

Application info

Magnum [09/90-04/06]

16-34 900 0006 | MMX1455

Gasket, exhaust manifold



Notes

Required quantity 2

References

74 20 855 371

Application info

Kerax [06/97-01/01]

Magnum [09/90-04/06]

16-34 001 0008 | MMX1551

Gasket, exhaust pipe



Notes

Hole Arrangement / Number 4

References

50 10 477 438

Application info

Kerax [06/97-01/01]

Premium [04/96--]

**Brake disc**
**36-15 523 0049 | MBD2099**
**Notes**

Wheel Bolt Bore Ø [mm]	10.8
	Vented
Centering Diameter [mm]	108
Minimum thickness [mm]	13
Outer diameter [mm]	280
Height [mm]	62.2
Bolt Hole Circle Ø [mm]	127
Brake Disc Thickness [mm]	16
Required quantity	2
Number of Holes	6
	Rear Axle

**References**

5001874635

**Application info**

Maxity (03/07-- )

**Brake disc**
**16-35 521 0001 | MBD0349**
**Notes**

	Vented
Centering Diameter [mm]	131
Minimum thickness [mm]	41
Outer diameter [mm]	438
Height [mm]	96.5
Bolt Hole Circle Ø [mm]	194
Brake System	MERITOR
Brake Disc Thickness [mm]	45
Required quantity	2
Number of Holes	10
	Front Axle

**References**

50 10 216 437

**Application info**

Magnum (09/90-04/06)

Premium (04/96-- )

**Brake disc**
**16-35 521 0013 | MBD1473**
**Notes**

	Internally Vented
Centering Diameter [mm]	170
Minimum thickness [mm]	27
Outer diameter [mm]	303.5
Height [mm]	134.8
Brake Disc Thickness [mm]	30
Number of Holes	6
	Front Axle

**References**

50 10 216 931

50 10 260 101

**16-35 521 0013 | MBD1473**

**Brake disc**

**Application info**

Midliner [10/82-01/00]



**Notes**

Centering Diameter [mm]	Vented 290
Minimum thickness [mm]	27.75
Outer diameter [mm]	322
Height [mm]	140
Bolt Hole Circle Ø [mm]	245
Brake System	BREMBO 2x68
Brake Disc Thickness [mm]	30
Number of Holes	6
	Front Axle

**References**

50 10 216 932 50 10 260 102

**Application info**

Midliner [10/82-01/00]

**16-35 521 0005 | MBD1661**

**Brake disc**



**Notes**

Centering Diameter [mm]	Vented 117
Minimum thickness [mm]	40
Outer diameter [mm]	380
Height [mm]	85
Bolt Hole Circle Ø [mm]	144
Brake System	MERITOR C-LISA
Brake System	WABCO PAN19-2
Brake Disc Thickness [mm]	45
Required quantity	2
Number of Holes	10
	Front Axle

**References**

50 10 260 218

**Application info**

Midlum [01/00--]





### Brake disc

16-35 521 0008 | MBD0352

#### Notes

Centering Diameter [mm]	Vented
Minimum thickness [mm]	102
Outer diameter [mm]	24
Height [mm]	290
Bolt Hole Circle Ø [mm]	42.5
Brake System	120
Brake Disc Thickness [mm]	BREMBO
Required quantity	26
Number of Holes	2
	10
	Front Axle

#### References

50 10 260 603



#### Application info

Maxity [03/07--]

### Brake disc

16-35 523 0006 | MBD1476

#### Notes

Centering Diameter [mm]	Internally Vented
Minimum thickness [mm]	95
Outer diameter [mm]	28
Height [mm]	330
Brake System	80
Brake Disc Thickness [mm]	WABCO PAN17
Number of Holes	34
	10
	Front Axle

#### References

50 10 422 262  
50 10 525 308

50 10 598 303



#### Application info

Midlum [01/00--]

2

16-35 521 0006 | MBD1662

Brake disc



Notes

Minimum thickness [mm]	Vented 38
Outer diameter [mm]	375
Height [mm]	99
Bolt Hole Circle Ø [mm]	144
Brake System	MERITOR C LISA
Brake System	WABCO PAN-19-2
Brake Disc Thickness [mm]	45
Required quantity	2
Number of Holes	10
	Front Axle

References

50 10 525 014

Application info

Midlum [01/00--]

16-35 523 0002 | MBD1664

Brake disc



Notes

Centering Diameter [mm]	Vented 275
Minimum thickness [mm]	38
Outer diameter [mm]	375
Height [mm]	166
Bolt Hole Circle Ø [mm]	275
Brake System	WABCO PAN 19-2 without bolts
Brake Disc Thickness [mm]	45
Number of Holes	8
	Rear Axle

References

50 10 525 362

Application info

Midlum [01/00--]



### Brake disc

16-35 523 0003 | MBD1665

#### Notes

Centering Diameter [mm]	Vented
Minimum thickness [mm]	262
Outer diameter [mm]	38
Height [mm]	375
Bolt Hole Circle Ø [mm]	167
Brake System	355
Brake System	WABCO PAN 19-2
Brake System	MERITOR C LISA
Brake Disc Thickness [mm]	45
Number of Holes	10
	Rear Axle

#### References

50 10 525 364



#### Application info

Midlum [01/00--]

### Brake disc

16-35 521 0012 | MBD1472

#### Notes

Centering Diameter [mm]	Internally Vented
Minimum thickness [mm]	194
Outer diameter [mm]	28
Height [mm]	330
Bolt Hole Circle Ø [mm]	137
Brake Disc Thickness [mm]	245
Number of Holes	34
	6
	Rear Axle
	Front Axle

#### References

50 10 598 304

74 82 421 131



#### Application info

Midlum [01/00--]

2

16-35 521 0011 | MBD1471

Brake disc



Notes

Centering Diameter [mm]	111
Minimum thickness [mm]	37
Outer diameter [mm]	375
Height [mm]	119
Bolt Hole Circle Ø [mm]	142
Brake Disc Thickness [mm]	45
Required quantity	2
Number of Holes	10
	Front Axle

References

50 10 598 305

Application info

Midlum [01/00--]

025 290 6522 | MBP0735

Brake pad set

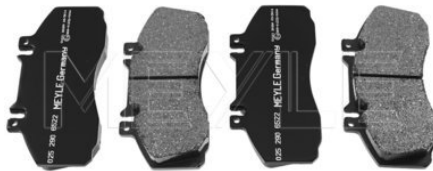

Notes

Thickness [mm]	22
Height [mm]	85.5
Width [mm]	175
Brake System	Lucas B2x60
	Front Axle

without add-on material  
excl. wear warning contact  
prepared for wear indicator

References

50 01 014 694

50 01 825 638

Application info

Midliner [10/82-01/00]

025 290 9028 | MBP0823

Brake pad set



Notes

Thickness [mm]	28.2
Height [mm]	114.2
Width [mm]	249.6
Brake System	Meritor D-LISA
	Front Axle

without add-on material  
prepared for wear indicator

References

50 01 846 034

Application info

Magnum [09/90-04/06]

Premium [04/96--]



### Brake pad set

025 291 3130 | MBP0720

#### Notes

Thickness [mm]  
Height [mm]  
Width [mm]  
Brake System

with add-on material  
prepared for wear indicator  
30.2  
118.2  
249.6  
Meritor D-Elsa 2  
Front Axle

#### References

50 01 855 646

50 01 863 904

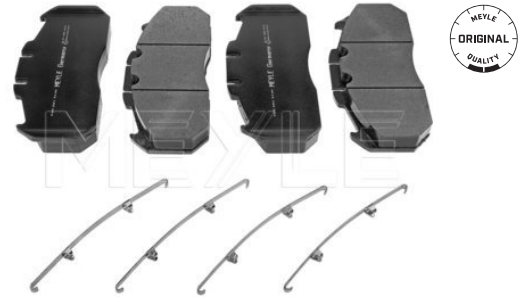

#### Application info

Magnum [09/90-04/06]

Premium [04/96--]

### Brake pad set

025 291 7429 | MBP0751

#### Notes

Thickness [mm]  
Height [mm]  
Width [mm]  
Brake System

without add-on material  
excl. wear warning contact  
29.2  
106.9  
249.6  
Meritor Elsa 225-3  
Rear Axle

#### References

50 01 864 363  
50 01 864 364

74 21 399 929  
74 21 496 555

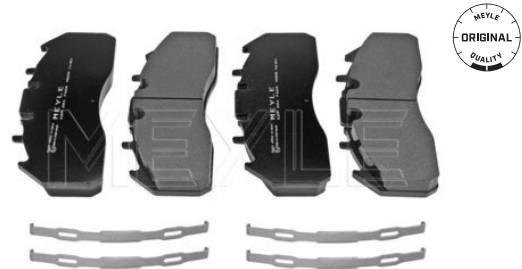

#### Application info

Magnum [09/90-04/06]

Premium 2 [10/05--]

### Brake pad set

025 291 7329 | MBP0749

#### Notes

Thickness [mm]  
Height [mm]  
Width [mm]  
Brake System

without add-on material  
excl. wear warning contact  
29  
97  
216.2  
Meritor Elsa 225-1  
Rear Axle  
Front Axle

#### References

50 01 864 365

74 21 399 915



#### Application info

Midlum [01/00--]

025 291 7329/S | MBP0750

Brake pad set



Notes

Thickness [mm]  
Height [mm]  
Width [mm]  
Brake System

with add-on material  
excl. wear warning contact  
29  
97  
216.2  
Meritor Elsa 225-1  
Front Axle

References

50 01 864 365

74 21 399 915

Application info

Midlum [01/00--]

025 291 8130 | MBP0754

Brake pad set



Notes

Thickness [mm]  
Height [mm]  
Width [mm]  
Brake System

without add-on material  
excl. wear warning contact  
30  
92  
210.3  
Haldex DB 19  
Rear Axle  
Front Axle

References

50 01 866 914

50 10 598 372

Application info

Midlum [01/00--]

16-34 527 0004 | MWS0140

Wear sensor



Notes

Warning Contact Length [mm]  
Required quantity

Disc Brake  
365  
2  
Front Axle

References

50 01 822 987  
68310622

68320902

Application info

Magnum [09/90-04/06]  
Major [05/91-10/96]

Premium [04/96--]

**Wear sensor**
**534 527 0001 | MWS0145**
**Notes**

 Warning Contact Length [mm]  
 Brake System  
 Required quantity

 Disc Brake  
 395  
 BREMBO  
 2  
 Front Axle

**References**

50 01 831 161

**Application info**

 Agora [01/96--]  
 Magnum [09/90-04/06]

Premium [04/96--]

**Wear sensor**
**16-34 527 0001 | MWS0137**
**Notes**

 Warning Contact Length [mm]  
 Required quantity

 Disc Brake  
 340  
 2  
 Front Axle

**References**

50 01 834 075

**Application info**

Magnum [09/90-04/06]

Premium [04/96--]

**Wear sensor**
**16-34 527 0003 | MWS0139**
**Notes**

 Warning Contact Length [mm]  
 Warning Contact Length [mm]  
 Required quantity

 Disc Brake  
 380  
 300  
 2  
 Front Axle

**References**

50 01 848 363



**Application info**

 Agora [01/96--]  
 G [10/82-03/93]  
 Iliade [01/97--]  
 Magnum [09/90-04/06]

 Major [05/91-10/96]  
 Manager [09/91-10/96]  
 Premium [04/96--]

16-34 527 0005 | MWS0141

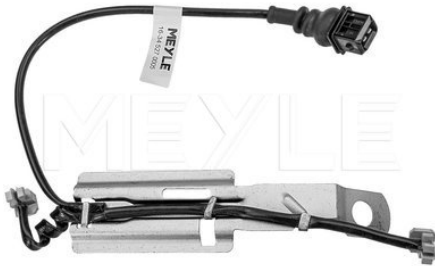
Wear sensor



Notes

Warning Contact Length [mm]  
Brake System  
Required quantity

Disc Brake  
204  
WABCO PAN 19-2  
2  
Front Axle

References

50 01 855 902

Application info

Midlum [01/00--]

16-34 527 0002 | MWS0138

Wear sensor



Notes

Warning Contact Length [mm]

Disc Brake  
300  
Front Axle  
Rear Axle

References

50 10 848 607

Application info

Midlum [01/00--]

16-34 054 0003 | MWS0135

Wear sensor



Notes

Warning Contact Length [mm]  
Warning Contact Length [mm]  
Required quantity

Disc Brake  
885  
780  
1

References

68320874

68320909

Application info

Midliner [10/82-01/00]





### Wear sensor

16-34 054 0005 | MWS0136

#### Notes

Warning Contact Length [mm]  
Required quantity

Disc Brake  
380  
2  
Left and right

#### References

68325408



#### Application info

Magnum [09/90-04/06]

Premium 2 [10/05--]

### ABS wheel sensor

16-34 533 0009 | MAS0124

#### Notes

Cable Length [mm]  
Operating voltage [V]  
Length [mm]  
Number of Poles  
Required quantity  
Resistance [Ohm]

with accessories  
Inductive Sensor  
for vehicles with ABS  
1980  
24  
2100  
2  
2  
1150  
Rear Axle  
Front Axle

#### References

50 10 457 862

74 20 916 175



#### Application info

Magnum [09/90-04/06]

### ABS wheel sensor

16-34 533 0017 | MAS0132

#### Notes

Cable Length [mm]  
Operating voltage [V]  
Length [mm]  
Number of Poles  
Required quantity  
Resistance [Ohm]

with accessories  
Inductive Sensor  
for vehicles with ABS  
2400  
24  
2500  
2  
2  
1150  
Rear Axle  
Front Axle

#### References

50 10 457 875



16-34 533 0017 | MAS0132

ABS wheel sensor

Application info

Magnum [09/90-04/06]

16-34 533 0016 | MAS0131

ABS wheel sensor



Notes

Cable Length [mm]  
Operating voltage [V]  
Length [mm]  
Number of Poles  
Required quantity  
Resistance [Ohm]

with accessories  
Inductive Sensor  
for vehicles with ABS  
3600  
24  
3655  
2  
2  
1150  
Rear Axle  
Front Axle

References

50 10 457 878

Application info

Magnum [09/90-04/06]

16-34 533 0002 | MAS0117

ABS wheel sensor



Notes

Cable Length [mm]  
Operating voltage [V]  
Length [mm]  
Number of Poles  
Required quantity  
Resistance [Ohm]

with accessories  
Inductive Sensor  
for vehicles with ABS  
2140  
24  
2200  
2  
1  
1150  
Rear Axle  
Front Axle

References

50 10 457 882

Counterpart

16-34 533 0003 | MAS0118

Application info

Premium [04/96--]

Premium 2 [10/05--]



### ABS wheel sensor

16-34 533 0003 | MAS0118

#### Notes

	with accessories
	Inductive Sensor
	for vehicles with ABS
Cable Length [mm]	2440
Operating voltage [V]	24
Length [mm]	2500
Number of Poles	2
Required quantity	1
Resistance [Ohm]	1150
	Rear Axle
	Front Axle



#### References

50 10 457 883                      74 21 363 479

#### Counterpart

16-34 533 0002 | MAS0117

#### Application info

Premium [04/96--]

Premium 2 [10/05--]

### ABS wheel sensor

16-34 533 0007 | MAS0122

#### Notes

	with accessories
	Inductive Sensor
	for vehicles with ABS
Cable Length [mm]	2180
Operating voltage [V]	24
Length [mm]	2250
Number of Poles	2
Required quantity	2
Resistance [Ohm]	1150
	Rear Axle
	Front Axle



#### References

74 20 795 150                      74 20 916 177

#### Application info

Magnum [09/90-04/06]

16-34 533 0005 | MAS0120

ABS wheel sensor



Notes

Cable Length [mm]  
Operating voltage [V]  
Length [mm]  
Number of Poles  
Required quantity  
Resistance [Ohm]

with accessories  
Inductive Sensor  
for vehicles with ABS  
5500  
24  
5550  
2  
1  
1150  
Rear Axle Right  
Front Axle Right

References

74 20 916 171

74 21 363 493

Counterpart

16-34 533 0004 | MAS0119

Application info

Kerax [06/97-01/01]

16-34 533 0004 | MAS0119

ABS wheel sensor



Notes

Cable Length [mm]  
Operating voltage [V]  
Length [mm]  
Number of Poles  
Required quantity  
Resistance [Ohm]

with accessories  
Inductive Sensor  
for vehicles with ABS  
3900  
24  
3950  
2  
1  
1150  
Rear Axle Left  
Front Axle Left

References

74 20 915 973

74 21 363 492

Counterpart

16-34 533 0005 | MAS0120

Application info

Kerax [06/97-01/01]



### ABS wheel sensor

534 533 0002 | MAS0377

#### Notes

	with accessories
Operating voltage [V]	Inductive Sensor 24
Number of Poles	2
Required quantity	1
Resistance [Ohm]	1150 Front Axle

#### References

74 24 427 344



#### Application info

Kerax [06/97-01/01]

### Air dryer cartridge

834 042 0001 | MBX0213

#### Notes

Inner thread [mm]	G 1 1/4
Outer diameter [mm]	139
Height [mm]	178

#### References

50 01 843 522                      50 21 170 077



#### Application info

Midlum [01/00--]

### Air dryer cartridge

12-34 042 0026 | MBX0165

#### Notes

Inner thread [mm]	M39x1,5
Outer diameter [mm]	141
Height [mm]	165

#### References

50 01 865 037                      74 21 267 820



2



12-34 042 0026 | MBX0165

Air dryer cartridge

Application info

Agora (01/96--)  
Ares (---)  
C (10/82-10/98)  
G (10/82-03/93)  
Kerax (06/97-01/01)  
Magnum (09/90-04/06)

Major (05/91-10/96)  
Maxter (10/92-06/97)  
Midliner (10/82-01/00)  
Midlum (01/00--)  
Premium 2 (10/05--)  
R (10/80-10/91)

16-34 042 0001 | MBX0199

Air dryer cartridge



Notes

Inner thread [mm]	M39x1,5
Outer diameter [mm]	136
Height [mm]	165

References

50 01 865 404	74 21 602 383
74 21 267 793	74 85 135 854

Application info

Kerax (06/97-01/01)  
Midlum (01/00--)

Premium (04/96--)  
Premium 2 (10/05--)

12-34 032 0000 | MBX0162

Air suspension valve



Notes

Left and right

References

50 10 136 105	74 20 746 460
---------------	---------------

Application info

Manager (09/91-10/96)

Maxter (10/92-06/97)

**Brake line coupling**
**034 042 0038 | MBX0072**
**Notes**

Number of connectors	Red
Connecting thread	1
Operating Pressure [bar]	M16x1,5
	8.1

**References**

50 00 435 826

**Counterpart**

034 042 0039 | MBX0073

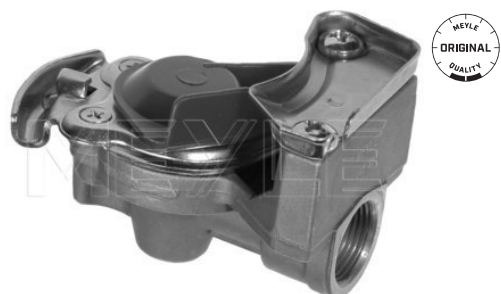
**Application info**

Magnum [09/90-04/06]

**Brake line coupling**
**034 042 0039 | MBX0073**
**Notes**

Number of connectors	Yellow
Connecting thread	1
Operating Pressure [bar]	M16x1,5
	8.1

**References**

50 00 438 153                      50 00 442 714

**Counterpart**

034 042 0038 | MBX0072

**Application info**

Manager [09/91-10/96]

**Brake line coupling**
**034 042 0033 | MBX0067**
**Notes**

Number of connectors	Red
Connecting thread	1
Operating Pressure [bar]	M22x1,5
	8.2

**References**

50 00 440 154

**Counterpart**

034 042 0034 | MBX0068

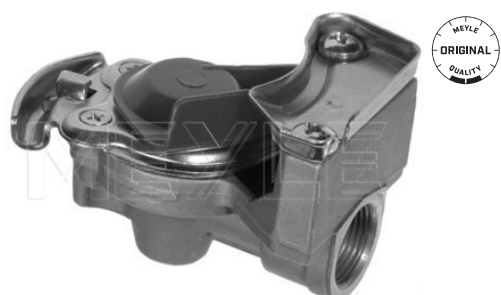
**Application info**

Magnum [09/90-04/06]

034 042 0034 | MBX0068

Brake line coupling



Notes

Number of connectors	Yellow
Connecting thread	1
Operating Pressure [bar]	M22x1,5
	8

References

50 00 440 155

Counterpart

034 042 0033 | MBX0067

Application info

Magnum (09/90-04/06)

16-34 042 0004 | MBX0258

Quick release valve



References

50 00 792 440

50 21 170 467

Application info

C (10/82-10/98)  
Magnum (09/90-04/06)

Midliner (10/82-01/00)

12-34 820 0002 | MBX0267

Pressure limiting valve



References

74 20 793 590

Application info

Premium 2 (10/05--)





### Control valve, trailer

16-34 042 0006 | MBX0251

#### References

50 10 260 535



#### Application info

Kerax [06/97-01/01]

Premium [04/96--]

### Diaphragm, brake cylinder

034 043 0002 | MBX0089

#### Notes

Equipment Variant

T20  
Rubber with textile reinforcement  
20"

Diameter [in]

#### References

50 00 243 913

50 21 170 276



#### Application info

Ares [---]

### Diaphragm, brake cylinder

034 042 0061 | MBX0087

#### Notes

Equipment Variant

T16L  
Rubber with textile reinforcement  
16"

Diameter [in]

#### References

50 00 296 998

50 21 170 275



#### Application info

Ares [---]

034 042 0002 | MBX0053

Diaphragm, brake cylinder



Notes

Equipment Variant

T30L

Rubber with textile reinforcement  
30"

Diameter [in]

References

50 00 807 176

50 21 170 283

Application info

Premium [04/96--]

034 042 0062 | MBX0088

Diaphragm, brake cylinder



Notes

Equipment Variant

T20L

Rubber with textile reinforcement  
20"

Diameter [in]

References

50 00 819 262

50 21 170 278

Application info

C [10/82-10/98]

034 042 0003 | MBX0054

Diaphragm, brake cylinder



Notes

Equipment Variant

T30

Rubber with textile reinforcement  
30"

Diameter [in]

References

50 21 170 282

77 01 005 197

Application info

Magnum [09/90-04/06]



## Valve, compressor system

12-34 026 0002 | MBX0161

### Notes

Multiport Valve

### References

50 01 855 098



### Application info

Kerax [06/97-01/01]  
Magnum [09/90-04/06]

Premium [04/96--]  
Premium 2 [10/05--]

2

16-34 154 0001 | MEX0591

Switch, splitter gearbox



Notes

Number of connectors 2

References

50 00 673 571

Application info

C [10/82-10/98]  
Kerax [06/97-01/01]  
Magnum [09/90-04/06]

Premium [04/96--]  
Premium 2 [10/05--]  
R [10/80-10/91]

14-34 043 0001 | MEX0567

Switch, splitter gearbox



References

74 21 318 366

Application info

Midliner [10/82-01/00]

16-34 321 0020 | MHF0029

Hydraulic filter, A/T



Notes

Inner diameter [mm] 33  
Outer diameter [mm] 64  
Length [mm] 150

References

74 01 521 527 74 21 990 552  
74 21 479 106 74 85 108 176

Application info

Kerax [06/97-01/01]  
Magnum [09/90-04/06]

Premium 2 [10/05--]

**Switch, differential lock**

**12-34 899 0023 | MEX0488**

**Notes**

Push control  
Mechanical

**References**

50 01 845 859                      74 21 318 083  
50 01 868 473                      74 85 116 453



**Application info**

Premium [04/96--]

3

**Joint, propeller shaft**

**12-34 126 6017 | MPJ0071**

**Notes**

Piece  
with add-on material  
Universal Joint  
57  
144  
Centre

Outer diameter [mm]  
Length [mm]

**References**

50 00 559 743                      50 00 815 148

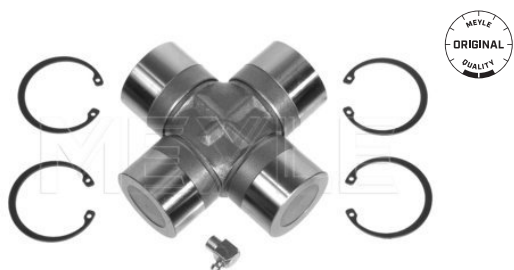

**Application info**

G [10/82-03/93]  
Maxter [10/92-06/97]

R [10/80-10/91]

**Release bearing**

**12-31 111 0003 | MMX1491**

**Notes**

Parameter                      KZISZ-5  
Height [mm]                      112

**References**

50 01 858 682                      50 01 873 287  
50 01 864 270



**Application info**

Magnum [09/90-04/06]

Premium [04/96--]

034 042 0016 | MBX0060

Clutch booster



Notes

Force output F [N]  
Operating Pressure [bar]  
Stroke [mm]

Brake Fluid  
6000  
10  
58

References

50 00 787 875

Application info

Midliner [10/82-01/00]

16-34 029 0003 | MBX0254

Clutch booster



Notes

Pressure [bar]  
Force output F [N]  
Operating Pressure [bar]  
Stroke [mm]

Brake Fluid  
8  
4000  
10  
85

References

50 10 452 472

Application info

Midlum [01/00--]

**Repair kit, kingpin**

**16-34 798 0001 | MCX0525**

**Notes**

Outer diameter [mm] 60  
Length [mm] 226  
Front Axle

**References**

74 20 590 486



**Application info**

Kerax [06/97-01/01]  
Magnum [09/90-04/06]

Premium [04/96--]  
Premium 2 [10/05--]

**Rubber stop, suspension**

**16-34 162 0001 | MRS0195**

**Notes**

Outer diameter [mm] 80  
Height [mm] 52  
Left and right

**References**

50 10 383 949



**Application info**

Midlum [01/00--]

**Rubber stop, suspension**

**16-34 162 0003 | MRS0196**

**Notes**

Outer diameter [mm] 79.5  
Height [mm] 100  
Left and right

**References**

50 10 383 951



**Application info**

Kerax [06/97-01/01]

4

534 162 0004 | MRS0190

Rubber stop, suspension



Notes

Height [mm]  
Width [mm]  
Length [mm]

Steel Elastomer  
40  
100  
60  
Front Axle

References

74 00 351 111

Application info

Kerax [06/97-01/01]

Premium [04/96--]

16-34 741 0013 | MCX0412

Bushing, leaf spring



Notes

Inner diameter [mm]  
Outer diameter [mm]  
Height [mm]

16  
44  
95  
Front and Rear  
Front Axle

References

50 00 448 404

Application info

Midliner [10/82-01/00]

Midlum [01/00--]

16-34 741 0011 | MCX0390

Bushing, leaf spring



Notes

Inner diameter [mm]  
Outer diameter [mm]  
Height [mm]

20  
54  
96  
Front and Rear  
Rear Axle

References

50 00 448 405

Application info

Midliner [10/82-01/00]

Midlum [01/00--]



**Bushing, leaf spring**

**16-34 032 0011 | MCX0411**

**Notes**

Inner diameter [mm] 30  
Outer diameter [mm] 70  
Height [mm] 103.5  
Front  
Rear Axle

**References**

50 01 852 218



**Application info**

Kerax [06/97-01/01]  
Magnum [09/90-04/06]  
Midlum [01/00--]

Premium [04/96--]  
Premium 2 [10/05--]

**Bushing, leaf spring**

**16-34 741 0002 | MCX0386**

**Notes**

Inner diameter [mm] 24  
Outer diameter [mm] 62  
Height [mm] 97  
Left and right

**References**

50 01 859 721



**Application info**

Kerax [06/97-01/01]  
Magnum [09/90-04/06]

Premium [04/96--]  
Premium 2 [10/05--]

**Bushing, leaf spring**

**16-34 741 0001/S | MCX0402**

**Notes**

Inner diameter [mm] 20  
Outer diameter [mm] 44.5  
Height [mm] 104  
Rear Axle left and right  
Front Axle left and right

**References**

50 10 060 127

**Parts list**

16-34 741 0007 | MCX0403      Bushing, leaf spring



16-34 741 0001/S | MCX0402

Bushing, leaf spring

Application info

G (10/82-03/93)  
Kerax (06/97-01/01)  
Magnum (09/90-04/06)  
Manager (09/91-10/96)

Maxter (10/92-06/97)  
Premium (04/96--)  
Premium 2 (10/05--)

16-34 741 0007 | MCX0403

Bushing, leaf spring



Notes

Inner diameter [mm]	20
Outer diameter [mm]	44.5
Height [mm]	104
	Left and right
	Rear Axle
	Front Axle

References

50 10 060 127

Application info

G (10/82-03/93)  
Kerax (06/97-01/01)  
Magnum (09/90-04/06)

Manager (09/91-10/96)  
Premium (04/96--)

16-34 741 0003 | MCX0387

Bushing, leaf spring



Notes

Inner diameter [mm]	16
Outer diameter [mm]	43
Height [mm]	81
	Left and right

References

50 10 294 961

Application info

Midlum (01/00--)



## Bushing, leaf spring

16-34 741 0008 | MCX0501

### Notes

Inner diameter [mm]	24
Outer diameter [mm]	62
Height [mm]	96
	Left and right

### References

50 10 557 698	74 20 929 989
---------------	---------------



### Application info

Kerax [06/97-01/01]

## Bushing, leaf spring

16-34 741 0004 | MCX0388

### Notes

Inner diameter [mm]	24
Outer diameter [mm]	61.5
Height [mm]	95
	Left and right

### References

50 10 557 875



### Application info

Magnum [09/90-04/06]

Premium [04/96--]

## Bushing, leaf spring

16-34 741 0005 | MCX0389

### Notes

Inner diameter [mm]	20
Outer diameter [mm]	50
Height [mm]	96
	Front Axle
	Left and right

### References

50 10 630 625	74 21 483 476
---------------	---------------



### Application info

Magnum [09/90-04/06]

Midlum [01/00--]

Premium [04/96--]

Premium 2 [10/05--]

4

534 032 0001 | MCX0393

Mount, leaf spring



Notes

Rear Axle  
Left and right

References

74 20 390 836

Application info

Premium [04/96--]

Premium 2 [10/05--]

16-34 741 0009 | MCX0477

Repair kit, spring bolt



Notes

Outer diameter [mm]  
Length [mm]

44.5  
104  
Rear Axle left and right  
Front Axle left and right

References

50 10 060 127

Parts list

16-34 741 0007 | MCX0403

Bushing, leaf spring

Application info

G [10/82-03/93]  
Kerax [06/97-01/01]  
Magnum [09/90-04/06]  
Manager [09/91-10/96]

Maxter [10/92-06/97]  
Premium [04/96--]  
Premium 2 [10/05--]

16-34 741 0010/S | MCX0527

Repair kit, spring bolt



Notes

Outer diameter [mm]  
Length [mm]

44.5  
104  
Front Axle

References

50 10 060 127

Repair kit, spring bolt

16-34 741 0010/S | MCX0527

Application info

G [10/82-03/93]  
Kerax [06/97-01/01]  
Magnum [09/90-04/06]  
Manager [09/91-10/96]

Maxter [10/92-06/97]  
Premium [04/96--]  
Premium 2 [10/05--]

Control arm

16-34 050 0002 | MCA1094

Notes

Hole Pitch 1/ Hole Pitch 2  
Bore Ø [mm]

Cast Iron  
115/115  
17  
Trailing Arm  
Rear Axle



References

74 20 443 044

Application info

Kerax [06/97-01/01]

Control arm

536 050 0005 | MCA0769

Notes

Hole Pitch 1/ Hole Pitch 2  
Bore Ø [mm]  
Length [mm]

Steel  
130mm/130mm  
21  
510  
Trailing Arm  
Rear Axle



References

74 20 522 934

74 21 051 052

Application info

Kerax [06/97-01/01]

4

16-36 050 0004 | MSR0111

Rod/strut, suspension



Notes

Bore Ø 1 [mm]	19
Hole Pitch 1/ Hole Pitch 2	Guide Rod 145mm/145mm
Pipe Ø [mm]	52
Length [mm]	575
	Trailing Arm Rear Axle

References

50 10 094 941

Application info

C [10/82-10/98]  
G [10/82-03/93]  
Kerax [06/97-01/01]

Magnum [09/90-04/06]  
R [10/80-10/91]

16-36 050 0002 | MSR0109

Rod/strut, suspension



Notes

Bore Ø 1 [mm]	21
Hole Pitch 1/ Hole Pitch 2	Guide Rod 152mm/152mm
Pipe Ø [mm]	50
Length [mm]	574
	Trailing Arm Front Axle

References

50 10 389 262

Application info

Kerax [06/97-01/01]

16-36 050 0003 | MSR0110

Rod/strut, suspension



Notes

Bore Ø 1 [mm]	21
Hole Pitch 1/ Hole Pitch 2	Guide Rod 152mm/152mm
Pipe Ø [mm]	50
Length [mm]	575
	Trailing Arm Rear Axle

References

50 10 467 915

Application info

Kerax [06/97-01/01]



### Repair kit, control arm

16-34 653 0001 | MCX0505

#### Notes

Bore Ø [mm]	15
Outer diameter [mm]	67
Length [mm]	129
	for drag link
	Front Axle

#### References

50 00 814 841



#### Application info

Kerax [06/97-01/01]

Premium [04/96--]

### Repair kit, control arm

16-34 653 0004 | MCX0508

#### Notes

Hole Pitch 1/ Hole Pitch 2	130
Bore Ø [mm]	21
Outer diameter [mm]	85
	for drag link
	Rear Axle

#### References

74 20 702 096



#### Application info

Kerax [06/97-01/01]

### Bushing, stabilizer

16-34 271 0001 | MCX0385

#### Notes

Inner diameter [mm]	30
Outer diameter [mm]	42
Height [mm]	19
Required quantity	2
	Front Axle

#### References

50 10 294 991

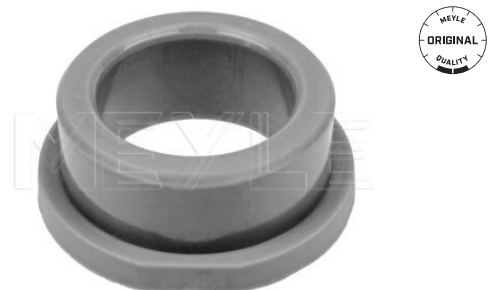

#### Application info

Magnum [09/90-04/06]  
 Manager [09/91-10/96]  
 Maxter [10/92-06/97]

Premium [04/96--]  
 Premium 2 [10/05--]

4

534 010 0028 | MCX0413

Bushing, stabilizer



Notes

Inner diameter [mm]	24
Outer diameter [mm]	61.5
Height [mm]	87
	Front Axle

References

74 20 839 455

Application info

Kerax [06/97-01/01]

16-34 032 0006 | MSB0307

Mount, stabilizer



Notes

Inner diameter [mm]	53
Outer diameter [mm]	90.5
Height [mm]	74
	Rear Axle

References

50 10 060 356

Application info

Kerax [06/97-01/01]  
Magnum [09/90-04/06]  
Manager [09/91-10/96]

Maxter [10/92-06/97]  
Premium [04/96--]  
Premium 2 [10/05--]

16-34 032 0012 | MSB0329

Mount, stabilizer



Notes

Inner diameter [mm]	38
Outer diameter [mm]	67
Height [mm]	60
	Front Axle

References

50 10 130 021

Application info

Magnum [09/90-04/06]  
Maxter [10/92-06/97]

Premium [04/96--]  
Premium 2 [10/05--]



**Mount, stabilizer**
**16-34 032 0008 | MSB0328**
**Notes**

Inner diameter [mm]	20
Outer diameter [mm]	30
Height [mm]	41
	Front Axle

**References**

50 10 239 135

**Application info**

 Magnum [09/90-04/06]  
 Maxter [10/92-06/97]

Premium [04/96--]

**Mount, stabilizer**
**16-34 032 0009 | MSB0296**
**Notes**

Inner diameter [mm]	42
Outer diameter [mm]	60.5
Height [mm]	26
Required quantity	2
	Upper
	Lower
	Rear Axle

**References**

50 10 239 670

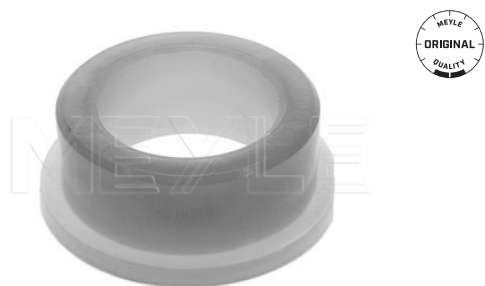
**Application info**

 Kerax [06/97-01/01]  
 Magnum [09/90-04/06]

Premium [04/96--]

**Mount, stabilizer**
**16-34 032 0005 | MSB0347**
**Notes**

Inner diameter [mm]	20
Outer diameter [mm]	51.5
Height [mm]	41
	Front Axle

**References**

50 10 383 545

**Application info**

 Magnum [09/90-04/06]  
 Midlum [01/00--]

 Premium [04/96--]  
 Premium 2 [10/05--]

**4**

16-34 032 0013 | MSB0357

Mount, stabilizer



Notes

Inner diameter [mm]	20
Outer diameter [mm]	45
Height [mm]	66
	Front Axle

References

50 10 557 129

Application info

Kerax [06/97-01/01]  
Maxity [03/07--]

Midliner [10/82-01/00]  
Midlum [01/00--]

16-34 032 0014 | MSB0366

Mount, stabilizer



Notes

Inner diameter [mm]	50
Outer diameter [mm]	65
Height [mm]	77
	Rear Axle
	Front Axle

References

50 10 557 313

Application info

C [10/82-10/98]  
G [10/82-03/93]  
Manager [09/91-10/96]

Maxter [10/92-06/97]  
Midliner [10/82-01/00]

16-34 032 0007 | MSB0337

Mount, stabilizer



Notes

Inner diameter [mm]	38
Outer diameter [mm]	58
Height [mm]	73
	Rear Axle

References

50 10 557 315

Mount, stabilizer

16-34 032 0007 | MSB0337

Application info

C [10/82-10/98]  
G [10/82-03/93]  
Kerax [06/97-01/01]  
Manager [09/91-10/96]

Midliner [10/82-01/00]  
Midlum [01/00--]  
R [10/80-10/91]

Mount, stabilizer

534 010 0024 | MSB0316

Notes

Inner diameter [mm]	28
Outer diameter [mm]	57.5
Height [mm]	64
	Rear Axle

References

74 01 134 955

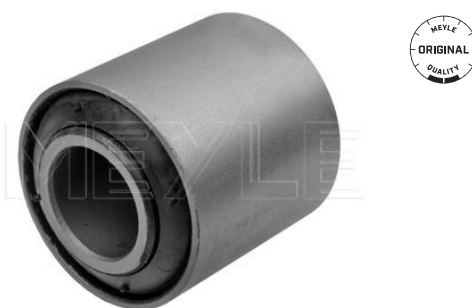

Application info

Kerax [06/97-01/01]

Mount, stabilizer

16-34 010 0001 | MSB0250

Notes

Inner diameter [mm]	60
Outer diameter [mm]	105
Outer diameter [mm]	80
Height [mm]	96
	Rear Axle

References

74 01 629 169



Application info

Kerax [06/97-01/01]  
Premium [04/96--]

Premium 2 [10/05--]

4

16-34 032 0010 | MSB0308

Mount, stabilizer



Notes

Inner diameter [mm]	41
Outer diameter [mm]	67
Height [mm]	60
	Front Axle

References

50 10 130 022	74 82 074 379
---------------	---------------

Application info

Magnum [09/90-04/06]  
Midlum [01/00--]

Premium [04/96--]  
Premium 2 [10/05--]

16-34 741 0015 | MCX0478

Repair kit, stabilizer bushing



Notes

Inner diameter [mm]	20
Outer diameter [mm]	54
Height [mm]	95
	Rear Axle

References

50 00 448 405

Parts list

16-34 741 0011   MCX0390	Bushing, leaf spring
--------------------------	----------------------

Application info

Midliner [10/82-01/00]

Midlum [01/00--]

16-34 741 0016 | MCX0463

Repair kit, stabilizer bushing



References

50 01 852 218

Parts list

16-34 032 0011   MCX0411	Bushing, leaf spring
--------------------------	----------------------

Application info

Kerax [06/97-01/01]  
Magnum [09/90-04/06]  
Midlum [01/00--]

Premium [04/96--]  
Premium 2 [10/05--]

**Wheel bearing**
**12-14 650 0005 | MWB0049**
**Notes**

Inner diameter [mm]	45
Outer diameter [mm]	85
Height [mm]	32.2
	Tapered Roller Bearing
	Outer
	Front Axle

**References**

50 10 439 060

**Application info**

 C [10/82-10/98]  
 G [10/82-03/93]  
 Manager [09/91-10/96]

 Midliner [10/82-01/00]  
 R [10/80-10/91]

**Wheel bearing**
**16-34 650 0003 | MWB0050**
**Notes**

Inner diameter [mm]	80
Outer diameter [mm]	140
Height [mm]	46
	Outer
	Rear Axle

**References**

50 10 587 008

**Application info**

 C [10/82-10/98]  
 G [10/82-03/93]  
 Kerax [06/97-01/01]  
 Magnum [09/90-04/06]  
 Manager [09/91-10/96]

 Maxter [10/92-06/97]  
 Midliner [10/82-01/00]  
 Midlum [01/00--]  
 Premium [04/96--]

**Wheel bearing**
**534 751 0002 | MWB0061**
**Notes**

Inner diameter [mm]	68
Outer diameter [mm]	125
Height [mm]	115
	Rear Axle

**References**

74 20 518 637	74 21 021 391
74 20 967 831	



534 751 0002 | MWB0061

Wheel bearing

Application info

Kerax [06/97-01/01]  
Magnum [09/90-04/06]

Premium 2 [10/05--]

16-34 650 0001 | MWB0059

Wheel bearing



Notes

Inner diameter [mm]	93.8
Outer diameter [mm]	148
Height [mm]	135
	Rear Axle

References

74 21 036 050

Application info

Magnum [09/90-04/06]

Premium 2 [10/05--]

16-34 753 0002 | MCX0431

Shaft seal, wheel hub



Notes

Inner diameter [mm]	85
Outer diameter [mm]	130
Height [mm]	22
	Rear Axle

References

50 10 534 863

Application info

Kerax [06/97-01/01]

16-34 753 0001 | MCX0268

Shaft seal, wheel hub



Notes

Inner diameter [mm]	120
Outer diameter [mm]	160
Height [mm]	15
	Rear Axle

References

50 00 671 980                      50 10 566 199

## Shaft seal, wheel hub

16-34 753 0001 | MCX0268

### Application info

C [10/82-10/98]

G [10/82-03/93]

Kerax [06/97-01/01]

Magnum [09/90-04/06]

Major [05/91-10/96]

Manager [09/91-10/96]

Maxter [10/92-06/97]

Midliner [10/82-01/00]

Premium [04/96--]

R [10/80-10/91]

16-36 040 0036 | MTA0146

Tie rod assembly



Notes

Pipe Ø [mm]  
Thread Measurement 2  
Thread Measurement 1  
Length [mm]  
Cone Size [mm]

Push Rod  
Nut with lateral notches  
60  
with metric thread  
M30x1,5  
M24x1,5  
1620  
30  
Front Axle

References

50 01 868 366  
50 10 587 034  
50 10 587 038  
74 21 560 963

Application info

Premium 2 [10/05--]

16-36 030 0013 | MDL0083

Drag link



Notes

Pipe Ø [mm]  
Thread Measurement 2  
Thread Measurement 1  
Length [mm]  
Cone Size [mm]

Push Rod  
Nut with lateral notches  
50  
with metric thread  
M30x1,5  
M24x1,5  
809  
for left-hand drive vehicles  
30  
Front Axle

References

50 10 294 287

Parts list

036 020 0004 | MTE0047  
Tie rod end

Application info

Premium [04/96--]



**Drag link**
**16-36 030 0041 | MDL0089**
**Notes**

Pipe Ø [mm]

Thread Measurement 2

Thread Measurement 1

Length [mm]

Cone Size [mm]

 Push Rod  
 Nut with lateral notches  
 52  
 with metric thread  
 M24 x 1,5  
 M30 x 1,5  
 934  
 for left-hand drive vehicles  
 30  
 Driver side

**References**

50 10 229 242

50 10 488 052

**Parts list**

036 020 0004 | MTE0047

Tie rod end

**Application info**

Kerax [06/97-01/01]

Maxter [10/92-06/97]

**Drag link**
**16-36 040 0008 | MDL0084**
**Notes**

Pipe Ø [mm]

Thread Measurement 2

Thread Measurement 1

Length [mm]

Cone Size [mm]

 Push Rod  
 Nut with lateral notches  
 56  
 with metric thread  
 M30x1,5  
 M24x1,5  
 910  
 30  
 Pitman Arm to track rod

**References**

74 20 760 425

74 21 560 913

**Application info**

Kerax [06/97-01/01]

036 020 0004 | MTE0047

Tie rod end



Notes

Thread Measurement 2  
Thread Measurement 1  
Length [mm]

Cone Size [mm]

References

00 03 406 169  
00 03 406 236  
00 03 406 251  
00 03 406 254  
00 03 406 260  
00 03 406 261

Nut with lateral notches  
with right-hand thread  
M30x1,5  
M24x1,5  
125  
for left-/right-hand traffic  
30  
Front Axle

50 00 288 360  
50 00 590 236  
50 00 804 824  
5001 858 773  
77 01 011 412

Counterpart

036 020 0005 | MTE0048

Application info

Magnum [09/90-04/06]

R [10/80-10/91]

036 020 0004/HD | MTE0047HD

Tie rod end



Notes

Thread Measurement 2  
Thread Measurement 1  
Length [mm]

Cone Size [mm]

Reinforced Version

References

00 03 406 169  
00 03 406 236  
00 03 406 251  
00 03 406 254  
00 03 406 260  
00 03 406 261

Nut with lateral notches  
with right-hand thread  
M30x1,5  
M24x1,5  
125  
for left-/right-hand traffic  
30  
Front Axle

50 00 288 360  
50 00 590 236  
50 00 804 824  
5001 858 773  
77 01 011 412

Counterpart

036 020 0005/HD | MTE0048HD

Application info

Magnum [09/90-04/06]

R [10/80-10/91]

**Tie rod end**

**036 020 0005 | MTE0048**

**Notes**

Thread Measurement 2  
Thread Measurement 1  
Length [mm]

Cone Size [mm]

**References**

00 03 401 170  
50 00 288 361

**Counterpart**

036 020 0004 | MTE0047

Nut with lateral notches  
with left-hand thread  
M30x1,5  
M24x1,5  
125  
for left-/right-hand traffic  
30  
Front Axle

50 01 858 774  
50 10 832 583



**Application info**

R (10/80-10/91)

**Tie rod end**

**036 020 0005/HD | MTE0048HD**

**Notes**

Thread Measurement 2  
Thread Measurement 1  
Length [mm]

Cone Size [mm]

Reinforced Version

**References**

00 03 401 170  
50 00 288 361

**Counterpart**

036 020 0004/HD | MTE0047HD

Nut with lateral notches  
with left-hand thread  
M30x1,5  
M24x1,5  
125  
for left-/right-hand traffic  
30  
Front Axle

50 01 858 774  
50 10 832 583



**Application info**

R (10/80-10/91)

036 020 0016 | MTE0059

Tie rod end



Notes

Thread Measurement 2  
Thread Measurement 1  
Length [mm]

Cone Size [mm]

References

50 00 514 097  
50 00 807 554

Nut with lateral notches  
with right-hand thread  
M24x1,5  
M16x1,5  
104  
for left-/right-hand traffic  
20  
Front Axle

50 00 814 097  
50 01 844 136

Counterpart

036 020 0015 | MTE0058

Application info

Midliner [10/82-01/00]

036 020 0001 | MTE0044

Tie rod end



Notes

Thread Measurement 2  
Thread Measurement 1  
Length [mm]

Cone Size [mm]

References

00 03 406 212  
00 03 406 253  
3 406 212  
3 406 253  
50 00 242 159

Nut with lateral notches  
with right-hand thread  
M30x1,5  
M20x1,5  
114  
for left-/right-hand traffic  
26  
Front Axle

50 00 295 214  
50 00 812 483  
50 01 831 473  
50 01 832 582  
77 01 016 946

Counterpart

036 020 0002 | MTE0045

Application info

Midliner [10/82-01/00]



## Tie rod end

036 020 0003 | MTE0046

### Notes

Thread Measurement 2  
Thread Measurement 1  
Length [mm]

Cone Size [mm]

Nut with lateral notches  
with right-hand thread  
M28x1,5  
M18x1,5  
106  
for left-/right-hand traffic  
22  
Front Axle

### References

00 03 406 242  
50 00 559 335

50 00 823 987  
50 01 825 687

### Counterpart

036 020 0008 | MTE0051



### Application info

Midliner (10/82-01/00)

## Tie rod end

036 020 0002 | MTE0045

### Notes

Thread Measurement 2  
Thread Measurement 1  
Length [mm]

Cone Size [mm]

Nut with lateral notches  
with left-hand thread  
M30x1,5  
M20x1,5  
114  
for left-/right-hand traffic  
26  
Front Axle

### References

50 00 295 215

50 01 832 581

### Counterpart

036 020 0001 | MTE0044



### Application info

Midliner (10/82-01/00)

## Tie rod end

16-36 020 0012 | MTE0740

### Notes

Thread Measurement 2  
Thread Measurement 1  
Length [mm]

Cone Size [mm]

Nut with lateral notches  
with right-hand thread  
M32x1,5  
M24x1,5  
120  
for left-/right-hand traffic  
30  
Front Axle

### References

50 01 866 165

50 01 867 774



5



16-36 020 0012 | MTE0740

Tie rod end

Application info

Kerax [06/97-01/01]

Magnum [09/90-04/06]

16-34 631 0002 | MHP0059

Hydraulic pump, P/S



Notes

Thread Measurement 2  
Number of connectors  
Thread Measurement 1  
Operating Pressure [bar]

Hydraulic  
Cast Aluminium  
M26x1,5  
2  
M16x1,5  
180  
Anti-clockwise rotation

References

74 20 701 199

74 21 017 710

Application info

Kerax [06/97-01/01]  
Magnum [09/90-04/06]

Premium 2 [10/05--]

034 046 0000 | MSX0026

Hydraulic filter, steering system



Notes

Thickness [mm]  
Inner diameter [mm]  
Outer diameter [mm]

100  
17.1  
59

References

50 00 814 407

50 00 820 895

Application info

C [10/82-10/98]  
Kerax [06/97-01/01]  
Magnum [09/90-04/06]  
Manager [09/91-10/96]  
Maxter [10/92-06/97]

Midliner [10/82-01/00]  
Midlum [01/00--]  
Premium [04/96--]  
Premium 2 [10/05--]

**Cabin air filter**
**14-12 319 0004 | MCF0122**
**Notes**

Height [mm]	20
Width [mm]	105
Length [mm]	230
	Filter Insert
	Particulate Filter

**References**

50 01 833 354

**Application info**

Kerax [06/97-01/01]

**Spacer, driver cab stabiliser**
**16-34 089 0004 | MIX0271**
**Notes**

Thickness [mm]	10
Required quantity	2

**References**

50 10 316 016

**Application info**

 Kerax [06/97-01/01]  
 Premium [04/96--]

Premium 2 [10/05--]

**Bushing, driver cab suspension**
**16-34 089 0010 | MIX0279**
**Notes**

Inner diameter 1 [mm]	12
Outer diameter 1 [mm]	40
Height 1 [mm]	42
	Left and right

**References**

50 00 789 265

**Application info**

 Kerax [06/97-01/01]  
 Premium [04/96--]

 Premium 2 [10/05--]  
 R [10/80-10/91]

16-34 089 0003 | MIX0270

Bushing, driver cab suspension



Notes

Inner diameter 1 [mm]	14
Outer diameter 1 [mm]	42
Height 1 [mm]	60

References

50 01 844 625

Application info

Magnum [09/90-04/06]

16-34 089 0008 | MIX0291

Bushing, driver cab suspension



Notes

Inner diameter 1 [mm]	30
Outer diameter 1 [mm]	68
Height 1 [mm]	49
	Left and right

References

50 10 228 947

Application info

Kerax [06/97-01/01]

16-34 089 0002 | MIX0319

Bushing, driver cab suspension



Notes

Inner diameter 1 [mm]	16.2
Outer diameter 1 [mm]	60.5
Height 1 [mm]	68
	Left and right

References

50 10 316 015                      74 21 271 207

Application info

Kerax [06/97-01/01]  
Midlum [01/00--]

Premium [04/96--]  
Premium 2 [10/05--]



**Bushing, driver cab suspension**
**16-34 089 0007 | MIX0284**
**Notes**

Inner diameter 1 [mm]	16.5
Height 1 [mm]	282
	Left and right

**References**

50 10 316 479

**Application info**

Kerax [06/97-01/01]

**Bushing, driver cab suspension**
**16-34 089 0005 | MIX0260**
**Notes**

Inner diameter 1 [mm]	16
Outer diameter 1 [mm]	38
Height 1 [mm]	90
	Front
	Left and right

**References**

50 10 418 820

**Application info**

Magnum [09/90-04/06]

**Bushing, driver cab suspension**
**16-34 089 0006 | MIX0283**
**Notes**

Inner diameter 1 [mm]	16.5
Outer diameter 1 [mm]	92
Height 1 [mm]	80
	Left and right

**References**

50 10 460 097

**Application info**

Kerax [06/97-01/01]

534 210 0005 | MIX0274

Rubber stop, cabin



Notes

Outer diameter [mm] 49.5  
Height [mm] 37.5

References

74 21 333 686

Application info

Kerax [06/97-01/01]

16-34 089 0009 | MIX0295

Repair kit, driver cab mounting



References

50 10 228 947

Application info

Kerax [06/97-01/01]

16-34 910 0101 | MIX0245

Tilt pump, driver cab



Notes

for left-hand drive vehicles

References

50 10 316 404

Application info

Premium [04/96--]

TR [05/71-12/81]

**Tilt pump, driver cab**

**16-34 910 0100 | MIX0244**

**References**

50 10 316 438



**Application info**

Kerax [06/97-01/01]

Premium [04/96--]

**Lock cylinder set**

**16-34 899 0001 | MIX0219**

**References**

50 01 855 397

74 85 116 317



**Application info**

Kerax [06/97-01/01]

Midlum [01/00--]

Premium [04/96--]

Premium 2 [10/05--]

**Windshield washer pump**

**16-34 870 0002 | MWI0030**

**Notes**

Voltage [V]

angular  
Mono Pump  
Black  
Electric  
24  
Front

**References**

50 10 276 022



**Application info**

Kerax [06/97-01/01]

Magnum [09/90-04/06]

Midlum [01/00--]

Premium [04/96--]

Premium 2 [10/05--]

029 600 2470 | MBL0035

Wiper Blade



Notes

Length [in]  
Length [mm]

Bracket wiper blade  
Beam wiper blade  
24  
600  
Front

References

50 00 550 175

Application info

Manager (09/91-10/96)  
Maxter (10/92-06/97)

Midliner (10/82-01/00)

029 100 4071 | MBL0063

Wiper Blade



Notes

Length [in]  
Length [mm]

Bracket wiper blade  
Beam wiper blade  
40  
1000  
Front

References

50 00 788 818

Application info

Agora (01/96--)  
Ares (---)

FR1 (01/83--)  
Iliade (01/97--)

029 500 2070/S | MBL0060

Wiper Blade



Notes

Observe service information

Length [in]  
Length [mm]

Beam wiper blade  
Bracket wiper blade

Set  
20  
500  
Front

References

50 01 821 423  
50 01 829 203  
50 01 829 204

50 01 865 591  
50 21 190 014

Application info

C (10/82-10/98)

G (10/82-03/93)

**Wiper Blade**

**029 600 2471 | MBL0071**

**Notes**

Observe service information

Length [in]  
Length [mm]

Beam wiper blade  
Bracket wiper blade  
Set  
24  
600  
with pipe connector  
with integrated washer-fluid  
jet  
Front



**References**

50 01 856 973                      50 01 865 593

**Application info**

Midlum [01/00--]

**Wiper Blade**

**029 700 2870 | MBL0040**

**Notes**

Length [in]  
Length [mm]

Bracket wiper blade  
Beam wiper blade  
28  
700  
Front



**References**

50 01 865 596                      50 10 441 122  
50 01 865 597                      50 21 190 021  
50 01 865 598                      50 21 190 022

**Application info**

Magnum [09/90-04/06]  
Premium [04/96--]

Premium 2 [10/05--]

**Wiper Blade**

**029 650 2671 | MBL0056**

**Notes**

Length [in]  
Length [mm]

Beam wiper blade  
Bracket wiper blade  
26  
650  
with pipe connector  
with integrated washer-fluid  
jet  
Left and right  
Front



**References**

50 01 867 083





**029 650 2671 | MBL0056**

**Wiper Blade**



**Application info**

Kerax [06/97-01/01]  
Premium [04/96--]

Premium 2 [10/05--]

MEYLE no.	Ref. no.	Page
<b>R.V.I.</b>		
025 290 6522	50 01 014 694 50 01 825 638	44
025 290 9028	50 01 846 034	44
025 291 3130	50 01 855 646 50 01 863 904	45
025 291 7329	50 01 864 365 74 21 399 915	45
025 291 7329/S	50 01 864 365 74 21 399 915	46
025 291 7429	50 01 864 363 50 01 864 364 74 21 399 929 74 21 496 555	45
025 291 8130	50 01 866 914 50 10 598 372	46
029 100 4071	50 00 788 818	92
029 500 2070/S	50 01 821 423 50 01 829 203 50 01 829 204 50 01 865 591 50 21 190 014	92
029 600 2470	50 00 550 175	92
029 600 2471	50 01 856 973 50 01 865 593	93
029 650 2671	50 01 867 083	93
029 700 2870	50 01 865 596 50 01 865 597 50 01 865 598 50 10 441 122 50 21 190 021 50 21 190 022	93
034 009 0003	50 01 833 652	15
034 015 0005	50 00 820 871	7
034 042 0002	50 00 807 176 50 21 170 283	58
034 042 0003	50 21 170 282 77 01 005 197	58
034 042 0016	50 00 787 875	62
034 042 0033	50 00 440 154	55
034 042 0034	50 00 440 155	56
034 042 0038	50 00 435 826	55
034 042 0039	50 00 438 153 50 00 442 714	55
034 042 0061	50 00 296 998 50 21 170 275	57
034 042 0062	50 00 819 262	58

MEYLE no.	Ref. no.	Page
<b>R.V.I.</b>		
	50 21 170 278	
034 043 0002	50 00 243 913 50 21 170 276	57
034 046 0000	50 00 814 407 50 00 820 895	86
034 323 0003	50 01 833 651	15
036 020 0001	00 03 406 212 00 03 406 253 3 406 212 3 406 253 50 00 242 159 50 00 295 214 50 00 812 483 50 01 831 473 50 01 832 582 77 01 016 946	84
036 020 0002	50 00 295 215 50 01 832 581	85
036 020 0003	00 03 406 242 50 00 559 335 50 00 823 987 50 01 825 687	85
036 020 0004	00 03 406 169 00 03 406 236 00 03 406 251 00 03 406 254 00 03 406 260 00 03 406 261 50 00 288 360 50 00 590 236 50 00 804 824 5001 858 773 77 01 011 412	82
036 020 0004/HD	00 03 406 169 00 03 406 236 00 03 406 251 00 03 406 254 00 03 406 260 00 03 406 261 50 00 288 360 50 00 590 236 50 00 804 824 5001 858 773 77 01 011 412	82
036 020 0005	00 03 401 170 50 00 288 361	83

MEYLE no.	Ref. no.	Page
<b>R.V.I.</b>		
	50 01 858 774 50 10 832 583	
036 020 0005/HD	00 03 401 170 50 00 288 361 50 01 858 774 50 10 832 583	83
036 020 0016	50 00 514 097 50 00 807 554 50 00 814 097 50 01 844 136	84
050 005 1010	50 00 670 728	35
050 005 1530	-	37
050 008 1435	74 20 543 484 74 22 100 457	36
050 009 1690	50 10 477 838	35
050 010 1342	74 21 190 824 74 22 100 459	37
050 010 1460	50 10 437 603	35
050 010 1487	74 20 724 776	36
050 010 1512	74 20 725 565	36
052 010 0975	50 00 182 327 50 00 663 785 50 00 788 120 50 00 831 564	33
052 010 1250	77 00 268 230 77 00 268 232 77 00 268 754 77 00 854 083 77 01 029 704	34
052 010 1575	5000 790 821	34
052 013 1550	50 00 786 246 50 00 786 359 50 00 787 739 50 00 789 954	34
114 323 0001	50 00 686 589 50 00 686 590 50 00 790 570 50 00 814 227 77 01 015 820 77 01 017 322 77 01 017 732	14
12-14 650 0005	50 10 439 060	77
12-31 111 0003	50 01 858 682 50 01 864 270 50 01 873 287	61
12-34 026 0002	50 01 855 098	59

MEYLE no.	Ref. no.	Page
<b>R.V.I.</b>		
12-34 032 0000	50 10 136 105 74 20 746 460	54
12-34 042 0026	50 01 865 037 74 21 267 820	53
12-34 099 0005	50 10 339 723	5
12-34 126 6017	50 00 559 743 50 00 815 148	61
12-34 321 0010	50 00 806 317	12
12-34 820 0002	74 20 793 590	56
12-34 899 0023	50 01 845 859 50 01 868 473 74 21 318 083 74 85 116 453	61
14-12 319 0004	50 01 833 354	87
14-34 043 0001	74 21 318 366	60
14-34 238 0002	55 16 031 803	29
16-14 322 0006	50 01 869 773 77 01 057 828	11
16-28 282 0001	74 20 560 249 74 21 237 213 74 21 412 639	27
16-28 283 0001	50 10 295 225	27
16-33 220 0001	50 00 670 157 50 01 837 298	25
16-33 220 0002	50 10 330 029	25
16-33 220 0004	50 01 866 278 74 20 734 268	26
16-33 220 0005	50 01 857 427 50 01 858 484	25
16-33 234 0001	50 10 140 460 50 10 315 180 50 10 315 182 50 10 375 179 50 10 514 058	22
16-34 000 0001	74 03 979 979	31
16-34 000 0002	74 20 487 079	31
16-34 000 0003	50 10 412 956	30
16-34 000 0005	50 10 284 807 50 10 553 993	30
16-34 000 0007	74 08 086 970	33
16-34 000 0008	50 10 550 335	30
16-34 001 0003	50 10 477 117	2
16-34 001 0004	74 20 495 935	3
16-34 001 0005	50 00 666 061 50 01 847 781	2
16-34 001 0006	50 01 834 578	1



MEYLE no.	Ref. no.	Page
<b>R.V.I.</b>		
16-34 001 0007	50 01 834 579	7
16-34 001 0008	50 10 477 438	38
16-34 010 0001	74 01 629 169	75
16-34 020 0001	74 20 880 406 74 20 993 866	22
16-34 020 0002	50 10 315 993	24
16-34 029 0003	50 10 452 472	62
16-34 030 0003	50 10 316 591	18
16-34 030 0004	50 10 316 592	18
16-34 030 0005	74 20 499 469 74 20 499 472	19
16-34 030 0006	50 10 316 521	17
16-34 030 0007	50 10 316 522	18
16-34 032 0005	50 10 383 545	73
16-34 032 0006	50 10 060 356	72
16-34 032 0007	50 10 557 315	74
16-34 032 0008	50 10 239 135	73
16-34 032 0009	50 10 239 670	73
16-34 032 0010	50 10 130 022 74 82 074 379	76
16-34 032 0011	50 01 852 218	65
16-34 032 0012	50 10 130 021	72
16-34 032 0013	50 10 557 129	74
16-34 032 0014	50 10 557 313	74
16-34 038 0002	50 10 550 818	9
16-34 042 0001	50 01 865 404 74 21 267 793 74 21 602 383 74 85 135 854	54
16-34 042 0004	50 00 792 440 50 21 170 467	56
16-34 042 0006	50 10 260 535	57
16-34 050 0002	74 20 443 044	69
16-34 054 0003	68320874 68320909	48
16-34 054 0005	68325408	49
16-34 089 0002	50 10 316 015 74 21 271 207	88
16-34 089 0003	50 01 844 625	88
16-34 089 0004	50 10 316 016	87
16-34 089 0005	50 10 418 820	89
16-34 089 0006	50 10 460 097	89
16-34 089 0007	50 10 316 479	89
16-34 089 0008	50 10 228 947	88
16-34 089 0009	50 10 228 947	90
16-34 089 0010	50 00 789 265	87

MEYLE no.	Ref. no.	Page
<b>R.V.I.</b>		
16-34 099 0001	74 08 148 259	6
16-34 099 0002	74 85 108 423	7
16-34 099 0003	50 00 694 668 50 03 087 031 50 10 359 806	5
16-34 099 0004	50 03 087 029 50 10 359 807	5
16-34 099 0005	50 03 087 026	4
16-34 099 0006	74 20 412 568 74 21 486 081	6
16-34 154 0001	50 00 673 571	60
16-34 162 0001	50 10 383 949	63
16-34 162 0003	50 10 383 951	63
16-34 223 0002	50 10 141 465 50 10 514 340 74 20 783 159 74 20 983 308 74 21 017 015 74 22 064 150 74 85 132 205	28
16-34 223 0003	74 20 828 416 74 21 055 339 74 55 064 150	27
16-34 223 0004	50 10 263 004 74 20 783 901 74 20 828 448 74 82 582 816	28
16-34 223 0005	74 20 783 896 74 20 783 898 74 20 983 314 74 21 017 010	29
16-34 232 0003	50 10 269 159	23
16-34 232 0011	50 10 514 839	24
16-34 232 0012	50 10 269 870	23
16-34 232 0022	50 10 597 547	24
16-34 232 0023	50 10 315 557	23
16-34 232 0024	50 10 140 298	22
16-34 234 0002	50 10 269 869	20
16-34 234 0003	50 10 315 427	20
16-34 234 0004	50 10 269 871	21
16-34 234 0005	50 10 514 014	21
16-34 234 0006	50 10 315 994	21
16-34 271 0001	50 10 294 991	71
16-34 321 0002	50 01 865 725 50 10 230 916	12
16-34 321 0003	50 01 865 723	12

MEYLE no.	Ref. no.	Page
<b>R.V.I.</b>		
	50 10 230 841	
16-34 321 0006	50 10 269 584	13
16-34 321 0007	50 01 865 724 50 10 315 990	13
16-34 321 0018	50 10 317 187	13
16-34 321 0020	74 01 521 527 74 21 479 106 74 21 990 552 74 85 108 176	60
16-34 322 0001	50 00 812 484 50 01 846 647 74 20 430 751 74 20 541 379 74 21 561 284	10
16-34 322 0002	50 01 846 642 74 20 708 907 74 20 709 459	10
16-34 322 0004	74 20 779 040 74 21 990 552	11
16-34 323 0001	74 20 875 666 74 20 972 291	17
16-34 323 0003	74 20 541 381 74 20 976 001 74 85 116 634	16
16-34 323 0004	74 20 514 654 74 20 541 383 74 20 998 634	16
16-34 323 0006	74 20 745 605 74 20 998 349 74 21 380 483	16
16-34 323 0008	50 01 853 860 50 10 412 350 50 10 450 824 50 10 477 855 50 10 505 337	15
16-34 527 0001	50 01 834 075	47
16-34 527 0002	50 10 848 607	48
16-34 527 0003	50 01 848 363	47
16-34 527 0004	50 01 822 987 68310622 68320902	46
16-34 527 0005	50 01 855 902	48
16-34 533 0002	50 10 457 882	50
16-34 533 0003	50 10 457 883 74 21 363 479	51
16-34 533 0004	74 20 915 973	52

MEYLE no.	Ref. no.	Page
<b>R.V.I.</b>		
	74 21 363 492	
16-34 533 0005	74 20 916 171 74 21 363 493	52
16-34 533 0007	74 20 795 150 74 20 916 177	51
16-34 533 0009	50 10 457 862 74 20 916 175	49
16-34 533 0016	50 10 457 878	50
16-34 533 0017	50 10 457 875	49
16-34 631 0002	74 20 701 199 74 21 017 710	86
16-34 650 0001	74 21 036 050	78
16-34 650 0003	50 10 587 008	77
16-34 653 0001	50 00 814 841	71
16-34 653 0004	74 20 702 096	71
16-34 741 0001/S	50 10 060 127	65
16-34 741 0002	50 01 859 721	65
16-34 741 0003	50 10 294 961	66
16-34 741 0004	50 10 557 875	67
16-34 741 0005	50 10 630 625 74 21 483 476	67
16-34 741 0007	50 10 060 127	66
16-34 741 0008	50 10 557 698 74 20 929 989	67
16-34 741 0009	50 10 060 127	68
16-34 741 0010/S	50 10 060 127	68
16-34 741 0011	50 00 448 405	64
16-34 741 0013	50 00 448 404	64
16-34 741 0015	50 00 448 405	76
16-34 741 0016	50 01 852 218	76
16-34 753 0001	50 00 671 980 50 10 566 199	78
16-34 753 0002	50 10 534 863	78
16-34 753 0003	50 03 087 028 50 10 295 831	4
16-34 798 0001	74 20 590 486	63
16-34 870 0002	50 10 276 022	91
16-34 899 0001	50 01 855 397 74 85 116 317	91
16-34 900 0001	00 00 771 149 50 00 670 202 50 10 295 726	2
16-34 900 0002	50 01 830 802	1
16-34 900 0003	00 00 771 684 50 00 694 271	3
16-34 900 0004	74 03 099 100	3

MEYLE no.	Ref. no.	Page
<b>R.V.I.</b>		
16-34 900 0005	74 08 170 959	38
16-34 900 0006	74 20 855 371	38
16-34 900 0007	50 10 295 218	37
16-34 900 0009	50 00 678 639	1
16-34 910 0100	50 10 316 438	91
16-34 910 0101	50 10 316 404	90
16-35 521 0001	50 10 216 437	39
16-35 521 0005	50 10 260 218	40
16-35 521 0006	50 10 525 014	42
16-35 521 0007	50 10 216 932 50 10 260 102	40
16-35 521 0008	50 10 260 603	41
16-35 521 0011	50 10 598 305	44
16-35 521 0012	50 10 598 304 74 82 421 131	43
16-35 521 0013	50 10 216 931 50 10 260 101	39
16-35 523 0002	50 10 525 362	42
16-35 523 0003	50 10 525 364	43
16-35 523 0006	50 10 422 262 50 10 525 308 50 10 598 303	41
16-36 020 0012	50 01 866 165 50 01 867 774	85
16-36 030 0013	50 10 294 287	80
16-36 030 0041	50 10 229 242 50 10 488 052	81
16-36 040 0008	74 20 760 425 74 21 560 913	81
16-36 040 0036	50 01 868 366 50 10 587 034 50 10 587 038 74 21 560 963	80
16-36 050 0002	50 10 389 262	70
16-36 050 0003	50 10 467 915	70
16-36 050 0004	50 10 094 941	70
214 321 0001	60 05 011 111	14
36-14 322 0003	50 01 869 771	9
36-15 523 0049	5001874635	39
533 220 0001	74 20 744 939 74 20 744 940 74 21 615 952 74 22 167 707 74 85 000 763 74 85 000 963 74 85 013 068	26

MEYLE no.	Ref. no.	Page
<b>R.V.I.</b>		
533 220 0004	74 21 959 184 74 21 960 480	26
534 000 0005	74 08 149 855	31
534 000 0006	74 20 739 751 74 20 935 521 74 21 819 687	32
534 000 0008	74 20 747 516	33
534 000 0010	74 21 479 276	32
534 000 0011	74 20 939 284 74 21 500 149	32
534 001 0005	74 20 538 793	4
534 009 0001	74 20 997 341 74 85 103 778	14
534 010 0024	74 01 134 955	75
534 010 0028	74 20 839 455	72
534 030 0001	74 20 499 470 74 20 796 970	19
534 032 0001	74 20 390 836	68
534 162 0004	74 00 351 111	64
534 210 0005	74 21 333 686	90
534 234 0021	74 21 012 697	20
534 323 0001	74 20 796 772 74 20 998 806	17
534 323 0002	74 20 796 782 74 20 998 809	11
534 527 0001	50 01 831 161	47
534 533 0002	74 24 427 344	53
534 751 0002	74 20 518 637 74 20 967 831 74 21 021 391	77
534 820 0001	74 20 484 678 74 20 796 740 74 20 898 038 74 21 302 639 74 21 540 602 74 21 634 021	8
534 820 0002	74 20 514 065 74 20 803 650	8
534 899 0014	50 10 437 653 74 20 524 936	8
536 050 0005	74 20 522 934 74 21 051 052	69
614 899 0038	50 10 412 450 74 20 513 340 74 85 137 860	29
814 013 0000	50 01 846 641	9



MEYLE no.	Ref. no.	Page
<b>R.V.I.</b>		
+	50 01 846 642	
	74 20 709 459	
	74 21 561 278	
	74 21 700 201	
834 042 0001	50 01 843 522 50 21 170 077	53



Ref. no.	MEYLE no.	Page
<b>R.V.I.</b>		
00 00 771 149	16-34 900 0001	2
00 00 771 684	16-34 900 0003	3
00 03 401 170	036 020 0005 036 020 0005/HD	83
00 03 406 169	036 020 0004 036 020 0004/HD	82
00 03 406 212	036 020 0001	84
00 03 406 236	036 020 0004 036 020 0004/HD	82
00 03 406 242	036 020 0003	85
00 03 406 251	036 020 0004 036 020 0004/HD	82
00 03 406 253	036 020 0001	84
00 03 406 254	036 020 0004 036 020 0004/HD	82
00 03 406 260	036 020 0004 036 020 0004/HD	82
00 03 406 261	036 020 0004 036 020 0004/HD	82
3 406 212	036 020 0001	84
3 406 253	036 020 0001	84
50 00 182 327	052 010 0975	33
50 00 242 159	036 020 0001	84
50 00 243 913	034 043 0002	57
50 00 288 360	036 020 0004 036 020 0004/HD	82
50 00 288 361	036 020 0005 036 020 0005/HD	83
50 00 295 214	036 020 0001	84
50 00 295 215	036 020 0002	85
50 00 296 998	034 042 0061	57
50 00 435 826	034 042 0038	55
50 00 438 153	034 042 0039	55
50 00 440 154	034 042 0033	55
50 00 440 155	034 042 0034	56
50 00 442 714	034 042 0039	55
50 00 448 404	16-34 741 0013	64
50 00 448 405	16-34 741 0011 16-34 741 0015	64, 76
50 00 514 097	036 020 0016	84
50 00 550 175	029 600 2470	92
50 00 559 335	036 020 0003	85
50 00 559 743	12-34 126 6017	61
50 00 590 236	036 020 0004 036 020 0004/HD	82
50 00 663 785	052 010 0975	33

Ref. no.	MEYLE no.	Page
<b>R.V.I.</b>		
50 00 666 061	16-34 001 0005	2
50 00 670 157	16-33 220 0001	25
50 00 670 202	16-34 900 0001	2
50 00 670 728	050 005 1010	35
50 00 671 980	16-34 753 0001	78
50 00 673 571	16-34 154 0001	60
50 00 678 639	16-34 900 0009	1
50 00 686 589	114 323 0001	14
50 00 686 590	114 323 0001	14
50 00 694 271	16-34 900 0003	3
50 00 694 668	16-34 099 0003	5
50 00 786 246	052 013 1550	34
50 00 786 359	052 013 1550	34
50 00 787 739	052 013 1550	34
50 00 787 875	034 042 0016	62
50 00 788 120	052 010 0975	33
50 00 788 818	029 100 4071	92
50 00 789 265	16-34 089 0010	87
50 00 789 954	052 013 1550	34
50 00 790 570	114 323 0001	14
5000 790 821	052 010 1575	34
50 00 792 440	16-34 042 0004	56
50 00 804 824	036 020 0004 036 020 0004/HD	82
50 00 806 317	12-34 321 0010	12
50 00 807 176	034 042 0002	58
50 00 807 554	036 020 0016	84
50 00 812 483	036 020 0001	84
50 00 812 484	16-34 322 0001	10
50 00 814 097	036 020 0016	84
50 00 814 227	114 323 0001	14
50 00 814 407	034 046 0000	86
50 00 814 841	16-34 653 0001	71
50 00 815 148	12-34 126 6017	61
50 00 819 262	034 042 0062	58
50 00 820 871	034 015 0005	7
50 00 820 895	034 046 0000	86
50 00 823 987	036 020 0003	85
50 00 831 564	052 010 0975	33
50 01 014 694	025 290 6522	44
50 01 821 423	029 500 2070/S	92
50 01 822 987	16-34 527 0004	46
50 01 825 638	025 290 6522	44
50 01 825 687	036 020 0003	85
50 01 829 203	029 500 2070/S	92
50 01 829 204	029 500 2070/S	92

Ref. no.	MEYLE no.	Page
<b>R.V.I.</b>		
50 01 830 802	16-34 900 0002	1
50 01 831 161	534 527 0001	47
50 01 831 473	036 020 0001	84
50 01 832 581	036 020 0002	85
50 01 832 582	036 020 0001	84
50 01 833 354	14-12 319 0004	87
50 01 833 651	034 323 0003	15
50 01 833 652	034 009 0003	15
50 01 834 075	16-34 527 0001	47
50 01 834 578	16-34 001 0006	1
50 01 834 579	16-34 001 0007	7
50 01 837 298	16-33 220 0001	25
50 01 843 522	834 042 0001	53
50 01 844 136	036 020 0016	84
50 01 844 625	16-34 089 0003	88
50 01 845 859	12-34 899 0023	61
50 01 846 034	025 290 9028	44
50 01 846 641	814 013 0000	9
50 01 846 642	16-34 322 0002 814 013 0000	9-10
50 01 846 647	16-34 322 0001	10
50 01 847 781	16-34 001 0005	2
50 01 848 363	16-34 527 0003	47
50 01 852 218	16-34 032 0011 16-34 741 0016	65, 76
50 01 853 860	16-34 323 0008	15
50 01 855 098	12-34 026 0002	59
50 01 855 397	16-34 899 0001	91
50 01 855 646	025 291 3130	45
50 01 855 902	16-34 527 0005	48
50 01 856 973	029 600 2471	93
50 01 857 427	16-33 220 0005	25
50 01 858 484	16-33 220 0005	25
50 01 858 682	12-31 111 0003	61
5001 858 773	036 020 0004 036 020 0004/HD	82
50 01 858 774	036 020 0005 036 020 0005/HD	83
50 01 859 721	16-34 741 0002	65
50 01 863 904	025 291 3130	45
50 01 864 270	12-31 111 0003	61
50 01 864 363	025 291 7429	45
50 01 864 364	025 291 7429	45
50 01 864 365	025 291 7329 025 291 7329/S	45-46
50 01 865 037	12-34 042 0026	53

Ref. no.	MEYLE no.	Page
<b>R.V.I.</b>		
50 01 865 404	16-34 042 0001	54
50 01 865 591	029 500 2070/S	92
50 01 865 593	029 600 2471	93
50 01 865 596	029 700 2870	93
50 01 865 597	029 700 2870	93
50 01 865 598	029 700 2870	93
50 01 865 723	16-34 321 0003	12
50 01 865 724	16-34 321 0007	13
50 01 865 725	16-34 321 0002	12
50 01 866 165	16-36 020 0012	85
50 01 866 278	16-33 220 0004	26
50 01 866 914	025 291 8130	46
50 01 867 083	029 650 2671	93
50 01 867 774	16-36 020 0012	85
50 01 868 366	16-36 040 0036	80
50 01 868 473	12-34 899 0023	61
50 01 869 771	36-14 322 0003	9
50 01 869 773	16-14 322 0006	11
50 01 873 287	12-31 111 0003	61
5001874635	36-15 523 0049	39
50 03 087 026	16-34 099 0005	4
50 03 087 028	16-34 753 0003	4
50 03 087 029	16-34 099 0004	5
50 03 087 031	16-34 099 0003	5
50 10 060 127	16-34 741 0001/S 16-34 741 0007 16-34 741 0009 16-34 741 0010/S	65-66, 68
50 10 060 356	16-34 032 0006	72
50 10 094 941	16-36 050 0004	70
50 10 130 021	16-34 032 0012	72
50 10 130 022	16-34 032 0010	76
50 10 136 105	12-34 032 0000	54
50 10 140 298	16-34 232 0024	22
50 10 140 460	16-33 234 0001	22
50 10 141 465	16-34 223 0002	28
50 10 216 437	16-35 521 0001	39
50 10 216 931	16-35 521 0013	39
50 10 216 932	16-35 521 0007	40
50 10 228 947	16-34 089 0008 16-34 089 0009	88, 90
50 10 229 242	16-36 030 0041	81
50 10 230 841	16-34 321 0003	12
50 10 230 916	16-34 321 0002	12
50 10 239 135	16-34 032 0008	73
50 10 239 670	16-34 032 0009	73

Ref. no.	MEYLE no.	Page
<b>R.V.I.</b>		
50 10 260 101	16-35 521 0013	39
50 10 260 102	16-35 521 0007	40
50 10 260 218	16-35 521 0005	40
50 10 260 535	16-34 042 0006	57
50 10 260 603	16-35 521 0008	41
50 10 263 004	16-34 223 0004	28
50 10 269 159	16-34 232 0003	23
50 10 269 584	16-34 321 0006	13
50 10 269 869	16-34 234 0002	20
50 10 269 870	16-34 232 0012	23
50 10 269 871	16-34 234 0004	21
50 10 276 022	16-34 870 0002	91
50 10 284 807	16-34 000 0005	30
50 10 294 287	16-36 030 0013	80
50 10 294 961	16-34 741 0003	66
50 10 294 991	16-34 271 0001	71
50 10 295 218	16-34 900 0007	37
50 10 295 225	16-28 283 0001	27
50 10 295 726	16-34 900 0001	2
50 10 295 831	16-34 753 0003	4
50 10 315 180	16-33 234 0001	22
50 10 315 182	16-33 234 0001	22
50 10 315 427	16-34 234 0003	20
50 10 315 557	16-34 232 0023	23
50 10 315 990	16-34 321 0007	13
50 10 315 993	16-34 020 0002	24
50 10 315 994	16-34 234 0006	21
50 10 316 015	16-34 089 0002	88
50 10 316 016	16-34 089 0004	87
50 10 316 404	16-34 910 0101	90
50 10 316 438	16-34 910 0100	91
50 10 316 479	16-34 089 0007	89
50 10 316 521	16-34 030 0006	17
50 10 316 522	16-34 030 0007	18
50 10 316 591	16-34 030 0003	18
50 10 316 592	16-34 030 0004	18
50 10 317 187	16-34 321 0018	13
50 10 330 029	16-33 220 0002	25
50 10 339 723	12-34 099 0005	5
50 10 359 806	16-34 099 0003	5
50 10 359 807	16-34 099 0004	5
50 10 375 179	16-33 234 0001	22
50 10 383 545	16-34 032 0005	73
50 10 383 949	16-34 162 0001	63
50 10 383 951	16-34 162 0003	63
50 10 389 262	16-36 050 0002	70

Ref. no.	MEYLE no.	Page
<b>R.V.I.</b>		
50 10 412 350	16-34 323 0008	15
50 10 412 450	614 899 0038	29
50 10 412 956	16-34 000 0003	30
50 10 418 820	16-34 089 0005	89
50 10 422 262	16-35 523 0006	41
50 10 437 603	050 010 1460	35
50 10 437 653	534 899 0014	8
50 10 439 060	12-14 650 0005	77
50 10 441 122	029 700 2870	93
50 10 450 824	16-34 323 0008	15
50 10 452 472	16-34 029 0003	62
50 10 457 862	16-34 533 0009	49
50 10 457 875	16-34 533 0017	49
50 10 457 878	16-34 533 0016	50
50 10 457 882	16-34 533 0002	50
50 10 457 883	16-34 533 0003	51
50 10 460 097	16-34 089 0006	89
50 10 467 915	16-36 050 0003	70
50 10 477 117	16-34 001 0003	2
50 10 477 438	16-34 001 0008	38
50 10 477 838	050 009 1690	35
50 10 477 855	16-34 323 0008	15
50 10 488 052	16-36 030 0041	81
50 10 505 337	16-34 323 0008	15
50 10 514 014	16-34 234 0005	21
50 10 514 058	16-33 234 0001	22
50 10 514 340	16-34 223 0002	28
50 10 514 839	16-34 232 0011	24
50 10 525 014	16-35 521 0006	42
50 10 525 308	16-35 523 0006	41
50 10 525 362	16-35 523 0002	42
50 10 525 364	16-35 523 0003	43
50 10 534 863	16-34 753 0002	78
50 10 550 335	16-34 000 0008	30
50 10 550 818	16-34 038 0002	9
50 10 553 993	16-34 000 0005	30
50 10 557 129	16-34 032 0013	74
50 10 557 313	16-34 032 0014	74
50 10 557 315	16-34 032 0007	74
50 10 557 698	16-34 741 0008	67
50 10 557 875	16-34 741 0004	67
50 10 566 199	16-34 753 0001	78
50 10 587 008	16-34 650 0003	77
50 10 587 034	16-36 040 0036	80
50 10 587 038	16-36 040 0036	80
50 10 597 547	16-34 232 0022	24

Ref. no.	MEYLE no.	Page
<b>R.V.I.</b>		
50 10 598 303	16-35 523 0006	41
50 10 598 304	16-35 521 0012	43
50 10 598 305	16-35 521 0011	44
50 10 598 372	025 291 8130	46
50 10 630 625	16-34 741 0005	67
50 10 832 583	036 020 0005 036 020 0005/HD	83
50 10 848 607	16-34 527 0002	48
50 21 170 077	834 042 0001	53
50 21 170 275	034 042 0061	57
50 21 170 276	034 043 0002	57
50 21 170 278	034 042 0062	58
50 21 170 282	034 042 0003	58
50 21 170 283	034 042 0002	58
50 21 170 467	16-34 042 0004	56
50 21 190 014	029 500 2070/S	92
50 21 190 021	029 700 2870	93
50 21 190 022	029 700 2870	93
55 16 031 803	14-34 238 0002	29
60 05 011 111	214 321 0001	14
68310622	16-34 527 0004	46
68320874	16-34 054 0003	48
68320902	16-34 527 0004	46
68320909	16-34 054 0003	48
68325408	16-34 054 0005	49
74 00 351 111	534 162 0004	64
74 01 134 955	534 010 0024	75
74 01 521 527	16-34 321 0020	60
74 01 629 169	16-34 010 0001	75
74 03 099 100	16-34 900 0004	3
74 03 979 979	16-34 000 0001	31
74 08 086 970	16-34 000 0007	33
74 08 148 259	16-34 099 0001	6
74 08 149 855	534 000 0005	31
74 08 170 959	16-34 900 0005	38
74 20 390 836	534 032 0001	68
74 20 412 568	16-34 099 0006	6
74 20 430 751	16-34 322 0001	10
74 20 443 044	16-34 050 0002	69
74 20 484 678	534 820 0001	8
74 20 487 079	16-34 000 0002	31
74 20 495 935	16-34 001 0004	3
74 20 499 469	16-34 030 0005	19
74 20 499 470	534 030 0001	19
74 20 499 472	16-34 030 0005	19
74 20 513 340	614 899 0038	29

Ref. no.	MEYLE no.	Page
<b>R.V.I.</b>		
74 20 514 065	534 820 0002	8
74 20 514 654	16-34 323 0004	16
74 20 518 637	534 751 0002	77
74 20 522 934	536 050 0005	69
74 20 524 936	534 899 0014	8
74 20 538 793	534 001 0005	4
74 20 541 379	16-34 322 0001	10
74 20 541 381	16-34 323 0003	16
74 20 541 383	16-34 323 0004	16
74 20 543 484	050 008 1435	36
74 20 560 249	16-28 282 0001	27
74 20 590 486	16-34 798 0001	63
74 20 701 199	16-34 631 0002	86
74 20 702 096	16-34 653 0004	71
74 20 708 907	16-34 322 0002	10
74 20 709 459	16-34 322 0002 814 013 0000	9-10
74 20 724 776	050 010 1487	36
74 20 725 565	050 010 1512	36
74 20 734 268	16-33 220 0004	26
74 20 739 751	534 000 0006	32
74 20 744 939	533 220 0001	26
74 20 744 940	533 220 0001	26
74 20 745 605	16-34 323 0006	16
74 20 746 460	12-34 032 0000	54
74 20 747 516	534 000 0008	33
74 20 760 425	16-36 040 0008	81
74 20 779 040	16-34 322 0004	11
74 20 783 159	16-34 223 0002	28
74 20 783 896	16-34 223 0005	29
74 20 783 898	16-34 223 0005	29
74 20 783 901	16-34 223 0004	28
74 20 793 590	12-34 820 0002	56
74 20 795 150	16-34 533 0007	51
74 20 796 740	534 820 0001	8
74 20 796 772	534 323 0001	17
74 20 796 782	534 323 0002	11
74 20 796 970	534 030 0001	19
74 20 803 650	534 820 0002	8
74 20 828 416	16-34 223 0003	27
74 20 828 448	16-34 223 0004	28
74 20 839 455	534 010 0028	72
74 20 855 371	16-34 900 0006	38
74 20 875 666	16-34 323 0001	17
74 20 880 406	16-34 020 0001	22
74 20 898 038	534 820 0001	8



Ref. no.	MEYLE no.	Page
<b>R.V.I.</b>		
74 20 915 973	16-34 533 0004	52
74 20 916 171	16-34 533 0005	52
74 20 916 175	16-34 533 0009	49
74 20 916 177	16-34 533 0007	51
74 20 929 989	16-34 741 0008	67
74 20 935 521	534 000 0006	32
74 20 939 284	534 000 0011	32
74 20 967 831	534 751 0002	77
74 20 972 291	16-34 323 0001	17
74 20 976 001	16-34 323 0003	16
74 20 983 308	16-34 223 0002	28
74 20 983 314	16-34 223 0005	29
74 20 993 866	16-34 020 0001	22
74 20 997 341	534 009 0001	14
74 20 998 349	16-34 323 0006	16
74 20 998 634	16-34 323 0004	16
74 20 998 806	534 323 0001	17
74 20 998 809	534 323 0002	11
74 21 012 697	534 234 0021	20
74 21 017 010	16-34 223 0005	29
74 21 017 015	16-34 223 0002	28
74 21 017 710	16-34 631 0002	86
74 21 021 391	534 751 0002	77
74 21 036 050	16-34 650 0001	78
74 21 051 052	536 050 0005	69
74 21 055 339	16-34 223 0003	27
74 21 190 824	050 010 1342	37
74 21 237 213	16-28 282 0001	27
74 21 267 793	16-34 042 0001	54
74 21 267 820	12-34 042 0026	53
74 21 271 207	16-34 089 0002	88
74 21 302 639	534 820 0001	8
74 21 318 083	12-34 899 0023	61
74 21 318 366	14-34 043 0001	60
74 21 333 686	534 210 0005	90
74 21 363 479	16-34 533 0003	51
74 21 363 492	16-34 533 0004	52
74 21 363 493	16-34 533 0005	52
74 21 380 483	16-34 323 0006	16
74 21 399 915	025 291 7329 025 291 7329/S	45-46
74 21 399 929	025 291 7429	45
74 21 412 639	16-28 282 0001	27
74 21 479 106	16-34 321 0020	60
74 21 479 276	534 000 0010	32
74 21 483 476	16-34 741 0005	67

Ref. no.	MEYLE no.	Page
<b>R.V.I.</b>		
74 21 486 081	16-34 099 0006	6
74 21 496 555	025 291 7429	45
74 21 500 149	534 000 0011	32
74 21 540 602	534 820 0001	8
74 21 560 913	16-36 040 0008	81
74 21 560 963	16-36 040 0036	80
74 21 561 278	814 013 0000	9
74 21 561 284	16-34 322 0001	10
74 21 602 383	16-34 042 0001	54
74 21 615 952	533 220 0001	26
74 21 634 021	534 820 0001	8
74 21 700 201	814 013 0000	9
74 21 819 687	534 000 0006	32
74 21 959 184	533 220 0004	26
74 21 960 480	533 220 0004	26
74 21 990 552	16-34 321 0020 16-34 322 0004	11, 60
74 22 064 150	16-34 223 0002	28
74 22 100 457	050 008 1435	36
74 22 100 459	050 010 1342	37
74 22 167 707	533 220 0001	26
74 24 427 344	534 533 0002	53
74 55 064 150	16-34 223 0003	27
74 82 074 379	16-34 032 0010	76
74 82 421 131	16-35 521 0012	43
74 82 582 816	16-34 223 0004	28
74 85 000 763	533 220 0001	26
74 85 000 963	533 220 0001	26
74 85 013 068	533 220 0001	26
74 85 103 778	534 009 0001	14
74 85 108 176	16-34 321 0020	60
74 85 108 423	16-34 099 0002	7
74 85 116 317	16-34 899 0001	91
74 85 116 453	12-34 899 0023	61
74 85 116 634	16-34 323 0003	16
74 85 132 205	16-34 223 0002	28
74 85 135 854	16-34 042 0001	54
74 85 137 860	614 899 0038	29
77 00 268 230	052 010 1250	34
77 00 268 232	052 010 1250	34
77 00 268 754	052 010 1250	34
77 00 854 083	052 010 1250	34
77 01 005 197	034 042 0003	58
77 01 011 412	036 020 0004 036 020 0004/HD	82
77 01 015 820	114 323 0001	14



Ref. no.	MEYLE no.	Page
<b>R.V.I.</b>		
77 01 016 946	036 020 0001	84
77 01 017 322	114 323 0001	14
77 01 017 732	114 323 0001	14
77 01 029 704	052 010 1250	34
77 01 057 828	16-14 322 0006	11



Short no.	MEYLE no.	Page
<b>R.V.I.</b>		
MAF0199	12-34 321 0010	12
MAF0240	16-34 321 0002	12
MAF0241	16-34 321 0003	12
MAF0244	16-34 321 0006	13
MAF0245	16-34 321 0007	13
MAF0256	16-34 321 0018	13
MAF0295	214 321 0001	14
MAS0117	16-34 533 0002	50
MAS0118	16-34 533 0003	51
MAS0119	16-34 533 0004	52
MAS0120	16-34 533 0005	52
MAS0122	16-34 533 0007	51
MAS0124	16-34 533 0009	49
MAS0131	16-34 533 0016	50
MAS0132	16-34 533 0017	49
MAS0377	534 533 0002	53
MBD0349	16-35 521 0001	39
MBD0352	16-35 521 0008	41
MBD1471	16-35 521 0011	44
MBD1472	16-35 521 0012	43
MBD1473	16-35 521 0013	39
MBD1476	16-35 523 0006	41
MBD1661	16-35 521 0005	40
MBD1662	16-35 521 0006	42
MBD1663	16-35 521 0007	40
MBD1664	16-35 523 0002	42
MBD1665	16-35 523 0003	43
MBD2099	36-15 523 0049	39
MBL0035	029 600 2470	92
MBL0040	029 700 2870	93
MBL0056	029 650 2671	93
MBL0060	029 500 2070/S	92
MBL0063	029 100 4071	92
MBL0071	029 600 2471	93
MBP0720	025 291 3130	45
MBP0735	025 290 6522	44
MBP0749	025 291 7329	45
MBP0750	025 291 7329/S	46
MBP0751	025 291 7429	45
MBP0754	025 291 8130	46
MBP0823	025 290 9028	44
MBT0034	16-34 000 0001	31
MBT0035	16-34 000 0002	31
MBT0045	534 000 0005	31
MBT0046	534 000 0006	32
MBT0062	16-34 000 0003	30

Short no.	MEYLE no.	Page
<b>R.V.I.</b>		
MBT0063	16-34 000 0008	30
MBT0072	534 000 0010	32
MBT0073	534 000 0011	32
MBT0075	16-34 000 0005	30
MBX0053	034 042 0002	58
MBX0054	034 042 0003	58
MBX0060	034 042 0016	62
MBX0067	034 042 0033	55
MBX0068	034 042 0034	56
MBX0072	034 042 0038	55
MBX0073	034 042 0039	55
MBX0087	034 042 0061	57
MBX0088	034 042 0062	58
MBX0089	034 043 0002	57
MBX0161	12-34 026 0002	59
MBX0162	12-34 032 0000	54
MBX0165	12-34 042 0026	53
MBX0199	16-34 042 0001	54
MBX0213	834 042 0001	53
MBX0251	16-34 042 0006	57
MBX0254	16-34 029 0003	62
MBX0258	16-34 042 0004	56
MBX0267	12-34 820 0002	56
MCA0769	536 050 0005	69
MCA1094	16-34 050 0002	69
MCF0122	14-12 319 0004	87
MCX0268	16-34 753 0001	78
MCX0385	16-34 271 0001	71
MCX0386	16-34 741 0002	65
MCX0387	16-34 741 0003	66
MCX0388	16-34 741 0004	67
MCX0389	16-34 741 0005	67
MCX0390	16-34 741 0011	64
MCX0393	534 032 0001	68
MCX0402	16-34 741 0001/S	65
MCX0403	16-34 741 0007	66
MCX0411	16-34 032 0011	65
MCX0412	16-34 741 0013	64
MCX0413	534 010 0028	72
MCX0431	16-34 753 0002	78
MCX0463	16-34 741 0016	76
MCX0477	16-34 741 0009	68
MCX0478	16-34 741 0015	76
MCX0501	16-34 741 0008	67
MCX0505	16-34 653 0001	71
MCX0508	16-34 653 0004	71

Short no.	MEYLE no.	Page
<b>R.V.I.</b>		
MCX0525	16-34 798 0001	63
MCX0527	16-34 741 0010/S	68
MDL0083	16-36 030 0013	80
MDL0084	16-36 040 0008	81
MDL0089	16-36 030 0041	81
MEM0638	16-34 030 0003	18
MEM0639	16-34 030 0004	18
MEM0640	16-34 030 0006	17
MEM0641	534 030 0001	19
MEM0702	16-34 030 0007	18
MEM0788	16-34 030 0005	19
MET0045	16-34 223 0002	28
MET0080	16-34 223 0003	27
MET0088	16-34 223 0004	28
MEX0143	034 015 0005	7
MEX0453	614 899 0038	29
MEX0488	12-34 899 0023	61
MEX0567	14-34 043 0001	60
MEX0579	534 820 0001	8
MEX0580	534 820 0002	8
MEX0583	16-34 223 0005	29
MEX0591	16-34 154 0001	60
MEX0601	534 899 0014	8
MFC0047	16-34 020 0001	22
MFC0051	16-34 234 0004	21
MFC0052	16-34 234 0005	21
MFC0053	16-34 234 0006	21
MFC0087	16-33 234 0001	22
MFF0023	034 009 0003	15
MFF0073	114 323 0001	14
MFF0098	16-34 323 0003	16
MFF0100	16-34 323 0008	15
MFF0245	034 323 0003	15
MFF0250	16-34 323 0001	17
MFF0261	534 323 0001	17
MFF0271	16-34 323 0004	16
MFF0272	16-34 323 0006	16
MFP0042	534 009 0001	14
MHF0029	16-34 321 0020	60
MHP0059	16-34 631 0002	86
MIX0219	16-34 899 0001	91
MIX0244	16-34 910 0100	91
MIX0245	16-34 910 0101	90
MIX0260	16-34 089 0005	89
MIX0270	16-34 089 0003	88
MIX0271	16-34 089 0004	87

Short no.	MEYLE no.	Page
<b>R.V.I.</b>		
MIX0274	534 210 0005	90
MIX0279	16-34 089 0010	87
MIX0283	16-34 089 0006	89
MIX0284	16-34 089 0007	89
MIX0291	16-34 089 0008	88
MIX0295	16-34 089 0009	90
MIX0319	16-34 089 0002	88
MMX0601	12-34 099 0005	5
MMX0721	16-34 099 0001	6
MMX0722	16-34 099 0002	7
MMX1316	16-34 900 0001	2
MMX1317	16-34 020 0002	24
MMX1319	16-34 232 0024	22
MMX1334	16-34 001 0003	2
MMX1335	16-34 001 0004	3
MMX1336	16-34 001 0006	1
MMX1337	16-34 099 0003	5
MMX1338	16-34 099 0004	5
MMX1339	16-34 099 0005	4
MMX1340	16-34 099 0006	6
MMX1341	16-34 753 0003	4
MMX1405	16-34 232 0003	23
MMX1413	16-34 232 0011	24
MMX1414	16-34 232 0012	23
MMX1424	16-34 232 0022	24
MMX1425	16-34 232 0023	23
MMX1455	16-34 900 0006	38
MMX1457	14-34 238 0002	29
MMX1490	16-34 001 0005	2
MMX1491	12-31 111 0003	61
MMX1517	16-34 900 0004	3
MMX1550	16-34 001 0007	7
MMX1551	16-34 001 0008	38
MMX1552	16-34 900 0002	1
MMX1553	16-34 900 0003	3
MMX1554	16-34 900 0005	38
MMX1569	16-34 900 0007	37
MMX1570	16-34 900 0009	1
MMX1587	534 001 0005	4
MMX1699	16-34 038 0002	9
MOF0079	16-14 322 0006	11
MOF0083	16-34 322 0001	10
MOF0156	36-14 322 0003	9
MOF0174	534 323 0002	11
MOF0209	814 013 0000	9
MOF0220	16-34 322 0002	10

Short no.	MEYLE no.	Page
<b>R.V.I.</b>		
MOF0229	16-34 322 0004	11
MPJ0071	12-34 126 6017	61
MRB0218	050 005 1010	35
MRB0275	050 005 1530	37
MRB0659	050 008 1435	36
MRB0718	050 010 1512	36
MRB0748	050 010 1342	37
MRB0754	050 009 1690	35
MRB0755	050 010 1460	35
MRB0756	050 010 1487	36
MRM0072	16-34 234 0002	20
MRM0073	16-34 234 0003	20
MRM0122	534 234 0021	20
MRS0190	534 162 0004	64
MRS0195	16-34 162 0001	63
MRS0196	16-34 162 0003	63
MSB0250	16-34 010 0001	75
MSB0296	16-34 032 0009	73
MSB0307	16-34 032 0006	72
MSB0308	16-34 032 0010	76
MSB0316	534 010 0024	75
MSB0328	16-34 032 0008	73
MSB0329	16-34 032 0012	72
MSB0337	16-34 032 0007	74
MSB0347	16-34 032 0005	73
MSB0357	16-34 032 0013	74
MSB0366	16-34 032 0014	74
MSR0109	16-36 050 0002	70
MSR0110	16-36 050 0003	70
MSR0111	16-36 050 0004	70
MSX0026	034 046 0000	86
MTA0146	16-36 040 0036	80
MTE0044	036 020 0001	84
MTE0045	036 020 0002	85
MTE0046	036 020 0003	85
MTE0047	036 020 0004	82
MTE0047HD	036 020 0004/HD	82
MTE0048	036 020 0005	83
MTE0048HD	036 020 0005/HD	83
MTE0059	036 020 0016	84
MTE0740	16-36 020 0012	85
MTH0112	16-28 282 0001	27
MTH0113	16-28 283 0001	27
MTR0034	534 000 0008	33
MTR0044	16-34 000 0007	33
MVB0063	052 010 0975	33

Short no.	MEYLE no.	Page
<b>R.V.I.</b>		
MVB0097	052 010 1250	34
MVB0116	052 010 1575	34
MVB0226	052 013 1550	34
MWB0049	12-14 650 0005	77
MWB0050	16-34 650 0003	77
MWB0059	16-34 650 0001	78
MWB0061	534 751 0002	77
MWI0030	16-34 870 0002	91
MWP0218	16-33 220 0001	25
MWP0219	16-33 220 0002	25
MWP0221	16-33 220 0004	26
MWP0222	16-33 220 0005	25
MWP0439	533 220 0001	26
MWP0553	533 220 0004	26
MWS0135	16-34 054 0003	48
MWS0136	16-34 054 0005	49
MWS0137	16-34 527 0001	47
MWS0138	16-34 527 0002	48
MWS0139	16-34 527 0003	47
MWS0140	16-34 527 0004	46
MWS0141	16-34 527 0005	48
MWS0145	534 527 0001	47





# MEYLE

**My longest relationship?  
The one with my truck.**



**The MEYLE brand supplies its customers with more than 21,000 extremely reliable and durable spare parts manufactured at our own production facilities or by trusted production partners. MEYLE boasts a highly diversified product range.**

Whether steering and suspension components, rubber-to-metal parts, brakes, damping components, cooling systems, filters, drive components, electric and sensors MEYLE is synonymous with top-grade quality-tested spare parts.

#### **Notes**

This catalogue is protected by copyright. Reproduction of text, graphic elements, photographs and/or data, even in part, is prohibited. MEYLE, **MEYLE**, or parts thereof, are registered trademarks of MEYLE AG.

All supplies and services are subject to our General Terms and Conditions. The original spare part numbers shown in this catalogue are for cross-reference purposes only and shall not be disclosed to third parties on invoices and delivery notes. While the information in this catalogue was compiled and edited with utmost care we do not assume responsibility or accept claims arising from errors or inconsistencies. Subject to technical and/or design changes.

This issue of the catalogue supersedes all previous issues.  
All rights reserved. © 2017 MEYLE AG



MEYLE parts are available through:

**MEYLE AG**

Merkurring 111, 22143 Hamburg, Germany  
Tel. +49 40 67506 510, Fax +49 40 67506 506  
[contact@meyle.com](mailto:contact@meyle.com)

[www.meyle.com](http://www.meyle.com)

**MEYLE**