

CORTECO GmbH
Badener Straße 4
69493 Hirschberg
Germany
Tel. +49 6201 25964-0
Fax +49 6201 25964-11

CORTECO S.A.S.
Z.A. La Couture
87140 Nantiat
France
Tel. +33 5 55 53 68 00
Fax +33 5 55 53 68 88

CORTECO S.r.l. (a socio unico)
Via P. Poccardi, 3
Zona Industriale Porporata
10064 Pinerolo (TO)
Italy
Tel. +39 0121 369-269
Fax +39 0121 369-299

CORTECO Ltd.
Unit 6, Wycliffe Industrial Park
Lutterworth, Leicestershire
LE17 4HG
United Kingdom
Tel +44 1455 550000
Fax +44 1455 550066

CORTECO Spain & Portugal
Freudenberg Sealing Technologies
S.L.U.
Pol. Ind. Can Volart
C/ Gurri 1
08150 Parets del Vallés (Barcelona)
España
Tel. +34 93 5738741
Fax +34 93 5624676

CORTECO Eastern Europe
Moscow Region,
Lenninskiy district,
142700 City Vidnoye,
Donbasskaya str. block 2
Office 718, Russia
Tel. +7-495 22361-84
Fax +7-495 22361-84

CORTECO Poland
53-014 Wrocław
U.I Warsztatowa 11
Poland
Tel. +48 71 33997-55
Fax +48 71 33997-00

CORTECO Balkan States
Gajeva 27.
21208 Sremska Kamenica
(Novi Sad) Serbia
Tel. +381 21 465268
Fax +381 21 465268

CORTECO Asia
18 Tractor Road
Singapore 627976
Singapore
Tel. +65 6561 6651
Fax +65 6561 6862

CORTECO India Pvt. Ltd.
370 First Floor, Udyog Vihar,
Phase 6, Sector 37,
Gurgaon 122001 Haryana
India
Tel. +91 124 4019274

CORTECO China Co.Ltd.
Suit 14-I International Ocean
Shipping Building,
720 Pudong Avenue,
Shanghai, P.R.C.
Tel. +86 21 3470 1680
Fax +86 21 3468 9697

CORTECO Ishino Japan
Corteco Ishino Corporation
1-4-8, Shiba-Daimon, Minato-ku,
Tokyo 105-0012
Japan
Tel. +81-3-5405-8411
Fax +81-3-5405-8412

CORTECO USA
11617 State Route 13
Milan, Ohio 44846
USA
Tel. +1 419 4992-502
Fax +1 419 4992-804

CORTECO South America
Av. Piraporinha, 411
09950-902 São Paulo / Diadema
Brasil
Tel. +55 11 40728010
Fax +55 11 40752535

CORTECO Mexico
Circuito El Marques Norte #14
Parque Industrial el Marques
El Marques, Querétaro
C.P 76240
Mexico
Tel. +52 (442) 153 3278

CORTECO Turkey
Freudenberg Sealing Technologies
Sanayi ve Ticaret A.Ş.
NOSAB 204 Sk. No: 3
16140 Nilüfer Bursa
Turkey

www.corteco.com

a brand of
FREUDENBERG

CORTECO[®]

a brand of
FREUDENBERG

CORTECO[®]

CABIN AIR FILTER | INNENRAUMFILTER | FILTRE D'HABITACLE | FILTRO ARIA ABITACOLO



SEALING | VIBRATION CONTROL | CABIN AIR FILTER











Innenraumfilter | Filtre d'habitacle |
Filtro aria abitacolo

CABIN AIR FILTER



99000100 DE 03/16 BECH

SIGNS AND SYMBOLS

 Vehicle model Fahrzeugmodell Modèle Modello	 With / Without air-conditioning Mit / Ohne Klimaanlage Avec / Sans climatisation Con / Senza aria condizionata	 Installation vehicle position Einbauposition im Fahrzeug Localisations dans le véhicule Posizionamento nel veicolo
 Year of construction Baujahr Année de fabrication Anno di costruzione	 Particle Filter Partikelfilter Filtre à particules Filtro particellare	 Installation time Einbauzeit Temps d'installation Tempo di sostituzione
 Information Information Information Informazioni	 Combi Filter Kombifilter Filtre combiné Filtro combinato	 Pictures Produktbilder Photos des filtres Foto

SEALING

VIBRATION CONTROL

CABIN AIR FILTER

www.corteco.com

WE DELIVER THE ORIGINAL.
Corteco, Freudenberg Group



FREUDENBERG

2 billion seals per year for the automotive industry in Europe



Trelleborg Vibracoustic

Market leader in vibration control with around EUR 1.7 billion turnover per year





micronAir

cabin air filters in every other new car

	EN	DE	FR	IT
+/-	with and without air conditioning	mit und ohne Klimaanlage	avec et sans climatisation	con o senza condizionatore
+ Partno.	additional to partno.	zusätzlich zu Artikelnr.	En complément de la référence	Aggiuntivo per codice
***	except cars with activated carbon filter systems	außer mit Geruchfilteranlagen	sauf véhicules avec système de filtres anti-odeurs	eccetto vetture con sistema a filtri con carboni attivi
2 !	2 filters needed	2 Filter werden benötigt	2 filtres sont nécessaires	Necessita di 2 filtri
AUT AC	with automatic air-conditioning	mit automatischer Klimaanlage	avec climatisation automatique	con condizionatore automatico
FC	Front Cabinet	Bugschrank	armoire avant	Comparto anteriore
FFV	Fast Fit version	Fast Fit version	version montage rapide	Versione montaggio facilitato
MAN AC	with manual air-conditioning	mit manueller Klimaanlage	avec climatisation manuelle	con condizionatore manuale
LHD	left hand drive	Linkslenker	conduite à gauche	guida a sinistra
NR	alternative filter	Alternativfilter	alternative au filtre d'origine	filtro alternativo
ocv	only for construction vehicles	nur für Baustellenfahrzeuge	Uniquement pour les véhicules de chantier	Solo macchine movimento terra
od	on demand	auf Anfrage	sur demande	Su richiesta
PF	Prefilter	Vorfilter	préfiltre	Prefiltro
RAC	Rear air conditioning	Heckklimaanlage	climatisation arrière	Climatizzatore posteriore
RCF	Recirculation filter	Umluftfilter	filtre de recyclage	Filtro ricircolo aria
RHD	right hand drive	Rechtslenker	conduite à droite	guida a destra
roof AC	roof AC	Dachklimaanlage	climatisation de toit	Tetto di aria condizionata
rv	rounded version	runde Version	Version ronde	Versione circolare
s	standard	Standard	Standard	Standard
Set	set	Set	jeu	Set
3-Set	set includes 3 filters	Set beinhaltet 3 Filter	Jeu de 3 filtres	Il set contiene 3 filtri
SAC	Stationary air conditioner	Standklima	Parking A/C	Condizionatore di sosta
w/o F	without frame	ohne Rahmen	sans cadre	Senza telaio
w F	with frame	mit Rahmen	avec cadre	Con telaio

CONTENTS

PRODUCT OVERVIEW	4
Produktübersicht L'offre Produits Catalogo Prodotti	
MORE THAN 160 YEARS OF EXPERTISE	6
Über 160 Jahre Fachkompetenz Plus de 160 ans d'expertise Oltre 160 anni di esperienza	
NEW AUTOMOTIVE GENERATION	8
Eine neue Generation in der Automobilindustrie Nouvelle génération d'automobiles Nuova generazione automotive	
HEALTH; THE GREATEST ASSET	10
Gesundheit; das höchste Gut La santé, le bien le plus précieux La salute; Il bene piu' importante	
ENGINE INTAKE AIR FILTERS	18
Motorzulufffilter Les filtres à air moteur Filtri aria motore	
VEHICLE APPLICATIONS	27
Fahrzeuganwendungen Applications Applicazioni	
VEHICLE APPLICATIONS	79
Fahrzeuganwendungen Applications Applicazioni	
OE-NUMBERS	91
OE-Nummern Correspondances Corteco-Originale Tabelle Comparative Corteco-OEM	
CROSS REFERENCE LIST	107
Vergleichsliste Correspondances Corteco Tabelle Comparative Corteco	
DISCLAIMER	145
Rechtliche Hinweise Informations Légales Avvertenze	
INSTALLATION POSITIONS	146
Einbaupositionen Localisations dans le véhicule Posizionamento nel veicolo	
SIGNS AND SYMBOLS	147
Zeichenerklärung Signes et Symboles Segni e Simboli	



Corteco, trust the expert

PRODUCT OVERVIEW



Gaskets and head bolts
Dichtungen und Zylinderkopfschrauben
Joints et kits de vis de culasse
Guarnizioni motore e bulloni testa

Cabin air filter
Innenraumfilter
Filtres d'habitacle
Filtri aria abitacolo

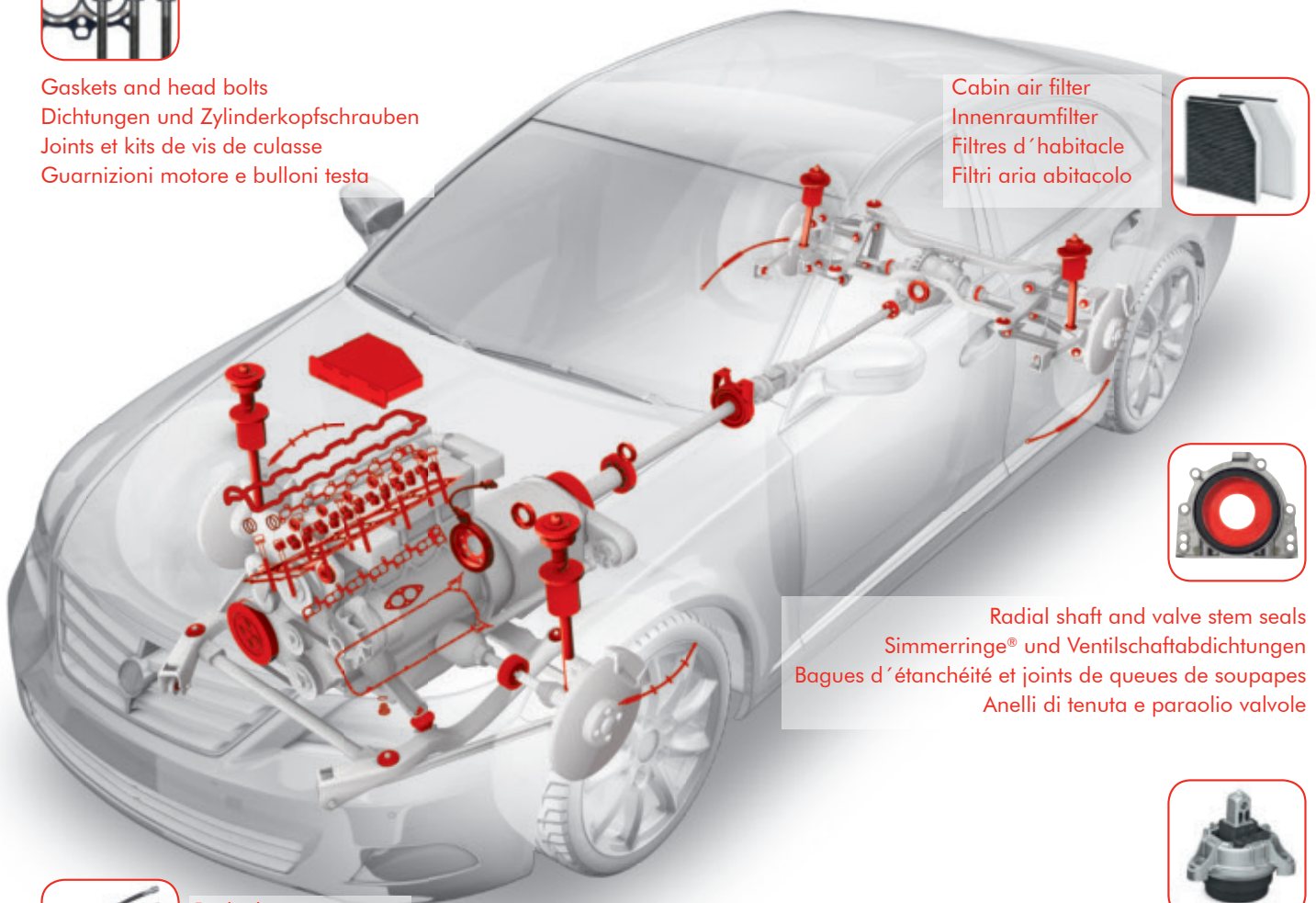

Radial shaft and valve stem seals
Simmerringe® und Ventilschaftabdichtungen
Bagues d'étanchéité et joints de queues de soupapes
Anelli di tenuta e paraolio valvole



Brake hoses
Bremsschläuche
Flexibles de freins
Tubi freno



Vibration control parts for chassis, engine and transmission
Schwingungstechnische Produkte für Fahrwerk, Motor und Getriebe
Pièces antivibratoires pour moteurs et transmissions
Ricambi per il controllo delle vibrazioni per telaio, motore e trasmissione



EN

No matter which products you choose from the CORTECO product portfolio, you always receive outstanding original quality. This high quality standard is directly linked to Freudenberg and characterises our comprehensive spare parts range. CORTECO offers more than 19,000 products and service kits to garages - among them leading brands such as the Simmerring® radial shaft seal. Our extensive product programme comprises Simmerrings, valve stem seals, flat gaskets and engine kits, vibration control technology such as engine mounts, pulleys and suspension mounts as well as cabin air filters and brake hoses.

DE

Für welches Produkt Sie sich aus der CORTECO-Produktfamilie auch entscheiden, Sie erhalten immer herausragende Original-Qualität. Dieser hohe Qualitätsstandard, dank unserer direkten Verbindung zu Freudenberg, kennzeichnet unser umfangreiches Ersatzteil-Sortiment. CORTECO bietet Werkstätten mehr als 19.000 Produkte und Service Kits - unter ihnen führende Marken wie z. B. den Simmerring® Radialwellendichtung. Unser breites Produktsortiment umfasst Simmerringe, Ventilschaftabdichtungen, Flachdichtungen und Motorsätze, Schwingungstechnik wie Motorlager, Riemenscheiben und Fahrwerkslager sowie Innenraumfilter und Bremsschläuche.

FR

Quelque soit le produit CORTECO que vous choisissez, vous bénéficiez avant tout de la qualité d'origine issue de la technologie et de l'innovation Freudenberg. CORTECO offre plus de 19.000 références de qualité, parmi lesquelles des marques leaders comme les bagues d'étanchéité Simmerring®. Nos gammes comprennent des bagues d'étanchéité dynamique, des joints de queues de soupapes, des joints et kits de joints, des pièces antivibratoires pour moteur, transmission ou châssis, des filtres d'habitacle ou encore des flexibles de freins.

IT

Qualunque prodotto scegliate dalla gamma CORTECO, troverete sempre la necessaria qualità originale. La nostra gamma è caratterizzata da prodotti di alta qualità garantiti dal gruppo Freudenberg. CORTECO offre alle officine più di 19.000 parti di ricambio e kit riparazione, tra i quali importanti marchi depositati come Simmerring® e CORTECO per gli anelli di tenuta. Il nostro programma di vendita include anelli di tenuta, paraolio stelo valvola, guarnizioni piane e kit guarnizioni motore, supporti motore, pulegge, supporti sospensioni ed anche ricambi di servizio come filtri aria abitacolo e tubi freno.

Innovating together

MORE THAN 160 YEARS OF EXPERTISE

1849



Carl Johann Freudenberg establishes tannery in Weinheim. Production of patent leather begins.

Carl Johann Freudenberg gründet Gerberei in Weinheim. Patentierte Lederfertigung beginnt.

Carl Johann Freudenberg crée une tannerie à Weinheim. La production de cuir verni commence.

Carl Johann Freudenberg fonda la sua conceria in Weinheim. Inizia la produzione brevettata di cuoio.

1936



Agreement with Carl Freudenberg company, distribution of technical leather goods for engines.

Vereinbarung mit dem Unternehmen von Carl Freudenberg, Vertrieb von technischen Lederwaren für Motoren.

Accord avec la société Carl Freudenberg, distribution de produits techniques en cuir pour les moteurs.

Accordo con l'azienda Carl Freudenberg per la distribuzione di prodotti tecnici in cuoio per motori.

1900



Hermann Ernst Freudenberg develops a tanning process using chrome liquor instead of vegetable products. The company becomes the largest leather manufacturer in Europe.

Hermann Ernst Freudenberg entwickelt ein Gerbverfahren, das auf einer Chromflüssigkeit statt auf Pflanzenprodukten basiert. Das Unternehmen wird der größte Lederhersteller in Europa.

Hermann Ernst Freudenberg développe un processus de tannage utilisant une solution à base de chrome à la place de produits végétaux. La société devient le plus gros fabricant de cuir en Europe.

Hermann Ernst Freudenberg sviluppa un processo di conciaturo che usa cromo liquido al posto di prodotti vegetali. L'azienda diventa il più grande produttore di cuoio in Europa.

1936



Perbunan (synthetic rubber) is used as a sealing material for Simmerrings and replaces leather.

Perbunan (synthetisches Gummi) wird als Dichtungsmaterial für Simmerringe verwendet und ersetzt Leder.

Le Perbunan (caoutchouc synthétique) est utilisé comme matériau d'étanchéité pour les bagues Simmerring® et remplace le cuir.

NBR (gomma nitrilica) è usato come base per i Simmerring al posto del cuoio.

1920s



Corte & Cosso established in Turin, Italy.

Corte & Cosso wird in Turin, Italien, gegründet.

Création de Corte & Cosso à Turin, Italie.

Viene fondata la Corte & Cosso a Torino, in Italia.

1932



The Simmerring® is developed on the basis of the first seals.

Der Simmerring® wird auf der Grundlage der ersten Dichtungsringe entwickelt.

La marque Simmerring® est développée sur la base des premiers joints d'étanchéité.

Il Simmerring® (anello di tenuta) è sviluppato sulla base delle prime tenute.

1957



In 1957 Freudenberg embraces vibration control technology.

1957 führt Freudenberg die Schwingungsdämpfungstechnik ein.

En 1957, Freudenberg se lance dans la technologie du contrôle des vibrations.

Nel 1957 la Freudenberg include la tecnologia per il controllo vibrazioni.

1960



Involvement with Nippon Oil Seal Industry Company Ltd, Tokyo (NOK) and partnership in Japanese Vilene Company Ltd (also Tokyo) the company becomes a worldwide operating business group.

Durch die Zusammenarbeit mit Nippon Oil Seal Industry Company Ltd, Tokio (NOK), und die Partnerschaft mit der japanischen Vilene Company Ltd (ebenfalls Tokio) entsteht eine weltweit tätige Unternehmensgruppe.

Engagement avec Nippon Oil Seal Industry Company Ltd, Tokyo (NOK) et joint-venture avec Japanese Vilene Company Ltd (également à Tokyo). La société devient un groupe d'affaires mondial.

Joint venture con la Nippon Oil Seal Industry Company Ltd, Tokyo (NOK) in partnership con la giapponese Vilene Company Ltd (sempre in Tokyo) l'azienda diventa una business group operante a livello mondiale.



1978

TRANStec®

TransTec established, partially owned by Freudenberg & Co.

Création de TransTec, partiellement détenue par Freudenberg & Co.

Gründung von TransTec im Miteigentum von Freudenberg & Co.

Viene fondata la TransTec, parzialmente di proprietà della Freudenberg & Co.

2008

CORTECO®

Corteco-Meillor S.A.S. becomes Corteco S.A.S.

Corteco-Meillor S.A.S. devient Corteco S.A.S.

Corteco-Meillor S.A.S. wird zu Corteco S.A.S.

Corteco-Meillor S.A.S. diventa Corteco S.A.S.

1988

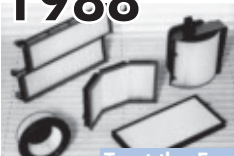

Trust the Expert

Particle filter development commences.

Le développement des filtres d'habitable à particules commence.

Die Partikelfilterentwicklung beginnt.

Inizia lo Sviluppo del Filtro Particolare.

2010



Foundation of Corteco China. Further branches open in Poland, Russia, America and Asia.

Création de Corteco Chine. D'autres succursales sont ouvertes en Pologne, Russie, Amérique et Asie.

Gründung von Corteco China. Weitere Niederlassungen werden in Polen, Russland, Amerika und Asien eröffnet.

Fondazione della Corteco Cina. Altre filiali vengono aperte in Polonia, Russia, America e Asia.

1996



Carbon activated filter production starts.

La production des filtres d'habitable à charbon actif démarre.

Die Herstellung von Aktiv-Kohlefilter beginnt.

Comincia la produzione del Filtro a Carboni Attivi.

2012

TrelleborgVibracoustic

TrelleborgVibracoustic established as joint venture company for automotive anti-vibration solutions. Corteco India and Corteco Ishino Japan are established.

Création de la joint-venture Trelleborg/Vibracoustic afin de renforcer la position de leader mondial en solutions antivibratoires pour l'automobile. Corteco Inde et Corteco Ishino au Japon sont fondés.

TrelleborgVibracoustic wird als Joint Venture für schwingungstechnische Lösungen im Automobilbau gegründet. Gründung der Corteco Indien und Corteco Ishino, Japan.

Trelleborg Vibracoustic viene fondata in joint venture come azienda per i componenti anti-vibranti per l'automotive. Vengono fondate Corteco India e Corteco Ishino Giappone

1996/97

CORTECO®

Corteco brand established in Turin (Italy), Viernheim (Germany) and Lutterworth (UK).

La marque Corteco s'installe à Turin (Italie), Viernheim (Allemagne) et Lutterworth (UK).

Die Marke Corteco wird in Turin (Italien), Viernheim (Deutschland) und Lutterworth (GB) gegründet.

Corteco da brand diventa anche azienda, e viene fondata in Pinerolo (Italia), Viernheim (Germany) e in Lutterworth (UK).

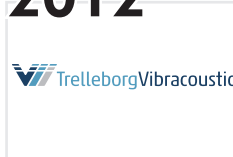

2014

AUTO SUPPLIERS LIMITED

Corteco expands power steering business. Auto Suppliers Ltd acquired by Corteco.

Corteco se développe dans le secteur de la direction assistée avec l'acquisition d'Auto Suppliers Ltd.

Corteco weitet Servolenkungsgeschäft aus. Corteco übernimmt Auto Suppliers Ltd.

Corteco incrementa il suo fatturato nella servoassistenza ed acquisisce Auto Suppliers LTD.

2001

vibracoustic

Vibracoustic created as joint venture between Freudenberg and Phoenix AG.

Vibracoustic est créé suite à la joint-venture entre Freudenberg et Phoenix AG.

Vibracoustic wird als Joint Venture von Freudenberg und Phoenix AG gegründet.

Nasce Vibracoustic come joint venture tra Freudenberg e Phoenix AG.

2001

CORTECO®

TransTec name changed to Corteco USA.

TransTec devient Corteco USA.

TransTec wird in Corteco USA umbenannt.

TransTec cambia il suo nome in Corteco USA.

2016



Corteco - a global company, with focus on partnership, service and quality.

Corteco - une entreprise mondiale focalisée sur le partenariat, le service et la qualité.

Corteco - ein weltweit tätiges Unternehmen mit Schwerpunkt auf Partnerschaft, Service und Qualität.

Corteco Oggi - un'azienda globale focalizzata in partnership, servizio e qualità.



Your partner for a

NEW AUTOMOTIVE GENERATION

FREUDENBERG - INNOVATING TOGETHER

We are inspired by technology and innovation. Together with our customers and with our research partners, we develop leading-edge technologies, products, solutions and services. Having pioneered innovation throughout our history – from chrome tanning and the development of the Simmerring to sophisticated and high-tech medical devices – our company is an innovation champion. For us, striving together for solutions that support global sustainability is both our motivation as well as our concept for success. We live “Innovating Together” across business groups and world regions. This enables us to provide our customers with solutions and answers to tomorrow’s questions, today.

Sustainable handling

One of the big challenges facing society today is safeguarding the cleanliness of air and liquids. Innovative solutions are called for. Freudenberg Filtration Technologies develops solutions that make processes more efficient, save resources and protect our environment, thereby raising the quality of life.

With almost 60 years of filtration experience dedicated to its customers; Freudenberg Filtration Technologies develops and supplies filtration solutions for surface treatment systems, engine intake air filters and cabin air filters for the automotive industry.

Corteco, subsidiary of the Freudenberg group, is responsible for the distribution of automotive products to the independent aftermarket. With OE connections like this and a reputation for customer service and logistical support that's second to none, it's no wonder that Corteco is able to deliver so many appropriate solutions for so many different countries.

FREUDENBERG – INNOVATING TOGETHER

Wir sind von Technologie und Innovation inspiriert: Gemeinsam mit unseren Kunden und unseren Forschungspartnern entwickeln wir führende Technologien, Produkte, Lösungen und Dienstleistungen. Von der Chromgerbung und der Entwicklung des Simmerrings bis hin zu komplexen, hochtechnologischen Medizingeräten: Unsere Firmenhistorie ist durch zukunftsweisende Innovationen geprägt. Als Meister der Innovation streben wir gemeinsam nach Lösungen, die die globale Nachhaltigkeit unterstützen. Das ist nicht nur unsere Motivation, sondern auch unser Erfolgskonzept. Wir leben das Motto „Innovating Together“ in allen Geschäftsbereichen und Regionen der Welt. So ist es uns möglich, unseren Kunden bereits heute Lösungen und Antworten auf die Fragen von morgen zu liefern.

Nachhaltiger Umgang

Die Bereitstellung von sauberer Luft und sauberen Flüssigkeiten ist eine der großen Herausforderungen, der sich unsere Gesellschaft stellt. Freudenberg Filtration Technologies entwickelt innovative Lösungen, die Prozesse wirtschaftlicher gestalten, Ressourcen schonen, Menschen und unsere Umwelt schützen und so zur Steigerung der Lebensqualität beitragen.

Mit rund 60 Jahren Filtrationserfahrung entwickelt und liefert Freudenberg Filtration Technologies seinen Kunden der Automobilindustrie Filtrationslösungen für die Oberflächentechnik, die Motorzuluft- und die Innenraumlufffiltration.

Die Freudenberg Tochter **Corteco** ist für den Vertrieb der Automobilprodukte an den freien Automobil-Ersatzteilmarkt zuständig. Mit OEM-Verbindungen wie dieser und einem Ruf für Kundenservice und logistische Unterstützung, die unübertroffen sind, wundert es nicht, dass Corteco so viele passende Lösungen für so viele verschiedene Länder anbieten kann.



FREUDENBERG – INNOVATING TOGETHER

La technologie et l'innovation nous inspirent. Ensemble avec nos clients et nos partenaires de recherche, nous développons des technologies de pointe, des produits, des solutions et des services. Tout au long de notre histoire, du tannage au chrome aux appareils médicaux sophistiqués et de haute technologie, en passant par le développement des bagues Simmering, notre entreprise a toujours fait preuve d'innovation. Pour nous, chercher ensemble des solutions favorisant la durabilité mondiale est à la fois notre motivation et notre concept de réussite. Nous vivons "Innovating together" au travers de groupes de travail dans le monde entier. Cela nous permet de fournir aujourd'hui à nos clients des solutions et des réponses aux questions de demain.

Gestion durable

Un des grands défis de la société d'aujourd'hui est la sauvegarde de la propreté de l'air et de l'eau. Il faut donc être novateur. Freudenberg Filtration Technologies développe des solutions pour des procédés plus efficaces tout en sauvegardant nos ressources et en protégeant notre environnement, augmentant ainsi la qualité de vie.

Avec presque 60 ans d'expérience dans la filtration, Freudenberg Filtration Technologies conçoit et fabrique des supports de filtration pour les installations de traitement de surface, pour les filtres à air moteur et pour les filtres d'habitacle de l'industrie automobile.

Corteco, filiale du groupe Freudenberg, est responsable de la distribution des pièces automobiles sur le marché de la rechange indépendante. Muni de tels liens avec l'équipement d'origine, et d'un service client et logistique sans égal, il n'est pas étonnant que Corteco puisse fournir autant de solutions adaptées pour autant de pays différents.

FREUDENBERG – INNOVATING TOGETHER

Ispirati dalla tecnologia e dall'innovazione, insieme con i nostri clienti e con i nostri partner, sviluppiamo tecnologie, prodotti, soluzioni e servizi all'avanguardia. L'innovazione ci accompagna fin dagli esordi – dalla conceria in cromo allo sviluppo del Simmerring® (anello di tenuta) fino ai sofisticati dispositivi medici hi-tech. Per questo, per noi, sviluppare soluzioni che supportano la sostenibilità globale è una filosofia ma anche la chiave per il successo. Viviamo "innovando insieme" ai Business Groups in tutte le regioni del mondo. Questo fa sì che già oggi, possiamo fornire ai nostri clienti soluzioni e risposte ai loro bisogni di domani.

Distribuzione sostenibile

Una delle più importanti sfide che la società moderna deve affrontare è la salvaguardia dell'ambiente. Freudenberg Filtration Technologies ha sviluppato soluzioni in grado di rendere i suoi processi produttivi più efficienti proteggendo le risorse naturali, l'ambiente e migliorando la qualità di vita.

Con una esperienza sessantennale dedicata ai suoi clienti, Freudenberg Filtration Technologies sviluppa e fornisce soluzioni di filtrazione per il settore automotive quali filtri aria abitacolo e filtri aria motore.

Corteco, quale sussidiaria del gruppo Freudenberg, è responsabile della distribuzione nell'indipendent aftermarket per i prodotti automotive. Con un link con l'OE come questo, unito ad un servizio clienti ed una capacità logistica seconda a nessuno, non è difficile comprendere che Corteco è in grado di fornire soluzioni appropriate ad ogni specifica area.

PROTECTS AGAINST POLLEN

micronAir: No. 1 for cabin air filters

HEALTH; THE GREATEST ASSET

Protection against pollutants and pollen

In vehicles without a cabin air filter, concentration levels of pollutants may be as much as six times higher than values at the roadside. Besides allergic reactions, they can also lead to breathing tract diseases, cardiovascular problems and asthma.

micronAir cabin air filters consist of an in-house produced, multi-layered filter medium, which protects occupants effectively against fine dust, pollen, road dust and other fine respirable particles. They ultimately minimize the health risks in the vehicle and provide comfort while driving.

7 THINGS TO KNOW ABOUT micronAir® CABIN AIR FILTERS

- Cabin air filters make sure that you have clean, fresh air in your car everyday
- Carbon activated / combi cabin air filters additionally free the air in your vehicle from ozone and odours
- Your cabin air filter needs to be changed every 10.000km or at least once a year
- Fogged windows may be due to an insufficient or clogged cabin air filter
- A clogged cabin air filter can negatively influence the service life of your air conditioning and heating system
- micronAir cabin air filters protect allergy and asthma sufferers against sneezing and watery eyes. A sneezing attack at a speed of 80 km/h leads to 25 meters of blind driving
- **micronAir cabin air filters are car manufacturers' first choice** – micronAir cabin air filters are installed in every second new car

Without cabin air filters, pollen, soot, dust and gases as well as unpleasant odours reach the interior of the vehicle directly and occupants breathe in unfiltered air, complete with pollutants. It is not only exhaust emissions and industrial pollution that can significantly impair the health and well-being of the occupants, agricultural substances such as fertilizers and liquid manure and natural irritants such as ozone also have a negative impact on health.



Trust the Expert in Filtration

A cabin air filter always provides clean air whilst driving

micronAir particle filters protect against fine dusts, and also against pollens, road dust, abraded particles, soot, bacteria, industrial dusts and other respirable ultra-fine particles.

The micronAir combi filter provides protection against the same pollutants as the particle filter - Using a layer of activated carbon, it additionally adsorbs odours and gases, like benzene or ozone. Besides the small solid particles, the gases, smaller by a factor of ten million, also penetrate as far as the deeper regions of the lung. The dangerous irritant gas ozone can cause reactions like headaches, coughing or streaming eyes. The activated-carbon layer in the micronAir combi filter will break down up to 99 percent of the ozone.



HIGH PROTECTION
+ activated carbon



HEALTH PROTECTION

- Protection against fine dust
- Protection against particles



DRIVING SAFETY

- Protection from poor visibility due to fogged windows
- Improved safety for allergy sufferers, no watery eyes or sneezing



SYSTEM PROTECTION

- Protects the heating and air conditioning system



DRIVING COMFORT

- Protection against ozone (can cause headaches / nausea)
- Protection against odours

SCHÜTZT VOR OZON

micronAir: Der Nr. 1 Innenraumfilter

GESUNDHEIT, DAS HÖCHSTE GUT

Schutz vor Verschmutzung und Pollen

In Fahrzeugen ohne Kfz-Innenraumfilter erreichen die ungefilterten Schadstoffe bis zu sechsfach höhere Werte als am Fahrbahnrand. Neben allergischen Reaktionen können diese auch zu Atemwegserkrankungen, Herz-Kreislauf-Problemen und Asthma führen.

micronAir Innenraumfilter bestehen aus einem eigengefertigten, vielschichtigen Filtermedium, das Fahrzeuginsassen, effektiv vor Feinstaub, Pollen, Straßenstaub und anderen lungengängigen Feinstpartikeln schützt. Sie minimieren die gesundheitlichen Risiken im Fahrzeug und sorgen für mehr Wohlbefinden während der Autofahrt.

7 WISSENSWERTE FAKTEN ÜBER micronAir® INNENRAUMFILTER

- Innenraumfilter sorgen jeden Tag für saubere und frische Luft in Ihrem Auto
- Aktivkohle / Kombifilter befreien zusätzlich die Luft in Ihrem Auto vor Ozon und Gerüchen
- Ihr Innenraumfilter muss alle 10.000 km oder mindestens einmal im Jahr gewechselt werden
- Beschlagene Scheiben können auf einen unzureichend oder verstopften Innenraumfilter hinweisen
- Ein verstopfter Innenraumfilter kann sich negativ auf die Lebensdauer der Klima- und Heizungsanlage auswirken
- micronAir Innenraumfilter schützen Allergiker und Asthmatiker vor tränende Augen und Niesenattacken. Ein Niesanfall mit einer Geschwindigkeit von 80 km/h führt zu 25 Meter blinder Fahrt
- **micronAir Innenraumfilter sind die erste Wahl für Automobilhersteller** - micronAir Innenraumfilter werden in jedem zweiten Neuwagen eingebaut

Ohne Kfz-Innenraumfilter gelangen Pollen, Ruß, Staub und Gase bzw. üble Gerüche direkt ins Auto. Die Insassen atmen dann ungefiltert Schadstoffe ein. Nicht nur Verkehrs- und Industrieabgase können die Gesundheit und das Wohlbefinden von Autoinsassen deutlich beeinträchtigen: Auch landwirtschaftliche Substanzen wie Düngemittel oder Gülle und natürliche Reizgase wie Ozon haben negative Auswirkungen auf die Gesundheit.



Vertrauen Sie dem Experten für Filtration

Ein Innenraumfilter sorgt immer für saubere Luft während der Fahrt

micronAir Partikelfilter schützen vor Feinstaub, aber auch vor Pollen, Straßenstaub, Abrieb, Ruß, Bakterien, Industriestäuben und anderen lungengängigen Feinstpartikeln.

Der micronAir Kombifilter bietet Schutz gegen die gleichen Schadstoffe wie ein Partikelfilter - Mittels Aktivkohleschicht adsorbiert er zusätzlich Gerüche und Gase, z. B. Benzol oder Ozon. Neben den kleinen Feststoffpartikeln gelangen auch die bis zehn Millionen Mal kleineren Gase in die tiefen Regionen der Lunge. Das gefährliche Reizgas Ozon kann Reaktionen wie Kopfschmerzen, Hustenreiz oder tränende Augen verursachen. Die Aktivkohleschicht des micronAir Kombi-Innenraumfilters baut bis zu 99 Prozent des Ozons ab.



HOHER SCHUTZ

+ Aktivkohle



GESUNDHEIT SCHÜTZEN

- Schutz gegen Feinstaub
- Schutz gegen Partikel



SICHERE FAHRT

- Schlechte Sicht durch beschlagene Scheiben vorbeugen
- Verbesserter Schutz für Allergiker, ohne tränende Augen oder Niesen



SYSTEMSCHUTZ

- Schützt die Heizung und Klimaanlage



FAHRKOMFORT

- Schutz vor Ozon (Kann Kopfschmerzen und Übelkeit verursachen)
- Schutz gegen Gerüche

STOP À LA POLLUTION

micronAir® : numéro 1 en filtres d'habitacle

LA SANTÉ, LE BIEN LE PLUS PRÉCIEUX

Protection contre les polluants et les pollens

Dans les véhicules sans filtre d'habitacle, les niveaux de concentration en polluants peuvent être 6 fois plus élevés que sur un bord de route. En plus des réactions allergiques, ils peuvent aussi provoquer des maladies respiratoires comme l'asthme, voire même des problèmes cardiovasculaires.

Les filtres d'habitacle micronAir® sont constitués d'un matériau multi-couches qui protège efficacement les occupants des fines poussières urbaines, des pollens et de toutes les autres particules respirables. Ils minimisent ainsi les risques pour la santé dans le véhicule et apportent un confort de conduite optimal.

7 CHOSES À SAVOIR SUR LES FILTRES D'HABITACLE micronAir®

- Les filtres d'habitacle vous permettent de bénéficier chaque jour d'un air propre et frais dans votre voiture.
- Les filtres d'habitacle à charbon actif offrent une protection supplémentaire contre l'ozone et les odeurs dans votre véhicule.
- Votre filtre d'habitacle doit être changé tous les 10 000 kms ou une fois par an.
- Des vitres embuées peuvent être dues à un filtre d'habitacle inefficace ou colmaté.
- Un filtre d'habitacle colmaté peut altérer la durée de vie de votre climatisation et de votre système de chauffage.
- Les filtres d'habitacle micronAir® permettent de réduire les crises d'éternuements et de larmoiement pour les personnes allergiques et asthmatiques. Une crise d'éternuements pendant une conduite à une vitesse de 80 km/h amène à conduire à l'aveugle sur 25 mètres.
- Les filtres d'habitacle micronAir® s'affichent comme le premier choix des constructeurs automobiles : ils sont installés sur plus d'un véhicule neuf sur deux.

Sans les filtres d'habitacle, les pollens, la suie, la poussière et les gaz aussi bien que les odeurs désagréables entrent directement par les aérations du véhicule et les passagers respirent un air totalement pollué. Ce sont non seulement des gaz d'échappement et des poussières industrielles qui peuvent détériorer la santé et le confort des occupants, mais aussi les substances agricoles comme les engrais et le purin, ou les gaz naturels irritants comme l'ozone qui ont un impact négatif sur la santé.



Faites confiance à l'expert en filtration

Un filtre d'habitacle purifie l'air lors de la conduite

Les filtres à particules micronAir® protègent des poussières fines, des pollens, des poussières urbaines, des particules abrasives, de la suie, des bactéries, des poussières industrielles et autres particules ultra-fines.

Les filtres à charbon actif micronAir® ont toutes les capacités de filtration des filtres à particules. Mais, grâce à leur couche de charbon actif, ils absorbent en plus les odeurs et gaz comme le benzène et l'ozone. En comparaison avec les petites particules solides, les particules de gaz, qui sont dix millions de fois plus petites, arrivent tout aussi bien à pénétrer en profondeur dans les poumons. Et l'ozone, gaz irritant et dangereux, peut provoquer maux de tête, quintes de toux et yeux qui pleurent.

La couche de charbon actif dans le filtre combiné micronAir® neutralisera jusqu'à 99% des molécules d'ozone.



HAUTE PROTECTION

+ charbon actif



PROTECTION DE LA SANTÉ

- Protection maximale contre les poussières fines
- Protection maximale contre les particules



SÉCURITÉ DE CONDUITE

- Protection contre la mauvaise visibilité due à des vitres embuées
- Protection contre les éternuements et les yeux larmoyants pour les victimes d'allergies



PROTECTION DES ÉQUIPEMENTS

- Protection des circuits de climatisation et de chauffage



CONFORT DE CONDUITE

- Protection contre l'ozone (qui peut provoquer des maux de têtes et des nausées)
- Protection contre les odeurs

PER LA MASSIMA VISIBILITÀ

micronAir: N°1 nella filtrazione abitacolo

LA SALUTE, IL BENE PIU' IMPORTANTE

Protezione dai pollini e dagli inquinanti

In veicoli non equipaggiati con filtri aria abitacolo, i livelli di inquinanti possono arrivare ad essere sei volte superiori a quelli presenti per strada. In aggiunta a reazioni allergiche, si potranno avere problemi al sistema respiratorio, cardiovascolare e sintomi come l'asma.

Il filtro aria abitacolo micronAir è composto da uno strato filtrante prodotto internamente al gruppo che protegge gli occupanti da polveri sottili, polline, polvere ed altre micro particelle respirabili. Minimizza al massimo i rischi per la salute e assicura un elevato comfort alla guida.

7 COSE DA SAPERE SUI FILTRI ARIA micronAir®

- I filtri aria abitacolo mantengono pulita l'aria nel tuo abitacolo ogni giorno
- I filtri ai carboni attivi / Combi, purificano l'aria dagli odori e dall'ozono
- Il vostro filtro aria abitacolo deve essere sostituito ogni 10.000km o, almeno, una volta l'anno
- I vetri appannati possono essere causa di un filtro aria abitacolo parzialmente o completamente occluso
- Un filtro aria appannato può influenzare negativamente la durata del sistema di condizionamento dell'auto
- I filtri aria abitacolo micronAir proteggono le persone affette da allergie ed asma dall'averne gli occhi lacrimanti e dagli attacchi di starnuti. Uno starnuto, quando si guida ad 80km/h, comporta uno spazio di 25 metri percorso ad occhi chiusi.
- **I filtri aria abitacolo micronAir sono la scelta principale dei costruttori auto** - un veicolo su due viene equipaggiato con un filtro aria abitacolo micronAir

Senza filtro aria abitacolo, pollini, polveri e gas, inclusi cattivi odori, entrano all'interno dell'abitacolo facendo respirare agli occupanti aria non filtrata. Non sono solo gas di scarico e fumi industriali a ridurre la qualità dell'aria; anche fertilizzanti, liquami ed irritanti presenti in natura, quali l'ozono, hanno un impatto negativo sulla salute.



Fidati degli esperti in filtrazione

Filtri aria abitacolo efficienti garantiscono aria pulita durante la guida

I filtri particellari micronAir proteggono dalle polveri sottili, pollini, polvere, fuliggine, batteri, polveri industriali ed altre particelle sospese.

I filtri combinati micronAir forniscono protezione dagli stessi agenti inquinanti dei filtri particellari, ed usando uno strato addizionale ai carboni attivi, assorbono inoltre odori e gas quali benzene ed ozono. Più fini delle particelle solide, i gas penetrano fino nelle più profonde aree dei polmoni. Gas irritanti, quali l'ozono, causano anche emicranie, tosse e lacrimazione degli occhi. Lo strato ai carboni attivi dei filtri micronAir è in grado di filtrare oltre il 99% dell'ozono presente nell'aria.



ELEVATA PROTEZIONE

+ carboni attivi



SALVAGUARDIA DELLA SALUTE

- Protezione contro le polveri sottili
- Protezione contro i particolati



SICUREZZA ALLA GUIDA

- Visibilità sempre perfetta, cristalli sempre puliti
- Maggior sicurezza per chi soffre di allergie. Mai più occhi che lacrimano o starnuti



PROTEZIONE DEL SISTEMA

- Protezione del sistema di condizionamento e riscaldamento dell'aria



COMFORT DI GUIDA

- Protezione dall'ozono (Causa di mal di testa / nausea)
- Protezione dagli odori



Peak performance with

ENGINE INTAKE AIR FILTERS

Modern high-performance engines need clean air for peak performance. The atmosphere contains both natural (pollen, dust, sand, etc.) and industrial (soot, abraded materials, pollutants, etc.) contaminants which can adversely affect the combustion process, cause engine damage, and affect the sensors present in modern engines.

Apart from standard filter features such as the removal of particles and water, the use of synthetic nonwovens allows the latest design options. These filters can be tailored to fit the available space in accordance with EU pedestrian protection requirements.

Filters for high-performance engines, made from synthetic materials, offer ground-breaking features, such as:

- optimum deep-bed filtration with 150% longer service life and improved initial filtration performance
- ageing resistance and resistance to pressure surge thanks to the use of fully synthetic materials
- non-combustible materials offering advantages in the case of fire
- new processing possibilities thanks to thermoplastic materials
- optimum system protection in accordance with ISO 5011



Overview Engine Intake Air Filters

Manufacturer	Model	Year of manufacture	OE number*	Corteco no.	Corteco shortcode
Audi	A4, A5, Q5	11.07	8R0 133 843 D	80005026	CEA1013
Audi	A8 4.2 FSI	03.10	4H0 129 620 F	80004666	CEA1006
Audi	A8 4.2 TDI	03.10	4H0 129 620 D	80004665	CEA1005
Audi	Q7 V12 TDI	03.06	4L0 129 620	80004667	CEA1007
Audi	R8 (V10) (AUT - 7)	10.14	420 133 844 E	49359273	CEA1020
Audi	R8 (V10) (MAN - 6)	03.07	420 133 844 D	80004669	CEA1009
Audi	R8 (V8) (AUT - 7)	10.14	420 133 843 C	49359272	CEA1019
Audi	R8 (V8) (MAN - 6)	03.07	420 133 843 B	80004668	CEA1008
Audi	A8 V6 TDI	03.10	4H0 129 620 L	80004664	CEA1004
Audi	S8	04.12	4H0 129 620 M	80005027	CEA1014
BMW	5 (F07, F10, F11, F18) / 7 (F01, F02, F03, F04)	09.08	13 71 7 800 151	80004661	CEA1001
BMW	X3 (F25) / X5 (E70, F15, F85) / X6 (E71, E72)	03.07	13 71 7 811 026	80004660	CEA1000
Mazda	3 (BK)	10.03	ZJ01 13 Z40 9A	80005149	CEA1017
Mazda	3 (BL)	06.09	LFBL 13 Z40 9A	80004663	CEA1003
Mazda	3/5	10.03	LF50 13 Z40 9A	80004662	CEA1002
Mazda	CX7	12.05	AJ57 13 Z40 9A	80005029	CEA1016
Mazda	323	06.97	RF4P 13 Z40 9A	80004671	CEA1011
Mazda	626	05.97	RF4F 13 Z40 9A	80004670	CEA1010
Mazda	MX5	05.98	B6MW 13Z40 9A	80004672	CEA1012
Mazda	MX5 III (NC)	03.05	LFG1 13 Z40 9A	80005150	CEA1018
Smart	Fortwo (451)	01.07	A 001 094 03 01	80005028	CEA1015

* The original equipment (OE) numbers shown above only serve for comparison.



Höchste Leistungsfähigkeit mit

MOTORIZULUFTFILTERN

DEUTSCH

Moderne Hochleistungsmotoren benötigen reine Luft um ihre höchste Leistungsfähigkeit zu entfalten. Umgebungsluft enthält Verunreinigungen natürlicher (Pollen, Staub, Sand etc.) und industrieller (Ruß, Abrieb, Emissionen etc.) Herkunft, welche den reibungslosen Ablauf des Verbrennungsprozesses beeinträchtigen und zu Motorschäden führen können. Ebenfalls Schaden nehmen kann die Sensorik von Hochleistungsmotoren.

Unsere Filter-Konzepte für Hochleistungsmotoren aus synthetischen Materialien, bieten zukunftsweisende Lösungen wie:

- optimale Tiefenfiltration, mit bis zu 150% längerer Standzeit und verbesserter Anfangsabscheideleistung
- Alterungsbeständigkeit und Beständigkeit gegen Wasserschlag durch die Verarbeitung von vollsynthetischen Medien
- Vorteile im Brandverhalten durch den Einsatz von nicht brennbaren Materialien
- Neue Verarbeitungsmöglichkeiten durch thermoplastische Konzepte
- Optimaler Systemschutz nach ISO 5011

Neben der standardmäßigen Filterleistung wie Abscheidung störender Partikel und Wasser, bietet die Verarbeitung von synthetischen Vliesstoffen neueste Design-Optionen. Dadurch ist eine optimale Anpassung an vorhandenen Einbauraum unter Berücksichtigung der EU-Fußgängerschutz-Richtlinien möglich.



Übersicht Motorzuluffilter

Hersteller	Model	Baujahr	OE-Nummer*	Corteco - Nr.	Corteco Shortcode
Audi	A4, A5, Q5	11.07	8R0 133 843 D	80005026	CEA1013
Audi	A8 4.2 FSI	03.10	4H0 129 620 F	80004666	CEA1006
Audi	A8 4.2 TDI	03.10	4H0 129 620 D	80004665	CEA1005
Audi	Q7 V12 TDI	03.06	4L0 129 620	80004667	CEA1007
Audi	R8 (V10) (AUT - 7)	10.14	420 133 844 E	49359273	CEA1020
Audi	R8 (V10) (MAN - 6)	03.07	420 133 844 D	80004669	CEA1009
Audi	R8 (V8) (AUT - 7)	10.14	420 133 843 C	49359272	CEA1019
Audi	R8 (V8) (MAN - 6)	03.07	420 133 843 B	80004668	CEA1008
Audi	A8 V6 TDI	03.10	4H0 129 620 L	80004664	CEA1004
Audi	S8	04.12	4H0 129 620 M	80005027	CEA1014
BMW	5 (F07, F10, F11, F18) / 7 (F01, F02, F03, F04)	09.08	13 71 7 800 151	80004661	CEA1001
BMW	X3 (F25) / X5 (E70, F15, F85) / X6 (E71, E72)	03.07	13 71 7 811 026	80004660	CEA1000
Mazda	3 (BK)	10.03	ZJ01 13 Z40 9A	80005149	CEA1017
Mazda	3 (BL)	06.09	LFBL 13 Z40 9A	80004663	CEA1003
Mazda	3/5	10.03	LF50 13 Z40 9A	80004662	CEA1002
Mazda	CX7	12.05	AJ57 13 Z40 9A	80005029	CEA1016
Mazda	323	06.97	RF4P 13 Z40 9A	80004671	CEA1011
Mazda	626	05.97	RF4F 13 Z40 9A	80004670	CEA1010
Mazda	MX5	05.98	B6MW 13Z40 9A	80004672	CEA1012
Mazda	MX5 III (NC)	03.05	LFG1 13 Z40 9A	80005150	CEA1018
Smart	Fortwo (451)	01.07	A 001 094 03 01	80005028	CEA1015

* Oben abgebildete Originalteil-Nummern (OE-Nummer) dienen nur zu Vergleichszwecken.

Performance maximale avec

LES FILTRES À AIR MOTEUR

Les moteurs modernes très performants ont besoin d'un air propre pour conserver un rendement maximal. L'atmosphère contient à la fois des polluants naturels (pollens, poussières, sable, etc...) et des polluants industriels (suie, particules abrasives, etc...) qui peuvent avoir des effets défavorables sur le procédé de combustion, entraîner des dégâts moteur et affecter les capteurs présents dans les nouveaux moteurs.

Les filtres pour les moteurs haute performance, fabriqués à partir de matériaux synthétiques, offrent des caractéristiques révolutionnaires, telles que :

- une amélioration de la performance de filtration initiale et une durée d'utilisation plus longue de 150%
- une résistance à l'usure et à la montée en pression grâce à l'utilisation de matériaux entièrement synthétiques
- des matières incombustibles en cas de chauffe moteur
- de nouvelles possibilités de traitement grâce aux matières thermoplastiques
- une protection optimale des équipements conforme à la norme ISO 5011

En dehors des caractéristiques du filtre standard comme la protection contre les particules et l'eau, l'utilisation de non-tissé synthétique permet de répondre aux dernières conceptions. Ces filtres peuvent s'adapter aux modifications des parties avant des véhicules qui doivent maintenant répondre aux exigences de l'Union Européenne sur la protection des piétons.



Liste des filtres à air moteur

Marque	Modèle	Date de mise en circulation	Référence constructeur*	Référence Corteco	Référence courte Corteco
Audi	A4, A5, Q5	11.07	8R0 133 843 D	80005026	CEA1013
Audi	A8 4.2 FSI	03.10	4H0 129 620 F	80004666	CEA1006
Audi	A8 4.2 TDI	03.10	4H0 129 620 D	80004665	CEA1005
Audi	Q7 V12 TDI	03.06	4L0 129 620	80004667	CEA1007
Audi	R8 (V10) (AUT - 7)	10.14	420 133 844 E	49359273	CEA1020
Audi	R8 (V10) (MAN - 6)	03.07	420 133 844 D	80004669	CEA1009
Audi	R8 (V8) (AUT - 7)	10.14	420 133 843 C	49359272	CEA1019
Audi	R8 (V8) (MAN - 6)	03.07	420 133 843 B	80004668	CEA1008
Audi	A8 V6 TDI	03.10	4H0 129 620 L	80004664	CEA1004
Audi	S8	04.12	4H0 129 620 M	80005027	CEA1014
BMW	5 (F07, F10, F11, F18) / 7 (F01, F02, F03, F04)	09.08	13 71 7 800 151	80004661	CEA1001
BMW	X3 (F25) / X5 (E70, F15, F85) / X6 (E71, E72)	03.07	13 71 7 811 026	80004660	CEA1000
Mazda	3 (BK)	10.03	ZJ01 13 Z40 9A	80005149	CEA1017
Mazda	3 (BL)	06.09	LFBL 13 Z40 9A	80004663	CEA1003
Mazda	3/5	10.03	LF50 13 Z40 9A	80004662	CEA1002
Mazda	CX7	12.05	AJ57 13 Z40 9A	80005029	CEA1016
Mazda	323	06.97	RF4P 13 Z40 9A	80004671	CEA1011
Mazda	626	05.97	RF4F 13 Z40 9A	80004670	CEA1010
Mazda	MX5	05.98	B6MW 13Z40 9A	80004672	CEA1012
Mazda	MX5 III (NC)	03.05	LFG1 13 Z40 9A	80005150	CEA1018
Smart	Fortwo (451)	01.07	A 001 094 03 01	80005028	CEA1015

* Les références constructeurs mentionnées ci-dessus ne sont données qu'à titre indicatif.



Performance al massimo con

FILTRI ARIA MOTORE

I motori ad elevate prestazioni necessitano di aria pulita per ottenere performance elevate. L'atmosfera contiene sia contaminanti naturali (polline, polvere, sabbia, ecc.) che industriali (fuliggine, particelle sospese, inquinanti, ecc.), i quali possono alterare il processo di combustione, danneggiare il motore e creare problemi ai sensori presenti nei motori moderni.

I filtri per motori ad alte prestazioni, costruiti con materiali di sintesi, offrono prestazioni importanti, quali:

- durata superiore del 150% ed un incremento delle capacità filtranti
- elevata resistenza all'usura ed all'aumento di pressione, grazie all'utilizzo di materie sintetiche
- materiali ignifughi offrono chiari vantaggi in caso di fiamme
- nuove capacità di costruzione grazie all'uso di materie termoplastiche
- ottima protezione, in ottemperanza alla ISO 5011

Oltre alle caratteristiche standard di ogni filtro, quali la rimozione di particelle e di umidità, l'utilizzo del tessuto non tessuto rende possibili infinite opzioni. Una delle quali è la possibilità di adattare la forma del filtro allo spazio presente nel vano motore senza interferire con le recenti normative di impatto col pedone.





Gamma Filtri Aria Motore

Costruttore	Modello	Anno di produzione	Codice OE*	Codice Corteco	Codice Corteco (Breve)
Audi	A4, A5, Q5	11.07	8R0 133 843 D	80005026	CEA1013
Audi	A8 4.2 FSI	03.10	4H0 129 620 F	80004666	CEA1006
Audi	A8 4.2 TDI	03.10	4H0 129 620 D	80004665	CEA1005
Audi	Q7 V12 TDI	03.06	4L0 129 620	80004667	CEA1007
Audi	R8 (V10) (AUT - 7)	10.14	420 133 844 E	49359273	CEA1020
Audi	R8 (V10) (MAN - 6)	03.07	420 133 844 D	80004669	CEA1009
Audi	R8 (V8) (AUT - 7)	10.14	420 133 843 C	49359272	CEA1019
Audi	R8 (V8) (MAN - 6)	03.07	420 133 843 B	80004668	CEA1008
Audi	A8 V6 TDI	03.10	4H0 129 620 L	80004664	CEA1004
Audi	S8	04.12	4H0 129 620 M	80005027	CEA1014
BMW	5 (F07, F10, F11, F18) / 7 (F01, F02, F03, F04)	09.08	13 71 7 800 151	80004661	CEA1001
BMW	X3 (F25) / X5 (E70, F15, F85) / X6 (E71, E72)	03.07	13 71 7 811 026	80004660	CEA1000
Mazda	3 (BK)	10.03	ZJ01 13 Z40 9A	80005149	CEA1017
Mazda	3 (BL)	06.09	LFBL 13 Z40 9A	80004663	CEA1003
Mazda	3/5	10.03	LF50 13 Z40 9A	80004662	CEA1002
Mazda	CX7	12.05	AJ57 13 Z40 9A	80005029	CEA1016
Mazda	323	06.97	RF4P 13 Z40 9A	80004671	CEA1011
Mazda	626	05.97	RF4F 13 Z40 9A	80004670	CEA1010
Mazda	MX5	05.98	B6MW 13Z40 9A	80004672	CEA1012
Mazda	MX5 III (NC)	03.05	LFG1 13 Z40 9A	80005150	CEA1018
Smart	Fortwo (451)	01.07	A 001 094 03 01	80005028	CEA1015

* I codici originali (OE) indicati sono solo ad uso comparativo



WE DELIVER THE ORIGINAL.
 – Corteco, Freudenberg Group



FREUDENBERG

2 billion seals per year for the automotive industry in Europe



TrelleborgVibracoustic

Market leader in vibration control with around EUR 1.7 billion turnover per year

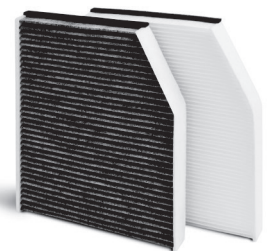

micronAir

cabin air filters in every other new car

VEHICLE APPLICATIONS



VEHICLE APPLICATIONS

FAHRZEUGANWENDUNGEN | APPLICATIONS | APPLICAZIONI



ALFA ROMEO										
146	12.94 → 12.00		+	8	10-20	CP1031 21651915		CC1031 21651951		385x170x17
147	01.01 →	Set	+	4	> 20	CP1202 80000375		CC1202 21652352		175x140x30
155	01.93 → 12.97		+	8	10-20	CP1031 21651915		CC1031 21651951		385x170x17
156	01.98 → 05.06	RHD	+	8	10-20	CP1038 21651970		CC1038 21651953		240x170x17
156 (+ Sportwagon)	09.97 → 12.01		+	8	10-20	CP1026 21651901		CC1026 21651952		290x160x30
156 (+ Sportwagon)	01.02 → 05.06	Set	+	8	10-20	CP1202 80000375		CC1202 21652352		175x140x30
159 (+ Sportwagon)	09.05 →		+	10	10-20	CP1192 80000345		CC1192 80000346		215x200x30
164	01.93 → 09.98		+	4	10-20	CP1021 21651896		-		288x225x13
166	09.98 →		+	3	10-20	CP1203 80000376		CC1203 21651954		292x225x20
Brera	01.06 →		+	10	10-20	CP1192 80000345		CC1192 80000346		215x200x30
GT	11.03 →	Set	+	4	10-20	CP1202 80000375		CC1202 21652352		175x140x30
GTV-Coupé	09.94 →		+	8	10-20	CP1031 21651915		CC1031 21651951		385x170x17
Giuletta (940)	05.10 →		+ / -	12		CP1429 80001770		CC1429 80001793		230x200x26
Mito	09.08 →		+	11		CP1221 80000541		CC1221 80000777		265x215x21
Spider (916)	09.94 → 04.05		+	8	10-20	CP1031 21651915		CC1031 21651951		385x170x17
Spider	09.06 →		+ / -	10		CP1192 80000345		CC1192 80000346		215x200x30
AUDI										
80, 90, Coupé, Cabriolet	06.93 → 08.00		+ / -	4	10-20	CP1015 21651890		CC1015 21651956		252x216x32
A1	05.10 →		+ / -	11	> 20	CP1436 80001783		CC1436 80001784		252x224x36



AUDI										
A2	02.00 → 08.05		+ / -	11	10-20	CP1074 21652356		CC1074 21652357		252x216x32
A3 (8L1) → 8LV-090 450 particle	09.96 → 05.03		+ / -	4	10-20	CP1027 21651912		CC1027 21651955		207x269x34
A3 (8L1) 8LV-090-451 → combi	09.96 → 05.03		+ / -	4	10-20	CP1027 21651912		CC1028 21651967		207x269x34
A3 (8P1)	05.03 →		+	11	10-20	CP1129 21653024		CC1129 21653008		207x269x34
A3 (8P1)	05.03 →	RHD	+	11	10-20	-		CC1298 80000602		385x145x25
A3 (8V1)	04.12 →		+ / -	10		CP1455 80004514		CC1455 80004515		255x235x30
A4 (8D2, B5)	01.95 → 09.01		+ / -	4	10-20	CP1015 21651890		CC1015 21651956		300x203x30
A4 (8E2, B6)	11.00 → 12.04		+ / -	4	10-20	CP1088 21652689		CC1088 21652713		300x203x30
A4 Cabriolet (8H7, 8HE)	04.02 →		+ / -	4	10-20	CP1088 21652689		CC1088 21652713		278x240x35
A4 (8EC, 8ED)	11.04 →		+ / -	4	10-20	CP1088 21652689		CC1088 21652713		278x240x35
A4 (8K2)	11.07 →		+ / -	11	10-20	CP1309 80000879		CC1309 80000880		278x240x35
A4 Allroad (8KH)	04.09 →		+ / -	11	10-20	CP1309 80000879		CC1309 80000880		278x240x35
A4 Avant (8K5)	04.08 →		+ / -	11	10-20	CP1309 80000879		CC1309 80000880		278x240x35
A4	09.15 →		+ / -			CP1524 49363446		CC1524 49363447		309x221x30,5
A5 (8T)	06.07 →		+ / -	11	10-20	CP1309 80000879		CC1309 80000880		342x212x20
A5 Cabriolet (8F)	03.09 →		+ / -	11	10-20	CP1309 80000879		CC1309 80000880		306x192x30
A6 (C4)	06.94 → 12.97		+	7	10-20	CP1029 21651913		CC1029 21651958		306x192x30
A6 (C4)	06.94 → 12.97		-	7	10-20	CP1030 21651914		CC1030 21651957		300x203x30
A6 (C5 - up to Chassis No.: → 4BX045000)	01.97 → 10.98		+ / -	7	10-20	CP1030 21651914		CC1030 21651957		306x101x30
A6 (C5 - from Chassis No.: 4BX045001 →)	10.98 → 01.05		+ / -	7	10-20	CP1088 21652689		CC1088 21652713		250x255x35
A6 (C6)	05.04 →	2 !	+	7	10-20	CP1139 21653067		CC1139 21653066		250x255x35



AUDI										
A6 (4G2)	03.11 →		+ / -	11		CP1431 80001782		CC1431 80001756		270x193x20
A7 Sportback	10.10 →		+ / -	11		CP1431 80001782		CC1431 80001756		403x180x40
A8 (4D2, 4D8)	03.94 → 09.02	Set	-	14	10-20	CP1128 21653023		CC1128 21652552		250x255x35
A8 (4E_)	10.02 → 07.10		+	14	10-20	CP1191 80000343		CC1191 21652898		300x203x30
A8 (4H_)	11.09 →		+ / -	11		CP1431 80001782		CC1431 80001756		207x269x34
Allroad	05.00 → 08.05		+	7	10-20	CP1088 21652689		CC1088 21652713		278x240x35
Q3	01.12 →		+ / -	11	10-20	CP1129 21653024		CC1129 21653008		207x269x34
Q5	11.08 →		+ / -	11	10-20	CP1309 80000879		CC1309 80000880		306x101x30
Q7	03.06 →		+ / -	11		CP1125 21653020		CC1125 21653015		279x207x25
Q7	01.15 →					CP1524 49363446		CC1524 49363447		309x221x30,5
R8	05.07 →	2!	+	11	10-20	CP1139 21653067		CC1139 21653066		279x207x25
TT (8L1) → 8LV-090 450 particle	10.98 →		+ / -	4	10-20	CP1027 21651912		CC1027 21651955		255x235x30
TT (8L1) 8LV-090-451 → combi	10.98 →		+ / -	4	10-20	CP1027 21651912		CC1028 21651967		207x269x34
TT (8J3, 8J9)	10.06 →		+ / -	11	10-20	CP1129 21653024		CC1129 21653008		207x269x34
TT (FV3, FV9)	09.14 →		+ / -	10		CP1455 80004514		CC1455 80004515		255x235x30
BMW										
1er/1 series (E81, E87)	09.04 →		+	8		CP1154 80000063		CC1154 80000064		831x156x32
1er/1 series (E82) Coupé	10.07 →		+	8		CP1154 80000063		CC1154 80000064		831x156x32
1er/1 series (E88)	03.08 →		+	8		CP1154 80000063		CC1154 80000064		831x156x32
1er/1 series (F20)	06.11 →		+ / -	11		CP1445 80004353		CC1445 80004354		324x157x40
2er/2 series (F45, F46)	10.13 →	Set	+ / -	11	10-20	CP1478 80005089		CC1478 80004825		233x116x31



BMW										
3er/3 series (E30)	09.82 → 03.92		+ / -			CP1376 80001488		-		179x179x73
3er/3 serie (E36) Compact	03.94 → 08.00	Set	+	10	> 20	CP1149 80000022		-		300x168x26
3er/3 series (E36)	09.90 → 10.99	Set	-	10	10-20	CP1158 80000073		-		676x120x19
3er/3 series (E36) no Compact	09.90 → 10.99		+	10	> 20	CP1009 21651198		CC1009 80000359		831x156x32
3er/3 series (E46)	02.98 → 02.05		+ / -	3		CP1037 21651969		CC1037 21652336		240x195x22
3er/3 series (E90, E91, E92)	01.05 →		+	3	10-20	CP1154 80000063		CC1154 80000064		831x156x32
3er/3 series M-Version (E90, E92, E93)	03.07 →	Set	+ / -	3		-		CC1377 80001029		248x200x41
3er/3 series (F30 + F31)	10.11 →		+ / -	11		CP1445 80004353		CC1445 80004354		248x200x41
3er/3 series (F34 Gran Turismo)	03.13 →		+ / -	11		CP1445 80004353		CC1445 80004354		337x166x34
4er/4 series (F32, F33, F36)	07.13 →		+ / -	11		CP1445 80004353		CC1445 80004354		327x165x23
5er/5 series (E34)	01.88 → 11.95		+ / -	10	10-20	CP1008 21651197		CC1008 80000377		274x204x34
5er/5 series (E34)	01.88 → 11.95	RHD	+ / -	10	10-20	CP1014 21651888		-		327x180x31
5er/5 series (E39)	11.95 → 05.04	Set	+ / -	2 / 4	10-20	CP1022 21651897		CC1022 21651882		247x206x30
5er/5 series (E60-E61)	07.03 →	Set	+ / -	2 / 4	10-20	CP1138 21653063		CC1138 21653064		247x206x30
5er/5 series (F07 Gran Turismo)	10.09 →	Set	+ / -	11		CP1342 80001210		CC1342 80001211		247x206x30
5er/5 series (F10)	03.10 →	Set	+ / -	11		CP1342 80001210		CC1342 80001211		247x206x30
5er/5 series (F11)	09.10 →	Set	+ / -	11		CP1342 80001210		CC1342 80001211		247x206x30
6er/6 series (E63-E64)	01.04 →	Set	+ / -	2 / 4	10-20	CP1138 21653063		CC1138 21653064		337x166x34
6er/6 series (F12-F13-F6)	03.11 →	Set	+ / -	11		CP1342 80001210		CC1342 80001211		247x206x30
7er/7 series (E32)	09.86 → 09.94		+ / -	10	10-20	CP1008 21651197		CC1008 80000377		374x181x35
7er/7 series (E32)	09.86 → 09.94	RHD	+ / -	10	10-20	CP1014 21651888		-		328x166x30

































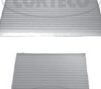





BMW										
7er/7 series (E38)	10.94 → 11.01	Set	+ / -	2 / 4	10-20	CP1135 21653030		CC1135 21651881		250x150x30
7er/7 series (E65-E66-E67)	11.01 → 08.08	Set	+ / -	2 / 4	10-20	CP1093 21652848		CC1093 21652851		247x206x30
7er/7 series (E65-E66-E67)	11.01 → 08.08	RAC	+ / -			-		CC1469 80004653		220x193x30
7er/7 series (F01-F02)	10.08 →	Set	+ / -	11		CP1342 80001210		CC1342 80001211		247x206x30
7er/7 series (F01-F02)	10.08 →	RAC	+ / -			-		CC1467 80004651		245x232x30
I 3	08.13 →	Set	+ / -	12	10-20	CP1478 80005089		CC1478 80004825		233x116x31
I 8	02.14 →		+ / -	11				CC1491 80005225		676x120x19
X1 (E84)	10.09 →		+	3		CP1154 80000063		CC1154 80000064		831x156x32
X1 (F48)	01.15 →		+ / -			CP1478 80005089		CC1478 80004825		440x117x30
X3 (E83)	01.04 →		+ / -	3	10-20	CP1037 21651969		CC1037 21652336		165x88x30
X3 (F25)	09.10 →	Set	+ / -			CP1434 80001776		CC1434 80001777		187x188x25
X3 (F25)	09.10 →	Set RCF				CP1449 80004359		CC1449 80004360		539x242x30
X4 (F26)	04.14 →	Set	+ / -			CP1434 80001776		CC1434 80001777		295x138x34
X5 (E53)	05.00 →		+ / -	3	10-20	CP1155 80000065		CC1155 21652916		198x170x20
X5 (E70)	03.07 →	Set	+ / -	4		CP1283 80000847		CC1283 80000848		295x138x34
X5 (E70) + X6 (E71)	02.07 →	RCF	+ / -			CP1450 80004406		-		295x138x34
X5 (F15)	05.13 →	Set	+ / -	4		CP1283 80000847		CC1283 80000848		261x233x30
X5 (F15)	05.13 →	RCF	+ / -			CP1450 80004406		-		295x138x34
X6 (E71)	05.08 →	Set	+ / -	4		CP1283 80000847		CC1283 80000848		261x233x30
X6 (F16)	08.14 →	RCF	+ / -			CP1450 80004406		-		295x138x34
Z4 (E85)	02.03 → 04.09		+ / -	3	10-20	CP1094 21652849		CC1094 21652852		230x200x20



BMW										
Z4 (E89)	05.09 →		+ / -	3	10-20	CP1094 21652849		CC1094 21652852		220x211x20
CHEVROLET										
Aveo	05.05 →		+ / -	10	10-20	CP1168 80000155		CC1168 80000773		277x206x27
Aveo (T300)	03.11 →		+ / -			CP1487 80005177	 NEW	CC1487 80005178	 NEW	240x204x35
Captiva	06.06 →		+ / -			CP1308 80000877		CC1308 80000878		299x185x30
Cruze (J300)	05.09 →		+ / -	10	10-20	CP1335 80001185		CC1335 80001186		299x185x30
Epica	01.05 →		+			CP1406 80001738		-		216x247x23
Evanda	03.05 →		+			CP1406 80001738		-		189x223x25
HHR	01.06 →		+ / -			CP1444 80004571		-		167x116x36
Lacetti	03.05 →		+	11	10-20	CP1268 80000804		CC1268 80000783		210x205x10
Malibu	01.12 →		+ / -	10	10-20	CP1335 80001185		CC1335 80001186		343x134x30
Matiz	03.05 →		-	11	10-20	CP1306 80000867		CC1306 80000868		240x204x35
Matiz	03.05 →		+	10	10-20	CP1307 80000869		CC1307 80000870		240x204x35
Orlando	12.10 →		+ / -	10	10-20	CP1335 80001185		CC1335 80001186		210x205x10
Rezzo	03.05 →	Set	+ / -		> 20	CP1321 80001033		-		212x198x18
Spark	05.05 →		+ / -	10	10-20	CP1307 80000869		CC1307 80000870		240x204x35
Spark	03.10 →		+ / -			CP1402 80001722		CC1402 80001723		310x212x30
Volt	11.11 →		+ / -	10	10-20	CP1335 80001185		CC1335 80001186		222x279x54
CHRYSLER										
300C	09.04 →		+	4	10-20	CP1205 80000407		CC1205 80000408		215x203x25
Crossfire	07.03 →	LHD + RHD	+	11	> 20	CP1007 21651196		CC1007 21651961		215x203x25
Dodge Avenger	06.07 →		+ / -			CP1337 80001189		CC1337 80001190		215x203x25



CHRYSLER

Dodge Caliber	06.06 →		+ / -			CP1337 80001189		CC1337 80001190		181x91x20
Dodge Journey	06.08 →		+ / -			CP1337 80001189		CC1337 80001190		230x200x30
Dodge Nitro	05.07 →	Set	+ / -			CP1400 80001718		CC1400 80001719		469x78x40
Grand Voyager	01.08 →		+ / -	10	10-20	CP1330 80001174		CC1330 80001175		181x91x20
Jeep Cherokee (KJ)	09.01 →		+ / -	4	> 20	CP1162 80000079		CC1162 80000415		469x78x40
Jeep Cherokee (KK)	01.08 →	Set	+ / -			CP1400 80001718		CC1400 80001719		215x203x25
Jeep Commander	09.05 →		+ / -	4	> 20	CP1162 80000079		CC1162 80000415		469x78x40
Jeep Compass	08.06 →		+ / -			CP1337 80001189		CC1337 80001190		181x91x20
Jeep Grand Cherokee II	10.98 →		+	4	> 20	CP1162 80000079		CC1162 80000415		262x243x32
Jeep Grand Cherokee III	06.05 →	Set	+ / -			CP1400 80001718		CC1400 80001719		215x240x20
Jeep Grand Cherokee IV	11.10 →		+ / -			CP1438 80001785		CC1438 80001786		215x203x25
Jeep Grand Cherokee V	10.13 →		+ / -			CP1490 80005209	 <small>NEW</small>	CC1490 80005210	 <small>NEW</small>	226x115x30
Jeep Patriot	01.08 →		+ / -			CP1337 80001189		CC1337 80001190		220x167x30
PT Cruiser	06.00 →		+ / -	7		CP1164 80000082		CC1164 80000759		300x235x17
Jeep Renegade	10.14 →		+ / -	10		CP1462 80004572		CC1462 80004719		300x217x24
Voyager III (RG)	02.00 →		+ / -	10	> 20	CP1148 21653151		CC1148 21652854		300x235x17
Voyager III (RG)	02.00 →	RHD	+ / -	10	> 20	CP1275 80000811		CC1275 21652855		194x195x20
Voyager IV	10.07 →			10	10-20	CP1330 80001174		CC1330 80001175		225x222x32
CITROËN										
Berlingo (MF)	07.96 → 12.00		+	11	10-20	CP1024 21651899		CC1024 80000077		225x222x32
Berlingo (MF)	12.00 →		+	11	10-20	CP1133 21653028		CC1133 21653146		292x96x30



CITROËN

Berlingo	04.08 →	Set	+	11	10-20	CP1282 80000839		CC1282 80000615		195x145x30,5
C1	06.05 → 04.14		+ / -	11	10-20	CP1259 80000662		CC1259 80000784		285x177x35
C1	05.14 →		+ / -	11		CP1489 80005194	 NEW	CC1489 80005202	 NEW	285x177x35
C2	09.03 →		+ / -	4	10-20	CP1082 21652548		CC1082 21652540		285x177x35
C3 (FC_)	02.02 →		+ / -	4	10-20	CP1082 21652548		CC1082 21652540		285x177x35
C3 II	11.09 →		+ / -	4	10-20	CP1082 21652548		CC1082 21652540		285x177x35
C3 Picasso	02.09 →		+ / -	4	10-20	CP1082 21652548		CC1082 21652540		285x177x35
C3 Pluriel (HB_)	05.03 →		+ / -	4	10-20	CP1082 21652548		CC1082 21652540		285x177x35
C4 (LC_)	06.04 →		+ / -	4	10-20	CP1082 21652548		CC1082 21652540		285x177x35
C4 (B7)	11.09 →		+ / -	4	10-20	CP1082 21652548		CC1082 21652540		285x177x35
C4 Picasso (+ Grand Picasso)	10.06 →	Set	+	11	10-20	CP1282 80000839		CC1282 80000615		215x200x30
C4 Picasso II (+ Grand Picasso)	02.13 →	Set	+	11	10-20	CP1282 80000839		CC1282 80000615		150x158x30 200x158x30
C4 Aircross	08.10 →		+ / -	10	10-20	CP1284 80000853		CC1284 80000854		330x168x78
C4 Cactus	09.14 →	Set	+ / -	4	10-20	CP1260 80000666		CC1260 80000667		150x158x30
C5 (DC_, DE_)	03.01 → 09.04		+	12	10-20	CP1144 21653141		CC1144 21653142		269x196x30
C5 (RC_, RE_)	09.04 →		+ / -	12	10-20	CP1271 80000807		CC1271 21653102		269x196x30
C5 (RD_, TD_)	02.08 →		+ / -	12		CP1371 80001458		CC1371 80001459		315x154x35
C6 (from Chassis No.: 11557 →)	07.08 →		+ / -			CP1371 80001458		CC1371 80001459		405x165x32
C6 (up to Chassis No.: → 11557)	09.05 → 07.08		+ / -	12	10-20	CP1271 80000807		CC1271 21653102		215x200x30
C8	07.02 →		+ / -	2	10-20	CP1096 21652856		CC1096 21653147		179x177x19
C-Crosser + Enterprise	02.07 →		+ / -	10	10-20	CP1284 80000853		CC1284 80000854		150x158x30 200x158x30



CITROËN

C-Zero	10.10 →		+ / -			CP1435 80001778		CC1435 80001779		285x177x35
DS 3	04.10 →	Set	+ / -	4	10-20	CP1260 80000666		CC1260 80000667		150x158x30
DS 4	04.11 →		+ / -	4	10-20	CP1082 21652548		CC1082 21652540		285x177x35
DS 5	11.11 →	Set	+ / -	11	> 20	CP1473 80004776		CC1473 80004703		435x144x17
Evasion	06.94 → 07.02	3-Set	+	3	10-20	CP1066 21652342		CC1066 80000765		435x144x17
Jumper (230)	02.94 → 04.02		+	4	10-20	CP1056 21651994		CC1056 80000432		235x250x25
Jumper (244)	04.02 → 03.06		+	4	10-20	CP1056 21651994		CC1056 80000432		184x93x30
Jumper	04.06 →		+ / -	12	10-20	CP1278 80000815		CC1278 80000816		376x176x49
Jumpy	06.94 → 12.06	3-Set	+	3	10-20	CP1066 21652342		CC1066 80000765		220x177x30
Jumpy	01.07 →		+ / -	8	10-20	CP1305 80000865		CC1305 80000866		194x195x20
Nemo	02.08 →		+ / -			CP1316 80001027		CC1316 80001171		429x171x32
Xantia	03.93 → 01.98		+	11	> 20	CP1024 21651899		CC1024 80000077		194x195x20
XM (Y4)	05.94 → 10.00		+ / -	4	10-20	CP1035 21651919		CC1035 80000748		270x193x20
Xsara	08.00 → 08.05		-	11	10-20	CP1024 21651899		CC1024 80000077		225x222x32
Xsara	08.00 → 08.05	MAN AC	+	11	10-20	CP1136 21653032		CC1136 80000344		194x195x20
Xsara	08.00 → 08.05	AUT AC	+	11	10-20	CP1133 21653028		CC1133 21653146		257x202x30
Xsara (N1)	04.97 → 04.05		+ / -	11	10-20	CP1024 21651899		CC1024 80000077		194x195x20
Xsara Picasso	11.99 →		+ / -	3	10-20	CP1079 21652543		CC1079 80000429		223x190x45
ZX Break (N2)	10.93 → 02.98		+ / -	11	10-20	CP1024 21651899		CC1024 80000077		248x180x35
DACIA										
Dokker	11.12 →		+ / -	11		CP1458 80004548		CC1458 80004702		228x160x30

**DACIA**

Duster	04.10 →		+ / -	10	10-20	CP1159 80000074		CC1159 80004402		222x190x43
Lodgy	07.12 →		+ / -	11		CP1458 80004548		CC1458 80004702		210x200x35
Logan	09.04 →		+ / -	11		CP1050 21651983		CC1050 80000114		223x190x45
Logan II + MVC II	01.12 →		+ / -	11		CP1465 80004638		CC1465 80004639		210x200x35
Sandero	06.08 →		+ / -	10	10-20	CP1159 80000074		CC1159 80004402		222x190x43
Sandero II	01.13 →		+ / -	11		CP1465 80004638		CC1465 80004639		210x200x35

DAEWOO

Evanda	03.05 →		+			CP1406 80001738		-		189x223x25
Kalos	09.02 →		+ / -	10	10-20	CP1168 80000155		CC1168 80000773		215x187x25
Lacetti	02.04 →		+	10	10-20	CP1268 80000804		CC1268 80000783		260x200x25
Lanos	05.97 →		+ / -	4	10-20	CP1062 21652338		-		260x200x25
Leganza	06.97 → 12.02		+ / -	4	10-20	CP1064 21652340		-		215x187x25
Leganza	06.97 → 12.02	RHD	+ / -	4	10-20	CP1065 21652341		-		215x187x25
Nubira	05.97 →		+ / -	4	10-20	CP1062 21652338		-		343x134x30
Nubira	05.97 →	RHD	+ / -	4	10-20	CP1063 21652339		-		155x140x20
Rezzo	09.00 →	Set	+ / -		> 20	CP1321 80001033		-		185x178x30

DAIHATSU

Cuore VII	05.03 →		+ / -	10		CP1276 80000812		CC1276 21653033		161x133x18
Cuore VIII	10.07 →		+	10		CP1226 80000603		CC1226 80000763		155x158x19
Materia	10.06 →		+ / -	10	10-20	CP1319 80001037		CC1319 80001038		185x178x30
Sirion	01.05 →		+ / -	4		CP1299 80004395		CC1299 80000617		161x133x18
Terios	05.06 →		+	10		CP1226 80000603		CC1226 80000763		215x200x30

**DAIHATSU**

Trevis	06.06 →		+ / -	10	10-20	CP1319 80001037		CC1319 80001038		372x86x30
--------	---------	--	-------	----	-------	---------------------------	--	---------------------------	--	-----------

FERRARI

360	01.99 →					CP1261 80000668		CC1261 80000778		372x86x30
360 Challenge	01.99 →					CP1261 80000668		CC1261 80000778		372x86x30
360 Challenge Stradale	01.99 →					CP1261 80000668		CC1261 80000778		372x86x30
360 GT	01.99 →					CP1261 80000668		CC1261 80000778		372x86x30
360 Modena	03.99 →					CP1261 80000668		CC1261 80000778		250x215x40
California	07.08 →		+	10	10-20	CP1192 80000345		CC1192 80000346		215x200x30
Enzo Ferrari	09.03 →					CP1261 80000668		CC1261 80000778		372x86x30
360 Spider	02.00 →					CP1261 80000668		CC1261 80000778		205x178x18
612 Scaglietti	04.04 →					-		CC1292 80000669		195x187x30

FIAT

500 + 500C	10.07 → 11.11		+ / -	11	10-20	CP1131 21653026		CC1131 80000754		220x167x30
500 + 500C	12.11 →		+ / -	11, 12	10-20	CP1451 80004407		CC1451 80004544		308x140x18
500L + 500X	10.12 →		+ / -	10		CP1462 80004572		CC1462 80004719		290x160x30
Barchetta	03.95 →		+	8	10-20	CP1019 21651894		CC1019 80000433		240x170x17
Brava / Bravo	10.95 → 10.01		+	8		CP1026 21651901		CC1026 21651952		233x182x22
Brava / Bravo	10.95 → 10.01	RHD	+	8		CP1038 21651970		CC1038 21651953		385x170x17
Bravo	04.07 →		+ / -	11		CP1132 21653027		CC1132 21652538		288x225x13
Coupé	11.93 → 08.00		+	8		CP1031 21651915		CC1031 21651951		330x163x30
Croma (154)	12.85 → 12.96		+	4	10-20	CP1021 21651896		-		216x163x25
Croma (194)	06.05 →		+ / -	3		CP1092 21652714		CC1092 21652715		220x177x30



FIAT										
Dobló (119, 223)	03.01 →		+	11	10-20	CP1080 21652544		CC1080 21651296		435x144x17
Dobló Cargo (152, 263)	02.10 →		+ / -			CP1316 80001027		CC1316 80001171		435x144x17
Ducato (230)	01.94 → 04.02		+	4	10-20	CP1056 21651994		CC1056 80000432		235x250x25
Ducato (244)	04.02 →		+	4	10-20	CP1056 21651994		CC1056 80000432		220x177x30
Ducato (250)	06.06 →		+	12	10-20	CP1278 80000815		CC1278 80000816		265x215x21
Fiorino	02.08 →		+ / -			CP1316 80001027		CC1316 80001171		215x203x25
Fiorino	02.08 →	RHD	+			CP1221 80000541		CC1221 80000777		265x215x21
Freemont	06.11 →		+ / -	10	10-20	CP1337 80001189		CC1337 80001190		216x163x25
Grande Punto	10.05 →		+	10	10-20	CP1221 80000541		CC1221 80000777		265x215x21
Idea	01.04 →		+	11		CP1080 21652544		CC1080 21651296		290x160x30
Linea	06.07 →		+ / -			CP1316 80001027		CC1316 80001171		240x170x17
Marea	09.96 →		+	8		CP1026 21651901		CC1026 21651952		293x160x35
Marea	09.96 →	RHD	+	8		CP1038 21651970		CC1038 21651953		234x213x12
Multipla	04.99 →		+ / -	4	10-20	CP1059 21652308		CC1059 80000430		405x212x60
Palio	12.95 → 05.99		+	12	> 20	CP1108 21652899		CC1108 80000755		205x178x18
Palio	05.99 → 03.01		+	12	> 20	CP1109 21652900		-	-	195x187x30
Panda (169)	09.03 →		+ / -	11	10-20	CP1131 21653026		CC1131 80000754		308x140x18
Panda (323)	01.12 →		+ / -	11, 12	10-20	CP1451 80004407		CC1451 80004544		216x163x25
Punto (176)	09.93 → 06.00		+	8	10-20	CP1019 21651894		CC1019 80000433		265x215x21
Punto (188)	09.99 →		+	11	10-20	CP1080 21652544		CC1080 21651296		265x215x21
Punto Evo	10.09 →		+			CP1221 80000541		CC1221 80000777		265x215x21



FIAT										
Punto (199)	03.12 →		+ / -			CP1221 80000541		CC1221 80000777		265x215x21
Qubo	09.08 →		+ / -			CP1316 80001027		CC1316 80001171		405x165x32
Scudo	02.96 →	3-Set	+	3	10-20	CP1066 21652342		CC1066 80000765		376x176x49
Scudo	01.04 →		+	2	10-20	CP1096 21652856		CC1096 21653147		185x178x30
Scudo	01.07 →		+ / -	8		CP1305 80000865		CC1305 80000866		233x182x22
Sedici	01.06 →		+	10	10-20	CP1226 80000603		CC1226 80000763		258x164x22
Stilo (+ Multiwagon)	10.01 →		+ / -	11	10-20	CP1132 21653027		CC1132 21652538		385x170x17
Strada	06.99 →		+	10	> 20	CP1240 80000637		CC1240 80000779		385x170x17
Tempra	03.90 → 08.97		+	8	10-20	CP1031 21651915		CC1031 21651951		184x93x30
Tipo	07.87 → 04.95		+	8	10-20	CP1031 21651915		CC1031 21651951		405x165x32
Ulysse (220)	06.94 → 08.02	3-Set	+	3	10-20	CP1066 21652342		CC1066 80000765		240x190x22
Ulysse (179AX)	08.02 →		+	2	> 20	CP1096 21652856		CC1096 21653147		240x208x35
FORD										
B-Max	10.12 →		+ / -			CP1326 80001128		CC1326 80001129		240x208x35
C-Max	10.03 → 10.07		+ / -	12	> 20	CP1137 21653034		CC1137 21653035		250x203x36
C-Max	02.07 →		+ / -	12	> 20	CP1137 21653034		CC1137 21653035		505x102x30
C-Max + Grand C-Max	12.10 →		+ / -	11		CP1432 80001772		CC1432 80001773		250x203x35
Cougar	10.98 → 04.02		+ / -	4	10-20	CP1000 21650107		CC1000 21652959		280x162x30
Courier	02.96 →		+ / -	4	10-20	CP1018 21651893		CC1018 21652355		240x190x22
Escape (US-Vehicle)	01.01 →		+ / -	4		CP1112 21652993		CC1112 80000284		350x151x30
Ecosport	10.13 →		+ / -			CP1326 80001128		CC1326 80001129		350x151x30



FORD										
Fiesta III	01.89 → 01.97		+ / -	4	10-20	CP1018 21651893		CC1018 21652355		242x186x35
Fiesta IV	06.95 → 12.01		+ / -	4	10-20	CP1018 21651893		CC1018 21652355		240x190x22
Fiesta V	11.01 →		+ / -	12	> 20	CP1097 21652857		CC1097 21652858		350x160x30
Fiesta VI	10.08 →		+ / -	12		CP1326 80001128		CC1326 80001129		235x209x35
Focus	10.98 → 11.04		+ / -	4	10-20	CP1057 21651995		CC1057 21652354		250x203x36
Focus II	11.04 →		+	12	> 20	CP1153 80000061		CC1153 80000062		235x209x35
Focus III	04.11 →		+ / -	11		CP1432 80001772		CC1432 80001773		250x203x35
Fusion	08.02 →		+ / -	12	> 20	CP1097 21652857		CC1097 21652858		240x208x35
Galaxy (WGR)	03.95 → 05.06		+ / -	4	10-20	CP1020 21651895		CC1020 21651960		350x151x30
Galaxy (WA6)	05.06 →		+ / -	12	> 20	CP1137 21653034		CC1137 21653035		205x177x20
Galaxy	01.15 →		+ / -			CP1515 49356179		CC1515 49356180		129x102x20
Ka	09.96 →		+ / -	8	10-20	CP1018 21651893		CC1018 21652355		240x208x35
Ka	02.09 →		+ / -			CP1131 21653026		CC1131 80000754		250x203x36
Kuga	03.08 →		+ / -	12	10-20	CP1137 21653034		CC1137 21653035		262x193x20
Kuga II	04.13 →		+ / -	11		CP1432 80001772		CC1432 80001773		250x203x35
Maverick	02.93 → 04.98		+	10	> 20	CP1069 21652347		CC1069 80000416		505x102x30
Maverick	02.01 →		+ / -	4	> 20	CP1112 21652993		CC1112 80000284		505x102x30
Mondeo I	01.93 → 08.96		+ / -	4	10-20	CP1000 21650107		CC1000 21652959		509x100x35
Mondeo II	09.96 → 11.00		+ / -	4	10-20	CP1000 21650107		CC1000 21652959		240x208x35
Mondeo III	11.00 →		+ / -	4	10-20	CP1089 21652709		CC1089 21652361		277x226x40
Mondeo IV	03.07 →		+ / -	12	> 20	CP1137 21653034		CC1137 21653035		350x151x30



FORD										
Mondeo V	09.14 →		+ / -	10	10-20	CP1515 49356179	 NEW	CC1515 49356180	 NEW	129x102x20
Mustang	01.05 → 01.15		+ / -			CP1529 49368138	 NEW	CC1529 49368139	 NEW	202x180x24
Mustang	02.15 →		+ / -			CP1528 49368136	 NEW	CC1528 49368137	 NEW	254x200x30,5
Puma	03.97 → 06.02		+ / -	8	10-20	CP1018 21651893		CC1018 21652355		240x208x35
Scorpio II	10.94 → 08.98	3-Set	+	4	10-20	CP1039 21651971		CC1039 80000793		354x120x24
S-Max (WA6)	05.06 →		+ / -	12		CP1137 21653034		CC1137 21653035		354x120x24
S-Max	01.15 →		+ / -			CP1515 49356179	 NEW	CC1515 49356180	 NEW	129x102x20
Tourneo	01.00 →		+	3	10-20	CP1077 21652360		CC1077 80000751		354x120x24
Transit (E...)	06.94 → 07.00		+	3	10-20	CP1077 21652360		CC1077 80000751		215x200x30
Transit (FA, FD, FB, FS, FZ, FC)	01.00 → 05.06		+	3	10-20	CP1077 21652360		CC1077 80000751		280x183x30
Transit	07.06 → 07.12		+ / -			CP1463 80004673		CC1463 80004573		280x183x30
Transit	08.12 →		+ / -			CP1466 80004650		CC1466 80005090	 NEW	240x190x22
Transit Connect	09.02 →		+	3	10-20	CP1057 21651995		CC1057 21652354		277x202x17
Transit Connect	09.13 →		+ / -			CP1432 80001772		CC1432 80001773		250x203x35
Transit Courier	02.14 →		+ / -			CP1326 80001128		CC1326 80001129		250x203x36
Transit Custom	12.12 →		+ / -			CP1466 80004650		CC1466 80005090	 NEW	350x160x30
HONDA										
Accord VII (no Coupé)	10.98 → 12.02		+	10	> 20	CP1076 21652359		CC1076 80000431		234x224x28
Accord VII Coupé	02.98 → 06.03	Set	+	10	10-20	CP1169 80000156		CC1169 80000791		234x224x28
Accord VIII	02.03 →		+	10	> 20	CP1179 80000330		CC1179 80000404		223x198x30
Accord IX	07.08 →		+	10	> 20	CP1179 80000330		CC1179 80000404		212x211x30



HONDA

Civic IV	09.87 → 11.95		+	11	> 20	CP1067 21652345		CC1067 80000428		225x112x30
Civic VI	09.94 → 03.01		+	10	> 20	CP1040 21651972		CC1040 80000742		240x197x30
Civic VII	02.01 → 09.05	Set, LHD + RHD	+ / -	10	> 20	CP1081 21652546		CC1081 80000148		234x224x28
Civic VII facelift	09.05 → 05.06		+	10	> 20	CP1234 80000620		CC1234 80000622		234x224x28
Civic VIII	05.06 → 02.12		+ / -	10		CP1179 80000330		CC1179 80000404		223x198x30
Civic IX	02.12 →		+ / -	10		CP1179 80000330		CC1179 80000404		212x211x30
CR-V I	10.95 → 02.02		+	10	> 20	CP1067 21652345		CC1067 80000428		225x112x30
CR-V I	10.95 → 02.02		-	11	> 20	CP1040 21651972		CC1040 80000742		234x224x28
CR-V II	03.02 → 09.06	Set, LHD + RHD	+ / -	10	> 20	CP1081 21652546		CC1081 80000148		234x224x28
CR-V III	01.07 →		+ / -	10		CP1179 80000330		CC1179 80000404		205x211x28
CR-V IV	11.12 →		+ / -	10		CP1179 80000330		CC1179 80000404		225x112x30
CR-Z	06.10 →		+ / -	10	10-20	CP1334 80001183		CC1334 80001184		180x95x30
FR-V	01.05 →	Set, LHD + RHD	+ / -	10	> 20	CP1081 21652546		CC1081 80000148		205x211x28
HR-V	03.99 →	2!	+ / -	10	> 20	CP1111 21652990		CC1111 80000439		223x198x30
Insight	04.09 →		+ / -	10	10-20	CP1334 80001183		CC1334 80001184		178x183x29
Insight (ZE)	08.00 → 12.06		+	11	> 20	CP1067 21652345		CC1067 80000428		205x211x28
Jazz II	03.02 →		+	10	> 20	CP1110 21652989		CC1110 80000437		200x103x25
Jazz III	09.08 →		+ / -	10	10-20	CP1334 80001183		CC1334 80001184		205x211x28
Jazz IV	01.14 →					CP1334 80001183		CC1334 80001184		205x211x28
Legend III	02.96 → 12.04	Set	-	10	> 20	CP1178 80000179		CC1178 80000790		160x150x20
Legend IV	09.06 →		+ / -	10		CP1179 80000330		CC1179 80000404		225x112x30



HONDA

S2000 Cabriolet	06.99 →		+	4	10-20	CP1207 80000410		CC1207 80000411		245x195x24
Stream	05.01 →	Set, LHD + RHD	+ / -	10	> 20	CP1081 21652546		CC1081 80000148		244x102x12

HYUNDAI

Accent	10.94 → 01.00		+ / -	10	10-20	CP1170 80000157		CC1170 80000400		236x199x20
Accent II	01.00 →	Set / wF	+	10	10-20	CP1166 80000084		CC1166 80000441		266x234x30
Accent III	11.05 →		+ / -	10	10-20	CP1277 80000813		CC1277 80000814		236x199x20
Coupé (GK)	02.02 →		+	10	> 20	CP1165 80000083		CC1165 80000440		260x208x25
Elantra	06.00 → 10.03		+	10	10-20	CP1165 80000083		CC1165 80000440		195x240x20
Elantra	10.03 → 10.06		+	10	10-20	CP1304 80000852		-	-	236x105x12
Elantra	11.06 →		+ / -	10	10-20	CP1516 49359582		NEW	-	238x195x20
Elantra	09.10 →		+ / -	10	10-20	CP1516 49359582		NEW	-	238x195x20
Getz	08.02 → 09.05	Set / wF	+	10	10-20	CP1166 80000084		CC1166 80000441		225x203x17
Getz	08.02 → 09.05		-			CP1405 80001739		-	-	223x256x30
Getz	10.05 →	Set	+	10	10-20	CP1251 80000650		-	-	150x112x25
Genesis Coupé	01.08 →		+	10	10-20	CP1253 80000652		CC1253 80000780		200x168x40
Grandeur	04.05 →		+	10	> 20	CP1266 80000767		CC1266 80000764		220x120x20
H 1	10.97 →		+ / -	11	10-20	CP1322 80001034		-	-	200x168x40
H 1 + Cargo	02.08 →	Set	+ / -	10		CP1327 80001130		CC1327 80001131		175x175x12
H-100	07.93 →		+ / -	11	10-20	CP1322 80001034		-	-	288x82x19
i 10	10.07 →		+ / -	10	10-20	CP1237 80000634		CC1237 80004405		246x173x21
i 20	09.08 →	Set	+ / -	10	10-20	CP1366 80001448		CC1366 80001449		190x145x20 190x73x20



HYUNDAI

i 20 (GB)	11.14 →		+ / -	10	10-20	CP1516 49359582				238x195x20
i 30	10.07 →	LHD	+ / -	10		CP1285 80000871		CC1285 80000872		246x173x21
i 30	10.07 →	Set, RHD	+ / -			CP1409 80001734		CC1409 80001733		187x238x19
i 30 (GD)	11.11 →		+ / -	10	10-20	CP1516 49359582				238x195x20
ix 20	11.10 →		+ / -	10	10-20	CP1369 80001454		CC1369 80001455		225x203x17
ix 35	01.10 →		+ / -	10		CP1344 80001214		CC1344 80001215		238x187x19
ix 40 CW	07.11 →		+	10	10-20	CP1253 80000652		CC1253 80000780		266x234x30
ix 55	09.08 →		+ / -	10	10-20	CP1360 80001437		CC1360 80001438		245x188x38
Matrix	06.01 →		+	10	10-20	CP1165 80000083		CC1165 80000440		223x256x30
Santa Fé	02.01 →		+	10	> 20	CP1171 80000158		CC1171 80000402		262x208x20
Santa Fé	03.06 →		+	10	> 20	CP1266 80000767		CC1266 80000764		227x254x20
Santa Fé (CM)	01.10 →		+ / -			CP1433 80001774		CC1433 80001775		245x188x38
Santa Fé (DM)	09.12 →		+ / -			CP1453 80004433		CC1453 80004434		258x102x38
Sonata III	03.98 → 09.01		+	10	> 20	CP1171 80000158		CC1171 80000402		223x256x30
Sonata IV	10.01 → 12.04	Set	+	10	> 20	CP1222 80000546		-		230x262x35
Sonata V	01.05 →		+ / -	10	> 20	CP1266 80000767		CC1266 80000764		236x200x25
Sonata VI	01.09 →		+ / -			CP1331 80001176		CC1331 80001177		236x100x25
Terracan	12.01 →		+ / -	10	10-20	CP1172 80000159		CC1172 80000401		245x188x38
Terracan	01.05 →	Set	+	10	10-20	CP1252 80000651		-		217x107x17
Trajét	03.00 →		+	10	10-20	CP1171 80000158		CC1171 80000402		225x203x17
Tucson	08.04 →	Set RHD	+ / -	10		CP1310 80000911		CC1310 80000912		187x238x19

**HYUNDAI**

Tucson	08.04 → 01.06		+	10	10-20	CP1253 80000652		CC1253 80000780		225x203x17
Tucson	02.06 → 12.14		+ / -	10		CP1344 80001214		CC1344 80001215		238x187x19
Tucson	01.15 →		+ / -	10		CP1344 80001214		CC1344 80001215		238x187x19
Veloster	03.11 →		+	10	10-20	CP1253 80000652		CC1253 80000780		222x200x30
XG 30/300	12.98 →		+	10	10-20	CP1171 80000158		CC1171 80000402		221x211x20

INFINITI

FX	01.03 →	LHD + RHD	+ / -	10		CP1068 21652346		CC1068 80000746		222x200x30
----	---------	-----------	-------	----	--	---------------------------	--	---------------------------	--	------------

ISUZU

D-Max	05.02 → 01.07		+ / -			CP1412 80001731		-		230x100x20
D-Max	01.07 →		+ / -	10		CP1068 21652346		CC1068 80000746		230x100x20
Trooper	08.91 → 08.99		+	10		CP1174 80000161		CC1174 80000774		290x160x30
Trooper	04.00 →	Set	+ / -	10		CP1173 80000160		CC1173 80000792		291x191x30







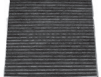

IVECO

Daily 2	05.99 →		+			CP1026 21651901		CC1026 21651952		250x182x45
Daily 3	05.06 →		+ / -			CP1311 80000915		CC1311 80000916		291x191x30
Daily 6	06.14 →		+ / -			CP1520 49361897		NEW		214x214x30
Massif	10.08 →		+ / -			CP1311 80000915		CC1311 80000916		291x191x30

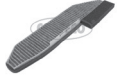











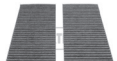







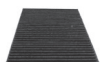

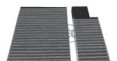

JAGUAR

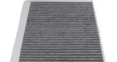
F-Type	10.12 →		+	4		CP1290 80004396		CC1290 80000606		260x184x43
S-Type	01.99 → 05.02		+	4	10-20	CP1228 80000607		-		197x192x200
S-Type	05.02 →		+	4	> 20	CP1273 80000809		CC1273 21652859		290x203x45
XF	03.08 →		+ / -	11		CP1332 80001178		CC1332 80001179		197x192x200
XJ X350	01.02 →		+ / -	4	10-20	CP1272 80000808		CC1272 21652991		411x120x17

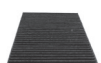
**JAGUAR**

XJ (X351)	01.10 →		+ / -	11		CP1332 80001178		CC1332 80001179		411x120x17
XK8	01.01 →		+	3	10-20	CP1090 21652710		CC1090 80000756		250x182x45
XK8	01.01 →	RHD	+	3	10-20	CP1091 21652711		CC1091 80000757		509x100x35
XK9	03.06 →		+			CP1290 80004396		CC1290 80000606		257x107x12
XType	06.01 →		+ / -	4	> 20	CP1089 21652709		CC1089 21652361		253x109x20

KIA

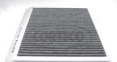
Carens I	11.00 → 07.02	Set	+	10	10-20	CP1223 80000547		CC1223 80000798		266x225x21
Carens II	07.02 →	Set	+	10	10-20	CP1224 80000548		CC1224 80000797		266x225x21
Carens III	09.06 →	Set	+	10	10-20	CP1224 80000548		CC1224 80000797		266x225x21
Carens IV	03.13 →		+ / -	10	10-20	CP1516 49359582		NEW		238x195x20
Carnival I	08.99 → 10.01		+	10	10-20	CP1219 80000537		CC1219 80000776		240x211x17
Carnival II	10.01 →		+	10	10-20	CP1219 80000537		CC1219 80000776		211x113x18
Carnival III	06.06 →	MAN AC	+	10		CP1256 80000655		CC1256 80000781		190x145x20 190x73x20
Carnival III	06.06 →	AUT AC	+	10		CP1362 80001441		CC1362 80001442		246x173x21
Cee'd	12.06 →	Set, RHD	+ / -			CP1409 80001734		CC1409 80001733		246x173x21
Cee'd	01.07 →	LHD	+ / -	10		CP1285 80000871		CC1285 80000872		246x173x21
Cee'd	05.12 →		+ / -	10	10-20	CP1516 49359582		NEW		238x195x20
Cerato	04.04 →	MAN AC	+	10	10-20	CP1256 80000655		CC1256 80000781		230x113x20
Cerato	04.04 →	AUT AC	+	10	10-20	CP1362 80001441		CC1362 80001442		245x188x38
Clarus	07.96 →	Set	+	10	10-20	CP1247 80000644		CC1247 80000801		223x256x30
Magentis I	05.01 →		+	10	10-20	CP1171 80000158		CC1171 80000402		230x262x35











KIA										
Magentis II	11.05 →		+	10	10-20	CP1266 80000767		CC1266 80000764		260x230x40
Magentis III	11.09 →		+ / -			CP1331 80001176		CC1331 80001177		227x254x20
Opirius	09.03 →		+	10		CP1243 80000640		CC1243 80000630		175x175x12
Optima	03.12 →		+ / -	10	10-20	CP1453 80004433		CC1453 80004434		246x173x21
Picanto (TA + BA)	04.04 →		+	10	10-20	CP1237 80000634		CC1237 80004405		226x102x25
Pro Ceed	02.08 →		+ / -	10	10-20	CP1285 80000871		CC1285 80000872		246x173x21
Pro Ceed	03.13 →		+ / -	10	10-20	CP1516 49359582				238x195x20
Rio I	08.00 → 03.05	Set	+	10	10-20	CP1255 80000654		CC1255 80000795		225x203x17
Rio II	03.05 →		+	10	10-20	CP1253 80000652		CC1253 80000780		241x105x20
Rio III	09.11 →		+	10	10-20	CP1253 80000652		CC1253 80000780		241x105x20
Shuma I	03.96 → 05.01	Set	+	10		CP1257 80000656		CC1257 80000799		245x188x38
Shuma II	05.01 → 08.04	Set	+	10		CP1257 80000656		CC1257 80000799		217x107x17
Sorento (JC)	08.02 →		+	10	10-20	CP1171 80000158		CC1171 80000402		240x211x17
Sorento (JC, Facelift)	12.06 →	Set, + AUT AC, RHD	+ / -	10		CP1310 80000911		CC1310 80000912		211x113x18
Sorento (XM)	11.09 →	MAN AC	+	10		CP1256 80000655		CC1256 80000781		182x160x25
Sorento (XM)	11.09 →	AUT AC	+			CP1362 80001441		CC1362 80001442		209x165x24,5
Sorento III	01.15 →		+ / -			CP1521 49361898		CC1521 49361899		240x210x28
Soul	02.09 → 02.14		+ / -	10	10-20	CP1340 80001206		CC1340 80001207		217x107x17
Soul	03.14 →		+ / -	10	10-20	CP1492 80005226		CC1492 49356083		225x203x17
Sportage (JE_)	09.04 →	Set RHD	+ / -	10	10-20	CP1310 80000911		CC1310 80000912		225x203x17
Sportage (JE_)	09.04 →	LHD	+	10	10-20	CP1253 80000652		CC1253 80000780		230x180x20



KIA										
Sportage (SL _L)	07.10 →		+ / -	10	10-20	CP1516 49359582				238x195x20
Venga	02.10 →		+ / -	10	10-20	CP1369 80001454		CC1369 80001455		236x184x40
LADA										
110	01.95 →		-	9	10-20	-		CC1293 80000671		236x184x40
111	01.95 →		-	9	10-20	-		CC1293 80000671		250x150x35
112	01.95 →		-	9	10-20	-		CC1293 80000671		236x184x40
Kalina	10.04 →					CP1313 80000998		CC1313 80000999		385x170x17
Priora	12.08 →		+ / -			-		CC1293 80000671		385x170x17
LANCIA										
Dedra	01.89 → 07.99		+	8	10-20	CP1031 21651915		CC1031 21651951		233x182x22
Delta II	06.93 → 08.99		+	8	10-20	CP1031 21651915		CC1031 21651951		215x203x25
Delta III	09.08 →		+ / -	11		CP1132 21653027		CC1132 21652538		279x218x17
Flavia Cabrio	03.12 →		+ / -	10	10-20	CP1337 80001189		CC1337 80001190		292x225x20
Kappa	08.94 → 10.01		+	2	10-20	CP1017 21651892		CC1017 80000760		290x160x30
Kappa (SW / Coupé)	06.96 → 10.01		+	3	10-20	CP1203 80000376		CC1203 21651954		216x163x25
Lybra	07.99 →		+	8	10-20	CP1026 21651901		CC1026 21651952		405x165x32
Musa	10.04 →		+	11	10-20	CP1080 21652544		CC1080 21651296		288x225x13
Phedra	09.02 →		+ / -	2	10-20	CP1096 21652856		CC1096 21653147		277x198x30
Thema	03.87 → 07.94		+	4	10-20	CP1021 21651896		-		320x190x30
Thema	01.11 →		+ / -			CP1446 80004351		CC1446 80004352		230x200x30
Thesis	07.02 →		+ / -	12	10-20	CP1269 80000805		CC1269 21652694		308x140x18
Voyager	09.11 →		+ / -	10	10-20	CP1330 80001174		CC1330 80001175		216x163x25









**LANCIA**

Ypsilon	11.95 →		+	8	10-20	CP1019 21651894		CC1019 80000433		195x187x30
Ypsilon	09.03 →		+ / -	11	10-20	CP1080 21652544		CC1080 21651296		184x93x30
Ypsilon	05.11 →		+ / -	11, 12	10-20	CP1451 80004407		CC1451 80004544		270x155x30
Zeta	05.95 → 09.02	3-Set	+	3	10-20	CP1066 21652342		CC1066 80000765		270x155x30

LAND ROVER

Discovery III	10.04 →		+	11	10-20	CP1199 80000360		CC1199 80000361		243x223x75
Discovery IV	05.10 →		+	11	10-20	CP1199 80000360		CC1199 80000361		270x193x30
Discovery Sport	12.14 →		+ / -	11		CP1264 80000712		CC1264 80000713		217x198x21
Freelander I (V6 and TD4)	02.98 →		+ / -	11	10-20	CP1152 80000060		CC1152 80000775		277x195x30
Freelander II	02.06 →		+	11		CP1264 80000712		CC1264 80000713		217x198x21
Range Rover Evoque	06.11 →		+ / -	10	10-20	CP1460 80004555		CC1460 80004556		539x242x30
Range Rover II	07.94 → 03.02	2 !	+	2 / 4	10-20	CP1156 80000066		CC1156 80000772		270x155x30
Range Rover III	03.02 →		+	3	10-20	CP1155 80000065		CC1155 21652916		209x194x30
Range Rover IV	01.12 →		+ / -			CP1486 80005175		CC1486 80005176		216x195x30
Range Rover Sport	02.05 →		+	11	10-20	CP1199 80000360		CC1199 80000361		235x215x17
Range Rover Sport II	01.13 →		+ / -			CP1486 80005175		CC1486 80005176		216x195x30

LEXUS

CT	03.11 →		+ / -	10		CP1227 80000604		CC1227 80000605		209x194x30
GS300	08.97 → 10.00		+	10		CP1175 80000162		CC1175 80000771		217x227x30
GS300	10.00 →		+ / -	10		-		CC1296 80000165		217x227x30
GS430	11.00 →		+ / -	10		-		CC1296 80000165		217x227x30
GS (GRS_UZS_)	04.05 →		+	10		CP1227 80000604		CC1227 80000605		209x194x30











LEXUS										
GS (GRS1_GWL1_)	03.12 →		+ / -	10		CP1068 21652346		CC1068 80000746		235x215x17
IS (GXE10)	04.99 →		+	10		CP1175 80000162		CC1175 80000771		209x194x30
IS Sport Cross	10.01 →		+	10		CP1175 80000162		CC1175 80000771		222x200x30
IS (GSE2)	10.05 →		+	10		CP1227 80000604		CC1227 80000605		209x194x30
IS (GSE3)	04.13 →		+ / -	10		CP1068 21652346		CC1068 80000746		217x227x30
LFA	10.10 →		+ / -	10		CP1227 80000604		CC1227 80000605		209x194x30
LS (FE)	10.00 →		+ / -	10		- -		CC1296 80000165		217x227x30
LS (UCF20)	10.94 → 10.00		+	10		CP1175 80000162		CC1175 80000771		235x215x17
RX (GYL_)	04.09 →		+	10		CP1227 80000604		CC1227 80000605		209x194x30
RX (U1)	08.97 → 05.03		+	10		CP1175 80000162		CC1175 80000771		217x227x30
RX II (MCU)	05.03 →	LHD + RHD	+			CP1078 21652539		CC1078 80000745		292x225x20
SC430	08.01 →		+ / -	10		- -		CC1296 80000165		250x215x40
MASERATI										
3200 GT / 4200	10.98 → 03.02		+	3	10-20	CP1203 80000376		CC1203 21651954		196x216x25
Quattroporte III	03.04 →		+	4	10-20	- -		CC1292 80000669		246x97x19
MAZDA										
2 (DY)	04.03 → 10.07		+	10	10-20	CP1146 21653145		CC1146 21652992		236x100x22
2 (DE)	10.07 →	Set	+ / -	11		CP1378 80001489		CC1378 80001743		251x105x17
3 (BK)	10.03 →	Set	+	11	10-20	CP1204 80000405		CC1204 80000406		235x215x33
3 (BL)	06.09 →	Set	+ / -	11		CP1408 80001736		CC1408 80001735		236x100x22
3 (BM)	09.13 →		+ / -	10	10-20	CP1461 80004567		CC1461 80004568		196x216x25
5	02.05 →	Set	+	11	10-20	CP1204 80000405		CC1204 80000406		215x193x25

**MAZDA**

6 (GG)	06.02 → 08.07		+ / -	11	> 20	CP1146 21653145		CC1146 21652992		235x215x33
6 (GH)	08.07 →		+ / -	10		CP1320 80001039		CC1320 80001040		350x151x30
6	12.12 →		+ / -	10	10-20	CP1461 80004567		CC1461 80004568		350x151x30
121 II	11.90 → 05.97		+ / -	4	10-20	CP1018 21651893		CC1018 21652355		120x218x25
121 III	01.96 →		+ / -	4	10-20	CP1018 21651893		CC1018 21652355		120x218x25
323 F VI	09.98 → 05.04	Set	+ / -	10	10-20	CP1098 21652860		CC1098 80000403		235x215x33
626 V (GF)	05.97 → 10.02	Set	+ / -	11	10-20	CP1098 21652860		CC1098 80000403		196x216x25
CX5	11.11 →		+ / -	10	10-20	CP1461 80004567		CC1461 80004568		232x111x22
CX7	10.07 →		+ / -	10		CP1146 21653145		CC1146 21652992		215x190x20
Demio (from Chassis No.: 300 001 →)	08.98 →	Set	+ / -	11		-		CC1312 80000849		219x100x25
Demio (up to Chassis No.: → 300 000)	10.96 → 08.98	Set	+ / -			CP1407 80001737		-		120x218x25
MPV II (from Chassis No.: 107753 →)	09.99 →		+ / -	10		CP1176 80000163		CC1176 80000208		219x100x25
Premacy	07.99 →	Set	+ / -	11	10-20	CP1098 21652860		CC1098 80000403		280x162x30
RX8 (from Chassis No.: 107753 →)	10.03 →		+ / -	10	10-20	CP1176 80000163		CC1176 80000208		226x128x22
Tribute	03.00 →		+ / -	4	10-20	CP1112 21652993		CC1112 80000284		200x203x40
Xedos 9 (TA)	08.93 → 01.00	Set	-	11		CP1263 80000689		-		200x203x40

MCC

Smart	10.98 → 01.04		+ / -	1	> 20	CP1186 80000338		CC1186 21653014		212x215x25
Smart Coupé / Cabrio / Crossblade	07.98 → 01.04		+ / -	1	> 20	CP1186 80000338		CC1186 21653014		214x213x25
Smart Fortwo	01.07 →		+	12		CP1323 80001724		CC1323 80001035		178x204x40
Smart Fortwo (453)	07.14 →		+ / -	11		CP1512 80005281		CC1512 80005282		364x246x30



MCC										
Smart Roadster / Coupé / Forfour	05.03 →		+ / -	11	10-20	CP1180 80000331		CC1180 21653013		395x184x32
MERCEDES										
A-Klasse/A-class (W168)	07.97 → 08.04		+ / -	3	> 20	CP1087 21652688		CC1087 21651292		265x254x41
A-Klasse/A-class (W169)	09.04 →		+ / -	8	10-20	CP1145 21653144		CC1145 21653143		395x184x32
A-Klasse/A-class (W176)	06.12 →		+ / -	11	10-20	CP1452 80004408		CC1452 80004409		265x254x41
B-Klasse/B-class (W245)	03.05 →		+ / -	8	10-20	CP1145 21653144		CC1145 21653143		239x108x23 275x23x12
B-Klasse/B-class (W246)	11.11 →		+ / -	11	10-20	CP1452 80004408		CC1452 80004409		222x279x54
Citan	12.12 →	Set	+ / -	10	10-20	CP1370 80001456		CC1370 80001457		334x191x25
C-Klasse/C-class (W202)	03.93 → 05.00	LHD + RHD	+ / -	11	> 20	CP1007 21651196		CC1007 21651961		334x191x25
C-Klasse/C-class (CL203)	03.01 →		+ / -	11	10-20	CP1075 21652358		CC1075 21652861		334x191x25
C-Klasse/C-class (W203)	04.00 →		+ / -	11	10-20	CP1075 21652358		CC1075 21652861		282x260x77
C-Klasse/C-class (W203)	04.00 →	RHD	+ / -	11	10-20	CP1061 21652335		CC1061 21652862		282x260x77
C-Klasse/C-class (S204)	01.07 →		+	11		CP1379 80004358		CC1379 80001527		260x282x77
C-Klasse/C-class (W204)	01.07 →		+	11		CP1379 80004358		CC1379 80001527		260x282x77
C-Klasse/C-class (C204)	06.11 →		+	11		CP1379 80004358		CC1379 80001527		260x282x77
C-Klasse/C-class (W205)	12.13 →		+ / -	11		CP1495 80005251		CC1495 80005252		246x190x30
C-Klasse/C-class (W205)	12.13 →	PF	+ / -	7	10-20	CP1456 80004550		-		265x254x41
C-Klasse/C-class (S205)	09.14 →	PF	+ / -	7	10-20	CP1456 80004550		-		222x279x54
CLA	01.13 →		+ / -	11	10-20	CP1452 80004408		CC1452 80004409		334x191x25
CLK (C208)	06.97 → 06.02	LHD + RHD	+ / -	11	10-20	CP1007 21651196		CC1007 21651961		222x279x54
CLK (C209)	06.02 →		+ / -	11	10-20	CP1075 21652358		CC1075 21652861		334x191x25



MERCEDES

CLK Cabriolet (A208)	06.97 → 06.02	LHD + RHD	+ / -	11	10-20	CP1007 21651196		CC1007 21651961		282x260x77
CLK Cabriolet (A209)	06.02 →		+ / -	11	10-20	CP1075 21652358		CC1075 21652861		312x257x35
CLS (C218)	01.11 →		+	11		CP1379 80004358		CC1379 80001527		260x282x77
CLS (C219)	10.04 → 12.10		+ / -	4 / 11	10-20	CP1099 21652863		CC1099 21652865		227x210x45
E-Klasse/E-class (W124)	06.93 → 06.95	Set	+ / -	3	> 20	CP1010 21651199		-		255x114x30
E-Klasse/E-class (S210)	06.96 → 03.03	Set, + AUT AC	+			-		CC1404 80001740		227x210x45
E-Klasse/E-class (W210)	06.95 → 03.02	Set	+ / -	11	> 20	CP1006 21651195		CC1006 80000421		222x279x54
E-Klasse/E-class (W210)	06.95 → 03.02	Set, + AUT AC	+			-		CC1404 80001740		312x257x35
E-Klasse/E-class (W210)	06.95 → 03.02	LHD + RHD	+ / -	11	> 20	CP1007 21651196		CC1007 21651961		312x257x35
E-Klasse/E-class (W211, S211)	03.02 →		+ / -	4 / 11	10-20	CP1099 21652863		CC1099 21652865		282x260x77
E-Klasse/E-class (W211, S211)	03.02 →	RHD	+ / -	4 / 11	10-20	CP1100 21652864		-		282x260x77
E-Klasse/E-class (W212)	01.09 →		+	11		CP1379 80004358		CC1379 80001527		260x282x77
E-Klasse/E-class (C207 + A207)	01.09 →		+	11		CP1379 80004358		CC1379 80001527		260x282x77
G-Klasse/G-class (W463)	04.98 →		+	11	10-20	CP1074 21652356		CC1074 21652357		252x216x32
GL-Klasse/GL-class (X164)	03.06 →	Set	+	10	> 20	CP1300 80001490		CC1300 80000647		253x133x40
GL-Klasse/GL-class (X204)	06.08 →		+	11		CP1379 80004358		CC1379 80001527		260x282x77
GL-Klasse/GL-class (X166)	07.12 →	Set	+ / -	10	> 20	CP1457 80004551		CC1457 80004552		225x204x40
GLA-Klasse/GLA-class (X156)	12.13 →		+ / -	11	10-20	CP1452 80004408		CC1452 80004409		248x133x40
GLC	01.15 →		+ / -			CP1495 80005251		CC1495 80005252		246x190x30
GLE	01.15 →	PF	+ / -	7	10-20	CP1456 80004550		-		248x133x40
GLE	01.15 →	Set	+ / -	10	> 20	CP1457 80004551		CC1457 80004552		391x257x43



MERCEDES

M-Klasse/M-class (W163)	02.98 → 06.05		+ / -	11	10-20	CP1134 21653029		CC1134 21651294		246x190x30
M-Klasse/M-class (W164)	07.05 →	Set	+	10	> 20	CP1300 80001490		CC1300 80000647		253x133x40
M-Klasse/M-class (W166)	06.11 →	PF	+ / -	7	10-20	CP1456 80004550		-	-	248x133x40
M-Klasse/M-class (W166)	06.11 →	Set	+ / -	10	> 20	CP1457 80004551		CC1457 80004552		391x257x43
R-Klasse/R-class (W251, V251)	09.05 →	Set	+	10	> 20	CP1300 80001490		CC1300 80000647		391x257x43
S-Klasse/S-class (W140)	02.91 → 10.98		+	4	10-20	CP1013 21651887		CC1013 21653010		223x144x8
S-Klasse/S-class (W140)	02.91 → 10.98	RHD	+	4	10-20	CP1042 21651974		CC1042 21653011		255x114x30
S-Klasse/S-class (W140-Fresh Air Filter)	02.91 → 10.98	+ 21651887	+	11	> 20	CP1117 21653002		-	-	227x210x45
S-Klasse/S-class (W220)	10.98 → 08.05	Set	+	10	> 20	CP1006 21651195		CC1006 80000421		227x210x45
S-Klasse/S-class (W220)	10.98 → 08.05	Set, + AUT AC	+			-	-	CC1404 80001740		260x183x30
S-Klasse/S-class (C215)	03.99 → 03.06	Set, + AUT AC	+			-	-	CC1404 80001740		260x183x30
S-Klasse/S-class (C216)	05.06 →	Set	+	11	10-20	CP1297 80001491		CC1297 80000538		260x30x184
S-Klasse/S-class (W221)	10.05 →	Set	+	11	10-20	CP1297 80001491		CC1297 80000538		498x98x43
S-Klasse/S-class (W222)	05.13 →	Set	+	11	10-20	CP1479 80005069		CC1479 80004826		260x182x30
SL (R129)	03.89 → 10.01		+ / -	3	> 20	CP1055 21651993		CC1055 80000382		282x260x77
SL	10.01 →	Set	+	11	10-20	-	-	CC1288 21652812		222x279x54
SL (R231)	01.12 →		+	11		CP1379 80004358		CC1379 80001527		260x282x77
SLK (R170)	04.96 → 04.04	LHD + RHD	+ / -	11	> 20	CP1007 21651196		CC1007 21651961		360x179x35
SLK (R171)	03.04 →		+	11	> 20	CP1270 80000806		CC1270 80000071		379x163x25
SLK (R172)	02.11 →		+	11	> 20	CP1270 80000806		CC1270 80000071		527x144x8
Sprinter	01.95 → 06.06		+ / -	3	> 20	CP1044 21651976		CC1044 21652985		352x234x35

**MERCEDES**

Sprinter	01.95 → 06.06	roof AC	+			CP1414 80001729		-		260x130x10
Sprinter	06.05 →		+			CP1233 80000614		CC1233 80000616		379x163x25
Sprinter	06.06 →	roof AC	+			CP1415 80001728		-		364x246x30
Sprinter (T1N)	01.02 →		+ / -	3	> 20	CP1044 21651976		CC1044 21652985		348x203x34
Vaneo	01.97 →		+ / -	3	10-20	CP1087 21652688		CC1087 21651292		374x218x28
Viano, Vito (W639)	09.03 →		+ / -	11	10-20	CP1130 21653025		CC1130 21653009		300x205x35,5
Vito, Viano V-Klasse (W638)	11.95 → 07.03		+ / -	11	10-20	CP1058 21652045		CC1058 80000427		230x40x115
Vito, Viano V-Klasse	04.14 →		+ / -			CP1493 80005230		CC1493 80005227		300x205x35,5

MINI

Mini (F55, F56)	12.13 →	Set	+ / -	11	10-20	CP1478 80005089		CC1478 80004825		440x117x30
Mini (R50-R52)	06.01 →		+ / -	1	10-20	CP1095 21652850		CC1095 21652853		215x200x30
Mini (R56-R57-R58-R59-R60)	01.06 →		+ / -	1	10-20	CP1265 80000740		CC1265 80000741		234x208x37
Mini Clubman (F54)	01.15 →	Set	+ / -			CP1478 80005089		CC1478 80004825		440x117x30

MITSUBISHI

ASX	02.10 →		+ / -	10	10-20	CP1284 80000853		CC1284 80000854		202x180x51
Carisma	07.95 → 06.06	Set	+	10	> 20	CP1101 21652867		CC1101 80000397		234x208x37
Carisma	07.95 → 06.07		-			CP1281 80000825		-		178x204x40
Colt V	09.95 → 05.04	Set	+	10	> 20	CP1101 21652867		CC1101 80000397		178x204x40
Colt VI	04.04 →		+ / -	11	10-20	CP1180 80000331		CC1180 21653013		276x176x56
Colt VII	09.08 →		+ / -	11	10-20	CP1180 80000331		CC1180 21653013		228x227x74
Galant VI	09.96 → 10.04		+	10	> 20	CP1102 21652868		-		179x177x19
Grandis	04.04 →		+	10	10-20	CP1301 80004397		CC1301 80000648		234x208x37



MITSUBISHI

i-MiEV	07.09 →		+ / -			CP1435 80001778		CC1435 80001779		234x208x37
L 200	06.96 →	Set	+	10	> 20	CP1101 21652867		CC1101 80000397		228x227x74
Lancer	12.95 → 10.03	Set	+	10	> 20	CP1101 21652867		CC1101 80000397		215x200x30
Lancer	10.03 →		+	10		CP1301 80004397		CC1301 80000648		228x227x74
Lancer	01.08 →		+ / -	10	10-20	CP1284 80000853		CC1284 80000854		215x200x30
Outlander	05.03 →		+	10		CP1301 80004397		CC1301 80000648		200x215x30
Outlander II	02.07 →		+ / -	10	10-20	CP1284 80000853		CC1284 80000854		200x215x30
Outlander III	12.12 →		+ / -	10	10-20	CP1284 80000853		CC1284 80000854		200x215x30
Pajero Classic	06.02 →		+	10		- -		CC1295 80000068		200x215x30
Pajero II	12.90 → 04.00		+	10		- -		CC1295 80000068		200x215x30
Pajero III	04.00 →		+	10		- -		CC1295 80000068		192x93x25
Pajero IV	02.07 →		+	10		- -		CC1295 80000068		234x208x37
Pajero Pinin	10.99 →	Set	+	10		CP1246 80000643		CC1246 80000794		224x207x35
Pajero Sport	11.98 →	Set	+	10	> 20	CP1101 21652867		CC1101 80000397		234x208x37
Space Runner	08.99 →		+	10		CP1280 80000824		- -		202x180x51
Space Star	06.98 →	Set	+	10	> 20	CP1101 21652867		CC1101 80000397		177x177x19
Space Star	06.98 →		-	10		CP1281 80000825		- -		224x207x35
Space Star	01.13 →		+ / -	10		CP1472 80004700		CC1472 80004701		217x200x20
Space Wagon	10.98 →		+	10		CP1280 80000824		- -		252x215x23

NISSAN

370 Z	04.09 →		+ / -	10	10-20	CP1417 80001759		CC1417 80001752		222x200x30
-------	---------	--	-------	----	-------	---------------------------	---	---------------------------	---	------------



NISSAN

Almera I	07.95 → 07.00		+ / -		10-20	CP1318 80001041		-		150x260x25
Almera II / Almera Tino	03.00 →	LHD + RHD	+ / -	10	10-20	CP1068 21652346		CC1068 80000746		230x200x30
Cube	03.10 →		+ / -			CP1401 80001720		CC1401 80001721		340x191x45
G-TR	02.09 →		+ / -			CP1413 80001730		-		238x152x30
Interstar	08.03 →		+ / -			CP1157 80000072		CC1157 80001170		228x160x30
Juke	06.10 →		+ / -	10	10-20	CP1418 80001760		CC1418 80001753		150x260x25
Kubistar	08.03 →		+	1		CP1050 21651983		CC1050 80000114		243x85x28
Leaf	11.11 →		+ / -	10	10-20	CP1401 80001720		CC1401 80001721		241x202x20
Maxima (A33)	03.00 →	2!	+	10		CP1274 80000810		CC1274 80000067		223x190x45
Micra (K11)	08.92 → 02.03		+	10	10-20	CP1103 21652870		-		211x225x20
Micra (K12)	01.03 →		+	10	10-20	CP1159 80000074		CC1159 80004402		222x190x43
Micra (K13)	05.10 →		+ / -	10	10-20	CP1437 80001780		CC1437 80001781		270x281x20
Murano	03.05 →	LHD + RHD	+ / -	10		CP1068 21652346		CC1068 80000746		264x100x25
Murano	11.07 →		+ / -	10	10-20	CP1339 80001204		CC1339 80001205		223x190x45
Navarra	07.05 →	2!		10		CP1250 80000649		CC1250 80000786		211x225x20
Note	03.06 →		+	10	10-20	CP1159 80000074		CC1159 80004402		222x190x43
Note	06.13 →		+ / -	12		CP1437 80001780		CC1437 80001781		270x220x24
Pathfinder	03.05 →	2!	+ / -	11	> 20	CP1250 80000649		CC1250 80000786		193x162x18
Patrol GR II	06.97 →	Set	+ / -		10-20	CP1325 80001024		-		340x191x45
Pixo	03.09 →		+ / -			CP1364 80001444		CC1364 80001445		206x193x16
Primastar	09.02 →		+ / -	1	10-20	CP1157 80000072		CC1157 80001170		262x193x20



NISSAN

Primera (P10, W10)	06.90 → 06.96		+ / -		10-20	CP1229 80000610		-		222x200x30
Primera (P11, WP11)	06.96 → 12.01		+ / -	10	10-20	CP1069 21652347		CC1069 80000416		192x267x20
Primera (P12, WP12)	03.02 →	LHD + RHD	+ / -	10	10-20	CP1068 21652346		CC1068 80000746		250x180x35
Qashqai	02.07 →		+ / -	12		CP1286 80000874		CC1286 80000875		232x202x16
Qashqai	02.14 →		+ / -			CP1485 80005173		CC1485 80005174		204x189x16
Serena	07.92 →		+ / -		10-20	CP1231 80000612		-		262x193x20
Sunny III	10.90 → 12.95		+ / -			CP1230 80000611		-		210x168x35
Terrano II	02.93 →		+	10	10-20	CP1069 21652347		CC1069 80000416		222x200x30
Tiida	09.07 →		+ / -			CP1363 80001443		-		192x267x20
X-Trail	07.01 →	LHD + RHD	+	10	10-20	CP1068 21652346		CC1068 80000746		265x215x21
X-Trail	02.07 →		+ / -	12		CP1286 80000874		CC1286 80000875		235x193x15
OPEL										
Adam	01.13 →		+ / -	10	10-20	CP1221 80000541		CC1221 80000777		265x215x21
Agila	09.00 →		+ / -	11	> 20	CP1072 21652350		CC1072 80000758		240x204x35
Agila II	09.07 →		+ / -	10		CP1324 80001036		CC1324 80001744		277x206x27
Ampera	11.11 →		+ / -	10	10-20	CP1335 80001185		CC1335 80001186		411x145x17
Antara	05.06 →		+ / -	10	10-20	CP1308 80000877		CC1308 80000878		258x231x30
Astra F	09.91 → 09.98		+ / -	3		CP1001 21651182		CC1001 21651964		294x200x30
Astra G (Behr)	02.98 → 02.04		+ / -	10	10-20	CP1047 21651980		CC1047 80000113		258x231x30
Astra G (Delphi)	02.98 → 02.04		+ / -	10	10-20	CP1046 21651979		CC1046 80000021		294x200x30
Astra H (Behr)	03.04 →		+	10	10-20	CP1047 21651980		CC1047 80000113		240x204x35



OPEL										
Astra H (Delphi)	03.04 →		+	10	10-20	CP1046 21651979		CC1046 80000021		411x145x17
Astra J + Sports Tourer	12.09 →		+ / -	10	10-20	CP1335 80001185		CC1335 80001186		240x204x35
Astra K	08.15 →		+ / -			CP1526 49365684	NEW	CC1526 49365685	NEW	240x204x33
Calibra	06.90 → 07.97		+ / -	3		CP1001 21651182		CC1001 21651964		411x145x17
Cascada	04.13 →		+ / -	10	10-20	CP1335 80001185		CC1335 80001186		330x188x17
Combo	07.94 → 10.01		+	3		CP1001 21651182		CC1001 21651964		220x177x30
Combo	07.94 → 10.01		-	3		CP1004 21651184		CC1004 21651965		330x188x17
Combo (X12)	02.12 →		+ / -	10	10-20	CP1316 80001027		CC1316 80001171		226x206x25
Corsa B	03.93 → 09.00		-	3		CP1004 21651184		CC1004 21651965		330x163x30
Corsa B	01.95 → 09.00	RHD	+	3		CP1048 21651981		CC1048 80000761		265x215x21
Corsa C	09.00 →		+ / -	3		CP1092 21652714		CC1092 21652715		265x215x21
Corsa D	07.06 →		+ / -	10	10-20	CP1221 80000541		CC1221 80000777		265x215x21
Corsa E	09.14 →		+ / -	10	10-20	CP1221 80000541		CC1221 80000777		265x215x21
Insignia	07.08 →		+ / -	10	10-20	CP1335 80001185		CC1335 80001186		240x204x35
Karl	01.15 →		+ / -	10	10-20	CP1335 80001185		CC1335 80001186		240x204x35
Meriva A	05.03 →		+ / -	3		CP1113 21652994		CC1113 21652995		240x204x30
Meriva B	06.10 → 06.12		+ / -	10	10-20	CP1335 80001185		CC1335 80001186		240x204x35
Meriva B	07.12 →		+ / -	10	>20	CP1471 80004698		CC1471 80004699		230x100x20
Mokka	06.12 →		+ / -	10	10-20	CP1335 80001185		CC1335 80001186		340x191x45
Monterey B	07.98 → 08.99	Set	+ / -	10	10-20	CP1173 80000160		CC1173 80000792		239x108x23 275x23x12
Movano A	07.98 →		+	1	> 20	CP1157 80000072		CC1157 80001170		290x226x17



OPEL										
Movano B	05.10 →	Set	+ / -	10	10-20	CP1370 80001456		CC1370 80001457		290x226x17
Omega B	03.94 → 09.99		+ / -	8	> 20	CP1002 21651183		-		330x163x30
Omega B	10.99 → 07.03		+ / -	8	> 20	-		CC1294 21652353		220x95x58
Signum	05.03 →		+	3		CP1092 21652714		CC1092 21652715		330x188x17
Sintra	11.96 → 04.99	Set	+	10	10-20	CP1049 21651982		CC1049 21652046		411x145x17
Tigra	07.94 → 12.00		-	3		CP1004 21651184		CC1004 21651965		330x163x30
Tigra	04.98 → 12.00		+	3		CP1001 21651182		CC1001 21651964		410x145x25
Vectra (C-Epsilon)	04.02 →		+ / -	3		CP1092 21652714		CC1092 21652715		340x191x45
Vectra B	10.95 → 07.03		+ / -	3		CP1005 21651185		CC1005 21651966		340x191x45
Vivaro	03.01 →		+	1	> 20	CP1157 80000072		CC1157 80001170		262x193x37
Vivaro	08.01 →		+ / -	1	> 20	CP1157 80000072		CC1157 80001170		258x231x30
Vivaro	06.14 →		+ / -	12		CP1367 80001450		CC1367 80001451		294x200x30
Zafira (Behr)	04.99 → 06.05		+ / -	10	> 20	CP1047 21651980		CC1047 80000113		258x231x30
Zafira (Delphi)	04.99 → 06.06		+	10	> 20	CP1046 21651979		CC1046 80000021		240x204x35
Zafira II	07.05 →			10	> 20	CP1047 21651980		CC1047 80000113		
Zafira III	01.11 →		+ / -	10	10-20	CP1335 80001185		CC1335 80001186		226x165x45
PEUGEOT										
106	01.96 → 01.04		+	4		CP1514 49356178				195x145x30,5
107	06.05 → 04.14		+	11	10-20	CP1259 80000662		CC1259 80000784		346x171x31
108	05.14 →		+ / -	11		CP1489 80005194		CC1489 80005202		150x158x30 200x158x30
206	08.98 →		+ / -	4	10-20	CP1011 21651293		CC1011 21653068		150x158x30 200x158x30



PEUGEOT

207	02.06 →	Set	+ / -	4	10-20	CP1260 80000666		CC1260 80000667		150x158x30
208	03.12 →	Set	+ / -	4	10-20	CP1260 80000666		CC1260 80000667		150x158x30
301	11.12 →	Set	+ / -			CP1476 80004779		CC1476 80004780		285x177x35
306	05.93 → 05.01		+ / -	4		CP1150 80000027		CC1150 80000624		285x177x35
307	08.00 →		+ / -	8	10-20	CP1082 21652548		CC1082 21652540		285x177x35
308	09.07 →		+ / -	8		CP1082 21652548		CC1082 21652540		285x177x35
308 II	09.13 →	Set	+	11	10-20	CP1477 80004812		CC1477 80004813		328x159x30
405	08.92 → 10.96		+ / -	4	10-20	CP1016 21651891		CC1016 80000743		269x196x30
406	10.95 → 05.04		+ / -	4	10-20	CP1036 21651920		CC1036 21652541		315x154x35
407 (from Chassis No.: 11438 →)	03.08 →		+ / -			CP1371 80001458		CC1371 80001459		267x187x35
407 (up to Chassis No.: → 11438)	04.04 → 03.08		+ / -	12	10-20	CP1271 80000807		CC1271 21653102		429x171x32
508	11.10 →		+ / -	12		CP1441 80001791		CC1441 80001792		517x146x40
605	06.89 → 09.99		+ / -	4	10-20	CP1035 21651919		CC1035 80000748		184x93x30
607	02.00 →		+	4	10-20	CP1147 21653148		CC1147 21653149		405x165x32
806	06.94 → 08.02	3-Set	+	3	10-20	CP1066 21652342		CC1066 80000765		285x177x35
807	06.02 →		+ / -	2	10-20	CP1096 21652856		CC1096 21653147		150x158x30 200x158x30
1007	04.05 →		+ / -	8	> 20	CP1082 21652548		CC1082 21652540		285x177x35
2008	03.13 →	Set	+ / -	4	10-20	CP1260 80000666		CC1260 80000667		150x158x30
3008	06.09 →	Set	+	11	10-20	CP1282 80000839		CC1282 80000615		215x200x30
4007	02.07 →		+ / -	10	10-20	CP1284 80000853		CC1284 80000854		292x96x30
4008	05.12 →		+ / -	10	10-20	CP1284 80000853		CC1284 80000854		220x177x30



PEUGEOT



5008	09.09 →	Set	+	11	10-20	CP1282 80000839		CC1282 80000615		235x250x25
Bipper	02.08 →		+ / -	10	10-20	CP1316 80001027		CC1316 80001171		435x144x17
Boxer	04.06 →		+ / -	12	10-20	CP1278 80000815		CC1278 80000816		435x144x17
Boxer (230)	02.94 → 04.02		+	4	10-20	CP1056 21651994		CC1056 80000432		184x93x30
Boxer (244)	04.02 → 04.06		+	4	10-20	CP1056 21651994		CC1056 80000432		376x176x49
Expert	07.95 →	3-Set	+	3	10-20	CP1066 21652342		CC1066 80000765		179x177x19
Expert	01.07 →		+ / -	8		CP1305 80000865		CC1305 80000866		194x195x20
iOn	11.10 →		+ / -			CP1435 80001778		CC1435 80001779		225x222x32
Partner / Ranch	06.96 →		+	11	10-20	CP1024 21651899		CC1024 80000077		292x96x30
Partner II / Ranch	08.01 →		+ / -	11	10-20	CP1133 21653028		CC1133 21653146		328x159x30
Partner Tepee	04.08 →	Set	+	11	10-20	CP1282 80000839		CC1282 80000615		247x201x40
RCZ	03.10 →		+ / -	8		CP1082 21652548		CC1082 21652540		285x177x35

PORSCHE

Boxster, 911 (Typ 996 + 997)	09.97 →		+ / -	9		CP1036 21651920		CC1036 21652541		247x201x40
Boxster	04.12 →		+ / -	4	10-20	-		CC1459 80004549		170x225x35
Boxster	04.12 →	PF	+ / -			CP1484 80005091				275x217x30
911 Carrera (991)	12.11 →		+ / -	4	10-20	-		CC1459 80004549		276x217x40
Carrera GT (Typ 980)	07.03 →		+	3	10-20	CP1267 80000803		CC1267 80000347		247x201x40
Cayenne	09.02 →		+ / -	11		CP1125 21653020		CC1125 21653015		300x90x30
Cayenne	06.10 →		+ / -	11		CP1403 80001742		CC1403 80001741		278x240x35
Cayman	03.13 →		+ / -	4	10-20	-		CC1459 80004549		217x36x253

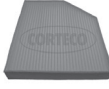
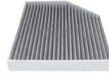

PORSCHE

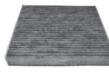
Cayman	03.13 →	PF	+ / -			CP1484 80005091				192x180x45
Macan	04.14 →		+ / -	11	10-20	CP1309 80000879		CC1309 80000880		210x200x35
Panamera	09.09 →		+ / -	11		CP1448 80004357		CC1448 80004356		177x65x20

RENAULT

Avantime	09.01 → 05.03	Set	+ / -	1		CP1086 21652687		CC1086 21653070		228x160x30
Captur	06.13 →		+ / -	10	10-20	CP1465 80004638		CC1465 80004639		210x200x35
Clio I	05.90 → 09.98	Set	+	1	10-20	CP1083 21652549		CC1083 80000766		210x200x35
Clio II	09.98 →		+	4	10-20	CP1050 21651983		CC1050 80000114		192x180x45
Clio III	06.05 →		+ / -	11	10-20	CP1159 80000074		CC1159 80004402		222x190x43
Clio IV + Grandtour IV	11.12 →		+ / -	10	10-20	CP1465 80004638		CC1465 80004639		210x200x35
Espace II	01.91 → 12.96	Set	+ / -	1	> 20	CP1086 21652687		CC1086 21653070		238x152x30
Espace III	11.96 → 10.02	Set	+ / -	1	> 20	CP1086 21652687		CC1086 21653070		236x240x48
Espace IV	11.02 →		+	1	10-20	CP1104 21652871		CC1104 21652872		262x193x37
Espace V	02.15 →		+ / -			CP1418 80001760		CC1418 80001753		239x108x23 275x23x12
Fluence	02.10 →		+ / -			CP1418 80001760		CC1418 80001753		239x108x23 275x23x12
Grand Scénic (JM 0/1_)	04.04 →			8	10-20	CP1163 80000080		CC1163 80004404		228x160x30
Grand Scénic (JZ 0/1_)	02.09 →		+ / -	10	10-20	CP1367 80001450		CC1367 80001451		248x181x20
Kadjar	06.15 →		+ / -			CP1418 80001760		CC1418 80001753		238x152x30
Kangoo (KC 0/1_)	08.97 →		+	4	10-20	CP1050 21651983		CC1050 80000114		249x182x17
Kangoo	02.08 →	Set	+ / -	10	10-20	CP1370 80001456		CC1370 80001457		249x182x17
Koleos	09.08 →		+ / -	12	> 20	CP1336 80001187		CC1336 80001188		210x204x30



RENAULT

Laguna I	11.93 → 03.01		+	4	10-20	CP1032 21651916		CC1032 80000434		343x134x30
Laguna I	11.93 → 03.01	RHD	+	4	10-20	CP1012 21651298		CC1012 80000747		340x103x25
Laguna II	03.01 →		+	10	10-20	CP1084 21652550		CC1084 21652542		239x108x23 275x23x12
Laguna III + Grandtour	10.07 →	Set	+ / -	10		CP1314 80001030		CC1314 80001031		263x170x35
Latitude	02.11 →	Set	+ / -			CP1439 80001787		CC1439 80001788		292x172x17
Master IV	02.10 →	Set	+ / -			CP1370 80001456		CC1370 80001457		243x169x16
Mégane I	11.95 → 04.98		+	3	10-20	CP1033 21651917		CC1033 80000435		274x187x40
Mégane I	05.98 → 08.03		+	11	10-20	CP1070 21652348		CC1070 80000750		231x179x25
Mégane I	05.98 → 08.03		-	2	10-20	CP1050 21651983		CC1050 80000114		263x170x35
Mégane II	11.02 →		+ / -	11	10-20	CP1140 21653071		CC1140 80000670		252x227x19
Mégane II	11.02 →	FFV	+ / -	11		CP1470 80004676		CC1470 80004677		235x220x19
Mégane III	11.08 →		+ / -	10	10-20	CP1372 80001460		CC1372 80001461		289x208x20
Mégane CC	06.10 →		+ / -			CP1372 80001460		CC1372 80001461		228x160x30
Mégane Scénic	01.97 → 01.98		+	11	10-20	CP1143 21653140		CC1143 80000762		221x221x20
Mégane Scénic	02.98 → 09.99		+	11	10-20	CP1051 21651984		CC1051 80000436		223x190x45
Mégane Scénic	01.97 → 09.99		-	11	10-20	CP1201 80000373		-		234x187x23
Mégane Scénic	01.97 → 09.99	RHD	+	11	10-20	CP1218 80000536		CC1218 80000788		229x196x30
Modus	10.04 →		+	10	10-20	CP1159 80000074		CC1159 80004402		222x190x43
Safrane I	04.92 → 07.96		+	4	10-20	CP1025 21651900		CC1025 80000753		236x240x48
Scénic	08.99 → 08.03		+	11	10-20	CP1071 21652349		CC1071 80000418		262x193x37
Scénic	01.99 → 08.03	RHD	+	11	10-20	CP1218 80000536		CC1218 80000788		228x160x30







RENAULT

Scénic II	02.03 →		+ / -	11	10-20	CP1163 80000080		CC1163 80004404		340x191x45
Scénic III	05.09 →		+ / -	10	10-20	CP1367 80001450		CC1367 80001451		262x193x37
Thalia + Thalia II	02.98 →		-	2	10-20	CP1050 21651983		CC1050 80000114		264x118x30
Trafic II	02.01 →		+ / -	1	10-20	CP1157 80000072		CC1157 80001170		223x190x45
Trafic III	05.14 →		+ / -			CP1367 80001450		CC1367 80001451		214x213x25
Twingo (C06_)	03.93 →		+	7	10-20	CP1054 21651991		CC1054 80000752		210x204x30
Twingo (CNO_)	03.07 →		+ / -	10	10-20	CP1159 80000074		CC1159 80004402		222x190x43
Twingo	09.14 →		+ / -	11	10-20	CP1512 80005281		CC1512 80005282		248x180x35
Vel Satis	06.02 →		+	10	10-20	CP1084 21652550		CC1084 21652542		225x190x32
Wind	07.10 →		+ / -	10	10-20	CP1159 80000074		CC1159 80004402		222x190x43
Zoe	06.12 →		+ / -			CP1458 80004548		CC1458 80004702		212x211x30





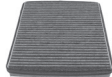







ROVER

25	09.99 →		+	10	10-20	CP1151 80000029		CC1151 80000749		397x262x32
45	02.00 →		+	10	> 20	CP1067 21652345		CC1067 80000428		225x190x32
45	02.00 →		-	10	> 20	CP1040 21651972		CC1040 80000742		225x190x32
75	02.99 →		+ / -	4	10-20	CP1122 21653017		CC1122 80000070		225x190x32
200	11.95 → 03.00		+	10	10-20	CP1151 80000029		CC1151 80000749		225x190x32
200 Coupé, Hatchback (XW)	10.89 → 06.99		+			CP1151 80000029		CC1151 80000749		212x211x30
400	01.93 → 04.95		+	10		CP1151 80000029		CC1151 80000749		225x190x32
400	05.95 → 03.00		+	10	> 20	CP1067 21652345		CC1067 80000428		225x190x32
400	05.95 → 03.00		-	10	> 20	CP1040 21651972		CC1040 80000742		225x190x32



**ROVER**

800 Coupé	08.92 → 02.99		+			CP1151 80000029		CC1151 80000749		441x126x30
Cabriolet	01.93 → 11.99		+	10		CP1151 80000029		CC1151 80000749		330x163x30
Streetwise	08.03 →		+	10	10-20	CP1151 80000029		CC1151 80000749		319x186x52

SAAB

9-3 (YS3D)	02.98 → 08.03		+ / -	3		CP1141 21653114		-		335x226x50
9-3 (YS3F)	09.02 →		+	4		CP1092 21652714		CC1092 21652715		240x204x35
9-5	09.97 →	w F	+ / -	10	> 20	CP1206 80000409		CC1206 21653115		441x126x30
9-5	09.97 →	w/o F	+ / -	10	> 20			CC1514 49356177	 NEW	441x126x30
9-5	05.10 →		+ / -	10	10-20	CP1335 80001185		CC1335 80001186		288x225x13
900 I	01.89 → 07.93		+ / -	4		CP1141 21653114		-		330x198x29
900 II	07.93 → 02.98		+ / -	4		CP1141 21653114		-		537x110x25
9000	09.84 → 09.91		+	3	10-20	CP1021 21651896		-		207x269x34
9000	04.85 → 12.98		-	4	10-20	CP1034 21651918		CC1034 80000417		207x269x34

SEAT

Alhambra	04.96 → 03.10		+ / -	4	10-20	CP1020 21651895		CC1020 21651960		207x269x34
Alhambra	06.10 →		+ / -	11	10-20	CP1129 21653024		CC1129 21653008		207x269x34
Altea	03.04 →		+ / -	11	10-20	CP1129 21653024		CC1129 21653008		207x269x34
Altea	03.04 →	RHD	+ / -	11	10-20	-		CC1298 80000602		279x207x25
Altea XL	01.06 →		+ / -	11	10-20	CP1129 21653024		CC1129 21653008		207x269x34
Altea XL	01.06 →	RHD	+ / -	11	10-20	-		CC1298 80000602		279x207x25
Arosa	02.97 → 06.04		+ / -	4	10-20	CP1027 21651912		CC1027 21651955		296x227x28
Arosa	02.97 → 06.04	w F	+ / -	4	10-20	CP1279 80000817		-		252x216x32



SEAT										
Cordoba	02.93 → 09.02		+ / -	4	10-20	CP1027 21651912		CC1027 21651955		300x203x30
Cordoba	02.93 → 09.02	w F	+ / -	4	10-20	CP1279 80000817		-		279x207x25
Cordoba	09.02 →		+ / -	11	10-20	CP1074 21652356		CC1074 21652357		252x216x32
Exeo	12.08 →		+ / -	7	10-20	CP1088 21652689		CC1088 21652713		279x207x25
Ibiza II	09.93 → 08.99		+ / -	4	10-20	CP1027 21651912		CC1027 21651955		296x227x28
Ibiza II	09.93 → 08.99	w F	+ / -	4	10-20	CP1279 80000817		-		252x216x32
Ibiza III	08.99 → 02.02		+ / -	4	10-20	CP1027 21651912		CC1027 21651955		252x216x32
Ibiza III	08.99 → 02.02	w F	+ / -	4	10-20	CP1279 80000817		-		252x224x36
Ibiza IV	02.02 → 03.08		+ / -	11	10-20	CP1074 21652356		CC1074 21652357		252x216x32
Ibiza V (PQ24, PQ25)	03.08 →		+ / -	11	> 20	CP1436 80001783		CC1436 80001784		252x224x36
Inca	11.95 →	w/o F	+ / -	4	10-20	CP1027 21651912		CC1027 21651955		296x227x28
Inca	11.95 →	w F	+ / -	4	10-20	CP1279 80000817		-		207x269x34
León	09.99 →		+ / -	4	10-20	CP1027 21651912		CC1028 21651967		255x235x30
León	09.99 →	w F	+ / -	4	10-20	CP1279 80000817		-		255x35x182
León II	09.05 →		+ / -	11	10-20	CP1129 21653024		CC1129 21653008		207x269x34
León III	09.12 →		+ / -	10		CP1455 80004514		CC1455 80004515		255x235x30
Mii	11.11 →		+ / -	11		CP1447 80004355		CC1447 80004403		296x227x28
Toledo I	01.91 → 03.99		+ / -	4		CP1239 80000636		CC1239 80000628		207x269x34
Toledo II	04.99 → 05.06		+ / -	4	10-20	CP1027 21651912		CC1027 21651955		207x269x34
Toledo II	04.99 → 05.06	w F	+ / -	4	10-20	CP1279 80000817		-		252x224x36
Toledo III	10.04 →		+ / -	11	10-20	CP1129 21653024		CC1129 21653008		207x269x34



SEAT										
Toledo III	10.04 →	RHD	+ / -	11	> 20	-			CC1298 80000602	252x216x32
Toledo IV	07.12 →		+ / -	11	> 20	CP1436 80001783		CC1436 80001784		252x224x36
SKODA										
Citigo	11.11 →		+ / -	11		CP1447 80004355		CC1447 80004403		252x224x36
Fabia I	08.99 →		+ / -	11	10-20	CP1074 21652356		CC1074 21652357		252x216x32
Fabia II	12.06 →		+ / -	11	10-20	CP1074 21652356		CC1074 21652357		252x216x32
Fabia II (facelift)	01.10 →		+ / -	11	> 20	CP1436 80001783		CC1436 80001784		252x224x36
Felicia I	10.94 → 03.98		+ / -	4	> 20	CP1027 21651912		CC1027 21651955		207x269x34
Octavia	09.96 →		+ / -	4	> 20	CP1027 21651912		CC1027 21651955		207x269x34
Octavia	09.96 →	w F	+ / -	4	> 20	CP1279 80000817		-		255x235x30
Octavia II	06.04 →		+ / -	11	10-20	CP1129 21653024		CC1129 21653008		207x269x34
Octavia II	06.04 →	RHD	+ / -	11	10-20	-		CC1298 80000602		252x216x32
Octavia III	11.12 →		+ / -	10		CP1455 80004514		CC1455 80004515		255x235x30
Rapid	10.12 →		+ / -	11	> 20	CP1436 80001783		CC1436 80001784		252x224x36
Roomster	09.06 →		+ / -	11	10-20	CP1074 21652356		CC1074 21652357		252x216x32
Roomster (Praktik)	02.10 →		+ / -	11	> 20	CP1436 80001783		CC1436 80001784		252x224x36
Superb (3U4)	02.02 →		+ / -	4	> 20	CP1027 21651912		CC1027 21651955		207x269x34
Superb (3T4)	07.08 →		+ / -	11	10-20	CP1129 21653024		CC1129 21653008		207x269x34
Superb (3V3)	01.15 →		+ / -	10		CP1455 80004514		CC1455 80004515		255x235x30
Yeti	05.09 →	LHD	+ / -	11	10-20	CP1129 21653024		CC1129 21653008		207x269x34
Yeti	05.09 →	RHD	+ / -	11	10-20	-		CC1298 80000602		200x227x20



SSANGYONG









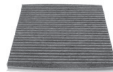

Actyon	11.05 →	Set	+ / -			CP1361 80001439		CC1361 80001440		221x96x25
Korando	12.96 →	Set	+ / -			CP1428 80001769		-		200x95x20
Korando	11.10 →		+ / -	10		CP1475 80004777		CC1475 80004778		270x99x20
Kryon	05.05 →	Set	+ / -			CP1361 80001439		CC1361 80001440		210x200x20
Musso	02.95 →	Set	+ / -			CP1428 80001769		-		178x183x29
Rexton (manuel)	04.02 →	Set	+ / -	10		CP1254 80000653		CC1254 80000800		220x170x20
Rodius	05.05 →	Set	+ / -			CP1427 80001768		-		215x200x20
Tivoli	06.15 →		+ / -			CP1527 49366992				180x180x25

SUBARU

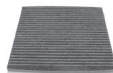



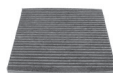



















BRZ	06.12 →		+	10	> 20	CP1110 21652989		CC1110 80000437		220x170x20
Forester (SF)	07.97 → 09.02		+ / -			CP1430 80001771		-		220x170x20
Forester (SG)	07.02 →		+ / -			CP1355 80001411		-		210x185x30
Forester (SH)	01.08 →		+ / -			CP1430 80001771		-		220x219x54
Impreza I	08.92 → 12.00		+ / -			CP1430 80001771		-		235x193x15
Impreza II	10.00 →		+ / -	10	10-20	CP1177 80000164		CC1177 80001750		155x158x19
Impreza III	01.08 →		+ / -			CP1426 80001767		-		217x213x17
Justy III	09.03 →		+	11		CP1072 21652350		CC1072 80000758		217x213x17
Justy IV	01.07 →		+ / -			CP1299 80004395		CC1299 80000617		209x194x30
Legacy III	10.98 → 08.03	LHD + RHD	+	10		CP1078 21652539		CC1078 80000745		217x213x17
Legacy IV	09.03 →	LHD + RHD	+	10		CP1078 21652539		CC1078 80000745		217x213x17
Legacy V	09.09 →		+	10		CP1227 80000604		CC1227 80000605		209x194x30



SUBARU

Outback	10.00 → 08.03	LHD + RHD	+	10		CP1078 21652539		CC1078 80000745		209x194x30
Outback II	09.03 → 09.09	LHD + RHD	+	10		CP1078 21652539		CC1078 80000745		217x213x17
Outback III	09.09 →	LHD + RHD	+	10		CP1078 21652539		CC1078 80000745		220x219x54
Trezia	TBD		+ / -	10		CP1227 80000604		CC1227 80000605		209x194x30
Tribeca	01.05 →	LHD + RHD	+			CP1078 21652539		CC1078 80000745		193x162x18
XV	03.12 →		+ / -			CP1426 80001767		-		194x270x20

SUZUKI

Alto IV	06.02 →		+ / -			CP1364 80001444		CC1364 80001445		230x110x18
Alto V	01.09 →		+ / -			CP1364 80001444		CC1364 80001445		258x198x30
Grand Vitara (FT / GT)	03.98 → 11.02	Set	+ / -	10		CP1317 80001023		-		215x185x20
Grand Vitara (FT / GT)	11.02 → 10.05		+ / -	10	> 20	CP1258 80000657		CC1258 80000785		246x217x19
Grand Vitara	10.05 →		+ / -	10	> 20	CP1262 80000676		CC1262 80000770		235x193x15
Vitara (LY)	01.15 →					CP1530 49370856				213x191x30
Ignis II	09.03 →		+	11	> 20	CP1072 21652350		CC1072 80000758		200x190x17
Jimny	09.98 →		+ / -			CP1365 80001446		CC1365 80001447		230x142x30
Kizashi	10.10 →					CP1440 80001789		CC1490 80001790		185x178x30
Liana	07.01 →		+ / -	10	10-20	CP1329 80001172		CC1329 80001173		185x178x30
Splash	01.08 →		+ / -	10		CP1324 80001036		CC1324 80001744		185x178x30
Swift III	01.05 →		+	11	10-20	CP1226 80000603		CC1226 80000763		235x193x15
Swift IV	10.10 →		+	11	10-20	CP1226 80000603		CC1226 80000763		217x213x17
SX4	06.06 →		+	10	10-20	CP1226 80000603		CC1226 80000763		209x194x30



SUZUKI

SCX4 S-Cross	11.13 →					CP1530				213x191x30
Wagon R (EM)	02.98 → 05.00		+	11	> 20	CP1072 21652350		CC1072 80000758		239x292x19
TOYOTA										
4 Runner	01.03 →	LHD + RHD	+			CP1078 21652539		CC1078 80000745		239x19x292
Auris	03.07 →		+	10		CP1227 80000604		CC1227 80000605		209x194x30
Avensis I	09.97 → 02.03	Set	+	10	> 20	CP1107 21652897		-		217x213x17
Avensis I	09.97 → 02.03	Set	ex.AC			CP1474 80004708		-		226x165x45
Avensis II	04.03 →	LHD + RHD	+	10	> 20	CP1106 21652874		CC1106 80000438		195x145x30,5
Avensis Verso	08.01 →	LHD + RHD	+ / -	10	> 20	CP1078 21652539		CC1078 80000745		217x213x17
Aygo	07.05 → 04.14		+	11	10-20	CP1259 80000662		CC1259 80000784		239x292x19
Aygo	05.14 →		+ / -	11		CP1489 80005194		CC1489 80005202		217x213x17
Camry (V30)	08.01 →	LHD + RHD	+ / -	10		CP1078 21652539		CC1078 80000745		206x220x20
Carina	12.97 →	Set	+ / -	10	> 20	CP1107 21652897		-		200x220x20
Celica	11.99 →	LHD + RHD	+ / -	10	> 20	CP1078 21652539		CC1078 80000745		194x213x20
Corolla (E10, E11)	04.97 → 01.02		+ / -	10	> 20	CP1105 21652873		-		209x194x30
Corolla (E12, E12L, E12T)	01.02 →	LHD + RHD	+ / -	10	> 20	CP1106 21652874		CC1106 80000438		273x167x10
Corolla Verso (ZER, ZZE)	03.04 →		+ / -	10	10-20	CP1368 80001452		CC1368 80001453		217x213x17
Hilux Pick-up	08.05 →		+ / -	10		CP1227 80000604		CC1227 80000605		209x194x30
iQ	01.09 →		+ / -	12		CP1341 80001208		CC1341 80001209		273x2197x11
Land Cruiser (J9, J10, J12, J15, J20)	04.95 →	LHD + RHD	+ / -	10	> 20	CP1078 21652539		CC1078 80000745		198x214x17
Picnic	05.01 →	LHD + RHD	+ / -	10	> 20	CP1085 21652551		CC1085 80000419		217x213x17



TOYOTA

Previa	08.00 →	LHD + RHD	+ / -	10	> 20	CP1078 21652539		CC1078 80000745		209x194x30
Prius	05.00 → 12.03	LHD + RHD	+ / -	10	> 20	CP1085 21652551		CC1085 80000419		198x214x17
Prius	01.04 →	LHD + RHD	+ / -	10	> 20	CP1078 21652539		CC1078 80000745		198x214x17
Prius	01.09 →		+ / -	10		CP1227 80000604		CC1227 80000605		209x194x30
RAV 4 I	01.94 → 09.00		+ / -	10	> 20	CP1085 21652551		CC1085 80000419		209x194x30
RAV 4 II	06.00 → 03.06	LHD + RHD	+ / -	10	> 20	CP1085 21652551		CC1085 80000419		209x194x30
RAV 4 III	04.06 →		+ / -	10		CP1227 80000604		CC1227 80000605		209x194x30
Urban Cruiser	04.09 →		+ / -	10		CP1227 80000604		CC1227 80000605		209x194x30
Verso	04.09 →		+ / -	10		CP1227 80000604		CC1227 80000605		209x194x30
Yaris	01.06 →		+ / -	10		CP1227 80000604		CC1227 80000605		209x194x30
Yaris (P13)	12.10 →		+ / -	10		CP1227 80000604		CC1227 80000605		209x194x30
Yaris / Yaris Verso (french production)	04.99 →	LHD + RHD	+ / -	10	> 20	CP1078 21652539		CC1078 80000745		270x169x30
Yaris / Yaris Verso (japanese production)	04.99 →	LHD + RHD	+ / -	10	> 20	CP1085 21652551		CC1085 80000419		250x203x36

VOLVO

440 / 460 / 480	04.86 → 12.96		+ / -			CP1315 80001025		-		235x209x35
850	06.91 → 12.96		+ / -	4	10-20	CP1052 21651986		CC1052 80000744		241x272x25
C1	TBD		+ / -			CP1432 80001772		CC1432 80001773		250x203x35
C30	10.06 →		+	12		CP1153 80000061		CC1153 80000062		235x209x35
C70	07.00 →		+	11	10-20	CP1060 21652317		CC1060 21652996		270x169x30
C70	07.00 →	RHD	+	11	10-20	CP1208 80000412		CC1208 80000069		235x209x35
C70 I Cabrio	03.98 → 10.05		+	12		CP1153 80000061		CC1153 80000062		235x209x35











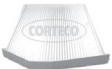



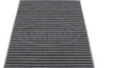



VOLVO

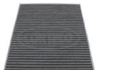





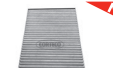



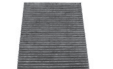

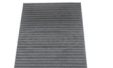



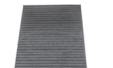

C70 I Coupé	06.97 → 06.00		+ / -	4	10-20	CP1052 21651986		CC1052 80000744		235x209x35
C70 II Cabrio	03.06 →		+	12		CP1153 80000061		CC1153 80000062		235x209x35
S40	07.95 → 12.03		+	11		CP1073 21652351		CC1073 21653069		275x242x25
S40 II	01.04 →		+	12	> 20	CP1153 80000061		CC1153 80000062		235x209x35
S60	11.00 →		+	11	10-20	CP1060 21652317		CC1060 21652996		275x242x25
S60	11.00 →	RHD	+	11	10-20	CP1208 80000412		CC1208 80000069		270x169x30
S60 II	04.10 →		+	11		CP1264 80000712		CC1264 80000713		241x272x25
S60 II	04.10 →	RHD	+	11	10-20	CP1208 80000412		CC1208 80000069		275x242x25
S70	06.97 → 11.00		+ / -	4	10-20	CP1052 21651986		CC1052 80000744		241x272x25
S70	07.00 →		+	11	10-20	CP1060 21652317		CC1060 21652996		275x242x25
S70	07.00 →	RHD	+	11	10-20	CP1208 80000412		CC1208 80000069		270x193x30
S80	05.98 → 07.06		+	11	10-20	CP1060 21652317		CC1060 21652996		270x169x30
S80	05.98 → 07.06	RHD	+	11	10-20	CP1208 80000412		CC1208 80000069		203x219x19
S80 II	03.06 →		+	11		CP1264 80000712		CC1264 80000713		250x203x36
S90 / V90	01.97 → 05.98		+ / -	3	> 20	CP1052 21651986		CC1052 80000744		235x209x35
V40	07.95 → 06.04		+	11		CP1073 21652351		CC1073 21653069		270x193x30
V40	03.12 →		+ / -	11	10-20	CP1432 80001772		CC1432 80001773		250x203x35
V50	04.04 →		+	12	> 20	CP1153 80000061		CC1153 80000062		235x209x35
V60	09.10 →		+ / -	11	10-20	CP1264 80000712		CC1264 80000713		275x242x25
V70 I	01.97 → 05.00		+ / -	4	10-20	CP1052 21651986		CC1052 80000744		270x193x30
V70 II	03.00 →		+	11	10-20	CP1060 21652317		CC1060 21652996		270x193x30

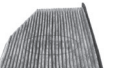

VOLVO

V70 II	03.00 →	RHD	+	11	10-20	CP1208 80000412		CC1208 8000069		241x272x25
V70 III	08.07 →		+	11		CP1264 80000712		CC1264 80000713		275x242x25
XC60	05.08 →		+	11		CP1264 80000712		CC1264 80000713		270x193x30
XC70 Cross Country	03.00 →		+ / -	10	10-20	CP1060 21652317		CC1060 21652996		241x272x25
XC70 Cross Country	03.00 →	RHD	+	10	10-20	CP1208 80000412		CC1208 8000069		275x242x25
XC70 II	08.07 →		+	11		CP1264 80000712		CC1264 80000713		275x217x30
XC90	10.02 →		+ / -	11	10-20	CP1060 21652317		CC1060 21652996		279x207x25
XC90	10.02 →	RHD	+	11	10-20	CP1208 80000412		CC1208 8000069		207x269x34
XC90 II	09.14 →					CP1523 49363444	 NEW	CC1523 49363445	 NEW	333x237x40

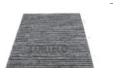
VW

Amarok	01.11 →		+ / -	11	> 20	CP1125 21653020		CC1125 21653015		279x207x25
Beetle	01.98 →		+ / -	4	10-20	CP1027 21651912		CC1028 21651967		279x207x25
Beetle (5C1)	06.11 →		+ / -	11	10-20	CP1129 21653024		CC1129 21653008		207x269x34
Bora	10.98 → 05.05		+ / -	4	10-20	CP1027 21651912		CC1028 21651967		207x269x34
Caddy II	11.95 → 01.04		+ / -	4	10-20	CP1027 21651912		CC1027 21651955		207x269x34
Caddy II	11.95 → 01.04	w F	+ / -	4	10-20	CP1279 80000817		-		352x234x35
Caddy III	03.04 →		+ / -	11	10-20	CP1129 21653024		CC1129 21653008		207x269x34
Caddy III	03.04 →	RHD	+	11	10-20	-	-	CC1298 80000602		252x216x32
Caddy IV	05.15 →		+ / -	11	10-20	CP1129 21653024		CC1129 21653008		207x269x34
Crafter	06.05 →		+	1		CP1233 80000614		CC1233 80000616		180x190x37
Eos	03.06 →		+ / -	11	10-20	CP1129 21653024		CC1129 21653008		207x269x34













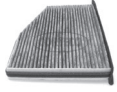

VW										
Fox	04.05 →		+ / -	11	10-20	CP1074 21652356		CC1074 21652357		252x216x32
Golf I / II	01.84 → 08.93		+ / -	4		CP1239 80000636		CC1239 80000628		279x207x25
Golf III	07.93 → 04.99		+ / -	4	10-20	CP1027 21651912		CC1027 21651955		296x227x28
Golf III	07.93 → 04.99	w F	+ / -	4	10-20	CP1279 80000817		-		207x269x34
Golf IV	08.97 → 06.05		+ / -	4	10-20	CP1027 21651912		CC1028 21651967		207x269x34
Golf IV	08.97 → 06.05	w F	+ / -	4	10-20	CP1279 80000817		-		207x269x34
Golf V	10.03 →		+ / -	11	10-20	CP1129 21653024		CC1129 21653008		207x269x34
Golf V	10.03 →	RHD	+	11	10-20	-		CC1298 80000602		207x269x34
Golf V Plus	01.05 →		+ / -	11	10-20	CP1129 21653024		CC1129 21653008		207x269x34
Golf V Plus	01.05 →	RHD	+	11	10-20	-		CC1298 80000602		255x235x30
Golf VI + Variant	08.08 →	RHD	+ / -	10		-		CC1298 80000602		207x269x34
Golf VI + Variant	08.08 →		+ / -	11	10-20	CP1129 21653024		CC1129 21653008		207x269x34
Golf VII + Variant	11.12 →		+ / -	10		CP1455 80004514		CC1455 80004515		255x235x30
Jetta III	08.05 →		+ / -	11	10-20	CP1129 21653024		CC1129 21653008		207x269x34
Jetta III	08.05 →	RHD	+ / -	11	10-20	-		CC1298 80000602		279x207x25
Jetta IV	02.11 →		+ / -	11	10-20	CP1129 21653024		CC1129 21653008		207x269x34
LT II	05.96 →		+ / -	1	10-20	CP1044 21651976		CC1044 21652985		248x181x30
Lupo	09.98 → 07.05		+ / -	4	10-20	CP1027 21651912		CC1028 21651967		385x145x25
Passat (3A2, 3A5, 35I)	08.90 → 07.94	rv	+ / -	4	10-20	CP1225 80000594		-		279x207x25
Passat (3A2, 3A5, 35I)	08.94 → 05.97		+ / -	4	10-20	CP1023 21651898		CC1023 21651968		207x269x34
Passat (B5)	10.96 → 10.00		+ / -	7	10-20	CP1015 21651890		CC1015 21651956		207x269x34



VW										
Passat (B6)	10.00 → 05.05		+ / -	7	10-20	CP1027 21651912		CC1027 21651955		207x269x34
Passat (B7)	03.05 →		+ / -	11	10-20	CP1129 21653024		CC1129 21653008		207x269x34
Passat (B7)	03.05 →	RHD	+	11		-		CC1298 80000602		207x269x34
Passat (362, 365)	08.10 →		+ / -	11	10-20	CP1129 21653024		CC1129 21653008		207x269x34
Passat	11.14 →		+ / -	10		CP1455 80004514		CC1455 80004515		255x235x30
Passat CC	06.08 →		+ / -	11	10-20	CP1129 21653024		CC1129 21653008		207x269x34
Phaeton	04.02 →	Set	+ / -	14		-		CC1289 21653031		252x216x32
Polo (6N1, 6N2)	11.94 → 09.01		+ / -	4	10-20	CP1027 21651912		CC1027 21651955		252x224x36
Polo (6N1, 6N2)	11.94 → 09.01	w F	+ / -	4	10-20	CP1279 80000817		-		207x269x34
Polo (9N_, PQ24)	10.01 →		+ / -	11	10-20	CP1074 21652356		CC1074 21652357		252x216x32
Polo (6R_, PQ25)	06.09 →		+ / -	11	> 20	CP1436 80001783		CC1436 80001784		252x224x36
Scirocco	09.08 →		+ / -	11	10-20	CP1129 21653024		CC1129 21653008		207x269x34
Sharan (7M)	05.95 →		+ / -	4	10-20	CP1020 21651895		CC1020 21651960		275x217x30
Sharan (7N)	05.10 →		+ / -	4	10-20	CP1020 21651895		CC1020 21651960		207x269x34
Sportsvan	02.14 →		+ / -	10		CP1455 80004514		CC1455 80004515		255x235x30
T4, Caravelle	01.96 → 04.03			4	10-20	CP1053 21651987		CC1053 80000028		275x217x30
T5	04.03 →		+ / -	11	> 20	CP1125 21653020		CC1125 21653015		276x217x40
T6			+ / -	11	> 20	CP1125 21653020		CC1125 21653015		276x217x40
Tiguan	09.07 →		+ / -	11	10-20	CP1129 21653024		CC1129 21653008		207x269x34
Touareg (7LA, 7L6, 7L7)	10.02 →		+ / -	11	> 20	CP1125 21653020		CC1125 21653015		207x269x34
Touareg (7P5)	04.10 →		+ / -	11		CP1403 80001742		CC1403 80001741		255x35x182



VW										
Touran (1T1, 1T2)	02.03 →		+ / -	11	10-20	CP1129 21653024		CC1129 21653008		207x269x34
Touran (1T1, 1T2)	02.03 →	RHD	+	11	10-20	CP1129 21653024		CC1298 80000602		207x269x34
Touran (1T3)	01.10 →		+ / -	11	10-20	CP1129 21653024		CC1298 21653008		207x269x34
Touran	01.15 →		+ / -	10		CP1455 80004514		CC1455 80004515		255x235x30
UP	11.11 →		+ / -	11		CP1447 80004355		CC1447 80004403		285x177x35
Vento	11.91 → 09.98		+ / -	4	10-20	CP1027 21651912		CC1027 21651955		215x200x30
Vento	11.91 → 09.98	w F	+ / -	4	10-20	CP1279 80000817		-		215x200x30

Fahrzeuganwendungen | Applications | Applicazioni

VEHICLE APPLICATIONS

























VEHICLE APPLICATIONS

FAHRZEUGANWENDUNGEN | APPLICATIONS | APPLICAZIONI



CLAAS								
Mähdrescher / Reaper (all models)			2 !	CP1216 80000449		-		550x130x29
DAF								
65 CF	02.98 → 12.00		+	CP1126 21653021		-		432x169x25
75 CF	02.98 → 12.00		+	CP1126 21653021		-		432x169x25
85 CF	03.98 → 12.00		+	CP1126 21653021		-		432x169x25
95	09.87 → 01.98		+	CP1196 80000354		-		265x215x27
CF 85	01.01 →		+	CP1114 21652997		CC1114 80000626		267x157x30
LF 45	01.01 →		+	CP1248 80000645		-		225x205x20
LF 55	01.01 →		+	CP1248 80000645		-		225x205x20
XF 95	09.98 → 12.00		+	CP1127 21653022		CC1127 80000623		330x241x25
XF 95	09.02 →		+	CP1114 21652997		CC1114 80000626		267x157x30
DREIHA								
Stadtbus / Citybus	01.95 →		+	CP1197 80000356		CC1197 80000768		448x236x30
IKARUS								
Ikarus				od		-		
IVECO								
EuroStar	01.93 → 01.04			CP1160 80000075		-		435x99x35
EuroTech MH	09.98 → 01.04			CP1160 80000075		-		435x99x35
EuroTech MP	01.92 → 01.04			CP1160 80000075		-		435x99x35
EuroTech MT	01.92 → 01.04			CP1160 80000075		-		435x99x35
EuroTrakker	01.93 → 01.04			CP1160 80000075		-		435x99x35



IVECO								
Irisbus Access Bus Webasto Aerosphere	01.02 →	roof AC	+	CP1184 80000336		- -		455x152x14
Irisbus Agora	01.03 →	FC		CP1328 80001182		- -		420x100x20
Irisbus Agora Webasto Aerosphere	01.03 →	roof AC	+	CP1184 80000336		- -		455x152x14
Irisbus Arway Webasto Aerosphere	01.06 →	roof AC	+	CP1184 80000336		- -		455x152x14
Irisbus Axer Webasto Aerosphere	10.03 → 01.07	roof AC	+	CP1184 80000336		- -		455x152x14
Irisbus Citelis	01.05 →	FC	+/-	CP1328 80001182		- -		420x100x20
Irisbus Citelis Webasto Aerosphere	09.05 →	roof AC	+	CP1184 80000336		- -		455x152x14
Irisbus Crealis	01.08 →	FC		CP1328 80001182		- -		420x100x20
Irisbus Crossway	06.06 →			CP1490 80005208		- -		497x173x30
Irisbus Domino Webasto Aerosphere	10.03 →	roof AC	+	CP1184 80000336		- -		455x152x14
Irisbus Evadys Webasto Aerosphere	10.03 →	roof AC	+	CP1184 80000336		- -		455x152x14
Irisbus Recreo Webasto Aerosphere	10.03 → 01.07	roof AC	+	CP1184 80000336		- -		455x152x14
Stralis	02.02 →		+	CP1181 80000333		CC1181 80001127		450x206x25
Strator	04.10 →			CP1181 80000333		CC1181 80001127		450x206x25
Trakker	10.04 →			CP1181 80000333		CC1181 80001127		450x206x25
JOHN DEERE								
5000-6000 series	10.09 →		+	CP1211 80000444		CC1211 80000627		205x130x40
6010-6610 series	01.99 →	Set	+/-	CP1217 80000535		CC1217 80000796		190x153x30
8010-8020-9000 series			+/-	CP1167 80000115		- -		318x165x48
9560-9570-9660-9670-9760-9770-98-60-9870 series	11.11 →			CP1488 80005193				320x130x48
KOMATSU								
Construction vehicle				CP1182 80000334		- -		194x190x15



KOMATSU								
Construction vehicle				CP1183 80000335		- -		300x200x16
Construction vehicle (D41-D85) series 15			+	CP1212 80000445		- -		251x139x20
Construction vehicle (PC160-340) series 7			+/-	CP1212 80000445		- -		251x139x20
Construction vehicle (WA270-320) series 3		w/o F	+/-	CP1214 80000447		- -		410x140x20
Construction vehicle (WA320-470) series 3			+/-	CP1213 80000446		- -		250x197x20
			+/-	CP1215 80000448		- -		235x140x20
LINDE								
39X series			+	CP1209 80000442		- -		220x118x30
Stapler / Forklift H25T-30			+	CP1210 80000443		- -		168x110x20
MAN								
33 t series	05.94 → 06.96		+	CP1041 21651973		- -		403x181x40
F2000	01.94 →		+	CP1041 21651973		- -		403x181x40
FE series	09.00 →		+	CP1041 21651973		- -		403x181x40
L2000	01.94 →		+	CP1121 21653016		- -		361x158x37
LE series	09.00 →		+	CP1041 21651973		- -		403x181x40
Lions City Konvekta P600 / P700 / P800 / HZ700	01.04 →	roof AC	+/-	CP1385 80001583		- -		390x145x33
Lions City A	06.96 →			CP1490 80005208		- -		497x173x30
Lions Coach	09.95 → 08.02		+	CP1198 80000357		CC1198 80000625		846x247x20
Lions Coach	09.02 →		+	CP1161 80000076		- -		400x132x20
Lions Coach Konvekta ACX632	01.00 →	roof AC	+/-	CP1387 80001584		- -		390x155x17
Lions Coach Webasto Aerosphere Top 2000	01.00 →	roof AC	+/-	CP1380 80001579		- -		490x144x12
Lions Comfort	09.96 →		+	CP1161 80000076		- -		400x132x20



MAN								
Lions Star	09.95 →		+	CP1198 80000357		CC1198 80000625		846x247x20
M2000	05.94 →		+	CP1041 21651973		-		403x181x40
ME series	09.00 →		+	CP1041 21651973		-		403x181x40
EL-EM series / NG-NL-NM-NÜ series	09.89 → 07.98			CP1416 80001758		CC1416 80001751		458x237x30
NG-NL-NM-NÜ series	09.89 → 07.98		+	CP1197 80000356		CC1197 80000768		448x236x30
NG-NL-NM-NÜ series Konvekta P600 / P700 / P800 / HZ700	01.98 →	roof AC	+/-	CP1385 80001583		-		390x145x33
NG-NL-NM-NÜ series Webasto Aerosphere	07.98 →	roof AC	+	CP1184 80000336		-		455x152x14
NG-NL-NM-NÜ series	07.98 →			CP1490 80005208	 NEW	-		497x173x30
TGS, TGX	01.07 →			CP1119 21653005		CC1119 80000364		465x179x69
TG-A	04.00 →		+	CP1119 21653005		CC1119 80000364		465x179x69
MERCEDES - BUS								
Evobus O402-O405-O408	10.85 → 12.98		+/-	CP1423 80001765		-		523x282x20
Evobus O404 (Fresh Air Filter)	01.91 →			CP1187 80000339		-		528x220x45
Evobus O404-O350	01.91 →	RCF		CP1188 80000340		-		340x135x34
Evobus O405-O407-O408	01.85 →			CP1189 80000341		-		428x230x40
Evobus Citaro O530	01.98 →			CP1161 80000076		-		400x132x20
Evobus Citaro O530 Konvekta	01.98 →	FC	+	CP1185 80000337		-		495x225x48
Evobus Citaro O530 Konvekta P600 / P700 / P800 / HZ700	01.98 →	roof AC	+/-	CP1385 80001583		-		390x145x33
Evobus Citaro O530 Webasto Aerosphere Top 2000	01.98 →	roof AC	+/-	CP1380 80001579		-		490x144x12
Evobus Citaro O530 Webasto Aerosphere	01.98 →	roof AC	+	CP1184 80000336		-		455x152x14
Evobus Citaro O530 Webasto Aerosphere	01.05 →	FC	+/-	CP1395 80001622		-		470x230x20



MERCEDES - BUS

Evobus Citaro O530 Webasto	01.07 →	FC	+/-	CP1386 80001626		- -		500x234x50
Evobus Citaro O530 Heating Webasto	01.98 →	FC	+/-	CP1422 80001764		- -		472x230x25
Evobus Citaro O628	01.12 →		+/-	CP1481 80004828		- -		905x209x21
Evobus Conecto O345 Webasto Aerosphere	11.01 →	roof AC	+	CP1184 80000336		- -		455x152x14
Evobus Integro O550 Webasto Aerosphere VT641	01.97 → 01.06	roof AC	+/-	CP1394 80001621		- -		1550x240x20
Evobus Integro O550	01.06 →		+	CP1242 80000639		CC1242 80000629		492x145x30
Evobus Integro O550 Konvekta P600 / P700 / P800 / HZ700	01.06 →	roof AC	+/-	CP1385 80001583		- -		390x145x33
Evobus Integro O550 Webasto	01.06 →	roof AC	+	CP1244 80000641		CC1244 80000631		454x147x30
Evobus Integro O550 Heating Webasto	01.06 →	FC	+/-	CP1421 80001763		- -		550x230x20
Evobus Intouro	01.05 →		+/-	CP1454 80004440		CC1454 80004441		557x228x40
Evobus Medio 0815 / 0818	01.00 →		+/-	CP1333 80001180		CC1333 80001181		558x148x40
Evobus Setra 300 series				CP1193 80000348		- -		1640x150x12
Evobus Setra 300 series				CP1238 80000635		- -		1490x152x5
Evobus Setra 300 series Webasto Aerosphere VT641	01.97 → 01.06	roof AC	+/-	CP1394 80001621		- -		1550x240x20
Evobus Setra 400 series	01.01 →			CP1190 80000342		- -		260x150x13
Evobus Setra 400 series	01.01 →		+	CP1242 80000639		CC1242 80000629		492x145x30
Evobus Setra 400 series Webasto	01.01 →	roof AC	+	CP1244 80000641		CC1244 80000631		454x147x30
Evobus Setra 400 series Webasto Aerosphere World, Aquasphere-/TopAir	10.01 →	roof AC	+/-	CP1390 80001629		- -		317x137x7
Evobus Setra 400 series Webasto Aquasphere TC400	10.02 →	roof AC	+/-	CP1389 80001628		- -		275x116x12
Evobus Setra 400 series Webasto Aquasphere TC400	10.02 →	roof AC	+/-	CP1388 80001627		- -		596x116x12
Evobus Setra 400 series Konvekta P600 / P700 / P800 / HZ700	01.03 →	roof AC	+/-	CP1385 80001583		- -		390x145x33

**MERCEDES - BUS**

Evobus Setra 400 series Heating Webasto	10.02 →	FC	+/-	CP1421 80001763		- -		550x230x20
Evobus Tourismo O350 Webasto Aerosphere Top 2000	09.94 →	roof AC	+/-	CP1380 80001579		- -		490x144x12
Evobus Tourismo O350	09.94 →		+/-	CP1420 80001762		CC1421 80001755		390x129x17
Evobus Tourismo O350	09.94 →		+/-	CP1424 80001766		- -		390x142x17
Evobus Tourismo O350 Konvekta	09.06 →	roof AC	+/-	CP1525 49363598				518x143x35
Evobus Travego O580	10.99 →		+	CP1242 80000639		CC1242 80000629		492x145x30
Evobus Travego O580 (FC) Heating Webasto	10.99 →	FC	+/-	CP1421 80001763		- -		550x230x20
Evobus Travego O580 Konvekta P600 / P700 / P800 / HZ700	10.99 →	roof AC	+/-	CP1385 80001583		- -		390x145x33
Evobus Travego O580 Thermoking	10.99 →	roof AC		CP1220 80000539		CC1220 80000787		545x200x20
Evobus Travego O580 Thermoking	10.99 →	roof AC	+/-	CP1396 80001623		- -		1555x150x12
Evobus Travego O580 Webasto Aerosphere	10.99 →	roof AC	+	CP1184 80000336		- -		455x152x14
Evobus Travego O580 Webasto	10.99 →	roof AC	+	CP1244 80000641		CC1244 80000631		454x147x30

MERCEDES - TRUCK

Actros (1831-1835-1840-1843-1848-1853-2031)	01.96 → 10.02	ocv	+	CP1118 21653003		CC1118 21653006		390x145x40
Actros	09.96 → 10.02		+/-	CP1045 21651977		- -		380x133x36
Actros	09.96 → 10.02	w/o F	+	CP1194 80000349		- -		335x100x10
Actros MP2	10.02 →		+/-	CP1045 21651977		- -		380x133x36
Actros MP2	10.02 →	w/o F	+	CP1194 80000349		- -		335x100x10
Actros MP2 (1831-1835-1840-1843-1848-1853-2031)	10.02 →	ocv	+	CP1118 21653003		CC1118 21653006		390x145x40
Actros MP4	07.11 →	SAC		CP1123 21653018				220x149x20
Actros MP4	07.11 →			CP1464 80004630		CC1464 80004631		312x230x38

**MERCEDES - TRUCK**

Antos	07.11 →	SAC		CP1123 21653018				220x149x20
Antos	07.11 →			CP1464 80004630		CC1464 80004631		312x230x38
Arocs	01.13 →	SAC		CP1123 21653018				220x149x20
Arocs	01.13 →			CP1464 80004630		CC1464 80004631		312x230x38
Atego 1, 2, 3 (958-860, 972-890, 972-899, 375-830, 375-850)	01.98 →		+	CP1115 21652998		CC1115 21652999		570x157x40
Atego 1, 2, 3 (958-860, 972-890, 972-899, 375-830, 375-850)	01.98 →	ocv	+	CP1116 21653001		-		572x160x40
Axor-Econic (958-870, 958-880, 375-810, 375-820, 375-860, 375-840, 944-899, 944-890, 940-899, 940-890)	01.98 →		+	CP1120 21653007		CC1120 21653000		456x184x56
Axor-Econic (958-870, 958-880, 375-810, 375-820, 375-860, 375-840, 944-899, 944-890, 940-899, 940-890)	01.98 →	ocv	+	CP1287 21652002		-		446x183x57
Econic II	04.13 →		+/-	CP1045 21651977		-		380x133x36
Evobus MK	12.87 → 09.96		+	CP1124 21653019		-		337x175x29
Unimog	01.13 →		+/-	CP1480 80004827				272x212x30

NEOPLAN

Centroliner	10.98 →		+	CP1197 80000356		CC1197 80000768		448x236x30
Centroliner	10.98 →			CP1416 80001758		CC1416 80001751		458x237x30
Centroliner Webasto Aerosphere	10.98 →	roof AC	+	CP1184 80000336		-		455x152x14
Cityliner Heating Webasto	01.01 → 01.06	FC		CP1382 80001581		-		450x190x30
Cityliner	09.04 →		+	CP1198 80000357		CC1198 80000625		846x247x20
Euroliner				CP1198 80000357		CC1198 80000625		846x247x20
Skyliner	09.96 →		+/-	CP1397 80001624		-		785x85x15 740x85x15
Skyliner	09.04 →		+	CP1198 80000357		CC1198 80000625		846x247x20
Skyliner Heating Webasto	01.07 →	FC	+/-	CP1382 80001581		-		450x190x30



NEOPLAN

Starliner Heating Webasto	09.96 →	FC	+/-	-		CC1382 80001580		395x255x30
Starliner Webasto	09.96 →		+/-	CP1384 80001582		-		290x150x20
Tourliner			+	CP1123 21653018		-		220x149x20
Tourliner Konvekta ACX632	01.00 →	roof AC	+/-	CP1387 80001584		-		390x155x17
Tourliner	01.03 →		+	CP1197 80000356		CC1197 80000768		448x236x30
Tourliner Webasto Aerosphere Top 2000	01.03 →	roof AC	+/-	CP1380 80001579		-		490x144x12
Transliner Heating Webasto	09.90 →	FC	+/-	CP1382 80001581		-		450x190x30
Trendliner	09.04 →		+	CP1198 80000357		CC1198 80000625		846x247x20

NEW HOLLAND

TS-A series	01.03 →		+/-	CP1245 80000642		CC1245 80000789		530x102x60
-------------	---------	--	-----	---------------------------	--	---------------------------	--	------------

RENAULT - BUS



Ares	01.97 →		+/-	CP1232 80000613		CC1232 80000769		390x120x30
------	---------	--	-----	---------------------------	--	---------------------------	--	------------

RENAULT - TRUCK



Agora	01.96 →		+/-	CP1232 80000613		CC1232 80000769		390x120x30
C-Serie	01.13 →			CP1483 80005071		CC1483 80005072		270x185x30
Kerax	01.01 → 01.06		+	CP1248 80000645		-		225x205x20
Kerax	01.06 →		+/-	CP1392 80001586		-		200x90x20
K-Serie	01.13 →			CP1483 80005071		CC1483 80005072		270x185x30
Magnum	09.90 →		+/-	CP1391 80001585		-		292x117x20
Midlum	01.00 →		+	CP1248 80000645		-		225x205x20
Midlum II	01.06 →		+/-	CP1392 80001586		-		200x90x20
Premium	01.01 →		+	CP1248 80000645		-		225x205x20
Premium Distribution / Route	01.05 →		+/-	CP1392 80001586		-		200x90x20



RENAULT - TRUCK

Premium Lander	01.05 →		+/-	CP1392 80001586		-		200x90x20
T-Serie	01.13 →			CP1483 80005071		CC1483 80005072		270x185x30



SCANIA

94-114-124-144-164 series 4	01.96 →		+/-	CP1200 80000362		-		237x177x70
Series 2 and 3	01.76 → 05.88		+	CP1249 80000646		-		355x250x50
Series 4 (E/R)	09.95 → 09.04		+	CP1195 80000350		-		232x162x10
Series P, G, R, T	03.04 →		+/-	CP1410 80001732		-		378x138x20











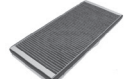

VAN HOOL

A-series / A308-A330-AG300 Webasto Aerosphere World, Aquasphere-/TopAir		roof AC	+/-	CP1390 80001629		-		317x137x7
--	--	---------	-----	---------------------------	--	---	--	-----------

VISEON





C Series	10.10 →			CP1490 80005208		-		497x173x30
L Series	10.10 →			CP1490 80005208		-		497x173x30

VOLVO - TRUCK

7700 - 8700 - 9700	01.99 →		+	CP1241 80000638		CC1241 80000782		410x180x30
F7 - F10 - F12 - F16	08.77 → 12.94			CP1236 80000633		-		260x183x46
FE	05.06 →		+/-	CP1392 80001586		-		200x90x20
FH12 - FH16 - FH - FM7 - FM9 - FM	08.93 →		+/-	CP1142 21653139		-		197x197x50
FL2	05.06 →		+/-	CP1392 80001586		-		200x90x20
FL4 - FL6 - FL10 - FL - FLC - FS7	09.85 →			CP1235 80000632		-		235x122x37
FH II	05.12 →	PF		CP1482 80005070				272x118x22
FH II	05.12 →			CP1483 80005071		CC1483 80005072		270x185x30
FH 16 II	04.09 →	PF		CP1482 80005070				272x118x22
FH 16 II	04.09 →			CP1483 80005071		CC1483 80005072		270x185x30



VOLVO - TRUCK

FMX II	09.13 →	PF	CP1482 80005070				272x118x22
FMX II	09.13 →		CP1483 80005071		CC1483 80005072		270x185x30
Mähdrescher / Reaper (all models)			CP1393 80001620		-		395x332x70
Radlader / Wheel Loader			CP1411 80001757		-		395x460x5

OE-Nummern | Correspondances CORTECO-
Origine | Tabelle Comparative CORTECO-OEM

OE-NUMBERS

OE-NUMBERS

OE-NUMMERN | CORRESPONDANCES CORTECO-ORIGINE | TABELLE COMPARATIVE CORTECO-OEM



OE NR   SET

ALFA			
6065364	• 21651952	Combi	
7797229	21651896	Particle	
46409630	21651915	Particle	
46409630	• 21651951	Combi	
46721923	21651915	Particle	
46722335	21651954	Combi	
46722335	• 80000376	Particle	
46799653	21652352	Combi	•
46799653	• 80000375	Particle	•
50511785	80001770	Particle	
52407563	80000346	Combi	
55702456	80000541	Particle	
55702456	• 80000777	Combi	
55702468	80000541	Particle	
55702468	• 80000777	Combi	
60653641	• 21651901	Particle	
60653641	• 21651952	Combi	
60653642	• 21651953	Combi	
60653642	21651970	Particle	
60809709	21651915	Particle	
60810570	21651915	Particle	
60813794	21651915	Particle	
60813795	21651915	Particle	
60814643	21651954	Combi	
60814643	• 80000376	Particle	
60815647	• 21651901	Particle	
60815647	• 21651952	Combi	
71712595	21651915	Particle	
71712595	• 21651951	Combi	
71712596	21651915	Particle	
71712596	• 21651951	Combi	
71754158	80000345	Particle	
77343481	80000345	Particle	
77363370	80000346	Combi	
77365352	80001770	Particle	
77365352	• 80001793	Combi	
82398550	21651896	Particle	
E3146721923	• 21651951	Combi	
AUDI			
893091700	21651956	Combi	
893819429	21651956	Combi	
1H0819638A	21651912	Particle	
1H0819644	21651912	Particle	
1H0819644A	21651912	Particle	
1H0819644B	21651912	Particle	
1K0819644	21653024	Particle	
1K0819644A	21653024	Particle	
1K0819644B	21653024	Particle	
1K1819653	21653008	Combi	
1K1819653A	21653008	Combi	
1K1819653B	21653008	Combi	
1K2819653	80000602	Combi	
1K2819653A	80000602	Combi	
1K2819653B	80000602	Combi	
4A0091800	21651958	Combi	
4A0819430A	• 21651957	Combi	
4A0819439A	21651914	Particle	

OE NR   SET

AUDI			
4A1820367	21651913	Particle	
4B0091800	• 21651957	Combi	
4B0819439A	• 21651957	Combi	
4B0819439C	21652713	Combi	
4D0819439	21653023	Particle	•
4D0819439A	21652552	Combi	•
4D0898438	21653023	Particle	•
4D0898438A	21652552	Combi	•
4E0819439A	21652898	Combi	
4E0819439A	• 80000343	Particle	
4F0819439	21653067	Particle	
4F0819439A	21653066	Combi	
4F0819439C	21653066	Combi	
4F0898438A	21653066	Combi	
4F0898439B	21653066	Combi	
4F0898439C	21653066	Combi	
4H0819439	80001756	Combi	
4H0819439	80001782	Particle	
4M0819439	49363446	Particle	
4M0819439A	49363447	Combi	
5Q0819644	80004514	Particle	
5Q0819653	80004515	Combi	
6Q0819653	21652357	Combi	
6Q0819653B	21652357	Combi	
6Q0820367	21652356	Particle	
6Q0820367A	21652356	Particle	
6Q0820367B	21652356	Particle	
6R0819653	80001784	Combi	
6R0820367	80001783	Particle	
7H0819631	21653020	Particle	
7H0819631A	21653015	Combi	
893091400A	21651890	Particle	
8A0819439	21651890	Particle	
8A0819439A	21651890	Particle	
8A0819439B	21651956	Combi	
8D0091800	21651956	Combi	
8E0819439	21652689	Particle	
8K0819439	80000879	Particle	
8K0819439A	80000880	Combi	
8K0819439B	80000880	Combi	
8L0091800	21651955	Combi	
AUDI FAW			
4B0819439C	21652713	Combi	
4F0819439	21653067	Particle	
4F0819439A	21653066	Combi	
8K0819439	80000879	Particle	
8K0819439A	80000880	Combi	
BMW			
64106907746	80004653	Combi	
64110008138	21651882	Combi	•
64111393241	80000073	Particle	•
64111393489	21651198	Particle	
64111393489	• 80000359	Combi	
64112182533	21651882	Combi	•
64116907450	21652336	Combi	
64116915763	21652849	Particle	
64116915764	21652852	Combi	

OE NR   SET

BMW			
64116921018	21652848	Particle	•
64116921019	21652851	Combi	•
64116945593	80000847	Particle	•
64116945594	80000848	Combi	•
64118363274	80000022	Particle	•
64118390447	21651881	Combi	•
64118391198	21651882	Combi	•
64118391198	21651897	Particle	•
64118391200	21651882	Combi	•
64119069895	21651198	Particle	
64119069895	• 80000359	Combi	
64119070073	21651882	Combi	•
64119163328	• 80001210	Particle	•
64119163328	80001794	Particle	•
64119163329	80001211	Combi	•
64119163329	80001795	Combi	•
64119216588	21651882	Combi	•
64119237159	80004359	Particle	•
64119237159	80004360	Combi	•
64119237554	80004353	Particle	
64119237555	80004354	Combi	
64119248294	80000848	Combi	•
64119272641	• 80001210	Particle	•
64119272641	80001794	Particle	•
64119272642	80001211	Combi	•
64119272642	80001795	Combi	•
64119321875	80004825	Combi	•
64119321876	• 80005089	Particle	
64119404386	80000073	Particle	•
64311000004	21651969	Particle	
64311390836	21651197	Particle	
64311390836	• 80000377	Combi	
64311390870	21651888	Particle	
64311394093	80001488	Particle	
64311496710	21652850	Particle	
64311496711	21652853	Combi	
64312182458	21652336	Combi	
64312207985	21651882	Combi	•
64312218428	21652916	Combi	
64312284827	80001776	Particle	•
64312284828	80001777	Combi	•
64316913506	21653064	Combi	•
64316915763	21652849	Particle	
64316915764	21652852	Combi	
64316930349	21652853	Combi	
64316930351	21652850	Particle	
64316935822	21653063	Particle	•
64316935823	21653064	Combi	•
64316945585	80000847	Particle	•
64316945586	80000848	Combi	•
64316945596	80004406	Particle	
64316946628	80000064	Combi	
64316946629	80000063	Particle	
64316962548	80000063	Particle	
64316962549	80000064	Combi	
64318350016	21651888	Particle	
64318361899	21651969	Particle	

BMW			
64318363274	80000022	Particle	•
64318390377	21653030	Particle	•
64318409043	• 80000065	Particle	
64318409044	21652916	Combi	
64319069926	21651881	Combi	•
64319069927	21651897	Particle	•
64319070072	21651881	Combi	•
64319071933	80000022	Particle	•
64319071934	21651969	Particle	
64319071935	21652336	Combi	
64319142114	80000063	Particle	
64319142115	80000064	Combi	
64319159606	80001029	Combi	•
64319159713	80004651	Combi	
64319171858	21653064	Combi	•
64319174370	21653063	Particle	•
64319175484	80004651	Combi	
64319194098	80004406	Particle	
64319195193	21652849	Particle	
64319195194	21652852	Combi	
64319216590	21652336	Combi	
64319216591	21651969	Particle	
64319218706	21652916	Combi	
64319224084	• 80000065	Particle	
64319224085	21652916	Combi	
64319237157	80001777	Combi	•
64319237158	80001776	Particle	•
64319257504	21652336	Combi	
64319257505	21652853	Combi	
64319297749	• 80005089	Particle	
64319312316	80001776	Particle	•
64319312318	80001777	Combi	•
64319313517	80000063	Particle	
64319313519	80000064	Combi	
64319346267	80005225	Combi	

CHEVROLET			
4803883	80000877	Particle	
4803883	• 80000878	Combi	
52493319	80004571	Particle	
95947238	80001722	Particle	
95947238	• 80001723	Combi	
95981206	80005177	Particle	
95981206	• 80005178	Combi	
96296618	80001738	Particle	
96327366	80001738	Particle	
96331028	80001033	Particle	•
96425700	80000869	Particle	
96425700	• 80000870	Combi	
96440878	80000877	Particle	
96440878	• 80000878	Combi	
96539649	80000155	Particle	
96539649	• 80000773	Combi	
96554378	• 80000783	Combi	
96554378	80000804	Particle	
96555003	80000867	Particle	
96555003	• 80000868	Combi	
96629614	80000877	Particle	
96629614	• 80000878	Combi	
96800069	80000877	Particle	
96800069	• 80000878	Combi	
EC96539649	80000155	Particle	
EC96539649	• 80000773	Combi	

CHRYSLER			
82204691	80000079	Particle	
82204691	• 80000415	Combi	
82205905	21652854	Combi	
82205905	21653151	Particle	
82208300	80000079	Particle	
82208300	• 80000415	Combi	
2108300818	21651961	Combi	
2108300918	21651961	Combi	
04596501AB	• 80000407	Particle	
04596501AB	80000408	Combi	
05013595AA	80000079	Particle	
05013595AA	• 80000415	Combi	
05013595AB	80000079	Particle	
05013595AB	• 80000415	Combi	
05058040AA	80000082	Particle	
05058040AA	• 80000759	Combi	
05058381AA	80001189	Particle	
05058381AA	• 80001190	Combi	
05058693AA	80001189	Particle	
05058693AA	• 80001190	Combi	
05072176AA	21652855	Combi	
05072176AA	• 80000811	Particle	
05101438AA	21651196	Particle	
05101439AA	21651196	Particle	
4596501AB	80000408	Combi	
5101438AA	21651196	Particle	
68033193AA	80001718	Particle	•
68033193AA	• 80001719	Combi	•
68042866AB	80001174	Particle	
68042866AB	• 80001175	Combi	
68079487AA	80001785	Particle	
68079487AA	• 80001786	Combi	
A2108300818	21651961	Combi	
B66809901	21651961	Combi	
B66809902	21651961	Combi	

CITROEN			
002440	21651919	Particle	
002440	• 80000748	Combi	
6479E0	80001027	Particle	
647945	• 80001458	Particle	
647945	80001459	Combi	
647963	80001027	Particle	
647963	• 80001171	Combi	
647975	21652540	Combi	
647993	80000615	Combi	•
95667986	21651899	Particle	
6479E5	21652856	Particle	
1609428080	80000666	Particle	•
9636086280	21653028	Particle	
9682603680	• 80001458	Particle	
9682603680	80001459	Combi	
9801448180	80004703	Combi	•
9801448180	• 80004776	Particle	•
6479E9	80000853	Particle	
6441EG	21651899	Particle	
6441EH	80000077	Combi	
6441EJ	21653102	Combi	
6441EJ	• 80000807	Particle	
6441EL	21652342	Particle	•
6441EL	• 80000765	Combi	•
6441EN	21652342	Particle	•
6441EN	• 80000765	Combi	•
6441G9	49356178	Particle	

CITROEN			
6441H7	21651899	Particle	
6447AK	21651899	Particle	
6447FF	21652543	Particle	
6447FF	• 80000429	Combi	
6447FG	21653032	Particle	
6447FG	• 80000344	Combi	
6447H0	21652342	Particle	•
6447H0	• 80000765	Combi	•
6447H1	21652342	Particle	•
6447H1	• 80000765	Combi	•
6447HP	21653028	Particle	
6447HT	• 21653141	Particle	
6447HV	• 21653141	Particle	
6447HV	21653142	Combi	
6447J0	21651994	Particle	
6447J0	• 80000432	Combi	
6447K6	21651919	Particle	
6447K6	• 80000748	Combi	
6447KR	21653028	Particle	
6447LN	• 80000429	Combi	
6447LV	21651899	Particle	
6447LZ	21652856	Particle	
6447NT	21652548	Particle	
6447NV	21652540	Combi	
6447PF	80000077	Combi	
6447SP	21653147	Combi	
6447SQ	21653146	Combi	
6447SR	80000077	Combi	
6447SY	21651994	Particle	
6447TA	21653147	Combi	
6447TC	21653102	Combi	
6447TC	• 80000807	Particle	
6447TL	21652548	Particle	
6447TV	80000662	Particle	
6447TV	• 80000784	Combi	
6447TY	21651994	Particle	
6447TY	• 80000432	Combi	
6447VX	80000667	Combi	•
6447VY	80000666	Particle	•
6447XF	80000839	Particle	
6447XG	80000615	Combi	•
6447YC	80000815	Particle	
6447YC	• 80000816	Combi	
6447YK	80000865	Particle	
6447YN	80000866	Combi	
6447Z4	21651899	Particle	
6447Z5	21651899	Particle	
6447ZY	80000853	Particle	
6447ZY	• 80000854	Combi	
6479A0	21651994	Particle	
6479A1	21653028	Particle	
6479A2	21653146	Combi	
6479A5	80000662	Particle	
6479A5	• 80000784	Combi	
6479A6	80000865	Particle	
6479A7	80000866	Combi	
6479C9	80000815	Particle	
6479J7	• 80001778	Particle	
6479J7	80001779	Combi	
6479K9	80001792	Combi	
663399D	21653028	Particle	
B0009775480	80005194	Particle	
B0009775480	80005202	Combi	

CITROEN			
E146001	21651899	Particle	
E146155	21652548	Particle	
E146163	• 21653141	Particle	
CLAAS			
0715250	80000449	Particle	
0715251	80000449	Particle	
DACIA			
7700424098	21651983	Particle	
7700424098	• 80000114	Combi	
7701042499	21651983	Particle	
7701042499	• 80000114	Combi	
7701059997	80000074	Particle	
7701062227	80000074	Particle	
272772835R	80000074	Particle	
272775081R	80004548	Particle	
272775081R	80004702	Particle	
272775374R	80000074	Particle	
DAEWOO			
96190645	21652338	Particle	
96190646	21652339	Particle	
96207422	21652340	Particle	
96207423	21652341	Particle	
96296618	80001738	Particle	
96327366	80001738	Particle	
96331028	80001033	Particle	•
96449577	80000155	Particle	
96539649	80000155	Particle	
96539649	• 80000773	Combi	
96554378	• 80000783	Combi	
96554378	80000804	Particle	
96554421	80000804	Particle	
96800837	80000804	Particle	
96962173	80000155	Particle	
EC96190645	21652338	Particle	
EC96327366	80001738	Particle	
EC96554378	80000804	Particle	
DAF			
1322255	21653022	Particle	
1322255	• 80000623	Combi	
1322259	21653021	Particle	
1347066	21653021	Particle	
1347068	80000354	Particle	
1362124	21652997	Particle	
1362168	80000626	Combi	
1389016	21653021	Particle	
1600428	80000645	Particle	
1658991	21653022	Particle	
1658991	• 80000623	Combi	
1659691	21653021	Particle	
1791192	21652997	Particle	
1825427	21653022	Particle	
1825427	• 80000623	Combi	
1825428	21653021	Particle	
1825431	80000626	Combi	
DAIHATSU			
71743821	80000603	Particle	
9906850112036	21653033	Combi	
08975B4000100	• 80000763	Combi	
9906850M2036	21653033	Combi	
99906850M2036	• 80000812	Particle	
99906850M2037	• 80001037	Particle	
99906850M2037	80001038	Combi	
99906850M2038	80000617	Combi	

DAIHATSU			
99906850M2038	80004395	Particle	
DEERE			
AL71259	80000535	Particle	•
AL71259	• 80000796	Combi	
H220870	80005193	Particle	
L155288	80000444	Combi	
NRL155288	• 80000627	Combi	
RE187966	80000115	Particle	
EVOBUS			
0018351347	80001621	Particle	
0018353447	80001622	Particle	
0018354647	80001623	Particle	
0018355847	80001629	Particle	
0018356147	80001627	Particle	
0018356247	80001628	Particle	
0018359147	80001626	Particle	
8440000941	80001621	Particle	
1100807A	80001629	Particle	
1100895A	80001628	Particle	
1100895B	80001628	Particle	
1101120A	80001627	Particle	
1102574A	80001180	Particle	
1102574A	• 80001181	Combi	
1302907A	80001626	Particle	
1302907B	80001626	Particle	
89697A	80001621	Particle	
94839A	80001622	Particle	
FERRARI			
65384300	80000668	Particle	
65384300	• 80000778	Combi	
66855200	80000669	Combi	
FIAT			
5908409	• 80000433	Combi	
7078711	21652899	Particle	
7078711	• 80000755	Combi	
7079682	21652900	Particle	
7082301	80000637	Particle	
7082301	• 80000779	Combi	
7082928	80000637	Particle	
7082928	• 80000779	Combi	
46409630	21651915	Particle	
46412715	• 21651953	Combi	
46412715	21651970	Particle	
46442422	• 21651901	Particle	
46442422	• 21651952	Combi	
46442422	• 21651953	Combi	
46513960	21652308	Particle	
46513960	• 80000430	Combi	
46721371	• 80000433	Combi	
46721374	21651894	Particle	
46721374	• 80000433	Combi	
46722862	• 21651296	Combi	
46722863	• 21651296	Combi	
46723245	• 21651296	Combi	
46723321	21653026	Particle	
46723321	• 80000754	Combi	
46723331	• 21651296	Combi	
46723331	21652544	Particle	
46723435	• 21652538	Combi	
46723435	21653027	Particle	
46768502	• 21651901	Particle	
46768502	• 21651952	Combi	
46770829	• 21651296	Combi	

FIAT			
46770834	• 21651296	Combi	
46794399	21652308	Particle	
46794399	• 80000430	Combi	
46844822	21652714	Particle	
46844822	80000621	Combi	
51805219	80000621	Combi	
51854918	• 80004544	Combi	
51854923	80004407	Particle	
55702456	80000541	Particle	
55702456	• 80000777	Combi	
55702468	80000541	Particle	
55702468	• 80000777	Combi	
60810570	21651915	Particle	
60811242	21651896	Particle	
60812197	21651915	Particle	
60812197	• 21651951	Combi	
60812597	21651915	Particle	
71736776	• 21652538	Combi	
71736776	21653027	Particle	
71743821	80000603	Particle	
71754152	• 21652538	Combi	
71754152	21653027	Particle	
71771732	80000637	Particle	
71771732	• 80000779	Combi	
71775824	• 80004719	Combi	
77362394	21652544	Particle	
77364063	80000815	Particle	
77364063	• 80000816	Combi	
77364561	80001027	Particle	
77364561	• 80001171	Combi	
77365763	• 80000754	Combi	
77365764	• 80000777	Combi	
77366065	21653026	Particle	
77366065	• 80000754	Combi	
77366480	80004572	Particle	
1312764080	21651994	Particle	
1312764080	• 80000432	Combi	
1312766080	21651994	Particle	
1312766080	• 80000432	Combi	
1475478080	21652342	Particle	•
1475478080	• 80000765	Combi	•
1475479080	21652342	Particle	•
1475479080	• 80000765	Combi	•
1484383080	21652856	Particle	
1497497080	80000865	Particle	
1497498080	80000866	Combi	
08975B4000100	• 80000763	Combi	
6447SP	21653147	Combi	
6447TA	21653147	Combi	
FORD			
1004051	21651893	Particle	
1054468	21651895	Particle	
1054491	21651971	Particle	•
1062253	21651995	Particle	
1089176	• 21652355	Combi	
1097670	21650107	Particle	
1101818	21652959	Combi	
1107351	21651960	Combi	
1111785	21652959	Combi	
1113627	21651960	Combi	
1115568	• 21652709	Particle	
1115650	21652361	Combi	
1119613	• 21652709	Particle	

FORD		
1119616	21652361	Combi
1120475	• 21652355	Combi
1121106	21652354	Combi
1125536	21651960	Combi
1132312	21652959	Combi
1132445	21652959	Combi
1139654	21652354	Combi
1139655	• 21652355	Combi
1148366	21651960	Combi
1204459	21652857	Particle
1204464	21652858	Combi
1215228	21650107	Particle
1221520	21650107	Particle
1225788	21652959	Combi
1253220	21653035	Combi
1253223	21650107	Particle
1315686	21653034	Particle
1315687	21653035	Combi
1349791	21652361	Combi
1349791	• 21652709	Particle
1353267	21652360	Particle
1353267	• 80000751	Combi
1353269	21652858	Combi
1353270	• 21652355	Combi
1353271	21651893	Particle
1354952	80000061	Particle
1354953	80000062	Combi
1382861	21652354	Combi
1451913	21652361	Combi
1452329	21652354	Combi
1452330	21652858	Combi
1452346	80000062	Combi
1452348	21651960	Combi
1452349	• 21652355	Combi
1459009	21652360	Particle
1459009	• 80000751	Combi
1488903	21652959	Combi
1491665	21650107	Particle
1491752	21651960	Combi
1494510	• 21652355	Combi
1494691	80000062	Combi
1494697	21653035	Combi
1557375	• 80000754	Combi
1566997	80001129	Combi
1585195	21651995	Particle
1585216	21652857	Particle
1594615	80001128	Particle
1672948	21652354	Combi
1673744	• 80000754	Combi
1709013	• 80001754	Combi
1709013	80001761	Particle
1709013	80001773	Combi
1713173	21652361	Combi
1713182	80000062	Combi
1745604	80004673	Particle
1748479	80004573	Combi
1748480	80004673	Particle
1812679	80004650	Particle
1839688	80005090	Combi
3401703	21650107	Particle
4042703	21652360	Particle
4042703	• 80000751	Combi
4416570	21652993	Particle

FORD		
4416570	• 80000284	Combi
4921117	• 49368138	Particle
4921117	49368139	Combi
5028225	21652347	Particle
5028226	21652347	Particle
5029916	21652347	Particle
5029916	• 80000416	Combi
5128504	80001772	Particle
5256078	• 49356179	Particle
5256078	49356180	Combi
5277386	• 49368136	Particle
5277386	49368137	Combi
7180932	21650107	Particle
7221435	21651971	Particle •
7221435	• 80000793	Combi •
46723321	21653026	Particle
1S7H16N619AC	• 21652709	Particle
1S7J19G244AAHF	21652361	Combi
256H19G244AA	21652858	Combi
3M5J18D543BA	21653034	Particle
3M5J19G244AA	21653035	Combi
4M5J19G244AA	80000062	Combi
4S7J19G244AA	21652361	Combi
6C1116N619AA	80004673	Particle
6C1116N619AAK	80004573	Combi
6M2Y19N551AA	21651960	Combi
6S8J16N619AA	21650107	Particle
8V5118D543	80001128	Particle
8V5118D543AA	80001128	Particle
8V5J19G244	80001129	Combi
8V5J19G244AA	80001129	Combi
93BW19G244BA	21652959	Combi
93BW19G244BB	21652959	Combi
94BW19N619AB	21650107	Particle
955116N619AA	• 80000754	Combi
95GX18N405AC	21651971	Particle •
95VW19N551AA	21651895	Particle
96FJ19G244AA	• 21652355	Combi
96FW16N619AB	21651893	Particle
96FW19G244AA	• 21652355	Combi
98FW16N619AA	• 21652355	Combi
A92FX9601CA	• 21652355	Combi
AV6N180543AA	80001772	Particle
AV6N19G244AA	80001773	Combi
BK2118D543AA	80004650	Particle
DG9H18D483BA	• 49356179	Particle
DG9H18D483BA	49356180	Combi
XS4H16N619AB	21651995	Particle
XS4H19G244CA	21652354	Combi
YC1H19N619AB	21652360	Particle
YC1H19N619AB	• 80000751	Combi
YC1J19N619AB	21652360	Particle
YL8419N619AA	21652993	Particle
YL8419N619AA	• 80000284	Combi
YL8Z19N619AB	21652993	Particle
YL8Z19N619AB	• 80000284	Combi
GM		
9166107	21652715	Combi
09179904	21652715	Combi
9196107	21652715	Combi
9196805	21652350	Particle
09200067	21651182	Particle
9201440	21652714	Particle

GM		
09207486	21652350	Particle
13271407	21652995	Combi
13345949	• 80000777	Combi
90383627	21651182	Particle
90386776	21651184	Particle
90464424	21651185	Particle
90520549	21651980	Particle
90590568	21651182	Particle
91132361	21651964	Combi
93172299	21652714	Particle
93174801	21652995	Combi
93182436	21651980	Particle
96172129	21652715	Combi
905658793	21651964	Combi
HONDA		
08R79ST3600	21651972	Particle
08R79ST3600	• 80000742	Combi
79370S1A505	21652359	Particle
79371SZ3A01	80000179	Particle •
79371SZ3A01	• 80000790	Combi •
79831S04003	21651972	Particle
79831S04003	• 80000742	Combi
79831S2A003	80000410	Particle
79831S2A003	• 80000411	Combi
79831ST3E01	21651972	Particle
79831ST3E01	• 80000742	Combi
79831ST3EC1	21651972	Particle
79831STE010M1	21651972	Particle
79831STE010M1	• 80000742	Combi
80290ST3E01	21652345	Particle
80290ST3E01	• 80000428	Combi
80291S2H505	21652990	Particle
80291S2H505	• 80000439	Combi
80291S2HE01	21652990	Particle
80291S2HE01	• 80000439	Combi
80291S84A01	80000156	Particle •
80291S84A01	• 80000791	Combi •
80291S84A010	80000156	Particle •
80291S84A010	• 80000791	Combi •
80291SAA505HE	21652989	Particle
80291SAA506HE	21652989	Particle
80291SAAE01	21652989	Particle
80291SAAE01	• 80000437	Combi
80291ST3505	21652345	Particle
80291ST3505	• 80000428	Combi
80291ST3515	21652345	Particle
80291ST3515	• 80000428	Combi
80291ST3E01	21652345	Particle
80291ST3E01	• 80000428	Combi
80292S5A003	• 21652546	Particle •
80292S5A003	• 80000148	Combi •
80292S5DA01	• 21652546	Particle •
80292S5DA01	• 80000148	Combi •
80292S6DG01	• 21652546	Particle •
80292S6DG01	• 80000148	Combi •
80292S6M901	• 21652546	Particle •
80292S7A003	• 80000148	Combi •
80292SCAE11	• 21652546	Particle •
80292SCAE11	• 80000148	Combi •
80292SCAG01	• 21652546	Particle •
80292SDAA01	80000330	Particle
80292SDC505HE	80000330	Particle
80292SDC505HE	• 80000404	Combi

HONDA		
80292SDCA01	80000330	Particle
80292SDCA01	• 80000404	Combi
80292SHJA41	80000330	Particle
80292SHJA41	• 80000404	Combi
80292SMGE01	80000620	Particle
80292SWWG01	80000330	Particle
80292SWWG01	• 80000404	Combi
80292T1GG01	80000330	Particle
80292TF0G01	80001183	Particle
80292TF0G01	• 80001184	Combi
80295S50003	21652990	Particle
80295S50003	• 80000439	Combi
H79370S1AG01	21652359	Particle
H79370S1AG01	• 80000431	Combi
JKR100080	• 80000428	Combi
NR80292SMGE01	• 80000622	Combi
HYUNDAI		
971331E000	80000813	Particle
971331E000	• 80000814	Combi
976193E000	• 80000402	Combi
9713307000	80000634	Particle
9713307010	80000634	Particle
9761037000	80000157	Particle
9761037000	• 80000400	Combi
9761725000	80000157	Particle
9761725000	• 80000400	Combi
9761938100	80000158	Particle
9761938100	• 80000402	Combi
971332E200	80000652	Particle
971332E200	• 80000780	Combi
971332E210	80000652	Particle
971332E210	• 80000780	Combi
971332E250	80001214	Particle
971332E250	• 80001215	Combi
971332E260	80001214	Particle
97030H1726	80000159	Particle
97030H1726	• 80000401	Combi
97030H1726AT	80000159	Particle
97030H1742	80000651	Particle
97030H1742AT	80000159	Particle
9713307010AT	80000634	Particle
971330X900	80000634	Particle
971331H000	80000871	Particle
971331H000	• 80000872	Combi
971331H500	• 80001733	Combi
971331H500	80001734	Particle
971331J000	80001448	Particle
971331J000	• 80001449	Combi
971331J000AT	80001448	Particle
971332B005	80001774	Particle
971332B005	• 80001775	Combi
971332B005AT	80001774	Particle
971332B010	80000767	Particle
971332B010AT	80000767	Particle
971332D000	80000083	Particle
971332D000	• 80000440	Combi
971332D100	80000083	Particle
971332D200	80000852	Particle
971332D205	80000852	Particle
971332D205AT	80000852	Particle
971332E210AT	80000652	Particle
971332E900	80000911	Particle
971332E900	• 80000912	Combi

HYUNDAI		
971332E910	80000911	Particle
971332E910	• 80000912	Combi
971332E950	80000911	Particle
971332G000	80001176	Particle
971332G000	• 80001177	Combi
971332H000	80001212	Particle
971332H000	• 80001213	Combi
971332H001	49359582	Particle
971332H001	80000813	Particle
971332H001AT	49359582	Particle
971333J100	80001437	Particle
971333J100	• 80001438	Combi
971333K000	• 80000764	Combi
971333K000	80000767	Particle
974064A900	80001034	Particle
974064A900AT	80001034	Particle
976171C000	80000084	Particle
976171C000	• 80000441	Combi
976171C000AT	80000084	Particle
976171C001	80000084	Particle
976171C001	• 80000441	Combi
976171C001AT	80000084	Particle
976171C001AT	• 80000441	Combi
976171C200	80000084	Particle
976171C200	• 80000441	Combi
976171C200	80000650	Particle
976174H000	80001130	Particle
976174H000	80001131	Combi
976174H900	80001130	Particle
976174H900	80001131	Combi
9761938100AT	80000158	Particle
9761938100AT	• 80000402	Combi
976193C100	• 80000402	Combi
976193C102	• 80000402	Combi
976193D000	80000546	Particle
976193D100	80000546	Particle
976193D200	80000546	Particle
99030H1726	80000159	Particle
99030H1726	• 80000401	Combi
9999Z07008	80001034	Particle
9999Z07010	80000158	Particle
9999Z07011	80000157	Particle
9999Z07011	• 80000400	Combi
9999Z07015	80000083	Particle
9999Z07015	• 80000440	Combi
9999Z07016	80000159	Particle
9999Z07016	• 80000401	Combi
9999Z07017	80000084	Particle
9999Z07017	• 80000441	Combi
9999Z07019	80001739	Particle
9999Z07025	80000767	Particle
9999Z07026	80001214	Particle
9999Z07026	• 80001215	Combi
F178KM7AA01	49359582	Particle
IRISB		
503138528	80001182	Particle
5006175605	80001182	Particle
5801295481	80001182	Particle
5801321121	80001182	Particle
ISUZU		
8971117880	80000161	Particle
8971117880	• 80000774	Combi
8971708040	80000160	Particle

ISUZU		
8971708040	• 80000792	Combi
8973561270	80001731	Particle
8981394280	21652346	Particle
8981394280	• 80000746	Combi
IVECO		
2994583	80001127	Combi
2994769	80000916	Combi
2995964	80000333	Particle
2995965	• 21651901	Particle
2995965	• 21651952	Combi
3802821	80000915	Particle
0008308018	80005208	Particle
0008308118	80005208	Particle
93162384	80000075	Particle
93162491	• 21651901	Particle
93162491	• 21651952	Combi
500314688	• 21651901	Particle
500314688	• 21651952	Combi
504024890	80000333	Particle
5801619418	49361897	Particle
JAGUAR		
1S7H19G244	21652361	Combi
1X4H16N619	• 21652709	Particle
1X4H19G244	21652361	Combi
1X4H19G244BA	21652361	Combi
2W9319G244AA	21652991	Combi
2W9319G244AA	• 80000808	Particle
6W8318D483AA	80000606	Combi
C2C6884	21652991	Combi
C2C6884	• 80000808	Particle
C2P2410	80000606	Combi
C2P2410	80004396	Particle
C2S16860	• 21652709	Particle
C2S16861	21652361	Combi
C2S8619	21652361	Combi
C2S8619	• 21652709	Particle
C2S8622	21652361	Combi
C2Z6525	• 80001178	Particle
C2Z6525	80001179	Combi
MJD6862	21652711	Particle
MJD6862	• 80000757	Combi
MJD6863	21652710	Particle
MJD6863	• 80000756	Combi
XR830254	21652859	Combi
XR830254	• 80000809	Particle
XR838396	80000607	Particle
JEEP		
71775824	• 80004719	Combi
77366480	80004572	Particle
82204691	80000079	Particle
82204691	• 80000415	Combi
82208300	80000079	Particle
82208300	• 80000415	Combi
05013595AA	80000079	Particle
05013595AA	• 80000415	Combi
05013595AB	80000079	Particle
05013595AB	• 80000415	Combi
05058381AA	80001189	Particle
05058381AA	• 80001190	Combi
05058693AA	80001189	Particle
05058693AA	• 80001190	Combi
68033193AA	80001718	Particle
68033193AA	• 80001719	Combi

JEEP		
68079487AA	80001785	Particle
68079487AA	• 80001786	Combi
K68223044AA	80005209	Particle
K68223044AA	• 80005210	Combi
KIA		
976193E000	80000158	Particle
9713307000	80000634	Particle
9713307000	• 80004405	Combi
9713307010	80000634	Particle
9713307010	• 80004405	Combi
9761938100	80000158	Particle
971332E200	80000652	Particle
971332E200	• 80000780	Combi
971332E210	80000652	Particle
971332E210	• 80000780	Combi
971333E270	80000655	Particle
971333E270	• 80000781	Combi
971333E270	80001441	Particle
971333E270	• 80001442	Combi
OK2C06152X	80000547	Particle
OK2C06152X	• 80000798	Combi
OK2C06153X	80000547	Particle
OK2FA6152X	80000548	Particle
OK2N16152X	80000656	Particle
OK55361C14	80000537	Particle
OK55361C14	• 80000776	Combi
OK55361C14A	80000537	Particle
OK9A46152X	80000644	Particle
OK9A46152X	• 80000801	Combi
OK9A46152XA	80000644	Particle
OK9A46152XA	• 80000801	Combi
971143B000	• 80000630	Combi
971143B000	80000640	Particle
9713307010AT	80000634	Particle
9713307010AT	• 80004405	Combi
971330X900	80000634	Particle
971330X900	• 80004405	Combi
971331H000	80000871	Particle
971331H000	• 80000872	Combi
971331H500	• 80001733	Combi
971331H500	80001734	Particle
971331P000	80001454	Particle
971331P000	• 80001455	Combi
971332E10AT	80000652	Particle
971332E900	80000911	Particle
971332E900	• 80000912	Combi
971332E910	80000911	Particle
971332E910	• 80000912	Combi
971332E950	80000911	Particle
971332F000	80000655	Particle
971332F000	• 80000781	Combi
971332F000	80001441	Particle
971332F000	• 80001442	Combi
971332H001	49359582	Particle
971332H001AT	49359582	Particle
971332K000	80001206	Particle
971332K000	• 80001207	Combi
971333K000	• 80000764	Combi
971333K000	80000767	Particle
971333SAA0	80004433	Particle
971333SAA0	• 80004434	Combi
97133B2000	• 49356083	Combi
97133B2000	80005226	Particle

KIA		
97133C5000	49361898	Particle
97133C5000	• 49361899	Combi
976193C100	80000158	Particle
976193C102	80000158	Particle
97619FD200	80000654	Particle
97619FD200	• 80000795	Combi
9999Z07010	• 80000402	Combi
F178KM7AA01	49359582	Particle
OK2FA6152X	• 80000797	Combi
OK2N16152X	• 80000799	Combi
P87901F200A	80000652	Particle
P87902F000A	80000655	Particle
P87902F000A	• 80000781	Combi
KOMATSU		
20Y9796261	80000445	Particle
42356HOP08	80000446	Particle
42Y07HOP00	80000447	Particle
42Y07HOP20	80000448	Particle
77Z9700010	80000334	Particle
77Z9700020	80000335	Particle
LADA		
11188122010	80000998	Particle
11188122010	• 80000999	Combi
211812202010	80000671	Combi
LANCIA		
46409630	21651915	Particle
46721047	21651892	Particle
46721047	• 80000760	Combi
46721374	21651894	Particle
46721374	• 80000433	Combi
46722335	21651954	Combi
46722335	• 80000376	Particle
46722862	• 21651296	Combi
46723024	21652694	Combi
46723024	• 80000805	Particle
46723245	• 21651296	Combi
46723331	• 21651296	Combi
46723331	21652544	Particle
46723435	• 21652538	Combi
46723435	21653027	Particle
46770829	• 21651296	Combi
46770834	• 21651296	Combi
51854923	80004407	Particle
60653641	• 21651901	Particle
60653641	• 21651952	Combi
60812197	21651915	Particle
60812197	• 21651951	Combi
60814643	21651954	Combi
60814643	• 80000376	Particle
60815647	• 21651901	Particle
60815647	• 21651952	Combi
71736776	21653027	Particle
77362394	21652544	Particle
82472557	21651896	Particle
1475478080	21652342	Particle
1475478080	• 80000765	Combi
1475479080	21652342	Particle
1475479080	• 80000765	Combi
1484383080	21652856	Particle
6447SP	21653147	Combi
6447TA	21653147	Combi
K68071668AA	80004351	Particle
K68071668AA	80004352	Combi

LANDROVER		
6G9N180543BA	80000712	Particle
6G9N19N619	80000713	Combi
BTR8037	80000066	Particle
BTR8037	• 80000772	Combi
JKR100280	80000060	Particle
JKR100280	• 80000775	Combi
JKR500010	80000360	Particle
JKR500020	80000361	Combi
JM0000010	21652916	Combi
JM0000010	• 80000065	Particle
LR019192	80004555	Particle
LR019589	80004556	Combi
LR023977	80000361	Combi
LR029773	80000060	Particle
LR029773	• 80000775	Combi
LR032199	21652916	Combi
LR036369	80005176	Combi
LR055993	80005175	Particle
LEXUS		
871390202	• 80000605	Combi
8713930010	80000162	Particle
8713930010	• 80000771	Combi
8713930040	• 80000605	Combi
8713930070	• 80000605	Combi
8713930100	21652346	Particle
8713930100	• 80000746	Combi
8713947010	21652539	Particle
8713948020	80000162	Particle
8713950030	80000165	Combi
8713952020	80000604	Particle
8850820120	21652539	Particle
8888020100	80000165	Combi
871394701083	21652539	Particle
871394802083	80000162	Particle
72880AG000	• 80000745	Combi
72880AG0009P	• 80000745	Combi
871390D010	80000604	Particle
87139YZZ01	80000165	Combi
87139YZZ04	80000162	Particle
87139YZZ04	• 80000771	Combi
87139YZZ08	80000604	Particle
LINDE		
9830210	80000443	Particle
9832067	80000442	Particle
MAN		
11033282	80001582	Particle
11033284	80001624	Particle
11034374	80001580	Combi
11034375	80001581	Particle
8177920155	80000356	Particle
36779100009	80001581	Particle
36779106009	80005208	Particle
81619100011	21651973	Particle
81619100018	21653005	Particle
81619100019	80000364	Combi
81779100012	80000356	Particle
81779100012	• 80000768	Combi
81779100016	80000336	Particle
81779100027	• 80001751	Combi
81779100027	80001758	Particle
81779720121	80000357	Particle
81779720121	• 80000625	Combi
81779720148	80000336	Particle

MAN		
83779100519	80001584	Particle
8377920608	• 80001579	Particle
8377920656	80001583	Particle
85619500025	21653016	Particle
88779100002	80000076	Particle
88779100003	21653018	Particle
1101194A	• 80001579	Particle
1101194B	• 80001579	Particle
1103462A	• 80001579	Particle
H14003495	80001583	Particle
N1011033282	80001582	Particle
N1011033284	80001624	Particle
N1011034375	80001581	Particle
N1011034376	80001580	Combi

MASERATI		
66855200	80000669	Combi
573228900	21651954	Combi
573228900	• 80000376	Particle

MAZDA		
410077732	21651893	Particle
410077732	• 21652355	Combi
1E0061J6X	21651893	Particle
1E0061J6XB	21651893	Particle
1E0061J6XD	21651893	Particle
1E0061J6Y	• 21652355	Combi
BBM461J6X	80000405	Particle •
BBP261J6X	• 80001735	Combi •
BBP261J6X	80001736	Particle •
BBP261J6X9A	80001736	Particle •
BP4K61J6X	80000405	Particle •
BP4K61J6X	• 80000406	Combi •
BP4K61J6X9A	• 80000406	Combi •
BP4K61J6XA9A	80000405	Particle •
BP4K61J6XA9A	• 80000406	Combi •
BP8P61J6X	80000405	Particle •
BP8P61J6X	• 80000406	Combi •
BP8P61J6XA9A	80000405	Particle •
C10261J6X	80000403	Combi •
CB1261J6X	80000403	Combi •
CB1261J6X9A	80000403	Combi •
CB1261J6X9B	80000403	Combi •
CC2961J6X	80000405	Particle •
CC2961J6X	• 80000406	Combi •
CC6461J6X	80000405	Particle •
CC6461J6X	• 80000406	Combi •
D65161J6X	80001489	Particle •
D65161J6X	80001743	Combi •
D65161J6X9A	80001489	Particle •
D65161J6X9A	80001743	Combi •
DC2161J6X	80001737	Particle •
DC3561J6X	80000849	Combi •
DD1061P11	21653145	Particle
EC136114Y	21652993	Particle
EC136114Y	• 80000284	Combi
EC1361J6QA	21652993	Particle
EC1361J6QA	• 80000284	Combi
EC1361J6XA	• 80000284	Combi
GE6T61J6X	21652860	Particle •
GE6T61J6X9A	21652860	Particle •
GE6T61J6X9B	21652860	Particle •
GE6T61J6XA9A	21652860	Particle •
GE6T61J6XA9B	21652860	Particle •
GJ6A61P11	• 21652992	Combi

MAZDA		
GJ6A61P11	21653145	Particle
GJ6A61P119A	21653145	Particle
GJ6A61P11A9A	• 21652992	Combi
GJ6A61P11A9B	• 21652992	Combi
GJ6A61P11A9B	21653145	Particle
GS1D61P11	80001039	Particle
GS1D61P11	• 80001040	Combi
KD4561J6X	80004567	Particle
KD4561J6X	• 80004568	Combi
LDY361J6X	80000208	Combi
LDY461J6X	80000163	Particle
N410077732	• 21652355	Combi
TA0561J6X	80000689	Particle •

MERCEDES		
0008301118	21651977	Particle
0008301218	21653003	Particle
0008301265	80001764	Particle
0008301318	21653006	Combi
0008303318	21651976	Particle
0008303418	21653006	Combi
0008307518	21653018	Particle
0008353047	21652045	Particle
0008356947	21653019	Particle
0008357047	21653019	Particle
0018255447	80000336	Particle
0018350547	80000341	Particle
0018350647	80001729	Particle
0018350747	80000349	Particle
0018351347	80001621	Particle
0018351547	80000337	Particle
0018352747	80000076	Particle
0018353047	21652045	Particle
0018353047	• 80000427	Combi
0018353447	80001622	Particle
0018354147	80000342	Particle
0018354347	80001763	Particle
0018354647	80001623	Particle
0018354747	80000539	Particle
18354747	• 80000787	Combi
0018354947	• 80001579	Particle
0018355447	80000336	Particle
0018355547	• 80001579	Particle
0018355847	80001629	Particle
0018356147	80001627	Particle
0018356247	80001628	Particle
0018357047	• 80000631	Combi
0018357047	80000641	Particle
0018357147	• 80000629	Combi
0018357147	80000639	Particle
0018358447	80001766	Particle
0018358747	80001728	Particle
0018359147	80001626	Particle
0018359247	80001583	Particle
0018359547	• 80001755	Combi
0018359547	80001762	Particle
0020401236	80000336	Particle
0028351347	80000641	Particle
66809903	21651294	Combi
1248300118	21651199	Particle •
1248350047	21651199	Particle •
1298350047	21651993	Particle
1298350047	• 80000382	Combi
1408350047	21651887	Particle

MERCEDES		
1408350147	21653010	Combi
1408350247	21653002	Particle
1408350447	21653011	Combi
1408350547	21651974	Particle
1638350047	21653029	Particle
1638350247	21653029	Particle
1648300218	80000647	Combi •
1648300218	• 80001490	Particle •
1668300018	80004550	Particle
1668300218	80004550	Particle
1668300318	• 80004551	Particle
1668300318	80004552	Combi
1688300018	21652688	Particle
1688300118	21651292	Combi
1688300718	21651292	Combi
1688300818	21651292	Combi
1698300118	21653144	Particle
1698300218	21653143	Combi
1718300218	80000806	Particle
1718300418	80000071	Combi
2028300018	21651196	Particle
2028300318	21651196	Particle
2038300118	21652358	Particle
2038300218	21652335	Particle
2038300918	21652861	Combi
2038301018	21652862	Combi
2048300018	80000844	Combi
2048300018	80001527	Combi
2048300018	• 80004358	Particle
2048300518	80000844	Combi
2048300518	80001527	Combi
2048300518	• 80004358	Particle
2058350147	• 80005251	Particle
2058350147	80005252	Combi
2108300018	21651195	Particle •
2108300018	• 80000421	Combi •
2108300218	80001740	Combi •
2108300318	80001740	Combi •
2108300618	21651196	Particle
2108300718	21651196	Particle
2108300818	21651961	Combi
2108300918	21651961	Combi
2108301018	21651195	Particle •
2108301018	• 80000421	Combi •
2108301118	80001740	Combi •
2108301218	21651961	Combi
2118300018	21652865	Combi
2118300218	21652863	Particle
2118300318	21652865	Combi
2118300418	21652864	Particle
2128300018	80000844	Combi
2128300018	80001527	Combi
2128300018	• 80004358	Particle
2128300118	• 80004358	Particle
2128300218	80000844	Combi
2128300218	80001527	Combi
2128300318	80001527	Combi
2128300318	• 80004358	Particle
2208300118	80001740	Combi •
2208300218	80001740	Combi •
2218300018	80000538	Combi •
2218300018	• 80001491	Particle •
2218300318	80000538	Combi •

MERCEDES		
2218300718	80000538	Combi •
2228300318	80004826	Combi •
2228300318	• 80005069	Particle •
2228300418	80004826	Combi •
2308300418	21652812	Combi •
3568303118	80000339	Particle
3568304218	80000340	Particle
3578350147	80001765	Particle
4058350047	80004827	Particle
4478300000	80005227	Combi
4478300000	• 80005230	Particle
4638300018	21652357	Combi
6278350247	80000635	Particle
6278350447	80000336	Particle
6288350347	80004828	Particle
6298306560	80000342	Particle
6388350047	21652045	Particle
6388350047	• 80000427	Combi
6398350247	21653025	Particle
6398350347	21653009	Combi
8440000941	80001621	Particle
9018300018	21651976	Particle
9018300418	• 21652985	Combi
9018300518	21651976	Particle
9068300218	80000614	Particle
9068300318	80000616	Combi
9408350047	21653007	Particle
9408350147	21653000	Combi
9408350247	21652002	Particle
9608300018	80004630	Particle
9608300118	80004631	Combi
9738350147	21652998	Particle
9738350147	21653001	Particle
9738350247	21652998	Particle
9738350247	21653001	Particle
9738350347	21652999	Combi
87540008760	80000635	Particle
164830021864	• 80001490	Particle •
325462150012	80000348	Particle
1100372A	80000336	Particle
1100372B	80000336	Particle
1100710A	80001763	Particle
1100807A	80001629	Particle
1100895A	80001628	Particle
1100895B	80001628	Particle
1101120A	80001627	Particle
1101193A	80000336	Particle
1101194A	• 80001579	Particle
1101194B	• 80001579	Particle
1101899A	80001764	Particle
1103196A	80000641	Particle
1103197A	80000639	Particle
1103462A	• 80001579	Particle
1302907A	80001626	Particle
1302907B	80001626	Particle
68074A	80001764	Particle
68951A	80000342	Particle
89697A	80001621	Particle
93350A	80000336	Particle
94839A	80001622	Particle
A0008301118	21651977	Particle
A0008301218	21653003	Particle
A0008303318	21651976	Particle

MERCEDES		
A0008356947	21653019	Particle
A0008357047	21653019	Particle
A0018352747	80000076	Particle
A0018353247	80004440	Particle
A0018353247	• 80004441	Combi
A0018354747	80000539	Particle
A1248300118	21651199	Particle •
A1248350047	21651199	Particle •
A1298350047	21651993	Particle
A1298350047	• 80000382	Combi
A1408350047	21651887	Particle
A1408350147	21653010	Combi
A1408350247	21653002	Particle
A1408350447	21653011	Combi
A1408350547	21651974	Particle
A1638350047	21653029	Particle
A1638350247	21653029	Particle
A1648300218	80000647	Combi •
A1688300018	21652688	Particle
A1688300118	21651292	Combi
A1688300718	21651292	Combi
A1688300818	21651292	Combi
A1718300218	80000806	Particle
A1718300418	80000071	Combi
A2038300118	21652358	Particle
A2038300218	21652335	Particle
A2038300918	21652861	Combi
A2038301018	21652862	Combi
A2058350147	• 80005251	Particle
A2058350147	80005252	Combi
A2108300018	21651195	Particle •
A2108300018	• 80000421	Combi •
A2108300818	21651961	Combi
A2108300918	21651961	Combi
A2108301018	21651195	Particle •
A2108301018	• 80000421	Combi •
A2108301218	21651961	Combi
A2118300418	21652864	Particle
A2228300318	80004826	Combi •
A2228300318	• 80005069	Particle •
A2228300418	80004826	Combi •
A2308300418	21652812	Combi •
A2468300018	• 80004408	Particle
A2468300018	80004409	Combi
A4158351100	80001456	Particle •
A4158351100	• 80001457	Combi •
A4478300000	80005227	Combi
A4478300000	• 80005230	Particle
A6298306560	80000342	Particle
A6398350247	21653025	Particle
A6398350347	21653009	Combi
A9018300018	21651976	Particle
A9018300418	• 21652985	Combi
A9018300518	21651976	Particle
A9068300218	80000614	Particle
A9068300318	80000616	Combi
A9408350047	21653007	Particle
B66809901	21651961	Combi
B66809902	21651961	Combi
B66809903	21651294	Combi
B67582411	21652999	Combi
B67582411	21653001	Particle
B67582412	21652998	Particle

MERCEDES		
B67582414	21653000	Combi
B67582415	21652002	Particle
H14003495	80001583	Particle
#NV	49363598	Particle
MINI		
64113422664	80000740	Particle
64113422665	80000741	Combi
64119321876	• 80005089	Particle
64311496710	21652850	Particle
64311496711	21652853	Combi
64316930351	21652850	Particle
64319127515	80000740	Particle
64319127516	80000741	Combi
64319257505	21652853	Combi
64319297749	• 80005089	Particle
MITSUBISHI		
7803A004	80000853	Particle
7803A005	• 80000854	Combi
7803A012	• 80001778	Particle
7803A012	80001779	Combi
7803A027	80000068	Combi
7803A028	80000068	Combi
7850A002	80004700	Particle
7850A002	80004701	Combi
MME61701	80000648	Combi
MR227823	21652867	Particle •
MR227823	• 80000397	Combi •
MR262425	80000825	Particle
MR315172	80000643	Particle •
MR360889	80000824	Particle
MR398288	80000648	Combi
MR398288	• 80004397	Particle
MR460201	21652867	Particle •
MR460201	• 80000397	Combi •
MR500058	80000068	Combi
MR500058	80000802	Particle
MR958016	• 80000331	Particle
MR958016P	• 80000331	Particle
MR958017	21653013	Combi
MZ311916	80000825	Particle
MZ311917	21652867	Particle •
MZ311917	• 80000397	Combi •
MZ3600031	80000824	Particle
MZ600138	80000824	Particle
MZ690361	80000648	Combi
XR315172	80000643	Particle •
XR315172D	80000643	Particle •
XR315172D	• 80000794	Combi •
XR31586D	21652858	Combi
XR315876	21652868	Particle
XR315876D	21652868	Particle
XR360889	80000824	Particle
XR398288D	80000648	Combi
XR500058	80000068	Combi
XR500058D	80000068	Combi
XZ311916	80000825	Particle
XZ311917	21652867	Particle •
XZ311917	• 80000397	Combi •
XZ311917D	21652867	Particle •
XZ311917D	• 80000397	Combi •
NEOPLAN		
11033282	80001582	Particle
11033284	80001624	Particle

NEOPLAN		
11034374	80001580	Combi
11034375	80001581	Particle
170740200	80001581	Particle
180412710	80001582	Particle
180412720	80001624	Particle
180740200	80001581	Particle
180740300	80001580	Combi
8177920155	80000356	Particle
81779100012	80000356	Particle
81779100012	• 80000768	Combi
81779100027	• 80001751	Combi
81779100027	80001758	Particle
81779720121	80000357	Particle
81779720121	• 80000625	Combi
83779100519	80001584	Particle
83779720608	• 80001579	Particle
1101194A	• 80001579	Particle
1101194B	• 80001579	Particle
1103462A	• 80001579	Particle
NISSAN		
272743Y700	80000067	Combi
272747J125	80001024	Particle
27274EA000	80000649	Particle
27274EA000	• 80000786	Combi
272751N626	80001041	Particle •
272751N6P6	80001041	Particle •
272761N605	80001041	Particle •
2727700A26	• 80001753	Combi
2727700A26	80001760	Particle
272771HE0E	80001780	Particle
272771HE0E	80001781	Combi
272771KA0A	• 80001753	Combi
272771KA0A	80001760	Particle
272773Y525	80000810	Particle
272774BU0A	80005173	Particle
272774BU0A	80005174	Combi
27277EG000	80001730	Particle
27277EN000	80000874	Particle
27277EN000	• 80000875	Combi
27277EN025	80000874	Particle
27277EN025	• 80000875	Combi
27277JN20A	80001204	Particle
27277JN20A	• 80001205	Combi
2729800QAA	80000072	Particle
2729800QAA	• 80001170	Combi
2789100QAA	21651983	Particle
2789100QAA	• 80000114	Combi
278911FE0A	80001720	Particle
278911FE0A	• 80001721	Combi
278912F000	21652347	Particle
278914A00C	80001444	Particle
278914A00C	• 80001445	Combi
27891AX010	80000074	Particle
27891AX01A	80000074	Particle
27891BM400	21652346	Particle
27891BM400	• 80000746	Combi
27891BM401	21652346	Particle
27891BM401	• 80000746	Combi
27891BM401KE	21652346	Particle
27891BM401KE	• 80000746	Combi
27891BM402	21652346	Particle
27891BM410	21652346	Particle
27891ELOOA	80001443	Particle

NISSAN		
278932F900	21652347	Particle
278936F600	21652870	Particle
278936F600KE	21652870	Particle
278939F500	21652347	Particle
278939F500	• 80000416	Combi
278939F500KE	21652347	Particle
278939F500KE	• 80000416	Combi
278939F900	21652347	Particle
278939F900	• 80000416	Combi
95861M68K10	80001444	Particle
95861M68K10	• 80001445	Combi
B72003Y000	80000067	Combi
B72005M000	21652346	Particle
B72771EA0A	• 80001752	Combi
B72771EA0A	80001759	Particle
B7277JN20A	80001204	Particle
B7277JN20A	• 80001205	Combi
B727A79925	21652346	Particle
B727C79925	80001024	Particle
B729800QAA	21651983	Particle
B729800QAA	• 80000114	Combi
B78911FC0A	80001720	Particle
B78911FC0A	• 80001721	Combi
B78911FE0A	80001720	Particle
KE27819C00	80000612	Particle
KE27860C00	80000611	Particle
KE27870J00	80000610	Particle
OPEL		
0470483	80000758	Combi
1718042	80000113	Combi
1718044	21651964	Combi
1718045	21651965	Combi
1718046	80000021	Combi
1718668	80000113	Combi
1718962	21652046	Combi •
1802422	21651980	Particle
1808012	• 80000777	Combi
1808020	• 80004698	Particle
1808020	80004699	Combi
1808149	21651982	Particle •
1808246	80001185	Particle
1808246	80001186	Combi
1808524	80001185	Particle
1808527	21652995	Combi
1808600	21651182	Particle
1808601	21651184	Particle
1808602	21651182	Particle
1808604	21651184	Particle
1808605	21651183	Particle
1808606	21651981	Particle
1808606	• 80000761	Combi
1808607	21651185	Particle
1808608	21651966	Combi
1808609	21651982	Particle •
1808610	21651979	Particle
1808612	21651980	Particle
1808613	80000160	Particle •
1808617	21652715	Combi
1808618	21652353	Combi
1808619	21652714	Particle
1808624	21652715	Combi
4408840	80000072	Particle
4419683	80001456	Particle •

OPEL		
4705463	21652350	Particle
4708106	21652350	Particle
4710210	80001036	Particle
4710210	• 80001744	Combi
4803883	80000877	Particle
4803883	• 80000878	Combi
6806612	21651184	Particle
6808600	21651182	Particle
6808601	21652714	Particle
6808604	21652994	Particle
6808605	21652995	Combi
6808606	21651979	Particle
6808607	80000021	Combi
6808610	21651182	Particle
6808611	21651980	Particle
6808612	21651184	Particle
6808613	21651183	Particle
6808614	21652353	Combi
6808615	80000072	Particle
6808616	21651966	Combi
6808617	21652715	Combi
6808618	21652995	Combi
6808622	80000541	Particle
6808623	80000541	Particle
6808623	• 80000777	Combi
9118699	80000113	Combi
9121625	21651964	Combi
9121626	21651965	Combi
9121627	80000021	Combi
9121653	21651982	Particle •
09121653	21652046	Combi •
09162646	21652353	Combi
09196805	21652350	Particle
9207486	21652350	Particle
12368753	21651982	Particle •
13175553	21651979	Particle
13175554	80000021	Combi
13271190	80001185	Particle
13271191	80001185	Particle
13271191	80001186	Combi
13271192	80001186	Combi
13271407	21652995	Combi
13356914	• 80004698	Particle
13356914	80004699	Combi
32026117	21652715	Combi
32026118	21652715	Combi
52420930	80001186	Combi
52425938	80001185	Particle
52470574	21651982	Particle •
55702456	80000541	Particle
90360171	21651182	Particle
90486282	21651182	Particle
90509367	21651184	Particle
90510338	21651183	Particle
90512706	21651981	Particle
90512706	• 80000761	Combi
90512779	21651185	Particle
90520689	21651979	Particle
90541317	21651966	Combi
90559549	21651980	Particle
90590568	21651182	Particle
91132374	21652046	Combi •
91160128	• 80001170	Combi

OPEL		
93165208	21652353	Combi
93174800	21652994	Particle
93174801	21652995	Combi
93182435	21651182	Particle
93182437	21651184	Particle
93182438	21651183	Particle
93185194	21651966	Combi
93188572	21652350	Particle
93194847	80001036	Particle
93194847	• 80001744	Combi
96440878	80000877	Particle
96440878	• 80000878	Combi
96629614	80000877	Particle
96629614	• 80000878	Combi
96800069	80000877	Particle
96800069	• 80000878	Combi
97170804	80000160	Particle •
911323367	21651966	Combi
8971708040	• 80000792	Combi
13356914/1808020	49365685	Combi
13356916/13508023	49365684	Particle
PEUGEOT		
002435	21653068	Combi
002440	21651919	Particle
002440	• 80000748	Combi
002442	80000624	Combi
002484	80000027	Particle
6479E0	80001027	Particle
644191	49356178	Particle
644793	21651891	Particle
647846	• 80001458	Particle
647904	• 80000807	Particle
647932	21652540	Combi
647941	21652548	Particle
647946	80001459	Combi
647962	• 80001171	Combi
647963	80001027	Particle
647975	21652540	Combi
647990	80000667	Combi •
647993	80000615	Combi •
95667986	21651899	Particle
6479E5	21652856	Particle
1609428080	80000666	Particle •
1609428180	80000667	Combi •
9636086280	21653028	Particle
9678792080	80004779	Particle •
9678792080	• 80004780	Combi •
9804163380	80004812	Particle •
9804163480	80004813	Combi •
6479E9	80000853	Particle
6441EG	21651899	Particle
6441EH	80000077	Combi
6441EJ	21653102	Combi
6441EJ	• 80000807	Particle
6441EL	21652342	Particle •
6441EL	• 80000765	Combi •
6441EN	21652342	Particle •
6441EN	• 80000765	Combi •
6441H7	21651899	Particle
6447AK	21651899	Particle
6447AZ	21651293	Particle
6447F2	80000743	Combi
6447GW	• 21653148	Particle

PEUGEOT		
6447GW	21653149	Combi
6447HP	21653028	Particle
6447J0	21651994	Particle
6447J0	• 80000432	Combi
6447K6	21651919	Particle
6447K6	• 80000748	Combi
6447KK	21652548	Particle
6447KL	21652540	Combi
6447KR	21653028	Particle
6447LV	21651899	Particle
6447LY	21652856	Particle
6447P2	21652342	Particle •
6447P2	• 80000765	Combi •
6447P3	21652342	Particle •
6447P3	• 80000765	Combi •
6447PE	21653068	Combi
6447PF	80000077	Combi
6447PG	21652541	Combi
6447RG	21653102	Combi
6447S5	21651920	Particle
6447SP	21653147	Combi
6447SR	80000077	Combi
6447SY	21651994	Particle
6447SZ	21653146	Combi
6447TA	21653147	Combi
6447TF	21651293	Particle
6447TT	80000662	Particle
6447TT	• 80000784	Combi
6447TY	21651994	Particle
6447TY	• 80000432	Combi
6447VX	80000667	Combi •
6447VY	80000666	Particle •
6447XF	80000839	Particle
6447XG	80000615	Combi •
6447YA	80000815	Particle
6447YA	• 80000816	Combi
6447YJ	80000865	Particle
6447YL	80000866	Combi
6447Z4	21651899	Particle
6447Z5	21651899	Particle
6447ZX	80000853	Particle
6447ZX	• 80000854	Combi
6479A0	21651994	Particle
6479A1	21653028	Particle
6479A2	21653146	Combi
6479A5	80000662	Particle
6479A5	• 80000784	Combi
6479A6	80000865	Particle
6479A7	80000866	Combi
6479C2	21652548	Particle
6479C9	80000815	Particle
6479J7	• 80001778	Particle
6479J7	80001779	Combi
6479K9	• 80001791	Particle
6479K9	80001792	Combi
B0009775480	80005194	Particle
B0009775480	80005202	Combi
E146001	21651899	Particle
E146155	21652548	Particle
PORSCHE		
9587221900	80001741	Combi
9587221900	• 80001742	Particle
95557221910	21653015	Combi

PORSCHE		
97057362300	80004356	Combi
97057362300	• 80004357	Particle
98057141901	80000347	Combi
98057141901	• 80000803	Particle
99157237100	80005091	Particle
99157362300	80004549	Combi
99657121900	21652541	Combi
99657121901	21652541	Combi
99657121903	21652541	Combi
99657221902	21651920	Particle
99757121900	21652541	Combi
99757121901	21652541	Combi
7H0819631	21653020	Particle
8K0819439	80000879	Particle
8K0819439A	80000880	Combi
8K0819439B	80000880	Combi
RENAULT		
5001010063	80000645	Particle
5001823129	80001585	Particle
5001833354	80000645	Particle
5001844054	80001585	Particle
5001867491	80001586	Particle
5010502404	80000613	Particle
5010502404	• 80000769	Combi
6025300301	21652687	Particle •
6025370624	21652687	Particle •
6025372486	21653070	Combi •
7482348995	80005071	Particle
7482351184	80005072	Combi
7700424093	21652348	Particle
7700424093	• 80000750	Combi
7700424098	21651983	Particle
7700424098	• 80000114	Combi
7700428820	21651984	Particle
7700428820	• 80000436	Combi
7700834814	21651916	Particle
7700834815	21651916	Particle
7700834816	21651916	Particle
7700834816	• 80000434	Combi
7700835266	21651298	Particle
7700835266	• 80000747	Combi
7700845219	80000373	Particle
7700845222	21653140	Particle
7700845222	• 80000762	Combi
7700845811	21651917	Particle
7700845811	• 80000435	Combi
7700846236	80000536	Particle
7700846236	• 80000788	Combi
7700854811	21651917	Particle
7700854811	• 80000435	Combi
7701040543	21651917	Particle
7701040543	• 80000435	Combi
7701042499	21651983	Particle
7701042499	• 80000114	Combi
7701047513	21652349	Particle
7701047513	• 80000418	Combi
7701048748	21652542	Combi
7701048748	21652550	Particle
7701048749	21652542	Combi
7701050319	80000072	Particle
7701050319	• 80001170	Combi
7701055109	21653071	Particle
7701055109	80004676	Particle

RENAULT		
7701055110	80000080	Particle
7701056389	21652871	Particle
7701056390	21652872	Combi
7701059997	80000074	Particle
7701062227	80000074	Particle
7701064235	80000670	Combi
7701064235	80004677	Combi
7701064237	80004404	Combi
7701205278	21651917	Particle
7701205278	• 80000435	Combi
7701205279	80000373	Particle
7701205280	80000536	Particle
7701205280	• 80000788	Combi
7701205281	21653140	Particle
7701205281	• 80000762	Combi
7701206046	21652348	Particle
7701209837	80001456	Particle •
7701209837	• 80001457	Combi •
7701409324	21651991	Particle
7701409324	• 80000752	Combi
7701418727	21651900	Particle
7701418727	• 80000753	Combi
7711211700	21652549	Particle •
7711211700	• 80000766	Combi •
7711228912	• 80000114	Combi
7711228919	• 80000418	Combi
7711426872	80004402	Combi
8201055422	80004402	Combi
8201108877	80000080	Particle
8201370532	80004402	Combi
272770001R	• 80001030	Particle •
272770001R	80001031	Combi •
272770567R	80004639	Combi
272770840R	80001188	Combi
272771128R	• 80001450	Particle
272771128R	80001451	Combi
272771205R	80001787	Particle •
272772100R	• 80001753	Combi
272772100R	80001760	Particle
272772435R	80004404	Combi
272772951R	80001031	Combi •
272773016R	80004638	Particle
272773488R	80001461	Combi
272774653R	80001788	Combi •
272774711R	• 80005281	Particle
272774711R	80005282	Combi
272774936R	• 80001753	Combi
272775374R	80000074	Particle
272778214R	80004638	Particle
272778970R	• 80001460	Particle
272778970R	80001461	Combi
272779683R	80004639	Combi
278912394R	21652872	Combi
27891JY10A	• 80001187	Particle
27891JY10A	80001188	Combi
ROVER		
JKR000030	21653017	Particle
JKR000040	80000070	Combi
JKR000041	80000070	Combi
JKR100020	80000029	Particle
JKR100020	• 80000749	Combi
JKR100021	80000029	Particle
JKR100080	21652345	Particle

ROVER		
JKR100080	• 80000428	Combi
JKR100183	21653017	Particle
JKR100193	80000070	Combi
JKX100010	21651972	Particle
JKX100010	• 80000742	Combi
JKY100020	80000029	Particle
JKY100020	• 80000749	Combi
SAAB		
4072211	21651918	Particle
4072211	• 80000417	Combi
4072393	21651918	Particle
4072393	• 80000417	Combi
4541546	21653115	Combi
4541546	49356177	Combi
4541546	• 80000409	Particle
4632493	21653114	Particle
5047113	21653114	Particle
5335948	21653115	Combi
5335948	49356177	Combi
5335948	• 80000409	Particle
5335955	21653115	Combi
5335955	49356177	Combi
5335955	• 80000409	Particle
9179905	21652714	Particle
9196343	21652715	Combi
9625674	21651896	Particle
12758727	21653115	Combi
12758727	49356177	Combi
12758727	• 80000409	Particle
12758728	21653115	Combi
12758729	21653115	Combi
12758729	49356177	Combi
12758729	• 80000409	Particle
SCANIA		
303520	80000646	Particle
1326180	80000350	Particle
1379952	80000362	Particle
1420197	80000362	Particle
1770813	80001732	Particle
1913500	80001732	Particle
1913503	80000362	Particle
SEAT		
191091700	• 80000628	Combi
191091700	80000636	Particle
191819638	• 80000628	Combi
191819638	80000636	Particle
1H0091800SE	21651955	Combi
1H0819638A	21651912	Particle
1H0819638A	80000817	Particle
1H0819644	21651912	Particle
1H0819644	80000817	Particle
1H0819644A	21651912	Particle
1H0819644A	80000817	Particle
1H0819644B	21651912	Particle
1H0819644B	80000817	Particle
1J0819644	21651967	Combi
1J0819644A	21651967	Combi
1K0819644	21653024	Particle
1K0819644A	21653024	Particle
1K0819644B	21653024	Particle
1K1819653	21653008	Combi
1K1819653A	21653008	Combi
1K1819653B	21653008	Combi

SEAT		
1K2819653	80000602	Combi
1K2819653A	80000602	Combi
1K2819653B	80000602	Combi
1S0820367	80004355	Particle
1S0820367	• 80004403	Combi
4B0819439C	21652713	Combi
5Q0819644	80004514	Particle
5Q0819653	80004515	Combi
6Q0819653	21652357	Combi
6Q0819653B	21652357	Combi
6Q0820367	21652356	Particle
6Q0820367B	21652356	Particle
6R0819653	80001784	Combi
6R0820367	80001783	Particle
7M0091800SE	21651960	Combi
7M0819638A	21651895	Particle
8E0819439	21652689	Particle
SETRA		
0018351347	80001621	Particle
0018354347	80001763	Particle
0018355847	80001629	Particle
0018356147	80001627	Particle
0018356247	80001628	Particle
0018359247	80001583	Particle
8440000941	80001621	Particle
1100710A	80001763	Particle
1100807A	80001629	Particle
1100895A	80001628	Particle
1100895B	80001628	Particle
1101120A	80001627	Particle
89697A	80001621	Particle
H14003495	80001583	Particle
SKODA		
1H0091800SE	21651955	Combi
1H0819644	21651912	Particle
1H0819644	80000817	Particle
1H0819644A	21651912	Particle
1H0819644A	80000817	Particle
1H0819644B	21651912	Particle
1H0819644B	80000817	Particle
1K0819644	21653024	Particle
1K0819644A	21653024	Particle
1K0819644B	21653024	Particle
1K1819653	21653008	Combi
1K1819653A	21653008	Combi
1K1819653B	21653008	Combi
1K2819653	80000602	Combi
1K2819653A	80000602	Combi
1K2819653B	80000602	Combi
1S0820367	80004355	Particle
1S0820367	• 80004403	Combi
5Q0819644	80004514	Particle
5Q0819653	80004515	Combi
6Q0819653	21652357	Combi
6Q0819653B	21652357	Combi
6Q0820367	21652356	Particle
6Q0820367B	21652356	Particle
6R0819653	80001784	Combi
6R0820367	80001783	Particle
SKODA SWV		
1K1819653A	21653008	Combi
6Q0819653	21652357	Combi
6Q0820367B	21652356	Particle

SMART		
4518300018	80001035	Combi
4518350247	80001035	Combi
4518350247	80001724	Particle
4538350300	• 80005281	Particle
4538350300	80005282	Combi
4548300018	21653013	Combi
0001104V017	21653014	Combi
0001105V017	21653014	Combi
0001110V003	21653014	Combi
0001110V003	• 80000338	Particle
0001110V004	21653014	Combi
0001110V004	• 80000338	Particle
0013871V001	21653013	Combi
0013871V001	• 80000331	Particle
0013871V002	21653013	Combi
A4548300018	21653013	Combi
A4548300018	• 80000331	Particle
SPERRY N H		
82034664	80000642	Particle
82034664	• 80000789	Combi
820223280	80000642	Particle
820223280	• 80000789	Combi
SSANGYONG		
6811021030	80001768	Particle •
6811235000	49366992	Particle
6811634000	80004777	Particle
6811634000	• 80004778	Combi
6812008130	80000653	Particle •
6812008130	• 80000800	Combi
6923005400	80001769	Particle •
68111091A0	80001439	Particle •
68111091A0	• 80001440	Combi •
SUBARU		
470483	80000758	Combi
8856852010	21652551	Particle
885685201083	21652551	Particle
72880AG000	21652539	Particle
72880AG000	• 80000745	Combi
72880AG0009P	21652539	Particle
72880AG0009P	• 80000745	Combi
72880AJ000	80000604	Particle
72880AJ000	• 80000605	Combi
72880AJ0009P	80000604	Particle
72880AJ0009P	• 80000605	Combi
72880AJ010	21652989	Particle
72880AJ010	• 80000437	Combi
72880FE000	80000164	Particle
72880FE000	80001750	Combi
72880FG000	80001767	Particle
72880FG0009P	80001767	Particle
72880SA000	80001411	Particle
72880XA00A	21652539	Particle
72880XA00A	21652551	Particle
9586078F10	21652350	Particle
99906850M2038	80004395	Particle
G3010SA100	80001411	Particle
G3210FC000	80001771	Particle
G3210FE000	80001750	Combi
SEDNF29100	80000604	Particle
SEDNF29110	80000604	Particle
SUZUKI		
470483	80000758	Combi
4710210	80001036	Particle

SUZUKI		
71743821	80000603	Particle
93194847	80001036	Particle
08975B4000100	• 80000763	Combi
278914A00C	80001444	Particle
278914A00C	• 80001445	Combi
9586051K10	• 80001744	Combi
9586062J00000	21652989	Particle
9586063J10000	21652989	Particle
9586063J10000	80000603	Particle
9586078F00	21652350	Particle
9586078F000	21652350	Particle
9586078F00000	21652350	Particle
9586081A01	80001446	Particle
9586081A01	• 80001447	Combi
9586081A10	80001446	Particle
9586081A10	• 80001447	Combi
9586081A20	80001446	Particle
9586081A20	• 80001447	Combi
9586154G00	80001172	Particle
9586154G00	• 80001173	Combi
9586154G00000	80001172	Particle
9586154G00000	• 80001173	Combi
9586154J00	80000657	Particle
9586154J00	• 80000785	Combi
9586154J00000	80000657	Particle
9586154J00000	• 80000785	Combi
9586157L00	80001789	Particle
9586157L00	• 80001790	Combi
9586164J00	80000676	Particle
9586164J00000	• 80000770	Combi
9586164J01000	80000676	Particle
9586165D00000	80001023	Particle •
95861M68K10	80001444	Particle
95861M68K10	• 80001445	Combi
99000990N0F10	80001023	Particle •
99000990N0F30	21652350	Particle
99000990N0F40	21652350	Particle
TOYOTA		
8713902020	• 80000605	Combi
8713906030	21652539	Particle
8713906040	21652539	Particle
8713906080	80000604	Particle
8713907010	80000604	Particle
8713928010	21652539	Particle
8713930040	• 80000605	Combi
8713930070	• 80000605	Combi
8713932010	21652539	Particle
8713947010	21652539	Particle
8713949010	21652539	Particle
8713952010	21652551	Particle
8713952010	• 80000419	Combi
8713952020	80000604	Particle
8850802010	21652873	Particle
8850812020	21652873	Particle
8850813010	80001452	Particle
8850813010	• 80001453	Combi
8850820040	21652897	Particle •
8850820050	21652897	Particle •
8850820060	21652897	Particle •
8850820070	21652897	Particle •
8850820080	21652897	Particle •
8850820090	21652897	Particle •
8850820120	21652539	Particle

TOYOTA		
8850820150	21652897	Particle •
8850820210	21652539	Particle
8856802020	21652539	Particle
8856802030	21652874	Particle
8856802030	• 80000438	Combi
8856813010	21652551	Particle
8856813010	80001452	Particle
8856813010	• 80001453	Combi
8856852010	21652551	Particle
8856852010	• 80000419	Combi
8856874010	80001208	Particle
8856874010	• 80001209	Combi
8856874011	80001208	Particle
8888020010	21652897	Particle •
8888020020	21652897	Particle •
8888020030	21652897	Particle •
8888020060	21652897	Particle •
8888020080	80004708	Particle •
8888020090	21652539	Particle
8888020110	21652897	Particle •
8888020130	80004708	Particle •
8888041010	21652539	Particle
8888044040	21652897	Particle •
871394701083	21652539	Particle
885685201083	21652551	Particle
885685201083	• 80000419	Combi
72880AG000	• 80000745	Combi
72880AG0009P	• 80000745	Combi
871390D010	80000604	Particle
871390D070	80000604	Particle
87139Y7706	80001452	Particle
87139Y7706	• 80001453	Combi
87139Y7713	80001452	Particle
87139Y7713	• 80001453	Combi
87139YZZ05	21652539	Particle
87139YZZ06	21652551	Particle
87139YZZ06	80001452	Particle
87139YZZ07	21652874	Particle
87139YZZ07	• 80000438	Combi
87139YZZ08	80000604	Particle
87139YZZ13	80001452	Particle
87139YZZ16	80000604	Particle
885080H010	80000662	Particle
885080H010	• 80000784	Combi
88508YV010	80005194	Particle
88508YV010	80005202	Combi
VAUXHALL		
0470483	80000758	Combi
1718042	80000113	Combi
1718044	21651964	Combi
1718045	21651965	Combi
1718046	80000021	Combi
1718668	80000113	Combi
1718962	21652046	Combi •
1808149	21651982	Particle •
1808246	80001186	Combi
1808524	80001185	Particle
1808600	21651182	Particle
1808602	21651182	Particle
1808604	21651184	Particle
1808605	21651183	Particle
1808606	21651981	Particle
1808606	• 80000761	Combi

VAUXHALL		
1808607	21651185	Particle
1808608	21651966	Combi
1808609	21651982	Particle •
1808610	21651979	Particle
1808612	21651980	Particle
1808613	80000160	Particle •
1808617	21652715	Combi
1808618	21652353	Combi
1808619	21652714	Particle
1808624	21652715	Combi
4705463	21652350	Particle
4708106	21652350	Particle
4710210	80001036	Particle
4803883	80000877	Particle
4803883	• 80000878	Combi
6806612	21651184	Particle
6808600	21651182	Particle
6808601	21652714	Particle
6808604	21652994	Particle
6808605	21652995	Combi
6808606	21651979	Particle
6808607	80000021	Combi
6808610	21651182	Particle
6808611	21651980	Particle
6808612	21651184	Particle
6808613	21651183	Particle
6808614	21652353	Combi
6808616	21651966	Combi
6808617	21652715	Combi
6808618	21652995	Combi
6808622	80000541	Particle
6808623	80000541	Particle
6808623	• 80000777	Combi
9118699	80000113	Combi
9121625	21651964	Combi
9121626	21651965	Combi
9121627	80000021	Combi
09121653	21652046	Combi •
09162646	21652353	Combi
09196805	21652350	Particle
9207486	21652350	Particle
12368753	21651982	Particle •
13175553	21651979	Particle
13175554	80000021	Combi
13271190	80001185	Particle
13271192	80001186	Combi
52420930	80001186	Combi
52425938	80001185	Particle
52470574	21651982	Particle •
55702456	80000541	Particle
90360171	21651182	Particle
90386776	21651184	Particle
90486282	21651182	Particle
90509367	21651184	Particle
90510338	21651183	Particle
90512706	21651981	Particle
90512706	• 80000761	Combi
90512779	21651185	Particle
90520689	21651979	Particle
90541317	21651966	Combi
90559549	21651980	Particle
91132374	21652046	Combi •
91160128	80000072	Particle

VAUXHALL		
91160128	• 80001170	Combi
93165208	21652353	Combi
93174800	21652994	Particle
93174801	21652995	Combi
93182435	21651182	Particle
93182437	21651184	Particle
93182438	21651183	Particle
93188572	21652350	Particle
93194847	80001036	Particle
96440878	80000877	Particle
96440878	• 80000878	Combi
96629614	80000877	Particle
96629614	• 80000878	Combi
96800069	80000877	Particle
96800069	• 80000878	Combi
97170804	80000160	Particle •
8971708040	• 80000792	Combi
VISEON		
0008308018	80005208	Particle
0008308118	80005208	Particle
VOLVO		
1343232	21651986	Particle
3465418	80001025	Particle
4771477	80000633	Particle
8143691	21653139	Particle
8687389	80000061	Particle
9171296	21651986	Particle
9171296	• 80000744	Combi
9171756	21652996	Combi
9171757	80000069	Combi
9184130	21651986	Particle
9192522	21651986	Particle
9192523	21651986	Particle
9204626	21652317	Particle
9204627	80000412	Particle
9488527	• 80000744	Combi
10058971	80000633	Particle
11005897	80000633	Particle
11007388	80000633	Particle
11007847	80001757	Particle
11007848	80001620	Particle
13432323	21651986	Particle
15845753	80000633	Particle
20559447	80001586	Particle
20746873	80000638	Particle
20746873	• 80000782	Combi
21130158	80000638	Particle
30612666	21652351	Particle
30630752	21652317	Particle
30630753	80000412	Particle
30630754	21652996	Combi
30630755	80000069	Combi
30662349	21653069	Combi
30676413	21652996	Combi
30676419	80000069	Combi
30676484	80000062	Combi
30733893	80000713	Combi
30767022	80000712	Particle
30767024	80000713	Combi
30780376	80000061	Particle
30780377	80000062	Combi
30883952	21653069	Combi
31369455	80001773	Combi

VOLVO		
31369456	80001772	Particle
31404958	80001773	Combi
31404959	80001772	Particle
31407748	• 49363444	Particle
31407748	49363445	Combi
47714773	80000633	Particle
47714779	80000633	Particle
67744524	80000632	Particle
70326723	80000638	Particle
82348995	80005071	Particle
82351184	80005072	Combi
82354791	80005070	Particle
85107862	80000638	Particle
92046267	21652317	Particle
110058971	80000633	Particle
110073889	80000633	Particle
VW		
191091700	• 80000628	Combi
191091700	80000636	Particle
191819638	• 80000628	Combi
191819638	80000636	Particle
357091700	80000594	Particle
357819638	80000594	Particle
703819989	21651987	Particle
703819989	• 80000028	Combi
893091700	21651956	Combi
893819429	21651956	Combi
68031730500	21651960	Combi
1H0091800	21651955	Combi
1H0819638A	21651912	Particle
1H0819638A	80000817	Particle
1H0819644	21651912	Particle
1H0819644	80000817	Particle
1H0819644A	21651912	Particle
1H0819644A	80000817	Particle
1H0819644B	21651912	Particle
1H0819644B	80000817	Particle
1J0819644	21651967	Combi
1J0819644A	21651967	Combi
1K0819644	21653024	Particle
1K0819644A	21653024	Particle
1K0819644B	21653024	Particle
1K1819653	21653008	Combi
1K1819653A	21653008	Combi
1K1819653B	21653008	Combi
1K2819653	80000602	Combi
1K2819653A	80000602	Combi
1K2819653B	80000602	Combi
1S0820367	80004355	Particle
1S0820367	• 80004403	Combi
2D0819638	21651976	Particle
2D0819638	• 21652985	Combi
2D0819638A	21651976	Particle
2D0819638A	• 21652985	Combi
2E0819638	80000614	Particle
2E0819638A	80000616	Combi
3A0091800	21651968	Combi
3A0819638	21651898	Particle
3A0819644	21651898	Particle
3B0091800	21651956	Combi
3D0898644	21653031	Combi •
5Q0819644	80004514	Particle
5Q0819653	80004515	Combi

VW			
6Q0819653	21652357	Combi	
6Q0819653B	21652357	Combi	
6Q0820367	21652356	Particle	
6Q0820367A	21652356	Particle	
6Q0820367B	21652356	Particle	
6R0819653	80001784	Combi	
6R0820367	80001783	Particle	
703819990A	21651987	Particle	
7D0819989	21651987	Particle	
7D0819989	• 80000028	Combi	
7H0819631	21653020	Particle	

VW			
7H0819631A	21653015	Combi	
7M0091800	21651960	Combi	
7M0819638A	21651895	Particle	
7M0819644	21651895	Particle	
7M3819644	21651960	Combi	
7M3819644A	21651960	Combi	
7P0819631	80001741	Combi	
7P0819631	• 80001742	Particle	
893091400A	21651890	Particle	
8A0819439A	21651890	Particle	
8A0819439B	21651956	Combi	

VW FAW			
191819638	80000636	Particle	
1J0819644	21651967	Combi	
1K1819653A	21653008	Combi	
VW SVW			
1J0819644A	21651967	Combi	
1K1819653A	21653008	Combi	
6Q0819653	21652357	Combi	
6Q0820367	21652356	Particle	
6Q0820367B	21652356	Particle	
8A0819439A	21651890	Particle	

Vergleichsliste | Correspondances CORTECO |
Tabelle Comparative CORTECO

CROSS REFERENCE LIST

CROSS REFERENCE LIST

VERGLEICHSLISTE | CORRESPONDANCES CORTECO |
TABELLE COMPARATIVE CORTECO



BOSCH			
0986475801	21653068	Combi	
0986AF4000	80000546	Particle	•
0986AF4006	80000764	Combi	
0986AF4006	80000767	Particle	
0986AF4008	80000797	Combi	•
0986AF4009	80000780	Combi	
0986AF4010	80000781	Combi	
0986AF4010	80001442	Combi	
0986AF4010	80001446	Particle	
0986AF4011	80001440	Combi	•
0986AF4016	80000330	Particle	
0986AF4016	80000404	Combi	
0986AF4017	21652339	Particle	
0986AF4099	80000538	Combi	•
0986AF4099	80001491	Particle	•
0986AF4100	80000083	Particle	
0986AF4100	80000440	Combi	
0986AF4102	80000546	Particle	•
0986AF4104	80000158	Particle	
0986AF4104	80000402	Combi	
0986AF4105	80000764	Combi	
0986AF4105	80000767	Particle	
0986AF4151	80000158	Particle	
0986AF4151	80000402	Combi	
0986AF4163	80000813	Particle	
0986AF4163	80000814	Combi	
0986AF5008	21652992	Combi	
0986AF5008	21653145	Particle	
0986AF5020	80000605	Combi	
0986AF5028	21652346	Particle	
0986AF5040	80000164	Particle	
0986AF5403	80000628	Combi	
0986AF5403	80000636	Particle	
0986AF5404	21651893	Particle	
0986AF5405	21651967	Combi	
0986AF5410	21652356	Particle	
0986AF5412	21651890	Particle	
0986AF5415	21652860	Particle	•
0986AF5415	80000403	Combi	•
0986AF5430	21652357	Combi	
0986AF5431	21653024	Particle	
0986AF5432	21653008	Combi	
0986AF5433	21653066	Combi	
0986BF0538	21651296	Combi	
0986BF0538	21652544	Particle	
0986BF0709	21651968	Combi	
0986BF0710	21651954	Combi	
0986BF0710	80000376	Particle	
0986BF0711	21651967	Combi	
0986BF0713	21652538	Combi	
0986BF0713	21653027	Particle	
1987429188	80004670	Air Filter	
1987431001	21651196	Particle	
1987431002	21651198	Particle	
1987431003	21651901	Particle	
1987431005	21651896	Particle	
1987431006	21651893	Particle	



BOSCH			
1987431007	21651920	Particle	
1987431008	21651919	Particle	
1987431009	21651917	Particle	
1987431010	21651182	Particle	
1987431011	80000636	Particle	•
1987431012	21651912	Particle	
1987431013	21651898	Particle	
1987431013	80000594	Particle	
1987431014	21651915	Particle	
1987431015	21651184	Particle	
1987431016	21651183	Particle	
1987431017	21651890	Particle	
1987431018	21650107	Particle	
1987431019	21651894	Particle	
1987431020	21651195	Particle	•
1987431021	21651899	Particle	
1987431022	21651891	Particle	
1987431023	21651900	Particle	
1987431023	80000753	Combi	
1987431024	21651914	Particle	
1987431025	21651971	Particle	•
1987431025	80000793	Combi	•
1987431026	21651972	Particle	
1987431027	21651916	Particle	
1987431028	21651895	Particle	
1987431029	21651892	Particle	
1987431029	80000760	Combi	
1987431030	21651185	Particle	
1987431031	21651981	Particle	
1987431031	80000761	Combi	
1987431032	21651197	Particle	
1987431033	21651913	Particle	
1987431034	21651984	Particle	
1987431034	21653140	Particle	
1987431034	80000436	Combi	
1987431034	80000762	Combi	
1987431035	21651975	Particle	
1987431036	21651969	Particle	
1987431037	21652688	Particle	
1987431038	21651980	Particle	
1987431039	21651983	Particle	
1987431040	21651979	Particle	
1987431041	21651888	Particle	
1987431042	21651994	Particle	
1987431043	21651976	Particle	
1987431044	21652045	Particle	
1987431045	21651995	Particle	
1987431046	21651918	Particle	
1987431047	21651911	Particle	
1987431047	21651986	Particle	
1987431048	21651293	Particle	
1987431049	21652687	Particle	•
1987431050	21651298	Particle	
1987431051	21651199	Particle	•
1987431051	21651993	Particle	
1987431051	80000382	Combi	
1987431052	21651982	Particle	•



BOSCH			
1987431053	21652345	Particle	
1987431053	80000428	Combi	
1987431054	21652543	Particle	
1987431055	21652359	Particle	
1987431056	21651987	Particle	
1987431057	21652356	Particle	
1987431058	21652347	Particle	
1987431059	21652308	Particle	
1987431060	21652342	Particle	•
1987431061	21652348	Particle	
1987431062	21651986	Particle	
1987431063	21652351	Particle	
1987431064	21652317	Particle	
1987431064	21652996	Combi	
1987431066	21652350	Particle	
1987431069	21652349	Particle	
1987431070	21652358	Particle	
1987431071	21652689	Particle	
1987431072	21652544	Particle	
1987431073	21652709	Particle	
1987431074	21652546	Particle	•
1987431075	21652346	Particle	
1987431076	21652714	Particle	
1987431079	21652548	Particle	
1987431081	21652863	Particle	
1987431082	21652850	Particle	
1987431083	21653028	Particle	
1987431084	21652551	Particle	
1987431085	21652539	Particle	
1987431088	21652874	Particle	
1987431091	21652856	Particle	
1987431093	21653071	Particle	
1987431094	80000080	Particle	
1987431095	21651991	Particle	
1987431096	21653114	Particle	
1987431097	21653024	Particle	
1987431113	80000061	Particle	
1987431150	21651977	Particle	
1987431151	21651973	Particle	
1987431152	21653022	Particle	
1987431153	80000362	Particle	
1987431154	21653003	Particle	
1987431155	21652002	Particle	
1987431156	21652998	Particle	
1987431156	21653001	Particle	
1987431157	21652998	Particle	
1987431157	21653001	Particle	
1987431159	80000633	Particle	
1987431160	80000632	Particle	
1987431162	21653016	Particle	
1987431163	21653005	Particle	
1987431164	21653021	Particle	
1987431165	80001625	Particle	
1987431166	80000333	Particle	
1987431167	21653139	Particle	
1987431168	21653007	Particle	
1987431169	21652997	Particle	

BOSCH		
1987431172	80001732	Particle
1987431174	21653019	Particle
1987431175	21653019	Particle
1987431300	21651967	Combi
1987431301	21651961	Combi
1987431303	21651901	Particle
1987431303	21651952	Combi
1987431306	21652355	Combi
1987431307	21652541	Combi
1987431310	21651964	Combi
1987431312	21651955	Combi
1987431313	21651968	Combi
1987431314	21651951	Combi
1987431315	21651965	Combi
1987431316	21651963	Combi
1987431317	21651956	Combi
1987431318	21652959	Combi
1987431324	21651957	Combi
1987431328	21651960	Combi
1987431330	21651966	Combi
1987431333	21651958	Combi
1987431335	21651961	Combi
1987431336	21652336	Combi
1987431337	21651292	Combi
1987431345	21652354	Combi
1987431354	80000429	Combi
1987431357	21652357	Combi
1987431360	21651954	Combi
1987431361	21651882	Combi •
1987431361	21651897	Particle •
1987431362	21651881	Combi •
1987431364	21651294	Combi
1987431364	21653029	Particle
1987431365	21651296	Combi
1987431366	21652353	Combi
1987431367	21652552	Combi •
1987431370	21652861	Combi
1987431371	21652713	Combi
1987431373	21652361	Combi
1987431376	21652715	Combi
1987431377	21652538	Combi
1987431378	21653014	Combi
1987431379	21652540	Combi
1987431380	21652542	Combi
1987431382	21652853	Combi
1987431386	21652352	Combi •
1987431387	21652858	Combi
1987431387	21653145	Particle
1987431397	21653008	Combi
1987431400	21652872	Combi
1987431401	21653115	Combi
1987431401	80000409	Particle
1987431409	21653035	Combi
1987431413	80000062	Combi
1987431452	80000626	Combi
1987431454	21653006	Combi
1987431456	21652999	Combi
1987431457	21653000	Combi
1987431458	80000364	Combi
1987431550	80000158	Particle
1987431550	80000402	Combi
1987431551	80000400	Combi
1987431553	80000083	Particle

BOSCH		
1987431553	80000440	Combi
1987431570	80000441	Combi •
1987431571	80000773	Combi
1987431953	21652539	Particle
1987431955	21652551	Particle
1987431955	21652874	Particle
1987431955	80000419	Combi
1987431955	80000438	Combi
1987431963	21652546	Particle •
1987431963	80000148	Combi •
1987432001	21651196	Particle
1987432001	21651975	Particle
1987432002	21651198	Particle
1987432003	21651901	Particle
1987432004	80001185	Particle
1987432005	21651896	Particle
1987432006	21651893	Particle
1987432007	21651920	Particle
1987432008	21651919	Particle
1987432009	21651917	Particle
1987432010	21651182	Particle
1987432011	80000636	Particle
1987432012	21651196	Particle
1987432012	21651912	Particle
1987432012	21651975	Particle
1987432012	21653008	Combi
1987432012	80000817	Particle
1987432013	21651898	Particle
1987432013	80000594	Particle
1987432014	21651915	Particle
1987432015	21651184	Particle
1987432016	21651183	Particle
1987432017	21651890	Particle
1987432018	21650107	Particle
1987432018	21652709	Particle
1987432019	21651894	Particle
1987432020	21651195	Particle •
1987432021	21651899	Particle
1987432021	80000077	Combi
1987432022	21651891	Particle
1987432023	21651900	Particle
1987432024	21651914	Particle
1987432025	21651971	Particle •
1987432026	21651972	Particle
1987432027	21651916	Particle
1987432028	21651895	Particle
1987432029	21651892	Particle
1987432030	21651185	Particle
1987432031	21651981	Particle
1987432032	21651197	Particle
1987432033	21651913	Particle
1987432034	21651984	Particle
1987432034	21653140	Particle
1987432036	21651969	Particle
1987432037	21652688	Particle
1987432038	21651980	Particle
1987432039	21651983	Particle
1987432040	21651979	Particle
1987432041	21651888	Particle
1987432041	80000027	Particle
1987432042	21651994	Particle
1987432043	21651976	Particle
1987432043	21652985	Combi

BOSCH		
1987432044	21652045	Particle
1987432045	21651995	Particle
1987432046	21651918	Particle
1987432048	21651293	Particle
1987432049	21652687	Particle •
1987432050	21651298	Particle
1987432051	21651199	Particle •
1987432051	21651993	Particle
1987432052	21651982	Particle •
1987432053	21652345	Particle
1987432054	21652543	Particle
1987432055	21652359	Particle
1987432055	80000871	Particle
1987432056	21651987	Particle
1987432056	80000028	Combi
1987432057	21652356	Particle
1987432058	21652347	Particle
1987432059	21652308	Particle
1987432059	80000430	Combi
1987432060	21652342	Particle •
1987432061	21651897	Particle •
1987432061	21652348	Particle
1987432062	21651986	Particle
1987432062	80000412	Particle
1987432063	21652351	Particle
1987432064	21652317	Particle
1987432065	80000815	Particle
1987432066	21652350	Particle
1987432068	21652849	Particle
1987432069	21652349	Particle
1987432070	21652358	Particle
1987432071	21652689	Particle
1987432072	21651296	Combi
1987432072	21652544	Particle
1987432073	21652709	Particle
1987432074	21652546	Particle •
1987432075	21652346	Particle
1987432076	21652714	Particle
1987432077	21653032	Particle
1987432078	80001456	Particle •
1987432079	21652548	Particle
1987432081	21652863	Particle
1987432082	21652850	Particle
1987432083	21653028	Particle
1987432084	21652551	Particle
1987432085	21652539	Particle
1987432086	21652867	Particle •
1987432087	21652857	Particle
1987432088	21652874	Particle
1987432088	80001452	Particle
1987432089	21653140	Particle
1987432090	21651984	Particle
1987432091	21651182	Particle
1987432091	21652856	Particle
1987432092	21653145	Particle
1987432092	80001039	Particle
1987432093	21653071	Particle
1987432093	80000670	Combi
1987432094	80000080	Particle
1987432095	21651991	Particle
1987432096	21653114	Particle
1987432097	21653024	Particle
1987432100	21652871	Particle

BOSCH			
1987432102	21653063	Particle	•
1987432103	21652848	Particle	•
1987432104	80000073	Particle	•
1987432105	21652338	Particle	
1987432106	21653026	Particle	
1987432107	21652899	Particle	
1987432108	21651916	Particle	
1987432108	21652900	Particle	
1987432109	21653034	Particle	
1987432111	21652994	Particle	
1987432113	80000061	Particle	
1987432114	21653020	Particle	
1987432115	21652989	Particle	
1987432117	21652860	Particle	•
1987432117	80000403	Combi	•
1987432118	80001041	Particle	•
1987432119	21652870	Particle	
1987432120	80000074	Particle	
1987432121	21652345	Particle	
1987432121	80000029	Particle	
1987432122	21653067	Particle	
1987432124	80000063	Particle	
1987432132	80001448	Particle	•
1987432133	80000345	Particle	
1987432134	21652867	Particle	•
1987432136	80000666	Particle	•
1987432137	80000839	Particle	
1987432148	80001444	Particle	
1987432150	21651977	Particle	
1987432151	21651973	Particle	
1987432152	21653022	Particle	
1987432153	80000362	Particle	
1987432155	21652873	Particle	
1987432156	80001023	Particle	•
1987432156	80001446	Particle	
1987432157	80000825	Particle	
1987432158	80000083	Particle	
1987432159	21652897	Particle	•
1987432160	80000546	Particle	•
1987432160	80001176	Particle	
1987432161	80000084	Particle	•
1987432163	80000405	Particle	•
1987432164	80000634	Particle	
1987432166	21651182	Particle	
1987432166	80000330	Particle	
1987432167	21652990	Particle	
1987432170	80000652	Particle	
1987432170	80000911	Particle	•
1987432171	80000867	Particle	
1987432171	80000869	Particle	
1987432172	80001172	Particle	
1987432173	21652989	Particle	
1987432173	80000603	Particle	
1987432175	21652340	Particle	
1987432176	80000644	Particle	•
1987432176	80000654	Particle	•
1987432182	21653017	Particle	
1987432183	80000637	Particle	
1987432188	80000541	Particle	
1987432189	80000662	Particle	
1987432190	80000604	Particle	
1987432192	21652360	Particle	
1987432193	21651983	Particle	

BOSCH			
1987432194	80000649	Particle	
1987432195	21653025	Particle	
1987432200	21651920	Particle	
1987432203	80000620	Particle	
1987432204	80000813	Particle	
1987432205	80000712	Particle	
1987432205	80004555	Particle	
1987432206	80000865	Particle	
1987432208	80000072	Particle	
1987432209	80001736	Particle	•
1987432211	80000656	Particle	•
1987432213	80000614	Particle	
1987432214	80001036	Particle	
1987432215	80001128	Particle	
1987432216	80000853	Particle	
1987432218	80001771	Particle	
1987432219	80000847	Particle	•
1987432220	21652546	Particle	•
1987432221	80000657	Particle	
1987432222	80000877	Particle	
1987432223	80000804	Particle	
1987432224	80001214	Particle	
1987432225	80000373	Particle	
1987432226	80000536	Particle	
1987432227	80000767	Particle	
1987432228	80001027	Particle	
1987432230	80000998	Particle	
1987432234	80001183	Particle	
1987432235	80000360	Particle	
1987432236	80000676	Particle	
1987432238	80000874	Particle	
1987432240	80001437	Particle	
1987432241	80000155	Particle	
1987432270	21652335	Particle	
1987432274	80004673	Particle	
1987432281	21652864	Particle	
1987432300	21651967	Combi	
1987432301	21651961	Combi	
1987432303	21651952	Combi	
1987432304	80001186	Combi	
1987432306	21652355	Combi	
1987432307	21652541	Combi	
1987432308	80001129	Combi	
1987432309	80000647	Combi	•
1987432310	21651964	Combi	
1987432311	80001459	Combi	
1987432312	21651955	Combi	
1987432313	21651968	Combi	
1987432314	21651951	Combi	
1987432315	21651965	Combi	
1987432315	80001211	Combi	•
1987432315	80001795	Combi	•
1987432317	21651956	Combi	
1987432318	21652959	Combi	
1987432324	21651957	Combi	
1987432326	80000844	Combi	
1987432326	80001527	Combi	
1987432327	80001461	Combi	
1987432328	21651960	Combi	
1987432330	21651966	Combi	
1987432333	21651958	Combi	
1987432335	21651961	Combi	
1987432336	21652336	Combi	

BOSCH			
1987432337	21651292	Combi	
1987432343	21652985	Combi	
1987432345	21652354	Combi	
1987432348	21653068	Combi	
1987432354	80000429	Combi	
1987432357	21652357	Combi	
1987432360	21651954	Combi	
1987432361	21651882	Combi	•
1987432362	21651881	Combi	•
1987432363	21653069	Combi	
1987432364	21651294	Combi	
1987432365	21651296	Combi	
1987432366	21651963	Combi	
1987432366	21652353	Combi	
1987432367	21652552	Combi	•
1987432368	21652852	Combi	
1987432369	80000880	Combi	
1987432370	21652861	Combi	
1987432371	21652713	Combi	
1987432373	21652361	Combi	
1987432376	21652715	Combi	
1987432376	80000621	Combi	
1987432377	21652538	Combi	
1987432378	21653014	Combi	
1987432379	21652540	Combi	
1987432380	21652542	Combi	
1987432381	21652865	Combi	
1987432382	21652853	Combi	
1987432386	21652352	Combi	•
1987432387	21652858	Combi	
1987432387	21653145	Particle	
1987432393	80000670	Combi	
1987432394	80004404	Combi	
1987432397	21653008	Combi	
1987432398	21653142	Combi	
1987432399	21653149	Combi	
1987432400	21652872	Combi	
1987432401	21653115	Combi	
1987432402	21653064	Combi	•
1987432405	80000713	Combi	
1987432405	80004556	Combi	
1987432406	80000866	Combi	
1987432407	21652541	Combi	
1987432409	21653035	Combi	
1987432410	21653143	Combi	
1987432411	21652995	Combi	
1987432412	21653102	Combi	
1987432413	80000062	Combi	
1987432415	80001129	Combi	
1987432419	80000848	Combi	•
1987432422	21653066	Combi	
1987432423	21652898	Combi	
1987432423	80000343	Particle	
1987432424	80000064	Combi	
1987432425	21652916	Combi	
1987432426	80000648	Combi	
1987432428	21652859	Combi	
1987432431	21653015	Combi	
1987432434	21653013	Combi	
1987432435	80000671	Combi	
1987432436	80000667	Combi	•
1987432437	80000615	Combi	•
1987432437	80004703	Combi	•

BOSCH

1987432438	80000538	Combi	•
1987432464	21652996	Combi	
1987432482	80000070	Combi	
1987432488	80000777	Combi	
1987432495	21653009	Combi	
1987432497	21652854	Combi	
1987432498	80000068	Combi	
1987432498	80000802	Particle	
1987432500	80001031	Combi	•
1987432512	21652865	Combi	
1987432513	80000616	Combi	
1987432533	80001740	Combi	•
1987432560	21652338	Particle	
1987432561	21652340	Particle	
1987432570	21652862	Combi	
1987432574	80004573	Combi	
1987432597	80000602	Combi	
1987432599	80004515	Combi	
1987435004	80005071	Particle	
1987435021	80004514	Particle	
1987435505	80004409	Combi	
1987435524	80005090	Combi	
F026400144	80005028	Air Filter	
F026400157	80005026	Air Filter	

DELPHI

LW21059	21653068	Combi	
TSP0325001	21651896	Particle	
TSP0325002	21651915	Particle	
TSP0325003	21651890	Particle	
TSP0325003C	21651890	Particle	
TSP0325003C	21651956	Combi	
TSP0325004	21651912	Particle	
TSP0325004C	21651912	Particle	
TSP0325004C	21651955	Combi	
TSP0325005	21651198	Particle	
TSP0325005C	21651198	Particle	
TSP0325005C	80000359	Combi	
TSP0325006	21651197	Particle	
TSP0325006	80000377	Combi	
TSP0325007	21651899	Particle	
TSP0325007	80000077	Combi	
TSP0325007C	21651899	Particle	
TSP0325009	21651901	Particle	
TSP0325009C	21651901	Particle	
TSP0325009C	21651952	Combi	
TSP0325010	21651894	Particle	
TSP0325010C	21651894	Particle	
TSP0325010C	80000433	Combi	
TSP0325011	21650107	Particle	
TSP0325011	21652709	Particle	
TSP0325011C	21650107	Particle	
TSP0325011C	21652361	Combi	
TSP0325011C	21652709	Particle	
TSP0325011C	21652959	Combi	
TSP0325012	21651893	Particle	
TSP0325012C	21651893	Particle	
TSP0325012C	21652355	Combi	
TSP0325013	21651892	Particle	
TSP0325014	80000376	Particle	
TSP0325015	21651182	Particle	
TSP0325015C	21651182	Particle	
TSP0325015C	21651964	Combi	
TSP0325015C	21651966	Combi	

DELPHI

TSP0325016	21651183	Particle	
TSP0325016	21651184	Particle	
TSP0325017	21651183	Particle	
TSP0325018	21651891	Particle	
TSP0325019	21651920	Particle	
TSP0325019C	21652541	Combi	
TSP0325020	21651916	Particle	
TSP0325020	80000434	Combi	
TSP0325021	21651917	Particle	
TSP0325022	80000594	Particle	
TSP0325022	80000636	Particle	
TSP0325024	21651898	Particle	
TSP0325024	80000594	Particle	
TSP0325025	21651898	Particle	
TSP0325026	21651185	Particle	
TSP0325027	21651967	Combi	
TSP0325027C	21651967	Combi	
TSP0325028	21651979	Particle	
TSP0325028C	21651979	Particle	
TSP0325028C	80000021	Combi	
TSP0325029	21651895	Particle	
TSP0325029C	21651895	Particle	
TSP0325029C	21651960	Combi	
TSP0325031	21651984	Particle	
TSP0325031C	21651984	Particle	
TSP0325031C	80000436	Combi	
TSP0325032	80000029	Particle	
TSP0325033	21651972	Particle	
TSP0325034	21651983	Particle	
TSP0325034C	21651983	Particle	
TSP0325034C	80000114	Combi	
TSP0325035	21651917	Particle	
TSP0325035	21653140	Particle	
TSP0325036	21652687	Particle	•
TSP0325037	21652348	Particle	
TSP0325037	80000750	Combi	
TSP0325038	21651897	Particle	•
TSP0325038C	21651882	Combi	•
TSP0325039	21651914	Particle	
TSP0325040	21651913	Particle	
TSP0325042	21651994	Particle	
TSP0325043	21652899	Particle	
TSP0325044	21652308	Particle	
TSP0325044C	21652308	Particle	
TSP0325044C	80000430	Combi	
TSP0325045	80000075	Particle	
TSP0325047	21651195	Particle	•
TSP0325047C	21651195	Particle	•
TSP0325047C	80000421	Combi	•
TSP0325048	21651995	Particle	
TSP0325048C	21652354	Combi	
TSP0325050	21652870	Particle	
TSP0325051	21651980	Particle	
TSP0325051C	80000113	Combi	
TSP0325052	21652338	Particle	
TSP0325053	21652340	Particle	
TSP0325055	21653114	Particle	
TSP0325056	80000409	Particle	
TSP0325057	21651911	Particle	
TSP0325057	21651986	Particle	
TSP0325058	21651986	Particle	
TSP0325058C	21651986	Particle	
TSP0325059	21652345	Particle	

DELPHI

TSP0325059	21652346	Particle	
TSP0325059C	21652345	Particle	
TSP0325059C	21652346	Particle	
TSP0325059C	80000428	Combi	
TSP0325059C	80000746	Combi	
TSP0325060	21652342	Particle	•
TSP0325061	21651292	Combi	
TSP0325061	21652688	Particle	
TSP0325061C	21651292	Combi	
TSP0325062	21651293	Particle	
TSP0325062C	21653068	Combi	
TSP0325064	21651971	Particle	•
TSP0325064	80000793	Combi	•
TSP0325065	21653023	Particle	•
TSP0325066	21653019	Particle	
TSP0325070	21651993	Particle	
TSP0325072	21652347	Particle	
TSP0325072	80000062	Combi	
TSP0325072C	21652347	Particle	
TSP0325072C	80000416	Combi	
TSP0325077	21651976	Particle	
TSP0325077	21652985	Combi	
TSP0325079	21651296	Combi	
TSP0325080	80000338	Particle	
TSP0325080C	21653014	Combi	
TSP0325080C	80000338	Particle	
TSP0325081	21651919	Particle	
TSP0325083	21652358	Particle	
TSP0325083C	21652861	Combi	
TSP0325084	21652349	Particle	
TSP0325085	21652543	Particle	
TSP0325085C	80000429	Combi	
TSP0325086	21653017	Particle	
TSP0325088C	21652996	Combi	
TSP0325089	21651900	Particle	
TSP0325092	80000027	Particle	
TSP0325093	21651975	Particle	
TSP0325096	21651298	Particle	
TSP0325098	21651982	Particle	•
TSP0325102	21652350	Particle	
TSP0325105	21651991	Particle	
TSP0325106	21652351	Particle	
TSP0325107	21651196	Particle	
TSP0325107	21651975	Particle	
TSP0325107C	21651961	Combi	
TSP0325108	21652346	Particle	
TSP0325108	80000746	Combi	
TSP0325110	80000375	Particle	•
TSP0325110C	21652352	Combi	•
TSP0325110C	80000375	Particle	•
TSP0325111	21652356	Particle	
TSP0325111C	21652357	Combi	
TSP0325112	21652689	Particle	
TSP0325112C	21652713	Combi	
TSP0325113	21653028	Particle	
TSP0325113	21653146	Combi	
TSP0325113C	21653146	Combi	
TSP0325114	21653032	Particle	
TSP0325115	21651296	Combi	
TSP0325115	21652544	Particle	
TSP0325115C	21651296	Combi	
TSP0325116	21653027	Particle	
TSP0325116C	21652538	Combi	

DELPHI			
TSP0325116C	21653027	Particle	
TSP0325119	21652860	Particle	•
TSP0325119	80000403	Combi	•
TSP0325122	21652714	Particle	
TSP0325122	21652715	Combi	
TSP0325122	80000621	Combi	
TSP0325122C	21652714	Particle	
TSP0325122C	21652715	Combi	
TSP0325122C	80000621	Combi	
TSP0325123	21652540	Combi	
TSP0325123	21652548	Particle	
TSP0325123	21653028	Particle	
TSP0325123C	21652540	Combi	
TSP0325124	21652542	Combi	
TSP0325124	21652550	Particle	
TSP0325124C	21652542	Combi	
TSP0325129	21652317	Particle	
TSP0325129	80000412	Particle	
TSP0325133	21653151	Particle	
TSP0325133C	21652854	Combi	
TSP0325133C	21653151	Particle	
TSP0325139	21652857	Particle	
TSP0325139	21652858	Combi	
TSP0325139	21652992	Combi	
TSP0325139	21653145	Particle	
TSP0325139C	21652858	Combi	
TSP0325140	21652360	Particle	
TSP0325141	21652546	Particle	•
TSP0325141	21652990	Particle	
TSP0325141	80000439	Combi	
TSP0325141C	21652546	Particle	•
TSP0325141C	80000148	Combi	•
TSP0325146	80000802	Particle	
TSP0325148	21652874	Particle	
TSP0325148C	21652874	Particle	
TSP0325148C	80000438	Combi	
TSP0325149	21652551	Particle	
TSP0325151	21651987	Particle	
TSP0325151	80000028	Combi	
TSP0325152	21651296	Combi	
TSP0325152	21652544	Particle	
TSP0325152C	21652544	Particle	
TSP0325153	80000330	Particle	
TSP0325154	21651970	Particle	
TSP0325155	21651969	Particle	
TSP0325155	21652336	Combi	
TSP0325155C	21652336	Combi	
TSP0325158	21652045	Particle	
TSP0325159	21652850	Particle	
TSP0325159	21652853	Combi	
TSP0325161	21652916	Combi	
TSP0325161	80000065	Particle	
TSP0325162	21652856	Particle	
TSP0325163	21653026	Particle	
TSP0325163C	21653026	Particle	
TSP0325163C	80000754	Combi	
TSP0325164	21653034	Particle	
TSP0325164	21653035	Combi	
TSP0325164	80000061	Particle	
TSP0325164	80000062	Combi	
TSP0325164C	21653035	Combi	
TSP0325165	21652990	Particle	
TSP0325165C	21652990	Particle	

DELPHI			
TSP0325165C	80000439	Combi	
TSP0325166	80000805	Particle	
TSP0325167	80000060	Particle	
TSP0325167C	80000060	Particle	
TSP0325167C	80000775	Combi	
TSP0325168	80000066	Particle	
TSP0325171	21652994	Particle	
TSP0325171	21652995	Combi	
TSP0325171C	21652995	Combi	
TSP0325172	21652871	Particle	
TSP0325172C	21652872	Combi	
TSP0325173	21652551	Particle	
TSP0325173C	21652551	Particle	
TSP0325173C	80000419	Combi	
TSP0325174	21653008	Combi	
TSP0325174	21653024	Particle	
TSP0325174C	21653008	Combi	
TSP0325175	21652539	Particle	
TSP0325175C	21652539	Particle	
TSP0325176	21652992	Combi	
TSP0325176	21653145	Particle	
TSP0325176C	21653145	Particle	
TSP0325178	80000074	Particle	
TSP0325178C	80000074	Particle	
TSP0325179	80000546	Particle	•
TSP0325180	80000061	Particle	
TSP0325180	80000062	Combi	
TSP0325180C	80000062	Combi	
TSP0325181	80001041	Particle	•
TSP0325182	80000634	Particle	
TSP0325183	80000807	Particle	
TSP0325183C	21653102	Combi	
TSP0325183C	80000807	Particle	
TSP0325184	80000063	Particle	
TSP0325184C	80000064	Combi	
TSP0325185	80000331	Particle	
TSP0325185C	21653013	Combi	
TSP0325185C	80000331	Particle	
TSP0325186	21653144	Particle	
TSP0325186C	21653143	Combi	
TSP0325186C	21653144	Particle	
TSP0325188	21653067	Particle	
TSP0325189	21651979	Particle	
TSP0325189	80000021	Combi	
TSP0325189C	80000021	Combi	
TSP0325190	80000082	Particle	
TSP0325191	21653025	Particle	
TSP0325193	80000072	Particle	
TSP0325194	21653071	Particle	
TSP0325194	80000670	Combi	
TSP0325194	80004676	Particle	
TSP0325194C	21653071	Particle	
TSP0325194C	80000670	Combi	
TSP0325194C	80004677	Combi	
TSP0325195	80000080	Particle	
TSP0325195C	80000080	Particle	
TSP0325196	21651294	Combi	
TSP0325196	21653029	Particle	
TSP0325196C	21651294	Combi	
TSP0325198C	80000071	Combi	
TSP0325199	80001490	Particle	•
TSP0325199C	80000647	Combi	•
TSP0325201	80000164	Particle	

DELPHI			
TSP0325202	80000405	Particle	•
TSP0325203	80000548	Particle	•
TSP0325204	80000620	Particle	
TSP0325204	80000622	Combi	
TSP0325204C	80000620	Particle	
TSP0325205	80000541	Particle	
TSP0325205C	80000541	Particle	
TSP0325205C	80000777	Combi	
TSP0325206	80000662	Particle	
TSP0325206C	80000662	Particle	
TSP0325206C	80000784	Combi	
TSP0325207C	80000346	Combi	
TSP0325208	21652863	Particle	
TSP0325208C	21652865	Combi	
TSP0325209	80000155	Particle	
TSP0325210	80001033	Particle	•
TSP0325211	80000083	Particle	
TSP0325212	21653063	Particle	•
TSP0325212C	21653064	Combi	•
TSP0325213	21653141	Particle	
TSP0325213	21653142	Combi	
TSP0325213C	21653142	Combi	
TSP0325218	80000603	Particle	
TSP0325218C	80000603	Particle	
TSP0325219	21652989	Particle	
TSP0325219	80000437	Combi	
TSP0325220	80000084	Particle	•
TSP0325220	80000650	Particle	•
TSP0325221	80000871	Particle	
TSP0325221C	80000871	Particle	
TSP0325221C	80000872	Combi	
TSP0325222	80000652	Particle	
TSP0325223	80000158	Particle	
TSP0325223C	80000158	Particle	
TSP0325223C	80000402	Combi	
TSP0325225	80000360	Particle	
TSP0325225C	80000361	Combi	
TSP0325226	80000712	Particle	
TSP0325226	80000713	Combi	
TSP0325226C	80000713	Combi	
TSP0325227	80000874	Particle	
TSP0325227C	80000874	Particle	
TSP0325227C	80000875	Combi	
TSP0325228	21652346	Particle	
TSP0325229	80000666	Particle	•
TSP0325229C	80000667	Combi	•
TSP0325231	80000676	Particle	
TSP0325231C	80000676	Particle	
TSP0325232	80000604	Particle	
TSP0325232C	80000604	Particle	
TSP0325232C	80000605	Combi	
TSP0325238	80000869	Particle	
TSP0325239	80000879	Particle	
TSP0325239C	80000880	Combi	
TSP0325240	21653020	Particle	
TSP0325240C	21653015	Combi	
TSP0325243	80000407	Particle	
TSP0325244	80000815	Particle	
TSP0325245	80000865	Particle	
TSP0325246	80000839	Particle	
TSP0325246C	80000615	Combi	•
TSP0325247	80000812	Particle	
TSP0325247	80001037	Particle	

DELPHI			
TSP0325250	80000813	Particle	
TSP0325251	80001034	Particle	
TSP0325252C	80000764	Combi	
TSP0325252C	80000767	Particle	
TSP0325254	80000915	Particle	
TSP0325254C	80000916	Combi	
TSP0325255	80000808	Particle	
TSP0325256	80000655	Particle	
TSP0325256	80001441	Particle	
TSP0325257	80000162	Particle	
TSP0325258	80004358	Particle	
TSP0325258C	80000844	Combi	
TSP0325259	80000614	Particle	
TSP0325259C	80000616	Combi	
TSP0325260	80000740	Particle	
TSP0325260C	80000741	Combi	
TSP0325262	80000649	Particle	
TSP0325263	80000877	Particle	
TSP0325263C	80000877	Particle	
TSP0325263C	80000878	Combi	
TSP0325264	21653148	Particle	
TSP0325264C	21653148	Particle	
TSP0325264C	21653149	Combi	
TSP0325265	80000853	Particle	
TSP0325265C	80000853	Particle	
TSP0325265C	80000854	Combi	
TSP0325286C	80001214	Particle	
TSP0325286C	80001215	Combi	
TSP0325291C	21653115	Combi	
TSP0325291C	80000409	Particle	
TSP0325296	21652714	Particle	
TSP0325296C	21651296	Combi	
TSP0325296C	21652714	Particle	
TSP0325296C	21652715	Combi	
TSP0325296C	80000621	Combi	
TSP0325300	80000084	Particle	•
TSP0325300	80000650	Particle	•
TSP0325302	21651971	Particle	•
TSP0325304	21651987	Particle	
TSP0325305	21653034	Particle	
TSP0325305	80000061	Particle	
TSP0325305C	21653035	Combi	
TSP0325305C	80001186	Combi	
TSP0325308	21651916	Particle	
TSP0325309	21652348	Particle	
TSP0325312	80001036	Particle	
TSP0325312C	80001036	Particle	
TSP0325312C	80001744	Combi	
TSP0325313	80001456	Particle	•
TSP0325314C	80001030	Particle	•
TSP0325314C	80001031	Combi	•
TSP0325315C	80001460	Particle	
TSP0325315C	80001461	Combi	
TSP0325316C	80001208	Particle	
TSP0325316C	80001209	Combi	
TSP0325317	80001448	Particle	•
TSP0325318	80001027	Particle	
TSP0325322C	80001793	Combi	
TSP0325323C	80001723	Combi	
TSP0325331	80001791	Particle	
TSP0325335C	80001721	Combi	
TSP0325338C	80001786	Combi	
TSP0325340C	80001775	Combi	

FILTRON			
K1000	21651182	Particle	
K1000A	21651964	Combi	
K1000A	21651966	Combi	
K1001	21651183	Particle	
K1001	21651981	Particle	
K1001	80000761	Combi	
K1001A	21651963	Combi	
K1001A	21652353	Combi	
K1002	21651184	Particle	
K1002A	21651965	Combi	
K1003	21651890	Particle	
K1004	21651890	Particle	
K1004A	21651956	Combi	
K1006	21651912	Particle	
K1006A	21651955	Combi	
K1006A	21651967	Combi	
K1007	21651899	Particle	
K1007	80000077	Combi	
K1008	21650107	Particle	
K1008	21652709	Particle	
K1008A	21652361	Combi	
K1008A	21652959	Combi	
K1009	21651185	Particle	
K1009A	21651966	Combi	
K1010	21651893	Particle	
K1010A	21652355	Combi	
K1011	21652338	Particle	
K1013	21652340	Particle	
K1014	21651979	Particle	
K1014A	80000021	Combi	
K1015	21651198	Particle	
K1015	80000359	Combi	
K1016	21651196	Particle	
K1016A	21651961	Combi	
K1016A	21651975	Particle	
K1017	21651972	Particle	
K1017	80000742	Combi	
K1018	21651891	Particle	
K1019	21651919	Particle	
K1019	80000748	Combi	
K1020	21651920	Particle	
K1020A	21652541	Combi	
K1021	21651900	Particle	
K1021	80000753	Combi	
K1022	21651916	Particle	
K1022	80000434	Combi	
K1023	21651917	Particle	
K1023	21653140	Particle	
K1023	80000435	Combi	
K1024	21651895	Particle	
K1024A	21651960	Combi	
K1025	21651892	Particle	
K10263x	21651971	Particle	•
K10263x	80000793	Combi	•
K1027	21651911	Particle	
K1027	21651986	Particle	
K1028	21651896	Particle	
K1028	21651918	Particle	
K1029	21653139	Particle	
K1030	21652348	Particle	
K1030	80000750	Combi	
K1031	21651197	Particle	
K1031	80000377	Combi	

FILTRON			
K1032	21651914	Particle	
K1032A	21651957	Combi	
K1032A	21651958	Combi	
K1033	21651915	Particle	
K1033	21651951	Combi	
K1034	21651894	Particle	
K1034	80000433	Combi	
K1035	21651901	Particle	
K1035	21651970	Particle	
K1035A	21651952	Combi	
K1035A	21651953	Combi	
K1036	21651913	Particle	
K1037	21651987	Particle	
K1038	21652687	Particle	•
K1038	21652899	Particle	
K1038	80000755	Combi	
K1039	21651887	Particle	
K10402x	21652687	Particle	•
K1041	21651973	Particle	
K1042	21651977	Particle	
K1042A	21653006	Combi	
K10442x	21651982	Particle	•
K10442x	21652046	Combi	•
K1045	21651898	Particle	
K1045A	21651968	Combi	
K1046	21651975	Particle	
K1046A	21651961	Combi	
K1047A	21651967	Combi	
K1049	21653016	Particle	
K1051	21651984	Particle	
K1051	80000436	Combi	
K1052	21651983	Particle	
K1052	80000114	Combi	
K10532x	21651195	Particle	•
K10532x	80000421	Combi	•
K1054	21651995	Particle	
K1054A	21652354	Combi	
K1055	21651980	Particle	
K1056	21651986	Particle	
K1056	21651994	Particle	
K1056	80000432	Combi	
K1057	21651983	Particle	
K1058	21651991	Particle	
K1058	80000752	Combi	
K1059	80000628	Combi	
K1059	80000636	Particle	
K1060	21652346	Particle	
K1060	80000746	Combi	
K10622x	21652342	Particle	•
K10622x	80000765	Combi	•
K1063	21652342	Particle	•
K1064	21653114	Particle	
K1065	21652688	Particle	
K1065A	21651292	Combi	
K1066	21651293	Particle	
K1066A	21653068	Combi	
K1067	80000373	Particle	
K1068	80000594	Particle	
K10692x	21653023	Particle	•
K1069A2x	21652552	Combi	•
K1070	21651298	Particle	
K1070	80000747	Combi	
K1071	80000027	Particle	

FILTRON			
K10722x	80000022	Particle	•
K1073A2x	21651881	Combi	•
K1075A2x	21651882	Combi	•
K1075A2x	21651897	Particle	•
K1076A	21652308	Particle	
K1076A	80000430	Combi	
K1077	21651918	Particle	
K1078	21652689	Particle	
K1078A	21652713	Combi	
K1079	21652356	Particle	
K1079A	21652357	Combi	
K1081	21652714	Particle	
K1081A	21652715	Combi	
K1081A	80000621	Combi	
K1082	21652345	Particle	
K1082	80000029	Particle	
K1082	80000749	Combi	
K1083	21652539	Particle	
K1083	21652551	Particle	
K1083	80000419	Combi	
K1083	80000745	Combi	
K1087	21652345	Particle	
K1087	80000428	Combi	
K1088	21651976	Particle	
K1088A	21652985	Combi	
K1089	21652550	Particle	
K1089A	21652542	Combi	
K1090	21652350	Particle	
K1091	21653022	Particle	
K1091	80000623	Combi	
K1092	21653019	Particle	
K1093	21652548	Particle	
K1093	21653028	Particle	
K1093A	21652540	Combi	
K1094	80000362	Particle	
K1095	21653140	Particle	
K1095	80000762	Combi	
K1096	21652347	Particle	
K1096	80000416	Combi	
K1097	21652349	Particle	
K1097	80000418	Combi	
K1101	21652544	Particle	
K1102	21652543	Particle	
K1102	80000429	Combi	
K1102A	80000429	Combi	
K1103	21653027	Particle	
K1103A	21652538	Combi	
K1103A	21653027	Particle	
K1104A	21651296	Combi	
K1105A2x	21652352	Combi	•
K1105A2x	80000375	Particle	•
K1106	21652358	Particle	
K1106A	21652861	Combi	
K1107	21653032	Particle	
K1107	80000344	Combi	
K1108	21652045	Particle	
K11092x	80001041	Particle	•
K1110	21652857	Particle	
K1110A	21652858	Combi	
K1111	21653024	Particle	
K1111A	21653008	Combi	
K1112-2X	21652860	Particle	•
K1113	21652360	Particle	

FILTRON			
K1113	80000751	Combi	
K1115	21652351	Particle	
K1115A	21653069	Combi	
K1116A	21651954	Combi	
K1116A	80000376	Particle	
K1117	21651986	Particle	
K1117A	80000744	Combi	
K1118A	21652898	Combi	
K1118A	80000343	Particle	
K1119	21652850	Particle	
K1119A	21652853	Combi	
K1120A	21651294	Combi	
K1121	80000072	Particle	
K1121	80001170	Combi	
K1122	21653026	Particle	
K1122	80000754	Combi	
K1123	21652874	Particle	
K1123	80000438	Combi	
K1125	21653141	Particle	
K1125A	21653142	Combi	
K1126	21652317	Particle	
K1126A	21652996	Combi	
K1127	21653028	Particle	
K1128	21652856	Particle	
K1128A	21653147	Combi	
K1130	21653071	Particle	
K1130	80000080	Particle	
K1130A	80000670	Combi	
K1131	21652871	Particle	
K1131A	21652871	Particle	
K1131A	21652872	Combi	
K1133	21653005	Particle	
K1133A	80000364	Combi	
K11342x	21652897	Particle	•
K1135	21651970	Particle	
K1136	21651969	Particle	
K1136A	21652336	Combi	
K1137A	21653148	Particle	
K1137A	21653149	Combi	
K1138	21652994	Particle	
K1138A	21652995	Combi	
K1139	21653021	Particle	
K1140	80000158	Particle	
K1140	80000402	Combi	
K1142	21652998	Particle	
K1142	21653001	Particle	
K1143-2X	21652345	Particle	
K1144	80000075	Particle	
K1145	21653017	Particle	
K1145A	80000070	Combi	
K1146	21652863	Particle	
K1146A	21652863	Particle	
K1146A	21652865	Combi	
K1147A	21653102	Combi	
K1148	21652709	Particle	
K1148A	21652361	Combi	
K1149	80000083	Particle	
K1149	80000440	Combi	
K1150	80000061	Particle	
K1150A	80000062	Combi	
K1151	80000536	Particle	
K1151	80000788	Combi	
K1152	80000074	Particle	

FILTRON			
K1153	21653003	Particle	
K1154	21653034	Particle	
K1154A	21653035	Combi	
K1155	21653020	Particle	
K1155A	21653015	Combi	
K1156	21651901	Particle	
K1156A	21651952	Combi	
K11582x	80001033	Particle	•
K1159A	21653115	Combi	
K1159A	80000409	Particle	
K11602x	21653063	Particle	•
K1160A2x	21653064	Combi	•
K1161	21653145	Particle	
K1161A	21652992	Combi	
K11622x	21653067	Particle	
K1162A2x	21653066	Combi	
K1164	21652989	Particle	
K1164	80000330	Particle	
K1164	80000404	Combi	
K1164	80000437	Combi	
K11652x	21652848	Particle	•
K1165A2x	21652851	Combi	•
K1167	80000080	Particle	
K1168A	21652854	Combi	
K1168A	21653151	Particle	
K1169	80000063	Particle	
K1169A	80000064	Combi	
K1171	80000333	Particle	
K1172	80000541	Particle	
K1174	21652870	Particle	
K1175	80000620	Particle	
K1176	21652900	Particle	
K1177	21652873	Particle	
K1178	80000155	Particle	
K11792x	80000666	Particle	•
K1179A2x	80000667	Combi	•
K1180-2X	21652867	Particle	•
K1181	80000164	Particle	
K1182-2X	80000084	Particle	•
K1182-2X	80000650	Particle	•
K1183	21652551	Particle	
K1188	21653025	Particle	
K11982x	21652546	Particle	•
K11982x	80000148	Combi	•
K1200A2x	80000647	Combi	•
K1201A2x	80000538	Combi	•
K1202A	21653143	Combi	
K12032x	80000548	Particle	•
K1204A	21653014	Combi	
K1204A	80000338	Particle	
K1205A	80000071	Combi	
K1207	80000662	Particle	
K1207	80000784	Combi	
K12082x	80000654	Particle	•
K12082x	80000795	Combi	
K1209	80000637	Particle	
K1209	80000779	Combi	
K1210	80000604	Particle	
K1210A	80005176	Combi	
K1211A	80000602	Combi	
K12122x	80000405	Particle	•
K12122x	80000406	Combi	•
K1213	80000657	Particle	

FILTRON		
K1213	80000785	Combi
K1214	80000157	Particle
K1214	80000400	Combi
K1215	80000825	Particle
K1216A	21653013	Combi
K1216A	80000331	Particle
K1217	21652346	Particle
K1219	80000764	Combi
K1219	80000767	Particle
K1221A-2X	21652865	Combi
K1227A-2X	80000615	Combi •
K1232	80000652	Particle
K1236	80000603	Particle
K1237	80000712	Particle
K1238A	80000866	Combi
K1240A	80000648	Combi
K1242-2X	21651199	Particle •
K1254-2X	80000649	Particle
K1259A	80000408	Combi
K1264	80000676	Particle
K1265	80000065	Particle
K1265A	21652916	Combi
K1269A	80001741	Combi
K1272-2X	80000073	Particle •
K1273A	80000068	Combi
K1280-2X	80000546	Particle •
K1282-2X	80000656	Particle •
K1287	80000634	Particle
K1288	80000614	Particle
K1288A	80000616	Combi
K1292	80001770	Particle
K1296A	80000361	Combi
K1306	21652335	Particle
K1306A	21652862	Combi
K1319A-2X	80000208	Combi
K1334	21652849	Particle
K1347	80005194	Particle
K1348A	49356180	Combi
K1355	80005173	Particle
FRAM		
CA10522	80005026	Air Filter
CA11074	80005029	Air Filter
CF10204-2	80000666	Particle •
CF10218-2	80000405	Particle •
CF10501	80001039	Particle
CF10511-2	80001489	Particle •
CF10536-2	80000839	Particle
CF10545	80001443	Particle
CF10546	80005177	Particle
CF10824-2	80001736	Particle •
CF11119	80001760	Particle
CF11243	80001780	Particle
CF11247-2	80000654	Particle •
CF11434	49359582	Particle
CF117452	80004779	Particle •
CF118152	80005089	Particle •
CF11854	80005173	Particle
CF11953	80005194	Particle
CF5475	21651182	Particle
CF5551	21651899	Particle
CF5662	21651890	Particle
CF5663	21651912	Particle
CF5664	21650107	Particle

FRAM		
CF5665	21651184	Particle
CF5816	21651183	Particle
CF5817	21651893	Particle
CF5818	21651894	Particle
CF5819	21651901	Particle
CF5823	21651915	Particle
CF5824	21651913	Particle
CF5841	21651896	Particle
CF5842	21651196	Particle
CF5845	21651919	Particle
CF5846	21651920	Particle
CF5847	21651900	Particle
CF5848	21651916	Particle
CF5849	21651917	Particle
CF5850	21651895	Particle
CF5851	21651892	Particle
CF5852	21651971	Particle •
CF5853	21651911	Particle
CF5863	21651185	Particle
CF5864	21651891	Particle
CF5865	21651972	Particle
CF5893	21652348	Particle
CF5935	21651197	Particle
CF5942	21651914	Particle
CF5972	21651195	Particle •
CF8103	21651198	Particle
CF8714	21651911	Particle
CF8714	21651986	Particle
CF8717	21653029	Particle
CF8719	80000066	Particle
CF8750	21653032	Particle
CF8773	21651977	Particle
CF8777	21651292	Combi
CF8777	21652688	Particle
CF8778	80000409	Particle
CF8799	21651984	Particle
CF8799	21653140	Particle
CF8800	21651973	Particle
CF8831	21651995	Particle
CF8831	21652354	Combi
CF8832	21652687	Particle •
CF8838	21651983	Particle
CF8867	21651980	Particle
CF8868	21651979	Particle
CF8890	21651994	Particle
CF8913	21651969	Particle
CF8914	21651982	Particle •
CF8947	21652342	Particle •
CF8948	21652342	Particle •
CF9051	21651976	Particle
CF9071	21651293	Particle
CF9077	21652308	Particle
CF9293	21652349	Particle
CF9294	21653028	Particle
CF9323	21652356	Particle
CF9335	21652350	Particle
CF9336	21652351	Particle
CF9337	21652347	Particle
CF9338	21652345	Particle
CF9363	21652346	Particle
CF9364	21652542	Combi
CF9364	21652550	Particle
CF9383	21652045	Particle

FRAM		
CF9386	21653021	Particle
CF9387	21653022	Particle
CF9394	21652340	Particle
CF9395	21652338	Particle
CF9396	21652317	Particle
CF9398	21652548	Particle
CF9399	21652359	Particle
CF9406	21652543	Particle
CF9408	80005226	Particle
CF9414	21651898	Particle
CF9414	21651968	Combi
CF9466	21652551	Particle
CF9485	21652360	Particle
CF9495	21652714	Particle
CF9509	21651298	Particle
CF9534	21652709	Particle
CF9546	80000373	Particle
CF9562	21653141	Particle
CF9569	21653005	Particle
CF9579	21651987	Particle
CF9586	21652856	Particle
CF9594	21652850	Particle
CF9640	21653017	Particle
CF9642	21652339	Particle
CF9645	21652689	Particle
CF9659	21652873	Particle
CF9666	21652857	Particle
CF9691	80000074	Particle
CF9714	21651981	Particle
CF9731	21651970	Particle
CF9740	21652897	Particle •
CF9756	80000158	Particle
CF9787	21653034	Particle
CF98192	21652546	Particle •
CF9827	21652871	Particle
CF9832-2	80001033	Particle •
CF9846	21652539	Particle
CF9881	21653020	Particle
CF9922	21653024	Particle
CFA10103-2	21653064	Combi •
CFA10205-2	80000667	Combi •
CFA10322	80005176	Combi
CFA10419-2	80000615	Combi •
CFA10419-2	80004703	Combi •
CFA10474-2	80001031	Combi •
CFA10657	80001461	Combi
CFA10761	80001451	Combi
CFA10828-2	80000647	Combi •
CFA8046	21650107	Particle
CFA8046	21652959	Combi
CFA8788	21651954	Combi
CFA8849	21653006	Combi
CFA8869	21651967	Combi
CFA8874	21651963	Combi
CFA8875	21651964	Combi
CFA8876	21651957	Combi
CFA8877	21651961	Combi
CFA8877	21651975	Particle
CFA8878	21651895	Particle
CFA8878	21651960	Combi
CFA8879	21651966	Combi
CFA8880	21651965	Combi
CFA8882	21651956	Combi

FRAM		
CFA8893	21651955	Combi
CFA8894	21651952	Combi
CFA8894	21651953	Combi
CFA8894	21651955	Combi
CFA8912	21651882	Combi •
CFA8912	21651897	Particle •
CFA8913	21652336	Combi
CFA9322	21651881	Combi •
CFA9404	21652357	Combi
CFA9405	21652352	Combi •
CFA9408	21651296	Combi
CFA9445	21653014	Combi
CFA9495	80000621	Combi
CFA9533	21652538	Combi
CFA9534	21652361	Combi
CFA9548	21652713	Combi
CFA9562	21653142	Combi
CFA9587	21652540	Combi
CFA9623	21652355	Combi
CFA9665	21652992	Combi
CFA9666	21652858	Combi
CFA9827	21652872	Combi
CFA9921	21653008	Combi
HENGST		
E1002L	80005028	Air Filter
E1901LI	21652360	Particle
E1903LC	21652858	Combi
E1903LC	21652992	Combi
E1903LI	21652857	Particle
E1903LI	21653145	Particle
E1904LI	80000349	Particle
E1905LI	80000633	Particle
E1906LI	21652546	Particle •
E1906LI	21652990	Particle
E1907LC	21653035	Combi
E1907LC	80000062	Combi
E1907LI	21653034	Particle
E1907LI	80000061	Particle
E1908LC	80001127	Combi
E1908LI	80000333	Particle
E1909LC	21653064	Combi •
E1909LI	21653063	Particle •
E1910LC	21653015	Combi
E1910LI	21653020	Particle
E1911LC	21652540	Combi
E1911LI	21652548	Particle
E1911LI	21653028	Particle
E1911LI	21653063	Particle •
E1912LC	21651294	Combi
E1912LI	21651294	Combi
E1912LI	21653029	Particle
E1913LI	21651199	Particle •
E1914LC	21652995	Combi
E1914LI	21652994	Particle
E1915LC	21653146	Combi
E1915LI	21653028	Particle
E1916LC	21652996	Combi
E1916LC01	21652995	Combi
E1916LC01	21652996	Combi
E1916LI	21652317	Particle
E1916LI	80000412	Particle
E1918LC	21653143	Combi
E1918LI	21653144	Particle

HENGST		
E1919LC	21652812	Combi •
E1920LC	21652851	Combi •
E1920LI	21652848	Particle •
E1921LI	21651915	Particle
E1923LI	80001579	Particle
E1925LC	21652872	Combi
E1925LI	21652871	Particle
E1926LC	21652992	Combi
E1926LI	21652992	Combi
E1926LI	21653145	Particle
E1926LI	80001039	Particle
E1927LI	21652551	Particle
E1927LI	21652874	Particle
E1928LC	21653013	Combi
E1929LI	21653026	Particle
E1929LI	80004407	Particle
E1930LC	21652352	Combi •
E1931LI	80001629	Particle
E1932LC	80000070	Combi
E1932LI	21653017	Particle
E1933LC	21652552	Combi •
E1934LC	21651952	Combi
E1934LC	21651953	Combi
E1935LC	21653031	Combi •
E1936LI	80000357	Particle
E1936LI	80000625	Combi
E1937LI	80000159	Particle
E1937LI	80000405	Particle •
E1938LC	80000403	Combi •
E1938LI	21652860	Particle •
E1939LI	21653071	Particle
E1939LI	80000670	Combi
E1939LI	80004676	Particle
E1942LI	80000594	Particle
E1942LI	80000628	Combi
E1942LI	80000636	Particle
E1943LC	21652916	Combi
E1943LI	80000065	Particle
E1944LC	21653066	Combi
E1944LI	21653067	Particle
E1945LI	21652002	Particle
E1946LI	80000022	Particle •
E1946LI2	80000022	Particle •
E1947LI	21651901	Particle
E1948LC	80000430	Combi
E1948LI	21652308	Particle
E1949LC	80000208	Combi
E1950LI	21652993	Particle
E1951LI	21651972	Particle
E1951LI	21652345	Particle
E1951LI	21652359	Particle
E1951LI	80000029	Particle
E1951LI	80000330	Particle
E1953LI	21652350	Particle
E1953LI	80000331	Particle
E1954LI	80000156	Particle •
E1955LC	21653069	Combi
E1955LI	21652351	Particle
E1956LI	80001585	Particle
E1958LI	21653018	Particle
E1959LC	80000064	Combi
E1959LI	80000063	Particle
E1960LI	21652342	Particle •

HENGST		
E1961LI	21652349	Particle
E1962LC	21651296	Combi
E1962LI	21651296	Combi
E1962LI	21652544	Particle
E1963LI	21652856	Particle
E1965LC	80000068	Combi
E1965LC	80000802	Particle
E1965LC01	80000068	Combi
E1965LC01	80000802	Particle
E1966LI	80000643	Particle •
E1967LI	80000824	Particle
E1970LI	80000350	Particle
E1971LI	80000334	Particle
E1972LI	80000335	Particle
E1975LI	21652347	Particle
E1976LI	80000634	Particle
E1977LI	80000536	Particle
E1978LC	21652898	Combi
E1978LC	80000343	Particle
E1981LI	21652867	Particle •
E1982LI	80000115	Particle
E1983LI	80000642	Particle
E1984LI	80000072	Particle
E1985LI	21651993	Particle
E1987LI	21652347	Particle
E1988LC	21653115	Combi
E1989LI	80000160	Particle •
E1990LC	80000062	Combi
E1990LI	80000061	Particle
E1991LI	80000348	Particle
E1992LI	80000635	Particle
E1993LI	80001623	Particle
E1994LI	80000641	Particle
E1995LI	80000354	Particle
E1996LI	80000079	Particle
E1997LI	80000644	Particle •
E1997LI	80000654	Particle •
E1998LC	80000648	Combi
E1999LI	80000537	Particle
E21L	80000632	Particle
E2900LI	80000073	Particle •
E2902LI	21651981	Particle
E2904LC	80000071	Combi
E2905LI	80000074	Particle
E2906LI	80000662	Particle
E2907LI	80000158	Particle
E2908LI	80001446	Particle
E2909LI	21652873	Particle
E2910LI	80000657	Particle
E2911LI	80000638	Particle
E2912LC	80000647	Combi •
E2912LC2	80000647	Combi •
E2913LC	21653009	Combi
E2913LI	21653025	Particle
E2914LI	21652338	Particle
E2914LI	80000804	Particle
E2915LI	21652539	Particle
E2916LC	80000616	Combi
E2916LI	80000614	Particle
E2917LI	21653032	Particle
E2918LI	80000620	Particle
E2918LI	80000622	Combi
E2919LC	80000538	Combi •

HENGST		
E2920LI	80000649	Particle
E2925LI	80000652	Particle
E2925LI	80000780	Combi
E2926LI	80001586	Particle
E2927LI	80000645	Particle
E2928LI	21652345	Particle
E2928LI	80000029	Particle
E2929LI	21652870	Particle
E2930LI	21652539	Particle
E2930LI	21652551	Particle
E2930LI	21652874	Particle
E2930LI	21652989	Particle
E2930LI	80001172	Particle
E2932LI	21651971	Particle •
E2933LC	21652852	Combi
E2933LI	21652849	Particle
E2934LI	21652897	Particle •
E2935LI	21651972	Particle
E2935LI	21652345	Particle
E2936LI	21653071	Particle
E2936LI	80000080	Particle
E2937LC	21653149	Combi
E2938LI	80001627	Particle
E2939LC	80000777	Combi
E2939LC	80000802	Particle
E2939LI	80000541	Particle
E2940LI	80000815	Particle
E2941LI	80001583	Particle
E2942LI	80000639	Particle
E2943LC	80000667	Combi •
E2943LI	80000666	Particle •
E2944LC	80000848	Combi •
E2944LI	80000847	Particle •
E2945LC	80005176	Combi
E2945LI	80000604	Particle
E2946LC	80001035	Combi
E2947LI	80000740	Particle
E2949LC	80000713	Combi
E2949LC	80004556	Combi
E2949LI	80000712	Particle
E2949LI	80004555	Particle
E2950LI	80001626	Particle
E2951LC	80000866	Combi
E2951LI	80000865	Particle
E2952LI	80001628	Particle
E2953LI	80000915	Particle
E2954LC	80000844	Combi
E2954LC01	80000844	Combi
E2954LC01	80001527	Combi
E2955LI	80000877	Particle
E2956LI	80000082	Particle
E2957LI	21652989	Particle
E2957LI	80000603	Particle
E2958LI	80001041	Particle •
E2959LI	21652989	Particle
E2959LI	80000330	Particle
E2959LI	80000603	Particle
E2961LI	21651920	Particle
E2962LI	80001185	Particle
E2963LC	21653064	Combi •
E2963LI	21653063	Particle •
E2964LI	80001128	Particle
E2974LC	80001461	Combi

HENGST		
E2974LI	80004673	Particle
E2975LC	80001451	Combi
E2976LI	80000874	Particle
E2977LC2	80004703	Combi •
E2980LC	80001741	Combi
E2983LI	80001454	Particle
E2984LI	80000871	Particle
E2985LI	80001760	Particle
E2986LC	80004631	Combi
E2986LI	80004630	Particle
E2987LI	80001027	Particle
E2988LI	80004355	Particle
E2994LC	80004573	Combi
E3902LI	49359582	Particle
E3903LI	80004567	Particle
E3907LC	80004699	Combi
E3913LI	80004700	Particle
E3914LC	80004639	Combi
E3921LI	80004650	Particle
E3937LI	80005071	Particle
E3942LI2	80004812	Particle •
E3945LI	80005091	Particle
E3952LI	80005173	Particle
E3954LI	80005226	Particle
E568L	21652993	Particle
E638L	21652551	Particle
E658L	80004662	Air Filter
E659L	80004670	Air Filter
E667L	80005149	Air Filter
E676L01	80005026	Air Filter
E900LC	21651955	Combi
E900LC	21651967	Combi
E900LI	21651912	Particle
E900LI	21651913	Particle
E900LI	21653008	Combi
E901LC	21651964	Combi
E901LC	21651966	Combi
E901LI	21651182	Particle
E901LI	21651183	Particle
E902LC	21651965	Combi
E902LI	21651183	Particle
E902LI	21651184	Particle
E903LC	21651963	Combi
E903LC	21652353	Combi
E903LI	21651183	Particle
E903LI	21651981	Particle
E903LI	21653024	Particle
E904LC	21651966	Combi
E904LI	21651185	Particle
E904LI	21652709	Particle
E905LC	21651956	Combi
E905LC	21651957	Combi
E905LI	21651890	Particle
E905LI	21651914	Particle
E905LI	21651956	Combi
E905LI	21653023	Particle •
E906LI	21651973	Particle
E907LC	21652959	Combi
E907LI	21650107	Particle
E907LI	21652709	Particle
E908LC	21652355	Combi
E908LI	21651893	Particle
E909LI	21651982	Particle •

HENGST		
E910LC	80000021	Combi
E910LI	21651979	Particle
E911LC	21651980	Particle
E911LC	80000113	Combi
E911LI	21651979	Particle
E911LI	21651980	Particle
E912LC	21652985	Combi
E912LI	21651976	Particle
E912LI	21652985	Combi
E913LC	21651292	Combi
E913LI	21652688	Particle
E914LC	21651961	Combi
E914LC01	21651961	Combi
E914LI	21651195	Particle •
E914LI	21651196	Particle
E914LI	21651975	Particle
E914LI01	21651975	Particle
E915LC	21651957	Combi
E915LC	21651958	Combi
E915LI	21651913	Particle
E915LI	21651914	Particle
E916LC	21653070	Combi •
E916LI	21652687	Particle •
E917LI	21651991	Particle
E919LC	21651960	Combi
E919LI	21651895	Particle
E919LI	21651917	Particle
E919LI	21652348	Particle
E919LI	21653140	Particle
E920LC	80000744	Combi
E920LI	21651911	Particle
E920LI	21651986	Particle
E921LC	21651968	Combi
E921LI	21651898	Particle
E921LI	80000594	Particle
E922LI	21651987	Particle
E922LI	80000028	Combi
E924LI	80001582	Particle
E925LC	80001580	Combi
E926LI	80001624	Particle
E927LI	80000339	Particle
E928LI	80000340	Particle
E929LI	80000336	Particle
E931LC	21653006	Combi
E931LI	21651977	Particle
E932LI	21653019	Particle
E932LI01	21653019	Particle
E933LC	21652999	Combi
E933LI	21652998	Particle
E933LI01	21653001	Particle
E934LI	21651901	Particle
E934LI	21651970	Particle
E935LI	21651972	Particle
E935LI	21652345	Particle
E935LI	80000029	Particle
E935LI	80000065	Particle
E936LC	21651957	Combi
E936LC	21651958	Combi
E936LI	21651913	Particle
E936LI	21651914	Particle
E937LI	80000075	Particle
E938LI	21651920	Particle
E939LI	21651198	Particle

HENGST		
E939LI	80001625	Particle
E940LI	21651899	Particle
E941LC	21652354	Combi
E941LI	21651995	Particle
E942LI	21651195	Particle •
E942LI	21651975	Particle
E943LI	21651894	Particle
E943LI	21651901	Particle
E944LI	21653022	Particle
E945LI	21653021	Particle
E947LI	21653139	Particle
E948LI	80000632	Particle
E949LI	21653016	Particle
E950LI	21652849	Particle
E950LI	21652899	Particle
E951LC	21652541	Combi
E951LI	21651920	Particle
E952LI	21651298	Particle
E952LI	21651916	Particle
E953LI	21651986	Particle
E953LI	21651994	Particle
E954LC	80000364	Combi
E954LI	21653005	Particle
E955LC	21651957	Combi
E955LC	21652713	Combi
E955LI	21652689	Particle
E956LI	80000362	Particle
E956LI01	80000362	Particle
E957LC	21653010	Combi
E957LC01	21653011	Combi
E957LI	21651887	Particle
E957LI	21651974	Particle
E957LI	21652002	Particle
E957LI	21653002	Particle
E958LI	80000341	Particle
E959LI	21651197	Particle
E960LC	21651882	Combi •
E960LC	21652865	Combi
E960LI	21651897	Particle •
E961LC	21652357	Combi
E961LI	21651912	Particle
E961LI	21652356	Particle
E961LI	80001783	Particle
E962LC	80000114	Combi
E962LI	21651983	Particle
E963LI	21652045	Particle
E964LC	21653014	Combi
E965LI	21651917	Particle
E965LI	21651983	Particle
E966LI	80000356	Particle
E967LI	21651984	Particle
E967LI	21652348	Particle
E967LI	21653140	Particle
E968LC	21652361	Combi
E968LI	21652709	Particle
E969LC	80000626	Combi
E969LI	21652997	Particle
E970LC	21652861	Combi
E970LC01	21652861	Combi
E970LC02	21652862	Combi
E970LI	21652335	Particle
E970LI	21652358	Particle
E970LI01	21652335	Particle

HENGST		
E971LC01	21653068	Combi
E971LI	21651293	Particle
E971LI01	21651293	Particle
E972LC	21651965	Combi
E972LC	21652715	Combi
E972LC	80000621	Combi
E972LI	21652714	Particle
E973LI	21651896	Particle
E973LI	21651918	Particle
E974LI	80000373	Particle
E975LI	21651972	Particle
E975LI	21652345	Particle
E975LI	21652346	Particle
E975LI	80000428	Combi
E976LI	21651892	Particle
E976LI	80000376	Particle
E977LC	21652336	Combi
E977LI	21651969	Particle
E978LI	21652543	Particle
E979LI	21651917	Particle
E979LI	21651984	Particle
E979LI	21652348	Particle
E980LC	21653000	Combi
E980LI	21653007	Particle
E981LI	21651984	Particle
E981LI	21652550	Particle
E981LI	21653140	Particle
E981LI	80000373	Particle
E982LI	21653003	Particle
E983LC	21651881	Combi •
E983LI	21653030	Particle •
E989LC	21652865	Combi
E989LI	21652863	Particle
E989LI	21652864	Particle
E989LI01	21652864	Particle
E990LC	21653142	Combi
E990LC	80000765	Combi •
E990LC01	21653102	Combi
E990LC01	80000807	Particle
E990LC02	21653102	Combi
E990LI	21652342	Particle •
E990LI	21653141	Particle
E991LI	80000825	Particle
E992LC	21652538	Combi
E992LC	21653027	Particle
E993LI	80000342	Particle
E994LC	21652853	Combi
E994LC01	21652853	Combi
E994LI	21652850	Particle
E994LI01	21652850	Particle
E995LI	80000076	Particle
E997LC	21652542	Combi
E997LI	21652550	Particle
E998LC	21653008	Combi
E998LC01	80000602	Combi
E998LI	21653024	Particle
E999LI	80000337	Particle
KNECHT		
06413223	21653026	Particle
06413322	21651891	Particle
06415988	21653139	Particle
06416705	80000632	Particle
06416937	80000633	Particle

KNECHT		
06417117	80000594	Particle
06417133	80000636	Particle
06417158	21651184	Particle
06417232	21651182	Particle
06417299	21651900	Particle
06417315	21651899	Particle
06417372	21651912	Particle
06417372	21651915	Particle
06417398	21651196	Particle
06417414	21651183	Particle
06417430	21651890	Particle
06417471	21651898	Particle
06417497	21651185	Particle
06417513	21651895	Particle
06417588	21650107	Particle
06417604	21651919	Particle
06417620	21651298	Particle
06417646	21651916	Particle
06417661	21651195	Particle •
06417687	21651987	Particle
06417703	21651901	Particle
06417745	21651894	Particle
06417802	21651981	Particle
06417869	21651917	Particle
06417885	80000373	Particle
06417901	21653140	Particle
06417927	80000403	Combi •
06417927	80000536	Particle
06417943	21651184	Particle
06417943	21651980	Particle
06417968	21651979	Particle
06417984	21651983	Particle
06418008	21651976	Particle
06418024	80000029	Particle
06418040	21651994	Particle
06418081	21652346	Particle
06418107	21652714	Particle
06418123	21652356	Particle
06418149	21651984	Particle
06418180	21651995	Particle
06418206	21651893	Particle
06418222	21651972	Particle
06418248	21651971	Particle •
06418289	21651920	Particle
06418305	80000027	Particle
06418388	21651973	Particle
06418420	21652687	Particle •
06418446	21651986	Particle
06418487	21652998	Particle
06418503	21652689	Particle
06418545	21652308	Particle
06418560	21651972	Particle
06418560	21652345	Particle
06418586	21652348	Particle
06418628	21652360	Particle
06418644	21651970	Particle
06418669	21652347	Particle
06418685	21652539	Particle
06418701	21652349	Particle
06418727	21653032	Particle
06418743	21652550	Particle
06418768	21652548	Particle
06418784	21652544	Particle

KNECHT		
06418792	21651901	Particle
06418818	21652543	Particle
06418834	21652989	Particle
06418859	21652874	Particle
06418875	21653145	Particle
06418891	21652856	Particle
06418917	21652897	Particle •
06418917	21652989	Particle
06418917	21652990	Particle
06418933	21652857	Particle
06418958	80000333	Particle
06418974	80000156	Particle •
06418990	80000082	Particle
06419014	21652993	Particle
06419030	21653028	Particle
06419071	80000330	Particle
06419097	80000080	Particle
06419139	21652350	Particle
06419154	21653005	Particle
06419170	21653020	Particle
06419196	21652994	Particle
06419212	21653034	Particle
06419212	80000061	Particle
06419238	21653025	Particle
06419253	21653067	Particle
06419279	21652709	Particle
06421200	21651991	Particle
06421655	80000163	Particle
06515225	21652348	Particle
06531446	21652544	Particle
06531453	21652308	Particle
06531479	21653139	Particle
06536130	80000632	Particle
06540132	21652550	Particle
06540231	21652540	Combi
06540264	21652548	Particle
06544704	21652542	Combi
06544712	80000148	Combi •
06558662	21651970	Particle
06588404	21651920	Particle
06598767	21652342	Particle •
06598767	21653141	Particle
06599765	21652347	Particle
06605406	21652992	Combi
06606099	21651972	Particle
06606099	21652345	Particle
06606164	21652349	Particle
06606172	21653032	Particle
06606180	21651986	Particle
06606198	21651901	Particle
06606271	21652856	Particle
06608160	21652687	Particle •
06608400	21651920	Particle
06610968	21652860	Particle •
06611941	80000364	Combi
06612279	21652860	Particle •
06612279	80000403	Combi •
06612303	80000156	Particle •
06612659	21651981	Particle
06626089	21652998	Particle
06628473	21652543	Particle
06634620	21651198	Particle
06634679	21652898	Combi

KNECHT		
06634687	80000333	Particle
06639785	21652539	Particle
06640104	21652997	Particle
06640163	21652997	Particle
06642300	21653029	Particle
06643845	21652992	Combi
06643845	21653145	Particle
06655773	80000330	Particle
06656029	21653031	Combi •
06658389	21651977	Particle
06693352	21653142	Combi
06693352	80000765	Combi •
06693386	80000347	Combi
06693501	80000080	Particle
06786362	21652873	Particle
06786370	21652812	Combi •
06787147	21652859	Combi
06787162	21651197	Particle
06787170	21652991	Combi
06807366	80000063	Particle
06808315	21653015	Combi
06808349	21653016	Particle
06818819	21653071	Particle
06818850	21652852	Combi
06818876	21652849	Particle
06822324	80000082	Particle
06827851	21653028	Particle
06827869	21652993	Particle
06827885	21652989	Particle
06827950	21653115	Combi
06828677	21652897	Particle •
06830087	21652874	Particle
06830772	21652853	Combi
06830780	21652850	Particle
06831010	21652862	Combi
06831028	21652861	Combi
06831036	21652864	Particle
06831044	21652863	Particle
06831531	21653102	Combi
06831630	21652851	Combi •
06831861	21652853	Combi
06831887	21653064	Combi •
06831903	21653031	Combi •
06831929	21652852	Combi
06831945	80000347	Combi
06832067	21651961	Combi
06832083	80000410	Particle
06832109	21652351	Particle
06832125	21653069	Combi
06832315	21652361	Combi
06832331	21652357	Combi
06832356	80000361	Combi
06832703	21653024	Particle
06833024	80000602	Combi
06833040	21653009	Combi
06833065	21652985	Combi
06878813	80000064	Combi
06886568	21653013	Combi
06886733	21652352	Combi •
06886782	21652872	Combi
06886964	21653035	Combi
06886964	80000062	Combi
06886980	21651969	Particle

KNECHT		
06887103	80000071	Combi
06887129	21653143	Combi
06887228	21653066	Combi
06887608	21652538	Combi
06887624	80000208	Combi
06887988	21652354	Combi
06888002	21651960	Combi
06888028	21652996	Combi
06888069	21651292	Combi
06888168	21653068	Combi
06888184	21651293	Particle
06888200	21651882	Combi •
06888226	21652355	Combi
06888242	21652540	Combi
06888267	21651294	Combi
06888283	21652542	Combi
06888325	21652992	Combi
06888366	80000403	Combi •
06888382	80000429	Combi
06888424	21652858	Combi
06888440	21652995	Combi
06888465	21651960	Combi
06888481	21651960	Combi
06888507	21653008	Combi
06888523	80000113	Combi
06888549	80000021	Combi
06888580	21652336	Combi
06888606	21653149	Combi
06888622	21653014	Combi
06888648	21653006	Combi
06888663	21652715	Combi
06888663	80000621	Combi
06888663	80000624	Combi
06888689	21652999	Combi
06888705	21652358	Particle
06888721	21652335	Particle
06888747	21651964	Combi
06888762	21651965	Combi
06888788	21652959	Combi
06888804	21651963	Combi
06888804	21652353	Combi
06888820	21653003	Particle
06888846	21651955	Combi
06888861	21652541	Combi
06888887	21651968	Combi
06888903	21651966	Combi
06888945	21652541	Combi
06888960	21651956	Combi
06889000	21652317	Particle
06889026	21651967	Combi
06889273	21651198	Particle
06889331	21652850	Particle
06889356	21653071	Particle
06889398	21653063	Particle •
06889430	21652849	Particle
06889455	21652861	Combi
08162158	21651917	Particle
08169625	80000373	Particle
08169633	21653140	Particle
08169674	80000536	Particle
08437352	80000113	Combi
08437360	80000021	Combi
08437378	21652713	Combi

KNECHT		
08437386	21651184	Particle
08437386	21651980	Particle
08437394	21651979	Particle
08437964	21653022	Particle
08444093	21651983	Particle
08445660	21651976	Particle
08445660	21652985	Combi
08445710	21652336	Combi
08457160	80000029	Particle
08457913	80000633	Particle
08459778	21653149	Combi
08464562	21653014	Combi
08518086	21653006	Combi
08559767	21651994	Particle
08559775	21652546	Particle •
08559775	80000148	Combi •
08561847	21652346	Particle
08564874	21652360	Particle
08567695	21652045	Particle
08567711	21651296	Combi
08571895	21652715	Combi
08571895	80000621	Combi
08571903	21652714	Particle
08571911	21652356	Particle
08573701	21652358	Particle
08573719	21652335	Particle
08594905	21652551	Particle
08598930	21652999	Combi
08658213	21651898	Particle
08658213	80000594	Particle
08658239	80000636	Particle
08659492	21651184	Particle
08672040	21650107	Particle
08672040	21652709	Particle
08672222	21651182	Particle
08673899	21651900	Particle
08673907	21651891	Particle
08673915	21651899	Particle
08688533	21651890	Particle
08698920	21651919	Particle
08698938	21651912	Particle
08698938	21653008	Combi
08705576	21651196	Particle
08708778	21651183	Particle
08718645	21651916	Particle
08718652	21651298	Particle
08751398	21651890	Particle
08751406	21651914	Particle
08752479	21651898	Particle
08758807	80000027	Particle
08771800	21651964	Combi
08771826	21651965	Combi
08771842	21652361	Combi
08771842	21652959	Combi
08771867	21652353	Combi
08791022	21651185	Particle
08796989	21651195	Particle •
08798258	21653023	Particle •
09601972	21651895	Particle
09622366	21651913	Particle
09625203	21653003	Particle
09625229	21651977	Particle
09635830	21651955	Combi

KNECHT		
09637042	21652541	Combi
09637059	21651968	Combi
09637067	21651966	Combi
09637075	21651957	Combi
09655358	21651956	Combi
09655366	21652541	Combi
09689167	21651987	Particle
09689167	80000028	Combi
09689407	21651901	Particle
09689407	21651952	Combi
09689407	21651953	Combi
09689464	21651915	Particle
09689472	21651894	Particle
09689480	80000412	Particle
09689498	21652317	Particle
09691379	21651967	Combi
09691874	21651973	Particle
09693573	80000624	Combi
09805250	21651952	Combi
09807629	21651293	Particle
09807637	21651984	Particle
09810888	21651882	Combi •
09817289	21653068	Combi
09821893	21651957	Combi
09824491	80000535	Particle •
09830548	21653021	Particle
09833567	21651954	Combi
09834805	21651995	Particle
09838699	21651292	Combi
09838707	21651893	Particle
09842451	21651961	Combi
09857657	80000069	Combi
09857657	80000412	Particle
09857681	21652996	Combi
09858150	21651972	Particle
09858150	80000742	Combi
09881475	21651960	Combi
09881483	21652354	Combi
09883398	21652916	Combi
09889452	21651971	Particle •
6531479	21653139	Particle
6533327	21652355	Combi
6540272	21651294	Combi
6606099	21652345	Particle
70316792	80000070	Combi
70316889	21652871	Particle
70316896	21651888	Particle
70317360	21651887	Particle
70317360	21652002	Particle
70317360	21653002	Particle
70317366	80000066	Particle
70318188	21652865	Combi
70318195	21652863	Particle
70320894	80000649	Particle
70323024	21652340	Particle
70323488	80000062	Combi
70324998	21652867	Particle •
70325568	80000538	Combi •
70325628	80000647	Combi •
70325642	21653147	Combi
70327586	80000360	Particle
70328552	80000074	Particle
70328864	80000667	Combi •

KNECHT		
70329163	80000408	Combi
70329438	80000666	Particle •
70330471	80000655	Particle
70342646	21653146	Combi
70342689	80000652	Particle
70345861	80000620	Particle
70345873	80000767	Particle
70345873	80001176	Particle
70346564	80000405	Particle •
70347247	80000606	Combi
70347250	80000155	Particle
70347253	80000336	Particle
70347257	80000340	Particle
70347259	80000804	Particle
70347261	80000060	Particle
70347264	80000662	Particle
70347281	80000651	Particle •
70347764	21652551	Particle
70347764	80001172	Particle
70348495	80001750	Combi
70348547	80000616	Combi
70348559	80000614	Particle
70349337	21651920	Particle
70350374	80000339	Particle
70350376	21653000	Combi
70350378	21653019	Particle
70350382	80000337	Particle
70350384	21653007	Particle
70350574	21652860	Particle •
70350716	80000539	Particle
70351041	80000541	Particle
70351689	80000084	Particle •
70351689	80000650	Particle •
70351692	80000607	Particle
70352090	21653017	Particle
70352092	21653019	Particle
70352788	80000825	Particle
70352792	80001033	Particle •
70353868	80000643	Particle •
70354940	80000848	Combi •
70354942	80000847	Particle •
70356496	21652868	Particle
70356513	80000160	Particle •
70356516	80000604	Particle
70356519	80000874	Particle
70356523	80000341	Particle
70356526	80000342	Particle
70360564	80000852	Particle
70360567	80001033	Particle •
70360572	21652870	Particle
70360574	80000670	Combi
70364755	21652346	Particle
70366157	80000644	Particle •
70366157	80000654	Particle •
70366567	80000676	Particle
70367807	80000877	Particle
70370618	80000915	Particle
70371286	80000362	Particle
70371662	80000866	Combi
70371991	80000813	Particle
70372530	80000548	Particle •
70372977	80000839	Particle
70373062	80000866	Combi

KNECHT		
70373154	80000844	Combi
70373162	80001031	Combi •
70374099	21652900	Particle
70374099	80000637	Particle
70374132	80000815	Particle
70374181	80000865	Particle
70374236	80001034	Particle
70374638	80000853	Particle
70374659	80000865	Particle
70376890	80000911	Particle •
70377385	80000083	Particle
70378486	21653145	Particle
70378486	80001039	Particle
70380340	80000824	Particle
70381211	80000634	Particle
70381279	80001035	Combi
70381704	80000062	Combi
70381704	80000072	Particle
70382973	80001411	Particle
70386626	80001038	Combi
70518123	80001188	Combi
70521738	80001211	Combi •
70521738	80001795	Combi •
70521862	80001456	Particle •
70526331	80000641	Particle
70527237	80001189	Particle
70528720	80000617	Combi
70528762	80000158	Particle
70530089	21652854	Combi
70531051	80000068	Combi
70531051	80000802	Particle
70531057	80000655	Particle
70531057	80001441	Particle
70531118	80001444	Particle
70532750	21651993	Particle
70536998	80000349	Particle
70537428	80000076	Particle
70537688	21652002	Particle
70537693	21652998	Particle
70537693	21653001	Particle
70537699	80000869	Particle
70546233	80000646	Particle
70546774	80000350	Particle
70546780	80000354	Particle
70546791	80001765	Particle
70549921	80001779	Combi
70551272	21653002	Particle
70551580	80000645	Particle
70552790	80001621	Particle
70552816	80001583	Particle
70552869	80001624	Particle
70556093	80001763	Particle
70558577	80001622	Particle
70559454	80000356	Particle
70559663	21653027	Particle
70560119	80001130	Particle
70562254	80004353	Particle
70562945	80001451	Combi
70562960	80001774	Particle
70562969	80000638	Particle
70563074	80001788	Combi •
76417760	21651983	Particle
76418123	80001783	Particle

KNECHT		
76418164	21653021	Particle
76418487	21653001	Particle
76418834	80000603	Particle
76421655	80000163	Particle
76832331	80001784	Combi
76832331	80004356	Combi
76833099	80001740	Combi •
76833131	21652865	Combi
76886964	80001754	Combi
76888408	80000077	Combi
8169633	21653140	Particle
8457160	80000029	Particle
8571911	21652356	Particle
8573701	21652358	Particle
LA 220	80001761	Particle
LA 469	80001187	Particle
LA 751/S	80001787	Particle •
LA10	21651900	Particle
LA100	21651972	Particle
LA100	21652345	Particle
LA102	21651969	Particle
LA107	21652351	Particle
LA108	21652348	Particle
LA109	21652551	Particle
LA109	80001172	Particle
LA11	21651182	Particle
LA117	21652714	Particle
LA118	21652360	Particle
LA119	21652346	Particle
LA120	21652356	Particle
LA120	80001783	Particle
LA121	21652045	Particle
LA122	21652546	Particle •
LA123	21651994	Particle
LA126	21651970	Particle
LA127	21652342	Particle •
LA127	21653141	Particle
LA129	21652358	Particle
LA1291	21652335	Particle
LA130	21652347	Particle
LA131	21652539	Particle
LA134	21652349	Particle
LA135	21653032	Particle
LA136	21652550	Particle
LA137	21651981	Particle
LA138	21652548	Particle
LA142	21653027	Particle
LA143	21652350	Particle
LA144	21652544	Particle
LA148	21653139	Particle
LA151	80000632	Particle
LA152	21651901	Particle
LA153	21652543	Particle
LA154	21653005	Particle
LA155	21652989	Particle
LA155	80000603	Particle
LA156	21652863	Particle
LA1561	21652864	Particle
LA157	21652874	Particle
LA158	21653145	Particle
LA166	80000410	Particle
LA167	21652856	Particle
LA168S	21652897	Particle •

KNECHT		
LA168S	21652989	Particle
LA168S	21652990	Particle
LA169	21652857	Particle
LA170	80000333	Particle
LA171	21652850	Particle
LA171	80000740	Particle
LA172	80000156	Particle •
LA175	21653071	Particle
LA177	21651197	Particle
LA1771	21651888	Particle
LA18	21651898	Particle
LA18	80000594	Particle
LA180	80000082	Particle
LA181	21653024	Particle
LA182	21653020	Particle
LA183	21652993	Particle
LA184	21653028	Particle
LA186S	21652897	Particle •
LA186S	80004708	Particle •
LA189	21652994	Particle
LA19	80000636	Particle
LA191S	80000666	Particle •
LA195S	80000084	Particle •
LA195S	80000650	Particle •
LA196	21652871	Particle
LA197	21653063	Particle •
LA198	80001625	Particle
LA21	21651184	Particle
LA216	80000330	Particle
LA220	21653034	Particle
LA220	80000061	Particle
LA221/S	80004406	Particle
LA221S	80000847	Particle •
LA225S	21653031	Combi •
LA227	80000080	Particle
LA229	21653025	Particle
LA23	21651916	Particle
LA230	80000074	Particle
LA234	21652849	Particle
LA235S	80000163	Particle
LA237	21651991	Particle
LA239	21653067	Particle
LA24	21651890	Particle
LA241	21653026	Particle
LA242	21652709	Particle
LA243	21653017	Particle
LA248	80000063	Particle
LA25	21650107	Particle
LA25	21652709	Particle
LA26	21651919	Particle
LA265	21652359	Particle
LA269	21652873	Particle
LA27	21651298	Particle
LA279	21653016	Particle
LA280	80000360	Particle
LA282	80000636	Particle
LA287	21651887	Particle
LA287	21652002	Particle
LA287	21653002	Particle
LA288	80000066	Particle
LA289	80000649	Particle
LA291	21652340	Particle
LA296S	21652867	Particle •

KNECHT		
LA297	80000345	Particle
LA298	80000655	Particle
LA298	80001441	Particle
LA301	80000652	Particle
LA304	80000662	Particle
LA306	80000541	Particle
LA307	80000614	Particle
LA31	21651912	Particle
LA31	80000817	Particle
LA32	21651920	Particle
LA322	21651920	Particle
LA323	21651920	Particle
LA33	21651917	Particle
LA34	21651915	Particle
LA343	80000767	Particle
LA343	80001176	Particle
LA344	80000620	Particle
LA345	80000164	Particle
LA346S	80000405	Particle •
LA347	80000158	Particle
LA348	80001452	Particle
LA349S	80000159	Particle
LA349S	80000651	Particle •
LA35	21651894	Particle
LA350	80000340	Particle
LA351	80000339	Particle
LA353	21653019	Particle
LA354	80001579	Particle
LA355	80000336	Particle
LA356S	80000644	Particle •
LA356S	80000654	Particle •
LA357	80000337	Particle
LA358	21653007	Particle
LA36	21651183	Particle
LA36	21651963	Combi
LA360	80000060	Particle
LA361	80000155	Particle
LA362	80000804	Particle
LA365S	80000548	Particle •
LA366S	80000643	Particle •
LA367	80000812	Particle
LA368	80001738	Particle
LA37	21651196	Particle
LA370	80000539	Particle
LA371	21651975	Particle
LA371	21652346	Particle
LA372	80001582	Particle
LA376	80000825	Particle
LA377	80001033	Particle •
LA377S	80001033	Particle •
LA378	21653019	Particle
LA379	80000607	Particle
LA38	80000027	Particle
LA382	80000072	Particle
LA384	21652868	Particle
LA387	80000712	Particle
LA387	80004555	Particle
LA39	80000373	Particle
LA392S	80001439	Particle •
LA393	80001627	Particle
LA394S	80000160	Particle •
LA395	80000604	Particle
LA396	80000874	Particle

KNECHT		
LA397	80000341	Particle
LA398	80000342	Particle
LA398	80001628	Particle
LA40	21653140	Particle
LA400	80001739	Particle
LA401	80000852	Particle
LA402S	80001033	Particle •
LA404	21652870	Particle
LA408	80000676	Particle
LA41	80000536	Particle
LA410	80000865	Particle
LA411	80000815	Particle
LA412	80000865	Particle
LA42	21651977	Particle
LA421	21651977	Particle
LA421	80000877	Particle
LA422	21652900	Particle
LA422	80000637	Particle
LA424	80000853	Particle
LA428S	80000839	Particle
LA43	21653003	Particle
LA432	80000362	Particle
LA435	80000330	Particle
LA438	80000613	Particle
LA439	80000915	Particle
LA44	21651898	Particle
LA440	80000083	Particle
LA441	80000871	Particle
LA443	21653145	Particle
LA443	80001039	Particle
LA444S	80000911	Particle •
LA447	80000813	Particle
LA449	80001036	Particle
LA45	21651890	Particle
LA451	80000824	Particle
LA452	80001411	Particle
LA453	80001034	Particle
LA456	80001771	Particle
LA457	80001027	Particle
LA46	21651914	Particle
LA460	80001174	Particle
LA461	80001767	Particle
LA462	80001183	Particle
LA463	80001128	Particle
LA468S	80001456	Particle •
LA471	80000634	Particle
LA472	80001185	Particle
LA473	80000655	Particle
LA473	80001441	Particle
LA475	80001208	Particle
LA476	21652338	Particle
LA477	21652539	Particle
LA47S	21651195	Particle •
LA48	21651983	Particle
LA480	80001443	Particle
LA482	80001212	Particle
LA483S	80001489	Particle •
LA484	80000157	Particle
LA49	21651185	Particle
LA492	80000639	Particle
LA494	80001626	Particle
LA495	80001448	Particle •
LA50	21653022	Particle

KNECHT		
LA500	80001444	Particle
LA501	21653022	Particle
LA501S	80001736	Particle •
LA502	80001732	Particle
LA506	21653114	Particle
LA51S	21653023	Particle •
LA52	21651895	Particle
LA531	80001206	Particle
LA532	80000641	Particle
LA53S	80000535	Particle •
LA54	21652317	Particle
LA541	80000412	Particle
LA55	21653021	Particle
LA551	21653021	Particle
LA56	21651901	Particle
LA568	80000076	Particle
LA569	80001189	Particle
LA57	21651293	Particle
LA570S	80001734	Particle •
LA575	21652002	Particle
LA58	21651913	Particle
LA581	21652998	Particle
LA581	21653001	Particle
LA582	21651993	Particle
LA586	80001444	Particle
LA60	21651984	Particle
LA624	80000869	Particle
LA625	80001583	Particle
LA634S	80001130	Particle
LA65	21651987	Particle
LA67	21651973	Particle
LA680	80000638	Particle
LA683	80000356	Particle
LA71	21652997	Particle
LA74	21651980	Particle
LA742	80004353	Particle
LA745	80001774	Particle
LA75	21651979	Particle
LA76S	21652687	Particle •
LA77	21651893	Particle
LA78	21651995	Particle
LA79	21651986	Particle
LA8	21651899	Particle
LA80	21651198	Particle
LA811	80004355	Particle
LA813	80001770	Particle
LA82	21651972	Particle
LA83	21651976	Particle
LA84	80000029	Particle
LA85	21652998	Particle
LA85	21653001	Particle
LA86S	21651971	Particle •
LA87	21651983	Particle
LA873/S	80004359	Particle
LA877	80004550	Particle
LA898	80004777	Particle
LA9	21651891	Particle
LA921S	80004779	Particle •
LA93	21652689	Particle
LA95	80001446	Particle
LA97	21652308	Particle
LA98	21653029	Particle
LA99	80000633	Particle

KNECHT			
LAK113S	21652860	Particle	•
LAK 58	21651958	Combi	
LAK 64	80000760	Combi	
LAK102	21652336	Combi	
LAK107	21653069	Combi	
LAK11	21651964	Combi	
LAK117	21652715	Combi	
LAK117	80000621	Combi	
LAK120	21652357	Combi	
LAK120	80001784	Combi	
LAK120	80004356	Combi	
LAK122	80000148	Combi	•
LAK124	21651296	Combi	
LAK127	21653142	Combi	
LAK127	80000765	Combi	•
LAK129	21652861	Combi	
LAK1291	21652862	Combi	
LAK136	21652542	Combi	
LAK138	21652540	Combi	
LAK141	21652352	Combi	•
LAK142	21652538	Combi	
LAK143	80000758	Combi	
LAK145	21652694	Combi	
LAK152	21651952	Combi	
LAK153	80000429	Combi	
LAK154	80000364	Combi	
LAK156	21652865	Combi	
LAK158	21652992	Combi	
LAK159	21652854	Combi	
LAK167	21653147	Combi	
LAK169	21652858	Combi	
LAK171	21652853	Combi	
LAK173	21652851	Combi	•
LAK175	80000670	Combi	
LAK176	21652898	Combi	
LAK181	21653008	Combi	
LAK1811	80000602	Combi	
LAK182	21653015	Combi	
LAK183	80000284	Combi	
LAK184	21653146	Combi	
LAK189	21652995	Combi	
LAK19	80000628	Combi	
LAK191S	80000667	Combi	•
LAK196	21652872	Combi	
LAK197	21653064	Combi	•
LAK21	21651965	Combi	
LAK220	21653035	Combi	
LAK220	80000062	Combi	
LAK220	80001754	Combi	
LAK221S	80000848	Combi	•
LAK225	21653115	Combi	
LAK225S	21653031	Combi	•
LAK226	21651960	Combi	
LAK228	21651960	Combi	
LAK229	21653009	Combi	
LAK230	80004402	Combi	
LAK232	21653102	Combi	
LAK234	21652852	Combi	
LAK235S	80000208	Combi	
LAK238	80000347	Combi	
LAK239	21653066	Combi	
LAK242	21652361	Combi	
LAK243	80000070	Combi	

KNECHT			
LAK246	80000071	Combi	
LAK247	80000408	Combi	
LAK248	80000064	Combi	
LAK249	21652991	Combi	
LAK25	21652361	Combi	
LAK25	21652959	Combi	
LAK250	21652859	Combi	
LAK251	21653013	Combi	
LAK252	21653143	Combi	
LAK255	21653115	Combi	
LAK265	80000431	Combi	
LAK278S	21652812	Combi	•
LAK280	80000361	Combi	
LAK292S	80000538	Combi	•
LAK293	80000062	Combi	
LAK295S	80000647	Combi	•
LAK307	80000616	Combi	
LAK31	21651955	Combi	
LAK321	21652541	Combi	
LAK345	80001750	Combi	
LAK358	21653000	Combi	
LAK359	80000617	Combi	
LAK36	21651963	Combi	
LAK36	21652353	Combi	
LAK364	80000606	Combi	
LAK367	21653033	Combi	
LAK37	21651961	Combi	
LAK373	80000777	Combi	
LAK38	80000624	Combi	
LAK385	80000741	Combi	
LAK387	80000713	Combi	
LAK387	80004556	Combi	
LAK410	80000866	Combi	
LAK412	80000866	Combi	
LAK413	80000844	Combi	
LAK413	80001527	Combi	
LAK426S	80001031	Combi	•
LAK428/S	80004703	Combi	•
LAK428S	80000615	Combi	•
LAK43	21653006	Combi	
LAK430	80001035	Combi	
LAK436	80000854	Combi	
LAK437	80001459	Combi	
LAK44	21651968	Combi	
LAK45	21651956	Combi	
LAK454	80001179	Combi	
LAK46	21651957	Combi	
LAK463	80001129	Combi	
LAK467S	80001211	Combi	•
LAK467S	80001795	Combi	•
LAK469	80001188	Combi	
LAK472	80001186	Combi	
LAK478	80000068	Combi	
LAK478	80000802	Particle	
LAK485	80000648	Combi	
LAK49	21651966	Combi	
LAK490	80001038	Combi	
LAK490	80005176	Combi	
LAK52	21651960	Combi	
LAK54	21652996	Combi	
LAK541	80000069	Combi	
LAK56	21651952	Combi	
LAK57	21653068	Combi	

KNECHT			
LAK58	21651957	Combi	
LAK589	80000068	Combi	
LAK589	80000802	Particle	
LAK59	21652541	Combi	
LAK62	21652916	Combi	
LAK63	21651967	Combi	
LAK636	80001779	Combi	
LAK64	21651954	Combi	
LAK667	80001756	Combi	
LAK686	80001451	Combi	
LAK70	21653149	Combi	
LAK73S	21651882	Combi	•
LAK74	80000113	Combi	
LAK75	80000021	Combi	
LAK751S	80001788	Combi	•
LAK77	21652355	Combi	
LAK78	21652354	Combi	
LAK8	80000077	Combi	
LAK81	21651292	Combi	
LAK812	80004354	Combi	
LAK83	21652985	Combi	
LAK85	21652999	Combi	
LAK87	80000114	Combi	
LAK878/S	80004552	Combi	
LAK879	80004409	Combi	
LAK93	21652713	Combi	
LAK96	21653014	Combi	
LAK98	21651294	Combi	
LAKG113S	80000403	Combi	•
LAP1	80001586	Particle	
LAP10	80000349	Particle	
LAP11	80000350	Particle	
LAP12	80000646	Particle	
LAP13	80000645	Particle	
LAP17	80001765	Particle	
LAP18S	80001624	Particle	
LAP23	21653002	Particle	
LAP24	49356178	Particle	
LAP3	80000354	Particle	
LAP4	80001622	Particle	
LAP6	80001763	Particle	
LAP7	80001621	Particle	
LAR12	21651956	Combi	
LKK156S	21652865	Combi	
LKK165S	21652865	Combi	
LKK72S	80001740	Combi	•
LX2046	80005026	Air Filter	
MAHLE ORIGINAL			
06413231	21653026	Particle	
06413330	21651891	Particle	
06415996	21653139	Particle	
06416713	80000632	Particle	
06416945	80000633	Particle	
06417125	80000594	Particle	
06417141	80000636	Particle	
06417166	21651184	Particle	
06417240	21651182	Particle	
06417323	21651899	Particle	
06417349	21651890	Particle	
06417380	21651912	Particle	
06417406	21651196	Particle	
06417422	21651183	Particle	
06417489	21651898	Particle	

MAHLE ORIGINAL			
06417505	21651185	Particle	
06417521	21651895	Particle	
06417596	21650107	Particle	
06417638	21651298	Particle	
06417638	21651890	Particle	
06417653	21651916	Particle	
06417679	21651195	Particle	•
06417695	21651987	Particle	
06417711	21651901	Particle	
06417737	21651915	Particle	
06417752	21651894	Particle	
06417810	21651981	Particle	
06417877	21651917	Particle	
06417893	80000373	Particle	
06417919	21653140	Particle	
06417935	80000536	Particle	
0641795	21651987	Particle	
06417950	21651184	Particle	
06417950	21651980	Particle	
06417976	21651979	Particle	
06417992	21651983	Particle	
06418016	21651976	Particle	
06418032	80000029	Particle	
06418057	21651994	Particle	
06418073	21652546	Particle	•
06418099	21652346	Particle	
06418115	21652714	Particle	
06418131	21652356	Particle	
06418156	21651984	Particle	
06418198	21651995	Particle	
06418214	21651893	Particle	
06418230	21651972	Particle	
06418255	21651971	Particle	•
06418297	21651920	Particle	
06418313	80000027	Particle	
06418396	21651973	Particle	
06418412	21652997	Particle	
06418438	21652687	Particle	•
06418453	21651986	Particle	
06418495	21652998	Particle	
06418511	21652689	Particle	
06418552	21652308	Particle	
06418578	21651972	Particle	
06418578	21652345	Particle	
06418594	21652348	Particle	
06418636	21652360	Particle	
06418651	21651970	Particle	
06418677	21652347	Particle	
06418693	21652539	Particle	
06418719	21652349	Particle	
06418735	21653032	Particle	
06418750	21652550	Particle	
06418776	21652548	Particle	
06418800	21651901	Particle	
06418826	21652543	Particle	
06418842	21652989	Particle	
06418867	21652874	Particle	
06418883	21653145	Particle	
06418909	21652856	Particle	
06418925	21652897	Particle	•
06418925	21652989	Particle	
06418925	21652990	Particle	
06418941	21652857	Particle	

MAHLE ORIGINAL			
06418966	80000333	Particle	
06418982	80000156	Particle	•
06419006	80000082	Particle	
06419022	21652993	Particle	
06419048	21653028	Particle	
06419089	80000330	Particle	
06419105	80000080	Particle	
06419147	21652350	Particle	
06419162	21653005	Particle	
06419188	21653020	Particle	
06419204	21652994	Particle	
06419220	80000061	Particle	
06419246	21653025	Particle	
06419261	21653067	Particle	
06419287	21652709	Particle	
06420533	21652544	Particle	
06421051	21651975	Particle	
06421218	21651991	Particle	
06421663	80000163	Particle	
0650132	21652550	Particle	
06515225	21652348	Particle	
06515225	80000750	Combi	
06531446	21651296	Combi	
06531446	21652544	Particle	
06531453	21652308	Particle	
06531453	80000430	Combi	
06531479	21653139	Particle	
06536130	80000632	Particle	
06540132	21652550	Particle	
06540231	21652540	Combi	
06540231	21653028	Particle	
06540264	21652548	Particle	
06544704	21652542	Combi	
06544712	80000148	Combi	•
06558662	21651953	Combi	
06558662	21651970	Particle	
06588404	21651920	Particle	
06598767	21652342	Particle	•
06598767	21653141	Particle	
06599765	21652347	Particle	
06599765	80000416	Combi	
06605406	21652992	Combi	
06605406	21653145	Particle	
06606099	21651972	Particle	
06606099	21652345	Particle	
06606099	80000428	Combi	
06606099	80000742	Combi	
06606164	21652349	Particle	
06606164	80000418	Combi	
06606172	21653032	Particle	
06606172	80000344	Combi	
06606180	21651986	Particle	
06606180	80000744	Combi	
06606198	21651901	Particle	
06606198	21651952	Combi	
06606271	21652856	Particle	
06608160	21652687	Particle	•
06608160	21653070	Combi	•
06608400	21651920	Particle	
06610968	21652860	Particle	•
06610968	80000403	Combi	•
06612279	21652860	Particle	•
06612279	80000403	Combi	•

MAHLE ORIGINAL			
06612303	80000156	Particle	•
06612659	21651981	Particle	
06612659	80000761	Combi	
06626089	21652998	Particle	
06626162	21652990	Particle	
06626162	80000439	Combi	
06628473	21652543	Particle	
06628473	80000429	Combi	
06634620	21651198	Particle	
06634620	80000359	Combi	
06634679	21652898	Combi	
06634679	80000343	Particle	
06634687	80000333	Particle	
06639785	21652539	Particle	
06639785	80000745	Combi	
06640163	21652997	Particle	
06642300	21651294	Combi	
06642300	21653029	Particle	
06643845	21652992	Combi	
06643845	21653145	Particle	
06655773	80000330	Particle	
06655773	80000404	Combi	
06656029	21653031	Combi	•
06658389	21651977	Particle	
06693352	21653142	Combi	
06693352	80000765	Combi	•
06693386	80000347	Combi	
06693386	80000803	Particle	
06693501	80000080	Particle	
06786388	21653016	Particle	
06787154	21652859	Combi	
06787188	21651197	Particle	
06787196	21652812	Combi	•
06807358	80000064	Combi	
06808323	21653015	Combi	
06808331	21652873	Particle	
06818819	21653071	Particle	
06818819	80000670	Combi	
06818850	21652852	Combi	
06818876	21652849	Particle	
06822324	80000082	Particle	
06822324	80000759	Combi	
06827851	21653028	Particle	
06827869	21652993	Particle	
06827885	21652989	Particle	
06827885	80000437	Combi	
06827950	21653115	Combi	
06828677	21652897	Particle	•
06830087	21652874	Particle	
06830087	80000438	Combi	
06830772	21652853	Combi	
06830780	21652850	Particle	
06831002	21652865	Combi	
06831010	21652862	Combi	
06831028	21652861	Combi	
06831036	21652864	Particle	
06831044	21652863	Particle	
06831549	21653102	Combi	
06831648	21652851	Combi	•
06831879	21652853	Combi	
06831895	21653063	Particle	•
06831895	21653064	Combi	•
06831911	21653031	Combi	•

MAHLE ORIGINAL		
06831937	21652852	Combi
06831952	80000347	Combi
06832075	21651961	Combi
06832091	80000410	Particle
06832117	21652351	Particle
06832133	21653069	Combi
06832323	21652361	Combi
06832349	21652357	Combi
06832364	80000361	Combi
06832711	21653024	Particle
06833032	80000602	Combi
06833057	21653009	Combi
06833073	21652985	Combi
06833081	80000364	Combi
06875769	21652991	Combi
06878821	80000063	Particle
06886998	21653035	Combi
06886998	80000062	Combi
06887012	21651969	Particle
06887111	80000071	Combi
06887137	21653143	Combi
06887236	21653066	Combi
06887566	21653013	Combi
06887574	21652872	Combi
06887616	21652538	Combi
06887632	80000208	Combi
06887673	21652352	Combi •
06887996	21652354	Combi
06888010	21651960	Combi
06888036	21652996	Combi
06888077	21651292	Combi
06888135	21651957	Combi
06888176	21653068	Combi
06888192	21651293	Particle
06888218	21651882	Combi •
06888234	21652355	Combi
06888259	21652540	Combi
06888275	21651294	Combi
06888291	21652542	Combi
06888317	80000148	Combi •
06888333	21652992	Combi
06888374	80000403	Combi •
06888390	80000429	Combi
06888432	21652858	Combi
06888457	21652995	Combi
06888473	21651960	Combi
06888499	21651960	Combi
06888515	21653008	Combi
06888531	80000113	Combi
06888556	80000021	Combi
06888572	21652713	Combi
06888598	21652336	Combi
06888614	21653149	Combi
06888630	21653014	Combi
06888655	21653006	Combi
06888671	21652715	Combi
06888671	80000621	Combi
06888697	21652999	Combi
06888713	21652358	Particle
06888739	21652335	Particle
06888754	21651964	Combi
06888770	21651965	Combi
06888796	21652959	Combi

MAHLE ORIGINAL		
06888812	21651963	Combi
06888812	21652353	Combi
06888838	21653003	Particle
06888853	21651955	Combi
06888895	21651968	Combi
06888911	21651966	Combi
06888952	21652541	Combi
06888978	21651956	Combi
06889018	21652317	Particle
06889034	21651967	Combi
06889059	80000624	Combi
06889091	21651952	Combi
06889281	21651198	Particle
06889349	21652850	Particle
06889364	21653071	Particle
06889406	21653063	Particle •
06889448	21652849	Particle
06889463	21652861	Combi
06889463	21652862	Combi
07417240	21651182	Particle
08162158	21651917	Particle
08162158	80000435	Combi
08169625	80000373	Particle
08169633	21653140	Particle
08169633	80000762	Combi
08169674	80000536	Particle
08169674	80000788	Combi
08437352	21651980	Particle
08437352	80000113	Combi
08437360	80000021	Combi
08437378	21652713	Combi
08437386	21651184	Particle
08437386	21651980	Particle
08437394	21651979	Particle
08437964	21653022	Particle
08444093	21651983	Particle
08444093	80000114	Combi
08445660	21651976	Particle
08445660	21652985	Combi
08445710	21652336	Combi
08457160	80000029	Particle
08457160	80000749	Combi
08457913	80000633	Particle
08459778	21653148	Particle
08459778	21653149	Combi
08464562	21653014	Combi
08464562	80000338	Particle
08518086	21653006	Combi
08559767	21651994	Particle
08559767	80000432	Combi
08559775	21652546	Particle •
08559775	80000148	Combi •
08561847	21652346	Particle
08561847	80000746	Combi
08564874	21652360	Particle
08567695	21652045	Particle
08567711	21651296	Combi
08571895	21652715	Combi
08571895	80000621	Combi
08571903	21652714	Particle
08571911	21652356	Particle
08573701	21652358	Particle
08573719	21652335	Particle

MAHLE ORIGINAL		
08594905	21652551	Particle
08594905	80000419	Combi
08598930	21652999	Combi
08658213	21651898	Particle
08658213	80000594	Particle
08658239	80000636	Particle
08659492	21651184	Particle
08672040	21650107	Particle
08672222	21651182	Particle
08673899	21651900	Particle
08673899	80000753	Combi
08673907	21651891	Particle
08673915	21651899	Particle
08673915	80000077	Combi
08688533	21651890	Particle
08698920	21651919	Particle
08698920	80000748	Combi
08698938	21651912	Particle
08698938	21653008	Combi
08705576	21651196	Particle
08708778	21651183	Particle
08718645	21651916	Particle
08718645	80000434	Combi
08718652	21651298	Particle
08718652	80000747	Combi
08751398	21651890	Particle
08751406	21651914	Particle
08752479	21651898	Particle
08758807	80000027	Particle
08771800	21651964	Combi
08771826	21651965	Combi
08771842	21652361	Combi
08771842	21652959	Combi
08771867	21652353	Combi
08779530	21651975	Particle
08791022	21651185	Particle
08796989	21651195	Particle •
08796989	80000421	Combi •
08798258	21653023	Particle •
09601972	21651895	Particle
09622366	21651913	Particle
09625203	21653003	Particle
09625229	21651977	Particle
09635830	21651955	Combi
09637042	21652541	Combi
09637059	21651968	Combi
09637067	21651966	Combi
09637075	21651957	Combi
09655358	21651956	Combi
09655366	21652541	Combi
09689167	21651987	Particle
09689167	80000028	Combi
09689407	21651901	Particle
09689407	21651952	Combi
09689407	21651953	Combi
09689464	21651915	Particle
09689464	21651951	Combi
09689472	21651894	Particle
09689480	80000412	Particle
09689498	21652317	Particle
09691379	21651967	Combi
09691874	21651973	Particle
09693573	80000624	Combi

MAHLE ORIGINAL		
09805250	21651952	Combi
09807629	21651293	Particle
09807637	21651984	Particle
09807637	80000436	Combi
09810888	21651882	Combi •
09810888	21651897	Particle •
09817289	21653068	Combi
09821893	21651957	Combi
09824491	80000535	Particle •
09830548	21653021	Particle
09833567	21651954	Combi
09833567	80000376	Particle
09834805	21651995	Particle
09838699	21651292	Combi
09838699	21652688	Particle
09838707	21651893	Particle
09838707	21652355	Combi
09842451	21651961	Combi
09857657	80000069	Combi
09857657	80000412	Particle
09857681	21652996	Combi
09858150	21651972	Particle
09858150	80000742	Combi
09881475	21651960	Combi
09881483	21652354	Combi
09883398	21652916	Combi
09889452	21651971	Particle •
6417448	21651890	Particle
6417950	21651980	Particle
6418115	21652356	Particle
6418131	21652356	Particle
6419220	21653034	Particle
6531479	21653139	Particle
6540272	21651294	Combi
6606099	21652345	Particle
6888515	21653008	Combi
6888879	21652541	Combi
6889281	21651198	Particle
70308196	21652863	Particle
70316793	80000070	Combi
70316890	21652871	Particle
70316897	21651888	Particle
70317361	21651887	Particle
70317361	21652002	Particle
70317361	21653002	Particle
70317367	80000066	Particle
70318189	21652865	Combi
70320926	80000649	Particle
70323026	21652340	Particle
70323489	80000062	Combi
70325001	21652867	Particle •
70325569	80000538	Combi •
70325629	80000647	Combi •
70325643	21653147	Combi
70327591	80000360	Particle
70328553	80000074	Particle
70328865	80000667	Combi •
70329164	80000408	Combi
70329440	80000666	Particle •
70330477	80000655	Particle
70342649	21653146	Combi
70342691	80000652	Particle
70345862	80000620	Particle

MAHLE ORIGINAL		
70345862	80000622	Combi
70345874	80000767	Particle
70346566	80000405	Particle •
70347249	80000606	Combi
70347252	80000155	Particle
70347254	80000336	Particle
70347258	80000340	Particle
70347262	80000060	Particle
70347265	80000662	Particle
70347282	80000651	Particle •
70347767	21652551	Particle
70347767	80001172	Particle
70348550	80000616	Combi
70348560	80000614	Particle
70349338	21651920	Particle
70350375	80000339	Particle
70350377	21653000	Combi
70350379	21653019	Particle
70350383	80000337	Particle
70350385	21653007	Particle
70350575	21652860	Particle •
70350729	80000539	Particle
70350729	80000787	Combi
70351042	80000541	Particle
70351690	80000084	Particle •
70351690	80000650	Particle •
70351693	80000607	Particle
70352091	21653017	Particle
70352093	21653019	Particle
70352791	80000825	Particle
70353869	80000643	Particle •
70354941	80000848	Combi •
70354943	80000847	Particle •
70356497	21652868	Particle
70356514	80000160	Particle •
70356517	80000604	Particle
70356520	80000874	Particle
70356524	80000341	Particle
70356527	80000342	Particle
70360565	80000852	Particle
70360568	80001033	Particle •
70360573	21652870	Particle
70360575	80000670	Combi
70364750	21652346	Particle
70366158	80000644	Particle •
70366158	80000654	Particle •
70366568	80000676	Particle
70367808	80000877	Particle
70370620	80000915	Particle
70371287	80000362	Particle
70371663	80000866	Combi
70371992	80000813	Particle
70372531	80000548	Particle •
70372981	80000839	Particle
70373063	80000866	Combi
70373155	80000844	Combi
70373164	80001031	Combi •
70374100	21652900	Particle
70374100	80000637	Particle
70374133	80000815	Particle
70374182	80000865	Particle
70374237	80001034	Particle
70374639	80000853	Particle

MAHLE ORIGINAL		
70374660	80000865	Particle
70376891	80000911	Particle •
70377386	80000083	Particle
70378492	80001039	Particle
70380341	80000824	Particle
70381212	80000634	Particle
70381280	80001035	Combi
70381705	80000072	Particle
76421663	80000163	Particle
8169633	21653140	Particle
8457160	80000029	Particle
8573701	21652358	Particle
ALK120	80001784	Combi
LA 198	80001625	Particle
LA 220	80001761	Particle
LA 372	80001582	Particle
LA 393	80001627	Particle
LA 398	80001628	Particle
LA 469	80001187	Particle
LA 494	80001626	Particle
LA 751/S	80001787	Particle •
LA10	21651900	Particle
LA100	21651972	Particle
LA100	21652345	Particle
LA102	21651969	Particle
LA107	21652351	Particle
LA108	21652348	Particle
LA109	21652551	Particle
LA109	80001172	Particle
LA11	21651182	Particle
LA117	21652714	Particle
LA118	21652360	Particle
LA119	21652346	Particle
LA120	21652356	Particle
LA120	80001783	Particle
LA120	80004357	Particle
LA121	21652045	Particle
LA122	21652546	Particle •
LA123	21651994	Particle
LA125	21652860	Particle •
LA126	21651970	Particle
LA127	21653141	Particle
LA129	21652358	Particle
LA1291	21652335	Particle
LA130	21652347	Particle
LA131	21652539	Particle
LA134	21652349	Particle
LA135	21653032	Particle
LA136	21652550	Particle
LA137	21651981	Particle
LA138	21652548	Particle
LA142	21653027	Particle
LA143	21652350	Particle
LA144	21652544	Particle
LA148	21653139	Particle
LA151	80000632	Particle
LA152	21651901	Particle
LA153	21652543	Particle
LA154	21653005	Particle
LA155	21652989	Particle
LA155	80000603	Particle
LA156	21652863	Particle
LA1561	21652864	Particle

MAHLE ORIGINAL			
LA157	21652874	Particle	
LA158	21653145	Particle	
LA166	80000410	Particle	
LA167	21652856	Particle	
LA168S	21652989	Particle	
LA168S	21652990	Particle	
LA169	21652857	Particle	
LA170	80000333	Particle	
LA171	21652850	Particle	
LA171	80000740	Particle	
LA172	80000156	Particle	•
LA175	21653071	Particle	
LA177	21651197	Particle	
LA1771	21651888	Particle	
LA18	21651898	Particle	
LA18	80000594	Particle	
LA180	80000082	Particle	
LA181	21653024	Particle	
LA182	21653020	Particle	
LA183	21652993	Particle	
LA184	21653028	Particle	
LA186S	21652897	Particle	•
LA186S	80004708	Particle	•
LA189	21652994	Particle	
LA19	80000636	Particle	
LA191S	80000666	Particle	•
LA195S	80000084	Particle	•
LA195S	80000650	Particle	•
LA196	21652871	Particle	
LA197	21653063	Particle	•
LA199	80000162	Particle	
LA21	21651184	Particle	
LA216	80000330	Particle	
LA220	21653034	Particle	
LA220	80000061	Particle	
LA221/S	80004406	Particle	
LA221S	80000847	Particle	•
LA227	80000080	Particle	
LA229	21653025	Particle	
LA23	21651916	Particle	
LA230	80000074	Particle	
LA234	21652849	Particle	
LA235S	80000163	Particle	
LA237	21651991	Particle	
LA239	21653067	Particle	
LA24	21651890	Particle	
LA241	21653026	Particle	
LA241	80004407	Particle	
LA242	21652709	Particle	
LA243	21653017	Particle	
LA248	80000063	Particle	
LA25	21650107	Particle	
LA255	80000409	Particle	
LA26	21651919	Particle	
LA265	21652359	Particle	
LA269	21652873	Particle	
LA27	21651298	Particle	
LA279	21653016	Particle	
LA280	80000360	Particle	
LA287	21651887	Particle	
LA287	21653002	Particle	
LA288	80000066	Particle	
LA289	80000649	Particle	

MAHLE ORIGINAL			
LA290	80000810	Particle	
LA291	21652340	Particle	
LA296S	21652867	Particle	•
LA297	80000345	Particle	
LA298	80000655	Particle	
LA298	80001441	Particle	
LA301	80000652	Particle	
LA304	80000662	Particle	
LA306	80000541	Particle	
LA307	80000614	Particle	
LA31	21651912	Particle	
LA31	80000817	Particle	
LA322	21651920	Particle	
LA323	21651920	Particle	
LA33	21651917	Particle	
LA34	21651915	Particle	
LA343	80000158	Particle	
LA343	80000767	Particle	
LA343	80001176	Particle	
LA344	80000620	Particle	
LA345	80000164	Particle	
LA346S	80000405	Particle	•
LA348	21652874	Particle	
LA348	80001452	Particle	
LA349S	80000159	Particle	
LA349S	80000651	Particle	•
LA35	21651894	Particle	
LA350	80000340	Particle	
LA351	80000339	Particle	
LA353	21653019	Particle	
LA354	80001579	Particle	
LA355	80000336	Particle	
LA356S	80000644	Particle	•
LA356S	80000654	Particle	•
LA357	80000337	Particle	
LA358	21653007	Particle	
LA36	21651183	Particle	
LA36	21651963	Combi	
LA360	80000060	Particle	
LA361	80000155	Particle	
LA362	80000804	Particle	
LA365S	80000548	Particle	•
LA366S	80000643	Particle	•
LA367	80000812	Particle	
LA368	80001738	Particle	
LA37	21651196	Particle	
LA370	80000539	Particle	
LA371	21651897	Particle	•
LA371	21651975	Particle	
LA371	21652346	Particle	
LA376	80000825	Particle	
LA377	80001033	Particle	•
LA378	21653019	Particle	
LA379	80000607	Particle	
LA379	80000809	Particle	
LA38	80000027	Particle	
LA382	80000072	Particle	
LA384	21652868	Particle	
LA387	80000712	Particle	
LA387	80004555	Particle	
LA39	80000373	Particle	
LA391S	80000653	Particle	•
LA392S	80001439	Particle	•

MAHLE ORIGINAL			
LA394S	80000160	Particle	•
LA395	80000604	Particle	
LA396	80000874	Particle	
LA397	80000341	Particle	
LA398	80000342	Particle	
LA399	80000159	Particle	
LA40	21651984	Particle	
LA40	21653140	Particle	
LA400	80001739	Particle	
LA401	80000852	Particle	
LA402S	80001033	Particle	•
LA404	21652870	Particle	
LA408	80000676	Particle	
LA41	80000536	Particle	
LA410	80000865	Particle	
LA411	80000815	Particle	
LA412	80000865	Particle	
LA421	21651977	Particle	
LA421	80000877	Particle	
LA422	21652900	Particle	
LA422	80000637	Particle	
LA424	80000853	Particle	
LA428S	80000839	Particle	
LA43	21653003	Particle	
LA432	80000362	Particle	
LA435	80000330	Particle	
LA438	80000613	Particle	
LA439	80000915	Particle	
LA44	21651898	Particle	
LA440	80000083	Particle	
LA441	80000871	Particle	
LA443	80001039	Particle	
LA444S	80000911	Particle	•
LA447	80000813	Particle	
LA449	80001036	Particle	
LA45	21651890	Particle	
LA451	80000824	Particle	
LA452	80001411	Particle	
LA453	80001034	Particle	
LA456	80001771	Particle	
LA457	80001027	Particle	
LA46	21651914	Particle	
LA460	80001174	Particle	
LA461	80001767	Particle	
LA462	80001183	Particle	
LA463	80001128	Particle	
LA468S	80001456	Particle	•
LA471	80000634	Particle	
LA472	80001185	Particle	
LA475	80001208	Particle	
LA476	21652338	Particle	
LA477	21652539	Particle	
LA47S	21651195	Particle	•
LA48	21651983	Particle	
LA480	80001443	Particle	
LA482	80001212	Particle	
LA483S	80001489	Particle	•
LA484	80000157	Particle	
LA49	21651185	Particle	
LA492	80000639	Particle	
LA495	80001448	Particle	•
LA50	21653022	Particle	
LA500	80001444	Particle	

MAHLE ORIGINAL			
LA501	21653022	Particle	
LA501S	80001736	Particle	•
LA502	80001732	Particle	
LA506	21653114	Particle	
LA51S	21653023	Particle	•
LA52	21651895	Particle	
LA531	80001206	Particle	
LA532	80000641	Particle	
LA53S	80000535	Particle	•
LA54	21652317	Particle	
LA541	80000412	Particle	
LA55	21653021	Particle	
LA56	21651901	Particle	
LA568	80000076	Particle	
LA569	80001189	Particle	
LA57	21651293	Particle	
LA570S	80001734	Particle	•
LA575	21652002	Particle	
LA58	21651913	Particle	
LA581	21653001	Particle	
LA582	21651993	Particle	
LA60	21651984	Particle	
LA624	80000867	Particle	
LA624	80000869	Particle	
LA625	80001583	Particle	
LA634S	80001130	Particle	
LA65	21651987	Particle	
LA67	21651973	Particle	
LA680	80000638	Particle	
LA683	80000356	Particle	
LA71	21652997	Particle	
LA74	21651980	Particle	
LA742	80004353	Particle	
LA745	80001774	Particle	
LA75	21651979	Particle	
LA76S	21652687	Particle	•
LA77	21651893	Particle	
LA78	21651995	Particle	
LA79	21651986	Particle	
LA8	21651899	Particle	
LA80	21651198	Particle	
LA80	80000022	Particle	•
LA811	80004355	Particle	
LA813	80001770	Particle	
LA82	21651972	Particle	
LA83	21651976	Particle	
LA83	80001728	Particle	
LA84	80000029	Particle	
LA85	21652998	Particle	
LA86S	21651971	Particle	•
LA87	21651983	Particle	
LA873/S	80004359	Particle	
LA877	80004550	Particle	
LA898	80004777	Particle	
LA9	21651891	Particle	
LA921S	80004779	Particle	•
LA93	21652689	Particle	
LA95	80001446	Particle	
LA97	21652308	Particle	
LA98	21653029	Particle	
LA99	80000633	Particle	
LAG113S	21652860	Particle	•
LAK 309	80001580	Combi	

MAHLE ORIGINAL			
LAK 58	21651958	Combi	
LAK 64	80000760	Combi	
LAK102	21652336	Combi	
LAK107	21653069	Combi	
LAK11	21651964	Combi	
LAK117	21652715	Combi	
LAK117	80000621	Combi	
LAK120	21652357	Combi	
LAK120	80004356	Combi	
LAK122	80000148	Combi	•
LAK124	21651296	Combi	
LAK127	21653142	Combi	
LAK129	21652861	Combi	
LAK129	21652862	Combi	
LAK1291	21652862	Combi	
LAK131	80000745	Combi	
LAK136	21652542	Combi	
LAK138	21652540	Combi	
LAK141	21652352	Combi	•
LAK142	21652538	Combi	
LAK143	80000758	Combi	
LAK145	21652694	Combi	
LAK153	80000429	Combi	
LAK154	80000364	Combi	
LAK156	21652865	Combi	
LAK157	80000438	Combi	
LAK158	21652992	Combi	
LAK159	21652854	Combi	
LAK167	21653147	Combi	
LAK169	21652858	Combi	
LAK171	21652853	Combi	
LAK171	80000741	Combi	
LAK173	21652851	Combi	•
LAK175	80000670	Combi	
LAK176	21652898	Combi	
LAK181	21653008	Combi	
LAK1811	80000602	Combi	
LAK182	21653015	Combi	
LAK183	80000284	Combi	
LAK184	21653146	Combi	
LAK189	21652995	Combi	
LAK19	80000628	Combi	
LAK191S	80000667	Combi	•
LAK196	21652872	Combi	
LAK197	21653064	Combi	•
LAK21	21651965	Combi	
LAK220	21653035	Combi	
LAK220	80000062	Combi	
LAK220	80001754	Combi	
LAK221S	80000848	Combi	•
LAK225S	21653031	Combi	•
LAK226	21651960	Combi	
LAK228	21651960	Combi	
LAK229	21653009	Combi	
LAK230	80004402	Combi	
LAK232	21653102	Combi	
LAK234	21652852	Combi	
LAK235S	80000208	Combi	
LAK238	80000347	Combi	
LAK239	21653066	Combi	
LAK242	21652361	Combi	
LAK243	80000070	Combi	
LAK246	80000071	Combi	

MAHLE ORIGINAL			
LAK247	80000408	Combi	
LAK248	80000064	Combi	
LAK249	21652991	Combi	
LAK25	21652959	Combi	
LAK250	21652859	Combi	
LAK251	21653013	Combi	
LAK252	21653143	Combi	
LAK255	21653115	Combi	
LAK265	80000431	Combi	
LAK278S	21652812	Combi	•
LAK280	80000361	Combi	
LAK292S	80000538	Combi	•
LAK293	80000062	Combi	
LAK294	80000165	Combi	
LAK295S	80000647	Combi	•
LAK297	80000346	Combi	
LAK307	80000616	Combi	
LAK31	21651955	Combi	
LAK321	21652541	Combi	
LAK345	80001750	Combi	
LAK353	80000433	Combi	
LAK358	21653000	Combi	
LAK359	80000617	Combi	
LAK36	21651963	Combi	
LAK36	21652353	Combi	
LAK364	80000606	Combi	
LAK367	21653033	Combi	
LAK37	21651961	Combi	
LAK371	21651882	Combi	•
LAK373	80000777	Combi	
LAK38	80000624	Combi	
LAK385	80000741	Combi	
LAK386	80000880	Combi	
LAK387	80000713	Combi	
LAK387	80004556	Combi	
LAK410	80000866	Combi	
LAK412	80000866	Combi	
LAK413	80000844	Combi	
LAK413	80001527	Combi	
LAK426S	80001031	Combi	•
LAK428/S	80004703	Combi	•
LAK428S	80000615	Combi	•
LAK43	21653006	Combi	
LAK430	80001035	Combi	
LAK436	80000854	Combi	
LAK437	80001459	Combi	
LAK44	21651968	Combi	
LAK448	80000785	Combi	
LAK45	21651956	Combi	
LAK454	80001179	Combi	
LAK46	21651957	Combi	
LAK463	80001129	Combi	
LAK467S	80001211	Combi	•
LAK467S	80001795	Combi	•
LAK469	80001188	Combi	
LAK472	80001186	Combi	
LAK478	80000068	Combi	
LAK485	80000648	Combi	
LAK49	21651966	Combi	
LAK490	80001038	Combi	
LAK490	80005176	Combi	
LAK52	21651960	Combi	
LAK54	21652996	Combi	

MAHLE ORIGINAL			
LAK541	80000069	Combi	
LAK56	21651952	Combi	
LAK57	21653068	Combi	
LAK58	21651957	Combi	
LAK59	21652541	Combi	
LAK62	21652916	Combi	
LAK63	21651967	Combi	
LAK636	80001779	Combi	
LAK64	21651954	Combi	
LAK667	80001756	Combi	
LAK686	80001451	Combi	
LAK70	21653149	Combi	
LAK73S	21651882	Combi	•
LAK74	80000113	Combi	
LAK75	80000021	Combi	
LAK751S	80001788	Combi	•
LAK77	21652355	Combi	
LAK78	21652354	Combi	
LAK79	80000744	Combi	
LAK8	80000077	Combi	
LAK81	21651292	Combi	
LAK812	80004354	Combi	
LAK83	21652985	Combi	
LAK85	21652999	Combi	
LAK87	80000114	Combi	
LAK878/S	80004552	Combi	
LAK879	80004409	Combi	
LAK93	21652713	Combi	
LAK96	21653014	Combi	
LAK98	21651294	Combi	
LAKG113S	80000403	Combi	•
LAP 1	80001586	Particle	
LAP10	80000349	Particle	
LAP11	80000350	Particle	
LAP12	80000646	Particle	
LAP13	80000645	Particle	
LAP17	80001621	Particle	
LAP17	80001765	Particle	
LAP18S	80001624	Particle	
LAP24	49356178	Particle	
LAP3	80000354	Particle	
LAP4	80001622	Particle	
LAP6	80001763	Particle	
LAR12	21651956	Combi	
LKK156S	21652865	Combi	
LKK72S	80000421	Combi	•
LKK72S	80001740	Combi	•
MANN - FILTER			
C31012	80005029	Air Filter	
C32130	80005026	Air Filter	
CU 155 0037 (4)	80001621	Particle	
CU 155 0037-10	80001621	Particle	
CU 156 0022-2	80001623	Particle	
CU 2101	80001586	Particle	
CU 22 013	80004673	Particle	
CU 2916	80001628	Particle	
CU 3001	80001585	Particle	
CU 3243	80001629	Particle	
CU 3933	80001584	Particle	
CU 3944	80001582	Particle	
CU 3959	80001583	Particle	
CU 4466	80001625	Particle	
CU 4811-10	80001622	Particle	

MANN - FILTER			
CU 5010-2	80001626	Particle	
CU 6034	80001627	Particle	
CU 81 000-4	80001624	Particle	
CU10062	80000022	Particle	•
CU1009	80000066	Particle	
CU12001	49356178	Particle	
CU13133	21651971	Particle	•
CU14900212	80000635	Particle	
CU15001	80001720	Particle	
CU1519	80001739	Particle	
CU1526	80001771	Particle	
CU1546	21651983	Particle	
CU1550037(4)	80001621	Particle	
CU16001	80000812	Particle	
CU16001	80001037	Particle	
CU1629	80001753	Combi	
CU1629	80001760	Particle	
CU16400242	80000348	Particle	
CU17001	80001444	Particle	
CU1719	80000804	Particle	
CU17202	80000073	Particle	•
CU1721-2	80004359	Particle	
CU1722	80000362	Particle	
CU1738	21651987	Particle	
CU1738	80000028	Combi	
CU18062	80001737	Particle	•
CU18112	80001718	Particle	•
CU1823	21652989	Particle	
CU1823	21652990	Particle	
CU1827	21652989	Particle	
CU1827	80000603	Particle	
CU1828	21652539	Particle	
CU1828	21652551	Particle	
CU1829	80000074	Particle	
CU1835	21652989	Particle	
CU190003	21652342	Particle	•
CU19001	80001206	Particle	
CU19002	80001034	Particle	
CU190042	80001776	Particle	•
CU1910	80000634	Particle	
CU1912	80001452	Particle	
CU1915	80000825	Particle	
CU1919	80000162	Particle	
CU1919	80000604	Particle	
CU1919	80005175	Particle	
CU19302	80000535	Particle	•
CU19312	21652687	Particle	•
CU1936	80000874	Particle	
CU200052	80000911	Particle	•
CU20006	80004407	Particle	
CU20010	80001722	Particle	
CU20013	80005194	Particle	
CU2015	21652873	Particle	
CU2026	21653026	Particle	
CU2027	80001172	Particle	
CU2028	80001036	Particle	
CU20332	21652860	Particle	•
CU2035	21652874	Particle	
CU2038	80000636	Particle	
CU2040	80001027	Particle	
CU2043	21653145	Particle	
CU2043	80001039	Particle	
CU210002	80000666	Particle	•

MANN - FILTER			
CU210012	21652897	Particle	•
CU21003	80001183	Particle	
CU210052	80001130	Particle	
CU21009	80005226	Particle	
CU21062	80000643	Particle	•
CU2129	80001446	Particle	
CU2131	21652539	Particle	
CU2132	80001724	Particle	
CU2136	80000444	Combi	
CU2137	21652351	Particle	
CU2138	80000676	Particle	
CU2141	80000853	Particle	
CU2143	21652994	Particle	
CU2145	80000164	Particle	
CU2149	21652550	Particle	
CU2184	21653139	Particle	
CU220012	80000065	Particle	
CU220012	80000405	Particle	•
CU220022	80001023	Particle	•
CU22003	80001411	Particle	
CU22004	80001767	Particle	
CU220092	80001439	Particle	•
CU22010	80001731	Particle	
CU22142	80000911	Particle	•
CU22162	80000160	Particle	•
CU2218	21653018	Particle	
CU22242	21651982	Particle	•
CU2225	21651899	Particle	
CU2227	80001189	Particle	
CU2232	80000345	Particle	
CU2240	21652349	Particle	
CU2243	80000541	Particle	
CU2245	21653028	Particle	
CU2252	21652346	Particle	
CU2253	21651972	Particle	
CU230002	21652867	Particle	•
CU230012	80001489	Particle	•
CU230052	80005089	Particle	•
CU23009	80001770	Particle	
CU23010	80001454	Particle	
CU23011	80001780	Particle	
CU2303	80000645	Particle	
CU2304	80000350	Particle	
CU2316	21653071	Particle	
CU2317	80000662	Particle	
CU2317	80000784	Combi	
CU2326	21652350	Particle	
CU2327	21652546	Particle	•
CU23272	21652546	Particle	•
CU2329	80000082	Particle	
CU2330	80000155	Particle	
CU2331	80000813	Particle	
CU2331	80001212	Particle	
CU2335	21652544	Particle	
CU2336	80000652	Particle	
CU2337	21652338	Particle	
CU23371	21652339	Particle	
CU2338	21653029	Particle	
CU2339	21652849	Particle	
CU2344	21652899	Particle	
CU2345	21652346	Particle	
CU2349	21651981	Particle	
CU2351	21652345	Particle	

MANN - FILTER		
CU2356	80000083	Particle
CU2358	80000330	Particle
CU2362	80000767	Particle
CU24001	80001789	Particle
CU24004	80001214	Particle
CU240122	80004779	Particle •
CU24013	49359582	Particle
CU24182	80001456	Particle •
CU2422	21653027	Particle
CU2423	80000060	Particle
CU2424	21652348	Particle
CU2425	80000536	Particle
CU2430	80000080	Particle
CU2431	21652350	Particle
CU2433	21652857	Particle
CU2435	21651984	Particle
CU2436	80001128	Particle
CU2440	80000061	Particle
CU2441	80000159	Particle
CU2441	80000651	Particle •
CU2442	80001185	Particle
CU2450	80000879	Particle
CU2454	80000620	Particle
CU25001	80004353	Particle
CU25002	80004550	Particle
CU25003	80005173	Particle
CU2504	21652900	Particle
CU25062	80000084	Particle •
CU25062	80000650	Particle •
CU2513	80000657	Particle
CU2516	21652870	Particle
CU2520	80000029	Particle
CU25212	80000644	Particle •
CU25212	80000654	Particle •
CU2525	21651916	Particle
CU25251	21651298	Particle
CU2530	21652347	Particle
CU2531	21651900	Particle
CU2532	80000871	Particle
CU25332	80001794	Particle •
CU2534	21652997	Particle
CU25422	80000546	Particle •
CU2544	80000815	Particle
CU2544	80000816	Combi
CU2545	21652356	Particle
CU2559	21653034	Particle
CU25911	21651970	Particle
CU260002	80000548	Particle •
CU26001	80001437	Particle
CU26004	80000998	Particle
CU26006	80004355	Particle
CU260082	80001736	Particle •
CU26010	80001783	Particle
CU260142	80004812	Particle •
CU2603(10)	80001728	Particle
CU260310	80001728	Particle
CU2622	80000877	Particle
CU2623	80000649	Particle
CU2628	80000157	Particle
CU2629	80000637	Particle
CU2630	21653032	Particle
CU2634	80000852	Particle
CU2640	80000537	Particle

MANN - FILTER		
CU2641	80001760	Particle
CU2642	21651991	Particle
CU2645	21652340	Particle
CU26451	21652341	Particle
CU2647	80000158	Particle
CU2650	21651986	Particle
CU2672	21651898	Particle
CU2680	21652543	Particle
CU27003	80005070	Particle
CU27003	80005071	Particle
CU27007	80001774	Particle
CU27008	80001785	Particle
CU2709	21652868	Particle
CU2733	80000712	Particle
CU2733	80004555	Particle
CU2734	21651984	Particle
CU2734	21653140	Particle
CU27362	21651897	Particle •
CU27452	21651195	Particle •
CU2746	21652993	Particle
CU2747	80000360	Particle
CU2750	21651898	Particle
CU2750	80000594	Particle
CU2757	21651980	Particle
CU2785	80000633	Particle
CU28003	80004351	Particle
CU28082	80001024	Particle
CU2835	21651198	Particle
CU2839	21652359	Particle
CU2841	21651918	Particle
CU2842	21653020	Particle
CU2855	21652317	Particle
CU28551	80000412	Particle
CU2861	21651891	Particle
CU2882	21651912	Particle
CU2897	21651196	Particle
CU29001	80001204	Particle
CU290022	80001448	Particle •
CU290032	80004776	Particle
CU2930	80000373	Particle
CU2939	21653024	Particle
CU2940	21652548	Particle
CU2940	21653028	Particle
CU29412	80000847	Particle •
CU2945	21651983	Particle
CU2949	21653023	Particle •
CU29492	21653023	Particle •
CU2951	21651901	Particle
CU2951	21651970	Particle
CU29511	21651970	Particle
CU2952	80000915	Particle
CU2956	21651901	Particle
CU30004	80005091	Particle
CU3020	21652308	Particle
CU3023	21653067	Particle
CU30232	21653067	Particle
CU3032	21651917	Particle
CU3037	21652689	Particle
CU30392	80000839	Particle
CU3040	80001738	Particle
CU3042	21651892	Particle
CU3054	21651979	Particle
CU3059	21651183	Particle

MANN - FILTER		
CU31242	21652848	Particle •
CU3132	21653022	Particle
CU3136	21651896	Particle
CU3138	21651894	Particle
CU3139	21653063	Particle •
CU31392	21653063	Particle •
CU3146	80000409	Particle
CU3172	21652863	Particle
CU31721	21652864	Particle
CU3192	21651914	Particle
CU32003	80005193	Particle
CU3240	80000807	Particle
CU3260	21651918	Particle
CU3337	21652714	Particle
CU3338	21651197	Particle
CU3340	21651920	Particle
CU3350	80001488	Particle
CU3360	21651920	Particle
CU3403(10)	80000349	Particle
CU340310	80000349	Particle
CU3411	80001025	Particle
CU3415	80000340	Particle
CU3423	21653019	Particle
CU3435	80000027	Particle
CU3448	21651293	Particle
CU3454	80000072	Particle
CU3454	80001170	Combi
CU3455	21651184	Particle
CU3461	21652358	Particle
CU34611	21652335	Particle
CU3466	80000632	Particle
CU3478	21653019	Particle
CU3518	21653141	Particle
CU3540	21653025	Particle
CU3553	21651893	Particle
CU3554	21651893	Particle
CU3562	21651913	Particle
CU3567	21651995	Particle
CU3569	80000614	Particle
CU36422	21653030	Particle •
CU3649	21652360	Particle
CU37001	80001732	Particle
CU37230	21653016	Particle
CU3759	21652045	Particle
CU3780	21652688	Particle
CU38222	21651199	Particle •
CU3840	21652871	Particle
CU3847	80000865	Particle
CU3855	21653003	Particle
CU3858	21651976	Particle
CU3869	21651977	Particle
CU3935	80001766	Particle
CU3942	21651915	Particle
CU3943	21653017	Particle
CU3955	21651890	Particle
CU3979	21651890	Particle
CU4007	21651887	Particle
CU4007	21651974	Particle
CU40071	21651974	Particle
CU40110	21651973	Particle
CU4033	80001762	Particle
CU4036	80000076	Particle
CU4054	21653144	Particle

MANN - FILTER		
CU4150	80000638	Particle
CU4151	21651185	Particle
CU4179	21652856	Particle
CU42001	80001182	Particle
CU4228	21653021	Particle
CU4236	80000341	Particle
CU4251	21651182	Particle
CU4260	21651919	Particle
CU4408	21652002	Particle
CU4416	21653114	Particle
CU4436	80000740	Particle
CU4442	21651994	Particle
CU4469	21653007	Particle
CU45120	80000356	Particle
CU45120	80001758	Particle
CU4580	80001581	Particle
CU4594	80000333	Particle
CU4603203	80000336	Particle
CU4624	21652850	Particle
CU4627	80000336	Particle
CU46276	80000336	Particle
CU4662	80000641	Particle
CU4727	80000079	Particle
CU4783	80001764	Particle
CU4795	21653005	Particle
CU4811(10)	80001622	Particle
CU4926	80001579	Particle
CU50001	80005208	Particle
CU5041	21651993	Particle
CU5067	80000639	Particle
CU5096	80000337	Particle
CU5141	21652709	Particle
CU5257	21650107	Particle
CU5257	21652709	Particle
CU5346	80000339	Particle
CU5366	80000065	Particle
CU5407(10)	80001729	Particle
CU540710	80001729	Particle
CU5476	80000539	Particle
CU5480	21651895	Particle
CU5620(10)	80001763	Particle
CU562010	80001763	Particle
CU5809	21652998	Particle
CU5809	21653001	Particle
CU5877	21652998	Particle
CU5877	21653001	Particle
CU6724	21651969	Particle
CU8430	80000063	Particle
CU8541	80000357	Particle
CU91001	80004828	Particle
CUK 24 003	80004699	Combi
CUK 4062	80001580	Combi
CUK1611	80000617	Combi
CUK180002	21652865	Combi
CUK18002	80001779	Combi
CUK18202	21652352	Combi •
CUK1830	21653013	Combi
CUK190042	80001777	Combi •
CUK1919	80000771	Combi
CUK1919	80005176	Combi
CUK19312	21653070	Combi •
CUK200002	21652861	Combi
CUK2030	80001179	Combi

MANN - FILTER		
CUK2032	21653014	Combi
CUK20332	80000403	Combi •
CUK210002	80000667	Combi •
CUK21002	80000667	Combi •
CUK21006	80000671	Combi
CUK2132	80001035	Combi
CUK2137	21653069	Combi
CUK2141	80000854	Combi
CUK2143	21652995	Combi
CUK2145	80001750	Combi
CUK2149	21652542	Combi
CUK220002	80001740	Combi •
CUK22005	80004356	Combi
CUK220084	80001029	Combi
CUK22013	80004573	Combi
CUK22021	80005282	Combi
CUK22242	21652046	Combi •
CUK2225	80000077	Combi
CUK2227	80001190	Combi
CUK2230	80000068	Combi
CUK22301	80000068	Combi
CUK2231	80000648	Combi
CUK22412	21652812	Combi •
CUK2243	80000777	Combi
CUK2245	21653146	Combi
CUK230012	80001461	Combi
CUK230042	80000208	Combi
CUK230052	80004825	Combi •
CUK2316	80000670	Combi
CUK2335	21651296	Combi
CUK2338	21651294	Combi
CUK2339	21652852	Combi
CUK2422	21652538	Combi
CUK2430	80004404	Combi
CUK2433	21652858	Combi
CUK2436	80001129	Combi
CUK2440	80000062	Combi
CUK2442	80001186	Combi
CUK2450	80000880	Combi
CUK25001	80004354	Combi
CUK25006	80004549	Combi
CUK25332	80001211	Combi •
CUK25332	80001795	Combi •
CUK2534	80000626	Combi
CUK2545	21652357	Combi
CUK2550	80000844	Combi
CUK2550	80001527	Combi
CUK2551	80000844	Combi
CUK2551	80001527	Combi
CUK2559	21653035	Combi
CUK2559	80001754	Combi
CUK26003	21652859	Combi
CUK26005	80001461	Combi
CUK26010	80001784	Combi
CUK260112	80000606	Combi
CUK260142	80004813	Combi •
CUK2620	80001188	Combi
CUK2639	80001461	Combi
CUK2641	80001756	Combi
CUK26462	80000647	Combi •
CUK2672	21651968	Combi
CUK2680	80000429	Combi
CUK27001	80001450	Particle

MANN - FILTER		
CUN27001	80001451	Combi
CUK27222	80000538	Combi •
CUK27232	80001031	Combi •
CUK2733	80000713	Combi
CUK2733	80004556	Combi
CUK27362	21651882	Combi •
CUK2742	80001459	Combi
CUK2743	80001792	Combi
CUK2747	80000361	Combi
CUK2757	80000113	Combi
CUK28001	49356180	Combi
CUK2842	21653015	Combi
CUK2847	80001741	Combi
CUK2855	21652996	Combi
CUK28551	80000069	Combi
CUK2862	21651967	Combi
CUK2882	21651955	Combi
CUK2897	21651961	Combi
CUK28971	21651961	Combi
CUK2939	21653008	Combi
CUK29391	80000602	Combi
CUK2940	21652540	Combi
CUK29412	80000848	Combi •
CUK2949	21652552	Combi •
CUK29492	21652552	Combi •
CUK2950	21652991	Combi
CUK2951	21651952	Combi
CUK2951	21651953	Combi
CUK2952	80000916	Combi
CUK2956	21651952	Combi
CUK3020	80000430	Combi
CUK3023	21653066	Combi
CUK30232	21653066	Combi
CUK3037	21651957	Combi
CUK3037	21652713	Combi
CUK3039-2	80004703	Combi •
CUK30392	80000615	Combi •
CUK3042	21651954	Combi
CUK3054	80000021	Combi
CUK3059	21651963	Combi
CUK3059	21652353	Combi
CUK31001	80005072	Combi
CUK31242	21652851	Combi •
CUK3137	80000408	Combi
CUK3139	21653064	Combi •
CUK31392	21653064	Combi •
CUK3142	21652854	Combi
CUK3172	21652865	Combi
CUK31721	21652865	Combi
CUK3192	21651957	Combi
CUK3192	21651958	Combi
CUK3220	21653115	Combi
CUK3240	21653102	Combi
CUK3241	21652694	Combi
CUK3337	21652715	Combi
CUK3337	80000621	Combi
CUK3340	21652541	Combi
CUK3360	21652541	Combi
CUK3448	21653068	Combi
CUK3455	21651965	Combi
CUK3461	21652861	Combi
CUK34611	21652862	Combi
CUK350002	21653031	Combi •

MANN - FILTER			
CUK3518	21653142	Combi	
CUK3540	21653009	Combi	
CUK3554	21652355	Combi	
CUK3562	21651958	Combi	
CUK3567	21652354	Combi	
CUK3569	80000616	Combi	
CUK3621	80000071	Combi	
CUK36422	21651881	Combi	•
CUK3780	21651292	Combi	
CUK3823	21653006	Combi	
CUK3840	21652872	Combi	
CUK3847	80000866	Combi	
CUK3858	21652985	Combi	
CUK3943	80000070	Combi	
CUK3955	21651956	Combi	
CUK3979	21651956	Combi	
CUK4007	21653010	Combi	
CUK40071	21653011	Combi	
CUK4054	21653143	Combi	
CUK4136	21652898	Combi	
CUK4151	21651966	Combi	
CUK4179	21653147	Combi	
CUK4251	21651964	Combi	
CUK4251	21651966	Combi	
CUK4436	80000741	Combi	
CUK4469	21653000	Combi	
CUK4594	80001127	Combi	
CUK4624	21652853	Combi	
CUK4795	80000364	Combi	
CUK5141	21652361	Combi	
CUK5257	21652361	Combi	
CUK5257	21652959	Combi	
CUK5258	21653149	Combi	
CUK5366	21652916	Combi	
CUK5480	21651960	Combi	
CUK5877	21652999	Combi	
CUK6724	21652336	Combi	
CUK8430	80000064	Combi	
MECAFILTER			
CLR7120	21651296	Combi	
EKR7000	21651964	Combi	
EKR7001	21651965	Combi	
EKR7002	21652353	Combi	
EKR7003	21651966	Combi	
EKR7004	21651955	Combi	
EKR7004	21651967	Combi	
EKR7005	21651956	Combi	
EKR7007	21652355	Combi	
EKR7009	21651895	Particle	
EKR7009	21651960	Combi	
EKR7019	21651952	Combi	
EKR7023	21651961	Combi	
EKR7027	21652541	Combi	
EKR7030	80000435	Combi	
EKR7036	21651968	Combi	
EKR7038	21651957	Combi	
EKR7040	80000021	Combi	
EKR7045	80000762	Combi	
EKR7048	80000436	Combi	
EKR7049	80000113	Combi	
EKR7050	80000750	Combi	
EKR7055	21652354	Combi	
EKR7059	21651954	Combi	

MECAFILTER			
EKR7059	80000376	Particle	
EKR7061	21652308	Particle	
EKR7061	80000430	Combi	
EKR7068	21653068	Combi	
EKR7073	21651292	Combi	
EKR7074	21651294	Combi	
EKR7074	21653029	Particle	
EKR7075	80000429	Combi	
EKR7076	21652357	Combi	
EKR7076	80001784	Combi	
EKR7077	21652985	Combi	
EKR7078	21651296	Combi	
EKR7081	21653010	Combi	
EKR7092	21652713	Combi	
EKR7095	21652542	Combi	
EKR7096	21652361	Combi	
EKR7097	21652540	Combi	
EKR7097	21653028	Particle	
EKR7098	21652336	Combi	
EKR7101	80000418	Combi	
EKR7104	21653142	Combi	
EKR7105	21653146	Combi	
EKR7106	21652715	Combi	
EKR7106	80000621	Combi	
EKR7107	21651960	Combi	
EKR7108	21652916	Combi	
EKR7117	21653147	Combi	
EKR7118	21652996	Combi	
EKR7119	21652538	Combi	
EKR7123	21652872	Combi	
EKR7124	80000670	Combi	
EKR7127	21653008	Combi	
EKR7128	80000062	Combi	
EKR7129	21653015	Combi	
EKR7130	21652858	Combi	
EKR7131	21652995	Combi	
EKR7132	21653009	Combi	
EKR7134	80004404	Combi	
EKR7135	21652854	Combi	
EKR7135	21653151	Particle	
EKR7136	21653148	Particle	
EKR7136	21653149	Combi	
EKR7137	21653143	Combi	
EKR7137	21653144	Particle	
EKR7142	21652853	Combi	
EKR7145	21653035	Combi	
EKR7146	21652865	Combi	
EKR7148	80000068	Combi	
EKR7148	80000802	Particle	
EKR7149	21652898	Combi	
EKR7149	80000343	Particle	
EKR7151	80000064	Combi	
EKR7156	21653115	Combi	
EKR7159	80000745	Combi	
EKR7162	21653102	Combi	
EKR7162	80000807	Particle	
EKR7163	21652852	Combi	
EKR7165	21652694	Combi	
EKR7165	80000805	Particle	
EKR7166	80000346	Combi	
EKR7170	21653069	Combi	
EKR7172	80000071	Combi	
EKR7174	80000361	Combi	

MECAFILTER			
EKR7187	80000777	Combi	
EKR7193	21653013	Combi	
EKR7193	80000331	Particle	
EKR7197	21652959	Combi	
EKR7212	80005176	Combi	
EKR7218	80000666	Particle	•
EKR7220	80000880	Combi	
EKR7235	80000648	Combi	
EKR7236	80004556	Combi	
EKR7244	80001188	Combi	
EKR7245	80001129	Combi	
EKR7248	80001035	Combi	
EKR7263	80001186	Combi	
EKR7266	80001461	Combi	
EKR7269	80001459	Combi	
EKR7295	80004639	Combi	
EKR7325	80005282	Combi	
EKR7503	21652999	Combi	
EKR7506	21653000	Combi	
EKR7513	80000626	Combi	
EKR7517	21653006	Combi	
EL9387	80004660	Air Filter	
ELP3064	80000632	Particle	
ELP9229	80004670	Air Filter	
ELP9283	80005026	Air Filter	
ELP9316	80005028	Air Filter	
ELR7000	21651182	Particle	
ELR7001	21651184	Particle	
ELR7002	21651183	Particle	
ELR7003	21651185	Particle	
ELR7004	21651912	Particle	
ELR7004	21653008	Combi	
ELR7004	80000817	Particle	
ELR7005	21651890	Particle	
ELR7006	21650107	Particle	
ELR7007	21651893	Particle	
ELR7009	21651895	Particle	
ELR7009	21651960	Combi	
ELR7010	21651896	Particle	
ELR7011	21651915	Particle	
ELR7011	21651951	Combi	
ELR7013	21651914	Particle	
ELR7014	21651198	Particle	
ELR7014	80000359	Combi	
ELR7016	21651197	Particle	
ELR7016	80000377	Combi	
ELR7017	21651899	Particle	
ELR7017	80000077	Combi	
ELR7018	21651994	Particle	
ELR7018	80000432	Combi	
ELR7019	21651901	Particle	
ELR7019	21651953	Combi	
ELR7020	21651894	Particle	
ELR7020	80000433	Combi	
ELR7021	80000029	Particle	
ELR7021	80000749	Combi	
ELR7022	21651892	Particle	
ELR7022	80000760	Combi	
ELR7023	21651196	Particle	
ELR7026	21651891	Particle	
ELR7027	21651920	Particle	
ELR7028	21651919	Particle	
ELR7028	80000748	Combi	

MECAFILTER		
ELR7029	21651916	Particle
ELR7029	80000434	Combi
ELR7030	21651917	Particle
ELR7031	21651900	Particle
ELR7031	80000753	Combi
ELR7036	21651898	Particle
ELR7040	21651979	Particle
ELR7041	80000633	Particle
ELR7044	21651987	Particle
ELR7044	80000028	Combi
ELR7045	21653140	Particle
ELR7047	21651983	Particle
ELR7047	80000114	Combi
ELR7048	21651984	Particle
ELR7049	21651980	Particle
ELR7050	21652348	Particle
ELR7051	21651972	Particle
ELR7051	80000742	Combi
ELR7052	21652338	Particle
ELR7053	21652340	Particle
ELR7055	21651995	Particle
ELR7056	21651991	Particle
ELR7056	80000752	Combi
ELR7058	21651986	Particle
ELR7060	21652899	Particle
ELR7060	80000755	Combi
ELR7061	21652308	Particle
ELR7062	80000409	Particle
ELR7068	21651293	Particle
ELR7069	21652345	Particle
ELR7069	80000428	Combi
ELR7070	21651298	Particle
ELR7070	80000747	Combi
ELR7071	80000373	Particle
ELR7072	80000536	Particle
ELR7072	80000788	Combi
ELR7073	21652688	Particle
ELR7075	21652543	Particle
ELR7075	80000429	Combi
ELR7076	21652356	Particle
ELR7077	21651976	Particle
ELR7077	21652985	Combi
ELR7079	21651953	Combi
ELR7079	21651970	Particle
ELR7081	21651887	Particle
ELR7083	21651975	Particle
ELR7084	21652358	Particle
ELR7085	21652335	Particle
ELR7089	21652045	Particle
ELR7089	80000427	Combi
ELR7092	21652689	Particle
ELR7093	21652350	Particle
ELR7094	21652360	Particle
ELR7094	80000751	Combi
ELR7095	21652550	Particle
ELR7096	21652709	Particle
ELR7097	21652548	Particle
ELR7098	21651969	Particle
ELR7099	21651981	Particle
ELR7099	80000761	Combi
ELR7100	21652347	Particle
ELR7100	80000416	Combi
ELR7101	21652349	Particle

MECAFILTER		
ELR7103	80000072	Particle
ELR7104	21653141	Particle
ELR7105	21653028	Particle
ELR7106	21652714	Particle
ELR7108	80000065	Particle
ELR7109	21652900	Particle
ELR7110	21653017	Particle
ELR7111	21651913	Particle
ELR7111	21651958	Combi
ELR7113	21652346	Particle
ELR7113	80000746	Combi
ELR7117	21652856	Particle
ELR7118	21652317	Particle
ELR7119	21653027	Particle
ELR7120	21652544	Particle
ELR7122	21652551	Particle
ELR7122	80000419	Combi
ELR7123	21652871	Particle
ELR7124	21653071	Particle
ELR7125	80000060	Particle
ELR7126	21653032	Particle
ELR7126	80000344	Combi
ELR7127	21653024	Particle
ELR7128	80000061	Particle
ELR7129	21653020	Particle
ELR7130	21652857	Particle
ELR7131	21652994	Particle
ELR7132	21653025	Particle
ELR7134	80000080	Particle
ELR7138	21653114	Particle
ELR7140	21652346	Particle
ELR7142	21652850	Particle
ELR7143	21653026	Particle
ELR7143	80000754	Combi
ELR7144	21652989	Particle
ELR7144	80000437	Combi
ELR7145	21653034	Particle
ELR7146	21652863	Particle
ELR7151	80000063	Particle
ELR7154	80000162	Particle
ELR7157	80000074	Particle
ELR7159	21652539	Particle
ELR7163	21652849	Particle
ELR7164	21652874	Particle
ELR7164	80000438	Combi
ELR7166	80000345	Particle
ELR7168	21653145	Particle
ELR7173	80000330	Particle
ELR7173	80000404	Combi
ELR7174	80000360	Particle
ELR7176	21652873	Particle
ELR7180	80000083	Particle
ELR7180	80000440	Combi
ELR7181	80000158	Particle
ELR7181	80000402	Combi
ELR7183	21651898	Particle
ELR7183	80000594	Particle
ELR7185	80000815	Particle
ELR7185	80000816	Combi
ELR7187	80000541	Particle
ELR7191	21652870	Particle
ELR7194	80000824	Particle
ELR7195	80000620	Particle

MECAFILTER		
ELR7195	80000622	Combi
ELR7196	21652351	Particle
ELR7198	80000804	Particle
ELR7199	80000155	Particle
ELR7199	80005177	Particle
ELR7203	80000082	Particle
ELR7203	80000759	Combi
ELR7206	80000652	Particle
ELR7206	80000780	Combi
ELR7207	80000767	Particle
ELR7208	80000657	Particle
ELR7208	80000785	Combi
ELR7212	80000604	Particle
ELR7212	80000605	Combi
ELR7213	80000662	Particle
ELR7213	80000784	Combi
ELR7214	80001452	Particle
ELR7215	80000637	Particle
ELR7215	80000779	Combi
ELR7216	21652359	Particle
ELR7218	80000865	Particle
ELR7219	80000874	Particle
ELR7220	80000879	Particle
ELR7221	80000603	Particle
ELR7227	80000853	Particle
ELR7236	80004555	Particle
ELR7245	80001128	Particle
ELR7251	80001738	Particle
ELR7254	80000634	Particle
ELR7259	80000655	Particle
ELR7259	80001441	Particle
ELR7260	80000813	Particle
ELR7261	80000871	Particle
ELR7262	80001731	Particle
ELR7263	80001185	Particle
ELR7267	80000676	Particle
ELR7272	80001760	Particle
ELR7273	80001027	Particle
ELR7319	49359582	Particle
ELR7337	80005209	Particle
ELR7338	80005173	Particle
ELR7343	80005194	Particle
ELR7500	21651977	Particle
ELR7501	21653139	Particle
ELR7503	21652998	Particle
ELR7504	21653022	Particle
ELR7504	80000623	Combi
ELR7505	80000333	Particle
ELR7506	21653007	Particle
ELR7507	21652002	Particle
ELR7509	80000076	Particle
ELR7510	21653001	Particle
ELR7515	80001581	Particle
ELR7516	21653016	Particle
ELR7518	80000362	Particle
ELR7523	80000915	Particle
JKR7015	21651882	Combi •
JKR7066	21651881	Combi •
JKR7088	80001740	Combi •
JKR7090	21652352	Combi •
JKR7090	80000375	Particle •
JKR7091	21652552	Combi •
JKR7121	21652851	Combi •

MECAFILTER

JKR7158	21653066	Combi	
JKR7161	21653064	Combi	•
JKR7171	80000849	Combi	•
JKR7201	80000647	Combi	•
JKR7217	80000667	Combi	•
JKR7234	80000615	Combi	•
JLR7008	21651971	Particle	•
JLR7008	80000793	Combi	•
JLR7015	21651897	Particle	•
JLR7039	21651982	Particle	•
JLR7046	21652687	Particle	•
JLR7046	21653070	Combi	•
JLR7054	80001041	Particle	•
JLR7064	21652342	Particle	•
JLR7064	80000765	Combi	•
JLR7065	80000022	Particle	•
JLR7080	21651199	Particle	•
JLR7087	21651195	Particle	•
JLR7087	80000421	Combi	•
JLR7091	21653023	Particle	•
JLR7102	21652549	Particle	•
JLR7102	80000766	Combi	•
JLR7116	21652860	Particle	•
JLR7116	80000403	Combi	•
JLR7121	21652848	Particle	•
JLR7141	80000073	Particle	•
JLR7152	21652546	Particle	•
JLR7152	80000148	Combi	•
JLR7158	21653067	Particle	
JLR7160	80001024	Particle	
JLR7161	21653063	Particle	•
JLR7190	80000160	Particle	•
JLR7190	80000792	Combi	
JLR7205	80000405	Particle	•
JLR7205	80000406	Combi	•
JLR7210	21652897	Particle	•
JLR7217	80000666	Particle	•
JLR7229	80000084	Particle	•
JLR7230	80001033	Particle	•
JLR7234	80000839	Particle	
JLR7253	80000546	Particle	•
JLR7257	80000911	Particle	•
JLR7305	80005089	Particle	•

PURFLUX

A1292	80005026	Air Filter	
A1409	80005029	Air Filter	
AH101	21651899	Particle	
AH101	80000077	Combi	
AH102	21651920	Particle	
AH103	21650107	Particle	
AH103	21652709	Particle	
AH104	21651912	Particle	
AH104	21651955	Combi	
AH104	21653008	Combi	
AH105	21651184	Particle	
AH106	21651182	Particle	
AH106	21651964	Combi	
AH106	21651966	Combi	
AH107	21651901	Particle	
AH108	21651894	Particle	
AH109	21651896	Particle	
AH110	21651915	Particle	
AH111	21651892	Particle	

PURFLUX

AH114	21651891	Particle	
AH115	21651919	Particle	
AH116	21651917	Particle	
AH117	21651916	Particle	
AH118	21651900	Particle	
AH119	21651890	Particle	
AH120	21651198	Particle	
AH121	21651915	Particle	
AH122	21651893	Particle	
AH123	21651971	Particle	•
AH124	21651185	Particle	
AH125	21651898	Particle	
AH125	80000594	Particle	
AH126	21652688	Particle	
AH127	21651972	Particle	
AH128	21651183	Particle	
AH129	21651895	Particle	
AH130	21651197	Particle	
AH132	80000373	Particle	
AH133	21653140	Particle	
AH135	80000628	Combi	
AH135	80000636	Particle	
AH137	21651195	Particle	•
AH138	21651196	Particle	
AH139	21651913	Particle	
AH140	21651293	Particle	
AH142	21651991	Particle	
AH142	80000752	Combi	
AH143	21651983	Particle	
AH144	21651984	Particle	
AH147	21651914	Particle	
AH149	21651986	Particle	
AH150	21652348	Particle	
AH151	21652897	Particle	•
AH157	21651982	Particle	•
AH158	21651976	Particle	
AH158	21652985	Combi	
AH159	21652045	Particle	
AH160	21652539	Particle	
AH160	21652551	Particle	
AH163	21652687	Particle	•
AH163	21653070	Combi	•
AH165	21651972	Particle	
AH165	21652345	Particle	
AH165	21652990	Particle	
AH165	80000029	Particle	
AH166	21652543	Particle	
AH167	21651995	Particle	
AH169	21652349	Particle	
AH170	21651979	Particle	
AH170	80000021	Combi	
AH171	21651980	Particle	
AH173	21652317	Particle	
AH173	80000412	Particle	
AH174	21652899	Particle	
AH175	21652350	Particle	
AH179	21652548	Particle	
AH180	21653032	Particle	
AH182	21651987	Particle	
AH182	80000028	Combi	
AH184	21652689	Particle	
AH185	21652550	Particle	
AH186	80000072	Particle	

PURFLUX

AH187	21651969	Particle	
AH189	21652874	Particle	
AH189	80001452	Particle	
AH191	21652356	Particle	
AH191	80001783	Particle	
AH192	21652850	Particle	
AH193	21653028	Particle	
AH194	21652358	Particle	
AH195	21652857	Particle	
AH198	21652714	Particle	
AH199	21653071	Particle	
AH199	80000670	Combi	
AH201	21651296	Combi	
AH201	21652544	Particle	
AH202	21653024	Particle	
AH203	21652871	Particle	
AH204	21652346	Particle	
AH205	21652856	Particle	
AH206	21652994	Particle	
AH206	21652995	Combi	
AH207	80000074	Particle	
AH209	21653020	Particle	
AH210	21652539	Particle	
AH212	21653034	Particle	
AH212	80000061	Particle	
AH214	21652359	Particle	
AH220	21652546	Particle	•
AH221	80000330	Particle	
AH223	80000662	Particle	
AH224	21652360	Particle	
AH225	21652347	Particle	
AH226	21652338	Particle	
AH227	21653017	Particle	
AH228	21653114	Particle	
AH230	80000158	Particle	
AH231	21651994	Particle	
AH233	21653026	Particle	
AH234	80000080	Particle	
AH238	80000061	Particle	
AH244	80000541	Particle	
AH245	80000666	Particle	•
AH2452	80000666	Particle	•
AH248	80000652	Particle	
AH248	80000911	Particle	•
AH249	80000603	Particle	
AH250	80000345	Particle	
AH251	80000405	Particle	•
AH255	80001452	Particle	
AH256	80000604	Particle	
AH257	80000083	Particle	
AH259	80000604	Particle	
AH260	80000767	Particle	
AH261	80000839	Particle	
AH262	80000853	Particle	
AH263	80000815	Particle	
AH265	80001027	Particle	
AH266	80000620	Particle	
AH267	80000712	Particle	
AH268	80000614	Particle	
AH270	80000871	Particle	
AH271	80001039	Particle	
AH273	80001456	Particle	•
AH275	80001489	Particle	•

PURFLUX		
AH280	21653025	Particle
AH282	80001128	Particle
AH285	80001208	Particle
AH287	80001206	Particle
AH288	80000409	Particle
AH289	21652346	Particle
AH289	21652351	Particle
AH291	80001444	Particle
AH292	80000405	Particle •
AH292	80001736	Particle •
AH295	21652873	Particle
AH297	21653029	Particle
AH300	80000740	Particle
AH301	80000634	Particle
AH303	21652989	Particle
AH306	80001760	Particle
AH3102	80001448	Particle •
AH319	21652548	Particle
AH319	21653028	Particle
AH330	80001770	Particle
AH332	80001454	Particle
AH340	80000874	Particle
AH341	80001780	Particle
AH3462	80000654	Particle •
AH347	80005177	Particle
AH360	49359582	Particle
AH370	80004355	Particle
AH371	80004407	Particle
AH373	80004353	Particle
AH412	80005090	Combi
AH4152	80004779	Particle •
AH4252	80004812	Particle •
AH4282	80005089	Particle •
AH482	80005173	Particle
AH495	80005194	Particle
AHC101	80000077	Combi
AHC102	21652541	Combi
AHC103	21652361	Combi
AHC103	21652959	Combi
AHC105	21651965	Combi
AHC107	21651952	Combi
AHC107	21651953	Combi
AHC112	80000765	Combi •
AHC113	80000765	Combi •
AHC119	21651890	Particle
AHC119	21651956	Combi
AHC120	80000359	Combi
AHC122	21652355	Combi
AHC124	21651185	Particle
AHC124	21651966	Combi
AHC126	21651292	Combi
AHC128	21651183	Particle
AHC128	21651963	Combi
AHC128	21652353	Combi
AHC129	21651960	Combi
AHC130	80000377	Combi
AHC134	21651882	Combi •
AHC134	21651897	Particle •
AHC136	21651898	Particle
AHC136	21651968	Combi
AHC138	21651961	Combi
AHC140	21653068	Combi
AHC142	80000752	Combi

PURFLUX		
AHC147	21651957	Combi
AHC147	21651958	Combi
AHC149	80000744	Combi
AHC153	80000430	Combi
AHC154	21651296	Combi
AHC156	21651954	Combi
AHC166	80000429	Combi
AHC167	21652354	Combi
AHC173	21652996	Combi
AHC177	21652352	Combi •
AHC1772	21652352	Combi •
AHC178	21651967	Combi
AHC179	21652540	Combi
AHC181	21653149	Combi
AHC183	21653142	Combi
AHC184	21652713	Combi
AHC185	21652542	Combi
AHC187	21652336	Combi
AHC188	21653014	Combi
AHC190	21652538	Combi
AHC191	21652357	Combi
AHC191	80001784	Combi
AHC192	21652853	Combi
AHC195	21652857	Particle
AHC195	21652858	Combi
AHC198	21652715	Combi
AHC198	80000621	Combi
AHC199	80000670	Combi
AHC202	21653008	Combi
AHC203	21652872	Combi
AHC205	21653147	Combi
AHC208	21652992	Combi
AHC211	21652865	Combi
AHC212	21653035	Combi
AHC212	80001754	Combi
AHC213	21653102	Combi
AHC215	21652865	Combi
AHC219	21653064	Combi •
AHC234	80004404	Combi
AHC237	21653143	Combi
AHC238	80000062	Combi
AHC239	21651882	Combi •
AHC241	80000647	Combi •
AHC245	80000667	Combi •
AHC2452	80000667	Combi •
AHC246	80000064	Combi
AHC247	21653066	Combi
AHC247	21653067	Particle
AHC250	80000346	Combi
AHC258	80000866	Combi
AHC259	80005176	Combi
AHC261	80000615	Combi •
AHC261	80004703	Combi •
AHC264	80001031	Combi •
AHC267	80000713	Combi
AHC267	80004556	Combi
AHC268	80000616	Combi
AHC272	80001459	Combi
AHC277	80001035	Combi
AHC278	21653013	Combi
AHC280	21653009	Combi
AHC281	80001461	Combi
AHC284	80001451	Combi

PURFLUX		
AHC286	80001186	Combi
AHC299	21652916	Combi
AHC300	80000741	Combi
AHC318	80000844	Combi
AHC318	80001527	Combi
AHC373	80004354	Combi
AHC386	80004702	Particle
AHC4252	80004813	Combi •
VALEO		
715589	49356178	Particle
402266	21653068	Combi
585157	80005026	Air Filter
656135	21651899	Particle
656135L	21651899	Particle
698146	21651899	Particle
698146	80000077	Combi
698149	21651917	Particle
698159	21651912	Particle
698159	21653008	Combi
698160	21651912	Particle
698163	21651898	Particle
698163	80000594	Particle
698164	21651890	Particle
698164	21651914	Particle
698164	21653023	Particle •
698165	21651182	Particle
698166	21651184	Particle
698167	21651183	Particle
698168	21650107	Particle
698169	21651196	Particle
698169	21651975	Particle
698170	21651197	Particle
698171	21651198	Particle
698172	21651918	Particle
698173	21651916	Particle
698174	21651915	Particle
698175	80000536	Particle
698176	80000373	Particle
698177	21653140	Particle
698196	21651972	Particle
698196	21652345	Particle
698196	21652359	Particle
698196	80000029	Particle
698197	21651901	Particle
698198	21651894	Particle
698199	21651896	Particle
698200	21651892	Particle
698200	80000376	Particle
698201	21651893	Particle
698202	21651185	Particle
698203	21651920	Particle
698235	21651891	Particle
698246	21651882	Combi •
698247	21651895	Particle
698255	21651983	Particle
698276	21651984	Particle
698276	21652348	Particle
698279	21651984	Particle
698279	21652348	Particle
698290	21652687	Particle •
698454	21652308	Particle
698469	80000022	Particle •
698470	21651881	Combi •

VALEO			
698471	21652308	Particle	
698472	21651971	Particle	•
698475	21652688	Particle	
698478	21651982	Particle	•
698487	21651995	Particle	
698488	21651293	Particle	
698489	21651969	Particle	
698512	21652349	Particle	
698535	21651296	Combi	
698535	21652544	Particle	
698540	21653141	Particle	
698541	21653142	Combi	
698594	21652550	Particle	
698606	21652689	Particle	
698657	21653028	Particle	
698662	21651979	Particle	
698663	21651980	Particle	
698664	21652548	Particle	
698679	21651912	Particle	
698680	21652543	Particle	
698681	21652551	Particle	
698682	21651957	Combi	
698683	21652713	Combi	
698684	21651958	Combi	
698685	21651912	Particle	
698685	21652356	Particle	
698686	21651955	Combi	
698687	21651952	Combi	
698687	21651953	Combi	
698688	21651954	Combi	
698688	80000760	Combi	•
698689	21651970	Particle	
698690	21652900	Particle	
698691	21652899	Particle	
698692	21652538	Combi	
698693	21652858	Combi	
698693	21652992	Combi	
698694	21652857	Particle	
698695	21652354	Combi	
698696	21651960	Combi	
698697	21651961	Combi	
698700	21652358	Particle	
698701	21652335	Particle	
698702	21652863	Particle	
698703	21653010	Combi	
698704	21651887	Particle	
698704	21651974	Particle	
698705	21652002	Particle	
698705	21653011	Combi	
698706	21651974	Particle	
698707	21652347	Particle	
698708	21651980	Particle	
698708	80000113	Combi	
698709	80000021	Combi	
698710	21652715	Combi	
698710	80000621	Combi	
698711	21652714	Particle	
698712	21651982	Particle	•
698713	21653149	Combi	
698714	21652540	Combi	
698715	21652542	Combi	
698716	21651967	Combi	
698723	21653115	Combi	

VALEO			
698724	21652850	Particle	
698725	21652853	Combi	
698730	21653071	Particle	
698730	80000670	Combi	
698731	21653032	Particle	
698732	21652342	Particle	•
698734	21652346	Particle	
698735	21652546	Particle	•
698736	80000080	Particle	
698737	21652871	Particle	
698737	21652872	Combi	
698738	21652856	Particle	
698739	21652357	Combi	
698741	21652865	Combi	
698743	21652861	Combi	
698744	21651292	Combi	
698745	21652361	Combi	
698746	21651963	Combi	
698747	21652352	Combi	•
698748	21652541	Combi	
698749	21653068	Combi	
698750	21652336	Combi	
698751	21652694	Combi	
698753	80000074	Particle	
698762	21652360	Particle	
698768	21653015	Combi	
698769	21652351	Particle	
698770	21651986	Particle	
698771	21652317	Particle	
698772	80001740	Combi	•
698773	21652350	Particle	
698774	21653014	Combi	
698775	80000065	Particle	
698776	21652916	Combi	
698777	21651294	Combi	
698777	21653029	Particle	
698778	21651294	Combi	
698779	21652709	Particle	
698790	21653023	Particle	•
698791	21652552	Combi	•
698792	21652898	Combi	
698793	21653031	Combi	•
698794	21651987	Particle	
698795	21652874	Particle	
698796	21652539	Particle	
698797	21653002	Particle	
698800	21653024	Particle	
698801	21653008	Combi	
698802	21653013	Combi	
698815	21651919	Particle	
698817	80000060	Particle	
698819	21651972	Particle	
698819	80000066	Particle	
698838	21653030	Particle	•
698839	21651296	Combi	
698840	21651976	Particle	
698840	21652985	Combi	
698856	21652848	Particle	•
698857	21652851	Combi	•
698858	21651994	Particle	
698859	21652340	Particle	
698860	21652338	Particle	
698861	21652849	Particle	

VALEO			
698862	21652852	Combi	
698863	21653063	Particle	•
698864	21653064	Combi	•
698865	21652854	Combi	
698866	21653026	Particle	
698866	80004407	Particle	
698867	21651296	Combi	
698867	21652544	Particle	
698868	80000330	Particle	
698869	21651972	Particle	
698869	21652345	Particle	
698870	21653145	Particle	
698871	21653025	Particle	
698872	21653009	Combi	
698873	80000067	Combi	
698874	21651979	Particle	
698875	80000021	Combi	
698876	21652994	Particle	
698877	21652995	Combi	
698878	21651991	Particle	
698879	21653017	Particle	
698880	80000070	Combi	
698882	21653034	Particle	
698883	21653035	Combi	
698884	21653102	Combi	
698885	21651912	Particle	
698886	21652989	Particle	
698886	80000603	Particle	
698887	80000537	Particle	
698888	80000158	Particle	
698890	21652860	Particle	•
698890	80000403	Combi	•
698891	21652860	Particle	•
698891	80000403	Combi	•
698892	80000405	Particle	•
698893	21652993	Particle	
698894	80000657	Particle	
698894	80001023	Particle	•
698895	80000655	Particle	
698895	80001441	Particle	
701019	80004354	Combi	
701020	80004515	Combi	
708146	21651899	Particle	
708146	80000077	Combi	
708149	21651917	Particle	
708160	21651912	Particle	
708163	21651898	Particle	
708163	80000594	Particle	
708164	21651890	Particle	
708165	21651182	Particle	
708166	21651184	Particle	
708167	21651183	Particle	
708168	21650107	Particle	
708169	21651196	Particle	
708169	21651975	Particle	
708170	21651197	Particle	
708171	21651198	Particle	
708173	21651916	Particle	
708174	21651915	Particle	
708176	80000373	Particle	
708177	21653140	Particle	
708196	21651972	Particle	
708196	80000029	Particle	

VALEO		
708196	80000749	Combi
708198	21651894	Particle
708199	21651896	Particle
708200	21651892	Particle
708200	21651954	Combi
708200	80000376	Particle
708200	80000760	Combi
708201	21651893	Particle
708202	21651185	Particle
708203	21651920	Particle
708235	21651891	Particle
708247	21651895	Particle
708255	21651983	Particle
708279	21651984	Particle
708290	21652687	Particle •
708454	21652308	Particle
708475	21652688	Particle
708487	21651995	Particle
708488	21651293	Particle
708512	21652349	Particle
708515	80000662	Particle
708530	21652342	Particle •
708541	21653142	Combi
708594	21652550	Particle
708606	21652689	Particle
708657	21653028	Particle
708662	21651979	Particle
708663	21651980	Particle
708664	21652548	Particle
708679	21651912	Particle
708680	21652543	Particle
708681	21652551	Particle
708682	21651957	Combi
708683	21652713	Combi
708685	21652356	Particle
708686	21651955	Combi
708693	21652858	Combi
708693	21652992	Combi
708693	21653145	Particle
708694	21652857	Particle
708695	21652354	Combi
708696	21651960	Combi
708700	21652358	Particle
708707	21652347	Particle
708707	80000416	Combi
708708	21651980	Particle
708708	80000113	Combi
708709	80000021	Combi
708710	21652715	Combi
708710	80000621	Combi
708711	21652714	Particle
708713	21653149	Combi
708714	21652540	Combi
708715	21652542	Combi
708716	21651967	Combi
708731	21653032	Particle
708735	21652546	Particle •
708736	80000080	Particle
708737	21652872	Combi
708738	21652856	Particle
708741	21652865	Combi
708745	21652361	Combi
708747	21652352	Combi

VALEO		
708748	21652541	Combi
708749	21653068	Combi
708750	21652336	Combi
708753	80000074	Particle
708796	21652539	Particle
708801	21653008	Combi
708815	21651919	Particle
708815	80000748	Combi
708866	21653026	Particle
708867	21651296	Combi
708867	21652544	Particle
708876	21652994	Particle
708878	21651991	Particle
708884	21653102	Combi
715500	21653067	Particle
715501	21653066	Combi
715502	80000063	Particle
715503	80000064	Combi
715504	21652991	Combi
715505	21652859	Combi
715506	21653144	Particle
715507	21653143	Combi
715508	80000071	Combi
715509	80000068	Combi
715509	80000802	Particle
715510	80000061	Particle
715511	80000062	Combi
715512	21652996	Combi
715513	80000072	Particle
715514	21653114	Particle
715515	80000662	Particle
715516	80000157	Particle
715517	80000083	Particle
715518	80000360	Particle
715519	80000361	Combi
715520	80000649	Particle
715521	80000652	Particle
715522	80000548	Particle •
715522	80000797	Combi •
715523	80000644	Particle •
715523	80000654	Particle •
715524	80000634	Particle
715525	80000084	Particle •
715526	80000804	Particle
715527	80000159	Particle
715529	80000158	Particle
715529	80000546	Particle •
715530	21652342	Particle •
715531	21651195	Particle •
715533	80000346	Combi
715534	80000082	Particle
715534	80000759	Combi
715535	80000155	Particle
715536	80001033	Particle •
715539	80000670	Combi
715540	80000620	Particle
715540	80000622	Combi
715541	80000764	Combi
715541	80000767	Particle
715542	80000162	Particle
715544	80000647	Combi •
715545	21652867	Particle •
715545	80000643	Particle •

VALEO		
715546	80000648	Combi
715547	80000824	Particle
715548	21652867	Particle •
715548	80000825	Particle
715549	21652870	Particle
715551	80000164	Particle
715552	80000541	Particle
715553	80000777	Combi
715554	80000839	Particle
715555	80000615	Combi •
715557	80000667	Combi •
715558	21653147	Combi
715559	80000874	Particle
715561	80001024	Particle
715562	21652871	Particle
715564	80000657	Particle
715564	80000676	Particle
715564	80000785	Combi
715565	21652873	Particle
715566	80001769	Particle
715568	21653070	Combi •
715569	80000160	Particle •
715570	80000807	Particle
715571	80000069	Combi
715571	80000412	Particle
715572	21652897	Particle •
715572	80004708	Particle •
715574	80000163	Particle
715575	80001041	Particle •
715576	80001737	Particle •
715577	21652045	Particle
715578	21651956	Combi
715579	80000879	Particle
715580	80000880	Combi
715581	21653020	Particle
715583	80000847	Particle •
715584	80000848	Combi •
715585	80000740	Particle
715586	80000741	Combi
715587	80001738	Particle
715588	80000869	Particle
715590	80000812	Particle
715591	80000852	Particle
715592	80000813	Particle
715593	80000156	Particle •
715594	21652990	Particle
715595	80000915	Particle
715597	80000712	Particle
715598	80000066	Particle
715600	80000844	Combi
715600	80001527	Combi
715601	80000614	Particle
715602	80000616	Combi
715607	80001031	Combi •
715608	80001035	Combi
715609	80000676	Particle
715610	80004404	Combi
715612	80000429	Combi
715613	80000866	Combi
715614	80000865	Particle
715615	80000637	Particle
715616	80001027	Particle
715617	21652355	Combi

VALEO			
715618	80000656	Particle	•
715619	80000745	Combi	
715621	21652812	Combi	•
715623	80000854	Combi	
715627	80000061	Particle	
715628	80000062	Combi	
715629	21653146	Combi	
715630	80000854	Combi	
715631	80000853	Particle	
715632	21651964	Combi	
715635	80001459	Combi	
715636	80000815	Particle	
715637	80000617	Combi	
715637	80004395	Particle	
715638	80000871	Particle	
715639	80000911	Particle	•
715640	80000606	Combi	
715641	80000165	Combi	
715642	80001489	Particle	•
715643	80000538	Combi	•
715644	80001036	Particle	
715647	80001461	Combi	
715648	80000408	Combi	
715653	80000628	Combi	
715653	80000636	Particle	
715654	80000877	Particle	
715656	80001739	Particle	
715657	80000689	Particle	•
715659	80001186	Combi	
715665	80000602	Combi	
715667	80001188	Combi	
715668	80001446	Particle	
715672	80001451	Combi	
715680	80001750	Combi	
715681	80001179	Combi	
715688	80000825	Particle	
715691	80001206	Particle	
715693	80004356	Combi	
715696	80001718	Particle	•
715698	80001172	Particle	
715702	80000713	Combi	
715702	80004556	Combi	
715704	80001741	Combi	
715705	80001770	Particle	
715706	80001780	Particle	
715708	80001443	Particle	
715719	80004354	Combi	
715721	80001760	Particle	
715964	80001444	Particle	•
716000	80001585	Particle	
716001	80000645	Particle	
716004	21653021	Particle	
716005	80000354	Particle	
716006	21653022	Particle	
716007	21652997	Particle	
716008	80000626	Combi	
716009	80001586	Particle	
716029	80001127	Combi	
716033	80001625	Particle	
716039	80000362	Particle	
716052	80001732	Particle	
716057	80000356	Particle	

WIXFILTERS			
WA9441	80004670	Air Filter	
WA9454	80004671	Air Filter	
WP2018	80001770	Particle	
WP2046	49359582	Particle	
WP2081	80004354	Combi	
WP2124	80005173	Particle	
WP2132	80005194	Particle	
WP2137	49356180	Combi	
WP6800	21651182	Particle	
WP6801	21651964	Combi	
WP6802	21651183	Particle	
WP6802	21651981	Particle	
WP6803	21651963	Combi	
WP6803	21652353	Combi	
WP6804	21651183	Particle	
WP6804	21651184	Particle	
WP6805	21651965	Combi	
WP6806	21651890	Particle	
WP6806	21651956	Combi	
WP6808	21651890	Particle	
WP6808	21651956	Combi	
WP6809	21651956	Combi	
WP6810	21651912	Particle	
WP6812	21651196	Particle	
WP6812	21651912	Particle	
WP6812	21651955	Combi	
WP6812	21651967	Combi	
WP6813	21651955	Combi	
WP6814	21651899	Particle	
WP6814	21653032	Particle	
WP6814	80000077	Combi	
WP6816	21650107	Particle	
WP6816	21652361	Combi	
WP6816	21652709	Particle	
WP6817	21650107	Particle	
WP6817	21652959	Combi	
WP6818	21651185	Particle	
WP6819	21651966	Combi	
WP6820	21651893	Particle	
WP6820	21652355	Combi	
WP6821	21652355	Combi	
WP6822	21652338	Particle	
WP6826	21652340	Particle	
WP6828	21651979	Particle	
WP6829	80000021	Combi	
WP6830	21651198	Particle	
WP6832	21651195	Particle	•
WP6832	21651196	Particle	
WP6833	21651961	Combi	
WP6834	21651972	Particle	
WP6836	21651891	Particle	
WP6838	21651919	Particle	
WP6840	21651920	Particle	
WP6841	21652541	Combi	
WP6841	21653149	Combi	
WP6842	21651900	Particle	
WP6844	21651298	Particle	
WP6844	21651916	Particle	
WP6846	21651917	Particle	
WP6846	21653140	Particle	
WP6848	21651895	Particle	
WP6848	21651960	Combi	
WP6849	21651895	Particle	

WIXFILTERS			
WP6849	21651960	Combi	
WP6850	21651892	Particle	
WP6850	21651954	Combi	
WP6852	21651971	Particle	•
WP6854	21651986	Particle	
WP6855	80000744	Combi	
WP6860	21651897	Particle	•
WP6860	21652348	Particle	
WP6864	21651913	Particle	
WP6864	21651914	Particle	
WP6865	21651957	Combi	
WP6865	21651958	Combi	
WP6866	21651915	Particle	
WP6868	21651894	Particle	
WP6870	21651901	Particle	
WP6871	21651901	Particle	
WP6871	21651952	Combi	
WP6872	21651913	Particle	
WP6873	21651957	Combi	
WP6873	21651958	Combi	
WP6874	21651987	Particle	
WP6876	21652687	Particle	•
WP6876	21652849	Particle	
WP6876	21652899	Particle	
WP6878	21651887	Particle	
WP6880	21652687	Particle	•
WP6888	21651982	Particle	•
WP6888	21652046	Combi	•
WP6890	21651898	Particle	
WP6891	21651898	Particle	
WP6891	21651968	Combi	
WP6893	21651961	Combi	
WP6895	21651967	Combi	
WP6898	80000594	Particle	
WP6898	80000628	Combi	
WP6898	80000636	Particle	
WP6900	21651197	Particle	
WP6910	21653114	Particle	
WP6912	21651986	Particle	
WP6912	21651994	Particle	
WP6914	21651292	Combi	
WP6914	21652688	Particle	
WP6915	21651292	Combi	
WP6918	21651184	Particle	
WP6918	21651964	Combi	
WP6918	21651979	Particle	
WP6918	21651980	Particle	
WP6922	21651983	Particle	
WP6924	21651991	Particle	
WP6926	21651293	Particle	
WP6927	21653068	Combi	
WP6928	21651983	Particle	
WP6928	21652348	Particle	
WP6930	80000373	Particle	
WP6932	21651984	Particle	
WP6934	21651195	Particle	•
WP6936	21651995	Particle	
WP6937	21652354	Combi	
WP6938	21652349	Particle	
WP6940	21651898	Particle	
WP6940	80000594	Particle	
WP6942	21653023	Particle	•
WP6943	21652552	Combi	•

WIXFILTERS			
WP6946	80000027	Particle	
WP6948	80000022	Particle	•
WP6951	21651881	Combi	•
WP6955	21651882	Combi	•
WP6955	21651897	Particle	•
WP6957	21652308	Particle	
WP6957	80000430	Combi	
WP6958	21651918	Particle	
WP6964	21651893	Particle	
WP6966	21651984	Particle	
WP6966	21653140	Particle	
WP6969	21651954	Combi	
WP6976	21653063	Particle	•
WP6977	21653064	Combi	•
WP6978	21652045	Particle	
WP6980	21652347	Particle	
WP6984	21651976	Particle	
WP6985	21652985	Combi	
WP6990	80000074	Particle	
WP6994	21652345	Particle	
WP6994	80000029	Particle	
WP6998	21652689	Particle	
WP6999	21651957	Combi	
WP6999	21652713	Combi	
WP9001	21651296	Combi	
WP9002	21651969	Particle	
WP9003	21651969	Particle	
WP9003	21652336	Combi	
WP9021	21651294	Combi	
WP9021	21653029	Particle	
WP9024	21652350	Particle	
WP9026	21652539	Particle	
WP9026	21652551	Particle	
WP9027	80000745	Combi	
WP9028	21653017	Particle	
WP9029	80000070	Combi	
WP9034	21651981	Particle	
WP9034	21652714	Particle	
WP9035	21651965	Combi	
WP9035	21652714	Particle	
WP9035	21652715	Combi	
WP9035	80000621	Combi	
WP9036	21651912	Particle	
WP9036	21652356	Particle	
WP9036	21652687	Particle	•
WP9037	21652357	Combi	
WP9090	21652351	Particle	
WP9091	21652351	Particle	
WP9091	21653069	Combi	
WP9092	21651953	Combi	
WP9092	21651970	Particle	
WP9094	21651298	Particle	
WP9096	21652360	Particle	
WP9100	21652317	Particle	
WP9101	21652996	Combi	
WP9102	21652335	Particle	
WP9102	21652358	Particle	
WP9103	21652861	Combi	
WP9103	21652862	Combi	
WP9104	21652346	Particle	
WP9106	21652542	Combi	
WP9106	21652550	Particle	
WP9107	21652542	Combi	

WIXFILTERS			
WP9108	21651972	Particle	
WP9108	21652345	Particle	
WP9110	21652857	Particle	
WP9111	21652858	Combi	
WP9112	21652548	Particle	
WP9113	21652540	Combi	
WP9114	21652543	Particle	
WP9115	21652543	Particle	
WP9115	80000429	Combi	
WP9117	21652538	Combi	
WP9118	21653032	Particle	
WP9120	21652346	Particle	
WP9120	80001041	Particle	•
WP9125	21652352	Combi	•
WP9128	21653141	Particle	
WP9129	21653142	Combi	
WP9130	21651296	Combi	
WP9130	21652544	Particle	
WP9132	21652860	Particle	•
WP9134	21651986	Particle	
WP9134	80000744	Combi	
WP9135	21651986	Particle	
WP9135	80000744	Combi	
WP9136	21652551	Particle	
WP9136	21652874	Particle	
WP9137	80000438	Combi	
WP9140	21652850	Particle	
WP9141	21652853	Combi	
WP9142	21653028	Particle	
WP9144	21652342	Particle	•
WP9146	21653024	Particle	
WP9147	21653008	Combi	
WP9148	21652863	Particle	
WP9149	21652863	Particle	
WP9149	21652865	Combi	
WP9160	21651972	Particle	
WP9160	21652345	Particle	
WP9160	80000066	Particle	
WP9162	21652361	Combi	
WP9162	21652709	Particle	
WP9163	21652361	Combi	
WP9163	21652959	Combi	
WP9164	21653034	Particle	
WP9165	21653015	Combi	
WP9165	21653035	Combi	
WP9166	21653020	Particle	
WP9167	21652540	Combi	
WP9167	21653015	Combi	
WP9168	21652848	Particle	•
WP9169	21652851	Combi	•
WP9170	80000158	Particle	
WP9171	21653148	Particle	
WP9171	21653149	Combi	
WP9173	21652898	Combi	
WP9174	21653071	Particle	
WP9174	80000080	Particle	
WP9175	80000670	Combi	
WP9176	21652871	Particle	
WP9177	21652871	Particle	
WP9177	21652872	Combi	
WP9178	21652994	Particle	
WP9179	21652995	Combi	
WP9181	21653115	Combi	

WIXFILTERS			
WP9183	21653102	Combi	
WP9184	80001033	Particle	•
WP9186	21652992	Combi	
WP9186	21653145	Particle	
WP9187	21652992	Combi	
WP9187	21653145	Particle	
WP9188	21653067	Particle	
WP9189	21653066	Combi	
WP9190	80000060	Particle	
WP9192	21652539	Particle	
WP9192	21652551	Particle	
WP9195	80001740	Combi	•
WP9197	21652865	Combi	
WP9199	21652861	Combi	
WP9200	80000083	Particle	
WP9202	80000536	Particle	
WP9204	21652897	Particle	•
WP9206	21652546	Particle	•
WP9208	21651182	Particle	
WP9208	21652856	Particle	
WP9209	21653147	Combi	
WP9210	21653026	Particle	
WP9212	80000080	Particle	
WP9214	21651901	Particle	
WP9215	21651901	Particle	
WP9215	21651952	Combi	
WP9216	21652989	Particle	
WP9216	80000330	Particle	
WP9220	21652867	Particle	•
WP9222	21653025	Particle	
WP9224	80000330	Particle	
WP9226	21652359	Particle	
WP9229	21652854	Combi	
WP9230	80000061	Particle	
WP9231	80000062	Combi	
WP9232	80000063	Particle	
WP9233	80000064	Combi	
WP9236	21652870	Particle	
WP9238	80000783	Combi	
WP9238	80000804	Particle	
WP9240	21652868	Particle	
WP9242	21652900	Particle	
WP9244	80000084	Particle	•
WP9244	80000650	Particle	•
WP9246	80000072	Particle	
WP9248	21652873	Particle	
WP9250	80000541	Particle	
WP9252	80000620	Particle	
WP9254	80000155	Particle	
WP9256	80000666	Particle	•
WP9257	80000667	Combi	•
WP9258	80000164	Particle	
WP9260	80000345	Particle	
WP9263	80000647	Combi	•
WP9265	80000538	Combi	•
WP9267	21653143	Combi	
WP9268	80000548	Particle	•
WP9271	21653014	Combi	
WP9273	80000071	Combi	
WP9274	80000644	Particle	•
WP9276	80000662	Particle	
WP9278	80000644	Particle	•
WP9278	80000654	Particle	•

WIXFILTERS			
WP9280	80000637	Particle	
WP9282	80000159	Particle	
WP9282	80000405	Particle	•
WP9284	80000657	Particle	
WP9286	80000157	Particle	
WP9288	21652867	Particle	•
WP9288	80000825	Particle	
WP9290	80000604	Particle	
WP9291	80005176	Combi	
WP9293	21653013	Combi	
WP9294	21652346	Particle	
WP9296	80000060	Particle	
WP9298	80000158	Particle	
WP9298	80000764	Combi	
WP9298	80000767	Particle	
WP9300	80000652	Particle	
WP9302	80000652	Particle	
WP9307	80001031	Combi	•
WP9308	80000712	Particle	
WP9309	80000713	Combi	
WP9311	80000866	Combi	

WIXFILTERS			
WP9313	80000648	Combi	
WP9314	21652989	Particle	
WP9314	80000603	Particle	
WP9320	80001027	Particle	
WP9322	80000853	Particle	
WP9324	80000871	Particle	
WP9326	80000065	Particle	
WP9327	21652916	Combi	
WP9327	80000065	Particle	
WP9328	80000879	Particle	
WP9330	80000614	Particle	
WP9332	21651199	Particle	•
WP9335	80000844	Combi	
WP9336	80001456	Particle	•
WP9338	80000847	Particle	•
WP9339	80000848	Combi	•
WP9340	80000073	Particle	•
WP9342	80000360	Particle	
WP9343	80000361	Combi	
WP9344	80000634	Particle	
WP9347	21652862	Combi	

WIXFILTERS			
WP9348	80001036	Particle	
WP9350	80000874	Particle	
WP9352	80000871	Particle	
WP9354	80000911	Particle	•
WP9356	80001185	Particle	
WP9357	80001186	Combi	
WP9359	80000602	Combi	
WP9362	80000740	Particle	
WP9365	80001459	Combi	
WP9366	80000915	Particle	
WP9368	80000815	Particle	
WP9370	80000676	Particle	
WP9374	80000852	Particle	
WP9378	80000869	Particle	
WP9383	80001450	Particle	
WP9384	80000082	Particle	
WP9386	21652551	Particle	
WP9386	80001172	Particle	
WP9389	80001035	Combi	
WP9394	80000656	Particle	•
WP9396	21652350	Particle	



WE DELIVER THE ORIGINAL.
 – Corteco, Freudenberg Group



FREUDENBERG

2 billion Seals per year for the automotive industry in Europe



TrelleborgVibracoustic

Market leader in Vibration Control with around EUR 1.7 billion turnover per year

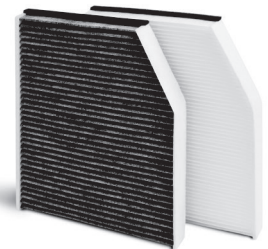

micronAir®

Cabin Air Filters in every other new car

DISCLAIMER

EN

Every care has been taken to ensure this information is correct at the time of publication. We cannot accept responsibility for errors. This catalogue contains products in original quality. We reserve the right to make technical changes. Original numbers from automobile manufacturers only serve as a cross-reference comparison with the CORTECO-No. and should not be used in delivery notes and invoices to vehicle owners. Full or partial reproduction permitted only with our written approval.

DE

Die Angaben in diesem Katalog wurden mit größter Sorgfalt auf ihre Richtigkeit überprüft. Trotzdem können Ersatzansprüche auf Grund von Angaben aus diesem Katalog nicht anerkannt werden. Alle Angaben erfolgen ohne Gewähr. Dieser Katalog enthält Produkte in Original-Qualität. Konstruktionsänderungen bleiben vorbehalten. Soweit wir in unseren Unterlagen Bezug auf die Ersatzteilnummer des Fahrzeugherstellers nehmen, dient diese nur zu Vergleichszwecken. Eine Verwendung derartiger Angaben in Rechnungen an den Fahrzeugbesitzer ist nicht statthaft. Der Nachdruck, auch auszugsweise, ist nur mit unserer schriftlichen Genehmigung gestattet.

FR

L'exactitude des données de ce catalogue a été vérifiée avec le plus grand soin. Néanmoins, tout droit à indemnité lié aux indications du présent catalogue est exclu. Ce catalogue comporte des produits de qualité d'équipement d'origine. Nous nous réservons le droit de procéder à des modifications techniques sans préavis. Si nous nous référons dans nos documents au numéro de pièce de rechange du fabricant automobile, nous le faisons uniquement à des fins de comparaison. Il est interdit de faire usage de telles données dans des factures adressées au propriétaire du véhicule. Toute réimpression, même sous forme d'extraits, requiert notre autorisation.

IT

Ci siamo adoperati affinché i dati contenuti in questo catalogo siano i più esatti possibili. Tuttavia decliniamo ogni responsabilità per eventuali inesattezze, non verranno da noi riconosciuti diritti di risarcimento di qualsiasi sorta causati da errori od omissioni. Questo catalogo contiene prodotti di qualità primo equipaggiamento. Ci riserviamo il diritto di apportare modifiche tecniche. I numeri originali e i nomi dei costruttori citati in questo catalogo servono esclusivamente a scopo comparativo e non possono essere utilizzati sulle bolle di accompagnamento e fatture ai proprietari di autoveicoli. La riproduzione, anche sommaria, è concessa solo dietro nostra autorizzazione.

Einbaupositionen | Localisations dans le véhicule | Posizionamento nel veicolo

INSTALLATION POSITIONS

The filter is located | Der Filter befindet sich | Le filtre se trouve | Il filtro si trova

- 1** in the engine compartment
im Motorraum
dans le compartiment moteur
nel vano motore
- 2** in the engine compartment on the driver's side under the cowl panel
im Motorraum auf der Fahrerseite unter der Windlaufblende
dans le compartiment moteur, côté conducteur, sous le capot
nel vano motore, lato guidatore, sotto il cruscotto
- 3** in the engine compartment located centrally under the cowl panel
im Motorraum mittig unter der Windlaufblende
dans le compartiment moteur, au centre, sous le capot
nel vano motore, centrale, sotto il cruscotto
- 4** in the engine compartment on the passenger's side under the cowl panel
im Motorraum auf der Beifahrerseite unter der Windlaufblende
dans le compartiment moteur, côté passager, sous le capot
nel vano motore, lato passeggero, sotto il cruscotto
- 5** in the engine compartment on the driver's side under the radiator tank cover
im Motorraum auf der Fahrerseite unter der Wasserkastenabdeckung
dans le compartiment moteur, côté conducteur, sous le cache du réservoir du radiateur
nel vano motore, lato guidatore, sotto il coperchio del serbatoio del radiatore
- 6** in the engine compartment located centrally under the radiator tank cover
im Motorraum mittig unter der Wasserkastenabdeckung
dans le compartiment moteur, au centre, sous le cache du réservoir du radiateur
nel vano motore, centrale, sotto il coperchio del serbatoio del radiatore
- 7** in the engine compartment on the passenger's side under the radiator tank cover
im Motorraum auf der Beifahrerseite unter der Wasserkastenabdeckung
dans le compartiment moteur, côté passager, sous le cache du réservoir du radiateur
nel vano motore, lato passeggero, sotto il coperchio del serbatoio del radiatore
- 8** in the engine compartment behind the ventilation grilles
im Motorraum hinter den Lüftungsgittern
dans le compartiment moteur, derrière les grilles de ventilation
nel vano motore, dietro la griglia di ventilazione
- 9** in the engine compartment at the heater (air-conditioner)
im Motorraum beim Heizungssystem (Klimaanlage)
dans le compartiment moteur, au niveau du radiateur de chauffage (air conditionné)
nel vano motore, adiacente al sistema di riscaldamento (condizionatore)
- 10** in the passenger compartment behind the glove compartment
im Fahrgastraum hinter dem Handschuhfach
dans l'habitacle, derrière la boîte à gants côté passager
nell'abitacolo, dietro il vano porta oggetti
- 11** in the passenger compartment under the glove compartment
im Fahrgastraum unter dem Handschuhfach
dans l'habitacle, sous la boîte à gants, côté passager
nell'abitacolo, sotto il vano porta oggetti
- 12** in the passenger compartment on the driver's side
im Fahrgastraum auf der Fahrerseite
dans l'habitacle, côté conducteur
nell'abitacolo, lato guidatore
- 13** in the grille under the wiper on the driver's side
im Gitter unter dem Scheibenwischer auf der Fahrerseite
dans la grille de ventilation, sous l'essuie-glace, côté conducteur
nella griglia del tergicristallo, lato guidatore
- 14** under the hood
unter der Motorhaube
sous le capot
sotto il cofano

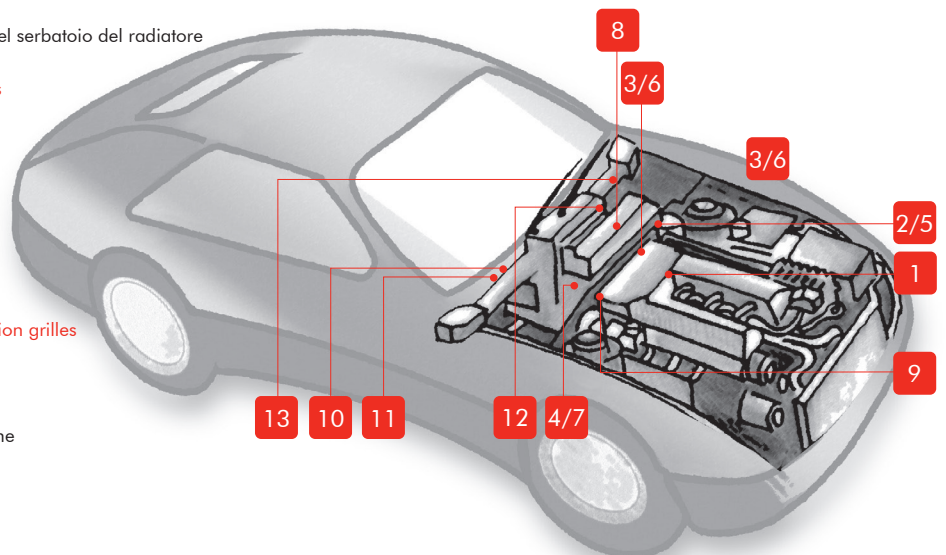

All particulars subject to alteration | Alle Angaben ohne Gewähr |
Tous les détails peuvent être soumis à changement | Tutti i dettagli possono essere soggetti a modifiche.