

MORE THAN JUST AFTERMARKET



 BRAKE PARTS

BRAKE DRUMS,
BRAKE SHOES,
PREMOUNTED KIT
2013



Tamburi freno, Ganasce freno, Rapid kit
Tambours de frein, Machoires de frein, Kit prémontés
Bremstrommeln, Bremsbacken, Vormontierte kit
Tambores de freno, Zapatas de freno, Kit premontados



AUTOMOTIVE PASSION

metelligroup



I cataloghi:

- Dischi e pastiglie freno;
- Tamburi, ganasce e Rapid KIT;
- Giunti, semiassi e KIT cuffia;
- Freni e frizioni idraulici;

Catalogues:

- Brake Discs & Pads;
- Brake Drums, Brake Shoes & Premounted KIT;
- C.V. Joints, Driveshafts & Boot KIT;
- Brake & Clutch Hydraulics;

INDICE - INDEX - INDEX - INLHAT - INDICE

Simbologia - Symbols-Symbologie - Symbole - Simbologia	pag. V
Abbreviazioni - Abbreviations - Abréviations - Zeichenerklärung - Abreviaturas	pag. VI-VII
Lista dei nuovi riferimenti - New references list	pag. VIII
Liste nouvelles références - Liste neue Sachnummer - Lista nuevas referencias	
Codici annullati - Cancelled part numbers	pag. IX
Références annulés - Stornierte Sachnummern - Códigos anulados	
Codici ad esaurimento - Discontinuing part numbers	pag. IX
Références en épuisement - Auslauf Sachnummern - Códigos en agotamiento	
Indice Marca e modello - Make and model Index	
Index marque et modèle - Inhalt Marke und Modell - Índice marca y modelo	pag. X-XVIII
Applicazioni - Applications - Applications - Anwendungen - Aplicaciones	pag. 1-305
Lista dei riferimenti - Cross References List	pag. 306-329
Table equivalences - Vergleichsliste - Lista de equivalencias	pag. 330
Forme tamburi - Brake drums shapes	
Formes tambours de frein - Formen Bremstrommeln - Formas tambores de freno	
Lista numerica - Numerical list - Liste numérique - Teilnummerliste - Lista numerica	pag. 331-352
Dimensioni cuscinetti tamburi - Dimensions of brake drums bearings	pag. 353
Cotês dimensionelles roulements tambours de frein	
Radlager-Abmessungen Bremstrommeln - Medidas rodamientos de rueda tambores de freno	
Disegni ganasce freno - Brake shoes drawings -Plans Machoires de frein	pag. 354-403
Zeichnungen der Bremsbacken - Dibujos de zapatas de freno	
Condizioni di vendita - Sales conditions - Conditions de vente	pag. 404-406
Verkaufsbedingungen - Condiciones de venta	



La Metelli nasce il 1° Agosto 1962 quale officina per lavorazioni meccaniche. Nel 1970 prende avvio la produzione delle parti motore e già nel 1975 inizia la fabbricazione delle parti freno e frizione idrauliche. Un ulteriore impulso all'espansione giunge nel 1991 con l'installazione della linea per la produzione dei giunti omocineticici a cui si aggiungono i semiassi nel 1999. Nel luglio del 2001 la Metelli S.p.A. acquista il 100% della società GRAF S.p.A., produttrice di pompe acqua e dischi freno. Nel 2008 vengono introdotte le pastiglie freno e nel 2010 le ganasce freno a completamento della gamma frenante. **Infine nel 2012 vengono lanciati il Kit distribuzione con pompa acqua e il kit cuffia.**

*Metelli was established on 1st August 1962 as a mechanical engineering workshop. In 1970, the company started producing engine parts and, in 1975, began manufacturing hydraulic brake and clutch parts. A further boost to expansion came in 1991 with the installation of the line for the production of constant velocity joints, later expanded in 1999 to include driveshafts. In July 2001, Metelli Co. acquired 100% of GRAF Co., a leading manufacturer of water pumps and brake discs. In order to complete the brake parts range Metelli introduced brake pads in 2008 and brake shoes in 2010. **Then in 2012 Metelli introduced the timing belt Kit with water pump and boot kit.***

*La société Metelli a été créée le 1er août 1962 comme atelier d'usinage. En 1970, l'entreprise a démarré la production de composants pour l'industrie des moteurs et a lancé en 1975 la fabrication de pièces de freinage et d'embrayage hydrauliques. En 1991, dans le cadre de sa politique d'expansion, la société a installé une nouvelle ligne pour la production de joints homocinétiques, à laquelle s'est ajoutée en 1999 celle des transmissions. En juillet 2001, Metelli S.p.A. a racheté la totalité de la société GRAF S.p.A., producteur leader de pompes à eau et de disques de frein. En 2008 nous avons introduits dans notre gamme les Plaquettes de Freins et en 2010 les Machoires de Frein à complètement de notre programme de freinage. **En 2012 nous avons introduits les kit distribution avec pompe à eau et les kit de soufflet de transmission.***

*Die Firma Metelli wurde am 1. August 1962 als mechanische Werkstätte gegründet. 1970 beginnt die Produktion von Motorteilen und bereits 1975 die Fertigung von hydraulischen Bremsenteilen und Kupplungsteilen. Einen weiteren Impuls zur Expansion erhält die Firma im 1991 durch die neue Produktionslinie Radgelenke und im Jahre im 1999 kommen dann Antriebswellen hinzu. Im Juli 2001 aquiriert die Metelli S.p.A. zu 100% die Gesellschaft GRAF S.p.A. auf, eine leitende Herstellerfirma von Wasserpumpen und Bremsscheiben. Im 2008 haben wir Bremsbeläge und im 2010 Bremsbacken in unserem Produktpalette eingefuehrt um unser Bremshydraulikprogramm zu vollstaendigen. **Im Jahr 2012 hat Metelli Zusaetzlich Spannrollen Kit mit Wasserpumpe und Faltenbalg-Satz im Programm vorgestellt.***

*La firma Metelli nace el 1 de Agosto de 1962 como taller para mecanizaciones. En 1970 comienza la realización de piezas para motores y ya en 1975 inicia la fabricación de piezas para frenos y embragues hidráulicos. Un mayor impulso a la expansión llega en 1991 con la instalación de una línea para la producción de juntas homocinéticas a las que se añadirán los semiejes en 1999. En el mes de Julio de 2001 Metelli S.p.A. adquiere el 100% de la firma GRAF S.p.A., fabricante líder de bombas de agua y discos de freno. En 2008 se introduce la gama de pastillas de freno y en 2010 la de zapatas de freno para completar la gama de frenos. **Los kit distribución con bomba de agua y los fuelle se introdujeron en 2012.***

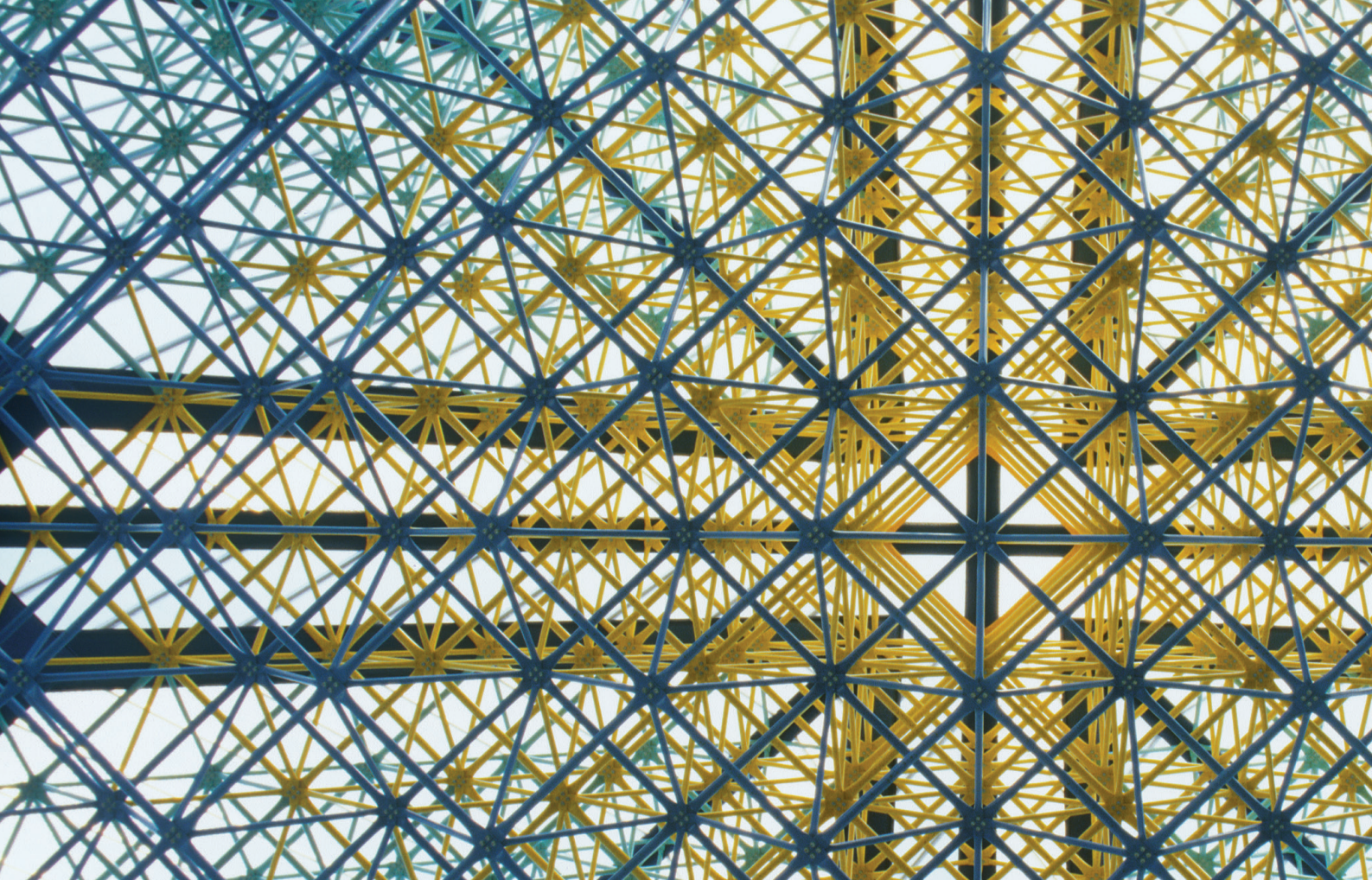



2013

Brake drums, Brake shoes, Premounted kit / Tamburi freno, Ganasce freno, Rapid kit / Tambours de frein, Machoires de frein, Kit prémontés / Bremstrommeln, Bremsbacken, Vormontierte kit / Tambores de freno, Zapatas de freno, Kit premontados

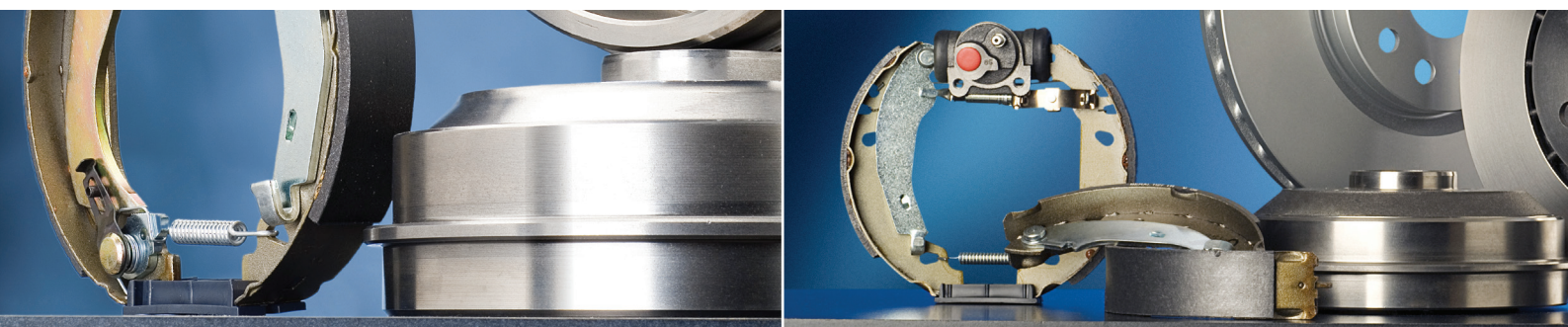
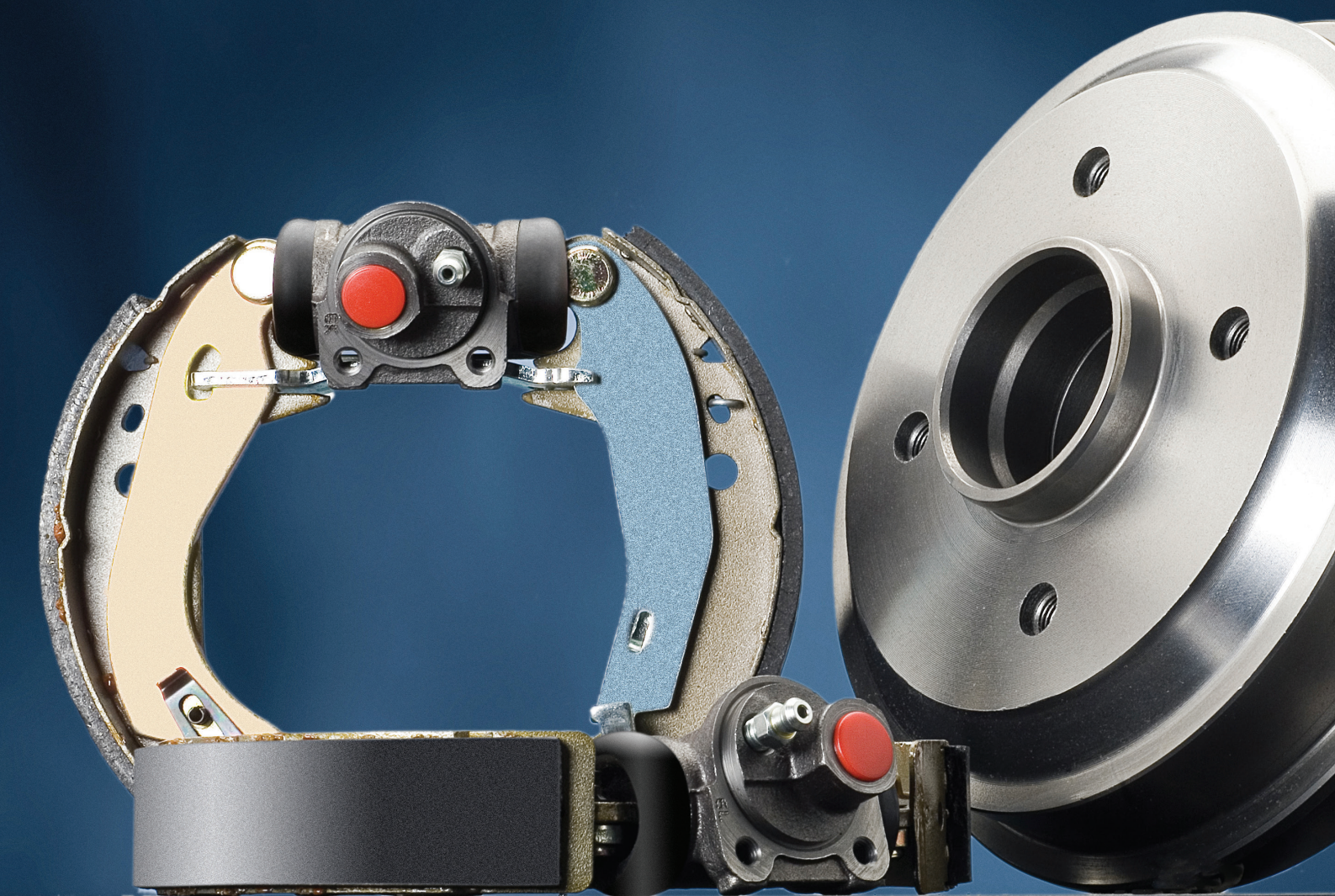



	 Simbologia	 Symbols	 Symbologie	 Symbole	 Simbologia
	Marca e modello	Make and model	Marque et modèle	Marke und Modell	Marca y modelo
	Anno	Year	Année	Baujahr	Año
	Ganasce freno con Kit Ridotto (Non montato) (153-...)	Brake shoes with reduced kit (Not fitted) (153-...)	Machoires de frein avec Kit réduit (Non monté) (153-...)	Bremsbacken mit einfachem Zubehörsatz (nicht montiert) (153-...)	Zapatras de freno con Kit sencillo (No montado) (153-...)
	Ganasce freno con Kit Completo (Non montato) (153-...K)	Brake shoes with complete kit (Not fitted) (153-...K)	Machoires de frein avec Kit complet (Non monté) (153-...K)	Bremsbacken mit komplettem Zubehörsatz (nicht montiert) (153-...K)	Zapatras de freno con Kit completo (No montado) (153-...K)
	Ganasce freno con Kit e leve (Montati) (153-...Y)	Brake shoes with kit and levers (Fitted) (153-...Y)	Machoires de frein avec Kit et des leviers (Monté) (153-...Y)	Bremsbacken mit Hebel und Zubehör (vormontiert) (153-...Y)	Zapatras de freno con Kit y levas (Montado) (153-...Y)
	Ganasce freno senza leva freno a mano (153-...J)	Brake shoes without handbrake lever (153-...J)	Machoires de frein sans levier de frein à main (153-...J)	Bremsbacken ohne Handbremshebel (153-...J)	Zapatras de freno sin leva de freno de mano (153-...J)
	Tamburi freno (700-...)	Brake drums (700-...)	Tambours de frein (700-...)	Bremstrommeln (700-...)	Tambores de freno (700-...)
	Tamburi freno con Kit (Cuscinetto ruota+Sede) (700-...K)	Brake drums with Kit (Wheel bearing+Seats) (700-...K)	Tambours de frein avec Kit (Roulements pour roues+Siège) (700-...K)	Bremstrommeln mit Satz (Radlager+Sitz) (700-...K)	Tambores de freno con Kit (Rodamientos de rueda+Asientos) (700-...K)
	Rapid kit (151-...)	Premounted kit (151-...)	Kit prémontés (151-...)	Vormontierte kit (151-...)	Kit premontados (151-...)
F/R	Anteriore / Posteriore	Front / Rear	Avant/ Arrière	Vorn / Hinten	Delantero / Trasero
L/R	Sinistro / Destro	Left / Right	Gauche / Droite	Links / Rechts	Izquierda / Derecha
CIFAM ref.	CIFAM ref.	CIFAM part No.	Réf. CIFAM	CIFAM Nr.	Ref. CIFAM
CIFAM ref. w/KIT	CIFAM ref. con Kit	CIFAM part No. with Kit	Réf. CIFAM avec Kit	CIFAM Nr. mit Satz	Ref. CIFAM con Kit
	Impianto frenante	Brake system	Système de freinage	Bremssystem	Sistema de frenada
DIMENSIONS mm.	Dimensioni mm.	Dimensions Millimeters	Dimensions mm.	Maße mm.	Dimensiones mm.
NOTE	Note	Remarks	Remarques	Anmerkungen	Anotaciones

					
	Abbreviazioni	Abbreviations	Legendes	Zeichenerklärung	Abreviaturas
-	Senza	Without	Sans	Ohne	Sin
(+o)	Con cuscinetto	With bearing	Avec roulement	Mit Lager	Con rodamiento
(-o)	Senza cuscinetto	Without bearing	Sans roulement	Ohne Lager	Sin rodamiento
+	Con	With	Avec	Mit	Con
16v	16 Valvole	6 Valves	16 Soupapes	16 Ventile	16 Válvulas
3/4/5p	3/4/5 Porte	3/4/5 Doors	3/4/5 Portes	3/4/5 -Türig	3/4/5 Puertas
4/5 Sp.	N° Rapporti del cambio	Number of gears	Nombre de vitesse	Ganganzahl	Número de engranes
4WD	Trazione integrale	Four wheel drive	4 Roues motrices	Vierradantrieb	Traccion integral
A/T	Cambio automatico	Automatic transmission	Automatique	Schaltgetriebe	Cambio automatico
ABS	Sistema di frenata antibloccaggio	Anti-lock brake system	Système anti-blocage	Anti Blockier System	Sistema de frenado anti bloque
Ake	Akebono	Akebono	Akebono	Akebono	Akebono
All models	Tutti i tipi	All models	Tous modèles	Alle Modelle	Todos modelos
Ambulance	Ambulanza	Ambulance	Ambulance	Krankenwagen	Ambulancia
Ap	Ap Lockheed	Ap Lockheed	Ap Lockheed	Ap Lockheed	Ap Lockheed
ASC	Controllo automatico di stabilità	Automatic stability control	Contrôle de stabilité automatique	Automatische Stabilitäts-Kontrolle	Control automático de estabilidad
ASR	Controllo anti-pattinaggio	Traction control system	Contrôle anti-patinage	Anti-Schlupf-Regulierung	Control antiderrapaje
Ate	Ate-Teves	Ate-Teves	Ate-Teves	Ate-Teves	Ate-Teves
Authority Car	Veicolo per enti statali	Authority Car	Véhicule communal	Behörde	Vehiculos oficiales
AW	Cerchi in lega leggera	Light alloy rims	Jantes en aluminium	Leichtmetallrädern	Llantas de aluminio
Axle	Assale	Axle	Essieu	Achse	Eje
Bdx	Bendix	Bendix	Bendix	Bendix	Bendix
Berlina	Berlina	Saloon	Berline	Limousine	Berlina
Bosch	Bosch	Bosch	Bosch	Bosch	Bosch
Bre	Brembo	Brembo	Brembo	Brembo	Brembo
BZ	Benzina	Petrol	Essence	Vergaser	Carburador
Carb.	Carburatore	Carburetor	Carbureteur	Vergaser	Carburador
-Ch	Fino telaio N.	To chassis No.	Jusqu'au chassis N.	Bis Fahrgestell Nr.	Hasta bastidor
Ch-	Dal telaio N.	From chassis No.	Depuis chassis N.	Ab Fahrgestell Nr.	Del bastidor N.
Cit	Citroen	Citroen	Citroen	Citroen	Citroen
CV	Cavalli vapore	HP	CV	PS	CV
Cyl.	Cilindro	Cylinder	Cylindre	Zylinder	Cilindro
D	Diesel	Diesel	Diesel	Diesel	Diesel
Del	Delco	Delco	Delco	Delco	Delco
Diam.	Diametro	Diameter	Diamètre	Diameter	Diámetro
Disability Vehicle	Veicoli per handicappati	Disability Vehicle	Véhicule pour handicapés	BehindertenFahrzeug	Vehículo para Minusválidos
Disc	Disco	Disc	Disque	Scheibe	Discos
Driving school	Scuola guida	Driving school	Véhicule école	Fahrschulenausführung	Versión Autoescuela
Drum	Tamburo	Drum	Tambour	Trommel	Tambores
DSC	Controllo dinamico di stabilità	Dynamic stability Control	Contrôle dynamique de stabilité	Dynamische Stabilitätsprogramm	Control dinámico de estabilidad
EDS	Bloccaggio elettronico del differenziale	Electronic differential lock	Blocage de différentiel électronique	Elektronische Differentialsperre	Bloqueo electrónico diferencial
-Eng.	Fino a motore N.	To engine No.	Jusqu'au moteur N.	Bis Motor Nr.	Hasta motor N.
Eng.-	Dal motore N.	From engine No.	Depuis moteur N.	Ab Motor Nr.	Del motor N.
EPB	Freno di stazionamento elettrico	Electronic parking brake	Frein d'arrêt électronique	Elektronischer Feststellbremse	Freno de detención electrónico
ESP	Controllo elettronico di stabilità	Electronic stability control	Contrôle électronique de stabilité	Elektronisches Stabilitätsprogramm	Sistema electrónico de estabilidad
Exc.	Escluso	Except	Sauf	Ausgenommen	Excepto
Fds	Fine serie	End of production	Fin de série	Endserie	Fin de producción
FR	Freno rinforzato	Reinforced brake	Frein renforcé	Verstärkte Bremse	Freno reforzado
Freno a mano	Freno a mano	Handbrake	Frein à main	Handbremse	Freno de mano
Front	Anteriore	Front	Avant	Vorn	Delantero
FWD	Trazione anteriore	Front wheel drive	Traction av.	Vorderradantrieb	Traccion delantera
Gir	Lucas-Girling	Lucas-Girling	Lucas-Girling	Lucas-Girling	Lucas-Girling
GM	General Motors	General Motors	General Motors	General Motors	General Motors
Hal	Haldex	Haldex	Haldex	Haldex	Haldex
H-Back	2 Volumi	Hatchback	Hayon arrière	Hatchback	Con portón trasero
HDB	Freno per carico pesante	Heavy duty brake	Freins renforcés	Verstärkte Bremse	Frenos reforzados
Hole	Foro	Hole	Trou	Bohrungen	Agujero
HP	Cavalli vapore	HP (Horse power)	CV (Cheval-vapeur)	PS (Pferdestärke)	Caballos de vapor
Hybrid	Ibrido	Hybrid	Hybride	Hybrid	Híbrido
ie	Iniezione elettronica	Electronic injection	Injection électronique	elektronische Injektion	Inyeccion electronica
Imp.	Impianto	Installation	Installation	Anlage	Equipo

					
	Abbreviazioni	Abbreviations	Legendes	Zeichenerklärung	Abreviaturas
Inch	Pollici	Inches	Pouces	Zoll	Pulgadas
Incl.	Incluso	Included	Compris	Inklusiv	Incluido
IP	Sospensione rinforzata	Increased payload	Charge utile augmentée	Erhöhter Nutzlast	Carga útil incrementada
IW	Cerchi in ghisa	Iron rims	Jantes en fonte	Grauguß Felgen	Llantas de fundición
K.	Kompressor	Kompressor	Kompressor	Kompressor	Kompressor
Kg	Kilogrammo	Kilo	Kilogramme	Kilo	Kilo
KH	Kelsey Hayes	Kelsey Hayes	Kelsey Hayes	Kelsey Hayes	Kelsey Hayes
Kno	Knorr	Knorr	Knorr	Knorr	Knorr
kW	Kilowatt	Kilowatt	Kilowatt	Kilowatt	Kilovatio
LCS	Sistema controllo d'assetto	Level control system	Correcteur d'assiette	Niveau-Regulierung	Suspension auto regulable en altura
LCV	Veicoli Commerciali	Light commercial (LCV)	Utilitaires légers	Leichte Nutzfahrzeuge	Camionetas
LHD	Guida sinistra	Left hand drive	Conduite à gauche	Linkslenkung	Dirección a la izquierda
Loc	Loockheed	Loockheed	Loockheed	Loockheed	Loockheed
LOS	LOS	LOS (Lucas One Shot)	LOS	LOS	LOS
Lucas	Lucas	Lucas	Lucas	Lucas	Lucas
M/T	Cambio manuale	Manual transmission	Boîte manuelle	man. Schaltgetriebe	Cambio manual
Mando	Mando	Mando	Mando	Mando	Mando
Mer	Meritor	Meritor	Meritor	Meritor	Meritor
Metano	Metano	Methane	Méthane	Methan	Metano
Mit	Mitsubishi	Mitsubishi	Mitsubishi	Mitsubishi	Mitsubishi
Mod.	Modello	Model	Modèle	Model	Modelo
MPB	Freno di stazionamento manuale	Manual parking brake	Frein d'arrêt manuelle	man. Feststellbremse	Freno de detención manual
Nabco	Nabco	Nabco	Nabco	Nabco	Nabco
Optional	Accessori	Optionals	Accessoires	Extraausstattung	Accesorios
Pacchetto sportivo	Pacchetto sportivo	Sports equipment	Kit Sport	Sportpaket	Kit deportivo
Pads	Pastiglie freno	Brake pads	Plaquettes de frein	Bremsbeläge	Pastillas de freno
Perr.	Perrot	Perrot	Perrot	Perrot	Perrot
Piston	Pistone	Piston	Piston	Kolben	Pistón
PS	Servosterzo	Power-steering	Direction assistée	Servolenkung	Servo direccion
Q	Quintale	Quintal	Quintal	Doppelzentner	Quintal
RAD	Registro automatico differenziale	Automatic self-adjustment system	Rattrapage Automatique à dents	Autom. Nachstellung der Bremsbacke	Reajuste automático con dientes
RAI	Registro automatico incrementale	Incremental self-adjustment system	Rattrapage Automatique incremental	Autom. Nachstellung incremental	Reajuste automático incremental
RC	Telaio rinforzato	Reinforced chassis	Châssis renforcé	Verstärkte Chassis	Chasis reforzado
Rear	Posteriore	Rear	Arrière	Hinten	Trasero
RHD	Guida destra	Right hand drive	Conduite à droite	Rechtslenkung	Dirección a la derecha
RWD	Trazione posteriore	Rear wheel drive	Traction ar.	Hinterradantrieb	Traccion trasera
SCS	Sistema di controllo frenata	Brake control system	Système contrôle freinage	Bremssystem-Kontrolle	Sistema de control frenada
Seats	Posti a sedere	Seats	Sièges	Sitzplätze	Asientos
SRW	Ruote posteriori singole	Single rear Wheels	Roues arrière simples	Einzelbereifung (hinten)	Rueda trasera única
Studs	Perno	Stud	Goujon	Gewindestift	Esparrago
Sum	Sumitomo	Sumitomo	Sumitomo	Sumitomo	Sumitomo
SW	Familiare	Station wagon	Break	Kombi	Familiar
t	Tonnellata	Ton	Tonne	Tonne	Tonelada
T.	Turbo	Turbo	Turbo	Turbo	Turbo
T.S.	Twin Spark	Twin Spark	Twin Spark	Twin Spark	Twin Spark
TC	Controllo della Trazione	Traction control system	Antipatinage	Traktions Kontrol	Sistema control estabilidad
TD	Turbodiesel	Turbodiesel	Turbodiesel	Turbodiesel	Turbodiesel
Tokiko	Tokiko	Tokiko	Tokiko	Tokiko	Tokiko
Ton	Tonnellata	Ton	Tonne	Tonne	Tonelada
Truck	Camion	Truck	Camion	Lastkraftwagen	Camión
TRW	Ruote posteriori gemellate	Twin rear wheels	Roues arrière jumelées	Doppelbereifung (hinten)	Rueda trasera doble
Twin caliper	Pinza doppia	Twin caliper	Double étrier	Doppelbremszange	Pinzas doble
VAG	Recupero Automatico	Self-adjustment system	Rattrapage Automatique	Autom. Nachstellung	Reajuste automático
Van	Furgone	Van	Fourgon	Lieferwagen	Furgonetta
VDC	Controllo dinamico del veicolo	Vehicle Dynamic Control	Contrôle dynamique du véhicule	Dynamische Fahrzeugkontrolle	Control dinámico del vehículo
Vent.	Disco Ventilato	Ventilated Disc	Disques Ventilés	Belüftete Scheiben	Discos ventilados
-Vett.	Fino a produz. N.	To production No.	Jusqu'à production N.	Bis Produktion Nr.	Hasta producción N.
Vett.-	Da produz. N.	From production No.	Depuis production N.	Ab Produktion Nr.	Del producción N.
Wab	Wabco	Wabco	Wabco	Wabco	Wabco
Wag	Wagner	Wagner	Wagner	Wagner	Wagner
Wheel	Ruota	Wheel	Roue	Rad	Rueda

MAKE - MODEL	PAGE	MAKE - MODEL	PAGE	MAKE - MODEL	PAGE
ACURA		50 (86) 8/74-7/78	6	3 V (E90) 1/05-	17
CL Coupe 10/96-9/03	1	5000 10/78-9/87	6	3 V Cabrio (E93) 3/07-	17
Legend III 8/96-	1	80 I (80, 82, B1) 5/72-8/78	6	3 V Coupe (E92) 9/06-	17
RL 1/96-1/98	1	80 II (81, 85, B2) 8/78-12/86	7	3 V Touring (E91) 1/05-	17
AIXAM		80 III (89, 89Q, 8A, B3) 8/86-7/92	8	5 I (E12) 8/72-8/81	18
A.721 1/05-	1	80 IV (8C, B4), Avant 9/91-1/96	9	5 II (E28) 6/81-6/90	18
A.741 1/05-	1	90 I (81, 85, B2) 10/84-3/87	9	5 III (E34) 1/88-9/95	18
A.751 1/05-	1	90 II (89, 89Q, 8A, B3) 4/87-9/91	10	5 III Touring (E34) 11/91-1/97	18
Berline, Mini van , Pick Up 1/96-	1	A2 (8Z0) 2/00-	10	5 IV (E39) 11/95-7/03	18
ALFA ROMEO		Coupe I (81, 85) 7/80-10/88	10	5 IV Touring (E39) 11/95-7/03	19
145, 146 (930) 7/94-1/01	1	Fox 1/75-1/79	11	5 V (E60) 7/03-7/09	19
1750-2000 3/68-12/83	1	Q7 (4L) 3/06-	11	5 V Touring (E61) 7/03-7/09	19
33 I (905,A), Sportwagon 5/83-12/89	1	AUTOBIANCHI		6 I (E24) 4/76-9/90	19
33 II (907A,B), Sportwagon 1/90-9/94	2	A112 10/69-12/85	11	6 II (E63, E64), Cabrio 1/04-1/11	19
Alfasud (901) 6/72-12/84	3	Y10 3/85-	11	7 I (E23) 5/77-8/86	20
Alfasud Sprint (902.A) 9/76-12/89	3	Y10 (RES. 1992) 6/92-	11	7 II (E32) 9/86-9/94	20
Alfetta (116) 1/74-1/86	3	AUVERLAND		7 III (E38) 10/94-11/01	20
Arna (920) 3/83-12/86	3	A3 4/87-	11	7 IV (E65, E66) 11/01-12/08	20
Giulia 6/64-12/78	3	BEDFORD		8 (E31) 4/90-12/99	20
Giulietta II (116) 10/77-12/85	3	Astra Van 1/82-1/92	12	X1 (E84) 9/09-	20
GT (105-115) 3/63-12/77	3	AstraMax Van 1/85-1/90	12	X3 (E83) 1/04-9/10	20
Montreal 12/72-3/79	3	Blitz (CF97) 8/69-10/87	12	X5 (E53) 5/00-12/06	20
Spider (105) 3/66-12/77	3	Brava	12	X5 (E70) 2/07-	20
ALFA ROMEO LCV		CF2 Van	12	X6 (E71) 3/08-	21
AR 6 (280) 1/82-8/90	4	Chevanne 1/76-12/82	12	Z1 6/88-6/91	21
AR 8 (280) 4/78-12/89	4	Euromidi	12	Z3 (E36) 10/95-1/03	21
AR 8 (280) Van 4/78-12/89	4	HA Van	12	Z4 I (E85, 86) 2/03-2/09	21
ALPINA		Midi	12	Z8 (E36) 6/00-6/03	21
B6 (E21) 3/78-3/83	4	Midi Van 1/87-12/92	12	CARBODIES	
Roadster (Z8) 6/02-	4	Pick-Up	12	Fx Fairway 1/87-	21
AMERICAN MOTORS		Rascal 7/86-6/90	13	Fx4 1/59-12/89	21
Concord	4	Serie KB Pick-up 1/79-12/89	13	Fx4s 1/86-12/89	21
Eagle - Sx4	4	BELLIER		CASALINI	
Gremlin	4	Asso 1/98-	13	Sulky 1/00-	21
Hornet	4	Divane 1/98-	13	Ydea 1/00-	21
Matador	4	BERTONE		CHATENET	
Pacer	4	Freeclimber 1/92-12/00	13	Barooder 1/98-	21
Spirit	4	BMW		Media 1/98-	21
ARO		02 (E10) 9/67-7/77	13	Speedino 1/98-	21
10 6/80-	4	1 (E81,87) 9/04-	13	CHEVROLET	
240-244 4/78-	5	1 (E82) Coupe 9/07-	13	Aveo I 5/05-4/08	21
ASIA MOTORS		1 (E88) Cabrio 11/07-	13	Camaro coupé, cabrio 1/11-	21
Hi-Topic 1/93-	5	1500-2000 10/62-7/72	13	Captiva (C100, 140) 6/06-	21
Rocsta 1/93-	5	2000 3.2 Coupe (E9) 10/65-3/76	14	Cruze 5/09-	22
AUDI		2500 3.3 (E3) 10/68-4/77	14	Epica 1/05-	22
100 II (43, C2), Avant 6/76-7/83	5	3 I (E21) 6/75-3/84	14	Joy 3/05-	22
100 III (44, 44Q, C3), Avant 8/82-7/91	5	3 II (E30) 9/82-10/93	14	Kalos 3/05-	22
100 IV (4A, C4), Avant 12/90-6/94	6	3 II Touring (E30) 7/87-6/94	15	Lacetti 3/05-	22
4000 10/78-9/87	6	3 III (E36) 9/90-2/98	15	Matiz 3/05-	22
AUTOBIANCHI		3 III Cabrio, Coupe (E36) 3/92-4/99	16	Nubira, SW 3/05-	22
AUVERLAND		3 III Compact (E36) 3/94-8/00	16	Rezzo 3/05-	22
BEDFORD		3 III Touring (E36) 1/95-10/99	16	Spark I 3/05-2/10	22
BELLIER		3 IV (E46) 2/98-12/04	16	Tacuma 1/05-	22
BERTONE		3 IV Cabrio, Coupe (E46) 4/99-12/04	16	Vivant 5/00-	22
BMW		3 IV Compact (E46) 6/01-12/04	17	CHRYSLER	
BUICK		3 IV Touring (E46) 10/99-12/04	17	300 C, Touring 9/04-	22
CADILLAC		CARBODIES		300 M (LR) 7/98-	23
CHRYSLER		CASALINI		Cirrus 5/94-9/00	23
CITROEN		CHATENET		Concorde I 10/92-9/97	23
DAEWOO		CHEVROLET		CHRYSLER	
DAEWOO		CHEVROLET		CHRYSLER	

MAKE - MODEL	PAGE	MAKE - MODEL	PAGE	MAKE - MODEL	PAGE
Concorde II 10/97-9/03.....	23	1310, SW 5/83-.....	38	DAIHATSU LCV	
Crossfire, Roadster 7/03-.....	23	1410 9/88-.....	38	Hijet II (U60) 1/92-..... 43	
Grand Voyager I 1/91-1/95.....	23	Logan, MCV 9/04-.....	38	DAIMLER	
Grand Voyager II 1/96-4/08.....	23	Sandero, Stepway 6/08-.....	39	Daimler (X300) 9/94-..... 44	
LHS I 1/94-12/97.....	23	DAEWOO		DALLAS	
LHS II 1/99-12/01.....	23	Aranos 1/95-11/97.....	39	Fun 1/94-..... 44	
Neon I (PL) 5/94-8/99.....	23	Cielo 2/95-.....	39	DODGE	
Neon II 8/99-.....	23	Espero (KLEJ) 10/91-9/99.....	39	Avenger 6/07-..... 44	
PT Cruiser 6/00-.....	23	Kalos (KLAS) 9/02-.....	39	Caliber 6/06-..... 44	
Sebring I (FJ) Coupe 5/95-9/00.....	24	Korando, Cabrio (KJ) 1/99-.....	39	Caravan..... 44	
Sebring II (JR), Cabrio 4/01-6/07.....	24	Lacetti (KLAN) 2/04-.....	39	Charger..... 44	
Sebring III 7/07-.....	24	Lanos (KLAT) 5/97-.....	39	Magnum..... 44	
Stratus (JA) 12/95-.....	24	Le Mans 1/90-.....	40	Mini Rma Van..... 44	
Voyager I (ES) 8/84-9/95.....	24	Leganza (KLAV) 6/97-12/02.....	40	Neon..... 44	
Voyager II (GS) 1/95-3/01.....	24	Matiz (KLYA) 9/98-.....	40	Nitro 6/07-..... 44	
Voyager III (RG) 2/00-12/07.....	24	Musso (FJ) 1/99-.....	40	Sprinter III 1/06-..... 44	
Voyager IV 1/08-.....	25	Nexia (KLETN) 2/95-.....	40	DODGE TRUCK	
CHRYSLER USA		Nubira (KLAJ), SW 5/97-.....	40	Dakota..... 44	
GS Daytona Shelby 10/87-10/92.....	25	Rexton 4/02-.....	40	Raider..... 44	
Le Baron.....	25	Rezzo 1/00-.....	40	Ram 1500 - 2500..... 44	
Le Baron GTS.....	25	Tacuma (KLAU) 9/00-.....	40	EAGLE	
Town & Country I 1/90-12/95.....	25	Tico (KLY3) 2/95-.....	41	Medallion 1/88-..... 44	
Town & Country II 10/00-8/07.....	25	DAEWOO LCV		Summit 1/88-12/95..... 44	
Voyager.....	25	Matiz Van 1/98-.....	41	ENASA	
CITROËN		DAF		Sava 9/77-..... 45	
2 CV 3/63-.....	25	33 7/67-9/74.....	41	FIAT	
Ax (ZA) 7/84-12/98.....	25	46, Kombi 9/74-8/75.....	41	126 9/72-9/00..... 45	
Berlingo I (MF) 7/96-5/08.....	27	600 1/59-12/63.....	41	127 6/71-12/86..... 45	
C1 (PM, PN) 6/05-.....	27	66 10/72-9/75.....	41	128 3/69-12/84..... 45	
C2 (JM) 9/03-.....	28	Daffodil 1/62-12/65.....	41	131 10/74-12/84..... 45	
C3 I (FC) 2/02-10/09.....	28	Serie 400 Van.....	41	132 4/72-12/82..... 46	
C3 I Pluriel (HB) 5/03-10/09.....	28	DAIHATSU		147 / Spazio 10/76-12/95..... 46	
C-Crosser (EP) 8/07-.....	28	Applause I 6/89-7/97.....	41	500 1/57-1/76..... 46	
Dyane 8/67-10/84.....	29	Applause II 7/97-.....	41	500 II (150) 7/07-..... 46	
Evasion (22,U6) 6/94-7/02.....	29	Charade I (G10) 10/77-2/83.....	41	600 3/55-2/72..... 46	
LN 9/76-7/79.....	29	Charade III (G100, G101, G102) 3/87-1/93.....	41	850 7/64-12/72..... 47	
LNA 11/76-10/86.....	29	Charade IV (G200, G202) 1/93-4/01.....	42	900 T/E 1/78-1/86..... 47	
Saxo (S0,S1) 5/96-.....	29	Charmant (A) 11/81-7/87.....	42	Albea 1/03-12/05..... 47	
Visa 9/78-3/91.....	30	Copen 9/03-.....	42	Argenta (132A) 6/78-7/86..... 47	
Xsara (N1/0), Coupe 4/97-.....	31	Cuore II / Mira II (L80, L81) 9/85-12/90.....	42	Brava, Bravo (182) 10/95-10/01..... 47	
Xsara (N2) Break 4/97-.....	32	Cuore III / Mira III (L201) 10/90-12/94.....	42	Cinquecento (170) 7/91-1/98..... 48	
Xsara Picasso (N68) 2/00-.....	33	Cuore IV (L501) 1/95-11/96.....	42	Doblo I (223) 3/01-4/05..... 48	
ZX (N2) 3/91-6/97.....	33	Cuore V (L5) 11/96-10/98.....	42	Doblo II (119) 5/05-12/09..... 48	
ZX (N2) Break 3/91-6/97.....	34	Cuore VI 10/98-5/03.....	42	Doblo III (152) 1/10-..... 49	
CITROËN LCV		Cuore VII 5/03-9/07.....	42	Duna (146 B), Weekend 1/87-12/91..... 49	
Berlingo I Van (M) 7/96-5/08.....	34	Cuore VIII 10/07-.....	42	Grande Punto IV (199) 9/05-..... 49	
C15 (VD), Van 10/84-.....	35	Domino.....	42	Idea (135) 1/04-..... 49	
C2 Van (JM) 9/03-.....	35	Feroza (F300) 10/88-.....	42	Linea (323) 6/07-..... 50	
C22 1/81-8/84.....	35	Fourtrack 1/84-.....	42	Marea (185) 9/96-..... 50	
C25 (280, 290) 9/81-2/94.....	35	Gran Move (G3) 10/96-.....	42	Marea (185) Weekend 9/96-..... 50	
C3 Van 2/03-10/09.....	36	Materia 1/07-.....	42		
Dispatch 1/94-12/00.....	36	Move (L6, L9) 10/96-.....	42		
Jumper I (230)/ Relay 3/94-4/02.....	36	Rocky (F7, F8) 4/84-.....	43		
Jumper II (244)/ Relay 4/02-3/06.....	37	Sirion (M1) 4/98-1/05.....	43		
Jumper III 4/06-.....	37	Sirion (M3) 1/05-.....	43		
Jumpy I (U6U) 10/95-12/06.....	37	Sportrak 1/89-.....	43		
Jumpy II/Dispatch 1/07-.....	37	Terios I (J1) 10/97-11/05.....	43		
Nemo (AA) 2/08-.....	38	Terios II (J2) / Bego 11/05-.....	43		
Synergie 1/94-.....	38	Trevis 6/06-.....	43		
DACIA		Wildcat 2/84-.....	43		
1210 1/85-12/94.....	38	YRV (M2) 2/01-.....	43		
1300, SW 12/72-5/83.....	38				

MAKE - MODEL	PAGE	MAKE - MODEL	PAGE	MAKE - MODEL	PAGE
Multipla (186) 4/99-.....	51	Fiesta III (GFJ) 1/89-12/95.....	71	Polonez III 9/92-.....	88
Palio Weekend (178DX) 4/96-.....	51	Fiesta IV (JA, JB) 8/95-1/02.....	73	GEO	
Palio/Siena (178BX) 4/96-.....	51	Fiesta V (JH) 11/01-9/08.....	74	Metro.....	88
Panda I (141A) 10/80-7/04.....	52	Fiesta VI 10/08-.....	74	Prizm.....	88
Panda II (169) 9/03-.....	52	Focus C-Max 10/03-4/08.....	75	Tracker.....	88
Punto I (176,C), Cabrio 9/93-9/99.....	53	Focus I, SW 10/98-10/04.....	75	HONDA	
Punto II (188) 9/99-7/03.....	53	Focus II 11/04-3/08.....	75	Accclaim.....	88
Punto III (188) 10/01-.....	54	Focus II Cabrio 10/06-3/08.....	75	Accord I (SJ, SY, SM, SV, SZ) 1/78-9/83 ...	88
Regata (138) 9/83-12/90.....	54	Focus II SW 11/04-3/08.....	75	Accord II (AC, AD) 9/83-10/85.....	88
Regata Weekend 1/84-12/90.....	54	Fusion (JU) 8/02-.....	76	Accord III (CA4, CA5), Aerode 11/85-12/89	88
Ritmo I (138A) 1/78-12/87.....	55	Granada I (GGTL,FL), SW 1/72-8/77.....	76	Accord IV (CB3, CB7) 1/90-12/93.....	88
Ritmo II (138A) 10/82-12/88.....	55	Granada II (GU), SW 8/77-8/85.....	76	Accord VII (CG) 2/98-1/03.....	89
Sedici (189) 1/06-.....	55	Ka I (RB) 9/96-11/08.....	76	Accord VIII, Tourer (CL, CM) 2/03-6/08.....	89
Seicento (187) 1/98-.....	55	Ka II 12/08-.....	77	Accord IX, Tourer (CU) 7/08-.....	89
Tempra (159) 3/90-8/96.....	55	Maverick I 2/93-4/98.....	77	Ballade 1/81-1/92.....	89
Tempra (159) SW 3/90-8/96.....	56	Maverick II 2/01-.....	77	Capa 4/98-.....	89
Tipo (160) 7/87-8/96.....	57	Mondeo I (GBP), SW 2/93-8/96.....	77	City 1/82-1/90.....	89
Ulysse I (220) 6/94-8/02.....	58	Mondeo II (BAP), SW 9/96-11/00.....	78	Civic I 7/72-12/84.....	89
Ulysse II (179AX) 8/02-.....	58	Mondeo III (B5Y), SW 11/00-4/07.....	78	Civic I Shuttle (AN, AR) 10/83-10/87.....	89
Uno (146A/E) 1/83-.....	58	Orion I (AFD) 7/83-3/86.....	78	Civic II 10/83-10/87.....	89
FIAT LCV		Orion II (AFF) 12/85-7/90.....	78	Civic II Shuttle (EE) 1/88-2/95.....	89
238-Serie 9/66-6/82.....	59	Orion III (GAL) 7/90-12/93.....	79	Civic III (EC, ED, EE) 9/87-9/91.....	89
Cinquecento Van 1/92-.....	59	Puma (EC) 3/97-.....	80	Civic IV (EG) 10/91-11/95.....	90
Doblo Cargo I-II (223) 3/01-12/09.....	59	Ranger II (TU) 10/99-.....	80	Civic IV Coupe (EJ) 1/94-3/96.....	90
Doblo Cargo III (263) 2/10-.....	60	Sierra I, SW 8/82-12/86.....	80	Civic IV Coupe (MA, MB) 9/94-1/97.....	90
Ducato I (280) 1/82-8/90.....	60	Sierra II, SW 1/87-2/93.....	81	Civic V (EJ9, EK1/3/4) 11/95-2/01.....	90
Ducato II (290) 3/89-3/94.....	61	Street Ka 5/03-.....	81	Civic V Aerodeck (MC) 4/98-2/01.....	90
Ducato III (230) 3/94-4/02.....	61	Taunus I (GBFK) 1/70-2/76.....	81	Civic V Coupe (EJ6, EJ8) 3/96-3/00.....	90
Ducato IV (244, Z) 4/02-1/06.....	62	Taunus II (GBTS,GBFS,CBTS) 5/75-7/79... ..	81	Civic V Fastback (MA, MB) 1/97-2/01.....	90
Ducato V (250,251) 2/06-.....	63	Taunus III 80 (GBS, GBNS) 7/79-7/82.....	81	Civic VI 2/01-9/05.....	90
Fiorino I (127) 10/77-12/87.....	63	FORD LCV, TRUCK		Civic VI Hatchback (EU, EP) 2/01-12/05.....	90
Fiorino II (147) 1/86-12/93.....	63	Escort I Van 1/68-1/73.....	82	Civic VII Ibrida 1/06-2/12.....	90
Fiorino III (146) 1/93-12/06.....	63	Escort II Van 1/73-1/81.....	82	Concerto (HW) 8/89-3/95.....	91
Fiorino IV (225) 1/07-.....	64	Escort III Van (AVA) 3/81-2/86.....	82	Cr-v I (RD1, 3) 10/95-6/05.....	91
Idea Van 1/04-.....	64	Escort IV Van (AVF) 2/86-7/90.....	82	Cr-v II (RD8) 7/02-12/06.....	91
Marengo 1/83-.....	64	Escort V Van (AVL) 7/90-12/94.....	82	Cr-v III (RE) 1/07-4/10.....	91
Multipla Van 4/99-.....	64	Escort VI Van (AVL) 1/95-.....	82	Crx I (AF, AS) 10/83-10/87.....	91
Panda Van I (141A) 1/86-8/98.....	64	Fiesta I Van 5/76-8/83.....	83	Crx II (ED, EE) 10/87-2/92.....	91
Panda Van II (271) 9/03-.....	64	Fiesta II Van 3/83-2/89.....	83	Crx III (EH, EG) 3/92-12/98.....	91
Punto Van I (176L) 4/96-2/00.....	64	Fiesta III Van, Courier 3/89-7/95.....	83	Element 7/02-.....	91
Punto Van II (188AX) 2/00-8/05.....	64	Fiesta IV Van, Courier 8/95-8/02.....	83	FR-V (BE) 2/05-.....	91
Qubo IV (300) 1/08-.....	64	Fiesta V Van 11/01-4/08.....	83	HR-V (GH) 3/99-.....	91
Scudo I (220L) 2/96-12/06.....	64	P 100 II 10/87-.....	83	Integra I (DA1,2,4) 10/85-8/89.....	91
Scudo II (272) 1/07-.....	65	Sierra I Van 8/82-12/86.....	83	Jazz I (AA) / Fit 10/83-10/86.....	91
Seicento Van 1/98-.....	65	Sierra II Van 1/87-2/93.....	83	Jazz III (GD)/ Fit 3/02-10/08.....	91
Strada I (178E) 6/99-1/05.....	65	Tourneo (EBS) 1/94-12/00.....	83	Jazz IV (GE)/ Fit 11/08-10/10.....	91
Strada II (178EXG) 2/05-.....	65	Tourneo Connect 9/02-.....	84	Legend III (KA9) 2/96-.....	92
Talento (290) 3/89-3/94.....	65	Transit Connect 9/02-.....	84	Logo (GA3) 3/99-3/02.....	92
Uno Van 1/83-10/95.....	65	Transit II 1/65-9/78.....	84	Odyssey I (RA1,5) 1/95-1/98.....	92
FORD EUROPE		Transit III (V) 11/77-10/86.....	85	Odyssey II (RL, RA6,9) 1/99-12/04.....	92
Anglia 1/59-1/67.....	66	Transit IV (T) 11/85-9/92.....	85	Odyssey III (RB1,2) 7/02-12/08.....	92
Capri I (ECJ) 12/68-2/74.....	66	Transit V (E1) 1/91-9/94.....	85	Passport 1/94-.....	92
Capri II (GECP) 2/74-12/77.....	66	Transit VI (E2) 7/94-6/00.....	86	Prelude I Coupe (SN) 1/78-10/83.....	92
Capri III (GECP) 1/78-4/87.....	66	Transit VII (FA, FD, FM) 1/00-3/06.....	86	Quintet (SU) 2/80-12/84.....	92
Consul (GGCL,FL,NL) 1/72-12/75.....	66	Transit VIII 7/06-.....	87	Shuttle (RA) 10/94-6/02.....	92
Cortina 10/62-3/72.....	66	Transit VIII Tourneo 7/06-.....	87	Stream (RN) 5/01-.....	92
Escort I (AFH,ATH) 1/68-2/76.....	66	FORD USA		HUMMER	
Escort II (ATH) 3/73-7/81.....	67	Explorer (U2) 1/93-.....	87	H2 9/04-.....	92
Escort III (GAA) 9/80-7/86.....	67	Probe I 8/88-7/93.....	87	H3 4/05-.....	92
Escort IV (GAF,AWF,ABFT) 10/85-10/90.....	68	Windstar (A3) 1/95-.....	87	HYUNDAI	
Escort V (GAL) 7/90-12/92.....	69	FSO		Accent I (X-3)/Pony III 10/94-1/00.....	92
Escort VI (GAL) 9/92-1/95.....	69	126P 7/72-9/00.....	87	Accent II (LC)/Verna 1/00-6/06.....	92
Escort VII (GAL,AAL,ABL) 1/95-8/00.....	70	127P 10/69-10/76.....	88		
Escort VIII (AAL,ABL) 10/98-7/00.....	70	Polonez I 10/77-12/91.....	88		
Fiesta I 5/76-8/83.....	71				
Fiesta II (FBD) 9/83-11/89.....	71				

MAKE - MODEL	PAGE	MAKE - MODEL	PAGE	MAKE - MODEL	PAGE
Accent III (MC) 6/06-10/10.....	93	Mark I 1/82-12/91.....	100	Magentis I (GD) 5/01-10/05.....	107
Atos (MX)/ Amica 2/98-.....	93	Midi Bus, Van 1/89-.....	100	Mentor 9/93-.....	107
Atos Prime (MX)/ Amica 8/99-.....	93	Oasis 1/96-12/99.....	100	Optima (GD) 5/01-10/05.....	107
Coupe I (RD)/Tiburon 8/96-4/02.....	93	Pick-Up (TFR-TFS).....	100	Picanto I (BC) 4/04-4/08.....	107
Elantra (XD) 6/00-.....	93	Rodeo 1/88-.....	101	Pride (DA) 1/90-.....	107
Excel I (X1) 1/86-1/90.....	94	Trooper I (UBS) 1/83-12/91.....	101	Pro Ceed (ED) 2/08-.....	107
Excel II (X2) 1/90-5/96.....	94	Trooper I Soft Top (UBS) 1/83-12/91.....	101	Rio I, SW (DC) 8/00-2/05.....	107
Galloper II (JK-01) 8/98-.....	94	Trooper II (UB), Soft Top 8/91-7/98.....	101	Rio II 3/05-9/11.....	107
Genesis 6/11-.....	94	Trooper III, Soft Top 4/00-.....	101	Sephia, Timor (FA) 9/93-.....	107
Getz (TB) 9/02-.....	94	Truck.....	101	Shuma (FB) 3/96-.....	107
Grandeur III (TG) 4/05-6/11.....	95	WFR 11 - 12 - 53 - 62.....	101	Sorento I (JC) 8/02-12/09.....	108
i20 3/09-.....	95			Sorento II (XM) 1/10-.....	108
i30 I, SW 9/07-4/12.....	95	IVECO		Spectra 1/00-12/05.....	108
ix35 (LM) 1/10-.....	95	Daily - Grinta 1/79-12/90.....	101	Sportage I (FM) 4/94-8/04.....	108
ix55 9/08-.....	95	Daily I 1/91-1/99.....	102	Sportage II (FQ) 9/04-6/10.....	108
Lantra I (J-1) 10/90-11/95.....	95	Daily II 2/99-4/06.....	102	Sportage III (SL) 7/10-.....	108
Lantra II (J-2), SW 11/95-9/00.....	95	Daily III 5/06-.....	102		
Matrix (FC) 6/01-.....	95			KIA LCV	
Pony I 6/74-9/89.....	96			Besta Van 2/96-.....	108
Pony II (X-2) 10/89-1/95.....	96	JAGUAR		K2500 1/99-.....	108
S Coupe (SLC) 2/90-5/96.....	96	XJ II (XJ 40,81) 10/86-11/94.....	103	K2700 10/99-.....	108
Santa Fe I (SM) 2/01-2/06.....	96	XJ III (X300) 11/94-6/97.....	103	Pregio (TB) 10/97-.....	108
Santa Fe II (CM) 3/06-12/10.....	96	XJ V 5/03-12/09.....	103		
Santa Fe III 1/11-.....	97	XJR 1/88-.....	103	LADA	
Sonata I (Y-2) 9/88-10/93.....	97	XJS Coupe, Convertible 9/75-3/96.....	103	110 1/95-.....	108
Sonata II (Y-3) 5/93-6/98.....	97	XK 8 (QDV, QEV) 3/96-.....	103	111 1/95-.....	108
Sonata III (EF) 3/98-10/01.....	97			112 1/95-.....	108
Sonata IV 10/01-12/04.....	97	JEEP		1200-1500 9/73-6/85.....	108
Sonata V (NF) 1/05-.....	97	Cherokee I 10/80-9/86.....	103	1200-1600 1/70-1/87.....	109
Starex (H1) 6/97-.....	97	Cherokee II (XJ) 10/84-8/01.....	104	Carlota.....	109
Terracan (HP) 12/01-.....	97	Cherokee III (KJ) 9/01-6/08.....	104	Kalina (1117, 1118, 1119) 10/04-.....	109
Trajat (FO) 3/00-.....	97	Cherokee IV (KK) 7/08-.....	104	Kalinda.....	109
Tucson (JM) 8/04-.....	97	CJ5 - CJ8 1/66-12/87.....	104	Nadeschda (2120) 12/97-.....	109
XG 12/98-.....	98	CJ7 1/82-12/92.....	104	Natasha (2120).....	109
		Comanche 10/86-9/96.....	104	Niva I (2121) 12/76-.....	109
HYUNDAI LCV		Comancho 9/05-.....	104	Nova (2105, 2108, 2109) 5/81-.....	109
Grace Bus 7/93-10/04.....	98	Compass 9/06-.....	104	Riva.....	109
H-1 Van, Starex 10/97-.....	98	Grand Cherokee I (Z) 9/91-4/99.....	104	Sagona.....	109
H100 Bus (P) 7/93-3/00.....	98	Grand Cherokee II (WJ, WG) 4/99-5/05.....	105	Samara, Forma (2108, 2109) 1/88-.....	109
H200 Bus (KMF) 10/97-.....	98	Grand Cherokee III (WH) 6/05-6/08.....	105	Signet.....	110
Highway Van 3/00-.....	98	Grand Cherokee IV (WK) 7/08-.....	105	Tavria.....	110
Porter 7/94-4/04.....	98	Liberty I (KJ) 9/01-12/07.....	105	Toscana.....	110
		Liberty II 1/08-.....	105		
INFINITI		Patriot 11/07-.....	105	LANCIA	
FX 1/03-.....	98	Wagoneer 1/85-1/89.....	105	Dedra (835) 4/89-7/99.....	110
M II 1/05-8/10.....	99	Wrangler I (YJ) 8/86-8/96.....	105	Delta I (831AB0) 9/79-1/94.....	110
QX4 1/97-.....	99	Wrangler II (TJ) 8/96-4/07.....	105	Delta II (836) 6/93-8/99.....	110
		Wrangler III (JK) 5/07-.....	105	Musa I (184) 10/04-11/10.....	110
INNOCENTI		Cherokee.....	106	Prisma (831AB0) 12/82-2/92.....	111
Elba (146) 4/86-.....	99	Comanche.....	106	Y (840A) 11/95-10/03.....	111
Koral 1/90-12/92.....	99	Grand Cherokee.....	106	Y10 (156) 3/85-12/95.....	111
Mille 1/94-.....	99	Renegade.....	106	Ypsilon I (843) 10/03-.....	111
Mini I 1/69-1/77.....	99	Wagoneer - Grand Wagoneer.....	106	Zeta (220) 5/95-9/02.....	112
Mini II 1/77-10/85.....	99	Wrangler.....	106		
Mini III 10/85-10/91.....	99			LAND ROVER	
Regent 1/74-12/75.....	99	KIA		109 9/63-12/86.....	112
		Carens I 11/00-7/02.....	106	110 9/83-7/90.....	112
ISUZU		Carens II 7/02-8/06.....	106	88 9/63-12/86.....	112
Amigo 1/89-.....	99	Carens III 9/06-12/09.....	106	90 9/83-7/90.....	113
Aska 1/83-.....	100	Carnival I (UP) 8/99-10/01.....	106	Defender I (LD) 110 9/90-.....	113
Axiom 1/02-12/04.....	100	Carnival II/ Sedona (GQ) 10/01-5/06.....	106	Defender I (LD) 130 9/90-.....	113
Campo 4/77-12/91.....	100	Carnival III/ Sedona (UVP) 6/06-.....	106	Defender I (LD) 90 9/90-4/07.....	113
D-Max/Wizard 5/02-.....	100	Ceed I, SW (ED) 3/07-.....	106	Discovery I 9/89-6/94.....	113
Euromidi.....	100	Cerato (CD) 4/04-.....	106	Discovery II (LJ, LT) 6/94-9/04.....	113
Fargo 1/81-12/94.....	100	Ceres 6/92-1/97.....	107	Discovery III (TAA) 10/04-7/09.....	113
Faster 1/81-12/87.....	100	Clarus (K9A), SW 7/96-.....	107	Freelander I (LN) 2/98-2/06.....	113
		K2500 1/03-.....	107		











































MAKE - MODEL	PAGE	MAKE - MODEL	PAGE	MAKE - MODEL	PAGE
Freelander II (FA) 2/06-	114	CX-7 8/07-	118	CLK I (C208) 6/97-6/02.....	132
Range Rover I 7/70-7/94	114	CX-9 1/07-	119	CLK I Cabrio (A208) 3/98-5/02	132
Range Rover II (LP) 7/94-3/02.....	114	Demio (DW) 8/98-.....	119	CLK II (C209) 6/02-.....	132
Range Rover III (LM) 3/02-.....	114	MPV I (LV) 1/89-9/99.....	119	CLK II Cabrio (A209) 2/03-	133
Range Rover Sport I (LS) 2/05-.....	114	MPV II (LW) 9/99-.....	119	CLS (C219) 10/04-12/10.....	133
LDV		MX-3 (EC) 7/91-.....	119	Coupe III (C124) 3/87-3/89.....	133
Convoy.....	114	MX-5 I (NA) 5/90-4/98.....	119	Coupe IV (C124) 3/89-5/93.....	133
Maxus 2/05-7/07.....	114	MX-6 (GD) 1/88-1/92.....	119	Heckflosse (W110) 1/55-12/68	133
Serie 400 1/89-.....	114	MX-6 (GE6) 2/92-12/97	119	SL (R198) 5/57-2/63.....	133
Sherpa II 1/83-3/89.....	114	Premacy (CP) 7/99-.....	119	SL I (R107) 5/71-8/89	133
LEXUS		Protege 1/90-1/92.....	119	SL I Coupe (C107) 1/72-9/81.....	133
ES I (F1, F2) 12/89-1/01	114	R100 1/68-12/73.....	119	SL II (R129) 3/89-10/01	133
ES II (VZV_) 8/01-10/06	114	RX 7 I (SA) 5/79-3/86	119	SL III (R230) 10/01-2/12.....	134
GS I (JZS147) 3/93-8/97.....	115	Tribute (EP) 3/00-.....	119	SLK I (R170) 9/96-2/04.....	134
GS II (JZS160) 8/97-.....	115	MAZDA LCV		SLK II (R171) 3/04-.....	134
GS III (GRS) 4/05-.....	115	B-Serie I (PE) 2/77-1/82	119	T-Model I (W123) 1/76-12/85.....	134
GX I (J12) 11/01-11/09	115	B-Serie I Rotary 1/71-2/77	120	T-Model I SW (S123) 9/77-12/85.....	134
IS I (GXE10), Sportcross 4/99-9/05.....	115	B-Serie II (UD) 10/81-8/85.....	120	T-Model II (W124) 12/84-6/93.....	134
IS II (XE2) 10/05-.....	115	B-Serie III (UF) 1/85-6/99	120	T-Model II SW (S124) 9/85-9/89.....	135
LS II (UCF20) 12/94-	115	B-Serie IV (UN) 2/99-.....	120	T-Model III SW (S124) 9/89-6/93.....	135
LS III (FE) 10/00-.....	115	E-Serie I (SR1) 1/71-6/84	120	Vaneo (W414) 2/02-.....	136
LX II (UZJ) 1/98-12/06	115	E-Serie II (SR2) 5/84-.....	120	Viano (W639) 9/03-.....	136
LX III (URJ) 1/08-.....	115	MEGA		MERCEDES BENZ LCV, TRUCK	
RX II (MCU) 5/03-5/09.....	115	Club I 1/92-6/99	120	200-300 (BM460) 2/79-.....	136
SC I 1/92-7/01.....	115	Tjaffer 1/92-6/99	121	MB100 (631) 2/88-12/94.....	136
SC II 8/01-.....	115	MERCEDES BENZ		Sprinter I 2-T (901, 902) 2/95-5/06	136
LIGIER		190 II (W201) 10/82-8/93.....	121	Sprinter I 3-T (903) 2/95-5/06	136
Ambra 12/96-.....	115	CL (216) 9/06-.....	121	Sprinter I 4-T (904) 2/96-5/06	136
Be Up 8/02-.....	115	Classe A I (W168) 7/97-8/04	121	Sprinter II 3,5-T (906) 6/06-.....	137
Nova 8/02-.....	115	Classe A II (W169) 9/04-.....	122	Sprinter II 3-T (906) 6/06-.....	137
LOTUS		Classe B I (W245) 3/05-9/11	122	Sprinter II 4,6-T (906) 6/06-.....	137
Europa I 10/66-4/76.....	116	Classe C I (W202) 3/93-5/00	122	Sprinter II 5-T (906) 6/06-.....	137
SuperSeven 1/58-12/68.....	116	Classe C I SW (S202) 6/96-3/01	123	Trasporter (BM601) 5/77-1/95	137
MARUTI		Classe C II (W203) 5/00-12/06	123	Trasporter (BM602) 5/77-1/95	137
Gipsy 4/88-8/98	116	Classe C II SportCou (CL203) 3/01-12/06	124	Vario 9/96-.....	137
Udyog 1/90-12/94	116	Classe C II SW (S203) 3/01-12/06	124	Vito I (638) 3/97-8/03.....	138
MAZDA		Classe C III (W204) 1/07-.....	124	Vito II (639) 9/03-.....	138
1000 1/75-1/77.....	116	Classe C III SW (S204) 1/08-.....	125	MITSUBISHI	
121 I (DA) 10/87-10/90	116	Classe E I (W124) 6/93-6/95	125	3000 GT (Z16A) 6/92-.....	138
121 II (DB) 11/90-3/96	116	Classe E I Cabrio (A124) 6/93-3/98	126	Airtrek 3/03-2/07	138
121 III (JASM, JBSM) 3/96-.....	116	Classe E I Coupe (C124) 6/93-6/97	126	Carisma (DA) 7/95-.....	138
1300 1/75-1/77.....	116	Classe E I SW (S124) 6/93-6/96	126	Colt II (C1A)/ Champ 2/84-4/88	139
2 I (DY) 4/03-7/07	116	Classe E II (W210) 6/95-3/02	126	Colt III (C5A) 4/88-5/92.....	139
2 II (DE) 8/07-.....	116	Classe E II SW (S210) 6/95-3/02	126	Colt IV (CAA) 4/92-4/96.....	139
323 I (FA), SW 1/77-5/86.....	117	Classe E II SW (S210) 6/96-3/03.....	127	Colt V (CJA) 11/95-6/04.....	139
323 II (BD) 9/80-10/89	117	Classe E III (W211) 3/02-2/09	127	Colt VI (CZ) 6/04-2/09.....	139
323 III (BF, BW) 8/85-10/95.....	117	Classe E III SW (S211) 3/03-2/09.....	128	Cordia (A21A) 10/82-12/86.....	139
323 IV (BG) 6/89-10/94.....	117	Classe G (W460) 3/79-7/93.....	128	Debonair II (S11) 1/86-12/92	139
323 V (BA) 8/94-9/98.....	117	Classe G (W461) 2/90-.....	129	Eclipse II (D3) 12/95-4/99.....	140
323 VI (BJ) 9/98-.....	118	Classe G (W463) 9/89-.....	129	Eclipse IV 4/05-.....	140
618 I-II 1/70-12/78	118	Classe G Cabrio (W463) 9/89-.....	129	Expo 10/91-8/99	140
626 I (CB) 5/79-5/82	118	Classe GL (X164) 9/06-.....	129	Galant III (E1A) 6/84-12/87	140
626 II (GC) 11/82-9/87	118	Classe GLK (X204) 9/08-.....	129	Galant IV (E3A) 11/87-10/92	140
626 III (GD, GV), SW 6/87-9/97	118	Classe M I (W163) 2/98-6/05.....	129	Galant V (E5A, E7A, E8A) 11/92-8/96.....	140
626 V (GF, GW), SW 5/97-.....	118	Classe M II (W164) 7/05-.....	129	Galant VI (EA), SW 9/96-9/03.....	140
		Classe R (W251) 1/06-.....	130	Gallant VII (ED, EF) 10/03-.....	140
		Classe S I (W108, W109) 1/66-8/72	130	Galloper 2/99-.....	140
		Classe S II (W116) 8/72-7/80	130	Grandis II (NA) 4/04-.....	141
		Classe S IV (W140) 2/91-10/98	130	L200 II (KT) 11/86-8/96.....	141
		Classe S IV Coupe (C140) 9/92-2/99	130	L200 III 6/96-5/06.....	141
		Classe S V (W220) 10/98-9/05	130	L200 IV (KA, KB) 5/06-.....	141
		Classe S V Coupe (C215) 3/99-9/05	131	Lancer III (C1A, C6A)/ Mirage 11/83-6/92	141
		Classe S VI (W221) 10/05-.....	131	Lancer III (C1V, C3V) SW/ 1/84-6/92	141
		Classe S VI Coupe (C216) 5/06-.....	132	Lancer IV (C6A, C7A)/ Mirage 4/88-5/94... ..	141
				Lancer V (CB/DA) SW 6/92-11/95	142
				Lancer V (CB/DA), Coupe 6/92-11/95	142
				Lancer VI (CK/PA) coupe 12/95-12/07	142



























MAKE - MODEL	PAGE	MAKE - MODEL	PAGE	MAKE - MODEL	PAGE
Lancer VII, SportBack (CX/CY) 1/08-	142	NX 1/91-12/93.....	148	Agila A 9/00-12/07	156
Outlander I (CU) 5/03-2/07	142	Pathfinder I (WD21) 9/82-2/98.....	148	Agila B 1/08-	157
Outlander II (CW) 11/06-	142	Pathfinder II (R50) 9/97-2/05	149	Antara (L07) 5/06-.....	157
Pajero I (L04G, L14G) 12/82-12/91	142	Pathfinder III (R51) 3/05-.....	149	Ascona A 10/70-8/75	157
Pajero II (V2W, V4W) 12/90-4/00	142	Patrol I (W/K160) SW / Safari 11/79-11/95	149	Ascona B / Cavalier I 9/75-8/81	157
Pajero III (V60) 4/00-1/07	143	Patrol I (W/K260) / Safari 10/84-4/98.....	149	Ascona C / Cavalier II 9/81-8/88	157
Pajero Pinin (H6W, H7W) 10/99-.....	143	Patrol I (Y60) Gr / Safari 9/82-6/97	149	Astra D, SW 9/79-8/91	158
Pajero Sport (K90) 11/98-.....	143	Patrol II (Y61) Gr / Safari 6/97-.....	149	Astra F Classic, SW 1/98-3/04.....	158
Precis 1/83-1/94.....	143	Pixo 6/09-.....	149	Astra F, SW 9/91-9/98	158
Santamo 5/99-.....	143	Prairie (M10, NM10) 7/83-9/88	149	Astra G, SW 9/98-3/04	160
Sigma III (F16A) 12/90-7/96	143	Prairie Pro (M11) 10/88-7/94	150	Astra H Cabriolet 9/05-11/09	161
Space Gear (PA/B/DV/W) 5/95-.....	143	Primera I (P10) 6/90-6/96	150	Astra H, SW, GTC 3/04-11/09	161
Space Runner I (N1W, N2W) 10/91-8/99 ..	143	Primera I (W10) SW/ Avenir 7/90-3/98	150	Calibra A 6/90-7/97	161
Space Runner II (N50) 8/99-.....	143	Primera II (P11) 9/96-2/02	150	Chevanne 1/76-1/82	161
Space Star (DG0) 6/98-.....	143	Primera II (WP11) SW 4/98-2/02	150	Commodore B, Coupe / Viceroy I /72-7/78 ..	161
Space Wagon I (D0V/W) 1/83-4/91	144	Pulsar I/ Langley 8/78-12/83.....	150	Commodore C, SW / Viceroy II 8/78-12/82 ..	162
Space Wagon II (N3W, N4W) 10/91-10/98 ..	144	Pulsar II/ Langley 1/82-12/86.....	150	Corsa A / Nova 9/82-3/93	162
Space Wagon III (N5W) 10/98-.....	144	Qashqai (J10) 2/07-.....	150	Corsa B / Corsa 3/93-9/00	163
Tredia (A21) 9/82-10/87.....	144	Sentra II (B11), SW 3/82-9/87	150	Corsa C / Corsa II 9/00-6/06.....	164
MITSUBISHI LCV		Sentra III (N13, B12) 6/86-10/91.....	150	Corsa D 7/06-	165
L300 I (L03P/G, L02P) 5/78-2/87.....	144	Sentra IV (N14, B13) 10/90-6/95	151	Diplomat A 10/64-3/69	165
L300 II (P0W, P1W, P2W) 11/86-4/94.....	144	Sentra VII (B16) 9/06-.....	151	Diplomat B 3/69-1/78	165
L400 (PAOV) 6/96-.....	144	Serena (C23M) 11/92-.....	151	Frontera A / Frontera 3/92-10/98.....	165
MORGAN		Silvia I (S110) 1/76-5/83	151	Frontera B / Frontera II 10/98-.....	165
Plus Four 1/85-.....	145	Silvia II (S12) 4/84-9/88	151	GT 9/68-8/73.....	166
NISSAN		Skyline 1/72-1/93.....	151	Kadett A, SW 9/62-8/65.....	166
100 NX (B13) 3/90-10/94.....	145	Stanza I 7/77-1/83	151	Kadett B, SW / Chevette B 9/65-8/73	166
200 SX (S11) 1/77-12/84	145	Stanza II (T11) 8/81-12/85.....	151	Kadett C, SW / Chevette C 8/73-7/79.....	166
350 Z (Z33) 10/03-.....	145	Stanza III (T12)/ Auster 1/86-12/90	151	Kadett D, SW / Astra D 8/79-8/84.....	166
Almera I (N15) 9/95-7/00	145	Sunny (140Y, 150Y) 1/70-2/82	151	Kadett E / Astra E, Belmont 9/84-8/91	168
Almera II (N16) 7/00-	145	Sunny I (B) 1/71-2/82.....	151	Kadett E Cabrio 9/84-8/91	170
Altima I (L30) 6/93-9/01	145	Sunny II (B11), SW 3/82-9/87.....	152	Kadett E SW 9/84-8/91	170
Altima II (L31) 1/02-.....	145	Sunny III (N13, B12) 6/86-10/91	152	Manta A 9/70-8/75	172
Avia 1/80-.....	145	Sunny IV (N14) 10/90-6/95.....	152	Manta B / Cavalier Coupe 9/75-8/88	172
Axxess 1/89-1/91.....	145	Sunny IV (Y10) 10/90-6/95.....	152	Midi II 6/88-	172
Bluebird (610) 7/74-11/79	145	Terrano I (WD21) 10/87-2/96.....	152	Monza A / Royal - Coupe 2/78-8/86	172
Bluebird (710) 7/74-1/77	145	Terrano II (R20) 2/93-.....	152	Olympia A 8/67-8/71	173
Bluebird (810) 1/76-1/83.....	145	Tiida (C11X)/ Versa 9/07-	153	Omega A, SW / Carlton III 9/86-3/94	173
Bluebird (910) 1/80-5/84.....	146	Trade 1/86-.....	153	Omega B, SW / Omega 3/94-7/03.....	173
Bluebird (T72, T12) 12/85-6/91.....	146	Violet 1/73-1/81.....	153	Rekord B 8/65-2/67.....	173
Bluebird (U11/ WU11) 11/83-12/90	146	X-Trail I (T30) 7/01-6/07	153	Rekord C, SW 8/66-12/71.....	173
Cedric 1/68-1/87	146	X-Trail II (T31) 7/07-	153	Rekord D, SW / Carlton I 1/72-8/77	173
Cherry III (N12) 5/82-12/86.....	146	NISSAN LCV		Rekord E, SW / Carlton II 8/77-8/86	174
Cherry IV (N13) 12/86-12/90	146	Atlas (E22, 23) 1/82-9/93.....	153	Sintra 11/96-4/99	174
Cube (Z12) 3/10-	146	Cabstar II (10Q) 1/82-12/87.....	153	Tigra A 7/94-12/00.....	174
Ebro 1/76-.....	146	Cabstar II (15Q) 1/82-12/90	153	Tigra B Twintop 6/04-	174
Fairlady 1/70-12/80.....	147	Cabstar III 1/82-12/98.....	153	Vectra A (86, 87) / Cavalier III 9/88-11/95 ..	174
Juke 8/10-.....	147	Cabstar IV (E) 1/98-9/06.....	153	Vectra B, SW / Vectra 10/95-4/02.....	175
Laurel (HLC230) 3/72-5/83.....	147	Cabstar V 10/06-.....	154	Zafira A 4/99-10/05	176
Laurel (JC31) 1/81-12/85.....	147	Interstar (X70) 7/02-.....	154	OPEL LCV	
Laurel (JC32) 1/85-12/89.....	147	Kubistar (X76) 8/03-.....	154	Arena 3/98-8/01.....	176
Leaf 11/10-.....	147	Pick-Up 1/65-12/79.....	154	Astra F Van (55) 10/91-1/99	176
Leopard (F30) 1/79-12/86.....	147	Pick-Up (720) 1/80-3/86.....	154	Astra G Van (F70) 1/99-2/04	177
Maxima 1/81-12/84	147	Pick-Up/King Cab (D21) 9/85-2/98	155	Astra H Van 3/04-11/09	177
Maxima (J30) 10/88-6/94.....	147	Pick-Up/King Cab (D22) 2/98-	155	Campo (TF) / Brava Pick-up 8/87-.....	177
Maxima Qx (A34) 1/04-12/08.....	147	Urvan I (E23) 7/81-11/88	155	Combo I (71) 7/94-10/01.....	177
Micra I (K10) 12/82-7/92	147	Urvan II (E24) 5/87-.....	156	Combo II 10/01-.....	177
Micra II (K11) 8/92-2/03.....	147	Vanette I (C12) 1/83-12/87	156	Corsa A Van / Nova Van 2/86-1/94	178
Micra III (K12) 1/03-11/10	148	Vanette II (C22) 10/86-12/95	156	Corsa B Van (73) / Corsa Van 8/99-9/00... ..	178
Micra III Cabrio 8/05-11/10	148	Vanette III Cargo (HC23) 1/95-.....	156	Corsa C Van (F08, W5L) 9/00-6/06.....	178
Murano I (Z50) 3/05-10/08.....	148	NSU		Corsa D Van 7/06-.....	179
Navara II (D40) 7/05-.....	148	RO 80 10/67-7/77	156	Kadett E Van / Astra E Van 8/84-7/94	179
Note (E11E) 3/06-.....	148	OPEL		Movano I 7/98-6/10.....	179
		Admiral B 3/69-1/78	156	PEUGEOT	
				1007 (KM) 4/05-.....	179
				104 10/72-6/88.....	180
				106 I (1A, 1C) 9/91-4/96	180

























































MAKE - MODEL	PAGE	MAKE - MODEL	PAGE	MAKE - MODEL	PAGE
106 II (1) 5/96-.....	181	PROTON		RENAULT LCV, TRUCK	
107 6/05-.....	182	Persona 300 3/96-.....	202	B 9/87-10/92.....	227
204 10/65-10/77.....	182	Persona 400 1/94-.....	202	Clio Van I (S57) 1/91-9/98.....	227
205 I (741A/C/B) 2/83-10/87.....	182	Saga.....	202	Clio Van II (SB0) 9/98-5/05.....	228
205 II (20A/C) 1/87-9/98.....	184	Wira 8/00-.....	203	Extra 1/86-1/98.....	228
206 (2A/C), SW 9/98-3/06.....	186	RELIANT		Kangoo I (FC0) Van 3/98-1/08.....	228
207, SW (WA, WC, WD, WK) 4/06-.....	187	RELIANT		Mascott 1/99-.....	229
304 10/69-10/80.....	187	RELIANT		Master I 8/80-7/98.....	229
305 I (581A) 11/77-9/82.....	188	RELIANT		Master II 7/98-9/03.....	230
305 II (581M/E), Break 10/82-7/90.....	188	RELIANT		R11 Van 3/83-12/88.....	230
306 (7B, N3) 5/93-10/00.....	188	RELIANT		R18 Van 5/79-7/86.....	230
306 (7D, N3,5) Cabrio 3/94-4/02.....	190	RELIANT		R19 I Van 1/88-12/92.....	230
306 (N5) Break 5/93-10/00.....	190	RELIANT		R19 II Van 3/92-12/95.....	230
309 I (10C, 10A) 10/85-12/89.....	191	RELIANT		R21 Van 6/86-4/95.....	230
309 II (3A/C) 7/89-12/93.....	192	RELIANT		R4 Van 9/66-12/93.....	231
4007 (GP) 8/07-.....	193	RELIANT		R5 Van 1/72-12/85.....	231
404 4/63-12/71.....	193	RELIANT		Rapid/Express (F40, G40) Van 7/85-8/98.....	231
405 I (15B) 1/87-12/93.....	193	RELIANT		Super 5 (S40) Van 10/84-12/96.....	232
405 I (15E) Break 1/87-12/92.....	193	RELIANT		Trafic I (P6) 3/80-4/89.....	233
405 II (4B) 8/92-10/96.....	194	RELIANT		Trafic I Bus 3/80-4/89.....	233
405 II (4E) Break 8/92-10/96.....	194	RELIANT		Trafic I Van 3/80-4/89.....	233
406 (8B/E/F), Break, Coupe 11/95-5/04.....	195	RELIANT		Trafic II (PXX) 5/89-3/01.....	233
504 7/68-7/86.....	195	RELIANT		Trafic II Bus (TXW) 5/89-3/01.....	234
505 (551A) 8/79-12/93.....	196	RELIANT		Trafic II Van (TXX) 5/89-3/01.....	234
505 Break (551D) 6/81-12/93.....	196	RELIANT		Twingo (S06) Van 3/93-.....	235
605 (6B) 6/89-9/99.....	196	RELIANT		ROVER	
607 (9D) 2/00-.....	196	RELIANT		100 (METRO) (Xp) 3/90-12/98.....	235
806 (221) 6/94-8/02.....	197	RELIANT		1000-Series Mk II 1/67-12/78.....	235
PEUGEOT LCV		RENAULT		200 I (XH) 3/85-9/89.....	235
106 Van 1/94-12/05.....	197	Clio I (B/C57, 5/357) 5/90-9/98.....	203	200 II (XW), Coupe 10/89-11/99.....	235
205 Van 10/87-.....	197	Clio II (B/C/B0/1) 9/98-5/05.....	204	200 III (RF) 11/95-3/00.....	236
206 Van 1/01-.....	197	Clio III (BR/CR0/1) 6/05-.....	205	2200-3500 (P6) 9/63-5/76.....	236
207 Van 10/09-.....	197	Clio III, Grandtour (KR0/1) 2/08-.....	206	25 (RF) 10/99-.....	236
306 Van 5/93-.....	198	Espace I (J11) 7/84-12/90.....	207	400 I (XW) 4/90-4/95.....	236
Bipper (AA) 2/08-.....	198	Espace II (J/S63) 1/91-10/96.....	207	400 II (RT) 5/95-3/00.....	237
Boxer I (230) 3/94-4/02.....	198	Espace III (JE) 11/96-11/02.....	207	45 (RT) 2/00-.....	237
Boxer II (244) 4/02-3/06.....	199	Fuego (136) 2/80-10/85.....	207	75 (RJ), SW 2/99-.....	237
Boxer III 4/06-.....	199	Grand Modus 6/08-.....	208	A40 1/61-12/67.....	237
Expert I (222,223,224) 2/96-12/06.....	199	Kangoo I (KC0) 3/98-12/07.....	208	Acclaim 1/82-12/85.....	237
Expert II Tepee (VF3V) 1/07-.....	199	Koleos 7/08-.....	209	Allegro (ADO 67) 5/73-.....	237
J5 (280/290) 9/81-.....	199	Laguna I (B56, 556) 11/93-3/01.....	209	Cityrover 1/04-.....	237
J7 8/68-3/80.....	200	Laguna I (K56) SW 9/95-3/01.....	210	Coupe 3/96-11/99.....	237
J9 3/80-6/87.....	200	Megane I (BA) 1/96-11/02.....	210	Dolomite 1/72-12/81.....	237
Partner/Ranch I (5F) 6/96-3/08.....	200	Megane I (DA) Coach 3/96-11/02.....	211	Elf Mk II-III 1/61-10/68.....	237
Partner/Ranch II, Tepee 4/08-.....	200	Megane I (EA0) Cabrio 10/96-11/02.....	211	Hornet Mk II-III 1/61-12/70.....	237
PIAGGIO		Megane I (JA0) Scenic 1/97-9/99.....	212	Ital Van 1/82-3/84.....	237
Porter, Van 2/93-.....	200	Megane I (KA) SW 3/99-11/02.....	212	Ital, SW 7/80-3/84.....	237
PORSCHE		Megane I (LA) Classic 9/96-11/02.....	212	Maestro I (XC) 3/83-1/91.....	238
911 (964) 12/88-5/94.....	201	Megane II, SW, Coupe 11/02-10/08.....	213	Maestro II 9/90-1/95.....	238
911 (993) 10/93-9/97.....	201	Modus (F/JP0) 12/04-.....	213	Marina I 4/71-9/75.....	238
911 (996) 6/97-3/04.....	201	R11 (B/C37) 3/83-12/90.....	214	Marina II 3/75-10/78.....	238
911 (997) 7/04-.....	201	R12 (117) 10/69-8/80.....	215	Marina III 9/78-10/80.....	238
924 11/75-8/89.....	201	R14 (121) 9/79-12/83.....	215	Marina Van 1/72-12/79.....	238
928 9/77-11/95.....	201	R17 3/72-10/80.....	216	Metro MG 10/80-9/90.....	238
944 6/81-7/91.....	202	R18 (134) 4/78-7/86.....	216	Metro Van 10/80-9/90.....	238
Boxster I (986) 9/96-11/07.....	202	R18 (135) Break 5/79-12/86.....	216	MG ZS 7/01-.....	238
Boxster II (987) 12/07-3/12.....	202	R19 I (B/C53) 1/88-12/92.....	216	MG ZT, ZT-T 6/01-.....	238
Carrera GT 7/03-.....	202	R19 I (D53) Cabrio 9/88-4/92.....	217	MGB GT 1/66-11/80.....	239
Cayenne (955) 9/02-.....	202	R19 I (L53) Chamade 1/88-12/92.....	217	MGR V8 9/92-12/95.....	239
Cayenne II 5/10-.....	202	R19 II (B/C53) 1/92-6/96.....	217	Midget 1/64-12/79.....	239
Cayman 11/05-.....	202	R19 II (D53) Cabrio 4/92-6/96.....	218	Mini Mk I 1/67-.....	239
Panamera 5/09-.....	202	R19 II (L53) Chamade 1/92-12/95.....	219	Mini Mk I Cooper 1/67-12/91.....	239
		R20 (127) 10/75-12/83.....	219	Mini Mk I Van, Pick-Up 1/67-6/93.....	239
		R21 (B48) 3/86-6/94.....	220	Minor, Cabrio, SW, Pick-up 1/55-10/71.....	239
		R21 (K48) Nevada 3/86-9/95.....	220	Montego (XE), SW 4/84-10/95.....	239
		R21 (L48) 3/86-6/94.....	221	Sherpa 1/74-1/89.....	240
		R25 (B29) 4/84-12/93.....	222	Sprite Mk II 1/62-12/70.....	240
		R30 (127) 2/75-3/86.....	223	Sprite Mk III 1/64-12/66.....	240
		R4 (112) 10/62-6/93.....	223	Sprite Mk IV 1/66-12/74.....	240
		R5 7/71-12/85.....	223		
		R6 10/69-4/87.....	223		
		R9 (L42) 9/81-12/89.....	224		
		Safrane I (B54) 4/92-7/96.....	225		
		Scenic I (JA) 9/99-6/03.....	225		
		Scenic II (JM) 6/03-5/09.....	225		
		Super 5 (B/C40) 10/84-12/96.....	225		
		Thalia 2/98-.....	227		
		Twingo I (C06) 3/93-6/07.....	227		
		Twingo II (CN0) 7/07-.....	227		

MAKE - MODEL	PAGE	MAKE - MODEL	PAGE	MAKE - MODEL	PAGE							
Streetwise 8/03-.....	240	SKODA LCV	Fabia Praktik 4/02-.....	SJ 413 9/84-8/90	259							
Toledo 10/70-12/77.....	240			Splash 4/08-.....	259							
SAAB	900 II, Coupe, Cabrio 7/93-2/98	SMART	Cabrio (450) 3/00-1/04.....	Swift I (AA) 10/83-12/89.....	259							
				Swift II (AH, AJ, EA, MA) 3/89-12/03.....	259							
				Swift III (SG) 9/05-.....	260							
				Sx4 (GY) 6/06-.....	260							
				Vitara (ET, TA) 7/88-3/99.....	260							
				Wagon R+ I (EM) 2/93-5/00.....	260							
				Wagon R+ II (MM) 5/00-.....	261							
				X-90 (EL) 9/95-.....	261							
Monte Carlo 1/66-12/67.....	241	Roadster, Coupe (452) 4/03-.....	254	XL-7 I 1/02-12/06.....	261							
SANTANA	300/350 9/98-.....	SSANGYONG	Actyon 1/07-.....	SUZUKI LCV	Carry I (ST90V) Van 11/80-10/85.....							
						Korando I (K4) 12/88-12/96	261					
SAO	Penza 1/91-12/94	Korando II (KJ) 12/96-.....	Kyoran 5/05-.....	Super Carry II (ED) Bus 10/85-3/99.....	261							
						SEAT	Musso (FJ) 10/95-.....	TALBOT	1307-1510 7/75-4/84	261		
											Rexton 4/02-.....	255
127 (127A) 4/72-12/82.....	241	SUBARU	Forester I (SF) 8/97-9/02	Alpine 1/75-.....	261							
						Forester II (SG) 9/02-5/08.....	255	California 1/66-12/70	262			
						Impreza I (GC, GF), SW 8/92-12/00.....	255	Chamois 1/64-12/70	262			
						Impreza II (GD, GG), SW 12/00-12/07	255	Express 1/82-1/94.....	262			
						Impreza III (GH, GR) 1/08-.....	256	Horizon 2/78-6/86	262			
						Justy I (KAD)/ Trendy 11/84-12/94	256	Husky 1/66-12/70.....	262			
						Justy II (JMA, MS) 10/95-8/03	256	Imp 1/66-1/76.....	262			
						Justy III (G3X) 9/03-10/08.....	256	Rancho 1/77-7/84	262			
						Justy IV (JDA) 11/08-.....	256	Samba (51A) 1/81-10/86	262			
						Legacy I (BC, BGF), SW 1/89-7/94	256	Simca 10/61-12/80.....	262			
						Legacy II (BD, BG), SW 9/94-3/99.....	256	Simca Sunbeam 7/77-3/83	263			
						Legacy III (BE, BH), SW 10/98-9/03	256	Solara 2/80-7/86	263			
						Legacy IV (BL, BP), SW 9/03-12/07	256	Stiletto 1/66-12/76.....	263			
						Libero (E10, E12)/ Domingo 1/83-2/00.....	257	Tagora 6/80-12/87	263			
						Mini Jumbo 1/82-.....	257	TATA	Indica/ Vista 1/98-.....	263		
						Outback I (BE, BH) 10/00-10/03.....	257				Indigo, SW 1/03-.....	263
						Outback II (BP) 11/03-.....	257	TOYOTA	4 Runner I (N6) 1/84-1/88.....	263		
Rex II 8/81-6/89.....	257	4 Runner II (N13) 8/87-3/96.....	263									
Trezia 4/11-.....	257	4 Runner III (N18) 11/95-.....	263									
Tribeca (B9) 1/05-.....	257	Avalon 10/96-.....	263									
Vivio 3/92-10/95.....	257	Avensis I (T22), SW 9/97-3/03.....	263									
SUZUKI	Alto I (SS80) 6/82-12/85	Suzuki	Alto II (EC) 1/86-11/93	Avensis II (T25), SW 4/03-1/09.....	264							
						Alto III (EF) 9/94-6/02	257				Avensis Verso (M20) 8/01-.....	264
						Alto IV (FF) 6/02-12/08	257				Aygo (KGB, WNB) 10/05-.....	264
Alto V (GF) 1/09-.....	257	Camry (V1)/ Vista/ Scepter 2/83-8/96.....	264									
Baleno (EG), SW 7/95-.....	257	Camry (V2), SW 10/86-5/91	264									
Cappuccino 2/92-8/95.....	257	Camry (V20) 8/96-11/01	265									
Cervo - Fronte 1/79-.....	257	Camry (V30) 11/01-12/05	265									
Cultus - Forsa II 7/88-.....	258	Carina I (TA4, TA6), SW 8/77-2/87.....	265									
Escudo 1/91-.....	258	Carina II (T15) 10/83-11/87.....	265									
Forenza, SW 1/04-12/06.....	258	Carina II (T17), SW 12/87-6/93.....	265									
Grand Vitara I (FT, GT) 3/98-9/05	258	Carina III E (T19), SW 4/92-9/97	265									
Grand Vitara II (JT) 10/05-.....	258	Celica I (TA2) 5/73-3/78.....	265									
Ignis I (FH) 10/00-9/03.....	258	Celica II (TA60, RA40, RA6) 8/77-10/86....	265									
Ignis II (MH) 9/03-.....	258	Celica III (T16) 8/85-8/90	266									
Jimny (FJ) 9/98-.....	258	Celica IV (T18) 10/89-1/94.....	266									
Liana (ER), SW 7/01-.....	258	Celica V (T20) 11/93-11/99.....	266									
LJ 80 1/80-1/84.....	258	Celica VI (ZZT23) 11/99-.....	266									
Samurai (SJ) 11/88-.....	258	Corolla I (KE, TE) 11/66-12/80	266									
Sidekick 7/88-1/98	259	Corolla II (E7) 9/79-9/83	266									
SJ 410 9/81-12/90	259	Corolla III (E8) 5/83-5/88	266									
			Corolla IV (E9), SW, 8/87-6/93	267								
SEAT LCV	Inca (6K9) 11/95-.....	SKODA	120 (742,744) 8/76-12/90	120 (742,744) 8/76-12/90	249							
						Marbella (028A) Van 1/87-12/93.....	249					
Terra (024A) Van 1/87-12/95.....	249	Fabia I (6Y2, 3, 5), SW 12/99-5/07	249									
120 (742,744) 8/76-12/90	249	Fabia II (5J2), SW 5/07-.....	250	Favorit (781) 5/89-9/94	250							
						Favorit Forman (785) 8/91-6/95.....	250					
						Favorit Pick-Up (787) 12/92-6/97.....	251					
						Felicia I (6U1, 6U5), SW 10/94-3/98.....	251					
						Felicia I (797) Pick-Up 1/95-2/98	251					
						Felicia II (6U1, 6U5), SW 3/98-6/01	251					
						Octavia II (1U2, 1U5), SW 9/96-6/04.....	251					
						Octavia III (1Z3, 1Z5), SW 6/04-.....	252					
						Rapid (120G, 130G, 135G) 2/83-10/91	252					
						Roomster (5J7) 9/06-.....	252					

MAKE - MODEL	PAGE	MAKE - MODEL	PAGE	MAKE - MODEL	PAGE
Corolla V (E10), SW, 7/92-4/97	267	VOLKSWAGEN		460 L (464) 9/88-7/96	299
Corolla VI (E11), SW, 4/97-1/02	268	1500,1600 (31, 36), Variant 4/61-7/73	275	66, SW 10/75-11/79	299
Corolla VII (E12) Verso 1/02-5/04	268	181 9/69-2/79	275	740 (744, 745) 8/83-8/92	299
Corolla VII (E12), SW 1/02-	268	Dasher 1/73-1/81	276	740 (744, 745) SW 8/84-8/92	300
Corolla VIII Verso (R1) 4/04-	269	Derby I (86) 2/77-12/81	276	760 (704, 764, 765) 8/81-7/92	300
Corona 1/61-12/75	269	Derby II (86C, 80) 8/81-12/88	276	780 8/86-7/90	300
Corona I (RX, RT) 12/75-1/81	269	Fox 1/87-1/91	276	850 (LS, LW), SW 6/91-12/96	301
Corona II 1/82-12/92	269	Fox (5Z1) 4/05-	276	940 I (944, 945), SW 8/90-7/95	301
Cressida II (RX3), SW 7/77-7/81	269	Golf I (17, 155) 4/74-4/93	276	940 II (944, 945), SW 8/94-10/98	301
Cressida III (X6), SW 9/80-3/85	269	Golf II (19E, 1G1) 8/83-12/92	277	960 I (964, 965), SW 8/90-7/94	301
Cressida IV (X7), SW 3/85-1/88	269	Golf III (1H1) 10/91-4/99	278	960 II (964, 965), SW 7/94-12/96	301
Cressida V (X8), SW 1/88-1/93	269	Golf III (1H5) Variant 10/91-4/99	280	C70 I Coupe, Cabrio 3/97-2/06	301
Crown I (S1) 1/61-12/94	269	Golf IV (1J1, 5), Variant 8/97-9/03	281	P 121 5/59-5/71	301
Duet 1/98-	269	Ittis (183) 3/79-12/88	281	P 122 S Amazon 5/59-5/71	302
Dyna I 100 8/77-12/89	270	Jetta I (17) 8/79-12/83	281	P 123 11/68-5/71	302
Dyna I 150 8/77-12/89	270	Jetta II (19E, 1G2) 1/84-12/91	281	P 131 11/64-5/71	302
Highlander 1/01-12/06	270	K 70 (48) 8/70-10/74	282	P 132 S 11/64-5/71	302
iQ (AJ1) 3/09-	270	Kaefer 4/49-7/03	282	P 133 11/64-5/71	302
Land Cruiser I (J4), Pick-Up 3/69-4/86	270	Karmann Ghia (14, 34) 1/60-7/74	282	P 1800 (182) 4/62-11/73	302
Land Cruiser II (J6) 10/81-12/89	270	Lupo (6X1, 6E1) 9/98-	283	P 1800 (183) 4/62-11/73	302
Land Cruiser III (J7) 11/84-	270	Passat I (32, 33), Variant 5/73-7/80	283	P 2200 SW 9/64-8/70	302
Land Cruiser V 90 (J9) 4/96-	271	Passat II (32B), Variant 8/80-3/88	284	P 544 8/61-7/67	302
Land Cruiser VI 100 (J10) 1/98-12/07	271	Passat III (3A2, 3A5, 35I), Variant 2/88-5/97	285	S60 I 11/00-3/10	302
Land Cruiser VII (J12) 9/02-	271	Passat IV (3B2, 3B5), Variant 8/96-11/00	286	S70 1/97-11/00	302
Land Cruiser VIII (J20) 1/08-	271	Polo I (86) 3/75-9/81	286	S80 I (TS, XY) 5/98-7/06	303
Matrix 9/01-2/04	271	Polo II (86C, 80), Coupe 10/81-9/94	286	S80 II 3/06-	303
Paseo I 4/91-8/95	271	Polo III (6N1) 10/94-10/99	287	S90 1/97-5/98	303
Paseo II (EL54) 8/95-7/99	271	Polo III-IV (6KV2) Classic 11/95-9/01	288	V70 I SW (P80) 1/97-3/00	303
Picnic I (XM10) 5/96-4/01	271	Polo IV (6KV5) Variant 5/97-9/01	288	V70 II SW 3/00-6/07	303
Previa I (TCR1, 2) 5/90-8/00	271	Polo V (6N2) 10/99-9/01	289	V70 III SW (P80) 7/07-	304
Previa II (ACR3) 8/00-	271	Polo V (9N) 10/01-6/09	289	V90 SW 1/97-12/98	304
Prius I (NHW11) 5/00-1/04	271	Polo VI (6R) 7/09-	289	XC70 I Cross Country 9/00-6/07	304
Prius II (NHW20) 1/04-12/08	271	Quantum I 1/85-7/90	290	XC70 II Cross Country 7/07-	304
Rav 4 I (XA1) 6/94-6/00	272	Rabbit 1/74-1/76	290	XC90 10/02-	304
Rav 4 II (XA2) 6/00-2/06	272	Santana I (32, 33), Variant 5/73-7/80	290	ZASTAVA	
Rav 4 III (XA3) 3/06-	272	Santana II (32B) 8/81-12/84	290	101 (1100) 6/73-12/93	304
Space Cruiser 1/83-12/88	272	Santana III 8/84-12/94	290	1300 - 1500 1/78-1/87	304
Starlet II (P6) 2/78-9/84	272	Scirocco I (53) 2/74-7/80	290	311 Van 1/83-1/93	305
Starlet III (P7) 10/84-12/89	272	Scirocco II (53B) 8/80-7/92	291	750 Old Type -1/82	305
Starlet IV (P8) 12/89-3/96	272	Touareg I (7LA) 10/02-4/10	291	Contact 1/78-1/83	305
Starlet V (P9) 4/96-3/99	272	Touareg II (7P5) 5/10-	292	Koral 1/90-	305
Supra III (JZA80) 5/93-8/98	272	Vento (1H2) 11/91-9/98	292	Nogaro 1/80-1/83	305
Tacoma 1/95-	272	VOLKSWAGEN LCV		Sana 1/89-	305
Tercel I (L1, L2) 3/79-4/86	272	Amarok 10/10-	292	Tempo 1/91-1/92	305
Tercel II (L3) 5/86-6/90	272	Caddy I (14) 8/82-7/92	292	Yugo 45/55/65 4/80-6/95	305
Tercel III (L4) 9/90-12/94	272	Caddy II (9K9) 11/95-1/04	293	Yugo 750 1/82-	305
Trueno 8/74-12/80	272	Caddy II (9U7) Pick-Up 11/95-2/04	294	Yugo Florida 10/88-	305
Tundra 1/02-	272	Caddy III (2KA, KB) 3/04-	295		
Verso 7/09-	273	Crafter (2E) 4/06-	295		
Yaris I (CP10)/Vitz 4/99-12/05	273	LT I 28-35 (281-363) 4/75-6/96	295		
Yaris I (NC/LP2) Verso 11/99-12/05	273	LT I 40-55 (291-293-512-909) 4/75-6/96	295		
Yaris II (C/SP9) 1/06-	273	LT II 28-46 (2DX0AE, FE, 2DM) 5/96-	296		
TOYOTA LCV		Multivan V (7HM) 4/03-	296		
Hiace I (H) 2/77-12/84	274	Polo Van I (86CF) 1/81-9/94	296		
Hiace II (H5) 3/83-11/89	274	Polo Van II (6NF) 10/94-	296		
Hiace III (H10) 8/89-8/95	274	Taro 4/89-3/97	297		
Hiace IV (H1, H2) 8/95-	274	Transporter II 8/67-7/79	297		
Hilux I (N) 1/72-1/89	274	Transporter III 5/79-7/92	297		
Hilux I (N) Pick-Up 1/84-	275	Transporter IV 7/90-3/03	297		
Hilux II 1/05-	275	Transporter V (7HA/B/H/J, JD/E/L) 4/03-	298		
Liteace I 10/79-1/95	275	Vanagon 1/72-1/87	298		
Modell F (R2, 31) Bus 11/82-1/90	275	VOLVO			
Pick-Up 1/75-	275	240 (P242, 244, 245), SW 8/74-8/93	298		
Pubblica 1/69-12/83	275	260 (P262, 264, 265), SW 8/74-7/82	298		
Townace 1/70-12/90	275	340-360 (343, 345, 344) 8/75-7/91	299		
VAU		440 K (445) 8/88-12/96	299		
Mega 1/998-	275				

		Spare Parts	F/R	L/R	CIFAM ref.	CIFAM ref. w/KIT		DIMENSIONS mm.	NOTE
CL Coupe 10/96-9/03									
3.2 Vtec Eng.J32A1 (165kW)	01-		R		153-159	153-159K		170,0x35	
3.2 Vtec Type S Eng.J32A4 (191kW)	01-		R		153-159	153-159K		170,0x35	
Legend III 8/96-									
3.5 Eng.C35A2 (151kW)			R		153-159	153-159K		170,0x35	
RL 1/96-1/98									
3.5 V6	1/96-1/98		R		153-159	153-159K		170,0x35	
AIXAM									
A.721 1/05-									
0.4 D (4kW)	1/05-		R		153-053			160,0x42	Fitted Adjuster, Hand Brake
	1/05-		R		153-054			180,0x32	Fitted Adjuster, Hand Brake
A.741 1/05-									
0.4 D (4kW)	1/05-		R		153-053			160,0x42	Fitted Adjuster, Hand Brake
	1/05-		R		153-054			180,0x32	Fitted Adjuster, Hand Brake
A.751 1/05-									
0.5 D (10kW)	1/05-		R		153-053			160,0x42	Fitted Adjuster, Hand Brake
	1/05-		R		153-054			180,0x32	Fitted Adjuster, Hand Brake
Berline, Mini van , Pick Up 1/96-									
340, 400, 500	1/96-		R		153-053			160,0x42	Fitted Adjuster, Hand Brake
	1/96-		R		153-054			180,0x32	Fitted Adjuster, Hand Brake
ALFA ROMEO									
145, 146 (930) 7/94-1/01									
1.4 i.e. Eng.AR33501 (66kW)	7/94-12/96		R		153-002	153-002Y	Bdx	203,2x39	Hand Brake
	7/94-12/96		R		153-067	153-067J	Bdx	228,6x42	Hand Brake
	94-12/96		R		700-035			Ø 228,3	
	94-12/96		R		151-049		Bdx	Ø 20,64 228,0x40	RAI
1.4 i.e. 16v T.S. Eng.AR33503/ AR38501 (76kW)	11/96-1/01		R		153-002	153-002Y	Bdx	203,2x39	Hand Brake
	11/96-1/01		R		153-067	153-067J	Bdx	228,6x42	Hand Brake
	1/97-		R		700-037			Ø 203,2	
	1/97-		R		151-057		Bdx	Ø 22,00 203,0x39	RAI
1.6 i.e. Eng.AR33201 (76kW)	10/94-12/96		R		153-002	153-002Y	Bdx	203,2x39	Hand Brake
	10/94-12/96		R		153-067	153-067J	Bdx	228,6x42	Hand Brake
	94-12/96		R		700-035			Ø 228,3	
	94-12/96		R		151-049		Bdx	Ø 20,64 228,0x40	RAI
1.6 i.e. 16v T.S. Eng.AR38201/ AR67601 (88kW)	12/96-1/01		R		153-002	153-002Y	Bdx	203,2x39	Hand Brake
	12/96-1/01		R		153-067	153-067J	Bdx	228,6x42	Hand Brake
	1/97-		R		700-037			Ø 203,2	
	1/97-		R		151-057		Bdx	Ø 22,00 203,0x39	RAI
1.9 D Eng.AR67501 (68kW)	7/94-2/99		R		153-002	153-002Y	Bdx	203,2x39	Hand Brake
	7/94-2/99		R		153-067	153-067J	Bdx	228,6x42	Hand Brake
1.9 JTD Eng.AR32302 (77kW)	2/99-1/01		R		153-067	153-067J	Bdx	228,6x42	-ABS, Hand Brake
	99-01			R		700-037			Ø 203,2
1.9 TD Eng.AR33601/ AR67501 (66kW)	10/94-2/99		R		153-002	153-002Y	Bdx	203,2x39	Hand Brake
	10/94-2/99		R		153-067	153-067J	Bdx	228,6x42	Hand Brake
	1/97-		R		700-037			Ø 203,2	
	4/94-12/96		R		700-035			Ø 228,3	
	1/97-		R		151-057		Bdx	Ø 22,00 203,0x39	RAI
94-12/96		R		151-049		Bdx	Ø 20,64 228,0x40	RAI	
1750-2000 3/68-12/83									
1750 Eng.AR00548 (83kW)	3/68-10/72		R		153-011	153-011K	Ate	160,0x25	Hand Brake
2000 Eng.AR10520 (97kW)	10/71-12/83		R		153-011	153-011K	Ate	160,0x25	Hand Brake
33 I (905,A), Sportwagon 5/83-12/89									
1.2 (Exc. SW) Eng.AR30585 (50kW)	83-86		R		153-340	153-340K	Bdx	228,6x42	Hand Brake
	83-86		R		153-475		Lucas	228,6x42	Hand Brake
	86-		R		153-002	153-002Y	Bdx	203,2x39	Hand Brake
	83-3/88		R		151-032		Bdx	Ø 17,46 228,0x42	RAD
	9/86-89		R		151-033		Bdx	Ø 17,46 203,0x39	RAI
1.3 (Exc. SW) Eng.AR30168/ AR30587 (63kW)	84-86		R		153-340	153-340K	Bdx	228,6x42	Hand Brake
	84-86		R		153-475		Lucas	228,6x42	Hand Brake
	86-		R		153-002	153-002Y	Bdx	203,2x39	Hand Brake
	84-3/88		R		151-032		Bdx	Ø 17,46 228,0x42	RAD
	9/86-89		R		151-033		Bdx	Ø 17,46 203,0x39	RAI
1.3 (Exc. SW) Eng.AR30502 (58kW)	83-86		R		153-340	153-340K	Bdx	228,6x42	Hand Brake
	83-86		R		153-475		Lucas	228,6x42	Hand Brake
	86-		R		153-002	153-002Y	Bdx	203,2x39	Hand Brake

		Spare Parts	F/R	L/R	CIFAM ref.	CIFAM ref. w/KIT		DIMENSIONS mm.	NOTE
1.3 (Exc. SW) Eng.AR30502 (58kW)	83-3/88		R		151-032		Bdx	Ø 17,46 228,0x42	RAD
	9/86-89		R		151-033		Bdx	Ø 17,46 203,0x39	RAI
1.3 (Exc. SW) Eng.AR30502/ AR30586 (55kW)	83-86		R		153-340	153-340K	Bdx	228,6x42	Hand Brake
	83-86		R		153-475		Lucas	228,6x42	Hand Brake
	86-		R		153-002	153-002Y	Bdx	203,2x39	Hand Brake
	83-3/88		R		151-032		Bdx	Ø 17,46 228,0x42	RAD
	9/86-89		R		151-033		Bdx	Ø 17,46 203,0x39	RAI
1.3 i.e. Eng.AR30168 (66kW)	83-86		R		153-340	153-340K	Bdx	228,6x42	Hand Brake
	83-86		R		153-475		Lucas	228,6x42	Hand Brake
	86-		R		153-002	153-002Y	Bdx	203,2x39	Hand Brake
	83-3/88		R		151-032		Bdx	Ø 17,46 228,0x42	RAD
	9/86-89		R		151-033		Bdx	Ø 17,46 203,0x39	RAI
1.5 Eng.AR30182 (70kW)	83-86		R		153-340	153-340K	Bdx	228,6x42	Hand Brake
	83-86		R		153-475		Lucas	228,6x42	Hand Brake
	86-		R		153-002	153-002Y	Bdx	203,2x39	Hand Brake
1.5 4WD Eng.AR30514 (70kW)	84-86		R		153-340	153-340K	Bdx	228,6x42	Hand Brake
	84-86		R		153-475		Lucas	228,6x42	Hand Brake
	86-		R		153-002	153-002Y	Bdx	203,2x39	Hand Brake
1.5, 4WD Eng.AR30143/ AR30504 (62kW)	83-85		R		153-340	153-340K	Bdx	228,6x42	Hand Brake
	83-85		R		153-475		Lucas	228,6x42	Hand Brake
	83-85		R		151-032		Bdx	Ø 17,46 228,0x42	RAD
1.5, 4WD Eng.AR30520 (66kW)	83-86		R		153-340	153-340K	Bdx	228,6x42	Hand Brake
	83-86		R		153-475		Lucas	228,6x42	Hand Brake
	83-86		R		151-032		Bdx	Ø 17,46 228,0x42	RAD
1.5, 4WD Eng.AR30588 (75kW)	86-		R		153-002	153-002Y	Bdx	203,2x39	Hand Brake
	9/86-89		R		151-033		Bdx	Ø 17,46 203,0x39	RAI
1.5, QV, 4WD Eng.AR30146/ AR30508/ AR30588 (77kW)	84-86		R		153-340	153-340K	Bdx	228,6x42	Hand Brake
	84-86		R		153-475		Lucas	228,6x42	Hand Brake
	86-		R		153-002	153-002Y	Bdx	203,2x39	Hand Brake
	84-88		R		151-056		Bdx	Ø 19,05 228,0x40	RAD
1.7 Eng.AR30550 (84-87kW)	3/88-12/89		R		153-002	153-002Y	Bdx	203,2x39	Quadrifoglio, Hand Brake
	88-		R		153-001		Bdx	203,2x39	
	88-89		R		151-056		Bdx	Ø 19,05 228,0x40	RAD
1.7 (Exc. SW) Eng.AR30550 (95kW)	1/86-12/89		R		153-002	153-002Y	Bdx	203,2x39	Quadrifoglio, Hand Brake
	86-		R		153-001		Bdx	203,2x39	
1.7 i.e., 4WD Eng.AR30558 (77kW)	88-		R		153-001		Bdx	203,2x39	
	9/88-12/89		R		153-002	153-002Y	Bdx	203,2x39	Quadrifoglio, Hand Brake
	9/88-12/89		R		153-340	153-340K	Bdx	228,6x42	4WD, Hand Brake
	88-89		R		151-033		Bdx	Ø 17,46 203,0x39	RAI
1.8 TD Eng.VM392HT (53kW)	1/87-12/90		R		153-002	153-002Y	Bdx	203,2x39	Hand Brake
	1/87-12/90		R		153-001		Bdx	203,2x39	Sweden/Switzerland
1.8 TD Eng.VM82A (54kW)	1/86-6/90		R		153-002	153-002Y	Bdx	203,2x39	Hand Brake
	1/86-6/90		R		153-001		Bdx	203,2x39	Sweden/Switzerland
	86-90		R		151-033		Bdx	Ø 17,46 203,0x39	RAI
1.8 TD Eng.VM82A (62kW)	1/86-6/86		R		153-002	153-002Y	Bdx	203,2x39	Hand Brake
	1/86-6/86		R		153-001		Bdx	203,2x39	Sweden/Switzerland
	1/86-6/86		R		151-033		Bdx	Ø 17,46 203,0x39	RAI
33 II (907A,B), Sportwagon 1/90-9/94									
1.4 (58kW)	91-94		R		153-002	153-002Y	Bdx	203,2x39	Hand Brake
	91-94		R		151-033		Bdx	Ø 17,46 203,0x39	RAI
1.4 i.e., 4WD Eng.AR30587/ AR30753/ AR30755 (66kW)	91-94		R		153-002	153-002Y	Bdx	203,2x39	Hand Brake
	91-94		R		151-033		Bdx	Ø 17,46 203,0x39	RAI
1.4 ie Eng.AR30753/ AR30755 (65kW)	91-94		R		153-002	153-002Y	Bdx	203,2x39	Hand Brake
1.5 Eng.AR30146 (77kW)	1/90-4/93		R		153-002	153-002Y	Bdx	203,2x39	Hand Brake
	90-93		R		151-033		Bdx	Ø 17,46 203,0x39	RAI
1.5 i.e Eng.AR30751 (71kW)	1/90-9/94		R		153-002	153-002Y	Bdx	203,2x39	Hand Brake
	90-94		R		151-033		Bdx	Ø 17,46 203,0x39	RAI
1.5 i.e. Eng.AR30750 (74kW)	7/90-8/91		R		153-002	153-002Y	Bdx	203,2x39	Hand Brake
	90-91		R		151-033		Bdx	Ø 17,46 203,0x39	RAI
1.7 16v, 4WD Eng.AR30746 (101kW)	1/90-9/94		R		153-001		Bdx	203,2x39	
	1/90-9/94		R		153-002	153-002Y	Bdx	203,2x39	Quadrifoglio, Hand Brake
1.7 16v, 4WD Eng.AR30747 (95-97kW)	1/90-9/94		R		153-001		Bdx	203,2x39	
	1/90-9/94		R		153-002	153-002Y	Bdx	203,2x39	Quadrifoglio, Hand Brake
	90-94		R		151-033		Bdx	Ø 17,46 203,0x39	RAI
1.7 i.e., 4WD Eng.AR30736/ AR30737 (77-79kW)	1/90-3/94		R		153-001		Bdx	203,2x39	
	1/90-3/94		R		153-002	153-002Y	Bdx	203,2x39	Quadrifoglio, Hand Brake
	90-94		R		151-033		Bdx	Ø 17,46 203,0x39	RAI

		Spare Parts	F/R	L/R	CIFAM ref.	CIFAM ref. w/KIT		DIMENSIONS mm.	NOTE
1.8 TD (Exc. SW) Eng.VM96A (62kW)	7/90-9/94		R		153-002	153-002Y	Bdx	203,2x39	Hand Brake
	7/90-9/94		R		153-001		Bdx	203,2x39	Sweden/Switzerland
	90-94		R		151-033		Bdx	Ø 17,46 203,0x39	RAI
Alfasud (901) 6/72-12/84									
1.5 Eng.AR30124 (61kW)	1/79-9/84		R		153-340	153-340K	Bdx	228,6x42	Hand Brake
1.5 Eng.AR30128 (70kW)	3/80-12/84		R		153-340	153-340K	Bdx	228,6x42	Hand Brake
1.5 Eng.AR30146 (77kW)	1/83-12/84		R		153-340	153-340K	Bdx	228,6x42	Hand Brake
	83-84		R		151-032		Bdx	Ø 17,46 228,0x42	RAD
Alfasud Sprint (902.A) 9/76-12/89									
1.3 Eng.AR30168 (63kW)	87-89		R		151-033		Bdx	Ø 17,46 203,0x39	RAI
1.5 Eng.AR30128 (70kW)	82-86		R		151-032		Bdx	Ø 17,46 228,0x42	RAD
1.5 Eng.AR30146 (77kW)	83-87		R		151-032		Bdx	Ø 17,46 228,0x42	RAD
1.5 Eng.AR30588 (75kW)	83-87		R		151-032		Bdx	Ø 17,46 228,0x42	RAD
1.7 Eng.AR30550 (87kW)	3/87-12/89		R		153-001		Bdx	203,2x39	
	3/87-12/89		R		153-002	153-002Y	Bdx	203,2x39	Quadrifoglio, Hand Brake
1.7 i.e., 4WD Eng.AR30558 (77kW)	10/87-12/89		R		153-001		Bdx	203,2x39	
	10/87-12/89		R		153-002	153-002Y	Bdx	203,2x39	Quadrifoglio, Hand Brake
	87-89		R		151-033		Bdx	Ø 17,46 203,0x39	RAI
Alfetta (116) 1/74-1/86									
1.6, GT Eng.AR01600 (79kW)	1/75-12/84		R		153-011	153-011K	Ate	160,0x25	Hand Brake
1.8 Eng.AR01678 (90kW)	10/79-12/84		R		153-011	153-011K	Ate	160,0x25	Hand Brake
1.8, GT Eng.AR01608 (90kW)	1/74-12/84		R		153-011	153-011K	Ate	160,0x25	Hand Brake
1.8, GT Eng.AR01608X (85kW)	7/74-12/77		R		153-011	153-011K	Ate	160,0x25	Hand Brake
2.0 Eng.AR11655/ AR58484 (96kW)	1/77-12/80		R		153-011	153-011K	Ate	160,0x25	Hand Brake
2.0 TD Eng.VM4HT2 (60kW)	10/79-3/83		R		153-011	153-011K	Ate	160,0x25	Hand Brake
2.0 TD Eng.VMHR488HT (70kW)	1/84-1/86		R		153-011	153-011K	Ate	160,0x25	Hand Brake
2.0, GT Eng.AR01623 (89kW)	3/77-1/86		R		153-011	153-011K	Ate	160,0x25	Hand Brake
2.0, GT Eng.AR01713/ AR10520 (97kW)	6/77-12/84		R		153-011	153-011K	Ate	160,0x25	Hand Brake
2.4 TD Eng.VM492HT (81kW)	1/84-1/86		R		153-011	153-011K	Ate	160,0x25	Hand Brake
2.4 TD Eng.VM4HT2.4 (70kW)	4/83-12/84		R		153-011	153-011K	Ate	160,0x25	Hand Brake
Arna (920) 3/83-12/86									
1.2 Eng.AR30102 (46kW)	3/83-12/86		R		153-272		Sumit.	180,0x35	Hand Brake
1.2 Eng.AR30500 (50kW)	3/83-12/86		R		153-272		Sumit.	180,0x35	Hand Brake
1.2 Eng.AR31000 (44kW)	3/83-12/86		R		153-272		Sumit.	180,0x35	Hand Brake
1.3 Eng.AR30100 (58kW)	3/83-12/86		R		153-272		Sumit.	180,0x35	Hand Brake
1.3 TI Eng.AR30168/ AR31010 (63kW)	3/83-12/86		R		153-272		Sumit.	180,0x35	Hand Brake
1.5 Eng.AR30182 (70kW)	3/83-12/86		R		153-272		Sumit.	180,0x35	Hand Brake
Giulia 6/64-12/78									
1.3 Eng.101.100/AR00506 (54-57kW)	1/64-12/67		R		153-011	153-011K	Ate	160,0x25	Hand Brake
1.3 Eng.AR00530 (64kW)	1/74-12/78		R		153-011	153-011K	Ate	160,0x25	Hand Brake
1.3 TI (62kW)	4/69-7/75		R		153-011	153-011K	Ate	160,0x25	Hand Brake
1.3 Ti Eng.101.10531 (48-49kW)	1/68-12/77		R		153-011	153-011K	Ate	160,0x25	Hand Brake
1.6 Eng.AR00526 (76kW)	1/74-12/78		R		153-011	153-011K	Ate	160,0x25	Hand Brake
1.6 Super Eng.AR00526 (71kW)	6/64-8/69		R		153-011	153-011K	Ate	160,0x25	Hand Brake
Giulietta II (116) 10/77-12/85									
1.3 Eng.AR01644 (66kW)	10/77-6/83		R		153-011	153-011K	Ate	160,0x25	Hand Brake
1.6 Eng.AR01600 (79kW)	10/77-4/85		R		153-011	153-011K	Ate	160,0x25	Hand Brake
1.8 Eng.AR01678 (90kW)	4/79-4/85		R		153-011	153-011K	Ate	160,0x25	Hand Brake
1.8 T. Eng.AR01354 (110kW)	1/84-12/85		R		153-011	153-011K	Ate	160,0x25	Hand Brake
2.0 Eng.AR01655/ AR11671 (96kW)	6/80-4/85		R		153-011	153-011K	Ate	160,0x25	Hand Brake
2.0 T. Eng.AR01699 (125kW)	7/83-6/84		R		153-011	153-011K	Ate	160,0x25	Hand Brake
2.0 TD Eng.VM4HT (61kW)	1/83-12/85		R		153-011	153-011K	Ate	160,0x25	Hand Brake
2.0 TD Eng.VMHR488HT (70kW)	1/83-12/85		R		153-011	153-011K	Ate	160,0x25	Hand Brake
GT (105-115) 3/63-12/77									
1.7 Eng.AR10525 (80kW)	4/68-11/71		R		153-011	153-011K	Ate	160,0x25	Hand Brake
1750 Eng.AR00548 (83kW)	1/67-12/72		R		153-011	153-011K	Ate	160,0x25	Hand Brake
2.0 V Eng.AR10527 (96kW)	1/71-12/77		R		153-011	153-011K	Ate	160,0x25	Hand Brake
Montreal 12/72-3/79									
2.6 Eng.AR10832 (143kW)	12/72-3/79		R		153-011	153-011K	Ate	160,0x25	Hand Brake
Spider (105) 3/66-12/77									
1.6 Eng.AR00526/ AR00536/ AR01600 (80kW)	3/66-12/68		R		153-011	153-011K	Ate	160,0x25	Hand Brake
1.7 Eng.AR10525 (80kW)	4/68-11/71		R		153-011	153-011K	Ate	160,0x25	Hand Brake
1750 Eng.AR00548 (83kW)	1/67-12/71		R		153-011	153-011K	Ate	160,0x25	Hand Brake

ALFA ROMEO



		Spare Parts	F/R	L/R	CIFAM ref.	CIFAM ref. w/KIT		DIMENSIONS mm.	NOTE
2.0 Eng.AR00512 (96kW)	1/71-12/77		R		153-011	153-011K	Ate	160,0x25	Hand Brake

ALFA ROMEO LCV

AR 6 (280) 1/82-8/90

1.8 Eng.169B(XM7T) (49-51kW)	1/82-10/88		R		153-062		Lucas	254,0x57	10/14 Q, Hand Brake
	82-88		R		700-013			Ø 254,0	Exc. 18Q
	85-88		R		700-016			Ø 254,0	18Q
1.9 D Eng.160D1.000 (51kW)	4/85-12/89		R		153-062		Lucas	254,0x57	10/14 Q, Hand Brake
	85-		R		700-013			Ø 254,0	10Q, 13Q Diesel, 14Q
2.0 Eng.170B (55kW)	1/86-8/90		R		153-062		Lucas	254,0x57	10/14 Q, Hand Brake
	86-90		R		700-016			Ø 254,0	18Q
	86-90		R		700-013			Ø 254,0	Exc. 18Q
2.4 D Eng.8144.61.200 (53kW)	4/85-2/86		R		153-062		Lucas	254,0x57	10/14 Q, Hand Brake
	85-		R		700-013			Ø 254,0	10Q, 13Q Diesel, 14Q
2.4 TD Eng.8144.21.220 (68kW)	9/86-12/89		R		153-062		Lucas	254,0x57	10/14 Q, Hand Brake
	86-		R		700-013			Ø 254,0	10Q, 13Q Diesel, 14Q
2.5 D Eng.8144.67.220 (55kW)	3/86-12/89		R		153-062		Lucas	254,0x57	10/14 Q, Hand Brake
	86-		R		700-013			Ø 254,0	10Q, 13Q Diesel, 14Q

AR 8 (280) 4/78-12/89

2.4 D Eng.8140.61.200 (53kW)	4/78-8/86		R		153-109		Ap	254,0x70	30/32, Hand Brake
	4/78-8/86		R		153-064		Ap	254,0x90	35/40, Hand Brake
	78-		R		700-014			Ø 254,0	
2.4 TD Eng.8140.21.200D.I. (68kW)	4/85-12/89		R		153-109		Ap	254,0x70	30/32, Hand Brake
	4/85-12/89		R		153-064		Ap	254,0x90	35/40, Hand Brake
	85-		R		700-014			Ø 254,0	
2.5 D Eng.8144.67.220 (55kW)	9/86-12/89		R		153-109		Ap	254,0x70	30/32, Hand Brake
	9/86-12/89		R		153-064		Ap	254,0x90	35/40, Hand Brake
	86-		R		700-014			Ø 254,0	

AR 8 (280) Van 4/78-12/89

2.4 D Eng.8140.61.200 (53kW)	4/78-8/86		R		153-109		Ap	254,0x70	30/32, Hand Brake
	4/78-8/86		R		153-064		Ap	254,0x90	35/40, Hand Brake
	78-86		R		700-013			Ø 254,0	
2.4 TD Eng.8140.21.200D.I. (68kW)	4/85-12/89		R		153-109		Ap	254,0x70	30/32, Hand Brake
	4/85-12/89		R		153-064		Ap	254,0x90	35/40, Hand Brake
	85-89		R		700-013			Ø 254,0	
2.5 D Eng.8144.67.220 (55kW)	9/86-12/89		R		153-109		Ap	254,0x70	30/32, Hand Brake
	9/86-12/89		R		153-064		Ap	254,0x90	35/40, Hand Brake
	86-89		R		700-013			Ø 254,0	

ALPINA

B6 (E21) 3/78-3/83

2.8 (147kW)	3/78-8/81		R		153-013	153-013K	Ate	180,0x25	Hand Brake
2.8 (160kW)	9/81-3/83		R		153-013	153-013K	Ate	180,0x25	Hand Brake

Roadster (Z8) 6/02-

4.8 V8 (280kW)	6/02-		R		153-013	153-013K	Ate	180,0x25	Hand Brake
----------------	-------	--	---	--	---------	----------	-----	----------	------------

AMERICAN MOTORS

Concord

4-6 Cyl.			R		153-348			254,0x46	Hand Brake
----------	--	--	---	--	---------	--	--	----------	------------

Eagle - Sx4

All models			R		153-348			254,0x46	Hand Brake
------------	--	--	---	--	---------	--	--	----------	------------

Gremlin

8 Cyl.			R		153-348			254,0x46	Hand Brake
All models			R		153-348			254,0x46	Hand Brake

Hornet

8 Cyl.			R		153-348			254,0x46	Hand Brake
--------	--	--	---	--	---------	--	--	----------	------------

Matador

6-8 Cyl.			R		153-348			254,0x46	Hand Brake
----------	--	--	---	--	---------	--	--	----------	------------

Pacer

All models			R		153-348			254,0x46	Hand Brake
------------	--	--	---	--	---------	--	--	----------	------------



















































Spirit

































































All models			R		153-348			254,0x46	Hand Brake
------------	--	--	---	--	---------	--	--	----------	------------































































ARO



















































10 6/80-















































1.3 Eng.810-02 (40kW)	6/80-11/86		R		153-340	153-340K	Bdx	228,6x42	Hand Brake
1.4 Eng.IAP810-R-99 (46kW)	6/84-		R		153-340	153-340K	Bdx	228,6x42	Hand Brake



























































		Spare Parts	F/R	L/R	CIFAM ref.	CIFAM ref. w/KIT		DIMENSIONS mm.	NOTE
240-244 4/78-									
2.5 D Eng.PeugeotXD3P (52kW)	1/83-		R		153-340	153-340K	Bdx	228,6x42	Hand Brake
ASIA MOTORS									
Hi-Topic 1/93-									
2.7 D Eng.SS (55kW)	1/93-		R		153-202		Sumit.	260,0x50	Hand Brake
Rocsta 1/93-									
1.8 i, 4WD Eng.F804 (57kW)	6/93-98		R		153-202		Sumit.	260,0x50	Hand Brake
2.2 D, 4WD (45kW)	1/93-98		R		153-199		Sumit.	260,0x45	
	1/93-98		R		153-202		Sumit.	260,0x50	4WD, Hand Brake
AUDI									
100 II (43, C2), Avant 6/76-7/83									
1.6 Eng.YV (63kW)	-1/82		R		153-462		Vag	200,0x40	C, CL, GL, GS, M/T+A/T, Hand Brake
	2/82-		R		153-462		Vag	200,0x40	C, CL, GL, GLS, Formel E, L, Hand Brake
	8/76-7/83		R		153-465		Vag	180,0x31	Hand Brake
	-9/80		R		153-008		Vag	230,0x40	Coupè, GT 5S, Hand Brake
	-81		R		151-108		Vag	Ø 15,87 200,0x40	Ch 439200001-, VAG
1.9 Eng.WH (74kW)	8/80-7/82		R		153-465		Vag	180,0x31	Hand Brake
	8/80-7/82		R		153-462		Vag	200,0x40	Hand Brake
	8/80-8/82		R		700-197	700-197K		Ø 230,0	
	80-82		R		151-107		Vag	Ø 17,46 200,0x40	VAG
2.0 Eng.WA (85kW)	6/76-8/80		R		153-465		Vag	180,0x31	Hand Brake
	6/76-8/80		R		153-462		Vag	200,0x40	Hand Brake
2.0 D Eng.CN (51kW)	79-8/82		R		700-197	700-197K		Ø 230,0	
	78-7/81		R		151-107		Vag	Ø 17,46 200,0x40	VAG
2.0 TD Eng.DE (63kW)	79-8/82		R		700-197	700-197K		Ø 230,0	
2.1 Eng.WB/ WE (85kW)	-1/82		R		153-462		Vag	200,0x40	Hand Brake
	2/82-		R		153-465		Vag	180,0x31	Hand Brake
	79-8/82		R		700-197	700-197K		Ø 230,0	
	77-7/81		R		151-107		Vag	Ø 17,46 200,0x40	VAG
2.1 Eng.WC (100kW)	3/77-7/83		R		153-462		Vag	200,0x40	Hand Brake
	79-8/82		R		700-197	700-197K		Ø 230,0	
	77-7/81		R		151-107		Vag	Ø 17,46 200,0x40	VAG
2.1 Eng.WG (100kW)	6/76-7/83		R		153-462		Vag	200,0x40	Hand Brake
	79-8/82		R		700-197	700-197K		Ø 230,0	
	77-7/81		R		151-107		Vag	Ø 17,46 200,0x40	VAG
100 III (44, 44Q, C3), Avant 8/82-7/91									
1.8 Eng.DR/ RS (55kW)	8/82-7/91		R		153-008		Vag	230,0x40	Hand Brake
	88-		R		700-198	700-198K		Ø 230,0	
	9/82-12/87		R		700-197	700-197K		Ø 230,0	
	82-		R		151-099		Vag	Ø 17,46 230,0x40	VAG
1.8 Eng.JW/ NP (66kW)	10/83-7/89		R		153-008		Vag	230,0x40	Hand Brake
	83-12/87		R		700-197	700-197K		Ø 230,0	
	88-89		R		700-198	700-198K		Ø 230,0	
	83-89		R		151-099		Vag	Ø 17,46 230,0x40	VAG
1.8 Eng.SH (65kW)	86-12/87		R		700-197	700-197K		Ø 230,0	
	88-12/90		R		700-198	700-198K		Ø 230,0	
1.8 Kat Eng.4B/ PH (66kW)	-86		R		153-008		Vag	230,0x40	Hand Brake
	85-12/87		R		700-197	700-197K		Ø 230,0	
	88-12/90		R		700-198	700-198K		Ø 230,0	
	8/89-		R		151-131		Ate	Ø 20,64 230,0x40	VAG
	85-		R		151-099		Vag	Ø 17,46 230,0x40	VAG
1.8 quattro Eng.JW/ NP (66kW)	10/83-7/89		R		153-008		Vag	230,0x40	Hand Brake
1.8 quattro Kat Eng.4B/ PH (66kW)	-86		R		153-008		Vag	230,0x40	Hand Brake
1.8, GT, quattro Eng.DS/ NE/ SF (66kW)	1/83-12/89		R		153-008		Vag	230,0x40	Hand Brake
1.9 Eng.WH (74kW)	8/82-7/84		R		153-008		Vag	230,0x40	Hand Brake
	9/82-7/84		R		700-197	700-197K		Ø 230,0	
	82-		R		151-099		Vag	Ø 17,46 230,0x40	VAG
2.0 Eng.KP (85kW)	9/84-12/87		R		700-197	700-197K		Ø 230,0	
	84-87		R		151-099		Vag	Ø 17,46 230,0x40	VAG
2.0 Eng.SL (83kW)	86-12/87		R		700-197	700-197K		Ø 230,0	
	86-		R		151-099		Vag	Ø 17,46 230,0x40	VAG
2.0 D Eng.CN (51kW)	8/82-7/90		R		153-008		Vag	230,0x40	Hand Brake
	88-12/90		R		700-198	700-198K		Ø 230,0	











		Spare Parts	F/R	L/R	CIFAM ref.	CIFAM ref. w/KIT		DIMENSIONS mm.	NOTE
2.0 D Eng.CN (51kW)	9/82-7/88		R		700-197	700-197K		Ø 230,0	
	82-		R		151-099		Vag	Ø 17,46 230,0x40	VAG
2.0 Kat Eng.RT (85kW)	1/88-11/90		R		153-008		Vag	230,0x40	Hand Brake
	88-12/90		R		700-198	700-198K		Ø 230,0	
	8/89-		R		151-131		Ate	Ø 20,64 230,0x40	VAG
	88-		R		151-099		Vag	Ø 17,46 230,0x40	VAG
2.0 TD Eng.DE (64kW)	8/82-2/88		R		153-008		Vag	230,0x40	Hand Brake
	9/82-7/88		R		700-197	700-197K		Ø 230,0	
	9/82-88		R		151-099		Vag	Ø 17,46 230,0x40	VAG
2.0 TD Eng.NC (74kW)	88-12/90		R		700-198	700-198K		Ø 230,0	
	8/89-		R		151-131		Ate	Ø 20,64 230,0x40	VAG
	88-		R		151-099		Vag	Ø 17,46 230,0x40	VAG
2.1 Eng.WC (100kW)	82-84		R		700-197	700-197K		Ø 230,0	
2.2 Eng.KZ (85kW)	84-86		R		700-197	700-197K		Ø 230,0	
	84-86		R		151-099		Vag	Ø 17,46 230,0x40	VAG
2.2, Kat Eng.KU/ HX (101kW)	84-7/88		R		700-197	700-197K		Ø 230,0	
2.4 D Eng.3D (60kW)	8/89-7/91		R		153-008		Vag	230,0x40	Hand Brake
	89-12/90		R		700-198	700-198K		Ø 230,0	
	8/89-		R		151-131		Ate	Ø 20,64 230,0x40	VAG
100 IV (4A, C4), Avant 12/90-6/94									
2.0 Eng.AAE (74kW)	12/90-6/94		R		153-009		Vag	230,0x40	Hand Brake
	1/91-		R		700-207	700-207K		Ø 230,0	Ch -4AN100000
	90-94		R		151-131		Ate	Ø 20,64 230,0x40	VAG
2.0 Eng.ADW (79kW)	1/92-12/94		R		153-009		Vag	230,0x40	Hand Brake
2.0 E Eng.AAD/ ABK (85kW)	12/90-6/94		R		153-009		Vag	230,0x40	Hand Brake
	1/91-		R		700-207	700-207K		Ø 230,0	Ch -4AN100000
	90-94		R		151-131		Ate	Ø 20,64 230,0x40	VAG
2.0 E 16v, quattro Eng.ACE (102kW)	7/92-6/94		R		153-009		Vag	230,0x40	Hand Brake
2.0 E quattro Eng.AAD/ ABK (85kW)	12/90-6/94		R		153-009		Vag	230,0x40	Hand Brake
	1/91-		R		700-207	700-207K		Ø 230,0	
	90-94		R		151-131		Ate	Ø 20,64 230,0x40	VAG
2.3 E Eng.AAR (98kW)	12/90-6/94		R		153-009		Vag	230,0x40	Hand Brake
2.3 E quattro Eng.AAR (98kW)	12/90-6/94		R		153-009		Vag	230,0x40	Hand Brake
2.4 D Eng.AAS (60kW)	12/90-6/94		R		153-009		Vag	230,0x40	Hand Brake
	1/91-		R		700-207	700-207K		Ø 230,0	Ch -4AN100000
	90-94		R		151-131		Ate	Ø 20,64 230,0x40	VAG
2.5 TDi Eng.AAT/ ABP (85kW)	-2/91		R		153-008		Vag	230,0x40	Hand Brake
	5/91-		R		153-009		Vag	230,0x40	Hand Brake
4000 10/78-9/87									
All models	10/78-9/87		R		153-462		Vag	200,0x40	Hand Brake
	81-86		R		700-188	700-188K		Ø 200,0	Coupé, Exc. S Quattro
	86-87		R		700-202	700-202K		Ø 200,0	Exc. S Quattro
50 (86) 8/74-7/78									
1.1 Eng.HB (37kW)	8/74-7/78		R		700-191	700-191K		Ø 180,0	
	8/74-7/78		R		151-031		Bdx	Ø 17,46 180,0x30	VAG, +CF
1.1 Eng.HC (44kW)	8/74-7/77		R		700-191	700-191K		Ø 180,0	
	8/74-7/77		R		151-031		Bdx	Ø 17,46 180,0x30	VAG, +CF
1.3 Eng.HH (44kW)	8/77-7/78		R		153-465		Vag	180,0x31	Hand Brake
	8/77-7/78		R		700-191	700-191K		Ø 180,0	
	8/77-7/78		R		151-031		Bdx	Ø 17,46 180,0x30	VAG, +CF
1.3 Eng.HJ (43kW)	1/77-7/78		R		153-465		Vag	180,0x31	Hand Brake
	8/77-7/78		R		700-191	700-191K		Ø 180,0	
	8/77-7/78		R		151-031		Bdx	Ø 17,46 180,0x30	VAG, +CF
5000 10/78-9/87									
All models	10/78-9/87		R		153-008		Vag	230,0x40	Hand Brake
	78-87		R		700-197	700-197K		Ø 230,0	S Quattro Exc. Turbo
80 I (80, 82, B1) 5/72-8/78									
1.3 Eng.ZA (40kW)	74-78		R		700-191	700-191K		Ø 180,0	
1.3 Eng.ZF (44kW)	74-78		R		700-191	700-191K		Ø 180,0	
1.5 Eng.YJ/ ZB (55kW)	74-75		R		700-191	700-191K		Ø 180,0	M/T
	74-75		R		700-188	700-188K		Ø 200,0	A/T
1.5 Eng.ZC (63kW)	74-75		R		700-191	700-191K		Ø 180,0	M/T
1.6 Eng.YN (55kW)	75-78		R		700-191	700-191K		Ø 180,0	M/T
	-78		R		700-188	700-188K		Ø 200,0	Ch 8452040210-, A/T
1.6 Eng.YP (63kW)	75-78		R		700-191	700-191K		Ø 180,0	M/T
	-78		R		700-188	700-188K		Ø 200,0	Ch 8452040210-, A/T

		Spare Parts	F/R	L/R	CIFAM ref.	CIFAM ref. w/KIT		DIMENSIONS mm.	NOTE
1.6 GTE Eng.YS (81kW)	-78		R		700-202	700-202K		Ø 200,0	Ch 8452040210-
80 II (81, 85, B2) 8/78-12/86									
1.2 Eng.FY (40kW)	9/78-7/81		R		153-465		Vag	180,0x31	Hand Brake
	78-81		R		700-191	700-191K		Ø 180,0	
	78-81		R		700-202	700-202K		Ø 200,0	HDB
	78-81		R		151-107		Vag	Ø 17,46 200,0x40	Ch -81A0046050, VAG, +CF, HDB
	-81		R		151-108		Vag	Ø 15,87 200,0x40	Ch 81A0046051-, VAG, +CF, HDB
1.2 Eng.FZ (44kW)	9/78-7/81		R		153-465		Vag	180,0x31	Hand Brake
	78-81		R		700-191	700-191K		Ø 180,0	
	78-81		R		700-202	700-202K		Ø 200,0	HDB
	78-81		R		151-107		Vag	Ø 17,46 200,0x40	Ch -81A0046050, VAG, +CF, HDB
	-81		R		151-108		Vag	Ø 15,87 200,0x40	Ch 81A0046051-, VAG, +CF, HDB
1.3 Eng.EP (44kW)	9/78-7/86		R		153-465		Vag	180,0x31	Hand Brake
	78-7/84		R		700-202	700-202K		Ø 200,0	HDB
	78-86		R		700-191	700-191K		Ø 180,0	
	78-86		R		151-107		Vag	Ø 17,46 200,0x40	Ch -81A0046050, VAG, +CF, HDB
	-86		R		151-108		Vag	Ø 15,87 200,0x40	Ch 81A0046051-, VAG, +CF, HDB
1.6 Eng.DT (55kW)	8/78-7/86		R		153-465		Vag	180,0x31	Hand Brake
	8/78-7/86		R		153-462		Vag	200,0x40	Hand Brake
	78-7/84		R		700-191	700-191K		Ø 180,0	
	78-86		R		700-202	700-202K		Ø 200,0	HDB
	78-86		R		151-107		Vag	Ø 17,46 200,0x40	Ch -81A0046050, VAG, +CF, HDB
	78-84		R		151-028		Bdx	Ø 14,30 180,0x30	VAG
	-86		R		151-108		Vag	Ø 15,87 200,0x40	Ch 81A0046051-, VAG, +CF, HDB
1.6 Eng.FS/ YN/ WV (55kW)	8/78-7/86		R		153-465		Vag	180,0x31	Hand Brake
	8/78-7/86		R		153-462		Vag	200,0x40	Hand Brake
	78-7/84		R		700-191	700-191K		Ø 180,0	
	78-87		R		700-202	700-202K		Ø 200,0	HDB
	78-87		R		151-107		Vag	Ø 17,46 200,0x40	Ch -81A0046050, VAG, +CF, HDB
	78-84		R		151-028		Bdx	Ø 14,30 180,0x30	VAG
1.6 Eng.SA (54kW)	2/86-7/86		R		153-465		Vag	180,0x31	Hand Brake
	2/86-7/86		R		153-462		Vag	200,0x40	Hand Brake
	1/79-12/80		R		153-465		Vag	180,0x31	Hand Brake
	1/79-12/80		R		153-462		Vag	200,0x40	Hand Brake
	1/78-12/80		R		153-465		Vag	180,0x31	Hand Brake
1.6 Eng.YG/ YH/ YK (63kW)	1/78-12/80		R		153-462		Vag	200,0x40	Hand Brake
	1/78-12/80		R		153-465		Vag	180,0x31	Hand Brake
	1/78-12/80		R		153-462		Vag	200,0x40	Hand Brake
	1/78-12/80		R		153-465		Vag	180,0x31	Hand Brake
	1/78-12/80		R		153-462		Vag	200,0x40	Hand Brake
1.6 Eng.YP (63kW)	8/78-2/83		R		153-465		Vag	180,0x31	Hand Brake
	8/78-2/83		R		153-462		Vag	200,0x40	Hand Brake
	78-83		R		700-191	700-191K		Ø 180,0	
	78-83		R		700-202	700-202K		Ø 200,0	HDB
	78-83		R		151-107		Vag	Ø 17,46 200,0x40	Ch -81A0046050, VAG, +CF, HDB
	78-83		R		151-028		Bdx	Ø 14,30 180,0x30	VAG
	-83		R		151-108		Vag	Ø 15,87 200,0x40	Ch 81A0046051-, VAG, +CF, HDB
1.6 Eng.YT/ YY (51kW)	8/78-7/81		R		153-465		Vag	180,0x31	Hand Brake
	8/78-7/81		R		153-462		Vag	200,0x40	Hand Brake
	78-81		R		151-107		Vag	Ø 17,46 200,0x40	Ch -81A0046050, VAG, +CF, HDB
	78-81		R		151-108		Vag	Ø 15,87 200,0x40	Ch 81A0046051-, VAG, +CF, HDB
	-81		R		151-107		Vag	Ø 17,46 200,0x40	Ch -81A0046050, VAG, +CF, HDB
1.6 D Eng.CR (40kW)	8/80-8/86		R		153-465		Vag	180,0x31	Hand Brake
	8/80-8/86		R		153-462		Vag	200,0x40	Hand Brake
	80-86		R		700-191	700-191K		Ø 180,0	
	80-86		R		700-202	700-202K		Ø 200,0	HDB
	80-86		R		151-107		Vag	Ø 17,46 200,0x40	Ch -81A0046050, VAG, +CF, HDB
	80-86		R		151-028		Bdx	Ø 14,30 180,0x30	VAG
	-86		R		151-108		Vag	Ø 15,87 200,0x40	Ch 81A0046051-, VAG, +CF, HDB
1.6 D Eng.JK (40kW)	8/80-8/86		R		153-465		Vag	180,0x31	Hand Brake
	8/80-8/86		R		153-462		Vag	200,0x40	Hand Brake
	80-86		R		700-191	700-191K		Ø 180,0	
	80-86		R		700-202	700-202K		Ø 200,0	HDB
	80-86		R		151-107		Vag	Ø 17,46 200,0x40	Ch -81A0046050, VAG, +CF, HDB
	80-86		R		151-028		Bdx	Ø 14,30 180,0x30	VAG
	-86		R		151-108		Vag	Ø 15,87 200,0x40	Ch 81A0046051-, VAG, +CF, HDB
1.6 GLE Eng.YZ (81kW)	1/79-12/86		R		153-465		Vag	180,0x31	Hand Brake
	1/79-12/86		R		153-462		Vag	200,0x40	Hand Brake
	79-7/84		R		700-191	700-191K		Ø 180,0	
	79-7/84		R		700-202	700-202K		Ø 200,0	HDB
	79-84		R		151-107		Vag	Ø 17,46 200,0x40	Ch -81A0046050, VAG, +CF, HDB
79-84		R		151-045		Ate	Ø 15,87 180,0x30	VAG	

		Spare Parts	F/R	L/R	CIFAM ref.	CIFAM ref. w/KIT		DIMENSIONS mm.	NOTE
1.6 GLE Eng.YZ (81kW)	-86		R		151-108		Vag	Ø 15,87 200,0x40	Ch 81A0046051-, VAG, +CF, HDB
1.6 TD Eng.CY (51kW)	8/81-5/86		R		153-465		Vag	180,0x31	Hand Brake
	8/81-5/86		R		153-462		Vag	200,0x40	Hand Brake
	81-7/84		R		700-191	700-191K		Ø 180,0	
	81-86		R		700-202	700-202K		Ø 200,0	HDB
	84-86		R		151-108		Vag	Ø 15,87 200,0x40	VAG
1.7 Eng.WT (58kW)	1/80-12/83		R		153-465		Vag	180,0x31	Hand Brake
1.8 Eng.DS (66kW)	1/83-8/86		R		153-465		Vag	180,0x31	Hand Brake
	1/83-8/86		R		153-462		Vag	200,0x40	Hand Brake
	-86		R		700-191	700-191K		Ø 180,0	Ch 81D000001-
	-86		R		700-202	700-202K		Ø 200,0	Ch 81D000001-, HDB
	83-86		R		151-028		Bdx	Ø 14,30 180,0x30	VAG
	83-86		R		151-108		Vag	Ø 15,87 200,0x40	VAG
1.8 Eng.SF (65kW)	2/86-7/86		R		153-462		Vag	200,0x40	Hand Brake
1.8 CC quattro Eng.NE (66kW)	8/84-8/86		R		153-465		Vag	180,0x31	Hand Brake
	8/84-8/86		R		153-462		Vag	200,0x40	Hand Brake
	-86		R		700-191	700-191K		Ø 180,0	Ch 81D000001-
	-86		R		700-202	700-202K		Ø 200,0	Ch 81D000001-, HDB
	84-86		R		151-108		Vag	Ø 15,87 200,0x40	VAG
1.8 GTE, quattro Eng.DZ (82kW)	8/84-8/86		R		153-462		Vag	200,0x40	Hand Brake
	-86		R		700-191	700-191K		Ø 180,0	Ch 81D000001-
	-86		R		700-202	700-202K		Ø 200,0	Ch 81D000001-, HDB
	84-86		R		151-108		Vag	Ø 15,87 200,0x40	VAG
	84-86		R		151-108		Vag	Ø 15,87 200,0x40	VAG
1.8 GTE, quattro Eng.PV (81kW)	3/85-8/86		R		153-462		Vag	200,0x40	Hand Brake
	-86		R		700-191	700-191K		Ø 180,0	Ch 81D000001-
	-86		R		700-202	700-202K		Ø 200,0	Ch 81D000001-, HDB
	85-86		R		151-108		Vag	Ø 15,87 200,0x40	VAG
1.8, quattro Eng.JN (68kW)	8/83-8/86		R		153-465		Vag	180,0x31	Hand Brake
	8/83-8/86		R		153-462		Vag	200,0x40	Hand Brake
	-7/84		R		700-191	700-191K		Ø 180,0	Ch 81D000001-
	-86		R		700-202	700-202K		Ø 200,0	Ch 81D000001-, HDB
	83-84		R		151-028		Bdx	Ø 14,30 180,0x30	VAG
	84-86		R		151-108		Vag	Ø 15,87 200,0x40	VAG
1.9 CD-5S Eng.WN (85kW)	9/81-7/83		R		153-465		Vag	180,0x31	Hand Brake
	9/81-7/83		R		153-462		Vag	200,0x40	Hand Brake
	81-83		R		700-191	700-191K		Ø 180,0	
	81-83		R		700-202	700-202K		Ø 200,0	HDB
	81-83		R		151-108		Vag	Ø 15,87 200,0x40	VAG
2.0, quattro Eng.HP/ JS (85kW)	10/83-9/84		R		153-465		Vag	180,0x31	Hand Brake
	10/83-9/84		R		153-462		Vag	200,0x40	Hand Brake
	-7/84		R		700-191	700-191K		Ø 180,0	Ch 81D000001-
	-7/84		R		700-202	700-202K		Ø 200,0	Ch 81D000001-, HDB
	83-84		R		700-196	700-196K		Ø 200,0	
	83-84		R		151-108		Vag	Ø 15,87 200,0x40	VAG
2.2, quattro Eng.WE (85kW)	10/80-7/83		R		153-462		Vag	200,0x40	Hand Brake
	80-83		R		700-191	700-191K		Ø 180,0	
	80-83		R		700-202	700-202K		Ø 200,0	HDB
	80-		R		151-107		Vag	Ø 17,46 200,0x40	Ch -81A0046050, VAG, +CF, HDB
	-83		R		151-108		Vag	Ø 15,87 200,0x40	Ch 81A0046051-, VAG, +CF, HDB
80 III (89, 89Q, 8A, B3) 8/86-7/92									
1.6 Eng.ABB (75kW)	8/90-10/91		R		153-465		Vag	180,0x31	Hand Brake
	8/90-10/91		R		153-462		Vag	200,0x40	Hand Brake
1.6 Eng.PP (51kW)	8/87-9/91		R		153-465		Vag	180,0x31	Hand Brake
	8/87-9/91		R		153-462		Vag	200,0x40	Hand Brake
			R		700-205	700-205K		Ø 200,0	Ch 89K120001-8AM095094, +ABS
	2/87-		R		700-196	700-196K		Ø 200,0	Ch -89K120000, +ABS
	-91		R		700-196	700-196K		Ø 200,0	Ch 8AM095095-, +ABS
			R		151-086		Vag	Ø 15,87 200,0x40	Ch 89K200001-8AM080000, VAG, -ABS
	87-		R		151-108		Vag	Ø 15,87 200,0x40	Ch -89K200000, VAG, -ABS, -CF
1.6 Eng.RN (55kW)	9/86-8/91		R		153-465		Vag	180,0x31	Hand Brake
	9/86-8/91		R		153-462		Vag	200,0x40	Hand Brake
			R		700-205	700-205K		Ø 200,0	Ch 89K120001-8AM095094, +ABS
	2/87-		R		700-196	700-196K		Ø 200,0	Ch -89K120000, +ABS
	-91		R		700-196	700-196K		Ø 200,0	Ch 8AM095095-, +ABS
	86-		R		151-086		Vag	Ø 15,87 200,0x40	Ch 89K200001-8AM080000, VAG, -ABS
1.6 D Eng.JK (40kW)	9/86-8/91		R		153-465		Vag	180,0x31	Hand Brake
	9/86-8/91		R		153-462		Vag	200,0x40	Hand Brake
			R		700-205	700-205K		Ø 200,0	Ch 89K120001-8AM095094, +ABS

		Spare Parts	F/R	L/R	CIFAM ref.	CIFAM ref. w/KIT		DIMENSIONS mm.	NOTE
1.6 D Eng.JK (40kW)	9/86-91		R		700-196	700-196K		Ø 200,0	Ch -89K120000, +ABS
			R		700-196	700-196K		Ø 200,0	Ch 8AM095095-, +ABS
			R		151-086		Vag	Ø 15,87 200,0x40	Ch 89K200001-8AM080000, VAG, -ABS
1.6 TD Eng.RA/ SB (59kW)	9/86-8/91		R		153-465		Vag	180,0x31	Hand Brake
	9/86-8/91		R		153-462		Vag	200,0x40	Hand Brake
	9/86-8/91		R		153-468		Vag	200,0x40	Hand Brake
			R		700-205	700-205K		Ø 200,0	Ch 89K120001-8AM095094, +ABS
	4/89-91		R		700-196	700-196K		Ø 200,0	Ch -89K120000, +ABS
			R		700-196	700-196K		Ø 200,0	Ch 8AM095095-, +ABS
	89-90		R		151-085		Ate	Ø 19,05 200,0x40	Ch 89K200001-8AM080000, VAG
1.8 Eng.RU (55kW)	10/86-1/90		R		153-462		Vag	200,0x40	Hand Brake
	10/86-1/90		R		153-468		Vag	200,0x40	Hand Brake
			R		700-205	700-205K		Ø 200,0	Ch 89K120001-8AM095094, +ABS
			R		700-196	700-196K		Ø 200,0	Ch -89K120000, +ABS
			R		700-196	700-196K		Ø 200,0	Ch 8AM095095-, +ABS
			R		151-085		Ate	Ø 19,05 200,0x40	Ch 89K200001-8AM080000, VAG, A/T
	89-90		R		151-086		Vag	Ø 15,87 200,0x40	Ch 89K200001-8AM080000, VAG, -ABS, M/T
1.8 S Eng.JN/ NE/ PM (66kW)	9/86-9/91		R		153-462		Vag	200,0x40	Hand Brake
	9/86-9/91		R		153-468		Vag	200,0x40	Hand Brake
			R		700-205	700-205K		Ø 200,0	Ch 89K120001-8AM095094, +ABS
	9/86-91		R		700-196	700-196K		Ø 200,0	Ch -89K120000, +ABS
			R		700-196	700-196K		Ø 200,0	Ch 8AM095095-, +ABS
			R		151-085		Ate	Ø 19,05 200,0x40	Ch 89K200001-8AM080000, VAG
	89-90		R		151-109		Vag	Ø 19,05 200,0x40	VAG
1.8 S Eng.SF (65kW)	9/86-90		R		700-205	700-205K		Ø 200,0	Ch 89K120001-8AM095094, +ABS
			R		700-196	700-196K		Ø 200,0	Ch -89K120000, +ABS
			R		700-196	700-196K		Ø 200,0	Ch 8AM095095-, +ABS
			R		151-085		Ate	Ø 19,05 200,0x40	Ch 89K200001-8AM080000, VAG
	89-90		R		151-109		Vag	Ø 19,05 200,0x40	VAG
1.9	9/89-91		R		700-205	700-205K		Ø 200,0	Ch 89K120001-8AM095094, +ABS
			R		700-196	700-196K		Ø 200,0	Ch -89K120000, +ABS
			R		700-196	700-196K		Ø 200,0	Ch 8AM095095-, +ABS
			R		151-085		Ate	Ø 19,05 200,0x40	Ch 89K200001-8AM080000, VAG
1.9 D Eng.1Y (50kW)	8/89-8/91		R		153-462		Vag	200,0x40	Hand Brake
	8/89-8/91		R		153-468		Vag	200,0x40	Hand Brake
			R		700-205	700-205K		Ø 200,0	Ch 89K120001-8AM095094, +ABS
	9/89-91		R		700-196	700-196K		Ø 200,0	Ch -89K120000, +ABS
			R		700-196	700-196K		Ø 200,0	Ch 8AM095095-, +ABS
	89-91		R		151-085		Ate	Ø 19,05 200,0x40	Ch 89K200001-8AM080000, VAG
1.9 quattro	9/89-91		R		700-205	700-205K		Ø 200,0	Ch 89K120001-8AM095094, +ABS
			R		700-196	700-196K		Ø 200,0	Ch -89K120000, +ABS
			R		700-196	700-196K		Ø 200,0	Ch 8AM095095-, +ABS
		R		151-085		Ate	Ø 19,05 200,0x40	Ch 89K200001-8AM080000, VAG	
80 IV (8C, B4), Avant 9/91-1/96									
1.6 Eng.ABM (52kW)	9/91-12/94		R		153-462		Vag	200,0x40	Hand Brake
	8/91-		R		700-197	700-197K		Ø 230,0	Ch -8CP050000
1.6 E Eng.ADA (74kW)	9/91-1/96		R		153-462		Vag	200,0x40	Hand Brake
	91-		R		700-197	700-197K		Ø 230,0	Ch -8CP050000
1.9 TD Eng.AAZ (55kW)	9/91-12/94		R		153-009		Vag	230,0x40	Hand Brake
	91-		R		700-197	700-197K		Ø 230,0	Ch -8CP050000
	91-94		R		151-129		Ate	Ø 17,46 230,0x40	VAG
1.9 TDi Eng.1Z (66kW)	9/91-1/96		R		153-009		Vag	230,0x40	Hand Brake
	8/91-		R		700-197	700-197K		Ø 230,0	Ch -8CP050000
	91-96		R		151-130		Ate	Ø 19,05 230,0x40	VAG
2.0 Eng.ABT (66kW)	9/91-1/96		R		153-009		Vag	230,0x40	Hand Brake
	8/91-		R		700-197	700-197K		Ø 230,0	Ch -8CP050000
	91-96		R		151-130		Ate	Ø 19,05 230,0x40	VAG, M/T
2.0 Eng.ADW (79kW)	12/93-7/96		R		153-009		Vag	230,0x40	Hand Brake
2.0 E Eng.ABK (85kW)	9/91-1/96		R		153-009		Vag	230,0x40	Hand Brake
90 I (81, 85, B2) 10/84-3/87									
1.6 TD Eng.CY (51kW)	10/85-1/87		R		153-462		Vag	200,0x40	Hand Brake
	85-7/86		R		700-196	700-196K		Ø 200,0	
	85-87		R		151-107		Vag	Ø 17,46 200,0x40	VAG
2.0 Eng.SK (83kW)	3/86-3/87		R		153-462		Vag	200,0x40	Hand Brake
	86-87		R		700-196	700-196K		Ø 200,0	





		Spare Parts	F/R	L/R	CIFAM ref.	CIFAM ref. w/KIT		DIMENSIONS mm.	NOTE
2.0 Eng.SK (83kW)	86-87		R		151-107		Vag	Ø 17,46 200,0x40	VAG
2.0, quattro Eng.HP/ JS (85kW)	10/84-3/87		R		153-462		Vag	200,0x40	Hand Brake
	8/84-8/87		R		700-196	700-196K		Ø 200,0	
	84-87		R		151-107		Vag	Ø 17,46 200,0x40	VAG
2.2 Eng.HY/ KV (100kW)	5/84-8/87		R		700-196	700-196K		Ø 200,0	
2.2 Eng.KX (85kW)	10/84-3/87		R		153-462		Vag	200,0x40	Hand Brake
	84-87		R		700-196	700-196K		Ø 200,0	
	84-87		R		151-107		Vag	Ø 17,46 200,0x40	VAG
90 II (89, 89Q, 8A, B3) 4/87-9/91									
1.6 TD Eng.RA/ SB (59kW)	4/87-9/91		R		153-462		Vag	200,0x40	Hand Brake
	4/87-9/91		R		153-468		Vag	200,0x40	Hand Brake
			R		700-205	700-205K		Ø 200,0	Ch 89K120001-8AM095094
	4/87-91		R		700-196	700-196K		Ø 200,0	Ch -89K120000
			R		700-196	700-196K		Ø 200,0	Ch 8AM095095-
	90-91		R		151-109		Vag	Ø 19,05 200,0x40	VAG
A2 (8Z0) 2/00-									
1.2 TDi Eng.ANY (45kW)	3/01-01		R		153-468		Vag	200,0x40	Hand Brake
			R		151-235		Vag	Ø 15,87 200,0x40	VAG
			R		700-358			Ø 200,0	
1.4 Eng.AUA/ BBY (55kW)	00-00		R		153-468		Vag	200,0x40	Hand Brake
			R		700-358			Ø 200,0	
			R		151-158		Vag	Ø 17,46 200,0x40	VAG
1.4 TDi Eng.AMF/ BHC (55kW)	00-00		R		153-468		Vag	200,0x40	Hand Brake
			R		700-358			Ø 200,0	
			R		151-158		Vag	Ø 17,46 200,0x40	VAG
1.4 TDi Eng.ATL (66kW)	03-		R		153-468		Vag	200,0x40	Hand Brake
1.6 FSI Eng.BAD (81kW)	5/02-		R		153-468		Vag	200,0x40	Hand Brake
Coupe I (81, 85) 7/80-10/88									
1.6 Eng.YN (55kW)	7/80-8/81		R		153-465		Vag	180,0x31	M/T, Hand Brake
	7/80-8/81		R		153-462		Vag	200,0x40	A/T, Hand Brake
	80-81		R		700-191	700-191K		Ø 180,0	M/T
	80-81		R		700-188	700-188K		Ø 200,0	A/T
	80-81		R		151-028		Bdx	Ø 14,30 180,0x30	VAG, M/T
	80-81		R		151-108		Vag	Ø 15,87 200,0x40	VAG, A/T
1.6 Eng.YV (63kW)	9/82-12/88		R		153-465		Vag	180,0x31	M/T, Hand Brake
	9/82-12/88		R		153-462		Vag	200,0x40	A/T, Hand Brake
1.8 Eng.DD (55kW)	8/81-7/83		R		153-465		Vag	180,0x31	Ch -85E220000, Hand Brake
	8/81-7/83		R		153-462		Vag	200,0x40	Ch 85F000001-, Hand Brake
	8/81-		R		700-191	700-191K		Ø 180,0	Ch -85E220000, M/T
	8/81-83		R		700-188	700-188K		Ø 200,0	M/T+A/T
			R		151-108		Vag	Ø 15,87 200,0x40	Ch 85F000001-, VAG
	81-		R		151-028		Bdx	Ø 14,30 180,0x30	Ch -85ZE220000, VAG, M/T
1.8 GT Eng.DS/ JV (66kW)	86-		R		153-465		Vag	180,0x31	Hand Brake
	8/88-10/88		R		700-202	700-202K		Ø 200,0	
	82-		R		700-191	700-191K		Ø 180,0	Ch -85ZE220000, M/T
	82-7/88		R		700-188	700-188K		Ø 200,0	M/T+A/T
			R		151-108		Vag	Ø 15,87 200,0x40	Ch 85F000001-, VAG
	82-		R		151-028		Bdx	Ø 14,30 180,0x30	Ch -85ZE220000, VAG
1.8 GT Eng.JN (68kW)	86-		R		153-465		Vag	180,0x31	Hand Brake
			R		151-108		Vag	Ø 15,87 200,0x40	Ch 85F000001-, VAG
1.8 GT Eng.PV (79kW)	86-		R		153-465		Vag	180,0x31	Hand Brake
	86-87		R		700-188	700-188K		Ø 200,0	M/T+A/T
			R		151-108		Vag	Ø 15,87 200,0x40	Ch 85F000001-, VAG
	86-		R		151-028		Bdx	Ø 14,30 180,0x30	Ch -85E220000, VAG
1.8 GT Eng.SF (65kW)	86-		R		153-465		Vag	180,0x31	Hand Brake
	8/88-10/88		R		700-202	700-202K		Ø 200,0	
	86-		R		700-191	700-191K		Ø 180,0	Ch -85E220000, M/T
	86-7/88		R		700-188	700-188K		Ø 200,0	M/T+A/T
			R		151-108		Vag	Ø 15,87 200,0x40	Ch 85F000001-, VAG
	86-		R		151-028		Bdx	Ø 14,30 180,0x30	Ch -85E220000, VAG
1.8 GT quattro Eng.DS/ JN/ NE (66kW)	86-		R		153-465		Vag	180,0x31	Hand Brake
1.8 GT, quattro Eng.DZ (82kW)	86-		R		153-465		Vag	180,0x31	Hand Brake
			R		151-108		Vag	Ø 15,87 200,0x40	Ch 85F000001-, VAG
1.9 Eng.WN (85kW)	8/80-7/83		R		153-462		Vag	200,0x40	Hand Brake
	10/80-		R		700-188	700-188K		Ø 200,0	Ch -85C250000
			R		151-108		Vag	Ø 15,87 200,0x40	Ch 85F000001-, VAG
2.0 Eng.HP/ JS (85kW)	9/83-7/86		R		153-462		Vag	200,0x40	Hand Brake
	83-86		R		700-188	700-188K		Ø 200,0	

		Spare Parts	F/R	L/R	CIFAM ref.	CIFAM ref. w/KIT		DIMENSIONS mm.	NOTE
2.0 Eng.HP/ JS (85kW)	83-86		R		151-107		Vag	Ø 17,46 200,0x40	VAG
2.0 Eng.SK (83kW)	3/86-4/88		R		153-462		Vag	200,0x40	Hand Brake
	86-7/87		R		700-188	700-188K		Ø 200,0	
	86-88		R		151-107		Vag	Ø 17,46 200,0x40	VAG
2.1 GT Eng.KE/ KL (96kW)	82-		R		700-188	700-188K		Ø 200,0	Ch -85C250000
	82-84		R		151-107		Vag	Ø 17,46 200,0x40	VAG
2.2 GT Eng.KX (85kW)	81-87		R		151-107		Vag	Ø 17,46 200,0x40	VAG

Fox 1/75-1/79













All models	75-79		R		700-188	700-188K		Ø 200,0	
------------	-------	---	---	--	----------------	-----------------	--	---------	--

Q7 (4L) 3/06-



















3.0 TDi quattro Eng.BUG (171kW)	3/06-		R		153-244	153-244K		210,0x31	Hand Brake
3.0 TDi quattro Eng.CAS/ CCMA/ CJGA (176kW)	11/07-		R		153-244	153-244K		210,0x31	Hand Brake
	3.6 V6 FSI quattro Eng.BHK (206kW)	1/07-		R	153-244	153-244K		210,0x31	Hand Brake
4.2 FSI quattro Eng.BAR (257kW)	3/06-		R		153-244	153-244K		210,0x31	Hand Brake
4.2 V8 TDi quattro Eng.BTR (240kW)	6/07-		R		153-244	153-244K		210,0x31	Hand Brake

AUTOBIANCHI





A112 10/69-12/85

0.9 Eng.100GL6.000 (33kW)	1/76-12/78		R		153-063		Fiat	185,0x31	Fitted Adjuster, Hand Brake
0.9 Eng.A112B1.000/ 141A40R (34kW)	1/73-12/77		R		153-063		Fiat	185,0x31	Fitted Adjuster, Hand Brake
	73-		R		700-003			Ø 185,0	
0.9 Junior Eng.A112A5.000/ A112B2.000 (31kW)	7/75-12/85		R		153-063		Fiat	185,0x31	Fitted Adjuster, Hand Brake
	1/78-10/82		R		700-003			Ø 185,0	
0.95 Eng.A112B1.000 (35kW)	11/77-12/85		R		153-063		Fiat	185,0x31	Fitted Adjuster, Hand Brake
	1/78-		R		700-003			Ø 185,0	
	-12/77		R		700-004			Ø 185,0	
1.0 Abarth (58kW)	1/74-12/84		R		153-063		Fiat	185,0x31	Fitted Adjuster, Hand Brake
	77-84		R		700-003			Ø 185,0	
1.0 Abarth Eng.A112A1.000 (43kW)	9/71-12/75		R		153-063		Fiat	185,0x31	Fitted Adjuster, Hand Brake
1.0 Abarth Eng.A112A2.000 (51kW)	1/74-12/84		R		153-063		Fiat	185,0x31	Fitted Adjuster, Hand Brake
	77-84		R		700-003			Ø 185,0	

Y10 3/85-





1.0 Eng.156A.000 (41kW)	3/85-		R		153-063		Fiat	185,0x31	Fitted Adjuster, Hand Brake
	85-92		R		700-003			Ø 185,0	
1.0 Eng.156A2.000 (33kW)	3/85-		R		153-063		Fiat	185,0x31	Fitted Adjuster, Hand Brake
	2/85-92		R		700-003			Ø 185,0	
1.0 4WD Eng.156A3.000 (37kW)	12/86-		R		153-063		Fiat	185,0x31	Fitted Adjuster, Hand Brake
	86-92		R		700-003			Ø 185,0	
1.0 Kat Eng.156A2.246 (33kW)	10/87-		R		153-063		Fiat	185,0x31	Fitted Adjuster, Hand Brake
	87-92		R		700-003			Ø 185,0	
1.0 T. Eng.156A1.000 (63kW)	3/85-		R		153-063		Fiat	185,0x31	Fitted Adjuster, Hand Brake
	85-92		R		700-003			Ø 185,0	
1.1 i.e. Kat Eng.156C.046 (42kW)	9/90-		R		153-063		Fiat	185,0x31	Fitted Adjuster, Hand Brake
	90-92		R		700-003			Ø 185,0	
1.1, 4WD Eng.156C.000 (42kW)	6/89-		R		153-063		Fiat	185,0x31	Fitted Adjuster, Hand Brake
	89-92		R		700-003			Ø 185,0	
1.3 i.e. GT Eng.146A5.046 (54kW)	6/89-		R		153-063		Fiat	185,0x31	Fitted Adjuster, Hand Brake
	89-92		R		700-003			Ø 185,0	
1.3 i.e. GT Eng.156B.000 (57kW)	6/89-		R		153-063		Fiat	185,0x31	Fitted Adjuster, Hand Brake
	89-92		R		700-003			Ø 185,0	























































Y10 (RES. 1992) 6/92-





















































1.1, 4WD Eng.156C.000 (42kW)	6/92-		R		153-069		Ap	185,0x31	Hand Brake
	92-95		R		700-003			Ø 185,0	
1.3 i.e. GT Eng.146A5.046 (54kW)	6/92-		R		153-069		Ap	185,0x31	Hand Brake
	92-95		R		700-003			Ø 185,0	























AUVERLAND































































A3 4/87-



















































1.6	1/91-		R		153-068		Lucas	254,0x57	
1.9 D (66kW)	4/87-91		R		153-062		Lucas	254,0x57	Hand Brake
	91-		R		153-068		Lucas	254,0x57	
2.1	1/91-		R		153-068		Lucas	254,0x57	









































		Spare Parts	F/R	L/R	CIFAM ref.	CIFAM ref. w/KIT		DIMENSIONS mm.	NOTE
Astra Van 1/82-1/92									
1.3 (34kW)	9/84-9/89		R		153-305		Lucas	200,0x45	Hand Brake
1.3 (44kW)	9/84-9/89		R		153-305		Lucas	200,0x45	Hand Brake
1.3, i Eng.1.3N/ S (44-55kW)	82-83		R		153-304		GM	200,0x46	Hand Brake
	83-		R		153-305		Lucas	200,0x45	Hand Brake
1.4 Eng.14 NV (44kW)	1/89-8/91		R		153-305		Lucas	200,0x45	Hand Brake
1.6 D (42kW)	9/87-8/89		R		153-305		Lucas	200,0x45	Hand Brake
1.6 D Eng.16D/ DA (40kW)	-83		R		153-301		GM	230,0x51	Hand Brake
	83-84		R		153-306		Lucas	230,0x50	Hand Brake
	84-		R		153-305		Lucas	200,0x45	Hand Brake
1.6, i Eng.16SH (66kW)	-83		R		153-301		GM	230,0x51	Hand Brake
	83-84		R		153-306		Lucas	230,0x50	Hand Brake
	84-		R		153-305		Lucas	200,0x45	Hand Brake
1.7 D (42kW)	9/88-8/91		R		153-305		Lucas	200,0x45	Hand Brake
AstraMax Van 1/85-1/90									
1.3 Eng.13N/ S/ NB (44-55kW)	1/87-12/88		R		153-306		Lucas	230,0x50	Hand Brake
1.4 Eng.14 NV/ C14NZ (44-55kW)	9/89-6/90		R		153-306		Lucas	230,0x50	Hand Brake
1.6 D (42kW)	9/85-8/88		R		153-306		Lucas	230,0x50	Hand Brake
1.6 D Eng.16D/ 16DA (40kW)	1/85-1/90		R		153-306		Lucas	230,0x50	Hand Brake
1.7 D (42kW)	9/88-6/90		R		153-306		Lucas	230,0x50	Hand Brake
Blitz (CF97) 8/69-10/87									
1.8 Eng.N18Z (49kW)	8/69-10/87		R		153-101		Lucas	203,2x38	Hand Brake
2.0 Eng.20N (56kW)	2/85-10/87		R		153-101		Lucas	203,2x38	Hand Brake
2.0 D Eng.20DTr (44kW)	10/80-10/83		R		153-101		Lucas	203,2x38	Hand Brake
2.1 D Eng.21D (44kW)	9/81-10/87		R		153-101		Lucas	203,2x38	Hand Brake
2.3 Eng.23L (58kW)	2/80-10/83		R		153-101		Lucas	203,2x38	Hand Brake
2.3 D Eng.23D (46kW)	1/73-10/87		R		153-101		Lucas	203,2x38	Hand Brake
Brava									
2.2 D	88-90		R		153-192		Ake	254,0x52	Hand Brake
			R		700-178			Ø 254,0	
2.3	88-		R		153-192		Ake	254,0x52	Hand Brake
			R		700-178			Ø 254,0	
2.5 D	90-		R		153-192		Ake	254,0x52	Hand Brake
			R		700-178			Ø 254,0	
CF2 Van									
All models			R		153-109		Ap	254,0x70	Hand Brake
Chevanne 1/76-12/82									
1.2 Eng.6/ 8/ 10 CWT (40-44kW)	76-82		R		700-300			Ø 200,0	
Euromidi									
All models	85-		R		700-178			Ø 254,0	Axle Isuzu
	85-		R		700-298			Ø 254,0	Axle Salisbury
HA Van									
1256 10-CWT			R		153-101		Lucas	203,2x38	Hand Brake
Midi									
1.8 Eng.4ZB1 (63kW)	9/84-5/88		R		153-190		Sumit.	254,0x50	Hand Brake
	85-88		R		700-178			Ø 254,0	Axle Isuzu
	85-88		R		700-298			Ø 254,0	Axle Salisbury
2.0 D, TD Eng.4FC1 (42-51kW)	8/84-8/92		R		153-190		Sumit.	254,0x50	Hand Brake
	85-90		R		700-178			Ø 254,0	Axle Isuzu
	85-90		R		700-298			Ø 254,0	Axle Salisbury
2.0, 4WD Eng.4ZC1 (62kW)	88-94		R		700-178			Ø 254,0	Axle Isuzu
	88-94		R		700-298			Ø 254,0	Axle Salisbury
2.2 D, 4WD Eng.22DIE (45kW)	6/88-8/92		R		153-190		Sumit.	254,0x50	Hand Brake
	88-94		R		700-178			Ø 254,0	Axle Isuzu
	88-94		R		700-298			Ø 254,0	Axle Salisbury
2.4 TD	94-		R		700-178			Ø 254,0	Axle Isuzu
	94-		R		700-298			Ø 254,0	Axle Salisbury
Midi Van 1/87-12/92									
2.0 D Eng.4FC1 (43kW)	85-90		R		700-178			Ø 254,0	Axle Isuzu
	85-90		R		700-298			Ø 254,0	Axle Salisbury
2.2 D, 4WD Eng.4FD1 (45kW)	88-94		R		700-178			Ø 254,0	Axle Isuzu
	88-94		R		700-298			Ø 254,0	Axle Salisbury
Pick-Up									
1.6	81-88		R		700-178			Ø 254,0	
1.9 D	82-88		R		700-178			Ø 254,0	





















































		Spare Parts	F/R	L/R	CIFAM ref.	CIFAM ref. w/KIT		DIMENSIONS mm.	NOTE
Rascal 7/86-6/90									
0.8, Pick up (30kW)	7/86-6/90		R		153-035		Sumit.	180,0x35	
1.0 Bus, Pick up (34kW)	7/86-6/90		R		153-035		Sumit.	180,0x35	4WD
	7/86-6/90		R		153-394		Sumit.	220,0x40	
1.0, Pick up Eng.FA10A (34kW)	7/86-6/90		R		153-035		Sumit.	180,0x35	4WD
	7/86-6/90		R		153-394		Sumit.	220,0x40	
Serie KB Pick-up 1/79-12/89									
1.6 Eng.G161Z	-84		R		153-190		Sumit.	254,0x50	Hand Brake
	84-		R		153-191		Ake	254,0x50	Hand Brake
1.8			R		153-190		Sumit.	254,0x50	Hand Brake
1.9 D	-84		R		153-190		Sumit.	254,0x50	Hand Brake
	84-		R		153-191		Ake	254,0x50	Hand Brake
2.0	-84		R		153-190		Sumit.	254,0x50	Hand Brake
	84-		R		153-191		Ake	254,0x50	Hand Brake
2.2 D	-84		R		153-190		Sumit.	254,0x50	Hand Brake
	84-		R		153-191		Ake	254,0x50	Hand Brake
BELLIER									
Asso 1/98-									
0.5	1/98-		R		153-053			160,0x42	Fitted Adjuster, Hand Brake
	1/98-		R		153-054			180,0x32	Fitted Adjuster, Hand Brake
Divane 1/98-									
0.5	1/98-		R		153-053			160,0x42	Fitted Adjuster, Hand Brake
	1/98-		R		153-054			180,0x32	Fitted Adjuster, Hand Brake
BERTONE									
Freeclimber 1/92-12/00									
1.6 i Eng.BMW 161 E1 (74kW)	1/92-12/00		R		153-033		Ake	254,0x45	
2.0, KAT Eng.BMW M20 B20/ Kat (95kW)	12/90-12/93		R		153-033		Ake	254,0x45	
2.4 TD (85kW)	6/89-12/93		R		153-033		Ake	254,0x45	
2.7 Eng.BMW M20 B27 (95kW)	12/90-12/93		R		153-033		Ake	254,0x45	
BMW									
02 (E10) 9/67-7/77									
2002 T. Eng.M10B20 (125kW)	73-75		R		700-044			Ø 250,0	
1 (E81,87) 9/04-									
116i Eng.N45B16A (85kW)	9/04-		R		153-018	153-018K	Ate	160,0x20	Hand Brake
118d Eng.M47N204D4 (90kW)	9/04-		R		153-018	153-018K	Ate	160,0x20	Hand Brake
118d Eng.N47D20A (100kW)	07-		R		153-018	153-018K	Ate	160,0x20	
118d Eng.N47D20A (105kW)	07-		R		153-018	153-018K	Ate	160,0x20	Hand Brake
118i Eng.N42B20B/ N46B20 (95kW)	9/04-		R		153-018	153-018K	Ate	160,0x20	Hand Brake
118i Eng.N43B20A (105kW)	07-		R		153-018	153-018K	Ate	160,0x20	Hand Brake
120d Eng.M47N204D4 (120kW)	9/04-		R		153-018	153-018K	Ate	160,0x20	Hand Brake
120d Eng.M47N204D4 (130kW)	4/07-		R		153-018	153-018K	Ate	160,0x20	Hand Brake
120i Eng.N42B20A (110kW)	9/04-		R		153-018	153-018K	Ate	160,0x20	Hand Brake
123d Eng.N47D20B (150kW)	9/07-		R		153-017		Ate	185,0x20	Hand Brake
130i Eng.N52B30/ N52B30A (195kW)	9/05-		R		153-017		Ate	185,0x20	Hand Brake
1 (E82) Coupe 9/07-									
120d Eng.M47N204D4 (130kW)	07-		R		153-018	153-018K	Ate	160,0x20	Hand Brake
123d Eng.N47D20B (150kW)	9/07-		R		153-018	153-018K	Ate	160,0x20	Hand Brake
	9/07-		R		153-017		Ate	185,0x20	Hand Brake
125i Eng.N53B30A (160kW)	3/08-		R		153-018	153-018K	Ate	160,0x20	Hand Brake
135i Eng.N54B30A (225kW)	9/07-		R		153-018	153-018K	Ate	160,0x20	Hand Brake
1 (E88) Cabrio 11/07-									
118d Eng.N47D20A (100kW)	9/08-		R		153-018	153-018K	Ate	160,0x20	
118d Eng.N47D20A (105kW)	9/08-		R		153-018	153-018K	Ate	160,0x20	Hand Brake
118i Eng.N43B20A (105kW)	3/08-		R		153-018	153-018K	Ate	160,0x20	Hand Brake
120d Eng.N47D20A (130kW)	08-		R		153-018	153-018K	Ate	160,0x20	Hand Brake
120i Eng.N43B20A (125kW)	11/07-		R		153-018	153-018K	Ate	160,0x20	Hand Brake
125i Eng.N53B30A (160kW)	11/07-		R		153-018	153-018K	Ate	160,0x20	Hand Brake
135i Eng.N54B30A (225kW)	3/08-		R		153-018	153-018K	Ate	160,0x20	Hand Brake
1500-2000 10/62-7/72									
1.5 Eng.M10B15 (59kW)	10/62-7/66		R		153-010		Lucas	250,0x42	Hand Brake
	62-66		R		700-044			Ø 250,0	
1600 Eng.M10B16 (59-61kW)	9/63-4/68		R		153-010		Lucas	250,0x42	Hand Brake
	63-68		R		700-044			Ø 250,0	



















































		Spare Parts	F/R	L/R	CIFAM ref.	CIFAM ref. w/KIT		DIMENSIONS mm.	NOTE
1800 Eng.M10B18 (66kW)	8/63-9/71		R		153-010		Lucas	250,0x42	Hand Brake
	63-71		R		700-044			Ø 250,0	
1800 Ti Eng.M10B18 (81-96kW)	10/63-4/68		R		153-010		Lucas	250,0x42	Hand Brake
	63-68		R		700-044			Ø 250,0	
2000 Eng.M10B20(40PDSi) (74kW)	9/68-7/72		R		153-010		Lucas	250,0x42	Hand Brake
	68-72		R		700-044			Ø 250,0	
2000 Ti / Tilux Eng.M10B20(40PHH) (88kW)	1/66-7/72		R		153-010		Lucas	250,0x42	Hand Brake
	66-72		R		700-044			Ø 250,0	
2000 Tii Eng.M10B20 (96kW)	12/69-7/72		R		153-010		Lucas	250,0x42	Hand Brake
	69-72		R		700-044			Ø 250,0	
2000 3.2 Coupe (E9) 10/65-3/76									
2800 CS Eng.M30B28 (125kW)	1/69-4/71		R		153-011	153-011K	Ate	160,0x25	Exc. CS, Hand Brake
	1/69-4/71		R		153-010		Lucas	250,0x42	Hand Brake
	70-71		R		700-043			Ø 250,0	
3.0 CS Eng.M30B30 (132kW)	5/71-3/76		R		153-011	153-011K	Ate	160,0x25	Hand Brake
3.0 Csi Eng.M30B30(L-Jetronic) (147kW)	7/71-3/76		R		153-011	153-011K	Ate	160,0x25	Hand Brake
2500 3.3 (E3) 10/68-4/77									
2500 Eng.M30B25 (110kW)	10/68-4/77		R		153-011	153-011K	Ate	160,0x25	Hand Brake
2800 Eng.M30B28 (125kW)	10/68-7/75		R		153-011	153-011K	Ate	160,0x25	Exc. CS, Hand Brake
	10/68-7/75		R		153-010		Lucas	250,0x42	Hand Brake
2800 L Eng.M30B28 (125kW)	2/75-4/77		R		153-011	153-011K	Ate	160,0x25	Exc. CS, Hand Brake
	2/75-4/77		R		153-010		Lucas	250,0x42	Hand Brake
3.0 S, L Eng.M30B30 (132kW)	5/71-4/77		R		153-011	153-011K	Ate	160,0x25	Hand Brake
3.0 Si Eng.M30B30(L-Jetronic) (143kW)	10/75-4/77		R		153-011	153-011K	Ate	160,0x25	Hand Brake
3.0 Si Eng.M30B30(L-Jetronic) (147kW)	7/71-9/75		R		153-011	153-011K	Ate	160,0x25	Hand Brake
3 I (E21) 6/75-3/84									
315 Eng.M10B16 (55kW)	3/81-3/84		R		153-010		Lucas	250,0x42	Hand Brake
	4/81-7/84		R		700-044			Ø 250,0	
316 Eng.M10B16 (66kW)	8/75-8/80		R		153-010		Lucas	250,0x42	Hand Brake
	75-80		R		700-044			Ø 250,0	
316 Eng.M10B18 (66kW)	9/80-8/82		R		153-010		Lucas	250,0x42	Hand Brake
	80-82		R		700-044			Ø 250,0	
318 Eng.M10B18 (72kW)	8/75-8/80		R		153-010		Lucas	250,0x42	Hand Brake
	75-80		R		700-044			Ø 250,0	
318 i Eng.M10B18(K-Jetronic) (77kW)	80-		R		153-010		Lucas	250,0x42	Hand Brake
	79-82		R		700-044			Ø 250,0	
320 Eng.M10B20 (80kW)	8/75-8/77		R		153-010		Lucas	250,0x42	Hand Brake
	75-77		R		700-044			Ø 250,0	
320 i Eng.M10B20(K-Jetronic) (92kW)	9/77-8/82		R		700-044			Ø 250,0	
320/6 Eng.M20B20 (90kW)	9/77-8/82		R		153-010		Lucas	250,0x42	Hand Brake
	77-82		R		700-044			Ø 250,0	
323 i Eng.M20B23(K-Jetronic) (105kW)	1/78-8/82		R		153-011	153-011K	Ate	160,0x25	Hand Brake
3 II (E30) 9/82-10/93									
315 Eng.M10B16(1B2) (55kW)	9/82-10/83		R		153-014		Lucas	228,6x42	-ABS, Hand Brake
	9/82-10/83		R		153-010		Lucas	250,0x42	Hand Brake
	82-83		R		700-044			Ø 250,0	
316 Eng.M10B18(2B4) (66kW)	82-86		R		153-475		Lucas	228,6x42	-ABS, Hand Brake
	9/82-12/90		R		153-014		Lucas	228,6x42	-ABS, Hand Brake
	3/82-90		R		700-045			Ø 228,6	
316 i Eng.M40B16(Kat.) (73kW)	82-8/90		R		151-149		Lucas	Ø 20,64 228,6x42	LUC
	87-12/91		R		700-045			Ø 228,6	
	87-8/90		R		151-149		Lucas	Ø 20,64 228,6x42	LUC
316 i, Cabrio Eng.M40B16 (75kW)	7/88-6/91		R		153-018	153-018K	Ate	160,0x20	Cabrio, Hand Brake
	7/88-6/91		R		153-014		Lucas	228,6x42	-ABS, Hand Brake
	88-12/91		R		700-045			Ø 228,6	
	88-8/90		R		151-149		Lucas	Ø 20,64 228,6x42	LUC
318 i Eng.M10B18(K-Jetronic) (77kW)	9/82-8/87		R		153-475		Lucas	228,6x42	Hand Brake
	9/82-8/87		R		153-014		Lucas	228,6x42	-ABS, Hand Brake
	3/82-87		R		700-045			Ø 228,6	
	82-8/86		R		151-149		Lucas	Ø 20,64 228,6x42	LUC
	9/86-87		R		151-150		Lucas	Ø 22,20 228,6x42	LUC







































		Spare Parts	F/R	L/R	CIFAM ref.	CIFAM ref. w/KIT		DIMENSIONS mm.	NOTE
318 i Eng.M10B18(L-Jetronic) (75kW)	8/87-8/88		R		153-014		Lucas	228,6x42	-ABS, Hand Brake
	8/87-8/88		R		153-475		Lucas	228,6x42	-ABS, Hand Brake
	8/87-8/88		R		700-045			Ø 228,6	
	84-8/86		R		151-149		Lucas	Ø 20,64 228,6x42	LUC
	9/86-88		R		151-150		Lucas	Ø 22,20 228,6x42	LUC
318 i Eng.M40B18 (85kW)	9/87-6/91		R		153-014		Lucas	228,6x42	-ABS, Hand Brake
	9/87-6/91		R		153-475		Lucas	228,6x42	-ABS, Hand Brake
	87-12/91		R		700-045			Ø 228,6	
	87-91		R		151-150		Lucas	Ø 22,20 228,6x42	LUC
318 i, Cabrio Eng.M40B18(Kat.) (83kW)	9/87-6/93		R		153-014		Lucas	228,6x42	-ABS, Hand Brake
	9/87-6/93		R		153-475		Lucas	228,6x42	-ABS, Hand Brake
	87-93		R		700-045			Ø 228,6	
	87-93		R		151-150		Lucas	Ø 22,20 228,6x42	LUC
318 is Eng.M42B18 (100kW)	9/89-8/91		R		153-014		Lucas	228,6x42	-ABS, Hand Brake
	9/89-8/91		R		153-475		Lucas	228,6x42	-ABS, Hand Brake
	89-91		R		700-045			Ø 228,6	
	89-91		R		151-149		Lucas	Ø 20,64 228,6x42	LUC
320 i Eng.M20 (110kW)	12/85-6/90		R		153-018	153-018K	Ate	160,0x20	+ABS, Hand Brake
	12/85-6/90		R		153-014		Lucas	228,6x42	-ABS, Hand Brake
320 i Eng.M20B20(L-Jetronic) (92kW)	9/82-12/85		R		153-018	153-018K	Ate	160,0x20	+ABS, Hand Brake
	9/82-12/85		R		153-475		Lucas	228,6x42	Hand Brake
	9/82-12/85		R		153-014		Lucas	228,6x42	-ABS, Hand Brake
	82-85		R		700-045			Ø 228,6	
	82-85		R		151-149		Lucas	Ø 20,64 228,6x42	LUC
320 i Cabrio Eng.M20B20/M20B20(Monotronic/ Kat) (95kW)	4/86-10/93		R		153-014		Lucas	228,6x42	-ABS, Hand Brake
320 i, Cabrio Eng.M20B20(L-Jetronic)/(Motronic/ Kat.) (95kW)	12/85-10/93		R		153-018	153-018K	Ate	160,0x20	+ABS, Hand Brake
	85-93		R		700-045			Ø 228,6	
	85-93		R		151-149		Lucas	Ø 20,64 228,6x42	LUC
324 D Eng.M21D24 (63kW)	85-8/87		R		153-475		Lucas	228,6x42	-ABS, Hand Brake
	9/87-		R		153-014		Lucas	228,6x42	-ABS, Hand Brake
	9/85-12/91		R		700-045			Ø 228,6	
	85-91		R		151-150		Lucas	Ø 22,20 228,6x42	LUC
3 II Touring (E30) 7/87-6/94									
316 i Eng.M40B16 (75kW)	9/91-6/94		R		153-014		Lucas	228,6x42	-ABS, Hand Brake
316 i Eng.M40B16(Kat.) (73kW)	9/91-6/94		R		153-014		Lucas	228,6x42	-ABS, Hand Brake
318 i Eng.M40B18 (85kW)	9/87-6/91		R		153-014		Lucas	228,6x42	-ABS, Hand Brake
318 i Eng.M40B18(Kat.) (83kW)	4/89-6/94		R		153-014		Lucas	228,6x42	-ABS, Hand Brake
320 i Eng.M20B20(Motronic/ Kat.) (95kW)	1/88-12/91		R		153-014		Lucas	228,6x42	-ABS, Hand Brake
3 III (E36) 9/90-2/98									
316 i Eng.M40B16 (75kW)	9/90-9/93		R		153-016	153-016K	Ate	160,0x25	+ABS, Hand Brake
	9/90-9/93		R		153-015		Lucas	228,6x42	Hand Brake
	90-93		R		700-046			Ø 228,6	
316 i Eng.M40B16(Kat.) (73kW)	9/90-9/93		R		153-016	153-016K	Ate	160,0x25	+ABS, Hand Brake
	9/90-9/93		R		153-015		Lucas	228,6x42	Hand Brake
	90-93		R		700-046			Ø 228,6	
316 i Eng.M43B16 (75kW)	7/93-2/98		R		153-016	153-016K	Ate	160,0x25	+ABS, Hand Brake
	7/93-2/98		R		153-015		Lucas	228,6x42	Hand Brake
318 i Eng.M40B18(Kat.) (83kW)	12/90-10/93		R		153-016	153-016K	Ate	160,0x25	+ABS, Hand Brake
	90-93		R		700-046			Ø 228,6	Exc. Japan/Australia
318 i Eng.M43B18 (85kW)	10/93-2/98		R		153-016	153-016K	Ate	160,0x25	+ABS, Hand Brake
	93-98		R		700-046			Ø 228,6	Exc. Japan/Australia
318 is Eng.M42B18 (103kW)	3/93-9/97		R		153-016	153-016K	Ate	160,0x25	+ABS, Hand Brake
318 is Eng.M44B19 (103kW)	9/95-2/98		R		153-016	153-016K	Ate	160,0x25	+ABS, Hand Brake
318 TDS Eng.M41D18(Inter.) (66kW)	1/95-2/98		R		153-016	153-016K	Ate	160,0x25	+ABS, Hand Brake
	1/95-2/98		R		153-015		Lucas	228,6x42	Hand Brake
	95-		R		700-046			Ø 228,6	
320 i Eng.M50B(206S1)/M52B(206S3)Vanos (110kW)	9/90-2/98		R		153-016	153-016K	Ate	160,0x25	+ABS, Hand Brake
323 i 2.5 Eng.M52B25(Vanos) (125kW)	3/95-2/98		R		153-016	153-016K	Ate	160,0x25	+ABS, Hand Brake
325 i Eng.M50B25(Vanos) (141kW)	9/90-9/95		R		153-016	153-016K	Ate	160,0x25	+ABS, Hand Brake
325 TD Eng.M51D25 (85kW)	9/91-2/98		R		153-016	153-016K	Ate	160,0x25	+ABS, Hand Brake
325 TDS Eng.M51D25(Inter.) (105kW)	5/93-2/98		R		153-016	153-016K	Ate	160,0x25	+ABS, Hand Brake
328 i Eng.M52B28 (142kW)	1/95-2/98		R		153-016	153-016K	Ate	160,0x25	+ABS, Hand Brake























		Spare Parts	F/R	L/R	CIFAM ref.	CIFAM ref. w/KIT		DIMENSIONS mm.	NOTE
M3 3.0 Eng.S50B30 (210kW)	8/94-9/95		R		153-013	153-013K	Ate	180,0x25	+ABS, Hand Brake
M3 3.2 Eng.S50B32 (236kW)	9/95-2/98		R		153-013	153-013K	Ate	180,0x25	+ABS, Hand Brake
3 III Cabrio, Coupe (E36) 3/92-4/99									
316 i (Exc. Cabrio) Eng.M43B16 (75kW)	93-99		R		700-046			Ø 228,6	
318 i (Exc. Coupe) Eng.M43B18 (85kW)	1/94-4/99		R		153-016	153-016K	Ate	160,0x25	+ABS, Hand Brake
318 is (Exc. Cabrio) Eng.M42B18 (103kW)	3/92-10/95		R		153-016	153-016K	Ate	160,0x25	+ABS, Hand Brake
320 i Eng.M50B(206S1)/M52B(206S3)Vanos (110kW)	3/92-4/99		R		153-016	153-016K	Ate	160,0x25	+ABS, Hand Brake
323 i 2.5 Eng.M52B25(Vanos) (125kW)	3/95-4/99		R		153-016	153-016K	Ate	160,0x25	+ABS, Hand Brake
325 i Eng.M52B25(Vanos) (141kW)	3/92-4/99		R		153-016	153-016K	Ate	160,0x25	+ABS, Hand Brake
328 i cabrio Eng.M52B28/ M52B28TU (142kW)	1/95-4/99		R		153-016	153-016K	Ate	160,0x25	+ABS, Hand Brake
328 i coupe Eng.M52B28 (142kW)	1/95-4/99		R		153-016	153-016K	Ate	160,0x25	+ABS, Hand Brake
M3 3.0 Eng.S50B30 (210kW)	10/92-1/95		R		153-013	153-013K	Ate	180,0x25	+ABS, Hand Brake
M3 3.0 (Exc. Cabrio) Eng.S50B30 (217kW)	1/95-10/95		R		153-013	153-013K	Ate	180,0x25	+ABS, Hand Brake
M3 3.2 Eng.S50B32 (236kW)	10/95-4/99		R		153-013	153-013K	Ate	180,0x25	+ABS, Hand Brake
3 III Compact (E36) 3/94-8/00									
316 g Eng.CNGB16K (75kW)	12/95-8/00		R		153-015		Lucas	228,6x42	Hand Brake
316 i Eng.M43B16 (75kW)	3/94-8/00		R		153-015		Lucas	228,6x42	Hand Brake
	94-98		R		700-046			Ø 228,6	
318 TDS Eng.M41D18(Inter.) (66kW)	95-		R		700-046			Ø 228,6	
318 ti Eng.M42B18 (103kW)	11/94-8/95		R		153-016	153-016K	Ate	160,0x25	+ABS, Hand Brake
318 ti Eng.M44B19 (103kW)	7/95-8/00		R		153-016	153-016K	Ate	160,0x25	+ABS, Hand Brake
323 ti Eng.M52B25(Vanos) (125kW)	8/97-8/00		R		153-018	153-018K	Ate	160,0x20	+ABS, Hand Brake
3 III Touring (E36) 1/95-10/99									
316 i Eng.M43B16 (75kW)	96-99		R		700-046			Ø 228,6	
318 i Eng.M43B18 (85kW)	7/95-10/99		R		153-016	153-016K	Ate	160,0x25	Hand Brake
	95-99		R		700-046			Ø 228,6	Exc. Japan/Australia
318 TDS Eng.M41D18(Inter.) (66kW)	1/95-10/99		R		153-016	153-016K	Ate	160,0x25	+ABS, Hand Brake
	95-		R		700-046			Ø 228,6	
320 i Eng.M52B(206S3)Vanos (110kW)	1/95-10/99		R		153-016	153-016K	Ate	160,0x25	+ABS, Hand Brake
323 i 2.5 Eng.M52B25(Vanos) (125kW)	9/95-10/99		R		153-016	153-016K	Ate	160,0x25	+ABS, Hand Brake
325 TDS Eng.M51D25(Inter.) (105kW)	1/95-10/99		R		153-016	153-016K	Ate	160,0x25	+ABS, Hand Brake
328 i Eng.M52B28 (142kW)	1/95-10/99		R		153-016	153-016K	Ate	160,0x25	+ABS, Hand Brake
3 IV (E46) 2/98-12/04									
316 i Eng.M43164E3 (77kW)	9/98-12/04		R		153-018	153-018K	Ate	160,0x20	Hand Brake
316 i Eng.M43B16(164E3) (77kW)	4/00-12/04		R		153-018	153-018K	Ate	160,0x20	Hand Brake
316 i Eng.N42B18 (85kW)	2/02-12/04		R		153-018	153-018K	Ate	160,0x20	Hand Brake
316 i Eng.N45B16A (85kW)	6/02-12/04		R		153-018	153-018K	Ate	160,0x20	Hand Brake
318 D Eng.M47N204D1 (85kW)	9/01-12/04		R		153-018	153-018K	Ate	160,0x20	Hand Brake
318 D Eng.M47N204D4 (85kW)	3/03-12/04		R		153-018	153-018K	Ate	160,0x20	Hand Brake
318 i Eng.M43B19 (87kW)	2/98-9/01		R		153-018	153-018K	Ate	160,0x20	+ABS, Hand Brake
318 i Eng.N42B20/ N46B20 (105kW)	9/01-12/04		R		153-018	153-018K	Ate	160,0x20	Hand Brake
320 D Eng.M47D204D1 (100kW)	4/98-9/01		R		153-018	153-018K	Ate	160,0x20	+ABS, Hand Brake
320 D Eng.M47N204D4 (110kW)	9/01-12/04		R		153-018	153-018K	Ate	160,0x20	+ABS, Hand Brake
320 D Eng.M47R (96kW)	11/02-12/04		R		153-018	153-018K	Ate	160,0x20	+ABS, Hand Brake
323 i Eng.M52B25(Vanos) (125kW)	3/98-9/00		R		153-018	153-018K	Ate	160,0x20	+ABS, Hand Brake
325 i, xi Eng.M54256S5 (141kW)	9/00-12/04		R		153-017	153-017K	Ate	185,0x20	Hand Brake
328 i Eng.M52B28 (142kW)	2/98-6/00		R		153-018	153-018K	Ate	160,0x20	Hand Brake
330 D, xd Eng.M57D30 (135kW)	10/99-12/04		R		153-017	153-017K	Ate	185,0x20	Hand Brake
330 D, xd Eng.M57N306D2 (150kW)	3/03-12/04		R		153-017	153-017K	Ate	185,0x20	Hand Brake
330 i, xi Eng.M54306S3 (170kW)	6/00-12/04		R		153-017	153-017K	Ate	185,0x20	Hand Brake
3 IV Cabrio, Coupe (E46) 4/99-12/04									
3.2 M3 Eng.S54326S4/ S54B32 (252kW)	6/00-12/04		R		153-019	153-019K	Ate	185,0x30	Hand Brake

		Spare Parts	F/R	L/R	CIFAM ref.	CIFAM ref. w/KIT		DIMENSIONS mm.	NOTE
3.2 M3 CSL (Exc. Cabrio) Eng.S54N326S4 (265kW)	6/03-12/04		R		153-019	153-019K	Ate	185,0x30	Hand Brake
320 Ci Eng.M54226S1/ M54B22 (125kW)	9/00-12/04		R		153-018	153-018K	Ate	160,0x20	+ABS, Hand Brake
320 Ci (Exc. Cabrio) Eng.M52B(206S4) (110kW)	8/99-9/00		R		153-018	153-018K	Ate	160,0x20	+ABS, Hand Brake
323 Ci Eng.M52B25(Vanos) (125kW)	4/99-9/00		R		153-018	153-018K	Ate	160,0x20	+ABS, Hand Brake
328 Ci (Exc. Cabrio) Eng.M52B28 (142kW)	4/99-6/00		R		153-018	153-018K	Ate	160,0x20	Hand Brake
3 IV Compact (E46) 6/01-12/04									
318 tD Eng.M47N204D4 (85kW)	3/03-12/04		R		153-018	153-018K	Ate	160,0x20	+ABS, Hand Brake
318 ti Eng.N42B20/ N46B20 (105kW)	9/01-12/04		R		153-018	153-018K	Ate	160,0x20	+ABS, Hand Brake
3 IV Touring (E46) 10/99-12/04									
318 i Eng.M43B19 (85-87kW)	10/99-9/01		R		153-018	153-018K	Ate	160,0x20	+ABS, Hand Brake
318 i Eng.N42B20/ N46B20 (105kW)	9/01-12/04		R		153-018	153-018K	Ate	160,0x20	+ABS, Hand Brake
320 D Eng.M47D20 (100kW)	3/00-9/01		R		153-018	153-018K	Ate	160,0x20	+ABS, Hand Brake
320 D Eng.M47N204D4 (110kW)	9/01-12/04		R		153-018	153-018K	Ate	160,0x20	+ABS, Hand Brake
320 i Eng.M52B(206S3)Vanos (110kW)	10/99-9/00		R		153-018	153-018K	Ate	160,0x20	+ABS, Hand Brake
320 i Eng.M54226S1 (125kW)	9/00-12/04		R		153-018	153-018K	Ate	160,0x20	+ABS, Hand Brake
328 i Eng.M52B28 (142kW)	10/99-6/00		R		153-018	153-018K	Ate	160,0x20	Hand Brake
3 V (E90) 1/05-									
316d Eng.N47D20A (85kW)	09-		R		153-018	153-018K	Ate	160,0x20	Hand Brake
316i Eng.N43B16A (90kW)	9/07-		R		153-018	153-018K	Ate	160,0x20	Hand Brake
316i Eng.N45B16A (85kW)	2/06-		R		153-018	153-018K	Ate	160,0x20	Hand Brake
318 D Eng.M47T2D20 (90kW)	9/05-		R		153-018	153-018K	Ate	160,0x20	Hand Brake
318 D Eng.N47D20A (105kW)	10/07-		R		153-018	153-018K	Ate	160,0x20	Hand Brake
318i Eng.N42B20 (105kW)	10/07-		R		153-018	153-018K	Ate	160,0x20	Hand Brake
318i Eng.N46B20 (95kW)	9/05-		R		153-018	153-018K	Ate	160,0x20	Hand Brake
320 D, xd Eng.M47N204D5/ N47D20C (120kW)	1/05-		R		153-018	153-018K	Ate	160,0x20	Hand Brake
320 D, xd Eng.N47D20A (130kW)	10/07-		R		153-018	153-018K	Ate	160,0x20	Hand Brake
320 si Eng.N45B20A (127kW)	5/06-		R		153-018	153-018K	Ate	160,0x20	Hand Brake
320i Eng.N43B20A (125kW)	10/07-		R		153-018	153-018K	Ate	160,0x20	Hand Brake
320i Eng.N46B20A/ C (110kW)	1/05-		R		153-018	153-018K	Ate	160,0x20	Hand Brake
325 Eng.N52NB25A (130kW)	06-07		R		153-018	153-018K	Ate	160,0x20	Hand Brake
325 D Eng.M57306D3 (145kW)	06-		R		153-018	153-018K	Ate	160,0x20	Hand Brake
325i Eng.N52B30A (160kW)	9/08-		R		153-018	153-018K	Ate	160,0x20	Hand Brake
325i, xi Eng.N52B25C (160kW)	1/05-		R		153-018	153-018K	Ate	160,0x20	Hand Brake
330 D, xd Eng.M57T2D30 (170kW)	05-		R		153-018	153-018K	Ate	160,0x20	Hand Brake
330 D, xd Eng.N57D30A (180kW)	9/08-		R		153-018	153-018K	Ate	160,0x20	Hand Brake
330i, xi Eng.N52B30A (190kW)	05-		R		153-018	153-018K	Ate	160,0x20	Hand Brake
330i, xi Eng.N53B30A (200kW)	07-		R		153-018	153-018K	Ate	160,0x20	Hand Brake
3 V Cabrio (E93) 3/07-									
325i Eng.N52B25A/ N52B25 (160kW)	07-		R		153-017	153-017K	Ate	185,0x20	Hand Brake
330 D Eng.M57306D3 (170kW)	3/07-		R		153-017	153-017K	Ate	185,0x20	Hand Brake
330i Eng.N52B30A (200kW)	07-		R		153-017	153-017K	Ate	185,0x20	Hand Brake
335i Eng.N54B30A (225kW)	3/07-		R		153-017	153-017K	Ate	185,0x20	Hand Brake
3 V Coupe (E92) 9/06-									
320i Eng.N43B20A (125kW)	3/07-		R		153-018	153-018K	Ate	160,0x20	Hand Brake
320i Eng.N46B20B (110kW)	11/06-6/07		R		153-018	153-018K	Ate	160,0x20	Hand Brake
325i, xi Eng.N52B25C/ N52B25/ N52B25A (160kW)	9/06-		R		153-018	153-018K	Ate	160,0x20	Hand Brake
3 V Touring (E91) 1/05-									
320i Eng.N43B20A (125kW)	9/07-		R		153-018	153-018K	Ate	160,0x20	Hand Brake
320i Eng.N46B20A/ C (110kW)	1/05-		R		153-018	153-018K	Ate	160,0x20	Hand Brake
325 Eng.N52NB25A (130kW)	06-07		R		153-018	153-018K	Ate	160,0x20	Hand Brake
325 D Eng.M57306D3 (145kW)	06-		R		153-018	153-018K	Ate	160,0x20	Hand Brake
325 i, xi Eng.N53B30/ N53B30A (160kW)	07-		R		153-018	153-018K	Ate	160,0x20	Hand Brake
325i Eng.N52B25C (160kW)	05-		R		153-018	153-018K	Ate	160,0x20	Hand Brake



		Spare Parts	F/R	L/R	CIFAM ref.	CIFAM ref. w/KIT		DIMENSIONS mm.	NOTE
5 I (E12) 8/72-8/81									
518 Eng.M10B18/(2B4)/(32-32DID) (66kW)	7/74-5/81		R		153-010		Lucas	250,0x42	Hand Brake
	6/74-81		R		700-043			Ø 250,0	
518i Eng.M10B18(K-Jetronic) (75kW)	8/79-8/81		R		153-010		Lucas	250,0x42	Hand Brake
520 Eng.M10B20(Strombergvergaser) (85kW)	8/72-8/77		R		153-010		Lucas	250,0x42	Hand Brake
	72-77		R		700-043			Ø 250,0	
520 i Eng.M10B20(K-Jetronic) (92kW)	10/75-5/79		R		153-010		Lucas	250,0x42	Hand Brake
	75-79		R		700-043			Ø 250,0	
520 i Eng.M10B20(Schäfer-Inj.) (96kW)	8/72-10/75		R		153-010		Lucas	250,0x42	Hand Brake
	72-75		R		700-043			Ø 250,0	
520/6 Eng.M20B20 (90kW)	9/77-5/81		R		153-010		Lucas	250,0x42	Hand Brake
	77-6/81		R		700-043			Ø 250,0	
525 Eng.M30B25(32-40INAT) (107kW)	8/73-10/76		R		153-011	153-011K	Ate	160,0x25	Hand Brake
525 Eng.M30B25(4A1) (110kW)	8/76-5/81		R		153-011	153-011K	Ate	160,0x25	Hand Brake
528 Eng.M30B28 (121-125kW)	1/75-8/77		R		153-011	153-011K	Ate	160,0x25	Hand Brake
528 i Eng.M30B28(L-Jetronic) (130-135kW)	4/77-5/81		R		153-011	153-011K	Ate	160,0x25	Hand Brake
5 II (E28) 6/81-6/90									
518 Eng.M10B18(2B4) (66kW)	6/81-8/84		R		153-013	153-013K	Ate	180,0x25	+ABS, Hand Brake
	6/81-8/84		R		153-012		Lucas	250,0x42	-ABS, Hand Brake
	81-84		R		700-043			Ø 250,0	
518 i Eng.M10B18(K-Jetronic) (75kW)	9/81-8/84		R		153-013	153-013K	Ate	180,0x25	+ABS, Hand Brake
	9/81-8/84		R		153-012		Lucas	250,0x42	-ABS, Hand Brake
	81-9/84		R		700-043			Ø 250,0	
518 i Eng.M10B18(L-Jetronic) (77kW)	9/83-12/87		R		153-013	153-013K	Ate	180,0x25	+ABS, Hand Brake
	9/83-12/87		R		153-012		Lucas	250,0x42	-ABS, Hand Brake
	83-3/86		R		700-043			Ø 250,0	
520 i Eng.M20 (110kW)	12/86-6/90		R		153-013	153-013K	Ate	180,0x25	+ABS, Hand Brake
	12/86-6/90		R		153-012		Lucas	250,0x42	-ABS, Hand Brake
520 i Eng.M20B20(L/ K-Jetronic) (92kW)	6/81-12/87		R		153-013	153-013K	Ate	180,0x25	+ABS, Hand Brake
	6/81-12/87		R		153-012		Lucas	250,0x42	-ABS, Hand Brake
	81-87		R		700-043			Ø 250,0	
520 i Eng.M20B20(Motronic/ Kat.) (95kW)	8/85-12/87		R		153-013	153-013K	Ate	180,0x25	+ABS, Hand Brake
	8/85-12/87		R		153-012		Lucas	250,0x42	-ABS, Hand Brake
	85-87		R		700-043			Ø 250,0	
524 D Eng.M21D24 (63kW)	3/86-12/87		R		153-013	153-013K	Ate	180,0x25	+ABS, Hand Brake
	3/86-12/87		R		153-012		Lucas	250,0x42	-ABS, Hand Brake
524 tD Eng.M21D24 (85kW)	9/83-12/87		R		153-013	153-013K	Ate	180,0x25	+ABS, Hand Brake
	9/83-12/87		R		153-012		Lucas	250,0x42	-ABS, Hand Brake
	83-87		R		700-043			Ø 250,0	
525 e 2.7 Eng.M20B27 (92-95kW)	5/83-12/87		R		153-013	153-013K	Ate	180,0x25	Hand Brake
525 i Eng.M30B25(L-Jet.) (110kW)	6/81-12/87		R		153-013	153-013K	Ate	180,0x25	Hand Brake
528 i Eng.M30B28(L-Jetronic) (135kW)	6/81-12/87		R		153-013	153-013K	Ate	180,0x25	Hand Brake
5 III (E34) 1/88-9/95									
3.8 M5 Eng.S38B38 (250kW)	3/92-9/95		R		153-013	153-013K	Ate	180,0x25	Hand Brake
525 Eng.M50B25 (141kW)	1/89-11/97		R		153-013	153-013K	Ate	180,0x25	Hand Brake
525 i Eng.M20B25(Kat.) (125kW)	1/88-8/91		R		153-013	153-013K	Ate	180,0x25	Hand Brake
525 i 24v, X Eng.M52B25(Vanos) (141kW)	9/89-9/95		R		153-013	153-013K	Ate	180,0x25	Hand Brake
530 i Eng.M30B30(Kat.) (138kW)	1/88-8/91		R		153-013	153-013K	Ate	180,0x25	Hand Brake
530 i V8 Eng.M60B30 (160kW)	9/92-9/95		R		153-013	153-013K	Ate	180,0x25	Hand Brake
535 i Eng.M30B35(Motronic/ 9:1/ Kat.) (155kW)	1/88-9/95		R		153-013	153-013K	Ate	180,0x25	Hand Brake
5 III Touring (E34) 11/91-1/97									
3.8 M5 Eng.S38B38 (250kW)	9/94-1/97		R		153-013	153-013K	Ate	180,0x25	Hand Brake
5 IV (E39) 11/95-7/03									
4.9 M5 Eng.S38B49 (294kW)	10/98-7/03		R		153-019	153-019K	Ate	185,0x30	Hand Brake
520 D Eng.M47N204D4 (110kW)	6/02-7/03		R		153-017	153-017K	Ate	185,0x20	Hand Brake
520 i Eng.M52B(206S3)Vanos (100kW)	4/99-7/03		R		153-017	153-017K	Ate	185,0x20	Hand Brake
520 i Eng.M52B(206S3-206S4) (110kW)	1/96-9/00		R		153-017	153-017K	Ate	185,0x20	Hand Brake
520 i Eng.M54B22 (125kW)	9/00-7/03		R		153-017	153-017K	Ate	185,0x20	Hand Brake

		Spare Parts	F/R	L/R	CIFAM ref.	CIFAM ref. w/KIT		DIMENSIONS mm.	NOTE
523 i Eng.M52B25(Vanos) (125kW)	11/95-9/00		R		153-017	153-017K	Ate	185,0x20	Hand Brake
525 D Eng.M57256D1 (120kW)	2/00-7/03		R		153-017	153-017K	Ate	185,0x20	Hand Brake
525 TD Eng.M51D25 (85kW)	1/97-7/03		R		153-017	153-017K	Ate	185,0x20	Hand Brake
525 TDs Eng.M51D25(Inter.) (105kW)	1/96-7/03		R		153-017	153-017K	Ate	185,0x20	Hand Brake
528 i Eng.M52B28 (142kW)	11/95-9/00		R		153-017	153-017K	Ate	185,0x20	Hand Brake
530 D Eng.M57D30 (135kW)	8/98-9/00		R		153-017	153-017K	Ate	185,0x20	Hand Brake
530 D Eng.M57D30 (142kW)	9/00-7/03		R		153-017	153-017K	Ate	185,0x20	Hand Brake
535 i Eng.M62B(358S1) (173kW)	4/96-3/99		R		153-017	153-017K	Ate	185,0x20	Hand Brake
535 i Eng.M62B(358S2) (180kW)	4/99-7/03		R		153-017	153-017K	Ate	185,0x20	Hand Brake
540 i Eng.M62B44 (210kW)	4/96-7/03		R		153-017	153-017K	Ate	185,0x20	Hand Brake
5 IV Touring (E39) 11/95-7/03									
520 D Eng.M47D20/ M47204D1 (100kW)	2/00-6/02		R		153-017	153-017K	Ate	185,0x20	Hand Brake
520 D Eng.M47N204D4 (110kW)	6/02-7/03		R		153-017	153-017K	Ate	185,0x20	Hand Brake
520 i Eng.M52B(206S3)Vanos (100kW)	4/99-7/03		R		153-017	153-017K	Ate	185,0x20	Hand Brake
520 i Eng.M52B(206S3-206S4) (110kW)	1/96-9/00		R		153-017	153-017K	Ate	185,0x20	Hand Brake
520 i Eng.M54B22 (125kW)	9/00-7/03		R		153-017	153-017K	Ate	185,0x20	Hand Brake
523 i Eng.M52B25(Vanos) (125kW)	11/95-9/00		R		153-017	153-017K	Ate	185,0x20	Hand Brake
525 D Eng.M57256D1/ M57D25 (120kW)	2/00-7/03		R		153-017	153-017K	Ate	185,0x20	Hand Brake
525 tDs Eng.M51D25(Inter.) (105kW)	1/96-7/03		R		153-017	153-017K	Ate	185,0x20	Hand Brake
528 i Eng.M52B28/ M52B28TU (142kW)	11/95-9/00		R		153-017	153-017K	Ate	185,0x20	Hand Brake
530 D Eng.M57D30 (135kW)	8/98-9/00		R		153-017	153-017K	Ate	185,0x20	Hand Brake
530 D Eng.M57D30 (142kW)	9/00-7/03		R		153-017	153-017K	Ate	185,0x20	Hand Brake
540 i Eng.M62B44/ M62B44TU/ M62448S2 (210kW)	4/96-7/03		R		153-017	153-017K	Ate	185,0x20	Hand Brake
5 V (E60) 7/03-7/09									
5.0 M5 Eng.S85B50A (373kW)	9/04-9/04		R		153-011	153-011K	Ate	160,0x25	Hand Brake
			R		153-019	153-019K	Ate	185,0x30	Hand Brake
520i Eng.M54226S1 (125kW)	7/03-7/03		R		153-019	153-019K	Ate	185,0x30	Hand Brake
525i Eng.M54256S5 (141kW)	03-09		R		153-019	153-019K	Ate	185,0x30	Hand Brake
525i Eng.N52B25A (160kW)	7/05-7/05		R		153-019	153-019K	Ate	185,0x30	Hand Brake
525xi Eng.N52B25A (160kW)	7/05-7/05		R		153-019	153-019K	Ate	185,0x30	Hand Brake
530 D Eng.N57306D2 (160kW)	7/03-7/03		R		153-019	153-019K	Ate	185,0x30	Hand Brake
530i Eng.M54306S3 (170kW)	7/03-7/03		R		153-019	153-019K	Ate	185,0x30	Hand Brake
545i Eng.N62B44 (245kW)	9/03-9/03		R		153-019	153-019K	Ate	185,0x30	Hand Brake
5 V Touring (E61) 7/03-7/09									
5.0 M5 Eng.S85B50A (373kW)	9/04-9/04		R		153-019	153-019K	Ate	185,0x30	Hand Brake
520i Eng.M54226S1 (125kW)	7/03-7/03		R		153-019	153-019K	Ate	185,0x30	Hand Brake
525i Eng.M54256S5 (141kW)	9/03-9/03		R		153-019	153-019K	Ate	185,0x30	Hand Brake
525i Eng.N52B25A/ N53B30A (160kW)	7/05-7/05		R		153-019	153-019K	Ate	185,0x30	Hand Brake
525xi Eng.N52B25A (160kW)	05-09		R		153-019	153-019K	Ate	185,0x30	Hand Brake
530 D Eng.N57306D2 (160kW)	7/03-7/03		R		153-019	153-019K	Ate	185,0x30	Hand Brake
530i Eng.M54306S3 (170kW)	7/03-7/03		R		153-019	153-019K	Ate	185,0x30	Hand Brake
545i Eng.N62B44 (245kW)	9/03-9/03		R		153-019	153-019K	Ate	185,0x30	Hand Brake
6 I (E24) 4/76-9/90									
628 CSi Eng.M30B28(L-Jetronic) (135kW)	9/79-8/87		R		153-011	153-011K	Ate	160,0x25	Hand Brake
630 CS Eng.M30B30(4A1) (136kW)	4/76-8/79		R		153-011	153-011K	Ate	160,0x25	Hand Brake
633 CSi Eng.M30B32(L-Jetronic) (147kW)	4/76-9/78		R		153-011	153-011K	Ate	160,0x25	Hand Brake
633 CSi Eng.M30B32(L-Jetronic/ 9:1) (145kW)	9/78-8/84		R		153-011	153-011K	Ate	160,0x25	Hand Brake
635 CSi Eng.M30B35 (141kW)	4/85-9/90		R		153-013	153-013K	Ate	180,0x25	Hand Brake
635 CSi Eng.M30B35(L-Jetronic/ 10:1) (160kW)	6/78-8/88		R		153-013	153-013K	Ate	180,0x25	Hand Brake
635 CSi Eng.M30B35(Motronic/ Kat.) (136-155kW)	4/76-5/89		R		153-013	153-013K	Ate	180,0x25	Hand Brake
6 II (E63, E64), Cabrio 1/04-1/11									
630i Eng.N52B30A (190kW)	9/04-9/04		R		153-019	153-019K	Ate	185,0x30	Hand Brake



		Spare Parts	F/R	L/R	CIFAM ref.	CIFAM ref. w/KIT		DIMENSIONS mm.	NOTE
645Ci Eng.N62B44A/ N62B44 (245kW)	1/04-		R		153-019	153-019K	Ate	185,0x30	Hand Brake
7 I (E23) 5/77-8/86									
728 Eng.M30B28 (125kW)	5/77-8/79		R		153-011	153-011K	Ate	160,0x25	Hand Brake
728 i Eng.M30B28(L-Jetronic) (135kW)	-8/81 9/81-		R		153-011	153-011K	Ate	160,0x25	Hand Brake
			R		153-013	153-013K	Ate	180,0x25	Hand Brake
730 Eng.M30B30(4A1) (135kW)	5/77-8/79		R		153-011	153-011K	Ate	160,0x25	Hand Brake
732 i/733 i Eng.M30B32(Motronic/ 10:1) (145kW)	-8/81 9/81-		R		153-011	153-011K	Ate	160,0x25	Hand Brake
			R		153-013	153-013K	Ate	180,0x25	Hand Brake
735 i Eng.M30B35(Motronic) (141-160kW)	9/79-8/86		R		153-011	153-011K	Ate	160,0x25	Hand Brake
735 i Eng.M30B35(Motronic/ 8:1/ Kat.) (136kW)	5/77-8/86		R		153-011	153-011K	Ate	160,0x25	Hand Brake
745 i Eng.M30B32(Turbo/ 8:1) (185kW)	4/80-4/83		R		153-011	153-011K	Ate	160,0x25	Hand Brake
7 II (E32) 9/86-9/94									
730 i,iL Eng.M30B30 (145kW)	12/86-9/94		R		153-013	153-013K	Ate	180,0x25	Hand Brake
730 i,iL Eng.M30B30(Kat.) (138kW)	12/86-9/94		R		153-013	153-013K	Ate	180,0x25	Hand Brake
730 i,iL V8 Eng.M60B30 (160kW)	4/92-9/94		R		153-013	153-013K	Ate	180,0x25	Hand Brake
735 i,iL Eng.M30B35(Motronic/ 9.2:1) (162kW)	9/86-12/87		R		153-013	153-013K	Ate	180,0x25	Hand Brake
735 i,iL Eng.M30B35(Motronic/ 9:1/ Kat.) (155kW)	9/86-9/92		R		153-013	153-013K	Ate	180,0x25	Hand Brake
740 i,iL V8 Eng.M60B40 (210kW)	4/92-9/94		R		153-013	153-013K	Ate	180,0x25	Hand Brake
750 i,iL V12 Eng.M70B50 (220kW)	9/87-9/94		R		153-013	153-013K	Ate	180,0x25	Hand Brake
7 III (E38) 10/94-11/01									
728 i,iL, iX Eng.M52B28 (142kW)	8/95-11/01		R		153-013	153-013K	Ate	180,0x25	Hand Brake
740 i,iL Eng.M60B40 (210kW)	10/94-11/01		R		153-013	153-013K	Ate	180,0x25	+ABS, Hand Brake
740 i,iL Eng.M62B44 (210kW)	1/96-11/01		R		153-013	153-013K	Ate	180,0x25	+ABS, Hand Brake
7 IV (E65, E66) 11/01-12/08									
730 D Eng.M57306D2 (160kW)	10/02-12/08		R		153-019	153-019K	Ate	185,0x30	Hand Brake
730 i,Li Eng.M54306S3 (170kW)	3/03-12/08		R		153-019	153-019K	Ate	185,0x30	Hand Brake
730 LD Eng.M54B30 (170kW)	7/05-12/08		R		153-019	153-019K	Ate	185,0x30	Hand Brake
730i, Li Eng.N52B30A (190kW)	7/05-12/08		R		153-019	153-019K	Ate	185,0x30	Hand Brake
735 i,Li Eng.N62B36 (200kW)	11/01-12/08		R		153-019	153-019K	Ate	185,0x30	Hand Brake
745 i,Li Eng.N62B44 (245kW)	11/01-12/08		R		153-019	153-019K	Ate	185,0x30	Hand Brake
760 Eng.N73B60A (320kW)	2/03-8/05		R		153-019	153-019K	Ate	185,0x30	Hand Brake
760 i,Li Eng.N73B60 (327kW)	1/03-12/08		R		153-019	153-019K	Ate	185,0x30	Hand Brake
8 (E31) 4/90-12/99									
840 Ci Eng.M62B44 (210kW)	1/96-12/99		R		153-013	153-013K	Ate	180,0x25	+ABS, Hand Brake
840 i Eng.M60B40 (210kW)	2/93-2/96		R		153-013	153-013K	Ate	180,0x25	+ABS, Hand Brake
840i Eng.M60B44 (210kW)	1/93-12/95		R		153-013	153-013K	Ate	180,0x25	+ABS, Hand Brake
850 Ci Eng.M73B54 (240kW)	9/94-12/99		R		153-013	153-013K	Ate	180,0x25	+ABS, Hand Brake
850 CSI Eng.S/ M70B56 (280kW)	4/93-12/96		R		153-013	153-013K	Ate	180,0x25	+ABS, Hand Brake
X1 (E84) 9/09-									
20d Eng.N47D20C (130kW)	09-		R		153-017		Ate	185,0x20	
23dA Eng.N47D20D (150kW)	09-		R		153-017		Ate	185,0x20	
28iA Eng.N52B30A (190kW)	09-		R		153-017		Ate	185,0x20	
X3 (E83) 1/04-9/10									
2.0 D Eng.M47N204D4 (110kW)	10/04-		R		153-019	153-019K	Ate	185,0x30	Hand Brake
2.5 Eng.M54256S5 (141kW)	1/04-		R		153-019	153-019K	Ate	185,0x30	Hand Brake
3.0 Eng.M54306S3 (170kW)	1/04-		R		153-019	153-019K	Ate	185,0x30	Hand Brake
3.0 D Eng.M57D306D3 (160kW)	1/04-		R		153-019	153-019K	Ate	185,0x30	Hand Brake
3.0 D Eng.M57N306D2 (150kW)	1/04-		R		153-019	153-019K	Ate	185,0x30	Hand Brake
X5 (E53) 5/00-12/06									
3.0 D Eng.M57306D1 (135kW)	5/01-12/03		R		153-019	153-019K	Ate	185,0x30	Hand Brake
3.0 D Eng.M57N306D4 (160kW)	12/03-12/06		R		153-019	153-019K	Ate	185,0x30	Hand Brake
3.0 i Eng.M54306S3 (163kW)	5/00-12/06		R		153-019	153-019K	Ate	185,0x30	Hand Brake
3.0 i Eng.M54306S3 (170kW)	5/00-12/06		R		153-019	153-019K	Ate	185,0x30	Hand Brake
4.4 i Eng.M62B44 (210kW)	5/00-12/03		R		153-019	153-019K	Ate	185,0x30	Hand Brake
4.4 i Eng.N62B44A (235kW)	12/03-12/06		R		153-019	153-019K	Ate	185,0x30	Hand Brake
4.6 is Eng.M67468S1 (255kW)	2/02-12/06		R		153-019	153-019K	Ate	185,0x30	Hand Brake
4.8 is Eng.N62B48A (265kW)	4/04-12/06		R		153-019	153-019K	Ate	185,0x30	Hand Brake
X5 (E70) 2/07-									
3.0 D Eng.M57306D3 (173kW)	07-		R		153-019	153-019K	Ate	185,0x30	Hand Brake
3.0s D Eng.M57N306D5 (210kW)	07-		R		153-019	153-019K	Ate	185,0x30	Hand Brake

		Spare Parts	F/R	L/R	CIFAM ref.	CIFAM ref. w/KIT		DIMENSIONS mm.	NOTE
3.0si Eng.N52B30A (200kW)	2/07-		R		153-019	153-019K	Ate	185,0x30	Hand Brake
4.8 i Eng.N62B48B (261kW)	9/07-		R		153-019	153-019K	Ate	185,0x30	Hand Brake
X6 (E71) 3/08-									
30d Eng.M57306D3 (173kW)	4/08-		R		153-019	153-019K	Ate	185,0x30	Hand Brake
35d Eng.M57N306D5 (210kW)	3/08-		R		153-019	153-019K	Ate	185,0x30	Hand Brake
35i Eng.N54B30A (225kW)	3/08-		R		153-019	153-019K	Ate	185,0x30	Hand Brake
50i Eng.N63B44 (300kW)	6/08-		R		153-019	153-019K	Ate	185,0x30	Hand Brake
Z1 6/88-6/91									
2.5 Eng.M20B25(Kat.) (125kW)	6/88-6/91		R		153-016	153-016K	Ate	160,0x25	Hand Brake
Z3 (E36) 10/95-1/03									
1.8 Eng.M43B18 (85kW)	10/95-10/98		R		153-016	153-016K	Ate	160,0x25	Hand Brake
1.9 Eng.M43194E1 (85kW)	1/99-1/03		R		153-016	153-016K	Ate	160,0x25	Hand Brake
1.9 Eng.M43B19 (87kW)	7/98-1/03		R		153-016	153-016K	Ate	160,0x25	Hand Brake
1.9 Eng.M44B19 (103kW)	10/95-3/99		R		153-016	153-016K	Ate	160,0x25	Hand Brake
Z4 I (E85, 86) 2/03-2/09									
2.0 i Eng.N46B20A (110kW)	4/05-2/09		R		153-018	153-018K	Ate	160,0x20	Hand Brake
2.2 i Eng.M54226S1 (125kW)	10/03-2/09		R		153-018	153-018K	Ate	160,0x20	Hand Brake
2.5 i Eng.M54256S5 (141kW)	03-09		R		153-018	153-018K	Ate	160,0x20	Hand Brake
2.5 i Eng.N52B25A (130kW)	1/06-2/09		R		153-018	153-018K	Ate	160,0x20	Hand Brake
2.5 si Eng.N52B25A (160kW)	1/06-2/09		R		153-018	153-018K	Ate	160,0x20	Hand Brake
3.0 i Eng.M54306S3 (170kW)	03-09		R		153-018	153-018K	Ate	160,0x20	Hand Brake
3.0 si, Coupe Eng.N52B30A (195kW)	1/06-2/09		R		153-018	153-018K	Ate	160,0x20	Hand Brake
Z8 (E36) 6/00-6/03									
5.0 Eng.S38B49 (294kW)	00-03		R		153-013	153-013K	Ate	180,0x25	Hand Brake



CARBODIES

Fx Fairway 1/87-									
2.7 TD Eng.TD27 (63kW)	1/87-		R		153-114		Ap	254,0x70	Hand Brake
Fx4 1/59-12/89									
2.5 D Eng.25V (49kW)	9/85-12/89		R		153-114		Ap	254,0x70	London Taxi, Hand Brake
Fx4s 1/86-12/89									
2.5 D Eng.25V (49kW)	1/86-12/89		R		153-114		Ap	254,0x70	London Taxi, Hand Brake











CASALINI

Sulky 1/00-									
0.5	1/00-		R		153-053			160,0x42	Fitted Adjuster, Hand Brake
	1/00-		R		153-054			180,0x32	Fitted Adjuster, Hand Brake
Ydea 1/00-									
0.5	1/00-		R		153-053			160,0x42	Fitted Adjuster, Hand Brake
	1/00-		R		153-054			180,0x32	Fitted Adjuster, Hand Brake

CHATENET



















































Barooder 1/98-									
0.5	1/98-		R		153-053			160,0x42	Fitted Adjuster, Hand Brake
Media 1/98-									
0.5	1/98-		R		153-053			160,0x42	Fitted Adjuster, Hand Brake
	1/98-		R		153-054			180,0x32	Fitted Adjuster, Hand Brake
Speedino 1/98-									
0.5	1/98-		R		153-053			160,0x42	Fitted Adjuster, Hand Brake









































CHEVROLET





































Aveo I 5/05-4/08									
1.2 Eng.B12S1 (53kW)	3/06-4/08		R		153-050		Lucas	200,0x37	+ABS, Hand Brake
	06-		R		151-196		Lucas	Ø 19,05 200,0x37	LUC
1.4 16v Eng.F14D3 (69kW)	3/06-4/08		R		153-050		Lucas	200,0x37	+ABS, Hand Brake
	06-		R		151-196		Lucas	Ø 19,05 200,0x37	LUC
Camaro coupé, cabrio 1/11-									
3.6 Eng.LLT (232kW)	11-		R		153-485			203,2x22	
6.2 Eng.L99 (298kW)	11-		R		153-485			203,2x22	
6.2 Eng.LS3 (318kW)	11-		R		153-485			203,2x22	
Captiva (C100, 140) 6/06-									
2.0 16v Eng.Z20S (110kW)	6/06-		R		153-317	153-317K		180,0x26	Hand Brake
2.0 VCDi Eng.Z20S (110kW)	9/07-		R		153-317	153-317K		180,0x26	Hand Brake
2.4 16v, quattro Eng.Z24SED (100kW)	6/06-		R		153-317	153-317K		180,0x26	Hand Brake
2.4, quattro Eng.Z24XED (104kW)	12/06-		R		153-317	153-317K		180,0x26	Hand Brake































CHEVROLET































































		Spare Parts	F/R	L/R	CIFAM ref.	CIFAM ref. w/KIT		DIMENSIONS mm.	NOTE
3.2 Eng.10HM (169kW)	6/06-		R		153-317	153-317K		180,0x26	Hand Brake
Cruze 5/09-									
1.6 Eng.F16D3 /LXT (80kW)	09-		R		153-484			254x41	
1.6 LS Eng.LXV (83kW)	09-		R		153-484			254x41	
	09-		R		153-484			254x41	
1.6, SW Eng.F16D4 (91kW)	09-		R		153-484			254x41	
1.7 D, SW Eng.LUD (96kW)	12-		R		153-484			254x41	
1.8 Eng.2H0 (104kW)	11-		R		153-484			254x41	
1.8 Eng.2H0/ F18D4 (102-104kW)	09-		R		153-484			254x41	
2.0 CDi Eng.LLW (90kW)	09-		R		153-484			254x41	
2.0 CDi Eng.LLW (92kW)	10-		R		153-484			254x41	
2.0 CDi, SW Eng.Z20D1 (120kW)	10-		R		153-484			254x41	
2.0 D LT Eng.LLW (110kW)	09-		R		153-484			254x41	
Epica 1/05-									
2.0 Eng.T20SED (98kW)	6/06-		R			153-052K		170x26	
2.0 Eng.T20SED4 (94kW)	6/06-		R			153-052K		170x26	
2.0 Eng.X20D1 (105kW)	6/06-		R			153-052K		170x26	
2.0 VCDi 16v Eng.Z20S (110kW)	07-		R			153-052K		170x26	
2.5 Eng.X25D1 (115kW)	6/06-		R			153-052K		170x26	
Joy 3/05-									
0.8 (Pakistan)	3/05-		R		153-046		Lucas	180,0x31	Hand Brake
1.0 (Pakistan)	3/05-		R		153-046		Lucas	180,0x31	Hand Brake
Kalos 3/05-									
1.2 Eng.B12S1 (53kW)	3/05-		R		153-050		Lucas	200,0x37	+ABS, Hand Brake
	05-		R		151-196		Lucas	Ø 19,05 200,0x37	LUC
1.4 16v Eng.F14D3 (69kW)	3/05-		R		153-050		Lucas	200,0x37	+ABS, Hand Brake
	05-		R		151-196		Lucas	Ø 19,05 200,0x37	LUC
1.4 16v Eng.F14S3 (61kW)	3/05-		R		153-050		Lucas	200,0x37	+ABS, Hand Brake
	05-		R		151-196		Lucas	Ø 19,05 200,0x37	LUC
Lacetti 3/05-									
1.4 16v Eng.F14D3 (70kW)	3/05-		R		153-052	153-052K		170,0x26	Hand Brake
1.6 Eng.F16D3 (80kW)	3/05-		R		153-052	153-052K		170,0x26	Hand Brake
1.8 Eng.F18D3 (89kW)	05-		R		153-052	153-052K		170,0x26	Hand Brake
1.8 Eng.T18SED (90kW)	3/05-		R		153-052	153-052K		170,0x26	Hand Brake
Matiz 3/05-									
0.8 Eng.F8CV (38kW)	3/05-		R		153-046		Lucas	180,0x31	Hand Brake
	05-		R		151-185		Lucas	Ø 17,46 180,0x31	LUC
1.0 Eng.B10S1 (49kW)	05-		R		153-046		Lucas	180,0x31	Hand Brake
	05-		R		151-185		Lucas	Ø 17,46 180,0x31	LUC
1.0 Eng.F10NS (47kW)	05-		R		153-046		Lucas	180,0x31	Hand Brake
Nubira, SW 3/05-									
1.6 Eng.F16D3 (80kW)	3/05-		R		153-052	153-052K		170,0x26	Hand Brake
1.8 Eng.F18D3 (89kW)	05-		R		153-052	153-052K		170,0x26	Hand Brake
1.8 Eng.T18SED (90kW)	3/05-		R		153-052	153-052K		170,0x26	Hand Brake
Rezzo 3/05-									
1.6 Eng.A16DMS (79kW)	3/05-		R		153-049		Lucas	230,0x52	Hand Brake
2.0 Eng.X20SED (90kW)	3/05-		R		153-049		Lucas	230,0x52	Hand Brake
Spark I 3/05-2/10									
0.8 Eng.F8CV (37kW)	05-10		R		153-046		Lucas	180,0x31	Hand Brake
1.0 Eng.F10NS (46kW)	05-10		R		153-046		Lucas	180,0x31	Hand Brake
Tacuma 1/05-									
1.6 Eng.A16DMS (77kW)	1/05-		R		153-049		Lucas	230,0x52	Hand Brake
1.6 Eng.A16DMS (79kW)	1/05-		R		153-049		Lucas	230,0x52	Hand Brake
2.0 16v Eng.T20SED (90kW)	8/05-		R		153-049		Lucas	230,0x52	Hand Brake
2.0 16v Eng.X20SED (89kW)	3/05-		R		153-049		Lucas	230,0x52	Hand Brake
Vivant 5/00-									
1.6 16v Eng.A16DMS (78kW)	5/00-		R		153-049		Lucas	230,0x52	Hand Brake
1.8 Eng.A18DMS (72kW)	9/00-		R		153-049		Lucas	230,0x52	Hand Brake
1.8 Eng.F18D2 (66kW)	9/00-		R		153-049		Lucas	230,0x52	Hand Brake
1.8 Eng.F18N2 (74kW)	9/00-		R		153-049		Lucas	230,0x52	Hand Brake
2.0 16v Eng.T20SED4 (94kW)	9/00-		R		153-049		Lucas	230,0x52	Hand Brake
2.0 16v Eng.X20SED (89kW)	9/01-		R		153-049		Lucas	230,0x52	Hand Brake
CHRYSLER									
300 C, Touring 9/04-									
2.7 Eng.EER (142kW)	9/04-		R		153-242	153-242K		183,0x31	Hand Brake
3.0 CRD Eng.OM664 (160kW)	9/05-		R		153-242	153-242K		183,0x31	Hand Brake



















































		Spare Parts	F/R	L/R	CIFAM ref.	CIFAM ref. w/KIT		DIMENSIONS mm.	NOTE
3.5, AWD Eng.EGG (183kW)	9/04-		R		153-242	153-242K		183,0x31	Hand Brake
5.7, AWD Eng.EZB (250kW)	9/04-		R		153-242	153-242K		183,0x31	Hand Brake
6.1 SRT8 Eng.ESF (317kW)	6/05-		R		153-242	153-242K		183,0x31	Hand Brake
300 M (LR) 7/98-									
2.7 V6 24v Eng.EER (149kW)	11/98-8/00		R		153-031			172,0x20	Hand Brake
2.7 V6 24v Eng.EER (150kW)	8/00-		R		153-031			172,0x20	Hand Brake
3.5 V6 24v Eng.EGG (185kW)	8/00-		R		153-031			172,0x20	Hand Brake
3.5 V6 24v Eng.EGG (187kW)	7/98-8/00		R		153-031			172,0x20	Hand Brake
Cirrus 5/94-9/00									
2.4 Eng.EDZ (103kW)	1/96-12/98		R		153-031			172,0x20	Hand Brake
2.5 Eng.EEB (120kW)	10/94-9/00		R		153-031			172,0x20	Hand Brake
Concorde I 10/92-9/97									
3.5 Eng.EGE (155kW)	10/92-9/97		R		153-031			172,0x20	Hand Brake
Concorde II 10/97-9/03									
2.7 Eng.EER (149kW)	10/97-9/03		R		153-031			172,0x20	Hand Brake
	97-03		R		153-482			220x42	Mod. Vision
3.5 Eng.EWZ (174-186kW)	10/97-9/03		R		153-031			172,0x20	Hand Brake
	97-03		R		153-482			220x42	Mod. Vision
Crossfire, Roadster 7/03-									
3.2 Eng.EGX (160kW)	7/03-		R		153-233	153-233K	Lucas	164,0x20	Hand Brake
3.2 SRT-6 Eng.EGZ (246kW)	9/04-		R		153-233	153-233K	Lucas	164,0x20	Hand Brake
Grand Voyager I 1/91-1/95									
3.3 V6 Eng.EGA (110kW)	1/91-1/95		R		153-349			228,6x65	Hand Brake
Grand Voyager II 1/96-4/08									
2.5 TD Eng.HR425CLI/ EE (84-87kW)	1/96-4/08		R		153-026			254,0x57	Hand Brake
3.8 V6 Eng.EGH (122kW)	1/96-4/08		R		153-026			254,0x57	Hand Brake
LHS I 1/94-12/97									
3.5 Eng.EGJ (160kW)	1/94-12/97		R		153-031			172,0x20	Hand Brake
LHS II 1/99-12/01									
3.5 Eng.EGJ (160kW)	1/99-12/01		R		153-031			172,0x20	Hand Brake
Neon I (PL) 5/94-8/99									
2.0 Eng.ECC (112-118kW)	10/96-9/00		R		153-028			200,0x34	Hand Brake
2.0 16v Eng.420H (98kW)	5/94-8/99		R		153-028			200,0x34	Hand Brake
2.0 16v Eng.420T (109kW)	4/96-8/99		R		153-028			200,0x34	Hand Brake
2.0 16v Eng.ECC (107kW)	6/94-8/99		R		153-028			200,0x34	Hand Brake
Neon II 8/99-									
2.0 16v Eng.ECB (98kW)	8/99-		R		153-028			200,0x34	Hand Brake
2.0 16v R/T Eng.ECH (110-112kW)	10/01-		R		153-028			200,0x34	Hand Brake
PT Cruiser 6/00-									
1.6 Eng.EJD (85kW)	11/01-		R		153-031			172,0x20	Hand Brake
	11/01-		R		153-029			220,0x42	Hand Brake
	6/02-			R		700-394			Ø 220,0
2.0 Eng.ECC (100kW)	10/04-		R		153-031			172,0x20	Hand Brake
	10/04-		R		153-029			220,0x42	Hand Brake
	10/04-		R		153-481		Lucas	228,6x42	
2.0 Eng.ECC (104kW)	10/04-		R		153-481		Lucas	228,6x42	
	6/00-		R		153-031			172,0x20	Hand Brake
	6/00-		R		153-029			220,0x42	Hand Brake
	00-04			R		700-394			Ø 220,0
2.2 CRD Eng.EDJ (89kW)	3/02-		R		153-031			172,0x20	Hand Brake
	3/02-		R		153-029			220,0x42	Hand Brake
	8/05-		R		153-481		Lucas	228,6x42	
	6/02-			R		700-394			Ø 220,0
2.2 CRD Eng.OM664 (110kW)	8/05-		R		153-031			172,0x20	Hand Brake
	8/05-		R		153-029			220,0x42	Hand Brake
	8/05-		R		153-481		Lucas	228,6x42	
2.4 (169kW)	8/05-		R		153-481		Lucas	228,6x42	
2.4 Eng.EDZ (105kW)	8/05-		R		153-031			172,0x20	Hand Brake
	8/05-		R		153-029			220,0x42	Hand Brake
	8/05-		R		153-481		Lucas	228,6x42	
2.4 Cabrio Eng.EDZ (105kW)	3/04-		R		153-031			172,0x20	Hand Brake
	3/04-		R		153-029			220,0x42	Hand Brake
	8/05-		R		153-481		Lucas	228,6x42	
2.4 GT, Cabrio Eng.EDV (164kW)	8/03-		R		153-031			172,0x20	Hand Brake
	8/03-		R		153-029			220,0x42	Hand Brake
	8/05-		R		153-481		Lucas	228,6x42	































































		Spare Parts	F/R	L/R	CIFAM ref.	CIFAM ref. w/KIT		DIMENSIONS mm.	NOTE
2.4, Cabrio Eng.EDZ (110kW)	6/00-		R		153-031			172,0x20	Hand Brake
	6/00-		R		153-029			220,0x42	Hand Brake
	8/05-		R		153-481		Lucas	228,6x42	
	11/04-11/05		R		700-394			Ø 220,0	
Sebring I (FJ) Coupe 5/95-9/00									
2.0 Eng.ECC (103kW)	5/95-9/00		R		153-031			172,0x20	Hand Brake
	5/95-9/00		R		153-030		Lucas	200,0x32,5	Hand Brake
2.5 LE Eng.EEB (120kW)	5/95-9/00		R		153-031			172,0x20	Hand Brake
	5/95-9/00		R		153-030		Lucas	200,0x32,5	Hand Brake
Sebring II (JR), Cabrio 4/01-6/07									
2.0, Cabrio Eng.ECC (104kW)	4/01-6/07		R		153-265	153-265K		167,0x32	Hand Brake
	4/01-6/07		R		153-031			172,0x20	Hand Brake
	4/01-6/07		R		153-256		Ake	228,6x40	Hand Brake
2.4 Turbo, Cabrio Eng.EDV (164kW)	9/01-6/07		R		153-265	153-265K		167,0x32	Hand Brake
2.4, Cabrio Eng.EDZ (112kW)	4/01-6/07		R		153-265	153-265K		167,0x32	Hand Brake
	4/01-6/07		R		153-031			172,0x20	Hand Brake
2.7 V6 24v, Cabrio Eng.EES (149kW)	4/01-6/07		R		153-265	153-265K		167,0x32	Hand Brake
	4/01-6/07		R		153-031			172,0x20	Hand Brake
	4/01-6/07		R		153-032		Lucas	228,6x45	Flex FI
Sebring III 7/07-									
2.0 CRD, Cabrio Eng.BYL (103kW)	7/07-		R		153-362			170,0x32	Hand Brake
	7/07-		R		153-296			228,6x37	
2.0 VVT Eng.ECN (115kW)	7/07-		R		153-362			170,0x32	Hand Brake
	7/07-		R		153-296			228,6x37	
2.7 Eng.EER (141kW)	7/07-		R		153-362			170,0x32	Hand Brake
	7/07-		R		153-296			228,6x37	
2.7 Cabrio Eng.EER (137kW)	7/07-		R		153-362			170,0x32	Hand Brake
	7/07-		R		153-296			228,6x37	
3.5 Eng.EGG (175kW)	11/07-		R		153-362			170,0x32	Hand Brake
	11/07-		R		153-296			228,6x37	
Stratus (JA) 12/95-									
2.0 16v Eng.ECB (98kW)	12/95-		R		153-030		Lucas	200,0x32,5	Hand Brake
	12/95-		R		153-032		Lucas	228,6x45	
2.0 LE, Cabrio Eng.C00/ 420X (96kW)	12/95-4/01		R		153-030		Lucas	200,0x32,5	Hand Brake
Voyager I (ES) 8/84-9/95									
2.5 i Eng.K (74kW)	8/90-9/95		R		153-349			228,6x65	Hand Brake
2.5 i Eng.K00 (72kW)	8/84-9/95		R		153-349			228,6x65	Hand Brake
2.5 TD Eng.09B/ M00 (87kW)	1/92-9/95		R		153-349			228,6x65	Hand Brake
3.0 Eng.EFA (100kW)	10/87-		R		153-349			228,6x65	Hand Brake
3.0 Eng.EFA (101kW)	10/87-		R		153-349			228,6x65	Hand Brake
3.0 Eng.EFA (104kW)	10/90-		R		153-349			228,6x65	Hand Brake
3.0 i Eng.6G72/ 300 (108kW)	8/84-9/95		R		153-349			228,6x65	Hand Brake
3.3 Eng.EGA (112kW)	10/89-		R		153-349			228,6x65	Hand Brake
3.3 i Eng.EGA (120kW)	8/90-9/95		R		153-349			228,6x65	Hand Brake
3.3 i, AWD Eng.EGA (110kW)	8/90-9/95		R		153-349			228,6x65	Hand Brake
3.3 i, AWD Eng.R00 (120kW)	8/90-9/95		R		153-349			228,6x65	Hand Brake
Voyager II (GS) 1/95-3/01									
2.0 i Eng.C00 (98kW)	1/95-3/01		R		153-349			228,6x65	Hand Brake
	1/95-3/01		R		153-172	153-172Y	Mando	254,0x55	Hand Brake
2.4 i, AWD Eng.EDZ (111kW)	1/95-3/01		R		153-349			228,6x65	Hand Brake
	1/95-3/01		R		153-026			254,0x57	Hand Brake
	1/95-3/01		R		153-172	153-172Y	Mando	254,0x55	Hand Brake
2.5 TD Eng.425CLIRS-X (85kW)	1/95-3/01		R		153-349			228,6x65	Hand Brake
	1/95-3/01		R		153-026			254,0x57	Hand Brake
	1/95-3/01		R		153-172	153-172Y	Mando	254,0x55	Hand Brake
2.5 TDiC AWD Eng.ENC (85kW)	10/95-3/01		R		153-026			254,0x57	Hand Brake
	10/95-3/01		R		153-172	153-172Y	Mando	254,0x55	Hand Brake
3.3 i Eng.R00 (116kW)	1/95-3/01		R		153-026			254,0x57	Hand Brake
3.3 i 4WD Eng.EGA (116kW)	1/95-3/01		R		153-026			254,0x57	Hand Brake
3.8 i, AWD Eng.EGH (122-131kW)	1/95-3/01		R		153-349			228,6x65	Hand Brake
	1/95-3/01		R		153-026			254,0x57	Hand Brake
	1/95-3/01		R		153-172	153-172Y	Mando	254,0x55	Hand Brake
Voyager III (RG) 2/00-12/07									
2.4 Eng.EDZ (108kW)	2/00-12/07		R		153-026			254,0x57	Hand Brake
2.5 CRD Eng.EDK (88kW)	8/05-12/07		R		153-027			180,0x30	Hand Brake
	8/05-12/07		R		153-026			254,0x57	Hand Brake





























		Spare Parts	F/R	L/R	CIFAM ref.	CIFAM ref. w/KIT		DIMENSIONS mm.	NOTE
2.5 CRD Eng.ENC/ ENJ (105kW)	2/00-12/07		R		153-027			180,0x30	Hand Brake
	2/00-12/07		R		153-026			254,0x57	Hand Brake
2.8 CRD Eng.ENR (110kW)	6/04-12/07		R		153-027			180,0x30	Hand Brake
3.3 Flexi-Fuel Eng.EGA (128kW)	2/00-12/07		R		153-027			180,0x30	Hand Brake
3.3, AWD Eng.EGA (128kW)	2/00-12/07		R		153-027			180,0x30	Hand Brake
3.8, AWD Eng.EGH (160kW)	2/00-12/07		R		153-027			180,0x30	Hand Brake
Voyager IV 1/08-									
3.3 Eng.EGV (125kW)	08-		R		153-027			180,0x30	Hand Brake
								CHRYSLER USA	
GS Daytona Shelby 10/87-10/92									
2.5 i T. Eng.EDT (110kW)	1/89-10/92		R		153-029			220,0x42	Hand Brake
Le Baron									
All models			R		153-028			200,0x34	Hand Brake
Le Baron GTS									
All models			R		153-028			200,0x34	Hand Brake
Town & Country I 1/90-12/95									
3.0 Eng.6G72 (106kW)	1/90-12/90		R		153-349			228,6x65	Hand Brake
	90-95		R		700-251			Ø 228,6	14Inch Wheels
	90-95		R		700-252			Ø 228,6	15Inch Wheels
3.3 Eng.EGA (112kW)	90-95		R		700-251			Ø 228,6	14Inch Wheels
	90-95		R		700-252			Ø 228,6	15Inch Wheels
3.8 Eng.EGH (121kW)	90-95		R		700-251			Ø 228,6	14Inch Wheels
	90-95		R		700-252			Ø 228,6	15Inch Wheels
Town & Country II 10/00-8/07									
3.3 V6 Eng.EGM (128kW)	10/00-8/07		R		153-027			180,0x30	Hand Brake
	10/00-8/07		R		153-026			254,0x57	Hand Brake
3.8, AWD Eng.EGH (160kW)	10/00-8/07		R		153-027			180,0x30	Hand Brake
	10/00-8/07		R		153-026			254,0x57	Hand Brake
Voyager									
All models	84-95		R		700-251			Ø 228,6	14Inch Wheels
	84-95		R		700-252			Ø 228,6	15Inch Wheels
	96-		R		700-253			Ø 250,0	14Inch Wheels
	96-		R		700-254			Ø 250,0	15Inch Wheels
								CITROËN	
2 CV 3/63-									
0.4 Eng.A79-1(AYA2) (17kW)	6/70-		F/R		700-340			Ø 200,0	
0.6 Eng.A06-635 (21kW)	6/70-		F/R		700-340			Ø 200,0	
Ax (ZA) 7/84-12/98									
0.95 Eng.C1A (32kW)	9/86-6/92		R			153-021Y	Bdx	165,0x30	
	9/86-6/92		R			153-021K	Bdx	165,0x30	Hand Brake
	9/86-6/92		R			153-024Y	Bdx	165,0x30	Hand Brake
0.95 Eng.CDY(TU9M) (33kW)	7/86-12/98		R			153-021Y	Bdx	165,0x30	
	7/86-12/98		R			153-021K	Bdx	165,0x30	Hand Brake
	7/86-12/98		R			153-024Y	Bdx	165,0x30	Hand Brake
	86-98		R		700-160	700-160K		Ø 165,0	-ABS
	86-98		R		700-164	700-164K		Ø 180,0	+ABS
	9/86-		R		151-002		Bdx	Ø 19,05 165,0x30	RAD
9/86-		R		151-001		Bdx	Ø 19,05 165,0x30	CRCI, RAD	
0.95 Eng.CDZ(TU9M) (37kW)	7/86-12/98		R			153-021Y	Bdx	165,0x30	
	7/86-12/98		R			153-021K	Bdx	165,0x30	Hand Brake
	7/86-12/98		R			153-024Y	Bdx	165,0x30	Hand Brake
	86-98		R		700-160	700-160K		Ø 165,0	-ABS
	86-98		R		700-164	700-164K		Ø 180,0	+ABS
	9/86-		R		151-002		Bdx	Ø 19,05 165,0x30	RAD
9/86-		R		151-001		Bdx	Ø 19,05 165,0x30	CRCI, RAD	
0.95 E Eng.C3A (30kW)	12/86-12/98		R			153-021Y	Bdx	165,0x30	
	12/86-12/98		R			153-021K	Bdx	165,0x30	Hand Brake
	12/86-12/98		R			153-024Y	Bdx	165,0x30	Hand Brake
	86-88		R		700-160	700-160K		Ø 165,0	-ABS
	86-88		R		700-164	700-164K		Ø 180,0	+ABS
	86-88		R		151-002		Bdx	Ø 19,05 165,0x30	RAD
86-88		R		151-001		Bdx	Ø 19,05 165,0x30	CRCI, RAD	
1.1 Eng.H1B (40kW)	12/86-6/90		R			153-021Y	Bdx	165,0x30	
	12/86-6/90		R			153-021K	Bdx	165,0x30	Hand Brake
	12/86-6/90		R			153-024Y	Bdx	165,0x30	Hand Brake
	9/86-90		R		700-160	700-160K		Ø 165,0	-ABS

































































		Spare Parts	F/R	L/R	CIFAM ref.	CIFAM ref. w/KIT		DIMENSIONS mm.	NOTE	
1.1 Eng.H1B (40kW)	9/86-90		R		151-002		Bdx	Ø 19,05 165,0x30	RAD	
	9/86-90		R		151-001		Bdx	Ø 19,05 165,0x30	CRCI, RAD	
1.1 Eng.HDZ(TU1M) (40kW)	10/89-12/97		R			153-021Y	Bdx	165,0x30		
	10/89-12/97		R			153-021K	Bdx	165,0x30	Hand Brake	
	10/89-12/97		R			153-024Y	Bdx	165,0x30	Hand Brake	
	89-97		R		700-160	700-160K		Ø 165,0	-ABS	
	89-97		R		700-164	700-164K		Ø 180,0	+ABS	
	9/86-9/86		R		151-002		Bdx	Ø 19,05 165,0x30	RAD	
	9/86-9/86		R		151-001		Bdx	Ø 19,05 165,0x30	CRCI, RAD	
1.1 4WD Eng.H1A (40kW)	6/91-7/92		R			153-021Y	Bdx	165,0x30		
	6/91-7/92		R			153-021K	Bdx	165,0x30	Hand Brake	
	6/91-7/92		R			153-024Y	Bdx	165,0x30	Hand Brake	
1.1 Kat Eng.HAZ(TU1CP) (40kW)	9/88-12/89		R			153-021Y	Bdx	165,0x30		
	9/88-12/89		R			153-021K	Bdx	165,0x30	Hand Brake	
	9/88-12/89		R			153-024Y	Bdx	165,0x30	Hand Brake	
	88-89		R		700-160	700-160K		Ø 165,0	-ABS	
	88-89		R		151-002		Bdx	Ø 19,05 165,0x30	RAD	
	88-89		R		151-001		Bdx	Ø 19,05 165,0x30	CRCI, RAD	
1.3 Sport Eng.M4A (70kW)	4/87-12/88		R			153-021Y	Bdx	165,0x30		
	4/87-12/88		R			153-021K	Bdx	165,0x30	Hand Brake	
	4/87-12/88		R			153-024Y	Bdx	165,0x30	Hand Brake	
	4/87-88		R		700-160	700-160K		Ø 165,0	-ABS	
	9/86-9/86		R		151-001		Bdx	Ø 19,05 165,0x30	CRCI, RAD	
	9/86-88		R		151-002		Bdx	Ø 19,05 165,0x30	RAD	
1.4 Eng.K1F (49kW)	6/88-12/89		R			153-021Y	Bdx	165,0x30		
	6/88-12/89		R			153-021K	Bdx	165,0x30	Hand Brake	
	6/88-12/89		R			153-024Y	Bdx	165,0x30	Hand Brake	
	88-89		R		700-160	700-160K		Ø 165,0	-ABS	
	88-89		R		151-002		Bdx	Ø 19,05 165,0x30	RAD	
1.4 Eng.K2A/ B (62kW)	1/88-12/92		R			153-021Y	Bdx	165,0x30		
	1/88-12/92		R			153-021K	Bdx	165,0x30	Hand Brake	
	1/88-12/92		R			153-024Y	Bdx	165,0x30	Hand Brake	
	5/91-92		R		700-164	700-164K		Ø 180,0	+ABS	
	88-92		R		700-160	700-160K		Ø 165,0	-ABS	
	88-91		R		151-002		Bdx	Ø 19,05 165,0x30	RAD	
	91-92		R		151-029		Bdx	Ø 19,05 203,0x39	RAI	
1.4 Eng.K2A/ D (55kW)	8/91-4/97		R			153-021Y	Bdx	165,0x30		
	8/91-4/97		R			153-021K	Bdx	165,0x30	Hand Brake	
	8/91-4/97		R			153-024Y	Bdx	165,0x30	Hand Brake	
	8/91-4/97		R			153-320Y	Bdx	180,0x32		
	8/91-4/97		R			153-320	153-320K	Bdx	180,0x32	Hand Brake
	8/91-4/97		R			153-329Y	Bdx	180,0x32	Hand Brake	
	91-97		R		700-160	700-160K		Ø 165,0	-ABS	
	91-97		R		700-164	700-164K		Ø 180,0	+ABS	
91-97		R		151-029		Bdx	Ø 19,05 203,0x39	RAI		
1.4 Eng.KAY(TU3CP) (44kW)	12/86-12/88		R			153-021Y	Bdx	165,0x30		
	12/86-12/88		R			153-021K	Bdx	165,0x30	Hand Brake	
	12/86-12/88		R			153-024Y	Bdx	165,0x30	Hand Brake	
	86-88		R		700-160	700-160K		Ø 165,0	-ABS	
	86-88		R		151-002		Bdx	Ø 19,05 165,0x30	RAD	
1.4 Eng.KDX(TU3M-Z) (55kW)	4/87-4/97		R			153-021Y	Bdx	165,0x30		
	4/87-4/97		R			153-021K	Bdx	165,0x30	Hand Brake	
	4/87-4/97		R			153-024Y	Bdx	165,0x30	Hand Brake	
	4/87-4/97		R			153-320Y	Bdx	180,0x32		
	4/87-4/97		R			153-320	153-320K	Bdx	180,0x32	Hand Brake
	4/87-4/97		R			153-329Y	Bdx	180,0x32	Hand Brake	
	10/87-97		R		700-160	700-160K		Ø 165,0	-ABS	
	5/91-97		R		700-164	700-164K		Ø 180,0	+ABS	
	9/86-91		R		151-002		Bdx	Ø 19,05 165,0x30	RAD	
	91-97		R		151-029		Bdx	Ø 19,05 203,0x39	RAI	
1.4 4WD Eng.KDY(TU3M) (55kW)	8/91-12/96		R			153-021Y	Bdx	165,0x30		
	8/91-12/96		R			153-021K	Bdx	165,0x30	Hand Brake	
	8/91-12/96		R			153-024Y	Bdx	165,0x30	Hand Brake	
	8/91-12/96		R			153-320Y	Bdx	180,0x32		
	8/91-12/96		R			153-320	153-320K	Bdx	180,0x32	Hand Brake
	8/91-12/96		R			153-329Y	Bdx	180,0x32	Hand Brake	
	8/91-12/96		R			153-346	153-346Y	Bdx	203,2x39	Hand Brake
	8/91-12/96		R							





















		Spare Parts	F/R	L/R	CIFAM ref.	CIFAM ref. w/KIT		DIMENSIONS mm.	NOTE
1.4 D Eng.K9A(TUD3) (38kW)	9/88-6/92		R			153-021Y	Bdx	165,0x30	
	9/88-6/92		R			153-021K	Bdx	165,0x30	Hand Brake
	9/88-6/92		R			153-024Y	Bdx	165,0x30	Hand Brake
	88-92		R		700-160	700-160K		Ø 165,0	-ABS
	88-92		R		700-164	700-164K		Ø 180,0	+ABS
	88-		R		151-001		Bdx	Ø 19,05 165,0x30	CRCI, RAD
	88-92		R		151-002		Bdx	Ø 19,05 165,0x30	RAD
1.4 D Eng.K9Y(TUD3Y) (37kW)	8/91-12/97		R			153-021Y	Bdx	165,0x30	
	8/91-12/97		R			153-021K	Bdx	165,0x30	Hand Brake
	8/91-12/97		R			153-024Y	Bdx	165,0x30	Hand Brake
	91-97		R		700-160	700-160K		Ø 165,0	-ABS
	91-97		R		700-164	700-164K		Ø 180,0	+ABS
	91-		R		151-002		Bdx	Ø 19,05 165,0x30	RAD
	91-		R		151-001		Bdx	Ø 19,05 165,0x30	CRCI, RAD
1.4 GTi Eng.KFY(TU3FJ2) (66kW)	8/91-12/96		R			153-320Y	Bdx	180,0x32	
	8/91-12/96		R		153-320	153-320K	Bdx	180,0x32	Hand Brake
	8/91-12/96		R			153-329Y	Bdx	180,0x32	Hand Brake
	5/91-96		R		700-164	700-164K		Ø 180,0	+ABS
	-91		R		151-002		Bdx	Ø 19,05 165,0x30	RAD
	92-		R		151-006		Bdx	Ø 19,05 180,0x30	CRCI, RAD
1.4 GTi Eng.KFZ(TU3FJ2) (69-74kW)	8/91-12/96		R			153-320Y	Bdx	180,0x32	
	8/91-12/96		R		153-320	153-320K	Bdx	180,0x32	Hand Brake
	8/91-12/96		R			153-329Y	Bdx	180,0x32	Hand Brake
	5/91-96		R		700-164	700-164K		Ø 180,0	+ABS
	-91		R		151-002		Bdx	Ø 19,05 165,0x30	RAD
	92-		R		151-006		Bdx	Ø 19,05 180,0x30	CRCI, RAD
1.5 D Eng.VJY/ VJZ(TUD5) (40-43kW)	94-97		R		700-160	700-160K		Ø 165,0	-ABS
	94-97		R		700-164	700-164K		Ø 180,0	+ABS
	94-97		R		151-001		Bdx	Ø 19,05 165,0x30	CRCI, RAD
Berlingo I (MF) 7/96-5/08									
1.1, i Eng.TU1M/ K/ MZ/ JP (41-44kW)	1/96-		R		153-023		Lucas	228,6x42	Hand Brake
	7/96-		R		700-233			Ø 228,5	
	96-		R		151-140		Lucas	Ø 22,00 228,6x42	LUC
1.4 (53kW)	11/02-10/05		R		153-023		Lucas	228,6x42	Hand Brake
1.4 Eng.KFV(TU3JP) (54kW)	5/05-		R		153-023		Lucas	228,6x42	Hand Brake
1.4 Bivalent (48kW)	11/02-		R		153-023		Lucas	228,6x42	Hand Brake
	02-		R		700-233			Ø 228,5	+ABS, -ESP
	02-		R		151-140		Lucas	Ø 22,00 228,6x42	LUC
1.4 i, Bivalent Eng.KFX(TU3JP) (55kW)	7/96-		R		153-023		Lucas	228,6x42	Hand Brake
	7/96-		R		700-233			Ø 228,5	
	96-		R		151-140		Lucas	Ø 22,00 228,6x42	LUC
1.6 16v Eng.NFU(TU5JP4) (80kW)	00-		R		700-233			Ø 228,5	
	00-		R		151-140		Lucas	Ø 22,00 228,6x42	LUC
1.6 HDi Eng.DV6ATED4 (66kW)	7/05-		R		153-023		Lucas	228,6x42	Hand Brake
	05-		R		700-233			Ø 228,5	+ABS, -ESP
1.6 HDi Eng.DV6B (55kW)	7/05-		R		153-023		Lucas	228,6x42	Hand Brake
	05-		R		700-233			Ø 228,5	+ABS, -ESP
1.6 HDi Eng.DV6TED4 (80kW)	8/05-		R		153-023		Lucas	228,6x42	Hand Brake
1.8 D Eng.A9A(XUD7) (43kW)	7/98-		R		153-023		Lucas	228,6x42	Hand Brake
	7/98-		R		700-233			Ø 228,5	
	98-		R		151-140		Lucas	Ø 22,00 228,6x42	LUC
1.8i Eng.LFX(XU7JB) (66kW)	97-		R		700-233			Ø 228,5	
	97-		R		151-140		Lucas	Ø 22,00 228,6x42	LUC
1.9 D Eng.DJY(XUD9A) (50kW)	7/96-		R		153-023		Lucas	228,6x42	Hand Brake
	7/96-		R		700-233			Ø 228,5	
	96-		R		151-140		Lucas	Ø 22,00 228,6x42	LUC
1.9 D, 4WD Eng.WJY(DW8B)/ WJZ(DW8) (51kW)	7/98-		R		153-023		Lucas	228,6x42	Hand Brake
	98-		R		700-233			Ø 228,5	
	98-		R		151-140		Lucas	Ø 22,00 228,6x42	LUC
2.0 HDi, 4WD Eng.RHY(DW10TD) (66kW)	12/99-		R		700-233			Ø 228,5	
	12/99-		R		151-140		Lucas	Ø 22,00 228,6x42	LUC
electrique (16kW)	00-		R		700-233			Ø 228,5	
C1 (PM, PN) 6/05-									
1.0 Eng.1KR-FE (50kW)	6/05-		R		153-438		Bosch	200,0x32	+ABS, Hand Brake
	05-		R		700-383			Ø 200,0	
	05-		R		151-183		Bosch	Ø 17,46 200,0x32	RAI
1.4 HDi Eng.DV4D (40kW)	6/05-		R		153-438		Bosch	200,0x32	Hand Brake
	05-		R		700-383			Ø 200,0	































































		Spare Parts	F/R	L/R	CIFAM ref.	CIFAM ref. w/KIT		DIMENSIONS mm.	NOTE	
1.4 HDi Eng.DV4D (40kW)	05-		R		151-183		Bosch	Ø 17,46 200,0x32	RAI	
C2 (JM) 9/03-										
1.1 Eng.HFX(TU1JP) (44kW)	03-		R		153-085		Bosch	203,2x39	+ABS, Hand Brake	
	03-		R		153-025		Lucas	203,2x39	+/-ABS, Hand Brake	
	03-		R		700-363	700-363K		Ø 203,0		
	03-		R		151-190		Bosch	Ø 20,64 203,2x39	RAI, +ABS	
	03-		R		151-164		Lucas	Ø 19,05 203,0x38	CRCI, LUC, -ABS	
	03-		R		151-165		Lucas	Ø 20,64 203,0x38	LUC, +ABS	
1.4 Eng.KFV(TU3JP) (54kW)	03-		R		153-085		Bosch	203,2x39	+ABS, Hand Brake	
	03-		R		153-025		Lucas	203,2x39	+/-ABS, Hand Brake	
	03-		R		700-363	700-363K		Ø 203,0		
	03-		R		151-190		Bosch	Ø 20,64 203,2x39	RAI, +ABS	
	03-		R		151-164		Lucas	Ø 19,05 203,0x38	CRCI, LUC, -ABS	
	03-		R		151-165		Lucas	Ø 20,64 203,0x38	LUC, +ABS	
1.4 16v Eng.KFU(ET3J4) (65kW)	06-		R		151-190		Bosch	Ø 20,64 203,2x39	RAI, +ABS	
	06-		R		151-164		Lucas	Ø 19,05 203,0x38	CRCI, LUC, -ABS	
	06-		R		151-165		Lucas	Ø 20,64 203,0x38	LUC, +ABS	
	1.4 HDi Eng.DV4TD (50kW)	9/03-		R		153-085		Bosch	203,2x39	+ABS, Hand Brake
		9/03-		R		153-025		Lucas	203,2x39	+/-ABS, Hand Brake
		9/03-		R		700-363	700-363K		Ø 203,0	
03-			R		151-190		Bosch	Ø 20,64 203,2x39	RAI, +ABS	
03-			R		151-164		Lucas	Ø 19,05 203,0x38	CRCI, LUC, -ABS	
03-			R		151-165		Lucas	Ø 20,64 203,0x38	LUC, +ABS	
C3 I (FC) 2/02-10/09										
1.1 Eng.HFX(TU1JP) (44kW)	2/02-		R		153-085		Bosch	203,2x39	+ABS, Hand Brake	
	2/02-		R		153-025		Lucas	203,2x39	+/-ABS, Hand Brake	
	2/02-		R		700-363	700-363K		Ø 203,0		
	02-		R		151-190		Bosch	Ø 20,64 203,2x39	RAI, +ABS	
	02-		R		151-164		Lucas	Ø 19,05 203,0x38	CRCI, LUC, -ABS	
	03-		R		151-165		Lucas	Ø 20,64 203,0x38	LUC, +ABS	
1.4 Eng.KFV(TU3JP) (54kW)	2/02-		R		153-085		Bosch	203,2x39	+ABS, Hand Brake	
	2/02-		R		153-025		Lucas	203,2x39	+/-ABS, Hand Brake	
	2/02-		R		700-363	700-363K		Ø 203,0		
	02-		R		151-190		Bosch	Ø 20,64 203,2x39	RAI, +ABS	
	02-		R		151-164		Lucas	Ø 19,05 203,0x38	CRCI, LUC, -ABS	
	03-		R		151-165		Lucas	Ø 20,64 203,0x38	LUC, +ABS	
1.4 16v Eng.KFU(ET3J4) (65kW)	12/03-		R		153-085		Bosch	203,2x39	+ABS, Hand Brake	
	12/03-		R		153-025		Lucas	203,2x39	+/-ABS, Hand Brake	
	03-		R		700-363	700-363K		Ø 203,0		
	03-		R		151-190		Bosch	Ø 20,64 203,2x39	RAI, +ABS	
1.4 HDi Eng.DV4TD (50kW)	2/02-		R		153-085		Bosch	203,2x39	+ABS, Hand Brake	
	2/02-		R		153-025		Lucas	203,2x39	+/-ABS, Hand Brake	
	2/02-		R		700-363	700-363K		Ø 203,0		
	02-		R		151-190		Bosch	Ø 20,64 203,2x39	RAI, +ABS	
	02-		R		151-164		Lucas	Ø 19,05 203,0x38	CRCI, LUC, -ABS	
	03-		R		151-165		Lucas	Ø 20,64 203,0x38	LUC, +ABS	
1.4 HDi Eng.DV4TED4 (66kW)	2/02-		R		153-085		Bosch	203,2x39	+ABS, Hand Brake	
	2/02-		R		153-025		Lucas	203,2x39	+/-ABS, Hand Brake	
1.6 16v Eng.NFU(TU5JP4) (80kW)	02-		R		153-025		Lucas	203,2x39	Hand Brake	
1.6 HDi Eng.DV6ATED4 (66kW)	10/05-		R		153-025		Lucas	203,2x39	Hand Brake	
1.6 HDi 16v Eng.DV6TED4 (80kW)	9/05-		R		153-025		Lucas	203,2x39	Hand Brake	
C3 I Pluriel (HB) 5/03-10/09										
1.4 Eng.KFV(TU3JP) (54kW)	5/03-		R		153-085		Bosch	203,2x39	+ABS, Hand Brake	
	5/03-		R		153-025		Lucas	203,2x39	+/-ABS, Hand Brake	
	03-		R		700-363	700-363K		Ø 203,0		
	02-		R		151-164		Lucas	Ø 19,05 203,0x38	CRCI, LUC, -ABS	
	03-		R		151-190		Bosch	Ø 20,64 203,2x39	RAI, +ABS	
	03-		R		151-165		Lucas	Ø 20,64 203,0x38	LUC, +ABS	
1.4 HDi Eng.DV4TD (50kW)	4/04-		R		153-085		Bosch	203,2x39	Hand Brake	
	04-		R		700-363	700-363K		Ø 203,0		
	02-		R		151-164		Lucas	Ø 19,05 203,0x38	CRCI, LUC, -ABS	
	04-		R		151-190		Bosch	Ø 20,64 203,2x39	RAI, +ABS	
	04-		R		151-165		Lucas	Ø 20,64 203,0x38	LUC, +ABS	
	1.6 16v Eng.NFU(TU5JP4) (80kW)	03-		R		153-025		Lucas	203,2x39	+/-ABS, Hand Brake
C-Crosser (EP) 8/07-										
2.2 HDi Eng.DW12M (115kW)	8/07-		R		153-268	153-268K		190,0x32	Hand Brake	
2.4 Eng.4B12 (125kW)	1/08-		R		153-268	153-268K		190,0x32	Hand Brake	

















		Spare Parts	F/R	L/R	CIFAM ref.	CIFAM ref. w/KIT		DIMENSIONS mm.	NOTE
Dyane 8/67-10/84									
0.4 Eng.A79-1(AYA2) (17kW)	6/70-		F		700-340			Ø 200,0	
0.6 Eng.M28(AM2) (22kW)	6/70-7/77		F		700-340			Ø 200,0	
0.6 Eng.M28-1(AK2) (24kW)	72-7/77		F		700-340			Ø 200,0	
Evasion (22,U6) 6/94-7/02									
1.8 Eng.XU7JP (76kW)	2/96-12/96		R		153-074	153-074Y	Bdx	256,0x61	Hand Brake
1.8i Eng.LFZ(XU7JP) (74kW)	5/97-7/02		R		153-074	153-074Y	Bdx	256,0x61	Hand Brake
	97-		R		700-017			Ø 255,0	-ABS
	97-		R		151-066		Bdx	Ø 19,05 255,0x60	RAI, -ABS
1.9 TD Eng.DHX(XUD9TF-BTF) (66kW)	11/94-7/02		R			153-331K		180,0x31	Hand Brake
	11/94-7/02		R		153-331		Ate	180,0x31	Hand Brake
	11/94-7/02		R		153-074	153-074Y	Bdx	256,0x61	Hand Brake
	6/94-		R		700-017			Ø 255,0	-ABS
1.9 TD Eng.DHY(XUD9TE) (68kW)	5/97-7/02		R			153-331K		180,0x31	Hand Brake
	5/97-7/02		R		153-331		Ate	180,0x31	Hand Brake
	5/97-7/02		R		153-074	153-074Y	Bdx	256,0x61	Hand Brake
	97-		R		700-017			Ø 255,0	-ABS
2.0 Eng.RFU(XU10J2C) (89kW)	6/94-7/02		R			153-331K		180,0x31	Hand Brake
	6/94-7/02		R		153-331		Ate	180,0x31	Hand Brake
	6/94-7/02		R		153-074	153-074Y	Bdx	256,0x61	Hand Brake
	6/94-		R		700-017			Ø 255,0	-ABS
2.0 16v Eng.RFN(EW10J4) (100kW)	5/00-7/02		R			153-331K		180,0x31	Hand Brake
	5/00-7/02		R		153-331		Ate	180,0x31	Hand Brake
	5/00-7/02		R		153-074	153-074Y	Bdx	256,0x61	Hand Brake
2.0 HDi Eng.RHS/ RHZ(DW10ATED) (80kW)	8/99-7/02		R			153-331K		180,0x31	Hand Brake
	8/99-7/02		R		153-331		Ate	180,0x31	Hand Brake
	99-02		R		700-017			Ø 255,0	-ABS
2.0 i 16v Eng.RFV(XU10J4R) (97kW)	5/98-4/00		R		153-074	153-074Y	Bdx	256,0x61	Hand Brake
2.0 T. Eng.RGX(XU10J2TE) (108kW)	6/94-7/02		R			153-331K		180,0x31	Hand Brake
	6/94-7/02		R		153-331	153-331K	Ate	180,0x31	Hand Brake
2.0 TD (68kW)	5/97-7/02		R		153-331	153-331K	Ate	180,0x31	Hand Brake
2.1 TD 12v Eng.P8C(XUD11BTE) (80kW)	5/96-7/02		R		153-331		Ate	180,0x31	Hand Brake
	3/96-		R		700-017			Ø 255,0	-ABS
	96-		R		151-066		Bdx	Ø 19,05 255,0x60	RAI, -ABS
LN 9/76-7/79									
3 CV Eng.M28(AM2) (25kW)	9/76-7/79		R		153-339	153-339K	Bdx	180,0x32	Hand Brake
	9/76-7/79		R		153-341	153-341K	Bdx	180,0x42	Hand Brake
	9/77-7/79		R		151-034		Bdx	Ø 22,00 180,0x30	RAD, Sys.Front Bdx
LNA 11/76-10/86									
0.6 Eng.V06-630 (26kW)	11/78-7/82		R		153-339	153-339K	Bdx	180,0x32	Hand Brake
	1/82-		R		700-158	700-158K		Ø 180,0	
	11/78-82		R		151-035		Bdx	Ø 20,64 180,0x30	RAD, Sys.Front Citroen
	11/78-82		R		151-034		Bdx	Ø 22,00 180,0x30	RAD, Sys.Front Bdx
0.6 Eng.V06-644 (25kW)	7/82-4/85		R		153-339	153-339K	Bdx	180,0x32	Hand Brake
	1/82-		R		700-158	700-158K		Ø 180,0	
	82-85		R		151-035		Bdx	Ø 20,64 180,0x30	RAD, Sys.Front Citroen
	82-85		R		151-034		Bdx	Ø 22,00 180,0x30	RAD, Sys.Front Bdx
0.95 Eng.108C (33kW)	1/84-86		R		700-158	700-158K		Ø 180,0	
1.1 Eng.109-5E (37kW)	7/82-4/85		R		153-339	153-339K	Bdx	180,0x32	Hand Brake
	7/82-85		R		700-158	700-158K		Ø 180,0	
	82-85		R		151-035		Bdx	Ø 20,64 180,0x30	RAD, Sys.Front Citroen
Saxo (S0,S1) 5/96-									
0.95 Eng.CDY/ CDZ(TU9M) (33-37kW)	5/96-		R			153-021Y	Bdx	165,0x30	
	5/96-		R			153-021K	Bdx	165,0x30	Hand Brake
	5/96-		R			153-024Y	Bdx	165,0x30	Hand Brake
	5/96-		R			153-320Y	Bdx	180,0x32	
	5/96-		R		153-320	153-320K	Bdx	180,0x32	Hand Brake
	5/96-		R			153-329Y	Bdx	180,0x32	Hand Brake
	3/96-		R		700-164	700-164K		Ø 180,0	-ABS
	96-		R		700-244	700-244K		Ø 165,0	-ABS
	96-		R		700-246	700-246K		Ø 203,0	+ABS
	5/96-		R		151-001		Bdx	Ø 19,05 165,0x30	CRCl, RAD, Sys.Front ATE
5/96-		R		151-006		Bdx	Ø 19,05 180,0x30	CRCl, RAD, Sys.Front Bdx	
1.1 Eng.HDZ(TU1M) (40kW)	5/96-		R			153-021Y	Bdx	165,0x30	
	5/96-		R			153-021K	Bdx	165,0x30	Hand Brake
	5/96-		R			153-024Y	Bdx	165,0x30	Hand Brake
	5/96-		R			153-320Y	Bdx	180,0x32	

		Spare Parts	F/R	L/R	CIFAM ref.	CIFAM ref. w/KIT		DIMENSIONS mm.	NOTE
1.1 Eng.HDZ(TU1M) (40kW)	5/96-		R		153-320	153-320K	Bdx	180,0x32	Hand Brake
	5/96-		R			153-329Y	Bdx	180,0x32	Hand Brake
	5/96-		R		153-350		Lucas	203,0x38	+ABS, Hand Brake
	3/96-		R		700-164	700-164K		Ø 180,0	-ABS, 4 Hole
	96-		R		700-244	700-244K		Ø 165,0	-ABS, 3 Hole
	96-		R		700-246	700-246K		Ø 203,0	+ABS
	5/96-		R		151-006		Bdx	Ø 19,05 180,0x30	CRCI, RAD
1.1 Eng.HFX(TU1JP) (44kW)	5/96-		R			153-021Y	Bdx	165,0x30	
	5/96-		R			153-021K	Bdx	165,0x30	Hand Brake
	5/96-		R			153-024Y	Bdx	165,0x30	Hand Brake
	5/96-		R			153-320Y	Bdx	180,0x32	
	5/96-		R		153-320	153-320K	Bdx	180,0x32	Hand Brake
	5/96-		R			153-329Y	Bdx	180,0x32	Hand Brake
	5/96-		R		153-350		Lucas	203,0x38	+ABS, Hand Brake
	3/96-		R		700-164	700-164K		Ø 180,0	-ABS, 4 Hole
	96-		R		700-244	700-244K		Ø 165,0	-ABS, 3 Hole
	96-		R		700-246	700-246K		Ø 203,0	+ABS
7/00-6/03		R		151-136		Lucas	Ø 20,64 203,0x38	LUC, +ABS	
1.4 VTS Eng.KFX/ KFW(TU3JP) (55kW)	5/96-		R			153-021Y	Bdx	165,0x30	
	5/96-		R			153-021K	Bdx	165,0x30	Hand Brake
	5/96-		R			153-024Y	Bdx	165,0x30	Hand Brake
	5/96-		R			153-320Y	Bdx	180,0x32	
	5/96-		R		153-320	153-320K	Bdx	180,0x32	Hand Brake
	5/96-		R			153-329Y	Bdx	180,0x32	Hand Brake
	5/96-		R		153-350		Lucas	203,0x38	+ABS, Hand Brake
	96-		R		700-164	700-164K		Ø 180,0	-ABS
	96-		R		700-246	700-246K		Ø 203,0	+ABS
	5/96-		R		151-006		Bdx	Ø 19,05 180,0x30	CRCI, RAD
5/96-6/03		R		151-136		Lucas	Ø 20,64 203,0x38	LUC, +ABS	
1.5 D Eng.VJY/ VJZ(TUD5) (40-42-43kW)	9/96-		R			153-320Y	Bdx	180,0x32	
	9/96-		R		153-320	153-320K	Bdx	180,0x32	Hand Brake
	9/96-		R			153-329Y	Bdx	180,0x32	Hand Brake
	9/96-		R		153-350		Lucas	203,0x38	+ABS, Hand Brake
	96-		R		700-164	700-164K		Ø 180,0	-ABS
	96-		R		700-246	700-246K		Ø 203,0	+ABS
	5/96-		R		151-006		Bdx	Ø 19,05 180,0x30	CRCI, RAD
	5/96-7/03		R		151-136		Lucas	Ø 20,64 203,0x38	LUC, +ABS
1.6 VTL,VTR Eng.NFZ(TU5JP) (65kW)	5/96-		R			153-021Y	Bdx	165,0x30	
	5/96-		R			153-021K	Bdx	165,0x30	Hand Brake
	5/96-		R			153-024Y	Bdx	165,0x30	Hand Brake
	5/96-		R			153-320Y	Bdx	180,0x32	
	5/96-		R		153-320	153-320K	Bdx	180,0x32	Hand Brake
	5/96-		R			153-329Y	Bdx	180,0x32	Hand Brake
	5/96-		R		153-350		Lucas	203,0x38	+ABS, Hand Brake
	96-		R		700-164	700-164K		Ø 180,0	-ABS
	96-		R		700-246	700-246K		Ø 203,0	+ABS
	5/96-		R		151-006		Bdx	Ø 19,05 180,0x30	CRCI, RAD
5/96-4/04		R		151-136		Lucas	Ø 20,64 203,0x38	LUC, +ABS	
1.6 VTS Eng.NFT(TU5JP) (74kW)	9/00-		R			153-021Y	Bdx	165,0x30	
	9/00-		R			153-021K	Bdx	165,0x30	Hand Brake
	9/00-		R			153-024Y	Bdx	165,0x30	Hand Brake
	9/00-		R			153-320Y	Bdx	180,0x32	
	9/00-		R		153-320	153-320K	Bdx	180,0x32	Hand Brake
	9/00-		R			153-329Y	Bdx	180,0x32	Hand Brake
	9/00-		R		153-350		Lucas	203,0x38	+ABS, Hand Brake
	9/00-		R						
1.6 VTS Eng.NFX(TU5JP4) (87kW)	6/96-		R			153-021Y	Bdx	165,0x30	
	6/96-		R			153-021K	Bdx	165,0x30	Hand Brake
	6/96-		R			153-024Y	Bdx	165,0x30	Hand Brake
	6/96-		R			153-320Y	Bdx	180,0x32	
	6/96-		R		153-320	153-320K	Bdx	180,0x32	Hand Brake
	6/96-		R			153-329Y	Bdx	180,0x32	Hand Brake
	6/96-		R		153-350		Lucas	203,0x38	+ABS, Hand Brake
	6/96-		R						
Visa 9/78-3/91									
0.6 Eng.V06-644 (25kW)	9/78-6/88		R		153-339	153-339K	Bdx	180,0x32	Hand Brake
	80-86		R		700-158	700-158K		Ø 180,0	
0.6 Eng.V06-665 (24kW)	7/82-3/91		R		153-339	153-339K	Bdx	180,0x32	Hand Brake
0.95 Eng.XV8-TU9 (33kW)	9/84-6/88		R		153-339	153-339K	Bdx	180,0x32	Hand Brake
	84-88		R		700-158	700-158K		Ø 180,0	

		Spare Parts	F/R	L/R	CIFAM ref.	CIFAM ref. w/KIT		DIMENSIONS mm.	NOTE
0.95 Eng.XV8-TU9 (33kW)	84-88		R		151-034		Bdx	Ø 22,00 180,0x30	RAD
1.1 E Eng.109-5 (42kW)	9/78-3/91		R		153-339	153-339K	Bdx	180,0x32	Hand Brake
1.1 E Eng.109K (35kW)	9/78-6/88		R		153-339	153-339K	Bdx	180,0x32	Hand Brake
	6/81-7/82		R		700-158	700-158K		Ø 180,0	
1.1 E, Cabriolet Eng.109-5F (37kW)	7/82-3/91		R		153-339	153-339K	Bdx	180,0x32	Hand Brake
	7/83-86		R		700-158	700-158K		Ø 180,0	
	82-86		R		151-035		Bdx	Ø 20,64 180,0x30	RAD, Sys.Front Citroen
	82-86		R		151-034		Bdx	Ø 22,00 180,0x30	RAD, Sys.Front Bdx
1.2 II Super X Eng.129-5 (47kW)	5/81-7/82		R		700-162			Ø 228,6	
	80-82		R		151-035		Bdx	Ø 20,64 180,0x30	RAD, Sys.Front Citroen
	80-82		R		151-034		Bdx	Ø 22,00 180,0x30	RAD, Sys.Front Bdx
1.4 Eng.150D(XY7) (44kW)	7/84-3/91		R		153-339	153-339K	Bdx	180,0x32	Hand Brake
	7/84-86		R		700-158	700-158K		Ø 180,0	
	84-86		R		151-034		Bdx	Ø 22,00 180,0x30	RAD
1.4 GT Eng.150B(XY8) (58kW)	3/82-3/91		R		153-339	153-339K	Bdx	180,0x32	Hand Brake
	7/82-86		R		700-158	700-158K		Ø 180,0	
1.4 GT Eng.KAZ (55kW)	3/82-3/87		R		153-339	153-339K	Bdx	180,0x32	Hand Brake
1.6 GTI Eng.180A(XU5J) (76kW)	1/85-86		R		700-163	700-163K		Ø 180,0	
1.8 D Eng.161A(XUD7) (44kW)	4/84-86		R		700-163	700-163K		Ø 180,0	
Xsara (N1/0), Coupe 4/97-									
1.4 HDi Eng.DV4TD (50kW)	03-		R		700-245	700-245K		Ø 203,0	
	03-		R		151-133		Lucas	Ø 20,64 203,0x38	LUC, +ABS
1.4 i Eng.KFX/ KFW(TU3JP) (55kW)	4/97-		R		153-022	153-022Y	Bdx	180,0x32	-ABS, Hand Brake
	4/97-		R		153-322		Lucas	180,0x32	-ABS, Hand Brake
	4/97-		R		153-350		Lucas	203,0x38	+ABS, Hand Brake
	97-		R		700-165	700-165K		Ø 180,0	-ABS
	97-		R		700-245	700-245K		Ø 203,0	+ABS
	10/97-		R		151-004		Bdx	Ø 20,64 180,0x30	CRCI, RAI
	10/97-		R		151-054		Lucas	Ø 20,64 180,0x30	CRCI, RAI
97-00		R		151-133		Lucas	Ø 20,64 203,0x38	LUC, +ABS	
1.5 D Eng.VJZ(TUD5) (42kW)	4/97-9/00		R		153-022	153-022Y	Bdx	180,0x32	-ABS, Hand Brake
	4/97-9/00		R		153-327		Bdx	228,6x42	+/-ABS, Hand Brake
	4/97-9/00		R		153-322		Lucas	180,0x32	-ABS, Hand Brake
	4/97-9/00		R		153-350		Lucas	203,0x38	+ABS, Hand Brake
	97-		R		700-165	700-165K		Ø 180,0	-ABS
97-		R		700-245	700-245K		Ø 203,0	+ABS	
1.6 16v Eng.NFU(TU5JP4) (80kW)	9/00-		R		153-350		Lucas	203,0x38	Hand Brake
1.6 i Eng.NFX(TU5JP) (65kW)	4/97-9/00		R		153-022	153-022Y	Bdx	180,0x32	-ABS, Hand Brake
	4/97-9/00		R		153-322		Lucas	180,0x32	-ABS, Hand Brake
	4/97-9/00		R		153-350		Lucas	203,0x38	+ABS, Hand Brake
	97-00		R		700-165	700-165K		Ø 180,0	-ABS
	97-00		R		700-245	700-245K		Ø 203,0	+ABS
	97-00		R		151-004		Bdx	Ø 20,64 180,0x30	CRCI, RAI
	97-00		R		151-054		Lucas	Ø 20,64 180,0x30	CRCI, RAI
	97-00		R		151-133		Lucas	Ø 20,64 203,0x38	LUC, +ABS
1.8 i Aut. Eng.LFZ(XU7JP) (74kW)	4/97-9/00		R		153-022	153-022Y	Bdx	180,0x32	-ABS, Hand Brake
	4/97-9/00		R		153-322		Lucas	180,0x32	-ABS, Hand Brake
	4/97-9/00		R		153-350		Lucas	203,0x38	+ABS, Hand Brake
	97-00		R		700-165	700-165K		Ø 180,0	-ABS
	97-00		R		700-245	700-245K		Ø 203,0	+ABS
	97-00		R		151-004		Bdx	Ø 20,64 180,0x30	CRCI, RAI
	97-00		R		151-054		Lucas	Ø 20,64 180,0x30	CRCI, RAI
97-00		R		151-133		Lucas	Ø 20,64 203,0x38	LUC, +ABS	
1.8 VTS Eng.6FZ(EW7J4) (85kW)	9/00-10/04		R		153-350		Lucas	203,0x38	Hand Brake
1.8i Eng.LFX(XU7JB) (66kW)	4/97-9/00		R		153-022	153-022Y	Bdx	180,0x32	-ABS, Hand Brake
	4/97-9/00		R		153-322		Lucas	180,0x32	-ABS, Hand Brake
	4/97-9/00		R		153-350		Lucas	203,0x38	+ABS, Hand Brake
	9/97-		R		700-165	700-165K		Ø 180,0	-ABS
	9/97-		R		700-245	700-245K		Ø 203,0	+ABS
	10/97-		R		151-004		Bdx	Ø 20,64 180,0x30	CRCI, RAI
	10/97-		R		151-054		Lucas	Ø 20,64 180,0x30	CRCI, RAI
97-00		R		151-133		Lucas	Ø 20,64 203,0x38	LUC, +ABS	
1.8i 16v Eng.LFY(XU7JP4) (81kW)	4/97-9/00		R		153-022	153-022Y	Bdx	180,0x32	-ABS, Hand Brake
	4/97-9/00		R		153-322		Lucas	180,0x32	-ABS, Hand Brake
	4/97-9/00		R		153-350		Lucas	203,0x38	+ABS, Hand Brake
1.9 D Eng.DJY(XUD9A) (50kW)	9/97-		R		700-165	700-165K		Ø 180,0	-ABS
	9/97-		R		700-245	700-245K		Ø 203,0	+ABS
	10/97-		R		151-004		Bdx	Ø 20,64 180,0x30	CRCI, RAI

		Spare Parts	F/R	L/R	CIFAM ref.	CIFAM ref. w/KIT		DIMENSIONS mm.	NOTE
1.9 D Eng.DJY(XUD9A) (50kW)	10/97-97-00		R		151-054		Lucas	Ø 20,64 180,0x30	CRCI, RAI
			R		151-133		Lucas	Ø 20,64 203,0x38	LUC, +ABS
1.9 D Eng.WJY(DW8B)/ WJZ(DW8) (51kW)	7/98-		R		153-350		Lucas	203,0x38	Hand Brake
	98-		R	700-165	700-165K		Ø 180,0	-ABS	
	98-		R	700-245	700-245K		Ø 203,0	+ABS	
	98-00		R	151-133		Lucas	Ø 20,64 203,0x38	LUC, +ABS	
1.9 SD Eng.DHV(XUD9BSD) (55kW)	1/98-9/00		R		153-022	153-022Y	Bdx	180,0x32	-ABS, Hand Brake
	1/98-9/00		R	153-322		Lucas	180,0x32	-ABS, Hand Brake	
	1/98-9/00		R	153-350		Lucas	203,0x38	+ABS, Hand Brake	
	98-		R	700-165	700-165K		Ø 180,0	-ABS	
	98-		R	700-245	700-245K		Ø 203,0	+ABS	
	98-		R	151-004		Bdx	Ø 20,64 180,0x30	CRCI, RAI	
	98-		R	151-054		Lucas	Ø 20,64 180,0x30	CRCI, RAI	
	98-00		R	151-133		Lucas	Ø 20,64 203,0x38	LUC, +ABS	
1.9 TD Eng.DHY(XUD9TE-Y) (66kW)	9/97-		R		700-165	700-165K		Ø 180,0	-ABS
	9/97-		R	700-245	700-245K		Ø 203,0	+ABS	
	10/97-		R	151-004		Bdx	Ø 20,64 180,0x30	CRCI, RAI	
	10/97-		R	151-054		Lucas	Ø 20,64 180,0x30	CRCI, RAI	
	97-00		R	151-133		Lucas	Ø 20,64 203,0x38	LUC, +ABS	
2.0 16v Eng.RFN(EW10J4) (100kW)	9/00-		R		153-350		Lucas	203,0x38	Hand Brake
2.0 HDi Eng.RHS/ RHZ(DW10ATED) (80kW)	5/01-		R		153-350		Lucas	203,0x38	Hand Brake
2.0 HDi Eng.RHY(DW10TD) (66kW)	2/99-		R		153-350		Lucas	203,0x38	Hand Brake
Xsara (N2) Break 4/97-									
1.4 HDi Eng.DV4TD (50kW)	1/03-03-		R		153-323		Bdx	228,6x42	+/-ABS, Hand Brake
			R	151-143		Bosch	Ø 22,00 228,0x42	RAI, +ABS	
1.4 i Eng.KFX/ KFW(TU3JP) (55kW)	4/97-		R		153-323		Bdx	228,6x42	+/-ABS, Hand Brake
	4/97-		R	153-327		Bdx	228,6x42	+/-ABS, Hand Brake	
	97-		R	700-233			Ø 228,5		
	4/98-8/00		R	151-142		Bosch	Ø 20,64 228,0x42	RAI, -ABS	
4/98-8/00	R	151-143		Bosch	Ø 22,00 228,0x42	RAI, +ABS			
	R	151-142		Bosch	Ø 20,64 228,0x42	RAI, -ABS			
	R	151-143		Bosch	Ø 22,00 228,0x42	RAI, +ABS			
1.5 D Eng.VJZ(TUD5) (42kW)	4/97-9/00		R		153-323		Bdx	228,6x42	+/-ABS, Hand Brake
	97-		R	700-233			Ø 228,5		
	4/98-8/00		R	151-142		Bosch	Ø 20,64 228,0x42	RAI, -ABS	
	4/98-8/00		R	151-143		Bosch	Ø 22,00 228,0x42	RAI, +ABS	
1.6 16v Eng.NFU(TU5JP4) (80kW)	9/00-		R		153-323		Bdx	228,6x42	+/-ABS, Hand Brake
	9/00-		R	153-327		Bdx	228,6x42	+/-ABS, Hand Brake	
1.6 i Eng.NFZ(TU5JP) (65kW)	4/97-9/00		R		153-323		Bdx	228,6x42	+/-ABS, Hand Brake
	4/97-9/00		R	153-327		Bdx	228,6x42	+/-ABS, Hand Brake	
	97-00		R	700-233			Ø 228,5		
	97-00		R	151-142		Bosch	Ø 20,64 228,0x42	RAI, -ABS	
	97-00		R	151-143		Bosch	Ø 22,00 228,0x42	RAI, +ABS	
1.8 D Eng.A9A(XUD7) (43kW)	4/97-9/00		R		153-323		Bdx	228,6x42	+/-ABS, Hand Brake
	97-00		R	700-233			Ø 228,5		
	4/98-8/00		R	151-142		Bosch	Ø 20,64 228,0x42	RAI, -ABS	
	4/98-8/00		R	151-143		Bosch	Ø 22,00 228,0x42	RAI, +ABS	
1.8 i Aut. Eng.LFZ(XU7JP) (74kW)	4/97-9/00		R		153-323		Bdx	228,6x42	+/-ABS, Hand Brake
	4/97-9/00		R	153-327		Bdx	228,6x42	+/-ABS, Hand Brake	
	97-00		R	700-233			Ø 228,5		
	97-00		R	151-142		Bosch	Ø 20,64 228,0x42	RAI, -ABS	
	97-00		R	151-143		Bosch	Ø 22,00 228,0x42	RAI, +ABS	
1.8i Eng.LFX(XU7JB) (66kW)	4/97-9/00		R		153-323		Bdx	228,6x42	+/-ABS, Hand Brake
	4/97-9/00		R	153-327		Bdx	228,6x42	+/-ABS, Hand Brake	
	97-		R	700-233			Ø 228,5		
	4/98-8/00		R	151-142		Bosch	Ø 20,64 228,0x42	RAI, -ABS	
4/98-8/00	R	151-143		Bosch	Ø 22,00 228,0x42	RAI, +ABS			
1.8i 16v Eng.LFY(XU7JP4) (81kW)	4/97-9/00		R		153-323		Bdx	228,6x42	+/-ABS, Hand Brake
	4/97-9/00		R	153-327		Bdx	228,6x42	+/-ABS, Hand Brake	
1.9 D Eng.DJY(XUD9A) (50kW)	4/97-9/00		R		153-323		Bdx	228,6x42	+/-ABS, Hand Brake
	4/97-9/00		R	153-327		Bdx	228,6x42	+/-ABS, Hand Brake	
	10/97-		R	700-233			Ø 228,5		
	4/98-8/00		R	151-142		Bosch	Ø 20,64 228,0x42	RAI, -ABS	
	4/98-8/00		R	151-143		Bosch	Ø 22,00 228,0x42	RAI, +ABS	
1.9 D Eng.WJY(DW8B)/ WJZ(DW8) (51kW)	7/98-		R		153-323		Bdx	228,6x42	+/-ABS, Hand Brake
	7/98-		R	153-327		Bdx	228,6x42	+/-ABS, Hand Brake	
	98-		R	700-233			Ø 228,5		
	4/98-8/00		R	151-142		Bosch	Ø 20,64 228,0x42	RAI, -ABS	
	4/98-8/00		R	151-143		Bosch	Ø 22,00 228,0x42	RAI, +ABS	

































































		Spare Parts	F/R	L/R	CIFAM ref.	CIFAM ref. w/KIT		DIMENSIONS mm.	NOTE
1.9 SD Eng.DHV(XUD9BSD) (55kW)	1/98-9/00		R		153-323		Bdx	228,6x42	+/-ABS, Hand Brake
	1/98-9/00		R		153-327		Bdx	228,6x42	+/-ABS, Hand Brake
	98-		R		700-233			Ø 228,5	
1.9 TD Eng.DHY(XUD9TE-Y) (66kW)	4/97-9/00		R		153-323		Bdx	228,6x42	+/-ABS, Hand Brake
	4/97-9/00		R		153-327		Bdx	228,6x42	+/-ABS, Hand Brake
	10/97-		R		700-233			Ø 228,5	
2.0 16v Eng.RFN(EW10J4) (100kW)	9/00-		R		153-323		Bdx	228,6x42	+/-ABS, Hand Brake
2.0 HDi Eng.RHS/ RHZ(DW10ATED) (80kW)	5/01-		R		153-323		Bdx	228,6x42	+/-ABS, Hand Brake
2.0 HDi Eng.RHY(DW10TD) (66kW)	2/99-		R		153-323		Bdx	228,6x42	+/-ABS, Hand Brake
2.0 i 16v Eng.RFV(XU10J4R) (97kW)	7/98-9/00		R		153-323		Bdx	228,6x42	+/-ABS, Hand Brake
Xsara Picasso (N68) 2/00-									
1.6 Eng.NFZ/ NFV(TU5JP) (65-70kW)	6/00-		R		153-023		Lucas	228,6x42	Hand Brake
	1/00-		R		700-233			Ø 228,5	
	00-		R		151-140		Lucas	Ø 22,00 228,6x42	LUC
1.8i 16v Eng.LFY(XU7JP4)/ 6FZ(EW7J4) (81-85kW)	2/00-		R		153-023		Lucas	228,6x42	Hand Brake
	1/00-		R		700-233			Ø 228,5	
	00-		R		151-140		Lucas	Ø 22,00 228,6x42	LUC
2.0 16v Eng.RFN(EW10J4) (100kW)	03-		R		700-233			Ø 228,5	
2.0 HDi Eng.RHY(DW10TD) (66kW)	6/00-		R		153-023		Lucas	228,6x42	Hand Brake
	1/00-		R		700-233			Ø 228,5	
	00-		R		151-140		Lucas	Ø 22,00 228,6x42	LUC
ZX (N2) 3/91-6/97									
1.1 Eng.HDZ(TU1M) (44kW)	3/91-6/97		R		153-022	153-022Y	Bdx	180,0x32	Ch -5718, Hand Brake
	3/91-6/97		R		153-322		Lucas	180,0x32	Hand Brake
	3/91-		R		700-165	700-165K		Ø 180,0	
	3/91-7/92		R		151-050		Bdx	Ø 20,64 180,0x30	CRCI, RAI
	3/91-7/92		R		151-051		Lucas	Ø 20,64 180,0x30	CRCI, RAI
	8/92-6/97		R		151-004		Bdx	Ø 20,64 180,0x30	CRCI, RAI
	8/92-6/97		R		151-054		Lucas	Ø 20,64 180,0x30	CRCI, RAI
	8/92-6/97		R		151-054		Lucas	Ø 20,64 180,0x30	CRCI, RAI
1.1 Eng.TU1M/ K/ MZ (40kW)	3/91-8/93		R		153-022	153-022Y	Bdx	180,0x32	Ch -5718, Hand Brake
	3/91-8/93		R		153-322		Lucas	180,0x32	Hand Brake
1.4 i Eng.KDX/ KDZ(TU3M-Z) (55kW)	3/91-6/97		R		153-022	153-022Y	Bdx	180,0x32	Ch -5718, Hand Brake
	3/91-6/97		R		153-322		Lucas	180,0x32	Hand Brake
	3/91-		R		700-165	700-165K		Ø 180,0	-ABS
	5/95-		R		700-245	700-245K		Ø 203,0	+ABS
	3/91-7/92		R		151-050		Bdx	Ø 20,64 180,0x30	CRCI, RAI
	3/91-7/92		R		151-051		Lucas	Ø 20,64 180,0x30	CRCI, RAI
	8/92-6/97		R		151-004		Bdx	Ø 20,64 180,0x30	CRCI, RAI
	8/92-6/97		R		151-054		Lucas	Ø 20,64 180,0x30	CRCI, RAI
1.4ie Eng.KFX(TU3JP) (55kW)	3/91-6/97		R		153-022	153-022Y	Bdx	180,0x32	Ch -5718, Hand Brake
	3/91-6/97		R		153-322		Lucas	180,0x32	Hand Brake
	3/91-		R		700-165	700-165K		Ø 180,0	-ABS
	5/95-		R		700-245	700-245K		Ø 203,0	+ABS
	3/91-7/92		R		151-050		Bdx	Ø 20,64 180,0x30	CRCI, RAI
	3/91-7/92		R		151-051		Lucas	Ø 20,64 180,0x30	CRCI, RAI
	8/92-6/97		R		151-004		Bdx	Ø 20,64 180,0x30	CRCI, RAI
	8/92-6/97		R		151-054		Lucas	Ø 20,64 180,0x30	CRCI, RAI
1.6 i Eng.BDY(XU5M)/ BFZ(XU5JP) (65-66kW)	3/91-6/97		R		153-022	153-022Y	Bdx	180,0x32	Ch -5718, -ABS, Hand Brake
	3/91-6/97		R		153-322		Lucas	180,0x32	-ABS, Hand Brake
	3/91-		R		700-165	700-165K		Ø 180,0	-ABS
	5/95-		R		700-245	700-245K		Ø 203,0	+ABS
	3/91-7/92		R		151-050		Bdx	Ø 20,64 180,0x30	CRCI, RAI
	3/91-7/92		R		151-051		Lucas	Ø 20,64 180,0x30	CRCI, RAI
	8/92-6/97		R		151-004		Bdx	Ø 20,64 180,0x30	CRCI, RAI
	8/92-6/97		R		151-054		Lucas	Ø 20,64 180,0x30	CRCI, RAI
1.8 D Eng.161A(XUD7) (44kW)	6/93-6/97		R		153-022	153-022Y	Bdx	180,0x32	Ch -5718, Hand Brake
	6/93-6/97		R		153-322		Lucas	180,0x32	Hand Brake
	93-97		R		700-165	700-165K		Ø 180,0	-ABS
	93-97		R		700-245	700-245K		Ø 203,0	+ABS
	97-00		R		151-133		Lucas	Ø 20,64 203,0x38	LUC, +ABS
1.8i Eng.LFZ(XU7JP) (74kW)	7/92-6/97		R		153-022	153-022Y	Bdx	180,0x32	Ch -5718, -ABS, Hand Brake
	7/92-6/97		R		153-322		Lucas	180,0x32	-ABS, Hand Brake
	5/95-		R		700-245	700-245K		Ø 203,0	+ABS
	8/92-		R		700-165	700-165K		Ø 180,0	-ABS
	8/92-6/97		R		151-004		Bdx	Ø 20,64 180,0x30	CRCI, RAI



























































		Spare Parts	F/R	L/R	CIFAM ref.	CIFAM ref. w/KIT		DIMENSIONS mm.	NOTE
1.8i Eng.LFZ(XU7JP) (74kW)	8/92-6/97		R		151-054		Lucas	Ø 20,64 180,0x30	CRCI, RAI
	92-7/92		R		151-050		Bdx	Ø 20,64 180,0x30	CRCI, RAI
	92-7/92		R		151-051		Lucas	Ø 20,64 180,0x30	CRCI, RAI
	97-00		R		151-133		Lucas	Ø 20,64 203,0x38	LUC, +ABS
1.9 D Eng.D9B(XUD9A-U) (51kW)	6/94-6/97		R		153-022	153-022Y	Bdx	180,0x32	Ch -5718, -ABS, Hand Brake
	6/94-6/97		R		153-322		Lucas	180,0x32	-ABS, Hand Brake
	6/94-6/97		R		153-350		Lucas	203,0x38	Hand Brake
	94-97		R		700-165	700-165K		Ø 180,0	-ABS
	94-97		R		700-245	700-245K		Ø 203,0	+ABS
	94-97		R		151-004		Bdx	Ø 20,64 180,0x30	CRCI, RAI
	94-97		R		151-054		Lucas	Ø 20,64 180,0x30	CRCI, RAI
1.9 D Eng.DJZ(XUD9Y) (47kW)	3/91-6/97		R		153-022	153-022Y	Bdx	180,0x32	Ch -5718, -ABS, Hand Brake
	3/91-6/97		R		153-322		Lucas	180,0x32	-ABS, Hand Brake
	3/91-6/97		R		153-350		Lucas	203,0x38	Hand Brake
	10/91-5/95		R		700-165	700-165K		Ø 180,0	-ABS
	3/91-7/92		R		700-245	700-245K		Ø 203,0	+ABS
	3/91-7/92		R		151-050		Bdx	Ø 20,64 180,0x30	CRCI, RAI
	3/91-7/92		R		151-051		Lucas	Ø 20,64 180,0x30	CRCI, RAI
	8/92-6/97		R		151-004		Bdx	Ø 20,64 180,0x30	CRCI, RAI
	8/92-6/97		R		151-054		Lucas	Ø 20,64 180,0x30	CRCI, RAI
1.9 DT Eng.XUD9TE (68kW)	92-		R		153-022	153-022Y	Bdx	180,0x32	Ch -5718, -ABS
	92-94		R		700-165	700-165K		Ø 180,0	-ABS
	92-94		R		151-004		Bdx	Ø 20,64 180,0x30	CRCI, RAI
	92-94		R		151-054		Lucas	Ø 20,64 180,0x30	CRCI, RAI
1.9 TD Eng.DHY(XUD9TE-Y) (66kW)	7/92-6/97		R		153-350		Lucas	203,0x38	Hand Brake
	92-97		R		700-165	700-165K		Ø 180,0	-ABS
	92-97		R		700-245	700-245K		Ø 203,0	+ABS
	92-97		R		151-004		Bdx	Ø 20,64 180,0x30	CRCI, RAI
	92-97		R		151-054		Lucas	Ø 20,64 180,0x30	CRCI, RAI
ZX (N2) Break 3/91-6/97									
1.4 i Eng.KDX/ KDZ(TU3M-Z) (55kW)	3/91-6/97		R		153-323		Bdx	228,6x42	-ABS, Hand Brake
	91-		R		700-245	700-245K		Ø 203,0	+ABS
	91-		R		700-161			Ø 228,6	-ABS
	91-		R		151-005		Bdx	Ø 20,64 228,6x42	RAI
1.4ie Eng.KFX(TU3JP) (55kW)	3/91-6/97		R		153-323		Bdx	228,6x42	-ABS, Hand Brake
	91-		R		700-245	700-245K		Ø 203,0	+ABS
	91-		R		700-161			Ø 228,6	-ABS
	91-		R		151-005		Bdx	Ø 20,64 228,6x42	RAI
1.6 i Eng.BDY(XU5M)/ BFZ(XU5JP) (65-66kW)	3/91-6/97		R		153-323		Bdx	228,6x42	-ABS, Hand Brake
	91-		R		700-245	700-245K		Ø 203,0	+ABS
	91-		R		700-161			Ø 228,6	-ABS
	91-		R		151-005		Bdx	Ø 20,64 228,6x42	RAI
1.8 D Eng.161A(XUD7) (44kW)	93-97		R		700-245	700-245K		Ø 203,0	+ABS
	93-97		R		700-161			Ø 228,6	-ABS
	93-97		R		151-005		Bdx	Ø 20,64 228,6x42	RAI
1.8i Eng.LFZ(XU7JP) (74kW)	7/92-6/97		R		153-323		Bdx	228,6x42	-ABS, Hand Brake
	92-97		R		700-233			Ø 228,5	
1.8i 16v Eng.LFY(XU7JP4) (81kW)	96-97		R		700-233			Ø 228,5	
1.9 D Eng.D9B(XUD9A-U) (51kW)	6/94-6/97		R		153-323		Bdx	228,6x42	-ABS, Hand Brake
	6/94-6/97		R		153-350		Lucas	203,0x38	Hand Brake
	94-97		R		700-245	700-245K		Ø 203,0	+ABS
	94-97		R		700-161			Ø 228,6	-ABS
	94-97		R		151-005		Bdx	Ø 20,64 228,6x42	RAI
1.9 D Eng.DJZ(XUD9Y) (47kW)	94-97		R		151-133		Lucas	Ø 20,64 203,0x38	LUC, +ABS
	3/91-6/97		R		153-323		Bdx	228,6x42	-ABS, Hand Brake
	3/91-6/97		R		153-350		Lucas	203,0x38	Hand Brake
	91-		R		700-245	700-245K		Ø 203,0	+ABS
1.9 TD Eng.DHY(XUD9TE-Y) (66kW)	91-		R		700-161			Ø 228,6	-ABS
	91-		R		151-005		Bdx	Ø 20,64 228,6x42	RAI
	7/92-6/97		R		153-350		Lucas	203,0x38	Hand Brake
	92-97		R		700-245	700-245K		Ø 203,0	+ABS
92-97	R		700-161			Ø 228,6	-ABS		
	R		151-005		Bdx	Ø 20,64 228,6x42	RAI		































CITROËN LCV























































Berlingo I Van (M) 7/96-5/08















1.1 Eng.HDZ(TU1M) (40kW)	7/96-		R		700-233			Ø 228,5	
	96-		R		151-140		Lucas	Ø 22,00 228,6x42	LUC

		Spare Parts	F/R	L/R	CIFAM ref.	CIFAM ref. w/KIT		DIMENSIONS mm.	NOTE
1.4 Bivalent (48kW)	02-		R		151-140		Lucas	Ø 22,00 228,6x42	LUC
1.4 i, Bivalent Eng.KFX/ KFW(TU3JP)	7/96-		R		700-233			Ø 228,5	
(55kW)	96-		R		151-140		Lucas	Ø 22,00 228,6x42	LUC
1.6 HDi Eng.DV6ATED4 (66kW)	05-		R		700-233			Ø 228,5	+ABS, -ESP
1.6 HDi Eng.DV6B (55kW)	05-		R		700-233			Ø 228,5	+ABS, -ESP
1.8 D Eng.A9A(XUD7) (43kW)	7/96-		R		700-233			Ø 228,5	
	96-		R		151-140		Lucas	Ø 22,00 228,6x42	LUC
1.9 D Eng.DJY(XUD9A) (50kW)	7/96-		R		700-233			Ø 228,5	
	96-		R		151-140		Lucas	Ø 22,00 228,6x42	LUC
1.9 D, 4WD Eng.WJZ(DW8) (51kW)	98-		R		700-233			Ø 228,5	
	98-		R		151-140		Lucas	Ø 22,00 228,6x42	LUC
2.0 HDi Eng.RHY(DW10TD) (66kW)	12/99-		R		700-233			Ø 228,5	
	12/99-		R		151-140		Lucas	Ø 22,00 228,6x42	LUC
C15 (VD), Van 10/84-									
0.95 Eng.XV8-TU9 (33kW)	10/84-12/97		R		153-324	153-324K	Bdx	228,6x42	Hand Brake
	10/84-87		R		700-162			Ø 228,6	
	11/86-		R		700-161			Ø 228,6	
1.1 Eng.109-5F/ K (35-37kW)	10/84-12/96		R		153-324	153-324K	Bdx	228,6x42	Hand Brake
	4/85-4/88		R		700-162			Ø 228,6	
	5/88-		R		700-161			Ø 228,6	
1.1 Eng.E1A (35kW)	10/84-12/96		R		153-324	153-324K	Bdx	228,6x42	Hand Brake
	4/85-4/88		R		700-162			Ø 228,6	
	5/88-		R		700-161			Ø 228,6	
1.1 Eng.HDZ(TU1M) (44kW)	7/88-12/96		R		153-324	153-324K	Bdx	228,6x42	Hand Brake
	5/88-		R		700-161			Ø 228,6	
1.3 Eng.G1A (47kW)	7/87-5/88		R		153-324	153-324K	Bdx	228,6x42	Hand Brake
	7/87-6/88		R		700-161			Ø 228,6	
1.4 Eng.K1H(TU3A) (49kW)	7/87-12/96		R		153-324	153-324K	Bdx	228,6x42	Hand Brake
	7/87-12/96		R		153-340	153-340K	Bdx	228,6x42	14Inch Wheels, Hand Brake
	2/87-4/88		R		700-162			Ø 228,6	
	5/88-		R		700-161			Ø 228,6	
1.4 E Eng.150B/ C/ D/ Y(XY7) (44-59kW)	5/87-12/96		R		153-324	153-324K	Bdx	228,6x42	Hand Brake
	5/87-12/96		R		153-340	153-340K	Bdx	228,6x42	14Inch Wheels, Hand Brake
	2/87-4/88		R		700-162			Ø 228,6	
	5/88-		R		700-161			Ø 228,6	
1.4 E Eng.K3A (40kW)	2/87-4/88		R		700-162			Ø 228,6	
	5/88-		R		700-161			Ø 228,6	
1.4 i Eng.KDY(TU3M/ FM) (55kW)	5/91-12/96		R		153-324	153-324K	Bdx	228,6x42	Hand Brake
	5/91-12/96		R		153-340	153-340K	Bdx	228,6x42	14Inch Wheels, Hand Brake
	91-96		R		700-161			Ø 228,6	
1.8 D Eng.161A(XUD7) (44kW)	7/86-12/00		R		153-324	153-324K	Bdx	228,6x42	Hand Brake
	7/86-12/00		R		153-340	153-340K	Bdx	228,6x42	Hand Brake
	86-		R		700-161			Ø 228,6	
	86-		R		151-036		Bdx	Ø 22,00 228,0x40	RAD
1.9 D Eng.WJX(DW8B) (44kW)	00-		R		700-161			Ø 228,6	
	00-		R		151-036		Bdx	Ø 22,00 228,0x40	RAD
C2 Van (JM) 9/03-									
1.4 HDi Eng.DV4TD (50kW)	9/03-		R		700-363	700-363K		Ø 203,0	
	03-		R		151-190		Bosch	Ø 20,64 203,2x39	RAI, +ABS
C22 1/81-8/84									
1.8	1/81-8/84		R		153-062		Lucas	254,0x57	Hand Brake
	81-8/84		R		700-015			Ø 254,0	
2.5 D	1/81-8/84		R		153-062		Lucas	254,0x57	Hand Brake
	81-8/84		R		700-015			Ø 254,0	
C25 (280, 290) 9/81-2/94									
1.8 E Eng.169(XM7T) (51kW)	7/87-2/94		R		153-062		Lucas	254,0x57	Hand Brake
	87-		R		700-015			Ø 254,0	
	87-		R		151-103		Lucas	Ø 22,22 254,0x57	LUC, 8Q
	-94		R		151-102		Lucas	Ø 25,40 254,0x57	LUC, 10-14Q
	-94		R		151-065		Lucas	Ø 27,00 254,0x57	LUC, 18Q
1.9 D Eng.D9B(XUD9A-U) (51kW)	7/87-2/94		R		153-062		Lucas	254,0x57	Hand Brake
	87-		R		700-015			Ø 254,0	
	-94		R		151-102		Lucas	Ø 25,40 254,0x57	LUC, 10-14Q
	-94		R		151-065		Lucas	Ø 27,00 254,0x57	LUC, 18Q
1.9 TD Eng.M705(280A1 FIAT) (60kW)	4/92-2/94		R		153-062		Lucas	254,0x57	Hand Brake
	92-		R		700-015			Ø 254,0	
	-94		R		151-102		Lucas	Ø 25,40 254,0x57	LUC, 10-14Q
	-94		R		151-065		Lucas	Ø 27,00 254,0x57	LUC, 18Q







































		Spare Parts	F/R	L/R	CIFAM ref.	CIFAM ref. w/KIT		DIMENSIONS mm.	NOTE
2.0 E, Van Eng.170A/ B(XN1T) (58kW)	9/81-2/94		R		153-062		Lucas	254,0x57	Hand Brake
	10/81-		R		700-015			Ø 254,0	
	81-12/82		R		151-101		Lucas	Ø 22,22 254,0x57	LUC, 10-14Q
	-94		R		151-102		Lucas	Ø 25,40 254,0x57	LUC, 10-14Q
	-94		R		151-065		Lucas	Ø 27,00 254,0x57	LUC, 18Q
2.0, Van, Flatbed Eng.170C (62kW)	2/91-2/94		R		153-062		Lucas	254,0x57	Hand Brake
	91-		R		700-015			Ø 254,0	
	-94		R		151-102		Lucas	Ø 25,40 254,0x57	LUC, 10-14Q
	-94		R		151-065		Lucas	Ø 27,00 254,0x57	LUC, 18Q
	-94		R		151-065		Lucas	Ø 27,00 254,0x57	LUC, 18Q
2.5 D, 4WD Eng.CRD93L(U25-661) (54-55kW)	1/87-2/94		R		153-068		Lucas	254,0x57	18Q
	1/87-2/94		R		153-062		Lucas	254,0x57	Exc. 18Q, Hand Brake
	87-		R		700-015			Ø 254,0	
	-94		R		151-102		Lucas	Ø 25,40 254,0x57	LUC, 10-14Q
	-94		R		151-065		Lucas	Ø 27,00 254,0x57	LUC, 18Q
2.5 TD, 4WD Eng.CRD93LS(U25-673/ M25-648) (70kW)	8/87-2/94		R		153-068		Lucas	254,0x57	18Q
	8/87-2/94		R		153-062		Lucas	254,0x57	Exc. 18Q, Hand Brake
	87-		R		700-015			Ø 254,0	
	-94		R		151-102		Lucas	Ø 25,40 254,0x57	LUC, 10-14Q
	-94		R		151-065		Lucas	Ø 27,00 254,0x57	LUC, 18Q
C3 Van 2/03-10/09									
1.4 Eng.KFV(TU3JP) (54kW)	2/02-		R		700-363	700-363K		Ø 203,0	
1.4 HDi Eng.DV4TD (50kW)	2/02-		R		700-363	700-363K		Ø 203,0	
Dispatch 1/94-12/00									
1.6 Eng.XU5JP (66kW)	1/94-12/00		R		153-074		Bdx	256,0x61	Hand Brake
			R		700-017			Ø 255,0	
1.9 D, TD Eng.DHX(XUD9TF-BTF) (66kW)	1/94-12/00		R		153-074	153-074Y	Bdx	256,0x61	Hand Brake
			R		700-017			Ø 255,0	
Jumper I (230)/ Relay 3/94-4/02									
1.9 D Eng.D9B(XUD9A-U) (51kW)	1/94-4/02		R		153-082		Ap	254,0x57	
	1/94-4/02		R		153-072		Lucas	254,0x57	Hand Brake
	2/94-		R		700-015			Ø 254,0	10-14Q
	99-		R		151-073		Lucas	Ø 25,40 254,0x57	LUC, 10-14Q
	99-		R		151-074		Lucas	Ø 28,60 254,0x57	LUC, 18Q
1.9 D Eng.DJY(XUD9A) (50kW)	99-02		R		153-082		Ap	254,0x57	
1.9 TD Eng.D8C(XUD9UTF) (66kW)	8/94-4/02		R		153-082		Ap	254,0x57	
	8/94-4/02		R		153-072		Lucas	254,0x57	10-14Q, Hand Brake
	8/94-4/02		R		153-073		Lucas	254,0x57	18Q, Hand Brake
	2/94-		R		700-015			Ø 254,0	10-14Q
	94-		R		151-073		Lucas	Ø 25,40 254,0x57	LUC, 10-14Q
	94-		R		151-074		Lucas	Ø 28,60 254,0x57	LUC, 18Q
1.9 TD Eng.D8C(XUD9UTF) (68kW)	8/96-4/02		R		153-082		Ap	254,0x57	
	8/96-4/02		R		153-072		Lucas	254,0x57	10-14Q, Hand Brake
	8/96-4/02		R		153-073		Lucas	254,0x57	18Q, Hand Brake
	96-		R		700-015			Ø 254,0	10-14Q
	96-		R		151-073		Lucas	Ø 25,40 254,0x57	LUC, 10-14Q
	96-		R		151-074		Lucas	Ø 28,60 254,0x57	LUC, 18Q
1.9 TD Eng.DHX(XUD9TF-BTF) (66kW)	3/94-4/02		R		153-082		Ap	254,0x57	
	3/94-4/02		R		153-072		Lucas	254,0x57	10-14Q, Hand Brake
	3/94-4/02		R		153-073		Lucas	254,0x57	18Q, Hand Brake
	2/94-		R		700-015			Ø 254,0	10-14Q
	94-		R		151-073		Lucas	Ø 25,40 254,0x57	LUC, 10-14Q
	94-		R		151-074		Lucas	Ø 28,60 254,0x57	LUC, 18Q
2.0 HDi Eng.RHV(DW10UTD) (62kW)	01-02		R		700-015			Ø 254,0	10-14Q
	01-02		R		700-016			Ø 254,0	18Q
	01-		R		151-073		Lucas	Ø 25,40 254,0x57	LUC, 10-14Q
	01-		R		151-074		Lucas	Ø 28,60 254,0x57	LUC, 18Q
2.0i Eng.RFX(XU10J2C) (90kW)	1/94-4/02		R		153-082		Ap	254,0x57	
2.0i, 4WD Eng.RFW(XU10J2U) (80kW)	3/94-4/02		R		153-082		Ap	254,0x57	
	3/94-4/02		R		153-072		Lucas	254,0x57	10-14Q, Hand Brake
	3/94-4/02		R		153-073		Lucas	254,0x57	18Q, Hand Brake
	96-		R		700-015			Ø 254,0	10-14Q
	96-		R		700-016			Ø 254,0	18Q
	96-		R		151-073		Lucas	Ø 25,40 254,0x57	LUC, 10-14Q
	96-		R		151-074		Lucas	Ø 28,60 254,0x57	LUC, 18Q
2.5 D, 4WD Eng.T9A(DJ5) (63kW)	3/94-4/02		R		153-082		Ap	254,0x57	
	3/94-4/02		R		153-072		Lucas	254,0x57	10-14Q, Hand Brake
	3/94-4/02		R		153-073		Lucas	254,0x57	18Q, Hand Brake
	96-02		R		700-015			Ø 254,0	10-14Q























































		Spare Parts	F/R	L/R	CIFAM ref.	CIFAM ref. w/KIT		DIMENSIONS mm.	NOTE
2.5 D, 4WD Eng.T9A(DJ5) (63kW)	96-02		R		700-016			Ø 254,0	18Q
	96-02		R		151-073		Lucas	Ø 25,40 254,0x57	LUC, 10-14Q
	96-02		R		151-074		Lucas	Ø 28,60 254,0x57	LUC, 18Q
2.5 TD Eng.DK5-ATE (96kW)	95-02		R		153-082		Ap	254,0x57	
2.5 TD, 4WD Eng.T8A(DJ5T) (76kW)	3/94-4/02		R		153-082		Ap	254,0x57	
	3/94-4/02		R		153-072		Lucas	254,0x57	10-14Q, Hand Brake
	3/94-4/02		R		153-073		Lucas	254,0x57	18Q, Hand Brake
	96-02		R		700-015			Ø 254,0	14Q
	96-02		R		700-016			Ø 254,0	18Q
	96-02		R		151-075		Lucas	Ø 27,00 254,0x57	LUC, 14Q
	96-02		R		151-074		Lucas	Ø 28,60 254,0x57	LUC, 18Q
2.5 TDi, 4WD Eng.THX(DJ5TED) (79kW)	96-00		R		153-082		Ap	254,0x57	
	96-00		R		153-072		Lucas	254,0x57	10-14Q, Hand Brake
	96-00		R		153-073		Lucas	254,0x57	18Q, Hand Brake
	96-00		R		700-015			Ø 254,0	14Q
	96-00		R		700-016			Ø 254,0	18Q
	96-00		R		151-075		Lucas	Ø 27,00 254,0x57	LUC, 14Q
	96-00		R		151-074		Lucas	Ø 28,60 254,0x57	LUC, 18Q
2.8 HDi, 4WD Eng.8140.43S (94kW)	00-02		R		153-089	153-089K		170,0x45	
	00-02		R		153-082		Ap	254,0x57	Flat Car
	00-02		R		153-072		Lucas	254,0x57	10-14Q, Hand Brake
	00-02		R		153-073		Lucas	254,0x57	18Q, Hand Brake
	00-02		R		700-016			Ø 254,0	18Q
	00-02		R		151-074		Lucas	Ø 28,60 254,0x57	LUC, 18Q
	00-02		R		151-074		Lucas	Ø 28,60 254,0x57	LUC, 18Q
Jumper II (244)/ Relay 4/02-3/06									
2.0 Eng.XU10J2 (81kW)	4/02-3/06		R		153-089	153-089K		170,0x45	
	4/02-3/06		R		153-082		Ap	254,0x57	Flat Car
2.0 bivalent Eng.XU10J2 (81kW)	2/03-3/06		R		153-089	153-089K		170,0x45	
	2/03-3/06		R		153-082		Ap	254,0x57	Flat Car
2.0 HDi Eng.RHV(DW10UTD) (62kW)	4/02-3/06		R		153-089	153-089K		170,0x45	
	4/02-3/06		R		153-082		Ap	254,0x57	
2.2 HDi Eng.DW12TED (74kW)	4/02-3/06		R		153-089	153-089K		170,0x45	
	4/02-3/06		R		153-082		Ap	254,0x57	Flat Car
2.8 HDi Eng.8140.43N (107kW)	5/04-3/06		R		153-089	153-089K		170,0x45	
2.8 HDi, 4WD Eng.8140.43S (94kW)	4/02-3/06		R		153-089	153-089K		170,0x45	
	4/02-3/06		R		153-082		Ap	254,0x57	
Jumper III 4/06-									
2.2 HDi Eng.4HU (88kW)	4/06-		R		153-094			172,0x40	
	4/06-		R			153-095K		172,0x40	
2.2 HDi Eng.DW12TED (74kW)	4/06-		R		153-094			172,0x40	
	4/06-		R			153-095K		172,0x40	
Jumpy I (U6U) 10/95-12/06									
1.6, Van Eng.220A2.000 (58kW)	10/95-12/06		R		153-074	153-074Y	Bdx	256,0x61	Hand Brake
	96-		R		700-017			Ø 255,0	Ch -8206, 8-9Q
	95-		R		151-066		Bdx	Ø 19,05 255,0x60	RAI, 8-9Q
1.9 D Eng.D9B(XUD9A-U) (51kW)	10/95-4/98		R		153-074	153-074Y	Bdx	256,0x61	Hand Brake
	96-		R		700-017			Ø 255,0	Ch -8206, 8-9Q
	95-		R		151-066		Bdx	Ø 19,05 255,0x60	RAI, 8-9Q
1.9 D, Van Eng.WJZ(DW8) (51kW)	4/95-12/06		R		153-074	153-074Y	Bdx	256,0x61	Hand Brake
	96-		R		700-017			Ø 255,0	Ch -8206, 8-9Q
	95-		R		151-066		Bdx	Ø 19,05 255,0x60	RAI, 8-9Q
1.9 TD Eng.DHX(XUD9TF-BTF) (66kW)	10/95-12/06		R		153-074	153-074Y	Bdx	256,0x61	Hand Brake
	95-		R		700-017			Ø 255,0	Ch -8206, 8-9Q
	95-		R		151-066		Bdx	Ø 19,05 255,0x60	RAI, 8-9Q
1.9 TD, Flatbed Eng.D8B(XUD9TF) (68kW)	96-		R		700-017			Ø 255,0	Ch -8206, 8-9Q
	96-		R		151-066		Bdx	Ø 19,05 255,0x60	RAI, 8-9Q
2.0 16v Eng.RFN(EW10J4) (100kW)	00-		R		700-017			Ø 255,0	
	00-		R		151-066		Bdx	Ø 19,05 255,0x60	RAI, 9Q
2.0 HDi, Van Eng.RHS/RHZ(DW10ATED) (80kW)	00-		R		151-066		Bdx	Ø 19,05 255,0x60	RAI, 9Q
2.0 HDi, Van, Flatbed Eng.RHX(DW10BTED) (69kW)	99-10/99-		R		700-017			Ø 255,0	Ch -8206, 8-9Q
			R		151-066		Bdx	Ø 19,05 255,0x60	RAI, 9Q
Jumpy II/Dispatch 1/07-									
1.6 HDi, Van Eng.DV6UTED4 (66kW)	1/07-		R		153-073		Lucas	254,0x57	Hand Brake
	07-		R		151-169		Lucas	Ø 22,20 254,0x57	LUC
2.0 16v Eng.EW10A (103kW)	07-		R		153-094			172,0x40	
	07-		R		153-073		Lucas	254,0x57	Hand Brake









		Spare Parts	F/R	L/R	CIFAM ref.	CIFAM ref. w/KIT		DIMENSIONS mm.	NOTE
2.0 HDi Eng.RHK(DW10UTED4) (88kW)	1/07-		R		153-094			172,0x40	
	07-		R		151-169		Lucas	Ø 22,20 254,0x57	LUC
2.0 HDi 16v Eng.RHR(DW10BTED4) (100kW)	1/07-		R		153-094			172,0x40	
	07-		R		151-169		Lucas	Ø 22,20 254,0x57	LUC
Nemo (AA) 2/08-									
1.4 Eng.KFV(TU3A) (54kW)	08-		R		153-099		Ap	228,6x43	Hand Brake
	08-		R		151-227		Ap	Ø 20,64 228,6x43	AP
1.4 HDi Eng.DV4TD (50kW)	2/08-		R		153-099		Ap	228,6x43	Hand Brake
	08-		R		151-227		Ap	Ø 20,64 228,6x43	AP
Synergie 1/94-									
1.8i Eng.LFZ(XU7JP) (73kW)	97-		R		700-017			Ø 255,0	-ABS
	97-		R		151-066		Bdx	Ø 19,05 255,0x60	RAI, -ABS
1.9 TD Eng.DHY(XUD9TE) (68kW)	1/94-		R		153-074	153-074Y	Bdx	256,0x61	Hand Brake
	94-		R		700-017			Ø 255,0	
2.0 Eng.RFU(XU10J2C) (88kW)	1/94-		R		153-074	153-074Y	Bdx	256,0x61	Hand Brake
	94-		R		700-017			Ø 255,0	
2.0 T. Eng.RGX(XU10J2TE) (108kW)	1/94-		R		153-074	153-074Y	Bdx	256,0x61	Hand Brake
DACIA									
1210 1/85-12/94									
1.2 (35kW)	1/85-12/94		R		153-340	153-340K	Bdx	228,6x42	Hand Brake
1300, SW 12/72-5/83									
1.3 Eng.810-02-99 (40kW)	12/72-5/83		R		153-341	153-341K	Bdx	180,0x42	Estate, Hand Brake
	12/72-5/83		R		153-340	153-340K	Bdx	228,6x42	Hand Brake
1310, SW 5/83-									
1.3 Eng.810-02-99 (40kW)	5/83-		R		153-341	153-341K	Bdx	180,0x42	Hand Brake
	5/83-		R		153-340	153-340K	Bdx	228,6x42	Wagon, Hand Brake
1410 9/88-									
1.4 Eng.847 (48kW)	9/88-		R		153-341	153-341K	Bdx	180,0x42	Hand Brake
	9/88-		R		153-340	153-340K	Bdx	228,6x42	Wagon, Van, Hand Brake
Logan, MCV 9/04-									
1.4 Eng.K7J710 (55kW)	9/04-		R		153-365		Bdx	230,0x46	MCV
	9/04-		R		153-359		Bosch	203,2x39	Hand Brake
	9/04-		R		153-350		Lucas	203,0x38	Hand Brake
	04-		R		700-381	700-381K		Ø 203,3	
	04-		R		700-382	700-382K		Ø 203,3	+ABS
	04-		R		151-180		Bosch	Ø 19,05 203,2x39	RAI, -ABS
	04-		R		151-095		Lucas	Ø 17,78 203,0x38	LUC, +ABS
	04-		R		153-365		Bdx	230,0x46	MCV
1.5 dCi Eng.K9K790 (48kW)	05-		R		153-365		Bdx	230,0x46	MCV
	05-		R		153-359		Bosch	203,2x39	Hand Brake
	05-		R		153-350		Lucas	203,0x38	Hand Brake
	05-		R		700-381	700-381K		Ø 203,3	
	05-		R		700-382	700-382K		Ø 203,3	+ABS
	05-		R		151-180		Bosch	Ø 19,05 203,2x39	RAI, -ABS
	05-		R		151-095		Lucas	Ø 17,78 203,0x38	LUC, +ABS
	05-		R		153-365		Bdx	230,0x46	MCV
1.5 dCi Eng.K9K792 (50kW)	1/06-		R		153-365		Bdx	230,0x46	MCV
	1/06-		R		153-359		Bosch	203,2x39	Hand Brake
	1/06-		R		153-350		Lucas	203,0x38	Hand Brake
	06-		R		700-381	700-381K		Ø 203,3	
	06-		R		700-382	700-382K		Ø 203,3	+ABS
	06-		R		151-180		Bosch	Ø 19,05 203,2x39	RAI, -ABS
	06-		R		151-095		Lucas	Ø 17,78 203,0x38	LUC, +ABS
	06-		R		153-365		Bdx	230,0x46	MCV
1.5 dCi Eng.K9K796 (63kW)	9/07-		R		153-365		Bdx	230,0x46	MCV
	9/07-		R		153-359		Bosch	203,2x39	Hand Brake
	9/07-		R		153-350		Lucas	203,0x38	Hand Brake
	07-		R		700-381	700-381K		Ø 203,3	
	07-		R		700-382	700-382K		Ø 203,3	+ABS
	07-		R		151-180		Bosch	Ø 19,05 203,2x39	RAI, -ABS
	07-		R		151-095		Lucas	Ø 17,78 203,0x38	LUC, +ABS
	07-		R		153-365		Bdx	230,0x46	MCV
1.6 Eng.K7M710 (64kW)	9/04-		R		153-365		Bdx	230,0x46	MCV
	9/04-		R		153-359		Bosch	203,2x39	Hand Brake
	9/04-		R		153-350		Lucas	203,0x38	Hand Brake
	04-		R		700-381	700-381K		Ø 203,3	
	04-		R		700-382	700-382K		Ø 203,3	+ABS
	04-		R		151-180		Bosch	Ø 19,05 203,2x39	RAI, -ABS
	04-		R		151-095		Lucas	Ø 17,78 203,0x38	LUC, +ABS
	04-		R		153-365		Bdx	230,0x46	MCV

		Spare Parts	F/R	L/R	CIFAM ref.	CIFAM ref. w/KIT		DIMENSIONS mm.	NOTE
1.6 Eng.K7M800 (62kW)	12/08-		R		153-365		Bdx	230,0x46	
1.6 16v Eng.K4M690/694 (77kW)	2/06-		R		153-365		Bdx	230,0x46	MCV
	2/06-		R		153-359		Bosch	203,2x39	Hand Brake
	2/06-		R		153-350		Lucas	203,0x38	Hand Brake
	06-		R		700-381	700-381K		Ø 203,3	
	06-		R		700-382	700-382K		Ø 203,3	+ABS
	06-		R		151-180		Bosch	Ø 19,05 203,2x39	RAI, -ABS
	06-		R		151-095		Lucas	Ø 17,78 203,0x38	LUC, +ABS
Sandero, Stepway 6/08-									
1.4 Eng.K7J710 (55kW)	08-		R		153-359		Bosch	203,2x39	Hand Brake
	08-		R		153-350		Lucas	203,0x38	Hand Brake
1.6 Eng.K7M710 (64kW)	6/08-		R		153-359		Bosch	203,2x39	Hand Brake
	6/08-		R		153-350		Lucas	203,0x38	Hand Brake

DAEWOO

		Spare Parts	F/R	L/R	CIFAM ref.	CIFAM ref. w/KIT		DIMENSIONS mm.	NOTE
Aranos 1/95-11/97									
1.5 Eng.V15L (66kW)	1/95-11/97		R		153-309		Lucas	200,0x45	Hand Brake
1.8 Eng.Y18L (70kW)	1/95-11/97		R		153-309		Lucas	200,0x45	Hand Brake
2.0 Eng.C20LE (77kW)	1/95-11/97		R		153-309		Lucas	200,0x45	Hand Brake
Cielo 2/95-									
1.5 Eng.A15MF (66kW)	95-		R		153-309		Lucas	200,0x45	Hand Brake
	95-		R		700-300			Ø 200,0	
	95-		R		151-079		Lucas	Ø 19,05 200,0x45	LUC
1.5 Eng.G15MF (55kW)	2/95-		R		153-309		Lucas	200,0x45	Hand Brake
	2/95-		R		700-300			Ø 200,0	
	2/95-		R		151-124		Lucas	Ø 17,46 200,0x46	LUC, GL, GLX, GTX
	2/95-8/97		R		151-079		Lucas	Ø 19,05 200,0x45	LUC
Espero (KLEJ) 10/91-9/99									
1.5 Eng.G15MF (55kW)	10/97-9/99		R		153-309		Lucas	200,0x45	Hand Brake
	97-		R		700-310			Ø 200,0	
	97-99		R		151-079		Lucas	Ø 19,05 200,0x45	LUC
1.5 16v Eng.A15MF (66kW)	10/93-9/94		R		153-309		Lucas	200,0x45	Hand Brake
	2/95-6/99		R		153-309		Lucas	200,0x45	Hand Brake
	93-94		R		700-300			Ø 200,0	
	95-97		R		700-300			Ø 200,0	
	97-		R		700-310			Ø 200,0	
	95-99		R		151-079		Lucas	Ø 19,05 200,0x45	LUC
1.8 Eng.C18LE (66-70kW)	2/95-9/99		R		153-309		Lucas	200,0x45	Hand Brake
	95-97		R		700-300			Ø 200,0	
	95-99		R		151-079		Lucas	Ø 19,05 200,0x45	LUC
2.0 Eng.C20LE (77kW)	2/95-6/99		R		153-309		Lucas	200,0x45	Hand Brake
	95-97		R		700-300			Ø 200,0	
	95-99		R		151-079		Lucas	Ø 19,05 200,0x45	LUC
2.0 Eng.C20NEF (74kW)	10/91-9/93		R		153-309		Lucas	200,0x45	Hand Brake
	91-93		R		700-300			Ø 200,0	
2.0 Eng.C20SED (81kW)	10/93-9/94		R		153-309		Lucas	200,0x45	Hand Brake
	93-94		R		700-300			Ø 200,0	
Kalos (KLAS) 9/02-									
1.2 Eng.B12S1 (53kW)	4/03-		R		153-050		Lucas	200,0x37	+ABS, Hand Brake
	03-		R		151-196		Lucas	Ø 19,05 200,0x37	LUC
1.4 16v Eng.F14D3 (69kW)	4/03-		R		153-050		Lucas	200,0x37	+ABS, Hand Brake
	03-		R		151-196		Lucas	Ø 19,05 200,0x37	LUC
1.4 16v Eng.F14S3 (61kW)	9/02-		R		153-050		Lucas	200,0x37	+ABS, Hand Brake
	02-		R		151-196		Lucas	Ø 19,05 200,0x37	LUC
Korando, Cabrio (KJ) 1/99-									
2.3 Eng.M161.973 (105kW)	2/99-		R		153-100		Lucas	254,0x57	Hand Brake
2.9 D Eng.OM662 (72kW)	2/99-		R		153-100		Lucas	254,0x57	Hand Brake
2.9 TD Eng.OM662.910 (88kW)	2/99-		R		153-100		Lucas	254,0x57	Hand Brake
3.2 (Exc. Cabrio) Eng.M104.995 (156kW)	1/99-		R		153-100		Lucas	254,0x57	Hand Brake
Lacetti (KLAN) 2/04-									
1.4 16v Eng.F14D3 (69kW)	2/04-		R		153-309		Lucas	200,0x45	Hand Brake
1.6 Eng.F16D (80kW)	2/04-		R		153-309		Lucas	200,0x45	Hand Brake
1.8 Eng.T18SED (90kW)	2/04-		R		153-309		Lucas	200,0x45	Hand Brake
Lanos (KLAT) 5/97-									
1.4 Eng.A13SMS (55kW)	5/97-		R		153-309		Lucas	200,0x45	Hand Brake
	97-		R		700-300			Ø 200,0	
	97-		R		151-124		Lucas	Ø 17,46 200,0x46	LUC















		Spare Parts	F/R	L/R	CIFAM ref.	CIFAM ref. w/KIT		DIMENSIONS mm.	NOTE
1.5 Eng.A15SMS (63kW)	5/97-		R		153-309		Lucas	200,0x45	Hand Brake
	97-		R		700-300			Ø 200,0	+ABS
	97-		R		700-310			Ø 200,0	-ABS
	97-		R		151-124		Lucas	Ø 17,46 200,0x46	LUC
1.6 16v Eng.A16DMS (78kW)	5/97-		R		153-309		Lucas	200,0x45	Hand Brake
	97-		R		151-079		Lucas	Ø 19,05 200,0x45	LUC
	97-		R		151-234		Lucas	Ø 20,64 200,0x45	LUC
Le Mans 1/90-									
1.6 (55kW)	90-94		R		700-300			Ø 200,0	
2.0	88-94		R		700-300			Ø 200,0	
Leganza (KLAV) 6/97-12/02									
2.0 (133kW)	01-12/02		R		153-483			167x25	(on axle)
2.0 16v Eng.T20SED (93kW)	7/00-12/02		R		153-483			167x25	(on axle)
	7/00-12/02		R		153-048		Lucas	230,0x52	
2.0 16v Eng.X20SED (98kW)	6/97-12/02		R		153-483			167x25	(on axle)
	6/97-12/02		R		153-048		Lucas	230,0x52	
Matiz (KLYA) 9/98-									
0.8 Eng.F8CV (38kW)	9/98-		R		153-046		Lucas	180,0x31	Hand Brake
			R		700-311			Ø 180,0	Ch 320904-
	98-		R		151-185		Lucas	Ø 17,46 180,0x31	LUC
1.0 Eng.B10S1 (47kW)	1/03-		R		153-046		Lucas	180,0x31	Hand Brake
			R		700-311			Ø 180,0	Ch 320904-
	03-		R		151-185		Lucas	Ø 17,46 180,0x31	LUC
Musso (FJ) 1/99-									
2.2 TD Eng.SY661LA (74kW)	9/99-		R		153-100		Lucas	254,0x57	Hand Brake
2.3 Eng.M111.970 (103kW)	1/99-		R		153-100		Lucas	254,0x57	Hand Brake
2.9 D Eng.OM662 (73kW)	1/99-9/99		R		153-100		Lucas	254,0x57	Hand Brake
2.9 TD Eng.OM662.920 (88kW)	1/99-		R		153-100		Lucas	254,0x57	Hand Brake
3.2 V6 Eng.M104.992 (162kW)	1/99-		R		153-100		Lucas	254,0x57	Hand Brake
Nexia (KLETN) 2/95-									
1.5 Eng.G15MF (44kW)	8/96-8/97		R		153-309		Lucas	200,0x45	Hand Brake
1.5 Eng.G15MF (52kW)	2/95-8/97		R		153-309		Lucas	200,0x45	Hand Brake
1.5 Eng.G15MF (55kW)	8/96-8/97		R		153-309		Lucas	200,0x45	Hand Brake
	96-		R		700-300			Ø 200,0	
	95-		R		151-124		Lucas	Ø 17,46 200,0x46	LUC, GL, GLX, GTX
1.5 16v Eng.A15MF (66kW)	2/95-8/97		R		153-309		Lucas	200,0x45	Hand Brake
	2/95-		R		700-300			Ø 200,0	
	95-97		R		151-079		Lucas	Ø 19,05 200,0x45	LUC
1.8 Eng.C18LE (74kW)	10/95-8/97		R		153-309		Lucas	200,0x45	Hand Brake
	10/95-		R		700-300			Ø 200,0	
	95-97		R		151-079		Lucas	Ø 19,05 200,0x45	LUC
Nubira (KLAJ), SW 5/97-									
1.6 16v Eng.616L (78kW)	5/97-		R		153-309		Lucas	200,0x45	Hand Brake
	97-		R		700-300			Ø 200,0	
	97-		R		700-310			Ø 200,0	
1.6 16v Eng.A16DMS (76kW)	7/00-		R		153-309		Lucas	200,0x45	Hand Brake
	00-		R		700-300			Ø 200,0	
1.6 16v Eng.F16D3 (80kW)	7/03-		R		153-309		Lucas	200,0x45	Hand Brake
	7/03-		R		700-300			Ø 200,0	
1.6 16v SW Eng.A16DMS (66kW)	6/97-		R		153-309		Lucas	200,0x45	Hand Brake
1.8 Eng.C18LE (70kW)	4/97-5/99		R		153-309		Lucas	200,0x45	Hand Brake
1.8 Eng.C18SED (90kW)	7/03-		R		153-309		Lucas	200,0x45	Hand Brake
Rexton 4/02-									
2.9 TD Eng.OM662.925 (88kW)	4/02-		R		153-100		Lucas	254,0x57	Hand Brake
Rezzo 1/00-									
1.6 16v Eng.A16DMS (78kW)	1/00-		R		153-049		Lucas	230,0x52	Hand Brake
1.8 (66kW)	1/00-		R		153-049		Lucas	230,0x52	Hand Brake
1.8 Eng.A18DMS (72kW)	1/00-		R		153-049		Lucas	230,0x52	Hand Brake
1.8 Eng.F18D2 (67kW)	9/00-		R		153-049		Lucas	230,0x52	Hand Brake
1.8 Eng.F18N2 (74kW)	9/00-		R		153-049		Lucas	230,0x52	Hand Brake
2.0 16v Eng.T20SED (89kW)	1/00-		R		153-049		Lucas	230,0x52	Hand Brake
2.0 16v Eng.T20SED4 (94kW)	1/00-		R		153-049		Lucas	230,0x52	Hand Brake
Tacuma (KLAU) 9/00-									
1.6 16v Eng.A16DMS (78kW)	1/00-		R		153-049		Lucas	230,0x52	Hand Brake
1.8 Eng.A18DMS (72kW)	9/00-		R		153-049		Lucas	230,0x52	Hand Brake
1.8 Eng.F18D2 (66kW)	9/00-		R		153-049		Lucas	230,0x52	Hand Brake
1.8 Eng.F18N2 (74kW)	9/00-		R		153-049		Lucas	230,0x52	Hand Brake

		Spare Parts	F/R	L/R	CIFAM ref.	CIFAM ref. w/KIT		DIMENSIONS mm.	NOTE
2.0 16v Eng.T20SED4 (94kW)	9/00-		R		153-049		Lucas	230,0x52	Hand Brake
2.0 16v Eng.X20SED (89kW)	9/01-		R		153-049		Lucas	230,0x52	Hand Brake
Tico (KLY3) 2/95-									
0.8 Eng.F8C (35kW)	2/95-		R		153-047		Lucas	180,0x31	
	2/95-		R		700-312			Ø 180,0	
	95-		R		151-186		Lucas	Ø 17,46 180,0x31	LUC



























DAEWOO LCV





































Matiz Van 1/98-									
0.8 i Eng.F8CV (38kW)			R		700-311			Ø 180,0	Ch 320904-























DAF

33 7/67-9/74									
0.7 Eng.B74 (21kW)	7/67-9/74		F		153-004		Ap	177,8x32	Hand Brake
46, Kombi 9/74-8/75									
0.8 Eng.B85 (25kW)	9/74-8/75		R		153-103		Lucas	203,2x38	Hand Brake
600 1/59-12/63									
All models	1/59-12/63		F		153-004		Ap	177,8x32	Hand Brake
66 10/72-9/75									
1.1,SW Eng.110E (35kW)	10/72-9/75		R		153-103		Lucas	203,2x38	Hand Brake
1.1SL,Marathon,Kombi Eng.110G (40kW)	10/72-8/75		R		153-103		Lucas	203,2x38	Hand Brake
1.3 Marathon,Kombi,Coupe Eng.B13/0S (42kW)	9/73-8/75		R		153-103		Lucas	203,2x38	Hand Brake
Daffodil 1/62-12/65									
750	1/62-12/65		F		153-004		Ap	177,8x32	Hand Brake
Serie 400 Van									
2.0	89-96		R		700-100			Ø 254,0	Exc. Bus, V8 Police
2.5D 428-435 Eng.EN55 (53kW)	4/89-8/93		R		153-139		Ap	254,0x57	Hand Brake
	4/89-8/93		R		153-109		Ap	254,0x70	Hand Brake
	89-93		R		700-100			Ø 254,0	Exc. Bus, V8 Police
2.5TD 428-435 Eng.ET70 (71kW)	89-93		R		700-100			Ø 254,0	Exc. Bus, V8 Police
3.5 V8	89-96		R		700-100			Ø 254,0	Exc. Bus, V8 Police
Bus,V8 Police	89-96		R		700-100			Ø 254,0	





DAIHATSU

Applause I 6/89-7/97									
1.6 16v (A101) Eng.HD (66kW)	6/89-7/97		R		153-037		Sumit.	200,0x30	
1.6 16v (A101,111) Eng.HDE (77kW)	6/89-7/97		R		153-037		Sumit.	200,0x30	
	6/89-		R		700-130			Ø 200,0	
1.6 4WD Eng.HDE (77kW)	6/89-7/97		R		153-037		Sumit.	200,0x30	
	6/89-		R		700-130			Ø 200,0	
Applause II 7/97-									
1.6 16v Eng.HDEEG (73kW)	7/97-		R		153-037		Sumit.	200,0x30	
Charade I (G10) 10/77-2/83									
1.0 Eng.CB20 (37kW)	77-81		F		153-390		Sumit.	220,0x40	
1.0 Eng.CB22 (38kW)	81-83		F		153-390		Sumit.	220,0x40	
Charade III (G100, G101, G102) 3/87-1/93									
1.0 (G100) Eng.CB23 (38kW)	3/87-12/92		R		153-036		Sumit.	180,0x26	
	2/87-92		R		700-131			Ø 180,0	
1.0 (G100) Eng.CB90 (40-41kW)	4/89-12/92		R		153-036		Sumit.	180,0x26	
	89-92		R		700-131			Ø 180,0	
1.0 D (G101) Eng.CL11 (27kW)	3/87-12/92		R		153-036		Sumit.	180,0x26	
	2/87-92		R		700-131			Ø 180,0	
1.0 GTi (G100) Eng.CB80 (74kW)	3/87-12/92		R		153-036		Sumit.	180,0x26	
	2/87-92		R		700-131			Ø 180,0	
1.0 T. (G100) Eng.CB61 (50kW)	3/87-10/90		R		153-036		Sumit.	180,0x26	
	2/87-90		R		700-131			Ø 180,0	
1.0 TD (G101) Eng.CL61 (35kW)	3/87-12/92		R		153-036		Sumit.	180,0x26	
	2/87-92		R		700-131			Ø 180,0	
1.3 4WD (G102) Eng.HCE (66kW)	6/88-1/93		R		153-036		Sumit.	180,0x26	
	6/88-1/93		R		153-037		Sumit.	200,0x30	Van
	1/88-91		R		700-130			Ø 200,0	
	1/88-91		R		700-132			Ø 200,0	
	10/88-11/93		R		700-131			Ø 180,0	
1.3 i (G102) Eng.HCE (66kW)	6/88-1/93		R		153-036		Sumit.	180,0x26	
	6/88-1/93		R		153-037		Sumit.	200,0x30	Van
	1/88-91		R		700-130			Ø 200,0	

		Spare Parts	F/R	L/R	CIFAM ref.	CIFAM ref. w/KIT		DIMENSIONS mm.	NOTE
1.3 i (G102) Eng.HCE (66kW)	1/88-91		R		700-132			Ø 200,0	
	10/88-11/93		R		700-131			Ø 180,0	
Charade IV (G200, G202) 1/93-4/01									
1.0 Eng.CB22 (38kW)	9/94-3/96		R		153-036		Sumit.	180,0x26	
	94-		R		700-131			Ø 180,0	
1.3, 16v Eng.HC (44-55-62kW)	1/93-11/99		R		153-036		Sumit.	180,0x26	
	1/93-11/99		R		153-037		Sumit.	200,0x30	
	7/97-		R		700-130			Ø 200,0	
	93-97		R		700-131			Ø 180,0	
1.5 Eng.HE (55kW)	94-		R		700-131			Ø 180,0	
1.5 16v Eng.HEEG (66kW)	97-		R		700-131			Ø 180,0	
1.6 GTi Eng.HDE (77kW)	3/93-6/97		R		153-036		Sumit.	180,0x26	
	93-		R		700-131			Ø 180,0	
Charmant (A) 11/81-7/87									
1.3 (A35) Eng.4K (48kW)	11/81-		R		153-409		Ake	200,0x36	
	11/81-8/83		R		153-408		Ake	228,6x41	Hand Brake
	3/82-12/82		R		700-126			Ø 200,0	
1.4 Eng.T	11/81-12/82		R		153-408		Ake	228,6x41	Hand Brake
1.5 Eng.3AU (59kW)	1/81-7/87		R		153-408		Ake	228,6x41	Hand Brake
1.6 Eng.12T (64kW)	1/76-12/81		R		153-408		Ake	228,6x41	Hand Brake
1.6 (A45) Eng.2T (55kW)	12/81-9/84		R		153-408		Ake	228,6x41	Hand Brake
1.6 (A60) Eng.4A (57-60-61kW)	8/83-7/87		R		153-408		Ake	228,6x41	Hand Brake
Copen 9/03-									
0.7 Eng.JB (47-50kW)	9/03-		R		153-039			180,0x38	
Cuore II / Mira II (L80, L81) 9/85-12/90									
0.8, 4WD (L81) Eng.ED10 (29-32kW)	-87		R		153-034		Ake	165,0x25	Exc. 4WD
Cuore III / Mira III (L201) 10/90-12/94									
0.8 Eng.ED10K (30kW)	90-		R		700-104			Ø 165,0	
Cuore IV (L501) 1/95-11/96									
0.8 Eng.ED20 (32kW)	1/95-11/96		R		153-038			165,0x25	
Cuore V (L5) 11/96-10/98									
0.8 Eng.EFEL (31kW)	11/96-10/98		R		153-038			165,0x25	
Cuore VI 10/98-5/03									
1.0 i (L701) Eng.EJDE (41kW)	10/98-5/03		R		153-038			165,0x25	-ABS
	10/98-5/03		R		153-039			180,0x38	
	10/98-5/03		R		153-035		Sumit.	180,0x35	+ABS
Cuore VII 5/03-9/07									
1.0 Eng.EJVE (43kW)	5/03-9/07		R		153-038			165,0x25	
Cuore VIII 10/07-									
1.0 Eng.1KRFE (51kW)	10/07-		R		153-045			165,0x26	
Domino									
All models	-94		R		153-038			165,0x25	
			R		700-104			Ø 165,0	
Feroza (F300) 10/88-									
1.6 16v HardTop, SoftTop Eng.HDC (63kW)	10/88-		R		153-033		Ake	254,0x45	
	10/88-		R		700-133			Ø 254,0	
1.6 i 16v HardTop, SoftTop Eng.HDE (70kW)	10/88-		R		153-033		Ake	254,0x45	
	10/88-		R		700-133			Ø 254,0	
Fourtrack 1/84-									
2.0 Eng.3Y (65kW)	1/84-		R		153-033		Ake	254,0x45	
	84-		R		700-133			Ø 254,0	
2.2	84-		R		700-133			Ø 254,0	
2.8 D, TD Eng.DL51/ DL52 (54-67-75kW)	1/84-		R		153-033		Ake	254,0x45	
	84-		R		700-133			Ø 254,0	
Gran Move (G3) 10/96-									
1.5 16v (G303) Eng.HEEG (66kW)	10/96-7/98		R		153-040			200,0x38	
	96-		R		700-130			Ø 200,0	
1.6 Eng.HDEP (70kW)	98-02		R		153-040			200,0x38	
	98-02		R		700-130			Ø 200,0	
1.6 16v (G301) Eng.HDEP (67kW)	98-		R		153-040			200,0x38	
	98-		R		700-130			Ø 200,0	
Materia 1/07-									
1.3 Eng.K3 (67kW)	1/07-		R		153-043			180,0x28	
1.5, 4WD Eng.3SZVE (76kW)	1/07-		R		153-043			180,0x28	
Move (L6, L9) 10/96-									
0.8 Eng.ED20 (32kW)	10/96-		R		153-034		Ake	165,0x25	

		Spare Parts	F/R	L/R	CIFAM ref.	CIFAM ref. w/KIT		DIMENSIONS mm.	NOTE
1.0 i Eng.EJDE (41kW)	10/98-		R		153-038			165,0x25	
	10/98-		R		153-039			180,0x38	
Rocky (F7, F8) 4/84-									
2.0 HardTop, SoftTop Eng.3Y (65kW)	2/85-4/93		R		153-033		Ake	254,0x45	
	85-		R		700-133			Ø 254,0	
2.2 4WD	4/84-		R		700-133			Ø 254,0	
2.8 D Hard Top, Soft Top Eng.DL (54kW)	2/85-		R		153-033		Ake	254,0x45	
	5/93-		R		153-426		Ake	270,0x55	
	85-		R		700-133			Ø 254,0	
2.8 TD Hard Top, Soft Top Eng.DL51 (67kW)	12/87-4/93		R		153-033		Ake	254,0x45	
	87-		R		700-133			Ø 254,0	
2.8 TD Hard Top, Soft Top Eng.DL52 (72-75kW)	5/93-		R		153-426		Ake	270,0x55	
	9/91-		R		153-033		Ake	254,0x45	
	91-		R		700-133			Ø 254,0	
Sirion (M1) 4/98-1/05									
1.0 i, 4WD Eng.EJDE (40-41kW)	4/98-9/00		R		153-039			180,0x38	
	4/98-9/00		R		153-035		Sumit.	180,0x35	
1.0, 4WD Eng.EJVE (43kW)	03-		R		153-435			180,0x38	
	9/00-		R		153-039			180,0x38	
	9/00-		R		153-035		Sumit.	180,0x35	
1.3 DVVT 16v, 4WD Eng.K3VE (75kW)	2/01-4/05		R		153-435			180,0x38	
1.3 Sport, 4WD Eng.K3VE2 (75kW)	8/00-		R		153-039			180,0x38	
Sirion (M3) 1/05-									
1.0, 4WD Eng.1KRFE (51kW)	1/05-		R		153-436			180,0x27	Hand Brake
	1/05-		R		153-043			180,0x28	
1.3 4WD Eng.K3VE (64kW)	4/05-		R		153-043			180,0x28	
1.3, 4WD Eng.K3VE (67kW)	08-		R		153-043			180,0x28	
1.5 Eng.3SZVE (76kW)	11/07-		R		153-043			180,0x28	
Sportrak 1/89-									
1.6i 16v Eng.HDC/ HDE (63-70kW)	1/89-		R		153-033		Ake	254,0x45	
	89-		R		700-133			Ø 254,0	
Terios I (J1) 10/97-11/05									
1.3 Eng.K3VE (63kW)	9/01-11/05		R		153-434		Sumit.	228,6x42	
	01-		R		700-355			Ø 228,6	+ABS
	01-		R		700-105			Ø 228,6	-ABS
1.3 4WD Eng.HEEJ (61kW)	10/97-10/00		R		153-429			228,6x42	
	98-		R		700-355			Ø 228,6	+ABS
	98-		R		700-105			Ø 228,6	-ABS
1.3 4WD Eng.K3VE (63kW)	10/00-11/05		R		153-434		Sumit.	228,6x42	
	00-		R		700-355			Ø 228,6	+ABS
	00-		R		700-105			Ø 228,6	-ABS
Terios II (J2) / Bego 11/05-									
1.3, 4WD Eng.K3VE (63kW)	05-		R		153-434		Sumit.	228,6x42	
1.5 Eng.3SZVE (77kW)	11/05-		R		153-434		Sumit.	228,6x42	
1.5 4WD Eng.3SZVE (77kW)	5/09-		R		153-434		Sumit.	228,6x42	
Trevis 6/06-									
1.0 Eng.EJVE (43kW)	6/06-		R		153-042			165,0x28	
Wildcat 2/84-									
2.0	84-		R		700-133			Ø 254,0	
2.2	84-		R		700-133			Ø 254,0	
2.8 D Eng.DL (54kW)	85-		R		700-133			Ø 254,0	
2.8 TD Eng.DL50 (65kW)	85-		R		700-133			Ø 254,0	
YRV (M2) 2/01-									
1.0 Eng.EJVE (43kW)	2/01-		R		153-041			180,0x31	
1.3 Eng.K3VE (64kW)	2/01-		R		153-039			180,0x38	
1.3 GTi Eng.K3VET (95kW)	7/02-		R		153-039			180,0x38	
1.3, 4WD Eng.K3VE (63kW)	2/01-		R		153-039			180,0x38	

DAIHATSU LCV

Hijet II (U60) 1/92-									
1.0 Eng.CB41 (33-34kW)	1/92-		R		153-040			200,0x38	Bus, Van
	1/92-		R		153-044		Ap	203,2x38	
1.0 i Eng.CB42 (35kW)	1/92-		R		153-040			200,0x38	Bus, Van
	1/92-		R		153-044		Ap	203,2x38	
1.2 D Eng.LDW12 (26kW)	1/92-		R		153-044		Ap	203,2x38	
1.3 i 16v Eng.HCES/ HCE (48kW)	1/92-		R		153-044		Ap	203,2x38	



DAIHATSU LCV



		Spare Parts	F/R	L/R	CIFAM ref.	CIFAM ref. w/KIT		DIMENSIONS mm.	NOTE
1.4 D Eng.LDW14 (28kW)	1/92-		R		153-044		Ap	203,2x38	



DAIMLER

Daimler (X300) 9/94-

Six 4.0 Eng.BC (209kW)	97-		R			153-197K		180,0x30	Hand Brake
V8 Super 4.0 Eng.DC (267kW)	97-		R			153-197K		180,0x30	

DALLAS

Fun 1/94-





1.4 i (55kW)	1/94-		R			153-320Y	Bdx	180,0x32	
	1/94-		R		153-320	153-320K	Bdx	180,0x32	Hand Brake
	1/94-		R			153-329Y	Bdx	180,0x32	Hand Brake
	1/94-		R		153-322		Lucas	180,0x32	Hand Brake
1.8 D (43kW)	1/94-		R			153-320Y	Bdx	180,0x32	
	1/94-		R		153-320	153-320K	Bdx	180,0x32	Hand Brake
	1/94-		R			153-329Y	Bdx	180,0x32	Hand Brake
	1/94-		R		153-322		Lucas	180,0x32	Hand Brake

DODGE

Avenger 6/07-

All models	08-		R		153-362			170,0x32	Hand Brake
	08-		R		153-296			228,6x37	

Caliber 6/06-

1.8 i 16v Eng.EBA (110kW)	06-		R		153-362			170,0x32	Hand Brake
	06-		R		153-296			228,6x37	
2.0 CRD Eng.ECD/ ECE (103kW)	06-		R		153-362			170,0x32	Hand Brake
	06-		R		153-296			228,6x37	
2.0 i 16v Eng.ECN (115kW)	06-		R		153-362			170,0x32	Hand Brake
	06-		R		153-296			228,6x37	
2.4 Eng.ED4 (217kW)	12/07-		R		153-362			170,0x32	Hand Brake
	12/07-		R		153-296			228,6x37	
2.4 i 16v Eng.ED3 (125kW)	06-		R		153-362			170,0x32	Hand Brake
	06-		R		153-296			228,6x37	

Caravan

All models			R		153-349			228,6x65	Hand Brake
	01-		R		153-027			180,0x30	Hand Brake
	96-		R		153-026			254,0x57	Hand Brake

Charger

All models			R		153-242			183,0x31	HDB, Hand Brake
------------	--	---	---	--	---------	--	--	----------	-----------------

Magnum

All models			R		153-242	153-242K		183,0x31	Hand Brake
------------	--	---	---	--	---------	----------	--	----------	------------

Mini Rma Van

All models			R			153-251Y		254,0x50	Hand Brake
			R		153-251		Ake	254,0x50	Hand Brake

Neon

All models			R		153-029			220,0x42	Hand Brake
------------	--	---	---	--	---------	--	--	----------	------------

Nitro 6/07-

2.8 CRD, 4WD Eng.ENR/ ENS (130kW)	6/07-		R		153-363			207,0x32	
-----------------------------------	-------	---	---	--	---------	--	--	----------	--

Sprinter III 1/06-

3.5 V6 Eng.M272 (190kW)	06-		R		153-249			174,0x42	rear axle SA 741, Hand Brake
-------------------------	-----	---	---	--	---------	--	--	----------	------------------------------

DODGE TRUCK

Dakota

All models			R		153-349			228,6x65	Hand Brake
------------	--	---	---	--	---------	--	--	----------	------------

Raider

All models			R			153-251Y		254,0x50	Hand Brake
			R		153-251	153-251Y	Ake	254,0x50	Hand Brake

Ram 1500 - 2500

All models			R		153-251		Ake	254,0x50	Hand Brake
------------	--	---	---	--	---------	--	-----	----------	------------



















































EAGLE

























































Medallion 1/88-































































2.2	1/88-		R		153-475		Lucas	228,6x42	Hand Brake
-----	-------	---	---	--	---------	--	-------	----------	------------

































































Summit 1/88-12/95













































1.5 (82AC)	1/88-12/95		R		153-253	153-253Y	Ake	180,0x36	Hand Brake
	91-		R		153-258		Ake	180,0x37	Exc. Wagon, Hand Brake
	91-		R		153-256		Ake	228,6x40	Wagon 4WD, Hand Brake



























































		Spare Parts	F/R	L/R	CIFAM ref.	CIFAM ref. w/KIT		DIMENSIONS mm.	NOTE
Sava 9/77-									
1.0 J4	9/77-12/80		R		153-475		Lucas	228,6x42	Hand Brake
1.1	9/77-		R		153-475		Lucas	228,6x42	Hand Brake
FIAT									
126 9/72-9/00									
0.6 Eng.126A.000 (17kW)	9/72-6/77		F		153-055		Fiat	170,0x31	Exc. Personal, Fitted Adjuster
	9/72-6/77		F		153-063		Fiat	185,0x31	Personal, Fitted Adjuster, Hand Brake
	9/72-		F		700-001			Ø 170,1	Ch -4472132 / 61299999
	9/72-		F/R		700-003			Ø 185,0	Ch -4472133 / 61300000
	9/72-		R		700-002			Ø 170,1	Ch -4472132 / 61299999
0.6 Eng.126AB.000 (13-17-18kW)	1/73-12/75		F		153-055		Fiat	170,0x31	Exc. Personal, Fitted Adjuster
	1/73-12/75		F		153-063		Fiat	185,0x31	Personal, Fitted Adjuster, Hand Brake
0.65 Eng.126A1.000/ 126A1.048 (17kW)	-87		F/R		700-003			Ø 185,0	
0.7 Eng.126A2.000/ 126A2.048 (19kW)	9/87-6/96		R		153-063		Fiat	185,0x31	Fitted Adjuster, Hand Brake
	9/87-		F/R		700-003			Ø 185,0	
127 6/71-12/86									
0.9 Eng.100GL.000 (33kW)	6/71-5/83		R		153-063		Fiat	185,0x31	Fitted Adjuster, Hand Brake
	71-77		R		700-004			Ø 185,0	
	78-83		R		700-003			Ø 185,0	
0.9 Eng.100GL.048 (29kW)	6/71-5/83		R		153-063		Fiat	185,0x31	Fitted Adjuster, Hand Brake
1.0 , Panorama Eng.127A.000 (37kW)	4/77-12/86		R		153-063		Fiat	185,0x31	Fitted Adjuster, Hand Brake
	-77		R		700-004			Ø 185,0	
	78-86		R		700-003			Ø 185,0	
1.0 Sport Eng.127A1.000 (51kW)	7/78-2/82		R		153-063		Fiat	185,0x31	Fitted Adjuster, Hand Brake
	6/78-		R		700-003			Ø 185,0	Vett -2545660
1.3 Eng.127A3.000 (55kW)	12/81-5/83		R		153-063		Fiat	185,0x31	Fitted Adjuster, Hand Brake
	2/82-83		R		700-003			Ø 185,0	
1.3 D, Panorama Eng.127A5.000 (33kW)	4/81-12/86		R		153-063		Fiat	185,0x31	Fitted Adjuster, Hand Brake
	-9/82		R		700-003			Ø 185,0	
128 3/69-12/84									
1.1 Coupe Eng.128AC5.000 (47-48kW)	3/72-2/81		R		153-063		Fiat	185,0x31	Fitted Adjuster, Hand Brake
	1/68-12/84		R		153-063		Fiat	185,0x31	Fitted Adjuster, Hand Brake
1.1, Familiare Eng.128A.000 (40kW)	3/69-12/84		R		153-063		Fiat	185,0x31	Fitted Adjuster, Hand Brake
	73-7/77		R		700-003			Ø 185,0	Vett 2318533-
	73-7/77		R		700-004			Ø 185,0	
1.1, Familiare Eng.128A.048 (33kW)	2/75-9/81		R		153-063		Fiat	185,0x31	Fitted Adjuster, Hand Brake
1.3 Coupe, Berlinetta Eng.128AC.000 (54-55kW)	3/72-12/79		R		153-063		Fiat	185,0x31	Fitted Adjuster, Hand Brake
	72-79		R		700-003			Ø 185,0	Vett 2318533-
	72-79		R		700-004			Ø 185,0	
1.3 Rally Eng.128AC.000 (49kW)	9/71-2/76		R		153-063		Fiat	185,0x31	Fitted Adjuster, Hand Brake
	71-76		R		700-003			Ø 185,0	Vett 2318533-
	71-76		R		700-004			Ø 185,0	
1.3 Sport, Familiare Eng.128A1.000 (44kW)	8/74-12/84		R		153-063		Fiat	185,0x31	Fitted Adjuster, Hand Brake
	74-7/77		R		700-003			Ø 185,0	Vett 2318533-
74-7/77		R		700-004			Ø 185,0		
131 10/74-12/84									
1.3 Mirafiori Eng.131A6.000 (40kW)	10/74-9/81		R		153-340	153-340K	Bdx	228,6x42	Hand Brake
	74-81		R		700-006			Ø 228,4	
1.3 Mirafiori Eng.131A7.000 (48kW)	10/74-12/82		R		153-340	153-340K	Bdx	228,6x42	Hand Brake
1.3 Mirafiori Eng.131AB.000 (41kW)	1/74-12/84		R		153-340	153-340K	Bdx	228,6x42	Hand Brake
1.3 Super Mirafiori Eng.131B.000/ A7/B7 (57kW)	3/78-12/80		R		153-340	153-340K	Bdx	228,6x42	Hand Brake
	78-80		R		700-006			Ø 228,4	
1.4 Eng.131C1.000 (51kW)	11/80-1/84		R		153-340	153-340K	Bdx	228,6x42	Hand Brake
	80-84		R		700-006			Ø 228,4	
1.4 Eng.131C1.000 (55kW)	4/81-12/83		R		153-340	153-340K	Bdx	228,6x42	Hand Brake
1.6 Mirafiori Eng.131A1.000/ AF1/ B1 (55kW)	10/74-9/81		R		153-340	153-340K	Bdx	228,6x42	Hand Brake
	77-81		R		700-006			Ø 228,4	

































































		Spare Parts	F/R	L/R	CIFAM ref.	CIFAM ref. w/KIT		DIMENSIONS mm.	NOTE
1.6 Mirafiori Eng.131C2.000 (63kW)	11/76-12/84		R		153-340	153-340K	Bdx	228,6x42	Hand Brake
1.6 Super Mirafiori Eng.131B1.000 (72kW)	3/79-3/82		R		153-340	153-340K	Bdx	228,6x42	Hand Brake
1.6 Super Mirafiori Eng.131C3.000 (71kW)	3/78-1/84		R		153-340	153-340K	Bdx	228,6x42	Hand Brake
	78-84		R		700-006			Ø 228,4	
2.0 Abarth Rally Eng.131B2.000 (103kW)	77-80		R		700-006			Ø 228,4	
2.0 D Eng.8144.65 (44kW)	7/78-8/84		R		153-340	153-340K	Bdx	228,6x42	Hand Brake
	78-84		R		700-006			Ø 228,4	
2.0 Racing Eng.131B2.000 (85kW)	6/78-12/81		R		153-340	153-340K	Bdx	228,6x42	Hand Brake
	78-81		R		700-006			Ø 228,4	
2.0 Super Mirafiori Eng.131C4.000 (83kW)	1/81-12/84		R		153-340	153-340K	Bdx	228,6x42	Hand Brake
2.5 D Eng.8144.61 (53kW)	78-84		R		700-006			Ø 228,4	
132 4/72-12/82									
1.6 Eng.132AB.000 (72kW)	1/74-12/82		R		153-340	153-340K	Bdx	228,6x42	Hand Brake
1.6 Eng.132BBOAO (72kW)	4/72-1/76		R		153-340	153-340K	Bdx	228,6x42	Hand Brake
1.6 Eng.132C.000 (65kW)	5/77-9/82		R		153-340	153-340K	Bdx	228,6x42	Hand Brake
1.6 Eng.132C.000 (72kW)	1/72-12/82		R		153-340	153-340K	Bdx	228,6x42	Hand Brake
	76-		R		700-006			Ø 228,4	
1.6 Eng.132C6.000 (66kW)	3/77-12/81		R		153-340	153-340K	Bdx	228,6x42	Hand Brake
2.0 Eng.132C2.000 (82kW)	77-		R		700-006			Ø 228,4	
2.0 D Eng.8144.65 (44kW)	7/78-7/82		R		153-340	153-340K	Bdx	228,6x42	Hand Brake
	78-		R		700-006			Ø 228,4	
2.5 D Eng.8144.61 (53kW)	7/78-7/82		R		153-340	153-340K	Bdx	228,6x42	Hand Brake
	78-		R		700-006			Ø 228,4	
147 / Spazio 10/76-12/95									
1.0, Panorama Eng.127AB/ AJ (37kW)	76-95		R		700-003			Ø 185,0	
1.1 Eng.138B.000 (40kW)	-12/82		R		700-003			Ø 185,0	
1.3 D (36kW)	80-95		R		700-003			Ø 185,0	
1.3 D, Panorama Eng.127A5.000 (33kW)	82-83		R		700-003			Ø 185,0	
1.3 Rallye (53kW)	82-		R		700-003			Ø 185,0	
1.3, Panorama (41-45kW)	82-		R		700-003			Ø 185,0	
1.4 (46kW)	88-93		R		700-003			Ø 185,0	
500 1/57-1/76									
0.5 Eng.110.000 (11kW)	1/57-12/74		F/R		153-055		Fiat	170,0x31	Fitted Adjuster
	65-74		F		700-001			Ø 170,1	F / L / R
	65-74		R		700-002			Ø 170,1	F / L / R
0.5 Eng.110D.000 (13kW)	1/65-12/75		F/R		153-055		Fiat	170,0x31	Fitted Adjuster
	65-74		F		700-001			Ø 170,1	F / L / R
	65-74		R		700-002			Ø 170,1	F / L / R
0.5 Eng.120F.000 (13kW)	1/63-12/73		F/R		153-055		Fiat	170,0x31	Fitted Adjuster
0.5 SW Eng.120.000 (11kW)	1/60-12/74		F/R		153-055		Fiat	170,0x31	Fitted Adjuster
	65-74		F		700-001			Ø 170,1	F / L / R
	65-74		R		700-002			Ø 170,1	F / L / R
0.6 Eng.126AB.000 (13kW)	5/65-1/76		F/R		153-055		Fiat	170,0x31	Fitted Adjuster
	65-74		F		700-001			Ø 170,1	F / L / R
	65-74		R		700-002			Ø 170,1	F / L / R
500 II (150) 7/07-									
0.9, Cabrio Eng.312A2.000 (63kW)	9/10-		R		153-488		Lockh.	180x30	
1.2 Eng.169A4.000 (51kW)	11-		R		153-488		Lockh.	180x30	
1.2, Cabrio Eng.169A4.000 (51kW)	07-		R		153-083		Ap	180,0x32	-ABS
	07-		R		153-090		Bosch	180,0x30	+ABS
	07-		R		700-011			Ø 180,0	
	07-		R		151-194		Bosch	Ø 20,64 180,0x30	RAI, +ABS
1.3 MJT, Cabrio Eng.169A1.000 (55kW)	7/07-		R		153-083		Ap	180,0x32	-ABS
	7/07-		R		153-090		Bosch	180,0x30	+ABS
	07-		R		700-011			Ø 180,0	
	07-		R		151-194		Bosch	Ø 20,64 180,0x30	RAI, +ABS
1.3 MJT, Cabrio Eng.199B1.000 (70kW)	10-		R		153-488		Lockh.	180x30	
600 3/55-2/72									
0.6 (15kW)	68-72		R		700-004			Ø 185,0	D-E / DM-T





























































		Spare Parts	F/R	L/R	CIFAM ref.	CIFAM ref. w/KIT		DIMENSIONS mm.	NOTE
0.8 (D) Eng.100D (17kW)	68-72		R		700-004			Ø 185,0	D-E / DM-T
850 7/64-12/72									
0.8 Eng.100G.000 (25kW)	7/64-10/72		R		153-063		Fiat	185,0x31	Fitted Adjuster, Hand Brake
0.8 Eng.100GB (35kW)	3/68-10/72		R		153-063		Fiat	185,0x31	Fitted Adjuster, Hand Brake
	68-72		R		700-004			Ø 185,0	
0.8 Berlina, super Eng.100G (27kW)	7/64-10/72		R		153-063		Fiat	185,0x31	Fitted Adjuster, Hand Brake
	64-72		F/R		700-004			Ø 185,0	
0.8 Spider Eng.100GS (36kW)	10/65-10/68		R		153-063		Fiat	185,0x31	Fitted Adjuster, Hand Brake
	65-68		R		700-004			Ø 185,0	
0.8 T-Familiare Eng.100GF (30kW)	7/64-10/72		R		153-063		Fiat	185,0x31	Fitted Adjuster, Hand Brake
			F/R		700-004			Ø 185,0	
0.9 Eng.100GBC (38kW)	68-72		R		700-004			Ø 185,0	
0.9 Sport Spider Eng.100GBS (38kW)	68-72		R		700-004			Ø 185,0	
900 T/E 1/78-1/86									
0.9 Eng.100GBC (38kW)	1/68-1/86		R		153-063		Fiat	185,0x31	Fitted Adjuster, Hand Brake
0.9 Panorama, Pulmino	1/78-1/86		R		153-063		Fiat	185,0x31	Fitted Adjuster, Hand Brake
Eng.100GF000 (26kW)	78-86		F/R		700-003			Ø 185,0	T-Fourgon / E Fourgon, Panorama
Albea 1/03-12/05									
1.2 i Eng.188A4.000 (44kW)	1/03-12/05		R		153-078			185,0x29	Hand Brake
1.2 i 16v Eng.188A5.000 (59kW)	1/03-12/05		R		153-078			185,0x29	Hand Brake
1.3 JTD Eng.188A9.000 (51kW)	1/03-12/05		R		153-078			185,0x29	Hand Brake
1.4 Fire Eng.305A1.000 (57kW)	1/03-12/05		R		153-078			185,0x29	Hand Brake
1.6 i 16v Eng.182B6.000 (76kW)	1/03-12/05		R		153-078			185,0x29	Hand Brake
Argenta (132A) 6/78-7/86									
1.6 Eng.132D.000 (72kW)	-85		R		700-006			Ø 228,4	
1.6 i.e Eng.131B1.000 (66kW)	4/81-12/85		R		153-340	153-340K	Bdx	228,6x42	Hand Brake
	-85		R		700-006			Ø 228,4	
2.0 Eng.132C2.000/ 132D1.000 (83kW)	6/78-12/85		R		153-340	153-340K	Bdx	228,6x42	Hand Brake
	-85		R		700-006			Ø 228,4	
2.0 i.e. Eng.132C3.000 (90kW)	6/81-7/86		R		153-340	153-340K	Bdx	228,6x42	Hand Brake
	-86		R		700-006			Ø 228,4	
2.0 Volumex Eng.132E (99kW)	6/83-7/85		R		153-340	153-340K	Bdx	228,6x42	Hand Brake
	-86		R		700-006			Ø 228,4	
2.5 D Eng.8144.61 (53kW)	6/81-11/85		R		153-340	153-340K	Bdx	228,6x42	Hand Brake
	-85		R		700-006			Ø 228,4	
2.5 TD Eng.8144.61.500.81 (66kW)	-85		R		700-006			Ø 228,4	
Brava, Bravo (182) 10/95-10/01									
1.2 16v Eng.182B2.000 (60kW)	12/98-10/00		R		153-070	153-070J	Ap	180,0x32	-ABS, Hand Brake
	12/98-10/00		R		153-076		Ap	203,2x39	+ABS, Hand Brake
	98-		R		700-011			Ø 180,0	-ABS
	98-		R		700-019			Ø 203,2	+ABS
	98-		R		151-058		Ap	Ø 22,00 180,0x30	RAD
1.2 16v Eng.188A5.000 (59kW)	10/00-10/01		R		153-070	153-070J	Ap	180,0x32	-ABS, Hand Brake
	10/00-10/01		R		153-076		Ap	203,2x39	+ABS, Hand Brake
	00-		R		700-011			Ø 180,0	-ABS
	00-		R		700-019			Ø 203,2	+ABS
	00-		R		151-058		Ap	Ø 22,00 180,0x30	RAD
1.4 Eng.182A5.000 (55kW)	95-		R		700-011			Ø 180,0	-ABS
	95-		R		700-019			Ø 203,2	+ABS
	6/95-96		R		151-030		Bdx	Ø 22,00 203,0x39	RAI, +ABS
	96-		R		151-058		Ap	Ø 22,00 180,0x30	RAD
	96-		R		151-089		Ap	Ø 22,22 203,0x38	RAI, +ABS
1.4 12v Eng.182A3.000 (59kW)	10/95-10/01		R		153-070	153-070J	Ap	180,0x32	-ABS, Hand Brake
	-9/96		R		153-002		Bdx	203,2x39	+ABS, Hand Brake
	9/96-		R		153-076		Ap	203,2x39	+ABS, Hand Brake
	95-		R		700-011			Ø 180,0	-ABS
	95-		R		700-019			Ø 203,2	+ABS
	6/95-96		R		151-030		Bdx	Ø 22,00 203,0x39	RAI, +ABS
	96-		R		151-058		Ap	Ø 22,00 180,0x30	RAD
	96-		R		151-089		Ap	Ø 22,22 203,0x38	RAI, +ABS
1.6 16v Eng.182A4.000 (76kW)	-9/96		R		153-002		Bdx	203,2x39	Hand Brake
	9/96-01		R		153-076		Ap	203,2x39	Hand Brake
	96-01		R		700-019			Ø 203,2	+ABS
	96-01		R		151-030		Bdx	Ø 22,00 203,0x39	RAI, +ABS
1.6 16v Eng.182A6.000 (66kW)	-9/96		R		153-002		Bdx	203,2x39	Hand Brake
	9/96-		R		153-076		Ap	203,2x39	Hand Brake















































		Spare Parts	F/R	L/R	CIFAM ref.	CIFAM ref. w/KIT		DIMENSIONS mm.	NOTE
1.6 16v Eng.182A6.000 (66kW)	12/96-		R		700-019			Ø 203,2	+ABS
	6/95-96		R		151-030		Bdx	Ø 22,00 203,0x39	RAI, +ABS
1.6 16v Eng.182B6.000 (76kW)	00-02		R		700-019			Ø 203,2	+ABS
1.8 16v Eng.182A2.000 (83kW)	-9/96		R		153-002		Bdx	203,2x39	Hand Brake
	9/96-		R		153-076		Ap	203,2x39	Hand Brake
	10/95-		R		700-019			Ø 203,2	+ABS
	6/95-96		R		151-030		Bdx	Ø 22,00 203,0x39	RAI, +ABS
1.9 D Eng.160A7.000 (48kW)	10/95-10/01		R		153-070	153-070J	Ap	180,0x32	-ABS, Hand Brake
	-9/96		R		153-002		Bdx	203,2x39	+ABS, Hand Brake
	9/96-		R		153-076		Ap	203,2x39	+ABS, Hand Brake
	3/96-		R		700-011			Ø 180,0	-ABS
	3/96-		R		700-019			Ø 203,2	+ABS
	6/95-96		R		151-030		Bdx	Ø 22,00 203,0x39	RAI, +ABS
	96-		R		151-058		Ap	Ø 22,00 180,0x30	RAD
96-		R		151-089		Ap	Ø 22,22 203,0x38	RAI, +ABS	
1.9 JTD Eng.182B9.000 (74kW)	00-01		R		700-019			Ø 203,2	+ABS
1.9 JTD 105 Eng.182B4.000 (77kW)			R		153-076		Ap	203,2x39	Hand Brake
	98-		R		700-019			Ø 203,2	+ABS
1.9 TD 100 Eng.182A7.000 (74kW)	-9/96		R		153-002		Bdx	203,2x39	Hand Brake
	9/96-		R		153-076		Ap	203,2x39	Hand Brake
	3/96-		R		700-019			Ø 203,2	+ABS
	96-96		R		151-030		Bdx	Ø 22,00 203,0x39	RAI, +ABS
1.9 TD 75 Eng.182A8.000 (55kW)	-9/96		R		153-002		Bdx	203,2x39	Hand Brake
	9/96-		R		153-076		Ap	203,2x39	Hand Brake
	3/96-		R		700-019			Ø 203,2	+ABS
	96-96		R		151-030		Bdx	Ø 22,00 203,0x39	RAI, +ABS
Cinquecento (170) 7/91-1/98									
0.7 Eng.170A.000 (23kW)	12/91-1/96		R		153-063		Fiat	185,0x31	Fitted Adjuster, Hand Brake
	91-96		R		700-003			Ø 185,0	
0.7 i Eng.170A.046 (22kW)	7/94-1/98		R		153-063		Fiat	185,0x31	Fitted Adjuster, Hand Brake
	94-		R		700-003			Ø 185,0	
0.9 Eng.170A1.000 (30kW)	7/91-12/93		R		153-063		Fiat	185,0x31	Fitted Adjuster, Hand Brake
	91-93		R		700-003			Ø 185,0	
0.9 i.e. Eng.170A1.046 (30kW)	7/91-12/93		R		153-063		Fiat	185,0x31	Fitted Adjuster, Hand Brake
	91-93		R		700-003			Ø 185,0	
0.9 i.e. S Eng.1170A1.046 (29kW)	7/91-1/98		R		153-063		Fiat	185,0x31	Fitted Adjuster, Hand Brake
	3/92-		R		700-003			Ø 185,0	
1.1 Sporting Eng.176B2.000 (40kW)	10/94-1/98		R		153-063		Fiat	185,0x31	Fitted Adjuster, Hand Brake
	94-		R		700-023			Ø 185,0	
Doblo I (223) 3/01-4/05									
1.2 Eng.223A5.000 (48kW)	3/01-4/05		R			153-081Y	Bdx	228,6x42	
	01-1/02		R		700-022			Ø 228,3	
	01-		R		151-152		Lucas	Ø 20,64 228,6x42	LUC
1.3 JTD Eng.188A9.000 (51kW)	5/04-4/05		R			153-081Y	Bdx	228,6x42	
	04-		R		700-022			Ø 228,3	
	04-		R		151-152		Lucas	Ø 20,64 228,6x42	LUC
1.6 16v Eng.182B6.000 (68-76kW)	10/01-4/05		R		153-088		Ap	228,6x43	
	10/01-4/05		R			153-081Y	Bdx	228,6x42	
	01-05		R		700-022			Ø 228,3	
	01-		R		151-152		Lucas	Ø 20,64 228,6x42	LUC
1.9 D Eng.223A6.000 (46kW)	3/01-4/05		R			153-081Y	Bdx	228,6x42	
	01-1/02		R		700-022			Ø 228,3	
	01-		R		151-152		Lucas	Ø 20,64 228,6x42	LUC
1.9 JTD Eng.182B9.000 (74kW)	10/01-4/05		R		153-088		Ap	228,6x43	
	10/01-4/05		R			153-081Y	Bdx	228,6x42	
	01-1/02		R		700-022			Ø 228,3	
	01-		R		151-152		Lucas	Ø 20,64 228,6x42	LUC
1.9 JTD Eng.223A7.000 (77kW)	7/03-4/05		R		153-088		Ap	228,6x43	
	7/03-4/05		R			153-081Y	Bdx	228,6x42	
	7/03-		R		151-152		Lucas	Ø 20,64 228,6x42	LUC
Doblo II (119) 5/05-12/09									
1.3 MJT (Germany) Eng.223A9.000 (62kW)	08-		R		700-022			Ø 228,3	
	05-		R		151-226		Ap	Ø 20,64 228,6x43	AP
1.3 MJT 16v Eng.199A2.000 (55kW)	5/05-		R		153-088		Ap	228,6x43	
	05-		R		151-226		Ap	Ø 20,64 228,6x43	AP
1.4 Eng.350A1.000 (55kW)	5/05-		R		153-088		Ap	228,6x43	
	05-		R		151-226		Ap	Ø 20,64 228,6x43	AP













































		Spare Parts	F/R	L/R	CIFAM ref.	CIFAM ref. w/KIT		DIMENSIONS mm.	NOTE
1.4 Eng.350A1.000 (57kW)	10/05-		R		153-088		Ap	228,6x43	
	08-		R		700-022			Ø 228,3	
	05-		R		151-226		Ap	Ø 20,64 228,6x43	AP
1.6 16v Eng.182B6.000 (76kW)	08-		R		700-022			Ø 228,3	
	05-		R		151-226		Ap	Ø 20,64 228,6x43	AP
1.9 MJT Eng.186A9.000 (88kW)	10/05-		R		153-088		Ap	228,6x43	
	08-		R		700-022			Ø 228,3	
	05-		R		151-226		Ap	Ø 20,64 228,6x43	AP
1.9 MJT Eng.223B1.000 (77kW)	05-		R		153-088		Ap	228,6x43	
	05-		R		700-022			Ø 228,3	
	05-		R		151-226		Ap	Ø 20,64 228,6x43	AP
1.9 MJT Eng.223B2.000 (74kW)	5/05-		R		153-088		Ap	228,6x43	
	05-		R		151-226		Ap	Ø 20,64 228,6x43	AP
Doblo III (152) 1/10-									
1.3 MJT Eng.263A2.000 (66kW)	2/10-		R		153-487		Lockh.	254x57	
1.4 Eng.843A1.000 (70kW)	2/10-		R		153-487		Lockh.	254x57	
1.4 T-Jet Eng.198A4.000 (88kW)	2/10-		R		153-487		Lockh.	254x57	
1.6 MJT Eng.198A3.000 (77kW)	2/10-		R		153-487		Lockh.	254x57	
1.6 MJT Eng.263A4.000 (66kW)	2/10-		R		153-487		Lockh.	254x57	
2.0 MJT Eng.263A1.000 (99kW)	2/10-		R		153-487		Lockh.	254x57	
Duna (146 B), Weekend 1/87-12/91									
1.1 60 Eng.146A6.000 (43kW)	1/87-12/91		R		153-063		Fiat	185,0x31	Fitted Adjuster, Hand Brake
	87-		R		700-003			Ø 185,0	
1.3 70 Eng.146A5.000 (49kW)	1/87-12/91		R		153-063		Fiat	185,0x31	Fitted Adjuster, Hand Brake
	87-		R		700-003			Ø 185,0	
1.7 D Eng.149B3.000 (44kW)	1/87-12/91		R		153-063		Fiat	185,0x31	Fitted Adjuster, Hand Brake
	87-		R		700-003			Ø 185,0	
Grande Punto IV (199) 9/05-									
1.2 Eng.199A4.000 (48kW)	9/05-		R		153-092		Ap	203,0x38	Hand Brake
	05-6/07		R		700-373			Ø 203,2	
	05-		R		151-225		Ap	Ø 20,64 203,0x38	AP
1.3 MJT 16v Eng.199A2.000 (55kW)	9/05-		R		153-093		Ap	228,0x40	Hand Brake
	05-		R		700-372			Ø 228,3	
	05-		R		151-224		Ap	Ø 20,64 228,0x40	AP
1.3 MJT 16v Eng.199A3.000 (66kW)	9/05-		R		153-093		Ap	228,0x40	Hand Brake
	05-		R		700-372			Ø 228,3	
	05-		R		151-224		Ap	Ø 20,64 228,0x40	AP
1.4 Eng.350A1.000 (57kW)	9/05-		R		153-093		Ap	228,0x40	Hand Brake
	05-		R		700-372			Ø 228,3	
	05-		R		151-224		Ap	Ø 20,64 228,0x40	AP
1.4 16v Eng.199A6.000 (70kW)	4/06-		R		153-093		Ap	228,0x40	Hand Brake
	06-		R		700-372			Ø 228,3	
	06-		R		151-224		Ap	Ø 20,64 228,0x40	AP
Idea (135) 1/04-									
1.2 16v Eng.188A5.000 (59kW)	-3/04		R		153-084		Ap	203,2x39	Hand Brake
	3/04-		R		153-091		Ap	203,0x38	
	1/04-		R		700-019			Ø 203,2	
	1/04-3/04		R		151-220		Ap	Ø 22,00 203,2x39	AP
	3/04-6/05		R		151-219		Ap	Ø 22,00 203,0x38	AP
1.3 JTD Eng.188A9.000 (51kW)	-3/04		R		153-084		Ap	203,2x39	Hand Brake
	3/04-		R		153-091		Ap	203,0x38	
	04-		R		700-019			Ø 203,2	
	1/04-3/04		R		151-220		Ap	Ø 22,00 203,2x39	AP
	3/04-6/05		R		151-219		Ap	Ø 22,00 203,0x38	AP
1.3 MJT 16v Eng.199A3.000 (66kW)	05-		R		700-022			Ø 228,3	
1.4 Eng.350A1.000 (57kW)	05-		R		700-019			Ø 203,2	
1.4 16v Eng.192B2.000 (66kW)	04-		R		700-019			Ø 203,2	
	1/04-3/04		R		151-220		Ap	Ø 22,00 203,2x39	AP
	3/04-6/05		R		151-219		Ap	Ø 22,00 203,0x38	AP
1.4 16v Eng.843A1.000 (70kW)	-3/04		R		153-084		Ap	203,2x39	Hand Brake
	3/04-		R		153-091		Ap	203,0x38	
	1/04-		R		700-019			Ø 203,2	
	1/04-3/04		R		151-220		Ap	Ø 22,00 203,2x39	AP
	3/04-6/05		R		151-219		Ap	Ø 22,00 203,0x38	AP
1.9 JTD Eng.188B2.000 (74kW)	1/04-		R		153-088		Ap	228,6x43	
	04-		R		700-022			Ø 228,3	































































			Spare Parts	F/R	L/R	CIFAM ref.	CIFAM ref. w/KIT		DIMENSIONS mm.	NOTE
Linea (323) 6/07-										
1.3 MJT Eng.199A3.000 (66kW)	6/07-		R			153-093		Ap	228,0x40	Hand Brake
	07-		R			151-224		Ap	Ø 20,64 228,0x40	AP
1.4 Eng.350A1.000 (57kW)	6/07-		R			153-093		Ap	228,0x40	Hand Brake
	07-		R			151-224		Ap	Ø 20,64 228,0x40	AP
Marea (185) 9/96-										
1.2 16v Eng.182B2.000 (60kW)	10/98-		R			153-076		Ap	203,2x39	Hand Brake
	98-		R			700-019			Ø 203,2	
	98-		R			151-217		Ap	Ø 20,64 203,2x39	AP, +/-ABS
1.4 12v Eng.182A3.000 (59kW)	-2/97		R			153-002		Bdx	203,2x39	Hand Brake
	2/97-		R			153-076		Ap	203,2x39	Hand Brake
	96-		R			700-019			Ø 203,2	
	96-		R			151-030		Bdx	Ø 22,00 203,0x39	RAI
	96-		R			151-217		Ap	Ø 20,64 203,2x39	AP, +/-ABS
1.6 16v Eng.182A4.000 (76kW)	-2/97		R			153-002		Bdx	203,2x39	Hand Brake
	2/97-		R			153-076		Ap	203,2x39	Hand Brake
	9/96-		R			700-019			Ø 203,2	
	96-		R			151-030		Bdx	Ø 22,00 203,0x39	RAI
	96-99		R			151-089		Ap	Ø 22,22 203,0x38	RAI
	96-		R			151-217		Ap	Ø 20,64 203,2x39	AP, +/-ABS
1.6 16v Bipower Eng.186A4.000/ 185A3.000 (76kW)	4/99-		R			153-075		Ap	228,6x42	
	99-		R			700-019			Ø 203,2	
	99-		R			151-030		Bdx	Ø 22,00 203,0x39	RAI
1.8 16v Eng.182A2.000 (83kW)	-2/97		R			153-002		Bdx	203,2x39	Hand Brake
	2/97-		R			153-076		Ap	203,2x39	Hand Brake
	9/96-		R			700-019			Ø 203,2	
	96-		R			151-030		Bdx	Ø 22,00 203,0x39	RAI
	96-		R			151-217		Ap	Ø 20,64 203,2x39	AP, +/-ABS
1.9 JTD 105 Eng.182B4.000 (77kW)	99-		R			700-019			Ø 203,2	
1.9 JTD 110 Eng.186A6.000 (81kW)	01-		R			700-019			Ø 203,2	
1.9 TD 100 Eng.182A7.000 (74kW)	-2/97		R			153-002		Bdx	203,2x39	Hand Brake
	2/97-		R			153-076		Ap	203,2x39	Hand Brake
	9/96-		R			700-019			Ø 203,2	
	96-		R			151-030		Bdx	Ø 22,00 203,0x39	RAI
	96-99		R			151-089		Ap	Ø 22,22 203,0x38	RAI
	96-		R			151-217		Ap	Ø 20,64 203,2x39	AP, +/-ABS
1.9 TD 75 Eng.182A8.000 (55kW)	-2/97		R			153-002		Bdx	203,2x39	Hand Brake
	2/97-		R			153-076		Ap	203,2x39	Hand Brake
	9/96-		R			700-019			Ø 203,2	
	96-		R			151-030		Bdx	Ø 22,00 203,0x39	RAI
	96-99		R			151-089		Ap	Ø 22,22 203,0x38	RAI
	96-		R			151-217		Ap	Ø 20,64 203,2x39	AP, +/-ABS
Marea (185) Weekend 9/96-										
1.2 16v Eng.182B2.000 (60kW)	10/98-		R			153-076		Ap	203,2x39	Hand Brake
	98-		R			700-019			Ø 203,2	
1.4 12v Eng.182A3.000 (59kW)	-2/97		R			153-002		Bdx	203,2x39	Hand Brake
	2/97-		R			153-076		Ap	203,2x39	Hand Brake
	96-		R			151-090		Bdx	Ø 20,64 228,0x40	RAI
1.6 16v Eng.182A4.000 (76kW)	-4/97		R			153-067	153-067J	Bdx	228,6x42	Hand Brake
	4/97-		R			153-075		Ap	228,6x42	
	9/96-		R			700-022			Ø 228,3	
	4/97-		R			151-154		Delco	Ø 20,64 229,5x42,5	RAI
	96-3/97		R			151-090		Bdx	Ø 20,64 228,0x40	RAI
	96-		R			151-216		Ap	Ø 22,00 228,6x42	AP, +/-ABS
1.8 16v Eng.182A2.000 (83kW)	-4/97		R			153-067	153-067J	Bdx	228,6x42	Hand Brake
	4/97-		R			153-075		Ap	228,6x42	
	9/96-		R			700-022			Ø 228,3	
	4/97-		R			151-154		Delco	Ø 20,64 229,5x42,5	RAI
	96-3/97		R			151-090		Bdx	Ø 20,64 228,0x40	RAI
	96-		R			151-216		Ap	Ø 22,00 228,6x42	AP, +/-ABS
1.9 JTD 105 Eng.182B4.000 (77kW)	99-		R			700-022			Ø 228,3	
	99-		R			151-154		Delco	Ø 20,64 229,5x42,5	RAI
1.9 JTD 110 Eng.186A6.000 (81kW)	01-		R			700-019			Ø 203,2	
	01-		R			151-154		Delco	Ø 20,64 229,5x42,5	RAI
1.9 TD 100 Eng.182A7.000 (74kW)	-4/97		R			153-067	153-067J	Bdx	228,6x42	Hand Brake
	4/97-		R			153-075		Ap	228,6x42	



























































		Spare Parts	F/R	L/R	CIFAM ref.	CIFAM ref. w/KIT		DIMENSIONS mm.	NOTE
1.9 TD 100 Eng.182A7.000 (74kW)	9/96-		R		700-022			Ø 228,3	
	4/97-		R		151-154		Delco	Ø 20,64 229,5x42,5	RAI
	96-3/97		R		151-090		Bdx	Ø 20,64 228,0x40	RAI
1.9 TD 75 Eng.182A8.000 (55kW)	-4/97		R		153-067	153-067J	Bdx	228,6x42	Hand Brake
	4/97-		R		153-075		Ap	228,6x42	
	9/96-		R		700-022			Ø 228,3	
	4/97-		R		151-154		Delco	Ø 20,64 229,5x42,5	RAI
	96-3/97		R		151-090		Bdx	Ø 20,64 228,0x40	RAI
2.4 JTD 130 Eng.839A5.000 (96kW)	99-		R		151-090		Bdx	Ø 20,64 228,0x40	RAI
2.4 TD 125 Eng.185A2.000 (91kW)	96-		R		151-090		Bdx	Ø 20,64 228,0x40	RAI
Multipla (186) 4/99-									
1.6 16v Eng.182A4.000 (76kW)	4/99-		R		153-075		Ap	228,6x42	
	4/99-02		R		700-022			Ø 228,3	
	4/99-		R		151-090		Bdx	Ø 20,64 228,0x40	RAI
1.6 16v Bipower Eng.182B6.000 (76kW)	10/01-		R		153-075		Ap	228,6x42	
	01-02		R		700-022			Ø 228,3	
	01-02		R		151-090		Bdx	Ø 20,64 228,0x40	RAI
1.6 16v Bipower Eng.186A4.000 (76kW)	4/99-		R		153-075		Ap	228,6x42	
	4/99-02		R		700-022			Ø 228,3	
	4/99-02		R		151-090		Bdx	Ø 20,64 228,0x40	RAI
1.6 16v Blpower Eng.186A3.000 (70kW)	4/99-		R		153-075		Ap	228,6x42	
	4/99-02		R		700-022			Ø 228,3	
	4/99-		R		151-090		Bdx	Ø 20,64 228,0x40	RAI
1.9 JTD 105 Eng.182B4.000 (77kW)	4/99-		R		153-075		Ap	228,6x42	
	4/99-02		R		700-022			Ø 228,3	
	4/99-		R		151-090		Bdx	Ø 20,64 228,0x40	RAI
1.9 JTD 110 Eng.186A6.000 (81kW)	01-02		R		153-075		Ap	228,6x42	
	01-02		R		700-022			Ø 228,3	
1.9 JTD 115 Eng.186A8.000 (85kW)	02-		R		153-075		Ap	228,6x42	
	02-		R		700-022			Ø 228,3	
1.9 MJT Eng.186A9.000 (88kW)	04-		R		700-022			Ø 228,3	
Palio Weekend (178DX) 4/96-									
1.2 Eng.178B5.000 (54kW)	4/96-2/01		R		153-075		Ap	228,6x42	
	96-		R		700-022			Ø 228,3	
	96-		R		151-090		Bdx	Ø 20,64 228,0x40	RAI
1.2 Eng.188A4.000 (44kW)	2/01-		R		153-087		Bdx	228,6x42	
	01-		R		700-022			Ø 228,3	
	01-		R		151-090		Bdx	Ø 20,64 228,0x40	RAI
1.6 16v Eng.178B3.000 (74kW)	4/96-2/01		R		153-075		Ap	228,6x42	
	96-		R		700-022			Ø 228,3	
	96-		R		151-090		Bdx	Ø 20,64 228,0x40	RAI
1.6 16v Eng.182B6.000 (76kW)	2/01-		R		153-075		Ap	228,6x42	
	2/01-		R		153-087		Bdx	228,6x42	
	01-		R		700-022			Ø 228,3	
	01-		R		151-090		Bdx	Ø 20,64 228,0x40	RAI
1.7 TD Eng.176A3.000 (51kW)	4/96-3/01		R		153-075		Ap	228,6x42	
	96-		R		700-022			Ø 228,3	
	96-		R		151-090		Bdx	Ø 20,64 228,0x40	RAI
1.9 D Eng.223A6.000 (46kW)	3/01-		R		153-075		Ap	228,6x42	
	3/01-		R		153-087		Bdx	228,6x42	
	01-		R		700-022			Ø 228,3	
	01-		R		151-090		Bdx	Ø 20,64 228,0x40	RAI
1.9 JTD Eng.188A2.000 (59kW)	01-		R		700-022			Ø 228,3	
Palio/Siena (178BX) 4/96-									
1.0 Eng.178A1.000/ 310A1.011 (45-56kW)	4/96-		R		153-098		Bosch	185,0x29	China
	96-		R		700-018			Ø 185,0	Tunisia
1.2 16v Eng.178B5.000 (54kW)	6/98-		R		153-078			185,0x29	Hand Brake
	6/98-		R		700-018			Ø 185,0	
1.4 Eng.178B2.000 (51kW)	4/96-		R		153-078			185,0x29	Hand Brake
	4/96-		R		153-098		Bosch	185,0x29	China
	96-		R		700-018			Ø 185,0	
1.4 Kat Eng.178B2.016 (51kW)	4/96-		R		153-078			185,0x29	Hand Brake
	4/96-		R		153-098		Bosch	185,0x29	China
	96-		R		700-018			Ø 185,0	
1.6 16v Eng.178B3.000 (74-78kW)	4/96-		R		153-078			185,0x29	Hand Brake
	96-		R		700-018			Ø 185,0	

























		Spare Parts	F/R	L/R	CIFAM ref.	CIFAM ref. w/KIT		DIMENSIONS mm.	NOTE
1.7 TD Eng.176A5.000 (51kW)	9/98-		R		700-018			Ø 185,0	
1.8 Eng.93313090-7U (81kW)	10/05-		R		153-098		Bosch	185,0x29	China
Panda I (141A) 10/80-7/04									
0.65 Eng.141A.000 (22kW)	1/82-7/04		R		153-063		Fiat	185,0x31	Fitted Adjuster, Hand Brake
	3/82-91		R		700-003			Ø 185,0	
0.75 Eng.156A4.048 (25kW)	1/95-12/97		R		153-063		Fiat	185,0x31	Fitted Adjuster, Hand Brake
			R		153-063		Fiat	185,0x31	Fitted Adjuster, Hand Brake
0.75 Fire Eng.156A4.000 (25kW)	1/86-1/95		R		153-063		Fiat	185,0x31	Fitted Adjuster, Hand Brake
			R		700-003			Ø 185,0	
0.75, Kat Eng.141B.000 (25kW)	1/86-1/95		R		153-063		Fiat	185,0x31	Fitted Adjuster, Hand Brake
			R		700-003			Ø 185,0	
0.8 Eng.100GL6.000 (25kW)	81-85		R		700-003			Ø 185,0	
0.9 Eng.100GL3.000/ 146A.000 (33kW)	10/80-6/94		R		153-063		Fiat	185,0x31	Fitted Adjuster, Hand Brake
			R		700-003			Ø 185,0	
0.9 Eng.1170A1.046 (29kW)	4/92-12/96		R		153-069		Ap	185,0x31	Hand Brake
			R		700-003			Ø 185,0	
0.95, 4WD Eng.A112B1.054 (35kW)	9/82-8/83		R		153-063		Fiat	185,0x31	Fitted Adjuster, Hand Brake
			R		700-003			Ø 185,0	Ch -5296653
1.0 4WD Eng.156A2.100/ 156A3.100 (32kW)	1/86-4/92		R		153-063		Fiat	185,0x31	Fitted Adjuster, Hand Brake
			R		700-003			Ø 185,0	
1.0 i.e. Kat, 4WD Eng.141C2.000/ 156A2.246 (33kW)	-12/92		R		153-063		Fiat	185,0x31	Fitted Adjuster, Hand Brake
			R		153-069		Ap	185,0x31	Exc. 4WD, Hand Brake
			R		700-003			Ø 185,0	
1.0, 4WD Eng.156A3.000 (37kW)	1/86-12/92		R		153-063		Fiat	185,0x31	Fitted Adjuster, Hand Brake
			R		700-003			Ø 185,0	
1.1, 4WD Eng.156C.046 (37kW)	10/91-7/04		R		153-069		Ap	185,0x31	Exc. 4WD, Hand Brake
			R		153-063		Fiat	185,0x31	Fitted Adjuster, Hand Brake
			R		700-003			Ø 185,0	
1.1, 4WD Eng.176B2.000 (40kW)	2/95-7/04		R		153-069		Ap	185,0x31	Exc. 4WD, Hand Brake
			R		700-003			Ø 185,0	
1.3 D Eng.156A5.000 (27kW)	4/86-12/92		R		153-063		Fiat	185,0x31	Fitted Adjuster, Hand Brake
			R		700-003			Ø 185,0	
Panda II (169) 9/03-									
1.1 Eng.187A1.000 (40kW)	11/10-9/03-9/03-03-03-03-		R		153-488		Lockh.	180x30	+ABS
			R		153-083		Ap	180,0x32	-ABS
			R		153-090		Bosch	180,0x30	+ABS
			R		700-011			Ø 180,0	
			R		151-181		Ap	Ø 20,64 180,0x32	RAD, -ABS
			R		151-194		Bosch	Ø 20,64 180,0x30	RAI, +ABS
1.2 Eng.188A4.000 (44kW)	11/10-9/03-9/03-03-03-03-		R		153-488		Lockh.	180x30	+ABS
			R		153-083		Ap	180,0x32	-ABS
			R		153-090		Bosch	180,0x30	+ABS
			R		700-011			Ø 180,0	
			R		151-181		Ap	Ø 20,64 180,0x32	RAD, -ABS
			R		151-194		Bosch	Ø 20,64 180,0x30	RAI, +ABS
1.2 4WD Eng.188A4.000 (44kW)	10/04-10/04-11/10-04-04-04-		R		153-083		Ap	180,0x32	-ABS
			R		153-090		Bosch	180,0x30	+ABS
			R		153-488		Lockh.	180x30	+ABS
			R		700-011			Ø 180,0	
			R		151-181		Ap	Ø 20,64 180,0x32	RAD, -ABS
			R		151-194		Bosch	Ø 20,64 180,0x30	RAI, +ABS
1.2, 4WD Eng.169A4.000 (51kW)	11/10-		R		153-488		Lockh.	180x30	+ABS
1.3 JTD Eng.188A9.000 (51kW)	9/03-9/03-9/03-03-03-03-		R		153-083		Ap	180,0x32	-ABS
			R		153-090		Bosch	180,0x30	+ABS
			R		700-011			Ø 180,0	
			R		151-181		Ap	Ø 20,64 180,0x32	RAD, -ABS
			R		151-194		Bosch	Ø 20,64 180,0x30	RAI, +ABS
			R		151-194		Bosch	Ø 20,64 180,0x30	RAI, +ABS
1.3 JTD 4WD Eng.188A9.000 (51kW)	10/04-10/04-9/10-04-04-04-		R		153-083		Ap	180,0x32	-ABS
			R		153-090		Bosch	180,0x30	+ABS
			R		153-488		Lockh.	180x30	+ABS
			R		700-011			Ø 180,0	
			R		151-181		Ap	Ø 20,64 180,0x32	RAD, -ABS
			R		151-194		Bosch	Ø 20,64 180,0x30	RAI, +ABS
1.3 MJT Eng.188A8.000 (55kW)	6/06-6/06-6/06-		R		153-083		Ap	180,0x32	-ABS
			R		153-090		Bosch	180,0x30	+ABS
			R		700-011			Ø 180,0	



















































		Spare Parts	F/R	L/R	CIFAM ref.	CIFAM ref. w/KIT		DIMENSIONS mm.	NOTE
1.3 MJT 4WD Eng.188A8.000 (55kW)	9/10-		R		153-488		Lockh.	180x30	
1.4 Bi-power, Natural power Eng.350A1.000 (57kW)	9/10-		R		153-488		Lockh.	180x30	
Punto I (176,C), Cabrio 9/93-9/99									
1.1 Eng.176A6.000/ 176B2.000 (40kW)	9/93-9/99		R		153-070	153-070J	Ap	180,0x32	Hand Brake
	9/93-9/99		R		153-066	153-066J	Bdx	180,0x32	Hand Brake
	11/93-99		R		700-011			Ø 180,0	
	7/93-99		R		151-052		Ap	Ø 20,64 180,0x30	RAD
	7/93-99		R		151-023		Bdx	Ø 20,64 180,0x30	RAI, +ABS
1.2 16v, Cabrio Eng.176B9.000 (63kW)	97-99		R		700-011			Ø 180,0	
	97-99		R		151-052		Ap	Ø 20,64 180,0x30	RAD
	97-99		R		151-023		Bdx	Ø 20,64 180,0x30	RAI, +ABS
1.2 60, Cabrio Eng.176A7.000 (43kW)	1/94-9/99		R		153-070	153-070J	Ap	180,0x32	Hand Brake
	1/94-9/99		R		153-066	153-066J	Bdx	180,0x32	Hand Brake
	94-99		R		700-011			Ø 180,0	
	94-99		R		151-052		Ap	Ø 20,64 180,0x30	RAD
	94-99		R		151-023		Bdx	Ø 20,64 180,0x30	RAI, +ABS
1.2 60, Cabrio Eng.176B1.000/ 176B4.000 (44kW)	3/94-9/99		R		153-070	153-070J	Ap	180,0x32	Hand Brake
	3/94-9/99		R		153-066	153-066J	Bdx	180,0x32	Hand Brake
	94-99		R		700-011			Ø 180,0	
	94-99		R		151-052		Ap	Ø 20,64 180,0x30	RAD
1.2 75 Eng.176A8.000 (54kW)	1/94-9/99		R		153-070	153-070J	Ap	180,0x32	Hand Brake
	1/94-9/99		R		153-066	153-066J	Bdx	180,0x32	Hand Brake
	94-99		R		700-011			Ø 180,0	
	94-99		R		151-052		Ap	Ø 20,64 180,0x30	RAD
1.6 90, Cabrio Eng.176A9.000 (65kW)	1/94-4/97		R		153-070	153-070J	Ap	180,0x32	Hand Brake
	1/94-4/97		R		153-066	153-066J	Bdx	180,0x32	Hand Brake
	94-97		R		700-011			Ø 180,0	
	94-97		R		151-052		Ap	Ø 20,64 180,0x30	RAD
1.7 D Eng.176B3.000 (42kW)	94-97		R		151-023		Bdx	Ø 20,64 180,0x30	RAI, +ABS
	94-97		R		700-011			Ø 180,0	
	94-97		R		151-052		Ap	Ø 20,64 180,0x30	RAD
1.7 TD Eng.176A5.000 (52kW)	94-97		R		151-023		Bdx	Ø 20,64 180,0x30	RAI, +ABS
	1/94-9/99		R		153-070	153-070J	Ap	180,0x32	Hand Brake
	1/94-9/99		R		153-066	153-066J	Bdx	180,0x32	Hand Brake
1.7 TD, TDs Eng.176A3.000 (51kW)	94-99		R		700-011			Ø 180,0	
	1/94-9/99		R		153-070	153-070J	Ap	180,0x32	Hand Brake
	1/94-9/99		R		153-066	153-066J	Bdx	180,0x32	Hand Brake
1.7 TD, TDs Eng.176B7.000 (46kW)	94-99		R		700-011			Ø 180,0	
	9/96-9/99		R		153-070	153-070J	Ap	180,0x32	Hand Brake
	9/96-9/99		R		153-066	153-066J	Bdx	180,0x32	Hand Brake
	96-99		R		700-011			Ø 180,0	
1.8 HGT Eng.183A1.000/ 188A6.000 (96kW)	96-99		R		151-052		Ap	Ø 20,64 180,0x30	RAD
	96-99		R		151-023		Bdx	Ø 20,64 180,0x30	RAI, +ABS
	96-99		R		700-011			Ø 180,0	
Punto II (188) 9/99-7/03									
1.2 Eng.188A4.000 (44kW)	9/99-7/03		R		153-080	153-080Y	Ap	180,0x32	+ABS, Hand Brake
	9/99-7/03		R		153-079	153-079Y	Ap	180,0x32	-ABS
	99-03		R		700-011			Ø 180,0	
	99-03		R		151-145		Ap	Ø 20,64 180,0x30	RAD, -ABS
1.2 16v Eng.188A5.000 (59kW)	9/99-7/03		R		153-080	153-080Y	Ap	180,0x32	+ABS, Hand Brake
	9/99-7/03		R		153-079	153-079Y	Ap	180,0x32	-ABS
	99-03		R		700-011			Ø 180,0	
1.8 DS 60 Eng.188A3.000 (44kW)	99-03		R		151-145		Ap	Ø 20,64 180,0x30	RAD, -ABS
	99-03		R		700-011			Ø 180,0	
	99-03		R		151-146		Ap	Ø 22,00 180,0x30	RAD, +ABS
1.9 JTD Eng.188A2.000 (59kW)	9/99-7/03		R		153-080	153-080Y	Ap	180,0x32	+ABS, Hand Brake
	9/99-7/03		R		153-079	153-079Y	Ap	180,0x32	-ABS
	99-03		R		700-011			Ø 180,0	
	99-03		R		151-146		Ap	Ø 22,00 180,0x30	RAD, +ABS
1.9 JTD Eng.188A7.000 (63kW)	1/01-12/03		R		153-080	153-080Y	Ap	180,0x32	+ABS, Hand Brake
	1/01-12/03		R		153-079	153-079Y	Ap	180,0x32	-ABS

















































		Spare Parts	F/R	L/R	CIFAM ref.	CIFAM ref. w/KIT		DIMENSIONS mm.	NOTE
Punto III (188) 10/01-									
1.2 16v Eng.188A5.000 (59kW)	03-05		R		700-011			Ø 180,0	
1.2 Natural Power Eng.188A4.000 (44kW)	03-05		R		700-011			Ø 180,0	
1.3 JTD Eng.188A9.000 (51kW)	03-05		R		151-145		Ap	Ø 20,64 180,0x30	RAD, -ABS
	-3/04		R		153-084		Ap	203,2x39	Hand Brake
	3/04-		R		153-091		Ap	203,0x38	
	03-05		R		700-011			Ø 180,0	
	03-3/04		R		151-218		Ap	Ø 20,64 203,2x39	AP
1.4 16v Eng.843A1.000 (70kW)	3/04-		R		151-219		Ap	Ø 22,00 203,0x38	AP
	3/04		R		153-084		Ap	203,2x39	Hand Brake
	03-05		R		153-091		Ap	203,0x38	
	03-3/04		R		700-019			Ø 203,2	
	3/04-		R		151-218		Ap	Ø 20,64 203,2x39	AP
1.9 JTD Eng.188A7.000 (63kW)	3/04-		R		151-221		Ap	Ø 20,64 203,0x38	AP
	3/04		R		153-084		Ap	203,2x39	Hand Brake
	01-05		R		153-091		Ap	203,0x38	
	03-3/04		R		700-011			Ø 180,0	
	3/04-		R		151-218		Ap	Ø 20,64 203,2x39	AP
1.9 JTD Eng.188B2.000 (74kW)	3/04-		R		151-221		Ap	Ø 20,64 203,0x38	AP
	3/04		R		153-084		Ap	203,2x39	Hand Brake
	03-05		R		153-091		Ap	203,0x38	
	03-3/04		R		700-019			Ø 203,2	Emotion
	3/04-		R		151-218		Ap	Ø 20,64 203,2x39	AP
									AP
Regata (138) 9/83-12/90									
1.3 70 Eng.138B2.000 (50kW)	9/83-7/86		R		153-063		Fiat	185,0x31	Fitted Adjuster, Hand Brake
	9/83-3/86		R		700-003			Ø 185,0	
1.3 70 Eng.149A3.000/ 149A7.000 (48kW)	9/83-7/89		R		153-063		Fiat	185,0x31	Fitted Adjuster, Hand Brake
	9/83-3/86		R		700-003			Ø 185,0	
1.5 75 Eng.138B3.048 (55kW)	12/83-12/85		R		153-063		Fiat	185,0x31	Fitted Adjuster, Hand Brake
	9/83-3/86		R		700-003			Ø 185,0	
1.5 75 Eng.138C3.048 (55kW)	1/86-12/87		R		153-063		Fiat	185,0x31	Fitted Adjuster, Hand Brake
	9/83-3/86		R		700-003			Ø 185,0	
1.5 85 Eng.138B3.000 (60kW)	9/83-4/85		R		153-063		Fiat	185,0x31	Fitted Adjuster, Hand Brake
	83-85		R		700-003			Ø 185,0	
1.5 85 Eng.149A5.000 (58kW)	5/85-12/87		R		153-063		Fiat	185,0x31	Fitted Adjuster, Hand Brake
	85-87		R		700-003			Ø 185,0	
1.5 i.e. 75 Eng.138C2.048/ 149C1.000 (55kW)	7/85-7/89		R		153-063		Fiat	185,0x31	Fitted Adjuster, Hand Brake
1.6 100 Super Eng.149A2.000/ 149A4.000/ 149C3.000 (70-74kW)	10/83-12/90		R		153-063		Fiat	185,0x31	Fitted Adjuster, Hand Brake
	9/83-3/86		R		700-003			Ø 185,0	
1.6 85 Eng.149A.000 (60kW)	9/83-3/86		R		700-003			Ø 185,0	
1.6 i.e. 90 Eng.149C2.000 (66kW)	1/87-7/89		R		153-063		Fiat	185,0x31	Fitted Adjuster, Hand Brake
	87-89		R		700-003			Ø 185,0	
1.7 D Eng.149B3.000 (44kW)	5/85-3/89		R		153-063		Fiat	185,0x31	Fitted Adjuster, Hand Brake
	85-89		R		700-003			Ø 185,0	
1.7 D 60 Eng.138B6.000 (43kW)	9/83-12/86		R		153-063		Fiat	185,0x31	Fitted Adjuster, Hand Brake
	9/83-3/86		R		700-003			Ø 185,0	
1.9 D 65 Eng.149A1.000 (48kW)	4/84-7/89		R		153-063		Fiat	185,0x31	Fitted Adjuster, Hand Brake
	84-89		R		700-003			Ø 185,0	
1.9 TD 80 Eng.831D1.000 (59kW)	5/86-7/89		R		153-063		Fiat	185,0x31	Fitted Adjuster, Hand Brake
	86-		R		700-003			Ø 185,0	
Regata Weekend 1/84-12/90									
1.3 70 Eng.138B2.000 (50kW)	1/84-7/89		R		153-063		Fiat	185,0x31	Fitted Adjuster, Hand Brake
	84-		R		700-003			Ø 185,0	
1.5 75 Eng.138C3.048 (55kW)	9/84-7/89		R		153-063		Fiat	185,0x31	Fitted Adjuster, Hand Brake
	84-		R		700-003			Ø 185,0	
1.5 85 Eng.138C3.000 (60kW)	1/84-4/89		R		153-063		Fiat	185,0x31	Fitted Adjuster, Hand Brake
	84-3/86		R		700-003			Ø 185,0	
1.5 i.e. 75 Kat Eng.138C2.048 (55kW)	12/86-7/89		R		153-063		Fiat	185,0x31	Fitted Adjuster, Hand Brake
1.6 100 Eng.149A4.000 (74kW)	84-3/86		R		700-003			Ø 185,0	
1.6 i.e. 100 Eng.149A2.000 (74kW)	87-90		R		700-003			Ø 185,0	
1.6 i.e. 90 Eng.149C2.000 (66kW)	87-89		R		700-003			Ø 185,0	
1.7 D Eng.149B3.000 (44kW)	1/84-12/89		R		153-063		Fiat	185,0x31	Fitted Adjuster, Hand Brake
	84-89		R		700-003			Ø 185,0	

		Spare Parts	F/R	L/R	CIFAM ref.	CIFAM ref. w/KIT		DIMENSIONS mm.	NOTE
1.9 D 65 Eng.149A1.000 (48kW)	4/84-7/89		R		153-063		Fiat	185,0x31	Fitted Adjuster, Hand Brake
	84-89		R		700-003			Ø 185,0	
1.9 TD 80 Eng.831D1.000 (59kW)	5/86-7/89		R		153-063		Fiat	185,0x31	Fitted Adjuster, Hand Brake
Ritmo I (138A) 1/78-12/87									
1.0 Eng.127A6.000 (44kW)	9/78-9/82		R		153-063		Fiat	185,0x31	Fitted Adjuster, Hand Brake
	79-7/82		R		700-003			Ø 185,0	
1.3 Eng.138A3.000 (55kW)	81-82		R		700-003			Ø 185,0	
1.3 65 Eng.138A1.000 (48kW)	1/78-9/82		R		153-063		Fiat	185,0x31	Fitted Adjuster, Hand Brake
	78-7/82		R		700-003			Ø 185,0	
1.3 70 Eng.149A3.000/ 149A7.000 (45kW)	11/83-8/85		R		153-063		Fiat	185,0x31	Fitted Adjuster, Hand Brake
	4/83-85		R		700-003			Ø 185,0	
1.5 Eng.138A2.000 (55-63kW)	3/81-7/82		R		700-003			Ø 185,0	
1.5 75 Eng.138C3.048 (55kW)	1/78-10/82		R		153-063		Fiat	185,0x31	Fitted Adjuster, Hand Brake
	3/81-7/82		R		700-003			Ø 185,0	
1.5 85 Eng.138A4.000 (63kW)	1/81-9/82		R		153-063		Fiat	185,0x31	Fitted Adjuster, Hand Brake
	3/81-7/82		R		700-003			Ø 185,0	
1.5 i.e. 75 Eng.138C2.048/ 149C1.000 (55kW)	10/85-5/87		R		153-063		Fiat	185,0x31	Fitted Adjuster, Hand Brake
1.6 105 Eng.138AR.000 (77kW)	5/81-12/82		R		153-063		Fiat	185,0x31	Fitted Adjuster, Hand Brake
	81-7/82		R		700-003			Ø 185,0	
1.7 D 55 Eng.138A5.000/ 138B5.000 (40-43kW)	10/79-9/82		R		153-063		Fiat	185,0x31	Fitted Adjuster, Hand Brake
	80-7/82		R		700-003			Ø 185,0	
2.0 TC Abarth Eng.138AR1.000 (92kW)	11/81-9/82		R		153-063		Fiat	185,0x31	Fitted Adjuster, Hand Brake
	81-82		R		700-007			Ø 185,0	
Ritmo II (138A) 10/82-12/88									
1.1 60 Eng.138B.000/ 138B1.000 (40kW)	10/82-10/85		R		153-063		Fiat	185,0x31	Fitted Adjuster, Hand Brake
	82-85		R		700-003			Ø 185,0	
1.1 60 Eng.146A4.048 (43kW)	4/85-12/87		R		153-063		Fiat	185,0x31	Fitted Adjuster, Hand Brake
1.3 70 Eng.138B2.000 (50kW)	1/83-4/85		R		153-063		Fiat	185,0x31	Fitted Adjuster, Hand Brake
1.5 75 Eng.138A4.000 (55kW)	9/85-12/88		R		153-063		Fiat	185,0x31	Fitted Adjuster, Hand Brake
1.5 85 Eng.138B3.000 (60kW)	1/83-12/87		R		153-063		Fiat	185,0x31	Fitted Adjuster, Hand Brake
	83-87		R		700-003			Ø 185,0	
1.5 85 Eng.149A5.000 (58kW)	8/85-5/87		R		153-063		Fiat	185,0x31	Fitted Adjuster, Hand Brake
1.5 i.e. 75 Eng.138C2.048/ 149C1.000 (55kW)	9/85-12/88		R		153-063		Fiat	185,0x31	Fitted Adjuster, Hand Brake
1.6 105 Eng.138AR.000 (77kW)	1/83-12/87		R		153-063		Fiat	185,0x31	Fitted Adjuster, Hand Brake
1.7 D Eng.138C.000/ 149B3.000 (44kW)	5/85-12/87		R		153-063		Fiat	185,0x31	Fitted Adjuster, Hand Brake
	85-87		R		700-003			Ø 185,0	
1.7 D 60 Eng.138B6.000 (43kW)	10/82-10/85		R		153-063		Fiat	185,0x31	Fitted Adjuster, Hand Brake
	82-85		R		700-003			Ø 185,0	
1.9 TD 80 Eng.831D1.000 (59kW)	12/85-12/87		R		153-063		Fiat	185,0x31	Fitted Adjuster, Hand Brake
	4/85-87		R		700-003			Ø 185,0	
2.0 TC Abarth Eng.138AR2.000 (92kW)	12/82-12/87		R		153-063		Fiat	185,0x31	Fitted Adjuster, Hand Brake
	82-87		R		700-007			Ø 185,0	
2.0 TC Abarth Eng.138AR2.000 (96kW)	4/83-12/87		R		153-063		Fiat	185,0x31	Fitted Adjuster, Hand Brake
	83-87		R		700-007			Ø 185,0	
Sedici (189) 1/06-									
1.6 16v 4WD Eng.M16A (79kW)	1/06-		R		153-096		Bosch	220,0x36	
	06-		R		151-201		Bosch	Ø 19,05 220,0x36	RAI
1.9 MJT, 4WD Eng.D19AA (88kW)	1/06-		R		153-096		Bosch	220,0x36	
	06-		R		151-201		Bosch	Ø 19,05 220,0x36	RAI
Seicento (187) 1/98-									
0.9 Eng.1170A1.046 (29kW)	1/98-		R		153-063		Fiat	185,0x31	Fitted Adjuster, Hand Brake
	4/98-		R		700-024			Ø 185,0	
1.1 Eng.176B2.000/ 187A1.000 (40kW)	1/98-		R		153-063		Fiat	185,0x31	Fitted Adjuster, Hand Brake
	4/98-		R		700-024			Ø 185,0	
Elektra (30kW)	1/99-		R		700-024			Ø 185,0	
Tempra (159) 3/90-8/96									
1.4 i.e. Eng.159A2.000 (57kW)	3/91-8/96		R		153-066	153-066J	Bdx	180,0x32	Hand Brake
	91-96		R		700-008			Ø 180,0	
	91-96		R		151-037		Bdx	Ø 17,50 228,0x40	RAI, SW
	91-96		R		151-024		Bdx	Ø 19,05 180,0x30	RAI, Exc. SW
1.4 i.e. Eng.160A1.046 (51kW)	3/92-8/96		R		153-066	153-066J	Bdx	180,0x32	Hand Brake
	3/93-		R		700-008			Ø 180,0	
	3/93-		R		151-026		Bdx	Ø 22,00 180,0x30	RAI
1.4 i.e. Eng.836A4.000 (52kW)	1/92-12/96		R		153-066	153-066J	Bdx	180,0x32	Hand Brake
	3/93-		R		700-008			Ø 180,0	
	3/93-		R		151-026		Bdx	Ø 22,00 180,0x30	RAI













		Spare Parts	F/R	L/R	CIFAM ref.	CIFAM ref. w/KIT		DIMENSIONS mm.	NOTE
1.6 Eng.159A3.000 (63kW)	12/90-4/93		R		153-066	153-066J	Bdx	180,0x32	Hand Brake
	90-93		R		700-008			Ø 180,0	
	90-93		R		700-009			Ø 228,3	
	90-93		R		151-037		Bdx	Ø 17,50 228,0x40	RAI, SW
	90-93		R		151-024		Bdx	Ø 19,05 180,0x30	RAI, Exc. SW
1.6 i.e. Eng.159A3.046 (57kW)	6/90-8/96		R		153-066	153-066J	Bdx	180,0x32	Hand Brake
	90-96		R		700-008			Ø 180,0	
	90-96		R		700-009			Ø 228,3	
	90-96		R		151-037		Bdx	Ø 17,50 228,0x40	RAI, SW
	90-96		R		151-024		Bdx	Ø 19,05 180,0x30	RAI, Exc. SW
1.6 i.e. Eng.159A3.048/ 835C1.000 (55kW)	6/92-8/96		R		153-066	153-066J	Bdx	180,0x32	Hand Brake
	3/93-		R		700-008			Ø 180,0	
	3/93-		R		151-026		Bdx	Ø 22,00 180,0x30	RAI
1.6 i.e. Eng.159B9.000 (63-66kW)	6/94-8/96		R		153-066	153-066J	Bdx	180,0x32	Hand Brake
1.8 i.e. Eng.159A4.000 (81kW)	3/90-8/96		R		153-067	153-067J	Bdx	228,6x42	Hand Brake
1.8 i.e. Eng.159A4.046 (77kW)	3/92-8/96		R		153-067	153-067J	Bdx	228,6x42	Hand Brake
	92-		R		700-009			Ø 228,3	
	3/93-		R		151-049		Bdx	Ø 20,64 228,0x40	RAI
	92-93		R		151-037		Bdx	Ø 17,50 228,0x40	RAI
1.8 i.e. Eng.835C2.000 (76kW)	9/93-8/96		R		153-067	153-067J	Bdx	228,6x42	Hand Brake
1.8 i.e. Eng.835C4.000 (66kW)	9/93-8/96		R		153-067	153-067J	Bdx	228,6x42	Hand Brake
1.8 i.e. Eng.836A5.000 (74kW)	10/94-8/96		R		153-067	153-067J	Bdx	228,6x42	Hand Brake
1.9 D Eng.160A7.000 (48kW)	7/91-8/96		R		153-066	153-066J	Bdx	180,0x32	Hand Brake
	91-		R		700-009			Ø 228,3	
	3/93-		R		151-026		Bdx	Ø 22,00 180,0x30	RAI
	91-93		R		151-037		Bdx	Ø 17,50 228,0x40	RAI
1.9 TD Eng.160A6.000/ 160D1.000 (66kW)	5/90-8/96		R		153-067	153-067J	Bdx	228,6x42	Hand Brake
	90-		R		700-009			Ø 228,3	
	3/93-		R		151-049		Bdx	Ø 20,64 228,0x40	RAI
	90-93		R		151-037		Bdx	Ø 17,50 228,0x40	RAI
1.9 TD Eng.160B6.046 (59kW)	7/92-8/96		R		153-067	153-067J	Bdx	228,6x42	Hand Brake
	92-		R		700-009			Ø 228,3	
	3/93-		R		151-049		Bdx	Ø 20,64 228,0x40	RAI
	92-93		R		151-037		Bdx	Ø 17,50 228,0x40	RAI
Tempra (159) SW 3/90-8/96									
1.4 i.e. Eng.159A2.000 (57kW)	3/91-8/96		R		153-067	153-067J	Bdx	228,6x42	Hand Brake
	91-96		R		700-008			Ø 180,0	
	91-96		R		151-037		Bdx	Ø 17,50 228,0x40	RAI, SW
	91-96		R		151-024		Bdx	Ø 19,05 180,0x30	RAI, Exc. SW
1.4 i.e. Eng.160A1.046/ 836A4.000 (51kW)	3/92-8/96		R		153-067	153-067J	Bdx	228,6x42	Hand Brake
	92-		R		700-008			Ø 180,0	
	92-		R		151-026		Bdx	Ø 22,00 180,0x30	RAI
1.4 i.e. Eng.836A4.000 (52kW)	1/92-12/96		R		153-067	153-067J	Bdx	228,6x42	Hand Brake
	92-		R		700-008			Ø 180,0	
	92-		R		151-026		Bdx	Ø 22,00 180,0x30	RAI
1.6 Eng.159A3.000 (63kW)	12/90-4/93		R		153-067	153-067J	Bdx	228,6x42	Hand Brake
	90-93		R		700-008			Ø 180,0	
	90-93		R		700-009			Ø 228,3	
	90-93		R		151-037		Bdx	Ø 17,50 228,0x40	RAI, SW
	90-93		R		151-024		Bdx	Ø 19,05 180,0x30	RAI, Exc. SW
1.6 i.e. Eng.159A3.046/ 835C1.000 (57kW)	6/90-8/96		R		153-067	153-067J	Bdx	228,6x42	Hand Brake
	90-96		R		700-008			Ø 180,0	
	90-96		R		700-009			Ø 228,3	
	90-96		R		151-037		Bdx	Ø 17,50 228,0x40	RAI, SW
	90-96		R		151-024		Bdx	Ø 19,05 180,0x30	RAI, Exc. SW
1.6 i.e. Eng.159A3.048/ 835C1.000 (55kW)	6/92-8/96		R		153-067	153-067J	Bdx	228,6x42	Hand Brake
	92-		R		700-008			Ø 180,0	
	92-		R		151-026		Bdx	Ø 22,00 180,0x30	RAI
1.6 i.e. Eng.159B9.000 (63-66kW)	6/94-8/96		R		153-067	153-067J	Bdx	228,6x42	Hand Brake
1.8 4WD Eng.159A4.000 (80kW)	7/92-6/93		R		153-067	153-067J	Bdx	228,6x42	Hand Brake
1.8 i.e. Eng.159A4.000 (81kW)	3/90-8/96		R		153-067	153-067J	Bdx	228,6x42	Hand Brake
1.8 i.e. Eng.159A4.046 (77kW)	3/92-8/96		R		153-067	153-067J	Bdx	228,6x42	Hand Brake
	92-		R		700-009			Ø 228,3	
	3/93-		R		151-049		Bdx	Ø 20,64 228,0x40	RAI
	92-93		R		151-037		Bdx	Ø 17,50 228,0x40	RAI



































































		Spare Parts	F/R	L/R	CIFAM ref.	CIFAM ref. w/KIT		DIMENSIONS mm.	NOTE
1.8 i.e. Eng.835C2.000 (76kW)	9/93-8/96		R		153-067	153-067J	Bdx	228,6x42	Hand Brake
1.8 i.e. Eng.835C4.000 (66kW)	9/93-8/96		R		153-067	153-067J	Bdx	228,6x42	Hand Brake
1.8 i.e. Eng.836A5.000 (74kW)	10/94-8/96		R		153-067	153-067J	Bdx	228,6x42	Hand Brake
1.9 D Eng.160A7.000 (48kW)	7/91-8/96		R		153-066	153-066J	Bdx	180,0x32	Hand Brake
			R		153-067	153-067J	Bdx	228,6x42	Hand Brake
	91-		R		700-009			Ø 228,3	
	3/93- 91-93		R		151-026		Bdx	Ø 22,00 180,0x30	RAI
1.9 TD Eng.160A6.000/ 160D1.000 (66kW)	5/90-8/96		R		153-067	153-067J	Bdx	228,6x42	Hand Brake
			R		700-009			Ø 228,3	
	3/93- 90-93		R		151-049		Bdx	Ø 20,64 228,0x40	RAI
1.9 TD Eng.160B6.046 (59kW)	7/92-8/96		R		153-067	153-067J	Bdx	228,6x42	Hand Brake
			R		700-009			Ø 228,3	
	3/93- 92-93		R		151-049		Bdx	Ø 20,64 228,0x40	RAI
				R		151-037		Bdx	Ø 17,50 228,0x40
Tipo (160) 7/87-8/96									
1.1 Eng.160A3.000 (41kW)	1/88-10/91		R		153-066	153-066J	Bdx	180,0x32	Hand Brake
			R		700-008			Ø 180,0	
	88-91		R		151-025		Bdx	Ø 15,00 180,0x30	RAI
1.4 Eng.160A1.000/ 160A1.048 (52kW)	7/87-12/89		R		153-066	153-066J	Bdx	180,0x32	Hand Brake
			R		700-008			Ø 180,0	
88-89		R		151-025		Bdx	Ø 15,00 180,0x30	RAI	
1.4 i.e. Eng.159A2.000 (57kW)	5/89-4/95		R		153-066	153-066J	Bdx	180,0x32	Hand Brake
1.4 i.e. Eng.160A1.046/ 836A4.000 (51kW)	5/89-4/95		R		153-066	153-066J	Bdx	180,0x32	Hand Brake
			R		700-008			Ø 180,0	
	89-93		R		151-025		Bdx	Ø 15,00 180,0x30	RAI
	93-		R		151-026		Bdx	Ø 22,00 180,0x30	RAI
1.6 Eng.160A2.000 (61kW)	1/88-10/91		R		153-066	153-066J	Bdx	180,0x32	Hand Brake
			R		153-067	153-067J	Bdx	228,6x42	Selecta, -ABS, A/T, Hand Brake
	88-91		R		700-008			Ø 180,0	
	88-91		R		700-009			Ø 228,3	
	88-91		R		151-025		Bdx	Ø 15,00 180,0x30	RAI
1.6 i.e. Eng.149C2.046 (66kW)	2/88-5/91		R		153-066	153-066J	Bdx	180,0x32	Hand Brake
			R		153-067	153-067J	Bdx	228,6x42	Selecta, -ABS, A/T, Hand Brake
	2/88-91		R		700-008			Ø 180,0	
	2/88-91		R		700-009			Ø 228,3	
	88-91		R		151-025		Bdx	Ø 15,00 180,0x30	RAI
	-91		R		151-026		Bdx	Ø 22,00 180,0x30	RAI
1.6 i.e. Eng.159A3.046 (57kW)	7/90-1/93		R		153-066	153-066J	Bdx	180,0x32	Hand Brake
			R		153-067	153-067J	Bdx	228,6x42	Selecta, -ABS, A/T, Hand Brake
	90-93		R		700-008			Ø 180,0	
	90-93		R		700-009			Ø 228,3	
	90-93		R		151-025		Bdx	Ø 15,00 180,0x30	RAI
	93-		R		151-026		Bdx	Ø 22,00 180,0x30	RAI
1.6 i.e. Eng.159A3.048/ 835C1.000 (55kW)	10/92-4/95		R		153-066	153-066J	Bdx	180,0x32	Hand Brake
			R		153-067	153-067J	Bdx	228,6x42	Selecta, -ABS, A/T, Hand Brake
	92-		R		700-008			Ø 180,0	
	92-		R		700-009			Ø 228,3	
	92-93		R		151-037		Bdx	Ø 17,50 228,0x40	RAI
	93-95		R		151-049		Bdx	Ø 20,64 228,0x40	RAI
1.7 D Eng.149B4.000 (43-45kW)	1/88-10/95		R		153-066	153-066J	Bdx	180,0x32	Hand Brake
			R		700-008			Ø 180,0	
	2/88- 89-93		R		151-024		Bdx	Ø 19,05 180,0x30	RAI
	93-		R		151-026		Bdx	Ø 22,00 180,0x30	RAI
1.8 i.e. Eng.836A5.000 (71kW)	3/93-4/95		R		153-067	153-067J	Bdx	228,6x42	Hand Brake
1.8 i.e. Eng.159A4.000 (74kW)	10/94-4/95		R		153-067	153-067J	Bdx	228,6x42	Hand Brake
1.8 i.e. Eng.159A4.000 (81kW)	10/90-6/93		R		153-067	153-067J	Bdx	228,6x42	Hand Brake
1.8 i.e. Eng.159A4.046 (77-81kW)	10/90-6/93		R		153-067	153-067J	Bdx	228,6x42	Hand Brake
			R		700-009			Ø 228,3	
	90-93		R		151-037		Bdx	Ø 17,50 228,0x40	RAI
	93-		R		151-049		Bdx	Ø 20,64 228,0x40	RAI
1.8 i.e. Eng.835C2.000 (76kW)	4/93-4/95		R		153-067	153-067J	Bdx	228,6x42	Hand Brake
1.8 i.e. Eng.835C4.000 (66kW)	9/93-4/95		R		700-009			Ø 228,3	
			R		153-067	153-067J	Bdx	228,6x42	Hand Brake































		Spare Parts	F/R	L/R	CIFAM ref.	CIFAM ref. w/KIT		DIMENSIONS mm.	NOTE
1.8 i.e.16v Sport Eng.160A5.000 (100kW)	11/89-6/92		R		153-066	153-066J	Bdx	180,0x32	Hand Brake
1.9 D Eng.160A7.000 (48kW)	7/91-8/96		R		153-066	153-066J	Bdx	180,0x32	Hand Brake
	3/93-		R		700-008			Ø 180,0	
	91-		R		151-026		Bdx	Ø 22,00 180,0x30	RAI
1.9 TD Eng.160A6.000/ 160A6.048/ 160D1.000 (66kW)	9/90-4/95		R		153-067	153-067J	Bdx	228,6x42	Hand Brake
	90-		R		700-009			Ø 228,3	
	90-93		R		151-037		Bdx	Ø 17,50 228,0x40	RAI
	93-95		R		151-049		Bdx	Ø 20,64 228,0x40	RAI
1.9 TD Eng.160B6.046 (59kW)	3/92-6/93		R		153-067	153-067J	Bdx	228,6x42	Hand Brake
	92-		R		700-009			Ø 228,3	
	92-93		R		151-037		Bdx	Ø 17,50 228,0x40	RAI
	93-		R		151-049		Bdx	Ø 20,64 228,0x40	RAI
Ulysse I (220) 6/94-8/02									
1.8 Eng.LFW (73kW)	5/97-8/02		R			153-331K		180,0x31	Hand Brake
	5/97-8/02		R		153-331		Ate	180,0x31	Hand Brake
	5/97-8/02		R		153-074	153-074Y	Bdx	256,0x61	-ABS, Hand Brake
	97-		R		700-017			Ø 255,0	
	97-		R		151-066		Bdx	Ø 19,05 255,0x60	RAI
	1.9 TD Eng.DHX(XUD9TF-L) (66kW)	2/95-8/02		R			153-331K		180,0x31
2/95-8/02			R		153-331		Ate	180,0x31	Hand Brake
2/95-8/02			R		153-074	153-074Y	Bdx	256,0x61	Hand Brake
95-			R		700-017			Ø 255,0	
95-			R		151-066		Bdx	Ø 19,05 255,0x60	RAI
2.0 Eng.RFU(XU10J2C) (89kW)		6/94-8/02		R			153-331K		180,0x31
	6/94-8/02		R		153-331		Ate	180,0x31	Hand Brake
	6/94-8/02		R		153-074	153-074Y	Bdx	256,0x61	Hand Brake
	6/94-		R		700-017			Ø 255,0	
	94-		R		151-066		Bdx	Ø 19,05 255,0x60	RAI
	2.0 16v Eng.RFN(EW10J4) (100kW)	9/00-8/02		R			153-331K		180,0x31
9/00-8/02			R		153-331		Ate	180,0x31	Hand Brake
9/00-8/02			R		153-074	153-074Y	Bdx	256,0x61	Hand Brake
00-			R		700-017			Ø 255,0	-ABS
00-			R		151-066		Bdx	Ø 19,05 255,0x60	RAI
2.0 16v Eng.RFV(XU10J4R) (97kW)		5/98-9/00		R			153-331K		180,0x31
	5/98-9/00		R		153-331		Ate	180,0x31	Hand Brake
	5/98-9/00		R		153-074	153-074Y	Bdx	256,0x61	Hand Brake
	98-00		R		700-017			Ø 255,0	
	98-00		R		151-066		Bdx	Ø 19,05 255,0x60	RAI
	2.0 JTD Eng.RHW(DW10ATED4) (81kW)	00-02		R			153-331K		180,0x31
00-02			R		153-331		Ate	180,0x31	
00-02			R		700-017			Ø 255,0	-ABS
2.0 JTD Eng.RHZ(DW10ATED) (80kW)		10/99-8/02		R			153-331K		180,0x31
	10/99-8/02		R		153-331		Ate	180,0x31	Hand Brake
	99-		R		700-017			Ø 255,0	-ABS
	2.0 T. Eng.RGX(XU10J2CTE) (108kW)	6/94-8/02		R			153-331K		180,0x31
6/94-8/02			R		153-331		Ate	180,0x31	Hand Brake
6/94-			R		700-017			Ø 255,0	-ABS
2.1 TD Eng.P8C (80kW)		3/96-10/99		R			153-331K		180,0x31
	3/96-10/99		R		153-331		Ate	180,0x31	Hand Brake
	96-99		R		700-017			Ø 255,0	-ABS
	96-		R		151-066		Bdx	Ø 19,05 255,0x60	RAI, -ABS
Ulysse II (179AX) 8/02-									
2.0 JTD Eng.RHM(DW10ATED4) (79kW)	03-		R			153-331K		180,0x31	Hand Brake
	03-		R		153-331	153-331K	Ate	180,0x31	Hand Brake
2.0 JTD Eng.RHW(DW10ATED4) (80kW)	8/02-		R		153-331		Ate	180,0x31	Hand Brake
Uno (146A/E) 1/83-									
0.9 Eng.100GL.000 (30kW)	2/84-8/89		R		153-063		Fiat	185,0x31	Fitted Adjuster, Hand Brake
0.9 Eng.146A.000/ 146A1.000 (33kW)	3/83-9/92		R		153-063		Fiat	185,0x31	Fitted Adjuster, Hand Brake
	1/83-9/89		R		700-003			Ø 185,0	
1.0 45 Eng.146A2.166 (37kW)	6/86-12/93		R		153-063		Fiat	185,0x31	Fitted Adjuster, Hand Brake
1.0 45 Eng.156A2.100/ 156A2.048 (32kW)	6/86-12/93		R		153-063		Fiat	185,0x31	Fitted Adjuster, Hand Brake
	86-9/89		R		700-003			Ø 185,0	
1.0 45 i.e. Eng.156A2.246 (33kW)	4/84-12/96		R		153-063		Fiat	185,0x31	Fitted Adjuster, Hand Brake
	84-		R		700-003			Ø 185,0	
1.0 55 Eng.146B4.000 (41kW)	4/94-		R		153-069		Ap	185,0x31	Hand Brake
	94-		R		700-003			Ø 185,0	

		Spare Parts	F/R	L/R	CIFAM ref.	CIFAM ref. w/KIT		DIMENSIONS mm.	NOTE
1.1 Eng.146A4.044 (43kW)	1/83-9/89		R		153-063		Fiat	185,0x31	Fitted Adjuster, Hand Brake
			R		700-003			Ø 185,0	
1.1 Eng.156C.046 (37kW)	1/90-12/93		R		153-063		Fiat	185,0x31	Fitted Adjuster, Hand Brake
	90-93		R		700-003			Ø 185,0	
1.1 Eng.160A3.000 (42kW)	4/89-12/92		R		153-063		Fiat	185,0x31	Fitted Adjuster, Hand Brake
1.1 50 Eng.146A4.044 (37kW)	1/86-12/89		R		153-063		Fiat	185,0x31	Fitted Adjuster, Hand Brake
1.1 55 Eng.138B.000 (40kW)	1/83-8/89		R		153-063		Fiat	185,0x31	Fitted Adjuster, Hand Brake
	-9/89		R		700-003			Ø 185,0	
1.1 60 Eng.146A4.048 (43kW)	1/83-8/89		R		153-063		Fiat	185,0x31	Fitted Adjuster, Hand Brake
	-9/89		R		700-003			Ø 185,0	
1.1 CS Brasile Eng.M201GA11A (40kW)	1/83-1/86-93		R		153-063		Fiat	185,0x31	Fitted Adjuster, Hand Brake
			R		700-003			Ø 185,0	
1.1.i.e. 50 Eng.146C3.000 (36kW)	6/92-12/93		R		153-063		Fiat	185,0x31	Fitted Adjuster, Hand Brake
	92-93		R		700-003			Ø 185,0	
1.3 70 Eng.138B2.000 (50kW)	1/83-4/85		R		153-063		Fiat	185,0x31	Fitted Adjuster, Hand Brake
	83-85		R		700-003			Ø 185,0	
1.3 70 Eng.149A7.000 (48kW)	5/85-8/89		R		153-063		Fiat	185,0x31	Fitted Adjuster, Hand Brake
	85-89		R		700-003			Ø 185,0	
1.3 D Eng.127A5.000/ 146B1.000 (27-33kW)	-93		R		153-063		Fiat	185,0x31	Fitted Adjuster, Hand Brake
	93-		R		153-069		Ap	185,0x31	Hand Brake
	83-		R		700-003			Ø 185,0	
1.3 T. i.e. Eng.146A2.000 (77kW)	85-89		R		700-003			Ø 185,0	
1.3 T. i.e. Eng.146A2.146 (73kW)	1/87-12/87		R		700-003			Ø 185,0	
1.3 T. i.e. Eng.146A2.246 (74kW)	89-91		R		700-003			Ø 185,0	
1.4 (49kW)	12/97-8/00		R		153-069		Ap	185,0x31	Hand Brake
1.4 70 S Eng.160A1.048 (52kW)	9/89-10/92		R		153-063		Fiat	185,0x31	Fitted Adjuster, A/T, Hand Brake
	89-		R		700-003			Ø 185,0	
1.4 i.e. Eng.146C1.000 (53kW)	1/89-12/93		R		153-063		Fiat	185,0x31	Fitted Adjuster, A/T, Hand Brake
1.4 i.e. Eng.159A2.000 (57kW)	-91		R		153-063		Fiat	185,0x31	Fitted Adjuster, A/T, Hand Brake
	93-		R		153-069		Ap	185,0x31	Hand Brake
	89-		R		700-003			Ø 185,0	
1.4 i.e. Eng.160A1.046 (51kW)	9/89-12/93		R		153-063		Fiat	185,0x31	Fitted Adjuster, A/T, Hand Brake
	89-		R		700-003			Ø 185,0	
1.4 TD 70 Eng.146B.000/ 146B3.000 (52kW)	10/86-10/90		R		153-063		Fiat	185,0x31	Fitted Adjuster, Hand Brake
	86-90		R		700-003			Ø 185,0	
1.5 75 iE (56kW)	1/94-10/95		R		153-069		Ap	185,0x31	Hand Brake
1.5 i.e. 75 Eng.138C2.048/ 149C1.000 (55kW)	10/85-12/93		R		153-063		Fiat	185,0x31	Fitted Adjuster, Hand Brake
	85-93		R		700-003			Ø 185,0	
1.7 D Eng.146B2.000 (42kW)	1/93-12/92		R		153-069		Ap	185,0x31	Hand Brake
			R		153-063		Fiat	185,0x31	Fitted Adjuster, Hand Brake
	89-93		R		700-003			Ø 185,0	
1.7 D Eng.149B3.000 (44kW)	7/86-8/89		R		153-063		Fiat	185,0x31	Fitted Adjuster, Hand Brake
	86-89		R		700-003			Ø 185,0	
1.9 D Eng.149B5.046 (44kW)	9/89-3/94		R		153-063		Fiat	185,0x31	Fitted Adjuster, Hand Brake
	89-94		R		700-003			Ø 185,0	

FIAT LCV

























































238-Serie 9/66-6/82									
1.4 (34kW)	9/66-6/76		R		153-060		Fiat	250,0x51	Hand Brake
1.4 Eng.131A.000/ AZ (55kW)	1/70-12/76		R		153-060		Fiat	250,0x51	Hand Brake
1.4 Eng.131AZ.000/ 131BZ.0C0/ 131FZ (38kW)	6/76-6/82		R		153-060		Fiat	250,0x51	Hand Brake
Cinquecento Van 1/92-									
0.9 i Eng.A1.046 (29kW)	3/92-		R		700-003			Ø 185,0	
Doblo Cargo I-II (223) 3/01-12/09									
1.2 Eng.223A5.000 (48kW)	01-1/02		R		700-022			Ø 228,3	
	01-		R		151-152		Lucas	Ø 20,64 228,6x42	LUC
1.3 JTD Eng.188A9.000 (51kW)	04-		R		151-152		Lucas	Ø 20,64 228,6x42	LUC
1.3 MJT 16v Eng.199A2.000 (55kW)	05-		R		151-226		Ap	Ø 20,64 228,6x43	AP
1.3 MTJ (Germany) Eng.223A9.000 (62kW)	05-		R		151-226		Ap	Ø 20,64 228,6x43	AP
1.4 Eng.350A1.000 (57kW)	05-		R		151-226		Ap	Ø 20,64 228,6x43	AP
1.6 16v Eng.182B6.000 (76kW)	01-		R		700-022			Ø 228,3	
	01-		R		151-152		Lucas	Ø 20,64 228,6x42	LUC



























































		Spare Parts	F/R	L/R	CIFAM ref.	CIFAM ref. w/KIT		DIMENSIONS mm.	NOTE
1.9 D Eng.223A6.000 (46kW)	01-1/02		R		700-022			Ø 228,3	
	01-		R		151-152		Lucas	Ø 20,64 228,6x42	LUC
1.9 JTD Eng.182B9.000 (74kW)	01-1/02		R		700-022			Ø 228,3	
	01-		R		151-152		Lucas	Ø 20,64 228,6x42	LUC
1.9 JTD Eng.223A7.000 (77kW)	7/03-		R		151-152		Lucas	Ø 20,64 228,6x42	LUC
1.9 MJT Eng.186A9.000 (88kW)	05-		R		151-226		Ap	Ø 20,64 228,6x43	AP
1.9 MJT Eng.223B1.000 (77kW)	05-		R		151-226		Ap	Ø 20,64 228,6x43	AP
Doblo Cargo III (263) 2/10-									
1.3 MJT Eng.263A2.000 (66kW)	2/10-		R		153-487		Lockh.	254x57	
1.4 Eng.198A4.000 (88kW)	6/10-		R		153-487		Lockh.	254x57	
1.4 Eng.843A1.000 (70kW)	2/10-		R		153-487		Lockh.	254x57	
1.6 D MJ Eng.263A3.000 (74kW)	2/11-		R		153-487		Lockh.	254x57	
1.6 D MJT Eng.263A4.000 (66kW)	2/10-		R		153-487		Lockh.	254x57	
1.6 MJTD Eng.198A3.000 (77kW)	2/10-		R		153-487		Lockh.	254x57	
2.0 MJT Eng.263A1.000 (99kW)	2/10-		R		153-487		Lockh.	254x57	
Ducato I (280) 1/82-8/90									
1.8 Eng.169B(XM7T) (49-51kW)	1/82-10/88		R		153-062		Lucas	254,0x57	Hand Brake
	1/82-10/88		R		153-071		Lucas	254,0x57	Hand Brake
	82-88		R		700-016			Ø 254,0	18Q
	82-88		R		700-013			Ø 254,0	Exc. 18Q
	82-12/82		R		151-101		Lucas	Ø 22,22 254,0x57	LUC, 10-14Q
	-88		R		151-102		Lucas	Ø 25,40 254,0x57	LUC, 10-14Q
1.9 D Eng.149B1.000 (52kW)	2/87-8/90		R		153-062		Lucas	254,0x57	Hand Brake
	2/87-8/90		R		153-071		Lucas	254,0x57	Hand Brake
	87-90		R		700-016			Ø 254,0	18Q
	87-90		R		700-013			Ø 254,0	Exc. 18Q
	-90		R		151-102		Lucas	Ø 25,40 254,0x57	LUC, 10-14Q
	-90		R		151-065		Lucas	Ø 27,00 254,0x57	LUC, 18Q
1.9 TD Eng.280A1.000 (60kW)	3/89-8/90		R		153-068		Lucas	254,0x57	
	89-90		R		700-016			Ø 254,0	18Q
	89-90		R		700-013			Ø 254,0	Exc. 18Q
	-90		R		151-102		Lucas	Ø 25,40 254,0x57	LUC, 10-14Q
	-90		R		151-065		Lucas	Ø 27,00 254,0x57	LUC, 18Q
	2.0 Eng.170B (55kW)	1/86-8/90		R		153-062		Lucas	254,0x57
1/86-8/90			R		153-071		Lucas	254,0x57	Hand Brake
86-90			R		700-016			Ø 254,0	18Q
86-90			R		700-013			Ø 254,0	Exc. 18Q
-90			R		151-102		Lucas	Ø 25,40 254,0x57	LUC, 10-14Q
-90			R		151-065		Lucas	Ø 27,00 254,0x57	LUC, 18Q
2.0 Eng.170D (62kW)	9/88-8/90		R		153-062		Lucas	254,0x57	Hand Brake
	9/88-8/90		R		153-071		Lucas	254,0x57	Hand Brake
	88-90		R		700-016			Ø 254,0	18Q
	88-90		R		700-013			Ø 254,0	Exc. 18Q
	-90		R		151-102		Lucas	Ø 25,40 254,0x57	LUC, 10-14Q
	-90		R		151-065		Lucas	Ø 27,00 254,0x57	LUC, 18Q
2.0 Eng.XN1T (58kW)	7/82-8/90		R		153-062		Lucas	254,0x57	Hand Brake
	7/82-8/90		R		153-071		Lucas	254,0x57	Hand Brake
	82-90		R		700-016			Ø 254,0	18Q
	82-90		R		700-013			Ø 254,0	Exc. 18Q
	-90		R		151-102		Lucas	Ø 25,40 254,0x57	LUC, 10-14Q
	-90		R		151-065		Lucas	Ø 27,00 254,0x57	LUC, 18Q
2.4 D Eng.8144.61 (53kW)	82-90		R		700-016			Ø 254,0	18Q
	82-90		R		700-013			Ø 254,0	Exc. 18Q
	-90		R		151-102		Lucas	Ø 25,40 254,0x57	LUC, 10-14Q
	-90		R		151-065		Lucas	Ø 27,00 254,0x57	LUC, 18Q
2.5 CRD Eng.CRD93L(U25-661) (55kW)	7/82-8/90		R		153-068		Lucas	254,0x57	18Q
	7/82-8/90		R		153-062		Lucas	254,0x57	Exc. 18Q, Hand Brake
	7/82-8/90		R		153-071		Lucas	254,0x57	Exc. 18Q, Hand Brake
	82-90		R		700-016			Ø 254,0	18Q
	82-90		R		700-013			Ø 254,0	Exc. 18Q
	-90		R		151-102		Lucas	Ø 25,40 254,0x57	LUC, 10-14Q
2.5 D, 4WD Eng.8144.67 (55kW)	7/82-8/90		R		153-068		Lucas	254,0x57	18Q
	7/82-8/90		R		153-062		Lucas	254,0x57	Exc. 18Q, Hand Brake
	7/82-8/90		R		153-071		Lucas	254,0x57	Exc. 18Q, Hand Brake
	82-90		R		700-016			Ø 254,0	18Q
	82-90		R		700-013			Ø 254,0	Exc. 18Q

























		Spare Parts	F/R	L/R	CIFAM ref.	CIFAM ref. w/KIT		DIMENSIONS mm.	NOTE
2.5 D, 4WD Eng.8144.67 (55kW)	-90		R		151-102		Lucas	Ø 25,40 254,0x57	LUC, 10-14Q
			R		151-065		Lucas	Ø 27,00 254,0x57	LUC, 18Q
2.5 TD, 4WD Eng.8144.21 (68kW)	1/86-8/90		R		153-068		Lucas	254,0x57	18Q
	1/86-8/90		R		153-062		Lucas	254,0x57	Exc. 18Q, Hand Brake
	1/86-8/90		R		153-071		Lucas	254,0x57	Exc. 18Q, Hand Brake
	86-90		R		700-016			Ø 254,0	18Q
	86-90		R		700-013			Ø 254,0	Exc. 18Q
	-90		R		151-102		Lucas	Ø 25,40 254,0x57	LUC, 10-14Q
	-90		R		151-065		Lucas	Ø 27,00 254,0x57	LUC, 18Q
Ducato II (290) 3/89-3/94									
1.9 D Eng.149B1.000 (52kW)	7/90-3/94		R		153-062		Lucas	254,0x57	Hand Brake
	7/90-3/94		R		153-071		Lucas	254,0x57	Hand Brake
	90-94		R		700-016			Ø 254,0	18Q
	90-94		R		700-013			Ø 254,0	Exc. 18Q
	90-94		R		151-102		Lucas	Ø 25,40 254,0x57	LUC, 10-14Q
	90-94		R		151-065		Lucas	Ø 27,00 254,0x57	LUC, 18Q
1.9 TD Eng.280A1.000 (60kW)	3/89-3/94		R		153-071		Lucas	254,0x57	Hand Brake
	89-94		R		700-016			Ø 254,0	18Q
	89-94		R		700-013			Ø 254,0	Exc. 18Q
	89-94		R		151-102		Lucas	Ø 25,40 254,0x57	LUC, 10-14Q
	89-94		R		151-065		Lucas	Ø 27,00 254,0x57	LUC, 18Q
2.0 Eng.170D (62kW)	7/90-3/94		R		153-062		Lucas	254,0x57	Hand Brake
	7/90-3/94		R		153-071		Lucas	254,0x57	Hand Brake
	90-94		R		700-016			Ø 254,0	18Q
	90-94		R		700-013			Ø 254,0	Exc. 18Q
	90-94		R		151-102		Lucas	Ø 25,40 254,0x57	LUC, 10-14Q
	90-94		R		151-065		Lucas	Ø 27,00 254,0x57	LUC, 18Q
2.0 4WD Eng.170D (63kW)	6/90-5/94		R		153-062		Lucas	254,0x57	Hand Brake
	6/90-5/94		R		153-071		Lucas	254,0x57	Hand Brake
	90-94		R		700-016			Ø 254,0	18Q
	90-94		R		700-013			Ø 254,0	Exc. 18Q
	90-94		R		151-102		Lucas	Ø 25,40 254,0x57	LUC, 10-14Q
	90-94		R		151-065		Lucas	Ø 27,00 254,0x57	LUC, 18Q
2.5 D, 4WD Eng.8144.67 (55kW)	7/90-3/94		R		153-068		Lucas	254,0x57	18Q
	7/90-3/94		R		153-062		Lucas	254,0x57	Exc. 18Q, Hand Brake
	7/90-3/94		R		153-071		Lucas	254,0x57	Exc. 18Q, Hand Brake
	90-94		R		700-016			Ø 254,0	18Q
	90-94		R		700-013			Ø 254,0	Exc. 18Q
	90-94		R		151-102		Lucas	Ø 25,40 254,0x57	LUC, 10-14Q
	90-94		R		151-065		Lucas	Ø 27,00 254,0x57	LUC, 18Q
	2.5 TD, 4WD Eng.8140.27 (70kW)	7/90-3/94		R		153-068		Lucas	254,0x57
7/90-3/94		R			153-062		Lucas	254,0x57	Exc. 18Q, Hand Brake
7/90-3/94			R		153-071		Lucas	254,0x57	Exc. 18Q, Hand Brake
90-94			R		700-016			Ø 254,0	18Q
90-94			R		700-013			Ø 254,0	Exc. 18Q
90-94			R		151-102		Lucas	Ø 25,40 254,0x57	LUC, 10-14Q
90-94			R		151-065		Lucas	Ø 27,00 254,0x57	LUC, 18Q
Ducato III (230) 3/94-4/02									
1.9 D Eng.230A2.000 (51kW)	3/94-4/02		R		153-073		Lucas	254,0x57	18Q, Hand Brake
	3/94-4/02		R		153-072		Lucas	254,0x57	9-10-14Q, Hand Brake
	2/94-		R		700-013			Ø 254,0	10-14Q
	94-02		R		151-073		Lucas	Ø 25,40 254,0x57	LUC, 10-14Q
	94-02		R		151-074		Lucas	Ø 28,60 254,0x57	LUC, 18Q
1.9 D Eng.D9B/ DJY (50kW)	4/98-4/02		R		153-073		Lucas	254,0x57	18Q, Hand Brake
	4/98-4/02		R		153-072		Lucas	254,0x57	9-10-14Q, Hand Brake
	98-02		R		700-013			Ø 254,0	10-14Q
	98-02		R		700-016			Ø 254,0	18Q
	98-02		R		151-073		Lucas	Ø 25,40 254,0x57	LUC, 10-14Q
	98-02		R		151-074		Lucas	Ø 28,60 254,0x57	LUC, 18Q
1.9 D Eng.DHX (59kW)	5/98-11/01		R		153-073		Lucas	254,0x57	18Q, Hand Brake
5/98-11/01	R			153-072		Lucas	254,0x57	9-10-14Q, Hand Brake	
1.9 TD Eng.230A4.000 (59kW)	8/94-4/02		R		153-073		Lucas	254,0x57	18Q, Hand Brake
	8/94-4/02		R		153-072		Lucas	254,0x57	9-10-14Q, Hand Brake
	2/94-		R		700-013			Ø 254,0	10-14Q
	94-02		R		151-073		Lucas	Ø 25,40 254,0x57	LUC, 10-14Q
	94-02		R		151-074		Lucas	Ø 28,60 254,0x57	LUC, 18Q
1.9 TD Eng.DHX(XUD9TF-L) (66kW)	4/98-4/02		R		153-073		Lucas	254,0x57	18Q, Hand Brake
	4/98-4/02		R		153-072		Lucas	254,0x57	9-10-14Q, Hand Brake





		Spare Parts	F/R	L/R	CIFAM ref.	CIFAM ref. w/KIT		DIMENSIONS mm.	NOTE
1.9 TD Eng.DHX(XUD9TF-L) (66kW)	98-02		R		700-013			Ø 254,0	10-14Q
	98-02		R		700-016			Ø 254,0	18Q
	98-02		R		151-073		Lucas	Ø 25,40 254,0x57	LUC, 10-14Q
	98-02		R		151-074		Lucas	Ø 28,60 254,0x57	LUC, 18Q
1.9 TD Panorama Eng.230A3.000 (60kW)	3/94-4/02		R		153-073		Lucas	254,0x57	18Q, Hand Brake
	3/94-4/02		R		153-072		Lucas	254,0x57	9-10-14Q, Hand Brake
	2/94-		R		700-013			Ø 254,0	10-14Q
	94-02		R		151-073		Lucas	Ø 25,40 254,0x57	LUC, 10-14Q
	94-02		R		151-074		Lucas	Ø 28,60 254,0x57	LUC, 18Q
2.0 JTD Eng.RHV(DW10) (62kW)	01-02		R		700-013			Ø 254,0	10-14Q
	01-02		R		700-016			Ø 254,0	18Q
	01-02		R		151-073		Lucas	Ø 25,40 254,0x57	LUC, 10-14Q
	01-02		R		151-074		Lucas	Ø 28,60 254,0x57	LUC, 18Q
2.0i, 4WD Eng.RFW(XU10J2/ C) (80kW)	3/94-4/02		R		153-089	153-089K		170,0x45	4WD
	3/94-4/02		R		153-073		Lucas	254,0x57	18Q, Hand Brake
	3/94-4/02		R		153-072		Lucas	254,0x57	9-10-14Q, Hand Brake
	2/94-		R		700-013			Ø 254,0	10-14Q
	2/94-		R		700-016			Ø 254,0	18Q
	94-02		R		151-073		Lucas	Ø 25,40 254,0x57	LUC, 10-14Q
	94-02		R		151-074		Lucas	Ø 28,60 254,0x57	LUC, 18Q
2.5 D, 4WD Eng.8140.67 (62kW)	8/94-4/02		R		153-073		Lucas	254,0x57	18Q, Hand Brake
	8/94-4/02		R		153-072		Lucas	254,0x57	9-10-14Q, Hand Brake
	2/94-		R		700-013			Ø 254,0	10-14Q
	2/94-		R		700-016			Ø 254,0	18Q
	94-02		R		151-073		Lucas	Ø 25,40 254,0x57	LUC, 10-14Q
	94-02		R		151-074		Lucas	Ø 28,60 254,0x57	LUC, 18Q
2.5 TD, 4WD Eng.8140.47 (85kW)	94-98		R		153-072		Lucas	254,0x57	Hand Brake
	94-98		R		700-013			Ø 254,0	10-14Q
	94-98		R		700-016			Ø 254,0	18Q
	94-98		R		151-075		Lucas	Ø 27,00 254,0x57	LUC, 14Q
	94-98		R		151-074		Lucas	Ø 28,60 254,0x57	LUC, 18Q
	2.5 TDi Panorama Eng.8140.47R (80kW)	7/94-4/02		R		153-072		Lucas	254,0x57
94-02		R			700-013			Ø 254,0	10-14Q
94-02			R		700-016			Ø 254,0	18Q
94-02			R		151-075		Lucas	Ø 27,00 254,0x57	LUC, 14Q
94-02			R		151-074		Lucas	Ø 28,60 254,0x57	LUC, 18Q
2.5 TDi Panorama, 4WD Eng.8140.47 (85kW)	3/94-4/02		R		153-072		Lucas	254,0x57	Hand Brake
	2/94-		R		700-013			Ø 254,0	18Q
	2/94-		R		700-016			Ø 254,0	18Q
	94-02		R		151-075		Lucas	Ø 27,00 254,0x57	LUC, 14Q
	94-02		R		151-074		Lucas	Ø 28,60 254,0x57	LUC, 18Q
2.8 D, 4WD Eng.8140.63 (64kW)	2/98-4/02		R		153-089	153-089K		170,0x45	4WD
	2/98-4/02		R		153-073		Lucas	254,0x57	18Q, Hand Brake
	2/98-4/02		R		153-072		Lucas	254,0x57	9-10-14Q, Hand Brake
	98-02		R		700-013			Ø 254,0	14Q
	98-02		R		700-016			Ø 254,0	18Q
	98-02		R		151-073		Lucas	Ø 25,40 254,0x57	LUC, 10-14Q
	98-02		R		151-074		Lucas	Ø 28,60 254,0x57	LUC, 18Q
2.8 JTD, 4WD Eng.8140.43S (94kW)	11/00-4/02		R		153-089	153-089K		170,0x45	4WD
	11/00-4/02		R		153-073		Lucas	254,0x57	18Q, Hand Brake
	11/00-4/02		R		153-072		Lucas	254,0x57	9-10-14Q, Hand Brake
	00-02		R		700-013			Ø 254,0	14Q
	00-02		R		700-016			Ø 254,0	18Q
	00-02		R		151-073		Lucas	Ø 25,40 254,0x57	LUC, 10-14Q
00-02		R		151-074		Lucas	Ø 28,60 254,0x57	LUC, 18Q	
2.8 TDi, 4WD Eng.8140.43 (90kW)	10/97-4/02		R		153-089	153-089K		170,0x45	4WD
	10/97-4/02		R		153-073		Lucas	254,0x57	18Q, Hand Brake
	10/97-4/02		R		153-072		Lucas	254,0x57	9-10-14Q, Hand Brake
	97-02		R		700-013			Ø 254,0	14Q
	97-02		R		700-016			Ø 254,0	18Q
	97-02		R		151-073		Lucas	Ø 25,40 254,0x57	LUC, 10-14Q
	97-02		R		151-074		Lucas	Ø 28,60 254,0x57	LUC, 18Q
Ducato IV (244, Z) 4/02-1/06									
2.0 JTD Eng.RHV(DW10) (62kW)	4/02-1/06		R		153-089	153-089K		170,0x45	
	4/02-1/06		R		153-082		Ap	254,0x57	
	4/02-1/06		R		153-073		Lucas	254,0x57	Hand Brake
	02-06		R		151-074		Lucas	Ø 28,60 254,0x57	LUC, 18Q































		Spare Parts	F/R	L/R	CIFAM ref.	CIFAM ref. w/KIT		DIMENSIONS mm.	NOTE
2.0, Bipower Eng.RFL(XU10J2U) (81kW)	4/02-1/06		R		153-089	153-089K		170,0x45	
			R		153-082		Ap	254,0x57	
2.3 JTD Eng.F1AE0481C (81kW)	4/02-1/06		R		153-089	153-089K		170,0x45	
	4/02-1/06		R		153-082		Ap	254,0x57	
	4/02-1/06		R		153-073		Lucas	254,0x57	Hand Brake
2.8 JTD Power Eng.8140.43N (107kW)	5/04-1/06		R		153-089	153-089K		170,0x45	
	5/04-1/06		R		153-082		Ap	254,0x57	
2.8 JTD, 4WD Eng.8140.43S (94kW)	4/02-1/06		R		153-089	153-089K		170,0x45	
	4/02-1/06		R		153-082		Ap	254,0x57	
Ducato V (250,251) 2/06-									
100 MJT Eng.4HV (74kW)	2/06-		R		153-094			172,0x40	
	2/06-		R			153-095K		172,0x40	
120 MJT Eng.F1AE0481D (88kW)	2/06-		R		153-094			172,0x40	
	2/06-		R			153-095K		172,0x40	
130 MJT Eng.F1AE0481N (96kW)	2/06-		R		153-094			172,0x40	
	2/06-		R			153-095K		172,0x40	
160 MJT Eng.F1CE0481D (117kW)	2/06-		R		153-094			172,0x40	
	2/06-		R			153-095K		172,0x40	
3.0 Nat. Power Eng.F1CE0441A (100kW)	10/09-		R		153-094			172,0x40	
	10/09-		R			153-095K		172,0x40	
Fiorino I (127) 10/77-12/87									
0.8 (28kW)	7/78-2/82		R		153-063		Fiat	185,0x31	Fitted Adjuster, Hand Brake
	78-81		R		700-003			Ø 185,0	
0.9 Eng.100GL.000 (33kW)	10/77-12/84		R		153-063		Fiat	185,0x31	Fitted Adjuster, Hand Brake
	77-84		R		700-003			Ø 185,0	
1.0 Eng.127A.000/ B (37kW)	1/80-12/87		R		153-063		Fiat	185,0x31	Fitted Adjuster, Hand Brake
	80-87		R		700-003			Ø 185,0	
1.3 D, Panorama Eng.127A5.000/ 146B1 (33kW)	4/81-12/86		R		153-063		Fiat	185,0x31	Fitted Adjuster, Hand Brake
	81-86		R		700-003			Ø 185,0	
Fiorino II (147) 1/86-12/93									
1.0 Eng.127A.000 (37kW)	1/80-12/87		R		153-063		Fiat	185,0x31	Fitted Adjuster, Hand Brake
1.0, Pick up Eng.156A.000 (41kW)	12/86-4/88		R		153-063		Fiat	185,0x31	Fitted Adjuster, Hand Brake
	86-88		R		700-003			Ø 185,0	
1.1 60 Eng.146A9.000 (40kW)	11/86-12/93		R		153-063		Fiat	185,0x31	Fitted Adjuster, Hand Brake
	86-93		R		700-003			Ø 185,0	
1.3 Eng.146A5.000 (49kW)	12/87-8/93		R		153-063		Fiat	185,0x31	Fitted Adjuster, Hand Brake
	87-93		R		700-003			Ø 185,0	
1.3 D Eng.127A5.000 (33kW)	1/86-12/88		R		153-063		Fiat	185,0x31	Fitted Adjuster, Hand Brake
1.5 i.e. 75 Eng.149C1.000 (55kW)	1/88-8/93		R		153-063		Fiat	185,0x31	Fitted Adjuster, Hand Brake
	88-93		R		700-003			Ø 185,0	
1.7 D Eng.149B2.000 (42kW)	1/88-8/93		R		153-063		Fiat	185,0x31	Fitted Adjuster, Hand Brake
	88-93		R		700-003			Ø 185,0	
1.7 D Eng.149B3.000 (44kW)	12/87-12/90		R		153-063		Fiat	185,0x31	Fitted Adjuster, Hand Brake
	87-90		R		700-003			Ø 185,0	
Fiorino III (146) 1/93-12/06									
1.3 (43kW)	6/94-9/98		R		153-067	153-067J	Bdx	228,6x42	Hand Brake
1.3 Eng.146A5.000 (49kW)	10/93-12/94		R		153-067	153-067J	Bdx	228,6x42	Hand Brake
	93-		R		700-009			Ø 228,3	
	93-		R		151-055		Bdx	Ø 20,64 228,0x40	RAI
1.4 i.e., Pick-up Eng.146C5.000/ 146D5.000 (49kW)	1/93-12/06		R		153-075		Ap	228,6x42	
	1/93-12/06		R		153-087		Bdx	228,6x42	
	92-		R		700-009			Ø 228,3	
1.6 i.e., Pick up Eng.146C6.000/ 146D6.000 (55kW)	10/93-12/06		R		153-075		Bdx	Ø 20,64 228,0x40	RAI
	10/93-12/06		R		153-067	153-067J	Bdx	228,6x42	Box Type Car, Hand Brake
	10/93-12/06		R		153-087		Bdx	228,6x42	Pick up
1.7 D Eng.146B2.000 (42kW)	93-		R		700-009			Ø 228,3	
	93-		R		151-055		Bdx	Ø 20,64 228,0x40	RAI
	10/93-12/06		R		153-075		Ap	228,6x42	
1.7 D Eng.146B3.000 (44kW)	10/93-12/06		R		153-067	153-067J	Bdx	228,6x42	Box Type Car, Hand Brake
	10/93-12/06		R		153-087		Bdx	228,6x42	Pick up
	93-		R		700-009			Ø 228,3	
1.7 TD, Pick up Eng.146D7.000 (46kW)	1/97-12/06		R		151-055		Bdx	Ø 20,64 228,0x40	RAI
	97-		R		153-087		Bdx	228,6x42	
								Ø 228,3	





























































		Spare Parts	F/R	L/R	CIFAM ref.	CIFAM ref. w/KIT		DIMENSIONS mm.	NOTE
Fiorino IV (225) 1/07-									
1.3 MJT 16v Eng.199A2.000 (55kW)	1/07-		R		153-099		Ap	228,6x43	Hand Brake
	07-		R		151-227		Ap	Ø 20,64 228,6x43	AP
1.4 Eng.KFV (54kW)	1/07-		R		153-099		Ap	228,6x43	Hand Brake
	07-		R		151-227		Ap	Ø 20,64 228,6x43	AP
Idea Van 1/04-									
1.3 MJT Eng.188A9.000 (51kW)	04-		R		700-019			Ø 203,2	
1.3 MJT Eng.199A3.000 (66kW)	05-		R		700-022			Ø 228,3	
1.4 Eng.192B2.000 (66kW)	03-		R		700-019			Ø 203,2	
	03-3/04		R		151-220		Ap	Ø 22,00 203,2x39	AP
	3/04-6/05		R		151-219		Ap	Ø 22,00 203,0x38	AP
1.4 16v Eng.843A1.000 (70kW)	1/04-		R		700-019			Ø 203,2	
1.9 JTD Eng.188B2.000 (74kW)	04-		R		700-022			Ø 228,3	
Marengo 1/83-									
Tempra 1.9 D Eng.160A7.000 (48kW)	90-93		R		700-009			Ø 228,3	
Tempra 1.9 TD Eng.160A6.000/ 160D1.000 (66kW)	90-93		R		700-009			Ø 228,3	
Multipla Van 4/99-									
1.6 16v Eng.182B6.000 (76kW)	4/99-02		R		700-022			Ø 228,3	
	4/99-		R		151-090		Bdx	Ø 20,64 228,0x40	RAI
1.9 JTD Eng.186A8.000 (85kW)	02-		R		700-022			Ø 228,3	
1.9 JTD Eng.186A9.000 (88kW)	04-		R		700-022			Ø 228,3	
Panda Van I (141A) 1/86-8/98									
0.75 Eng.141B.000 (25kW)	1/86-1/95		R		153-063		Fiat	185,0x31	Fitted Adjuster, Hand Brake
	86-95		R		700-003			Ø 185,0	
1.0 i.e. Kat, 4WD Eng.141C2.000/ 156A2.246 (33kW)	87-98		R		700-003			Ø 185,0	
1.0, 4WD Eng.156A2.100/ 156A3.100 (32kW)	86-92		R		700-003			Ø 185,0	
1.3 D Eng.156A5.000 (27kW)	86-92		R		700-003			Ø 185,0	
Panda Van II (271) 9/03-									
1.1 Eng.187A1.000 (40kW)	03-		R		700-011			Ø 180,0	
	03-		R		151-181		Ap	Ø 20,64 180,0x32	RAD, -ABS
1.2 Eng.188A4.000 (38kW)	03-		R		700-011			Ø 180,0	
	03-		R		151-181		Ap	Ø 20,64 180,0x32	RAD, -ABS
1.2, 4WD Eng.188A4.000 (44kW)	03-		R		700-011			Ø 180,0	
	03-		R		151-181		Ap	Ø 20,64 180,0x32	RAD, -ABS
1.3 JTD Eng.169A1.000 (55kW)	06-		R		700-011			Ø 180,0	
	06-		R		151-181		Ap	Ø 20,64 180,0x32	RAD, -ABS
1.3 JTD Eng.188A9.000 (51kW)	9/03-		R		700-011			Ø 180,0	
	03-		R		151-181		Ap	Ø 20,64 180,0x32	RAD, -ABS
Punto Van I (176L) 4/96-2/00									
1.1 Eng.176B2.000 (40kW)	96-00		R		700-011			Ø 180,0	
1.7 D Eng.176B3.000 (42kW)	96-00		R		700-011			Ø 180,0	
1.7 TD Eng.176A5.000 (52kW)	96-00		R		700-011			Ø 180,0	
Punto Van II (188AX) 2/00-8/05									
1.2 Eng.188A4.000 (44kW)	2/00-		R		153-080	153-080Y	Ap	180,0x32	+ABS, Hand Brake
	2/00-		R		153-079	153-079Y	Ap	180,0x32	-ABS
	00-		R		700-011			Ø 180,0	
	2/00-6/03		R		151-145		Ap	Ø 20,64 180,0x30	RAD, -ABS
1.3 JTD Eng.188A9.000 (51kW)	03-05		R		700-011			Ø 180,0	
1.9 DS 60 Eng.188A3.000 (44kW)	2/00-		R		153-080	153-080Y	Ap	180,0x32	+ABS, Hand Brake
	2/00-		R		153-079	153-079Y	Ap	180,0x32	-ABS
	00-		R		700-011			Ø 180,0	
1.9 JTD Eng.188A7.000 (63kW)	2/00-		R		153-080	153-080Y	Ap	180,0x32	+ABS, Hand Brake
	2/00-		R		153-079	153-079Y	Ap	180,0x32	-ABS
	00-		R		700-011			Ø 180,0	
Qubo IV (300) 1/08-									
1.3 JTD Eng.199A2.000 (55kW)	08-		R		153-099		Ap	228,6x43	Hand Brake
	08-		R		151-227		Ap	Ø 20,64 228,6x43	AP
1.4 Eng.350A1.000 (57kW)	09-		R		153-099		Ap	228,6x43	
	09-		R		151-227		Ap	Ø 20,64 228,6x43	AP
1.4 Eng.KFV (54kW)	08-		R		153-099		Ap	228,6x43	Hand Brake
	08-		R		151-227		Ap	Ø 20,64 228,6x43	AP
Scudo I (220L) 2/96-12/06									
1.6 Eng.220A2.000 (58kW)	2/96-12/06		R		153-074	153-074Y	Bdx	256,0x61	Hand Brake
	96-		R		700-017			Ø 255,0	



























		Spare Parts	F/R	L/R	CIFAM ref.	CIFAM ref. w/KIT		DIMENSIONS mm.	NOTE
1.6 Eng.220A2.000 (58kW)	96-		R		151-066		Bdx	Ø 19,05 255,0x60	RAI
1.9 D Eng.D9B/ D8A/ U (51kW)	2/96-12/06		R		153-074	153-074Y	Bdx	256,0x61	Hand Brake
	96-		R		700-017			Ø 255,0	
	96-		R		151-066		Bdx	Ø 19,05 255,0x60	RAI
1.9 D Eng.WJZ(DW8) (51kW)	4/98-12/06		R		153-074	153-074Y	Bdx	256,0x61	Hand Brake
	98-		R		700-017			Ø 255,0	
	98-		R		151-066		Bdx	Ø 19,05 255,0x60	RAI
1.9 TD Eng.D8B (68kW)	2/98-12/06		R		153-074	153-074Y	Bdx	256,0x61	Hand Brake
	98-		R		700-017			Ø 255,0	
	98-		R		151-066		Bdx	Ø 19,05 255,0x60	RAI
1.9 TD Eng.DHX(XUD9TF-L) (66kW)	2/96-12/06		R		153-074	153-074Y	Bdx	256,0x61	Hand Brake
	96-		R		700-017			Ø 255,0	
	96-		R		151-066		Bdx	Ø 19,05 255,0x60	RAI
2.0 Eng.RFN(EW10J4) (100kW)	9/02-12/06		R		153-074	153-074Y	Bdx	256,0x61	Hand Brake
	02-		R		151-066		Bdx	Ø 19,05 255,0x60	RAI
2.0 JTD Eng.RHX (69kW)	12/99-12/06		R		153-074	153-074Y	Bdx	256,0x61	Hand Brake
	99-		R		700-017			Ø 255,0	
2.0 JTD Eng.RHZ(DW10ATED)/RHW(DW10ATED4) (80kW)	12/02-12/06		R		153-074	153-074Y	Bdx	256,0x61	Hand Brake
	02-		R		700-017			Ø 255,0	
Scudo II (272) 1/07-									
1.6 JTD Eng.DV6UTED4 (66kW)	1/07-		R		153-073		Lucas	254,0x57	Hand Brake
	07-		R		151-169		Lucas	Ø 22,20 254,0x57	LUC
2.0 JTD Eng.RHR(DW10BTED4) (100kW)	07-		R		151-169		Lucas	Ø 22,20 254,0x57	LUC
2.0 JTD, 4WD Eng.RHK(DW10UTED4) (88kW)	07-		R		151-169		Lucas	Ø 22,20 254,0x57	LUC
Seicento Van 1/98-									
0.9 i Eng.1170A1.046 (29kW)	4/98-		R		700-024			Ø 185,0	
1.1 i Eng.176B2.000/187A1.000 (40kW)	4/98-		R		700-024			Ø 185,0	
Strada I (178E) 6/99-1/05									
1.2 Eng.188A4.000 (44kW)	4/03-1/05		R		153-087		Bdx	228,6x42	
	4/03-1/05		R		153-067	153-067J	Bdx	228,6x42	Hand Brake
	03-05		R		151-232		Bdx	Ø 19,05 228,6x42	RAI
1.2 16v Eng.178B5.000 (54kW)	6/99-1/05		R		153-087		Bdx	228,6x42	
	99-05		R		151-232		Bdx	Ø 19,05 228,6x42	RAI
1.7 TD Eng.176A3.000 (51kW)	6/99-1/05		R		153-087		Bdx	228,6x42	
	6/99-1/05		R		153-067	153-067J	Bdx	228,6x42	TDs, Hand Brake
	99-05		R		151-232		Bdx	Ø 19,05 228,6x42	RAI
1.9 D Eng.223A6.000 (46kW)	00-05		R		153-075		Ap	228,6x42	Trekking
	00-05		R		153-087		Bdx	228,6x42	
	00-05		R		151-232		Bdx	Ø 19,05 228,6x42	RAI
Strada II (178EXG) 2/05-									
1.2 8v MPI Eng.178B7.045 (44kW)	05-		R		151-232		Bdx	Ø 19,05 228,6x42	RAI
1.2 Trekking Eng.182B2.000 (60kW)	11/05-		R		153-075		Ap	228,6x42	
1.3 MJT (Germany) Eng.223A9.000 (63kW)	2/05-		R		153-087		Bdx	228,6x42	
	05-		R		151-232		Bdx	Ø 19,05 228,6x42	RAI
1.7 TD Eng.176A3.000 (51kW)	05-		R		151-232		Bdx	Ø 19,05 228,6x42	RAI
Talento (290) 3/89-3/94									
1.9 D Eng.149B1.000 (52kW)	3/89-3/94		R		153-062		Lucas	254,0x57	Hand Brake
	9/89-94		R		700-013			Ø 254,0	
	89-94		R		151-103		Lucas	Ø 22,22 254,0x57	LUC
2.0 Eng.170B (55kW)	3/89-3/94		R		153-062		Lucas	254,0x57	Hand Brake
	9/89-94		R		700-013			Ø 254,0	
	89-94		R		151-103		Lucas	Ø 22,22 254,0x57	LUC
Uno Van 1/83-10/95									
1.0 Eng.156A2.000 (32kW)	90-95		R		700-003			Ø 185,0	
1.3 D Eng.146B1.000 (33kW)	-93		R		153-063		Fiat	185,0x31	Fitted Adjuster, Hand Brake
	93-		R		153-069		Ap	185,0x31	Hand Brake
	83-		R		700-003			Ø 185,0	
1.4 TD Eng.146B3.000 (52kW)	86-90		R		700-003			Ø 185,0	
1.7 D Eng.146B2.000 (42kW)	9/89-12/93		R		153-063		Fiat	185,0x31	Fitted Adjuster, Hand Brake
	89-93		R		700-003			Ø 185,0	
1.7 D Eng.149B3.000 (44kW)	1/90-1/95		R		153-069		Ap	185,0x31	Hand Brake
	90-95		R		700-003			Ø 185,0	











































		Spare Parts	F/R	L/R	CIFAM ref.	CIFAM ref. w/KIT		DIMENSIONS mm.	NOTE
Anglia 1/59-1/67									
1.2 Eng.HMDA (34-35kW)	1/59-1/67		R		153-101		Lucas	203,2x38	Hand Brake
Capri I (ECJ) 12/68-2/74									
1.3 Eng.K13L (35-37-39-48-53kW)	68-72		R		700-268			Ø 203,0	
1.6 Eng.LE (53-65kW)	72-74		R		700-268			Ø 203,0	
Capri II (GCEP) 2/74-12/77									
1.3 Eng.J1E (37kW)	2/74-8/77		R		153-103		Lucas	203,2x38	Hand Brake
	2/74-8/77		R		153-104		Lucas	228,6x45	
	11/74-12/77		R		700-268			Ø 203,0	
1.3 Eng.J1E/ K13L (40-42kW)	2/74-8/77		R		153-103		Lucas	203,2x38	Hand Brake
	2/74-8/77		R		153-104		Lucas	228,6x45	
	74-77		R		700-277			Ø 228,6	
1.6 Eng.LAC (50kW)	9/74-12/77		R		153-104		Lucas	228,6x45	
1.6 Eng.LCE (53kW)	2/74-12/77		R		153-104		Lucas	228,6x45	
	74-77		R		700-277			Ø 228,6	
1.6 Eng.LEC (65kW)	2/74-12/77		R		153-104		Lucas	228,6x45	
2.0 Eng.NYL/ NWN/ TL20H (66-72kW)	4/74-12/77		R		153-104		Lucas	228,6x45	
	74-77		R		700-277			Ø 228,6	
2.3 Eng.YYE/ TV23 (79kW)	2/74-12/77		R		153-104		Lucas	228,6x45	
	74-77		R		700-277			Ø 228,6	
3.0 Eng.HYF/ EV30H (101kW)	74-77		R		700-277			Ø 228,6	
Capri III (GCEP) 1/78-4/87									
1.3 Eng.J1E/ K13L (40kW)	1/78-6/85		R		153-103		Lucas	203,2x38	Hand Brake
	78-81		R		700-268			Ø 203,0	
1.6 Eng.LCN (49-52-54kW)	1/78-4/87		R		153-104		Lucas	228,6x45	
	78-87		R		700-277			Ø 228,6	
2.0 Eng.NEN/ TL20H/ NYL (64-66-74kW)	1/78-12/85		R		153-104		Lucas	228,6x45	
	78-85		R		700-277			Ø 228,6	
2.3 Super Eng.YYN (84kW)	6/79-12/85		R		153-104		Lucas	228,6x45	
2.8 i T. Eng.TV28 (138-150kW)	82-87		R		700-272			Ø 228,6	
2.8 Super Inj. Eng.PRN/ TV28 (118kW)	81-87		R		700-272			Ø 228,6	
3.0 Eng.EV30H (101kW)	78-81		R		700-272			Ø 228,6	
Consul (GGCL,FL,NL) 1/72-12/75									
1.7, Coupe, SW Eng.17M/ EV17L (48-51-55kW)	1/72-12/75		R		153-100		Lucas	254,0x57	Hand Brake
2.0 Eng.2602E/ 2724E/ 3006E/ 3010E (60-66kW)	1/72-12/75		R		153-100		Lucas	254,0x57	Hand Brake
2.0, Coupe, SW Eng.TL20H (73kW)	1/72-12/75		R		153-100		Lucas	254,0x57	Hand Brake
2.3, Coupe, SW Eng.YYE/ TV23 (79kW)	1/72-12/75		R		153-100		Lucas	254,0x57	Hand Brake
3.0 Eng.EV30H (101kW)	1/72-12/74		R		153-100		Lucas	254,0x57	Hand Brake
Cortina 10/62-3/72									
1.2, Coupe, Estate Eng.HMDA (34-35kW)	10/62-9/66		R		153-101		Lucas	203,2x38	Hand Brake
	62-66		R		700-268			Ø 203,0	
1.3, Coupe, Estate Eng.K13L (35-37-40-42kW)	66-72		R		700-268			Ø 203,0	
	8/71-72		R		700-277			Ø 228,6	
1.5 GT, Coupe, Estate (56kW)	10/62-9/66		R		153-101		Lucas	203,2x38	Hand Brake
	62-66		R		700-268			Ø 203,0	
1.5, Coupe, Estate (43kW)	10/62-9/66		R		153-101		Lucas	203,2x38	Hand Brake
1.6, Coupe, Estate Eng.TL16L (45-50-51kW)	67-72		R		700-268			Ø 203,0	
2.0, Coupe, Estate (72kW)	70-72		R		700-277			Ø 228,6	GT, GLX
2.3 (83kW)	62-72		R		700-277			Ø 228,6	GT, GLX
Escort I (AFH,ATH) 1/68-2/76									
0.95 Eng.KL09H(711M) (25-26kW)	8/68-8/74		R		153-101		Lucas	203,2x38	Hand Brake
1.1 Eng.G1/ KL11L/ H(751M) (33kW)	6/68-6/71		R		153-101		Lucas	203,2x38	Hand Brake
1.1, SW Eng.G1/ KL11L/ H(751M) (29-32kW)	1/68-2/76		R		153-101		Lucas	203,2x38	Hand Brake
	68-74		R		700-268			Ø 203,0	
1.1, SW Eng.G2/ KL11L/ H(751M) (35kW)	6/70-2/76		R		153-101		Lucas	203,2x38	Hand Brake
	70-76		R		700-268			Ø 203,0	
1.3 Eng.J1F/ K13L (40kW)	9/73-2/76		R		153-101		Lucas	203,2x38	Hand Brake
	73-76		R		700-268			Ø 203,0	
1.3 Eng.J3D (53kW)	6/70-2/76		R		153-101		Lucas	203,2x38	Hand Brake



		Spare Parts	F/R	L/R	CIFAM ref.	CIFAM ref. w/KIT		DIMENSIONS mm.	NOTE
1.3 Eng.K13L (35-38kW)	6/68-6/71		R		153-101		Lucas	203,2x38	Hand Brake
	68-71		R		700-268			Ø 203,0	
1.3 GT Eng.KL13H (47kW)	6/68-6/71		R		153-104		Lucas	228,6x45	
	68-71		R		700-268			Ø 203,0	
1.3, SW Eng.J2/ K13L (42kW)	6/70-2/76		R		153-101		Lucas	203,2x38	Hand Brake
Escort II (ATH) 3/73-7/81									
1.1 Eng.G2/ KL11L/ H(751M) (35kW)	12/74-8/80		R		153-103		Lucas	203,2x38	Hand Brake
	12/74-8/80		R		153-106		Lucas	203,2x38	Spain
	75-80		R		700-268			Ø 203,0	
1.1, SW Eng.G1/ KL11L/ H(751M) (32-34kW)	12/74-8/80		R		153-103		Lucas	203,2x38	Hand Brake
	12/74-8/80		R		153-106		Lucas	203,2x38	Spain
	75-80		R		700-268			Ø 203,0	
1.3 Eng.J3/ KL13H (51kW)	12/74-8/80		R		153-103		Lucas	203,2x38	Hand Brake
	12/74-8/80		R		153-106		Lucas	203,2x38	Spain
	12/74-8/80		R		153-104		Lucas	228,6x45	Sport
	75-1/76		R		700-268			Ø 203,0	
	75-80		R		700-277			Ø 228,6	
1.3, SW Eng.J1F/ K13L (40kW)	12/74-7/81		R		153-103		Lucas	203,2x38	Hand Brake
	12/74-7/81		R		153-106		Lucas	203,2x38	Spain
	12/74-7/81		R		153-104		Lucas	228,6x45	Sport
	75-1/76		R		700-268			Ø 203,0	
	75-80		R		700-277			Ø 228,6	
1.3, SW Eng.J2/ K13L (42-44kW)	12/74-8/80		R		153-103		Lucas	203,2x38	Hand Brake
	12/74-8/80		R		153-106		Lucas	203,2x38	Spain
	12/74-8/80		R		153-104		Lucas	228,6x45	Sport
1.6 Eng.LC (62kW)	12/74-8/80		R		153-104		Lucas	228,6x45	
	75-80		R		700-277			Ø 228,6	
1.6 Sport Eng.L3E/ KL16G(751M) (63kW)	12/74-8/77		R		153-104		Lucas	228,6x45	
	75-77		R		700-277			Ø 228,6	
1.8 RS Eng.KL18S (92kW)	3/75-8/77		R		153-104		Lucas	228,6x45	
	75-77		R		700-277			Ø 228,6	
2.0 RS Eng.TL20H (73kW)	-5/73		R		153-101		Lucas	203,2x38	Hand Brake
	74-		R		153-104		Lucas	228,6x45	
2.0 RS Heckantrieb Eng.NE (80kW)	8/75-8/80		R		153-104		Lucas	228,6x45	
	75-80		R		700-277			Ø 228,6	
Escort III (GAA) 9/80-7/86									
1.1 Eng.GPA/ GMA/ GLB/ GLA/ GLW (43kW)	9/80-8/83		R		153-105		Lucas	180,0x32	
	9/80-8/83		R		153-113		Lucas	180,0x32	
	9/80-8/83		R		153-106		Lucas	203,2x38	
	8/80-83		R		700-270	700-270K		Ø 180,0	
1.1, SW Eng.GMA/ GPA/ GLB/ GLA/ GLW (40kW)	9/80-8/83		R		153-105		Lucas	180,0x32	
	9/80-8/83		R		153-113		Lucas	180,0x32	
	9/80-8/83		R		153-106		Lucas	203,2x38	
	8/80-83		R		700-270	700-270K		Ø 180,0	
1.1, SW Eng.GSB/ C/ E/ F/ G/ H (37kW)	8/83-12/85		R		153-105		Lucas	180,0x32	
	8/83-12/85		R		153-113		Lucas	180,0x32	
	8/83-12/85		R		153-106		Lucas	203,2x38	
	83-85		R		700-270	700-270K		Ø 180,0	
1.3 Eng.JGA (43kW)	1/84-12/85		R		153-105		Lucas	180,0x32	
	1/84-12/85		R		153-113		Lucas	180,0x32	
	1/84-12/85		R		153-106		Lucas	203,2x38	
1.3, SW, Cabrio Eng.JPA/ C (51kW)	9/80-12/85		R		153-105		Lucas	180,0x32	
	9/80-12/85		R		153-113		Lucas	180,0x32	
	9/80-12/85		R		153-106		Lucas	203,2x38	
	8/80-85		R		700-270	700-270K		Ø 180,0	
1.6 Eng.CHT1600 (48kW)	5/83-7/86		R		153-105		Lucas	180,0x32	
	5/83-7/86		R		153-106		Lucas	203,2x38	
1.6 Eng.LP1/ LP2/ LUA/ B/ C/ D/ H (71kW)	9/80-10/82		R		153-105		Lucas	180,0x32	
	9/80-10/82		R		153-106		Lucas	203,2x38	
	80-82		R		700-270	700-270K		Ø 180,0	
1.6 D, SW Eng.LTA/ B/ C (40kW)	2/84-12/85		R		153-105		Lucas	180,0x32	
	84-85		R		700-270	700-270K		Ø 180,0	
1.6 i Eng.L4B (66kW)	7/85-12/85		R		153-105		Lucas	180,0x32	
	7/85-12/85		R		153-106		Lucas	203,2x38	
	7/85-12/85		R		700-270	700-270K		Ø 180,0	
1.6 T. RS Eng.LHA/ LNA/ B (97kW)	11/84-12/85		R		153-105		Lucas	180,0x32	
	11/84-12/85		R		153-106		Lucas	203,2x38	
	84-85		R		700-277			Ø 228,6	





























		Spare Parts	F/R	L/R	CIFAM ref.	CIFAM ref. w/KIT		DIMENSIONS mm.	NOTE
1.6, SW, Cabrio Eng.LP1/ LP2/ LUA/ B/ C/ D/ H (58kW)	9/80-12/85		R		153-105		Lucas	180,0x32	
	9/80-12/85		R		153-106		Lucas	203,2x38	
	8/80-85		R		700-270	700-270K		Ø 180,0	
1.6i RS Eng.LR1/ LRA/ B (85kW)	5/82-12/85		R		153-105		Lucas	180,0x32	
	5/82-12/85		R		153-106		Lucas	203,2x38	
	82-85		R		700-270	700-270K		Ø 180,0	
1.6i XR3i, Cabrio Eng.LR1/ LRA/ B (77kW)	10/82-12/85		R		153-105		Lucas	180,0x32	
	10/82-12/85		R		153-106		Lucas	203,2x38	
	10/82-1/84		R		700-270	700-270K		Ø 180,0	
	2/84-85		R		700-277			Ø 228,6	
Escort IV (GAF,AWF,ABFT) 10/85-10/90									
1.1, SW Eng.GSB/ C/ E/ F/ G/ H (37-40kW)	12/85-7/90		R		153-105		Lucas	180,0x32	
	12/85-7/90		R		153-113		Lucas	180,0x32	
	12/85-7/90		R		153-106		Lucas	203,2x38	
	85-90		R		700-270	700-270K		Ø 180,0	
1.3 Eng.JBA (46kW)	7/88-10/90		R		153-105		Lucas	180,0x32	
	7/88-10/90		R		153-113		Lucas	180,0x32	
	7/88-10/90	R		153-106		Lucas	203,2x38		
	-7/88		R		700-270	700-270K		Ø 180,0	
	8/88-90		R		700-268			Ø 203,0	
1.3, SW Eng.JLA/ B/ JBB (44kW)	1/86-7/90		R		153-105		Lucas	180,0x32	
	1/86-7/90		R		153-113		Lucas	180,0x32	
	1/86-7/90		R		153-106		Lucas	203,2x38	
	2/86-7/88		R		700-270	700-270K		Ø 180,0	
	8/88-90		R		700-268			Ø 203,0	
1.3, SW Eng.JPA/ C (51kW)	11/86-7/88		R		153-105		Lucas	180,0x32	
	11/86-7/88		R		153-113		Lucas	180,0x32	
	11/86-7/88		R		153-106		Lucas	203,2x38	
1.4, Cabrio, SW Eng.F6D/ F6B/ FUC (54kW)	1/86-7/90		R		153-145	153-145K		180,0x25	Hand Brake
	1/86-7/90		R		153-113		Lucas	180,0x32	
	1/86-7/90		R		153-105		Lucas	180,0x32	-ABS
	1/86-7/90		R		153-106		Lucas	203,2x38	
	2/86-7/88		R		700-270	700-270K		Ø 180,0	
	8/88-90		R		700-268			Ø 203,0	
1.4, Cabrio, SW Eng.FUA/ B/ C/ D/ G/ H/ J (55kW)	1/86-7/90		R		153-145	153-145K		180,0x25	Hand Brake
	1/86-7/90		R		153-113		Lucas	180,0x32	
	1/86-7/90		R		153-105		Lucas	180,0x32	-ABS
	1/86-7/90		R		153-106		Lucas	203,2x38	
	2/86-7/88		R		700-270	700-270K		Ø 180,0	
	8/88-90		R		700-268			Ø 203,0	
1.4, SW Eng.FUAA/ FUBA (51kW)	10/85-10/90		R		153-145	153-145K		180,0x25	Hand Brake
	10/85-10/90		R		153-113		Lucas	180,0x32	
	10/85-10/90		R		153-105		Lucas	180,0x32	-ABS
	10/85-10/90		R		153-106		Lucas	203,2x38	
	8/88-90		R		700-268			Ø 203,0	
	85-7/88		R		700-270	700-270K		Ø 180,0	
1.6 D, SW Eng.LTA/ B/ C (40kW)	1/86-1/89		R		153-105		Lucas	180,0x32	
	1/86-1/89		R		153-113		Lucas	180,0x32	
	2/86-7/88		R		700-270	700-270K		Ø 180,0	
	8/88-89		R		700-268			Ø 203,0	
1.6 i, Cabrio Eng.LJB (75kW)	8/89-7/90		R		153-113		Lucas	180,0x32	
	8/89-7/90		R		153-105		Lucas	180,0x32	-ABS
	8/89-7/90		R		153-106		Lucas	203,2x38	+ABS
	89-90		R		700-270	700-270K		Ø 180,0	
1.6 i, Cabrio, SW Eng.L4B (66kW)	1/86-7/90		R		153-113		Lucas	180,0x32	
	1/86-7/90		R		153-105		Lucas	180,0x32	-ABS
	1/86-7/90		R		153-106		Lucas	203,2x38	+ABS
	2/86-7/88			R		700-270	700-270K		Ø 180,0
	8/88-90	R			700-268			Ø 203,0	
1.6 T. RS Eng.LHA/ LNA/ B (97kW)	1/86-7/90		R		153-113		Lucas	180,0x32	
	1/86-7/90		R		153-105		Lucas	180,0x32	-ABS
	1/86-7/90		R		153-106		Lucas	203,2x38	+ABS
	86-90		R		700-315			Ø 228,6	
1.6, Cabrio, SW Eng.LP1/ LP2/ LUA/ B/ C/ D/ H (58kW)	1/86-12/88		R		153-113		Lucas	180,0x32	
	1/86-12/88		R		153-105		Lucas	180,0x32	-ABS
	1/86-12/88		R		153-106		Lucas	203,2x38	+ABS





























		Spare Parts	F/R	L/R	CIFAM ref.	CIFAM ref. w/KIT		DIMENSIONS mm.	NOTE
1.6i XR3i, Cabrio Eng.LR1/ LRA/ B (77kW)	1/86-8/89		R		153-106		Lucas	203,2x38	+ABS
	2/86-7/88		R		700-270	700-270K		Ø 180,0	
	8/88-89		R		700-268			Ø 203,0	
1.6i, 16v Eng.LUG/ K/ J (66kW)	4/89-7/90		R		153-113		Lucas	180,0x32	
	4/89-7/90		R		153-105		Lucas	180,0x32	-ABS
	4/89-7/90		R		153-106		Lucas	203,2x38	+ABS
	89-90		R		700-268			Ø 203,0	
1.8 D, SW Eng.RTA/ B/ C/ D/ E/ F/ G/ H/ J/ K (44kW)	1/89-7/90		R		153-105		Lucas	180,0x32	
	1/89-7/90		R		153-113		Lucas	180,0x32	
	1/89-7/90		R		153-106		Lucas	203,2x38	SW
	89-90		R		700-268			Ø 203,0	
Escort V (GAL) 7/90-12/92									
1.1i Eng.G6A (37kW)	7/90-9/92		R		153-119		Lucas	180,0x32	Hand Brake
1.3, SW Eng.J4B/ J6A (44kW)	7/90-9/92		R		153-119		Lucas	180,0x32	Hand Brake
	7/90-9/92		R		153-120		Lucas	203,0x39	Hand Brake
	90-92		R		700-276	700-276K		Ø 180,0	-ABS
	90-92		R		700-287	700-287K		Ø 203,0	+ABS
1.4, Cabrio, SW Eng.F6A/ B/ C/ D/ E/ F/ G (52kW)	7/90-9/92		R		153-145	153-145K		180,0x25	Hand Brake
	7/90-9/92		R		153-119		Lucas	180,0x32	Hand Brake
	7/90-9/92		R		153-120		Lucas	203,0x39	Hand Brake
	90-92		R		700-276	700-276K		Ø 180,0	-ABS
	90-92		R		700-287	700-287K		Ø 203,0	+ABS
1.6i, 16v Eng.LUG/ K/ J (66kW)	7/90-8/92		R		153-120		Lucas	203,0x39	Hand Brake
	90-92		R		700-276	700-276K		Ø 180,0	-SCS
	90-92		R		700-287	700-287K		Ø 203,0	+SCS
1.6i, Cabrio, SW Eng.LJF (77kW)	7/90-12/92		R		153-120		Lucas	203,0x39	Hand Brake
	90-12/92		R		700-287	700-287K		Ø 203,0	
1.8 16v XR3i, Cabrio Eng.RQB/ C (96kW)	2/92-12/92		R		153-145	153-145K		180,0x25	XR3i, Hand Brake
	2/92-12/92		R		153-120		Lucas	203,0x39	Hand Brake
	1/92-12/92		R		700-287	700-287K		Ø 203,0	
1.8 D, SW Eng.RTA/ B/ C/ D/ E/ F/ G/ H/ J/ K (44kW)	7/90-12/92		R		153-120		Lucas	203,0x39	Hand Brake
	90-92		R		700-287	700-287K		Ø 203,0	
1.8i 16v XR3i, Cabrio, SW Eng.RDA/ B (77kW)	2/92-12/92		R		153-145	153-145K		180,0x25	XR3i, Hand Brake
	2/92-12/92		R		153-120		Lucas	203,0x39	Hand Brake
	1/92-12/92		R		700-287	700-287K		Ø 203,0	
Escort VI (GAL) 9/92-1/95									
1.3, SW Eng.J4B/ J6A (44kW)	9/92-1/95		R		153-119		Lucas	180,0x32	Hand Brake
	9/92-1/95		R		153-120		Lucas	203,0x39	Hand Brake
	92-95		R		700-276	700-276K		Ø 180,0	-ABS
	92-95		R		700-287	700-287K		Ø 203,0	+ABS
1.4 Eng.FUH (55kW)	1/94-1/95		R		153-145	153-145K		180,0x25	Hand Brake
	1/94-1/95		R		153-119		Lucas	180,0x32	Hand Brake
	1/94-1/95		R		153-120		Lucas	203,0x39	Hand Brake
	94-95		R		700-276	700-276K		Ø 180,0	-ABS
	94-95		R		700-287	700-287K		Ø 203,0	+ABS
1.4, Cabrio, SW Eng.F4A/ B (55kW)	8/93-1/95		R		153-145	153-145K		180,0x25	Hand Brake
	8/93-1/95		R		153-119		Lucas	180,0x32	Hand Brake
	8/93-1/95		R		153-120		Lucas	203,0x39	Hand Brake
	93-95		R		700-276	700-276K		Ø 180,0	-ABS
	93-95		R		700-287	700-287K		Ø 203,0	+ABS
1.4, Cabrio, SW Eng.F6A/ B/ C/ D/ E/ F/ G (52kW)	-7/95		R		153-119		Lucas	180,0x32	SW, Cabrio, Hand Brake
	9/92-1/95		R		153-145	153-145K		180,0x25	Hand Brake
	9/92-1/95		R		153-128		Lucas	180,0x32	+ABS, Hand Brake
	9/92-1/95		R		153-120		Lucas	203,0x39	Berlina, Hand Brake
	92-95		R		700-276	700-276K		Ø 180,0	-ABS
	92-95		R		700-287	700-287K		Ø 203,0	+ABS
1.6i 16v, Cabrio, SW Eng.L1E/ F/ G/ H/ J/ K/ L/ N/ Q (65-66kW)	1/92-1/95		R		153-120		Lucas	203,0x39	Hand Brake
	94-95		R		700-287	700-287K		Ø 203,0	
1.8 16v XR3i, Cabrio, SW Eng.RQB/ C (96kW)	9/92-1/95		R		153-145	153-145K		180,0x25	Hand Brake
	9/92-1/95		R		153-120		Lucas	203,0x39	-ABS, Hand Brake
	92-95		R		700-287	700-287K		Ø 203,0	
1.8 D, SW Eng.RTA/ B/ C/ D/ E/ F/ G/ H/ J/ K (44kW)	92-95		R		700-287	700-287K		Ø 203,0	
1.8 TD, SW Eng.RFA/ B/ D/ K/ L/ M/ N/ S (66kW)	7/93-12/94		R		700-287	700-287K		Ø 203,0	Exc. SW
1.8i 16v, Cabrio, SW Eng.RDA/ B (77kW)	8/93-1/95		R		153-120		Lucas	203,0x39	Hand Brake
	93-95		R		700-287	700-287K		Ø 203,0	





























































		Spare Parts	F/R	L/R	CIFAM ref.	CIFAM ref. w/KIT		DIMENSIONS mm.	NOTE
2.0 RS Cosworth 4WD Eng.N5F (162kW)	9/92-1/95		R		153-145	153-145K		180,0x25	Hand Brake
2.0 RS, 4WD Eng.N7A (110kW)	9/92-1/95		R		153-145	153-145K		180,0x25	Hand Brake
Escort VII (GAL,AAL,ABL) 1/95-8/00									
1.3, SW Eng.J4B/ J6A (44kW)	1/95-10/98		R		153-128		Lucas	180,0x32	+ABS, Hand Brake
	1/95-10/98		R		153-120		Lucas	203,0x39	Berlina, -ABS, Hand Brake
	1/95-10/98		R		153-129		Lucas	203,2x39	SW, Encore, -ABS
	-7/95		R		153-119		Lucas	180,0x32	-ABS, Hand Brake
	8/95-		R		153-124		Lucas	203,0x38	-ABS, Hand Brake
	95-98		R		700-289	700-289K		Ø 180,0	+ABS
	95-98		R		700-287	700-287K		Ø 203,0	-ABS
1.4, Cabrio, SW Eng.F4A/ B/ FUH (55kW)	1/95-2/99		R		153-145	153-145K		180,0x25	Hand Brake
	1/95-2/99		R		153-128		Lucas	180,0x32	+ABS, Hand Brake
	1/95-2/99		R		153-119		Lucas	180,0x32	SW, Cabrio, Hand Brake
	1/95-2/99		R		153-120		Lucas	203,0x39	Berlina, Hand Brake
	-3/96		R		153-129		Lucas	203,2x39	
	9/95-98		R		700-290	700-290K		Ø 203,0	8Inch Drum, -ABS
	95-98		R		700-289	700-289K		Ø 180,0	+ABS
1.6i 16v, Cabrio, SW, 4WD Eng.L1E/ F/ G/ H/ J/ K/ L/ N/ Q (65-66kW)	1/95-10/98		R		153-145	153-145K		180,0x25	Hand Brake
	1/95-10/98		R		153-119		Lucas	180,0x32	Hand Brake
	1/95-10/98		R		153-128		Lucas	180,0x32	Hand Brake
	1/95-10/98		R		153-120		Lucas	203,0x39	SW, Hand Brake
	1/95-10/98		R		153-129		Lucas	203,2x39	-ABS
	95-98		R		700-289	700-289K		Ø 180,0	+ABS
	95-98		R		700-287	700-287K		Ø 203,0	-ABS
1.8 16v XR3i Cabrio Eng.RQB/ C (96kW)	1/95-10/98		R		153-145	153-145K		180,0x25	Hand Brake
	1/95-10/98		R		153-119		Lucas	180,0x32	Hand Brake
	1/95-10/98		R		153-128		Lucas	180,0x32	Hand Brake
	1/95-10/98		R		153-120		Lucas	203,0x39	SW, Hand Brake
	1/95-10/98		R		153-129		Lucas	203,2x39	-ABS
	95-98		R		700-289	700-289K		Ø 180,0	+ABS
	95-98		R		700-287	700-287K		Ø 203,0	-ABS
1.8 16v, Cabrio, SW Eng.RKC (85kW)	1/95-10/98		R		153-145	153-145K		180,0x25	Hand Brake
	1/95-10/98		R		153-124		Lucas	203,0x38	16v, SW, Hand Brake
	1/95-10/98		R		153-120		Lucas	203,0x39	SW, Cabrio, Hand Brake
	1/95-10/98		R		153-129		Lucas	203,2x39	
	1/95-10/98		R		700-287	700-287K		Ø 203,0	-ABS
	1/95-10/98		R		700-290	700-290K		Ø 203,0	8Inch Drum, -ABS
	1/95-10/98		R		151-238		Lucas	Ø 19,05 203,0x38	LUC
1.8 D, SW Eng.RTA/ B/ C/ D/ E/ F/ G/ H/ J/ K (44kW)	1/95-12/96		R		153-128		Lucas	180,0x32	+ABS, Hand Brake
	1/95-12/96		R		153-119		Lucas	180,0x32	SW, Hand Brake
	1/95-12/96		R		153-129		Lucas	203,2x39	
	95-96		R		700-287	700-287K		Ø 203,0	-ABS
	95-96		R		700-290	700-290K		Ø 203,0	8Inch Drum, -ABS
	95-96		R		151-191		Lucas	Ø 19,05 180,0x32	LOS
	95-96		R		151-191		Lucas	Ø 19,05 180,0x32	LOS
1.8 TD, Cabrio, SW Eng.RFA/ B/ D/ K/ L/ M/ N/ S (66kW)	1/95-10/98		R		153-145	153-145K		180,0x25	Hand Brake
	1/95-10/98		R		153-129		Lucas	203,2x39	
	8/95-		R		153-120		Lucas	203,0x39	Hand Brake
	95-98		R		700-287	700-287K		Ø 203,0	-ABS
	95-98		R		700-290	700-290K		Ø 203,0	8Inch Drum, -ABS
	95-98		R		151-191		Lucas	Ø 19,05 180,0x32	LOS
	95-98		R		151-191		Lucas	Ø 19,05 180,0x32	LOS
1.8 TD, Cabrio, SW Eng.RVA (51kW)	12/95-10/98		R		153-145	153-145K		180,0x25	Hand Brake
	12/95-10/98		R		153-120		Lucas	203,0x39	Hand Brake
	95-98		R		700-287	700-287K		Ø 203,0	-ABS
	95-98		R		700-290	700-290K		Ø 203,0	8Inch Drum, -ABS
	95-98		R		151-191		Lucas	Ø 19,05 180,0x32	LOS
	95-98		R		151-191		Lucas	Ø 19,05 180,0x32	LOS
	95-98		R		151-191		Lucas	Ø 19,05 180,0x32	LOS
1.8i 16v, Cabrio, SW Eng.RDA/ B (77kW)	1/95-8/95		R		153-145	153-145K		180,0x25	Hand Brake
	1/95-8/95		R		153-124		Lucas	203,0x38	16v, SW, Hand Brake
	1/95-8/95		R		153-120		Lucas	203,0x39	SW, Cabrio, Hand Brake
	1/95-8/95		R		153-129		Lucas	203,2x39	
	1/95-8/95		R		700-287	700-287K		Ø 203,0	-ABS
	1/95-8/95		R		700-290	700-290K		Ø 203,0	8Inch Drum, -ABS
	1/95-8/95		R		151-238		Lucas	Ø 19,05 203,0x38	LUC
2.0 RS, 4WD Eng.N7A (110kW)	2/95-10/98		R		153-145	153-145K		180,0x25	Hand Brake
Escort VIII (AAL,ABL) 10/98-7/00									
1.6i 16v, SW Eng.L1E/ F/ G/ H/ J/ K/ L/ N/ Q (66kW)	98-00		R		700-289	700-289K		Ø 180,0	+ABS
	98-00		R		700-290	700-290K		Ø 203,0	-ABS

































		Spare Parts	F/R	L/R	CIFAM ref.	CIFAM ref. w/KIT		DIMENSIONS mm.	NOTE
1.8 TD, SW Eng.RFA/ B/ D/ K/ L/ M/ N/ S (66kW)	98-00		R		700-289	700-289K		Ø 180,0	+ABS
	98-00		R		700-290	700-290K		Ø 203,0	-ABS
Fiesta I 5/76-8/83									
0.95 Eng.TKA/ W/ BL09L/ H (29kW)	76-8/83		R		700-267	700-267K		Ø 177,8	
0.95 Eng.TLA/ BL09L/ H (33kW)	76-8/83		R		700-267	700-267K		Ø 177,8	
1.1 Eng.GMA/ GPA/ GLB/ GLA/ GLW (39kW)	76-8/83		R		700-267	700-267K		Ø 177,8	
1.3 Eng.J3E (49kW)	77-8/83		R		700-267	700-267K		Ø 177,8	
1.6 XR2 Eng.L3E/ KL16G(751M) (63kW)	7/81-7/83		R		700-267	700-267K		Ø 177,8	
Fiesta II (FBD) 9/83-11/89									
1.0 Eng.TKB (33kW)	9/83-2/89		R			153-111K	Bdx	178,0x32	Hand Brake
	9/83-2/89		R			153-131Y	Bdx	178,0x32	Hand Brake
	83-89		R		700-267	700-267K		Ø 177,8	
	83-89		R		151-038		Bdx	Ø 17,46 180,0x30	RAD
1.1 Eng.GSB/ C/ E/ F/ G/ H (37kW)	9/83-2/89		R			153-111K	Bdx	178,0x32	Hand Brake
	9/83-2/89		R			153-131Y	Bdx	178,0x32	Hand Brake
	83-89		R		700-267	700-267K		Ø 177,8	
	83-89		R		151-038		Bdx	Ø 17,46 180,0x30	RAD
1.3 (44kW)	9/83-9/89		R			153-111K	Bdx	178,0x32	Hand Brake
	9/83-9/89		R			153-131Y	Bdx	178,0x32	Hand Brake
1.3 Eng.JPA/ C (51kW)	9/83-1/87		R			153-111K	Bdx	178,0x32	Hand Brake
	9/83-1/87		R			153-131Y	Bdx	178,0x32	Hand Brake
	83-87		R		700-267	700-267K		Ø 177,8	
	83-87		R		151-038		Bdx	Ø 17,46 180,0x30	RAD
1.4 Eng.F6A/ B/ C/ D/ E/ F/ G (52kW)	10/86-2/89		R			153-111K	Bdx	178,0x32	Hand Brake
	10/86-2/89		R			153-131Y	Bdx	178,0x32	Hand Brake
	86-89		R		700-267	700-267K		Ø 177,8	
	86-89		R		151-038		Bdx	Ø 17,46 180,0x30	RAD
1.4 Eng.FUA/ B/ C/ D/ G/ H/ J (54kW)	2/87-2/89		R			153-111K	Bdx	178,0x32	Hand Brake
	2/87-2/89		R			153-131Y	Bdx	178,0x32	Hand Brake
	87-89		R		700-267	700-267K		Ø 177,8	
	87-89		R		151-038		Bdx	Ø 17,46 180,0x30	RAD
1.4 Eng.FUB (55kW)	10/85-11/89		R			153-111K	Bdx	178,0x32	Hand Brake
	10/85-11/89		R			153-131Y	Bdx	178,0x32	Hand Brake
	85-89		R		700-267	700-267K		Ø 177,8	
	85-89		R		151-038		Bdx	Ø 17,46 180,0x30	RAD
1.4 Eng.FUBA (51kW)	-1/87		R			153-111K	Bdx	178,0x32	Hand Brake
	-1/87		R			153-131Y	Bdx	178,0x32	Hand Brake
1.6 Eng.LP3 (58kW)	1/85-11/89		R			153-111K	Bdx	178,0x32	Hand Brake
	1/85-11/89		R			153-131Y	Bdx	178,0x32	Hand Brake
1.6 D Eng.LTB (40kW)	4/84-2/89		R			153-111K	Bdx	178,0x32	Hand Brake
	4/84-2/89		R			153-131Y	Bdx	178,0x32	Hand Brake
	3/84-89		R		700-267	700-267K		Ø 177,8	
	84-89		R		151-046		Bdx	Ø 15,00 180,0x30	RAD
1.6 XR2 Eng.LP1/ LP2/ LUA/ B/ C/ D/ H (70kW)	3/84-2/89		R			153-111K	Bdx	178,0x32	Hand Brake
	3/84-2/89		R			153-131Y	Bdx	178,0x32	Hand Brake
	84-89		R		151-053		Bdx	Ø 20,64 180,0x30	RAD
Fiesta III (GFJ) 1/89-12/95									
1.0 Eng.TLB (33kW)	3/89-12/95		R			153-117Y	Bdx	178,0x32	
	3/89-12/95		R			153-132Y	Bdx	178,0x32	
	3/89-12/95		R			153-117K	Bdx	178,0x32	Hand Brake
	2/89-4/91		R		700-275	700-275K		Ø 203,0	+SCS
	2/89-4/95		R		700-276	700-276K		Ø 180,0	-SCS
2/89-		R		151-027		Bdx	Ø 17,46 180,0x30	RAD	
1.1 Eng.GUD/ E (40kW)	3/89-12/95		R			153-117Y	Bdx	178,0x32	
	3/89-12/95		R			153-132Y	Bdx	178,0x32	
	3/89-12/95		R			153-117K	Bdx	178,0x32	Hand Brake
	3/89-12/95		R			153-118K	Bdx	203,2x38	
	2/89-12/95		R		700-276	700-276K		Ø 180,0	-SCS
	2/89-12/95		R		700-275	700-275K		Ø 203,0	+SCS
	2/89-		R		151-027		Bdx	Ø 17,46 180,0x30	RAD
1.1i Eng.G6A (37kW)	3/89-12/95		R			153-117Y	Bdx	178,0x32	
	3/89-12/95		R			153-132Y	Bdx	178,0x32	
	3/89-12/95		R			153-117K	Bdx	178,0x32	Hand Brake
	3/89-12/95		R			153-118K	Bdx	203,2x38	
	2/89-12/95		R		700-276	700-276K		Ø 180,0	-SCS



















































		Spare Parts	F/R	L/R	CIFAM ref.	CIFAM ref. w/KIT		DIMENSIONS mm.	NOTE
1.1i Eng.G6A (37kW)	2/89-12/95		R		700-275	700-275K		Ø 203,0	+SCS
	2/89-		R		151-027		Bdx	Ø 17,46 180,0x30	RAD
1.3, Kat Eng.J6B/ JBC (44kW)	3/89-12/95		R			153-117Y	Bdx	178,0x32	
	3/89-12/95		R			153-132Y	Bdx	178,0x32	
	3/89-12/95		R			153-117K	Bdx	178,0x32	Hand Brake
	3/89-12/95		R			153-118K	Bdx	203,2x38	
	91-12/95		R		700-276	700-276K		Ø 180,0	-SCS
	91-12/95		R		700-275	700-275K		Ø 203,0	+SCS
1.4 Eng.F6A/ B/ C/ D/ E/ F/ G (52kW)	3/89-12/95		R			153-117Y	Bdx	178,0x32	
	3/89-12/95		R			153-132Y	Bdx	178,0x32	
	3/89-12/95		R			153-117K	Bdx	178,0x32	Hand Brake
	3/89-12/95		R			153-118K	Bdx	203,2x38	
	2/89-95		R		700-276	700-276K		Ø 180,0	-SCS
	2/89-95		R		700-275	700-275K		Ø 203,0	+SCS
	2/89-		R		151-027		Bdx	Ø 17,46 180,0x30	RAD
1.4 Eng.FUA/ B/ C/ D/ G/ H/ J (54kW)	3/89-12/95		R			153-117Y	Bdx	178,0x32	
	3/89-12/95		R			153-132Y	Bdx	178,0x32	
	3/89-12/95		R			153-117K	Bdx	178,0x32	Hand Brake
	3/89-12/95		R			153-118K	Bdx	203,2x38	
	2/89-95		R		700-276	700-276K		Ø 180,0	-SCS
	2/89-95		R		700-275	700-275K		Ø 203,0	+SCS
	2/89-		R		151-027		Bdx	Ø 17,46 180,0x30	RAD
1.4 Eng.FUF (55kW)	92-96		R			153-117Y	Bdx	178,0x32	
	92-96		R			153-132Y	Bdx	178,0x32	
	92-96		R			153-117K	Bdx	178,0x32	Hand Brake
	92-96		R			153-118K	Bdx	203,2x38	
	92-96		R		700-276	700-276K		Ø 180,0	-SCS
	92-96		R		700-275	700-275K		Ø 203,0	+SCS
1.4 Kat Eng.F4A/ B (54kW)	3/89-12/95		R			153-117Y	Bdx	178,0x32	
	3/89-12/95		R			153-132Y	Bdx	178,0x32	
	3/89-12/95		R			153-117K	Bdx	178,0x32	Hand Brake
	3/89-12/95		R			153-118K	Bdx	203,2x38	
	2/89-95		R		700-276	700-276K		Ø 180,0	-SCS
	2/89-95		R		700-275	700-275K		Ø 203,0	+SCS
	2/89-		R		151-027		Bdx	Ø 17,46 180,0x30	RAD
1.6 Eng.LP1/ LP2/ LUA/ B/ C/ D/ H (65kW)	1/89-1/94		R			153-117Y	Bdx	178,0x32	
	1/89-1/94		R			153-132Y	Bdx	178,0x32	
	1/89-1/94		R			153-117K	Bdx	178,0x32	Hand Brake
	1/89-1/94		R			153-118K	Bdx	203,2x38	
	89-12/92		R		700-275	700-275K		Ø 203,0	+SCS
	89-94		R		700-276	700-276K		Ø 180,0	-SCS
5/89-94		R		151-047		Bdx	Ø 19,05 180,0x30	RAD	
1.6 Eng.LUH (66kW)	3/89-12/92		R			153-117Y	Bdx	178,0x32	
	3/89-12/92		R			153-132Y	Bdx	178,0x32	
	3/89-12/92		R			153-117K	Bdx	178,0x32	Hand Brake
	3/89-12/92		R			153-118K	Bdx	203,2x38	
1.6 T. RS Eng.LHA/ LNA/ B (96kW)	3/90-10/92		R			153-118K	Bdx	203,2x38	
	90-92		R		700-276	700-276K		Ø 180,0	-SCS
	90-92		R		700-275	700-275K		Ø 203,0	+SCS
	90-92		R		151-047		Bdx	Ø 19,05 180,0x30	RAD
1.6 XR2i Eng.LJC (81kW)	3/89-12/95		R			153-118K	Bdx	203,2x38	
	89-12/92		R		700-275	700-275K		Ø 203,0	+SCS
	89-94		R		700-276	700-276K		Ø 180,0	-SCS
	5/89-94		R		151-047		Bdx	Ø 19,05 180,0x30	RAD
1.6 XR2i Eng.LJD (76kW)	3/89-12/95		R			153-118K	Bdx	203,2x38	
	89-12/92		R		700-275	700-275K		Ø 203,0	+SCS
	89-94		R		700-276	700-276K		Ø 180,0	-SCS
	5/89-94		R		151-047		Bdx	Ø 19,05 180,0x30	RAD
	1.6i 16v Eng.L1E/ F/ G/ H/ J/ K/ L/ N/ Q (65kW)	1/94-12/95		R			153-117Y	Bdx	178,0x32
1/94-12/95		R			153-132Y	Bdx	178,0x32		
1/94-12/95		R			153-117K	Bdx	178,0x32	Hand Brake	
1/94-12/95		R			153-118K	Bdx	203,2x38		
94-95		R		700-276	700-276K		Ø 180,0	-SCS	
94-95		R		700-275	700-275K		Ø 203,0	+SCS	
94-95		R		151-047		Bdx	Ø 19,05 180,0x30	RAD	
1.8 16v XR2i Eng.RQB/ C (96kW)	2/92-12/95		R			153-118K	Bdx	203,2x38	
	92-95		R		700-276	700-276K		Ø 180,0	-SCS
	92-95		R		700-275	700-275K		Ø 203,0	+ABS, +SCS



































		Spare Parts	F/R	L/R	CIFAM ref.	CIFAM ref. w/KIT		DIMENSIONS mm.	NOTE
1.8 16v XR2i Eng.RQB/ C (96kW)	92-95		R		151-047		Bdx	Ø 19,05 180,0x30	RAD
1.8 D Eng.RTA/ B/ C/ D/ E/ F/ G/ H/ J/ K (44kW)	3/89-12/95		R			153-117Y	Bdx	178,0x32	
	3/89-12/95		R			153-132Y	Bdx	178,0x32	
	3/89-12/95		R			153-117K	Bdx	178,0x32	Hand Brake
	3/89-12/95		R			153-118K	Bdx	203,2x38	
	2/89-12/95		R		700-276	700-276K		Ø 180,0	-SCS
	2/89-12/95		R		700-275	700-275K		Ø 203,0	+SCS
	2/89-		R		151-027		Bdx	Ø 17,46 180,0x30	RAD
1.8 TD Eng.RFA/ B/ D/ K/ L/ M/ N/ S (57kW)	3/93-12/95		R			153-117Y	Bdx	178,0x32	
	3/93-12/95		R			153-132Y	Bdx	178,0x32	
	3/93-12/95		R			153-117K	Bdx	178,0x32	Hand Brake
	3/93-12/95		R			153-118K	Bdx	203,2x38	
	93-95		R		700-276	700-276K		Ø 180,0	-SCS
	93-95		R		700-275	700-275K		Ø 203,0	+ABS, +SCS
1.8i 16v Eng.RDA/ B (77kW)	2/92-12/95		R			153-117Y	Bdx	178,0x32	
	2/92-12/95		R			153-132Y	Bdx	178,0x32	
	2/92-12/95		R			153-117K	Bdx	178,0x32	Hand Brake
	2/92-12/95		R			153-118K	Bdx	203,2x38	
	92-95		R		700-276	700-276K		Ø 180,0	-SCS
	92-95		R		700-275	700-275K		Ø 203,0	+ABS, +SCS
	92-95		R		151-047		Bdx	Ø 19,05 180,0x30	RAD
Fiesta IV (JA, JB) 8/95-1/02									
1.0 i (38kW)	97-99		R		700-292			Ø 180,0	
1.0 i (48kW)	2/00-		R		700-290	700-290K		Ø 203,0	+ABS
	99-1/00		R		700-289	700-289K		Ø 180,0	
	99-1/00		R		700-292			Ø 180,0	-ABS
	00-		R		151-168		Ap	Ø 17,78 180,0x32	RAD, -ABS
1.2 i 16v Eng.DHA/ B/ C/ D/ E/ F/ G (55kW)	8/95-1/02		R		153-137		Ap	180,0x32	-ABS, Hand Brake
	8/95-1/02		R		153-136		Ap	203,2x38	+ABS, Hand Brake
	8/95-1/02		R		153-128		Lucas	180,0x32	+ABS, Hand Brake
	1/96-9/99		R		700-289	700-289K		Ø 180,0	+SCS
	1/96-9/99		R		700-292			Ø 180,0	-SCS
	9/99-		R		700-290	700-290K		Ø 203,0	+SCS
	-99		R		151-151		Ap	Ø 19,05 180,0x29	RAD
	00-		R		151-168		Ap	Ø 17,78 180,0x32	RAD, -ABS
	95-		R		151-228		Ap	Ø 19,05 203,2x38	AP, +ABS
	96-00		R		151-192		Lucas	Ø 17,78 180,0x32	LOS
96-02		R		151-191		Lucas	Ø 19,05 180,0x32	LOS	
1.3 i Eng.J4C/ L/ Q/ R/ T/ J (44kW)	8/95-1/02		R		153-137		Ap	180,0x32	-ABS, Hand Brake
	8/95-1/02		R		153-136		Ap	203,2x38	+ABS, Hand Brake
	8/95-1/02		R		153-128		Lucas	180,0x32	+ABS, Hand Brake
	1/96-9/99		R		700-289	700-289K		Ø 180,0	+SCS
	1/96-9/99		R		700-292			Ø 180,0	-SCS
	9/99-		R		700-290	700-290K		Ø 203,0	+SCS
	-99		R		151-151		Ap	Ø 19,05 180,0x29	RAD
	00-		R		151-168		Ap	Ø 17,78 180,0x32	RAD, -ABS
96-9/99		R		151-192		Lucas	Ø 17,78 180,0x32	LOS	
1.3 i Eng.JJA/ C/ E/ K/ J/ M (37kW)	8/95-1/02		R		153-137		Ap	180,0x32	-ABS, Hand Brake
	8/95-1/02		R		153-136		Ap	203,2x38	+ABS, Hand Brake
	8/95-1/02		R		153-128		Lucas	180,0x32	+ABS, Hand Brake
	1/96-9/99		R		700-289	700-289K		Ø 180,0	+SCS
	1/96-9/99		R		700-292			Ø 180,0	-SCS
	9/99-		R		700-290	700-290K		Ø 203,0	+SCS
	-99		R		151-151		Ap	Ø 19,05 180,0x29	RAD
	00-		R		151-168		Ap	Ø 17,78 180,0x32	RAD, -ABS
96-9/99		R		151-192		Lucas	Ø 17,78 180,0x32	LOS	
1.4i 16v Eng.FHA/ D/ E/ F (66kW)	4/96-1/02		R		153-137		Ap	180,0x32	-ABS, Hand Brake
	4/96-1/02		R		153-136		Ap	203,2x38	+ABS, Hand Brake
	4/96-1/02		R		153-128		Lucas	180,0x32	+ABS, Hand Brake
	1/96-9/99		R		700-289	700-289K		Ø 180,0	+SCS
	1/96-9/99		R		700-292			Ø 180,0	-SCS
	9/99-		R		700-290	700-290K		Ø 203,0	+SCS
	-99		R		151-151		Ap	Ø 19,05 180,0x29	RAD
00-		R		151-168		Ap	Ø 17,78 180,0x32	RAD, -ABS	
1.6 16v Sport Eng.L1T/ V (76kW)	2/00-1/02		R		153-137		Ap	180,0x32	-ABS, Hand Brake
	2/00-1/02		R		153-136		Ap	203,2x38	+ABS, Hand Brake
	2/00-1/02		R		153-128		Lucas	180,0x32	+ABS, Hand Brake
	00-02		R		700-289	700-289K		Ø 180,0	



		Spare Parts	F/R	L/R	CIFAM ref.	CIFAM ref. w/KIT		DIMENSIONS mm.	NOTE
1.6 16v Sport Eng.L1T/ V (76kW)	00-00-02		R		151-168		Ap	Ø 17,78 180,0x32	RAD, -ABS
			R		151-191		Lucas	Ø 19,05 180,0x32	LOS
1.8 D Eng.RTA/ B/ C/ D/ E/ F/ G/ H/ J/ K (44kW)	8/95-4/00		R		153-137		Ap	180,0x32	-ABS, Hand Brake
	8/95-4/00		R		153-136		Ap	203,2x38	+ABS, Hand Brake
	8/95-4/00		R		153-128		Lucas	180,0x32	+ABS, Hand Brake
	1/96-9/99		R		700-289	700-289K		Ø 180,0	+SCS
	1/96-9/99		R		700-292			Ø 180,0	-SCS
	9/99-00-4/00		R		700-290	700-290K		Ø 203,0	+SCS
	00-4/00		R		151-151		Ap	Ø 19,05 180,0x29	RAD
			R		151-168		Ap	Ø 17,78 180,0x32	RAD, -ABS
1.8 Di Eng.RTN/ P/ Q (55kW)	4/00-1/02		R		153-137		Ap	180,0x32	-ABS, Hand Brake
	4/00-1/02		R		153-136		Ap	203,2x38	+ABS, Hand Brake
	4/00-1/02		R		153-128		Lucas	180,0x32	+ABS, Hand Brake
	00-02		R		700-289	700-289K		Ø 180,0	
	00-02		R		151-168		Ap	Ø 17,78 180,0x32	RAD, -ABS
				R		151-191		Lucas	Ø 19,05 180,0x32
Fiesta V (JH) 11/01-9/08									
1.2 16v Eng.FUJA/ B (55kW)	02-02-02-03		R		700-365	700-365K		Ø 203,0	
			R		700-388	700-388K		Ø 203,0	+ABS
			R		151-153		Ap	Ø 19,05 203,0x39	AP
			R		151-167		Ap	Ø 19,05 180,0x32	RAD, -ABS
1.2 16v Eng.M7JA/ B (51kW)	03-03-03-03		R		700-365	700-365K		Ø 203,0	
			R		700-388	700-388K		Ø 203,0	+ABS
			R		151-153		Ap	Ø 19,05 203,0x39	AP
			R		151-167		Ap	Ø 19,05 180,0x32	RAD, -ABS
1.3 Eng.A9JA/ B (51kW)	11/01-9/08		R		153-137		Ap	180,0x32	-ABS, Hand Brake
	11/01-9/08		R		153-136		Ap	203,2x38	+ABS, Hand Brake
	01-01-01-01		R		700-365	700-365K		Ø 203,0	
			R		700-388	700-388K		Ø 203,0	+ABS
			R		151-153		Ap	Ø 19,05 203,0x39	AP
			R		151-167		Ap	Ø 19,05 180,0x32	RAD, -ABS
1.3i Eng.BAJA (44kW)	11/01-9/08		R		153-137		Ap	180,0x32	-ABS, Hand Brake
	11/01-9/08		R		153-136		Ap	203,2x38	+ABS, Hand Brake
	01-01-01-01		R		700-365	700-365K		Ø 203,0	
			R		700-388	700-388K		Ø 203,0	+ABS
			R		151-153		Ap	Ø 19,05 203,0x39	AP
			R		151-167		Ap	Ø 19,05 180,0x32	RAD, -ABS
1.4 16v Eng.FXJA/ B (59kW)	11/01-9/08		R		153-137		Ap	180,0x32	-ABS, Hand Brake
	11/01-9/08		R		153-136		Ap	203,2x38	+ABS, Hand Brake
	01-01-01-01		R		700-365	700-365K		Ø 203,0	
			R		700-388	700-388K		Ø 203,0	+ABS
			R		151-153		Ap	Ø 19,05 203,0x39	AP
			R		151-167		Ap	Ø 19,05 180,0x32	RAD, -ABS
1.4 TDCi Eng.F6JA/ B/ C (50kW)	11/01-9/08		R		153-137		Ap	180,0x32	-ABS, Hand Brake
	11/01-9/08		R		153-136		Ap	203,2x38	+ABS, Hand Brake
	01-01-01-01		R		700-365	700-365K		Ø 203,0	
			R		700-388	700-388K		Ø 203,0	+ABS
1.6 16v Eng.FYJA (74kW)	11/01-9/08		R		153-137		Ap	180,0x32	-ABS, Hand Brake
	11/01-9/08		R		153-136		Ap	203,2x38	+ABS, Hand Brake
	01-01-01-01		R		700-365	700-365K		Ø 203,0	
			R		700-388	700-388K		Ø 203,0	+ABS
			R		151-153		Ap	Ø 19,05 203,0x39	AP
			R		151-167		Ap	Ø 19,05 180,0x32	RAD, -ABS
1.6 TDCi Eng.HHJA/ B (66kW)	04-04		R		700-388	700-388K		Ø 203,0	+ABS
			R		151-167		Ap	Ø 19,05 180,0x32	RAD, -ABS
Fiesta VI 10/08-									
1.2 16v Eng.SNJA/ B (60kW)	10/08-08		R		153-490		Lucas	200x32	Hand Brake
			R		700-399			Ø 200,0	
1.2 16v Eng.STJA/ B (44kW)	10/08-08		R		153-490		Lucas	200x32	Hand Brake
			R		700-399			Ø 200,0	
1.4 16v, LPG Eng.SPJA/ C, RTJA/ B (71kW)	12/08-08		R		153-490		Lucas	200x32	Hand Brake
			R		700-399			Ø 200,0	
1.4 TDCi Eng.F6JD (52kW)	10/08-08		R		153-490		Lucas	200x32	Hand Brake
			R		700-399			Ø 200,0	
1.6 (70kW)	10/08		R		153-490		Lucas	200x32	
1.6 (72kW)	10-		R		153-490		Lucas	200x32	



































		Spare Parts	F/R	L/R	CIFAM ref.	CIFAM ref. w/KIT		DIMENSIONS mm.	NOTE
1.6 Eng.HXJA, HXJB (88kW)	10/08-08-		R		153-490		Lucas	200x32	Hand Brake
			R		700-399			Ø 200,0	
1.6 TDCi Eng.HHJC/ D/ E (66kW)	08-08-		R		153-490		Lucas	200x32	Hand Brake
			R		700-399			Ø 200,0	
1.6 TDCi Eng.HHJF/ UBJA (55kW)	08-08-		R		153-490		Lucas	200x32	Hand Brake
			R		700-399			Ø 200,0	
1.6 TDCi Eng.TZJA/ B (70kW)	10-10-		R		153-490		Lucas	200x32	
			R		700-399			Ø 200,0	
1.6 Ti (99kW)	10-		R		153-490		Lucas	200x32	
Focus C-Max 10/03-4/08									
1.6 Eng.HWDA/ B (74kW)	03-08		R		153-133		Lucas	203,2x39	Hand Brake
1.6 TDCi Eng.G8DA/ B (80kW)	03-08		R		153-133		Lucas	203,2x39	Hand Brake
1.6 TDCi Eng.HHDA/ B (66kW)	05-08		R		153-133		Lucas	203,2x39	Hand Brake
1.6 Ti Eng.HXDA (85kW)	04-08		R		153-133		Lucas	203,2x39	Hand Brake
1.8 Eng.CSDA/ B (88kW)	10/03-		R		153-133		Lucas	203,2x39	Hand Brake
1.8 Eng.QQDA/ B (92kW)	04-08		R		153-133		Lucas	203,2x39	Hand Brake
1.8 Flexifuel Eng.QQDA/ B (92kW)	06-08		R		153-133		Lucas	203,2x39	Hand Brake
1.8 TDCi Eng.KKDA (85kW)	05-08		R		153-133		Lucas	203,2x39	Hand Brake
2.0 Eng.AODA/ B (107kW)	04-08		R		153-133		Lucas	203,2x39	Hand Brake
2.0 TDCi Eng.G6DA/ B (100kW)	03-08		R		153-133		Lucas	203,2x39	Hand Brake
Focus I, SW 10/98-10/04									
1.4 16v Eng.FXDA/ B/ C/ D (55kW)	10/98-10/04		R		153-133		Lucas	203,2x39	Hand Brake
			R		700-319	700-319K		Ø 203,0	
			R		700-391	700-391K		Ø 203,0	
			R		151-197			Ø 20,64 203,2x39	
98-04			R		151-199		Lucas	Ø 22,20 203,2x39	LOS, Only SW
			R		153-133		Lucas	203,2x39	Hand Brake
1.4i 16v Eng.FHA/ D/ E/ F (66kW)	1/98-10/04		R		153-133		Lucas	203,2x39	Hand Brake
1.6 16v Eng.FYDA/ B/ C/ D (74kW)	10/98-10/04		R		153-133		Lucas	203,2x39	Hand Brake
			R		700-319	700-319K		Ø 203,0	
			R		700-391	700-391K		Ø 203,0	
			R		151-197			Ø 20,64 203,2x39	
98-04			R		151-199		Lucas	Ø 22,20 203,2x39	LOS, Only SW
			R		153-133		Lucas	203,2x39	Hand Brake
1.8 16v Eng.EYDB/ C/ D/ E/ F (85kW)	10/98-10/04		R		153-133		Lucas	203,2x39	Hand Brake
			R		700-319	700-319K		Ø 203,0	
			R		700-391	700-391K		Ø 203,0	
			R		151-197			Ø 20,64 203,2x39	
98-04			R		151-199		Lucas	Ø 22,20 203,2x39	LOS, Only SW
			R		153-133		Lucas	203,2x39	Hand Brake
1.8 Di / TDDi Eng.BHDA/ B (55kW)	8/99-10/04		R		153-133		Lucas	203,2x39	Hand Brake
			R		700-319	700-319K		Ø 203,0	
			R		700-391	700-391K		Ø 203,0	
			R		151-198			Ø 19,05 203,2x39	
99-04			R		151-197		Lucas	Ø 20,64 203,2x39	LOS, SW
			R		153-133		Lucas	203,2x39	Hand Brake
1.8 TDCi Eng.F9DA/ B (85kW)	3/01-10/04		R		153-133		Lucas	203,2x39	Hand Brake
1.8 TDCi Eng.FFDA (74kW)	9/02-10/04		R		153-133		Lucas	203,2x39	Hand Brake
1.8 TDi / TDDi Eng.C9DA/ B/ C (66kW)	10/98-10/04		R		153-133		Lucas	203,2x39	Hand Brake
			R		700-319	700-319K		Ø 203,0	
			R		700-391	700-391K		Ø 203,0	
			R		151-198			Ø 19,05 203,2x39	
98-04			R		151-197		Lucas	Ø 20,64 203,2x39	LOS, SW
			R		151-197		Lucas	Ø 20,64 203,2x39	LOS, SW
Focus II 11/04-3/08									
1.4 Eng.ASDA/ B (59kW)	11/04-3/08		R		153-133		Lucas	203,2x39	Hand Brake
			R		700-390			Ø 228,3	
1.6 Eng.HWDA/ B/ SHDA (74kW)	11/04-3/08		R		153-133		Lucas	203,2x39	Hand Brake
1.6 Ti Eng.HXDA (85kW)	11/04-3/08		R		153-133		Lucas	203,2x39	Hand Brake
2.0 TDCi Eng.G6DA/ B/ D (100kW)	11/04-3/08		R		153-142		Ap	228,6x43	
Focus II Cabrio 10/06-3/08									
2.0 TDCi Eng.G6DA/ B (100kW)	06-08		R		153-142		Ap	228,6x43	AP
			R		151-229			Ø 20,64 228,6x43	
Focus II SW 11/04-3/08									
1.4 Eng.ASDA/ B (59kW)	05-08		R		153-142		Ap	228,6x43	
			R		700-390			Ø 228,3	
			R		151-229			Ø 20,64 228,6x43	
1.6 Eng.HWDA/ B (74kW)	05-08		R		153-142		Ap	228,6x43	
			R		151-229			Ø 20,64 228,6x43	
1.6 TDCi Eng.G8DA/ B (80kW)	05-08		R		153-142		Ap	228,6x43	
			R		151-229			Ø 20,64 228,6x43	





























































		Spare Parts	F/R	L/R	CIFAM ref.	CIFAM ref. w/KIT		DIMENSIONS mm.	NOTE
1.6 TDCi Eng.HHDA/ B (66kW)	05-08		R		153-142		Ap	228,6x43	
	05-08		R		151-229		Ap	Ø 20,64 228,6x43	AP
1.6 Ti Eng.HXDA (85kW)	05-08		R		153-142		Ap	228,6x43	
	05-08		R		151-229		Ap	Ø 20,64 228,6x43	AP
2.0 Eng.AODA/ B (107kW)	04-08		R		153-142		Ap	228,6x43	
2.0 TDCi Eng.G6DA/ B (100kW)	1/05-3/08		R		153-142		Ap	228,6x43	
	05-08		R		151-229		Ap	Ø 20,64 228,6x43	AP
Fusion (JU) 8/02-									
1.2 16v Eng.FUJA/ B (55kW)	04-		R		700-365	700-365K		Ø 203,0	
1.4 16v Eng.FXJA/ B (59kW)	8/02-		R		153-136		Ap	203,2x38	+ABS, Hand Brake
	8/02-		R		700-365	700-365K		Ø 203,0	
	8/02-		R		151-153		Ap	Ø 19,05 203,0x39	AP
1.4 TDCi Eng.F6JA/ B (50kW)	8/02-		R		153-136		Ap	203,2x38	+ABS, Hand Brake
	8/02-		R		700-365	700-365K		Ø 203,0	
	8/02-		R		151-153		Ap	Ø 19,05 203,0x39	AP
1.6 16v Eng.FYJA (74kW)	8/02-		R		153-136		Ap	203,2x38	+ABS, Hand Brake
	8/02-		R		700-365	700-365K		Ø 203,0	
	8/02-		R		151-153		Ap	Ø 19,05 203,0x39	AP
1.6 TDCi Eng.HHJA/ B (66kW)	04-		R		700-365	700-365K		Ø 203,0	
Granada I (GGTL,FL), SW 1/72-8/77									
1.7 Eng.17M/ EV17L (48-51-55kW)	12/74-8/77		R		153-100		Lucas	254,0x57	Hand Brake
1.7 Eng.17M/ EV17L (55kW)	3/72-2/75		R		153-100		Lucas	254,0x57	Hand Brake
1.7, Coupe Eng.EY (48kW)	3/72-2/75		R		153-100		Lucas	254,0x57	Hand Brake
2.0 Eng.NYP/ TL20H (66kW)	1/75-8/77		R		153-100		Lucas	254,0x57	Hand Brake
2.0 Eng.OHCLC (64kW)	1/76-8/77		R		153-100		Lucas	254,0x57	Hand Brake
2.0, Coupe Eng.OHCHC/ TL20H (70-73kW)	1/75-7/77		R		153-100		Lucas	254,0x57	Hand Brake
2.3, Coupe Eng.YYH/ TV23 (79kW)	1/72-8/77		R		153-100		Lucas	254,0x57	Hand Brake
3.0, Coupe Eng.EV30H (101kW)	1/72-2/76		R		153-100		Lucas	254,0x57	Hand Brake
Granada II (GU), SW 8/77-8/85									
1.7 Eng.17M/ EV17L (48-51-55kW)	8/77-7/81		R		153-062		Lucas	254,0x57	Hand Brake
	8/77-7/81		R		153-100		Lucas	254,0x57	Hand Brake
1.9 D (Exc. SW) Eng.XD4.88 (40kW)	8/77-8/82		R		153-100		Lucas	254,0x57	Hand Brake
2.0 Eng.NEK (77kW)	8/81-8/85		R		153-062		Lucas	254,0x57	Hand Brake
2.0 Eng.NEP/ TL20H (74kW)	8/79-8/85		R		153-062		Lucas	254,0x57	Hand Brake
2.0 Eng.NYP/ TL20H (66kW)	8/77-8/85		R		153-062		Lucas	254,0x57	Hand Brake
2.0 Eng.OHCLC (64kW)	8/77-7/79		R		153-062		Lucas	254,0x57	Hand Brake
2.1 D (Exc. SW) Eng.WTA (46kW)	8/77-8/82		R		153-100		Lucas	254,0x57	Hand Brake
2.3 Eng.YYH/ TV23 (79kW)	8/77-6/79		R		153-062		Lucas	254,0x57	Hand Brake
	8/77-6/79		R		153-100		Lucas	254,0x57	Hand Brake
2.3 Eng.YYP/ TV23 (84kW)	6/79-8/85		R		153-062		Lucas	254,0x57	Hand Brake
	6/79-8/85		R		153-100		Lucas	254,0x57	Hand Brake
2.3 Eng.YYU/ TV23 (82kW)	6/81-8/85		R		153-062		Lucas	254,0x57	Hand Brake
	6/81-8/85		R		153-100		Lucas	254,0x57	Hand Brake
2.5 D Eng.STP (51kW)	8/82-8/85		R		153-062		Lucas	254,0x57	Hand Brake
2.8 Eng.PYA/ TV28 (99kW)	8/77-8/85		R		153-062		Lucas	254,0x57	Hand Brake
	8/77-8/85		R		153-100		Lucas	254,0x57	Hand Brake
2.8 Eng.PYU/ TV28 (97kW)	6/81-8/85		R		153-062		Lucas	254,0x57	Hand Brake
	6/81-8/85		R		153-100		Lucas	254,0x57	Hand Brake
2.8 i Eng.PR/ TV28 (118kW)	8/77-8/81		R		153-062		Lucas	254,0x57	Hand Brake
	8/77-8/81		R		153-100		Lucas	254,0x57	Hand Brake
2.8 i Eng.PRC/ TV28 (110kW)	10/82-8/85		R		153-062		Lucas	254,0x57	Hand Brake
	10/82-8/85		R		153-100		Lucas	254,0x57	Hand Brake
2.8 i Eng.PRD/ TV28 (108kW)	8/77-8/85		R		153-062		Lucas	254,0x57	Hand Brake
	8/77-8/85		R		153-100		Lucas	254,0x57	Hand Brake
Ka I (RB) 9/96-11/08									
1.0 i Eng.ZH10JRB (38-48kW)	7/97-11/08		R		153-137		Ap	180,0x32	Hand Brake
	7/97-11/08		R		153-128		Lucas	180,0x32	+ABS, Hand Brake
	97-		R		700-289	700-289K		Ø 180,0	+ABS
	97-		R		700-292			Ø 180,0	-ABS
1.3 i Eng.A9JA/ B (51kW)	3/00-		R		151-168		Ap	Ø 17,78 180,0x32	RAD
	8/02-11/08		R		153-137		Ap	180,0x32	Hand Brake
	8/02-11/08		R		153-128		Lucas	180,0x32	+ABS, Hand Brake
	02-		R		700-292			Ø 180,0	-ABS
	02-		R		700-289	700-289K		Ø 180,0	7Inch Drum, +ABS
	02-		R		700-275	700-275K		Ø 203,0	8Inch Drum, +ABS
02-		R		151-168		Ap	Ø 17,78 180,0x32	RAD	







		Spare Parts	F/R	L/R	CIFAM ref.	CIFAM ref. w/KIT		DIMENSIONS mm.	NOTE
1.3 i Eng.A9JA/ B (51kW)	02-		R		151-192		Lucas	Ø 17,78 180,0x32	LOS
1.3 i Eng.J4D/ K/ M/ N/ P/ S (44kW)	9/96-11/08		R		153-137		Ap	180,0x32	Hand Brake
	9/96-11/08		R		153-128		Lucas	180,0x32	+ABS, Hand Brake
	9/99-2/00		R		700-275	700-275K		Ø 203,0	8Inch Drum, +ABS
	96-9/99		R		700-292			Ø 180,0	-ABS
	96-9/99		R		700-289	700-289K		Ø 180,0	7Inch Drum, +ABS
	99-		R		151-151		Ap	Ø 19,05 180,0x29	RAD
	3/00-		R		151-168		Ap	Ø 17,78 180,0x32	RAD
	96-9/99		R		151-192		Lucas	Ø 17,78 180,0x32	LOS
1.3 i Eng.JJB (37kW)	9/96-11/08		R		153-137		Ap	180,0x32	Hand Brake
	9/96-11/08		R		153-128		Lucas	180,0x32	+ABS, Hand Brake
	9/99-2/00		R		700-275	700-275K		Ø 203,0	8Inch Drum, +ABS
	96-9/99		R		700-292			Ø 180,0	-ABS
	96-9/99		R		700-289	700-289K		Ø 180,0	7Inch Drum, +ABS
	99-		R		151-151		Ap	Ø 19,05 180,0x29	RAD
	3/00-		R		151-168		Ap	Ø 17,78 180,0x32	RAD
	96-9/99		R		151-192		Lucas	Ø 17,78 180,0x32	LOS
1.3 i Eng.JJD/ F/ G/ H/ L (36kW)	6/98-11/08		R		153-137		Ap	180,0x32	Hand Brake
	6/98-11/08		R		153-128		Lucas	180,0x32	+ABS, Hand Brake
	9/99-2/00		R		700-275	700-275K		Ø 203,0	8Inch Drum, +ABS
	98-9/99		R		700-292			Ø 180,0	-ABS
	98-9/99		R		700-289	700-289K		Ø 180,0	7Inch Drum, +ABS
	99-		R		151-151		Ap	Ø 19,05 180,0x29	RAD
	3/00-		R		151-168		Ap	Ø 17,78 180,0x32	RAD
	98-9/99		R		151-192		Lucas	Ø 17,78 180,0x32	LOS
1.6i SportKa Eng.CDB/ C (70kW)	03-		R		700-290	700-290K		Ø 203,0	
	03-		R		151-167		Ap	Ø 19,05 180,0x32	RAD, -ABS
Ka II 12/08-									
1.2 8v Eng.LSED (51kW)	6/10-		R		153-488		Lockh.	180x30	
1.3 TDCi Eng.DD0X (55kW)	6/10-		R		153-488		Lockh.	180x30	
Maverick I 2/93-4/98									
2.4 i Eng.KA24 (85-87kW)	9/96-4/98		R		153-287		Lucas	254,0x57	Hand Brake
	96-		R		700-293			Ø 254,0	
2.4 i Eng.KA24-E (91kW)	2/93-8/96		R		153-287		Lucas	254,0x57	Hand Brake
	7/93-		R		700-293			Ø 254,0	
2.7 TD Eng.TD27 (74kW)	2/93-8/96		R		153-287		Lucas	254,0x57	Hand Brake
	7/93-		R		700-293			Ø 254,0	
2.7 TD Eng.TD27E (92kW)	9/96-4/98		R		153-287		Lucas	254,0x57	Hand Brake
	96-		R		700-293			Ø 254,0	
Maverick II 2/01-									
2.0 16v Eng.YF (91kW)	2/01-		R		153-216		Ake	228,6x42	Hand Brake
	2/01-		R		153-287		Lucas	254,0x57	Hand Brake
3.0 24v Eng.AJ (149kW)	3/04-		R		153-216		Ake	228,6x42	Hand Brake
3.0 V6 24v Eng.AJD (145kW)	2/01-		R		153-216		Ake	228,6x42	Hand Brake
Mondeo I (GBP), SW 2/93-8/96									
1.6i 16v Eng.L1E/ F/ G/ H/ J/ K/ L/ N/ Q (65kW)	7/94-8/96		R		153-124		Lucas	203,0x38	Berlina, Hand Brake
	6/94-7/96		R		153-130		Lucas	228,6x45	SW, Hand Brake
	94-96		R		700-291			Ø 203,0	
	94-96		R		151-202		Lucas	Ø 22,22 203,0x38	LOS, Exc. SW
1.6i 16v Eng.L1E/ F/ G/ H/ J/ K/ L/ N/ Q (66kW)	2/93-8/96		R		153-130		Lucas	228,6x45	SW, Hand Brake
	-5/94		R		153-130		Lucas	228,6x45	Berlina, Hand Brake
	6/94-		R		153-124		Lucas	203,0x38	Berlina, Hand Brake
	2/93-5/94		R		700-275	700-275K		Ø 203,0	
	2/93-5/94		R		700-283			Ø 228,6	
	6/94-7/96		R		700-291			Ø 203,0	
1.8 i 16v Eng.RKB (82kW)	6/94-7/96		R		151-202		Lucas	Ø 22,22 203,0x38	LOS, Exc. SW
	7/94-8/96		R		153-124		Lucas	203,0x38	Berlina, Hand Brake
	6/94-7/96		R		153-130		Lucas	228,6x45	SW, Hand Brake
	94-96		R		700-291			Ø 203,0	
1.8 i 16v, 4WD Eng.RKA (85kW)	2/93-8/96		R		153-130		Lucas	228,6x45	SW, Hand Brake
	-5/94		R		153-130		Lucas	228,6x45	Berlina, Hand Brake
	6/94-		R		153-124		Lucas	203,0x38	Berlina, Hand Brake
	2/93-5/94		R		700-275	700-275K		Ø 203,0	
	2/93-5/94		R		700-283			Ø 228,6	
	6/94-7/96		R		700-291			Ø 203,0	
6/94-7/96		R		151-202		Lucas	Ø 22,22 203,0x38	LOS, Exc. SW	

		Spare Parts	F/R	L/R	CIFAM ref.	CIFAM ref. w/KIT		DIMENSIONS mm.	NOTE
1.8 TD Eng.RFA/ B/ D/ K/ L/ M/ N/ S (65-66kW)	-5/94		R		153-130		Lucas	228,6x45	Berlina, Hand Brake
	6/93-8/96		R		153-130		Lucas	228,6x45	SW, Hand Brake
	6/94-		R		153-124		Lucas	203,0x38	Berlina, Hand Brake
	2/93-5/94		R		700-275	700-275K		Ø 203,0	
	2/93-5/94		R		700-283			Ø 228,6	
	6/94-7/96		R		700-291			Ø 203,0	
2.0 i 16v, 4WD Eng.NGA (97-100kW)	6/94-7/96		R		151-202		Lucas	Ø 22,22 203,0x38	LOS, Exc. SW
	2/93-8/96		R		153-130		Lucas	228,6x45	SW, Hand Brake
	-5/94		R		153-130		Lucas	228,6x45	Berlina, Hand Brake
	6/94-		R		153-124		Lucas	203,0x38	Berlina, Hand Brake
	2/93-96		R		700-275	700-275K		Ø 203,0	
	2/93-96		R		700-283			Ø 228,6	
2.5 24v Eng.SEA (125kW)	6/94-7/96		R		700-291			Ø 203,0	
	7/94-8/96		R		153-125		Lucas	228,6x45	Hand Brake
Mondeo II (BAP), SW 9/96-11/00									
1.6 i 16v Eng.L1L/ N/ Q (70kW)	5/98-11/00		R		153-124		Lucas	203,0x38	Berlina, Hand Brake
	5/98-11/00		R		153-125		Lucas	228,6x45	SW, Hand Brake
	8/96-11/00		R		700-291			Ø 203,0	Berlina
	8/96-11/00		R		700-283			Ø 228,6	SW
1.6i 16v Eng.L1E/ F/ G/ H/ J/ K/ L/ N/ Q (66kW)	9/96-11/00		R		153-124		Lucas	203,0x38	Berlina, Hand Brake
	9/96-11/00		R		153-125		Lucas	228,6x45	SW, Hand Brake
	8/96-11/00		R		700-291			Ø 203,0	Exc. SW
	8/96-11/00		R		700-283			Ø 228,6	Only SW
	96-00		R		151-202		Lucas	Ø 22,22 203,0x38	LOS
1.8 i Eng.RKB/ F/ H/ K/ J (85kW)	9/96-11/00		R		153-124		Lucas	203,0x38	Berlina, Hand Brake
	9/96-11/00		R		153-125		Lucas	228,6x45	SW, Hand Brake
	8/96-11/00		R		700-291			Ø 203,0	Exc. SW
	8/96-11/00		R		700-283			Ø 228,6	Only SW
	8/96-00		R		151-202		Lucas	Ø 22,22 203,0x38	LOS, Exc. SW
1.8 TD Eng.RFA/ B/ D/ K/ L/ M/ N/ S (66kW)	9/96-11/00		R		153-125		Lucas	228,6x45	SW, Hand Brake
	96-00		R		153-124		Lucas	203,0x38	Berlina, Hand Brake
	96-00		R		700-291			Ø 203,0	Exc. SW
	96-00		R		700-283			Ø 228,6	Only SW
	96-00		R		151-202		Lucas	Ø 22,22 203,0x38	LOS, Exc. SW
2.0 i Eng.NGA/ B/ C/ D (96kW)	9/96-11/00		R		153-125		Lucas	228,6x45	Berlina, Hand Brake
	9/96-11/00		R		153-130		Lucas	228,6x45	SW, Hand Brake
	96-00		R		700-283			Ø 228,6	
Mondeo III (B5Y), SW 11/00-4/07									
2.5 V6 24v Eng.LCBD (125kW)	05-		R		153-372			184,0x31	USA, Hand Brake
Orion I (AFD) 7/83-3/86									
1.3 Eng.JPA/ C (51kW)	7/83-3/86		R		153-105		Lucas	180,0x32	
	5/83-86		R		700-270	700-270K		Ø 180,0	
1.6 Eng.LP1/ LP2/ LUA/ B/ C/ D/ H (58kW)	7/83-3/86		R		153-105		Lucas	180,0x32	
	7/83-3/86		R		153-106		Lucas	203,2x38	
	5/83-86		R		700-270	700-270K		Ø 180,0	
1.6 D Eng.LTA/ B/ C (40kW)	2/84-3/86		R		153-105		Lucas	180,0x32	
	3/84-86		R		700-270	700-270K		Ø 180,0	
1.6i Eng.LR1/ LRA/ B (77kW)	7/83-3/86		R		153-105		Lucas	180,0x32	
	7/83-3/86		R		153-106		Lucas	203,2x38	
	5/83-86		R		700-268			Ø 203,0	
86-		R		700-270	700-270K		Ø 180,0		
Orion II (AFF) 12/85-7/90									
1.3 Eng.JLA/ B/ JBB (44kW)	12/85-7/90		R		153-105		Lucas	180,0x32	
	12/85-7/90		R		153-113		Lucas	180,0x32	
	12/85-7/90		R		153-106		Lucas	203,2x38	
	86-90		R		700-270	700-270K		Ø 180,0	
1.3 Eng.JPA/ C (51kW)	11/86-7/88		R		153-105		Lucas	180,0x32	
	11/86-7/88		R		153-113		Lucas	180,0x32	
	11/86-7/88		R		153-106		Lucas	203,2x38	
	86-		R		700-270	700-270K		Ø 180,0	
1.4 Eng.F6A/ B/ C/ D/ E/ F/ G (52kW)	3/86-7/90		R		153-105		Lucas	180,0x32	
	3/86-7/90		R		153-113		Lucas	180,0x32	
	3/86-7/90		R		153-106		Lucas	203,2x38	
1.4 Eng.FUA/ B/ C/ D/ G/ H/ J (54kW)	1/86-7/90		R		153-105		Lucas	180,0x32	
	1/86-7/90		R		153-113		Lucas	180,0x32	
	1/86-7/90		R		153-106		Lucas	203,2x38	
	86-90		R		700-270	700-270K		Ø 180,0	















		Spare Parts	F/R	L/R	CIFAM ref.	CIFAM ref. w/KIT		DIMENSIONS mm.	NOTE
1.4 Eng.FUA/ B/ C/ D/ G/ H/ J (55kW)	12/85-7/90		R		153-105		Lucas	180,0x32	
	12/85-7/90		R		153-113		Lucas	180,0x32	
	12/85-7/90		R		153-106		Lucas	203,2x38	
	86-90		R		700-270	700-270K		Ø 180,0	
1.4 Kat Eng.F6D/ F6B/ FUC (54kW)	2/87-7/90		R		153-105		Lucas	180,0x32	
	2/87-7/90		R		153-113		Lucas	180,0x32	
	2/87-7/90		R		153-106		Lucas	203,2x38	
	87-90		R		700-270	700-270K		Ø 180,0	
1.6 (58kW)	4/86-12/88		R		153-105		Lucas	180,0x32	
	4/86-12/88		R		153-113		Lucas	180,0x32	
	4/86-12/88		R		153-106		Lucas	203,2x38	
1.6 Eng.LP1/ LP2/ LUA/ B/ C/ D/ H (66kW)	12/85-7/90		R		153-105		Lucas	180,0x32	
	12/85-7/90		R		153-113		Lucas	180,0x32	
	12/85-7/90		R		153-106		Lucas	203,2x38	
	85-86		R		700-268			Ø 203,0	
	86-90		R		700-270	700-270K		Ø 180,0	
1.6 D Eng.LTA/ B/ C (40kW)	12/85-1/89		R		153-105		Lucas	180,0x32	
	12/85-1/89		R		153-113		Lucas	180,0x32	
	12/85-1/89		R		153-106		Lucas	203,2x38	
	85-89		R		700-270	700-270K		Ø 180,0	
1.6 i Eng.LJB (75kW)	8/89-7/90		R		153-105		Lucas	180,0x32	
	8/89-7/90		R		153-113		Lucas	180,0x32	
	8/89-7/90		R		153-106		Lucas	203,2x38	
	89-90		R		700-270	700-270K		Ø 180,0	
1.6i Eng.LR1/ LRA/ B (77kW)	3/86-7/90		R		153-105		Lucas	180,0x32	
	3/86-7/90		R		153-113		Lucas	180,0x32	
	3/86-7/90		R		153-106		Lucas	203,2x38	
	-86		R		700-268			Ø 203,0	
	86-90		R		700-270	700-270K		Ø 180,0	
1.6i Kat Eng.L4B (66kW)	3/86-7/90		R		153-105		Lucas	180,0x32	
	3/86-7/90		R		153-113		Lucas	180,0x32	
	3/86-7/90		R		153-106		Lucas	203,2x38	
	-86		R		700-268			Ø 203,0	
	86-90		R		700-270	700-270K		Ø 180,0	
1.8 D Eng.RTA/ B/ C/ D/ E/ F/ G/ H/ J/ K (44kW)	1/89-7/90		R		153-105		Lucas	180,0x32	
	1/89-7/90		R		153-113		Lucas	180,0x32	
	1/89-7/90		R		153-106		Lucas	203,2x38	
	89-90		R		700-270	700-270K		Ø 180,0	
Orion III (GAL) 7/90-12/93									
1.3 Eng.J4B/ J6A (44kW)	7/90-12/93		R		153-119		Lucas	180,0x32	Hand Brake
	7/90-12/93		R		153-120		Lucas	203,0x39	Hand Brake
	90-93		R		700-276	700-276K		Ø 180,0	
	91-93		R		700-287	700-287K		Ø 203,0	
1.4 Eng.F6A/ B/ C/ D/ E/ F/ G (52kW)	7/90-12/93		R		153-119		Lucas	180,0x32	Hand Brake
	7/90-12/93		R		153-120		Lucas	203,0x39	Hand Brake
	90-93		R		700-276	700-276K		Ø 180,0	
	90-93		R		700-287	700-287K		Ø 203,0	
1.4 Eng.F6A/ B/ C/ D/ E/ F/ G (54kW)	7/90-12/93		R		153-119		Lucas	180,0x32	Hand Brake
	7/90-12/93		R		153-120		Lucas	203,0x39	Hand Brake
	90-93		R		700-276	700-276K		Ø 180,0	
	90-93		R		700-287	700-287K		Ø 203,0	
1.6i Eng.LJF (77kW)	7/90-9/92		R		153-119		Lucas	180,0x32	Hand Brake
	7/90-9/92		R		153-120		Lucas	203,0x39	Hand Brake
	90-92		R		700-287	700-287K		Ø 203,0	-ABS
1.6i 16v Eng.L1E/ F/ G/ H/ J/ K/ L/ N/ Q (66kW)	7/92-12/93		R		153-145	153-145K		180,0x25	Hand Brake
	7/92-12/93		R		153-119		Lucas	180,0x32	Hand Brake
	7/92-12/93		R		153-120		Lucas	203,0x39	Hand Brake
1.6i, 16v Eng.LUG/ K/ J (66kW)	7/90-12/92		R		153-119		Lucas	180,0x32	Hand Brake
	7/90-12/92		R		153-120		Lucas	203,0x39	Hand Brake
	90-92		R		700-287	700-287K		Ø 203,0	-ABS
1.8 16v Eng.RQB/ C (96kW)	1/92-12/93		R		153-145	153-145K		180,0x25	Hand Brake
	1/92-12/93		R		153-120		Lucas	203,0x39	Hand Brake
	92-93		R		700-287	700-287K		Ø 203,0	-ABS
1.8 D Eng.RTA/ B/ C/ D/ E/ F/ G/ H/ J/ K (44kW)	11/90-12/93		R		153-145	153-145K		180,0x25	Hand Brake
	11/90-12/93		R		153-120		Lucas	203,0x39	+ABS, Hand Brake
	92-93		R		700-287	700-287K		Ø 203,0	-ABS











































		Spare Parts	F/R	L/R	CIFAM ref.	CIFAM ref. w/KIT		DIMENSIONS mm.	NOTE
1.8 TD Eng.RFA/ B/ D/ K/ L/ M/ N/ S (66kW)	3/92-12/93		R		153-145	153-145K		180,0x25	Hand Brake
	3/92-12/93		R		153-120		Lucas	203,0x39	+ABS, Hand Brake
	92-93		R		700-287	700-287K		Ø 203,0	-ABS
1.8i 16v Eng.RDA/ B (77kW)	2/92-12/93		R		153-145	153-145K		180,0x25	Hand Brake
	2/92-12/93		R		153-120		Lucas	203,0x39	-ABS, Hand Brake
	92-93		R		700-287	700-287K		Ø 203,0	-ABS
Puma (EC) 3/97-									
1.4i 16v Eng.FHA/ D/ E/ F (66kW)	11/97-10/00		R		153-137		Ap	180,0x32	Hand Brake
	11/97-10/00		R		153-136		Ap	203,2x38	Hand Brake
	11/97-10/00		R		153-128		Lucas	180,0x32	Hand Brake
	98-9/99		R		700-292			Ø 180,0	
	97-2/00		R		151-151		Ap	Ø 19,05 180,0x29	RAD
98-9/99		R		151-191		Lucas	Ø 19,05 180,0x32	LOS	
1.6 16v Eng.FYJA (76kW)	8/00-		R		153-137		Ap	180,0x32	Hand Brake
	8/00-		R		153-136		Ap	203,2x38	+ABS, Hand Brake
	8/00-12/01		R		700-290	700-290K		Ø 203,0	
1.6 ST 160 (118kW)	6/99-		R		153-137		Ap	180,0x32	Hand Brake
	6/99-		R		153-136		Ap	203,2x38	+ABS, Hand Brake
1.7 16v Eng.MHA/ B (92kW)	3/97-		R		153-137		Ap	180,0x32	Hand Brake
	3/97-		R		153-136		Ap	203,2x38	Hand Brake
	3/97-		R		153-128		Lucas	180,0x32	Hand Brake
	97-9/99		R		700-292			Ø 180,0	
	97-2/00		R		151-151		Ap	Ø 19,05 180,0x29	RAD
	97-9/99		R		151-191		Lucas	Ø 19,05 180,0x32	LOS
Ranger II (TU) 10/99-									
2.5 D, 4WD Eng.WL (57kW)	10/99-4/02		R		153-144			270,0x54	Hand Brake
	10/99-4/02		R		153-143			295,0x56	Hand Brake
2.5 TD 4WD Eng.WL-T (80kW)	10/99-		R		153-144			270,0x54	Hand Brake
	10/99-		R		153-143			295,0x56	Hand Brake
2.5 TD, 4WD Eng.WL (62kW)	4/02-		R		153-144			270,0x54	Hand Brake
	4/02-		R		153-143			295,0x56	Hand Brake
2.5 TDCi, 4WD (105kW)	10/99-		R		153-144			270,0x54	Hand Brake
	10/99-		R		153-143			295,0x56	Hand Brake
Sierra I, SW 8/82-12/86									
1.3 (Exc. SW) Eng.JCT (44kW)	8/82-12/86		R		153-107		Bdx	203,2x38	Hand Brake
	8/82-12/86		R			153-112K	Bdx	203,2x38	Hand Brake
	82-86		R		700-268			Ø 203,0	
1.6 (51kW)	10/82-12/86		R		153-107		Bdx	203,2x38	Hand Brake
	10/82-12/86		R			153-112K	Bdx	203,2x38	Hand Brake
	10/82-12/86		R		153-108		Lucas	228,6x57	Hand Brake
1.6 Eng.LCS/ T/ LSD (55kW)	8/82-12/86		R		153-107		Bdx	203,2x38	Hand Brake
	8/82-12/86		R			153-112K	Bdx	203,2x38	Hand Brake
	8/82-12/86		R		153-108		Lucas	228,6x57	Hand Brake
	82-86		R		700-268			Ø 203,0	
82-86		R		700-272			Ø 228,6		
1.6 (Exc. SW) Eng.LP1/ LP2/ LUA/ B/ C/ D/ H (58kW)	8/84-12/86		R		153-107		Bdx	203,2x38	Hand Brake
	8/84-12/86		R			153-112K	Bdx	203,2x38	Hand Brake
	8/84-12/86		R		153-108		Lucas	228,6x57	Hand Brake
1.8 Eng.REB (66kW)	10/84-12/86		R		153-108		Lucas	228,6x57	Hand Brake
	84-86			R		700-272			Ø 228,6
1.8 Eng.REB/ C/ D/ F TL18H (59kW)	1/84-12/86		R		153-108		Lucas	228,6x57	Hand Brake
2.0 Eng.NET/ TL20H (77kW)	8/82-12/86		R		153-108		Lucas	228,6x57	Hand Brake
	82-86			R		700-272			Ø 228,6
2.0 Eng.NRD/ TL20H (74kW)	10/85-12/86		R		153-108		Lucas	228,6x57	Hand Brake
	85-86			R		700-272			Ø 228,6
2.0 Eng.NYT (66kW)	8/82-10/84		R		153-108		Lucas	228,6x57	Hand Brake
	82-84			R		700-272			Ø 228,6
2.0 4WD Eng.N5B (150kW)	10/85-12/86		R		153-108		Lucas	228,6x57	Hand Brake
2.0 i Eng.NR2/ NRB/ TL20 EFI (85kW)	3/85-12/86		R		153-108		Lucas	228,6x57	Hand Brake
	85-86			R		700-272			Ø 228,6
2.3 Eng.YYT/ TV23 (84kW)	8/82-12/86		R		153-108		Lucas	228,6x57	Hand Brake
	82-86			R		700-272			Ø 228,6
2.3 D Eng.YTR/ T (49kW)	8/82-12/86		R		153-108		Lucas	228,6x57	Hand Brake
	82-86			R		700-272			Ø 228,6



















		Spare Parts	F/R	L/R	CIFAM ref.	CIFAM ref. w/KIT		DIMENSIONS mm.	NOTE
2.8 XR, 4WD Eng.PRT/ TV28 (110kW)	82-86		R		700-318			Ø 254,0	-ABS
Sierra II, SW 1/87-2/93									
1.6 Eng.LSE (55kW)	1/87-2/93		R			153-112K	Bdx	203,2x38	Hand Brake
	1/87-2/93		R		153-108		Lucas	228,6x57	Hand Brake
	87-93		R		700-268			Ø 203,0	
	87-93		R		700-272			Ø 228,6	
1.6 Eng.LSF (53kW)	1/88-2/93		R			153-112K	Bdx	203,2x38	Hand Brake
	1/88-2/93		R		153-108		Lucas	228,6x57	Hand Brake
	88-93		R		700-268			Ø 203,0	
	88-93		R		700-272			Ø 228,6	
1.6 i Eng.L6B (59kW)	10/89-2/93		R			153-112K	Bdx	203,2x38	Hand Brake
	10/89-2/93		R		153-108		Lucas	228,6x57	Hand Brake
	89-93		R		700-268			Ø 203,0	
	89-93		R		700-272			Ø 228,6	
1.8 Eng.R2A/ RED (66kW)	1/87-5/88		R		153-108		Lucas	228,6x57	Hand Brake
	87-88		R		700-272			Ø 228,6	
1.8 Eng.R2C/ R6A (64kW)	5/88-2/93		R		153-108		Lucas	228,6x57	Hand Brake
	88-93		R		700-272			Ø 228,6	
1.8 Eng.REF/ D (59kW)	10/87-9/89		R		153-108		Lucas	228,6x57	Hand Brake
	87-89		R		700-272			Ø 228,6	
1.8 TD Eng.RFA/ B/ D/ K/ L/ M/ N/ S (55kW)	88-93		R		700-272			Ø 228,6	
2.0 Eng.N8C/ NES/ TL20H (77kW)	1/87-2/93		R		153-108		Lucas	228,6x57	Hand Brake
	87-93		R		700-272			Ø 228,6	
2.0 i Eng.N4A/ I/ TL20 EFi (85kW)	1/87-2/93		R		153-108		Lucas	228,6x57	Hand Brake
	87-93		R		700-272			Ø 228,6	
2.0 i Eng.N8A (80kW)	6/89-2/93		R		153-108		Lucas	228,6x57	Hand Brake
	89-93		R		700-272			Ø 228,6	
2.0 i Eng.NEJ/ NE5 (74kW)	1/87-12/89		R		153-108		Lucas	228,6x57	Hand Brake
	87-89		R		700-272			Ø 228,6	
2.0 i (Only Coda Spiovente) Eng.N9B/ C/ D/ F (92kW)	6/89-2/93		R		153-108		Lucas	228,6x57	Hand Brake
	89-93		R		700-272			Ø 228,6	
2.0 i DOHC Eng.N9E (85kW)	12/91-2/93		R		153-108		Lucas	228,6x57	Hand Brake
2.0 i Kat Eng.N4B (74kW)	1/87-2/93		R		153-108		Lucas	228,6x57	Hand Brake
	87-93		R		700-272			Ø 228,6	
2.0, 4WD Eng.N9C (88-92kW)	5/89-2/93		R		153-108		Lucas	228,6x57	Hand Brake
	89-93		R		700-272			Ø 228,6	
2.3 D Eng.YTR/ T (49kW)	1/87-9/89		R		153-108		Lucas	228,6x57	Hand Brake
	87-89		R		700-272			Ø 228,6	
2.8 i, 4WD Eng.PRG/ TV28 (110kW)	87-88		R		700-318			Ø 254,0	
Street Ka 5/03-									
1.6 Eng.CDB/ C (70kW)	5/03-		R		153-136		Ap	203,2x38	Hand Brake
	03-		R		700-290	700-290K		Ø 203,0	
Taurus I (GBFK) 1/70-2/76									
1.3, SW, Coupe Eng.JAC (40-43kW)	70-75		R		700-268			Ø 203,0	
1.6, Coupe (53-65kW)	70-75		R		700-268			Ø 203,0	
1.6, SW Eng.LAD (50kW)	74-75		R		700-268			Ø 203,0	
1.6, SW, Coupe Eng.LCJ (53kW)	70-75		R		700-268			Ø 203,0	
Taurus II (GBTS,GBFS,CBTS) 5/75-7/79									
1.3, SW Eng.JAC (40-43kW)	75-79		R		700-277			Ø 228,6	
1.6, SW Eng.LAD (50kW)	75-79		R		700-272			Ø 228,6	
	79-		R		700-277			Ø 228,6	
1.6, SW Eng.LCJ (53kW)	75-79		R		700-272			Ø 228,6	
	79-		R		700-277			Ø 228,6	
2.0, SW Eng.NYR/ TV20H (66kW)	75-79		R		700-272			Ø 228,6	
	79-		R		700-277			Ø 228,6	
2.3, SW Eng.YYF/ TV23 (79kW)	75-79		R		700-272			Ø 228,6	
	79-		R		700-277			Ø 228,6	
Taurus III 80 (GBS, GBNS) 7/79-7/82									
1.3, SW Eng.JCC (43kW)	79-82		R		700-277			Ø 228,6	
1.6, SW Eng.LAR (51kW)	-79		R		700-272			Ø 228,6	
	79-82		R		700-277			Ø 228,6	
1.6, SW Eng.LCJ (54kW)	-79		R		700-272			Ø 228,6	
	79-82		R		700-277			Ø 228,6	



















		Spare Parts	F/R	L/R	CIFAM ref.	CIFAM ref. w/KIT		DIMENSIONS mm.	NOTE
2.0, SW Eng.NWR/ TV20H (66kW)	-79		R		700-272			Ø 228,6	
	79-82		R		700-277			Ø 228,6	
2.3, SW Eng.YYR/ TV23 (84kW)	-79		R		700-272			Ø 228,6	
	79-82		R		700-277			Ø 228,6	





















































FORD LCV, TRUCK



































Escort I Van 1/68-1/73									
1.1 Eng.G1/ KL11L/ H(751M) (28-29-32-35kW)	1/68-1/73		R		153-101		Lucas	203,2x38	Hand Brake
	68-73		R		700-268			Ø 203,0	
1.3 Eng.J1F/ K13L (42kW)	1/68-1/73		R		153-101		Lucas	203,2x38	Hand Brake
	68-73		R		700-268			Ø 203,0	
1.3 Eng.K13L (35kW)	1/68-1/73		R		153-101		Lucas	203,2x38	Hand Brake
	68-73		R		700-268			Ø 203,0	
Escort II Van 1/73-1/81									
1.1 Eng.G2/ KL11L/ H(751M) (32-35kW)	1/73-1/81		R		153-103		Lucas	203,2x38	Hand Brake
	75-80		R		700-277			Ø 228,6	
	76-80		R		700-268			Ø 203,0	
1.3 Eng.J1F/ K13L (40kW)	1/73-1/81		R		153-103		Lucas	203,2x38	30 cwt, Hand Brake
	1/73-1/81		R		153-104		Lucas	228,6x45	45 cwt
	76-80		R		700-268			Ø 203,0	
1.3 Eng.J2/ K13L (42-45kW)	1/73-1/81		R		153-103		Lucas	203,2x38	30 cwt, Hand Brake
	1/73-1/81		R		153-104		Lucas	228,6x45	45 cwt
	75-80		R		700-277			Ø 228,6	
Escort III Van (AVA) 3/81-2/86									
1.1 Eng.GLB/ GMA (40kW)	3/81-8/83		R		153-106		Lucas	203,2x38	
1.1 Eng.GSB/ C/ E/ F/ G/ H (37kW)	3/81-2/86		R		153-106		Lucas	203,2x38	
	81-86		R		700-268			Ø 203,0	
1.3 Eng.JPA/ C (51kW)	3/81-2/86		R		153-106		Lucas	203,2x38	
	81-86		R		700-268			Ø 203,0	
1.6 (61kW)	81-86		R		700-268			Ø 203,0	
1.6 D Eng.LTA/ B/ C (40kW)	84-86		R		700-270	700-270K		Ø 180,0	
Escort IV Van (AVF) 2/86-7/90									
1.1 Eng.GSB/ C/ E/ F/ G/ H (37kW)	-1/88		R		153-106		Lucas	203,2x38	
	86-90		R		700-268			Ø 203,0	
1.3 (51kW)	11/86-7/88		R		153-106		Lucas	203,2x38	
1.3 Eng.JBA (46kW)	7/88-7/90		R		153-106		Lucas	203,2x38	
	88-90		R		700-268			Ø 203,0	
1.3 Eng.JLA/ B/ JBB (44kW)	2/86-7/90		R		153-106		Lucas	203,2x38	
	86-90		R		700-268			Ø 203,0	
1.4 Eng.FUA (55kW)	1/86-7/90		R		153-106		Lucas	203,2x38	
1.4 i Eng.F6D/ F6B/ FUC (54kW)	2/86-7/90		R		153-106		Lucas	203,2x38	
	86-90		R		700-268			Ø 203,0	
1.6 (60kW)	2/86-7/90		R		153-106		Lucas	203,2x38	
	86-90		R		700-268			Ø 203,0	
1.6 Eng.LP2 (58kW)	1/86-1/90		R		153-106		Lucas	203,2x38	
1.6 D Eng.LTA/ B/ C (40kW)	2/86-7/90		R		153-106		Lucas	203,2x38	
	86-90		R		700-268			Ø 203,0	
1.6 i Eng.L4B (66kW)	1/86-7/90		R		153-106		Lucas	203,2x38	
1.8 D Eng.RTA/ B/ C/ D/ E/ F/ G/ H/ J/ K (44kW)	88-90		R		700-268			Ø 203,0	
Escort V Van (AVL) 7/90-12/94									
1.3 Eng.J4B/ J6A (44kW)	9/91-9/92		R		153-121		Lucas	228,6x45	
1.3 Eng.JBD (46kW)	7/90-12/94		R		153-121		Lucas	228,6x45	
	90-94		R		700-277			Ø 228,6	
1.4 Eng.F6A/ B/ C/ D/ E/ F/ G (52-54kW)	7/90-12/94		R		153-121		Lucas	228,6x45	
	90-94		R		700-277			Ø 228,6	
1.6 Eng.LJF (77kW)	7/90-9/92		R		153-121		Lucas	228,6x45	
1.6i, 16v Eng.LUG/ K/ J (66kW)	7/90-12/94		R		153-121		Lucas	228,6x45	
	90-94		R		700-277			Ø 228,6	
1.8 D Eng.RTH/ RTE/ RTF (44kW)	7/90-12/94		R		153-121		Lucas	228,6x45	
	90-94		R		700-277			Ø 228,6	
1.8i 16v Eng.RDA/ B (77kW)	90-94		R		700-277			Ø 228,6	
Escort VI Van (AVL) 1/95-									
1.3 Eng.J4B/ J6A (44kW)	9/92-1/95		R		153-121		Lucas	228,6x45	
1.4 Eng.F4A/ B/ H (54kW)	95-98		R		700-292			Ø 180,0	-ABS
1.4 Eng.F6F/ G (52kW)	9/92-1/94		R		153-121		Lucas	228,6x45	











































		Spare Parts	F/R	L/R	CIFAM ref.	CIFAM ref. w/KIT		DIMENSIONS mm.	NOTE
1.8 D Eng.RTA/ B/ C/ D/ E/ F/ G/ H/ J/ K (44kW)	1/95-		R		153-121		Lucas	228,6x45	
	95-98		R		700-292			Ø 180,0	
1.8 TD Eng.RVA (51kW)	12/95-6/01		R		153-121		Lucas	228,6x45	
	95-98		R		700-292			Ø 180,0	
Fiesta I Van 5/76-8/83									
0.95 Eng.BL09L/ H (27kW)	76-8/83		R		700-267	700-267K		Ø 177,8	
1.1 Eng.GMA/ GPA/ GLB/ GLA/ GLW (40kW)	76-8/83		R		700-267	700-267K		Ø 177,8	
Fiesta II Van 3/83-2/89									
1.0 Eng.BL09L/ H (29kW)	9/83-89		R		700-267	700-267K		Ø 177,8	
1.1 Eng.GSB/ C/ E/ F/ G/ H (33-37-39kW)	83-89		R		700-267	700-267K		Ø 177,8	
1.4 Eng.F6A/ B/ C/ D/ E/ F/ G (52kW)	9/86-2/89		R			153-111K	Bdx	178,0x32	Express, Hand Brake
	9/86-2/89		R			153-131Y	Bdx	178,0x32	Express, Hand Brake
	86-89		R		700-267	700-267K		Ø 177,8	
	86-89		R		151-038		Bdx	Ø 17,46 180,0x30	RAD
1.6 D Eng.LTB (40kW)	84-89		R		700-267	700-267K		Ø 177,8	
Fiesta III Van, Courier 3/89-7/95									
1.0 Eng.TKB (33kW)	11/89-7/95		R			153-117Y	Bdx	178,0x32	
	11/89-7/95		R			153-132Y	Bdx	178,0x32	
	11/89-7/95		R			153-117K	Bdx	178,0x32	Hand Brake
1.3 Eng.J6B/ JBC (44kW)	1/91-7/95		R			153-118K	Bdx	203,2x38	Van
	1/91-7/95		R		153-129		Lucas	203,2x39	Courier
	-94		R		700-288			Ø 203,0	
	94-95		R		700-275	700-275K		Ø 203,0	
1.8 D Eng.RTA/ B/ C/ D/ E/ F/ G/ H/ J/ K (44kW)	3/89-7/95		R			153-117Y	Bdx	178,0x32	Van
	3/89-7/95		R			153-132Y	Bdx	178,0x32	Van
	3/89-7/95		R			153-117K	Bdx	178,0x32	Van, Hand Brake
	3/89-7/95		R			153-118K	Bdx	203,2x38	Courier, +ABS
	89-94		R		700-276	700-276K		Ø 180,0	Van
	-94		R		700-288			Ø 203,0	Courier
	94-95		R		700-275	700-275K		Ø 203,0	Courier
	89-95		R		151-027		Bdx	Ø 17,46 180,0x30	RAD
Fiesta IV Van, Courier 8/95-8/02									
1.3i Eng.BAJA/ J4C (44kW)	8/95-8/02		R		153-128		Lucas	180,0x32	Courier, Hand Brake
	8/95-8/02		R		153-129		Lucas	203,2x39	Courier
	95-		R		700-288			Ø 203,0	Van / Courier
1.4 i Eng.FHA (66kW)	4/96-10/99		R		153-128		Lucas	180,0x32	Courier, Hand Brake
1.8 D Eng.RTA/ B/ C/ D/ E/ F/ G/ H/ J/ K (44kW)	8/95-8/02		R		153-128		Lucas	180,0x32	Courier, Hand Brake
	8/95-8/02		R		153-129		Lucas	203,2x39	Courier 50
	95-		R		700-288			Ø 203,0	Van / Courier
1.8 TD Eng.RTN/ RTP/ RTQ (55kW)	5/98-		R		153-129		Lucas	203,2x39	Courier
Fiesta V Van 11/01-4/08									
1.4 TDCi Eng.F6JA/ B (50kW)	11/01-4/08		R		153-136		Ap	203,2x38	Hand Brake
	01-		R		700-365	700-365K		Ø 203,0	
P 100 II 10/87-									
1.8 TD Eng.RFA/ B/ D/ K/ L/ M/ N/ S (55kW)	10/87-12/92		R		153-115		Ap	228,6x45	Hand Brake
	10/87-12/92		R		153-100		Lucas	254,0x57	Hand Brake
	87-92		R		700-278			Ø 228,6	
2.0 Eng.NAE (57kW)	10/87-		R		153-115		Ap	228,6x45	Hand Brake
	10/87-		R		153-100		Lucas	254,0x57	Hand Brake
	87-93		R		700-278			Ø 228,6	
Sierra I Van 8/82-12/86									
1.6 Eng.LCS/ T/ LSD (55kW)	8/82-12/86		R		153-108		Lucas	228,6x57	-ABS, Hand Brake
2.3 D Eng.YTT (49kW)	8/82-12/86		R		153-108		Lucas	228,6x57	Hand Brake
Sierra II Van 1/87-2/93									
1.8 TD Eng.RFA/ B/ L (55kW)	8/88-2/93		R		153-108		Lucas	228,6x57	-ABS, Hand Brake
2.3 D Eng.YTR (49kW)	-90		R		153-108		Lucas	228,6x57	Hand Brake
Tourneo (EBS) 1/94-12/00									
2.0i Eng.NSF/ H (85kW)	94-97		R		153-126		Bdx	254,0x50	FT80, 100, 115, 120, SRW
	94-97		R		153-123		Bdx	280,0x64	Hand Brake
	94-97		R		153-127		Bdx	280,0x64	FT130, 150, 190, TRW
	94-97		R		153-313		Bdx	280,0x65	
	94-97		R		700-284			Ø 254,0	Axle Timken
	94-97		R		700-285			Ø 280,0	Axle Salisbury
2.4 D Eng.4HA (55kW)	8/94-6/00		R		153-126		Bdx	254,0x50	FT80, 100, 115, 120, SRW
	8/94-6/00		R		153-127		Bdx	280,0x64	FT130, 150, 190, TRW
	8/94-6/00		R		153-313		Bdx	280,0x65	























































		Spare Parts	F/R	L/R	CIFAM ref.	CIFAM ref. w/KIT		DIMENSIONS mm.	NOTE
2.5 D, TD Eng.4GB/ D/ A/ C/ 4HA/ B/ C (55-62kW)	94-97		R		153-126		Bdx	254,0x50	FT80, 100, 115, 120, SRW
			R		153-123		Bdx	280,0x64	Hand Brake
			R		153-127		Bdx	280,0x64	FT130, 150, 190, TRW
			R		153-313		Bdx	280,0x65	
	94-97		R		700-284			Ø 254,0	FT80, FT100, FT120, FT150, FT190, 14Inch Wheels
	R			700-285			Ø 280,0	FT100, FT120, FT130, FT150, FT190, 15Inch Wheels	
2.5 DI Eng.4FA/ B/ C/ D (51kW)	11/94-12/00		R		153-123		Bdx	280,0x64	Hand Brake
	8/94-3/00		R		153-126		Bdx	254,0x50	FT80, 100, 115, 120, SRW
	8/94-3/00		R		153-127		Bdx	280,0x64	FT130, 150, 190, TRW
	8/94-3/00		R		153-313		Bdx	280,0x65	
	94-00		R		700-284			Ø 254,0	FT80, FT100, FT150, FT190, 14Inch Wheels
	94-00		R		700-285			Ø 280,0	FT100, FT130, FT150, FT190, 15Inch Wheels
2.5 TD Eng.4EB/ C (74kW)	98-00		R		153-126		Bdx	254,0x50	FT80, 100, 115, 120, SRW
	98-00		R		153-127		Bdx	280,0x64	FT130, 150, 190, TRW
	98-00		R		153-313		Bdx	280,0x65	
	94-00		R		700-285			Ø 280,0	FT120, FT130, FT150, FT190, 15Inch Wheels
	98-00		R		700-284			Ø 254,0	FT120, FT150, FT190, 14Inch Wheels
Tourneo Connect 9/02-									
1.8 16v Eng.EYPA (85kW)	02-		R		153-138		Ap	228,6x58	-ABS, Hand Brake
	02-		R		700-366			Ø 228,6	-TC
	02-		R		151-230		Ap	Ø 20,64 228,6x58	AP
1.8 Di Eng.BHPA (55kW)	02-		R		153-138		Ap	228,6x58	-ABS, Hand Brake
	02-		R		700-366			Ø 228,6	-TC
	02-		R		151-230		Ap	Ø 20,64 228,6x58	AP
1.8 TDCi Eng.HCPA (66kW)	02-		R		153-138		Ap	228,6x58	-ABS, Hand Brake
	02-		R		700-366			Ø 228,6	-TC
Transit Connect 9/02-									
1.8 16v Eng.EYPA (85kW)	9/02-		R		153-138		Ap	228,6x58	-ABS, Hand Brake
	9/02-		R		700-366			Ø 228,6	
	02-		R		151-230		Ap	Ø 20,64 228,6x58	AP
1.8 Di Eng.BHPA (55kW)	9/02-		R		153-138		Ap	228,6x58	-ABS, Hand Brake
	9/02-		R		700-366			Ø 228,6	
	02-		R		151-230		Ap	Ø 20,64 228,6x58	AP
1.8 TDCi Eng.HCPA (66kW)	9/02-		R		153-138		Ap	228,6x58	-ABS, Hand Brake
	9/02-		R		700-366			Ø 228,6	
Transit II 1/65-9/78									
1.5 Eng.EX (44kW)	11/65-5/78		R		153-139		Ap	254,0x57	FT100, Hand Brake
	73-78		R		700-280			Ø 254,0	FT75, FT100, TRW
1.6 Eng.EY (48kW)	4/71-9/78		R		153-102		Ap	228,6x45	FT80, 100, 115 Van, Bus 13, Hand Brake
	4/71-9/78		R		153-139		Ap	254,0x57	FT90, 100, 115, 130, 150, 175, Hand Brake
	76-78		R		700-280			Ø 254,0	FT100, FT115, FT125, TRW
1.7 Eng.17M/ EV17L (48-51-55kW)	1/71-12/78		R		153-102		Ap	228,6x45	FT80, 100, 115 Van, Bus 13, Hand Brake
	1/71-12/78		R		153-139		Ap	254,0x57	FT90, 100, 115, 130, 150, 175, Hand Brake
1.7 Eng.EY (48kW)	1/65-3/78		R		153-102		Ap	228,6x45	FT80, 100, 115 Van, Bus 13, Hand Brake
	1/65-3/78		R		153-139		Ap	254,0x57	FT90, 100, 115, 130, 150, 175, Hand Brake
2.0 Eng.4RC (43-55-57kW)	4/71-9/78		R		153-102		Ap	228,6x45	FT80, 100, 115 Van, Bus 13, Hand Brake
	4/71-9/78		R		153-139		Ap	254,0x57	FT90, 100, 115, 130, 150, 175, Hand Brake
	76-78		R		700-280			Ø 254,0	FT100L, FT115, FT125, FT150, FT175, FT190, TRW
2.0 (V4) Eng.4RC (43-55-57kW)	4/71-9/78		R		153-102		Ap	228,6x45	FT80, 100, 115 Van, Bus 13, Hand Brake
	4/71-9/78		R		153-139		Ap	254,0x57	FT90, 100, 115, 130, 150, 175, Hand Brake
	70-78		R		700-280			Ø 254,0	FT100, FT130, TRW
2.3 D (46kW)	11/71-9/78		R		153-102		Ap	228,6x45	FT80, 100, 115 Van, Bus 13, Hand Brake
	11/71-9/78		R		153-139		Ap	254,0x57	FT90, 100, 115, 130, 150, 175, Hand Brake
2.4 D Eng.4AA (46kW)	4/71-9/78		R		153-102		Ap	228,6x45	FT80, 100, 115 Van, Bus 13, Hand Brake
	4/71-9/78		R		153-139		Ap	254,0x57	FT90, 100, 115, 130, 150, 175, Hand Brake























































		Spare Parts	F/R	L/R	CIFAM ref.	CIFAM ref. w/KIT		DIMENSIONS mm.	NOTE
2.4 D Eng.4AA (46kW)	76-78		R		700-280			Ø 254,0	FT75, FT115, FT125, FT130, FT150, FT175, FT190, TRW
Transit III (V) 11/77-10/86									
1.6 Eng.4RB (48kW)	12/77-10/86		R		153-102		Ap	228,6x45	FT80, 100, 115, 120, Hand Brake
	77-86		R		700-280			Ø 254,0	FT80, FT100, FT120, TRW
1.6 Eng.L3C (62kW)	1/78-10/87		R		153-102		Ap	228,6x45	FT80, 100, 115, 120, Hand Brake
2.0 Eng.4RC (43-55-57kW)	11/77-10/86		R		153-102		Ap	228,6x45	FT80, 100, 115, 120, Hand Brake
	11/77-10/86		R		153-109		Ap	254,0x70	FT120, 130, HDB, Hand Brake
	77-86		R		700-280			Ø 254,0	FT80, FT100, FT120, FT130, FT160, FT175, FT190, TRW
2.4 D Eng.4AA (46kW)	12/77-10/86		R		153-102		Ap	228,6x45	FT80, 100, 115, 120, Hand Brake
	12/77-10/86		R		153-109		Ap	254,0x70	FT120, 130, HDB, Hand Brake
	77-86		R		700-280			Ø 254,0	FT80, FT100, FT120, FT160, FT175, TRW
2.5 D Eng.4AB/ 4BA/ 4CA (50kW)	10/83-10/86		R		153-102		Ap	228,6x45	FT80, 100, 115, 120, Hand Brake
	10/83-10/86		R		153-109		Ap	254,0x70	FT120, 130, HDB, Hand Brake
	83-86		R		700-280			Ø 254,0	FT80, FT100, FT130, FT160, FT190, TRW
Transit IV (T) 11/85-9/92									
1.6 (62kW)	11/85-12/88		R		153-115		Ap	228,6x45	FT80, 100, 115, 120, Hand Brake
	11/85-12/88		R		153-116		Ap	254,0x70	FT130, 160, 190, 190A (2 Piston Caliper), Hand Brake
	11/85-12/88		R		153-114		Ap	254,0x70	FT130, 160, 190, 190A (4 Piston Caliper), Hand Brake
1.6 Eng.LAT (46kW)	12/85-1/89		R		153-115		Ap	228,6x45	FT80, 100, 115, 120, Hand Brake
	12/85-1/89		R		153-116		Ap	254,0x70	FT130, 160, 190, 190A (2 Piston Caliper), Hand Brake
	12/85-1/89		R		153-114		Ap	254,0x70	FT130, 160, 190, 190A (4 Piston Caliper), Hand Brake
	85-89		R		700-278			Ø 228,6	FT80, FT100, SRW
2.0, Kat., 16v Eng.N6T/ NAT/ V (57kW)	11/85-9/92		R		153-115		Ap	228,6x45	FT80, 100, 115, 120, Hand Brake
	11/85-9/92		R		153-116		Ap	254,0x70	FT130, 160, 190, 190A (2 Piston Caliper), Hand Brake
	11/85-9/92		R		153-114		Ap	254,0x70	FT130, 160, 190, 190A (4 Piston Caliper), Hand Brake
	85-92		R		700-278			Ø 228,6	FT80, FT100, FT120, SRW
	85-92		R		700-286			Ø 254,0	FT130, FT160, FT190
2.5 D Eng.4AB/ 4BA/ 4CA (50-52kW)	12/85-9/92		R		153-115		Ap	228,6x45	FT80, 100, 115, 120, Hand Brake
	12/85-9/92		R		153-116		Ap	254,0x70	FT130, 160, 190, 190A (2 Piston Caliper), Hand Brake
	12/85-9/92		R		153-114		Ap	254,0x70	FT130, 160, 190, 190A (4 Piston Caliper), Hand Brake
	85-92		R		700-278			Ø 228,6	FT80, FT100, FT120, SRW
	85-92		R		700-286			Ø 254,0	FT130, FT160, FT190
2.5 TD Eng.D25 (58kW)	9/88-9/92		R		153-115		Ap	228,6x45	FT80, 100, 115, 120, Hand Brake
	9/88-9/92		R		153-116		Ap	254,0x70	FT130, 160, 190, 190A (2 Piston Caliper), Hand Brake
	9/88-9/92		R		153-114		Ap	254,0x70	FT130, 160, 190, 190A (4 Piston Caliper), Hand Brake
	88-92		R		700-278			Ø 228,6	FT80, FT100, FT120, SRW
	88-92		R		700-286			Ø 254,0	FT130, FT160, FT190
Transit V (E1) 1/91-9/94									
2.0 Eng.NBA (66kW)	9/91-9/94		R		153-122		Bdx	254,0x50	FT80, 100, 115, 120, SRW, Hand Brake
	9/91-9/94		R		153-123		Bdx	280,0x64	FT130, 150, 190, TRW, Hand Brake
	91-94		R		700-284			Ø 254,0	FT100, FT150, FT190, 14Inch Wheels
	91-94		R		700-285			Ø 280,0	FT100, FT150, FT190, 15Inch Wheels
2.0 i Eng.NCA (72kW)	9/91-7/94		R		153-122		Bdx	254,0x50	FT80, 100, 115, 120, SRW, Hand Brake
	9/91-7/94		R		153-123		Bdx	280,0x64	FT130, 150, 190, TRW, Hand Brake
	91-94		R		700-284			Ø 254,0	FT80, FT120, FT150, FT190, 14Inch Wheels
	91-94		R		700-285			Ø 280,0	FT120, FT130, FT150, FT190, 15Inch Wheels
2.0i Eng.TL20 Efi (85kW)	1/91-12/94		R		153-122		Bdx	254,0x50	FT80, 100, 115, 120, SRW, Hand Brake
	1/91-12/94		R		153-123		Bdx	280,0x64	FT130, 150, 190, TRW, Hand Brake
2.5 Di Eng.4DA (59kW)	9/91-7/94		R		153-122		Bdx	254,0x50	FT80, 100, 115, 120, SRW, Hand Brake
	9/91-7/94		R		153-123		Bdx	280,0x64	FT130, 150, 190, TRW, Hand Brake
2.5 Di Eng.4FA/ B/ C/ D (51kW)	8/91-7/94		R		153-122		Bdx	254,0x50	FT80, 100, 115, 120, SRW, Hand Brake
	8/91-7/94		R		153-123		Bdx	280,0x64	FT130, 150, 190, TRW, Hand Brake
	91-94		R		700-284			Ø 254,0	FT80, FT100, FT150, FT190, 14Inch Wheels

























































		Spare Parts	F/R	L/R	CIFAM ref.	CIFAM ref. w/KIT		DIMENSIONS mm.	NOTE
2.5 Di Eng.4FA/ B/ C/ D (51kW)	91-94		R		700-285			Ø 280,0	FT100, FT130, FT150, FT190, 15Inch Wheels
2.5 TD Eng.4EA (74kW)	9/91-7/94		R		153-122		Bdx	254,0x50	FT80, 100, 115, 120, SRW, Hand Brake
	9/91-7/94		R		153-123		Bdx	280,0x64	FT130, 150, 190, TRW, Hand Brake
	91-94		R		700-284			Ø 254,0	FT120, FT150, FT190, 14Inch Wheels
	91-94		R		700-285			Ø 280,0	FT120, FT130, FT150, FT190, 15Inch Wheels
2.5 TD Eng.4GA/ B/ C/ D/ E/ F (63kW)	10/92-7/94		R		153-122		Bdx	254,0x50	FT80, 100, 115, 120, SRW, Hand Brake
	10/92-7/94		R		153-123		Bdx	280,0x64	FT130, 150, 190, TRW, Hand Brake
	92-94		R		700-284			Ø 254,0	FT80, FT100, FT120, FT190, 14Inch Wheels
	92-94		R		700-285			Ø 280,0	FT100, FT120, FT130, FT190, 15Inch Wheels
2.9 i Eng.BRT (107kW)	1/91-7/94		R		153-122		Bdx	254,0x50	FT80, 100, 115, 120, SRW, Hand Brake
	1/91-7/94		R		153-123		Bdx	280,0x64	FT130, 150, 190, TRW, Hand Brake
	91-94		R		700-284			Ø 254,0	FT150, FT190, 14Inch Wheels
	91-94		R		700-285			Ø 280,0	FT150, FT190, 15Inch Wheels
Transit VI (E2) 7/94-6/00									
2.0, CNG Eng.NSF/ G/ H/ D (84kW)	9/95-3/00		R		153-126		Bdx	254,0x50	FT80, 100, 115, 120, SRW, Hand Brake
	9/95-3/00		R		153-127		Bdx	280,0x64	FT130, 150, 190, TRW, Hand Brake
	9/95-3/00		R		153-313		Bdx	280,0x65	Hand Brake
2.5 Di Eng.4ED (85kW)	8/97-3/00		R		153-126		Bdx	254,0x50	FT80, 100, 115, 120, SRW, Hand Brake
	8/97-3/00		R		153-127		Bdx	280,0x64	FT130, 150, 190, TRW, Hand Brake
	8/97-3/00		R		153-313		Bdx	280,0x65	Hand Brake
2.5 Di Eng.4FA/ B/ C/ D (51kW)	8/94-3/00		R		153-126		Bdx	254,0x50	FT80, 100, 115, 120, SRW, Hand Brake
	8/94-3/00		R		153-127		Bdx	280,0x64	FT130, 150, 190, TRW, Hand Brake
	8/94-3/00		R		153-313		Bdx	280,0x65	Hand Brake
	94-00		R		700-284			Ø 254,0	FT80, FT100, FT150, FT190, 14Inch Wheels
	94-00		R		700-285			Ø 280,0	FT100, FT130, FT150, FT190, 15Inch Wheels
2.5 Di Eng.4HB/ C (56kW)	7/94-3/00		R		153-126		Bdx	254,0x50	FT80, 100, 115, 120, SRW, Hand Brake
	7/94-3/00		R		153-127		Bdx	280,0x64	FT130, 150, 190, TRW, Hand Brake
	7/94-3/00		R		153-313		Bdx	280,0x65	Hand Brake
2.5 TD Eng.4EB/ C (74kW)	7/94-3/00		R		153-126		Bdx	254,0x50	FT80, 100, 115, 120, SRW, Hand Brake
	7/94-3/00		R		153-127		Bdx	280,0x64	FT130, 150, 190, TRW, Hand Brake
	7/94-3/00		R		153-313		Bdx	280,0x65	Hand Brake
	94-00		R		700-284			Ø 254,0	FT120, FT150, FT190, 14Inch Wheels
	94-00		R		700-285			Ø 280,0	FT120, FT130, FT150, FT190, 15Inch Wheels
2.5 TD Eng.4GA/ B/ C/ D/ E/ F (63kW)	1/95-3/00		R		153-126		Bdx	254,0x50	FT80, 100, 115, 120, SRW, Hand Brake
	1/95-3/00		R		153-127		Bdx	280,0x64	FT130, 150, 190, TRW, Hand Brake
	1/95-3/00		R		153-313		Bdx	280,0x65	Hand Brake
	95-00		R		700-284			Ø 254,0	FT80, FT100, FT120, FT150, FT190, 14Inch Wheels
	95-00		R		700-285			Ø 280,0	FT100, FT120, FT130, FT150, FT190, 15Inch Wheels
2.5 TD Eng.4HA/ D (55kW)	8/94-6/00		R		153-126		Bdx	254,0x50	FT80, 100, 115, 120, SRW, Hand Brake
	8/94-6/00		R		153-127		Bdx	280,0x64	FT130, 150, 190, TRW, Hand Brake
	8/94-6/00		R		153-313		Bdx	280,0x65	Hand Brake
Transit VII (FA, FD, FM) 1/00-3/06									
2.0 Eng.NSF (84kW)	9/00-3/06		R		153-134		Bosch	280,0x65	+ABS, RWD, 16Inch Wheels, Hand Brake
2.0 Di Eng.ABFA (74kW)	8/00-3/06		R		153-135		Bosch	254,0x52	
	8/00-3/06		R		153-134		Bosch	280,0x65	+ABS, RWD, 16Inch Wheels, Hand Brake
	9/00-		R		700-368			Ø 254,0	FWD, SRW
	9/00-		R		700-369			Ø 280,0	TRW
	9/00-		R		700-367			Ø 280,0	RWD, SRW
2.0 Di Eng.D3FA (55kW)	8/00-3/06		R		153-135		Bosch	254,0x52	
	8/00-3/06		R		153-134		Bosch	280,0x65	+ABS, RWD, 16Inch Wheels, Hand Brake
	9/00-		R		700-368			Ø 254,0	FWD, SRW
	9/00-		R		700-369			Ø 280,0	TRW
2.0 Di Eng.F3FA (63kW)	8/00-3/06		R		700-367			Ø 280,0	RWD, SRW
	8/00-3/06		R		153-135		Bosch	254,0x52	
	8/00-3/06		R		153-134		Bosch	280,0x65	+ABS, RWD, 16Inch Wheels, Hand Brake
	9/00-		R		700-368			Ø 254,0	FWD, SRW
	9/00-		R		700-369			Ø 280,0	TRW
	9/00-		R		700-367			Ø 280,0	RWD, SRW

		Spare Parts	F/R	L/R	CIFAM ref.	CIFAM ref. w/KIT		DIMENSIONS mm.	NOTE
2.0 TDCi Eng.F1FA (92kW)	8/02-3/06		R		153-135		Bosch	254,0x52	
	8/02-3/06		R		153-134		Bosch	280,0x65	+ABS, RWD, 16Inch Wheels, Hand Brake
2.3 16v Eng.E5FA/ C (105-107kW)	01-06		R		153-135		Bosch	254,0x52	FWD, 15Inch Wheels
	01-06		R		153-134		Bosch	280,0x65	Hand Brake
	01-06		R		153-134		Bosch	280,0x65	+ABS, RWD, 16Inch Wheels, Hand Brake
2.4 Di Eng.D2FA/ B/ E (66kW)	1/00-3/06		R		153-135		Bosch	254,0x52	FWD, 15Inch Wheels
	1/00-3/06		R		153-134		Bosch	280,0x65	+ABS, 16Inch Wheels, Hand Brake
	1/00-3/06		R		153-134		Bosch	280,0x65	+ABS, RWD, 16Inch Wheels, Hand Brake
	9/00-	R		700-368			Ø 254,0	FWD, SRW	
	9/00-		R		700-369			Ø 280,0	TRW
	9/00-	R		700-367			Ø 280,0	RWD, SRW	
2.4 Di Eng.D4FA (88kW)	1/00-3/06		R		153-135		Bosch	254,0x52	FWD, 15Inch Wheels
	1/00-3/06		R		153-134		Bosch	280,0x65	+ABS, 16Inch Wheels, Hand Brake
	1/00-3/06		R		153-134		Bosch	280,0x65	+ABS, RWD, 16Inch Wheels, Hand Brake
	9/00-	R		700-368			Ø 254,0	FWD, SRW	
	9/00-		R		700-369			Ø 280,0	TRW
2.4 Di Eng.F4FA (55kW)	1/00-3/06		R		153-135		Bosch	254,0x52	FWD, 15Inch Wheels
	1/00-3/06		R		153-134		Bosch	280,0x65	+ABS, 16Inch Wheels, Hand Brake
	1/00-3/06		R		153-134		Bosch	280,0x65	+ABS, RWD, 16Inch Wheels, Hand Brake
	9/00-	R		700-368			Ø 254,0	FWD, SRW	
	9/00-		R		700-369			Ø 280,0	TRW
2.4 TDCi Eng.H9FA (101kW)	3/04-3/06		R		153-135		Bosch	254,0x52	FWD, 15Inch Wheels
	3/04-3/06		R		153-134		Bosch	280,0x65	+ABS, 16Inch Wheels, Hand Brake
	3/04-3/06		R		153-134		Bosch	280,0x65	+ABS, RWD, 16Inch Wheels, Hand Brake
2.4 TDE Eng.D0FA (92kW)	7/01-3/06		R		153-135		Bosch	254,0x52	FWD, 15Inch Wheels
	7/01-3/06		R		153-134		Bosch	280,0x65	+ABS, 16Inch Wheels, Hand Brake
	7/01-3/06		R		153-134		Bosch	280,0x65	+ABS, RWD, 16Inch Wheels, Hand Brake
2.4 TDE Eng.FXFA (85kW)	04-06		R		153-135		Bosch	254,0x52	FWD, 15Inch Wheels
	04-06		R		153-134		Bosch	280,0x65	+ABS, 16Inch Wheels, Hand Brake
	04-06		R		153-134		Bosch	280,0x65	+ABS, RWD, 16Inch Wheels, Hand Brake
Transit VIII 7/06-									
2.2 TDCi Eng.P8FA/ B (63kW)	7/06-		R		153-135		Bosch	254,0x52	FWD
2.2 TDCi Eng.PGFA (103kW)	07-		R		153-135		Bosch	254,0x52	FWD
2.2 TDCi Eng.QVFA (81kW)	7/06-		R		153-135		Bosch	254,0x52	FWD
2.2 TDCi Eng.QWFA (96kW)	7/06-		R		153-135		Bosch	254,0x52	FWD
2.2 TDCi Eng.SRFA/ B/ V/ D/ E (85kW)	08-		R		153-135		Bosch	254,0x52	FWD
2.4 TDCi Eng.JXFA (85kW)	06-		R		153-135		Bosch	254,0x52	FWD
2.4 TDCi Eng.PHFA/ C (74kW)	06-		R		153-135		Bosch	254,0x52	FWD
2.4 TDCi, Allrad Eng.H9FB (103kW)	06-		R		153-135		Bosch	254,0x52	FWD
Transit VIII Tourneo 7/06-									
2.2 TDCi Eng.PGFA (103kW)	07-		R		153-135		Bosch	254,0x52	
2.2 TDCi Eng.QVFA (81kW)	7/06-		R		153-135		Bosch	254,0x52	
2.2 TDCi Eng.QWFA (96kW)	7/06-		R		153-135		Bosch	254,0x52	
2.2 TDCi Eng.SRFA/ B/ V/ D/ E (85kW)	08-		R		153-135		Bosch	254,0x52	
FORD USA									
Explorer (U2) 1/93-									
4.0 V6 Eng.V6X244 (115-121kW)	1/93-		R		153-146			184,0x30	Hand Brake
	1/93-		R		153-147			185,0x30	Flex
4.0 V6 Eng.XS (150-152kW)	5/98-		R		153-146			184,0x30	Hand Brake
	5/98-		R		153-147			185,0x30	Flex
4.9 V6 Eng.V8N302 (157kW)	1/96-		R		153-146			184,0x30	Hand Brake
Probe I 8/88-7/93									
2.2 (82kW)	8/88-7/93		R		153-205		Sumit.	228,6x32	Hand Brake
Windstar (A3) 1/95-									
3.0 V6 (108kW)	2/99-		R		153-146			184,0x30	Hand Brake
3.8 V6 (149kW)	1/95-		R		153-146			184,0x30	Hand Brake
FSO									
126P 7/72-9/00									
0.6 (17kW)	74-		F		153-055		Fiat	170,0x31	Fitted Adjuster
	-77		F		700-001			Ø 170,1	
	-77			R		700-002			Ø 170,1

		Spare Parts	F/R	L/R	CIFAM ref.	CIFAM ref. w/KIT		DIMENSIONS mm.	NOTE
0.6 (22kW)	7/77-12/91		F		153-055		Fiat	170,0x31	Fitted Adjuster
	-12/78		F		700-001			Ø 170,1	
	1/79-		R		700-003			Ø 185,0	
	-12/78		R		700-002			Ø 170,1	
650 Eng.126A1.048 (18kW)	81-		R		700-003			Ø 185,0	
127P 10/69-10/76									
0.9 (33kW)	10/69-10/76		R		153-063		Fiat	185,0x31	Fitted Adjuster, Hand Brake
	3/74-76		R		700-003			Ø 185,0	
Polonez I 10/77-12/91									
1.5 Eng.AA (55kW)	10/77-8/88		R		153-063		Fiat	185,0x31	Fitted Adjuster, Hand Brake
1.5 Eng.AB (60kW)	1/78-8/88		R		153-063		Fiat	185,0x31	Fitted Adjuster, Hand Brake
1.5 T. (70kW)	1/78-12/91		R		153-063		Fiat	185,0x31	Fitted Adjuster, Hand Brake
Polonez III 9/92-									
1.6 i Eng.CE (57kW)	9/92-		R		153-476		Lucas	203,0x38	
1.9 D Eng.XUD9A (51kW)	9/92-		R		153-476		Lucas	203,0x38	
GEO									
Metro									
1.3 GTI Eng.G13B (74kW)	1/89-12/98		R		153-398		Sumit.	180,0x25	
Prizm									
All models			R		153-422		Sumit.	200,0x37	Twin Cam, Hand Brake
Tracker									
All models			R		153-397		Sumit.	220,0x36	Hand Brake
HONDA									
Acclaim									
All models			R		153-152		Sumit.	180,0x25	
Accord I (SJ, SY, SM, SV, SZ) 1/78-9/83									
1.6 L/EX (SY), H-Back Eng.EG/ EL/ EF/ EP (59kW)	1/78-9/83		R		153-149		Ake	200,0x35	
1.8 Eng.EK1 (66kW)	1/78-12/83		R		153-149		Ake	200,0x35	
Accord II (AC, AD) 9/83-10/85									
1.6 EX (AC), H-Back Eng.EZ/ EP (65kW)	9/83-10/85		R		153-149		Ake	200,0x35	
	9/83-10/85		R		153-153		Ake	200,0x35	GB made, Hand Brake
1.8 Eng.ES/ ET (96kW)	1/83-1/85		R		153-153		Ake	200,0x35	Hand Brake
1.8 EX (AD), H-Back Eng.ET1 (74kW)	9/83-10/85		R		153-153		Ake	200,0x35	Hand Brake
Accord III (CA4, CA5), Aerodeck 11/85-12/89									
1.6 L (CA4) Eng.A16A1 (65kW)	11/85-12/89		R		153-149		Ake	200,0x35	
	86-87		R		700-081			Ø 200,0	
1.8 (CA1) Eng.A18A (90kW)	11/85-9/89		R		153-154		Ake	220,0x35	
1.8 (CA2) Eng.B18A1 (81kW)	11/85-9/89		R		153-154		Ake	220,0x35	
2.0 EX (CA5) Eng.A20A1 (75-76kW)	11/85-12/89		R		153-149		Ake	200,0x35	Aerodeck
	11/85-12/89		R		153-154		Ake	220,0x35	
	86-12/89		R		700-081			Ø 200,0	
2.0 EX (CA5) Eng.A20A2 (78kW)	11/85-5/89		R		153-149		Ake	200,0x35	Aerodeck
	11/85-5/89		R		153-154		Ake	220,0x35	
2.0 EXi (CA5) Eng.A20A3 (85kW)	1/86-12/89		R		153-149		Ake	200,0x35	Aerodeck
	1/86-12/89		R		153-154		Ake	220,0x35	
	86-12/89		R		700-081			Ø 200,0	
2.0 EXi (CA5) Eng.A20A4 (90kW)	11/85-12/87		R		153-149		Ake	200,0x35	Aerodeck
	11/85-12/87		R		153-154		Ake	220,0x35	
2.0 i 16v (CA5) (Exc. Aerodeck) Eng.B20A2/ B20A8 (98-101kW)	10/87-12/89		R		153-154		Ake	220,0x35	
Accord IV (CB3, CB7) 1/90-12/93									
1.8 (77kW)	1/90-12/91		R		153-154		Ake	220,0x35	
1.8 (CB1,2), Aerodeck Eng.F18A2 (74kW)	1/90-1/91		R		153-154		Ake	220,0x35	
	91-		R		700-083			Ø 220,0	Incl. Usa
2.0 16v (CB3) Eng.F20A2 (81kW)	1/90-3/93		R		153-154		Ake	220,0x35	
	91-93		R		700-083			Ø 220,0	Incl. Usa
2.0 16v (CB3) Eng.F20A6 (66kW)	1/90-3/93		R		153-154		Ake	220,0x35	
	91-93		R		700-083			Ø 220,0	Incl. Usa
2.0 i 16v (CB3) Eng.F20A4/ F20A8 (98kW)	1/90-3/93		R		153-154		Ake	220,0x35	
2.2 i 16v (CB8) Aerodeck Eng.F22A7 (110kW)	1/91-12/93		R		153-154		Ake	220,0x35	
	91-93		R		700-083			Ø 220,0	Incl. Usa

		Spare Parts	F/R	L/R	CIFAM ref.	CIFAM ref. w/KIT		DIMENSIONS mm.	NOTE
2.2 i 16v (CB8) Aerodeck Eng.F22A8 (108kW)	1/91-12/93		R		153-154		Ake	220,0x35	
	91-93		R		700-083			Ø 220,0	Incl. Usa
2.2 i 16v, Automatik (CB7) Eng.F22A3 (108kW)	91-93		R		700-083			Ø 220,0	Incl. Usa
Accord VII (CG) 2/98-1/03									
1.6 i Eng.D16B6 (85kW)	10/98-1/03		R		153-157		Lucas	228,6x42	
Accord VIII, Tourer (CL, CM) 2/03-6/08									
2.0 Eng.K20A6 (114kW)	2/03-6/08		R		153-159	153-159K		170,0x35	
2.2 CTDi Eng.N22A1 (103kW)	04-08		R		153-159	153-159K		170,0x35	
2.4 Eng.K24A (140kW)	03-08		R		153-159	153-159K		170,0x35	
2.4 Eng.K24A2/ 4 (118kW)	7/03-3/06		R		153-159	153-159K		170,0x35	
Accord IX, Tourer (CU) 7/08-									
2.0 i-VTEC Eng.R20A3 (115kW)	7/08-		R		153-495			190x27	
2.0i Eng.R20A4 (110kW)	7/08-		R		153-495			190x27	
2.2i-DTEC Eng.N22B1 (110kW)	7/08-		R		153-495			190x27	
2.2i-DTEC Eng.N22B2 (132kW)	10-		R		153-495			190x27	
2.4 i-VTEC Eng.K24Z3 (148kW)	7/08-		R		153-495			190x27	
2.4i Eng.K24Z5 (133kW)	7/08-		R		153-495			190x27	
Ballade 1/81-1/92									
1.3 Eng.EN4/ EJ (52kW)	1/81-12/83		R		153-152		Sumit.	180,0x25	
1.3 (EF1) Eng.D13B (55kW)	84-86		R		700-080			Ø 180,0	
	86-89		R		700-081			Ø 200,0	
1.3 12v (AG, AJ, VJ) Eng.EV2 (59kW)	84-86		R		700-080			Ø 180,0	
	86-89		R		700-081			Ø 200,0	
1.5 12v (AH, AK) Eng.EW2/ 3/ 4 (62-67-78-74kW)	1/85-		R		153-150		Ake	180,0x31	
	-12/84		R		153-152		Sumit.	180,0x25	
	84-86		R		700-080			Ø 180,0	
	86-89		R		700-081			Ø 200,0	
1.6 16v (AT,AU,AS,EF3,EF7) Eng.ZC (92kW)	1/87-1/92		R		153-153		Ake	200,0x35	Hand Brake
	84-86		R		700-080			Ø 180,0	
	86-89		R		700-081			Ø 200,0	
Capa 4/98-									
1.5 16v Eng.D15B (72kW)	4/98-		R		153-154		Ake	220,0x35	
City 1/82-1/90									
1.2 16v (VF) Eng.ER (61kW)	1/82-1/86		R		153-152		Sumit.	180,0x25	
Civic I 7/72-12/84									
1.3 L Eng.EN2 (33kW)	9/80-9/83		R		153-152		Sumit.	180,0x25	
1.3 L (SS) Eng.EN1 (44kW)	9/79-9/83		R		153-152		Sumit.	180,0x25	
1.3 S Eng.EN4 (52kW)	10/79-12/84		R		153-152		Sumit.	180,0x25	
1.5 Eng.EC/ ED/ EM/ EW (66kW)	80-		R		153-152		Sumit.	180,0x25	
Civic I Shuttle (AN, AR) 10/83-10/87									
1.5 (AN) Eng.EW2 (63kW)	10/83-10/87		R		153-151		Ake	200,0x30	
1.5 4WD (AR) Eng.EW2 (63kW)	10/83-10/87		R		153-151		Ake	200,0x30	
Civic II 10/83-10/87									
1.2 Eng.D12B/ ZA2 (40kW)	10/83-10/87		R		153-150		Ake	180,0x31	
	84-87		R		700-080			Ø 180,0	
1.3 12v Eng.EV2 (52kW)	10/83-10/87		R		153-150		Ake	180,0x31	
	84-87		R		700-080			Ø 180,0	
1.5 GL Eng.EW2 (63kW)	10/83-10/87		R		153-150		Ake	180,0x31	
	84-87		R		700-080			Ø 180,0	
1.5 GT Eng.EW3 (74kW)	10/83-10/87		R		153-150		Ake	180,0x31	
1.5 GTI Eng.EW4 (66kW)	3/86-10/87		R		153-150		Ake	180,0x31	
Civic II Shuttle (EE) 1/88-2/95									
1.6 i 16v 4WD (EE4) Eng.D16A6 (80kW)	1/88-2/95		R		153-151		Ake	200,0x30	
Civic III (EC, ED, EE) 9/87-9/91									
1.3 (EC8) Eng.D13B1 (55kW)	10/87-12/89		R		153-150		Ake	180,0x31	
	87-89		R		700-080			Ø 180,0	
1.3 16v (EC8) Kat H-Back Eng.D13B2 (55kW)	9/89-9/91		R		153-150		Ake	180,0x31	
	89-91		R		700-080			Ø 180,0	
1.4 L (EC9, ED2) Eng.D14A1 (66kW)	10/87-12/89		R		153-150		Ake	180,0x31	
	10/87-12/89		R		153-151		Ake	200,0x30	Shuttle
	87-89		R		700-080			Ø 180,0	
1.5 i 16v (ED3, 6), Shuttle, 4WD Eng.D15B2 (66-69kW)	10/87-9/91		R		153-150		Ake	180,0x31	
	10/87-9/91		R		153-151		Ake	200,0x30	Shuttle
	87-91		R		700-080			Ø 180,0	

























		Spare Parts	F/R	L/R	CIFAM ref.	CIFAM ref. w/KIT		DIMENSIONS mm.	NOTE
1.6 i 16v (ED4, 7) Eng.D16A6 (80kW)	87-91		R		700-080			Ø 180,0	
1.6 i 16v (ED4, 7) Eng.D16Z2 (82kW)	87-91		R		700-080			Ø 180,0	
1.6 i 16v 4WD Shuttle Eng.D16A6 (80kW)	87-91		R		700-080			Ø 180,0	
Civic IV (EG) 10/91-11/95									
1.3 16v (EG3, 7) Eng.D13B2 (55kW)	10/91-11/95		R		153-150		Ake	180,0x31	
	10/91-11/95		R		153-155		Ake	180,0x31	Hand Brake
	91-95		R		700-080			Ø 180,0	
1.5 i 16v (EG4) Eng.D15Z1 (66kW)	10/91-11/95		R		153-155		Ake	180,0x31	Hand Brake
	91-95		R		700-081			Ø 200,0	
1.5 i 16v (EG8) Eng.D15B2/ Z1 (69kW)	10/91-11/95		R		153-153		Ake	200,0x35	Hand Brake
	91-95		R		700-081			Ø 200,0	
1.6 16v Vtec (EG5), 4WD Eng.D16Z6/ 7 (92kW)	10/91-11/95		R		153-153		Ake	200,0x35	Hand Brake
	91-95		R		700-081			Ø 200,0	
Civic IV Coupe (EJ) 1/94-3/96									
1.5 i LSi (EJ2) Eng.D15B7 (74kW)	1/94-11/95		R		153-153		Ake	200,0x35	Hand Brake
1.6 i (EJ6) Eng.D16Y7 (77kW)	1/94-11/95		R		153-153		Ake	200,0x35	Hand Brake
1.6 i Vtec (EJ1) Eng.D16Z9/ D16Y6 (92kW)	1/94-3/96		R		153-153		Ake	200,0x35	Hand Brake
	94-96		R		700-081			Ø 200,0	
Civic IV Coupe (MA, MB) 9/94-1/97									
1.4 i (MA8) Eng.D14A2 (66kW)	9/94-1/97		R		153-006		Lucas	203,0x38	Hand Brake
1.4 i (MA8) Eng.D14A5 (55kW)	9/95-1/97		R		153-006		Lucas	203,0x38	Hand Brake
1.5 i Vtec-E (MA9) Eng.D15Z3 (66kW)	9/94-1/97		R		153-006		Lucas	203,0x38	Hand Brake
	94-95		R		700-081			Ø 200,0	
1.6 i Vtec (MB1) Eng.D16Y2 (93kW)	94-97		R		700-081			Ø 200,0	
Civic V (EJ9, EK1/3/4) 11/95-2/01									
1.4 i (EJ9) Eng.D14A3/ 4 (55kW)	11/95-2/01		R		153-155		Ake	180,0x31	-ABS, Hand Brake
	11/95-2/01		R		153-153		Ake	200,0x35	+ABS, Hand Brake
	-12/95		R		700-082			Ø 203,0	
	96-97		R		700-081			Ø 200,0	
1.4 i S (EJ9) Eng.D14A2 (66kW)	11/95-2/01		R		153-153		Ake	200,0x35	Hand Brake
	-12/95		R		700-082			Ø 203,0	
	96-97		R		700-081			Ø 200,0	
1.5 Eng.D14A4 (66kW)	12/96-2/01		R		153-153		Ake	200,0x35	Hand Brake
1.5 16v Eng.D15B (69kW)	1/95-12/01		R		153-153		Ake	200,0x35	Hand Brake
1.5 i (EK3) Eng.D15Z6 (84kW)	11/95-2/01		R		153-153		Ake	200,0x35	Hand Brake
	-12/95		R		700-082			Ø 203,0	
	96-97		R		700-081			Ø 200,0	
1.6 i (EK1) Eng.D16Y5/ Y6/ Y8 (84-92kW)	11/95-2/01		R		153-153		Ake	200,0x35	Hand Brake
	95-01		R		700-081			Ø 200,0	
Civic V Aerodeck (MC) 4/98-2/01									
1.4 16v (MB8) Eng.D14A7 (55kW)	4/98-2/01		R		153-006		Lucas	203,0x38	Hand Brake
	98-		R		700-081			Ø 200,0	
1.4 16v (MB8) Eng.D14A8 (66kW)	4/98-2/01		R		153-006		Lucas	203,0x38	Hand Brake
	98-		R		700-081			Ø 200,0	
1.5 16v (MB9) Eng.D15Z8 (84kW)	4/98-2/01		R		153-006		Lucas	203,0x38	Hand Brake
	98-		R		700-081			Ø 200,0	
1.6 16v (MC1) Eng.D16B2 (85kW)	98-01		R		700-081			Ø 200,0	
Civic V Coupe (EJ6, EJ8) 3/96-3/00									
1.6 i Eng.D16Y7 (77kW)	3/96-3/00		R		153-153		Ake	200,0x35	Hand Brake
1.6 i Vtec Eng.D16Z9 (92kW)	3/96-3/00		R		153-153		Ake	200,0x35	Hand Brake
Civic V Fastback (MA, MB) 1/97-2/01									
1.4 16v (MB2) Eng.D14A7 (55kW)	-12/97		R		700-081			Ø 200,0	
1.4 16v (MB2) Eng.D14A8 (66kW)	-97		R		700-081			Ø 200,0	
1.5 16v (MB3) Eng.D15Z8 (84kW)	-97		R		700-081			Ø 200,0	
1.6 16v (MB4) Eng.D16B2 (85kW)	-97		R		700-081			Ø 200,0	
Civic VI 2/01-9/05									
1.4 Eng.D14Z5 (66kW)	2/01-9/05		R		153-154		Ake	220,0x35	
Civic VI Hatchback (EU, EP) 2/01-12/05									
1.4 i Eng.D14E1/ Z2 (55kW)	2/01-9/05		R		153-494			200x36	
1.4 iS Eng.D14Z6 (66kW)	2/01-12/05		R		153-154		Ake	220,0x35	
Civic VII Ibrida 1/06-2/12									
1.3 Eng.LDA2 (70-85kW)	06-		R		153-493			200x31	4 porte















































		Spare Parts	F/R	L/R	CIFAM ref.	CIFAM ref. w/KIT		DIMENSIONS mm.	NOTE
Concerto (HW) 8/89-3/95									
1.4 Eng.D14A1 (61kW)	10/89-10/92		R		153-006		Lucas	203,0x38	Hand Brake
1.4 Eng.D14A1/ D14A8 (66kW)	8/89-10/91		R		153-006		Lucas	203,0x38	Hand Brake
	89-91		R		700-082			Ø 203,0	
1.5 i 16v Eng.D15B2 (66kW)	8/89-3/95		R		153-006		Lucas	203,0x38	Hand Brake
	89-91		R		700-082			Ø 203,0	
1.6 16v Eng.D16B2 (85kW)	1/90-12/92		R		153-006		Lucas	203,0x38	Hand Brake
1.6 16v Eng.D16Z1 (77kW)	8/89-3/95		R		153-006		Lucas	203,0x38	Hand Brake
	89-91		R		700-082			Ø 203,0	
1.6 i 16v Eng.D16A8 (90kW)	8/89-3/95		R		153-006		Lucas	203,0x38	Hand Brake
	89-91		R		700-082			Ø 203,0	
1.6 i 16v Eng.D16Z2 (82kW)	8/89-3/95		R		153-006		Lucas	203,0x38	Hand Brake
	89-91		R		700-082			Ø 203,0	
Cr-v I (RD1, 3) 10/95-6/05									
2.0 16v Eng.B20B (94kW)	10/95-1/99		R		153-154		Ake	220,0x35	
	97-		R		700-085			Ø 220,0	
2.0 16v Eng.B20Z1/ 3/ 9 (98-108kW)	1/99-6/05		R		153-154		Ake	220,0x35	
	99-		R		700-085			Ø 220,0	
Cr-v II (RD8) 7/02-12/06									
2.0 Eng.K20A4 (110kW)	7/02-12/06		R		153-159	153-159K		170,0x35	
2.2 CTDi Eng.N22A2 (103kW)	2/05-12/06		R		153-161	153-161K		198,0x35	
Cr-v III (RE) 1/07-4/10									
2.0i Vtec Eng.R20A2 (110kW)	1/07-		R		153-162	153-162K		198,0x35	
2.2i CDTi Eng.N22A2 (103kW)	1/07-		R		153-162	153-162K		198,0x35	
Crx I (AF, AS) 10/83-10/87									
1.3 12v Eng.EV2 (52kW)	83-87		R		700-080			Ø 180,0	
1.5i (AF) Eng.EW3 (66-74kW)	10/83-11/86		R		153-150		Ake	180,0x31	
	83-86		R		700-080			Ø 180,0	
1.6 i 16v (AS) Eng.ZC1 (92kW)	3/86-10/87		R		153-150		Ake	180,0x31	
	86-87		R		700-080			Ø 180,0	
Crx II (ED, EE) 10/87-2/92									
1.6 i 16v (ED9) Eng.D16A9 (96kW)	-12/87		R		153-150		Ake	180,0x31	
	87-89		R		700-080			Ø 180,0	
1.6 i 16v (ED9) Eng.D16Z5 (91kW)	-12/87		R		153-150		Ake	180,0x31	
	87-92		R		700-080			Ø 180,0	
Crx III (EH, EG) 3/92-12/98									
1.6 ESi (EH6) Eng.D16Z6 (96-80kW)	3/92-12/98		R		153-155		Ake	180,0x31	Hand Brake
	3/92-		R		700-080			Ø 180,0	
1.6 VTi (EG2) Eng.B16A2 (118kW)	3/92-12/98		R		153-155		Ake	180,0x31	Hand Brake
Element 7/02-									
2.4, 4WD Eng.K24A6 (118kW)	7/02-		R		153-159	153-159K		170,0x35	
FR-V (BE) 2/05-									
1.7 16v Eng.D17A2 (92kW)	2/05-		R		153-159	153-159K		170,0x35	
1.8 16v Eng.R18A1 (103kW)	6/07-		R		153-159	153-159K		170,0x35	
2.0 Eng.K20A9 (110kW)	2/05-		R		153-159	153-159K		170,0x35	
2.2 CTDi Eng.N22A1 (103kW)	7/05-		R		153-159	153-159K		170,0x35	
HR-V (GH) 3/99-									
1.6 16v 4WD Eng.D16W5 (91kW)	10/99-		R		153-153		Ake	200,0x35	Hand Brake
	99-		R		700-086			Ø 200,0	
1.6 16v, 4WD Eng.D16W1 (77kW)	3/99-		R		153-153		Ake	200,0x35	Hand Brake
	99-		R		700-086			Ø 200,0	
Integra I (DA1,2,4) 10/85-8/89									
1.5 (DA2) Eng.EW (56kW)	1/85-8/89		R		153-151		Ake	200,0x30	
1.5 (DA4) Eng.D15A1 (63kW)	10/85-8/89		R		153-151		Ake	200,0x30	
1.6 Eng.D16A3 (88kW)	3/86-8/89		R		153-151		Ake	200,0x30	
1.6 (DA1, AV) Eng.ZC (85-88kW)	1/86-8/89		R		153-151		Ake	200,0x30	
Jazz I (AA) / Fit 10/83-10/86									
1.2 Eng.ER1 (41kW)	10/83-10/86		R		153-152		Sumit.	180,0x25	Inc. Van
1.2 Eng.ER2 (33kW)	2/84-10/86		R		153-152		Sumit.	180,0x25	Inc. Van
1.2 Eng.ER4 (40kW)	9/84-10/86		R		153-152		Sumit.	180,0x25	Inc. Van
Jazz III (GD)/ Fit 3/02-10/08									
1.2 DSi Eng.L12A1 (57kW)	07-		R		153-492			180x31	
	3/02-07		R		153-158			180,0x32	
1.4 DSi Eng.L13A1 (61-63kW)	07-		R		153-492			180x31	
	3/02-07		R		153-158			180,0x32	
Jazz IV (GE)/ Fit 11/08-10/10									
1.2 i-VTEC Eng.L12B2 (66kW)	08-		R		153-492			180x31	



































HONDA





















































































			Spare Parts	F/R	L/R	CIFAM ref.	CIFAM ref. w/KIT		DIMENSIONS mm.	NOTE
1.3 i-VTEC Eng.L13Z2 (73kW)	08-		R			153-153		Ake	200,0x35	Hand Brake
1.4 (74kW)	08-		R			153-493			200x31	
Legend III (KA9) 2/96-										
3.5 i 24v Eng.C35A2 (151kW)	2/96-		R			153-159	153-159K		170,0x35	
Logo (GA3) 3/99-3/02										
1.3 Eng.D13B7 (48kW)	3/99-3/02		R			153-156			180,0x30	
	99-02		R			700-081			Ø 200,0	
Odyssey I (RA1,5) 1/95-1/98										
2.2 Eng.F22B (110kW)	1/95-1/98		R			153-159	153-159K		170,0x35	
2.3 4WD Eng.F23A7 (110kW)	1/97-1/98		R			153-159	153-159K		170,0x35	
Odyssey II (RL, RA6,9) 1/99-12/04										
2.3, 4WD Eng.F23A7 (110kW)	1/99-12/02		R			153-160			254,0x47	
3.5 24v Eng.J35A (155kW)	1/99-12/02		R			153-160			254,0x47	
3.5 24v Eng.J35A (177kW)	1/02-12/04		R			153-160			254,0x47	
Odyssey III (RB1,2) 7/02-12/08										
2.3, 4x4 Eng.F23A (110kW)	02-03		R				153-315K	Ake	210x32	
2.4 Eng.K24A4 (140kW)	02-04		R				153-315K	Ake	210x32	
	7/02-12/08		R			153-315	153-315K	Ake	210,0x32	Hand Brake
2.4 Eng.K24A5 (118kW)	7/02-12/08		R			153-315	153-315K	Ake	210,0x32	Hand Brake
3.5 Eng.J35A (171kW)	7/02-8/04		R			153-315		Ake	210,0x32	Hand Brake
3.5 Eng.J35A5 (188kW)	9/04-9/05		R			153-315		Ake	210,0x32	Hand Brake
3.5 Eng.J35A8 (182kW)	9/05-		R			153-315		Ake	210,0x32	Hand Brake
Passport 1/94-										
2.6 (89kW)	1/00-		R			153-312		Ake	302,0x46	
	96-02		R				153-315K	Ake	210x32	
3.2 24v Eng.6DV1 (130kW)	1/94-		R			153-315	153-315K	Ake	210,0x32	Hand Brake
Prelude I Coupe (SN) 1/78-10/83										
1.6 Eng.EL (59-66kW)	11/78-10/83		R			153-152		Sumit.	180,0x25	
Quintet (SU) 2/80-12/84										
1.6 EX Eng.EL/ EP (59-66kW)	2/80-12/84		R			153-152		Sumit.	180,0x25	
Shuttle (RA) 10/94-6/02										
2.2 16v Eng.F22B8 (110kW)	10/94-2/98		R			153-159	153-159K		170,0x35	
2.3 16v Eng.F23A7 (110kW)	1/98-5/01		R			153-159	153-159K		170,0x35	
Stream (RN) 5/01-										
1.7 16v Eng.D17A2 (92kW)	5/01-		R			153-159	153-159K		170,0x35	
2.0 16v Eng.K20A1 (115kW)	5/01-		R			153-159	153-159K		170,0x35	
HUMMER										
H2 9/04-										
6.0 Eng.LQ4 (237kW)	9/04-		R			153-163			205,0x45	
H3 4/05-										
3.5 Eng.L52 (162kW)	4/05-		R			153-164			210,0x35	
5.3 V8 Eng.LH8 (224kW)	10/08-		R			153-164			210,0x35	
HYUNDAI										
Accent I (X-3)/Pony III 10/94-1/00										
1.3 i, 12v Eng.G4EH (44-55-62kW)	10/94-1/00		R			153-169		Mando	180,0x32	
1.5 i 12v Eng.G4EK (65kW)	10/94-1/00		R			153-169		Mando	180,0x32	
1.5i 16v Eng.G4K (73kW)	12/95-1/00		R			153-169		Mando	180,0x32	
Accent II (LC)/Verna 1/00-6/06										
1.3 Eng.G4EA (55-61-62-63kW)	1/00-6/06		R			153-167		Mando	180,0x35	Only Verna, Hand Brake
	1/00-6/06		R			153-170		Mando	180,0x38	
	00-7/02		R			151-211		Mando	Ø 19,05 180,0x38	MANDO
	8/02-06		R			151-210		Mando	Ø 17,78 180,0x38	MANDO
1.5 Eng.G4EB (66kW)	1/00-6/06		R			153-167		Mando	180,0x35	Only Verna, Hand Brake
	1/00-6/06		R			153-170		Mando	180,0x38	
	00-7/02		R			151-211		Mando	Ø 19,05 180,0x38	MANDO
	8/02-06		R			151-210		Mando	Ø 17,78 180,0x38	MANDO
1.5 Eng.G4EC-G (75kW)	9/00-6/06		R			153-167		Mando	180,0x35	Only Verna, Hand Brake
	9/00-6/06		R			153-170		Mando	180,0x38	
	00-7/02		R			151-211		Mando	Ø 19,05 180,0x38	MANDO
	9/02-06		R			151-210		Mando	Ø 17,78 180,0x38	MANDO
1.5 CRDi Eng.D3EA (60kW)	4/02-6/06		R			153-170		Mando	180,0x38	
	4/02-8/02		R			151-211		Mando	Ø 19,05 180,0x38	MANDO
	9/02-06		R			151-210		Mando	Ø 17,78 180,0x38	MANDO
1.6 Eng.G4ED-G (77kW)	12/02-6/06		R			153-170		Mando	180,0x38	

		Spare Parts	F/R	L/R	CIFAM ref.	CIFAM ref. w/KIT		DIMENSIONS mm.	NOTE
Accent III (MC) 6/06-10/10									
1.4 Eng.G4EE (71kW)	06-		R			153-187K		170x32	
	6/06-		R		153-187		170,0x32		
	6/06-		R		153-182	Mando	203,2x32		
1.5 CRDi Eng.D4FA (81kW)	06-		R			153-187K		170x32	
	6/06-		R		153-187		170,0x32		
	6/06-		R		153-182	Mando	203,2x32		
Atos (MX)/ Amica 2/98-									
1.0 i Eng.G4HC (40kW)	2/98-		R		153-168		Mando	180,0x32	
	2/98-		R		700-349		Ø 180,0		
	2/98-		R		700-362			Ø 180,0	+ABS
	98-02		R		151-209	Mando	Ø 17,78 180,0x32	MANDO	
1.0 i Eng.G4HC-E (43kW)	01-		R		153-168		Mando	180,0x32	
	01-02		R		151-209	Mando	Ø 17,78 180,0x32	MANDO	
1.1 Eng.G4HG (46kW)	3/04-		R		153-168		Mando	180,0x32	
Atos Prime (MX)/ Amica 8/99-									
1.0 i Eng.G4HC (40kW)	99-		R		153-168		Mando	180,0x32	
	99-		R		700-349		Ø 180,0		
	99-		R		700-362			Ø 180,0	+ABS
	99-02		R		151-209	Mando	Ø 17,78 180,0x32	MANDO	
1.0 i Eng.G4HC-E (43kW)	01-		R		153-168		Mando	180,0x32	
	01-		R		700-349		Ø 180,0		
	01-		R		700-362		Ø 180,0	+ABS	
01-02	R		151-209	Mando	Ø 17,78 180,0x32	MANDO			
1.1 Eng.G4HD (43kW)	6/03-		R		153-168		Mando	180,0x32	
Coupe I (RD)/Tiburon 8/96-4/02									
1.6 16v Eng.G4GR/ G4DR (84kW)	12/96-4/02		R		153-166		Mando	203,2x39	
	12/96-4/02		R		153-171		Mando	203,2x39	Hand Brake
	97-02		R		700-226			Ø 203,2	
	96-02		R		151-236	Mando	Ø 19,05 203,2x39	MANDO	
Elantra (XD) 6/00-									
1.6 Eng.G4GA (82kW)	03-		R			153-179K	Mando	190x40	
	9/03-		R		153-179Y	Mando	190,0x40	Hand Brake	
	9/03-		R		153-171	Mando	203,2x39	Hand Brake	
	9/03-		R		153-176	Mando	203,2x39	GLS, Hand Brake	
1.6 16v Eng.G4ED (66kW)	6/00-7/03		R			153-179Y	Mando	190,0x40	Hand Brake
	6/00-7/03		R		153-171	Mando	203,2x39	Hand Brake	
	9/01-		R		153-179K	Mando	190x40		
1.6 16v Eng.G4ED-G (77kW)	03-		R			153-179K	Mando	190x40	
	5/03-		R		153-179Y	Mando	190,0x40	Hand Brake	
	5/03-		R		153-171	Mando	203,2x39	Hand Brake	
	5/03-		R		153-176	Mando	203,2x39	GLS, Hand Brake	
	03-		R		151-212	Mando	Ø 19,05 203,2x39	MANDO	
1.6 16v Eng.G4ED-G (79kW)	6/00-		R			153-179Y	Mando	190,0x40	Hand Brake
	6/00-		R		153-171	Mando	203,2x39	Hand Brake	
	6/00-		R		153-176	Mando	203,2x39	GLS, Hand Brake	
	9/01-00-		R		153-179K	Mando	190x40		
00-	R		151-212	Mando	Ø 19,05 203,2x39	MANDO			
1.8 Eng.G4GB (98kW)	11/02-		R		153-171		Mando	203,2x39	Hand Brake
	11/02-		R		153-176		Mando	203,2x39	GLS, Hand Brake
1.8 Eng.G4GM-G (97kW)	6/00-		R		153-171		Mando	203,2x39	Hand Brake
	6/00-		R		153-176		Mando	203,2x39	GLS, Hand Brake
2.0 Eng.G4GC-G (102kW)	6/00-		R			153-179Y	Mando	190,0x40	Hand Brake
	6/00-		R		153-171		Mando	203,2x39	Hand Brake
	6/00-		R		153-176		Mando	203,2x39	GLS, Hand Brake
	6/00-		R		153-166		Mando	203,2x39	Sedan
	9/01-00-		R		153-179K		Mando	190x40	
	00-		R		151-212		Mando	Ø 19,05 203,2x39	MANDO
2.0 Eng.G4GC-G (104kW)	6/00-		R			153-179Y	Mando	190,0x40	Hand Brake
	6/00-		R		153-171		Mando	203,2x39	Hand Brake
	6/00-		R		153-176		Mando	203,2x39	GLS, Hand Brake
	6/00-		R		153-166		Mando	203,2x39	Sedan
	9/01-00-		R		153-179K		Mando	190x40	
	00-		R		151-212		Mando	Ø 19,05 203,2x39	MANDO
2.0 Eng.G4GC-G (105kW)	03-		R			153-179K	Mando	190x40	
	10/03-		R		153-179Y	Mando	190,0x40	Hand Brake	
	10/03-		R		153-171		Mando	203,2x39	Hand Brake
	10/03-		R		153-176		Mando	203,2x39	GLS, Hand Brake

		Spare Parts	F/R	L/R	CIFAM ref.	CIFAM ref. w/KIT		DIMENSIONS mm.	NOTE
2.0 Eng.G4GC-G (105kW)	10/03-		R		153-166		Mando	203,2x39	Sedan
2.0 CRDi Eng.D4EA (83kW)	4/01-		R			153-179K	Mando	190x40	
	4/01-		R			153-179Y	Mando	190,0x40	Hand Brake
	4/01-		R		153-171		Mando	203,2x39	Hand Brake
	4/01-		R		153-176		Mando	203,2x39	Hand Brake
	01-		R		151-212		Mando	Ø 19,05 203,2x39	MANDO
Excel I (X1) 1/86-1/90									
1.5 Eng.G15B (53kW)	1/86-1/90		R		153-253	153-253Y	Ake	180,0x36	Hand Brake
Excel II (X2) 1/90-5/96									
1.3 Eng.G4DG (43kW)	2/96-5/96		R		700-228			Ø 180,0	
	90-93		R		700-227		Mando	Ø 180,0	
1.5 Eng.G4DJ (53kW)	1/90-5/96		R		153-165		Bdx	180,0x34	GLS, SLX, SGX, Hand Brake
	1/90-5/96		R		153-167		Mando	180,0x35	Hand Brake
	2/96-5/96		R		700-228			Ø 180,0	
	90-93		R		700-227		Mando	Ø 180,0	
1.5 12v Eng.G4EK (65kW)	1/90-5/96		R		153-165		Bdx	180,0x34	GLS, SLX, SGX, Hand Brake
	1/90-5/96		R		153-167		Mando	180,0x35	Hand Brake
Galloper II (JK-01) 8/98-									
2.5 TD Eng.D4BH (65kW)	8/98-		R		153-173			270,0x54	Hand Brake
2.5 TD Eng.D4BH (77kW)	8/98-		R		153-173			270,0x54	Hand Brake
2.5 TD intercooler Eng.D4BH (73kW)	8/98-		R		153-173			270,0x54	Hand Brake
3.0i V6 Eng.G6AT (104kW)	8/98-		R		153-173			270,0x54	Hand Brake
Genesis 6/11-									
2.0 T (204kW)	12-		R		153-497			190x26	
2.0 TS (157kW)	11-		R		153-497			190x26	
3.8 V6 (213kW)	11-		R		153-497			190x26	
3.8 V6 Sport Eng.G6DA (223kW)	11-		R		153-497			190x26	
Getz (TB) 9/02-									
1.1 Eng.G4HD/ SOCH 12v (46kW)	9/02-		R		153-178		Mando	180,0x32	-ABS
	9/02-		R		153-177		Mando	203,2x32	+ABS
	02-		R		700-397			Ø 180,0	
	02-		R		151-213		Mando	Ø 17,78 180,0x32	MANDO, -ABS
	02-		R		151-215		Mando	Ø 17,78 203,2x32	MANDO, +ABS
1.1 Eng.G4HG (49kW)	12/05-		R		153-186			170,0x32	
	05-		R		700-397			Ø 180,0	
	02-		R		151-215		Mando	Ø 17,78 203,2x32	MANDO, +ABS
	05-		R		151-213		Mando	Ø 17,78 180,0x32	MANDO, -ABS
1.3 Eng.G4EA (60kW)	9/02-		R		153-178		Mando	180,0x32	-ABS
	9/02-		R		153-177		Mando	203,2x32	+ABS
	02-		R		700-397			Ø 180,0	
	02-		R		151-213		Mando	Ø 17,78 180,0x32	MANDO, -ABS
	02-		R		151-215		Mando	Ø 17,78 203,2x32	MANDO, +ABS
1.3 Eng.G4EA (63kW)	9/03-		R		153-178		Mando	180,0x32	-ABS
	9/03-		R		153-177		Mando	203,2x32	+ABS
	03-		R		700-397			Ø 180,0	
	03-		R		151-213		Mando	Ø 17,78 180,0x32	MANDO, -ABS
	03-		R		151-215		Mando	Ø 17,78 203,2x32	MANDO, +ABS
1.4 16v Eng.G4EE (71kW)	12/05-		R		153-186			170,0x32	
	05-		R		151-213		Mando	Ø 17,78 180,0x32	MANDO, -ABS
	05-		R		151-215		Mando	Ø 17,78 203,2x32	MANDO, +ABS
1.5 CRDi Eng.D3EA (60kW)	3/03-		R		153-178		Mando	180,0x32	-ABS
	3/03-		R		153-177		Mando	203,2x32	+ABS
	03-		R		700-397			Ø 180,0	
	03-		R		151-213		Mando	Ø 17,78 180,0x32	MANDO, -ABS
	03-		R		151-215		Mando	Ø 17,78 203,2x32	MANDO, +ABS
1.5 CRDi Eng.D4FA (65kW)	12/05-		R		153-186			170,0x32	
	05-		R		700-397			Ø 180,0	
	05-		R		151-213		Mando	Ø 17,78 180,0x32	MANDO, -ABS
	05-		R		151-215		Mando	Ø 17,78 203,2x32	MANDO, +ABS
	05-		R		151-213		Mando	Ø 17,78 180,0x32	MANDO, -ABS
1.5 CRDi Eng.D4FA (81kW)	8/05-		R		153-186			170,0x32	
	05-		R		700-397			Ø 180,0	
	05-		R		151-213		Mando	Ø 17,78 180,0x32	MANDO, -ABS
	05-		R		151-215		Mando	Ø 17,78 203,2x32	MANDO, +ABS
1.6 Eng.G4ED-G (77kW)	8/05-		R		153-186			170,0x32	
	9/02-		R		153-178		Mando	180,0x32	-ABS
	9/02-		R		153-177		Mando	203,2x32	+ABS
	02-		R		700-397			Ø 180,0	











		Spare Parts	F/R	L/R	CIFAM ref.	CIFAM ref. w/KIT		DIMENSIONS mm.	NOTE
1.6 Eng.G4ED-G (77kW)		02-	R		151-213		Mando	Ø 17,78 180,0x32	MANDO, -ABS
		02-	R		151-215		Mando	Ø 17,78 203,2x32	MANDO, +ABS
Grandeur III (TG) 4/05-6/11									
2.2 CRDi Eng.D4EB (110kW)		06-	R		153-499			167x27	
2.2 CRDi Eng.D4EB (114kW)		06-	R		153-499			167x27	
2.7 (141kW)		06-	R		153-499			167x27	
3.3 (191kW)		10-	R		153-499			167x27	
3.3 Eng.G6DB (173kW)		05-	R		153-499			167x27	
i20 3/09-									
1.2 (63kW)		12-	R			153-186K	Mando	170x32	
1.2 Eng.G4LA (57kW)		09-	R			153-186K	Mando	170x32	
		09-	R		153-189		Mando	203,2x32	
1.4 Eng.G4FA (74kW)		09-	R			153-186K	Mando	170x32	
		3/09-	R		153-189		Mando	203,2x32	
1.4 CRDi Eng.D4FC (55kW)		09-	R			153-186K	Mando	170x32	
1.4 CRDi Eng.D4FC (66kW)		09-	R			153-186K	Mando	170x32	
1.6 CRDi Eng.D4FB (85kW)		09-	R			153-186K	Mando	170x32	
		3/09-	R		153-189		Mando	203,2x32	
i30 I, SW 9/07-4/12									
1.4 Eng.G4FA (77kW)		07-	R			153-185K		170x27	
		10/07-	R		153-185	153-185K		170,0x27	
1.4 16v Eng.G4FA (80kW)		9/07-	R		153-185	153-185K		170,0x27	
1.6 (85kW)		10/07-	R		153-185	153-185K		170,0x27	
1.6 16v Eng.G4FC (90kW)		9/07-	R		153-185	153-185K		170,0x27	
1.6 CRDi Eng.D4FB (94kW)		10-	R			153-185K		170x27	
1.6 CRDi 16v Eng.D4FB (85kW)		07-	R			153-185K		170x27	
		9/07-	R		153-185	153-185K		170,0x27	
1.6 CRDi 16v Eng.D4FB-L (66kW)		9/07-	R		153-185	153-185K		170,0x27	
2.0 16v Eng.G4GC (105kW)		10/07-	R		153-185	153-185K		170,0x27	
2.0 CRDi Eng.D4EA (103kW)		10/07-	R		153-185	153-185K		170,0x27	
ix35 (LM) 1/10-									
2.0 16v, Allrad Eng.G4KD (120kW)		10-	R			153-185K		170x27	
2.0 CRDi Allrad Eng.D4HA (135kW)		10-	R			153-185K		170x27	
2.0 CRDi, Allrad Eng.D4HA (100kW)		10-	R			153-185K		170x27	
2.4 Allrad (130kW)		10-	R			153-185K		170x27	
ix55 9/08-									
3.0 V6 CRDi Eng.G6EN (176kW)		9/08-	R		153-188			212,0x40	
Lantra I (J-1) 10/90-11/95									
1.5 Eng.G15B/ G4DJ (63-53kW)		10/90-11/95	R		153-166		Mando	203,2x39	
		10/90-11/95	R		153-171		Mando	203,2x39	Hand Brake
1.6 i.e. 16v Eng.G4CR (78-84kW)		10/90-11/95	R		153-166		Mando	203,2x39	
		10/90-11/95	R		153-171		Mando	203,2x39	Hand Brake
1.8 i.e. 16v Eng.G4CN (93kW)		10/90-11/95	R		153-171		Mando	203,2x39	Hand Brake
Lantra II (J-2), SW 11/95-9/00									
1.5 12v Eng.G4EK (65kW)		12/96-9/00	R		153-171		Mando	203,2x39	Hand Brake
		96-00	R		700-226			Ø 203,2	
1.6 16v Eng.G4GR/ G4DR (84kW)		11/95-9/00	R		153-171		Mando	203,2x39	Hand Brake
		95-00	R		700-226			Ø 203,2	
1.6 i Eng.G4GR (66kW)		11/95-9/00	R		153-171		Mando	203,2x39	Hand Brake
		95-00	R		700-226			Ø 203,2	
1.8 16v Eng.G4GM (94kW)		11/95-9/00	R		153-171		Mando	203,2x39	Hand Brake
		11/95-9/00	R		153-166		Mando	203,2x39	GLS
		95-00	R		700-226			Ø 203,2	
1.9 D Eng.XUD9 (50kW)		3/98-9/00	R		153-171		Mando	203,2x39	Hand Brake
		98-00	R		700-226			Ø 203,2	
2.0 16v Eng.G4GF (102kW)		8/96-9/00	R		153-171		Mando	203,2x39	Hand Brake
Matrix (FC) 6/01-									
1.5 CRDi Eng.D3EA (60kW)		03-	R		153-176		Mando	203,2x39	Hand Brake
		10/01-	R		153-171		Mando	203,2x39	Hand Brake
		10/01-	R		153-175		Mando	228,6x45	
		01-	R		151-212		Mando	Ø 19,05 203,2x39	MANDO
1.5 CRDi Eng.D4FA (75kW)		03-	R		153-176		Mando	203,2x39	Hand Brake
		12/04-	R		153-171		Mando	203,2x39	Hand Brake
		12/04-	R		153-175		Mando	228,6x45	
		04-	R		151-212		Mando	Ø 19,05 203,2x39	MANDO

		Spare Parts	F/R	L/R	CIFAM ref.	CIFAM ref. w/KIT		DIMENSIONS mm.	NOTE
1.5 CRDi Eng.D4FA (81kW)		03-	R		153-176		Mando	203,2x39	Hand Brake
		2/06-	R		153-171		Mando	203,2x39	Hand Brake
		2/06-	R		153-175		Mando	228,6x45	
		06-	R		151-212		Mando	Ø 19,05 203,2x39	MANDO
1.6 Eng.G4ED-G (76kW)		03-	R		153-176		Mando	203,2x39	Hand Brake
		6/01-	R		153-171		Mando	203,2x39	Hand Brake
		6/01-	R		153-175		Mando	228,6x45	
		01-	R		151-212		Mando	Ø 19,05 203,2x39	MANDO
1.6 Eng.G4ED-L (66kW)		02-05	R		153-171		Mando	203,2x39	Hand Brake
		02-05	R		153-175		Mando	228,6x45	
		03-	R		153-176		Mando	203,2x39	Hand Brake
1.8 Eng.G4GB-G (90kW)		03-	R		153-176		Mando	203,2x39	Hand Brake
		6/01-	R		153-175		Mando	228,6x45	
		01-	R		151-212		Mando	Ø 19,05 203,2x39	MANDO
Pony I 6/74-9/89									
1.2, Wagon Eng.4G36 (40-41-59kW)		6/74-9/89	R		153-103		Lucas	203,2x38	Hand Brake
		90-91	R		700-227		Mando	Ø 180,0	
1.4, Wagon Eng.4G33 (50-68kW)		8/77-9/89	R		153-103		Lucas	203,2x38	Hand Brake
		90-91	R		700-227		Mando	Ø 180,0	
1.5 Eng.G15B/ G4DJ (53kW)		-89	R		700-227		Mando	Ø 180,0	
Pony II (X-2) 10/89-1/95									
1.3 Eng.G13B (49kW)		10/89-1/95	R		153-165		Bdx	180,0x34	Hand Brake
		91-94	R		700-227		Mando	Ø 180,0	
		95-	R		700-228			Ø 180,0	
1.3 Eng.G4DG (43kW)		10/89-1/95	R		153-165		Bdx	180,0x34	Hand Brake
		91-94	R		700-227		Mando	Ø 180,0	
		95-	R		700-228			Ø 180,0	
1.3 Eng.G4DG (48kW)		12/92-9/94	R		153-165		Bdx	180,0x34	Hand Brake
1.3 12v Eng.G4N (62kW)		10/89-1/95	R		153-165		Bdx	180,0x34	Hand Brake
1.5 Eng.G15B/ G4DJ (53-61-62kW)		10/89-1/95	R		153-165		Bdx	180,0x34	Hand Brake
		91-94	R		700-227		Mando	Ø 180,0	
		95-	R		700-228			Ø 180,0	
S Coupe (SLC) 2/90-5/96									
1.5 Eng.G15B/ G4DJ (62-53kW)		2/90-5/96	R		153-165		Bdx	180,0x34	A/T, Hand Brake
		2/90-5/96	R		153-167		Mando	180,0x35	M/T, Hand Brake
1.5 i Eng.G4EK (65kW)		4/92-5/96	R		153-165		Bdx	180,0x34	A/T, Hand Brake
		4/92-5/96	R		153-167		Mando	180,0x35	M/T, Hand Brake
		91-94	R		700-227		Mando	Ø 180,0	
1.5 i T. Eng.G4EK-TC (85kW)		4/91-5/96	R		153-165		Bdx	180,0x34	A/T, Hand Brake
		4/91-5/96	R		153-167		Mando	180,0x35	M/T, Hand Brake
		91-94	R		700-227		Mando	Ø 180,0	
Santa Fe I (SM) 2/01-2/06									
2.0 CRDi, 4WD Eng.D4EA (83kW)		4/01-	R			153-179K	Mando	190x40	
		4/01-2/06	R			153-179Y	Mando	190,0x40	Hand Brake
		4/01-2/06	R		153-172	153-172Y	Mando	254,0x55	Hand Brake
		4/01-2/06	R		153-180		Mando	254,0x57	Hand Brake
2.0 CRDi, 4WD Eng.D4EA (92kW)		11/03-2/06	R			153-179K	Mando	190x40	
		8/03-2/06	R			153-179Y	Mando	190,0x40	Hand Brake
		8/03-2/06	R		153-172	153-172Y	Mando	254,0x55	Hand Brake
		8/03-2/06	R		153-180		Mando	254,0x57	Hand Brake
2.4 16v, 4WD Eng.G4JS-G (100-107kW)		2/01-	R			153-179K	Mando	190x40	
		2/01-2/06	R			153-179Y	Mando	190,0x40	Hand Brake
		2/01-2/06	R		153-172	153-172Y	Mando	254,0x55	Hand Brake
		2/01-2/06	R		153-180		Mando	254,0x57	Hand Brake
2.7 V6 4WD Eng.G6BA-G (127kW)		2/01-	R			153-179K	Mando	190x40	
		2/01-2/06	R			153-179Y	Mando	190,0x40	Hand Brake
		2/01-2/06	R		153-172	153-172Y	Mando	254,0x55	Hand Brake
		2/01-2/06	R		153-180		Mando	254,0x57	Hand Brake
2.7, 4WD Eng.G6EA (139kW)		05-	R			153-179K	Mando	190x40	
		10/05-	R			153-179Y	Mando	190,0x40	Hand Brake
		10/05-	R		153-172	153-172Y	Mando	254,0x55	Hand Brake
		10/05-	R		153-180		Mando	254,0x57	Hand Brake
Santa Fe II (CM) 3/06-12/10									
2.2 CRDi Eng.D4EB (114kW)		06-10	R			153-186K	Mando	170x32	
2.2 CRDi, 4WD (102kW)		06-10	R			153-186K	Mando	170x32	
2.2 CRDi, 4WD Eng.D4EB (110kW)		06-10	R			153-186K	Mando	170x32	
2.7 Eng.G6BA (129kW)		06-10	R			153-186K	Mando	170x32	

		Spare Parts	F/R	L/R	CIFAM ref.	CIFAM ref. w/KIT		DIMENSIONS mm.	NOTE
2.7 V6 Eng.G6BA-G (125kW)	06-10		R			153-186K	Mando	170x32	
2.7 V6, 4WD Eng.G6EA (139kW)	06-10		R			153-186K	Mando	170x32	
Santa Fe III 1/11-									
2.0 CRDi, 4WD Eng.D4HA (110kW)	11-		R		153-498			190x26	
2.2 CRDi, 4WD Eng.D4HB (145kW)	11-		R		153-498			190x26	
2.4 16v Eng.G4KE (128kW)	11-		R		153-498			190x26	
Sonata I (Y-2) 9/88-10/93									
1.8 i Eng.G4M (70kW)	9/88-10/93		R		153-277		Sumit.	228,6x40	Hand Brake
2.0 i Eng.G4CP (74kW)	9/88-8/91		R		153-277		Sumit.	228,6x40	Hand Brake
2.0 i Eng.G4CP-U (80kW)	1/91-10/93		R		153-277		Sumit.	228,6x40	Hand Brake
2.0 i 16v Eng.G4CP-D (96-102kW)	1/91-10/93		R		153-277		Sumit.	228,6x40	Hand Brake
2.4 i Eng.G4CS (82-84-90kW)	9/88-8/91		R		153-277		Sumit.	228,6x40	Hand Brake
3.0i V6 Eng.G6AT (107-104kW)	1/91-10/93		R		153-277		Sumit.	228,6x40	Hand Brake
Sonata II (Y-3) 5/93-6/98									
1.8 i Eng.G4CM (72kW)	96-		R		153-100		Lucas	254,0x57	Hand Brake
2.0 i Eng.G4CP (70kW)	96-6/98		R		153-500			184x32	
	96-98		R		153-100		Lucas	254,0x57	Hand Brake
2.0 i Eng.G4CP (77kW)	94-96		R		153-500			184x32	
2.0 i 16v Eng.G4CP-D (96-102kW)	5/93-6/98		R		153-500			184x32	
2.0 i 16v Eng.G4CP-DM (92kW)	6/96-6/98		R		153-100		Lucas	254,0x57	Hand Brake
	96-6/98		R		153-500			184x32	
3.0i V6 Eng.G6AT (107-104kW)	5/93-6/98		R		153-500			184x32	
Sonata III (EF) 3/98-10/01									
2.0 16v Eng.G4JP-G (100kW)	6/98-10/01		R			153-186K	Mando	170x32	
	98-01		R		153-186	153-186K		170,0x32	
2.4 16v Eng.G4JS (105kW)	98-01		R		153-186	153-186K		170,0x32	
2.5 V6 24v Eng.G6BV-G (118kW)	98-01		R		153-186			170,0x32	
Sonata IV 10/01-12/04									
2.0 Eng.G4JP-EG (96kW)	10/01-10/01-10/01-11/04		R		153-186			170,0x32	
			R		153-175		Mando	228,6x45	
			R			153-186K	Mando	170x32	
2.7 V6 Eng.G6BA (129kW)	02-11/04		R			153-186K	Mando	170x32	
	11/02-		R		153-186			170,0x32	
2.7 V6 Eng.G6BA-G (127kW)	10/01-		R		153-186	153-186K		170,0x32	
Sonata V (NF) 1/05-									
2.0 VVTi GLS Eng.G4KD (121kW)	1/08-		R		153-184	153-184K		170,0x27	Hand Brake
3.3 Eng.G6DB (184kW)	1/08-		R		153-184	153-184K		170,0x27	Hand Brake
Starex (H1) 6/97-									
2.4, 4WD Eng.G4BS (82kW)	6/97-		R		153-100		Lucas	254,0x57	Hand Brake
2.5 CRDi (85kW)	10-		R		153-501			295x52	Mod. Travel
2.5 TD, 4WD Eng.D4BF (59kW)	6/97-		R		153-100		Lucas	254,0x57	Hand Brake
Terracan (HP) 12/01-									
2.5 TD Eng.D4BH (73-65-77kW)	12/01-		R		153-183	153-183K		190,0x40	
2.9 CRDi Eng.HJ3 (110kW)	12/01-		R		153-183	153-183K		190,0x40	
2.9 CRDi Eng.HJ3 (120kW)	11/03-		R		153-183	153-183K		190,0x40	
3.5 i V6 4WD Eng.G6CU (143kW)	12/01-		R		153-183	153-183K		190,0x40	
3.5 i V6 4WD Eng.G6CU (147kW)	12/01-		R		153-183	153-183K		190,0x40	
Trajet (FO) 3/00-									
2.0 Eng.G4GC (103kW)	1/04-1/04-		R			153-179K	Mando	190x40	
			R			153-179Y	Mando	190,0x40	Hand Brake
2.0 16v Eng.G4JP-G (100kW)	3/00-3/00-3/00-		R			153-179K	Mando	190x40	+ABS
			R			153-179Y	Mando	190,0x40	Hand Brake
			R		153-172	153-172Y	Mando	254,0x55	Hand Brake
2.0 CRDi Eng.D4EA (83kW)	4/01-4/01-4/01-		R			153-179K	Mando	190x40	+ABS
			R			153-179Y	Mando	190,0x40	+ABS, Hand Brake
			R		153-172	153-172Y	Mando	254,0x55	Hand Brake
2.7 V6 Eng.G6BA-G (127kW)	9/00-9/00-		R			153-179K	Mando	190x40	
			R			153-179Y	Mando	190,0x40	Hand Brake
Tucson (JM) 8/04-									
2.0 CRDi Eng.D4EA (100kW)	1/06-1/06-1/06-		R		153-184	153-184K		170,0x27	2WD, Hand Brake
			R			153-179K	Mando	190x40	
			R			153-179Y	Mando	190,0x40	4WD, Hand Brake
2.0 CRDi Eng.D4EA-F/ -V (103kW)	8/06-8/06-8/06-		R		153-184	153-184K		170,0x27	2WD, Hand Brake
			R			153-179K	Mando	190x40	
			R			153-179Y	Mando	190,0x40	4WD, Hand Brake
2.0 CRDi, 4WD Eng.D4EA (83kW)	8/04-8/04-8/04-		R		153-184	153-184K		170,0x27	2WD, Hand Brake
			R			153-179K	Mando	190x40	
			R			153-179Y	Mando	190,0x40	4WD, Hand Brake

HYUNDAI





		Spare Parts	F/R	L/R	CIFAM ref.	CIFAM ref. w/KIT		DIMENSIONS mm.	NOTE
2.0 CRDi, 4WD Eng.D4EA (88kW)	1/07-		R		153-184	153-184K		170,0x27	2WD, Hand Brake
	1/07-		R			153-179K	Mando	190x40	
	1/07-		R			153-179Y	Mando	190,0x40	4WD, Hand Brake
2.0 CRDi, Allrad Eng.D4EA (110kW)	1/09-		R		153-502			190x40	
2.0, 4WD Eng.G4GC (104kW)	04-		R		153-184	153-184K		170,0x27	2WD, Hand Brake
	04-		R			153-179Y	Mando	190,0x40	4WD, Hand Brake
2.7 4WD Eng.G6BA (129kW)	8/04-		R			153-179K	Mando	190x40	
	8/04-		R			153-179Y	Mando	190,0x40	Hand Brake

XG 12/98-



















30/300 Eng.G6CT-G (138kW)	12/98-		R		153-175		Mando	228,6x45	
---------------------------	--------	---	---	--	---------	--	-------	----------	--

HYUNDAI LCV







Grace Bus 7/93-10/04

2.5 D Eng.D4BA (55kW)	7/93-6/94		R		153-173			270,0x54	Hand Brake
2.5 TD Eng.D4BF (59kW)	6/98-10/01		R		153-173			270,0x54	Hand Brake
2.6 D (57kW)	10/99-10/04		R		153-173			270,0x54	Hand Brake









H-1 Van, Starex 10/97-

2.4 (107kW)	-06		R		153-173			270,0x54	Hand Brake
	06-		R		153-181		Mando	295,0x54	
2.4 Eng.G4JS (101kW)	2/03-4/04		R		153-173			270,0x54	Hand Brake
2.4, 4WD Eng.G4CS (82-84-90kW)	-06		R		153-173			270,0x54	Hand Brake
	06-		R		153-181		Mando	295,0x54	
2.5 CRDi (81kW)	1/07-		R		153-181		Mando	295,0x54	
2.5 CRDi (85kW)	11-		R		153-501			295x52	Mod. Travel
2.5 CRDi Eng.D4CB (125kW)	2/08-		R		153-501			295x52	Mod. Travel
2.5 CRDi, 4WD Eng.D4CB (100-103kW)	-06		R		153-173			270,0x54	Hand Brake
	06-		R		153-181		Mando	295,0x54	
2.5 D Eng.D4BB (57kW)	-06		R		153-173			270,0x54	Hand Brake
	06-		R		153-181		Mando	295,0x54	
2.5 TD Eng.D4BF (59kW)	-06		R		153-173			270,0x54	Hand Brake
	06-		R		153-181		Mando	295,0x54	
2.5 TD, 4WD Eng.D4BH (73kW)	-06		R		153-173			270,0x54	Hand Brake
	06-		R		153-181		Mando	295,0x54	
2.5 TD, 4WD Eng.D4BH (74kW)	-06		R		153-173			270,0x54	Hand Brake
	06-		R		153-181		Mando	295,0x54	
2.6 TDiC Eng.D4BB (63kW)			R		153-173			270,0x54	Hand Brake





H100 Bus (P) 7/93-3/00

2.4 Eng.G4CS (82-84-90kW)	7/93-3/00		R		153-100		Lucas	254,0x57	Hand Brake
2.5 D, Van Eng.D4BB/ A (57kW)	12/94-3/00		R		153-100		Lucas	254,0x57	Bus, Hand Brake
	12/94-3/00		R		153-221		Sumit.	220,0x57	Van, Hand Brake
2.5 D, Van Eng.D4BX/ D4BA (55kW)	7/93-12/94		R		153-100		Lucas	254,0x57	Bus, Hand Brake
	7/93-12/94		R		153-221		Sumit.	220,0x57	Van, Hand Brake
2.5 TD Eng.D4BF (59kW)	7/93-3/00		R		153-100		Lucas	254,0x57	Bus, Hand Brake



H200 Bus (KMF) 10/97-

2.4 (101kW)	2/03-4/04		R		153-173			270,0x54	Hand Brake
2.4 (107kW)	11/01-		R		153-173			270,0x54	Hand Brake
2.4, 4WD Eng.G4CS (82kW)	10/97-		R		153-173			270,0x54	Hand Brake
2.5 CRDi, 4WD (81kW)	6/06-		R		153-173			270,0x54	Hand Brake
2.5 D Eng.D4BB (57kW)	10/97-		R		153-173			270,0x54	Hand Brake
2.5 TD Eng.D4BF (59kW)	10/97-		R		153-173			270,0x54	Hand Brake
2.5 TD, 4WD Eng.D4BH (73-74kW)	10/99-		R		153-173			270,0x54	Hand Brake
2.6 TDiC Eng.D4BB (63kW)	10/97-10/02		R		153-173			270,0x54	Hand Brake

Highway Van 3/00-

2.0 16v Eng.G4JP-G (100kW)	3/00-		R			153-179K	Mando	190x40	
	3/00-		R			153-179Y	Mando	190,0x40	Hand Brake
2.7 V6 Eng.G6BA-G (125kW)	3/00-		R			153-179K	Mando	190x40	
	3/00-		R			153-179Y	Mando	190,0x40	Hand Brake







Porter 7/94-4/04

2.4 Eng.G4CS (82kW)	3/96-4/04		R		153-174			220,0x47	
2.5 TD Eng.D4BA (57kW)	7/94-4/04		R		153-100		Lucas	254,0x57	Hand Brake
2.5 TD Eng.D4BH (73kW)	7/94-4/04		R		153-100		Lucas	254,0x57	Hand Brake













INFINITI

FX 1/03-







35 (223kW)	12-		R			153-297K		190x33	
------------	-----	---	---	--	--	----------	--	--------	--





		Spare Parts	F/R	L/R	CIFAM ref.	CIFAM ref. w/KIT		DIMENSIONS mm.	NOTE
35 3.5 V6 24v Eng.VQ35DE (206kW)	-04		R		153-294			172,0x32	Hand Brake
	05-		R		153-297	153-297K		190,0x33	Hand Brake
45 4.5 V8 32v Eng.VK45DE (232kW)	-04		R		153-294			172,0x32	Hand Brake
	05-		R		153-297	153-297K		190,0x33	Hand Brake
M II 1/05-8/10									
4.5 Eng.VK45DE (250kW)	1/05-		R		153-299			172,0x27	
QX4 1/97-									
3.3 Eng.VG33E (125kW)	1/97-		R		153-282		Ake	295,0x50	Hand Brake













INNOCENTI





Elba (146) 4/86-									
1.3 Eng.146A5.000 (49kW)	8/91-		R		153-063		Fiat	185,0x31	Fitted Adjuster, Hand Brake
	91-			R		700-003		Ø 185,0	
1.4 ie Eng.146C5.000/ 146D5.000 (49kW)	9/94-12/96		R		153-063		Fiat	185,0x31	Fitted Adjuster, Hand Brake
	94-96			R		700-003		Ø 185,0	
1.5 (49kW)	1/92-12/96		R		153-063		Fiat	185,0x31	Fitted Adjuster, Hand Brake
1.5 Eng.149C1.000 (55kW)	8/92-9/94		R		153-063		Fiat	185,0x31	Fitted Adjuster, Hand Brake
	92-			R		700-003		Ø 185,0	
1.6 (69kW)	1/94-12/96		R		153-063		Fiat	185,0x31	Fitted Adjuster, Hand Brake
1.6 ie Eng.146C6.000/ 146D6.000 (55kW)	9/94-12/96		R		153-063		Fiat	185,0x31	Fitted Adjuster, Hand Brake
	94-96			R		700-003		Ø 185,0	
1.7 D Eng.146B2.000 (42kW)	8/91-12/96		R		153-063		Fiat	185,0x31	Fitted Adjuster, Hand Brake
	91-			R		700-003		Ø 185,0	

Koral 1/90-12/92									
0.9 45 Eng.100GL064 (33kW)	90-92		R		700-032			Ø 185,0	
1.1 55 Eng.128A (40kW)	90-92		R		700-032			Ø 185,0	

Mille 1/94-									
1.0	1/94-		R		153-063		Fiat	185,0x31	Fitted Adjuster, Hand Brake
	94-			R		700-003		Ø 185,0	
1.0ie Eng.146C7 (33kW)	1/96-		R		153-063		Fiat	185,0x31	Fitted Adjuster, Hand Brake
1.4 Eng.160A1.048 (52kW)	1/94-		R		153-063		Fiat	185,0x31	Fitted Adjuster, Hand Brake
	94-			R		700-003		Ø 185,0	
1.4ie T. Eng.146A8.000/ .046 (82-87kW)	1/96-		R		153-063		Fiat	185,0x31	Fitted Adjuster, Hand Brake
1.7 D Eng.146B2.000 (42kW)	1/96-		R		153-063		Fiat	185,0x31	Fitted Adjuster, Hand Brake



Mini I 1/69-1/77									
1.0 (39kW)			R		700-073			Ø 117,8	Ch 364532-
1.0 Eng.BLMC99H (32kW)			R		700-073			Ø 117,8	Ch 364532-
1.0 Eng.BLMC99H (35kW)			R		700-073			Ø 117,8	Ch 364532-
90-120	74-77		R		700-073			Ø 117,8	























































Mini II 1/77-10/85									
1.0 Eng.BLMC99H (27kW)	1/77-10/85		R		153-004		Ap	177,8x32	Hand Brake
				R		700-073		Ø 117,8	Ch 364532-
1.0 Eng.BLMC99H (32kW)	1/77-10/85		R		153-004		Ap	177,8x32	Hand Brake
				R		700-073		Ø 117,8	Ch 364532-
1.0 Eng.BLMC99H (35kW)	1/77-10/85		R		153-004		Ap	177,8x32	Hand Brake
				R		700-073		Ø 117,8	Ch 364532-
1.0 Eng.CB23 (39kW)	1/77-10/85		R		153-004		Ap	177,8x32	Hand Brake
			R		700-073			Ø 117,8	Ch 364532-
1.1 (33-37kW)	67-74		R		700-073			Ø 117,8	
1.3 De Tomaso Eng.BLMC12HH (51kW)	1/77-2/82		R		153-004		Ap	177,8x32	Hand Brake
1.3 S (44kW)	1/77-10/85		R		153-004		Ap	177,8x32	Hand Brake
	67-74			R		700-073		Ø 117,8	











Mini III 10/85-10/91									
1.0 T. De Tomaso Eng.CB60/ CB61 (53kW)	10/85-10/91		R		153-063		Fiat	185,0x31	Fitted Adjuster, Hand Brake
1.1 (33-37kW)	67-74		R		700-073			Ø 117,8	
1.3 Eng.BLMC99H (47kW)	67-74		R		700-073			Ø 117,8	
1.3 S (44kW)	69-71		R		700-073			Ø 117,8	

































































Regent 1/74-12/75									
1.3 Eng.12H (46kW)	1/74-12/75		R		153-101		Lucas	203,2x38	Hand Brake
1.5 Eng.14L (55kW)	1/74-12/75		R		153-101		Lucas	203,2x38	Hand Brake













ISUZU

Amigo 1/89-									
2.2 16v, 4WD Eng.Y22E (96kW)	1/98-		R		153-315	153-315K	Ake	210,0x32	Hand Brake
	98-			R		700-178		Ø 254,0	

			Spare Parts	F/R	L/R	CIFAM ref.	CIFAM ref. w/KIT		DIMENSIONS mm.	NOTE
2.3 8v, AWD	1/89-12/93		R			153-192		Ake	254,0x52	Hand Brake
	89-93		R			700-178			Ø 254,0	
2.6 8v, 4WD Eng.4ZE1 (84kW)	1/89-12/94		R			153-312		Ake	302,0x46	
	89-94		R			700-178			Ø 254,0	
3.2 24v, 4WD	1/98-12/00		R			153-315	153-315K	Ake	210,0x32	Hand Brake
Aska 1/83-										
2.0 Eng.4ZC1 (61-81kW)	1/83-		R			153-253	153-253Y	Ake	180,0x36	Hand Brake
Axiom 1/02-12/04										
3.5 24v, 4WD	1/03-12/03		R				153-315K	Ake	210x32	
	1/03-12/03		R			153-315	153-315K	Ake	210,0x32	Hand Brake
	1/04-12/04		R			153-315		Ake	210,0x32	Hand Brake
Campo 4/77-12/91										
2.0, 4WD Eng.4ZC1 (52kW)	1/83-3/88		R			153-192		Ake	254,0x52	Hand Brake
2.0, 4WD Eng.G200N (48kW)	4/77-12/82		R			153-192		Ake	254,0x52	Hand Brake
2.0, 4WD Eng.G200Z (58-65kW)	6/85-12/88		R			153-192		Ake	254,0x52	Hand Brake
2.2 Eng.4ZD1 (66kW)	1/89-12/90		R			153-192		Ake	254,0x52	Hand Brake
2.2 D 4WD Eng.C223 (39-45kW)	1/83-12/91		R			153-192		Ake	254,0x52	Hand Brake
	88-		R			700-178			Ø 254,0	
2.3 Eng.23P (72kW)	1/88-12/91		R			153-192		Ake	254,0x52	Hand Brake
	88-		R			700-178			Ø 254,0	
2.5 D, 4WD Eng.4JA1 (55kW)	88-		R			700-178			Ø 254,0	
3.1 TD Eng.4J52T (77kW)	88-		R			700-178			Ø 254,0	
D-Max/Wizard 5/02-										
2.5 D 4WD Eng.4JA1-T (74kW)	5/02-		R			153-194			254,0x52	2WD
	5/02-		R			153-193			295,0x47	4WD
	5/02-		R				153-194Y		254x52	2WD
3.0 D 4WD Eng.4JH1-TC (96kW)	5/02-		R			153-193			295,0x47	
Euromidi										
All models	85-		R			700-178			Ø 254,0	Axle Isuzu
	85-		R			700-298			Ø 254,0	Axle Salisbury
Fargo 1/81-12/94										
1.8 D, TD Eng.4FB1 (45-54kW)	6/82-12/94		R			153-190		Sumit.	254,0x50	Hand Brake
	7/88-		R			700-178			Ø 254,0	Axle Isuzu
	7/88-		R			700-298			Ø 254,0	Axle Salisbury
2.2 D Eng.4FD1 (54kW)	11/83-12/94		R			153-190		Sumit.	254,0x50	Hand Brake
	7/88-		R			700-178			Ø 254,0	Axle Isuzu
	7/88-		R			700-298			Ø 254,0	Axle Salisbury
2.4 D Eng.4FG1	7/88-		R			700-178			Ø 254,0	Axle Isuzu
	7/88-		R			700-298			Ø 254,0	Axle Salisbury
Faster 1/81-12/87										
KB20, 21	-84		R			153-190		Sumit.	254,0x50	Hand Brake
	84-		R			153-191		Ake	254,0x50	Hand Brake
	81-84		R			700-298			Ø 254,0	
	84-87		R			700-178			Ø 254,0	
KB25	-84		R			153-190		Sumit.	254,0x50	Hand Brake
	84-		R			153-191		Ake	254,0x50	Hand Brake
KB26	-84		R			153-190		Sumit.	254,0x50	Hand Brake
	84-		R			153-191		Ake	254,0x50	Hand Brake
KB41	1/84-12/88		R			153-191		Ake	254,0x50	Hand Brake
Mark I 1/82-12/91										
1.5, T, Eng.4XC1-T (49kW)	85-89		R			700-178			Ø 254,0	Exc. Turbo -87
1.6 16v Eng.4XE1W (98kW)	85-89		R			700-178			Ø 254,0	Exc. Turbo -87
1.8 D, TD Eng.4FB1 (45-54kW)	85-89		R			700-178			Ø 254,0	Exc. Turbo -87
Midi Bus, Van 1/89-										
2.0 TD Eng.4FC1T (51kW)			R			700-178			Ø 254,0	
2.0, 4WD Eng.4ZC1 (61-81kW)	1/89-		R			153-190		Sumit.	254,0x50	Hand Brake
			R			700-178			Ø 254,0	
2.2 D, 4WD Eng.4FD1 (45kW)	1/89-		R			153-190		Sumit.	254,0x50	Hand Brake
			R			700-178			Ø 254,0	
2.4 D, 4WD Eng.4FG1T (56kW)			R			700-178			Ø 254,0	
Oasis 1/96-12/99										
2.2 16v	1/96-12/97		R			153-159	153-159K		170,0x35	
2.3 16v	1/98-12/98		R			153-159	153-159K		170,0x35	
	1/99-12/99		R			153-159	153-159K		170,0x35	
Pick-Up (TFR-TFS)										
1.6 4WD Eng.G161Z (58kW)	81-87		R			700-178			Ø 254,0	
2.0 Eng.G200Z (57kW)	81-87		R			700-178			Ø 254,0	





		Spare Parts	F/R	L/R	CIFAM ref.	CIFAM ref. w/KIT		DIMENSIONS mm.	NOTE
2.2 D Eng.C223 (38kW)			R		153-192		Ake	254,0x52	Hand Brake
	81-87		R		700-178			Ø 254,0	
2.3, 4WD Eng.4ZD1 (68kW)	8/85-9/87		R		153-192		Ake	254,0x52	Hand Brake
2.3, 4WD Eng.4ZD1 (70kW)	10/87-8/96		R		153-192		Ake	254,0x52	Hand Brake
2.5 D, TD, 4WD Eng.4JA1/ 4JA1T (56kW)	6/90-		R		153-192		Ake	254,0x52	Hand Brake
2.8 D Eng.4BA1 (55kW)	81-87		R		700-178			Ø 254,0	
Rodeo 1/88-									
2.2 16v, 4WD Eng.Y22E (96kW)	1/98-12/03		R			153-315K	Ake	210x32	
	1/98-12/03		R		153-315		Ake	210,0x32	Hand Brake
2.6 8V, 4WD Eng.4ZE1/ D1 (85-81kW)	1/91-12/97		R		153-312		Ake	302,0x46	
	94-12/97		R			153-315K	Ake	210x32	
3.1 12v, 4WD	1/91-12/92		R		153-192		Ake	254,0x52	Hand Brake
3.2 24v, 4WD	1/93-12/04		R		153-315	153-315K	Ake	210,0x32	Hand Brake
Trooper I (UBS) 1/83-12/91									
2.0 Eng.G200Z (58kW)	1/83-12/91		R		153-192		Ake	254,0x52	Hand Brake
	1/83-12/91		R		153-190		Sumit.	254,0x50	Hand Brake
	84-85		R		700-178			Ø 254,0	
2.2 D 4WD Eng.C223 (39kW)	5/84-12/89		R		153-192		Ake	254,0x52	Hand Brake
	5/84-12/89		R		153-190		Sumit.	254,0x50	Hand Brake
2.8 TD Eng.4JB1T (71kW)	10/87-12/91		R		153-192		Ake	254,0x52	Hand Brake
2.8 TD Eng.4JB1TC (78kW)	10/88-12/91		R		153-192		Ake	254,0x52	Hand Brake
Trooper I Soft Top (UBS) 1/83-12/91									
2.0 Eng.G200Z (58kW)	1/83-12/85		R		153-192		Ake	254,0x52	Hand Brake
	1/83-12/85		R		153-190		Sumit.	254,0x50	Hand Brake
2.2 Eng.4ZD1 (66kW)	-87		R		153-191		Ake	254,0x50	Hand Brake
	88-		R		153-192		Ake	254,0x52	Hand Brake
2.2 D Eng.C223 (45kW)	1/83-12/83		R		153-192		Ake	254,0x52	Hand Brake
	1/83-12/83		R		153-190		Sumit.	254,0x50	Hand Brake
2.2 D 4WD Eng.C223 (39kW)	5/84-7/89		R		153-192		Ake	254,0x52	Hand Brake
	5/84-7/89		R		153-190		Sumit.	254,0x50	Hand Brake
2.6 Eng.4ZE1/ D1 (85-81kW)	10/87-12/91		R		153-192		Ake	254,0x52	Hand Brake
Trooper II (UB), Soft Top 8/91-7/98									
3.1 D Eng.4JG2-TC (84kW)	8/91-7/98		R		153-195			210,0x31	
3.2 Eng.6VD1 (130kW)	8/91-7/98		R		153-195			210,0x31	
Trooper III, Soft Top 4/00-									
3.0 DTI Eng.4JX1 (118kW)	4/00-		R		153-195			210,0x31	
3.5 V6 24v Eng.6VE1 (158kW)	4/00-		R		153-195			210,0x31	
Truck									
All models	88-91		R		700-178			Ø 254,0	
WFR 11 - 12 - 53 - 62									
1.8 (61kW)			R		153-190		Sumit.	254,0x50	Hand Brake
	86-91		R		700-178			Ø 254,0	
2.0 Eng.4ZC1 (69kW)	1/86-8/90		R		153-190		Sumit.	254,0x50	Hand Brake
2.2 D Eng.C223 (44kW)			R		153-190		Sumit.	254,0x50	Hand Brake
	85-8/90		R		700-178			Ø 254,0	
IVECO									
Daily - Grinta 1/79-12/90									
30 F	1/79-12/90		R		153-109		Ap	254,0x70	+AA, SRW, Hand Brake
30.8 Eng.8140.61 (53kW)	1/79-12/90		R		153-064		Ap	254,0x90	Hand Brake
32 F	1/79-12/90		R		153-109		Ap	254,0x70	+AA, SRW, Hand Brake
32.8 Eng.8140.61 (53kW)	1/79-12/90		R		153-109		Ap	254,0x70	+AA, SRW, Hand Brake
	1/79-12/90		R		153-064		Ap	254,0x90	Hand Brake
35.10 Eng.8140.21 (68kW)	82-		R		700-014			Ø 254,0	
35.10 T. Eng.8140.21 (68kW)	82-		R		700-014			Ø 254,0	
35.12 T. Eng.8140.61 (53kW)	82-		R		700-014			Ø 254,0	
35.8 Eng.8140.61 (53kW)	1/79-12/90		R		153-064		Ap	254,0x90	Hand Brake
	82-		R		700-014			Ø 254,0	
40.10 Eng.8140.21 (68kW)	82-		R		700-014			Ø 254,0	
40.10 T. Eng.8140.21 (68kW)	82-		R		700-014			Ø 254,0	
40.12	82-		R		700-014			Ø 254,0	
40.8 Eng.8140.61 (53kW)	1/79-12/90		R		153-064		Ap	254,0x90	Hand Brake
	82-		R		700-014			Ø 254,0	
45.10 Eng.8140.21 (68kW)	1/79-12/90		R		153-064		Ap	254,0x90	Hand Brake
	82-		R		700-014			Ø 254,0	

		Spare Parts	F/R	L/R	CIFAM ref.	CIFAM ref. w/KIT		DIMENSIONS mm.	NOTE
49.10 T. Eng.8140.21 (68kW)	1/79-12/90		R		153-064		Ap	254,0x90	Hand Brake
	82-		R		700-014			Ø 254,0	
49.12			R		700-014			Ø 254,0	
50.10	79-90		R		153-489			310x101	
Daily I 1/91-1/99									
35.10 Eng.8140.21 (68kW)	1/91-1/99		R		153-065		Ap	254,0x90	
	1/91-1/99		R		153-077	153-077K	Brembo	170,0x45	
	1/91-1/99		R		153-097	153-097K	Brembo	170,0x45	Hand Brake
	1/91-1/99		R		153-086	153-086K	Brembo	190,0x42	Hand Brake
35.10 Eng.8140.23 (76kW)	1/96-12/99		R		153-077	153-077K	Brembo	170,0x45	
	1/96-12/99		R		153-097	153-097K	Brembo	170,0x45	Hand Brake
35.10 Eng.8140.47R (76kW)	1/89-4/96		R		153-065		Ap	254,0x90	
	1/89-4/96		R		153-077	153-077K	Brembo	170,0x45	
	1/89-4/96		R		153-097	153-097K	Brembo	170,0x45	Hand Brake
	1/89-4/96		R		153-086	153-086K	Brembo	190,0x42	Hand Brake
35.12 Eng.8140.47 (85kW)	1/90-1/96		R		153-065		Ap	254,0x90	
35.12 V, C Eng.8140.61 (53kW)	96-		R		153-077	153-077K	Brembo	170,0x45	
	96-		R		153-097	153-097K	Brembo	170,0x45	Hand Brake
	96-		R		153-086	153-086K	Brembo	190,0x42	Hand Brake
35.8 Eng.8140.07 (55kW)			R		153-077	153-077K	Brembo	170,0x45	
			R		153-097	153-097K	Brembo	170,0x45	Hand Brake
	1/89-12/98		R		153-065		Ap	254,0x90	F8
	96-		R		153-109		Ap	254,0x70	Hand Brake
35.8 Eng.8140.61 (53kW)	96-		R		153-086	153-086K	Brembo	190,0x42	Hand Brake
	96-		R		153-077	153-077K	Brembo	170,0x45	
35.8 Eng.8140.61 (53kW)	1/91-1/99		R		153-097	153-097K	Brembo	170,0x45	Hand Brake
			R		153-065		Ap	254,0x90	
			R		153-086	153-086K	Brembo	190,0x42	Hand Brake
			R		153-077	153-077K	Brembo	170,0x45	
35.8 Eng.8140.63 (62kW)	1/91-1/99		R		153-077	153-077K	Brembo	170,0x45	
			R		153-097	153-097K	Brembo	170,0x45	Hand Brake
			R		153-065		Ap	254,0x90	F8
			R		153-109		Ap	254,0x70	Hand Brake
35.8 Eng.8140.63 (62kW)	96-		R		153-086	153-086K	Brembo	190,0x42	Hand Brake
	96-		R		153-077	153-077K	Brembo	170,0x45	
35.8 Eng.8140.67F (55-60kW)	1/91-8/98		R		153-077	153-077K	Brembo	170,0x45	
			R		153-097	153-097K	Brembo	170,0x45	Hand Brake
			R		153-065		Ap	254,0x90	F8
			R		153-086	153-086K	Brembo	190,0x42	Hand Brake
40.10 Eng.8140.21 (68kW)	97-		R		153-486			260x80	
	91-99		R		700-014			Ø 254,0	
40.10 Eng.8140.23 (76kW)	97-		R		153-486			260x80	
40.10 Eng.8140.27 (76kW)	97-		R		153-486			260x80	
40.8 Eng.8140.61 (53kW)	1/91-1/99		R		153-065		Ap	254,0x90	F8
	91-99		R		700-014			Ø 254,0	
49.10 TD Eng.8140.21 (68kW)	91-99		R		700-014			Ø 254,0	
			R		700-014			Ø 254,0	
Daily II 2/99-4/06									
35C11V 2.8 D Eng.8140.43C/ B (78kW)	2/99-4/06		R		153-077	153-077K	Brembo	170,0x45	
	2/99-4/06		R		153-097	153-097K	Brembo	170,0x45	Hand Brake
35C13V 2.8 D Eng.8140.43S (92-94kW)	2/99-4/06		R		153-077	153-077K	Brembo	170,0x45	
	2/99-4/06		R		153-097	153-097K	Brembo	170,0x45	Hand Brake
35C15V Eng.8140.43N (107kW)			R		153-077	153-077K	Brembo	170,0x45	
			R		153-097	153-097K	Brembo	170,0x45	Hand Brake
35C9 2.8 D Eng.8140.63 (62kW)	2/99-4/06		R		153-077	153-077K	Brembo	170,0x45	
	2/99-4/06		R		153-097	153-097K	Brembo	170,0x45	Hand Brake
35S11 2.8 D Eng.8140.43C (78kW)	2/99-4/06		R		153-077	153-077K	Brembo	170,0x45	
	2/99-4/06		R		153-097	153-097K	Brembo	170,0x45	Hand Brake
	2/99-4/06		R		153-086	153-086K	Brembo	190,0x42	Hand Brake
35S13 2.8 D Eng.8140.43S (92kW)	2/99-4/06		R		153-077	153-077K	Brembo	170,0x45	
	2/99-4/06		R		153-097	153-097K	Brembo	170,0x45	Hand Brake
	2/99-4/06		R		153-086	153-086K	Brembo	190,0x42	Hand Brake
35S15 2.8 D Eng.8140.43N (107kW)	2/99-4/06		R		153-077	153-077K	Brembo	170,0x45	
	2/99-4/06		R		153-097	153-097K	Brembo	170,0x45	Hand Brake
	2/99-4/06		R		153-086	153-086K	Brembo	190,0x42	Hand Brake
35S9 2.8 D Eng.8140.63 (62kW)	2/99-4/06		R		153-077	153-077K	Brembo	170,0x45	
	2/99-4/06		R		153-097	153-097K	Brembo	170,0x45	Hand Brake
Daily III 5/06-									
2.3 HPI Eng.F1AE0481FA (71kW)	06-		R		153-486			260x80	(35.8, 40.10, 45.10, 49.10)
2.3 HPI Eng.F1AE0481FA (78kW)	09-		R		153-486			260x80	(35.8, 40.10, 45.10, 49.10)



		Spare Parts	F/R	L/R	CIFAM ref.	CIFAM ref. w/KIT		DIMENSIONS mm.	NOTE
2.3 HPI Eng.F1AE0481GA (85kW)	06-		R		153-486			260x80	(35.8, 40.10, 45.10, 49.10)
2.3 HPI Eng.F1AE0481GA (93kW)	09-		R		153-486			260x80	(35.8, 40.10, 45.10, 49.10)
2.3 HPI Eng.F1AE0481HA (100kW)	06-		R		153-486			260x80	(35.8, 40.10, 45.10, 49.10)
3.0 HPI Eng.F1CE0441A (100kW)	09-		R		153-486			260x80	(35.8, 40.10, 45.10, 49.10)
3.0 HPI Eng.F1CE0481FA (108kW)	06-		R		153-486			260x80	(35.8, 40.10, 45.10, 49.10)
3.0 HPI Eng.F1CE0481HA (130kW)	06-		R		153-486			260x80	(35.8, 40.10, 45.10, 49.10)
3.0 HPT Eng.F1CE0481HC (130kW)	07-		R		153-486			260x80	(35.8, 40.10, 45.10, 49.10)
3.0 Nat. Power Eng.F1CE0441A (100kW)	09-		R		153-486			260x80	(35.8, 40.10, 45.10, 49.10)
3.0 TT Eng.F1CE0481HA (125kW)	10-		R		153-486			260x80	(35.8, 40.10, 45.10, 49.10)
3.0 TT Eng.F1CE3481LC (103kW)	10-		R		153-486			260x80	(35.8, 40.10, 45.10, 49.10)

JAGUAR





XJ II (XJ 40,81) 10/86-11/94

2.9 Eng.AJ6 (108-117-123kW)	10/86-8/90		R		153-197	153-197K		180,0x30	Hand Brake
3.2 24v Eng.9BPMNA/ AJ6 (146kW)	9/90-11/94		R		153-197	153-197K		180,0x30	Hand Brake
4.0 Eng.9EPCNA/ AJ6 (163kW)	9/89-11/94		R		153-197	153-197K		180,0x30	Hand Brake
6.0 V12 Eng.8E (229kW)	3/93-11/94		R		153-197	153-197K		180,0x30	Hand Brake

XJ III (X300) 11/94-6/97

3.2 Eng.9JPGRB (155kW)	11/94-6/97		R		153-197	153-197K		180,0x30	Hand Brake
	11/94-6/97		R		153-325	153-325K	Bdx	185,0x20	Hand Brake
4.0 Sovereign Eng.9JPFRB (177kW)	11/94-6/97		R		153-197	153-197K		180,0x30	Hand Brake
6.0 V12 Eng.8E (229kW)	11/94-6/97		R		153-197	153-197K		180,0x30	Hand Brake
	11/94-6/97		R		153-325	153-325K	Bdx	185,0x20	Hand Brake













XJ V 5/03-12/09

2.7 D Eng.7G (152kW)	10/05-		R		153-197	153-197K		180,0x30	Hand Brake
3.0 Eng.VB/ VG (175kW)	5/03-		R		153-197	153-197K		180,0x30	Hand Brake
3.5 Eng.RB/ RG (190kW)	5/03-		R		153-197	153-197K		180,0x30	Hand Brake
4.2 Eng.SB/ SG (219kW)	5/03-		R		153-197	153-197K		180,0x30	Hand Brake
4.2 R Eng.TB/ TG (291kW)	5/03-		R		153-197	153-197K		180,0x30	Hand Brake







XJR 1/88-

4.0 24v Eng.AJ-V8	1/89-		R		153-197	153-197K		180,0x30	Hand Brake
-------------------	-------	---	---	--	----------------	-----------------	--	----------	------------

XJS Coupe, Convertible 9/75-3/96



3.6 Eng.9DPALA/ AJ6 (146kW)	1/88-5/91		R		153-197	153-197K		180,0x30	Hand Brake
3.6 Eng.AJ6 (156-162kW)	88-		R		153-197	153-197K		180,0x30	Hand Brake
3.6 Eng.AJ64 (136kW)	8/87-5/92		R		153-197	153-197K		180,0x30	Hand Brake
4.0 Eng.9EPCNA/ AJ6 (163kW)	5/91-9/94		R		153-197	153-197K		180,0x30	Hand Brake
4.0 Eng.9LPFRB (171kW)	7/94-3/96		R		153-197	153-197K		180,0x30	Hand Brake
	7/94-3/96		R		153-325	153-325K	Bdx	185,0x20	Cabrio, Hand Brake
4.0 24v Eng.AJ-V8	91-		R		153-197	153-197K		180,0x30	Hand Brake
	94-		R		153-325		Bdx	185,0x20	Cabrio, Hand Brake
5.3 Eng.8C (202kW)	1/88-6/91		R		153-197	153-197K		180,0x30	Hand Brake
5.3 Eng.8S (207kW)	5/91-8/93		R		153-197	153-197K		180,0x30	Hand Brake
5.3 Eng.V12 (211kW)	1/88-5/92		R		153-197	153-197K		180,0x30	Hand Brake
5.3 Eng.V12HE	88-		R		153-197	153-197K		180,0x30	Hand Brake
5.3 H.E. Eng.8S (194kW)	88-		R		153-197	153-197K		180,0x30	Hand Brake
5.3 H.E. Eng.V12 (217kW)	88-		R		153-197	153-197K		180,0x30	Hand Brake
6.0 Eng.8D (222kW)	5/93-3/96		R		153-197	153-197K		180,0x30	Hand Brake
	5/93-3/96		R		153-325	153-325K	Bdx	185,0x20	Cabrio, Hand Brake









































XK 8 (QDV, QEV) Convertible, Coupe, Cabrio 3/96-











































4.0 (216kW)	5/96-7/99		R		153-197	153-197K		180,0x30	Hand Brake
	5/96-7/99		R		153-325	153-325K	Bdx	185,0x20	Hand Brake
4.0 Eng.CC/ CE (209kW)	3/96-		R		153-197	153-197K		180,0x30	Hand Brake
	3/96-		R		153-325	153-325K	Bdx	185,0x20	Hand Brake
4.0 Eng.EC (267kW)	2/98-		R		153-197	153-197K		180,0x30	Hand Brake
	2/98-		R		153-325	153-325K	Bdx	185,0x20	Hand Brake
4.2 Eng.5G (219kW)	8/02-		R		153-197	153-197K		180,0x30	Hand Brake
4.2 R V8 Eng.1B/ 1G (291kW)	8/02-		R		153-197	153-197K		180,0x30	Hand Brake
4.2 V8 R Eng.9G (306kW)	8/07-		R		153-197	153-197K		180,0x30	Hand Brake









JEEP

Cherokee I 10/80-9/86



























2.5 (81kW)	10/83-9/86		R		153-348			254,0x46	Hand Brake
2.5 4WD (87kW)	10/83-6/86		R		153-348			254,0x46	Hand Brake
2.8 4WD (81kW)	10/83-9/86		R		153-348			254,0x46	Hand Brake









		Spare Parts	F/R	L/R	CIFAM ref.	CIFAM ref. w/KIT		DIMENSIONS mm.	NOTE
Cherokee II (XJ) 10/84-8/01									
2.1 TD, 4WD Eng.J8S (59-64kW)	10/84-3/92		R		153-349			228,6x65	Hand Brake
	10/84-3/92				153-348			254,0x46	Hand Brake
2.5 i Eng.EPE/ HX (87-90kW)	12/91-8/01		R		153-349			228,6x65	Hand Brake
2.5 SE Eng.EPE (87kW)	10/96-9/99		R		153-349			228,6x65	Hand Brake
2.5 TD, 4WD Eng.VM425 (85-89kW)	1/88-8/01		R		153-349			228,6x65	Hand Brake
4.0 i Eng.C698QA (127-131kW)	1/95-8/01		R		153-357			228,6x64	Hand Brake
	98-				153-349			228,6x65	Hand Brake
4.0 i Eng.ERH (136kW)	1/88-8/01		R		153-357			228,6x64	Hand Brake
	98-				153-349			228,6x65	Hand Brake
4.0 i Eng.MX (135kW)	12/91-8/01		R		153-357			228,6x64	Hand Brake
	98-				153-349			228,6x65	Hand Brake
4.0 i Eng.S01 (135kW)	4/00-8/01		R		153-357			228,6x64	Hand Brake
	4/00-8/01				153-349			228,6x65	Hand Brake
4.0, 4WD Eng.ERH (131kW)	10/86-9/90		R		153-348			254,0x46	Hand Brake
Cherokee III (KJ) 9/01-6/08									
2.4 Eng.ED1 (108kW)	9/01-6/08		R		153-364			184,0x31	Hand Brake
	9/01-6/08				153-358			254,0x46	Hand Brake
2.5 CRD Eng.ENJ (105kW)	9/01-6/08		R		153-364			184,0x31	Hand Brake
	9/01-6/08				153-358			254,0x46	Hand Brake
2.8 CRD Eng.ENR (110kW)	11/02-6/08		R		153-364			184,0x31	Hand Brake
	11/02-6/08				153-372			184,0x31	Hand Brake
	11/02-6/08				153-349			228,6x65	Hand Brake
	11/02-6/08				153-358			254,0x46	Hand Brake
2.8 CRD Eng.ENR (120kW)	11/04-6/08		R		153-364			184,0x31	Hand Brake
	11/04-6/08				153-372			184,0x31	Hand Brake
	11/04-6/08				153-349			228,6x65	Hand Brake
	11/04-6/08				153-358			254,0x46	Hand Brake
3.7 V6 Eng.EKG (150-155-157kW)	9/01-6/08		R		153-364			184,0x31	Hand Brake
	9/01-6/08				153-358			254,0x46	Hand Brake
Cherokee IV (KK) 7/08-									
2.8 CRD Eng.50C (130kW)	08-		R		153-363			207,0x32	
CJ5 - CJ8 1/66-12/87									
2.5 (65kW)	1/80-12/83		R		153-348			254,0x46	Hand Brake
2.5 (78kW)	1/84-12/87		R		153-348			254,0x46	Hand Brake
4.2 (76kW)	1/72-12/87		R		153-348			254,0x46	Hand Brake
5.0 (89kW)	1/73-12/81		R		153-348			254,0x46	Hand Brake
CJ7 1/82-12/92									
2.1 TD Eng.J8S (59-64kW)	1/82-12/92		R		153-348			254,0x46	Hand Brake
2.5	1/80-12/86		R		153-348			254,0x46	Hand Brake
4.2 12v AWD	1/76-12/86		R		153-348			254,0x46	Hand Brake
5.0 16v AWD Eng.304 CID (110kW)	1/76-12/81		R		153-348			254,0x46	Hand Brake
Comanche 10/86-9/96									
2.1 D, 4WD Eng.J8S814 (63kW)	10/86-9/90		R		153-348			254,0x46	Hand Brake
2.5, 4WD Eng.EPE (90kW)	10/86-9/90		R		153-348			254,0x46	Hand Brake
4.0, 4WD (130kW)	10/87-9/96		R		153-348			254,0x46	Hand Brake
Commander 9/05-									
3.0 CRD Eng.OM642.980 (160kW)	4/06-		R		153-361			205,0x31	Hand Brake
3.7 V6 Eng.EKG (157kW)	9/05-		R		153-361			205,0x31	Hand Brake
4.7 V8 Eng.M661 (175kW)	9/05-		R		153-361			205,0x31	Hand Brake
5.7 V8 Eng.EZBHEMI (246kW)	9/05-		R		153-361			205,0x31	Hand Brake
Compass 9/06-									
2.0 CRD Eng.BMM (103kW)	9/06-		R		153-362			170,0x32	Hand Brake
2.4 Eng.ERZ (125kW)	9/06-		R		153-362			170,0x32	Hand Brake
Grand Cherokee I (Z) 9/91-4/99									
2.5 TD Eng.M52/ M51 (85kW)	10/95-4/99		R		153-146			184,0x30	Hand Brake
	10/95-4/99				153-352			254,0x46	16Inch Wheels, Hand Brake
4.0 Eng.S01 (130kW)	10/95-4/99		R		153-146			184,0x30	Hand Brake
	95-				153-514			185x31	
4.0 i Eng.MX (132-135kW)	-94		R		153-352			254,0x46	Hand Brake
	94-				153-514			185x31	
	95-				153-146			184,0x30	Hand Brake
4.0 Laredo Eng.ERH (131kW)	96-		R		153-514			185x31	
5.2 Eng.Y01 (155-156-158kW)	-94		R		153-352			254,0x46	Hand Brake
	94-				153-514			185x31	
	95-				153-146			184,0x30	Hand Brake
5.2 Limited 4WD Eng.ELF (136kW)	10/96-9/98		R		153-352			254,0x46	Hand Brake
	96-				153-514			185x31	







































		Spare Parts	F/R	L/R	CIFAM ref.	CIFAM ref. w/KIT		DIMENSIONS mm.	NOTE
5.2, 4WD Eng.ELF (164kW)	10/96-9/98		R		153-146			184,0x30	Hand Brake
	96-		R		153-514			185x31	
5.9 i Eng.Z00 (177kW)	8/97-4/99		R		153-146			184,0x30	Hand Brake
Grand Cherokee II (WJ,WG) 4/99-5/05									
3.1 TD Eng.EXA/ EGG (103kW)	4/99-5/05		R		153-360			195,0x30	Hand Brake
4.0 i Eng.MX (140kW)	4/99-5/05		R		153-360			195,0x30	Hand Brake
4.7 V8 Eng.EVA (162kW)	4/99-8/00		R		153-360			195,0x30	Hand Brake
4.7 V8 Eng.EVA (164kW)	8/00-5/05		R		153-360			195,0x30	Hand Brake
4.7 V8 Eng.EVA (167kW)	6/03-5/05		R		153-360			195,0x30	Hand Brake
4.7 V8 Eng.EVC (190kW)	10/01-5/05		R		153-360			195,0x30	Hand Brake
Grand Cherokee III (WH) 6/05-6/08									
3.0 CRD, RWD Eng.OM642.980 (160kW)	6/05-6/08		R		153-361			205,0x31	Hand Brake
3.7 V6, RWD Eng.EKG (157kW)	6/05-6/08		R		153-361			205,0x31	Hand Brake
4.7 V8 Eng.M661 (170kW)	6/05-6/08		R		153-361			205,0x31	Hand Brake
5.7 V8 Eng.WKR582 (240kW)	6/05-6/08		R		153-361			205,0x31	Hand Brake
Grand Cherokee IV (WK) 7/08-									
3.0 CRD (140kW)	11-		R		153-515			205x32	
3.0 CRD (177kW)	11-		R		153-515			205x32	
3.0 CRD Eng.OM642.980 (160kW)	2/11-		R		153-515			205x32	
6.1 V8 Eng.ESF (313kW)	7/08-		R		153-361			205,0x31	Hand Brake
Liberty I (KJ) 9/01-12/07									
2.4, Laredo Eng.ED1 (108kW)	10/01-9/04		R		153-358			254,0x46	Hand Brake
			R		153-364			184,0x31	Hand Brake
2.5 CRD Eng.ENJ (105kW)	9/01-9/01-		R		153-364			184,0x31	Hand Brake
			R		153-358			254,0x46	Hand Brake
2.8 CRD Eng.ENR (110kW)	11/02-11/02-		R		153-364			184,0x31	Hand Brake
			R		153-358			254,0x46	Hand Brake
2.8 CRD Eng.ENR (120kW)	11/04-11/04-		R		153-372			184,0x31	Hand Brake
			R		153-349			228,6x65	Hand Brake
3.7 V6 Eng.EKG (155kW)	9/01-9/01-		R		153-364			184,0x31	Hand Brake
			R		153-358			254,0x46	Hand Brake
Liberty II 1/08-									
2.8 CRD Eng.ENR (130kW)	1/08-		R		153-363			207,0x32	
Patriot 11/07-									
2.0 CRD Eng.BYL / ECD/ ECE (103kW)	11/07-		R		153-362			170,0x32	Hand Brake
2.4 Eng.ERZ/ ED3 (125kW)	07-		R		153-362			170,0x32	Hand Brake
Wagoneer 1/85-1/89									
2.5	-90		R		153-348			254,0x46	Hand Brake
	90-		R		153-349			228,6x65	Hand Brake
2.8	-90		R		153-348			254,0x46	Hand Brake
	90-		R		153-349			228,6x65	Hand Brake
4.0i	-90		R		153-348			254,0x46	Hand Brake
	90-		R		153-349			228,6x65	Hand Brake
Wrangler I (YJ) 8/86-8/96									
2.5 (76kW)	1/88-12/91		R		153-349			228,6x65	Hand Brake
2.5 Eng.P00 (89kW)	12/91-8/96		R		153-349			228,6x65	Hand Brake
4.0, 2WD Eng.ERH/ M400L (131kW)	12/91-8/96		R		153-349			228,6x65	Hand Brake
			R		153-348			254,0x46	Sahara, Hand Brake
4.2 Eng.6L C2V (84kW)	8/86-8/89		R		153-348			254,0x46	Hand Brake
4.2 2WD (82kW)	10/86-9/90		R		153-348			254,0x46	Hand Brake
Wrangler II (TJ) 8/96-4/07									
2.4 Eng.ED1 (105kW)	11/02-4/07		R		153-364			184,0x31	Hand Brake
2.5 Eng.P00 (87kW)	8/96-4/07		R		153-364			184,0x31	Hand Brake
			R		153-357			228,6x64	Hand Brake
4.0 Eng.S00 (124kW)	6/98-4/07		R		153-364			184,0x31	Hand Brake
			R		153-357			228,6x64	Hand Brake
			R		153-349			228,6x65	Hand Brake
4.0 Eng.S01 (130kW)	8/96-4/07		R		153-364			184,0x31	Hand Brake
			R		153-357			228,6x64	Hand Brake
			R		153-349			228,6x65	Hand Brake
4.0 Rubicon (128kW)	8/03-4/07		R		153-364			184,0x31	Hand Brake
			R		153-357			228,6x64	Hand Brake
Wrangler III (JK) 5/07-									
2.8 CRD Eng.ENR (130kW)	07-		R		153-363			207,0x32	
3.8 Eng.EGH (146kW)	5/07-		R		153-363			207,0x32	





























































		Spare Parts	F/R	L/R	CIFAM ref.	CIFAM ref. w/KIT		DIMENSIONS mm.	NOTE
Cherokee									
All models	74-91		R		700-181			Ø 254,0	
	93-96		R		700-183			Ø 228,5	Only Limited, Luxe, Country
	93-96		R		700-182			Ø 254,0	Axle 34
Comanche									
All models	86-92		R		700-181			Ø 254,0	HDB
	93-96		R		700-183			Ø 228,5	
	93-96		R		700-182			Ø 254,0	Axle 34
Grand Cherokee									
All models	74-91		R		700-181			Ø 254,0	
	93-96		R		700-183			Ø 228,5	Only Limited, Luxe, Country
	93-96		R		700-182			Ø 254,0	Axle 34
Renegade									
4.0i	1/87-89		R		700-181			Ø 254,0	
	90-		R		700-183			Ø 228,5	
Wagoneer - Grand Wagoneer									
All models	74-91		R		700-181			Ø 254,0	
	93-96		R		700-182			Ø 254,0	
Wrangler									
All models	1/90-12/96		R		700-183			Ø 228,5	
	87-89		R		700-181			Ø 254,0	

















KIA

Carens I 11/00-7/02									
1.8 Eng.TBD (81kW)	11/00-7/02		R		153-212		Sumit.	228,6x32	Hand Brake
Carens II 7/02-8/06									
1.8 Eng.TB (93kW)	7/02-8/06		R		153-212		Sumit.	228,6x32	Hand Brake
2.0 CRDi Eng.D4EA (103kW)	11/05-8/06		R		153-212		Sumit.	228,6x32	Hand Brake
2.0 CRDi Eng.D4EA (83kW)	7/02-8/06		R		153-212		Sumit.	228,6x32	Hand Brake
Carens III 9/06-12/09									
2.0 CRDi Eng.D4EA (100kW)	09-		R		153-505			170x32	
2.0 CRDi Eng.D4EA (103kW)	9/06-		R		153-505			170x32	
2.0 CVVT Eng.G4KA (106kW)	9/06-		R		153-505			170x32	
Carnival I (UP) 8/99-10/01									
2.5 V6 Eng.KV6 (121kW)	8/99-10/01		R		153-026			254,0x57	Hand Brake
2.9 TD Eng.J3 TCI (93kW)	8/99-10/01		R		153-026			254,0x57	Hand Brake
Carnival II/ Sedona (GQ) 10/01-5/06									
2.5 V6 Eng.OK52 (110kW)	01-06		R		153-026			254,0x57	Hand Brake
	01-06		R		153-225		Mando	254,0x57	
	01-06		R		153-180		Mando	254,0x57	Hand Brake
	03-		R		153-226		Mando	295,0x54	Hand Brake
2.9 CRDi Eng.OK53 (106kW)	03-		R		153-226		Mando	295,0x54	Hand Brake
	10/01-5/06		R		153-026			254,0x57	Hand Brake
	10/01-5/06		R		153-225		Mando	254,0x57	
	10/01-5/06		R		153-180		Mando	254,0x57	Hand Brake
3.5 V6 24v Eng.6G74 (143kW)	7/02-5/06		R		153-026			254,0x57	Hand Brake
	7/02-5/06		R		153-225		Mando	254,0x57	
Carnival III/ Sedona (UVP) 6/06-									
2.7 V6 Eng.G6EA (139kW)	6/06-		R		153-231			190,0x32	
2.9 CRDi Eng.J3 (136kW)	6/06-		R		153-231			190,0x32	
Ceed I, SW (ED) 3/07-									
1.4 Eng.G4FA (80kW)	07-		R			153-185K		170x27	
	3/07-		R		153-185	153-185K		170,0x27	
1.6 CRDi Eng.D4FB (85kW)	3/07-		R		153-185	153-185K		170,0x27	
1.6 CRDi Eng.D4FB-L (66kW)	3/07-		R		153-185	153-185K		170,0x27	
1.6 CVVT Eng.G4FC (90-93kW)	3/07-		R		153-185	153-185K		170,0x27	
2.0 Eng.G4GC (105kW)	3/07-		R		153-185			170,0x27	
2.0 CRDi Eng.D4EA-F (103kW)	9/07-		R		153-185	153-185K		170,0x27	
Cerato (CD) 4/04-									
1.5 CRDi Eng.D4FA (75kW)	07-09		R		153-504			203,2x36	
1.6 Eng.G4GD (77kW)	07-09		R		153-504			203,2x36	
1.6 CRDi Eng.D4FB (85kW)	07-09		R		153-504			203,2x36	
1.6, Coupe Eng.G4FC (90kW)	07-09		R		153-504			203,2x36	
2.0 Eng.G4GC (105kW)	07-09		R		153-504			203,2x36	
2.0 CRDi Eng.D4DA (83kW)	07-09		R		153-504			203,2x36	































		Spare Parts	F/R	L/R	CIFAM ref.	CIFAM ref. w/KIT		DIMENSIONS mm.	NOTE
Ceres 6/92-1/97									
2.2 D Eng.S2 (52kW)	6/92-1/97		R		153-199		Sumit.	260,0x45	
Clarus (K9A), SW 7/96-									
1.8 i 16v Eng.T8 (85kW)	7/96-		R		153-212		Sumit.	228,6x32	Hand Brake
2.0 i 16v Eng.FE(16V) (98kW)	7/96-		R		153-212		Sumit.	228,6x32	Hand Brake
K2500 1/03-									
2.5 TD Eng.D4BH (69kW)	1/03-		R		153-221		Sumit.	220,0x57	Hand Brake
Magentis I (GD) 5/01-10/05									
2.0 Eng.G4JP (100kW)	5/01		R			153-186K	Mando	170x32	
	5/01-		R		153-186			170,0x32	
2.5 V6 Eng.G6BV (124kW)	5/01-		R		153-186	153-186K		170,0x32	
Mentor 9/93-									
1.5 i 16v Eng.B5 (59kW)	2/96-		R		153-213		Sumit.	200,0x36	Hand Brake
	2/96-		R		153-217		Sumit.	200,0x36	Hand Brake
1.6 i Eng.B6 (59kW)	9/93-		R		153-213		Sumit.	200,0x36	Hand Brake
	9/93-		R		153-217		Sumit.	200,0x36	Hand Brake
Optima (GD) 5/01-10/05									
2.0 Eng.G4JP (100kW)	5/01-		R		153-175		Mando	228,6x45	
Picanto I (BC) 4/04-4/08									
1.0 Eng.G4HE (45kW)	9/05-4/08		R		153-229			180,0x32	
1.1 Eng.G4HG (48kW)	4/04-4/08		R		153-229			180,0x32	
1.1 D Eng.D3FA (55kW)	11/05-4/08		R		153-229			180,0x32	
Pride (DA) 1/90-									
1.1 i Eng.B1 (38kW)	1/91-		R		153-206		Ake	170,0x25	
1.3 16v Eng.B3 (44-47-53kW)	1/90-		R		153-206		Ake	170,0x25	
1.3 16V Eng.B3 (53kW)	1/90-		R		153-206		Ake	170,0x25	
1.3 i (51kW)	1/90-		R		153-206		Ake	170,0x25	
Pro Ceed (ED) 2/08-									
1.4 Eng.G4FA (77kW)	2/08-		R			153-185K		170x27	
	2/08-		R		153-185	153-185K		170,0x27	
1.4 Eng.G4FA (80kW)	2/08-		R		153-185	153-185K		170,0x27	
1.4 CVVT Eng.G4FA-L (66kW)	10-		R		153-185	153-185K		170,0x27	
1.6 Eng.G4FC (90kW)	2/08-		R		153-185	153-185K		170,0x27	
1.6 Eng.G4FC (93kW)	2/08-		R		153-185	153-185K		170,0x27	
1.6 CRDi Eng.D4FB (85kW)	2/08-		R		153-185	153-185K		170,0x27	
1.6 CRDi Eng.D4FB (94kW)	10-		R		153-185	153-185K		170,0x27	
1.6 CRDi Eng.D4FB-L (66kW)	2/08-		R		153-185	153-185K		170,0x27	
2.0 Eng.G4GC (105kW)	2/08-		R		153-185	153-185K		170,0x27	
2.0 CRDi Eng.D4EA-F (103kW)	2/08-		R		153-185			170,0x27	
Rio I, SW (DC) 8/00-2/05									
1.3 Eng.A3E (55-60kW)	8/00-2/05		R		153-220		Sumit.	200,0x26	
	9/00-2/05		R		153-506			200x31	
	7/02-05			R		700-392			Ø 200,0
1.5 Eng.A5D (71-72kW)	8/00-2/05		R		153-220		Sumit.	200,0x26	
	9/00-2/05		R		153-506			200x31	
	7/02-05			R		700-392			Ø 200,0
Rio II 3/05-9/11									
1.4 16v Eng.G4EE (71kW)	06-		R			153-187K		170x32	
	3/05-		R		153-187			170,0x32	
	3/05-		R		153-182		Mando	203,2x32	
1.5 CRDi Eng.D4FA (81kW)	06-		R			153-187K		170x32	
	3/05-		R		153-187			170,0x32	
	3/05-		R		153-182		Mando	203,2x32	
1.6 16v Eng.G4ED (82kW)	06-		R			153-187K		170x32	
	3/05-		R		153-187			170,0x32	
	3/05-		R		153-182		Mando	203,2x32	
Sephia, Timor (FA) 9/93-									
1.5 i 16v Eng.B5 (59kW)	2/96-10/97		R		153-145	153-145K		180,0x25	Hand Brake
	2/96-10/97		R		153-213		Sumit.	200,0x36	Hand Brake
	2/96-10/97		R		153-217		Sumit.	200,0x36	Hand Brake
1.6 i Eng.B6 (59kW)	9/93-		R		153-213		Sumit.	200,0x36	Hand Brake
	9/93-		R		153-217		Sumit.	200,0x36	Hand Brake
1.8 i 16v Eng.T8 (82kW)	1/95-		R		153-145	153-145K		180,0x25	Hand Brake
	1/95-		R		153-213		Sumit.	200,0x36	Hand Brake
	1/95-		R		153-217		Sumit.	200,0x36	Hand Brake
Shuma (FB) 3/96-									
1.5 Eng.BFD (59kW)	3/96-12/98		R		153-145	153-145K		180,0x25	Hand Brake

































		Spare Parts	F/R	L/R	CIFAM ref.	CIFAM ref. w/KIT		DIMENSIONS mm.	NOTE
1.5 i 16v Eng.15BFD (65kW)	10/97-		R		153-213		Sumit.	200,0x36	Hand Brake
	10/97-		R		153-217		Sumit.	200,0x36	Hand Brake
1.8 i 16v Eng.18TED (81kW)	10/97-		R		153-145	153-145K		180,0x25	Hand Brake
	10/97-		R		153-213		Sumit.	200,0x36	Hand Brake
	10/97-		R		153-217		Sumit.	200,0x36	Hand Brake
Sorento I (JC) 8/02-12/09									
2.4 Eng.G4JSG (102kW)	8/02-		R			153-227K		190,0x40	
	8/02-		R		153-227	153-227K		190,0x40	Hand Brake
2.5 CRDi Eng.D4CB (103kW)	8/02-		R		153-227			190,0x40	Hand Brake
2.5 CRDi Eng.D4CBV (125kW)	9/06-		R		153-230			190,0x32	
3.3 V6 Eng.G6HV (177kW)	12/06-		R		153-230			190,0x32	
3.5 V6 24v Eng.G6G74 (143-149kW)	8/02-		R			153-227K		190,0x40	
	8/02-		R		153-227			190,0x40	Hand Brake
Sorento II (XM) 1/10-									
2.0 CRDi, 4WD Eng.D4HA (110kW)	10-		R		153-498			190x26	
2.2 CRDi, 4WD (145kW)	10-		R		153-498			190x26	
2.4 16V (128kW)	10-		R		153-498			190x26	
2.4 16v, 4WD Eng.G4KE (128kW)	10-		R		153-498			190x26	
Spectra 1/00-12/05									
1.8 16v	1/00-12/04		R		153-217		Sumit.	200,0x36	Hand Brake
2.0 16v	1/05-12/05		R		153-217		Sumit.	200,0x36	Hand Brake
Sportage I (FM) 4/94-8/04									
2.0 i 16v, 4WD Eng.FE(16V) (94kW)	4/94-8/04		R		153-215			252,0x57	Hand Brake
2.0 i 4WD Eng.FE (70kW)	4/94-8/99		R		153-215			252,0x57	Hand Brake
2.0 TD 4WD Eng.RF (61kW)	10/97-8/04		R		153-215			252,0x57	Hand Brake
Sportage II (FQ) 9/04-6/10									
2.0 CRDi Eng.D4EA (103kW)	1/06-		R		153-184	153-184K		170,0x27	Hand Brake
2.0 CRDi, 4WD Eng.D4EA (110kW)	10/08-		R		153-184	153-184K		170,0x27	Hand Brake
2.0 CRDi, 4WD Eng.D4EA (83kW)	04-06		R			153-179K	Mando	190x40	
	9/04-		R			153-179Y	Mando	190,0x40	Hand Brake
Sportage III (SL) 7/10-									
1.6 GDi Eng.G4FD (99kW)	2/11-		R		153-502			190x40	
1.7 CRDi Eng.D4FD-L (85kW)	2/11-		R		153-502			190x40	
2.0 CRDi AWD (135kW)	12-		R		153-502			190x40	
2.0 CRDi, AWD Eng.D4HA (100kW)	7/10-		R		153-502			190x40	
2.0, AWD Eng.G4KD (120kW)	7/10-		R		153-502			190x40	
KIA LCV									
Besta Van 2/96-									
2.2 D Eng.R2 (48kW)	2/96-		R		153-202		Sumit.	260,0x50	Hand Brake
K2500 1/99-									
2.5 TD Eng.D4BH (69kW)	1/99-		R		153-221		Sumit.	220,0x57	Hand Brake
K2700 10/99-									
2.7 D Eng.J2 (60kW)	10/99-		R		153-202		Sumit.	260,0x50	Hand Brake
Pregio (TB) 10/97-									
2.5 TCi Eng.D4BH (69kW)	9/02-		R		153-202		Sumit.	260,0x50	Hand Brake
2.7 D Eng.J2 (60kW)	10/97-		R		153-202		Sumit.	260,0x50	Hand Brake
LADA									
110 1/95-									
1.3 Wankel Eng.VAZ-415 (88kW)	97-		R		700-027			Ø 200,0	
1.5, 16v Eng.VAZ 2111/ VAZ 2112 (57-67-70kW)	00-		R		700-027			Ø 200,0	
			R					Ø 200,0	
2.0 i Eng.C20XE (110kW)	96-		R		700-027			Ø 200,0	
111 1/95-									
1.5 Eng.2111 (56kW)	00-		R		700-027			Ø 200,0	
1.5 Eng.VAZ 2111 (57kW)	96-		R		700-027			Ø 200,0	
1.5 16v Eng.VAZ 2112 (67-70kW)	95-		R		700-027			Ø 200,0	
112 1/95-									
1.5 Eng.2111 (56kW)	00-		R		700-027			Ø 200,0	
1.5 Eng.VAZ 2111 (54-57kW)	95-		R		700-027			Ø 200,0	
1.5 16v Eng.VAZ 2112 (67kW)	00-		R		700-027			Ø 200,0	
1.5 16v Eng.VAZ 2112 (70kW)	95-		R		700-027			Ø 200,0	
1200-1500 9/73-6/85									
1200 Eng.BA32101 (44kW)	9/73-8/84		R		153-060		Fiat	250,0x51	Hand Brake
1300 Eng.BA32105 (49kW)	1/81-12/82		R		153-060		Fiat	250,0x51	Hand Brake





























		Spare Parts	F/R	L/R	CIFAM ref.	CIFAM ref. w/KIT		DIMENSIONS mm.	NOTE
1200-1600 1/70-1/87									
1.2, SW Eng.BA32101 (44kW)	1/70-6/86		R		153-060		Fiat	250,0x51	Hand Brake
	70-86		R		700-025			Ø 250,0	
1.3 Eng.BA32103 (51kW)	8/74-8/84		R		153-060		Fiat	250,0x51	Hand Brake
	74-		R		700-025			Ø 250,0	
1.3, SW Eng.BA321011 (48kW)	5/78-1/87		R		153-060		Fiat	250,0x51	Hand Brake
	78-		R		700-025			Ø 250,0	
1.5, SW Eng.BA32105 (55kW)	11/72-10/86		R		153-060		Fiat	250,0x51	Hand Brake
	72-		R		700-025			Ø 250,0	
1.6 (58kW)	72-		R		700-025			Ø 250,0	
1.6 Eng.BA32106 (57kW)	79-		R		700-025			Ø 250,0	
Carlota									
All models	90-		R		700-027			Ø 200,0	
Kalina (1117, 1118, 1119) 10/04-									
1.6 Eng.21114 (60kW)	04-		R		700-027			Ø 200,0	
1.6 16v (66kW)	04-		R		700-027			Ø 200,0	
Kalinda									
1.5	93-		R		700-027			Ø 200,0	
Nadeschda (2120) 12/97-									
1.7 Eng.VAZ-2121.3 (59-60kW)	97-		R		700-026			Ø 250,0	
1.8 Eng.VAZ-2130 (60-67kW)	97-		R		700-026			Ø 250,0	
Natasha (2120)									
1.1	93-		R		700-027			Ø 200,0	+AA
1.5	93-		R		700-027			Ø 200,0	+AA
Niva I (2121) 12/76-									
1.6 Eng.BA32121 (54kW)	1/87-3/95		R		153-060		Fiat	250,0x51	Hand Brake
	87-95		R		700-026			Ø 250,0	
1.6 Eng.BA32121 (56-59kW)	84-		R		153-060		Fiat	250,0x51	Hand Brake
	76-		R		700-026			Ø 250,0	
1.7 i (60kW)	00-		R		700-026			Ø 250,0	
1.7 i Eng.BA321214 (59kW)	96-		R		700-026			Ø 250,0	
1.9 D Eng.XUD9A (47kW)	1/93-		R		153-060		Fiat	250,0x51	Hand Brake
	93-		R		700-026			Ø 250,0	
1.9 D Eng.XUD9SD (55kW)	99-		R		700-026			Ø 250,0	
Nova (2105, 2108, 2109) 5/81-									
1.2, SW Eng.BA32101 (44kW)	9/81-		R		153-060		Fiat	250,0x51	Hand Brake
	81-		R		700-025			Ø 250,0	+AA
1.3 Eng.BA32105 (48kW)	5/81-		R		153-060		Fiat	250,0x51	Hand Brake
	81-		R		700-025			Ø 250,0	+AA
1.5 S Eng.BA32111 (52kW)	89-		R		700-025			Ø 250,0	+AA
1.5, SW Eng.BA32103 (55kW)	3/85-		R		153-060		Fiat	250,0x51	Hand Brake
	85-		R		700-025			Ø 250,0	+AA
1.6 Eng.BA32106 (56kW)	88-		R		700-025			Ø 250,0	+AA
1.7 i Classic, SW (62kW)	94-		R		700-025			Ø 250,0	+AA
Riva									
1.2 Eng.1200 (44kW)	83-89		R		700-025			Ø 250,0	+AA
1.3 (48-52kW)	83-92		R		153-060		Fiat	250,0x51	Hand Brake
			R		700-025			Ø 250,0	+AA
1.5i (51-52-55kW)	84-		R		153-060		Fiat	250,0x51	Hand Brake
			R		700-025			Ø 250,0	+AA
1.6 (62kW)	86-92		R		700-025			Ø 250,0	+AA
Sagona									
1.5 D	95-		R		700-027			Ø 200,0	+AA
1.5i	91-		R		153-456		Fiat	200,0x40	Hand Brake
			R		700-027			Ø 200,0	+AA
Samara, Forma (2108, 2109) 1/88-									
1.1 Eng.BA321081 (39kW)	2/88-		R		153-456		Fiat	200,0x40	Hand Brake
	88-		R		700-027			Ø 200,0	+AA
1.1 Eng.BA321081(KAT) (43kW)	2/96-		R		153-456		Fiat	200,0x40	Hand Brake
1.3 Eng.2108 (46kW)	1/88-		R		153-456		Fiat	200,0x40	Hand Brake
	88-		R		700-027			Ø 200,0	+AA
1.3 Eng.BA32108 (48kW)	1/86-7/97		R		153-456		Fiat	200,0x40	Hand Brake
	1/86-		R		700-027			Ø 200,0	+AA
1.3 Eng.BA32108(KAT) (45kW)	9/91-		R		153-456		Fiat	200,0x40	Hand Brake
	91-		R		700-027			Ø 200,0	+AA
1.3 Eng.BA321115 (50kW)	2/96-		R		153-456		Fiat	200,0x40	Hand Brake
1.5 Eng.BA321083 (53kW)	1/88-		R		153-456		Fiat	200,0x40	Hand Brake
	88-		R		700-027			Ø 200,0	+AA

		Spare Parts	F/R	L/R	CIFAM ref.	CIFAM ref. w/KIT		DIMENSIONS mm.	NOTE
1.5 Eng.BA321083(KAT) (50kW)	7/91-		R		153-456		Fiat	200,0x40	Hand Brake
	91-		R		700-027			Ø 200,0	+AA
1.5 Eng.BA32111 (52kW)	11/94-		R		153-456		Fiat	200,0x40	Hand Brake
	94-		R		700-027			Ø 200,0	+AA
Signet									
All models	79-85		R		700-025			Ø 250,0	
Tavria									
1.1	91-		R		700-027			Ø 200,0	
1.3	91-		R		700-027			Ø 200,0	
1.5	91-		R		700-027			Ø 200,0	
Toscana									
1.3 Eng.BA32105 (48kW)	12/85-		R		153-060		Fiat	250,0x51	Hand Brake
	85-		R		700-025			Ø 250,0	
1.5 Eng.BA32103 (55kW)	9/83-2/93		R		153-060		Fiat	250,0x51	Hand Brake
	83-		R		700-025			Ø 250,0	
1.6	84-92		R		700-025			Ø 250,0	



























LANCIA

Dedra (835) 4/89-7/99									
1.6 16v, SW Eng.182A4.000/182B6.000 (76kW)	1/96-7/99		R		153-070	153-070J	Ap	180,0x32	Hand Brake
	4/93-7/99		R		153-070	153-070J		180,0x32	Hand Brake
1.6 i.e. Eng.835A1.000/ 835C1.000 (55kW)	93-		R		700-010		Bdx	Ø 180,0	
	93-94		R		151-024			Ø 19,05 180,0x30	RAI
1.6 i.e. Eng.835A1.046 (57kW)	8/89-3/93		R		153-066	153-066J	Bdx	180,0x32	Hand Brake
	3/89-		R		700-010			Ø 180,0	
	89-93		R		151-024			Ø 19,05 180,0x30	RAI
1.6, SW Eng.159B9.000 (66kW)	4/94-7/99		R		153-070	153-070J	Ap	180,0x32	
	94-		R		700-010			Ø 180,0	
1.8 16v, SW Eng.183A1.000/183A2.000 (83-96kW)	3/96-7/99		R		153-066	153-066J	Bdx	180,0x32	Hand Brake
1.8 i.e. Eng.835C5.000 (66-55kW)	8/93-7/99		R		153-066	153-066J	Bdx	180,0x32	Hand Brake
1.8 i.e., SW Eng.835A2.000/835A2.046/ 836A5.000 (74-77-80kW)	7/94-7/99		R		153-066	153-066J	Bdx	180,0x32	Hand Brake
Delta I (831AB0) 9/79-1/94									
1.1 Eng.831B8.000 (47kW)	86-90		R		700-003			Ø 185,0	
1.3 Eng.831A1.000/ A2.000/ AB.000 (58kW)	9/83-8/92		R		153-063		Fiat	185,0x31	Fitted Adjuster, Hand Brake
	9/79-8/92		R		153-063			185,0x31	Fitted Adjuster, Hand Brake
1.3 Eng.831A2.000/ 831B.000 (55kW)	10/79-92		R		700-003			Ø 185,0	
	9/79-12/92		R		153-063			Fiat	185,0x31
1.5 Eng.138A1.000/ A3.000/ 831A1.000/ B1.000 (62-63kW)	10/79-92		R		700-003			Ø 185,0	
	10/86-12/89		R		153-063			Fiat	185,0x31
1.9 TD Eng.831D1.000 (59kW)	86-89		R		700-003			Ø 185,0	
Delta II (836) 6/93-8/99									
1.4 i.e. Eng.160A1.046/ 836A4.000 (51kW)	10/94-8/99		R		153-070	153-070J	Ap	180,0x32	Hand Brake
	10/94-99		R		700-008			Ø 180,0	
	94-		R		151-026			Bdx	Ø 22,00 180,0x30
1.6 16v Eng.182A4.000/ 182B6.000 (76kW)	1/96-8/99		R		153-066	153-066J	Bdx	180,0x32	Hand Brake
	96-		R		700-008			Ø 180,0	
	96-		R		151-026			Bdx	Ø 22,00 180,0x30
1.6 i.e. Eng.182A6.000 (66kW)	3/96-8/99		R		153-066	153-066J	Bdx	180,0x32	Hand Brake
	96-		R		700-008			Ø 180,0	
	96-		R		151-026			Bdx	Ø 22,00 180,0x30
1.6 i.e. Eng.835A1.000/ 835C1.000 (55kW)	6/93-8/99		R		153-070	153-070J	Ap	180,0x32	Hand Brake
	93-99		R		700-008			Ø 180,0	
	93-		R		151-026			Bdx	Ø 22,00 180,0x30
1.9 TD Eng.160D1.000/ 835A4.000 (66kW)	10/94-8/99		R		153-070	153-070J	Ap	180,0x32	Hand Brake
	94-99		R		700-019			Ø 203,2	-ABS
Musa I (184) 10/04-11/10									
1.3 MJT Eng.188A9.000 (51kW)	04-		R		153-084		Ap	203,2x39	Hand Brake
	04-6/05		R		151-220			Ø 22,00 203,2x39	AP
1.3 MJT 16v Eng.199A3.000 (66kW)	7/08-		R		700-022			Ø 228,3	
1.4 Eng.350A1.000 (57kW)	9/05-		R		153-084		Ap	203,2x39	Hand Brake
1.4 16v Eng.843A1.000 (70kW)	10/04-		R		153-084		Ap	203,2x39	Hand Brake
	10/04-06/05		R		151-220			Ø 22,00 203,2x39	AP















		Spare Parts	F/R	L/R	CIFAM ref.	CIFAM ref. w/KIT		DIMENSIONS mm.	NOTE
1.4 16v AUSTRIA Eng.192B2.000 (66kW)	10/04-6/05		R		151-220		Ap	Ø 22,00 203,2x39	AP
1.9 Multijet Eng.188B2.000 (74kW)	10/04-		R		153-088		Ap	228,6x43	
Prisma (831AB0) 12/82-2/92									
1.3 Eng.831A1.000/ A2.000/ AB.000 (58kW)	1/83-2/92		R		153-063		Fiat	185,0x31	Fitted Adjuster, Hand Brake
	1/83-86		R		700-003			Ø 185,0	
1.5 Eng.831B1.000/ A1.000/ 138A2/ A3 (59-62-63kW)	8/86-2/92		R		153-063		Fiat	185,0x31	Fitted Adjuster, Hand Brake
1.5 Eng.831B1.048/ 138C2.048 (55kW)	9/85-2/92		R		153-063		Fiat	185,0x31	Fitted Adjuster, Hand Brake
1.6 GT Eng.149C2.000/ 831A4.000/ B4.000/ B7.000 (66-77-79-80-97kW)	82-86		R		700-003			Ø 185,0	
1.9 D Eng.831D.000 (48kW)	1/83-2/92		R		153-063		Fiat	185,0x31	Fitted Adjuster, Hand Brake
	1/83-		R		700-003			Ø 185,0	
1.9 TD Eng.831D1.000 (59kW)	5/85-12/89		R		153-063		Fiat	185,0x31	Fitted Adjuster, Hand Brake
Y (840A) 11/95-10/03									
1.1 Eng.176B2.000 (40kW)	95-		R		700-011			Ø 180,0	
	95-		R		151-052		Ap	Ø 20,64 180,0x30	RAD
	95-		R		151-023		Bdx	Ø 20,64 180,0x30	RAI, +ABS
1.2 Eng.840A3.000/ A4.000 (44kW)	3/96-10/03		R		153-070	153-070J	Ap	180,0x32	Hand Brake
	3/96-10/03		R		153-066	153-066J	Bdx	180,0x32	Hand Brake
	96-		R		700-011			Ø 180,0	
	96-		R		151-052		Ap	Ø 20,64 180,0x30	RAD
	96-		R		151-023		Bdx	Ø 20,64 180,0x30	RAI, +ABS
1.2 16v Eng.176B9.000 (63kW)	4/97-9/00		R		153-070	153-070J	Ap	180,0x32	Hand Brake
	4/97-9/00		R		153-066	153-066J	Bdx	180,0x32	Hand Brake
	97-00		R		700-011			Ø 180,0	
	97-00		R		151-052		Ap	Ø 20,64 180,0x30	RAD, -ABS
	97-00		R		151-023		Bdx	Ø 20,64 180,0x30	RAI, +ABS
1.2 16v Eng.188A5.000 (59kW)	10/00-10/03		R		153-070	153-070J	Ap	180,0x32	Hand Brake
	10/00-10/03		R		153-066	153-066J	Bdx	180,0x32	Hand Brake
	00-		R		700-011			Ø 180,0	
	00-		R		151-052		Ap	Ø 20,64 180,0x30	RAD
	00-		R		151-023		Bdx	Ø 20,64 180,0x30	RAI, +ABS
1.4 12v Eng.840A2.000 (59kW)	10/96-10/03		R		153-070	153-070J	Ap	180,0x32	Hand Brake
	10/96-10/03		R		153-066	153-066J	Bdx	180,0x32	Hand Brake
	96-03		R		700-011			Ø 180,0	
	96-		R		151-052		Ap	Ø 20,64 180,0x30	RAD, -ABS
	96-		R		151-023		Bdx	Ø 20,64 180,0x30	RAI, +ABS
1.4 12v Eng.840A4.000 (55kW)	3/96-10/03		R		153-070	153-070J	Ap	180,0x32	Hand Brake
	3/96-10/03		R		153-066	153-066J	Bdx	180,0x32	Hand Brake
	96-		R		700-011			Ø 180,0	
	96-		R		151-052		Ap	Ø 20,64 180,0x30	RAD, -ABS
	96-		R		151-023		Bdx	Ø 20,64 180,0x30	RAI, +ABS
Y10 (156) 3/85-12/95									
1.0 Fire Eng.156A.000 (41kW)	85-		R		700-003			Ø 185,0	
1.0 Fire Eng.156A2.100 (32kW)	85-		R		700-003			Ø 185,0	
1.0 Fire, 4WD Eng.146A2.166 (37kW)	85-		R		700-003			Ø 185,0	
1.0 Fire, 4WD Eng.156A2.246 (33kW)	87-		R		700-003			Ø 185,0	
1.0 T. Eng.156A1.000 (62kW)	85-		R		700-003			Ø 185,0	
1.1 Avenue, 4WD Eng.176B2.000 (40kW)	95-		R		700-003			Ø 185,0	
1.1 i.e, 4WD Eng.156C.000 (42kW)	89-92		R		700-003			Ø 185,0	
1.1 i.e. Fire, 4WD Eng.156C.046 (37kW)	89-		R		700-003			Ø 185,0	
1.3 i.e. Fire Eng.146A5.046 (53kW)	87-		R		700-003			Ø 185,0	
1.3 i.e. Fire Eng.156B.000 (53kW)	87-		R		700-003			Ø 185,0	
Ypsilon I (843) 10/03-									
1.2 Eng.169A4/ A5.000 (51kW)	10-		R		153-085		Bosch	203,2x39	
	10-		R		151-188		Bosch	Ø 19,05 203,2x39	RAI, +ABS
1.2 16v Eng.188A5.000 (59kW)	10/03-		R		153-085		Bosch	203,2x39	Hand Brake
	03-		R		151-189		Bosch	Ø 20,64 203,2x39	RAI, +ABS

		Spare Parts	F/R	L/R	CIFAM ref.	CIFAM ref. w/KIT		DIMENSIONS mm.	NOTE
1.2 8v Eng.188A4.000 (44kW)	10/03-03		R		153-085			203,2x39	Hand Brake
			R		151-188			Ø 19,05 203,2x39	RAI, +ABS
1.3 MJT Eng.188A9.000 (51kW)	10/03-03		R		153-085			203,2x39	Hand Brake
			R		151-189			Ø 20,64 203,2x39	RAI, +ABS
1.3 MJT Eng.199A2.000 (55kW)	9/06-03		R		153-085			203,2x39	Hand Brake
			R		151-189			Ø 20,64 203,2x39	RAI, +ABS
1.3 MJT Eng.843A2.000 (77kW)	08-08		R		153-085			203,2x39	Hand Brake
			R		151-189			Ø 20,64 203,2x39	RAI, +ABS
1.3 MJT 16v Eng.199A3.000 (66kW)	9/06-03		R		153-085			203,2x39	Hand Brake
			R		151-189			Ø 20,64 203,2x39	RAI, +ABS
1.4 Eng.350A1.000 (57kW)	9/06-		R		153-085			203,2x39	Hand Brake
1.4 16v Eng.843A1.000 (70kW)	10/03-03		R		153-085			203,2x39	Hand Brake
			R		151-189			Ø 20,64 203,2x39	RAI, +ABS





















Zeta (220) 5/95-9/02

2.0 16v Eng.RFN(EW10J4) (100kW)	00-02		R		153-074	153-074Y		256,0x61	Hand Brake	
			R		700-017			Ø 255,0	-ABS	
			R		151-066			Bdx	Ø 19,05 255,0x60	RAI, -ABS
2.0 16v Eng.RFV(XU10J4R) (97kW)	98-00		R			153-331K		180,0x31	Hand Brake	
			R		153-331		Ate	180,0x31	Hand Brake	
			R		153-074	153-074Y		Bdx	256,0x61	Hand Brake
			R		700-017				Ø 255,0	-ABS
			R		151-066			Bdx	Ø 19,05 255,0x60	RAI, -ABS
2.0 JTD, 16v Eng.RHW/RHZ(DW10ATED/ 4) (80kW)	9/99-9/02		R		153-074	153-074Y		256,0x61	Hand Brake	
			R		700-017			Ø 255,0	-ABS	
			R		151-066			Bdx	Ø 19,05 255,0x60	RAI, -ABS
2.0 T. Eng.RGX(XU10J2CTE) (108kW)	5/96-9/02		R			153-331K		180,0x31	Hand Brake	
			R		153-331		Ate	180,0x31	Hand Brake	
			R		153-074	153-074Y		Bdx	256,0x61	Hand Brake
			R		700-017				Ø 255,0	-ABS
			R		151-066			Bdx	Ø 19,05 255,0x60	RAI, -ABS
2.1 TD Eng.P8C (80kW)	5/96-9/99		R			153-331K		180,0x31	Hand Brake	
			R		153-331		Ate	180,0x31	Hand Brake	
			R		153-074	153-074Y		Bdx	256,0x61	Hand Brake
			R		700-017				Ø 255,0	-ABS
			R		151-066			Bdx	Ø 19,05 255,0x60	RAI, -ABS



LAND ROVER**109 9/63-12/86**













































2.3 Eng.11H (51kW)	9/63-12/86		R		153-366			Lucas	279,4x57	Hand Brake
			F/R		700-088				Ø 279,4	Exc. Axle H
2.3 D Eng.10J (46kW)	9/63-12/86		R		153-366			Lucas	279,4x57	Hand Brake
			F/R		700-088				Ø 279,4	Exc. Axle H
2.6 Eng.941 (63kW)	9/63-12/86		R		153-366			Lucas	279,4x57	Hand Brake
			F/R		700-088				Ø 279,4	Exc. Axle H
2.6 D Eng.10J (45kW)	9/63-12/86		R		153-366			Lucas	279,4x57	Hand Brake
			F/R		700-088				Ø 279,4	Exc. Axle H
3.5 Eng.10G (68kW)	1/80-12/83		R		153-366			Lucas	279,4x57	Hand Brake
			F/R		700-088				Ø 279,4	Exc. Axle H

110 9/83-7/90

2.25 (55kW)	9/83-7/90		R		153-366			Lucas	279,4x57	Hand Brake
			R		700-088				Ø 279,4	
2.3 D 4WD Eng.10J (44-46kW)	83-84		R		700-088				Ø 279,4	
2.5 Eng.17H (62kW)	9/85-7/90		R		153-371			Ap	254,0x70	Hand Brake
			R		700-088				Ø 279,4	
2.5 D Eng.12J (49kW)	9/83-7/90		R		153-366			Lucas	279,4x57	Hand Brake
			R		700-088				Ø 279,4	
2.5 TD Eng.19J (63kW)	9/86-7/90		R		153-371			Ap	254,0x70	Hand Brake
			R		153-366			Lucas	279,4x57	Hand Brake
			R		700-088				Ø 279,4	
3.5 V8 Eng.24G (100kW)	9/83-7/90		R		153-371			Ap	254,0x70	Hand Brake
			R		153-366			Lucas	279,4x57	Hand Brake
			R		700-088				Ø 279,4	

88 9/63-12/86











































2.0 (38kW)	9/63-12/83		R		153-366			Lucas	279,4x57	Hand Brake
			F/R		700-089				Ø 254,0	
2.3 Eng.11H (51kW)	9/63-12/86		R		153-366			Lucas	279,4x57	Hand Brake
			F		700-088				Ø 279,4	
			F/R		700-087				Ø 254,0	







		Spare Parts	F/R	L/R	CIFAM ref.	CIFAM ref. w/KIT		DIMENSIONS mm.	NOTE
2.3 Eng.11H (51kW)	63-9/71		F/R		700-089			Ø 254,0	
2.3 D Eng.10J (46kW)	9/63-12/86		R		153-366		Lucas	279,4x57	Hand Brake
	80-		F		700-088			Ø 279,4	
	10/71-80		F/R		700-087			Ø 254,0	
	63-9/71		F/R		700-089			Ø 254,0	
3.5 Eng.10G (68kW)	1/80-12/83		R		153-366		Lucas	279,4x57	Hand Brake
90 9/83-7/90									
2.5 Eng.17H (62kW)	9/85-7/90		R		153-371		Ap	254,0x70	Hand Brake
	9/85-7/90		R		153-366		Lucas	279,4x57	Hand Brake
	84-90		R		700-089			Ø 254,0	
2.5 D Eng.12J (49kW)	9/86-7/90		R		153-371		Ap	254,0x70	Hand Brake
	9/86-7/90		R		153-366		Lucas	279,4x57	Hand Brake
	86-90		R		700-089			Ø 254,0	
2.5 TD Eng.19J (63kW)	9/86-7/90		R		153-371		Ap	254,0x70	Hand Brake
	9/86-7/90		R		153-366		Lucas	279,4x57	Hand Brake
	86-90		R		700-089			Ø 254,0	
3.5 V8 Eng.15G/ 24G (100kW)	9/83-7/90		R		153-371		Ap	254,0x70	Hand Brake
	9/83-7/90		R		153-366		Lucas	279,4x57	Hand Brake
	85-89		R		700-089			Ø 254,0	
Defender I (LD) 110 9/90-									
2.5 Eng.17H (60kW)	90-92		R		700-088			Ø 279,4	
2.5 D Eng.12J (49kW)	90-93		R		700-088			Ø 279,4	
2.5 TD5 4WD, SW, Pick-up Eng.10/ 15P (90kW)	6/98-		R		153-373	153-373K		254,0x70	Hand Brake
2.5 TDi, SW Eng.11L/ 16L (83kW)	9/90-		R		153-366		Lucas	279,4x57	Hand Brake
	94-		R		700-088			Ø 279,4	
3.5 Eng.24G (98kW)	9/90-		R		153-366		Lucas	279,4x57	Hand Brake
	90-93		R		700-088			Ø 279,4	
Defender I (LD) 130 9/90-									
2.5 TD5 4WD, SW, Pick-up Eng.10/ 15P (90kW)	6/98-		R		153-373	153-373K		254,0x70	Hand Brake
2.5 TDi, SW Eng.11L/ 16L (83kW)	9/90-		R		153-373	153-373K		254,0x70	Hand Brake
	90-94		R		700-088			Ø 279,4	
3.5 Eng.24G (98kW)	90-93		R		700-088			Ø 279,4	
Defender I (LD) 90 9/90-4/07									
2.5 Eng.17H (60kW)	90-94		R		700-089			Ø 254,0	
2.5 D Eng.12J (49kW)	90-94		R		700-088			Ø 279,4	
2.5 TDi, SW Eng.11L/ 16L (83kW)	9/90-4/07		R		153-373	153-373K		254,0x70	Hand Brake
	9/90-4/07		R		153-366		Lucas	279,4x57	Hard-Top, Hand Brake
	92-94		R		700-089			Ø 254,0	
3.5 Eng.24G (98kW)	9/90-4/07		R		153-373	153-373K		254,0x70	Hand Brake
	90-94		R		700-089			Ø 254,0	
Discovery I 9/89-6/94									
2.5 TDi Eng.17L/ 19L (83kW)	9/89-6/94		R		153-371		Ap	254,0x70	Hand Brake
	9/89-6/94		R		153-366		Lucas	279,4x57	Hand Brake
3.5 Eng.13D/ 17D/ 18D/ 22D/ 24D/ 25D/ 31D (93-107-113-120kW)	9/89-6/94		R		153-371		Ap	254,0x70	Hand Brake
	9/89-6/94		R		153-366		Lucas	279,4x57	Hand Brake
Discovery II (LJ, LT) 6/94-9/04									
2.0 16v Eng.20T4 (99kW)	6/94-9/04		R		153-373	153-373K		254,0x70	Hand Brake
2.5 TD5 Eng.10P/ 15P/ 16P (102kW)	1/99-9/04		R		153-373	153-373K		254,0x70	Hand Brake
2.5 TDi Eng.17L/ 19L (83kW)	8/96-9/04		R		153-373	153-373K		254,0x70	Hand Brake
2.5 TDi Eng.21L (90kW)	10/95-9/04		R		153-373	153-373K		254,0x70	Hand Brake
3.9 V8 Eng.35D/ 36D/ 37D/ 38D/ 37L (127-134-136kW)	6/94-11/98		R		153-373	153-373K		254,0x70	Hand Brake
4.0 V8 Eng.39D (136kW)	11/98-9/04		R		153-373	153-373K		254,0x70	Hand Brake
Discovery III (TAA) 10/04-7/09									
2.7 TD Eng.276DT (140kW)	04-07		R		153-375			210,0x30	
	07-09		R		153-376			210,0x30	Hand Brake
4.4 Eng.448PN (220kW)	10/04-		R		153-375			210,0x30	
Freelander I (LN) 2/98-2/06									
1.8 16v Eng.18K16HOL/ HOU/ 18K4F (86kW)	11/00-2/06		R		153-370		Lucas	254,0x45	Hand Brake
	00-		R		700-348			Ø 254,0	
1.8 16v, SoftTop Eng.18K16 (88kW)	2/98-2/06		R		153-368		Lucas	254,0x39	Hand Brake
	98-		R		700-348			Ø 254,0	
	98-		R		151-195		Lucas	Ø 20,64 254,0x39	LOS

LAND ROVER



		Spare Parts	F/R	L/R	CIFAM ref.	CIFAM ref. w/KIT		DIMENSIONS mm.	NOTE
2.0 Di, Soft Top Eng.20T2N (72kW)	2/98-2/06		R		153-368		Lucas	254,0x39	Hand Brake
	98-		R		700-348			Ø 254,0	
	98-		R		151-195		Lucas	Ø 20,64 254,0x39	LOS
2.0 TD4 Eng.TD4/ M47R (80-82kW)	11/00-2/06		R		153-370		Lucas	254,0x45	Hand Brake
2.5 V6 Eng.25K4F (130kW)	11/00-2/06		R		153-370		Lucas	254,0x45	Hand Brake
Freelander II (FA) 2/06-									
2.2 TD4 Eng.224DT (110-112-115kW)	1/07-		R		153-374	153-374K		190,0x30	Hand Brake
2.2 TD4 Eng.22DDER (118kW)	2/06-		R		153-374	153-374K		190,0x30	Hand Brake
3.2 Eng.B6324S (171kW)	2/06-		R		153-374	153-374K		190,0x30	Hand Brake
3.2 i6 HSE 4WD Eng.6324T (170kW)	10/06-		R		153-374	153-374K		190,0x30	Hand Brake
Range Rover I 7/70-7/94									
2.4 D Eng.11A (78kW)	4/86-12/90		R		153-371		Ap	254,0x70	Hand Brake
3.5 Eng.20D/ 21G (98kW)	7/70-8/81		R		153-371		Ap	254,0x70	Hand Brake
3.5 Eng.31D (107kW)	1/87-9/90		R		153-371		Ap	254,0x70	Hand Brake
3.5 4WD (96kW)	10/85-8/91		R		153-371		Ap	254,0x70	Hand Brake
3.5 Vogue Eng.11D (93kW)	8/81-9/90		R		153-371		Ap	254,0x70	Hand Brake
3.5 Vogue Eng.24D/ 25D (120kW)	10/85-9/90		R		153-371		Ap	254,0x70	Hand Brake
4.3 Vogue LSE Eng.40D (149kW)	9/92-7/94		R		153-371		Ap	254,0x70	Hand Brake
Range Rover II (LP) 7/94-3/02									
2.5 D Eng.14L (83kW)	8/94-3/02		R		153-373	153-373K		254,0x70	Hand Brake
2.5 D Eng.256T(BMW) (100kW)	7/94-3/02		R		153-373	153-373K		254,0x70	Hand Brake
3.9 Eng.42D (140kW)	7/94-3/02		R		153-373	153-373K		254,0x70	Hand Brake
4.0 V8 Eng.39D (136kW)	6/98-3/02		R		153-373	153-373K		254,0x70	Hand Brake
4.6 Eng.46D (160-165kW)	7/94-3/02		R		153-373	153-373K		254,0x70	Hand Brake
Range Rover III (LM) 3/02-									
3.0 TD6 Eng.306D1 (130kW)	3/06-		R		153-244	153-244K		210,0x31	
4.4 Eng.448PN (225kW)	3/06-		R		153-244	153-244K		210,0x31	
Range Rover Sport I (LS) 2/05-									
2.7 TDVM Eng.276DT (140kW)	07-09		R		153-376			210,0x30	Hand Brake
	2/05-		R		153-375			210,0x30	
3.6 TDV8 Eng.368DT (200kW)	1/07-		R		153-375			210,0x30	
	1/07-		R		153-376			210,0x30	Hand Brake
4.2 Eng.428PS (287kW)	05-		R		153-375			210,0x30	
	07-09		R		153-376			210,0x30	Hand Brake
4.4 V8 Eng.448PN (220kW)	2/05-		R		153-375			210,0x30	
LDV									
Convoy									
2.5 TD Eng.ET70 (74kW)			R		153-139		Ap	254,0x57	Hand Brake
Maxus 2/05-7/07									
2.5 CDi (88kW)	2/05-		R		153-134		Bosch	280,0x65	Hand Brake
2.5 CDi Eng.VM39C (70kW)	2/05-		R		153-134		Bosch	280,0x65	Hand Brake
Serie 400 1/89-									
2.0 Eng.O Series 2.0 (65kW)	1/89-		R		153-139		Ap	254,0x57	Hand Brake
2.5 D Eng.EN55 (53kW)	4/89-3/96		R		153-139		Ap	254,0x57	Hand Brake
Sherpa II 1/83-3/89									
1.6 Eng.G16A (48kW)	-85		R		153-139		Ap	254,0x57	Hand Brake
1.7 (54kW)	82-86		R		153-109		Ap	254,0x70	TRW, Hand Brake
	-85		R		153-139		Ap	254,0x57	Hand Brake
1.8 Eng.G18A (50kW)	1/83-9/88		R		153-109		Ap	254,0x70	TRW, Hand Brake
	-85		R		153-139		Ap	254,0x57	Hand Brake
1.8 D (38kW)	-85		R		153-139		Ap	254,0x57	Hand Brake
2.0 Eng.G20A (64kW)	1/83-9/88		R		153-109		Ap	254,0x70	TRW, Hand Brake
	-85		R		153-139		Ap	254,0x57	Hand Brake
2.5 D Eng.12J (59kW)	-85		R		153-139		Ap	254,0x57	Hand Brake
2.5 D, Allrad (51kW)	-85		R		153-139		Ap	254,0x57	Hand Brake
2.6 D Eng.K25D (59kW)	-85		R		153-139		Ap	254,0x57	Hand Brake
3.5 (103kW)	-85		R		153-139		Ap	254,0x57	Hand Brake
LEXUS									
ES I (F1, F2) 12/89-1/01									
300 Eng.3VZ-FE (138kW)	95-96		R		153-442	153-442K		170,0x40	Hand Brake
ES II (VZV_) 8/01-10/06									
3.3 Eng.3MZF E (168kW)	6/03-10/06		R		153-442	153-442K		170,0x40	Hand Brake











































		Spare Parts	F/R	L/R	CIFAM ref.	CIFAM ref. w/KIT		DIMENSIONS mm.	NOTE
GS I (JZS147) 3/93-8/97									
300 Eng.2JZ-GE (156kW)	3/93-8/97		R		153-439	153-439K		190,0x45	Hand Brake
GS II (JZS160) 8/97-									
300 Eng.2JZ-GE (161kW)	10/00-		R		153-439	153-439K		190,0x45	Hand Brake
300 T3 Eng.2JZ-GE (163kW)	8/97-10/00		R		153-439	153-439K		190,0x45	Hand Brake
430 Eng.3UZ-FE (208kW)	11/00-		R		153-439	153-439K		190,0x45	Hand Brake
GS III (GRS) 4/05-									
300 Eng.3GR (183kW)	4/05-		R		153-449			190,0x26	Hand Brake
430 Eng.3UZ-FE (208kW)	4/05-		R		153-449			190,0x26	Hand Brake
450 h Eng.2GR-FSE (218kW)	2/06-		R		153-449			190,0x26	Hand Brake
460 Eng.1UR-FSE (255kW)	5/08-		R		153-449			190,0x26	Hand Brake
GX I (J12) 11/01-11/09									
4.7 32v AWD Eng.2UZ-FE (175kW)	03-04		R		153-441			210,0x46	
IS I (GXE10), Sportcross 4/99-9/05									
200 Eng.1G-FE (114kW)	4/99-		R		153-439	153-439K		190,0x45	Hand Brake
300 Eng.2JZ-GE (157kW)	9/01-		R		153-439	153-439K		190,0x45	Hand Brake
IS II (XE2) 10/05-									
250, Coupe, Cabrio Eng.4GRFSE (153kW)	10/05-		R		153-449			190,0x26	Hand Brake
350 V6 Eng.2GR-FSE (228kW)	1/06-		R		153-449			190,0x26	Hand Brake
500, F (USE20) Eng.2UR-GSE (311kW)	8/08-		R		153-449			190,0x26	Hand Brake
LS II (UCF20) 12/94-									
400 Eng.1UZ-FE (194-203-209kW)	12/94-		R		153-439	153-439K		190,0x45	Hand Brake
LS III (FE) 10/00-									
430 Eng.3UZ-FE (208kW)	10/00-		R		153-449			190,0x26	Hand Brake
460 Eng.1UR-FE (255kW)	08-		R		153-522			190x31	
460 Eng.1URFSE (280kW)	08-		R		153-522			190x31	
460 Eng.1UR-FSE (279kW)	07-		R		153-522			190x31	
460 AWD Eng.1URFSE (270kW)	08-		R		153-522			190x31	
600 h Eng.2URFSE (290kW)	07-		R		153-522			190x31	
600h (327kW)	10-		R		153-522			190x31	
LX II (UZJ) 1/98-12/06									
4.7 4WD Eng.2UZFE (173kW)	01-07		R		153-524			228,6x45	
4.7 4WD Eng.2UZFE (197kW)	98-02		R		153-524			228,6x45	
4.7 4WD Eng.2UZFE (202kW)	02-07		R		153-524			228,6x45	
4.7 V8 32v Eng.2UZFE (170kW)	98-06		R		153-524			228,6x45	
LX III (URJ) 1/08-									
5.7 V8 Eng.3YR-FE (286kW)	1/08-		R		153-451			242,0x32	Hand Brake
RX II (MCU) 5/03-5/09									
330 Eng.3MZ-FE (168kW)	1/04-12/06		R		153-439	153-439K		190,0x45	Hand Brake
350 Eng.2GR (203kW)	2/06-		R		153-439	153-439K		190,0x45	Hand Brake
400 h (200kW)	9/08-		R		153-439	153-439K		190,0x45	Hand Brake
400 h, FWD Eng.3MZ-FE (155kW)	9/04-		R		153-439	153-439K		190,0x45	Hand Brake
SC I 1/92-7/01									
300 Eng.2JZ-GE (158-169kW)	1/96-12/00		R		153-439	153-439K		190,0x45	Hand Brake
400 Eng.1UZ-FE (216kW)	1/92-12/00		R		153-439	153-439K		190,0x45	Hand Brake
SC II 8/01-									
430 Eng.3UZ-FE (210kW)	8/01-		R		153-439	153-439K		190,0x45	Hand Brake
LIGIER									
Ambra 12/96-									
0.5 (14kW)	12/96-		R		153-053			160,0x42	Fitted Adjuster, Hand Brake
	12/96-		R		153-054			180,0x32	Fitted Adjuster, Hand Brake
Be Up 8/02-									
0.5 (14kW)	8/02-		R		153-053			160,0x42	Fitted Adjuster, Hand Brake
	8/02-		R		153-054			180,0x32	Fitted Adjuster, Hand Brake
Nova 8/02-									
400 (5kW)	8/02-		R		153-053			160,0x42	Fitted Adjuster, Hand Brake
	8/02-		R		153-054			180,0x32	Fitted Adjuster, Hand Brake
500 (4kW)	8/02-		R		153-053			160,0x42	Fitted Adjuster, Hand Brake
	8/02-		R		153-054			180,0x32	Fitted Adjuster, Hand Brake
650 (14kW)	8/02-		R		153-053			160,0x42	Fitted Adjuster, Hand Brake
	8/02-		R		153-054			180,0x32	Fitted Adjuster, Hand Brake





























































		Spare Parts	F/R	L/R	CIFAM ref.	CIFAM ref. w/KIT		DIMENSIONS mm.	NOTE
Europa I 10/66-4/76									
1.5 (57kW)	10/66-10/70		R		153-101		Lucas	203,2x38	Hand Brake
SuperSeven 1/58-12/68									
1.1	1/58-12/61		R		153-101		Lucas	203,2x38	Hand Brake
1.3	1/62-12/68		R		153-101		Lucas	203,2x38	Hand Brake
1.5	1/62-12/68		R		153-101		Lucas	203,2x38	Hand Brake





























































MARUTI





Gipsy 4/88-8/98									
1.0 Eng.F10A (33kW)	4/88-8/98		R		153-380		Sumit.	180,0x30	Hand Brake
Udyog 1/90-12/94									
0.8 Eng.F8B (26kW)	1/90-12/94		R		153-380		Sumit.	180,0x30	Hand Brake

MAZDA

1000 1/75-1/77									
1.0 Eng.PC (33kW)	1/75-1/77		F		153-198		Sumit.	200,0x33	Hand Brake
121 I (DA) 10/87-10/90									
1.1 (40kW)	4/89-10/90		R		153-206		Ake	170,0x25	
1.1 Eng.B1/ B116 (42kW)	10/87-10/90		R		153-206		Ake	170,0x25	
	87-90		R		700-274			Ø 170,0	
1.3 Eng.B3 (40-44kW)	10/87-10/90		R		153-206		Ake	170,0x25	
	87-90		R		700-274			Ø 170,0	
121 II (DB) 11/90-3/96									
1.1 Eng.B1 (40kW)	11/90-10/93		R		153-206		Ake	170,0x25	
	11/90-10/93		R		153-211		Ake	180,0x31	Hand Brake
1.3 Eng.B3 (39kW)	11/90-3/96		R		153-206		Ake	170,0x25	
	11/90-3/96		R		153-211		Ake	180,0x31	Hand Brake
	91-95		R		700-274			Ø 170,0	
1.3 16v Eng.B3(16v) (40-53-54kW)	11/90-3/96		R		153-206		Ake	170,0x25	
	91-95		R		700-274			Ø 170,0	
121 III (JASM, JBSM) 3/96-									
1.25 Eng.DHF/ DHG (55kW)	3/96-		R		153-128		Lucas	180,0x32	Hand Brake
	96-		R		700-294	700-294K		Ø 180,0	
	96-		R		151-151		Ap	Ø 19,05 180,0x29	RAD, -ABS
	96-		R		151-192		Lucas	Ø 17,78 180,0x32	LOS
1.3 Eng.J4C (37-44kW)	3/96-		R		153-128		Lucas	180,0x32	Hand Brake
	96-		R		700-294	700-294K		Ø 180,0	
	96-		R		151-151		Ap	Ø 19,05 180,0x29	RAD, -ABS
	96-		R		151-192		Lucas	Ø 17,78 180,0x32	LOS
1.8 D Eng.RTK/ RTJ (44kW)	3/96-		R		153-128		Lucas	180,0x32	Hand Brake
	96-		R		700-294	700-294K		Ø 180,0	
	96-		R		151-151		Ap	Ø 19,05 180,0x29	RAD, -ABS
	96-		R		151-192		Lucas	Ø 17,78 180,0x32	LOS
1300 1/75-1/77									
1.3 Eng.TC (44kW)	1/75-1/77		F		153-198		Sumit.	200,0x33	Hand Brake
2 I (DY) 4/03-7/07									
1.25 Eng.FUJA (55kW)	03-07		R		153-136		Ap	203,2x38	Hand Brake
	03-07		R		151-153		Ap	Ø 19,05 203,0x39	AP
1.4 Eng.FXJA (59kW)	03-07		R		153-136		Ap	203,2x38	Hand Brake
	03-07		R		151-153		Ap	Ø 19,05 203,0x39	AP
1.4 TD Eng.F6JA/ F6JB (50kW)	4/03-7/07		R		153-136		Ap	203,2x38	Hand Brake
	03-		R		151-153		Ap	Ø 19,05 203,0x39	AP
1.6 Eng.FYJA (74kW)	4/03-7/07		R		153-136		Ap	203,2x38	Hand Brake
	03-		R		151-153		Ap	Ø 19,05 203,0x39	AP
2 II (DE) 8/07-									
1.3 16v Eng.ZJ06 (55kW)	8/07-		R		153-148		Lucas	200,0x32	Hand Brake
	07-		R		700-393			Ø 200,0	
1.3 16v Eng.ZJ07 (63kW)	8/07-		R		153-148		Lucas	200,0x32	Hand Brake
	07-		R		700-393			Ø 200,0	
1.4 TD Eng.Y404 (50kW)	4/08-		R		153-148		Lucas	200,0x32	Hand Brake
	08-		R		700-393			Ø 200,0	
1.5 16v Eng.ZY05/ ZYDE (76kW)	8/07-		R		153-148		Lucas	200,0x32	Hand Brake
	07-		R		700-393			Ø 200,0	
1.6 TD (70kW)	12-		R		700-393			Ø 200,0	
1.6 TD Eng.Y401 (66kW)	09-		R		153-148		Lucas	200,0x32	Hand Brake
	09-		R		700-393			Ø 200,0	

		Spare Parts	F/R	L/R	CIFAM ref.	CIFAM ref. w/KIT		DIMENSIONS mm.	NOTE
323 I (FA), SW 1/77-5/86									
1.0 Eng.PB	1/77-1/79		F		153-198		Sumit.	200,0x33	Hand Brake
1.0 (Exc. SW) Eng.PC (33kW)	77-80		F		153-198		Sumit.	200,0x33	Hand Brake
1.2 Eng.TB	1/68-12/74		R		153-198		Sumit.	200,0x33	Hand Brake
1.3 Eng.TC (44kW)	-80		R		153-198		Sumit.	200,0x33	Hand Brake
1.4 Eng.UC (51kW)	5/78-5/82		R		153-198		Sumit.	200,0x33	Hand Brake
1.5 SW Eng.D5 (52kW)	4/82-5/86		R		153-198		Sumit.	200,0x33	Hand Brake
323 II (BD) 9/80-10/89									
1.1 Eng.E1 (40kW)	11/80-10/85		R		153-200		Sumit.	180,0x30	Hand Brake
1.3 Eng.E3 (44-50kW)	-85		R		153-200		Sumit.	180,0x30	Hand Brake
1.5 Eng.E5 (63-65-70kW)	3/82-9/86		R		153-200		Sumit.	180,0x30	Hand Brake
1.5 Eng.E5OHC (55-59kW)	11/80-12/85		R		153-200		Sumit.	180,0x30	Hand Brake
323 III (BF, BW) 8/85-10/95									
1.1 Eng.E1 (40kW)	8/85-4/90		R		153-203		Ake	200,0x25	Hand Brake
	85-90		R		700-282			Ø 200,0	
1.3, SW Eng.E3 (40-44kW)	8/85-4/90		R		153-203		Ake	200,0x25	Hand Brake
	8/85-4/90		R		153-204		Sumit.	228,6x25	Van, Hand Brake
	85-89		R		700-282			Ø 200,0	
1.4 Eng.B3 (40-44-49-52kW)	85-89		R		700-292			Ø 180,0	
1.5 i Eng.E5E3 (70kW)	8/85-5/89		R		153-203		Ake	200,0x25	Hand Brake
	8/85-5/89		R		153-204		Sumit.	228,6x25	Van, Hand Brake
	85-89		R		700-282			Ø 200,0	
1.5 i T. Eng.E5E2 (85kW)	8/85-5/89		R		153-203		Ake	200,0x25	Hand Brake
	8/85-5/89		R		153-204		Sumit.	228,6x25	Van, Hand Brake
1.5, SW Eng.B5/ B5E/ B50/ B53 (54-55-65kW)	9/87-10/89		R		153-203		Ake	200,0x25	Hand Brake
	9/87-10/89		R		153-204		Sumit.	228,6x25	SW, Van, Hand Brake
	87-89		R		700-282			Ø 200,0	
1.5, SW Eng.E5/ B50/ B53 (55-59-63-65kW)	8/85-5/89		R		153-203		Ake	200,0x25	Hand Brake
	8/85-5/89		R		153-204		Sumit.	228,6x25	SW, Van, Hand Brake
	85-89		R		700-282			Ø 200,0	
1.6 GT Eng.B6D/ E/ F (63-77kW)	8/85-10/89		R		153-203		Ake	200,0x25	Hand Brake
	85-89		R		700-282			Ø 200,0	
1.6 H-Back Eng.B68 (54kW)	9/87-10/89		R		153-203		Ake	200,0x25	Hand Brake
	87-89		R		700-282			Ø 200,0	
1.6, 4WD SW Eng.B6D/ E/ F/ B65M (63kW)	9/86-10/95		R		153-203		Ake	200,0x25	Hand Brake
1.7 D Eng.PN27 (40kW)	9/86-5/89		R		153-204		Sumit.	228,6x25	Hand Brake
	86-89		R		700-282			Ø 200,0	
1.7 D Eng.PN46 (42kW)	87-89		R		700-282			Ø 200,0	
1.7 D SW Eng.PN26/ PN54 (40kW)	11/86-3/93		R		153-204		Sumit.	228,6x25	Hand Brake
1.7 D SW Eng.PN26/ PN54 (42kW)	11/86-10/89		R		153-204		Sumit.	228,6x25	Hand Brake
323 IV (BG) 6/89-10/94									
1.3 Eng.B3E/ B383 (49kW)	9/89-7/94		R		153-207		Sumit.	200,0x25	Van, Hand Brake
	9/89-7/94		R		153-210		Sumit.	200,0x35	Hand Brake
	89-94		R		700-296			Ø 200,0	
1.3 16v Eng.B3(16v) (53-54kW)	9/89-7/94		R		153-203		Ake	200,0x25	Hand Brake
	9/89-7/94		R		153-207		Sumit.	200,0x25	Van, Hand Brake
	89-94		R		700-296			Ø 200,0	
1.5 Eng.E5 (55-63kW)	1/89-7/94		R		153-210		Sumit.	200,0x35	Hand Brake
1.6 (66kW)	4/91-4/94		R		153-207		Sumit.	200,0x25	Hand Brake
1.6 Eng.B6E (62kW)	9/89-6/91		R		153-207		Sumit.	200,0x25	Hand Brake
	89-91		R		700-296			Ø 200,0	-ABS
1.6 16v Eng.B6/ D/ E/ F (65kW)	8/89-10/94		R		153-207		Sumit.	200,0x25	Hand Brake
	89-94		R		700-296			Ø 200,0	-ABS
1.7 D Eng.PN46/ PN54/ PN62 (42kW)	8/89-7/94		R		153-207		Sumit.	200,0x25	SW, Hand Brake
	8/89-7/94		R		153-205		Sumit.	228,6x32	Sedan, Hand Brake
	89-94		R		700-296			Ø 200,0	-ABS
323 V (BA) 8/94-9/98									
1.3 16v Eng.B3(16v) (54kW)	8/94-9/98		R		153-210		Sumit.	200,0x35	Hand Brake
	8/94-9/98		R		700-296			Ø 200,0	+ABS
1.5 16v Eng.Z5-DE (65kW)	8/94-9/98		R		153-210		Sumit.	200,0x35	Hand Brake
	8/94-9/98		R		700-296			Ø 200,0	+ABS
1.7 TD Eng.4EE1-T (60kW)	2/95-9/98		R		700-282			Ø 200,0	+ABS
1.8 16v Eng.BP-ZE (84-103kW)	8/94-9/98		R		153-210		Sumit.	200,0x35	Hand Brake
2.0 24v Eng.KF (106kW)	8/94-9/98		R		153-210		Sumit.	200,0x35	Hand Brake
2.0 D Eng.RF (52kW)	96-98		R		700-296			Ø 200,0	

		Spare Parts	F/R	L/R	CIFAM ref.	CIFAM ref. w/KIT		DIMENSIONS mm.	NOTE
323 VI (BJ) 9/98-									
1.3 Eng.B3 (53kW)	01-		R		700-296			Ø 200,0	
1.3 16v Eng.B3ME (54kW)	9/98-		R		153-214		Sumit.	200,0x37	Hand Brake
1.5 16v Eng.ZL-DE (65kW)	9/98-		R		153-214		Sumit.	200,0x37	Hand Brake
	98-		R		700-296			Ø 200,0	
618 I-II 1/70-12/78									
1.6 Eng.NA	10/78-9/80		R		153-198		Sumit.	200,0x33	Hand Brake
1.8 Eng.VB	1/70-12/78		R		153-198		Sumit.	200,0x33	Hand Brake
2.0 Eng.MA	10/78-9/80		R		153-198		Sumit.	200,0x33	Hand Brake
626 I (CB) 5/79-5/82									
1.6 Eng.NA (55kW)	5/79-5/82		R		153-198		Sumit.	200,0x33	Hand Brake
1.8 Eng.VC (60-62kW)	1/74-12/82		R		153-198		Sumit.	200,0x33	Hand Brake
2.0 Eng.HE3/ MA (66kW)	5/79-5/82		R		153-198		Sumit.	200,0x33	Hand Brake
626 II (GC) 11/82-9/87									
1.6 Eng.F6 (55-59kW)	11/82-6/87		R		153-201		Ake	200,0x25	Hand Brake
1.8 Eng.F8 (66-70kW)	11/82-1/87		R		153-201		Ake	200,0x25	Hand Brake
2.0 GT Eng.FE (88kW)	3/83-9/87		R		153-201		Ake	200,0x25	Hand Brake
2.0, 12v Eng.FE (60-63-66-68-70-74-79-81-85kW)	11/82-9/87		R		153-201		Ake	200,0x25	Hand Brake
626 III (GD,GV), SW 6/87-9/97									
1.6, Coupe Eng.F6 (60kW)	6/87-5/92		R		153-205		Sumit.	228,6x32	Hand Brake
	87-92		R		700-295			Ø 228,6	4 Hole
	87-92		R		700-281			Ø 228,6	5 Hole
1.8 H-Back Eng.F8 (69kW)	-89		R		153-207		Sumit.	200,0x25	GD6P, Hand Brake
	-89		R		153-205		Sumit.	228,6x32	GD8P, Hand Brake
	90-		R		153-205		Sumit.	228,6x32	Hand Brake
1.8, Coupe Eng.F8 (65-69kW)	-89		R		153-207		Sumit.	200,0x25	GD6P, Hand Brake
	-89		R		153-205		Sumit.	228,6x32	GD8P, Hand Brake
	90-		R		153-205		Sumit.	228,6x32	Hand Brake
	87-92		R		700-295			Ø 228,6	4 Hole
	87-92		R		700-281			Ø 228,6	5 Hole
2.0 12v, Coupe Eng.FE(12v) (60-63-66-68-70-74-79-81-85-88kW)	-89		R		153-207		Sumit.	200,0x25	GD6P, Hand Brake
	-89		R		153-205		Sumit.	228,6x32	GD8P, Hand Brake
	90-		R		153-205		Sumit.	228,6x32	Hand Brake
	87-92		R		700-295			Ø 228,6	4 Hole
	87-92		R		700-281			Ø 228,6	5 Hole
2.0 16v, Coupe Eng.FEKat.(16v) (103kW)	11/87-5/92		R		153-205		Sumit.	228,6x32	Hand Brake
	87-92		R		700-295			Ø 228,6	4 Hole
	87-92		R		700-281			Ø 228,6	5 Hole
2.0 16v, Coupe Eng.FEKat.(16v) (109kW)	7/87-5/92		R		153-205		Sumit.	228,6x32	Hand Brake
2.0 D Eng.RF-N (44-46-55-60kW)	7/87-7/91		R		153-205		Sumit.	228,6x32	Hand Brake
	87-91		R		700-295			Ø 228,6	4 Hole
	87-91		R		700-281			Ø 228,6	5 Hole
2.0 D Complex SW Eng.RF-CX (55kW)	5/93-11/96		R		153-205		Sumit.	228,6x32	Hand Brake
	93-96		R		700-295			Ø 228,6	4 Hole
	93-96		R		700-281			Ø 228,6	5 Hole
2.0 D SW Eng.RF-N (60kW)	11/94-9/97		R		153-205		Sumit.	228,6x32	Hand Brake
	94-97		R		700-295			Ø 228,6	4 Hole
	94-97		R		700-281			Ø 228,6	5 Hole
2.0, Coupe Eng.FEKat. (66kW)	-89		R		153-207		Sumit.	200,0x25	GD6P, Hand Brake
	-89		R		153-205		Sumit.	228,6x32	GD8P, Hand Brake
	90-		R		153-205		Sumit.	228,6x32	Hand Brake
	87-92		R		700-295			Ø 228,6	4 Hole
	87-92		R		700-281			Ø 228,6	5 Hole
2.2 12v, Coupe, 4WD Eng.F2 (65-85-94-100kW)	11/87-11/96		R		153-205		Sumit.	228,6x32	Hand Brake
	87-96		R		700-295			Ø 228,6	4 Hole
	87-96		R		700-281			Ø 228,6	5 Hole
626 V (GF,GW), SW 5/97-									
1.8 Eng.FP9A (74-84kW)	12/99-		R		153-216		Ake	228,6x42	Hand Brake
1.8 Eng.FPY3 (66kW)	5/97-1/00		R		153-216		Ake	228,6x42	Hand Brake
2.0 TD Eng.RF3F (66kW)	4/98-		R		153-216		Ake	228,6x42	Hand Brake
2.0 TD Eng.RF4F (74kW)	4/98-		R		153-216		Ake	228,6x42	Hand Brake
2.0 TDi Eng.RF-T Hi Power (81kW)	10/00-		R		153-216		Ake	228,6x42	Hand Brake
CX-7 8/07-									
2.3 16v T. DISI Eng.L3 (191kW)	07-		R		153-491	153-491K		190x25	

		Spare Parts	F/R	L/R	CIFAM ref.	CIFAM ref. w/KIT		DIMENSIONS mm.	NOTE
CX-9 1/07-									
3.7, AWD Eng.CA (204kW)	07-		R		153-491	153-491K		190x25	
Demio (DW) 8/98-									
1.3 16v Eng.B3(16v) (40-53-54kW)	8/98-4/00		R		153-219		Ake	200,0x32	Hand Brake
1.5 16v Eng.B5E (54-55-65kW)	4/00-		R		153-219		Ake	200,0x32	Hand Brake
MPV I (LV) 1/89-9/99									
2.5 TD Eng.LE (85kW)	5/96-9/99		R		153-228			190,0x32	
2.6 Eng.G6 (90kW)	91-94		R		153-208			260,0x50	Nato, Hand Brake
3.0 i V6 Eng.JE94 (109-113kW)	1/89-9/99		R		153-228			190,0x32	
	1/89-9/99		R		153-208			260,0x50	Nato, RWD, Hand Brake
	1/89-9/99		R		153-209			260,0x50	Usa, Hand Brake
MPV II (LW) 9/99-									
2.0 Eng.FS-DS (88-90kW)	9/99-7/02		R		153-228			190,0x32	
	9/99-7/02		R		153-218		Ake	254,0x52	
2.0 Di Eng.RF5C (100kW)	7/02-		R		153-228			190,0x32	
2.3 Eng.L3 (104kW)	7/02-		R		153-228			190,0x32	
2.5 V6 Eng.GY-DE (125kW)	9/99-3/02		R		153-228			190,0x32	
	9/99-3/02		R		153-218		Ake	254,0x52	
3.0 V6 Eng.AJ (147kW)	3/02-		R		153-228			190,0x32	
	3/02-		R		153-209			260,0x50	USA, Hand Brake
MX-3 (EC) 7/91-									
1.6 i Eng.B69 (65kW)	7/91-		R		153-210		Sumit.	200,0x35	Hand Brake
	7/91-			R		700-296			Ø 200,0
1.6 i Eng.B6D (79kW)	1/94-		R		153-210		Sumit.	200,0x35	Hand Brake
	94-			R		700-296			Ø 200,0
1.8 i V6 Eng.K819 (98kW)	1/92-1/94		R		153-210		Sumit.	200,0x35	Hand Brake
1.8 i V6 Eng.K838 (95kW)	1/94-		R		153-210		Sumit.	200,0x35	Hand Brake
MX-5 I (NA) 5/90-4/98									
1.6 Eng.B6EGI (66kW)	1/95-4/98		R		153-210		Sumit.	200,0x35	Hand Brake
MX-6 (GD) 1/88-1/92									
1.8 Eng.F8 (65-69kW)	1/88-1/92		R		153-205		Sumit.	228,6x32	Hand Brake
2.2 12v, 4WD Eng.F2 (68-85-94-100kW)	1/88-12/92		R		153-205		Sumit.	228,6x32	Hand Brake
MX-6 (GE6) 2/92-12/97									
1.8i Eng.FP (77kW)	2/92-12/97		R		153-212		Sumit.	228,6x32	Hand Brake
2.0 Eng.FS (85kW)	2/92-12/97		R		153-212		Sumit.	228,6x32	Hand Brake
	92-			R		700-281			Ø 228,6
2.5 i 24v Eng.KL (120-121kW)	2/92-12/97		R		153-212		Sumit.	228,6x32	Hand Brake
	92-			R		700-281			Ø 228,6
Premacy (CP) 7/99-									
1.8 16v Eng.FP (74-84kW)	7/99-		R		153-216		Ake	228,6x42	Hand Brake
2.0 TD Eng.RF3F (66kW)	10/99-7/00		R		153-216		Ake	228,6x42	Hand Brake
2.0 TD Eng.RF4F (74kW)	7/00-		R		153-216		Ake	228,6x42	Hand Brake
Protege 1/90-1/92									
1.6 Eng.SOHC	-91		R		153-205		Sumit.	228,6x32	Hand Brake
	92-		R		153-210		Sumit.	200,0x35	Hand Brake
	90-			R		700-296			Ø 200,0
1.8 Eng.DOHC	-91		R		153-205		Sumit.	228,6x32	Hand Brake
	92-		R		153-210		Sumit.	200,0x35	Hand Brake
	90-			R		700-296			Ø 200,0
R100 1/68-12/73									
1.0 (75kW)	1/68-12/73		R		153-198		Sumit.	200,0x33	Hand Brake
1.1	1/71-12/72		R		153-198		Sumit.	200,0x33	Hand Brake
RX 7 I (SA) 5/79-3/86									
1.1 Wankel Eng.12AN2 (77-83-85kW)	5/79-3/86		R		153-198		Sumit.	200,0x33	Hand Brake
1.3 Wankel Eng.13B RE-EGI (101kW)	5/79-3/86		R		153-198		Sumit.	200,0x33	Hand Brake
Tribute (EP) 3/00-									
2.0, 4WD Eng.YFD (91kW)	3/00-		R		153-216		Ake	228,6x42	Hand Brake
3.0 V6 24v 4WD Eng.AJD (145kW)	3/00-		R		153-216		Ake	228,6x42	Hand Brake
MAZDA LCV									
B-Serie I (PE) 2/77-1/82									
1.6 Eng.NA (55kW)	2/77-9/78		R		153-199		Sumit.	260,0x45	
1.8 Eng.VC (60-62kW)	2/77-1/82		F		153-199		Sumit.	260,0x45	









MAZDA LCV



































		Spare Parts	F/R	L/R	CIFAM ref.	CIFAM ref. w/KIT		DIMENSIONS mm.	NOTE
B-Serie I Rotary 1/71-2/77									
1.6 Eng.NA (55kW)	1/72-12/75		F		153-199		Sumit.	260,0x45	
B-Serie II (UD) 10/81-8/85									
2.0 Eng.MA (66kW)	1/81-8/85		R		153-199		Sumit.	260,0x45	
2.0 Eng.UA (57kW)	1/83-12/84		R		153-199		Sumit.	260,0x45	
2.0, 12v Eng.FE (60-63-66-68-70-74-79-81-85-88kW)	1/83-8/85		R		153-199		Sumit.	260,0x45	
2.2 D (42kW)	2/82-12/84		R		153-199		Sumit.	260,0x45	
B-Serie III (UF) 1/85-6/99									
1.6 Eng.F6 (55-59kW)	89-		R		153-208			260,0x50	Hand Brake
2.0 Eng.FE (62-65kW)			R		153-208			260,0x50	Hand Brake
2.2 12v Eng.F2L8 (68-85-94-100kW)	8/91-12/96		R		153-208			260,0x50	Hand Brake
2.5 D 4WD Eng.MD25NA (57kW)	9/98-6/99		R		153-209			260,0x50	Hand Brake
2.5 D, 4WD Eng.WL (63kW)	2/96-6/99		R		153-208			260,0x50	Hand Brake
2.6 12v 4WD Eng.G6MPV (90kW)	1/90-6/99		R		153-208			260,0x50	Hand Brake
2.6 4WD Eng.AM (73kW)	1/87-10/90		R		153-208			260,0x50	Hand Brake
B-Serie IV (UN) 2/99-									
2.2 4WD Eng.R5A2 (60kW)	2/99-		R		153-144			270,0x54	Hand Brake
	2/99-		R		153-143			295,0x56	Hand Brake
2.2 8v 4WD Eng.JL22 (68kW)	6/99-		R		153-144			270,0x54	Hand Brake
	6/99-		R		153-143			295,0x56	Hand Brake
2.5 D, 4WD Eng.MD25NA (57kW)	6/99-		R		153-144			270,0x54	Hand Brake
	6/99-		R		153-143			295,0x56	Hand Brake
2.5 D, 4WD Eng.WLLE7 (62kW)	12/02-		R		153-144			270,0x54	Hand Brake
	12/02-		R		153-143			295,0x56	Hand Brake
2.5 TD 4WD Eng.MD25TI (80kW)	6/99-		R		153-144			270,0x54	Hand Brake
	6/99-		R		153-143			295,0x56	Hand Brake
2.6 12v 4WD Eng.JK26 (90kW)	6/99-		R		153-144			270,0x54	Hand Brake
	6/99-		R		153-143			295,0x56	Hand Brake
E-Serie I (SR1) 1/71-6/84									
1.6 Eng.NA (51-55kW)	80-		R		153-221		Sumit.	220,0x57	Hand Brake
E-Serie II (SR2) 5/84-									
2.0 Eng.FEBN (60kW)	3/91-5/94		R		153-209			260,0x50	Hand Brake
	3/91-5/94		R		153-202		Sumit.	260,0x50	Hand Brake
2.0 Eng.FEKat. (70kW)	6/94-		R		153-209			260,0x50	Hand Brake
	9/99-		R		153-222		Ake	220,0x57	
	9/99-		R		153-223		Ake	270,0x52	
2.0 4WD Eng.FE60/ FE61 (60kW)	10/88-9/89		R		153-209			260,0x50	Hand Brake
2.0, 4WD Eng.FE18/ FE58/ FEV4 (63kW)	5/85-4/89		R		153-221		Sumit.	220,0x57	4WD Bus, Hand Brake
	5/85-4/89		R		153-202		Sumit.	260,0x50	Hand Brake
2.2 D Eng.R203/ R207 (46kW)	5/84-2/88		R		153-221		Sumit.	220,0x57	Hand Brake
	5/84-2/88		R		153-202		Sumit.	260,0x50	Hand Brake
2.2 D 4WD Eng.R2/ R203/ R207 (47kW)	3/91-		R		153-209			260,0x50	Van, Hand Brake
	3/91-		R		153-221		Sumit.	220,0x57	Hand Brake
	9/99-		R		153-222		Ake	220,0x57	
	9/99-		R		153-223		Ake	270,0x52	
2.2 D, 4WD Eng.R2 (52kW)	2/97-		R		153-209			260,0x50	Van, Hand Brake
	2/97-		R		153-221		Sumit.	220,0x57	Hand Brake
	9/99-		R		153-222		Ake	220,0x57	
	9/99-		R		153-223		Ake	270,0x52	









































MEGA



































Club I 1/92-6/99										
1.1 i (44kW)	1/92-6/99		R			153-021Y	Bdx	165,0x30		
	1/92-6/99		R			153-021K	Bdx	165,0x30	Hand Brake	
	1/92-6/99		R			153-024Y	Bdx	165,0x30	Hand Brake	
1.4 i (55kW)	1/92-6/99		R			153-021Y	Bdx	165,0x30		
	1/92-6/99		R			153-021K	Bdx	165,0x30	Hand Brake	
	1/92-6/99		R			153-024Y	Bdx	165,0x30	Hand Brake	
1.4 i 4WD (55kW)	1/92-6/99		R			153-021Y	Bdx	165,0x30		
	1/92-6/99		R			153-021K	Bdx	165,0x30	Hand Brake	
	1/92-6/99		R			153-024Y	Bdx	165,0x30	Hand Brake	
1.5 D (43kW)	1/94-6/99		R			153-320Y	Bdx	180,0x32		
	1/94-6/99		R			153-320	153-320K	Bdx	180,0x32	Hand Brake
	1/94-6/99		R			153-329Y	Bdx	180,0x32	Hand Brake	
1.5 D 4WD (43kW)	1/94-6/99		R			153-320Y	Bdx	180,0x32		
	1/94-6/99		R			153-320	153-320K	Bdx	180,0x32	Hand Brake



































		Spare Parts	F/R	L/R	CIFAM ref.	CIFAM ref. w/KIT		DIMENSIONS mm.	NOTE
1.5 D 4WD (43kW)	1/94-6/99		R			153-329Y	Bdx	180,0x32	Hand Brake
Tjaffer 1/92-6/99									
1.1 i (44kW)	1/92-6/99		R			153-021Y	Bdx	165,0x30	
	1/92-6/99		R			153-021K	Bdx	165,0x30	Hand Brake
	1/92-6/99		R			153-024Y	Bdx	165,0x30	Hand Brake
1.4 i (55kW)	1/92-6/99		R			153-021Y	Bdx	165,0x30	
	1/92-6/99		R			153-021K	Bdx	165,0x30	Hand Brake
	1/92-6/99		R			153-024Y	Bdx	165,0x30	Hand Brake
1.4 i 4WD (55kW)	1/92-6/99		R			153-021Y	Bdx	165,0x30	
	1/92-6/99		R			153-021K	Bdx	165,0x30	Hand Brake
	1/92-6/99		R			153-024Y	Bdx	165,0x30	Hand Brake
1.5 D (43kW)	1/94-6/99		R			153-320Y	Bdx	180,0x32	
	1/94-6/99		R		153-320	153-320K	Bdx	180,0x32	Hand Brake
	1/94-6/99		R			153-329Y	Bdx	180,0x32	Hand Brake
1.5 D 4WD (43kW)	1/94-6/99		R			153-320Y	Bdx	180,0x32	
	1/94-6/99		R		153-320	153-320K	Bdx	180,0x32	Hand Brake
	1/94-6/99		R			153-329Y	Bdx	180,0x32	Hand Brake









































MERCEDES BENZ



































190 II (W201) 10/82-8/93									
1.8 E (201.018) Eng.M102.910 (77-80kW)	4/90-8/93		R		153-233	153-233K	Lucas	164,0x20	Hand Brake
2.0 Eng.M102.921 (66kW)	10/82-10/84		R		153-233	153-233K	Lucas	164,0x20	Hand Brake
2.0 Eng.M102.924 (75-77kW)	9/84-5/90		R		153-233	153-233K	Lucas	164,0x20	Hand Brake
2.0 D (201.122) Eng.OM601.911 (53-55kW)	8/83-8/93		R		153-233	153-233K	Lucas	164,0x20	Hand Brake
2.2 D Eng.OM601.921 (53kW)	1/83-8/93		R		153-233	153-233K	Lucas	164,0x20	Hand Brake
2.3 E (201.028) Eng.M102.985 (97-100kW)	10/86-8/93		R		153-233	153-233K	Lucas	164,0x20	Hand Brake
2.3-16 E (201.034) Eng.M102.983 (125-130-136kW)	4/84-8/88		R		153-233	153-233K	Lucas	164,0x20	Hand Brake
2.5 D (201.126) Eng.OM602.911 (66-69kW)	4/85-8/93		R		153-233	153-233K	Lucas	164,0x20	Hand Brake
2.5 E Evolution II Eng.M102.992 (173kW)	5/90-8/93		R		153-233	153-233K	Lucas	164,0x20	Hand Brake
2.5 TD (201.128) Eng.OM602.961 (90-93kW)	2/88-8/93		R		153-233	153-233K	Lucas	164,0x20	Hand Brake
2.5-16 E Eng.M102.990 (150kW)	9/88-8/93		R		153-233	153-233K	Lucas	164,0x20	Hand Brake
2.5-16 E Eng.M102.991 (143kW)	3/89-8/93		R		153-233	153-233K	Lucas	164,0x20	Hand Brake
2.6 E (201.029) Eng.M103.942 (118-122kW)	9/86-8/93		R		153-233	153-233K	Lucas	164,0x20	Hand Brake
200 E Eng.M102.962 (85-87kW)	2/85-8/93		R		153-233	153-233K	Lucas	164,0x20	Hand Brake
200 E Eng.M102.962 (93kW)	10/82-6/93		R		153-233	153-233K	Lucas	164,0x20	Hand Brake
200 E (201.024) Eng.M102.961/ 962 (83kW)	10/82-6/93		R		153-233	153-233K	Lucas	164,0x20	Hand Brake
CL (216) 9/06-									
500 (216.371) Eng.M237.961 (285kW)	9/06-		R		153-247	153-247K		180,0x25	Hand Brake
600 (216.376) Eng.M275.953 (380kW)	9/06-		R		153-247	153-247K		180,0x25	Hand Brake
63 AMG (216.377) Eng.M156.986 (386kW)	1/07-		R		153-247	153-247K		180,0x25	Hand Brake
65 AMG (216.379) Eng.M275.982 (450kW)	7/07-		R		153-247	153-247K		180,0x25	Hand Brake
Classe A I (W168) 7/97-8/04									
A 140 (168.031/.131) Eng.M166.940 (60kW)	7/97-8/04		R		153-235		Lucas	180,0x42	Hand Brake
	97-		R		700-223			Ø 180,0	
	97-04		R		151-171		Lucas	Ø 17,78 180,0x42	Ch J168710-, LUC, +ESP
	97-04		R		151-172		Lucas	Ø 19,05 180,0x42	Ch -J168709, LUC
A 160 (168.033/.133) Eng.M166.960 (75kW)	7/97-8/04		R		153-233	153-233K	Lucas	164,0x20	Hand Brake
	7/97-8/04		R		153-235		Lucas	180,0x42	Hand Brake
	97-		R		700-223			Ø 180,0	
	97-04		R		151-171		Lucas	Ø 17,78 180,0x42	Ch J168710-, LUC, +ESP
A 160 CDi (168.006) Eng.OM668.940 (55kW)	7/97-8/04		R		151-172		Lucas	Ø 19,05 180,0x42	Ch -J168709, LUC
	2/01-8/04		R		153-233	153-233K	Lucas	164,0x20	Hand Brake
	01-		R		700-223			Ø 180,0	
	01-04		R		151-171		Lucas	Ø 17,78 180,0x42	Ch J168710-, LUC, +ESP
01-04		R		151-172		Lucas	Ø 19,05 180,0x42	Ch -J168709, LUC	





































		Spare Parts	F/R	L/R	CIFAM ref.	CIFAM ref. w/KIT		DIMENSIONS mm.	NOTE
A 160 CDi (168.007) Eng.OM668.941 (44kW)	7/98-2/01		R		153-235		Lucas	180,0x42	Hand Brake
	98-		R		700-223			Ø 180,0	
	98-01		R		151-171		Lucas	Ø 17,78 180,0x42	Ch J168710-, LUC, +ESP
	98-01		R		151-172		Lucas	Ø 19,05 180,0x42	Ch -J168709, LUC
A 170 CDi (168.008) Eng.OM668.940 (66kW)	7/98-2/01		R		153-235		Lucas	180,0x42	Hand Brake
	98-		R		700-223			Ø 180,0	
	98-01		R		151-171		Lucas	Ø 17,78 180,0x42	Ch J168710-, LUC, +ESP
	98-01		R		151-172		Lucas	Ø 19,05 180,0x42	Ch -J168709, LUC
A 170 CDi (168.009/109) Eng.OM668.942 (70kW)	2/01-8/04		R		153-233	153-233K	Lucas	164,0x20	Hand Brake
	01-		R		700-223			Ø 180,0	
	01-04		R		151-171		Lucas	Ø 17,78 180,0x42	Ch J168710-, LUC, +ESP
	01-04		R		151-172		Lucas	Ø 19,05 180,0x42	Ch -J168709, LUC
A 190 (168.032/.132) Eng.M166.990 (92kW)	3/99-8/04		R		153-233	153-233K	Lucas	164,0x20	Hand Brake
A 210 (168.035/.135) Eng.M166.995 (103kW)	3/02-8/04		R		153-233	153-233K	Lucas	164,0x20	Hand Brake
Classe A II (W169) 9/04-									
A 150 (169.031/331) Eng.M266.920 (70kW)	9/04-		R		153-233	153-233K	Lucas	164,0x20	Hand Brake
A 160 (169.031/331) Eng.M266.920 (70kW)	09-		R		153-233	153-233K	Lucas	164,0x20	
A 160 CDi (169.006/306) Eng.OM640.942 (60kW)	9/04-		R		153-233	153-233K	Lucas	164,0x20	Hand Brake
A 170 (169.032/332) Eng.M266.940 (85kW)	9/04-		R		153-233	153-233K	Lucas	164,0x20	Hand Brake
A 170 NGT (245.233) Eng.M266.940 (85kW)	08-		R		153-233	153-233K	Lucas	164,0x20	
A 180 (169.032/332) Eng.M266.940 (85kW)	09-		R		153-233	153-233K	Lucas	164,0x20	
A 180 CDi (169.007/307) Eng.OM640.940 (80kW)	9/04-		R		153-233	153-233K	Lucas	164,0x20	Hand Brake
A 200 (169.033/333) Eng.M266.960 (100kW)	9/04-		R		153-233	153-233K	Lucas	164,0x20	Hand Brake
A 200 CDi (169.008/308) Eng.OM640.941 (100-103kW)	9/04-		R		153-233	153-233K	Lucas	164,0x20	Hand Brake
Classe B I (W245) 3/05-9/11									
B 150 (245.231) Eng.M266.920 (70kW)	3/05-		R		153-233	153-233K	Lucas	164,0x20	Hand Brake
B 160 (245.231) Eng.M266.920 (70kW)	09-		R		153-233	153-233K	Lucas	164,0x20	
B 170 (245.232) Eng.M266.940 (85kW)	3/05-		R		153-233	153-233K	Lucas	164,0x20	Hand Brake
B 180 (245.232) Eng.M266.940 (85kW)	09-		R		153-233	153-233K	Lucas	164,0x20	
B 180 CDi (245.207) Eng.OM640.940 (80kW)	3/05-		R		153-233	153-233K	Lucas	164,0x20	Hand Brake
B 200 CDi (245.208) Eng.OM640.941 (103kW)	3/05-		R		153-233	153-233K	Lucas	164,0x20	Hand Brake
Classe C I (W202) 3/93-5/00									
C 180 (202.018) Eng.M111.920/ 921 (89-90kW)	3/93-5/00		R		153-233	153-233K	Lucas	164,0x20	Hand Brake
C 200 (202.020) Eng.M111.941/ 945 (100kW)	1/94-5/00		R		153-233	153-233K	Lucas	164,0x20	Hand Brake
C 200 CDi (202.134) Eng.OM611.960 (75kW)	3/98-5/00		R		153-233	153-233K	Lucas	164,0x20	Hand Brake
C 200 D (202.120) Eng.OM601.913 (55kW)	3/93-5/00		R		153-233	153-233K	Lucas	164,0x20	Hand Brake
C 200 D (202.122) Eng.OM604.915 (65kW)	10/96-5/00		R		153-233	153-233K	Lucas	164,0x20	Hand Brake
C 200 K. (202.025) Eng.M111.944 (132-141kW)	10/95-5/00		R		153-233	153-233K	Lucas	164,0x20	Hand Brake
C 220 (202.022) Eng.M111.961 (110kW)	3/93-5/00		R		153-233	153-233K	Lucas	164,0x20	Hand Brake
C 220 CDi (202.133) Eng.OM611.960 (92kW)	9/97-5/00		R		153-233	153-233K	Lucas	164,0x20	Hand Brake





































		Spare Parts	F/R	L/R	CIFAM ref.	CIFAM ref. w/KIT		DIMENSIONS mm.	NOTE
C 220 D (202.121) Eng.OM604.910 (55-70kW)	8/93-5/00		R		153-233	153-233K	Lucas	164,0x20	Hand Brake
C 230 (202.023) Eng.M111.974 (110kW)	6/96-5/00		R		153-233	153-233K	Lucas	164,0x20	Hand Brake
C 230 K. (202.024) Eng.M111.975 (142kW)	10/95-5/00		R		153-233	153-233K	Lucas	164,0x20	Hand Brake
C 250 D (202.125) Eng.OM605.910 (83kW)	5/93-5/00		R		153-233	153-233K	Lucas	164,0x20	Hand Brake
C 250 TD (202.128) Eng.OM605.960 (110kW)	10/95-5/00		R		153-233	153-233K	Lucas	164,0x20	Hand Brake
C 280 (202.028) Eng.M104.941 (142kW)	5/93-5/00		R		153-233	153-233K	Lucas	164,0x20	Hand Brake
C 280 (202.029) Eng.M112.920 (145kW)	6/97-5/00		R		153-233	153-233K	Lucas	164,0x20	Hand Brake
Classe C I SW (S202) 6/96-3/01									
C 180 T (202.078) Eng.M111.920/921 (90kW)	6/96-9/00		R		153-233	153-233K	Lucas	164,0x20	Hand Brake
C 180 T (202.081) Eng.M111.952 (95kW)	9/00-3/01		R		153-233	153-233K	Lucas	164,0x20	Hand Brake
C 200 T (202.080) Eng.M111.941/945 (100kW)	6/96-9/00		R		153-233	153-233K	Lucas	164,0x20	Hand Brake
C 200 T CDi (202.194) Eng.OM611.960 (75kW)	3/98-3/01		R		153-233	153-233K	Lucas	164,0x20	Hand Brake
C 200 T K. (202.082) Eng.M111.944 (141kW)	11/96-3/01		R		153-233	153-233K	Lucas	164,0x20	Hand Brake
C 200 T K. (202.087) Eng.M111.956 (120kW)	9/00-3/01		R		153-233	153-233K	Lucas	164,0x20	Hand Brake
C 200 TD (202.180) Eng.OM604.915 (65kW)	10/96-3/01		R		153-233	153-233K	Lucas	164,0x20	Hand Brake
C 220 T CDi (202.193) Eng.OM611.960 (92kW)	9/97-3/01		R		153-233	153-233K	Lucas	164,0x20	Hand Brake
C 220 TD (202.182) Eng.OM604.910 (55-70kW)	6/96-3/01		R		153-233	153-233K	Lucas	164,0x20	Hand Brake
C 230 T (202.083) Eng.M111.974 (110kW)	6/96-3/01		R		153-233	153-233K	Lucas	164,0x20	Hand Brake
C 230 T K. (202.085) Eng.M111.975 (142kW)	6/97-9/00		R		153-233	153-233K	Lucas	164,0x20	Hand Brake
C 250 T TD (202.188) Eng.OM605.960 (110kW)	6/96-3/01		R		153-233	153-233K	Lucas	164,0x20	Hand Brake
C 280 T (202.089) Eng.M112.920 (145kW)	6/97-3/01		R		153-233	153-233K	Lucas	164,0x20	Hand Brake
Classe C II (W203) 5/00-12/06									
C 180 (203.035) Eng.M111.951 (95kW)	10/00-5/02		R		153-233	153-233K	Lucas	164,0x20	Hand Brake
C 180 K. (203.046) Eng.M271.946 (105kW)	5/02-12/06		R		153-233	153-233K	Lucas	164,0x20	Hand Brake
C 200 CDi Eng.OM646.962 (75kW)	2/01-12/06		R		153-233	153-233K	Lucas	164,0x20	Hand Brake
C 200 CDi (203.004) Eng.OM611.962 (85kW)	9/00-12/06		R		153-233	153-233K	Lucas	164,0x20	Hand Brake
C 200 CDi (203.007) Eng.OM646.962 (90kW)	4/03-12/06		R		153-233	153-233K	Lucas	164,0x20	Hand Brake
C 200 CGI K. (203.043) Eng.M271.942 (125kW)	7/03-12/06		R		153-233	153-233K	Lucas	164,0x20	Hand Brake
C 200 K. (203.042) Eng.M271.940 (120kW)	5/02-12/06		R		153-233	153-233K	Lucas	164,0x20	Hand Brake
C 200 K. (203.045) Eng.M111.955 (120kW)	5/00-5/02		R		153-233	153-233K	Lucas	164,0x20	Hand Brake
C 220 CDi (203.006) Eng.OM611.962 (105kW)	5/00-12/06		R		153-233	153-233K	Lucas	164,0x20	Hand Brake
C 220 CDi (203.008) Eng.OM646.963 (110kW)	2/04-12/06		R		153-233	153-233K	Lucas	164,0x20	Hand Brake
C 240 (203.061) Eng.M112.912 (125kW)	5/00-12/06		R		153-233	153-233K	Lucas	164,0x20	Hand Brake
C 240 4-matic (203.081) Eng.M112.916 (125kW)	7/02-12/06		R		153-233	153-233K	Lucas	164,0x20	Hand Brake





































		Spare Parts	F/R	L/R	CIFAM ref.	CIFAM ref. w/KIT		DIMENSIONS mm.	NOTE
C 270 CDi (203.016) Eng.OM612.962 (125kW)	12/00-12/06		R		153-233	153-233K	Lucas	164,0x20	Hand Brake
C 320 (203.064) Eng.M112.946 (160kW)	5/00-12/06		R		153-233	153-233K	Lucas	164,0x20	Hand Brake
C 320 4-matic (203.084) Eng.M112.953 (160kW)	7/02-12/06		R		153-233	153-233K	Lucas	164,0x20	Hand Brake
C 320 CDi (203.020) Eng.OM642.910 (165kW)	1/05-12/06		R		153-233	153-233K	Lucas	164,0x20	Hand Brake
Classe C II SportCoupe (CL203) 3/01-12/06									
C 180 (203.735) Eng.M111.951 (95kW)	3/01-5/02		R		153-233	153-233K	Lucas	164,0x20	Hand Brake
C 180 K. (203.746) Eng.M271.946 (105kW)	5/02-12/06		R		153-233	153-233K	Lucas	164,0x20	Hand Brake
C 200 CDi (203.707) Eng.OM646.962 (90kW)	7/03-12/06		R		153-233	153-233K	Lucas	164,0x20	Hand Brake
C 200 CGI K. (203.743) Eng.M271.942 (125kW)	7/03-12/06		R		153-233	153-233K	Lucas	164,0x20	Hand Brake
C 200 K. (203.742) Eng.M271.940 (120kW)	5/02-12/06		R		153-233	153-233K	Lucas	164,0x20	Hand Brake
C 200 K. (203.745) Eng.M111.955 (120kW)	3/01-5/02		R		153-233	153-233K	Lucas	164,0x20	Hand Brake
C 220 CDi (203.706) Eng.OM611.962 (105kW)	3/01-12/06		R		153-233	153-233K	Lucas	164,0x20	Hand Brake
C 220 CDi (203.708) Eng.OM646.963 (110kW)	2/04-12/06		R		153-233	153-233K	Lucas	164,0x20	Hand Brake
C 320 (203.764) Eng.M112.946 (160kW)	9/02-12/06		R		153-233	153-233K	Lucas	164,0x20	Hand Brake
Classe C II SW (S203) 3/01-12/06									
C 180 (203.235) Eng.M111.951 (95kW)	3/01-5/02		R		153-233	153-233K	Lucas	164,0x20	Hand Brake
C 180 K. (203.246) Eng.M271.946 (105kW)	5/02-12/06		R		153-233	153-233K	Lucas	164,0x20	Hand Brake
C 200 CDi Eng.OM646.962 (75kW)	3/01-12/06		R		153-233	153-233K	Lucas	164,0x20	Hand Brake
C 200 CDi (203.204) Eng.OM611.962 (85kW)	3/01-12/06		R		153-233	153-233K	Lucas	164,0x20	Hand Brake
C 200 CDi (203.207) Eng.OM646.962 (90kW)	4/03-12/06		R		153-233	153-233K	Lucas	164,0x20	Hand Brake
C 200 CGI K. (203.243) Eng.M271.942 (125kW)	7/03-12/06		R		153-233	153-233K	Lucas	164,0x20	Hand Brake
C 200 K. (203.242) Eng.M271.940 (120kW)	5/02-12/06		R		153-233	153-233K	Lucas	164,0x20	Hand Brake
C 200 K. (203.245) Eng.M111.955 (120kW)	3/01-5/02		R		153-233	153-233K	Lucas	164,0x20	Hand Brake
C 220 CDi (203.206) Eng.OM611.962 (105kW)	3/01-12/06		R		153-233	153-233K	Lucas	164,0x20	Hand Brake
C 220 CDi (203.208) Eng.OM646.963 (110kW)	2/04-12/06		R		153-233	153-233K	Lucas	164,0x20	Hand Brake
C 240 (203.261) Eng.M112.912 (125kW)	3/01-12/06		R		153-233	153-233K	Lucas	164,0x20	Hand Brake
C 240 4-matic (203.281) Eng.M112.916 (125kW)	7/02-12/06		R		153-233	153-233K	Lucas	164,0x20	Hand Brake
C 270 CDi (203.216) Eng.OM612.962 (125kW)	3/01-12/06		R		153-233	153-233K	Lucas	164,0x20	Hand Brake
C 320 (203.264) Eng.M112.946 (160kW)	3/01-12/06		R		153-233	153-233K	Lucas	164,0x20	Hand Brake
C 320 4-matic (203.284) Eng.M112.953 (160kW)	7/02-12/06		R		153-233	153-233K	Lucas	164,0x20	Hand Brake
C 320 CDi (203.220) Eng.OM642.910 (165kW)	1/06-12/06		R		153-233	153-233K	Lucas	164,0x20	Hand Brake
Classe C III (W204) 1/07-									
C 180 K. (204.046) Eng.M271.952 (115kW)	1/07-		R		153-245	153-245K		170,0x25	Hand Brake
C 200 CDi (204.007) Eng.OM646.811 (100kW)	3/07-		R		153-245	153-245K		170,0x25	Hand Brake
C 200 K. (204.041) Eng.M271.950 (135kW)	3/07-		R		153-245	153-245K		170,0x25	Hand Brake



































		Spare Parts	F/R	L/R	CIFAM ref.	CIFAM ref. w/KIT		DIMENSIONS mm.	NOTE
C 220 CDi (204.008) Eng.OM646.811 (125kW)	3/07-		R		153-245	153-245K		170,0x25	Hand Brake
C 230 (204.052) Eng.M272.921 (150kW)	1/07-		R		153-245	153-245K		170,0x25	Hand Brake
C 230 4-Matic (204.085) Eng.M272.921 (150kW)	7/07-		R		153-245	153-245K		170,0x25	Hand Brake
C 280 (204.054) Eng.M272.947 (170kW)	1/07-		R		153-245	153-245K		170,0x25	Hand Brake
C 280 4-Matic (204.081) Eng.M272.947 (170kW)	7/07-		R		153-245	153-245K		170,0x25	Hand Brake
C 350 (204.056) Eng.M272.962 (200kW)	1/07-		R		153-245	153-245K		170,0x25	Hand Brake
C 350 4-Matic (204.087) Eng.M272.962 (200kW)	7/07-		R		153-245	153-245K		170,0x25	Hand Brake
C 350 CDi (204.022) Eng.OM642.960 (165kW)	1/07-		R		153-245	153-245K		170,0x25	Hand Brake
C 350 CDi (204.025) Eng.OM642.832 (170kW)	09-		R		153-245	153-245K		170,0x25	Hand Brake
C 350 CDi 4-Matic (204.089) Eng.OM642.960 (165kW)	7/07-		R		153-245	153-245K		170,0x25	Hand Brake
C 350 CGI Eng.M272.982 (215kW)	09-		R		153-245	153-245K		170,0x25	Hand Brake
Classe C III SW (S204) 1/08-									
C 180 K Eng.M271.952 (115kW)	1/08-		R		153-245	153-245K		170,0x25	Hand Brake
C 200 CDi Eng.OM646.811 (100kW)	1/08-		R		153-245	153-245K		170,0x25	Hand Brake
C 200 K. Eng.M271.950 (135kW)	1/08-		R		153-245	153-245K		170,0x25	Hand Brake
C 220 CDi Eng.OM646.811 (125kW)	1/08-		R		153-245	153-245K		170,0x25	Hand Brake
C 230 Eng.M272.921 (150kW)	1/08-		R		153-245	153-245K		170,0x25	Hand Brake
C 280 Eng.M272.947 (170kW)	1/08-		R		153-245	153-245K		170,0x25	Hand Brake
C 350 Eng.M272.961 (200kW)	1/08-		R		153-245	153-245K		170,0x25	Hand Brake
C 350 CDi Eng.OM642.960 (165kW)	1/08-		R		153-245	153-245K		170,0x25	Hand Brake
C 350 CDi (204.225) Eng.OM642.832 (170kW)	09-		R		153-245	153-245K		170,0x25	Hand Brake
C 350 CDi 4-matic Eng.OM642.960 (165kW)	1/08-		R		153-245	153-245K		170,0x25	Hand Brake
Classe E I (W124) 6/93-6/95									
E 200 (124.019) Eng.M111.940 (100kW)	6/93-6/95		R		153-233	153-233K	Lucas	164,0x20	Hand Brake
	6/93-6/95		R		153-234	153-234K	Lucas	164,0x25	Hand Brake
E 200 D (124.120) Eng.OM601.912 (55kW)	6/93-6/95		R		153-233	153-233K	Lucas	164,0x20	Hand Brake
	6/93-6/95		R		153-234	153-234K	Lucas	164,0x25	Hand Brake
E 220 (124.022) Eng.M111.960 (110kW)	6/93-6/95		R		153-233	153-233K	Lucas	164,0x20	Hand Brake
E 250 D Eng.OM602.912 (65-69kW)	1/85-1/93		R		153-233	153-233K	Lucas	164,0x20	Hand Brake
E 250 D (124.126/.129) Eng.OM605.911 (83kW)	7/93-6/95		R		153-233	153-233K	Lucas	164,0x20	Hand Brake
E 250 TD (124.128) Eng.OM602.962 (93kW)	6/93-6/95		R		153-233	153-233K	Lucas	164,0x20	Hand Brake
E 280 (124.028) Eng.M104.942 (145kW)	6/93-6/95		R		153-233	153-233K	Lucas	164,0x20	Hand Brake
E 280 lungo (124.029) Eng.M104.942 (142kW)	6/93-6/95		R		153-233	153-233K	Lucas	164,0x20	Hand Brake
E 300 (124.030) Eng.M103.983 (132kW)	6/93-6/95		R		153-233	153-233K	Lucas	164,0x20	Hand Brake
E 300 4-matic (124.230) Eng.M103.985 (132kW)	6/93-6/95		R		153-233	153-233K	Lucas	164,0x20	Hand Brake
E 300 D (124.031) Eng.OM606.910 (100kW)	6/93-6/95		R		153-233	153-233K	Lucas	164,0x20	Hand Brake
E 300 D (124.131) Eng.OM606.910 (100kW)	7/93-6/95		R		153-233	153-233K	Lucas	164,0x20	Hand Brake
E 300 TD (124.133) Eng.OM603.960 (108kW)	6/93-6/95		R		153-233	153-233K	Lucas	164,0x20	Hand Brake
E 300 TD 4-matic (124.333) Eng.OM603.963 (108kW)	6/93-6/95		R		153-233	153-233K	Lucas	164,0x20	Hand Brake
E 320 (124.032) Eng.M104.992 (162kW)	6/93-6/95		R		153-233	153-233K	Lucas	164,0x20	Hand Brake
E 420 (124.034) Eng.M119.975 (205kW)	6/93-6/95		R		153-234	153-234K	Lucas	164,0x25	Hand Brake







































		Spare Parts	F/R	L/R	CIFAM ref.	CIFAM ref. w/KIT		DIMENSIONS mm.	NOTE
E 500 (124.036) Eng.M119.974 (235kW)	6/93-6/95		R		153-233	153-233K	Lucas	164,0x20	Hand Brake
Classe E I Cabrio (A124) 6/93-3/98									
E 200 (124.060) Eng.M111.940 (100kW)	6/93-3/98		R		153-233	153-233K	Lucas	164,0x20	Hand Brake
	6/93-3/98		R		153-234	153-234K	Lucas	164,0x25	Hand Brake
E 220 (124.062) Eng.M111.960 (110kW)	6/93-3/98		R		153-233	153-233K	Lucas	164,0x20	Hand Brake
E 300 (124.061)	6/93-3/98		R		153-233	153-233K	Lucas	164,0x20	Hand Brake
E 320 (124.066) Eng.M104.992/ 995 (162kW)	6/93-3/98		R		153-233	153-233K	Lucas	164,0x20	Hand Brake
Classe E I Coupe (C124) 6/93-6/97									
E 200 (124.040) Eng.M111.940 (100kW)	6/93-6/97		R		153-233	153-233K	Lucas	164,0x20	Hand Brake
	6/93-6/97		R		153-234	153-234K	Lucas	164,0x25	Hand Brake
E 220 (124.042) Eng.M111.960 (110kW)	6/93-6/97		R		153-233	153-233K	Lucas	164,0x20	Hand Brake
E 320 (124.052) Eng.M104.992 (162kW)	6/93-6/97		R		153-233	153-233K	Lucas	164,0x20	Hand Brake
Classe E I SW (S124) 6/93-6/96									
E 200 (124.079) Eng.M111.940 (100kW)	6/93-6/96		R		153-233	153-233K	Lucas	164,0x20	Hand Brake
	6/93-6/96		R		153-234	153-234K	Lucas	164,0x25	Hand Brake
E 220 (124.082) Eng.M111.960 (110kW)	6/93-6/96		R		153-233	153-233K	Lucas	164,0x20	Hand Brake
E 250 D (124.186) Eng.OM605.911 (83kW)	6/93-6/96		R		153-233	153-233K	Lucas	164,0x20	Hand Brake
E 250 TD Eng.OM602.962 (93kW)	6/93-6/96		R		153-233	153-233K	Lucas	164,0x20	Hand Brake
E 280 (124.088) Eng.M104.942 (142-145kW)	6/93-6/96		R		153-233	153-233K	Lucas	164,0x20	Hand Brake
E 300 4-matic (124.290) Eng.M103.985 (132kW)	6/93-6/96		R		153-233	153-233K	Lucas	164,0x20	Hand Brake
E 300 D (124.191) Eng.OM606.910 (100kW)	6/93-6/96		R		153-233	153-233K	Lucas	164,0x20	Hand Brake
E 300 TD (124.193) Eng.OM603.960 (108kW)	6/93-6/96		R		153-233	153-233K	Lucas	164,0x20	Hand Brake
E 300 TD 4-matic (124.393) Eng.OM603.963 (108kW)	6/93-6/96		R		153-233	153-233K	Lucas	164,0x20	Hand Brake
E 300 TE-24 AMG (124.091) Eng.M104.980 (162kW)	6/93-6/96		R		153-233	153-233K	Lucas	164,0x20	Hand Brake
E 320 (124.092) Eng.M104.992 (162kW)	6/93-6/96		R		153-233	153-233K	Lucas	164,0x20	Hand Brake
Classe E II (W210) 6/95-3/02									
E 200 (210.035) Eng.M111.942 (100kW)	6/95-8/00		R		153-233	153-233K	Lucas	164,0x20	Hand Brake
E 200 CDi (210.007) Eng.OM611.961 (75kW)	6/98-7/99		R		153-233	153-233K	Lucas	164,0x20	Hand Brake
E 200 CDi (210.007) Eng.OM611.961 (85kW)	7/99-3/02		R		153-233	153-233K	Lucas	164,0x20	Hand Brake
E 200 D (210.003) Eng.OM604.917 (65kW)	1/96-3/02		R		153-233	153-233K	Lucas	164,0x20	Hand Brake
E 200 K. (210.045) Eng.M111.947 (137kW)	6/97-3/02		R		153-233	153-233K	Lucas	164,0x20	Hand Brake
E 200 K. (210.048) Eng.M111.957 (120kW)	8/00-3/02		R		153-233	153-233K	Lucas	164,0x20	Hand Brake
E 220 CDi (210.006) Eng.OM611.961 (105kW)	7/99-3/02		R		153-233	153-233K	Lucas	164,0x20	Hand Brake
E 220 CDi (210.006) Eng.OM611.961 (92kW)	6/98-7/99		R		153-233	153-233K	Lucas	164,0x20	Hand Brake
E 220 D (210.004) Eng.OM604.912 (55-70kW)	6/95-3/02		R		153-233	153-233K	Lucas	164,0x20	Hand Brake
E 230 (210.037) Eng.M111.970 (110kW)	6/95-6/97		R		153-233	153-233K	Lucas	164,0x20	Hand Brake
	6/95-6/97		R		153-234	153-234K	Lucas	164,0x25	Hand Brake
E 240 (210.061) Eng.M112.911 (125kW)	6/97-8/00		R		153-233	153-233K	Lucas	164,0x20	Hand Brake
E 250 D (210.010) Eng.OM605.912 (83kW)	6/95-7/99		R		153-233	153-233K	Lucas	164,0x20	Hand Brake
E 250 TD (210.015) Eng.OM605.962 (110kW)	6/97-7/99		R		153-233	153-233K	Lucas	164,0x20	Hand Brake





































		Spare Parts	F/R	L/R	CIFAM ref.	CIFAM ref. w/KIT		DIMENSIONS mm.	NOTE
E 270 CDi (210.016) Eng.OM612.961 (125kW)	7/99-3/02		R		153-233	153-233K	Lucas	164,0x20	Hand Brake
E 280 (210.053) Eng.M104.945 (142kW)	1/96-6/97		R		153-233	153-233K	Lucas	164,0x20	Hand Brake
E 280 (210.063) Eng.M112.921 (150kW)	12/96-3/02		R		153-233	153-233K	Lucas	164,0x20	Hand Brake
E 280 4-matic (210.081) Eng.M112.921 (150kW)	12/96-3/02		R		153-233	153-233K	Lucas	164,0x20	Hand Brake
E 290 TD (210.017) Eng.OM602.982 (95kW)	3/96-7/99		R		153-233	153-233K	Lucas	164,0x20	Hand Brake
	3/96-7/99		R		153-234	153-234K	Lucas	164,0x25	Hand Brake
E 300 D (210.020) Eng.OM606.912 (100kW)	6/95-6/97		R		153-233	153-233K	Lucas	164,0x20	Hand Brake
E 300 TD (210.025) Eng.OM606.962 (130kW)	12/96-7/99		R		153-233	153-233K	Lucas	164,0x20	Hand Brake
E 320 (210.055) Eng.M104.992/ 995 (162kW)	6/95-6/97		R		153-233	153-233K	Lucas	164,0x20	Hand Brake
E 320 (210.065) Eng.M112.941 (165kW)	6/97-3/02		R		153-233	153-233K	Lucas	164,0x20	Hand Brake
E 320 4-matic (210.082) Eng.M112.941 (165kW)	6/97-3/02		R		153-233	153-233K	Lucas	164,0x20	Hand Brake
E 320 CDi (210.026) Eng.OM613.961 (145kW)	7/99-3/02		R		153-233	153-233K	Lucas	164,0x20	Hand Brake
E 420 (210.072) Eng.M119.985 (205kW)	1/96-6/97		R		153-233	153-233K	Lucas	164,0x20	Hand Brake
E 430 (210.070) Eng.M113.940 (205kW)	6/97-3/02		R		153-233	153-233K	Lucas	164,0x20	Hand Brake
E 430 4-matic (210.083) Eng.M113.940 (205kW)	5/99-3/02		R		153-233	153-233K	Lucas	164,0x20	Hand Brake
E 50 AMG (210.072) Eng.M119.985 (255kW)	2/96-8/97		R		153-233	153-233K	Lucas	164,0x20	Hand Brake
E 55 AMG (210.074) Eng.M113.980 (260kW)	8/97-3/02		R		153-233	153-233K	Lucas	164,0x20	Hand Brake
E 55 AMG 4-matic (210.083) Eng.M113.980 (260kW)	3/01-3/02		R		153-233	153-233K	Lucas	164,0x20	Hand Brake
Classe E II SW (S210) 6/96-3/03									
E 230 (210.237) Eng.M111.970 (110kW)	6/96-6/97		R		153-234	153-234K	Lucas	164,0x25	Hand Brake
E 290 TD (210.217) Eng.OM602.982 (95kW)	6/96-7/99		R		153-234	153-234K	Lucas	164,0x25	Hand Brake
Classe E III (W211) 3/02-2/09									
E 200 CDi (211.004) Eng.OM646.951 (75kW)	7/02-2/09		R		153-243	153-243K		180,0x25	Hand Brake
E 200 CDi (211.004) Eng.OM646.951 (90kW)	7/02-2/09		R		153-243	153-243K		180,0x25	Hand Brake
E 200 CGI Eng.M271.946 (125kW)	11/02-2/09		R		153-243	153-243K		180,0x25	Hand Brake
E 200 K. (211.042) Eng.M271.941 (120kW)	11/02-2/09		R		153-243	153-243K		180,0x25	Hand Brake
E 200 NGT Eng.M271.941 (120kW)	3/04-2/09		R		153-243	153-243K		180,0x25	Hand Brake
E 220 CDi (211.006) Eng.OM646.961 (100kW)	02-09		R		153-243	153-243K		180,0x25	Hand Brake
E 220 CDi (211.006) Eng.OM646.961 (110kW)	3/02-2/09		R		153-243	153-243K		180,0x25	Hand Brake
E 240 (211.061) Eng.M112.913 (130kW)	3/02-2/09		R		153-243	153-243K		180,0x25	Hand Brake
E 240 4-matic (211.080) Eng.M112.917 (130kW)	3/03-2/09		R		153-243	153-243K		180,0x25	Hand Brake
E 270 CDi (211.016) Eng.OM647.961 (130kW)	3/02-2/09		R		153-243	153-243K		180,0x25	Hand Brake
E 280 CDi Eng.OM642.920 (140kW)	3/05-2/09		R		153-243	153-243K		180,0x25	Hand Brake
E 280 CDi (211.023) Eng.OM648.961 (130kW)	5/04-2/09		R		153-243	153-243K		180,0x25	Hand Brake
E 280 CDi 4-matic Eng.OM642.921 (140kW)	3/05-2/09		R		153-243	153-243K		180,0x25	Hand Brake
E 320 (211.065) Eng.M112.949 (165kW)	3/02-2/09		R		153-243	153-243K		180,0x25	Hand Brake





































		Spare Parts	F/R	L/R	CIFAM ref.	CIFAM ref. w/KIT		DIMENSIONS mm.	NOTE
E 320 4-matic (211.082) Eng.M112.954 (165kW)	3/03-2/09		R		153-243	153-243K		180,0x25	Hand Brake
E 320 CDi (211.026) Eng.OM648.961 (150kW)	11/02-2/09		R		153-243	153-243K		180,0x25	Hand Brake
E 320 CDi, 4-matic Eng.OM642.920/ 910 (165kW)	3/05-2/09		R		153-243	153-243K		180,0x25	Hand Brake
E 400 CDi (211.028) Eng.OM628.961 (191kW)	2/03-2/09		R		153-243	153-243K		180,0x25	Hand Brake
E 500 (211.070) Eng.M113.967 (225kW)	3/02-2/09		R		153-243	153-243K		180,0x25	Hand Brake
E 500 4-matic (211.083) Eng.M113.969 (225kW)	10/03-2/09		R		153-243	153-243K		180,0x25	Hand Brake
E 55 AMG K. (211.076) Eng.M113.990 (350kW)	10/02-2/09		R		153-243	153-243K		180,0x25	Hand Brake
Classe E III SW (S211) 3/03-2/09									
E 200 K. (211.242) Eng.M271.941 (120kW)	3/03-2/09		R		153-233	153-233K	Lucas	164,0x20	Hand Brake
E 220 CDi (211.206) Eng.OM646.961 (100kW)	3/03-		R		153-243	153-243K		180,0x25	Hand Brake
	3/03-		R		153-233	153-233K	Lucas	164,0x20	Hand Brake
E 220 T CDi (211.206) Eng.OM646.961 (110kW)	3/03-2/09		R		153-243	153-243K		180,0x25	Hand Brake
	3/03-2/09		R		153-233	153-233K	Lucas	164,0x20	Hand Brake
E 240 (211.261) Eng.M112.913 (130kW)	3/03-2/09		R		153-243	153-243K		180,0x25	Hand Brake
	3/03-2/09		R		153-233	153-233K	Lucas	164,0x20	Hand Brake
E 240 4-matic (211.280) Eng.M112.917 (130kW)	7/03-2/09		R		153-243	153-243K		180,0x25	Hand Brake
	7/03-2/09		R		153-233	153-233K	Lucas	164,0x20	Hand Brake
E 270 CDi (211.216) Eng.OM647.961 (130kW)	3/03-2/09		R		153-243	153-243K		180,0x25	Hand Brake
	3/03-2/09		R		153-233	153-233K	Lucas	164,0x20	Hand Brake
E 280 Eng.M272.943 (170kW)	3/05-2/09		R		153-233	153-233K	Lucas	164,0x20	Hand Brake
E 280 CDi Eng.OM642.920 (140kW)	3/05-2/09		R		153-233	153-233K	Lucas	164,0x20	Hand Brake
E 280 CDi Eng.OM648.961 (130kW)	5/04-2/09		R		153-233	153-233K	Lucas	164,0x20	Hand Brake
E 280 CDi 4-matic Eng.OM642.921 (140kW)	3/05-2/09		R		153-233	153-233K	Lucas	164,0x20	Hand Brake
E 280 T 4-matic Eng.M272.943 (170kW)	3/05-2/09		R		153-233	153-233K	Lucas	164,0x20	Hand Brake
E 320 (211.265) Eng.M112.949 (165kW)	3/03-2/09		R		153-243	153-243K		180,0x25	Hand Brake
	3/03-2/09		R		153-233	153-233K	Lucas	164,0x20	Hand Brake
E 320 4-matic (211.282) Eng.M112.954 (165kW)	7/03-2/09		R		153-243	153-243K		180,0x25	Hand Brake
	7/03-2/09		R		153-233	153-233K	Lucas	164,0x20	Hand Brake
E 320 CDi Eng.OM642.920 (165kW)	3/05-2/09		R		153-243	153-243K		180,0x25	Hand Brake
	3/05-2/09		R		153-233	153-233K	Lucas	164,0x20	Hand Brake
E 320 CDi (211.226) Eng.OM648.961 (150kW)	3/03-2/09		R		153-243	153-243K		180,0x25	Hand Brake
	3/03-2/09		R		153-233	153-233K	Lucas	164,0x20	Hand Brake
E 320 T CDi 4-matic Eng.OM642.920 (165kW)	3/05-2/09		R		153-243	153-243K		180,0x25	Hand Brake
	3/05-2/09		R		153-233	153-233K	Lucas	164,0x20	Hand Brake
E 500 (211.270) Eng.M113.967 (225kW)	10/03-2/09		R		153-243	153-243K		180,0x25	Hand Brake
E 500 4-matic (211.283) Eng.M113.969 (225kW)	10/03-2/09		R		153-243	153-243K		180,0x25	Hand Brake
E 500 T. 4-matic (211.290) Eng.M273.962 (285kW)	06-		R		153-243	153-243K		180,0x25	Hand Brake
Classe G (W460) 3/79-7/93									
230 (460,2) Eng.M102.979/ 987 (90kW)	87-92		R		700-221			Ø 260,0	
230 (460,2) Eng.M102.981/ 987 (92kW)	82-92		R		700-221			Ø 260,0	
230 (460,2) Eng.M115.973 (66kW)	79-93		R		700-221			Ø 260,0	
230 (460,2) Eng.M115.973 (75kW)	80-87		R		700-221			Ø 260,0	
240 (460,3) Eng.OM616.936 (53kW)	79-87		R		700-221			Ø 260,0	
250 (460,3) Eng.OM602.930 (62-68kW)	87-92		R		700-221			Ø 260,0	
280 (460,2) Eng.M110.994 (110-115kW)	79-89		R		700-221			Ø 260,0	
300 (460,3) Eng.OM603.912 (83kW)	79-93		R		700-221			Ø 260,0	







































		Spare Parts	F/R	L/R	CIFAM ref.	CIFAM ref. w/KIT		DIMENSIONS mm.	NOTE
300 (460.3) Eng.OM617.931 (65kW)	79-91		R		700-221			Ø 260,0	
Classe G (W461) 2/90-									
230 (461) Eng.M102.996 (92kW)	93-		R		700-221			Ø 260,0	
230 (461.238/.239) Eng.M102.979 (90kW)	93-		R		700-221			Ø 260,0	
250 (461) Eng.OM602.939 (68kW)	90-		R		700-221			Ø 260,0	
290 D (461.337/.338) Eng.OM602.942 (70kW)	93-		R		700-221			Ø 260,0	
290 TD (461.335/.336) Eng.OM602.983 (88kW)	97-		R		700-221			Ø 260,0	
Classe G (W463) 9/89-									
270 CDi (463.322/.323) Eng.OM612.966 (115kW)	10/01-		R		153-239	153-239K	Bosch	160,0x40	Hand Brake
300 (463.327/.328) Eng.OM603.931 (83kW)	9/89-		R		153-239	153-239K	Bosch	160,0x40	Hand Brake
300 TD (463.330/.331) Eng.OM606.964 (130kW)	8/96-		R		153-239	153-239K	Bosch	160,0x40	Hand Brake
320 (463.230/.231) Eng.M104.996 (155kW)	9/94-12/97		R		153-239	153-239K	Bosch	160,0x40	Hand Brake
320 (463.232/.233) Eng.M112.945 (158kW)	7/97-		R		153-239	153-239K	Bosch	160,0x40	Hand Brake
500 (463.247/.248/.249) Eng.M113.962 (218kW)	4/98-		R		153-239	153-239K	Bosch	160,0x40	Hand Brake
Classe G Cabrio (W463) 9/89-									
320 (463.208) Eng.M104.996 (155kW)	9/94-11/97		R		153-239	153-239K	Bosch	160,0x40	Hand Brake
320 (463.209) Eng.M112.945 (158kW)	11/97-		R		153-239	153-239K	Bosch	160,0x40	Hand Brake
500 (463) Eng.M113.962 (218kW)	4/98-		R		153-239	153-239K	Bosch	160,0x40	Hand Brake
Classe GL (X164) 9/06-									
GL 320 CDi Eng.OM642.940 (165kW)	9/06-		R		153-244	153-244K		210,0x31	Hand Brake
GL 420 CDi Eng.OM629.912 (225kW)	9/06-		R		153-244	153-244K		210,0x31	Hand Brake
GL 450 Eng.M273.923 (250kW)	9/06-		R		153-244	153-244K		210,0x31	Hand Brake
GL 500, 4matic Eng.M273.963 (285kW)	9/06-		R		153-244	153-244K		210,0x31	Hand Brake
Classe GLK (X204) 9/08-									
220 CDi Eng.OM651.916 (125kW)	9/08-		R		153-250	153-250K		180,0x25	Hand Brake
280 4Matic Eng.M272.947 (170kW)	9/08-		R		153-250	153-250K		180,0x25	Hand Brake
300 4Matic Eng.M272.948 (170kW)	09-		R		153-250	153-250K		180,0x25	Hand Brake
320 CDi Eng.OM642.960 (165kW)	9/08-		R		153-250	153-250K		180,0x25	Hand Brake
350 CDi Eng.OM642.832 (165kW)	09-		R		153-250	153-250K		180,0x25	Hand Brake
350, 4Matic Eng.M272.962 (200kW)	9/08-		R		153-250	153-250K		180,0x25	Hand Brake
Classe M I (W163) 2/98-6/05									
ML 230 (163.136) Eng.M111.977 (110kW)	2/98-6/05		R		153-242	153-242K		183,0x31	Hand Brake
ML 270 CDi (163.113) Eng.OM612.963 (120kW)	12/99-6/05		R		153-242	153-242K		183,0x31	Hand Brake
ML 320 (163.154) Eng.M112.942 (160kW)	2/98-8/02		R		153-242	153-242K		183,0x31	Hand Brake
ML 350 Eng.M112.970 (173kW)	2/03-6/05		R		153-242	153-242K		183,0x31	Hand Brake
ML 350 (163.157) Eng.M112.970 (180kW)	8/02-6/05		R		153-242	153-242K		183,0x31	Hand Brake
ML 400 CDi (163.128) Eng.OM628.963 (184kW)	9/01-6/05		R		153-242	153-242K		183,0x31	Hand Brake
ML 430 (163.172) Eng.M113.942 (200kW)	2/98-6/05		R		153-242	153-242K		183,0x31	Hand Brake
ML 500 (163.175) Eng.M113.964/ 965 (215kW)	9/01-6/05		R		153-242	153-242K		183,0x31	Hand Brake
Classe M II (W164) 7/05-									
ML 280 CDi (164.120) Eng.OM642.940 (140kW)	7/05-		R		153-244	153-244K		210,0x31	Hand Brake



























		Spare Parts	F/R	L/R	CIFAM ref.	CIFAM ref. w/KIT		DIMENSIONS mm.	NOTE
ML 300 CDi Eng.OM642.940 (140kW)	09-		R		153-244	153-244K		210,0x31	
ML 320 CDi (164.122) Eng.OM642.940 (165kW)	7/05-		R		153-244	153-244K		210,0x31	Hand Brake
ML 350 (164.186) Eng.M272.962 (200kW)	7/05-		R		153-244	153-244K		210,0x31	Hand Brake
ML 420 CDi Eng.OM629.912 (225kW)	7/06-		R		153-244	153-244K		210,0x31	Hand Brake
ML 500 (164.175) Eng.M113.964 (225kW)	7/05-		R		153-244	153-244K		210,0x31	Hand Brake
ML 63 AMG Eng.M156.980 (375kW)	1/06-		R		153-244	153-244K		210,0x31	Hand Brake
Classe R (W251) 1/06-									
R 280 CDi (251.026, 251.126) Eng.OM642.950 (140kW)	9/06-		R		153-244	153-244K		210,0x31	Hand Brake
R 280 CDi 4-matic (251.020) Eng.OM642.940 (140kW)	5/06-		R		153-244	153-244K		210,0x31	Hand Brake
R 280, 4-matic Eng.M272.945 (170kW)	9/07-		R		153-244	153-244K		210,0x31	Hand Brake
R 320 CDi Eng.OM642.940 (165kW)	1/06-		R		153-244	153-244K		210,0x31	Hand Brake
R 350 (251.056, 251.156) Eng.M272.967 (200kW)	1/06-		R		153-244	153-244K		210,0x31	Hand Brake
R 500 Eng.M113.971 (225kW)	1/06-		R		153-244	153-244K		210,0x31	Hand Brake
R 500 Eng.M273.963 (285kW)	9/07-		R		153-244	153-244K		210,0x31	Hand Brake
Classe S I (W108,W109) 1/66-8/72									
300 SEL (109.016) Eng.M130.981 (118kW)	1/68-8/72		R		153-011	153-011K	Ate	160,0x25	Hand Brake
Classe S II (W116) 8/72-7/80									
4.5 (143kW)	8/72-7/75		R		153-011	153-011K	Ate	160,0x25	Hand Brake
450 SE,SEL (116.032) Eng.M117.983/ 986 (165kW)	1/73-4/80		R		153-011	153-011K	Ate	160,0x25	Hand Brake
450 SE,SEL (116.033) Eng.M117.985/ 986 (160kW)	12/75-4/80		R		153-011	153-011K	Ate	160,0x25	Hand Brake
450 SEL 6.9 (116.036) Eng.M100.985 (210kW)	7/75-3/80		R		153-011	153-011K	Ate	160,0x25	Hand Brake
Classe S IV (W140) 2/91-10/98									
S 280 (140.028) Eng.M104.944 (142-145kW)	2/93-10/98		R		153-234	153-234K	Lucas	164,0x25	Hand Brake
S 300 SE,SEL Eng.M104.944 (145kW)	3/91-10/98		R		153-234	153-234K	Lucas	164,0x25	Hand Brake
S 300 SE,SEL (140.033) Eng.M104.994 (170kW)	3/91-10/98		R		153-234	153-234K	Lucas	164,0x25	Hand Brake
S 300 TD (140.135) Eng.OM606.961 (130kW)	5/96-10/98		R		153-234	153-234K	Lucas	164,0x25	Hand Brake
S 320 SE,SEL (140.032) Eng.M104.990 (170kW)	3/91-10/98		R		153-234	153-234K	Lucas	164,0x25	Hand Brake
S 400/420 (140.043) Eng.M119.971 (210kW)	2/91-10/98		R		153-234	153-234K	Lucas	164,0x25	
S 420 (140.042) Eng.M119.971 (205kW)	2/91-10/98		R		153-234	153-234K	Lucas	164,0x25	Hand Brake
S 500 (140.050/.051) Eng.M119.970 (235-240kW)	2/91-10/98		R		153-234	153-234K	Lucas	164,0x25	Hand Brake
S 600 (140.056/.057) Eng.M120.980/ 982 (290-300kW)	2/91-10/98		R		153-234	153-234K	Lucas	164,0x25	Hand Brake
Classe S IV Coupe (C140) 9/92-2/99									
SEC/CL 420 (140.063) Eng.M119.971 (205kW)	10/94-2/99		R		153-234	153-234K	Lucas	164,0x25	Hand Brake
SEC/CL 500 (140.070) Eng.M119.970 (235kW)	10/92-2/99		R		153-234	153-234K	Lucas	164,0x25	Hand Brake
SEC/CL 600 (140.076) Eng.M120.980 (290kW)	9/92-2/99		R		153-234	153-234K	Lucas	164,0x25	Hand Brake
Classe S V (W220) 10/98-9/05									
S 280 (220.063/.163) Eng.M112.922 (150kW)	10/98-9/05		R		153-241	153-241K		180,0x25	Hand Brake
S 320 (220.065/.165) Eng.M112.944 (165kW)	10/98-9/05		R		153-241	153-241K		180,0x25	Hand Brake

		Spare Parts	F/R	L/R	CIFAM ref.	CIFAM ref. w/KIT		DIMENSIONS mm.	NOTE
S 320 CDi (220.025/.125) Eng.OM648.960 (150kW)	9/02-9/05		R		153-241	153-241K		180,0x25	Hand Brake
S 320 CDi (220.026/.126) Eng.OM613.960 (145kW)	8/99-9/02		R		153-241	153-241K		180,0x25	Hand Brake
S 350 (220.067/.167) Eng.M112.972 (180kW)	9/02-9/05		R		153-241	153-241K		180,0x25	Hand Brake
S 350 4-matic (220.087/.187) Eng.M112.975 (180kW)	6/03-9/05		R		153-241	153-241K		180,0x25	Hand Brake
S 400 CDi Eng.OM628.960 (191kW)	6/03-9/05		R		153-241	153-241K		180,0x25	Hand Brake
S 400 CDi (220.028/.128) Eng.OM628.960 (184kW)	6/00-9/05		R		153-241	153-241K		180,0x25	Hand Brake
S 430 (220.070/.170) Eng.M113.941 (205kW)	10/98-9/05		R		153-241	153-241K		180,0x25	Hand Brake
S 430 4-matic (220.083/.183) Eng.M113.948 (205kW)	9/02-9/05		R		153-241	153-241K		180,0x25	Hand Brake
S 500 (220.075/.175/.875) Eng.M113.960 (225kW)	10/98-9/05		R		153-241	153-241K		180,0x25	Hand Brake
S 500 4-matic (220.084/.184) Eng.M113.966 (225kW)	9/02-9/05		R		153-241	153-241K		180,0x25	Hand Brake
S 55 AMG (220.073/.173) Eng.M113.986 (265kW)	4/99-9/05		R		153-241	153-241K		180,0x25	Hand Brake
S 55 AMG K. (220.074/.174) Eng.M113.991 (368kW)	6/02-9/05		R		153-241	153-241K		180,0x25	Hand Brake
S 600 (220.176) Eng.M275.950 (368kW)	9/02-9/05		R		153-241	153-241K		180,0x25	Hand Brake
S 600 (220.878/.178) Eng.M137.970 (270kW)	1/00-9/05		R		153-241	153-241K		180,0x25	Hand Brake
Classe S V Coupe (C215) 3/99-9/05									
CL 500 (215.375) Eng.M113.960 (225kW)	3/99-9/05		R		153-241	153-241K		180,0x25	Hand Brake
CL 55 AMG (215.373) Eng.M113.986 (265kW)	10/99-9/05		R		153-241	153-241K		180,0x25	Hand Brake
CL 55 AMG K. (215.374) Eng.M113.991 (368kW)	6/02-9/05		R		153-241	153-241K		180,0x25	Hand Brake
CL 600 (215.376) Eng.M275.950 (368kW)	9/02-9/05		R		153-241	153-241K		180,0x25	Hand Brake
CL 600 (215.378) Eng.M137.970 (270kW)	3/99-9/05		R		153-241	153-241K		180,0x25	Hand Brake
CL 65 AMG (215.379) Eng.M275.980 (450kW)	9/03-9/05		R		153-241	153-241K		180,0x25	Hand Brake
Classe S VI (W221) 10/05-									
S 250 CDi Eng.OM651.961 (150kW)	11-		R		153-507	153-507K		186x36	
S 320 CDi (221.022) Eng.OM642.930 (173kW)	12/06-		R		153-247	153-247K		180,0x25	Hand Brake
S 350 Eng.M272.965 (200kW)	10/05-		R		153-247	153-247K		180,0x25	Hand Brake
	11-		R		153-507	153-507K		186x36	
S 350 CDI (173kW)	1/11-		R		153-507	153-507K		186x36	
S 350 D (190kW)	1/11-		R		153-507	153-507K		186x36	
S 350, 4-matic Eng.M276.950 (225kW)	11-		R		153-507	153-507K		186x36	
S 350, 4-matic Eng.OM642.868 (190kW)	11-		R		153-507	153-507K		186x36	
S 400 Eng.M272.974 (205-220kW)	09-		R		153-507	153-507K		186x36	
S 420 CDi Eng.OM629.911 (235kW)	12/06-		R		153-247	153-247K		180,0x25	Hand Brake
S 450 Eng.M273.923 (250kW)	12/06-		R		153-247	153-247K		180,0x25	Hand Brake
S 450 4-matic Eng.M273.923 (250kW)	12/05-		R		153-247	153-247K		180,0x25	Hand Brake
S 500 (221.071, 221.171) Eng.M273.961 (285kW)	10/05-		R		153-247	153-247K		180,0x25	Hand Brake
	11-		R		153-507	153-507K		186x36	
S 500 4-matic Eng.M273.961 (285kW)	10/05-		R		153-247	153-247K		180,0x25	Hand Brake
	11-		R		153-507	153-507K		186x36	
S 500, 4-matic Eng.M278.932 (320kW)	11-		R		153-507	153-507K		186x36	
S 600 (221.176) Eng.M275.953 (380kW)	12/06-		R		153-247	153-247K		180,0x25	Hand Brake
S 63 AMG Eng.M156.984 (386kW)	1/07-		R		153-247	153-247K		180,0x25	Hand Brake
	11-		R		153-507	153-507K		186x36	



















		Spare Parts	F/R	L/R	CIFAM ref.	CIFAM ref. w/KIT		DIMENSIONS mm.	NOTE
S 63 AMG Eng.M157.980 (400kW)	11-		R		153-507	153-507K		186x36	
S 63 AMG (221.074, 221.174) Eng.M157.980 (420kW)	12-		R		153-507	153-507K		186x36	
S 65 AMG Eng.M275.982 (450kW)	11-		R		153-507	153-507K		186x36	
	6/09-		R		153-247	153-247K		180,0x25	Hand Brake
S 65 AMG Eng.M275.982 (463kW)	11-		R		153-507	153-507K		186x36	
Classe S VI Coupe (C216) 5/06-									
CL 500 Eng.M273.961 (285kW)	6/06-		R		153-247	153-247K		180,0x25	Hand Brake
CL 500 4-Matic Eng.M273.968 (285kW)	2/08-		R		153-247	153-247K		180,0x25	Hand Brake
CL 600 Eng.M275.953 (380kW)	5/06-		R		153-247	153-247K		180,0x25	Hand Brake
S 63 AMG Eng.M156.984 (386kW)	10/06-		R		153-247	153-247K		180,0x25	Hand Brake
S 65 AMG Eng.M275.982 (450kW)	10/06-		R		153-247	153-247K		180,0x25	Hand Brake
Classe V (638/2) 9/96-									
200 (638.214) Eng.M111.948 (95kW)	2/97-		R		153-236	153-236K	Bosch	180,0x20	Hand Brake
200 CDi (638.294) Eng.OM611.980 (75kW)	3/99-		R		153-236	153-236K	Bosch	180,0x20	Hand Brake
220 CDi (638.294) Eng.OM611.980 (90kW)	3/99-		R		153-236	153-236K	Bosch	180,0x20	Hand Brake
230 (638.234) Eng.M111.978 (105kW)	10/96-		R		153-236	153-236K	Bosch	180,0x20	Hand Brake
230 TD (638.274) Eng.OM601.970 (72kW)	9/96-		R		153-236	153-236K	Bosch	180,0x20	Hand Brake
280 (638.244) Eng.M104.900 (128kW)	8/97-		R		153-236	153-236K	Bosch	180,0x20	Hand Brake
CLK I (C208) 6/97-6/02									
200 (208.335) Eng.M111.941/ 945 (100kW)	6/97-6/02		R		153-233	153-233K	Lucas	164,0x20	Hand Brake
200 K. (208.344) Eng.M111.956 (120kW)	6/00-6/02		R		153-233	153-233K	Lucas	164,0x20	Hand Brake
200 K. (208.345) Eng.M111.944 (132-141kW)	6/97-6/00		R		153-233	153-233K	Lucas	164,0x20	Hand Brake
230 K. (208.347) Eng.M111.973/ 975 (142kW)	6/97-6/00		R		153-233	153-233K	Lucas	164,0x20	Hand Brake
230 K. (208.348) Eng.M111.982 (145kW)	6/00-6/02		R		153-233	153-233K	Lucas	164,0x20	Hand Brake
320 (208.365) Eng.M112.940 (160kW)	6/97-6/02		R		153-233	153-233K	Lucas	164,0x20	Hand Brake
430 (208.370) Eng.M113.943 (205kW)	7/98-6/02		R		153-233	153-233K	Lucas	164,0x20	Hand Brake
CLK I Cabrio (A208) 3/98-5/02									
200 (208.435) Eng.M111.941/ 945 (100kW)	3/98-5/02		R		153-233	153-233K	Lucas	164,0x20	Hand Brake
200 K. (208.444) Eng.M111.956 (120kW)	6/00-5/02		R		153-233	153-233K	Lucas	164,0x20	Hand Brake
200 K. (208.445) Eng.M111.944 (132-141kW)	3/98-6/00		R		153-233	153-233K	Lucas	164,0x20	Hand Brake
230 K. (208.447) Eng.M111.973/ 975 (142kW)	3/98-6/00		R		153-233	153-233K	Lucas	164,0x20	Hand Brake
230 K. (208.448) Eng.M111.982 (145kW)	6/00-5/02		R		153-233	153-233K	Lucas	164,0x20	Hand Brake
320 (208.465) Eng.M112.940 (160kW)	3/98-5/02		R		153-233	153-233K	Lucas	164,0x20	Hand Brake
430 (208.470) Eng.M113.943 (205kW)	9/98-5/02		R		153-233	153-233K	Lucas	164,0x20	Hand Brake
CLK II (C209) 6/02-									
200 CGI K. (209.343) Eng.M271.942 (125kW)	7/03-		R		153-233	153-233K	Lucas	164,0x20	Hand Brake
200 K. (209.341) Eng.M271.940 (135kW)	1/07-		R		153-233	153-233K	Lucas	164,0x20	Hand Brake
200 K. (209.342) Eng.M271.940 (120kW)	9/02-		R		153-233	153-233K	Lucas	164,0x20	Hand Brake
220 CDi (209.308) Eng.OM646.963 (110kW)	1/05-		R		153-233	153-233K	Lucas	164,0x20	Hand Brake

		Spare Parts	F/R	L/R	CIFAM ref.	CIFAM ref. w/KIT		DIMENSIONS mm.	NOTE
240 (209.361) Eng.M112.912 (125kW)	6/02-		R		153-233	153-233K	Lucas	164,0x20	Hand Brake
270 CDi (209.316) Eng.OM612.962/967 (125kW)	10/02-		R		153-233	153-233K	Lucas	164,0x20	Hand Brake
280 (209.354) Eng.M272.940 (170kW)	1/05-		R		153-233	153-233K	Lucas	164,0x20	Hand Brake
320 (209.365) Eng.M112.946 (160kW)	6/02-		R		153-233	153-233K	Lucas	164,0x20	Hand Brake
320 CDi (209.320) Eng.OM642.910 (165kW)	1/05-		R		153-233	153-233K	Lucas	164,0x20	Hand Brake
55 AMG (209.376) Eng.M113.987 (270kW)	9/02-		R		153-233	153-233K	Lucas	164,0x20	Hand Brake
63 AMG (209.377) Eng.M156.982 (354-373kW)	1/07-		R		153-233	153-233K	Lucas	164,0x20	Hand Brake
CLK II Cabrio (A209) 2/03-									
200 CGI (209.443) Eng.M271.942 (125kW)	7/03-		R		153-233	153-233K	Lucas	164,0x20	Hand Brake
200 K. Eng.M271.940 (135kW)	1/07-		R		153-233	153-233K	Lucas	164,0x20	Hand Brake
200 K. (209.442) Eng.M271.940 (120kW)	2/03-		R		153-233	153-233K	Lucas	164,0x20	Hand Brake
240 (209.461) Eng.M112.912 (125kW)	2/03-		R		153-233	153-233K	Lucas	164,0x20	Hand Brake
280 Eng.M272.940/.943 (170kW)	1/05-		R		153-233	153-233K	Lucas	164,0x20	Hand Brake
320 (209.465) Eng.M112.946 (160kW)	2/03-		R		153-233	153-233K	Lucas	164,0x20	Hand Brake
320 CDi Eng.OM642.910 (165kW)	2/07-		R		153-233	153-233K	Lucas	164,0x20	Hand Brake
55 AMG (209.476) Eng.M113.987 (270kW)	2/03-		R		153-233	153-233K	Lucas	164,0x20	Hand Brake
63 AMG Eng.M156.982 (354kW)	1/07-		R		153-233	153-233K	Lucas	164,0x20	Hand Brake
CLS (C219) 10/04-12/10									
350 Eng.M272.964 (200kW)	10/04-		R		153-243	153-243K		180,0x25	Hand Brake
350 Eng.M272.985 (215kW)	4/06-		R		153-243	153-243K		180,0x25	Hand Brake
500 Eng.M113.967 (225kW)	10/04-		R		153-243	153-243K		180,0x25	Hand Brake
55 AMG Eng.M113.990 (350kW)	1/05-		R		153-243	153-243K		180,0x25	Hand Brake
Coupe III (C124) 3/87-3/89									
200 CE (124.041) Eng.M102.963 (90kW)	3/87-3/89		R		153-233	153-233K	Lucas	164,0x20	Hand Brake
300 CE (124.045/.050) Eng.M103.983 (132-138kW)	3/87-3/89		R		153-233	153-233K	Lucas	164,0x20	Hand Brake
Coupe IV (C124) 3/89-5/93									
200 CE (124.041) Eng.M102.963 (90kW)	3/89-5/93		R		153-234	153-234K	Lucas	164,0x25	Hand Brake
300 CE (124.045/.050) Eng.M103.983 (132-138kW)	3/89-5/93		R		153-233	153-233K	Lucas	164,0x20	Hand Brake
300 CE-24 (124.051) Eng.M104.980 (162-170kW)	9/89-12/92		R		153-233	153-233K	Lucas	164,0x20	Hand Brake
Heckflosse (W110) 1/55-12/68									
200 Eng.M115.926 (70kW)	7/65-2/68		R		153-011	153-011K	Ate	160,0x25	Hand Brake
200 (110.010) Eng.M121.940 (61kW)	1/65-12/68		R		153-011	153-011K	Ate	160,0x25	Hand Brake
SL (R198) 5/57-2/63									
300 SL (198.042) Eng.M198.980/982 (158kW)	5/57-2/63		R		153-011	153-011K	Ate	160,0x25	Hand Brake
SL I (R107) 5/71-8/89									
450 SL (107.044) Eng.M117.982/985 (160-165kW)	10/72-10/80		R		153-011	153-011K	Ate	160,0x25	Hand Brake
SL I Coupe (C107) 1/72-9/81									
450 SLC (107.024) Eng.M117.982/985 (160-165kW)	1/73-8/79		R		153-011	153-011K	Ate	160,0x25	Hand Brake
450 SLC 5.0 (107.026) Eng.M117.960 (177kW)	6/78-2/80		R		153-011	153-011K	Ate	160,0x25	Hand Brake
SL II (R129) 3/89-10/01									
280 (129.058) Eng.M104.943 (142kW)	8/93-10/01		R		153-233	153-233K	Lucas	164,0x20	Hand Brake
	8/93-10/01		R		153-234	153-234K	Lucas	164,0x25	Hand Brake
280 (129.059) Eng.M112.923/925 (150kW)	5/98-10/01		R		153-233	153-233K	Lucas	164,0x20	Hand Brake
	5/98-10/01		R		153-234	153-234K	Lucas	164,0x25	Hand Brake





































		Spare Parts	F/R	L/R	CIFAM ref.	CIFAM ref. w/KIT		DIMENSIONS mm.	NOTE
320 (129.063) Eng.M104.991 (170kW)	9/93-10/01		R		153-233	153-233K	Lucas	164,0x20	Hand Brake
	9/93-10/01		R		153-234	153-234K	Lucas	164,0x25	Hand Brake
320 (129.064) Eng.M112.943 (165kW)	5/98-10/01		R		153-233	153-233K	Lucas	164,0x20	Hand Brake
	5/98-10/01		R		153-234	153-234K	Lucas	164,0x25	Hand Brake
500 (129.067) Eng.M119.972 (235kW)	9/92-10/01		R		153-233	153-233K	Lucas	164,0x20	Hand Brake
	9/92-10/01		R		153-234	153-234K	Lucas	164,0x25	Hand Brake
500 (129.068) Eng.M113.961 (225kW)	5/98-10/01		R		153-233	153-233K	Lucas	164,0x20	Hand Brake
	5/98-10/01		R		153-234	153-234K	Lucas	164,0x25	Hand Brake
500 SL (129.066) Eng.M119.960/ 972 (240kW)	9/89-8/92		R		153-234	153-234K	Lucas	164,0x25	Hand Brake
55 AMG Eng.M113.992 (350kW)	8/99-7/01		R		153-233	153-233K	Lucas	164,0x20	Hand Brake
55 AMG (129.068) Eng.M113.985 (260kW)	3/00-10/01		R		153-233	153-233K	Lucas	164,0x20	Hand Brake
60 AMG (129.067) Eng.M120.981 (280kW)	5/97-10/01		R		153-233	153-233K	Lucas	164,0x20	Hand Brake
600 (129.076) Eng.M120.981/ 983 (290kW)	7/92-10/01		R		153-233	153-233K	Lucas	164,0x20	Hand Brake
	7/92-10/01		R		153-234	153-234K	Lucas	164,0x25	Hand Brake
600 SL Eng.M120.980 (300kW)	2/92-5/93		R		153-234	153-234K	Lucas	164,0x25	Hand Brake
SL III (R230) 10/01-2/12									
350 Eng.M272.966 (200kW)	3/06-		R		153-243	153-243K		180,0x25	Hand Brake
350 Eng.M272.968 (232kW)	5/08-		R		153-243	153-243K		180,0x25	Hand Brake
350 (230.467) Eng.M112.973 (180kW)	3/03-		R		153-243	153-243K		180,0x25	Hand Brake
500 Eng.M273.965 (285kW)	3/06-		R		153-243	153-243K		180,0x25	Hand Brake
500 (230.475) Eng.M113.963 (225kW)	10/01-		R		153-243	153-243K		180,0x25	Hand Brake
55 AMG Eng.M113.995 (380kW)	3/06-		R		153-243	153-243K		180,0x25	Hand Brake
55 AMG (230.474) Eng.M113.992 (350kW)	10/01-6/02		R		153-243	153-243K		180,0x25	Hand Brake
55 AMG K. (230.474) Eng.M113.992 (368kW)	6/02-		R		153-243	153-243K		180,0x25	Hand Brake
600 Eng.M113.995 (380kW)	3/06-		R		153-243	153-243K		180,0x25	Hand Brake
600 (230.476) Eng.M275.951 (368kW)	4/03-		R		153-243	153-243K		180,0x25	Hand Brake
SLK I (R170) 9/96-2/04									
200 (170.435) Eng.M111.946 (100kW)	9/96-3/00		R		153-233	153-233K	Lucas	164,0x20	Hand Brake
	9/96-3/00		R		153-234	153-234K	Lucas	164,0x25	Hand Brake
200 K. (170.444) Eng.M111.958 (120kW)	3/00-2/04		R		153-234	153-234K	Lucas	164,0x25	Hand Brake
200 K. (170.445) Eng.M111.943 (141kW)	10/96-3/00		R		153-233	153-233K	Lucas	164,0x20	Hand Brake
	10/96-3/00		R		153-234	153-234K	Lucas	164,0x25	Hand Brake
230 K. (170.447) Eng.M111.973 (142kW)	9/96-3/00		R		153-233	153-233K	Lucas	164,0x20	Hand Brake
	9/96-3/00		R		153-234	153-234K	Lucas	164,0x25	Hand Brake
230 K. (170.449) Eng.M111.983 (145kW)	3/00-2/04		R		153-234	153-234K	Lucas	164,0x25	Hand Brake
SLK II (R171) 3/04-									
200 K Eng.M271.940 (135kW)	4/08-		R		153-233	153-233K	Lucas	164,0x20	Hand Brake
200 K. (171.442) Eng.M271.944 (120kW)	3/04-3/08		R		153-233	153-233K	Lucas	164,0x20	Hand Brake
350 Eng.M272.969 (224kW)	4/08-		R		153-233	153-233K	Lucas	164,0x20	Hand Brake
350 (171.456) Eng.M272.963 (200kW)	6/04-3/08		R		153-233	153-233K	Lucas	164,0x20	Hand Brake
55 AMG (171.473) Eng.M113.989 (265kW)	6/04-		R		153-233	153-233K	Lucas	164,0x20	Hand Brake
T-Model I (W123) 1/76-12/85									
200 (123.020) Eng.M115.938/ 939 (62-69kW)	2/76-8/80		R		153-232	153-232K	Ate	160,0x25	
200 (123.220) Eng.M102.920/ 939 (74-80kW)	6/80-11/85		R		153-232	153-232K	Ate	160,0x25	
T-Model I SW (S123) 9/77-12/85									
200 T (123.280) Eng.M102.920/ 939 (74-80kW)	11/80-11/85		R		153-232	153-232K	Ate	160,0x25	
T-Model II (W124) 12/84-6/93									
200 (124.020) Eng.M102.922 (75-77-80kW)	12/85-5/90		R		153-233	153-233K	Lucas	164,0x20	Hand Brake
200 E Eng.M102.962 (90kW)	1/88-12/89		R		153-233	153-233K	Lucas	164,0x20	Hand Brake



		Spare Parts	F/R	L/R	CIFAM ref.	CIFAM ref. w/KIT		DIMENSIONS mm.	NOTE
200 E (124.019) Eng.M111.940 (100kW)	10/92-6/93		R		153-233	153-233K	Lucas	164,0x20	Hand Brake
200 E (124.021) Eng.M102.963 (87-90kW)	9/88-8/92		R		153-233	153-233K	Lucas	164,0x20	Hand Brake
300 E 4-matic (124.230) Eng.M103.985 (132kW)	9/86-6/93		R		153-233	153-233K	Lucas	164,0x20	Hand Brake
300 E, 4-matic (124.030) Eng.M103.980/ 983 (132-138kW)	8/85-8/92		R		153-233	153-233K	Lucas	164,0x20	Hand Brake
300 E-24 (124.031) Eng.M104.980 (162-170kW)	9/88-8/92		R		153-233	153-233K	Lucas	164,0x20	Hand Brake
400 E 4.2 (124.034) Eng.M119.975 (205kW)	10/92-6/93		R		153-234	153-234K	Lucas	164,0x25	Hand Brake
500 E (124.036) Eng.M119.974 (240kW)	1/91-6/93		R		153-234	153-234K	Lucas	164,0x25	Hand Brake
500 E AMG 6.0 (275kW)	1/92-6/93		R		153-234	153-234K	Lucas	164,0x25	Hand Brake
T-Model II SW (S124) 9/85-9/89									
200 (124.081) Eng.M102.963 (87kW)	9/88-9/89		R		153-233	153-233K	Lucas	164,0x20	Hand Brake
200 D (124.180) Eng.OM601.912 (53-55kW)	9/85-9/89		R		153-233	153-233K	Lucas	164,0x20	Hand Brake
200 E Eng.M102.962 (90kW)	9/88-9/89		R		153-233	153-233K	Lucas	164,0x20	Hand Brake
200 T (124.080) Eng.M102.922 (75-77-80kW)	9/85-9/89		R		153-233	153-233K	Lucas	164,0x20	Hand Brake
230, Kat. (124.083) Eng.M102.982 (97-100kW)	9/85-9/89		R		153-233	153-233K	Lucas	164,0x20	Hand Brake
250 D (124.185) Eng.OM602.912 (66-69kW)	9/85-9/89		R		153-233	153-233K	Lucas	164,0x20	Hand Brake
260 FGST. Eng.M103.940 (118-122kW)	9/85-9/89		R		153-233	153-233K	Lucas	164,0x20	Hand Brake
300 (124.090) Eng.M103.983 (132-138kW)	1/86-9/89		R		153-233	153-233K	Lucas	164,0x20	Hand Brake
300 4-matic (124.290) Eng.M103.985 (132-138kW)	1/86-9/89		R		153-233	153-233K	Lucas	164,0x20	Hand Brake
300 D (124.190) Eng.OM603.912 (80-81-83kW)	9/86-9/89		R		153-233	153-233K	Lucas	164,0x20	Hand Brake
300 TD, 4-matic (124.193) Eng.OM603.960 (108kW)	1/89-9/89		R		153-233	153-233K	Lucas	164,0x20	Hand Brake
300 TD, 4-matic (124.393) Eng.OM603.963 (105kW)	9/86-1/89		R		153-233	153-233K	Lucas	164,0x20	Hand Brake
T-Model III SW (S124) 9/89-6/93									
200 (124.079) Eng.M111.940 (100kW)	10/92-6/93		R		153-233	153-233K	Lucas	164,0x20	Hand Brake
200 (124.080) Eng.M102.922 (75-77-80kW)	9/89-5/90		R		153-233	153-233K	Lucas	164,0x20	Hand Brake
200 (124.081) Eng.M102.963 (87kW)	9/89-8/92		R		153-233	153-233K	Lucas	164,0x20	Hand Brake
220 (124.082) Eng.M111.960 (110kW)	10/92-5/93		R		153-233	153-233K	Lucas	164,0x20	Hand Brake
230, Kat. (124.083) Eng.M102.982 (97-100kW)	9/89-8/92		R		153-233	153-233K	Lucas	164,0x20	Hand Brake
250 D (124.185) Eng.OM602.912 (66-69kW)	9/89-6/93		R		153-233	153-233K	Lucas	164,0x20	Hand Brake
250 TD (124.188) Eng.OM602.962 (93kW)	9/89-6/93		R		153-233	153-233K	Lucas	164,0x20	Hand Brake
260 FGST. Eng.M103.940 (118-122kW)	9/89-8/92		R		153-233	153-233K	Lucas	164,0x20	Hand Brake
280 (124.088) Eng.M104.942 (145kW)	10/92-6/93		R		153-234	153-234K	Lucas	164,0x25	Hand Brake
300 (124.090) Eng.M103.983 (132-138kW)	9/89-6/93		R		153-233	153-233K	Lucas	164,0x20	Hand Brake
300 4-matic (124.290) Eng.M103.985 (132-138kW)	9/89-6/93		R		153-233	153-233K	Lucas	164,0x20	Hand Brake
300 D (124.190) Eng.OM603.912 (80-81-83kW)	9/89-6/93		R		153-233	153-233K	Lucas	164,0x20	Hand Brake
300 TD, 4-matic (124.193) Eng.OM603.960 (108kW)	9/89-6/93		R		153-233	153-233K	Lucas	164,0x20	Hand Brake

MERCEDES BENZ

		Spare Parts	F/R	L/R	CIFAM ref.	CIFAM ref. w/KIT		DIMENSIONS mm.	NOTE
300 TD, 4-matic (124.393) Eng.OM603.963 (105kW)	1/89-6/93		R		153-233	153-233K	Lucas	164,0x20	Hand Brake
300-24 (124.091) Eng.M104.980 (162-170kW)	9/89-8/92		R		153-233	153-233K	Lucas	164,0x20	Hand Brake
Vaneo (W414) 2/02-									
1.6 Eng.M166.961 (60kW)	2/02-		R		153-233	153-233K	Lucas	164,0x20	Hand Brake
1.6 Eng.M166.961 (75kW)	2/02-		R		153-233	153-233K	Lucas	164,0x20	Hand Brake
1.7 CDi Eng.OM668.914 (55kW)	2/02-		R		153-233	153-233K	Lucas	164,0x20	Hand Brake
1.7 CDi Eng.OM668.914 (67kW)	2/02-		R		153-233	153-233K	Lucas	164,0x20	Hand Brake
1.7 CDi Eng.OM668.940 (70kW)	2/02-		R		153-233	153-233K	Lucas	164,0x20	Hand Brake
1.9 Eng.M166.991 (92kW)	2/02-		R		153-233	153-233K	Lucas	164,0x20	Hand Brake
Viano (W639) 9/03-									
2.2 CDi Eng.OM646.980 (85kW)	05-		R		153-248	153-248K		186,0x20	Hand Brake
2.2 CDi Eng.OM646.982 (110kW)	9/03-		R		153-248	153-248K		186,0x20	Hand Brake
2.2 CDi Eng.OM646.982 (80kW)	9/03-		R		153-248	153-248K		186,0x20	Hand Brake
3.2 Eng.M112.951 (140kW)	03-		R		153-248	153-248K		186,0x20	Hand Brake
3.2 Eng.M112.951 (160kW)	03-		R		153-248	153-248K		186,0x20	Hand Brake
3.7 Eng.M112.976 (170kW)	04-		R		153-248	153-248K		186,0x20	Hand Brake
	04-		R		153-236	153-236K	Bosch	180,0x20	Hand Brake

MERCEDES BENZ LCV, TRUCK

200-300 (BM460) 2/79-									
200	5/86-		R		700-221			Ø 260,0	Incl. Italy
230 (66-75kW)	2/79-8/85		R		700-221			Ø 260,0	
240 (90-92kW)	2/79-		R		700-221			Ø 260,0	
250 (53kW)	8/87-		R		700-221			Ø 260,0	
280 (110-115kW)	2/79-		R		700-221			Ø 260,0	
300 (65-83kW)	2/79-		R		700-221			Ø 260,0	
350 TD (100kW)	91-97		R		700-221			Ø 260,0	
MB100 (631) 2/88-12/94									
2.0 D Eng.OM615.970 (44kW)	4/88-8/93		R		153-100		Lucas	254,0x57	Hand Brake
	4/88-8/93		R		153-342		Lucas	255,0x57	Van Mevosa (Motor iberica)
2.0 D Eng.OM615.970 (45kW)	9/93-4/96		R		153-100		Lucas	254,0x57	Hand Brake
	9/93-4/96		R		153-342		Lucas	255,0x57	Van Mevosa (Motor iberica)
2.4 D Eng.OM616.963 (41-53-55kW)	2/88-5/92		R		153-100		Lucas	254,0x57	Hand Brake
	2/88-5/92		R		153-342		Lucas	255,0x57	Van Mevosa (Motor iberica)
	88-		R		700-222			Ø 254,0	
Sprinter I 2-T (901, 902) 2/95-5/06									
208 CDi Eng.OM611.987 (60kW)	-00		R		153-100		Lucas	254,0x57	2t, 3t, Hand Brake
	4/00-5/06		R		153-239	153-239K	Bosch	160,0x40	Hand Brake
208 D Eng.OM601.943 (58-60kW)	2/95-4/00		R		153-239	153-239K	Bosch	160,0x40	Hand Brake
	2/95-4/00		R		153-100		Lucas	254,0x57	Hand Brake
210 D Eng.OM602.980 (75kW)	1/97-4/00		R		153-239	153-239K	Bosch	160,0x40	Hand Brake
214 Eng.M111.979/ 984 (105kW)	2/95-5/06		R		153-239	153-239K	Bosch	160,0x40	Hand Brake
	2/95-5/06		R		153-100		Lucas	254,0x57	2t, 3t, Hand Brake
214 NGT Eng.M111.984 (92kW)	4/00-5/06		R		153-239	153-239K	Bosch	160,0x40	Hand Brake
	4/00-5/06		R		153-100		Lucas	254,0x57	2t, 3t, Hand Brake
Sprinter I 3-T (903) 2/95-5/06									
308 CDi Eng.OM611.987 (60kW)	4/00-5/06		R		153-239	153-239K	Bosch	160,0x40	Hand Brake
308 D 2.3 Eng.OM601.943 (60kW)	2/95-4/00		R		153-239	153-239K	Bosch	160,0x40	Hand Brake
308 D 2.3, 4WD Eng.OM601.943 (58kW)	2/95-4/00		R		153-239	153-239K	Bosch	160,0x40	Hand Brake
308 E (903.372) (40kW)	4/00-5/06		R		153-239	153-239K	Bosch	160,0x40	Hand Brake
310 D 2.9, 4WD Eng.OM602.980 (75kW)	2/95-4/00		R		153-239	153-239K	Bosch	160,0x40	Hand Brake
314 NGT Eng.M111.984 (92kW)	4/00-5/06		R		153-239	153-239K	Bosch	160,0x40	Hand Brake
314, 4WD Eng.M111.979/ 984 (105kW)	2/95-5/06		R		153-239	153-239K	Bosch	160,0x40	Hand Brake
Sprinter I 4-T (904) 2/96-5/06									
408 CDi Eng.OM611.987 (60kW)	4/00-5/06		R		153-240	153-240K	Ate	170,0x40	Hand Brake
408 D, 4WD Eng.OM601.943 (58kW)	2/96-5/06		R		153-240	153-240K	Ate	170,0x40	Hand Brake
410 D, 4WD Eng.OM602.980 (75kW)	5/97-5/06		R		153-240	153-240K	Ate	170,0x40	Hand Brake
412 D, 4WD Eng.OM602.980 (85kW)	2/96-5/06		R		153-240	153-240K	Ate	170,0x40	Hand Brake
412 D, 4WD Eng.OM602.980 (90kW)	2/96-5/06		R		153-240	153-240K	Ate	170,0x40	Hand Brake
414, 4WD Eng.M111.979/ 984 (105kW)	2/96-5/06		R		153-240	153-240K	Ate	170,0x40	Hand Brake

		Spare Parts	F/R	L/R	CIFAM ref.	CIFAM ref. w/KIT		DIMENSIONS mm.	NOTE
416 CDi, 4WD Eng.OM612.981 (115kW)	4/00-5/06		R		153-240	153-240K	Ate	170,0x40	Hand Brake
Sprinter II 3,5-T (906) 6/06-									
309 CDi Eng.OM646.984 (65kW)	6/06-		R		153-246	153-246K		180,0x25	Hand Brake
311 CDi, 4WD Eng.OM646.985 (80kW)	6/06-		R		153-246	153-246K		180,0x25	Hand Brake
315 CDi, 4WD Eng.OM646.984 (110kW)	6/06-		R		153-246	153-246K		180,0x25	Hand Brake
318 CDi, 4WD Eng.OM646.984 (135kW)	6/06-		R		153-246	153-246K		180,0x25	Hand Brake
324 Eng.M272.979 (190kW)	6/06-		R		153-246	153-246K		180,0x25	Hand Brake
Sprinter II 3-T (906) 6/06-									
209 CDi Eng.OM646.984 (65kW)	6/06-		R		153-246	153-246K		180,0x25	Hand Brake
211 CDi Eng.OM646.984 (80kW)	6/06-		R		153-246	153-246K		180,0x25	Hand Brake
211 CDi Eng.OM646.985 (80kW)	6/06-		R		153-246	153-246K		180,0x25	Hand Brake
213 CDi Eng.OM646.DELA (95kW)	6/06-		R		153-246	153-246K		180,0x25	Hand Brake
215 CDi Eng.OM646.986 (110kW)	6/06-		R		153-246	153-246K		180,0x25	Hand Brake
218 CDi Eng.OM642.992 (135kW)	6/06-		R		153-246	153-246K		180,0x25	Hand Brake
224 Eng.M272.979 (190kW)	6/06-		R		153-246	153-246K		180,0x25	Hand Brake
Sprinter II 4,6-T (906) 6/06-									
413 CDi Eng.OM646.DELA (95kW)	06-6/06-		R			153-249K		174x42	rear axle SA 741
			R		153-249	153-249K		174,0x42	rear axle SA 741, Hand Brake
416 CDi Eng.OM651.957 (120kW)	09-		R		153-249	153-249K		174,0x42	rear axle SA 741
418 CDi Eng.OM642.DELA (135kW)	6/06-		R		153-249			174,0x42	rear axle SA 741
419 CDi Eng.OM642.992 (140kW)	09-		R		153-249	153-249K		174,0x42	rear axle SA 741
424 Eng.M272.979 (190kW)	06-6/06-		R			153-249K		174x42	rear axle SA 741
			R		153-249	153-249K		174,0x42	rear axle SA 741
Sprinter II 5-T (906) 6/06-									
509 CDi Eng.OM646.984 (65kW)	06-		R		153-249			174,0x42	
510 CDi Eng.OM651.955 (70kW)	09		R		153-249	153-249K		174,0x42	
511 CDi Eng.OM646.985 (80kW)	06-06-		R			153-249K		174x42	
			R		153-249	153-249K		174,0x42	
513 CDi Eng.OM646.DELA (95kW)	06-		R		153-249	153-249K		174,0x42	
513 CDi 4WD (95kW)	11-		R		153-249	153-249K		174,0x42	
515 CDi Eng.OM646.DELA (110kW)	06-		R		153-249	153-249K		174,0x42	
516 Eng.M271.951 (115kW)	08-		R		153-249	153-249K		174,0x42	
516 CDi, 4WD Eng.OM651.957 (120kW)	09-		R		153-249	153-249K		174,0x42	
516 NGT Eng.M271.951 (115kW)	08-		R		153-249	153-249K		174,0x42	
518 CDi Eng.OM642.DELA (135kW)	06-		R		153-249	153-249K		174,0x42	
519 CDi Eng.OM642.992 (140kW)	09-		R		153-249	153-249K		174,0x42	
524 Eng.M272.979 (190kW)	06-		R		153-249			174,0x42	
Trasporter (BM601) 5/77-1/95									
207 D Eng.OM616.917/ 934 (48kW)	5/77-1/95		R		153-238		Perr.	230,0x35	Hand Brake
	77-82		R		700-220			Ø 230,0	
207 D Eng.OM616.937/ 939 (53kW)	5/77-1/95		R		153-238		Perr.	230,0x35	Hand Brake
	82-90		R		700-220			Ø 230,0	
208 Eng.M115.955/ 972 (63kW)	5/77-1/95		R		153-238		Perr.	230,0x35	Hand Brake
	5/77-		R		700-220			Ø 230,0	
208 D Eng.OM601.940 (58-60kW)	5/77-1/95		R		153-238		Perr.	230,0x35	Hand Brake
	9/88-		R		700-220			Ø 230,0	
209 D Eng.OM617.913 (65kW)	5/77-1/95		R		153-238		Perr.	230,0x35	Hand Brake
	5/77-		R		700-220			Ø 230,0	
210 Eng.M102.945/ 942 (70-77kW)	5/77-1/95		R		153-238		Perr.	230,0x35	Hand Brake
	5/77-		R		700-220			Ø 230,0	
210 D Eng.OM602.940 (70-72kW)	5/77-1/95		R		153-238		Perr.	230,0x35	Hand Brake
	9/88-95		R		700-220			Ø 230,0	
Trasporter (BM602) 5/77-1/95									
307 D Eng.OM616.937/ .939/917 (48-53kW)	5/77-		R		700-221			Ø 260,0	
308 (57-62kW)	5/77-		R		700-221			Ø 260,0	
308 D Eng.OM601.940 (58-60kW)	9/88-		R		700-221			Ø 260,0	
309 D Eng.OM617.913 (65kW)	5/77-		R		700-221			Ø 260,0	
310 Eng.M102.942 (69-77kW)	5/77-		R		700-221			Ø 260,0	
310 D Eng.OM601.940 (70-72kW)	9/88-		R		700-221			Ø 260,0	
Vario 9/96-									
512 D Eng.OM602.984 (90kW)	9/96-9/96-		R		153-240	153-240K	Ate	170,0x40	Hand Brake
			R		153-239	153-239K	Bosch	160,0x40	Hand Brake

MERCEDES BENZ LCV, TRUCK



			Spare Parts	F/R	L/R	CIFAM ref.	CIFAM ref. w/KIT		DIMENSIONS mm.	NOTE
612 D Eng.OM602.984/ .985 (90kW)			9/96-	R		153-240	153-240K	Ate	170,0x40	Hand Brake
				R		153-239	153-239K	Bosch	160,0x40	Hand Brake
613/614 D Eng.OM904.908 (95-100kW)			9/96-	R		153-240	153-240K	Ate	170,0x40	Hand Brake
				R		153-239	153-239K	Bosch	160,0x40	Hand Brake
615/616 D Eng.OM904.923 (112-115kW)			9/98-	R		153-240	153-240K	Ate	170,0x40	Hand Brake
				R		153-239	153-239K	Bosch	160,0x40	Hand Brake
810 Eng.OM904.904 (75kW)			9/96-	R		153-240	153-240K	Ate	170,0x40	Hand Brake
				R		153-239	153-239K	Bosch	160,0x40	Hand Brake
810 Eng.OM904.908 (100kW)			9/96-	R		153-240	153-240K	Ate	170,0x40	Hand Brake
				R		153-239	153-239K	Bosch	160,0x40	Hand Brake
810 Eng.OM904.923 (112kW)			9/96-	R		153-240	153-240K	Ate	170,0x40	Hand Brake
				R		153-239	153-239K	Bosch	160,0x40	Hand Brake
812 D Eng.OM602.984/ .985 (90kW)			9/96-	R		153-240	153-240K	Ate	170,0x40	Hand Brake
				R		153-239	153-239K	Bosch	160,0x40	Hand Brake
813/814 Eng.OM904.908 (95-100kW)			9/96-	R		153-240	153-240K	Ate	170,0x40	Hand Brake
				R		153-239	153-239K	Bosch	160,0x40	Hand Brake
815/816 D Eng.OM904.923 (112-115kW)			9/96-	R		153-240	153-240K	Ate	170,0x40	Hand Brake
				R		153-239	153-239K	Bosch	160,0x40	Hand Brake

Vito I (638) 3/97-8/03

108 CDi 2.2 Eng.OM611A (60kW)	3/99-8/03		R		153-236	153-236K	Bosch	180,0x20	Hand Brake
108 D 2.3 (638.064) Eng.OM601.942 (58kW)	3/97-8/03		R		153-236	153-236K	Bosch	180,0x20	Hand Brake
110 CDi 2.2 Eng.OM611LA (75kW)	3/99-8/03		R		153-236	153-236K	Bosch	180,0x20	Hand Brake
110 D 2.3 (638.074) Eng.OM601.970 (72kW)	3/97-8/03		R		153-236	153-236K	Bosch	180,0x20	Hand Brake
112 CDi 2.2 Eng.OM611.980 (90kW)	3/99-8/03		R		153-236	153-236K	Bosch	180,0x20	Hand Brake
113 2.0 (638.014) Eng.M111.948 (95kW)	3/97-8/03		R		153-236	153-236K	Bosch	180,0x20	Hand Brake
114 2.3 (638.034) Eng.M111.978 (105kW)	3/97-8/03		R		153-236	153-236K	Bosch	180,0x20	Hand Brake

Vito II (639) 9/03-

109 CDi 2.2 Eng.OM646.983 (65kW)	9/03-		R		153-248	153-248K		186,0x20	Hand Brake
			R		153-236	153-236K	Bosch	180,0x20	Hand Brake
109 CDi 2.2, 4WD Eng.OM646.980/ 981 (70kW)	9/07-		R		153-248	153-248K		186,0x20	Hand Brake
			R		153-236	153-236K	Bosch	180,0x20	Hand Brake
111 CDi 2.2 Eng.OM646.980/ 982 (85kW)	9/07-		R		153-248	153-248K		186,0x20	Hand Brake
			R		153-236	153-236K	Bosch	180,0x20	Hand Brake
111 CDi 2.2, 4WD Eng.OM646.982 (80kW)	9/03-		R		153-248	153-248K		186,0x20	Hand Brake
			R		153-236	153-236K	Bosch	180,0x20	Hand Brake
115 CDi 2.2, 4WD Eng.OM646.982 (110kW)	9/03-		R		153-248	153-248K		186,0x20	Hand Brake
			R		153-236	153-236K	Bosch	180,0x20	Hand Brake
119 Eng.M112.951 (140kW)	9/03-		R		153-248	153-248K		186,0x20	Hand Brake
			R		153-236	153-236K	Bosch	180,0x20	Hand Brake
122 3.2 Eng.M112.951 (160kW)	9/03-		R		153-248	153-248K		186,0x20	Hand Brake
			R		153-236	153-236K	Bosch	180,0x20	Hand Brake
123 Eng.M112.976 (170kW)	04-		R		153-248	153-248K		186,0x20	Hand Brake
			R		153-236	153-236K	Bosch	180,0x20	Hand Brake

MITSUBISHI

3000 GT (Z16A) 6/92-

























































3.0 24v 4WD Eng.6G72 (210kW)	6/92-		R		153-265	153-265K		167,0x32	Hand Brake
------------------------------	-------	--	---	--	---------	----------	--	----------	------------













































Airtrek 3/03-2/07





























































2.0 4WD (177kW)	5/03-2/07		R		153-265	153-265K		167,0x32	Hand Brake
2.0 4WD (93kW)	5/03-2/07		R		153-265	153-265K		167,0x32	Hand Brake
2.0 4WD Eng.4G63-7 (100kW)	5/03-2/07		R		153-265	153-265K		167,0x32	Hand Brake
2.0 T. 4WD Eng.4G63-7 (148kW)	4/04-2/07		R		153-265	153-265K		167,0x32	Hand Brake
2.4 4WD Eng.4G64 (102kW)	5/03-2/07		R		153-265	153-265K		167,0x32	Hand Brake
2.4 4WD Eng.4G69-2 (118kW)	11/03-2/07		R		153-265	153-265K		167,0x32	Hand Brake









































Carisma (DA) 7/95-



















































1.6 Eng.4G92 (66kW)	6/99-8/00		R		153-259		Bosch	203,2x40	Hand Brake
			R		153-253	153-253Y	Ake	180,0x36	Hand Brake
			R		153-257		Ake	203,0x37	Hand Brake
1.6 Eng.4G92 (70-73kW)	5/97-		R		153-253	153-253Y	Ake	180,0x36	Hand Brake
			R		153-257		Ake	203,0x37	Hand Brake
			R		153-259		Bosch	203,2x40	Hand Brake
1.8 Eng.4G93 (85kW)	6/99-8/00		R		153-259		Bosch	203,2x40	Hand Brake
			R		153-253	153-253Y	Ake	180,0x36	Hand Brake



























		Spare Parts	F/R	L/R	CIFAM ref.	CIFAM ref. w/KIT		DIMENSIONS mm.	NOTE
1.8 Eng.4G93 (85kW)	7/95-		R		153-257		Ake	203,0x37	Hand Brake
	95-10/05		R		700-384			Ø 203,0	-ABS
1.8 16v Eng.4G93 (103kW)	6/99-8/00		R		153-259		Bosch	203,2x40	Hand Brake
	7/95-		R		153-253	153-253Y	Ake	180,0x36	Hand Brake
	7/95-		R		153-257		Ake	203,0x37	Hand Brake
	95-10/05		R		700-384			Ø 203,0	-ABS
1.8 GDi Eng.4G93(GDI) (90kW)	00-10/05		R		700-384			Ø 203,0	-ABS
1.8 GDi Eng.4G93(GDI) (92kW)	6/99-8/00		R		153-259		Bosch	203,2x40	Hand Brake
	9/97-		R		153-253	153-253Y	Ake	180,0x36	Hand Brake
	9/97-		R		153-257		Ake	203,0x37	Hand Brake
	97-10/05		R		700-384			Ø 203,0	-ABS
1.9 DI-D Eng.F9Q1 (75kW)	9/00-		R		153-259		Bosch	203,2x40	Hand Brake
1.9 DI-D Eng.F9Q2 (85kW)	9/00-		R		153-259		Bosch	203,2x40	Hand Brake
1.9 TD Eng.F8QT (66kW)	10/96-9/00		R		153-259		Bosch	203,2x40	Hand Brake
	96-00		R		700-384			Ø 203,0	-ABS
Colt II (C1A)/ Champ 2/84-4/88									
1.2 (C15A) Eng.4G16 (40-44kW)	2/84-4/88		R		153-253	153-253Y	Ake	180,0x36	Hand Brake
1.5 (C12A) Eng.4G15 (55kW)	9/84-4/88		R		153-253	153-253Y	Ake	180,0x36	Hand Brake
1.5 (C12A) Eng.G15B (51kW)	9/85-4/88		R		153-253	153-253Y	Ake	180,0x36	Hand Brake
1.6 T. ECi (C13A) Eng.4G32T-C (92kW)	2/84-4/88		R		153-253	153-253Y	Ake	180,0x36	Hand Brake
1.6 T. ECi (C13A) Eng.G32B (60-77kW)	7/86-4/88		R		153-253	153-253Y	Ake	180,0x36	Hand Brake
1.8 D (C14A) Eng.4D65 (44kW)	2/84-4/88		R		153-253	153-253Y	Ake	180,0x36	Hand Brake
Colt III (C5A) 4/88-5/92									
1.3 Eng.4G13 (44kW)	4/88-12/90		R		153-253	153-253Y	Ake	180,0x36	Hand Brake
	88-90		R		700-249			Ø 180,0	Europe
1.3 (C51A) Eng.4G13 (51kW)	-5/90		R		153-253	153-253Y	Ake	180,0x36	Hand Brake
	6/90-		R		153-258		Ake	180,0x37	Hand Brake
	88-92		R		700-249			Ø 180,0	Europe
1.3 12v (C51A) Eng.4G13 (55kW)	7/90-5/92		R		153-258		Ake	180,0x37	Hand Brake
	90-92		R		700-249			Ø 180,0	Europe
1.5 (C52A) Eng.4G15 (62kW)	-5/90		R		153-253	153-253Y	Ake	180,0x36	Hand Brake
	6/90-		R		153-258		Ake	180,0x37	Hand Brake
	88-92		R		700-249			Ø 180,0	Europe
1.5 (C52A) Eng.4G15 (66kW)	-5/90		R		153-253	153-253Y	Ake	180,0x36	Hand Brake
	6/90-		R		153-258		Ake	180,0x37	Hand Brake
	88-92		R		700-249			Ø 180,0	Europe
1.8 D GLX (C54A) Eng.4D65 (44kW)	-5/90		R		153-253	153-253Y	Ake	180,0x36	Hand Brake
	6/90-		R		153-258		Ake	180,0x37	Hand Brake
	88-92		R		700-249			Ø 180,0	Europe
Colt IV (CAA) 4/92-4/96									
1.6 16v (CA4A) Eng.4G92 (66-70-73-84kW)	4/92-4/96		R		153-258		Ake	180,0x37	Hand Brake
1.8 GTi 16v (CA5A) Eng.4G93 (103kW)	4/92-4/96		R		153-258		Ake	180,0x37	Hand Brake
Colt V (CJA) 11/95-6/04									
1.3 12v (CJ1A) Eng.4G13 (55kW)	5/96-9/00		R		153-259		Bosch	203,2x40	Hand Brake
1.3 16v Eng.4G13(16v) (60-61-63kW)	9/00-6/04		R		153-259		Bosch	203,2x40	Hand Brake
Colt VI (CZ) 6/04-2/09									
1.1 12v Eng.3A91 (55kW)	10/04-2/09		R		153-266		Lucas	203,2x39	Hand Brake
	04-		R		151-214		Lucas	Ø 19,05 203,2x39	LUC
1.3 16v Eng.4A90 (70kW)	6/04-2/09		R		153-266		Lucas	203,2x39	Hand Brake
	04-		R		151-214		Lucas	Ø 19,05 203,2x39	LUC
1.5 16v, CZC Cabrio Eng.4A91 (80kW)	6/04-2/09		R		153-266		Lucas	203,2x39	Hand Brake
1.5 Di-D Eng.OM636.939 (50kW)	8/04-2/09		R		153-266		Lucas	203,2x39	Hand Brake
	04-		R		151-214		Lucas	Ø 19,05 203,2x39	LUC
1.5 Di-D HP Eng.OM639.939 (70kW)	8/04-2/09		R		153-266		Lucas	203,2x39	Hand Brake
	04-		R		151-214		Lucas	Ø 19,05 203,2x39	LUC
Cordia (A21A) 10/82-12/86									
1.8 (A215A) Eng.4G37 (66kW)	10/86-12/86		R		153-252		Ake	203,0x37	Hand Brake
1.8 T. ECi (A213A) Eng.4G62T(ECI) (100kW)	10/84-12/86		R		153-252		Ake	203,0x37	Hand Brake
Debonair II (S11) 1/86-12/92									
2.0 Eng.6G71 (88kW)	1/86-12/92		R		153-256		Ake	228,6x40	Hand Brake

		Spare Parts	F/R	L/R	CIFAM ref.	CIFAM ref. w/KIT		DIMENSIONS mm.	NOTE
Eclipse II (D3) 12/95-4/99									
2.0 16v Eng.4G63 (107kW)	12/95-4/99		R		153-265	153-265K		167,0x32	Hand Brake
2.0 GT 16v, 4WD (157kW)	12/95-4/99		R		153-265	153-265K		167,0x32	Hand Brake
2.4 GS 16v Eng.4G64 (105kW)	9/98-4/99		R		153-265	153-265K		167,0x32	Hand Brake
Eclipse IV 4/05-									
2.4 GS Eng.4G69 (120kW)	4/05-		R		153-362			170,0x32	Hand Brake
3.8 GT Eng.6G75 (192kW)	4/05-		R		153-362			170,0x32	Hand Brake
Expo 10/91-8/99									
1.8 16v, 4WD	1/92-12/94		R		153-257		Ake	203,0x37	Usa, Exc. 4WD, Hand Brake
	1/92-12/94		R		153-256		Ake	228,6x40	Usa, 4WD, Hand Brake
1.8, 4WD (N11W, N21W) Eng.4G93 (90kW)	10/91-8/99		R		153-257		Ake	203,0x37	Usa, Exc. 4WD, Hand Brake
	10/91-8/99		R		153-256		Ake	228,6x40	Usa, 4WD, Hand Brake
2.4 16v, 4WD	1/93-12/95		R		153-257		Ake	203,0x37	Usa, Exc. 4WD, Hand Brake
	1/93-12/95		R		153-256		Ake	228,6x40	Usa, 4WD, Hand Brake
2.4, 4WD	1/92-12/92		R		153-257		Ake	203,0x37	Usa, Exc. 4WD, Hand Brake
	1/92-12/92		R		153-256		Ake	228,6x40	Usa, 4WD, Hand Brake
Galant III (E1A) 6/84-12/87									
1.6 (E11A) Eng.4G32 (55kW)	6/84-12/87		R		153-252		Ake	203,0x37	Hand Brake
1.8 (E12A) Eng.4G37 (60-66kW)	6/84-12/87		R		153-252		Ake	203,0x37	Hand Brake
1.8 T. (E13A) Eng.G62B (100kW)	1/86-8/87		R		153-252		Ake	203,0x37	Hand Brake
1.8 TD (E14A) Eng.4D65T (60kW)	6/84-12/87		R		153-252		Ake	203,0x37	Hand Brake
2.0 (E15A) Eng.4G63 (75-82-106-110kW)	6/84-12/87		R		153-252		Ake	203,0x37	Hand Brake
2.0 (E15A) Eng.G63B (66kW)	6/86-12/87		R		153-252		Ake	203,0x37	Hand Brake
2.0 T. ECi (E15A) Eng.4G63T (110kW)	6/84-5/85		R		153-252		Ake	203,0x37	Hand Brake
Galant IV (E3A) 11/87-10/92									
1.6 (E31A) Eng.4G32B (60kW)	11/88-10/92		R		153-257		Ake	203,0x37	Hand Brake
1.8 (E32A) Eng.4G37 (63-66kW)	11/87-10/92		R		153-257		Ake	203,0x37	Hand Brake
	11/87-10/92		R		153-252		Ake	203,0x37	-ABS, Hand Brake
1.8 D (E34A) Eng.4D65 (55kW)	-4/90		R		153-252		Ake	203,0x37	Hand Brake
	5/90-		R		153-257		Ake	203,0x37	Hand Brake
2.0 (E33A) Eng.4G63 (80kW)	4/89-10/92		R		153-257		Ake	203,0x37	Hand Brake
2.0 Gti 16v, 4WD (E33A, E39A) Eng.4G63 (106-107kW)	11/87-10/92		R		153-257		Ake	203,0x37	Hand Brake
Galant V (E5A, E7A, E8A) 11/92-8/96									
1.8 (E52A) Eng.4G93 (85kW)	2/94-8/96		R		153-265	153-265K		167,0x32	Hand Brake
	2/94-8/96		R		153-257		Ake	203,0x37	Hand Brake
	94-96		R		700-364			Ø 203,0	
1.8 GDi (E52A) Eng.4G93(GDI) (93kW)	11/92-8/96		R		153-265	153-265K		167,0x32	Hand Brake
	11/92-8/96		R		153-257		Ake	203,0x37	Hand Brake
	92-96		R		700-364			Ø 203,0	
2.0 TD (E57A) Eng.4D68/ T (66kW)	11/92-8/96		R		153-257		Ake	203,0x37	Hand Brake
	92-96		R		700-364			Ø 203,0	Mod. E57A
2.0 V6-24v (E54A) Eng.6A12 (110kW)	11/92-8/96		R		153-257		Ake	203,0x37	Hand Brake
2.0, 4WD (E75A,E55A) Eng.4G63 (101kW)	11/92-8/96		R		153-257		Ake	203,0x37	Hand Brake
Galant VI (EA, SW) 9/96-9/03									
2.0 Eng.4G63 (100kW)	9/96-9/03		R		153-265	153-265K		167,0x32	Hand Brake
2.0 Eng.4G63 (98kW)	9/96-9/03		R		153-265	153-265K		167,0x32	Hand Brake
2.0 TDi (EA6A) Eng.4D68/ SOCH (66kW)	9/96-9/03		R		153-265	153-265K		167,0x32	Hand Brake
2.4 GDi Eng.4G64 (106-110kW)	2/99-9/03		R		153-265	153-265K		167,0x32	Hand Brake
2.5 V6 24v (EA5A) Eng.6A13 (118kW)	9/96-9/03		R		153-265	153-265K		167,0x32	Hand Brake
2.5 V6 24v (EA5A) Eng.6A13 (120kW)	9/96-9/03		R		153-265	153-265K		167,0x32	Hand Brake
Gallant VII (ED, EF) 10/03-									
2.0 GDi, 4WD Eng.4G94 (107kW)	10/03-		R		153-362			170,0x32	Hand Brake
2.4 GDi, 4WD Eng.4G69 (121kW)	10/03-		R		153-362			170,0x32	Hand Brake
3.8 GDi, 4WD (171kW)	10/03-		R		153-362			170,0x32	Hand Brake
Galloper 2/99-									
2.5 TD Eng.D4BF (65kW)	2/99-		R		153-173			270,0x54	Hand Brake
2.5 TD intercooler Eng.D4BH (73kW)	2/99-		R		153-173			270,0x54	Hand Brake
3.0 V6 Eng.G6AT (104kW)	2/99-		R		153-173			270,0x54	Hand Brake



























		Spare Parts	F/R	L/R	CIFAM ref.	CIFAM ref. w/KIT		DIMENSIONS mm.	NOTE
Grandis II (NA) 4/04-									
2.0 DI-D Eng.BSY (100kW)	9/05-		R		153-261		Ake	228,6x32	Hand Brake
2.0 DI-D Eng.BSY (103kW)	2/07-		R		153-261		Ake	228,6x32	Hand Brake
2.4 Eng.4G69 (121kW)	4/04-		R		153-261		Ake	228,6x32	Hand Brake
L200 II (KT) 11/86-8/96									
1.6 Eng.4G32B (60kW)	4/87-5/92		R			153-251Y		254,0x50	Hand Brake
	4/87-5/92		R		153-251	153-251Y	Ake	254,0x50	Hand Brake
2.0, 4WD Eng.4G63 (69-75kW)	11/86-8/96		R		153-251	153-251Y	Ake	254,0x50	Hand Brake
2.5 D, 4WD (K24T/K14T/K64T)	11/86-8/96		R		153-251		Ake	254,0x50	Hand Brake
Eng.4D56 (51kW)	11/86-		R		700-250			Ø 254,0	
2.5 TD 4WD Eng.4D56T (85kW)	8/01-11/05		R			153-251Y		254,0x50	Hand Brake
	8/01-11/05		R		153-251	153-251Y	Ake	254,0x50	Hand Brake
2.5 TD 4WD (K34T) Eng.4D56T (64kW)	11/92-8/96		R		153-251		Ake	254,0x50	Hand Brake
	92-96		R		700-250			Ø 254,0	
2.6 4WD (K33T) Eng.G54B (76kW)	89-95		R		700-250			Ø 254,0	
L200 III 6/96-5/06									
2.0 (K62T) Eng.4G63 (90kW)	6/96-5/06		R			153-251Y		254,0x50	Hand Brake
	6/96-5/06		R		153-251		Ake	254,0x50	Hand Brake
	96-		R		700-250			Ø 254,0	
2.4 4WD (K75T) Eng.4G64 (97kW)	6/96-5/06		R		153-260		Ake	270,0x52	Hand Brake
	96-		R		700-250			Ø 254,0	
2.5 D (K64T) Eng.4D56 (55kW)	6/96-5/06		R			153-251Y		254,0x50	Hand Brake
	6/96-5/06		R		153-251		Ake	254,0x50	Hand Brake
	6/96-5/06		R		153-260		Ake	270,0x52	Hand Brake
2.5 TD Eng.4D56T (66kW)	8/01-11/05		R		153-260		Ake	270,0x52	Hand Brake
2.5 TD 4WD Eng.4D56T (98kW)	8/03-5/06		R			153-251Y		254,0x50	Hand Brake
	8/03-5/06		R		153-251		Ake	254,0x50	Hand Brake
	03-		R		700-250			Ø 254,0	
2.5 TD 4WD (K74T) Eng.4D56 (73-74-85kW)	6/96-5/06		R			153-251Y		254,0x50	Hand Brake
	6/96-5/06		R		153-251		Ake	254,0x50	Hand Brake
	6/96-5/06		R		153-260		Ake	270,0x52	Hand Brake
	96-		R		700-250			Ø 254,0	
L200 IV (KA, KB) 5/06-									
2.5 DI-D Eng.4D56HP (123kW)	10/07-		R		153-269		Ake	300,0x51	Hand Brake
2.5 DI-D, RWD Eng.4D56 (100kW)	5/06-		R		153-269		Ake	300,0x51	Hand Brake
Lancer III (C1A, C6A)/ Mirage 11/83-6/92									
1.3 (C11) Eng.4G13B (51kW)	1/86-6/92		R		153-252		Ake	203,0x37	Hand Brake
	90-		R		153-258		Ake	180,0x37	Hand Brake
1.6 ECi (C13A) Eng.G32B (60-77kW)	11/83-6/92		R		153-253	153-253Y	Ake	180,0x36	Hand Brake
1.6 T. (C13A) Eng.4G32T-C (92kW)	10/83-12/88		R		153-253	153-253Y	Ake	180,0x36	Hand Brake
1.8 D (C14AS) Eng.4D65 (43-44kW)	1/84-6/92		R		153-253	153-253Y	Ake	180,0x36	Hand Brake
	-8/88		R		153-252		Ake	203,0x37	Hand Brake
Lancer III (C1V, C3V) SW/ Mirage 1/84-6/92									
1.5 (C12V) Eng.4G15 (55kW)	9/85-12/87		R		153-252		Ake	203,0x37	Hand Brake
1.5 (C12V) Eng.G15B (51kW)	9/85-8/89		R		153-252		Ake	203,0x37	Hand Brake
1.5 12v (C12V) Eng.4G15(12v) (66kW)	9/90-12/91		R		153-252		Ake	203,0x37	Hand Brake
1.8 4WD (C37V) Eng.4G37 (63-66-69kW)	1/87-6/92		R		153-257		Ake	203,0x37	Hand Brake
1.8 4WD (C37V) Eng.G37B (61kW)	1/87-8/89		R		153-253	153-253Y	Ake	180,0x36	Hand Brake
1.8 D (C14V) Eng.4D65 (43-44kW)	1/84-6/92		R		153-253	153-253Y	Ake	180,0x36	Hand Brake
	-8/88		R		153-252		Ake	203,0x37	Hand Brake
Lancer IV (C6A, C7A)/ Mirage 4/88-5/94									
1.3 (C61A) Eng.4G13 (44-51kW)	4/88-5/92		R		153-253	153-253Y	Ake	180,0x36	Hand Brake
	6/88-92		R		700-249			Ø 180,0	
1.3 12v (C61A) Eng.4G13 (55kW)	6/92-5/94		R		153-253	153-253Y	Ake	180,0x36	Hand Brake
	6/92-5/94		R		153-258		Ake	180,0x37	Hand Brake
	92-94		R		700-249			Ø 180,0	
1.5 Eng.4G15 (62kW)	6/88-5/92		R		153-258		Ake	180,0x37	Hand Brake
	88-92		R		700-249			Ø 180,0	
1.5 12v (C62A) Eng.4G15(12v) (61-62-66kW)	4/88-5/92		R		153-253	153-253Y	Ake	180,0x36	Hand Brake
	4/88-5/92		R		153-258		Ake	180,0x37	(66kW), Hand Brake
	88-90		R		700-249			Ø 180,0	
1.6 16v (C66A, C76A) Eng.4G92 (66-70-73-83kW)	6/92-5/94		R		153-258		Ake	180,0x37	Hand Brake
	6/92-5/94		R		153-257		Ake	203,0x37	Hand Brake
	92-94		R		700-249			Ø 180,0	-ABS







		Spare Parts	F/R	L/R	CIFAM ref.	CIFAM ref. w/KIT		DIMENSIONS mm.	NOTE
1.8 4WD (C77A) Eng.4G37 (71kW)	9/89-6/92		R		153-252		Ake	203,0x37	Hand Brake
	9/89-6/92		R		153-257		Ake	203,0x37	Hand Brake
	89-92		R		700-364			Ø 203,0	
1.8 D (C64A) Eng.4D65 (44kW)	-5/90		R		153-253	153-253Y	Ake	180,0x36	Hand Brake
	6/90-		R		153-258		Ake	180,0x37	Hand Brake
	88-90		R		700-249			Ø 180,0	
Lancer V (CB/DA)/ Mirage SW 6/92-11/95									
1.6 16v, 4WD (CB/CD4W) Eng.4G92 (66-70-73-83kW)	6/92-11/95		R		153-257		Ake	203,0x37	Hand Brake
	6/92-11/95		R		153-256		Ake	228,6x40	Hand Brake
2.0 D (CB8W) Eng.4D68 (50kW)	6/92-11/95		R		153-257		Ake	203,0x37	Hand Brake
Lancer V (CB/DA)/ Mirage, Coupe 6/92-11/95									
1.3 12v (CB1A) Eng.G13(BJ90-92/12V) (55-56-58kW)	6/92-11/95		R		153-258		Ake	180,0x37	Hand Brake
1.6 16v, 4WD (CB/CD4A) Eng.4G92 (66-70-73-83kW)	6/92-11/95		R		153-257		Ake	203,0x37	Hand Brake
	6/92-11/95		R		153-256		Ake	228,6x40	Hand Brake
2.0 D (CB8A) Eng.4D68 (50kW)	6/92-11/95		R		153-257		Ake	203,0x37	Hand Brake
Lancer VI (CK/PA)/ Mirage coupe 12/95-12/07									
1.3 12v (CK1A) Eng.4G13 (55kW)	02-		R		153-263			203,2x32	Hand Brake
1.3 16v Eng.4G13(16v) (60-61-63kW)	9/03-12/07		R		153-265	153-265K		167,0x32	Hand Brake
1.5 16v (CK2A) Eng.4G15(16v) (69kW)	01/02-		R		153-263			203,2x32	Hand Brake
1.6 16v (CK4A) Eng.4G92 (66-70-73-83kW)	12/95-12/07		R		153-263			203,2x32	Hand Brake
1.6 16v, SW Eng.4G18 (72kW)	9/03-12/07		R		153-265	153-265K		167,0x32	Hand Brake
2.0 16v (CP9A) Eng.4G63T (206kW)	1/99-12/07		R		153-265	153-265K		167,0x32	Hand Brake
2.0 16v EVO IX Eng.4G63 (208kW)	1/06-12/07		R		153-265	153-265K		167,0x32	Hand Brake
2.0 16v EVO VIII Eng.4G63 (195kW)	3/04-12/07		R		153-265	153-265K		167,0x32	Hand Brake
2.0, SW Eng.4G63 (99kW)	12/03-12/07		R		153-265	153-265K		167,0x32	Hand Brake
	12/03-12/07		R		153-263			203,2x32	Hand Brake
Lancer VII, SportBack (CX/CY) 1/08-									
2.0 Evo X Eng.4B11FQ30 (217kW)	1/08-		R		153-362			170,0x32	Hand Brake
Outlander I (CU) 5/03-2/07									
2.0 4WD (177kW)	5/03-2/07		R		153-265	153-265K		167,0x32	Hand Brake
	5/03-2/07		R		153-261		Ake	228,6x32	Hand Brake
2.0 4WD Eng.4G63 (93kW)	5/03-2/07		R		153-265	153-265K		167,0x32	Hand Brake
	5/03-2/07		R		153-261		Ake	228,6x32	Hand Brake
2.0 4WD Eng.4G63-7 (100kW)	5/03-2/07		R		153-265	153-265K		167,0x32	Hand Brake
	5/03-2/07		R		153-261		Ake	228,6x32	Hand Brake
2.0 T. 4WD Eng.4G63-7 (148kW)	4/04-2/07		R		153-265	153-265K		167,0x32	Hand Brake
2.4 4WD Eng.4G64 (102kW)	5/03-2/07		R		153-265	153-265K		167,0x32	Hand Brake
	5/03-2/07		R		153-261		Ake	228,6x32	Hand Brake
2.4 4WD Eng.4G69-2 (118kW)	11/03-2/07		R		153-265	153-265K		167,0x32	Hand Brake
	11/03-2/07		R		153-261		Ake	228,6x32	Hand Brake
Outlander II (CW) 11/06-									
2.0 DI-D Eng.BSY (103kW)	3/07-		R		153-268	153-268K		190,0x32	Hand Brake
2.4 Eng.4B12 (125kW)	1/08-		R		153-268	153-268K		190,0x32	Hand Brake
3.0 4WD, FWD Eng.6B31 (162kW)	11/06-		R		153-268	153-268K		190,0x32	Hand Brake
Pajero I (L04G, L14G)/ Montero I/ Shogun I 12/82-12/91									
2.3 TD (L043G, L048G) Eng.4D55T (62kW)	12/82-4/86		R			153-251Y		254,0x50	Hand Brake
	12/82-4/86		R		153-251		Ake	254,0x50	Hand Brake
	82-86		R		700-250			Ø 254,0	
2.5 D Eng.4D56 (51kW)	82-91		R		700-331			Ø 254,0	
2.5 TD (L044G, L049G) Eng.4D56T (62-64-70kW)	5/86-12/91		R			153-251Y		254,0x50	Hand Brake
	5/86-12/91		R		153-251		Ake	254,0x50	Hand Brake
	86-91		R		700-250			Ø 254,0	
2.6 (L042G, L047G) Eng.4G54 (76kW)	1/83-11/90		R			153-251Y		254,0x50	Hand Brake
	1/83-11/90		R		153-251		Ake	254,0x50	Hand Brake
	1/83-5/87		R		700-250			Ø 254,0	
3.0 V6 (L141G, L146G) Eng.6G72 (104-110-125-130-151-210kW)	11/88-11/90		R			153-251Y		254,0x50	Hand Brake
	11/88-11/90		R		153-251		Ake	254,0x50	Hand Brake
	88-90		R		700-250			Ø 254,0	
Pajero II (V2W, V4W)/ Montero II/ Shogun II 12/90-4/00									
2.4 Eng.4G64 (82-91-97-110kW)	4/91-4/00		R		153-264	153-264K		197,0x40	Hand Brake

		Spare Parts	F/R	L/R	CIFAM ref.	CIFAM ref. w/KIT		DIMENSIONS mm.	NOTE
2.5 TD (V24C, V24W) Eng.4D56TD (73kW)	12/90-4/00		R		153-264	153-264K		197,0x40	Hand Brake
2.8 TD (V46W) Eng.4M40 (92kW)	6/94-4/00		R		153-264	153-264K		197,0x40	Hand Brake
3.0 V6 (V23W, V43W, V23C) Eng.6G72 (110kW)	12/90-12/95		R		153-264	153-264K		197,0x40	Hand Brake
3.0 V6 24v Eng.6G72(24v) (130-133kW)	6/94-4/00		R		153-264	153-264K		197,0x40	Hand Brake
3.5 V6 24v Eng.6G74 (143kW)	7/97-4/00		R		153-264	153-264K		197,0x40	Hand Brake
3.5 V6 24v (V25W, V45W) Eng.6G74 (149-153kW)	6/94-4/00		R		153-264	153-264K		197,0x40	Hand Brake
Pajero III (V60)/ Montero III/ Shogun III 4/00-1/07									
2.5 TDi Eng.4D56 (73kW)	4/00-4/00-1/07		R			153-267K		200x32	
			R		153-267	153-267K		200,0x32	Hand Brake
2.5 TDi Eng.4D56 (85kW)	9/01-1/07		R		153-267	153-267K		200,0x32	Hand Brake
3.2 DI-D Eng.4M41 (118kW)	4/00-1/07		R		153-267	153-267K		200,0x32	Hand Brake
3.2 DI-D Eng.4M41 (121kW)	4/00-1/07		R		153-267	153-267K		200,0x32	Hand Brake
3.2 DI-D Eng.4M41 (125kW)	06-		R		153-267	153-267K		200,0x32	
3.5 V6 24v Eng.6G74 (149kW)	4/00-1/07		R		153-267			200,0x32	Hand Brake
Pajero Pinin (H6W, H7W) 10/99-									
1.8 Eng.4G93 (84kW)	11/01-01-		R		153-265	153-265K		167,0x32	Hand Brake
			R		700-398			Ø 228,3	
1.8 GDi (H66W) Eng.4G93(GDI) (88kW)	10/99-		R		153-265	153-265K		167,0x32	Hand Brake
	10/99-99-		R		153-261		Ake	228,6x32	Hand Brake
			R		700-398			Ø 228,3	
2.0 GDi (H67W, H77W) Eng.4G94 (95kW)	10/00-		R		153-265	153-265K		167,0x32	Hand Brake
Pajero Sport (K90) 11/98-									
2.5 TD Eng.4D56/ T (73-83-85kW)	11/98-		R		153-264	153-264K		197,0x40	Hand Brake
2.5 TD Eng.4D56T (98kW)	11/98-		R		153-264	153-264K		197,0x40	Hand Brake
3.0 V6 Eng.6G72 (125kW)	6/00-		R		153-264	153-264K		197,0x40	Hand Brake
3.0 V6 24v Eng.6G72(24v) (130kW)	11/98-		R		153-264	153-264K		197,0x40	Hand Brake
Precis 1/83-1/94									
All models	90-91		R		153-165		Bdx	180,0x34	Hand Brake
	94-		R		153-167		Mando	180,0x35	Hand Brake
	92-94		R		700-227		Mando	Ø 180,0	
Santamo 5/99-									
2.0 16v, 4WD Eng.G4CP (102kW)	5/99-		R		153-256		Ake	228,6x40	Hand Brake
Sigma III (F16A) 12/90-7/96									
3.0 V6 (F16A) Eng.6G72 (130kW)	12/90-7/96		R		153-265	153-265K		167,0x32	Hand Brake
3.0 V6 (F16A) Eng.6G72 (151kW)	12/90-7/96		R		153-265	153-265K		167,0x32	Hand Brake
Space Gear (PA/B/DV/W) 5/95-									
2.0 16v (PA3V/W, PB3V) Eng.4G63 (75-82-85-106-110kW)	5/95-5/95-		R			153-251Y		254,0x50	Hand Brake
			R		153-251	153-251Y	Ake	254,0x50	Hand Brake
2.4, 4WD (PD4V/W) Eng.4G64 (82-91-97-110kW)	5/95-		R		153-251	153-251Y	Ake	254,0x50	Hand Brake
2.5 TD (PA5V/W, PB5V) Eng.4D56T (64kW)	5/95-5/95-		R		153-251		Ake	254,0x50	Hand Brake
			R		153-260		Ake	270,0x52	Hand Brake
2.5 TD, 4WD (PD5V/W) Eng.4D56TD (73kW)	5/95-5/95-		R			153-251Y		254,0x50	Hand Brake
			R		153-251		Ake	254,0x50	Hand Brake
			R		153-260		Ake	270,0x52	Hand Brake
Space Runner I (N1W, N2W) 10/91-8/99									
1.8, 4WD (N21W/N11W) Eng.4G93 (85-90-103kW)	10/91-8/99		R		153-265	153-265K		167,0x32	Hand Brake
	10/91-8/99		R		153-257		Ake	203,0x37	Van, Hand Brake
	10/91-8/99		R		153-256		Ake	228,6x40	Van, Hand Brake
2.0 16v Eng.4G63 (75-82-93-106-110kW)	6/97-8/99		R		153-265	153-265K		167,0x32	Hand Brake
	6/97-8/99		R		153-257		Ake	203,0x37	Van, Hand Brake
2.0 TD GLX (N18W) Eng.4D68T (60kW)	10/92-8/99		R		153-265	153-265K		167,0x32	Hand Brake
Space Runner II (N50) 8/99-									
2.0 Eng.4G63 (100kW)	8/99-		R		153-261		Ake	228,6x32	Hand Brake
2.4 GDi Eng.4G64(GDI) (82-91-97-108-110kW)	8/99-		R		153-261		Ake	228,6x32	Hand Brake
Space Star (DG0) 6/98-									
1.3 16v Eng.4G13(16v) (60-61-63kW)	12/98-12/98-		R		153-257		Ake	203,0x37	Van, Hand Brake
	98-06		R		153-259		Bosch	203,2x40	Hand Brake
			R		700-384			Ø 203,0	-ABS





		Spare Parts	F/R	L/R	CIFAM ref.	CIFAM ref. w/KIT		DIMENSIONS mm.	NOTE
1.8 GDi Eng.4G93(GDI) (82kW)	10/02-		R		153-259		Bosch	203,2x40	Hand Brake
	02-06		R		700-384			Ø 203,0	-ABS
1.8 GDi Eng.4G93(GDI) (87kW)	6/98-		R		153-259		Bosch	203,2x40	Hand Brake
	98-06		R		700-384			Ø 203,0	-ABS
1.8 GDi Eng.4G93(GDI) (90-92-93-96kW)	6/98-		R		153-259		Bosch	203,2x40	Hand Brake
	98-06		R		700-384			Ø 203,0	-ABS
Space Wagon I (D0V/W) 1/83-4/91									
1.8 (D05W) Eng.4G37 (66kW)	1/83-4/91		R		153-252		Ake	203,0x37	Hand Brake
1.8 4WD (D05V) Eng.4G37 (66kW)	1/84-8/88		R		153-252		Ake	203,0x37	Hand Brake
1.8 D (D09W) Eng.4D65 (55kW)	6/86-4/91		R		153-252		Ake	203,0x37	Hand Brake
1.8 TD Eng.4D65T (60kW)	4/88-		R		153-252		Ake	203,0x37	Van, Hand Brake
2.0 (D04W) Eng.4G63 (75kW)	3/85-4/91		R		153-252		Ake	203,0x37	Hand Brake
2.0 (D04W) Eng.G63B (62kW)	6/86-5/88		R		153-252		Ake	203,0x37	Hand Brake
2.0 4WD (D08W) Eng.4G63 (75-82-106-110kW)	3/85-4/91		R		153-252		Ake	203,0x37	Hand Brake
2.0 4WD (D08W) Eng.G63B (62kW)	6/86-5/88		R		153-252		Ake	203,0x37	Hand Brake
Space Wagon II (N3W, N4W) 10/91-10/98									
1.8 D (N35W) Eng.4D65 (55kW)	10/91-10/98		R		153-252		Ake	203,0x37	Hand Brake
1.8, 4WD (N41W, N31W) Eng.4G93 (85-90-103kW)	10/91-10/98		R		153-252		Ake	203,0x37	Hand Brake
2.0 TD GLX (N38W) Eng.4D68T (60kW)	10/92-10/98		R		153-252		Ake	203,0x37	Hand Brake
2.0, 4WD (N33W, N43W) Eng.4G63 (75-77-82-98-106-110kW)	10/92-10/98		R		153-252		Ake	203,0x37	Van, Hand Brake
	10/92-10/98		R		153-261		Ake	228,6x32	Hand Brake
2.4, AWD (N34W) Eng.4G64 (85kW)	10/91-5/96		R		153-252		Ake	203,0x37	Hand Brake
Space Wagon III (N5W) 10/98-									
2.4 GDi, 4WD Eng.4G64(GDI) (82-91-97-108-110kW)	10/98-		R		153-265	153-265K		167,0x32	Hand Brake
Tredia (A21) 9/82-10/87									
1.8 (A215) Eng.4G37 (66kW)	8/84-7/86		R		153-253	153-253Y	Ake	180,0x36	Hand Brake
1.8 T. (A213A) Eng.G62B (100kW)	8/84-7/86		R		153-253	153-253Y	Ake	180,0x36	Hand Brake



MITSUBISHI LCV



L300 I (L03P/G, L02P) 5/78-2/87									
1.6 (L032P, L062P) Eng.4G32 (48-51kW)	4/81-10/86		R			153-251Y		254,0x50	Hand Brake
	4/81-10/86		R		153-251		Ake	254,0x50	Hand Brake
1.8, 4WD (L035G) Eng.4G62 (60kW)	83-86		R			153-251Y		Ø 254,0	
	8/84-2/87		R		153-251		Ake	254,0x50	Hand Brake
	84-87		R		700-250			Ø 254,0	
2.0 4WD (L037G) Eng.4G63 (65kW)	86-87		R		700-250			Ø 254,0	
2.3 D (L038P, L068P) Eng.4D55 (50kW)	9/83-10/86		R			153-251Y		254,0x50	Hand Brake
	9/83-10/86		R		153-251		Ake	254,0x50	Hand Brake
	83-86		R		700-250			Ø 254,0	
L300 II (P0W, P1W, P2W)/ Delica 11/86-4/94									
1.4 (P01) Eng.4G33 (50kW)	11/86-		R		700-250			Ø 254,0	
1.6 (P02V, P12V) Eng.4G32 (51kW)	11/86-4/94		R			153-251Y		254,0x50	Hand Brake
	11/86-4/94		R		153-251		Ake	254,0x50	Hand Brake
	86-		R		700-250			Ø 254,0	
2.0 (P03V/W, P13V) Eng.G63B (64-66kW)	11/86-4/94		R			153-251Y		254,0x50	Hand Brake
	11/86-4/94		R		153-251		Ake	254,0x50	Hand Brake
	86-		R		700-250			Ø 254,0	
2.0 4WD (P23V, P23W) Eng.4G63 (65kW)	86-		R		700-250			Ø 254,0	
2.4 4WD (P04W, P14V, P04V) Eng.4G64 (82kW)	90-		R		700-250			Ø 254,0	
2.4 4WD (P24W, P24V) Eng.G64B (80-82kW)	11/86-		R		700-250			Ø 254,0	
2.5 D (P05V, P05W, P15V) Eng.4D56 (51kW)	11/86-4/94		R			153-251Y		254,0x50	Hand Brake
	11/86-4/94		R		153-251		Ake	254,0x50	Hand Brake
	86-		R		700-250			Ø 254,0	
2.5 TD, 4WD (P25W, P25V) Eng.4D56T (64kW)	86-		R		700-250			Ø 254,0	
L400 (PAOV) 6/96-									
2.5 TD, 4WD Eng.4D56T (64kW)	96-		R		153-260		Ake	270,0x52	Hand Brake
	99-		R			153-251Y		254,0x50	Hand Brake
	99-		R		153-251		Ake	254,0x50	Hand Brake









		Spare Parts	F/R	L/R	CIFAM ref.	CIFAM ref. w/KIT		DIMENSIONS mm.	NOTE
Plus Four 1/85-									
1.8 i (96kW)	93-		R		153-115		Ap	228,6x45	Hand Brake
2.0 i (99kW)	92-		R		153-115		Ap	228,6x45	
2.0 i Eng.132 C 3.000 (90kW)	85-88		R		153-115		Ap	228,6x45	
2.0 i Eng.M16i (103kW)	88-92		R		153-115		Ap	228,6x45	





NISSAN

100 NX (B13) 3/90-10/94									
1.6 SR Eng.GA16DE (73-75kW)	9/93-10/94		R		153-281		Tokiko	180,0x31	Hand Brake
	93-94		R		700-055			Ø 180,0	
1.6, 16v Eng.GA16DS (66-71-73kW)	3/90-10/94		R		153-281		Tokiko	180,0x31	Hand Brake
	90-94		R		700-055			Ø 180,0	





200 SX (S11) 1/77-12/84									
1.8 T. Eng.Z18ET (124kW)	4/77-12/84		R		700-328			Ø 228,5	
2.0 i 16v Eng.Z20 (103kW)	4/77-12/84		R		700-328			Ø 228,5	

350 Z (Z33) 10/03-									
3.5 Roadster Eng.VQ35DE (230kW)	4/07-		R		153-294			172,0x32	Hand Brake
3.5, Roadster Eng.VQ35DE (206kW)	10/03-		R		153-294			172,0x32	Hand Brake
3.5, Roadster Eng.VQ35DE (221kW)	4/06-		R		153-294			172,0x32	Hand Brake

Almera I (N15) 9/95-7/00									
1.4 i, 16v Eng.GA14DE (55-64kW)	9/95-7/00		R		153-281		Tokiko	180,0x31	Hand Brake
	7/95-00		R		700-055			Ø 180,0	
1.6 Eng.GA16DE (66-73-75kW)	9/95-7/00		R		153-283Y		Bdx	203x38	
	9/95-7/00		R		153-283		Bdx	203,0x38	
	9/95-7/00		R		153-281		Tokiko	180,0x31	Hand Brake
	7/95-00		R		700-055			Ø 180,0	
2.0 D Eng.CD20 (55kW)	11/95-7/00		R		153-281		Tokiko	180,0x31	Hand Brake
	7/95-00		R		700-055			Ø 180,0	
2.0 GTi Eng.SR20DE (105kW)	96-00		R		700-055			Ø 180,0	





Almera II (N16) 7/00-									
1.5 Eng.QG15DE (66kW)	7/00-		R		153-292			203,2x37	Hand Brake
	00-		R		700-353			Ø 203,0	-ABS
1.5 Eng.QG15DE (72kW)	02-		R		153-292			203,2x37	Hand Brake
	02-		R		700-353			Ø 203,0	-ABS
1.5 DCi Eng.K9K702/ 710/ 722 (60kW)	1/03-		R		153-292			203,2x37	Hand Brake

Altima I (L30) 6/93-9/01									
2.4 Eng.KA24DE (112kW)	1/93-9/01		R		153-383			228,6x37	Hand Brake
	93-		R		700-328			Ø 228,5	





Altima II (L31) 1/02-									
2.5 Eng.QR25DE (121kW)	8/01-9/06		R		153-294			172,0x32	Hand Brake
2.5 Eng.QR25DE (128kW)	10/06-		R		153-294			172,0x32	Hand Brake
3.5 Eng.VQ35DE (180kW)	8/01-9/06		R		153-294			172,0x32	Hand Brake
3.5 V6 Eng.VQ35DE (201kW)	1/02-		R		153-294			172,0x32	Hand Brake































































Avia 1/80-									
1.2 F275	1/80-		R		153-342		Lucas	255,0x57	
2.0	1/80-		R		153-342		Lucas	255,0x57	



















































Axxess 1/89-1/91									
All models	89-91		R		700-328			Ø 228,5	











































Bluebird (610) 7/74-11/79									
1.6 Eng.L16 (75kW)	1/68-12/81		R		153-271		Ake	228,6x40	Hand Brake
1.8 Eng.L18 (59kW)	7/74-11/79		R		153-271		Ake	228,6x40	Hand Brake
1.8 Eng.L18 (65kW)	7/74-11/79		R		153-271		Ake	228,6x40	Hand Brake
2.0 Eng.L20B (81kW)	74-79		R		700-328			Ø 228,5	





































Bluebird (710) 7/74-1/77									
1.8 Eng.L18 (59kW)	74-77		R		700-328			Ø 228,5	
2.0 Eng.L20B (81kW)	74-77		R		700-328			Ø 228,5	







































Bluebird (810) 1/76-1/83									
2.0 Eng.L20/ A/ E/ P/ S (83kW)	1/78-1/83		R		153-271		Ake	228,6x40	Hand Brake
2.0 Eng.L20E	1/78-1/83		R		153-271		Ake	228,6x40	Hand Brake
2.4 Eng.L24 (96kW)	7/76-80		R		700-328			Ø 228,5	
2.8 D Eng.LD28 (62kW)	7/76-80		R		700-328			Ø 228,5	
3.0	7/76-80		R		700-328			Ø 228,5	

		Spare Parts	F/R	L/R	CIFAM ref.	CIFAM ref. w/KIT		DIMENSIONS mm.	NOTE
Bluebird (910) 1/80-5/84									
1.6 Eng.L16S (60kW)	1/80-11/83		R		153-271		Ake	228,6x40	Hand Brake
1.8 Coupe Eng.L18T (66kW)	1/80-5/84		R		153-271		Ake	228,6x40	Hand Brake
1.8, SW Eng.L18S (65kW)	1/80-5/84		R		153-271		Ake	228,6x40	Hand Brake
	80-83		R		700-328			Ø 228,5	Europe, SW
2.0 D, SW Eng.LD20 (44kW)	80-83		R		700-328			Ø 228,5	Europe, SW
2.0 i, Coupe Eng.Z20E (80kW)	1/82-5/84		R		153-271		Ake	228,6x40	Hand Brake
Bluebird (T72 , T12) 12/85-6/91									
1.6 Eng.CA16S (61kW)	3/86-6/90		R		153-277		Sumit.	228,6x40	Hand Brake
	86-90		R		700-058			Ø 228,6	
1.6 Eng.CA16S (66kW)	3/86-6/91		R		153-277		Sumit.	228,6x40	Hand Brake
1.8 Eng.CA18 (74kW)	1/83-12/90		R		153-277		Sumit.	228,6x40	Hand Brake
1.8 Eng.CA18l (65kW)	1/87-1/90		R		153-277		Sumit.	228,6x40	Hand Brake
1.8 16v Eng.CA18D (95kW)	2/89-12/90		R		153-277		Sumit.	228,6x40	Hand Brake
1.8 T. Eng.CA18T (99kW)	12/85-5/90		R		153-277		Sumit.	228,6x40	Hand Brake
2.0 Eng.CA20S (75kW)	12/85-12/87		R		153-277		Sumit.	228,6x40	Hand Brake
	85-87		R		700-058			Ø 228,6	
2.0 D Eng.LD20 (49kW)	86-90		R		700-058			Ø 228,6	
2.0 i Eng.CA20E (85kW)	9/88-9/90		R		153-277		Sumit.	228,6x40	Hand Brake
2.0 i, kat Eng.CA20E/ KAT (77kW)	9/88-9/90		R		153-277		Sumit.	228,6x40	Hand Brake
	88-90		R		700-058			Ø 228,6	
Bluebird (U11/ WU11) 11/83-12/90									
1.6 Eng.CA16S (61-66kW)	-85		R		153-271		Ake	228,6x40	Hand Brake
1.8 Eng.CA18S (66kW)	1/86-		R		153-277		Sumit.	228,6x40	Hand Brake
	-12/85		R		153-271		Ake	228,6x40	Hand Brake
	83-88		R		700-058			Ø 228,6	
1.8 T. Eng.CA18T (99kW)	1/86-		R		153-277		Sumit.	228,6x40	Hand Brake
	-12/85		R		153-271		Ake	228,6x40	Hand Brake
2.0 D, SW Eng.LD20 (43kW)	1/86-		R		153-277		Sumit.	228,6x40	Hand Brake
	-12/85		R		153-271		Ake	228,6x40	Hand Brake
	84-90		R		700-058			Ø 228,6	
2.0 D, SW Eng.LD20 (49kW)	1/86-		R		153-277		Sumit.	228,6x40	Hand Brake
	-12/85		R		153-271		Ake	228,6x40	Hand Brake
	84-90		R		700-058			Ø 228,6	
2.0 i, kat Eng.CA20E/ KAT (77kW)	89-		R		153-277		Sumit.	228,6x40	Hand Brake
	84-90		R		700-058			Ø 228,6	
2.0 i, SW Eng.CA20E (85kW)	89-		R		153-277		Sumit.	228,6x40	Hand Brake
Cedric 1/68-1/87									
All models	68-87		R		700-328			Ø 228,5	
Cherry III (N12) 5/82-12/86									
1.0 Eng.E10 (37kW)	5/82-5/86		R		153-272		Sumit.	180,0x35	Hand Brake
	4/82-86		R		700-051			Ø 180,0	
1.3 Eng.E13 (44kW)	5/82-10/86		R		153-272		Sumit.	180,0x35	Hand Brake
	4/82-86		R		700-051			Ø 180,0	
1.5 Eng.E15S (55kW)	11/83-10/86		R		153-272		Sumit.	180,0x35	Hand Brake
	83-86		R		700-051			Ø 180,0	
1.5 T. Eng.E15ET (77kW)	1/83-12/85		R		153-272		Sumit.	180,0x35	Hand Brake
	83-85		R		700-051			Ø 180,0	
1.6 (54kW)	82-86		R		700-051			Ø 180,0	
1.7 D Eng.CD17 (40kW)	10/82-12/86		R		153-272		Sumit.	180,0x35	Hand Brake
	82-86		R		700-051			Ø 180,0	
Cherry IV (N13) 12/86-12/90									
1.3 Eng.E13S (57-59kW)	12/86-12/90		R		153-272		Sumit.	180,0x35	Hand Brake
1.4 Eng.GA14S (55kW)	12/86-12/90		R		153-272		Sumit.	180,0x35	Hand Brake
1.6 Eng.E16i/ E16S (54-62kW)	12/86-		R		153-272		Sumit.	180,0x35	Hand Brake
1.7 D Eng.CD17 (40kW)	12/86-		R		153-272		Sumit.	180,0x35	Hand Brake
Cube (Z12) 3/10-									
1.5 DCi Eng.K9K (78kW)	10-		R			153-450K		170x32	
	10-		R		153-295			172,0x32	
1.5 DCi Eng.K9K (81kW)	10-		R			153-450K		170x32	
	10-		R		153-295			172,0x32	
1.6 16v Eng.HR16DE (81kW)	10-		R			153-450K		170x32	
	10-		R		153-295			172,0x32	
Ebro 1/76-									
2.8	1/91-		R		153-280		Ake	295,0x60	Hand Brake
	-11/90		R		153-275		Ake	270,0x50	Hand Brake
D350	-79		R		153-342		Lucas	255,0x57	























































		Spare Parts	F/R	L/R	CIFAM ref.	CIFAM ref. w/KIT		DIMENSIONS mm.	NOTE
F275	79-		R		153-342		Lucas	255,0x57	
F350	1/76-		R		153-342		Lucas	255,0x57	
	76-		R		700-063			Ø 270,0	Spain
L35	-79		R		153-342		Lucas	255,0x57	
Fairlady 1/70-12/80									
2.0 Eng.L20/ A/ E/ P/ S (83kW)	1/70-12/77		R		153-271		Ake	228,6x40	Hand Brake
2.4 Eng.L24 (96kW)	1/72-12/75		R		153-271		Ake	228,6x40	Hand Brake
Juke 8/10-									
1.5 DCi Eng.K9K (81kW)	10-		R			153-450K		170x32	
	10-		R		153-295			172,0x32	
1.6 16v Eng.HR16DE (86kW)	10-		R			153-450K		170x32	
	10-		R		153-295			172,0x32	
1.6 16v Dig-T, 4WD Eng.MR16DDT (140kW)	10-		R			153-450K		170x32	
	10-		R		153-295			172,0x32	
Laurel (HLC230) 3/72-5/83									
1.8 Eng.L18 (78kW)	3/72-5/83		R		153-271		Ake	228,6x40	Hand Brake
2.0 Eng.L20A (71kW)	-12/79		R		153-271		Ake	228,6x40	Hand Brake
2.0 Eng.L20E	-12/79		R		153-271		Ake	228,6x40	Hand Brake
Laurel (JC31) 1/81-12/85									
2.0 Eng.L20A (71kW)	81-84		R		700-328			Ø 228,5	
2.0 D Eng.LD20 (44kW)	81-84		R		700-328			Ø 228,5	
2.4 Eng.L24 (83-88-96kW)	1/81-12/85		R		153-271		Ake	228,6x40	Hand Brake
	81-85		R		700-328			Ø 228,5	
2.8 D Eng.LD28 (62kW)	1/81-10/85		R		153-271		Ake	228,6x40	Hand Brake
	81-85		R		700-328			Ø 228,5	
Laurel (JC32) 1/85-12/89									
2.4 Eng.L24E/ S (94kW)	1/85-12/87		R		153-277		Sumit.	228,6x40	Hand Brake
2.8 D Eng.LD28 (62kW)	1/85-12/87		R		153-277		Sumit.	228,6x40	Hand Brake
2.8 D Eng.RD28 (66kW)	1/85-12/89		R		153-277		Sumit.	228,6x40	Hand Brake
Leaf 11/10-									
Electric Eng.EM61 (80kW)	10-		R			153-450K		170x32	
	10-		R		153-295			172,0x32	
Leopard (F30) 1/79-12/86									
1.8 Eng.Z18 (78kW)	1/79-12/86		R		153-271		Ake	228,6x40	Hand Brake
Maxima 1/81-12/84									
2.4 Eng.L24E (103kW)	1/81-12/84		R		153-271		Ake	228,6x40	Hand Brake
2.8 D Eng.LD28 (67kW)	1/81-12/84		R		153-271		Ake	228,6x40	Hand Brake
Maxima (J30) 10/88-6/94									
3.0 i Eng.VG30E (125kW)	10/88-6/94		R		153-277		Sumit.	228,6x40	Hand Brake
	88-94		R		700-328			Ø 228,5	SW
Maxima Qx (A34) 1/04-12/08									
3.5 V6 Eng.VQ35DE (170kW)	04-08		R		153-294			172,0x32	Hand Brake
Micra I (K10) 12/82-7/92									
1.0 Eng.MA10S (37-40-43kW)	12/82-5/91		R		153-273		Ake	180,0x28	
	82-88		R		700-056			Ø 180,0	
	88-91		R		700-057			Ø 180,0	
1.2 Eng.MA12S (40-44kW)	7/86-7/92		R		153-273		Ake	180,0x28	
	86-88		R		700-056			Ø 180,0	
	88-92		R		700-057			Ø 180,0	
Micra II (K11) 8/92-2/03									
1.0 i 16v Eng.CG10DE (44kW)	9/00-2/03		R		153-288		Lucas	180,0x28	Hand Brake
	00-03		R		700-069			Ø 180,0	AW
	00-03		R		700-060			Ø 180,0	IW
	00-03		R		151-174		Lucas	Ø 17,78 180,0x28	LUC
1.0 i 16v Eng.CG10DE/ GE (40kW)	8/92-9/00		R		153-284		Lucas	180,0x27	Hand Brake
	92-00		R		700-069			Ø 180,0	AW
	92-00		R		700-060			Ø 180,0	IW
	92-98		R		151-173		Lucas	Ø 17,78 180,0x27	LUC
1.3 i 16v Eng.CG13DE/ GE (55kW)	8/92-9/00		R		153-284		Lucas	180,0x27	Hand Brake
	92-00		R		700-069			Ø 180,0	AW
	92-00		R		700-060			Ø 180,0	IW
	92-98		R		151-173		Lucas	Ø 17,78 180,0x27	LUC
1.4 i 16v Eng.CGA3DE (60kW)	9/00-2/03		R		153-288		Lucas	180,0x28	Hand Brake
	00-03		R		700-069			Ø 180,0	AW
	00-03		R		700-060			Ø 180,0	IW
	00-03		R		151-174		Lucas	Ø 17,78 180,0x28	LUC
1.5 D Eng.TD15/ TUD5 (42kW)	-98		R		153-284		Lucas	180,0x27	Hand Brake
	98-		R		153-288		Lucas	180,0x28	Hand Brake















		Spare Parts	F/R	L/R	CIFAM ref.	CIFAM ref. w/KIT		DIMENSIONS mm.	NOTE
1.5 D Eng.TD15/ TUD5 (42kW)	98-03		R		700-069			Ø 180,0	AW
	98-03		R		700-060			Ø 180,0	IW
	98-03		R		151-174		Lucas	Ø 17,78 180,0x28	LUC
Micra III (K12) 1/03-11/10									
1.0 16v Eng.CR10DE (48kW)	1/03-		R		153-290		Ap	203,0x38	Hand Brake
	1/03-03-		R		700-352	700-352K		Ø 203,3	
	03-		R		151-231		Ap	Ø 19,05 203,0x38	AP
1.2 16v Eng.CR12 (48kW)	1/03-		R		153-290		Ap	203,0x38	Hand Brake
	1/03-03-		R		700-352	700-352K		Ø 203,3	
	03-		R		151-231		Ap	Ø 19,05 203,0x38	AP
1.2 16v Eng.CR12DE (59kW)	1/03-		R		153-290		Ap	203,0x38	Hand Brake
	1/03-03-		R		700-352	700-352K		Ø 203,3	
	03-		R		151-231		Ap	Ø 19,05 203,0x38	AP
1.4 16v Eng.CR14DE (65kW)	1/03-		R		153-290		Ap	203,0x38	Hand Brake
	1/03-03-		R		700-352	700-352K		Ø 203,3	
	03-		R		151-231		Ap	Ø 19,05 203,0x38	AP
1.5 DCi Eng.K9K (48kW)	1/03-		R		153-290		Ap	203,0x38	Hand Brake
	1/03-03-		R		700-352	700-352K		Ø 203,3	
	03-		R		151-231		Ap	Ø 19,05 203,0x38	AP
1.5 DCi Eng.K9K (50kW)	1/03-		R		153-290		Ap	203,0x38	Hand Brake
	03-		R		151-231		Ap	Ø 19,05 203,0x38	AP
1.5 DCi Eng.K9K (60kW)	9/03-		R		153-290		Ap	203,0x38	Hand Brake
	1/03-03-		R		700-352	700-352K		Ø 203,3	
	03-		R		151-231		Ap	Ø 19,05 203,0x38	AP
1.5 DCi Eng.K9K (63kW)	07-		R		700-352	700-352K		Ø 203,3	
	07-		R		700-352	700-352K		Ø 203,3	
	07-		R		151-231		Ap	Ø 19,05 203,0x38	AP
1.6 16v Eng.HR16DE (81kW)	5/05-		R		153-290		Ap	203,0x38	Hand Brake
	05-		R		700-352	700-352K		Ø 203,3	
	05-		R		151-231		Ap	Ø 19,05 203,0x38	AP
Micra III Cabrio 8/05-11/10									
1.4 16v Eng.CR14DE (65kW)	05-		R		700-352	700-352K		Ø 203,3	
	05-		R		151-231		Ap	Ø 19,05 203,0x38	AP
1.6 16v Eng.HR16DE (81kW)	05-		R		700-352	700-352K		Ø 203,3	
	05-		R		151-231		Ap	Ø 19,05 203,0x38	AP
Murano I (Z50) 3/05-10/08									
3.5 4WD Eng.VQ35DE (172kW)	3/05-		R			153-297K		190x33	
	3/05-10/08		R		153-297			190,0x33	Hand Brake
Navara II (D40) 7/05-									
2.5 DCi Eng.YD25DDTI (106kW)	05-		R			153-298K		190x33	
	05-		R		153-508		295x57		
	7/05-		R		153-298	153-298K		190,0x33	Hand Brake
2.5 DCi Eng.YD25DDTI (126kW)	05-		R		153-508			295x57	
	10/06-		R		153-298	153-298K		190,0x33	Hand Brake
2.5 DCi 4WD Eng.YD25DDTI (128kW)	05-		R		153-508			295x57	
	7/05-		R		153-298	153-298K		190,0x33	Hand Brake
2.5 DCi 4WD Eng.YD25DDTI (140kW)	10-		R		153-508			295x57	
Note (E11E) 3/06-									
1.4 16v Eng.CR14DE (65kW)	3/06-		R		153-290		Ap	203,0x38	Hand Brake
	3/06-		R		700-352	700-352K		Ø 203,3	
	06-		R		151-231		Ap	Ø 19,05 203,0x38	AP
1.5 DCi Eng.K9K (63kW)	3/06-		R		153-290		Ap	203,0x38	Hand Brake
	3/06-		R		700-352	700-352K		Ø 203,3	
	06-		R		151-231		Ap	Ø 19,05 203,0x38	AP
1.5 DCi Eng.K9K752 (50kW)	3/06-		R		153-290		Ap	203,0x38	Hand Brake
	3/06-		R		700-352	700-352K		Ø 203,3	
	06-		R		151-231		Ap	Ø 19,05 203,0x38	AP
1.6 16v Eng.HR16DE (81kW)	3/06-		R		153-290		Ap	203,0x38	Hand Brake
	3/06-		R		700-352	700-352K		Ø 203,3	
	06-		R		151-231		Ap	Ø 19,05 203,0x38	AP
NX 1/91-12/93									
1.6 16v Eng.GA16DS (66-70kW)	1/91-12/93		R		153-281		Tokiko	180,0x31	Hand Brake
Pathfinder I (WD21) 9/82-2/98									
2.4 i 4WD Eng.Z24i (76-79kW)	3/86-4/92		R		153-278		Ake	254,0x60	Hand Brake
	1/90-12/90		R		700-052			Ø 260,0	
	86-88		R		700-054			Ø 254,0	
2.5 D 4WD Eng.SD25 (53-55kW)	1/90-12/90		R		700-052			Ø 260,0	
	86-88		R		700-054			Ø 254,0	

























































		Spare Parts	F/R	L/R	CIFAM ref.	CIFAM ref. w/KIT		DIMENSIONS mm.	NOTE
2.7 TD 4WD Eng.TD27 (58-73kW)	1/90-12/90		R		700-052			Ø 260,0	
			R		700-054			Ø 254,0	
3.0 i V6 4WD Eng.VG30E (109kW)	-88		R		153-278		Ake	254,0x60	USA, Hand Brake
			R		153-279		Ake	260,0x50	USA, Hand Brake
3.0 V6 Eng.VG30 (133kW)	-88		R		153-278		Ake	254,0x60	USA, Hand Brake
			R		153-279		Ake	260,0x50	USA, Hand Brake
Pathfinder II (R50) 9/97-2/05									
2.7 TD 4WD Eng.TD27ETi (96kW)	97-04		R		700-376		Ake	Ø 295,0	
3.2 TD 4WD Eng.QD32ETi (110kW)	9/97-2/05		R		153-282		Ake	295,0x50	Hand Brake
			R		700-376		Ake	Ø 295,0	
3.3 V6 4WD Eng.VG33E (110kW)	3/98-10/00		R		153-282		Ake	295,0x50	Hand Brake
			R		700-376		Ake	Ø 295,0	
3.3 V6 4WD Eng.VG33E (125kW)	9/97-2/05		R		153-282		Ake	295,0x50	Hand Brake
			R		700-376		Ake	Ø 295,0	
3.5 V6 4WD Eng.VQ35 (162kW)	11/00-2/05		R		153-282		Ake	295,0x50	Hand Brake
			R		700-376		Ake	Ø 295,0	
Pathfinder III (R51) 3/05-									
2.5 DCi Eng.YD25DDTi (126kW)	08-4/08-		R			153-298K		190x33	
			R		153-298	153-298K		190,0x33	Hand Brake
2.5 DCi 4WD Eng.YD25DDTi (128kW)	3/05-		R		153-298	153-298K		190,0x33	Hand Brake
3.0 DCi (170kW)	10-		R		153-298			190,0x33	
4.0 4WD Eng.VQ40DE (198kW)	9/05-		R		153-298	153-298K		190,0x33	Hand Brake
Patrol I (W/K160) SW / Safari 11/79-11/95									
2.8 Eng.L28 (88-89kW)	82-83		R		153-275		Ake	270,0x50	Hand Brake
			R		700-062			Ø 270,0	Japan
			R		700-063			Ø 270,0	Spain
2.8 TD Eng.RD28T (85kW)	5/86-11/95		R		153-280		Ake	295,0x60	Hand Brake
			R		700-062			Ø 270,0	Japan
			R		700-063			Ø 270,0	Spain
3.3 D Eng.SD33 (70kW)	11/79-8/88		R		153-275		Ake	270,0x50	Hand Brake
			R		700-062			Ø 270,0	Japan
			R		700-063			Ø 270,0	Spain
3.3 TD Eng.SD33T (81kW)	7/83-8/88		R		153-275		Ake	270,0x50	Hand Brake
			R		700-062			Ø 270,0	Japan
			R		700-063			Ø 270,0	Spain
3.9 (85kW)	7/83-8/85		R		153-275		Ake	270,0x50	Hand Brake
			R		700-062			Ø 270,0	Japan
			R		700-063			Ø 270,0	Spain
Patrol I (W/K260) / Safari 10/84-4/98									
2.8 D, 4WD (62kW)	10/84-2/89		R		153-275		Ake	270,0x50	Spain, Hand Brake
2.8 D, 4WD Eng.A428 (55kW)	10/84-2/89		R		153-275		Ake	270,0x50	Spain, Hand Brake
2.8 TD 4WD Eng.RD28T (86kW)	3/93-6/93		R		153-275		Ake	270,0x50	Hand Brake
			R		153-415		Ake	295,0x60	Van
2.8 TD, 4WD Eng.A428T (88kW)	10/84-2/89		R		153-275		Ake	270,0x50	Spain, Hand Brake
3.0 (99kW)	89-93		R		153-415		Ake	295,0x60	Van
3.2 D Eng.SD33T (81kW)	8/88-6/90		R		153-275		Ake	270,0x50	Hand Brake
Patrol I (Y60) Gr / Safari 9/82-6/97									
2.8 TD Eng.RD28T (85kW)	9/88-6/97		R		153-275		Ake	270,0x50	Hand Brake
			R		153-280		Ake	295,0x60	Hand Brake
			R		700-064			Ø 295,0	
4.2 D Eng.TD42 (85kW)	88-97		R		700-064			Ø 295,0	
4.2 Kat Eng.TB42E (121kW)	11/88-6/97		R		153-280		Ake	295,0x60	Hand Brake
			R		700-064			Ø 295,0	
Patrol II (Y61) Gr / Safari 6/97-									
2.8 TD Eng.RD28Ti (95kW)	6/97-5/00		R		153-289			203,2x47	
3.0 DTi Eng.ZD30DDTi (116kW)	5/00-		R		153-289			203,2x47	
4.2 TD Eng.TD42T (107kW)	6/97-		R		153-289			203,2x47	
4.5 i Eng.TB45E (147kW)	6/97-		R		153-289			203,2x47	
Pixo 6/09-									
1.0 Eng.K10B (50kW)	6/09-		R		153-518			180x26	
Prairie (M10, NM10) 7/83-9/88									
1.5 S Eng.E15S (55kW)	1/84-12/87		R		153-277		Sumit.	228,6x40	Hand Brake
1.8 Eng.CA18S (66kW)	7/83-10/87		R		153-277		Sumit.	228,6x40	Hand Brake
2.0 2WD Eng.CA20S (68-71-77-85kW)	6/86-9/88		R		153-277		Sumit.	228,6x40	Hand Brake
			R		700-328			Ø 228,5	













































		Spare Parts	F/R	L/R	CIFAM ref.	CIFAM ref. w/KIT		DIMENSIONS mm.	NOTE
2.0 4WD Eng.CA20S (68-71-77-85kW)	6/86-9/88		R		153-277		Sumit.	228,6x40	Hand Brake
	86-88		R		700-328			Ø 228,5	
Prairie Pro (M11) 10/88-7/94									
2.0 i Eng.CA20EKat. (71-72-77-85kW)	10/88-12/92		R		153-277		Sumit.	228,6x40	Hand Brake
	88-92		R		700-328			Ø 228,5	
2.0 i 4WD Eng.CA20EKat. (71-72-77-85kW)	10/88-12/92		R		153-277		Sumit.	228,6x40	Hand Brake
	88-92		R		700-328			Ø 228,5	
Primera I (P10) 6/90-6/96									
1.6 Eng.GA16DE/ DS (66-71-73-75kW)	6/90-1/96		R		153-283	153-283Y	Bdx	203,0x38	-ABS
	90-96		R		700-059			Ø 203,0	
2.0 D Eng.CD20 (55kW)	1/91-1/96		R		153-283		Bdx	203,0x38	-ABS
	91-96		R		700-059			Ø 203,0	
Primera I (W10) SW/ Avenir 7/90-3/98									
1.6 Eng.GA16DE/ DS (66-71-73-75kW)	7/90-		R			153-283Y		203x38	
	7/90-3/98		R		153-277		Sumit.	228,6x40	-ABS, Hand Brake
	90-98		R		700-328			Ø 228,5	
2.0 D Eng.CD20 (55kW)	7/90-		R			153-283Y		203x38	-ABS
	7/90-12/95		R		153-277		Sumit.	228,6x40	-ABS, Hand Brake
	90-95		R		700-328			Ø 228,5	
Primera II (P11) 9/96-2/02									
1.6 16v Eng.GA16DE (66-73kW)	9/96-2/02		R		153-286		Bdx	203,2x38	Hand Brake
	9/96-2/02		R		153-354			228,6x42	
	6/99-02		R		700-353			Ø 203,0	
	9/96-6/99		R		700-070			Ø 228,6	
1.6 16v Eng.QG16DE (78kW)	9/00-2/02		R		153-286		Bdx	203,2x38	Hand Brake
	9/00-2/02		R		153-354			228,6x42	
2.0 TD Eng.CD20T (66kW)	9/96-2/02		R		153-286		Bdx	203,2x38	Hand Brake
	9/96-2/02		R		153-354			228,6x42	
	9/96-99		R		700-070			Ø 228,6	
Primera II (WP11) SW 4/98-2/02									
1.6 16v Eng.GA16DE (66-73kW)	6/99-02		R		700-353			Ø 203,0	
	98-6/99		R		700-070			Ø 228,6	
2.0 TD Eng.CD20T (66kW)	98-02		R		700-070			Ø 228,6	
Pulsar I/ Langley 8/78-12/83									
1.0 Eng.A10S (32kW)	78-81		R		700-051			Ø 180,0	
1.2, Coupe, SW Eng.A12 (38kW)	78-81		R		700-051			Ø 180,0	
1.3, Coupe, SW Eng.E13 (44kW)	81-83		R		700-051			Ø 180,0	
1.4, Coupe, SW Eng.A14S (59kW)	80-81		R		700-051			Ø 180,0	
1.5 Eng.E15 (51-62kW)	81-82		R		700-051			Ø 180,0	
Pulsar II/ Langley 1/82-12/86									
1.3 Eng.E13S (44kW)	1/82-12/86		R		153-272		Sumit.	180,0x35	Hand Brake
Qashqai (J10) 2/07-									
1.5 DCi Eng.K9K (81kW)	10-		R			153-450K		170x32	
	10-		R		153-295		172,0x32		
1.5 DCi Eng.K9K764 (78kW)	07-		R			153-450K		170x32	
	07-		R		153-295		172,0x32		
1.5 DCi Eng.K9K772 (76kW)	08-		R			153-450K		170x32	
	08-		R		153-295		172,0x32		
1.6 Eng.HR16DE (86kW)	10-		R			153-450K		170x32	
	10-		R		153-295		172,0x32		
1.6 16v Eng.HR16DE (84kW)	07-		R			153-450K		170x32	
	07-		R		153-295		172,0x32		
2.0 16v, Allrad Eng.MR20DE (104kW)	07-		R			153-450K		170x32	
	07-		R		153-295		172,0x32		
2.0 DCi, Allrad Eng.M9R7 (110kW)	07-		R			153-450K		170x32	
	07-		R		153-295		172,0x32		
Sentra II (B11), SW 3/82-9/87									
1.5, Coupe Eng.E15S (55kW)	3/82-10/86		R		153-272		Sumit.	180,0x35	Hand Brake
Sentra III (N13, B12) 6/86-10/91									
1.6 i 12v, SW, Coupe, 4WD Eng.GA16i (66kW)	10/88-6/91		R		153-277		Sumit.	228,6x40	Hand Brake
1.6, 4WD, Coupe, SW Eng.E16i (54kW)	6/86-10/90		R		153-277		Sumit.	228,6x40	Hand Brake
1.7 D, SW Eng.CD17 (40kW)	6/86-5/89		R		153-277		Sumit.	228,6x40	Hand Brake
1.8 GTI 16v, Coupe Eng.CA18D (92kW)	1/89-6/91		R		153-277		Sumit.	228,6x40	Hand Brake



































		Spare Parts	F/R	L/R	CIFAM ref.	CIFAM ref. w/KIT		DIMENSIONS mm.	NOTE
Sentra IV (N14, B13) 10/90-6/95									
1.3 Eng.GA13DS	91-		R		700-055			Ø 180,0	
1.4 i Eng.GA14DS (55kW)	90-		R		700-055			Ø 180,0	
1.4 i 16v Eng.GA14DE (64kW)	91-		R		700-055			Ø 180,0	
1.5 Eng.GA15DS (77kW)	91-		R		700-055			Ø 180,0	
1.5 4WD Eng.GA15DS (77kW)	90-		R		700-055			Ø 180,0	
1.6 16v, 4WD, SW Eng.GA16DE (73-75kW)	10/92-5/95		R		153-281		Tokiko	180,0x31	Hand Brake
	92-		R		700-055			Ø 180,0	
1.6, 16v 4WD, SW Eng.GA16DS (66kW)	10/90-5/95		R		153-281		Tokiko	180,0x31	Hand Brake
	90-		R		700-055			Ø 180,0	
1.7 D Eng.CD17 (40kW)	90-		R		700-055			Ø 180,0	
1.7 D 4WD Eng.CD17 (40kW)	90-		R		700-055			Ø 180,0	
2.0 D, SW Eng.CD20 (55kW)	90-		R		700-055			Ø 180,0	
Sentra VII (B16) 9/06-									
2.0 Eng.MR20DE (104kW)	9/06-		R		153-296			228,6x37	
Serena (C23M) 11/92-									
1.6 16v Eng.GA16DE (71kW)	2/93-		R		153-287		Lucas	254,0x57	Hand Brake
	93-		R		700-065			Ø 254,0	
2.0 16v Eng.SR20DE (93kW)	11/92-		R		153-287		Lucas	254,0x57	Hand Brake
	92-		R		700-065			Ø 254,0	
2.0 D Eng.LD20 (49kW)	11/92-		R		153-287		Lucas	254,0x57	Hand Brake
	92-		R		700-065			Ø 254,0	
2.3 D Eng.LD23 (55kW)	1/95-		R		153-287		Lucas	254,0x57	Hand Brake
	95-		R		700-065			Ø 254,0	
Silvia I (S110) 1/76-5/83									
1.8 Eng.L18 (59kW)	1/76-12/81		R		153-271		Ake	228,6x40	Hand Brake
1.8 T. Eng.CA18ET (68kW)	1/79-5/83		R		153-271		Ake	228,6x40	Hand Brake
	79-83		R		700-328			Ø 228,5	
2.0 Eng.Z20 (64kW)	1/79-5/83		R		153-271		Ake	228,6x40	Hand Brake
Silvia II (S12) 4/84-9/88									
2.0 GP Eng.FJ20E (107kW)	4/84-9/88		R		153-271		Ake	228,6x40	Hand Brake
	84-88		R		700-328			Ø 228,5	
Skyline 1/72-1/93									
1.6 Eng.L16S (60kW)	1/79-1/93		R		153-271		Ake	228,6x40	Hand Brake
1.8 Eng.L18 (59kW)	1/72-12/81		R		153-271		Ake	228,6x40	Hand Brake
	9/72-7/77		R		700-328			Ø 228,5	
2.0	1/72-1/93		R		153-271		Ake	228,6x40	Hand Brake
2.0 Eng.L20/ A/ E/ P/ S (83kW)	1/70-1/93		R		153-271		Ake	228,6x40	Hand Brake
2.0 Eng.Z20 (64kW)	1/79-1/93		R		153-271		Ake	228,6x40	Hand Brake
2.4 K GT Eng.L24 (96kW)	9/72-7/77		R		700-328			Ø 228,5	
C110	12/72-11/75		R		700-328			Ø 228,5	
C210	9/72-7/77		R		700-328			Ø 228,5	
Stanza I 7/77-1/83									
1.6 Eng.L16 (75kW)	1/77-1/83		R		153-271		Ake	228,6x40	Hand Brake
Stanza II (T11) 8/81-12/85									
1.6 Eng.CA16S (61kW)	81-85		R		700-328			Ø 228,5	Sedan, Van Wagon
	81-85		R		700-058			Ø 228,6	Sedan, SW 4x4
1.7 TD Eng.CD17T	81-85		R		700-328			Ø 228,5	Sedan, Van Wagon
	81-85		R		700-058			Ø 228,6	Sedan, SW 4x4
1.8, SGL Eng.CA18/ S (65-66kW)	81-85		R		700-328			Ø 228,5	Sedan, Van Wagon
	81-85		R		700-058			Ø 228,6	Sedan, SW 4x4
Stanza III (T12)/ Auster 1/86-12/90									
1.6 Eng.CA16S (61kW)	12/85-12/88		R		153-279		Ake	260,0x50	Hand Brake
	12/85-12/88		R		153-277		Sumit.	228,6x40	Wagon, Hand Brake
1.8 Eng.CA18I (65-74kW)	1/86-12/90		R		153-279		Ake	260,0x50	Hand Brake
	1/86-12/90		R		153-277		Sumit.	228,6x40	Wagon, Hand Brake
1.8 16v Eng.CA18D (92-95kW)	1/88-12/90		R		153-277		Sumit.	228,6x40	Hand Brake
1.8 T. Eng.CA18DET (124kW)	1/86-12/88		R		153-279		Ake	260,0x50	Hand Brake
	1/86-12/88		R		153-277		Sumit.	228,6x40	Wagon, Hand Brake
2.0 Eng.CA20E/ S (71-77-85kW)	12/85-7/86		R		153-279		Ake	260,0x50	Hand Brake
Sunny (140Y, 150Y) 1/70-2/82									
1.4 Eng.L14 (63kW)	1/70-12/78		R		153-270			203,2x36	Hand Brake
1.4, SW Eng.A14 (48-49-59kW)	1/70-2/82		R		153-270			203,2x36	Hand Brake
Sunny I (B) 1/71-2/82									
110	1/71-2/82		R		153-270			203,2x36	Hand Brake
120, Pick-up Eng.A12 (38kW)	1/71-2/82		R		153-270			203,2x36	Hand Brake
210	1/71-2/82		R		153-270			203,2x36	Hand Brake

		Spare Parts	F/R	L/R	CIFAM ref.	CIFAM ref. w/KIT		DIMENSIONS mm.	NOTE
Sunny II (B11), SW 3/82-9/87									
1.3, Coupe Eng.E13S (44kW)	3/82-9/87		R		153-272		Sumit.	180,0x35	Hand Brake
	82-87		R		700-051			Ø 180,0	Europe
1.5 Eng.E15 (62kW)	1/82-12/86		R		153-272		Sumit.	180,0x35	Hand Brake
1.5, Coupe Eng.E15S (55kW)	3/82-10/86		R		153-272		Sumit.	180,0x35	Hand Brake
	3/82-86		R		700-051			Ø 180,0	Europe
1.7 D Eng.CD17 (40kW)	3/82-10/86		R		153-272		Sumit.	180,0x35	Hand Brake
	3/82-86		R		700-051			Ø 180,0	Europe
Sunny III (N13, B12) 6/86-10/91									
1.0 Eng.E10 (37kW)	7/86-9/90		R		153-272		Sumit.	180,0x35	Hand Brake
1.3 Eng.E13S (44kW)	7/86-10/91		R		153-272		Sumit.	180,0x35	Hand Brake
	86-91		R		700-061			Ø 180,0	
1.4 Eng.GA14S (55kW)	10/88-8/91		R		153-272		Sumit.	180,0x35	Hand Brake
	88-91		R		700-061			Ø 180,0	
1.5, SW, Coupe Eng.E15S (52kW)	86-88		R		700-061			Ø 180,0	
1.6 GTI 16v, Coupe Eng.CA16D (81kW)	2/87-10/88		R		153-277		Sumit.	228,6x40	Hand Brake
	87-88		R		700-061			Ø 180,0	
1.6 i 12v, SW, Coupe, 4WD Eng.GA16i (66kW)	10/88-6/91		R		153-272		Sumit.	180,0x35	Hand Brake
	88-91		R		700-061			Ø 180,0	
1.6, 4WD, Coupe, SW Eng.E16i (54kW)	6/86-10/90		R		153-272		Sumit.	180,0x35	Hand Brake
	6/86-10/90		R		153-277		Sumit.	228,6x40	Hand Brake
	86-90		R		700-061			Ø 180,0	
1.6, SW, Coupe Eng.E16S (62kW)	6/86-10/88		R		153-272		Sumit.	180,0x35	Hand Brake
	86-88		R		700-061			Ø 180,0	
1.7 D, SW Eng.CD17 (40kW)	6/86-5/89		R		153-272		Sumit.	180,0x35	Hand Brake
	88-89		R		153-277		Sumit.	228,6x40	Hand Brake
	86-89		R		700-061			Ø 180,0	
1.8 GTI 16v, Coupe Eng.CA18D (92kW)	1/89-6/91		R		153-277		Sumit.	228,6x40	Hand Brake
	89-91		R		700-061			Ø 180,0	
Sunny IV (N14) 10/90-6/95									
1.4 i Eng.GA14DS/ DE (55kW)	10/90-5/95		R		153-272		Sumit.	180,0x35	Hand Brake
	90-95		R		700-055			Ø 180,0	-ABS
1.6 16v, 4WD, SW Eng.GA16DE (75-78kW)	10/92-5/95		R		153-277		Sumit.	228,6x40	Hand Brake
	10/92-5/95		R		153-281		Tokiko	180,0x31	Hand Brake
1.6, 16v 4WD, SW Eng.GA16DS/ DE/ DEL (66kW)	10/90-5/95		R		153-277		Sumit.	228,6x40	Hand Brake
	10/90-5/95		R		153-281		Tokiko	180,0x31	Hand Brake
	90-95		R		700-055			Ø 180,0	-ABS
1.7 D Eng.CD17 (40kW)	10/90-6/95		R		153-272		Sumit.	180,0x35	Hand Brake
1.7 D 4WD Eng.CD17 (40kW)	10/90-6/95		R		153-272		Sumit.	180,0x35	Hand Brake
2.0 D, SW Eng.CD20 (55kW)	10/90-5/95		R		153-281		Tokiko	180,0x31	Hand Brake
	90-95		R		700-055			Ø 180,0	-ABS
2.0 GTI-R 4WD Eng.SR20DET (147-162kW)	10/90-5/95		R		153-281		Tokiko	180,0x31	Hand Brake
Sunny IV (Y10) 10/90-6/95									
1.6, 16v 4WD, SW Eng.GA16DS/ DE (66kW)	90-95		R		700-061			Ø 180,0	Only SW
2.0 D, SW Eng.CD20 (55kW)	10/90-5/95		R		153-277		Sumit.	228,6x40	Hand Brake
	90-95		R		700-061			Ø 180,0	Only SW
Terrano I (WD21) 10/87-2/96									
2.4 i 4WD Eng.Z24i (74-76-79kW)	10/87-2/93		R		153-279		Ake	260,0x50	Hand Brake
	87-93		R		700-052			Ø 260,0	
2.5 TD Eng.TD25T (76kW)	10/87-2/96		R		153-279		Ake	260,0x50	Hand Brake
2.7 TD 4WD Eng.TD27T (73kW)	89-96		R		700-052			Ø 260,0	
3.0 Eng.VG30 (133kW)	1/86-2/96		R		153-279		Ake	260,0x50	Hand Brake
3.0 i 4WD Eng.VG30E (109kW)	1/90-12/95		R		153-279		Ake	260,0x50	Hand Brake
Terrano II (R20) 2/93-									
2.4 4WD Eng.KA24E (85-87kW)	5/96-1/02		R		153-291		Bosch	280,0x65	Hand Brake
	5/96-1/02		R		153-287		Lucas	254,0x57	Hand Brake
	5/96-		R		700-330			Ø 254,0	
2.4 i 12v 4WD Eng.KA24E (91kW)	2/93-6/96		R		153-291		Bosch	280,0x65	Hand Brake
	2/93-6/96		R		153-287		Lucas	254,0x57	Hand Brake
	93-96		R		700-330			Ø 254,0	
2.7 TD 4WD Eng.TD27T (74kW)	2/93-1/02		R		153-291		Bosch	280,0x65	Hand Brake
	2/93-1/02		R		153-287		Lucas	254,0x57	Hand Brake
	93-02		R		700-330			Ø 254,0	
2.7 TDi 4WD Eng.TD27TI (92kW)	5/96-		R		153-291		Bosch	280,0x65	Hand Brake
	5/96-		R		153-287		Lucas	254,0x57	Hand Brake
	96-		R		700-330			Ø 254,0	

		Spare Parts	F/R	L/R	CIFAM ref.	CIFAM ref. w/KIT		DIMENSIONS mm.	NOTE
3.0 Di 4WD Eng.ZD30Ti (113kW)	5/02-		R		153-291		Bosch	280,0x65	Hand Brake
Tiida (C11X)/ Versa 9/07-									
1.5 DCi Eng.K9K (78kW)	07-		R		153-509			205x30	Hatchback
	9/07-		R		153-290		Ap	203,0x38	Hand Brake
	07-		R		700-352	700-352K		Ø 203,3	
	07-		R		151-231		Ap	Ø 19,05 203,0x38	AP
1.6 Eng.HR16DE (81kW)	07-		R		153-509			205x30	Hatchback
	9/07-		R		153-290		Ap	203,0x38	Hand Brake
	07-		R		700-352	700-352K		Ø 203,3	
	07-		R		151-231		Ap	Ø 19,05 203,0x38	AP
1.8 Eng.MR18DE (93kW)	07-		R		153-509			205x30	Hatchback
	9/07-		R		153-290		Ap	203,0x38	Hand Brake
	07-		R		700-352	700-352K		Ø 203,3	
	07-		R		151-231		Ap	Ø 19,05 203,0x38	AP
Trade 1/86-									
2.0 D Eng.LD20 (44kW)	11/86-3/93		R		153-342		Lucas	255,0x57	
2.0 D Eng.LD20 (47-49kW)	1/86-		R		153-342		Lucas	255,0x57	
	91-		R		700-068			Ø 254,0	
2.8 D Eng.A428 (56-62kW)	1/86-12/89		R		153-279		Ake	260,0x50	Hand Brake
	1/86-12/89		R		153-342		Lucas	255,0x57	
2.8 D Eng.A428II (59kW)	12/86-6/94		R		153-279		Ake	260,0x50	Hand Brake
	12/86-6/94		R		153-342		Lucas	255,0x57	
3.0 D Eng.BD-30II (63kW)	1/86-12/98		R		153-342		Lucas	255,0x57	
Violet 1/73-1/81									
1.4 Eng.A14 (59kW)	1/77-12/81		R		153-271		Ake	228,6x40	Hand Brake
1.4 Eng.L14 (63kW)	1/68-12/81		R		153-271		Ake	228,6x40	Hand Brake
1.6 Eng.L16S (75kW)	1/73-1/81		R		153-271		Ake	228,6x40	Hand Brake
X-Trail I (T30) 7/01-6/07									
2.0 16v Eng.QR20DE (103kW)	7/01-6/07		R		153-293	153-293K		170,0x22	Hand Brake
2.2 DCi Eng.YD22DDT (81-84-93kW)	7/01-6/07		R		153-293	153-293K		170,0x22	Hand Brake
2.2 DCi Eng.YD22DDTi (100kW)	12/03-6/07		R		153-293	153-293K		170,0x22	Hand Brake
2.5 Eng.QR25DE (121kW)	1/03-6/07		R		153-293	153-293K		170,0x22	Hand Brake
X-Trail II (T31) 7/07-									
2.0 16v, FWD Eng.QR20DE (103kW)	07-		R			153-450K		170x32	
	07-		R		153-295			172,0x32	
2.0 DCi Eng.M9R7 (110kW)	07-		R			153-450K		170x32	
	07-		R		153-295			172,0x32	
2.0 DCi Eng.M9R760 (127kW)	07-		R			153-450K		170x32	
	07-		R		153-295			172,0x32	
2.0, FWD Eng.MR20DE (104kW)	07-		R			153-450K		170x32	
	07-		R		153-295			172,0x32	
2.5 16v, 4WD Eng.QR25DE (124kW)	07-		R			153-450K		170x32	
	07-		R		153-295			172,0x32	
NISSAN LCV									
Atlas (E22, 23) 1/82-9/93									
2.0 Eng.Z20S (66kW)	1/82-6/92		R		153-275		Ake	270,0x50	Hand Brake
2.4 Eng.Z24 (76kW)	9/85-9/93		R		153-274		Ake	254,0x46	Hand Brake
2.5 TD (71kW)	1/92-9/93		R		153-275		Ake	270,0x50	Hand Brake
Cabstar II (10Q) 1/82-12/87									
2.0 Eng.Z20 (64kW)	1/82-12/87		R		153-275		Ake	270,0x50	Hand Brake
	82-12/87		R		700-332			Ø 254,0	
2.3 D Eng.SD23 (51-54kW)	-4/83		R		153-274		Ake	254,0x46	Hand Brake
	1/87-12/87		R		700-332			Ø 254,0	
2.5 D Eng.SD25 (53kW)	1/82-12/87		R		153-275		Ake	270,0x50	Hand Brake
	82-87		R		700-332			Ø 254,0	
Cabstar II (15Q) 1/82-12/90									
2.0 Eng.Z20 (64kW)	1/82-12/90		R		153-275		Ake	270,0x50	Hand Brake
	82-90		R		700-063			Ø 270,0	
2.3 D Eng.TD23 (51kW)	1/87-90		R		700-063			Ø 270,0	
2.5 D Eng.TD25 (52-59kW)	1/82-12/90		R		153-275		Ake	270,0x50	Hand Brake
	82-90		R		700-063			Ø 270,0	
Cabstar III 1/82-12/98									
2.0 Eng.Z20S (66kW)	-94		R		153-275		Ake	270,0x50	Hand Brake
Cabstar IV (E) 1/98-9/06									
2.3 D Eng.LD23 (55kW)	1/98-9/06		R		153-100		Lucas	254,0x57	Hand Brake

		Spare Parts	F/R	L/R	CIFAM ref.	CIFAM ref. w/KIT		DIMENSIONS mm.	NOTE
2.7 TDi Eng.TD27T (66kW)	1/98-9/06		R		153-100		Lucas	254,0x57	Hand Brake
3.0 TDi Eng.BD-30Ti (78-88-92kW)	1/98-9/06		R		153-100		Lucas	254,0x57	Hand Brake
Cabstar V 10/06-									
2.5 TD Eng.YD25 (81kW)	10/06-		R		153-291		Bosch	280,0x65	Hand Brake
3.0 TD (96kW)	10/06-		R		153-291		Bosch	280,0x65	Hand Brake
3.0 TD Eng.ZD30 (110kW)	10/06-		R		153-291		Bosch	280,0x65	Hand Brake
Interstar (X70) 7/02-									
1.9 DCi Eng.F9Q772 (60kW)	7/02-		R		153-313		Bdx	280,0x65	15Inch Wheels, Hand Brake
2.2 DCi Eng.G9T722 (66kW)	7/02-		R		153-313		Bdx	280,0x65	15Inch Wheels, Hand Brake
2.5 DCi Eng.G9U632 (107kW)	9/06-		R		153-313		Bdx	280,0x65	15Inch Wheels, Hand Brake
2.5 DCi Eng.G9U632 (88kW)	9/06-		R		153-313		Bdx	280,0x65	15Inch Wheels, Hand Brake
2.5 DCi Eng.G9U650 (74kW)	4/06-		R		153-313		Bdx	280,0x65	15Inch Wheels, Hand Brake
2.5 DCi Eng.G9U720 (84kW)	02-		R		153-313		Bdx	280,0x65	15Inch Wheels, Hand Brake
2.5 DCi Eng.G9U754 (73kW)	11/03-		R		153-313		Bdx	280,0x65	15Inch Wheels, Hand Brake
3.0 DCi 140 Eng.ZD3A2 (100kW)	11/03-		R		153-313		Bdx	280,0x65	15Inch Wheels, Hand Brake
Kubistar (X76) 8/03-									
1.2 Eng.D7F726 (44kW)	8/03-		R		153-355		Bdx	203,2x39	Hand Brake
	8/03-		R		153-354		Bdx	228,6x42	Hand Brake
	03-		R		700-374	700-374K		Ø 203,3	-RC
	03-		R		700-144			Ø 228,6	+RC
	03-		R		151-097		Bdx	Ø 19,05 203,0x38	RAI, 6Q, -RC
	03-		R		151-096		Bdx	Ø 22,00 228,0x42	RAI, 8Q, +RC
1.2 16v Eng.D4F712 (55kW)	4/06-		R		153-355		Bdx	203,2x39	Hand Brake
	06-		R		700-374	700-374K		Ø 203,3	-RC
	06-		R		700-144			Ø 228,6	+RC
	06-		R		151-097		Bdx	Ø 19,05 203,0x38	RAI, 6Q, -RC
1.2 16v Eng.D4F730 (55kW)	06-		R		151-096		Bdx	Ø 22,00 228,0x42	RAI, 8Q, +RC
	05-		R		153-355		Bdx	203,2x39	
	05-		R		700-374	700-374K		Ø 203,3	-RC
	05-		R		700-144			Ø 228,6	+RC
1.5 DCi Eng.K9K (42kW)	05-		R		151-097		Bdx	Ø 19,05 203,0x38	RAI, 6Q, -RC
	05-		R		151-096		Bdx	Ø 22,00 228,0x42	RAI, 8Q, +RC
	05-		R		700-374	700-374K		Ø 203,3	-RC
	05-		R		700-144			Ø 228,6	+RC
1.5 DCi Eng.K9K (45kW)	03-		R		700-374	700-374K		Ø 203,3	-RC
	03-		R		700-144			Ø 228,6	+RC
1.5 DCi Eng.K9K704 (48kW)	05-		R		700-374	700-374K		Ø 203,3	-RC
	05-		R		700-144			Ø 228,6	+RC
	8/03-		R		153-355		Bdx	203,2x39	
	8/03-		R		153-354		Bdx	228,6x42	
	03-		R		700-374	700-374K		Ø 203,3	-RC
	03-		R		700-144			Ø 228,6	+RC
1.5 DCi Eng.K9K710/ 722 (60kW)	03-05		R		700-375			Ø 228,6	810 Kg, 820 Kg
	03-		R		151-097		Bdx	Ø 19,05 203,0x38	RAI, 6Q, -RC
	03-		R		151-096		Bdx	Ø 22,00 228,0x42	RAI, 8Q, +RC
	8/03-		R		153-355		Bdx	203,2x39	Hand Brake
	8/03-		R		153-354		Bdx	228,6x42	Hand Brake
	03-		R		700-374	700-374K		Ø 203,3	-RC
1.5 DCi Eng.K9K718 (62kW)	03-		R		700-144			Ø 228,6	+RC
	06-		R		700-374	700-374K		Ø 203,3	-RC
1.5 DCi Eng.K9K752 (50kW)	06-		R		700-144			Ø 228,6	+RC
	06-		R		700-374	700-374K		Ø 203,3	-RC
1.6 16v Eng.K4M752 (70kW)	06-		R		700-144			Ø 228,6	+RC
	8/03-		R		153-355		Bdx	203,2x39	Hand Brake
	8/03-		R		153-354		Bdx	228,6x42	Hand Brake
	03-		R		700-374	700-374K		Ø 203,3	-RC
	03-		R		700-144			Ø 228,6	+RC
	03-		R		151-097		Bdx	Ø 19,05 203,0x38	RAI, 6Q, -RC
03-		R		151-096		Bdx	Ø 22,00 228,0x42	RAI, 8Q, +RC	
Pick-Up 1/65-12/79									
1.3 Eng.J13 (50kW)	1/65-12/70		R		153-270			203,2x36	Hand Brake
Pick-Up (720) 1/80-3/86									
1.6 Eng.J16 (51-59kW)	1/80-1/81		R		153-274		Ake	254,0x46	Hand Brake
	80-81		R		700-054			Ø 254,0	
1.6 Eng.L16 (75kW)	1/68-12/81		R		153-274		Ake	254,0x46	Hand Brake

		Spare Parts	F/R	L/R	CIFAM ref.	CIFAM ref. w/KIT		DIMENSIONS mm.	NOTE
1.8 Eng.L18 (59kW)	1/83-3/86		R		153-274		Ake	254,0x46	Hand Brake
	83-86		R		700-054			Ø 254,0	
2.0 Eng.L20B (81kW)	1/74-12/80		R		153-274		Ake	254,0x46	Hand Brake
2.2 4WD Eng.Z22 (71kW)	4/83-3/86		R		153-274		Ake	254,0x46	Hand Brake
	83-86		R		700-332			Ø 254,0	
2.2 D Eng.SD22 (47kW)	82-84		R		700-054			Ø 254,0	
2.4 4WD	83-86		R		700-332			Ø 254,0	
2.5 D 4WD Eng.SD25 (53-57kW)	83-86		R		700-053			Ø 254,0	2WD
Pick-Up/King Cab (D21) 9/85-2/98									
2.0 Eng.Z20 (64-66kW)	85-89		R		153-274		Ake	254,0x46	Hand Brake
	85-89		R		153-278		Ake	254,0x60	Hand Brake
	85-92		R		153-279		Ake	260,0x50	Hand Brake
	90-	R		153-282		Ake	295,0x50	Hand Brake	
	85-91		R		700-052			Ø 260,0	
	85-91		R		700-052			Ø 260,0	
2.3 D Eng.SD23 (51-54kW)	9/85-8/88		R		153-279		Ake	260,0x50	Hand Brake
	85-88		R		700-052			Ø 260,0	
2.4 i 12v Eng.KA24E (91kW)	4/92-2/98		R		153-279		Ake	260,0x50	Hand Brake
	92-98		R		700-052			Ø 260,0	
2.4 i 12v 4WD Eng.KA24E (93kW)	4/92-2/98		R		153-282		Ake	295,0x50	Hand Brake
	92-98		R		700-066			Ø 295,0	
2.4 i, 4WD Eng.Z24i (74kW)	3/86-4/92		R		153-279		Ake	260,0x50	Hand Brake
	3/86-4/92		R		153-282		Ake	295,0x50	4WD, Hand Brake
	86-88		R		153-274		Ake	254,0x46	Hand Brake
	85-89		R		700-054			Ø 254,0	
	89-92		R		700-066			Ø 295,0	
2.4, 4WD Eng.Z24 (76kW)	1/92-12/96		R		153-282		Ake	295,0x50	4WD, Hand Brake
2.4, 4WD Eng.Z24 (79kW)	1/92-12/96		R		153-282		Ake	295,0x50	4WD, Hand Brake
2.5 D 4WD Eng.SD25 (53-55kW)	9/85-8/91		R		153-274		Ake	254,0x46	Hand Brake
	9/85-8/91		R		153-282		Ake	295,0x50	4WD, Hand Brake
	85-89		R		700-054			Ø 254,0	
	89-91		R		700-066			Ø 295,0	
2.5 TD, 4WD Eng.TD25 (55-59-61kW)	9/87-2/98		R		153-279		Ake	260,0x50	Hand Brake
	9/87-2/98		R		153-282		Ake	295,0x50	4WD, Hand Brake
	87-89		R		700-054			Ø 254,0	
	89-98		R		700-066			Ø 295,0	
2.7 TD, 4WD Eng.TD27 (58-73kW)	87-89		R		700-054			Ø 254,0	
	89-98		R		700-066			Ø 295,0	
3.0 i V6 4WD Eng.VG30E (125-149-109kW)	90-98		R		700-066			Ø 295,0	
Pick-Up/King Cab (D22) 2/98-									
2.4 Eng.KA24E (87kW)	2/98-10/01		R		153-282		Ake	295,0x50	Hand Brake
2.4 i 4WD Eng.KA24DE (98kW)	3/02-		R		153-282		Ake	295,0x50	Hand Brake
	3/02-		R		153-421		Ake	295,0x50	Hand Brake
2.4 i, 4WD Eng.KA24E (88kW)	2/98-		R		153-282		Ake	295,0x50	Hand Brake
	98-		R		700-072			Ø 295,0	
2.4, 4WD (79kW)	1/97-12/02		R		153-282		Ake	295,0x50	Hand Brake
2.4, 4WD Eng.KA24DE (110kW)	1/03-		R		153-282		Ake	295,0x50	Hand Brake
	1/03-		R		153-421		Ake	295,0x50	Hand Brake
2.5 Di, 4WD Eng.YD25DDTi (98kW)	3/02-		R		153-282		Ake	295,0x50	Hand Brake
	02-		R		700-052			Ø 260,0	
2.5 TD 4WD Eng.TD25TI (76kW)	5/98-		R		153-282		Ake	295,0x50	Hand Brake
	5/98-		R		153-421		Ake	295,0x50	Hand Brake
	98-		R		700-072			Ø 295,0	
2.5 TD, 4WD Eng.TD25 (61kW)	2/98-		R		153-282		Ake	295,0x50	Hand Brake
	2/98-		R		153-421		Ake	295,0x50	Hand Brake
	98-		R		700-072			Ø 295,0	
2.7 TD, 4WD Eng.TD27T (73kW)	1/97-10/01		R		153-282		Ake	295,0x50	Hand Brake
2.8 D (101kW)	11/01-		R		153-282		Ake	295,0x50	Hand Brake
3.0 DDTi, 4WD Eng.ZD30DDT (110kW)	11/01-		R		153-282		Ake	295,0x50	Hand Brake
3.2 D 4WD Eng.QD32 (76kW)	12/98-		R		153-282		Ake	295,0x50	Hand Brake
3.3 V6 Eng.VG33E (125kW)	1/03-		R		153-282		Ake	295,0x50	Hand Brake
Urvan I (E23) 7/81-11/88									
2.0 Eng.H20 (55kW)	7/81-11/82		R		153-274		Ake	254,0x46	Hand Brake
	81-82		R		700-332			Ø 254,0	
2.0 Eng.Z20 (64kW)	12/82-11/88		R		153-274		Ake	254,0x46	Hand Brake
	82-88		R		700-332			Ø 254,0	

		Spare Parts	F/R	L/R	CIFAM ref.	CIFAM ref. w/KIT		DIMENSIONS mm.	NOTE
2.2 D Eng.SD23 (47kW)	81-82		R		700-332			Ø 254,0	
2.3 D Eng.SD23 (50-51kW)	11/82-11/88		R		153-274		Ake	254,0x46	Hand Brake
	82-88		R		700-332			Ø 254,0	
Urvan II (E24) 5/87-									
2.0 Eng.Z20/ S (64-66kW)	5/87-		R		153-279		Ake	260,0x50	Hand Brake
	87-92		R		700-052			Ø 260,0	
2.3 D Eng.TD23 (51kW)	1/88-		R		153-279		Ake	260,0x50	Hand Brake
	88-		R		700-052			Ø 260,0	
2.4 i Eng.Z24i (72-74-79kW)	89-92		R		700-052			Ø 260,0	
2.5 D Eng.TD25 (59kW)	12/88-		R		153-279		Ake	260,0x50	Hand Brake
	12/88-		R		153-277		Sumit.	228,6x40	Hand Brake
	88-92		R		700-052			Ø 260,0	
2.7 TD (92kW)	10/95-8/00		R		153-279		Ake	260,0x50	Hand Brake
Vanette I (C12) 1/83-12/87									
1.5 Eng.A15 (51kW)	1/83-12/87		R		153-271		Ake	228,6x40	Hand Brake
	83-87		R		700-328			Ø 228,5	
1.5 Eng.A15S (49kW)	7/81-6/87		R		153-271		Ake	228,6x40	Hand Brake
1.5 Eng.A15S (60kW)	3/83-11/86		R		153-271		Ake	228,6x40	Hand Brake
2.0 D Eng.LD20 (43-47-49kW)	1/83-12/87		R		153-271		Ake	228,6x40	Hand Brake
	83-87		R		700-328			Ø 228,5	
Vanette II (C22) 10/86-12/95									
1.5 Eng.A15S (51kW)	10/86-12/95		R		153-277		Sumit.	228,6x40	Hand Brake
	86-95		R		700-052			Ø 260,0	
	88-		R		700-329			Ø 228,5	
2.0 Eng.Z20S (66kW)	1/89-12/90		R		153-277		Sumit.	228,6x40	Hand Brake
2.0 D Eng.LD20 (47-49kW)	10/86-12/95		R		153-279		Ake	260,0x50	Made in Japan, Hand Brake
	86-95		R		700-329			Ø 228,5	
	86-95		R		700-052			Ø 260,0	
2.4 i Eng.Z24i (74-77kW)	86-93		R		700-052			Ø 260,0	
Vanette III Cargo (HC23) 1/95-									
1.6 Eng.GA16DE (71-72-75kW)	1/95-		R		153-287		Lucas	254,0x57	Hand Brake
	95-		R		700-336			Ø 254,0	
2.0 D Eng.LD20 (49kW)	95-		R		700-336			Ø 254,0	
2.3 D Eng.LD23 (55kW)	1/95-		R		153-287		Lucas	254,0x57	Hand Brake
	95-		R		700-336			Ø 254,0	





NSU

RO 80 10/67-7/77



















1.0 Eng.KKM (85kW)	10/67-7/77		R		153-011	153-011K	Ate	160,0x25	Hand Brake
--------------------	------------	---	---	--	---------	----------	-----	----------	------------













































OPEL



































































Admiral B 3/69-1/78































2.8 Eng.28E (118-121kW)	3/69-1/78		R			153-302K		160,0x25	Hand Brake
	3/69-1/78		R		153-302	153-302K	Ate	160,0x25	Hand Brake
2.8 Eng.28H (103-107kW)	3/69-7/76		R		153-302	153-302K	Ate	160,0x25	Hand Brake
2.8 Eng.28S (95-97kW)	3/69-1/78		R		153-302		Ate	160,0x25	Hand Brake





























































Agila A 9/00-12/07























































1.0 12v Eng.Z10XE (43kW)	9/00-12/07		R		153-314		GM	180,0x26	
	9/00-		R		700-370			Ø 180,0	+ABS
	9/00-		R		700-371			Ø 180,0	-ABS
	00-		R		151-187		GM	Ø 15,87 180,0x26	-Ch 2G999999, LUC
	-07		R		151-207		Lucas	Ø 15,87 200,0x29	Ch 3G0000001-, LUC
1.0 12v Eng.Z10XEP (44kW)	8/03-12/07		R		153-318			200,0x29	
	03-07		R		151-207		Lucas	Ø 15,87 200,0x29	LUC
1.2 16v Eng.Z12XE (55kW)	9/00-12/07		R		153-318			200,0x29	
	9/00-12/07		R		153-314		GM	180,0x26	
	9/00-		R		700-370			Ø 180,0	+ABS
	9/00-		R		700-371			Ø 180,0	-ABS
	00-		R		151-187		GM	Ø 15,87 180,0x26	-Ch 2G999999, LUC
1.2 16v Twinport Eng.Z12XEP (59kW)	7/04-12/07		R		153-318			200,0x29	
	7/04-12/07		R		153-314		GM	180,0x26	
	04-		R		700-370			Ø 180,0	+ABS
1.3 CDTi 16v Eng.Z13DT (51kW)	8/03-12/07		R		700-371			Ø 180,0	-ABS
	8/03-		R		151-207		Lucas	Ø 15,87 200,0x29	LUC
	8/03-		R		153-318			200,0x29	































		Spare Parts	F/R	L/R	CIFAM ref.	CIFAM ref. w/KIT		DIMENSIONS mm.	NOTE
1.3 CDTi 16v Eng.Z13DT (51kW)	03-		R		151-207		Lucas	Ø 15,87 200,0x29	LUC
Agila B 1/08-									
1.0 12v Eng.K10B (48kW)	1/08-		R		153-438		Bosch	200,0x32	Hand Brake
1.2 16v Eng.K12B (63kW)	1/08-		R		153-438		Bosch	200,0x32	Hand Brake
1.3 CDTi 16v Eng.Z13DTJ (55kW)	1/08-		R		153-438		Bosch	200,0x32	Hand Brake
Antara (L07) 5/06-									
2.0 CDTi Eng.Z20DM (93kW)	3/07-		R		153-317	153-317K		180,0x26	Hand Brake
2.0 CDTi Eng.Z20DMH/ Z20S (110kW)	5/06-		R		153-317	153-317K		180,0x26	Hand Brake
2.4 16v Eng.Z24XED (104kW)	5/06-		R		153-317	153-317K		180,0x26	Hand Brake
3.2 V6 Eng.10HM (167kW)	5/06-		R		153-317	153-317K		180,0x26	Hand Brake
3.2 V6 Eng.Z32SEE (165kW)	5/06-		R		153-317	153-317K		180,0x26	Hand Brake
Ascona A 10/70-8/75									
1.2 Eng.12S (44kW)	72-75		R		700-300			Ø 200,0	
1.6 Eng.16N (50kW)	10/70-8/75		R		153-301		GM	230,0x51	Hand Brake
1.6 S Eng.16S (55-59kW)	10/70-8/75		R		153-301		GM	230,0x51	Hand Brake
	-75		R		700-300			Ø 200,0	Ch 9662825-
	8/70-		R		700-302			Ø 230,0	Ch -9662824
1.9 Eng.19S (65-66kW)	3/71-8/75		R		153-301		GM	230,0x51	Hand Brake
	71-		R		700-302			Ø 230,0	Ch -9662824
	-75		R		700-300			Ø 200,0	Ch 9662825-
Ascona B / Cavalier I 9/75-8/81									
1.2 Eng.12N (40kW)	76-79		R		700-300			Ø 200,0	
	76-79		R		700-302			Ø 230,0	Exc. Mod. L
1.2 Eng.12S (44kW)	75-79		R		700-300			Ø 200,0	
1.3 Eng.13N (44kW)	79-81		R		700-300			Ø 200,0	
	79-81		R		700-302			Ø 230,0	Mod. S
1.3 Eng.13S (55kW)	79-81		R		700-300			Ø 200,0	
	79-81		R		700-302			Ø 230,0	Mod. S
1.6 Eng.16N (44kW)	9/75-8/81		R		153-301		GM	230,0x51	Hand Brake
	75-81		R		700-300			Ø 200,0	M/T
	75-81		R		700-302			Ø 230,0	A/T
1.6 Eng.16S (55kW)	9/75-8/81		R		153-301		GM	230,0x51	Hand Brake
	75-81		R		700-300			Ø 200,0	M/T
	75-81		R		700-302			Ø 230,0	A/T
1.9 Eng.19N (55kW)	8/76-8/81		R		153-301		GM	230,0x51	Hand Brake
1.9 Eng.19S (66kW)	9/75-8/81		R		153-301		GM	230,0x51	Hand Brake
	75-81		R		700-302			Ø 230,0	
2.0 Eng.20E (81kW)	8/79-8/81		R		153-301		GM	230,0x51	Hand Brake
	79-81		R		700-302			Ø 230,0	
2.0 Eng.20N (66kW)	8/77-8/81		R		153-301		GM	230,0x51	Hand Brake
	77-81		R		700-302			Ø 230,0	
2.0 Eng.20S (74kW)	8/77-8/81		R		153-301		GM	230,0x51	Hand Brake
	77-81		R		700-302			Ø 230,0	
2.0 D Eng.20D (43kW)	8/78-8/81		R		153-301		GM	230,0x51	Hand Brake
	78-81		R		700-302			Ø 230,0	
Ascona C / Cavalier II 9/81-8/88									
1.3 Eng.13N (44kW)	9/81-8/86		R		153-304		GM	200,0x46	Hand Brake
	9/81-8/86		R		153-305		Lucas	200,0x45	Hand Brake
	81-86		R		700-300			Ø 200,0	Exc. Estate
	81-86		R		151-111		GM	Ø 17,46 200,0x46	Ch D1288028-G10001772, LUC
1.3 Eng.13S (55kW)	9/81-8/88		R		153-304		GM	200,0x46	Hand Brake
	9/81-8/88		R		153-305		Lucas	200,0x45	Hand Brake
	81-88		R		700-300			Ø 200,0	
	81-88		R		151-111		GM	Ø 17,46 200,0x46	Ch D1288028-G10001772, LUC
1.6 Eng.16N (51kW)	9/81-7/86		R		153-304		GM	200,0x46	Hand Brake
	9/81-7/86		R		153-305		Lucas	200,0x45	Hand Brake
1.6 Eng.16N/ NZ (55kW)	9/86-8/88		R		153-304		GM	200,0x46	Hand Brake
	9/86-8/88		R		153-305		Lucas	200,0x45	Hand Brake
	86-88		R		700-300			Ø 200,0	Exc. Estate
	86-88		R		151-111		GM	Ø 17,46 200,0x46	Ch D1288028-G10001772, LUC
1.6 Eng.16SH (66kW)	9/81-8/86		R		153-304		GM	200,0x46	Hand Brake
	9/81-8/86		R		153-305		Lucas	200,0x45	Hand Brake
	81-86		R		700-300			Ø 200,0	
	81-86		R		151-111		GM	Ø 17,46 200,0x46	Ch D1288028-G10001772, LUC
1.6 Eng.16SV (60kW)	9/86-8/88		R		153-304		GM	200,0x46	Hand Brake
	9/86-8/88		R		153-305		Lucas	200,0x45	Hand Brake
	86-88		R		700-300			Ø 200,0	





































































		Spare Parts	F/R	L/R	CIFAM ref.	CIFAM ref. w/KIT		DIMENSIONS mm.	NOTE
1.6 Eng.16SV (60kW)			R		151-111		GM	Ø 17,46 200,0x46	Ch D1288028-G10001772, LUC
1.6 D Eng.16D/ 16DA (40kW)	3/82-8/88		R		153-304		GM	200,0x46	Hand Brake
	3/82-8/88		R		153-305		Lucas	200,0x45	Hand Brake
	82-88		R		700-300			Ø 200,0	Exc. Estate
1.6 i, Kat Eng.C16LZ/ E16NZ (55kW)	9/86-8/88		R		151-111		GM	Ø 17,46 200,0x46	Ch D1288028-G10001772, LUC
	9/86-8/88		R		153-304		GM	200,0x46	Hand Brake
	9/86-8/88		R		153-305		Lucas	200,0x45	Hand Brake
	86-88		R		700-300			Ø 200,0	Exc. Estate
1.8 Eng.18E (85kW)	9/82-8/86		R		151-111		GM	Ø 17,46 200,0x46	Ch D1288028-G10001772, LUC
	9/82-8/86		R		153-304		GM	200,0x46	Hand Brake
	9/82-8/86		R		153-305		Lucas	200,0x45	Hand Brake
	82-86		R		700-300			Ø 200,0	
1.8 Eng.18SE (82kW)	1/86-12/88		R		151-111		GM	Ø 17,46 200,0x46	Ch D1288028-G10001772, LUC
1.8 Eng.E18NV (62kW)	9/87-8/88		R		153-305		Lucas	200,0x45	Hand Brake
	9/87-8/88		R		153-304		GM	200,0x46	Hand Brake
	87-88		R		153-305		Lucas	200,0x45	Hand Brake
1.8 i Eng.C18NE/ S18NV (74kW)	9/81-8/86		R		700-300			Ø 200,0	Exc. Estate
	9/81-8/86		R		151-111		GM	Ø 17,46 200,0x46	Ch D1288028-G10001772, LUC
	9/81-8/86		R		153-304		GM	200,0x46	Hand Brake
	-86		R		153-305		Lucas	200,0x45	Hand Brake
2.0 i Eng.C20NEF (74kW)	8/87-8/88		R		700-300			Ø 200,0	Exc. Estate
	8/87-8/88		R		151-111		GM	Ø 17,46 200,0x46	Ch D1288028-G10001772, LUC
	8/87-8/88		R		153-305		Lucas	200,0x45	Hand Brake
	87-88		R		700-300			Ø 200,0	
2.0 i GT Eng.20SEH (95kW)	3/87-8/88		R		151-111		GM	Ø 17,46 200,0x46	Ch D1288028-G10001772, LUC
	87-88		R		700-300			Ø 200,0	
2.0 i, Kat Eng.20NE/ C20NE (85kW)	9/86-8/88		R		153-305		Lucas	200,0x45	Hand Brake
	86-88		R		700-300			Ø 200,0	
			R		151-111		GM	Ø 17,46 200,0x46	Ch D1288028-G10001772, LUC
Astra D, SW 9/79-8/91									
1.0 Eng.10S (29-38kW)	81-86		R		700-300			Ø 200,0	M/T
	81-86		R		700-302			Ø 230,0	A/T
1.2 Eng.12S (40-44kW)	82-84		R		700-300			Ø 200,0	M/T
1.3 Eng.13S (55kW)	79-84		R		700-300			Ø 200,0	M/T
1.6 Eng.16SH (66kW)	-84		R		700-302			Ø 230,0	Ch E2501708-
1.6 D Eng.16DA (40kW)	-84		R		700-302			Ø 230,0	Ch E2501708-
1.8 GTE Eng.18E/ 18SE (82-85kW)	83-86		R		700-300			Ø 200,0	
Astra F Classic, SW 1/98-3/04									
1.4 i Eng.X14NZ/ C/ SZ (44kW)	98-		R		700-299			Ø 200,0	HDB
1.6 16v Eng.X16XEL/ Z16XE (74kW)	98-		R		700-299			Ø 200,0	HDB
1.6 i 16v Eng.X16SZR (55kW)	98-		R		700-300			Ø 200,0	
Astra F, SW 9/91-9/98									
1.4 , Cabrio Eng.14SE (60kW)	9/92-1/98		R		153-308		Lucas	200,0x29	Ch -SP999999, Hand Brake
	9/92-1/98		R		153-309		Lucas	200,0x45	Ch -SP999999, SW, Hand Brake
	9/92-1/98		R		153-309		Lucas	200,0x45	Ch T2500001-, Hand Brake
	9/92-1/98		R		153-311		Lucas	230,0x42	Ch T2500001-, SW, Hand Brake
1.4 i Eng.C14NZ (44kW)	9/91-9/98		R		153-308		Lucas	200,0x29	Ch -SP999999, Hand Brake
	9/91-9/98		R		153-309		Lucas	200,0x45	Ch -SP999999, SW, Hand Brake
	9/91-9/98		R		153-309		Lucas	200,0x45	Ch T2500001-, Hand Brake
	9/91-9/98		R		153-311		Lucas	230,0x42	Ch T2500001-, SW, Hand Brake
	91-96		R		700-300			Ø 200,0	
	96-98		R		700-299			Ø 200,0	HDB
	91-		R		151-081		GM	Ø 19,05 200,0x28	Ch R000001-, LUC
	91-		R		151-141		GM	Ø 19,05 230,0x42	Ch T2500001-, LUC, SW
1.4 i 16v, Cabrio Eng.X14XE (66kW)	2/96-9/98		R		151-079		Delco	Ø 19,05 200,0x45	LUC
	2/96-9/98		R		151-123		GM	Ø 17,46 200,0x29	Ch -R2500000, LUC
	2/96-9/98		R		153-308		Lucas	200,0x29	Ch -SP999999, Hand Brake
	2/96-9/98		R		153-309		Lucas	200,0x45	Ch -SP999999, SW, Hand Brake
	2/96-9/98		R		153-309		Lucas	200,0x45	Ch T2500001-, Hand Brake
	2/96-9/98		R		153-311		Lucas	230,0x42	Ch T2500001-, SW, Hand Brake
	96-98		R		700-305			Ø 230,0	
	96-		R		151-123		GM	Ø 17,46 200,0x29	Ch -R2500000, LUC
96-		R		151-124		Lucas	Ø 17,46 200,0x46	Ch -R2500000, LUC	
-98		R		151-141		GM	Ø 19,05 230,0x42	Ch T2500001-, LUC, SW	
1.4 S Eng.14NV (53-55kW)	9/91-9/93		R		153-308		Lucas	200,0x29	Ch -SP999999, Hand Brake
	9/91-9/93		R		153-309		Lucas	200,0x45	Ch -SP999999, SW, Hand Brake

























































		Spare Parts	F/R	L/R	CIFAM ref.	CIFAM ref. w/KIT		DIMENSIONS mm.	NOTE	
1.4 S Eng.14NV (53-55kW)	9/91-9/93		R		153-309		Lucas	200,0x45	Ch T2500001-, M/T+A/T, Hand Brake	
			R		153-311		Lucas	230,0x42	Ch T2500001-, SW, Hand Brake	
	91-93		R		700-300			Ø 200,0		
			R		151-079		Delco	Ø 19,05 200,0x45	Ch -R2500000, LUC	
			R		151-081		GM	Ø 19,05 200,0x28	Ch R000001-, LUC	
1.4 Si, Cabrio Eng.C14SE (60kW)	3/92-9/98		R		153-308		Lucas	200,0x29	Ch -SP999999, Hand Brake	
			R		153-309		Lucas	200,0x45	Ch -SP999999, SW, Hand Brake	
			R		153-309		Lucas	200,0x45	Ch T2500001-, Hand Brake	
			R		153-311		Lucas	230,0x42	Ch T2500001-, SW, Hand Brake	
	92-96		R		700-300			Ø 200,0		
			R		700-299			Ø 200,0	HDB	
	96-98		R		151-081		GM	Ø 19,05 200,0x28	Ch R000001-, LUC	
			R		151-141		GM	Ø 19,05 230,0x42	Ch T2500001-, LUC, SW	
			R		151-079		Delco	Ø 19,05 200,0x45	LUC	
			R		151-123		GM	Ø 17,46 200,0x29	Ch -R2500000, LUC	
			R		151-124		Lucas	Ø 17,46 200,0x46	Ch -R2500000, LUC	
	1.6 Eng.16NZR (55kW)	9/95-9/98		R		153-308		Lucas	200,0x29	Ch -SP999999, Hand Brake
				R		153-309		Lucas	200,0x45	Ch -SP999999, SW, Hand Brake
R					153-309		Lucas	200,0x45	Ch T2500001-, Hand Brake	
R					153-311		Lucas	230,0x42	Ch T2500001-, SW, Hand Brake	
95-98			R		700-300			Ø 200,0	Eng. LZ2	
			R		700-305			Ø 230,0	Eng. NZR, -ABS	
95-98			R		151-123		GM	Ø 17,46 200,0x29	Ch -R2500000, LUC	
			R		151-141		GM	Ø 19,05 230,0x42	Ch T2500001-, LUC, SW	
			R		151-123		GM	Ø 17,46 200,0x29	Ch -R2500000, LUC	
1.6 i Eng.16LZ2 (55kW)		9/95-9/98		R		153-308		Lucas	200,0x29	Ch -SP999999, Hand Brake
				R		153-309		Lucas	200,0x45	Ch -SP999999, SW, Hand Brake
	R				153-309		Lucas	200,0x45	Ch T2500001-, Hand Brake	
	R				153-311		Lucas	230,0x42	Ch T2500001-, SW, Hand Brake	
	95-98		R		700-300			Ø 200,0	Eng. LZ2	
			R		700-305			Ø 230,0	Eng. NZR, -ABS	
	95-98		R		151-123		GM	Ø 17,46 200,0x29	Ch -R2500000, LUC	
			R		151-141		GM	Ø 19,05 230,0x42	Ch T2500001-, LUC, SW	
1.6 i Eng.C16NZ/ E16NZ (55kW)	3/92-8/94		R		153-308		Lucas	200,0x29	Ch -SP999999, Hand Brake	
			R		153-309		Lucas	200,0x45	Ch -SP999999, SW, Hand Brake	
			R		153-309		Lucas	200,0x45	Ch T2500001-, Hand Brake	
			R		153-311		Lucas	230,0x42	Ch T2500001-, SW, Hand Brake	
	92-94		R		700-300			Ø 200,0		
			R		151-123		GM	Ø 17,46 200,0x29	Ch -R2500000, LUC	
	94-94		R		151-079		Delco	Ø 19,05 200,0x45	Ch R000001-, LUC	
			R		151-081		GM	Ø 19,05 200,0x28	Ch R000001-, LUC	
94-94		R		151-141		GM	Ø 19,05 230,0x42	Ch T2500001-, LUC, SW		
1.6 i 16v Eng.X16XEL (74kW)	8/94-9/98		R		153-309		Lucas	200,0x45	Hand Brake	
			R		700-300			Ø 200,0		
	94-96		R		700-299			Ø 200,0	HDB	
			R		151-079		Delco	Ø 19,05 200,0x45	Ch R000001-, LUC	
	96-98		R		151-081		GM	Ø 19,05 200,0x28	Ch R000001-, LUC	
			R		151-141		GM	Ø 19,05 230,0x42	Ch T2500001-, LUC, SW	
1.6 i, Cabrio Eng.X16SZ (52kW)	5/93-7/96		R		153-308		Lucas	200,0x29	Ch -SP999999, Hand Brake	
			R		153-309		Lucas	200,0x45	Ch -SP999999, SW, Hand Brake	
			R		153-309		Lucas	200,0x45	Ch T2500001-, Hand Brake	
			R		153-311		Lucas	230,0x42	Ch T2500001-, SW, Hand Brake	
	93-96		R		700-300			Ø 200,0		
			R		151-079		Delco	Ø 19,05 200,0x45	Ch R000001-, LUC	
	93-96		R		151-081		GM	Ø 19,05 200,0x28	Ch R000001-, LUC	
			R		151-141		GM	Ø 19,05 230,0x42	Ch T2500001-, LUC, SW	
93-96		R		151-124		Lucas	Ø 17,46 200,0x46	Ch -R2500000, LUC		
1.6 i, Cabrio Eng.X16SZR (55kW)	8/96-9/98		R		153-308		Lucas	200,0x29	Ch -SP999999, Hand Brake	
			R		153-309		Lucas	200,0x45	Ch -SP999999, SW, Hand Brake	
			R		153-309		Lucas	200,0x45	Ch T2500001-, Hand Brake	
			R		153-311		Lucas	230,0x42	Ch T2500001-, SW, Hand Brake	
	96-98		R		700-300			Ø 200,0	A/T	
			R		700-299			Ø 200,0	M/T, HDB	
	96-98		R		151-123		GM	Ø 17,46 200,0x29	Ch -R2500000, LUC	
			R		151-124		Lucas	Ø 17,46 200,0x46	Ch -R2500000, LUC	
	96-98		R		151-141		GM	Ø 19,05 230,0x42	Ch T2500001-, LUC, SW	
1.6 Si Eng.C16SE (74kW)	5/92-12/94		R		153-308		Lucas	200,0x29	Ch -SP999999, Hand Brake	
			R		153-309		Lucas	200,0x45	Ch -SP999999, SW, Hand Brake	
			R		153-309		Lucas	200,0x45	Ch T2500001-, Hand Brake	

































		Spare Parts	F/R	L/R	CIFAM ref.	CIFAM ref. w/KIT		DIMENSIONS mm.	NOTE
1.6 Si Eng.C16SE (74kW)	5/92-12/94		R		153-311		Lucas	230,0x42	Ch T2500001-, SW, Hand Brake
	92-94		R		700-300			Ø 200,0	
			R		151-141		GM	Ø 19,05 230,0x42	Ch T2500001-, LUC, SW
1.7 D Eng.17D (42kW)	3/92-9/92		R		153-308		Lucas	200,0x29	Ch -SP999999, Hand Brake
	3/92-9/92		R		153-309		Lucas	200,0x45	Ch -SP999999, SW, Hand Brake
	3/92-9/92		R		153-309		Lucas	200,0x45	Ch T2500001-, Hand Brake
	3/92-9/92		R		153-311		Lucas	230,0x42	Ch T2500001-, SW, Hand Brake
	3/92-9/92		R		700-300			Ø 200,0	
	91-		R		151-081		GM	Ø 19,05 200,0x28	Ch R2500001-, LUC
1.7 D Eng.17D/ DR (44kW)	7/92-9/98		R		153-308		Lucas	200,0x29	Ch -SP999999, Hand Brake
	7/92-9/98		R		153-309		Lucas	200,0x45	Ch -SP999999, SW, Hand Brake
	7/92-9/98		R		153-309		Lucas	200,0x45	Ch T2500001-, Hand Brake
	7/92-9/98		R		153-311		Lucas	230,0x42	Ch T2500001-, SW, Hand Brake
	92-96		R		700-300			Ø 200,0	
	96-98		R		700-299			Ø 200,0	HDB
			R		151-081		GM	Ø 19,05 200,0x28	Ch R000001-, LUC
	92-		R		151-141		GM	Ø 19,05 230,0x42	Ch T2500001-, LUC, SW
1.7 TD Eng.X17DTL (50kW)	11/94-9/98		R		153-309		Lucas	200,0x45	Hand Brake
	11/94-9/98		R		153-309		Lucas	200,0x45	Ch -SP999999, SW, Hand Brake
	11/94-9/98		R		153-311		Lucas	230,0x42	Ch T2500001-, SW, Hand Brake
	94-96		R		700-300			Ø 200,0	
	96-98		R		700-299			Ø 200,0	HDB
	94-		R		151-141		GM	Ø 19,05 230,0x42	Ch T2500001-, LUC, SW
1.7 TDS Eng.17DT(TC4EE1)/ X17DT (60kW)	3/92-9/98		R		153-309		Lucas	200,0x45	Hand Brake
	3/92-9/98		R		153-309		Lucas	200,0x45	Ch -SP999999, SW, Hand Brake
	3/92-9/98		R		153-311		Lucas	230,0x42	Ch T2500001-, SW, Hand Brake
	92-96		R		700-300			Ø 200,0	
	96-98		R		700-299			Ø 200,0	HDB
	92-		R		151-079		Delco	Ø 19,05 200,0x45	Ch R000001-, LUC
1.8 i Eng.C18NZ (66kW)	3/92-9/98		R		153-309		Lucas	200,0x45	Hand Brake
	3/92-9/98		R		153-309		Lucas	200,0x45	Ch -SP999999, SW, Hand Brake
	3/92-9/98		R		153-311		Lucas	230,0x42	Ch T2500001-, SW, Hand Brake
	92-96		R		700-300			Ø 200,0	
	96-98		R		700-299			Ø 200,0	
	92-		R		151-141		GM	Ø 19,05 230,0x42	Ch T2500001-, LUC, SW
1.8 i 16v, Cabrio Eng.C18XE (92kW)	6/93-10/94		R			153-302K		160,0x25	Hand Brake
	6/93-10/94		R		153-302	153-302K	Ate	160,0x25	Hand Brake
			R		153-302		Ate	160,0x25	Hand Brake
1.8 Cabrio Eng.18SE (85kW)	11/91-7/93		R		153-309		Lucas	200,0x45	Hand Brake
	11/91-7/93		R		153-309		Lucas	200,0x45	Ch -SP999999, SW, Hand Brake
	11/91-7/93		R		153-311		Lucas	230,0x42	Ch T2500001-, SW, Hand Brake
2.0 16v SW Eng.C20XE (110kW)	1/92-9/98		R			153-302K		160,0x25	Hand Brake
	1/92-9/98		R		153-302	153-302K	Ate	160,0x25	Hand Brake
2.0 i 16v Eng.X20XE (100kW)	2/95-9/98		R		153-302		Ate	160,0x25	Hand Brake
2.0 i, Cabrio Eng.C20NE (85kW)	3/92-9/98		R		153-309		Lucas	200,0x45	Hand Brake
	92-96		R		700-300			Ø 200,0	
	96-98		R		700-299			Ø 200,0	
	92-		R		151-141		GM	Ø 19,05 230,0x42	Ch T2500001-, LUC, SW
	92-98		R		151-124		Lucas	Ø 17,46 200,0x46	Ch -R2500000, LUC
92-98		R		151-079		Delco	Ø 19,05 200,0x45	LUC	
Astra G, SW 9/98-3/04									
1.2 16v Eng.Z12XE (55kW)	9/00-3/04		R		153-311		Lucas	230,0x42	Hand Brake
	00-04		R		700-300			Ø 200,0	Berlina
	00-04		R		700-305			Ø 230,0	SW
	00-		R		151-141		GM	Ø 19,05 230,0x42	Ch -18999999, LUC
1.2 i 16v Eng.X12XE (48kW)	9/98-9/00		R		153-311		Lucas	230,0x42	Hand Brake
	98-00		R		700-300			Ø 200,0	Berlina
	98-00		R		700-305			Ø 230,0	SW

		Spare Parts	F/R	L/R	CIFAM ref.	CIFAM ref. w/KIT		DIMENSIONS mm.	NOTE
1.2 i 16v Eng.X12XE (48kW)	98-		R		151-141		GM	Ø 19,05 230,0x42	Ch -18999999, LUC
			R		151-176		Lucas	Ø 19,05 230,0x42	Ch 22000001-, LUC, SW
1.4 i 16v Eng.X14XE/ Z14XE (66kW)	9/98-3/04		R		153-311		Lucas	230,0x42	Hand Brake
	98-04		R		700-305			Ø 230,0	
	98-		R		151-141		GM	Ø 19,05 230,0x42	Ch -18999999, LUC
1.6 Eng.Z16SE (62kW)	9/00-3/04		R		153-311		Lucas	230,0x42	Hand Brake
	00-04		R		700-305			Ø 230,0	
	00-		R		151-141		GM	Ø 19,05 230,0x42	Ch -18999999, LUC
1.6 16v, Cabrio Eng.X16XEL/ Z16XE (74kW)	9/98-3/04		R		153-311		Lucas	230,0x42	Hand Brake
	98-04		R		700-305			Ø 230,0	
			R		151-141		GM	Ø 19,05 230,0x42	Ch -18999999, LUC
1.6 16v, Cabrio, Coupe Eng.Z16XEP (76kW)	3/00-3/04		R		153-311		Lucas	230,0x42	Hand Brake
	00-		R		700-305			Ø 230,0	-ABS
			R		151-141		GM	Ø 19,05 230,0x42	Ch -18999999, LUC, -ABS
1.6 CNG SW Eng.Z16YNG (71kW)	03-04		R		700-305			Ø 230,0	-ABS
			R		151-141		GM	Ø 19,05 230,0x42	Ch -18999999, LUC, -ABS
			R		151-176		Lucas	Ø 19,05 230,0x42	Ch 22000001-, LUC
1.6 i 16v Eng.X16SZR (55kW)	9/98-9/00		R		153-311		Lucas	230,0x42	Hand Brake
	98-00		R		700-305			Ø 230,0	
			R		151-141		GM	Ø 19,05 230,0x42	Ch -18999999, LUC
1.7 CDTi Eng.Z17DTL (59kW)	03-04		R		700-305			Ø 230,0	
1.7 DTi 16v Eng.Y17DT (48-55kW)	2/00-3/04		R		153-311		Lucas	230,0x42	Hand Brake
	00-04		R		700-305			Ø 230,0	
			R		151-141		GM	Ø 19,05 230,0x42	Ch -18999999, LUC
1.7 TD Eng.X17DTL (50kW)	98-00		R		700-305			Ø 230,0	
			R		151-141		GM	Ø 19,05 230,0x42	Ch -18999999, LUC
			R		151-176		Lucas	Ø 19,05 230,0x42	Ch 22000001-, LUC
Astra H Cabriolet 9/05-11/09									
1.6 16v Eng.Z16XEP (77kW)	9/05-		R		153-319		Ap	230,0x40	
	9/05-		R		153-311		Lucas	230,0x42	Hand Brake
Astra H, SW, GTC 3/04-11/09									
1.4 16v Eng.Z14XEP (66kW)	3/04-		R		153-319		Ap	230,0x40	
	3/04-		R		153-311		Lucas	230,0x42	GTC, Hand Brake
	04-		R		700-389			Ø 230,0	-ABS
	04-		R		151-177		Lucas	Ø 20,64 230,0x42	LUC
1.6 16v Eng.Z16XEP (77kW)	3/04-		R		153-319		Ap	230,0x40	
	3/04-		R		153-311		Lucas	230,0x42	Hand Brake
	04-		R		700-389			Ø 230,0	-ABS
1.7 CDTi Eng.Z17DTH (74kW)	04-09		R		153-311		Lucas	230,0x42	Hand Brake
	04-09		R		700-389			Ø 230,0	-ABS
	04-09		R		151-177		Lucas	Ø 20,64 230,0x42	LUC
1.7 CDTi (Exc. GTC) Eng.Z17DTL (59kW)	8/04-		R		153-311		Lucas	230,0x42	Hand Brake
	04-		R		700-389			Ø 230,0	-ABS
	04-		R		151-177		Lucas	Ø 20,64 230,0x42	LUC
Calibra A 6/90-7/97									
2.0 16v, 4WD Eng.C20XE (110-115kW)	6/90-2/94		R			153-302K		160,0x25	Hand Brake
	6/90-2/94		R		153-302	153-302K	Ate	160,0x25	Hand Brake
2.0 i Eng.C20NE (85kW)	6/90-7/97		R		153-302	153-302K	Ate	160,0x25	Hand Brake
2.0 i 16v, 4WD Eng.X20XEV (100kW)	2/94-7/97		R		153-302	153-302K	Ate	160,0x25	Hand Brake
2.0 i 4WD Eng.C20NE (85kW)	6/90-7/97		R		153-302	153-302K	Ate	160,0x25	Hand Brake
2.0 i T. 4WD Eng.C20LET (150kW)	3/92-7/97		R		153-302	153-302K	Ate	160,0x25	Hand Brake
2.5 i V6 Eng.C25XE/ X25XE (125kW)	4/93-7/97		R		153-302		Ate	160,0x25	Hand Brake
Chevanne 1/76-1/82									
1.3 (40kW)	76-82		R		700-300			Ø 200,0	
Commodore B, Coupe / Viceroy I 1/72-7/78									
2.5 Eng.25E/ N (100-103kW)	1/72-12/78		R		153-301		GM	230,0x51	Hand Brake
2.5 Eng.25S (85kW)	1/72-7/78		R		153-301		GM	230,0x51	Hand Brake
2.5 GS Eng.25H (96kW)	1/72-8/75		R		153-301		GM	230,0x51	Hand Brake





















		Spare Parts	F/R	L/R	CIFAM ref.	CIFAM ref. w/KIT		DIMENSIONS mm.	NOTE
2.8 GSE Eng.28E/ EC (118kW)	7/72-2/75		R		153-301		GM	230,0x51	Hand Brake
2.8 GSE Eng.28HC (103kW)	3/75-7/78		R		153-301		GM	230,0x51	Hand Brake
2.8 GSE Eng.28HC (104kW)	1/72-7/78		R		153-301		GM	230,0x51	Hand Brake
2.8 GSE Eng.28HC (114-118-121kW)	3/75-7/78		R		153-301		GM	230,0x51	Hand Brake
Commodore C, SW / Viceroy II 8/78-12/82									
2.5 Eng.25E (96kW)	5/81-12/82		R		153-301		GM	230,0x51	Hand Brake
2.5 Eng.25S (85kW)	8/78-12/82		R		153-301		GM	230,0x51	Hand Brake
Corsa A / Nova 9/82-3/93									
1.0 Eng.10S (33kW)	9/82-3/93		R		153-303		GM	200,0x29	Hand Brake
	-91		R		153-307		Lucas	200,0x29	Hand Brake
	91-		R		153-308		Lucas	200,0x29	Hand Brake
	82-93		R		700-304	700-304K		Ø 200,0	
	82-93		R		700-313	700-313K		Ø 200,0	Only Vauxhall, -ABS
			R		151-120		GM	Ø 14,28 200,0x29	Ch E4008341-G4000000, LUC
			R		151-119		GM	Ø 14,28 200,0x29	Ch G4000001-M4000000, LUC
			R		151-121		GM	Ø 17,46 200,0x29	Ch E4008341-G4000000, LUC
	8/86-93		R		151-080		GM	Ø 17,46 200,0x30	LUC
	-93		R		151-123		GM	Ø 17,46 200,0x29	Ch N4000001-, LUC
1.2 Eng.12NV (38kW)	1/90-3/93		R		153-303		GM	200,0x29	Hand Brake
	-91		R		153-307		Lucas	200,0x29	Hand Brake
	91-		R		153-308		Lucas	200,0x29	Hand Brake
	90-93		R		700-304	700-304K		Ø 200,0	
	90-93		R		700-313	700-313K		Ø 200,0	Only Vauxhall, -ABS
			R		151-121		GM	Ø 17,46 200,0x29	Ch E4008341-G4000000, LUC
	-93		R		151-123		GM	Ø 17,46 200,0x29	Ch N4000001-, LUC
1.2 Eng.12S (44kW)			R		153-307		Lucas	200,0x29	Hand Brake
	9/82-8/90		R		153-303		GM	200,0x29	Hand Brake
1.2 Eng.12ST (40kW)			R		153-307		Lucas	200,0x29	Hand Brake
	9/82-2/90		R		153-303		GM	200,0x29	Hand Brake
	9/82-90		R		700-304	700-304K		Ø 200,0	
	9/82-90		R		700-313	700-313K		Ø 200,0	Only Vauxhall, -ABS
			R		151-121		GM	Ø 17,46 200,0x29	Ch E4008341-G4000000, LUC
	-90		R		151-123		GM	Ø 17,46 200,0x29	Ch N4000001-, LUC
1.2, i Eng.12NC/ C12NZ/ E12GV (33kW)	9/82-3/93		R		153-303		GM	200,0x29	Hand Brake
	-91		R		153-307		Lucas	200,0x29	Hand Brake
	91-		R		153-308		Lucas	200,0x29	Hand Brake
	89-93		R		700-313	700-313K		Ø 200,0	Only Vauxhall, -ABS
	9/82-93		R		700-304	700-304K		Ø 200,0	
			R		151-121		GM	Ø 17,46 200,0x29	Ch E4008341-G4000000, LUC
	8/86-93		R		151-080		GM	Ø 17,46 200,0x30	LUC
			R		151-123		GM	Ø 17,46 200,0x29	Ch N4000001-, LUC
	-93		R		153-307		Lucas	200,0x29	Hand Brake
1.3 Eng.13SB (51kW)	9/82-10/89		R		153-303		GM	200,0x29	Hand Brake
	9/82-89		R		700-304	700-304K		Ø 200,0	
	9/82-89		R		700-313	700-313K		Ø 200,0	Only Vauxhall, -ABS
			R		151-121		GM	Ø 17,46 200,0x29	Ch E4008341-G4000000, LUC
	82-89		R		151-080		GM	Ø 17,46 200,0x30	LUC
			R		151-123		GM	Ø 17,46 200,0x29	Ch N4000001-, LUC
	-89		R		153-307		Lucas	200,0x29	Hand Brake
			R		153-303		GM	200,0x29	Hand Brake
1.3i, Kat Eng.13NB/ C13N (44kW)	9/85-9/90		R		153-307		Lucas	200,0x29	Hand Brake
	85-90		R		700-304	700-304K		Ø 200,0	
	85-90		R		700-313	700-313K		Ø 200,0	Only Vauxhall, -ABS
			R		151-121		GM	Ø 17,46 200,0x29	Ch E4008341-G4000000, LUC
	85-90		R		151-080		GM	Ø 17,46 200,0x30	LUC
	-90		R		151-123		GM	Ø 17,46 200,0x29	Ch N4000001-, LUC
1.4 i Eng.C14NZ (40kW)	1/85-3/93		R		153-307		Lucas	200,0x29	Hand Brake
	1/85-3/93		R		153-308		Lucas	200,0x29	Hand Brake
1.4 i Eng.C14NZ/ X14SZ (44kW)	1/90-3/93		R		153-307		Lucas	200,0x29	Hand Brake
	1/90-3/93		R		153-308		Lucas	200,0x29	Hand Brake
	90-93		R		700-304	700-304K		Ø 200,0	
	90-91		R		151-080		GM	Ø 17,46 200,0x30	LUC
	-93		R		151-123		GM	Ø 17,46 200,0x29	Ch N4000001-, LUC
1.4 S Eng.14NV (53-55kW)	1/90-3/93		R		153-307		Lucas	200,0x29	Hand Brake
	1/90-3/93		R		153-308		Lucas	200,0x29	Hand Brake
	90-93		R		700-304	700-304K		Ø 200,0	
	90-93		R		700-313	700-313K		Ø 200,0	Only Vauxhall, -ABS
	90-93		R		151-080		GM	Ø 17,46 200,0x30	LUC



















		Spare Parts	F/R	L/R	CIFAM ref.	CIFAM ref. w/KIT		DIMENSIONS mm.	NOTE
1.4 Si Eng.C14SE (60kW)	9/91-3/93		R		153-307		Lucas	200,0x29	Hand Brake
	9/91-3/93		R		153-308		Lucas	200,0x29	Hand Brake
	91-93		R		700-304	700-304K		Ø 200,0	
	91-93		R		700-313	700-313K		Ø 200,0	Only Vauxhall, -ABS
	91-93		R		151-080		GM	Ø 17,46 200,0x30	LUC
1.5 D Eng.15D(4EC1) (37kW)	9/87-3/93		R		153-307		Lucas	200,0x29	Hand Brake
	9/87-3/93		R		153-308		Lucas	200,0x29	Hand Brake
	8/87-93		R		700-304	700-304K		Ø 200,0	
	87-93		R		700-313	700-313K		Ø 200,0	Only Vauxhall, -ABS
	8/87-93		R		151-080		GM	Ø 17,46 200,0x30	LUC
	-93		R		151-123		GM	Ø 17,46 200,0x29	Ch N4000001-, LUC
1.5 TD Eng.15DT(T4EC1) (49kW)	3/88-3/93		R		153-307		Lucas	200,0x29	Hand Brake
	88-93		R		700-304	700-304K		Ø 200,0	
	88-93		R		700-313	700-313K		Ø 200,0	Only Vauxhall, -ABS
	88-93		R		151-080		GM	Ø 17,46 200,0x30	LUC
	-93		R		151-123		GM	Ø 17,46 200,0x29	Ch N4000001-, LUC
1.6 (60kW)			R		153-307		Lucas	200,0x29	Hand Brake
1.6 GSI Eng.C16SEI (72kW)	-91		R		153-307		Lucas	200,0x29	Hand Brake
	91-		R		153-308		Lucas	200,0x29	Hand Brake
	89-93		R		700-304	700-304K		Ø 200,0	
	89-93		R		700-313	700-313K		Ø 200,0	Only Vauxhall, -ABS
	89-93		R		151-080		GM	Ø 17,46 200,0x30	LUC
	-93		R		151-123		GM	Ø 17,46 200,0x29	Ch N4000001-, LUC
1.6 GSI, Kat Eng.C16SE/ E16SE (74kW)	92-93		R		153-308		Lucas	200,0x29	Hand Brake
	92-93		R		700-304	700-304K		Ø 200,0	
	-10/92		R		151-123		GM	Ø 17,46 200,0x29	Ch N4000001-, LUC
	92-93		R		151-080		GM	Ø 17,46 200,0x30	LUC
1.6 i Eng.C16NZ (55kW)	-91		R		153-307		Lucas	200,0x29	Hand Brake
	91-		R		153-308		Lucas	200,0x29	Hand Brake
	88-92		R		700-304	700-304K		Ø 200,0	
	88-92		R		151-080		GM	Ø 17,46 200,0x30	LUC
Corsa B / Corsa 3/93-9/00									
1.0 i 12v Eng.X10XE (40kW)	11/96-9/00		R		153-308		Lucas	200,0x29	Hand Brake
	96-00		R		700-301	700-301K		Ø 200,0	+ABS
	96-00		R		700-304	700-304K		Ø 200,0	-ABS
	96-00		R		151-081		GM	Ø 19,05 200,0x28	LUC
1.2 i 16v Eng.X12XE (48kW)	3/98-9/00		R		153-308		Lucas	200,0x29	Hand Brake
	98-00		R		700-301	700-301K		Ø 200,0	+ABS
	98-00		R		700-304	700-304K		Ø 200,0	-ABS
	98-00		R		151-081		GM	Ø 19,05 200,0x28	LUC
1.2i Eng.12NZ/ C12NZ/ X12SZ (33kW)	3/93-9/00		R		153-308		Lucas	200,0x29	Hand Brake
	93-00		R		700-301	700-301K		Ø 200,0	+ABS
	93-00		R		700-304	700-304K		Ø 200,0	-ABS
	93-00		R		151-081		GM	Ø 19,05 200,0x28	LUC
1.4 i Eng.C14NZ/ X14SZ (40-44kW)	3/93-9/00		R		153-308		Lucas	200,0x29	Hand Brake
	93-00		R		700-301	700-301K		Ø 200,0	+ABS
	93-00		R		700-304	700-304K		Ø 200,0	-ABS
	93-00		R		151-081		GM	Ø 19,05 200,0x28	LUC
1.4 i 16v Eng.C14S/ C14SEL (63kW)	8/97-9/00		R		153-308		Lucas	200,0x29	Hand Brake
	97-00		R		700-301	700-301K		Ø 200,0	+ABS
	97-00		R		700-304	700-304K		Ø 200,0	-ABS
	97-00		R		151-081		GM	Ø 19,05 200,0x28	LUC
1.4 i 16v, SW Eng.X14XE (66kW)	9/94-9/00		R		153-308		Lucas	200,0x29	Hand Brake
	94-00		R		700-301	700-301K		Ø 200,0	+ABS
	94-00		R		700-304	700-304K		Ø 200,0	-ABS
	94-00		R		151-081		GM	Ø 19,05 200,0x28	LUC
1.4 Si Eng.C14SE (60kW)	3/93-9/00		R		153-308		Lucas	200,0x29	Hand Brake
	93-00		R		700-301	700-301K		Ø 200,0	+ABS
	93-00		R		700-304	700-304K		Ø 200,0	-ABS
	93-00		R		151-081		GM	Ø 19,05 200,0x28	LUC
1.5 D Eng.15D(4EC1) (37kW)	3/93-9/00		R		153-308		Lucas	200,0x29	Hand Brake
	93-00		R		700-301	700-301K		Ø 200,0	+ABS
	93-00		R		700-304	700-304K		Ø 200,0	-ABS
	93-00		R		151-081		GM	Ø 19,05 200,0x28	LUC
1.5 TD Eng.15DT(T4EC1) (49kW)	3/93-9/00		R		153-308		Lucas	200,0x29	Hand Brake
	93-00		R		700-301	700-301K		Ø 200,0	+ABS
	93-00		R		700-304	700-304K		Ø 200,0	-ABS
	93-00		R		151-081		GM	Ø 19,05 200,0x28	LUC













































		Spare Parts	F/R	L/R	CIFAM ref.	CIFAM ref. w/KIT		DIMENSIONS mm.	NOTE
1.6 GSI 16v Eng.C16XE (80kW)	3/93-9/00		R		153-308		Lucas	200,0x29	Hand Brake
	93-00		R		700-301	700-301K		Ø 200,0	+ABS
	93-00		R		700-304	700-304K		Ø 200,0	-ABS
	93-00		R		151-081		GM	Ø 19,05 200,0x28	LUC
1.6 i 16v Eng.C16SEL (74kW)	8/97-9/00		R		153-308		Lucas	200,0x29	Hand Brake
	97-00		R		700-301	700-301K		Ø 200,0	+ABS
	97-00		R		700-304	700-304K		Ø 200,0	-ABS
	97-00		R		151-081		GM	Ø 19,05 200,0x28	LUC
1.6 i 16v Eng.X16XE (78kW)	9/94-9/00		R		153-308		Lucas	200,0x29	Hand Brake
	94-00		R		700-301	700-301K		Ø 200,0	+ABS
	94-00		R		700-304	700-304K		Ø 200,0	-ABS
	94-00		R		151-081		GM	Ø 19,05 200,0x28	LUC
1.7 D Eng.17D(4EE1)/ X17D (44kW)	2/96-9/00		R		153-308		Lucas	200,0x29	Hand Brake
	96-00		R		700-301	700-301K		Ø 200,0	+ABS
	96-00		R		700-304	700-304K		Ø 200,0	-ABS
	96-00		R		151-081		GM	Ø 19,05 200,0x28	LUC
Corsa C / Corsa II 9/00-6/06									
1.0 12v Eng.Z10XE (43kW)	9/00-6/06		R		153-308		Lucas	200,0x29	Hand Brake
	9/00-6/06		R		153-309		Lucas	200,0x45	Hand Brake
	9/00-00-06		R		700-351	700-351K		Ø 200,0	+ABS
	9/00-00-06		R		700-350	700-350K		Ø 200,0	-ABS
	9/00-00-06		R		151-159		Lucas	Ø 19,05 200,0x45	LUC, +ABS
1.0 12v Eng.Z10XEP (44kW)	6/03-6/06		R		153-308		Lucas	200,0x29	Hand Brake
	6/03-6/06		R		153-309		Lucas	200,0x45	Hand Brake
	03-03-00-06		R		700-351	700-351K		Ø 200,0	+ABS
	03-03-00-06		R		700-350	700-350K		Ø 200,0	-ABS
	03-03-00-06		R		151-159		Lucas	Ø 19,05 200,0x45	LUC, +ABS
1.2 16v Eng.Z12XE (55kW)	9/00-6/06		R		153-308		Lucas	200,0x29	Hand Brake
	9/00-6/06		R		153-309		Lucas	200,0x45	Hand Brake
	9/00-00-06		R		700-351	700-351K		Ø 200,0	+ABS
	9/00-00-06		R		700-350	700-350K		Ø 200,0	-ABS
	9/00-00-06		R		151-159		Lucas	Ø 19,05 200,0x45	LUC, +ABS
1.2 16v Twinport Eng.Z12XEP (59kW)	7/04-6/06		R		153-308		Lucas	200,0x29	Hand Brake
	7/04-6/06		R		153-309		Lucas	200,0x45	Hand Brake
	04-04-00-06		R		700-351	700-351K		Ø 200,0	+ABS
	04-04-00-06		R		700-350	700-350K		Ø 200,0	-ABS
	04-04-00-06		R		151-159		Lucas	Ø 19,05 200,0x45	LUC, +ABS
1.3 CDTi 16v Eng.Z13DT (51kW)	6/03-6/06		R		153-308		Lucas	200,0x29	Hand Brake
	6/03-6/06		R		153-309		Lucas	200,0x45	Hand Brake
	6/03-6/03-00-06		R		700-351	700-351K		Ø 200,0	+ABS
	6/03-6/03-00-06		R		700-350	700-350K		Ø 200,0	-ABS
	6/03-6/03-00-06		R		151-159		Lucas	Ø 19,05 200,0x45	LUC, +ABS
1.4 16v Eng.Z14XE (66kW)	9/00-6/06		R		153-308		Lucas	200,0x29	Hand Brake
	9/00-6/06		R		153-309		Lucas	200,0x45	Hand Brake
	9/00-9/00-00-06		R		700-351	700-351K		Ø 200,0	+ABS
	9/00-9/00-00-06		R		700-350	700-350K		Ø 200,0	-ABS
1.4 16v Twinport Eng.Z14XEP (66kW)	6/03-6/06		R		153-308		Lucas	200,0x29	Hand Brake
	6/03-6/06		R		153-309		Lucas	200,0x45	Hand Brake
	03-03-00-06		R		700-351	700-351K		Ø 200,0	+ABS
1.6 Eng.Z16YNG (71kW)	8/05-7/06		R		153-308		Lucas	200,0x29	Hand Brake
	8/05-7/06		R		153-309		Lucas	200,0x45	Hand Brake
1.7 CDTi Eng.Z17DTH (74kW)	6/03-6/06		R		153-308		Lucas	200,0x29	Hand Brake
	6/03-6/06		R		153-309		Lucas	200,0x45	Hand Brake
	03-03-00-06		R		151-234		Lucas	Ø 20,64 200,0x45	LUC, -ABS
1.7 Di 16v Eng.Y17DTL (48kW)	9/00-6/06		R		153-308		Lucas	200,0x29	Hand Brake
	9/00-6/06		R		153-309		Lucas	200,0x45	Hand Brake
	9/00-9/00-00-06		R		700-351	700-351K		Ø 200,0	+ABS
	9/00-9/00-00-06		R		700-350	700-350K		Ø 200,0	-ABS
	9/00-9/00-00-06		R		151-159		Lucas	Ø 19,05 200,0x45	LUC, +ABS
1.7 DTi 16v Eng.Y17DT (55kW)	9/00-6/06		R		153-308		Lucas	200,0x29	Hand Brake
	9/00-6/06		R		153-309		Lucas	200,0x45	Hand Brake
	9/00-9/00-00-06		R		700-351	700-351K		Ø 200,0	+ABS
	9/00-9/00-00-06		R		700-350	700-350K		Ø 200,0	-ABS
	9/00-9/00-00-06		R		151-159		Lucas	Ø 19,05 200,0x45	LUC, +ABS
1.8 16v Eng.Z18XE (92kW)	9/00-6/06		R		153-308		Lucas	200,0x29	Hand Brake
	9/00-6/06		R		153-309		Lucas	200,0x45	Hand Brake































		Spare Parts	F/R	L/R	CIFAM ref.	CIFAM ref. w/KIT		DIMENSIONS mm.	NOTE
Corsa D 7/06-									
1.0 12v Eng.Z10XEP (44kW)	7/06-		R		153-092		Ap	203,0x38	3p, Hand Brake
	7/06-		R		153-093		Ap	228,0x40	5p, Hand Brake
	10/06-		R		700-373			Ø 203,2	3p
	06-		R		151-222		Ap	Ø 19,05 203,0x38	AP, +EBD, +ABS, 3p
	06-		R		151-223		Ap	Ø 19,05 228,0x40	AP, +EBD, +ABS, 5p
1.2 16v Eng.Z12XEP (59kW)	7/06-		R		153-092		Ap	203,0x38	3p, Hand Brake
	7/06-		R		153-093		Ap	228,0x40	5p, Hand Brake
	10/06-		R		700-373			Ø 203,2	3p
	06-		R		151-222		Ap	Ø 19,05 203,0x38	AP, +EBD, +ABS, 3p
	06-		R		151-223		Ap	Ø 19,05 228,0x40	AP, +EBD, +ABS, 5p
1.3 CDTi 16v Eng.Z13DTH (66kW)	7/06-		R		153-092		Ap	203,0x38	3p, Hand Brake
	7/06-		R		153-093		Ap	228,0x40	5p, Hand Brake
	05-		R		700-372			Ø 228,3	
	06-		R		151-222		Ap	Ø 19,05 203,0x38	AP, +EBD, +ABS, 3p
	06-		R		151-223		Ap	Ø 19,05 228,0x40	AP, +EBD, +ABS, 5p
1.3 CDTi 16v Eng.Z13DTJ/ A13DTC (55kW)	7/06-		R		153-092		Ap	203,0x38	3p, Hand Brake
	7/06-		R		153-093		Ap	228,0x40	5p, Hand Brake
	05-		R		700-372			Ø 228,3	
	06-		R		151-222		Ap	Ø 19,05 203,0x38	AP, +EBD, +ABS, 3p
	06-		R		151-223		Ap	Ø 19,05 228,0x40	AP, +EBD, +ABS, 5p
1.4 16v Eng.Z14XEP (66kW)	7/06-		R		153-092		Ap	203,0x38	3p, Hand Brake
	7/06-		R		153-093		Ap	228,0x40	5p, Hand Brake
	05-		R		700-372			Ø 228,3	
	06-		R		151-222		Ap	Ø 19,05 203,0x38	AP, +EBD, +ABS, 3p
	06-		R		151-223		Ap	Ø 19,05 228,0x40	AP, +EBD, +ABS, 5p
Diplomat A 10/64-3/69									
2.8 Eng.28S (95kW)	1/65-12/69		R			153-302K		160,0x25	Hand Brake
	1/65-12/69		R		153-302	153-302K	Ate	160,0x25	Hand Brake
5.3, Coupe Eng.54S (169kW)	9/66-3/69		R		153-302	153-302K	Ate	160,0x25	Hand Brake
Diplomat B 3/69-1/78									
2.8 Eng.28E (121kW)	3/69-2/75		R		153-302	153-302K	Ate	160,0x25	Hand Brake
2.8 Eng.28HC (103kW)	9/72-8/78		R		153-302	153-302K	Ate	160,0x25	Hand Brake
2.8 Eng.28S (95kW)	1/69-12/77		R		153-302	153-302K	Ate	160,0x25	Hand Brake
5.3 Eng.54S (169kW)	3/69-1/78		R		153-302		Ate	160,0x25	Hand Brake
Frontera A / Frontera 3/92-10/98									
2.0 i Sport Eng.C20NE/ X20SE (85kW)	3/92-10/98		R			153-315K	Ake	210x32	
	3/92-10/98		R		153-315		Ake	210,0x32	Hand Brake
	3/92-10/98		R		153-310		Ake	254,0x52	
	3/92-10/98		R		153-192		Ake	254,0x52	Hand Brake
	92-		R		700-298			Ø 254,0	Ch -PV561270
2.2 i Eng.X22XE (100kW)	3/95-10/98		R			153-315K	Ake	210x32	
	3/95-10/98		R		153-315	153-315K	Ake	210,0x32	Hand Brake
2.3 TD Eng.23DTR (74kW)	3/92-10/98		R		153-315		Ake	210,0x32	Hand Brake
	3/92-10/98		R		153-310		Ake	254,0x52	
	3/92-10/98		R		153-192		Ake	254,0x52	Hand Brake
	92-			R		700-298			Ø 254,0
2.4 i Eng.C24NE (92kW)	3/92-10/98		R			153-315K	Ake	210x32	
	3/92-10/98		R		153-315		Ake	210,0x32	Hand Brake
	3/92-10/98		R		153-310		Ake	254,0x52	
	3/92-10/98		R		153-192		Ake	254,0x52	Hand Brake
	92-			R		700-298			Ø 254,0
2.5 TDS, Sport Eng.VM41B (85kW)	9/96-10/98		R			153-315K	Ake	210x32	
	9/96-10/98		R		153-315		Ake	210,0x32	Hand Brake
	9/96-10/98		R		153-310		Ake	254,0x52	
	9/96-10/98		R		153-192		Ake	254,0x52	Hand Brake
2.8 TD, Sport Eng.4JB1T (83kW)	3/95-10/98		R		153-315		Ake	210,0x32	Hand Brake
	3/95-10/98		R		153-310		Ake	254,0x52	
	3/95-10/98		R		153-192		Ake	254,0x52	Hand Brake
	3/95-8/96		R			153-315K	Ake	210x32	
Frontera B / Frontera II 10/98-									
2.2 DTI Eng.X22DTH (85kW)	10/98-9/02		R			153-315K	Ake	210x32	
	10/98-9/02		R		153-315	153-315K	Ake	210,0x32	Hand Brake
2.2 DTI 16v Eng.Y22DTH (88kW)	9/02-		R		153-315	153-315K	Ake	210,0x32	Hand Brake
2.2 i Eng.X22SE/ Y22SE (100kW)	10/98-		R		153-315	153-315K	Ake	210,0x32	Hand Brake
3.2 i Eng.6VD1/ Y32NE (151kW)	10/98-		R		153-315		Ake	210,0x32	Hand Brake































		Spare Parts	F/R	L/R	CIFAM ref.	CIFAM ref. w/KIT		DIMENSIONS mm.	NOTE	
GT 9/68-8/73										
1.1 Eng.11SR (44kW)	9/68-12/70		R		153-300		GM	200,0x29	Hand Brake	
1.9 Eng.19S (66kW)	9/68-8/73		R		153-301		GM	230,0x51	Hand Brake	
	68-73		R		700-302			Ø 230,0		
Kadett A, SW 9/62-8/65										
1.0 Eng.10N (29kW)	9/62-8/65		R		153-300		GM	200,0x29	Hand Brake	
1.0, Coupe Eng.10S (35kW)	9/62-8/65		R		153-300		GM	200,0x29	Hand Brake	
Kadett B, SW / Chevette B 9/65-8/73										
1.1, Coupe Eng.11N (33-37kW)	9/65-8/73		R		153-300		GM	200,0x29	Hand Brake	
	65-73		R		700-300			Ø 200,0		
1.1, Coupe Eng.11S (40kW)	9/65-7/71		R		153-300		GM	200,0x29	Hand Brake	
1.1, Coupe (Exc. SW) Eng.11SR (44kW)	11/66-7/71		R		153-300		GM	200,0x29	Hand Brake	
1.2, Coupe Eng.12S (44kW)	8/71-8/73		R		153-300		GM	200,0x29	Hand Brake	
	71-73		R		700-300			Ø 200,0	Incl. Scandinavia	
1.5 (47kW)	8/71-7/73		R		153-301		GM	230,0x51	Hand Brake	
1.7 (Exc. SW) Eng.17N/ S (44-49-61kW)	8/67-8/71		R		153-301		GM	230,0x51	Hand Brake	
	67-71		R		700-302			Ø 230,0		
1.9 Coupe (Exc. SW) Eng.19S (66kW)	8/67-8/73		R		153-301		GM	230,0x51	Hand Brake	
	67-73		R		700-300			Ø 200,0		
	67-73		R		700-302			Ø 230,0		
Kadett C, SW / Chevette C 8/73-7/79										
1.0, Coupe Eng.10N (29kW)	1/74-7/79		R		153-300		GM	200,0x29	Hand Brake	
	74-79		R		700-300			Ø 200,0		
1.2, Coupe Eng.12N (38-40kW)	8/73-7/79		R		153-300		GM	200,0x29	Hand Brake	
	8/73-7/79		R		153-301		GM	230,0x51	Hand Brake	
	73-79		R		700-300			Ø 200,0		
1.2, Coupe Eng.12S (44kW)	8/73-7/79		R		153-300		GM	200,0x29	Hand Brake	
	8/73-7/79		R		153-301		GM	230,0x51	Hand Brake	
	73-79		R		700-300			Ø 200,0		
1.6, Coupe Eng.16S/ SH (55kW)	5/77-7/79		R		153-301		GM	230,0x51	Hand Brake	
	77-79		R		700-302			Ø 230,0		
1.9 GTE Coupe (Exc. SW) Eng.19E (77kW)	9/75-7/77		R		153-301		GM	230,0x51	Hand Brake	
	75-77		R		700-302			Ø 230,0		
2.0 GTE Coupe (Exc. SW) Eng.20EH (85kW)	8/77-7/79		R		153-301		GM	230,0x51	Hand Brake	
	8/77-7/79		R		700-302			Ø 230,0		
2.0 Rallye Coupe (Exc. SW) Eng.20E (81kW)	8/77-7/79		R		153-301		GM	230,0x51	Hand Brake	
	8/77-7/79		R		700-302			Ø 230,0		
Kadett D, SW / Astra D 8/79-8/84										
1.0 Eng.10N (30kW)	9/79-8/82		R		153-303		GM	200,0x29	Ch -E508740/ E2501707/ E605529, Hand Brake	
	9/79-8/82		R		153-304		GM	200,0x46	Ch -E508740/ E2501707/ E605529, FR, Hand Brake	
	9/79-8/82		R		153-307		Lucas	200,0x29	Ch E508741/ E2501708/ E605530-, Hand Brake	
	9/79-8/82		R		153-305		Lucas	200,0x45	Ch E508741/ E2501708/ E605530-, FR, Hand Brake	
1.0 Eng.10S (33kW)	8/79-8/84		R		153-303		GM	200,0x29	Ch -E508740/ E2501707/ E605529	
	8/79-8/84		R		153-304		GM	200,0x46	Ch -E508740/ E2501707/ E605529, FR	
	8/79-8/84		R		153-307		Lucas	200,0x29	Ch E508741/ E2501708/ E605530-	
	8/79-8/84		R		153-305		Lucas	200,0x45	Ch E508741/ E2501708/ E605530-, FR	
	79-84		R		700-299			Ø 200,0	M/T	
	79-84			R		700-300			Ø 200,0	M/T
	79-84			R		700-302			Ø 230,0	A/T
	83-84		R		151-120		GM	Ø 14,28 200,0x29	LUC	
1.2 Eng.12N (39kW)	8/79-7/82		R		153-303		GM	200,0x29	Ch -E508740/ E2501707/ E605529, Hand Brake	
	8/79-7/82		R		153-304		GM	200,0x46	Ch -E508740/ E2501707/ E605529, FR, Hand Brake	
	8/79-7/82		R		153-307		Lucas	200,0x29	Ch E508741/ E2501708/ E605530-, Hand Brake	
	8/79-7/82		R		153-305		Lucas	200,0x45	Ch E508741/ E2501708/ E605530-, FR, Hand Brake	
	79-82		R		700-299			Ø 200,0	M/T	
	79-82			R		700-300			Ø 200,0	M/T
	79-82		R		700-302			Ø 230,0	A/T	

















































		Spare Parts	F/R	L/R	CIFAM ref.	CIFAM ref. w/KIT		DIMENSIONS mm.	NOTE
1.2 Eng.12S (44kW)	8/79-8/84		R		153-303		GM	200,0x29	Ch -E508740/ E2501707/ E605529, Hand Brake
	8/79-8/84		R		153-304		GM	200,0x46	Ch -E508740/ E2501707/ E605529, FR, Hand Brake
	8/79-8/84		R		153-307		Lucas	200,0x29	Ch E508741/ E2501708/ E605530-, Hand Brake
	8/79-8/84		R		153-305		Lucas	200,0x45	Ch E508741/ E2501708/ E605530-, FR, Hand Brake
	79-84		R		700-299			Ø 200,0	M/T
	79-84		R		700-300			Ø 200,0	M/T
	79-84		R		700-302			Ø 230,0	A/T
	83-84		R		151-120		GM	Ø 14,28 200,0x29	LUC
1.2 (Exc. SW) Eng.12ST (40kW)	8/82-8/84		R		153-303		GM	200,0x29	Ch -E508740/ E2501707/ E605529, Hand Brake
	8/82-8/84		R		153-304		GM	200,0x46	Ch -E508740/ E2501707/ E605529, FR, Hand Brake
	8/82-8/84		R		153-307		Lucas	200,0x29	Ch E508741/ E2501708/ E605530-, Hand Brake
	8/82-8/84		R		153-305		Lucas	200,0x45	Ch E508741/ E2501708/ E605530-, FR, Hand Brake
	82-84		R		700-299			Ø 200,0	M/T
	82-84		R		700-300			Ø 200,0	M/T
	82-84		R		700-302			Ø 230,0	A/T
	82-84		R		151-120		GM	Ø 14,28 200,0x29	LUC
1.3 Eng.13N (44kW)	8/79-8/84		R		153-303		GM	200,0x29	Ch -E508740/ E2501707/ E605529, Hand Brake
	8/79-8/84		R		153-304		GM	200,0x46	Ch -E508740/ E2501707/ E605529, FR, Hand Brake
	8/79-8/84		R		153-307		Lucas	200,0x29	Ch E508741/ E2501708/ E605530-, Hand Brake
	8/79-8/84		R		153-305		Lucas	200,0x45	Ch E508741/ E2501708/ E605530-, FR, Hand Brake
	8/79-8/84		R		153-306		Lucas	230,0x50	Hand Brake
	79-84		R		700-299			Ø 200,0	M/T
	79-84		R		700-300			Ø 200,0	M/T
	79-84		R		700-302			Ø 230,0	A/T
	83-84		R		151-120		GM	Ø 14,28 200,0x29	LUC, M/T
1.3 Eng.13S (55kW)	8/79-8/84		R		153-303		GM	200,0x29	Ch -E508740/ E2501707/ E605529, Hand Brake
	8/79-8/84		R		153-304		GM	200,0x46	Ch -E508740/ E2501707/ E605529, FR, Hand Brake
	8/79-8/84		R		153-307		Lucas	200,0x29	Ch E508741/ E2501708/ E605530-, Hand Brake
	8/79-8/84		R		153-305		Lucas	200,0x45	Ch E508741/ E2501708/ E605530-, FR, Hand Brake
	8/79-8/84		R		153-306		Lucas	230,0x50	Hand Brake
	79-84		R		700-299			Ø 200,0	M/T
	79-84		R		700-300			Ø 200,0	M/T
	79-84		R		700-302			Ø 230,0	A/T
8/83-7/84		R		151-111		GM	Ø 17,46 200,0x46	LUC	
1.6 Eng.16N (51kW)	9/79-8/84		R		153-304		GM	200,0x46	Ch -E508740/ E2501707/ E605529, FR, Hand Brake
	9/79-8/84		R		153-305		Lucas	200,0x45	Ch E508741/ E2501708/ E605530-, FR, Hand Brake
	9/79-8/84		R		153-306		Lucas	230,0x50	Hand Brake
1.6 Eng.16N (55kW)	9/79-8/84		R		153-304		GM	200,0x46	Ch -E508740/ E2501707/ E605529, FR, Hand Brake
	9/79-8/84		R		153-305		Lucas	200,0x45	Ch E508741/ E2501708/ E605530-, FR, Hand Brake
	9/79-8/84		R		153-306		Lucas	230,0x50	Hand Brake
1.6 Eng.16N/ S/ SH (66kW)	9/81-8/84		R		153-304		GM	200,0x46	Ch -E508740/ E2501707/ E605529, FR, Hand Brake
	9/81-8/84		R		153-305		Lucas	200,0x45	Ch E508741/ E2501708/ E605530-, FR, Hand Brake
	9/81-8/84		R		153-306		Lucas	230,0x50	Hand Brake
	81-84		R		700-300			Ø 200,0	M/T
	81-84		R		700-302			Ø 230,0	A/T
81-7/84		R		151-111		GM	Ø 17,46 200,0x46	LUC	

























































		Spare Parts	F/R	L/R	CIFAM ref.	CIFAM ref. w/KIT		DIMENSIONS mm.	NOTE
1.6 D Eng.16D (40kW)	3/82-8/84		R		153-304		GM	200,0x46	Ch -E508740/ E2501707/ E605529, FR, Hand Brake
	3/82-8/84		R		153-305		Lucas	200,0x45	Ch E508741/ E2501708/ E605530-, FR, Hand Brake
	3/82-8/84		R		153-306		Lucas	230,0x50	Hand Brake
	82-84		R		700-300			Ø 200,0	M/T
	-84		R		700-302			Ø 230,0	Ch E2501708-, A/T
	8/83-7/84		R		151-111		GM	Ø 17,46 200,0x46	LUC
1.8 GTE (Exc. SW) Eng.18E (85kW)	2/83-8/84		R		153-304		GM	200,0x46	Ch -E508740/ E2501707/ E605529, FR, Hand Brake
	2/83-8/84		R		153-305		Lucas	200,0x45	Ch E508741/ E2501708/ E605530-, FR, Hand Brake
	2/83-8/84		R		153-306		Lucas	230,0x50	Hand Brake
	83-84		R		700-300			Ø 200,0	M/T
	83-84		R		151-111		GM	Ø 17,46 200,0x46	LUC
	Kadett E / Astra E, Belmont 9/84-8/91								
1.2 Eng.12SC (40kW)	9/84-7/86		R		153-307		Lucas	200,0x29	Hand Brake
	9/84-7/86		R		153-305		Lucas	200,0x45	Hand Brake
	9/84-7/86		R		153-306		Lucas	230,0x50	Hand Brake
	84-86		R		700-300			Ø 200,0	A/T
	84-86		R		700-299			Ø 200,0	M/T
			R		151-119		GM	Ø 14,28 200,0x29	Ch G5000001-M5000000, LUC
			R		151-080		GM	Ø 17,46 200,0x30	Ch M5000001-, LUC
			R		151-112		GM	Ø 17,46 200,0x46	Ch G5000001-M5000000, LUC
			R		151-122		GM	Ø 19,05 200,0x29	Ch G5000000-, LUC, IP
		84-		R	151-120		GM	Ø 14,28 200,0x29	Ch -G5000000, LUC
1.2 Eng.12ST (40kW)	1/84-12/88		R		153-307		Lucas	200,0x29	Hand Brake
	1/84-12/88		R		153-305		Lucas	200,0x45	Hand Brake
	1/84-12/88		R		153-306		Lucas	230,0x50	Hand Brake
1.3 Eng.13S (55kW)	9/84-8/87		R		153-307		Lucas	200,0x29	Hand Brake
	9/84-8/87		R		153-305		Lucas	200,0x45	Hand Brake
	9/84-8/87		R		153-306		Lucas	230,0x50	Hand Brake
	84-87		R		700-300			Ø 200,0	A/T
	84-87		R		700-299			Ø 200,0	M/T
			R		151-080		GM	Ø 17,46 200,0x30	Ch G5000001-, LUC, M/T
			R		151-112		GM	Ø 17,46 200,0x46	Ch G5000001-, LUC, A/T
		84-		R	151-111		GM	Ø 17,46 200,0x46	Ch -G5000000, LUC, A/T
1.3i, Kat Eng.13NB/ C13N/ 13N (44kW)	9/85-8/91		R		153-307		Lucas	200,0x29	Hand Brake
	9/85-8/91		R		153-305		Lucas	200,0x45	Hand Brake
	9/85-8/91		R		153-306		Lucas	230,0x50	Hand Brake
	85-91		R		700-300			Ø 200,0	A/T
	85-91		R		700-299			Ø 200,0	M/T
			R		151-119		GM	Ø 14,28 200,0x29	Ch G5000001-M5000000, LUC
			R		151-117		GM	Ø 14,28 200,0x46	Ch G5000001-M5000000, LUC
			R		151-080		GM	Ø 17,46 200,0x30	Ch M5000001-, LUC
			R		151-112		GM	Ø 17,46 200,0x46	Ch G5000001-M5000000, LUC, A/T
			R		151-122		GM	Ø 19,05 200,0x29	Ch G5000001-, LUC, IP
	85-		R	151-120		GM	Ø 14,28 200,0x29	Ch -G5000000, LUC	
1.4 i Eng.C14NZ/ X14SZ (44kW)	1/90-8/91		R		153-307		Lucas	200,0x29	Hand Brake
	1/90-8/91		R		153-305		Lucas	200,0x45	Hand Brake
	1/90-8/91		R		153-306		Lucas	230,0x50	Hand Brake
			R		151-119		GM	Ø 14,28 200,0x29	Ch G5000001-M5000000, LUC
			R		151-080		GM	Ø 17,46 200,0x30	Ch M5000001-, LUC
			R		151-112		GM	Ø 17,46 200,0x46	Ch G5000001-M5000000, LUC
			R		151-122		GM	Ø 19,05 200,0x29	Ch G5000001-, LUC, IP
1.4 S Eng.14NV (55kW)	1/90-8/91		R		153-307		Lucas	200,0x29	Hand Brake
	1/90-8/91		R		153-305		Lucas	200,0x45	Hand Brake
	1/90-8/91		R		153-306		Lucas	230,0x50	Hand Brake
			R		151-119		GM	Ø 14,28 200,0x29	Ch G5000001-M5000000, LUC
			R		151-080		GM	Ø 17,46 200,0x30	Ch M5000001-, LUC
			R		151-112		GM	Ø 17,46 200,0x46	Ch G5000001-M5000000, LUC
			R		151-122		GM	Ø 19,05 200,0x29	Ch G5000001-, LUC, IP
1.4 Si Eng.C14SE (60kW)	9/89-8/91		R		153-307		Lucas	200,0x29	Hand Brake
	9/89-8/91		R		153-305		Lucas	200,0x45	Hand Brake
	9/89-8/91		R		153-306		Lucas	230,0x50	Hand Brake
1.5 D Eng.4EC1 (37kW)	1/87-8/91		R		153-307		Lucas	200,0x29	Hand Brake
	1/87-8/91		R		153-305		Lucas	200,0x45	Hand Brake
	1/87-8/91		R		153-306		Lucas	230,0x50	Hand Brake





















































		Spare Parts	F/R	L/R	CIFAM ref.	CIFAM ref. w/KIT		DIMENSIONS mm.	NOTE
1.5 TD Eng.15DT(T4EC1) (49-53kW)	7/88-8/91		R		153-307		Lucas	200,0x29	Hand Brake
	7/88-8/91		R		153-305		Lucas	200,0x45	Hand Brake
	7/88-8/91		R		153-306		Lucas	230,0x50	Hand Brake
	88-91		R		700-300			Ø 200,0	M/T
	88-91		R		151-082		GM	Ø 19,05 200,0x45	LUC
1.6 Eng.16N/ S/ SH (66kW)	9/84-8/86		R		153-307		Lucas	200,0x29	Hand Brake
	9/84-8/86		R		153-305		Lucas	200,0x45	Hand Brake
	9/84-8/86		R		153-306		Lucas	230,0x50	Hand Brake
	84-86		R		700-300			Ø 200,0	
	8/84-		R		151-112		GM	Ø 17,46 200,0x46	Ch G5000001-M5000000, LUC
			R		151-082		GM	Ø 19,05 200,0x45	Ch G5000001-, LUC, IP
			R		151-111		GM	Ø 17,46 200,0x46	Ch -G5000000, LUC
1.6 Eng.16SV (60kW)	9/86-8/91		R		153-307		Lucas	200,0x29	Hand Brake
	9/86-8/91		R		153-305		Lucas	200,0x45	Hand Brake
	9/86-8/91		R		153-306		Lucas	230,0x50	Hand Brake
	86-91		R		700-300			Ø 200,0	
	86-		R		151-112		GM	Ø 17,46 200,0x46	Ch G5000001-M5000000, LUC
			R		151-082		GM	Ø 19,05 200,0x45	Ch G5000001-, LUC, IP
			R		151-111		GM	Ø 17,46 200,0x46	Ch -G5000000, LUC
1.6 Eng.E16SE (74kW)	1/86-12/90		R		153-307		Lucas	200,0x29	Hand Brake
	1/86-12/90		R		153-305		Lucas	200,0x45	Hand Brake
	1/86-12/90		R		153-306		Lucas	230,0x50	Hand Brake
1.6 D Eng.16D/ 16DA (40kW)	9/84-1/89		R		153-307		Lucas	200,0x29	Hand Brake
	9/84-1/89		R		153-305		Lucas	200,0x45	Hand Brake
	9/84-1/89		R		153-306		Lucas	230,0x50	Hand Brake
	84-89		R		700-300			Ø 200,0	
	9/84-		R		700-299			Ø 200,0	Ch -G5000000
			R		151-080		GM	Ø 17,46 200,0x30	Ch G5184470-, LUC
			R		151-111		GM	Ø 17,46 200,0x46	Ch -G5000000, LUC
			R		151-112		GM	Ø 17,46 200,0x46	Ch G5000001-G5184469, LUC
			R		151-082		GM	Ø 19,05 200,0x45	Ch G5000001-, LUC, IP
1.6 i, Kat Eng.C16LZ/ NZ/ E16NZ (55kW)	9/86-8/91		R		153-307		Lucas	200,0x29	Hand Brake
	9/86-8/91		R		153-305		Lucas	200,0x45	Hand Brake
	9/86-8/91		R		153-306		Lucas	230,0x50	Hand Brake
	86-91		R		700-300			Ø 200,0	
	86-		R		151-112		GM	Ø 17,46 200,0x46	Ch G5000001-M5000000, LUC
			R		151-082		GM	Ø 19,05 200,0x45	Ch G5000001-, LUC, IP
			R		151-111		GM	Ø 17,46 200,0x46	Ch -G5000000, LUC
1.7 D Eng.17D (42kW)	2/89-8/91		R		153-307		Lucas	200,0x29	Hand Brake
	2/89-8/91		R		153-305		Lucas	200,0x45	Hand Brake
	2/89-8/91		R		153-306		Lucas	230,0x50	Hand Brake
	89-91		R		700-299			Ø 200,0	
	89-91		R		700-300			Ø 200,0	M/T
			R		151-122		GM	Ø 19,05 200,0x29	LUC, -ABS, IP
			R		151-082		GM	Ø 19,05 200,0x45	LUC, +ABS
1.8 Eng.18E (85kW)	9/84-8/91		R		153-307		Lucas	200,0x29	Hand Brake
	9/84-8/91		R		153-305		Lucas	200,0x45	Hand Brake
	9/84-8/91		R		153-306		Lucas	230,0x50	Hand Brake
	84-91		R		700-300			Ø 200,0	
	8/84-		R		151-112		GM	Ø 17,46 200,0x46	Ch G5000001-M5000000, LUC
			R		151-111		GM	Ø 17,46 200,0x46	Ch -G5000000, LUC
1.8 Eng.18SE (82kW)	1/86-12/93		R		153-307		Lucas	200,0x29	Hand Brake
	1/86-12/93		R		153-305		Lucas	200,0x45	Hand Brake
	1/86-12/93		R		153-306		Lucas	230,0x50	Hand Brake
1.8 Eng.E18NV (62kW)	9/87-8/91		R		153-307		Lucas	200,0x29	Hand Brake
	9/87-8/91		R		153-305		Lucas	200,0x45	Hand Brake
	9/87-8/91		R		153-306		Lucas	230,0x50	Hand Brake
	87-91		R		700-300			Ø 200,0	
	87-		R		151-112		GM	Ø 17,46 200,0x46	Ch G5000001-M5000000, LUC
			R		151-111		GM	Ø 17,46 200,0x46	Ch -G5000000, LUC
1.8 i Eng.C18NE (74kW)	10/85-8/86		R		153-307		Lucas	200,0x29	Hand Brake
	10/85-8/86		R		153-305		Lucas	200,0x45	Hand Brake
	10/85-8/86		R		153-306		Lucas	230,0x50	Hand Brake
	85-86		R		700-300			Ø 200,0	
	85-		R		151-112		GM	Ø 17,46 200,0x46	Ch G5000001-M5000000, LUC
			R		151-111		GM	Ø 17,46 200,0x46	Ch -G5000000, LUC
1.8 i Eng.C18NT/ NZ/ NV (66kW)	9/90-8/91		R		153-307		Lucas	200,0x29	Hand Brake
	9/90-8/91		R		153-305		Lucas	200,0x45	Hand Brake

































































		Spare Parts	F/R	L/R	CIFAM ref.	CIFAM ref. w/KIT		DIMENSIONS mm.	NOTE
1.8 i Eng.C18NT/ NZ/ NV (66kW)	9/90-8/91		R		153-306		Lucas	230,0x50	Hand Brake
	90-91		R		700-300			Ø 200,0	
	90-		R		151-112		GM	Ø 17,46 200,0x46	Ch G5000001-M5000000, LUC
			R		151-111		GM	Ø 17,46 200,0x46	Ch -G5000000, LUC
2.0 GSI Eng.20SEH (95kW)	9/86-8/91		R			153-302K		160,0x25	Hand Brake
	9/86-8/91		R		153-302		Ate	160,0x25	Hand Brake
	9/86-8/91		R		153-307		Lucas	200,0x29	Hand Brake
	9/86-8/91		R		153-305		Lucas	200,0x45	Hand Brake
	9/86-8/91		R		153-306		Lucas	230,0x50	Hand Brake
	86-91		R		700-300			Ø 200,0	
2.0 GSI 16v Eng.20XE (115kW)	12/87-8/91		R			153-302K		160,0x25	Hand Brake
	12/87-8/91		R		153-302		Ate	160,0x25	Hand Brake
	12/87-8/91		R		153-307		Lucas	200,0x29	Hand Brake
	12/87-8/91		R		153-305		Lucas	200,0x45	Hand Brake
	12/87-8/91		R		153-306		Lucas	230,0x50	Hand Brake
2.0 GSI 16v, Kat Eng.20XE/ 20XEJ/ C20XE (110kW)	3/88-8/91		R			153-302K		160,0x25	Hand Brake
	3/88-8/91		R		153-302		Ate	160,0x25	Hand Brake
	3/88-8/91		R		153-307		Lucas	200,0x29	Hand Brake
	3/88-8/91		R		153-305		Lucas	200,0x45	Hand Brake
	3/88-8/91		R		153-306		Lucas	230,0x50	Hand Brake
	88-91		R		700-300			Ø 200,0	Exc. 16v
2.0 i, Kat Eng.20NE/ C20NE (85kW)	3/87-8/91		R		153-307		Lucas	200,0x29	Hand Brake
	3/87-8/91		R		153-305		Lucas	200,0x45	Hand Brake
	3/87-8/91		R		153-306		Lucas	230,0x50	Hand Brake
	87-		R		700-300			Ø 200,0	
			R		151-112		GM	Ø 17,46 200,0x46	Ch K2500078-, LUC
			R		151-082		GM	Ø 19,05 200,0x45	Ch -K2500077, LUC
Kadett E Cabrio 9/84-8/91									
1.3 Eng.13S (55kW)	9/84-8/87		R		153-307		Lucas	200,0x29	Hand Brake
	9/84-8/87		R		153-305		Lucas	200,0x45	Hand Brake
	9/84-8/87		R		153-306		Lucas	230,0x50	Hand Brake
	84-		R		151-120		GM	Ø 14,28 200,0x29	Ch -G5000000, LUC
1.4 i Eng.C14NZ/ X14SZ (44kW)	1/90-8/91		R		153-307		Lucas	200,0x29	Hand Brake
	1/90-8/91		R		153-305		Lucas	200,0x45	Hand Brake
	1/90-8/91		R		153-306		Lucas	230,0x50	Hand Brake
	90-91		R		700-300			Ø 200,0	
1.4 S Eng.14NV (55kW)	1/90-8/91		R		153-307		Lucas	200,0x29	Hand Brake
	1/90-8/91		R		153-305		Lucas	200,0x45	Hand Brake
	1/90-8/91		R		153-306		Lucas	230,0x50	Hand Brake
	90-91		R		700-300			Ø 200,0	
1.6 Eng.16SV (60kW)	9/86-8/91		R		153-307		Lucas	200,0x29	Hand Brake
	9/86-8/91		R		153-305		Lucas	200,0x45	Hand Brake
	9/86-8/91		R		153-306		Lucas	230,0x50	Hand Brake
	86-91		R		700-300			Ø 200,0	
1.6 i, Kat Eng.C16LZ/ NZ/ E16NZ (55kW)	9/86-8/91		R		153-307		Lucas	200,0x29	Hand Brake
	9/86-8/91		R		153-305		Lucas	200,0x45	Hand Brake
	9/86-8/91		R		153-306		Lucas	230,0x50	Hand Brake
	86-91		R		700-300			Ø 200,0	
2.0 GSi Eng.20XE (115kW)	9/90-5/92		R			153-302K		160,0x25	Hand Brake
	9/90-5/92		R		153-302		Ate	160,0x25	Hand Brake
	9/90-5/92		R		153-307		Lucas	200,0x29	Hand Brake
	9/90-5/92		R		153-305		Lucas	200,0x45	Hand Brake
	9/90-5/92		R		153-306		Lucas	230,0x50	Hand Brake
2.0 GSI 16V Eng.20XE/ 20XEJ/ C20XE (110kW)	9/90-5/92		R			153-302K		160,0x25	Hand Brake
	9/90-5/92		R		153-302		Ate	160,0x25	Hand Brake
	9/90-5/92		R		153-307		Lucas	200,0x29	Hand Brake
	9/90-5/92		R		153-305		Lucas	200,0x45	Hand Brake
	9/90-5/92		R		153-306		Lucas	230,0x50	Hand Brake
2.0 i GSI, KAT Eng.20NE/ C20NE (85kW)	3/87-8/91		R			153-302K		160,0x25	Hand Brake
	3/87-8/91		R		153-302		Ate	160,0x25	Hand Brake
	3/87-8/91		R		153-307		Lucas	200,0x29	Hand Brake
	3/87-8/91		R		153-305		Lucas	200,0x45	Hand Brake
	3/87-8/91		R		153-306		Lucas	230,0x50	Hand Brake
	3/87-		R		700-300			Ø 200,0	
Kadett E SW 9/84-8/91									
1.2 Eng.12SC (40kW)	9/84-7/86		R		153-307		Lucas	200,0x29	Hand Brake
	9/84-7/86		R		153-305		Lucas	200,0x45	Hand Brake
	9/84-7/86		R		153-306		Lucas	230,0x50	Hand Brake





















		Spare Parts	F/R	L/R	CIFAM ref.	CIFAM ref. w/KIT		DIMENSIONS mm.	NOTE
1.2 Eng.12SC (40kW)	84-86		R		700-300			Ø 200,0	M/T
			R		700-302		Ø 230,0		
	84-		R		151-113		GM	Ø 19,05 200,0x46	Ch -G5000000, LUC
			R		151-115		GM	Ø 19,05 200,0x46	Ch -E215465, LUC
1.3 Eng.13S (55kW)	9/84-8/87		R		153-307		Lucas	200,0x29	Hand Brake
	9/84-8/87		R		153-305		Lucas	200,0x45	Hand Brake
	9/84-8/87		R		153-306		Lucas	230,0x50	Hand Brake
	84-87		R		700-300			Ø 200,0	M/T
			R		700-302			Ø 230,0	
	84-		R		151-114		GM	Ø 17,46 200,0x46	Ch -G5000000, LUC, IP
			R		151-116		GM	Ø 17,46 200,0x46	Ch G5000001-, LUC, IP
			R		151-113		GM	Ø 19,05 200,0x46	Ch -G5000000, LUC
			R		151-115		GM	Ø 19,05 200,0x46	Ch -E215465, LUC
			R		151-113		GM	Ø 19,05 200,0x46	Ch -G5000000, LUC
1.3i, Kat Eng.13NB/ C13N (44kW)	9/85-8/91		R		153-307		Lucas	200,0x29	Hand Brake
	9/85-8/91		R		153-305		Lucas	200,0x45	Hand Brake
	9/85-8/91		R		153-306		Lucas	230,0x50	Hand Brake
	85-91		R		700-300			Ø 200,0	M/T
			R		700-302			Ø 230,0	
	85-		R		151-114		GM	Ø 17,46 200,0x46	Ch -G5000000, LUC, IP
			R		151-116		GM	Ø 17,46 200,0x46	Ch G5000001-, LUC, IP
			R		151-113		GM	Ø 19,05 200,0x46	Ch -G5000000, LUC
			R		151-115		GM	Ø 19,05 200,0x46	Ch -E215465, LUC
R				151-113		GM	Ø 19,05 200,0x46	Ch -G5000000, LUC	
1.4 i Eng.C14NZ/ X14SZ (44kW)	1/90-8/91		R		153-307		Lucas	200,0x29	Hand Brake
	1/90-8/91		R		153-305		Lucas	200,0x45	Hand Brake
	1/90-8/91		R		153-306		Lucas	230,0x50	Hand Brake
1.4 S Eng.14NV (55kW)	1/90-8/91		R		153-307		Lucas	200,0x29	Hand Brake
	1/90-8/91		R		153-305		Lucas	200,0x45	Hand Brake
	1/90-8/91		R		153-306		Lucas	230,0x50	Hand Brake
1.5 TD Eng.15DT(T4EC1) (49-53kW)	7/88-8/91		R		153-307		Lucas	200,0x29	Hand Brake
	7/88-8/91		R		153-305		Lucas	200,0x45	Hand Brake
	7/88-8/91		R		153-306		Lucas	230,0x50	Hand Brake
	88-91		R		700-302			Ø 230,0	M/T
			R		151-082		GM	Ø 19,05 200,0x45	LUC
1.6 Eng.16N/ S/ SH (66kW)	9/84-8/86		R		153-307		Lucas	200,0x29	Hand Brake
	9/84-8/86		R		153-305		Lucas	200,0x45	Hand Brake
	9/84-8/86		R		153-306		Lucas	230,0x50	Hand Brake
	84-86		R		700-302			Ø 230,0	
1.6 Eng.16SV (60kW)	9/86-8/91		R		153-307		Lucas	200,0x29	Hand Brake
	9/86-8/91		R		153-305		Lucas	200,0x45	Hand Brake
	9/86-8/91		R		153-306		Lucas	230,0x50	Hand Brake
	86-91		R		700-302			Ø 230,0	Incl. Dysability vehicle, M/T
			R		151-082		GM	Ø 19,05 200,0x45	Ch E215466-, LUC
1.6 D Eng.16D/ 16DA (40kW)	9/84-1/89		R		153-307		Lucas	200,0x29	Hand Brake
	9/84-1/89		R		153-305		Lucas	200,0x45	Hand Brake
	9/84-1/89		R		153-306		Lucas	230,0x50	Hand Brake
	84-89		R		700-302			Ø 230,0	M/T
1.6 i, Kat Eng.C16LZ/ NZ/ E16NZ (55kW)	9/86-8/91		R		153-307		Lucas	200,0x29	Hand Brake
	9/86-8/91		R		153-305		Lucas	200,0x45	Hand Brake
	9/86-8/91		R		153-306		Lucas	230,0x50	Hand Brake
	86-91		R		700-302			Ø 230,0	Incl. Dysability vehicle, M/T
1.7 D Eng.17D (42kW)	2/89-8/91		R		153-307		Lucas	200,0x29	Hand Brake
	2/89-8/91		R		153-305		Lucas	200,0x45	Hand Brake
	2/89-8/91		R		153-306		Lucas	230,0x50	Hand Brake
	89-91		R		700-302			Ø 230,0	
			R		151-082		GM	Ø 19,05 200,0x45	Ch E215466-, LUC
1.8 Eng.18E (85kW)	9/84-8/86		R		153-307		Lucas	200,0x29	Hand Brake
	9/84-8/86		R		153-305		Lucas	200,0x45	Hand Brake
	9/84-8/86		R		153-306		Lucas	230,0x50	Hand Brake
	84-86		R		700-300			Ø 200,0	M/T
			R		700-302			Ø 230,0	Incl. Dysability vehicle, A/T
1.8 Eng.E18NV (62kW)	9/87-8/91		R		153-307		Lucas	200,0x29	Hand Brake
	9/87-8/91		R		153-305		Lucas	200,0x45	Hand Brake
	9/87-8/91		R		153-306		Lucas	230,0x50	Hand Brake
	87-91		R		700-300			Ø 200,0	M/T
			R		700-302			Ø 230,0	Incl. Dysability vehicle, A/T
87-91		R		151-082		GM	Ø 19,05 200,0x45	Ch E215466-, LUC	

		Spare Parts	F/R	L/R	CIFAM ref.	CIFAM ref. w/KIT		DIMENSIONS mm.	NOTE
1.8 i Eng.C18NE/ NT (74kW)	10/85-8/86		R		153-307		Lucas	200,0x29	Hand Brake
	10/85-8/86		R		153-305		Lucas	200,0x45	Hand Brake
	10/85-8/86		R		153-306		Lucas	230,0x50	Hand Brake
	85-86		R		700-300			Ø 200,0	M/T
	85-86		R		700-302			Ø 230,0	Incl. Dysability vehicle, A/T
1.8 i Eng.C18NZ (66kW)	9/90-8/91		R		153-307		Lucas	200,0x29	Hand Brake
	9/90-8/91		R		153-305		Lucas	200,0x45	Hand Brake
	9/90-8/91		R		153-306		Lucas	230,0x50	Hand Brake
	90-91		R		700-300			Ø 200,0	M/T
	90-91		R		700-302			Ø 230,0	Incl. Dysability vehicle, A/T
2.0 i, Kat Eng.20NE/ C20NE (85kW)	3/87-8/91		R		153-307		Lucas	200,0x29	Hand Brake
	3/87-8/91		R		153-305		Lucas	200,0x45	Hand Brake
	3/87-8/91		R		153-306		Lucas	230,0x50	Hand Brake
	87-91		R		700-302			Ø 230,0	M/T
			R		151-082		GM	Ø 19,05 200,0x45	Ch E215466-, LUC
Manta A 9/70-8/75									
1.2 Eng.12S (44kW)	72-75		R		700-300			Ø 200,0	
1.6 Eng.16N (44-50-66kW)	70-		R		700-300			Ø 200,0	Ch -2724057
	-75		R		700-302			Ø 230,0	Ch 2724058-
1.9 Eng.19S (65-66kW)	-75		R		700-302			Ø 230,0	Ch 2724058-
Manta B / Cavalier Coupe 9/75-8/88									
1.2 Eng.12N (40kW)	76-83		R		700-300			Ø 200,0	
1.2 Eng.12S (44kW)	75-79		R		700-300			Ø 200,0	
1.3 Eng.13N (44kW)	79-80		R		700-300			Ø 200,0	
1.3 Eng.13S (55kW)	-83		R		153-301		GM	230,0x51	Hand Brake
	83-		R		153-306		Lucas	230,0x50	Hand Brake
	81-		R		700-300			Ø 200,0	Ch -G6100000
	81-86		R		700-302			Ø 230,0	
1.6 Eng.16N (44kW)	9/75-12/80		R		153-301		GM	230,0x51	Hand Brake
	75-80		R		700-300			Ø 200,0	M/T
	75-80		R		700-302			Ø 230,0	A/T
1.6 Eng.16S/ SH (55kW)	9/75-12/81		R		153-301		GM	230,0x51	Hand Brake
	75-81		R		700-300			Ø 200,0	Exc. Norway
1.8 Eng.18S (66kW)	7/82-8/87		R		153-301		GM	230,0x51	Hand Brake
	7/82-8/87		R		153-306		Lucas	230,0x50	Hand Brake
	82-87		R		700-302			Ø 230,0	
1.9 Eng.19N (55kW)	8/76-12/81		R		153-301		GM	230,0x51	Hand Brake
	76-81		R		700-302			Ø 230,0	
1.9 Eng.19S (66kW)	9/75-12/80		R		153-301		GM	230,0x51	Hand Brake
1.9 GTE Eng.19E (77kW)	9/75-8/77		R		153-301		GM	230,0x51	Hand Brake
2.0 (92kW)	8/81-7/88		R		153-301		GM	230,0x51	Hand Brake
	8/81-7/88		R		153-306		Lucas	230,0x50	Hand Brake
2.0 Eng.20E (81kW)	8/77-8/88		R		153-301		GM	230,0x51	Hand Brake
	8/77-8/88		R		153-306		Lucas	230,0x50	Hand Brake
	77-88		R		700-302			Ø 230,0	
2.0 Eng.20N (66kW)	8/77-12/80		R		153-301		GM	230,0x51	Hand Brake
	8/77-12/80		R		153-306		Lucas	230,0x50	Hand Brake
	77-80		R		700-302			Ø 230,0	
2.0 Eng.20S (74kW)	8/77-8/84		R		153-301		GM	230,0x51	Hand Brake
	8/77-8/84		R		153-306		Lucas	230,0x50	Hand Brake
	77-84		R		700-302			Ø 230,0	
2.4 400 Eng.24E (106kW)	7/80-8/84		R		153-301		GM	230,0x51	Hand Brake
	80-		R		700-302			Ø 230,0	Ch -G6100000
Midi II 6/88-									
2.0 Eng.20PET (62kW)	6/88-		R		153-190		Sumit.	254,0x50	Hand Brake
2.2 D Eng.4FD1 (45kW)	7/90-8/94		R		153-190		Sumit.	254,0x50	Hand Brake
2.4 D Eng.4FG1T (56kW)	10/94-8/97		R		153-190		Sumit.	254,0x50	Hand Brake
2.4 TD Eng.4FG1T (56kW)	9/94-		R		153-190		Sumit.	254,0x50	Hand Brake
Monza A / Royal - Coupe 2/78-8/86									
2.0 Eng.20E (81kW)	1/83-12/86		R			153-302K		160,0x25	Hand Brake
	1/83-12/86		R		153-302	153-302K	Ate	160,0x25	Hand Brake
2.0 Eng.H20E (85kW)	3/83-10/84		R		153-302	153-302K	Ate	160,0x25	Hand Brake
2.2 Eng.22E (85kW)	11/84-8/86		R		153-302	153-302K	Ate	160,0x25	Hand Brake
2.5 Eng.25E/ H (100-103kW)	5/81-8/86		R		153-302	153-302K	Ate	160,0x25	Hand Brake
2.8 Eng.28H (103-107kW)	2/78-4/81		R		153-302	153-302K	Ate	160,0x25	Hand Brake















		Spare Parts	F/R	L/R	CIFAM ref.	CIFAM ref. w/KIT		DIMENSIONS mm.	NOTE
2.8 Eng.28S (95kW)	1/79-12/81		R		153-302	153-302K	Ate	160,0x25	Hand Brake
3.0 Eng.30H (110kW)	4/78-7/82		R		153-302	153-302K	Ate	160,0x25	Hand Brake
3.0 Eng.30S	1/78-12/82		R		153-302	153-302K	Ate	160,0x25	Hand Brake
3.0 GSE Eng.30E (132kW)	2/78-8/86		R		153-302	153-302K	Ate	160,0x25	Hand Brake
3.0 GSE Eng.C30LE (115kW)	9/85-8/86		R		153-302		Ate	160,0x25	Hand Brake
Olympia A 8/67-8/71									
1.0, Coupe Eng.11SR (44kW)	67-71		R		700-302			Ø 230,0	
1.7, Coupe Eng.17N/ S (55kW)	67-71		R		700-302			Ø 230,0	
1.9 Coupe Eng.19S (65-66kW)	67-71		R		700-302			Ø 230,0	
Omega A, SW / Carlton III 9/86-3/94									
1.8 Eng.18NV (60kW)	9/86-8/87		R			153-302K		160,0x25	Hand Brake
	9/86-8/87		R		153-302	153-302K	Ate	160,0x25	Hand Brake
1.8 Eng.18SEH (85kW)	9/86-3/94		R		153-302	153-302K	Ate	160,0x25	Hand Brake
1.8 Eng.18SV (66kW)	9/86-3/94		R		153-302	153-302K	Ate	160,0x25	Hand Brake
1.8 Eng.E18NVR (65kW)	9/87-3/94		R		153-302	153-302K	Ate	160,0x25	Hand Brake
2.0, i Eng.20SE/ C20NE/ NEF/ NEJ (73-74-85-90kW)	9/86-3/94		R		153-302	153-302K	Ate	160,0x25	Hand Brake
2.3 D Eng.23YD (54-66kW)	10/86-3/94		R		153-302	153-302K	Ate	160,0x25	Hand Brake
2.3 TD, TDi Eng.23DTR/ YDT (66-74kW)	10/86-3/94		R		153-302	153-302K	Ate	160,0x25	Hand Brake
2.4 i Eng.C24NE (92kW)	9/88-3/94		R		153-302	153-302K	Ate	160,0x25	Hand Brake
2.6 i Eng.C26NE (110kW)	9/90-3/94		R		153-302	153-302K	Ate	160,0x25	Hand Brake
3.0 Eng.30E (132kW)	1/78-12/87		R		153-302	153-302K	Ate	160,0x25	Hand Brake
3.0 Eng.C30LE (115kW)	3/87-12/87		R		153-302	153-302K	Ate	160,0x25	Hand Brake
3.0 24v Eng.C30SEJ (147kW)	9/89-3/94		R		153-302	153-302K	Ate	160,0x25	Hand Brake
3.0 24v (Exc. SW) Eng.C30SE (150kW)	9/89-3/94		R		153-302	153-302K	Ate	160,0x25	Hand Brake
3.0 24v Evolution500 (Exc. SW) Eng.C30XEI (169kW)	3/91-7/92		R		153-302	153-302K	Ate	160,0x25	Hand Brake
3.0 i, Kat Eng.30NE/ C30NE (130kW)	3/87-9/90		R		153-302	153-302K	Ate	160,0x25	Hand Brake
Omega B, SW / Omega 3/94-7/03									
2.0 Eng.20SE (90kW)	1/94-12/00		R		153-302	153-302K	Ate	160,0x25	Hand Brake
2.0 Eng.20SE/ X20SE (85kW)	3/94-12/00		R		153-302	153-302K	Ate	160,0x25	Hand Brake
2.0 DTi 16v Eng.X20DTH (74kW)	9/97-9/00		R		153-302	153-302K	Ate	160,0x25	Hand Brake
2.0 i 16v Eng.X20XEV (100kW)	3/94-9/99		R		153-302	153-302K	Ate	160,0x25	Hand Brake
2.2 16v Eng.Y22XE/ Z22XE (106kW)	9/99-7/03		R		153-302	153-302K	Ate	160,0x25	Hand Brake
2.2 DTi Eng.Y22DTH (81kW)	9/00-7/03		R		153-302	153-302K	Ate	160,0x25	Hand Brake
2.2 DTi 16v Eng.Y22DTH (88kW)	9/00-7/03		R		153-302	153-302K	Ate	160,0x25	Hand Brake
2.5 DTi Eng.Y25DT (110kW)	9/01-7/03		R		153-302	153-302K	Ate	160,0x25	Hand Brake
2.5 TD Eng.25DT/ X25DT/ X25TD (96kW)	4/94-7/03		R		153-302	153-302K	Ate	160,0x25	Hand Brake
2.5 V6 Eng.X25XE (125kW)	3/94-9/00		R		153-302		Ate	160,0x25	Hand Brake
Rekord B 8/65-2/67									
1.5, SW (44kW)	9/65-7/66		R		700-302			Ø 230,0	
1.7, Coupe, SW Eng.17S (55kW)	9/65-7/66		R		700-302			Ø 230,0	
1.9, Coupe Eng.19E (66kW)	65-67		R		700-302			Ø 230,0	
Rekord C, SW 8/66-12/71									
1.5 Eng.15 (43-44kW)	9/66-68		R		700-302			Ø 230,0	
1.7 Eng.17N (44-49-61kW)	8/66-12/71		R		153-301		GM	230,0x51	Hand Brake
1.7, Coupe Eng.17S (44-49-55-61kW)	8/66-12/71		R		153-301		GM	230,0x51	Hand Brake
	9/66-68		R		700-302			Ø 230,0	
1.9 Sprint, Coupe (Exc. SW) Eng.19H/ SH (78kW)	8/67-12/71		R		153-301		GM	230,0x51	Hand Brake
1.9, Coupe Eng.19S (65-66kW)	8/66-12/71		R		153-301		GM	230,0x51	Hand Brake
	9/66-68		R		700-302			Ø 230,0	
2.2, Coupe (Exc. SW) (70kW)	66-69		R		700-302			Ø 230,0	
Rekord D, SW / Carlton I 1/72-8/77									
1.7 Eng.17N (44-49-61kW)	1/72-8/77		R		153-301		GM	230,0x51	Hand Brake
1.7, Coupe Eng.17S (44-49-61kW)	1/72-2/75		R		153-301		GM	230,0x51	Hand Brake
	72-75		R		700-302			Ø 230,0	
1.9, Coupe Eng.19N (55kW)	3/75-8/77		R		153-301		GM	230,0x51	Hand Brake
1.9, Coupe Eng.19SH (66-71kW)	1/72-8/77		R		153-301		GM	230,0x51	Hand Brake
	72-77		R		700-302			Ø 230,0	
2.0 Eng.20N (66kW)	1/75-12/77		R		153-301		GM	230,0x51	Hand Brake
2.0 D Eng.20D (40kW)	8/74-8/77		R		153-301		GM	230,0x51	Hand Brake

		Spare Parts	F/R	L/R	CIFAM ref.	CIFAM ref. w/KIT		DIMENSIONS mm.	NOTE
2.0, Coupe Eng.20S (74kW)	9/75-8/77		R		153-301		GM	230,0x51	Hand Brake
	75-77		R		700-302			Ø 230,0	
2.1 D Eng.21D (44kW)	9/72-8/77		R		153-301		GM	230,0x51	Hand Brake
	72-77		R		700-302			Ø 230,0	
Rekord E, SW / Carlton II 8/77-8/86									
1.7 Eng.17N/ S (44-49-61kW)	9/77-10/82		R		153-301		GM	230,0x51	Hand Brake
	1/77-9/82		R		700-302			Ø 230,0	
1.8 Eng.18N (55kW)	82-		R		153-306		Lucas	230,0x50	Hand Brake
	82-86		R		700-302			Ø 230,0	
1.8 Eng.18S (66kW)	82-		R		153-306		Lucas	230,0x50	Hand Brake
	82-86		R		700-302			Ø 230,0	
1.8 i Eng.C18NV (74kW)	85-86		R		153-306		Lucas	230,0x50	Hand Brake
			R		700-302			Ø 230,0	
1.9 Eng.19N (55kW)	9/77-10/82		R		153-301		GM	230,0x51	Hand Brake
	77-82		R		700-302			Ø 230,0	
1.9 Eng.19SH (66-71kW)	1/77-12/82		R		153-301		GM	230,0x51	Hand Brake
2.0 Eng.20E (81kW)	-82		R		153-301		GM	230,0x51	Hand Brake
	82-		R		153-306		Lucas	230,0x50	Hand Brake
2.0 Eng.20N (66kW)	-82		R		153-301		GM	230,0x51	Hand Brake
	82-		R		153-306		Lucas	230,0x50	Hand Brake
2.0 Eng.20S (74kW)	-82		R		153-301		GM	230,0x51	Hand Brake
	82-		R		153-306		Lucas	230,0x50	Hand Brake
	77-86		R		700-302			Ø 230,0	
2.0 D Eng.20D (43kW)	9/77-10/82		R		153-301		GM	230,0x51	Hand Brake
	77-82		R		700-302			Ø 230,0	
2.1 D Eng.21D (44kW)	77-78		R		700-302			Ø 230,0	
2.2 Eng.22E (85kW)			R		153-306		Lucas	230,0x50	Hand Brake
2.2 D Eng.23D (52kW)	82-		R		153-306		Lucas	230,0x50	Hand Brake
2.2 TD Eng.23TD (63kW)			R		153-306		Lucas	230,0x50	Hand Brake
	84-86		R		700-302			Ø 230,0	
2.3 D Eng.23D (48-52kW)	-82		R		153-301		GM	230,0x51	Hand Brake
	82-		R		153-306		Lucas	230,0x50	Hand Brake
	78-86		R		700-302			Ø 230,0	
Sintra 11/96-4/99									
2.2 i 16v Eng.X22XE (104kW)	11/96-4/99		R		153-491	153-491K		190x25	
3.0 i 24v Eng.X30XE (148kW)	11/96-4/99		R		153-491	153-491K		190x25	
Tigra A 7/94-12/00									
1.4 i 16v Eng.X14XE (63-66kW)	7/94-12/00		R		153-308		Lucas	200,0x29	Hand Brake
	94-		R		700-313	700-313K		Ø 200,0	Only Vauxhall, -ABS
	94-00		R		700-301	700-301K		Ø 200,0	+ABS
	94-00		R		700-304	700-304K		Ø 200,0	-ABS
1.6 i 16v Eng.C16SEL (74kW)	94-00		R		151-081		GM	Ø 19,05 200,0x28	LUC
	8/97-8/98		R		153-308		Lucas	200,0x29	Hand Brake
	97-98		R		700-301	700-301K		Ø 200,0	+ABS
1.6 i 16v Eng.X16XE (78kW)	97-98		R		700-304	700-304K		Ø 200,0	-ABS
	7/94-8/98		R		153-308		Lucas	200,0x29	Hand Brake
	94-		R		700-313	700-313K		Ø 200,0	Only Vauxhall, -ABS
	94-98		R		700-301	700-301K		Ø 200,0	+ABS
	94-98		R		700-304	700-304K		Ø 200,0	-ABS
			R		700-304	700-304K		Ø 200,0	-ABS
Tigra B Twintop 6/04-									
1.3 CDTi 16v Eng.Z13DT (51kW)	6/04-		R		153-309		Lucas	200,0x45	Hand Brake
	04-		R		151-159		Lucas	Ø 19,05 200,0x45	LUC, +ABS
1.4 16v Eng.Z14XEP (66kW)	6/04-		R		153-309		Lucas	200,0x45	Hand Brake
	04-		R		151-159		Lucas	Ø 19,05 200,0x45	LUC, +ABS
Vectra A (86, 87) / Cavalier III 9/88-11/95									
1.4 S Eng.14NV (55kW)	-6/92		R		153-305		Lucas	200,0x45	Hand Brake
	-91		R		153-306		Lucas	230,0x50	Hand Brake
	91-		R		153-308		Lucas	200,0x29	Hand Brake
	91-		R		153-309		Lucas	200,0x45	Hand Brake
	88-92		R		700-300			Ø 200,0	
	88-92		R		151-082		GM	Ø 19,05 200,0x45	LUC
1.6 (65kW)	-6/92		R		153-305		Lucas	200,0x45	Hand Brake
	92-		R		153-308		Lucas	200,0x29	Hand Brake
	92-		R		153-309		Lucas	200,0x45	Hand Brake
1.6 Eng.16SV (60kW)	-6/92		R		153-305		Lucas	200,0x45	Hand Brake
	-91		R		153-306		Lucas	230,0x50	Hand Brake
	91-		R		153-308		Lucas	200,0x29	Hand Brake
	91-		R		153-309		Lucas	200,0x45	Hand Brake

		Spare Parts	F/R	L/R	CIFAM ref.	CIFAM ref. w/KIT		DIMENSIONS mm.	NOTE
1.6 Eng.16SV (60kW)	88-93		R		700-300			Ø 200,0	
	88-92		R		151-082		GM	Ø 19,05 200,0x45	LUC
	92-93		R		151-079		Delco	Ø 19,05 200,0x45	LUC
1.6 i Eng.X16SZ (52kW)	93-		R		153-308		Lucas	200,0x29	Hand Brake
	93-		R		153-309		Lucas	200,0x45	Hand Brake
	93-95		R		700-300			Ø 200,0	
	93-95		R		151-079		Delco	Ø 19,05 200,0x45	LUC
1.6 i, Kat Eng.16LZ2/ C16NZ/ NZ2/ E16NZ (55kW)	-6/92		R		153-305		Lucas	200,0x45	Hand Brake
	-91		R		153-306		Lucas	230,0x50	Hand Brake
	91-		R		153-308		Lucas	200,0x29	Hand Brake
	91-		R		153-309		Lucas	200,0x45	Hand Brake
	88-95		R		700-300			Ø 200,0	
1.7 D Eng.17D/ DR (42-44kW)	-6/92		R		153-305		Lucas	200,0x45	Hand Brake
	-91		R		153-306		Lucas	230,0x50	Hand Brake
	91-		R		153-308		Lucas	200,0x29	Hand Brake
	91-		R		153-309		Lucas	200,0x45	Hand Brake
	88-92		R		700-300			Ø 200,0	
	88-92		R		151-082		GM	Ø 19,05 200,0x45	LUC
1.7 TDS Eng.17DT(TC4EE1)/ X17DT (60kW)	-6/92		R		153-305		Lucas	200,0x45	Hand Brake
	-91		R		153-306		Lucas	230,0x50	Hand Brake
	91-		R		153-308		Lucas	200,0x29	Hand Brake
	91-		R		153-309		Lucas	200,0x45	Hand Brake
	90-95		R		700-300			Ø 200,0	
	90-92		R		151-082		GM	Ø 19,05 200,0x45	LUC
1.8, 4WD, Kat Eng.18SV/ C18NZ/ E18NVR (65-66kW)	-6/92		R		153-305		Lucas	200,0x45	Hand Brake
	-91		R		153-306		Lucas	230,0x50	Hand Brake
	91-		R		153-308		Lucas	200,0x29	Hand Brake
	91-		R		153-309		Lucas	200,0x45	Hand Brake
	88-95		R		700-300			Ø 200,0	
	88-92		R		151-082		GM	Ø 19,05 200,0x45	LUC
	92-95		R		151-079		Delco	Ø 19,05 200,0x45	LUC
	2.0 GT 16v Kat, 4WD Eng.20XE/ 20XEJ/ C20XE (110kW)	1/89-11/95		R			153-302K		160,0x25
1/89-11/95			R		153-302	153-302K	Ate	160,0x25	Hand Brake
2.0 i Eng.C20NEF (74kW)	9/88-9/89		R		153-302		Ate	160,0x25	Hand Brake
	9/88-9/89		R		153-305		Lucas	200,0x45	Hand Brake
	9/88-9/89		R		153-306		Lucas	230,0x50	Hand Brake
2.0 i 16v, 4WD Eng.X20XEV (100kW)	6/94-11/95		R			153-302K		160,0x25	Hand Brake
	6/94-11/95		R		153-302	153-302K	Ate	160,0x25	Hand Brake
2.0 i T. 4WD Eng.C20LET (150kW)	6/94-11/95		R		153-302	153-302K	Ate	160,0x25	Hand Brake
2.0 i, 4WD Eng.20SEH (95kW)	9/88-9/92		R		153-302		Ate	160,0x25	Hand Brake
	9/88-9/92		R		153-305		Lucas	200,0x45	Hand Brake
	9/88-9/92		R		153-306		Lucas	230,0x50	Hand Brake
2.0 i, 4WD, Kat Eng.20NE/ C20NE (85kW)	9/88-11/95		R			153-302K		160,0x25	Hand Brake
	9/88-11/95		R		153-302		Ate	160,0x25	Hand Brake
	9/88-11/95		R		153-305		Lucas	200,0x45	Hand Brake
	9/88-11/95		R		153-306		Lucas	230,0x50	Hand Brake
2.5 i V6 Eng.C25XE (125kW)	2/93-11/95		R			153-302K		160,0x25	Hand Brake
	2/93-11/95		R		153-302	153-302K	Ate	160,0x25	Hand Brake
Vectra B, SW / Vectra 10/95-4/02									
1.6 i Eng.16LZ2 (55kW)	10/95-4/02		R		153-302		Ate	160,0x25	Hand Brake
	10/95-4/02		R		153-311		Lucas	230,0x42	Hand Brake
	95-		R		700-305			Ø 230,0	
			R		151-141		GM	Ø 19,05 230,0x42	Ch W7154259-W7999999, LUC
			R		151-177		Lucas	Ø 20,64 230,0x42	Ch X5000001-/X7000001-, LUC
1.6 i Eng.X16SZR (55kW)	10/95-4/02		R			153-302K		160,0x25	Hand Brake
	10/95-4/02		R		153-302		Ate	160,0x25	Hand Brake
	10/95-4/02		R		153-311		Lucas	230,0x42	Hand Brake
	95-		R		700-305			Ø 230,0	
			R		151-141		GM	Ø 19,05 230,0x42	Ch W7154259-W7999999, LUC
1.6 i 16v Eng.X16XEL/ Y16XE/ Z16XE (74kW)	10/95-4/02		R			153-302K		160,0x25	Hand Brake
	10/95-4/02		R		153-302		Ate	160,0x25	Hand Brake
	10/95-4/02		R		153-311		Lucas	230,0x42	Hand Brake
1.7 TD Eng.X17DT(TC4EE1) (60kW)	10/95-11/96		R			153-302K		160,0x25	Hand Brake
	10/95-11/96		R		153-302		Ate	160,0x25	Hand Brake
	10/95-11/96		R		153-311		Lucas	230,0x42	Hand Brake







		Spare Parts	F/R	L/R	CIFAM ref.	CIFAM ref. w/KIT		DIMENSIONS mm.	NOTE
1.8 16v Eng.X18XE (85kW)	10/95-9/00		R			153-302K		160,0x25	Hand Brake
	10/95-9/00		R		153-302	153-302K	Ate	160,0x25	Hand Brake
1.8 16v Eng.X18XE1 (85kW)	10/95-9/00		R		153-302	153-302K	Ate	160,0x25	Hand Brake
1.8 16v Eng.Z18XE (92kW)	9/00-4/02		R		153-302		Ate	160,0x25	Hand Brake
2.0 Di 16v Eng.X20DTL (60kW)	11/96-4/02		R		153-311		Lucas	230,0x42	Hand Brake
			R		700-305			Ø 230,0	
			R		151-141		GM	Ø 19,05 230,0x42	Ch W7154259-W7999999, LUC
			R		151-177		Lucas	Ø 20,64 230,0x42	Ch X5000001-/X7000001-, LUC
2.0 i Eng.20NEJ (82kW)	10/95-4/02		R			153-302K		160,0x25	Hand Brake
	10/95-4/02		R		153-302	153-302K	Ate	160,0x25	Hand Brake
2.0 i 16v Eng.C20SEL (100kW)	10/95-9/00		R		153-302	153-302K	Ate	160,0x25	Hand Brake
2.0 i 16v Eng.X20XE (100kW)	10/95-9/00		R		153-302	153-302K	Ate	160,0x25	Hand Brake
2.2 16v Eng.Z22SE (108kW)	9/00-4/02		R		153-302	153-302K	Ate	160,0x25	Hand Brake
2.2 DTI 16v Eng.Y22DTR (92kW)	9/00-4/02		R		153-302	153-302K	Ate	160,0x25	Hand Brake
2.5 i 500 Eng.X25XE (143kW)	5/98-9/00		R		153-302	153-302K	Ate	160,0x25	Hand Brake
2.5 i V6 Eng.X25XE (125kW)	10/95-9/00		R		153-302	153-302K	Ate	160,0x25	Hand Brake
2.6 V6 Eng.Y26SE (125kW)	9/00-4/02		R		153-302		Ate	160,0x25	Hand Brake

Zafira A 4/99-10/05























1.6 16v Eng.X16XEL/ Z16XE (74kW)	99-05		R		153-311		Lucas	230,0x42	Hand Brake
	99-05		R		700-306			Ø 230,0	
	99-05		R		151-177		Lucas	Ø 20,64 230,0x42	Ch -12999999, LUC, Exc. Germany, Austrian, Switzerland
1.6 CNG Eng.Z16YNG (71kW)	01-05		R		700-306			Ø 230,0	
	01-05		R		151-177		Lucas	Ø 20,64 230,0x42	Ch -12999999, LUC, Exc. Germany, Austrian, Switzerland
1.6 i 16v Eng.X16SZR (55kW)	4/99-10/05		R		153-311		Lucas	230,0x42	Hand Brake
	99-		R		700-306			Ø 230,0	Exc. Germany/Switzerland/Austria
1.8 16v Eng.X18XE/ 1 (85kW)	4/99-9/00		R		153-311		Lucas	230,0x42	Hand Brake
1.8 16v Eng.Z18XE (92kW)	9/00-10/05		R		153-311		Lucas	230,0x42	Hand Brake
2.0 16v T. OPC Eng.Z20LET (141kW)	9/01-10/05		R		153-311		Lucas	230,0x42	Hand Brake
2.0 Di 16v Eng.X20DTL (60kW)	10/99-10/05		R		153-311		Lucas	230,0x42	Hand Brake
2.0 DTI 16v Eng.Y20DTH (74kW)	9/00-10/05		R		153-311		Lucas	230,0x42	Hand Brake
2.0 T. 16v Eng.Z20LER (147kW)	11/02-10/05		R		153-311		Lucas	230,0x42	Hand Brake
2.2 16v Eng.Z22SE (108kW)	9/00-10/05		R		153-311		Lucas	230,0x42	Hand Brake





























OPEL LCV

























Arena 3/98-8/01









1.9 D Eng.F8Q600/ 606 (44kW)	3/98-8/01		R		153-071		Lucas	254,0x57	Hand Brake
	98-01		R		700-168			Ø 255,0	-ABS
	98-01		R		151-138		Lucas	Ø 25,40 254,0x57	LUC
2.5 D Eng.S8U758/ 780/ 782 (55kW)	3/98-8/01		R		153-071		Lucas	254,0x57	Hand Brake
	98-01		R		700-168			Ø 255,0	-ABS
	98-01		R		151-138		Lucas	Ø 25,40 254,0x57	LUC

Astra F Van (55) 10/91-1/99













1.4 i Eng.C14NZ (44kW)	10/91-1/99		R		153-309		Lucas	200,0x45	Hand Brake
			R		700-300			Ø 200,0	Ch -S299999, HDB
			R		700-305			Ø 230,0	Ch T2500001-
			R		151-141		GM	Ø 19,05 230,0x42	Ch T2500001-, LUC
1.6 i Eng.C16NZ (55kW)	92-		R		153-309		Lucas	200,0x45	Hand Brake
			R		700-300			Ø 200,0	Ch -S299999, HDB
			R		700-305			Ø 230,0	Ch T2500001-
			R		151-141		GM	Ø 19,05 230,0x42	Ch T2500001-, LUC
1.6 i Eng.X16SZ (52kW)	95-96		R		153-311		Lucas	230,0x42	Hand Brake
			R		153-309		Lucas	200,0x45	Hand Brake
			R		700-300			Ø 200,0	Ch -S299999, HDB
			R		700-305			Ø 230,0	Ch T2500001-
			R		151-141		GM	Ø 19,05 230,0x42	Ch T2500001-, LUC
1.7 D Eng.17D (42kW)			R		153-309		Lucas	200,0x45	Hand Brake
			R		700-300			Ø 200,0	Ch -S299999, HDB
			R		700-305			Ø 230,0	Ch T2500001-
			R		151-141		GM	Ø 19,05 230,0x42	Ch T2500001-, LUC
			R		153-311		Lucas	230,0x42	Hand Brake
1.7 D Eng.17D/ DR (44kW)	95-96		R		153-309		Lucas	200,0x45	Hand Brake
			R		700-300			Ø 200,0	Ch -S299999, HDB
			R		700-305			Ø 230,0	Ch T2500001-
			R		151-141		GM	Ø 19,05 230,0x42	Ch T2500001-, LUC

		Spare Parts	F/R	L/R	CIFAM ref.	CIFAM ref. w/KIT		DIMENSIONS mm.	NOTE
1.7 TD Eng.X17DTL (50kW)	95-96		R		153-311		Lucas	230,0x42	Hand Brake
			R		153-309		Lucas	200,0x45	Hand Brake
			R		700-300			Ø 200,0	Ch -S299999, HDB
			R		700-305			Ø 230,0	Ch T2500001-
			R		151-141		GM	Ø 19,05 230,0x42	Ch T2500001-, LUC
Astra G Van (F70) 1/99-2/04									
1.6i Eng.X16SZR (55kW)	99-00		R		700-305			Ø 230,0	
			R		151-141		GM	Ø 19,05 230,0x42	Ch -18999999, LUC
1.6i Eng.Z16SE (62kW)	00-		R		700-305			Ø 230,0	
1.7 CDTi Eng.Z17DTL (59kW)	03-04		R		700-305			Ø 230,0	
1.7 DTi Eng.Y17DT (55kW)	01-04		R		700-305			Ø 230,0	
			R		151-141		GM	Ø 19,05 230,0x42	Ch -18999999, LUC
			R		151-176		Lucas	Ø 19,05 230,0x42	Ch 22000001-, LUC
1.7 TD Eng.X17DTL (50kW)	99-04		R		700-305			Ø 230,0	
Astra H Van 3/04-11/09									
1.6 16v Eng.Z16XEP (76kW)	05-		R		700-389			Ø 230,0	-ABS
	05-		R		151-177		Lucas	Ø 20,64 230,0x42	LUC
1.7 CDTi Eng.Z17DTL (59kW)	05-06		R		700-389			Ø 230,0	-ABS
	05-06		R		151-177		Lucas	Ø 20,64 230,0x42	LUC
Campo (TF) / Brava Pick-up 8/87-									
2.2 D, 4WD Eng.C223 (39kW)	91-96		R		700-178			Ø 254,0	
2.3, 4WD Eng.23P (72kW)	94-96		R		700-178			Ø 254,0	
2.3, 4WD Eng.4ZD1 (69kW)	91-94		R		700-178			Ø 254,0	
2.5 D, 4WD Eng.4JA1 (56kW)	91-94		R		700-178			Ø 254,0	
	91-94		R		700-307			Ø 295,0	Mod. 4WD
2.5 DTi, 4WD Eng.4JA1T (74kW)	01-		R		700-178			Ø 254,0	
2.5 TD, 4WD Eng.4JA1T (56kW)	7/94-		R		153-191		Ake	254,0x50	Hand Brake
	7/94-		R		153-312		Ake	302,0x46	
	94-		R		700-178			Ø 254,0	
	94-		R		700-307			Ø 295,0	Mod. 4WD
3.0 TD (96kW)	10/96-		R		153-191		Ake	254,0x50	Hand Brake
	10/96-		R		153-312		Ake	302,0x46	
3.1 TD, 4WD Eng.4JG2T (80kW)	12/92-		R		153-191		Ake	254,0x50	Hand Brake
	12/92-		R		153-312		Ake	302,0x46	
	92-		R		700-178			Ø 254,0	
	92-		R		700-307			Ø 295,0	Mod. 4WD
Combo I (71) 7/94-10/01									
1.2 Eng.C12NZ/ X12SZ (33kW)	7/94-10/01		R		153-306		Lucas	230,0x50	Hand Brake
	94-		R		700-302			Ø 230,0	
	94-		R		151-175		Lucas	Ø 19,05 230,0x50	LUC
1.4 i Eng.C14NZ/ X14SZ (44kW)	7/94-10/01		R		153-311		Lucas	230,0x42	+ABS, Hand Brake
	7/94-10/01		R		153-306		Lucas	230,0x50	Hand Brake
	-96		R		153-309		Lucas	200,0x45	Hand Brake
	94-01		R		700-302			Ø 230,0	
	94-		R		151-175		Lucas	Ø 19,05 230,0x50	LUC
1.4 i 16v Eng.X14XE (66kW)	8/99-10/01		R		153-311		Lucas	230,0x42	+ABS, Hand Brake
	8/99-10/01		R		153-306		Lucas	230,0x50	Hand Brake
	3/93-97		R			700-304K		Ø 200,0	
	99-01		R		700-304			Ø 200,0	
	99-01		R		700-301	700-301K		Ø 200,0	+ABS
1.4 Si Eng.C14SE (60kW)	7/94-10/01		R		153-311		Lucas	230,0x42	+ABS, Hand Brake
	7/94-10/01		R		153-306		Lucas	230,0x50	Hand Brake
	-96		R		153-309		Lucas	200,0x45	Hand Brake
	93-97		R		700-302			Ø 230,0	
	94-		R		151-175		Lucas	Ø 19,05 230,0x50	LUC
1.6 Eng.C16SEL (74kW)	1/94-12/96		R		153-309		Lucas	200,0x45	Hand Brake
1.7 D Eng.17D(4EE1)/ X17D (44kW)	7/94-10/01		R		153-311		Lucas	230,0x42	+ABS, Hand Brake
	7/94-10/01		R		153-306		Lucas	230,0x50	Hand Brake
	-96		R		153-309		Lucas	200,0x45	Hand Brake
	7/94-		R		700-302			Ø 230,0	
	94-		R		151-175		Lucas	Ø 19,05 230,0x50	LUC
Combo II 10/01-									
1.3 CDTi 16v Eng.Z13DT/ Y13DT (51kW)	10/04-		R		153-311		Lucas	230,0x42	Hand Brake
	04-		R		700-305			Ø 230,0	
	04-		R		151-176		Lucas	Ø 19,05 230,0x42	LUC
1.3 CDTi 16v Eng.Z13DTJ (55kW)	10/05-		R		153-311		Lucas	230,0x42	Hand Brake
	04-		R		151-176		Lucas	Ø 19,05 230,0x42	LUC
	05-		R		151-079		Delco	Ø 19,05 200,0x45	LUC







		Spare Parts	F/R	L/R	CIFAM ref.	CIFAM ref. w/KIT		DIMENSIONS mm.	NOTE
1.4 16v Eng.Z14XEP (66kW)		04-	R		700-305			Ø 230,0	Ch -33999999
		04-	R		700-389			Ø 230,0	Ch 43000001-
		04-	R		151-176		Lucas	Ø 19,05 230,0x42	LUC
1.6 Eng.Z16SE (62kW)	8/01-10/04		R		153-311		Lucas	230,0x42	Hand Brake
1.6 Eng.Z16SE (64kW)		10/01-	R		153-311		Lucas	230,0x42	Hand Brake
		01-	R		700-305			Ø 230,0	
		04-	R		151-176		Lucas	Ø 19,05 230,0x42	LUC
1.6 16v Eng.Z16YNG (69kW)	6/06-		R		153-311		Lucas	230,0x42	Hand Brake
1.7 Di 16v Eng.Y17DTL (48kW)		10/01-	R		153-311		Lucas	230,0x42	Hand Brake
		01-	R		700-305			Ø 230,0	
		04-	R		151-176		Lucas	Ø 19,05 230,0x42	LUC
1.7 DTI 16v Eng.Y17DT (55kW)		10/01-	R		153-311		Lucas	230,0x42	Hand Brake
		01-	R		700-305			Ø 230,0	
		04-	R		151-176		Lucas	Ø 19,05 230,0x42	LUC
Corsa A Van / Nova Van 2/86-1/94									
1.0 Eng.10S (33kW)		2/86-4/89	R		153-307		Lucas	200,0x29	Hand Brake
		86-89	R		700-304	700-304K		Ø 200,0	
		86-89	R		700-313	700-313K		Ø 200,0	Only Vauxhall, -ABS
			R		151-120		GM	Ø 14,28 200,0x29	Ch E4008341-G4000000, LUC
			R		151-119		GM	Ø 14,28 200,0x29	Ch G4000001-M4000000, LUC
			R		151-121		GM	Ø 17,46 200,0x29	Ch E4008341-G4000000, LUC
		-89	R		151-123		GM	Ø 17,46 200,0x29	Ch N4000001-, LUC
1.2 Eng.12NC/ E12GV (33kW)		2/86-4/89	R		153-307		Lucas	200,0x29	Hand Brake
		86-89	R		700-304	700-304K		Ø 200,0	
		-89	R		151-121		GM	Ø 17,46 200,0x29	Ch E4008341-G4000000, LUC
	R		151-123		GM	Ø 17,46 200,0x29	Ch N4000001-, LUC		
1.2 Eng.12NV (38kW)	1/90-10/94		R		153-307		Lucas	200,0x29	Hand Brake
1.2 Eng.12S (44kW)	2/86-7/90		R		153-307		Lucas	200,0x29	Hand Brake
1.2 Eng.12ST (40kW)		2/86-4/89	R		153-307		Lucas	200,0x29	Hand Brake
		86-89	R		700-304	700-304K		Ø 200,0	
		86-89	R		700-313	700-313K		Ø 200,0	Only Vauxhall, -ABS
			R		151-121		GM	Ø 17,46 200,0x29	Ch E4008341-G4000000, LUC
		-89	R		151-123		GM	Ø 17,46 200,0x29	Ch N4000001-, LUC
1.3 Eng.13NB (44kW)		86-89	R		700-304	700-304K		Ø 200,0	
		86-89	R		700-313	700-313K		Ø 200,0	Only Vauxhall, -ABS
		-89	R		151-121		GM	Ø 17,46 200,0x29	Ch E4008341-G4000000, LUC
	R		151-123		GM	Ø 17,46 200,0x29	Ch N4000001-, LUC		
1.3 Eng.13SB (51kW)		82-89	R		700-313	700-313K		Ø 200,0	Only Vauxhall, -ABS
		86-89	R		700-304	700-304K		Ø 200,0	
		-89	R		151-121		GM	Ø 17,46 200,0x29	Ch E4008341-G4000000, LUC
	R		151-123		GM	Ø 17,46 200,0x29	Ch N4000001-, LUC		
1.5 D Eng.15D(4EC1) (37kW)		6/87-4/89	R		153-307		Lucas	200,0x29	Hand Brake
		86-89	R		700-313	700-313K		Ø 200,0	Only Vauxhall, -ABS
		87-89	R		700-304	700-304K		Ø 200,0	
		-89	R		151-123		GM	Ø 17,46 200,0x29	Ch N4000001-, LUC
Corsa B Van (73) / Corsa Van 8/99-9/00									
1.4 i Eng.X14SZ (44kW)		99-00	R		700-301	700-301K		Ø 200,0	+ABS
		99-00	R		700-304	700-304K		Ø 200,0	-ABS
1.5 D Eng.15D (37kW)		8/94-12/95	R		153-307		Lucas	200,0x29	Hand Brake
		94-95	R		700-301	700-301K		Ø 200,0	+ABS
		94-95	R		700-304	700-304K		Ø 200,0	-ABS
		94-95	R		151-081		GM	Ø 19,05 200,0x28	LUC
1.7 D Eng.17D(4EE1)/ X17D (44kW)		8/99-9/00	R		153-307		Lucas	200,0x29	Hand Brake
		99-00	R		700-301	700-301K		Ø 200,0	+ABS
		99-00	R		700-304	700-304K		Ø 200,0	-ABS
Corsa C Van (F08, W5L) / Corsa II Van 9/00-6/06									
1.2 16v Eng.Z12XE (55kW)		9/00-6/06	R		153-307		Lucas	200,0x29	Hand Brake
		9/00-	R		700-351	700-351K		Ø 200,0	+ABS
		9/00-	R		700-350	700-350K		Ø 200,0	-ABS
		00-	R		151-120		GM	Ø 14,28 200,0x29	LUC
1.2 16v Eng.Z12XEP (59kW)	7/05-6/06		R		153-307		Lucas	200,0x29	Hand Brake
1.4 Eng.Z14XE (66kW)		03-	R		700-351	700-351K		Ø 200,0	+ABS
		03-	R		700-350	700-350K		Ø 200,0	-ABS
1.7 CDTi Eng.Z17DTH (74kW)		8/03-6/06	R		153-307		Lucas	200,0x29	Hand Brake
		03-	R		700-389			Ø 230,0	
1.7 Di 16v Eng.Y17DTL (48kW)		9/00-6/06	R		153-307		Lucas	200,0x29	Hand Brake
		9/00-	R		700-351	700-351K		Ø 200,0	+ABS
		9/00-	R		700-350	700-350K		Ø 200,0	-ABS

		Spare Parts	F/R	L/R	CIFAM ref.	CIFAM ref. w/KIT		DIMENSIONS mm.	NOTE
1.7 Di 16v Eng.Y17DTL (48kW)	00-		R		151-120		GM	Ø 14,28 200,0x29	LUC
1.7 DTi 16v Eng.Y17DT (55kW)	9/00-6/06		R		153-307		Lucas	200,0x29	Hand Brake
	9/00-		R		700-351	700-351K		Ø 200,0	+ABS
	9/00-		R		700-350	700-350K		Ø 200,0	-ABS
	00-		R		151-120		GM	Ø 14,28 200,0x29	LUC





























Corsa D Van 7/06-

1.0 12v Eng.Z10XEP/ A10XEP (44-48kW)	7/06-		R		153-092		Ap	203,0x38	3p, Hand Brake
	7/06-		R		153-093		Ap	228,0x40	5p, Hand Brake
	7/06-		R		151-222		Ap	Ø 19,05 203,0x38	AP, +EBD, +ABS, 3p
	7/06-		R		151-223		Ap	Ø 19,05 228,0x40	AP, +EBD, +ABS, 5p
1.2 16v Eng.Z12XEP/ A12XER (59-63kW)	7/06-		R		153-092		Ap	203,0x38	3p, Hand Brake
	7/06-		R		153-093		Ap	228,0x40	5p, Hand Brake
	7/06-		R		151-222		Ap	Ø 19,05 203,0x38	AP, +EBD, +ABS, 3p
	7/06-		R		151-223		Ap	Ø 19,05 228,0x40	AP, +EBD, +ABS, 5p
1.3 CDTi 16v Eng.Z13DTJ (55kW)	7/06-		R		153-092		Ap	203,0x38	3p, Hand Brake
	7/06-		R		153-093		Ap	228,0x40	5p, Hand Brake
	7/06-		R		151-222		Ap	Ø 19,05 203,0x38	AP, +EBD, +ABS, 3p
	7/06-		R		151-223		Ap	Ø 19,05 228,0x40	AP, +EBD, +ABS, 5p

Kadett E Van / Astra E Van 8/84-7/94









1.2 Eng.12SC (40kW)	9/84-7/86		R		153-305		Lucas	200,0x45	Hand Brake
1.4 i Eng.C14NZ/ X14SZ (44kW)	1/90-7/94		R		153-305		Lucas	200,0x45	Hand Brake
1.4 S Eng.14NV (55kW)	7/89-8/91		R		153-305		Lucas	200,0x45	Hand Brake
1.6 Eng.16SV (60kW)	9/86-12/91		R		153-306		Lucas	230,0x50	Hand Brake
1.6 D Eng.16D/ 16DA (40kW)	84-89		R		700-302			Ø 230,0	SW
1.6 i Eng.C16NZ (55kW)	8/89-7/94		R		153-306		Lucas	230,0x50	Hand Brake
1.7 D Eng.17D/ DR (42-44kW)	8/88-7/94		R		153-306		Lucas	230,0x50	Hand Brake

























































Movano I 7/98-6/10

















































1.9 DTi Eng.F9Q770/ 774 (59-60kW)	00-		R		153-313		Bdx	280,0x65	Hand Brake
	00-		R		700-308			Ø 280,0	
2.2 DTi Eng.G9T720 (66kW)	00-		R		700-308			Ø 280,0	
2.5 CDTi Eng.G9U632 (107kW)	8/06-		R		153-127		Bdx	280,0x64	Hand Brake
	8/06-		R		153-313		Bdx	280,0x65	Hand Brake
	8/06-		R		153-071		Lucas	254,0x57	Hand Brake
2.5 CDTi Eng.G9U632 (88kW)	06-		R		153-127		Bdx	280,0x64	Hand Brake
	06-		R		153-313		Bdx	280,0x65	Hand Brake
	06-		R		153-071		Lucas	254,0x57	Hand Brake
2.5 CDTi Eng.G9U650 (74kW)	07-10		R		153-127		Bdx	280,0x64	
	07-10		R		153-313		Bdx	280,0x65	
	07-10		R		153-071		Lucas	254,0x57	
2.5 D Eng.S8U770 (59kW)	1/99-		R		153-127		Bdx	280,0x64	Hand Brake
	1/99-		R		153-313		Bdx	280,0x65	Hand Brake
	1/99-		R		153-071		Lucas	254,0x57	Hand Brake
	99-		R		700-308			Ø 280,0	
	99-00		R		151-138		Lucas	Ø 25,40 254,0x57	LUC
2.5 DTi Eng.G9U720/ 724/ 750/ 754 (84kW)	01-10		R		153-127		Bdx	280,0x64	Hand Brake
	01-10		R		153-313		Bdx	280,0x65	Hand Brake
	01-10		R		153-071		Lucas	254,0x57	Hand Brake
	01-10		R		700-308			Ø 280,0	
2.5 DTi Eng.G9U754 (73kW)	07-10		R		153-127		Bdx	280,0x64	Hand Brake
	07-10		R		153-313		Bdx	280,0x65	Hand Brake
	07-10		R		153-071		Lucas	254,0x57	Hand Brake
2.8 DTi Eng.S9W702 (84kW)	7/98-		R		153-127		Bdx	280,0x64	Hand Brake
	7/98-		R		153-313		Bdx	280,0x65	Hand Brake
	7/98-		R		153-071		Lucas	254,0x57	Hand Brake
	98-		R		700-308			Ø 280,0	
	98-		R		151-138		Lucas	Ø 25,40 254,0x57	LUC







































PEUGEOT



























1007 (KM) 4/05-













































1.4 Eng.KFV(TU3JP) (55kW)	4/05-		R		153-085		Bosch	203,2x39	+ABS, Hand Brake
	4/05-		R		153-025		Lucas	203,2x39	Hand Brake
	4/05-		R		700-363	700-363K		Ø 203,0	
	05-		R		151-190		Bosch	Ø 20,64 203,2x39	RAI, +ABS
1.4 16v Eng.KFU(ET3J4) (65kW)	05-		R		151-166		Lucas	Ø 20,64 203,0x38	LUC, +ABS
	10/05-		R		153-085		Bosch	203,2x39	+ABS, Hand Brake
	10/05-		R		153-025		Lucas	203,2x39	Hand Brake
	05-		R		700-363	700-363K		Ø 203,0	
	05-		R		151-190		Bosch	Ø 20,64 203,2x39	RAI, +ABS















































































		Spare Parts	F/R	L/R	CIFAM ref.	CIFAM ref. w/KIT		DIMENSIONS mm.	NOTE
1.4 16v Eng.KFU(ET3J4) (65kW)	05-		R		151-166		Lucas	Ø 20,64 203,0x38	LUC, +ABS
1.4 HDi Eng.DV4TD (50kW)	4/05-		R		153-085		Bosch	203,2x39	+ABS, Hand Brake
	4/05-		R		153-025		Lucas	203,2x39	Hand Brake
	05-		R		700-363	700-363K		Ø 203,0	
	05-		R		151-190		Bosch	Ø 20,64 203,2x39	RAI, +ABS
	05-		R		151-166		Lucas	Ø 20,64 203,0x38	LUC, +ABS
104 10/72-6/88									
0.95 Eng.108C(XV8) (32kW)	9/83-6/88		R		153-339	153-339K	Bdx	180,0x32	Hand Brake
	83-88		R		151-034		Bdx	Ø 22,00 180,0x30	RAD
0.95, Coupe Eng.108(XV3/ 5) (32-33-34kW)	-77		R		153-341	153-341K	Bdx	180,0x42	Hand Brake
	77-		R		153-339	153-339K	Bdx	180,0x32	Hand Brake
	10/76-83		R		151-034		Bdx	Ø 22,00 180,0x30	RAD
1.1, Coupe Eng.109(XW3) (42kW)	-77		R		153-341	153-341K	Bdx	180,0x42	Hand Brake
	77-		R		153-339	153-339K	Bdx	180,0x32	Hand Brake
1.1, Coupe Eng.109F(XW3/ 7) (37-42-49kW)	8/79-6/88		R		153-339	153-339K	Bdx	180,0x32	Hand Brake
1.1, Coupe Eng.121(XW3S) (48-49kW)	-77		R		153-341	153-341K	Bdx	180,0x42	Hand Brake
	77-		R		153-339	153-339K	Bdx	180,0x32	Hand Brake
	10/76-80		R		151-034		Bdx	Ø 22,00 180,0x30	RAD
	79-		R		151-035		Bdx	Ø 20,64 180,0x30	Ch -7241000, RAD
1.2 Eng.129(XZ5) (42-49kW)	8/79-6/83		R		153-339	153-339K	Bdx	180,0x32	Hand Brake
	79-83		R		151-034		Bdx	Ø 22,00 180,0x30	RAD
1.4, Coupe Eng.150(XY6B) (44-53kW)	8/79-6/84		R		153-339	153-339K	Bdx	180,0x32	Hand Brake
	79-84		R		151-034		Bdx	Ø 22,00 180,0x30	RAD
106 I (1A, 1C) 9/91-4/96									
0.95 Eng.CDY(TU9) (33kW)	9/91-4/96		R			153-021Y	Bdx	165,0x30	
	9/91-4/96		R			153-021K	Bdx	165,0x30	Hand Brake
	9/91-4/96		R			153-024Y	Bdx	165,0x30	Hand Brake
	9/91-4/96		R			153-320Y	Bdx	180,0x32	
	9/91-4/96		R		153-320	153-320K	Bdx	180,0x32	Hand Brake
	9/91-4/96		R			153-329Y	Bdx	180,0x32	Hand Brake
	9/91-96		R		700-239	700-239K		Ø 165,0	-ABS
	9/91-96		R		700-242	700-242K		Ø 180,0	+ABS
	91-96		R		151-001		Bdx	Ø 19,05 165,0x30	CRCI, RAD, 3 Hole
	91-96		R		151-007		Bdx	Ø 19,05 180,0x30	RAD, +ABS
	91-96		R		151-006		Bdx	Ø 19,05 180,0x30	CRCI, RAD, -ABS, 4 Hole
0.95 Eng.CDZ(TU9M) (37kW)	9/91-4/96		R			153-021Y	Bdx	165,0x30	
	9/91-4/96		R			153-021K	Bdx	165,0x30	Hand Brake
	9/91-4/96		R			153-024Y	Bdx	165,0x30	Hand Brake
	9/91-4/96		R			153-320Y	Bdx	180,0x32	
	9/91-4/96		R		153-320	153-320K	Bdx	180,0x32	Hand Brake
	9/91-4/96		R			153-329Y	Bdx	180,0x32	Hand Brake
	9/91-96		R		700-239	700-239K		Ø 165,0	
1.1 Eng.HDY/ HDZ(TU1M) (40-44kW)	9/91-4/96		R			153-021Y	Bdx	165,0x30	
	9/91-4/96		R			153-021K	Bdx	165,0x30	Hand Brake
	9/91-4/96		R			153-024Y	Bdx	165,0x30	Hand Brake
	9/91-4/96		R			153-320Y	Bdx	180,0x32	
	9/91-4/96		R		153-320	153-320K	Bdx	180,0x32	Hand Brake
	9/91-4/96		R			153-329Y	Bdx	180,0x32	Hand Brake
	9/91-96		R		700-239	700-239K		Ø 165,0	-ABS
	9/91-96		R		700-242	700-242K		Ø 180,0	+ABS
	91-96		R		151-007		Bdx	Ø 19,05 180,0x30	RAD, +ABS
1.1 Eng.HDZ(TU1M/ MZ) (44kW)	9/91-4/96		R			153-021Y	Bdx	165,0x30	
	9/91-4/96		R			153-021K	Bdx	165,0x30	Hand Brake
	9/91-4/96		R			153-024Y	Bdx	165,0x30	Hand Brake
	9/91-4/96		R			153-320Y	Bdx	180,0x32	
	9/91-4/96		R		153-320	153-320K	Bdx	180,0x32	Hand Brake
1.3 Eng.TU2J2/ TU3FJ2K (70-72kW)	93-96		R			700-242	700-242K	Ø 180,0	+ABS
	93-96		R			700-241	700-241K	Ø 180,0	-ABS
	93-96		R			151-007		Ø 19,05 180,0x30	RAD, +ABS
1.4 Eng.KAY(TU3FCP) (44kW)	1/91-12/96		R			153-320Y	Bdx	180,0x32	
	1/91-12/96		R		153-320	153-320K	Bdx	180,0x32	Hand Brake
	1/91-12/96		R			153-329Y	Bdx	180,0x32	Hand Brake











































		Spare Parts	F/R	L/R	CIFAM ref.	CIFAM ref. w/KIT		DIMENSIONS mm.	NOTE
1.4 Eng.KDY/ KDZ(TU3A/ AN/ S/ M/ 2/ 2K/ MC/ F2) (47-55kW)	9/91-4/96		R			153-320Y	Bdx	180,0x32	
	9/91-4/96		R		153-320	153-320K	Bdx	180,0x32	Hand Brake
	9/91-4/96		R			153-329Y	Bdx	180,0x32	Hand Brake
	9/91-96		R		700-239	700-239K		Ø 165,0	-ABS
	9/91-96		R		700-242	700-242K		Ø 180,0	+ABS
	91-96		R		151-007		Bdx	Ø 19,05 180,0x30	RAD, +ABS
	91-96		R		151-006		Bdx	Ø 19,05 180,0x30	CRCI, RAD, -ABS
1.4 Eng.KFZ(TU3J2-Z) (69kW)	9/91-4/96		R			153-320Y	Bdx	180,0x32	
	9/91-4/96		R		153-320	153-320K	Bdx	180,0x32	Hand Brake
	9/91-4/96		R			153-329Y	Bdx	180,0x32	Hand Brake
	9/91-96		R		700-242	700-242K		Ø 180,0	+ABS
	9/91-96		R		700-241	700-241K		Ø 180,0	-ABS
	91-96		R		151-007		Bdx	Ø 19,05 180,0x30	RAD, +ABS
	91-96		R		151-006		Bdx	Ø 19,05 180,0x30	CRCI, RAD, -ABS
1.4 Eng.NFZ(TU5JP) (65kW)	9/91-4/96		R			153-320Y	Bdx	180,0x32	
	9/91-4/96		R		153-320	153-320K	Bdx	180,0x32	Hand Brake
	9/91-4/96		R			153-329Y	Bdx	180,0x32	Hand Brake
	9/91-96		R		700-242	700-242K		Ø 180,0	
	91-96		R		151-007		Bdx	Ø 19,05 180,0x30	RAD, +ABS
	91-96		R		151-006		Bdx	Ø 19,05 180,0x30	CRCI, RAD
	1.4 D Eng.K9Y(TUD3Y) (37kW)	9/92-4/96		R			153-320Y	Bdx	180,0x32
9/92-4/96			R		153-320	153-320K	Bdx	180,0x32	Hand Brake
9/92-4/96			R			153-329Y	Bdx	180,0x32	Hand Brake
92-96			R		700-239	700-239K		Ø 165,0	-ABS
92-96			R		700-242	700-242K		Ø 180,0	+ABS
92-96			R		151-007		Bdx	Ø 19,05 180,0x30	RAD, +ABS
92-96			R		151-006		Bdx	Ø 19,05 180,0x30	CRCI, RAD, -ABS
1.5 D Eng.VJX(TUD5B) (43kW)	6/94-4/96		R			153-320Y	Bdx	180,0x32	
	6/94-4/96		R		153-320	153-320K	Bdx	180,0x32	Hand Brake
	6/94-4/96		R			153-329Y	Bdx	180,0x32	Hand Brake
	94-96		R		700-239	700-239K		Ø 165,0	-ABS
	94-96		R		700-242	700-242K		Ø 180,0	+ABS
	94-96		R		151-007		Bdx	Ø 19,05 180,0x30	RAD, +ABS
	1.5 D Eng.VJY(TUD5) (40kW)	6/94-4/96		R			153-320Y	Bdx	180,0x32
6/94-4/96			R		153-320	153-320K	Bdx	180,0x32	Hand Brake
6/94-4/96			R			153-329Y	Bdx	180,0x32	Hand Brake
94-96			R		700-239	700-239K		Ø 165,0	-ABS
94-96			R		700-242	700-242K		Ø 180,0	+ABS
94-96			R		151-007		Bdx	Ø 19,05 180,0x30	RAD, +ABS
1.6 Eng.NFY(TU5J2) (76kW)		1/94-4/96		R			153-320Y	Bdx	180,0x32
	1/94-4/96		R		153-320	153-320K	Bdx	180,0x32	Hand Brake
	1/94-4/96		R			153-329Y	Bdx	180,0x32	Hand Brake
	94-96		R		700-242	700-242K		Ø 180,0	+ABS
	94-96		R		700-241	700-241K		Ø 180,0	-ABS
	94-96		R		151-007		Bdx	Ø 19,05 180,0x30	RAD, +ABS
	1.6 Eng.NFZ(TU5JP) (65kW)	6/93-4/96		R			153-320Y	Bdx	180,0x32
6/93-4/96			R		153-320	153-320K	Bdx	180,0x32	Hand Brake
6/93-4/96			R			153-329Y	Bdx	180,0x32	Hand Brake
93-96			R		700-239	700-239K		Ø 165,0	-ABS
93-96			R		700-242	700-242K		Ø 180,0	+ABS
93-96			R		151-007		Bdx	Ø 19,05 180,0x30	RAD, +ABS
93-96			R		151-006		Bdx	Ø 19,05 180,0x30	CRCI, RAD, -ABS
106 II (1) 5/96-									
0.95 Eng.CDY/ Z(TU9M) (33-37kW)	5/96		R		153-350		Lucas	203,0x38	Hand Brake
	3/96		R		700-241	700-241K		Ø 180,0	Sys.Front Bdx, -ABS, 4 Hole
	96		R		700-244	700-244K		Ø 165,0	Sys.Front ATE, -ABS, 3 Hole
	96		R		700-246	700-246K		Ø 203,0	+ABS
	96		R		151-001		Bdx	Ø 19,05 165,0x30	CRCI, RAD, Sys.Front ATE
	96		R		151-006		Bdx	Ø 19,05 180,0x30	CRCI, RAD, Sys.Front Bdx
	1.1 Eng.HDY(TU1M) (40kW)	1/97		R		153-350		Lucas	203,0x38
97			R		700-244	700-244K		Ø 165,0	Sys.Front ATE, -ABS, 3 Hole
97			R		700-241	700-241K		Ø 180,0	Sys.Front Bdx, -ABS, 4 Hole
97			R		151-001		Bdx	Ø 19,05 165,0x30	CRCI, RAD, Sys.Front ATE
97			R		151-006		Bdx	Ø 19,05 180,0x30	CRCI, RAD, Sys.Front Bdx
97			R		151-136		Lucas	Ø 20,64 203,0x38	LUC, +ABS
1.1 Eng.HFX(TU1JP) (44kW)		5/96		R		153-350		Lucas	203,0x38
	96		R		700-246	700-246K		Ø 203,0	+ABS
	5/96-7/04		R		151-136		Lucas	Ø 20,64 203,0x38	LUC, +ABS



































		Spare Parts	F/R	L/R	CIFAM ref.	CIFAM ref. w/KIT		DIMENSIONS mm.	NOTE
1.1 Eng.HFX(TU1JP) (44kW)	96-		R		151-001		Bdx	Ø 19,05 165,0x30	CRCI, RAD, Sys.Front ATE
			R		151-006		Bdx	Ø 19,05 180,0x30	CRCI, RAD, Sys.Front Bdx
1.4 Eng.KFW/ KFX(TU3JP) (55kW)	5/96-		R		153-350		Lucas	203,0x38	Hand Brake
	96-		R		700-241	700-241K		Ø 180,0	-ABS
	96-		R		700-246	700-246K		Ø 203,0	+ABS
	5/96-7/04		R		151-136		Lucas	Ø 20,64 203,0x38	LUC, +ABS
	96-		R		151-006		Bdx	Ø 19,05 180,0x30	CRCI, RAD, Sys.Front Bdx
1.5 D Eng.VJY/ X(TUD5) (40-43kW)	5/96-		R		153-350		Lucas	203,0x38	Hand Brake
	96-		R		700-241	700-241K		Ø 180,0	-ABS
	96-		R		700-246	700-246K		Ø 203,0	+ABS
	10/00-7/04		R		151-136		Lucas	Ø 20,64 203,0x38	LUC, +ABS
	96-		R		151-006		Bdx	Ø 19,05 180,0x30	CRCI, RAD, Sys.Front Bdx
1.6 Eng.NFW/ NFY(TU5J2) (74kW)	5/96-		R		153-350		Lucas	203,0x38	Hand Brake
1.6 Eng.NFZ(TU5JP) (65kW)	5/96-		R		153-350		Lucas	203,0x38	Hand Brake
	96-		R		700-241	700-241K		Ø 180,0	-ABS
	96-		R		700-246	700-246K		Ø 203,0	+ABS
	5/96-10/99		R		151-136		Lucas	Ø 20,64 203,0x38	LUC, +ABS
	96-		R		151-006		Bdx	Ø 19,05 180,0x30	CRCI, RAD, Sys.Front Bdx
Electric (20kW)	3/96-		R		700-242	700-242K		Ø 180,0	
107 6/05-									
1.0 Eng.1KRFE (50kW)	6/05-		R		153-438		Bosch	200,0x32	Hand Brake
	05-		R		700-383			Ø 200,0	
	05-		R		151-183		Bosch	Ø 17,46 200,0x32	RAI
1.4 HDi Eng.DV4D (40kW)	6/05-		R		153-438		Bosch	200,0x32	Hand Brake
	05-		R		700-383			Ø 200,0	
	05-		R		151-183		Bosch	Ø 17,46 200,0x32	RAI
204 10/65-10/77									
1.1 Eng.XK5 (40-43kW)	9/75-7/77		R		153-340	153-340K	Bdx	228,6x42	Hand Brake
	9/75-7/77		R		153-475		Lucas	228,6x42	Hand Brake
	75-77		R		151-008		Bdx	Ø 23,81 228,0x42	RAD
	75-77		R		151-105		Lucas	Ø 22,00 228,6x42	LUC
1.1, Cabrio, Coupe, Break Eng.XK4 (40kW)	75-		R		153-340	153-340K	Bdx	228,6x42	Hand Brake
	75-		R		153-475		Lucas	228,6x42	Hand Brake
	75-77		R		151-008		Bdx	Ø 23,81 228,0x42	RAD
	75-77		R		151-105		Lucas	Ø 22,00 228,6x42	LUC
1.4 D, Break Eng.XL4D (33kW)	1/73-10/77		R		153-340	153-340K	Bdx	228,6x42	Hand Brake
	1/73-10/77		R		153-475		Lucas	228,6x42	Hand Brake
	75-77		R		151-008		Bdx	Ø 23,81 228,0x42	RAD
	75-77		R		151-105		Lucas	Ø 22,00 228,6x42	LUC
205 I (741A/C/B) 2/83-10/87									
0.95 Eng.108C(XV3/ 5/ 8) (32-33-34kW)	2/83-10/87		R			153-320Y	Bdx	180,0x32	
	2/83-10/87		R		153-320	153-320K	Bdx	180,0x32	Hand Brake
	2/83-10/87		R			153-329Y	Bdx	180,0x32	Hand Brake
	2/83-10/87		R		153-322		Lucas	180,0x32	Hand Brake
	83-		R		700-234	700-234K		Ø 180,0	
	83-90		R		151-010		Bdx	Ø 19,05 180,0x30	CRCI, RAD, +Servo
	83-90		R		151-009		Bdx	Ø 20,64 180,0x30	CRCI, RAD
	83-90		R		151-039		Lucas	Ø 19,05 180,0x30	CRCI, RAI, +Servo
1.1 Eng.109F(XW7) (36kW)	2/83-10/87		R			153-320Y	Bdx	180,0x32	
	2/83-10/87		R		153-320	153-320K	Bdx	180,0x32	Hand Brake
	2/83-10/87		R			153-329Y	Bdx	180,0x32	Hand Brake
	2/83-10/87		R		153-322		Lucas	180,0x32	Hand Brake
	83-		R		700-234	700-234K		Ø 180,0	
	83-90		R		151-010		Bdx	Ø 19,05 180,0x30	CRCI, RAD, +Servo
	83-90		R		151-009		Bdx	Ø 20,64 180,0x30	CRCI, RAD
	83-90		R		151-039		Lucas	Ø 19,05 180,0x30	CRCI, RAI, +Servo
1.1 Eng.109N(XW7) (36kW)	8/86-10/87		R			153-320Y	Bdx	180,0x32	
	8/86-10/87		R		153-320	153-320K	Bdx	180,0x32	Hand Brake
	8/86-10/87		R			153-329Y	Bdx	180,0x32	Hand Brake
	8/86-10/87		R		153-322		Lucas	180,0x32	Hand Brake
	86-87		R		700-234	700-234K		Ø 180,0	
	86-87		R		151-010		Bdx	Ø 19,05 180,0x30	CRCI, RAD, +Servo
	86-87		R		151-009		Bdx	Ø 20,64 180,0x30	CRCI, RAD
	86-87		R		151-039		Lucas	Ø 19,05 180,0x30	CRCI, RAI, +Servo
1.1 Eng.HDZ(TU1M/ MZ) (44kW)	1/87-10/87		R			153-320Y	Bdx	180,0x32	
	1/87-10/87		R		153-320	153-320K	Bdx	180,0x32	Hand Brake
	1/87-10/87		R			153-329Y	Bdx	180,0x32	Hand Brake
	1/87-10/87		R		153-322		Lucas	180,0x32	Hand Brake







		Spare Parts	F/R	L/R	CIFAM ref.	CIFAM ref. w/KIT		DIMENSIONS mm.	NOTE	
1.3 Eng.G1A (47kW)	2/84-10/87		R		153-344		Lucas	180,0x42	Hand Brake	
1.4 Eng.150(XY6B) (44-53kW)	2/83-10/87		R			153-320Y	Bdx	180,0x32		
	2/83-10/87		R		153-320	153-320K	Bdx	180,0x32	Hand Brake	
	2/83-10/87		R			153-329Y	Bdx	180,0x32	Hand Brake	
	2/83-10/87		R		153-322		Lucas	180,0x32	Hand Brake	
	2/83-10/87		R		153-344		Lucas	180,0x42	GTi, Hand Brake	
	83-		R		700-234	700-234K			Ø 180,0	
	83-90		R		151-010		Bdx	Ø 19,05 180,0x30	CRCI, RAD, +Servo	
83-90		R		151-009		Bdx	Ø 20,64 180,0x30	CRCI, RAD		
83-90		R		151-039		Lucas	Ø 19,05 180,0x30	CRCI, RAI, +Servo		
1.4 Eng.TU3FCP/ TU3M/ MC (55kW)	1/86-12/87		R			153-320Y	Bdx	180,0x32		
	1/86-12/87		R		153-320	153-320K	Bdx	180,0x32	Hand Brake	
	1/86-12/87		R			153-329Y	Bdx	180,0x32	Hand Brake	
	1/86-12/87		R		153-322		Lucas	180,0x32	Hand Brake	
	1/86-12/87		R		153-344		Lucas	180,0x42	GTi, Hand Brake	
1.4, Cabrio Eng.150B/ H(XY8) (44-53-58kW)	2/83-12/88		R			153-320Y	Bdx	180,0x32		
	2/83-12/88		R		153-320	153-320K	Bdx	180,0x32	Hand Brake	
	2/83-12/88		R			153-329Y	Bdx	180,0x32	Hand Brake	
	2/83-12/88		R		153-322		Lucas	180,0x32	Hand Brake	
	2/83-12/88		R		153-344		Lucas	180,0x42	GTi, Hand Brake	
	83-		R		700-234	700-234K			Ø 180,0	
	83-88		R		151-010		Bdx	Ø 19,05 180,0x30	CRCI, RAD, +Servo	
83-88		R		151-009		Bdx	Ø 20,64 180,0x30	CRCI, RAD		
83-88		R		151-039		Lucas	Ø 19,05 180,0x30	CRCI, RAI, +Servo		
1.4, Cabrio Eng.150D/ G(XY7) (44kW)	2/83-5/89		R			153-320Y	Bdx	180,0x32		
	2/83-5/89		R		153-320	153-320K	Bdx	180,0x32	Hand Brake	
	2/83-5/89		R			153-329Y	Bdx	180,0x32	Hand Brake	
	2/83-5/89		R		153-322		Lucas	180,0x32	Hand Brake	
	2/83-5/89		R		153-344		Lucas	180,0x42	GTi, Hand Brake	
	83-		R		700-234	700-234K			Ø 180,0	
	83-90		R		151-010		Bdx	Ø 19,05 180,0x30	CRCI, RAD, +Servo	
83-90		R		151-009		Bdx	Ø 20,64 180,0x30	CRCI, RAD		
83-90		R		151-039		Lucas	Ø 19,05 180,0x30	CRCI, RAI, +Servo		
1.5 Eng.Y2-K (63kW)	2/84-10/87		R		153-344		Lucas	180,0x42	GTi, Hand Brake	
	84-87		R		700-234	700-234K		Ø 180,0		
	84-87		R		151-010		Bdx	Ø 19,05 180,0x30	CRCI, RAD, +Servo	
	84-87		R		151-009		Bdx	Ø 20,64 180,0x30	CRCI, RAD	
	84-87		R		151-039		Lucas	Ø 19,05 180,0x30	CRCI, RAI, +Servo	
1.6 Eng.B1A(XU51C) (55kW)	8/86-10/87		R			153-320Y	Bdx	180,0x32		
	8/86-10/87		R		153-320	153-320K	Bdx	180,0x32	Hand Brake	
	8/86-10/87		R			153-329Y	Bdx	180,0x32	Hand Brake	
	8/86-10/87		R		153-322		Lucas	180,0x32	Hand Brake	
	86-87		R		700-234	700-234K		Ø 180,0		
	86-87		R		151-010		Bdx	Ø 19,05 180,0x30	CRCI, RAD, +Servo	
	86-87		R		151-009		Bdx	Ø 20,64 180,0x30	CRCI, RAD	
86-87		R		151-039		Lucas	Ø 19,05 180,0x30	CRCI, RAI, +Servo		
1.6 Eng.B1A/ BAZ(XU51C/ CP) (55-66-76-85kW)	8/86-10/87		R			153-320Y	Bdx	180,0x32		
	8/86-10/87		R		153-320	153-320K	Bdx	180,0x32	Hand Brake	
	8/86-10/87		R			153-329Y	Bdx	180,0x32	Hand Brake	
	8/86-10/87		R		153-322		Lucas	180,0x32	Hand Brake	
	86-87		R		700-234	700-234K		Ø 180,0		
	86-87		R		151-010		Bdx	Ø 19,05 180,0x30	CRCI, RAD, +Servo	
	86-87		R		151-009		Bdx	Ø 20,64 180,0x30	CRCI, RAD	
86-87		R		151-039		Lucas	Ø 19,05 180,0x30	CRCI, RAI, +Servo		
1.6 Eng.B1E(XU51C) (53kW)	3/87-10/87		R			153-320Y	Bdx	180,0x32		
	3/87-10/87		R		153-320	153-320K	Bdx	180,0x32	Hand Brake	
	3/87-10/87		R			153-329Y	Bdx	180,0x32	Hand Brake	
	3/87-10/87		R		153-322		Lucas	180,0x32	Hand Brake	
	3/87-10/87		R		700-234	700-234K		Ø 180,0		
	3/87-10/87		R		151-010		Bdx	Ø 19,05 180,0x30	CRCI, RAD, +Servo	
	3/87-10/87		R		151-009		Bdx	Ø 20,64 180,0x30	CRCI, RAD	
3/87-10/87		R		151-039		Lucas	Ø 19,05 180,0x30	CRCI, RAI, +Servo		
1.6 GTI, CTI Cabrio Eng.180A/ Z(XU5J-J/ JA/ JP) (76kW)	12/84-10/87		R			153-320Y	Bdx	180,0x32		
	12/84-10/87		R		153-320	153-320K	Bdx	180,0x32	Hand Brake	
	12/84-10/87		R			153-329Y	Bdx	180,0x32	Hand Brake	
	12/84-10/87		R		153-322		Lucas	180,0x32	Hand Brake	
	12/84-10/87		R		153-344		Lucas	180,0x42	GTi, Hand Brake	
	84-87		R		700-235	700-235K		Ø 180,0		













































		Spare Parts	F/R	L/R	CIFAM ref.	CIFAM ref. w/KIT		DIMENSIONS mm.	NOTE	
1.6 GTI, CTI Cabrio Eng.180A/ Z(XU5J-J/ JA/ JP) (76kW)	84-87		R		151-009		Bdx	Ø 20,64 180,0x30	CRCI, RAD	
	84-87		R		151-040		Lucas	Ø 19,05 180,0x40	RAI, GTi, CTi, Rallye, TD, +ABS	
1.8 D Eng.161A(XUD7) (44kW)	8/83-10/87		R			153-320Y	Bdx	180,0x32		
	8/83-10/87		R		153-320	153-320K	Bdx	180,0x32	Hand Brake	
	8/83-10/87		R			153-329Y	Bdx	180,0x32	Hand Brake	
	8/83-10/87		R		153-322		Lucas	180,0x32	Hand Brake	
	83-		R		700-234	700-234K		Ø 180,0		
	83-90		R		151-010		Bdx	Ø 19,05 180,0x30	CRCI, RAD, +Servo	
	83-90		R		151-009		Bdx	Ø 20,64 180,0x30	CRCI, RAD	
	83-90		R		151-039		Lucas	Ø 19,05 180,0x30	CRCI, RAI, +Servo	
1.9 D Eng.DJZ(XUD9Y) (47kW)	83-		R		700-234	700-234K		Ø 180,0		
	83-90		R		151-010		Bdx	Ø 19,05 180,0x30	CRCI, RAD, Exc. GTi, CTi, Rallye, TD, +Servo	
	83-90		R		151-009		Bdx	Ø 20,64 180,0x30	CRCI, RAD	
	83-90		R		151-039		Lucas	Ø 19,05 180,0x30	CRCI, RAI, Exc. GTi, CTi, Rallye, +Servo	
1.9 GTi, Cabrio Eng.D6B(XU9JA/ Z) (94-96kW)	10/86-10/87		R		153-344		Lucas	180,0x42	GTi, Hand Brake	
	86-87		R		700-235	700-235K		Ø 180,0		
	86-87		R		151-009		Bdx	Ø 20,64 180,0x30	CRCI, RAD	
	86-87		R		151-040		Lucas	Ø 19,05 180,0x40	RAI, GTi, CTi, Rallye, TD, +ABS	
205 II (20A/C) 1/87-9/98										
0.95 Eng.CDY/ Z(TU9M) (33-37kW)	10/87-9/98		R			153-320Y	Bdx	180,0x32		
	10/87-9/98		R		153-320	153-320K	Bdx	180,0x32	Hand Brake	
	10/87-9/98		R			153-329Y	Bdx	180,0x32	Hand Brake	
	10/87-9/98		R		153-322		Lucas	180,0x32	Hand Brake	
	87-98		R		700-234	700-234K		Ø 180,0		
	87-98		R		151-010		Bdx	Ø 19,05 180,0x30	CRCI, RAD, +Servo	
	87-98		R		151-039		Lucas	Ø 19,05 180,0x30	CRCI, RAI, +Servo	
1.1 Eng.109N(XW7) (36kW)	10/87-9/98		R			153-320Y	Bdx	180,0x32		
	10/87-9/98		R		153-320	153-320K	Bdx	180,0x32	Hand Brake	
	10/87-9/98		R			153-329Y	Bdx	180,0x32	Hand Brake	
	10/87-9/98		R		153-322		Lucas	180,0x32	Hand Brake	
	87-98		R		700-234	700-234K		Ø 180,0		
87-98		R		151-010		Bdx	Ø 19,05 180,0x30	CRCI, RAD, +Servo		
87-98		R		151-039		Lucas	Ø 19,05 180,0x30	CRCI, RAI, +Servo		
1.1 Eng.H1B(TU1) (40kW)	10/87-10/90		R			153-320Y	Bdx	180,0x32		
	10/87-10/90		R		153-320	153-320K	Bdx	180,0x32	Hand Brake	
	10/87-10/90		R			153-329Y	Bdx	180,0x32	Hand Brake	
	10/87-10/90		R		153-322		Lucas	180,0x32	Hand Brake	
	87-90		R		700-234	700-234K		Ø 180,0		
	87-90		R		151-010		Bdx	Ø 19,05 180,0x30	CRCI, RAD, +Servo	
87-90		R		151-039		Lucas	Ø 19,05 180,0x30	CRCI, RAI, +Servo		
1.1, CJ Cabrio Eng.HDZ(TU1M/ MZ) (44kW)	10/89-12/94		R			153-320Y	Bdx	180,0x32		
	10/89-12/94		R		153-320	153-320K	Bdx	180,0x32	Hand Brake	
	10/89-12/94		R			153-329Y	Bdx	180,0x32	Hand Brake	
	10/89-12/94		R		153-322		Lucas	180,0x32	Hand Brake	
	89-94		R		700-234	700-234K		Ø 180,0		
89-94		R		151-010		Bdx	Ø 19,05 180,0x30	CRCI, RAD, +Servo		
89-94		R		151-039		Lucas	Ø 19,05 180,0x30	CRCI, RAI, +Servo		
1.3 Rallye Eng.TU24 (74kW)	10/87-10/90		R		153-344		Lucas	180,0x42	Hand Brake	
	87-90			R		700-235	700-235K		Ø 180,0	
	87-90			R		151-010		Bdx	Ø 19,05 180,0x30	CRCI, RAD, +Servo
	87-90			R		151-009		Bdx	Ø 20,64 180,0x30	CRCI, RAD
	87-90		R		151-039		Lucas	Ø 19,05 180,0x30	CRCI, RAI, +Servo	
87-90		R		151-040		Lucas	Ø 19,05 180,0x40	RAI, +ABS		
1.4 Eng.150(XY6B) (44-53kW)	1/87-7/88		R			153-320Y	Bdx	180,0x32		
	1/87-7/88		R		153-320	153-320K	Bdx	180,0x32	Hand Brake	
	1/87-7/88		R			153-329Y	Bdx	180,0x32	Hand Brake	
	1/87-7/88		R		153-322		Lucas	180,0x32	Hand Brake	
	1/87-7/88		R		153-344		Lucas	180,0x42	Hand Brake	
	87-88		F		700-234	700-234K		Ø 180,0		
	87-88		R		151-010		Bdx	Ø 19,05 180,0x30	CRCI, RAD, +Servo	
87-88		R		151-039		Lucas	Ø 19,05 180,0x30	CRCI, RAI, +Servo		
1.4 Eng.150B/ H(XY8) (44-53-58kW)	7/88-5/89		R			153-320Y	Bdx	180,0x32		
	7/88-5/89		R		153-320	153-320K	Bdx	180,0x32	Hand Brake	
	7/88-5/89		R			153-329Y	Bdx	180,0x32	Hand Brake	
	7/88-5/89		R		153-322		Lucas	180,0x32	Hand Brake	
	7/88-5/89		R		153-344		Lucas	180,0x42	Hand Brake	



















































		Spare Parts	F/R	L/R	CIFAM ref.	CIFAM ref. w/KIT		DIMENSIONS mm.	NOTE
1.4 Eng.150B/ H(XY8) (44-53-58kW)	88-89		F		700-234	700-234K		Ø 180,0	
			R		151-010		Bdx	Ø 19,05 180,0x30	CRCI, RAD, +Servo
			R		151-039		Lucas	Ø 19,05 180,0x30	CRCI, RAI, +Servo
1.4 Eng.150D/ G(XY7) (44kW)	10/87-5/89		R		153-320	153-320Y	Bdx	180,0x32	
			R		153-320	153-320K	Bdx	180,0x32	Hand Brake
			R		153-320	153-329Y	Bdx	180,0x32	Hand Brake
			R		153-322		Lucas	180,0x32	Hand Brake
			R		153-344		Lucas	180,0x42	Hand Brake
	87-89		F		700-234	700-234K		Ø 180,0	
			R		151-010		Bdx	Ø 19,05 180,0x30	CRCI, RAD, +Servo
			R		151-039		Lucas	Ø 19,05 180,0x30	CRCI, RAI, +Servo
1.4 Eng.K2B(TU3S) (62kW)	6/87-12/89		R		153-320	153-320Y	Bdx	180,0x32	
			R		153-320	153-320K	Bdx	180,0x32	Hand Brake
			R		153-320	153-329Y	Bdx	180,0x32	Hand Brake
			R		153-322		Lucas	180,0x32	Hand Brake
			R		153-344		Lucas	180,0x42	Hand Brake
	87-89		R		700-234	700-234K		Ø 180,0	
		R		151-010		Bdx	Ø 19,05 180,0x30	CRCI, RAD, +Servo	
		R		151-039		Lucas	Ø 19,05 180,0x30	CRCI, RAI, +Servo	
1.4 Eng.Y2-K (63kW)	6/87-12/89		R		153-320	153-320Y	Bdx	180,0x32	
			R		153-320	153-320K	Bdx	180,0x32	Hand Brake
			R		153-320	153-329Y	Bdx	180,0x32	Hand Brake
			R		153-322		Lucas	180,0x32	Hand Brake
			R		153-344		Lucas	180,0x42	Hand Brake
1.4, Cabrio Eng.K1D(TU3A/ AN/ S/ M/ 2/ 2K) (49kW)	10/87-12/94		R		153-320	153-320Y	Bdx	180,0x32	
			R		153-320	153-320K	Bdx	180,0x32	Hand Brake
			R		153-320	153-329Y	Bdx	180,0x32	Hand Brake
			R		153-322		Lucas	180,0x32	Hand Brake
			R		153-344		Lucas	180,0x42	Hand Brake
	87-94		R		700-234	700-234K		Ø 180,0	
		R		151-010		Bdx	Ø 19,05 180,0x30	CRCI, RAD, +Servo	
		R		151-039		Lucas	Ø 19,05 180,0x30	CRCI, RAI, +Servo	
1.4, Cabrio Eng.KFW/ KFX(TU3JP)/ KDX(TU3MC) (55kW)	7/88-9/98		R		153-320	153-320Y	Bdx	180,0x32	
			R		153-320	153-320K	Bdx	180,0x32	Hand Brake
			R		153-320	153-329Y	Bdx	180,0x32	Hand Brake
			R		153-322		Lucas	180,0x32	Hand Brake
			R		153-344		Lucas	180,0x42	Hand Brake
	88-98		R		700-234	700-234K		Ø 180,0	
		R		151-010		Bdx	Ø 19,05 180,0x30	CRCI, RAD, +Servo	
		R		151-039		Lucas	Ø 19,05 180,0x30	CRCI, RAI, +Servo	
1.4, Kat Cabrio Eng.KAY(TU3FCP) (44kW)	1/89-9/93		R		153-320	153-320Y	Bdx	180,0x32	
			R		153-320	153-320K	Bdx	180,0x32	Hand Brake
			R		153-320	153-329Y	Bdx	180,0x32	Hand Brake
			R		153-322		Lucas	180,0x32	Hand Brake
			R		153-344		Lucas	180,0x42	Hand Brake
	89-93		R		700-234	700-234K		Ø 180,0	
		R		151-010		Bdx	Ø 19,05 180,0x30	CRCI, RAD, +Servo	
		R		151-039		Lucas	Ø 19,05 180,0x30	CRCI, RAI, +Servo	
1.6 Eng.B1E(XU51C) (53kW)	10/87-9/98		R		153-320	153-320Y	Bdx	180,0x32	
			R		153-320	153-320K	Bdx	180,0x32	Hand Brake
			R		153-320	153-329Y	Bdx	180,0x32	Hand Brake
			R		153-322		Lucas	180,0x32	Hand Brake
			R		153-344		Lucas	180,0x42	Hand Brake
	87-90		R		700-234	700-234K		Ø 180,0	
			R		700-235	700-235K		Ø 180,0	
87-98		R		151-010		Bdx	Ø 19,05 180,0x30	CRCI, RAD, +Servo	
		R		151-039		Lucas	Ø 19,05 180,0x30	CRCI, RAI, +Servo	
1.6 Eng.J2 (69kW)	1/87-10/91		R		153-320	153-320Y	Bdx	180,0x32	
			R		153-320	153-320K	Bdx	180,0x32	Hand Brake
			R		153-320	153-329Y	Bdx	180,0x32	Hand Brake
			R		153-322		Lucas	180,0x32	Hand Brake
			R		153-344		Lucas	180,0x42	Hand Brake
1.6 Aut. Eng.B1A(XU51C-K) (58kW)	10/87-9/98		R		153-320	153-320Y	Bdx	180,0x32	
			R		153-320	153-320K	Bdx	180,0x32	Hand Brake
			R		153-320	153-329Y	Bdx	180,0x32	Hand Brake
			R		153-322		Lucas	180,0x32	Hand Brake
			R		153-344		Lucas	180,0x42	Hand Brake
	87-90		R		700-234	700-234K		Ø 180,0	















































		Spare Parts	F/R	L/R	CIFAM ref.	CIFAM ref. w/KIT		DIMENSIONS mm.	NOTE
1.6 Aut. Eng.B1A(XU51C-K) (58kW)	90-98		R		700-235	700-235K		Ø 180,0	
	87-98		R		151-010		Bdx	Ø 19,05 180,0x30	CRCI, RAD, +Servo
	87-98		R		151-039		Lucas	Ø 19,05 180,0x30	CRCI, RAI, +Servo
1.6 Cabrio, Aut Eng.BDY(XU5M2Z/3Z) (65-66kW)	5/90-9/98		R			153-320Y	Bdx	180,0x32	
	5/90-9/98		R		153-320	153-320K	Bdx	180,0x32	Hand Brake
	5/90-9/98		R			153-329Y	Bdx	180,0x32	Hand Brake
	5/90-9/98		R		153-322		Lucas	180,0x32	Hand Brake
	5/90-9/98		R		153-344		Lucas	180,0x42	Hand Brake
	90-98		R		700-235	700-235K		Ø 180,0	
	90-98		R		151-010		Bdx	Ø 19,05 180,0x30	CRCI, RAD, +Servo
1.6 GTI Eng.180A/ Z(XU5J-J/ JA/ JP) (76kW)	10/87-12/89		R			153-320Y	Bdx	180,0x32	
	10/87-12/89		R		153-320	153-320K	Bdx	180,0x32	Hand Brake
	10/87-12/89		R			153-329Y	Bdx	180,0x32	Hand Brake
	10/87-12/89		R		153-322		Lucas	180,0x32	Hand Brake
	10/87-12/89		R		153-344		Lucas	180,0x42	Hand Brake
	87-89		R		700-235	700-235K		Ø 180,0	
1.6 GTI Eng.B6D(XU5J) (85kW)	10/87-12/89		R			153-320Y	Bdx	180,0x32	
	10/87-12/89		R		153-320	153-320K	Bdx	180,0x32	Hand Brake
	10/87-12/89		R			153-329Y	Bdx	180,0x32	Hand Brake
	10/87-12/89		R		153-322		Lucas	180,0x32	Hand Brake
	10/87-12/89		R		153-344		Lucas	180,0x42	Hand Brake
	87-89		R		700-235	700-235K		Ø 180,0	
1.6, Kat Eng.B1A/ BAZ(XU51C/ CP) (55kW)	10/87-9/98		R			153-320Y	Bdx	180,0x32	
	10/87-9/98		R		153-320	153-320K	Bdx	180,0x32	Hand Brake
	10/87-9/98		R			153-329Y	Bdx	180,0x32	Hand Brake
	10/87-9/98		R		153-322		Lucas	180,0x32	Hand Brake
	10/87-9/98		R		153-344		Lucas	180,0x42	Hand Brake
	87-90		R		700-234	700-234K		Ø 180,0	
	90-98		R		700-235	700-235K		Ø 180,0	
	87-98		R		151-010		Bdx	Ø 19,05 180,0x30	CRCI, RAD, +Servo
1.8 D Eng.161A(XUD7) (44kW)	87-98		R		151-039		Lucas	Ø 19,05 180,0x30	CRCI, RAI, +Servo
	7/87-12/89		R			153-320Y	Bdx	180,0x32	
	7/87-12/89		R		153-320	153-320K	Bdx	180,0x32	Hand Brake
	7/87-12/89		R			153-329Y	Bdx	180,0x32	Hand Brake
	7/87-12/89		R		153-322		Lucas	180,0x32	Hand Brake
	87-89		R		700-234	700-234K		Ø 180,0	
1.8 TD Eng.A8B(XUD7TE) (57kW)	87-89		R		151-010		Bdx	Ø 19,05 180,0x30	CRCI, RAD, +Servo
	87-89		R		151-039		Lucas	Ø 19,05 180,0x30	CRCI, RAI, +Servo
	1/90-9/98		R			153-320Y	Bdx	180,0x32	
	1/90-9/98		R		153-320	153-320K	Bdx	180,0x32	Hand Brake
	1/90-9/98		R			153-329Y	Bdx	180,0x32	Hand Brake
	1/90-9/98		R		153-322		Lucas	180,0x32	Hand Brake
1.9 D Eng.DJZ(XUD9Y) (47kW)	90-98		R		700-234	700-234K		Ø 180,0	
	90-98		R		700-235	700-235K		Ø 180,0	
	90-98		R		151-040		Lucas	Ø 19,05 180,0x40	RAI, +ABS
	10/87-9/98		R		153-344		Lucas	180,0x42	Hand Brake
	87-98		R		700-234	700-234K		Ø 180,0	
1.9 GTI Eng.D2A(XU92C/ 2S) (75-77kW)	87-98		R		151-010		Bdx	Ø 19,05 180,0x30	CRCI, RAD, +Servo
	87-98		R		151-039		Lucas	Ø 19,05 180,0x30	CRCI, RAI, +Servo
	87-89		R		700-235	700-235K		Ø 180,0	
	87-89		R		151-039		Lucas	Ø 19,05 180,0x30	CRCI, RAI, -ABS
1.9 GTi Eng.D6B(XU9JA/ Z) (94-96kW)	87-89		R		151-040		Lucas	Ø 19,05 180,0x40	RAI, +ABS
	10/87-9/98		R		153-344		Lucas	180,0x42	Hand Brake
	10/87-10/94		R		153-344		Lucas	180,0x42	Hand Brake
1.9 GTI, CTI Cabrio, Kat Eng.DFZ(XU9J1) (75kW)	3/87-12/94		R		153-344		Lucas	180,0x42	Hand Brake
	87-94		R		700-235	700-235K		Ø 180,0	
	87-94		R		151-040		Lucas	Ø 19,05 180,0x40	RAI, +ABS
1.9 Sport MI-16 Eng.D6C(XU9J4) (118kW)	90-94		R		151-039		Lucas	Ø 19,05 180,0x30	CRCI, RAI, -ABS
	1/87-9/98		R		153-344		Lucas	180,0x42	Hand Brake
206 (2A/C), SW 9/98-3/06									
1.1 Eng.HDZ(TU1M)/ HFX(TU1JP) (40-44kW)	9/98-3/06		R		153-328		Bdx	180,0x32	
	9/98-3/06		R		153-350		Lucas	203,0x38	Hand Brake
	9/98-3/06		R		153-332		Lucas	203,0x39	
	98-		R		700-241	700-241K		Ø 180,0	-ABS































































		Spare Parts	F/R	L/R	CIFAM ref.	CIFAM ref. w/KIT		DIMENSIONS mm.	NOTE
1.1 Eng.HDZ(TU1M)/ HFX(TU1JP) (40-44kW)	98-		R		700-246	700-246K		Ø 203,0	+ABS
	98-		R		151-093		Bdx	Ø 19,05 180,0x32	RAI, +PS
	98-		R		151-092		Bdx	Ø 20,64 180,0x32	CRCI, RAI
	98-8/02		R		151-134		Lucas	Ø 20,64 203,0x38	LUC, +ABS
	98-		R		151-193		Lucas	Ø 20,64 203,0x39	Ch 09457-, LUC, +ABS
1.4 Eng.KFW/ KFX(TU3JP) (55kW)	9/98-3/06		R		153-328		Bdx	180,0x32	
	9/98-3/06		R		153-350		Lucas	203,0x38	Hand Brake
	9/98-3/06		R		153-332		Lucas	203,0x39	
	98-		R		700-241	700-241K		Ø 180,0	-ABS
	98-		R		700-246	700-246K		Ø 203,0	+ABS
	98-		R		151-093		Bdx	Ø 19,05 180,0x32	RAI, +PS
	98-		R		151-092		Bdx	Ø 20,64 180,0x32	CRCI, RAI
	98-		R		151-134		Lucas	Ø 20,64 203,0x38	LUC, +ABS
1.4 16v Eng.KFU(ET3J4) (65kW)	10/03-3/06		R		153-328		Bdx	180,0x32	
	10/03-3/06		R		153-350		Lucas	203,0x38	Hand Brake
	10/03-3/06		R		153-332		Lucas	203,0x39	
	03-		R		700-246	700-246K		Ø 203,0	+ABS
	03-		R		151-093		Bdx	Ø 19,05 180,0x32	RAI, +PS
1.4 HDi Eng.DV4TD (50-51kW)	9/01-3/06		R		153-328		Bdx	180,0x32	
	9/01-3/06		R		153-332		Lucas	203,0x39	
	01-		R		700-246	700-246K		Ø 203,0	+ABS
	01-		R		151-134		Lucas	Ø 20,64 203,0x38	LUC, +ABS
	01-		R		151-193		Lucas	Ø 20,64 203,0x39	Ch 09457-, LUC, +ABS
1.6 (Exc. SW) Eng.NFZ(TU5JP) (65kW)	9/98-12/00		R		153-328		Bdx	180,0x32	
	9/98-12/00		R		153-350		Lucas	203,0x38	Hand Brake
	9/98-12/00		R		153-332		Lucas	203,0x39	
	98-		R		700-241	700-241K		Ø 180,0	-ABS
	98-		R		700-246	700-246K		Ø 203,0	+ABS
	98-		R		151-093		Bdx	Ø 19,05 180,0x32	RAI, +PS
	98-		R		151-092		Bdx	Ø 20,64 180,0x32	CRCI, RAI
	98-12/00		R		151-134		Lucas	Ø 20,64 203,0x38	LUC, +ABS
1.6 16v, Cabrio Eng.NFU(TU5JP4) (80-87kW)	12/00-3/06		R		153-328		Bdx	180,0x32	
	12/00-3/06		R		153-350		Lucas	203,0x38	Hand Brake
	12/00-3/06		R		153-332		Lucas	203,0x39	
	00-		R		151-193		Lucas	Ø 20,64 203,0x39	Ch 09457-, LUC, +ABS
1.9 D (Exc. SW) Eng.WJZ/WJY(DW8/B) (51kW)	9/98-11/01		R		153-328		Bdx	180,0x32	
	9/98-11/01		R		153-350		Lucas	203,0x38	Hand Brake
	9/98-11/01		R		153-332		Lucas	203,0x39	
	98-		R		700-241	700-241K		Ø 180,0	-ABS
	98-		R		700-246	700-246K		Ø 203,0	Exc. Scandinavia, +ABS
	98-		R		151-093		Bdx	Ø 19,05 180,0x32	RAI, +PS
	98-		R		151-094		Bdx	Ø 19,05 180,0x32	CRCI, RAI
	98-11/01		R		151-134		Lucas	Ø 20,64 203,0x38	LUC, +ABS
2.0 HDi Eng.RHY(DW10TD) (66kW)	98-01		R		151-193		Lucas	Ø 20,64 203,0x39	Ch 09457-, LUC, +ABS
	12/99-3/06		R		153-332		Lucas	203,0x39	
	99-		R		700-246	700-246K		Ø 203,0	Exc. Scandinavia, +ABS
	99-8/02		R		151-134		Lucas	Ø 20,64 203,0x38	LUC, +ABS
	99-		R		151-193		Lucas	Ø 20,64 203,0x39	Ch 09457-, LUC, +ABS
207, SW (WA, WC, WD, WK) 4/06-									
1.4 Eng.KFV(TU3JP) (53kW)	4/06-		R		153-333			228,6x42	
	06-		R		151-205		Bosch	Ø 20,64 228,6x42	CRCI, RAI, -ABS
1.4 16v Eng.8FS(EP3) (70kW)	8/07-		R		153-333			228,6x42	
1.4 16v Eng.KFU(ET3J4) (65kW)	4/06-		R		153-333			228,6x42	
1.4 HDi Eng.8HZ(DV4TD) (50kW)	4/06-		R		153-333			228,6x42	
	06-		R		151-205		Bosch	Ø 20,64 228,6x42	CRCI, RAI, -ABS
304 10/69-10/80									
1.1 Break Eng.XK5 (40-43kW)	76-80		R		151-008		Bdx	Ø 23,81 228,0x42	RAD, Berlina, Break
1.3 Break, GT, Coupe, Cabrio Eng.XL3/ XL3S (48-55kW)	8/75-9/75		R		151-008		Bdx	Ø 23,81 228,0x42	RAD, Berlina, Break
1.3, Break Eng.118(XL5/ S) (44-48-51kW)	9/72-11/79		R		153-340	153-340K	Bdx	228,6x42	Hand Brake
	9/72-11/79		R		153-475		Lucas	228,6x42	Hand Brake
	7/75-79		R		151-008		Bdx	Ø 23,81 228,0x42	RAD, Berlina, Break
	72-79		R		151-105		Lucas	Ø 22,00 228,6x42	LUC































































		Spare Parts	F/R	L/R	CIFAM ref.	CIFAM ref. w/KIT		DIMENSIONS mm.	NOTE
1.3, Coupe, Cabrio Eng.118(XL5/ S) (44-51-55kW)	8/75-76		R		151-008		Bdx	Ø 23,81 228,0x42	RAD, Berlina, Break
1.4 D, Break Eng.XL4D (33kW)	10/76-10/79		R		153-340	153-340K	Bdx	228,6x42	Hand Brake
			R		153-475		Lucas	228,6x42	Hand Brake
	76-79		R		151-008		Bdx	Ø 23,81 228,0x42	RAD, Berlina, Break
			R		151-105		Lucas	Ø 22,00 228,6x42	LUC
305 I (581A) 11/77-9/82									
1.3, Break Eng.118(XL5/ S/ XK5) (40-44-48-51kW)	11/77-9/82		R		153-340	153-340K	Bdx	228,6x42	Hand Brake
	11/77-9/82		R		153-475		Lucas	228,6x42	Hand Brake
	77-82		R		151-008		Bdx	Ø 23,81 228,0x42	RAD, Berlina
	77-82		R		151-105		Lucas	Ø 22,00 228,6x42	LUC
1.5 Eng.117(XR5A/ S) (65kW)	5/80-9/82		R		153-340	153-340K	Bdx	228,6x42	Hand Brake
	5/80-9/82		R		153-475		Lucas	228,6x42	Hand Brake
	80-82		R		151-008		Bdx	Ø 23,81 228,0x42	RAD, Berlina
	80-82		R		151-105		Lucas	Ø 22,00 228,6x42	LUC
1.5 D, Break Eng.149(XID) (32-36kW)	11/77-9/82		R		153-340	153-340K	Bdx	228,6x42	Hand Brake
	11/77-9/82		R		153-475		Lucas	228,6x42	Hand Brake
	77-82		R		151-008		Bdx	Ø 23,81 228,0x42	RAD, Berlina
	77-82		R		151-105		Lucas	Ø 22,00 228,6x42	LUC
1.5, Break Eng.142(XR5A/ S) (54kW)	11/79-9/82		R		153-340	153-340K	Bdx	228,6x42	Hand Brake
	11/79-9/82		R		153-475		Lucas	228,6x42	Hand Brake
	79-82		R		151-008		Bdx	Ø 23,81 228,0x42	RAD, Berlina
	79-82		R		151-105		Lucas	Ø 22,00 228,6x42	LUC
305 II (581M/E), Break 10/82-7/90									
1.3 Eng.118(XL5/ S) (44-51kW)	10/82-8/85		R		153-324	153-324K	Bdx	228,6x42	Hand Brake
	10/82-8/85		R		153-340	153-340K	Bdx	228,6x42	Hand Brake
	82-85		R		700-233			Ø 228,5	
	-85		R		151-041		Bdx	Ø 20,64 228,0x42	Ch 8987001-, RAD, Berlina
1.5 Eng.142(XR5) (50kW)	9/85-7/90		R		153-324	153-324K	Bdx	228,6x42	Hand Brake
	9/85-7/90		R		153-340	153-340K	Bdx	228,6x42	Hand Brake
1.5 Eng.142(XR5A/ S) (54kW)	10/82-8/85		R		153-324	153-324K	Bdx	228,6x42	Hand Brake
	10/82-8/85		R		153-340	153-340K	Bdx	228,6x42	Hand Brake
	82-85		R		700-233			Ø 228,5	
	-85		R		151-041		Bdx	Ø 20,64 228,0x42	Ch 8987001-, RAD, Berlina
1.6 Eng.171(XU5S) (66kW)	10/82-8/87		R		153-324	153-324K	Bdx	228,6x42	Hand Brake
	10/82-8/87		R		153-340	153-340K	Bdx	228,6x42	Hand Brake
	82-87		R		700-233			Ø 228,5	
	-87		R		151-041		Bdx	Ø 20,64 228,0x42	Ch 8987001-, RAD, Berlina
1.6 Eng.171(XU5S) (71kW)	10/82-6/88		R		153-324	153-324K	Bdx	228,6x42	Hand Brake
	10/82-6/88		R		153-340	153-340K	Bdx	228,6x42	Hand Brake
1.6 Eng.B1A(XU51C) (55kW)	10/82-7/88		R		153-324	153-324K	Bdx	228,6x42	Hand Brake
	10/82-7/88		R		153-340	153-340K	Bdx	228,6x42	Hand Brake
1.6 Eng.BAZ(XU5CP) (54kW)	11/86-12/88		R		153-324	153-324K	Bdx	228,6x42	Hand Brake
	11/86-12/88		R		153-340	153-340K	Bdx	228,6x42	Hand Brake
	86-88		R		700-233			Ø 228,5	
	-88		R		151-041		Bdx	Ø 20,64 228,0x42	Ch 8987001-, RAD, Berlina
1.6 (Exc. Break) Eng.171B(XU5S) (69kW)	10/82-6/88		R		153-324	153-324K	Bdx	228,6x42	Hand Brake
	10/82-6/88		R		153-340	153-340K	Bdx	228,6x42	Hand Brake
1.8 D Eng.161A(XUD7) (44kW)	82-87		R		700-233			Ø 228,5	
	-88		R		151-041		Bdx	Ø 20,64 228,0x42	Ch 8987001-, RAD, Berlina
1.9 Eng.159(XU9C/ 2S) (75kW)	10/82-8/85		R		153-324	153-324K	Bdx	228,6x42	Hand Brake
	10/82-8/85		R		153-340	153-340K	Bdx	228,6x42	Hand Brake
	10/82-8/85		R		153-475		Lucas	228,6x42	Hand Brake
1.9 Eng.DFZ(XU9J1) (72kW)	11/86-12/88		R		153-324	153-324K	Bdx	228,6x42	Hand Brake
	11/86-12/88		R		153-340	153-340K	Bdx	228,6x42	Hand Brake
	11/86-12/88		R		153-475		Lucas	228,6x42	Hand Brake
	86-88		R		700-233			Ø 228,5	
	-88		R		151-041		Bdx	Ø 20,64 228,0x42	Ch 8987001-, RAD, Berlina
1.9 D Eng.162/ D9A(XUD9)/ DJZ(XUD9Y) (47kW)	10/82-7/88		R		153-324	153-324K	Bdx	228,6x42	Hand Brake
	10/82-7/88		R		153-340	153-340K	Bdx	228,6x42	Hand Brake
	10/82-7/88		R		153-475		Lucas	228,6x42	Hand Brake
	82-87		R		700-233			Ø 228,5	
	-88		R		151-041		Bdx	Ø 20,64 228,0x42	Ch 8987001-, RAD, Berlina
1.9 Sport MI-16 Eng.D6C(XU9J4) (118kW)	1/83-7/90		R		153-340	153-340K	Bdx	228,6x42	Hand Brake
306 (7B, N3) 5/93-10/00									
1.1 Eng.HDZ(TU1M/ MZ) (44kW)	5/93-10/00		R		153-022	153-022Y	Bdx	180,0x32	Hand Brake
	5/93-10/00		R		153-350		Lucas	203,0x38	Hand Brake

















































		Spare Parts	F/R	L/R	CIFAM ref.	CIFAM ref. w/KIT		DIMENSIONS mm.	NOTE
1.1 Eng.HDZ(TU1M/ MZ) (44kW)	2/93-96		R		700-238	700-238K		Ø 180,0	-ABS
	2/93-		R		151-004		Bdx	Ø 20,64 180,0x30	CRCI, RAI
	2/93-		R		151-054		Lucas	Ø 20,64 180,0x30	CRCI, RAI
1.4 Eng.KDY(TU3A/ AN/ S/ M/ 2/ 2K) (47kW)	1/93-10/00		R		153-022	153-022Y	Bdx	180,0x32	Hand Brake
	1/93-10/00		R		153-327		Bdx	228,6x42	Hand Brake
	1/93-10/00		R		153-322		Lucas	180,0x32	Hand Brake
	1/93-10/00		R		153-350		Lucas	203,0x38	Hand Brake
1.4 SL Eng.KFW/ KFX(TU3JP)/ KDX(TU3MC) (55kW)	5/93-10/00		R		153-022	153-022Y	Bdx	180,0x32	Hand Brake
	5/93-10/00		R		153-327		Bdx	228,6x42	Hand Brake
	5/93-10/00		R		153-322		Lucas	180,0x32	Hand Brake
	5/93-10/00		R		153-350		Lucas	203,0x38	Hand Brake
	2/93-		R		700-238	700-238K		Ø 180,0	-ABS
	6/93-		R		700-245	700-245K		Ø 203,0	+ABS
	2/93-		R		151-004		Bdx	Ø 20,64 180,0x30	CRCI, RAI
	97-00		R		151-133		Lucas	Ø 20,64 203,0x38	LUC, +ABS
1.6 Eng.NFT (72kW)	10/00-10/00		R		153-022	153-022Y	Bdx	180,0x32	Hand Brake
	10/00-10/00		R		153-327		Bdx	228,6x42	Hand Brake
	10/00-10/00		R		153-322		Lucas	180,0x32	Hand Brake
	10/00-10/00		R		153-350		Lucas	203,0x38	Hand Brake
	00-		R		700-238	700-238K		Ø 180,0	-ABS
	00-		R		700-245	700-245K		Ø 203,0	+ABS
	00-		R		151-143		Bosch	Ø 22,00 228,0x42	RAI, +ABS
	00-		R		151-133		Lucas	Ø 20,64 203,0x38	LUC, +ABS
1.6 SR Eng.NFZ(TU5JP) (65-66kW)	5/93-10/00		R		153-022	153-022Y	Bdx	180,0x32	Hand Brake
	5/93-10/00		R		153-327		Bdx	228,6x42	Hand Brake
	5/93-10/00		R		153-322		Lucas	180,0x32	Hand Brake
	5/93-10/00		R		153-350		Lucas	203,0x38	Hand Brake
	6/93-		R		700-238	700-238K		Ø 180,0	-ABS
	6/93-		R		700-245	700-245K		Ø 203,0	+ABS
	2/93-		R		151-004		Bdx	Ø 20,64 180,0x30	CRCI, RAI
	97-00		R		151-133		Lucas	Ø 20,64 203,0x38	LUC, +ABS
1.8 Eng.LFZ(XU7JP) (74kW)	5/93-10/00		R		153-022	153-022Y	Bdx	180,0x32	-ABS, Hand Brake
	5/93-10/00		R		153-323		Bdx	228,6x42	+ABS, Hand Brake
	5/93-10/00		R		153-322		Lucas	180,0x32	-ABS, Hand Brake
	5/93-10/00		R		153-350		Lucas	203,0x38	Hand Brake
	4/94-96		R		700-238	700-238K		Ø 180,0	-ABS
	7/93-96		R		700-245	700-245K		Ø 203,0	+ABS
	2/93-		R		151-004		Bdx	Ø 20,64 180,0x30	CRCI, RAI
	93-95		R		151-005		Bdx	Ø 20,64 228,6x42	RAI, +ABS
97-00		R		151-133		Lucas	Ø 20,64 203,0x38	LUC, +ABS	
1.8 16v Eng.LFY(XU7JP4) (81kW)	3/97-10/00		R		153-327		Bdx	228,6x42	+/-ABS, Hand Brake
1.8 D Eng.A9A(XUD7) (43kW)	6/93-		R		700-238	700-238K		Ø 180,0	-ABS
	6/93-		R		700-245	700-245K		Ø 203,0	+ABS
1.8i Eng.L6A(XU7P/ K) (69kW)	5/93-10/00		R		153-022	153-022Y	Bdx	180,0x32	-ABS, Hand Brake
	5/93-10/00		R		153-323		Bdx	228,6x42	+ABS, Hand Brake
	5/93-10/00		R		153-322		Lucas	180,0x32	-ABS, Hand Brake
	5/93-10/00		R		153-350		Lucas	203,0x38	Hand Brake
	93-		R		700-238	700-238K		Ø 180,0	-ABS
	93-		R		700-245	700-245K		Ø 203,0	+ABS
1.9 D Eng.DHV(XUD9BSD) (55kW)	3/98-10/00		R		153-022	153-022Y	Bdx	180,0x32	Hand Brake
	3/98-10/00		R		153-327		Bdx	228,6x42	Hand Brake
	3/98-10/00		R		153-322		Lucas	180,0x32	Hand Brake
	3/98-10/00		R		153-350		Lucas	203,0x38	Hand Brake
	98-		R		700-238	700-238K		Ø 180,0	-ABS
	98-		R		700-245	700-245K		Ø 203,0	+ABS
	4/98-8/00		R		151-143		Bosch	Ø 22,00 228,0x42	RAI, +ABS
	97-00		R		151-133		Lucas	Ø 20,64 203,0x38	LUC, +ABS
1.9 D Eng.WJZ/ WJY(DW8/ B) (51kW)	9/98-10/00		R		153-022	153-022Y	Bdx	180,0x32	Hand Brake
	9/98-10/00		R		153-327		Bdx	228,6x42	Hand Brake
	9/98-10/00		R		153-322		Lucas	180,0x32	Hand Brake
	9/98-10/00		R		153-350		Lucas	203,0x38	Hand Brake
	98-		R		700-238	700-238K		Ø 180,0	-ABS
	98-		R		700-245	700-245K		Ø 203,0	+ABS
	98-		R		151-004		Bdx	Ø 20,64 180,0x30	CRCI, RAI, -ABS
	98-00		R		151-133		Lucas	Ø 20,64 203,0x38	LUC, +ABS
	98-8/00		R		151-143		Bosch	Ø 22,00 228,0x42	RAI, +ABS



























































		Spare Parts	F/R	L/R	CIFAM ref.	CIFAM ref. w/KIT		DIMENSIONS mm.	NOTE
1.9 D, SLD Eng.DJZ(XUD9Y) (47kW)	5/93-10/00		R		153-022	153-022Y	Bdx	180,0x32	Hand Brake
	5/93-10/00		R		153-327		Bdx	228,6x42	Hand Brake
	5/93-10/00		R		153-322		Lucas	180,0x32	Hand Brake
	5/93-10/00		R		153-350		Lucas	203,0x38	Hand Brake
	6/93-96		R		700-238	700-238K		Ø 180,0	-ABS
	6/93-96		R		700-245	700-245K		Ø 203,0	+ABS
	2/93-		R		151-004		Bdx	Ø 20,64 180,0x30	CRCI, RAI
1.9 SLD Eng.DJY(XUD9A) (50-51kW)	6/94-10/00		R		153-022	153-022Y	Bdx	180,0x32	Hand Brake
	6/94-10/00		R		153-327		Bdx	228,6x42	Hand Brake
	6/94-10/00		R		153-322		Lucas	180,0x32	Hand Brake
	6/94-10/00		R		153-350		Lucas	203,0x38	Hand Brake
	6/94-96		R		700-238	700-238K		Ø 180,0	-ABS
	6/94-96		R		700-245	700-245K		Ø 203,0	+ABS
	97-00		R		151-133		Lucas	Ø 20,64 203,0x38	LUC, +ABS
1.9 TD Eng.DHY(XUD9TE) (66-68kW)	5/93-10/00		R		153-022	153-022Y	Bdx	180,0x32	Hand Brake
	5/93-10/00		R		153-327		Bdx	228,6x42	Hand Brake
	5/93-10/00		R		153-322		Lucas	180,0x32	Hand Brake
	5/93-10/00		R		153-350		Lucas	203,0x38	Hand Brake
	6/93-		R		700-245	700-245K		Ø 203,0	+ABS
	6/93-96		R		700-238	700-238K		Ø 180,0	-ABS
	2/93-93-95		R		151-004		Bdx	Ø 20,64 180,0x30	CRCI, RAI
2/93-93-95		R		151-005		Bdx	Ø 20,64 228,6x42	RAI, +ABS	
2.0, XSi Eng.RFX(XU10J2/ 2C) (89kW)	5/93-10/00		R		153-322		Lucas	180,0x32	Hand Brake
306 (7D, N3,5) Cabrio 3/94-4/02									
1.6 Eng.NFT (72kW)	10/00-10/00		R		153-022	153-022Y	Bdx	180,0x32	
	10/00-10/00		R		153-327		Bdx	228,6x42	
	10/00-10/00		R		153-322		Lucas	180,0x32	
	10/00-10/00		R		153-350		Lucas	203,0x38	
	00-02		R		700-238	700-238K		Ø 180,0	-ABS
	00-02		R		700-245	700-245K		Ø 203,0	+ABS
	00-02		R		151-143		Bosch	Ø 22,00 228,0x42	RAI, +ABS
00-02		R		151-133		Lucas	Ø 20,64 203,0x38	LUC, +ABS	
1.6 Eng.NFZ(TU5JP) (65kW)	96-00		R		153-022	153-022Y	Bdx	180,0x32	
	96-00		R		153-327		Bdx	228,6x42	
	96-00		R		153-322		Lucas	180,0x32	
	96-00		R		153-350		Lucas	203,0x38	
	96-00		R		700-238	700-238K		Ø 180,0	-ABS
	96-00		R		700-245	700-245K		Ø 203,0	+ABS
	96-00		R		151-004		Bdx	Ø 20,64 180,0x30	CRCI, RAI
96-00		R		151-133		Lucas	Ø 20,64 203,0x38	LUC, +ABS	
1.8 Eng.LFZ(XU7JP) (74kW)	3/94-02		R		153-022	153-022Y	Bdx	180,0x32	-ABS
	3/94-02		R		153-323		Bdx	228,6x42	+ABS
	3/94-02		R		153-322		Lucas	180,0x32	-ABS
	3/94-02		R		153-350		Lucas	203,0x38	
	3/94-96		R		700-238	700-238K		Ø 180,0	-ABS
	3/94-96		R		700-245	700-245K		Ø 203,0	+ABS
	2/93-3/94-95		R		151-004		Bdx	Ø 20,64 180,0x30	CRCI, RAI
3/94-95		R		151-005		Bdx	Ø 20,64 228,6x42	RAI, +ABS	
97-02		R		151-133		Lucas	Ø 20,64 203,0x38	LUC, +ABS	
2.0 Eng.RFX(XU10J2) (89kW)	94-02		R		153-322		Lucas	180,0x32	
306 (N5) Break 5/93-10/00									
1.4 SL Eng.KFW/ KFX(TU3JP)/ KDX(TU3MC) (55kW)	97-		R		153-323		Bdx	228,6x42	+ABS, Hand Brake
	4/97-8/00		R		700-233			Ø 228,5	-ABS
	93-		R		700-245	700-245K		Ø 203,0	+ABS
1.6 Eng.NFT (72kW)	00-		R		151-143		Bosch	Ø 22,00 228,0x42	RAI, +ABS
1.6 SR Eng.NFZ(TU5JP) (65kW)	97-		R		153-323		Bdx	228,6x42	+ABS, Hand Brake
	4/97-8/00		R		700-233			Ø 228,5	-ABS
	93-00		R		700-245	700-245K		Ø 203,0	+ABS
	4/98-8/00		R		151-143		Bosch	Ø 22,00 228,0x42	RAI, +ABS
1.8 Eng.LFZ(XU7JP) (74kW)	97-		R		153-323		Bdx	228,6x42	+ABS, Hand Brake
	93-		R		700-245	700-245K		Ø 203,0	+ABS
	4/98-8/00		R		151-143		Bosch	Ø 22,00 228,0x42	RAI, +ABS
1.8 16v Eng.LFY(XU7JP4) (81kW)	3/97-10/00		R		153-323		Bdx	228,6x42	+ABS, Hand Brake
1.8 D Eng.A9A(XUD7) (43kW)	97-		R		153-323		Bdx	228,6x42	+ABS, Hand Brake
	4/97-8/00		R		700-233			Ø 228,5	-ABS
	93-02		R		700-245	700-245K		Ø 203,0	+ABS











































		Spare Parts	F/R	L/R	CIFAM ref.	CIFAM ref. w/KIT		DIMENSIONS mm.	NOTE
1.8i Eng.L6A(XU7P/ K) (69kW)	93-00		R		153-323		Bdx	228,6x42	+ABS, Hand Brake
	93-00		R		700-245	700-245K		Ø 203,0	+ABS
1.9 D Eng.DHV(XUD9BSD) (55kW)	3/98-10/00		R		153-323		Bdx	228,6x42	+ABS, Hand Brake
	98-02		R		700-245	700-245K		Ø 203,0	+ABS
	98-02		R		700-233			Ø 228,5	-ABS
	4/98-02		R		151-143		Bosch	Ø 22,00 228,0x42	RAI, +ABS
1.9 D Eng.WJZ/ WJY(DW8/ B) (51kW)	9/85-10/00		R		153-323		Bdx	228,6x42	+ABS, Hand Brake
	98-		R		700-245	700-245K		Ø 203,0	+ABS
	98-8/00		R		700-233			Ø 228,5	-ABS
	4/98-8/00		R		151-143		Bosch	Ø 22,00 228,0x42	RAI, +ABS
1.9 SLD Eng.DJY(XUD9A) (50kW)	97-		R		153-323		Bdx	228,6x42	+ABS, Hand Brake
	94-02		R		700-245	700-245K		Ø 203,0	+ABS
	94-02		R		700-233			Ø 228,5	-ABS
	94-02		R		151-143		Bosch	Ø 22,00 228,0x42	RAI, +ABS
1.9 TD Eng.DHY(XUD9TE) (66-68kW)	97-		R		153-323		Bdx	228,6x42	+ABS, Hand Brake
	93-02		R		700-245	700-245K		Ø 203,0	+ABS
	93-02		R		151-143		Bosch	Ø 22,00 228,0x42	RAI, +ABS
2.0 16v Eng.RFV(XU10J4R) (97kW)	3/97-10/00		R		153-323		Bdx	228,6x42	+ABS, Hand Brake
309 I (10C, 10A) 10/85-12/89									
1.1 Eng.E1/ A (40kW)	10/85-7/89		R		153-343	153-343K	Bdx	180,0x42	
	10/85-7/89		R			153-343Y	Bdx	180,0x42	
	10/85-7/89		R		153-344		Lucas	180,0x42	Hand Brake
	9/85-6/89		R		700-235	700-235K		Ø 180,0	
	85-6/89		R		151-011		Bdx	Ø 17,46 180,0x40	RAD
1.3 Eng.G1A (47kW)	10/85-7/89		R		153-343	153-343K	Bdx	180,0x42	
	10/85-7/89		R			153-343Y	Bdx	180,0x42	
	10/85-7/89		R		153-344		Lucas	180,0x42	Hand Brake
	9/85-6/89		R		700-235	700-235K		Ø 180,0	
	85-6/89		R		151-011		Bdx	Ø 17,46 180,0x40	RAD
1.6 (83kW)	7/86-6/89		R		153-343	153-343K	Bdx	180,0x42	
	7/86-6/89		R			153-343Y	Bdx	180,0x42	
	7/86-6/89		R		153-344		Lucas	180,0x42	Hand Brake
1.6 Eng.B1A(XU51C-K) (58kW)	10/85-7/89		R		153-343	153-343K	Bdx	180,0x42	
	10/85-7/89		R			153-343Y	Bdx	180,0x42	
	10/85-7/89		R		153-344		Lucas	180,0x42	Hand Brake
	9/85-6/89		R		700-235	700-235K		Ø 180,0	
	85-6/89		R		151-022		Bdx	Ø 22,00 180,0x40	RAD
	85-6/89		R		151-042		Lucas	Ø 22,22 180,0x40	RAI
1.6 Eng.B1E(XU51C) (53kW)	8/87-7/89		R		153-343	153-343K	Bdx	180,0x42	
	8/87-7/89		R			153-343Y	Bdx	180,0x42	
	8/87-7/89		R		153-344		Lucas	180,0x42	Hand Brake
1.6 Eng.B6B/ 180Z(XU5J) (76kW)	11/85-9/88		R		153-343	153-343K	Bdx	180,0x42	
	11/85-9/88		R			153-343Y	Bdx	180,0x42	
	11/85-9/88		R		153-344		Lucas	180,0x42	Hand Brake
	85-88		R		700-235	700-235K		Ø 180,0	
	85-88		R		151-022		Bdx	Ø 22,00 180,0x40	RAD
1.6 Eng.J2 (69kW)	1/86-7/89		R		153-343	153-343K	Bdx	180,0x42	
	1/86-7/89		R			153-343Y	Bdx	180,0x42	
	1/86-7/89		R		153-344		Lucas	180,0x42	Hand Brake
	86-89		R		700-235	700-235K		Ø 180,0	
	86-89		R		151-022		Bdx	Ø 22,00 180,0x40	RAD
	86-89		R		151-042		Lucas	Ø 22,22 180,0x40	RAI
1.6, Kat Eng.B1A/ BAZ(XU51C/ CP) (55kW)	10/85-7/89		R		153-343	153-343K	Bdx	180,0x42	
	10/85-7/89		R			153-343Y	Bdx	180,0x42	
	10/85-7/89		R		153-344		Lucas	180,0x42	Hand Brake
	9/85-6/89		R		700-235	700-235K		Ø 180,0	
	85-6/89		R		151-022		Bdx	Ø 22,00 180,0x40	RAD
	85-6/89		R		151-042		Lucas	Ø 22,22 180,0x40	RAI
1.9 Eng.D2B(XU9S) (75kW)	10/85-7/89		R		153-343	153-343K	Bdx	180,0x42	
	10/85-7/89		R			153-343Y	Bdx	180,0x42	
	10/85-7/89		R		153-344		Lucas	180,0x42	Hand Brake
1.9 Eng.DDZ(XU9M) (80kW)	7/88-7/89		R		153-343	153-343K	Bdx	180,0x42	
	7/88-7/89		R			153-343Y	Bdx	180,0x42	
	7/88-7/89		R		153-344		Lucas	180,0x42	Hand Brake
1.9 Eng.DFZ(XU9J1) (72kW)	3/86-7/89		R		153-343	153-343K	Bdx	180,0x42	
	3/86-7/89		R			153-343Y	Bdx	180,0x42	
	3/86-7/89		R		153-344		Lucas	180,0x42	Hand Brake































		Spare Parts	F/R	L/R	CIFAM ref.	CIFAM ref. w/KIT		DIMENSIONS mm.	NOTE	
1.9 Eng.DFZ(XU9J1) (72kW)	86-89		R		700-235	700-235K		Ø 180,0		
	86-89		R		151-022		Bdx	Ø 22,00 180,0x40	RAD	
	86-89		R		151-042		Lucas	Ø 22,22 180,0x40	RAI	
1.9 D Eng.16Z/ D9A(XUD9)/ DJZ(XUD9Y) (47kW)	86-89		R		700-235	700-235K		Ø 180,0		
	86-89		R		151-022		Bdx	Ø 22,00 180,0x40	RAD, Exc. GTi, 16v	
	86-89		R		151-042		Lucas	Ø 22,22 180,0x40	RAI, Exc. GTi, 16v	
1.9 GTi Eng.D6B(XU9JA/ Z/ 2C/ S) (88-94-96kW)	10/86-7/89		R		153-343	153-343K	Bdx	180,0x42		
	10/86-7/89		R			153-343Y	Bdx	180,0x42		
	10/86-7/89		R		153-344		Lucas	180,0x42	Hand Brake	
1.9 GTI Eng.DKZ(XU9JA/ Z/ 2C/ S) (77-88-96kW)	7/88-7/89		R		153-343	153-343K	Bdx	180,0x42		
	7/88-7/89		R			153-343Y	Bdx	180,0x42		
	7/88-7/89		R		153-344		Lucas	180,0x42	Hand Brake	
309 II (3A/C) 7/89-12/93										
1.1 Eng.HDZ(TU1M/ MZ) (44kW)	8/90-12/93		R			153-320Y	Bdx	180,0x32		
	8/90-12/93		R		153-320	153-320K	Bdx	180,0x32	Hand Brake	
	8/90-12/93		R			153-329Y	Bdx	180,0x32	Hand Brake	
	8/90-12/93		R		153-322		Lucas	180,0x32	Hand Brake	
	8/90-12/93		R		153-344		Lucas	180,0x42	Hand Brake	
	90-93		R		700-235	700-235K		Ø 180,0	+ABS	
	90-93		R		700-238	700-238K		Ø 180,0	-ABS	
	90-93		R		151-009		Bdx	Ø 20,64 180,0x30	CRCl, RAD	
	90-93		R		151-051		Lucas	Ø 20,64 180,0x30	CRCl, RAI	
1.4 Eng.K1D(TU3A/ AN/ S/ M/ 2/ 2K/ MC) (47-49-55kW)	7/90-12/93		R			153-320Y	Bdx	180,0x32		
	7/90-12/93		R		153-320	153-320K	Bdx	180,0x32	Hand Brake	
	7/90-12/93		R			153-329Y	Bdx	180,0x32	Hand Brake	
	7/90-12/93		R		153-322		Lucas	180,0x32	Hand Brake	
	7/90-12/93		R		153-344		Lucas	180,0x42	Hand Brake	
	90-93		R		700-235	700-235K		Ø 180,0	+ABS	
	90-93		R		700-238	700-238K		Ø 180,0	-ABS	
	90-93		R		151-009		Bdx	Ø 20,64 180,0x30	CRCl, RAD	
	90-93		R		151-051		Lucas	Ø 20,64 180,0x30	CRCl, RAI	
1.4 Eng.KDY/ KDZ(TU3A/ AN/ S/ M/ 2/ 2K/ MC/ F2) (47-55kW)	7/89-12/93		R			153-320Y	Bdx	180,0x32		
	7/89-12/93		R		153-320	153-320K	Bdx	180,0x32	Hand Brake	
	7/89-12/93		R			153-329Y	Bdx	180,0x32	Hand Brake	
	7/89-12/93		R		153-322		Lucas	180,0x32	Hand Brake	
	7/89-12/93		R		153-344		Lucas	180,0x42	Hand Brake	
	89-93		R		700-235	700-235K		Ø 180,0	+ABS	
	89-93		R		700-238	700-238K		Ø 180,0	-ABS	
	89-93		R		151-009		Bdx	Ø 20,64 180,0x30	CRCl, RAD	
	89-93		R		151-051		Lucas	Ø 20,64 180,0x30	CRCl, RAI	
1.6 Eng.B2A(XU52C-K) (68-69kW)	7/89-12/93		R		153-344		Lucas	180,0x42	Hand Brake	
	89-93		R		700-235	700-235K		Ø 180,0	+ABS	
	89-93		R		700-238	700-238K		Ø 180,0	-ABS	
	89-93		R		151-060		Lucas	Ø 20,64 180,0x42	CRCl, RAI	
	1.6 Eng.BDY(XU5M2Z/ 3Z)/ BDZ(XU5M) (65kW)	7/89-12/93		R		153-344		Lucas	180,0x42	Hand Brake
		89-93		R		700-235	700-235K		Ø 180,0	+ABS
		89-93		R		700-238	700-238K		Ø 180,0	-ABS
		89-93		R		151-060		Lucas	Ø 20,64 180,0x42	CRCl, RAI
	1.8 D Eng.161A(XUD7) (44kW)	7/89-12/93		R		153-344		Lucas	180,0x42	Hand Brake
89-93			R		700-235	700-235K		Ø 180,0	+ABS	
89-93			R		700-238	700-238K		Ø 180,0	-ABS	
89-93			R		151-060		Lucas	Ø 20,64 180,0x42	CRCl, RAI	
1.8 TD Eng.A8B(XUD7TE) (57-66kW)	8/89-12/93		R		153-344		Lucas	180,0x42	Hand Brake	
	89-93		R		700-235	700-235K		Ø 180,0	+ABS	
	89-93		R		700-238	700-238K		Ø 180,0	-ABS	
	89-93		R		151-060		Lucas	Ø 20,64 180,0x42	CRCl, RAI	
1.9 Eng.DDZ(XU9M) (80kW)	10/90-12/93		R		153-344		Lucas	180,0x42	Hand Brake	
1.9 Eng.DFZ(XU9J1) (72kW)	8/89-12/93		R		153-344		Lucas	180,0x42	Hand Brake	
	89-93		R		700-235	700-235K		Ø 180,0	+ABS	
	89-93		R		700-238	700-238K		Ø 180,0	-ABS	
1.9 D Eng.16Z/ D9A(XUD9)/ DJZ(XUD9Y) (47kW)	7/89-12/93		R		153-344		Lucas	180,0x42	Hand Brake	
	89-93		R		700-235	700-235K		Ø 180,0	+ABS	
	89-93		R		700-238	700-238K		Ø 180,0	-ABS	
	89-93		R		151-060		Lucas	Ø 20,64 180,0x42	CRCl, RAI	
1.9 GTI Eng.DKZ(XU9JA/ Z) (88kW)	7/89-12/93		R		153-344		Lucas	180,0x42	Hand Brake	

		Spare Parts	F/R	L/R	CIFAM ref.	CIFAM ref. w/KIT		DIMENSIONS mm.	NOTE
1.9 Sport MI-16 Eng.D6C(XU9J4) (116-118kW)	8/89-7/90		R		153-344		Lucas	180,0x42	Hand Brake
1.9 Sport MI-16 Eng.DFW(XU9J4Z) (108kW)	10/90-12/93		R		153-344		Lucas	180,0x42	Hand Brake
4007 (GP) 8/07-									
2.2 HDi 16v Eng.DW12M (115kW)	8/07-		R		153-268	153-268K		190,0x32	Hand Brake
2.4 16v Eng.4B12 (125kW)	1/08-		R		153-268	153-268K		190,0x32	Hand Brake
404 4/63-12/71									
Thermostable	63-71		R		700-233			Ø 228,5	
405 I (15B) 1/87-12/93									
1.4 Eng.KDY(TU3A/ AN/ S/ M/ 2/ 2K) (47kW)	1/87-7/92		R		153-323		Bdx	228,6x42	-ABS, Hand Brake
	1/87-7/92		R		153-475		Lucas	228,6x42	+ABS, Hand Brake
	87-92		R		700-233			Ø 228,5	
	87-92		R		151-012		Bdx	Ø 20,64 228,0x42	CRCI, RAI
	87-92		R		151-087		Lucas	Ø 20,64 228,0x40	LUC, ABS:Bendix, +ABS
1.6 Eng.B1E(XU51C) (53kW)	7/87-12/92		R		153-323		Bdx	228,6x42	-ABS, Hand Brake
	7/87-12/92		R		153-475		Lucas	228,6x42	+ABS, Hand Brake
	87-92		R		700-233			Ø 228,5	
	87-92		R		151-012		Bdx	Ø 20,64 228,0x42	CRCI, RAI
	87-92		R		151-087		Lucas	Ø 20,64 228,0x40	LUC, ABS:Bendix, +ABS
1.6 Eng.B2A(XU52C)/ S (66-69kW)	1/87-12/92		R		153-323		Bdx	228,6x42	-ABS, Hand Brake
	1/87-12/92		R		153-475		Lucas	228,6x42	+ABS, Hand Brake
	87-92		R		700-233			Ø 228,5	
	87-92		R		151-012		Bdx	Ø 20,64 228,0x42	CRCI, RAI
	87-92		R		151-087		Lucas	Ø 20,64 228,0x40	LUC, ABS:Bendix, +ABS
1.6 Eng.BAZ(XU5CP) (55kW)	7/87-6/88		R		153-323		Bdx	228,6x42	-ABS, Hand Brake
	7/87-6/88		R		153-475		Lucas	228,6x42	+ABS, Hand Brake
	87-88		R		700-233			Ø 228,5	
	87-88		R		151-012		Bdx	Ø 20,64 228,0x42	CRCI, RAI
	87-88		R		151-087		Lucas	Ø 20,64 228,0x40	LUC, ABS:Bendix, +ABS
1.6 Eng.BDY(XU5M2Z/ 3Z)/ BDZ(XU5M) (65-66-69kW)	7/87-12/92		R		153-323		Bdx	228,6x42	-ABS, Hand Brake
	7/87-12/92		R		153-475		Lucas	228,6x42	+ABS, Hand Brake
	87-92		R		700-233			Ø 228,5	
	87-92		R		151-012		Bdx	Ø 20,64 228,0x42	CRCI, RAI
	87-92		R		151-087		Lucas	Ø 20,64 228,0x40	LUC, ABS:Bendix, +ABS
1.8 TD Eng.A8A(XUD7TE)/ AJZ(XUD7TEY) (66kW)	3/88-12/92		R		153-323		Bdx	228,6x42	-ABS, Hand Brake
	3/88-12/92		R		153-475		Lucas	228,6x42	+ABS, Hand Brake
	88-92		R		700-233			Ø 228,5	
	88-92		R		151-012		Bdx	Ø 20,64 228,0x42	CRCI, RAI
	88-92		R		151-087		Lucas	Ø 20,64 228,0x40	LUC, ABS:Bendix, +ABS
1.9 Eng.D2C(XU92C) (70kW)	7/87-12/92		R		153-323		Bdx	228,6x42	-ABS, Hand Brake
	7/87-12/92		R		153-475		Lucas	228,6x42	+ABS, Hand Brake
	87-92		R		700-233			Ø 228,5	
	87-92		R		151-012		Bdx	Ø 20,64 228,0x42	CRCI, RAI
	87-92		R		151-087		Lucas	Ø 20,64 228,0x40	LUC, ABS:Bendix, +ABS
1.9 D Eng.D9B(XUD9A) (51kW)	3/88-12/92		R		153-323		Bdx	228,6x42	-ABS, Hand Brake
	3/88-12/92		R		153-475		Lucas	228,6x42	+ABS, Hand Brake
	88-92		R		700-233			Ø 228,5	
	88-92		R		151-012		Bdx	Ø 20,64 228,0x42	CRCI, RAI
	88-92		R		151-087		Lucas	Ø 20,64 228,0x40	LUC, ABS:Bendix, +ABS
1.9 D Eng.DJZ(XUD9Y) (47kW)	7/88-9/92		R		153-323		Bdx	228,6x42	-ABS, Hand Brake
	7/88-9/92		R		153-475		Lucas	228,6x42	+ABS, Hand Brake
	88-92		R		700-233			Ø 228,5	
	88-92		R		151-012		Bdx	Ø 20,64 228,0x42	CRCI, RAI
	88-92		R		151-087		Lucas	Ø 20,64 228,0x40	LUC, ABS:Bendix, +ABS
1.9 GRi/SRI 4WD Eng.DDZ(XU9M) (80kW)	88-92		R		700-233			Ø 228,5	
1.9 GTi Eng.DKZ(XU9JA/ Z/ 2C/ S) (88-96kW)	88-92		R		700-233			Ø 228,5	
	88-92		R		151-012		Bdx	Ø 20,64 228,0x42	CRCI, RAI
	88-92		R		151-087		Lucas	Ø 20,64 228,0x40	LUC, ABS:Bendix, +ABS
1.9i Eng.DFZ(XU9J1) (77kW)	87-92		R		700-233			Ø 228,5	
	87-92		R		151-012		Bdx	Ø 20,64 228,0x42	CRCI, RAI
	87-92		R		151-087		Lucas	Ø 20,64 228,0x40	LUC, ABS:Bendix, +ABS
405 I (15E) Break 1/87-12/92									
1.6 Eng.B1E(XU51C) (53kW)	7/87-12/92		R		153-475		Lucas	228,6x42	Hand Brake
	87-92		R		700-233			Ø 228,5	+ABS
	87-92		R		151-087		Lucas	Ø 20,64 228,0x40	LUC, ABS:Bendix, +ABS

























		Spare Parts	F/R	L/R	CIFAM ref.	CIFAM ref. w/KIT		DIMENSIONS mm.	NOTE	
1.6 Eng.B2A(XU52C)/ S (66-69kW)	1/87-12/92		R		153-475		Lucas	228,6x42	Hand Brake	
	87-92		R		700-233			Ø 228,5	+ABS	
	87-92		R		151-087		Lucas	Ø 20,64 228,0x40	LUC, ABS:Bendix, +ABS	
1.6 Eng.BAZ(XU5CP) (55kW)	7/87-6/88		R		153-475		Lucas	228,6x42	Hand Brake	
	87-88		R		700-233			Ø 228,5	+ABS	
	87-88		R		151-087		Lucas	Ø 20,64 228,0x40	LUC, ABS:Bendix, +ABS	
1.6 Eng.BDY(XU5M2Z/ 3Z)/ BDZ(XU5M) (65-66kW)	7/87-12/92		R		153-475		Lucas	228,6x42	Hand Brake	
	87-92		R		700-233			Ø 228,5	+ABS	
	87-92		R		151-087		Lucas	Ø 20,64 228,0x40	LUC, ABS:Bendix, +ABS	
1.8 TD Eng.A8A(XUD7TE)/ AJZ(XUD7TEY) (66kW)	3/88-12/92		R		153-475		Lucas	228,6x42	Hand Brake	
	1.9 Eng.D2C(XU92C) (70kW)	7/87-12/92		R		153-475		Lucas	228,6x42	Hand Brake
		1.9 D Eng.D9B(XUD9A) (51kW)	3/88-12/92		R		153-475		Lucas	228,6x42
88-92			R		700-233			Ø 228,5	+ABS	
88-92		R		151-087		Lucas	Ø 20,64 228,0x40	LUC, ABS:Bendix, +ABS		
	1.9 D Eng.DJZ(XUD9Y) (47kW)	7/88-9/92		R		153-475		Lucas	228,6x42	Hand Brake
88-92			R		700-233			Ø 228,5	+ABS	
88-92			R		151-087		Lucas	Ø 20,64 228,0x40	LUC, ABS:Bendix, +ABS	
1.9 GRI/SRI Eng.DDZ(XU9M) (80kW)	88-92		R		700-233			Ø 228,5	+ABS	
	88-92		R		151-087		Lucas	Ø 20,64 228,0x40	LUC, ABS:Bendix, +ABS	
405 II (4B) 8/92-10/96										
1.4 Eng.KDY/ KDZ(TU3A/ AN/ S/ M/ 2/ 2K/ MC/ F2) (47-55kW)	8/92-10/96		R		153-323		Bdx	228,6x42	-ABS, Hand Brake	
	8/92-10/96		R		153-023		Lucas	228,6x42	Hand Brake	
	8/92-10/96		R		153-475		Lucas	228,6x42	ABS:Bendix, +ABS, Hand Brake	
	92-96		R		700-233			Ø 228,5		
	92-96		R		151-012		Bdx	Ø 20,64 228,0x42	CRCI, RAI	
1.6 Eng.BDY(XU5M2Z/ 3Z)/ XU5JP (65-66-69-76-85kW)	8/92-10/95		R		153-323		Bdx	228,6x42	-ABS, Hand Brake	
	8/92-10/95		R		153-475		Lucas	228,6x42	ABS:Bendix, +ABS, Hand Brake	
	92-95		R		700-233			Ø 228,5		
	92-95		R		151-012		Bdx	Ø 20,64 228,0x42	CRCI, RAI	
	92-95		R		151-087		Lucas	Ø 20,64 228,0x40	LUC, ABS:Bendix, +ABS	
1.8 Eng.LFZ(XU7JP) (74kW)	8/92-10/95		R		153-323		Bdx	228,6x42	-ABS, Hand Brake	
	8/92-10/95		R		153-475		Lucas	228,6x42	ABS:Bendix, +ABS, Hand Brake	
	92-95		R		151-087		Lucas	Ø 20,64 228,0x40	LUC, ABS:Bendix, +ABS	
1.9 D Eng.DJY(XUD9A) (50kW)	6/94-10/95		R		153-323		Bdx	228,6x42	-ABS, Hand Brake	
	6/94-10/95		R		153-475		Lucas	228,6x42	ABS:Bendix, +ABS, Hand Brake	
1.9 D Eng.DJZ(XUD9Y) (47kW)	8/92-10/95		R		153-323		Bdx	228,6x42	-ABS, Hand Brake	
	8/92-10/95		R		153-475		Lucas	228,6x42	ABS:Bendix, +ABS, Hand Brake	
	92-95		R		700-233			Ø 228,5		
92-95		R		151-087		Lucas	Ø 20,64 228,0x40	LUC, ABS:Bendix, +ABS		
405 II (4E) Break 8/92-10/96										
1.4 Eng.KDY/ KDZ(TU3A/ AN/ S/ M/ 2/ 2K/ MC/ F2) (47-55kW)	8/92-10/96		R		153-023		Lucas	228,6x42	Ch S71211990-, ABS:Bosch, +/-ABS, Hand Brake	
	92-96		R		700-233			Ø 228,5		
	92-96		R		151-087		Lucas	Ø 20,64 228,0x40	LUC, ABS:Bendix, +ABS	
1.6 Eng.BDY(XU5M2Z/ 3Z)/ XU5JP (65-66-69-76-85kW)	8/92-10/95		R		153-475		Lucas	228,6x42	Ch -S71211989, ABS:Bendix, +/-ABS, Hand Brake	
	8/92-10/95		R		153-023		Lucas	228,6x42	Ch S71211990-, ABS:Bosch, +/-ABS, Hand Brake	
	92-95		R		700-233			Ø 228,5		
	2/94-10/95		R		151-137		Lucas	Ø 20,64 228,6x40	LUC	
	92-95		R		151-087		Lucas	Ø 20,64 228,0x40	LUC, ABS:Bendix, +ABS	
1.8 Eng.LFZ(XU7JP) (74kW)	8/92-10/95		R		153-475		Lucas	228,6x42	Ch -S71211989, ABS:Bendix, +/-ABS, Hand Brake	
	8/92-10/95		R		153-023		Lucas	228,6x42	Ch S71211990-, ABS:Bosch, +/-ABS, Hand Brake	
	2/94-10/95		R		151-137		Lucas	Ø 20,64 228,6x40	LUC	
	92-95		R		151-087		Lucas	Ø 20,64 228,0x40	LUC, ABS:Bendix, +ABS	
	1.9 Eng.D2A(XU92C) (77kW)	92-95		R		700-233			Ø 228,5	
92-95			R		151-087		Lucas	Ø 20,64 228,0x40	LUC, ABS:Bendix, +ABS	
1.9 D Eng.DJY(XUD9A) (50-51kW)	6/94-10/95		R		153-475		Lucas	228,6x42	Ch -S71211989, ABS:Bendix, +/-ABS, Hand Brake	
	6/94-10/95		R		153-023		Lucas	228,6x42	Ch S71211990-, ABS:Bosch, +/-ABS, Hand Brake	
	94-95		R		700-233			Ø 228,5		
	94-95		R		151-087		Lucas	Ø 20,64 228,0x40	LUC, ABS:Bendix, +ABS	
	94-95		R		151-137		Lucas	Ø 20,64 228,6x40	LUC	

























































		Spare Parts	F/R	L/R	CIFAM ref.	CIFAM ref. w/KIT		DIMENSIONS mm.	NOTE
1.9 D Eng.DJZ(XUD9Y) (47kW)	8/92-10/95		R		153-475		Lucas	228,6x42	Ch -S71211989, ABS:Bendix, +/-ABS, Hand Brake
	8/92-10/95		R		153-023		Lucas	228,6x42	Ch S71211990-, ABS:Bosch, +/-ABS, Hand Brake
	92-95		R		700-233			Ø 228,5	
	2/94-10/95		R		151-137		Lucas	Ø 20,64 228,6x40	LUC
	92-95		R		151-087		Lucas	Ø 20,64 228,0x40	LUC, ABS:Bendix, +ABS
1.9 TD Eng.DHY(XUD9TE) (66-68kW)	8/92-10/95		R		153-023		Lucas	228,6x42	Ch S71211990-, -ABS, Hand Brake
2.0 X4 Eng.RFX(XU10J2/ 2C) (89kW)	8/92-10/95		R		153-023		Lucas	228,6x42	FWD, Hand Brake
406 (8B/E/F), Break, Coupe 11/95-5/04									
1.6 (Exc. Break) Eng.BFZ(XU5JP/ J1/ JA) (65-76-85kW)	11/95-5/04		R		153-326		Bdx	228,6x42	
	10/95-95-95		R		700-233			Ø 228,5	
	95-95		R		151-078		Bdx	Ø 20,64 228,0x40	RAI, +ABS
	95-95		R		151-077		Bdx	Ø 20,64 228,0x40	RAI, -ABS
1.8 Eng.LFX(XU7JB) (66kW)	5/97-5/04		R		153-326		Bdx	228,6x42	
	97-04		R		700-233			Ø 228,5	
	97-04		R		151-078		Bdx	Ø 20,64 228,0x40	RAI, +ABS
	97-04		R		151-077		Bdx	Ø 20,64 228,0x40	RAI, -ABS
1.8 Eng.LFZ(XU7JP) (74kW)	1/95-5/04		R		153-326		Bdx	228,6x42	
1.8 16v Eng.6FZ(EW7J4) (85kW)	10/00-5/04		R		153-326		Bdx	228,6x42	
1.8 16v Eng.LFY(XU7JP4) (81kW)	11/95-10/00		R		153-326		Bdx	228,6x42	
	95-00		R		700-233			Ø 228,5	
	95-00		R		151-078		Bdx	Ø 20,64 228,0x40	RAI, +ABS
	95-00		R		151-077		Bdx	Ø 20,64 228,0x40	RAI, -ABS
1.9 D Eng.DHW(XUD9SD/ BSD) (55kW)	10/96-5/04		R		153-326		Bdx	228,6x42	
	96-04		R		700-233			Ø 228,5	
	96-04		R		151-078		Bdx	Ø 20,64 228,0x40	RAI, +ABS
	96-04		R		151-077		Bdx	Ø 20,64 228,0x40	RAI, -ABS
1.9 TD Eng.DHX(XUD9TE) (66-68kW)	1/96-5/04		R		153-326		Bdx	228,6x42	
	96-04		R		700-233			Ø 228,5	
	96-04		R		151-078		Bdx	Ø 20,64 228,0x40	RAI, +ABS
	96-04		R		151-077		Bdx	Ø 20,64 228,0x40	RAI, -ABS
1.9 TD (Exc. Break) Eng.DHY(XUD9TE) (66-68kW)	1/96-5/04		R		153-326		Bdx	228,6x42	
	96-04		R		700-233			Ø 228,5	
	96-04		R		151-078		Bdx	Ø 20,64 228,0x40	RAI, +ABS
	96-04		R		151-077		Bdx	Ø 20,64 228,0x40	RAI, -ABS
2.0 16v HPI Eng.RLZ(EW10D) (103kW)	5/01-5/04		R		153-330	153-330K	Ate	185,0x30	
	5/01-5/04		R		153-326		Bdx	228,6x42	
2.0 16v, Coupe Eng.RFN(EW10J4) (100kW)	8/00-5/04		R		153-330	153-330K	Ate	185,0x30	
	8/00-5/04		R		153-326		Bdx	228,6x42	
2.0 16v, Coupe Eng.RFR(DEW10J4) (99kW)	1/99-8/00		R		153-330	153-330K	Ate	185,0x30	
	1/99-8/00		R		153-326		Bdx	228,6x42	
2.0 16v, Coupe Eng.RFV(XU10J4R) (97kW)	11/95-5/04		R		153-330	153-330K	Ate	185,0x30	
	11/95-5/04		R		153-326		Bdx	228,6x42	
2.0 HDi Eng.RHZ(DW10ATED) (80kW)	2/99-8/01		R		153-330	153-330K	Ate	185,0x30	
2.0 HDi FAP Eng.RHS(DW10ATED4) (79kW)	8/01-5/04		R		153-330	153-330K	Ate	185,0x30	
2.0 T. Eng.RGX(XU10J2TE) (108kW)	4/96-5/04		R		153-330	153-330K	Ate	185,0x30	
	4/96-5/04		R		153-326		Bdx	228,6x42	
2.1 TD 12v Eng.PHZ/ P8C(XUD11ATE/ BTE) (80kW)	1/96-5/04		R		153-330	153-330K	Ate	185,0x30	
3.0 V6 24v, Coupe Eng.XFX(ES9J4S) (152kW)	3/00-5/04		R		153-330	153-330K	Ate	185,0x30	
504 7/68-7/86									
1.8 Eng.XM1 (60kW)	68-71		R		700-231			Ø 255,0	Incl. Camionette
1.8 Eng.XM7 (58kW)	71-83		R		700-231			Ø 255,0	Incl. Camionette
1.8i Eng.KF5/ KF6 (71kW)	68-71		R		700-231			Ø 255,0	Incl. Camionette
1.9 D Eng.XD4x88 (37-40kW)	73-86		R		700-231			Ø 255,0	Incl. Camionette
2.0 Eng.106(XN1/ A/ P/ T) (71kW)	71-86		R		700-231			Ø 255,0	Incl. Camionette
2.0 Coupe, Cabrio Eng.106(XN1A) (75kW)	10/74-8/82		R		153-011	153-011K	Ate	160,0x25	Hand Brake
	11/74-82		R		700-231			Ø 255,0	Incl. Camionette
2.0 TI, Coupe, Cabrio Eng.107(XN2) (64-78kW)	1/71-8/84		R		153-011	153-011K	Ate	160,0x25	Hand Brake
71-84		R		700-231			Ø 255,0	Incl. Camionette	





























































		Spare Parts	F/R	L/R	CIFAM ref.	CIFAM ref. w/KIT		DIMENSIONS mm.	NOTE
2.1 D Eng.XD4x90 (48kW)	71-86		R		700-231			Ø 255,0	Incl. Camionette
2.3 D Eng.134(XD2) (51kW)	75-83		R		700-231			Ø 255,0	Incl. Camionette
2.7 Coupe Eng.140(ZMJ) (106kW)	77-84		R		700-231			Ø 255,0	Incl. Camionette
505 (551A) 8/79-12/93									
1.6 Eng.XC7/ P (44kW)	82-86		R		700-231			Ø 255,0	
1.8 Eng.105(XM7/ A) (60-62kW)	82-86		R		700-231			Ø 255,0	
1.8 Eng.105(XM7/ P) (55kW)	81-85		R		700-231			Ø 255,0	
2.0 Eng.106(XN1/ A/ P/ T) (71-72kW)	80-91		R		700-231			Ø 255,0	
2.3 D Eng.147(XD2) (47-51-59kW)	82-86		R		700-231			Ø 255,0	
2.3 TD Eng.147(XD2S) (54-59kW)	80-86		R		700-231			Ø 255,0	
2.5 D Eng.155(XD3) (51-55kW)	81-93		R		700-231			Ø 255,0	
2.5 TD Eng.152A(XD3T) (66kW)	83-93		R		700-231			Ø 255,0	
2.5 TD Eng.152B(XD3TE) (77kW)	86-93		R		700-231			Ø 255,0	
505 Break (551D) 6/81-12/93									
1.8 Eng.105(XM7/ A) (60-62kW)	82-86		R		700-231			Ø 255,0	
1.8 Eng.105(XM7/ P) (55kW)	81-85		R		700-231			Ø 255,0	
2.0 Eng.106(XN1) (69kW)	83-85		R		700-231			Ø 255,0	
2.0 Eng.106E(XN1A) (72kW)	85-87		R		700-231			Ø 255,0	
2.2 Eng.851X(ZDJL) (84-85kW)	86-93		R		700-231			Ø 255,0	
2.2 GTI Eng.851B(ZDJL) (85-96kW)	85-86		R		700-231			Ø 255,0	
2.3 D Eng.147(XD2) (51kW)	82-84		R		700-231			Ø 255,0	
2.3 D Eng.147(XD2) (59kW)	82-86		R		700-231			Ø 255,0	
2.5 D Eng.155(XD3) (51-55-66kW)	86-93		R		700-231			Ø 255,0	
2.5 D Eng.155(XD3) (55kW)	83-93		R		700-231			Ø 255,0	
2.5 TD Eng.152A(XD3T) (66kW)	85-87		R		700-231			Ø 255,0	
2.5 TD Eng.152B(XD3TE) (77kW)	86-93		R		700-231			Ø 255,0	
605 (6B) 6/89-9/99									
1.8 TD Eng.A8A(XUD7TE)/ AJZ(XUD7TEY) (66kW)	1/88-12/92		R		153-325	153-325K	Bdx	185,0x20	Hand Brake
2.0 Eng.R5A(XU102C) (84kW)	6/89-9/99		R		153-325	153-325K	Bdx	185,0x20	Hand Brake
2.0 Eng.R5A(XU10M) (79kW)	2/90-9/99		R		153-325	153-325K	Bdx	185,0x20	Hand Brake
2.0 Eng.RFZ(XU10J2Z) (89kW)	6/89-9/99		R		153-325	153-325K	Bdx	185,0x20	Hand Brake
2.0 16v Eng.RFV(XU10J4R) (97kW)	7/94-9/99		R		153-325	153-325K	Bdx	185,0x20	Hand Brake
2.0 T. Eng.RGX(XU10J2TE) (108kW)	7/91-9/99		R		153-325	153-325K	Bdx	185,0x20	Hand Brake
2.0 T. Eng.RGY(XU10J2TE) (104kW)	7/92-9/99		R		153-325	153-325K	Bdx	185,0x20	Hand Brake
2.1 D Eng.P9A(XUD11A) (60kW)	6/89-7/95		R		153-325	153-325K	Bdx	185,0x20	Hand Brake
2.1 TD 12v Eng.P8C(XUD11BTE) (80kW)	8/94-9/99		R		153-325	153-325K	Bdx	185,0x20	Hand Brake
2.1 TD 12v Eng.PHZ(XUD11ATE) (80kW)	6/89-9/99		R		153-325	153-325K	Bdx	185,0x20	Hand Brake
2.5 TD Eng.THY(DK5ATE) (95kW)	7/94-9/99		R		153-325	153-325K	Bdx	185,0x20	Hand Brake
3.0 V6 12v Eng.UFZ(ZPJ) (123kW)	10/89-9/99		R		153-325	153-325K	Bdx	185,0x20	Hand Brake
3.0 V6 12v Eng.XFZ(ES9J4) (140kW)	4/97-9/99		R		153-325	153-325K	Bdx	185,0x20	Hand Brake
3.0 V6 24v Eng.UKZ(ZPJ4Z) (147kW)	8/89-9/99		R		153-325	153-325K	Bdx	185,0x20	Hand Brake
607 (9D) 2/00-									
2.0 16v Eng.RFN(EW10J4) (100kW)	2/00-		R		153-330	153-330K	Ate	185,0x30	
2.0 HDi Eng.RHS(DW10ATED) (79kW)	3/01-7/04		R		153-330	153-330K	Ate	185,0x30	
2.0 HDi Eng.RHZ(DW10ATED) (80kW)	5/00-		R		153-330	153-330K	Ate	185,0x30	
2.0 HDi 16v Eng.RHR(DW10BTED4) (100kW)	9/05-		R		153-330	153-330K	Ate	185,0x30	
2.2 16v Eng.3FY(EW12J4) (120kW)	9/05-		R		153-330	153-330K	Ate	185,0x30	
2.2 16v Eng.3FZ(EW12J4) (116kW)	2/00-		R		153-330	153-330K	Ate	185,0x30	
2.2 HDi Eng.4HX(DW12TED4-FAP) (98kW)	2/00-		R		153-330	153-330K	Ate	185,0x30	
2.2 HDi 16v Eng.4HT(DW12BTED4) (125kW)	5/06-		R		153-330	153-330K	Ate	185,0x30	
2.7 HDi 24v Eng.DT17TED4 (150kW)	12/04-		R		153-330	153-330K	Ate	185,0x30	

















		Spare Parts	F/R	L/R	CIFAM ref.	CIFAM ref. w/KIT		DIMENSIONS mm.	NOTE
3.0 V6 24v Eng.XFV(ES9A) (155kW)	3/04-		R		153-330	153-330K	Ate	185,0x30	
3.0 V6 24v Eng.XFX(ES9J4S) (152kW)	2/00-		R		153-330	153-330K	Ate	185,0x30	
806 (221) 6/94-8/02									
1.8 Eng.LFW(XU7JP) (73kW)	7/95-8/02		R		153-074	153-074Y	Bdx	256,0x61	Hand Brake
	6/95-95-		R		700-017			Ø 255,0	
			R		151-066		Bdx	Ø 19,05 255,0x60	RAI
1.9 TD Eng.DHX(XUD9TE) (66-68kW)	7/95-8/02		R			153-331K		180,0x31	Hand Brake
	7/95-8/02		R		153-331		Ate	180,0x31	Hand Brake
	7/95-8/02		R		153-325	153-325K	Bdx	185,0x20	Hand Brake
	95-8/02		R		700-017			Ø 255,0	
1.9 TD Eng.DHY(XUD9TE) (66-68kW)	5/97-8/02		R			153-331K		180,0x31	Hand Brake
	5/97-8/02		R		153-331		Ate	180,0x31	Hand Brake
	5/97-8/02		R		153-325	153-325K	Bdx	185,0x20	Hand Brake
	97-02		R		700-017			Ø 255,0	
2.0 Eng.RFU(XU10J2) (89kW)	6/94-8/02		R			153-331K		180,0x31	Hand Brake
	6/94-8/02		R		153-331		Ate	180,0x31	Hand Brake
	6/94-8/02		R		153-074	153-074Y	Bdx	256,0x61	Hand Brake
	6/94-5/99		R		700-017			Ø 255,0	
	94-99		R		151-066		Bdx	Ø 19,05 255,0x60	RAI
2.0 16v Eng.RFN(EW10J4) (100kW)	9/00-8/02		R			153-331K		180,0x31	Hand Brake
	9/00-8/02		R		153-331	153-331K	Ate	180,0x31	Hand Brake
2.0 16v Eng.RFV(XU10J4R) (97kW)	5/98-9/00		R		153-331		Ate	180,0x31	Hand Brake
2.0 HDi, 16v Eng.RHW/RHZ(DW10ATED4) (80kW)	99-02		R		700-017			Ø 255,0	
2.0 T. Eng.RGX(XU10J2TE) (108kW)	6/94-8/02		R			153-331K		180,0x31	Hand Brake
	6/94-8/02		R		153-331	153-331K	Ate	180,0x31	Hand Brake
2.1 TD 12v Eng.PHZ/P8C(XUD11ATE/ BTE) (80kW)	6/96-8/99		R		153-331		Ate	180,0x31	Hand Brake
	3/96-5/99		R		700-017			Ø 255,0	
	96-99		R		151-066		Bdx	Ø 19,05 255,0x60	RAI

PEUGEOT LCV







106 Van 1/94-12/05									
1.5 D Eng.VJY/ X(TUD5) (40-42kW)	1/94-12/05		R			153-320Y	Bdx	180,0x32	
	1/94-12/05		R		153-320	153-320K	Bdx	180,0x32	Hand Brake
	1/94-12/05		R			153-329Y	Bdx	180,0x32	Hand Brake
205 Van 10/87-									
1.1 Eng.109N(XW7) (36kW)	10/87-9/98		R			153-320Y	Bdx	180,0x32	
	10/87-9/98		R		153-320	153-320K	Bdx	180,0x32	Hand Brake
	10/87-9/98		R			153-329Y	Bdx	180,0x32	Hand Brake
	10/87-9/98		R		153-344		Lucas	180,0x42	Hand Brake
	87-98		R		700-234	700-234K		Ø 180,0	
	87-98		R		151-010		Bdx	Ø 19,05 180,0x30	CRCI, RAD, +Servo
1.1 Eng.H1B(TU1) (40kW)	8/87-7/90		R			153-320Y	Bdx	180,0x32	
	8/87-7/90		R		153-320	153-320K	Bdx	180,0x32	Hand Brake
	8/87-7/90		R			153-329Y	Bdx	180,0x32	Hand Brake
	8/87-7/90		R		153-344		Lucas	180,0x42	Hand Brake
	8/87-7/90		R			153-320Y	Bdx	180,0x32	
1.4 (44kW)	2/83-7/87		R			153-320Y	Bdx	180,0x32	
	2/83-7/87		R		153-320	153-320K	Bdx	180,0x32	Hand Brake
	2/83-7/87		R			153-329Y	Bdx	180,0x32	Hand Brake
	2/83-7/87		R		153-344		Lucas	180,0x42	Hand Brake
1.8 D Eng.161A(XUD7) (44kW)	3/94-		R			153-320Y	Bdx	180,0x32	
	3/94-		R		153-320	153-320K	Bdx	180,0x32	Hand Brake
	3/94-		R			153-329Y	Bdx	180,0x32	Hand Brake
	3/94-		R		153-344		Lucas	180,0x42	Hand Brake
	94-		R		700-235	700-235K		Ø 180,0	
206 Van 1/01-									
1.4 HDi Eng.DV4TD (50kW)	1/01-		R		153-350		Lucas	203,0x38	Hand Brake
	9/01-3/06		R		153-328		Bdx	180,0x32	
	9/01-3/06		R		153-332		Lucas	203,0x39	
	01-		R		700-246	700-246K		Ø 203,0	+ABS
	01-		R		151-134		Lucas	Ø 20,64 203,0x38	LUC, +ABS
	01-		R		151-193		Lucas	Ø 20,64 203,0x39	Ch 09457-, LUC, +ABS
207 Van 10/09-									
1.4 HDi Eng.8HZ(DV4TD) (50kW)	09-		R		153-333			228,6x42	
	09-		R		151-205		Bosch	Ø 20,64 228,6x42	CRCI, RAI, -ABS

		Spare Parts	F/R	L/R	CIFAM ref.	CIFAM ref. w/KIT		DIMENSIONS mm.	NOTE
306 Van 5/93-									
1.4 SL Eng.KFW/ KFX(TU3JP)/ KDX(TU3MC) (55kW)	5/93-93-		R		153-323		Bdx	228,6x42	-ABS, Hand Brake
			R		700-233			Ø 228,5	
1.6 SR, Cabrio Eng.NFZ(TU5JP) (65kW)	5/93-10/00		R		153-323		Bdx	228,6x42	-ABS, Hand Brake
	93-00		R		700-233			Ø 228,5	
1.8 D Eng.A9A(XUD7) (43kW)	5/93-93-		R		153-323		Bdx	228,6x42	-ABS, Hand Brake
			R		700-233			Ø 228,5	
1.9 D Eng.DHV(XUD9BSD) (55kW)	3/98-98-		R		153-323		Bdx	228,6x42	-ABS, Hand Brake
			R		700-233			Ø 228,5	
1.9 STD Eng.DJY(XUD9A) (50kW)	6/94-94-		R		153-323		Bdx	228,6x42	-ABS, Hand Brake
			R		700-233			Ø 228,5	
1.9 TD Eng.DHY(XUD9TE) (66-68-69kW)	5/93-		R		153-323		Bdx	228,6x42	-ABS, Hand Brake
Bipper (AA) 2/08-									
1.4 Eng.KFV(TU3A) (54kW)	2/08-08-		R		153-099		Ap	228,6x43	Hand Brake
			R		151-227		Ap	Ø 20,64 228,6x43	AP
1.4 HDi Eng.DV4TED (50kW)	2/08-08-		R		153-099		Ap	228,6x43	Hand Brake
			R		151-227		Ap	Ø 20,64 228,6x43	AP
Boxer I (230) 3/94-4/02									
1.9 D Eng.D8C(XUD9AU) (51kW)	3/94-4/02		R		153-082		Ap	254,0x57	
	3/94-4/02		R		153-072		Lucas	254,0x57	Hand Brake
	94-02		R		700-013			Ø 254,0	10-14Q
	94-02		R		151-073		Lucas	Ø 25,40 254,0x57	LUC, 10-14Q
	94-02		R		151-074		Lucas	Ø 28,60 254,0x57	LUC, 18Q
1.9 D Eng.DJY(XUD9A) (50kW)	7/99-4/02		R		153-082		Ap	254,0x57	
	7/99-4/02		R		153-072		Lucas	254,0x57	Hand Brake
	99-02		R		700-013			Ø 254,0	10-14Q
	99-02		R		151-073		Lucas	Ø 25,40 254,0x57	LUC, 10-14Q
	99-02		R		151-074		Lucas	Ø 28,60 254,0x57	LUC, 18Q
1.9 TD, 4WD Eng.D8C(XUD9UTF) (68kW)	3/94-4/02		R		153-082		Ap	254,0x57	
	3/94-4/02		R		153-072		Lucas	254,0x57	Hand Brake
	2/94-		R		700-013			Ø 254,0	10-14Q
	94-02		R		151-073		Lucas	Ø 25,40 254,0x57	LUC, 10-14Q
	94-02		R		151-074		Lucas	Ø 28,60 254,0x57	LUC, 18Q
1.9 TD, 4WD Eng.DHY(XUD9TE) (66-68kW)	8/94-4/02		R		153-082		Ap	254,0x57	
	8/94-4/02		R		153-072		Lucas	254,0x57	Hand Brake
	2/94-		R		700-013			Ø 254,0	10-14Q
	94-02		R		151-073		Lucas	Ø 25,40 254,0x57	LUC, 10-14Q
	94-02		R		151-074		Lucas	Ø 28,60 254,0x57	LUC, 18Q
2.0 HDi Eng.RHV(DW10UTD) (62kW)	8/01-4/02		R		153-089	153-089K		170,0x45	
	01-02		R		151-073		Lucas	Ø 25,40 254,0x57	LUC, 10-14Q
	01-02		R		151-074		Lucas	Ø 28,60 254,0x57	LUC, 18Q
2.0, 4WD Eng.RFW(XU10J2/ C) (80kW)	6/94-4/02		R		153-082		Ap	254,0x57	
	6/94-4/02		R		153-072		Lucas	254,0x57	Hand Brake
	6/94-4/02		R		153-073		Lucas	254,0x57	Hand Brake
	94-02		R		700-013			Ø 254,0	10-14Q
	94-02		R		700-016			Ø 254,0	18Q
	94-02		R		151-073		Lucas	Ø 25,40 254,0x57	LUC, 10-14Q
	94-02		R		151-074		Lucas	Ø 28,60 254,0x57	LUC, 18Q
2.5 D, 4WD Eng.T9A(DJ5) (63kW)	3/94-4/02		R		153-072		Lucas	254,0x57	Hand Brake
	3/94-4/02		R		153-073		Lucas	254,0x57	Hand Brake
	2/94-		R		700-013			Ø 254,0	10-14Q
	2/94-		R		700-016			Ø 254,0	18Q
	94-02		R		151-073		Lucas	Ø 25,40 254,0x57	LUC, 10-14Q
	94-02		R		151-074		Lucas	Ø 28,60 254,0x57	LUC, 18Q
2.5 DT (62kW)	10/97-11/01		R		153-072		Lucas	254,0x57	Hand Brake
	10/97-11/01		R		153-073		Lucas	254,0x57	Hand Brake
2.5 TD, 4WD Eng.T8A(DJ5T) (76-95kW)	3/94-4/02		R		153-072		Lucas	254,0x57	Hand Brake
	3/94-4/02		R		153-073		Lucas	254,0x57	Hand Brake
	2/94-		R		700-013			Ø 254,0	10-14Q
	2/94-		R		700-016			Ø 254,0	18Q
	94-02		R		151-075		Lucas	Ø 27,00 254,0x57	LUC, 14Q
	94-02		R		151-074		Lucas	Ø 28,60 254,0x57	LUC, 18Q
2.5 TDi, 4WD Eng.THX(DJ5TED) (79kW)	1/97-4/02		R		153-072		Lucas	254,0x57	Hand Brake
	1/97-4/02		R		153-073		Lucas	254,0x57	Hand Brake
	97-02		R		700-013			Ø 254,0	10-14Q
	97-02		R		700-016			Ø 254,0	18Q
	97-02		R		151-075		Lucas	Ø 27,00 254,0x57	LUC, 14Q





		Spare Parts	F/R	L/R	CIFAM ref.	CIFAM ref. w/KIT		DIMENSIONS mm.	NOTE
2.5 TDi, 4WD Eng.THX(DJ5TED) (79kW)	97-02		R		151-074		Lucas	Ø 28,60 254,0x57	LUC, 18Q
2.8 HDi, 4WD Eng.8140.43S (93-94kW)	11/00-4/02		R		153-089	153-089K		170,0x45	
	11/00-4/02		R		153-082		Ap	254,0x57	
	00-02		R		700-016			Ø 254,0	18Q
	00-02		R		151-074		Lucas	Ø 28,60 254,0x57	LUC, 18Q
Boxer II (244) 4/02-3/06									
2.0 Eng.RFL(XU10J2U) (81kW)	4/02-3/06		R		153-089	153-089K		170,0x45	
	4/02-3/06		R		153-082		Ap	254,0x57	
2.0 HDi Eng.RHV(DW10UTD) (62kW)	4/02-3/06		R		153-089	153-089K		170,0x45	
	4/02-3/06		R		153-082		Ap	254,0x57	
2.2 HDi Eng.4HY(DW12UTED) (74kW)	4/02-3/06		R		153-089	153-089K		170,0x45	
	4/02-3/06		R		153-082		Ap	254,0x57	
2.8 HDi Eng.8140.43N (107kW)	4/04-3/06		R		153-089	153-089K		170,0x45	
	4/04-3/06		R		153-082		Ap	254,0x57	
2.8 HDi, 4WD Eng.8140.43S (94kW)	4/02-3/06		R		153-089	153-089K		170,0x45	
	4/02-3/06		R		153-082		Ap	254,0x57	
Boxer III 4/06-									
2.2 HDi Eng.4HU (88kW)	4/06-		R		153-094			172,0x40	
	4/06-		R			153-095K		172,0x40	
2.2 HDi Eng.DW12TED (74kW)	1/06-		R		153-094			172,0x40	
	1/06-		R			153-095K		172,0x40	
Expert I (222,223,224) 2/96-12/06									
1.6 Eng.220A2.000 (58kW)	2/96-12/06		R		153-074	153-074Y	Bdx	256,0x61	Hand Brake
	96-		R		700-017			Ø 255,0	Ch -8206
	96-		R		151-066		Bdx	Ø 19,05 255,0x60	RAI
1.8 Eng.LFW(XU7JP) (66-74kW)	2/96-12/06		R		153-074	153-074Y	Bdx	256,0x61	Hand Brake
1.9 D Eng.D9B/ C(XUD9/ AU/ Y) (48-51kW)	2/96-12/06		R		153-074	153-074Y	Bdx	256,0x61	Hand Brake
	96-		R		700-017			Ø 255,0	Ch -8206
	96-		R		151-066		Bdx	Ø 19,05 255,0x60	RAI
1.9 D Eng.WJZ(DW8) (51kW)	12/98-12/06		R		153-074	153-074Y	Bdx	256,0x61	Hand Brake
	98-		R		700-017			Ø 255,0	Ch -8206
	98-		R		151-066		Bdx	Ø 19,05 255,0x60	RAI
1.9 TD Eng.DHX(XUD9TE) (66-68kW)	2/96-12/06		R		153-074	153-074Y	Bdx	256,0x61	Hand Brake
	96-		R		700-017			Ø 255,0	Ch -8206
	96-		R		151-066		Bdx	Ø 19,05 255,0x60	RAI
2.0 16v Eng.RFN(EW10J4) (100kW)	7/00-12/06		R		153-073		Lucas	254,0x57	Hand Brake
2.0 HDi Eng.RHX(DW10BTED) (69kW)	00-		R		700-017			Ø 255,0	
	00-		R		151-066		Bdx	Ø 19,05 255,0x60	RAI
2.0 HDi, 16v Eng.RHW/ RHZ(DW10ATED4) (80kW)	00-06		R		700-017			Ø 255,0	
	00-06		R		151-066		Bdx	Ø 19,05 255,0x60	RAI
Expert II Tepee (VF3V) 1/07-									
1.6 HDi 16v Eng.DV6UTED4 (66kW)	1/07-		R		153-073		Lucas	254,0x57	Hand Brake
	07-		R		151-169		Lucas	Ø 22,20 254,0x57	LUC
2.0 HDi Eng.DW10UTED4 (88kW)	07-		R		151-169		Lucas	Ø 22,20 254,0x57	LUC
2.0 HDi 16v Eng.RHR(DW10BTED4) (100kW)	07-		R		151-169		Lucas	Ø 22,20 254,0x57	LUC
J5 (280/290) 9/81-									
1.8 Eng.169B(XM7T) (51kW)	1/83-11/88		R		153-062		Lucas	254,0x57	Hand Brake
	83-		R		700-013			Ø 254,0	
	83-88		R		151-103		Lucas	Ø 22,22 254,0x57	Ch 0077160-, LUC, 8Q
	83-88		R		151-102		Lucas	Ø 25,40 254,0x57	LUC, 10-14Q
1.9 D Eng.D9B(XUD9/ A/ Y) (51kW)	10/90-		R		153-062		Lucas	254,0x57	Hand Brake
	90-		R		700-013			Ø 254,0	
	90-		R		151-102		Lucas	Ø 25,40 254,0x57	LUC, 10-14Q
	90-		R		151-065		Lucas	Ø 27,00 254,0x57	LUC, 18Q
2.0 Eng.170A/ B(XN1P/ T) (58kW)	1/83-9/90		R		153-062		Lucas	254,0x57	Hand Brake
	83-		R		700-013			Ø 254,0	
	1/83-12/83		R		151-101		Lucas	Ø 22,22 254,0x57	LUC, 10-14Q
	83-90		R		151-102		Lucas	Ø 25,40 254,0x57	LUC, 10-14Q
2.0 Eng.170B/ XN1T (55kW)	83-90		R		151-065		Lucas	Ø 27,00 254,0x57	LUC, 18Q
	9/81-9/90		R		153-062		Lucas	254,0x57	Hand Brake
	10/81-		R		700-013			Ø 254,0	
2.0 Eng.170D(XN1TACP) (62kW)	81-90		R		151-102		Lucas	Ø 25,40 254,0x57	LUC, 10-14Q
	81-90		R		151-065		Lucas	Ø 27,00 254,0x57	LUC, 18Q
	10/90-		R		153-062		Lucas	254,0x57	Hand Brake
90-		R		700-013			Ø 254,0		

		Spare Parts	F/R	L/R	CIFAM ref.	CIFAM ref. w/KIT		DIMENSIONS mm.	NOTE
2.0 Eng.170D(XN1TACP) (62kW)	90-		R		151-102		Lucas	Ø 25,40 254,0x57	LUC, 10-14Q
	90-		R		151-065		Lucas	Ø 27,00 254,0x57	LUC, 18Q
2.5 D, 4WD Eng.CRD93(U25-661/651/ 673) (54-55-70kW)	9/81-		R		153-068		Lucas	254,0x57	
	9/81-		R		153-062		Lucas	254,0x57	Hand Brake
	10/81-		R		700-013			Ø 254,0	
	81-		R		151-101		Lucas	Ø 22,22 254,0x57	LUC, 10-14Q
	81-		R		151-102		Lucas	Ø 25,40 254,0x57	LUC, 10-14Q
	81-		R		151-065		Lucas	Ø 27,00 254,0x57	LUC, 18Q
2.5 TD, 4WD Eng.CRD93LS(U25-673) (55-70kW)	10/90-		R		153-068		Lucas	254,0x57	
	10/90-		R		153-062		Lucas	254,0x57	Hand Brake
	90-		R		700-013			Ø 254,0	
	90-		R		151-102		Lucas	Ø 25,40 254,0x57	LUC, 10-14Q
	90-		R		151-065		Lucas	Ø 27,00 254,0x57	LUC, 18Q



























J7 8/68-3/80

1.5 Eng.XB5P (61kW)	68-70		R		700-243			Ø 300,0	
1.6 Eng.XC5/ P (50kW)	73-80		R		700-243			Ø 300,0	
1.6 Eng.XC7/ P (44kW)	73-80		R		700-243			Ø 300,0	
1.8 Eng.105(XM7/ P) (48kW)	70-80		R		700-243			Ø 300,0	
1.9 D Eng.XDP88 (37-40kW)	73-78		R		700-243			Ø 300,0	
2.1 D Eng.XDPX90 (41-42kW)	9/73-77		R		700-243			Ø 300,0	
2.3 D Eng.XD2PX94 (49kW)	77-80		R		700-243			Ø 300,0	

J9 3/80-6/87

1.6 Eng.XC7/ P (44kW)	80-87		R		700-243			Ø 300,0	
2.0 Eng.XN1/ P/ T/ XNA (57kW)	80-87		R		700-243			Ø 300,0	
2.1 D Eng.XDPX90 (41-42kW)	80-87		R		700-243			Ø 300,0	
2.3 D Eng.XD2PX94 (49kW)	80-82		R		700-243			Ø 300,0	
2.5 D Eng.XD3P (53kW)	82-87		R		700-243			Ø 300,0	

Partner/Ranch I (5F) 6/96-3/08





1.1 Eng.HDZ(TU1M)/ HFX(TU1JP) (44kW)	6/96-3/08		R		153-023		Lucas	228,6x42	Hand Brake
	7/96-		R		700-233			Ø 228,5	
	96-		R		151-140		Lucas	Ø 22,00 228,6x42	LUC
1.4 Eng.KDY(TU3A/ AN/ S/ M/ 2/ 2K) (47kW)	1/96-3/08		R		153-023		Lucas	228,6x42	Hand Brake
	06-08		R		153-023		Lucas	228,6x42	
	06-08		R		700-233			Ø 228,5	
1.4, Bifuel Eng.KFW/ KFX(TU3JP) (55kW)	6/96-3/08		R		153-023		Lucas	Ø 22,00 228,6x42	LUC
	7/96-		R		700-233			Ø 228,5	
	96-		R		151-140		Lucas	Ø 22,00 228,6x42	LUC
1.6 16v Eng.NFU(TU5JP4) (80kW)	7/01-3/08		R		153-023		Lucas	228,6x42	Hand Brake
	01-		R		700-233			Ø 228,5	
	01-		R		151-140		Lucas	Ø 22,00 228,6x42	LUC
1.8 Eng.LFX(XU7JB) (66kW)	5/97-3/08		R		153-023		Lucas	228,6x42	Hand Brake
	5/97-		R		700-233			Ø 228,5	
	97-		R		151-140		Lucas	Ø 22,00 228,6x42	LUC
1.8 D Eng.A9A(XUD7) (43kW)	96-		R		700-233			Ø 228,5	
	96-		R		151-140		Lucas	Ø 22,00 228,6x42	LUC
1.9 D Eng.DJY(XUD9A/ DW8/ B) (50kW)	6/96-3/08		R		153-023		Lucas	228,6x42	Hand Brake
	96-		R		700-233			Ø 228,5	
	96-		R		151-140		Lucas	Ø 22,00 228,6x42	LUC
1.9 D, 4WD Eng.WJZ/ WJY(DW8/ B) (51kW)	12/98-3/08		R		153-023		Lucas	228,6x42	Hand Brake
	98-		R		700-233			Ø 228,5	
	98-		R		151-140		Lucas	Ø 22,00 228,6x42	LUC
2.0 HDi, 4WD Eng.RHY(DW10TD) (66kW)	00-08		R		153-023		Lucas	228,6x42	Hand Brake
	00-08		R		700-233			Ø 228,5	
	00-08		R		151-140		Lucas	Ø 22,00 228,6x42	LUC





Partner/Ranch II, Tepee 4/08-

1.6 HDi Eng.9HX(DV6ATED4) (66kW)	08-		R		700-233			Ø 228,5	
----------------------------------	-----	---	---	--	---------	--	--	---------	--

PIAGGIO





Porter, Van 2/93-

1.0 Eng.CB41 (33kW)	2/93-6/94		R		153-040			200,0x38	
	2/93-6/94		R		153-044		Ap	203,2x38	
1.0 Eng.CB42 (35kW)	7/94-		R		153-040			200,0x38	
	7/94-		R		153-044		Ap	203,2x38	
1.2 D Eng.LDW12 (26kW)	5/95-		R		153-044		Ap	203,2x38	









		Spare Parts	F/R	L/R	CIFAM ref.	CIFAM ref. w/KIT		DIMENSIONS mm.	NOTE
1.3 16v, 4WD (48kW)	5/98-		R		153-044		Ap	203,2x38	
1.4 D (28kW)	4/98-		R		153-044		Ap	203,2x38	

PORSCHE











911 (964) 12/88-5/94

3.3 T. Eng.M30.69 (235kW)	8/90-9/93		R		153-336			180,0x26	Hand Brake
3.3 T. S Eng.M30.69S (261kW)	6/91-12/92		R		153-336			180,0x26	Hand Brake
3.6 Carrera RS Eng.M64.03 (191kW)	6/91-9/93		R		153-336			180,0x26	Hand Brake
3.6 Carrera, 4, Cabrio Eng.M64.01/.02 (184kW)	12/88-5/94		R		153-336			180,0x26	Hand Brake
3.6 T. Eng.M64.50 (265kW)	1/93-9/93		R		153-336			180,0x26	Hand Brake







911 (993) 10/93-9/97

3.6 Carrera, 4, Cabrio Eng.M64.05/.06/.07/.08 (200kW)	10/93-8/95		R		153-336			180,0x26	Hand Brake
3.6 Carrera, 4, Cabrio, Targa Eng.M64.21/.22/.23/.24 (210kW)	8/95-9/97		R		153-336			180,0x26	Hand Brake
3.6 T. 4 Eng.M64.60 (300kW)	3/95-9/97		R		153-336			180,0x26	Hand Brake
3.6 T. GT2 4 (331kW)	6/97-9/97		R		153-336			180,0x26	Hand Brake
3.6 T. GT2, 4 Eng.M64.60R (316kW)	3/95-9/97		R		153-336			180,0x26	Hand Brake
3.8 Cabrio Carrera RS, 4 Eng.M64.21S (221kW)	8/95-9/97		R		153-336			180,0x26	Hand Brake
3.8 Carrera RS, 4, Targa Eng.M64.20 (221kW)	8/95-9/97		R		153-336			180,0x26	Hand Brake
3.8 Carrera, 4, Cabrio Eng.M64.05S/.06S (210kW)	6/95-9/97		R		153-336			180,0x26	Hand Brake







911 (996) 6/97-3/04

3.4 Carrera, 4, Cabrio Eng.M96.01/.02/.04 (221kW)	6/97-9/01		R		153-336			180,0x26	Hand Brake
3.4 Carrera, 4, Cabrio Eng.M96.02S (235kW)	5/01-3/04		R		153-337			180,0x26	Hand Brake
3.6 Carrera, 4, Cabrio Eng.M96.03S (254kW)	6/02-3/04		R		153-337			180,0x26	Hand Brake
3.6 Carrera, 4, Cabrio, Targa Eng.M96.03 (235kW)	10/01-3/04		R		153-337			180,0x26	Hand Brake
3.6 GT2 Eng.M96.70S (340kW)	4/01-3/04		R		153-337			180,0x26	Hand Brake
3.6 GT2 Eng.M96.70SL (355kW)	10/03-3/04		R		153-336			180,0x26	Hand Brake
3.6 GT3 Eng.M79.80 (280kW)	3/03-3/04		R		153-336			180,0x26	Hand Brake
3.6 GT3 Eng.M96.76 (265kW)	3/99-3/04		R		153-336			180,0x26	Hand Brake
3.6 T. 4, Cabrio Eng.M96.70 (309kW)	6/00-3/04		R		153-337			180,0x26	Hand Brake
3.6 T. 4, Cabrio Eng.M96.70E (331kW)	2/03-3/04		R		153-337			180,0x26	Hand Brake

911 (997) 7/04-

3.6 Carrera, Cabrio Eng.M96.05 (239kW)	04-08		R		153-336			180,0x26	Hand Brake
3.6 GT 2 Eng.M97.70S (390kW)	07-9/07-		R		153-512			180x25	
			R		153-336			180,0x26	Hand Brake
3.6 GT 3 Eng.M97.76 (305kW)	06-3/06-		R		153-512			180x25	
			R		153-336			180,0x26	Hand Brake
3.6 GT2 RS Eng.M97.70 (456kW)	10-		R		153-512			180x25	
3.8 GT3 Eng.M97.77 (320kW)	09-5/09-		R		153-512			180x25	
			R		153-336			180,0x26	Hand Brake
3.8 GT3 RS Eng.M97.77 (331kW)	09-		R		153-512			180x25	
4.0 GT3 RS Eng.M97.74 (368kW)	11-		R		153-512			180x25	





924 11/75-8/89

2.0 Eng.XJ (92kW)	11/75-8/89		R		153-459		Vag	230,0x40	Hand Brake
2.0 Carrera GT Eng.M31.50 (154kW)	6/80-10/86		R		153-459		Vag	230,0x40	Hand Brake
2.0 T. Eng.M31.01 (125kW)	11/78-6/80		R		153-459		Vag	230,0x40	Hand Brake
2.0 T. Eng.M31.03 (130kW)	6/80-10/86		R		153-459		Vag	230,0x40	Hand Brake
2.5 S Eng.M44.01/.03 (120kW)	10/81-12/84		R		153-459		Vag	230,0x40	Hand Brake
2.5 S Eng.M44.07/.08 (110kW)	9/85-7/87		R		153-336			180,0x26	Hand Brake
2.5 S Eng.M44.09/.10 (118kW)	8/87-7/88		R		153-336			180,0x26	Hand Brake









928 9/77-11/95

4.4 Eng.M28.09/.10 (177kW)	9/77-8/82		R		153-336			180,0x26	Hand Brake
----------------------------	-----------	---	---	--	----------------	--	--	----------	------------











































		Spare Parts	F/R	L/R	CIFAM ref.	CIFAM ref. w/KIT		DIMENSIONS mm.	NOTE
4.6 (200kW)	8/84-7/85		R		153-336			180,0x26	Hand Brake
4.6 S Eng.M28.11/ .12 (221kW)	9/79-7/83		R		153-336			180,0x26	Hand Brake
4.6 S Eng.M28.21/ .22 (228kW)	8/83-7/86		R		153-336			180,0x26	Hand Brake
5.0 GT Eng.M28.47 (236-243kW)	1/89-7/91		R		153-336			180,0x26	Hand Brake
5.0 S, S4, Kat Eng.M28.41/ .42 (235-236kW)	8/86-7/91		R		153-336			180,0x26	Hand Brake
944 6/81-7/91									
2.5 Eng.M44.01/ .03/ .05/ .06 (120kW)	-83		R		153-459		Vag	230,0x40	Hand Brake
2.5 Eng.M44.02/ .04/ .07/ .08 (110kW)	-83		R		153-459		Vag	230,0x40	Hand Brake
Boxster I (986) 9/96-11/07									
2.5 Eng.M96.20 (150kW)	9/96-8/99		R		153-336			180,0x26	Hand Brake
2.7 Eng.M96.22 (162kW)	99-02		R		153-336			180,0x26	Hand Brake
2.7 Eng.M96.23 (168kW)	7/02-11/07		R		153-337			180,0x26	Hand Brake
2.7 Eng.M96.25 (176kW)	04-07		R		153-337			180,0x26	Hand Brake
3.2 S Eng.M96.21 (185kW)	99-02		R		153-336			180,0x26	Hand Brake
3.2 S Eng.M96.24 (191kW)	02-07		R		153-336			180,0x26	Hand Brake
3.2 S Eng.M96.24 (196kW)	04-07		R		153-336			180,0x26	Hand Brake
3.2 S Eng.M96.26 (206kW)	04-07		R		153-336			180,0x26	Hand Brake
Boxster II (987) 12/07-3/12									
2.7 Eng.M97.20 (180kW)	07-09		R		153-337			180,0x26	Hand Brake
2.9 Eng.MA1.20 (188kW)	09-		R		153-337			180,0x26	Hand Brake
3.4 S Eng.M97.21 (217kW)	12/07-		R		153-336			180,0x26	Hand Brake
3.4 S Eng.M97.22 (223kW)	08-		R		153-336			180,0x26	Hand Brake
3.4 S Eng.MA1.21 (228kW)	09-		R		153-336			180,0x26	Hand Brake
Carrera GT 7/03-									
5.7 Eng.M80.01 (450kW)	7/03-		R		153-336			180,0x26	Hand Brake
Cayenne (955) 9/02-									
3.2 Eng.BFD (184kW)	10/03-		R		153-244	153-244K		210,0x31	Hand Brake
4.5 S Eng.M48.00 (250kW)	9/02-		R		153-244	153-244K		210,0x31	Hand Brake
4.5 T. Eng.M48.50 (331kW)	9/02-		R		153-244	153-244K		210,0x31	Hand Brake
4.5 T. S Eng.M48.50S (368kW)	1/04-		R		153-244	153-244K		210,0x31	Hand Brake
4.5 T. S Eng.M48.50T (383kW)	3/06-		R		153-244	153-244K		210,0x31	Hand Brake
Cayenne II 5/10-									
3.0 (279kW)	6/10-		R		153-528			210x31	
3.0 D Eng.MCR.CA (180kW)	6/10-		R		153-528			210x31	
3.0 D Eng.MCR.CB (155kW)	6/10-		R		153-528			210x31	
3.6 Eng.M55.02 (220kW)	6/10-		R		153-528			210x31	
4.8 (270kW)	6/10-		R		153-528			210x31	
4.8 Eng.M48.02 (294kW)	6/10-		R		153-528			210x31	
4.8 Turbo Eng.M48.52 (397kW)	6/10-		R		153-528			210x31	
S Hybrid 3.0 Eng.MCGFA/ EA (245kW)	6/10-		R		153-528			210x31	
Cayman 11/05-									
3.4 S Eng.M97.21 (217kW)	11/05-		R		153-337			180,0x26	Hand Brake
Panamera 5/09-									
3.6 Eng.M46.20/ .40 (220kW)	5/10-		R		153-511			180x25	
4.8 GTS Eng.M48.40 (316kW)	12-		R		153-511			180x25	
4.8 S Eng.M48.20/ .40 (294kW)	9/09-		R		153-511			180x25	
4.8 T Eng.M48.70 (368kW)	9/09-		R		153-511			180x25	
4.8 T Eng.M48.70 (397kW)	8/10-		R		153-511			180x25	
4.8 TS Eng.M48.70 (408kW)	11-		R		153-511			180x25	
PROTON									
Persona 300 3/96-									
313i Eng.G13B (55kW)	3/96-		R		153-258		Ake	180,0x37	Hand Brake
315 GLi/GLSi Eng.4G15P (66kW)	3/96-		R		153-258		Ake	180,0x37	Hand Brake
315 GLSi Eng.G15B (64kW)	9/96-		R		153-258		Ake	180,0x37	Hand Brake
Persona 400 1/94-									
413 Eng.4G13 (55kW)	1/94-		R		153-258		Ake	180,0x37	Hand Brake
415 GLi/GLSi Eng.4G15 (66kW)	1/94-		R		153-258		Ake	180,0x37	Hand Brake
420 GLS D Eng.4D68 (48kW)	5/96-		R		153-258		Ake	180,0x37	Hand Brake
Saga									
All models	85-90		R		153-253	153-253Y	Ake	180,0x36	Mod. C21,22, Hand Brake
	90-		R		153-258		Ake	180,0x37	Mod. C52, Hand Brake



























		Spare Parts	F/R	L/R	CIFAM ref.	CIFAM ref. w/KIT		DIMENSIONS mm.	NOTE
Wira 8/00-									
1.3 Eng.4G13 (55kW)	8/00-		R		153-258		Ake	180,0x37	Hand Brake
1.5 Eng.4G15M (64kW)	8/00-		R		153-258		Ake	180,0x37	Hand Brake















RELIANT

































































Fox 1/82-1/90									
All models	1/82-1/90		F		153-003		Ap	177,8x38	
	1/82-1/90		R		153-004		Ap	177,8x32	Hand Brake
Kitten, SW 1/75-12/83									
0.85 (30kW)	1/75-12/83		F		153-003		Ap	177,8x38	
	1/75-12/83		R		153-004		Ap	177,8x32	Hand Brake
Scimitar Cabrio 1/80-12/85									
2.8 GTC (99kW)	1/80-12/85		R		153-007		Ap	254,0x45	
Scimitar Roadster 1/85-12/90									
1.8 Ti Eng.CA18ET (99kW)	1/86-8/90		R		153-004		Ap	177,8x32	Hand Brake
Scimitar SW 1/68-12/86									
2.8 GTE (99kW)	1/80-12/86		R		153-007		Ap	254,0x45	
3.0 GTE (99kW)	1/68-12/79		R		153-007		Ap	254,0x45	























































RENAULT



































































Clio I (B/C57, 5/357) 5/90-9/98									
1.1 (B/C571) Eng.C1E700 (25-33-35kW)	1/91-9/98		R		153-345	153-345Y	Bdx	180,0x42	Hand Brake
	1/91-9/98		R		153-344		Lucas	180,0x42	Hand Brake
	1/91-9/98		R		700-142	700-142K		Ø 180,2	
	1/91-3/91		R		151-013		Bdx	Ø 20,64 180,0x40	CRCI, RAI
	3/91-9/98		R		151-014		Bdx	Ø 20,64 180,0x40	CRCI, RAI
1.2 (5/357Y, 5/357K) Eng.D7F730 (40-43kW)	3/91-9/98		R		151-048		Lucas	Ø 20,64 180,0x40	CRCI, RAI
	1/96-9/98		R		153-345	153-345Y	Bdx	180,0x42	Hand Brake
	1/96-9/98		R		153-344		Lucas	180,0x42	Hand Brake
	96-98		R		700-142	700-142K		Ø 180,2	
	96-98		R		151-014		Bdx	Ø 20,64 180,0x40	CRCI, RAI
1.2 (B/C/S572) Eng.E5F710 (44kW)	96-98		R		151-048		Lucas	Ø 20,64 180,0x40	CRCI, RAI
	5/90-3/96		R		153-345	153-345Y	Bdx	180,0x42	Hand Brake
	5/90-3/96		R		153-344		Lucas	180,0x42	Hand Brake
	90-96		R		700-142	700-142K		Ø 180,2	
	3/91-96		R		151-014		Bdx	Ø 20,64 180,0x40	CRCI, RAI
1.2 (B/C/S577) Eng.C3G720 (40kW)	3/91-96		R		151-048		Lucas	Ø 20,64 180,0x40	CRCI, RAI
	5/90-3/91		R		151-013		Bdx	Ø 20,64 180,0x40	CRCI, RAI
	1/96-12/96		R		153-345	153-345Y	Bdx	180,0x42	Hand Brake
	1/96-12/96		R		153-344		Lucas	180,0x42	Hand Brake
	1/96-12/96		R		700-142	700-142K		Ø 180,2	
1.2 (B/C/S57A/R/S, 5/357F/L/R) Eng.E7F700/ 750/ 708/ 706/ C3G (40-43kW)	1/96-12/96		R		151-014		Bdx	Ø 20,64 180,0x40	CRCI, RAI
	1/96-12/96		R		151-048		Lucas	Ø 20,64 180,0x40	CRCI, RAI
	5/90-9/98		R		153-345	153-345Y	Bdx	180,0x42	Hand Brake
	5/90-9/98		R		153-344		Lucas	180,0x42	Hand Brake
	5/90-98		R		700-142	700-142K		Ø 180,2	
1.4 (B/C57T/Y/J) Eng.E7J710/ 711/ 718/ 719/ 754/ 756/ 757 (55-58-59kW)	3/91-98		R		151-014		Bdx	Ø 20,64 180,0x40	CRCI, RAI
	3/91-98		R		151-048		Lucas	Ø 20,64 180,0x40	CRCI, RAI
	5/90-3/91		R		151-013		Bdx	Ø 20,64 180,0x40	CRCI, RAI
	1/91-9/98		R		153-345	153-345Y	Bdx	180,0x42	Hand Brake
	1/91-9/98		R		153-344		Lucas	180,0x42	Hand Brake
1.7 (B/C574) Eng.F2N770 (55-59-64-68kW)	1/91-9/98		R		700-142	700-142K		Ø 180,2	
	1/91-3/91		R		151-013		Bdx	Ø 20,64 180,0x40	CRCI, RAI
	3/91-12/93		R		151-014		Bdx	Ø 20,64 180,0x40	CRCI, RAI
	3/91-12/93		R		151-048		Lucas	Ø 20,64 180,0x40	CRCI, RAI
	1/91-12/93		R		153-345	153-345Y	Bdx	180,0x42	Hand Brake
1.8 Eng.F3P714/ 758 (70kW)	1/91-9/98		R		153-344		Lucas	180,0x42	Hand Brake
	1/91-9/98		R		153-345	153-345Y	Bdx	180,0x42	Hand Brake
1.8 (B/C578) Eng.F3P754/ 755 (64-66kW)	8/94-9/98		R		153-344		Lucas	180,0x42	Hand Brake
	8/94-9/98		R		153-345	153-345Y	Bdx	180,0x42	Hand Brake
	94-98		R		700-142	700-142K		Ø 180,2	
	94-98		R		151-014		Bdx	Ø 20,64 180,0x40	CRCI, RAI
	94-98		R		151-048		Lucas	Ø 20,64 180,0x40	CRCI, RAI





















		Spare Parts	F/R	L/R	CIFAM ref.	CIFAM ref. w/KIT		DIMENSIONS mm.	NOTE
1.8 (B/C57C/U) Eng.F3P710/ 714 (65kW)	1/91-9/98		R		153-345	153-345Y	Bdx	180,0x42	Hand Brake
	1/91-9/98		R		153-344		Lucas	180,0x42	Hand Brake
	91-98		R		700-142	700-142K		Ø 180,2	
	91-98		R		151-014		Bdx	Ø 20,64 180,0x40	CRCI, RAI
	91-98		R		151-048		Lucas	Ø 20,64 180,0x40	CRCI, RAI
1.8 16v (C57D) Eng.F7P722 (99-101kW)	8/91-6/94		R		153-345	153-345Y	Bdx	180,0x42	Hand Brake
	8/91-6/94		R		153-344		Lucas	180,0x42	Hand Brake
1.8 Rsi (B/C579) Eng.F3P712 (79kW)	1/93-8/95		R		153-345	153-345Y	Bdx	180,0x42	Hand Brake
	1/93-8/95		R		153-344		Lucas	180,0x42	Hand Brake
1.8 Rsi (B/C57H) Eng.F3P758 (79-80-81kW)	8/95-9/98		R		153-345	153-345Y	Bdx	180,0x42	Hand Brake
	8/95-9/98		R		153-344		Lucas	180,0x42	Hand Brake
1.9 D (B/C/57I) Eng.F8Q640/ 682 (40kW)	1/97-9/98		R		153-345	153-345Y	Bdx	180,0x42	Hand Brake
	1/97-9/98		R		153-344		Lucas	180,0x42	Hand Brake
	97-98		R		700-142	700-142K		Ø 180,2	
	97-98		R		151-014		Bdx	Ø 20,64 180,0x40	CRCI, RAI
	97-98		R		151-048		Lucas	Ø 20,64 180,0x40	CRCI, RAI
1.9 D (B/C/S576/57L) Eng.F8Q730/ 732 (47-66-68kW)	1/91-9/98		R		153-345	153-345Y	Bdx	180,0x42	Hand Brake
	1/91-9/98		R		153-344		Lucas	180,0x42	Hand Brake
	91-98		R		700-142	700-142K		Ø 180,2	
	1/91-3/91		R		151-013		Bdx	Ø 20,64 180,0x40	CRCI, RAI
	3/91-98		R		151-014		Bdx	Ø 20,64 180,0x40	CRCI, RAI
3/91-98	R		151-048		Lucas	Ø 20,64 180,0x40	CRCI, RAI		
Clio II (B/C/B0/1) 9/98-5/05									
1.2 (B/CB0F/A, B/CB1O/K, B/CB2 D/H) Eng.D7F710/ 720/ 726 (40-43kW)	9/98-5/05		R		153-356		Bdx	180,0x42	-ABS
	9/98-5/05		R		153-359		Bosch	203,2x39	+ABS, Hand Brake
	9/98-5/05		R		153-350		Lucas	203,0x38	-ABS, Hand Brake
	02-		R		700-382	700-382K		Ø 203,3	+ABS
	9/98-		R		700-156	700-156K		Ø 180,2	-ABS
	9/98-		R		700-157	700-157K		Ø 203,3	+ABS
	98-		R		151-098		Bdx	Ø 19,05 180,0x42	RAI
	98-		R		151-095		Lucas	Ø 17,78 203,0x38	LUC, +ABS
	98-05		R		151-155		Bosch	Ø 17,46 203,0x39	RAI, +ABS
	98-05	R		151-161		Lucas	Ø 20,64 203,0x38	CRCI, LUC	
1.2 16v (B/CB05) Eng.D4F712/ 714 (55kW)	6/01-5/05		R		153-356		Bdx	180,0x42	-ABS
	6/01-5/05		R		153-359		Bosch	203,2x39	+ABS, Hand Brake
	6/01-5/05		R		153-350		Lucas	203,0x38	-ABS, Hand Brake
	11/03-		R		700-382	700-382K		Ø 203,3	+ABS
	6/01-		R		700-157	700-157K		Ø 203,3	+ABS
	6/01-		R		151-098		Bdx	Ø 19,05 180,0x42	RAI
	6/01-		R		151-095		Lucas	Ø 17,78 203,0x38	LUC, +ABS
	01-05		R		151-161		Lucas	Ø 20,64 203,0x38	CRCI, LUC
98-05	R			151-155		Bosch	Ø 17,46 203,0x39	RAI, +ABS	
1.4 (B/CB0C) Eng.E7J780 (55kW)	9/98-5/05		R		153-356		Bdx	180,0x42	
	9/98-5/05		R		153-359		Bosch	203,2x39	+ABS, Hand Brake
	9/98-5/05		R		153-350		Lucas	203,0x38	Hand Brake
	9/98-		R		700-156	700-156K		Ø 180,2	-ABS
	9/98-		R		700-157	700-157K		Ø 203,3	+ABS
	9/98-		R		700-382	700-382K		Ø 203,3	+ABS
	98-		R		151-098		Bdx	Ø 19,05 180,0x42	RAI
	98-		R		151-095		Lucas	Ø 17,78 203,0x38	LUC, +ABS
98-05	R			151-155		Bosch	Ø 17,46 203,0x39	RAI, +ABS	
98-05	R		151-161		Lucas	Ø 20,64 203,0x38	CRCI, LUC		
1.4 16v (B/CB0L) Eng.K4J712/ 713 (70kW)	10/99-8/00		R		153-356		Bdx	180,0x42	
	10/99-8/00		R		153-359		Bosch	203,2x39	+ABS, Hand Brake
	10/99-8/00		R		153-350		Lucas	203,0x38	Hand Brake
	99-8/00		R		700-156	700-156K		Ø 180,2	-ABS
	99-8/00		R		700-157	700-157K		Ø 203,3	+ABS
	99-8/00		R		700-382	700-382K		Ø 203,3	+ABS
	99-8/00		R		151-098		Bdx	Ø 19,05 180,0x42	RAI
	99-8/00		R		151-095		Lucas	Ø 17,78 203,0x38	LUC, +ABS
98-05	R			151-155		Bosch	Ø 17,46 203,0x39	RAI, +ABS	
99-05	R		151-161		Lucas	Ø 20,64 203,0x38	CRCI, LUC		
1.4 16v (B/CB0P) Eng.K4J700/ 712/ 713 (72kW)	8/00-5/05		R		153-356		Bdx	180,0x42	
	8/00-5/05		R		153-359		Bosch	203,2x39	+ABS, Hand Brake
	8/00-5/05		R		153-350		Lucas	203,0x38	Hand Brake
	00-		R		700-156	700-156K		Ø 180,2	-ABS
	00-		R		700-157	700-157K		Ø 203,3	+ABS
03-	R		700-382	700-382K		Ø 203,3	+ABS		



























































		Spare Parts	F/R	L/R	CIFAM ref.	CIFAM ref. w/KIT		DIMENSIONS mm.	NOTE
1.4 16v (B/CB0P) Eng.K4J700/ 712/ 713 (72kW)		00-	R		151-098		Bdx	Ø 19,05 180,0x42	RAI
		00-	R		151-095		Lucas	Ø 17,78 203,0x38	LUC, +ABS
		00-05	R		151-161		Lucas	Ø 20,64 203,0x38	CRCI, LUC
		98-05	R		151-155		Bosch	Ø 17,46 203,0x39	RAI, +ABS
1.5 DCi Eng.K9K702 (59kW)		01-03	R		153-359		Bosch	203,2x39	+ABS
		01-03	R		153-350		Lucas	203,0x38	+ABS
		01-03	R		700-157	700-157K		Ø 203,3	+ABS
		01-03	R		700-382	700-382K		Ø 203,3	+ABS
		01-03	R		151-095		Lucas	Ø 17,78 203,0x38	LUC, +ABS
		01-03	R		151-155		Bosch	Ø 17,46 203,0x39	RAI, +ABS
1.5 DCi Eng.K9K712 (74kW)		04-05	R		153-359		Bosch	203,2x39	+ABS, Hand Brake
		04-05	R		700-157	700-157K		Ø 203,3	+ABS
		04-05	R		700-382	700-382K		Ø 203,3	+ABS
		04-05	R		151-098		Bdx	Ø 19,05 180,0x42	RAI
		04-05	R		151-095		Lucas	Ø 17,78 203,0x38	LUC, +ABS
		04-05	R		151-155		Bosch	Ø 17,46 203,0x39	RAI, +ABS
1.5 DCi (B/CB07) Eng.K9K700/ 704 (48kW)		01-05	R		153-350		Lucas	203,0x38	
		6/01-5/05	R		153-359		Bosch	203,2x39	+ABS, Hand Brake
		01-	R		700-157	700-157K		Ø 203,3	+ABS
		01-	R		700-382	700-382K		Ø 203,3	+ABS
		01-	R		151-095		Lucas	Ø 17,78 203,0x38	LUC, +ABS
		98-05	R		151-155		Bosch	Ø 17,46 203,0x39	RAI, +ABS
1.5 DCi (B/CB08) Eng.K9K702/ 710/ 722 (60kW)		01-05	R		153-359		Bosch	203,2x39	+ABS, Hand Brake
		01-05	R		153-350		Lucas	203,0x38	+ABS
		01-05	R		700-157	700-157K		Ø 203,3	+ABS
		01-05	R		700-382	700-382K		Ø 203,3	+ABS
		01-05	R		151-095		Lucas	Ø 17,78 203,0x38	LUC, +ABS
		01-05	R		151-155		Bosch	Ø 17,46 203,0x39	RAI, +ABS
1.6 (B/CB0D) Eng.K7M744/ 745 (55-66kW)		9/98-5/05	R		153-359		Bosch	203,2x39	+ABS, Hand Brake
		9/98-5/05	R		153-350		Lucas	203,0x38	Hand Brake
		9/98-	R		700-157	700-157K		Ø 203,3	+ABS
		9/98-	R		700-382	700-382K		Ø 203,3	+ABS
		98-	R		151-095		Lucas	Ø 17,78 203,0x38	LUC, +ABS
		98-05	R		151-155		Bosch	Ø 17,46 203,0x39	RAI, +ABS
1.6 16v (CB0T/H) Eng.K4M708/ 748 (70-79-83kW)		9/98-5/05	R		153-359		Bosch	203,2x39	+ABS, Hand Brake
		9/98-5/05	R		153-350		Lucas	203,0x38	Hand Brake
		04-	R		700-382	700-382K		Ø 203,3	+ABS
		9/98-	R		700-157	700-157K		Ø 203,3	+ABS
		98-	R		151-095		Lucas	Ø 17,78 203,0x38	LUC, +ABS
		98-05	R		151-155		Bosch	Ø 17,46 203,0x39	RAI, +ABS
1.9 D (B/CB0E) Eng.F8Q606/ 630/ 632/ 662 (40-44-47kW)		9/98-5/05	R		153-356		Bdx	180,0x42	
		9/98-5/05	R		153-359		Bosch	203,2x39	+ABS, Hand Brake
		9/98-5/05	R		153-350		Lucas	203,0x38	Hand Brake
		9/98-	R		700-156	700-156K		Ø 180,2	-ABS
		9/98-	R		700-157	700-157K		Ø 203,3	+ABS
		9/98-	R		700-382	700-382K		Ø 203,3	+ABS
1.9 DTi (B/CB0U) Eng.F9Q780 (59-68-75-77-81-88-96kW)		98-	R		151-098		Bdx	Ø 19,05 180,0x42	RAI
		98-	R		151-095		Lucas	Ø 17,78 203,0x38	LUC, +ABS
		98-05	R		151-155		Bosch	Ø 17,46 203,0x39	RAI, +ABS
		98-05	R		151-161		Lucas	Ø 20,64 203,0x38	CRCI, LUC
		2/00-5/05	R		153-356		Bdx	180,0x42	
		2/00-5/05	R		153-359		Bosch	203,2x39	+ABS, Hand Brake
1.2 Eng.D7F800 (43kW)		6/05-	R		151-231		Ap	Ø 19,05 203,0x38	AP
		6/05-	R		153-290		Ap	203,0x38	Hand Brake
		05-	R		700-381	700-381K		Ø 203,3	
		05-	R		151-231		Ap	Ø 19,05 203,0x38	AP
		6/05-	R		153-290		Ap	203,0x38	Hand Brake
		05-	R		700-381	700-381K		Ø 203,3	
1.2 16v Eng.D4F740 (55kW)		05-	R		151-231		Ap	Ø 19,05 203,0x38	AP
		05-	R		151-231		Ap	Ø 19,05 203,0x38	AP

























































		Spare Parts	F/R	L/R	CIFAM ref.	CIFAM ref. w/KIT		DIMENSIONS mm.	NOTE
1.2 16v Eng.D4F764 (58kW)	6/05-		R		153-290		Ap	203,0x38	Hand Brake
	05-		R		700-381	700-381K		Ø 203,3	
	05-		R		151-231		Ap	Ø 19,05 203,0x38	AP
1.2 16v TCE Eng.D4F784 (74kW)	07-		R		153-290		Ap	203,0x38	Hand Brake
	07-		R		700-381			Ø 203,3	
	07-		R		151-231		Ap	Ø 19,05 203,0x38	AP
1.4 16v Eng.K4J780 (70-72kW)	6/05-		R		153-290		Ap	203,0x38	Hand Brake
	05-		R		700-381	700-381K		Ø 203,3	
	05-		R		151-231		Ap	Ø 19,05 203,0x38	AP
1.5 DCi Eng.K9K718/ 750 (60-62kW)	07-		R		153-290		Ap	203,0x38	Hand Brake
	07-		R		700-381	700-381K		Ø 203,3	
	07-		R		151-231		Ap	Ø 19,05 203,0x38	AP
1.5 DCi Eng.K9K740 (47kW)	6/05-		R		153-290		Ap	203,0x38	Hand Brake
	05-		R		700-381	700-381K		Ø 203,3	
	05-		R		151-231		Ap	Ø 19,05 203,0x38	AP
1.5 DCi Eng.K9K752 (48kW)	6/05-		R		153-290		Ap	203,0x38	Hand Brake
	05-		R		700-381	700-381K		Ø 203,3	
	05-		R		151-231		Ap	Ø 19,05 203,0x38	AP
1.5 DCi Eng.K9K764 (78kW)	05-		R		700-381	700-381K		Ø 203,3	
	05-		R		151-231		Ap	Ø 19,05 203,0x38	AP
	6/05-		R		153-290		Ap	203,0x38	Hand Brake
1.5 DCi Eng.K9K766 (63kW)	05-		R		700-381	700-381K		Ø 203,3	
	05-		R		151-231		Ap	Ø 19,05 203,0x38	AP
	6/05-		R		153-290		Ap	203,0x38	Hand Brake
1.5 DCi Eng.K9K768 (50kW)	05-		R		700-381	700-381K		Ø 203,3	
	05-		R		151-231		Ap	Ø 19,05 203,0x38	AP
	6/05-		R		153-290		Ap	203,0x38	Hand Brake
1.5 DCi Eng.K9K772/ 776 (76kW)	05-		R		700-381			Ø 203,3	
	05-		R		151-231		Ap	Ø 19,05 203,0x38	AP
	6/05-		R		153-290		Ap	203,0x38	Hand Brake
1.6 16v Eng.K4M800/ 801 (82kW)	05-		R		700-381	700-381K		Ø 203,3	
	05-		R		151-231		Ap	Ø 19,05 203,0x38	AP
	6/05-		R		153-290		Ap	203,0x38	Hand Brake
1.6 16v Eng.K4M804 (65kW)	05-		R		700-381	700-381K		Ø 203,3	
	05-		R		151-231		Ap	Ø 19,05 203,0x38	AP
	6/05-		R		153-290		Ap	203,0x38	Hand Brake
2.0 16v Eng.F4R830 (148kW)	09-		R		700-381			Ø 203,3	
2.0 16v Sport Eng.F4R830 (145kW)	06-		R		700-381			Ø 203,3	
Clio III, Grandtour (KR0/1) 2/08-									
1.2 16v Eng.D4F740 (55kW)	08-		R		153-290		Ap	203,0x38	Hand Brake
	08-		R			700-381K		Ø 203,3	
	08-		R		700-381			Ø 203,3	
	08-		R		151-231		Ap	Ø 19,05 203,0x38	AP
1.2 16v Eng.D4F764 (58kW)	08-		R		153-290		Ap	203,0x38	Hand Brake
	08-		R		700-381	700-381K		Ø 203,3	
	08-		R		151-231		Ap	Ø 19,05 203,0x38	AP
1.2 16v Eng.D4F784 (74kW)	08-		R		153-290		Ap	203,0x38	Hand Brake
	08-		R		700-381	700-381K		Ø 203,3	
	08-		R		151-231		Ap	Ø 19,05 203,0x38	AP
	08-		R		153-290		Ap	203,0x38	Hand Brake
1.5 DCi Eng.K9K764 (78kW)	08-		R			700-381K		Ø 203,3	
	08-		R		700-381			Ø 203,3	
	08-		R		151-231		Ap	Ø 19,05 203,0x38	AP
	08-		R		153-290		Ap	203,0x38	Hand Brake
1.5 DCi Eng.K9K766 (63kW)	08-		R			700-381K		Ø 203,3	
	08-		R		700-381			Ø 203,3	
	08-		R		151-231		Ap	Ø 19,05 203,0x38	AP
	08-		R		153-290		Ap	203,0x38	Hand Brake
1.5 DCi Eng.K9K768 (50kW)	08-		R			700-381K		Ø 203,3	
	08-		R		700-381			Ø 203,3	
	08-		R		151-231		Ap	Ø 19,05 203,0x38	AP
	08-		R		153-290		Ap	203,0x38	Hand Brake
1.5 DCi Eng.K9K772/ 776 (76kW)	08-		R			700-381K		Ø 203,3	
	08-		R		700-381			Ø 203,3	
	08-		R		151-231		Ap	Ø 19,05 203,0x38	AP
	08-		R		153-290		Ap	203,0x38	Hand Brake
1.6 16v Eng.K4M800/ 801 (82kW)	08-		R			700-381K		Ø 203,3	
	08-		R		700-381			Ø 203,3	
	08-		R		151-231		Ap	Ø 19,05 203,0x38	AP

















































		Spare Parts	F/R	L/R	CIFAM ref.	CIFAM ref. w/KIT		DIMENSIONS mm.	NOTE
Espace I (J11) 7/84-12/90									
2.0 (J/S112) Eng.J6R234/ 236 (74-77-81kW)	7/84-12/90		R		153-340	153-340K	Bdx	228,6x42	Hand Brake
	84-90		R		700-144			Ø 228,6	
	84-90		R		151-015		Bdx	Ø 22,00 228,0x42	RAD, Exc. 4WD, +LCS
2.0 (J/S112) Eng.J6R734 (74kW)	1/88-12/90		R		153-340	153-340K	Bdx	228,6x42	Hand Brake
	88-90		R		700-144			Ø 228,6	
	88-90		R		151-015		Bdx	Ø 22,00 228,0x42	RAD, Exc. 4WD, +LCS
2.0, 4WD (J116) Eng.J7R760 (76-87-88-99-119-129kW)	3/88-12/90		R		153-340	153-340K	Bdx	228,6x42	Hand Brake
	88-90		R		700-144			Ø 228,6	
	88-90		R		151-015		Bdx	Ø 22,00 228,0x42	RAD, Exc. 4WD, +LCS
2.1 TD (J/S115) Eng.J8S774/ 240 (44-48-53-66kW)	10/84-12/90		R		153-340	153-340K	Bdx	228,6x42	Hand Brake
	84-90		R		700-144			Ø 228,6	
	84-90		R		151-015		Bdx	Ø 22,00 228,0x42	RAD, Exc. 4WD, +LCS
2.2, 4WD (J117) Eng.J7T770 (67-70-74-76-79-85-89-91-101kW)	7/86-12/90		R		153-340	153-340K	Bdx	228,6x42	Hand Brake
	86-90		R		700-144			Ø 228,6	
	86-90		R		151-015		Bdx	Ø 22,00 228,0x42	RAD, Exc. 4WD, +LCS
Espace II (J/S63) 1/91-10/96									
2.0 (J636) Eng.J7R768 (76-88-99-119-129kW)	1/91-10/96		R		153-340	153-340K	Bdx	228,6x42	+LCS, Hand Brake
	1/91-10/96		R		153-475		Lucas	228,6x42	-LCS, Hand Brake
	91-96		R		700-144			Ø 228,6	
	91-92		R		151-015		Bdx	Ø 22,00 228,0x42	RAD, +LCS
	92-96		R		151-072		Lucas	Ø 22,20 229,0x42	LUC
2.1 TD (J633, J634, J/S635, J/S63D) Eng.J8S610/ 772/ 776/ 778 (44-48-53-66kW)	1/91-10/96		R		153-340	153-340K	Bdx	228,6x42	Hand Brake
	5/92-96		R		700-144			Ø 228,6	
	91-92		R		151-015		Bdx	Ø 22,00 228,0x42	RAD, +LCS
2.1 TD (J63E) Eng.J8S612 (44-48-53-66kW)	11/94-10/96		R		153-340	153-340K	Bdx	228,6x42	Hand Brake
	94-96		R		700-144			Ø 228,6	
	94-96		R		151-015		Bdx	Ø 22,00 228,0x42	RAD, +LCS
	94-96		R		151-072		Lucas	Ø 22,20 229,0x42	LUC
2.2, 4WD (J/S637, J63G) Eng.J7T772/ 773/ 776 (79kW)	1/91-10/96		R		153-340	153-340K	Bdx	228,6x42	+LCS, Hand Brake
	1/91-10/96		R		153-475		Lucas	228,6x42	-LCS, Hand Brake
	91-96		R		700-144			Ø 228,6	
	91-96		R		151-072		Lucas	Ø 22,20 229,0x42	LUC, Exc. 4WD
Espace III (JE) 11/96-11/02									
1.9 DTi (JE0M) Eng.F9Q722 (60-68-75-77-81-88-96kW)	99-		R		700-154			Ø 228,6	
2.0 (JE0A) Eng.F3R728/ 729/ 742/ 768/ 769 (80-84kW)	11/96-10/00		R		153-023		Lucas	228,6x42	Hand Brake
	96-00		R		700-154			Ø 228,6	
2.0 16v (JE0L, JE0N) Eng.F4R700/ 701 (89-103-120-124kW)	10/98-11/02		R		153-023		Lucas	228,6x42	Hand Brake
	98-		R		700-154			Ø 228,6	
2.2 DCi (JE0K, JE0S) Eng.G9T710 (85-95kW)	10/00-11/02		R		153-023		Lucas	228,6x42	Hand Brake
2.2 DT (JE0E, H, P) Eng.G8T714/ 716/ 740/ 760 (83kW)	11/96-10/00		R		153-023		Lucas	228,6x42	Hand Brake
	96-00		R		700-154			Ø 228,6	
Fuego (136) 2/80-10/85									
1.4 (1360) Eng.847720 (35-43-46kW)	2/80-10/85		R		153-341	153-341K	Bdx	180,0x42	Hand Brake
	2/80-10/85		R		153-340	153-340K	Bdx	228,6x42	Hand Brake
	2/80-10/85		R		153-475		Lucas	228,6x42	Hand Brake
	80-85		R		151-044		Bdx	Ø 22,00 180,0x40	RAD
	80-85		R		151-106		Lucas	Ø 22,22 228,6x42	LUC
1.6 (1361) Eng.A2M723 (52kW)	4/83-10/85		R		153-341	153-341K	Bdx	180,0x42	Hand Brake
	4/83-10/85		R		153-340	153-340K	Bdx	228,6x42	Hand Brake
	4/83-10/85		R		153-475		Lucas	228,6x42	Hand Brake
	83-85		R		700-144			Ø 228,6	
	83-85		R		151-044		Bdx	Ø 22,00 180,0x40	RAD
1.6 (1362) Eng.843723/ 724/ A6M725/ 726 (66-68-71kW)	10/80-10/85		R		153-341	153-341K	Bdx	180,0x42	Hand Brake
	10/80-10/85		R		153-340	153-340K	Bdx	228,6x42	Hand Brake
	10/80-10/85		R		153-475		Lucas	228,6x42	Hand Brake
	80-85		R		700-144			Ø 228,6	
	80-85		R		151-015		Bdx	Ø 22,00 228,0x42	RAD
1.6 T. (1365) Eng.A5L750 (97kW)	8/83-10/85		R		153-341	153-341K	Bdx	180,0x42	Hand Brake
	8/83-10/85		R		153-340	153-340K	Bdx	228,6x42	Hand Brake
	8/83-10/85		R		153-475		Lucas	228,6x42	Hand Brake
2.0 (1363) Eng.829710/ J6R710/ 712/ 715/ 726 (81kW)	10/80-10/85		R		153-340	153-340K	Bdx	228,6x42	Hand Brake
	80-85		R		700-144			Ø 228,6	
	80-85		R		151-015		Bdx	Ø 22,00 228,0x42	RAD

























































		Spare Parts	F/R	L/R	CIFAM ref.	CIFAM ref. w/KIT		DIMENSIONS mm.	NOTE
2.1 TD (1366) Eng.J8S712 (44-48-53-66kW)	82-85		R		700-144			Ø 228,6	
			R		151-015		Bdx	Ø 22,00 228,0x42	RAD
2.2 (136B) Eng.J7T762 (76kW)	83-85		R		700-144			Ø 228,6	
Grand Modus 6/08-									
1.2 16v Eng.D4F740 (55kW)	08-		R		153-290		Ap	203,0x38	Hand Brake
			R		700-381	700-381K		Ø 203,3	
			R		151-231		Ap	Ø 19,05 203,0x38	AP
1.2 16v TCE Eng.D4F784 (74kW)	08-		R		153-290		Ap	203,0x38	Hand Brake
			R		700-381	700-381K		Ø 203,3	
			R		151-231		Ap	Ø 19,05 203,0x38	AP
1.5 DCi Eng.K9K750 (63kW)	6/08-		R		153-290		Ap	203,0x38	Hand Brake
			R		700-381	700-381K		Ø 203,3	
			R		151-231		Ap	Ø 19,05 203,0x38	AP
1.5 DCi Eng.K9K752 (50kW)	6/08-		R		153-290		Ap	203,0x38	Hand Brake
			R		700-381	700-381K		Ø 203,3	
			R		151-231		Ap	Ø 19,05 203,0x38	AP
1.5 DCi Eng.K9K764 (78kW)	6/08-		R		153-290		Ap	203,0x38	Hand Brake
			R		700-381	700-381K		Ø 203,3	
			R		151-231		Ap	Ø 19,05 203,0x38	AP
1.5 DCi Eng.K9K772 (76kW)	6/08-		R		153-290		Ap	203,0x38	Hand Brake
			R		700-381	700-381K		Ø 203,3	
			R		151-231		Ap	Ø 19,05 203,0x38	AP
1.6 16v Eng.K4M790 (82kW)	6/08-		R		153-290		Ap	203,0x38	Hand Brake
			R		700-381	700-381K		Ø 203,3	
			R		151-231		Ap	Ø 19,05 203,0x38	AP
Kangoo I (KC0) 3/98-12/07									
1.2 (KC0A/K/F/1) Eng.D7F710/ 720/ 722/ 726/ 746 (43kW)	3/98-12/07		R		153-355		Bdx	203,2x39	6Q, Hand Brake
			R		153-354		Bdx	228,6x42	8Q, Hand Brake
	3/98-		R		700-152	700-152K		Ø 203,3	-RC
			R		700-144			Ø 228,6	+RC
			R		151-097		Bdx	Ø 19,05 203,0x38	RAI, 6Q, -RC
			R		151-096		Bdx	Ø 22,00 228,0x42	RAI, 8Q, +RC
1.2 16v (KC03/5/6/T/W) Eng.D4F712/ 714/ 716 (55kW)	6/01-12/07		R		153-355		Bdx	203,2x39	6Q, Hand Brake
			R		153-354		Bdx	228,6x42	8Q, Hand Brake
	6/01-		R		700-152	700-152K		Ø 203,3	-RC
			R		700-144			Ø 228,6	+RC
			R		151-097		Bdx	Ø 19,05 203,0x38	RAI, 6Q, -RC
			R		151-096		Bdx	Ø 22,00 228,0x42	RAI, 8Q, +RC
1.4 Eng.E7J634/ 635/ 780 (55kW)	3/98-12/07		R		153-355		Bdx	203,2x39	6Q, Hand Brake
			R		153-354		Bdx	228,6x42	8Q, Hand Brake
	3/98-		R		700-152	700-152K		Ø 203,3	-RC
			R		700-144			Ø 228,6	+RC
			R		151-097		Bdx	Ø 19,05 203,0x38	RAI, 6Q, -RC
			R		151-096		Bdx	Ø 22,00 228,0x42	RAI, 8Q, +RC
1.4 (KC0C/H/B/M) Eng.K7J700/ 701 (55kW)	3/98-12/07		R		153-355		Bdx	203,2x39	6Q, Hand Brake
			R		153-354		Bdx	228,6x42	8Q, Hand Brake
	3/98-		R		700-152	700-152K		Ø 203,3	-RC
			R		700-144			Ø 228,6	+RC
			R		151-097		Bdx	Ø 19,05 203,0x38	RAI, 6Q, -RC
			R		151-096		Bdx	Ø 22,00 228,0x42	RAI, 8Q, +RC
1.5 DCi Eng.K9K710 (42kW)	7/03-12/07		R		153-355		Bdx	203,2x39	6Q, Hand Brake
			R		153-354		Bdx	228,6x42	8Q, Hand Brake
	03-		R		700-152	700-152K		Ø 203,3	-RC
			R		700-144			Ø 228,6	+RC
			R		151-097		Bdx	Ø 19,05 203,0x38	RAI, 6Q, -RC
			R		151-096		Bdx	Ø 22,00 228,0x42	RAI, 8Q, +RC
1.5 DCi Eng.K9K718 (62kW)	6/05-12/07		R		153-355		Bdx	203,2x39	6Q, Hand Brake
			R		153-354		Bdx	228,6x42	8Q, Hand Brake
1.5 DCi Eng.K9K752 (50kW)	6/05-12/07		R		153-355		Bdx	203,2x39	6Q, Hand Brake
			R		153-354		Bdx	228,6x42	8Q, Hand Brake
	05-		R		700-152	700-152K		Ø 203,3	-RC
			R		700-144			Ø 228,6	+RC
			R		151-097		Bdx	Ø 19,05 203,0x38	RAI, 6Q, -RC
			R		151-096		Bdx	Ø 22,00 228,0x42	RAI, 8Q, +RC
1.5 DCi (KC07) Eng.K9K700/ 704 (48kW)	12/01-12/07		R		153-355		Bdx	203,2x39	6Q, Hand Brake
			R		153-354		Bdx	228,6x42	8Q, Hand Brake
	6/01-		R		700-152	700-152K		Ø 203,3	-RC
			R		700-144			Ø 228,6	+RC

















		Spare Parts	F/R	L/R	CIFAM ref.	CIFAM ref. w/KIT		DIMENSIONS mm.	NOTE
1.5 DCi (KC07) Eng.K9K700/ 704 (48kW)		01-01	R		151-097		Bdx	Ø 19,05 203,0x38	RAI, 6Q, -RC
		01-01	R		151-096		Bdx	Ø 22,00 228,0x42	RAI, 8Q, +RC
1.5 DCi (KC08/9) Eng.K9K702/ 710/ 722 (60kW)		02-07	R		153-355		Bdx	203,2x39	6Q, Hand Brake
		02-07	R		153-354		Bdx	228,6x42	8Q, Hand Brake
		02-07	R		700-152	700-152K		Ø 203,3	-RC
		02-07	R		700-144			Ø 228,6	+RC
		02-07	R		151-097		Bdx	Ø 19,05 203,0x38	RAI, 6Q, -RC
		02-07	R		151-096		Bdx	Ø 22,00 228,0x42	RAI, 8Q, +RC
1.6 16v bivalent Eng.K7M7 (60kW)		6/05-12/07	R		153-355		Bdx	203,2x39	6Q, Hand Brake
		6/05-12/07	R		153-354		Bdx	228,6x42	8Q, Hand Brake
1.6 16v, 4WD (KC0P/S/L) Eng.K4M750/ 752/ 753 (70kW)		01-07	R		153-355		Bdx	203,2x39	6Q, Hand Brake
		01-07	R		153-354		Bdx	228,6x42	8Q, Hand Brake
		01-07	R		700-152	700-152K		Ø 203,3	Exc. 4WD, -RC
		01-07	R		700-144			Ø 228,6	Exc. 4WD, +RC
		01-07	R		151-097		Bdx	Ø 19,05 203,0x38	RAI, 6Q, -RC
		01-07	R		151-096		Bdx	Ø 22,00 228,0x42	RAI, 8Q, +RC
1.9 D (KC0D) Eng.F8Q662 (40kW)		3/98-12/07	R		153-355		Bdx	203,2x39	6Q, Hand Brake
		3/98-12/07	R		153-354		Bdx	228,6x42	8Q, Hand Brake
		3/98-	R		700-152	700-152K		Ø 203,3	-RC
		3/98-	R		700-144			Ø 228,6	+RC
		3/98-	R		151-097		Bdx	Ø 19,05 203,0x38	RAI, 6Q, -RC
		3/98-	R		151-096		Bdx	Ø 22,00 228,0x42	RAI, 8Q, +RC
1.9 D (KC0E/2/J/N) Eng.F8Q630/ 632 (47kW)		3/98-12/07	R		153-355		Bdx	203,2x39	6Q, Hand Brake
		3/98-12/07	R		153-354		Bdx	228,6x42	8Q, Hand Brake
		3/98-	R		700-152	700-152K		Ø 203,3	-RC
		3/98-	R		700-144			Ø 228,6	+RC
		3/98-	R		151-097		Bdx	Ø 19,05 203,0x38	RAI, 6Q, -RC
		3/98-	R		151-096		Bdx	Ø 22,00 228,0x42	RAI, 8Q, +RC
1.9 DCi 4WD Eng.F9Q790 (62kW)		10/03-12/07	R		153-355		Bdx	203,2x39	6Q, Hand Brake
		10/03-12/07	R		153-354		Bdx	228,6x42	8Q, Hand Brake
1.9 DCi 4WD (KC0V) Eng.F9Q782/ 790 (59kW)		01-07	R		153-355		Bdx	203,2x39	6Q, Hand Brake
		01-07	R		153-354		Bdx	228,6x42	8Q, Hand Brake
1.9 DTi (KC0U) Eng.F9Q780 (59kW)		2/00-12/07	R		153-355		Bdx	203,2x39	6Q, Hand Brake
		2/00-12/07	R		153-354		Bdx	228,6x42	8Q, Hand Brake
		2/00-	R		700-152	700-152K		Ø 203,3	-RC
		2/00-	R		700-144			Ø 228,6	+RC
		2/00-	R		151-097		Bdx	Ø 19,05 203,0x38	RAI, 6Q, -RC
		2/00-	R		151-096		Bdx	Ø 22,00 228,0x42	RAI, 8Q, +RC
Koleos 7/08-									
2.0 DCi Eng.M9R (130kW)		08-08-	R			153-450K		170x32	
		08-08-	R		153-295			172,0x32	
2.0 DCi Eng.M9R830 (127kW)		08-08-	R			153-450K		170x32	
		08-08-	R		153-295			172,0x32	
2.0 DCi Eng.M9R832/ 833 (110kW)		08-08-	R			153-450K		170x32	
		08-08-	R		153-295			172,0x32	
2.5, 4WD Eng.2TR700/ 703 (126kW)		08-08-	R			153-450K		170x32	
08-08-	R		153-295				172,0x32		
Laguna I (B56, 556) 11/93-3/01									
1.6 16v (B568, B561) Eng.K4M720/ 724 (79kW)		11/97-3/01	R		153-346	153-346Y	Bdx	203,2x39	Hand Brake
		11/97-3/01	R		153-350		Lucas	203,0x38	Hand Brake
		97-01	R		700-151	700-151K		Ø 203,3	+ABS
1.8 (B560/S/T) Eng.F3P670/ 678 (66kW)		8/95-3/01	R		153-346	153-346Y	Bdx	203,2x39	-ABS, Hand Brake
		8/95-3/01	R		153-350		Lucas	203,0x38	-ABS, Hand Brake
		95-01	R		700-151	700-151K		Ø 203,3	+ABS
		95-01	R		700-150	700-150K		Ø 203,3	-ABS
		95-4/98	R		151-063		Lucas	Ø 19,05 203,0x38	LUC
		95-01	R		151-157		Bdx	Ø 19,05 203,2x39	RAI
1.8 (B56A/B/Z) Eng.F3P720/ 724 (66-69-70kW)		11/93-3/01	R		153-346	153-346Y	Bdx	203,2x39	-ABS, Hand Brake
		11/93-3/01	R		153-350		Lucas	203,0x38	-ABS, Hand Brake
		93-01	R		700-150	700-150K		Ø 203,3	-ABS
		93-01	R		151-063		Lucas	Ø 19,05 203,0x38	LUC
		93-01	R		151-157		Bdx	Ø 19,05 203,2x39	RAI
1.8 16v (B563, B564) Eng.F4P760 (88kW)		4/98-3/01	R		153-350		Lucas	203,0x38	-ABS, Hand Brake
		4/98-01	R		700-151	700-151K		Ø 203,3	+ABS
		98-01	R		151-157		Bdx	Ø 19,05 203,2x39	RAI
		98-01	R		151-063		Lucas	Ø 19,05 203,0x38	LUC

























		Spare Parts	F/R	L/R	CIFAM ref.	CIFAM ref. w/KIT		DIMENSIONS mm.	NOTE
1.9 DTi (B56J) Eng.F9Q710/ 716 (72kW)	10/97-3/01		R		153-350		Lucas	203,0x38	Hand Brake
	97-01		R		700-151	700-151K		Ø 203,3	+ABS
	97-01		R		151-063		Lucas	Ø 19,05 203,0x38	LUC
2.0 (B56C/H/L/N) Eng.F3R611/ 722/ 723/ 768 (70-80-83kW)	11/93-3/01		R		153-346	153-346Y	Bdx	203,2x39	-ABS, Hand Brake
	11/93-3/01		R		153-350		Lucas	203,0x38	-ABS, Hand Brake
	2/99-01		R		700-150	700-150K		Ø 203,3	-ABS
	93-1/99		R		700-151	700-151K		Ø 203,3	+ABS
	93-01		R		151-063		Lucas	Ø 19,05 203,0x38	LUC
	93-01		R		151-157		Bdx	Ø 19,05 203,2x39	RAI
2.0 16v (556A/B) Eng.F4R780 (103kW)	99-01		R		151-157		Bdx	Ø 19,05 203,2x39	RAI
2.0 16v (B56 D/M) Eng.N7Q700/ 704 (102-103kW)	95-01		R		151-157		Bdx	Ø 19,05 203,2x39	RAI
2.2 D Eng.G8T752/ 794 (61kW)	11/96-3/01		R		153-346	153-346Y	Bdx	203,2x39	-ABS, Hand Brake
	11/96-3/01		R		153-350		Lucas	203,0x38	-ABS, Hand Brake
	96-01		R		700-150	700-150K		Ø 203,3	-ABS
	96-01		R		151-063		Lucas	Ø 19,05 203,0x38	LUC
	96-01		R		151-157		Bdx	Ø 19,05 203,2x39	RAI
2.2 D (B56F/2) Eng.G8T706/ 790 (61kW)	11/93-3/01		R		153-346	153-346Y	Bdx	203,2x39	-ABS, Hand Brake
	11/93-3/01		R		153-350		Lucas	203,0x38	-ABS, Hand Brake
	93-01		R		700-150	700-150K		Ø 203,3	-ABS
	93-01		R		151-063		Lucas	Ø 19,05 203,0x38	LUC
	93-01		R		151-157		Bdx	Ø 19,05 203,2x39	RAI
2.2 DT (B569) Eng.G8T714/ 716/ 740/ 760 (83kW)	3/96-3/01		R			153-346Y	Bdx	203,2x39	Hand Brake
	3/96-3/01		R		153-346		Bdx	203,2x39	-ABS, Hand Brake
Laguna I (K56) SW 9/95-3/01									
1.6 16v (K568) Eng.K4M720/ 724 (79kW)	11/97-3/01		R		153-351		Lucas	228,6x42	
	97-01		R		700-144			Ø 228,6	
1.8 (K56S/T/O) Eng.F3P670/ 678 (66kW)	9/95-3/01		R		153-351		Lucas	228,6x42	-ABS
	95-01		R		700-144			Ø 228,6	
	95-98		R		151-067		Lucas	Ø 20,64 228,0x40	LUC, +ABS
	98-01		R		151-068		Lucas	Ø 22,20 228,0x40	LUC, +ABS
1.8 (K56Z) Eng.F3P720/ 724 (66-69kW)	9/95-3/01		R		153-351		Lucas	228,6x42	-ABS
	95-01		R		700-144			Ø 228,6	
	95-98		R		151-067		Lucas	Ø 20,64 228,0x40	LUC, +ABS
	98-01		R		151-068		Lucas	Ø 22,20 228,0x40	LUC, +ABS
1.8 16v (K563, K564) Eng.F4P760 (88kW)	4/98-3/01		R		153-351		Lucas	228,6x42	
	98-01		R		700-144			Ø 228,6	
1.9 DTi (K56J) Eng.F9Q710/ 716 (72kW)	10/97-3/01		R		153-351		Lucas	228,6x42	
	97-01		R		700-144			Ø 228,6	
2.0 (K56C/H) Eng.F3R722/ 723/ 768 (80-84kW)	9/95-3/01		R		153-351		Lucas	228,6x42	-ABS
	95-01		R		700-144			Ø 228,6	
	95-98		R		151-067		Lucas	Ø 20,64 228,0x40	LUC, +ABS
	98-01		R		151-068		Lucas	Ø 22,20 228,0x40	LUC, +ABS
2.2 D Eng.G8T752/ 794 (61kW)	1/96-3/01		R		153-351		Lucas	228,6x42	-ABS
	96-01		R		700-144			Ø 228,6	
	7/98-01		R		151-068		Lucas	Ø 22,20 228,0x40	LUC, +ABS
	96-6/98		R		151-067		Lucas	Ø 20,64 228,0x40	LUC, +ABS
2.2 D (K56F/2, S56F) Eng.G8T706/ 790 (61kW)	9/95-3/01		R		153-351		Lucas	228,6x42	-ABS
	95-01		R		700-144			Ø 228,6	
	95-98		R		151-067		Lucas	Ø 20,64 228,0x40	LUC, +ABS
	98-01		R		151-068		Lucas	Ø 22,20 228,0x40	LUC, +ABS
Megane I (BA) 1/96-11/02									
1.4 16v (BA0D/W,1H/O) Eng.K4J714/ 750 (70kW)	3/99-11/02		R		153-353	153-353Y	Bdx	203,0x38	Hand Brake
	99-02		R		151-160		Bdx	Ø 19,05 203,2x39	RAI, +ABS, -ASR
1.4 e (BA0E/V) Eng.E7J626/ 764 (55kW)	1/96-11/02		R		153-353	153-353Y	Bdx	203,0x38	Hand Brake
	96-02		R		151-160		Bdx	Ø 19,05 203,2x39	RAI, +ABS, -ASR
1.4 Eco (BA0T) Eng.E7J624 (52kW)	1/96-3/99		R		153-353	153-353Y	Bdx	203,0x38	Hand Brake
	96-99		R		700-149	700-149K		Ø 203,3	
	96-99		R		151-061		Bdx	Ø 17,46 203,0x38	RAI
	96-99		R		151-067		Lucas	Ø 20,64 228,0x40	LUC
1.6 16v (BA11/04/0B/1J) Eng.K4M700/ 701/ 704/ 708 (64-70-79-83kW)	3/99-11/02		R		153-353	153-353Y	Bdx	203,0x38	Hand Brake
	99-02		R		151-160		Bdx	Ø 19,05 203,2x39	RAI, +ABS, -ASR
1.6 e (BA0F/S) Eng.K7M702/ 703/ 790 (66kW)	1/96-3/99		R		153-353	153-353Y	Bdx	203,0x38	Hand Brake
	96-99		R		700-149	700-149K		Ø 203,3	
	96-99		R		151-061		Bdx	Ø 17,46 203,0x38	RAI
	96-99		R		151-067		Lucas	Ø 20,64 228,0x40	LUC



















		Spare Parts	F/R	L/R	CIFAM ref.	CIFAM ref. w/KIT		DIMENSIONS mm.	NOTE
1.6 i (BA0L) Eng.K7M720 (55-66kW)	1/96-3/99		R		153-353	153-353Y	Bdx	203,0x38	Hand Brake
	96-99		R		700-149	700-149K		Ø 203,3	
	96-99		R		151-061		Bdx	Ø 17,46 203,0x38	RAI
	96-99		R		151-067		Lucas	Ø 20,64 228,0x40	LUC
1.8 16v (BA06, BA12/A/M/R) Eng.F4P720/ 722 (85-88kW)	1/01-11/02		R		153-353	153-353Y	Bdx	203,0x38	Hand Brake
	01-01-02		R		700-148	700-148K		Ø 203,3	+ABS
	01-02		R		151-160		Bdx	Ø 19,05 203,2x39	RAI, +ABS, -ASR
1.9 D (B/SA0U/A) Eng.F8Q620/ 624 (47kW)	1/96-11/02		R		153-353	153-353Y	Bdx	203,0x38	Hand Brake
	96-02		R		700-149	700-149K		Ø 203,3	
	96-02		R		151-061		Bdx	Ø 17,46 203,0x38	RAI, Mod. A/U
	96-02		R		151-160		Bdx	Ø 19,05 203,2x39	RAI, +ABS, -ASR
1.9 DCi (BA05, BA1F) Eng.F9Q732/ 733 (75kW)	2/01-11/02		R		153-353	153-353Y	Bdx	203,0x38	+TC, Hand Brake
	01-02		R		700-153			Ø 228,6	
	01-02		R		151-160		Bdx	Ø 19,05 203,2x39	RAI, +ABS, -ASR
1.9 DT (B/SA0K/Y) Eng.F8Q784/ 786 (66kW)	1/96-11/02		R		153-353	153-353Y	Bdx	203,0x38	Hand Brake
	96-02		R		700-149	700-149K		Ø 203,3	
	96-02		R		151-061		Bdx	Ø 17,46 203,0x38	RAI
	96-02		R		151-067		Lucas	Ø 20,64 228,0x40	LUC
1.9 DTi (BA08/N) Eng.F9Q730/ 731/ 732/ 733/ 734/ 736 (72kW)	3/97-11/02		R		153-353	153-353Y	Bdx	203,0x38	Hand Brake
	97-02		R		700-149	700-149K		Ø 203,3	
	97-02		R		151-061		Bdx	Ø 17,46 203,0x38	RAI
	97-02		R		151-160		Bdx	Ø 19,05 203,2x39	RAI, +ABS, -ASR
1.9 DTi (BA1U) Eng.F9Q744 (59kW)	2/01-11/02		R		153-353	153-353Y	Bdx	203,0x38	Hand Brake
01-01-02		R		700-149	700-149K		Ø 203,3		
1.9 TDi Eng.F8Q784 (69kW)	9/96-11/02		R		153-353	153-353Y	Bdx	203,0x38	Hand Brake
	96-02		R		700-149	700-149K		Ø 203,3	
2.0 (BA0G) Eng.F3R750/ 751 (80-83-84kW)	1/96-11/02		R		153-353	153-353Y	Bdx	203,0x38	Hand Brake
	96-02		R		700-149	700-149K		Ø 203,3	
	96-02		R		151-061		Bdx	Ø 17,46 203,0x38	RAI
	96-02		R		151-067		Lucas	Ø 20,64 228,0x40	LUC
Megane I (DA) Coach 3/96-11/02									
1.4 16v (DA0D/W, DA1H/0) Eng.K4J714/ 750 (70kW)	3/99-11/02		R		153-353	153-353Y	Bdx	203,0x38	Hand Brake
	99-02		R		700-149	700-149K		Ø 203,3	
	99-02		R		151-160		Bdx	Ø 19,05 203,2x39	RAI, +ABS, -ASR
1.6 16v (DA0B/4, DA11) Eng.K4M700/ 701/ 708 (79kW)	3/99-11/02		R		153-353	153-353Y	Bdx	203,0x38	Hand Brake
	99-02		R		151-160		Bdx	Ø 19,05 203,2x39	RAI, +ABS, -ASR
1.6 e (DA0F) Eng.K7M702/ 703 (66kW)	3/96-3/99		R		153-353	153-353Y	Bdx	203,0x38	Hand Brake
	96-99		R		700-149	700-149K		Ø 203,3	
	96-99		R		151-061		Bdx	Ø 17,46 203,0x38	RAI
1.9 DCi (DA05, DA1F) Eng.F9Q732/ 733 (75-77kW)	2/01-11/02		R		153-353	153-353Y	Bdx	203,0x38	+TC, Hand Brake
	01-02		R		700-149	700-149K		Ø 203,3	
	01-02		R		151-160		Bdx	Ø 19,05 203,2x39	RAI, +ABS, -ASR
1.9 DTi (DA0N) Eng.F9Q730/ 731/ 732/ 733/ 734/ 736 (72kW)	3/97-11/02		R		153-353	153-353Y	Bdx	203,0x38	Hand Brake
	97-02		R		700-149	700-149K		Ø 203,3	
	97-02		R		151-061		Bdx	Ø 17,46 203,0x38	RAI
97-02		R		151-160		Bdx	Ø 19,05 203,2x39	RAI, +ABS, -ASR	
2.0 (DA0G) Eng.F3R750/ 751 (80-84kW)	3/96-11/02		R		153-353	153-353Y	Bdx	203,0x38	Hand Brake
	96-02		R		700-149	700-149K		Ø 203,3	
	96-02		R		151-061		Bdx	Ø 17,46 203,0x38	RAI
Megane I (EA0) Cabrio 10/96-11/02									
1.4 16v (EA0D/W,1H/0) Eng.K4J714/ 750 (70kW)	3/99-11/02		R		153-353	153-353Y	Bdx	203,0x38	Hand Brake
	99-02		R		700-149	700-149K		Ø 203,3	
	99-02		R		151-160		Bdx	Ø 19,05 203,2x39	RAI, +ABS, -ASR
1.6 16v (EA0B/4, EA11) Eng.K4M700/ 701/ 708 (79kW)	3/99-11/02		R		153-353	153-353Y	Bdx	203,0x38	Hand Brake
	99-02		R		151-160		Bdx	Ø 19,05 203,2x39	RAI, +ABS, -ASR
1.6 e (EA0F) Eng.K7M702/ 703 (66kW)	10/96-3/99		R		153-353	153-353Y	Bdx	203,0x38	Hand Brake
	96-99		R		700-149	700-149K		Ø 203,3	
	96-99		R		151-061		Bdx	Ø 17,46 203,0x38	RAI
2.0 (EA0G) Eng.F3R750/ 751 (84kW)	4/97-11/02		R		153-353	153-353Y	Bdx	203,0x38	Hand Brake
	97-02		R		700-149	700-149K		Ø 203,3	
	97-02		R		151-061		Bdx	Ø 17,46 203,0x38	RAI
2.0 (EA0G) Eng.F3R791/ 796 (80kW)	3/99-11/02		R		153-353	153-353Y	Bdx	203,0x38	Hand Brake
	99-02		R		700-149	700-149K		Ø 203,3	
	99-02		R		151-061		Bdx	Ø 17,46 203,0x38	RAI
2.0 16v Eng.F4R740/ 741/ 746 (102kW)	1/02-11/02		R		153-002	153-002Y	Bdx	203,2x39	Hand Brake





























































		Spare Parts	F/R	L/R	CIFAM ref.	CIFAM ref. w/KIT		DIMENSIONS mm.	NOTE
2.0 16v (EA0H) Eng.F7R710/ 714 (108kW)	10/96-11/99		R		153-002	153-002Y	Bdx	203,2x39	Hand Brake
2.0 16v IDE (EA03/P, EA14) Eng.F5R740 (103kW)	11/99-11/02		R		153-002	153-002Y	Bdx	203,2x39	Hand Brake
Megane I (JA0) Scenic 1/97-9/99									
1.4 (JA0E) Eng.E7J764 (52-55kW)	1/97-9/99		R		153-002	153-002Y	Bdx	203,2x39	Hand Brake
	1/97-3/97		R		700-144			Ø 228,6	
	4/97-99		R		700-153			Ø 228,6	
	97-99		R		151-067		Lucas	Ø 20,64 228,0x40	LUC
1.6 16v Eng.K4M700/ 708 (79kW)	1/97-9/99		R		153-002	153-002Y	Bdx	203,2x39	Hand Brake
	97-99		R		700-153			Ø 228,6	
1.6 e (JA0F) Eng.K7M702/ 703 (66kW)	1/97-9/99		R		153-002	153-002Y	Bdx	203,2x39	Hand Brake
	1/97-3/97		R		700-144			Ø 228,6	
	4/97-99		R		700-153			Ø 228,6	
	97-99		R		151-067		Lucas	Ø 20,64 228,0x40	LUC
1.6 i (JA0L) Eng.K7M720 (55kW)	1/97-9/99		R		153-002	153-002Y	Bdx	203,2x39	Hand Brake
	1/97-3/97		R		700-144			Ø 228,6	
	4/97-99		R		700-153			Ø 228,6	
	97-99		R		151-067		Lucas	Ø 20,64 228,0x40	LUC
1.9 D Eng.F8Q788/ 790 (47kW)	3/97-9/99		R		153-002	153-002Y	Bdx	203,2x39	Hand Brake
	97-98		R		700-153			Ø 228,6	
	97-98		R		151-067		Lucas	Ø 20,64 228,0x40	LUC
1.9 DT (JA0K/Y) Eng.F8Q784/ 786 (66kW)	1/97-9/99		R		153-002	153-002Y	Bdx	203,2x39	Hand Brake
	1/97-3/97		R		700-144			Ø 228,6	
	4/97-99		R		700-153			Ø 228,6	
	97-99		R		151-067		Lucas	Ø 20,64 228,0x40	LUC
1.9 DTi (JA0N) Eng.F9Q730/ 734 (72kW)	4/97-9/99		R		153-002	153-002Y	Bdx	203,2x39	Hand Brake
	97-99		R		700-153			Ø 228,6	
	97-99		R		151-067		Lucas	Ø 20,64 228,0x40	LUC
2.0 (JA0G) Eng.F3R750/ 751 (84kW)	1/97-3/97		R		700-144			Ø 228,6	
	4/97-9/98		R		700-153			Ø 228,6	
	97-99		R		151-067		Lucas	Ø 20,64 228,0x40	LUC
2.0 (JA0G) Eng.F3R796 (80kW)	1/99-9/99		R		700-153			Ø 228,6	
Megane I (KA) SW 3/99-11/02									
1.4 16v (KA0D/W,1H/0) Eng.K4J714/ 750 (70kW)	3/99-11/02		R		153-353	153-353Y	Bdx	203,0x38	Hand Brake
	99-02		R		700-149	700-149K		Ø 203,3	
1.4 e (KA0V) Eng.E7J626 (55kW)	3/99-11/02		R		153-353	153-353Y	Bdx	203,0x38	Hand Brake
	99-02		R		700-149	700-149K		Ø 203,3	
1.6 16v (KA0B/4, KA11) Eng.K4M700/ 701/ 704/ 708 (79kW)	3/99-11/02		R		153-353	153-353Y	Bdx	203,0x38	Hand Brake
	99-02		R		700-149	700-149K		Ø 203,3	
1.6 e (KA0F) Eng.K7M702/ 703 (66kW)	3/99-11/02		R		153-353	153-353Y	Bdx	203,0x38	Hand Brake
	99-02		R		700-149	700-149K		Ø 203,3	
1.8 16v (KA0S, KA12/A/M/R) Eng.F4P720/ 722 (85-88kW)	1/01-11/02		R		153-353	153-353Y	Bdx	203,0x38	Hand Brake
	01-02		R		700-148	700-148K		Ø 203,3	+ABS
1.9 D Eng.F8Q606/ 630/ 662/ 790 (40-44-47kW)	4/99-11/02		R		153-353	153-353Y	Bdx	203,0x38	Hand Brake
	99-02		R		700-149	700-149K		Ø 203,3	
1.9 DCi (KA05, KA1F) Eng.F9Q732/ 733 (75kW)	1/01-11/02		R		153-353	153-353Y	Bdx	203,0x38	+TC, Hand Brake
	01-02		R		700-153			Ø 228,6	
1.9 DTi (KA0N) Eng.F9Q731/ 736 (72kW)	3/99-2/01		R		153-353	153-353Y	Bdx	203,0x38	Hand Brake
	99-01		R		700-149	700-149K		Ø 203,3	
1.9 DTi (KA1U) Eng.F9Q744 (59kW)	1/01-11/02		R		153-353	153-353Y	Bdx	203,0x38	Hand Brake
	01-02		R		700-149	700-149K		Ø 203,3	
Megane I (LA) Classic 9/96-11/02									
1.4 16v (LA0D/W,1H/0) Eng.K4J714/ 750 (70kW)	3/99-11/02		R		153-353	153-353Y	Bdx	203,0x38	Hand Brake
	3/99-02		R		700-149	700-149K		Ø 203,3	
	99-02		R		151-160		Bdx	Ø 19,05 203,2x39	RAI, +ABS, -ASR
1.4 e (LA0E/V) Eng.E7J626/ 764 (52-55kW)	9/96-11/02		R		153-353	153-353Y	Bdx	203,0x38	Hand Brake
	96-02		R		700-149	700-149K		Ø 203,3	
	96-02		R		151-160		Bdx	Ø 19,05 203,2x39	RAI, +ABS, -ASR
1.6 16v (LA04/B, LA11/C/J) Eng.K4M700/ 701/ 708 (70-79-83kW)	3/99-11/02		R		153-353	153-353Y	Bdx	203,0x38	Hand Brake
	3/99-02		R		700-149	700-149K		Ø 203,3	
	99-02		R		151-160		Bdx	Ø 19,05 203,2x39	RAI, +ABS, -ASR
1.6 e (LA0F/S) Eng.K7M702/ 703/ 790 (66kW)	9/96-3/99		R		153-353	153-353Y	Bdx	203,0x38	Hand Brake
	96-99		R		700-149	700-149K		Ø 203,3	
1.6 i (LA0L) Eng.K7M720 (55kW)	9/96-3/99		R		153-353	153-353Y	Bdx	203,0x38	Hand Brake
	96-99		R		700-149	700-149K		Ø 203,3	



























































		Spare Parts	F/R	L/R	CIFAM ref.	CIFAM ref. w/KIT		DIMENSIONS mm.	NOTE
1.8 16v (LA06, LA12/A/M/R) Eng.F4P720/ 722 (85-88kW)	1/01-11/02		R		153-353	153-353Y	Bdx	203,0x38	Hand Brake
	01-02		R		700-148	700-148K		Ø 203,3	+ABS
	01-02		R		151-160		Bdx	Ø 19,05 203,2x39	RAI, +ABS, -ASR
1.9 D (LA0A/U) Eng.F8Q620/ 624 (47-66-68kW)	9/96-11/02		R		153-353	153-353Y	Bdx	203,0x38	Hand Brake
	96-02		R		700-149	700-149K		Ø 203,3	
1.9 DCi (LA05, LA1F) Eng.F9Q732/ 733/ 738 (75kW)	2/01-11/02		R		153-353	153-353Y	Bdx	203,0x38	+TC, Hand Brake
	01-02		R		151-160		Bdx	Ø 19,05 203,2x39	RAI, +ABS, -ASR
1.9 DT (LA0K/Y) Eng.F8Q784/ 786 (66kW)	9/96-11/02		R		153-353	153-353Y	Bdx	203,0x38	Hand Brake
	96-02		R		700-149	700-149K		Ø 203,3	
1.9 DTi (LA08/N) Eng.F9Q730/ 731/ 734/ 736 (72kW)	3/97-2/01		R		153-353	153-353Y	Bdx	203,0x38	Hand Brake
	97-01		R		700-149	700-149K		Ø 203,3	
1.9 DTi (LA1U) Eng.F9Q744 (59kW)	2/01-11/02		R		153-353	153-353Y	Bdx	203,0x38	Hand Brake
	01-02		R		700-149	700-149K		Ø 203,3	
	01-02		R		151-160		Bdx	Ø 19,05 203,2x39	RAI, +ABS, -ASR
1.9 TDi Eng.F8Q784 (69kW)	9/96-11/02		R		153-353	153-353Y	Bdx	203,0x38	Hand Brake
	96-02		R		700-149	700-149K		Ø 203,3	
2.0 (LA07/G) Eng.F3R750/ 751/ 752 (80-83-84kW)	9/96-11/02		R		153-353	153-353Y	Bdx	203,0x38	Hand Brake
	9/96-02		R		700-149	700-149K		Ø 203,3	
	96-02		R		151-160		Bdx	Ø 19,05 203,2x39	RAI, +ABS, -ASR
Megane II (BM0, CM0), SW, Coupe 11/02-10/08									
1.4 16v (BM0B, CM0B) Eng.K4J730 (70-72kW)	11/02-10/08		R		153-353	153-353Y	Bdx	203,0x38	Hand Brake
1.4 16v (Exc. SW) Eng.K4J732 (60kW)	10/03-10/08		R		153-353	153-353Y	Bdx	203,0x38	Hand Brake
1.5 DCi Eng.K9K728/ 729 (74kW)	03-08		R		153-353	153-353Y	Bdx	203,0x38	Hand Brake
1.5 DCi Eng.K9K734 (76kW)	07-08		R		153-353	153-353Y	Bdx	203,0x38	Hand Brake
1.5 DCi (BM0F, CM0F) Eng.K9K702/ 710/ 722 (60kW)	11/02-10/08		R		153-353	153-353Y	Bdx	203,0x38	Hand Brake
1.5 DCi, Coupe, Cabrio Eng.K9K724 (63kW)	5/05-10/08		R		153-353	153-353Y	Bdx	203,0x38	Hand Brake
1.5 DCi, Coupe, Cabrio Eng.K9K764/ 732 (78kW)	05-08		R		153-353	153-353Y	Bdx	203,0x38	Hand Brake
1.6 Eng.K4M768 (75kW)	9/03-11/08		R		153-353	153-353Y	Bdx	203,0x38	Hand Brake
1.6 16v Eng.K4M762/ 788 (77kW)	5/05-10/08		R		153-353	153-353Y	Bdx	203,0x38	Hand Brake
1.6 16v GPL Eng.K4M764 (77kW)	11/06-10/08		R		153-353	153-353Y	Bdx	203,0x38	Hand Brake
1.6 16v, Coupe, Cabrio (BM0C, CM0C) Eng.K4M760/ 761 (83kW)	11/02-10/08		R		153-353	153-353Y	Bdx	203,0x38	Hand Brake
1.9 DCi Eng.F9Q800 (88kW)	9/03-10/08		R		153-353	153-353Y	Bdx	203,0x38	Hand Brake
1.9 DCi Eng.F9Q808 (66kW)	02-05		R		153-353	153-353Y	Bdx	203,0x38	Hand Brake
1.9 DCi Eng.F9Q808 (68kW)	3/04-10/08		R		153-353	153-353Y	Bdx	203,0x38	Hand Brake
1.9 DCi, Coupe, Cabrio Eng.F9Q (81kW)	5/05-10/08		R		153-353	153-353Y	Bdx	203,0x38	Hand Brake
1.9 DCi, Coupe, Cabrio Eng.F9Q803/ 804 (96kW)	5/05-10/08		R		153-353	153-353Y	Bdx	203,0x38	Hand Brake
1.9 DCi, Coupe, Cabrio (BM0G, CM0G) Eng.F9Q730/ 731/ 734/ 736/ 800 (60-75-77-88kW)	11/02-10/08		R		153-353	153-353Y	Bdx	203,0x38	Hand Brake
2.0 16v T., Coupe, Cabrio (Exc. SW) Eng.F4R776 (120kW)	5/04-10/08		R		153-353	153-353Y	Bdx	203,0x38	Hand Brake
2.0 16v, Coupe, Cabrio (BM0U, CM0U) Eng.F4R770/ 771 (99kW)	11/02-10/08		R		153-353	153-353Y	Bdx	203,0x38	Hand Brake
Modus (F/JP0) 12/04-									
1.2 16v Eng.D4F740 (48kW)	5/05-04		R		153-290		Ap	203,0x38	Hand Brake
	05		R		700-381	700-381K		Ø 203,3	
	05		R		151-231		Ap	Ø 19,05 203,0x38	AP
1.2 16v Eng.D4F740 (55kW)	12/04-04		R		153-290		Ap	203,0x38	Hand Brake
	05		R		700-381	700-381K		Ø 203,3	
	05		R		151-231		Ap	Ø 19,05 203,0x38	AP
1.2 16v Eng.D4F764 (58kW)	06-06		R		153-290		Ap	203,0x38	Hand Brake
	06		R		700-381	700-381K		Ø 203,3	
	06		R		151-231		Ap	Ø 19,05 203,0x38	AP
1.2 16v TCE Eng.D4F784 (74kW)	07-07		R		153-290		Ap	203,0x38	Hand Brake
	07		R		700-381	700-381K		Ø 203,3	
	07		R		151-231		Ap	Ø 19,05 203,0x38	AP
1.4 16v Eng.K4J770 (72kW)	04-04		R		153-290		Ap	203,0x38	Hand Brake
	04		R		700-381	700-381K		Ø 203,3	
	04		R		151-231		Ap	Ø 19,05 203,0x38	AP















































		Spare Parts	F/R	L/R	CIFAM ref.	CIFAM ref. w/KIT		DIMENSIONS mm.	NOTE
1.5 DCi Eng.K9K750 (60kW)		05-	R		153-290		Ap	203,0x38	
		05-	R		700-381	700-381K		Ø 203,3	
		05-	R		151-231		Ap	Ø 19,05 203,0x38	AP
1.5 DCi Eng.K9K750 (63kW)		04-	R		153-290		Ap	203,0x38	Hand Brake
		04-	R		700-381	700-381K		Ø 203,3	
		04-	R		151-231		Ap	Ø 19,05 203,0x38	AP
1.5 DCi Eng.K9K752 (48kW)		06-	R		153-290		Ap	203,0x38	Hand Brake
		06-	R		700-381	700-381K		Ø 203,3	
		06-	R		151-231		Ap	Ø 19,05 203,0x38	AP
1.5 DCi Eng.K9K752 (50kW)		04-	R		153-290		Ap	203,0x38	Hand Brake
		04-	R		700-381	700-381K		Ø 203,3	
		04-	R		151-231		Ap	Ø 19,05 203,0x38	AP
1.5 DCi Eng.K9K764 (78kW)		5/05-	R		153-290		Ap	203,0x38	Hand Brake
		05-	R		700-381	700-381K		Ø 203,3	
		05-	R		151-231		Ap	Ø 19,05 203,0x38	AP
1.5 DCi Eng.K9K772 (76kW)		06-	R		153-290		Ap	203,0x38	Hand Brake
		06-	R		700-381	700-381K		Ø 203,3	
		06-	R		151-231		Ap	Ø 19,05 203,0x38	AP
1.6 Eng.K4M794 (65kW)		12/04-	R		153-290		Ap	203,0x38	Hand Brake
		05-	R		151-231		Ap	Ø 19,05 203,0x38	AP
1.6 16v Eng.K4M790 (82kW)		12/04-	R		153-290		Ap	203,0x38	Hand Brake
		04-	R		700-381	700-381K		Ø 203,3	
05-	R		151-231		Ap	Ø 19,05 203,0x38	AP		
R11 (B/C37) 3/83-12/90									
1.1 (B/C371) Eng.C1E715/ 720 (25-33-35kW)		3/83-12/90	R		153-343	153-343K	Bdx	180,0x42	
		3/83-12/90	R			153-343Y	Bdx	180,0x42	
		3/83-12/90	R		153-345	153-345Y	Bdx	180,0x42	Hand Brake
		3/83-12/90	R		153-344		Lucas	180,0x42	Hand Brake
		83-90	R		700-142	700-142K		Ø 180,2	
		83-6/86	R		151-011		Bdx	Ø 17,46 180,0x40	RAD
83-6/86	R		151-059		Lucas	Ø 17,78 180,0x40	RAI		
1.2 (B/C37S) Eng.C1G700/ 710 (40kW)		10/84-12/90	R		153-343	153-343K	Bdx	180,0x42	
		10/84-12/90	R			153-343Y	Bdx	180,0x42	
		10/84-12/90	R		153-345	153-345Y	Bdx	180,0x42	Hand Brake
		10/84-12/90	R		153-344		Lucas	180,0x42	Hand Brake
		84-90	R		700-142	700-142K		Ø 180,2	
		84-9/86	R		151-022		Bdx	Ø 22,00 180,0x40	RAD
84-9/86	R		151-042		Lucas	Ø 22,22 180,0x40	RAI		
1.4 (B/C372, B/C37C) Eng.C1J715 (35-43-44kW)		3/83-12/90	R		153-343	153-343K	Bdx	180,0x42	
		3/83-12/90	R			153-343Y	Bdx	180,0x42	
		3/83-12/90	R		153-345	153-345Y	Bdx	180,0x42	Hand Brake
		3/83-12/90	R		153-344		Lucas	180,0x42	Hand Brake
		86-90	R		700-142	700-142K		Ø 180,2	
		83-9/86	R		151-022		Bdx	Ø 22,00 180,0x40	RAD
83-9/86	R		151-042		Lucas	Ø 22,22 180,0x40	RAI		
1.4 (B/C372/373) Eng.C2J717/ 755 (43-46-50-53kW)		5/83-12/90	R		153-343	153-343K	Bdx	180,0x42	
		5/83-12/90	R			153-343Y	Bdx	180,0x42	
		5/83-12/90	R		153-345	153-345Y	Bdx	180,0x42	Hand Brake
		5/83-12/90	R		153-344		Lucas	180,0x42	Hand Brake
		83-90	R		700-142	700-142K		Ø 180,2	Incl. Spain
		83-9/86	R		151-022		Bdx	Ø 22,00 180,0x40	RAD
83-9/86	R		151-042		Lucas	Ø 22,22 180,0x40	RAI		
1.4 (B/C372/373) Eng.C2J718/ 757 (43-46-50-53kW)		3/83-12/90	R		153-343	153-343K	Bdx	180,0x42	
		3/83-12/90	R			153-343Y	Bdx	180,0x42	
		3/83-12/90	R		153-345	153-345Y	Bdx	180,0x42	Hand Brake
		3/83-12/90	R		153-344		Lucas	180,0x42	Hand Brake
		83-90	R		700-142	700-142K		Ø 180,2	Incl. Spain
		83-9/86	R		151-022		Bdx	Ø 22,00 180,0x40	RAD
83-9/86	R		151-042		Lucas	Ø 22,22 180,0x40	RAI		
1.4 (B/C37A/C/R) Eng.C2J720/ 730/ 766/ 767/ 768 (43-46-50-53kW)		3/83-12/90	R		153-343	153-343K	Bdx	180,0x42	
		3/83-12/90	R			153-343Y	Bdx	180,0x42	
		3/83-12/90	R		153-345	153-345Y	Bdx	180,0x42	Hand Brake
		3/83-12/90	R		153-344		Lucas	180,0x42	Hand Brake
		86-90	R		700-142	700-142K		Ø 180,2	
		83-9/86	R		151-022		Bdx	Ø 22,00 180,0x40	RAD
83-9/86	R		151-042		Lucas	Ø 22,22 180,0x40	RAI		

























































		Spare Parts	F/R	L/R	CIFAM ref.	CIFAM ref. w/KIT		DIMENSIONS mm.	NOTE
1.4 T. (B/C375) Eng.C1J760/ 764 (77kW)	4/84-9/86		R		153-343	153-343K	Bdx	180,0x42	
	4/84-9/86		R			153-343Y	Bdx	180,0x42	
	4/84-9/86		R		153-344		Lucas	180,0x42	Hand Brake
	84-86		R		700-142	700-142K		Ø 180,2	
	84-86		R		151-022		Bdx	Ø 22,00 180,0x40	RAD
	84-86		R		151-042		Lucas	Ø 22,22 180,0x40	RAI
1.4 T. (B/C375) Eng.C1J770/ 782 (85-88kW)	10/86-12/90		R		153-343	153-343K	Bdx	180,0x42	
	10/86-12/90		R			153-343Y	Bdx	180,0x42	
	10/86-12/90		R		153-344		Lucas	180,0x42	Hand Brake
1.6 D, TD (B/C374) Eng.F8M700/ 720/ 730 (40kW)	8/83-12/90		R		153-343	153-343K	Bdx	180,0x42	
	8/83-12/90		R			153-343Y	Bdx	180,0x42	
	8/83-12/90		R		153-345	153-345Y	Bdx	180,0x42	Hand Brake
	8/83-12/90		R		153-344		Lucas	180,0x42	Hand Brake
	83-90		R		700-142	700-142K		Ø 180,2	
	83-86		R		151-022		Bdx	Ø 22,00 180,0x40	RAD
	83-86		R		151-042		Lucas	Ø 22,22 180,0x40	RAI
	86-90		R		151-013		Bdx	Ø 20,64 180,0x40	CRCI, RAI
1.7 (B/C37 D/N) Eng.F2N708/ 710/ 732/ 742/ 798 (55-59-64-68kW)	6/87-12/90		R		153-343	153-343K	Bdx	180,0x42	
	6/87-12/90		R			153-343Y	Bdx	180,0x42	
	6/87-12/90		R		153-345	153-345Y	Bdx	180,0x42	Hand Brake
	6/87-12/90		R		153-344		Lucas	180,0x42	Hand Brake
	87-90		R		700-142	700-142K		Ø 180,2	
1.7 (B/C376) Eng.F2N700/ 704 (55-59-64-68kW)	10/83-12/86		R		153-343	153-343K	Bdx	180,0x42	
	10/83-12/86		R			153-343Y	Bdx	180,0x42	
	10/83-12/86		R		153-345	153-345Y	Bdx	180,0x42	Hand Brake
	10/83-12/86		R		153-344		Lucas	180,0x42	Hand Brake
	83-86		R		700-142	700-142K		Ø 180,2	
	83-86		R		151-022		Bdx	Ø 22,00 180,0x40	RAD
1.7 (B/C37E) Eng.F3N708 (69kW)	6/87-12/90		R		153-343	153-343K	Bdx	180,0x42	
	6/87-12/90		R			153-343Y	Bdx	180,0x42	
	6/87-12/90		R		153-345	153-345Y	Bdx	180,0x42	Hand Brake
	6/87-12/90		R		153-344		Lucas	180,0x42	Hand Brake
	87-90		R		700-142	700-142K		Ø 180,2	
1.7 (B/C37F) Eng.F3N718 (55-66-70kW)	10/84-12/90		R		153-343	153-343K	Bdx	180,0x42	
	10/84-12/90		R			153-343Y	Bdx	180,0x42	
	10/84-12/90		R		153-345	153-345Y	Bdx	180,0x42	Hand Brake
	10/84-12/90		R		153-344		Lucas	180,0x42	Hand Brake
	84-90		R		700-142	700-142K		Ø 180,2	
	84-86		R		151-022		Bdx	Ø 22,00 180,0x40	RAD
1.7 (B/C37L) Eng.F2N730 (55-59-64-68kW)	10/86-12/90		R		153-343	153-343K	Bdx	180,0x42	
	10/86-12/90		R			153-343Y	Bdx	180,0x42	
	10/86-12/90		R		153-345	153-345Y	Bdx	180,0x42	Hand Brake
	10/86-12/90		R		153-344		Lucas	180,0x42	Hand Brake
	86-90		R		700-142	700-142K		Ø 180,2	
All models (Old Type)									
R12 (117) 10/69-8/80									
1.3 (1170), Break Eng.81002 (37kW)	7/75-4/80		R		153-340	153-340K	Bdx	228,6x42	Hand Brake
1.3 (1170), Break Eng.8100297 (40kW)	10/69-8/80		R		153-340	153-340K	Bdx	228,6x42	Hand Brake
1.3 (1171) Break Eng.810 (33kW)	8/70-8/80		R		153-340	153-340K	Bdx	228,6x42	Hand Brake
1.3 (1330) Break Eng.81002 (36-39kW)	8/72-8/80		R		153-340	153-340K	Bdx	228,6x42	Hand Brake
1.3 TS (1177) Eng.81006 (44kW)	8/72-8/80		R		153-340	153-340K	Bdx	228,6x42	Hand Brake
1.3 TS (1337) Break Eng.81006 (44kW)	8/72-8/80		R		153-340	153-340K	Bdx	228,6x42	Hand Brake
R14 (121) 9/79-12/83									
1.2 (1210) Eng.129 (42-43kW)	1/80-12/83		R		153-341	153-341K	Bdx	180,0x42	Hand Brake
	80-83		R		151-044		Bdx	Ø 22,00 180,0x40	RAD
1.4 (1212) Eng.150 (52kW)	9/79-6/83		R		153-341	153-341K	Bdx	180,0x42	Hand Brake
	79-83		R		151-044		Bdx	Ø 22,00 180,0x40	RAD
1.4 (1213) Eng.126/ 150700/ X5J7 (44-52kW)	12/81-12/83		R		153-341	153-341K	Bdx	180,0x42	Hand Brake
	81-83		R		151-044		Bdx	Ø 22,00 180,0x40	RAD



































		Spare Parts	F/R	L/R	CIFAM ref.	CIFAM ref. w/KIT		DIMENSIONS mm.	NOTE
R17 3/72-10/80									
1.6 (1312, 1316, 1322) Eng.80710/ 11 (66kW)	3/72-1/76		R		153-340	153-340K	Bdx	228,6x42	Hand Brake
1.6 Gordini (1318, 1328) Eng.84305 (68-79kW)	3/74-10/80		R		153-340	153-340K	Bdx	228,6x42	Hand Brake
R18 (134) 4/78-7/86									
1.4 (1340) Eng.847720/ 722 (46kW)	4/78-7/86		R		153-341	153-341K	Bdx	180,0x42	Hand Brake
	78-86		R		151-044		Bdx	Ø 22,00 180,0x40	RAD
1.4 (1349) Eng.847720/ 722 (49kW)	4/78-7/86		R		153-341	153-341K	Bdx	180,0x42	Hand Brake
1.6 (1341) Eng.841717 (54kW)	4/82-7/86		R		153-341	153-341K	Bdx	180,0x42	Hand Brake
	82-86		R		151-044		Bdx	Ø 22,00 180,0x40	RAD
1.6 (1341) Eng.841725/ 726 (58kW)	4/78-9/82		R		153-341	153-341K	Bdx	180,0x42	Hand Brake
	78-82		R		151-044		Bdx	Ø 22,00 180,0x40	RAD
1.6 (1342) Eng.A6M725/ 726 (71kW)	5/82-7/86		R		153-341	153-341K	Bdx	180,0x42	Hand Brake
	82-86		R		151-044		Bdx	Ø 22,00 180,0x40	RAD
1.6 T. (134,135A) Eng.A7L752 (82kW)	9/82-7/86		R		153-340	153-340K	Bdx	228,6x42	Hand Brake
1.6 T. (1345) Eng.807727 (80kW)	10/80-9/82		R		153-340	153-340K	Bdx	228,6x42	Hand Brake
	80-82		R		700-144			Ø 228,6	Exc. Spain
	80-82		R		151-015		Bdx	Ø 22,00 228,0x42	RAD
1.6 T. (1345) Eng.A5L717/ 718 (92kW)	10/82-7/86		R		153-340	153-340K	Bdx	228,6x42	Hand Brake
2.0 (1343) Eng.J6R716 (74-77-81kW)	5/82-7/86		R		153-340	153-340K	Bdx	228,6x42	Hand Brake
	82-86		R		700-144			Ø 228,6	Exc. Spain
	82-86		R		151-015		Bdx	Ø 22,00 228,0x42	RAD
2.1 D (1344) Eng.852710/ J8S711 (43-46-50-53kW)	11/81-7/86		R		153-341	153-341K	Bdx	180,0x42	Hand Brake
	81-86		R		151-044		Bdx	Ø 22,00 180,0x40	RAD
2.1 TD (1346) Eng.J8S712 (65kW)	11/81-7/86		R		153-340	153-340K	Bdx	228,6x42	Hand Brake
	81-86		R		700-144			Ø 228,6	
	81-86		R		151-015		Bdx	Ø 22,00 228,0x42	RAD
R18 (135) Break 5/79-12/86									
1.4 (1350) Eng.847720/ 722 (46kW)	5/79-7/86		R		153-340	153-340K	Bdx	228,6x42	Hand Brake
	-86		R		700-144			Ø 228,6	Ch 114801-
	79-		R		151-015		Bdx	Ø 22,00 228,0x42	Ch -114800, RAD
1.4 (1359) Eng.847720/ 722 (49kW)	5/79-7/86		R		153-340	153-340K	Bdx	228,6x42	Hand Brake
	-86		R		700-144			Ø 228,6	Ch 201-, Switzerland
1.6 Eng.A7L752 (82kW)	10/83-9/86		R		153-340	153-340K	Bdx	228,6x42	Hand Brake
1.6 (R1352) Eng.A6M725/ 726 (71kW)	5/82-7/86		R		153-340	153-340K	Bdx	228,6x42	Hand Brake
	82-86		R		700-144			Ø 228,6	
	82-		R		151-015		Bdx	Ø 22,00 228,0x42	Ch -5400, RAD
1.6, 4WD (1351) Eng.841717/ A2M723 (54kW)	1/82-7/86		R		153-340	153-340K	Bdx	228,6x42	Hand Brake
	-86		R		700-144			Ø 228,6	Ch 3401-, Exc. Spain
1.6, 4WD (1351) Eng.841725/ 726 (58kW)	5/79-9/82		R		153-340	153-340K	Bdx	228,6x42	Hand Brake
	-82		R		700-144			Ø 228,6	Ch 3401-, Exc. Spain
	79-82		R		151-015		Bdx	Ø 22,00 228,0x42	RAD
2.0 (1353) Eng.J6R716 (77kW)	10/81-7/86		R		153-340	153-340K	Bdx	228,6x42	Hand Brake
	81-86		R		700-144			Ø 228,6	
	81-86		R		151-015		Bdx	Ø 22,00 228,0x42	RAD
2.0 Allroad Eng.J6R712/ 714/ 716/ 780 (77kW)	5/83-12/86		R		153-340	153-340K	Bdx	228,6x42	Hand Brake
2.1 D (1354) Eng.852710/ J8S711 (49-53kW)	11/80-7/86		R		153-340	153-340K	Bdx	228,6x42	Hand Brake
	80-86		R		700-144			Ø 228,6	Exc. Spain
	80-86		R		151-015		Bdx	Ø 22,00 228,0x42	RAD
2.1 TD (1356) Eng.J8S712 (65kW)	11/81-7/86		R		153-340	153-340K	Bdx	228,6x42	Hand Brake
	81-86		R		700-144			Ø 228,6	
	81-86		R		151-015		Bdx	Ø 22,00 228,0x42	RAD
2.2 (135B) Eng.J7T718 (76kW)	6/84-7/86		R		153-340	153-340K	Bdx	228,6x42	Hand Brake
	84-86		R		700-144			Ø 228,6	Switzerland
	84-86		R		151-015		Bdx	Ø 22,00 228,0x42	RAD
R19 I (B/C53) 1/88-12/92									
1.2 (B/C530) Eng.C1G730 (40kW)	1/88-12/92		R		153-345	153-345Y	Bdx	180,0x42	Hand Brake
	88-4/92		R		700-142	700-142K		Ø 180,2	
	88-92		R		151-021		Bdx	Ø 20,64 180,0x40	CRCl, RAI
1.4 (B/C532) Kat Eng.C3J710 (43kW)	1/89-4/92		R		153-345	153-345Y	Bdx	180,0x42	Hand Brake
	1/89-92		R		700-142	700-142K		Ø 180,2	
	1/89-92		R		151-021		Bdx	Ø 20,64 180,0x40	CRCl, RAI





























		Spare Parts	F/R	L/R	CIFAM ref.	CIFAM ref. w/KIT		DIMENSIONS mm.	NOTE
1.4 (B/C53A,G) Eng.E6J700/ 701 (59kW)	1/88-12/92		R		153-345	153-345Y	Bdx	180,0x42	Hand Brake
	88-4/92		R		700-142	700-142K		Ø 180,2	
	88-92		R		151-021		Bdx	Ø 20,64 180,0x40	CRCI, RAI
1.4 (B/C53P) Eng.C2J772 (43-46-50-53kW)	1/89-12/89		R		153-345	153-345Y	Bdx	180,0x42	Hand Brake
	1/89-12/89		R		700-142	700-142K		Ø 180,2	
	1/89-12/89		R		151-021		Bdx	Ø 20,64 180,0x40	CRCI, RAI
1.7 (B/C53B) Eng.F3N740/ 741 (55-66-70kW)	9/88-4/92		R		153-345	153-345Y	Bdx	180,0x42	Hand Brake
	88-4/92		R		700-142	700-142K		Ø 180,2	
	88-92		R		151-021		Bdx	Ø 20,64 180,0x40	CRCI, RAI
1.7 (B/C53C) Eng.F3N742/ 743 (55-66-70kW)	9/88-4/92		R		153-345	153-345Y	Bdx	180,0x42	Hand Brake
	88-4/92		R		700-142	700-142K		Ø 180,2	
	88-92		R		151-021		Bdx	Ø 20,64 180,0x40	CRCI, RAI
1.8 16v (B/C53D) Eng.F7P704 (99-101kW)	6/89-4/92		R		153-345	153-345Y	Bdx	180,0x42	Hand Brake
1.9 D (B/C534, B/C53J) Eng.F8Q706/ 742 (47kW)	9/88-4/92		R		153-345	153-345Y	Bdx	180,0x42	Hand Brake
	88-4/92		R		700-142	700-142K		Ø 180,2	
	88-92		R		151-021		Bdx	Ø 20,64 180,0x40	CRCI, RAI
1.9 TD (C/B53K) Eng.F8Q740/ 756/ 764 (66-68kW)	9/90-4/92		R		153-345	153-345Y	Bdx	180,0x42	Hand Brake
	90-4/92		R		700-142	700-142K		Ø 180,2	
	90-92		R		151-021		Bdx	Ø 20,64 180,0x40	CRCI, RAI
R19 I (D53) Cabrio 9/88-4/92									
1.7 (D53B) Eng.F3N740/ 741 (55-66-70kW)	9/88-4/92		R		153-345	153-345Y	Bdx	180,0x42	Hand Brake
	91-		R		153-344		Lucas	180,0x42	Hand Brake
	88-4/92		R		700-142	700-142K		Ø 180,2	
1.7 (D53F) Eng.F3N742/ 743 (55-66-70kW)	88-92		R		151-021		Bdx	Ø 20,64 180,0x40	CRCI, RAI
	7/91-4/92		R		153-345	153-345Y	Bdx	180,0x42	Hand Brake
	7/91-4/92		R		153-344		Lucas	180,0x42	Hand Brake
1.8 16v (D53D) Eng.F7P704 (99-101kW)	91-92		R		700-142	700-142K		Ø 180,2	
	6/89-4/92		R		153-345	153-345Y	Bdx	180,0x42	Hand Brake
R19 I (L53) Chamade 1/88-12/92									
1.4 (L532, L53A/P) Eng.C2J710/ 772 (43-44-46-49-50-51-52-53kW)	7/88-4/92		R		153-345	153-345Y	Bdx	180,0x42	Hand Brake
	88-92		R		700-142	700-142K		Ø 180,2	
1.7 (L533) Eng.F2N720/ 721 (68kW)	9/88-12/92		R		153-345	153-345Y	Bdx	180,0x42	Hand Brake
1.7 (L53B) Eng.F3N740/ 741 (55-66-70kW)	10/89-4/92		R		153-345	153-345Y	Bdx	180,0x42	Hand Brake
	89-92		R		700-142	700-142K		Ø 180,2	
1.7 (L53C, F) Eng.F3N742/ 743/ 746 (55-66-70-79kW)	7/88-4/92		R		153-345	153-345Y	Bdx	180,0x42	Hand Brake
	88-92		R		700-142	700-142K		Ø 180,2	
1.8 16v (L539) Eng.F7P704 (99kW)	7/88-4/92		R		153-345	153-345Y	Bdx	180,0x42	Hand Brake
1.8 16v (L53D) Eng.F7P704 (99-101kW)	10/89-4/92		R		153-345	153-345Y	Bdx	180,0x42	Hand Brake
	89-92		R		700-142	700-142K		Ø 180,2	
1.9 D (L534, L53J) Eng.F8Q706/ 742 (47kW)	10/89-4/92		R		153-345	153-345Y	Bdx	180,0x42	Hand Brake
	89-92		R		700-142	700-142K		Ø 180,2	
1.9 TD (L53K) Eng.F8Q740 (66-68kW)	9/90-4/92		R		153-345	153-345Y	Bdx	180,0x42	Hand Brake
	90-92		R		700-142	700-142K		Ø 180,2	
R19 II (B/C53) 1/92-6/96									
1.2 (B/C530) Eng.C1G730 (40kW)	4/92-12/95		R		153-345	153-345Y	Bdx	180,0x42	Hand Brake
	92-95		R		700-142	700-142K		Ø 180,2	
	92-95		R		151-021		Bdx	Ø 20,64 180,0x40	CRCI, RAI
	92-95		R		151-048		Lucas	Ø 20,64 180,0x40	CRCI, RAI
1.2 (B/C53W) Eng.E7F700/ 706/ 730 (46kW)	4/92-12/95		R		153-345	153-345Y	Bdx	180,0x42	Hand Brake
	92-95		R		700-142	700-142K		Ø 180,2	
	92-95		R		151-021		Bdx	Ø 20,64 180,0x40	CRCI, RAI
	92-95		R		151-048		Lucas	Ø 20,64 180,0x40	CRCI, RAI
1.4 (B/C531/537) Eng.E7J700 (58kW)	1/92-12/95		R		153-345	153-345Y	Bdx	180,0x42	Hand Brake
	92-95		R		700-142	700-142K		Ø 180,2	
	92-95		R		151-021		Bdx	Ø 20,64 180,0x40	CRCI, RAI
	92-95		R		151-048		Lucas	Ø 20,64 180,0x40	CRCI, RAI
1.4 (B/C532) Eng.C3J710 (43kW)	4/92-12/95		R		153-345	153-345Y	Bdx	180,0x42	Hand Brake
	92-95		R		700-142	700-142K		Ø 180,2	
	92-95		R		151-021		Bdx	Ø 20,64 180,0x40	CRCI, RAI
	92-95		R		151-048		Lucas	Ø 20,64 180,0x40	CRCI, RAI
1.4 (B/C535) Eng.E7J742 (52-55kW)	1/92-12/95		R		153-345	153-345Y	Bdx	180,0x42	Hand Brake
	92-95		R		700-142	700-142K		Ø 180,2	-ABS























































		Spare Parts	F/R	L/R	CIFAM ref.	CIFAM ref. w/KIT		DIMENSIONS mm.	NOTE
1.4 (B/C53A,G) Eng.E6J700/ 701 (59kW)	1/92-12/95		R		153-345	153-345Y	Bdx	180,0x42	Hand Brake
	92-95		R		700-142	700-142K		Ø 180,2	
	92-95		R		151-021		Bdx	Ø 20,64 180,0x40	CRCI, RAI
	92-95		R		151-048		Lucas	Ø 20,64 180,0x40	CRCI, RAI
1.4 (B/C53H,B) Eng.C3J710 (43kW)	1/92-12/95		R		153-345	153-345Y	Bdx	180,0x42	Hand Brake
	92-95		R		700-142	700-142K		Ø 180,2	
	92-95		R		151-021		Bdx	Ø 20,64 180,0x40	CRCI, RAI
	92-95		R		151-048		Lucas	Ø 20,64 180,0x40	CRCI, RAI, Exc. 16S
1.7 (B/C533) Eng.F3N742 (68kW)	4/92-12/95		R		153-345	153-345Y	Bdx	180,0x42	Hand Brake
	4/92-12/95		R		153-344		Lucas	180,0x42	Hand Brake
	92-95		R		700-142	700-142K		Ø 180,2	
	92-95		R		151-021		Bdx	Ø 20,64 180,0x40	CRCI, RAI
1.7 (B/C53B, C) Eng.F3N740/ 741 (55-66-70kW)	4/92-12/95		R		153-345	153-345Y	Bdx	180,0x42	Hand Brake
	4/92-12/95		R		153-344		Lucas	180,0x42	Hand Brake
	92-95		R		700-142	700-142K		Ø 180,2	
	92-95		R		151-021		Bdx	Ø 20,64 180,0x40	CRCI, RAI
1.7 (B/C53F) Eng.F3N742/ 743 (55-66-70kW)	4/92-12/95		R		153-346	153-346Y	Bdx	203,2x39	Hand Brake
	4/92-12/95		R		153-344		Lucas	180,0x42	Hand Brake
	92-95		R		700-142	700-142K		Ø 180,2	
	92-95		R		700-148	700-148K		Ø 203,3	
1.7 (B/C53E, B53M) Eng.F3N740/ 741 (55-66-70kW)	4/92-12/95		R		153-345	153-345Y	Bdx	180,0x42	Hand Brake
	4/92-12/95		R		153-346	153-346Y	Bdx	203,2x39	Hand Brake
	4/92-12/95		R		153-344		Lucas	180,0x42	Hand Brake
	92-95		R		700-142	700-142K		Ø 180,2	
1.7 16v (B/C539) Eng.F7P704 (99kW)	4/92-12/95		R		153-345	153-345Y	Bdx	180,0x42	Hand Brake
	4/92-12/95		R		153-346	153-346Y	Bdx	203,2x39	Hand Brake
	4/92-12/95		R		153-344		Lucas	180,0x42	Hand Brake
	92-96		R		700-142	700-142K		Ø 180,2	-ABS
1.8 (5/853/353A) Eng.F3P706/ 760 (65-66-70-80-81kW)	92-96		R		151-048		Lucas	Ø 20,64 180,0x40	CRCI, RAI
	94-96		R		700-148	700-148K		Ø 203,3	-ABS
1.8 (5/853/353F, B/C538) Eng.F3P682/ 764/ 765 (65-66-70-80-81kW)	94-96		R		151-048		Lucas	Ø 20,64 180,0x40	CRCI, RAI
	94-96		R		151-048		Lucas	Ø 20,64 180,0x40	CRCI, RAI
1.8 (B/C538) Eng.F3P700 (65-66-70-80-81kW)	4/92-5/94		R		153-346	153-346Y	Bdx	203,2x39	Hand Brake
	92-94		R		700-148	700-148K		Ø 203,3	
	92-94		R		151-029		Bdx	Ø 19,05 203,0x39	RAI
	92-94		R		151-048		Lucas	Ø 20,64 180,0x40	CRCI, RAI
1.8 (B/C53Y) Eng.F3P704/ 705/ 706/ 707/ 708/ 760 (65-66-70-80-81kW)	92-96		R		700-142	700-142K		Ø 180,2	
	92-96		R		151-048		Lucas	Ø 20,64 180,0x40	CRCI, RAI
1.9 D (B/C53J) Eng.F8Q742 (47-66-68kW)	4/92-12/95		R		153-345	153-345Y	Bdx	180,0x42	Hand Brake
	92-95		R		700-142	700-142K		Ø 180,2	
	92-95		R		151-029		Bdx	Ø 19,05 203,0x39	RAI, Societé
	92-95		R		151-021		Bdx	Ø 20,64 180,0x40	CRCI, RAI
1.9 DT (B/C53K) Eng.F8Q744 (47-66-68kW)	4/92-12/95		R		153-346	153-346Y	Bdx	203,2x39	Hand Brake
	92-95		R		700-142	700-142K		Ø 180,2	
	92-95		R		151-029		Bdx	Ø 19,05 203,0x39	RAI, Societé
	92-95		R		151-021		Bdx	Ø 20,64 180,0x40	CRCI, RAI
1.9 DT (B/C53T) Eng.F8Q744 (47-66-68kW)	4/92-12/95		R		151-048		Lucas	Ø 20,64 180,0x40	CRCI, RAI
	92-95		R		700-148	700-148K		Ø 203,3	
	92-95		R		151-029		Bdx	Ø 19,05 203,0x39	RAI, Societé
	92-95		R		151-021		Bdx	Ø 20,64 180,0x40	CRCI, RAI
R19 II (D53) Cabrio 4/92-6/96									
1.7 (D53F) Eng.F3N742/ 743 (55-66-70kW)	4/92-12/95		R		153-345	153-345Y	Bdx	180,0x42	Hand Brake
	4/92-12/95		R		153-344		Lucas	180,0x42	Hand Brake
1.8 (853A, D53Y) Eng.F3P704/ 705/ 706/ 707/ 708/ 760 (65-66-70-80-81kW)	92-95		R		700-148	700-148K		Ø 203,3	
	92-96		R		153-344		Lucas	180,0x42	Hand Brake
	92-96		R		700-142	700-142K		Ø 180,2	
	92-96		R		151-048		Lucas	Ø 20,64 180,0x40	CRCI, RAI



























		Spare Parts	F/R	L/R	CIFAM ref.	CIFAM ref. w/KIT		DIMENSIONS mm.	NOTE
1.8 (D53C, V) Eng.F3P682/ 764/ 765 (65-66-70-80-81kW)	5/94-6/96		R		153-344		Lucas	180,0x42	Hand Brake
R19 II (L53) Chamade 1/92-12/95									
1.2 (L530) Eng.C1G730 (40kW)	4/92-12/95		R		153-345	153-345Y	Bdx	180,0x42	Hand Brake
	92-95		R		700-142	700-142K		Ø 180,2	
	92-95		R		151-021		Bdx	Ø 20,64 180,0x40	CRCI, RAI
	92-95		R		151-048		Lucas	Ø 20,64 180,0x40	CRCI, RAI
1.2 (L53W) Eng.E7F700/ 706/ 730 (46kW)	4/92-12/95		R		153-345	153-345Y	Bdx	180,0x42	Hand Brake
	92-95		R		700-142	700-142K		Ø 180,2	
	92-95		R		151-021		Bdx	Ø 20,64 180,0x40	CRCI, RAI
	92-95		R		151-048		Lucas	Ø 20,64 180,0x40	CRCI, RAI
1.4 (L532/531) Eng.C3J710 (43kW)	4/92-12/95		R		153-345	153-345Y	Bdx	180,0x42	Hand Brake
	92-95		R		700-142	700-142K		Ø 180,2	
	92-95		R		151-021		Bdx	Ø 20,64 180,0x40	CRCI, RAI
	92-95		R		151-048		Lucas	Ø 20,64 180,0x40	CRCI, RAI
1.4 (L535) Eng.E7J742 (52-55-57kW)	11/93-12/95		R		153-345	153-345Y	Bdx	180,0x42	Hand Brake
	93-95		R		700-142	700-142K		Ø 180,2	-ABS
1.4 (L53A,G) Eng.E6J700/ 701 (59kW)	1/92-12/95		R		153-345	153-345Y	Bdx	180,0x42	Hand Brake
	92-95		R		700-142	700-142K		Ø 180,2	
	92-95		R		151-021		Bdx	Ø 20,64 180,0x40	CRCI, RAI
	92-95		R		151-048		Lucas	Ø 20,64 180,0x40	CRCI, RAI
1.7 (L533) Eng.F3N742/ 743 (55-68-70kW)	4/92-12/95		R		153-345	153-345Y	Bdx	180,0x42	Hand Brake
	4/92-12/95		R		153-344		Lucas	180,0x42	Hand Brake
	92-95		R		700-142	700-142K		Ø 180,2	
	92-95		R		151-021		Bdx	Ø 20,64 180,0x40	CRCI, RAI
1.7 (L53B) Eng.F3N740/ 741 (55-66-70kW)	4/92-12/95		R		153-345	153-345Y	Bdx	180,0x42	Hand Brake
	4/92-12/95		R		153-344		Lucas	180,0x42	Hand Brake
	92-95		R		700-142	700-142K		Ø 180,2	
	92-95		R		151-021		Bdx	Ø 20,64 180,0x40	CRCI, RAI
1.7 (L53C, F) Eng.F3N742/ 743 (55-66-70kW)	4/92-12/95		R		153-345	153-345Y	Bdx	180,0x42	Hand Brake
	92-95		R		700-148	700-148K		Ø 203,3	
	92-95		R		153-345	153-345Y	Bdx	180,0x42	Hand Brake
	92-95		R		153-344		Lucas	180,0x42	Hand Brake
1.8 (L453A/F) Eng.F3P706/ 760 (65-66-70-80-81kW)	4/92-12/95		R		153-344		Lucas	180,0x42	Hand Brake
	92-95		R		700-142	700-142K		Ø 180,2	-ABS
	92-95		R		151-048		Lucas	Ø 20,64 180,0x40	CRCI, RAI
	92-95		R		153-346	153-346Y	Bdx	203,2x39	Hand Brake
1.8 (L538) Eng.F3P700 (65-66-70-80-81kW)	4/92-5/94		R		153-346	153-346Y	Bdx	203,2x39	Hand Brake
	92-94		R		700-148	700-148K		Ø 203,3	
	92-94		R		153-346	153-346Y	Bdx	203,2x39	Hand Brake
	94-95		R		700-148	700-148K		Ø 203,3	-ABS
1.8 (L53V, L538) Eng.F3P682/ 764/ 765 (65-66-70-80-81kW)	5/94-12/95		R		153-346	153-346Y	Bdx	203,2x39	Hand Brake
	94-95		R		700-148	700-148K		Ø 203,3	-ABS
	94-95		R		151-048		Lucas	Ø 20,64 180,0x40	CRCI, RAI
	94-95		R		153-344		Lucas	180,0x42	Hand Brake
1.8 (L53Y) Eng.F3P704/ 705/ 706/ 707/ 708/ 760 (65kW)	4/92-12/95		R		153-344		Lucas	180,0x42	Hand Brake
	92-95		R		700-142	700-142K		Ø 180,2	
	92-95		R		151-048		Lucas	Ø 20,64 180,0x40	CRCI, RAI
	92-95		R		153-345	153-345Y	Bdx	180,0x42	Hand Brake
1.9 D (L53J) Eng.F8Q742 (47-66-68kW)	4/92-12/95		R		153-345	153-345Y	Bdx	180,0x42	Hand Brake
	92-95		R		700-142	700-142K		Ø 180,2	
	92-95		R		151-029		Bdx	Ø 19,05 203,0x39	RAI, Societé
	92-95		R		151-021		Bdx	Ø 20,64 180,0x40	CRCI, RAI
	92-95		R		151-048		Lucas	Ø 20,64 180,0x40	CRCI, RAI
1.9 DT (L53K) Eng.F8Q744 (68kW)	4/92-12/95		R		153-345	153-345Y	Bdx	180,0x42	Hand Brake
	4/92-12/95		R		153-346	153-346Y	Bdx	203,2x39	Hand Brake
	92-95		R		700-148	700-148K		Ø 203,3	
	92-95		R		153-345	153-345Y	Bdx	180,0x42	Hand Brake
1.9 DT (L53T) Eng.F8Q744 (47-66-68kW)	4/92-12/95		R		153-346	153-346Y	Bdx	203,2x39	Hand Brake
	4/92-12/95		R		153-345	153-345Y	Bdx	180,0x42	Hand Brake
	92-95		R		700-148	700-148K		Ø 203,3	
R20 (127) 10/75-12/83									
1.6 (1271) Eng.843720/ 721 (66-68-71kW)	10/75-12/83		R		153-340	153-340K	Bdx	228,6x42	Hand Brake
	10/75-12/83		R		153-475		Lucas	228,6x42	Hand Brake
	75-83		R		151-019		Bdx	Ø 22,00 228,0x42	RAD
2.0 (1272) Eng.829700/ 701 (59-63-76-80-81kW)	10/77-10/80		R		153-340	153-340K	Bdx	228,6x42	Hand Brake
	10/77-10/80		R		153-475		Lucas	228,6x42	Hand Brake
	77-80		R		700-144			Ø 228,6	Sweden
	77-80		R		151-019		Bdx	Ø 22,00 228,0x42	RAD
2.0 (1277) Eng.829702/ 703 (59-63-76-80-81kW)	10/80-12/83		R		153-340	153-340K	Bdx	228,6x42	Hand Brake
	10/80-12/83		R		153-475		Lucas	228,6x42	Hand Brake
	80-83		R		700-144			Ø 228,6	





























































		Spare Parts	F/R	L/R	CIFAM ref.	CIFAM ref. w/KIT		DIMENSIONS mm.	NOTE
2.0 (1277) Eng.829702/ 703 (59-63-76-80-81kW)	80-83		R		151-019		Bdx	Ø 22,00 228,0x42	RAD
2.1 D (1276) Eng.852710 (43-46-50kW)	10/80-12/83		R		153-340	153-340K	Bdx	228,6x42	Hand Brake
	10/80-12/83		R		153-475		Lucas	228,6x42	Hand Brake
	80-83		R		700-144			Ø 228,6	
2.1 TD (1270) Eng.J8S702 (63kW)	80-83		R		151-019		Bdx	Ø 22,00 228,0x42	RAD
	1/82-12/83		R		153-340	153-340K	Bdx	228,6x42	Hand Brake
	1/82-12/83		R		153-475		Lucas	228,6x42	Hand Brake
	82-83		R		700-144			Ø 228,6	
2.2 (1279) Eng.851700 (67-70-74-76-79-85-89-91-101kW)	82-83		R		151-019		Bdx	Ø 22,00 228,0x42	RAD
	10/80-12/83		R		153-340	153-340K	Bdx	228,6x42	Hand Brake
	10/80-12/83		R		153-475		Lucas	228,6x42	Hand Brake
	80-83		R		151-019		Bdx	Ø 22,00 228,0x42	RAD
R21 (B48) 3/86-6/94									
1.4 (B48D) Eng.C2J770 (43-46-50-53kW)	6/88-5/93		R		153-345	153-345Y	Bdx	180,0x42	Hand Brake
	6/89-		R		700-143	700-143K		Ø 180,2	
1.4 (B48U) Eng.C2J770 (50kW)	6/88-5/93		R		153-345	153-345Y	Bdx	180,0x42	Hand Brake
	90-92		R		700-143	700-143K		Ø 180,2	
1.7 (B481,484) Eng.F2N712 (55-59-64-68kW)	7/86-2/94		R		153-345	153-345Y	Bdx	180,0x42	Hand Brake
	7/86-2/94		R		153-346	153-346Y	Bdx	203,2x39	GTS, Hand Brake
	86-94		R		700-143	700-143K		Ø 180,2	
1.7 (B482) Eng.F2N712/ 716 (55kW)	7/86-2/94		R		153-345	153-345Y	Bdx	180,0x42	Hand Brake
	7/86-2/94		R		153-346	153-346Y	Bdx	203,2x39	GTS, Hand Brake
	86-94		R		700-143	700-143K		Ø 180,2	Incl. Spain
	3/87-3/91		R		151-020		Bdx	Ø 22,00 180,0x40	CRCI, RAI
1.7 (B48A,F,P) Eng.F2N750/ F3N726 (54kW)	7/86-2/94		R		153-345	153-345Y	Bdx	180,0x42	Hand Brake
	7/86-2/94		R		153-346	153-346Y	Bdx	203,2x39	GTS, Hand Brake
	86-91		R		700-143	700-143K		Ø 180,2	
	91-94		R		700-144			Ø 228,6	
	3/87-3/91		R		151-020		Bdx	Ø 22,00 180,0x40	CRCI, RAI
86-2/87		R		151-017		Bdx	Ø 22,00 180,0x40	RAI	
1.7 (B48E) Eng.F3N722/ 723 (66-69kW)	3/86-2/94		R		153-345	153-345Y	Bdx	180,0x42	Hand Brake
	3/86-2/94		R		153-346	153-346Y	Bdx	203,2x39	GTS, Hand Brake
	86-94		R		700-143	700-143K		Ø 180,2	
	3/87-3/91		R		151-020		Bdx	Ø 22,00 180,0x40	CRCI, RAI
1.9 D (B48H/I) Eng.F8Q710 (47kW)	9/89-10/93		R		153-345	153-345Y	Bdx	180,0x42	Hand Brake
	89-93		R		700-143	700-143K		Ø 180,2	
	89-3/91		R		151-020		Bdx	Ø 22,00 180,0x40	CRCI, RAI
2.0 (B483) Eng.J7R750 (86kW)	6/89-93		R		700-144			Ø 228,6	
	86-93		R		151-062		Lucas	Ø 22,20 229,0x41	LUC
2.0 (B48C) Eng.J7R746/ 747 (88kW)	3/86-12/93		R		153-345	153-345Y	Bdx	180,0x42	Hand Brake
	3/86-12/93		R		153-475		Lucas	228,6x42	Hand Brake
	90-93		R		700-144			Ø 228,6	
2.0 (B48J) Eng.F2R702 (64kW)	3/86-12/93		R		153-345	153-345Y	Bdx	180,0x42	Hand Brake
	3/86-12/93		R		153-475		Lucas	228,6x42	Hand Brake
	86-93		R		700-143	700-143K		Ø 180,2	
	3/87-3/91		R		151-020		Bdx	Ø 22,00 180,0x40	CRCI, RAI
86-2/87		R		151-017		Bdx	Ø 22,00 180,0x40	RAI	
2.1 D (B480) Eng.J8S784 (43-46-50-53kW)	4/92-6/94		R		153-345	153-345Y	Bdx	180,0x42	Hand Brake
	4/92-6/94		R		153-475		Lucas	228,6x42	Hand Brake
	92-94		R		700-143	700-143K		Ø 180,2	
2.1 D (B48V, B48O) Eng.J8S600/ 740 (44-48-53-66kW)	9/89-6/94		R		153-345	153-345Y	Bdx	180,0x42	Hand Brake
	9/89-6/94		R		153-475		Lucas	228,6x42	Hand Brake
	89-94		R		700-143	700-143K		Ø 180,2	
2.1 TD (B486/B488/B48V) Eng.J8S714/ 786/ 788 (65kW)	3/86-6/94		R		153-345	153-345Y	Bdx	180,0x42	Hand Brake
	3/86-6/94		R		153-475		Lucas	228,6x42	Hand Brake
	6/89-94		R		700-144			Ø 228,6	Only Mod. B488/B48V
	86-94		R		700-143	700-143K		Ø 180,2	Only Mod. B486
	3/87-3/91		R		151-020		Bdx	Ø 22,00 180,0x40	CRCI, RAI, Only Mod. B486
	86-2/87		R		151-017		Bdx	Ø 22,00 180,0x40	RAI, Only Mod. B486
86-94		R		151-062		Lucas	Ø 22,20 229,0x41	LUC, Only Mod. B488/B48V	
2.2, 4WD (B48K) Eng.J7T754 (79kW)	7/86-2/94		R		153-475		Lucas	228,6x42	Hand Brake
	86-94		R		700-144			Ø 228,6	
	86-94		R		151-062		Lucas	Ø 22,20 229,0x41	LUC
R21 (K48) Nevada 3/86-9/95									
1.7 (K481) Eng.F2N712 (55kW)	6/86-3/93		R		153-345	153-345Y	Bdx	180,0x42	Hand Brake
	6/86-3/93		R		153-346	153-346Y	Bdx	203,2x39	GTS, Hand Brake













		Spare Parts	F/R	L/R	CIFAM ref.	CIFAM ref. w/KIT		DIMENSIONS mm.	NOTE
1.7 (K482) Eng.F2N710 (65kW)	10/86-12/88		R		153-345	153-345Y	Bdx	180,0x42	Hand Brake
	10/86-12/88		R		153-346	153-346Y	Bdx	203,2x39	GTS, Hand Brake
	86-		R		700-144			Ø 228,6	
	86-		R		151-067		Lucas	Ø 20,64 228,0x40	LUC
	86-		R		151-062		Lucas	Ø 22,20 229,0x41	LUC, Exc. 4WD
1.7 (K48E) Eng.F3N722/ 723 (66-69kW)	6/86-12/93		R		153-345	153-345Y	Bdx	180,0x42	Hand Brake
	6/86-12/93		R		153-346	153-346Y	Bdx	203,2x39	GTS, Hand Brake
1.7 (K48F) Kat Eng.F3N726 (54kW)	5/88-6/93		R		153-345	153-345Y	Bdx	180,0x42	Hand Brake
	5/88-6/93		R		153-346	153-346Y	Bdx	203,2x39	GTS, Hand Brake
	5/88-6/93		R		153-475		Lucas	228,6x42	Hand Brake
1.7 (K48M) Eng.F2N750 (54kW)	6/86-12/89		R		153-345	153-345Y	Bdx	180,0x42	Hand Brake
	6/86-12/89		R		153-346	153-346Y	Bdx	203,2x39	GTS, Hand Brake
1.7 (K48N) Eng.F2N752 (64kW)	6/87-4/89		R		153-345	153-345Y	Bdx	180,0x42	Hand Brake
	6/87-4/89		R		153-346	153-346Y	Bdx	203,2x39	GTS, Hand Brake
	6/87-4/89		R		153-475		Lucas	228,6x42	Hand Brake
1.9 D (K48H/I) Eng.F8Q710 (47kW)	3/86-8/94		R		153-345	153-345Y	Bdx	180,0x42	Hand Brake
2.0 (K483) Eng.J7R750/ 751 (85kW)	86-88		R		700-144			Ø 228,6	
	86-88		R		151-062		Lucas	Ø 22,20 229,0x41	LUC
2.0 (K489) Eng.J6R758/ 759/ 792/ 793 (74-77-81kW)	86-89		R		700-144			Ø 228,6	
2.0 (K48R/Y) Eng.J7R740 (99kW)	90-94		R		700-144			Ø 228,6	
	90-94		R		151-062		Lucas	Ø 22,20 229,0x41	LUC
2.1 D (K480) Eng.J8S784 (44-48-53-66kW)	2/92-9/95		R		153-345	153-345Y	Bdx	180,0x42	Hand Brake
	2/92-9/95		R		153-475		Lucas	228,6x42	Hand Brake
	92-95		R		700-144			Ø 228,6	
	92-95		R		151-062		Lucas	Ø 22,20 229,0x41	LUC
2.1 D (K48V,O) Eng.J8S600/ 740 (44-48-53-66kW)	8/89-12/92		R		153-345	153-345Y	Bdx	180,0x42	Hand Brake
	8/89-12/92		R		153-475		Lucas	228,6x42	Hand Brake
	89-92		R		700-144			Ø 228,6	
	89-92		R		151-062		Lucas	Ø 22,20 229,0x41	LUC
2.1 D, 4WD (K486) Eng.J8S704 (48kW)	86-92		R		700-144			Ø 228,6	
	86-92		R		151-062		Lucas	Ø 22,20 229,0x41	LUC, Exc. 4WD
2.1 TD (K488) Eng.J8S788 (65kW)	86-93		R		700-144			Ø 228,6	
	86-93		R		151-062		Lucas	Ø 22,20 229,0x41	LUC
2.1 TD (K48A/P/W, K487) Eng.J8S714/ 786 (65kW)	86-93		R		700-144			Ø 228,6	
	86-93		R		151-062		Lucas	Ø 22,20 229,0x41	LUC
2.2 (K48B) Eng.J7T754/ 755 (79kW)	86-93		R		700-144			Ø 228,6	
	86-93		R		151-062		Lucas	Ø 22,20 229,0x41	LUC
2.2 (K48C) Eng.J7T754/ 755 (79kW)	86-93		R		700-144			Ø 228,6	
	86-93		R		151-062		Lucas	Ø 22,20 229,0x41	LUC
2.2, 4WD (K48K) Eng.J7T754/ 755 (79kW)	86-93		R		700-144			Ø 228,6	
R21 (L48) 3/86-6/94									
1.4 (L48D) Eng.C2J770 (43-46-50-53kW)	6/88-5/93		R		153-345	153-345Y	Bdx	180,0x42	Hand Brake
	88-93		R		700-143	700-143K		Ø 180,2	
	88-3/91		R		151-020		Bdx	Ø 22,00 180,0x40	CRCI, RAI
1.4 (L48U) Eng.C2J770 (50kW)	6/88-5/93		R		153-345	153-345Y	Bdx	180,0x42	Hand Brake
	4/91-		R		700-143	700-143K		Ø 180,2	
	6/88-3/91		R		700-144			Ø 228,6	
1.7 (L481) Eng.F2N712 (55kW)	3/86-12/87		R		153-345	153-345Y	Bdx	180,0x42	Hand Brake
	3/86-12/87		R		153-346	153-346Y	Bdx	203,2x39	GTS, Hand Brake
	3/86-12/87		R		153-475		Lucas	228,6x42	Hand Brake
1.7 (L482) Eng.F2N710 (65kW)	3/86-3/93		R		153-345	153-345Y	Bdx	180,0x42	Hand Brake
	3/86-3/93		R		153-346	153-346Y	Bdx	203,2x39	GTS, Hand Brake
	3/86-5/87		R		700-143	700-143K		Ø 180,2	
	3/87-3/91		R		151-020		Bdx	Ø 22,00 180,0x40	CRCI, RAI
	86-2/87		R		151-017		Bdx	Ø 22,00 180,0x40	RAI
1.7 (L484) Eng.F2N710 (65kW)	3/86-3/93		R		153-345	153-345Y	Bdx	180,0x42	Hand Brake
	3/86-3/93		R		153-346	153-346Y	Bdx	203,2x39	GTS, Hand Brake
	6/90-5/92		R		700-143	700-143K		Ø 180,2	
	6/92-		R		700-144			Ø 228,6	
	86-3/91		R		151-020		Bdx	Ø 22,00 180,0x40	CRCI, RAI
1.7 (L48A/P/F) Eng.F2N750/ F3N726 (54kW)	7/86-2/94		R		153-345	153-345Y	Bdx	180,0x42	Hand Brake
	7/86-2/94		R		153-346	153-346Y	Bdx	203,2x39	GTS, Hand Brake
	7/86-2/94		R		153-475		Lucas	228,6x42	Hand Brake
	86-91		R		700-143	700-143K		Ø 180,2	
	91-94		R		700-144			Ø 228,6	





























































		Spare Parts	F/R	L/R	CIFAM ref.	CIFAM ref. w/KIT		DIMENSIONS mm.	NOTE
1.7 (L48A/P/F) Eng.F2N750/ F3N726 (54kW)	3/87-3/91		R		151-020		Bdx	Ø 22,00 180,0x40	CRCI, RAI
	86-2/87		R		151-017		Bdx	Ø 22,00 180,0x40	RAI
1.7 (L48E) Eng.F3N722/ 723 (66-69kW)	3/86-2/94		R		153-345	153-345Y	Bdx	180,0x42	Hand Brake
	3/86-2/94		R		153-346	153-346Y	Bdx	203,2x39	GTS, Hand Brake
1.7 (L48M/N) Eng.F2N752 (44kW)	6/87-4/89		R		153-345	153-345Y	Bdx	180,0x42	Hand Brake
	6/87-4/89		R		153-346	153-346Y	Bdx	203,2x39	GTS, Hand Brake
	6/87-4/89		R		153-475		Lucas	228,6x42	Hand Brake
	87-89		R		700-143	700-143K		Ø 180,2	Germany/Benelux
	87-89		R		151-020		Bdx	Ø 22,00 180,0x40	CRCI, RAI
1.9 D (L48I/H) Eng.F8Q710 (47kW)	9/89-10/93		R		153-345	153-345Y	Bdx	180,0x42	Hand Brake
	89-93		R		700-143	700-143K		Ø 180,2	
	89-3/91		R		151-020		Bdx	Ø 22,00 180,0x40	CRCI, RAI
2.0 (L483) Eng.J7R750/ 751 (85kW)	3/86-12/88		R		153-345	153-345Y	Bdx	180,0x42	Hand Brake
	3/86-12/88		R		153-475		Lucas	228,6x42	Hand Brake
	6/89-12/95		R		700-144			Ø 228,6	
	86-93		R		151-062		Lucas	Ø 22,20 229,0x41	LUC
2.0 (L489) Eng.J6R758/ 759/ 792/ 793 (75kW)	86-89		R		700-144			Ø 228,6	
2.0 (L48C) Eng.J7R746/ 747 (88kW)	90-93		R		700-144			Ø 228,6	
2.0 (L48J) Eng.F2R702 (64kW)	7/86-10/93		R		153-345	153-345Y	Bdx	180,0x42	Hand Brake
	7/86-10/93		R		153-475		Lucas	228,6x42	Hand Brake
	86-88		R		700-143	700-143K		Ø 180,2	
	3/87-88		R		151-020		Bdx	Ø 22,00 180,0x40	CRCI, RAI
	86-2/87		R		151-017		Bdx	Ø 22,00 180,0x40	RAI
2.0 (L48Q) Eng.J7R740 (99kW)	89-94		R		700-144			Ø 228,6	
2.1 D (L480) Eng.J8S784 (49-51kW)	4/92-6/94		R		153-345	153-345Y	Bdx	180,0x42	Hand Brake
	4/92-6/94		R		153-346	153-346Y	Bdx	203,2x39	Hand Brake
	92-94		R		700-142	700-142K		Ø 180,2	
2.1 D (L48V/O) Eng.J8S600/ 740 (53kW)	9/89-6/94		R		153-345	153-345Y	Bdx	180,0x42	Hand Brake
	89-94		R		700-143	700-143K		Ø 180,2	
	89-3/91		R		151-020		Bdx	Ø 22,00 180,0x40	CRCI, RAI
2.1 TD (L486) Eng.J8S704 (48kW)	3/86-12/89		R		153-345	153-345Y	Bdx	180,0x42	Hand Brake
	3/86-12/89		R		153-475		Lucas	228,6x42	Hand Brake
	86-89		R		700-143	700-143K		Ø 180,2	
	3/87-89		R		151-020		Bdx	Ø 22,00 180,0x40	CRCI, RAI
	86-2/87		R		151-017		Bdx	Ø 22,00 180,0x40	RAI
2.1 TD (L48A/W, L487, L488) Eng.J8S714/ 786/ 788 (65kW)	3/86-6/94		R		153-475		Lucas	228,6x42	Hand Brake
	86-94		R		700-144			Ø 228,6	
	86-94		R		151-062		Lucas	Ø 22,20 229,0x41	LUC
2.2, 4WD (L48K) Eng.J7T754/ 755 (79-81kW)	7/86-2/94		R		153-475		Lucas	228,6x42	Hand Brake
	86-94		R		700-144			Ø 228,6	
	86-94		R		151-062		Lucas	Ø 22,20 229,0x41	LUC
R25 (B29) 4/84-12/93									
2.0 (B297, B29J) Eng.J6R706/ 707/ 760/ 762/ 763 (74-77-81kW)	4/84-12/92		R		153-340	153-340K	Bdx	228,6x42	Hand Brake
	4/84-12/92		R		153-475		Lucas	228,6x42	Hand Brake
	84-5/88		R		700-144			Ø 228,6	
	84-92			R		151-019		Bdx	Ø 22,00 228,0x42
84-92	R			151-088		Lucas	Ø 22,22 228,0x40	LUC	
2.0 (B29H) Eng.J7R720/ 721/ 726 (76-88-99-103-119kW)	3/87-12/93		R		153-340	153-340K	Bdx	228,6x42	Hand Brake
3/87-12/93	R			153-475		Lucas	228,6x42	Hand Brake	
2.1 D Eng.J8S736 (44-48-53kW)	84-89		R		700-144			Ø 228,6	
2.1 D (B296) Eng.J8S706 (44-48-53kW)	4/84-5/89		R		153-340	153-340K	Bdx	228,6x42	Hand Brake
	4/84-5/89		R		153-475		Lucas	228,6x42	Hand Brake
	84-89		R		700-144			Ø 228,6	
2.1 TD (B290/ B29W) Eng.J8S708 (63kW)	4/84-12/92		R		153-340	153-340K	Bdx	228,6x42	Hand Brake
	4/84-12/92		R		153-475		Lucas	228,6x42	Hand Brake
	84-92		R		700-144			Ø 228,6	
	84-92		R		151-019		Bdx	Ø 22,00 228,0x42	RAD
	84-92		R		151-088		Lucas	Ø 22,22 228,0x40	LUC
2.2 (B29B) Eng.J7T708/ 732/ 733 (67-70-74-76-79-85-89-91-101kW)	9/86-12/92		R		153-340	153-340K	Bdx	228,6x42	Hand Brake
	9/86-12/92		R		153-475		Lucas	228,6x42	Hand Brake
	86-92		R		700-144			Ø 228,6	
	86-92		R		151-019		Bdx	Ø 22,00 228,0x42	RAD
86-92	R		151-088		Lucas	Ø 22,22 228,0x40	LUC		
2.2 (B29E) Eng.J7T706/ 707/ 714/ 715 (67-70-74-76-79-85-89-91-101kW)	4/84-12/89		R		153-340	153-340K	Bdx	228,6x42	Hand Brake
	4/84-12/89		R		153-475		Lucas	228,6x42	Hand Brake
	84-89		R		700-144			Ø 228,6	









































		Spare Parts	F/R	L/R	CIFAM ref.	CIFAM ref. w/KIT		DIMENSIONS mm.	NOTE
2.2 (B29E) Eng.J7T706/ 707/ 714/ 715 (67-70-74-76-79-85-89-91-101kW)	84-89		R		151-019		Bdx	Ø 22,00 228,0x42	RAD
	84-89		R		151-088		Lucas	Ø 22,22 228,0x40	LUC
2.2 (B29E) Eng.J7T730/ 731 (67-70-74-76-79-85-89-91-101kW)	4/84-12/89		R		153-340	153-340K	Bdx	228,6x42	Hand Brake
	4/84-12/89		R		153-475		Lucas	228,6x42	Hand Brake
	84-89		R		700-144			Ø 228,6	
	84-89		R		151-019		Bdx	Ø 22,00 228,0x42	RAD
	84-89		R		151-088		Lucas	Ø 22,22 228,0x40	LUC
R30 (127) 2/75-3/86									
2.1 TD (1270) Eng.J8S702 (44-48-53-66kW)	2/82-3/86		R		153-340	153-340K	Bdx	228,6x42	Hand Brake
	2/82-3/86		R		153-475		Lucas	228,6x42	Hand Brake
	82-86		R		700-144			Ø 228,6	
	82-86		R		151-019		Bdx	Ø 22,00 228,0x42	RAD
R4 (112) 10/62-6/93									
0.8 (1120) Eng.839 (20kW)	81-		R		700-323			Ø 160,3	Ch -501245
0.8 (1123) Eng.800 (21kW)	10/62-9/83		R		153-339	153-339K	Bdx	180,0x32	Hand Brake
	-83		R		700-323			Ø 160,3	Ch 1755388-
	-83		F		151-018		Bdx	Ø 23,81 228,0x42	Ch 329647-, RAD
0.8 (1123) Eng.800705/ 81302/ B1B707 (21kW)	10/83-10/88		R		153-339	153-339K	Bdx	180,0x32	Hand Brake
	-88		R		700-323			Ø 160,3	Ch 1755388-
0.8 (1124) Eng.B1B705/ 707 (21kW)	10/83-10/88		R		153-339	153-339K	Bdx	180,0x32	Hand Brake
0.8 (1126) Eng.B1B705/ 707 (21kW)	10/76-8/82		R		153-339	153-339K	Bdx	180,0x32	Hand Brake
	76-		R		700-323			Ø 160,3	Ch -501245
	-82		F		151-018		Bdx	Ø 23,81 228,0x42	Ch 329647-, RAD
0.95 (112C) Eng.C1C708 (25-30-31-32-33kW)	6/87-6/93		R		153-339	153-339K	Bdx	180,0x32	Hand Brake
	87-93		R		700-334			Ø 180,2	
	87-93		R		151-043		Bdx	Ø 22,00 180,0x30	RAD
1.1 Eng.688711/ 712/ C1E714/ 718/ 719 (25-32-33-35kW)	6/86-6/90		R		153-339	153-339K	Bdx	180,0x32	Hand Brake
1.1 (1128) Eng.688712/ C1E714/ 719 (25-33-35kW)	6/78-6/90		R		153-339	153-339K	Bdx	180,0x32	Hand Brake
	78-		R		700-334			Ø 180,2	Ch -461100
	-82		F		151-018		Bdx	Ø 23,81 228,0x42	Ch 329647-, RAD
	82-90		R		151-043		Bdx	Ø 22,00 180,0x30	RAD
R5 7/71-12/85									
0.8 (1220) Eng.800710 (19-21-25-26-27kW)	10/72-8/84		R		153-339	153-339K	Bdx	180,0x32	Hand Brake
	1/82-12/84		R		153-339	153-339K	Bdx	180,0x32	Hand Brake
0.8 (1221) Eng.800710 (27kW)	-82		F		151-018		Bdx	Ø 23,81 228,0x42	Ch 329647-, RAD
	82-84		R		151-043		Bdx	Ø 22,00 180,0x30	RAD
0.8 (1391) Eng.800710 (27kW)	1/82-12/84		R		153-339	153-339K	Bdx	180,0x32	Hand Brake
	82-84		R		151-043		Bdx	Ø 22,00 180,0x30	RAD
0.95 (1222) Eng.689710 (25-30-31-32-33kW)	82-85		R		151-043		Bdx	Ø 22,00 180,0x30	RAD
0.95 (1392) Eng.689710 (25-30-31-32-33kW)	72-85		R		151-043		Bdx	Ø 22,00 180,0x30	RAD
1.1 Eng.688713/ C1E726 (35kW)	7/71-4/80		R		153-339	153-339K	Bdx	180,0x32	Hand Brake
1.1 (1226/1227) Eng.688713/ C1E726 (25-30-31-32-33kW)	9/80-12/85		R		153-339	153-339K	Bdx	180,0x32	Hand Brake
	9/80-12/85		R			153-343K	Bdx	180,0x42	
	80-85		R		151-043		Bdx	Ø 22,00 180,0x30	RAD
1.1 (1397) Eng.688713/ C1E726 (25-33-35kW)	9/80-12/85		R		153-339	153-339K	Bdx	180,0x32	Hand Brake
	80-85		R		151-043		Bdx	Ø 22,00 180,0x30	RAD
1.3 (1224) Eng.810725 (29-31-32-33-37-40-44-47kW)	82-84		R		151-043		Bdx	Ø 22,00 180,0x30	RAD
1.3 (1225), Autom. Eng.810719/ 726/ 729 (29-31-32-33-37-40-44-47kW)	76-79		R		151-043		Bdx	Ø 22,00 180,0x30	RAD
1.3 (1395/1396), Autom. Eng.810719/ 729 (33kW)	79-84		R		151-043		Bdx	Ø 22,00 180,0x30	RAD
1.4 (1229) Eng.847725/ C2J713 (35-43-46kW)	1/82-12/85		R		153-339	153-339K	Bdx	180,0x32	Hand Brake
	82-85		R		151-043		Bdx	Ø 22,00 180,0x30	RAD
1.4 (1399) Eng.847725/ C2J713 (43-46-50-53kW)	1/82-12/85		R		153-339	153-339K	Bdx	180,0x32	Hand Brake
	82-85		R		151-043		Bdx	Ø 22,00 180,0x30	RAD
R6 10/69-4/87									
0.8 (1180) Eng.B1B800 (19-21-25-26-27kW)	-80		F		151-018		Bdx	Ø 23,81 228,0x42	Ch 329647-, RAD































































		Spare Parts	F/R	L/R	CIFAM ref.	CIFAM ref. w/KIT		DIMENSIONS mm.	NOTE	
R9 (L42) 9/81-12/89										
1.1 (L421) Eng.C1E715/ 720 (25-33-35kW)		-86	R		153-343	153-343K	Bdx	180,0x42		
		-86	R			153-343Y	Bdx	180,0x42		
		86-	R		153-345	153-345Y	Bdx	180,0x42	Hand Brake	
		9/81-5/87	R		153-344		Lucas	180,0x42	Hand Brake	
		10/81-87		R		700-142	700-142K		Ø 180,2	
		10/81-6/86		R		151-011		Bdx	Ø 17,46 180,0x40	RAD
1.2 (L42S) Eng.C1G700/ 710 (40kW)		-86	R		153-343	153-343K	Bdx	180,0x42		
		-86	R			153-343Y	Bdx	180,0x42		
		86-	R		153-345	153-345Y	Bdx	180,0x42	Hand Brake	
		9/85-12/88	R		153-344		Lucas	180,0x42	Hand Brake	
		85-88		R		700-142	700-142K		Ø 180,2	Incl. Spain
		85-88		R		151-022		Bdx	Ø 22,00 180,0x40	RAD
1.4 (L422/L42C) Eng.C1J715/ 792/ 796/ C2J730 (44kW)		12/81-12/88	R		153-344		Lucas	180,0x42	Hand Brake	
		-86	R		153-343	153-343K	Bdx	180,0x42		
		-86	R			153-343Y	Bdx	180,0x42		
		86-	R		153-345	153-345Y	Bdx	180,0x42	Hand Brake	
		81-88		R		700-142	700-142K		Ø 180,2	
		81-86		R		151-022		Bdx	Ø 22,00 180,0x40	RAD, Exc. L421
1.4 (L423) Eng.C2J718/ 757 (43-46-50-53kW)		81-86	R		151-042		Lucas	Ø 22,22 180,0x40	RAI, Exc. L421	
		-86	R		153-343	153-343K	Bdx	180,0x42		
		-86	R			153-343Y	Bdx	180,0x42		
		86-	R		153-345	153-345Y	Bdx	180,0x42	Hand Brake	
1.4 (L423, L42R) Eng.C2J717/ 720/ 755/ 766/ 767/ 768 (49-53kW)		9/81-12/85	R		153-344		Lucas	180,0x42	Hand Brake	
		-86	R		153-343	153-343K	Bdx	180,0x42		
		-86	R			153-343Y	Bdx	180,0x42		
		86-	R		153-345	153-345Y	Bdx	180,0x42	Hand Brake	
		9/81-12/88	R		153-344		Lucas	180,0x42	Hand Brake	
		81-88		R		700-142	700-142K		Ø 180,2	Incl. Spain
1.4 T. Eng.C1J760/ 764 (77-85-88kW)		81-86	R		151-022		Bdx	Ø 22,00 180,0x40	RAD	
		81-86	R		151-042		Lucas	Ø 22,22 180,0x40	RAI	
		81-86	R		153-344		Lucas	180,0x42	Hand Brake	
1.4 T. (L425) Eng.C1J760/ 764 (77-85-88kW)		12/86-12/89	R		153-344		Lucas	180,0x42	Hand Brake	
		4/84-12/86	R		153-344		Lucas	180,0x42	Hand Brake	
		84-86		R		700-142	700-142K		Ø 180,2	
1.6 D, TD (L424) Eng.F8M700/ 720/ 730 (40kW)		84-86	R		151-022		Bdx	Ø 22,00 180,0x40	RAD	
		84-86	R		151-042		Lucas	Ø 22,22 180,0x40	RAI	
		84-86	R		153-344		Lucas	180,0x42	Hand Brake	
		10/82-12/88	R		153-344		Lucas	180,0x42	Hand Brake	
		-86	R		153-343	153-343K	Bdx	180,0x42		
		-86	R			153-343Y	Bdx	180,0x42		
1.7 (L426) Eng.F2N700/ 704 (55-59-64-68kW)		86-	R		153-345	153-345Y	Bdx	180,0x42	Hand Brake	
		86-	R			153-345Y	Bdx	180,0x42		
		9/84-12/88	R		153-344		Lucas	180,0x42	Hand Brake	
		84-88		R		700-142	700-142K		Ø 180,2	Incl. Spain
		84-88	R		151-022		Bdx	Ø 22,00 180,0x40	RAD	
		84-88		R		151-042		Lucas	Ø 22,22 180,0x40	RAI
1.7 (L42E) Eng.F3N708 (55-66-70kW)		86-	R		153-345	153-345Y	Bdx	180,0x42	Hand Brake	
		86-	R		153-344		Lucas	180,0x42	Hand Brake	
		86-	R		153-343	153-343K	Bdx	180,0x42		
1.7 (L42F) Eng.F3N718 (55-66-70kW)		10/86-12/88	R			153-343Y	Bdx	180,0x42		
		-86	R		153-345	153-345Y	Bdx	180,0x42	Hand Brake	
		86-	R		700-142	700-142K		Ø 180,2		
		86-88		R		151-022		Bdx	Ø 22,00 180,0x40	RAD
		86-88		R		151-042		Lucas	Ø 22,22 180,0x40	RAI
		86-88	R		153-345	153-345Y	Bdx	180,0x42	Hand Brake	
1.7 (L42L) Eng.F2N730 (55-59-64-68kW)		86-	R		153-344		Lucas	180,0x42	Hand Brake	
		86-	R		153-343	153-343K	Bdx	180,0x42		























































		Spare Parts	F/R	L/R	CIFAM ref.	CIFAM ref. w/KIT		DIMENSIONS mm.	NOTE
1.7 (L42N) Eng.F2N708/ 710/ 798 (55-59-64-68kW)	86-		R		153-345	153-345Y	Bdx	180,0x42	Hand Brake
Old Type	81-88		R		700-146	700-146K		Ø 180,2	
Safrane I (B54) 4/92-7/96									
2.0 (B540) Eng.J7R732/ 733 (76-88-99-119-129kW)	11/92-7/96		R		153-475		Lucas	228,6x42	Hand Brake
	11/92-7/96		R		153-014		Lucas	228,6x42	-ABS, Hand Brake
	92-96		R		700-144			Ø 228,6	
2.1 TD (B546) Eng.J8S760 (65kW)	11/93-7/96		R		153-475		Lucas	228,6x42	Hand Brake
	11/93-7/96		R		153-014		Lucas	228,6x42	-ABS, Hand Brake
	93-96		R		700-144			Ø 228,6	
	93-96		R		151-132		Lucas	Ø 22,20 228,6x42	LUC, -ABS
2.2 (B541) Eng.J7T762 (79kW)	4/92-7/96		R		153-475		Lucas	228,6x42	Hand Brake
	4/92-7/96		R		153-014		Lucas	228,6x42	-ABS, Hand Brake
	92-2/95		R		700-144			Ø 228,6	
	92-96		R		151-132		Lucas	Ø 22,20 228,6x42	LUC, -ABS
Scenic I (JA) 9/99-6/03									
1.4 16v (JA0 D/W, JA1H/0) Eng.K4J714/ 750 (70-72kW)	9/99-6/03		R		153-351		Lucas	228,6x42	
	99-		R		700-153			Ø 228,6	
	99-		R		151-067		Lucas	Ø 20,64 228,0x40	LUC
1.6 16v (JA0B/4, JA11) Eng.K4M700/ 701/ 704/ 708/ 709 (75-79kW)	9/99-6/03		R		153-351		Lucas	228,6x42	
	99-		R		700-153			Ø 228,6	
	99-		R		151-067		Lucas	Ø 20,64 228,0x40	LUC
1.6 e (JA0F) Eng.K7M702/ 703 (66kW)	9/99-6/03		R		153-351		Lucas	228,6x42	
1.6 i (JA0L) Eng.K7M720 (55kW)	9/99-6/03		R		153-351		Lucas	228,6x42	
1.8 16v (JA12/R/M/A) Eng.F4P720/ 722 (85-88kW)	01-		R		700-148	700-148K		Ø 203,3	+ABS
1.9 DCi (JA05, JA1F) Eng.F9Q732/ 733 (75kW)	11/00-6/03		R		153-351		Lucas	228,6x42	
1.9 DCi RX4 Eng.F9Q740 (74-75kW)	11/00-6/03		R		153-351		Lucas	228,6x42	
1.9 DTi (JA0N) Eng.F9Q731/ 734/ 736 (72kW)	9/99-6/03		R		153-351		Lucas	228,6x42	
	99-		R		700-153			Ø 228,6	-ABS
1.9 DTi (JA1U) Eng.F9Q744 (59kW)	1/01-6/03		R		153-351		Lucas	228,6x42	
2.0 16v (JA1B/D) Eng.F4R740/ 741 (102-103kW)	7/00-6/03		R		153-351		Lucas	228,6x42	
2.0 16v IDE Eng.F5R740 (103kW)	9/99-6/03		R		153-351		Lucas	228,6x42	
2.0 16v RX4 Eng.F4R744 (102kW)	6/00-6/03		R		153-351		Lucas	228,6x42	
Scenic II (JM) 6/03-5/09									
1.4 16v Eng.K4J730 (72kW)	03-09		R		153-351		Lucas	228,6x42	
1.6 Eng.K4M788 (77kW)	06-09		R		153-351		Lucas	228,6x42	
1.6 16v Eng.K4M761/ 782 (83kW)	03-09		R		153-351		Lucas	228,6x42	
1.6 16v Eng.K4M766 (82kW)	07-09		R		153-351		Lucas	228,6x42	
Super 5 (B/C40) 10/84-12/96									
0.95 (B/C/400) Eng.C1C700 (30kW)	10/84-10/88		R		153-343	153-343K	Bdx	180,0x42	
	10/84-10/88		R			153-343Y	Bdx	180,0x42	
	10/84-10/88		R		153-345	153-345Y	Bdx	180,0x42	Hand Brake
	10/84-10/88		R		153-344		Lucas	180,0x42	Hand Brake
	84-88		R		700-142	700-142K		Ø 180,2	
	6/87-10/88		R		151-013		Bdx	Ø 20,64 180,0x40	CRCI, RAI
	7/86-5/87		R		151-017		Bdx	Ø 22,00 180,0x40	RAI
1.1 (B/C/401) Eng.C1E750/ 752/ 754 (25-33-35kW)	84-12/87		R		151-042		Lucas	Ø 22,22 180,0x40	RAI
	84-6/86		R		151-022		Bdx	Ø 22,00 180,0x40	RAD
	10/84-10/88		R		153-343	153-343K	Bdx	180,0x42	
	10/84-10/88		R			153-343Y	Bdx	180,0x42	
	10/84-10/88		R		153-345	153-345Y	Bdx	180,0x42	Hand Brake
	10/84-10/88		R		153-344		Lucas	180,0x42	Hand Brake
1.1 (B/C/401/H) Eng.C1E750/ 752/ 756/ 760 (34-35kW)	84-88		R		700-142	700-142K		Ø 180,2	
	6/87-10/88		R		151-013		Bdx	Ø 20,64 180,0x40	CRCI, RAI
	7/86-5/87		R		151-017		Bdx	Ø 22,00 180,0x40	RAI
	84-12/87		R		151-042		Lucas	Ø 22,22 180,0x40	RAI
	84-6/86		R		151-022		Bdx	Ø 22,00 180,0x40	RAD
	1/86-3/95		R		153-343	153-343K	Bdx	180,0x42	
1.1 (B/C/401/H) Eng.C1E750/ 752/ 756/ 760 (34-35kW)	1/86-3/95		R			153-343Y	Bdx	180,0x42	
	1/86-3/95		R		153-345	153-345Y	Bdx	180,0x42	Hand Brake
	1/86-3/95		R		153-344		Lucas	180,0x42	Hand Brake
	86-93		R		700-142	700-142K		Ø 180,2	





























































		Spare Parts	F/R	L/R	CIFAM ref.	CIFAM ref. w/KIT		DIMENSIONS mm.	NOTE
1.1 (B/C401/H) Eng.C1E750/ 752/ 756/ 760 (34-35kW)	1/86-12/87		R		151-042		Lucas	Ø 22,22 180,0x40	RAI
	1/86-6/86		R		151-022		Bdx	Ø 22,00 180,0x40	RAD
	4/91-95		R		151-048		Lucas	Ø 20,64 180,0x40	CRCI, RAI
	6/87-95		R		151-013		Bdx	Ø 20,64 180,0x40	CRCI, RAI
	7/86-5/87		R		151-017		Bdx	Ø 22,00 180,0x40	RAI
1.2 (B/C40F) Eng.C1G702/ 720/ 722 (40kW)	1/87-8/90		R		153-343	153-343K	Bdx	180,0x42	
	1/87-8/90		R			153-343Y	Bdx	180,0x42	
	1/87-8/90		R		153-345	153-345Y	Bdx	180,0x42	Hand Brake
	1/87-8/90		R		153-344		Lucas	180,0x42	Hand Brake
	87-90		R		700-142	700-142K		Ø 180,2	
	1/87-12/87		R		151-042		Lucas	Ø 22,22 180,0x40	RAI
	1/87-5/87		R		151-017		Bdx	Ø 22,00 180,0x40	RAI
	6/87-90		R		151-013		Bdx	Ø 20,64 180,0x40	CRCI, RAI
1.4 (B/C402/407), Kat Eng.C1J/ C3J700/ 702/ 760/ 768/ 780 (35-43-44kW)	10/84-6/88		R		153-343	153-343K	Bdx	180,0x42	
	10/84-6/88		R			153-343Y	Bdx	180,0x42	
	10/84-6/88		R		153-345	153-345Y	Bdx	180,0x42	Hand Brake
	10/84-6/88		R		153-344		Lucas	180,0x42	Hand Brake
	84-88		R		700-142	700-142K		Ø 180,2	
	6/87-88		R		151-013		Bdx	Ø 20,64 180,0x40	CRCI, RAI
	7/86-5/87		R		151-017		Bdx	Ø 22,00 180,0x40	RAI
	84-12/87		R		151-042		Lucas	Ø 22,22 180,0x40	RAI
	84-6/86		R		151-022		Bdx	Ø 22,00 180,0x40	RAD
	1.4 (B/C403) Eng.C2J700/ 780/ 781/ 788/ 798 (43-46-50-53kW)		10/84-7/89		R		153-343	153-343K	Bdx
10/84-7/89		R				153-343Y	Bdx	180,0x42	
10/84-7/89		R			153-345	153-345Y	Bdx	180,0x42	Hand Brake
10/84-7/89		R			153-344		Lucas	180,0x42	Hand Brake
1.4 (B/C40J) Eng.C2J782 (43-46-50-53kW)	6/87-7/89		R		153-343	153-343K	Bdx	180,0x42	
	6/87-7/89		R			153-343Y	Bdx	180,0x42	
	6/87-7/89		R		153-345	153-345Y	Bdx	180,0x42	Hand Brake
	6/87-7/89		R		153-344		Lucas	180,0x42	Hand Brake
1.4 (B/C40M) Eng.C2J784 (43-46-50-53kW)	6/87-8/90		R		153-343	153-343K	Bdx	180,0x42	
	6/87-8/90		R			153-343Y	Bdx	180,0x42	
	6/87-8/90		R		153-345	153-345Y	Bdx	180,0x42	Hand Brake
	6/87-8/90		R		153-344		Lucas	180,0x42	Hand Brake
	87-90		R		700-142	700-142K		Ø 180,2	
	6/87-12/87		R		151-042		Lucas	Ø 22,22 180,0x40	RAI
	6/87-90		R		151-013		Bdx	Ø 20,64 180,0x40	CRCI, RAI
1.6 D (B/C/404) Eng.F8M720/ 730 (40kW)	8/85-12/96		R		153-343	153-343K	Bdx	180,0x42	
	8/85-12/96		R			153-343Y	Bdx	180,0x42	
	8/85-12/96		R		153-345	153-345Y	Bdx	180,0x42	Hand Brake
	8/85-12/96		R		153-344		Lucas	180,0x42	Hand Brake
	85-96		R		700-142	700-142K		Ø 180,2	
	4/91-96		R		151-048		Lucas	Ø 20,64 180,0x40	CRCI, RAI, Exc. GTE, GT Turbo
	6/87-96		R		151-013		Bdx	Ø 20,64 180,0x40	CRCI, RAI, Exc. GTE, GT Turbo
	7/86-5/87		R		151-017		Bdx	Ø 22,00 180,0x40	RAI, Exc. GTE, GT Turbo
	8/85-6/86		R		151-022		Bdx	Ø 22,00 180,0x40	RAD, Exc. GTE, GT Turbo
	85-12/87		R		151-042		Lucas	Ø 22,22 180,0x40	RAI, Exc. GTE, GT Turbo
1.7 (B/C408) Eng.F3N716/ 717 (54kW)	10/86-3/95		R		153-343	153-343K	Bdx	180,0x42	
	10/86-3/95		R			153-343Y	Bdx	180,0x42	
	10/86-3/95		R		153-345	153-345Y	Bdx	180,0x42	Hand Brake
	10/86-3/95		R		153-344		Lucas	180,0x42	Hand Brake
	86-95		R		700-142	700-142K		Ø 180,2	
	4/91-95		R		151-048		Lucas	Ø 20,64 180,0x40	CRCI, RAI
	6/87-95		R		151-013		Bdx	Ø 20,64 180,0x40	CRCI, RAI
	7/85-6/86		R		151-022		Bdx	Ø 22,00 180,0x40	RAD
	7/86-5/87		R		151-017		Bdx	Ø 22,00 180,0x40	RAI
	86-91		R		151-042		Lucas	Ø 22,22 180,0x40	RAI
1.7 (B/C40K/G) Eng.F2N740/ 742 (64-66kW)	6/87-3/95		R		153-343	153-343K	Bdx	180,0x42	
	6/87-3/95		R			153-343Y	Bdx	180,0x42	
	6/87-3/95		R		153-345	153-345Y	Bdx	180,0x42	Hand Brake
	6/87-3/95		R		153-344		Lucas	180,0x42	Hand Brake
	87-95		R		700-142	700-142K		Ø 180,2	
	4/91-95		R		151-048		Lucas	Ø 20,64 180,0x40	CRCI, RAI
	6/87-12/87		R		151-042		Lucas	Ø 22,22 180,0x40	RAI
1.7 (C409) Eng.F3N702/ 722 (69kW)	6/87-95		R		151-013		Bdx	Ø 20,64 180,0x40	CRCI, RAI
	10/86-8/91		R		153-343	153-343K	Bdx	180,0x42	
	10/86-8/91		R			153-343Y	Bdx	180,0x42	
	10/86-8/91		R		153-345	153-345Y	Bdx	180,0x42	Hand Brake















		Spare Parts	F/R	L/R	CIFAM ref.	CIFAM ref. w/KIT		DIMENSIONS mm.	NOTE
1.7 (C409) Eng.F3N702/ 722 (69kW)	10/86-8/91		R		153-344		Lucas	180,0x42	Hand Brake
Thalia 2/98-									
1.4 Eng.K7J700/ 701 (55kW)	8/00-		R		153-359		Bosch	203,2x39	Hand Brake
	8/00-		R		153-350		Lucas	203,0x38	Hand Brake
	00-		R		151-095		Lucas	Ø 17,78 203,0x38	LUC, +ABS
	00-		R		151-155		Bosch	Ø 17,46 203,0x39	RAI, +ABS
1.4 16v Eng.K4J712/ 713 (72kW)	8/00-		R		153-359		Bosch	203,2x39	Hand Brake
	8/00-		R		153-350		Lucas	203,0x38	Hand Brake
	00-		R		151-095		Lucas	Ø 17,78 203,0x38	LUC, +ABS
	00-		R		151-155		Bosch	Ø 17,46 203,0x39	RAI, +ABS
1.5 DCi Eng.K9K700/ 704 (48kW)	4/02-		R		153-359		Bosch	203,2x39	Hand Brake
	4/02-		R		153-350		Lucas	203,0x38	Hand Brake
	02-		R		151-095		Lucas	Ø 17,78 203,0x38	LUC, +ABS
	02-		R		151-155		Bosch	Ø 17,46 203,0x39	RAI, +ABS
1.5 DCi Eng.K9K702/ 710/ 722 (60kW)	6/01-		R		153-359		Bosch	203,2x39	Hand Brake
	6/01-		R		153-350		Lucas	203,0x38	Hand Brake
	01-		R		151-095		Lucas	Ø 17,78 203,0x38	LUC, +ABS
	01-		R		151-155		Bosch	Ø 17,46 203,0x39	RAI, +ABS
1.5 DCi Eng.K9K752 (50kW)	03-		R		151-095		Lucas	Ø 17,78 203,0x38	LUC, +ABS
	03-		R		151-155		Bosch	Ø 17,46 203,0x39	RAI, +ABS
1.6 16v Eng.K4M740 (79kW)	4/02-		R		153-359		Bosch	203,2x39	Hand Brake
	4/02-		R		153-350		Lucas	203,0x38	Hand Brake
	02-		R		151-095		Lucas	Ø 17,78 203,0x38	LUC, +ABS
	02-		R		151-155		Bosch	Ø 17,46 203,0x39	RAI, +ABS
Twingo I (C06) 3/93-6/07									
1.2 (C063/64) Eng.C3G700/ 702 (40kW)	3/93-10/96		R		153-345	153-345Y	Bdx	180,0x42	Hand Brake
	93-96		R		700-142	700-142K		Ø 180,2	
	93-96		R		151-014		Bdx	Ø 20,64 180,0x40	CRCI, RAI
	93-96		R		151-156		Bdx	Ø 20,64 180,0x42	RAI, +ABS
1.2 (C066/68) Eng.D7F702/ 703/ 704 (43-44kW)	96-07		R		153-345	153-345Y	Bdx	180,0x42	-ABS, Hand Brake
	96-98		R		153-345	153-345Y	Bdx	180,0x42	+ABS, Hand Brake
	98-07		R		153-350		Lucas	203,0x38	+ABS, Hand Brake
	5/96-96-98		R		700-142	700-142K		Ø 180,2	
1.2 (C067) Eng.D7F700/ 701 (40kW)	96-07		R		153-345	153-345Y	Bdx	180,0x42	-ABS, Hand Brake
	96-98		R		153-345	153-345Y	Bdx	180,0x42	+ABS, Hand Brake
	98-07		R		153-350		Lucas	203,0x38	+ABS, Hand Brake
	96-96-98		R		700-142	700-142K		Ø 180,2	
1.2 16v Eng.D4F708 (44kW)	04-07		R		153-350		Lucas	203,0x38	Hand Brake
	04-07		R		700-142	700-142K		Ø 180,2	
1.2 16v (C06C/ D/K) Eng.D4F702/ 704 (55kW)	1/01-6/07		R		153-350		Lucas	203,0x38	Hand Brake
	01-		R		700-142	700-142K		Ø 180,2	
Twingo II (CN0) 7/07-									
1.2 Eng.D7F800 (43kW)	07-		R		153-513		Lucas	203,2x39	
1.2 16v Eng.D4F722/ 772 (55kW)	09-		R		153-513		Lucas	203,2x39	
1.2 16v Eng.D4F772 (56kW)	07-		R		153-513		Lucas	203,2x39	
1.2 16v TCE Eng.D4F780 (74kW)	07-		R		153-513		Lucas	203,2x39	
1.5 DCi Eng.K9K718 (62kW)	08-		R		153-513		Lucas	203,2x39	
1.5 DCi Eng.K9K740 (47kW)	07-		R		153-513		Lucas	203,2x39	
1.5 DCi Eng.K9K770 (55kW)	10-		R		153-513		Lucas	203,2x39	
1.6 RS Eng.K4M8 (98kW)	07-		R		153-513		Lucas	203,2x39	
RENAULT LCV, TRUCK									
B 9/87-10/92									
70 Eng.8140.61 (53kW)	9/87-5/89		R		153-342		Lucas	255,0x57	
90, 4WD Eng.8140.21 (68kW)	9/87-10/92		R		153-342		Lucas	255,0x57	
90, 4WD Eng.8140.27S (71kW)	10/91-10/92		R		153-342		Lucas	255,0x57	
Clio Van I (S57) 1/91-9/98									
1.1 (S571) Eng.C1E700 (35kW)	1/91-98		R		700-142	700-142K		Ø 180,2	
	1/91-3/91		R		151-013		Bdx	Ø 20,64 180,0x40	CRCI, RAI
	3/91-98		R		151-014		Bdx	Ø 20,64 180,0x40	CRCI, RAI
	3/91-98		R		151-048		Lucas	Ø 20,64 180,0x40	CRCI, RAI
1.2 (S572, S57A,R) Eng.E7F706 (40kW)	5/90-98		R		700-142	700-142K		Ø 180,2	
	1/91-3/91		R		151-013		Bdx	Ø 20,64 180,0x40	CRCI, RAI
	3/91-98		R		151-014		Bdx	Ø 20,64 180,0x40	CRCI, RAI
	3/91-98		R		151-048		Lucas	Ø 20,64 180,0x40	CRCI, RAI













































		Spare Parts	F/R	L/R	CIFAM ref.	CIFAM ref. w/KIT		DIMENSIONS mm.	NOTE
1.2 (S573) Eng.E7F750 (43-44kW)	1/91-98		R		700-142	700-142K		Ø 180,2	
	1/91-3/91		R		151-013		Bdx	Ø 20,64 180,0x40	CRCI, RAI
	3/91-98		R		151-014		Bdx	Ø 20,64 180,0x40	CRCI, RAI
	3/91-98		R		151-048		Lucas	Ø 20,64 180,0x40	CRCI, RAI
1.9 D (S57L, I, S575,576) Eng.F8Q730/ 732 (47-66-68kW)	1/91-98		R		700-142	700-142K		Ø 180,2	
	1/91-3/91		R		151-013		Bdx	Ø 20,64 180,0x40	CRCI, RAI
	3/91-98		R		151-014		Bdx	Ø 20,64 180,0x40	CRCI, RAI
	3/91-98		R		151-048		Lucas	Ø 20,64 180,0x40	CRCI, RAI
Clio Van II (SB0) 9/98-5/05									
1.2 (SB0A) Eng.D7F720/ 722 (43kW)	03-05		R		700-382	700-382K		Ø 203,3	+ABS
	98-		R		700-156	700-156K		Ø 180,2	-ABS
	98-		R		700-157	700-157K		Ø 203,3	+ABS
	98-		R		151-098		Bdx	Ø 19,05 180,0x42	RAI
	98-		R		151-095		Lucas	Ø 17,78 203,0x38	LUC, +ABS
1.9 D (SB0E) Eng.F8Q606/ 630/ 662 (40-44-47kW)	9/98-		R		700-156	700-156K		Ø 180,2	-Clim, -ABS
	9/98-		R		700-157	700-157K		Ø 203,3	+Clim, +ABS
	98-		R		151-098		Bdx	Ø 19,05 180,0x42	RAI
	98-		R		151-095		Lucas	Ø 17,78 203,0x38	LUC, +ABS
1.9 DTi Eng.F9Q780 (59kW)	00-01		R		700-382	700-382K		Ø 203,3	
Extra 1/86-1/98									
1.0 (30kW)	86-91		R		700-143	700-143K		Ø 180,2	
	86-		R		151-042		Lucas	Ø 22,22 180,0x40	RAI, RHD
1.1 Eng.C1E700 (35kW)	86-91		R		700-143	700-143K		Ø 180,2	
	86-		R		151-042		Lucas	Ø 22,22 180,0x40	RAI, RHD
1.2 Eng.C3G710/ 712 (40kW)	91-		R		700-145	700-145K		Ø 203,3	
1.4 Eng.C2J784 (44kW)	86-		R		700-145	700-145K		Ø 203,3	
	91-		R		700-144			Ø 228,6	
	86-		R		151-042		Lucas	Ø 22,22 180,0x40	RAI, RHD
1.6 D Eng.F8M720/ 730/ 736/ 760 (40kW)	86-		R		700-145	700-145K		Ø 203,3	
	91-		R		700-144			Ø 228,6	
	86-		R		151-042		Lucas	Ø 22,22 180,0x40	RAI, RHD
Kangoo I (FC0) Van 3/98-1/08									
1.2 (FC01,0A,0F) Eng.D7F710/ 720/ 722/ 744/ 746 (43kW)	3/98-		R		700-152	700-152K		Ø 203,3	-RC
	3/98-		R		700-144			Ø 228,6	+RC
	3/98-		R		151-097		Bdx	Ø 19,05 203,0x38	RAI, 6Q, -RC
	3/98-		R		151-096		Bdx	Ø 22,00 228,0x42	RAI, 8Q, +RC
1.2 16v (FC05) Eng.D4F712/ 714 (55kW)	6/01-		R		700-152	700-152K		Ø 203,3	-RC
	6/01-		R		700-144			Ø 228,6	+RC
	01-		R		151-097		Bdx	Ø 19,05 203,0x38	RAI, 6Q, -RC
1.4 (FC0C,0B,0H,0M) Eng.E7J634/ 635/ 780/ K7J700/ 701 (55kW)	3/98-		R		700-152	700-152K		Ø 203,3	-RC
	3/98-		R		700-144			Ø 228,6	+RC
	3/98-		R		151-097		Bdx	Ø 19,05 203,0x38	RAI, 6Q, -RC
	3/98-		R		151-096		Bdx	Ø 22,00 228,0x42	RAI, 8Q, +RC
1.5 DCi Eng.K9K702/ 710/ 722 (60kW)	03-		R		700-152	700-152K		Ø 203,3	-RC
	03-		R		700-144			Ø 228,6	+RC
	03-		R		151-097		Bdx	Ø 19,05 203,0x38	RAI, 6Q, -RC
	03-		R		151-096		Bdx	Ø 22,00 228,0x42	RAI, 8Q, +RC
1.5 DCi Eng.K9K710 (42kW)	02-		R		700-152	700-152K		Ø 203,3	-RC
	02-		R		700-144			Ø 228,6	+RC
1.5 DCi Eng.K9K714 (50kW)	05-		R		700-152	700-152K		Ø 203,3	-RC
	05-		R		700-144			Ø 228,6	+RC
	05-		R		151-097		Bdx	Ø 19,05 203,0x38	RAI, 6Q, -RC
	05-		R		151-096		Bdx	Ø 22,00 228,0x42	RAI, 8Q, +RC
1.5 DCi (FC07) Eng.K9K700/ 704 (48kW)	6/01-		R		700-152	700-152K		Ø 203,3	-RC
	6/01-		R		700-144			Ø 228,6	+RC
	01-		R		151-097		Bdx	Ø 19,05 203,0x38	RAI, 6Q, -RC
	01-		R		151-096		Bdx	Ø 22,00 228,0x42	RAI, 8Q, +RC
1.6 16v, 4WD (FC0L, FC0P, FC0S) Eng.K4M750/ 752/ 753 (70kW)	01-08		R		700-152	700-152K		Ø 203,3	Exc. 4WD, -RC
	01-08		R		700-144			Ø 228,6	Exc. 4WD, +RC
	01-08		R		151-097		Bdx	Ø 19,05 203,0x38	RAI, 6Q, -RC
	01-08		R		151-096		Bdx	Ø 22,00 228,0x42	RAI, 8Q, +RC
1.9 D (FC0E,02,0J,0N) Eng.F8Q630/ 632 (47kW)	3/98-		R		700-152	700-152K		Ø 203,3	-RC
	3/98-		R		700-144			Ø 228,6	+RC
	3/98-		R		151-097		Bdx	Ø 19,05 203,0x38	RAI, 6Q, -RC
	3/98-		R		151-096		Bdx	Ø 22,00 228,0x42	RAI, 8Q, +RC
1.9 D 55 (FC0D) Eng.F8Q606/ 630/ 662 (40kW)	3/98-		R		700-152	700-152K		Ø 203,3	-RC
	3/98-		R		700-144			Ø 228,6	+RC
	3/98-		R		151-097		Bdx	Ø 19,05 203,0x38	RAI, 6Q, -RC



































		Spare Parts	F/R	L/R	CIFAM ref.	CIFAM ref. w/KIT		DIMENSIONS mm.	NOTE
1.9 D 55 (FC0D) Eng.F8Q606/ 630/ 662 (40kW)	3/98-		R		151-096		Bdx	Ø 22,00 228,0x42	RAI, 8Q, +RC
1.9 DTi (FC0U) Eng.F9Q780 (59kW)	2/00-		R		700-152	700-152K		Ø 203,3	-RC
	2/00-		R		700-144			Ø 228,6	+RC
	2/00-		R		151-097		Bdx	Ø 19,05 203,0x38	RAI, 6Q, -RC
	2/00-		R		151-096		Bdx	Ø 22,00 228,0x42	RAI, 8Q, +RC
Mascott 1/99-									
110 Eng.8140.43B/ C (78kW)	1/99-6/04		R		153-077	153-077K	Brembo	170,0x45	
	1/99-6/04		R		153-097	153-097K	Brembo	170,0x45	Hand Brake
120.35 Eng.ZD3A600/ DXi3 (85kW)	5/04-		R		153-077	153-077K	Brembo	170,0x45	
	5/04-		R		153-097	153-097K	Brembo	170,0x45	Hand Brake
120.55 Eng.ZD3A600 (85kW)	5/04-		R		153-077	153-077K	Brembo	170,0x45	
	5/04-		R		153-097	153-097K	Brembo	170,0x45	Hand Brake
120.65 Eng.ZD3A600 (85kW)	5/04-		R		153-077	153-077K	Brembo	170,0x45	
	5/04-		R		153-097	153-097K	Brembo	170,0x45	Hand Brake
130 Eng.8140.43S (92kW)	1/99-5/04		R		153-077	153-077K	Brembo	170,0x45	
	1/99-5/04		R		153-097	153-097K	Brembo	170,0x45	Hand Brake
140 Eng.8140.43K (103kW)	1/01-6/04		R		153-077	153-077K	Brembo	170,0x45	
	1/01-6/04		R		153-097	153-097K	Brembo	170,0x45	Hand Brake
150.35 Eng.8140.43N (107kW)	1/01-6/04		R		153-077	153-077K	Brembo	170,0x45	
	1/01-6/04		R		153-097	153-097K	Brembo	170,0x45	Hand Brake
150.55/ .65 Eng.8140.43N (107kW)	10/01-6/04		R		153-077	153-077K	Brembo	170,0x45	
	10/01-6/04		R		153-097	153-097K	Brembo	170,0x45	Hand Brake
160.35 Eng.ZD3A604 (115kW)	5/04-		R		153-077	153-077K	Brembo	170,0x45	
	5/04-		R		153-097	153-097K	Brembo	170,0x45	Hand Brake
160.55 Eng.ZD3A604 (115kW)	5/04-		R		153-077	153-077K	Brembo	170,0x45	
	5/04-		R		153-097	153-097K	Brembo	170,0x45	Hand Brake
160.65 Eng.ZD3A604 (115kW)	5/04-		R		153-077	153-077K	Brembo	170,0x45	
	5/04-		R		153-097	153-097K	Brembo	170,0x45	Hand Brake
90 Eng.8140.63 (63-78kW)	1/99-12/01		R		153-077	153-077K	Brembo	170,0x45	
	1/99-12/01		R		153-097	153-097K	Brembo	170,0x45	Hand Brake
Master I 8/80-7/98									
2.0 28-35 Eng.829731/ 730 (59-63-76-80-81kW)	8/80-9/86		R		153-071		Lucas	254,0x57	Hand Brake
	8/80-9/86		R		153-100		Lucas	254,0x57	Hand Brake
	8/80-9/86		R		153-342		Lucas	255,0x57	
	80-86		R		700-175			Ø 255,0	Exc. Switzerland/Norway/Sweden
2.0 28-35 Eng.J5R718/ 728 (58-60kW)	10/86-7/98		R		153-071		Lucas	254,0x57	Hand Brake
	10/86-7/98		R		153-100		Lucas	254,0x57	Hand Brake
	10/86-7/98		R		153-342		Lucas	255,0x57	
	86-89		R		700-175			Ø 255,0	Exc. Switzerland/Norway/Sweden
	89-98		R		700-176	700-176K		Ø 254,0	Exc. Switzerland/Norway/Sweden
	86-98		R		151-139		Lucas	Ø 25,40 254,0x57	LUC
2.1 D 28-35 Eng.J8S330 (44-48-53-66kW)	8/80-7/98		R		153-071		Lucas	254,0x57	Hand Brake
	8/80-7/98		R		153-100		Lucas	254,0x57	Hand Brake
	8/80-7/98		R		153-342		Lucas	255,0x57	
	80-89		R		700-175			Ø 255,0	Exc. Switzerland/Norway/Sweden
	89-94		R		700-176	700-176K		Ø 254,0	Exc. Switzerland/Norway/Sweden
2.2 30 Eng.J7T782/ 788 (67-70-74-76-79-85-89-91-101kW)	8/80-7/98		R		153-071		Lucas	254,0x57	Hand Brake
	80-89		R		700-175			Ø 255,0	Exc. Switzerland/Norway/Sweden
	89-98		R		700-176	700-176K		Ø 254,0	Exc. Switzerland/Norway/Sweden
	80-98		R		151-139		Lucas	Ø 25,40 254,0x57	LUC
2.4 D 28-35 Eng.Sofim-8140.61.2300/ S8U731 (52-55-59kW)	8/80-8/89		R		153-071		Lucas	254,0x57	Hand Brake
	8/80-8/89		R		153-100		Lucas	254,0x57	Hand Brake
	80-89		R		700-175			Ø 255,0	Exc. Switzerland/Norway/Sweden
2.5 D 28-35 Eng.Sofim-8140.67.2510/ S8U742 (55kW)	8/89-7/98		R		153-071		Lucas	254,0x57	Hand Brake
	8/89-7/98		R		153-342		Lucas	255,0x57	
	89-94		R		700-176	700-176K		Ø 254,0	Exc. Switzerland/Norway/Sweden
	94-98		R		151-139		Lucas	Ø 25,40 254,0x57	LUC
2.5 TD 28-35 Eng.Sofim-8140.27.2580/ S9U702 (72kW)	8/89-7/98		R		153-071		Lucas	254,0x57	Hand Brake
	89-94		R		700-176	700-176K		Ø 254,0	Exc. Switzerland/Norway/Sweden
	94-98		R		151-139		Lucas	Ø 25,40 254,0x57	LUC
2.5 TD 35 Eng.Sofim-8140.27.2500/ .2510/ S9U714 (55-69-73kW)	8/89-7/98		R		153-071		Lucas	254,0x57	Hand Brake
	8/89-7/98		R		153-342		Lucas	255,0x57	
	89-94		R		700-176	700-176K		Ø 254,0	Exc. Switzerland/Norway/Sweden
	94-98		R		151-139		Lucas	Ø 25,40 254,0x57	LUC































		Spare Parts	F/R	L/R	CIFAM ref.	CIFAM ref. w/KIT		DIMENSIONS mm.	NOTE
Master II 7/98-9/03									
1.9 DTi Eng.F9Q770 (59kW)	00-03		R		153-313		Bdx	280,0x65	Hand Brake
	00-03		R		700-134			Ø 280,0	
2.5 D Eng.S8U770 (59kW)	7/98-1/01		R		153-127		Bdx	280,0x64	Hand Brake
	7/98-1/01		R		153-313		Bdx	280,0x65	Hand Brake
	7/98-1/01		R		153-071		Lucas	254,0x57	Hand Brake
	98-01		R		700-134			Ø 280,0	
2.8 DTi Eng.S9W702 (84kW)	7/98-10/01		R		153-127		Bdx	280,0x64	Hand Brake
	7/98-10/01		R		153-313		Bdx	280,0x65	Hand Brake
	7/98-10/01		R		153-071		Lucas	254,0x57	Hand Brake
	98-01		R		700-134			Ø 280,0	
R11 Van 3/83-12/88									
1.1 (S371) Eng.C1E715/ 720 (35kW)	83-86		R		700-142	700-142K		Ø 180,2	
	83-6/86		R		151-011		Bdx	Ø 17,46 180,0x40	RAD
	93-6/86		R		151-059		Lucas	Ø 17,78 180,0x40	RAI
1.2 (S37S) Eng.C1G700/ 710 (40kW)	84-88		R		700-142	700-142K		Ø 180,2	
	84-9/86		R		151-022		Bdx	Ø 22,00 180,0x40	RAD
	84-9/86		R		151-042		Lucas	Ø 22,22 180,0x40	RAI
1.4 (S372) Eng.C1J715/ 792/ 796/ C2J730 (35-43-44kW)	83-86		R		700-142	700-142K		Ø 180,2	Incl. Spain
	83-86		R		151-022		Bdx	Ø 22,00 180,0x40	RAD
	83-86		R		151-042		Lucas	Ø 22,22 180,0x40	RAI
1.4 (S373) Eng.C2J768 (43-46-50-53kW)	83-86		R		700-142	700-142K		Ø 180,2	Incl. Spain
	83-86		R		151-022		Bdx	Ø 22,00 180,0x40	RAD
	83-86		R		151-042		Lucas	Ø 22,22 180,0x40	RAI
1.6 D (S374) Eng.F8M700/ 720/ 730 (40kW)	83-88		R		700-142	700-142K		Ø 180,2	
	83-86		R		151-022		Bdx	Ø 22,00 180,0x40	RAD
	83-86		R		151-042		Lucas	Ø 22,22 180,0x40	RAI
	86-88		R		151-013		Bdx	Ø 20,64 180,0x40	CRCI, RAI
R18 Van 5/79-7/86									
1.4 (2350) Eng.847720/ 722 (35-43-46kW)	-86		R		700-144			Ø 228,6	Ch 3401-
2.1 D (2354) Eng.852710/ J8S711 (43-46-50-53kW)	81-86		R		700-144			Ø 228,6	
R19 I Van 1/88-12/92									
1.2 (S530) Eng.C1G730 (40kW)	89-4/92		R		700-142	700-142K		Ø 180,2	
	88-92		R		151-021		Bdx	Ø 20,64 180,0x40	CRCI, RAI, Exc. 16S
1.4 (S537) Eng.E7F700/ 706 (59kW)	1/88-12/92		R		153-345	153-345Y		180,0x42	Hand Brake
	89-4/92		R		700-142	700-142K		Ø 180,2	
1.9 D (S534, I, J) Eng.F8Q706/ 742 (47-66-68kW)	88-92		R		151-021		Bdx	Ø 20,64 180,0x40	CRCI, RAI, Exc. 16S
	1/88-12/92		R		153-345	153-345Y		180,0x42	Hand Brake
	89-4/92		R		700-142	700-142K		Ø 180,2	
88-92		R		151-021		Bdx	Ø 20,64 180,0x40	CRCI, RAI, Exc. 16S	
R19 II Van 3/92-12/95									
1.2 (S530) Eng.C1G730 (40kW)	5/92-96		R		700-142	700-142K		Ø 180,2	
	4/91-95		R		151-021		Bdx	Ø 20,64 180,0x40	CRCI, RAI
	92-95		R		151-048		Lucas	Ø 20,64 180,0x40	CRCI, RAI
1.4 (S537) Eng.E7F700/ 706 (58kW)	5/92-95		R		700-142	700-142K		Ø 180,2	
	92-95		R		151-021		Bdx	Ø 20,64 180,0x40	CRCI, RAI
	92-95		R		151-048		Lucas	Ø 20,64 180,0x40	CRCI, RAI
1.9 D (S534) Eng.F8Q706/ 742 (47-66-68kW)	3/92-12/95		R		153-345	153-345Y		180,0x42	Hand Brake
	5/92-95		R		700-142	700-142K		Ø 180,2	
	92-95		R		151-029		Bdx	Ø 19,05 203,0x39	RAI, Societé
	92-95		R		151-021		Bdx	Ø 20,64 180,0x40	CRCI, RAI
92-95		R		151-048		Lucas	Ø 20,64 180,0x40	CRCI, RAI	
1.9 TD (S53K) Eng.F8Q706/ 742 (47-66-68kW)	92-95		R		700-142	700-142K		Ø 180,2	
	92-95		R		151-029		Bdx	Ø 19,05 203,0x39	RAI, Societé
	92-95		R		151-021		Bdx	Ø 20,64 180,0x40	CRCI, RAI
	92-95		R		151-048		Lucas	Ø 20,64 180,0x40	CRCI, RAI
R21 Van 6/86-4/95									
1.7 (S481,482) Eng.F2N710 (65kW)	6/86-4/95		R		153-345	153-345Y		180,0x42	Hand Brake
	6/86-4/95		R		153-475		Lucas	228,6x42	Hand Brake
	86-95		R		700-144			Ø 228,6	
	86-95		R		151-062		Lucas	Ø 22,20 229,0x41	LUC
1.9 D (S48H) Eng.F8Q710 (47kW)	86-94		R		700-143	700-143K		Ø 180,2	
	86-94		R		151-020		Bdx	Ø 22,00 180,0x40	CRCI, RAI
2.1 D (S486) Eng.J8S704 (48kW)	86-94		R		700-144			Ø 228,6	
	86-94		R		151-062		Lucas	Ø 22,20 229,0x41	LUC

		Spare Parts	F/R	L/R	CIFAM ref.	CIFAM ref. w/KIT		DIMENSIONS mm.	NOTE
R4 Van 9/66-12/93									
0.8 (2105,2102,2104) Eng.839 (19kW)			R		700-323			Ø 160,3	Ch -501245
0.8 (2106) Eng.80001 (25kW)			R		700-323			Ø 160,3	Ch -501245
	-88		F		151-018		Bdx	Ø 23,81 228,0x42	Ch 329647-, RAD
0.8 (210B) Eng.80001 (25kW)	10/76-7/89		R		153-339	153-339K	Bdx	180,0x32	Hand Brake
	82-89		R		151-043		Bdx	Ø 22,00 180,0x30	RAD
0.8 (2391/2392) Eng.800705/ B1B707 (21kW)	-89		R		700-323			Ø 160,3	Ch 2226-
0.8 (2430) Eng.B1B705/ 707 (21kW)	9/71-7/89		R		153-339	153-339K	Bdx	180,0x32	Hand Brake
	71-89		R		700-323			Ø 160,3	Fourgonette
	-82		F		151-018		Bdx	Ø 23,81 228,0x42	Ch 329647-, RAD
	82-89		R		151-043		Bdx	Ø 22,00 180,0x30	RAD
0.95 (2109) Eng.C1C708 (25-30-31-32-33kW)	6/87-12/93		R		153-339	153-339K	Bdx	180,0x32	Hand Brake
	87-93		R		700-323			Ø 160,3	
	-93		F		151-018		Bdx	Ø 23,81 228,0x42	Ch 329647-, RAD
1.1 (2370) Eng.688711/ 712/ C1E714/ 718/ 719 (25-32-33-35kW)	10/76-7/89		R		153-339	153-339K	Bdx	180,0x32	Hand Brake
	76-89		R		700-323			Ø 160,3	Fourgonette
	-89		R		700-334			Ø 180,2	Ch 361751-
	-82		F		151-018		Bdx	Ø 23,81 228,0x42	Ch 329647-, RAD
	82-89		R		151-043		Bdx	Ø 22,00 180,0x30	RAD
1.1 (239B) Eng.C1E718/ 719 (26kW)	7/82-5/89		R		153-339	153-339K	Bdx	180,0x32	Hand Brake
	-89		R		700-334			Ø 180,2	Ch 2181-
	82-89		R		151-043		Bdx	Ø 22,00 180,0x30	RAD
1.1 (3C2370) Eng.688711/ 712/ C1E714/ 718/ 719 (25kW)	10/76-7/89		R		153-339	153-339K	Bdx	180,0x32	Hand Brake
	-89		R		700-334			Ø 180,2	Ch 361751-
1.1 (S128) Eng.688712/ C1E714/ 719 (25kW)	76-89		R		700-334			Ø 180,2	
	76-89		R		151-043		Bdx	Ø 22,00 180,0x30	RAD
R5 Van 1/72-12/85									
0.8 (2381) Eng.800710 (19-21-25-26-27kW)	-82		F		151-018		Bdx	Ø 23,81 228,0x42	Ch 329647-, RAD
1.3 (2387) Eng.810726 (29-31-32-33-37-40-44-47kW)	76-82		R		151-043		Bdx	Ø 22,00 180,0x30	RAD
Rapid/Express (F40, G40) Van 7/85-8/98									
0.95 (F400) Eng.C1C706 (25-30-31-32-33kW)	2/86-5/92		R		153-345	153-345Y	Bdx	180,0x42	Hand Brake
	2/86-5/92		R		153-344		Lucas	180,0x42	Hand Brake
	86-92		R		700-143	700-143K		Ø 180,2	
	86-92		R		151-016		Bdx	Ø 20,64 203,0x39	RAI, Italy, Exc. F40T
	86-92		R		151-017		Bdx	Ø 22,00 180,0x40	RAI, Exc. Italy/France
	86-92		R		151-042		Lucas	Ø 22,22 180,0x40	RAI, Exc. Italy/France
1.1 (F401) Eng.C1E750/ 752/ 760/ 762/ 792 (34kW)	7/85-4/95		R		153-345	153-345Y	Bdx	180,0x42	Hand Brake
	7/85-4/95		R		153-346	153-346Y	Bdx	203,2x39	Hand Brake
	7/85-4/95		R		153-344		Lucas	180,0x42	Hand Brake
	93-95		R		153-001		Bdx	203,2x39	Rapid
	85-95		R		700-143	700-143K		Ø 180,2	Exc. Italy
	85-95		R		700-145	700-145K		Ø 203,3	Italy
	85-95		R		151-016		Bdx	Ø 20,64 203,0x39	RAI, Italy, Exc. F40T
	85-95		R		151-017		Bdx	Ø 22,00 180,0x40	RAI, Exc. Italy/France
	85-95		R		151-042		Lucas	Ø 22,22 180,0x40	RAI, Exc. Italy/France
1.1 (F40H) Eng.C1E756 (25-33-35kW)	6/87-9/91		R		153-345	153-345Y	Bdx	180,0x42	Hand Brake
	6/87-9/91		R		153-346	153-346Y	Bdx	203,2x39	Hand Brake
	6/87-9/91		R		153-344		Lucas	180,0x42	Hand Brake
	87-91		R		700-143	700-143K		Ø 180,2	Exc. Italy
	87-91		R		700-145	700-145K		Ø 203,3	Italy
	87-91		R		151-016		Bdx	Ø 20,64 203,0x39	RAI, Italy, Exc. F40T
	87-91		R		151-017		Bdx	Ø 22,00 180,0x40	RAI, Exc. Italy/France
	87-91		R		151-042		Lucas	Ø 22,22 180,0x40	RAI, Exc. Italy/France
1.2 Eng.E7F708 (48kW)	5/95-11/98		R		153-002	153-002Y	Bdx	203,2x39	Hand Brake
1.2 (F406, G40A) Eng.C3G710/ 712 (40kW)	9/91-3/98		R		153-002	153-002Y	Bdx	203,2x39	Hand Brake
	91-98		R		700-145	700-145K		Ø 203,3	
1.2 (F40F) Eng.C1G726 (40-55kW)	9/91-3/98		R		153-002	153-002Y	Bdx	203,2x39	Hand Brake
	91-98		R		700-145	700-145K		Ø 203,3	
1.4 Eng.E6J734 (44kW)	9/91-8/93		R		153-346	153-346Y	Bdx	203,2x39	Hand Brake
1.4 (F40) Eng.E7J770/ 771 (55kW)	1/96-3/98		R		153-002	153-002Y	Bdx	203,2x39	Hand Brake
	1/96-3/98		R		153-346	153-346Y	Bdx	203,2x39	Hand Brake
	91-98		R		700-145	700-145K		Ø 203,3	
	91-98		R		700-153			Ø 228,6	IP







		Spare Parts	F/R	L/R	CIFAM ref.	CIFAM ref. w/KIT		DIMENSIONS mm.	NOTE
1.4 (F402) Eng.C1J768/ 780 (35-43-44kW)	7/85-8/91		R		153-346	153-346Y	Bdx	203,2x39	Hand Brake
	7/85-8/91		R		153-001		Bdx	203,2x39	Rapid
	7/85-8/91		R		153-344		Lucas	180,0x42	Hand Brake
	7/85-8/91		R		153-475		Lucas	228,6x42	Rapid, Hand Brake
	85-8/91		R		700-145	700-145K		Ø 203,3	
1.4 (F407) Kat Eng.C3J700/ 702/ 760/ 762 (43kW)	8/88-3/98		R		153-345	153-345Y	Bdx	180,0x42	Hand Brake
	8/88-3/98		R		153-346	153-346Y	Bdx	203,2x39	Hand Brake
	8/88-3/98		R		153-475		Lucas	228,6x42	Rapid, Hand Brake
	93-95		R		153-001		Bdx	203,2x39	Rapid
	88-98		R		700-145	700-145K		Ø 203,3	
1.4 (F40D) Eng.E7J728 (58kW)	1/94-3/98		R		153-002	153-002Y	Bdx	203,2x39	Hand Brake
	1/94-3/98		R		153-346	153-346Y	Bdx	203,2x39	Hand Brake
	-95		R		153-001		Bdx	203,2x39	Rapid
	-95		R		153-475		Lucas	228,6x42	Rapid, Hand Brake
	94-98		R		700-145	700-145K		Ø 203,3	
	94-98		R		700-153			Ø 228,6	IP
1.4 (F40M) Eng.C2J784 (43-46-50-53kW)	3/86-8/91		R		153-346	153-346Y	Bdx	203,2x39	Hand Brake
	3/86-8/91		R		153-001		Bdx	203,2x39	Rapid
	3/86-8/91		R		153-475		Lucas	228,6x42	Rapid, Hand Brake
	86-8/91		R		700-145	700-145K		Ø 203,3	
1.4 (F40U, F40V) Eng.E7J720/ 724/ 726/ 773 (43-52-55kW)	9/91-3/98		R		153-346	153-346Y	Bdx	203,2x39	Hand Brake
	9/91-3/98		R		153-475		Lucas	228,6x42	Hand Brake
	93-95		R		153-001		Bdx	203,2x39	Rapid
	91-98		R		700-145	700-145K		Ø 203,3	
	91-98		R		700-153			Ø 228,6	IP
1.6 D (F404) Eng.F8M730/ 736/ 760 (40kW)	3/86-8/98		R		153-345	153-345Y	Bdx	180,0x42	Hand Brake
	3/86-8/98		R		153-346	153-346Y	Bdx	203,2x39	Hand Brake
	3/86-8/98		R		153-001		Bdx	203,2x39	Rapid
	3/86-8/98		R		153-344		Lucas	180,0x42	Hand Brake
	91-		R		153-475		Lucas	228,6x42	Rapid, Hand Brake
	86-8/91		R		700-143	700-143K		Ø 180,2	France
	86-98		R		700-145	700-145K		Ø 203,3	Exc. France
	9/91-98		R		700-153			Ø 228,6	IP
	86-98		R		151-016		Bdx	Ø 20,64 203,0x39	RAI, Italy, Exc. F40T
	86-98		R		151-017		Bdx	Ø 22,00 180,0x40	RAI, Exc. Italy/France
86-98	R		151-042		Lucas	Ø 22,22 180,0x40	RAI, Exc. Italy/France		
1.9 D (F40P/N/E) Eng.F8Q722/ 724/ 774/ 776 (47-66-68kW)	9/91-3/98		R		153-002	153-002Y	Bdx	203,2x39	Hand Brake
	9/91-3/98		R		153-346	153-346Y	Bdx	203,2x39	Hand Brake
	9/91-3/98		R		153-001		Bdx	203,2x39	Rapid
	9/91-3/98		R		153-014		Lucas	228,6x42	Hand Brake
	9/91-3/98		R		153-475		Lucas	228,6x42	Rapid, Hand Brake
	9/91-98		R		700-145	700-145K		Ø 203,3	
	9/91-98		R		700-153			Ø 228,6	IP
1.9 D (F40R) Eng.F8Q640/ 682 (40kW)	9/94-3/98		R		153-346	153-346Y	Bdx	203,2x39	Hand Brake
	9/94-3/98		R		153-001		Bdx	203,2x39	Rapid
	9/94-3/98		R		153-014		Lucas	228,6x42	Hand Brake
	9/94-3/98		R		153-475		Lucas	228,6x42	Rapid, Hand Brake
	94-98		R		700-145	700-145K		Ø 203,3	
	94-98		R		700-153			Ø 228,6	IP
Super 5 (S40) Van 10/84-12/96									
0.95 (S400) Eng.C1C688/ 689/ 700 (30kW)	85-92		R		700-142	700-142K		Ø 180,2	
	6/87-10/88		R		151-013		Bdx	Ø 20,64 180,0x40	CRCI, RAI
	7/86-5/87		R		151-017		Bdx	Ø 22,00 180,0x40	RAI
	84-12/87		R		151-042		Lucas	Ø 22,22 180,0x40	RAI
	84-6/86		R		151-022		Bdx	Ø 22,00 180,0x40	RAD
1.1 (S401) Eng.C1E750/ 752/ 754 (34kW)	84-96		R		700-142	700-142K		Ø 180,2	
	4/91-96		R		151-048		Lucas	Ø 20,64 180,0x40	CRCI, RAI
	6/87-96		R		151-013		Bdx	Ø 20,64 180,0x40	CRCI, RAI
	7/86-5/87		R		151-017		Bdx	Ø 22,00 180,0x40	RAI
	84-6/86		R		151-022		Bdx	Ø 22,00 180,0x40	RAD
	85-12/87		R		151-042		Lucas	Ø 22,22 180,0x40	RAI
1.2 (S40F) Eng.C1G702/ 720/ 722 (40kW)	87-96		R		700-142	700-142K		Ø 180,2	
	1/87-12/87		R		151-042		Lucas	Ø 22,22 180,0x40	RAI
	1/87-5/87		R		151-017		Bdx	Ø 22,00 180,0x40	RAI
	6/87-96		R		151-013		Bdx	Ø 20,64 180,0x40	CRCI, RAI
	91-96		R		151-048		Lucas	Ø 20,64 180,0x40	CRCI, RAI
1.2 (S40F, S407) (44kW)	87-96		R		700-142	700-142K		Ø 180,2	
	1/87-12/87		R		151-042		Lucas	Ø 22,22 180,0x40	RAI

		Spare Parts	F/R	L/R	CIFAM ref.	CIFAM ref. w/KIT		DIMENSIONS mm.	NOTE
1.2 (S40F, S40T) (44kW)	1/87-5/87		R		151-017		Bdx	Ø 22,00 180,0x40	RAI
	4/91-96		R		151-048		Lucas	Ø 20,64 180,0x40	CRCI, RAI
	6/87-96		R		151-013		Bdx	Ø 20,64 180,0x40	CRCI, RAI
1.6 D (S404) Eng.F8M720/ 730 (40kW)	10/84-12/96		R		153-343	153-343K	Bdx	180,0x42	
	10/84-12/96		R			153-343Y	Bdx	180,0x42	
	10/84-12/96		R		153-346	153-346Y	Bdx	203,2x39	Hand Brake
	10/84-12/96		R		153-344		Lucas	180,0x42	Hand Brake
	84-96		R		700-142	700-142K		Ø 180,2	
	6/87-96		R		151-013		Bdx	Ø 20,64 180,0x40	CRCI, RAI
	7/86-5/87		R		151-017		Bdx	Ø 22,00 180,0x40	RAI
	84-12/87		R		151-042		Lucas	Ø 22,22 180,0x40	RAI
	84-6/86		R		151-022		Bdx	Ø 22,00 180,0x40	RAD
91-96		R		151-048		Lucas	Ø 20,64 180,0x40	CRCI, RAI	
Trafic I (P6) 3/80-4/89									
1.4 Eng.847700/ 701/ C1J700 (35-43-44kW)	3/80-4/89		R		153-071		Lucas	254,0x57	Hand Brake
	80-8/83		R		700-172			Ø 255,0	
	80-85		R		151-070		Bdx	Ø 22,20 255,0x45	RAD
1.6, 4WD Eng.841705/ A1M705/ 707/ 708 (47-66-68kW)	1/84-6/86		R		153-071		Lucas	254,0x57	Hand Brake
	84-86		R		151-070		Bdx	Ø 22,20 255,0x45	RAD
1.7 Eng.F1N720/ 722/ 724 (50kW)	6/86-4/89		R		153-071		Lucas	254,0x57	Hand Brake
	86-89		R		700-169	700-169K		Ø 255,0	
2.0 Eng.829720/ 721 (63kW)	3/80-12/86		R		153-071		Lucas	254,0x57	Hand Brake
	80-8/83		R		700-172			Ø 255,0	
	80-86		R		151-070		Bdx	Ø 22,20 255,0x45	RAD
2.0, 4WD Eng.J5R716/ 722/ 726 (58-63-76-81kW)	3/80-4/89		R		153-071		Lucas	254,0x57	Hand Brake
	80-8/83		R		700-172			Ø 255,0	
	80-85		R		151-070		Bdx	Ø 22,20 255,0x45	RAD
2.1 D, 4WD Eng.852720/ 750 (43-49kW)	9/80-4/89		R		153-071		Lucas	254,0x57	Hand Brake
	80-8/83		R		700-172			Ø 255,0	
	80-85		R		151-070		Bdx	Ø 22,20 255,0x45	RAD
2.4 D Eng.Sofim-8140.61.240/ S8U720/ 722 (51kW)	3/80-4/89		R		153-071		Lucas	254,0x57	Hand Brake
	80-89		R		151-070		Bdx	Ø 22,20 255,0x45	RAD
Trafic I Bus 3/80-4/89									
1.4 Eng.847700/ 701/ C1J700 (35kW)	3/80-4/89		R		153-071		Lucas	254,0x57	Hand Brake
	9/85-2/89		R		700-168			Ø 255,0	
	80-85		R		151-070		Bdx	Ø 22,20 255,0x45	RAD
1.6, 4WD Eng.841705/ A1M705/ 707/ 708 (47-66-68kW)	1/84-6/86		R		153-071		Lucas	254,0x57	Hand Brake
	9/85-86		R		700-168			Ø 255,0	
	84-86		R		151-070		Bdx	Ø 22,20 255,0x45	RAD
1.7 Eng.F1N720/ 722/ 724 (50kW)	6/86-4/89		R		153-071		Lucas	254,0x57	Hand Brake
	3/89-4/89		R		700-170	700-170K		Ø 254,0	
	86-2/89		R		700-168			Ø 255,0	
2.0, 4WD Eng.J5R716/ 722/ 726 (58-63-76-81kW)	3/80-4/89		R		153-071		Lucas	254,0x57	Hand Brake
	80-89		R		700-168			Ø 255,0	
	80-89		R		151-070		Bdx	Ø 22,20 255,0x45	RAD
2.1 D Eng.852720/ 750 (43-49kW)	9/80-4/89		R		153-071		Lucas	254,0x57	Hand Brake
	9/85-2/89		R		700-168			Ø 255,0	
	80-89		R		151-070		Bdx	Ø 22,20 255,0x45	RAD
Trafic I Van 3/80-4/89									
1.4 Eng.847700/ 701/ C1J700 (35kW)	3/80-4/89		R		153-071		Lucas	254,0x57	Hand Brake
	9/85-2/89		R		700-168			Ø 255,0	
	80-89		R		151-070		Bdx	Ø 22,20 255,0x45	RAD
1.6, 4WD Eng.841705/ A1M705/ 707/ 708 (47-66-68kW)	1/84-6/86		R		153-071		Lucas	254,0x57	Hand Brake
	9/85-86		R		700-168			Ø 255,0	
	84-86		R		151-070		Bdx	Ø 22,20 255,0x45	RAD
1.7 Eng.F1N720/ 722/ 724 (50kW)	6/86-4/89		R		153-071		Lucas	254,0x57	Hand Brake
	3/89-4/89		R		700-170	700-170K		Ø 254,0	
	86-2/89		R		700-168			Ø 255,0	
2.0, 4WD Eng.J5R716/ 722/ 726 (58-63-76-81kW)	3/80-4/89		R		153-071		Lucas	254,0x57	Hand Brake
	80-89		R		151-070		Bdx	Ø 22,20 255,0x45	RAD
	80-89		R		151-070		Bdx	Ø 22,20 255,0x45	RAD
2.1 D, 4WD Eng.852720/ 750 (43kW)	9/80-4/89		R		153-071		Lucas	254,0x57	Hand Brake
	9/85-2/89		R		700-168			Ø 255,0	
	80-89		R		151-070		Bdx	Ø 22,20 255,0x45	RAD
Trafic II (PXX) 5/89-3/01									
1.7 Eng.F1N720/ 722/ 724 (50kW)	5/89-8/94		R		153-071		Lucas	254,0x57	Hand Brake
	89-94		R		700-174			Ø 254,0	
	89-94		R		151-138		Lucas	Ø 25,40 254,0x57	LUC

		Spare Parts	F/R	L/R	CIFAM ref.	CIFAM ref. w/KIT		DIMENSIONS mm.	NOTE
2.0 Eng.J5R716/ 726 (59kW)	5/89-10/97		R		153-071		Lucas	254,0x57	Hand Brake
	89-97		R		700-174			Ø 254,0	
	89-97		R		151-138		Lucas	Ø 25,40 254,0x57	LUC
2.1 D Eng.852720/ 750 (43kW)	5/89-6/94		R		153-071		Lucas	254,0x57	Hand Brake
	89-94		R		700-174			Ø 254,0	
	89-94		R		700-171	700-171K		Ø 254,0	+ABS
	89-94		R		700-169	700-169K		Ø 255,0	-ABS
	89-94		R		151-138		Lucas	Ø 25,40 254,0x57	LUC
2.1 D Eng.J8S620/ 758 (47kW)	6/94-10/97		R		153-071		Lucas	254,0x57	Hand Brake
	6/94-10/97		R		153-100		Lucas	254,0x57	Hand Brake
	94-97		R		700-172			Ø 255,0	
	94-97		R		151-138		Lucas	Ø 25,40 254,0x57	LUC
2.2 Eng.J7T600 (74kW)	9/94-4/98		R		153-071		Lucas	254,0x57	Hand Brake
	9/94-4/98		R		153-100		Lucas	254,0x57	Hand Brake
2.4 D Eng.Sofim-8140.61.240/ S8U720/ 722 (51kW)	5/89-3/01		R		153-071		Lucas	254,0x57	Hand Brake
	89-01		R		700-170	700-170K		Ø 254,0	
	89-01		R		151-138		Lucas	Ø 25,40 254,0x57	LUC
2.5 D Eng.S8U750 (56kW)	3/89-8/94		R		153-071		Lucas	254,0x57	Hand Brake
2.5 D Eng.S8U758 (58kW)	9/94-1/99		R		153-071		Lucas	254,0x57	Hand Brake
	9/94-1/99		R		153-100		Lucas	254,0x57	Hand Brake
2.5 D Eng.Sofim-8140.67.2500/ .2550/ .2580/ S8U750/ 752 (55kW)	3/89-4/98		R		153-071		Lucas	254,0x57	Hand Brake
	3/89-4/98		R		153-100		Lucas	254,0x57	Hand Brake
Traffic II Bus (TXW) 5/89-3/01									
1.7 Eng.F1N720/ 722/ 724 (50kW)	5/89-8/94		R		153-071		Lucas	254,0x57	Hand Brake
	89-94		R		700-171	700-171K		Ø 254,0	+ABS
	89-94		R		700-169	700-169K		Ø 255,0	-ABS
	89-94		R		151-138		Lucas	Ø 25,40 254,0x57	LUC
1.9 D Eng.F8Q606/ 630/ 662 (44kW)	6/97-3/01		R		153-071		Lucas	254,0x57	Hand Brake
	97-01		R		700-171	700-171K		Ø 254,0	+ABS
	97-01		R		700-169	700-169K		Ø 255,0	-ABS
	97-01		R		151-138		Lucas	Ø 25,40 254,0x57	LUC
2.0 Eng.J5R716/ 726 (59kW)	5/89-10/97		R		153-071		Lucas	254,0x57	Hand Brake
	89-97		R		700-171	700-171K		Ø 254,0	+ABS
	89-97		R		700-169	700-169K		Ø 255,0	-ABS
	89-97		R		151-138		Lucas	Ø 25,40 254,0x57	LUC
	89-97		R		153-071		Lucas	254,0x57	Hand Brake
2.1 D Eng.852720/ 750 (43kW)	5/89-6/94		R		153-071		Lucas	254,0x57	Hand Brake
	89-94		R		700-174			Ø 254,0	
	89-94		R		700-171	700-171K		Ø 254,0	+ABS
	89-94		R		700-169	700-169K		Ø 255,0	-ABS
	89-94		R		151-138		Lucas	Ø 25,40 254,0x57	LUC
2.1 D Eng.J8S620/ 758 (47kW)	6/94-10/97		R		153-071		Lucas	254,0x57	Hand Brake
	6/94-10/97		R		153-100		Lucas	254,0x57	Hand Brake
	94-97		R		700-172			Ø 255,0	
	94-97		R		151-138		Lucas	Ø 25,40 254,0x57	LUC
2.2, 4WD Eng.J7T600 (74kW)	6/94-10/97		R		153-071		Lucas	254,0x57	Hand Brake
	6/94-10/97		R		153-100		Lucas	254,0x57	Hand Brake
	94-97		R		700-172			Ø 255,0	
	94-97		R		151-138		Lucas	Ø 25,40 254,0x57	LUC
2.2, 4WD Eng.J7T780 (70kW)	5/89-6/94		R		153-071		Lucas	254,0x57	Hand Brake
	89-94		R		700-170	700-170K		Ø 254,0	
	89-94		R		151-138		Lucas	Ø 25,40 254,0x57	LUC
2.5 D Eng.S8U758 (58kW)	9/94-4/98		R		153-071		Lucas	254,0x57	Hand Brake
	9/94-4/98		R		153-100		Lucas	254,0x57	Hand Brake
2.5 D, 4WD Eng.Sofim-8140.67.2500/ .2550/ .2580/ S8U750/ 752 (55kW)	5/89-3/01		R		153-071		Lucas	254,0x57	Hand Brake
	5/89-3/01		R		153-100		Lucas	254,0x57	Hand Brake
	89-01		R		700-170	700-170K		Ø 254,0	
	89-01		R		151-138		Lucas	Ø 25,40 254,0x57	LUC
Traffic II Van (TXX) 5/89-3/01									
1.4 Eng.C1J700 (35kW)	5/89-6/91		R		153-071		Lucas	254,0x57	Hand Brake
	89-91		R		700-174			Ø 254,0	
	89-91		R		700-171	700-171K		Ø 254,0	+ABS
	89-91		R		700-169	700-169K		Ø 255,0	-ABS
	89-91		R		151-138		Lucas	Ø 25,40 254,0x57	LUC
1.7 Eng.F1N720/ 722/ 724 (50kW)	5/89-8/94		R		153-071		Lucas	254,0x57	Hand Brake
	89-94		R		700-174			Ø 254,0	
	89-94		R		700-171	700-171K		Ø 254,0	+ABS
	89-94		R		700-169	700-169K		Ø 255,0	-ABS
	89-94		R		151-138		Lucas	Ø 25,40 254,0x57	LUC













		Spare Parts	F/R	L/R	CIFAM ref.	CIFAM ref. w/KIT		DIMENSIONS mm.	NOTE
1.9 D Eng.F8Q606/ 630/ 662 (44kW)	6/97-3/01		R		153-071		Lucas	254,0x57	Hand Brake
	97-01		R		151-138		Lucas	Ø 25,40 254,0x57	LUC
2.0 Eng.J5R716/ 726 (59kW)	5/89-10/97		R		153-071		Lucas	254,0x57	Hand Brake
	89-97		R		700-174			Ø 254,0	
	89-97		R		700-171	700-171K		Ø 254,0	+ABS
	89-97		R		700-169	700-169K		Ø 255,0	-ABS
	89-97		R		151-138		Lucas	Ø 25,40 254,0x57	LUC
2.1 D Eng.852720/ 750 (43kW)	5/89-6/94		R		153-071		Lucas	254,0x57	Hand Brake
	89-94		R		700-174			Ø 254,0	
	89-94		R		700-171	700-171K		Ø 254,0	+ABS
	89-94		R		700-169	700-169K		Ø 255,0	-ABS
	89-94		R		151-138		Lucas	Ø 25,40 254,0x57	LUC
2.1 D Eng.J8S620/ 758 (47kW)	6/94-10/97		R		153-071		Lucas	254,0x57	Hand Brake
	6/94-10/97		R		153-100		Lucas	254,0x57	Hand Brake
	94-97		R		700-172			Ø 255,0	
	94-97		R		151-138		Lucas	Ø 25,40 254,0x57	LUC
2.2, 4WD Eng.J7T600 (74kW)	6/94-10/97		R		153-071		Lucas	254,0x57	Hand Brake
	6/94-10/97		R		153-100		Lucas	254,0x57	Hand Brake
	94-97		R		700-172			Ø 255,0	
	94-97		R		151-138		Lucas	Ø 25,40 254,0x57	LUC
2.2, 4WD Eng.J7T780 (70kW)	5/89-6/94		R		153-071		Lucas	254,0x57	Hand Brake
	89-94		R		700-170	700-170K		Ø 254,0	
	89-94		R		151-138		Lucas	Ø 25,40 254,0x57	LUC
2.5 D Eng.S8U750 (56kW)	5/89-8/94		R		153-071		Lucas	254,0x57	Hand Brake
2.5 D, 4WD Eng.Sofim-8140.67.2500/ .2550/ .2580/ S8U750/ 752 (55kW)	5/89-3/01		R		153-071		Lucas	254,0x57	Hand Brake
	5/89-3/01		R		153-100		Lucas	254,0x57	Hand Brake
	89-01		R		700-170	700-170K		Ø 254,0	
	89-01		R		151-138		Lucas	Ø 25,40 254,0x57	LUC

Twingo (S06) Van 3/93-



1.2 (S063, S064) Eng.C3G700/ 702 (40kW)	93-96		R		153-345	153-345Y	Bdx	180,0x42	+/-ABS, Hand Brake
	93-96		R		700-142	700-142K		Ø 180,2	
	93-96		R		151-014		Bdx	Ø 20,64 180,0x40	CRCI, RAI
1.2 (S066, S068) Eng.D7F700/ 701/ 702/ 703/ 704/ 706 (40-43kW)	96-07		R		153-345	153-345Y	Bdx	180,0x42	-ABS, Hand Brake
	96-98		R		153-345	153-345Y	Bdx	180,0x42	+ABS, Hand Brake
	98-07		R		153-350		Lucas	203,0x38	+ABS, Hand Brake
	5/96-		R		700-142	700-142K		Ø 180,2	

ROVER







100 (METRO) (Xp) 3/90-12/98

111, Cabrio Eng.11K2A/ D (44kW)	3/90-12/98		R		153-004		Ap	177,8x32	Hand Brake
	90-98		R		700-096			Ø 177,8	
114 D Eng.TUD3 (38kW)	10/92-12/94		R		153-004		Ap	177,8x32	Hand Brake
	92-94		R		700-096			Ø 177,8	
114 GTI 16v, GSi, Cabrio Eng.14K4F (76kW)	8/91-12/98		R		153-004		Ap	177,8x32	Hand Brake
	91-98		R		700-096			Ø 177,8	
114 GTI/GT 16v, Kat Eng.14K4C/ D (66-69-70kW)	3/90-12/98		R		153-004		Ap	177,8x32	Hand Brake
	90-98		R		700-096			Ø 177,8	
114, Cabrio Eng.14K2A/ D (55kW)	3/90-12/98		R		153-004		Ap	177,8x32	Hand Brake
	90-98		R		700-096			Ø 177,8	
115 D Eng.TUD5 (42kW)	12/94-12/98		R		153-004		Ap	177,8x32	Hand Brake
	94-98		R		700-096			Ø 177,8	





1000-Series Mk II 1/67-12/78











































1.1 Eng.10H (33-36-40-41kW)	70-78		R		153-377		Ap	203,2x38	
1.3 (39kW)	70-78		R		153-377		Ap	203,2x38	
1.3 GT (50kW)	70-78		R		153-377		Ap	203,2x38	





















































200 I (XH) 3/85-9/89





















213 Eng.EV2 (54kW)	9/85-9/89		R		153-150		Ake	180,0x31	
	85-89		R		700-092			Ø 180,0	
216 EFi Eng.16H (61kW)	3/85-9/89		R		153-150		Ake	180,0x31	
	85-89		R		700-092			Ø 180,0	
216 Vitesse Eng.16H (75kW)	3/85-9/89		R		153-150		Ake	180,0x31	
	85-89		R		700-092			Ø 180,0	



























































200 II (XW), Coupe 10/89-11/99























































214 Eng.14K2A/ D (55kW)	9/93-10/95		R		153-006		Lucas	203,0x38	Hand Brake
	93-95		R		700-097			Ø 203,0	
214 16v Si, GSi, Cabrio Eng.14K4F (76kW)	1/93-11/99		R		153-006		Lucas	203,0x38	Hand Brake
	93-99		R		700-097			Ø 203,0	















































		Spare Parts	F/R	L/R	CIFAM ref.	CIFAM ref. w/KIT		DIMENSIONS mm.	NOTE
214 Si, Gsi, Cabrio Eng.14K4C (66-70kW)	1/90-10/95		R		153-006		Lucas	203,0x38	Hand Brake
	90-95		R		700-097			Ø 203,0	
214, Si, GSi, Cabrio Eng.14K4C/ D (66kW)	10/89-11/99		R		153-006		Lucas	203,0x38	Hand Brake
	89-99		R		700-097			Ø 203,0	
216 16v Cabrio Eng.16K4F (82kW)	1/96-11/99		R		153-006		Lucas	203,0x38	Hand Brake
	96-99		R		700-097			Ø 203,0	
216 GSi Eng.D16A7 (85kW)	10/89-10/95		R		153-006		Lucas	203,0x38	Hand Brake
	89-95		R		700-097			Ø 203,0	
216 GSi Eng.D16Z2 (82kW)	10/89-10/95		R		153-006		Lucas	203,0x38	Hand Brake
	89-95		R		700-097			Ø 203,0	
216 GTi Eng.D16A9 (96kW)	9/90-10/95		R		153-006		Lucas	203,0x38	Hand Brake
216, GTi, Cabrio Eng.D16A8 (90kW)	9/90-11/99		R		153-006		Lucas	203,0x38	Hand Brake
	90-99		R		700-097			Ø 203,0	
218 D Eng.XUD9AL (49-52kW)	9/91-10/95		R		153-006		Lucas	203,0x38	Hand Brake
	91-95		R		700-097			Ø 203,0	
218 TD Eng.XUD7TE (65kW)	9/91-10/95		R		153-006		Lucas	203,0x38	Hand Brake
	91-95		R		700-097			Ø 203,0	
220 GTi Eng.20M4F (103kW)	91-95		R		700-097			Ø 203,0	
220 GTi, GSi Eng.20T4H (100kW)	93-99		R		700-097			Ø 203,0	
220 T. Eng.20T4G (147kW)	93-95		R		700-097			Ø 203,0	
200 III (RF) 11/95-3/00									
211 Eng.11K2A/ D (44kW)	98-00		R		700-097			Ø 203,0	
214 Eng.14K2F (55kW)	11/95-3/00		R		153-006		Lucas	203,0x38	Hand Brake
	95-00		R		700-097			Ø 203,0	
214 Si Eng.14K4F (76kW)	11/95-3/00		R		153-006		Lucas	203,0x38	Hand Brake
	95-00		R		700-097			Ø 203,0	
216 Si Eng.16K4F (82kW)	11/95-3/00		R		153-006		Lucas	203,0x38	Hand Brake
	95-00		R		700-097			Ø 203,0	
218 Eng.18K4K(VVC) (88-107kW)	95-00		R		700-097			Ø 203,0	
220 D/SD Eng.20T2R (63kW)	11/95-3/00		R		153-006		Lucas	203,0x38	Hand Brake
	95-00		R		700-097			Ø 203,0	
220 SDi Eng.20T2N (74-77kW)	11/95-3/00		R		153-006		Lucas	203,0x38	Hand Brake
	95-00		R		700-097			Ø 203,0	
2200-3500 (P6) 9/63-5/76									
3.5 (104kW)	4/68-5/76		R		153-366		Lucas	279,4x57	M/T+A/T, Hand Brake
3.5 (110kW)	4/68-5/76		R		153-366		Lucas	279,4x57	M/T+A/T, Hand Brake
25 (RF) 10/99-									
1.1 (44kW)	01-04		R		700-377			Ø 203,0	
1.4 Eng.14K4M (62kW)	10/99-		R		153-006		Lucas	203,0x38	Hand Brake
	10/99-		R		700-377			Ø 203,0	
1.4 16v Eng.14K4F (76kW)	10/99-		R		153-006		Lucas	203,0x38	Hand Brake
	10/99-		R		700-377			Ø 203,0	
1.6 16v Eng.16K4F/ 16 (80kW)	10/99-		R		153-006		Lucas	203,0x38	Hand Brake
	10/99-		R		700-097			Ø 203,0	
1.8 16v Eng.18K4F/ 16 (85kW)	10/99-		R		700-377			Ø 203,0	
1.8 16v Eng.18K4K(VVC) (107kW)	2/00-		R		700-377			Ø 203,0	
2.0 i DT Eng.20T2N (74-77-83kW)	10/99-		R		153-006		Lucas	203,0x38	Hand Brake
	10/99-		R		700-377			Ø 203,0	
400 I (XW) 4/90-4/95									
414 GSi/Si Kat Eng.14K4F (76kW)	1/93-4/95		R		153-006		Lucas	203,0x38	Hand Brake
	93-95		R		700-097			Ø 203,0	
414 Si, Gsi Eng.14K4C/ D (66kW)	4/90-4/95		R		153-006		Lucas	203,0x38	Hand Brake
	90-95		R		700-097			Ø 203,0	
414 Si, Gsi, Cabrio Eng.14K4C/ D (69-70kW)	1/93-4/95		R		153-006		Lucas	203,0x38	Hand Brake
	93-95		R		700-097			Ø 203,0	
416 GSi, SW Eng.D16Z2 (82kW)	4/90-4/95		R		153-006		Lucas	203,0x38	Hand Brake
	90-95		R		700-097			Ø 203,0	
416 GSi/GSE Eng.16K16 (85kW)	4/90-4/95		R		153-006		Lucas	203,0x38	Hand Brake
416 GTi, SW Eng.D16A8 (90kW)	4/90-4/95		R		153-006		Lucas	203,0x38	Hand Brake
	90-95		R		700-097			Ø 203,0	
416 GTi/GTE Eng.D16A9 (96kW)	4/90-4/95		R		153-006		Lucas	203,0x38	Hand Brake
418 D Eng.XUD9AL (49kW)	9/91-4/95		R		153-006		Lucas	203,0x38	Hand Brake
418 TD, SW Eng.XUD7TE (65kW)	9/91-4/95		R		153-006		Lucas	203,0x38	Hand Brake
420 GSi/SLI/GTI/Vitesse, SW Eng.20T4H (100-132kW)	93-95		R		700-097			Ø 203,0	





























































		Spare Parts	F/R	L/R	CIFAM ref.	CIFAM ref. w/KIT		DIMENSIONS mm.	NOTE
420 GTI/GSI/Vitesse Eng.20M4F (103kW)	92-95		R		700-097			Ø 203,0	
420 T. Eng.20T4G (147kW)	93-95		R		700-097			Ø 203,0	
400 II (RT) 5/95-3/00									
414 Si Eng.14K4F (76kW)	5/95-3/00		R		153-006		Lucas	203,0x38	Hand Brake
	95-00		R		700-097			Ø 203,0	
416 Si Eng.16K4F (82kW)	5/95-3/00		R		153-006		Lucas	203,0x38	Hand Brake
	95-00		R		700-097			Ø 203,0	
416 Si Eng.D16Y2 (83kW)	5/95-3/00		R		153-006		Lucas	203,0x38	Hand Brake
	95-00		R		700-097			Ø 203,0	
418 SW Eng.18K4K(VVC) (88-107kW)	6/96-11/98		R		153-006		Lucas	203,0x38	Hand Brake
420 D Eng.20T2R (63kW)	11/95-3/00		R		153-006		Lucas	203,0x38	Hand Brake
	95-00		R		700-097			Ø 203,0	
420 Di Eng.20T2N (74-77kW)	5/95-3/00		R		153-006		Lucas	203,0x38	Hand Brake
	95-00		R		700-097			Ø 203,0	
420 Si Lux Eng.20T4H/ T16 (100kW)	12/95-3/00		R		153-006		Lucas	203,0x38	Hand Brake
	95-00		R		700-097			Ø 203,0	
45 (RT) 2/00-									
1.4 16v Eng.14K4F (76kW)	2/00-		R		153-006		Lucas	203,0x38	Hand Brake
	00-		R		700-377			Ø 203,0	
1.6 16v Eng.16K4F/ 16 (80kW)	2/00-		R		153-006		Lucas	203,0x38	Hand Brake
	00-		R		700-377			Ø 203,0	
1.8 16v Eng.18K4F/ 16 (85-86kW)	00-		R		700-377			Ø 203,0	
2.0 i DT Eng.20T2N (74-77-83kW)	2/00-		R		153-006		Lucas	203,0x38	Hand Brake
	00-		R		700-377			Ø 203,0	
75 (R.J), SW 2/99-									
1.8 Eng.18K16 (88kW)	2/99-		R		153-369	153-369K		160,0x20	Hand Brake
1.8 T. Eng.18K4K (110kW)	5/03-		R		153-369	153-369K		160,0x20	Hand Brake
2.0 CDT Eng.M47R (85kW)	2/99-		R		153-369	153-369K		160,0x20	Hand Brake
2.0 CDTi Eng.204D2 (96kW)	2/03-		R		153-369	153-369K		160,0x20	Hand Brake
2.0 V6 Eng.20K4F (110kW)	2/99-		R		153-369	153-369K		160,0x20	Hand Brake
2.5 V6 Eng.25K4F/ KV6 (129-130kW)	2/99-		R		153-369	153-369K		160,0x20	Hand Brake
A40 1/61-12/67									
0.9 Eng.A0.9	1/58-12/61		R		153-004		Ap	177,8x32	Hand Brake
1.0 Eng.H99	1/65-12/67		R		153-004		Ap	177,8x32	Hand Brake
1.1 Eng.10H (33-36-40-41kW)	1/61-12/67		R		153-004		Ap	177,8x32	Hand Brake
Acclaim 1/82-12/85									
1.3 Eng.EJ (51-52kW)	1/82-12/85		R		153-152		Sumit.	180,0x25	
Allegro (ADO 67) 5/73-									
1.1 Eng.10H (33-36-40-41kW)	5/73-10/81		R		153-101		Lucas	203,2x38	Hand Brake
1.3 Eng.A1.3 (46-56kW)	1/79-10/83		R		153-101		Lucas	203,2x38	Hand Brake
1.3, SW Eng.12H (40-43kW)	5/73-3/82		R		153-101		Lucas	203,2x38	Hand Brake
1.5, SW Eng.14H (50-56kW)	5/73-3/82		R		153-101		Lucas	203,2x38	Hand Brake
1.7 SW (50kW)	8/79-		R		153-101		Lucas	203,2x38	Hand Brake
Cityover 1/04-									
1.4 Eng.14K4M (62kW)	1/04-		R		153-006		Lucas	203,0x38	Hand Brake
Coupe 3/96-11/99									
1.6 16v Eng.16K4F (82kW)	96-99		R		700-097			Ø 203,0	
1.8 16v Eng.18K4K(VVC) (107kW)	96-99		R		700-097			Ø 203,0	
Dolomite 1/72-12/81									
1.3 Eng.FM2/ 3/ FM8 (43-46-56kW)	1/77-12/81		R		153-101		Lucas	203,2x38	Hand Brake
Elf Mk II-III 1/61-10/68									
0.8	1/61-		F/R		153-004		Ap	177,8x32	Hand Brake
1.0 Eng.A1.0 (31-41kW)	3/63-10/68		F		153-003		Ap	177,8x38	
	3/63-10/68		R		153-004		Ap	177,8x32	Hand Brake
Hornet Mk II-III 1/61-12/70									
0.8	1/61-		F/R		153-004		Ap	177,8x32	Hand Brake
1.0 Eng.A1.0 (28-31-41kW)	63-		F		153-003		Ap	177,8x38	
	1/61-12/70		R		153-004		Ap	177,8x32	Hand Brake
Ital Van 1/82-3/84									
440L	1/82-3/84		R		153-101		Lucas	203,2x38	Hand Brake
575L	1/82-3/84		R		153-101		Lucas	203,2x38	Hand Brake
Ital, SW 7/80-3/84									
1.3 Eng.A1.3 (44-56kW)	7/80-3/84		R		153-101		Lucas	203,2x38	Hand Brake

		Spare Parts	F/R	L/R	CIFAM ref.	CIFAM ref. w/KIT		DIMENSIONS mm.	NOTE
1.7 Eng.P (58-64kW)	7/80-3/84		R		153-101		Lucas	203,2x38	Hand Brake
2.0 (67kW)	7/80-3/84		R		153-101		Lucas	203,2x38	Hand Brake
Maestro I (XC) 3/83-1/91									
1.3 Eng.12H/ 12HC32/ 12H999AA (45-46kW)	3/83-8/85		R		153-005		Lucas	203,2x38	
1.3 LS Eng.12H (49kW)	3/83-8/90		R		153-005		Lucas	203,2x38	
	83-90		R		700-091			Ø 203,2	Exc. Van
1.6 (76kW)	3/83-9/84		R		153-005		Lucas	203,2x38	
1.6 Eng.16H956AK (59kW)	3/83-10/84		R		153-005		Lucas	203,2x38	
1.6 Mayfair HLS Eng.16HC37 (61kW)	3/83-8/90		R		153-005		Lucas	203,2x38	
1.6 MG Eng.16HA03AL (72kW)	3/83-8/85		R		153-005		Lucas	203,2x38	
	83-85		R		700-091			Ø 203,2	Exc. Van
1.6 MG Eng.16HA35AL (73kW)	3/83-8/90		R		153-005		Lucas	203,2x38	
	83-90		R		700-091			Ø 203,2	Exc. Van
2.0 Eng.20H/ R (69-77kW)	1/84-1/91		R		153-005		Lucas	203,2x38	
2.0 EFi Eng.20HA50AA/ 20HC51AA/ 20HC81 (83kW)	10/84-8/90		R		153-005		Lucas	203,2x38	
	84-90		R		700-091			Ø 203,2	
2.0 EFi Eng.20HE99 (86kW)	10/84-9/90		R		153-005		Lucas	203,2x38	
2.0 T. Eng.20H (112kW)	10/88-9/90		R		153-005		Lucas	203,2x38	
	88-90		R		700-091			Ø 203,2	
Maestro II 9/90-1/95									
1.3 Eng.12HE (49-51kW)	90-95		R		700-091			Ø 203,2	Exc. Van
1.6 Eng.16HE (63kW)	90-95		R		700-091			Ø 203,2	Exc. Van
2.0 D Eng.MDi (44kW)	90-92		R		700-091			Ø 203,2	Exc. Van
2.0 TD Eng.MDi (60kW)	90-95		R		700-091			Ø 203,2	Exc. Van
Marina I 4/71-9/75									
1.3, Coupe (42-44kW)	4/71-6/75		R		153-101		Lucas	203,2x38	Hand Brake
1.8, SW, Coupe Eng.18V (53-57-59-68-70kW)	4/71-9/75		R		153-101		Lucas	203,2x38	Hand Brake
Marina II 3/75-10/78									
1.3 Eng.12H (42kW)	10/75-9/78		R		153-103		Lucas	203,2x38	Hand Brake
1.8, Coupe, GT Eng.18VTC (70kW)	3/75-10/78		R		153-101		Lucas	203,2x38	Hand Brake
	3/75-10/78		R		153-103		Lucas	203,2x38	Hand Brake
1.8, SW (54-57kW)	10/75-9/78		R		153-101		Lucas	203,2x38	Hand Brake
	10/75-9/78		R		153-103		Lucas	203,2x38	Hand Brake
Marina III 9/78-10/80									
1.3, SW Eng.12V (42-43kW)	10/78-10/80		R		153-101		Lucas	203,2x38	Hand Brake
Marina Van 1/72-12/79									
1.1 Eng.10H (33-36-40-41kW)	1/72-12/79		R		153-101		Lucas	203,2x38	Hand Brake
Metro MG 10/80-9/90									
1.0 Eng.99H (31-33-41kW)	10/80-4/90		R		153-004		Ap	177,8x32	Hand Brake
1.0 Eng.99HA65P (35kW)	10/80-4/90		R		153-004		Ap	177,8x32	Hand Brake
1.0 Eng.A1.0 (30-31-41kW)	10/80-4/90		R		153-004		Ap	177,8x32	Hand Brake
1.3 Eng.12H996AA (52kW)	10/80-12/85		R		153-004		Ap	177,8x32	Hand Brake
1.3 Eng.12HA83AA (39-45-51kW)	10/80-4/90		R		153-004		Ap	177,8x32	Hand Brake
1.3 Eng.12HC21AA (44kW)	11/85-4/90		R		153-004		Ap	177,8x32	Hand Brake
1.3 Eng.12HL (39-45-51kW)	10/80-12/83		R		153-004		Ap	177,8x32	Hand Brake
1.3 Eng.A1.3 (54-56kW)	5/82-9/90		R		153-004		Ap	177,8x32	Hand Brake
1.3 T. Eng.12HA85AA (66-69kW)	10/82-4/90		R		153-004		Ap	177,8x32	Hand Brake
Metro Van 10/80-9/90									
1.0 (30kW)	10/80-4/90		R		153-004		Ap	177,8x32	Hand Brake
	90-4/90		R		700-096			Ø 177,8	Exc. Van
1.0 Eng.99H (33kW)	10/80-4/90		R		153-004		Ap	177,8x32	Hand Brake
	90-4/90		R		700-096			Ø 177,8	Exc. Van
1.0 Eng.99HA65P (35kW)	10/80-4/90		R		153-004		Ap	177,8x32	Hand Brake
	90-4/90		R		700-096			Ø 177,8	Exc. Van
1.3 Eng.12HC21AA (44kW)	90-4/90		R		700-096			Ø 177,8	Exc. Van
1.3 T. Eng.12HA85AA (66-69kW)	90-		R		700-096			Ø 177,8	Exc. Van
MG ZS 7/01-									
120 1.8 Eng.18K4F (86kW)	7/01-		R		153-006		Lucas	203,0x38	Hand Brake
2.0 TD Eng.20T2N (74-83kW)	1/04-		R		153-006		Lucas	203,0x38	Hand Brake
MG ZT, ZT-T 6/01-									
1.8 16v Eng.18K4F (88kW)	03-		R		153-369	153-369K		160,0x20	
1.8 T 16v (118kW)	03-		R		153-369	153-369K		160,0x20	
2.0 CDTi Eng.204D2 (85kW)	02-03		R		153-369	153-369K		160,0x20	
2.0 CDTi Eng.204D2 (96kW)	02-		R		153-369	153-369K		160,0x20	



























































		Spare Parts	F/R	L/R	CIFAM ref.	CIFAM ref. w/KIT		DIMENSIONS mm.	NOTE
2.5 Eng.25K4F (118kW)	01-		R		153-369	153-369K		160,0x20	
2.5 Eng.25K4F (130kW)	03-		R		153-369	153-369K		160,0x20	
2.5 Eng.25K4F (140kW)	01-		R		153-369	153-369K		160,0x20	
4.6 Eng.46F2F (191kW)	03-		R		153-369	153-369K		160,0x20	
MGB GT 1/66-11/80									
1.8, Cabrio Eng.18V/ G/ GA/ GB/ GD/ GF/ GG (57-68-70kW)	1/66-11/80		R		153-007		Ap	254,0x45	
3.5 Eng.38A/ 39A (101-116kW)	1/73-12/76		R		153-007		Ap	254,0x45	
MGR V8 9/92-12/95									
3.9 Eng.V8 (140kW)	9/92-12/95		R		153-102		Ap	228,6x45	Hand Brake
Midget 1/64-12/79									
0.9 Eng.A0.9	1/61-12/62		R		153-004		Ap	177,8x32	Hand Brake
1.5 Eng.GFM11 (49-53kW)	9/74-12/79		R		153-004		Ap	177,8x32	Hand Brake
Mini Mk I 1/67-									
0.8 Eng.BMCSerieA (25-30kW)	1/67-8/79		F		153-003		Ap	177,8x38	
	1/67-8/79		R		153-004		Ap	177,8x32	Hand Brake
1.0 (26kW)	10/67-9/84		F		153-003		Ap	177,8x38	
	10/67-9/84		R		153-004		Ap	177,8x32	Hand Brake
1.0 (44kW)	9/62-8/69		R		153-004		Ap	177,8x32	Hand Brake
1.0 Eng.CL Daihatsu (27kW)	1/83-1/83-		F		153-003		Ap	177,8x38	
	1/83-		R		153-004		Ap	177,8x32	Hand Brake
1.0 Mayfair Eng.99H997P/ 99HA53P/ 99HC20P (31-41kW)	8/82-6/93		F		153-003		Ap	177,8x38	
	8/82-6/93		R		153-004		Ap	177,8x32	Hand Brake
1.0, Mayfair Sport Eng.99HD81 (30kW)	9/88-6/93		F		153-003		Ap	177,8x38	
	9/88-6/93		R		153-004		Ap	177,8x32	Hand Brake
1.1 (46kW)	11/62-8/64		R		153-004		Ap	177,8x32	Hand Brake
1.1 Special Eng.10H (33-36-40-41kW)	1/76-8/81		R		153-004		Ap	177,8x32	Hand Brake
1.25 GT (39kW)	69-80		R		700-333			Ø 177,8	
1.3 Eng.12A2A (44kW)	10/67-12/91		R		153-004		Ap	177,8x32	Hand Brake
	67-91		R		700-333			Ø 177,8	
1.3 Eng.12A2A (45kW)	1/91-12/91		R		153-004		Ap	177,8x32	Hand Brake
	91-		R		700-073			Ø 117,8	Incl. Cooper, Cabrio
1.3 Eng.12A2B (37kW)	10/92-		R		153-004		Ap	177,8x32	Hand Brake
	92-		R		700-073			Ø 117,8	Incl. Cooper, Cabrio
1.3 Eng.12A2D (39kW)	1/92-4/95		R		153-004		Ap	177,8x32	Hand Brake
1.3 Eng.12H (48kW)	4/74-9/80		R		153-004		Ap	177,8x32	Hand Brake
1.3 T. Eng.A1.3 (53-56-58-68kW)	1/67-4/95		R		153-004		Ap	177,8x32	Hand Brake
	91-95		R		700-073			Ø 117,8	Incl. Cooper, Cabrio
1.3, Cabrio Eng.12A2E/ L (46kW)	1/92-		R		153-004		Ap	177,8x32	Hand Brake
Mini Mk I Cooper 1/67-12/91									
0.8 Cooper S Eng.BMCSerieA (25kW)	1/67-8/79		R		153-004		Ap	177,8x32	Hand Brake
	67-79		R		700-073			Ø 117,8	
1.0 Cooper Eng.99H (29kW)	10/67-9/84		R		153-004		Ap	177,8x32	Hand Brake
1.3 Cooper S Eng.12A2A (44kW)	10/67-12/91		R		153-004		Ap	177,8x32	Hand Brake
	67-91		R		700-073			Ø 117,8	
Mini Mk I Van, Pick-Up 1/67-6/93									
0.8 Eng.BMCSerieA (25kW)	1/67-8/79		R		153-004		Ap	177,8x32	Hand Brake
1.0 (26kW)	10/67-9/84		R		153-004		Ap	177,8x32	Hand Brake
1.0 Mayfair Eng.99H997P/ 99HA53P/ 99HC20P (31kW)	8/82-6/93		R		153-004		Ap	177,8x32	Hand Brake
	82-93		R		700-073			Ø 117,8	
1.0, Mayfair Sport Eng.99HD81 (30kW)	9/88-6/93		R		153-004		Ap	177,8x32	Hand Brake
	88-93		R		700-073			Ø 117,8	
1.1 Special Eng.10H (33-36-40-41kW)	1/76-8/81		R		153-004		Ap	177,8x32	Hand Brake
	76-81		R		700-073			Ø 117,8	
Minor, Cabrio, SW, Pick-up 1/55-10/71									
1.1 (37kW)	1/62-10/71		R		153-004		Ap	177,8x32	Hand Brake
Montego (XE), SW 4/84-10/95									
1.3, SW Eng.12H (39-45-50-51kW)	10/84-10/88		R		153-005		Lucas	203,2x38	
	84-88		R		700-091			Ø 203,2	SW
1.6 LS,HL Eng.16HC37 (61kW)	4/84-8/88		R		153-005		Lucas	203,2x38	
	84-88		R		700-091			Ø 203,2	SW
2.0 Eng.20H/ HSC (74kW)	4/84-8/91		R		153-005		Lucas	203,2x38	
	84-91		R		700-091			Ø 203,2	SW
2.0 D (61kW)	12/88-9/92		R		153-005		Lucas	203,2x38	
2.0 EFi, Mayfair Eng.20H (86kW)	4/84-9/90		R		153-005		Lucas	203,2x38	
2.0 GTi Eng.20H (86kW)	10/88-10/91		R		153-005		Lucas	203,2x38	

























































		Spare Parts	F/R	L/R	CIFAM ref.	CIFAM ref. w/KIT		DIMENSIONS mm.	NOTE
2.0 T. (Exc. SW) Eng.20HC85 (110-119kW)	10/84-9/90		R		153-005		Lucas	203,2x38	
2.0 TD Eng.BB (60kW)	10/88-10/95		R		153-005		Lucas	203,2x38	
	88-95		R		700-091			Ø 203,2	SW
2.0, GTI, LXI, HLi Eng.20H/ HSC (74-83kW)	4/84-8/91		R		153-005		Lucas	203,2x38	
Sherpa 1/74-1/89									
185 Eng.18V (57-70kW)	85-89		R		700-101			Ø 254,0	
200 Eng.20H/ R (69-77kW)	85-89		R		700-101			Ø 254,0	
200 Eng.P (64kW)	85-89		R		700-101			Ø 254,0	
215 Eng.18V (57-70kW)	85-		R		153-102		Ap	228,6x45	Hand Brake
220 Eng.18V (57-70kW)	85-89		R		700-101			Ø 254,0	
230 Eng.20H/ R (69-77kW)	85-		R		153-102		Ap	228,6x45	Hand Brake
	85-89		R		700-101			Ø 254,0	
230 Eng.P (64kW)	85-		R		153-102		Ap	228,6x45	Hand Brake
	85-89		R		700-101			Ø 254,0	
240 Eng.18V (57-70kW)	85-89		R		700-101			Ø 254,0	
250 Eng.20H/ R (69-77kW)	1/84-12/91		R		153-102		Ap	228,6x45	Hand Brake
250 Eng.P (64kW)	85-		R		153-102		Ap	228,6x45	Hand Brake
255 Eng.20H/ R (69-77kW)	85-89		R		700-101			Ø 254,0	
255 Eng.P (64kW)	85-89		R		700-101			Ø 254,0	
280 Eng.20H/ R (69-77kW)	1/84-12/91		R		153-102		Ap	228,6x45	+AA, Hand Brake
	82-89		R		700-100			Ø 254,0	Exc. V8
285	1/82-1/89		R		153-109		Ap	254,0x70	Hand Brake
	82-89		R		700-100			Ø 254,0	Exc. V8
285 Eng.20H/ R (69-77kW)	1/84-12/91		R		153-109		Ap	254,0x70	Hand Brake
	82-89		R		700-100			Ø 254,0	Exc. V8
310	1/82-1/89		R		153-109		Ap	254,0x70	Hand Brake
	82-89		R		700-100			Ø 254,0	Exc. V8
310 Eng.20H/ R (69-77kW)	1/84-12/91		R		153-109		Ap	254,0x70	Hand Brake
	82-89		R		700-100			Ø 254,0	Exc. V8
350	1/82-1/89		R		153-109		Ap	254,0x70	TRW, Hand Brake
	82-89		R		700-100			Ø 254,0	Exc. V8
350 Eng.20H/ R (69-77kW)	1/84-12/91		R		153-109		Ap	254,0x70	TRW, Hand Brake
	82-89		R		700-100			Ø 254,0	Exc. V8
Sprite Mk II 1/62-12/70									
1.1 Eng.10H (33-36-40-41kW)	1/62-12/70		R		153-004		Ap	177,8x32	Hand Brake
Sprite Mk III 1/64-12/66									
1.1 Eng.10H (33-36-40-41kW)	1/64-12/66		R		153-004		Ap	177,8x32	Hand Brake
Sprite Mk IV 1/66-12/74									
1.3 Eng.A1275 (39-45-51kW)	1/66-12/71		R		153-004		Ap	177,8x32	Hand Brake
Streetwise 8/03-									
1.4 Eng.14K4M (62kW)	8/03-		R		153-006		Lucas	203,0x38	Hand Brake
	8/03-		R		700-097			Ø 203,0	
1.4 16v Eng.14K4F (76kW)	8/03-		R		153-006		Lucas	203,0x38	Hand Brake
	8/03-		R		700-097			Ø 203,0	
2.0 TD Eng.20T2N (74kW)	8/03-		R		153-006		Lucas	203,0x38	Hand Brake
	8/03-		R		700-097			Ø 203,0	
Toledo 10/70-12/77									
1.3 Eng.FM2/ 3/ FM8 (43-46-56kW)	10/70-12/77		R		153-101		Lucas	203,2x38	Hand Brake
SAAB									
900 II, Coupe, Cabrio 7/93-2/98									
2.0-16 Eng.B204I (96kW)	8/94-2/98		R			153-302K		160,0x25	Hand Brake
	8/94-2/98		R		153-302	153-302K	Ate	160,0x25	Hand Brake
2.0-16 (Exc. Cabrio) Eng.B206I (98kW)	7/93-7/94		R		153-302	153-302K	Ate	160,0x25	Hand Brake
2.0-16 T. Eng.B204L (136kW)	12/93-2/98		R		153-302	153-302K	Ate	160,0x25	Hand Brake
2.3-16 Eng.B234I (110kW)	12/93-2/98		R		153-302	153-302K	Ate	160,0x25	Hand Brake
2.5-24 V6 Eng.B258I (125kW)	12/93-2/98		R		153-302		Ate	160,0x25	Hand Brake
9-2x 1/05-12/06									
2.0 16v AWD	1/05-12/06		R		153-386	153-386K		170,0x32	
2.5 16v AWD	1/05-12/06		R		153-386	153-386K		170,0x32	
9-3 I (YS3D), Cabrio 2/98-9/02									
2.0 T. Eng.B204E (110-113kW)	10/98-9/02		R			153-302K		160,0x25	Hand Brake
	10/98-9/02		R		153-302	153-302K	Ate	160,0x25	Hand Brake

























































		Spare Parts	F/R	L/R	CIFAM ref.	CIFAM ref. w/KIT		DIMENSIONS mm.	NOTE
2.0 T. Eng.B204L (136kW)	2/98-9/02		R		153-302	153-302K	Ate	160,0x25	Hand Brake
2.0 T. Eng.B204R (147kW)	2/98-9/02		R		153-302	153-302K	Ate	160,0x25	Hand Brake
2.0 T. Eng.B205E (110kW)	1/01-9/02		R		153-302	153-302K	Ate	160,0x25	Hand Brake
2.0 T. Eng.B205L/ R (151kW)	10/99-9/02		R		153-302	153-302K	Ate	160,0x25	Hand Brake
2.0-16 Eng.B204I (96kW)	2/98-9/02		R		153-302	153-302K	Ate	160,0x25	Hand Brake
2.2 TiD (Exc. Cabrio) Eng.D223L (92kW)	11/00-9/02		R		153-302	153-302K	Ate	160,0x25	Hand Brake
2.2 TiD (Exc. Cabrio) Eng.X22DTH (85kW)	2/98-11/00		R		153-302	153-302K	Ate	160,0x25	Hand Brake
2.3 i Eng.B234I (108-110kW)	2/98-9/02		R		153-302	153-302K	Ate	160,0x25	Hand Brake
2.3 T. Eng.B234L (170kW)	1/98-12/02		R		153-302	153-302K	Ate	160,0x25	Hand Brake
2.3 T. Eng.B235R (165-169kW)	10/98-9/02		R		153-302	153-302K	Ate	160,0x25	Hand Brake
9-5 I (YS3E), SW 9/97-4/10									
2.0 Eng.B205L (136kW)	7/00-7/01		R		153-302	153-302K	Ate	160,0x25	Hand Brake
2.0 T. Eng.B204L (141kW)	98-		R		153-302	153-302K	Ate	160,0x25	Hand Brake
2.0 T. Eng.B205E (110kW)	9/97-		R		153-302	153-302K	Ate	160,0x25	Hand Brake
2.0 T. Eng.B205E (132kW)	10/07-		R		153-302	153-302K	Ate	160,0x25	Hand Brake
2.2 TiD Eng.D223L (85-88-92kW)	3/02-		R		153-302	153-302K	Ate	160,0x25	Hand Brake
2.3 T. Eng.B235E (125-169kW)	9/97-		R		153-302	153-302K	Ate	160,0x25	Hand Brake
2.3 T. Eng.B235E (136kW)	1/01-		R		153-302	153-302K	Ate	160,0x25	Hand Brake
2.3 T. Eng.B235L (162kW)	7/03-		R		153-302	153-302K	Ate	160,0x25	Hand Brake
2.3 T. Eng.B235R (169kW)	10/99-9/01		R		153-302	153-302K	Ate	160,0x25	Hand Brake
2.3 T. Eng.B235R (184kW)	9/01-		R		153-302	153-302K	Ate	160,0x25	Hand Brake
2.3 T. Eng.B235R (191kW)	05-		R		153-302	153-302K	Ate	160,0x25	Hand Brake
3.0 TiD Eng.D308L (130kW)	7/01-		R		153-302	153-302K	Ate	160,0x25	Hand Brake
3.0 V6t Eng.B308E (147kW)	1/98-		R		153-302		Ate	160,0x25	Hand Brake
96 10/65-8/80									
1.5 GT Eng.FordV4 (50kW)	10/65-8/80		R		153-377		Ap	203,2x38	
1.5 V4 Eng.FordV4 (46-48-50kW)	10/65-8/80		R		153-377		Ap	203,2x38	
99 4/72-12/84									
2.0 Eng.B20C/ B20I (74-85-87-80-93kW)	9/74-12/84		R		153-377		Ap	203,2x38	
2.0 Eng.B20I (74-85-87-80-93kW)	9/74-12/78		R		153-377		Ap	203,2x38	
2.0 Eng.B20P (70kW)	10/72-8/74		R		153-377		Ap	203,2x38	
2.0 Eng.BH120/ B20IH (74-85-87-80-93kW)	4/72-8/74		R		153-377		Ap	203,2x38	
Monte Carlo 1/66-12/67									
0.8 (39kW)	1/66-12/67		R		153-377		Ap	203,2x38	
SANTANA									
300/350 9/98-									
1.6 D, Cabrio Eng.DV6ATED4 (66kW)	05-		R		153-403			254,0x47	
SAO									
Penza 1/91-12/94									
1.3 Eng.B3E Mazda (49kW)	1/91-12/94		R		153-207		Sumit.	200,0x25	Hand Brake
SEAT									
127 (127A) 4/72-12/82									
0.9 Eng.A112A5 (33kW)	4/72-12/82		R		153-063		Fiat	185,0x31	Fitted Adjuster, Hand Brake
	78-82		R		700-029			Ø 185,0	
	82-12/82		R		700-003			Ø 185,0	
1.0 Eng.127A.000 (38kW)	4/72-12/82		R		153-063		Fiat	185,0x31	Fitted Adjuster, Hand Brake
	78-82		R		700-029			Ø 185,0	
	82-12/82		R		700-003			Ø 185,0	
128 1/76-12/80									
1.2 (49kW)	1/76-12/80		R		153-063		Fiat	185,0x31	Fitted Adjuster, Hand Brake
	76-80		R		700-029			Ø 185,0	
1.4 (57kW)	1/76-12/80		R		153-063		Fiat	185,0x31	Fitted Adjuster, Hand Brake
	76-80		R		700-029			Ø 185,0	
131 10/74-12/86									
1.3 Mirafiori Eng.131A6.000 (40kW)	74-81		R		700-030			Ø 228,4	
1.3 Super Mirafiori Eng.131B.000 (57kW)	78-80		R		700-030			Ø 228,4	

		Spare Parts	F/R	L/R	CIFAM ref.	CIFAM ref. w/KIT		DIMENSIONS mm.	NOTE
1.4 Mirafiori Eng.131C1.000 (51kW)	80-84		R		700-030			Ø 228,4	
1.6 Eng.132BBOAO (71kW)	82-85		R		700-030			Ø 228,4	
133 5/74-11/79									
0.8 Eng.DG/ 100GL6 (25kW)	5/74-11/79		R		153-063		Fiat	185,0x31	Fitted Adjuster, Hand Brake
	74-79		R		700-029			Ø 185,0	
600 3/55-4/70									
0.8 D Eng.100D (17kW)	63-70		R		700-004			Ø 185,0	
850 1/66-7/75									
0.9 Eng.100G (25-27kW)	66-75		F/R		700-004			Ø 185,0	
0.9 Eng.100GB (35kW)	66-74		F/R		700-004			Ø 185,0	
Arosa (6H) 5/97-									
1.0 Eng.AHT (37kW)	5/97-		R		153-465		Vag	180,0x31	-ABS, Hand Brake
	5/97-		R		153-468		Vag	200,0x40	+ABS, Hand Brake
	5/99-		R		700-219			Ø 200,0	+ABS
	97-4/99		R		700-191	700-191K		Ø 180,0	-ABS
	97-4/99		R		700-202	700-202K		Ø 200,0	+ABS
	97-		R		151-045		Ate	Ø 15,87 180,0x30	VAG
	97-		R		151-086		Vag	Ø 15,87 200,0x40	VAG, -ABS
	97-		R		151-235		Vag	Ø 15,87 200,0x40	VAG, +ABS
1.0 i Eng.AER/ ALD/ ALL/ ANV/ AUC (37kW)	5/97-		R		153-465		Vag	180,0x31	-ABS, Hand Brake
	5/97-		R		153-468		Vag	200,0x40	+ABS, Hand Brake
	5/99-		R		700-219			Ø 200,0	+ABS
	97-4/99		R		700-191	700-191K		Ø 180,0	-ABS
	97-4/99		R		700-202	700-202K		Ø 200,0	+ABS
	97-		R		151-045		Ate	Ø 15,87 180,0x30	VAG
	97-		R		151-086		Vag	Ø 15,87 200,0x40	VAG, -ABS
	97-		R		151-235		Vag	Ø 15,87 200,0x40	VAG, +ABS
1.4 Eng.AEX/ AKV/ APQ (44kW)	5/97-		R		153-465		Vag	180,0x31	-ABS, Hand Brake
	5/97-		R		153-468		Vag	200,0x40	+ABS, Hand Brake
	5/99-		R		700-219			Ø 200,0	+ABS
	97-4/99		R		700-191	700-191K		Ø 180,0	-ABS
	97-4/99		R		700-202	700-202K		Ø 200,0	+ABS
	97-		R		151-045		Ate	Ø 15,87 180,0x30	VAG
	97-		R		151-086		Vag	Ø 15,87 200,0x40	VAG, -ABS
	97-		R		151-235		Vag	Ø 15,87 200,0x40	VAG, +ABS
1.4 Eng.AKK/ AUD (44kW)	5/97-		R		153-465		Vag	180,0x31	-ABS, Hand Brake
	5/97-		R		153-468		Vag	200,0x40	+ABS, Hand Brake
	5/99-		R		700-219			Ø 200,0	+ABS
	97-4/99		R		700-191	700-191K		Ø 180,0	-ABS
	97-4/99		R		700-202	700-202K		Ø 200,0	+ABS
	97-		R		151-045		Ate	Ø 15,87 180,0x30	VAG
	97-		R		151-086		Vag	Ø 15,87 200,0x40	VAG, -ABS
	97-		R		151-235		Vag	Ø 15,87 200,0x40	VAG, +ABS
1.4 Eng.ANW (44kW)	5/97-		R		153-465		Vag	180,0x31	-ABS, Hand Brake
	5/97-		R		153-468		Vag	200,0x40	+ABS, Hand Brake
	5/99-		R		700-219			Ø 200,0	+ABS
	97-4/99		R		700-191	700-191K		Ø 180,0	-ABS
	97-4/99		R		700-202	700-202K		Ø 200,0	+ABS
	97-		R		151-045		Ate	Ø 15,87 180,0x30	VAG
	97-		R		151-086		Vag	Ø 15,87 200,0x40	VAG, -ABS
	97-		R		151-235		Vag	Ø 15,87 200,0x40	VAG, +ABS
1.4 16v Eng.AFK/ ANM/ AQQ/ AUB (74kW)	1/00-		R		153-465		Vag	180,0x31	-ABS, Hand Brake
	1/00-		R		153-468		Vag	200,0x40	+ABS, Hand Brake
	1/00-		R		700-202	700-202K		Ø 200,0	+ABS
	1/00-		R		151-045		Ate	Ø 15,87 180,0x30	VAG
	1/00-		R		151-086		Vag	Ø 15,87 200,0x40	VAG, -ABS
1.4 TDi Eng.AMF (55kW)	1/00-		R		153-468		Vag	200,0x40	+ABS, Hand Brake
	1/00-		R		700-191	700-191K		Ø 180,0	-ABS
	1/00-		R		700-202	700-202K		Ø 200,0	+ABS
	1/00-		R		151-045		Ate	Ø 15,87 180,0x30	VAG
	1/00-		R		151-086		Vag	Ø 15,87 200,0x40	VAG, -ABS
	1/00-		R		151-235		Vag	Ø 15,87 200,0x40	VAG, +ABS
	1/00-		R		151-235		Vag	Ø 15,87 200,0x40	VAG, +ABS
1.7 SdI Eng.AKU (44kW)	8/97-		R		153-465		Vag	180,0x31	-ABS, Hand Brake
	8/97-		R		153-468		Vag	200,0x40	+ABS, Hand Brake
	5/99-		R		700-219			Ø 200,0	+ABS
	97-4/99		R		700-191	700-191K		Ø 180,0	-ABS
	97-4/99		R		700-202	700-202K		Ø 200,0	+ABS









































		Spare Parts	F/R	L/R	CIFAM ref.	CIFAM ref. w/KIT		DIMENSIONS mm.	NOTE
1.7 SDi Eng.AKU (44kW)	97-		R		151-045		Ate	Ø 15,87 180,0x30	VAG
	97-		R		151-086		Vag	Ø 15,87 200,0x40	VAG, -ABS
	97-		R		151-235		Vag	Ø 15,87 200,0x40	VAG, +ABS
Cordoba I (6K2/C2/6K5), Vario 2/93-6/99									
1.0 i Eng.AER/ ALD/ ALL/ ANV/ AUC (37kW)	9/96-6/99		R		153-465		Vag	180,0x31	Hand Brake
	9/96-6/99		R		153-468		Vag	200,0x40	Vario, Hand Brake
	96-99		R		700-191	700-191K		Ø 180,0	-ABS
	96-99		R		700-202	700-202K		Ø 200,0	+ABS
	96-99		R		151-031		Bdx	Ø 17,46 180,0x30	VAG
1.4 (40kW)	12/97-4/99		R		153-465		Vag	180,0x31	Hand Brake
	12/97-4/99		R		153-468		Vag	200,0x40	Vario, Hand Brake
1.4 Eng.AEX/ AKV/ ANX/ APQ (44kW)	1/96-12/99		R		153-465		Vag	180,0x31	Hand Brake
	1/96-12/99		R		153-468		Vag	200,0x40	Vario, Hand Brake
	96-99		R		700-191	700-191K		Ø 180,0	
	96-99		R		151-084		Ate	Ø 17,46 200,0x40	VAG, +ABS
	96-99		R		151-031		Bdx	Ø 17,46 180,0x30	VAG
1.4 Eng.AKK/ AUD (44kW)	1/96-12/99		R		153-465		Vag	180,0x31	Hand Brake
	1/96-12/99		R		153-468		Vag	200,0x40	Vario, Hand Brake
	94-6/99		R		700-191	700-191K		Ø 180,0	
	94-6/99		R		151-084		Ate	Ø 17,46 200,0x40	VAG, +ABS
	94-6/99		R		151-031		Bdx	Ø 17,46 180,0x30	VAG
1.4 Eng.ANW (44kW)	1/96-12/99		R		153-465		Vag	180,0x31	Hand Brake
	1/96-12/99		R		153-468		Vag	200,0x40	Vario, Hand Brake
	96-99		R		700-191	700-191K		Ø 180,0	
	96-99		R		151-084		Ate	Ø 17,46 200,0x40	VAG, +ABS
	96-99		R		151-031		Bdx	Ø 17,46 180,0x30	VAG
1.4 i Eng.ABD (44kW)	6/94-6/99		R		153-465		Vag	180,0x31	Hand Brake
	6/94-6/99		R		153-468		Vag	200,0x40	Vario, Hand Brake
	94-6/99		R		700-191	700-191K		Ø 180,0	
	94-6/99		R		151-084		Ate	Ø 17,46 200,0x40	VAG, +ABS
	94-6/99		R		151-031		Bdx	Ø 17,46 180,0x30	VAG
1.4 i 16v Eng.AFH (74kW)	9/96-6/99		R		153-465		Vag	180,0x31	Hand Brake
	9/96-6/99		R		153-468		Vag	200,0x40	Vario, Hand Brake
	96-6/99		R		700-191	700-191K		Ø 180,0	
	96-6/99		R		151-084		Ate	Ø 17,46 200,0x40	VAG, +ABS
	96-6/99		R		151-031		Bdx	Ø 17,46 180,0x30	VAG
1.6 i Eng.AFT (74kW)	7/96-6/99		R		153-465		Vag	180,0x31	Hand Brake
	7/96-6/99		R		153-468		Vag	200,0x40	Vario, Hand Brake
	7/96-6/99		R		700-191	700-191K		Ø 180,0	
	7/96-6/99		R		700-202	700-202K		Ø 200,0	+ABS, HDB
	7/96-6/99		R		151-084		Ate	Ø 17,46 200,0x40	VAG, +ABS
	7/96-6/99		R		151-031		Bdx	Ø 17,46 180,0x30	VAG
1.6i Eng.1F (52-54-55kW)	9/96-6/99		R		153-465		Vag	180,0x31	Hand Brake
	9/96-6/99		R		153-468		Vag	200,0x40	Vario, Hand Brake
	9/96-99		R		700-191	700-191K		Ø 180,0	
	9/96-99		R		151-084		Ate	Ø 17,46 200,0x40	VAG, +ABS
	9/96-99		R		151-031		Bdx	Ø 17,46 180,0x30	VAG
1.6i Eng.ABU (55kW)	9/96-6/99		R		153-465		Vag	180,0x31	Hand Brake
	9/96-6/99		R		153-468		Vag	200,0x40	Vario, Hand Brake
	9/96-99		R		700-191	700-191K		Ø 180,0	
	9/96-99		R		151-084		Ate	Ø 17,46 200,0x40	VAG, +ABS
	9/96-99		R		151-031		Bdx	Ø 17,46 180,0x30	VAG
1.6i Eng.AEE/ ALM (55kW)	9/96-6/99		R		153-465		Vag	180,0x31	Hand Brake
	9/96-6/99		R		153-468		Vag	200,0x40	Vario, Hand Brake
	9/96-99		R		700-191	700-191K		Ø 180,0	
	9/96-99		R		151-084		Ate	Ø 17,46 200,0x40	VAG, +ABS
	9/96-99		R		151-031		Bdx	Ø 17,46 180,0x30	VAG
1.7 SDi Eng.AKU (44kW)	7/97-6/99		R		700-202	700-202K		Ø 200,0	
1.8 i Eng.ABS/ ADZ (66kW)	2/93-6/99		R		153-468		Vag	200,0x40	Hand Brake
	93-6/99		R		700-202	700-202K		Ø 200,0	
	93-6/99		R		151-084		Ate	Ø 17,46 200,0x40	VAG, +ABS
1.8 i 16v Eng.ADL (95kW)	10/93-8/96		R		153-468		Vag	200,0x40	Hand Brake
1.9 D Eng.1Y (47-50kW)	2/93-8/96		R		153-468		Vag	200,0x40	Hand Brake
	93-96		R		700-202	700-202K		Ø 200,0	
	93-96		R		151-084		Ate	Ø 17,46 200,0x40	VAG, +ABS
1.9 SDi Eng.AEF/ AEY (47kW)	8/96-6/99		R		153-468		Vag	200,0x40	Hand Brake
	96-6/99		R		700-202	700-202K		Ø 200,0	
	96-99		R		151-084		Ate	Ø 17,46 200,0x40	VAG, +ABS

		Spare Parts	F/R	L/R	CIFAM ref.	CIFAM ref. w/KIT		DIMENSIONS mm.	NOTE
1.9 TD Eng.AAZ (50-55kW)	2/93-8/96		R		153-468		Vag	200,0x40	Hand Brake
	93-96		R		700-202	700-202K		Ø 200,0	
	93-96		R		151-084		Ate	Ø 17,46 200,0x40	VAG, +ABS
1.9 TDi Eng.1Z/ AHU/ ANU (66kW)	8/96-6/99		R		153-468		Vag	200,0x40	Hand Brake
	96-99		R		700-202	700-202K		Ø 200,0	+ABS, HDB
	96-99		R		151-084		Ate	Ø 17,46 200,0x40	VAG, +ABS
1.9 TDi Eng.AFN (81kW)	3/97-6/99		R		153-468		Vag	200,0x40	Hand Brake
2.0 i Eng.2E/ AGG/ ADY (85kW)	2/93-6/99		R		153-468		Vag	200,0x40	Hand Brake
2.0 i 16v Eng.ABF (110kW)	8/96-6/99		R		153-468		Vag	200,0x40	Hand Brake
Cordoba II (6K2/6K5), Vario 6/99-10/02									
1.0 Eng.ALD/ ANV/ AUC (37kW)	6/99-10/02		R		153-465		Vag	180,0x31	Hand Brake
	6/99-10/02		R		153-468		Vag	200,0x40	Vario, Hand Brake
	99-02		R		700-219			Ø 200,0	
1.0 16v Eng.AST/ AVZ (51kW)	5/00-10/02		R		153-465		Vag	180,0x31	Hand Brake
	5/00-10/02		R		153-468		Vag	200,0x40	Vario, Hand Brake
1.4 Eng.AEX/ AKV/ APQ (44kW)	6/99-10/02		R		153-465		Vag	180,0x31	Hand Brake
	6/99-10/02		R		153-468		Vag	200,0x40	Vario, Hand Brake
	99-02		R		700-219			Ø 200,0	
	99-02		R		151-084		Ate	Ø 17,46 200,0x40	VAG, +ABS
1.4 Eng.AKK/ AUD/ ANW (44kW)	6/99-10/02		R		153-465		Vag	180,0x31	Hand Brake
	6/99-10/02		R		153-468		Vag	200,0x40	Vario, Hand Brake
	99-02		R		700-219			Ø 200,0	
	99-02		R		151-084		Ate	Ø 17,46 200,0x40	VAG, +ABS
1.4 16v Eng.AFK/ ANM/ AQQ/ AUB (74kW)	2/00-10/02		R		153-465		Vag	180,0x31	Hand Brake
	2/00-10/02		R		153-468		Vag	200,0x40	Vario, Hand Brake
	00-02		R		700-219			Ø 200,0	
1.4 16v Eng.APE/ AUA (55kW)	5/00-10/02		R		153-465		Vag	180,0x31	Hand Brake
	5/00-10/02		R		153-468		Vag	200,0x40	Vario, Hand Brake
	00-02		R		700-219			Ø 200,0	
	00-02		R		151-084		Ate	Ø 17,46 200,0x40	VAG, +ABS
1.6 Eng.AEH/ AKL/ APF/ AUR (74kW)	6/99-10/02		R		153-465		Vag	180,0x31	Hand Brake
	6/99-10/02		R		153-468		Vag	200,0x40	Vario, Hand Brake
	99-02		R		700-219			Ø 200,0	
1.6 Eng.ALM (55kW)	6/99-10/02		R		153-465		Vag	180,0x31	Hand Brake
	6/99-10/02		R		153-468		Vag	200,0x40	Vario, Hand Brake
	99-02		R		151-084		Ate	Ø 17,46 200,0x40	VAG, +ABS
1.8 T. 20v Cupra Eng.AQX/ AYP (115kW)	7/00-10/02		R		153-468		Vag	200,0x40	Hand Brake
1.9 SDi Eng.AGP/ AQM (50kW)	6/99-10/02		R		153-468		Vag	200,0x40	Hand Brake
	99-02		R		700-219			Ø 200,0	
	99-02		R		151-084		Ate	Ø 17,46 200,0x40	VAG, +ABS
1.9 TDi Eng.AGR/ ALH (66kW)	6/99-10/02		R		153-468		Vag	200,0x40	Hand Brake
	99-02		R		151-084		Ate	Ø 17,46 200,0x40	VAG, +ABS
1.9 TDi Eng.ASK/ ASV (81kW)	6/99-10/02		R		153-468		Vag	200,0x40	Hand Brake
Cordoba III (6L2) 10/02-									
1.2 Eng.AZQ (47kW)	10/02-		R		153-468		Vag	200,0x40	Hand Brake
	10/02-		R		700-358			Ø 200,0	
1.4 16v Eng.BBY (55kW)	10/02-		R		153-468		Vag	200,0x40	Hand Brake
	10/02-		R		700-358			Ø 200,0	
1.4 16v Eng.BBZ (74kW)	10/02-		R		153-468		Vag	200,0x40	Hand Brake
1.4 TDi Eng.AMF (55kW)	10/02-		R		700-358			Ø 200,0	
1.9 SDi Eng.ASY (47kW)	10/02-		R		153-468		Vag	200,0x40	Hand Brake
	10/02-		R		700-358			Ø 200,0	
Fura (025A) 1/82-12/86									
0.9 Eng.09NCA/ 100GL7000 (29kW)	3/84-12/86		R		153-063		Fiat	185,0x31	Fitted Adjuster, Hand Brake
0.9 Eng.100GL (33kW)	1/82-6/86		R		153-063		Fiat	185,0x31	Fitted Adjuster, Hand Brake
0.9 Eng.HB90 (31kW)	1/82-6/86		R		153-063		Fiat	185,0x31	Fitted Adjuster, Hand Brake
Ibiza I (021A) 6/84-12/93									
0.9 Eng.09NCA/ A112A5 (29kW)	8/90-5/93		R		153-063		Fiat	185,0x31	Fitted Adjuster, Hand Brake
	90-93		R		700-028			Ø 185,0	
0.9 Eng.146A.000 (32kW)	8/86-5/93		R		153-063		Fiat	185,0x31	Fitted Adjuster, Hand Brake
	86-93		R		700-028			Ø 185,0	
1.2 Eng.021A.1000 (44-46kW)	11/84-12/93		R		153-063		Fiat	185,0x31	Fitted Adjuster, Hand Brake
	84-93		R		700-028			Ø 185,0	
1.2 i Eng.021C.1000 (52kW)	1/89-5/93		R		153-063		Fiat	185,0x31	Fitted Adjuster, Hand Brake
	89-93		R		700-028			Ø 185,0	
1.5 Eng.021A.2000 (62-63kW)	11/84-5/93		R		153-063		Fiat	185,0x31	Fitted Adjuster, Hand Brake
	84-93		R		700-028			Ø 185,0	

		Spare Parts	F/R	L/R	CIFAM ref.	CIFAM ref. w/KIT		DIMENSIONS mm.	NOTE
1.5 i Eng.021B.2000 (74kW)	10/86-5/93		R		153-063		Fiat	185,0x31	Fitted Adjuster, Hand Brake
	86-93		R		700-028			Ø 185,0	
1.5 i Eng.021D.2000 (65kW)	10/86-5/93		R		153-063		Fiat	185,0x31	Fitted Adjuster, Hand Brake
	86-93		R		700-028			Ø 185,0	
1.5 i Kat Eng.021C.2000 (66kW)	10/86-5/93		R		153-063		Fiat	185,0x31	Fitted Adjuster, Hand Brake
	86-93		R		700-028			Ø 185,0	
1.7 Eng.021A.3000 (72kW)	1/91-5/93		R		153-063		Fiat	185,0x31	Fitted Adjuster, Hand Brake
	91-93		R		700-028			Ø 185,0	
1.7 Eng.021B.3000 (76kW)	1/91-5/93		R		153-063		Fiat	185,0x31	Fitted Adjuster, Hand Brake
	91-93		R		700-028			Ø 185,0	
1.7 D Eng.022A.5000 (40-42kW)	6/84-5/93		R		153-063		Fiat	185,0x31	Fitted Adjuster, Hand Brake
	84-93		R		700-028			Ø 185,0	
Ibiza II (6K1) 3/93-8/99									
1.0 Eng.AAU (33kW)	3/93-9/96		R		153-465		Vag	180,0x31	Hand Brake
	93-96		R		700-191	700-191K		Ø 180,0	
	93-96		R		151-031		Bdx	Ø 17,46 180,0x30	VAG
1.0 i Eng.AER/ ALD/ ALL/ ANV/ AUC (37kW)	9/96-8/99		R		153-465		Vag	180,0x31	Hand Brake
	9/96-8/99		R		153-468		Vag	200,0x40	Hand Brake
	96-99		R		700-191	700-191K		Ø 180,0	
	96-99		R		151-031		Bdx	Ø 17,46 180,0x30	VAG
1.3 i Eng.AAV (40kW)	3/93-8/99		R		153-465		Vag	180,0x31	Hand Brake
	93-99		R		700-191	700-191K		Ø 180,0	
	93-99		R		151-031		Bdx	Ø 17,46 180,0x30	VAG
1.4 (40kW)	12/97-4/99		R		153-468		Vag	200,0x40	Hand Brake
1.4 Eng.AEX/ AKV/ APQ (44kW)	1/97-12/99		R		153-468		Vag	200,0x40	Hand Brake
	93-99		R		700-191	700-191K		Ø 180,0	
	93-99		R		151-084		Ate	Ø 17,46 200,0x40	VAG, +ABS
	93-99		R		151-031		Bdx	Ø 17,46 180,0x30	VAG
1.4 Eng.AKK/ AUD (44kW)	1/97-12/99		R		153-468		Vag	200,0x40	Hand Brake
	93-99		R		700-191	700-191K		Ø 180,0	
	93-99		R		151-084		Ate	Ø 17,46 200,0x40	VAG, +ABS
	93-99		R		151-031		Bdx	Ø 17,46 180,0x30	VAG
1.4 Eng.ANW (44kW)	1/97-12/99		R		153-468		Vag	200,0x40	Hand Brake
	93-99		R		700-191	700-191K		Ø 180,0	
	93-99		R		151-084		Ate	Ø 17,46 200,0x40	VAG, +ABS
	93-99		R		151-031		Bdx	Ø 17,46 180,0x30	VAG
1.4 i Eng.ABD (44kW)	9/93-8/99		R		153-468		Vag	200,0x40	Hand Brake
	93-99		R		700-191	700-191K		Ø 180,0	
	93-99		R		151-084		Ate	Ø 17,46 200,0x40	VAG, +ABS
	93-99		R		151-031		Bdx	Ø 17,46 180,0x30	VAG
1.4 i 16v Eng.AFH (74kW)	9/96-8/99		R		153-468		Vag	200,0x40	Hand Brake
	96-99		R		700-191	700-191K		Ø 180,0	
	96-99		R		151-084		Ate	Ø 17,46 200,0x40	VAG, +ABS
	96-99		R		151-031		Bdx	Ø 17,46 180,0x30	VAG
1.6 i Eng.AEE/ ALM (55kW)	3/93-8/99		R		153-465		Vag	180,0x31	Hand Brake
	3/93-8/99		R		153-468		Vag	200,0x40	Hand Brake
	93-99		R		700-191	700-191K		Ø 180,0	
	93-99		R		151-084		Ate	Ø 17,46 200,0x40	VAG, +ABS
1.6 i Eng.AFT (74kW)	4/96-8/99		R		153-465		Vag	180,0x31	Hand Brake
	4/96-8/99		R		153-468		Vag	200,0x40	Hand Brake
	96-99		R		700-191	700-191K		Ø 180,0	+ABS, HDB
	96-99		R		151-084		Ate	Ø 17,46 200,0x40	VAG, +ABS
1.6i Eng.1F (52-54-55kW)	4/96-8/99		R		151-031		Bdx	Ø 17,46 180,0x30	VAG
	96-99		R		153-468		Vag	200,0x40	Hand Brake
	96-99		R		700-191	700-191K		Ø 180,0	
	96-99		R		151-084		Ate	Ø 17,46 200,0x40	VAG, +ABS
1.6i Eng.ABU (55kW)	3/93-8/99		R		153-465		Vag	180,0x31	Hand Brake
	3/93-8/99		R		153-468		Vag	200,0x40	Hand Brake
	93-99		R		700-191	700-191K		Ø 180,0	
	93-99		R		151-084		Ate	Ø 17,46 200,0x40	VAG, +ABS
1.7 SDi Eng.AHB/ AKU (44kW)	7/97-8/99		R		151-031		Bdx	Ø 17,46 180,0x30	VAG
	97-99		R		700-191	700-191K		Ø 180,0	
1.8 i Eng.ABS/ ADZ (66kW)	7/97-8/99		R		151-084		Ate	Ø 17,46 200,0x40	VAG, +ABS
	3/93-8/99		R		153-468		Vag	200,0x40	Hand Brake
	93-99		R		700-191	700-191K		Ø 180,0	
93-99		R		151-084		Ate	Ø 17,46 200,0x40	VAG, +ABS	

















		Spare Parts	F/R	L/R	CIFAM ref.	CIFAM ref. w/KIT		DIMENSIONS mm.	NOTE
1.8 i 16v Eng.ADL (95kW)	11/93-8/96		R		153-468		Vag	200,0x40	Hand Brake
1.9 D Eng.1Y (47-50kW)	4/93-8/96		R		153-468		Vag	200,0x40	Hand Brake
	93-96		R		700-191	700-191K		Ø 180,0	
	93-96		R		151-084		Ate	Ø 17,46 200,0x40	VAG, +ABS
1.9 SDi Eng.AEF/ AEY (47kW)	8/96-8/99		R		153-468		Vag	200,0x40	Hand Brake
	96-99		R		700-191	700-191K		Ø 180,0	
	96-99		R		151-084		Ate	Ø 17,46 200,0x40	VAG, +ABS
1.9 TD Eng.AAZ (50-55kW)	3/93-8/96		R		153-468		Vag	200,0x40	Hand Brake
	93-96		R		700-191	700-191K		Ø 180,0	
	93-96		R		151-084		Ate	Ø 17,46 200,0x40	VAG, +ABS
1.9 TDi Eng.1Z/ AHU/ ANU (66kW)	8/96-8/99		R		153-468		Vag	200,0x40	Hand Brake
	96-99		R		700-191	700-191K		Ø 180,0	
	96-99		R		151-084		Ate	Ø 17,46 200,0x40	VAG, +ABS
1.9 TDi Eng.AFN (81kW)	2/97-8/99		R		153-468		Vag	200,0x40	Hand Brake
2.0 i Eng.2E/ AGG (85kW)	3/93-8/99		R		153-468		Vag	200,0x40	Hand Brake
2.0 i 16v Eng.ABF (110kW)	8/96-8/99		R		153-468		Vag	200,0x40	Hand Brake
Ibiza III (6K1) 8/99-2/02									
1.0 Eng.ALD/ ANV/ AUC (37kW)	8/99-2/02		R		153-468		Vag	200,0x40	Hand Brake
	99-02		R		700-219			Ø 200,0	
	99-02		R		151-084		Ate	Ø 17,46 200,0x40	VAG, +ABS
1.0 16v Eng.AST/ AVZ (51kW)	5/00-2/02		R		153-468		Vag	200,0x40	Hand Brake
	00-02		R		700-219			Ø 200,0	
1.4 Eng.AKK/ AUD (44kW)	8/99-2/02		R		153-468		Vag	200,0x40	Hand Brake
	8/99-02		R		700-191	700-191K		Ø 180,0	
	99-02		R		151-084		Ate	Ø 17,46 200,0x40	VAG, +ABS
1.4 Eng.ANW (44kW)	8/99-2/02		R		153-468		Vag	200,0x40	Hand Brake
	8/99-02		R		700-191	700-191K		Ø 180,0	
	99-02		R		151-084		Ate	Ø 17,46 200,0x40	VAG, +ABS
1.4 16v Eng.AFK/ ANM/ AQQ/ AUB (74kW)	8/99-2/02		R		153-468		Vag	200,0x40	Hand Brake
	8/99-02		R		700-191	700-191K		Ø 180,0	
1.4 16v Eng.APE (55kW)	5/00-2/02		R		153-468		Vag	200,0x40	Hand Brake
	00-02		R		700-191	700-191K		Ø 180,0	
	00-02		R		151-084		Ate	Ø 17,46 200,0x40	VAG, +ABS
1.4 16v Eng.AUA (55kW)	1/00-12/00		R		153-468		Vag	200,0x40	Hand Brake
	00-02		R		700-191	700-191K		Ø 180,0	
	00-02		R		151-084		Ate	Ø 17,46 200,0x40	VAG, +ABS
1.6 Eng.AEH/ AKL/ APF/ AUR (74kW)	8/99-2/02		R		153-468		Vag	200,0x40	Hand Brake
	99-02		R		700-219			Ø 200,0	
1.6 Eng.ALM (55kW)	8/99-2/02		R		153-468		Vag	200,0x40	Hand Brake
	8/99-02		R		700-191	700-191K		Ø 180,0	
	99-02		R		151-084		Ate	Ø 17,46 200,0x40	VAG, +ABS
1.9 SDi Eng.AGP/ AQM (50kW)	8/99-2/02		R		153-468		Vag	200,0x40	Hand Brake
	8/99-02		R		700-191	700-191K		Ø 180,0	
	99-02		R		151-084		Ate	Ø 17,46 200,0x40	VAG, +ABS
1.9 TDi Eng.AGR/ ALH/ ALK (66kW)	8/99-2/02		R		153-468		Vag	200,0x40	Hand Brake
	8/99-02		R		700-191	700-191K		Ø 180,0	
	99-02		R		151-084		Ate	Ø 17,46 200,0x40	VAG, +ABS
1.9 TDi Eng.ASK/ ASV (81kW)	8/99-2/02		R		153-468		Vag	200,0x40	Hand Brake
	8/99-02		R		700-191	700-191K		Ø 180,0	
Ibiza IV (6L1) 2/02-6/08									
1.2 Eng.AZQ (47kW)	2/02-6/08		R		153-468		Vag	200,0x40	Hand Brake
	10/02-		R		700-358			Ø 200,0	
1.2 12v Eng.BXV (51kW)	3/07-6/08		R		153-468		Vag	200,0x40	Hand Brake
1.4 16v Eng.AUB/ BBZ (74kW)	2/02-6/08		R		153-468		Vag	200,0x40	Hand Brake
1.4 16v Eng.BBY (55kW)	2/02-6/08		R		153-468		Vag	200,0x40	Hand Brake
	10/02-		R		700-358			Ø 200,0	
1.4 16v Eng.BXW (63kW)	3/07-6/08		R		153-468		Vag	200,0x40	Hand Brake
1.4 TDi Eng.AMF (55kW)	02-08		R		153-468		Vag	200,0x40	Hand Brake
	02-08		R		700-358			Ø 200,0	
1.4 TDi Eng.BMS (59kW)	6/05-6/08		R		153-468		Vag	200,0x40	Hand Brake
1.4 TDi Eng.BNM (51kW)	05-08		R		153-468		Vag	200,0x40	Hand Brake
1.6 Eng.BAH (74kW)	2/03-6/08		R		153-468		Vag	200,0x40	Hand Brake
1.6 16v Eng.BTS (77kW)	11/06-6/08		R		153-468		Vag	200,0x40	Hand Brake
	06-		R		700-358			Ø 200,0	
1.9 SDi Eng.ASY (47kW)	2/02-6/08		R		153-468		Vag	200,0x40	Hand Brake
	10/02-		R		700-358			Ø 200,0	
1.9 TDi Eng.ASZ (96kW)	2/02-6/08		R		153-468		Vag	200,0x40	Hand Brake



























































		Spare Parts	F/R	L/R	CIFAM ref.	CIFAM ref. w/KIT		DIMENSIONS mm.	NOTE
1.9 TDi Eng.ATD (74kW)	2/02-6/08		R		153-468		Vag	200,0x40	Hand Brake
Ibiza V (6J5,1,8), Sportcoupe, ST SW 7/08-									
1.2 12v Eng.BXV/ BZG/ CGPA (51kW)	08-		R		153-468		Vag	200,0x40	Hand Brake
1.4 16v Eng.BXW/ CGGB (63kW)	08-		R		153-468		Vag	200,0x40	Hand Brake
1.4 TDi Eng.BMS/ BNV (59kW)	08-		R		700-358			Ø 200,0	
1.6 16v Eng.BTS (77kW)	08-		R		700-358			Ø 200,0	
1.9 TDi Eng.BLS (77kW)	08-		R		153-468		Vag	200,0x40	Hand Brake
	08-		R		700-358			Ø 200,0	
1.9 TDi Eng.BXJ (66kW)	7/08-		R		153-468		Vag	200,0x40	Hand Brake
	08-		R		700-358			Ø 200,0	
2.0 Eng.CEKA (85kW)	08-		R		700-358			Ø 200,0	
Malaga (023A) 11/84-12/93									
1.2 Eng.021A.1000 (44-46kW)	11/84-12/93		R		153-063		Fiat	185,0x31	Fitted Adjuster, Hand Brake
	84-93		R		700-028			Ø 185,0	
1.2 i Eng.021C.1000 (52kW)	12/89-12/93		R		153-063		Fiat	185,0x31	Fitted Adjuster, Hand Brake
	89-93		R		700-028			Ø 185,0	
1.5 Eng.021A.2000 (63kW)	5/85-12/93		R		153-063		Fiat	185,0x31	Fitted Adjuster, Hand Brake
	85-93		R		700-028			Ø 185,0	
1.5 i Eng.021B.2000 (74kW)	1/87-12/93		R		153-063		Fiat	185,0x31	Fitted Adjuster, Hand Brake
	87-93		R		700-028			Ø 185,0	
1.5 i Kat Eng.021C.2000 (66kW)	10/86-12/93		R		153-063		Fiat	185,0x31	Fitted Adjuster, Hand Brake
	86-93		R		700-028			Ø 185,0	
1.7 D Eng.022A.5000 (40-42kW)	5/85-12/93		R		153-063		Fiat	185,0x31	Fitted Adjuster, Hand Brake
	85-93		R		700-028			Ø 185,0	
Marbella (28) 8/86-10/98									
0.8 Eng.08NCA/ 100GB (25kW)	8/86-12/93		R		153-063		Fiat	185,0x31	Fitted Adjuster, Hand Brake
	86-93		R		700-028			Ø 185,0	
0.9, Kat Eng.08NCB/ 146A (30-32kW)	11/96-10/98		R		153-063		Fiat	185,0x31	Fitted Adjuster, Hand Brake
	96-98		R		700-028			Ø 185,0	
0.9, Kat Eng.09NCA/ B (29kW)	1/87-11/96		R		153-063		Fiat	185,0x31	Fitted Adjuster, Hand Brake
	87-96		R		700-028			Ø 185,0	
Panda (141A) 10/80-8/98									
0.75, Kat, Van Eng.156A4.000 (25kW)	86-97		R		700-003			Ø 185,0	
0.75,Kat, Van Eng.141B.000 (25kW)	86-97		R		700-003			Ø 185,0	
0.8 Eng.100GL6.000 (25kW)	81-85		R		700-003			Ø 185,0	
0.9 Eng.100GL3.000/ 146A.000 (31-33kW)	10/80-6/94		R		153-063		Fiat	185,0x31	Fitted Adjuster, Hand Brake
	80-94		R		700-003			Ø 185,0	
1.0 i.e. Kat, 4WD, Van Eng.141C2.000 (33kW)	87-98		R		700-003			Ø 185,0	
1.0 i.e. Kat, 4WD, Van Eng.156A2.246 (33kW)	87-98		R		700-003			Ø 185,0	
Ritmo (138) 7/78-9/83									
1.2 Eng.021A.1000 (44-46kW)	78-83		R		700-003			Ø 185,0	
1.4 (57kW)	78-83		R		700-003			Ø 185,0	
1.7 D Eng.022A.5000 (41kW)	79-83		R		700-003			Ø 185,0	
Ronda (022A) 6/82-11/88									
1.2 Eng.021A.1000 (44-46kW)	10/84-12/86		R		153-063		Fiat	185,0x31	Fitted Adjuster, Hand Brake
	84-86		R		700-028			Ø 185,0	
1.2 Eng.124B6.000 (47kW)	8/83-5/85		R		153-063		Fiat	185,0x31	Fitted Adjuster, Hand Brake
	83-85		R		700-028			Ø 185,0	
1.4 Eng.124B7.000 (54kW)	82-88		R		700-028			Ø 185,0	
1.5 Eng.021A.2000 (62-63kW)	9/84-12/86		R		153-063		Fiat	185,0x31	Fitted Adjuster, Hand Brake
	84-86		R		700-028			Ø 185,0	
1.6 Eng.022A000/ 138AR6000 (68kW)	8/83-9/85		R		153-063		Fiat	185,0x31	Fitted Adjuster, Hand Brake
	83-85		R		700-028			Ø 185,0	
1.7 D Eng.022A.5000 (40-42kW)	6/82-12/86		R		153-063		Fiat	185,0x31	Fitted Adjuster, Hand Brake
	82-86		R		700-028			Ø 185,0	
Terra (24) 2/87-12/96									
1.3 D Eng.MN (33kW)	90-94		R		700-028			Ø 185,0	
1.4 D Eng.1W (35kW)	90-95		R		700-028			Ø 185,0	
Toledo I (1L) 5/91-3/99									
1.6 i Eng.AFT (74kW)	11/96-3/99		R		153-465		Vag	180,0x31	Ch -1LZD310000, Hand Brake
	11/96-3/99		R		153-468		Vag	200,0x40	Ch 1LZD310001-, Hand Brake
	96-99		R		700-191	700-191K		Ø 180,0	
	96-99		R		151-084		Ate	Ø 17,46 200,0x40	VAG, +ABS













		Spare Parts	F/R	L/R	CIFAM ref.	CIFAM ref. w/KIT		DIMENSIONS mm.	NOTE
1.6 i Eng.EZ/ ABN (54kW)	5/91-3/99		R		153-465		Vag	180,0x31	Ch -1LZD310000, Hand Brake
	5/91-3/99		R		153-468		Vag	200,0x40	Ch 1LZD310001-, Hand Brake
	91-99		R		700-191	700-191K		Ø 180,0	
	91-93		R		151-031		Bdx	Ø 17,46 180,0x30	VAG
	93-99		R		151-084		Ate	Ø 17,46 200,0x40	VAG, +ABS
1.6i Eng.1F (52-54-55kW)	5/91-3/99		R		153-465		Vag	180,0x31	Ch -1LZD310000, Hand Brake
	5/91-3/99		R		153-468		Vag	200,0x40	Ch 1LZD310001-, Hand Brake
	91-99		R		700-191	700-191K		Ø 180,0	
	91-93		R		151-031		Bdx	Ø 17,46 180,0x30	VAG
	93-99		R		151-084		Ate	Ø 17,46 200,0x40	VAG, +ABS
1.8 i Eng.ABS/ ADZ (66kW)	11/93-12/96		R		153-462		Vag	200,0x40	Hand Brake
	11/93-12/96		R		153-468		Vag	200,0x40	Hand Brake
	93-96		R		700-191	700-191K		Ø 180,0	
	93-96		R		151-084		Ate	Ø 17,46 200,0x40	VAG, +ABS
1.8 i Eng.RP (65kW)	5/91-12/96		R		153-462		Vag	200,0x40	Hand Brake
	5/91-12/96		R		153-468		Vag	200,0x40	Hand Brake
	91-96		R		700-191	700-191K		Ø 180,0	
	91-96		R		151-084		Ate	Ø 17,46 200,0x40	VAG, +ABS
1.9 D Eng.1Y (47-50kW)	5/91-3/99		R		153-462		Vag	200,0x40	Hand Brake
	5/91-3/99		R		153-468		Vag	200,0x40	Hand Brake
	91-99		R		700-191	700-191K		Ø 180,0	
	91-99		R		151-084		Ate	Ø 17,46 200,0x40	VAG, +ABS
1.9 SDi Eng.AEF/ AEY (47kW)	1/95-12/99		R		153-468		Vag	200,0x40	Hand Brake
	95-99		R		700-191	700-191K		Ø 180,0	
	95-99		R		151-084		Ate	Ø 17,46 200,0x40	VAG, +ABS
1.9 TD Eng.AAZ (50-55kW)	5/91-3/99		R		153-462		Vag	200,0x40	Hand Brake
	5/91-3/99		R		153-468		Vag	200,0x40	Hand Brake
	91-99		R		700-191	700-191K		Ø 180,0	
	91-99		R		151-084		Ate	Ø 17,46 200,0x40	VAG, +ABS
1.9 TDi Eng.1Z/ AHU/ ANU (66kW)	8/95-3/99		R		153-462		Vag	200,0x40	Hand Brake
	8/95-3/99		R		153-468		Vag	200,0x40	Hand Brake
	-99		R		700-191	700-191K		Ø 180,0	Ch 1LZD315001-
	95-99		R		151-084		Ate	Ø 17,46 200,0x40	VAG, +ABS
1.9 TDi Eng.AFN (81kW)	11/96-3/99		R		153-462		Vag	200,0x40	Hand Brake
	11/96-3/99		R		153-468		Vag	200,0x40	Hand Brake
	-99		R		700-191	700-191K		Ø 180,0	Ch 1LZD315001-
	96-99		R		151-084		Ate	Ø 17,46 200,0x40	VAG, +ABS





SEAT LCV































































Inca (6K9) 11/95-





1.4 Eng.AEX/ AKV/ APQ (44kW)	11/95-		R		153-379		Vag	230,0x32	Hand Brake
	11/95-		R		153-009		Vag	230,0x40	Hand Brake
				R		700-359		Ø 230,0	Ch 9KX023409-, -ABS
	95-		R		700-213	700-213K		Ø 200,0	
	95-		R		700-208	700-208K		Ø 230,0	Ch -9KX023408, -ABS
	95-5/99		R		151-147		Vag	Ø 20,64 230,0x32	Ch 9KX023409-, VAG
1.4 Eng.AKK/ AUD (44kW)	11/95-		R		153-379		Vag	230,0x32	Hand Brake
	11/95-		R		153-009		Vag	230,0x40	Hand Brake
			R		700-359			Ø 230,0	Ch 9KX023409-, -ABS
	95-		R		700-213	700-213K		Ø 200,0	
	95-		R		700-208	700-208K		Ø 230,0	Ch -9KX023408, -ABS
	95-5/99		R		151-147		Vag	Ø 20,64 230,0x32	Ch 9KX023409-, VAG
1.4 Eng.ANW (44kW)	11/95-		R		153-379		Vag	230,0x32	Hand Brake
	11/95-		R		153-009		Vag	230,0x40	Hand Brake
			R		700-359			Ø 230,0	Ch 9KX023409-, -ABS
	95-		R		700-213	700-213K		Ø 200,0	
	95-		R		700-208	700-208K		Ø 230,0	Ch -9KX023408, -ABS
	95-5/99		R		151-147		Vag	Ø 20,64 230,0x32	Ch 9KX023409-, VAG
1.4 16v Eng.AUA (55kW)	4/00-		R		153-379		Vag	230,0x32	Hand Brake
	4/00-		R		153-009		Vag	230,0x40	Hand Brake
			R		700-359			Ø 230,0	Ch 9KX023409-, -ABS
			R		151-147		Vag	Ø 20,64 230,0x32	Ch 9KX023409-, VAG
1.6 i Eng.AEE (55kW)	11/95-5/98		R		153-379		Vag	230,0x32	Hand Brake
	11/95-5/98		R		153-009		Vag	230,0x40	Hand Brake
	95-		R		700-213	700-213K		Ø 200,0	

		Spare Parts	F/R	L/R	CIFAM ref.	CIFAM ref. w/KIT		DIMENSIONS mm.	NOTE
1.6 i Eng.AEE (55kW)	95-		R		700-208	700-208K		Ø 230,0	Ch -9KX023408, -ABS
			R		151-147		Vag	Ø 20,64 230,0x32	Ch 9KX023409-, VAG
			R		151-131		Ate	Ø 20,64 230,0x40	VAG
1.6i Eng.1F (52-54-55kW)	11/95-5/98		R		153-379		Vag	230,0x32	Hand Brake
			R		153-009		Vag	230,0x40	Hand Brake
	95-		R		700-213	700-213K		Ø 200,0	
			R		700-208	700-208K		Ø 230,0	Ch -9KX023408, -ABS
	95-5/99		R		151-147		Vag	Ø 20,64 230,0x32	Ch 9KX023409-, VAG
			R		151-131		Ate	Ø 20,64 230,0x40	VAG
1.7 D Eng.AHB (42kW)	9/96-		R		153-379		Vag	230,0x32	Hand Brake
			R		153-009		Vag	230,0x40	Hand Brake
	96-		R		700-359			Ø 230,0	Ch 9KX023409-, -ABS
			R		700-213	700-213K		Ø 200,0	
	96-		R		700-208	700-208K		Ø 230,0	Ch -9KX023408, -ABS
			R		151-147		Vag	Ø 20,64 230,0x32	Ch 9KX023409-, VAG
	96-		R		151-131		Ate	Ø 20,64 230,0x40	VAG
			R		153-379		Vag	230,0x32	Hand Brake
1.9 D Eng.1Y (47kW)	11/95-		R		153-379		Vag	230,0x32	Hand Brake
			R		153-009		Vag	230,0x40	Hand Brake
	95-		R		700-359			Ø 230,0	Ch 9KX023409-, -ABS
			R		700-213	700-213K		Ø 200,0	
	95-		R		700-208	700-208K		Ø 230,0	Ch -9KX023408, -ABS
			R		151-147		Vag	Ø 20,64 230,0x32	Ch 9KX023409-, VAG
	95-5/99		R		151-131		Ate	Ø 20,64 230,0x40	VAG
			R		153-379		Vag	230,0x32	Hand Brake
1.9 SDi Eng.AEY/ AYQ (47kW)	11/95-		R		153-379		Vag	230,0x32	Hand Brake
			R		153-009		Vag	230,0x40	Hand Brake
	95-		R		700-359			Ø 230,0	Ch 9KX023409-, -ABS
			R		700-213	700-213K		Ø 200,0	
	95-		R		700-208	700-208K		Ø 230,0	Ch -9KX023408, -ABS
			R		151-147		Vag	Ø 20,64 230,0x32	Ch 9KX023409-, VAG
	95-5/99		R		151-131		Ate	Ø 20,64 230,0x40	VAG
			R		153-379		Vag	230,0x32	Hand Brake
1.9 TDi Eng.1Z/ AHU/ ALH/ ANU (66kW)	9/96-		R		153-379		Vag	230,0x32	Hand Brake
			R		153-009		Vag	230,0x40	Hand Brake
	96-		R		700-359			Ø 230,0	Ch 9KX023409-, -ABS
			R		700-213	700-213K		Ø 200,0	
	96-		R		700-208	700-208K		Ø 230,0	Ch -9KX023408, -ABS
Marbella (028A) Van 1/87-12/93									
0.9 Eng.09NCA/ B (29kW)	1/87-12/93		R		153-063		Fiat	185,0x31	Fitted Adjuster, Hand Brake
			R		700-028			Ø 185,0	
Terra (024A) Van 1/87-12/95									
0.9, Kat Eng.09NCA/ B (29kW)	1/87-12/95		R		153-063		Fiat	185,0x31	Fitted Adjuster, Hand Brake
			R		700-028			Ø 185,0	
1.3 D Eng.MN (33kW)	3/90-2/92		R		153-063		Fiat	185,0x31	Fitted Adjuster, Hand Brake
			R		700-028			Ø 185,0	
1.4 D Eng.1W (35kW)	90-92		R		700-028			Ø 185,0	
SKODA									
120 (742,744) 8/76-12/90									
1.2 Eng.742/ 12 (35kW)	87-90		R		700-259	700-259K		Ø 200,0	
1.2 Eng.742/ 12 (38kW)	76-90		R		700-259	700-259K		Ø 200,0	
1.2 Eng.742/ 12X (43kW)	76-90		R		700-259	700-259K		Ø 200,0	
Fabia I (6Y2, 3, 5), SW 12/99-5/07									
1.0 (Exc. SW) Eng.AQV/ ARV/ ATY (37kW)	12/99-8/02		R		153-462		Vag	200,0x40	Hand Brake
			R		153-468		Vag	200,0x40	Hand Brake
	99-02		R		700-358			Ø 200,0	
			R		151-085		Ate	Ø 19,05 200,0x40	VAG
1.2 Eng.AWY/ BMD (40kW)	8/02-5/07		R		153-468		Vag	200,0x40	Hand Brake
			R		700-358			Ø 200,0	
	02-		R		151-085		Ate	Ø 19,05 200,0x40	VAG
1.2 Eng.AZQ/ BME (47kW)	1/03-5/07		R		153-468		Vag	200,0x40	Hand Brake
			R		700-358			Ø 200,0	
	03-		R		151-085		Ate	Ø 19,05 200,0x40	VAG
1.4 Eng.AME/ AQW/ ATZ (50kW)	9/00-5/07		R		153-462		Vag	200,0x40	Hand Brake
			R		153-468		Vag	200,0x40	Hand Brake
	00-		R		700-358			Ø 200,0	
			R		151-085		Ate	Ø 19,05 200,0x40	VAG
1.4 Eng.AZE/ AZF (44kW)	11/00-5/07		R		153-462		Vag	200,0x40	Hand Brake
			R		153-468		Vag	200,0x40	Hand Brake
	00-		R		700-358			Ø 200,0	

		Spare Parts	F/R	L/R	CIFAM ref.	CIFAM ref. w/KIT		DIMENSIONS mm.	NOTE
1.4 Eng.AZE/ AZF (44kW)	00-		R		151-085		Ate	Ø 19,05 200,0x40	VAG
1.4 16v Eng.AUA/ BBY/ BKY (55kW)	12/99-5/07		R		153-462		Vag	200,0x40	Hand Brake
	12/99-5/07		R		153-468		Vag	200,0x40	Hand Brake
	99-		R		700-358			Ø 200,0	
	99-		R		151-085		Ate	Ø 19,05 200,0x40	VAG
1.4 16v Eng.AUB/ BBZ (74kW)	12/99-5/07		R		153-462		Vag	200,0x40	Hand Brake
	12/99-5/07		R		153-468		Vag	200,0x40	Hand Brake
	99-		R		700-358			Ø 200,0	
	99-		R		151-085		Ate	Ø 19,05 200,0x40	VAG
1.4 16v Eng.BUD (59kW)	4/06-5/07		R		153-462		Vag	200,0x40	Hand Brake
	4/06-5/07		R		153-468		Vag	200,0x40	Hand Brake
1.4 TDi Eng.AMF (55kW)	4/03-5/07		R		153-468		Vag	200,0x40	Hand Brake
	03-07		R		700-358			Ø 200,0	
1.4 TDi Eng.BNM (51kW)	10/05-5/07		R		153-468		Vag	200,0x40	Hand Brake
	05-		R		700-358			Ø 200,0	
1.4 TDi Eng.BNV (59kW)	10/05-5/07		R		153-468		Vag	200,0x40	Hand Brake
	05-		R		700-358			Ø 200,0	
1.9 SDi Eng.ASY (47kW)	12/99-5/07		R		153-468		Vag	200,0x40	Hand Brake
	99-		R		700-358			Ø 200,0	
	99-		R		151-085		Ate	Ø 19,05 200,0x40	VAG
1.9 TDi Eng.ATD/ AXR (74kW)	9/00-5/07		R		153-468		Vag	200,0x40	Hand Brake
	00-		R		700-358			Ø 200,0	
	00-		R		151-085		Ate	Ø 19,05 200,0x40	VAG
1.9 TDi (Exc. SW) Eng.ASZ (96kW)	03-07		R		153-468		Vag	200,0x40	Hand Brake
Fabia II (5J2), SW 5/07-									
1.2 Eng.BBM (44kW)	10/07-		R		153-468		Vag	200,0x40	Hand Brake
1.2 12v Eng.BZG/ CEVA (51kW)	5/07-		R		153-468		Vag	200,0x40	Hand Brake
1.4 16v Eng.BXW (63kW)	5/07-		R		153-468		Vag	200,0x40	Hand Brake
1.4 TDi Eng.BMS/ BNV (59kW)	5/07-		R		153-468		Vag	200,0x40	Hand Brake
1.4 TDi Eng.BNM (51kW)	5/07-		R		153-468		Vag	200,0x40	Hand Brake
1.6 16v Eng.BTS (77kW)	07-		R		153-468		Vag	200,0x40	Hand Brake
1.9 TDi Eng.BLS/ BSW (77kW)	5/07-		R		153-468		Vag	200,0x40	Hand Brake
Favorit (781) 5/89-9/94									
1.3 Eng.136B (50kW)	1/94-9/94		R		700-259	700-259K		Ø 200,0	
	1/94-9/94		R		151-125		Vag	Ø 19,05 200,0x40	VAG
1.3 Eng.136L (45kW)	10/90-9/94		R		153-378		Vag	200,0x32	Hand Brake
	1/93-		R		700-259	700-259K		Ø 200,0	
	90-92		R		700-257			Ø 200,0	
	90-94		R		151-125		Vag	Ø 19,05 200,0x40	VAG
1.3 Eng.781.135 (42kW)	12/91-9/94		R		153-378		Vag	200,0x32	Hand Brake
	91-94		R		151-125		Vag	Ø 19,05 200,0x40	VAG
1.3 Eng.781.135 (43kW)	5/89-9/94		R		153-378		Vag	200,0x32	Hand Brake
	89-94		R		151-125		Vag	Ø 19,05 200,0x40	VAG
1.3 Eng.781.135 (44kW)	10/90-9/94		R		153-378		Vag	200,0x32	Hand Brake
	90-94		R		151-125		Vag	Ø 19,05 200,0x40	VAG
1.3 Eng.781.135E (40kW)	1/90-9/94		R		153-378		Vag	200,0x32	Hand Brake
	1/93-		R		700-259	700-259K		Ø 200,0	
	89-92		R		700-257			Ø 200,0	
	90-94		R		151-125		Vag	Ø 19,05 200,0x40	VAG
Favorit Forman (785) 8/91-6/95									
1.3 Eng.136B (50kW)	1/94-6/95		R		153-378		Vag	200,0x32	Hand Brake
	1/94-6/95		R		153-468		Vag	200,0x40	Hand Brake
	94-95		R		700-259	700-259K		Ø 200,0	
	94-95		R		151-125		Vag	Ø 19,05 200,0x40	VAG
1.3 Eng.781.135 (40-42-43-44kW)	12/91-6/95		R		153-378		Vag	200,0x32	Hand Brake
	12/91-6/95		R		153-468		Vag	200,0x40	Hand Brake
	91-92		R		700-257			Ø 200,0	
	93-95		R		700-259	700-259K		Ø 200,0	
	91-95		R		151-125		Vag	Ø 19,05 200,0x40	VAG
1.3 Eng.781.135E (40kW)	12/92-6/95		R		153-378		Vag	200,0x32	Hand Brake
	12/92-6/95		R		153-468		Vag	200,0x40	Hand Brake
	92-95		R		700-259	700-259K		Ø 200,0	
	92-95		R		151-125		Vag	Ø 19,05 200,0x40	VAG
1.3 Eng.OHC (45kW)	8/91-6/95		R		153-378		Vag	200,0x32	Hand Brake
	8/91-6/95		R		153-468		Vag	200,0x40	Hand Brake
	91-92		R		700-257			Ø 200,0	
	93-9/94		R		700-259	700-259K		Ø 200,0	









		Spare Parts	F/R	L/R	CIFAM ref.	CIFAM ref. w/KIT		DIMENSIONS mm.	NOTE
1.3 Eng.OHC (45kW)	91-95		R		151-125		Vag	Ø 19,05 200,0x40	VAG
1.6, 16v (50-55kW)	92-95		R		700-259	700-259K		Ø 200,0	
1.9 SDi, TD (46-66kW)	92-95		R		700-259	700-259K		Ø 200,0	
Favorit Pick-Up (787) 12/92-6/97									
1.3 (46kW)	12/92-9/93		R		153-468		Vag	200,0x40	Hand Brake
1.3 Eng.135B (40kW)	12/92-6/97		R		153-468		Vag	200,0x40	Hand Brake
	92-97		R		700-259	700-259K		Ø 200,0	
	92-97		R		151-128		Vag	Ø 19,05 200,0x40	VAG
1.3 Eng.136B (50kW)	12/92-6/97		R		153-468		Vag	200,0x40	Hand Brake
	92-97		R		700-259	700-259K		Ø 200,0	
	92-97		R		151-128		Vag	Ø 19,05 200,0x40	VAG
1.3 Eng.781.135 (40-42-43kW)	12/92-6/97		R		153-468		Vag	200,0x40	Hand Brake
	92-97		R		700-259	700-259K		Ø 200,0	
	92-97		R		151-128		Vag	Ø 19,05 200,0x40	VAG
Felicia I (6U1, 6U5), SW 10/94-3/98									
1.3 Eng.135B/ AMG (40kW)	10/94-3/98		R		153-378		Vag	200,0x32	Hand Brake
	10/94-3/98		R		153-468		Vag	200,0x40	Hand Brake
	94-98		R		700-213	700-213K		Ø 200,0	
	94-98		R		151-126		Vag	Ø 22,22 200,0x40	VAG
1.3 Eng.135L/ AMJ (43kW)	10/94-3/98		R		153-378		Vag	200,0x32	Hand Brake
	10/94-3/98		R		153-468		Vag	200,0x40	Hand Brake
	94-98		R		700-213	700-213K		Ø 200,0	
	94-98		R		151-126		Vag	Ø 22,22 200,0x40	VAG
1.3 Eng.136B/ AMH (50kW)	10/94-3/98		R		153-378		Vag	200,0x32	Hand Brake
	10/94-3/98		R		153-468		Vag	200,0x40	Hand Brake
	94-98		R		700-213	700-213K		Ø 200,0	
	94-98		R		151-125		Vag	Ø 19,05 200,0x40	VAG
1.6 Eng.AEE (55kW)	8/95-3/98		R		153-378		Vag	200,0x32	Hand Brake
	8/95-3/98		R		153-468		Vag	200,0x40	Hand Brake
	95-98		R		700-213	700-213K		Ø 200,0	
	95-98		R		151-126		Vag	Ø 22,22 200,0x40	VAG
1.9 D Eng.AEF (47kW)	10/95-3/98		R		153-378		Vag	200,0x32	Hand Brake
	10/95-3/98		R		153-468		Vag	200,0x40	Hand Brake
	95-98		R		700-213	700-213K		Ø 200,0	
	95-98		R		151-127		Vag	Ø 20,64 200,0x40	VAG
	95-98		R		151-126		Vag	Ø 22,22 200,0x40	VAG
Felicia I (797) Pick-Up 1/95-2/98									
1.3 Eng.135M (40kW)	1/95-2/98		R		153-468		Vag	200,0x40	Hand Brake
	95-98		R		700-213	700-213K		Ø 200,0	
	95-98		R		151-126		Vag	Ø 22,22 200,0x40	VAG
1.3 Eng.136B/ 136M (50kW)	1/95-2/98		R		153-468		Vag	200,0x40	Hand Brake
	95-98		R		700-213	700-213K		Ø 200,0	
	95-98		R		151-126		Vag	Ø 22,22 200,0x40	VAG
1.3 Eng.AMJ (43kW)	10/95-4/98		R		153-468		Vag	200,0x40	Hand Brake
1.6 Eng.AEE (55kW)	1/95-2/98		R		153-468		Vag	200,0x40	Hand Brake
	95-98		R		700-213	700-213K		Ø 200,0	
	95-98		R		151-126		Vag	Ø 22,22 200,0x40	VAG
1.9 D Eng.AEF (47kW)	1/95-2/98		R		153-468		Vag	200,0x40	Hand Brake
	95-98		R		700-213	700-213K		Ø 200,0	
	95-98		R		151-126		Vag	Ø 22,22 200,0x40	VAG
Felicia II (6U1, 6U5), SW 3/98-6/01									
1.3 Eng.AMH (50kW)	98-01		R		700-213	700-213K		Ø 200,0	
	98-01		R		151-125		Vag	Ø 19,05 200,0x40	VAG, +ABS
	98-01		R		151-126		Vag	Ø 22,22 200,0x40	VAG
1.3 (Exc. SW) Eng.AMG (40kW)	98-01		R		700-213	700-213K		Ø 200,0	
	98-01		R		151-125		Vag	Ø 19,05 200,0x40	VAG, +ABS
1.3 (Exc. SW) Eng.AMJ (43kW)	98-01		R		700-213	700-213K		Ø 200,0	
	98-01		R		151-125		Vag	Ø 19,05 200,0x40	VAG, +ABS
1.6 Eng.AEE (55kW)	98-01		R		700-213	700-213K		Ø 200,0	
	98-01		R		151-125		Vag	Ø 19,05 200,0x40	VAG, +ABS
	98-01		R		151-126		Vag	Ø 22,22 200,0x40	VAG
1.9 D Eng.AEF (47kW)	98-01		R		700-213	700-213K		Ø 200,0	
	98-01		R		151-125		Vag	Ø 19,05 200,0x40	VAG, +ABS
	98-01		R		151-127		Vag	Ø 20,64 200,0x40	VAG
Octavia II (1U2, 1U5), SW 9/96-6/04									
1.4 Eng.AXP/ BCA (55kW)	00-04		R		700-260			Ø 230,0	
	00-04		R		151-148		Vag	Ø 19,05 230,0x32	VAG, A/T
	00-04		R		151-147		Vag	Ø 20,64 230,0x32	VAG, M/T

		Spare Parts	F/R	L/R	CIFAM ref.	CIFAM ref. w/KIT		DIMENSIONS mm.	NOTE
1.4 (Exc. SW) Eng.AMD (44kW)	99-04		R		700-260			Ø 230,0	
	99-04		R		151-148		Vag	Ø 19,05 230,0x32	VAG, A/T
	99-04		R		151-147		Vag	Ø 20,64 230,0x32	VAG, M/T
1.6 Eng.AEE (55kW)	9/96-6/04		R		153-379		Vag	230,0x32	Hand Brake
	96-04		R		700-260			Ø 230,0	LHD
	96-04		R		151-148		Vag	Ø 19,05 230,0x32	VAG, A/T
	96-04		R		151-147		Vag	Ø 20,64 230,0x32	VAG, M/T
	96-04		R		151-178		Vag	Ø 19,05 230,0x40	VAG, A/T
	96-04		R		151-147		Vag	Ø 20,64 230,0x32	VAG, M/T
1.6 Eng.AEH/ AKL/ APF (74kW)	2/97-6/04		R		153-379		Vag	230,0x32	Hand Brake
	97-04		R		700-260			Ø 230,0	
	97-04		R		151-148		Vag	Ø 19,05 230,0x32	VAG, A/T
	97-04		R		151-147		Vag	Ø 20,64 230,0x32	VAG, M/T
1.6 Eng.AVU/ BFQ (75kW)	11/00-6/04		R		153-379		Vag	230,0x32	Hand Brake
	00-04		R		700-260			Ø 230,0	
	00-04		R		151-148		Vag	Ø 19,05 230,0x32	VAG, A/T
	00-04		R		151-147		Vag	Ø 20,64 230,0x32	VAG, M/T
1.9 SDi Eng.AGP/ AQM (50kW)	6/97-6/04		R		153-379		Vag	230,0x32	Hand Brake
	97-04		R		700-260			Ø 230,0	
	97-04		R		151-148		Vag	Ø 19,05 230,0x32	VAG, A/T
	97-04		R		151-147		Vag	Ø 20,64 230,0x32	VAG, M/T
1.9 SDi (Exc. SW) Eng.AEY (47kW)	9/96-6/04		R		153-379		Vag	230,0x32	Hand Brake
	96-04		R		700-260			Ø 230,0	LHD
	96-04		R		151-148		Vag	Ø 19,05 230,0x32	VAG, A/T
	96-04		R		151-147		Vag	Ø 20,64 230,0x32	VAG, M/T
	96-04		R		151-178		Vag	Ø 19,05 230,0x40	VAG, A/T
1.9 TDi Eng.AHF/ ASV (81kW)	8/97-6/04		R		153-379		Vag	230,0x32	Hand Brake
1.9 TDi Eng.ASZ (96kW)	1/03-6/04		R		153-379		Vag	230,0x32	Hand Brake
1.9 TDi 4WD SW Eng.ATD/ AXR (74kW)	9/00-6/04		R		153-379		Vag	230,0x32	Hand Brake
1.9 TDi, 4WD Eng.AGR/ ALH (66kW)	9/96-6/04		R		153-379		Vag	230,0x32	Hand Brake
	96-04		R		700-260			Ø 230,0	
	96-04		R		151-148		Vag	Ø 19,05 230,0x32	VAG, A/T
	96-04		R		151-147		Vag	Ø 20,64 230,0x32	VAG, M/T
	96-04		R		151-178		Vag	Ø 19,05 230,0x40	VAG, A/T
Octavia III (1Z3, 1Z5), SW 6/04-									
1.4 Eng.AXP/ BCA (55kW)	6/04-		R		153-379		Vag	230,0x32	Hand Brake
1.4 Eng.BUD (59kW)	2/07-		R		153-379		Vag	230,0x32	Hand Brake
1.6 Eng.BGU/ BSE/ BSF (75kW)	6/04-		R		153-379		Vag	230,0x32	Hand Brake
1.6 FSI Eng.BLF (85kW)	6/04-		R		153-379		Vag	230,0x32	Hand Brake
1.9 TDi Eng.BKC/ BJB/ BLS/ BXE (77kW)	6/04-		R		153-379		Vag	230,0x32	Hand Brake
1.9 TDi 4WD SW Eng.BKC/ BJB (77kW)	11/04-		R		153-379		Vag	230,0x32	Hand Brake
2.0 TDi Eng.AZV (100kW)	6/04-		R		153-379		Vag	230,0x32	Hand Brake
2.0 TDi 16v RS Eng.BMN/ CEGA (125kW)	06-		R		153-379		Vag	230,0x32	Hand Brake
2.0 TDi, 4WD Eng.BKD/ BMM/ CFHC (103kW)	6/04-		R		153-379		Vag	230,0x32	Hand Brake
Rapid (120G, 130G, 135G) 2/83-10/91									
1.2 (43kW)	2/83-12/90		R		153-378		Vag	200,0x32	Hand Brake
	83-90		R		700-259	700-259K		Ø 200,0	
1.3 (39kW)	8/87-10/91		R		153-378		Vag	200,0x32	Hand Brake
1.3 Eng.135-8 (43kW)	9/84-12/90		R		153-378		Vag	200,0x32	Hand Brake
	84-90		R		700-259	700-259K		Ø 200,0	
1.3 Eng.742/ 13 (45kW)	3/85-8/88		R		153-378		Vag	200,0x32	Hand Brake
	85-88		R		700-259	700-259K		Ø 200,0	
Roomster (5J7) 9/06-									
1.2 12v Eng.BZG/ CGPA (51kW)	9/06-		R		153-379		Vag	230,0x32	Hand Brake
	06-		R		151-178		Vag	Ø 19,05 230,0x40	VAG
1.2 TSi Eng.CBZA (63kW)	10-		R		700-260			Ø 230,0	
1.4 16v Eng.BXW (63kW)	9/06-		R		153-379		Vag	230,0x32	Hand Brake
	06-		R		151-178		Vag	Ø 19,05 230,0x40	VAG
1.4 TDi Eng.BMS (59kW)	9/06-		R		153-379		Vag	230,0x32	Hand Brake
	06-		R		151-178		Vag	Ø 19,05 230,0x40	VAG
1.4 TDi Eng.BNM (51kW)	9/06-		R		153-379		Vag	230,0x32	Hand Brake
	06-		R		151-178		Vag	Ø 19,05 230,0x40	VAG
1.6 16v Eng.BTS (77kW)	9/06-		R		153-379		Vag	230,0x32	Hand Brake

		Spare Parts	F/R	L/R	CIFAM ref.	CIFAM ref. w/KIT		DIMENSIONS mm.	NOTE
1.6 TDi Eng.CAYB (66kW)	10-		R		700-260			Ø 230,0	
1.9 TDi Eng.BLS (77kW)	9/06-		R		153-379		Vag	230,0x32	Hand Brake



















SKODA LCV

Fabia Praktik 4/02-



























1.2 Eng.AWY/ BMD (40kW)	02-		R		700-358			Ø 200,0	
	02-		R		151-085		Ate	Ø 19,05 200,0x40	VAG
1.2 Eng.AZQ/ BME (47kW)	03-		R		700-358			Ø 200,0	
	03-		R		151-085		Ate	Ø 19,05 200,0x40	VAG
1.4 Eng.AME/ AQW/ ATZ (50kW)	00-		R		700-358			Ø 200,0	
	00-		R		151-085		Ate	Ø 19,05 200,0x40	VAG
1.4 TDi Eng.BNM (51kW)	05-		R		700-358			Ø 200,0	
1.9 SDi Eng.ASY (47kW)	99-		R		700-358			Ø 200,0	
	99-		R		151-085		Ate	Ø 19,05 200,0x40	VAG

SMART

Cabrio (450) 3/00-1/04



























0.6 Eng.M160E6ALB03 (40kW)	3/00-1/04		R		153-237		Bosch	200,0x32	Hand Brake
	00-04		R		700-361			Ø 203,0	
	00-04		R		151-162		Bosch	Ø 22,00 200,0x32	RAI
0.6 Eng.M160E6ALB05 (45kW)	1/01-1/04		R		153-237		Bosch	200,0x32	Hand Brake
	01-04		R		700-361			Ø 203,0	
	01-04		R		151-162		Bosch	Ø 22,00 200,0x32	RAI
0.6 Eng.Suprex (52kW)	6/02-1/04		R		153-237		Bosch	200,0x32	Hand Brake
	02-04		R		700-361			Ø 203,0	
	02-04		R		151-162		Bosch	Ø 22,00 200,0x32	RAI
0.7 Eng.M160.910/ 920 (55kW)	1/03-1/04		R		153-237		Bosch	200,0x32	Hand Brake
	03-04		R		700-361			Ø 203,0	
	03-04		R		151-162		Bosch	Ø 22,00 200,0x32	RAI
0.7 Eng.M160R3 (45kW)	1/03-1/04		R		153-237		Bosch	200,0x32	Hand Brake
	03-04		R		700-361			Ø 203,0	
	03-04		R		151-162		Bosch	Ø 22,00 200,0x32	RAI
0.8 CDi Eng.OM660DE8LA (30kW)	3/01-1/04		R		153-237		Bosch	200,0x32	Hand Brake
	01-04		R		700-361			Ø 203,0	
	01-04		R		151-162		Bosch	Ø 22,00 200,0x32	RAI

City-Coupe (450) 7/98-1/04

0.6 Eng.M160E6ALB03 (40kW)	7/98-1/04		R		153-237		Bosch	200,0x32	Hand Brake
	98-04		R		700-361			Ø 203,0	
	11/99-04		R		151-162		Bosch	Ø 22,00 200,0x32	RAI
	98-10/99		R		151-163		Bosch	Ø 17,46 200,0x32	RAI
0.6 Eng.M160E6ALB04 (33kW)	7/98-1/04		R		153-237		Bosch	200,0x32	Hand Brake
	98-04		R		700-361			Ø 203,0	
	11/99-04		R		151-162		Bosch	Ø 22,00 200,0x32	RAI
	98-10/99		R		151-163		Bosch	Ø 17,46 200,0x32	RAI
0.6 Eng.M160E6ALB05 (45kW)	1/01-1/04		R		153-237		Bosch	200,0x32	Hand Brake
	01-04		R		700-361			Ø 203,0	
	01-04		R		151-162		Bosch	Ø 22,00 200,0x32	RAI
0.6 Eng.Suprex (52kW)	6/02-1/04		R		153-237		Bosch	200,0x32	Hand Brake
	02-04		R		700-361			Ø 203,0	
	02-04		R		151-162		Bosch	Ø 22,00 200,0x32	RAI
0.7 Eng.M170 (37kW)	1/03-1/04		R		153-237		Bosch	200,0x32	Hand Brake
	03-04		R		700-361			Ø 203,0	
	03-04		R		151-162		Bosch	Ø 22,00 200,0x32	RAI
0.7 Eng.M170 (45kW)	1/03-1/04		R		153-237		Bosch	200,0x32	Hand Brake
	03-04		R		700-361			Ø 203,0	
	03-04		R		151-162		Bosch	Ø 22,00 200,0x32	RAI
0.7 Eng.M170 (55kW)	1/03-1/04		R		153-237		Bosch	200,0x32	Hand Brake
	03-04		R		700-361			Ø 203,0	
	03-04		R		151-162		Bosch	Ø 22,00 200,0x32	RAI
0.8 CDi Eng.OM660DE8LA (30kW)	11/99-1/04		R		153-237		Bosch	200,0x32	Hand Brake
	99-04		R		700-361			Ø 203,0	
	99-04		R		151-162		Bosch	Ø 22,00 200,0x32	RAI





Crossblade 6/02-

0.6 Eng.Suprex (52kW)	6/02-		R		153-237		Bosch	200,0x32	Hand Brake
	02-		R		700-361			Ø 203,0	
	02-		R		151-162		Bosch	Ø 22,00 200,0x32	RAI

		Spare Parts	F/R	L/R	CIFAM ref.	CIFAM ref. w/KIT		DIMENSIONS mm.	NOTE
Fortwo I (450) 1/04-2/07									
0.7 Eng.M160.910/ 920 (37kW)	1/04-2/07		R		153-237		Bosch	200,0x32	Hand Brake
	1/04-04		R		700-361			Ø 203,0	
			R		151-162		Bosch	Ø 22,00 200,0x32	RAI
0.7 Eng.M160.910/ 920 (55kW)	1/04-2/07		R		153-237		Bosch	200,0x32	Hand Brake
	1/04-04		R		700-361			Ø 203,0	
			R		151-162		Bosch	Ø 22,00 200,0x32	RAI
0.7 Eng.M170 (37-45-55kW)	1/04-2/07		R		153-237		Bosch	200,0x32	Hand Brake
	1/04-04		R		700-361			Ø 203,0	
			R		151-162		Bosch	Ø 22,00 200,0x32	RAI
0.8 CDi Eng.OM660DE8LA (30kW)	1/04-2/07		R		153-237		Bosch	200,0x32	Hand Brake
	1/04-04		R		700-361			Ø 203,0	
			R		151-162		Bosch	Ø 22,00 200,0x32	RAI
Fortwo II, Cabrio, Coupe (451) 3/07-									
0.8 CDi Eng.OM660.940 (30kW)	3/07-		R		153-237		Bosch	200,0x32	Hand Brake
0.8 CDi Eng.OM660.950 (33kW)	3/07-		R		153-237		Bosch	200,0x32	Hand Brake
1.0 Eng.M132.910 (45kW)	3/07-		R		153-237		Bosch	200,0x32	Hand Brake
1.0 Eng.M132.910 (52kW)	3/07-		R		153-237		Bosch	200,0x32	Hand Brake
1.0 T. Eng.M132.930 (62kW)	3/07-		R		153-237		Bosch	200,0x32	Hand Brake
1.0, Brabus Eng.3B21 (72kW)	9/07-		R		153-237		Bosch	200,0x32	Hand Brake
Roadster, Coupe (452) 4/03-									
0.7 Eng.M160.921 (45kW)	4/03-		R		153-237		Bosch	200,0x32	Hand Brake
0.7 Eng.M160.922 (60kW)	4/03-		R		153-237		Bosch	200,0x32	Hand Brake
	4/03-		R		700-361			Ø 203,0	
0.7 Brabus Eng.M160.923 (74kW)	12/03-03-		R		153-237		Bosch	200,0x32	Hand Brake
			R		700-361			Ø 203,0	

SSANGYONG









Actyon 1/07-

2.0 Xd, 4WD Eng.D20DTR (114kW)	11-		R		153-491	153-491K		190x25	
2.0 Xdi, 4WD Eng.D20DT (100kW)	07-		R		153-491	153-491K		190x25	
2.0 XDi, Sport Eng.OM664.951 (104kW)	07-1/07-		R		153-491	153-491K		190x25	
			R		153-100		Lucas	254,0x57	Hand Brake
2.3 4WD Eng.M161.951 (110kW)	07-		R		153-491	153-491K		190x25	



Korando I (K4) 12/88-12/96

2.2 D Eng.DC23 (50kW)	12/88-12/96		R		153-100		Lucas	254,0x57	Hand Brake
2.5 D Eng.XD3P (58kW)	6/93-12/96		R		153-100		Lucas	254,0x57	Hand Brake







Korando II (KJ) 12/96-





















2.0 Eng.M161.943 (94kW)	5/97-		R		153-100		Lucas	254,0x57	Hand Brake
2.3 D Eng.OM601.940 (58kW)	12/96-		R		153-100		Lucas	254,0x57	Hand Brake
2.3, Cabrio Eng.M161.970 (103kW)	5/97-		R		153-100		Lucas	254,0x57	Hand Brake
2.3, Cabrio Eng.M161.973 (105kW)	1/99-		R		153-100		Lucas	254,0x57	Hand Brake
2.9 D, Cabrio Eng.OM602.940/ .942 (73kW)	96-		R		153-491	153-491K		190x25	
2.9 TD, Cabrio Eng.OM662.920 (88kW)	4/98-		R		153-100		Lucas	254,0x57	Hand Brake
3.2 Eng.M104.995 (156kW)	1/99-		R		153-100		Lucas	254,0x57	Hand Brake
3.2, Cabrio Eng.M104.995 (154kW)	12/96-		R		153-100		Lucas	254,0x57	Hand Brake
3.2, Cabrio Eng.M162.993 (162kW)	6/97-		R		153-100		Lucas	254,0x57	Hand Brake

Kyron 5/05-









































2.0 XDi, 4WD Eng.OM664.950 (104kW)	5/05-		R		153-100		Lucas	254,0x57	Hand Brake
2.7 XDi, AWD Eng.OM665.950 (121kW)	5/05-		R		153-491	153-491K		190x25	





Musso (FJ) 10/95-





































2.0 Eng.E20 (93kW)	10/96-		R		153-100		Lucas	254,0x57	Hand Brake
2.3 Eng.M111.970 (103kW)	10/96-		R		153-491	153-491K		190x25	
	10/96-		R		153-100		Lucas	254,0x57	Hand Brake
2.3 Eng.M161.970 (110kW)	4/03-		R		153-100		Lucas	254,0x57	Hand Brake
2.3 D Eng.OM601.940 (59kW)	10/95-		R		153-100		Lucas	254,0x57	Hand Brake
	10/96-		R		153-491	153-491K		190x25	
2.3 TDiC (74kW)	5/97-10/03		R		153-100		Lucas	254,0x57	Hand Brake

		Spare Parts	F/R	L/R	CIFAM ref.	CIFAM ref. w/KIT		DIMENSIONS mm.	NOTE
2.9 D Eng.OM602.940/ .942 (73kW)	3/96-		R		153-100		Lucas	254,0x57	Hand Brake
2.9 TD (108kW)	4/98-		R		153-491	153-491K		190x25	
2.9 TD Eng.OM662.920 (88kW)	4/98-		R		153-491	153-491K		190x25	
	4/98-		R		153-100		Lucas	254,0x57	Hand Brake
3.2 Eng.M104.992 (162kW)	10/96-		R		153-491	153-491K		190x25	
Rexton 4/02-									
2.3 4WD Eng.M111 (110kW)	02-5/02-		R		153-100		Lucas	254,0x57	
			R		153-491	153-491K		190x25	
2.7 XDi Eng.OM665.926 (120kW)	04-8/04		R		153-100		Lucas	254,0x57	
			R		153-491	153-491K		190x25	
2.7 XDi 4WD Eng.D27DT (118kW)	11-11-		R		153-491	153-491K		190x25	
			R		153-100		Lucas	254,0x57	
2.7 Xdi Turbo 4WD Eng.D27DTP (132kW)	11-11-		R		153-491	153-491K		190x25	
			R		153-100		Lucas	254,0x57	
2.9 TD Eng.OM662.920 (88kW)	02-4/02-		R		153-100		Lucas	254,0x57	
			R		153-491	153-491K		190x25	
3.2 Eng.M162.995 (162kW)	02-4/02-		R		153-100		Lucas	254,0x57	
			R		153-491	153-491K		190x25	



















SUBARU











Forester I (SF) 8/97-9/02									
2.0 Eng.EJ20 (90-92kW)	9/98-9/02		R		153-386	153-386K		170,0x32	
	9/98-9/02		R		153-383			228,6x37	Hand Brake
	98-02		R		700-396			Ø 228,6	SW
2.0 16v Eng.EJ205 (130kW)	1/98-9/02		R		153-386	153-386K		170,0x32	
	1/98-9/02		R		153-383			228,6x37	Hand Brake
2.0 16v Eng.EJ20J (85kW)	8/97-9/02		R		153-386	153-386K		170,0x32	
	8/97-9/02		R		153-383			228,6x37	Hand Brake
	97-02		R		700-262			Ø 228,5	-ABS
2.0 T. 16v Eng.EJ20G (155kW)	8/97-12/00		R		153-386	153-386K		170,0x32	
	8/97-12/00		R		153-383			228,6x37	Hand Brake
Forester II (SG) 9/02-5/08									
2.0 Eng.EJ20 (116kW)	9/05-5/08		R		153-386	153-386K		170,0x32	
	9/05-5/08		R		153-383			228,6x37	Hand Brake
	05-08		R		700-396			Ø 228,6	SW
2.0 16v Eng.EJ20J (92kW)	9/02-5/08		R		153-386	153-386K		170,0x32	
	9/02-5/08		R		153-383			228,6x37	Hand Brake
	02-08		R		700-396			Ø 228,6	SW
2.0 T. Eng.EJ20T (130kW)	9/02-5/08		R		153-386	153-386K		170,0x32	
	9/02-5/08		R		153-383			228,6x37	Hand Brake
2.5 Eng.EJ25 (155kW)	12/03-5/08		R		153-386	153-386K		170,0x32	
	12/03-5/08		R		153-383			228,6x37	Hand Brake
2.5 Eng.EJ25 (169kW)	9/05-5/08		R		153-386	153-386K		170,0x32	
	9/05-5/08		R		153-383			228,6x37	Hand Brake
Impreza I (GC, GF), SW 8/92-12/00									
1.6 i, 4WD Eng.EJ16 (66kW)	8/92-12/00		R		153-383			228,6x37	Hand Brake
	92-00		R		700-262			Ø 228,5	
1.6 i, 4WD Eng.EJ16 (70kW)	6/98-12/00		R		153-383			228,6x37	Hand Brake
	98-00		R		700-262			Ø 228,5	Exc. SW
	98-00		R		700-396			Ø 228,6	Only SW
1.8, 4WD Eng.EJ18E (76kW)	8/92-12/00		R		153-383			228,6x37	Hand Brake
	92-00		R		700-262			Ø 228,5	
2.0 16v 4WD Eng.EJ20E/ EJ20J/EJ201 (85-92kW)	95-00		R		700-262			Ø 228,5	Exc. SW
	95-00		R		700-396			Ø 228,6	Only SW
2.0 T. 16v Eng.EJ20G (155kW)	3/94-12/00		R		153-383			228,6x37	Hand Brake
2.0 T. GT 4WD Eng.EJ20 (160kW)	6/98-12/00		R		153-383			228,6x37	Hand Brake
2.0 T. GT 4WD Eng.EJ205 (130kW)	3/94-12/00		R		153-383			228,6x37	Hand Brake
Impreza II (GD, GG), SW 12/00-12/07									
1.5 R Eng.EJ150 (77kW)	06-07		R		700-396			Ø 228,6	
1.6 i, 4WD Eng.EJ16 (66-70kW)	00-05		R		700-396			Ø 228,6	
2.0 WRX STi (Exc. SW) (235kW)	2/04-12/07		R		153-388			192,0x32	
2.0 WRX STi (Exc. SW) Eng.EJ207 (195kW)	11/01-12/07		R		153-388			192,0x32	
2.5 AWD (130kW)	12/00-6/04		R		153-386	153-386K		170,0x32	
2.5 WRX Eng.EJ25 (169kW)	9/05-12/07		R		153-386	153-386K		170,0x32	





































		Spare Parts	F/R	L/R	CIFAM ref.	CIFAM ref. w/KIT		DIMENSIONS mm.	NOTE
2.5 WRX STi (Exc. SW) Eng.EJ25 (206kW)	9/05-12/07		R		153-388			192,0x32	
Impreza III (GH, GR) 1/08-									
1.5 R (79kW)	09-		R		153-268	153-268K		190,0x32	
1.5 R Eng.EL154 (79kW)	08-		R		153-268	153-268K		190,0x32	
2.0 D (110kW)	09-		R		153-268	153-268K		190,0x32	
2.0 R (110kW)	09-		R		153-268	153-268K		190,0x32	
2.0 R Eng.EJ204 (110kW)	08-		R		153-268	153-268K		190,0x32	
2.5 (169kW)	08-		R		153-268	153-268K		190,0x32	
2.5 STi CS400 Eng.EJ257 (294kW)	10-		R		153-516			254x42	
2.5 WRX Eng.EJ257 (221kW)	08-		R		153-516			254x42	
Justy I (KAD)/ Trendy 11/84-12/94									
0.7	11/84-12/94		R		153-380		Sumit.	180,0x30	Hand Brake
1.0, 4WD Eng.EF10 (37kW)	5/87-11/94		R		153-380		Sumit.	180,0x30	Hand Brake
	87-94		R		700-261			Ø 180,0	
1.0, 4WD Eng.EF10 (40kW)	11/84-12/90		R		153-380		Sumit.	180,0x30	Hand Brake
	84-90		R		700-261			Ø 180,0	
1.2 4WD Eng.EF12 (55kW)	10/90-12/94		R		153-380		Sumit.	180,0x30	Hand Brake
	90-94		R		700-261			Ø 180,0	
1.2, 4WD Eng.EF12 (49-50kW)	10/86-5/91		R		153-380		Sumit.	180,0x30	Hand Brake
	86-91		R		700-261			Ø 180,0	
Justy II (JMA, MS) 10/95-8/03									
1.3 4WD Eng.EF13 (50kW)	10/95-8/03		R		153-406			203,2x32	
	10/95-8/03		R		153-037		Sumit.	200,0x30	
1.3 4WD Eng.G13BB (63kW)	4/01-8/03		R		153-406			203,2x32	
	4/01-8/03		R		153-037		Sumit.	200,0x30	
Justy III (G3X) 9/03-10/08									
1.3 Eng.M13A (69kW)	9/03-10/08		R		153-318			200,0x29	
	9/03-10/08		R		153-037		Sumit.	200,0x30	
1.5 Eng.M15A (73kW)	9/03-10/08		R		153-318			200,0x29	
	9/03-10/08		R		153-037		Sumit.	200,0x30	
Justy IV (JDA) 11/08-									
1.0 Eng.1KRFE (51kW)	11/08-		R		153-043			180,0x28	
Legacy I (BC, BJJ), SW 1/89-7/94									
1.6 GL Eng.EJ16 (70kW)	1/89-10/93		R		153-383			228,6x37	Hand Brake
1.8 Eng.EJ18SPI (76kW)	1/89-9/91		R		153-383			228,6x37	Hand Brake
	89-91		R		700-262			Ø 228,5	
1.8 4WD Eng.EJ18SPI (76kW)	1/89-9/91		R		153-383			228,6x37	Hand Brake
	89-91		R		700-262			Ø 228,5	
2.0 Eng.EJ20EMPI (85kW)	8/91-7/94		R		153-383			228,6x37	Hand Brake
	91-94		R		700-262			Ø 228,5	
2.0 4WD Eng.EJ20EMPI (85-92kW)	8/91-7/94		R		153-383			228,6x37	Hand Brake
	91-94		R		700-262			Ø 228,5	
2.2 i 4WD Eng.EJ22EMPI (94-96-100kW)	1/89-7/94		R		153-383			228,6x37	Hand Brake
Legacy II (BD, BG), SW 9/94-3/99									
2.0 16v 4WD Eng.EJ20E/ J (85-92kW)	9/94-3/99		R		153-387			174,0x35	
	9/94-3/99		R		153-383			228,6x37	Hand Brake
	9/94-3/99		R			153-387K		170x36	
	94-99		R		700-262			Ø 228,5	
2.2 i 4WD Eng.EJ22EMPI (94kW)	9/94-3/99		R		153-387			174,0x35	
	94-99		R		700-262			Ø 228,5	
2.2 i 4WD Eng.EJ22EMPI (96kW)	6/96-3/99		R		153-387			174,0x35	
	96-99		R		700-262			Ø 228,5	
2.5 4WD Eng.EJ25D (110kW)	6/96-3/99		R		153-387	153-387K		174,0x35	
Legacy III (BE, BH), SW 10/98-9/03									
2.0 16v Eng.EJ20J (85-92kW)	4/99-9/03		R		153-387			174,0x35	
	4/99-9/03		R		153-383			228,6x37	Hand Brake
	4/99-9/03		R		153-384			228,6x38	
	4/99-9/03		R			153-387K		170x36	
2.5 Eng.EJ25 (110-115kW)	10/98-9/03		R		153-387			174,0x35	
	10/98-9/03		R		153-384			228,6x38	
	10/98-9/03		R			153-387K		170x36	
Legacy IV (BL, BP), SW 9/03-12/07									
2.0 Eng.EJ20 (101kW)	9/03-		R		153-387			174,0x35	
	9/03-		R		153-383			228,6x37	Hand Brake
	9/03-		R			153-387K		170x36	

















































			Spare Parts	F/R	L/R	CIFAM ref.	CIFAM ref. w/KIT		DIMENSIONS mm.	NOTE
2.0 Eng.EJ20 (110kW)	9/03-			R		153-387			174,0x35	
				R		153-383			228,6x37	Hand Brake
				R			153-387K		170x36	
2.5 Eng.EJ251 (121kW)	9/03-			R		153-387			174,0x35	
				R		153-383			228,6x37	Hand Brake
				R			153-387K		170x36	
3.0 Eng.EZ305 (180kW)	9/03-			R		153-387			174,0x35	
				R		153-383			228,6x37	Hand Brake
				R			153-387K		170x36	
Libero (E10, E12)/ Domingo 1/83-2/00										
1.2 4WD Eng.EF12 (38kW)	8/86-2/00			R		153-380		Sumit.	180,0x30	Hand Brake
				R		153-385		Sumit.	180,0x31	+ABS
1.2 4WD Eng.EF12 (40kW)	8/91-2/00			R		153-380		Sumit.	180,0x30	Hand Brake
				R		153-385		Sumit.	180,0x31	+ABS
Mini Jumbo 1/82-										
0.7	1/82-			R		153-382		Sumit.	180,0x25	Hand Brake
Outback I (BE, BH) 10/00-10/03										
2.5 Eng.EJ25 (115kW)	10/00-10/03			R		153-387			174,0x35	
3.0 Eng.EZ30D (154kW)	10/00-10/03			R		153-387	153-387K		174,0x35	
Outback II (BP) 11/03-										
2.5 Eng.EJ25 (121kW)	11/03-			R		153-387	153-387K		174,0x35	
2.5 i Eng.EJ253 (123kW)	11/09-			R		153-387	153-387K		174,0x35	
2.5i 16V Eng.EJ251 (127kW)	11/08-			R		153-387	153-387K		174,0x35	
3.0 Eng.EZ305 (180kW)	11/03-			R		153-387			174,0x35	
Rex II 8/81-6/89										
550, 4WD Eng.EK23 (23kW)	8/81-6/87			R		153-380		Sumit.	180,0x30	Hand Brake
550, 4WD Eng.EK236V (26kW)	6/87-6/89			R		153-382		Sumit.	180,0x25	Hand Brake
Trezia 4/11-										
1.3i Eng.1NRFE (73kW)	11-			R		153-517			228,6x37	
1.4 D Eng.1ND-TV (66kW)	11-			R		153-517			228,6x37	
Tribeca (B9) 1/05-										
3.0 Eng.EZ30 (184kW)	1/05-			R		153-389			206,0x40	
3.0 Eng.EZ305E (180kW)	06-			R		153-389			206,0x40	
Vivio 3/92-10/95										
660 4WD Eng.EN07E (32kW)	3/92-10/95			R		153-382		Sumit.	180,0x25	Hand Brake
ALTO I (SS80) 6/82-12/85										
0.8 Eng.F8B (29kW)	6/82-12/85			R		153-380		Sumit.	180,0x30	Hand Brake
ALTO II (EC) 1/86-11/93										
0.8 (SB308/CA) Eng.F8B (29kW)	1/86-11/93			R		153-380		Sumit.	180,0x30	Hand Brake
	1/86-11/93			R		153-396		Sumit.	180,0x30	Hand Brake
ALTO III (EF) 9/94-6/02										
1.0 Eng.G10B (39kW)	9/94-6/02			R		153-396		Sumit.	180,0x30	Hand Brake
ALTO IV (FF) 6/02-12/08										
1.1 Eng.F10D (46kW)	6/02-			R		153-396		Sumit.	180,0x30	Hand Brake
ALTO V (GF) 1/09-										
1.0 Eng.K10B (50kW)	1/09-			R		153-518			180x26	
Baleno (EG), SW 7/95-										
1.3 Eng.G13B (63kW)	7/95-			R		153-037		Sumit.	200,0x30	
	95-			R		700-385			Ø 200,0	
1.3 Eng.G13BA (52kW)	9/96-			R		153-401			220,0x42	
	96-			R		700-385			Ø 200,0	
1.6i 16v Eng.G16B (72kW)	7/95-			R		153-037		Sumit.	200,0x30	
	95-			R		700-385			Ø 200,0	
1.6i 16v 4WD Eng.G16B (72kW)	7/95-			R		153-037		Sumit.	200,0x30	
	95-			R		700-385			Ø 200,0	
1.8 GT Eng.J18A (89kW)	3/96-			R		153-401			220,0x42	
	3/96-			R		153-037		Sumit.	200,0x30	
1.9 TD Eng.XUD9TE (55kW)	4/98-			R		153-401			220,0x42	
	4/98-			R		153-037		Sumit.	200,0x30	
	98-			R		700-385			Ø 200,0	
Cappuccino 2/92-8/95										
0.6 Eng.F6A (47kW)	2/92-8/95			R		153-401			220,0x42	
Cervo - Fronte 1/79-										
800 Eng.F8B (29kW)	1/79-			R		153-392		Sumit.	220,0x40	Ch 180000-
800 71LAC Eng.F8B (29kW)	1/79-			R		153-392		Sumit.	220,0x40	Ch 180000-





















































		Spare Parts	F/R	L/R	CIFAM ref.	CIFAM ref. w/KIT		DIMENSIONS mm.	NOTE
Cultus - Forsa II 7/88-									
1.3, 4WD, GTi Eng.G13A/ B (50-52-74kW)	7/88-		R		153-398		Sumit.	180,0x25	
Escudo 1/91-									
1.6i 16v, 4WD Eng.G16B (71kW)	91-		R		700-339			Ø 220,0	
Forenza, SW 1/04-12/06									
2.0 16v (94-95kW)	04-06		R			153-052K		170x26	
	04-06		R		153-052			170,0x26	
Grand Vitara I (FT, GT) 3/98-9/05									
1.6i 16v, 4WD Eng.G16B (69-73kW)	3/98-9/05		R		153-401			220,0x42	
	3/98-9/05		R		153-475		Lucas	228,6x42	Hand Brake
		98-05		R		700-395			Ø 220,0
2.0 Eng.J20A (94kW)	3/98-9/05		R		153-401			220,0x42	
	98-05		R		700-395			Ø 220,0	
2.0 HDi Eng.RHW/ RHZ(DW10ATED4) (80kW)	01-05		R		700-400			Ø 220,0	
2.0 TD Eng.RF (64kW)	98-05		R		700-395			Ø 220,0	
2.5 V6 24v Eng.H25A (106kW)	4/98-9/05		R		153-401			220,0x42	
	98-05		R		700-400			Ø 220,0	
2.5 V6 24v Eng.H25A (116kW)	8/04-9/05		R		153-401			220,0x42	
2.7 Eng.H27B (135kW)	4/03-9/05		R		153-405		Ake	254,0x57	
	03-		R		700-386			Ø 254,0	
2.7 V6 Eng.H27A (127kW)	9/01-9/05		R		153-405		Ake	254,0x57	
	01-		R		700-386			Ø 254,0	
Grand Vitara II (JT) 10/05-									
1.6 Eng.M16A (78kW)	10/05-		R		153-407			254,0x42	
1.9 DDiS Eng.F9Q (95kW)	10/05-		R		153-407			254,0x42	
2.0 Eng.J20A (103kW)	10/05-		R		153-407			254,0x42	
2.4 Eng.J24B (122kW)	3/09-		R		153-519			200x37	
2.4 Eng.J24B (124kW)	3/09-		R		153-519			200x37	
3.2 V6 Eng.N32A (171kW)	3/09-		R		153-519			200x37	
Ignis I (FH) 10/00-9/03									
1.3, 4WD Eng.M13A (60-61-66kW)	10/00-9/03		R		153-404		Sumit.	180,0x26	
Ignis II (MH) 9/03-									
1.3 16v Eng.M13A (69kW)	9/03-		R		153-318			200,0x29	
	9/03-		R		153-404		Sumit.	180,0x26	
1.3 DDiS 16v Eng.Z13DT (51kW)	9/03-		R		153-318			200,0x29	
	9/03-		R		153-404		Sumit.	180,0x26	
1.5 Sport Eng.M15A (80kW)	12/03-		R		153-318			200,0x29	
	12/03-		R		153-404		Sumit.	180,0x26	
1.5, 4WD Eng.M15A (73kW)	03-		R		153-318			200,0x29	
	03-		R		153-404		Sumit.	180,0x26	
Jimny (FJ) 9/98-									
1.3 16v, 4WD Eng.G13BB (59kW)	9/98-		R		153-154		Ake	220,0x35	
	98-04		R		700-395			Ø 220,0	
1.3 16v, 4WD Eng.M13A (60-66kW)	2/01-		R		153-154		Ake	220,0x35	
	01-04		R		700-395			Ø 220,0	
1.5 DDiS Eng.K9K760 (63kW)	8/05-		R		153-154		Ake	220,0x35	
1.5 DDiS 4WD Eng.K9K (48kW)	12/03-		R		153-154		Ake	220,0x35	
Liana (ER), SW 7/01-									
1.3 Eng.M13A (60-66kW)	7/01-		R		153-037		Sumit.	200,0x30	
	02-		R		700-385			Ø 200,0	
1.4 DDiS Eng.RB414D (66kW)	3/05-		R		153-037		Sumit.	200,0x30	
	05-		R		700-385			Ø 200,0	
1.6, 4WD Eng.M16A (76-78kW)	4/02-		R		153-037		Sumit.	200,0x30	
	02-		R		700-385			Ø 200,0	
LJ 80 1/80-1/84									
0.8 Eng.F8A (29kW)	1/80-1/84		R		153-392		Sumit.	220,0x40	
Samurai (SJ) 11/88-									
1.0 (SJ410) Eng.F10A (30-31-33kW)	11/88-		R		153-475		Lucas	228,6x42	Hand Brake
	88-90		R		700-265			Ø 220,0	Exc. Usa, Incl. Santana, Cabrio
	88-90		R		700-263			Ø 220,0	Usa, Incl. Santana, Cabrio
	88-90		R		700-264			Ø 228,6	Exc. Usa, Incl. Santana, Cabrio
1.3 (SJ413) Eng.G13A (44-47-50-52-54kW)	4/90-		R		153-397		Sumit.	220,0x36	Mod. Metal Top Luxe, Hand Brake
	88-		R		153-475		Lucas	228,6x42	Hand Brake
	92-	R		153-393		Sumit.	220,0x40	Incl. Mod. Metal Top Luxe -3/90	
	88-	R		700-265			Ø 220,0	Exc. Usa, Incl. Santana	
	88-		R		700-263			Ø 220,0	Usa, Incl. Santana
	88-		R		700-264			Ø 228,6	Exc. Usa, Incl. Santana





















































		Spare Parts	F/R	L/R	CIFAM ref.	CIFAM ref. w/KIT		DIMENSIONS mm.	NOTE
1.3 (SJ413) Eng.G13BA (50-51-58-63-74kW)	4/90-		R		153-397		Sumit.	220,0x36	Mod. Metal Top Luxe, Hand Brake
	88-		R		153-475		Lucas	228,6x42	Hand Brake
	92-		R		153-393		Sumit.	220,0x40	Incl. Mod. Metal Top Luxe -3/90
	88-		R		700-265			Ø 220,0	Exc. Usa, Incl. Santana
	88-		R		700-263			Ø 220,0	Usa, Incl. Santana
88-		R		700-264			Ø 228,6	Exc. Usa, Incl. Santana	
1.9 TD Eng.XUD9/ TE (46kW)	11/98-		R		153-475		Lucas	228,6x42	Hand Brake
Sidekick 7/88-1/98									
All models	-6/90		R		153-397		Sumit.	220,0x36	Hand Brake
	7/90-		R		153-399			254,0x45	
	91-95		R		700-339			Ø 220,0	3p
SJ 410 9/81-12/90									
1.0, Cabrio Eng.F10A (33kW)	-84		F		153-390		Sumit.	220,0x40	
	9/81-12/90		R		153-475		Lucas	228,6x42	Spain, Hand Brake
	9/81-12/90		R		153-391		Sumit.	180,0x30	
	82-90		R		700-265			Ø 220,0	Exc. Usa, Incl. Santana, Cabrio
	82-90		R		700-263			Ø 220,0	Usa, Incl. Santana, Cabrio
	82-90		R		700-264			Ø 228,6	Exc. Usa, Incl. Santana, Cabrio
SJ 413 9/84-8/90									
1.3 Eng.G13A (44-47kW)	9/84-8/90		R		153-395		Sumit.	180,0x30	
	9/84-8/90		R		153-390		Sumit.	220,0x40	
	9/84-8/90		R		153-392		Sumit.	220,0x40	
	84-		R		700-265			Ø 220,0	Exc. Usa, Incl. Santana
	84-		R		700-263			Ø 220,0	Usa, Incl. Santana
	84-		R		700-264			Ø 228,6	Exc. Usa, Incl. Santana
Splash 4/08-									
1.0 Eng.K10B (50kW)	4/08-		R		153-438		Bosch	200,0x32	Hand Brake
	08-		R		151-184		Bosch	Ø 19,05 200,0x32	RAI
1.2 Eng.K12B (63kW)	4/08-		R		153-438		Bosch	200,0x32	Hand Brake
	08-		R		151-184		Bosch	Ø 19,05 200,0x32	RAI
1.3 DDiS Eng.D13A (55kW)	4/08-		R		153-438		Bosch	200,0x32	Hand Brake
	08-		R		151-184		Bosch	Ø 19,05 200,0x32	RAI
Swift I (AA) 10/83-12/89									
1.0 (SA310, AA41/43) Eng.G10A (37-39-40kW)	10/83-3/89		R		153-391		Sumit.	180,0x30	
	10/83-3/89		R		153-395		Sumit.	180,0x30	
1.3 (SA413, AA51/53) Eng.G13A (44-47-50-52-54kW)	10/84-3/89		R		153-391		Sumit.	180,0x30	
1.3 GTi/GXi (SA413, AA33) Eng.G13B (50-51-58-63-74kW)	8/86-3/89		R		153-395		Sumit.	180,0x30	
Swift II (AH, AJ, EA, MA) 3/89-12/03									
1.0 Eng.G10A (39-40kW)	3/89-05/01		R		153-398		Sumit.	180,0x25	
	3/89-05/01		R		153-395		Sumit.	180,0x30	
	97-01		R		153-521			180x26	
	98-		R		153-406			203,2x32	
	89-92		R		700-344			Ø 180,0	Front Disc Solid
	89-92		R		700-343			Ø 180,0	Front Disc Ventelated, -ABS
	95-		R		151-206		Bosch	Ø 17,46 203,2x32	RAI, Exc. H-Back, +ABS
1.0 (SF310, AA44) Eng.G10A (37kW)	3/89-05/01		R		153-398		Sumit.	180,0x25	
	3/89-05/01		R		153-395		Sumit.	180,0x30	
	97-01		R		153-521			180x26	
	98-		R		153-406			203,2x32	
	89-92		R		700-344			Ø 180,0	Front Disc Solid
	89-92		R		700-343			Ø 180,0	Front Disc Ventelated, -ABS
	95-		R		151-206		Bosch	Ø 17,46 203,2x32	RAI, Exc. H-Back, +ABS
1.3 (SF413, AH35, MA), Cabrio Eng.G13A (50-51-52-63kW)	3/89-5/01		R		153-406			203,2x32	+ABS
	3/89-5/01		R		153-398		Sumit.	180,0x25	
	3/89-5/01		R		153-395		Sumit.	180,0x30	
	97-01		R		153-521			180x26	
	89-92		R		700-344			Ø 180,0	Front Disc Solid
	89-92		R		700-343			Ø 180,0	Front Disc Ventelated, -ABS
	95-		R		700-345			Ø 180,0	+ABS
95-		R		151-206		Bosch	Ø 17,46 203,2x32	RAI, Exc. H-Back, +ABS	
1.3 GTi (SF413, AA34) Eng.G13B (74kW)	3/89-5/01		R		153-406			203,2x32	+ABS
	3/89-5/01		R		153-398		Sumit.	180,0x25	
	3/89-5/01		R		153-395		Sumit.	180,0x30	
	97-01		R		153-521			180x26	
	89-		R		700-343			Ø 180,0	Front Disc Ventelated, -ABS















































		Spare Parts	F/R	L/R	CIFAM ref.	CIFAM ref. w/KIT		DIMENSIONS mm.	NOTE
1.6 Eng.G16A (59-60kW)	97-01		R		153-521			180x26	
1.6i 16v, 4WD (SF416, AH, AJ14)	3/89-5/01		R		153-037		Sumit.	200,0x30	
Eng.G16B (68-70kW)	97-01		R		153-521			180x26	
	89-		R		700-345			Ø 180,0	+ABS
	89-		R		700-344			Ø 180,0	Front Disc Solid
	89-		R		700-343			Ø 180,0	Front Disc Ventelated, -ABS
Swift III (SG) 9/05-									
1.3 4WD Eng.M13A (66kW)	1/06-		R		153-520			200x32	Made in Japan
	1/06-		R		153-438		Bosch	200,0x32	Hand Brake
	06-		R		151-184		Bosch	Ø 19,05 200,0x32	RAI
1.3 DDis Eng.D13A (55kW)	9/05-		R		153-520			200x32	Made in Japan
	9/05-		R		153-438		Bosch	200,0x32	Hand Brake
1.3 DDis 16v Eng.Z13DT (51kW)	9/05-		R		153-520			200x32	Made in Japan
	9/05-		R		153-438		Bosch	200,0x32	Hand Brake
	05-		R		151-184		Bosch	Ø 19,05 200,0x32	RAI
1.3, 4WD Eng.M13A (68kW)	2/05-		R		153-520			200x32	Made in Japan
	2/05-		R		153-438		Bosch	200,0x32	Hand Brake
	05-		R		151-184		Bosch	Ø 19,05 200,0x32	RAI
1.5, 4WD Eng.M15A (75kW)	2/05-		R		153-520			200x32	Made in Japan
	2/05-		R		153-438		Bosch	200,0x32	Hand Brake
	05-		R		151-184		Bosch	Ø 19,05 200,0x32	RAI
1.6 16v Eng.M16A (92kW)	07-		R		153-520			200x32	Made in Japan
Sx4 (GY) 6/06-									
1.5 Eng.M15A (73kW)	6/06-		R		153-096		Bosch	220,0x36	
	06-		R		151-201		Bosch	Ø 19,05 220,0x36	RAI
1.6, 4WD Eng.M16A (79kW)	6/06-		R		153-096		Bosch	220,0x36	
	06-		R		151-201		Bosch	Ø 19,05 220,0x36	RAI
1.9 DDiS, 4WD Eng.D19AA (88kW)	6/06-		R		153-096		Bosch	220,0x36	
	06-		R		151-201		Bosch	Ø 19,05 220,0x36	RAI
Vitara (ET, TA) 7/88-3/99									
1.6, Cabrio Eng.G16A (59-60kW)	7/88-1/95		R		153-402			220,0x36	
	7/88-1/95		R		153-399			254,0x45	Usa
	7/88-1/95		R		153-475		Lucas	228,6x42	Hand Brake
	7/88-1/95		R		153-397		Sumit.	220,0x36	Hand Brake
	10/88-1/93		R		700-346			Ø 254,0	
	88-		R		700-266			Ø 228,6	Spain
1.6i 16v, Cabrio Eng.G16B (68-69-70-71-72kW)	7/90-3/99		R		153-402			220,0x36	
	7/90-3/99		R		153-399			254,0x45	Usa
	7/90-3/99		R		153-475		Lucas	228,6x42	Hand Brake
	7/90-3/99		R		153-397		Sumit.	220,0x36	Hand Brake
	90-99		R		700-346			Ø 254,0	
1.9 D, Cabrio Eng.XUD9/ A (50kW)	1/95-3/98		R		153-403			254,0x47	
	1/95-3/98		R		153-397		Sumit.	220,0x36	Hand Brake
	95-98		R		700-266			Ø 228,6	Spain
1.9 D, Cabrio Eng.XUD9SD (55kW)	8/96-3/99		R		153-403			254,0x47	
	8/96-3/99		R		153-397		Sumit.	220,0x36	Hand Brake
	96-99		R		700-346			Ø 254,0	
2.0 16v, Cabrio Eng.J20A (97kW)	12/96-3/99		R		153-403			254,0x47	
	12/96-3/99		R		153-397		Sumit.	220,0x36	Hand Brake
	96-99		R		700-339			Ø 220,0	2p
	96-99		R		700-346			Ø 254,0	4p
2.0 TD Eng.RF (52kW)	12/94-3/98		R		153-403			254,0x47	
	94-97		R		700-346			Ø 254,0	
	97-98		R		700-339			Ø 220,0	
	97-98		R		700-266			Ø 228,6	Spain
2.0 TD Eng.RF (64kW)	12/95-3/98		R		153-403			254,0x47	
	95-98		R		700-346			Ø 254,0	
2.0 V6 24v Eng.H20A (100kW)	12/94-3/98		R		153-403			254,0x47	
	12/94-3/98		R		153-397		Sumit.	220,0x36	Hand Brake
	94-98		R		700-339			Ø 220,0	2p
	94-98		R		700-346			Ø 254,0	4p
Wagon R+ I (EM) 2/93-5/00									
1.0 Eng.K10A (48kW)	2/98-5/00		R		153-400		Nabco	180,0x25	
	98-00		R		700-387			Ø 180,0	
1.2, 4WD Eng.K12A (51kW)	2/98-5/00		R		153-400		Nabco	180,0x25	
	98-00		R		700-387			Ø 180,0	



		Spare Parts	F/R	L/R	CIFAM ref.	CIFAM ref. w/KIT		DIMENSIONS mm.	NOTE
Wagon R+ II (MM) 5/00-									
1.3 16v, 4WD Eng.G13BB (56kW)	5/00-		R		153-314		GM	180,0x26	
	5/00-		R		153-404		Sumit.	180,0x26	
	9/00-		R		700-370			Ø 180,0	+ABS
	9/00-		R		700-371			Ø 180,0	-ABS
1.3 DDis 16v Eng.Z13DT (51kW)	9/03-		R		153-318			200,0x29	
	9/03-		R		153-314	GM	180,0x26		
	03-		R		700-370			Ø 180,0	+ABS
	03-		R		700-371			Ø 180,0	-ABS
1.3, 4WD Eng.M13A (69kW)	03-		R		153-318		GM	200,0x29	
	03-		R		153-314		180,0x26		
	03-		R		700-370			Ø 180,0	+ABS
	03-		R		700-371			Ø 180,0	-ABS
X-90 (EL) 9/95-									
1.6i 16v, 4WD Eng.G16B (68-69-70-71-72kW)	9/95-		R		153-402			220,0x36	
	95-		R		700-339			Ø 220,0	
XL-7 I 1/02-12/06									
2.7 24v, AWD Eng.H27A (138kW)	1/02-12/06		R		153-405		Ake	254,0x57	
SUZUKI LCV									
Carry I (ST90V) Van 11/80-10/85									
0.8 Eng.F8A (27kW)	11/80-10/85		F		153-390		Sumit.	220,0x40	
Carry II (FD) Van 3/99-									
1.3 16v Eng.G13BB (50-51-58-63-74kW)	3/99-		R		153-154		Ake	220,0x35	
Super Carry II (ED) Bus 10/85-3/99									
1.0 Eng.F10A (30-31-33kW)	-87		F		153-390		Sumit.	220,0x40	
	87-		R		153-394		Sumit.	220,0x40	
TALBOT									
1307-1510 7/75-4/84									
1.3 Simca 1307 Eng.371 (44kW)	9/75-1/80		R		153-340	153-340K	Bdx	228,6x42	Hand Brake
	9/75-1/80		R		153-475		Lucas	228,6x42	Hand Brake
1.3 Simca 1307 Eng.6G1 (50kW)	7/75-1/80		R		153-340	153-340K	Bdx	228,6x42	Hand Brake
	7/75-1/80		R		153-475		Lucas	228,6x42	Hand Brake
1.3 Simca 1307 Eng.6G1D (40kW)	1/78-8/81		R		153-340	153-340K	Bdx	228,6x42	Hand Brake
	1/78-8/81		R		153-475		Lucas	228,6x42	Hand Brake
1.3 Simca 1307 S Eng.1G4 (60kW)	7/75-12/78		R		153-340	153-340K	Bdx	228,6x42	Hand Brake
	7/75-12/78		R		153-475		Lucas	228,6x42	Hand Brake
1.4 Simca 1308 Eng.6G1 (51kW)	1/80-4/84		R		153-340	153-340K	Bdx	228,6x42	Hand Brake
	1/80-4/84		R		153-475		Lucas	228,6x42	Hand Brake
	80-84		R		151-105		Lucas	Ø 22,00 228,6x42	LUC
1.4 Simca 1308 Eng.6Y2 (63kW)	11/78-8/81		R		153-340	153-340K	Bdx	228,6x42	Hand Brake
	11/78-8/81		R		153-475		Lucas	228,6x42	Hand Brake
	78-81		R		151-105		Lucas	Ø 22,00 228,6x42	LUC
1.4 Simca 1308 Eng.6Y2/ 6Y2D (55kW)	1/80-4/81		R		153-340	153-340K	Bdx	228,6x42	Hand Brake
	1/80-4/81		R		153-475		Lucas	228,6x42	Hand Brake
	80-81		R		151-105		Lucas	Ø 22,00 228,6x42	LUC
1.6 Simca 1510 Eng.6J1 (54kW)	11/80-12/83		R		153-340	153-340K	Bdx	228,6x42	Hand Brake
	11/80-12/83		R		153-475		Lucas	228,6x42	Hand Brake
	80-83		R		151-015		Bdx	Ø 22,00 228,0x42	RAD
80-83		R		151-105		Lucas	Ø 22,00 228,6x42	LUC	
1.6 Simca 1510 Eng.6J2 (65kW)	10/78-1/80		R		153-340	153-340K	Bdx	228,6x42	Hand Brake
	10/78-1/80		R		153-475		Lucas	228,6x42	Hand Brake
	7/81-6/82		R		153-340	153-340K	Bdx	228,6x42	Hand Brake
7/81-6/82		R		153-475		Lucas	228,6x42	Hand Brake	
81-82		R		151-015		Bdx	Ø 22,00 228,0x42	RAD	
81-82		R		151-105		Lucas	Ø 22,00 228,6x42	LUC	
160 1/73-3/79									
1.6 (59kW)	1/73-3/79		R		153-340	153-340K	Bdx	228,6x42	Hand Brake
	1/73-3/79		R		153-475		Lucas	228,6x42	Hand Brake
1.6 Eng.7R2 (66kW)	7/76-3/79		R		153-340	153-340K	Bdx	228,6x42	Hand Brake
	7/76-3/79		R		153-475		Lucas	228,6x42	Hand Brake
Alpine 1/75-									
1.3 (49kW)	83-85		R		151-015		Bdx	Ø 22,00 228,0x42	RAD
1.5 (62kW)	1/75-		R		153-340	153-340K	Bdx	228,6x42	Hand Brake
	1/75-		R		153-475		Lucas	228,6x42	Hand Brake
	83-85		R		151-015		Bdx	Ø 22,00 228,0x42	RAD































































			Spare Parts	F/R	L/R	CIFAM ref.	CIFAM ref. w/KIT		DIMENSIONS mm.	NOTE
1.6 Minx, Rapier (65kW)		80-85		R		151-015		Bdx	Ø 22,00 228,0x42	RAD
Californian 1/66-12/70										
All models		1/66-12/70		R		153-101		Lucas	203,2x38	Hand Brake
Chamois 1/64-12/70										
All models		1/64-12/70		R		153-101		Lucas	203,2x38	Hand Brake
Express 1/82-1/94										
1.8 Eng.XM7T (49-51kW)	1/82-1/94			R		153-062		Lucas	254,0x57	Hand Brake
	1/82-90			R		700-013			Ø 254,0	RHD
1.9 D Eng.XUD9A (52-58kW)	1/82-1/94			R		153-062		Lucas	254,0x57	Hand Brake
	1/82-94			R		700-013			Ø 254,0	RHD
2.0 Eng.170/ XN1TA (56kW)	1/82-1/94			R		153-062		Lucas	254,0x57	Hand Brake
	1/82-94			R		700-013			Ø 254,0	RHD
2.5 D, TD Eng.CRD93 (54-68-70kW)	1/82-1/94			R		153-062		Lucas	254,0x57	Hand Brake
	1/82-94			R		700-013			Ø 254,0	RHD
Horizon 2/78-6/86										
1.1 Eng.E1 (43-48kW)	1/79-9/84			R		153-340	153-340K	Bdx	228,6x42	Hand Brake
	1/79-9/84			R		153-475		Lucas	228,6x42	Hand Brake
1.1 Eng.E1B (40kW)	1/79-9/84			R		153-340	153-340K	Bdx	228,6x42	Hand Brake
	1/79-9/84			R		153-475		Lucas	228,6x42	Hand Brake
1.3 Eng.2G1 (50kW)	2/78-1/80			R		153-340	153-340K	Bdx	228,6x42	Hand Brake
	2/78-1/80			R		153-475		Lucas	228,6x42	Hand Brake
1.3 Eng.2G1-BTC (40-43kW)	9/78-6/86			R		153-340	153-340K	Bdx	228,6x42	Hand Brake
	9/78-6/86			R		153-475		Lucas	228,6x42	Hand Brake
1.3 Eng.G1/ G2 (47-50kW)	2/78-1/80			R		153-340	153-340K	Bdx	228,6x42	Hand Brake
	2/78-1/80			R		153-475		Lucas	228,6x42	Hand Brake
1.4 Eng.2Y1 (51kW)	7/79-6/86			R		153-340	153-340K	Bdx	228,6x42	Hand Brake
	7/79-6/86			R		153-475		Lucas	228,6x42	Hand Brake
1.4 Eng.2Y1B (48kW)	2/82-9/84			R		153-340	153-340K	Bdx	228,6x42	Hand Brake
	2/82-9/84			R		153-475		Lucas	228,6x42	Hand Brake
1.4 Eng.2Y2/ Y2 (61kW)	7/79-6/86			R		153-340	153-340K	Bdx	228,6x42	Hand Brake
	7/79-6/86			R		153-475		Lucas	228,6x42	Hand Brake
1.6 Eng.6J2A/ J2A (54-66kW)	7/82-6/86			R		153-340	153-340K	Bdx	228,6x42	Hand Brake
	7/82-6/86			R		153-475		Lucas	228,6x42	Hand Brake
1.9 D Eng.XUD9 (47-48kW)	7/82-6/86			R		153-340	153-340K	Bdx	228,6x42	Hand Brake
	7/82-6/86			R		153-475		Lucas	228,6x42	Hand Brake
Husky 1/66-12/70										
All models		1/66-12/70		R		153-101		Lucas	203,2x38	Hand Brake
Imp 1/66-1/76										
All models		1/66-1/76		R		153-101		Lucas	203,2x38	Hand Brake
Rancho 1/77-7/84										
1.4 Eng.X3Y2 (59kW)	1/77-7/84			R		153-340	153-340K	Bdx	228,6x42	Hand Brake
	1/77-7/84			R		153-475		Lucas	228,6x42	Hand Brake
	77-84			R		151-105		Lucas	Ø 22,00 228,6x42	LUC
	80-84			R		151-015		Bdx	Ø 22,00 228,0x42	RAD
Samba (51A) 1/81-10/86										
0.9 Eng.5C1(XV5/ 8) (31kW)	1/81-12/85			R		153-339	153-339K	Bdx	180,0x32	Hand Brake
	81-85			R		151-034		Bdx	Ø 22,00 180,0x30	RAD
1.1 Eng.XW7 (37kW)	1/81-6/86			R		153-339	153-339K	Bdx	180,0x32	Hand Brake
	81-86			R		151-034		Bdx	Ø 22,00 180,0x30	RAD
1.2 Rallye Eng.129D/ XZ7R (65kW)	1/83-10/86			R		153-339	153-339K	Bdx	180,0x32	Hand Brake
	83-86			R		151-034		Bdx	Ø 22,00 180,0x30	RAD
1.4 Eng.150D (44kW)	6/83-10/86			R		153-339	153-339K	Bdx	180,0x32	Hand Brake
	83-86			R		151-034		Bdx	Ø 22,00 180,0x30	RAD
1.4 Eng.XY7/ XY8 (53kW)	1/81-6/86			R		153-339	153-339K	Bdx	180,0x32	Hand Brake
	81-86			R		151-034		Bdx	Ø 22,00 180,0x30	RAD
1.4 Rallye, Cabrio Eng.XY8 (58-59kW)	1/83-10/86			R		153-339	153-339K	Bdx	180,0x32	Hand Brake
	83-86			R		151-034		Bdx	Ø 22,00 180,0x30	RAD
Simca 10/61-12/80										
1.1 LE,LX,LS,GLS,ES, SW Eng.350/ 351/ 3E1A (44kW)	10/76-1/80			R		153-340	153-340K	Bdx	228,6x42	Hand Brake
	10/76-1/80			R		153-475		Lucas	228,6x42	Hand Brake
1.1 LS,SR,GLS Eng.E1B (40kW)	74-			R		153-340	153-340K	Bdx	228,6x42	Hand Brake
	74-			R		153-475		Lucas	228,6x42	Hand Brake
1.1, SW Eng.3E1 (37kW)	10/76-1/80			R		153-340	153-340K	Bdx	228,6x42	Hand Brake
	10/76-1/80			R		153-475		Lucas	228,6x42	Hand Brake
1.6 Eng.7R2 (66kW)				R		153-340	153-340K	Bdx	228,6x42	Hand Brake
				R		153-475		Lucas	228,6x42	Hand Brake

























































		Spare Parts	F/R	L/R	CIFAM ref.	CIFAM ref. w/KIT		DIMENSIONS mm.	NOTE
Simca Sunbeam 7/77-3/83									
1.6 Eng.H16D (51kW)	7/77-4/81		R		153-340	153-340K	Bdx	228,6x42	Hand Brake
	7/77-4/81		R		153-475		Lucas	228,6x42	Hand Brake
1.6 Eng.TB (59kW)	10/78-4/81		R		153-340	153-340K	Bdx	228,6x42	Hand Brake
	10/78-4/81		R		153-475		Lucas	228,6x42	Hand Brake
1.6 Ti Eng.TB (74kW)	10/78-3/83		R		153-340	153-340K	Bdx	228,6x42	Hand Brake
	10/78-3/83		R		153-475		Lucas	228,6x42	Hand Brake
Solara 2/80-7/86									
1.3 Eng.6G1D-VP (40kW)	2/80-86		R		151-015		Bdx	Ø 22,00 228,0x42	RAD
1.4 Eng.6Y1 (51kW)	7/82-4/84		R		153-340	153-340K	Bdx	228,6x42	Hand Brake
	7/82-4/84		R		153-475		Lucas	228,6x42	Hand Brake
	82-84		R		151-015		Bdx	Ø 22,00 228,0x42	RAD
1.6 Eng.6J1 (54kW)	9/81-10/84		R		153-340	153-340K	Bdx	228,6x42	Hand Brake
	9/81-10/84		R		153-475		Lucas	228,6x42	Hand Brake
	81-84		R		151-015		Bdx	Ø 22,00 228,0x42	RAD
1.6 Eng.6J2 (65kW)	2/80-81		R		151-015		Bdx	Ø 22,00 228,0x42	RAD
	2/80-81		R		151-105		Lucas	Ø 22,00 228,6x42	LUC
1.6 Eng.J1B (51-66kW)	7/82-4/84		R		153-340	153-340K	Bdx	228,6x42	Hand Brake
	7/82-4/84		R		153-475		Lucas	228,6x42	Hand Brake
	82-84		R		151-105		Lucas	Ø 22,00 228,6x42	LUC
Stiletto 1/66-12/76									
All models	1/66-12/76		R		153-101		Lucas	203,2x38	Hand Brake
Tagora 6/80-12/87									
2.1 Eng.5N2 (85kW)	80-83		R		700-231			Ø 255,0	
2.3 TD Eng.XD2S (59kW)	81-83		R		700-231			Ø 255,0	
2.6 Eng.9L6 (122kW)	81-83		R		700-231			Ø 255,0	
TATA									
Indica/ Vista 1/98-									
1.4 (44kW)	6/98-9/02		R		153-037		Sumit.	200,0x30	
1.4 Eng.475MPFI (63kW)	1/98-		R		153-037		Sumit.	200,0x30	
1.4 Eng.475Si (55kW)	10/98-		R		153-037		Sumit.	200,0x30	
1.4 D Eng.475DL (39kW)	10/98-		R		153-037		Sumit.	200,0x30	
1.4 D Eng.475DTI (52kW)	1/98-		R		153-037		Sumit.	200,0x30	
Indigo, SW 1/03-									
1.2 (48kW)	06-		R		153-037		Sumit.	200,0x30	
1.4 Eng.475MPFI (63kW)	03-		R		153-037		Sumit.	200,0x30	
1.4 D (46kW)	03-		R		153-037		Sumit.	200,0x30	
1.4 D Eng.475DTI (52kW)	03-		R		153-037		Sumit.	200,0x30	
TOYOTA									
4 Runner I (N6) 1/84-1/88									
2.4 SR5 4WD Eng.22R (79kW)	8/84-7/86		R		153-413		Ake	254,0x58	Hand Brake
All models	-86		R		153-413		Ake	254,0x58	4WD, Hand Brake
	87-		R		153-421		Ake	295,0x50	4WD, Hand Brake
4 Runner II (N13) 8/87-3/96									
2.2 (YN135) Eng.4Y/ 4YEC (72kW)	89-91		R		700-121			Ø 295,0	
2.4 (RN61) Eng.22REC (82kW)	8/87-3/96		R		153-421		Ake	295,0x50	Hand Brake
2.4 TD (LN130) (80-82kW)	89-95		R		700-121			Ø 295,0	
2.8 D (LN130) Eng.3L (66kW)	89-95		R		700-121			Ø 295,0	
3.0 TD (KZN130) Eng.1KZT (92kW)	2/88-11/95		R		153-421		Ake	295,0x50	Hand Brake
3.0 V6 (VZN 130) Eng.3VZE (105kW)	2/88-11/95		R		153-421		Ake	295,0x50	Hand Brake
4 Runner III (N18) 11/95-									
3.0 TD Eng.1KZT (92kW)	03-04		R		153-441			210,0x46	
3.0 TDi Eng.1KZTE (103kW)	9/00-7/02		R		153-447			290,0x51	Hand Brake
Avalon 10/96-									
2.4 16v (112kW)	8/01-4/05		R		153-442	153-442K		170,0x40	Hand Brake
3.0 V6 24v Eng.1MZFE (135-140-150kW)	10/96-		R		153-442	153-442K		170,0x40	Hand Brake
Avensis I (T22), SW 9/97-3/03									
1.6 (AT220) Eng.4AFE (66-70-74-78-81-85kW)	9/97-10/00		R		153-439	153-439K		190,0x45	Hand Brake
	9/97-10/00		R		153-430		Lucas	228,6x35	
	97-10/00		R		700-109			Ø 228,6	
	97-00		R		151-179		Lucas	Ø 20,64 228,6x35	LUC
1.6 VVT-i Eng.3ZZFE (81kW)	10/00-3/03		R		153-444	153-444K		170,0x40	
	10/00-3/03		R		153-439	153-439K		190,0x45	Hand Brake
	00-03		R		700-109			Ø 228,6	











































		Spare Parts	F/R	L/R	CIFAM ref.	CIFAM ref. w/KIT		DIMENSIONS mm.	NOTE
1.6 VVT-i Eng.3ZZFE (81kW)	00-03		R		151-179		Lucas	Ø 20,64 228,6x35	LUC
1.8 16v (AT221) Eng.7AFE (79-81-85-86kW)	9/97-10/00		R		153-439	153-439K		190,0x45	Hand Brake
	9/97-10/00		R		153-430		Lucas	228,6x35	
	97-10/00		R		700-109			Ø 228,6	
1.8 16v VVTi Eng.1ZZFE (92-95-99-103kW)	97-00		R		151-179		Lucas	Ø 20,64 228,6x35	LUC
	10/00-3/03		R		153-444	153-444K		170,0x40	
	10/00-3/03		R		153-439	153-439K		190,0x45	Hand Brake
2.0 16v (ST220) Eng.3SFE (90-95-98kW)	00-03		R		700-109			Ø 228,6	
	00-03		R		151-179		Lucas	Ø 20,64 228,6x35	LUC
	9/97-10/00		R		153-439	153-439K		190,0x45	Hand Brake
2.0 16v (ST220) Eng.3SFE (90-95-98kW)	9/97-10/00		R		153-430		Lucas	228,6x35	
	97-10/00		R		700-109			Ø 228,6	
	97-00		R		151-179		Lucas	Ø 20,64 228,6x35	LUC
2.0 D-4D Eng.1CDFTV (81kW)	10/99-3/03		R		153-439	153-439K		190,0x45	Hand Brake
	10/99-3/03		R		153-430		Lucas	228,6x35	
	99-03		R		700-109			Ø 228,6	
2.0 TD (CT220) Eng.2CTE (66kW)	99-03		R		151-179		Lucas	Ø 20,64 228,6x35	LUC
	9/97-3/03		R		153-439	153-439K		190,0x45	Hand Brake
	9/97-3/03		R		153-430		Lucas	228,6x35	
2.0 VVT-i Eng.1AZFE/ FSE (110kW)	97-03		R		700-109			Ø 228,6	
	97-03		R		151-179		Lucas	Ø 20,64 228,6x35	LUC
	10/00-3/03		R		153-444	153-444K		170,0x40	
2.0 VVT-i Eng.1AZFE/ FSE (110kW)	10/00-3/03		R		153-439	153-439K		190,0x45	Hand Brake
Avensis II (T25), SW 4/03-1/09									
1.6 VVT-i Eng.3ZZFE (81kW)	4/03-1/09		R		153-443	153-443K		174,0x32	
1.8 16v VVTi Eng.1ZZFE (95kW)	4/03-1/09		R		153-443	153-443K		174,0x32	
2.0 Eng.1AZFSE (108kW)	4/03-1/09		R		153-443	153-443K		174,0x32	
2.0 D-4D Eng.1ADFTV (93kW)	3/06-1/09		R		153-443	153-443K		174,0x32	
2.0 D-4D Eng.1CDFTV (85kW)	4/03-1/09		R		153-443	153-443K		174,0x32	
2.2 D-4D Eng.2ADFTV (110kW)	05-09		R		153-443	153-443K		174,0x32	
2.2 D-CAT Eng.2ADFHV (130kW)	05-09		R		153-443	153-443K		174,0x32	
2.4 Eng.2AZFSE (120kW)	10/03-1/09		R		153-443	153-443K		174,0x32	
2.4 Eng.2AZFSE (125kW)	9/03-1/09		R		153-443	153-443K		174,0x32	
Avensis Verso (M20) 8/01-									
2.0 D4-D Eng.1CDFTV (85kW)	8/01-		R		153-439	153-439K		190,0x45	Hand Brake
2.0 VVT-i Eng.1AZFE/ FSE (110kW)	8/01-		R		153-439	153-439K		190,0x45	Hand Brake
Aygo (KGB,WNB) 10/05-									
1.0 VVT-i Eng.1KRFE (50kW)	05-		R		153-438		Bosch	200,0x32	Hand Brake
	05-		R		700-383			Ø 200,0	
	05-		R		151-183		Bosch	Ø 17,46 200,0x32	RAI
1.4 HDi Eng.DV4D (40kW)	7/05-		R		153-438		Bosch	200,0x32	Hand Brake
	05-		R		700-383			Ø 200,0	
	05-		R		151-183		Bosch	Ø 17,46 200,0x32	RAI
Camry (V1)/ Vista/ Scepter 2/83-8/96									
1.8 Eng.1SL (66-74kW)	2/83-10/86		R		153-417		Sumit.	200,0x37	Hand Brake
1.8 GT Eng.3TG (77kW)	1/78-12/84		R		153-417		Sumit.	200,0x37	Hand Brake
2.0 Eng.21R (77kW)	1/78-12/82		R		153-408		Ake	228,6x41	Hand Brake
2.0 Eng.2SE/ 2SELC (73-89kW)	4/86-1/88		R		153-442	153-442K		170,0x40	Hand Brake
2.0 Eng.2SEL (79kW)	3/83-10/86		R		153-417		Sumit.	200,0x37	Hand Brake
2.2 (SXV10), SW Eng.5SFE (100kW)	6/91-8/96		R		153-442	153-442K		170,0x40	Hand Brake
3.0 (VCV10), SW Eng.3VZFE (138kW)	6/91-8/96		R		153-442	153-442K		170,0x40	Hand Brake
Camry (V2), SW 10/86-5/91									
1.8 i (SV20) Eng.1SL (66-74kW)	10/86-8/88		R		153-417		Sumit.	200,0x37	Hand Brake
	86-88		R		700-119			Ø 200,0	Exc. SW
2.0 16v, 4WD (SV21, SV25) Eng.3SFE (90-95-98kW)	11/86-5/91		R		153-442	153-442K		170,0x40	Hand Brake
	11/86-5/91		R		153-423			200,0x37	Van, Hand Brake
	11/86-5/91		R		153-417		Sumit.	200,0x37	Hand Brake
2.0 TD (CV20) Eng.2CT (62-63kW)	86-91		R		700-119			Ø 200,0	Exc. SW
	11/86-5/91		R		153-423			200,0x37	Van, Hand Brake
	11/86-5/91		R		153-417		Sumit.	200,0x37	Hand Brake
2.5 V6 GXi (VZV21) Eng.2VZFE (118kW)	86-91		R		700-119			Ø 200,0	Exc. SW
	2/88-5/91		R		153-442	153-442K		170,0x40	Hand Brake
	2/88-5/91		R		153-417		Sumit.	200,0x37	Hand Brake
	88-91		R		700-119			Ø 200,0	Exc. SW



































		Spare Parts	F/R	L/R	CIFAM ref.	CIFAM ref. w/KIT		DIMENSIONS mm.	NOTE
Camry (V20) 8/96-11/01									
2.2 Eng.5SFE (93kW)	11/00-11/01		R		153-444	153-444K		170,0x40	
2.2 Eng.5SFE (96kW)	8/96-11/01		R		153-444	153-444K		170,0x40	
3.0 V6 24v Eng.1MZFE (135kW)	4/00-11/01		R		153-444	153-444K		170,0x40	
3.0 V6 24v Eng.1MZFE (140kW)	8/96-11/01		R		153-444	153-444K		170,0x40	
Camry (V30) 11/01-12/05									
2.4 VVTi Eng.2AZFE (112-117kW)	11/01-		R		153-444	153-444K		170,0x40	
3.0 V6 24v Eng.1MZFE (137kW)	11/01-		R		153-444	153-444K		170,0x40	
Carina I (TA4, TA6), SW 8/77-2/87									
1.4 Eng.T (70kW)	1/70-12/79		R		153-408		Ake	228,6x41	Hand Brake
1.6 ST (TA4C, TA60) (Exc. SW) Eng.2TB/ 4AL (63-66kW)	8/77-8/85		R		153-408		Ake	228,6x41	Hand Brake
1.6, LT Coupe Eng.2T (55kW)	1/78-9/83		R		153-408		Ake	228,6x41	Hand Brake
1.8 Eng.3T (63-70kW)	1/82-2/87		R		153-408		Ake	228,6x41	Hand Brake
1.8 Eng.3TC (57kW)	1/78-5/83		R		153-408		Ake	228,6x41	Hand Brake
1.8 D Eng.1C (48kW)	4/82-9/83		R		153-408		Ake	228,6x41	Hand Brake
Carina II (T15) 10/83-11/87									
1.6 (AT151) Eng.4AL (62-63kW)	10/83-11/87		R		153-417		Sumit.	200,0x37	Hand Brake
	83-87		R		700-115			Ø 200,0	
1.6 (AT151) Eng.4ALC (55-89kW)	10/83-11/87		R		153-417		Sumit.	200,0x37	Hand Brake
	83-87		R		700-115			Ø 200,0	
1.8 GLI (ST150) Eng.1SL (74kW)	10/83-11/87		R		153-417		Sumit.	200,0x37	Hand Brake
	83-87		R		700-115			Ø 200,0	
2.0 D (CT150) Eng.2C/ L (50-51-53kW)	12/85-11/87		R		153-417		Sumit.	200,0x37	Hand Brake
	85-87		R		700-115			Ø 200,0	
Carina II (T17), SW 12/87-6/93									
1.6 (AT171) Eng.4AF (66kW)	12/87-11/89		R		153-417		Sumit.	200,0x37	Hand Brake
	87-89		R		700-116			Ø 200,0	13Inch Wheels
1.6 (AT171) Eng.4AFE (72-75kW)	12/87-3/92		R		153-417		Sumit.	200,0x37	Hand Brake
	87-92		R		700-116			Ø 200,0	13Inch Wheels
1.6 16v Eng.4AGE (89-95kW)	1/88-12/92		R		153-417		Sumit.	200,0x37	Hand Brake
2.0 16v (ST182/3) Eng.3SGE (115kW)	8/89-6/93		R		153-417		Sumit.	200,0x37	Hand Brake
2.0 D Eng.2C/ L (53-54kW)	3/88-6/93		R		153-417		Sumit.	200,0x37	Hand Brake
	88-93		R		700-116			Ø 200,0	
2.0 GLI (ST171) Eng.3SFE (90-95-98kW)	12/87-3/92		R		153-417		Sumit.	200,0x37	Hand Brake
	87-92		R		700-116			Ø 200,0	13Inch Wheels
Carina III E (T19), SW 4/92-9/97									
1.6 (AT190) Eng.4AFE (73-85kW)	12/93-9/97		R		153-417		Sumit.	200,0x37	Hand Brake
	93-97		R		700-122			Ø 200,0	
1.6 16v (AT190) (Exc. SW) Eng.4AFE (78kW)	12/93-9/97		R		153-432		Lucas	200,0x35	
	93-97		R		700-122			Ø 200,0	
1.6 GLi (Exc. SW) Eng.4AFE (79kW)	10/95-9/97		R		153-432		Lucas	200,0x35	
	95-97		R		700-122			Ø 200,0	
1.8 (T190) Eng.4SFE	8/92-12/94		R		153-432		Lucas	200,0x35	
1.8 16v (AT191) Eng.7AFE (79-81-85-86kW)	1/95-9/97		R		153-432		Lucas	200,0x35	
	95-97		R		700-122			Ø 200,0	
2.0 16v (ST191) Eng.3SFE (93kW)	93-97		R		700-122			Ø 200,0	Incl. SW
2.0 D (CT190) Eng.2C (53kW)	4/92-1/96		R		153-432		Lucas	200,0x35	
	4/92-1/96		R		153-417		Sumit.	200,0x37	Hand Brake
	92-96		R		700-122			Ø 200,0	Incl. SW
2.0 GLI (ST191) Eng.3SFE (90-95-98kW)	4/92-9/97		R		153-432		Lucas	200,0x35	
	4/92-9/97		R		153-417		Sumit.	200,0x37	Hand Brake
	92-97		R		700-122			Ø 200,0	Incl. SW
2.0 GTi (ST191) (Exc. SW) Eng.3SGE (116kW)	4/92-2/94		R		153-432		Lucas	200,0x35	
2.0 GTi 16v (ST191) (Exc. SW) Eng.3SGE (115-125-129kW)	3/94-9/97		R		153-444	153-444K		170,0x40	
2.0 TD (CT190) Eng.2CT (61-62kW)	1/96-9/97		R		153-432		Lucas	200,0x35	
	96-97		R		700-122			Ø 200,0	
Celica I (TA2) 5/73-3/78									
1.4 Eng.T (70kW)	1/70-12/77		R		153-408		Ake	228,6x41	Hand Brake
2.0 Eng.18R (63kW)	10/75-7/77		R		153-408		Ake	228,6x41	Hand Brake
Celica II (TA60, RA40, RA6) 8/77-10/86									
1.6 Eng.2T (55kW)	1/78-12/80		R		153-408		Ake	228,6x41	Hand Brake
1.6 GT Eng.2TG (80kW)	1/76-12/84		R		153-408		Ake	228,6x41	Hand Brake









































		Spare Parts	F/R	L/R	CIFAM ref.	CIFAM ref. w/KIT		DIMENSIONS mm.	NOTE
1.6 GT 16v Coupe Eng.4AGE (91kW) 12/83-10/86 83-86			R		153-417		Sumit.	200,0x37	Hand Brake
			R		153-525			167x40	
1.6 ST (TA60) Eng.2TB (63-66-80kW) 8/77-8/85			R		153-408		Ake	228,6x41	Hand Brake
1.8 Eng.3T (70kW) 1/77-12/82			R		153-408		Ake	228,6x41	Hand Brake
2.0 Coupe, XT Eng.21R/ 21RC (77kW) 82-86			R		153-525			167x40	
Celica III (T16) 8/85-8/90									
1.6 Eng.4AL (63kW) 4/86-2/90 86-90			R		153-417		Sumit.	200,0x37	Hand Brake
			R		700-116			Ø 200,0	
1.6 GT Eng.4AGELC (85-89kW) 8/87-8/89			R		153-417		Sumit.	200,0x37	Hand Brake
1.6 GT 16v Eng.4AGEL (91kW) 9/85-8/89 85-89			R		153-442	153-442K		170,0x40	Hand Brake
			R		700-116		Ø 200,0		
1.8 (ST160) Eng.1SLU (66-74kW) 8/85-12/89			R		153-417		Sumit.	200,0x37	Hand Brake
2.0 Eng.2S (89kW) 1/86-12/87			R		153-417		Sumit.	200,0x37	Rear Drum Brake, Hand Brake
2.0 (ST162) Eng.3SF 8/87-8/89			R		153-417		Sumit.	200,0x37	Rear Drum Brake, Hand Brake
2.0 GT, Cabrio (ST162), Coupe Eng.3SGELC (103kW) 9/85-8/90			R		153-442	153-442K		170,0x40	Hand Brake
			R		153-417		Sumit.	200,0x37	Liftback (16TC), Hand Brake
2.0, GT, Cabrio (ST162) Eng.3SGEL (110kW) 8/85-8/90			R		153-442	153-442K		170,0x40	Hand Brake
			R		153-417		Sumit.	200,0x37	Liftback (16TC), Hand Brake
Celica IV (T18) 10/89-1/94									
1.6 STI (AT180) Coupe Eng.4AFE (66-70-74-78-81-85kW) 89-94			R		153-423			200,0x37	Hand Brake
			R		700-119		Ø 200,0	+ABS	
2.0 GTi (ST182) Coupe, Cabrio 10/89-1/94			R		153-423			200,0x37	Hand Brake
Eng.3SGE (115-118kW) 89-94			R		700-119			Ø 200,0	+ABS
2.2 (ST184) Eng.5SFE (100kW) 10/89-1/94			R		153-442	153-442K		170,0x40	Hand Brake
Celica V (T20) 11/93-11/99									
1.8 16v (AT200/ST) Eng.7AFE (79-81-85-86kW) 11/93-11/99			R		153-444	153-444K		170,0x40	
2.0 i T. 4WD (ST205) Eng.3SGTE (178kW) 2/94-11/99			R		153-444	153-444K		170,0x40	
2.0i 16v (ST202/GT) Eng.3SGE (129kW) 11/93-11/99			R		153-444	153-444K		170,0x40	
2.0i 16v, Cabrio Eng.3SGE (115-125kW) 4/96-11/99			R		153-444	153-444K		170,0x40	
Celica VI (ZZT23) 11/99-									
1.8 16v VVTi Eng.1ZZFE (92-95-99-103-105kW) 11/99-			R		153-443	153-443K		174,0x32	
1.8 VVTi TS (ZZT231) Eng.2ZZGE (141-165kW) 11/99-			R		153-443	153-443K		174,0x32	
Corolla I (KE, TE) 11/66-12/80									
1.2, Coupe, SW Eng.3KB/ C/ H (40-43kW) 74-80			F		153-390		Sumit.	220,0x40	
			R		700-126			Ø 200,0	KE30,35,36,50
1.4 Eng.T (70kW) 1/70-12/79			R		153-408		Ake	228,6x41	Hand Brake
1.6 GT Eng.2TG (65kW) 1/76-12/79			R		153-408		Ake	228,6x41	Hand Brake
1.6 LiftB. Eng.2T (55kW) 9/76-1/80			R		153-408		Ake	228,6x41	Hand Brake
1.6 LiftB. Eng.2TB (62kW) 9/76-1/80			R		153-408		Ake	228,6x41	Hand Brake
Corolla II (E7) 9/79-9/83									
1.3 Eng.2A (54kW) 1/79-12/83			R		153-409		Ake	200,0x36	Hand Brake
1.3 (KE70), SW, LiftB. Eng.4KC (43-48kW) 2/82-1/83			R		153-409		Ake	200,0x36	Hand Brake
1.6 (TE71) LiftB. Eng.2TB (63kW) 9/79-5/83			R		153-409		Ake	200,0x36	Hand Brake
			R		153-408		Ake	228,6x41	Liftback, Hand Brake
1.6 (TE71), LiftB. Eng.2T (55kW) 9/79-5/83			R		153-409		Ake	200,0x36	Hand Brake
			R		153-408		Ake	228,6x41	Liftback, Hand Brake
1.6 GT (TE71) LiftB. Eng.2TG (81kW) 5/80-9/83			R		153-408		Ake	228,6x41	Hand Brake
			R		153-408		Ake	228,6x41	Liftback, Hand Brake
			R		700-126		Ø 200,0		
1.8 (TE72) LiftB. Eng.3TC (57kW) 9/79-5/82			R		153-409		Ake	200,0x36	Hand Brake
			R		153-408		Ake	228,6x41	Liftback, Hand Brake
			R		700-126		Ø 200,0	Sweden/Switzerland	
1.8 D (CE70), SW Eng.1C (43-48kW) 1/83-9/83			R		153-409		Ake	200,0x36	Van, Hand Brake
Corolla III (E8) 5/83-5/88									
1.3 Eng.4K (43kW) 1/83-12/88			R		153-419		Sumit.	200,0x37	
1.3 (AE80), LiftB. Eng.2AL (51kW) 6/83-12/84			R		153-419		Sumit.	200,0x37	
			R		700-116		Ø 200,0		
			R		700-115		Ø 200,0	Incl. Sedan	





















































		Spare Parts	F/R	L/R	CIFAM ref.	CIFAM ref. w/KIT		DIMENSIONS mm.	NOTE
1.3 (AE80/EE80), LiftB., Compact FX Eng.2EL/ 2ELC (55-68kW)	10/84-8/87		R		153-419		Sumit.	200,0x37	
			R		700-115			Ø 200,0	Incl. Sedan
			R		700-116			Ø 200,0	
1.6 (AE82), LiftB. Eng.4AL (62kW)	6/83-8/87		R		153-419		Sumit.	200,0x37	
			R		700-116			Ø 200,0	
			R		700-115			Ø 200,0	
1.6 (AE82), LiftB., Compact FX Eng.4ALC (53kW)	8/85-5/88		R		153-419		Sumit.	200,0x37	
			R		700-115			Ø 200,0	
			R		700-116			Ø 200,0	
1.6 Compact FX Eng.4AC (55-85-89-91kW)	1/86-87		R		700-116			Ø 200,0	
			R		700-115			Ø 200,0	
1.6 GT 16v Compact FX Eng.4AGEL (85-89-91kW)	8/85-8/87		R		153-409		Ake	200,0x36	Mod. ST, Hand Brake
			R		153-408		Ake	228,6x41	Mod. GT, Hand Brake
1.6 GT 16v Coupe Eng.4AGE (91kW)	8/83-7/87		R		153-409		Ake	200,0x36	Mod. ST, Hand Brake
			R		153-408		Ake	228,6x41	Mod. GT, Hand Brake
1.6 LiftB. Eng.4AL (63kW)	85-88		R		700-115			Ø 200,0	
1.8 D, LiftB., Compact FX Eng.1C (43kW)	6/83-5/88		R		153-409		Ake	200,0x36	SW, Hand Brake
			R		153-419		Sumit.	200,0x37	
			R		700-115			Ø 200,0	
1.8 D, LiftB., Compact FX Eng.1CL (48kW)	6/83-5/88		R		153-409		Ake	200,0x36	SW, Hand Brake
			R		153-419		Sumit.	200,0x37	
			R		700-115			Ø 200,0	
Corolla IV (E9), SW, Compact, Liftback 8/87-6/93									
1.3 Eng.2E (60kW)	8/87-4/92		R		153-448			200,0x37	
			R		153-422		Sumit.	200,0x37	Hand Brake
			R		153-417		Sumit.	200,0x37	Van, Hand Brake
1.3 12v (EE90) Eng.2E/ 2EE (55kW)	8/87-12/92		R		153-448			200,0x37	
			R		153-422		Sumit.	200,0x37	Hand Brake
			R		153-417		Sumit.	200,0x37	Van, Hand Brake
			R		700-116			Ø 200,0	
1.6 (AE92) Eng.4AF (66kW)	8/87-5/92		R		153-448			200,0x37	
			R		153-419		Sumit.	200,0x37	
			R		153-417		Sumit.	200,0x37	Van, Hand Brake
			R		700-116			Ø 200,0	
			R		700-113			Ø 200,0	Tercel
1.6 (AE92) (Exc. Compact) Eng.4AF (70kW)	12/87-4/92		R		153-448			200,0x37	
			R		153-419		Sumit.	200,0x37	
			R		153-417		Sumit.	200,0x37	Van, Hand Brake
			R		700-116			Ø 200,0	
			R		700-113			Ø 200,0	Tercel
1.6 GTi (AE92) (Exc. SW) Eng.4AGE (85-89-92-95kW)	8/87-6/93		R		153-448			200,0x37	
			R		153-419		Sumit.	200,0x37	
			R		700-116			Ø 200,0	
1.6i, 4WD Eng.4AFE (74-78-81kW)	10/87-6/93		R		153-424			200,0x36	SW, 4WD
			R		153-423			200,0x37	SW, 2WD, Hand Brake
			R		153-408		Ake	228,6x41	SW, 4WD, Hand Brake
			R		153-419		Sumit.	200,0x37	
			R		153-417		Sumit.	200,0x37	Van, Hand Brake
			R		700-116			Ø 200,0	
1.8 D (CE90) Eng.1C (47-48kW)	8/87-6/93		R		153-448			200,0x37	SW
			R		153-417		Sumit.	200,0x37	Hand Brake
			R		153-419		Sumit.	200,0x37	Liftback
			R		700-116			Ø 200,0	
Corolla V (E10), SW, Compact, Liftback 7/92-4/97									
1.3 12v (EE100) Eng.2E (53-68kW)	95-		R		153-419		Sumit.	200,0x37	
			R		700-120			Ø 200,0	
1.3 XLI (EE101) Eng.4EFE (55kW)	9/95-4/97		R		153-419		Sumit.	200,0x37	
			R		700-120			Ø 200,0	
1.3 XLI 16v (EE101) Eng.4EFE (65kW)	95-		R		153-419		Sumit.	200,0x37	
			R		700-120			Ø 200,0	
1.5 (AE103,104) Eng.5EFE	7/92-1/94		R		153-422		Sumit.	200,0x37	Hand Brake
1.5 (AE107,108) Eng.3E	7/92-1/94		R		153-422		Sumit.	200,0x37	Hand Brake
1.6 Si, GLI (AE101) Eng.4AFE (66-70-74-78-81-85kW)	7/92-4/97		R		153-422		Sumit.	200,0x37	Hand Brake
	92-97		R		700-120			Ø 200,0	































































		Spare Parts	F/R	L/R	CIFAM ref.	CIFAM ref. w/KIT		DIMENSIONS mm.	NOTE
1.8 16v 4WD, GT (AE102, 103) Eng.7AFE (79-81-85-86-88kW)	11/92-4/97		R		153-422		Sumit.	200,0x37	Hand Brake
2.0 D (CE100) Eng.2C (53kW)	7/92-4/97		R		153-422		Sumit.	200,0x37	Hand Brake
	92-97		R		700-120			Ø 200,0	
Corolla VI (E11), SW, Compact, Liftback 4/97-1/02									
1.3 Eng.2E (55kW)	5/97-10/01		R		153-433		Sumit.	200,0x38	
1.4 (EE111) Eng.4EFE (63kW)	4/97-2/00		R		153-432		Lucas	200,0x35	
	4/97-2/00		R		153-433		Sumit.	200,0x38	
	97-00		R		700-324			Ø 200,0	
	97-00		R		700-380			Ø 200,0	
1.4 16v (ZZE111) Eng.4ZZFE (71kW)	2/00-1/02		R		153-432		Lucas	200,0x35	
	2/00-1/02		R		153-433		Sumit.	200,0x38	
	00-02		R		700-324			Ø 200,0	
	00-02		R		700-380			Ø 200,0	
1.6 (AE111) Eng.4AFE (81kW)	4/97-2/00		R		153-423			200,0x37	Hand Brake
	4/97-2/00		R		153-432		Lucas	200,0x35	
	4/97-2/00		R		153-433		Sumit.	200,0x38	
	97-00		R		700-324			Ø 200,0	
	97-00		R		700-380			Ø 200,0	
1.6 16v Eng.3ZZFE (81kW)	2/00-1/02		R		153-433		Sumit.	200,0x38	
	00-02		R		700-324			Ø 200,0	
	00-02		R		700-380			Ø 200,0	
	00-02		R		700-380			Ø 200,0	
1.6 Aut. (AE111) Eng.4AFE (79kW)	4/97-2/00		R		153-419		Sumit.	200,0x37	
	4/97-2/00		R		153-433		Sumit.	200,0x38	
	97-00		R		700-324			Ø 200,0	
	97-00		R		700-380			Ø 200,0	
1.8, AWD (AE115) (Only SW) Eng.7AFE (79-81-85-86kW)	4/97-1/02		R		153-423			200,0x37	Hand Brake
	4/97-1/02		R		153-433		Sumit.	200,0x38	
1.9 D (WZE110) Eng.1WZ (51kW)	2/00-1/02		R		153-432		Lucas	200,0x35	
	2/00-1/02		R		153-433		Sumit.	200,0x38	
	00-02		R		700-324			Ø 200,0	
	00-02		R		700-380			Ø 200,0	
2.0 D (CE110) Eng.2CE (53kW)	4/97-2/00		R		153-423			200,0x37	Hand Brake
	4/97-2/00		R		153-433		Sumit.	200,0x38	
	97-00		R		700-324			Ø 200,0	
	97-00		R		700-380			Ø 200,0	
2.0 D-4D Eng.1CDFTV (66kW)	9/00-1/02		R		153-433		Sumit.	200,0x38	
Corolla VII (E12) Verso 1/02-5/04									
1.4 VVT-i Eng.4ZZFE (71kW)	1/02-5/04		R		153-443	153-443K		174,0x32	
1.6 VVT-i Eng.3ZZFE (81kW)	-4/04		R		153-443	153-443K		174,0x32	
	4/04		R		153-453		Bdx	185,0x32	
1.8 16v VVTi Eng.1ZZFE (99kW)	-4/04		R		153-443	153-443K		174,0x32	
	4/04		R		153-453		Bdx	185,0x32	
2.0 D-4D Eng.1CDFTV (66kW)	-4/04		R		153-443	153-443K		174,0x32	
	4/04		R		153-453		Bdx	185,0x32	
Corolla VII (E12), SW 1/02-									
1.4 D-4D Eng.1NDTV (66kW)	1/09-7/04		R		153-517			228,6x37	
	7/04		R		153-446	153-446K		172,0x22	
1.4 VVT-i Eng.4ZZFE (71kW)	1/02-		R		153-446	153-446K		172,0x22	
1.6 Eng.1ZRFAE (97kW)	1/09-		R		153-517			228,6x37	
1.6 VVTi Eng.1ZRFE (91kW)	1/09-		R		153-517			228,6x37	
1.6 VVT-i Eng.3ZZFE (81kW)	04-08		R		153-523			200x32	
	1/02-		R		153-446	153-446K		172,0x22	
	1/09-		R		153-517			228,6x37	
1.8 VVTLi TS Eng.2ZZGE (160-165kW)	09-		R		153-517			228,6x37	Mod. XRS
	09-		R		153-517			228,6x37	Mod. XRS
1.8 VVTLi TS (Exc. SW) Eng.2ZZGE (141kW)	1/02-		R		153-446	153-446K		172,0x22	
2.0 D-4D Eng.1ADFTV (93kW)	1/07-		R		153-446	153-446K		172,0x22	
	1/07-		R		153-443	153-443K		174,0x32	
	1/07-		R		153-517			228,6x37	
2.0 D-4D Eng.1CDFTV (66kW)	1/02-		R		153-446	153-446K		172,0x22	
	1/02-		R		153-443	153-443K		174,0x32	
	1/07-		R		153-517			228,6x37	
2.0 D-4D Eng.1CDFTV (81kW)	1/02-		R		153-446	153-446K		172,0x22	
	1/02-		R		153-443	153-443K		174,0x32	
	1/07-		R		153-517			228,6x37	





		Spare Parts	F/R	L/R	CIFAM ref.	CIFAM ref. w/KIT		DIMENSIONS mm.	NOTE
2.0 D-4D Eng.1CDFTV (85kW)	1/07-		R		153-517			228,6x37	
	5/03-		R		153-446	153-446K		172,0x22	
	5/03-		R		153-443	153-443K		174,0x32	
	03-		R		700-378			Ø 200,0	Rear Drum Brake
Corolla VIII Verso (R1) 4/04-									
1.6 VVT-i Eng.3ZZFE (81kW)	04-		R			153-453K	Bdx	185x32	
	04-		R		153-453	153-453K	Bdx	185,0x32	
1.8 16v VVTi Eng.1ZZFE (95kW)	04-		R		153-453	153-453K	Bdx	185,0x32	
2.0 D-4D Eng.1CDFTV (85kW)	04-		R		153-453	153-453K	Bdx	185,0x32	
2.2 D Eng.2ADFHV (130kW)	10/05-		R		153-453	153-453K	Bdx	185,0x32	
2.2 D-4D Eng.2ADFTV (100kW)	10/05-		R		153-453		Bdx	185,0x32	
Corona 1/61-12/75									
1.5 Eng.2R	72-		R		153-408		Ake	228,6x41	Van, Hand Brake
1.6 Eng.12R (48kW)	73-		R		153-408		Ake	228,6x41	Hand Brake
1.6 Eng.2T (55kW)	73-		R		153-408		Ake	228,6x41	Hand Brake
Corona I (RX, RT) 12/75-1/81									
1.6 GT Eng.2TG (65kW)	1/76-12/84		R		153-408		Ake	228,6x41	Hand Brake
1.8 Eng.16R (77kW)	1/73-12/80		R		153-408		Ake	228,6x41	Hand Brake
1.8 GT Eng.3TG (77kW)	1/78-12/84		R		153-408		Ake	228,6x41	Hand Brake
1.8, LiftB. Eng.3T (63-70kW)	6/79-1/81		R		153-408		Ake	228,6x41	Hand Brake
2.0 GT, XT Eng.18RG (87kW)	1/72-12/82		R		153-408		Ake	228,6x41	Hand Brake
2.0, SW Eng.18R (65-81kW)	12/75-5/79		R		153-408		Ake	228,6x41	Hand Brake
Corona II 1/82-12/92									
1.5 (AT150) Eng.3ALU (61kW)	10/83-11/87		R		153-417		Sumit.	200,0x37	Hand Brake
1.6 Eng.4ALU (55kW)	1/83-3/88		R		153-417		Sumit.	200,0x37	Hand Brake
1.8 (ST140,150,160) Eng.1SEL (74kW)	1/82-12/88		R		153-417		Sumit.	200,0x37	Hand Brake
1.8 (ST163,170,180) Eng.4SF	12/87-9/93		R		153-423			200,0x37	SW, Hand Brake
	12/87-9/93		R		153-417		Sumit.	200,0x37	Hand Brake
2.0 Eng.2S (89kW)	1/82-12/92		R		153-408		Ake	228,6x41	Hand Brake
	1/82-12/92		R		153-417		Sumit.	200,0x37	Hand Brake
	88-		R		153-423			200,0x37	SW, Hand Brake
2.0 Eng.3SFE (90-98kW)	1/86-12/92		R		153-417		Sumit.	200,0x37	Hand Brake
	88-		R		153-423			200,0x37	SW, Hand Brake
2.0 (RT133) Eng.21RU (77kW)	1/82-8/94		R		153-408		Ake	228,6x41	Hand Brake
	88-		R		153-423			200,0x37	SW, Hand Brake
Cressida II (RX3), SW 7/77-7/81									
2.0 Eng.18R (66kW)	7/77-7/81		R		153-408		Ake	228,6x41	Hand Brake
2.6 Eng.4M	1/77-7/81		R		153-408		Ake	228,6x41	Hand Brake
Cressida III (X6), SW 9/80-3/85									
1.8 Eng.1SU	8/82-3/85		R		153-408		Ake	228,6x41	Hand Brake
1.8 Eng.2YPUJE	8/82-3/85		R		153-408		Ake	228,6x41	Hand Brake
2.0 Eng.21R/ 21RC (77kW)	2/81-3/85		R		153-408		Ake	228,6x41	Hand Brake
2.0 Eng.2S (89kW)	1/82-3/85		R		153-408		Ake	228,6x41	Hand Brake
2.0 GLI (Exc. SW) Eng.1GE (80kW)	11/82-12/84		R		153-408		Ake	228,6x41	Hand Brake
2.2 D Eng.L (49kW)	9/80-3/85		R		153-408		Ake	228,6x41	Hand Brake
2.8 Eng.5MGE (125kW)	9/80-3/85		R		153-408		Ake	228,6x41	Hand Brake
Cressida IV (X7), SW 3/85-1/88									
2.4 D Eng.2LT (63-66kW)	3/85-1/88		R		153-408		Ake	228,6x41	Hand Brake
	85-88		R		153-525			167x40	
2.8 Eng.5ME (106kW)	5/85-1/88		R		153-408		Ake	228,6x41	Hand Brake
	85-88		R		153-525			167x40	
Cressida V (X8), SW 1/88-1/93									
2.0 Eng.3YP (65kW)	1/88-1/93		R		153-408		Ake	228,6x41	Hand Brake
Crown I (S1) 1/61-12/94									
2.0 Eng.5R	71-79		R		153-416		Ake	254,0x50	Hand Brake
2.2 Eng.4Y (69kW)	1/88-12/94		R		153-416		Ake	254,0x50	Van, Hand Brake
2.2 D (LS110) Eng.L (49-53kW)	4/80-7/83		R		153-416		Ake	254,0x50	Hand Brake
2.6 Eng.4M (88kW)	9/74-8/79		R		153-416		Ake	254,0x50	Hand Brake
2.8 Eng.5MGE (125kW)	2/84-3/85		R		153-416		Ake	254,0x50	Hand Brake
2.8 SI (MS122/132/133), SW Eng.5ME (107kW)	4/80-12/91		R		153-416		Ake	254,0x50	Hand Brake
Duet 1/98-									
1.0 Eng.EJVE (43kW)	6/00-		R		153-435			180,0x38	
1.3 (81kW)	6/00-		R		153-435			180,0x38	

		Spare Parts	F/R	L/R	CIFAM ref.	CIFAM ref. w/KIT		DIMENSIONS mm.	NOTE
Dyna I 100 8/77-12/89									
1.8 Eng.2Y (58kW)	1/86-12/89		R		153-412		Ake	254,0x58	
2.0 Eng.3Y (79kW)	9/84-8/87		R		153-413		Ake	254,0x58	Hand Brake
2.4 D Eng.2J (55kW)	9/84-8/87		R		153-412		Ake	254,0x58	
	9/84-8/87		R		153-413		Ake	254,0x58	Hand Brake
2.4 D Eng.2L (71kW)	1/86-12/89		R		153-412		Ake	254,0x58	
	1/86-12/89		R		153-413		Ake	254,0x58	Hand Brake
Dyna I 150 8/77-12/89									
1.8 Eng.2Y (58kW)	1/86-12/89		R		153-412		Ake	254,0x58	
2.0 Eng.3Y (79kW)	9/84-8/87		R		153-413		Ake	254,0x58	Hand Brake
2.4 D Eng.2J (55kW)	9/84-8/87		R		153-412		Ake	254,0x58	
	9/84-8/87		R		153-413		Ake	254,0x58	Hand Brake
2.4 D Eng.2L (71kW)	1/86-12/89		R		153-412		Ake	254,0x58	
	1/86-12/89		R		153-413		Ake	254,0x58	Hand Brake
Highlander 1/01-12/06									
2.4 16v, AWD Eng.2AZFE (119kW)	04-		R		153-439	153-439K		190,0x45	Hand Brake
3.0 24v, AWD Eng.1MZFE (164kW)	1/01-12/03		R		153-442	153-442K		170,0x40	Hand Brake
3.3 24v, AWD Eng.3MZFE (172kW)	-03		R		153-442	153-442K		170,0x40	Hand Brake
	04-		R		153-439	153-439K		190,0x45	Hand Brake
iQ (AJ1) 3/09-									
1.0 Eng.1KRFE (50kW)	1/09-		R		153-526			180x28	
1.3 Eng.1NRFE (72-74kW)	1/09-		R		153-526			180x28	
1.4 D-4D Eng.1NDTV (66kW)	1/09-		R		153-526			180x28	
Land Cruiser I (J4), Pick-Up 3/69-4/86									
3.0 D (BJ40V, BJ43) (Exc. Pick-up) Eng.B (59kW)	2/74-10/84		F		153-411		Ake	295,0x78	
	80-84		R		700-325			Ø 295,0	
3.4 D (BJ42V, BJ45_V/P, BJ46) Eng.3B (66kW)	8/80-10/84		F		153-411		Ake	295,0x78	
	8/80-10/84		R		153-440			160,0x35	On Axle
	80-84		R		700-325			Ø 295,0	
3.6 D (HJ45V/P) Eng.H (66kW)	4/79-7/80		R		153-441			210,0x46	
3.9 Eng.F (96kW)	3/69-1/75		F		153-411		Ake	295,0x78	
4.0 D (HJ47V/P) Eng.2H (74-76kW)	8/80-10/84		R		153-440			160,0x35	On Axle
	80-84		R		700-325			Ø 295,0	
4.2 (FJ40V, FJ43, FJ45_V/P, FJ55) Eng.2F (89kW)	1/75-4/86		F		153-411		Ake	295,0x78	
	1/75-4/86		R		153-440			160,0x35	On Axle
	80-86		R		700-325			Ø 295,0	
Land Cruiser II (J6) 10/81-12/89									
3.4 D (BJ60V) Eng.3B (66kW)	10/81-8/87		R		153-440			160,0x35	On Axle
	10/81-8/87		R		153-415		Ake	295,0x60	Van, Hand Brake
	81-87		R		700-124			Ø 254,0	Hardtop
	81-87		R		700-325			Ø 295,0	
4.0 (FJ62G) Eng.3FE (115kW)	8/87-12/89		R		153-440			160,0x35	On Axle
4.0 (FJ62V) Eng.3F (101kW)	11/84-8/87		R		153-440			160,0x35	On Axle
	84-87		R		700-124			Ø 254,0	
4.0 D (HJ60) Eng.2H (74kW)	1/82-12/85		R		153-440			160,0x35	On Axle
	82-85		R		700-325			Ø 295,0	
4.0 D (HJ60) Eng.2H (76kW)	10/81-12/87		R		153-440			160,0x35	On Axle
	81-87		R		700-325			Ø 295,0	
4.0 D (HJ60V) Eng.2H (77kW)	10/81-1/88		R		153-440			160,0x35	On Axle
	81-84		R		700-325			Ø 295,0	
4.0 TD (HJ61V) Eng.12HT (100kW)	85-89		R		700-325			Ø 295,0	
4.2 (FJ60V) Eng.2F (88-100kW)	10/81-1/88		R		153-440			160,0x35	On Axle
	81-88		R		700-325			Ø 295,0	
Land Cruiser III (J7) 11/84-									
2.4 (RJ70, RJ73) Eng.22R (77kW)	11/84-5/93		R		153-440			160,0x35	On Axle
	11/84-5/93		R		153-416		Ake	254,0x50	Incl. Van, Hand Brake
	84-90		R		700-124			Ø 254,0	
2.4 (RJ70, RJ73) Eng.22R (81kW)	11/84-5/93		R		153-440			160,0x35	On Axle
	11/84-5/93		R		153-416		Ake	254,0x50	Hand Brake
	84-90		R		700-124			Ø 254,0	
2.4 (RJ70V, RJ73_V) Eng.22RE (84kW)	12/88-12/96		R		153-440			160,0x35	On Axle
	-93		R		153-416		Ake	254,0x50	Hand Brake
	93-		R		153-441			210,0x46	
2.4 D (LJ70) Eng.2L (53-71kW)	11/84-10/85		R		153-416		Ake	254,0x50	Hand Brake
2.4 TD (LJ70, LJ73) Eng.2LT (63kW)	10/85-5/90		R		153-416		Ake	254,0x50	Hand Brake
	10/85-5/90		R		153-415		Ake	295,0x60	Van, Hand Brake

		Spare Parts	F/R	L/R	CIFAM ref.	CIFAM ref. w/KIT		DIMENSIONS mm.	NOTE
2.4 TD (LJ70,77), Hardtop Eng.2LT (66kW)	1/90-5/93		R		153-440			160,0x35	On Axle
	1/90-5/93		R		153-416		Ake	254,0x50	Hand Brake
	1/90-5/93		R		153-415		Ake	295,0x60	Van, Hand Brake
3.0 TD (KZJ70, 73, 77), Hardtop Eng.1KZT (92kW)	93-96		R		700-108			Ø 295,0	
3.4 D (BJ70V, BJ73) Eng.3B (66-70kW)	-91		R		153-440			160,0x35	On Axle
	84-90		R		700-124			Ø 254,0	Hardtop
	84-90		R		700-325			Ø 295,0	
	90-96		R		700-108			Ø 295,0	
3.4 TD (BJ71V) Eng.13BT (91kW)	85-86		R		700-325			Ø 295,0	
4.0 4WD Eng.3F (101kW)	8/87-12/89		R		153-440			160,0x35	On Axle
4.2 4WD Eng.2F (89kW)	3/84-8/04		R		153-440			160,0x35	On Axle
4.2 TD (HZJ7_V), 4WD Eng.1HZ (96-100kW)	90-		R		700-124			Ø 254,0	
Land Cruiser V 90 (J9) 4/96-									
3.0 D-4D Eng.1KDFTV (120kW)	10/00-		R		153-441			210,0x46	
3.0 TD Eng.1KZTE (103kW)	4/96-		R		153-524			228,6x45	
3.0 TD (KZJ90, KZJ95) Eng.1KZTE (92kW)	4/96-		R		153-441			210,0x46	
	4/96-		R		153-524			228,6x45	
3.4 i 24v (VZJ90, VZJ95) Eng.5VZFE (131kW)	4/96-		R		153-441			210,0x46	
	4/96-		R		153-524			228,6x45	
Land Cruiser VI 100 (J10) 1/98-12/07									
4.2 TD (HDJ100) Eng.1HDFTE (150kW)	1/98-		R		153-524			228,6x45	
4.7 V8 32V (UZJ100) Eng.2UZFE (173kW)	1/98-		R		153-524			228,6x45	
Land Cruiser VII (J12) 9/02-									
2.7 Eng.2TRFE (120kW)	03-8/04		R		153-524			228,6x45	
2.7 Eng.3RZFE (112kW)	9/02-8/04		R		153-524			228,6x45	
3.0 D-4D Eng.1KDFTV (120-122kW)	03-		R		153-524			228,6x45	
	1/03-		R		153-441			210,0x46	
3.0 D-4D Eng.1KDFTV (127kW)	07-		R		153-524			228,6x45	
3.0 D-4D Eng.1KZTE (92kW)	02-		R		153-441			210,0x46	
	9/02-		R		153-524			228,6x45	
4.0 Eng.1GRFE (183kW)	1/03-		R		153-524			228,6x45	
Land Cruiser VIII (J20) 1/08-									
4.5 D-4D Eng.1VDFTV (210kW)	08-		R		153-451			242,0x32	Hand Brake
4.5 D-4D V8 Eng.1VDFTV (195kW)	08-		R		153-451			242,0x32	Hand Brake
4.7 VVTi Eng.2UZFE (212kW)	08-		R		153-451			242,0x32	Hand Brake
Matrix 9/01-2/04									
1.8 VVTi Eng.1ZZFE (91kW)	9/01-2/04		R		153-443	153-443K		174,0x32	
1.8 VVTi Eng.1ZZFE (96kW)	9/01-2/04		R		153-443	153-443K		174,0x32	
Paseo I 4/91-8/95									
1.5 Eng.5EFE (74kW)	4/91-8/95		R		153-425		Sumit.	180,0x28	Usa
Paseo II (EL54) 8/95-7/99									
1.5 (85kW)	8/95-7/99		R		153-425		Sumit.	180,0x28	
1.5 16v, Cabrio Eng.5EFE (66kW)	8/95-7/99		R		153-425		Sumit.	180,0x28	
	95-99		R		700-123			Ø 180,0	
Picnic I (XM10) 5/96-4/01									
2.0 Eng.3SFE (90kW)	1/01-4/01		R		153-423			200,0x37	Hand Brake
	1/01-4/01		R		153-434		Sumit.	228,6x42	
2.0 16v (SXM10) Eng.3SFE (94kW)	5/96-4/01		R		153-417		Sumit.	200,0x37	Hand Brake
2.2 D (CMX10) Eng.3CTE (66kW)	8/97-4/01		R		153-434		Sumit.	228,6x42	
Previa I (TCR1, 2) 5/90-8/00									
2.4, 4WD Eng.2TZFE (97kW)	5/90-8/00		R		153-439	153-439K		190,0x45	Hand Brake
	5/90-8/00		R		153-416		Ake	254,0x50	10,11,20,21TCR, Hand Brake
Previa II (ACR3) 8/00-									
2.0 D-4D Eng.1CDFTV (66-81-85kW)	3/01-		R		153-439	153-439K		190,0x45	Hand Brake
2.4 16v Eng.2AZFE (115kW)	8/00-		R		153-439	153-439K		190,0x45	Hand Brake
Prius I (NHW11) 5/00-1/04									
1.5 Eng.1NZFXE (53kW)	5/00-1/04		R		153-443	153-443K		174,0x32	
	5/00-1/04		R		153-431		Ake	203,0x32	
	00-04		R		700-357			Ø 200,0	
Prius II (NHW20) 1/04-12/08									
1.5 Eng.1NZFXE (57kW)	1/04-12/08		R		153-443	153-443K		174,0x32	
	1/04-12/08		R		153-431		Ake	203,0x32	







		Spare Parts	F/R	L/R	CIFAM ref.	CIFAM ref. w/KIT		DIMENSIONS mm.	NOTE
Rav 4 I (XA1) 6/94-6/00									
2.0 16v, Cabrio Eng.3SFE (90-95-98kW)	6/94-6/00		R		153-429			228,6x42	
Rav 4 II (XA2) 6/00-2/06									
1.8 16v VVTi Eng.1ZZFE (92-95-99-103kW)	2/01-2/06		R		153-439	153-439K		190,0x45	Hand Brake
	2/01-2/06		R		153-437			228,6x42	
	01-05		R		151-208		Ake	Ø 19,05 228,6x42	AKE
2.0 D-4D 4WD Eng.1CDFTV (66-81-85kW)	9/01-2/06		R		153-439	153-439K		190,0x45	Hand Brake
	9/01-2/06		R		153-437			228,6x42	
	01-05		R		151-208		Ake	Ø 19,05 228,6x42	AKE
2.0 VVTi 4WD Eng.1AZFE/ FSE (110kW)	6/00-2/06		R		153-439	153-439K		190,0x45	Hand Brake
	6/00-2/06		R		153-437			228,6x42	
	01-03		R		151-208		Ake	Ø 19,05 228,6x42	AKE
2.4 VVTi 4WD Eng.2AZFE (112kW)	1/03-12/05		R		153-437			228,6x42	
Rav 4 III (XA3) 3/06-									
2.0 Eng.3ZRFAE (116kW)	09-		R		153-450	153-450K		170,0x32	
2.0 VVT-i Eng.1AZFE/ FSE (112kW)	3/06-		R			153-450K		170x32	
2.0 VVTi, 4WD Eng.3ZRFAE (109kW)	09-		R		153-450	153-450K		170,0x32	
2.4 VVTi, 4WD Eng.2AZFE (125kW)	11/05-		R			153-450K		170x32	
3.5 VVTi Eng.2GRFE (201kW)	11/05-		R			153-450K		170x32	
Space Cruiser 1/83-12/88									
2.0 Eng.3Y/ 3YC (65kW)	1/83-12/88		R		153-408		Ake	228,6x41	Model F, Hand Brake
	1/83-12/88		R		153-416		Ake	254,0x50	Model F, Hand Brake
	1/83-12/88		R		153-413		Ake	254,0x58	Hand Brake
Starlet II (P6) 2/78-9/84									
1.0 (KP60), SW Eng.2K (33-43kW)	2/78-9/84		R		153-424			200,0x36	
1.2 S (KP62), SW Eng.3KH (39-41-57kW)	10/78-8/82		R		153-424			200,0x36	
Starlet III (P7) 10/84-12/89									
1.0 (EP70L) Eng.1EL (40kW)	10/84-12/89		R		153-425		Sumit.	180,0x28	
	84-89		R		700-123			Ø 180,0	
1.3 (52kW)	10/84-11/89		R		153-425		Sumit.	180,0x28	
1.3 (EP71L) Eng.2ELC (55-68kW)	10/84-12/89		R		153-425		Sumit.	180,0x28	
	84-89		R		700-123			Ø 180,0	
1.5 D (NP70L) Eng.1N (40kW)	12/86-12/89		R		153-425		Sumit.	180,0x28	
	86-89		R		700-123			Ø 180,0	
Starlet IV (P8) 12/89-3/96									
1.0 (EP80) Eng.1E (40kW)	12/89-12/92		R		153-425		Sumit.	180,0x28	
	89-92		R		700-123			Ø 180,0	
1.3 12v (EP81), Kat Eng.2E/ 2EE (55kW)	12/89-3/96		R		153-425		Sumit.	180,0x28	
	89-96		R		700-123			Ø 180,0	
1.5 D (NP80) Eng.1N (40kW)	12/89-3/96		R		153-425		Sumit.	180,0x28	
Starlet V (P9) 4/96-3/99									
1.3 (EP91) Eng.4EFE (55kW)	96-99		R		700-123			Ø 180,0	
Supra III (JZA80) 5/93-8/98									
3.0 i Bi-T. Eng.2JZGTE (243kW)	5/93-8/98		R		153-439	153-439K		190,0x45	Hand Brake
Tacoma 1/95-									
All models	1/95-		R		153-447			290,0x51	4WD, Hand Brake
	95-		R		700-112			Ø 254,0	
	95-		R		700-121			Ø 295,0	4WD
Tercel I (L1, L2) 3/79-4/86									
1.3 (AL20, AL11) Eng.2A (48kW)	90-		R		700-123			Ø 180,0	
1.5 TD	90-		R		700-123			Ø 180,0	
1.5, 4WD (AL25) Eng.3AC/ LU/ U (52kW)	10/82-4/86		R		153-424			200,0x36	4WD
	10/86-3/88		R		700-113			Ø 200,0	SW, 4WD
	83-88		R		700-115			Ø 200,0	
	90-		R		700-123			Ø 180,0	
Tercel II (L3) 5/86-6/90									
1.5 Eng.3E	5/86-12/89		R		153-419		Sumit.	200,0x37	
Tercel III (L4) 9/90-12/94									
1.5 Eng.3E/ 3EE	9/90-8/92		R		153-425		Sumit.	180,0x28	
1.5 Eng.5EFE	9/90-12/94		R		153-425		Sumit.	180,0x28	
Trueno 8/74-12/80									
1.2 (40kW)	74-80		R		700-126			Ø 200,0	
Tundra 1/02-									
4.0 V6 Eng.1GRFE V6 (174kW)	1/02-		R		153-447			290,0x51	4WD, Hand Brake

		Spare Parts	F/R	L/R	CIFAM ref.	CIFAM ref. w/KIT		DIMENSIONS mm.	NOTE
4.7 V8 Eng.2UZFE V8 (181-200kW)	1/02-		R		153-447			290,0x51	4WD, Hand Brake
Verso 7/09-									
1.6 Eng.1ZRFAE (97kW)	4/09-		R		153-527			185x32	
1.8 Eng.2ZRFAE (108kW)	4/09-		R		153-527			185x32	
2.0 D Eng.1ADFTV (93kW)	4/09-		R		153-527			185x32	
2.2 D-Cat Eng.2ADFHV (130kW)	4/09-		R		153-527			185x32	
2.2 D-Cat Eng.2ADFTV (110kW)	4/09-		R		153-527			185x32	
Yaris I (CP10)/ Vitz 4/99-12/05									
1.0 16v Eng.1SZFE (48kW)	3/03-12/05		R		153-443	153-443K		174,0x32	Made in Japan
	3/03-12/05		R		153-431		Ake	203,0x32	Made in Japan
	3/03-12/05		R		153-438		Bosch	200,0x32	Made in France, Hand Brake
	03-		R		151-182		Bosch	Ø 19,05 200,0x32	RAI, Made in France
1.0 16v Eng.1SZFE (50kW)	4/99-12/05		R		153-443	153-443K		174,0x32	Made in Japan
	4/99-12/05		R		153-436			180,0x27	Made in Japan, Hand Brake
	4/99-12/05		R		153-431		Ake	203,0x32	Made in Japan
	4/99-12/05		R		153-438		Bosch	200,0x32	Made in France, Hand Brake
	99-		R		700-107			Ø 200,0	
	99-		R		700-356			Ø 200,0	Made in France
	1/99-8/99		R		151-203		Ake	Ø 17,46 203,0x32	AKE
8/99-03		R		151-204		Ake	Ø 17,46 203,0x32	AKE	
1.3 Eng.2SZFE (64kW)	4/02-12/05		R		153-443	153-443K		174,0x32	Made in Japan
	4/02-12/05		R		153-438		Bosch	200,0x32	Made in France, Hand Brake
	02-		R		700-107			Ø 200,0	
	02-		R		700-356			Ø 200,0	Made in France
1.3 16v (NCP10) Eng.2NZFE (63kW)	11/99-12/05		R		153-443	153-443K		174,0x32	Made in Japan
	11/99-12/05		R		153-436			180,0x27	Made in Japan, Hand Brake
	11/99-12/05		R		153-431		Ake	203,0x32	Made in Japan
	11/99-12/05		R		153-438		Bosch	200,0x32	Made in France, Hand Brake
	99-		R		700-107			Ø 200,0	
	99-		R		700-356			Ø 200,0	Made in France
	1/99-8/99		R		151-203		Ake	Ø 17,46 203,0x32	AKE
1.4 D-4D Eng.1NDTV (55kW)	12/01-12/05		R		153-443	153-443K		174,0x32	Made in Japan
	12/01-12/05		R		153-436			180,0x27	Made in Japan, Hand Brake
	12/01-12/05		R		153-431		Ake	203,0x32	Made in Japan
	12/01-12/05		R		153-438		Bosch	200,0x32	Made in France, Hand Brake
	01-		R		700-107			Ø 200,0	
	01-03		R		151-204		Ake	Ø 17,46 203,0x32	AKE
1.5 TS (NCP13) Eng.1NZFE (77kW)	1/03-12/05		R		153-443	153-443K		174,0x32	Made in Japan
	1/03-12/05		R		153-431		Ake	203,0x32	Made in Japan
	1/03-12/05		R		153-438		Bosch	200,0x32	Made in France, Hand Brake
1.5 VVT-i TS Eng.1NZFE (110kW)	1/03-12/05		R		153-443	153-443K		174,0x32	Made in Japan
	1/03-12/05		R		153-431		Ake	203,0x32	Made in Japan
	1/03-12/05		R		153-438		Bosch	200,0x32	Made in France, Hand Brake
1.5 VVT-i TS Eng.1NZFE (78kW)	01-		R		153-443	153-443K		174,0x32	Made in Japan
	01-		R		153-436			180,0x27	Made in Japan, Hand Brake
	01-		R		153-431		Ake	203,0x32	Made in Japan
	01-		R		153-438		Bosch	200,0x32	Made in France, Hand Brake
Yaris I (NC/LP2) Verso 11/99-12/05									
1.3 16v (NCP22) Eng.2NZFE (63kW)	11/99-12/05		R		153-443	153-443K		174,0x32	
	11/99-12/05		R		153-431		Ake	203,0x32	
	99-		R		700-379			Ø 200,0	
	99-		R		151-233		Ake	Ø 19,05 203,0x32	AKE
1.4 D-4D Eng.1NDTV (55kW)	12/01-12/05		R		153-443	153-443K		174,0x32	
	12/01-12/05		R		153-431		Ake	203,0x32	
	01-		R		700-379			Ø 200,0	
1.5 (NCP21) Eng.1NZFE (78kW)	12/01-		R		151-233		Ake	Ø 19,05 203,0x32	AKE
	3/00-12/05		R		153-443	153-443K		174,0x32	
	3/00-12/05		R		153-431		Ake	203,0x32	
00-		R		151-233		Ake	Ø 19,05 203,0x32	AKE	
Yaris II (C/SP9) 1/06-									
1.0 VVT-i Eng.1KRFE (51kW)	1/06-		R		153-454		Ap	203,0x38	
1.3 VVT-i Eng.1NRFE (74kW)	09-		R		153-454		Ap	203,0x38	
1.3 VVT-i, 4WD Eng.2SZFE/2NZFE (64kW)	1/06-		R		153-454		Ap	203,0x38	
1.4 D-4D Eng.1NDTV (66kW)	1/06-		R		153-454		Ap	203,0x38	









		Spare Parts	F/R	L/R	CIFAM ref.	CIFAM ref. w/KIT		DIMENSIONS mm.	NOTE
1.8 Eng.2ZRFE (98kW)	11/07-		R		153-454		Ap	203,0x38	
1.8 TS (72kW)	4/07-		R		153-454		Ap	203,0x38	

TOYOTA LCV







Hiace I (H) 2/77-12/84

1.6 Eng.12R (48-49kW)	2/77-12/84		F		153-414		Ake	254,0x50	
	2/77-12/84		R		153-416		Ake	254,0x50	Wagon, Hand Brake
	2/77-12/84		R		153-413		Ake	254,0x58	Bus, Van, Hand Brake
1.8 Eng.16R (77kW)	1/77-12/78		F		153-414		Ake	254,0x50	
	1/77-12/78		R		153-413		Ake	254,0x58	Bus, Van, Hand Brake
2.0 Eng.21R (77kW)	1/78-12/82		F		153-414		Ake	254,0x50	
	1/78-12/82		R		153-413		Ake	254,0x58	Van, Bus, Hand Brake
2.0 (RH25-32) Eng.18R (65-81kW)	7/77-3/83		F		153-414		Ake	254,0x50	
	7/77-3/83		R		153-413		Ake	254,0x58	Van, Bus, Hand Brake
2.2 Eng.20R (81kW)	1/74-12/78		R		153-416		Ake	254,0x50	Wagon, Hand Brake
	1/74-12/78		R		153-413		Ake	254,0x58	Van, Bus, Hand Brake
2.2 D (LH20-30) Eng.L (46kW)	1/79-3/83		F		153-414		Ake	254,0x50	



Hiace II (H5) 3/83-11/89

1.6 Eng.12R (49kW)	3/83-11/89		R		153-413		Ake	254,0x58	Hand Brake
1.8 Eng.2Y (58kW)	3/83-11/89		R		153-413		Ake	254,0x58	Hand Brake
	1/86-87			R		700-121			Ø 295,0
2.0 Eng.3Y/ 3YC (65kW)	1/84-11/89		R		153-416		Ake	254,0x50	Wagon, Hand Brake
	1/84-11/89		R		153-413		Ake	254,0x58	Van, Bus, Hand Brake
	1/86-89		R		700-121			Ø 295,0	
2.2, 4WD Eng.4Y/ 4YEC (69-72kW)	1/87-12/89		R		153-413		Ake	254,0x58	Van, Bus, Hand Brake
2.4 D Eng.2L (71kW)	1/84-12/89		R		153-413		Ake	254,0x58	Hand Brake
2.4 D, 4WD Eng.2L (55kW)	5/84-11/89		R		153-413		Ake	254,0x58	Hand Brake
	1/86-89			R		700-121			Ø 295,0







Hiace III (H10) 8/89-8/95















































2.0 (RZH102) Eng.1RZ (74kW)	8/89-8/95		R		153-428			270,0x55	DX, RWD, 9p
	8/89-8/95		R		153-413		Ake	254,0x58	Van, Bus, Wagon, Hand Brake
	8/89-8/95		R		153-426		Ake	270,0x55	Van, Truck LH100, Hand Brake
	8/89-8/95		R		153-421		Ake	295,0x50	Van, Bus RZH119, Hand Brake
	89-		R		700-128			Ø 270,0	
	89-		R		700-326			Ø 270,0	
	90-94		R		700-125			Ø 254,0	Van
	90-94		R		700-121			Ø 295,0	Van
2.2 Eng.4Y/ 4YEC (72kW)	1/89-12/95		R		153-426		Ake	270,0x55	Hand Brake
2.4 D (LH102), 4WD Eng.2L (55-57-71kW)	8/89-8/95		R		153-428			270,0x55	RWD, 9p
	8/89-8/95		R		153-413		Ake	254,0x58	Hand Brake
	8/89-8/95		R		153-421		Ake	295,0x50	Van, 4WD 61,108,118, Hand Brake
	92-		R		700-125			Ø 254,0	
92-	R		700-121				Ø 295,0		
2.4, 4WD (RZH103) Eng.2RZE (88kW)	89-93		R		700-326			Ø 270,0	HA1
	92-95		R		700-125			Ø 254,0	
	92-95		R		700-121			Ø 295,0	
	94-95		R		700-128			Ø 270,0	HA1































































Hiace IV (H1, H2) 8/95-











2.4 TD, 4WD Eng.2LT (63-66kW)	8/95-		R		153-428			270,0x55	
2.5 D-4D Eng.2KDFTV (65-70-75kW)	11/01-		R		153-452			254,0x52	
2.5 D-4D Eng.2KDFTV (86kW)	8/06-		R		153-452			254,0x52	























































Hilux I (N) 1/72-1/89





























































1.6 Eng.12R (46-48kW)	1/72-1/89		F		153-414		Ake	254,0x50	
	-77		R		153-412		Ake	254,0x58	
	78-		R		153-413		Ake	254,0x58	Hand Brake
1.8 Eng.2Y (58kW)	83-		F		153-414		Ake	254,0x50	
	80-		R		153-413		Ake	254,0x58	Hand Brake
2.0 Eng.3Y/ 3YC (65kW)	78-83		F		153-414		Ake	254,0x50	
	1/72-1/89		R		153-413		Ake	254,0x58	Hand Brake
2.0, 4WD Eng.18R (81kW)	78-83		F		153-414		Ake	254,0x50	
	1/72-12/83		R		153-413		Ake	254,0x58	Hand Brake
2.2 Eng.20R (81kW)	79-		R		153-413		Ake	254,0x58	Hand Brake
2.2 D Eng.L (49kW)	78-83		F		153-414		Ake	254,0x50	
	1/72-1/89		R		153-413		Ake	254,0x58	Hand Brake
	83-		F		153-414		Ake	254,0x50	
2.4 D Eng.2L (57-71kW)	86-8/88		R		153-413		Ake	254,0x58	Hand Brake
	9/88-89		R		153-421		Ake	295,0x50	Hand Brake
			R		153-413		Ake	254,0x58	Hand Brake





































		Spare Parts	F/R	L/R	CIFAM ref.	CIFAM ref. w/KIT		DIMENSIONS mm.	NOTE
Hilux I (N) Pick-Up 1/84-									
1.8 Eng.2Y (58-61kW)	8/88-7/94		R		153-413		Ake	254,0x58	Hand Brake
2.2 4WD Eng.4Y/ 4YEC (69-72kW)	1/87-12/89		R		153-421		Ake	295,0x50	Hand Brake
2.4 4WD Eng.2RZFE (103kW)	8/97-		R		153-421		Ake	295,0x50	Hand Brake
2.4 D, 4WD Eng.2L (58-61kW)	1/94-		R		153-428			270,0x55	RWD
	1/94-		R		153-421		Ake	295,0x50	Hand Brake
2.4 i 4WD Eng.22R (84kW)	6/89-		R		153-416		Ake	254,0x50	Long Bed, Hand Brake
	6/89-		R		153-413		Ake	254,0x58	Cab, Hand Brake
	6/89-		R		153-421		Ake	295,0x50	Hand Brake
2.5 D-4D Eng.2KDFTV (65kW)	11/01-		R		153-413		Ake	254,0x58	Hand Brake
2.5 D-4D 4WD Eng.2KDFTV (75kW)	11/01-		R		153-413		Ake	254,0x58	Hand Brake
Hilux II 1/05-									
2.5 D-4D Eng.2KDFTV (75kW)	8/05-		R		153-445			300,0x62	
2.5 D-4D 4WD Eng.2KDFTV (88kW)	1/05-		R		153-445			300,0x62	
2.7 Eng.2TRFE (118kW)	8/05-		R		153-445			300,0x62	
3.0 D-4D, 4WD Eng.1KDFTV (126kW)	1/05-		R		153-445			300,0x62	
4.0 Eng.1GRFE (175kW)	8/05-		R		153-445			300,0x62	
Liteace I 10/79-1/95									
1.3 Eng.4KC/ 4K (42-43kW)	10/79-10/86		R		153-408		Ake	228,6x41	4WD, Hand Brake
1.5 Eng.5K (51-52-61kW)	10/85-9/91		R		153-408		Ake	228,6x41	Hand Brake
	10/85-9/91		R		153-408		Ake	228,6x41	4WD, Hand Brake
1.8 Eng.2Y (58kW)	10/82-1/92		R		153-408		Ake	228,6x41	9Inch Brake, Hand Brake
	10/82-1/92		R		153-416		Ake	254,0x50	10Inch Brake, Hand Brake
1.8 Eng.3T (70kW)	1/77-12/82		R		153-408		Ake	228,6x41	9Inch Brake, Hand Brake
	1/77-12/82		R		153-416		Ake	254,0x50	10Inch Brake, Hand Brake
1.8 D Eng.1C (41kW)	10/82-9/85		R		153-408		Ake	228,6x41	4WD, Hand Brake
1.8 D Eng.1C (46-48kW)	10/85-8/88		R		153-408		Ake	228,6x41	4WD, Hand Brake
2.0 Eng.3Y/ 3YC (65-79kW)	10/79-1/92		R		153-416		Ake	254,0x50	10Inch Brake, Hand Brake
2.0 D Eng.2C (51-53kW)	1/92-5/94		R		153-416		Ake	254,0x50	Hand Brake
2.2 Eng.4YEC (72kW)	1/92-1/95		R		153-416		Ake	254,0x50	Hand Brake
Modell F (R2, 31) Bus 11/82-1/90									
1.8 (YR20) Eng.2Y/ 2YC (58kW)	11/82-1/90		R		153-408		Ake	228,6x41	Hand Brake
	11/82-1/90		R		153-416		Ake	254,0x50	Hand Brake
2.0 Eng.3Y (66kW)	8/88-1/90		R		153-408		Ake	228,6x41	Hand Brake
	8/88-1/90		R		153-416		Ake	254,0x50	Hand Brake
2.0 Eng.3Y/ 3YC (65kW)	8/84-8/88		R		153-408		Ake	228,6x41	Hand Brake
	8/84-8/88		R		153-416		Ake	254,0x50	Hand Brake
Pick-Up 1/75-									
1 ton	75-		R		700-112			Ø 254,0	
All models	75-		R		700-121			Ø 295,0	Exc. Turbo, 4WD
Pubblica 1/69-12/83									
1.0 Eng.2K (33-43kW)	1/74-12/75		R		153-409		Ake	200,0x36	Hand Brake
Townace 1/70-12/90									
1.6 Eng.2T (55kW)	1/70-12/80		R		153-408		Ake	228,6x41	Hand Brake
1.8 Eng.3T (70kW)	1/77-12/82		R		153-408		Ake	228,6x41	Hand Brake
VAU									
Mega 1/998-									
0.3	1/98-		R		153-054			180,0x32	Fitted Adjuster, Hand Brake
VOLKSWAGEN									
1500,1600 (31, 36), Variant 4/61-7/73									
1.5 Eng.341 (40kW)	63-65		R		700-185			Ø 230,0	
1.5 Eng.K (33kW)	4/61-7/73		F		153-457		Vag	230,0x40	
	8/66-70		R		700-185			Ø 230,0	
1.6 (Exc. SW) Eng.P (37kW)	7/64-7/73		F		153-457		Vag	230,0x40	
	64-73		R		700-185			Ø 230,0	
1.6 L Eng.T/ U (40kW)	65-70		R		700-185			Ø 230,0	
181 9/69-2/79									
1.5 Eng.H (32kW)	9/69-7/70		F		153-457		Vag	230,0x40	
	9/69-7/70		F		153-459		Vag	230,0x40	Hand Brake
1.6 Eng.AG (32kW)	8/70-3/73		F		153-457		Vag	230,0x40	
	8/70-3/73		F		153-459		Vag	230,0x40	Hand Brake
1.6 Eng.AL/ AM (35kW)	3/73-2/79		F		153-457		Vag	230,0x40	
	3/73-2/79		F		153-459		Vag	230,0x40	Hand Brake













































		Spare Parts	F/R	L/R	CIFAM ref.	CIFAM ref. w/KIT		DIMENSIONS mm.	NOTE
Dasher 1/73-1/81									
All models	73-81		R		700-188	700-188K		Ø 200,0	
Derby I (86) 2/77-12/81									
0.9 Eng.HA (29kW)	2/77-12/81		R		153-465		Vag	180,0x31	Hand Brake
	1/77-		R		700-191	700-191K		Ø 180,0	Ch -F127903
	77-81		R		151-028		Bdx	Ø 14,30 180,0x30	VAG
	77-81		R		151-031		Bdx	Ø 17,46 180,0x30	VAG, +CF
1.1 Eng.HB (37kW)	2/77-12/81		R		153-465		Vag	180,0x31	Hand Brake
	77-81		R		700-191	700-191K		Ø 180,0	
	77-81		R		151-028		Bdx	Ø 14,30 180,0x30	VAG
	77-81		R		151-031		Bdx	Ø 17,46 180,0x30	VAG, +CF
1.3 Eng.HH (44kW)	77-81		R		700-191	700-191K		Ø 180,0	
	77-81		R		151-028		Bdx	Ø 14,30 180,0x30	VAG
	77-81		R		151-031		Bdx	Ø 17,46 180,0x30	VAG, +CF
Derby II (86C, 80) 8/81-12/88									
1.0 Eng.GL (29kW)	81-88		R		153-465		Vag	180,0x31	Hand Brake
1.0 Eng.HZ (33kW)	8/81-12/88		R		153-465		Vag	180,0x31	Hand Brake
	81-88		R		700-191	700-191K		Ø 180,0	
	3/85-88		R		151-045		Ate	Ø 15,87 180,0x30	VAG
	81-2/85		R		151-028		Bdx	Ø 14,30 180,0x30	VAG
	81-2/85		R		151-031		Bdx	Ø 17,46 180,0x30	VAG, +CF
1.1 Eng.HB (37kW)	8/81-12/88		R		153-465		Vag	180,0x31	Hand Brake
	81-88		R		700-191	700-191K		Ø 180,0	
	3/85-88		R		151-045		Ate	Ø 15,87 180,0x30	VAG
	81-2/85		R		151-028		Bdx	Ø 14,30 180,0x30	VAG
1.3 Eng.2G/ HK/ HW/ MH (37-40kW)	83-84		R		153-465		Vag	180,0x31	Hand Brake
	82-88		R		153-465		Vag	180,0x31	Hand Brake
	8/81-12/88		R		153-465		Vag	180,0x31	Hand Brake
1.3 Eng.3F/ GK (55kW)	81-88		R		700-191	700-191K		Ø 180,0	
	3/85-88		R		151-045		Ate	Ø 15,87 180,0x30	VAG
	81-2/85		R		151-028		Bdx	Ø 14,30 180,0x30	VAG
	81-2/85		R		151-031		Bdx	Ø 17,46 180,0x30	VAG, +CF
1.3 Eng.HK/ NZ (40kW)	8/83-12/88		R		153-465		Vag	180,0x31	Hand Brake
1.3 D Eng.MN (33kW)	-12/88		R		700-191	700-191K		Ø 180,0	Ch F127904-
	3/85-88		R		151-045		Ate	Ø 15,87 180,0x30	VAG
	82-2/85		R		151-028		Bdx	Ø 14,30 180,0x30	VAG
	82-2/85		R		151-031		Bdx	Ø 17,46 180,0x30	VAG, +CF
Fox 1/87-1/91									
All models	87-91		R		700-191	700-191K		Ø 180,0	Exc. SW
	87-91		R		700-202	700-202K		Ø 200,0	SW
Fox (5Z1) 4/05-									
1.2 Eng.BMD (40kW)	4/05-		R		153-468		Vag	200,0x40	Hand Brake
	05-		R		151-084		Ate	Ø 17,46 200,0x40	VAG, +ABS
1.2 Eng.CHFA (44kW)	10-		R		153-468		Vag	200,0x40	
	10-		R		151-084		Ate	Ø 17,46 200,0x40	VAG, +ABS
1.4 Eng.BKR (55kW)	4/05-		R		153-468		Vag	200,0x40	Hand Brake
	05-		R		151-084		Ate	Ø 17,46 200,0x40	VAG, +ABS
1.4 TDi Eng.BNM (51kW)	4/05-		R		153-468		Vag	200,0x40	Hand Brake
	05-		R		151-084		Ate	Ø 17,46 200,0x40	VAG, +ABS
Golf I (17, 155) 4/74-4/93									
1.1 Eng.FA/ GG (37kW)	4/74-7/83		R		153-465		Vag	180,0x31	Hand Brake
	4/74-10/83		R		700-191	700-191K		Ø 180,0	
	78-12/83		R		151-028		Bdx	Ø 14,30 180,0x30	VAG
1.1 Eng.FJ (38kW)	1/81-12/83		R		153-465		Vag	180,0x31	Hand Brake
	4/81-10/83		R		700-191	700-191K		Ø 180,0	
	81-12/83		R		151-028		Bdx	Ø 14,30 180,0x30	VAG
1.1 Eng.HC (44kW)	1/81-7/83		R		153-465		Vag	180,0x31	Hand Brake
1.3 Eng.GF (44kW)	8/79-7/83		R		153-465		Vag	180,0x31	Hand Brake
	79-83		R		700-191	700-191K		Ø 180,0	
	79-83		R		151-028		Bdx	Ø 14,30 180,0x30	VAG
1.3 Eng.GS (43kW)	8/82-12/83		R		153-465		Vag	180,0x31	Hand Brake
1.3 Eng.HK (40kW)	8/83-7/86		R		153-465		Vag	180,0x31	Hand Brake
1.3 Cabrio Eng.GF (44kW)	2/79-7/86		R		153-465		Vag	180,0x31	Hand Brake
1.5 Eng.FH (51kW)	4/74-12/75		R		153-465		Vag	180,0x31	Hand Brake
	74-75		R		700-191	700-191K		Ø 180,0	
	74-75		R		151-028		Bdx	Ø 14,30 180,0x30	VAG





























































		Spare Parts	F/R	L/R	CIFAM ref.	CIFAM ref. w/KIT		DIMENSIONS mm.	NOTE
1.5 D Eng.CK (37kW)	8/76-7/80		R		153-465		Vag	180,0x31	Hand Brake
	8/76-7/80		R		700-191	700-191K		Ø 180,0	
	78-7/80		R		151-028		Bdx	Ø 14,30 180,0x30	VAG
1.6 Eng.FP (55kW)	8/75-7/77		R		153-465		Vag	180,0x31	Hand Brake
	75-77		R		700-187			Ø 180,0	
	75-77		R		700-191	700-191K		Ø 180,0	
	75-77		R		151-028		Bdx	Ø 14,30 180,0x30	VAG
1.6 Eng.FT/ EWA (51kW)	8/75-7/77		R		153-465		Vag	180,0x31	Hand Brake
1.6 Cabrio Eng.RE (53kW)	4/86-2/90		R		153-465		Vag	180,0x31	Hand Brake
	86-90		R		700-191	700-191K		Ø 180,0	
1.6 D (44kW)	1/82-7/84		R		153-465		Vag	180,0x31	Hand Brake
1.6 D Eng.CR/ JK (40kW)	8/80-7/83		R		153-465		Vag	180,0x31	Hand Brake
	8/80-10/83		R		700-191	700-191K		Ø 180,0	
	8/80-10/83		R		151-028		Bdx	Ø 14,30 180,0x30	VAG
1.6 TD Eng.CY (51kW)	3/82-7/83		R		153-465		Vag	180,0x31	Hand Brake
	82-83		R		700-191	700-191K		Ø 180,0	
	82-83		R		151-028		Bdx	Ø 14,30 180,0x30	VAG
1.6, Cabrio Eng.EW/ HN (55kW)	8/83-4/92		R		153-465		Vag	180,0x31	Hand Brake
	83-92		R		700-191	700-191K		Ø 180,0	
1.6, Cabrio, GTi Eng.EG (81kW)	8/76-7/82		R		153-465		Vag	180,0x31	Hand Brake
1.8 Cabrio Eng.2H (72kW)	8/89-3/93		R		153-465		Vag	180,0x31	Hand Brake
	89-93		R		700-191	700-191K		Ø 180,0	
1.8 Cabrio Eng.EX (66kW)	8/83-9/92		R		153-465		Vag	180,0x31	Hand Brake
	83-92		R		700-191	700-191K		Ø 180,0	
	83-92		R		151-028		Bdx	Ø 14,30 180,0x30	VAG
1.8 Cabrio Eng.JH (70kW)	8/83-4/93		R		153-465		Vag	180,0x31	Hand Brake
	83-93		R		700-191	700-191K		Ø 180,0	
1.8 GTi Eng.DX/ EV/ PB (82kW)	8/82-12/89		R		153-465		Vag	180,0x31	Hand Brake
	82-89		R		151-031		Bdx	Ø 17,46 180,0x30	VAG
1.8 GTi Cabrio Eng.DX/ EV/ PB (82kW)	8/82-12/89		R		153-465		Vag	180,0x31	Hand Brake
	82-89		R		151-031		Bdx	Ø 17,46 180,0x30	VAG
Golf II (19E, 1G1) 8/83-12/92									
1.0 Eng.GN (33kW)	11/83-8/85		R		153-465		Vag	180,0x31	Hand Brake
	83-85		R		700-191	700-191K		Ø 180,0	
	83-85		R		151-028		Bdx	Ø 14,30 180,0x30	VAG
1.0 Eng.HZ (37kW)	8/85-10/91		R		153-465		Vag	180,0x31	Hand Brake
	85-91		R		700-191	700-191K		Ø 180,0	
	85-91		R		151-028		Bdx	Ø 14,30 180,0x30	VAG
1.3 Eng.GT (44kW)	8/83-10/86		R		153-465		Vag	180,0x31	Hand Brake
	83-86		R		700-191	700-191K		Ø 180,0	
	83-86		R		151-028		Bdx	Ø 14,30 180,0x30	VAG
1.3 Eng.NU (37kW)	8/85-12/87		R		153-465		Vag	180,0x31	Hand Brake
	85-87		R		700-191	700-191K		Ø 180,0	
	85-87		R		151-028		Bdx	Ø 14,30 180,0x30	VAG
1.3, Kat Eng.2G/ HK/ MH/ NZ (40kW)	8/83-12/92		R		153-465		Vag	180,0x31	Hand Brake
	8/83-92		R		700-191	700-191K		Ø 180,0	
	8/83-91		R		151-028		Bdx	Ø 14,30 180,0x30	VAG
1.6 Eng.EZ/ HM (55kW)	8/83-8/91		R		153-465		Vag	180,0x31	Hand Brake
	8/83-91		R		700-191	700-191K		Ø 180,0	
	8/83-91		R		151-028		Bdx	Ø 14,30 180,0x30	VAG
1.6 Eng.PN/ EZA (51kW)	10/86-12/92		R		153-465		Vag	180,0x31	Hand Brake
	86-92		R		700-191	700-191K		Ø 180,0	
	86-92		R		151-028		Bdx	Ø 14,30 180,0x30	VAG
1.6 Eng.RF(KAT) (53kW)	2/86-10/91		R		153-465		Vag	180,0x31	Hand Brake
	86-91		R		700-191	700-191K		Ø 180,0	
	86-91		R		151-028		Bdx	Ø 14,30 180,0x30	VAG
1.6 D Eng.CS (37kW)	8/83-10/91		R		153-465		Vag	180,0x31	Hand Brake
	83-91		R		700-191	700-191K		Ø 180,0	
	83-91		R		151-028		Bdx	Ø 14,30 180,0x30	VAG
1.6 D Eng.JP/ ME (40kW)	8/83-10/91		R		153-465		Vag	180,0x31	Hand Brake
	83-91		R		700-191	700-191K		Ø 180,0	
	83-91		R		151-028		Bdx	Ø 14,30 180,0x30	VAG
1.6 TD Eng.1V (44kW)	8/89-10/91		R		153-465		Vag	180,0x31	Hand Brake
	90-		R		153-462		Vag	200,0x40	Hand Brake
1.6 TD Eng.JR/ MF (51kW)	8/83-10/91		R		153-465		Vag	180,0x31	Hand Brake
	90-		R		153-462		Vag	200,0x40	Hand Brake
	8/83-92		R			700-191K		Ø 180,0	
	83-91		R		700-191			Ø 180,0	





























































		Spare Parts	F/R	L/R	CIFAM ref.	CIFAM ref. w/KIT		DIMENSIONS mm.	NOTE
1.6 TD Eng.JR/ MF (51kW)	83-91		R		151-031		Bdx	Ø 17,46 180,0x30	VAG
1.6 TD Eng.RA/ SB (59kW)	4/89-10/91		R		153-465		Vag	180,0x31	Hand Brake
	90-		R		153-462		Vag	200,0x40	Hand Brake
1.8 Eng.HV/ GU/ GX (66kW)	2/86-7/91		R		153-465		Vag	180,0x31	Hand Brake
	86-91		R		700-191	700-191K		Ø 180,0	
	86-91		R		151-031		Bdx	Ø 17,46 180,0x30	VAG
1.8 Eng.RH (62kW)	8/86-1/90		R		153-465		Vag	180,0x31	Hand Brake
	86-90		R		700-191	700-191K		Ø 180,0	
	86-90		R		151-031		Bdx	Ø 17,46 180,0x30	VAG
1.8 16v Eng.KR (102kW)	2/86-6/90		R		153-465		Vag	180,0x31	Hand Brake
1.8 16v GTi Eng.PL (95kW)	2/86-10/91		R		153-465		Vag	180,0x31	Hand Brake
1.8 G60, Syncro Eng.1H/ PG (118kW)	8/88-7/91		R		153-465		Vag	180,0x31	Hand Brake
	8/88-7/91		R		153-008		Vag	230,0x40	Hand Brake
1.8 GTI Eng.DX/ EV/ GZ/ PB (82kW)	8/83-10/91		R		153-465		Vag	180,0x31	Hand Brake
	83-91		R		700-191	700-191K		Ø 180,0	
1.8 GTI Eng.HT (77kW)	1/85-7/85		R		153-465		Vag	180,0x31	Hand Brake
	1/85-7/85		R		153-008		Vag	230,0x40	Hand Brake
1.8 GTI, Kat Eng.PF/ RD (79kW)	8/85-10/91		R		153-465		Vag	180,0x31	Hand Brake
	85-91		R		700-191	700-191K		Ø 180,0	
1.8 Syncro Eng.1P (72kW)	8/88-7/91		R		153-465		Vag	180,0x31	Hand Brake
	8/88-7/91		R		153-008		Vag	230,0x40	Hand Brake
	88-91		R		700-214			Ø 230,0	
1.8 Syncro Eng.GU/ GX (66kW)	2/86-7/91		R		153-465		Vag	180,0x31	Hand Brake
	2/86-7/91		R		153-008		Vag	230,0x40	Hand Brake
	86-91		R		700-214			Ø 230,0	
1.8, Syncro Eng.RP (66kW)	1/87-12/91		R		153-465		Vag	180,0x31	Hand Brake
	1/87-12/91		R		153-008		Vag	230,0x40	Hand Brake
	86-91		R		700-191	700-191K		Ø 180,0	
	86-91		R		151-031		Bdx	Ø 17,46 180,0x30	VAG
Golf III (1H1) 10/91-4/99									
1.4 Eng.ABD (40kW)	11/91-4/99		R		153-468		Vag	200,0x40	Hand Brake
	91-99		R		700-202	700-202K		Ø 200,0	
	91-99		R		151-084		Ate	Ø 17,46 200,0x40	VAG, +ABS
	91-99		R		151-086		Vag	Ø 15,87 200,0x40	VAG
	91-99		R		151-235		Vag	Ø 15,87 200,0x40	VAG
1.4 Eng.AEX/ APQ (44kW)	10/91-4/99		R		153-468		Vag	200,0x40	Hand Brake
	91-99		R		700-202	700-202K		Ø 200,0	
	91-99		R		151-084		Ate	Ø 17,46 200,0x40	VAG, +ABS
	91-99		R		151-086		Vag	Ø 15,87 200,0x40	VAG
1.6 Eng.ABU (55kW)	9/92-8/97		R		153-468		Vag	200,0x40	Hand Brake
	11/91-97		R		700-202	700-202K		Ø 200,0	
	92-97		R		151-084		Ate	Ø 17,46 200,0x40	VAG, +ABS
1.6 Eng.AEA/ AEE (55kW)	9/92-8/97		R		153-468		Vag	Ø 15,87 200,0x40	VAG
	11/91-97		R		700-202	700-202K		Ø 200,0	
	92-97		R		151-084		Ate	Ø 17,46 200,0x40	VAG, +ABS
1.6 GT (66kW)	9/92-8/97		R		151-086		Vag	Ø 15,87 200,0x40	VAG
	11/91-4/99		R		153-468		Vag	200,0x40	Hand Brake
	91-99		R		700-202	700-202K		Ø 200,0	
1.6, Cabrio Eng.AEK/ AFT/ AKS (74kW)	11/91-4/99		R		151-084		Ate	Ø 17,46 200,0x40	VAG, +ABS
	94-99		R		153-468		Vag	200,0x40	Hand Brake
	94-99		R		700-202	700-202K		Ø 200,0	
1.8 Eng.AAM (55kW)	94-99		R		151-086		Vag	Ø 15,87 200,0x40	VAG
	11/91-4/99		R		153-468		Vag	200,0x40	Hand Brake
	11/91-4/99		R		153-009		Vag	230,0x40	Country, Hand Brake
	91-99		R		700-202	700-202K		Ø 200,0	
	91-99		R		151-084		Ate	Ø 17,46 200,0x40	VAG, +ABS
1.8 Eng.ABS/ ADZ (66kW)	91-99		R		151-086		Vag	Ø 15,87 200,0x40	VAG
	91-99		R		151-235		Vag	Ø 15,87 200,0x40	VAG, A/T
	11/91-4/99		R		153-468		Vag	200,0x40	Hand Brake
	11/91-4/99		R		153-009		Vag	230,0x40	Country, Hand Brake
	91-99		R		700-202	700-202K		Ø 200,0	
	91-99		R		151-084		Ate	Ø 17,46 200,0x40	VAG, +ABS
1.8 Eng.ABS/ ADZ (66kW)	91-99		R		151-086		Vag	Ø 15,87 200,0x40	VAG
	91-99		R		151-235		Vag	Ø 15,87 200,0x40	VAG, A/T
	91-99		R		151-086		Vag	Ø 15,87 200,0x40	VAG
	91-		R		151-235		Vag	Ø 15,87 200,0x40	VAG, A/T



































































		Spare Parts	F/R	L/R	CIFAM ref.	CIFAM ref. w/KIT		DIMENSIONS mm.	NOTE
1.8 Cabrio Eng.AAM (55kW)	11/91-4/99		R		153-468		Vag	200,0x40	Hand Brake
	11/91-4/99		R		153-009		Vag	230,0x40	Country, Hand Brake
	91-99		R		700-202	700-202K		Ø 200,0	
	91-99		R		151-084		Ate	Ø 17,46 200,0x40	VAG, +ABS
	91-99		R		151-086		Vag	Ø 15,87 200,0x40	VAG
	91-		R		151-235		Vag	Ø 15,87 200,0x40	VAG, A/T
1.8 Cabrio Eng.ABS/ ADZ (66kW)	11/91-4/99		R		153-468		Vag	200,0x40	Hand Brake
	11/91-4/99		R		153-009		Vag	230,0x40	Country, Hand Brake
	91-99		R		700-202	700-202K		Ø 200,0	
	91-99		R		151-084		Ate	Ø 17,46 200,0x40	VAG, +ABS
	91-99		R		151-086		Vag	Ø 15,87 200,0x40	VAG
	91-		R		151-235		Vag	Ø 15,87 200,0x40	VAG, A/T
1.8 GT Eng.ABS/ ACC/ ADZ (66kW)	11/91-4/99		R		153-468		Vag	200,0x40	Hand Brake
	11/91-4/99		R		153-009		Vag	230,0x40	Country, Hand Brake
	91-99		R		700-202	700-202K		Ø 200,0	
	91-99		R		151-084		Ate	Ø 17,46 200,0x40	VAG, +ABS
	91-99		R		151-086		Vag	Ø 15,87 200,0x40	VAG
	91-		R		151-235		Vag	Ø 15,87 200,0x40	VAG, A/T
1.8 Syncro Eng.ADZ (66kW)	11/91-4/99		R		153-468		Vag	200,0x40	Hand Brake
	11/91-4/99		R		153-009		Vag	230,0x40	Country, Hand Brake
	91-99		R		151-084		Ate	Ø 17,46 200,0x40	VAG, +ABS
1.9 D Eng.1Y (48kW)	11/91-4/99		R		153-468		Vag	200,0x40	Hand Brake
	91-99		R		700-202	700-202K		Ø 200,0	
	91-99		R		151-084		Ate	Ø 17,46 200,0x40	VAG, +ABS
1.9 SDi Eng.AEY (47kW)	4/97-4/99		R		153-468		Vag	200,0x40	Hand Brake
	97-99		R		700-202	700-202K		Ø 200,0	
	97-99		R		151-084		Ate	Ø 17,46 200,0x40	VAG, +ABS
	97-99		R		151-086		Vag	Ø 15,87 200,0x40	VAG
1.9 TD Eng.AAZ (55kW)	11/91-4/99		R		153-468		Vag	200,0x40	Hand Brake
	91-99		R		700-202	700-202K		Ø 200,0	
	91-99		R		151-084		Ate	Ø 17,46 200,0x40	VAG, +ABS
	91-99		R		151-086		Vag	Ø 15,87 200,0x40	VAG
	91-		R		151-235		Vag	Ø 15,87 200,0x40	VAG
1.9 TDi Eng.1Z (66kW)	9/93-4/99		R		153-468		Vag	200,0x40	Hand Brake
	93-99		R		700-202	700-202K		Ø 200,0	
	93-99		R		151-084		Ate	Ø 17,46 200,0x40	VAG, +ABS
1.9 TDi Eng.AFN (81kW)	4/96-4/99		R		153-468		Vag	200,0x40	Hand Brake
1.9 TDi Eng.AHU/ ALE (66kW)	9/93-4/99		R		153-468		Vag	200,0x40	Hand Brake
	93-99		R		700-202	700-202K		Ø 200,0	
	93-99		R		151-084		Ate	Ø 17,46 200,0x40	VAG, +ABS
1.9 TDi Cabrio Eng.1Z (66kW)	9/93-4/99		R		153-468		Vag	200,0x40	Hand Brake
	93-99		R		700-202	700-202K		Ø 200,0	
	93-99		R		151-084		Ate	Ø 17,46 200,0x40	VAG, +ABS
1.9 TDi Cabrio Eng.AFN (81kW)	4/96-4/99		R		153-468		Vag	200,0x40	Hand Brake
1.9 TDi Cabrio Eng.AHU/ ALE (66kW)	9/93-4/99		R		153-468		Vag	200,0x40	Hand Brake
	93-99		R		700-202	700-202K		Ø 200,0	
	93-99		R		151-084		Ate	Ø 17,46 200,0x40	VAG, +ABS
1.9 TDi Syncro Eng.1Z (66kW)	9/93-4/99		R		153-468		Vag	200,0x40	Hand Brake
	93-99		R		700-202	700-202K		Ø 200,0	
	93-99		R		151-084		Ate	Ø 17,46 200,0x40	VAG, +ABS
1.9 TDi Syncro Eng.AHU/ ALE (66kW)	9/93-4/99		R		153-468		Vag	200,0x40	Hand Brake
	93-99		R		700-202	700-202K		Ø 200,0	
	93-99		R		151-084		Ate	Ø 17,46 200,0x40	VAG, +ABS
2.0 Eng.2E (85kW)	11/91-4/99		R		153-468		Vag	200,0x40	Hand Brake
	91-		R		700-202	700-202K		Ø 200,0	Ch -1SK016363
	91-99		R		151-084		Ate	Ø 17,46 200,0x40	VAG, +ABS
2.0 Eng.ADY/ AGG/ AKR (85kW)	11/91-4/99		R		153-468		Vag	200,0x40	Hand Brake
	91-		R		700-202	700-202K		Ø 200,0	Ch -1SK016363
	91-99		R		151-084		Ate	Ø 17,46 200,0x40	VAG, +ABS
2.0 Cabrio Eng.2E (85kW)	11/91-4/99		R		153-468		Vag	200,0x40	Hand Brake
	91-		R		700-202	700-202K		Ø 200,0	
	91-99		R		151-084		Ate	Ø 17,46 200,0x40	VAG, +ABS
2.0 Cabrio Eng.ADY/ AGG/ AKR (85kW)	11/91-4/99		R		153-468		Vag	200,0x40	Hand Brake
	91-		R		700-202	700-202K		Ø 200,0	
	91-99		R		151-084		Ate	Ø 17,46 200,0x40	VAG, +ABS
2.0 GTi 16v Eng.ABF (110kW)	8/92-8/97		R		153-468		Vag	200,0x40	Hand Brake
	92-97		R		151-084		Ate	Ø 17,46 200,0x40	VAG, +ABS







































































		Spare Parts	F/R	L/R	CIFAM ref.	CIFAM ref. w/KIT		DIMENSIONS mm.	NOTE
2.0 Syncro Eng.2E (85kW)	11/91-4/99		R		153-468		Vag	200,0x40	Hand Brake
	91-		R		700-202	700-202K		Ø 200,0	Ch -1SK016363
	91-99		R		151-084		Ate	Ø 17,46 200,0x40	VAG, +ABS
2.0 Syncro Eng.ADY/ AGG/ AKR (85kW)	11/91-4/99		R		153-468		Vag	200,0x40	Hand Brake
	91-		R		700-202	700-202K		Ø 200,0	Ch -1SK016363
	91-99		R		151-084		Ate	Ø 17,46 200,0x40	VAG, +ABS
2.8 VR6 Eng.AAA (128kW)	92-97		R		151-084		Ate	Ø 17,46 200,0x40	VAG, +ABS
2.9 VR6 Eng.ABV (140kW)	94-99		R		151-084		Ate	Ø 17,46 200,0x40	VAG, +ABS
2.9 VR6 Syncro Eng.ABV (140kW)	94-99		R		151-084		Ate	Ø 17,46 200,0x40	VAG, +ABS
Golf III (1H5) Variant 10/91-4/99									
1.4 Eng.ABD (40kW)	11/91-4/99		R		153-468		Vag	200,0x40	Hand Brake
	91-		R		700-202	700-202K		Ø 200,0	
	91-		R		151-085		Ate	Ø 19,05 200,0x40	VAG
1.4 Eng.AEX/ APQ (44kW)	10/91-4/99		R		153-468		Vag	200,0x40	Hand Brake
	91-		R		700-202	700-202K		Ø 200,0	
	91-		R		151-085		Ate	Ø 19,05 200,0x40	VAG
1.6 Eng.ABU (55kW)	9/92-8/97		R		153-468		Vag	200,0x40	Hand Brake
	7/94-97		R		700-202	700-202K		Ø 200,0	
	93-		R		151-085		Ate	Ø 19,05 200,0x40	VAG
1.6 Eng.AEA/ AEE (55kW)	9/92-8/97		R		153-468		Vag	200,0x40	Hand Brake
	7/94-97		R		700-202	700-202K		Ø 200,0	
	93-		R		151-085		Ate	Ø 19,05 200,0x40	VAG
1.6 Eng.AEK/ AFT/ AKS (74kW)	10/94-4/99		R		153-468		Vag	200,0x40	Hand Brake
	94-99		R		700-202	700-202K		Ø 200,0	
1.8 Eng.AAM (55kW)	11/91-4/99		R		153-468		Vag	200,0x40	Hand Brake
	91-99		R		700-202	700-202K		Ø 200,0	
	91-99		R		151-085		Ate	Ø 19,05 200,0x40	VAG
1.8 Eng.ABS/ ADZ (66kW)	11/91-4/99		R		153-468		Vag	200,0x40	Hand Brake
	91-99		R		700-202	700-202K		Ø 200,0	
	91-99		R		151-085		Ate	Ø 19,05 200,0x40	VAG
1.8 Syncro Eng.ABS/ ADZ (66kW)	11/91-4/99		R		153-468		Vag	200,0x40	Hand Brake
	-99		R		700-214			Ø 230,0	Ch 1S400001-, 4WD
	91-99		R		151-085		Ate	Ø 19,05 200,0x40	VAG
1.9 D Eng.1Y (48kW)	11/91-4/99		R		153-468		Vag	200,0x40	Hand Brake
	91-99		R		700-202	700-202K		Ø 200,0	
1.9 SDi Eng.AEY (47kW)	4/97-4/99		R		153-468		Vag	200,0x40	Hand Brake
	97-99		R		700-202	700-202K		Ø 200,0	
	97-99		R		151-085		Ate	Ø 19,05 200,0x40	VAG
1.9 TD Eng.AAZ (55kW)	11/91-4/99		R		153-468		Vag	200,0x40	Hand Brake
	91-99		R		700-202	700-202K		Ø 200,0	
	91-99		R		151-085		Ate	Ø 19,05 200,0x40	VAG
1.9 TDi Eng.1Z (66kW)	9/93-4/99		R		153-468		Vag	200,0x40	Hand Brake
	93-99		R		700-202	700-202K		Ø 200,0	
	93-99		R		151-085		Ate	Ø 19,05 200,0x40	VAG
1.9 TDi Eng.AFN (81kW)	4/96-4/99		R		153-468		Vag	200,0x40	Hand Brake
	93-99		R		153-468		Vag	200,0x40	Hand Brake
1.9 TDi Eng.AHU/ ALE (66kW)	9/93-4/99		R		153-468		Vag	200,0x40	Hand Brake
	93-99		R		700-202	700-202K		Ø 200,0	
	93-99		R		151-085		Ate	Ø 19,05 200,0x40	VAG
1.9 TDi Syncro Eng.1Z (66kW)	9/93-4/99		R		153-468		Vag	200,0x40	Hand Brake
	93-99		R		700-214			Ø 230,0	4WD
	93-99		R		151-085		Ate	Ø 19,05 200,0x40	VAG
1.9 TDi Syncro Eng.AHU/ ALE (66kW)	9/93-4/99		R		153-468		Vag	200,0x40	Hand Brake
	93-99		R		700-214			Ø 230,0	4WD
	93-99		R		151-085		Ate	Ø 19,05 200,0x40	VAG
2.0 Eng.2E (85kW)	11/91-4/99		R		153-468		Vag	200,0x40	Hand Brake
	91-99		R		700-202	700-202K		Ø 200,0	
	91-99		R		151-085		Ate	Ø 19,05 200,0x40	VAG
2.0 Eng.ADY/ AGG/ AKR (85kW)	11/91-4/99		R		153-468		Vag	200,0x40	Hand Brake
	91-99		R		700-202	700-202K		Ø 200,0	
	91-99		R		151-085		Ate	Ø 19,05 200,0x40	VAG
2.0 Syncro Eng.2E (85kW)	11/91-4/99		R		153-468		Vag	200,0x40	Hand Brake
	91-99		R		700-214			Ø 230,0	4WD
	91-99		R		151-085		Ate	Ø 19,05 200,0x40	VAG
2.0 Syncro Eng.ADY/ AGG/ AKR (85kW)	11/91-4/99		R		153-468		Vag	200,0x40	Hand Brake
	91-99		R		700-214			Ø 230,0	4WD
	91-99		R		151-085		Ate	Ø 19,05 200,0x40	VAG



































































		Spare Parts	F/R	L/R	CIFAM ref.	CIFAM ref. w/KIT		DIMENSIONS mm.	NOTE
Golf IV (1J1, 5), Variant 8/97-9/03									
1.4 16v Eng.AHW/ AKQ/ APE/ AXP/ BCA (55kW)	8/97-9/03		R		153-468		Vag	200,0x40	Hand Brake
1.6 Eng.AEH/ AKL/ APF (74kW)	8/97-2/00		R		153-468		Vag	200,0x40	Hand Brake
1.6 Eng.AVU/ BFQ (75kW)	8/00-9/03		R		153-468		Vag	200,0x40	Hand Brake
1.6 16v Eng.ATN/ AUS/ AZD/ BCB (77kW)	2/00-9/03		R		153-468		Vag	200,0x40	Hand Brake
1.6 16v Eng.AWB (78kW)	1/00-9/03		R		153-468		Vag	200,0x40	Hand Brake
1.6 Cabrio Eng.AFT/ AKS (74kW)	8/97-2/00		R		153-468		Vag	200,0x40	Hand Brake
1.6 FSI Eng.BAG (81kW)	1/02-9/03		R		153-468		Vag	200,0x40	Hand Brake
1.6 FSI Eng.BAD (85kW)	10/03-7/04		R		153-468		Vag	200,0x40	Hand Brake
1.9 SDi Eng.AGP/ AQM (50kW)	8/97-9/03		R		153-468		Vag	200,0x40	Hand Brake
1.9 TD Eng.AAZ (55kW)	10/97-9/99		R		153-468		Vag	200,0x40	Hand Brake
1.9 TDi Eng.AFN/ AHF/ ASV/ AVG (81kW)	8/97-6/01		R		153-468		Vag	200,0x40	Hand Brake
1.9 TDi Cabrio Eng.AFN/ AHF/ ASV/ AVG (81kW)	8/97-6/01		R		153-468		Vag	200,0x40	Hand Brake
1.9 TDi Cabrio Eng.AGR/ AHU/ ALH/ ALE (66kW)	4/98-6/01		R		153-468		Vag	200,0x40	Hand Brake
1.9 TDi, 4motion Eng.AGR/ AHU/ ALH/ ALE (66kW)	4/98-6/01		R		153-468		Vag	200,0x40	Hand Brake
1.9 TDi, 4motion Eng.AJM/ AUJ (85kW)	12/98-6/01		R		153-468		Vag	200,0x40	Hand Brake
1.9 TDi, 4motion Eng.ASZ (96kW)	11/00-9/03		R		153-468		Vag	200,0x40	Hand Brake
1.9 TDi, 4motion Eng.ATD/ AXR (74kW)	9/00-9/03		R		153-468		Vag	200,0x40	Hand Brake
1.9 TDi, 4motion (Exc. SW) Eng.ARL (110kW)	2/00-9/03		R		153-468		Vag	200,0x40	Hand Brake
2.0 (Exc. SW) Eng.APK/ AQY/ AZG/ AZJ (85kW)	7/98-9/03		R		153-468		Vag	200,0x40	Hand Brake
2.0 4motion Eng.AZH/ AZJ (85kW)	10/00-9/03		R		153-468		Vag	200,0x40	Hand Brake
2.0 Cabrio (Exc. SW) Eng.AGG/ AKR/ ATU/ AWF/ AWG (85kW)	6/98-9/03		R		153-468		Vag	200,0x40	Hand Brake
Ittis (183) 3/79-12/88									
1.6 TD Eng.1C (51kW)	8/87-12/88		R		153-459		Vag	230,0x40	Hand Brake
1.7 Eng.WL/ YX (55kW)	3/79-12/88		R		153-459		Vag	230,0x40	Hand Brake
Jetta I (17) 8/79-12/83									
1.1 Eng.FA/ GG (37kW)	79-83		R		700-191	700-191K		Ø 180,0	
	79-83		R		151-028		Bdx	Ø 14,30 180,0x30	VAG
1.3 Eng.GF (44kW)	79-83		R		700-191	700-191K		Ø 180,0	
	79-83		R		151-028		Bdx	Ø 14,30 180,0x30	VAG
1.5 Eng.JB (51kW)	79-83		R		700-191	700-191K		Ø 180,0	
	79-83		R		151-028		Bdx	Ø 14,30 180,0x30	VAG
1.6 Eng.EG (81kW)	79-82		R		700-191	700-191K		Ø 180,0	
	79-82		R		151-031		Bdx	Ø 17,46 180,0x30	VAG
1.6 Eng.FR (63kW)	80-83		R		700-191	700-191K		Ø 180,0	
	80-83		R		151-028		Bdx	Ø 14,30 180,0x30	VAG
1.6 D Eng.CR/ JK (40kW)	80-83		R		700-191	700-191K		Ø 180,0	
	80-83		R		151-028		Bdx	Ø 14,30 180,0x30	VAG
1.6 TD Eng.CY (51kW)	82-83		R		700-191	700-191K		Ø 180,0	
	82-83		R		151-028		Bdx	Ø 14,30 180,0x30	VAG, Exc. GLi
	82-83		R		151-031		Bdx	Ø 17,46 180,0x30	VAG, GLi
1.8 Eng.DX (82kW)	82-83		R		700-191	700-191K		Ø 180,0	
	82-83		R		151-028		Bdx	Ø 14,30 180,0x30	VAG, M/T
	82-83		R		151-031		Bdx	Ø 17,46 180,0x30	VAG, A/T
Jetta II (19E, 1G2) 1/84-12/91									
1.0 Eng.HZ (33-37kW)	84-91		R		700-191	700-191K		Ø 180,0	
1.3 Eng.GT (44kW)	84-86		R		700-191	700-191K		Ø 180,0	
	84-86		R		151-028		Bdx	Ø 14,30 180,0x30	VAG
1.3, Kat Eng.2G/ HK/ MH/ NZ (40kW)	84-91		R		700-191	700-191K		Ø 180,0	
	84-91		R		151-028		Bdx	Ø 14,30 180,0x30	VAG
1.6 Eng.EZ/ HM (55kW)	84-91		R		700-191	700-191K		Ø 180,0	
	84-91		R		151-028		Bdx	Ø 14,30 180,0x30	VAG
1.6 Eng.PN (51kW)	86-91		R		700-191	700-191K		Ø 180,0	
	86-91		R		151-028		Bdx	Ø 14,30 180,0x30	VAG
1.6 Eng.RF(KAT) (53kW)	86-91		R		700-191	700-191K		Ø 180,0	
	86-91		R		151-028		Bdx	Ø 14,30 180,0x30	VAG
1.6 D Eng.JP/ ME (40kW)	84-91		R		700-191	700-191K		Ø 180,0	
	84-91		R		151-028		Bdx	Ø 14,30 180,0x30	VAG





































		Spare Parts	F/R	L/R	CIFAM ref.	CIFAM ref. w/KIT		DIMENSIONS mm.	NOTE
1.6 TD Eng.JR/ MF (51kW)	84-91		R		700-191	700-191K		Ø 180,0	
	84-91		R		151-031		Bdx	Ø 17,46 180,0x30	VAG, CLi
1.8 Eng.RH (62kW)	8/86-1/90		R		153-462		Vag	200,0x40	Hand Brake
	86-90		R		700-191	700-191K		Ø 180,0	
	86-90		R		151-028		Bdx	Ø 14,30 180,0x30	VAG
1.8 16v GTi Eng.PL (95kW)	8/86-10/91		R		153-465		Vag	180,0x31	Hand Brake
1.8 GT, Syncro, Kat Eng.HV/ GU/ GX (66kW)	8/84-10/91		R		153-465		Vag	180,0x31	Hand Brake
	8/84-10/91		R		153-008		Vag	230,0x40	Hand Brake
	84-91		R		700-191	700-191K		Ø 180,0	
	84-91		R		700-214			Ø 230,0	Syncro, 4WD
1.8 GTi Eng.EV/ GZ/ PB (82kW)	1/84-10/91		R		153-465		Vag	180,0x31	Hand Brake
	1/84-10/91		R		153-008		Vag	230,0x40	Hand Brake
	84-91		R		700-191	700-191K		Ø 180,0	
1.8 GTi, Kat Eng.PF/ RD (79kW)	8/85-10/87		R		153-008		Vag	230,0x40	Hand Brake
	85-87		R		700-191	700-191K		Ø 180,0	
1.8 Syncro Eng.1P (72kW)	8/88-7/91		R		153-465		Vag	180,0x31	Hand Brake
	8/88-7/91		R		153-462		Vag	200,0x40	Hand Brake
	8/88-7/91		R		153-008		Vag	230,0x40	Hand Brake
	88-91		R		700-214			Ø 230,0	4WD
1.8, Syncro Eng.RP (66kW)	1/87-12/91		R		153-465		Vag	180,0x31	Hand Brake
	1/87-12/91		R		153-008		Vag	230,0x40	Hand Brake
	84-91		R		700-191	700-191K		Ø 180,0	
	84-91		R		700-214			Ø 230,0	Syncro, 4WD
K 70 (48) 8/70-10/74									
1.6 Eng.DA (66kW)	8/70-10/74		F		153-465		Vag	180,0x31	Hand Brake
	8/70-10/74		F		153-457		Vag	230,0x40	
	8/70-10/74		R		153-459		Vag	230,0x40	Hand Brake
1.6 Eng.DB (55kW)	8/70-7/71		F		153-465		Vag	180,0x31	Hand Brake
	8/70-7/71		R		153-459		Vag	230,0x40	Hand Brake
1.8 Eng.DC (74kW)	8/73-10/74		F		153-457		Vag	230,0x40	
	8/73-10/74		R		153-459		Vag	230,0x40	Hand Brake
Kaefer 4/49-7/03									
1.2 Eng.M51 (22kW)	1/54-7/65		F		153-457		Vag	230,0x40	
	1/67-		R		700-185			Ø 230,0	
1.2, Cabrio Eng.D (25kW)	1/60-12/85		F		153-457		Vag	230,0x40	
	70-74		F		153-460		Vag	248,0x46	
	68-		F/R		153-459		Vag	230,0x40	Hand Brake
	64-68		R		153-458		Vag	230,0x30	Hand Brake
	1/67-		R		700-185			Ø 230,0	
1.3 Eng.E (27kW)	8/65-7/70		F		153-457		Vag	230,0x40	
	8/65-7/70		F/R		153-459		Vag	230,0x40	Hand Brake
	65-68		R		153-458		Vag	230,0x30	Hand Brake
	8/67-70		R		700-185			Ø 230,0	
1.3, Cabrio Eng.AB/ AR (32kW)	-74		F		153-460		Vag	248,0x46	
	8/70-3/81		F		153-457		Vag	230,0x40	
	8/70-3/81		F/R		153-459		Vag	230,0x40	Hand Brake
	70-81		R		700-185			Ø 230,0	
1.3, Cabrio, Karmann Eng.113/ AC/ F (29-30kW)	7/64-7/75		F		153-457		Vag	230,0x40	
	-74		F		153-460		Vag	248,0x46	
	67-		F/R		153-459		Vag	230,0x40	Hand Brake
	8/67-75		R		700-185			Ø 230,0	
1.5, Cabrio Eng.H (32kW)	8/66-11/73		F		153-457		Vag	230,0x40	
	8/66-11/73		R		153-459		Vag	230,0x40	Hand Brake
1.6 Cabrio Eng.B (35kW)	7/69-7/70		F		153-457		Vag	230,0x40	
	-74		F		153-460		Vag	248,0x46	
1.6, Cabrio Eng.AD/ AJ/ AS (37kW)	1/70-12/79		F		153-457		Vag	230,0x40	
	-74		F		153-460		Vag	248,0x46	
	1/70-12/79		R		153-459		Vag	230,0x40	Hand Brake
1.6, Cabrio Eng.AE/ AH/ AK (35kW)	-74		F		153-460		Vag	248,0x46	
	8/70-12/79		F		153-457		Vag	230,0x40	
	8/70-12/79		R		153-459		Vag	230,0x40	Hand Brake
	8/70-		R		700-185			Ø 230,0	
1.6, Cabrio Eng.AF (34kW)	8/70-9/92		F		153-460		Vag	248,0x46	
	8/70-9/92		R		153-459		Vag	230,0x40	Hand Brake
Karmann Ghia (14, 34) 1/60-7/74									
1.5 Eng.341 (40kW)	61-70		R		700-185			Ø 230,0	
1.5 Cabrio Eng.113/ F (29-30kW)	64-74		R		700-185			Ø 230,0	

































		Spare Parts	F/R	L/R	CIFAM ref.	CIFAM ref. w/KIT		DIMENSIONS mm.	NOTE
1.5 Coupe Eng.H (32kW)	66-69		R		700-185			Ø 230,0	
1.6 Coupe Eng.AD (35kW)	71-74		R		700-185			Ø 230,0	
1.6 Coupe Eng.AD (37kW)	70-73		R		700-185			Ø 230,0	
Lupo (6X1, 6E1) 9/98-									
1.0 Eng.AER/ AHT/ ALD/ ALL/ ANV/ AUC (37kW)	9/98-		R		153-465		Vag	180,0x31	Ch -6XX003000, Hand Brake
	9/98-		R		153-468		Vag	200,0x40	Ch 6XX003001-, Hand Brake
	98-		R		700-218			Ø 180,0	-ABS
	98-		R		700-219			Ø 200,0	+ABS
	98-		R		151-045		Ate	Ø 15,87 180,0x30	-Ch 6XX003000, VAG, -ABS
	98-		R		151-086		Vag	Ø 15,87 200,0x40	Ch 6XX003001-, VAG, -ABS
	98-		R		151-084		Ate	Ø 17,46 200,0x40	Ch 6XX003001-, VAG, +ABS
1.2 TDi 3L Eng.ANY/ AYZ (45kW)	7/99-		R		153-470		Vag	180,0x31	-ABS, Hand Brake
	7/99-		R		153-468		Vag	200,0x40	+ABS, Hand Brake
	7/99-		R		700-219			Ø 200,0	+ABS
1.4 Eng.AKK/ AUD (44kW)	10/00-		R		153-468		Vag	200,0x40	Hand Brake
	00-		R		700-218			Ø 180,0	-ABS
	00-		R		700-219			Ø 200,0	+ABS
	00-		R		151-086		Vag	Ø 15,87 200,0x40	VAG, -ABS
	00-		R		151-084		Ate	Ø 17,46 200,0x40	Ch 6XX003001-, VAG, +ABS
	00-		R		151-235		Vag	Ø 15,87 200,0x40	VAG, -ABS
1.4 16v Eng.AFK/ ANM/ AQQ/ AUB (74kW)	8/99-		R		153-465		Vag	180,0x31	Ch -6XX003000, Hand Brake
	8/99-		R		153-468		Vag	200,0x40	Ch 6XX003001-, Hand Brake
	99-		R		700-218			Ø 180,0	-ABS
	99-		R		700-219			Ø 200,0	+ABS
	99-		R		151-235		Vag	Ø 15,87 200,0x40	VAG, -ABS
1.4 16v Eng.AHW/ AKQ/ APE/ AUA/ BBY (55kW)	9/98-		R		153-465		Vag	180,0x31	Ch -6XX003000, Hand Brake
	9/98-		R		153-468		Vag	200,0x40	Ch 6XX003001-, Hand Brake
	9/98-		R		700-218			Ø 180,0	-ABS
	9/98-		R		700-219			Ø 200,0	+ABS
	9/98-		R		151-045		Ate	Ø 15,87 180,0x30	-Ch 6XX003000, VAG, -ABS
	9/98-		R		151-086		Vag	Ø 15,87 200,0x40	Ch 6XX003001-, VAG, -ABS
	9/98-		R		151-084		Ate	Ø 17,46 200,0x40	Ch 6XX003001-, VAG, +ABS
	98-		R		151-235		Vag	Ø 15,87 200,0x40	VAG, -ABS
1.4 FSI Eng.ARR (77kW)	01-		R		700-218			Ø 180,0	-ABS
	01-		R		700-219			Ø 200,0	+ABS
	01-		R		151-086		Vag	Ø 15,87 200,0x40	VAG, -ABS
1.4 TDi Eng.AMF (55kW)	1/99-		R		153-465		Vag	180,0x31	Ch -6XX003000, Hand Brake
	1/99-		R		153-468		Vag	200,0x40	Ch 6XX003001-, Hand Brake
	1/99-		R		700-218			Ø 180,0	-ABS
	1/99-		R		700-219			Ø 200,0	+ABS
	1/99-		R		151-045		Ate	Ø 15,87 180,0x30	-Ch 6XX003000, VAG, -ABS
	1/99-		R		151-086		Vag	Ø 15,87 200,0x40	Ch 6XX003001-, VAG, -ABS
	99-		R		151-084		Ate	Ø 17,46 200,0x40	Ch 6XX003001-, VAG, +ABS
1.7 SDi Eng.AKU (44kW)	9/98-		R		153-465		Vag	180,0x31	Ch -6XX003000, Hand Brake
	9/98-		R		153-468		Vag	200,0x40	Ch 6XX003001-, Hand Brake
	9/98-		R		700-218			Ø 180,0	-ABS
	9/98-		R		700-219			Ø 200,0	+ABS
	9/98-		R		151-045		Ate	Ø 15,87 180,0x30	-Ch 6XX003000, VAG, -ABS
	9/98-		R		151-086		Vag	Ø 15,87 200,0x40	Ch 6XX003001-, VAG, -ABS
	98-		R		151-084		Ate	Ø 17,46 200,0x40	Ch 6XX003001-, VAG, +ABS
Passat I (32, 33), Variant 5/73-7/80									
1.3 Eng.FY (40kW)	5/73-7/80		R		153-465		Vag	180,0x31	Hand Brake
	73-80		R		700-191	700-191K		Ø 180,0	
	78-80		R		151-028		Bdx	Ø 14,30 180,0x30	VAG
	78-80		R		151-107		Vag	Ø 17,46 200,0x40	VAG
1.3 Eng.ZA (40kW)	5/73-7/80		R		153-465		Vag	180,0x31	Hand Brake
	73-80		R		700-191	700-191K		Ø 180,0	
	78-80		R		151-028		Bdx	Ø 14,30 180,0x30	VAG
	78-80		R		151-107		Vag	Ø 17,46 200,0x40	VAG
1.3 Eng.ZF (44kW)	5/73-1/78		R		153-465		Vag	180,0x31	Hand Brake
	73-78		R		700-191	700-191K		Ø 180,0	
	73-78		R		151-028		Bdx	Ø 14,30 180,0x30	VAG
1.5 Eng.YJ/ ZB (55kW)	73-75		R		700-191	700-191K		Ø 180,0	Incl. Sweden, M/T
	73-75		R		700-188	700-188K		Ø 200,0	SW, A/T















































		Spare Parts	F/R	L/R	CIFAM ref.	CIFAM ref. w/KIT		DIMENSIONS mm.	NOTE
1.5 Eng.ZC (63kW)	73-75		R		700-191	700-191K		Ø 180,0	Incl. Sweden, M/T
	73-75		R		700-188	700-188K		Ø 200,0	SW, A/T
1.5 D Eng.CK (37kW)	2/77-7/80		R		153-462		Vag	200,0x40	Hand Brake
	77-80		R		700-191	700-191K		Ø 180,0	M/T
	77-80		R		700-188	700-188K		Ø 200,0	A/T
	77-80		R		151-028		Bdx	Ø 14,30 180,0x30	VAG
	77-80		R		151-107		Vag	Ø 17,46 200,0x40	VAG
1.6 Eng.YP (63kW)	8/75-7/80		R		153-465		Vag	180,0x31	Hand Brake
	75-80		R		700-191	700-191K		Ø 180,0	M/T
	75-80		R		700-188	700-188K		Ø 200,0	SW, A/T
	78-80		R		151-028		Bdx	Ø 14,30 180,0x30	VAG
	78-80		R		151-107		Vag	Ø 17,46 200,0x40	VAG
1.6 (Exc. SW) Eng.FS (53kW)	8/75-7/80		R		153-465		Vag	180,0x31	Hand Brake
	75-80		R		700-191	700-191K		Ø 180,0	M/T
	75-80		R		151-028		Bdx	Ø 14,30 180,0x30	VAG
1.6 D SW Eng.CR (40kW)	79-80		R		700-188	700-188K		Ø 200,0	A/T
	79-80		R		151-028		Bdx	Ø 14,30 180,0x30	VAG
	79-80		R		151-107		Vag	Ø 17,46 200,0x40	VAG
1.6 i SW Eng.YS (81kW)	6/78-7/80		R		153-465		Vag	180,0x31	Hand Brake
	78-80		R		700-188	700-188K		Ø 200,0	A/T
	78-80		R		151-028		Bdx	Ø 14,30 180,0x30	VAG
1.6 SW Eng.YN (55kW)	2/76-7/80		R		153-465		Vag	180,0x31	Hand Brake
	76-80		R		700-188	700-188K		Ø 200,0	A/T
	76-80		R		151-028		Bdx	Ø 14,30 180,0x30	VAG
	76-80		R		151-107		Vag	Ø 17,46 200,0x40	VAG
Passat II (32B), Variant 8/80-3/88									
1.3 Eng.EP (44kW)	8/80-7/86		R		153-465		Vag	180,0x31	Hand Brake
	8/80-7/86		R		153-462		Vag	200,0x40	Hand Brake
	8/84-86		R		700-188	700-188K		Ø 200,0	
	80-7/84		R		700-191	700-191K		Ø 180,0	
	80-84		R		151-107		Vag	Ø 17,46 200,0x40	VAG
	80-86		R		151-028		Bdx	Ø 14,30 180,0x30	VAG
	82-86		R		151-045		Ate	Ø 15,87 180,0x30	VAG
1.3 Eng.EU/ FZ (44kW)	8/80-7/86		R		153-465		Vag	180,0x31	Hand Brake
	8/80-7/86		R		153-462		Vag	200,0x40	Hand Brake
	8/84-86		R		700-188	700-188K		Ø 200,0	
	80-7/84		R		700-191	700-191K		Ø 180,0	
	80-84		R		151-107		Vag	Ø 17,46 200,0x40	VAG
	80-86		R		151-028		Bdx	Ø 14,30 180,0x30	VAG
1.3 Eng.FY (40kW)	8/80-7/83		R		153-465		Vag	180,0x31	Hand Brake
	8/80-7/83		R		153-462		Vag	200,0x40	Hand Brake
	80-83		R		700-191	700-191K		Ø 180,0	
	80-83		R		151-045		Ate	Ø 15,87 180,0x30	VAG
	80-83		R		151-028		Bdx	Ø 14,30 180,0x30	VAG
1.6 Eng.DT/ WV/ YN (55kW)	8/80-3/88		R		153-465		Vag	180,0x31	Hand Brake
	8/80-3/88		R		153-462		Vag	200,0x40	Hand Brake
	80-88		R		700-188	700-188K		Ø 200,0	
	80-88		R		151-045		Ate	Ø 15,87 180,0x30	VAG
	80-88		R		151-028		Bdx	Ø 14,30 180,0x30	VAG
1.6 Eng.PP (51kW)	8/87-3/88		R		153-465		Vag	180,0x31	Hand Brake
	8/87-3/88		R		153-462		Vag	200,0x40	Hand Brake
	87-88		R		700-188	700-188K		Ø 200,0	
	87-88		R		151-045		Ate	Ø 15,87 180,0x30	VAG
	87-88		R		151-028		Bdx	Ø 14,30 180,0x30	VAG
1.6 Eng.RF/ RL (53kW)	87-88		R		151-107		Vag	Ø 17,46 200,0x40	VAG
	2/86-3/88		R		153-465		Vag	180,0x31	Hand Brake
	2/86-3/88		R		153-462		Vag	200,0x40	Hand Brake
	86-88		R		700-188	700-188K		Ø 200,0	
	86-88		R		151-045		Ate	Ø 15,87 180,0x30	VAG
1.6 Eng.YP (63kW)	86-88		R		151-028		Bdx	Ø 14,30 180,0x30	VAG
	86-88		R		151-107		Vag	Ø 17,46 200,0x40	VAG
	1/81-2/83		R		153-465		Vag	180,0x31	Hand Brake
	1/81-2/83		R		153-462		Vag	200,0x40	Hand Brake
1.6 Eng.YP (63kW)	81-83		R		700-188	700-188K		Ø 200,0	
	81-83		R		151-045		Ate	Ø 15,87 180,0x30	VAG

































































		Spare Parts	F/R	L/R	CIFAM ref.	CIFAM ref. w/KIT		DIMENSIONS mm.	NOTE
1.6 Eng.YP (63kW)	81-83		R		151-028		Bdx	Ø 14,30 180,0x30	VAG
	81-83		R		151-107		Vag	Ø 17,46 200,0x40	VAG
1.6 D Eng.CR/ JK (40kW)	8/80-3/88		R		153-465		Vag	180,0x31	Hand Brake
	8/80-3/88		R		153-462		Vag	200,0x40	Hand Brake
	8/80-7/81		R		700-191	700-191K		Ø 180,0	
	8/83-3/88		R		700-188	700-188K		Ø 200,0	
	80-84		R		151-107		Vag	Ø 17,46 200,0x40	VAG
	80-88		R		151-028		Bdx	Ø 14,30 180,0x30	VAG
	82-88		R		151-045		Ate	Ø 15,87 180,0x30	VAG
1.6 TD Eng.CY (51kW)	4/82-3/88		R		153-465		Vag	180,0x31	Hand Brake
	4/82-3/88		R		153-462		Vag	200,0x40	Hand Brake
	82-3/88		R		700-188	700-188K		Ø 200,0	
	82-84		R		151-107		Vag	Ø 17,46 200,0x40	VAG
1.6 TD (Exc. SW) Eng.RA (59kW)	5/86-3/88		R		153-465		Vag	180,0x31	Hand Brake
	5/86-3/88		R		153-462		Vag	200,0x40	Hand Brake
	86-88		R		700-188	700-188K		Ø 200,0	
	86-88		R		151-107		Vag	Ø 17,46 200,0x40	VAG
1.8 Eng.DS/ JN/ JV (66kW)	1/86-3/88		R		153-465		Vag	180,0x31	Hand Brake
	1/86-3/88		R		153-462		Vag	200,0x40	Hand Brake
	86-88		R		700-188	700-188K		Ø 200,0	
	86-88		R		151-045		Ate	Ø 15,87 180,0x30	VAG
	86-88		R		151-107		Vag	Ø 17,46 200,0x40	VAG
	86-88		R		151-107		Vag	Ø 17,46 200,0x40	VAG
1.8 Eng.DZ (82kW)	12/83-3/88		R		153-462		Vag	200,0x40	Hand Brake
	85-		R		153-465		Vag	180,0x31	Hand Brake
	83-88		R		151-107		Vag	Ø 17,46 200,0x40	VAG
1.8 Eng.RM (64kW)	5/86-3/88		R		153-465		Vag	180,0x31	Hand Brake
	5/86-3/88		R		153-462		Vag	200,0x40	Hand Brake
	86-88		R		700-188	700-188K		Ø 200,0	
	86-88		R		151-045		Ate	Ø 15,87 180,0x30	VAG
	86-88		R		151-107		Vag	Ø 17,46 200,0x40	VAG
1.8 Syncro Eng.DS/ JN/ JV (66kW)	1/86-3/88		R		153-465		Vag	180,0x31	Hand Brake
	1/86-3/88		R		153-462		Vag	200,0x40	Hand Brake
	86-88		R		700-188	700-188K		Ø 200,0	
	86-88		R		151-045		Ate	Ø 15,87 180,0x30	VAG
	86-88		R		151-107		Vag	Ø 17,46 200,0x40	VAG
1.9 Eng.WN (85kW)	1/81-7/83		R		153-465		Vag	180,0x31	Hand Brake
	1/81-7/83		R		153-462		Vag	200,0x40	Hand Brake
	1/81-7/81		R		700-188	700-188K		Ø 200,0	
	81-83		R		700-202	700-202K		Ø 200,0	
	1/81-7/81		R		151-108		Vag	Ø 15,87 200,0x40	VAG
	8/81-83		R		151-107		Vag	Ø 17,46 200,0x40	VAG
2.0, Syncro Eng.HP/ JS (85kW)	8/83-3/88		R		153-462		Vag	200,0x40	Hand Brake
	8/83-3/88		R		700-188	700-188K		Ø 200,0	
	83-88		R		151-107		Vag	Ø 17,46 200,0x40	VAG
2.2 Eng.KV (100kW)	1/81-3/88		R		700-188	700-188K		Ø 200,0	Incl. Sweden
2.2 Eng.KX (85kW)	85-88		R		700-188	700-188K		Ø 200,0	Incl. Sweden
	85-88		R		151-107		Vag	Ø 17,46 200,0x40	VAG
2.2 Syncro SW Eng.JT (88kW)	85-88		R		700-188	700-188K		Ø 200,0	Incl. Sweden
Passat III (3A2, 3A5, 35I), Variant 2/88-5/97									
1.6 Eng.1F (53kW)	2/88-9/91		R		153-468		Vag	200,0x40	Hand Brake
	4/88-		R		700-188	700-188K		Ø 200,0	Ch -31L085000
	-91		R		700-192	700-192K		Ø 230,0	Ch 31L085001-
	88-89		R		151-100		Vag	Ø 20,64 230,0x40	Ch -31M280000, VAG
1.6 Eng.AEK/ AFT (74kW)	10/94-8/96		R		153-468		Vag	200,0x40	Hand Brake
	94-96		R		700-192	700-192K		Ø 230,0	
	94-96		R		151-085		Ate	Ø 19,05 200,0x40	VAG
	94-96		R		151-100		Vag	Ø 20,64 230,0x40	Ch -31M280000, VAG
1.6 Eng.EZ/ HM (55kW)	4/88-12/88		R		153-468		Vag	200,0x40	Hand Brake
	-12/88		R		700-192	700-192K		Ø 230,0	Ch 31L085001-
	4/88-		R		700-188	700-188K		Ø 200,0	Ch -31L085000
	4/88-		R		151-085		Ate	Ø 19,05 200,0x40	VAG
	4/88-		R		151-100		Vag	Ø 20,64 230,0x40	Ch -31M280000, VAG
1.6 TD Eng.RA/ SB (59kW)	8/88-9/93		R		153-008		Vag	230,0x40	Hand Brake
	8/88-9/93		R		153-009		Vag	230,0x40	Hand Brake
	88-93		R		700-192	700-192K		Ø 230,0	
	90-93		R		151-131		Ate	Ø 20,64 230,0x40	VAG
	90-93		R		151-100		Vag	Ø 20,64 230,0x40	Ch -31M280000, VAG

































































		Spare Parts	F/R	L/R	CIFAM ref.	CIFAM ref. w/KIT		DIMENSIONS mm.	NOTE
1.8 Eng.AAM (55kW)	8/90-8/96		R		153-468		Vag	200,0x40	Hand Brake
	8/90-8/96		R		153-008		Vag	230,0x40	Hand Brake
	8/90-8/96		R		153-009		Vag	230,0x40	Hand Brake
	90-96		R		700-192	700-192K		Ø 230,0	
			R		151-100		Vag	Ø 20,64 230,0x40	Ch -31M280000, VAG
	90-96		R		151-131		Ate	Ø 20,64 230,0x40	VAG, FWD
1.8 Eng.ABS/ ADZ (66kW)	2/88-5/97		R		153-468		Vag	200,0x40	Hand Brake
	2/88-5/97		R		153-008		Vag	230,0x40	Hand Brake
	88-97		R		700-192	700-192K		Ø 230,0	
	88-97		R		151-131		Ate	Ø 20,64 230,0x40	VAG, FWD
	88-97		R		151-100		Vag	Ø 20,64 230,0x40	Ch -31M280000, VAG
1.8 Eng.PF (79kW)	88-93		R		151-131		Ate	Ø 20,64 230,0x40	VAG, FWD
1.9 D Eng.1Y (50kW)	5/89-10/93		R		153-008		Vag	230,0x40	Hand Brake
	5/89-10/93		R		153-009		Vag	230,0x40	Hand Brake
	89-93		R		700-192	700-192K		Ø 230,0	
	89-93		R		151-131		Ate	Ø 20,64 230,0x40	VAG, FWD
	89-93		R		151-100		Vag	Ø 20,64 230,0x40	Ch -31M280000, VAG
1.9 TD Eng.AAZ (55kW)	3/91-5/97		R		153-008		Vag	230,0x40	Hand Brake
	3/91-5/97		R		153-009		Vag	230,0x40	Hand Brake
	91-97		R		700-192	700-192K		Ø 230,0	
	91-97		R		151-131		Ate	Ø 20,64 230,0x40	VAG, FWD
			R		151-100		Vag	Ø 20,64 230,0x40	VAG, FWD
1.9 TDi Eng.1Z/ AHU (66kW)	93-97		R		700-192	700-192K		Ø 230,0	
	93-97		R		151-131		Ate	Ø 20,64 230,0x40	VAG, FWD
1.9 TDi Eng.AFN (81kW)	96-97		R		700-192	700-192K		Ø 230,0	
2.0 GTi 16v Eng.ABF (110kW)	1/94-5/97		R		153-008		Vag	230,0x40	Hand Brake
Passat IV (3B2, 3B5), Variant 8/96-11/00									
1.6 Eng.ADP (74kW)	10/96-11/00		R		153-009		Vag	230,0x40	Hand Brake
1.6 Eng.AHL/ ANA/ ARM (74kW)	10/96-11/00		R		153-009		Vag	230,0x40	Hand Brake
Polo I (86) 3/75-9/81									
0.9 Eng.HA (29kW)	9/75-9/81		R		153-465		Vag	180,0x31	Hand Brake
	75-81		R		700-191	700-191K		Ø 180,0	
	75-81		R		151-031		Bdx	Ø 17,46 180,0x30	VAG
1.1 Eng.HB (37kW)	3/75-9/81		R		153-465		Vag	180,0x31	Hand Brake
	75-81		R		700-191	700-191K		Ø 180,0	
	75-81		R		151-031		Bdx	Ø 17,46 180,0x30	VAG
1.1 Eng.HC (44kW)	3/75-9/81		R		153-465		Vag	180,0x31	Hand Brake
	75-81		R		700-191	700-191K		Ø 180,0	
	75-81		R		151-031		Bdx	Ø 17,46 180,0x30	VAG
1.3 Eng.HH (44kW)	12/76-9/81		R		153-465		Vag	180,0x31	Hand Brake
	76-81		R		700-191	700-191K		Ø 180,0	
	76-81		R		151-031		Bdx	Ø 17,46 180,0x30	VAG
Polo II (86C, 80), Classic, Coupe 10/81-9/94									
1.0 Eng.GL (29kW)	10/81-10/86		R		153-465		Vag	180,0x31	Hand Brake
	81-86		R		700-191	700-191K		Ø 180,0	
	81-86		R		151-045		Ate	Ø 15,87 180,0x30	VAG
1.0, Kat Eng.AAK/ AAU/ ACM/ HZ (33-37kW)	11/86-9/94		R		153-465		Vag	180,0x31	Hand Brake
	86-94		R		700-191	700-191K		Ø 180,0	
1.1 (Exc. Classic) Eng.HB (37kW)	86-9/94		R		151-045		Ate	Ø 15,87 180,0x30	VAG
	10/81-9/89		R		153-465		Vag	180,0x31	Hand Brake
	10/81-81-89		R		700-191	700-191K		Ø 180,0	Ch -F127903
1.3 Eng.3F (57kW)	3/91-9/94		R		153-465		Vag	180,0x31	Hand Brake
	91-94		R		700-191	700-191K		Ø 180,0	
	91-9/94		R		151-045		Ate	Ø 15,87 180,0x30	VAG
1.3 Eng.HW (37kW)	8/83-7/85		R		153-465		Vag	180,0x31	Hand Brake
1.3 (Exc. Classic) Eng.HH (44kW)	10/81-7/83		R		153-465		Vag	180,0x31	Hand Brake
	81-83		R		700-191	700-191K		Ø 180,0	
	81-83		R		151-045		Ate	Ø 15,87 180,0x30	VAG
1.3 (Exc. Coupe) Eng.HJ (43kW)	10/81-7/82		R		153-465		Vag	180,0x31	Hand Brake
	81-82		R		700-191	700-191K		Ø 180,0	
	81-82		R		151-045		Ate	Ø 15,87 180,0x30	VAG
1.3 D Eng.MN (33kW)	8/86-7/90		R		153-465		Vag	180,0x31	Hand Brake
	-90		R		700-191	700-191K		Ø 180,0	Ch F127904-
	86-90		R		151-045		Ate	Ø 15,87 180,0x30	VAG
1.3 G40 (Exc. Classic) Eng.PY (83kW)	1/87-9/94		R		153-465		Vag	180,0x31	Hand Brake
	-94		R		700-191	700-191K		Ø 180,0	Ch F127904-
	87-9/94		R		151-045		Ate	Ø 15,87 180,0x30	VAG

















































		Spare Parts	F/R	L/R	CIFAM ref.	CIFAM ref. w/KIT		DIMENSIONS mm.	NOTE
1.3, Kat Eng.2G/ AAV/ HK/ MH/ NZ (40kW)	8/83-9/94		R		153-465		Vag	180,0x31	Hand Brake
	83-94		R		700-191	700-191K		Ø 180,0	
	83-9/94		R		151-045		Ate	Ø 15,87 180,0x30	VAG
1.3, Kat (Exc. Classic) Eng.3F/ GK (55kW)	10/89-9/94		R		153-465		Vag	180,0x31	Hand Brake
	89-94		R		700-191	700-191K		Ø 180,0	
	89-9/94		R		151-045		Ate	Ø 15,87 180,0x30	VAG
1.4 D Eng.1W (35kW)	8/90-9/94		R		153-465		Vag	180,0x31	Hand Brake
	-94		R		700-191	700-191K		Ø 180,0	Ch F127904-
	90-9/94		R		151-045		Ate	Ø 15,87 180,0x30	VAG
Polo III (6N1) 10/94-10/99									
1.0 Eng.AER/ ALL (37kW)	9/96-10/99		R		153-465		Vag	180,0x31	Hand Brake
	9/96-10/99		R		153-468		Vag	200,0x40	Hand Brake
			R		700-219			Ø 200,0	Ch 6NZXY420001-
	96-		R		700-191	700-191K		Ø 180,0	Ch -6NZXY227489, -ABS
	96-		R		700-202	700-202K		Ø 200,0	Ch -6NZXY227489, +ABS
1.0 Eng.AEV (33kW)	10/94-9/96		R		153-465		Vag	180,0x31	Hand Brake
	10/94-9/96		R		153-468		Vag	200,0x40	Hand Brake
			R		700-219			Ø 200,0	Ch 6NZXY420001-
	94-		R		700-191	700-191K		Ø 180,0	Ch -6NZXY227489, -ABS
	94-		R		700-202	700-202K		Ø 200,0	Ch -6NZXY227489, +ABS
1.3 Eng.ADX (40kW)	10/94-7/95		R		153-465		Vag	180,0x31	Hand Brake
	10/94-7/95		R		153-468		Vag	200,0x40	Hand Brake
	94-95		R		700-191	700-191K		Ø 180,0	-ABS
	94-		R		151-084		Ate	Ø 17,46 200,0x40	VAG, +ABS
1.4 Eng.AEX/ AKV/ ANX/ APQ (40-44kW)	7/95-10/99		R		153-465		Vag	180,0x31	Hand Brake
	7/95-10/99		R		153-468		Vag	200,0x40	Hand Brake
			R		700-219			Ø 200,0	Ch 6NZXY420001-
	7/95-		R		700-191	700-191K		Ø 180,0	Ch -6NZXY227489, Exc. Germany, -ABS
	7/95-		R		700-202	700-202K		Ø 200,0	Ch -6NZXY227489, Exc. Germany, +ABS
1.4 16v Eng.AFH (74kW)	4/96-10/99		R		153-465		Vag	180,0x31	Hand Brake
	4/96-10/99		R		153-468		Vag	200,0x40	Hand Brake
			R		700-219			Ø 200,0	Ch 6NZXY420001-, Exc. Germany
	96-		R		700-191	700-191K		Ø 180,0	Ch -6NZXY227489, Exc. Germany, -ABS
	96-		R		700-202	700-202K		Ø 200,0	Ch -6NZXY227489, Exc. Germany, +ABS
	96-99		R		151-084		Ate	Ø 17,46 200,0x40	VAG, +ABS
1.6 Eng.AEA/ AEE/ AHS (55kW)	10/94-10/99		R		153-465		Vag	180,0x31	Hand Brake
	10/94-10/99		R		153-468		Vag	200,0x40	Hand Brake
	94-99		R		700-191	700-191K		Ø 180,0	-ABS
	94-99		R		700-202	700-202K		Ø 200,0	+ABS
	94-99		R		151-084		Ate	Ø 17,46 200,0x40	VAG, +ABS
	94-99		R		151-031		Bdx	Ø 17,46 180,0x30	VAG
1.7 SDi Eng.AHG (42kW)	4/97-10/99		R		153-465		Vag	180,0x31	Hand Brake
	4/97-10/99		R		153-468		Vag	200,0x40	Hand Brake
	97-		R		700-191	700-191K		Ø 180,0	Ch -6NZXY227489, -ABS
	97-		R		700-202	700-202K		Ø 200,0	Ch -6NZXY227489, +ABS
	-99		R		700-219			Ø 200,0	Ch 6NZXY420001-
	97-99		R		151-084		Ate	Ø 17,46 200,0x40	VAG, +ABS
1.7 SDi Eng.AKU (44kW)	8/97-10/99		R		153-465		Vag	180,0x31	Hand Brake
	8/97-10/99		R		153-468		Vag	200,0x40	Hand Brake
			R		700-219			Ø 200,0	Ch 6NZXY420001-
	97-		R		700-191	700-191K		Ø 180,0	Ch -6NZXY227489, -ABS
	97-		R		700-202	700-202K		Ø 200,0	Ch -6NZXY227489, +ABS
	97-99		R		151-084		Ate	Ø 17,46 200,0x40	VAG, +ABS
1.9 D Eng.AEF (47kW)	10/94-10/99		R		153-465		Vag	180,0x31	Hand Brake
	10/94-10/99		R		153-468		Vag	200,0x40	Hand Brake
			R		700-219			Ø 200,0	Ch 6NZXY420001-
	94-		R		700-191	700-191K		Ø 180,0	Ch -6NZXY227489, -ABS
	94-		R		700-202	700-202K		Ø 200,0	Ch -6NZXY227489, +ABS
1.9 SDi Eng.AGD (47kW)	7/96-10/99		R		151-084		Ate	Ø 17,46 200,0x40	VAG, +ABS
	7/96-10/99		R		151-031		Bdx	Ø 17,46 180,0x30	VAG
			R		153-465		Vag	180,0x31	Hand Brake
			R		153-468		Vag	200,0x40	Hand Brake
			R		700-219			Ø 200,0	Ch 6NZXY420001-

		Spare Parts	F/R	L/R	CIFAM ref.	CIFAM ref. w/KIT		DIMENSIONS mm.	NOTE
1.9 SDi Eng.AGD (47kW)	96-		R		700-191	700-191K		Ø 180,0	Ch -6NZXY227489, -ABS
	96-		R		700-202	700-202K		Ø 200,0	Ch -6NZXY227489, +ABS
	96-99		R		151-084		Ate	Ø 17,46 200,0x40	VAG, +ABS
	96-99		R		151-031		Bdx	Ø 17,46 180,0x30	VAG
Polo III-IV (6KV2) Classic 11/95-9/01									
1.4 Eng.AEX/ AKW/ ANX/ APQ (40-44kW)	95-99		R		700-191	700-191K		Ø 180,0	-ABS
	95-99		R		700-202	700-202K		Ø 200,0	+ABS
	99-01		R		700-219			Ø 200,0	
	95-01		R		151-084		Ate	Ø 17,46 200,0x40	VAG, +ABS
	95-01		R		151-031		Bdx	Ø 17,46 180,0x30	VAG, -ABS
1.4 Eng.AKK/ AUD (44kW)	95-99		R		700-191	700-191K		Ø 180,0	-ABS
	95-99		R		700-202	700-202K		Ø 200,0	+ABS
	99-01		R		700-219			Ø 200,0	
	95-01		R		151-084		Ate	Ø 17,46 200,0x40	VAG, +ABS
	95-01		R		151-031		Bdx	Ø 17,46 180,0x30	VAG, -ABS
1.4 Eng.ANW (44kW)	95-99		R		700-191	700-191K		Ø 180,0	-ABS
	95-99		R		700-202	700-202K		Ø 200,0	+ABS
	99-01		R		700-219			Ø 200,0	
	95-01		R		151-084		Ate	Ø 17,46 200,0x40	VAG, +ABS
	95-01		R		151-031		Bdx	Ø 17,46 180,0x30	VAG, -ABS
1.4 16v Eng.AHW/ AKQ/ APE/ AUA (55kW)	99-		R		700-219			Ø 200,0	Ch 6NZXY420001-, -ABS
			R		700-202	700-202K		Ø 200,0	Ch -6NZXY227489, -ABS
1.6 Eng.1F (53-55kW)	95-99		R		700-191	700-191K		Ø 180,0	-ABS
	95-99		R		700-202	700-202K		Ø 200,0	+ABS
	99-01		R		700-219			Ø 200,0	
	95-01		R		151-084		Ate	Ø 17,46 200,0x40	VAG, +ABS
1.6 Eng.AEE/ ALM (55kW)	95-99		R		700-191	700-191K		Ø 180,0	-ABS
	95-99		R		700-202	700-202K		Ø 200,0	+ABS
	99-01		R		700-219			Ø 200,0	
	95-01		R		151-084		Ate	Ø 17,46 200,0x40	VAG, +ABS
1.6 Eng.AEH/ AKL/ APF/ AUR (74kW)	95-99		R		700-202	700-202K		Ø 200,0	
	99-01		R		700-219			Ø 200,0	
	95-01	R		151-084		Ate	Ø 17,46 200,0x40	VAG, +ABS	
1.6 Eng.AFT (74kW)	95-99		R		700-202	700-202K		Ø 200,0	
	95-99		R		151-084		Ate	Ø 17,46 200,0x40	VAG, +ABS
1.7 SDi Eng.AKW (42kW)	10/99-01		R		700-219			Ø 200,0	
	97-9/99		R		700-202	700-202K		Ø 200,0	
1.8 Eng.ADD/ ADZ (66kW)	97-99		R		700-202	700-202K		Ø 200,0	
	99-01		R		700-219			Ø 200,0	
1.9 D Eng.1Y/ AEY (47-50kW)	12/95-99		R		700-202	700-202K		Ø 200,0	
	99-01		R		700-219			Ø 200,0	
	95-01		R		151-084		Ate	Ø 17,46 200,0x40	VAG, +ABS
1.9 SDi Eng.AGP/ AQM (50kW)	99-01		R		700-219			Ø 200,0	
	99-01		R		151-084		Ate	Ø 17,46 200,0x40	VAG, +ABS
1.9 TDi Eng.AGR/ AHU/ ALH/ ALE (66kW)	96-99		R		700-202	700-202K		Ø 200,0	
	99-01		R		700-219			Ø 200,0	
	96-01		R		151-084		Ate	Ø 17,46 200,0x40	VAG, +ABS
2.0 Eng.ADC (85kW)	10/99-01		R		700-219			Ø 200,0	
	3/99-9/99		R		700-202	700-202K		Ø 200,0	
Polo IV (6KV5) Variant 5/97-9/01									
1.4 Eng.AEX/ AKV/ ANX/ APQ (44kW)	5/97-9/01		R		153-468		Vag	200,0x40	Hand Brake
	97-01		R		700-219			Ø 200,0	
	97-01		R		151-085		Ate	Ø 19,05 200,0x40	VAG
1.4 Eng.AKK/ AUD (44kW)	5/97-9/01		R		153-468		Vag	200,0x40	Hand Brake
	97-01		R		700-219			Ø 200,0	
	97-01		R		151-085		Ate	Ø 19,05 200,0x40	VAG
1.4 Eng.AKP (40kW)	10/99-9/01		R		153-468		Vag	200,0x40	Hand Brake
	99-01		R		700-219			Ø 200,0	
	99-01		R		151-085		Ate	Ø 19,05 200,0x40	VAG
1.4 Eng.ANW (44kW)	5/97-9/01		R		153-468		Vag	200,0x40	Hand Brake
	97-01		R		700-219			Ø 200,0	
	97-01		R		151-085		Ate	Ø 19,05 200,0x40	VAG
1.4 16v Eng.AHW/ AKQ/ APE/ AUA (55kW)	10/99-9/01		R		153-468		Vag	200,0x40	Hand Brake
			R		700-219			Ø 200,0	Ch 6NZXY420001-, -ABS
1.6 Eng.AEE/ ALM (55kW)	5/97-9/01		R		153-468		Vag	200,0x40	Hand Brake
	97-99		R		700-202	700-202K		Ø 200,0	
	99-01		R		700-219			Ø 200,0	
	97-01		R		151-085		Ate	Ø 19,05 200,0x40	VAG









		Spare Parts	F/R	L/R	CIFAM ref.	CIFAM ref. w/KIT		DIMENSIONS mm.	NOTE
1.6 Eng.AEH/ AKL/ APF/ AUR (74kW)	10/99-9/01		R		153-468		Vag	200,0x40	Hand Brake
	99-01		R		700-219			Ø 200,0	
	99-01		R		151-085		Ate	Ø 19,05 200,0x40	VAG
1.7 SDi Eng.AKU/ AKW (44kW)	99-01		R		700-219			Ø 200,0	
1.9 SDi Eng.AEY (47kW)	10/99-9/01		R		153-468		Vag	200,0x40	Hand Brake
	99-		R		700-219			Ø 200,0	
	99-01		R		151-085		Ate	Ø 19,05 200,0x40	VAG
1.9 SDi Eng.AGD/ ASX (47kW)	10/99-9/01		R		153-468		Vag	200,0x40	Hand Brake
	99-		R		700-219			Ø 200,0	
	99-01		R		151-085		Ate	Ø 19,05 200,0x40	VAG
1.9 SDi Eng.AGP/ AQM (50kW)	8/99-9/01		R		153-468		Vag	200,0x40	Hand Brake
	99-		R		700-219			Ø 200,0	
	99-01		R		151-085		Ate	Ø 19,05 200,0x40	VAG
1.9 TDi Eng.AFN/ ASV (81kW)	6/98-9/01		R		153-468		Vag	200,0x40	Hand Brake
1.9 TDi Eng.AGR/ AHU/ ALH/ ALE (66kW)	5/97-9/01		R		153-468		Vag	200,0x40	Hand Brake
	97-99		R		700-202	700-202K		Ø 200,0	
	99-01		R		700-219			Ø 200,0	
	97-01		R		151-085		Ate	Ø 19,05 200,0x40	VAG
Polo IV (6N2) 10/99-9/01									
1.0 Eng.ALD/ ALL/ ANV/ AUC (37kW)			R		700-219			Ø 200,0	Ch 6NZXY420001-
	99-		R		700-191	700-191K		Ø 180,0	Ch -6NZXY227489, -ABS
	99-		R		700-202	700-202K		Ø 200,0	Ch -6NZXY227489, +ABS
1.4 Eng.AEX/ AKV/ ANX/ APQ (44kW)			R		700-219			Ø 200,0	Ch 6NZXY420001-
	99-		R		700-191	700-191K		Ø 180,0	Ch -6NZXY227489, -ABS
	99-		R		700-202	700-202K		Ø 200,0	Ch -6NZXY227489, +ABS
1.4 Eng.AKK/ AUD (44kW)			R		700-219			Ø 200,0	Ch 6NZXY420001-
	99-		R		700-191	700-191K		Ø 180,0	Ch -6NZXY227489, -ABS
	99-		R		700-202	700-202K		Ø 200,0	Ch -6NZXY227489, +ABS
1.4 Eng.AKP (40kW)			R		700-219			Ø 200,0	Ch 6NZXY420001-
	99-		R		700-191	700-191K		Ø 180,0	Ch -6NZXY227489, -ABS
	99-		R		700-202	700-202K		Ø 200,0	Ch -6NZXY227489, +ABS
1.4 Eng.ANW (44kW)			R		700-219			Ø 200,0	Ch 6NZXY420001-
	99-		R		700-191	700-191K		Ø 180,0	Ch -6NZXY227489, -ABS
	99-		R		700-202	700-202K		Ø 200,0	Ch -6NZXY227489, +ABS
1.4 16v Eng.AFK/ AUB (74kW)			R		700-219			Ø 200,0	Ch 6NZXY420001-, Exc. Germany
	99-		R		700-191	700-191K		Ø 180,0	Ch -6NZXY227489, Exc. Germany, -ABS
	99-		R		700-202	700-202K		Ø 200,0	Ch -6NZXY227489, Exc. Germany, +ABS
1.4 16v Eng.AHW/ AKQ/ APE/ AUA (55kW)			R		700-219			Ø 200,0	Ch 6NZXY420001-, -ABS
	99-		R		700-202	700-202K		Ø 200,0	Ch -6NZXY227489, -ABS
	99-01		R		151-085		Ate	Ø 19,05 200,0x40	VAG, -ABS
1.4 TDi Eng.AMF (55kW)			R		700-219			Ø 200,0	Ch 6NZXY420001-, -ABS
	99-		R		700-202	700-202K		Ø 200,0	Ch -6NZXY227489, -ABS
	99-01		R		151-085		Ate	Ø 19,05 200,0x40	VAG, -ABS
1.7 SDi Eng.AKU/ AKW (44kW)			R		700-219			Ø 200,0	Ch 6NZXY420001-
	99-		R		700-191	700-191K		Ø 180,0	Ch -6NZXY227489, -ABS
	99-		R		700-202	700-202K		Ø 200,0	Ch -6NZXY227489, +ABS
1.9 D Eng.AEF (47kW)			R		700-219			Ø 200,0	Ch 6NZXY420001-
	99-		R		700-191	700-191K		Ø 180,0	Ch -6NZXY227489, -ABS
	99-		R		700-202	700-202K		Ø 200,0	Ch -6NZXY227489, +ABS
1.9 SDi Eng.AEY/ AGD/ ASX (47kW)			R		700-219			Ø 200,0	Ch 6NZXY420001-
	99-		R		700-191	700-191K		Ø 180,0	Ch -6NZXY227489, -ABS
	99-		R		700-202	700-202K		Ø 200,0	Ch -6NZXY227489, +ABS
Polo V (9N) 10/01-6/09									
1.2 Eng.AWY/ BHD/ BMD (40kW)	1/02-		R		700-358			Ø 200,0	-ABS
1.2 Eng.BBM (44kW)	07-		R		700-358			Ø 200,0	
1.2 12v Eng.AZQ/ BME (47kW)	01-		R		700-358			Ø 200,0	-ABS
1.2 12v Eng.BZG (51kW)	07-		R		700-358			Ø 200,0	
1.4 16v Eng.AHW/ AKQ/ APE/ AUA/ BBY/ BKY (55kW)	10/01-		R		700-358			Ø 200,0	-ABS
1.4 FSI Eng.AXU (63kW)	5/02-		R		700-358			Ø 200,0	-ABS
1.4 TDi Eng.AMF/ BAY (55kW)	01-		R		700-358			Ø 200,0	-ABS
1.4 TDi Eng.BMS/ BNV (59kW)	05-		R		700-358			Ø 200,0	-ABS
1.4 TDi Eng.BNM/ BWB (51kW)	05-09		R		700-358			Ø 200,0	-ABS
1.9 SDi Eng.ASY (47kW)	01-		R		700-358			Ø 200,0	
Polo VI (6R) 7/09-									
1.2 Eng.CGPA (51kW)	09-		R		700-358			Ø 200,0	
1.2 Eng.CHFA/ CGPB (44kW)	09-		R		700-358			Ø 200,0	

























































		Spare Parts	F/R	L/R	CIFAM ref.	CIFAM ref. w/KIT		DIMENSIONS mm.	NOTE
Quantum I 1/85-7/90									
All models	86-88		R		700-188	700-188K		Ø 200,0	
Rabbit 1/74-1/76									
All models	74-76		R		700-191	700-191K		Ø 180,0	
Santana I (32, 33), Variant 5/73-7/80									
1.3 Eng.FY (40kW)	78-5/73-80		R		153-465		Vag	180,0x31	Hand Brake
			R		700-191	700-191K		Ø 180,0	
1.3 Eng.ZA (40kW)	78-5/73-80		R		153-465		Vag	180,0x31	Hand Brake
			R		700-191	700-191K		Ø 180,0	
1.3 Eng.ZF (44kW)	73-78		R		700-191	700-191K		Ø 180,0	
1.5 Eng.YJ/ ZB (55kW)	73-75		R		700-191	700-191K		Ø 180,0	Incl. Sweden, M/T
	73-75		R		700-188	700-188K		Ø 200,0	A/T
1.5 Eng.ZC (63kW)	73-75		R		700-191	700-191K		Ø 180,0	Incl. Sweden, M/T
	73-75		R		700-188	700-188K		Ø 200,0	A/T
1.5 D Eng.CK (37kW)	8/77-7/80		R		700-191	700-191K		Ø 180,0	M/T
	8/77-7/80		R		700-188	700-188K		Ø 200,0	A/T
1.6 Eng.YP (63kW)	75-80		R		700-191	700-191K		Ø 180,0	M/T
	75-80		R		700-188	700-188K		Ø 200,0	A/T
1.6 (Exc. SW) Eng.FS (53kW)	75-80		R		700-191	700-191K		Ø 180,0	M/T
	75-80		R		700-188	700-188K		Ø 200,0	A/T
1.6 D SW Eng.CR (40kW)	79-80		R		700-191	700-191K		Ø 180,0	M/T
	79-80		R		700-188	700-188K		Ø 200,0	A/T
1.6 i SW Eng.YS (81kW)	78-80		R		700-191	700-191K		Ø 180,0	M/T
	78-80		R		700-188	700-188K		Ø 200,0	A/T
1.6 SW Eng.YN (55kW)	76-80		R		700-191	700-191K		Ø 180,0	M/T
	76-80		R		700-188	700-188K		Ø 200,0	A/T
Santana II (32B) 8/81-12/84									
1.3 Eng.FZ (44kW)	8/81-7/83		R		153-465		Vag	180,0x31	Hand Brake
	81-83		R		700-191	700-191K		Ø 180,0	
1.6 Eng.DT/ WV (55kW)	8/81-12/84		R		153-465		Vag	180,0x31	Hand Brake
	8/81-12/84		R		153-462		Vag	200,0x40	Hand Brake
	81-84		R		700-188	700-188K		Ø 200,0	
	81-84		R		151-045		Ate	Ø 15,87 180,0x30	VAG
	81-84		R		151-107		Vag	Ø 17,46 200,0x40	VAG
1.6 Eng.YP (63kW)	8/81-12/82		R		153-465		Vag	180,0x31	Hand Brake
	8/81-12/82		R		153-462		Vag	200,0x40	Hand Brake
	81-82		R		700-188	700-188K		Ø 200,0	
	81-82		R		151-045		Ate	Ø 15,87 180,0x30	VAG
	81-82		R		151-107		Vag	Ø 17,46 200,0x40	VAG
1.6 D Eng.CR/ JK (40kW)	8/81-12/84		R		153-465		Vag	180,0x31	Hand Brake
	8/81-12/84		R		153-462		Vag	200,0x40	Hand Brake
	81-84		R		700-188	700-188K		Ø 200,0	
	81-84		R		151-045		Ate	Ø 15,87 180,0x30	VAG
	81-84		R		151-107		Vag	Ø 17,46 200,0x40	VAG
1.6 TD Eng.CY (51kW)	12/81-12/84		R		153-465		Vag	180,0x31	Hand Brake
	12/81-12/84		R		153-462		Vag	200,0x40	Hand Brake
	81-84		R		700-188	700-188K		Ø 200,0	
	81-84		R		151-107		Vag	Ø 17,46 200,0x40	VAG
1.8 Eng.DS (66kW)	1/83-12/84		R		153-465		Vag	180,0x31	Hand Brake
	1/83-12/84		R		153-462		Vag	200,0x40	Hand Brake
	83-84		R		700-188	700-188K		Ø 200,0	
	83-84		R		151-107		Vag	Ø 17,46 200,0x40	VAG
1.9 Eng.WN (85kW)	8/81-7/83		R		153-462		Vag	200,0x40	Hand Brake
	81-83		R		700-202	700-202K		Ø 200,0	
	81-83		R		151-107		Vag	Ø 17,46 200,0x40	VAG
2.0, Syncro Eng.HP/ JS (85kW)	8/83-12/84		R		153-462		Vag	200,0x40	Hand Brake
	83-84		R		700-188	700-188K		Ø 200,0	
	83-84		R		151-107		Vag	Ø 17,46 200,0x40	VAG
2.1 Eng.WE (85kW)	8/82-12/83		R		153-462		Vag	200,0x40	Hand Brake
	82-83		R		700-188	700-188K		Ø 200,0	Incl. Sweden
Santana III 8/84-12/94									
1.8 Eng.JH (71kW)	-88		R		153-462		Vag	200,0x40	Hand Brake
Scirocco I (53) 2/74-7/80									
1.1 Eng.FA/ GG (37kW)	4/74-7/79		R		153-465		Vag	180,0x31	Hand Brake
	74-79		R		700-191	700-191K		Ø 180,0	
	74-79		R		151-028		Bdx	Ø 14,30 180,0x30	VAG
1.3 Eng.GF (44kW)	79-80		R		700-191	700-191K		Ø 180,0	
	79-80		R		151-028		Bdx	Ø 14,30 180,0x30	VAG





























		Spare Parts	F/R	L/R	CIFAM ref.	CIFAM ref. w/KIT		DIMENSIONS mm.	NOTE
1.5 Eng.FH (51kW)	2/74-7/80		R		153-465		Vag	180,0x31	Hand Brake
	74-80		R		700-191	700-191K		Ø 180,0	
	78-80		R		151-028		Bdx	Ø 14,30 180,0x30	VAG
1.5 Eng.JB (51kW)	2/74-7/80		R		153-465		Vag	180,0x31	Hand Brake
	74-80		R		700-191	700-191K		Ø 180,0	
	78-80		R		151-028		Bdx	Ø 14,30 180,0x30	VAG
1.6 Eng.EG (81kW)	6/76-7/80		R		153-465		Vag	180,0x31	Hand Brake
	76-80		R		700-191	700-191K		Ø 180,0	
	76-80		R		151-028		Bdx	Ø 14,30 180,0x30	VAG
1.6 Eng.FP (55kW)	75-77		R		700-191	700-191K		Ø 180,0	
	75-77		R		151-028		Bdx	Ø 14,30 180,0x30	VAG
1.6 Eng.FR (63kW)	8/75-7/80		R		153-465		Vag	180,0x31	Hand Brake
	75-80		R		700-191	700-191K		Ø 180,0	
	78-80		R		151-028		Bdx	Ø 14,30 180,0x30	VAG
Scirocco II (53B) 8/80-7/92									
1.3 Eng.GF (44kW)	8/80-12/83		R		153-465		Vag	180,0x31	Hand Brake
	80-83		R		700-191	700-191K		Ø 180,0	LHD/RHD
	80-83		R		151-031		Bdx	Ø 17,46 180,0x30	VAG
1.5 Eng.JB (51kW)	8/80-12/83		R		153-465		Vag	180,0x31	Hand Brake
	80-83		R		700-191	700-191K		Ø 180,0	Incl. Sweden, LHD/RHD
	80-83		R		151-031		Bdx	Ø 17,46 180,0x30	VAG
1.6 Eng.EG (81kW)	8/80-7/82		R		153-465		Vag	180,0x31	Hand Brake
	80-82		R		700-191	700-191K		Ø 180,0	LHD/RHD
	80-82		R		151-031		Bdx	Ø 17,46 180,0x30	VAG
1.6 Eng.EW (55kW)	1/83-12/89		R		153-465		Vag	180,0x31	Hand Brake
	83-89		R		700-191	700-191K		Ø 180,0	LHD/RHD
	83-89		R		151-031		Bdx	Ø 17,46 180,0x30	VAG
1.6 Eng.EWA (51kW)	8/83-7/84		R		153-465		Vag	180,0x31	Hand Brake
1.6 Eng.FR (63kW)	8/80-4/84		R		153-465		Vag	180,0x31	Hand Brake
	80-84		R		700-191	700-191K		Ø 180,0	LHD/RHD
	80-84		R		151-031		Bdx	Ø 17,46 180,0x30	VAG
1.6 Eng.RE (53kW)	4/86-7/90		R		153-465		Vag	180,0x31	Hand Brake
	86-90		R		700-191	700-191K		Ø 180,0	LHD/RHD
	86-90		R		151-031		Bdx	Ø 17,46 180,0x30	VAG
1.8 Eng.EX (66kW)	8/83-7/92		R		153-465		Vag	180,0x31	Hand Brake
	83-92		R		700-191	700-191K		Ø 180,0	LHD/RHD
	83-92		R		151-031		Bdx	Ø 17,46 180,0x30	VAG
1.8 Eng.JH (70kW)	11/85-7/92		R		153-465		Vag	180,0x31	Hand Brake
	85-92		R		700-191	700-191K		Ø 180,0	LHD/RHD
	85-92		R		151-031		Bdx	Ø 17,46 180,0x30	VAG
1.8 16v Eng.KR (102kW)	10/85-7/89		R		153-465		Vag	180,0x31	Hand Brake
1.8 16v GTi Eng.PL (95kW)	3/86-7/92		R		153-465		Vag	180,0x31	Hand Brake
1.8 GTI Eng.DX/ EV/ PB (82kW)	8/82-12/89		R		153-465		Vag	180,0x31	Hand Brake
	82-89		R		700-191	700-191K		Ø 180,0	LHD/RHD
	82-89		R		151-031		Bdx	Ø 17,46 180,0x30	VAG
Touareg I (7LA) 10/02-4/10									
2.5 R5 TDi Eng.BAC/ BPE (128kW)	1/03-		R		153-244	153-244K		210,0x31	Hand Brake
	1/03-		R		153-019	153-019K	Ate	185,0x30	Hand Brake
2.5 TDi Eng.BLK/ BPD (120kW)	8/03-		R		153-244	153-244K		210,0x31	Hand Brake
	8/03-		R		153-019	153-019K	Ate	185,0x30	Hand Brake
3.0 TDi Eng.BUN (155kW)	12/06-		R		153-244	153-244K		210,0x31	Hand Brake
	12/06-		R		153-019	153-019K	Ate	185,0x30	Hand Brake
3.0 V6 TDi Eng.BKS (165kW)	11/04-		R		153-244	153-244K		210,0x31	Hand Brake
	11/04-		R		153-019	153-019K	Ate	185,0x30	Hand Brake
3.0 V6 TDi Eng.CAS (176kW)	12/07-		R		153-244	153-244K		210,0x31	Hand Brake
	12/07-		R		153-019	153-019K	Ate	185,0x30	Hand Brake
3.2 V6 Eng.AZZ/ BKJ (162kW)	10/02-		R		153-244	153-244K		210,0x31	Hand Brake
	10/02-		R		153-019	153-019K	Ate	185,0x30	Hand Brake
3.2 V6 Eng.BMV/ BMX (177kW)	11/04-		R		153-244	153-244K		210,0x31	Hand Brake
	11/04-		R		153-019	153-019K	Ate	185,0x30	Hand Brake
3.6 V6 FSI Eng.BHK/ BHL (206kW)	3/06-		R		153-244	153-244K		210,0x31	Hand Brake
4.2 V8 Eng.AXQ/ BHX (228kW)	12/02-		R		153-244	153-244K		210,0x31	Hand Brake
	12/02-		R		153-019	153-019K	Ate	185,0x30	Hand Brake
5.0 V10 TDi Eng.AYH (230kW)	10/02-		R		153-244	153-244K		210,0x31	Hand Brake
	10/02-		R		153-019	153-019K	Ate	185,0x30	Hand Brake
6.0 W12 Eng.BJN (331kW)	3/05-		R		153-244	153-244K		210,0x31	Hand Brake
	3/05-		R		153-019	153-019K	Ate	185,0x30	Hand Brake





























		Spare Parts	F/R	L/R	CIFAM ref.	CIFAM ref. w/KIT		DIMENSIONS mm.	NOTE
Touareg II (7P5) 5/10-									
3.0 Hybrid 24v Eng.CGEA (245kW)	10-		R		153-528			210x31	
3.0 TDi V6 Eng.CASD/ CJMA (150kW)	10-		R		153-528			210x31	
3.0 TDi V6 Eng.CJGD (180kW)	11-		R		153-528			210x31	
3.0 V6 TDi Eng.CASA (176kW)	10-		R		153-528			210x31	
4.2 V8 TDi (240kW)	10-		R		153-528			210x31	
4.2 V8 TDi Eng.CKDA (250kW)	10-		R		153-528			210x31	
Vento (1H2) 11/91-9/98									
1.4 Eng.ABD (40kW)	11/91-9/98		R		153-468		Vag	200,0x40	Hand Brake
	91-98		R		700-202	700-202K		Ø 200,0	
	91-98		R		151-084		Ate	Ø 17,46 200,0x40	VAG, +ABS
1.4 Eng.AEX (44kW)	11/91-9/98		R		153-468		Vag	200,0x40	Hand Brake
	91-94		R		700-202	700-202K		Ø 200,0	
	91-94		R		151-084		Ate	Ø 17,46 200,0x40	VAG, +ABS
1.6 Eng.ABU (55kW)	9/92-9/98		R		153-468		Vag	200,0x40	Hand Brake
	1/92-98		R		700-202	700-202K		Ø 200,0	
	92-98		R		151-084		Ate	Ø 17,46 200,0x40	VAG, +ABS
1.6 Eng.AEA/ AEE (55kW)	9/92-9/98		R		153-468		Vag	200,0x40	Hand Brake
	1/92-98		R		700-202	700-202K		Ø 200,0	
	92-98		R		151-084		Ate	Ø 17,46 200,0x40	VAG, +ABS
1.6 Eng.AEK/ AFT (74kW)	10/94-9/98		R		153-468		Vag	200,0x40	Hand Brake
	7/94-98		R		700-202	700-202K		Ø 200,0	
	7/94-98		R		151-084		Ate	Ø 17,46 200,0x40	VAG, +ABS
1.8 Eng.AAM (55kW)	11/91-9/98		R		153-468		Vag	200,0x40	Hand Brake
	91-98		R		700-202	700-202K		Ø 200,0	
	91-98		R		151-084		Ate	Ø 17,46 200,0x40	VAG, +ABS
	91-98		R		151-086		Vag	Ø 15,87 200,0x40	VAG
1.8 Eng.ABS/ ADZ (66kW)	11/91-9/98		R		153-468		Vag	200,0x40	Hand Brake
	91-98		R		700-202	700-202K		Ø 200,0	
	91-98		R		151-084		Ate	Ø 17,46 200,0x40	VAG, +ABS
1.9 D Eng.1Y (47-50kW)	11/91-9/98		R		153-468		Vag	200,0x40	Hand Brake
	91-94		R		700-202	700-202K		Ø 200,0	
	91-98		R		151-084		Ate	Ø 17,46 200,0x40	VAG, +ABS
1.9 SDi Eng.AEY (47kW)	4/97-9/98		R		153-468		Vag	200,0x40	Hand Brake
	97-98		R		700-202	700-202K		Ø 200,0	
	97-98		R		151-084		Ate	Ø 17,46 200,0x40	VAG, +ABS
1.9 TD Eng.AAZ (55kW)	11/91-9/98		R		153-468		Vag	200,0x40	Hand Brake
	91-98		R		700-202	700-202K		Ø 200,0	
	91-98		R		151-084		Ate	Ø 17,46 200,0x40	VAG, +ABS
	91-98		R		151-086		Vag	Ø 15,87 200,0x40	VAG
1.9 TDi Eng.1Z (66kW)	9/93-9/98		R		153-468		Vag	200,0x40	Hand Brake
	93-98		R		700-202	700-202K		Ø 200,0	
	93-98		R		151-084		Ate	Ø 17,46 200,0x40	VAG, +ABS
1.9 TDi Eng.AFN (81kW)	4/96-9/98		R		153-468		Vag	200,0x40	Hand Brake
	96-98		R		700-202	700-202K		Ø 200,0	
	96-98		R		151-084		Ate	Ø 17,46 200,0x40	VAG, +ABS
1.9 TDi Eng.AHU/ ALE (66kW)	9/93-9/98		R		153-468		Vag	200,0x40	Hand Brake
	93-98		R		700-202	700-202K		Ø 200,0	
	93-98		R		151-084		Ate	Ø 17,46 200,0x40	VAG, +ABS
2.0 Eng.2E/ ADY/ AGG/ AKR (85kW)	11/91-9/98		R		153-468		Vag	200,0x40	Hand Brake
2.0 GTi 16v Eng.ABF (110kW)	11/91-9/98		R		153-468		Vag	200,0x40	Hand Brake



































VOLKSWAGEN LCV





Amarok 10/10-									
2.0 BiTDi, 4motion Eng.CDCA (120kW)	10-		R		153-529			295x57	
2.0 TDi, 4motion Eng.CDBA (90kW)	10-		R		153-529			295x57	
Caddy I (14) 8/82-7/92									
1.5 Eng.JB (51kW)	8/82-7/83		R		153-465		Vag	180,0x31	Hand Brake
	8/82-7/83		R		153-009		Vag	230,0x40	Hand Brake
	8/82-83		R		700-200	700-200K		Ø 230,0	
	82-83		R		151-131		Ate	Ø 20,64 230,0x40	VAG
1.6 Eng.EM/ EW (55kW)	-83		R		153-465		Vag	180,0x31	Hand Brake
	83-		R		153-008		Vag	230,0x40	Hand Brake
	83-		R		153-009		Vag	230,0x40	Hand Brake



























































		Spare Parts	F/R	L/R	CIFAM ref.	CIFAM ref. w/KIT		DIMENSIONS mm.	NOTE
1.6 Eng.EM/ EW (55kW)	8/82-7/92		R		700-200	700-200K		Ø 230,0	
	82-92		R		151-131		Ate	Ø 20,64 230,0x40	VAG
1.6 D Eng.JK/ ME (40kW)	8/82-7/92		R		153-008		Vag	230,0x40	Hand Brake
	8/82-7/92		R		153-009		Vag	230,0x40	Hand Brake
	8/82-7/92		R		700-200	700-200K		Ø 230,0	
	82-92		R		151-131		Ate	Ø 20,64 230,0x40	VAG
1.8 Eng.JH (70kW)	8/85-7/92		R		153-008		Vag	230,0x40	Hand Brake
	8/85-7/92		R		153-009		Vag	230,0x40	Hand Brake
	85-92		R		700-200	700-200K		Ø 230,0	
	85-92		R		151-131		Ate	Ø 20,64 230,0x40	VAG
Caddy II (9K9) 11/95-1/04									
1.4 Eng.AEX/ AKV/ APQ (44kW)	11/95-1/04		R		153-009		Vag	230,0x40	Hand Brake
			R		700-359			Ø 230,0	Ch 9KX023409-, -ABS
	11/95-		R		700-213	700-213K		Ø 200,0	Ch -9KX023408
	11/95-		R		700-208	700-208K		Ø 230,0	Ch -9KX023408, -ABS
	95-		R		151-147		Vag	Ø 20,64 230,0x32	Ch 9KY500748-, VAG
	95-		R		151-131		Ate	Ø 20,64 230,0x40	Ch -9KY500747, VAG
1.4 Eng.AUD (44kW)	11/95-1/04		R		153-009		Vag	230,0x40	Hand Brake
			R		700-359			Ø 230,0	Ch 9KX023409-, -ABS
	11/95-		R		700-213	700-213K		Ø 200,0	Ch -9KX023408
	11/95-		R		700-208	700-208K		Ø 230,0	Ch -9KX023408, -ABS
	95-		R		151-147		Vag	Ø 20,64 230,0x32	Ch 9KY500748-, VAG
	95-		R		151-131		Ate	Ø 20,64 230,0x40	Ch -9KY500747, VAG
1.4 16v Eng.AHW/ AKQ/ APE/ AUA (55kW)	8/00-1/04		R		153-379		Vag	230,0x32	Hand Brake
			R		700-359			Ø 230,0	Ch 9KX023409-, -ABS
	00-00-		R		700-213	700-213K		Ø 200,0	Ch -9KX023408
	00-00-		R		700-208	700-208K		Ø 230,0	Ch -9KX023408, -ABS
	95-		R		151-147		Vag	Ø 20,64 230,0x32	Ch 9KY500748-, VAG
	95-		R		151-131		Ate	Ø 20,64 230,0x40	Ch -9KY500747, VAG
1.6 Eng.1F (53-55kW)	11/95-9/00		R		153-468		Vag	200,0x40	Hand Brake
			R		153-009		Vag	230,0x40	Hand Brake
	11/95-		R		700-359			Ø 230,0	Ch 9KX023409-, -ABS
	11/95-		R		700-213	700-213K		Ø 200,0	Ch -9KX023408
	11/95-		R		700-208	700-208K		Ø 230,0	Ch -9KX023408, -ABS
	95-		R		151-147		Vag	Ø 20,64 230,0x32	Ch 9KY500748-, VAG
1.6 Eng.AEE (55kW)	11/95-9/00		R		153-468		Vag	200,0x40	Hand Brake
			R		153-009		Vag	230,0x40	Hand Brake
	11/95-		R		700-359			Ø 230,0	Ch 9KX023409-, -ABS
	11/95-		R		700-213	700-213K		Ø 200,0	Ch -9KX023408
	11/95-		R		700-208	700-208K		Ø 230,0	Ch -9KX023408, -ABS
	95-		R		151-147		Vag	Ø 20,64 230,0x32	Ch 9KY500748-, VAG
1.7 SDi Eng.AHB (42kW)	7/96-9/00		R		153-009		Vag	230,0x40	Hand Brake
			R		700-359			Ø 230,0	Ch 9KX023409-, -ABS
	96-96-		R		700-213	700-213K		Ø 200,0	Ch -9KX023408
	96-96-		R		700-208	700-208K		Ø 230,0	Ch -9KX023408, -ABS
	96-		R		151-147		Vag	Ø 20,64 230,0x32	Ch 9KY500748-, VAG
	96-		R		151-131		Ate	Ø 20,64 230,0x40	Ch -9KY500747, VAG
1.9 D Eng.1Y (47kW)	11/95-1/04		R		153-468		Vag	200,0x40	Hand Brake
			R		153-379		Vag	230,0x32	Hand Brake
	11/95-1/04		R		153-009		Vag	230,0x40	Hand Brake
	11/95-		R		700-359			Ø 230,0	Ch 9KX023409-, -ABS
	11/95-		R		700-213	700-213K		Ø 200,0	Ch -9KX023408
	11/95-		R		700-208	700-208K		Ø 230,0	Ch -9KX023408, -ABS
1.9 D Eng.AEF (47kW)	11/95-1/04		R		153-468		Vag	200,0x40	Hand Brake
			R		153-379		Vag	230,0x32	Hand Brake
	11/95-		R		153-009		Vag	230,0x40	Hand Brake
	11/95-		R		700-359			Ø 230,0	Ch 9KX023409-, -ABS
	11/95-		R		700-213	700-213K		Ø 200,0	Ch -9KX023408
	11/95-		R		700-208	700-208K		Ø 230,0	Ch -9KX023408, -ABS
1.9 SDi Eng.AEY/ AYQ (47kW)	11/95-1/04		R		153-468		Vag	200,0x40	Hand Brake
			R		153-379		Vag	230,0x32	Hand Brake
	11/95-1/04		R		153-009		Vag	230,0x40	Hand Brake
	95-		R		700-359			Ø 230,0	Ch 9KX023409-, -ABS































































		Spare Parts	F/R	L/R	CIFAM ref.	CIFAM ref. w/KIT		DIMENSIONS mm.	NOTE
1.9 SDi Eng.AEY/ AYQ (47kW)	11/95-		R		700-213	700-213K		Ø 200,0	Ch -9KX023408
	11/95-		R		700-208	700-208K		Ø 230,0	Ch -9KX023408, -ABS
	-04		R		151-147		Vag	Ø 20,64 230,0x32	Ch 9KY500748-, VAG
	95-		R		151-131		Ate	Ø 20,64 230,0x40	Ch -9KY500747, VAG
1.9 TDi Eng.AHU/ ALE/ ALH (66kW)	9/96-1/04		R		153-468		Vag	200,0x40	Hand Brake
	9/96-1/04		R		153-379		Vag	230,0x32	Hand Brake
	9/96-1/04		R		153-009		Vag	230,0x40	Hand Brake
			R		700-359			Ø 230,0	Ch 9KX023409-, -ABS
	96-		R		700-213	700-213K		Ø 200,0	Ch -9KX023408
	96-		R		700-208	700-208K		Ø 230,0	Ch -9KX023408, -ABS
			R		151-147		Vag	Ø 20,64 230,0x32	Ch 9KY500748-, VAG
	96-		R		151-131		Ate	Ø 20,64 230,0x40	Ch -9KY500747, VAG
Caddy II (9U7) Pick-Up 11/95-2/04									
1.4 Eng.AEX/ AKV/ APQ (44kW)	11/95-2/04		R		153-009		Vag	230,0x40	Hand Brake
			R		700-359			Ø 230,0	Ch 9KX023409-, -ABS
	11/95-		R		700-213	700-213K		Ø 200,0	Ch -9KX023408
	11/95-		R		700-208	700-208K		Ø 230,0	Ch -9KX023408, -ABS
1.4 Eng.AUA (55kW)	8/00-2/04		R		153-379		Vag	230,0x32	Hand Brake
			R		700-359			Ø 230,0	Ch 9KX023409-, -ABS
	00-		R		700-213	700-213K		Ø 200,0	Ch -9KX023408
	00-		R		700-208	700-208K		Ø 230,0	Ch -9KX023408, -ABS
1.4 Eng.AUD (44kW)	11/95-2/04		R		153-009		Vag	230,0x40	Hand Brake
			R		700-359			Ø 230,0	Ch 9KX023409-, -ABS
	11/95-		R		700-213	700-213K		Ø 200,0	Ch -9KX023408
	11/95-		R		700-208	700-208K		Ø 230,0	Ch -9KX023408, -ABS
1.6 Eng.1F (53-55kW)	11/95-2/04		R		153-468		Vag	200,0x40	Hand Brake
	11/95-2/04		R		153-009		Vag	230,0x40	Hand Brake
			R		700-359			Ø 230,0	Ch 9KX023409-, -ABS
			R		700-213	700-213K		Ø 200,0	Ch -9KX023408
	11/95-		R		700-208	700-208K		Ø 230,0	Ch -9KX023408, -ABS
	11/95-		R		151-147		Vag	Ø 20,64 230,0x32	Ch 9KY500748-, VAG
	95-		R		151-125		Vag	Ø 19,05 200,0x40	VAG, +ABS
	95-12/00		R		151-131		Ate	Ø 20,64 230,0x40	VAG
1.6 Eng.AEE (55kW)	11/95-2/04		R		153-468		Vag	200,0x40	Hand Brake
	11/95-2/04		R		153-009		Vag	230,0x40	Hand Brake
			R		700-359			Ø 230,0	Ch 9KX023409-, -ABS
	11/95-		R		700-213	700-213K		Ø 200,0	Ch -9KX023408
	11/95-		R		700-208	700-208K		Ø 230,0	Ch -9KX023408, -ABS
			R		151-147		Vag	Ø 20,64 230,0x32	Ch 9KY500748-, VAG
	95-		R		151-125		Vag	Ø 19,05 200,0x40	VAG, +ABS
	95-12/00		R		151-131		Ate	Ø 20,64 230,0x40	VAG
1.7 SDi Eng.AHB (42kW)	7/96-2/04		R		153-009		Vag	230,0x40	Hand Brake
			R		700-359			Ø 230,0	Ch 9KX023409-, -ABS
	96-		R		700-213	700-213K		Ø 200,0	Ch -9KX023408
	96-		R		700-208	700-208K		Ø 230,0	Ch -9KX023408, -ABS
1.9 D Eng.1Y (47kW)	11/95-2/04		R		153-468		Vag	200,0x40	Hand Brake
	11/95-2/04		R		153-379		Vag	230,0x32	Hand Brake
	11/95-2/04		R		153-009		Vag	230,0x40	Hand Brake
			R		700-359			Ø 230,0	Ch 9KX023409-, -ABS
	11/95-		R		700-213	700-213K		Ø 200,0	Ch -9KX023408
	11/95-		R		700-208	700-208K		Ø 230,0	Ch -9KX023408, -ABS
			R		151-147		Vag	Ø 20,64 230,0x32	Ch 9KY500748-, VAG
			R		151-131		Ate	Ø 20,64 230,0x40	VAG
95-		R		151-125		Vag	Ø 19,05 200,0x40	VAG, +ABS	
		R		151-131		Ate	Ø 20,64 230,0x40	VAG	
1.9 D Eng.AEF (47kW)	11/95-2/04		R		153-468		Vag	200,0x40	Hand Brake
	11/95-2/04		R		153-379		Vag	230,0x32	Hand Brake
	11/95-2/04		R		153-009		Vag	230,0x40	Hand Brake
			R		700-359			Ø 230,0	Ch 9KX023409-, -ABS
	11/95-		R		700-213	700-213K		Ø 200,0	Ch -9KX023408
	11/95-		R		700-208	700-208K		Ø 230,0	Ch -9KX023408, -ABS
			R		151-147		Vag	Ø 20,64 230,0x32	Ch 9KY500748-, VAG
			R		151-131		Ate	Ø 20,64 230,0x40	VAG
95-		R		151-125		Vag	Ø 19,05 200,0x40	VAG, +ABS	
		R		151-131		Ate	Ø 20,64 230,0x40	VAG	
1.9 SDi Eng.AEY/ AYQ (47kW)	11/95-2/04		R		153-468		Vag	200,0x40	Hand Brake
	11/95-2/04		R		153-379		Vag	230,0x32	Hand Brake
	11/95-2/04		R		153-009		Vag	230,0x40	Hand Brake
			R		700-359			Ø 230,0	Ch 9KX023409-, -ABS
	11/95-		R		700-213	700-213K		Ø 200,0	Ch -9KX023408



























































		Spare Parts	F/R	L/R	CIFAM ref.	CIFAM ref. w/KIT		DIMENSIONS mm.	NOTE
1.9 SDi Eng.AEY/ AYQ (47kW)	11/95-		R		700-208	700-208K		Ø 230,0	Ch -9KX023408, -ABS
1.9 TDi Eng.AHU/ ALE (66kW)	9/96-2/04		R		153-468		Vag	200,0x40	Hand Brake
	9/96-2/04		R		153-379		Vag	230,0x32	Hand Brake
	9/96-2/04		R		153-009		Vag	230,0x40	Hand Brake
			R		700-359			Ø 230,0	Ch 9KX023409-, -ABS
	96-		R		700-213	700-213K		Ø 200,0	Ch -9KX023408
96-		R		700-208	700-208K		Ø 230,0	Ch -9KX023408, -ABS	
Caddy III (2KA, KB) 3/04-									
1.4 16v Eng.BCA (55kW)	3/04-		R		153-379		Vag	230,0x32	Hand Brake
1.4 16v Eng.BUD (59kW)	06-		R		153-379		Vag	230,0x32	Hand Brake
1.6 Eng.BGU/ BSE/ BSF (75kW)	4/04-		R		153-379		Vag	230,0x32	Hand Brake
1.6 Eng.BRY (74kW)	3/05-		R		153-379		Vag	230,0x32	Hand Brake
1.9 TDi Eng.BJB (77kW)	4/04-		R		153-379		Vag	230,0x32	Hand Brake
1.9 TDi Eng.BSU (55kW)	9/05-		R		153-379		Vag	230,0x32	Hand Brake
1.9 TDi 4motion Eng.BLS (77kW)	08-		R		153-379		Vag	230,0x32	
Crafter (2E) 4/06-									
2.5 TDi Eng.BJJ (65kW)	06-		R		153-249			174,0x42	5p
	4/06-		R		153-246	153-246K		180,0x25	3p, Hand Brake
	4/06-		R			153-249K		174x42	30-35
2.5 TDi Eng.BJK (80kW)	06-		R		153-249			174,0x42	5p
	4/06-		R		153-246	153-246K		180,0x25	Hand Brake
	4/06-		R			153-249K		174x42	30-35
2.5 TDi Eng.BJL (100kW)	06-		R		153-249			174,0x42	5p
	4/06-		R		153-246	153-246K		180,0x25	Hand Brake
	4/06-		R			153-249K		174x42	30-35
2.5 TDi Eng.BJM (120kW)	06-		R		153-249			174,0x42	5p
	4/06-		R		153-246	153-246K		180,0x25	Hand Brake
	4/06-		R			153-249K		174x42	30-35
LT I 28-35 (281-363) 4/75-6/96									
2.0 Eng.CH (55kW)	4/75-9/83		R		153-466		Vag	252,0x56	Hand Brake
	75-83		R		700-189			Ø 252,0	SRW
	75-83		R		700-199			Ø 270,0	TRW
2.4 Eng.DL (66kW)	12/82-7/92		R		153-466		Vag	252,0x56	Hand Brake
	12/82-7/92		R		153-463		Vag	270,0x66	Hand Brake
	87-		R		153-467		Vag	270,0x66	4WD Van, Hand Brake
	82-92		R		700-189			Ø 252,0	SRW
	82-92		R		700-199			Ø 270,0	TRW
2.4 D Eng.1S/ ACT (51kW)	89-96		R		700-189			Ø 252,0	SRW
	89-96		R		700-199			Ø 270,0	TRW
2.4 D Eng.CP/ DW (55kW)	79-90		R		700-189			Ø 252,0	SRW
	79-90		R		700-199			Ø 270,0	TRW
2.4 i Eng.1E (69kW)	3/94-6/96		R		153-466		Vag	252,0x56	Hand Brake
	3/94-6/96		R		153-467		Vag	270,0x66	Hand Brake
	94-96		R		700-189			Ø 252,0	SRW
	94-96		R		700-199			Ø 270,0	TRW
2.4 TD Eng.1G (68kW)	8/88-8/92		R		153-467		Vag	270,0x66	Hand Brake
	88-90		R		700-189			Ø 252,0	SRW
	88-90		R		700-199			Ø 270,0	TRW
2.4 TD Eng.ACL (70kW)	6/92-5/96		R		153-467		Vag	270,0x66	Hand Brake
	92-96		R		700-189			Ø 252,0	SRW
	92-96		R		700-199			Ø 270,0	TRW
2.4 TD Eng.DV (75kW)	2/86-8/92		R		153-467		Vag	270,0x66	Hand Brake
	86-90		R		700-189			Ø 252,0	SRW
	86-90		R		700-199			Ø 270,0	TRW
2.7 D Eng.CG (48kW)	11/75-1/80		R		153-466		Vag	252,0x56	Hand Brake
	75-80		R		700-189			Ø 252,0	SRW
	75-80		R		700-199			Ø 270,0	TRW
LT I 40-55 (291-293-512-909) 4/75-6/96									
2.0 Eng.CH (55kW)	75-83		R		700-189			Ø 252,0	SRW
	75-83		R		700-199			Ø 270,0	TRW
2.4 D Eng.1S/ ACT (51kW)	8/90-6/96		R		153-466		Vag	252,0x56	LT50, Hand Brake
	8/90-6/96		R		153-467		Vag	270,0x66	Van, Hand Brake
	90-96		R		700-189			Ø 252,0	SRW
	90-96		R		700-199			Ø 270,0	TRW
2.4 D, 4WD Eng.CP/ DW (55kW)	12/78-2/91		R		153-463		Vag	270,0x66	Syncro Long, Short, Hand Brake
	12/78-2/91		R		153-467		Vag	270,0x66	Van, Hand Brake
	78-90		R		700-189			Ø 252,0	SRW
	78-90		R		700-199			Ø 270,0	TRW























































		Spare Parts	F/R	L/R	CIFAM ref.	CIFAM ref. w/KIT		DIMENSIONS mm.	NOTE
2.4 i Eng.1E (69kW)	3/94-6/96		R		153-466		Vag	252,0x56	Hand Brake
	3/94-6/96		R		153-467		Vag	270,0x66	LT55 Long Van, Hand Brake
	94-96		R		700-189			Ø 252,0	SRW
	94-96		R		700-199			Ø 270,0	TRW
2.4 TD Eng.1G (68kW)	8/88-8/92		R		153-467		Vag	270,0x66	Hand Brake
	88-90		R		700-189			Ø 252,0	SRW
	88-90	R		700-199			Ø 270,0	TRW	
2.4 TD Eng.ACL (70kW)	6/92-5/96		R		153-467		Vag	270,0x66	Hand Brake
	92-96		R		700-189			Ø 252,0	SRW
	92-96	R		700-199			Ø 270,0	TRW	
2.4 TD, 4WD Eng.DV (75kW)	8/78-3/92		R		153-467		Vag	270,0x66	Hand Brake
	78-90		R		700-189			Ø 252,0	SRW
	78-90	R		700-199			Ø 270,0	TRW	
2.4, 4WD Eng.DL (66kW)	12/82-7/92		R		153-466		Vag	252,0x56	Hand Brake
	12/82-7/92		R		153-463		Vag	270,0x66	Hand Brake
	89-	R		153-467		Vag	270,0x66	LT55 Long Van, Hand Brake	
	82-90		R		700-189			Ø 252,0	SRW
	82-90		R		700-199			Ø 270,0	TRW
LT II 28-46 (2DX0AE, FE, 2DM) 5/96-									
2.3 Eng.AGL (105kW)	5/96-		R		153-240	153-240K	Ate	170,0x40	Hand Brake
	5/96-		R		153-239	153-239K	Bosch	160,0x40	Hand Brake
2.5 SDi Eng.AGX (55kW)	7/96-		R		153-240	153-240K	Ate	170,0x40	Hand Brake
	7/96-		R		153-239	153-239K	Bosch	160,0x40	Hand Brake
2.5 TDi Eng.AHD (75kW)	5/96-8/99		R		153-240	153-240K	Ate	170,0x40	Hand Brake
	5/96-8/99		R		153-239	153-239K	Bosch	160,0x40	Hand Brake
2.5 TDi Eng.ANJ/ AVR (80kW)	5/99-		R		153-240	153-240K	Ate	170,0x40	Hand Brake
	5/99-		R		153-239	153-239K	Bosch	160,0x40	Hand Brake
2.5 TDi Eng.APA (66kW)	5/99-		R		153-240	153-240K	Ate	170,0x40	Hand Brake
	5/99-		R		153-239	153-239K	Bosch	160,0x40	Hand Brake
2.5 TDi Eng.BBE (61kW)	5/01-		R		153-240	153-240K	Ate	170,0x40	Hand Brake
	5/01-		R		153-239	153-239K	Bosch	160,0x40	Hand Brake
2.5 TDi Eng.BBF (70kW)	5/01-		R		153-240	153-240K	Ate	170,0x40	Hand Brake
	5/01-		R		153-239	153-239K	Bosch	160,0x40	Hand Brake
2.8 TDi Eng.AGK (92kW)	6/97-12/98		R		153-240	153-240K	Ate	170,0x40	Hand Brake
2.8 TDi Eng.ATA (96kW)	1/99-		R		153-240	153-240K	Ate	170,0x40	Hand Brake
2.8 TDi Eng.AUH/ BCQ (116kW)	4/02-		R		153-240	153-240K	Ate	170,0x40	Hand Brake
Multivan V (7HM) 4/03-									
1.9 TDi Eng.AXB (77kW)	4/03-		R		153-019	153-019K	Ate	185,0x30	Hand Brake
2.0 Eng.AXA (85kW)	4/03-		R		153-019	153-019K	Ate	185,0x30	Hand Brake
2.5 TDi, 4motion Eng.AXD/ BNZ (96kW)	7/04-		R		153-019	153-019K	Ate	185,0x30	Hand Brake
2.5 TDi, 4motion Eng.AXE/ BPC (128kW)	7/04-		R		153-019	153-019K	Ate	185,0x30	Hand Brake
3.2 V6 Eng.BDL (170kW)	4/03-		R		153-019	153-019K	Ate	185,0x30	Hand Brake
3.2 V6, 4motion Eng.BKK/ CFLA (173kW)	7/04-		R		153-019	153-019K	Ate	185,0x30	Hand Brake
Polo Van I (86CF) 1/81-9/94									
1.0 Eng.AAU (33kW)	10/81-94		R		700-191	700-191K		Ø 180,0	
	3/85-9/94		R		151-045		Ate	Ø 15,87 180,0x30	VAG
1.3 Eng.AAV (40kW)	10/81-94		R		700-191	700-191K		Ø 180,0	
	3/85-9/94		R		151-045		Ate	Ø 15,87 180,0x30	VAG
1.4 D Eng.1W (35kW)	-94		R		700-191	700-191K		Ø 180,0	Ch F127904-
	3/85-9/94		R		151-045		Ate	Ø 15,87 180,0x30	VAG
Polo Van II (6NF) 10/94-									
1.0 Eng.AAU (33kW)			R		700-219			Ø 200,0	Ch 6NZXY420001-
	94-		R		700-191	700-191K		Ø 180,0	Ch -6NZXY227489, -ABS
	94-		R		700-202	700-202K		Ø 200,0	Ch -6NZXY227489, +ABS
	94-		R		151-031		Bdx	Ø 17,46 180,0x30	VAG
1.4 Eng.AEX/ AKV/ ANX/ APQ (44kW)			R		700-219			Ø 200,0	Ch 6NZXY420001-
	98-		R		700-191	700-191K		Ø 180,0	Ch -6NZXY227489, Exc. Germany, -ABS
	98-		R		700-202	700-202K		Ø 200,0	Ch -6NZXY227489, Exc. Germany, +ABS
1.6 Eng.AEA (55kW)	94-95		R		700-191	700-191K		Ø 180,0	
	94-95		R		151-031		Bdx	Ø 17,46 180,0x30	VAG
1.7 SDi Eng.AKU (44kW)			R		700-219			Ø 200,0	Ch 6NZXY420001-
	97-		R		700-191	700-191K		Ø 180,0	Ch -6NZXY227489, -ABS
	97-		R		700-202	700-202K		Ø 200,0	Ch -6NZXY227489, +ABS
1.9 D Eng.AEF (47kW)			R		700-219			Ø 200,0	Ch 6NZXY420001-
	94-		R		700-191	700-191K		Ø 180,0	Ch -6NZXY227489, -ABS

























































		Spare Parts	F/R	L/R	CIFAM ref.	CIFAM ref. w/KIT		DIMENSIONS mm.	NOTE
1.9 D Eng.AEF (47kW)		94-	R		700-202	700-202K		Ø 200,0	Ch -6NZXY227489, +ABS
		94-99	R		151-084		Ate	Ø 17,46 200,0x40	VAG, +ABS
		94-99	R		151-031		Bdx	Ø 17,46 180,0x30	VAG
1.9 SDi Eng.AGD (47kW)			R		700-219			Ø 200,0	Ch 6NZXY420001-
		96-	R		700-191	700-191K		Ø 180,0	Ch -6NZXY227489, -ABS
		96-	R		700-202	700-202K		Ø 200,0	Ch -6NZXY227489, +ABS
		96-99	R		151-084		Ate	Ø 17,46 200,0x40	VAG, +ABS
		96-99	R		151-031		Bdx	Ø 17,46 180,0x30	VAG
Taro 4/89-3/97									
1.8 Eng.2Y (61kW)		4/89-9/94	R		153-413		Ake	254,0x58	Hand Brake
		4/89-9/94	R		153-421		Ake	295,0x50	4WD, Hand Brake
		89-	R		700-204			Ø 254,0	Ch -7AR9510000
		89-	R		700-206			Ø 295,0	Single front payload
2.2, 4WD Eng.4Y (69kW)		6/89-7/94	R		153-413		Ake	254,0x58	Hand Brake
		6/89-7/94	R		153-421		Ake	295,0x50	4WD, Hand Brake
		89-	R		700-204			Ø 254,0	Ch -7AR9510000
		89-	R		700-206			Ø 295,0	Single front payload
2.4 D, 4WD Eng.2L (58-61kW)		6/89-3/97	R		153-428			270,0x55	RWD
		89-	R		700-206			Ø 295,0	Single front payload
2.4 i, 4WD Eng.22R (84kW)		6/89-3/97	R		153-413		Ake	254,0x58	Hand Brake
		6/89-3/97	R		153-421		Ake	295,0x50	4WD, Hand Brake
Transporter II 8/67-7/79									
1.3 Eng.AR (32kW)		1/70-12/79	R		153-457		Vag	230,0x40	Ch -20069408
		1/70-12/79	R		153-459		Vag	230,0x40	Ch 20069409-, Hand Brake
1.6 Eng.AD/ AH/ AS (37kW)		8/68-7/79	R		153-461		Vag	252,0x56	Hand Brake
		72-79	R		700-195			Ø 252,0	
1.6 Eng.AF (34kW)		67-70	R		700-195			Ø 252,0	
1.8 Eng.AP (50kW)		73-75	R		700-195			Ø 252,0	
2.0 Eng.CJ/ GD/ GE (51-52kW)		75-79	R		700-195			Ø 252,0	
Transporter III 5/79-7/92									
1.6 Eng.CT (37kW)		79-82	R		700-194			Ø 252,0	
1.6 D Eng.CS (37kW)		1/81-7/87	R		153-464		Vag	252,0x56	Hand Brake
		81-87	R		700-194			Ø 252,0	
1.6 TD, Syncro Eng.JX (51kW)		8/84-7/92	R		153-464		Vag	252,0x56	Hand Brake
		12/84-90	R		700-194			Ø 252,0	Syncro
1.7 D Eng.KY (42kW)		7/89-7/92	R		153-464		Vag	252,0x56	Hand Brake
		7/89-7/92	R		153-467		Vag	270,0x66	Syncro, Hand Brake
		89-92	R		700-194			Ø 252,0	
1.9 Eng.DF (44kW)		10/82-7/92	R		153-464		Vag	252,0x56	Hand Brake
		82-92	R		700-194			Ø 252,0	
1.9 Eng.DH (61kW)		1/83-2/89	R		153-464		Vag	252,0x56	Hand Brake
		83-89	R		700-194			Ø 252,0	
1.9 Eng.GW (66kW)		8/83-2/89	R		153-464		Vag	252,0x56	Hand Brake
		83-89	R		700-194			Ø 252,0	
1.9, Syncro Eng.DF/ DG (44-57kW)		10/82-7/92	R		153-464		Vag	252,0x56	Hand Brake
		82-92	R		700-194			Ø 252,0	
2.0 Eng.CU/ CV (51kW)		5/79-4/86	R		153-464		Vag	252,0x56	Hand Brake
		79-86	R		700-194			Ø 252,0	
2.1 i Eng.SS (68kW)		7/89-7/92	R		153-464		Vag	252,0x56	Hand Brake
		89-92	R		700-194			Ø 252,0	
2.1, Syncro Eng.DJ (82kW)		8/85-7/92	R		153-464		Vag	252,0x56	Incl. Syncro 16Inch, Hand Brake
		8/85-7/92	R		153-467		Vag	270,0x66	Syncro, Hand Brake
		85-92	R		700-194			Ø 252,0	
2.1, Syncro Eng.MV (70kW)		8/85-7/92	R		153-464		Vag	252,0x56	Incl. Syncro 16Inch, Hand Brake
		8/85-7/92	R		153-467		Vag	270,0x66	Syncro, Hand Brake
		85-92	R		700-194			Ø 252,0	
2.1, Syncro Eng.SR (64kW)		10/86-7/92	R		153-464		Vag	252,0x56	Incl. Syncro 16Inch, Hand Brake
		10/86-7/92	R		153-467		Vag	270,0x66	Syncro, Hand Brake
		86-92	R		700-194			Ø 252,0	
Transporter IV (70XA/B/C/D, DB, 7DW) 7/90-3/03									
1.8 (62kW)		7/92-7/00	R		153-469		Vag	270,0x55	Hand Brake
1.8 Eng.PD (49kW)		12/90-7/92	R		153-469		Vag	270,0x55	Hand Brake
		90-	R		700-203			Ø 268,0	Ch -70T199999
1.9 D Eng.1X (44-45kW)		7/90-3/03	R		153-469		Vag	270,0x55	Hand Brake
		90-	R		700-203			Ø 268,0	Ch -70T199999
1.9 TD Eng.ABL (50kW)		92-	R		700-203			Ø 268,0	Ch -70T199999
2.0 Eng.AAC (62kW)		9/90-3/03	R		153-469		Vag	270,0x55	Hand Brake
		90-	R		700-203			Ø 268,0	Ch -70T199999























































		Spare Parts	F/R	L/R	CIFAM ref.	CIFAM ref. w/KIT		DIMENSIONS mm.	NOTE
2.4 D Eng.AJA (55kW)	97-		R		700-203			Ø 268,0	Ch -70T199999
2.4 D, Syncro Eng.AAB (57kW)	90-		R		700-203			Ø 268,0	Ch -70T199999
2.5 Eng.AAF/ ACU (81kW)	11/90-3/03		R		153-469		Vag	270,0x55	Hand Brake
	90-		R		700-203			Ø 268,0	Ch -70T199999
2.5 Eng.AEN/ AEU (81kW)	11/90-3/03		R		153-469		Vag	270,0x55	Hand Brake
	90-		R		700-203			Ø 268,0	Ch -70T199999
2.5 Eng.AET/ APL/ AVT (85kW)	7/96-3/03		R		153-469		Vag	270,0x55	Hand Brake
2.5 Syncro Eng.AAF/ ACU (81kW)	11/90-3/03		R		153-469		Vag	270,0x55	Hand Brake
	90-		R		700-203			Ø 268,0	
2.5 Syncro Eng.AEN/ AEU (81kW)	11/90-3/03		R		153-469		Vag	270,0x55	Hand Brake
	90-		R		700-203			Ø 268,0	
2.5 Syncro Eng.AET/ APL/ AVT (85kW)	7/96-3/03		R		153-469		Vag	270,0x55	Hand Brake
2.5 TDi Eng.AC/ V/ AUF/ AYC (75kW)	95-		R		700-203			Ø 268,0	
2.5 TDi Eng.AHY/ AXG (111kW)	98-		R		700-203			Ø 268,0	Ch -70T199999
2.5 TDi Eng.AJT/ AYY (65kW)	98-		R		700-203			Ø 268,0	Ch -70T199999
2.5 TDi Syncro Eng.AC/ V/ AXL (75kW)	95-		R		700-203			Ø 268,0	Ch -70T199999
Transporter V (7HA/B/H/J, JD/E/L) 4/03-									
1.9 TDi Eng.AXB (77kW)	03-		R		153-019	153-019K	Ate	185,0x30	Hand Brake
1.9 TDi Eng.AXC (63kW)	03-		R		153-019	153-019K	Ate	185,0x30	Hand Brake
1.9 TDi Eng.BRR (62kW)	1/06-		R		153-019	153-019K	Ate	185,0x30	Hand Brake
1.9 TDi Eng.BRS (75kW)	6/06-		R		153-019	153-019K	Ate	185,0x30	Hand Brake
2.0 Eng.AXA (85kW)	4/03-		R		153-019	153-019K	Ate	185,0x30	Hand Brake
2.5 TDi Eng.BLJ (120kW)	11/03-		R		153-019	153-019K	Ate	185,0x30	Hand Brake
2.5 TDi, 4motion Eng.AXD/ BNZ (96kW)	4/03-		R		153-019	153-019K	Ate	185,0x30	Hand Brake
2.5 TDi, 4motion Eng.AXE/ BPC (128kW)	4/03-		R		153-019	153-019K	Ate	185,0x30	Hand Brake
3.2 V6 Eng.BDL (170kW)	4/03-		R		153-019	153-019K	Ate	185,0x30	Hand Brake
3.2 V6, 4motion Eng.BKK/ CFLA (173kW)	8/03-		R		153-019	153-019K	Ate	185,0x30	Hand Brake
Vanagon 1/72-1/87									
All models	72-79		R		700-195			Ø 252,0	
	79-87		R		700-194			Ø 252,0	
VOLVO									
240 (P242, 244, 245), SW 8/74-8/93									
1.8 Eng.B17A	1/79-12/84		R		153-473	153-473K	Lucas	160,0x25	Hand Brake
2.0 Eng.B19A/ K (66-70-71kW)	8/76-7/83		R		153-473	153-473K	Lucas	160,0x25	Hand Brake
2.0 Eng.B19ET (100kW)	10/82-8/84		R		153-473	153-473K	Lucas	160,0x25	Hand Brake
2.0 Eng.B200E (89kW)	9/84-12/93		R		153-473	153-473K	Lucas	160,0x25	Hand Brake
2.0 Eng.B200F (82kW)	9/88-12/93		R		153-473	153-473K	Lucas	160,0x25	Hand Brake
2.0 Eng.B200K (75-76-77kW)	8/84-7/85		R		153-473	153-473K	Lucas	160,0x25	Hand Brake
2.0 Eng.B20A (60kW)	8/74-7/76		R		153-473	153-473K	Lucas	160,0x25	Hand Brake
2.0 SW Eng.B200E (86kW)	8/83-7/93		R		153-473	153-473K	Lucas	160,0x25	Hand Brake
2.0 SW Eng.D20 (50kW)	9/78-10/80		R		153-473	153-473K	Lucas	160,0x25	Hand Brake
2.1 Eng.B21A (71-74-79kW)	8/74-7/84		R		153-473	153-473K	Lucas	160,0x25	Hand Brake
2.1 Eng.B21E (90kW)	8/74-7/80		R		153-473	153-473K	Lucas	160,0x25	Hand Brake
2.1 SW Eng.B21F (80kW)	8/80-7/84		R		153-473	153-473K	Lucas	160,0x25	Hand Brake
2.1 T. Eng.B21ET (114kW)	8/80-7/84		R		153-473	153-473K	Lucas	160,0x25	Hand Brake
2.3 Eng.B230A (81kW)	8/84-7/86		R		153-473	153-473K	Lucas	160,0x25	Hand Brake
2.3 Eng.B230E (96kW)	8/83-7/85		R		153-473	153-473K	Lucas	160,0x25	Hand Brake
2.3 Eng.B230K (85-86kW)	8/86-12/88		R		153-473	153-473K	Lucas	160,0x25	Hand Brake
2.3 Eng.B23A (82-84kW)	8/80-7/84		R		153-473	153-473K	Lucas	160,0x25	Hand Brake
2.3 Eng.B23E (95-98-100kW)	8/80-12/89		R		153-473	153-473K	Lucas	160,0x25	Hand Brake
2.3 (Exc. SW) Eng.B23E (103kW)	8/78-7/80		R		153-473	153-473K	Lucas	160,0x25	Hand Brake
2.3 16v Eng.B230F (83-85kW)	8/86-7/93		R		153-473	153-473K	Lucas	160,0x25	Hand Brake
2.3 Kat Eng.B230F (100kW)	8/91-7/92		R		153-473	153-473K	Lucas	160,0x25	Hand Brake
2.4 D Eng.D24 (58-60kW)	8/78-8/93		R		153-473	153-473K	Lucas	160,0x25	Hand Brake
2.7 (Exc. SW) Eng.B27E (104kW)	8/79-7/80		R		153-473	153-473K	Lucas	160,0x25	Hand Brake
2.8 Eng.B28A (95kW)	10/81-9/82		R		153-473	153-473K	Lucas	160,0x25	Hand Brake
2.8 Eng.B28E (114kW)	10/80-9/82		R		153-473	153-473K	Lucas	160,0x25	Hand Brake
260 (P262, 264, 265), SW 8/74-7/82									
2.7 Eng.B27A (92kW)	8/76-7/82		R		153-473	153-473K	Lucas	160,0x25	Hand Brake
2.7 Eng.B27F (109kW)	8/78-7/82		R		153-473	153-473K	Lucas	160,0x25	Hand Brake















































		Spare Parts	F/R	L/R	CIFAM ref.	CIFAM ref. w/KIT		DIMENSIONS mm.	NOTE
2.7, Coupe Eng.B27E (104kW)	8/74-7/80		R		153-473	153-473K	Lucas	160,0x25	Hand Brake
2.8 Eng.B28E (114kW)	8/80-7/82		R		153-473	153-473K	Lucas	160,0x25	Hand Brake
2.8 (Exc. SW) Eng.B28A (95kW)	8/80-7/82		R		153-473	153-473K	Lucas	160,0x25	Hand Brake
340-360 (343, 345, 344) 8/75-7/91									
1.4 Eng.B14.3E (46-47kW)	-81		R		153-103		Lucas	203,2x38	Hand Brake
	81-		R		153-475		Lucas	228,6x42	Hand Brake
	82-85		R		151-110		Lucas	Ø 20,64 228,6x42	LUC
1.4 Eng.B14.4S (50-51-52kW)	-81		R		153-103		Lucas	203,2x38	Hand Brake
	81-		R		153-475		Lucas	228,6x42	Hand Brake
	82-88		R		151-110		Lucas	Ø 20,64 228,6x42	LUC
1.6 D Eng.D16 (40kW)	8/84-7/91		R		153-475		Lucas	228,6x42	Hand Brake
	94-91		R		151-110		Lucas	Ø 20,64 228,6x42	LUC
1.7 Eng.B172K (59-60-67kW)	8/85-7/91		R		153-475		Lucas	228,6x42	Hand Brake
	85-91		R		151-110		Lucas	Ø 20,64 228,6x42	LUC
2.0 Eng.B19A (65-66-68-70kW)	-81		R		153-103		Lucas	203,2x38	Hand Brake
	81-		R		153-475		Lucas	228,6x42	Hand Brake
	80-84		R		151-110		Lucas	Ø 20,64 228,6x42	LUC
2.0 Eng.B19E (83-85kW)	8/82-7/84		R		153-475		Lucas	228,6x42	Hand Brake
2.0 Eng.B200E (85-87kW)	8/84-7/86		R		153-475		Lucas	228,6x42	Hand Brake
2.0 Eng.B200F/ EA (80-81-82kW)	8/88-7/89		R		153-475		Lucas	228,6x42	Hand Brake
	88-89		R		151-110		Lucas	Ø 20,64 228,6x42	LUC, 343-345-360
2.0 Eng.B200K (75-77kW)	8/84-7/87		R		153-475		Lucas	228,6x42	Hand Brake
	84-87		R		151-110		Lucas	Ø 20,64 228,6x42	LUC, 343-345-360
440 K (445) 8/88-12/96									
1.6 Eng.B16/ A/ B/ F (44-61kW)	9/88-12/96		R		153-476		Lucas	203,0x38	Hand Brake
	9/94-3/96		R		700-049			Ø 203,3	
1.7 Eng.B18EP (75-78kW)	9/88-12/96		R		153-476		Lucas	203,0x38	Hand Brake
	8/88-12/92		R		700-049			Ø 203,3	
1.7 Eng.B18F (70kW)	8/88-7/89		R		153-476		Lucas	203,0x38	Hand Brake
	88-89		R		700-049			Ø 203,3	
1.7 Eng.B18FP (75kW)	8/89-12/96		R		153-476		Lucas	203,0x38	Hand Brake
	89-12/92		R		700-049			Ø 203,3	
1.7 Eng.B18K/ KP (64kW)	9/88-12/96		R		153-476		Lucas	203,0x38	Hand Brake
1.7 T. Eng.B18FT (88-90kW)	8/88-7/96		R		153-476		Lucas	203,0x38	Hand Brake
	9/94-3/96		R		700-049			Ø 203,3	
1.8 Eng.B18U (66kW)	8/91-7/96		R		153-476		Lucas	203,0x38	Hand Brake
	7/91-96		R		700-049			Ø 203,3	
1.9 TD Eng.D19T (66kW)	7/94-12/96		R		153-476		Lucas	203,0x38	Hand Brake
	94-96		R		700-049			Ø 203,3	
2.0 Eng.B20F (80-81kW)	8/92-7/96		R		153-476		Lucas	203,0x38	Hand Brake
	92-96		R		700-049			Ø 203,3	
460 L (464) 9/88-7/96									
1.6 Eng.B16/ A/ B/ F (44-61kW)	7/92-7/96		R		153-476		Lucas	203,0x38	Hand Brake
	9/94-3/96		R		700-049			Ø 203,3	
1.7 Eng.B18EP (70-75-78kW)	8/89-7/92		R		153-476		Lucas	203,0x38	Hand Brake
	89-92		R		700-049			Ø 203,3	
1.7 Eng.B18KP (64kW)	9/88-7/96		R		153-476		Lucas	203,0x38	Hand Brake
1.7 Eng.B18KP (66kW)	9/90-7/96		R		153-476		Lucas	203,0x38	Hand Brake
1.7 T. Eng.B18FT (88kW)	8/89-7/96		R		153-476		Lucas	203,0x38	Hand Brake
	89-92		R		700-049			Ø 203,3	
1.7 T. Eng.B18FT (90kW)	1/91-7/96		R		153-476		Lucas	203,0x38	Hand Brake
	91-12/92		R		700-049			Ø 203,3	
1.8 Eng.B18U (66kW)	8/91-7/96		R		153-476		Lucas	203,0x38	Hand Brake
	91-96		R		700-049			Ø 203,3	
1.9 TD Eng.D19T (66kW)	7/94-7/96		R		153-476		Lucas	203,0x38	Hand Brake
	94-96		R		700-049			Ø 203,3	
2.0 Eng.B20F (80-81kW)	8/92-7/96		R		153-476		Lucas	203,0x38	Hand Brake
	92-96		R		700-049			Ø 203,3	
66, SW 10/75-11/79									
1.1 DL Eng.B11 (33kW)	10/75-11/79		R		153-103		Lucas	203,2x38	Hand Brake
1.3 GL Eng.B130 (42kW)	10/75-11/79		R		153-103		Lucas	203,2x38	Hand Brake
740 (744, 745) 8/83-8/92									
2.0 Eng.B19ET (110kW)	12/83-7/84		R		153-473	153-473K	Lucas	160,0x25	Hand Brake
2.0 Eng.B200E (86kW)	1/87-8/88		R		153-473	153-473K	Lucas	160,0x25	Hand Brake
2.0 Eng.B200ET (118-120kW)	1/83-8/90		R		153-473	153-473K	Lucas	160,0x25	Hand Brake
2.0 Eng.B200G (89kW)	8/85-7/92		R		153-473	153-473K	Lucas	160,0x25	Hand Brake
2.0 Eng.B200K (76kW)	9/88-8/90		R		153-473	153-473K	Lucas	160,0x25	Hand Brake

		Spare Parts	F/R	L/R	CIFAM ref.	CIFAM ref. w/KIT		DIMENSIONS mm.	NOTE
2.0 Eng.B204E (100kW)	1/88-12/90		R		153-473	153-473K	Lucas	160,0x25	Hand Brake
2.0 T. Eng.B204FT (140-147kW)	1/88-12/90		R		153-473	153-473K	Lucas	160,0x25	Hand Brake
2.3 Eng.B230A (82kW)	8/85-7/86		R		153-473	153-473K	Lucas	160,0x25	Hand Brake
2.3 Eng.B230E (96kW)	8/84-7/88		R		153-473	153-473K	Lucas	160,0x25	Hand Brake
2.3 Eng.B230F (85kW)	8/87-7/92		R		153-473	153-473K	Lucas	160,0x25	Hand Brake
2.3 Eng.B230K (86kW)	9/85-7/90		R		153-473	153-473K	Lucas	160,0x25	Hand Brake
2.3 Eng.B234F (111-114-117kW)	8/87-8/92		R		153-473	153-473K	Lucas	160,0x25	Hand Brake
2.3 Eng.B23A (82kW)	8/84-7/90		R		153-473	153-473K	Lucas	160,0x25	Hand Brake
2.3 Eng.B23E (95-98-100kW)	8/83-7/84		R		153-473	153-473K	Lucas	160,0x25	Hand Brake
2.3 16v Eng.B230F (83-85kW)	8/85-12/92		R		153-473	153-473K	Lucas	160,0x25	Hand Brake
2.3 16v Eng.B230FB (96-100kW)	8/88-7/90		R		153-473	153-473K	Lucas	160,0x25	Hand Brake
2.3 T. Eng.B230ET (134kW)	8/85-7/88		R		153-473	153-473K	Lucas	160,0x25	Hand Brake
2.3 T. Eng.B230FT (115-121-126kW)	8/86-7/89		R		153-473	153-473K	Lucas	160,0x25	Hand Brake
2.3 T. Eng.B230FT (140-121-126kW)	8/89-7/90		R		153-473	153-473K	Lucas	160,0x25	Hand Brake
2.3 T. Eng.B230FT/ GT (121kW)	8/89-7/90		R		153-473	153-473K	Lucas	160,0x25	Hand Brake
2.4 D Eng.D24 (60kW)	8/84-7/92		R		153-473	153-473K	Lucas	160,0x25	Hand Brake
2.4 TD Eng.D24T (80-83kW)	9/85-7/92		R		153-473	153-473K	Lucas	160,0x25	Hand Brake
2.4 TDi Eng.D24TIC (85-90kW)	8/86-10/88		R		153-473	153-473K	Lucas	160,0x25	Hand Brake
740 (744, 745) SW 8/84-8/92									
2.0 Eng.B200E (86kW)	1/87-8/88		R		153-473	153-473K	Lucas	160,0x25	Hand Brake
2.0 Eng.B200F (80-81-82kW)	8/89-7/91		R		153-473	153-473K	Lucas	160,0x25	Hand Brake
2.0 Eng.B200G (89kW)	8/85-7/92		R		153-473	153-473K	Lucas	160,0x25	Hand Brake
2.0 Eng.B200K (76kW)	9/88-8/90		R		153-473	153-473K	Lucas	160,0x25	Hand Brake
2.0 Eng.B204FTE (147kW)	9/90-8/92		R		153-473	153-473K	Lucas	160,0x25	Hand Brake
2.0 16v Eng.B204E (100kW)	9/87-8/90		R		153-473	153-473K	Lucas	160,0x25	Hand Brake
2.3 Eng.B230A (82kW)	8/85-7/86		R		153-473	153-473K	Lucas	160,0x25	Hand Brake
2.3 Eng.B230E (96kW)	8/84-7/88		R		153-473	153-473K	Lucas	160,0x25	Hand Brake
2.3 Eng.B230K (86kW)	9/85-7/90		R		153-473	153-473K	Lucas	160,0x25	Hand Brake
2.3 Eng.B234F (111-114-117kW)	8/87-8/92		R		153-473	153-473K	Lucas	160,0x25	Hand Brake
2.3 16v Eng.B230F (83-85-87kW)	8/85-7/92		R		153-473	153-473K	Lucas	160,0x25	Hand Brake
2.3 16v Eng.B230FB (96-100kW)	8/88-7/90		R		153-473	153-473K	Lucas	160,0x25	Hand Brake
2.3 T. Eng.B230ET (134kW)	8/85-7/88		R		153-473	153-473K	Lucas	160,0x25	Hand Brake
2.3 T. Eng.B230FT (115-125kW)	8/86-7/89		R		153-473	153-473K	Lucas	160,0x25	Hand Brake
2.3 T. Eng.B230FT (140-126kW)	8/89-7/90		R		153-473	153-473K	Lucas	160,0x25	Hand Brake
2.3 T. Eng.B230FT/ GT (121kW)	8/89-7/90		R		153-473	153-473K	Lucas	160,0x25	Hand Brake
2.4 D Eng.D24 (60kW)	8/84-7/92		R		153-473	153-473K	Lucas	160,0x25	Hand Brake
2.4 TD Eng.D24T (80-83kW)	9/85-7/92		R		153-473	153-473K	Lucas	160,0x25	Hand Brake
2.4 TDi Eng.D24TIC (85-90kW)	8/86-10/88		R		153-473	153-473K	Lucas	160,0x25	Hand Brake
760 (704, 764, 765) 8/81-7/92									
2.0 T. Eng.B204FT/ GT (140-147kW)	5/86-7/92		R		153-473	153-473K	Lucas	160,0x25	Hand Brake
2.3 Eng.B230FT (115-119kW)	1/88-7/92		R		153-473	153-473K	Lucas	160,0x25	Hand Brake
2.3 Eng.B230K (84kW)	8/84-8/87		R		153-473	153-473K	Lucas	160,0x25	Hand Brake
2.3 T. Eng.B230ET (130-134kW)	8/84-8/90		R		153-473	153-473K	Lucas	160,0x25	Hand Brake
2.3 T. Eng.B23ET (127kW)	8/82-7/84		R		153-473	153-473K	Lucas	160,0x25	Hand Brake
2.4 D Eng.D24 (60kW)	1/82-7/92		R		153-473	153-473K	Lucas	160,0x25	Hand Brake
2.4 TD Eng.D24T (80-83kW)	4/87-7/92		R		153-473	153-473K	Lucas	160,0x25	Hand Brake
2.4 TDi Eng.D24TIC (85-90kW)	8/87-7/92		R		153-473	153-473K	Lucas	160,0x25	Hand Brake
2.8 Eng.B280F (105-108kW)	5/86-8/91		R		153-473	153-473K	Lucas	160,0x25	Hand Brake
2.8 Eng.B28A (95kW)	5/86-12/87		R		153-473	153-473K	Lucas	160,0x25	Hand Brake
2.8 Eng.B28E/ B280E (115-122-125kW)	8/81-7/88		R		153-473	153-473K	Lucas	160,0x25	Hand Brake
760 (704, 764, 765) SW 8/81-7/92									
2.3 16v Eng.B230F (83-85kW)	5/86-7/92		R		153-473	153-473K	Lucas	160,0x25	Hand Brake
2.3 16v Eng.B230FB (96-110kW)	5/86-7/92		R		153-473	153-473K	Lucas	160,0x25	Hand Brake
2.3 T. Eng.B230ET (134kW)	8/84-8/90		R		153-473	153-473K	Lucas	160,0x25	Hand Brake
2.4 D Eng.D24 (60kW)	1/82-7/92		R		153-473	153-473K	Lucas	160,0x25	Hand Brake
2.4 TD Eng.D24T (80-83kW)	4/87-7/92		R		153-473	153-473K	Lucas	160,0x25	Hand Brake
2.4 TDi Eng.D24TIC (85-90kW)	8/87-7/92		R		153-473	153-473K	Lucas	160,0x25	Hand Brake
2.8 Eng.B280E (125kW)	8/84-8/90		R		153-473	153-473K	Lucas	160,0x25	Hand Brake
2.8 Eng.B280F (105-108kW)	5/86-8/91		R		153-473	153-473K	Lucas	160,0x25	Hand Brake
2.8 Eng.B28A (95kW)	5/86-12/87		R		153-473	153-473K	Lucas	160,0x25	Hand Brake
2.8 Eng.B28E/ B280E (115kW)	8/81-7/88		R		153-473	153-473K	Lucas	160,0x25	Hand Brake
780 8/86-7/90									
2.9 Eng.B280E (115kW)	8/86-7/87		R		153-473	153-473K	Lucas	160,0x25	Hand Brake











		Spare Parts	F/R	L/R	CIFAM ref.	CIFAM ref. w/KIT		DIMENSIONS mm.	NOTE
2.9 Eng.B280F (105-108kW)	8/87-7/90		R		153-477	153-477K	Lucas	160,0x25	Hand Brake
850 (LS, LW), SW 6/91-12/96									
2.0 Eng.B5202S (93kW)	8/94-12/96		R		153-478	153-478K	Lucas	177,8x25	Hand Brake
2.0 20v Eng.B5204F (105kW)	6/91-12/96		R		153-478	153-478K	Lucas	177,8x25	Hand Brake
2.3 T5 Eng.B5234FT (166kW)	2/93-12/96		R		153-478	153-478K	Lucas	177,8x25	Hand Brake
2.4 AWD Eng.B5254T (142kW)	4/96-12/96		R		153-478	153-478K	Lucas	177,8x25	Hand Brake
2.5 Eng.B5252 (103kW)	6/91-7/94		R		153-478	153-478K	Lucas	177,8x25	Hand Brake
2.5 Eng.B5252S (106kW)	8/94-12/96		R		153-478	153-478K	Lucas	177,8x25	Hand Brake
2.5 Eng.B5254S (125kW)	9/92-12/96		R		153-478	153-478K	Lucas	177,8x25	Hand Brake
940 I (944, 945), SW 8/90-7/95									
2.0 Eng.B200F (80-81-82kW)	1/92-7/94		R		153-473	153-473K	Lucas	160,0x25	Hand Brake
2.0 T. Eng.B200FT (114kW)	1/91-7/95		R		153-473	153-473K	Lucas	160,0x25	Hand Brake
2.0 T. Eng.B204FT (140-147kW)	1/91-7/95		R		153-473	153-473K	Lucas	160,0x25	Hand Brake
2.3 Eng.B230FD (85kW)	8/92-7/94		R		153-473	153-473K	Lucas	160,0x25	Hand Brake
2.3 Eng.B234F (111-114-118kW)	8/90-7/91		R		153-473	153-473K	Lucas	160,0x25	Hand Brake
2.3 16v Eng.B230FB/ G (96-100kW)	8/90-12/94		R		153-473	153-473K	Lucas	160,0x25	Hand Brake
2.3 T. Eng.B230FT (115-121-126kW)	8/90-7/94		R		153-473	153-473K	Lucas	160,0x25	Hand Brake
2.3 T. Eng.B230FT+ (140kW)	8/91-7/93		R		153-473	153-473K	Lucas	160,0x25	Hand Brake
2.4 D Eng.D24 (60kW)	8/90-7/95		R		153-473	153-473K	Lucas	160,0x25	Hand Brake
2.4 TD Eng.D24T (80-83kW)	8/90-12/94		R		153-473	153-473K	Lucas	160,0x25	Hand Brake
2.4 TDi Eng.D24TIC (85-90kW)	8/90-12/94		R		153-473	153-473K	Lucas	160,0x25	Hand Brake
2.8 Bertone Eng.B280F (105-108kW)	1/90-7/95		R		153-473	153-473K	Lucas	160,0x25	Hand Brake
940 II (944, 945), SW 8/94-10/98									
2.0 T. Eng.B200FT (114kW)	4/96-10/98		R		153-473	153-473K	Lucas	160,0x25	Hand Brake
2.3 Eng.B230FD (85kW)	8/94-7/95		R		153-473	153-473K	Lucas	160,0x25	Hand Brake
2.3 16v Eng.B230FB (96-100kW)	8/94-10/98		R		153-473	153-473K	Lucas	160,0x25	Hand Brake
2.3 T. Eng.B230FT (115-121-126-140kW)	8/94-10/98		R		153-473	153-473K	Lucas	160,0x25	Hand Brake
2.3 ti Eng.B230FK (99kW)	1/95-10/98		R		153-473	153-473K	Lucas	160,0x25	Hand Brake
2.4 TDi Eng.D24TIC (85-90kW)	8/94-10/98		R		153-473	153-473K	Lucas	160,0x25	Hand Brake
960 I (964, 965), SW 8/90-7/94									
2.0 Eng.B200F (82kW)	9/90-9/93		R		153-477	153-477K	Lucas	160,0x25	Hand Brake
2.0 Eng.B204E (103kW)	9/90-8/93		R		153-477	153-477K	Lucas	160,0x25	Hand Brake
2.0 T. Eng.B204FT (140-147kW)	8/90-9/93		R		153-477	153-477K	Lucas	160,0x25	Hand Brake
2.4 TDi Eng.D24TIC (85-90kW)	9/91-7/94		R		153-477	153-477K	Lucas	160,0x25	Hand Brake
2.8 Bertone Eng.B280F (105-108kW)	1/90-7/94		R		153-477	153-477K	Lucas	160,0x25	Hand Brake
2.9 Eng.B6304F/ S (150kW)	8/90-7/94		R		153-477	153-477K	Lucas	160,0x25	Hand Brake
960 II (964, 965), SW 7/94-12/96									
2.5 Eng.B6254S (125kW)	7/94-12/96		R		153-477	153-477K	Lucas	160,0x25	Hand Brake
2.9 Eng.B6304S (150kW)	7/94-12/96		R		153-477	153-477K	Lucas	160,0x25	Hand Brake
C70 I Coupe, Cabrio 3/97-2/06									
2.0 T. Eng.B5204T3 (166kW)	3/97-9/02		R		153-478	153-478K	Lucas	177,8x25	Hand Brake
2.0 T. Eng.B5204T4 (120kW)	3/00-9/02		R		153-478	153-478K	Lucas	177,8x25	Hand Brake
2.0 T. Cabrio Eng.B5204T2 (132kW)	3/97-9/02		R		153-478	153-478K	Lucas	177,8x25	Hand Brake
2.3 T5 Eng.B5234T3 (176kW)	3/97-9/02		R		153-478	153-478K	Lucas	177,8x25	Hand Brake
2.3 T5 Cabrio Eng.B5234T9 (180kW)	7/02-2/06		R		153-478	153-478K	Lucas	177,8x25	Hand Brake
2.4 T Cabrio Eng.B5244T7 (147kW)	7/02-2/06		R		153-478	153-478K	Lucas	177,8x25	Hand Brake
2.4 T. Eng.B5254T (142kW)	3/97-9/02		R		153-478	153-478K	Lucas	177,8x25	Hand Brake
P 121 5/59-5/71									
1.6 Eng.B16A (44-61kW)	5/59-9/66		R		153-472			228,6x51	Hand Brake
	9/61-66		R		700-050			Ø 228,6	
1.8 Eng.B18 (55-59-63-76kW)	-12/68		R		153-471		Lucas	228,6x51	Hand Brake
	2/67-5/71		R		153-472			228,6x51	Hand Brake
	67-68		R		700-050			Ø 228,6	
1.8 Eng.B18A (50-55kW)			R		153-471		Lucas	228,6x51	Hand Brake
	5/59-9/66		R		153-472			228,6x51	Hand Brake
	9/61-66		R		700-050			Ø 228,6	
2.0 Eng.B20A (60kW)	11/68-5/71		R		153-472			228,6x51	Hand Brake
	-12/70		R		153-471		Lucas	228,6x51	Hand Brake

























		Spare Parts	F/R	L/R	CIFAM ref.	CIFAM ref. w/KIT		DIMENSIONS mm.	NOTE
P 122 S Amazon 5/59-5/71									
1.6 Eng.B16/ A/ B/ F (61kW)	5/59-9/66		R		153-472			228,6x51	Hand Brake
	64-66		R		700-050			Ø 228,6	
1.8 Eng.B18 (63kW)	-12/68		R		153-471		Lucas	228,6x51	Hand Brake
1.8 Eng.B18 (76kW)	66-8/68		R		700-050			Ø 228,6	
1.8, SW Eng.B18 (55-59kW)	5/59-7/67		R		153-472			228,6x51	Hand Brake
	65-		R		153-471		Lucas	228,6x51	Hand Brake
	64-65		R		700-050			Ø 228,6	
P 123 11/68-5/71									
GT	68-71		R		700-050			Ø 228,6	
P 131 11/64-5/71									
All models	1/64-5/71		R		153-471		Lucas	228,6x51	Hand Brake
	6/64-7/70		R		700-050			Ø 228,6	
P 132 S 11/64-5/71									
All models	11/64-5/71		R		153-471		Lucas	228,6x51	Hand Brake
	64-68		R		700-050			Ø 228,6	
P 133 11/64-5/71									
All models	11/64-5/71		R		153-471		Lucas	228,6x51	Hand Brake
	64-7/70		R		700-050			Ø 228,6	
P 1800 (182) 4/62-11/73									
1.8 (66kW)	4/62-5/70		R		153-471		Lucas	228,6x51	Hand Brake
	68-		R		700-050			Ø 228,6	Ch -30000
1.8 (76kW)	4/62-5/70		R		153-471		Lucas	228,6x51	Hand Brake
	68-		R		700-050			Ø 228,6	Ch -30000
1.8 S (71kW)	4/62-5/70		R		153-471		Lucas	228,6x51	Hand Brake
	68-		R		700-050			Ø 228,6	Ch -30000
P 1800 (183) 4/62-11/73									
1.8 (66kW)	4/62-5/70		R		153-471		Lucas	228,6x51	Hand Brake
	62-68		R		700-050			Ø 228,6	
1.8 (76kW)	4/62-5/70		R		153-471		Lucas	228,6x51	Hand Brake
	62-68		R		700-050			Ø 228,6	
1.8 S (71kW)	4/62-5/70		R		153-471		Lucas	228,6x51	Hand Brake
	62-68		R		700-050			Ø 228,6	
P 2200 SW 9/64-8/70									
1.8 (50kW)	6/64-7/70		R		700-050			Ø 228,6	
1.8 (59kW)	6/64-7/70		R		700-050			Ø 228,6	
1.8 (63kW)	6/64-7/70		R		700-050			Ø 228,6	
P 544 8/61-7/67									
1.6 Eng.B16/ A/ B/ F (44kW)	8/61-7/66		R		153-472			228,6x51	Hand Brake
1.6 Eng.B16B (61kW)	8/61-7/67		R		153-472			228,6x51	Hand Brake
1.8 Eng.B18A (50-55kW)	8/61-7/67		F		153-474			228,6x51	
	8/61-7/67		R		153-472			228,6x51	Hand Brake
1.8 Eng.B18D (59-66kW)	8/61-7/67		F		153-474			228,6x51	
	8/61-7/67		R		153-472			228,6x51	Hand Brake
S60 I 11/00-3/10									
2.0 T. Eng.B5204T5 (132kW)	9/01-		R		153-479	153-479K	Lucas	177,8x25	Hand Brake
2.4 Eng.B5244S (125kW)	11/00-		R		153-479	153-479K	Lucas	177,8x25	Hand Brake
2.4 D Eng.D5244T (93kW)	9/05-		R		153-479	153-479K	Lucas	177,8x25	Hand Brake
2.4 D Eng.D5244T2 (96kW)	12/01-		R		153-479	153-479K	Lucas	177,8x25	Hand Brake
2.4 D5 Eng.D5244T4 (136kW)	9/05-		R		153-479	153-479K	Lucas	177,8x25	Hand Brake
2.4 D5 Eng.D5244T5 (120kW)	7/01-		R		153-479	153-479K	Lucas	177,8x25	Hand Brake
2.4 T. Eng.B5244T3 (147kW)	11/00-		R		153-479	153-479K	Lucas	177,8x25	Hand Brake
2.4 T. AWD Eng.B5244T3 (147kW)	11/01-		R		153-479	153-479K	Lucas	177,8x25	Hand Brake
2.4 T5 Eng.B5244T5 (184-191kW)	4/04-		R		153-479	153-479K	Lucas	177,8x25	Hand Brake
2.4, Bifuel Eng.B5244S2/ SG (103kW)	11/00-		R		153-479	153-479K	Lucas	177,8x25	Hand Brake
2.5 T. Eng.B5254T2 (154kW)	2/04-		R		153-479	153-479K	Lucas	177,8x25	Hand Brake
2.5 T. AWD Eng.B5254T2 (154kW)	4/04-		R		153-479	153-479K	Lucas	177,8x25	Hand Brake
2.5 T. AWD Eng.B5254T4 (221-224kW)	3/03-		R		153-479	153-479K	Lucas	177,8x25	Hand Brake
S70 1/97-11/00									
2.0 Eng.B5202S (93kW)	1/97-11/00		R		153-478	153-478K	Lucas	177,8x25	Hand Brake
	1/97-11/00		R		153-480	153-480K	Lucas	177,8x25	Hand Brake
2.0 20v Eng.B5204F (105kW)	1/97-11/00		R		153-478	153-478K	Lucas	177,8x25	Hand Brake
	1/97-11/00		R		153-480	153-480K	Lucas	177,8x25	Hand Brake
2.0 T. Eng.B5204T (155kW)	1/97-11/00		R		153-478	153-478K	Lucas	177,8x25	Hand Brake
	1/97-11/00		R		153-480	153-480K	Lucas	177,8x25	Hand Brake

		Spare Parts	F/R	L/R	CIFAM ref.	CIFAM ref. w/KIT		DIMENSIONS mm.	NOTE
2.0 T. Eng.B5204T2 (132kW)	1/97-11/00		R		153-478	153-478K	Lucas	177,8x25	Hand Brake
	1/97-11/00		R		153-480	153-480K	Lucas	177,8x25	Hand Brake
2.0 T. Eng.B5204T3 (166kW)	1/97-11/00		R		153-478	153-478K	Lucas	177,8x25	Hand Brake
	1/97-11/00		R		153-480	153-480K	Lucas	177,8x25	Hand Brake
2.0 T. Eng.B5204T4 (120kW)	1/97-11/00		R		153-478	153-478K	Lucas	177,8x25	Hand Brake
	1/97-11/00		R		153-480	153-480K	Lucas	177,8x25	Hand Brake
2.3 T5 Eng.B5234T3 (176kW)	1/97-11/00		R		153-478	153-478K	Lucas	177,8x25	Hand Brake
	1/97-11/00		R		153-480	153-480K	Lucas	177,8x25	Hand Brake
2.4, AWD, Bifuel Eng.B5244S2/ SG (103kW)	7/99-11/00		R		153-478	153-478K	Lucas	177,8x25	Hand Brake
	7/99-11/00		R		153-480	153-480K	Lucas	177,8x25	Hand Brake
2.4, AWD, Bifuel Eng.GB/ B5252S/ FS (106kW)	10/98-11/00		R		153-478	153-478K	Lucas	177,8x25	Hand Brake
	10/98-11/00		R		153-480	153-480K	Lucas	177,8x25	Hand Brake
2.5 TDi, AWD Eng.D5252T (103kW)	1/97-11/00		R		153-480	153-480K	Lucas	177,8x25	Hand Brake
S80 I (TS, XY) 5/98-7/06									
2.0 T. Eng.B5204T3 (166kW)	6/98-7/06		R		153-479	153-479K	Lucas	177,8x25	Hand Brake
2.0 T. Eng.B5204T4 (120kW)	6/98-7/06		R		153-479	153-479K	Lucas	177,8x25	Hand Brake
2.0 T. Eng.B5204T5 (132kW)	12/99-7/06		R		153-479	153-479K	Lucas	177,8x25	Hand Brake
2.4 Eng.B5244S (125kW)	1/99-7/06		R		153-479	153-479K	Lucas	177,8x25	Hand Brake
2.4 D Eng.D5244T2 (96kW)	10/01-7/06		R		153-479	153-479K	Lucas	177,8x25	Hand Brake
2.4 D5 Eng.D5244T (120kW)	8/01-7/06		R		153-479	153-479K	Lucas	177,8x25	Hand Brake
2.4 T5 Eng.B5244T3 (147kW)	6/00-7/06		R		153-479	153-479K	Lucas	177,8x25	Hand Brake
2.4 T5 AWD Eng.B5254T3 (147kW)	4/00-9/03		R		153-479	153-479K	Lucas	177,8x25	Hand Brake
2.4, Bifuel Eng.B5244S2/ SG2 (103kW)	1/99-7/06		R		153-479	153-479K	Lucas	177,8x25	Hand Brake
2.5 T., AWD Eng.B5254T2 (154kW)	7/03-7/06		R		153-479	153-479K	Lucas	177,8x25	Hand Brake
2.5 TDi Eng.D5252T (103kW)	99-06		R		153-479	153-479K	Lucas	177,8x25	Hand Brake
2.8 T6 Eng.B6284T (200kW)	5/98-7/06		R		153-479	153-479K	Lucas	177,8x25	Hand Brake
2.9 Eng.B6294S (147kW)	3/99-7/06		R		153-479	153-479K	Lucas	177,8x25	Hand Brake
2.9 Eng.B6304S3 (150kW)	5/98-7/06		R		153-479	153-479K	Lucas	177,8x25	Hand Brake
3.0 Eng.B6294S2 (144kW)	6/01-7/06		R		153-479	153-479K	Lucas	177,8x25	Hand Brake
3.0 T6 Eng.B6294T (200kW)	6/01-7/06		R		153-479	153-479K	Lucas	177,8x25	Hand Brake
S80 II 3/06-									
2.0 TD 20v Eng.D4204T (100kW)	12/07-		R		153-479	153-479K	Lucas	177,8x25	Hand Brake
2.4 D Eng.D5244T5 (120kW)	7/06-		R		153-479	153-479K	Lucas	177,8x25	Hand Brake
2.4 D5, AWD Eng.D5244T4 (136kW)	3/06-		R		153-479	153-479K	Lucas	177,8x25	Hand Brake
2.5 T. (219kW)	7/06-		R		153-479	153-479K	Lucas	177,8x25	Hand Brake
2.5 T. Eng.B5254T6/ T8 (147kW)	3/06-		R		153-479	153-479K	Lucas	177,8x25	Hand Brake
3.0 T6 AWD Eng.B6304T (210kW)	7/07-		R		153-479	153-479K	Lucas	177,8x25	Hand Brake
3.2 Eng.B6324S (175kW)	3/06-		R		153-479	153-479K	Lucas	177,8x25	Hand Brake
4.4 V8 Eng.B8444S (232kW)	3/06-		R		153-479	153-479K	Lucas	177,8x25	Hand Brake
S90 1/97-5/98									
2.9 Eng.B6304G (150kW)	1/97-5/98		R		153-473	153-473K	Lucas	160,0x25	Hand Brake
2.9 Eng.B6304S2 (132kW)	1/97-5/98		R		153-473	153-473K	Lucas	160,0x25	Hand Brake
V70 I SW (P80) 1/97-3/00									
2.0 Eng.B5202S (93kW)	1/97-3/00		R		153-478	153-478K	Lucas	177,8x25	Hand Brake
2.0 20v Eng.B5204F (105kW)	1/97-3/00		R		153-478	153-478K	Lucas	177,8x25	Hand Brake
2.0 T. Eng.B5204T (155kW)	1/97-3/00		R		153-478	153-478K	Lucas	177,8x25	Hand Brake
2.0 T. Eng.B5204T2 (132kW)	1/97-3/00		R		153-478	153-478K	Lucas	177,8x25	Hand Brake
2.0 T. Eng.B5204T4 (120kW)	1/97-3/00		R		153-478	153-478K	Lucas	177,8x25	Hand Brake
2.0 T., AWD Eng.B5204T3 (166kW)	1/97-3/00		R		153-478	153-478K	Lucas	177,8x25	Hand Brake
2.3 T., AWD Eng.B5234FT+ (184kW)	4/97-3/00		R		153-480	153-480K	Lucas	177,8x25	Hand Brake
2.3 T5, AWD Eng.B5234T3 (176kW)	1/97-3/00		R		153-478	153-478K	Lucas	177,8x25	Hand Brake
2.4, Bifuel Eng.B5244SG/ GB5244SG (103kW)	8/99-3/00		R		153-480	153-480K	Lucas	177,8x25	Hand Brake
	8/99-3/00		R		153-478	153-478K	Lucas	177,8x25	Bifuel, Hand Brake
2.5 Eng.B5254S (121kW)	6/98-3/00		R		153-480	153-480K	Lucas	177,8x25	Hand Brake
2.5 Eng.B5254S (125kW)	1/97-3/00		R		153-480	153-480K	Lucas	177,8x25	Hand Brake
2.5 AWD Eng.B5244T2 (195kW)	3/99-3/00		R		153-480	153-480K	Lucas	177,8x25	Hand Brake
2.5 T., AWD Eng.B5254T (142kW)	1/97-3/00		R		153-480	153-480K	Lucas	177,8x25	Hand Brake
2.5, Bifuel Eng.GB/ B5252S (106kW)	10/98-8/99		R		153-480	153-480K	Lucas	177,8x25	Hand Brake
	10/98-8/99		R		153-478	153-478K	Lucas	177,8x25	Bifuel, Hand Brake
V70 II SW 3/00-6/07									
2.0 T. Eng.B5204T2 (132kW)	7/01-6/07		R		153-479	153-479K	Lucas	177,8x25	Hand Brake
2.3 T5 Eng.B5234T4 (184kW)	3/00-6/07		R		153-478	153-478K	Lucas	177,8x25	Hand Brake
	3/00-6/07		R		153-479	153-479K	Lucas	177,8x25	Hand Brake
2.4 Eng.B5244S2 (125kW)	3/00-6/07		R		153-479	153-479K	Lucas	177,8x25	Hand Brake
2.4 AWD Eng.B5254S (121kW)	3/00-9/03		R		153-479	153-479K	Lucas	177,8x25	Hand Brake

		Spare Parts	F/R	L/R	CIFAM ref.	CIFAM ref. w/KIT		DIMENSIONS mm.	NOTE
2.4 D Eng.D5244T (93kW)	05-07		R		153-479	153-479K	Lucas	177,8x25	Hand Brake
2.4 D Eng.D5244T2 (96kW)	01-07		R		153-479	153-479K	Lucas	177,8x25	Hand Brake
2.4 D5, AWD Eng.D5244T (120kW)	3/03-6/07		R		153-479	153-479K	Lucas	177,8x25	Hand Brake
2.4 D5, AWD Eng.D5244T4 (136kW)	12/05-6/07		R		153-479	153-479K	Lucas	177,8x25	Hand Brake
2.4 T. AWD Eng.B5244T3 (147kW)	9/01-6/07		R		153-479	153-479K	Lucas	177,8x25	Hand Brake
2.4 T5 Eng.B5244T5 (191kW)	4/04-6/07		R		153-479	153-479K	Lucas	177,8x25	Hand Brake
2.4, Bifuel Eng.B5244SG (103kW)	9/01-6/07		R		153-479	153-479K	Lucas	177,8x25	Bifuel, Hand Brake
2.5 T. AWD R Eng.B5254T4 (221kW)	3/03-6/07		R		153-479	153-479K	Lucas	177,8x25	Hand Brake
2.5 T., AWD Eng.B5254T2 (154kW)	9/02-6/07		R		153-479	153-479K	Lucas	177,8x25	Hand Brake
2.5 TDi Eng.D5252T (103kW)	3/00-6/07		R		153-479	153-479K	Lucas	177,8x25	Hand Brake
V70 III SW (P80) 7/07-									
2.0 Eng.B4204S3 (107kW)	6/08-		R		153-479	153-479K	Lucas	177,8x25	Hand Brake
2.0 D 20v Eng.D4204T (100kW)	12/07-		R		153-479	153-479K	Lucas	177,8x25	Hand Brake
2.4 D Eng.D5244T14 (129kW)	09-		R		153-479	153-479K	Lucas	177,8x25	Hand Brake
2.4 D4 AWD Eng.D5244T5 (120kW)	7/07-		R		153-479	153-479K	Lucas	177,8x25	Hand Brake
2.4 D5 Eng.D5244T4 (136kW)	7/07-		R		153-479	153-479K	Lucas	177,8x25	Hand Brake
2.4 D5, AWD Eng.D5244T10 (151kW)	7/09-		R		153-479	153-479K	Lucas	177,8x25	Hand Brake
2.5 T. Eng.B5254T10 (170kW)	7/09-		R		153-479	153-479K	Lucas	177,8x25	Hand Brake
2.5 T. Eng.B5254T6 (147kW)	1/07-		R		153-479	153-479K	Lucas	177,8x25	Hand Brake
3.0 T6 Eng.B6304T (210kW)	7/07-		R		153-479	153-479K	Lucas	177,8x25	Hand Brake
3.2 (251kW)	7/07-		R		153-479	153-479K	Lucas	177,8x25	Hand Brake
3.2, AWD Eng.B6324S (175-179kW)	12/07-		R		153-479	153-479K	Lucas	177,8x25	Hand Brake
V90 SW 1/97-12/98									
2.9 Eng.B6304G (150kW)	1/97-12/98		R		153-473	153-473K	Lucas	160,0x25	Hand Brake
2.9 Eng.B6304S2 (132kW)	1/97-12/98		R		153-473	153-473K	Lucas	160,0x25	Hand Brake
XC70 I Cross Country 9/00-6/07									
2.4 D5 AWD Eng.D5244T (120kW)	9/02-6/07		R		153-479	153-479K	Lucas	177,8x25	Hand Brake
2.4 D5 AWD Eng.D5244T4 (136kW)	05-07		R		153-479	153-479K	Lucas	177,8x25	Hand Brake
2.4 T. AWD Eng.B5244T3 (147kW)	9/00-9/02		R		153-479	153-479K	Lucas	177,8x25	Hand Brake
2.5 T. AWD Eng.B5254T2 (154kW)	9/02-6/07		R		153-479	153-479K	Lucas	177,8x25	Hand Brake
XC70 II Cross Country 7/07-									
2.4 D4 AWD Eng.D5244T5 (120kW)	8/07-		R		153-479	153-479K	Lucas	177,8x25	Hand Brake
2.4 D5 Eng.D5244T4 (136kW)	07-		R		153-479	153-479K	Lucas	177,8x25	Hand Brake
3.2 Eng.B6324S/ B6324S5 (175-179kW)	7/07-		R		153-479	153-479K	Lucas	177,8x25	Hand Brake
XC90 10/02-									
2.4 D5 Eng.D5244T (120kW)	02-		R		153-530	153-530K153-530K	Lucas	177,8x25	
	10/02-		R		153-479	153-479K	Lucas	177,8x25	Hand Brake
2.4 D5 Eng.D5244T5 (120kW)	09-		R		153-530	153-530K	Lucas	177,8x25	
2.4 D5 AWD Eng.D5244T4 (136kW)	05-		R		153-530	153-530K	Lucas	177,8x25	
	05-		R		153-479	153-479K	Lucas	177,8x25	Hand Brake
2.5 T. Eng.B5254T2 (154kW)	10/02-		R		153-530	153-530K	Lucas	177,8x25	
	10/02-		R		153-479	153-479K	Lucas	177,8x25	Hand Brake
3.0 T6 Eng.B6294T (200kW)	02-		R		153-530	153-530K	Lucas	177,8x25	
	10/02-		R		153-479	153-479K	Lucas	177,8x25	Hand Brake
3.2 Eng.B6324S5 (179kW)	10-		R		153-530	153-530K	Lucas	177,8x25	
3.2 AWD Eng.B6324S (175kW)	06-		R		153-530	153-530K	Lucas	177,8x25	
	12/06-		R		153-479	153-479K	Lucas	177,8x25	Hand Brake
4.4 V8 Eng.B8444S (232kW)	05-		R		153-530	153-530K	Lucas	177,8x25	
	1/05-		R		153-479	153-479K	Lucas	177,8x25	Hand Brake

ZASTAVA

101 (1100) 6/73-12/93									
1.1 Eng.128A.000 (37kW)	12/75-1/80		R		153-063		Fiat	185,0x31	Fitted Adjuster, Hand Brake
	75-80		R		700-032			Ø 185,0	
1.1 Eng.128A.000 (40kW)	6/73-1/90		R		153-063		Fiat	185,0x31	Fitted Adjuster, Hand Brake
	73-90		R		700-032			Ø 185,0	
1.1 Eng.128A.064 (41kW)	5/75-12/93		R		153-063		Fiat	185,0x31	Fitted Adjuster, Hand Brake
	75-93		R		700-032			Ø 185,0	
1.1 Super Eng.128AC.5000 (47kW)	7/79-9/81		R		153-063		Fiat	185,0x31	Fitted Adjuster, Hand Brake
	79-81		R		700-032			Ø 185,0	
1.3 Eng.128A.6064 (48kW)	10/81-12/93		R		153-063		Fiat	185,0x31	Fitted Adjuster, Hand Brake
	81-93		R		700-032			Ø 185,0	
1300 - 1500 1/78-1/87									
All models	1/78-1/87		R		153-063		Fiat	185,0x31	Fitted Adjuster, Hand Brake

		Spare Parts	F/R	L/R	CIFAM ref.	CIFAM ref. w/KIT		DIMENSIONS mm.	NOTE
311 Van 1/83-1/93									
All models	83-93		R		700-032			Ø 185,0	
750 Old Type -1/82									
All models	-82		R		700-004			Ø 185,0	
Contact 1/78-1/83									
1.1 Super	3/78-83		R		700-032			Ø 185,0	
Koral 1/90-									
1.2	90-		R		700-032			Ø 185,0	
Nogaro 1/80-1/83									
1.3	80-83		R		700-032			Ø 185,0	
Sana 1/89-									
All models	89-		R		700-008			Ø 180,0	
Tempo 1/91-1/92									
All models	1/91-1/92		R		153-063		Fiat	185,0x31	Fitted Adjuster, Hand Brake
	91-92		R		700-003			Ø 185,0	
Yugo 45/55/65 4/80-6/95									
0.9 Eng.100GL/ 064 (33kW)	4/80-6/92		R		153-063		Fiat	185,0x31	Fitted Adjuster, Hand Brake
	80-92		R		700-032			Ø 185,0	
1.1 Eng.128A.000 (41kW)	1/80-6/95		R		153-063		Fiat	185,0x31	Fitted Adjuster, Hand Brake
1.1 60 EFI Eng.11E1.064 (44kW)	8/91-6/95		R		153-066	153-066J	Bdx	180,0x32	Hand Brake
	91-95		R		700-032			Ø 185,0	
1.3 65 EFI Eng.13E1.064 (48kW)	8/91-6/95		R		153-066	153-066J	Bdx	180,0x32	Hand Brake
	8/91-6/95		R		153-063		Fiat	185,0x31	Fitted Adjuster, Hand Brake
	91-95		R		700-032			Ø 185,0	
Yugo 750 1/82-									
All models	82-		R		700-032			Ø 185,0	
Yugo Florida 10/88-									
1.1 Eng.128A.000 (44kW)	89-		R		700-032			Ø 185,0	
1.3 Eng.13E3.064 (50kW)	3/91-		R		153-066	153-066J	Bdx	180,0x32	Hand Brake
	91-		R		700-032			Ø 185,0	
1.4 Eng.160A1.000 (52kW)	88-95		R		700-032			Ø 185,0	

Adaptable for OES	CIFAM ref..	Adaptable for OES	CIFAM ref.	Adaptable for OES	CIFAM ref.	Adaptable for OES	CIFAM ref.	Adaptable for OES	CIFAM ref.
CITROËN		4241.N4	153-073	DAEWOO LCV		04497-20030	153-408	4373442	153-063
		4241.N5	153-094			04497-20060	153-408	4379680	700-003
		4241.N8	153-099			42403-87222	700-104	4382264	153-063
4241.H6	153-023	4241.P0	153-099	96316636	700-311	42403-87703	700-131	46407799	153-076
4241.H7	153-074	4242.21	153-073			42403-87706	700-132	46448407	700-024
4241.J0	153-323	4245.72	153-340			42431-12020	700-126	4644847	700-023
4241.J1	153-350	4247.24	700-233	DAF		42431-12021	700-126	46467186	153-076
4241.J6	153-320K	4247.37	700-017			42431-12050	700-126	46621077	700-003
4241.J8	153-023	4247.38	700-016			42431-12110	700-126	46819776	700-011
4241.J9	153-320	4247.46	700-363	01922750	153-139	42431-87401	700-105	55701379	700-373
4241.K1	153-323	4250.12	153-340	31004381	153-004	42431-87402	700-355	55701380	700-372
4241.K2	153-323	4251.H4	153-072	3266302	153-103	42431-87602	700-133	55703042	700-373
4241.K3	153-327	70557300000	153-324K	91112875	153-109	42431-87709	700-130	55704050	700-373
4241.K6	153-074	70596500000	153-324K	91112944	153-109	47420-87501	153-035	55704058	700-372
4241.K8	153-023	770121381	153-324K	BAU4537	700-100	47620-12050	153-408	5880890	153-055
4241.L0	153-025	91509908	700-161	RTC3432	153-139	53200-69G11	153-037	5880891	153-063
4241.L3	153-320	95600003	700-162	SR3157755	153-139	53210-70C00	153-037	5880993	153-340
4241.L4	153-022	95624959	153-324					5881040	153-063
4241.L7	153-085	95625020	153-324					5881050	153-063
4241.N2	153-438	95643713	153-062	DAIHATSU		DAIHATSU LCV		5881159	153-340
4241.N6	153-268	95661851	153-062					5881214	153-063
424100000	153-322	ZF04449694	700-015					5881964	153-063
42410000000	153-021K			04494-87602	153-033	04495-87508	153-040	5888143	153-340
424100000000	153-320			04495-12010	153-409	04495-87714	153-040	5888144	153-063
4242.01	153-025	DACIA		04495-12011	153-409	04495-87Z01	153-044	5888433	153-066
4242.10	153-085			04495-12040	153-409			5888453	153-067
4242.11	153-085			04495-12050	153-409			5888542	153-340
4242.27	153-085	60 01 547 630	153-350	04495-14020	153-408	DAIMLER		5888606	153-055
4242.55	153-323	60 01 549 703	153-365	04495-14021	153-408			5890500	153-066
4247.24	700-233	60 01 549 704	153-359	04495-20081	153-408			5923606	700-018
4247.37	700-017	60 01 551 409	153-359	04495-22050	153-408	CBC2347	153-197K	5923924	700-006
4247.40	700-245	60 01 551 413	153-359	04495-22051	153-408			5953538	153-055
4247.41	700-246	77 01 206 429	153-359	04495-22080	153-408			5974792	700-007
4247.42	700-244	77 01 207 178	153-359	04495-22081	153-408	DODGE		5975061	700-007
4247.43	700-244	82 00 243 735	700-382	04495-22090	153-408			60750467	153-340
4247.45	700-246	84 55 458 161	153-341	04495-42010	153-429			7074668	153-063
4247.46	700-363	84 55 458 172	153-340	04495-59010	153-436	4423606	153-349	7078585	153-078
4247.48	700-383	84 55 499 157	153-340	04495-87203	153-034	4761833	153-349	7081572	153-078
4251.J5	153-350			04495-87204	153-038	4882059	153-026	7081832	153-087
91502484	700-158			04495-87210	153-038	4882576	153-027	7082149	153-081Y
91509908	700-161			04495-87214	153-034	4883833AA	153-026	71738375	153-063
9404241998	153-339K	DAEWOO		04495-87215	153-038	5018209AA	153-029	71738376	153-066
9430655421	700-160			04495-87401	153-429	5018211AA	153-029	71738377	153-069
9478267980	700-165	1605056	153-309	04495-87402	153-434	5019802AA	153-027	71738378	153-070
95600003	700-162	1605910	153-309	04495-87508	153-040	5114493AA	153-029	71742832	153-096
95619206	700-160	290611	153-047	04495-87601	153-033	5191215AA	153-362	7569600	700-009
95619515	153-021K	43511-A84000	700-312	04495-87603	153-033	68003589AA	153-363	7599325	700-008
95637178	700-163	4520005	153-309	04495-87605	153-033	68026168AA	153-249	7672577	700-023
95653213	153-024Y	4520008	153-050	04495-87608	153-037	K5018209AA	153-029	7672577	700-024
95655344	153-021K	48330-05000	153-100	04495-87608	153-426			77362284	153-075
95659470	153-022	90105445	700-300	04495-87704	153-036			77362292	153-063
95659622	700-164	90168958	700-300	04495-87706	153-036	DODGE TRUCK		77362295	153-079Y
95659661	153-346	91024352	700-300	04495-87707	153-037			77362296	153-080Y
95659671	153-320	91149506	153-309	04495-87708	153-037			77362449	153-084
95659676	153-322	93740251	153-050	04495-87711	153-036	4423606	153-349	77362451	153-074
AY4516	700-340	93740252	153-050	04495-87712	153-036	4761833	153-349	77362452	153-081Y
AY4516A	700-340	94608757	700-300	04495-87714	153-040			77362453	153-081Y
RB337335	153-320K	96175281	700-300	04495-88000	153-033			77362454	153-078
		96193771	700-310	04495-97201	153-435	FIAT		77362491	153-083
		96193878	700-310	04495-97202	153-041			77362615	153-090
		96268686	153-046	04495-97203	153-035			77362756	153-088
		96298282	153-048	04495-97204	153-435	1311823080	700-017	77362929	153-091
		96316636	700-311	04495-97205	153-038	1471288080	700-017	77363855	153-092
		96319066	153-049	04495-97206	153-039	4121616	700-004	77363858	153-093
		96349066	153-049	04495-97208	153-039	4234857	700-004	77363946	153-088
		96394977	153-049	04495-97213	153-039	4236768	700-004	77364029	153-091
		96430417	153-309	04495-97215	153-041	4267288	700-004	77364264	153-093
		96446178	153-046	04495-97220	153-045	4299052	700-002	77364744	153-092
		96473229	153-050	04495-B1030	153-043	4299429	700-001	77365346	153-487
		B521040	153-483	04495-B1170	153-043	4340300	700-001	77365795	153-488
		NP1441	153-309	04495-B2060	153-045	4340301	700-002	77366214	153-488
		NP1464	153-309	04495-B2170	153-045	4340305	700-002	7750119	700-011
		SF327	153-309	04495-B2180	153-042	4340810	153-055	7763353	700-009
				04495-B2220	153-042	4340811	153-055	7769850	700-022
				04497-12010	153-409	4352373	153-063	7774593	700-019
				04497-12050	153-408	4360976	700-002	7777842	700-003
				04497-14010	153-408	4360988	700-001	93189993	153-092
				04497-14020	153-408	4368516	700-004	9566926980	153-331

CROSS REFERENCES LIST

Adaptable for OES	CIFAM ref.	Adaptable for OES	CIFAM ref.	Adaptable for OES	CIFAM ref.	Adaptable for OES	CIFAM ref.	Adaptable for OES	CIFAM ref.
FIAT		7777842	700-003	1555151	153-104	6113131	153-106	91AB1113AD	700-287
		946560	153-062	1558094	153-148	6132809	153-105	91AB2200GA	153-119
		9467549388	153-073	1560229	153-103	6134909	153-107	91AB2200LA	153-120
9566949580	153-074	95643714	153-068	1581895	153-148	6137292	700-268	92AX2200AA	153-119
956692680	153-074	9566949580	153-074	1591135	153-062	6142943	700-268	92AX2200BA	153-120
95882091	153-063	9569692680	153-074	1598117	700-270	6149499	153-108	92FB2200AA	153-117K
98601861	700-023	95882091	153-063	1604982	153-105	6150270	153-113	93BB1126AB	700-291
98845054	153-081Y	9939718	153-062	1610955	153-100	6150271	153-106	93BB1126CA	700-283
98845069	153-078	9940553	153-068	1613131	153-106	6159641	153-112K	93BB2200AB	153-130
98845348	153-098	9940559	153-062	1619135	153-111K	6162658	153-108	93BB2200BD	153-124
9945371	153-069	9941210	153-068	1619136	153-111K	6176743	700-276	93BB2200CB	153-125
9945640	153-069	9941243	153-071	1619228	700-267	6176744	700-275	94FB2200AA	153-117K
9945690	153-076	9943934	153-062	1625069	700-318	6177227	153-111K	95AB2200AA	153-128
9945975	153-070	9943935	153-068	1625131	153-111K	6183822	700-268	95AB2200BA	153-129
9947106	153-002	9945371	153-069	1634564	700-315	6183876	153-117K	95AB2200BB	153-129
9947690	153-076	9945640	153-069	1648631	153-111K	6183877	153-118K	95AB2200BC	153-129
9947773	153-070	9945884	153-073	1661851	700-272	6492327	700-276	95AX2200BB	153-129
9947939	153-075	9945885	153-072	1695033	153-490	6492328	700-275	96AB2200AB	153-129
9948200	153-066	9946560	153-071	1954475	700-293	6500943	153-119	96AB2200AC	153-129
9948235	153-063	9946561	153-068	1954496	153-287	6500944	153-120	96AX2200AB	153-129
9948240	153-063	9947939	153-075	1960416	153-287	6500946	153-145	96FB2200AA	153-128
9948372	153-079Y	9948235	153-063	2218AA	153-101	6559229	700-272	96FB2200AC	153-128
9948373	153-080Y	9948240	153-063	2596270	153-101	6569230	153-108	96FX2200AA	153-128
FA16500250	700-004	9948372	153-079Y	2930E2218A	153-101	6560026	700-276	98AB1126BE	700-319
		9948373	153-080Y	2S612200AA	153-136	6560027	700-275	98AB2200BD	153-133
		9949490	153-082	2S6J2200BA	153-136	6560028	700-287	98AB2200BE	153-133
FIAT LCV		9949494	153-089	3049844	700-319	6710010	700-283	98AX2200BD	153-133
		GBS1079	153-060	3049884	700-391	6710016	153-125	AB2200AA	153-105
				3645890	153-143	6710017	153-124	D8RZ1126A	700-267
				3651347	153-143	6749045	153-145	GBS802	153-104
1306211080	700-016			3M511126AC	700-390	6837963	700-291	V83AB2200AA	153-106
1311823080	700-017	FORD EUROPE		3M512200BA	153-142	69053200	153-100	V84FB2200AB	153-111K
1313675080	700-013			4034886	700-289	6920710	700-276	V86AB1126AA	700-315
1471288080	700-017			4034886	700-289	6920711	700-287	YC152200AE	153-134
4263843	153-060	1000859	700-289	4053719	700-388	6920711	700-287	YL84L2L362AD	153-216
4352373	153-063	1005960	153-128	4145506	700-391	6978969	153-117K	YS512200AB	153-137
4373442	153-063	1005968	153-129	4154689	700-391	7055297	153-130	YS5J2200AA	153-137
4379680	700-003	1005970	153-128	4186874	700-391	7166588	153-117K	YS612200AB	153-136
4382264	153-063	1011288	700-290	4329656	700-365	7176735	153-124	YS6J2200AC	153-136
4389374	700-013	1014655	153-124	4345314	700-365	71BB1126DB	700-268	YS6J2200AA	153-136
4449694	700-013	1017209	153-129	4438930	153-216	7267808	153-125		
46448407	700-024	1017668	700-289	4509601	153-143	7296355	700-290		
46621077	700-003	1027371	700-283	5015657	153-106	7296356	700-292		
46819776	700-011	1041484	153-118K	5015659	153-106	738771	153-101		
5880891	153-063	1041906	153-129	5015665	153-108	77FB1113BC	700-267	FORD LCV, TRUCK	
5880898	153-060	1041909	153-129	5019037	153-103	78EB1126AA	700-277		
5881040	153-063	1044141	153-130	5019046	153-100	78EB1126BA	700-272	1005960	153-128
5881050	153-063	1045392	700-292	5020408	153-106	81AB1113AF	700-270	1005968	153-129
5881214	153-063	1055033	153-129	5020409	153-108	81AB1126CA	700-268	1005970	153-128
5881964	153-063	1059500	153-128	5020413	153-105	81AB1126CB	700-268	1014316	153-126
5888144	153-063	1060096	153-129	5020545	153-104	81AB2200AA	153-105	1014317	153-127
5888453	153-067	1060102	153-129	5020547	153-105	81AB2200AB	153-105	1017209	153-129
7074668	153-063	1065033	153-129	5020548	153-106	83BB1126CB	700-318	1041484	153-118K
7081832	153-087	1065036	153-129	5020552	153-108	83BB2200AB	153-112K	1041906	153-129
71738375	153-063	1075549	153-133	5020556	153-100	83BB2200BD	153-108	1041909	153-129
71738377	153-069	1104128	153-128	5020560	153-107	84AB2200AA	153-105	1045392	700-292
7569600	700-009	1106633	153-136	5020562	153-111K	84FB2200AB	153-111K	1055033	153-129
7672577	700-024	1121669	153-133	5021303	153-107	84FB2200AC	153-111K	1059500	153-128
77362284	153-075	1123789	153-137	5027751	153-119	84FB2200AD	153-111K	1060096	153-129
77362286	153-082	1123790	153-136	5027752	153-120	85AB2200AA	153-106	1060102	153-129
77362290	153-089	1126158	153-133	5030105	153-117K	866AB1126AA	700-268	1065033	153-129
77362292	153-063	1135082	153-128	5079622	153-104	86BX2200FA	153-108	1065036	153-129
77362295	153-079Y	113E2220	153-101	6013846	153-101	87BB2200AA	153-107	1104128	153-128
77362296	153-080Y	1145292	153-136	6019623	153-103	88AX2200DA	153-105	1106633	153-136
77362428	153-072	1151001	700-365	6046462	700-267	88BX2200AA	153-108	1123790	153-136
77362429	153-072	1197674	153-136	6063754	700-274	88BX2200JA	153-108	1135082	153-128
77362451	153-074	1213352	700-365	6063755	700-272	88BX2200MA	153-107	113E2220	153-101
77362696	153-089	1236882	153-136	6069059	153-107	88FX2200BA	153-111K	1145292	153-136
77362699	153-089	1315740	700-365	6069143	153-108	88FX2200DA	153-111K	1151001	700-365
77363478	153-089	1327834	700-390	6070681	700-268	88FX2200RA	153-107	1197674	153-136
77363479	153-089	1347420	153-142	6070682	700-268	89BB1126AA	700-272	1213352	700-365
77364023	153-094	1385735	153-142	6079622	153-104	89FB1113AD	700-276	1227045	153-135
77364667	153-099	1490274	700-277	6079623	153-103	89FB1113AE	700-276	1227046	153-134
77365346	153-487	1490767	700-268	6080431	700-270	89FB1113BC	700-287	1236882	153-136
77365620	153-099	1505165	700-272	6086628	700-270	89FB2200BB	153-118K	1315740	700-365
7750119	700-011	1520032	153-101	6088223	153-105	8A06095526B	153-009	1365486	153-138
7763353	700-009	1535923	700-399	6088224	153-106	8A06095527B	153-009	1427965	700-280
7769850	700-022	1539262	153-103	6096058	153-107	8A06095528B	153-009	1481386	153-102
7774593	700-019	1550225	153-148	6096358	700-318				

Adaptable for OES	CIFAM ref..	Adaptable for OES	CIFAM ref.	Adaptable for OES	CIFAM ref.	Adaptable for OES	CIFAM ref.	Adaptable for OES	CIFAM ref.
FORD LCV, TRUCK		6079622	153-104	92VB1126BA	700-285	42610-SK3-E10	700-082	43153-SN4-003	153-151
		6079623	153-103	92VB1126RD	700-285	42610-SM4-010	700-083	43153-SR3-A01	153-155
		6080431	700-270	92VB2200BB	153-123	42610-SR1-000	700-081	43153-SR4-A02	153-153
1490274	700-277	6086628	700-270	94FB2200AA	153-117K	42610-SR3-000	700-081	43153-SR7-003	153-153
1490767	700-268	6088224	153-106	94VB2200AB	153-126	43015-SP8-000	153-006	43153-ST0-J01	153-153
1520032	153-101	6109245	700-280	94VB2200BB	153-127	43053-S0X-000	153-160	43153-SV4-J01	153-153
1527723	153-102	6113131	153-106	94VX2200BB	153-127	43053-S10-A00	153-154	43154-5A0-003	153-152
1539262	153-103	6137292	700-268	95AB2200AA	153-128	43053-S2G-E50	153-153	43154-5A0-013	153-152
1543998	153-139	6142943	700-268	95AB2200BA	153-129	43053-S47-E50	153-159	43154-5A0-023	153-152
1543999	153-109	6149499	153-108	95AB2200BB	153-129	43053-S5A-E50	153-153	43154-5A0-671	153-152
1545199	700-280	6150091	153-115	95AB2200BC	153-129	43053-S9A-E51	153-161	43154-S47-N01	153-154
1548324	153-102	6150092	153-115	95AX2200BB	153-129	43053-S9A-E51	153-161K	43154-SA0-003	153-152
1555151	153-104	6150093	153-116	96AB2200AB	153-129	43053-S9A-E52	153-161	43154-SA0-013	153-152
1560229	153-103	6150094	153-114	96AB2200AC	153-129	43053-SAA-E50	153-158	43154-SA0-023	153-152
1598117	700-270	6150095	153-114	96AX2200AB	153-129	43053-SAA-E51	153-158	43154-SA0-671	153-152
1610955	153-100	6150271	153-106	96FB2200AA	153-128	43053-SED-E50	153-159	43154-SA0-672	153-152
1613131	153-106	6162658	153-108	96FB2200AC	153-128	43053-SJA-E00	153-495	43154-SA0-901	153-152
1619135	153-111K	6166058	700-278	96FX2200AA	153-128	43053-SJF-E00	153-159	43154-SAA-004	153-158
1619136	153-111K	6166059	700-286	D8RZ1126A	700-267	43053-SM4-A00	153-154	43154-SM4-A01	153-154
1619228	700-267	6167629	700-278	GBS802	153-104	43053-SM4-E50	153-154	43154-STK-A01	153-162
1625131	153-111K	6176743	700-276	V83AB2200AA	153-106	43053-SR3-A00	153-155	43154-SX0-000	153-159
1648631	153-111K	6176744	700-275	V8FB2200AB	153-111K	43053-SWW-000	153-162	43154-SX0-003	153-159
1662293	153-114	6177227	153-111K	VBS367	153-115	43053-SWW-000	153-162K	43155-SAA-004	153-158
1662294	153-116	6177473	153-116	YC152200AA	153-134	43153-5A0-013	153-152	43155-SM4-A01	153-154
1C152200AC	153-135	6183822	700-268	YC152200AC	153-134	43153-5A0-023	153-152		
2218AA	153-101	6183876	153-117K	YC152200AD	153-134	43153-5A0-672	153-152		
2696270	153-101	6183877	153-118K	YS612200AB	153-136	43153-692-003	153-152	HYUNDAI	
2930E2218A	153-101	6192365	153-115	YS612200AC	153-136	43153-692-601	153-152		
2S612200AA	153-136	6192490	700-288	YS6J2200AA	153-136	43153-692-603	153-152		
2S6J2200BA	153-136	6198026	700-285			43153-S04-A01	153-155	52710-02000	700-349
2T142200AA	153-138	6464214	700-284			43153-S10-A01	153-154	52710-02100	700-362
30215026344	153-115	6492327	700-276	FORD USA		43153-S2G-951	153-153	52711-24001	700-227
4005724	153-134	6492328	700-275			43153-S2H-003	153-153	58205-33A00	153-500
4055724	153-134	6500945	153-121			43153-S50-003	153-156	58305-01GA0	153-182
4078769	700-367	650945	153-121	3309694	153-146	43153-S5A-J01	153-153	58305-02A00	153-168
4078770	700-369	6559230	153-108	4001277	153-146	43153-S6A-J01	153-154	58305-02A10	153-168
4095038	153-135	6560026	700-276	4796337	153-146	43153-SA0-013	153-152	58305-05A00	153-168
4110585	153-135	6560027	700-275	E92Z2200B	153-205	43153-SA0-023	153-152	58305-17A00	153-176
4143208	153-134	6579150	153-122	F58Z2648A	153-146	43153-SA0-671	153-152	58305-1CA00	153-178
4146930	700-368	6733350	153-123	F6AZ2N712B	153-146	43153-SA0-672	153-152	58305-1CA10	153-177
4329656	700-365	69053200	153-100	XF222648AA	153-146	43153-SA0-901	153-152	58305-1GA00	153-182
4345314	700-365	6920710	700-276			43153-SA5-672	153-149	58305-21A00	153-253
4367102	700-366	6978969	153-117K			43153-SA6-672	153-149	58305-22A01	153-169
4367103	700-366	7098234	700-288	FSO		43153-SAA-004	153-158	58305-23A00	153-165
4387344	153-138	7125122	153-126			43153-SB2-003	153-150	58305-24020	153-170
4446218	700-367	7125123	153-127			43153-SB2-601	153-150	58305-24A00	153-167
4455981	700-366	7166588	153-117K	063584	153-476	43153-SB2-602	153-150	58305-24A20	153-167
4455986	153-134	71BB1126DB	700-268	4299052	700-002	43153-SB2-603	153-150	58305-24A30	153-170
4467600	700-366	7296356	700-292	4299429	700-001	43153-SB3-023	153-150	58305-25A00	153-170
4525732	153-134	738771	153-101	4340300	700-001	43153-SB6-003	153-151	58305-25A10	153-176
4540771	153-135	76VB1126AS	700-280	4340301	700-002	43153-SB6-671	153-151	58305-26A00	153-180
5015657	153-106	76VB1126AT	700-280	4340305	700-002	43153-SD9-003	153-151	58305-26A10	153-180
5015659	153-106	77FB1113BC	700-267	4360976	700-002	43153-SD9-671	153-151	58305-28A00	153-166
5015665	153-108	78EB1126AA	700-277	4360988	700-001	43153-SD9-672	153-151	58305-28A60	153-166
5015680	153-102	801469	153-114	4379680	700-003	43153-SE0-003	153-153	58305-28A70	153-166
5019037	153-103	81AB1113AF	700-270	46621077	700-003	43153-SE0-013	153-153	58305-28B00	153-166
5019046	153-100	81AB1126CA	700-268	655880892	153-055	43153-SE0-N51	153-153	58305-28C00	153-166
5020408	153-106	81AB1126CB	700-268	655881040	153-063	43153-SE0-S01	153-153	58305-28D00	153-166
5020409	153-108	82VB1126AA	700-284	7777842	700-003	43153-SEL-003	153-492	58305-28E00	153-166
5020545	153-104	83BB2200BD	153-108			43153-SH0-505	153-150	58305-29A00	153-166
5020548	153-106	84FB2200AB	153-111K			43153-SH0-A02	153-150	58305-29A10	153-171
5020552	153-108	84FB2200AC	153-111K			43153-SH3-003	153-150	58305-2DA10	153-166
5020556	153-100	84FB2200AD	153-111K			43153-SH3-013	153-150	58305-2MA00	153-497
5020562	153-111K	85AB2200AA	153-106			43153-SH3-507	153-150	58305-2PA00	153-498
5022245	153-102	866AB1126AA	700-268	04431-JT3-E00	153-006	43153-SH3-517	153-150	58305-2SA00	153-185K
5022246	153-102	86BX2200FA	153-108	04431-S1A-E60	153-157	43153-SH3-A01	153-150	58305-2SA30	153-502
5027753	153-121	86VB1126TB	700-280	04431-S5S-E01	153-153	43153-SH3-A02	153-151	58305-31020	153-277
5027771	153-123	87VB1126AA	700-278	04431-S5S-E50	153-494	43153-SH3-G02	153-150	58305-34A10	153-100
5030105	153-117K	88BX2200AA	153-108	04431-ST3-E00	153-006	43153-SH5-003	153-151	58305-38A00	153-175
5079622	153-104	88BX2200JA	153-108	06450-S9A-E51	153-154	43153-SH5-013	153-151	58305-3AA00	153-172Y
6013846	153-101	88FX2200BA	153-111K	42610-S2H-000	700-086	43153-SH5-A01	153-151	58305-3LA00	153-499
6019623	153-103	88FX2200DA	153-111K	42610-S70-000	700-085	43153-SH5-A02	153-151	58305-3LA10	153-499
6046462	700-267	89FB1113AD	700-276	42610-SB2-000	700-080	43153-SH5-G01	153-151	58305-44A00	153-100
6049432	700-280	89FB1113AE	700-276	42610-SB2-010	700-080	43153-SJ-6-023	153-151	58305-44A10	153-100
6063754	700-277	89FB2200BB	153-118K	42610-SB2-760	700-080	43153-SK7-003	153-153	58305-44A40	153-100

Adaptable for OES	CIFAM ref..	Adaptable for OES	CIFAM ref.	Adaptable for OES	CIFAM ref.	Adaptable for OES	CIFAM ref.	Adaptable for OES	CIFAM ref.
MARUTI		BL53-26-38Z9A	153-203	MERCEDES BENZ		906 420 03 30	153-246	MN102642	153-261
		BP18-26-38Z	153-204			906 420 04 20	153-249	MN150861	153-267
		BP18-26-38Z9A	153-204			MITSUBISHI			
53210-46A50	153-380	BSY6-26-38Z	153-207	000 420 79 20	153-238				
53210-50A10	153-380	BW7Y-26-251	700-296	002 420 47 20	153-236				
53210-84010	153-380	BWYA-26-38Z	153-205	002 420 58 20	153-239				
53800-50800	153-380	BWYB-26-38Z	153-205	003 420 14 20	153-239				
53800-M70F10	153-380	C030-26-310A	153-201	003 420 70 20	153-236	4600A106	153-269	MR129854	153-265
53830-60F90	153-380	C1Y0-26-38Z	153-216	004 420 86 20	153-245	4600A122	153-269	MR129855	153-265
		C1Y0-26-38ZA	153-216	005 420 36 20	153-250	4800A001	153-268	MR129856	153-265
		C1Y0-26-38ZB	153-216	108 420 01 20	153-232	52711-24001	700-227	MR1485638	153-265
		CA15-26-38ZA	153-206	116 420 00 20	153-232	L8009E4100	153-259	MR178823	153-251
		CBY9-26-38Z	153-216	120 420 14 20	153-232	MB102643	153-260	MR178826	153-260
		D001-26-310	153-206	120 420 15 20	153-232	MB193596	700-331	MR178827	153-264
		D102-26-251	700-296	123 412 01 20	153-232K	MB238114	153-251	MR205575	700-384
		D1Y2-26-38ZA	153-219	123 420 01 20	153-232	MB238520	153-251	MR249796	153-259
		DA01-26-251	700-274	124 420 02 20	153-233	MB238521	153-251	MR249797	153-259
		DA15-26-38Z	153-206	124 420 03 20	153-233	MB238522	153-251	MR249798	153-259
		DA15-26-38ZA	153-206	124 420 03 30	153-233	MB238523	153-251	MR307746	700-398
		DBY2-26-38Z	153-211	124 420 05 20	153-233	MB366143	153-252	MR391631	153-265
		DDY2-26-38Z	153-136	124 420 07 20	153-233	MB366443	153-253Y	MR449086	153-263
		DF71-26-251	700-393	126 412 01 20	153-232	MB366444	153-253Y	MR449087	153-263
		DFY1-26-38Z	153-148	126 420 01 20	153-232	MB366445	153-253Y	MR465094	153-259
		E8BZ-11-26A	700-274	128 420 01 20	153-232	MB366446	153-253Y	MR476000	153-261
		F2C6-12-448	700-296	140 420 04 20	153-234	MB465094	153-259	MR485638	153-265
		F2CZ-11-26A	700-296	140 420 08 20	153-234	MB515476	700-249	MR496333	153-260
		G030-26-310	153-201	140 420 09 20	153-234	MB534235	700-331	MR535718	153-267
		G030-26-310A	153-201	163 420 02 20	153-242	MB534245	700-250	MR535718	153-267K
		G030-26-310B	153-201	164 420 06 20	153-244	MB534245	700-331	MR586653	153-261
		G030-26-38Z	153-201	168 420 02 20	153-235	MB534594	153-253Y	MR981238	153-252
		G0Y0-26-38Z	153-201	168 420 03 20	153-235	MB534595	153-253Y	MZ981179	153-251
		G211-26-38Z	153-207	168 420 03 30	153-235	MB534596	153-253Y	MZ981180	153-251
		GAYB-26-38ZB	153-205	168 420 06 20	153-235	MB534597	153-253Y	MZ981184	153-253Y
		GAYB-26-38ZC	153-205	168 423 02 01	700-223	MB534656	153-252		
		GEYT-26-38Z	153-216	168 423 04 01	700-223	MB587659	153-251		
		GEYT-26-38ZA	153-216	201 420 08 20	153-233	MB587660	153-251		
		GJ21-26-251	700-281	201 420 09 20	153-233	MB587661	153-251		
		GJ21-26-251A	700-281	203 420 01 20	153-233	MB618192	153-252		
		GJ21-26-38Z	153-205	210 420 03 20	153-234	MB618193	153-252	MB102643	153-260
		GJ21-26-38ZB	153-205	210 420 03 30	153-234	MB618194	153-252	MB238114	153-251
		GJ83-26-38Z	153-205	220 420 05 20	153-241	MB618914	153-264	MB238520	153-251
		GJ83-26-38ZA	153-205	221 420 01 20	153-247	MB618916	153-264	MB238521	153-251
		GK59-26-251	700-295	221 420 05 20	153-247	MB668336	153-256	MB238522	153-251
		LCY2-24-38ZA	153-218	221 420 06 20	153-507	MB668540	700-364	MB238523	153-251
		LCY2-26-38ZB	153-218	221 420 06 20	153-507K	MB668742	153-258	MB534245	700-250
		LCY2-26-38ZC	153-218	230 420 03 20	153-243	MB668745	153-258	MB587659	153-251
		LDY3-26-38Z	153-218	230 420 03 30	153-243	MB668746	153-258	MB587660	153-251
		LDY4-26-38Z	153-218	404 420 10 20	153-247	MB668747	153-258	MB587661	153-251
		LFY4-44-39Z	153-491	414 420 03 20	153-233	MB668906	153-265	MB699017	153-251
		LFY4-44-39Z	153-491K	414 420 03 30	153-233	MB668907	153-265	MB699018	153-251
		S31A-26-310A	153-221	601 423 50 01	700-221	MB668908	153-265	MB699019	153-251
		U0Y9-26-38ZA	153-209	638 420 00 20	153-236	MB699017	153-251	MB858876	153-251
		UBY2-26-38ZB	153-209	638 420 01 20	153-236	MB699018	153-251	MN102637	153-251
				639 420 02 20	153-248	MB699019	153-251	MR178823	153-251
				904 420 03 20	153-240	MB699334	153-257	MR178826	153-260
				906 420 03 20	153-246	MB699335	153-257	MR496333	153-260
		MAZDA LCV				MB699336	153-257	MZ981179	153-251
						MB857295	153-265	MZ981180	153-251
						MB858665	153-258		
						MB858684	153-258		
						MB858685	153-258		
						MB858686	153-258		
						MB858876	153-251		
						MB858877	153-251		
						MB858926	153-265	05191-306AA	153-296
						MB858927	153-265	062050591	700-068
						MB858928	153-265	069022810	153-279
						MB950064	153-257	069053200	153-342
						MB950065	153-256	36160-51N25	153-289
						MB950205	153-265	36160-C9625	153-289
						MB950206	153-265	40206-21000	700-328
						MB950211	153-265	40206-21001	700-328
						MB950212	153-265	40206-U4800	700-328
						MB950951	700-331	40222-M7101	700-051
						MN102634	153-265	41060-B8626	153-274
						MN102635	153-265	41060-B9600	153-274
						MN102637	153-251	43202-08M01	700-051
						MN102640	153-264	43202-09E00	700-058
								43202-50A12	700-061

CROSS REFERENCES LIST

Adaptable for OES	CIFAM ref.	Adaptable for OES	CIFAM ref.	Adaptable for OES	CIFAM ref.	Adaptable for OES	CIFAM ref.	Adaptable for OES	CIFAM ref.
NISSAN		44060-7C325	153-287	43200-00QAF	700-375	44070-W0300	153-271	4544326	153-302
		44060-7C326	153-287	43200-00QAG	700-374	8717109255218	153-291	4544334	153-302
		44060-7E625	153-354	43200-00QAL	700-144	D4000-W0300	153-271	4704579	700-371
43203-09E00	700-058	44060-86R25	153-277	43206-08G11	700-052	D4060-18025	153-270	4704595	700-370
43204-01B00	700-056	44060-8H725	153-293	43206-15G11	700-053	D4060-G0300	153-270	4705128	153-314
43204-01B01	700-056	44060-8M126	153-292	43206-1E410	700-328	D4060-G0325	153-270	4706273	153-314
43206-08G11	700-052	44060-99B26	153-284	43206-2S600	700-072	D4060-Qf125	153-271	4706836	153-318
43206-0F001	700-330	44060-9C025	153-287	43206-31G11	700-054	D4060-U8725	153-271	4708598	153-438
43206-0W710	700-376	44060-AX625	153-290	43206-37G10	700-066	D4060-W0301	153-271	4804768	153-317
43206-1E410	700-328	44060-CA00J	153-297	43206-80W10	700-332	D4060-W0325	153-271	4804801	153-317
43206-21B10	700-057	44060-CY025	153-295	43206-9C502	700-336	D4060-W0326	153-271	4838652	153-302
43206-2F010	700-070	44060-D5725	153-277	43206-G9500	700-063	D4070-W0300	153-271	552107	153-300
43206-31G11	700-054	44060-E4100	153-271	43206-T6000	700-332	D4070-W0301	153-271	552123	153-302
43206-50Y10	700-055	44060-E4125	153-271	44050-18000	153-270	DD060-T6025	153-274	552152	153-302
43206-5F011	700-069	44060-EA025	153-298	44060-00QAK	153-354			552158	153-191
43206-5F012	700-060	44060-EA025	153-298K	44060-03N26	153-278			552166	153-491
43206-5F013	700-069	44060-EB326	153-508	44060-05N25	153-279	OPEL		552166	153-491K
43206-5F014	700-060	44060-ED025	153-509	44060-06F25	153-271			552217	153-301
43206-6N000	700-353	44060-G0300	153-270	44060-07C25	153-271			552240	153-191
43206-97J10	700-059	44060-G0325	153-270	44060-08G25	153-279	11717147	153-303	568038	700-302
43206-9C000	700-065	44060-G2200	153-270	44060-0F026	153-287	1605041	153-308	568039	700-300
43206-AX650	700-352	44060-G2225	153-270	44060-0F027	153-287	1605042	153-309	568051	700-302
43206-C6000	700-062	44060-G9825	153-415	44060-0W725	153-282	1605052	153-308	568053	700-299
43206-C9000	700-065	44060-H0100	153-270	44060-0W726	153-282	1605064	153-311	568054	700-300
43206-G9500	700-063	44060-H0125	153-270	44060-0W727	153-282	1605262	153-311	568056	700-302
43206-G9800	700-064	44060-H7225	153-270	44060-0X825	153-291	1605458	153-092	568057	700-300
43222-50A00	700-051	44060-Q0101	153-271	44060-16C25	153-279	1605459	153-093	568058	700-299
44050-18000	153-270	44060-Q0125	153-271	44060-16C26	153-279	1605462	153-309	568060	700-306
44060-00QAK	153-354	44060-Q1325	153-271	44060-18025	153-270	1605477	153-303	568061	700-298
44060-01A25	153-272	44060-T0425	153-275	44060-20R25	153-277	1605478	153-304	568063	700-305
44060-01A26	153-272	44060-T6425	153-275	44060-20W25	153-274	1605568	153-303	568066	700-389
44060-01J25	153-280	44060-U2000	153-271	44060-25T25	153-275	1605590	153-305	568269	700-373
44060-03N26	153-278	44060-U2025	153-271	44060-28N25	153-279	1605591	153-306	568270	700-372
44060-04B25	153-273	44060-U8700	153-271	44060-31G25	153-278	1605592	153-307	8983848	153-301
44060-05N25	153-279	44060-U8725	153-271	44060-35G25	153-278	1605593	153-307	90007526	700-313
44060-06F25	153-271	44060-W0300	153-271	44060-36G25	153-278	1605594	153-306	90077721	700-302
44060-07C25	153-271	44060-W0325	153-271	44060-37G25	153-282	1605674	153-307	90086194	700-299
44060-08G25	153-279	44060-WL026	153-297	44060-37G26	153-282	1605686	153-302	90090085	700-302
44060-0F026	153-287	44070-18000	153-270	44060-3J325	153-354	1605689	153-305	90093417	153-300
44060-0F027	153-287	44070-E4100	153-271	44060-47L25	153-277	1605690	153-306	90094695	153-303
44060-0W725	153-282	44070-G2200	153-270	44060-47L26	153-277	1605734	153-306	90094696	153-304
44060-0W726	153-282	44070-H0100	153-270	44060-48L25	153-270	1605741	153-300	90105445	700-300
44060-0W727	153-282	44070-N4600	153-271	44060-48L26	153-277	1605742	153-303	90135264	700-302
44060-0X825	153-291	44070-Q0101	153-271	44060-55L25	153-277	1605743	153-304	90135504	700-313
44060-16C25	153-279	44070-U2000	153-271	44060-56G26	153-282	1605764	153-302	90166533	153-303
44060-16C26	153-279	44070-W0300	153-271	44060-56L25	153-277	1605771	153-304	90168958	700-300
44060-18025	153-270	8717109255218	153-291	44060-56L26	153-277	1605773	153-301	90182658	153-302
44060-18B25	153-273	D1060-B9600	153-274	44060-56L27	153-277	1605774	153-305	90193915	700-299
44060-20R25	153-277	D1060-B9625	153-274	44060-60Y25	153-277	1605781	153-307	90271938	153-307
44060-25T25	153-275	D4000-W0300	153-271	44060-70N25	153-277	1605792	153-305	90273259	153-302
44060-28B25	153-273	D4060-18025	153-270	44060-7C325	153-287	1605811	153-308	90297485	153-303
44060-28N25	153-279	D4060-8H725	153-293	44060-7C326	153-287	1605812	153-309	90343627	153-302
44060-31B25	153-273	D4060-8M126	153-292	44060-7E625	153-354	1605842	153-303	90350169	153-305
44060-31G25	153-278	D4060-CA01A	153-297K	44060-86R25	153-277	1605845	153-306	90375251	700-301
44060-35G25	153-278	D4060-G0300	153-270	44060-9C025	153-287	1605859	153-315	90392944	153-315
44060-36G25	153-278	D4060-G0325	153-270	44060-D5725	153-277	1605859	153-315K	90397655	153-307
44060-37G25	153-282	D4060-Qf125	153-271	44060-G0300	153-270	1605887	153-306	90399218	153-305
44060-37G26	153-282	D4060-U8725	153-271	44060-G0325	153-270	1605897	153-302	90421796	153-308
44060-3J325	153-354	D4060-W0301	153-271	44060-G2200	153-270	1605909	153-308	90421797	153-309
44060-41A25	153-272	D4060-W0325	153-271	44060-G2225	153-270	1605914	153-315	90444681	153-306
44060-47L25	153-277	D4060-W0326	153-271	44060-H0100	153-270	1605920	153-311	90495034	700-305
44060-47L26	153-277	D4070-W0300	153-271	44060-H0125	153-270	1605921	153-302	90509107	700-301
44060-48L25	153-277	D4070-W0301	153-271	44060-H7225	153-270	1605929	153-309	90509606	153-302
44060-48L26	153-277	D40F0AR025	153-294	44060-Q0101	153-271	1605938	153-302	90512792	153-311
44060-4A00F	153-518	D40F0AR06K	153-294	44060-Q0125	153-271	1605952	153-308	90538928	700-306
44060-50Y25	153-281			44060-Q1325	153-271	1605953	153-309	90541081	153-309
44060-55L25	153-277			44060-T0425	153-275	1605969	153-311	90541931	153-302
44060-56G26	153-282	NISSAN LCV		44060-T6025	153-274	1605977	153-314	90542862	153-308
44060-56L25	153-277			44060-T6425	153-275	24444064	700-389	90542863	153-309
44060-56L26	153-277			44060-U8700	153-271	2798647	153-303	91024352	700-300
44060-56L27	153-277	04495-25110	153-421	44060-U8725	153-271	2798648	153-304	91118872	700-298
44060-60Y25	153-277	04495-25111	153-421	44060-W0300	153-271	418000	700-350	91143043	153-310
44060-68A25	153-272	04495-25151	153-421	44060-W0325	153-271	418001	700-351	91143303	153-192
44060-6F625	153-288	069029000	153-100	44070-18000	153-270				

Adaptable for OES	CIFAM ref..	Adaptable for OES	CIFAM ref.	Adaptable for OES	CIFAM ref.	Adaptable for OES	CIFAM ref.	Adaptable for OES	CIFAM ref.
OPEL		568062	700-178	4241.E6	153-344	4241.58	153-062	PROTON	
		568063	700-305	4241.E7	153-021K	4241.59	153-068		
		568064	700-307	4241.E8	153-320	4241.71	153-344		
91158365	153-305	568066	700-389	4241.E9	153-325	4241.73	153-320	MB366443	153-253Y
91158366	153-309	90007526	700-313	4241.G3	153-022	4241.E6	153-340	MB366444	153-253Y
91158368	153-306	90077721	700-302	4241.G5	153-325	4241.E8	153-320	MB366445	153-253Y
91158369	153-311	90090085	700-302	4241.G6	153-323	4241.G6	153-323	MB366446	153-253Y
9196287	700-350	90105445	700-300	4241.G7	153-331	4241.H4	153-072	MB534594	153-253Y
9196290	700-351	90135264	700-302	4241.H6	153-023	4241.H5	153-073	MB534595	153-253Y
9196291	153-308	90135504	700-313	4241.H7	153-074	4241.H6	153-023	MB534596	153-253Y
9196292	153-309	90168958	700-300	4241.J0	153-323	4241.H7	153-074	MB534597	153-253Y
9208531	700-371	90271938	153-307	4241.J1	153-350	4241.H8	153-062	MB668742	153-258
9208532	700-370	90350169	153-305	4241.J2	153-330	4241.H9	153-062	MB668745	153-258
9209090	153-314	90397655	153-307	4241.J3	153-325	4241.J0	153-323	MB668746	153-258
9212698	153-314	90399218	153-305	4241.J4	153-326	4241.J1	153-350	MB668747	153-258
9214834	153-314	90421797	153-309	4241.J5	153-350	4241.J5	153-350	MB858665	153-258
9214843	153-318	90444681	153-306	4241.J6	153-320K	4241.J6	153-320K	MB858684	153-258
93158369	153-311	90512792	153-311	4241.J7	153-330	4241.J8	153-023	MB858685	153-258
93170618	153-311	90541081	153-309	4241.J8	153-023	4241.J9	153-320	MB858686	153-258
9317065	153-311	90542863	153-309	4241.J9	153-320	4241.K1	153-323	MZ981184	153-253Y
93171065	153-311	90543385	153-191	4241.K1	153-323	4241.K2	153-323		
93173149	153-314	90543394	153-312	4241.K2	153-323	4241.K6	153-074		
93190003	153-093	91024352	700-300	4241.K3	153-327	4241.K8	153-023		
93193429	153-438	9108323	153-071	4241.K4	153-330	4241.L1	153-089	RELIANT	
94230539	153-190	9111957	700-168	4241.K5	153-328	4241.L2	153-082		
94608757	700-300	91158362	153-307	4241.K6	153-074	4241.L3	153-320	GBS1107	153-106
96175281	700-300	91158365	153-305	4241.K8	153-023	4241.L9	153-089	GBS6017	153-004
96625871	153-317	91158366	153-309	4241.K9	153-330	4241.N4	153-073	GBS6028	153-004
96626083	153-317	91158368	153-306	4241.L0	153-025	4241.N5	153-094	GBS6127	153-003
		91158369	153-311	4241.L3	153-320	4241.N8	153-099	GBS6171	153-004
		9160399	700-308	4241.L4	153-022	4241.P0	153-099	GBS702	153-003
		9161446	153-313	4241.L5	153-332	4241000000	153-344	GBS7400	153-007
		9196292	153-309	4241.L7	153-085	424100000000	153-320		
		93158369	153-311	4241.N2	153-438	4242.21	153-073		
1605042	153-309	93170618	153-311	4241.N3	153-333	4242.55	153-323	RENAULT	
1605064	153-311	9317065	153-311	4241.N6	153-268	4246.40	700-243		
1605262	153-311	93171065	153-311	4241.N6	153-322	4247.22	700-213		
1605458	153-092	93172113	153-312	4241000000	153-344	4247.24	700-233	60 01 549 704	153-359
1605459	153-093	93173181	153-313	424100000000	153-320	4247.25	700-234	60 01 551 409	153-359
1605590	153-305	93190003	153-093	4242.01	153-025	4247.27	700-235	60 01 551 413	153-359
1605591	153-306	94226829	700-178	4242.10	153-085	4247.30	700-235	60 25 170 698	153-475
1605592	153-307	94608757	700-300	4242.11	153-085	4247.31	700-234	60 25 370 305	153-023
1605593	153-307	96175281	700-300	4242.20	153-333	4247.37	700-017	77 00 304 984	700-152
1605594	153-306	97113020	700-307	4242.27	153-085	4247.38	700-016	77 00 419 824	700-156
1605674	153-307			4242.55	153-323	4251.H4	153-072	77 00 421 739	700-153
1605689	153-305			4245.72	153-340	95659671	153-320	77 00 685 473	700-142
1605690	153-306	PEUGEOT		4247.17	700-231	RB337335	153-320K	77 00 710 511	700-144
1605734	153-306			4247.24	700-233			77 00 710 513	700-154
1605774	153-305			4247.25	700-234			77 00 752 363	700-142
1605781	153-307	4236.46	153-339K	4247.27	700-235	PIAGGIO		77 00 783 030	700-142
1605792	153-305	4238.04	153-475	4247.30	700-235			77 00 783 392	700-143
1605812	153-309	4238.05	153-475	4247.31	700-234			77 00 818 346	700-148
1605845	153-306	4238.46	153-339	4247.32	700-238	0449587508	153-040	77 00 820 816	700-150
1605887	153-306	4238.49	153-339K	4247.33	700-239			77 00 827 866	700-149
1605920	153-311	424000000	153-322	4247.34	700-242			77 00 839 322	700-157
1605929	153-309	4241.15	153-475	4247.35	700-241	PORSCHE		77 00 840 711	700-151
1605953	153-309	4241.21	153-320	4247.37	700-017			77 01 201 211	153-339
1605969	153-311	4241.23	153-322	4247.40	700-245			77 01 201 213	153-341K
24444064	700-389	4241.24	153-322	4247.41	700-246	477609537B	153-459	77 01 201 221	153-340
418000	700-350	4241.25	153-344	4247.42	700-244	477609537C	153-459	77 01 201 229	153-475
418001	700-351	4241.43	153-343	4247.43	700-244	477609537D	153-459	77 01 201 381	153-340
418025	700-301	4241.49	153-339	4247.44	700-241	481609537C	153-459	77 01 201 399	153-475
418051	700-301	4241.55	153-323	4247.45	700-246	92835209710	153-336	77 01 201 482	153-339
418117	700-304	4241.56	153-475	4247.46	700-363	92835299300	153-336	77 01 201 679	153-343
4400323	153-071	4241.57	153-343	4247.48	700-383	9535292500	153-244	77 01 201 758	153-350
4403294	153-071	4241.5P	153-339K	4250.12	153-340	95835292500	153-528	77 01 201 800	153-344
4403957	700-168	4241.5R	153-339K	95625020	153-324	97035299300	153-511	77 01 202 287	153-343
4500099	700-308	4241.71	153-344	95659671	153-320	98635209501	153-336	77 01 202 288	153-344
4501146	153-313	4241.72	153-322	RB337335	153-320K	98635209710	153-336	77 01 202 381	153-475
552153	153-312	4241.73	153-320			98635299501	153-336	77 01 202 384	153-475
552241	153-312	4241.79	153-325			99635209301	153-336	77 01 202 542	153-345
552441	153-312	4241.8L	153-328	PEUGEOT LCV		99635299300	153-336	77 01 202 543	153-346
568038	700-302	4241.91	153-475			99635299301	153-336	77 01 202 555	153-341
568039	700-300	4241.94	153-340			99635299302	153-336	77 01 202 661	153-345
568051	700-302	4241.95	153-341K	4238.99	153-062	99735299301	153-512	77 01 202 820	153-345
568054	700-300	4241.99	153-339	4241.21	153-320			77 01 202 898	153-344
568056	700-302	4241.A4	153-324	4241.25	153-344			77 01 202 899	153-344
568057	700-300	4241.E5	153-322	4241.55	153-323			77 01 202 901	153-339K

CROSS REFERENCES LIST

Adaptable for OES	CIFAM ref.	Adaptable for OES	CIFAM ref.	Adaptable for OES	CIFAM ref.	Adaptable for OES	CIFAM ref.	Adaptable for OES	CIFAM ref.
RENAULT		77 00 728 633	700-174	ROVER		GDB102	700-091	823 501 615B	700-191
		77 00 752 363	700-142			GDB105	700-333	867 609 526	153-465
		77 00 771 653	700-145			GDB106	700-073	867 609 528	153-465
77 01 202 919	153-346	77 00 783 030	700-142	102733	153-003	GDB110	700-091	985853528	153-063
77 01 202 921	153-475	77 00 783 031	700-145	18G8682	153-004	GDB114	700-097	FA16500250	700-004
77 01 202 922	153-340	77 00 783 392	700-143	21A22	700-333	GDB115	700-092	FA16500250	700-029
77 01 202 965	153-341	77 00 839 322	700-157	38722308	700-333	GDB117	700-096	JA16520151	700-030
77 01 202 967	153-343	77 01 201 211	153-339	6615066	153-102	NAM5027	700-091	SE021165299A	153-063
77 01 203 216	153-344	77 01 201 229	153-475	75242532	153-377	NAM7758	700-091	SE022165201A	700-028
77 01 203 545	153-475	77 01 201 399	153-475	BAU4504	700-101	RTC3430	153-109	SE022165299A	153-063
77 01 203 563	153-475	77 01 201 482	153-339	BAU4537	700-100	SFS100090	153-006	SE028165299B	153-063
77 01 203 716	153-475	77 01 201 617	153-071	DBP3798	700-092	SFS100190	153-369	SE141165209A	153-063
77 01 203 979	153-350	77 01 201 679	153-343	EPG1358	700-377	VBS167	153-377		
77 01 204 216	153-344	77 01 201 758	153-350	G85190	153-350	VBS362	153-377		
77 01 204 236	153-343	77 01 201 800	153-344	G8S730	153-003			SEAT LCV	
77 01 204 268	153-345	77 01 202 287	153-343	GB5102	153-003				
77 01 204 835	153-353	77 01 202 288	153-344	GB5603	153-101	SAAB			
77 01 204 883	153-351	77 01 202 381	153-475	GB56127	153-003			1J0 698 525	153-379
77 01 205 051	153-339	77 01 202 384	153-475	GB5702	153-003			1J0 698 525A	153-379
77 01 205 310	153-475	77 01 202 542	153-345	GB5807	153-152	4543419	153-302	1J0 698 525B	153-379
77 01 205 311	153-344	77 01 202 543	153-346	GB590733	153-003	4836441	153-302	357 609 525C	153-009
77 01 205 312	153-344	77 01 202 661	153-345	GB590807	153-152	4838660	153-302	357 609 526C	153-009
77 01 205 339	153-351	77 01 202 820	153-345	GBS046	153-101	4905493	153-302	357 609 527E	153-009
77 01 205 368	153-475	77 01 202 897	153-100	GBS101	153-004	8816738	153-377	357 609 528E	153-009
77 01 205 517	153-354	77 01 202 898	153-344	GBS102	153-003	8817157	153-377	357 698 525CV	153-009
77 01 205 523	153-355	77 01 202 899	153-344	GBS1052	153-152	GBS1002	153-377	357 698 525CX	153-009
77 01 205 720	153-350	77 01 202 901	153-339K	GBS1066	153-101			443 609 528A	153-009
77 01 205 758	153-356	77 01 202 919	153-346	GBS1098	153-103			443 698 525BX	153-009
77 01 206 429	153-359	77 01 202 921	153-475	GBS1106	153-005	SANTANA		443 698 525CX	153-009
77 01 206 962	153-350	77 01 202 967	153-343	GBS515	153-101			6K9 501 615	700-208
77 01 207 178	153-359	77 01 203 063	153-001	GBS520	153-007			6K9 609 617	700-359
77 01 207 266	153-353	77 01 203 072	153-100	GBS593	153-101	000354112	153-403	6U0 501 615A	700-213
77 01 207 556	153-354	77 01 203 216	153-344	GBS594	153-101	000354156	153-403	6U0 501 615B	700-213
77 01 208 063	153-354	77 01 203 545	153-475	GBS595	153-007			8A0 609 525B	153-009
77 01 208 111	153-350	77 01 203 563	153-475	GBS601	153-101			8A0 609 526B	153-009
77 01 208 357	153-290	77 01 203 716	153-475	GBS6017	153-004	SEAT		8A0 609 527B	153-009
77 01 209 586	153-290	77 01 203 979	153-350	GBS603	153-101			8A0 609 528B	153-009
77 01 209 586	153-513	77 01 204 216	153-344	GBS625	153-004			985853528	153-063
77 01 209 839	153-355	77 01 204 236	153-343	GBS701	153-004	171 501 615B	700-191	SE021165299A	153-063
77 01 262 919	153-346	77 01 204 268	153-345	GBS733	153-003	171 501 615C	700-191	SE022165201A	700-028
77 01 349 648	153-344	77 01 204 634	153-071	GBS734	153-377	191 501 615A	700-202	SE022165299A	153-063
77 01 349 649	153-343	77 01 204 637	153-071	GBS738	153-101	191 501 615B	700-191	SE028165299B	153-063
77 01 349 705	153-340	77 01 204 638	153-071	GBS745	153-152	191 609 526	153-465	SE141165209A	153-063
77 01 349 706	153-475	77 01 204 639	153-342	GBS753	153-366	1H0 501 615A	700-202		
77 01 349 744	153-339	77 01 205 051	153-339	GBS754	153-152	1H0 609 527	153-468		
77 01 349 780	153-345	77 01 205 290	153-127	GBS767	153-101	1H0 609 528	153-468		
77 01 349 928	153-475	77 01 205 310	153-475	GBS771	153-101	305 501 6151	700-191	SKODA	
77 01 458 163	153-340	77 01 205 311	153-344	GBS781	153-101	321 698 545	153-462		
77 01 458 164	153-340	77 01 205 312	153-344	GBS788	153-004	321 698 5545	153-462	007 440 071A	153-468
77 01 458 176	153-341K	77 01 205 368	153-475	GBS805	153-366	323 501 615	700-202	007 440 071B	153-468
77 01 460 325	700-323	77 01 205 720	153-350	GBS807	153-152	331 609 525	153-462	007 440 077B	153-468
77 01 460 327	700-334	77 01 205 915	153-100	GBS815	153-101	331 609 526	153-462	115 330 140	153-378
77 01 463 277	700-146	77 01 206 962	153-350	GBS817	153-005	331 609 527F	153-462	115 330 141	153-378
77 01 499 152	153-340	77 01 208 111	153-350	GBS90701	153-004	331 609 528F	153-462	115 330 143	153-378
77 01 499 153	153-340	77 01 262 919	153-346	GBS90733	153-003	4121616	700-004	115 330 149	153-378
77 01 949 780	153-345	77 01 349 648	153-344	GBS90738	153-101	4234857	700-004	115 330 191	700-257
77 02 124 892	153-340	77 01 349 649	153-343	GBS90767	153-101	4236768	700-004	115 330 192	700-259
77 02 189 786	700-143	77 01 349 706	153-475	GBS90771	153-101	4267288	700-004	115 331 140	153-468
82 00 243 735	700-382	77 01 349 744	153-339	GBS90820	153-005	4368516	700-004	115 331 141	153-468
82 00 276 843	700-381	77 01 349 780	153-345	GBS90821	153-150	4379680	700-003	115 331 142	153-468
RB337373	153-343K	77 01 349 928	153-475	GBS90824	153-004	443 609 525	153-462	115 331 143	153-468
		77 01 460 325	700-323	GBS90827	153-004	443 609 526	153-462	115 331 144	153-468
		77 01 460 327	700-334	GBS90827AF	153-004	443 609 527	153-462	1J0 609 617B	700-260
		77 01 463 939	700-168	GBS90828	153-005	443 609 528	153-462	1J0 698 525	153-379
		77 01 465 898	700-170	GBS90828AF	153-005	443 698 525X	153-462	1J0 698 525A	153-379
		77 01 465 899	700-169	GBS90829	153-150	46621077	700-003	1J0 698 525B	153-379
		77 01 468 958	700-171	GBS9082AF	153-004	531 698 525X	153-465	321 698 545	153-462
		77 01 642 511	700-170	GBS90830	153-006	687 698 525X	153-465	321 698 5545	153-462
		77 01 642 515	700-169	GBS90830AF	153-006	6Q0 609 617	700-358	331 609 525	153-462
		77 01 949 780	153-345	GBS90834	153-004	6X0 609 617A	700-219	331 609 526	153-462
		77 02 085 305	700-168	GBS90835	153-006	7777842	700-003	331 609 527F	153-462
		77 02 189 786	700-143	GBS90835AF	153-006	811 609 525E	153-462	331 609 528F	153-462
		82 00 243 735	700-382	GBS90836	153-006	811 609 526E	153-462	443 609 525	153-462
		RB337373	153-343K	GBS90836AF	153-006	811 609 527E	153-462	443 609 526	153-462
				GBS90837	153-004	811 609 528E	153-462	443 609 527	153-462
				GBS90837AF	153-004	811 698 525A	153-462	443 609 528	153-462

Adaptable for OES	CIFAM ref..	Adaptable for OES	CIFAM ref.	Adaptable for OES	CIFAM ref.	Adaptable for OES	CIFAM ref.	Adaptable for OES	CIFAM ref.
SKODA		0000A00899	153-475	53200-86G00	153-318	GBS1047	153-340	04495-20080	153-408
		0000A00902	153-475	53200-M68K00	153-518	VBS170	153-003	04495-20090	153-417
		0000A01220	153-475	53200-M76G31	153-404	VBS172	153-101	04495-20091	153-417
6U0 501 615	700-259	43500-80810	700-265	53201-70A00	153-393	VBS358	153-062	04495-20092	153-417
6U0 501 615A	700-213	43500-83810	700-263	53201-70A10	153-393			04495-20100	153-417
6U0 501 615B	700-213	43511-50G50	700-345	53201-70A20	153-393			04495-20101	153-417
811 609 525E	153-462	43511-52D00	700-386	53201-83300	153-393	TATA		04495-20120	153-417
811 609 526E	153-462	43511-60A10	700-339	53201-83310	153-393			04495-20121	153-417
811 609 527E	153-462	43511-60AB0	700-339	53202-70A00	153-393	277942300121	153-037	04495-20150	153-417
811 609 528E	153-462	43511-60B00	700-344	53202-70A10	153-393			04495-22030	153-408
811 698 525A	153-462	43511-60G00	700-385	53202-70A20	153-393	TOYOTA		04495-22031	153-408
811 698 525AV	153-462	43511-60G10	700-385	53202-83300	153-393			04495-22040	153-408
811 698 525AX	153-462	43511-62B00	700-343	53202-83310	153-393			04495-26040	153-413
		43511-65D00	700-395	53210-46A50	153-380			04495-26041	153-413
		43511-65D10	700-400	53210-50A10	153-380			04495-26050	153-421
SMART		43511-75F02	700-387	53210-56B00	153-399	04047-30070	153-416	04495-26051	153-421
		43511-77E00	700-346	53210-56B30	153-399	04494-20101	153-408	04495-26060	153-421
		43511-77EA0	700-346	53210-601310	153-398	04494-60020	153-411	04495-26061	153-421
0001440V001	153-237	43511-80001	700-264	53210-60A00	153-397	04495-01030	153-423	04495-26080	153-416
0004329V001	700-361	43511-83002	700-263	53210-60A20	153-397	04495-02020	153-432	04495-26091	153-416
0007333V001	153-237	43511-83003	700-263	53210-60B00	153-395	04495-02070	153-446	04495-26121	153-416
0012172V001	153-237	43511-83810	700-263	53210-60B10	153-398	04495-02120	153-446	04495-26150	153-413
451 423 00 08	153-237	43511-83E00	700-370	53210-70C10	153-037	04495-02180	153-446	04495-26240	153-452
454 420 02 02	153-266	43511-83E50	700-371	53210-82030	153-391	04495-02190	153-446	04495-27041	153-408
		43511-A60A00	700-266	53210-82031	153-391	04495-05010	153-432	04495-27050	153-408
		43511-A83003R	700-264	53210-83040	153-392	04495-05020	153-430	04495-27051	153-408
SSANGYONG		52200-70820	153-390	53210-83041	153-392	04495-05040	153-443	04495-28061	153-416
		52200-80840	153-390	53210-84010	153-380	04495-0D010	153-438	04495-28080	153-416
		52210-77300	153-390	53210-86000	153-391	04495-0D020	153-438	04495-28100	153-434
483 300 50 00	153-100	52210-77301	153-390	53210-86040	153-391	04495-0D040	153-454	04495-30050	153-416
483KT05000	153-491	52210-77370	153-390	53800-50800	153-380	04495-0F010	153-453	04495-30060	153-416
483KT05000	153-491K	52210-79240	153-390	53800-60800	153-396	04495-0F010	153-453K	04495-30070	153-416
		52210-79241	153-390	53800-M70F10	153-380	04495-0F020	153-527	04495-32010	153-417
		52210-79260	153-390	53830-60F90	153-380	04495-0H010	153-438	04495-32011	153-417
		52210-80040	153-390	54600-77K00	153-519	04495-0K010	153-416	04495-32030	153-417
SUBARU		52210-85400	153-390	DD060-B3025	153-404	04495-0K060	153-416	04495-32031	153-417
		53200-52D00	153-405			04495-0K100	153-416	04495-35031	153-413
		53200-52D10	153-405	SUZUKI LCV		04495-10070	153-425	04495-35051	153-413
		53200-52D20	153-405			04495-10071	153-425	04495-35052	153-413
		53200-56810	153-399			04495-10080	153-425	04495-35090	153-413
		53200-56821	153-399			04495-10110	153-425	04495-35100	153-413
26214-KA080	153-382	53200-60812	153-399	52200-70820	153-390	04495-10120	153-425	04495-35101	153-413
26214-TA010	153-385	53200-60820	153-395	52200-80840	153-390	04495-11060	153-409	04495-35120	153-413
26214-TA020	153-385	53200-60821	153-398	52210-77300	153-390	04495-11061	153-409	04495-35121	153-413
26214-TA030	153-385	53200-60830	153-393	52210-77301	153-390	04495-12010	153-409	04495-35122	153-413
26214-TA060	153-385	53200-60841	153-037	52210-77370	153-390	04495-12012	153-409	04495-35150	153-421
26214-TA071	153-385	53200-60871	153-393	52210-79240	153-390	04495-12020	153-417	04495-35151	153-421
26257-AA030	153-383	53200-60880	153-402	52210-79241	153-390	04495-12030	153-409	04495-35180	153-413
26257-AA040	153-383	53200-62J00	153-438	52210-79260	153-390	04495-12050	153-409	04495-35230	153-421
26257-AA050	153-383	53200-62J01	153-438	52210-80040	153-390	04495-12060	153-409	04495-40021	153-416
26290-KA080	153-382	53200-62J02	153-438	52210-85400	153-390	04495-12070	153-408	04495-42010	153-429
26290-TA060	153-385	53200-63J02	153-520	53200-50800	153-394	04495-12071	153-433	04495-42030	153-429
26290-TA071	153-385	53200-65D00	153-401	53200-80850	153-394	04495-12071	153-433	04495-42050	153-437
26290-TA080	153-385	53200-65D01	153-401	53200-80870	153-394	04495-12080	153-419	04495-42080	153-437
26298-AA010	153-383	53200-65D11	153-401	53200-81A01	153-154	04495-12081	153-419	04495-44010	153-434
26298-AA020	153-383	53200-65D11	153-401	53200-81A11	153-154	04495-12082	153-419	04495-44020	153-434
26298-AA030	153-386	53200-65J00	153-407	53210-85200	153-394	04495-12083	153-419	04495-47010	153-431
26298-AC000	153-383	53200-65J01	153-407	53210-85201	153-394	04495-12090	153-419	04495-52020	153-431
26340-AA010	700-262	53200-70800	153-393	53210-85206	153-394	04495-12091	153-419	04495-52040	153-431
26614-KC020	153-382	53200-70820	153-400	53210-85250	153-394	04495-12110	153-448	04495-52130	153-517
26690-KC000	153-382	53200-70821	153-400	53210-85260	153-394	04495-12111	153-448	04495-59010	153-436
26694-7G010	153-387	53200-76G00	153-404	53210-85270	153-394	04495-12140	153-424	04495-59020	153-431
26694-7G010	153-387K	53200-76G10	153-404			04495-12141	153-424	04495-60010	153-415
26694-FG000	153-268	53200-76G20	153-404			04495-12170	153-422	04495-60011	153-415
26698-AC000	153-386	53200-76G31	153-404			04495-12171	153-422	04495-60020	153-415
26740-FA000	700-396	53200-76G50	153-404			04495-12181	153-424	04495-60030	153-415
5012759098394	153-385	53200-76G51	153-404			04495-12210	153-433	04495-60031	153-415
53200-60841	153-037	53200-77810	153-403	0013545800	153-475	04495-12220	153-417	04495-60051	153-415
53200-70F31	153-380	53200-77811	153-403	13557400	153-340	04495-12240	153-422	04495-60060	153-415
53200-80ECO	153-406	53200-79J00	153-096	17489500	153-475	04495-14000	153-408	04495-60070	153-415
53200-86G00	153-318	53200-80830	153-392	17582600	153-340	04495-14010	153-409	04495-74020	153-431
7251-78170	153-380	53200-80ECO	153-406	17591600	153-475	04495-14011	153-408	04495-74020	153-526
7251-78480	153-380	53200-81A01	153-154	4247.22	700-013	04495-14030	153-408	04495-87402	153-434
7251-78481	153-380	53200-81A11	153-154	7910028721	700-231	04495-14031	153-408	04495-97201	153-435
7254-11601	700-261	53200-84E00	153-318	9404238468	153-339	04495-20030			

CROSS REFERENCES LIST

Adaptable for OES	CIFAM ref.	Adaptable for OES	CIFAM ref.	Adaptable for OES	CIFAM ref.	Adaptable for OES	CIFAM ref.	Adaptable for OES	CIFAM ref.
TOYOTA		46540-20060	153-444	04495-20050	153-408	42431-35200	700-121	443 609 525	153-462
		46540-20070	153-444	04495-20051	153-408	47610-12050	153-409	443 609 525A	153-008
		46540-20080	153-443	04495-20080	153-408	47610-12070	153-409	443 609 526	153-462
04497-12030	153-409	46540-28010	153-439	04495-22030	153-408	47610-14010	153-408	443 609 527	153-462
04497-12031	153-409	46540-32020	153-443	04495-22031	153-408	47610-14030	153-408	443 609 528	153-462
04497-12040	153-409	46540-42020	153-450	04495-22040	153-408	47620-12030	153-409	443 609 528A	153-009
04497-12041	153-409	46540-42020	153-450K	04495-26020	153-414	47620-12040	153-409	443 698 525	153-008
04497-12110	153-433	46540-44010	153-439	04495-26040	153-413	47620-14010	153-408	443 698 525AX	153-008
04497-14010	153-408	46540-50010	153-439	04495-26041	153-413	47620-14020	153-408	443 698 525BX	153-009
04497-14011	153-408	46540-60010	153-440	04495-26050	153-421	47620-22040	153-408	443 698 525CX	153-009
04497-14020	153-408	46540-60020	153-441	04495-26051	153-421	47620-27050	153-408	443 698 525X	153-462
04497-14021	153-408	46540-60060	153-441	04495-26060	153-421	47630-27010	153-408	531 609 525	153-465
04497-14030	153-408	46550-20020	153-444	04495-26061	153-421			531 609 537	153-465
04497-20010	153-408	46550-20030	153-444	04495-26080	153-416			6E0 609 525	153-470
04497-20011	153-408	46550-20040	153-444	04495-26091	153-416			6E0 609 526	153-465
04497-20012	153-408	46550-20050	153-444	04495-26121	153-416			6E0 609 527	153-465
04497-20031	153-408	46550-20060	153-444	04495-26130	153-426			6E0 698 525	153-468
04497-20061	153-408	46550-24010	153-525	04495-26150	153-413			6Q0 609 527A	153-468
04497-20070	153-417	46550-24011	153-525	04495-26180	153-428	111 698 051	153-458	6Q0 609 617	700-358
04497-20071	153-417	46550-28010	153-439	04495-26190	153-428	113 501 615G	700-185	6Q0 698 525	153-468
04497-20072	153-417	46550-33020	153-444	04495-26210	153-428	113 501 615J	700-185	6Q0 698 525A	153-468
04497-20080	153-417	46550-44010	153-439	04495-26220	153-428	113 609 237	153-459	6U0 698 451	153-468
04497-20081	153-417	46550-50010	153-439	04495-27041	153-408	113 609 237A	153-459	6U0 698 451	153-468
04497-20090	153-417	46550-60041	153-441	04495-27050	153-408	113 609 237B	153-459	6U0 698 525	153-468
04497-20091	153-417	46550-60070	153-441	04495-27051	153-408	113 609 237C	153-459	6U0 698 525A	153-468
04497-20100	153-417	46580-60050	153-524	04495-27051	153-408	113 609 237L	153-460	6U0 698 525AX	153-468
04497-22040	153-408	46580-60060	153-441	04495-28061	153-416	113 609 537C	153-459	6X0 609 617	700-218
04497-22041	153-408	46590-20020	153-444	04495-28080	153-416	113 609 538C	153-459	6X0 609 617A	700-219
04497-22050	153-408	46590-20030	153-444	04495-30050	153-416	113 698 237QX	153-460	6Y0 698 525	153-468
04497-27030	153-408	46590-20040	153-444	04495-30060	153-416	113 698 537	153-459	7L0 698 525	153-244
04497-32010	153-417	46590-20040	153-444	04495-30070	153-416	113 698 537CX	153-459	7L6 698 525	153-019
04497-32011	153-417	46590-20050	153-444	04495-35031	153-413	113 698 537QV	153-459	7P0 698 525	153-528
04907-0D010	153-454	46590-20060	153-444	04495-35051	153-413	113 698 537QX	153-459	811 609 525	153-465
42403-10020	700-123	46590-28010	153-439	04495-35052	153-413	131 609 237B	153-459	811 609 525A	153-465
42403-10060	700-123	46590-33020	153-444	04495-35090	153-413	131 609 237C	153-459	811 609 525E	153-462
42403-19015	700-123	46590-44010	153-439	04495-35100	153-413	131 698 237CX	153-459	811 609 526E	153-462
42403-19075	700-123	46590-50010	153-439	04495-35101	153-413	131 698 237QV	153-459	811 609 527	153-465
42403-19085	700-123	47610-12050	153-409	04495-35120	153-413	131 698 537CX	153-458	811 609 527A	153-465
42431-01020	700-116	47610-12070	153-409	04495-35121	153-413	171 501 615A	700-187	811 609 527E	153-462
42431-02100	700-378	47610-14010	153-408	04495-35122	153-413	171 501 615B	700-191	811 609 528E	153-462
42431-04010	700-112	47610-14030	153-408	04495-35150	153-421	171 501 615C	700-191	811 698 525A	153-462
42431-04020	700-121	47620-12030	153-409	04495-35151	153-421	171 698 525AX	153-465	811 698 525AV	153-462
42431-05020	700-109	47620-12040	153-409	04495-35200	153-428	171 698 525BX	153-465	811 698 525AX	153-462
42431-0D010	700-356	47620-14010	153-408	04495-35230	153-421	181 609 237B	153-459	823 501 615B	700-191
42431-0H010	700-383	47620-14020	153-408	04495-40021	153-416	191 501 615A	700-202	841 501 615A	700-188
42431-12020	700-126	47620-20230	153-417	04497-12010	153-409	191 501 615B	700-191	867 609 525	153-465
42431-12021	700-126	47620-22040	153-408	04497-12011	153-409	191 609 525	153-465	867 609 527	153-465
42431-12050	700-126	47620-27050	153-408	04497-12030	153-409	191 609 527	153-465	867 698 525V	153-465
42431-12110	700-126	47630-20190	153-417	04497-12031	153-409	191 609 528	153-465	867 698 525X	153-465
42431-12130	700-120	47630-27010	153-408	04497-12040	153-409	191 609 617	700-214	867 698 526V	153-465
42431-12140	700-324	94840683	153-419	04497-12041	153-409	191 609 617A	700-214	867 698 527V	153-465
42431-12180	700-380			04497-14010	153-408	193 609 537C	153-459	867 698 528V	153-465
42431-16030	700-113			04497-14011	153-408	1H0 501 615A	700-202	867 909 527	153-465
42431-16031	700-113			04497-14020	153-408	1H0 609 525	153-468	8A0 609 525B	153-009
42431-20070	700-115			04497-14021	153-408	1H0 609 526	153-468	8A0 609 526B	153-009
42431-20080	700-116	04047-30070	153-416	04497-14030	153-408	1H0 609 528	153-468	8A0 609 527B	153-009
42431-20190	700-122	04494-20101	153-408	04497-20010	153-408	1H0 698 520	153-468	8A0 609 528B	153-009
42431-20250	700-120	04495-0K010	153-416	04497-20011	153-408	1H0 698 520X	153-468	J04495-35122	153-413
42431-32020	700-119	04495-0K060	153-416	04497-20012	153-408	1H0 698 525	153-468		
42431-35080	700-112	04495-0K070	153-445	04497-20031	153-408	1H0 698 525B	153-468		
42431-35110	700-121	04495-0K100	153-416	04497-20061	153-408	1H0 698 525V	153-468		
42431-35120	700-112	04495-0K120	153-445	04497-22040	153-408	1H0 698 525X	153-468		
42431-35135	700-112	04495-11060	153-409	04497-22041	153-408	211 609 237A	153-459		
42431-35150	700-112	04495-11061	153-409	04497-22050	153-408	305 501 6151	700-191	113 609 237	153-459
42431-35151	700-112	04495-12010	153-409	04497-27030	153-408	321 698 545	153-462	113 609 237A	153-459
42431-35180	700-121	04495-12012	153-409	42431-04010	700-112	321 698 545	153-462	113 609 237B	153-459
42431-35200	700-121	04495-12012	153-409	42431-04020	700-121	323 501 615	700-202	113 609 237C	153-459
42431-47010	700-357	04495-12030	153-409	42431-26030	700-125	331 609 525	153-462	113 609 537C	153-459
42431-52020	700-107	04495-12050	153-409	42431-26070	700-125	331 609 526	153-462	113 609 538C	153-459
42431-52021	700-379	04495-12060	153-409	42431-26071	700-125	331 609 527F	153-462	113 698 537	153-459
42431-60020	700-325	04495-12061	153-408	42431-26080					

Adaptable for OES	CIFAM ref..	Adaptable for OES	CIFAM ref.	Adaptable for OES	CIFAM ref.	Adaptable for OES	CIFAM ref.	Adaptable for OES	CIFAM ref.
VOLKSWAGEN LCV		443 698 525CX	153-009	2723989	153-479	03.0137-0118.2	153-103	03.0137-0241.2	153-106
		531 609 525	153-465	274267	153-478	03.0137-0119.2	153-104	03.0137-0244.2	153-234
		531 609 537	153-465	274270	153-478	03.0137-0126.2	153-465	03.0137-0245.2	153-100
171 501 615C	700-191	6E0 609 526	153-465	274271	153-479	03.0137-0128.2	153-232	03.0137-0245.2	153-342
171 698 525AX	153-465	6E0 609 527	153-465	274504	153-479	03.0137-0130.2	153-409	03.0137-0247.2	153-015
171 698 525BX	153-465	6E0 698 525	153-468	30666344	153-477	03.0137-0132.2	153-408	03.0137-0248.2	153-016
181 609 237B	153-459	6K9 501 615	700-208	30666345	153-480	03.0137-0138.2	153-105	03.0137-0251.2	153-466
191 501 615A	700-202	6K9 609 617	700-359	31262621	153-477	03.0137-0139.2	153-324K	03.0137-0252.2	153-467
191 501 615B	700-191	6Q0 609 527A	153-468	31262626	153-478	03.0137-0141.2	153-339K	03.0137-0253.2	153-125
191 609 525	153-465	6Q0 698 525	153-468	31262869	153-479	03.0137-0143.2	153-303	03.0137-0254.2	153-115
191 609 527	153-465	6Q0 698 525A	153-468	31262874	153-530	03.0137-0144.2	153-304	03.0137-0255.2	153-258
191 609 528	153-465	6U0 501 615A	700-213	31262874	153-530K	03.0137-0145.2	153-008	03.0137-0256.2	153-469
193 609 537C	153-459	6U0 501 615B	700-213	3266303	153-103	03.0137-0146.2	153-462	03.0137-0257.2	153-425
1H0 501 615A	700-202	6U0 698 451	153-468	32778300	153-475	03.0137-0148.2	153-464	03.0137-0258.2	153-476
1H0 609 525	153-468	6U0 698 525	153-468	3287600	153-103	03.0137-0149.2	153-011	03.0137-0259.2	153-466
1H0 609 526	153-468	6U0 698 525A	153-468	32876005	153-103	03.0137-0150.2	153-013	03.0137-0260.2	153-478
1H0 609 528	153-468	6U0 698 525AX	153-468	3296108	153-103	03.0137-0151.2	153-014	03.0137-0261.2	153-022
1H0 698 520	153-468	6X0 609 617A	700-219	3342305	153-475	03.0137-0152.2	153-012	03.0137-0262.2	153-002
1H0 698 520X	153-468	6Y0 698 525	153-468	33423054	153-475	03.0137-0154.2	153-109	03.0137-0263.2	153-211
1H0 698 525	153-468	701 609 531	153-469	3342329	153-103	03.0137-0156.2	153-001	03.0137-0264.2	153-009
1H0 698 525B	153-468	701 609 531A	153-469	33423294	153-103	03.0137-0156.2	153-107	03.0137-0265.2	153-281
1H0 698 525V	153-468	701 609 531D	153-469	3343436	153-476	03.0137-0157.2	153-108	03.0137-0266.2	153-308
1H0 698 525X	153-468	701 609 531E	153-469	33434366	153-476	03.0137-0160.2	153-102	03.0137-0267.2	153-309
1J0 698 525	153-379	701 609 532	153-469	33434666	153-476	03.0137-0164.2	153-111K	03.0137-0268.2	153-468
1J0 698 525A	153-379	701 609 532A	153-469	3450387	700-049	03.0137-0165.2	153-307	03.0137-0269.2	153-068
1J0 698 525B	153-379	701 609 532D	153-469	3516881	153-478	03.0137-0166.2	153-305	03.0137-0270.2	153-391
211 609 237A	153-459	701 609 532E	153-469	35168814	153-478	03.0137-0167.2	153-306	03.0137-0271.2	153-475
211 609 537N	153-461	701 609 617	700-203	423886	153-475	03.0137-0169.2	153-473	03.0137-0272.2	153-124
211 609 537S	153-461	701 698 525	153-469	667102	700-050	03.0137-0170.2	153-233K	03.0137-0273.2	153-069
211 609 615	700-195	701 698 525A	153-469	6695167	153-471	03.0137-0171.2	153-232K	03.0137-0274.2	153-070
211 698 5375X	153-461	701 698 525B	153-469	6695175	153-471	03.0137-0172.2	153-302	03.0137-0275.2	153-284
211 698 537NX	153-461	704 783 037	700-203	6708410	153-471	03.0137-0176.2	153-152	03.0137-0276.2	153-283
211 698 537SV	153-461	7L6 698 525	153-019	7701201219	153-475	03.0137-0177.2	153-149	03.0137-0278.2	153-210
211 698 537SX	153-461	811 609 525	153-465	7701458174	153-475	03.0137-0179.2	153-150	03.0137-0282.2	153-121
251 609 531G	153-464	811 609 525A	153-465	8623137	153-479	03.0137-0180.2	153-198	03.0137-0283.2	153-310
251 609 531K	153-464	811 609 527	153-465	8623138	153-479	03.0137-0181.2	153-200	03.0137-0284.2	153-155
251 609 531M	153-464	811 609 527A	153-465	9434169	153-480	03.0137-0182.2	153-201	03.0137-0287.2	153-154
251 609 531P	153-464	823 501 615B	700-191			03.0137-0183.2	153-203	03.0137-0288.2	153-256
251 609 532	153-464	867 609 525	153-465			03.0137-0184.2	153-204	03.0137-0289.2	153-257
251 609 532G	153-464	867 609 527	153-465			03.0137-0185.2	153-205	03.0137-0290.2	153-122
251 609 532K	153-464	867 698 525V	153-465			03.0137-0186.2	153-036	03.0137-0291.2	153-123
251 609 532M	153-464	867 698 525X	153-465			03.0137-0188.2	153-251	03.0137-0292.2	153-116
251 609 532Q	153-464	867 698 526V	153-465	4121616	700-004	03.0137-0189.2	153-271	03.0137-0293.2	153-114
251 609 615	700-194	867 698 527V	153-465	4216652	153-063	03.0137-0190.2	153-272	03.0137-0294.2	153-153
251 609 631P	153-464	867 698 528V	153-465	4234857	700-004	03.0137-0191.2	153-273	03.0137-0295.2	153-005
251 698 531EX	153-464	8A0 609 525B	153-009	4236768	700-004	03.0137-0192.2	153-419	03.0137-0297.2	153-275
251 698 531LV	153-464	8A0 609 526B	153-009	4267288	700-004	03.0137-0193.2	153-416	03.0137-0298.2	153-415
251 698 531LX	153-464	8A0 609 527B	153-009	4368516	700-004	03.0137-0194.2	153-417	03.0137-0299.2	153-477
281 609 527H	153-466	8A0 609 528B	153-009	4373614	700-032	03.0137-0195.2	153-021K	03.0137-0300.2	153-064
281 609 617	700-189	J04495-35151	153-421	4379680	700-003	03.0137-0196.2	153-320Y	03.0137-0302.2	153-383
281 698 527GV	153-466	J04495-35200	153-428	46619313	153-063	03.0137-0197.2	153-322	03.0137-0305.2	153-017
281 698 527GX	153-466	J42431-35190	700-204	46621077	700-003	03.0137-0201.2	153-344	03.0137-0306.2	153-392
291 609 617	700-199	J42431-35200	700-206	46621077	700-032	03.0137-0202.2	153-323	03.0137-0307.2	153-416
291 698 527B	153-467			5888433	153-066	03.0137-0203.2	153-343Y	03.0137-0308.2	153-421
291 698 527BX	153-467			5890500	153-066	03.0137-0204.2	153-206	03.0137-0309.2	153-109
291 698 527GV	153-467			71738376	153-066	03.0137-0205.2	153-425	03.0137-0310.2	153-279
291 698 527GX	153-467			7599325	700-008	03.0137-0207.2	153-066	03.0137-0311.2	153-190
2D0 609 538	153-240			7777842	700-003	03.0137-0208.2	153-067	03.0137-0312.2	153-350
2D0 698 525	153-239	12124286	153-473	790833	700-032	03.0137-0209.2	153-345	03.0137-0313.2	153-417
2E0 698 525	153-246	12294286	153-473	9948200	153-066	03.0137-0210.2	153-277	03.0137-0314.2	153-074
2E0 698 525A	153-249	1330310	153-473	FA16500250	700-004	03.0137-0211.2	153-346	03.0137-0315.2	153-037
2E0 698 525A	153-249K	13303102	153-473			03.0137-0212.2	153-062	03.0137-0316.2	153-033
2H0 698 525	153-529	1387798	153-477			03.0137-0213.2	153-151	03.0137-0318.2	153-429
305 501 6151	700-191	13877980	153-477			03.0137-0215.2	153-252	03.0137-0319.2	153-282
323 501 615	700-202	270986	153-474			03.0137-0216.2	153-253Y	03.0137-0322.2	153-311
357 609 525C	153-009	270989	153-472			03.0137-0221.2	153-422	03.0137-0330.2	153-071
357 609 526C	153-009	270990	153-471	03.0137-0009.2	153-010	03.0137-0222.2	153-380	03.0137-0331.2	153-126
357 609 527E	153-009	27197	153-473	03.0137-0014.2	153-055	03.0137-0223.2	153-390	03.0137-0332.2	153-127
357 609 528E	153-009	271997	153-473	03.0137-0015.2	153-063	03.0137-0224.2	153-397	03.0137-0333.2	153-072
357 698 525CV	153-009	271998	153-478	03.					

CROSS REFERENCES LIST

Adaptable for OES	CIFAM ref.	Adaptable for OES	CIFAM ref.	Adaptable for OES	CIFAM ref.	Adaptable for OES	CIFAM ref.	Adaptable for OES	CIFAM ref.
ATE		03.0137-0433.2	153-401	03.0520-0415.3	151-086	03.0520-4017.3	151-185	24.0218-0014.1	700-234
		03.0137-0434.2	153-070	03.0520-0419.3	151-039	03.0520-4020.3	151-014	24.0218-0015.1	700-235
		03.0137-0435.2	153-091	03.0520-0515.3	151-025	03.0520-4117.3	151-183	24.0218-0016.1	700-165
03.0137-0346.2	153-129	03.0137-0436.2	153-201	03.0520-0517.3	151-111	03.0520-4120.3	151-087	24.0218-0017.1	700-242
03.0137-0347.2	153-023	03.0137-0437.2	153-171	03.0520-0519.3	151-001	03.0520-4219.3	151-085	24.0218-0018.1	700-080
03.0137-0348.2	153-047	03.0137-0438.2	153-138	03.0520-0520.3	151-009	03.0520-4419.3	151-047	24.0218-0019.2	700-292
03.0137-0349.2	153-235	03.0137-0439.2	153-085	03.0520-0522.3	151-019	03.0520-4619.3	151-172	24.0218-0020.1	700-241
03.0137-0350.2	153-355	03.0137-0440.2	153-368	03.0520-0523.3	151-008	03.0520-4719.3	151-098	24.0218-0021.1	700-056
03.0137-0351.2	153-354	03.0137-0441.2	153-078	03.0520-0617.3	151-031	03.0520-4812.3	151-093	24.0218-0022.1	700-057
03.0137-0352.2	153-075	03.0137-0442.2	153-159	03.0520-0619.3	151-010	03.0520-4919.3	151-094	24.0218-0023.1	700-223
03.0137-0354.2	153-328	03.0137-0443.2	153-292	03.0520-0622.3	151-043	03.0520-5019.3	151-160	24.0218-0024.2	700-289
03.0137-0356.2	153-133	03.0137-0444.2	153-192	03.0520-0625.3	151-139	03.0520-5022.3	151-030	24.0218-0025.1	700-055
03.0137-0357.2	153-379	03.0137-0445.2	153-312	03.0520-0719.3	151-002	03.0520-5120.3	151-223	24.0218-0026.1	700-227
03.0137-0358.2	153-356	03.0137-0446.2	153-332	03.0520-0723.3	151-070	03.0520-5122.3	151-140	24.0218-0027.1	700-228
03.0137-0359.2	153-079Y	03.0137-0448.2	153-437	03.0520-0817.3	151-080	03.0520-5219.3	151-079	24.0218-0028.1	700-069
03.0137-0360.2	153-080Y	03.0137-0449.2	153-478	03.0520-0820.3	151-048	03.0520-5219.3	151-159	24.0218-0029.2	700-261
03.0137-0363.2	153-046	03.0137-0450.2	153-479	03.0520-0822.3	151-034	03.0520-5220.3	151-052	24.0218-0031.2	700-061
03.0137-0364.2	153-431	03.0137-0451.2	153-244	03.0520-0825.3	151-138	03.0520-5222.3	151-058	24.0218-0032.1	700-156
03.0137-0365.2	153-430	03.0137-0452.2	153-265	03.0520-0919.3	151-040	03.0520-5319.3	151-125	24.0218-0033.2	700-249
03.0137-0366.2	153-169	03.0137-0453.2	153-265	03.0520-0920.3	151-013	03.0520-5419.3	151-148	24.0218-0035.1	700-311
03.0137-0367.2	153-170	03.0137-0454.2	153-290	03.0520-0922.3	151-022	03.0520-5420.3	151-137	24.0218-0036.1	700-218
03.0137-0368.2	153-034	03.0137-0455.2	153-506	03.0520-1017.3	151-038	03.0520-5520.3	151-067	24.0218-0039.1	700-370
03.0137-0369.2	153-166	03.0137-0456.2	153-177	03.0520-1019.3	151-081	03.0520-5620.3	151-136	24.0218-0042.1	700-343
03.0137-0370.2	153-327	03.0137-0459.2	153-443	03.0520-1020.3	151-014	03.0520-5622.3	151-096	24.0218-0043.1	700-060
03.0137-0375.2	153-432	03.0137-0460.2	153-293	03.0520-1022.3	151-017	03.0520-5719.3	151-141	24.0218-0044.2	700-349
03.0137-0376.2	153-287	03.0137-0461.2	153-248	03.0520-1117.3	151-011	03.0520-5720.3	151-133	24.0218-0044.2	700-362
03.0137-0377.2	153-217	03.0137-0464.2	153-446	03.0520-1122.3	151-042	03.0520-5722.3	151-097	24.0218-0046.1	700-387
03.0137-0379.2	153-018	03.0137-0465.2	153-318	03.0520-1219.3	151-024	03.0520-5819.3	151-175	24.0218-0707.2	700-187
03.0137-0380.2	153-331	03.0137-0467.2	153-142	03.0520-1220.3	151-012	03.0520-5919.3	151-198	24.0218-0707.2	700-191
03.0137-0381.2	153-330	03.0137-0474.2	153-260	03.0520-1222.3	151-020	03.0520-5922.3	151-068	24.0218-0713.2	700-143
03.0137-0382.2	153-313	03.0137-0475.2	153-045	03.0520-1315.3	151-187	03.0520-6019.3	151-176	24.0218-0714.2	700-234
03.0137-0383.2	153-236	03.0137-0476.2	153-041	03.0520-1317.3	151-059	03.0520-6022.3	151-030	24.0218-0715.2	700-235
03.0137-0384.2	153-234	03.0137-0477.2	153-266	03.0520-1319.3	151-082	03.0520-6119.3	151-164	24.0218-0716.2	700-165
03.0137-0385.2	153-233	03.0137-0480.2	153-370	03.0520-1320.3	151-041	03.0520-6120.3	151-131	24.0218-0716.2	700-238
03.0137-0386.2	153-168	03.0137-0482.2	153-251	03.0520-1417.3	151-027	03.0520-6219.3	151-167	24.0218-0717.2	700-242
03.0137-0387.2	153-400	03.0137-0483.2	153-416	03.0520-1517.3	151-084	03.0520-6222.3	151-199	24.0218-0720.2	700-164
03.0137-0389.2	153-265	03.0137-0484.2	153-226	03.0520-1519.3	151-007	03.0520-6319.3	151-228	24.0218-0720.2	700-241
03.0137-0390.2	153-264	03.0137-0485.2	153-445	03.0520-1522.3	151-088	03.0520-6320.3	151-048	24.0218-0724.2	700-276
03.0137-0393.2	153-237	03.0137-0487.2	153-237	03.0520-1617.3	151-112	03.0520-6419.3	151-231	24.0218-0724.2	700-289
03.0137-0394.2	153-136	03.0137-0489.2	153-043	03.0520-1619.3	151-006	03.0520-6420.3	151-134	24.0218-0724.2	700-292
03.0137-0395.2	153-308	03.0137-0491.2	153-333	03.0520-1720.3	151-035	03.0520-6422.3	151-237	24.0218-0724.2	700-294
03.0137-0396.2	153-309	03.0137-0492.2	153-434	03.0520-1722.3	151-062	03.0520-6519.3	151-182	24.0218-0732.2	700-142
03.0137-0397.2	153-239	03.0137-0493.2	153-099	03.0520-1820.3	151-051	03.0520-6520.3	151-092	24.0218-0732.2	700-156
03.0137-0398.2	153-434	03.0137-0494.2	153-042	03.0520-1822.3	151-105	03.0520-6522.3	151-162	24.0218-5001.1	700-003
03.0137-0399.2	153-314	03.0137-0495.2	153-182	03.0520-1917.3	151-123	03.0520-6522.3	151-163	24.0218-5002.1	700-018
03.0137-0400.2	153-439	03.0137-0496.2	153-365	03.0520-2017.3	151-121	03.0520-6620.3	151-197	24.0218-5002.1	700-023
03.0137-0401.2	153-219	03.0137-0497.2	153-148	03.0520-2020.3	151-021	03.0520-6622.3	151-146	24.0218-5002.1	700-024
03.0137-0402.2	153-442	03.0137-0497.2	153-490	03.0520-2022.3	151-036	03.0520-6719.3	151-222	24.0220-0001.2	700-300
03.0137-0402.2	153-444	03.0137-0498.2	153-513	03.0520-2119.3	151-001	03.0520-6819.3	151-223	24.0220-0002.1	700-188
03.0137-0404.2	153-038	03.0137-3002.2	153-336	03.0520-2122.3	151-202	03.0520-6920.3	151-147	24.0220-0011.2	700-299
03.0137-0405.2	153-242	03.0137-3003.2	153-267	03.0520-2219.3	151-063	03.0520-6922.3	151-219	24.0220-0012.1	700-304
03.0137-0406.2	153-039	03.0137-3003.2	153-267K	03.0520-2317.3	151-033	03.0520-7122.3	151-169	24.0220-0016.1	700-196
03.0137-0407.2	153-210	03.0137-3004.2	153-179K	03.0520-2319.3	151-040	03.0520-7220.3	151-145	24.0220-0017.1	700-205
03.0137-0408.2	153-369	03.0137-3005.2	153-077	03.0520-2420.3	151-009	03.0520-7320.3	151-177	24.0220-0018.1	700-202
03.0137-0409.2	153-325	03.0137-3006.2	153-294	03.0520-2422.3	151-072	03.0520-7420.3	151-181	24.0220-0019.1	700-301
03.0137-0410.2	153-240	03.0137-3007.2	153-441	03.0520-2520.3	151-054	03.0520-7620.3	151-165	24.0220-0020.1	700-027
03.0137-0411.2	153-134	03.0137-3008.2	153-524	03.0520-2522.3	151-132	03.0520-7620.3	151-166	24.0220-0022.1	700-122
03.0137-0412.2	153-137	03.0137-3009.2	153-227	03.0520-2619.3	151-066	03.0520-7720.3	151-193	24.0220-0023.1	700-120
03.0137-0413.2	153-288	03.0137-3012.2	153-295	03.0520-2620.3	151-004	03.0520-8020.3	151-230	24.0220-0024.1	700-116
03.0137-0414.2	153-395	03.0137-3013.2	153-185	03.0520-2720.3	151-060	03.0520-8120.3	151-229	24.0220-0026.1	700-296
03.0137-0415.2	153-081Y	03.0137-3013.2	153-185K	03.0520-2722.3	151-103	03.0520-8320.3	151-234	24.0220-0027.1	700-257
03.0137-0416.2	153-216	03.0137-3014.2	153-227	03.0520-2920.3	151-048	03.0520-8420.3	151-179	24.0220-0029.1	700-282
03.0137-0418.2	153-171	03.0137-3015.2	153-268	03.0520-3020.3	151-016	03.0520-8520.3	151-190	24.0220-0030.1	700-081
03.0137-0418.8	153-171	03.0137-3019.2	153-528	03.0520-3122.3</					

Adaptable for OES	CIFAM ref..	Adaptable for OES	CIFAM ref.	Adaptable for OES	CIFAM ref.	Adaptable for OES	CIFAM ref.	Adaptable for OES	CIFAM ref.
ATE		24.0225-2001.2	700-195	329043B	700-056	329314B	700-396	346233B	153-206
		24.0225-2002.2	700-194	329044B	700-057	329328B	700-385	346238B	153-378
		24.0225-2003.1	700-189	329045B	700-058	329714B	700-319	346239B	153-117K
24.0220-0718.2	700-188	24.0225-4002.1	700-013	329060B	700-080	329715B	700-289	346240B	153-118K
24.0220-0718.2	700-202	24.0225-4003.1	700-222	329062B	700-082	329731B	700-381	361001B	153-055
24.0220-0718.2	700-213	24.0225-4004.1	700-284	329063B	700-085	329732B	700-382	361028B	153-010
24.0220-0718.2	700-259	24.0225-4005.1	700-016	329066B	700-091	329741B	700-367	361038B	153-004
24.0220-0738.2	700-351	24.0225-4007.1	700-298	329067B	700-092	330127B	153-105	361040B	153-101
24.0220-3001.2	700-268	24.0225-4011.2	700-176	329070B	700-096	330765B	153-462	361046B	153-100
24.0220-3002.2	700-275	24.0225-4012.1	700-065	329071B	700-097	330768B	153-271	361052B	153-002
24.0220-3003.1	700-148	24.0225-4012.1	700-336	329083B	700-116	330769B	153-303	361052B	153-002Y
24.0220-3004.2	700-287	24.0225-4014.1	700-293	329092B	700-122	330770B	153-304	361055B	153-270
24.0220-3005.1	700-145	24.0225-4014.1	700-330	329106B	700-142	330773B	153-200	361063B	153-300
24.0220-3006.1	700-291	24.0225-4015.2	700-170	329107B	700-143	330774B	153-152	361066B	153-301
24.0220-3007.1	700-019	24.0225-4015.2	700-171	329108B	700-144	330776B	153-409	361085B	153-458
24.0220-3008.2	700-288	24.0225-4016.1	700-368	329110B	700-145	330778B	153-413	361087B	153-459
24.0220-3009.2	700-290	24.0225-4017.1	700-348	329113B	700-148	330781B	153-302	361091B	153-408
24.0220-3009.2	700-388	24.0225-4018.1	700-112	329121B	700-164	330783B	153-464	361092B	153-409
24.0220-3010.1	700-152	24.0225-5003.1	700-017	329122B	700-165	330785B	153-149	361099B	153-464
24.0220-3010.1	700-374	24.0225-5004.2	700-168	329126B	700-188	330794B	153-417	361105B	153-198
24.0220-3011.1	700-097	24.0225-5004.2	700-169	329127B	700-189	330798B	153-062	361125B	153-341
24.0220-3012.1	700-151	24.0226-0001.1	700-221	329129B	700-191	330801B	153-344	361133B	153-339K
24.0220-3013.1	700-246	24.0226-0002.1	700-052	329131B	700-194	330803B	153-108	361156B	153-473
24.0220-3014.1	700-245	24.0226-8001.1	700-203	329133B	700-197	330804B	153-272	361159B	153-011
24.0220-3015.1	700-049	24.0227-0001.1	700-199	329135B	700-200	330809B	153-322	361168B	153-103
24.0220-3016.1	700-082	24.0228-0001.1	700-285	329136B	700-202	337976B	153-345	361169B	153-104
24.0220-3020.2	700-319	24.0228-0002.1	700-134	329137B	700-203	338390B	153-001	361174B	153-302
24.0220-3021.1	700-149	24.0228-0002.1	700-308	329141B	700-220	338490B	153-305	361181B	153-014
24.0220-3021.1	700-157	24.0228-0003.1	700-369	329143B	700-222	338495B	153-106	361182B	153-102
24.0220-3022.1	700-059	24.0228-0004.1	700-367	329150B	700-233	338500B	153-274	361196B	153-232
24.0220-3026.2	700-365	24.0229-5002.1	700-108	329151B	700-234	338502B	153-343	361212B	153-113
24.0220-302811	700-384	24.0270-0007.1	700-191	329152B	700-235	338503B	153-111K	361213B	153-008
24.0220-3029.1	700-363			329155B	700-238	338507B	153-012	361216B	153-465
24.0220-3030.1	700-352			329156B	700-239	338508B	153-307	361223B	153-271
24.0220-3033.1	700-381			329158B	700-241	338509B	153-306	361229B	153-199
24.0220-3034.1	700-353			329159B	700-242	338512B	153-190	361237B	153-303
24.0220-3035.1	700-373			329168B	700-259	338513B	153-005	361238B	153-304
24.0220-3036.1	700-382	325493B	153-004	329173B	700-267	338514B	153-466	361260B	153-462
24.0220-3045.1	700-226	325496B	153-377	329175B	700-268	338515B	153-150	361262B	153-233
24.0220-3720.2	700-319	325501B	153-377	329178B	700-270	338518B	153-461	361265B	153-100
24.0222-0001.1	700-083	325504B	153-003	329180B	700-272	338520B	153-253Y	361266B	153-013
24.0222-0002.1	700-085	325507B	153-101	329182B	700-274	338521B	153-251	361267B	153-152
24.0222-8009.1	700-045	325524B	153-103	329183B	700-287	338525B	153-209	361270B	153-106
24.0222-8010.2	700-272	325525B	153-104	329184B	700-276	338526B	153-273	361271B	153-464
24.0222-8011.1	700-278	325532B	153-102	329187B	700-278	338529B	153-273	361272B	153-343Y
24.0222-8013.1	700-046	325535B	153-465	329189B	700-281	338538B	153-413	361273B	153-467
24.0222-8014.1	700-283	325543B	153-063	329191B	700-283	338542B	153-416	361276B	153-200
24.0222-8015.1	700-144	325544B	153-459	329192B	700-284	338549B	153-275	361278B	153-060
24.0222-8017.1	700-233	325549B	153-301	329193B	700-285	338550B	153-115	361281B	153-064
24.0222-8018.1	700-022	325554B	153-340	329198B	700-292	338551B	153-114	361283B	153-062
24.0222-8019.2	700-153	325565B	153-341	329200B	700-298	338552B	153-116	361287B	153-149
24.0222-8023.1	700-262	325571B	153-060	329201B	700-299	338555B	153-201	361296B	153-413
24.0222-8025.2	700-058	325579B	153-010	329202B	700-300	338556B	153-456	361302B	153-108
24.0222-8027.1	700-328	325583B	153-409	329204B	700-302	338557B	153-203	361306B	153-272
24.0222-8027.1	700-329	325585B	153-408	329206B	700-304	338558B	153-419	361308B	153-063
24.0222-8028.1	700-281	325590B	153-339	329208B	700-001	338560B	153-067	361310B	153-107
24.0222-8029.1	700-070	325613B	153-473	329209B	700-002	338562B	153-323	361313B	153-344
24.0222-8031.1	700-109	325617B	153-011	329210B	700-010	338563B	153-013	361315B	153-005
24.0222-8032.1	700-154	325624B	153-100	329211B	700-019	338564B	153-024Y	361341B	153-416
24.0222-8033.1	700-366	325636B	153-152	329212B	700-160	338571B	153-151	361342B	153-417
24.0222-8035.1	700-390	326532B	153-233	329213B	700-022	338573B	153-191	361343B	153-411
24.0223-0003.1	700-185	329000B	700-007	329214B	700-023	338583B	153-380	361350B	153-366
24.0223-0007.1	700-197	329003B	700-006	329214B	700-024	338585B	153-392	361352B	153-006
24.0223-0008.2	700-302	329005B	700-008	329215B	700-059	338587B	153-391	361353B	153-390
24.0223-0009.1	700-220	329006B	700-009	329216B	700-060	343743B	153-066	361361B	153-111K
24.0223-0011.1	700-198	329007B	700-011	329217B	700-150	346151B	153-425	361362B	153-034
24.0223-0012.1	700-192	329008B	700-013	329218B	700-151	346156B	153-415	361369B	153-012
24.0223-0013.2	700-305	329008B	700-015	329219B	700-152	346162B	153-033	361371B	153-307
24.0223-0015.1	700-208	329009B	700-014	329220B	700-153	346169B	153-366	361373B	153-253Y
24.0223-0016.1	700-260	329011B	700-016	329221B	700-280	346174B	153-416	361374B	153-251
24.0223-0017.1	700-214	329012B	700-017	329253B	700-358	346175B	153-408	361375B	153-252
24.0223-0018.2	700-306	329016B	700-028	329257B	700-379	346176B	153-064	361376B	153-425
24.0223-0020.1	700-359	329020B	700-032	329261B	700-373	346177B	153-475	361377B	153-322
24.0223-0021.1	700-389	329022B	700-035	329265B	700-38				

CROSS REFERENCES LIST

Adaptable for OES	CIFAM ref.	Adaptable for OES	CIFAM ref.	Adaptable for OES	CIFAM ref.	Adaptable for OES	CIFAM ref.	Adaptable for OES	CIFAM ref.
BENDIX		362228B	153-346	362391B	153-133	381050B	151-034	381335B	151-154
		362229B	153-340	362392B	153-075	381053B	151-039	381337B	151-063
		362230B	153-022	362393B	153-328	381054B	151-012	381338B	151-078
361395B	153-190	362237B	153-153	362394B	153-046	381062B	151-036	381339B	151-077
361401B	153-277	362239B	153-207	362395B	153-168	381066B	151-001	381340B	151-061
361402B	153-273	362240B	153-201	362396B	153-076	381067B	151-002	381343B	151-075
361403B	153-416	362243B	153-306	362397B	153-235	381068B	151-036	381344B	151-073
361408B	153-392	362247B	153-021Y	362399B	153-430	381071B	151-019	381345B	151-074
361409B	153-391	362248B	153-475	362400B	153-331	381072B	151-087	381346B	151-054
361414B	153-466	362249B	153-320Y	362401B	153-431	381092B	151-121	381347B	151-023
361415B	153-467	362251B	153-323	362401B	153-526	381093B	151-031	381352B	151-030
361417B	153-305	362252B	153-343	362402B	153-017	381132B	151-038	381353B	151-137
361419B	153-115	362263B	153-003	362403B	153-279	381135B	151-013	381357B	151-052
361420B	153-116	362265B	153-460	362404B	153-314	381136B	151-121	381358B	151-079
361421B	153-114	362270B	153-014	362405B	153-079Y	381142B	151-017	381359B	151-006
361426B	153-021Y	362282B	153-275	362406B	153-080Y	381145B	151-020	381360B	151-007
361427B	153-036	362285B	153-074	362407B	153-330	381146B	151-021	381361B	151-133
361428B	153-066J	362287B	153-124	362408B	153-018	381148B	151-016	381361B	151-136
361429B	153-067	362288B	153-125	362409B	153-025	381149B	151-014	381362B	151-005
361430B	153-068	362289B	153-345	362410B	153-082	381152B	151-029	381362B	151-142
361436B	153-205	362290B	153-021K	362411B	153-081Y	381153B	151-059	381364B	151-067
361439B	153-323	362291B	153-279	362412B	153-137	381154B	151-048	381365B	151-096
361443B	153-394	362297B	153-380	362413B	153-136	381155B	151-062	381366B	151-097
361446B	153-456	362300B	153-117K	362414B	153-135	381157B	151-009	381367B	151-117
361448B	153-324	362301B	153-126	362415B	153-134	381161B	151-040	381368B	151-098
361449B	153-346	362302B	153-127	362416B	153-138	381162B	151-051	381371B	151-070
361450B	153-345	362303B	153-340K	362417B	153-077	381163B	151-060	381372B	151-005
361453B	153-192	362308B	153-323	362418B	153-214	381165B	151-014	381372B	151-142
361457B	153-154	362309B	153-022	362419B	153-237	381166B	151-139	381373B	151-143
361457B	153-494	362312B	153-070	362420B	153-240	381167B	151-138	381375B	151-140
361467B	153-274	362313B	153-069	362421B	153-239	381168B	151-006	381376B	151-173
361496B	153-419	362314B	153-065	362422B	153-236	381170B	151-001	381378B	151-133
361529B	153-206	362315B	153-284	362423B	153-233	381171B	151-007	381378B	151-136
361531B	153-397	362318B	153-350	362424B	153-242	381172B	151-006	381380B	151-085
361532B	153-395	362318B	153-513	362425B	153-259	381178B	151-004	381389B	151-066
361535B	153-378	362319B	153-326	362426B	153-311	381179B	151-005	381392B	151-048
361536B	153-117K	362320B	153-353	362427B	153-359	381179B	151-142	381393B	151-192
361537B	153-118K	362324B	153-002	362428B	153-438	381189B	151-120	381394B	151-175
361538B	153-415	362325B	153-067	362429B	153-462	381192B	151-045	381395B	151-191
361552B	153-283	362326B	153-325	362430B	153-078	381193B	151-027	381396B	151-237
361554B	153-320Y	362328B	153-422	362431B	153-083	381195B	151-047	381400B	151-176
361555B	153-119	362335B	153-354	362432B	153-439	381212B	151-102	381402B	151-093
361556B	153-120	362337B	153-072	362433B	153-019	381218B	151-037	381403B	151-094
361557B	153-121	362338B	153-073	362434B	153-159	381219B	151-024	381404B	151-092
361560B	153-122	362339B	153-426	362435B	153-265	381220B	151-025	381406B	151-058
361561B	153-123	362340B	153-351	362436B	153-264	381222B	151-111	381407B	151-160
361570B	153-210	362341B	153-320K	362437B	153-315	381230B	151-082	381411B	151-030
361571B	153-166	362342B	153-327	362438B	153-369	381231B	151-080	381412B	151-134
361572B	153-167	362344B	153-414	362439B	153-479	381232B	151-033	381414B	151-197
361576B	153-308	362349B	153-421	362439B	153-530	381234B	151-119	381416B	151-156
361578B	153-468	362351B	153-383	362440B	153-244	381242B	151-072	381418B	151-172
361605B	153-151	362352B	153-425	362441B	153-091	381243B	151-048	381419B	151-171
361841B	153-037	362354B	153-155	362442B	153-088	381244B	151-048	381420B	151-124
361848B	153-476	362355B	153-282	362443B	153-085	381245B	151-132	381423B	151-096
361867B	153-281	362356B	153-211	362444B	153-404	381246B	151-054	381425B	151-164
361926B	153-035	362359B	153-327	362445B	153-400	381247B	151-042	381427B	151-133
361927B	153-256	362360B	153-399	362448B	153-287	381248B	151-054	381427B	151-136
361929B	153-477	362362B	153-354	362492B	153-506	381249B	151-040	381428B	151-068
361932B	153-383	362363B	153-355	381002B	151-018	381250B	151-087	381429B	151-165
361937B	153-257	362367B	153-071	381007B	151-043	381251B	151-051	381430B	151-145
361938B	153-258	362368B	153-023	381013B	151-044	381253B	151-048	381433B	151-095
361941B	153-478	362369B	153-350	381016B	151-015	381264B	151-110	381436B	151-235
361955B	153-208	362370B	153-127	381017B	151-019	381268B	151-056	381462B	151-228
361967B	153-278	362373B	153-356	381021B	151-011	381291B	151-123	381472B	151-219
361970B	153-202	362374B	153-234	381022B	151-022	381296B	151-013	381474B	151-163
362002B	153-034	362375B	153-016	381023B	151-088	381296B	151-014	381490B	151-231
362003B	153-191	362376B	153-280	381024B	151-042	381299B	151-202	381491B	151-221
362006B	153-109	362377B	153-422	381025B	151-088	381303B	151-004		
362007B	153-165	362379B	153-348	381026B	151-048	381304B	151-112		
362010B	153-204	362380B	153-257	381028B	151-013	381305B	151-103		
362012B	153-275	362381B	153-416	381032B	151-034	381306B	151-065		
362018B	153-424	362382B	153-023	381033B	151-034	381308B	151-021		
362019B	153-469	362383B	153-001	381034B	151-035	381330B	151-081	0 204 114 001	151-015
362218B	153-309	362384B	153-129	381037B	151-008	381331B	151-084	0 204 114 002	151-019
362219B	153-393	362385B	153-379	381038B	151-105	381332B	151-086	0 204 114 003	151-022
362220B	153-009	362386B	153-128	381047B	151-009	381334B	151-026	0 204 114 004	151-013
362225B	153-015	362389B	153-311	381048B	151-010	381335B	151-049	0 204 114 006	151-017
362227B	153-320K	362390B	153-026	381049B	151-041	381335B	151-090	0 204 114 008	

Adaptable for OES	CIFAM ref..	Adaptable for OES	CIFAM ref.	Adaptable for OES	CIFAM ref.	Adaptable for OES	CIFAM ref.	Adaptable for OES	CIFAM ref.
BOSCH		0 204 114 521	151-111	0 204 115 427	153-117K	0 986 487 215	153-473	0 986 487 330	153-125
		0 204 114 522	151-121	0 204 115 446	153-356	0 986 487 217	153-060	0 986 487 331	153-069
		0 204 114 523	151-048	0 204 115 447	153-354	0 986 487 219	153-456	0 986 487 333	153-190
0 204 114 009	151-020	0 204 114 525	151-054	0 204 115 448	153-355	0 986 487 228	153-117K	0 986 487 336	153-324K
0 204 114 010	151-014	0 204 114 526	151-051	0 204 115 492	153-127	0 986 487 229	153-118K	0 986 487 344	153-234
0 204 114 011	151-013	0 204 114 527	151-072	0 204 115 496	153-071	0 986 487 232	153-102	0 986 487 346	153-022
0 204 114 012	151-014	0 204 114 528	151-054	0 204 115 497	153-328	0 986 487 233	153-150	0 986 487 347	153-109
0 204 114 013	151-021	0 204 114 529	151-132	0 204 115 511	153-477	0 986 487 235	153-272	0 986 487 348	153-472
0 204 114 015	151-061	0 204 114 531	151-103	0 204 115 547	153-259	0 986 487 237	153-322	0 986 487 351	153-100
0 204 114 019	151-001	0 204 114 532	151-059	0 204 211 027	153-477	0 986 487 240	153-119	0 986 487 354	153-415
0 204 114 020	151-002	0 204 114 535	151-137	0 986 477 012	700-272	0 986 487 241	153-121	0 986 487 356	153-151
0 204 114 022	151-005	0 204 114 544	151-119	0 986 477 015	700-270	0 986 487 242	153-115	0 986 487 358	153-122
0 204 114 023	151-034	0 204 114 546	151-084	0 986 477 029	700-197	0 986 487 243	153-323	0 986 487 359	153-202
0 204 114 024	151-035	0 204 114 547	151-086	0 986 477 029	700-200	0 986 487 246	153-322	0 986 487 360	153-463
0 204 114 025	151-036	0 204 114 548	151-134	0 986 477 030	700-185	0 986 487 248	153-121	0 986 487 361	153-426
0 204 114 027	151-001	0 204 114 549	151-133	0 986 477 072	700-061	0 986 487 250	153-066	0 986 487 364	153-006
0 204 114 028	151-006	0 204 114 550	151-138	0 986 477 073	700-056	0 986 487 251	153-346	0 986 487 366	153-204
0 204 114 029	151-004	0 204 114 551	151-063	0 986 477 082	700-116	0 986 487 252	153-021Y	0 986 487 367	153-458
0 204 114 034	151-030	0 204 114 552	151-048	0 986 477 084	700-318	0 986 487 255	153-067	0 986 487 369	153-279
0 204 114 036	151-070	0 204 114 553	151-136	0 986 477 089	700-096	0 986 487 257	153-207	0 986 487 370	153-474
0 204 114 039	151-004	0 204 114 554	151-095	0 986 477 091	700-282	0 986 487 258	153-205	0 986 487 372	153-283
0 204 114 040	151-023	0 204 114 556	151-140	0 986 477 099	700-289	0 986 487 259	153-100	0 986 487 373	153-192
0 204 114 041	151-056	0 204 114 576	151-125	0 986 477 102	700-319	0 986 487 260	153-253Y	0 986 487 375	153-065
0 204 114 046	151-007	0 204 114 577	151-126	0 986 477 141	700-385	0 986 487 262	153-284	0 986 487 376	153-191
0 204 114 047	151-027	0 204 114 578	151-127	0 986 477 148	700-383	0 986 487 263	153-308	0 986 487 377	153-414
0 204 114 048	151-024	0 204 114 579	151-085	0 986 487 002	153-465	0 986 487 264	153-309	0 986 487 379	153-395
0 204 114 049	151-025	0 204 114 580	151-068	0 986 487 008	153-008	0 986 487 266	153-350	0 986 487 380	153-457
0 204 114 050	151-033	0 204 114 581	151-081	0 986 487 011	153-107	0 986 487 268	153-392	0 986 487 383	153-325
0 204 114 052	151-028	0 204 114 582	151-079	0 986 487 012	153-010	0 986 487 269	153-380	0 986 487 384	153-033
0 204 114 053	151-031	0 204 114 583	151-124	0 986 487 013	153-014	0 986 487 270	153-468	0 986 487 386	153-460
0 204 114 056	151-011	0 204 114 586	151-192	0 986 487 019	153-341K	0 986 487 271	153-055	0 986 487 387	153-166
0 204 114 057	151-044	0 204 114 591	151-171	0 986 487 020	153-339K	0 986 487 272	153-345	0 986 487 388	153-206
0 204 114 058	151-043	0 204 114 592	151-122	0 986 487 025	153-409	0 986 487 273	153-004	0 986 487 389	153-467
0 204 114 059	151-018	0 204 114 601	151-237	0 986 487 027	153-055	0 986 487 274	153-320K	0 986 487 391	153-284
0 204 114 060	151-008	0 204 114 602	151-052	0 986 487 030	153-063	0 986 487 275	153-343K	0 986 487 392	153-278
0 204 114 061	151-012	0 204 114 603	151-197	0 986 487 033	153-101	0 986 487 276	153-008	0 986 487 396	153-349
0 204 114 062	151-041	0 204 114 605	151-193	0 986 487 034	153-104	0 986 487 277	153-419	0 986 487 397	153-104
0 204 114 063	151-010	0 204 114 607	151-172	0 986 487 035	153-105	0 986 487 278	153-200	0 986 487 399	153-165
0 204 114 064	151-009	0 204 114 608	151-120	0 986 487 050	153-152	0 986 487 279	153-464	0 986 487 400	153-167
0 204 114 066	151-038	0 204 114 609	151-175	0 986 487 053	153-198	0 986 487 280	153-103	0 986 487 401	153-123
0 204 114 067	151-009	0 204 114 610	151-117	0 986 487 054	153-200	0 986 487 281	153-009	0 986 487 406	153-101
0 204 114 068	151-021	0 204 114 612	151-173	0 986 487 068	153-303	0 986 487 282	153-203	0 986 487 411	153-198
0 204 114 070	151-013	0 204 114 613	151-165	0 986 487 069	153-300	0 986 487 286	153-113	0 986 487 412	153-477
0 204 114 071	151-020	0 204 114 614	151-164	0 986 487 072	153-301	0 986 487 287	153-064	0 986 487 414	153-421
0 204 114 073	151-098	0 204 114 618	151-146	0 986 487 075	153-475	0 986 487 289	153-346	0 986 487 416	153-270
0 204 114 074	151-096	0 204 114 619	151-181	0 986 487 076	153-475	0 986 487 290	153-416	0 986 487 417	153-210
0 204 114 108	151-142	0 204 114 620	151-167	0 986 487 084	153-344	0 986 487 291	153-320	0 986 487 422	153-423
0 204 114 109	151-143	0 204 114 622	151-221	0 986 487 090	153-324K	0 986 487 292	153-413	0 986 487 423	153-209
0 204 114 112	151-066	0 204 114 623	151-219	0 986 487 092	153-377	0 986 487 293	153-422	0 986 487 425	153-397
0 204 114 122	151-078	0 204 114 625	151-228	0 986 487 097	153-408	0 986 487 294	153-008	0 986 487 427	153-394
0 204 114 124	151-077	0 204 114 626	151-231	0 986 487 099	153-459	0 986 487 295	153-002	0 986 487 430	153-398
0 204 114 127	151-093	0 204 114 629	151-185	0 986 487 102	153-462	0 986 487 296	153-152	0 986 487 435	153-208
0 204 114 128	151-094	0 204 114 630	151-159	0 986 487 109	153-304	0 986 487 297	153-003	0 986 487 436	153-037
0 204 114 129	151-092	0 204 114 633	151-176	0 986 487 117	153-461	0 986 487 298	153-425	0 986 487 440	153-154
0 204 114 130	151-163	0 204 114 635	151-147	0 986 487 118	153-464	0 986 487 299	153-005	0 986 487 451	153-257
0 204 114 151	151-182	0 204 114 636	151-177	0 986 487 126	153-232	0 986 487 300	153-277	0 986 487 453	153-424
0 204 114 152	151-155	0 204 114 637	151-234	0 986 487 127	153-103	0 986 487 301	153-112K	0 986 487 454	153-382
0 204 114 153	151-160	0 204 114 638	151-179	0 986 487 128	153-062	0 986 487 302	153-149	0 986 487 455	153-258
0 204 114 156	151-097	0 204 114 643	151-198	0 986 487 133	153-106	0 986 487 304	153-107	0 986 487 457	153-366
0 204 114 181	151-190	0 204 114 644	151-199	0 986 487 142	153-108	0 986 487 305	153-274	0 986 487 460	153-155
0 204 114 190	151-183	0 204 114 645	151-194	0 986 487 149	153-060	0 986 487 306	153-471	0 986 487 461	153-199
0 204 114 192	151-205	0 204 114 647	151-229	0 986 487 164	153-271	0 986 487 307	153-036	0 986 487 462	153-169
0 204 114 333	151-184	0 204 114 648	151-187	0 986 487 189	153-201	0 986 487 309	153-114	0 986 487 463	153-383
0 204 114 453	151-123	0 204 114 649	151-162	0 986 487 190	153-233	0 986 487 310	153-377	0 986 487 464	153-282
0 204 114 500	151-039	0 204 114 655	151-224	0 986 487 192	153-343	0 986 487 312	153-469	0 986 487 468	153-411
0 204 114 501	15								

CROSS REFERENCES LIST

Adaptable for OES	CIFAM ref.	Adaptable for OES	CIFAM ref.	Adaptable for OES	CIFAM ref.	Adaptable for OES	CIFAM ref.	Adaptable for OES	CIFAM ref.
BOSCH		0 986 487 615	153-439	0 986 487 708	153-227	14.4722.10	700-302	14.6758.10	700-148
		0 986 487 616	153-401	0 986 487 709	153-226	14.4733.10	700-178	14.6764.10	700-283
		0 986 487 621	153-066	0 986 487 710	153-267	14.4785.10	700-112	14.6773.10	700-053
0 986 487 528	153-351	0 986 487 622	153-371	0 986 487 711	153-179Y	14.4798.10	700-113	14.6774.10	700-054
0 986 487 529	153-352	0 986 487 623	153-479	0 986 487 712	153-089K	14.4970.10	700-115	14.6775.10	700-055
0 986 487 530	153-280	0 986 487 624	153-137	0 986 487 713	153-446	14.4976.10	700-091	14.6776.10	700-082
0 986 487 531	153-393	0 986 487 625	153-019	0 986 487 716	153-091	14.4978.10	700-304	14.6778.10	700-096
0 986 487 532	153-071	0 986 487 626	153-081Y	0 986 487 717	153-088	14.4978.50	700-304K	14.6779.10	700-097
0 986 487 533	153-322	0 986 487 627	153-359	0 986 487 718	153-248	14.4979.10	700-270	14.6795.10	700-280
0 986 487 534	153-108	0 986 487 628	153-046	0 986 487 719	153-264	14.4979.50	700-270K	14.6796.10	700-301
0 986 487 535	153-461	0 986 487 629	153-087	0 986 487 720	153-246	14.4980.10	700-234	14.6796.50	700-301K
0 986 487 536	153-462	0 986 487 630	153-078	0 986 487 721	153-333	14.4980.50	700-163K	14.7000.10	700-035
0 986 487 537	153-120	0 986 487 631	153-216	0 986 487 723	153-245	14.4980.50	700-234K	14.7005.10	700-123
0 986 487 541	153-340	0 986 487 633	153-133	0 986 487 724	153-241	14.5008.10	700-313	14.7006.10	700-122
0 986 487 542	153-232K	0 986 487 634	153-172	0 986 487 725	153-247	14.5008.50	700-313K	14.7008.10	700-287
0 986 487 543	153-233K	0 986 487 636	153-213	0 986 487 726	153-094	14.5068.10	700-081	14.7008.50	700-287K
0 986 487 545	153-074	0 986 487 642	153-368	0 986 487 727	153-441	14.5069.10	700-080	14.7076.10	700-016
0 986 487 546	153-340	0 986 487 643	153-370	0 986 487 729	153-099	14.5071.10	700-008	14.7077.10	700-017
0 986 487 547	153-071	0 986 487 647	153-336	0 986 487 730	153-317	14.5072.10	700-092	14.7078.10	700-026
0 986 487 548	153-478	0 986 487 648	153-100	0 986 487 731	153-096	14.5073.10	700-052	14.7079.10	700-027
0 986 487 549	153-326	0 986 487 649	153-325	0 986 487 732	153-374	14.5075.10	700-051	14.7081.10	700-056
0 986 487 550	153-353	0 986 487 650	153-369	0 986 487 733	153-042	14.5076.10	700-028	14.7082.10	700-057
0 986 487 551	153-023	0 986 487 651	153-275	0 986 487 734	153-295	14.5102.10	700-009	14.7083.10	700-058
0 986 487 552	153-023	0 986 487 652	153-214	0 986 487 735	153-434	14.5106.10	700-274	14.7091.10	700-205
0 986 487 553	153-128	0 986 487 653	153-219	0 986 487 736	153-407	14.5379.10	700-272	14.7093.10	700-164
0 986 487 554	153-311	0 986 487 654	153-216	0 986 487 737	153-183	14.5493.10	700-142	14.7093.10	700-241
0 986 487 555	153-379	0 986 487 655	153-170	0 986 487 738	153-184	14.5493.50	700-142K	14.7094.10	700-242
0 986 487 556	153-356	0 986 487 657	153-237	0 986 487 740	153-215	14.5494.10	700-143	14.7096.10	700-331
0 986 487 557	153-133	0 986 487 657	153-241	0 986 487 741	153-158	14.5494.50	700-143K	14.7098.10	700-284
0 986 487 558	153-038	0 986 487 658	153-311	0 986 487 742	153-038	14.5495.10	700-194	14.7099.10	700-285
0 986 487 559	153-075	0 986 487 659	153-026	0 986 487 743	153-428	14.5496.10	700-195	14.7100.10	700-298
0 986 487 560	153-076	0 986 487 660	153-135	0 986 487 745	153-513	14.5590.10	700-014	14.7127.20	700-022
0 986 487 561	153-129	0 986 487 661	153-157	0 986 487 748	153-182	14.5591.10	700-144	14.7241.10	700-049
0 986 487 563	153-214	0 986 487 662	153-312	0 986 487 749	153-023	14.5592.10	700-158	14.7242.10	700-207
0 986 487 564	153-215	0 986 487 664	153-025	0 986 487 750	153-185	14.5594.10	700-160	14.7243.10	700-208
0 986 487 565	153-235	0 986 487 665	153-438	0 986 487 753	153-490	14.5594.50	700-160K	14.7244.10	700-250
0 986 487 567	153-327	0 986 487 666	153-243	0 986 487 755	153-528	14.5595.10	700-161	14.7246.10	700-289
0 986 487 568	153-328	0 986 487 667	153-138	0 986 487 760	153-518	14.5596.10	700-162	14.7246.50	700-289K
0 986 487 569	153-354	0 986 487 668	153-290	0 986 487 900	153-465	14.5597.10	700-196	14.7247.10	700-290
0 986 487 570	153-355	0 986 487 669	153-083	0 986 487 901	153-468	14.5598.10	700-197	14.7247.50	700-290K
0 986 487 571	153-401	0 986 487 670	153-084	0 986 487 902	153-008	14.5599.10	700-198	14.7248.10	700-291
0 986 487 572	153-430	0 986 487 671	153-315	0 986 487 903	153-022	14.5601.10	700-199	14.7249.10	700-288
0 986 487 574	153-480	0 986 487 672	153-332	0 986 BB3 541	153-207	14.5602.10	700-200	14.7250.10	700-344
0 986 487 576	153-314	0 986 487 673	153-176			14.5604.10	700-235	14.7251.10	700-343
0 986 487 577	153-259	0 986 487 674	153-129			14.5604.50	700-235K	14.7252.10	700-345
0 986 487 578	153-281	0 986 487 675	153-084			14.5609.10	700-277	14.7253.10	700-125
0 986 487 579	153-330	0 986 487 676	153-404	BREMBO		14.5610.10	700-278	14.7254.10	700-124
0 986 487 580	153-136	0 986 487 677	153-402			14.5722.10	700-276	14.7255.10	700-150
0 986 487 581	153-168	0 986 487 678	153-393	14.3106.10	700-001	14.5722.10	700-292	14.7256.10	700-151
0 986 487 582	153-233	0 986 487 679	153-443	14.3151.10	700-002	14.5722.50	700-276K	14.7257.10	700-149
0 986 487 583	153-287	0 986 487 680	153-442	14.3152.10	700-003	14.5723.10	700-275	14.7259.10	700-019
0 986 487 584	153-234	0 986 487 680	153-444	14.3152.20	700-007	14.5723.50	700-275K	14.7260.10	700-023
0 986 487 585	153-350	0 986 487 681	153-386	14.3156.10	700-004	14.5810.10	700-046	14.7711.10	700-065
0 986 487 586	153-432	0 986 487 682	153-385	14.3157.20	700-006	14.5814.10	700-119	14.7712.10	700-330
0 986 487 587	153-211	0 986 487 683	153-265	14.3161.10	700-013	14.5815.10	700-120	14.7714.10	700-243
0 986 487 588	153-434	0 986 487 684	153-260	14.3162.10	700-025	14.5817.10	700-323	14.7715.10	700-305
0 986 487 589	153-431	0 986 487 685	153-265	14.3165.10	700-043	14.5818.10	700-145	14.7738.10	700-263
0 986 487 591	153-213	0 986 487 686	153-159	14.3165.20	700-044	14.5820.10	700-334	14.7739.10	700-085
0 986 487 593	153-400	0 986 487 687	153-201	14.3166.10	700-267	14.5821.10	700-340	14.7740.10	700-059
0 986 487 594	153-403	0 986 487 687	153-506	14.3167.10	700-268	14.5822.10	700-338	14.7741.10	700-070
0 986 487 595	153-429	0 986 487 688	153-201	14.3168.10	700-333	14.5822.50	700-238K	14.7742.10	700-336
0 986 487 596	153-080Y	0 986 487 689	153-039	14.3169.10	700-073	14.5823.10	700-239	14.7743.10	700-329
0 986 487 597	153-079Y	0 986 487 690	153-085	14.3178.10	700-087	14.5823.50	700-239K	14.7744.10	700-089
0 986 487 598	153-128	0 986 487 691	153-292	14.3179.10	700-088	14.5825.10	700-257	14.7746.10	700-253
0 986 487 599	153-136	0 986 487 692	153-437	14.3185.10	700-045	14.5826.10	700-202	14.7747.10	700-254
0 986 487 600	153-237	0 986 487 693	153-171	14.3220.10	700-185	14.5826.50	700-202K	14.7749.10	700-131
0 986 487 602	153-444	0 986 487 695	153-438	14.3251.10	700-188	14.5827.10	700-281	14.7751.10	700-296
0 986 487 604	153-284	0 986 487 696	153-142	14.3252.10	700-189	14.5828.10	700-282	14.7753.10	700-037
0 986 487 605	153-236	0 9							

Adaptable for OES	CIFAM ref..	Adaptable for OES	CIFAM ref.	Adaptable for OES	CIFAM ref.	Adaptable for OES	CIFAM ref.	Adaptable for OES	CIFAM ref.
DELPHI		BF2-F	700-333	BF409-F	700-218	KP648	151-025	KP850	151-085
		BF300-F	700-056	BF410-F	700-219	KP650	151-026	KP851	151-084
		BF301-F	700-057	BF-411	700-107	KP662	151-027	KP851	151-107
BF102-F	700-300	BF302-F	700-069	BF412-F	700-324	KP665	151-028	KP852	151-123
BF103-F	700-302	BF303-F	700-060	BF-413	700-037	KP666	151-029	KP853	151-081
BF107-F	700-267	BF30-F	700-268	BF-416	700-293	KP671	151-015	KP854	151-124
BF108-F	700-087	BF310-F	700-202	BF-419	700-085	KP676	151-019	KP855	151-079
BF109-F	700-270	BF313-F	700-214	BF423	700-374	KP676	151-031	KP863	151-029
BF111-F	700-304	BF314-F	700-283	BF-425	700-154	KP677	151-032	KP864	151-048
BF-133	700-100	BF315-F	700-275	BF-426	700-156	KP698	151-033	KP868	151-006
BF135-F	700-234	BF316-F	700-284	BF427	700-382	KP715	151-034	KP868	151-072
BF136-F	700-003	BF317-F	700-285	BF-430	700-208	KP717	151-035	KP869	151-007
BF147-F	700-091	BF318-F	700-205	BF434	700-349	KP719	151-107	KP870	151-001
BF151-F	700-299	BF319-F	700-198	BF43-F	700-073	KP720	151-036	KP873	151-072
BF152-F	700-006	BF320-F	700-192	BF441	700-396	KP732	151-037	KP874	151-063
BF153-F	700-013	BF323-F	700-043	BF449	700-385	KP733	151-038	KP875	151-132
BF154-F	700-025	BF324-F	700-164	BF-460	700-348	KP742	151-111	KP877	151-005
BF155-F	700-044	BF325-F	700-017	BF461	700-376	KP743	151-119	KP878	151-129
BF156-F	700-045	BF326-F	700-013	BF463	700-358	KP744	151-112	KP879	151-131
BF164-F	700-328	BF327-F	700-016	BF-465	700-361	KP745	151-039	KP880	151-130
BF165-F	700-191	BF328-F	700-019	BF-467	700-369	KP747	151-110	KP881	151-026
BF166-F	700-189	BF329-F	700-289	BF468	700-388	KP748	151-120	KP882	151-138
BF168-F	700-220	BF330-F	700-286	BF-471	700-350	KP749	151-040	KP883	151-099
BF169-F	700-233	BF331-F	700-083	BF-472	700-351	KP753	151-149	KP888	151-175
BF172-F	700-280	BF334-F	700-274	BF473	700-370	KP755	151-001	KP890	151-202
BF173-F	700-158	BF335-F	700-027	BF474	700-371	KP756	151-002	KP891	151-125
BF176-F	700-323	BF336-F	700-055	BF478	700-367	KP756	151-042	KP891	151-128
BF178-F	700-231	BF337-F	700-149	BF479	700-368	KP757	151-101	KP894	151-077
BF180-F	700-318	BF338-F	700-145	BF480	700-352	KP758	151-043	KP895	151-067
BF181-F	700-221	BF339-F	700-176	BF481	700-353	KP758	151-102	KP897	151-192
BF182-F	700-200	BF340-F	700-175	BF482	700-377	KP760	151-024	KP899	151-136
BF183-F	700-195	BF-341	700-122	BF484	700-363	KP761	151-037	KP901	151-078
BF184-F	700-194	BF342-F	700-326	BF485	700-384	KP763	151-012	KP902	151-079
BF186-F	700-199	BF343-F	700-128	BF487	700-365	KP763	151-044	KP903	151-080
BF187-F	700-272	BF344-F	700-298	BF488	700-366	KP766	151-017	KP903	151-137
BF190-F	700-234	BF345-F	700-203	BF496	700-381	KP766	151-045	KP904	151-081
BF200-F	700-008	BF346-F	700-049	BF497	700-364	KP768	151-046	KP905	151-082
BF201-F	700-009	BF349-F	700-125	BF-507	700-387	KP771	151-016	KP906	151-066
BF202-F	700-028	BF350-F	700-026	BF514	700-263	KP771	151-047	KP907	151-065
BF203-F	700-051	BF353-F	700-124	BF518	700-104	KP772	151-070	KP908	151-140
BF204-F	700-092	BF354-F	700-123	BF52-F	700-277	KP773	151-048	KP911	151-030
BF208-F	700-081	BF355-F	700-250	BF82-F	700-088	KP774	151-048	KP914	151-173
BF229-F	700-276	BF356-F	700-058	BF8-F	700-089	KP775	151-108	KP915	151-084
BF230-F	700-275	BF359-F	700-242	BF92-F	700-004	KP780	151-048	KP918	151-133
BF236-F	700-043	BF363-F	700-182	BF96	700-358	KP782	151-121	KP929	151-134
BF239-F	700-332	BF364-F	700-183	DS00037	153-136	KP783	151-009	KP930	151-093
BF241-F	700-052	BF366-F	700-019	DS00038	153-093	KP783	151-049	KP931	151-097
BF250-F	700-116	BF367	700-389	FC230602	153-319	KP785	151-041	KP932	151-096
BF254-F	700-178	BF367-F	700-305	KP1009	151-058	KP786	151-010	KP934	151-143
BF256-F	700-185	BF369-F	700-291	KP1033	151-089	KP786	151-050	KP935	151-199
BF258-F	700-188	BF-372	700-150	KP1055	151-031	KP787	151-051	KP936	151-198
BF263-F	700-274	BF377-F	700-153	KP1057	151-068	KP788	151-011	KP937	151-197
BF265-F	700-161	BF378-F	700-245	KP1058	151-005	KP788	151-052	KP940	151-237
BF266-F	700-162	BF379-F	700-022	KP1058	151-142	KP789	151-053	KP942	151-141
BF267-F	700-160	BF-380	700-151	KP1059	151-126	KP789	151-139	KP942	151-176
BF268-F	700-163	BF381-F	700-315	KP1060	151-094	KP792	151-109	KP943	151-141
BF270-F	700-235	BF382-F	700-290	KP1063	151-127	KP793	151-115	KP944	151-147
BF271-F	700-143	BF383-F	700-059	KP1064	151-133	KP816	151-100	KP945	151-148
BF272-F	700-142	BF386-F	700-251	KP1064	151-136	KP822	151-054	KP949	151-151
BF273-F	700-144	BF387-F	700-252	KP1075	151-187	KP823	151-050	KP949	151-191
BF274-F	700-011	BF389-F	700-018	KP1077	151-155	KP824	151-047	KP950	151-098
BF275-F	700-046	BF390-F	700-082	KP1078	151-165	KP825	151-014	KP951	151-095
BF-278	700-120	BF391-F	700-010	KP1079	151-182	KP826	151-056	KP963	151-048
BF-280	700-097	BF392-F	700-246	KP1081	151-162	KP827	151-014	KP967	151-030
BF281-F	700-148	BF393-F	700-245	KP1086	151-231	KP827	151-057	KP968	151-079
BF282-F	700-165	BF394-F	700-293	KP1088	151-190	KP828	151-021	KP972	151-052
BF283-F	700-196	BF395-F	700-223	KP1089	151-164	KP828	151-058	KP981	151-160
BF284-F	700-197	BF399-F	700-310	KP1090	151-181	KP829	151-020	KP982	151-085
BF286-F	700-188	BF400-F	700-311	KP1091	151-194	KP829	151-059	KP982	151-092
BF287-F	700-238	BF401-F	700-312	KP1092	151-193	KP830	151-004	KP983	151-172
BF288-F	700-239	BF402	700-391	KP1099	151-219	KP832	151-103	KP984	151-171
BF289-F	700-257	BF402-F	700-319	KP1100	151-177	KP833	151-061	KP987	151-156
BF290-F	700-281	BF403-F	700-306	KP620	151-018	KP834	151-060	LG15058	151-145
BF291-F	700-282	BF404-F	700-308	KP620	151-022	KP834	151-062	LG15061	151-146
BF292-F	700-278	BF-405	700-109	KP632	151-105	KP836	151-150	LG15072	151-153
BF293-F	700-301	BF406-F	700-260	KP638	151-022	KP837	151-054	LG15072	151-228
BF294-F	700-014	BF407-F	700-175	KP641	151-023	KP848	151-023	LG15956	151-086
BF298-F	700-207	BF408-F	700-176	KP643	151-024	KP849	151-086	LG15972	151-087

CROSS REFERENCES LIST

Adaptable for OES	CIFAM ref.	Adaptable for OES	CIFAM ref.	Adaptable for OES	CIFAM ref.	Adaptable for OES	CIFAM ref.	Adaptable for OES	CIFAM ref.
DELPHI		LS1311	153-115	LS1523	153-411	LS1719	153-287	LS1882	153-401
		LS1312	153-116	LS1535	153-460	LS1720	153-023	LS1883	153-432
		LS1313	153-114	LS1546	153-205	LS1721	153-324	LS1884	153-479
LG16009	151-088	LS1315	153-417	LS1553	153-279	LS1723	153-326	LS1885	153-017
LG16033	151-089	LS1317	153-008	LS1570	153-068	LS1724	153-353	LS1890	153-429
LG16044	151-090	LS1318	153-012	LS1573	153-013	LS1726	153-071	LS1891	153-168
LG16045	151-090	LS1319	153-021Y	LS1575	153-002	LS1728	153-128	LS1892	153-439
LG16046	151-181	LS1321	153-112K	LS1586	153-393	LS1729	153-311	LS1893	153-217
LG16047	151-218	LS1322	153-150	LS1597	153-325	LS1744	153-428	LS1894	153-432
LG16048	151-220	LS1323	153-456	LS1598	153-382	LS1745	153-429	LS1895	153-330
LG16051	151-231	LS1324	153-203	LS1599	153-397	LS1746	153-130	LS1896	153-313
LG16053	151-220	LS1326	153-201	LS1600	153-423	LS1759	153-352	LS1897	153-143
LG16054	151-226	LS1329	153-322	LS1601	153-422	LS1760	153-174	LS1898	153-264
LG16055	151-224	LS1331	153-394	LS1602	153-424	LS1778	153-113	LS1899	153-386
LG16056	151-229	LS1332	153-151	LS1604	153-383	LS1779	153-253	LS1900	153-159
LS1015	153-003	LS1333	153-425	LS1605	153-065	LS1780	153-349	LS1901	153-444
LS1022	153-377	LS1335	153-413	LS1609	153-167	LS1781	153-478	LS1902	153-236
LS1023	153-007	LS1338	153-391	LS1610	153-166	LS1782	153-129	LS1903	153-432
LS1042	153-101	LS1339	153-392	LS1613	153-008	LS1783	153-129	LS1904	153-218
LS1047	153-101	LS1341	153-153	LS1614	153-476	LS1784	153-379	LS1905	153-239
LS1050	153-101	LS1343	153-253Y	LS1615	153-468	LS1793	153-028	LS1906	153-029
LS1072	153-366	LS1344	153-251	LS1616	153-119	LS1800	153-349	LS1908	153-080Y
LS1097	153-458	LS1347	153-323	LS1617	153-120	LS1814	153-026	LS1909	153-170
LS1098	153-459	LS1351	153-152	LS1618	153-121	LS1820	153-028	LS1910	153-237
LS1118	153-300	LS1352	153-380	LS1620	153-283	LS1821	153-046	LS1912	153-136
LS1120	153-341	LS1353	153-408	LS1621	153-308	LS1822	153-047	LS1913	153-265
LS1129	153-270	LS1356	153-419	LS1622	153-309	LS1823	153-400	LS1914	153-134
LS1138	153-409	LS1357	153-416	LS1625	153-468	LS1824	153-213	LS1915	153-135
LS1140	153-408	LS1359	153-033	LS1629	153-373	LS1825	153-215	LS1916	153-081Y
LS1142	153-340	LS1362	153-034	LS1631	153-122	LS1826	153-251	LS1917	153-240
LS1144	153-301	LS1365	153-191	LS1632	153-123	LS1827	153-287	LS1918	153-220
LS1173	153-103	LS1366	153-274	LS1633	153-014	LS1828	153-354	LS1918	153-506
LS1175	153-471	LS1367	153-275	LS1634	153-015	LS1829	153-311	LS1919	153-077
LS1179	153-100	LS1368	153-414	LS1637	153-234	LS1830	153-023	LS1920	153-019
LS1195	153-109	LS1370	153-011	LS1638	153-425	LS1831	153-434	LS1921	153-025
LS1200	153-377	LS1371	153-233	LS1640	153-069	LS1832	153-480	LS1922	153-242
LS1201	153-102	LS1372	153-232	LS1641	153-154	LS1833	153-327	LS1923	153-243
LS1216	153-104	LS1375	153-473	LS1642	153-208	LS1834	153-280	LS1924	153-078
LS1219	153-060	LS1378	153-066	LS1643	153-257	LS1835	153-221	LS1925	153-082
LS1229	153-010	LS1379	153-067	LS1644	153-415	LS1836	153-169	LS1926	153-137
LS1233	153-475	LS1381	153-302	LS1645	153-006	LS1837	153-385	LS1927	153-314
LS1236	153-064	LS1382	153-343K	LS1646	153-155	LS1838	153-023	LS1928	153-315
LS1240	153-152	LS1391	153-339K	LS1649	153-258	LS1840	153-076	LS1929	153-359
LS1242	153-105	LS1394	153-341	LS1650	153-281	LS1841	153-235	LS1930	153-369
LS1246	153-303	LS1402	153-346	LS1651	153-399	LS1842	153-355	LS1932	153-213
LS1247	153-304	LS1403	153-466	LS1654	153-426	LS1843	153-430	LS1933	153-404
LS1249	153-106	LS1404	153-345	LS1655	153-009	LS1844	153-356	LS1934	153-173
LS1250	153-344	LS1405	153-277	LS1656	153-469	LS1845	153-403	LS1935	153-172Y
LS1254	153-271	LS1406	153-421	LS1657	153-477	LS1846	153-400	LS1936	153-041
LS1259	153-339	LS1408	153-415	LS1679	153-210	LS1847	153-075	LS1937	153-039
LS1261	153-109	LS1409	153-416	LS1681	153-022	LS1848	153-328	LS1938	153-156
LS1262	153-064	LS1413	153-476	LS1682	153-070	LS1849	153-327	LS1939	153-312
LS1267	153-107	LS1415	153-004	LS1683	153-124	LS1850	153-133	LS1940	153-138
LS1268	153-108	LS1417	153-149	LS1684	153-125	LS1851	153-018	LS1941	153-370
LS1269	153-005	LS1418	153-114	LS1685	153-037	LS1852	153-260	LS1942	153-437
LS1270	153-139	LS1419	153-116	LS1687	153-310	LS1854	153-431	LS1943	153-436
LS1272	153-111K	LS1423	153-320K	LS1689	153-284	LS1855	153-214	LS1952	153-171
LS1273	153-343	LS1430	153-060	LS1690	153-475	LS1856	153-402	LS1953	153-176
LS1275	153-198	LS1432	153-279	LS1691	153-350	LS1857	153-017	LS1954	153-197
LS1276	153-465	LS1434	153-001	LS1698	153-100	LS1858	153-079	LS1955	153-405
LS1277	153-462	LS1435	153-117K	LS1699	153-211	LS1859	153-080Y	LS1956	153-044
LS1278	153-200	LS1436	153-118K	LS1700	153-126	LS1860	153-069	LS1958	153-233
LS1281	153-467	LS1437	153-206	LS1701	153-127	LS1866	153-371	LS1960	153-031
LS1282	153-475	LS1438	153-378	LS1702	153-467	LS1867	153-373	LS1961	153-438
LS1285	153-273	LS1440	153-192	LS1704	153-016	LS1868	153-071	LS1962	153-089
LS1286	153-461	LS1467	153-390	LS1705	153-256	LS1869	153-346	LS1963	153-216
LS1288	153-150	LS1470	153-062	LS1706	153-209	LS1870	153-368	LS1964	153-292
LS1289	153-272	LS1471	153-252	LS1707	153-257	LS1871	153-157	LS1965	153-290
LS1290	153-063	LS1476	153-202	LS1709	153-282	LS1872	153-358	LS1966	153-178
LS1291	153-055	LS1477	153-221	LS1710	153-398	LS1873	153-331	LS1967	153-248
LS1292	153-305	LS1479	153-411	LS1711	153-426	LS1874	153-038	LS1968	153-085
LS1293	153-320	LS1494	153-277	LS1712	153-072	LS1875	153-035	LS1969	153-050
LS1295	153-062	LS1501	153-204	LS1713	153-073	LS1876	153-212	LS1970	153-083
LS1297	153-306	LS1504	153-278	LS1714	153-351	LS1877	153-216	LS1971	153-090
LS1301	153-464	LS1505	153-279	LS1715	153-074	LS1878	153-219	LS1972	153-332
LS1304	153-199	LS1509	153-036	LS1716	153-023	LS1879	153-216	LS1973	153-091
LS1307	153-307	LS1514	153-165	LS1717	153-350	LS1880	153-259	LS1974	153-442
LS1310	153-190	LS1516	153-207	LS1718	153-287	LS1881	153-330	LS1974	153-444

Adaptable for OES	CIFAM ref..	Adaptable for OES	CIFAM ref.	Adaptable for OES	CIFAM ref.	Adaptable for OES	CIFAM ref.	Adaptable for OES	CIFAM ref.
DELPHI		FMK163	151-014	FMK357	151-171	FSB196	153-233	FSB296	153-120
		FMK164	151-048	FMK358	151-156	FSB196R	153-233	FSB296R	153-120
		FMK165	151-060	FMK400	151-097	FSB197	153-005	FSB297	153-119
LS1975	153-085	FMK167	151-009	FMK401	151-096	FSB198	153-305	FSB298	153-121
LS1976	153-024Y	FMK168	151-112	FMK405	151-127	FSB199	153-306	FSB298R	153-121
LS1977	153-027	FMK169	151-119	FMK406	151-145	FSB203	153-062	FSB3	153-301
LS1978	153-094	FMK171	151-001	FMK407	151-146	FSB204	153-150	FSB306	153-001
LS1979	153-088	FMK173	151-047	FMK409	151-162	FSB208	153-417	FSB307	153-067
LS1980	153-092	FMK174	151-027	FMK410	151-163	FSB210	153-201	FSB308	153-283
LS1981	153-093	FMK176	151-050	FMK417	151-173	FSB211	153-190	FSB309	153-273
LS1982	153-145	FMK180	151-051	FMK420	151-182	FSB211R	153-190	FSB31	153-270
LS1983	153-142	FMK184	151-123	FMK421	151-157	FSB213	153-415	FSB310	153-167
LS1984	153-158	FMK185	151-082	FMK422	151-155	FSB215	153-112K	FSB312	153-391
LS1985	153-179Y	FMK186	151-001	FMK424	151-158	FSB216	153-307	FSB314	153-036
LS1986	153-180	FMK187	151-006	FMK425	151-165	FSB219	153-153	FSB315	153-207
LS1987	153-226	FMK188	151-014	FMK426	151-164	FSB220	153-151	FSB316	153-397
LS1990	153-318	FMK190	151-029	FMK427	151-167	FSB223	153-467	FSB317	153-278
LS1991	153-336	FMK191	151-132	FMK429	151-187	FSB224	153-425	FSB318	153-154
LS1992	153-233	FMK192	151-072	FMK432	151-177	FSB225	153-322	FSB319	153-166
LS1993	153-406	FMK202	151-080	FMK434	151-159	FSB225R	153-322	FSB321	153-422
LS1994	153-443	FMK206	151-109	FMK435	151-179	FSB227	153-302	FSB324	153-426
LS1995	153-244	FMK207	151-004	FMK436	151-161	FSB227R	153-302	FSB325	153-378
LS1996	153-182	FMK208	151-054	FMK437	151-166	FSB228	153-252	FSB325R	153-378
LS1997	153-376	FMK210	151-026	FMK441	151-231	FSB23	153-055	FSB327	153-033
LS1998	153-244	FMK211	151-202	FMK442	151-222	FSB231	153-149	FSB328	153-034
LS1999	153-450	FMK215	151-084	FMK443	151-223	FSB232	153-021K	FSB33	153-300
LS2000	153-333	FMK217	151-048	FMK446	151-224	FSB233	153-394	FSB330	153-476
LS2001	153-184	FMK222	151-086	FMK447	151-205	FSB234	153-012	FSB331	153-123
LS2002	153-513	FMK223	151-081	FMK448	151-194	FSB234R	153-012	FSB331 W/L	153-123
LS2003	153-453	FMK224	151-079	FMK451	151-160	FSB238	153-203	FSB331R	153-123
LS2011	153-186	FMK225	151-124	FMK452	151-030	FSB239	153-204	FSB332	153-122
LS2046	153-520	FMK230	151-138	FMK453	151-199	FSB23M	153-055	FSB332 W/L	153-122
LS2047	153-488	FMK237	151-052	FMK456	151-190	FSB240	153-456	FSB332R	153-122
		FMK238	151-023	FMK457	151-183	FSB241	153-419	FSB333	153-324
		FMK239	151-063	FMK458	151-227	FSB243	153-345	FSB333K	153-324K
FERODO		FMK242	151-066	FMK459	151-169	FSB243M	153-345	FSB334	153-308
		FMK243	151-007	FMK552	151-237	FSB243R	153-345	FSB335	153-309
		FMK249	151-133	FMK553	151-157	FSB246	153-253Y	FSB336	153-145
FMK002	151-031	FMK249	151-136	FMK555	151-164	FSB249	153-251	FSB337	153-022
FMK003	151-028	FMK254	151-058	FMK556	151-165	FSB250	153-275	FSB339	153-383
FMK016	151-034	FMK255	151-030	FMK557	151-167	FSB251	153-274	FSB340	153-393
FMK040	151-008	FMK258	151-139	FSB11	153-459	FSB252	153-380	FSB341	153-037
FMK041	151-105	FMK260	151-073	FSB119	153-279	FSB254	153-414	FSB343	153-208
FMK042	151-010	FMK261	151-074	FSB11R	153-459	FSB257	153-191	FSB347	153-366
FMK054	151-043	FMK262	151-137	FSB12	153-458	FSB258	153-277	FSB347R	153-366
FMK063	151-015	FMK263	151-140	FSB134	153-271	FSB260	153-392	FSB348R	153-371
FMK064	151-019	FMK264	151-078	FSB142	153-199	FSB263	153-066	FSB350	153-101
FMK066	151-044	FMK265	151-067	FSB150	153-462	FSB263M	153-066	FSB355	153-101
FMK068	151-088	FMK266	151-061	FSB153	153-105	FSB263R	153-066	FSB361	153-100
FMK071	151-087	FMK269	151-077	FSB154	153-460	FSB264	153-206	FSB361R	153-100
FMK079	151-011	FMK270	151-075	FSB157	153-303	FSB265	153-117K	FSB362	153-103
FMK080	151-022	FMK271	151-134	FSB158	153-304	FSB265M	153-117K	FSB363	153-104
FMK081	151-042	FMK280	151-033	FSB163	153-152	FSB266	153-118K	FSB372	153-377
FMK082	151-035	FMK281	151-049	FSB164	153-106	FSB268	153-323	FSB373	153-003
FMK089	151-045	FMK281	151-090	FSB171	153-413	FSB269	153-165	FSB384	153-139
FMK094	151-036	FMK284	151-065	FSB172	153-200	FSB27	153-063	FSB384R	153-139
FMK096	151-038	FMK289	151-005	FSB173	153-475	FSB270	153-068	FSB385	153-102
FMK103	151-039	FMK289	151-142	FSB173R	153-475	FSB271	153-006	FSB385R	153-102
FMK104	151-040	FMK291	151-176	FSB174	153-464	FSB272	153-013	FSB391	153-064
FMK105	151-041	FMK302	151-048	FSB174R	153-464	FSB272R	153-013	FSB391MR	153-064
FMK108	151-059	FMK319	151-125	FSB175	153-107	FSB273	153-008	FSB391R	153-064
FMK110	151-017	FMK319	151-128	FSB175R	153-107	FSB273R	153-008	FSB393	153-109
FMK115	151-025	FMK320	151-126	FSB176	153-108	FSB276	153-205	FSB393R	153-109
FMK117	151-024	FMK324	151-085	FSB176R	153-108	FSB278	153-004	FSB394	153-115
FMK121	151-002	FMK326	151-095	FSB179	153-272	FSB278R	153-004	FSB394R	153-115
FMK122	151-009	FMK330	151-192	FSB180	153-463	FSB279	153-466	FSB395	153-116
FMK125	151-013	FMK331	151-191	FSB180R	153-463	FSB27B	153-063	FSB395R	153-116
FMK130	151-012	FMK334	151-178	FSB182	153-343Y	FSB27M	153-063	FSB396	153-114
FMK131	151-013	FMK336	151-147	FSB183	153-344	FSB27R	153-063	FSB396R	153-114
FMK131	151-021	FMK339	151-197	FSB184	153-412	FSB282	153-279	FSB39R	153-301
FMK132	151-102	FMK344	151-005	FSB186	153-152	FSB284	153-416	FSB40	153-408
FMK145	151-120	FMK344	151-142	FSB187	153-111K	FSB285	153-411	FSB4000	153-244
FMK147	151-121	FMK345	151-093	FSB187R	153-111K	FSB288	153-202	FSB4001	153-246
FMK149	151-111	FMK346	151-092	FSB188	153-320Y	FSB289	153-221	FSB4002	153-247
FMK159	151-016	FMK347	151-094	FSB188M	153-320Y	FSB292	153-197	FSB4003	153-248
FMK160	151-062	FMK351	151-143	FSB190	153-390	FSB293	153-343Y	FSB4004	153-293
FMK161	151-020	FMK352	151-098	FSB191	153-465	FSB293M	153-343Y	FSB4005	153-294
FMK162	151-021	FMK356	151-172	FSB191M	153-465	FSB293R	153-343Y	FSB4006	153-317

CROSS REFERENCES LIST



Adaptable for OES	CIFAM ref.	Adaptable for OES	CIFAM ref.	Adaptable for OES	CIFAM ref.	Adaptable for OES	CIFAM ref.	Adaptable for OES	CIFAM ref.
FERODO		FSB4067	153-451	FSB531	153-467	FSB605	153-169	FSB683	153-282
		FSB4068	153-492	FSB532	153-015	FSB606	153-170	FSB684	153-143
		FSB407	153-065	FSB533	153-071	FSB607	153-171	FSB686	153-256
FSB4007	153-318	FSB4070	153-146	FSB533R	153-071	FSB608	153-172Y	FSB687	153-142
FSB4008	153-444	FSB4074	153-481	FSB534	153-072	FSB609	153-217	FSB688	153-090
FSB4009	153-406	FSB4078	153-486	FSB534R	153-072	FSB610	153-218	FSB690	153-245
FSB401	153-002	FSB407MR	153-065	FSB535	153-074	FSB611	153-219	FSB691	153-096
FSB4010	153-445	FSB407R	153-064	FSB536	153-236	FSB612	153-220	FSB692	153-291
FSB4011	153-446	FSB408	153-468	FSB536K	153-236K	FSB613	153-221	FSB694	153-333
FSB4012	153-332	FSB4080	153-490	FSB537	153-130	FSB614	153-227	FSB695	153-049
FSB4013	153-396	FSB4081	153-493	FSB538	153-211	FSB615	153-238	FSB696	153-094
FSB4014	153-443	FSB4088	153-497	FSB539	153-234K	FSB616	153-259	FSB72	153-339
FSB4015	153-099	FSB4089	153-498	FSB540	153-210	FSB617	153-260	FSB72K	153-339K
FSB4016	153-044	FSB409	153-009	FSB541	153-127	FSB618	153-313	FSB76	153-475
FSB4017	153-052	FSB4098	153-504	FSB541R	153-127	FSB619	153-357	FSB76R	153-475
FSB4017	153-052K	FSB4099	153-505	FSB542	153-126	FSB620	153-358	FSB82	153-461
FSB4018	153-148	FSB41	153-409	FSB542R	153-126	FSB621	153-434	FSB86	153-473
FSB4019	153-159	FSB4100	153-506	FSB543	153-128	FSB623	153-330	FSB86R	153-473
FSB401R	153-002	FSB4103	153-249	FSB544	153-353	FSB624	153-239	FSB89	153-472
FSB402	153-155	FSB4108	153-508	FSB545	153-311	FSB624K	153-239K	FSB90	153-474
FSB4020	153-183	FSB4109	153-513	FSB546	153-016	FSB625	153-240	FSB92	153-011
FSB4021	153-184	FSB411	153-421	FSB547	153-326	FSB625K	153-240K	FSB97	153-010
FSB4022	153-185	FSB4110	153-514	FSB548	153-215	FSB626	153-025	FSB97R	153-010
FSB4022	153-185K	FSB4112	153-387	FSB549	153-379	FSB627	153-041		
FSB4023	153-194	FSB4113	153-516	FSB552	153-129	FSB628	153-173		
FSB4023	153-194Y	FSB4116	153-519	FSB553	153-346	FSB629	153-384	FTE	
FSB4024	153-228	FSB412	153-281	FSB554	153-113	FSB63	153-232		
FSB4025	153-229	FSB4123	153-522	FSB555	153-076	FSB630	153-423		
FSB4026	153-250	FSB4124	153-523	FSB556	153-368	FSB631	153-433	BB00996	153-017
FSB4027	153-267	FSB4125	153-524	FSB557	153-312	FSB632	153-314	BB0955	153-023
FSB4027	153-267K	FSB4126	153-525	FSB556	153-471	FSB633	153-369	BB0982	153-038
FSB4028	153-268	FSB4127	153-526	FSB561	153-400	FSB635	153-136	BB1001A2	153-341
FSB4029	153-295	FSB4129	153-528	FSB563	153-428	FSB636	153-137	BB1002A1	153-004
FSB403	153-258	FSB413	153-398	FSB564	153-429	FSB638	153-261	BB1004	153-023
FSB4030	153-298	FSB4130	153-530	FSB565	153-133	FSB639	153-263	BB1005A1	153-108
FSB4031	153-365	FSB4131	153-179K	FSB566	153-046	FSB63R	153-232	BB1007A2	153-339
FSB4032	153-374	FSB414	153-393	FSB567	153-023	FSB640	153-288	BB1010A1	153-301
FSB4033	153-375	FSB416	153-035	FSB568	153-026	FSB641	153-289	BB1013A1	153-063
FSB4034	153-407	FSB417	153-284	FSB569	153-235	FSB642	153-359	BB1014A1	153-103
FSB4035	153-450	FSB421	153-124	FSB570	153-038	FSB643	153-404	BB1017	153-432
FSB4035	153-450K	FSB421R	153-124	FSB571	153-075	FSB644	153-436	BB1017A1	153-465
FSB4036	153-453	FSB422	153-125	FSB572	153-156	FSB645	153-479	BB1018	153-430
FSB4036	153-453K	FSB425	153-325	FSB573	153-214	FSB646	153-480	BB1018A6	153-232K
FSB4037	153-454	FSB428	153-469	FSB574	153-286	FSB647	153-241	BB1021A1	153-010
FSB4038	153-032	FSB428R	153-469	FSB575	153-327	FSB647K	153-241K	BB1023	153-076
FSB4039	153-042	FSB429	153-348	FSB576	153-328	FSB648	153-138	BB1023A1	153-113
FSB404	153-257	FSB43	153-340	FSB577	153-354	FSB649	153-290	BB1025A1	153-060
FSB4040	153-043	FSB437	153-192	FSB578	153-401	FSB650	153-437	BB1026A1	153-409
FSB4041	153-045	FSB447	153-015	FSB579	153-402	FSB651	153-370	BB1027A1	153-409
FSB4042	153-147	FSB454	153-028	FSB580	153-403	FSB652	153-082	BB1028A1	153-271
FSB4043	153-161	FSB46	153-341	FSB581	153-430	FSB653	153-028	BB1029A1	153-303
FSB4044	153-162	FSB466	153-349	FSB582	153-431	FSB654	153-029	BB1030A1	153-304
FSB4045	153-186	FSB469	153-287	FSB583	153-355	FSB655	153-083	BB1031	153-312
FSB4045	153-186K	FSB47	153-475	FSB584	153-356	FSB656	153-084	BB1032A1	153-462
FSB4046	153-187	FSB470	153-192	FSB585	153-017	FSB657	153-085	BB1033	153-354
FSB4046	153-187K	FSB470R	153-192	FSB586	153-168	FSB658	153-086	BB1033A1	153-006
FSB4047	153-189	FSB471	153-310	FSB587	153-216	FSB659	153-157	BB1033A5	153-011
FSB4048	153-227	FSB471R	153-310	FSB589	153-342	FSB660	153-176	BB1034	153-355
FSB4049	153-230	FSB473	153-373	FSB59	153-060	FSB662	153-242	BB1034A5	153-473
FSB405	153-274	FSB473R	153-373	FSB590	153-134	FSB662K	153-242K	BB1035	153-429
FSB4050	153-231	FSB477	153-070	FSB590R	153-134	FSB663	153-264	BB1036A2	153-320K
FSB4051	153-266	FSB479	153-212	FSB591	153-432	FSB664	153-265	BB1037A1	153-102
FSB4052	153-269	FSB497	153-425	FSB592	153-018	FSB665	153-315	BB1038A1	153-100
FSB4053	153-296	FSB509	153-382	FSB593	153-077	FSB666	153-331	BB1039	153-216
FSB4054	153-297	FSB513	153-073	FSB594	153-078	FSB667	153-336	BB1039A2	153-111K
FSB4055	153-319	FSB513R	153-073	FSB595	153-047	FSB668	153-019	BB1041A1	153-152
FSB4056	153-337	FSB515	153-069	FSB596	153-135	FSB669	153-243K	BB1042A1	153-200
FSB4057	153-360	FSB516	153-213	FSB596R	153-135	FSB671	153-385	BB1043	153-235
FSB4058	153-361	FSB517	153-287	FSB597	153-027	FSB672	153-438	BB1043A2	153-343K
FSB4059	153-362	FSB519	153-350	FSB598	153-039	FSB673	153-386	BB1044	153-282
FSB406	153-424	FSB520	153-399	FSB599	153-040	FSB674	153-439	BB1044A2	153-344
FSB4060	153-363	FSB522	153-478	FSB59R	153-060	FSB675	153-087	BB1045A1	153-106
FSB4061	153-364	FSB524	153-352	FSB6	153-457	FSB676	153-088	BB1046	153-400
FSB4062	153-376	FSB526	153-014	FSB600	153-053	FSB678	153-177	BB1046A6	153-233K
FSB4063	153-388	FSB527	153-069	FSB601	153-054	FSB679	153-050	BB1047A2	153-307
FSB4064	153-389	FSB528	153-477	FSB602	153-079Y	FSB680	153-089	BB1048A2	153-305
FSB4065	153-447	FSB529	153-351	FSB603	153-080Y	FSB681	153-092	BB1049A2	153-306
FSB4066	153-449	FSB53	153-198	FSB604	153-081Y	FSB682	153-093	BB1050	153-401

Adaptable for OES	CIFAM ref..	Adaptable for OES	CIFAM ref.	Adaptable for OES	CIFAM ref.	Adaptable for OES	CIFAM ref.	Adaptable for OES	CIFAM ref.
FTE		BB1139A1	153-207	BB1295A6	153-240	TK2043	151-197	DB4082B	700-196K
		BB1140A1	153-342	BB1296A1	153-356	TK2048	151-195	DB4083	700-197
		BB1141A1	153-258	BB1297A2	153-047	TK2064	151-221	DB4083B	700-197K
BB1050A2	153-062	BB1143A1	153-281	BB1298A1	153-219	TK2067	151-229	DB4083B	700-200K
BB1051A2	153-322	BB1144A1	153-070	BB1299A1	153-079Y	TK2068	151-230	DB4084	700-087
BB1052	153-133	BB1145A1	153-125	BB1300A1	153-080Y	TK2241	151-237	DB4085	700-198
BB1053	153-368	BB1146A2	153-068	BB1301A1	153-135	TK2253	151-146	DB4085B	700-198K
BB1055A1	153-272	BB1147A1	153-069	BB1302A1	153-134	TK2254	151-219	DB4087	700-199
BB1056	153-046	BB1148A1	153-154	BB1303A1	153-313	TK2301	151-070	DB4088	700-200
BB1057	153-075	BB1149A1	153-150	BB1304A1	153-314			DB4088B	700-200K
BB1057A1	153-149	BB1150A1	153-210	BB1305A1	153-081Y			DB4089	700-221
BB1058	153-431	BB1151A1	153-211	BB1306A1	153-025	TRW		DB4090	700-235
BB1058A1	153-201	BB1152A1	153-256	BB1307A5	153-369			DB4090B	700-235K
BB1059	153-463	BB1153A1	153-257	BB1308A1	153-368	DB4092	700-272	DB4092	700-272
BB1059A1	153-417	BB1154A2	153-284	BB1310A1	153-039	DB4002	700-300	DB4096	700-233
BB1061A1	153-464	BB1156A1	153-395	BB1311A1	153-040	DB4003	700-302	DB4097B	700-158K
BB1062A1	153-463	BB1157A2	153-425	BB1313A1	153-288	DB4004	700-267	DB4099	700-115
BB1064A5	153-013	BB1158A5	153-016	BB1314A5	153-234	DB4004B	700-267K	DB4102	700-278
BB1065A2	153-014	BB1159A1	153-350	BB1315A5	153-233	DB4005	700-270	DB4104	700-011
BB1066A2	153-012	BB1160A1	153-351	BB1316A5	153-330	DB4005B	700-270K	DB4105	700-008
BB1067A1	153-392	BB1161A1	153-026	BB1317A5	153-331	DB4006	700-313	DB4107	700-028
BB1069A1	153-273	BB1162A1	153-072	BB1318A1	153-137	DB4006B	700-304K	DB4108	700-046
BB1071A1	153-275	BB1163A1	153-073	BB1319A1	153-136	DB4006B	700-313K	DB4109	700-092
BB1073A1	153-190	BB1164U1	153-348	BB1320A1	153-359	DB4012	700-100	DB4114	700-119
BB1074A1	153-150	BB1165A1	153-349	BB1321A1	153-214	DB4013	700-003	DB4115	700-120
BB1075A1	153-456	BB1168U1	153-349	BB1323A1	153-035	DB4014	700-188	DB4117	700-096
BB1076A1	153-252	BB1170A1	153-126	BB1324A1	153-171	DB4014B	700-188K	DB4118	700-097
BB1077A2	153-251	BB1171A1	153-127	BB1326A1	153-172Y	DB4014B	700-202K	DB4119	700-323
BB1079A1	153-203	BB1172A5	153-478	BB1327A1	153-138	DB4015	700-043	DB4120	700-145
BB1080A1	153-391	BB1173A2	153-311	BB1328A1	153-082	DB4016	700-006	DB4120B	700-145K
BB1081A1	153-425	BB1174A1	153-466	BB1330A1	153-213	DB4017	700-009	DB4122	700-334
BB1082A1	153-419	BB1175A1	153-124	BB1331A2	153-404	DB4018	700-051	DB4123	700-148
BB1083A1	153-115	BB1176A1	153-074	BB1332A2	153-370	DB4019	700-091	DB4123B	700-148K
BB1084A1	153-116	BB1177A1	153-153	BB1333A5	153-479	DB4020	700-081	DB4124	700-163
BB1085A2	153-253Y	BB1178A5	153-477	BB1333A5	153-530	DB4021	700-299	DB4124B	700-163K
BB1087A1	153-390	BB1179A1	153-433	BB1334A5	153-019	DB4023	700-013	DB4124B	700-234K
BB1090A1	153-277	BB1180A1	153-429	BB1335A6	153-242	DB4024	700-025	DB4125	700-340
BB1091A2	153-107	BB1191A1	153-064	BB1336A6	153-243	DB4025	700-044	DB4126	700-165
BB1097A1	153-378	BB1209A1	153-046	BB1339A1	153-084	DB4026	700-045	DB4126B	700-165K
BB1098A5	153-302	BB1212A1	153-121	BB1340A1	153-083	DB4028	700-276	DB4127	700-202
BB1099A2	153-021K	BB1213A1	153-166	BB1341A1	153-290	DB4028B	700-276K	DB4127B	700-202K
BB1100A2	153-066J	BB1216A1	153-353	BB1342A1	153-438	DB4029	700-275	DB4127B	700-213K
BB1101A2	153-067	BB1217A1	153-326	BB1343U5	153-027	DB4029B	700-275K	DB4127B	700-259K
BB1102A2	153-117K	BB1218A2	153-076	BB1344U5	153-364	DB4035	700-191	DB4128	700-238
BB1103A1	153-118K	BB1220A2	153-071	BB1359U5	153-031	DB4036	700-189	DB4128B	700-165K
BB1103A2	153-118K	BB1221A1	153-168	BB701	153-466	DB4038	700-220	DB4128B	700-238K
BB1104A2	153-476	BB1222A1	153-128	BB863	153-467	DB4042	700-280	DB4129	700-239
BB1105A2	153-346	BB1223A1	153-129	BB943	153-287	DB4043	700-274	DB4129B	700-160K
BB1106A1	153-205	BB1235A2	153-421	BB952	153-213	DB4047	700-328	DB4129B	700-239K
BB1108A1	153-323	BB1238A1	153-167	BB953	153-287	DB4048	700-234	DB4129B	700-244K
BB1109A2	153-001	BB1240A5	153-197	BB955	153-351	DB4048B	700-234K	DB4131	700-257
BB1110A1	153-034	BB1241A1	153-287	BB958	153-074	DB4049	700-231	DB4132	700-281
BB1111A1	153-036	BB1243A1	153-217	BB989	153-064	DB4053	700-194	DB4133	700-282
BB1112A1	153-037	BB1245A1	153-379	BB991	153-379	DB4056	700-333	DB4134	700-301
BB1114A1	153-165	BB1246A1	153-023	BB997	153-403	DB4058	700-268	DB4134B	700-301K
BB1115A2	153-192	BB1247A2	153-396	BT1018	700-289	DB4062	700-080	DB4134BR	700-301
BB1116A1	153-204	BB1248A2	153-046	BT1025	700-363	DB4063	700-073	DB4135	700-113
BB1117A1	153-206	BB1249A1	153-075	BT1026	700-389	DB4065	700-277	DB4136	700-178
BB1119A1	153-279	BB1252A1	153-400	BT1033	700-372	DB4066	700-142	DB4140	700-332
BB1120A2	153-324	BB1253A1	153-431	BT1038	700-400	DB4066B	700-142K	DB4141	700-052
BB1121A5	153-325	BB1260A1	153-312	BT1039	700-395	DB4066B	700-146K	DB4143	700-185
BB1122A2	153-345	BB1261A5	153-146	BT1040	700-392	DB4067	700-143	DB4146	700-083
BB1123A1	153-383	BB1262A5	153-017	BT1041	700-394	DB4067B	700-143K	DB4147	700-121
BB1124A1	153-397	BB1263A1	153-216	BT1043	700-397	DB4067B	700-146K	DB4154	700-283
BB1125A2	153-015	BB1264A1	153-327	BT1046	700-396	DB4071	700-014	DB4155	700-222
BB1126A1	153-119	BB1265A1	153-328	BT346	700-374	DB4072	700-144	DB4156	700-287
BB1127A1	153-120	BB1267A1	153-401	BT545	700-260	DB4073	700-158	DB4156B	700-287K
BB1128A1	153-283	BB1273A2	153-235	BT594	700-358	DB4073B	700-158K	DB4157	700-017
BB1129A1	153-469	BB1274A5	153-018	BT617	700-351	DB4075	700-160	DB4158	700-011
BB1130A2	153-308	BB1275A1	153-355	TK1717	151-171	DB4075B	700-160K	DB4159	700-164
BB1131A2	153-309	BB1276A1	153-354	TK1718	151-192	DB4076	700-089	DB4159B	700-164K
BB1132A1	153-468	BB1280A2	153-430	TK1720	151-173	DB4077	700-161	DB4160	700-242
BB1133A1	153-006	BB1286A1	153-169	TK1721	151-163	DB4078	700-088	DB4160B	700-242K
BB1134A6	153-234	BB1291A1	153-403	TK1913	151-175	DB4079	700-162	DB4161	700-205
BB1135A1	153-009	BB1293A1	153-237	TK1926	151-172	DB4080	700-195	DB4161B	700-205K
BB1136A2	153-022	BB1294A5	153-239	TK1933	151-160	DB4081	700-191	DB4162	700-016
BB1137A1	153-122	BB1294A6	153-239	TK1939	151-231	DB4081B	700-191K	DB4166	700-284
BB1138A1	153-123	BB1295A5	153-240	TK1940	151-228	DB4082	700-196	DB4167	700-285

CROSS REFERENCES LIST

Adaptable for OES	CIFAM ref.	Adaptable for OES	CIFAM ref.	Adaptable for OES	CIFAM ref.	Adaptable for OES	CIFAM ref.	Adaptable for OES	CIFAM ref.
TRW		DB4301	700-351	GS6220	153-109	GS8205	153-201	GS8439	153-220
		DB4301B	700-350K	GS6221	153-190	GS8207	153-068	GS8440	153-077
		DB4302	700-350	GS6222	153-114	GS8208	153-233	GS8441	153-172Y
DB4170	700-026	DB4302B	700-351K	GS6223	153-116	GS8209	153-012	GS8442	153-081Y
DB4171	700-027	DB4303	700-370	GS6224	153-115	GS8210	153-456	GS8443	153-143
DB4173	700-331	DB4304	700-371	GS6226	153-112K	GS8211	153-345	GS8444	153-352
DB4174	700-056	DB4305B	700-388K	GS6227	153-106	GS8215	153-149	GS8445	153-386
DB4175	700-057	DB4306	700-289	GS6228	153-322	GS8217	153-013	GS8446	153-439
DB4176	700-058	DB4306B	700-289K	GS6232	153-475	GS8218	153-232	GS8447	153-480
DB4177	700-298	DB4308	700-365	GS6233	153-476	GS8219	153-011	GS8448	153-391
DB4181	700-123	DB4308B	700-365K	GS6236	153-371	GS8221	153-252	GS8452	153-039
DB4182	700-122	DB4309	700-366	GS6237	153-014	GS8222	153-060	GS8453	153-137
DB4183	700-030	DB4310	700-363	GS6238	153-475	GS8223	153-302	GS8454	153-136
DB4188	700-192	DB4310B	700-363K	GS6240	153-476	GS8224	153-419	GS8455	153-359
DB4188B	700-192K	DB4314	700-368	GS6242	153-394	GS8225	153-253Y	GS8456	153-037
DB4189	700-203	DB4315	700-369	GS6245	153-191	GS8231	153-055	GS8462	153-312
DB4190	700-055	DB4316	700-367	GS6246	153-006	GS8233	153-055	GS8465	153-029
DB4191	700-116	DB4328	700-384	GS6250	153-100	GS8234	153-063	GS8466	153-240
DB4193	700-169	DB4333	700-355	GS6251	153-475	GS8240	153-002	GS8467	153-025
DB4193B	700-169K	DB4338	700-319	GS6253	153-119	GS8243	153-425	GS8468	153-314
DB4194	700-170	DB4338B	700-391K	GS6254	153-120	GS8244	153-324K	GS8469	153-369
DB4194B	700-170K	DB4339	700-356	GS6255	153-121	GS8245	153-153	GS8470	153-290
DB4196	700-168	DB4340	700-352	GS7031	153-280	GS8248	153-391	GS8471	153-138
DB4200	700-035	DB4340B	700-352K	GS7066	153-411	GS8251	153-033	GS8472	153-082
DB4201	700-023	DB4341	700-183	GS7185	153-155	GS8259	153-274	GS8473	153-083
DB4202	700-019	DB4342	700-362	GS7230	153-257	GS8264	153-233	GS8474	153-085
DB4204	700-029	DB4343	700-324	GS7256	153-395	GS8265	153-232	GS8475	153-242
DB4209	700-291	DB4343	700-380	GS7801	153-143	GS8269	153-066J	GS8476	153-404
DB4210	700-022	DB4344	700-133	GS8015	153-301	GS8270	153-067J	GS8477	153-370
DB4211	700-243	DB4346	700-263	GS8025	153-459	GS8271	153-021K	GS8478	153-019
DB4212	700-152	DB4347	700-370	GS8028	153-458	GS8272	153-323	GS8479	153-265
DB4212B	700-152K	DB4347	700-387	GS8032	153-270	GS8278	153-392	GS8480	153-438
DB4212B	700-374K	DB4349	700-353	GS8042	153-198	GS8279	153-117K	GS8481	153-233
DB4213	700-151	DB4352	700-128	GS8046	153-409	GS8280	153-118K	GS8482	153-241
DB4213B	700-150K	DB4353	700-326	GS8047	153-408	GS8281	153-036	GS8483	153-291
DB4213B	700-151K	DB4357	700-125	GS8055	153-377	GS8282	153-034	GS8484	153-087
DB4214	700-149	DB4360	700-372	GS8074	153-416	GS8283	153-035	GS8485	153-222
DB4214B	700-149K	DB4361	700-373	GS8085	153-152	GS8286	153-203	GS8486	153-201
DB4214B	700-157K	DB4362	700-383	GS8090	153-408	GS8287	153-424	GS8487	153-292
DB4214MR	700-157	DB4363	700-381	GS8092	153-462	GS8288	153-204	GS8488	153-084
DB4215	700-049	DB4363B	700-381K	GS8094	153-010	GS8289	153-063	GS8489	153-175
DB4218	700-153	DB4364	700-312	GS8098	153-341	GS8290	153-207	GS8490	153-041
DB4219	700-150	DB4369	700-375	GS8110	153-100	GS8291	153-422	GS8491	153-039
DB4219B	700-150K	DB4373	700-382	GS8111	153-271	GS8300	153-378	GS8492	153-437
DB4220	700-246	DB4373B	700-382K	GS8113	153-008	GS8301	153-397	GS8493	153-154
DB4221	700-207	DB4374	700-064	GS8120	153-199	GS8302	153-380	GS8494	153-265
DB4221B	700-207K	DB4381	700-063	GS8125	153-200	GS8307	153-253Y	GS8495	153-358
DB4221B	700-246K	DB4382	700-364	GS8129	153-271	GS8308	153-277	GS8497	153-315
DB4223	700-085	DB4406	700-392	GS8133	153-343	GS8310	153-342	GS8501	153-421
DB4225	700-226	GS6028	153-004	GS8140	153-416	GS8315	153-324K	GS8502	153-415
DB4226	700-060	GS6034	153-003	GS8143	153-414	GS8315	153-340K	GS8510	153-322
DB4227	700-059	GS6040	153-377	GS8144	153-300	GS8317	153-324K	GS8511	153-466
DB4228	700-336	GS6049	153-101	GS8146	153-320	GS8318	153-341	GS8512	153-279
DB4229	700-305	GS6054	153-101	GS8148	153-064	GS8319	153-339K	GS8513	153-278
DB4230	700-262	GS6060	153-471	GS8149	153-461	GS8320	153-112K	GS8519	153-206
DB4233	700-346	GS6070	153-101	GS8151	153-467	GS8321	153-343Y	GS8520	153-205
DB4235	700-223	GS6082	153-366	GS8152	153-062	GS8322	153-320Y	GS8523	153-202
DB4237	700-244	GS6124	153-103	GS8155	153-100	GS8412	153-348	GS8524	153-014
DB4238	700-245	GS6125	153-104	GS8156	153-272	GS8413	153-349	GS8525	153-475
DB4238B	700-245K	GS6129	153-007	GS8157	153-273	GS8416	153-457	GS8526	153-468
DB4241	700-037	GS6140	153-102	GS8158	153-344	GS8419	153-472	GS8527	153-284
DB4242	700-024	GS6151	153-113	GS8161	153-339	GS8420	153-474	GS8528	153-015
DB4243	700-069	GS6160	153-475	GS8164	153-060	GS8421	153-352	GS8529	153-283
DB4244	700-070	GS6171	153-106	GS8166	153-465	GS8423	153-113	GS8530	153-469
DB4245	700-156	GS6176	153-005	GS8168	153-274	GS8424	153-346	GS8531	153-022
DB4245B	700-156K	GS6181	153-100	GS8169	153-275	GS8425	153-416	GS8534	153-350
DB4246	700-157	GS6186	153-304	GS8170	153-413	GS8426	153-463	GS8536	153-130
DB4266	700-349	GS6187	153-303	GS8171	153-412	GS8427	153-310	GS8537	153-124
DB4269	700-385	GS6190	153-475	GS8173	153-464	GS8428	153-221	GS8538	153-001
DB4275	700-319	GS6191	153-324K	GS8177	153-475	GS8429	153-373	GS8539	153-122
DB4275B	700-319K	GS6204	153-190	GS8181	153-417	GS8430	153-444	GS8540	153-123
DB4276B	700-289K	GS6206	153-107	GS8183	153-275	GS8431	153-396	GS8542	153-308
DB4277B	700-290K	GS6207	153-108	GS8184	153-416	GS8432	153-018	GS8543	153-309
DB4292B	700-171K	GS6209	153-139	GS8185	153-251	GS8433	153-239	GS8544	153-009
DB4296B	700-294K	GS6210	153-150	GS8191	153-460	GS8434	153-238	GS8545	153-072
DB4297	700-348	GS6211	153-306	GS8195	153-390	GS8435	153-218	GS8546	153-073
DB4299	700-358	GS6212	153-305	GS8201	153-151	GS8436	153-078	GS8547	153-325
DB4300	700-359	GS6214	153-307	GS8204	153-473	GS8438	153-432	GS8548	153-393

Adaptable for OES	CIFAM ref..	Adaptable for OES	CIFAM ref.	Adaptable for OES	CIFAM ref.	Adaptable for OES	CIFAM ref.	Adaptable for OES	CIFAM ref.
TRW		GS8653	153-075	GSK1015	151-011	GSK1253	151-078		
		GS8654	153-076	GSK1016	151-022	GSK1255	151-134		
		GS8655	153-354	GSK1017	151-017	GSK1258	151-094		
GS8549	153-037	GS8656	153-017	GSK1019	151-013	GSK1259	151-093		
GS8550	153-209	GS8658	153-169	GSK1020	151-021	GSK1260	151-092		
GS8551	153-310	GS8659	153-168	GSK1021	151-020	GSK1261	151-143		
GS8552	153-165	GS8660	153-215	GSK1022	151-013	GSK1262	151-169		
GS8553	153-258	GS8661	153-214	GSK1024	151-070	GSK1404	151-084		
GS8554	153-425	GS8662	153-216	GSK1025	151-016	GSK1461	151-125		
GS8555	153-023	GS8663	153-219	GSK1026	151-014	GSK1462	151-126		
GS8556	153-281	GS8664	153-216	GSK1029	151-139	GSK1463	151-127		
GS8557	153-287	GS8665	153-259	GSK1033	151-088	GSK1500	151-028		
GS8559	153-154	GS8666	153-257	GSK1036	151-042	GSK1501	151-031		
GS8561	153-071	GS8667	153-251	GSK1037	151-059	GSK1507	151-045		
GS8562	153-068	GS8668	153-331	GSK1040	151-062	GSK1508	151-099		
GS8563	153-074	GS8669	153-356	GSK1043	151-072	GSK1511	151-086		
GS8564	153-071	GS8670	153-401	GSK1044	151-048	GSK1512	151-085		
GS8565	153-071	GS8671	153-402	GSK1045	151-048	GSK1516	151-100		
GS8566	153-069	GS8672	153-429	GSK1046	151-132	GSK1556	151-172		
GS8567	153-351	GS8673	153-431	GSK1047	151-020	GSK1557	151-171		
GS8568	153-167	GS8673	153-526	GSK1048	151-021	GSK1558	151-163		
GS8569	153-166	GS8674	153-479	GSK1049	151-014	GSK1559	151-162		
GS8570	153-070	GS8674	153-530	GSK1050	151-063	GSK1604	151-121		
GS8581	153-211	GS8675	153-213	GSK1052	151-138	GSK1606	151-120		
GS8582	153-210	GS8678	153-171	GSK1053	151-067	GSK1607	151-111		
GS8583	153-382	GS8680	153-385	GSK1056	151-068	GSK1608	151-112		
GS8584	153-383	GS8681	153-468	GSK1057	151-048	GSK1609	151-080		
GS8587	153-256	GS8683	153-330	GSK1058	151-095	GSK1610	151-119		
GS8590	153-282	GS8684	153-170	GSK1060	151-061	GSK1611	151-082		
GS8593	153-426	GS8685	153-237	GSK1063	151-165	GSK1613	151-175		
GS8594	153-016	GS8686	153-079Y	GSK1064	151-164	GSK1621	151-122		
GS8595	153-234	GS8687	153-080Y	GSK1069	151-164	GSK1622	151-081		
GS8596	153-399	GS8688	153-248	GSK1070	151-098	GSK1623	151-123		
GS8597	153-398	GS8689	153-135	GSK1071	151-097	GSK1624	151-079		
GS8598	153-065	GS8690	153-134	GSK1072	151-096	GSK1625	151-124		
GS8599	153-478	GS8691	153-260	GSK1075	151-155	GSK1626	151-117		
GS8603	153-432	GS8692	153-217	GSK1078	151-160	GSK1627	151-222		
GS8604	153-023	GS8693	153-428	GSK1107	151-035	GSK1628	151-223		
GS8605	153-350	GS8694	153-212	GSK1109	151-002	GSK1642	151-038		
GS8606	153-197	GS8695	153-264	GSK1123	151-054	GSK1648	151-027		
GS8607	153-129	GS8696	153-173	GSK1130	151-101	GSK1649	151-047		
GS8608	153-129	GS8697	153-159	GSK1134	151-051	GSK1651	151-202		
GS8609	153-128	GS8699	153-038	GSK1136	151-054	GSK1674	151-191		
GS8611	153-128	GS8702	153-174	GSK1137	151-050	GSK1675	151-237		
GS8612	153-006	GS8704	153-153	GSK1138	151-133	GSK1676	151-192		
GS8613	153-023	GS8705	153-357	GSK1139	151-001	GSK1686	151-197		
GS8614	153-067	GS8706	153-336	GSK1140	151-036	GSK1688	151-187		
GS8616	153-353	GS8707	153-178	GSK1142	151-006	GSK1694	151-228		
GS8617	153-326	GS8708	153-087	GSK1144	151-029	GSK1695	151-198		
GS8620	153-023	GS8709	153-443	GSK1145	151-102	GSK1696	151-199		
GS8621	153-477	GS8710	153-293	GSK1146	151-103	GSK1697	151-230		
GS8622	153-287	GS8711	153-090	GSK1150	151-140	GSK1698	151-229		
GS8624	153-068	GS8714	153-442	GSK1206	151-034	GSK1702	151-033		
GS8625	153-287	GS8715	153-089	GSK1209	151-008	GSK1703	151-056		
GS8626	153-327	GS8716	153-440	GSK1214	151-041	GSK1727	151-024		
GS8627	153-235	GS8717	153-158	GSK1215	151-010	GSK1728	151-025		
GS8629	153-126	GS8718	153-244	GSK1216	151-012	GSK1729	151-037		
GS8630	153-313	GS8719	153-093	GSK1217	151-009	GSK1730	151-049		
GS8631	153-002	GS8720	153-092	GSK1222	151-142	GSK1732	151-026		
GS8632	153-430	GS8721	153-247	GSK1223	151-137	GSK1733	151-023		
GS8633	153-368	GS8722	153-227	GSK1224	151-066	GSK1734	151-052		
GS8635	153-023	GS8723	153-443	GSK1225	151-012	GSK1735	151-058		
GS8636	153-133	GS8724	153-318	GSK1226	151-005	GSK1736	151-030		
GS8637	153-311	GS8725	153-386	GSK1232	151-105	GSK1740	151-090		
GS8639	153-379	GS8726	153-145	GSK1237	151-087	GSK1755	151-226		
GS8640	153-157	GS8727	153-406	GSK1238	151-039	GSK1756	151-224		
GS8641	153-403	GS8728	153-031	GSK1239	151-040	GSK1757	151-225		
GS8642	153-328	GS8730	153-294	GSK1240	151-042	GSK1758	151-219		
GS8643	153-026	GS8744	153-094	GSK1241	151-051	GSK1760	151-221		
GS8644	153-028	GS8746	153-094	GSK1242	151-060	GSK1762	151-146		
GS8645	153-046	GS8759	153-027	GSK1244	151-040	GSK1770	151-181		
GS8646	153-047	GS8771	153-513	GSK1245	151-009	GSK1863	151-195		
GS8647	153-040	GS8787	153-490	GSK1246	151-054	GSK1936	151-173		
GS8648	153-035	GSK1002	151-015	GSK1248	151-001	GSK1948	151-231		
GS8649	153-429	GSK1009	151-018	GSK1249	151-007				
GS8650	153-355	GSK1011	151-043	GSK1250	151-004				
GS8651	153-400	GSK1013	151-044	GSK1251	151-004				
GS8652	153-434	GSK1014	151-019	GSK1252	151-077				

CIFAM ref.	H A N D B R A K E	C R C I	A D J	Marca - Make	Ø mm	Cilindretto Freno Wheel Cylinder		RapidKit Brake Shoe			Brake Drum			Pagina Page	
						CIFAM ref.		A	B	C	D (TH)	min. TH	N Fori Holes		Forma Shape
						Left	Right								
 Tamburo Freno - Brake Drum															
700-001				Fiat, Fso				170,1	67,0	37,0	35 / 43	4+1	t2	45-46, 87-88	
700-002				Fiat, Fso				170,1	57,0	37,0	34	4+5	t3	45-46, 87-88	
700-003				Autobianchi, Fiat, Fiat Lcv, Fso, Innocenti, Lancia, Seat, Zastava				185,0	53,1	36,5	59	4+2	t3	11, 45-49, 52, 54-55, 58-59, 63-65, 88, 99, 110-111, 241, 247, 305	
700-004				Autobianchi, Fiat, Seat, Zastava				185,0	53,1	36,5	58	4+4	t3	11, 45-47, 242, 305	
700-006				Fiat				228,4	75,5	48,6	59,5	4+2	t3	45-47	
700-007				Fiat				185,0	53,1	36,5	59	4+2	t3	55	
700-008				Fiat, Lancia, Zastava				180,0	54,0	40,1	59	4+2	t3	55-58, 110, 305	
700-009				Fiat, Fiat Lcv				228,3	61,0	48,0	59	4+2	t3	56-58, 63-64	
700-010				Lancia				180,0	54,0	40,1	59	4+2	t3	110	
700-011				Fiat, Fiat Lcv, Lancia				180,0	54,0	40,1	59	4+2	t3	46-48, 52-54, 64, 111	
700-013				Alfa Romeo Lcv, Fiat Lcv, Peugeot Lcv, Talbot				254,0	98,0	64,5	72	5+5	t3	4, 60-62, 65, 198-200, 262	
700-014				Alfa Romeo Lcv, Iveco				254,0	122,5	96,5	129,8	6+1	t3	4, 101-102	
700-015				Citroën Lcv				254,0	98,0	64,5	72	5+5	t3	35-37	
700-016				Alfa Romeo Lcv, Citroën Lcv, Fiat Lcv, Peugeot Lcv				254,0	98,0	64,5	79	5+5	t3	4, 36-37, 60-62, 198-199	
700-017				Citroën, Citroën Lcv, Fiat, Fiat Lcv, Lancia, Peugeot, Peugeot Lcv				255,0	85,0	67,0	59	5+1	t3	29, 36-38, 58, 64-65, 112, 197, 199	
700-018				Fiat				185,0	53,1	36,5	59	4+3	t3	51-52	
700-019				Fiat, Fiat Lcv, Lancia				203,2	61,0	48,5	59	4+3	t3	47-50, 54, 64, 110	
700-022				Fiat, Fiat Lcv, Lancia				228,3	61,0	48,0	59	4+3	t3	48-51, 59-60, 63-64, 110	
700-023				Fiat				185,0	53,1	36,5	59	4+3	t3	48	
700-024				Fiat, Fiat Lcv				185,0	53,1	36,5	59	4+3	t3	55, 65	
700-025				Lada				250,0	65,0	57,5	58	4+4	t3	109-110	
700-026				Lada				250,0	89,5	57,5	100	5+4	t3	109	
700-027				Lada				200,0	67,5	50,0	60	4+4	t3	108-110	
700-028				Seat, Seat Lcv				185,0	53,1	36,5	59	4+2	t3	244-245, 247, 249	
700-029				Seat				185,0	53,1	36,5	58	4+4	t3	241-242	
700-030				Seat				228,4	75,5	48,6	58,5	4+4	t3	241-242	
700-032				Innocenti, Zastava				185,0	53,1	36,5	59	4+2	t3	99, 304-305	
700-035				Alfa Romeo				228,3	61,0	48,0	59	4+3	t3	1	
700-037				Alfa Romeo				203,2	61,0	48,5	59	4+3	t3	1	
700-043				Bmw				250,0	62,5	47,0	75	5+1	t3	14, 18	
700-044				Bmw				250,0	62,5	47,0	58	4+1	t3	13-14	
700-045				Bmw				228,6	58,5	46,5	62	4+1	t3	14-15	
700-046				Bmw				228,6	59,0	47,0	75	5+1	t3	15-16	
700-049				Volvo				203,3	55,5	46,5	60	4+1	t3	299	
700-050				Volvo				228,6	74,5	59,0	84	5+1	t4	301-302	
700-051				Nissan				180,0	82,0	41,5	45,2 / 50,2	4 Studs	t2	146, 150, 152	
700-052				Nissan, Nissan Lcv				260,0	73,0	63,5	100,5	6+2	t3	148-149, 152, 155-156	
700-053				Nissan Lcv				254,0	80,0	55,5	100,5	6+2	t3	155	
700-054				Nissan, Nissan Lcv				254,0	80,0	68,5	100,5	6+2	t3	148-149, 154-155	
700-055				Nissan				180,0	57,5	37,5	68	4+2	t3	145, 151-152	
700-056				Nissan				180,0	60,5	31,5	45,2 / 50,2	4	t2	147	
700-057				Nissan				180,0	52,0	32,5	61	4+2	t3	147	
700-058				Nissan				228,6	78,0	47,0	45,2 / 54	4 Studs	t2	146, 151	
700-059				Nissan				203,0	60,0	45,5	68	4+2	t3	150	
700-060				Nissan				180,0	53,0	32,5	61	4	t3	147-148	
700-061				Nissan				180,0	73,2	42,0	52	4 Studs	t2	152	
700-062				Nissan				270,0	73,0	64,0	102	6+3	t3	149	
700-063				Nissan, Nissan Lcv				270,0	73,0	64,0	102	6+3	t3	147, 149, 153	
700-064				Nissan				295,0	85,5	71,0	111	6+3	t3	149	
700-065				Nissan				254,0	75,0	67,0	68	5+2	t3	151	
700-066				Nissan Lcv				295,0	88,5	69,0	100,5	6+2	t3	155	
700-068				Nissan				254,0	136,0	66,0	110	5+2	t3	153	
700-069				Nissan				180,0	53,0	32,0	61	4	t3	147-148	
700-070				Nissan				228,6	60,5	51,0	68	4	t3	150	
700-072				Nissan Lcv				295,0	88,5	69,0	100,5	6+3	t3	155	
700-073				Innocenti, Rover				117,8	83,0	47,5	74	4+2	t3	99, 239	
700-080				Honda				180,0	61,5	37,5	61	4+2	t3	89-91	

NUMERICAL LIST

CIFAM ref.	H A N D B R A K E	C R C I	A D J	Marca - Make	Ø mm	Cilindretto Freno Wheel Cylinder		RapidKit Brake Shoe			Brake Drum			Pagina Page	
						CIFAM ref.		A	B	C	D (TH)	min. TH	N Fori Holes		Forma Shape
						Left	Right								
 Tamburo Freno - Brake Drum															
700-081				Honda				200,0	59,0	42,5	61		4+2	t3	88-90, 92
700-082				Honda				203,0	62,5	45,5	61		4+4	t3	90-91
700-083				Honda				220,0	60,0	44,5	64		4+2	t3	88-89
700-085				Honda				220,0	60,0	44,5	64		5+2	t3	91
700-086				Honda				200,0	60,0	44,5	64,1		5+2	t3	91
700-087				Land Rover				254,0	87,0	59,0	114,3		5+8	t3	112-113
700-088				Land Rover				279,4	88,0	68,0	114,3		5+8	t3	112-113
700-089				Land Rover				254,0	87,0	59,0	114,3		5+8	t3	112-113
700-091				Rover				203,2	89,0	47,5	47 / 56		4 Studs	t2	238-240
700-092				Rover				180,0	61,5	37,5	61		4+2	t3	235
700-096				Rover				177,8	70,0	42,5	65,5		4+1	t3	235, 238
700-097				Rover				203,0	62,5	45,5	61		4+4	t3	235-237, 240
700-100				Daf, Rover				254,0	118,5	83,0	132		6+1	t3	41, 240
700-101				Rover				254,0	90,0	69,0	82		6+1	t3	240
700-104				Daihatsu				165,0	70,5	33,5	40 / 52		4 Studs	t2	42
700-105				Daihatsu				228,6	69,0	53,5	66,5		5+2	t3	43
700-107				Toyota				200,0	51,5	43,0	55		4+2	t3	273
700-108				Toyota				295,0	80,2	69,0	106		6+8	t3	271
700-109				Toyota				228,6	66,5	58,0	55		5+2	t3	263-264
700-112				Toyota, Toyota Lcv				254,0	72,0	62,0	67		5+4	t3	272, 275
700-113				Toyota				200,0	70,5	59,0	54		4+2	t3	267, 272
700-115				Toyota				200,0	66,5	47,0	54		4+2	t3	265-267, 272
700-116				Toyota				200,0	65,5	55,0	54		4+2	t3	265-267
700-119				Toyota				200,0	65,5	55,0	54		5+2	t3	264, 266
700-120				Toyota				200,0	65,5	55,0	55		4+2	t3	267-268
700-121				Toyota, Toyota Lcv				295,0	83,0	67,0	106		6+8	t3	263, 272, 274-275
700-122				Toyota				200,0	65,5	55,0	55		5+2	t3	265
700-123				Toyota				180,0	80,5	34,5	39,8 / 49		4 Studs	t2	271-272
700-124				Toyota				254,0	74,0	62,0	91		6+8	t3	270-271
700-125				Toyota Lcv				254,0	72,0	63,5	67		5+4	t3	274
700-126				Daihatsu, Toyota				200,0	63,5	49,0	60		4+2	t3	42, 266, 272
700-128				Toyota Lcv				270,0	81,0	68,0	67		5+7	t3	274
700-130				Daihatsu				200,0	56,5	41,0	56		4+3	t3	41-42
700-131				Daihatsu				180,0	72,5	36,0	47 / 52		4 Studs	t2	41-42
700-132				Daihatsu				200,0	72,5	40,0	47 / 52		4	t2	41-42
700-133				Daihatsu				254,0	66,0	52,0	107		5+2	t3	42-43
700-134				Renault Lcv, Truck				280,0	105,0	70,0	132		5+3	t3	230
700-142				Renault, Renault Lcv, Truck				180,2	83,0	53,5	52		4	t1	203-204, 214-219, 222, 224-228, 230, 232-233, 235
700-142K				Renault, Renault Lcv, Truck				180,2	83,0	53,5	52		4	t1	203-204, 214-219, 222, 224-228, 230, 232-233, 235
700-143				Renault, Renault Lcv, Truck				180,2	83,0	53,5	52		4	t1	220-222, 228, 230-232
700-143K				Renault, Renault Lcv, Truck				180,2	83,0	53,5	52		4	t1	220-222, 228, 230-232
700-144				Nissan Lcv, Renault, Renault Lcv, Truck				228,6	72,5	52,5	66		4+4	t4	154, 207-210, 212, 216, 219-223, 225, 228-230
700-145				Renault Lcv, Truck				203,3	76,0	50,5	55		4	t1	228, 231-232
700-145K				Renault Lcv, Truck				203,3	76,0	50,5	55		4	t1	228, 231-232
700-146				Renault				180,2	83,0	53,5	52		4	t1	215, 225
700-146K				Renault				180,2	83,0	53,5	52		4	t1	215, 225
700-148				Renault				203,3	76,0	50,5	52		4	t1	211-213, 218-219, 225
700-148K				Renault				203,3	76,0	50,5	52		4	t1	211-213, 218-219, 225
700-149				Renault				203,3	76,0	50,5	52		4	t1	210-213
700-149K				Renault				203,3	76,0	50,5	52		4	t1	210-213
700-150				Renault				203,3	85,5	50,0	55		4	t1	209-210
700-150K				Renault				203,3	85,5	50,0	55		4	t1	209-210
700-151				Renault				203,3	85,5	50,0	55		4	t1	209-210
700-151K				Renault				203,3	85,5	50,0	55		4	t1	209-210
700-152				Renault, Renault Lcv, Truck				203,3	76,0	50,5	55		4	t1	208-209, 228-229
700-152K				Renault, Renault Lcv, Truck				203,3	76,0	50,5	55		4	t1	208-209, 228-229
700-153				Renault, Renault Lcv, Truck				228,6	72,5	52,5	66		4+2	t4	211-212, 225, 231-232
700-154				Renault				228,6	72,5	52,5	66		5+2	t4	207

CIFAM ref.	H A N D B R A K E	C R C I	A D J	Marca - Make	Ø mm	Cilindretto Freno Wheel Cylinder		RapidKit Brake Shoe			Brake Drum			Pagina Page	
						CIFAM ref.		A	B	C	D (TH)	min. TH	N Fori Holes		Forma Shape
						Left	Right								
 Tamburo Freno - Brake Drum															
700-156				Renault, Renault Lcv, Truck				180,2	83,0	51,5	52		4+2	t1	204-205, 228
700-156K				Renault, Renault Lcv, Truck				180,2	83,0	51,5	52		4+2	t1	204-205, 228
700-157				Renault, Renault Lcv, Truck				203,3	76,0	50,5	52		4	t1	204-205, 228
700-157K				Renault, Renault Lcv, Truck				203,3	76,0	50,5	52		4	t1	204-205, 228
700-158				Citroën				180,0	64,5	39,0	42 / 47		3 Studs	t2	29-31
700-158K				Citroën				180,0	64,5	39,0	42 / 47		3 Studs	t2	29-31
700-160				Citroën				165,0	58,0	38,5	56		3	t1	25-27
700-160K				Citroën				165,0	58,0	38,5	56		3	t1	25-27
700-161				Citroën, Citroën Lcv				228,6	66,0	50,5	71		4+2	t3	34-35
700-162				Citroën, Citroën Lcv				228,6	66,0	50,5	71		3+1	t3	31, 35
700-163				Citroën				180,0	70,5	43,0	52		4	t1	31
700-163K				Citroën				180,0	70,5	43,0	52		4	t1	31
700-164				Citroën				180,0	80,0	46,0	52		4	t1	25-27, 29-30
700-164K				Citroën				180,0	80,0	46,0	52		4	t1	25-27, 29-30
700-165				Citroën				180,0	81,0	44,5	52		4	t1	31-34
700-165K				Citroën				180,0	81,0	44,5	52		4	t1	31-34
700-168				Opel Lcv, Renault Lcv, Truck				255,0	91,0	56,0	52 / 62		4 Studs	t2	176, 233
700-169				Renault Lcv, Truck				255,0	91,0	56,0	52 / 62		4 Studs	t2	233-235
700-169K				Renault Lcv, Truck				255,0	91,0	56,0	52 / 62		4 Studs	t2	233-235
700-170				Renault Lcv, Truck				254,0	103,0	70,0	52 / 72		4 Studs	t2	233-235
700-170K				Renault Lcv, Truck				254,0	103,0	70,0	52 / 72		4 Studs	t2	233-235
700-171				Renault Lcv, Truck				254,0	103,0	70,0	52 / 72		4 Studs	t2	234-235
700-171K				Renault Lcv, Truck				254,0	103,0	70,0	52 / 72		4 Studs	t2	234-235
700-172				Renault Lcv, Truck				255,0	77,0	55,5	126		4+4	t3	233-235
700-174				Renault Lcv, Truck				254,0	91,0	70,0	126		4+4	t3	233-235
700-175				Renault Lcv, Truck				255,0	94,5	69,0	144		5+3	t3	229
700-176				Renault Lcv, Truck				254,0	110,0	80,0	52 / 72		5 Studs	t2	229
700-176K				Renault Lcv, Truck				254,0	110,0	80,0	52 / 72		5 Studs	t2	229
700-178				Bedford, Isuzu, Opel Lcv				254,0	71,0	61,0	96,5		6+1	t3	12, 99-101, 177
700-181				Jeep Usa				254,0	101,0	55,5	72,2		5+3	t4	106
700-182				Jeep Usa				254,0	102,0	55,0	72,2		5	t4	106
700-183				Jeep Usa				228,5	90,0	77,0	72		5	t4	106
700-185				Volkswagen				230,0	94,5	50,5	26,3		4	t5	275, 282-283
700-187				Volkswagen				180,0	74,5	38,5	39,8 / 50,2		4	t2	277
700-188				Audi, Volkswagen				200,0	81,0	51,0	39,8 / 50,2		4	t2	6, 10-11, 276, 283-285, 290
700-188K				Audi, Volkswagen				200,0	81,0	51,0	39,8 / 50,2		4	t2	6, 10-11, 276, 283-285, 290
700-189				Volkswagen Lcv				252,0	83,0	65,5	93		5+4	t3	295-296
700-191				Audi, Seat, Volkswagen, Volkswagen Lcv				180,0	74,5	38,5	39,8 / 50,2		4	t2	6-8, 10, 242-243, 245-248, 276-278, 281-291, 296-297
700-191K				Audi, Seat, Volkswagen, Volkswagen Lcv				180,0	74,5	38,5	39,8 / 50,2		4	t2	6-8, 10, 242-243, 245-248, 276-278, 281-291, 296-297
700-192				Volkswagen				230,0	84,5	53,5	39,8 / 50,2		4	t2	285-286
700-192K				Volkswagen				230,0	84,5	53,5	39,8 / 50,2		4	t2	285-286
700-194				Volkswagen Lcv				252,0	77,5	64,0	65		5+2	t4	297-298
700-195				Volkswagen Lcv				252,0	77,5	64,0	65		5+2	t4	297-298
700-196				Audi				200,0	80,5	51,5	39,8 / 50,2		4	t2	8-10
700-196K				Audi				200,0	80,5	51,5	39,8 / 50,2		4	t2	8-10
700-197				Audi				230,0	90,0	53,5	45,2 / 50,2		4	t2	5-6, 9
700-197K				Audi				230,0	90,0	53,5	45,2 / 50,2		4	t2	5-6, 9
700-198				Audi				230,0	90,0	53,5	45,2 / 50,2		4	t2	5-6
700-198K				Audi				230,0	90,0	53,5	45,2 / 50,2		4	t2	5-6
700-199				Volkswagen Lcv				270,0	141,0	75,0	164		6+5	t3	295-296
700-200				Volkswagen Lcv				230,0	90,0	52,0	45,2 / 50,2		4	t2	292-293
700-200K				Volkswagen Lcv				230,0	90,0	52,0	45,2 / 50,2		4	t2	292-293
700-202				Audi, Seat, Volkswagen, Volkswagen Lcv				200,0	81,0	49,5	39,8 / 50,2		4	t2	6-8, 10, 242-244, 276, 278-280, 285, 287-290, 292, 296-297
700-202K				Audi, Seat, Volkswagen, Volkswagen Lcv				200,0	81,0	49,5	39,8 / 50,2		4	t2	6-8, 10, 242-244, 276, 278-280, 285, 287-290, 292, 296-297



NUMERICAL LIST

CIFAM ref.	H A N D B R A K E	C R C I	A D J	Marca - Make	Ø mm	Cilindretto Freno Wheel Cylinder		RapidKit Brake Shoe			Brake Drum			Pagina Page	
						CIFAM ref.		A	B	C	D (TH)	min. TH	N Fori Holes		Forma Shape
						Left	Right								
 Tamburo Freno - Brake Drum															
700-203				Volkswagen Lcv				268,0	88,0	68,0	68		5+4	t3	297-298
700-204				Volkswagen Lcv				254,0	78,0	66,5	67		5+2	t3	297
700-205				Audi				200,0	80,5	52,0	39,8 / 50,2		4	t2	8-10
700-205K				Audi				200,0	80,5	52,0	39,8 / 50,2		4	t2	8-10
700-206				Volkswagen Lcv				295,0	83,0	67,0	106		6+8	t3	297
700-207				Audi				230,0	90,0	51,0	45 / 50,2		5	t2	6
700-207K				Audi				230,0	90,0	51,0	45 / 50,2		5	t2	6
700-208				Seat Lcv, Volkswagen Lcv				230,0	90,0	51,0	45 / 50,2		4	t2	248-249, 293-295
700-208K				Seat Lcv, Volkswagen Lcv				230,0	90,0	51,0	45 / 50,2		4	t2	248-249, 293-295
700-213				Seat Lcv, Skoda, Volkswagen Lcv				200,0	81,0	49,5	39,8 / 50,2		4	t2	248-249, 251, 293-295
700-213K				Seat Lcv, Skoda, Volkswagen Lcv				200,0	81,0	49,5	39,8 / 50,2		4	t2	248-249, 251, 293-295
700-214				Volkswagen				230,0	63,0	48,0	65		4+1	t3	278, 280, 282
700-218				Volkswagen				180,0	52,5	40,5	65		4+1	t3	283
700-219				Seat, Volkswagen, Volkswagen Lcv				200,0	59,0	50,5	65		4+1	t3	242, 244, 246, 283, 287-289, 296-297
700-220				Mercedes Benz Lcv, Truck				230,0	73,0	43,0	85		5+1	t3	137
700-221				Mercedes Benz, Mercedes Benz Lcv, Truck				260,0	83,0	64,0	85		5+1	t3	128-129, 136-137
700-222				Mercedes Benz Lcv, Truck				254,0	93,0	65,0	90		5+10	t3	136
700-223				Mercedes Benz				180,0	57,5	49,0	67		5+1	t3	121-122
700-226				Hyundai				203,2	61,0	47,0	76		4+2	t3	93, 95
700-227				Hyundai, Mitsubishi				180,0	71,5	46,5	52 / 52		4	t2	94, 96, 143
700-228				Hyundai				180,0	58,5	39,0	90		4+2	t3	94, 96
700-231				Peugeot, Talbot				255,0	70,5	55,5	93		4+2	t3	195-196, 263
700-233				Citroën, Citroën Lcv, Peugeot, Peugeot Lcv				228,5	66,0	50,5	71		4+2	t3	27, 32-35, 188, 190-191, 193-195, 198, 200
700-234				Peugeot, Peugeot Lcv				180,0	70,5	43,0	52		4	t1	182-186, 197
700-234K				Peugeot, Peugeot Lcv				180,0	70,5	43,0	52		4	t1	182-186, 197
700-235				Peugeot, Peugeot Lcv				180,0	79,5	53,5	52		4	t1	183-186, 191-192, 197
700-235K				Peugeot, Peugeot Lcv				180,0	79,5	53,5	52		4	t1	183-186, 191-192, 197
700-238				Peugeot				180,0	81,0	44,5	52		4	t1	189-190, 192
700-238K				Peugeot				180,0	81,0	44,5	52		4	t1	189-190, 192
700-239				Peugeot				165,0	58,0	38,5	56		3	t1	180-181
700-239K				Peugeot				165,0	58,0	38,5	56		3	t1	180-181
700-241				Peugeot				180,0	80,0	46,0	52		4	t1	180-182, 186-187
700-241K				Peugeot				180,0	80,0	46,0	52		4	t1	180-182, 186-187
700-242				Peugeot				180,0	75,0	40,5	52		4	t1	180-182
700-242K				Peugeot				180,0	75,0	40,5	52		4	t1	180-182
700-243				Peugeot Lcv				300,0	84,5	72,5	140		5+4	t3	200
700-244				Citroën, Peugeot				165,0	58,0	38,5	56		3	t1	29-30, 181
700-244K				Citroën, Peugeot				165,0	58,0	38,5	56		3	t1	29-30, 181
700-245				Citroën, Peugeot				203,0	81,0	46,5	52		4	t1	31-34, 189-191
700-245K				Citroën, Peugeot				203,0	81,0	46,5	52		4	t1	31-34, 189-191
700-246				Citroën, Peugeot, Peugeot Lcv				203,0	71,5	46,5	52		4	t1	29-30, 181-182, 187, 197
700-246K				Citroën, Peugeot, Peugeot Lcv				203,0	71,5	46,5	52		4	t1	29-30, 181-182, 187, 197
700-249				Mitsubishi				180,0	71,5	39,0	50,2 / 50,2		4 Studs	t2	139, 141-142
700-250				Mitsubishi, Mitsubishi Lcv				254,0	83,0	62,0	93,5		6+2	t3	141-142, 144
700-251				Chrysler Usa				228,6	104,0	71,0	57,5		5	t4	25
700-252				Chrysler Usa				228,6	105,0	76,0	72,2		5	t4	25
700-253				Chrysler Usa				250,0	78,0	64,0	57,5		5	t3	25
700-254				Chrysler Usa				250,0	78,0	65,0	72		5	t3	25
700-257				Skoda				200,0	62,0	38,0	58,5		4+6	t3	250
700-259				Skoda				200,0	81,0	49,5	39,8 / 50,2		4	t2	249-252
700-259K				Skoda				200,0	81,0	49,5	39,8 / 50,2		4	t2	249-252
700-260				Skoda				230,0	57,5	39,0	65		5+1	t3	251-253
700-261				Subaru				180,0	64,5	41,0	28		4 Studs	t5	256
700-262				Subaru				228,5	63,0	43,0	58		5+4	t3	255-256
700-263				Suzuki				220,0	63,0	50,0	57		5Stud+4	t3	258-259
700-264				Suzuki				228,6	61,0	49,0	57		5Stud+4	t3	258-259
700-265				Suzuki				220,0	64,0	49,0	57		5Stud+4	t3	258-259

CIFAM ref.	H A N D	B R A K E	C R C I	A D J	Marca - Make	Ø mm	Cilindretto Freno Wheel Cylinder		RapidKit Brake Shoe			Brake Drum			Pagina Page	
							CIFAM ref.		A	B	C	D (TH)	min. TH	N Fori Holes		Forma Shape
							Left	Right								
 Tamburo Freno - Brake Drum																
700-266					Suzuki				228,6	61,0	49,0	50		5+4	t3	260
700-267					Ford Europe, Ford Lcv, Truck				177,8	73,0	39,0	39,8 / 50,2		4	t2	71, 83
700-267K					Ford Europe, Ford Lcv, Truck				177,8	73,0	39,0	39,8 / 50,2		4	t2	71, 83
700-268					Ford Europe, Ford Lcv, Truck				203,0	65,5	45,0	63,5		4+2	t4	66-69, 78-82
700-270					Ford Europe, Ford Lcv, Truck				180,0	76,5	46,0	39,8 / 50,2		4	t2	67-69, 78-79, 82
700-270K					Ford Europe, Ford Lcv, Truck				180,0	76,5	46,0	39,8 / 50,2		4	t2	67-69, 78-79, 82
700-272					Ford Europe				228,6	81,0	64,0	63,5		4+1	t4	66, 80-82
700-274					Mazda				170,0	72,0	34,5	39,8 / 50,2		4	t2	116
700-275					Ford Europe, Ford Lcv, Truck				203,0	72,0	48,0	50,2 / 50,2		4 Studs	t2	71-73, 76-78, 83
700-275K					Ford Europe, Ford Lcv, Truck				203,0	72,0	48,0	50,2 / 50,2		4 Studs	t2	71-73, 76-78, 83
700-276					Ford Europe, Ford Lcv, Truck				180,0	76,0	44,0	50,2 / 50,2		4 Studs	t2	69, 71-73, 79, 83
700-276K					Ford Europe, Ford Lcv, Truck				180,0	76,0	44,0	50,2 / 50,2		4 Studs	t2	69, 71-73, 79, 83
700-277					Ford Europe, Ford Lcv, Truck				228,6	71,0	53,5	63,5		4	t4	66-68, 81-82
700-278					Ford Lcv, Truck				228,6	84,0	57,5	115		5	t3	83, 85
700-280					Ford Lcv, Truck				254,0	147,0	85,0	130,1		6+1	t3	84-85
700-281					Mazda				228,6	72,0	37,0	58		5	t1	118-119
700-282					Mazda				200,0	65,5	32,0	45,5 / 50,2		4	t2	117
700-283					Ford Europe				228,6	66,5	54,0	63,5		4	t3	77-78
700-284					Ford Lcv, Truck				254,0	96,0	57,5	132		5	t3	83-86
700-285					Ford Lcv, Truck				280,0	132,5	75,5	142,5		6	t3	83-86
700-286					Ford Lcv, Truck				254,0	148,0	85,0	130,1		6+1	t3	85
700-287					Ford Europe				203,0	80,0	49,0	50,2 / 50,2		4 Studs	t2	69-70, 79-80
700-287K					Ford Europe				203,0	80,0	49,0	50,2 / 50,2		4 Studs	t2	69-70, 79-80
700-288					Ford Lcv, Truck				203,0	65,5	45,0	63,5		4+2	t4	83
700-289					Ford Europe				180,0	76,0	44,0	50,2 / 50,2		4 Studs	t2	70-71, 73-74, 76-77
700-289K					Ford Europe				180,0	76,0	44,0	50,2 / 50,2		4 Studs	t2	70-71, 73-74, 76-77
700-290					Ford Europe				203,0	80,0	49,0	50,2 / 50,2		4 Studs	t2	70-71, 73-74, 77, 80-81
700-290K					Ford Europe				203,0	80,0	49,0	50,2 / 50,2		4 Studs	t2	70-71, 73-74, 77, 80-81
700-291					Ford Europe				203,0	63,5	48,5	63,5		4	t3	77-78
700-292					Ford Europe, Ford Lcv, Truck, Mazda				180,0	76,0	44,0	50,2 / 50,2		4 Studs	t2	73-74, 76-77, 80, 82-83, 117
700-293					Ford Europe				254,0	74,0	65,0	100,5		6+2	t3	77
700-294					Mazda				180,0	76,0	44,0	50,2 / 50,2		4 Studs	t2	116
700-294K					Mazda				180,0	76,0	44,0	50,2 / 50,2		4 Studs	t2	116
700-295					Mazda				228,6	72,0	37,0	58		4	t1	118
700-296					Mazda				200,0	58,0	42,0	55		4+4	t3	117-119
700-298					Bedford, Isuzu, Opel				254,0	75,0	61,5	95		6+1	t3	12, 100, 165
700-299					Opel				200,0	56,0	37,5	57		4+1	t4	158-160, 166-169
700-300					Bedford, Daewoo, Opel, Opel Lcv				200,0	67,0	53,0	57		4+1	t4	12, 39-40, 157-161, 166-172, 174-177
700-301					Opel, Opel Lcv				200,0	84,0	35,0	39,8 / 50,2		4	t2	163-164, 174, 177-178
700-301K					Opel, Opel Lcv				200,0	84,0	35,0	39,8 / 50,2		4	t2	163-164, 174, 177-178
700-302					Opel, Opel Lcv				230,0	75,5	59,5	57		4+1	t4	157-158, 166-168, 171-174, 177, 179
700-304					Opel, Opel Lcv				200,0	84,0	35,0	39,8 / 50,2		4	t2	162-164, 174, 177-178
700-304K					Opel, Opel Lcv				200,0	84,0	35,0	39,8 / 50,2		4	t2	162-164, 174, 177-178
700-305					Opel, Opel Lcv				230,0	65,5	50,0	57		4+1	t4	158-161, 175-178
700-306					Opel				230,0	66,0	49,5	65,5		5+1	t4	176
700-307					Opel Lcv				295,0	80,5	61,0	96,5		6+1	t3	177
700-308					Opel Lcv				280,0	105,0	70,0	132		5+3	t3	179
700-310					Daewoo				200,0	81,0	52,5	39,8 / 50,2		4	t2	39-40
700-311					Daewoo, Daewoo Lcv				180,0	79,5	40,0	47 / 52		4	t2	40-41
700-312					Daewoo				180,0	65,5	40,0	47 / 52		4	t2	41
700-313					Opel, Opel Lcv				200,0	84,0	35,0	39,8 / 50,2		4	t2	162-163, 174, 178
700-313K					Opel, Opel Lcv				200,0	84,0	35,0	39,8 / 50,2		4	t2	162-163, 174, 178
700-315					Ford Europe				228,6	71,0	53,5	63,5		4+1	t4	68
700-318					Ford Europe				254,0	80,0	64,0	63,5		4	t4	81
700-319					Ford Europe				203,0	81,0	44,5	53		4 Studs	t1	75
700-319K					Ford Europe				203,0	81,0	44,5	53		4 Studs	t1	75
700-323					Renault, Renault Lcv, Truck				160,3	68,0	35,0	42 / 47		3 Studs	t2	223, 231
700-324					Toyota				200,0	60,5	49,0	55		4+2	t3	268
700-325					Toyota				295,0	85,5	76,0	106		6+4	t3	270-271

NUMERICAL LIST

CIFAM ref.	H A N D B R A K E	C R C I	A D J	Marca - Make	Ø mm	Cilindretto Freno Wheel Cylinder		RapidKit Brake Shoe			Brake Drum			Pagina Page	
						CIFAM ref.		A	B	C	D (TH)	min. TH	N Fori Holes		Forma Shape
						Left	Right								
 Tamburo Freno - Brake Drum															
700-326				Toyota Lcv				270,0	80,5	66,5	67		5+7	t3	274
700-328				Nissan, Nissan Lcv				228,5	62,5	54,5	68		4+2	t3	145-147, 149-151, 156
700-329				Nissan Lcv				228,5	62,5	54,5	68		4+2	t3	156
700-330				Nissan				254,0	74,0	65,0	100,5		6+2	t3	152
700-331				Mitsubishi				254,0	83,0	62,0	93,5		6+2	t3	142
700-332				Nissan Lcv				254,0	69,0	56,0	90		6+2	t3	153, 155-156
700-333				Rover				177,8	60,0	47,5	74		4+2	t3	239
700-334				Renault, Renault Lcv, Truck				180,2	68,5	42,0	42 / 47		3 Studs	t2	223, 231
700-336				Nissan Lcv				254,0	75,0	67,0	68		5+2	t3	156
700-339				Suzuki				220,0	61,0	41,0	100		5+2	t3	258-261
700-340				Citroën				200,0	61,0	44,5	83		6	t3	25, 29
700-343				Suzuki				180,0	74,0	36,0	47 / 52		4	t2	259-260
700-344				Suzuki				180,0	65,5	36,0	47 / 52		4	t2	259-260
700-345				Suzuki				180,0	51,0	36,0	64		4+4	t3	259-260
700-346				Suzuki				254,0	66,5	54,0	100		5+2	t3	260
700-348				Land Rover				254,0	56,2	47,0	66,1		5+2	t3	113-114
700-349				Hyundai				180,0	71,5	36,0	39,8 / 50,2		4 Studs	t2	93
700-350				Opel, Opel Lcv				200,0	84,0	34,0	52,9		4	t1	164, 178-179
700-350K				Opel, Opel Lcv				200,0	84,0	34,0	52,9		4	t1	164, 178-179
700-351				Opel, Opel Lcv				200,0	94,2	54,0	52,9		4	t1	164, 178-179
700-351K				Opel, Opel Lcv				200,0	94,2	54,0	52,9		4	t1	164, 178-179
700-352				Nissan				203,3	76,0	50,5	52		4	t1	148, 153
700-352K				Nissan				203,3	76,0	50,5	52		4	t1	148, 153
700-353				Nissan				203,0	66,5	43,5	68		4+2	t3	145, 150
700-355				Daihatsu				228,6	68,0	58,0	66,5		5+2	t3	43
700-356				Toyota				200,0	51,5	41,0	55		4+2	t3	273
700-357				Toyota				200,0	51,5	43,0	55		4+2	t3	271
700-358				Audi, Seat, Skoda, Skoda Lcv, Volkswagen				200,0	59,0	50,5	65		5+1	t3	10, 244, 246-247, 249-250, 253, 289
700-359				Seat Lcv, Volkswagen Lcv				230,0	57,5	39,0	65		4+1	t3	248-249, 293-295
700-361				Smart				203,0	59,3	38,5	58		3+1	t3	253-254
700-362				Hyundai				180,0	71,5	36,0	39,8 / 50,2		4 Studs	t2	93
700-363				Citroën, Citroën Lcv, Peugeot				203,0	71,5	42,0	52		4	t1	28, 35-36, 179-180
700-363K				Citroën, Citroën Lcv, Peugeot				203,0	71,5	42,0	52		4	t1	28, 35-36, 179-180
700-364				Mitsubishi				203,0	60,0	44,5	90		4+2	t3	140, 142
700-365				Ford Europe, Ford Lcv, Truck				203,0	81,0	44,5	53		4 Studs	t1	74, 76, 83
700-365K				Ford Europe, Ford Lcv, Truck				203,0	81,0	44,5	53		4 Studs	t1	74, 76, 83
700-366				Ford Lcv, Truck				228,6	89,5	68,0	63,4		5	t3	84
700-367				Ford Lcv, Truck				280,0	105,0	80,5	118		5	t3	86-87
700-368				Ford Lcv, Truck				254,0	96,0	57,5	132		5	t3	86-87
700-369				Ford Lcv, Truck				280,0	132,5	75,5	142		6	t3	86-87
700-370				Opel, Suzuki				180,0	63,0	34,5	52		4	t1	156, 261
700-371				Opel, Suzuki				180,0	63,0	34,5	52		4	t1	156, 261
700-372				Fiat, Opel				228,3	61,0	48,0	60		4+3+2	t3	49, 165
700-373				Fiat, Opel				203,2	61,0	47,0	60		4+3+2	t3	49, 165
700-374				Nissan Lcv				203,3	76,0	50,5	55		4	t1	154
700-374K				Nissan Lcv				203,3	76,0	50,5	55		4	t1	154
700-375				Nissan Lcv				228,6	72,5	52,5	66		4+2	t4	154
700-376				Nissan				295,0	88,5	69,0	100,5		6+2	t3	149
700-377				Rover				203,0	62,5	45,5	61		4+2+2	t3	236-237
700-378				Toyota				200,0	51,5	41,0	55		5+2	t3	269
700-379				Toyota				200,0	51,5	42,0	55		4+2	t3	273
700-380				Toyota				200,0	65,5	55,0	55		4+2	t3	268
700-381				Dacia, Renault				203,3	76,0	50,5	52		4	t1	38-39, 205-206, 208, 213-214
700-381K				Dacia, Renault				203,3	76,0	50,5	52		4	t1	38-39, 205-206, 208, 213-214
700-382				Dacia, Renault, Lcv, Truck				203,3	76,0	50,5	52		4	t1	38-39, 204-205, 228
700-382K				Dacia, Renault, Lcv, Truck				203,3	76,0	50,5	52		4	t1	38-39, 204-205, 228
700-383				Citroën, Peugeot, Toyota				200,0	53,5	41,5	55		4+2+1	t3	27, 182, 264
700-384				Mitsubishi				203,0	64,0	42,0	90		4+2	t3	139, 143-144
700-385				Suzuki				200,0	56,5	40,0	58		4+2+1	t3	257-258

CIFAM ref.	H A N D B R A K E	C R C I	A D J	Marca - Make	Ø mm	Cilindretto Freno Wheel Cylinder		RapidKit Brake Shoe			Brake Drum			Pagina Page	
						CIFAM ref.		A	B	C	D (TH)	min. TH	N Fori Holes		Forma Shape
						Left	Right								
 Tamburo Freno - Brake Drum															
700-386				Suzuki				254,0	70,0	63,5	108,3		5+2	t3	258
700-387				Suzuki				180,0	82,0	41,0	47 / 52		4	t2	260
700-388				Ford Europe				203,0	80,0	49,0	50,2 / 50,2		4 Studs	t2	74
700-388K				Ford Europe				203,0	80,0	49,0	50,2 / 50,2		4 Studs	t2	74
700-389				Opel, Opel Lcv				230,0	69,0	50,0	57		4+1	t3	161, 177-178
700-390				Ford Europe				228,3	66,0	49,0	63,5		5	t3	75
700-391				Ford Europe				203,0	81,0	44,5	52,9		4 Studs	t1	75
700-391K				Ford Europe				203,0	81,0	44,5	52,9		4 Studs	t1	75
700-392 *				Kia				200,0	67,5	34,0	45,2 / 50,2		4 Studs	t2	107
700-393 *				Mazda				200,0	57,5	40,0	55,0		4+2	t3	116
700-394 *				Chrysler				220,0	59,5	46,2	57,6		5	t4	23-24
700-395 *				Suzuki				220,0	64,0	54,0	100,0		5	t3	258
700-396 *				Subaru				228,6	69,0	43,0	58,0		5	t3	255
700-397 *				Hyundai				180,0	58,0	40,0	62,5		4+2	t3	94
700-398 *				Mitsubishi				228,3	60,0	38,5	90,0		5+2	t3	143
700-399 *				Ford Europe				200,0	57,5	40,0	63,5		4+2	t3	74-75
700-400 *				Suzuki				220,0	64,0	54,0	108,2		5+2	t3	258
 Rapidkit - Premounted Kit															
151-001				• RAD Citroën, Peugeot	19,05			165,0		30					25-27, 29, 180-182
151-002				RAD Citroën	19,05			165,0		30					25-27
151-004				• RAI Citroën, Peugeot	20,64			180,0		30					31-34, 189-190
151-005				RAI Citroën, Peugeot	20,64			228,6		42					34, 189-190
151-006				• RAD Citroën, Peugeot	19,05			180,0		30					27, 29-30, 180-182
151-007				RAD Peugeot	19,05			180,0		30					180-181
151-008				RAD Peugeot	23,81			228,0		42					182, 187-188
151-009				• RAD Peugeot	20,64			180,0		30					182-184, 192
151-010				• RAD Peugeot, Peugeot Lcv	19,05			180,0		30					182-186, 197
151-011				RAD Peugeot, Renault, Lcv, Truck	17,46			180,0		40					191, 214, 224, 230
151-012				• RAI Peugeot	20,64			228,0		42					193-194
151-013				• RAI Renault, Renault Lcv, Truck	20,64			180,0		40					203-204, 215, 224-228, 230, 232-233
151-014				• RAI Renault, Renault Lcv, Truck	20,64			180,0		40					203-204, 227-228, 235
151-015				RAD Renault, Talbot	22,00			228,0		42					207-208, 216, 261-263
151-016				RAI Renault Lcv, Truck	20,64			203,0		39					231-232
151-017				RAI Renault, Renault Lcv, Truck	22,00			180,0		40					220-222, 225-226, 231-233
151-018				RAD Renault, Renault Lcv, Truck	23,81			228,0		42					223, 231
151-019				RAD Renault	22,00			228,0		42					219-220, 222-223
151-020				• RAI Renault, Renault Lcv, Truck	22,00			180,0		40					220-222, 230
151-021				• RAI Renault, Renault Lcv, Truck	20,64			180,0		40					216-219, 230
151-022				RAD Peugeot, Renault, Renault Lcv, Truck	22,00			180,0		40					191-192, 214-215, 224-226, 230, 232-233
151-023				RAI Fiat, Lancia	20,64			180,0		30					53, 111
151-024				RAI Fiat, Lancia	19,05			180,0		30					55-57, 110
151-025				RAI Fiat	15,00			180,0		30					57
151-026				RAI Fiat, Lancia	22,00			180,0		30					55-58, 110
151-027				RAD Ford Europe, Ford Lcv, Truck	17,46			180,0		30					71-73, 83
151-028				VAG Audi, Volkswagen	14,30			180,0		30					7-8, 10, 276-277, 281-285, 290-291
151-029				RAI Citroën, Renault, Lcv, Truck	19,05			203,0		39					26, 218-219, 230
151-030				RAI Fiat	22,00			203,0		39					47-48, 50
151-031				VAG Audi, Seat, Volkswagen, Volkswagen Lcv	17,46			180,0		30					6, 243, 245, 248, 276-278, 281-282, 286-288, 291, 296-297
151-032				RAD Alfa Romeo	17,46			228,0		42					1-3
151-033				RAI Alfa Romeo	17,46			203,0		39					1-3
151-034				RAD Citroën, Peugeot, Talbot	22,00			180,0		30					29, 31, 180, 262
151-035				RAD Citroën, Peugeot	20,64			180,0		30					29, 31, 180
151-036				RAD Citroën Lcv	22,00			228,0		40					35
151-037				RAI Fiat	17,50			228,0		40					55-58
151-038				RAD Ford Europe, Ford Lcv, Truck	17,46			180,0		30					71, 83
151-039				• RAI Peugeot, Peugeot Lcv	19,05			180,0		30					182-186, 197

NUMERICAL LIST



CIFAM ref.	H A N D B R A K E	C R C I	A D J	Marca - Make	Ø mm	Cilindretto Freno Wheel Cylinder		RapidKit Brake Shoe			Brake Drum			Pagina Page	
						CIFAM ref.		A	B	C	D (TH)	min. TH	N Fori Holes		Forma Shape
						Left	Right								
 Rapidkit - Premounted Kit															
151-040			RAI	Peugeot	19,05			180,0		40				184, 186	
151-041			RAD	Peugeot	20,64			228,0		42				188	
151-042			RAI	Peugeot, Renault, Renault Lcv, Truck	22,22			180,0		40				191-192, 214-215, 224-226, 228, 230-233	
151-043			RAD	Renault, Renault Lcv, Truck	22,00			180,0		30				223, 231	
151-044			RAD	Renault	22,00			180,0		40				207, 215-216	
151-045			VAG	Audi, Seat, Volkswagen, Volkswagen Lcv	15,87			180,0		30				7, 242-243, 276, 283-287, 290, 296	
151-046			RAD	Ford Europe	15,00			180,0		30				71	
151-047			RAD	Ford Europe	19,05			180,0		30				72-73	
151-048			• RAI	Renault, Renault Lcv, Truck	20,64			180,0		40				203-204, 217-219, 226-228, 230, 232-233	
151-049			RAI	Alfa Romeo, Fiat	20,64			228,0		40				1, 56-58	
151-050			• RAI	Citroën	20,64			180,0		30				33-34	
151-051			• RAI	Citroën, Peugeot	20,64			180,0		30				33-34, 192	
151-052			RAD	Fiat, Lancia	20,64			180,0		30				53, 111	
151-053			RAD	Ford Europe	20,64			180,0		30				71	
151-054			• RAI	Citroën, Peugeot	20,64			180,0		30				31-34, 189	
151-055			RAI	Fiat Lcv	20,64			228,0		40				63	
151-056			RAD	Alfa Romeo	19,05			228,0		40				2	
151-057			RAI	Alfa Romeo	22,00			203,0		39				1	
151-058			RAD	Fiat	22,00			180,0		30				47-48	
151-059			RAI	Renault, Renault Lcv, Truck	17,78			180,0		40				214, 224, 230	
151-060			• RAI	Peugeot	20,64			180,0		42				192	
151-061			RAI	Renault	17,46			203,0		38				210-211	
151-062			LUC	Renault, Renault Lcv, Truck	22,20			229,0		41				220-222, 230	
151-063			LUC	Renault	19,05			203,0		38				209-210	
151-065			LUC	Citroën Lcv, Fiat Lcv, Peugeot Lcv	27,00			254,0		57				35-36, 60-61, 199-200	
151-066			RAI	Citroën, Citroën Lcv, Fiat, Fiat Lcv, Lancia, Peugeot, Peugeot Lcv	19,05			255,0		60				29, 37-38, 58, 65, 112, 197, 199	
151-067			LUC	Renault	20,64			228,0		40				210-212, 221, 225	
151-068			LUC	Renault	22,20			228,0		40				210	
151-070			RAD	Renault Lcv, Truck	22,20			255,0		45				233	
151-072			LUC	Renault	22,20			229,0		42				207	
151-073			LUC	Citroën Lcv, Fiat Lcv, Peugeot Lcv	25,40			254,0		57				36-37, 61-62, 198	
151-074			LUC	Citroën Lcv, Fiat Lcv, Peugeot Lcv	28,60			254,0		57				36-37, 61-62, 198-199	
151-075			LUC	Citroën Lcv, Fiat Lcv, Peugeot Lcv	27,00			254,0		57				37, 62, 198	
151-077			RAI	Peugeot	20,64			228,0		40				195	
151-078			RAI	Peugeot	20,64			228,0		40				195	
151-079			LUC	Daewoo, Opel, Opel Lcv	19,05			200,0		45				39-40, 158-160, 175, 177	
151-080			LUC	Opel	17,46			200,0		30				162-163, 168-169	
151-081			LUC	Opel, Opel Lcv	19,05			200,0		28				158-160, 163-164, 174, 178	
151-082			LUC	Opel	19,05			200,0		45				169-172, 174-175	
151-084			VAG	Seat, Volkswagen, Volkswagen Lcv	17,46			200,0		40				243-248, 276, 278-280, 283, 287-288, 292, 297	
151-085			VAG	Audi, Skoda, Skoda Lcv, Volkswagen	19,05			200,0		40				9, 249-250, 253, 280, 285, 288-289	
151-086			VAG	Audi, Seat, Volkswagen	15,87			200,0		40				8-9, 242-243, 278-279, 283, 292	
151-087			LUC	Peugeot	20,64			228,0		40				193-195	
151-088			LUC	Renault	22,22			228,0		40				222-223	
151-089			RAI	Fiat	22,22			203,0		38				47-48, 50	
151-090			RAI	Fiat, Fiat Lcv	20,64			228,0		40				50-51, 64	
151-092			• RAI	Peugeot	20,64			180,0		32				187	
151-093			RAI	Peugeot	19,05			180,0		32				187	
151-094			• RAI	Peugeot	19,05			180,0		32				187	
151-095			LUC	Dacia, Renault, Renault Lcv, Truck	17,78			203,0		38				38-39, 204-205, 227-228	
151-096			RAI	Nissan Lcv, Renault, Lcv, Truck	22,00			228,0		42				154, 208-209, 228-229	
151-097			RAI	Nissan Lcv, Renault, Lcv, Truck	19,05			203,0		38				154, 208-209, 228-229	
151-098			RAI	Renault, Renault Lcv, Truck	19,05			180,0		42				204-205, 228	
151-099			VAG	Audi	17,46			230,0		40				5-6	

CIFAM ref.	H A N D B R A K E	C R C I	A D J	Marca - Make	Ø mm	Cilindretto Freno Wheel Cylinder		RapidKit Brake Shoe			Brake Drum			Pagina Page	
						CIFAM ref.		A	B	C	D (TH)	min. TH	N Fori Holes		Forma Shape
						Left	Right								
Rapidkit - Premounted Kit															
151-100			VAG	Volkswagen	20,64			230,0		40				285-286	
151-101			LUC	Citroën Lcv, Fiat Lcv, Peugeot Lcv	22,22			254,0		57				36, 60, 199-200	
151-102			LUC	Citroën Lcv, Fiat Lcv, Peugeot Lcv	25,40			254,0		57				35-36, 60-61, 199-200	
151-103			LUC	Citroën Lcv, Fiat Lcv, Peugeot Lcv	22,22			254,0		57				35, 65, 199	
151-105			LUC	Peugeot, Talbot	22,00			228,6		42				182, 187-188, 261-263	
151-106			LUC	Renault	22,22			228,6		42				207	
151-107			VAG	Audi, Volkswagen	17,46			200,0		40				5, 7-11, 283-285, 290	
151-108			VAG	Audi, Volkswagen	15,87			200,0		40				5, 7-8, 10, 285	
151-109			VAG	Audi	19,05			200,0		40				9-10	
151-110			LUC	Volvo	20,64			228,6		42				299	
151-111			LUC	Opel	17,46			200,0		46				157-158, 167-170	
151-112			LUC	Opel	17,46			200,0		46				168-170	
151-113			LUC	Opel	19,05			200,0		46				171	
151-114			LUC	Opel	17,46			200,0		46				171	
151-115			LUC	Opel	19,05			200,0		46				171	
151-116			LUC	Opel	17,46			200,0		46				171	
151-117			LUC	Opel	14,28			200,0		46				168	
151-119			LUC	Opel, Opel Lcv	14,28			200,0		29				162, 168, 178	
151-120			LUC	Opel, Opel Lcv	14,28			200,0		29				162, 166-168, 170, 178-179	
151-121			LUC	Opel, Opel Lcv	17,46			200,0		29				162, 178	
151-122			LUC	Opel	19,05			200,0		29				168-169	
151-123			LUC	Opel, Opel Lcv	17,46			200,0		29				158-160, 162-163, 178	
151-124			LUC	Daewoo, Opel	17,46			200,0		46				39-40, 158-160	
151-125			VAG	Skoda, Volkswagen Lcv	19,05			200,0		40				250-251, 294	
151-126			VAG	Skoda	22,22			200,0		40				251	
151-127			VAG	Skoda	20,64			200,0		40				251	
151-128			VAG	Skoda	19,05			200,0		40				251	
151-129			VAG	Audi	17,46			230,0		40				9	
151-130			VAG	Audi	19,05			230,0		40				9	
151-131			VAG	Audi, Seat Lcv, Volkswagen, Volkswagen Lcv	20,64			230,0		40				5-6, 248-249, 285-286, 292-294	
151-132			LUC	Renault	22,20			228,6		42				225	
151-133			LUC	Citroën, Peugeot	20,64			203,0		38				31-34, 189-190	
151-134			LUC	Peugeot, Peugeot Lcv	20,64			203,0		38				187, 197	
151-136			LUC	Citroën, Peugeot	20,64			203,0		38				30, 181-182	
151-137			LUC	Peugeot	20,64			228,6		40				194-195	
151-138			LUC	Opel Lcv, Renault Lcv, Truck	25,40			254,0		57				176, 179, 233-235	
151-139			LUC	Renault Lcv, Truck	25,40			254,0		57				229	
151-140			LUC	Citroën, Citroën Lcv, Peugeot Lcv	22,00			228,6		42				27, 33-35, 200	
151-141			LUC	Opel, Opel Lcv	19,05			230,0		42				158-161, 175-177	
151-142			RAI	Citroën	20,64			228,0		42				32	
151-143			RAI	Citroën, Peugeot	22,00			228,0		42				32, 189-191	
151-145			RAD	Fiat, Fiat Lcv	20,64			180,0		30				53-54, 64	
151-146			RAD	Fiat	22,00			180,0		30				53	
151-147			VAG	Seat Lcv, Skoda, Volkswagen Lcv	20,64			230,0		32				248-249, 251-252, 293-294	
151-148			VAG	Skoda	19,05			230,0		32				251-252	
151-149			LUC	Bmw	20,64			228,6		42				14-15	
151-150			LUC	Bmw	22,20			228,6		42				14-15	
151-151			RAD	Ford Europe, Mazda	19,05			180,0		29				73-74, 77, 80, 116	
151-152			LUC	Fiat, Fiat Lcv	20,64			228,6		42				48, 59-60	
151-153			AP	Ford Europe, Mazda	19,05			203,0		39				74, 76, 116	
151-154			RAI	Fiat	20,64			229,5		42,5				50-51	
151-155			RAI	Renault	17,46			203,0		39				204-205, 227	
151-156			RAI	Renault	20,64			180,0		42				227	
151-157			RAI	Renault	19,05			203,2		39				209-210	
151-158			VAG	Audi, Volkswagen	17,46			200,0		40				10, 283	
151-159			LUC	Opel	19,05			200,0		45				164, 174	
151-160			RAI	Renault	19,05			203,2		39				210-213	
151-161			• LUC	Renault	20,64			203,0		38				204-205	
151-162			RAI	Smart	22,00			200,0		32				253-254	

NUMERICAL LIST



CIFAM ref.	H A N D B R A K E	C R C I	A D J	Marca - Make	Ø mm	Cilindretto Freno Wheel Cylinder		RapidKit Brake Shoe			Brake Drum			Pagina Page	
						CIFAM ref.		A	B	C	D (TH)	min. TH	N Fori Holes		Forma Shape
						Left	Right								
 Rapidkit - Premounted Kit															
151-163			RAI Smart		17,46			200,0		32				253	
151-164		•	LUC Citroën		19,05			203,0		38				28	
151-165			LUC Citroën		20,64			203,0		38				28	
151-166			LUC Peugeot		20,64			203,0		38				179-180	
151-167			RAD Ford Europe		19,05			180,0		32				74, 77	
151-168			RAD Ford Europe		17,78			180,0		32				73-74, 76-77	
151-169			LUC Citroën Lcv, Fiat Lcv, Peugeot Lcv		22,20			254,0		57				37-38, 65, 199	
151-171			LUC Mercedes Benz		17,78			180,0		42				121-122	
151-172			LUC Mercedes Benz		19,05			180,0		42				121-122	
151-173			LUC Nissan		17,78			180,0		27				147	
151-174			LUC Nissan		17,78			180,0		28				147-148	
151-175			LUC Opel Lcv		19,05			230,0		50				177	
151-176			LUC Opel, Opel Lcv		19,05			230,0		42				160-161, 177-178	
151-177			LUC Opel, Opel Lcv		20,64			230,0		42				161, 175-177	
151-178			VAG Skoda		19,05			230,0		40				252	
151-179			LUC Toyota		20,64			228,6		35				263-264	
151-180			RAI Dacia		19,05			203,2		39				38-39	
151-181			RAD Fiat, Fiat Lcv		20,64			180,0		32				52, 64	
151-182			RAI Toyota		19,05			200,0		32				273	
151-183			RAI Citroën, Peugeot, Toyota		17,46			200,0		32				27-28, 182, 264	
151-184			RAI Suzuki		19,05			200,0		32				259-260	
151-185			LUC Chevrolet, Daewoo		17,46			180,0		31				22, 40	
151-186			LUC Daewoo		17,46			180,0		31				41	
151-187			LUC Opel		15,87			180,0		26				156	
151-188			RAI Lancia		19,05			203,2		39				111-112	
151-189			RAI Lancia		20,64			203,2		39				111-112	
151-190			RAI Citroën, Citroën Lcv, Peugeot		20,64			203,2		39				28, 35, 179-180	
151-191			LOS Ford Europe		19,05			180,0		32				70, 73-74, 80	
151-192			LOS Ford Europe, Mazda		17,78			180,0		32				73, 77, 116	
151-193			LUC Peugeot, Peugeot Lcv		20,64			203,0		39				187, 197	
151-194			RAI Fiat		20,64			180,0		30				46, 52	
151-195			LOS Land Rover		20,64			254,0		39				113-114	
151-196			LUC Chevrolet, Daewoo		19,05			200,0		37				21-22, 39	
151-197			LOS Ford Europe		20,64			203,2		39				75	
151-198			LOS Ford Europe		19,05			203,2		39				75	
151-199			LOS Ford Europe		22,20			203,2		39				75	
151-201			RAI Fiat, Suzuki		19,05			220,0		36				55, 260	
151-202			LOS Ford Europe		22,22			203,0		38				77-78	
151-203			AKE Toyota		17,46			203,0		32				273	
151-204			AKE Toyota		17,46			203,0		32				273	
151-205		•	RAI Peugeot, Peugeot Lcv		20,64			228,6		42				187, 197	
151-206			RAI Suzuki		17,46			203,2		32				259	
151-207			LUC Opel		15,87			200,0		29				156-157	
151-208			AKE Toyota		19,05			228,6		42				272	
151-209			MANDO Hyundai		17,78			180,0		32				93	
151-210			MANDO Hyundai		17,78			180,0		38				92	
151-211			MANDO Hyundai		19,05			180,0		38				92	
151-212			MANDO Hyundai		19,05			203,2		39				93-96	
151-213			MANDO Hyundai		17,78			180,0		32				94-95	
151-214			LUC Mitsubishi		19,05			203,2		39				139	
151-215			MANDO Hyundai		17,78			203,2		32				94-95	
151-216			AP Fiat		22,00			228,6		42				50	
151-217			AP Fiat		20,64			203,2		39				50	
151-218			AP Fiat		20,64			203,2		39				54	
151-219			AP Fiat, Fiat Lcv		22,00			203,0		38				49, 54, 64	
151-220			AP Fiat, Fiat Lcv, Lancia		22,00			203,2		39				49, 64, 110-111	
151-221			AP Fiat		20,64			203,0		38				54	
151-222			AP Opel, Opel Lcv		19,05			203,0		38				165, 179	
151-223			AP Opel, Opel Lcv		19,05			228,0		40				165, 179	
151-224			AP Fiat		20,64			228,0		40				49-50	
151-225			AP Fiat		20,64			203,0		38				49	

CIFAM ref.	H A N D	B R A K E	C R C I	A D J	Marca - Make	Ø mm	Cilindretto Freno Wheel Cylinder		RapidKit Brake Shoe			Brake Drum			Pagina Page	
							CIFAM ref.		A	B	C	D (TH)	min. TH	N Fori Holes		Forma Shape
							Left	Right								
 Rapidkit - Premounted Kit																
151-226				AP	Fiat, Fiat Lcv	20,64			228,6		43				48-49, 59-60	
151-227				AP	Citroën Lcv, Fiat Lcv, Peugeot Lcv	20,64			228,6		43				38, 64, 198	
151-228				AP	Ford Europe	19,05			203,2		38				73	
151-229				AP	Ford Europe	20,64			228,6		43				75-76	
151-230				AP	Ford Lcv, Truck	20,64			228,6		58				84	
151-231				AP	Nissan, Renault	19,05			203,0		38				148, 153, 205-206, 208, 213-214	
151-232				RAI	Fiat Lcv	19,05			228,6		42				65	
151-233				AKE	Toyota	19,05			203,0		32				273	
151-234				LUC	Daewoo, Opel	20,64			200,0		45				40, 164	
151-235				VAG	Audi, Seat, Volkswagen	15,87			200,0		40				10, 242-243, 278-279, 283	
151-236				MANDO	Hyundai	19,05			203,2		39				93	
151-237				LUC	Ford Europe	22,20			203,0		38				70	
151-238				LUC	Ford Europe	19,05			203,0		38				70	
 Ganasce Freno - Brake Shoes																
153-001					Alfa Romeo, Renault Lcv, Truck				203,2		39				2-3, 231-232	
153-002	•				Alfa Romeo, Fiat, Renault, Renault Lcv, Truck				203,2		39				1-3, 47-48, 50, 211-212, 231-232	
153-002Y	•				Alfa Romeo, Renault, Lcv, Truck				203,2		39				1-3, 211-212, 231-232	
153-003					Reliant, Rover				177,8		38				203, 237, 239	
153-004	•				Daf, Innocenti, Reliant, Rover				177,8		32				41, 99, 203, 235, 237-240	
153-005					Rover				203,2		38				238-240	
153-006	•				Honda, Rover				203,0		38				90-91, 235-238, 240	
153-007					Reliant, Rover				254,0		45				203, 239	
153-008	•				Audi, Volkswagen, Volkswagen Lcv				230,0		40				5-6, 278, 282, 285-286, 292-293	
153-009	•				Audi, Seat Lcv, Volkswagen, Volkswagen Lcv				230,0		40				6, 9, 248-249, 278-279, 285-286, 292-295	
153-010	•				Bmw				250,0		42				13-14, 18	
153-011	•				Alfa Romeo, Bmw, Mercedes Benz, Nsu, Peugeot				160,0		25				1, 3-4, 14, 18-20, 130, 133, 156, 195	
153-011K	•				Alfa Romeo, Bmw, Mercedes Benz, Nsu, Peugeot				160,0		25				1, 3-4, 14, 18-20, 130, 133, 156, 195	
153-012	•				Bmw				250,0		42				18	
153-013	•				Alpina, Bmw				180,0		25				4, 16, 18-21	
153-013K	•				Alpina, Bmw				180,0		25				4, 16, 18-21	
153-014	•				Bmw, Renault, Renault Lcv, Truck				228,6		42				14-15, 225, 232	
153-015	•				Bmw				228,6		42				15-16	
153-016	•				Bmw				160,0		25				15-16, 21	
153-016K	•				Bmw				160,0		25				15-16, 21	
153-017	•				Bmw				185,0		20				13, 16-20	
153-017K	•				Bmw				185,0		20				16-19	
153-018	•				Bmw				160,0		20				13-17, 21	
153-018K	•				Bmw				160,0		20				13-17, 21	
153-019	•				Bmw, Volkswagen, Lcv				185,0		30				16-21, 291, 296, 298	
153-019K	•				Bmw, Volkswagen, Lcv				185,0		30				16-21, 291, 296, 298	
153-021K	•				Citroën, Mega, Peugeot				165,0		30				25-27, 29-30, 120-121, 180	
153-021Y					Citroën, Mega, Peugeot				165,0		30				25-27, 29-30, 120-121, 180	
153-022	•				Citroën, Peugeot				180,0		32				31-34, 188-190	
153-022Y	•				Citroën, Peugeot				180,0		32				31-34, 188-190	
153-023	•				Citroën, Peugeot, Peugeot Lcv, Renault				228,6		42				27, 33, 194-195, 200, 207	
153-024Y	•				Citroën, Mega, Peugeot				165,0		30				25-27, 29-30, 120-121, 180	
153-025	•				Citroën, Peugeot				203,2		39				28, 179-180	
153-026	•				Chrysler, Dodge, Kia				254,0		57				23-25, 44, 106	
153-027	•				Chrysler, Chrysler Usa, Dodge				180,0		30				24-25, 44	
153-028	•				Chrysler, Chrysler Usa				200,0		34				23, 25	
153-029	•				Chrysler, Chrysler Usa, Dodge				220,0		42				23-25, 44	

NUMERICAL LIST

CIFAM ref.	H A N D B R A K E	C R C I	A D J	Marca - Make	Ø mm	Cilindretto Freno Wheel Cylinder		RapidKit Brake Shoe			Brake Drum			Pagina Page	
						CIFAM ref.		A	B	C	D (TH)	min. TH	N Fori Holes		Forma Shape
						Left	Right								
 Ganasce Freno - Brake Shoes															
153-030	•			Chrysler				200,0		33				24	
153-031	•			Chrysler				172,0		20				23-24	
153-032				Chrysler				228,6		45				24	
153-033				Bertone, Daihatsu				254,0		45				13, 42-43	
153-034				Daihatsu				165,0		25				42	
153-035				Bedford, Daihatsu				180,0		35				13, 42-43	
153-036				Daihatsu				180,0		26				41-42	
153-037				Daihatsu, Subaru, Suzuki, Tata				200,0		30				41-42, 256-258, 260, 263	
153-038				Daihatsu				165,0		25				42-43	
153-039				Daihatsu				180,0		38				42-43	
153-040				Daihatsu, Daihatsu Lcv, Piaggio				200,0		38				42-43, 200	
153-041				Daihatsu				180,0		31				43	
153-042				Daihatsu				165,0		28				43	
153-043				Daihatsu, Subaru				180,0		28				42-43, 256	
153-044				Daihatsu Lcv, Piaggio				203,2		38				43-44, 200-201	
153-045				Daihatsu				165,0		26				42	
153-046	•			Chevrolet, Daewoo				180,0		31				22, 40	
153-047				Daewoo				180,0		31				41	
153-048				Daewoo				230,0		52				40	
153-049	•			Chevrolet, Daewoo				230,0		52				22, 40-41	
153-050	•			Chevrolet, Daewoo				200,0		37				21-22, 39	
153-052	•			Chevrolet, Suzuki				170,0		26				22, 258	
153-052K *	•			Chevrolet, Suzuki				170		26				22, 258	
153-053	•			Aixam, Bellier, Casalini, Chatenet, Ligier				160,0		42				1, 13, 21, 115	
153-054	•			Aixam, Bellier, Casalini, Chatenet, Ligier, Vau				180,0		32				1, 13, 21, 115, 275	
153-055				Fiat, Fso				170,0		31				45-46, 87-88	
153-060	•			Fiat Lcv, Lada				250,0		51				59, 108-110	
153-062	•			Alfa Romeo Lcv, Auverland, Citroën Lcv, Fiat Lcv, Ford, Peugeot Lcv, Talbot				254,0		57				4, 11, 35-36, 60-61, 65, 76, 199-200, 262	
153-063	•			Autobianchi, Fiat, Fiat Lcv, Fso, Innocenti, Lancia, Seat, Seat Lcv, Zastava				185,0		31				11, 45, 47-49, 52, 54-55, 58-59, 63-65, 88, 99, 110-111, 241-242, 244-245, 247, 249, 304-305	
153-064	•			Alfa Romeo Lcv, Iveco				254,0		90				4, 101-102	
153-065				Iveco				254,0		90				102	
153-066	•			Fiat, Lancia, Zastava				180,0		32				53, 55-58, 110-111, 305	
153-066J	•			Fiat, Lancia, Zastava				180,0		32				53, 55-58, 110-111, 305	
153-067	•			Alfa Romeo, Fiat, Fiat Lcv				228,6		42				1, 50-51, 56-58, 63, 65	
153-067J	•			Alfa Romeo, Fiat, Fiat Lcv				228,6		42				1, 50-51, 56-58, 63, 65	
153-068				Auverland, Citroën Lcv, Fiat Lcv, Peugeot Lcv				254,0		57				11, 36, 60-61, 200	
153-069	•			Autobianchi, Fiat, Fiat Lcv				185,0		31				11, 52, 58-59, 65	
153-070	•			Fiat, Lancia				180,0		32				47-48, 53, 110-111	
153-070J	•			Fiat, Lancia				180,0		32				47-48, 53, 110-111	
153-071	•			Fiat Lcv, Opel Lcv, Renault Lcv, Truck				254,0		57				60-61, 176, 179, 229-230, 233-235	
153-072	•			Citroën Lcv, Fiat Lcv, Peugeot Lcv				254,0		57				36-37, 61-62, 198	
153-073	•			Citroën Lcv, Fiat Lcv, Peugeot Lcv				254,0		57				36-37, 61-63, 65, 198-199	
153-074	•			Citroën, Citroën Lcv, Fiat, Fiat Lcv, Lancia, Peugeot, Peugeot Lcv				256,0		61				29, 36-38, 58, 64-65, 112, 197, 199	
153-074Y	•			Citroën, Citroën Lcv, Fiat, Fiat Lcv, Lancia, Peugeot, Peugeot Lcv				256,0		61				29, 36-38, 58, 64-65, 112, 197, 199	
153-075				Fiat, Fiat Lcv				228,6		42				50-51, 63, 65	
153-076	•			Fiat				203,2		39				47-48, 50	
153-077				Iveco, Renault Lcv, Truck				170,0		45				102, 229	
153-077K	•			Iveco, Renault Lcv, Truck				170,0		45				102, 229	
153-078	•			Fiat				185,0		29				47, 51	
153-079				Fiat, Fiat Lcv				180,0		32				53, 64	
153-079Y	•			Fiat, Fiat Lcv				180,0		32				53, 64	
153-080	•			Fiat, Fiat Lcv				180,0		32				53, 64	
153-080Y	•			Fiat, Fiat Lcv				180,0		32				53, 64	

CIFAM ref.	H A N D B R A K E	C R C I	A D J	Marca - Make	Ø mm	Cilindretto Freno Wheel Cylinder		RapidKit Brake Shoe			Brake Drum			Pagina Page	
						CIFAM ref.		A	B	C	D (TH)	min. TH	N Fori Holes		Forma Shape
						Left	Right								
 Ganasce Freno - Brake Shoes															
153-081Y				Fiat				228,6		42				48	
153-082				Citroën Lcv, Fiat Lcv, Peugeot Lcv				254,0		57				36-37, 62-63, 198-199	
153-083				Fiat				180,0		32				46, 52	
153-084	•			Fiat, Lancia				203,2		39				49, 54, 110	
153-085	•			Citroën, Lancia, Peugeot				203,2		39				28, 111-112, 179-180	
153-086	•			Iveco				190,0		42				102	
153-086K	•			Iveco				190,0		42				102	
153-087				Fiat, Fiat Lcv				228,6		42				51, 63, 65	
153-088				Fiat, Lancia				228,6		43				48-49, 111	
153-089				Citroën Lcv, Fiat Lcv, Peugeot Lcv				170,0		45				37, 62-63, 198-199	
153-089K				Citroën Lcv, Fiat Lcv, Peugeot Lcv				170,0		45				37, 62-63, 198-199	
153-090				Fiat				180,0		30				46, 52	
153-091				Fiat				203,0		38				49, 54	
153-092	•			Fiat, Opel, Opel Lcv				203,0		38				49, 165, 179	
153-093	•			Fiat, Opel, Opel Lcv				228,0		40				49-50, 165, 179	
153-094				Citroën Lcv, Fiat Lcv, Peugeot Lcv				172,0		40				37-38, 63, 199	
153-095K				Citroën Lcv, Fiat Lcv, Peugeot Lcv				172,0		40				37, 63, 199	
153-096				Fiat, Suzuki				220,0		36				55, 260	
153-097	•			Iveco, Renault Lcv, Truck				170,0		45				102, 229	
153-097K	•			Iveco, Renault Lcv, Truck				170,0		45				102, 229	
153-098				Fiat				185,0		29				51-52	
153-099	•			Citroën Lcv, Fiat Lcv, Peugeot Lcv				228,6		43				38, 64, 198	
153-100	•			Daewoo, Ford, Ford Lcv, Truck, Hyundai, Lcv, Mercedes Lcv, Truck, Nissan Lcv, Renault Lcv, Truck, Ssangyong				254,0		57				39-40, 66, 76, 83, 97-98, 136, 153-154, 229, 234-235, 254-255	
153-101	•			Bedford, Ford, Lcv, Truck, Innocenti, Lotus, Rover, Talbot				203,2		38				12, 66-67, 82, 99, 116, 237-238, 240, 262-263	
153-102	•			Ford Lcv, Truck, Rover				228,6		45				84-85, 239-240	
153-103	•			Daf, Ford Europe, Ford Lcv, Truck, Hyundai, Rover, Volvo				203,2		38				41, 66-67, 82, 96, 238, 299	
153-104				Ford Europe, Ford Lcv, Truck				228,6		45				66-67, 82	
153-105				Ford Europe				180,0		32				67-69, 78-79	
153-106				Ford Europe, Ford Lcv, Truck				203,2		38				67-69, 78-79, 82	
153-107	•			Ford Europe				203,2		38				80	
153-108	•			Ford Europe, Ford Lcv, Truck				228,6		57				80-81, 83	
153-109	•			Alfa Romeo Lcv, Bedford, Daf, Ford Lcv, Truck, Iveco, Ldv, Rover				254,0		70				4, 12, 41, 85, 101-102, 114, 240	
153-111K	•			Ford Europe, Ford Lcv, Truck				178,0		32				71, 83	
153-112K	•			Ford Europe				203,2		38				80-81	
153-113				Ford Europe				180,0		32				67-69, 78-79	
153-114	•			Carbodies, Ford Lcv, Truck				254,0		70				21, 85	
153-115	•			Ford Lcv, Truck, Morgan				228,6		45				83, 85, 145	
153-116	•			Ford Lcv, Truck				254,0		70				85	
153-117K	•			Ford Europe, Ford Lcv, Truck				178,0		32				71-73, 83	
153-117Y				Ford Europe, Ford Lcv, Truck				178,0		32				71-73, 83	
153-118K				Ford Europe, Ford Lcv, Truck				203,2		38				71-73, 83	
153-119	•			Ford Europe				180,0		32				69-70, 79	
153-120	•			Ford Europe				203,0		39				69-70, 79-80	
153-121				Ford Lcv, Truck				228,6		45				82-83	
153-122	•			Ford Lcv, Truck				254,0		50				85-86	
153-123	•			Ford Lcv, Truck				280,0		64				83-86	
153-124	•			Ford Europe				203,0		38				70, 77-78	
153-125	•			Ford Europe				228,6		45				78	
153-126	•			Ford Lcv, Truck				254,0		50				83-84, 86	
153-127	•			Ford Lcv, Truck, Opel Lcv, Renault Lcv, Truck				280,0		64				83-84, 86, 179, 230	
153-128	•			Ford, Ford Lcv, Truck, Mazda				180,0		32				69-70, 73-74, 76-77, 80, 83, 116	
153-129				Ford Europe, Ford Lcv, Truck				203,2		39				70, 83	
153-130	•			Ford Europe				228,6		45				77-78	
153-131Y	•			Ford Europe, Ford Lcv, Truck				178,0		32				71, 83	
153-132Y				Ford Europe, Ford Lcv, Truck				178,0		32				71-73, 83	
153-133	•			Ford Europe				203,2		39				75	

NUMERICAL LIST





CIFAM ref.	H A N D B R A K E	C R C I	A D J	Marca - Make	Ø mm	Cilindretto Freno Wheel Cylinder		RapidKit Brake Shoe			Brake Drum			Pagina Page	
						CIFAM ref.		A	B	C	D (TH)	min. TH	N Fori Holes		Forma Shape
						Left	Right								
 Ganasce Freno - Brake Shoes															
153-134	•			Ford Lcv, Truck, Ldv				280,0		65				86-87, 114	
153-135				Ford Lcv, Truck				254,0		52				86-87	
153-136	•			Ford Europe, Ford Lcv, Truck, Mazda				203,2		38				73-74, 76, 80-81, 83, 116	
153-137	•			Ford Europe				180,0		32				73-74, 76-77, 80	
153-138	•			Ford Lcv, Truck				228,6		58				84	
153-139	•			Daf, Ford Lcv, Truck, Ldv				254,0		57				41, 84, 114	
153-142				Ford Europe				228,6		43				75-76	
153-143	•			Ford Europe, Mazda Lcv				295,0		56				80, 120	
153-144	•			Ford Europe, Mazda Lcv				270,0		54				80, 120	
153-145	•			Ford Europe, Kia				180,0		25				68-70, 79-80, 107-108	
153-145K	•			Ford Europe, Kia				180,0		25				68-70, 79-80, 107-108	
153-146	•			Ford Usa, Jeep				184,0		30				87, 104-105	
153-147				Ford Usa				185,0		30				87	
153-148	•			Mazda				200,0		32				116	
153-149				Honda				200,0		35				88	
153-150				Honda, Rover				180,0		31				89-91, 235	
153-151				Honda				200,0		30				89, 91	
153-152				Honda, Rover				180,0		25				88-89, 91-92, 237	
153-153	•			Honda				200,0		35				88-92	
153-154				Honda, Suzuki, Suzuki Lcv				220,0		35				88-91, 258, 261	
153-155	•			Honda				180,0		31				90-91	
153-156				Honda				180,0		30				92	
153-157				Honda				228,6		42				89	
153-158				Honda				180,0		32				91	
153-159				Acura, Honda, Isuzu				170,0		35				1, 89, 91-92, 100	
153-159K				Acura, Honda, Isuzu				170,0		35				1, 89, 91-92, 100	
153-160				Honda				254,0		47				92	
153-161				Honda				198,0		35				91	
153-161K *	•			Honda				198		35				91	
153-162				Honda				198,0		35				91	
153-162K *	•			Honda				198		35				91	
153-163				Hummer				205,0		45				92	
153-164				Hummer				210,0		35				92	
153-165	•			Hyundai, Mitsubishi				180,0		34				94, 96, 143	
153-166				Hyundai				203,2		39				93-95	
153-167	•			Hyundai, Mitsubishi				180,0		35				92, 94, 96, 143	
153-168				Hyundai				180,0		32				93	
153-169				Hyundai				180,0		32				92	
153-170				Hyundai				180,0		38				92	
153-171	•			Hyundai				203,2		39				93-96	
153-172	•			Chrysler, Hyundai				254,0		55				24, 96-97	
153-172Y	•			Chrysler, Hyundai				254,0		55				24, 96-97	
153-173	•			Hyundai, Hyundai Lcv, Mitsubishi				270,0		54				94, 98, 140	
153-174				Hyundai Lcv				220,0		47				98	
153-175				Hyundai, Kia				228,6		45				95-98, 107	
153-176	•			Hyundai				203,2		39				93-96	
153-177				Hyundai				203,2		32				94	
153-178				Hyundai				180,0		32				94	
153-179K *	•			Hyundai, Hyundai Lcv, Kia				190		40				93-94, 96-98, 108	
153-179Y	•			Hyundai, Hyundai Lcv, Kia				190,0		40				93-94, 96-98, 108	
153-180	•			Hyundai, Kia				254,0		57				96, 106	
153-181				Hyundai Lcv				295,0		54				98	
153-182				Hyundai, Kia				203,2		32				93, 107	
153-183				Hyundai				190,0		40				97	
153-183K				Hyundai				190,0		40				97	
153-184	•			Hyundai, Kia				170,0		27				97-98, 108	
153-184K	•			Hyundai, Kia				170,0		27				97-98, 108	
153-185				Hyundai, Kia				170,0		27				95, 106-107	
153-185K *	•			Hyundai, Kia				170		27				95, 106-107	
153-186				Hyundai, Kia				170,0		32				94, 97, 107	
153-186K *	•			Hyundai, Kia				170		32				95-97, 107	

CIFAM ref.	H A N D B R A K E	C R C I	A D J	Marca - Make	Ø mm	Cilindretto Freno Wheel Cylinder		RapidKit Brake Shoe			Brake Drum			Pagina Page	
						CIFAM ref.		A	B	C	D (TH)	min. TH	N Fori Holes		Forma Shape
						Left	Right								
 Ganasce Freno - Brake Shoes															
153-187				Hyundai, Kia				170,0		32				93, 107	
153-187K *	•			Hyundai, Kia				170		32				93, 107	
153-188				Hyundai				212,0		40				95	
153-189				Hyundai				203,2		32				95	
153-190	•			Bedford, Isuzu, Opel				254,0		50				12-13, 100-101, 172	
153-191	•			Bedford, Isuzu, Opel Lcv				254,0		50				13, 100-101, 177	
153-192	•			Bedford, Isuzu, Opel				254,0		52				12, 100-101, 165	
153-193				Isuzu				295,0		47				100	
153-194				Isuzu				254,0		52				100	
153-194Y *				Isuzu				254		52				100	
153-195				Isuzu				210,0		31				101	
153-197	•			Jaguar				180,0		30				103	
153-197K	•			Daimler, Jaguar				180,0		30				44, 103	
153-198	•			Mazda				200,0		33				116-119	
153-199				Asia Motors, Kia, Mazda Lcv				260,0		45				5, 107, 119-120	
153-200	•			Mazda				180,0		30				117	
153-201	•			Mazda				200,0		25				118	
153-202	•			Asia Motors, Kia Lcv, Mazda Lcv				260,0		50				5, 108, 120	
153-203	•			Mazda				200,0		25				117	
153-204	•			Mazda				228,6		25				117	
153-205	•			Ford Usa, Mazda				228,6		32				87, 117-119	
153-206				Kia, Mazda				170,0		25				107, 116	
153-207	•			Mazda, Sao				200,0		25				117-118, 241	
153-208	•			Mazda, Mazda Lcv				260,0		50				119-120	
153-209	•			Mazda, Mazda Lcv				260,0		50				119-120	
153-210	•			Mazda				200,0		35				117, 119	
153-211	•			Mazda				180,0		31				116	
153-212	•			Kia, Mazda				228,6		32				106-107, 119	
153-213	•			Kia				200,0		36				107-108	
153-214	•			Mazda				200,0		37				118	
153-215	•			Kia				252,0		57				108	
153-216	•			Ford Europe, Mazda				228,6		42				77, 118-119	
153-217	•			Kia				200,0		36				107-108	
153-218				Mazda				254,0		52				119	
153-219	•			Mazda				200,0		32				119	
153-220				Kia				200,0		26				107	
153-221	•			Hyundai Lcv, Kia, Lcv, Mazda Lcv				220,0		57				98, 107-108, 120	
153-222				Mazda Lcv				220,0		57				120	
153-223				Mazda Lcv				270,0		52				120	
153-225				Kia				254,0		57				106	
153-226	•			Kia				295,0		54				106	
153-227	•			Kia				190,0		40				108	
153-227K				Kia				190,0		40				108	
153-228				Mazda				190,0		32				119	
153-229				Kia				180,0		32				107	
153-230				Kia				190,0		32				108	
153-231				Kia				190,0		32				106	
153-232				Mercedes Benz				160,0		25				134	
153-232K				Mercedes Benz				160,0		25				134	
153-233	•			Chrysler, Mercedes Benz				164,0		20				23, 121-128, 132-136	
153-233K	•			Chrysler, Mercedes Benz				164,0		20				23, 121-128, 132-136	
153-234	•			Mercedes Benz				164,0		25				125-127, 130, 133-135	
153-234K	•			Mercedes Benz				164,0		25				125-127, 130, 133-135	
153-235	•			Mercedes Benz				180,0		42				121-122	
153-236	•			Mercedes , Lcv, Truck				180,0		20				132, 136, 138	
153-236K	•			Mercedes Lcv, Truck				180,0		20				132, 136, 138	
153-237	•			Smart				200,0		32				253-254	
153-238	•			Mercedes Benz Lcv, Truck				230,0		35				137	
153-239	•			Mercedes, Lcv, Truck, VW Lcv				160,0		40				129, 136-138, 296	
153-239K	•			Mercedes, Lcv, Truck, VW Lcv				160,0		40				129, 136-138, 296	
153-240	•			Mercedes, Lcv, Truck, VW Lcv				170,0		40				136-138, 296	

NUMERICAL LIST

CIFAM ref.	H A N D B R A K E	C R C I	A D J	Marca - Make	Ø mm	Cilindretto Freno Wheel Cylinder		RapidKit Brake Shoe			Brake Drum			Pagina Page	
						CIFAM ref.		A	B	C	D (TH)	min. TH	N Fori Holes		Forma Shape
						Left	Right								
 Ganasce Freno - Brake Shoes															
153-240K	•			Mercedes, Lcv, Truck, VW Lcv				170,0		40				136-138, 296	
153-241	•			Mercedes Benz				180,0		25				130-131	
153-241K	•			Mercedes Benz				180,0		25				130-131	
153-242	•			Chrysler, Dodge, Mercedes Benz				183,0		31				22-23, 44, 129	
153-242K	•			Chrysler, Dodge, Mercedes Benz				183,0		31				22-23, 44, 129	
153-243	•			Mercedes Benz				180,0		25				127-128, 133-134	
153-243K	•			Mercedes Benz				180,0		25				127-128, 133-134	
153-244	•			Audi, Land Rover, Mercedes Benz, Porsche, Volkswagen				210,0		31				11, 114, 129-130, 202, 291	
153-244K	•			Audi, Land Rover, Mercedes Benz, Porsche, Volkswagen				210,0		31				11, 114, 129-130, 202, 291	
153-245	•			Mercedes Benz				170,0		25				124-125	
153-245K	•			Mercedes Benz				170,0		25				124-125	
153-246	•			Mercedes, Lcv, Truck, VW Lcv				180,0		25				137, 295	
153-246K	•			Mercedes, Lcv, Truck, VW Lcv				180,0		25				137, 295	
153-247	•			Mercedes Benz				180,0		25				121, 131-132	
153-247K	•			Mercedes Benz				180,0		25				121, 131-132	
153-248	•			Mercedes Benz, Lcv, Truck				186,0		20				136, 138	
153-248K	•			Mercedes Benz, Lcv, Truck				186,0		20				136, 138	
153-249	•			Dodge, Mercedes Benz Lcv, Truck, Volkswagen Lcv				174,0		42				44, 137, 295	
153-249K *	•			Mercedes, Lcv, Truck, VW Lcv				174		42				137, 295	
153-250	•			Mercedes Benz				180,0		25				129	
153-250K	•			Mercedes Benz				180,0		25				129	
153-251	•			Dodge, Dodge Truck, Mitsubishi, Mitsubishi Lcv				254,0		50				44, 141-144	
153-251Y	•			Dodge, Dodge Truck, Mitsubishi, Mitsubishi Lcv				254,0		50				44, 141-144	
153-252	•			Mitsubishi				203,0		37				139-142, 144	
153-253	•			Eagle, Hyundai, Isuzu, Mitsubishi, Proton				180,0		36				44, 94, 100, 138-139, 141-142, 144, 202	
153-253Y	•			Eagle, Hyundai, Isuzu, Mitsubishi, Proton				180,0		36				44, 94, 100, 138-139, 141-142, 144, 202	
153-256	•			Chrysler, Eagle, Mitsubishi				228,6		40				24, 44, 139-140, 142-143	
153-257	•			Mitsubishi				203,0		37				138-143	
153-258	•			Eagle, Mitsubishi, Proton				180,0		37				44, 139, 141-142, 202-203	
153-259	•			Mitsubishi				203,2		40				138-139, 143-144	
153-260	•			Mitsubishi, Mitsubishi Lcv				270,0		52				141, 143-144	
153-261	•			Mitsubishi				228,6		32				141-144	
153-263	•			Mitsubishi				203,2		32				142	
153-264	•			Mitsubishi				197,0		40				142-143	
153-264K	•			Mitsubishi				197,0		40				142-143	
153-265	•			Chrysler, Mitsubishi				167,0		32				24, 138, 140, 142-144	
153-265K	•			Chrysler, Mitsubishi				167,0		32				24, 138, 140, 142-144	
153-266	•			Mitsubishi				203,2		39				139	
153-267	•			Mitsubishi				200,0		32				143	
153-267K *	•			Mitsubishi				200		32				143	
153-268	•			Citroën, Mitsubishi, Peugeot, Subaru				190,0		32				28, 142, 193, 256	
153-268K	•			Citroën, Mitsubishi, Peugeot, Subaru				190,0		32				28, 142, 193, 256	
153-269	•			Mitsubishi				300,0		51				141	
153-270	•			Nissan, Nissan Lcv				203,2		36				151, 154	
153-271	•			Nissan, Nissan Lcv				228,6		40				145-147, 151, 153, 156	
153-272	•			Alfa Romeo, Nissan				180,0		35				3, 146, 150, 152	
153-273	•			Nissan				180,0		28				147	
153-274	•			Nissan Lcv				254,0		46				153-156	
153-275	•			Nissan, Nissan Lcv				270,0		50				146, 149, 153	
153-277	•			Hyundai, Nissan, Nissan Lcv				228,6		40				97, 146-147, 149-152, 156	
153-278	•			Nissan, Nissan Lcv				254,0		60				148-149, 155	
153-279	•			Nissan, Nissan Lcv				260,0		50				149, 151-153, 155-156	
153-280	•			Nissan				295,0		60				146, 149	

CIFAM ref.	H A N D B R A K E	C R C I	A D J	Marca - Make	Ø mm	Cilindretto Freno Wheel Cylinder		RapidKit Brake Shoe			Brake Drum			Pagina Page	
						CIFAM ref.		A	B	C	D (TH)	min. TH	N Fori Holes		Forma Shape
						Left	Right								
 Ganasce Freno - Brake Shoes															
153-281	•			Nissan				180,0		31				145, 148, 151-152	
153-282	•			Infiniti, Nissan, Nissan Lcv				295,0		50				99, 149, 155	
153-283				Nissan				203,0		38				145, 150	
153-283Y *				Nissan				203		38				145, 150	
153-284	•			Nissan				180,0		27				147	
153-286	•			Nissan				203,2		38				150	
153-287	•			Ford Europe, Nissan, Nissan Lcv				254,0		57				77, 151-152, 156	
153-288	•			Nissan				180,0		28				147	
153-289				Nissan				203,2		47				149	
153-290	•			Nissan, Renault				203,0		38				148, 153, 205-206, 208, 213-214	
153-291	•			Nissan, Nissan Lcv				280,0		65				152-154	
153-292	•			Nissan				203,2		37				145	
153-293	•			Nissan				170,0		22				153	
153-293K	•			Nissan				170,0		22				153	
153-294	•			Infiniti, Nissan				172,0		32				99, 145, 147	
153-295	•			Nissan, Renault				172,0		32				146-147, 150, 153, 209	
153-296				Chrysler, Dodge, Nissan				228,6		37				24, 44, 151	
153-297	•			Infiniti, Nissan				190,0		33				99, 148	
153-297K *	•			Infiniti, Nissan				190		33				98-99, 148	
153-298	•			Nissan				190,0		33				148-149	
153-298K *	•			Nissan				190		33				148-149	
153-299				Infiniti				172,0		27				99	
153-300	•			Opel				200,0		29				166	
153-301	•			Bedford, Opel				230,0		51				12, 157, 161-162, 166, 172-174	
153-302	•			Opel, Saab				160,0		25				156, 160-161, 165, 170, 172-173, 175-176, 240-241	
153-302K	•			Opel, Saab				160,0		25				156, 160-161, 165, 170, 172-173, 175-176, 240-241	
153-303	•			Opel				200,0		29				162, 166-167	
153-304	•			Bedford, Opel				200,0		46				12, 157-158, 166-168	
153-305	•			Bedford, Opel, Opel Lcv				200,0		45				12, 157-158, 166-172, 174-175, 179	
153-306	•			Bedford, Opel, Opel Lcv				230,0		50				12, 167-172, 174-175, 177, 179	
153-307	•			Opel, Opel Lcv				200,0		29				162-163, 166-172, 178-179	
153-308	•			Opel				200,0		29				158-160, 162-164, 174-175	
153-309	•			Daewoo, Opel, Opel Lcv				200,0		45				39-40, 158-160, 164, 174-177	
153-310				Opel				254,0		52				165	
153-311	•			Opel, Opel Lcv				230,0		42				158-161, 175-178	
153-312				Honda, Isuzu, Opel Lcv				302,0		46				92, 100-101, 177	
153-313	•			Ford Lcv, Truck, Nissan Lcv, Opel Lcv, Renault Lcv, Truck				280,0		65				83-84, 86, 154, 179, 230	
153-314				Opel, Suzuki				180,0		26				156, 261	
153-315	•			Honda, Isuzu, Opel				210,0		32				92, 99-101, 165	
153-315K *	•			Honda, Isuzu, Opel				210		32				92, 99-101, 165	
153-317	•			Chevrolet, Opel				180,0		26				21-22, 157	
153-317K	•			Chevrolet, Opel				180,0		26				21-22, 157	
153-318				Opel, Subaru, Suzuki				200,0		29				156, 256, 258, 261	
153-319				Opel				230,0		40				161	
153-320	•			Citroën, Dallas, Mega, Peugeot Lcv				180,0		32				26-27, 29-30, 44, 120-121, 180-186, 192, 197	
153-320K	•			Citroën, Dallas, Mega, Peugeot, Peugeot Lcv				180,0		32				26-27, 29-30, 44, 120-121, 180-186, 192, 197	
153-320Y				Citroën, Dallas, Mega, Peugeot, Peugeot Lcv				180,0		32				26-27, 29-30, 44, 120-121, 180-186, 192, 197	
153-322	•			Citroën, Dallas, Peugeot				180,0		32				31-34, 44, 182-186, 189-190, 192	

CIFAM ref.	H A N D B R A K E	C R C I	A D J	Marca - Make	Ø mm	Cilindretto Freno Wheel Cylinder		RapidKit Brake Shoe			Brake Drum			Pagina Page	
						CIFAM ref.		A	B	C	D (TH)	min. TH	N Fori Holes		Forma Shape
						Left	Right								
 Ganasce Freno - Brake Shoes															
153-323	•			Citroën, Peugeot, Peugeot Lcv				228,6		42				32-34, 189-191, 193-194, 198	
153-324	•			Citroën Lcv, Peugeot				228,6		42				35, 188	
153-324K	•			Citroën Lcv, Peugeot				228,6		42				35, 188	
153-325	•			Jaguar, Peugeot				185,0		20				103, 196-197	
153-325K	•			Jaguar, Peugeot				185,0		20				103, 196-197	
153-326				Peugeot				228,6		42				195	
153-327	•			Citroën, Peugeot				228,6		42				31-33, 189-190	
153-328				Peugeot, Peugeot Lcv				180,0		32				186-187, 197	
153-329Y	•			Citroën, Dallas, Mega, Peugeot, Peugeot Lcv				180,0		32				26-27, 29-30, 44, 120-121, 180-186, 192, 197	
153-330				Peugeot				185,0		30				195-197	
153-330K				Peugeot				185,0		30				195-197	
153-331	•			Citroën, Fiat, Lancia, Peugeot				180,0		31				29, 58, 112, 197	
153-331K	•			Citroën, Fiat, Lancia, Peugeot				180,0		31				29, 58, 112, 197	
153-332				Peugeot, Peugeot Lcv				203,0		39				186-187, 197	
153-333				Peugeot, Peugeot Lcv				228,6		42				187, 197	
153-336	•			Porsche				180,0		26				201-202	
153-337	•			Porsche				180,0		26				201-202	
153-339	•			Citroën, Peugeot, Renault, Renault Lcv, Truck, Talbot				180,0		32				29-31, 180, 223, 231, 262	
153-339K	•			Citroën, Peugeot, Renault, Renault Lcv, Truck, Talbot				180,0		32				29-31, 180, 223, 231, 262	
153-340	•			Alfa Romeo, Aro, Citroën Lcv, Dacia, Fiat, Peugeot, Renault, Talbot				228,6		42				1-5, 35, 38, 45-47, 182, 187-188, 207, 215-216, 219-220, 222-223, 261-263	
153-340K	•			Alfa Romeo, Aro, Citroën Lcv, Dacia, Fiat, Peugeot, Renault, Talbot				228,6		42				1-5, 35, 38, 45-47, 182, 187-188, 207, 215-216, 219-220, 222-223, 261-263	
153-341	•			Citroën, Dacia, Peugeot, Renault				180,0		42				29, 38, 180, 207, 215-216	
153-341K	•			Citroën, Dacia, Peugeot, Renault				180,0		42				29, 38, 180, 207, 215-216	
153-342				Mercedes Benz Lcv, Truck, Nissan, Renault Lcv, Truck				255,0		57				136, 145-147, 153, 227, 229	
153-343				Peugeot, Renault, Renault Lcv, Truck				180,0		42				191-192, 214-215, 224-226, 233	
153-343K				Peugeot, Renault, Renault Lcv, Truck				180,0		42				191-192, 214-215, 223-226, 233	
153-343Y				Peugeot, Renault, Renault Lcv, Truck				180,0		42				191-192, 214-215, 224-226, 233	
153-344	•			Peugeot, Peugeot Lcv, Renault, Renault Lcv, Truck				180,0		42				183-186, 191-193, 197, 203-204, 214-215, 217-219, 224-227, 231-233	
153-345	•			Renault, Renault Lcv, Truck				180,0		42				203-204, 214-222, 224-227, 230-232, 235	
153-345Y	•			Renault, Renault Lcv, Truck				180,0		42				203-204, 214-222, 224-227, 230-232, 235	
153-346	•			Citroën, Renault, Renault Lcv, Truck				203,2		39				26, 209-210, 218-222, 231-233	
153-346Y	•			Citroën, Renault, Renault Lcv, Truck				203,2		39				26, 209-210, 218-222, 231-233	
153-348	•			American Motors, Jeep				254,0		46				4, 103-105	
153-349	•			Chrysler, Dodge, Truck, Jeep				228,6		65				23-25, 44, 104-105	
153-350	•			Citroën, Dacia, Peugeot, Peugeot Lcv, Renault, Renault Lcv, Truck				203,0		38				30-32, 34, 38-39, 181-182, 186-190, 197, 204-205, 209-210, 227, 235	
153-351				Renault				228,6		42				210, 225	
153-352	•			Jeep				254,0		46				104	
153-353	•			Renault				203,0		38				210-213	
153-353Y	•			Renault				203,0		38				210-213	
153-354	•			Nissan, Nissan Lcv, Renault				228,6		42				150, 154, 208-209	
153-355	•			Nissan Lcv, Renault				203,2		39				154, 208-209	
153-356				Renault				180,0		42				204-205	

CIFAM ref.	H A N D B R A K E	C R C I	A D J	Marca - Make	Ø mm	Cilindretto Freno Wheel Cylinder		RapidKit Brake Shoe			Brake Drum			Pagina Page	
						CIFAM ref.		A	B	C	D (TH)	min. TH	N Fori Holes		Forma Shape
						Left	Right								
Ganasce Freno - Brake Shoes															
153-357	•			Jeep				228,6		64				104-105	
153-358	•			Jeep				254,0		46				104-105	
153-359	•			Dacia, Renault				203,2		39				38-39, 204-205, 227	
153-360	•			Jeep				195,0		30				105	
153-361	•			Jeep				205,0		31				104-105	
153-362	•			Chrysler, Dodge, Jeep, Mitsubishi				170,0		32				24, 44, 104-105, 140, 142	
153-363				Dodge, Jeep				207,0		32				44, 104-105	
153-364	•			Jeep				184,0		31				104-105	
153-365				Dacia				230,0		46				38-39	
153-366	•			Land Rover, Rover				279,4		57				112-113, 236	
153-368	•			Land Rover				254,0		39				113-114	
153-369	•			Rover				160,0		20				237-239	
153-369K	•			Rover				160,0		20				237-239	
153-370	•			Land Rover				254,0		45				113-114	
153-371	•			Land Rover				254,0		70				112-114	
153-372	•			Ford Europe, Jeep				184,0		31				78, 104-105	
153-373	•			Land Rover				254,0		70				113-114	
153-373K	•			Land Rover				254,0		70				113-114	
153-374	•			Land Rover				190,0		30				114	
153-374K	•			Land Rover				190,0		30				114	
153-375				Land Rover				210,0		30				113-114	
153-376	•			Land Rover				210,0		30				113-114	
153-377				Rover, Saab				203,2		38				235, 241	
153-378	•			Skoda				200,0		32				250-252	
153-379	•			Seat Lcv, Skoda, Volkswagen Lcv				230,0		32				248-249, 252-253, 293-295	
153-380	•			Maruti, Subaru, Suzuki				180,0		30				116, 256-257	
153-382	•			Subaru				180,0		25				257	
153-383	•			Nissan, Subaru				228,6		37				145, 255-257	
153-384				Subaru				228,6		38				256	
153-385				Subaru				180,0		31				257	
153-386				Saab, Subaru				170,0		32				240, 255	
153-386K				Saab, Subaru				170,0		32				240, 255	
153-387				Subaru				174,0		35				256-257	
153-387K *	•			Subaru				170		36				256-257	
153-388				Subaru				192,0		32				255-256	
153-389				Subaru				206,0		40				257	
153-390				Daihatsu, Suzuki, Lcv, Toyota				220,0		40				41, 259, 261, 266	
153-391				Suzuki				180,0		30				259	
153-392				Suzuki				220,0		40				257-259	
153-393				Suzuki				220,0		40				258-259	
153-394				Bedford, Suzuki Lcv				220,0		40				13, 261	
153-395				Suzuki				180,0		30				259	
153-396	•			Suzuki				180,0		30				257	
153-397	•			Geo, Suzuki				220,0		36				88, 258-260	
153-398				Geo, Suzuki				180,0		25				88, 258-259	
153-399				Suzuki				254,0		45				259-260	
153-400				Suzuki				180,0		25				260	
153-401				Suzuki				220,0		42				257-258	
153-402				Suzuki				220,0		36				260-261	
153-403				Santana, Suzuki				254,0		47				241, 260	
153-404				Suzuki				180,0		26				258, 261	
153-405				Suzuki				254,0		57				258, 261	
153-406				Subaru, Suzuki				203,2		32				256, 259	
153-407				Suzuki				254,0		42				258	
153-408	•			Daihatsu, Toyota, Toyota Lcv				228,6		41				42, 264-267, 269, 272, 275	
153-409	•			Daihatsu, Toyota, Toyota Lcv				200,0		36				42, 266-267, 275	
153-411				Toyota				295,0		78				270	
153-412				Toyota, Toyota Lcv				254,0		58				270, 274	

NUMERICAL LIST

CIFAM ref.	H A N D B R A K E	C R C I	A D J	Marca - Make	Ø mm	Cilindretto Freno Wheel Cylinder		RapidKit Brake Shoe			Brake Drum			Pagina Page	
						CIFAM ref.		A	B	C	D (TH)	min. TH	N Fori Holes		Forma Shape
						Left	Right								
 Ganasce Freno - Brake Shoes															
153-413	•			Toyota, Toyota Lcv, Volkswagen Lcv				254,0		58				263, 270, 272, 274-275, 297	
153-414				Toyota Lcv				254,0		50				274	
153-415	•			Nissan, Toyota				295,0		60				149, 270-271	
153-416	•			Toyota, Toyota Lcv				254,0		50				269-272, 274-275	
153-417	•			Toyota				200,0		37				264-267, 269, 271	
153-419				Toyota				200,0		37				266-268, 272	
153-421	•			Nissan Lcv, Toyota, Lcv, VW Lcv				295,0		50				155, 263, 274-275, 297	
153-422	•			Geo, Toyota				200,0		37				88, 267-268	
153-423	•			Toyota				200,0		37				264, 266-269, 271	
153-424				Toyota				200,0		36				267, 272	
153-425				Toyota				180,0		28				271-272	
153-426	•			Daihatsu, Toyota Lcv				270,0		55				43, 274	
153-428				Toyota Lcv, Volkswagen Lcv				270,0		55				274-275, 297	
153-429				Daihatsu, Toyota				228,6		42				43, 272	
153-430				Toyota				228,6		35				263-264	
153-431				Toyota				203,0		32				271, 273	
153-432				Toyota				200,0		35				265, 268	
153-433				Toyota				200,0		38				268	
153-434				Daihatsu, Toyota				228,6		42				43, 271	
153-435				Daihatsu, Toyota				180,0		38				43, 269	
153-436	•			Daihatsu, Toyota				180,0		27				43, 273	
153-437				Toyota				228,6		42				272	
153-438	•			Citroën, Opel, Peugeot, Suzuki, Toyota				200,0		32				27, 157, 182, 259-260, 264, 273	
153-439	•			Lexus, Toyota				190,0		45				115, 263-264, 270-272	
153-439K	•			Lexus, Toyota				190,0		45				115, 263-264, 270-272	
153-440				Toyota				160,0		35				270-271	
153-441				Lexus, Toyota				210,0		46				115, 263, 270-271	
153-442	•			Lexus, Toyota				170,0		40				114, 263-264, 266, 270	
153-442K	•			Lexus, Toyota				170,0		40				114, 263-264, 266, 270	
153-443				Toyota				174,0		32				264, 266, 268-269, 271, 273	
153-443K	•			Toyota				174,0		32				264, 266, 268-269, 271, 273	
153-444				Toyota				170,0		40				263-266	
153-444K				Toyota				170,0		40				263-266	
153-445				Toyota Lcv				300,0		62				275	
153-446				Toyota				172,0		22				268-269	
153-446K				Toyota				172,0		22				268-269	
153-447	•			Toyota				290,0		51				263, 272-273	
153-448				Toyota				200,0		37				267	
153-449	•			Lexus				190,0		26				115	
153-450				Toyota				170,0		32				272	
153-450K *	•			Nissan, Renault, Toyota				170		32				146-147, 150, 153, 209, 272	
153-451	•			Lexus, Toyota				242,0		32				115, 271	
153-452				Toyota Lcv				254,0		52				274	
153-453				Toyota				185,0		32				268-269	
153-453K *	•			Toyota				185		32				269	
153-454				Toyota				203,0		38				273-274	
153-456	•			Lada				200,0		40				109-110	
153-457				Volkswagen, Volkswagen Lcv				230,0		40				275, 282, 297	
153-458	•			Volkswagen				230,0		30				282	
153-459	•			Porsche, Volkswagen, Volkswagen Lcv				230,0		40				201-202, 275, 281-282, 297	
153-460				Volkswagen				248,0		46				282	
153-461	•			Volkswagen Lcv				252,0		56				297	
153-462	•			Audi, Seat, Skoda, Volkswagen				200,0		40				5-11, 248-250, 277-278, 282, 284-285, 290	
153-463	•			Volkswagen Lcv				270,0		66				295-296	
153-464	•			Volkswagen Lcv				252,0		56				297	

CIFAM ref.	H A N D B R A K E	C R C I	A D J	Marca - Make	ø mm	Cilindretto Freno Wheel Cylinder		RapidKit Brake Shoe			Brake Drum			Pagina Page	
						CIFAM ref.		A	B	C	D (TH)	min. TH	N Fori Holes		Forma Shape
						Left	Right								
 Ganasce Freno - Brake Shoes															
153-465	•			Audi, Seat, Volkswagen, Volkswagen Lcv				180,0		31				5-10, 242-245, 247-248, 276-278, 282-287, 290-292	
153-466	•			Volkswagen Lcv				252,0		56				295-296	
153-467	•			Volkswagen Lcv				270,0		66				295-297	
153-468	•			Audi, Seat, Skoda, Volkswagen, Volkswagen Lcv				200,0		40				9-10, 242-251, 276, 278-281, 283, 285-289, 292-295	
153-469	•			Volkswagen Lcv				270,0		55				297-298	
153-470	•			Volkswagen				180,0		31				283	
153-471	•			Volvo				228,6		51				301-302	
153-472	•			Volvo				228,6		51				301-302	
153-473	•			Volvo				160,0		25				298-301, 303-304	
153-473K	•			Volvo				160,0		25				298-301, 303-304	
153-474				Volvo				228,6		51				302	
153-475	•			Alfa Romeo, Bmw, Eagle, Enasa, Peugeot, Renault, Renault Lcv, Truck, Suzuki, Talbot, Volvo				228,6		42				1-2, 14-15, 44-45, 182, 187-188, 193-195, 207, 219-223, 225, 230, 232, 258-263, 299	
153-476	•			Fso, Volvo				203,0		38				88, 299	
153-477	•			Volvo				160,0		25				301	
153-477K	•			Volvo				160,0		25				301	
153-478	•			Volvo				177,8		25				301-303	
153-478K	•			Volvo				177,8		25				301-303	
153-479	•			Volvo				177,8		25				302-304	
153-479K	•			Volvo				177,8		25				302-304	
153-480	•			Volvo				177,8		25				302-303	
153-480K	•			Volvo				177,8		25				302-303	
153-481 *				Chrysler				228,6		42				23-24	
153-482 *				Chrysler				220		42				23	
153-483 *	•			Daewoo				167		25				40	
153-484 *				Chevrolet				254		41				22	
153-485 *	•			Chevrolet				203,2		22				21	
153-486 *	•			Iveco				260		80				102-103	
153-487 *				Fiat, Fiat Lcv				254		57				49, 60	
153-488 *				Fiat, Ford Europe				180		30				46, 52-53, 77	
153-489 *				Iveco				310		101				102	
153-490 *				Ford Europe				200		32				74-75	
153-491 *	•			Mazda, Opel, Ssangyong				190		25				118-119, 174, 254-255	
153-491K *	•			Mazda, Opel, Ssangyong				190		25				118-119, 174, 254-255	
153-492 *				Honda				180		31				91	
153-493 *				Honda				200		31				90, 92	
153-494 *				Honda				200		36				90	
153-495 *	•			Honda				190		27				89	
153-497 *	•			Hyundai				190		26				94	
153-498 *				Hyundai, Kia				190		26				97, 108	
153-499 *	•			Hyundai				167		27				95	
153-500 *	•			Hyundai				184		32				97	
153-501 *				Hyundai, Hyundai Lcv				295		52				97-98	
153-502 *	•			Hyundai, Kia				190		40				98, 108	
153-504 *				Kia				203,2		36				106	
153-505 *	•			Kia				170		32				106	
153-506 *				Kia				200		31				107	
153-507 *	•			Mercedes Benz				186		36				131-132	
153-507K *	•			Mercedes Benz				186		36				131-132	
153-508 *				Nissan				295		57				148	
153-509 *				Nissan				205		30				153	
153-511 *	•			Porsche				180		25				202	
153-512 *	•			Porsche				180		25				201	
153-513 *				Renault				203,2		39				227	
153-514 *	•			Jeep				185		31				104-105	
153-515 *	•			Jeep				205		32				105	
153-516 *				Subaru				254		42				256	

NUMERICAL LIST



CIFAM ref.	H A N D B R A K E	C R C I	A D J	Marca - Make	Ø mm	Cilindretto Freno Wheel Cylinder		RapidKit Brake Shoe			Brake Drum			Pagina Page	
						CIFAM ref.		A	B	C	D (TH)	min. TH	N Fori Holes		Forma Shape
						Left	Right								
 Ganasce Freno - Brake Shoes															
153-517 *				Subaru, Toyota				228,6		37				257, 268-269	
153-518 *				Nissan, Suzuki				180		26				149, 257	
153-519 *				Suzuki				200		37				258	
153-520 *				Suzuki				200		32				260	
153-521 *				Suzuki				180		26				259-260	
153-522 *	•			Lexus				190		31				115	
153-523 *				Toyota				200		32				268	
153-524 *	•			Lexus, Toyota				228,6		45				115, 271	
153-525 *	•			Toyota				167		40				266, 269	
153-526 *				Toyota				180		28				270	
153-527 *	•			Toyota				185		32				273	
153-528 *	•			Porsche, Volkswagen				210		31				202, 292	
153-529 *				Volkswagen Lcv				295		57				292	
153-530 *	•			Volvo				177,8		25				304	

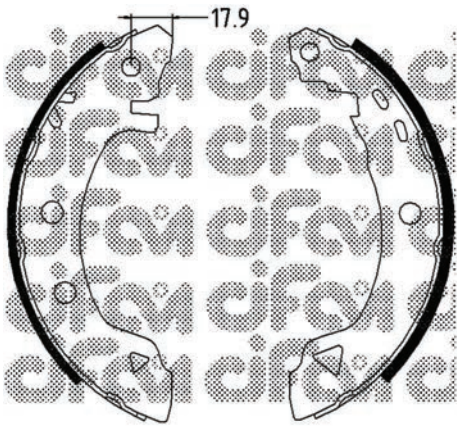

153-001 (Ø 203,2 x 39)

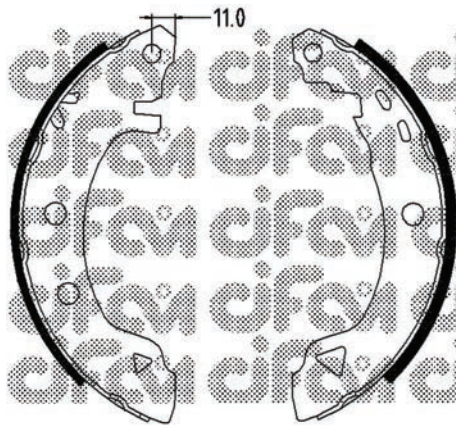

153-002 (Ø 203,2 x 39)

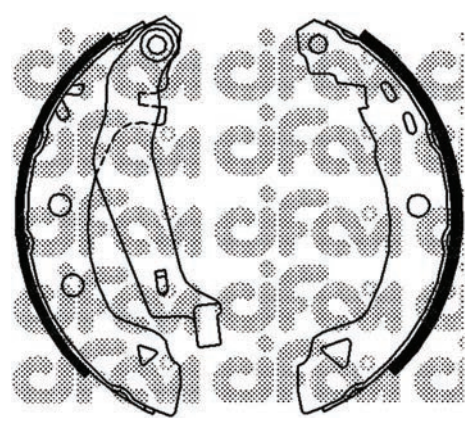

153-002Y (Ø 203,2 x 39)

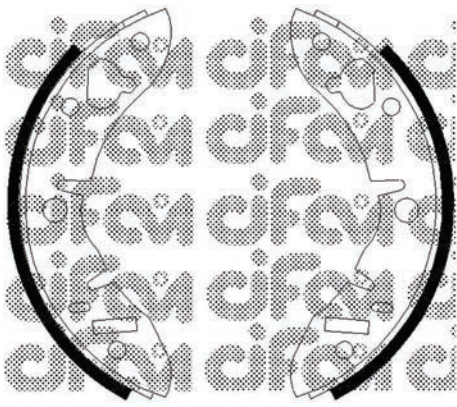

153-003 (Ø 177,8 x 38)

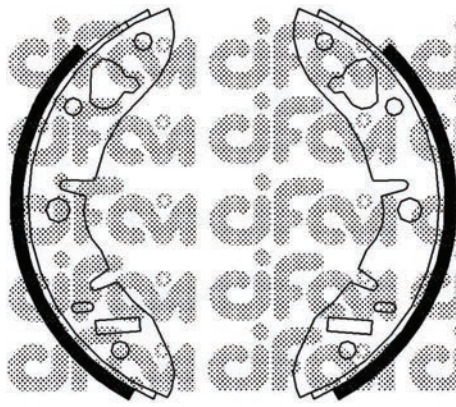

153-004 (Ø 177,8 x 32)

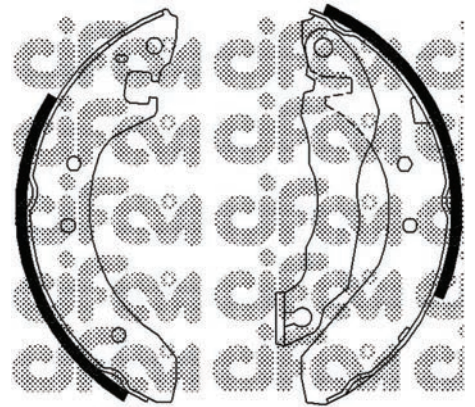

153-005 (Ø 203,2 x 38)

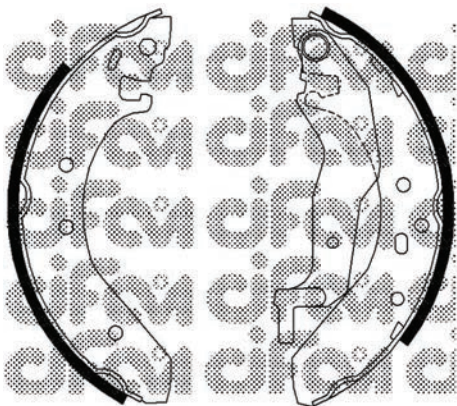

153-006 (Ø 203,0 x 38)

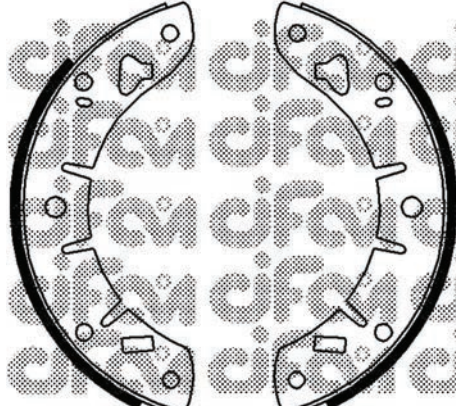

153-007 (Ø 254,0 x 45)

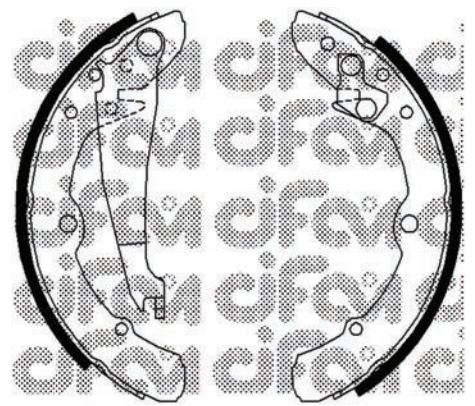

153-008 (Ø 230,0 x 40)

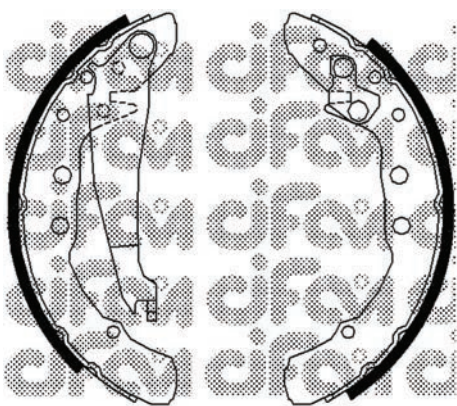

153-009 (Ø 230,0 x 40)

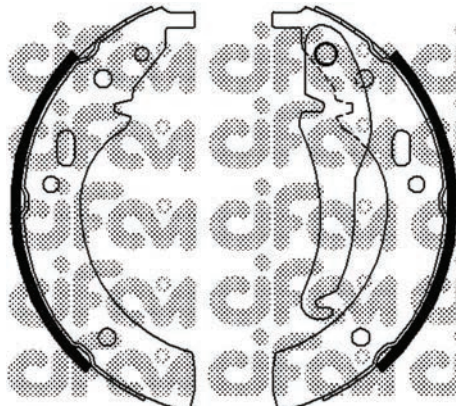

153-010 (Ø 250,0 x 42)

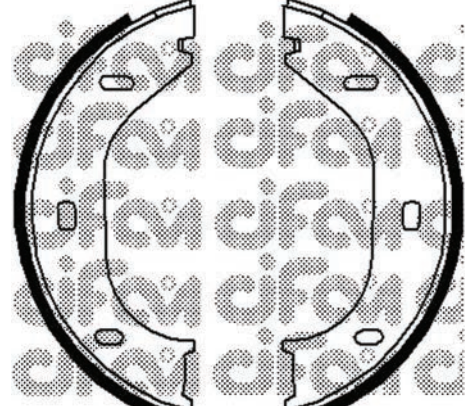

153-011 (Ø 160,0 x 25)

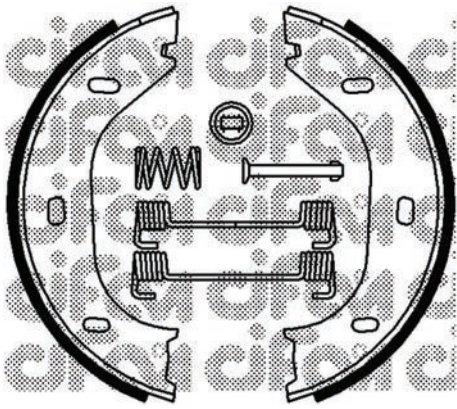

153-011K (Ø 160,0 x 25)

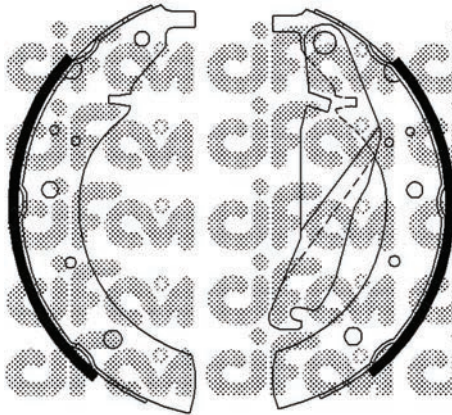

153-012 (Ø 250,0 x 42)

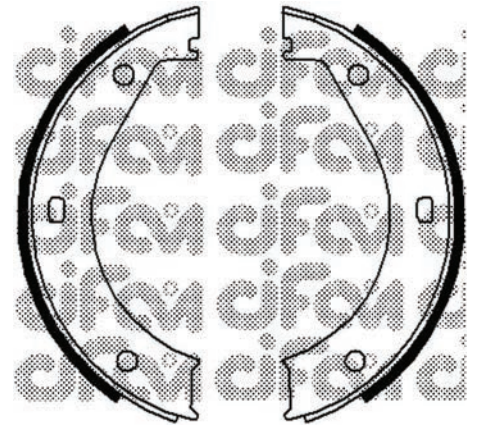

153-013 (Ø 180,0 x 25)

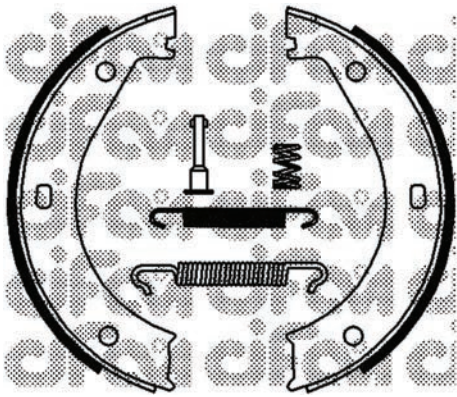

153-013K (Ø 180,0 x 25)

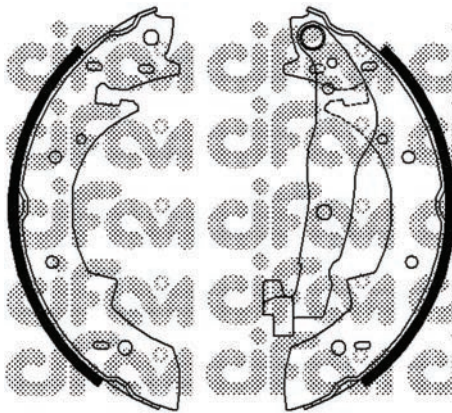

153-014 (Ø 228,6 x 42)

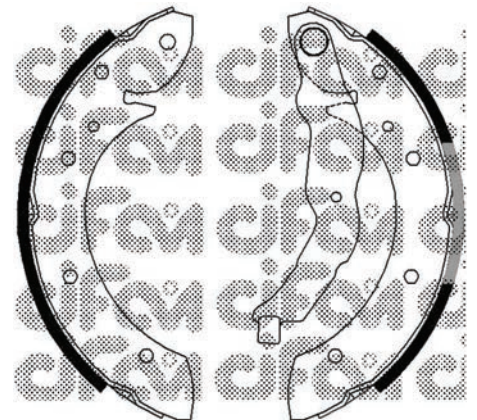

153-015 (Ø 228,6 x 42)

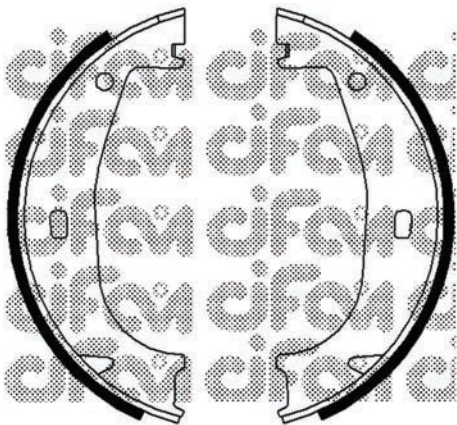

153-016 (Ø 160,0 x 25)

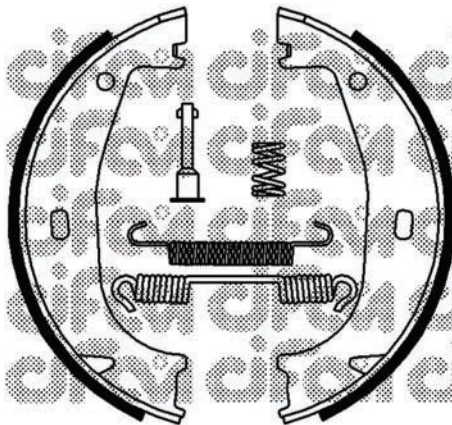

153-016K (Ø 160,0 x 25)

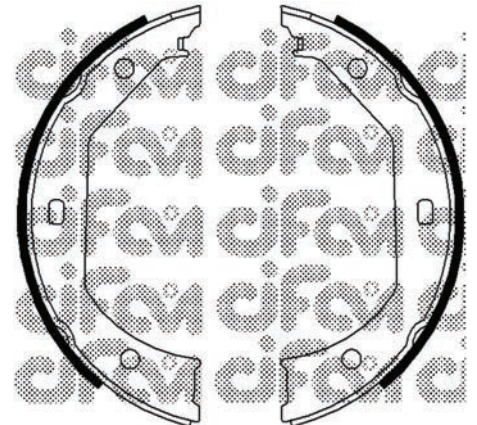

153-017 (Ø 185,0 x 20)

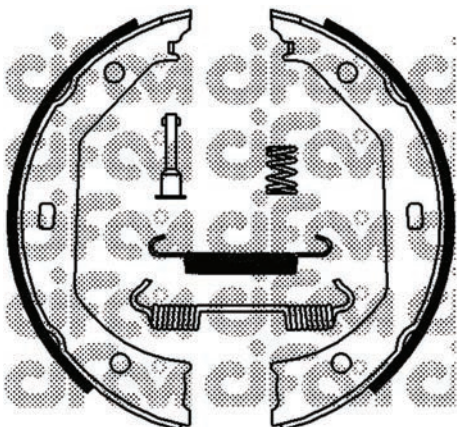

153-017K (Ø 185,0 x 20)

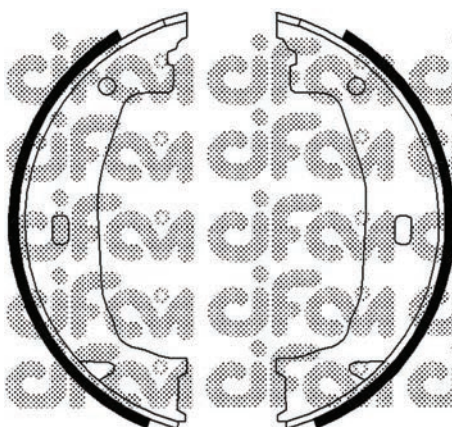

153-018 (Ø 160,0 x 20)

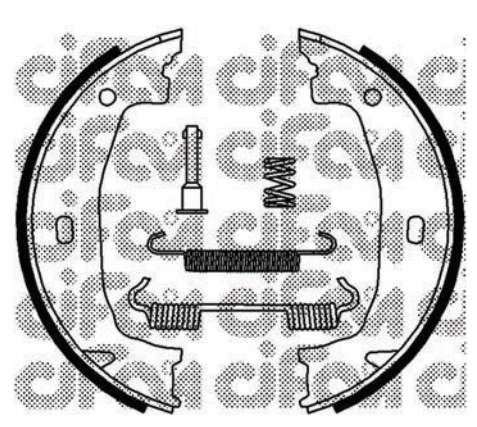

153-018K (Ø 160,0 x 20)

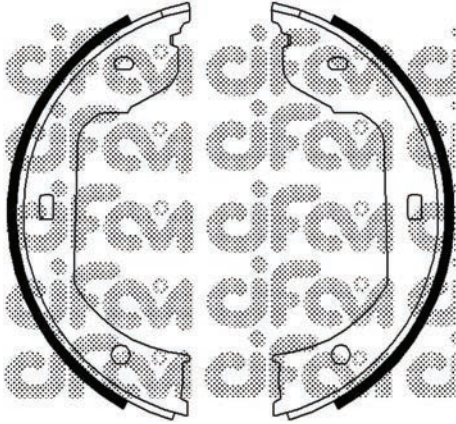

153-019 (Ø 185,0 x 30)

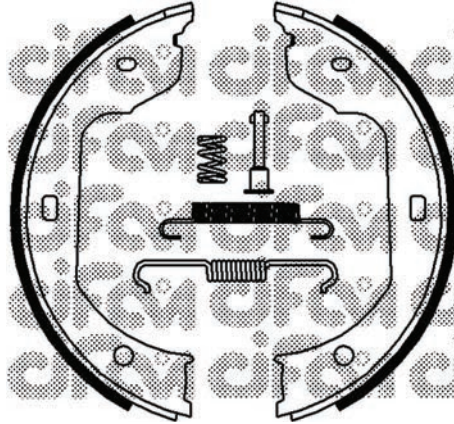

153-019K (Ø 185,0 x 30)

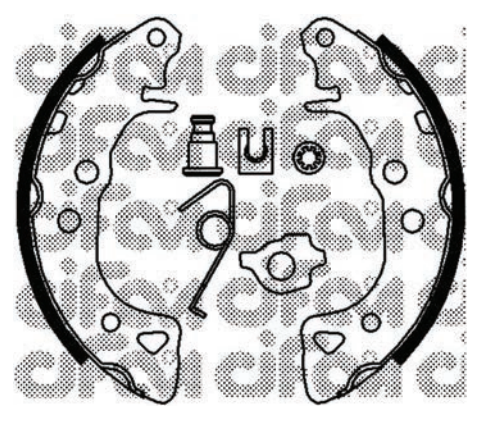

153-021K (Ø 165,0 x 30)

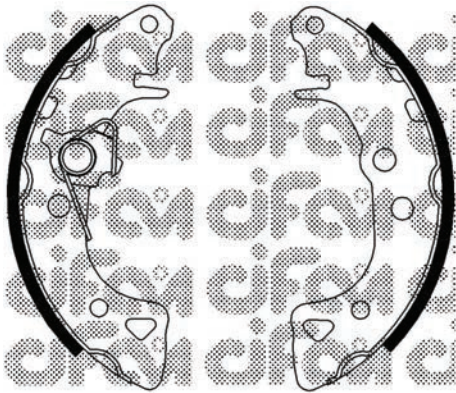

153-021Y (Ø 165,0 x 30)

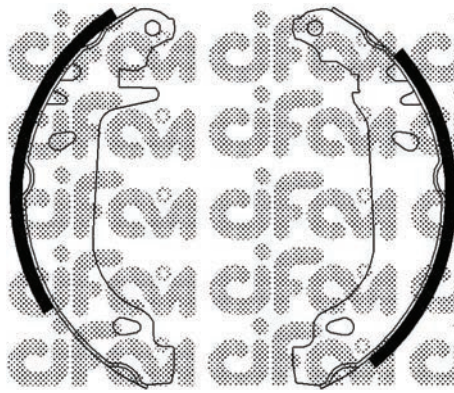

153-022 (Ø 180,0 x 32)

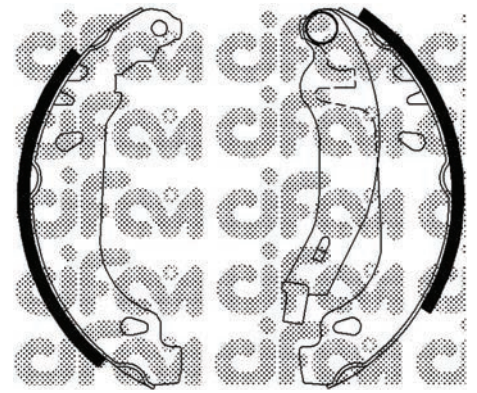

153-022Y (Ø 180,0 x 32)

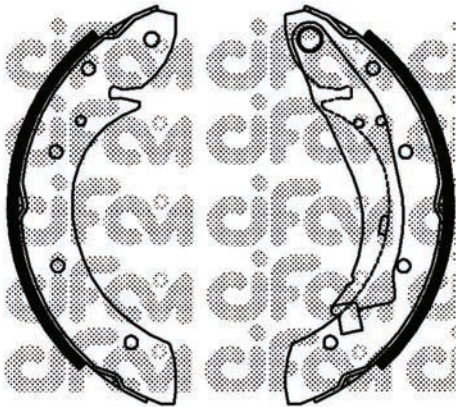

153-023 (Ø 228,6 x 42)

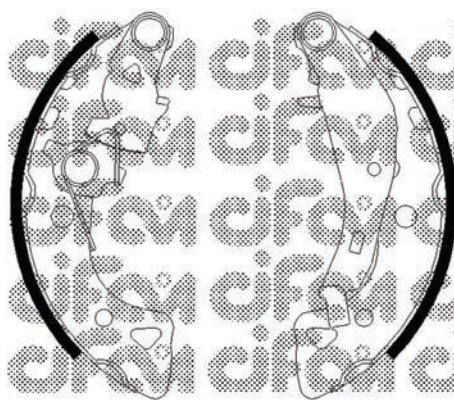

153-024Y (Ø 165,0 x 30)

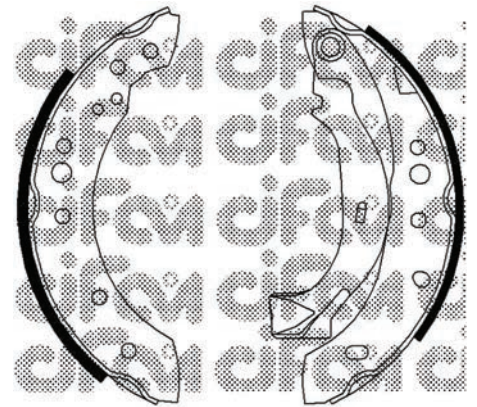

153-025 (Ø 203,2 x 39)

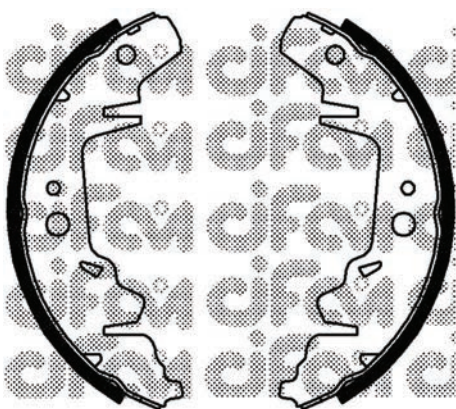

153-026 (Ø 254,0 x 57)

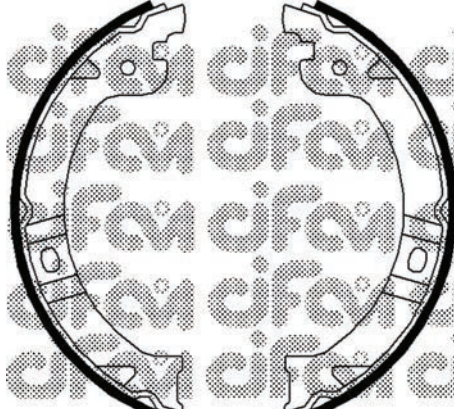

153-027 (Ø 180,0 x 30)

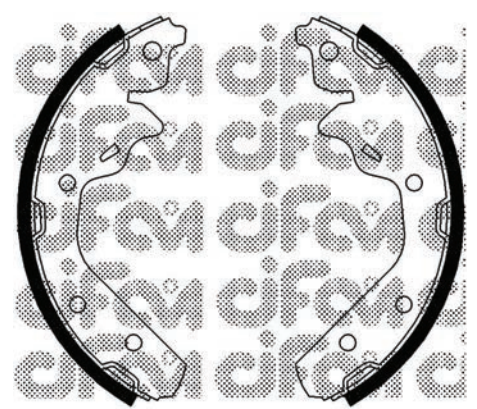

153-028 (Ø 200,0 x 34)

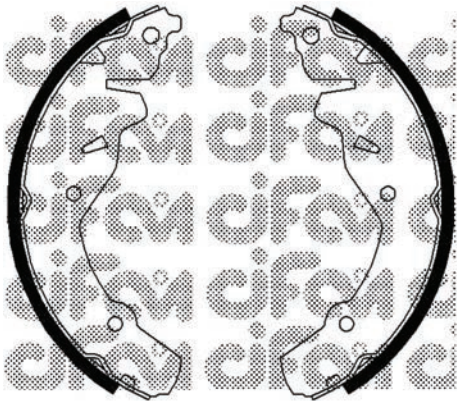

153-029 (Ø 220,0 x 42)

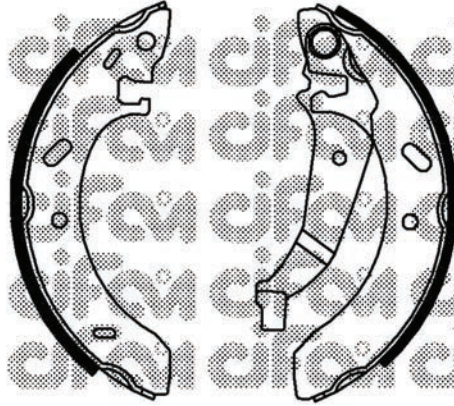

153-030 (Ø 200,0 x 32,5)

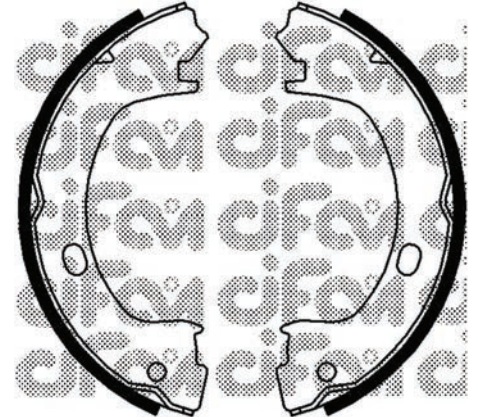

153-031 (Ø 172,0 x 20)

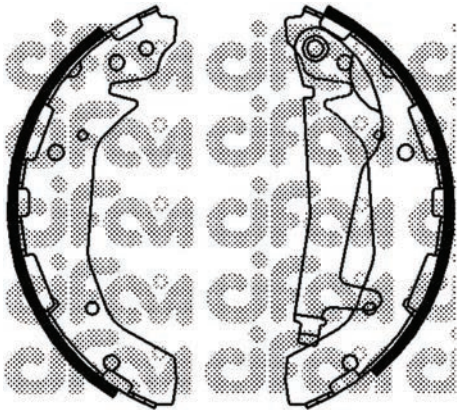

153-032 (Ø 228,6 x 45)

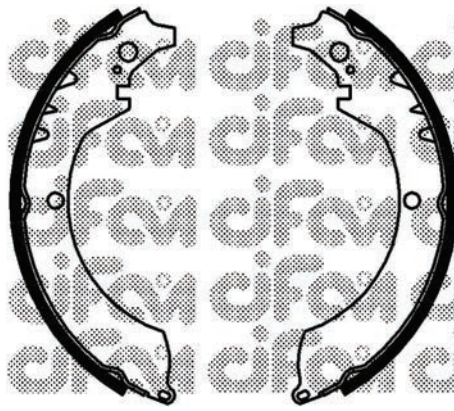

153-033 (Ø 254,0 x 45)

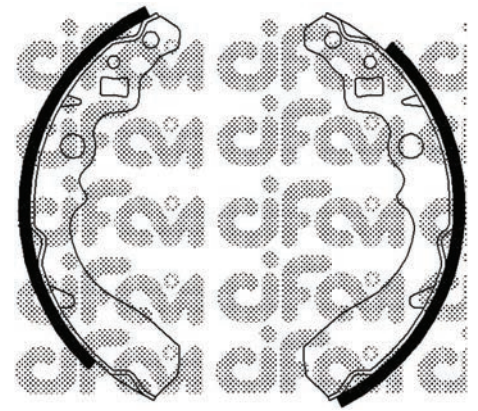

153-034 (Ø 165,0 x 25)

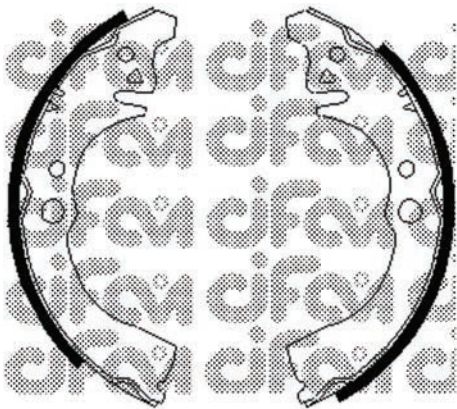

153-035 (Ø 180,0 x 35)

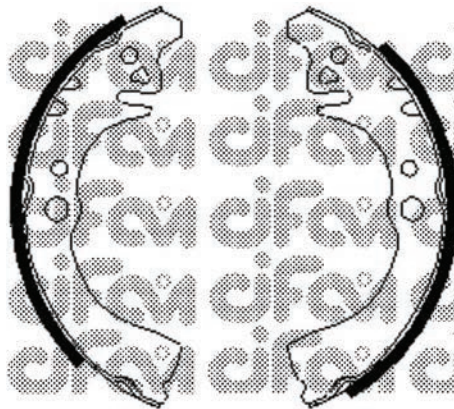

153-036 (Ø 180,0 x 26)

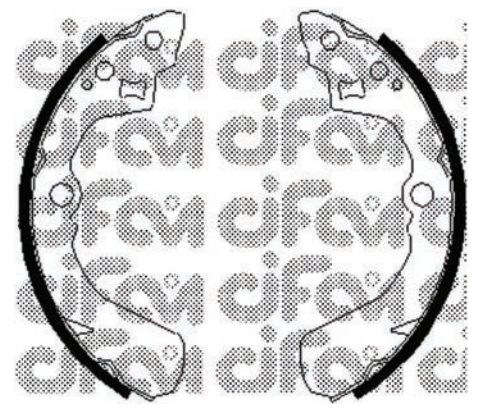

153-037 (Ø 200,0 x 30)

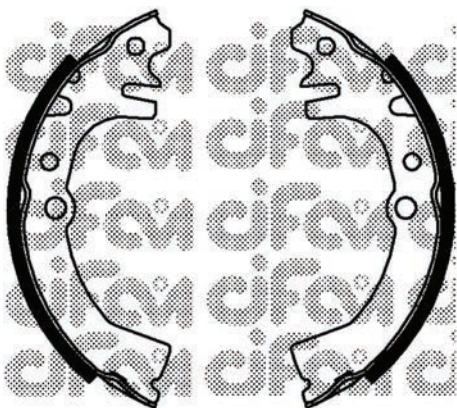

153-038 (Ø 165,0 x 25)

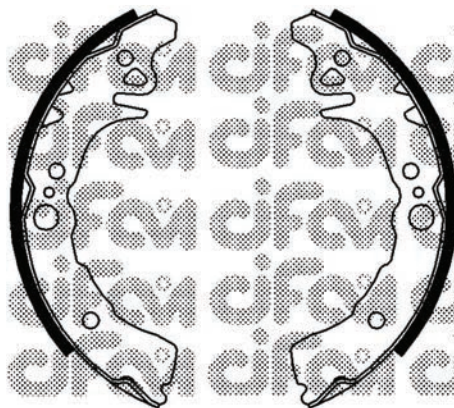

153-039 (Ø 180,0 x 38)

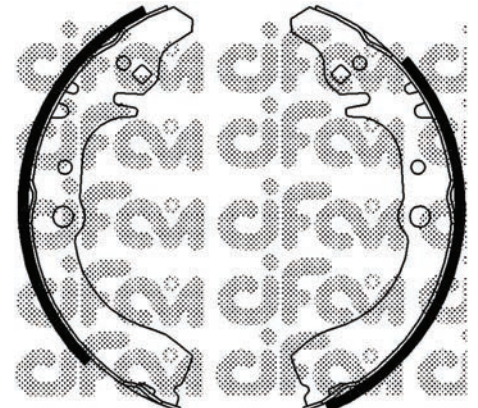

153-040 (Ø 200,0 x 38)

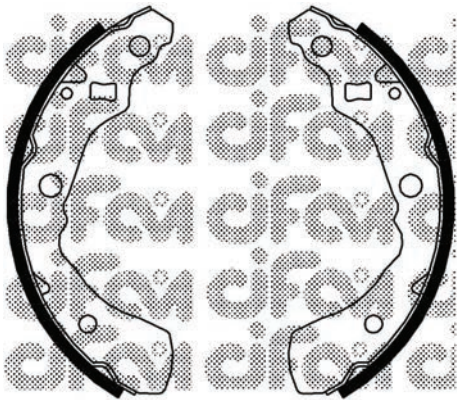

153-041 (Ø 180,0 x 31)

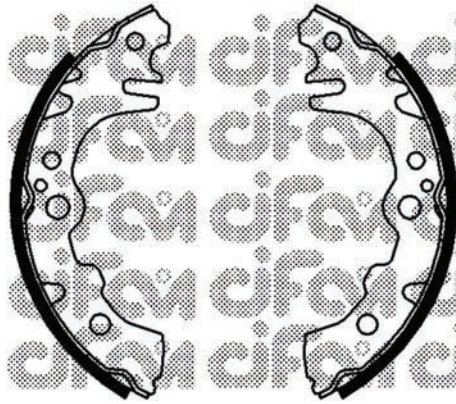

153-042 (Ø 165,0 x 28)

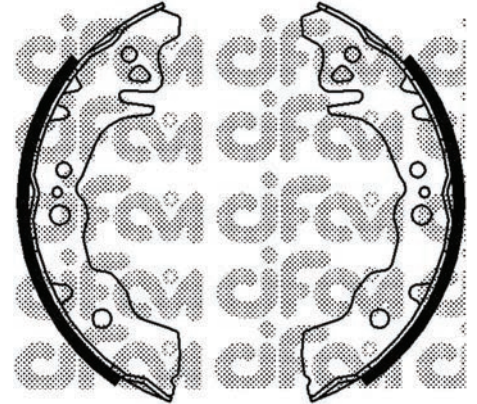

153-043 (Ø 180,0 x 28)

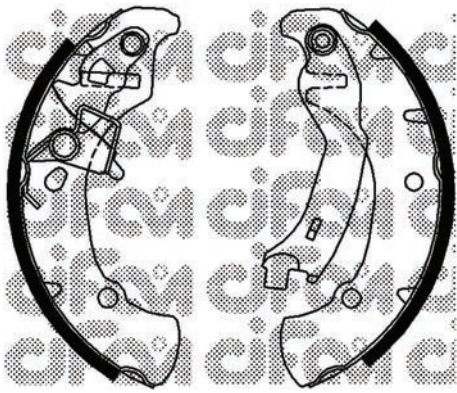

153-044 (Ø 203,2 x 38)

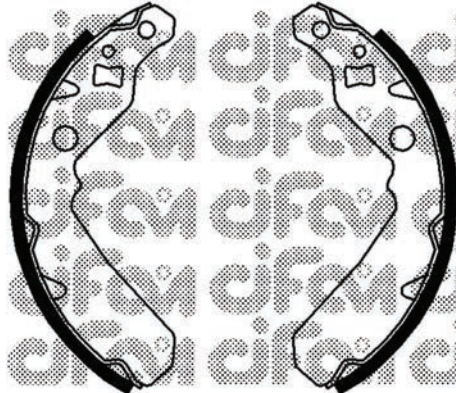

153-045 (Ø 165,0 x 26)



153-046 (Ø 180,0 x 31)

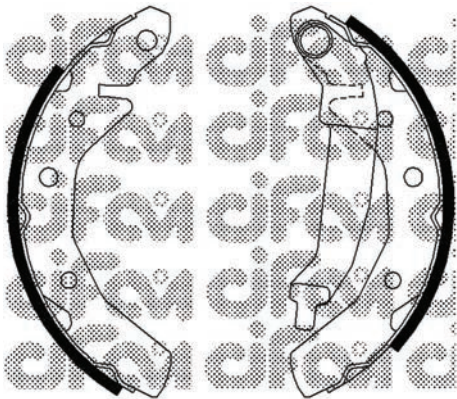

153-047 (Ø 180,0 x 31)

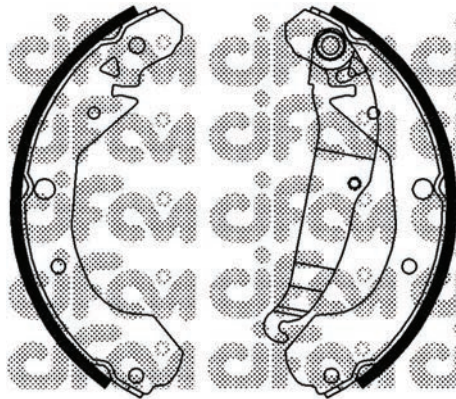

153-048 (Ø 230,0 x 52)

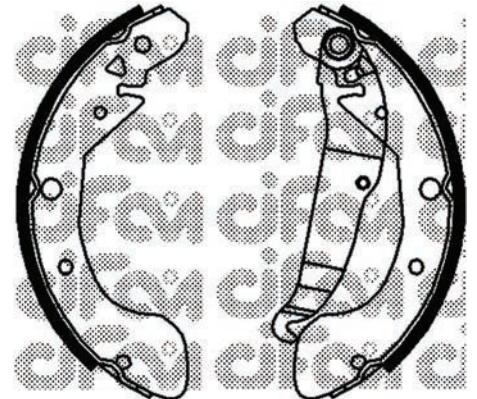

153-049 (Ø 230,0 x 52)

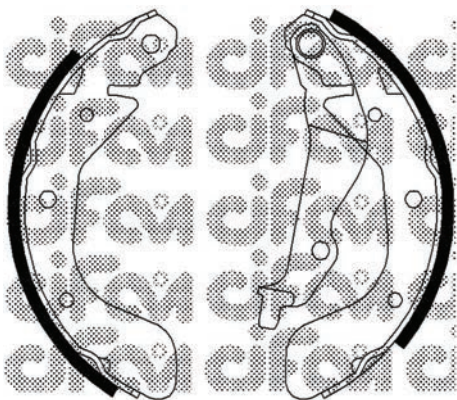

153-050 (Ø 200,0 x 37)

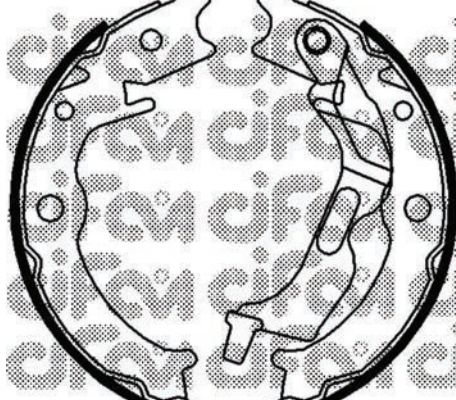

153-052 (Ø 170,0 x 26)

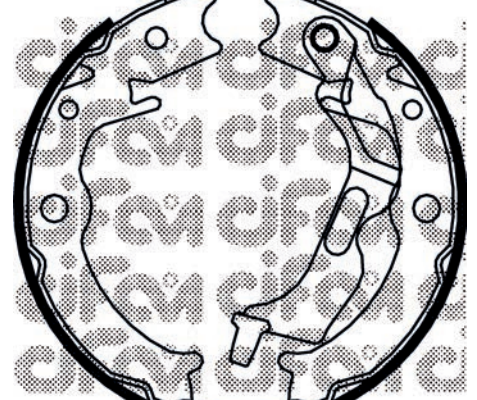

153-052K (Ø 170 x 26)

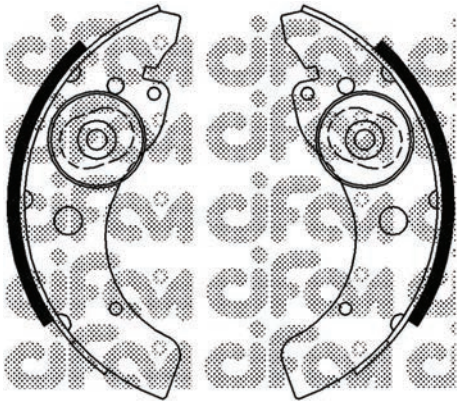

153-053 (Ø 160,0 x 42)

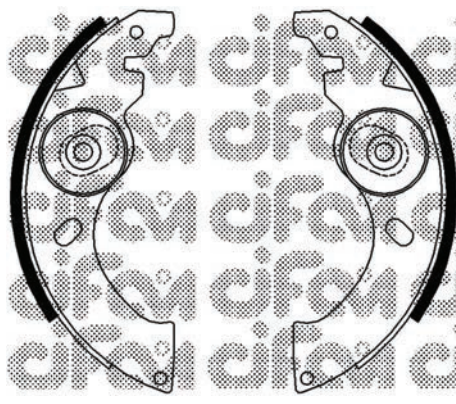

153-054 (Ø 180,0 x 32)

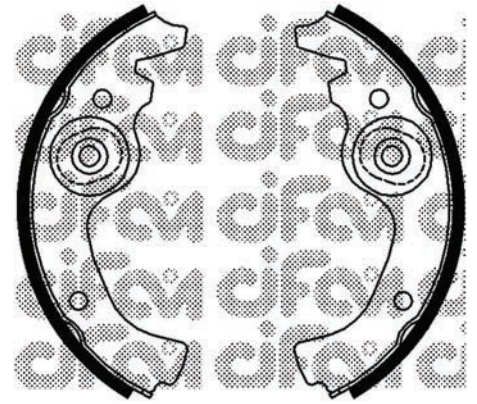

153-055 (Ø 170,0 x 31)

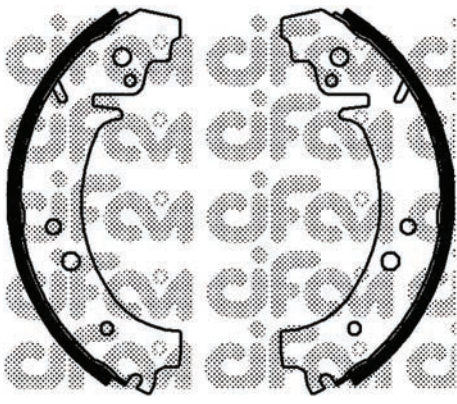

153-060 (Ø 250,0 x 51)

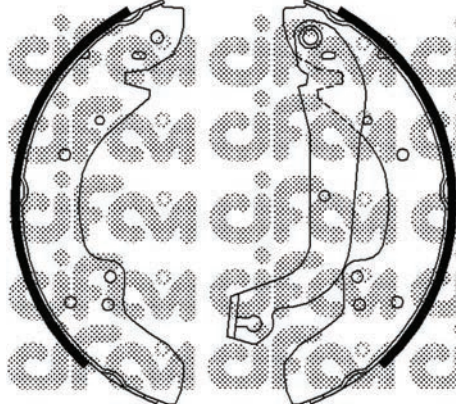

153-062 (Ø 254,0 x 57)

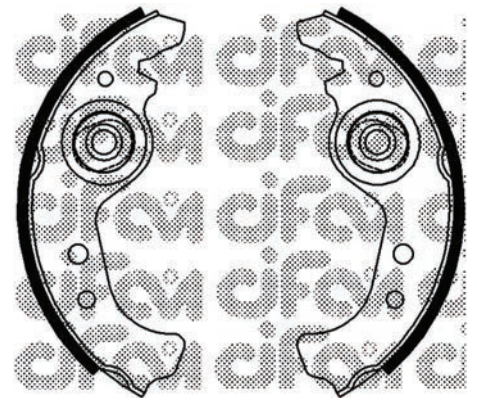

153-063 (Ø 185,0 x 31)

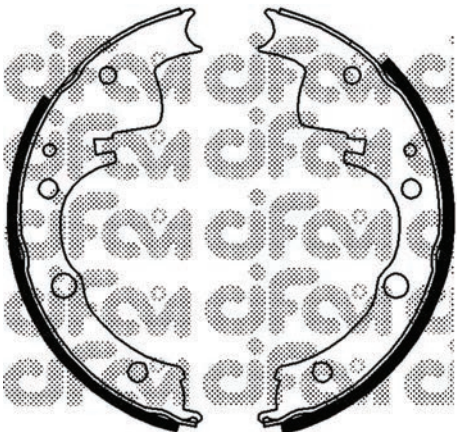

153-064 (Ø 254,0 x 90)

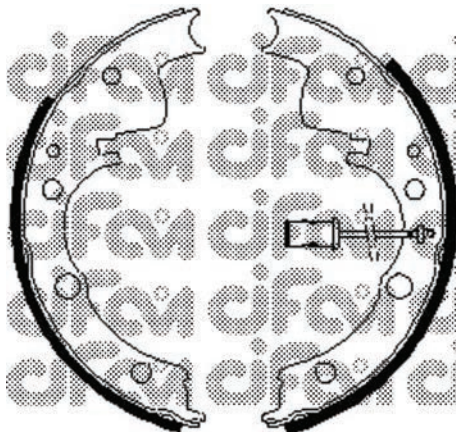

153-065 (Ø 254,0 x 90)

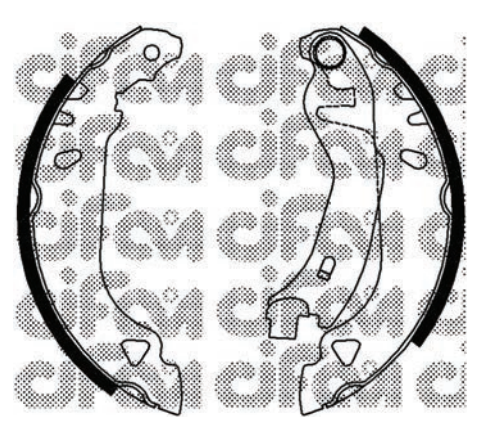

153-066 (Ø 180,0 x 32)

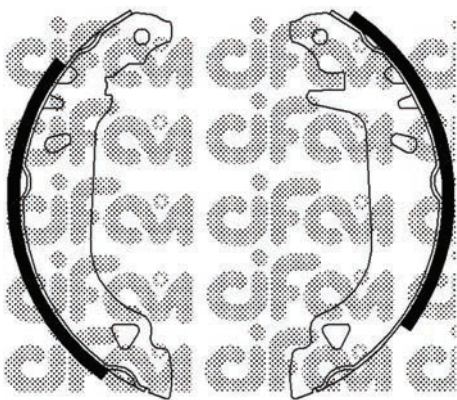

153-066J (Ø 180,0 x 32)

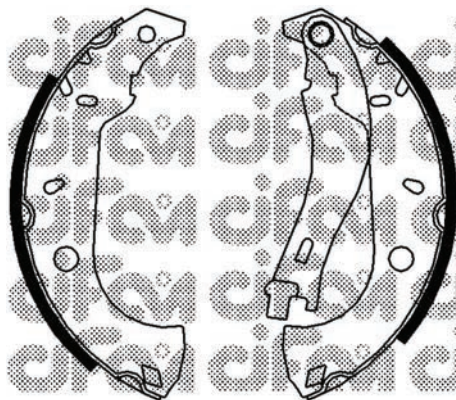

153-067 (Ø 228,6 x 42)

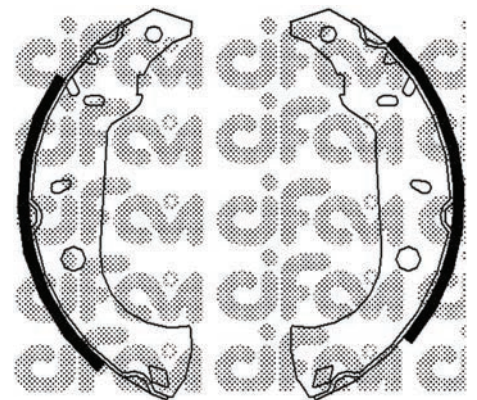

153-067J (Ø 228,6 x 42)

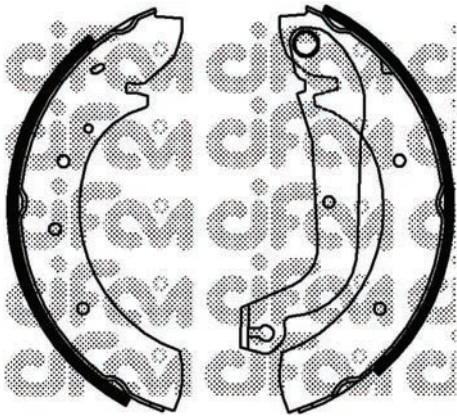

153-068 (Ø 254,0 x 57)

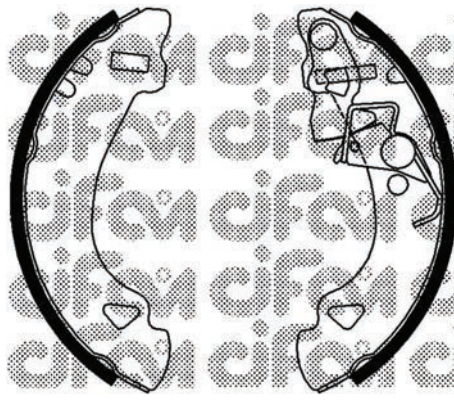

153-069 (Ø 185,0 x 31)

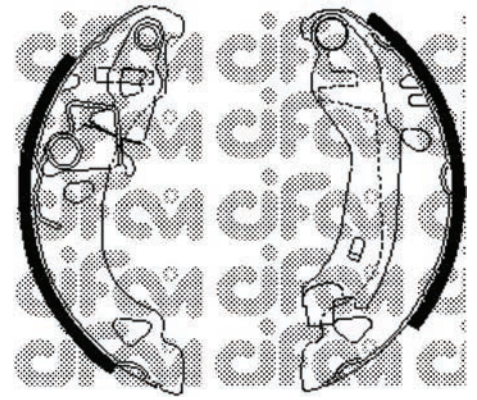

153-070 (Ø 180,0 x 32)

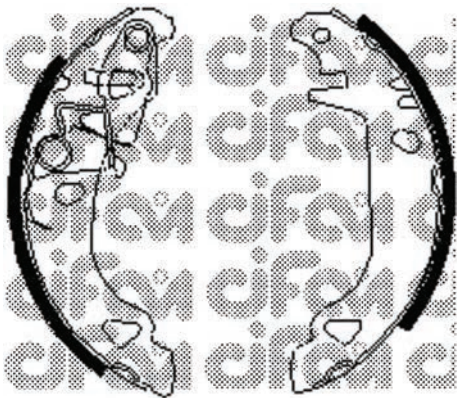

153-070J (Ø 180,0 x 32)

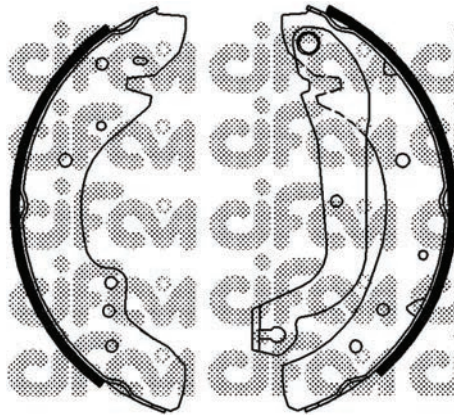

153-071 (Ø 254,0 x 57)

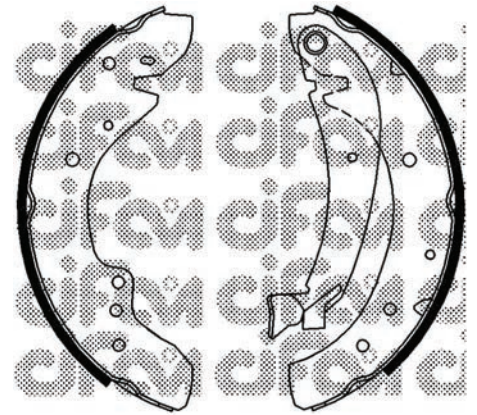

153-072 (Ø 254,0 x 57)

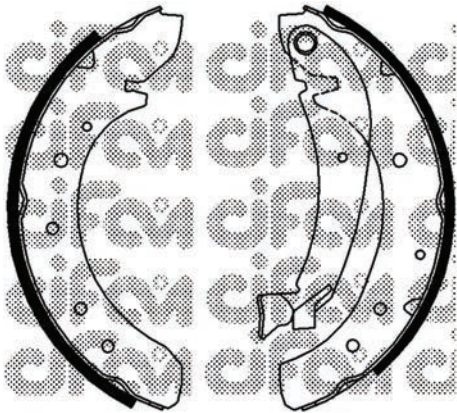

153-073 (Ø 254,0 x 57)

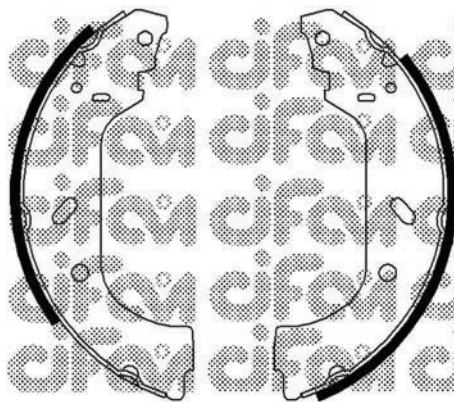

153-074 (Ø 256,0 x 61)

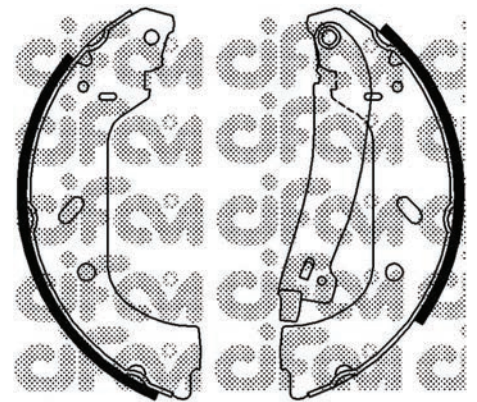

153-074Y (Ø 256,0 x 61)

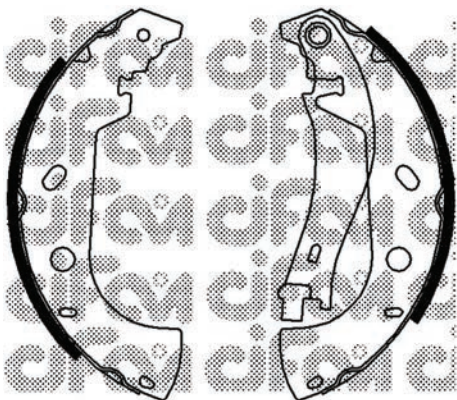

153-075 (Ø 228,6 x 42)

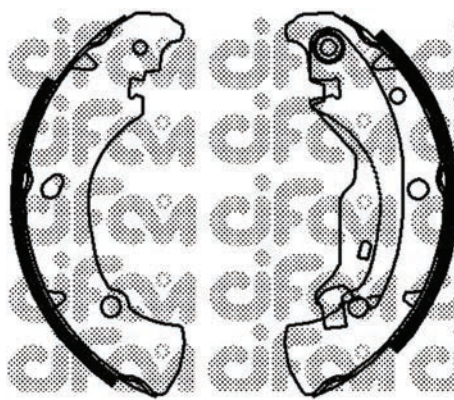

153-076 (Ø 203,2 x 39)

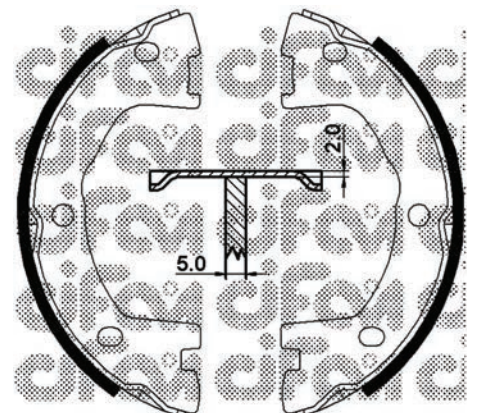

153-077 (Ø 170,0 x 45)

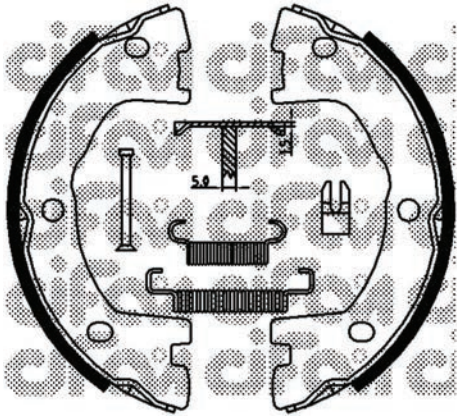

153-077K (Ø 170,0 x 45)

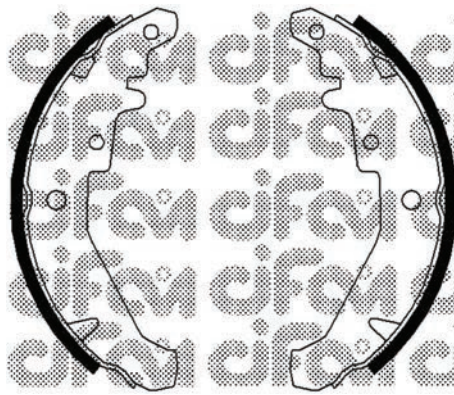

153-078 (Ø 185,0 x 29)

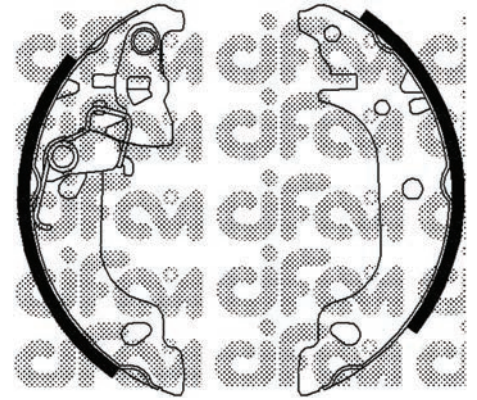

153-079 (Ø 180,0 x 32)

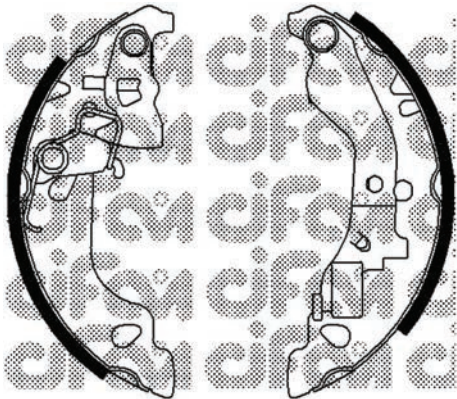

153-079Y (Ø 180,0 x 32)

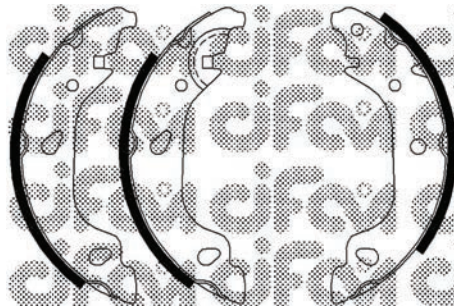

153-080 (Ø 180,0 x 32)

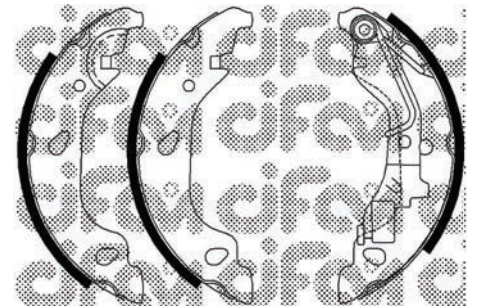

153-080Y (Ø 180,0 x 32)

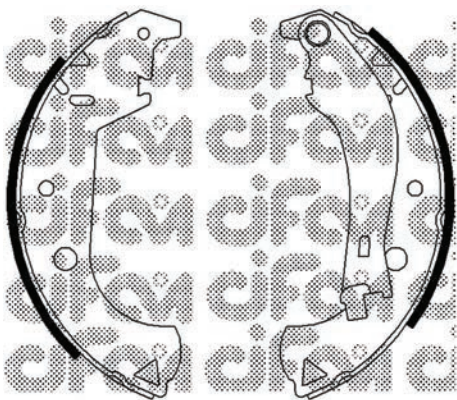

153-081Y (Ø 228,6 x 42)

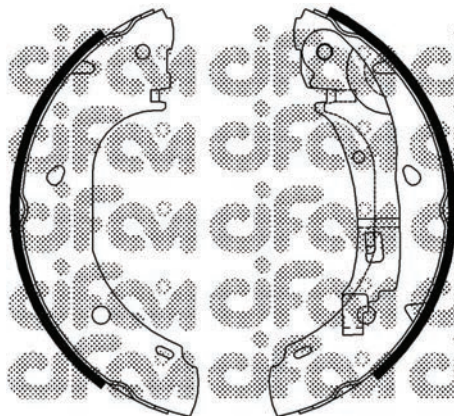

153-082 (Ø 254,0 x 57)

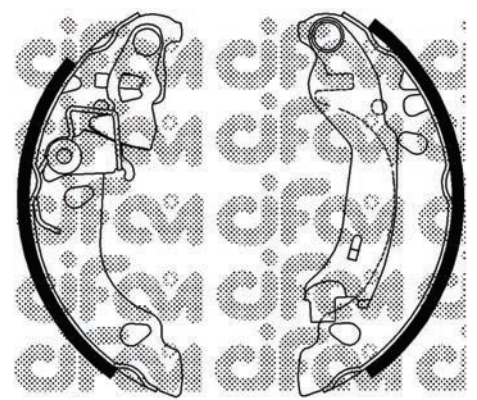

153-083 (Ø 180,0 x 32)

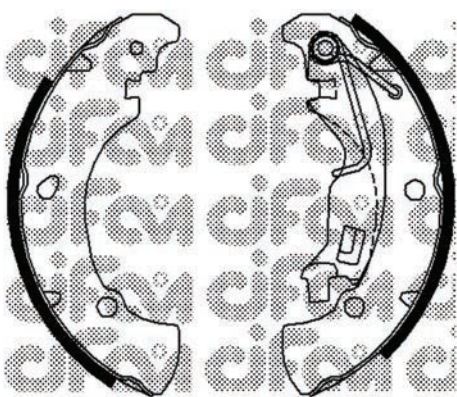

153-084 (Ø 203,2 x 39)

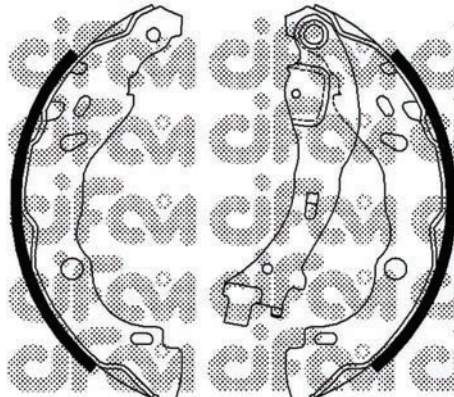

153-085 (Ø 203,2 x 39)

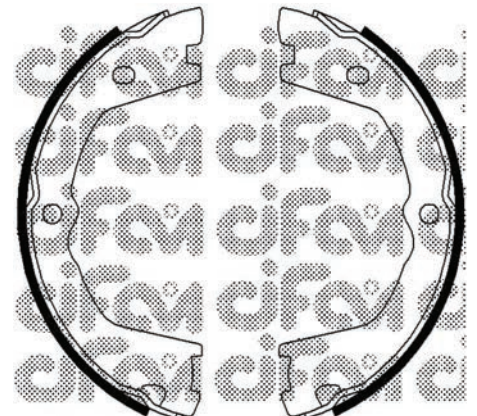

153-086 (Ø 190,0 x 42)

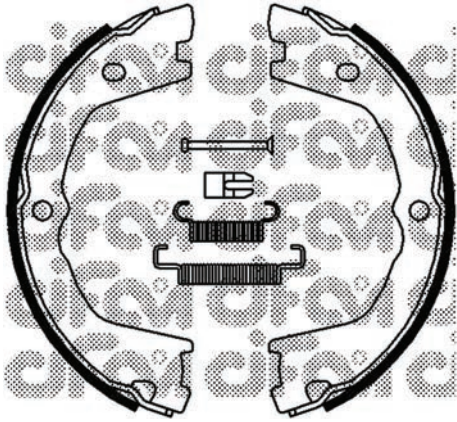

153-086K (Ø 190,0 x 42)

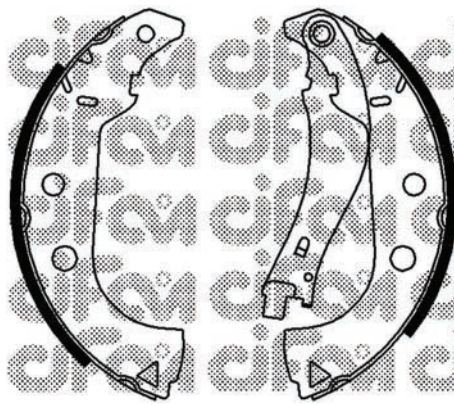

153-087 (Ø 228,6 x 42)

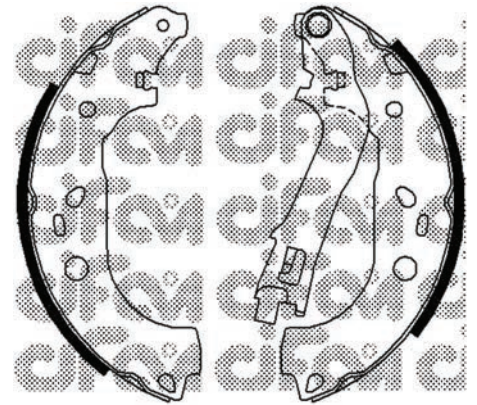

153-088 (Ø 228,6 x 43)

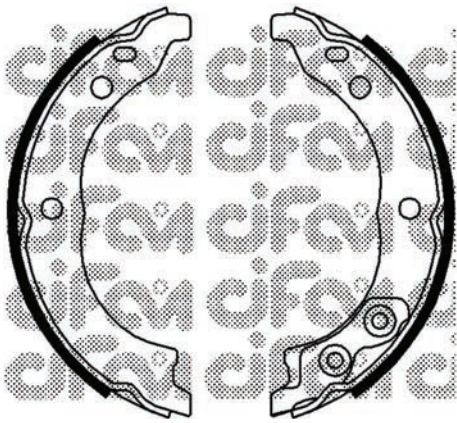

153-089 (Ø 170,0 x 45)

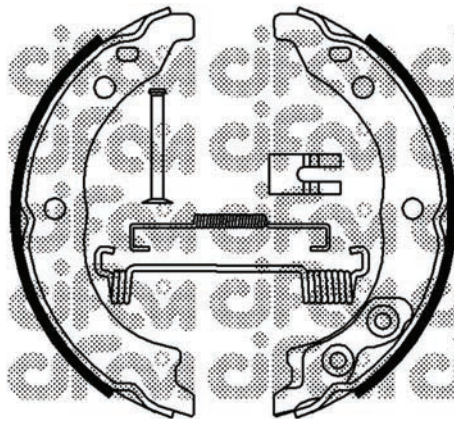

153-089K (Ø 170,0 x 45)

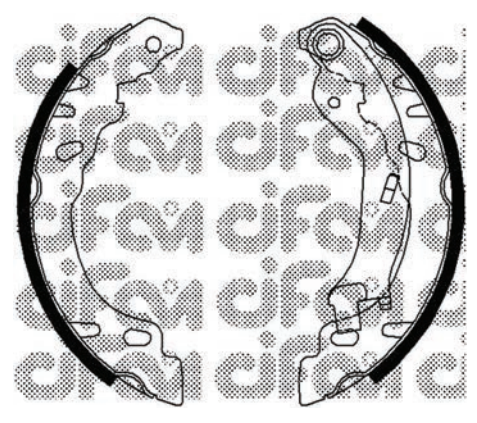

153-090 (Ø 180,0 x 30)

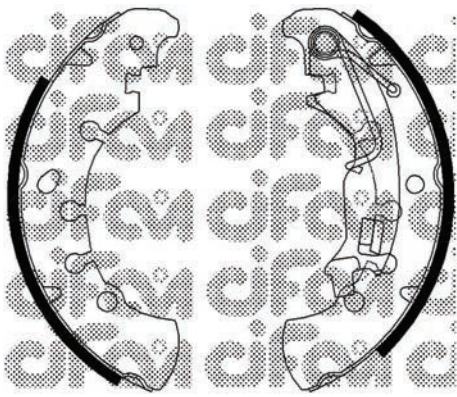

153-091 (Ø 203,0 x 38)

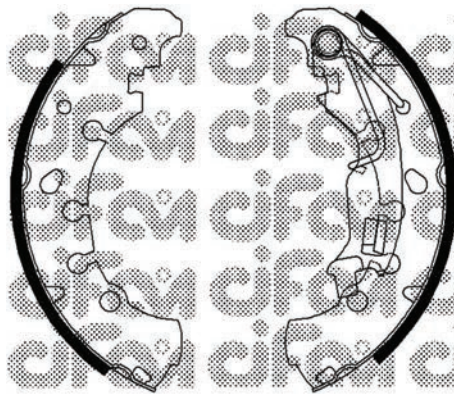

153-092 (Ø 203,0 x 38)

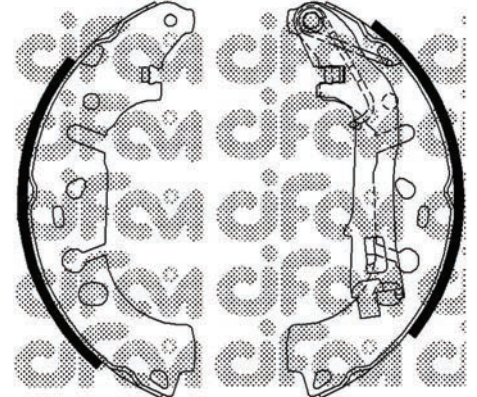

153-093 (Ø 228,0 x 40)

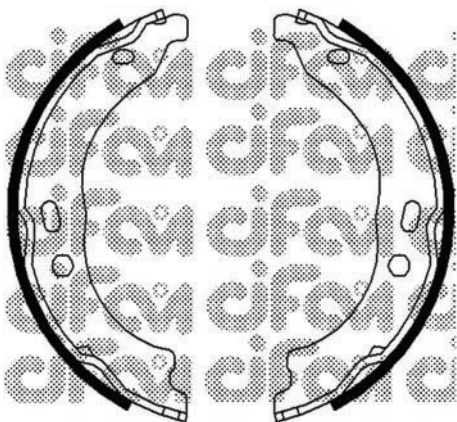

153-094 (Ø 172,0 x 40)

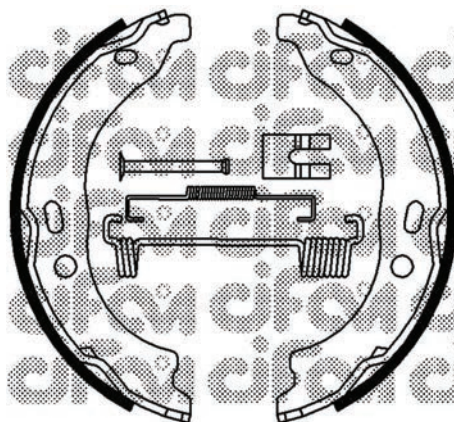

153-095K (Ø 172,0 x 40)

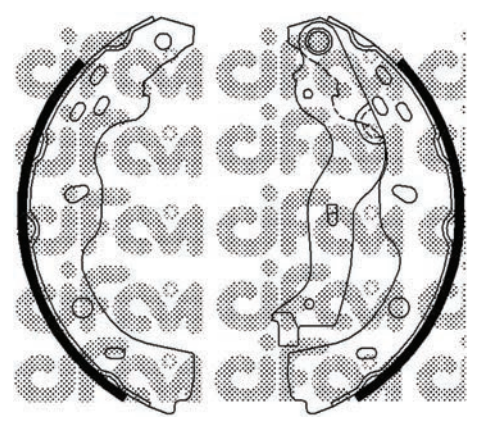

153-096 (Ø 220,0 x 36)

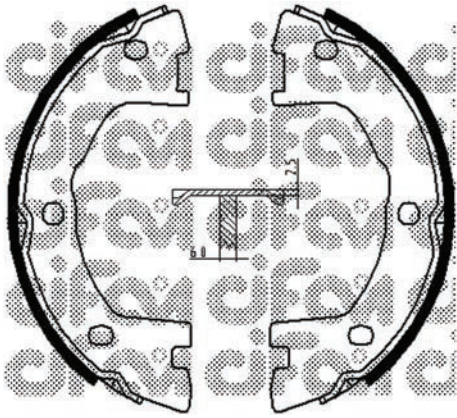

153-097 (Ø 170,0 x 45)

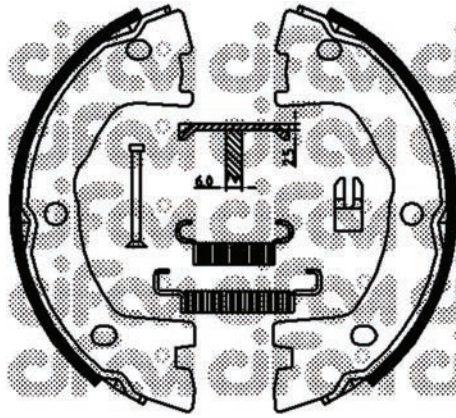

153-097K (Ø 170,0 x 45)

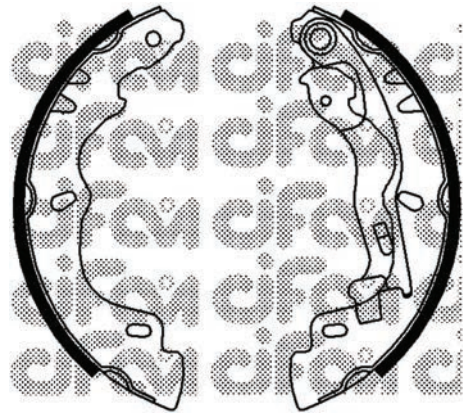

153-098 (Ø 185,0 x 29)

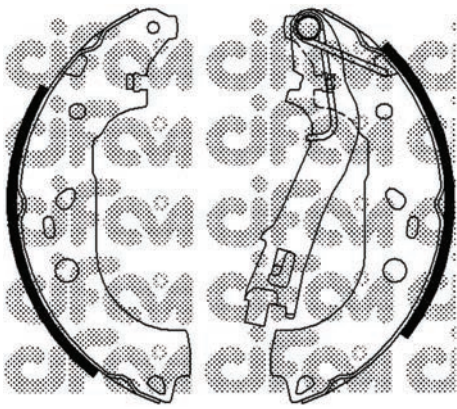

153-099 (Ø 228,6 x 43)

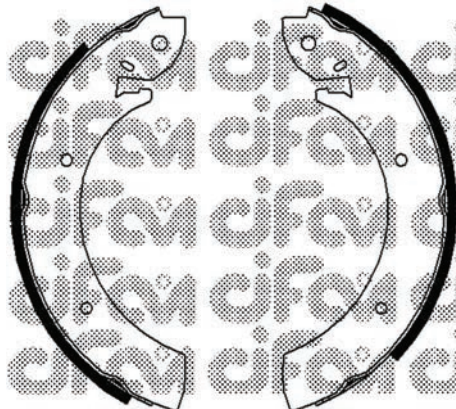

153-100 (Ø 254,0 x 57)

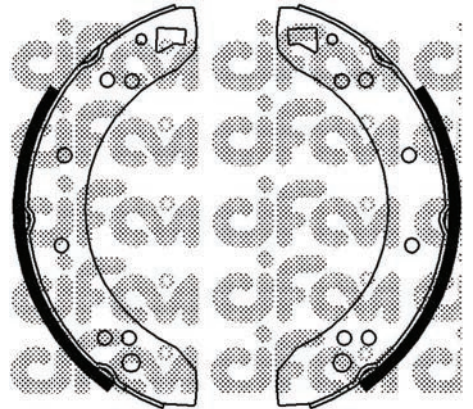

153-101 (Ø 203,2 x 38)

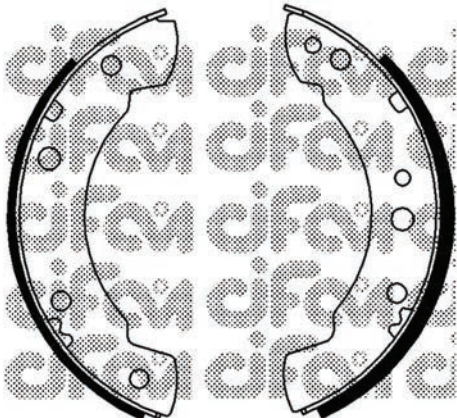

153-102 (Ø 228,6 x 45)

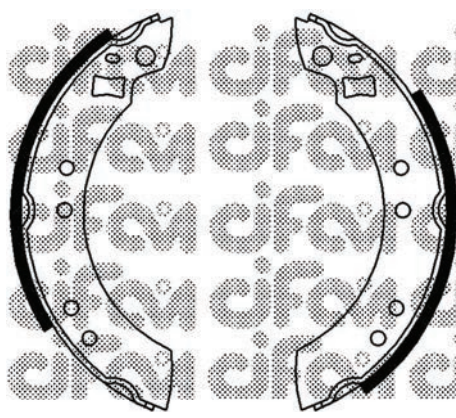

153-103 (Ø 203,2 x 38)

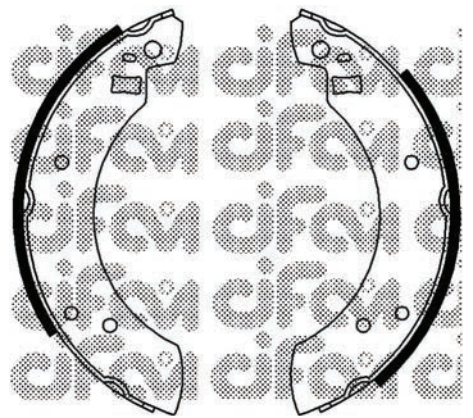

153-104 (Ø 228,6 x 45)

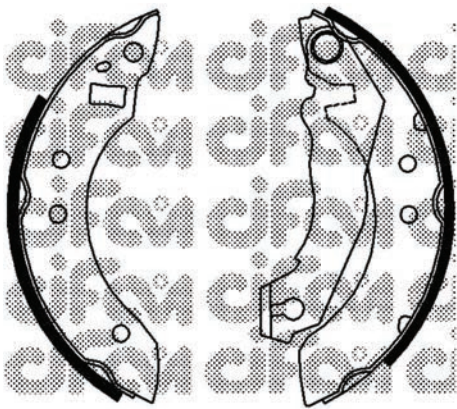

153-105 (Ø 180,0 x 32)

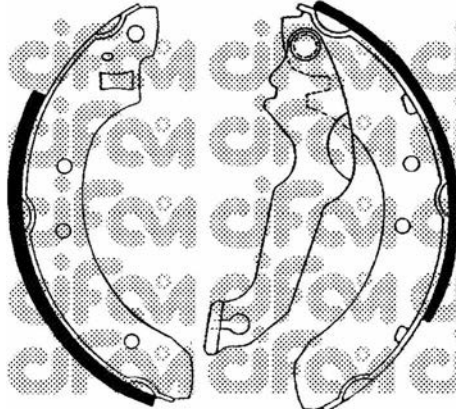

153-106 (Ø 203,2 x 38)

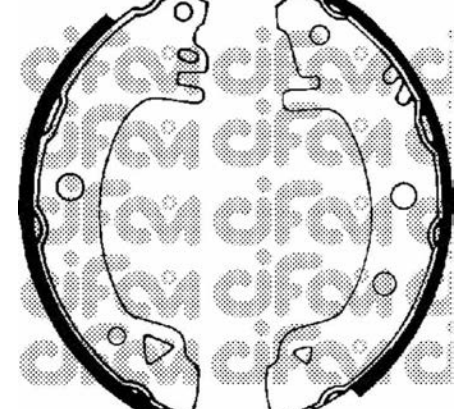

153-107 (Ø 203,2 x 38)

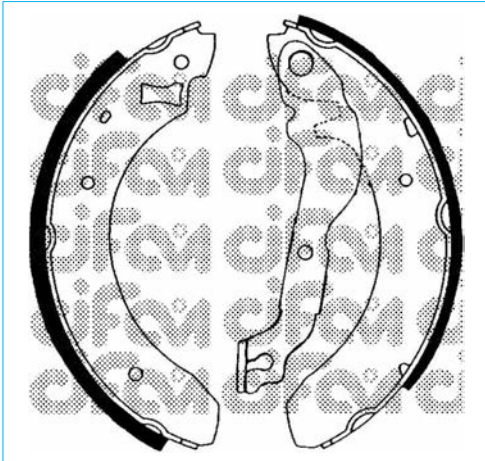

153-108 (Ø 228,6 x 57)

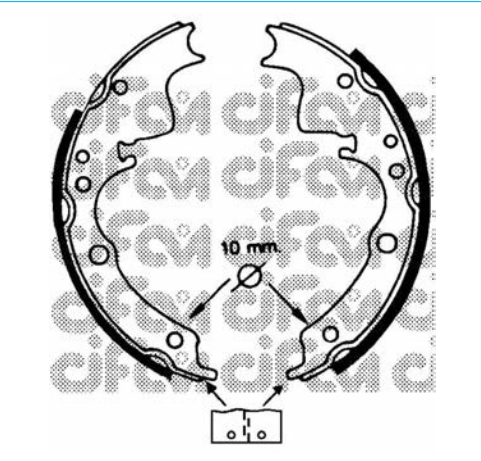

153-109 (Ø 254,0 x 70)

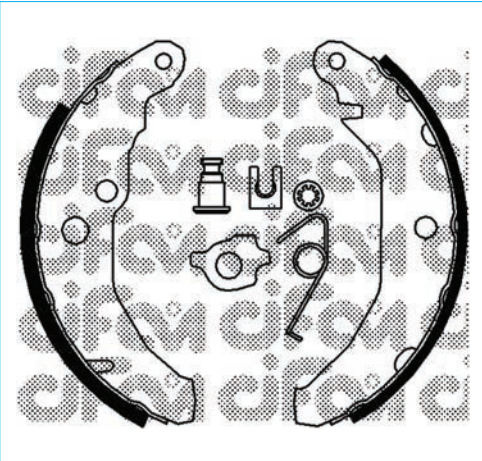

153-111K (Ø 178,0 x 32)

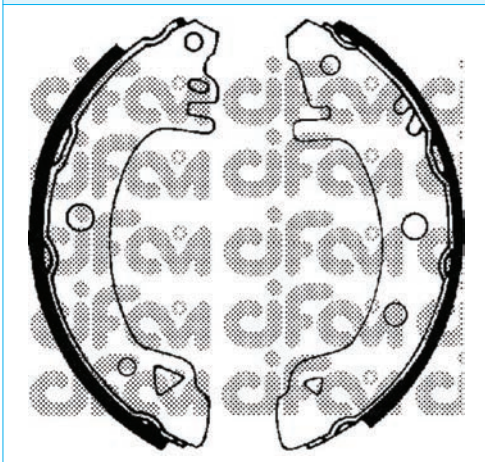

153-112K (Ø 203,2 x 38)

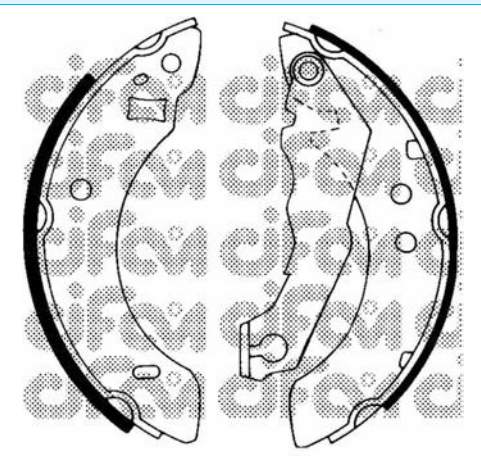

153-113 (Ø 180,0 x 32)

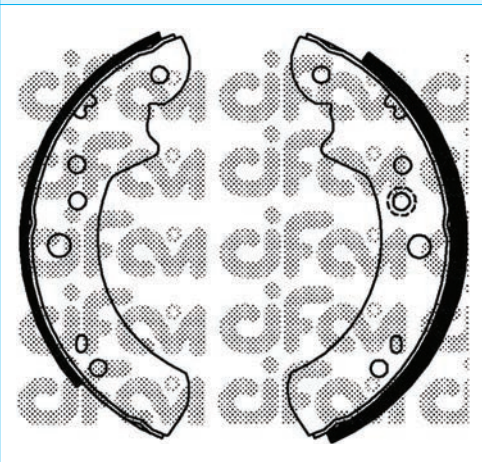

153-114 (Ø 254,0 x 70)

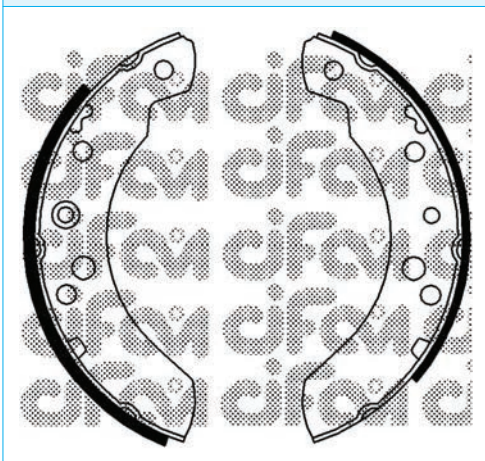

153-115 (Ø 228,6 x 45)



153-116 (Ø 254,0 x 70)

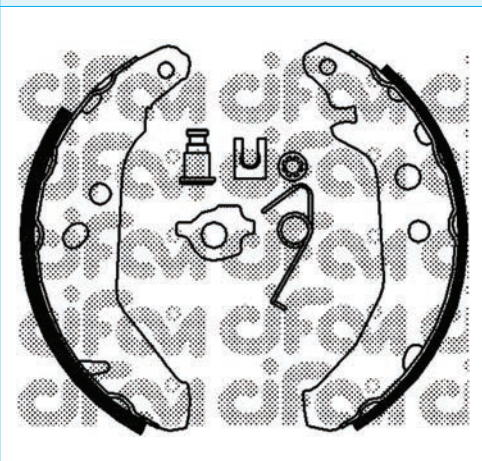

153-117K (Ø 178,0 x 32)

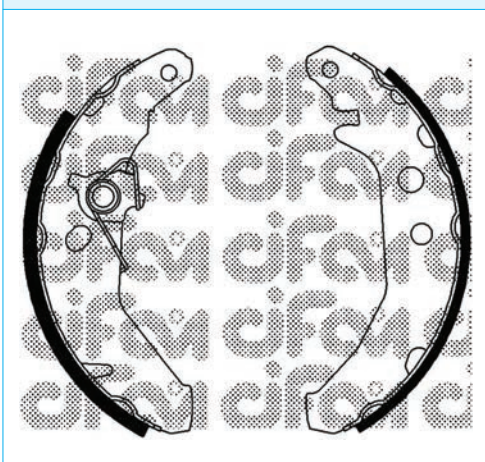

153-117Y (Ø 178,0 x 32)



153-118K (Ø 203,2 x 38)

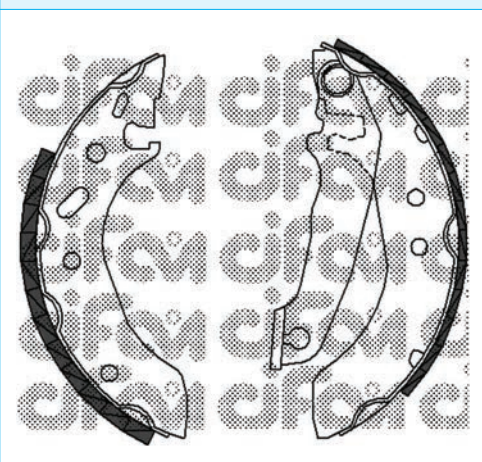

153-119 (Ø 180,0 x 32)

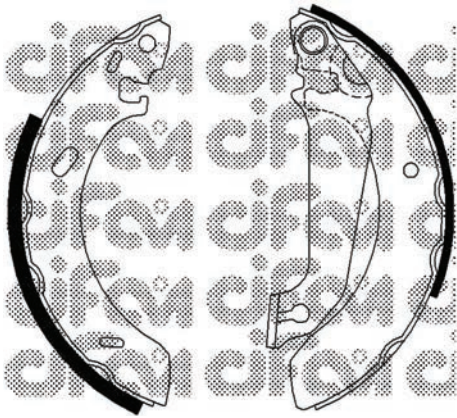

153-120 (Ø 203,0 x 39)

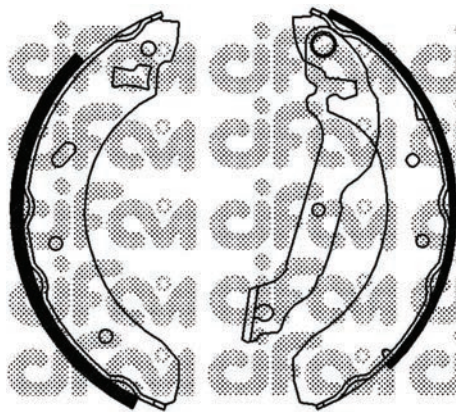

153-121 (Ø 228,6 x 45)

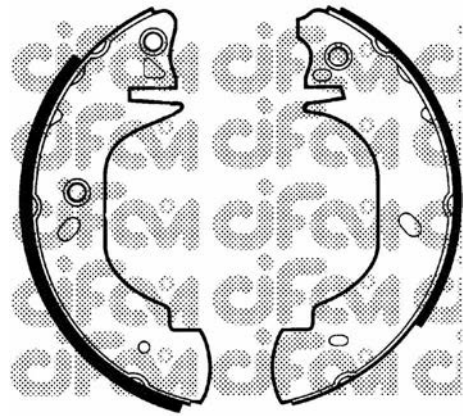

153-122 (Ø 254,0 x 50)

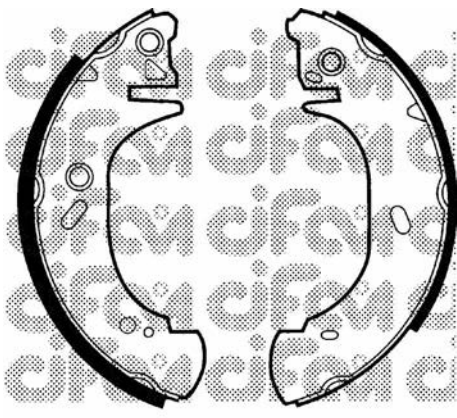

153-123 (Ø 280,0 x 64)



153-124 (Ø 203,0 x 38)

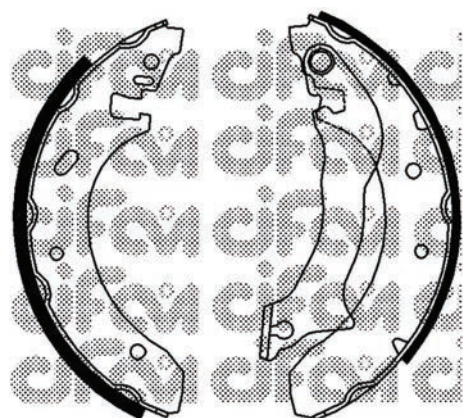

153-125 (Ø 228,6 x 45)

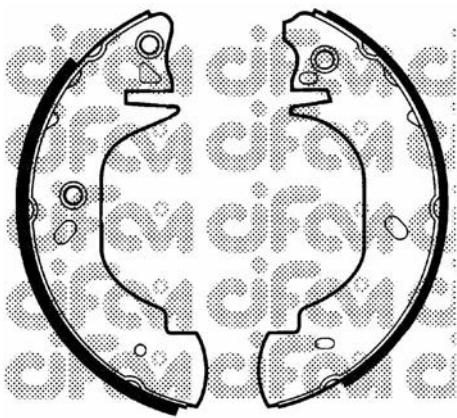

153-126 (Ø 254,0 x 50)

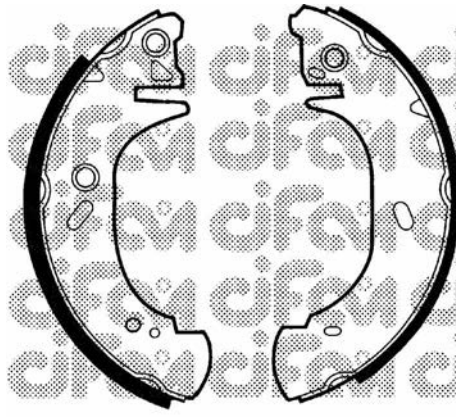

153-127 (Ø 280,0 x 64)

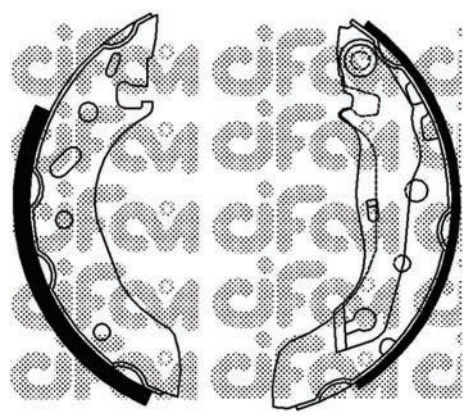

153-128 (Ø 180,0 x 32)

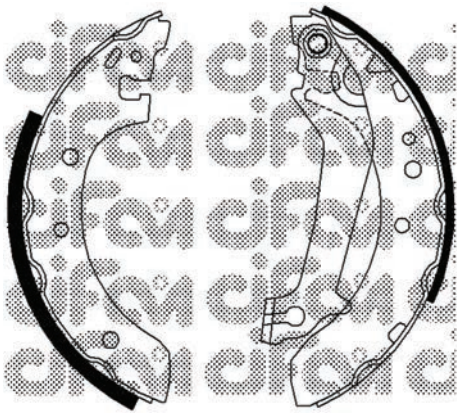

153-129 (Ø 203,2 x 39)

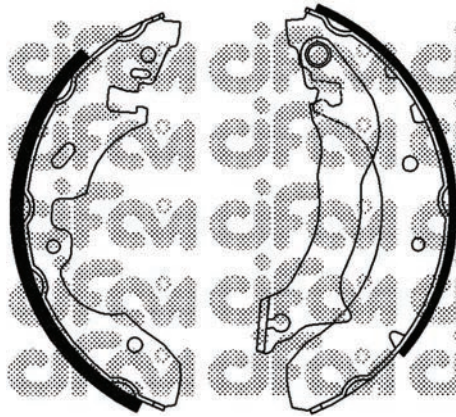

153-130 (Ø 228,6 x 45)

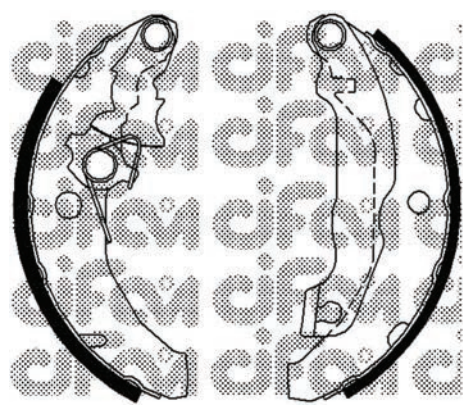

153-131Y (Ø 178,0 x 32)

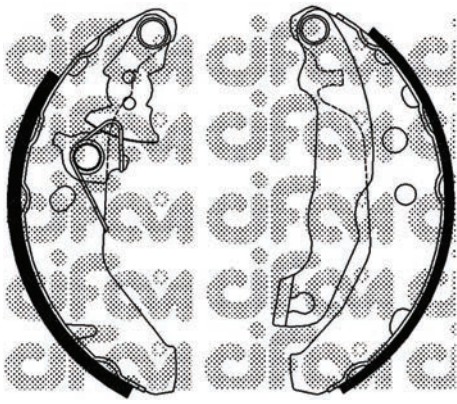

153-132Y (Ø 178,0 x 32)

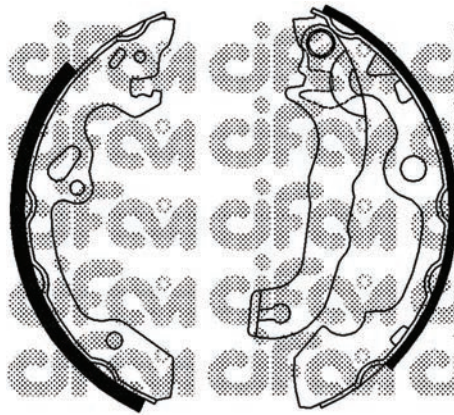

153-133 (Ø 203,2 x 39)

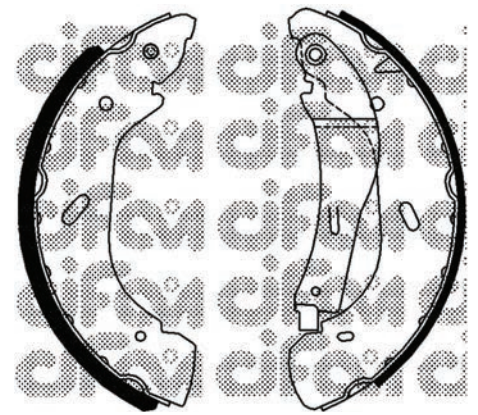

153-134 (Ø 280,0 x 65)

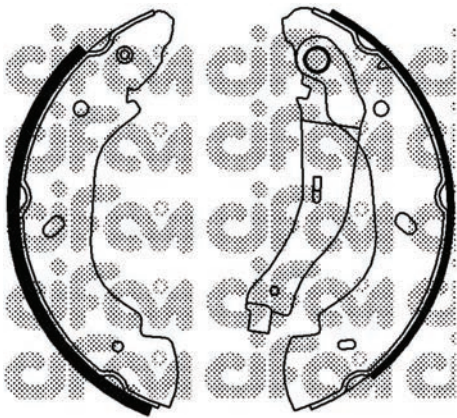

153-135 (Ø 254,0 x 52)

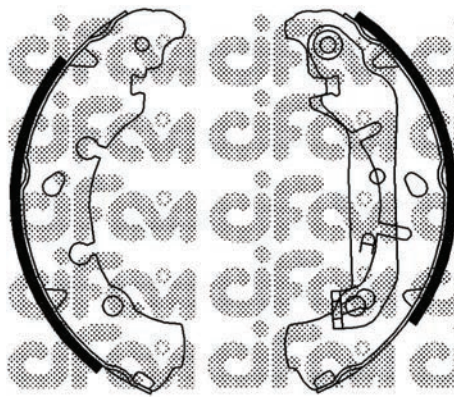

153-136 (Ø 203,2 x 38)

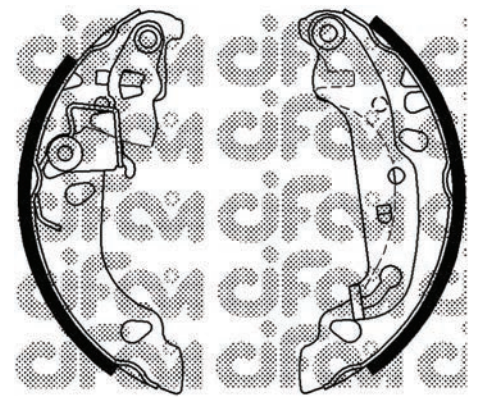

153-137 (Ø 180,0 x 32)

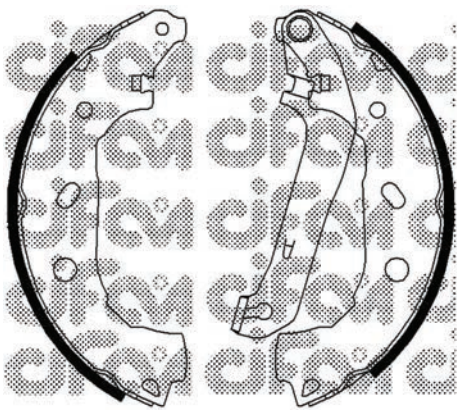

153-138 (Ø 228,6 x 58)

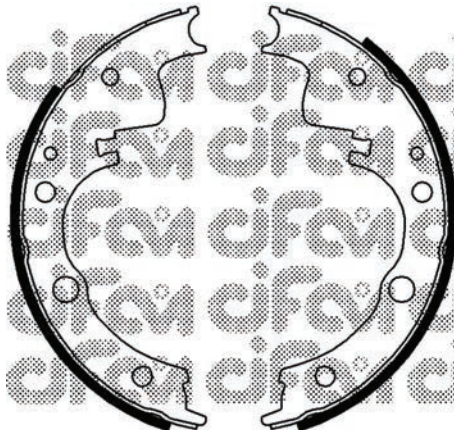

153-139 (Ø 254,0 x 57)

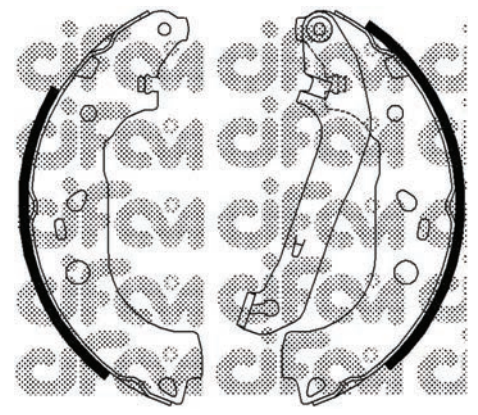

153-142 (Ø 228,6 x 43)

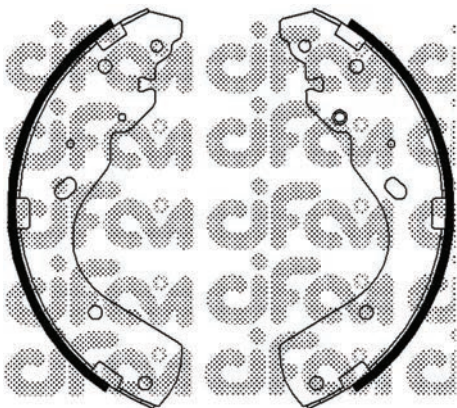

153-143 (Ø 295,0 x 56)

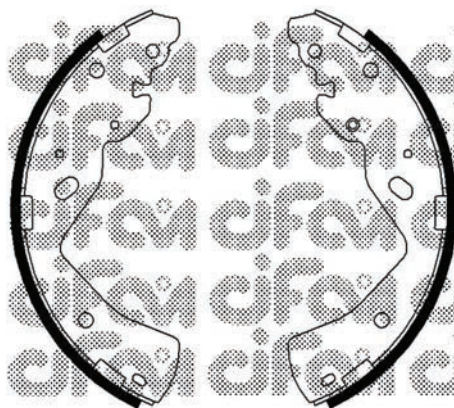

153-144 (Ø 270,0 x 54)

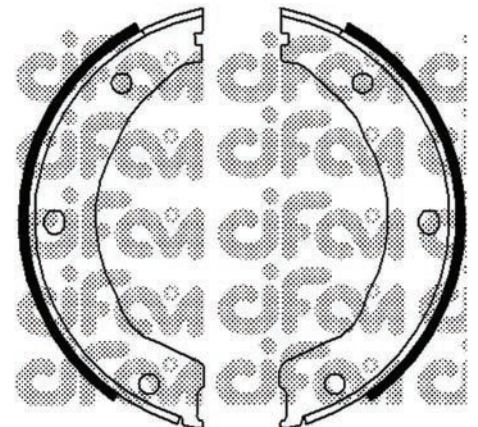

153-145 (Ø 180,0 x 25)

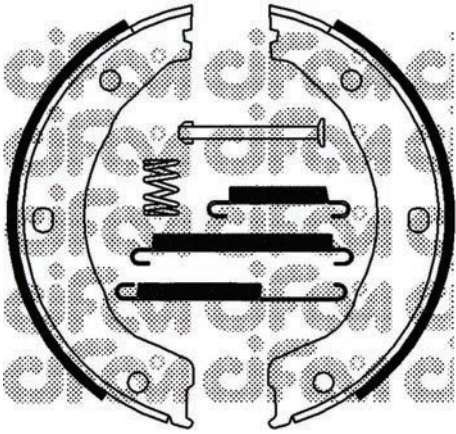

153-145K (Ø 180,0 x 25)

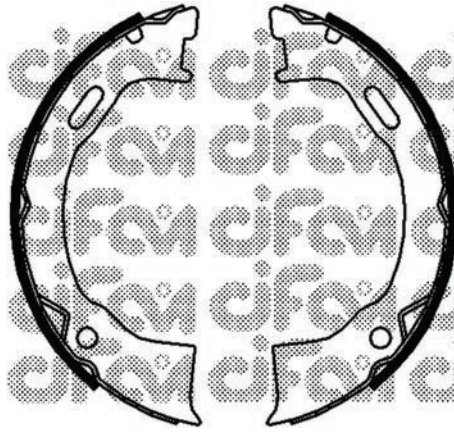

153-146 (Ø 184,0 x 30)



153-147 (Ø 185,0 x 30)

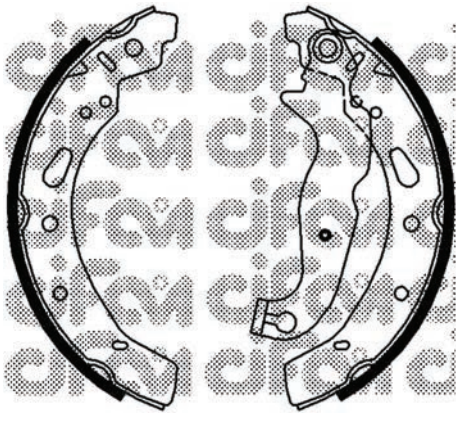

153-148 (Ø 200,0 x 32)

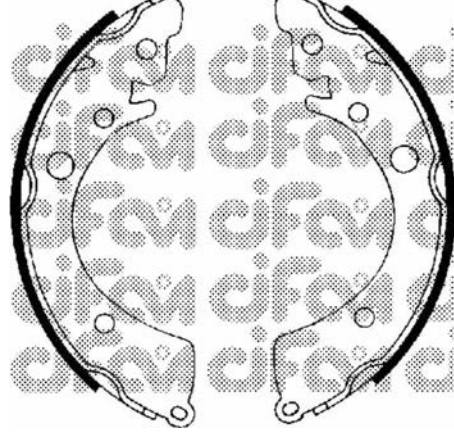

153-149 (Ø 200,0 x 35)

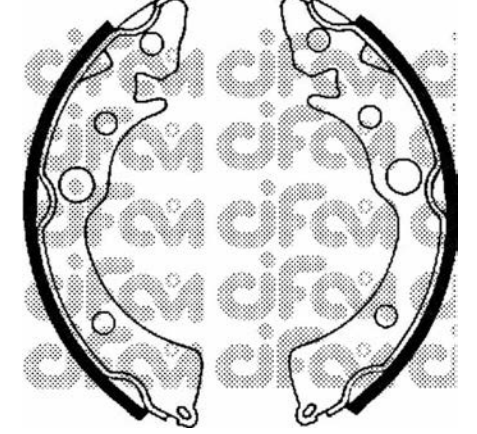

153-150 (Ø 180,0 x 31)

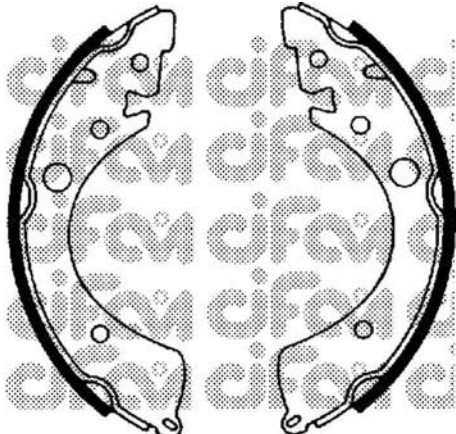

153-151 (Ø 200,0 x 30)



153-152 (Ø 180,0 x 25)

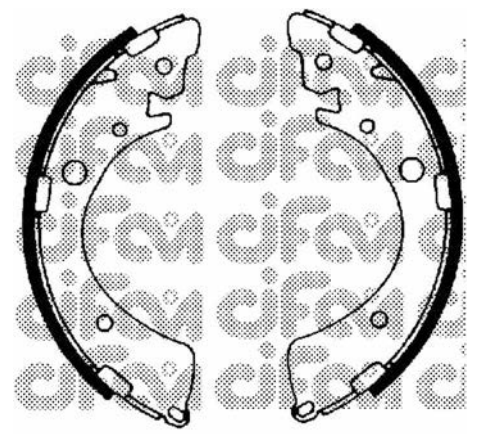

153-153 (Ø 200,0 x 35)

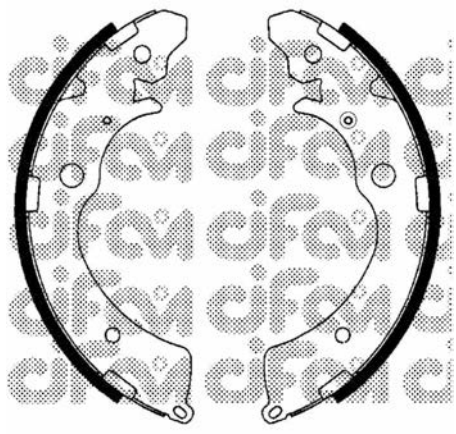

153-154 (Ø 220,0 x 35)

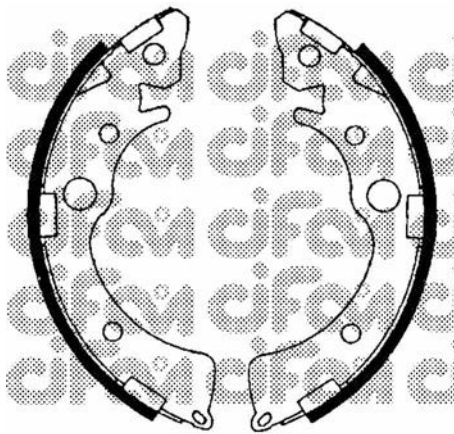

153-155 (Ø 180,0 x 31)

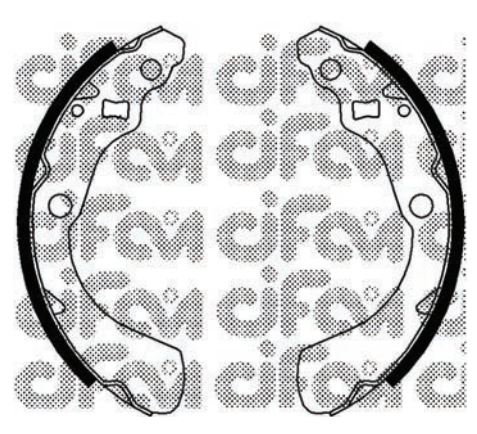

153-156 (Ø 180,0 x 30)

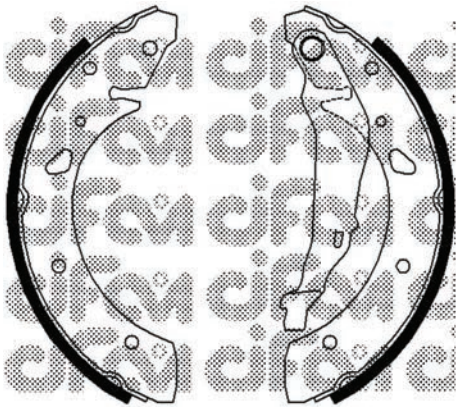

153-157 (Ø 228,6 x 42)

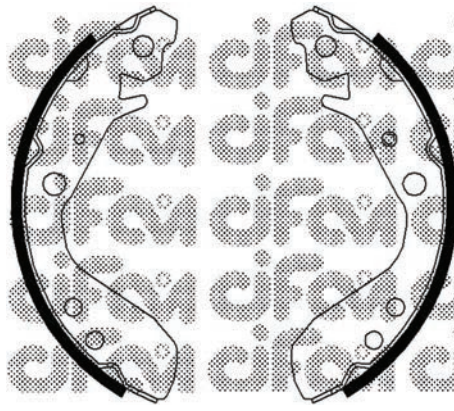

153-158 (Ø 180,0 x 32)

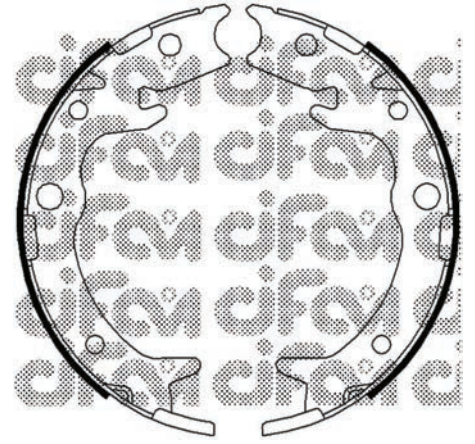

153-159 (Ø 170,0 x 35)

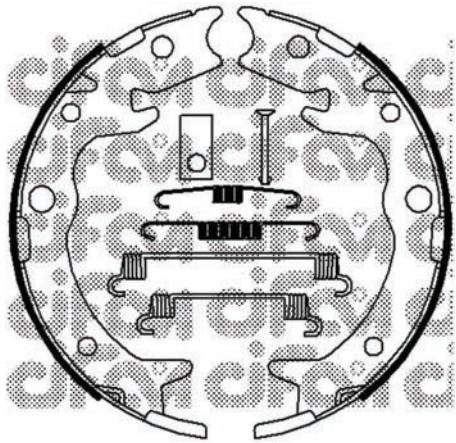

153-159K (Ø 170,0 x 35)

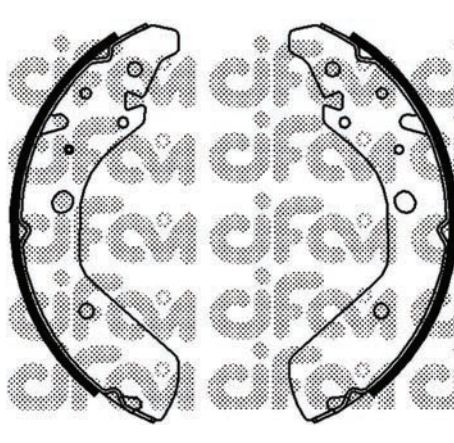

153-160 (Ø 254,0 x 47)

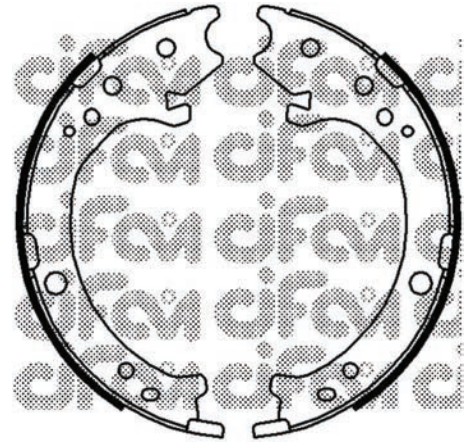

153-161 (Ø 198,0 x 35)

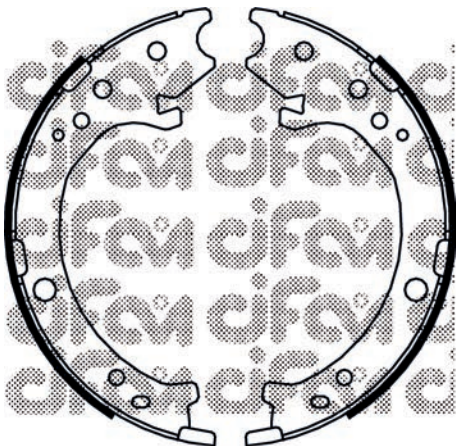

153-161K (Ø 198 x 35)

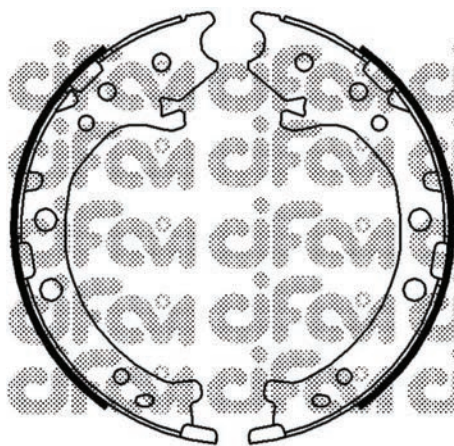

153-162 (Ø 198,0 x 35)

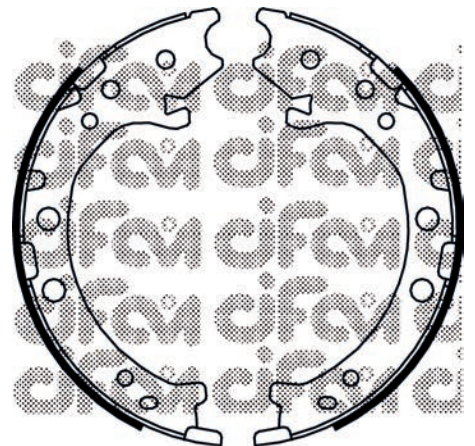

153-162K (Ø 198 x 35)

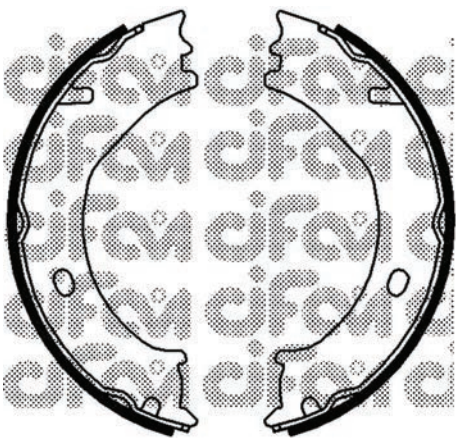

153-163 (Ø 205,0 x 45)

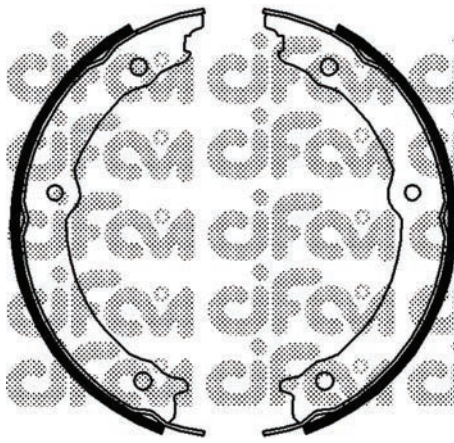

153-164 (Ø 210,0 x 35)

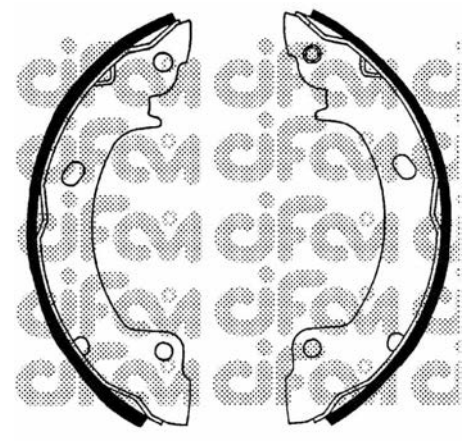

153-165 (Ø 180,0 x 34)

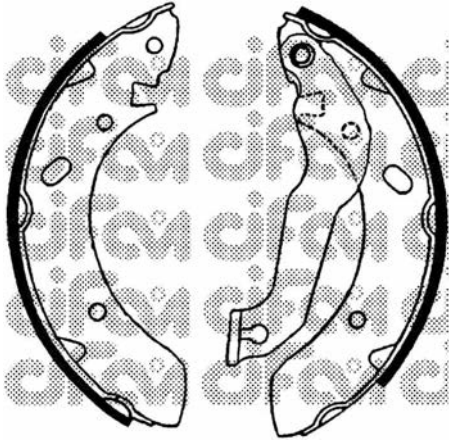

153-166 (Ø 203,2 x 39)

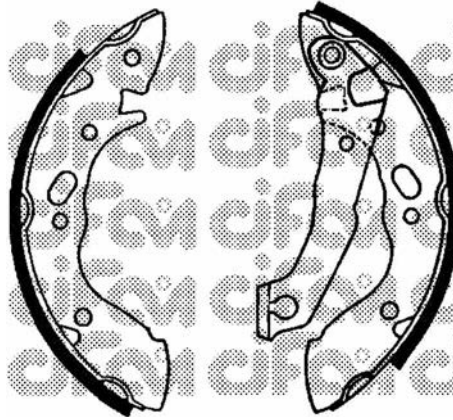

153-167 (Ø 180,0 x 35)

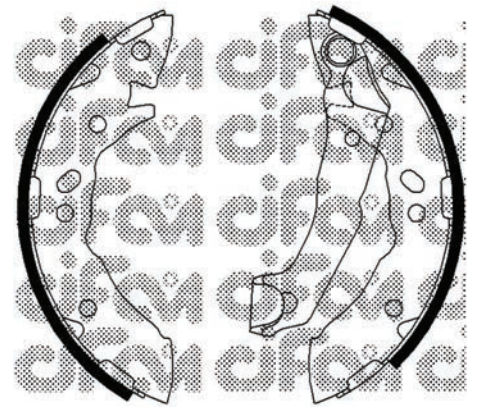

153-168 (Ø 180,0 x 32)

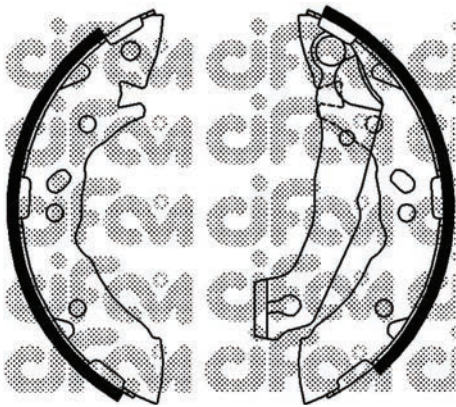

153-169 (Ø 180,0 x 32)

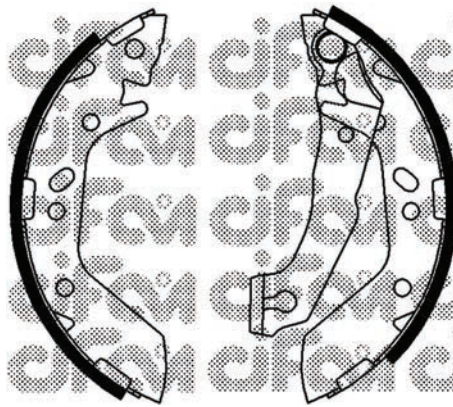

153-170 (Ø 180,0 x 38)

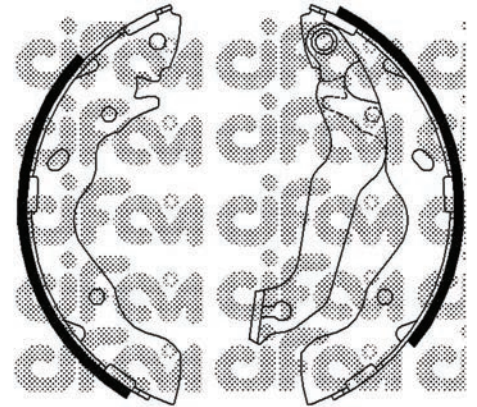

153-171 (Ø 203,2 x 39)

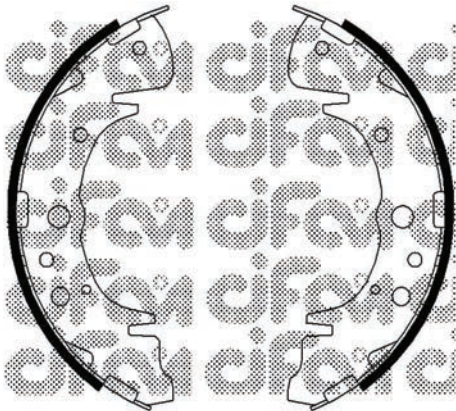

153-172 (Ø 254,0 x 55)

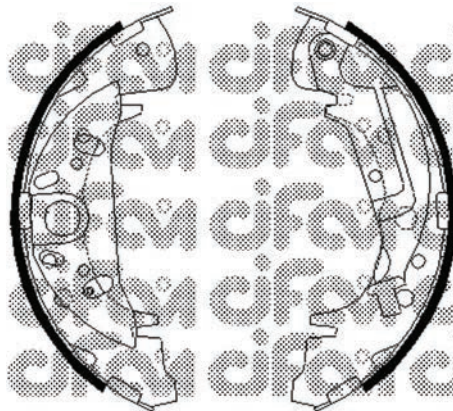

153-172Y (Ø 254,0 x 55)

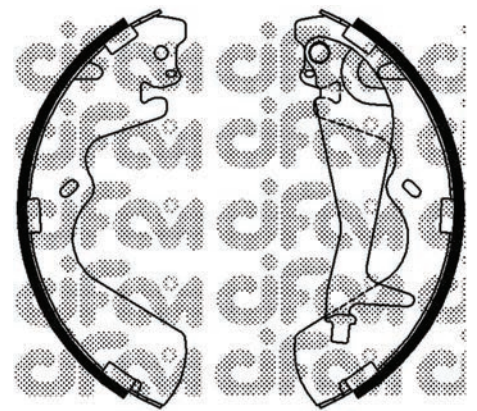

153-173 (Ø 270,0 x 54)

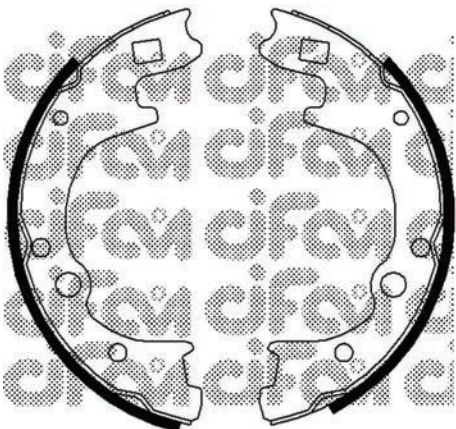

153-174 (Ø 220,0 x 47)

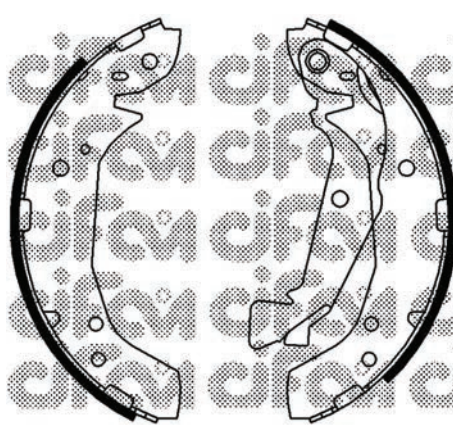

153-175 (Ø 228,6 x 45)

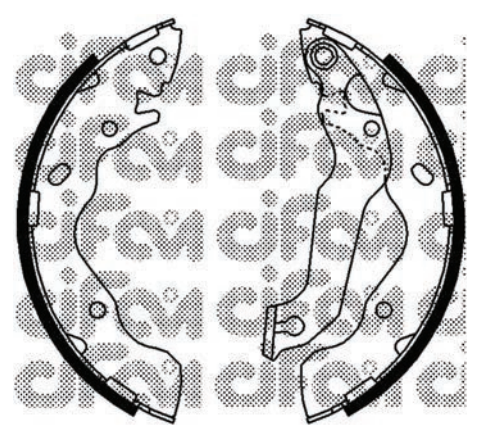

153-176 (Ø 203,2 x 39)

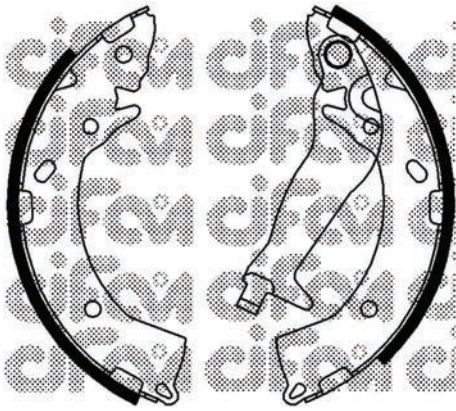

153-177 (Ø 203,2 x 32)

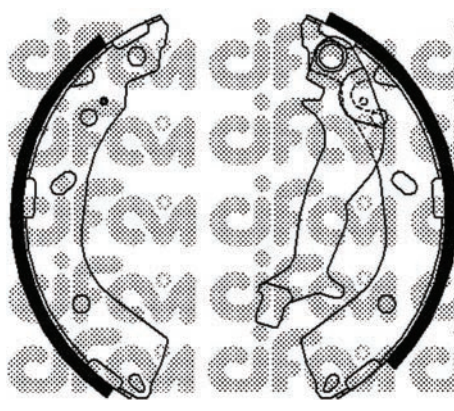

153-178 (Ø 180,0 x 32)

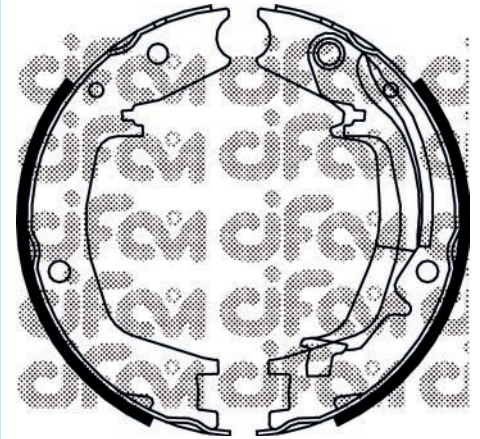

153-179K (Ø 190 x 40)

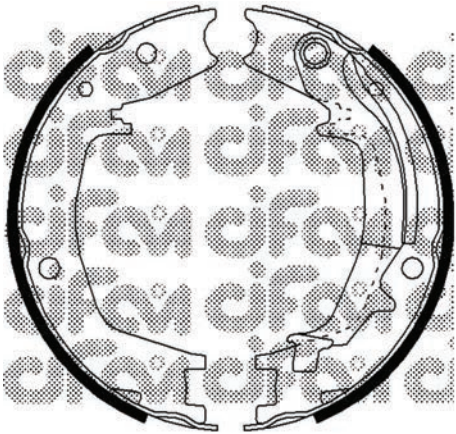

153-179Y (Ø 190,0 x 40)

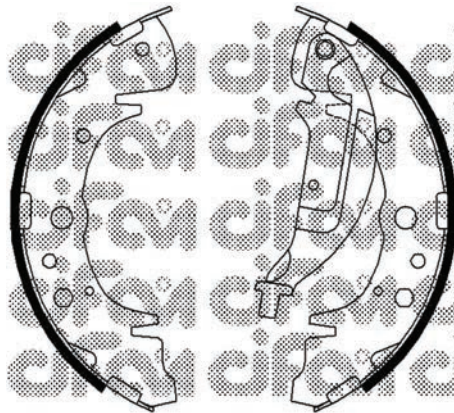

153-180 (Ø 254,0 x 57)

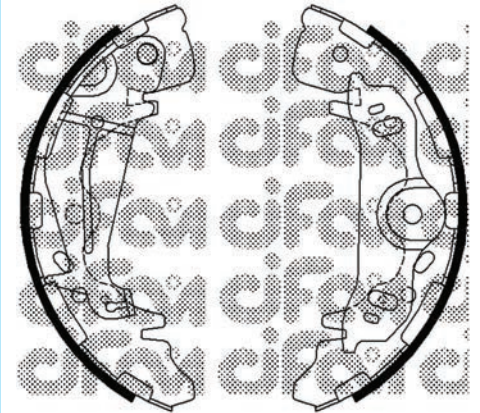

153-181 (Ø 295,0 x 54)

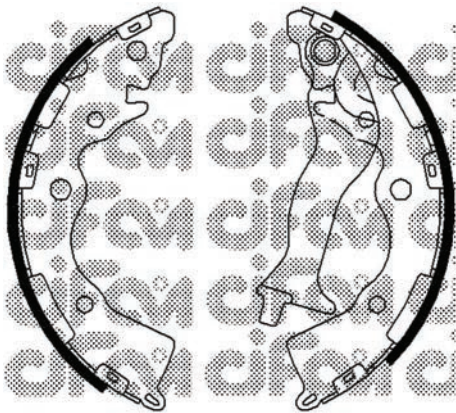

153-182 (Ø 203,2 x 32)

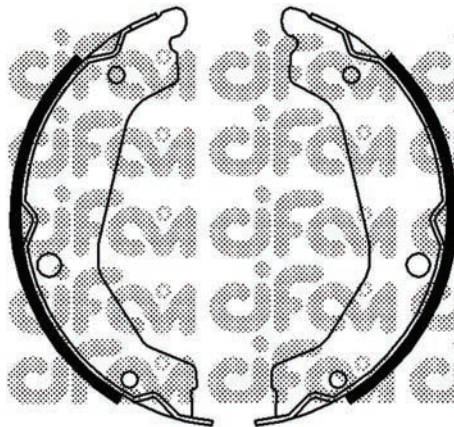

153-183 (Ø 190,0 x 40)

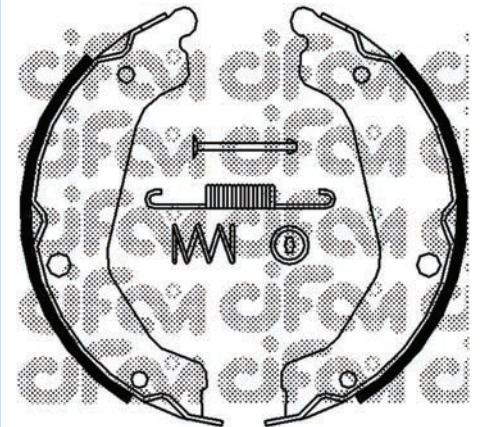

153-183K (Ø 190,0 x 40)

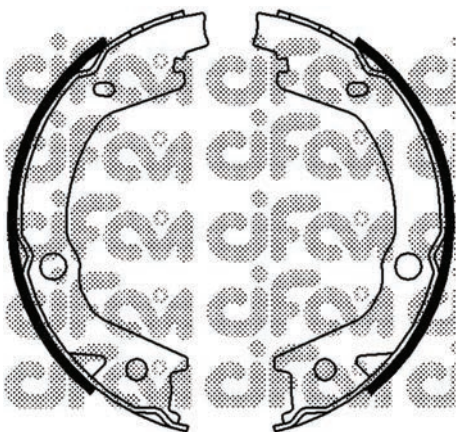

153-184 (Ø 170,0 x 27)

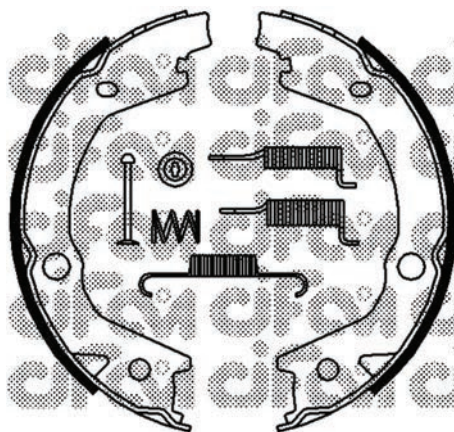

153-184K (Ø 170,0 x 27)

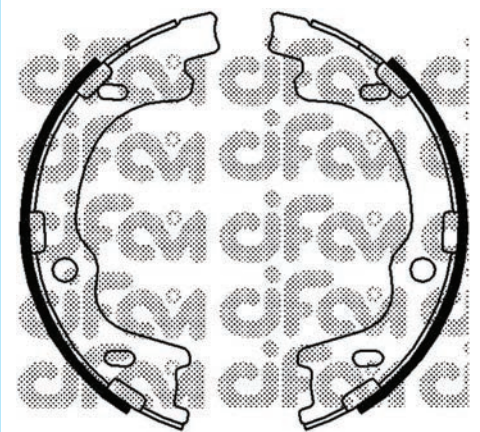

153-185 (Ø 170,0 x 27)

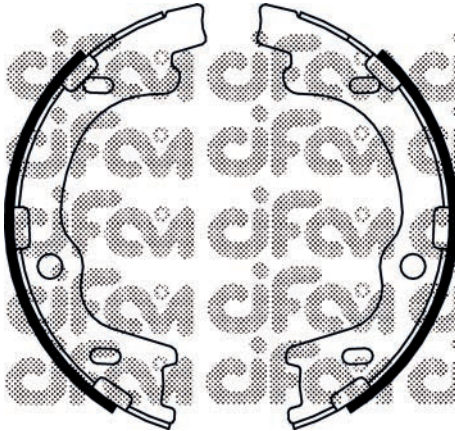
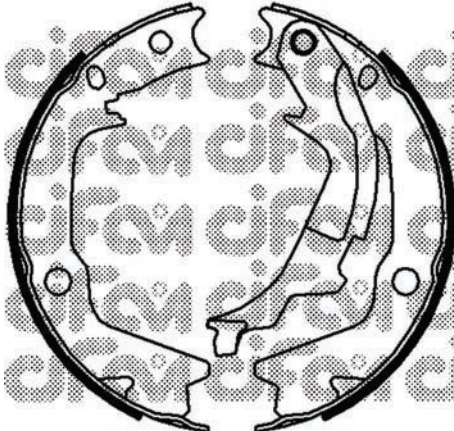
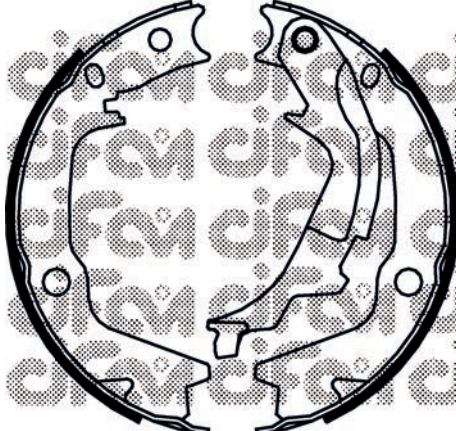
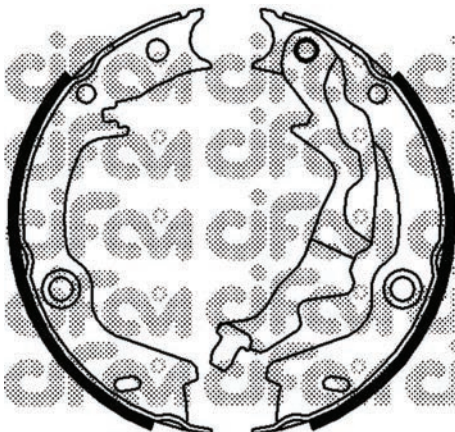
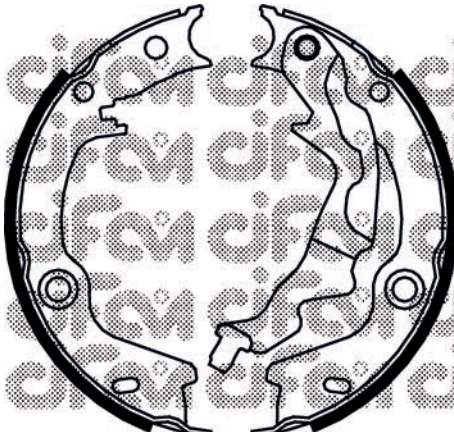
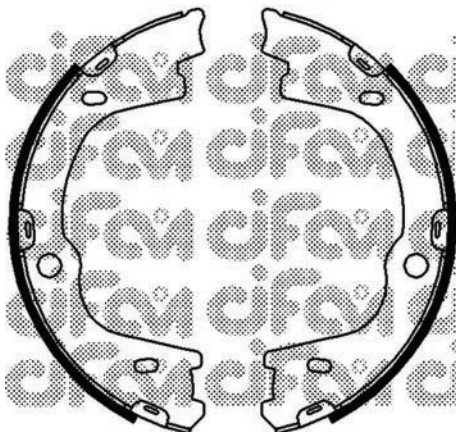
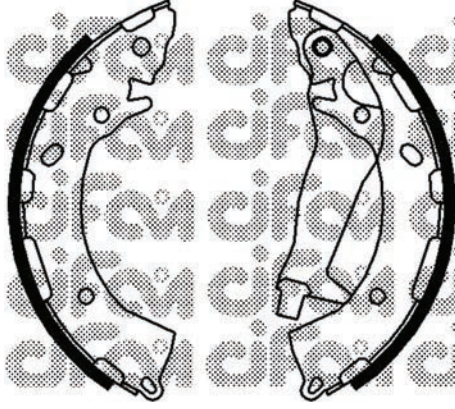
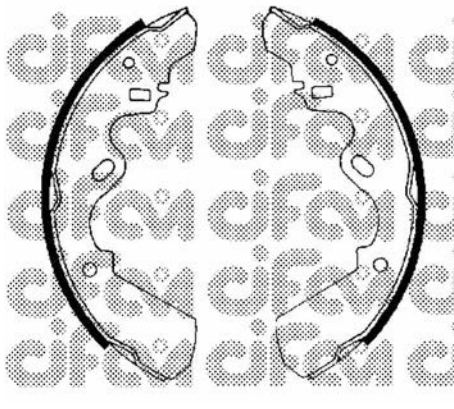
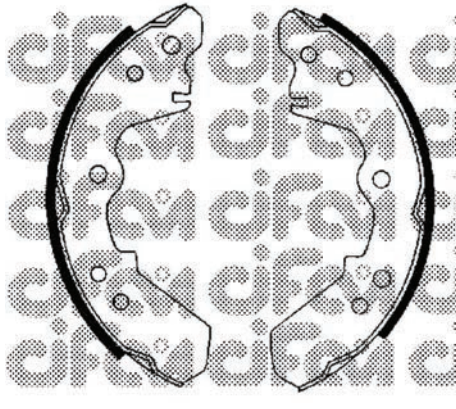
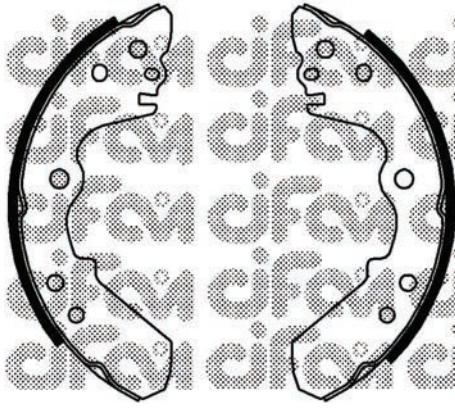
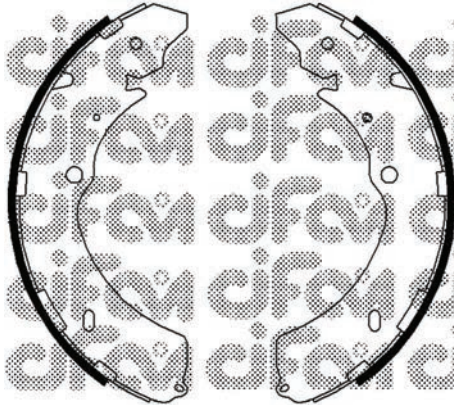
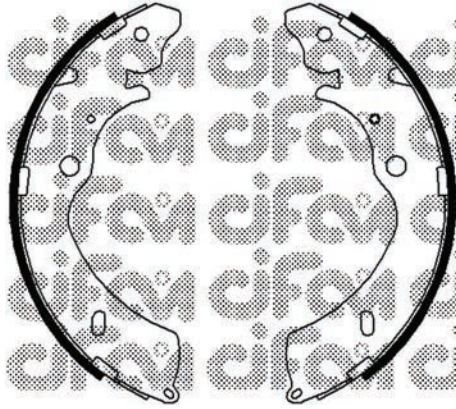
		
<p>153-185K (Ø 170 x 27)</p>	<p>153-186 (Ø 170,0 x 32)</p>	<p>153-186K (Ø 170 x 32)</p>
		
<p>153-187 (Ø 170,0 x 32)</p>	<p>153-187K (Ø 170 x 32)</p>	<p>153-188 (Ø 212,0 x 40)</p>
		
<p>153-189 (Ø 203,2 x 32)</p>	<p>153-190 (Ø 254,0 x 50)</p>	<p>153-191 (Ø 254,0 x 50)</p>
		
<p>153-192 (Ø 254,0 x 52)</p>	<p>153-193 (Ø 295,0 x 47)</p>	<p>153-194 (Ø 254,0 x 52)</p>

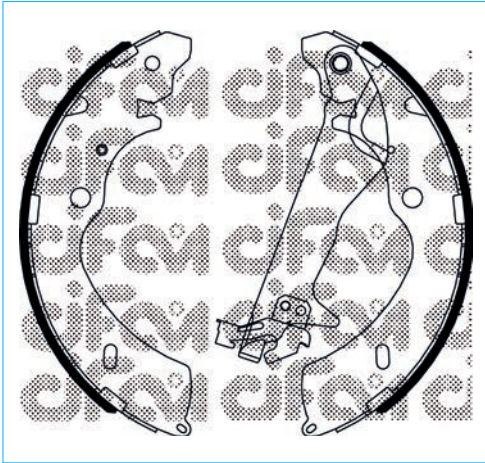

153-194Y (Ø 254 x 52)

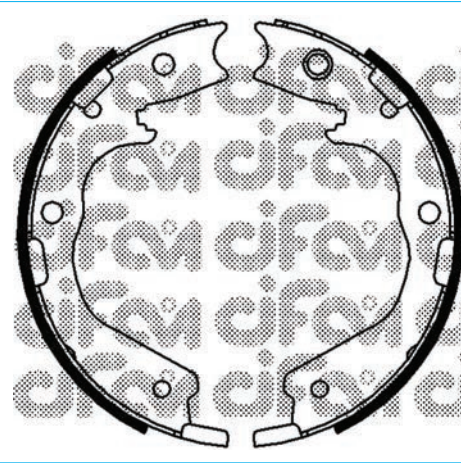

153-195 (Ø 210,0 x 31)

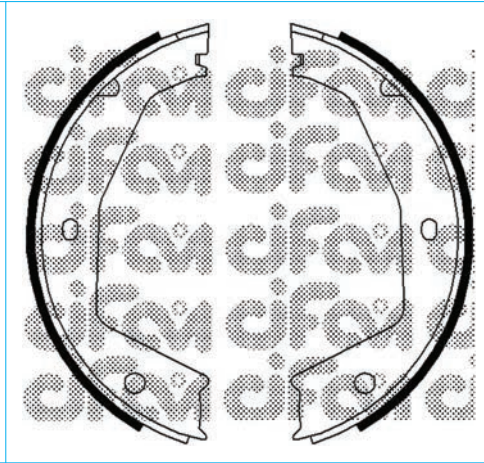

153-197 (Ø 180,0 x 30)

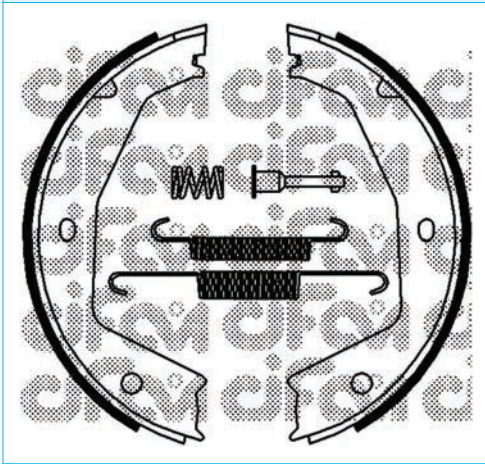

153-197K (Ø 180,0 x 30)

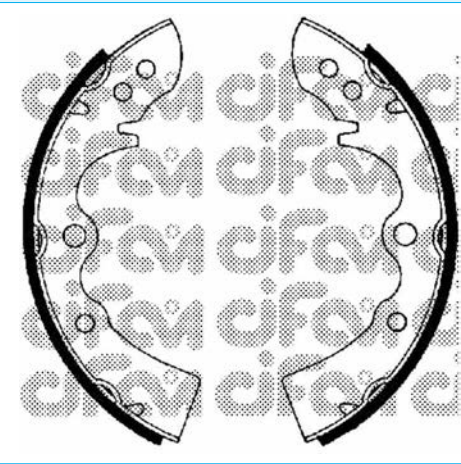

153-198 (Ø 200,0 x 33)

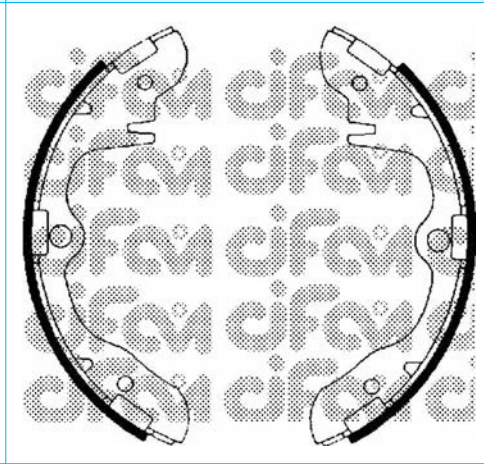

153-199 (Ø 260,0 x 45)

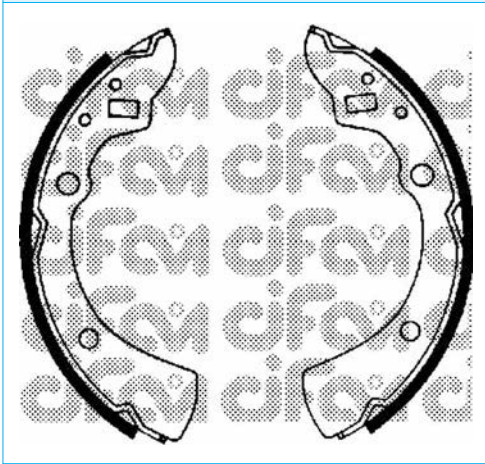

153-200 (Ø 180,0 x 30)

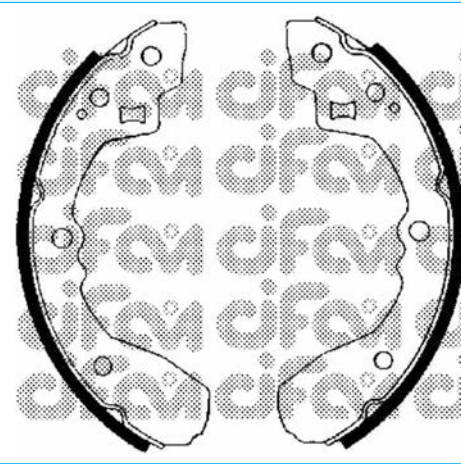

153-201 (Ø 200,0 x 25)



153-202 (Ø 260,0 x 50)

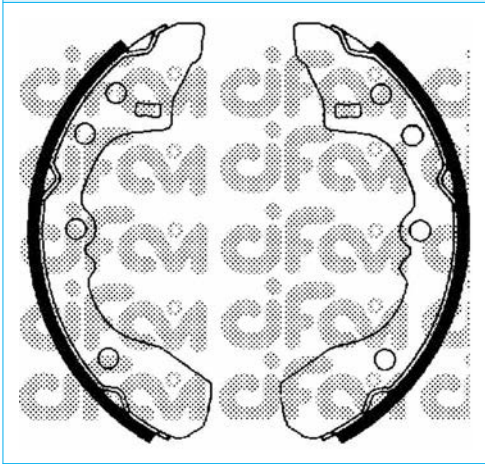

153-203 (Ø 200,0 x 25)

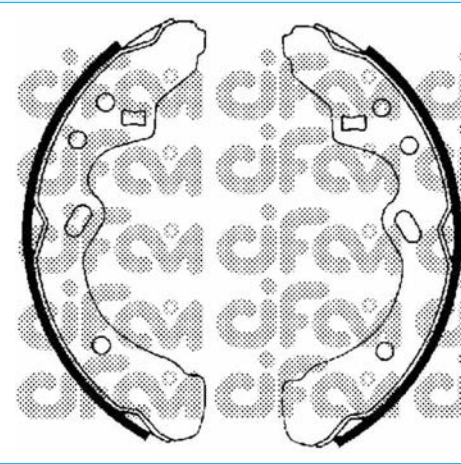

153-204 (Ø 228,6 x 25)

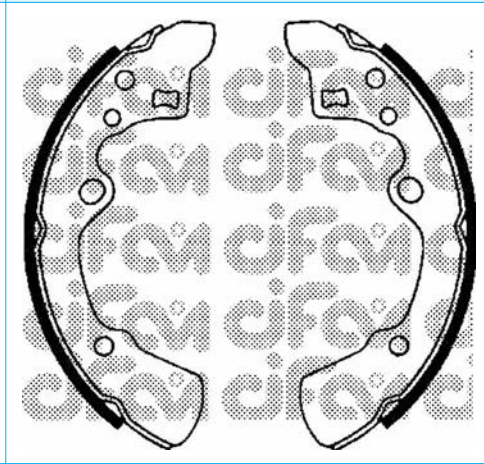

153-205 (Ø 228,6 x 32)

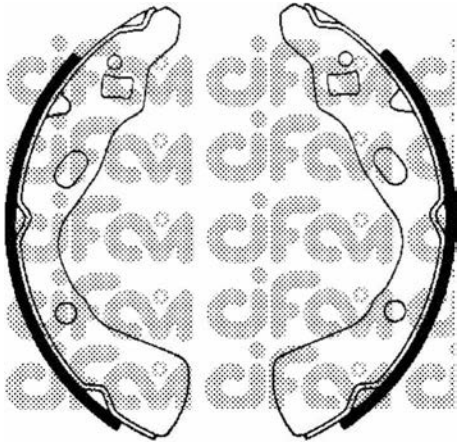

153-206 (Ø 170,0 x 25)

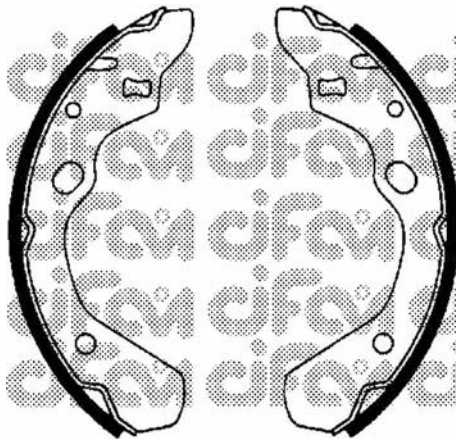

153-207 (Ø 200,0 x 25)

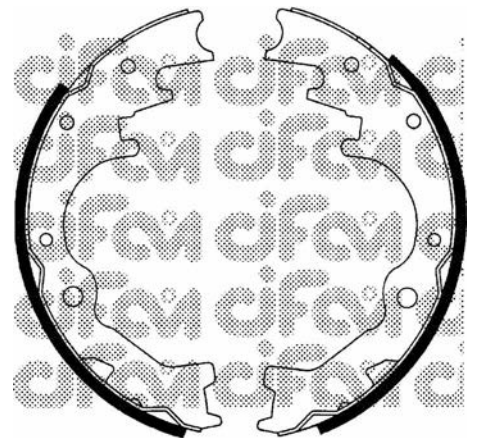

153-208 (Ø 260,0 x 50)

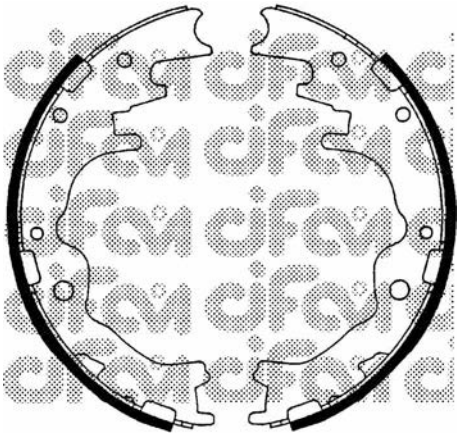

153-209 (Ø 260,0 x 50)

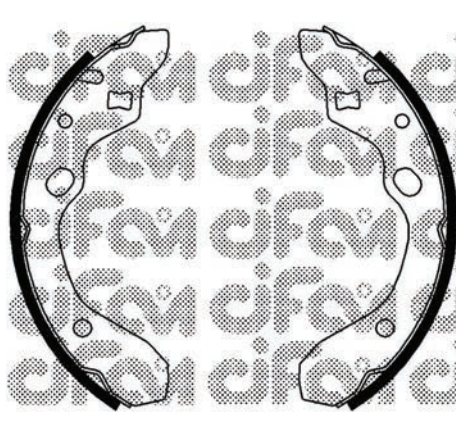

153-210 (Ø 200,0 x 35)

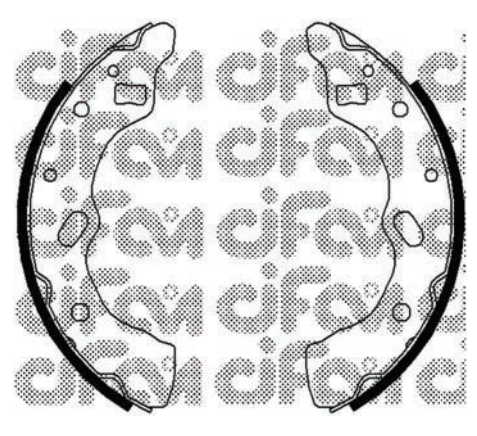

153-211 (Ø 180,0 x 31)

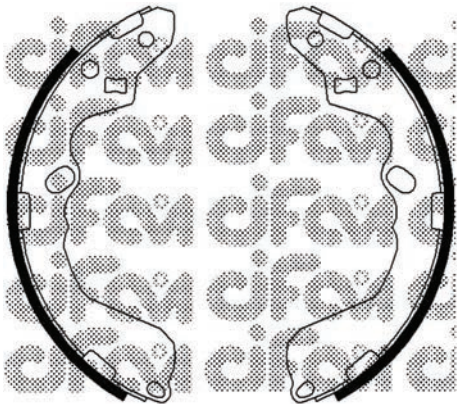

153-212 (Ø 228,6 x 32)

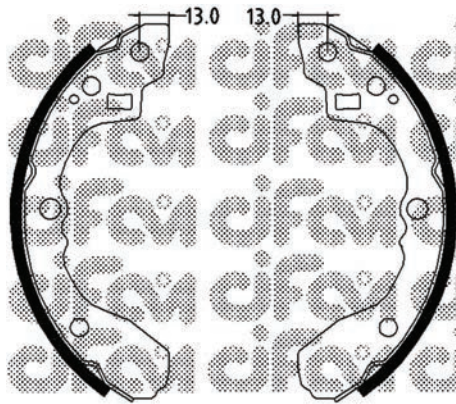

153-213 (Ø 200,0 x 36)

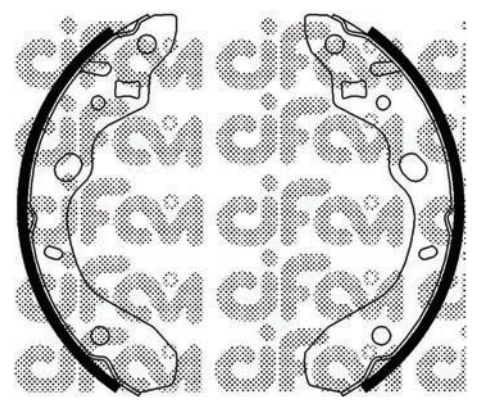

153-214 (Ø 200,0 x 37)

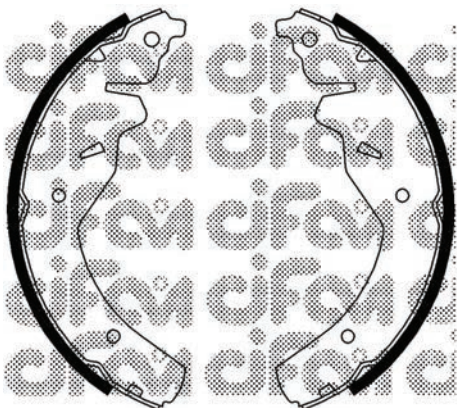

153-215 (Ø 252,0 x 57)

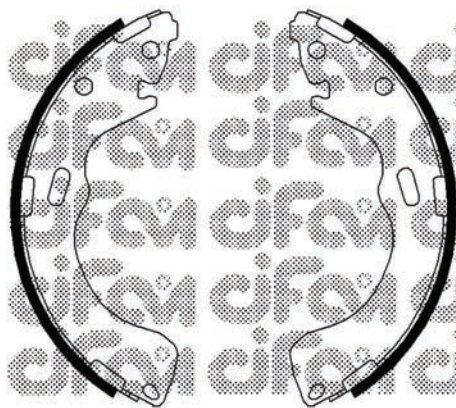

153-216 (Ø 228,6 x 42)

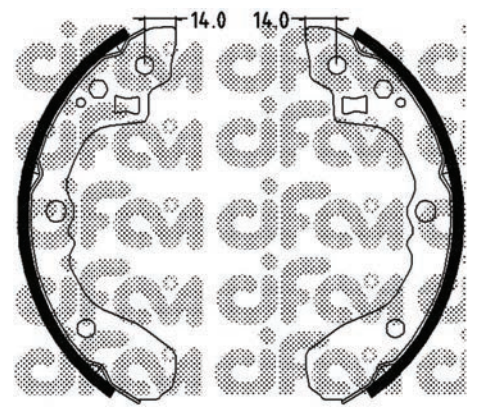

153-217 (Ø 200,0 x 36)

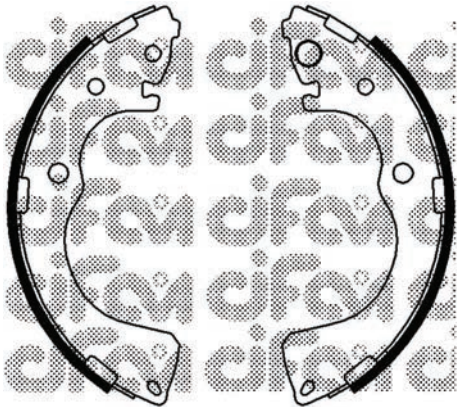

153-218 (Ø 254,0 x 52)

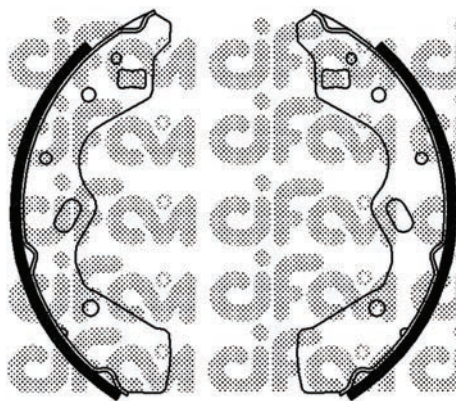

153-219 (Ø 200,0 x 32)

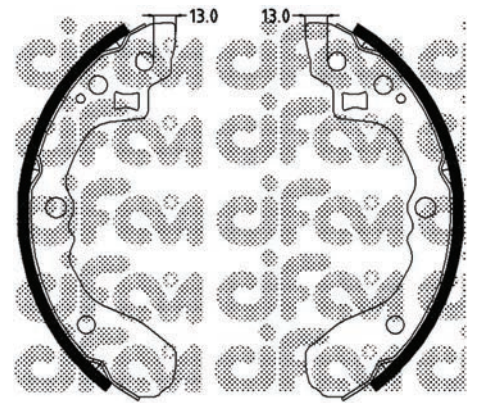

153-220 (Ø 200,0 x 26)

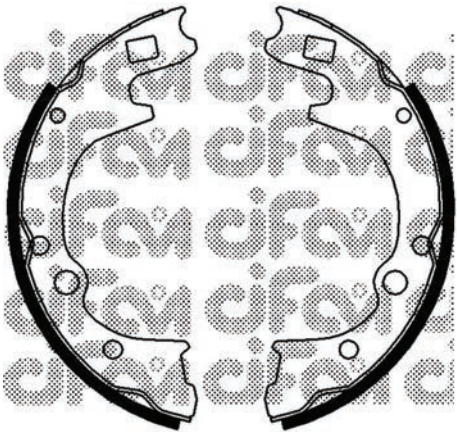

153-221 (Ø 220,0 x 57)

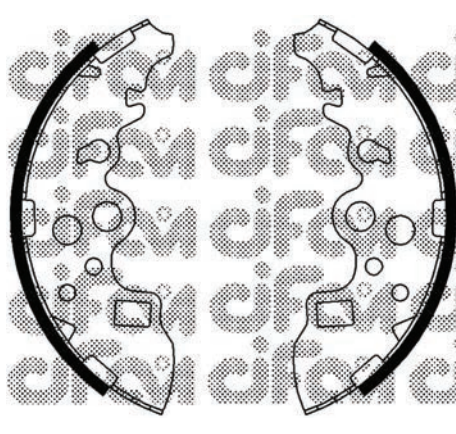

153-222 (Ø 220,0 x 57)

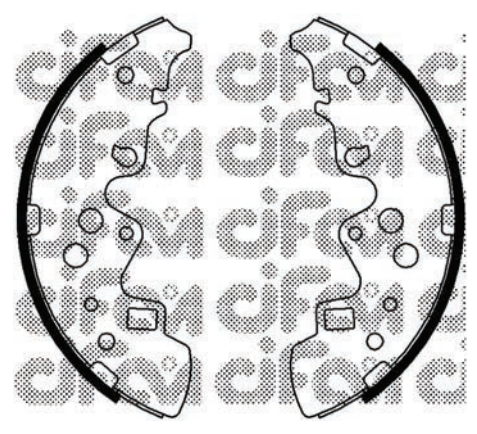

153-223 (Ø 270,0 x 52)

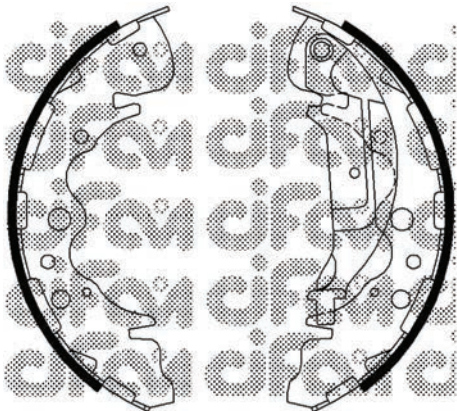

153-225 (Ø 254,0 x 57)



153-226 (Ø 295,0 x 54)

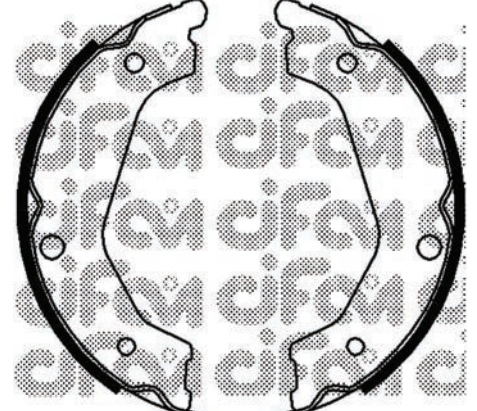

153-227 (Ø 190,0 x 40)

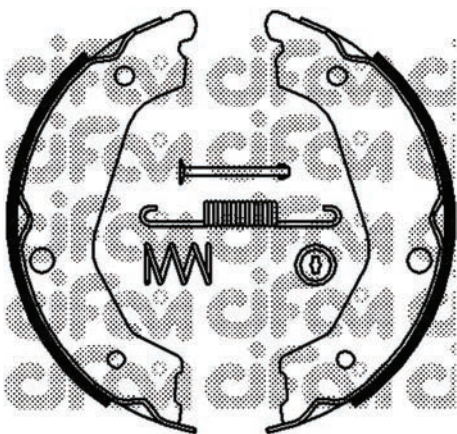

153-227K (Ø 190,0 x 40)

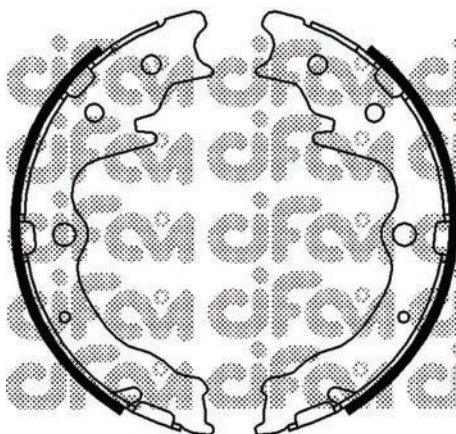

153-228 (Ø 190,0 x 32)

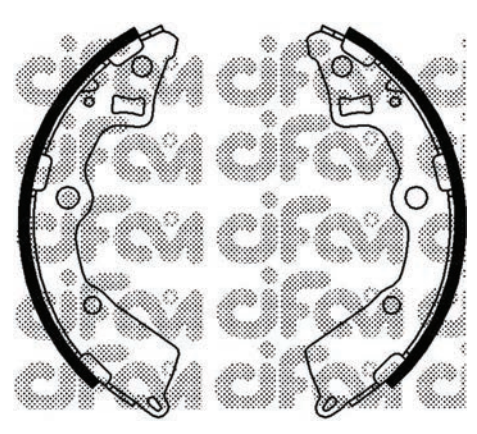

153-229 (Ø 180,0 x 32)

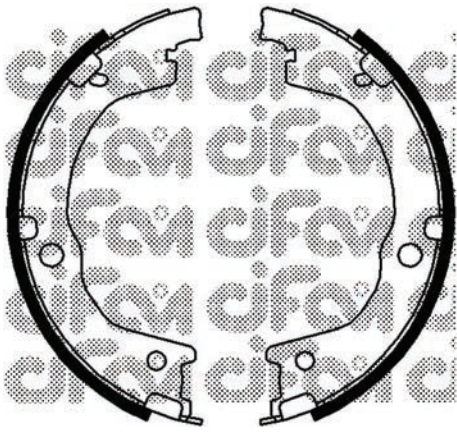

153-230 (Ø 190,0 x 32)

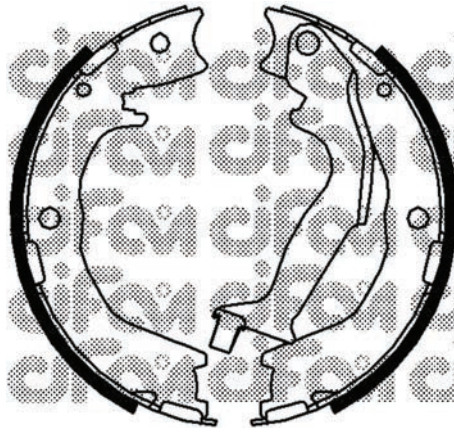

153-231 (Ø 190,0 x 32)

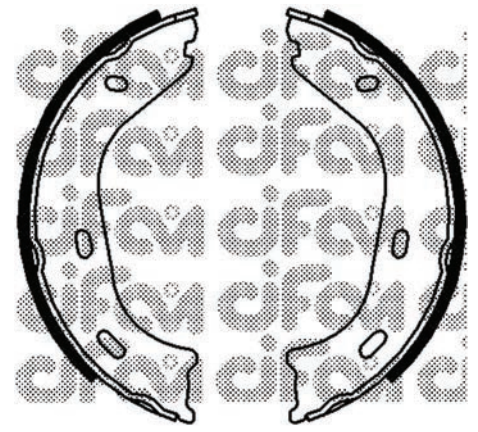

153-232 (Ø 160,0 x 25)

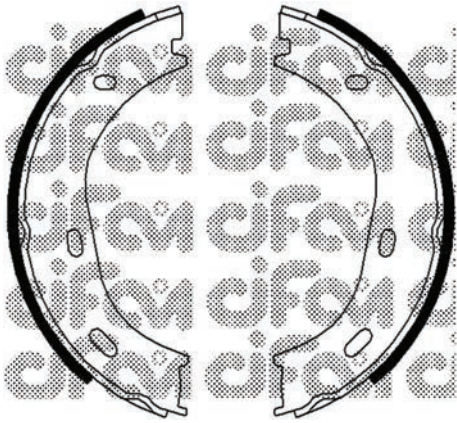

153-232K (Ø 160,0 x 25)

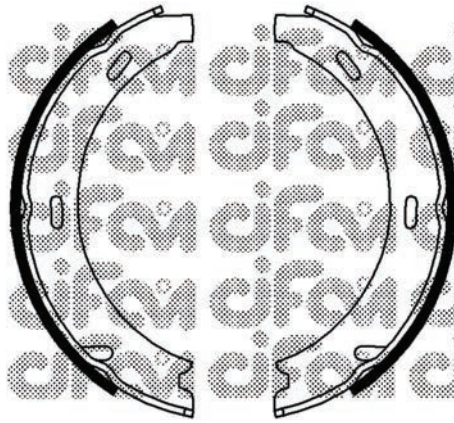

153-233 (Ø 164,0 x 20)

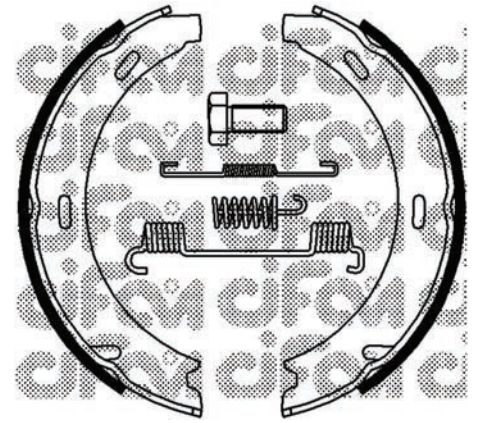

153-233K (Ø 164,0 x 20)

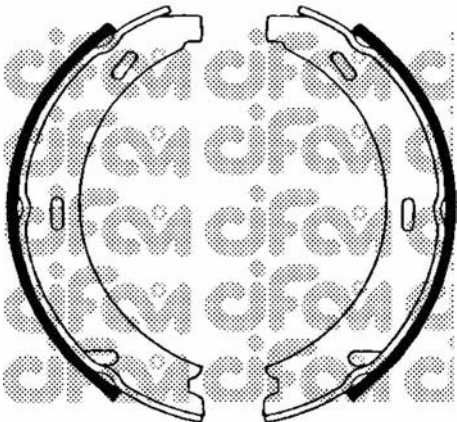

153-234 (Ø 164,0 x 25)

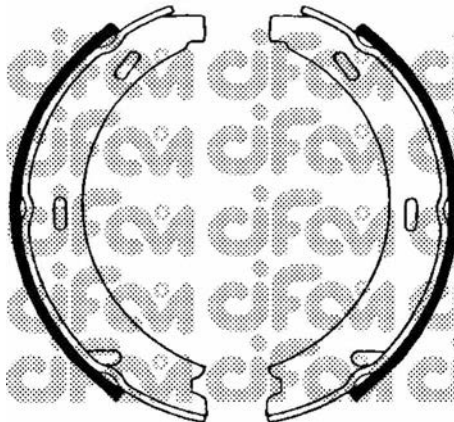

153-234K (Ø 164,0 x 25)

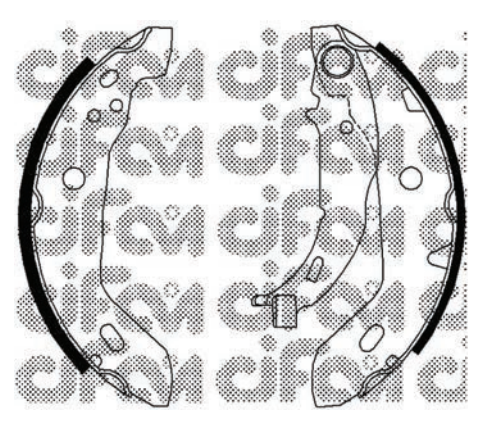

153-235 (Ø 180,0 x 42)

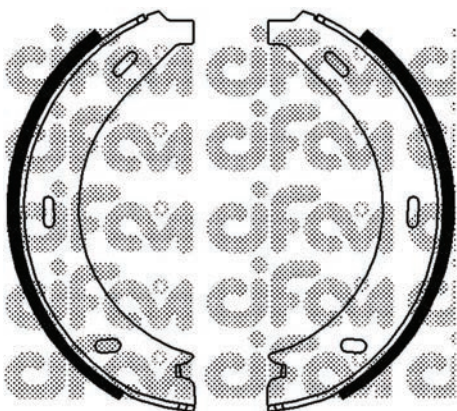

153-236 (Ø 180,0 x 20)

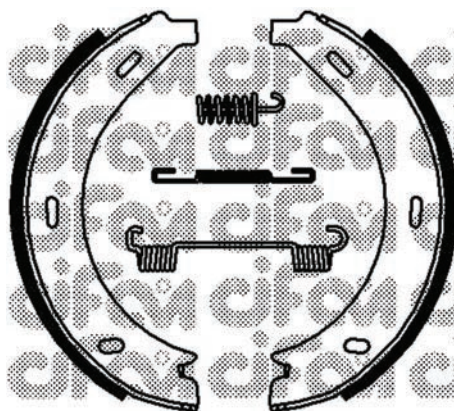

153-236K (Ø 180,0 x 20)

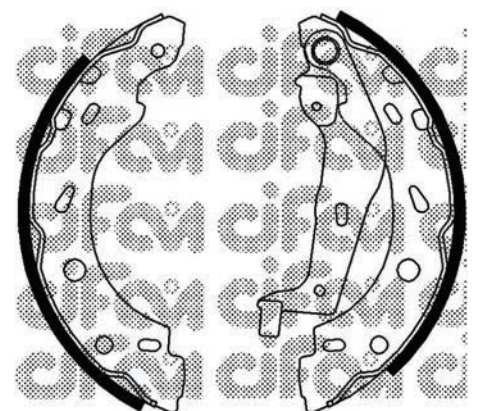

153-237 (Ø 200,0 x 32)

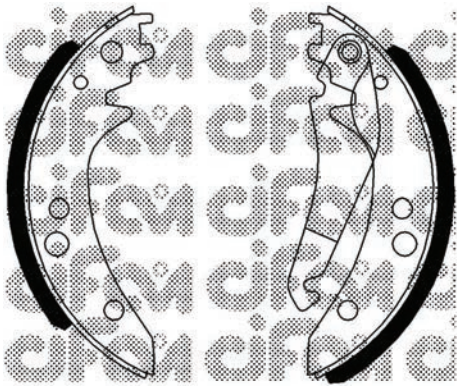

153-238 (Ø 230,0 x 35)

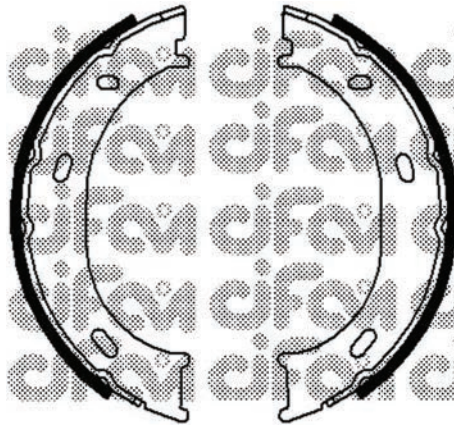

153-239 (Ø 160,0 x 40)

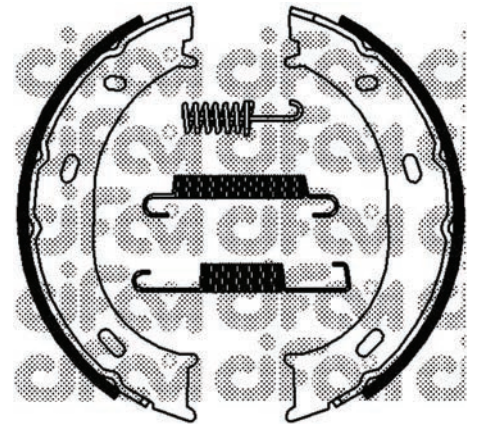

153-239K (Ø 160,0 x 40)

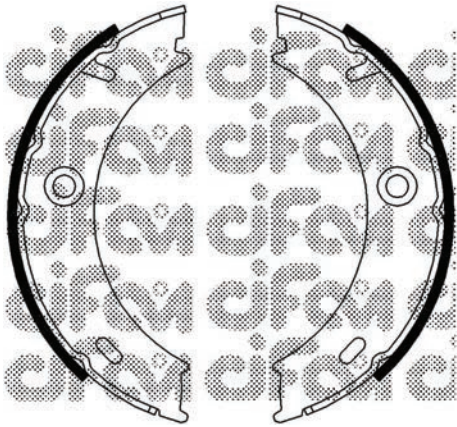

153-240 (Ø 170,0 x 40)

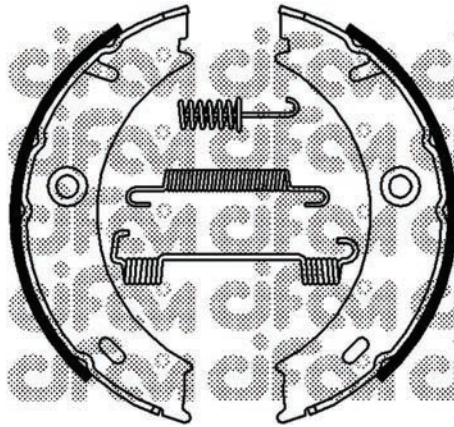

153-240K (Ø 170,0 x 40)

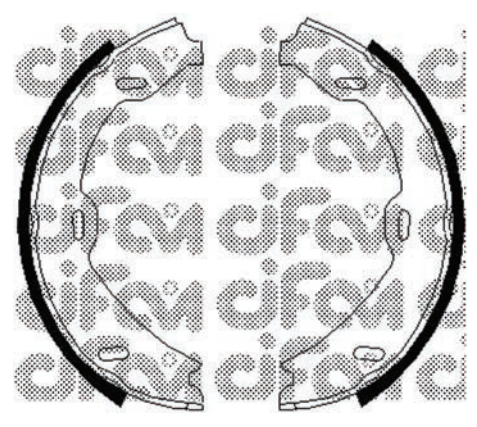

153-241 (Ø 180,0 x 25)

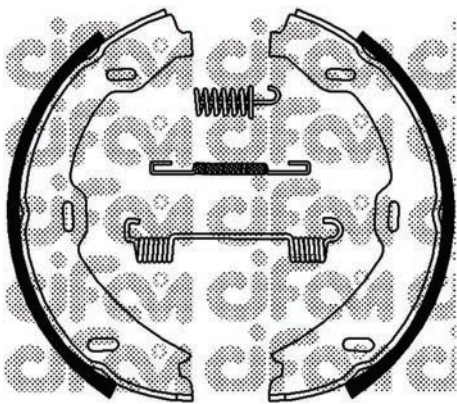

153-241K (Ø 180,0 x 25)

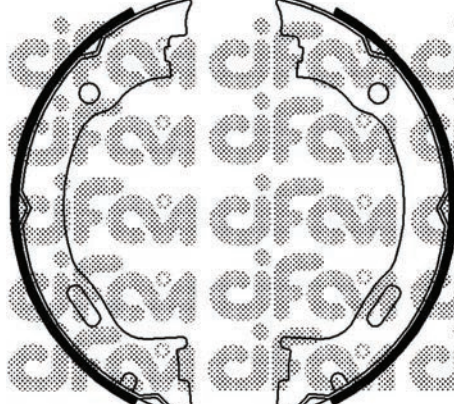

153-242 (Ø 183,0 x 31)

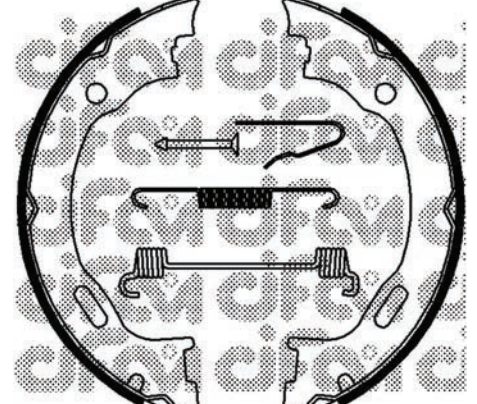

153-242K (Ø 183,0 x 31)

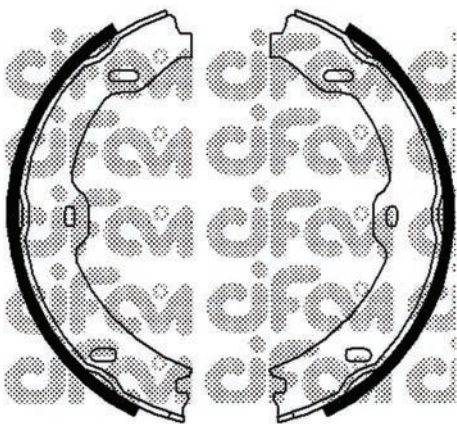

153-243 (Ø 180,0 x 25)

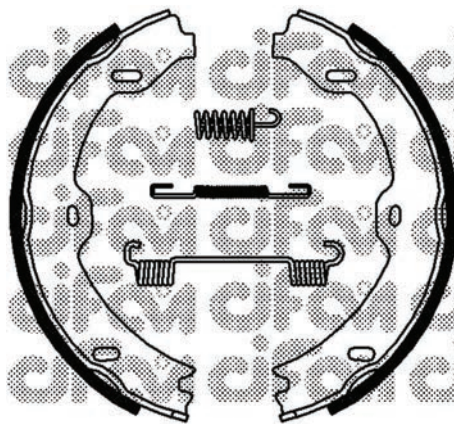

153-243K (Ø 180,0 x 25)

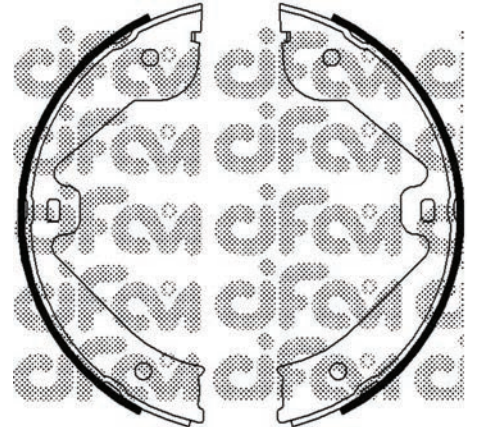

153-244 (Ø 210,0 x 31)

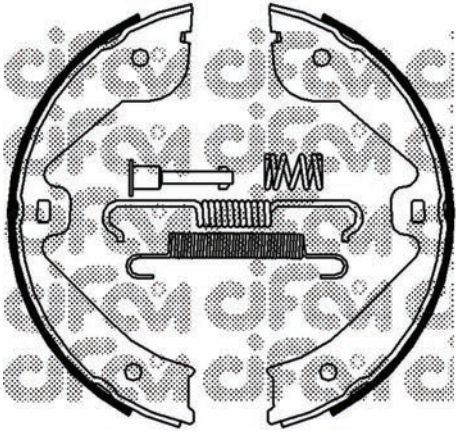

153-244K (Ø 210,0 x 31)

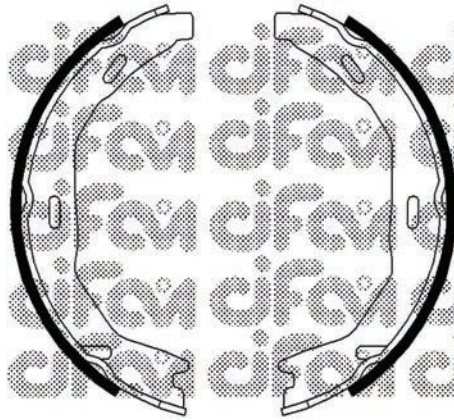

153-245 (Ø 170,0 x 25)

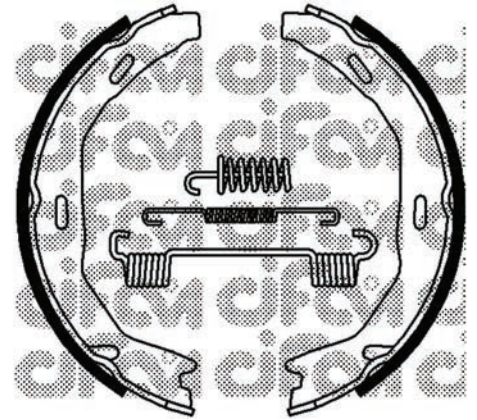

153-245K (Ø 170,0 x 25)

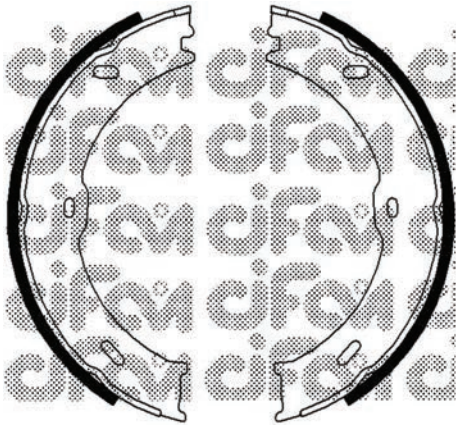

153-246 (Ø 180,0 x 25)

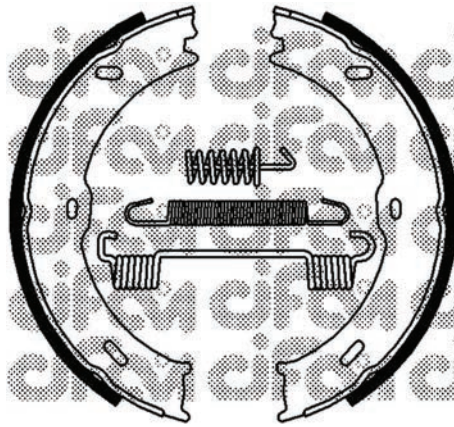

153-246K (Ø 180,0 x 25)

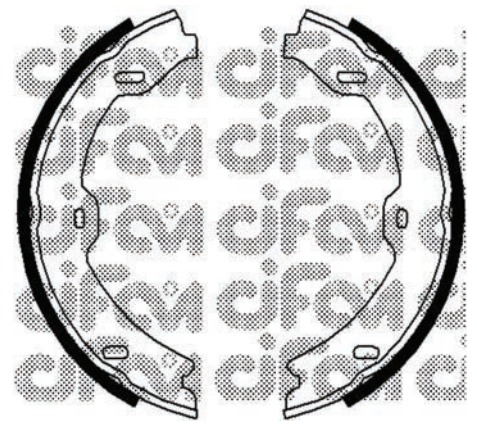

153-247 (Ø 180,0 x 25)

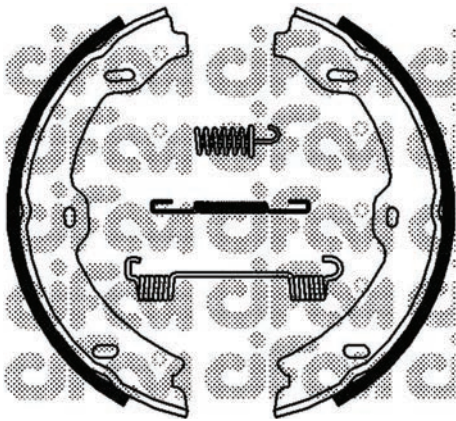

153-247K (Ø 180,0 x 25)

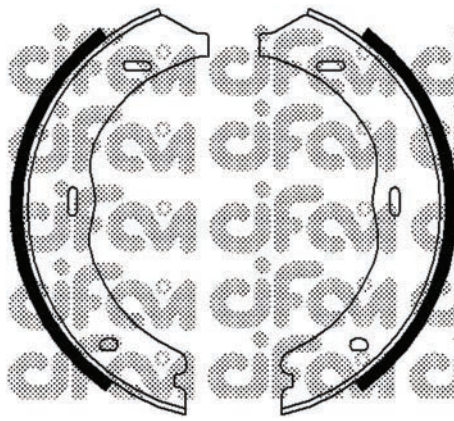

153-248 (Ø 186,0 x 20)

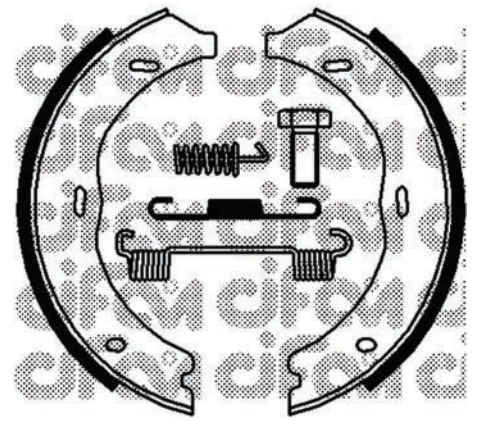

153-248K (Ø 186,0 x 20)

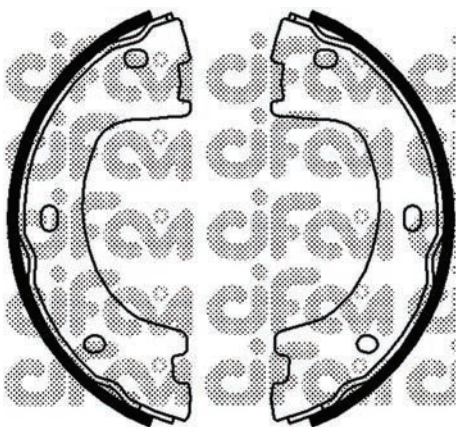

153-249 (Ø 174,0 x 42)

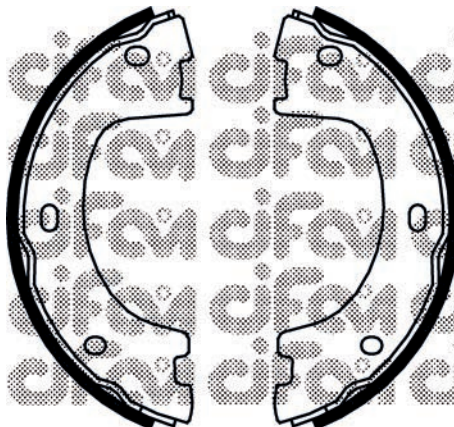

153-249K (Ø 174 x 42)

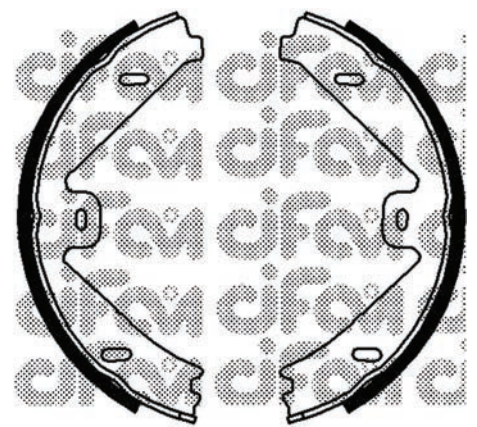

153-250 (Ø 180,0 x 25)

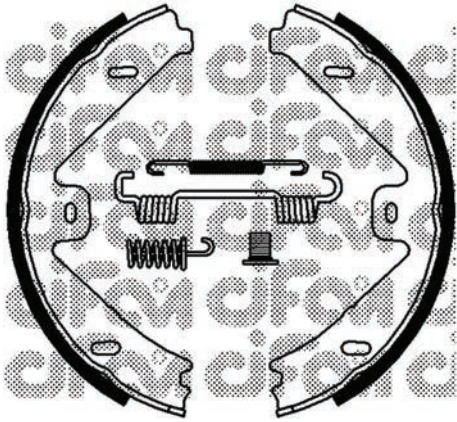

153-250K (Ø 180,0 x 25)

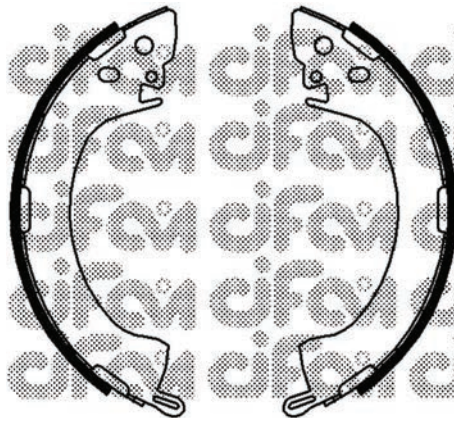

153-251 (Ø 254,0 x 50)

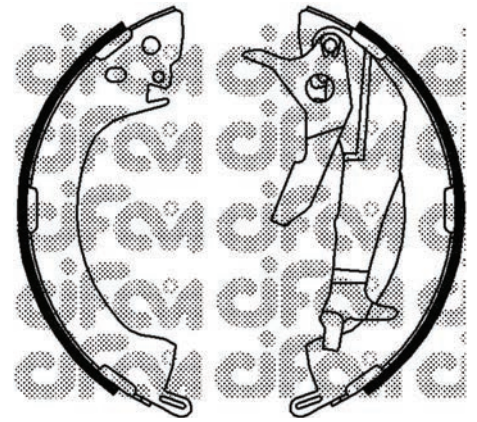

153-251Y (Ø 254,0 x 50)

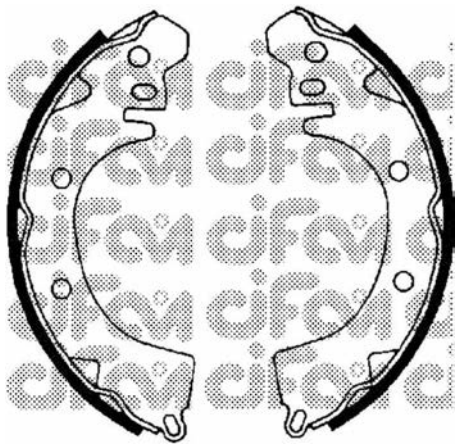

153-252 (Ø 203,0 x 37)

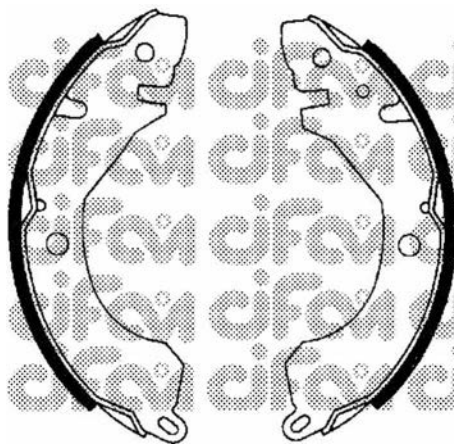

153-253 (Ø 180,0 x 36)

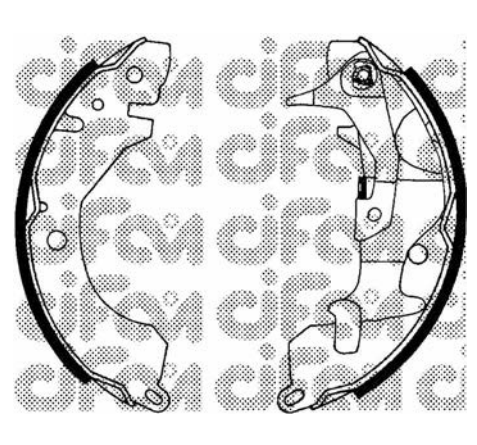

153-253Y (Ø 180,0 x 36)

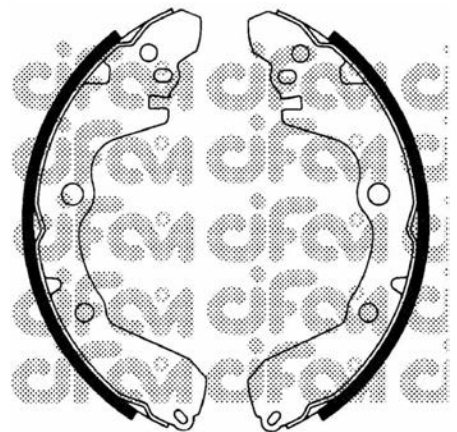

153-256 (Ø 228,6 x 40)

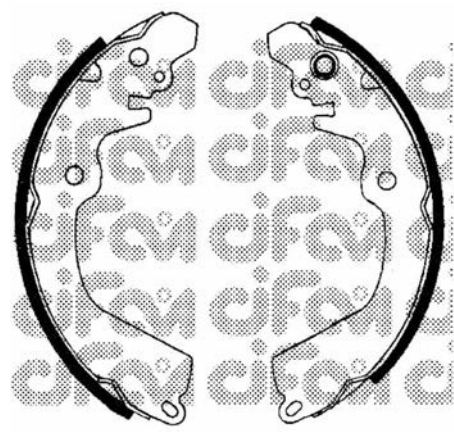

153-257 (Ø 203,0 x 37)

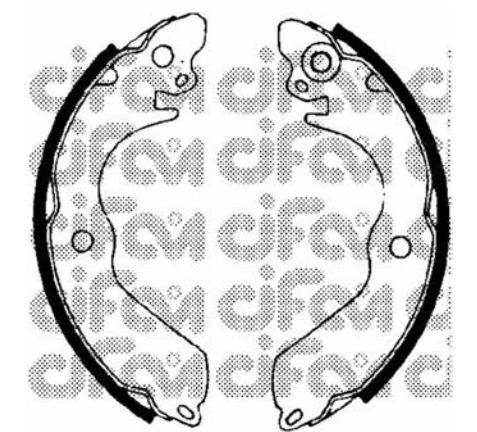

153-258 (Ø 180,0 x 37)

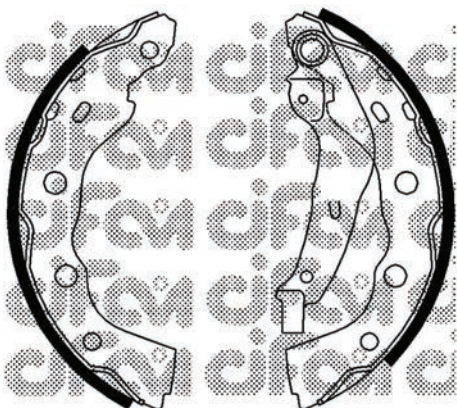

153-259 (Ø 203,2 x 40)

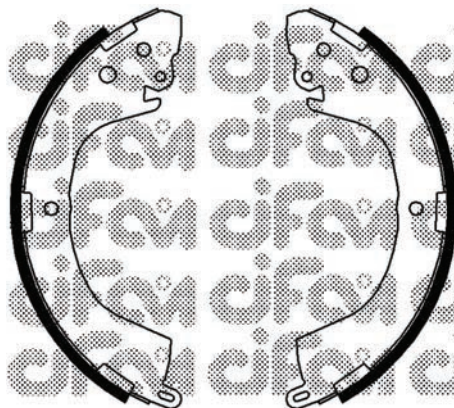

153-260 (Ø 270,0 x 52)

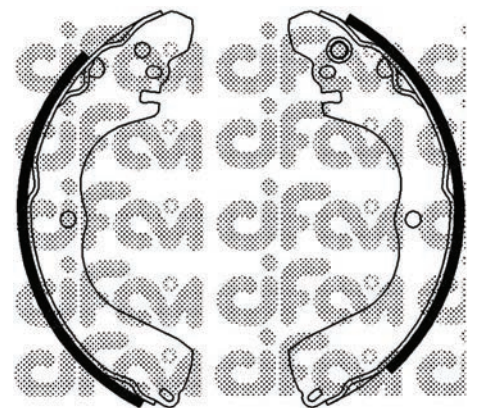

153-261 (Ø 228,6 x 32)

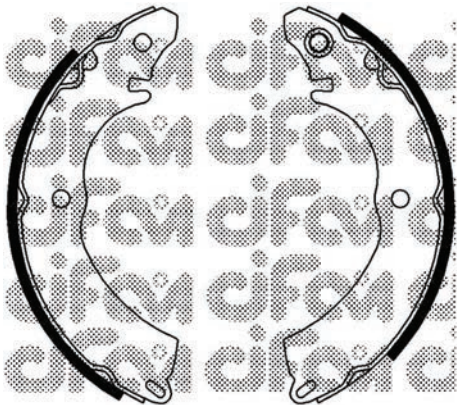

153-263 (Ø 203,2 x 32)

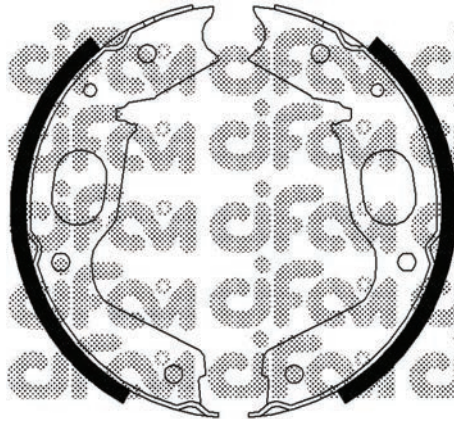

153-264 (Ø 197,0 x 40)

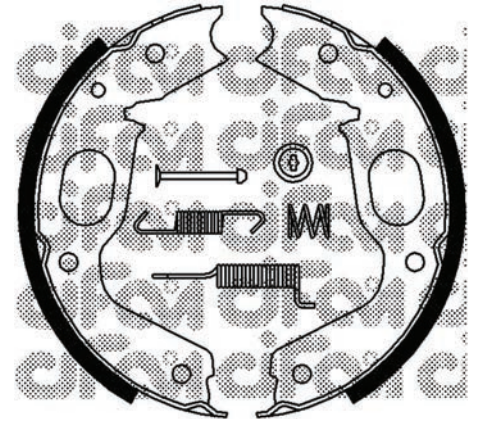

153-264K (Ø 197,0 x 40)

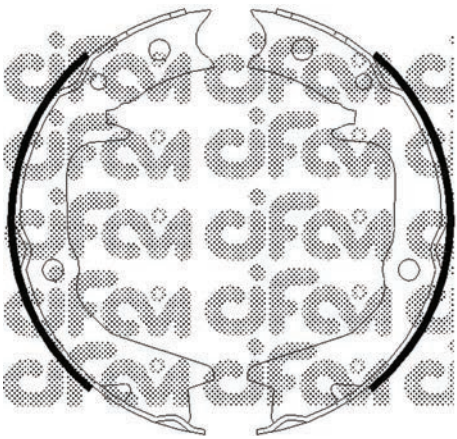

153-265 (Ø 167,0 x 32)

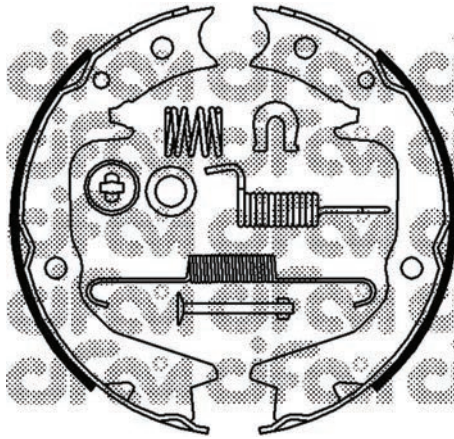

153-265K (Ø 167,0 x 32)

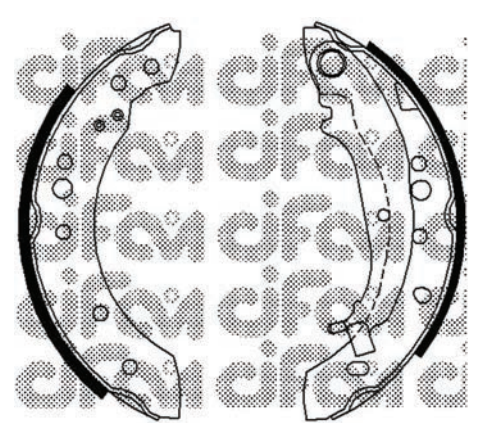

153-266 (Ø 203,2 x 39)

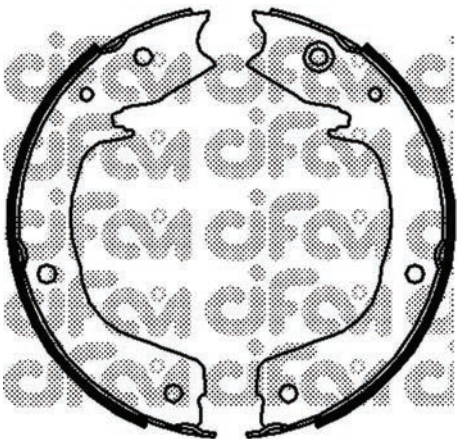

153-267 (Ø 200,0 x 32)

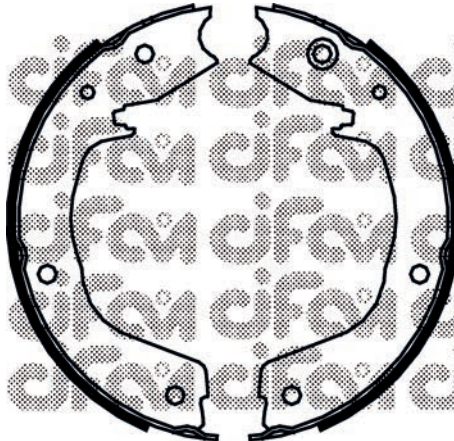

153-267K (Ø 200 x 32)

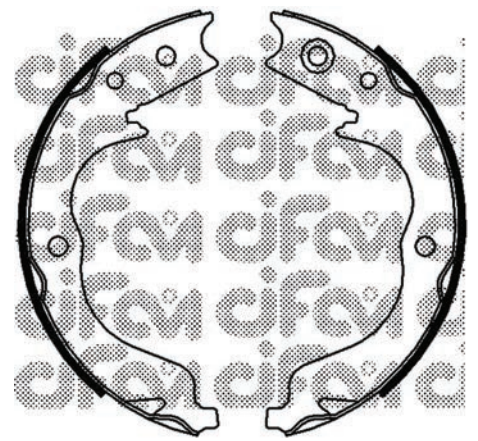

153-268 (Ø 190,0 x 32)

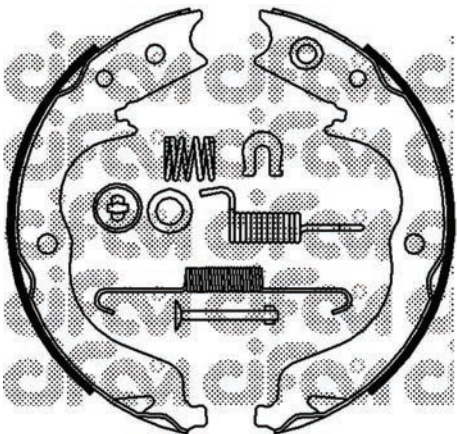

153-268K (Ø 190,0 x 32)

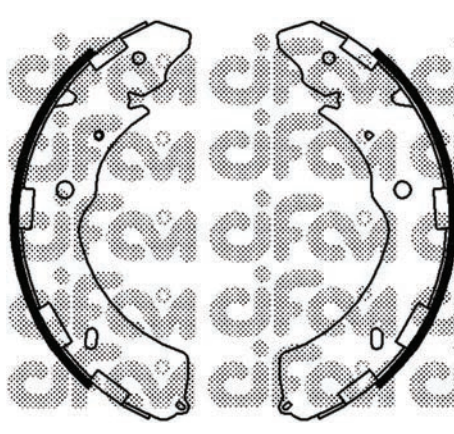

153-269 (Ø 300,0 x 51)

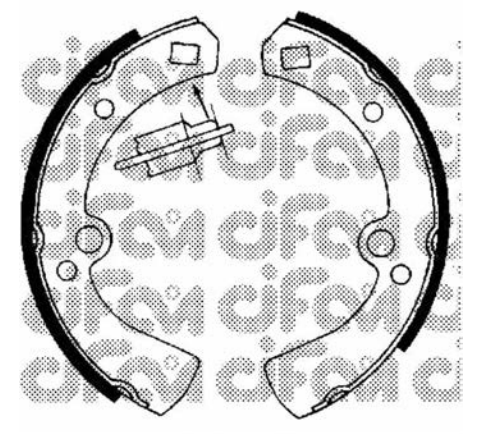

153-270 (Ø 203,2 x 36)

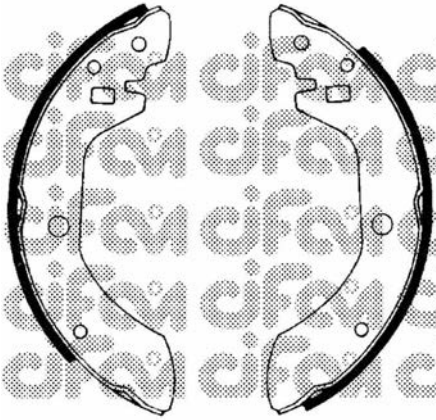

153-271 (Ø 228,6 x 40)

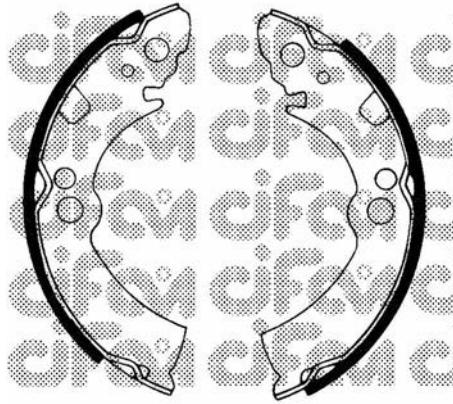

153-272 (Ø 180,0 x 35)

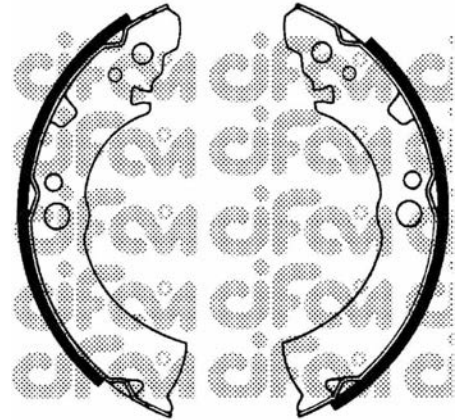

153-273 (Ø 180,0 x 28)

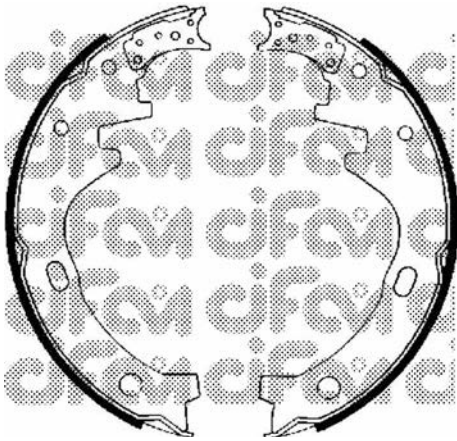

153-274 (Ø 254,0 x 46)

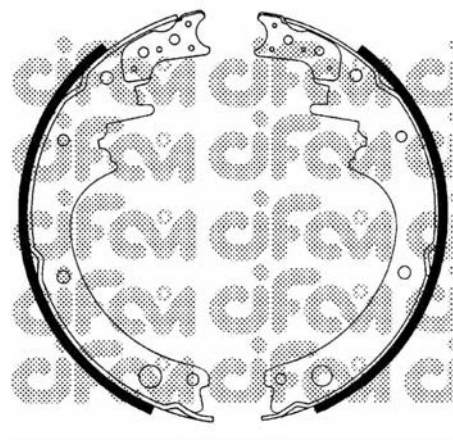

153-275 (Ø 270,0 x 50)

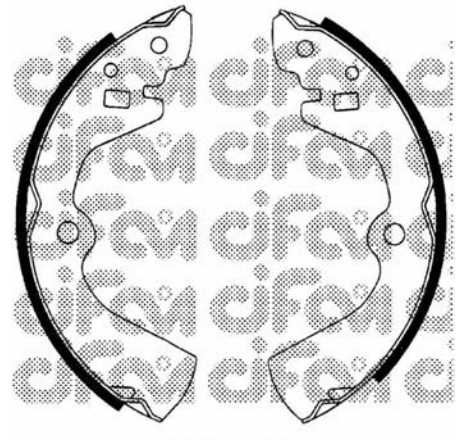

153-277 (Ø 228,6 x 40)

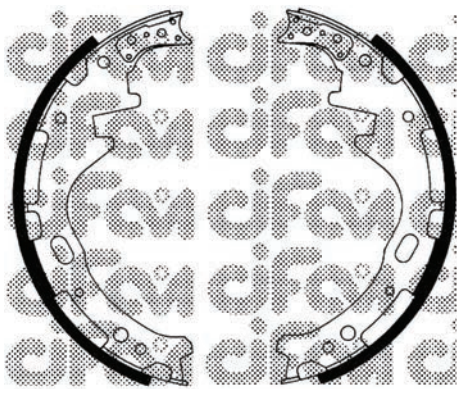

153-278 (Ø 254,0 x 60)



153-279 (Ø 260,0 x 50)



153-280 (Ø 295,0 x 60)

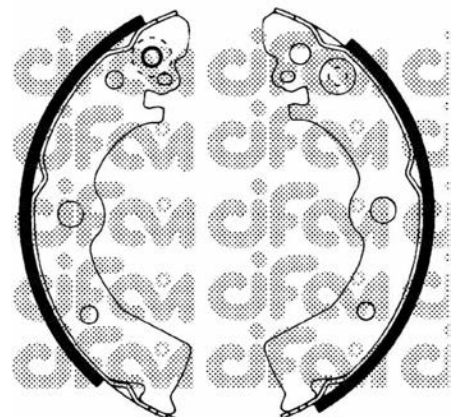

153-281 (Ø 180,0 x 31)

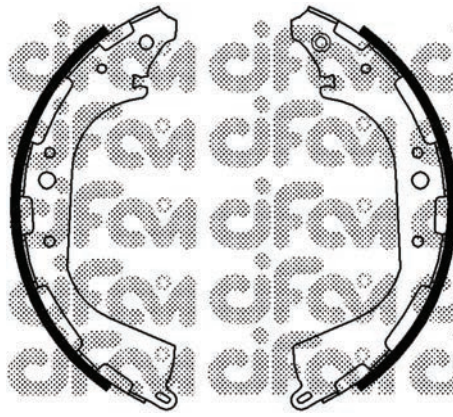

153-282 (Ø 295,0 x 50)

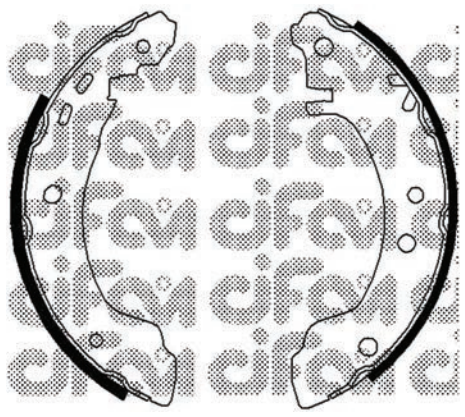

153-283 (Ø 203,0 x 38)

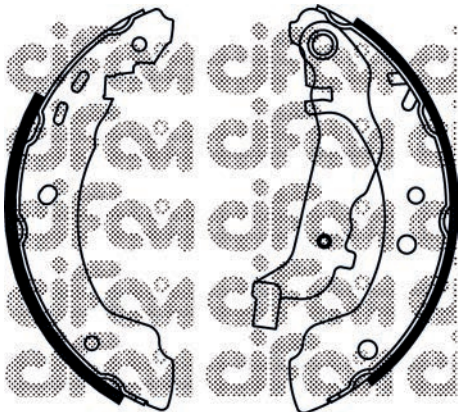

153-283Y (Ø 203 x 38)

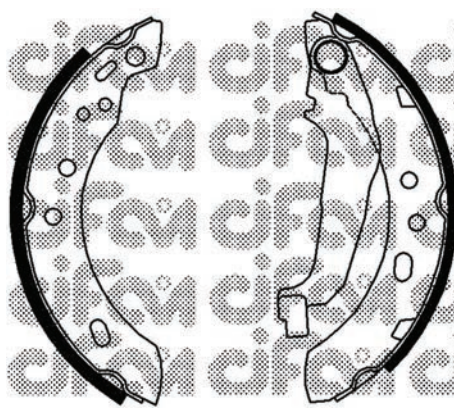

153-284 (Ø 180,0 x 27)

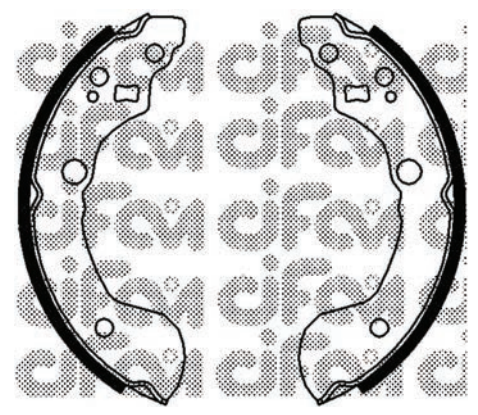

153-286 (Ø 203,2 x 38)

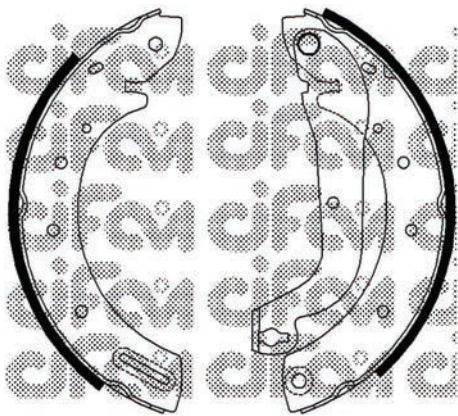

153-287 (Ø 254,0 x 57)

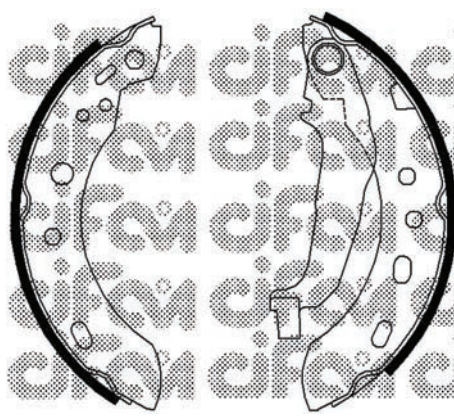

153-288 (Ø 180,0 x 28)

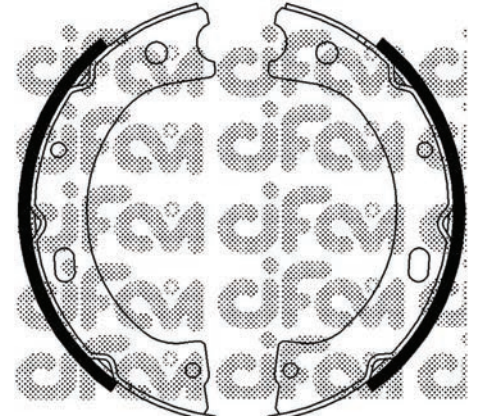

153-289 (Ø 203,2 x 47)

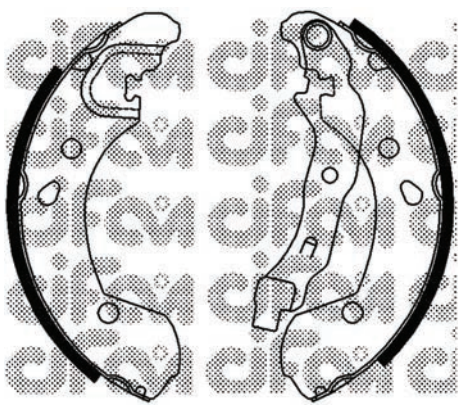

153-290 (Ø 203,0 x 38)

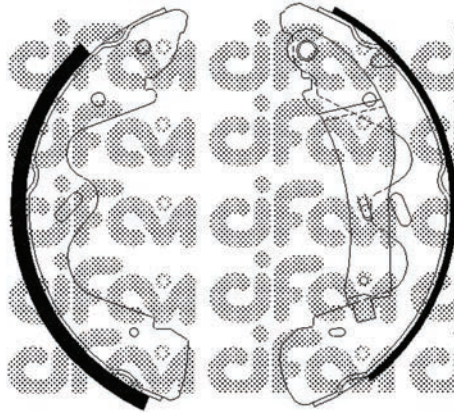

153-291 (Ø 280,0 x 65)

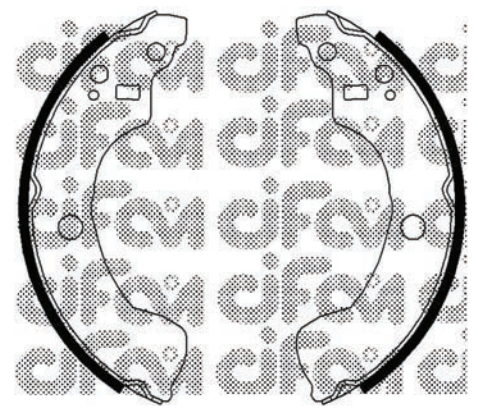

153-292 (Ø 203,2 x 37)

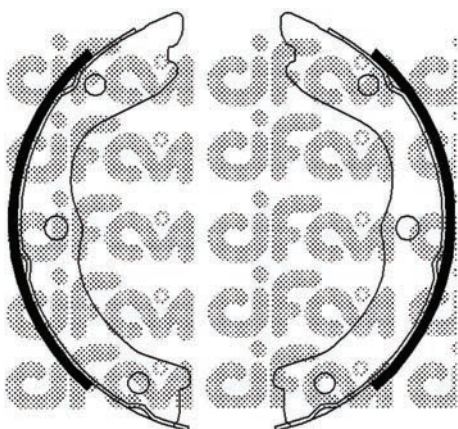

153-293 (Ø 170,0 x 22)

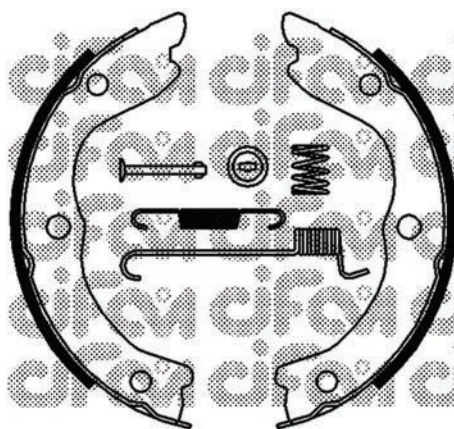

153-293K (Ø 170,0 x 22)

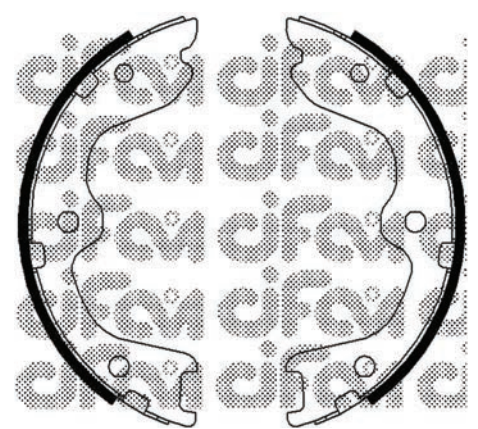

153-294 (Ø 172,0 x 32)

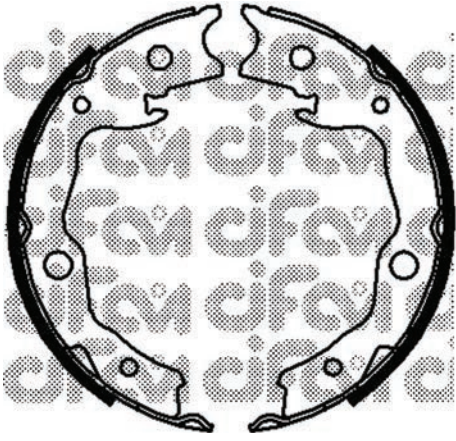

153-295 (Ø 172,0 x 32)

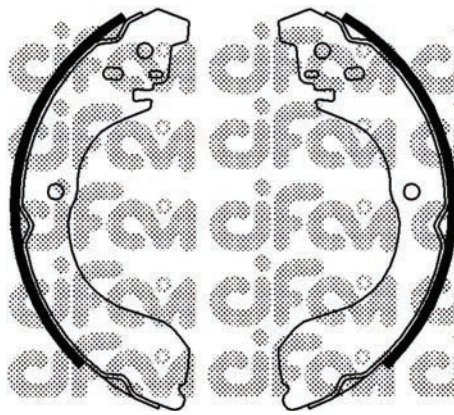

153-296 (Ø 228,6 x 37)

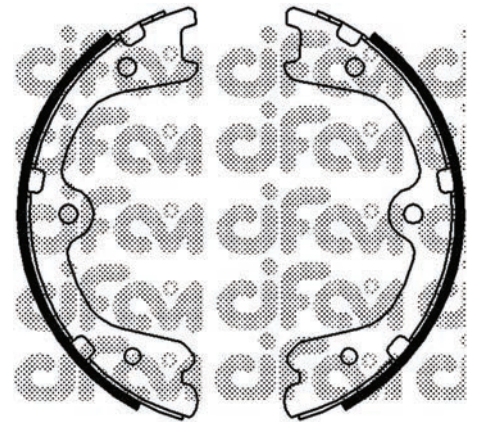

153-297 (Ø 190,0 x 33)

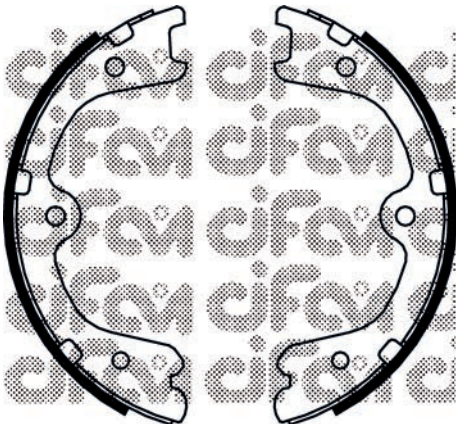

153-297K (Ø 190 x 33)

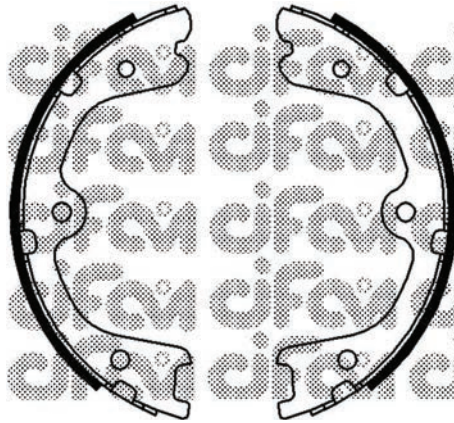

153-298 (Ø 190,0 x 33)

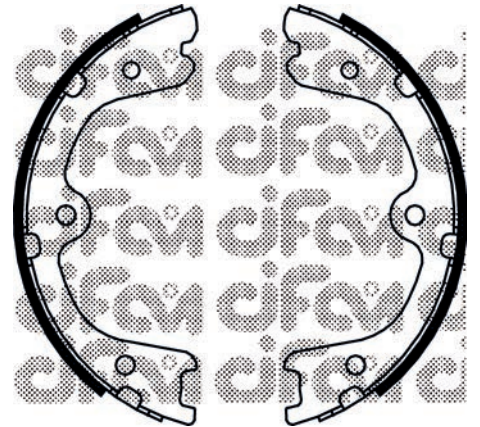

153-298K (Ø 190 x 33)

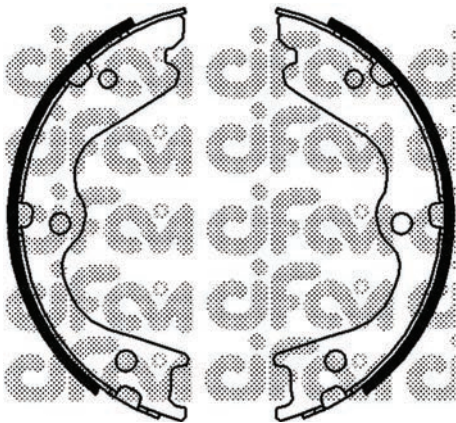

153-299 (Ø 172,0 x 27)



153-300 (Ø 200,0 x 29)

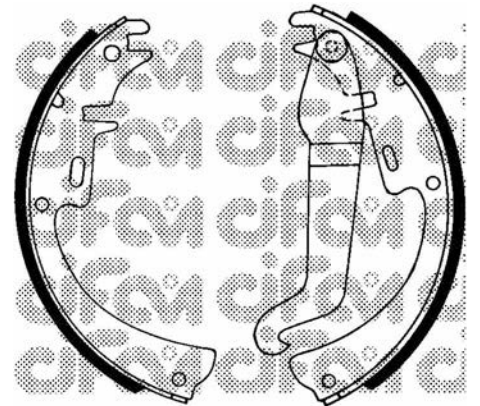

153-301 (Ø 230,0 x 51)

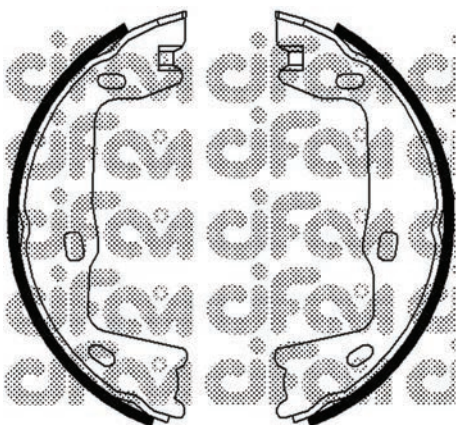

153-302 (Ø 160,0 x 25)

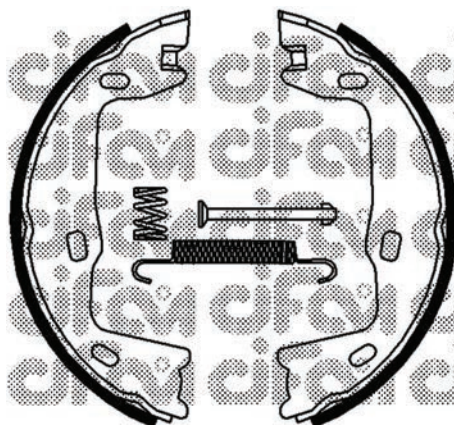

153-302K (Ø 160,0 x 25)

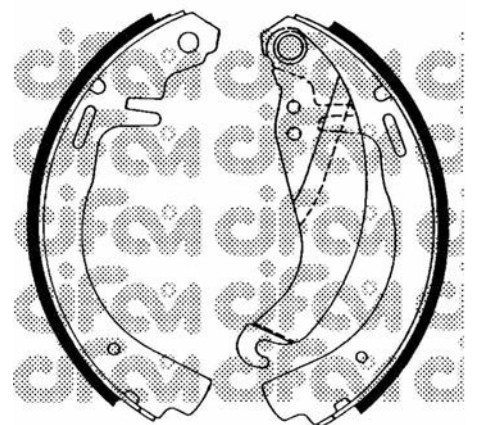

153-303 (Ø 200,0 x 29)

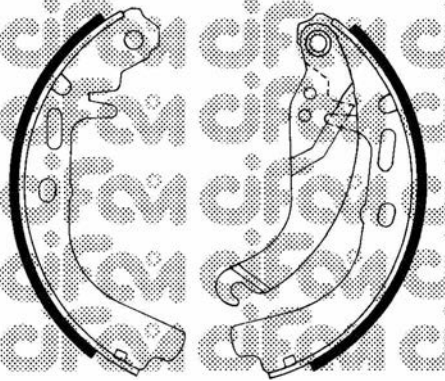

153-304 (Ø 200,0 x 46)

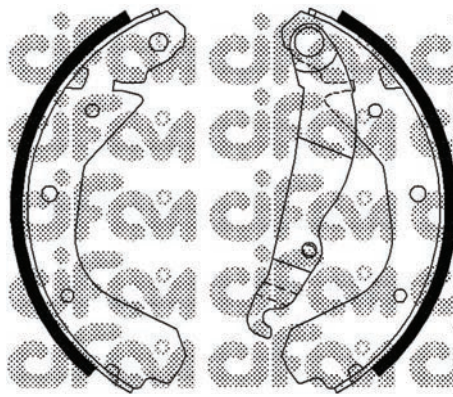

153-305 (Ø 200,0 x 45)

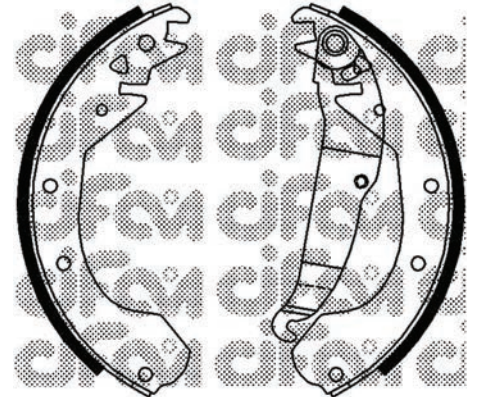

153-306 (Ø 230,0 x 50)

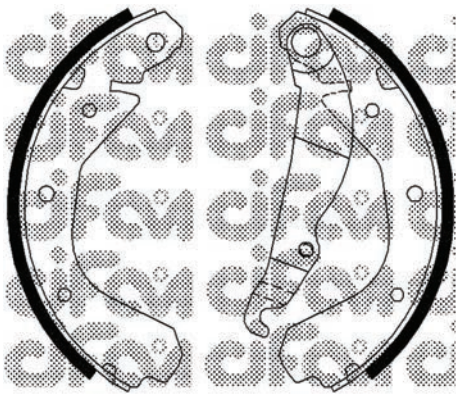

153-307 (Ø 200,0 x 29)

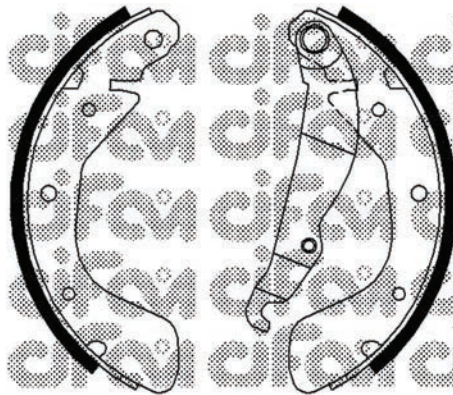

153-308 (Ø 200,0 x 29)

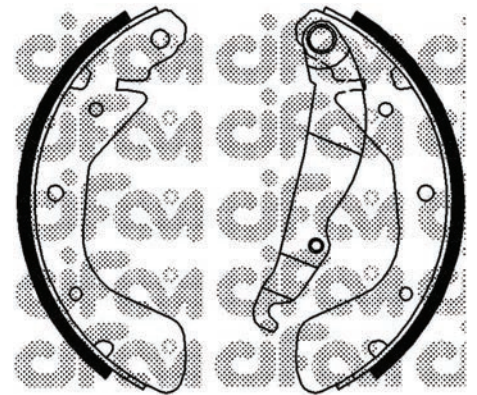

153-309 (Ø 200,0 x 45)

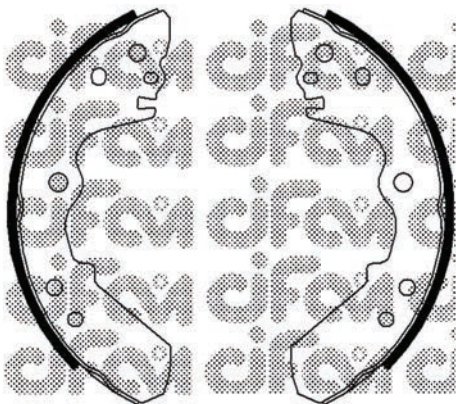

153-310 (Ø 254,0 x 52)

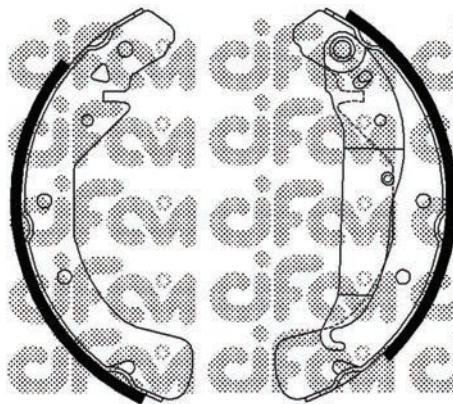

153-311 (Ø 230,0 x 42)

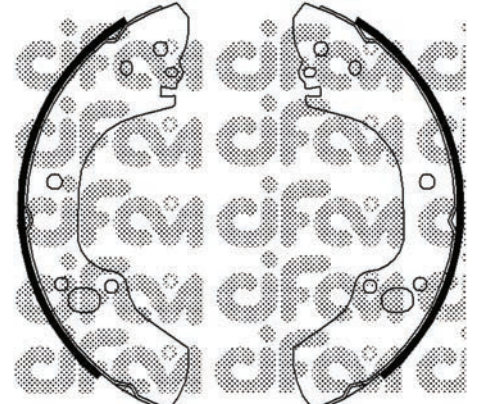

153-312 (Ø 302,0 x 46)

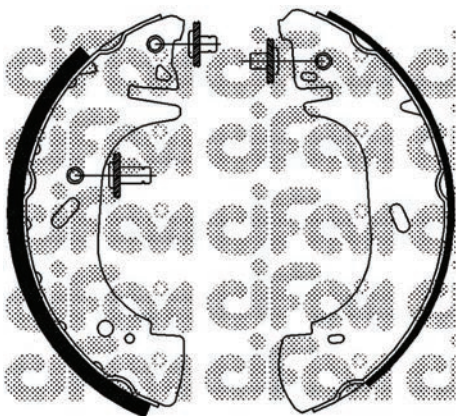

153-313 (Ø 280,0 x 65)

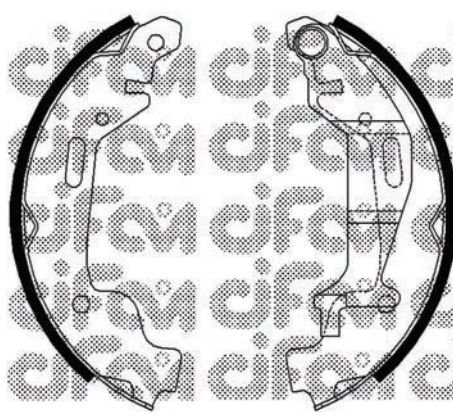

153-314 (Ø 180,0 x 26)

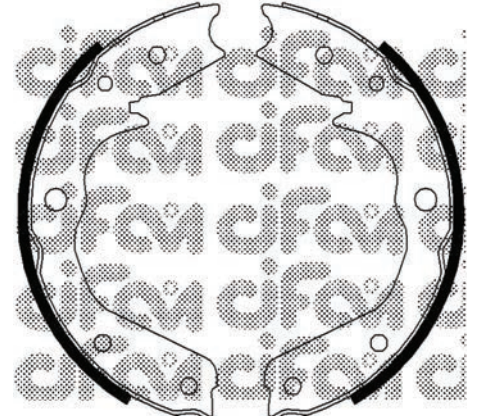

153-315 (Ø 210,0 x 32)

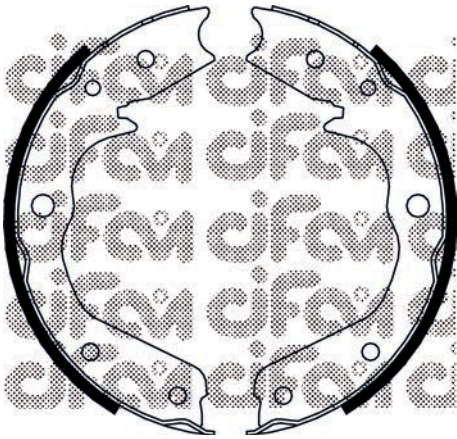

153-315K (Ø 210 x 32)

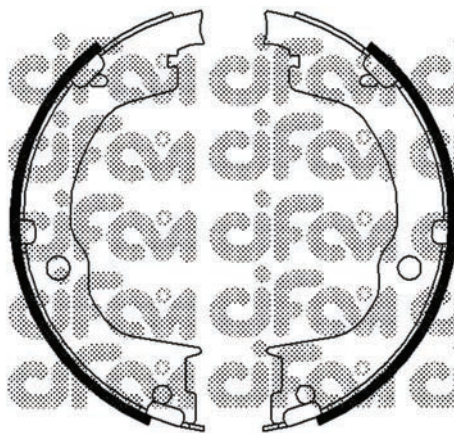

153-317 (Ø 180,0 x 26)

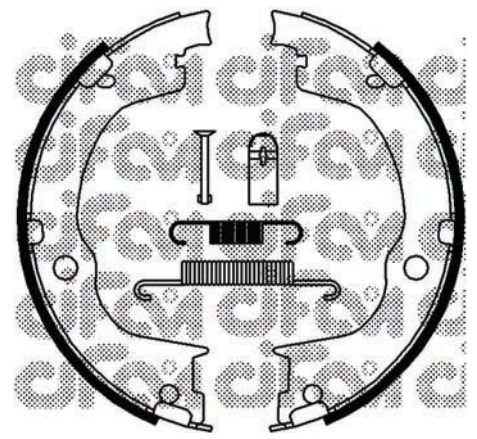

153-317K (Ø 180,0 x 26)

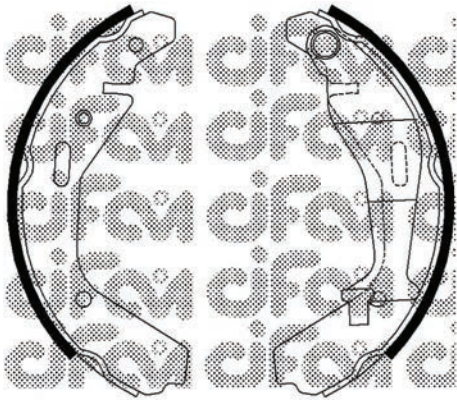

153-318 (Ø 200,0 x 29)

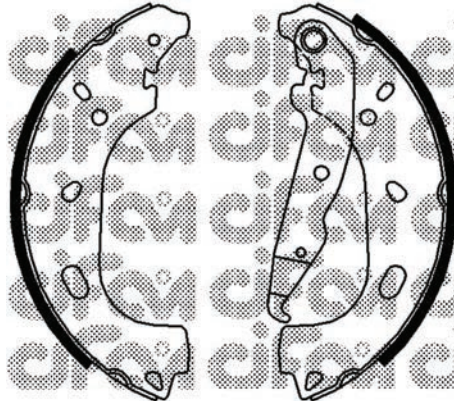

153-319 (Ø 230,0 x 40)

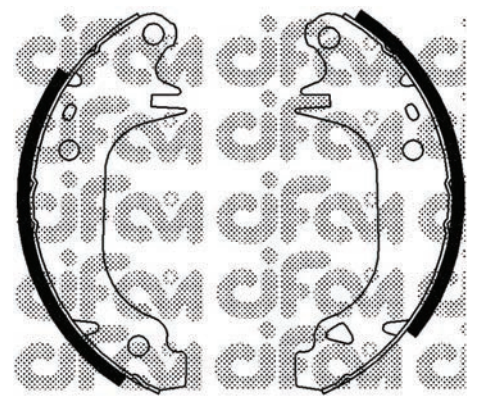

153-320 (Ø 180,0 x 32)

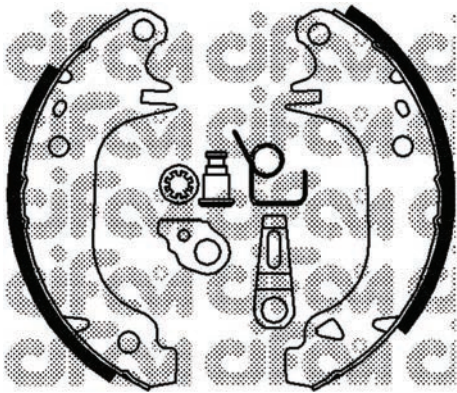

153-320K (Ø 180,0 x 32)

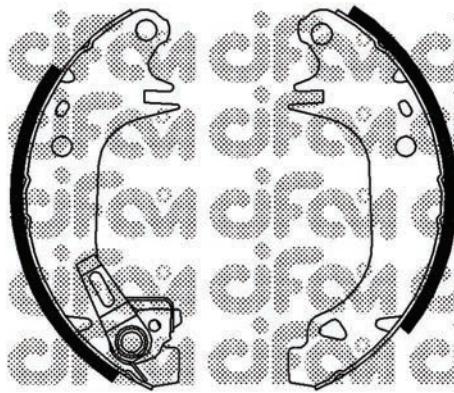

153-320Y (Ø 180,0 x 32)

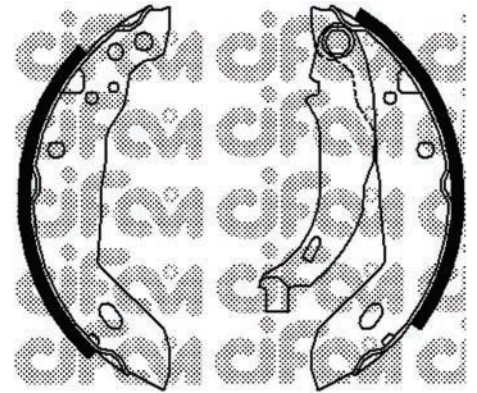

153-322 (Ø 180,0 x 32)

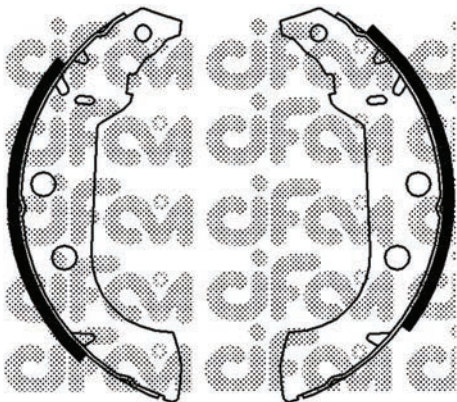

153-323 (Ø 228,6 x 42)

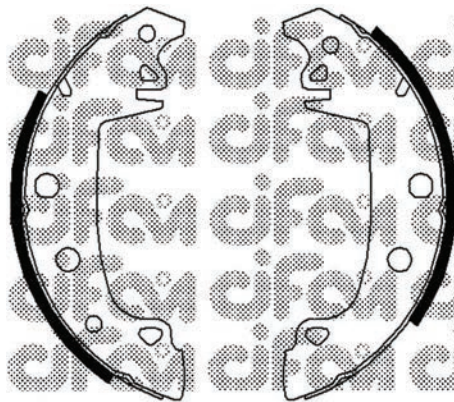

153-324 (Ø 228,6 x 42)

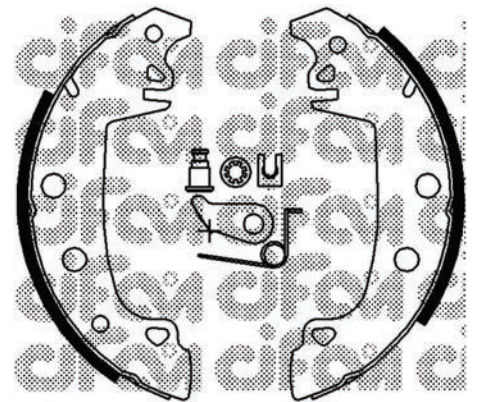

153-324K (Ø 228,6 x 42)

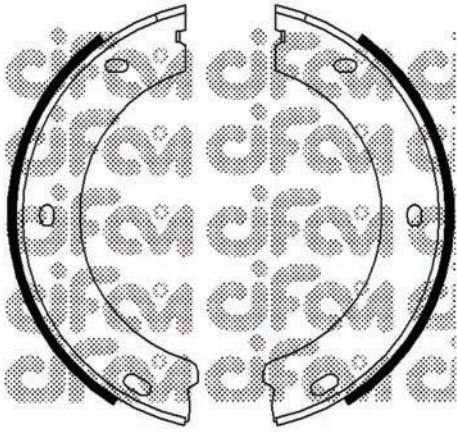

153-325 (Ø 185,0 x 20)

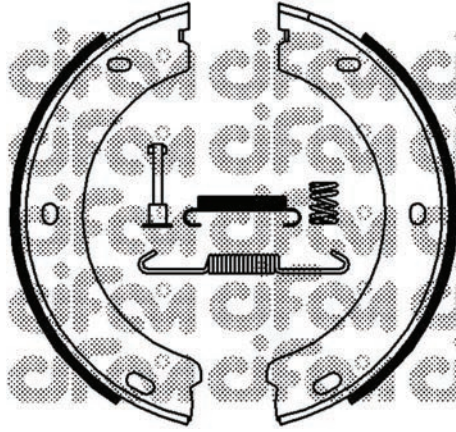

153-325K (Ø 185,0 x 20)

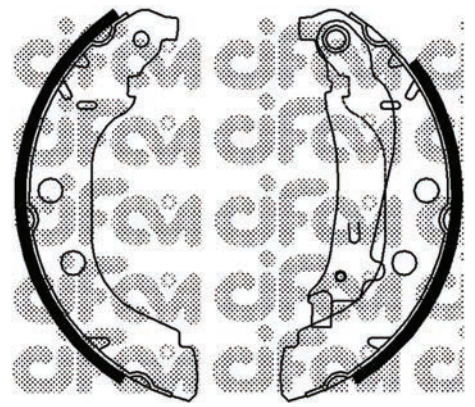

153-326 (Ø 228,6 x 42)

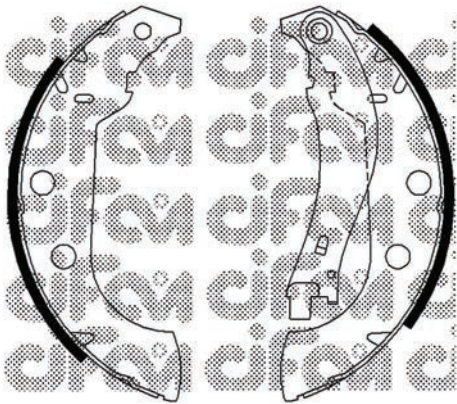

153-327 (Ø 228,6 x 42)

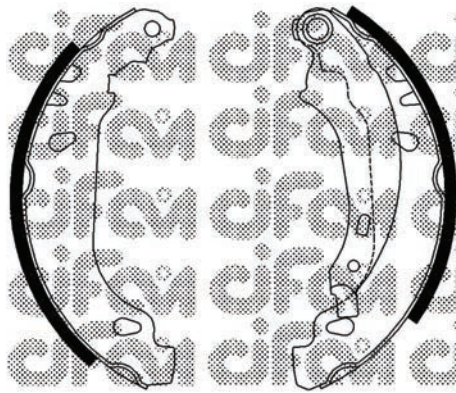

153-328 (Ø 180,0 x 32)

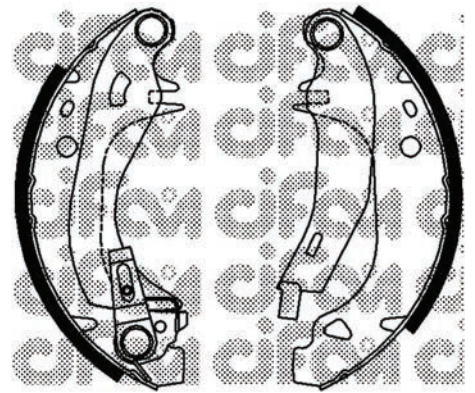

153-329Y (Ø 180,0 x 32)

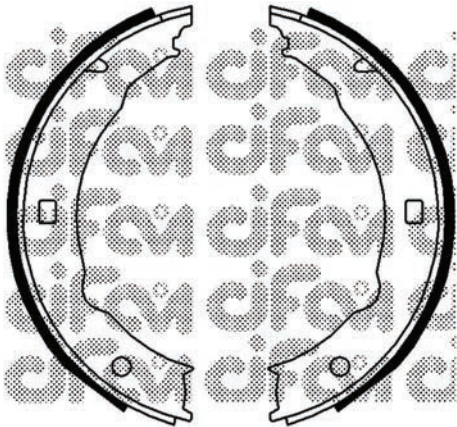

153-330 (Ø 185,0 x 30)

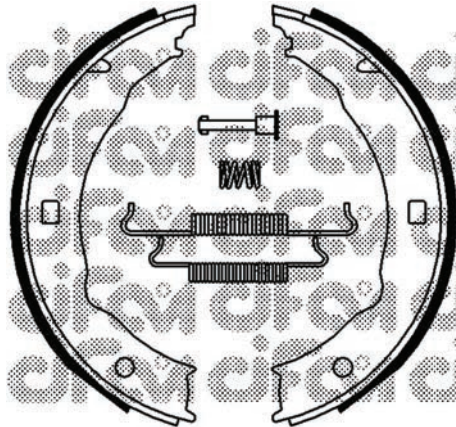

153-330K (Ø 185,0 x 30)

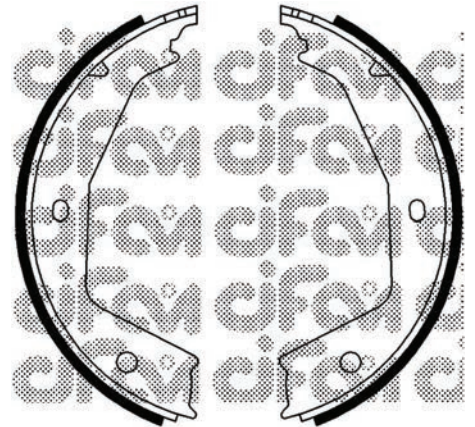

153-331 (Ø 180,0 x 31)

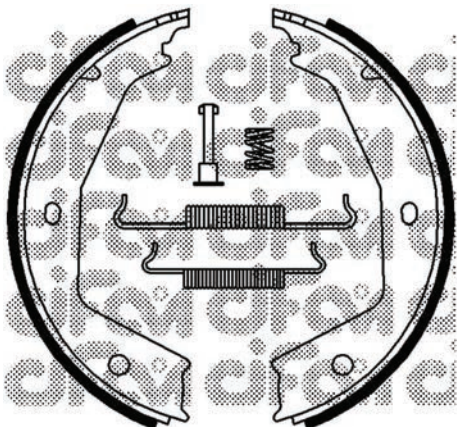

153-331K (Ø 180,0 x 31)

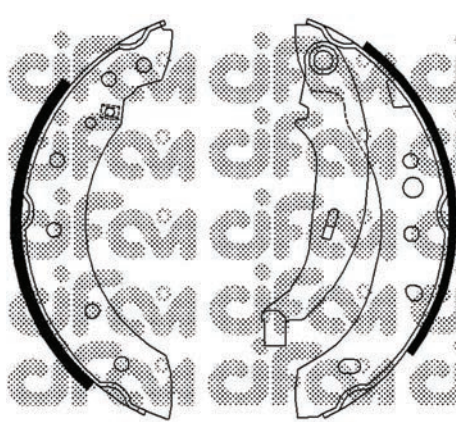

153-332 (Ø 203,0 x 39)

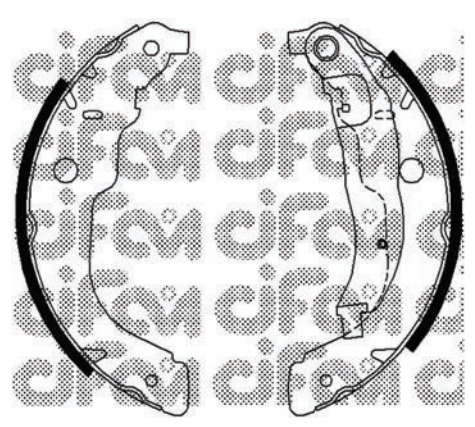

153-333 (Ø 228,6 x 42)

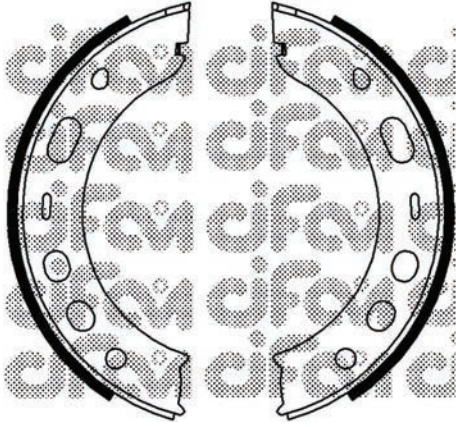

153-336 (Ø 180,0 x 26)

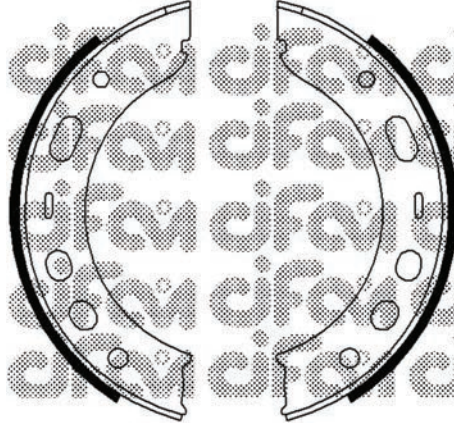

153-337 (Ø 180,0 x 26)

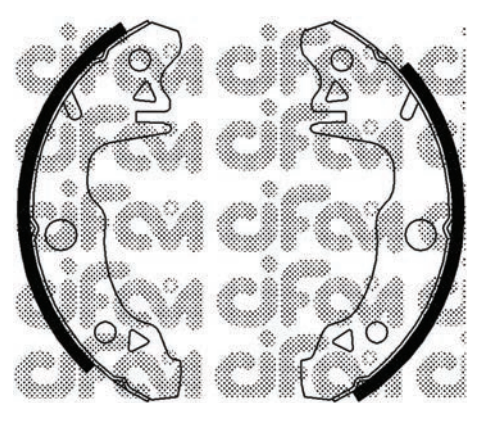

153-339 (Ø 180,0 x 32)

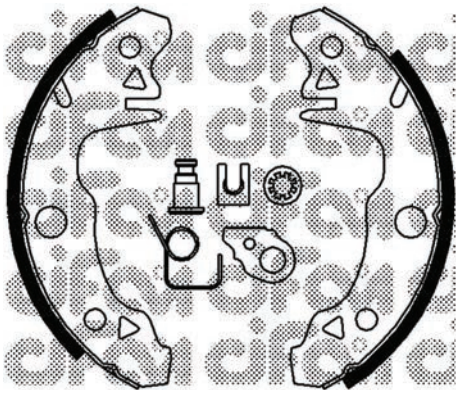

153-339K (Ø 180,0 x 32)

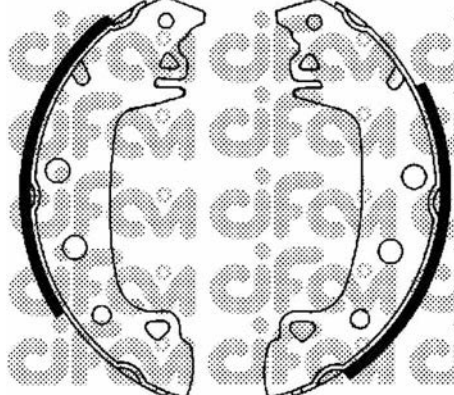

153-340 (Ø 228,6 x 42)

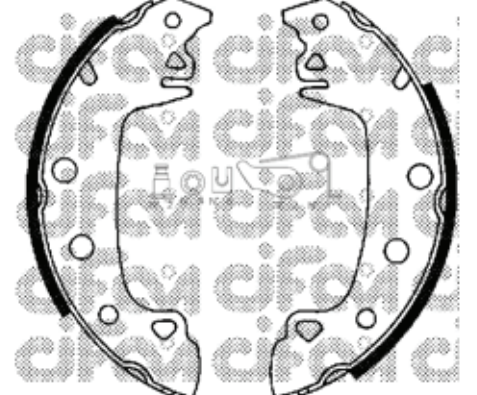

153-340K (Ø 228,6 x 42)

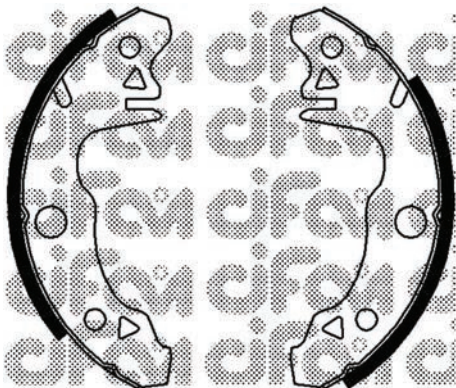

153-341 (Ø 180,0 x 42)

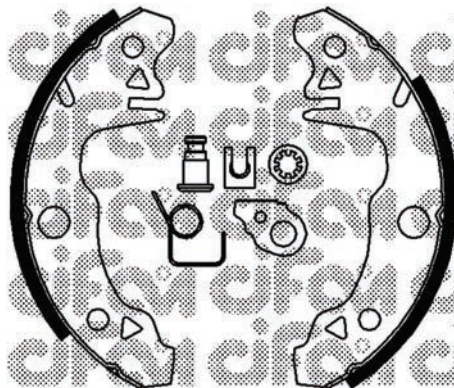

153-341K (Ø 180,0 x 42)

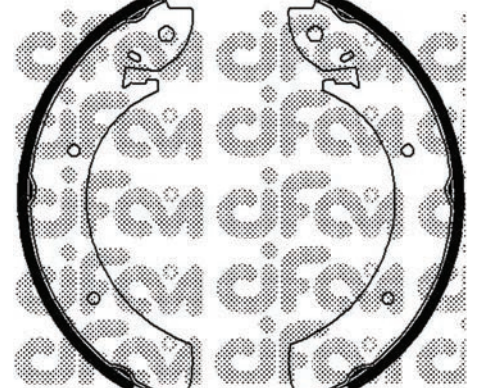

153-342 (Ø 255,0 x 57)

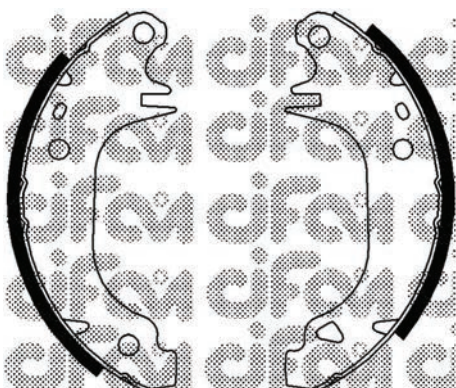

153-343 (Ø 180,0 x 42)

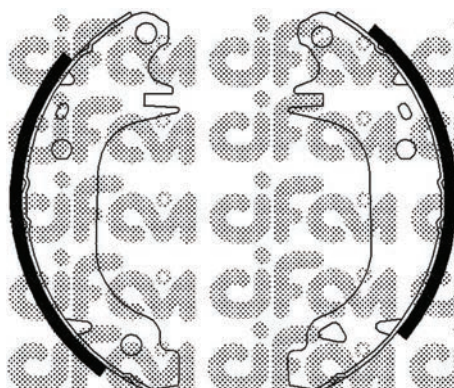

153-343K (Ø 180,0 x 42)

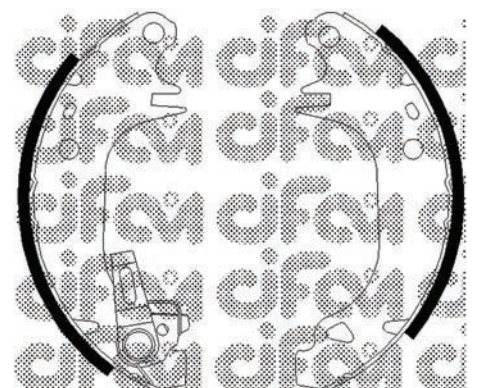

153-343Y (Ø 180,0 x 42)

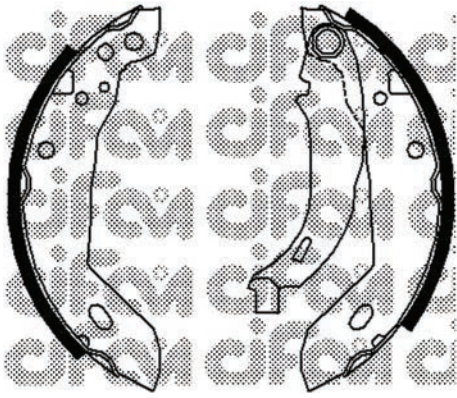

153-344 (Ø 180,0 x 42)

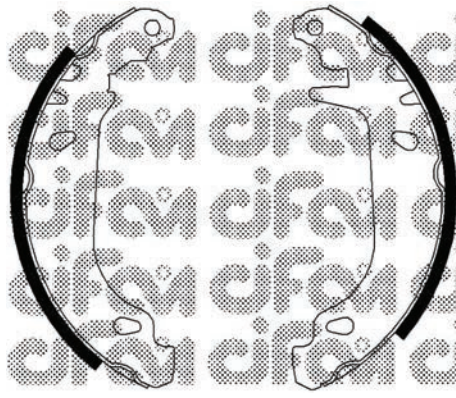

153-345 (Ø 180,0 x 42)

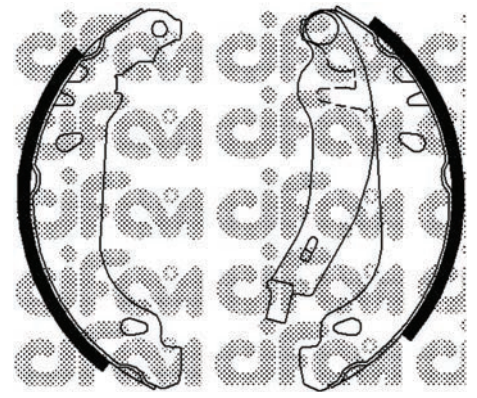

153-345Y (Ø 180,0 x 42)

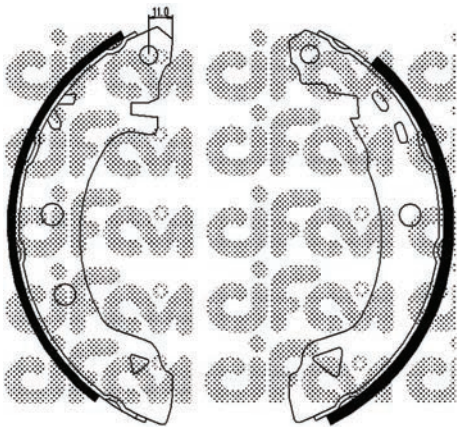

153-346 (Ø 203,2 x 39)

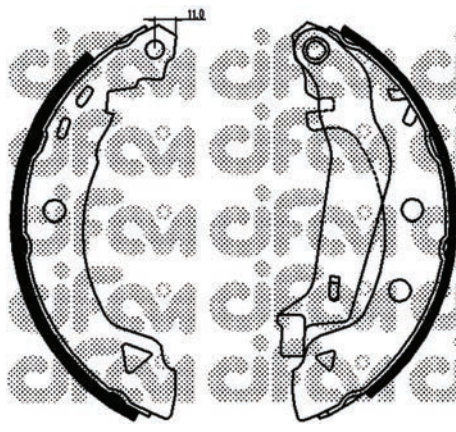

153-346Y (Ø 203,2 x 39)



153-348 (Ø 254,0 x 46)

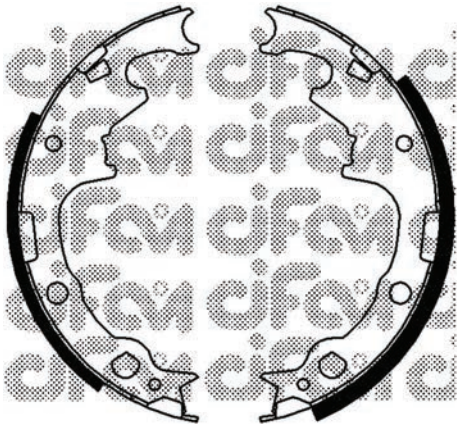

153-349 (Ø 228,6 x 65)

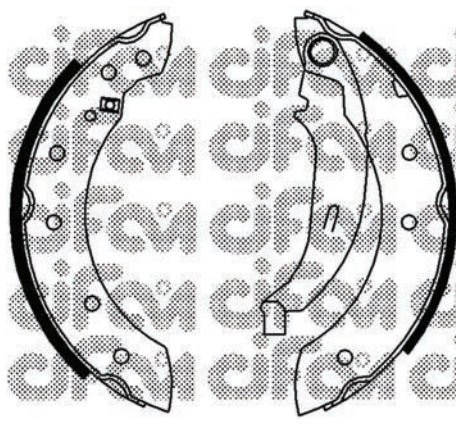

153-350 (Ø 203,0 x 38)

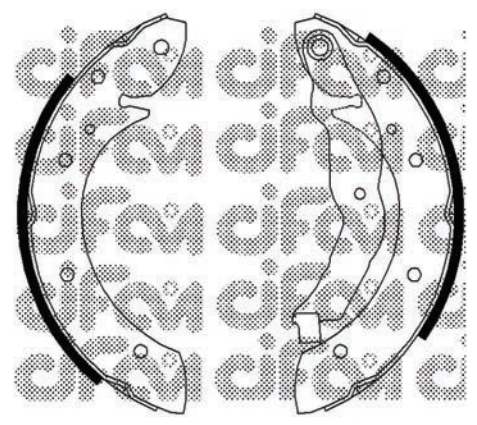

153-351 (Ø 228,6 x 42)

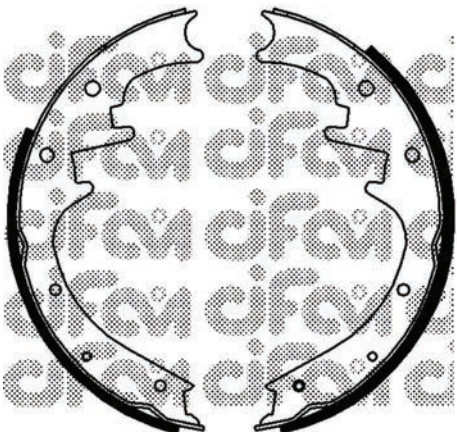

153-352 (Ø 254,0 x 46)

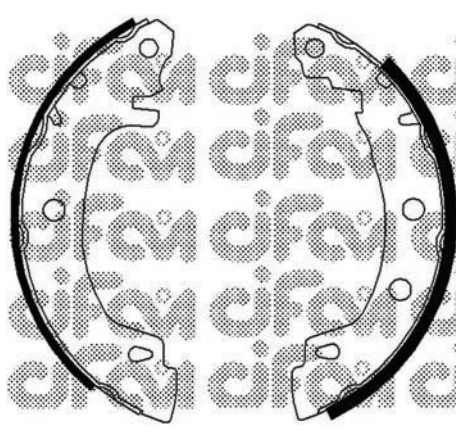

153-353 (Ø 203,0 x 38)

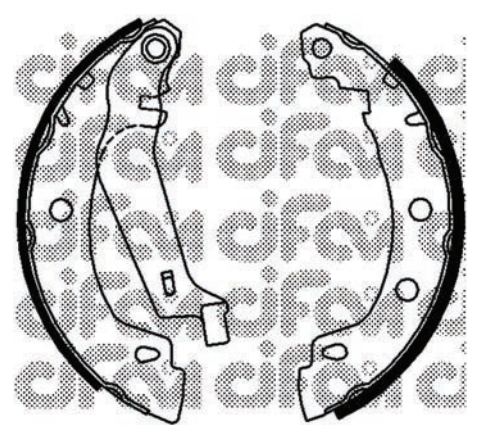

153-353Y (Ø 203,0 x 38)

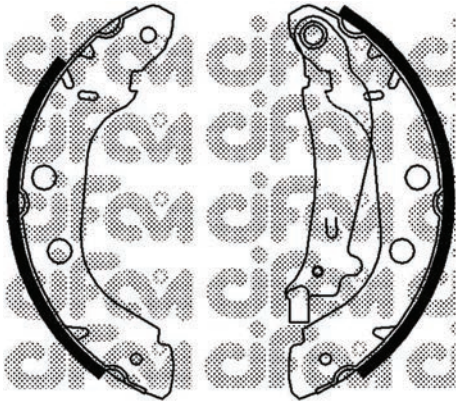

153-354 (Ø 228,6 x 42)

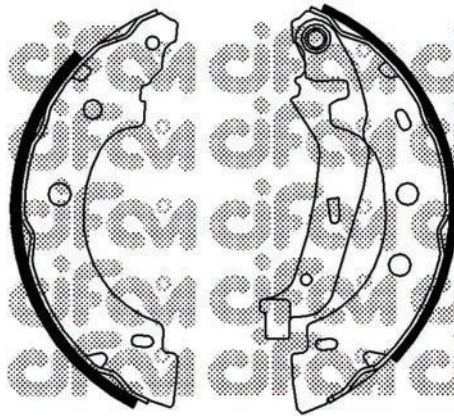

153-355 (Ø 203,2 x 39)

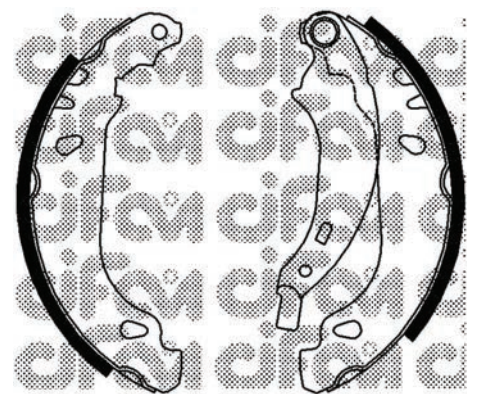

153-356 (Ø 180,0 x 42)



153-357 (Ø 228,6 x 64)

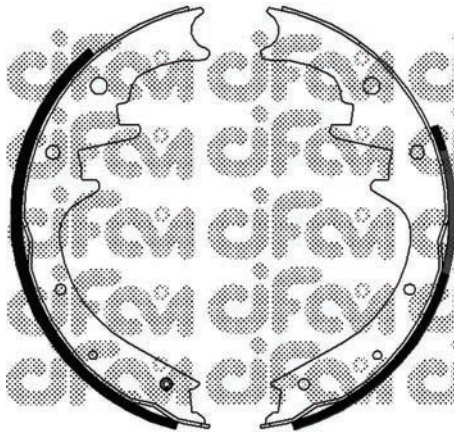

153-358 (Ø 254,0 x 46)

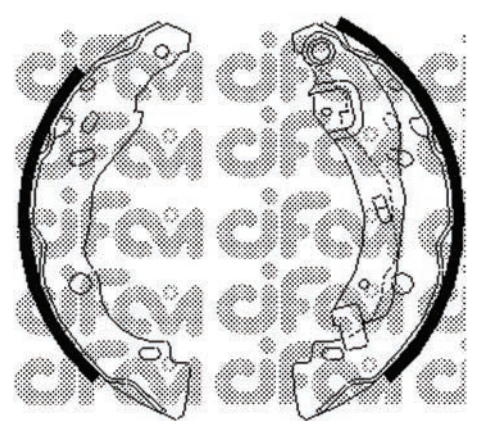

153-359 (Ø 203,2 x 39)

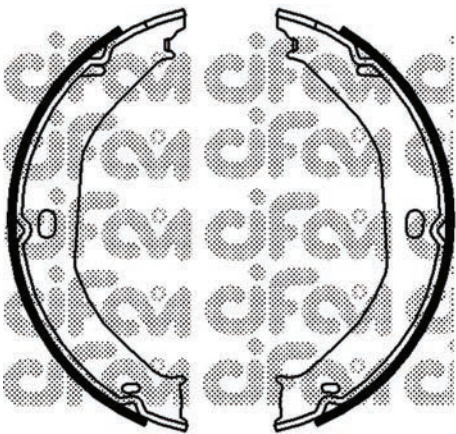

153-360 (Ø 195,0 x 30)

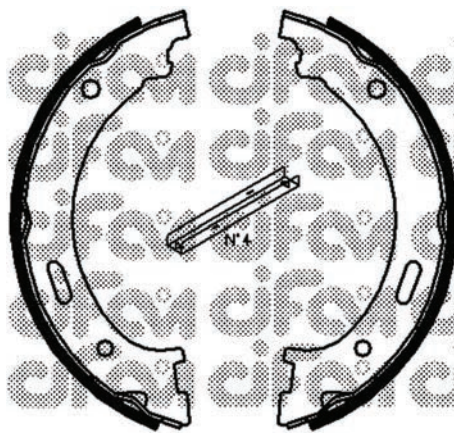

153-361 (Ø 205,0 x 31)

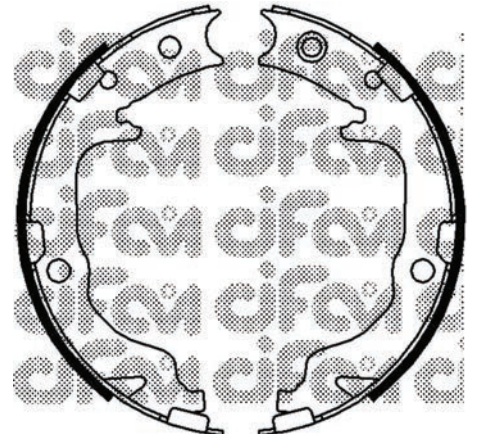

153-362 (Ø 170,0 x 32)



153-363 (Ø 207,0 x 32)



153-364 (Ø 184,0 x 31)

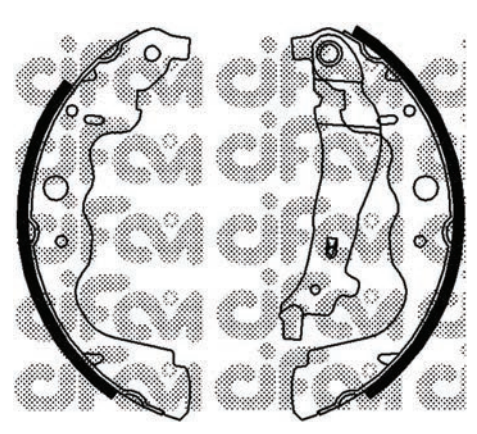

153-365 (Ø 230,0 x 46)

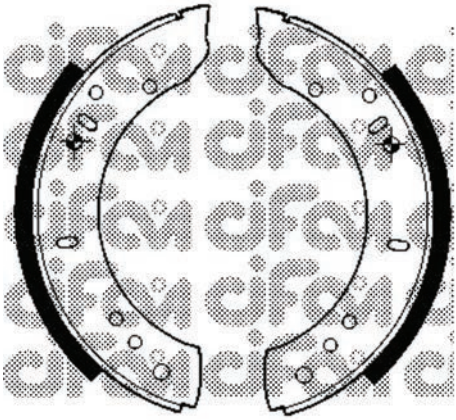

153-366 (Ø 279,4 x 57)

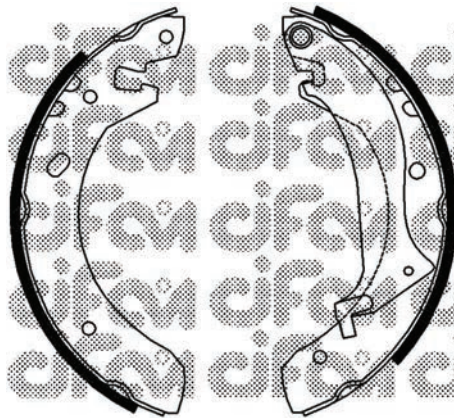

153-368 (Ø 254,0 x 39)

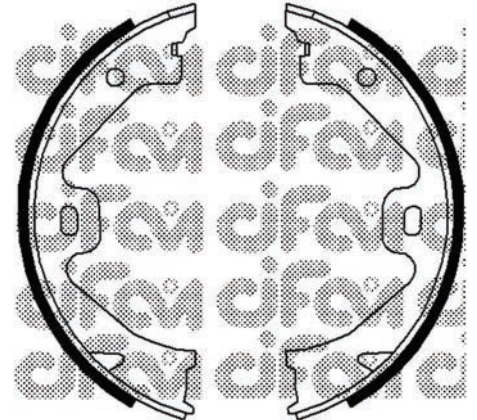

153-369 (Ø 160,0 x 20)

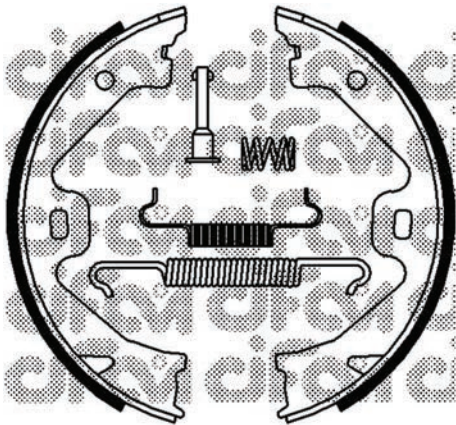

153-369K (Ø 160,0 x 20)

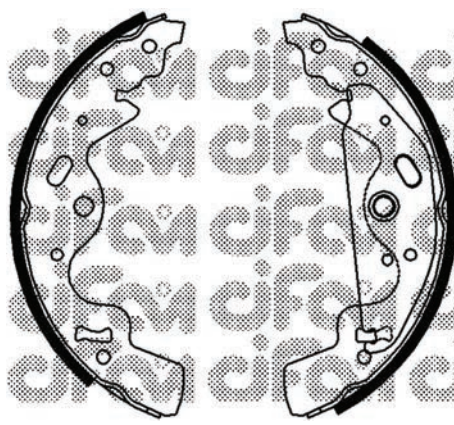

153-370 (Ø 254,0 x 45)

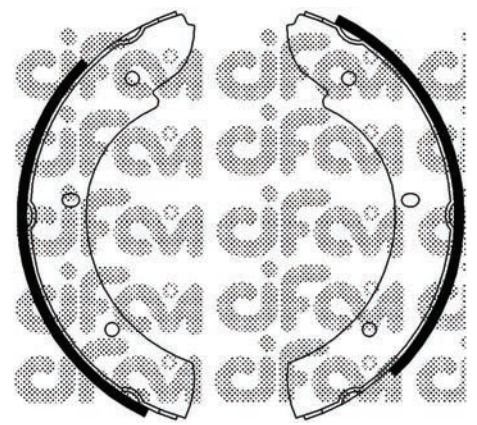

153-371 (Ø 254,0 x 70)

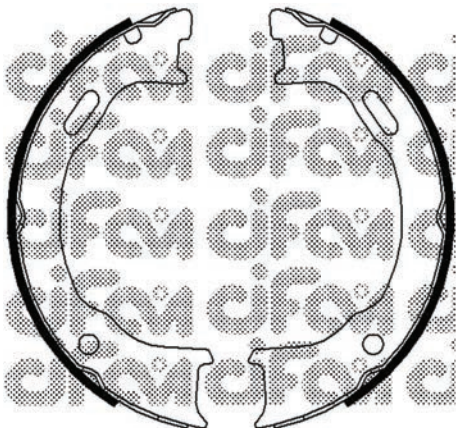

153-372 (Ø 184,0 x 31)

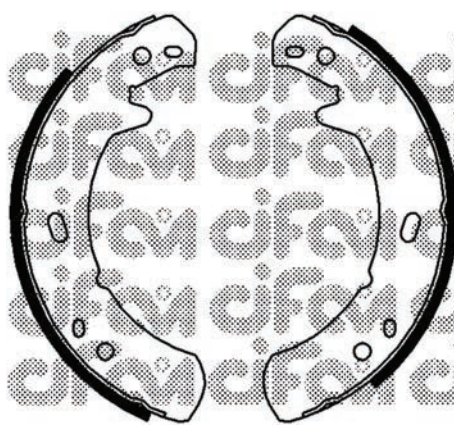

153-373 (Ø 254,0 x 70)

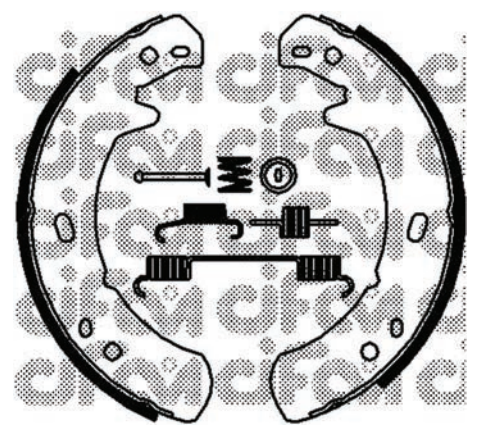

153-373K (Ø 254,0 x 70)

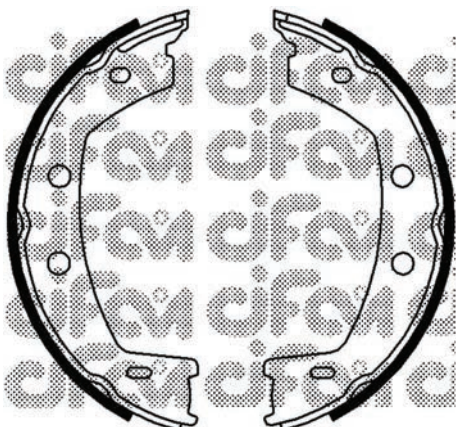

153-374 (Ø 190,0 x 30)

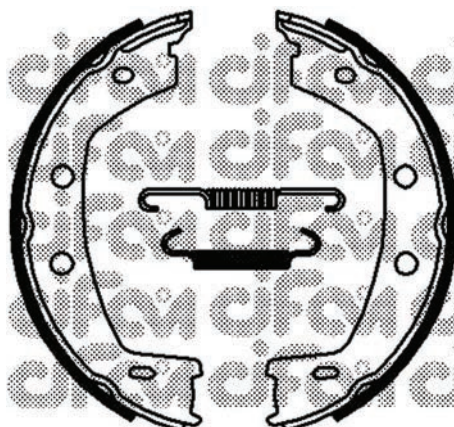

153-374K (Ø 190,0 x 30)

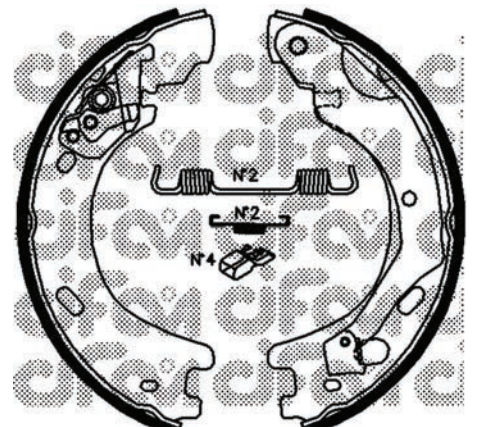

153-375 (Ø 210,0 x 30)

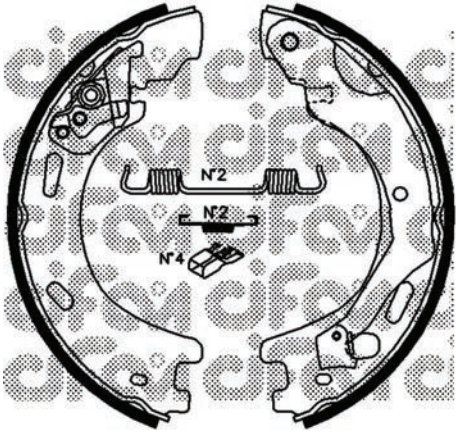

153-376 (Ø 210,0 x 30)

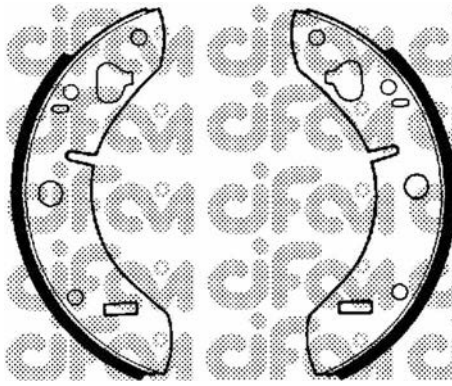

153-377 (Ø 203,2 x 38)

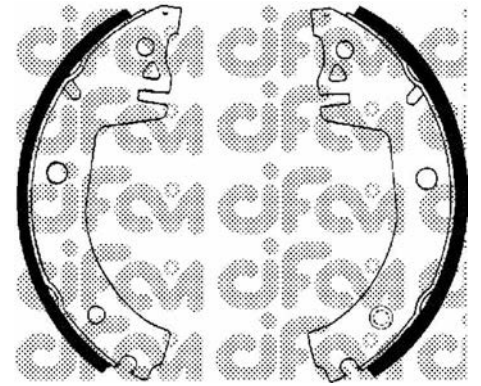

153-378 (Ø 200,0 x 32)

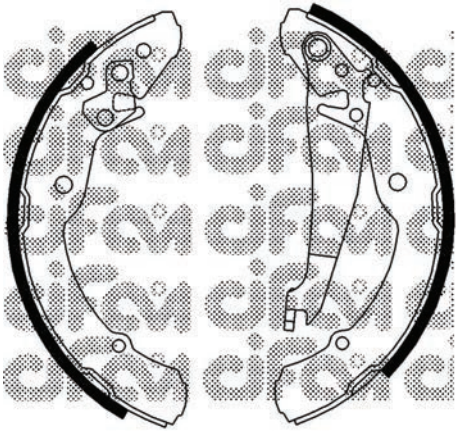

153-379 (Ø 230,0 x 32)

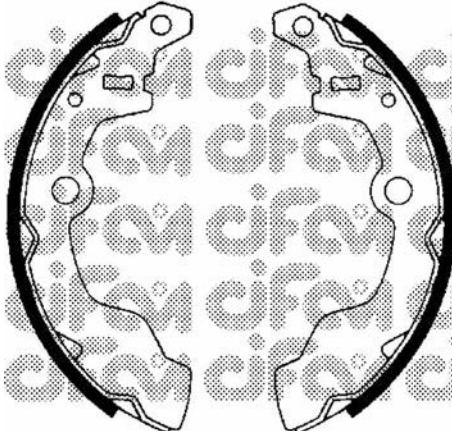

153-380 (Ø 180,0 x 30)

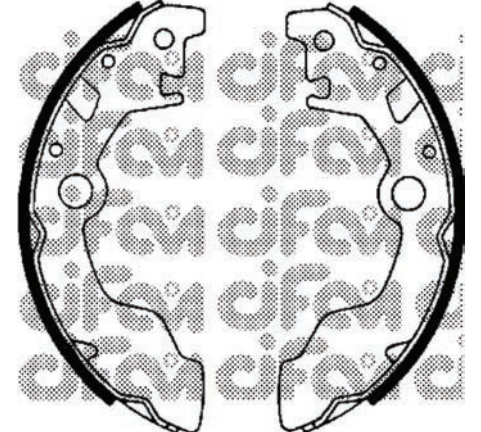

153-382 (Ø 180,0 x 25)

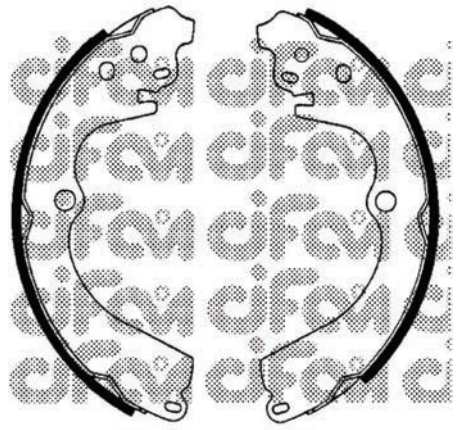

153-383 (Ø 228,6 x 37)

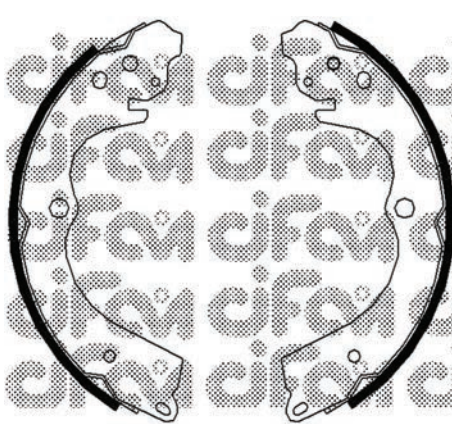

153-384 (Ø 228,6 x 38)

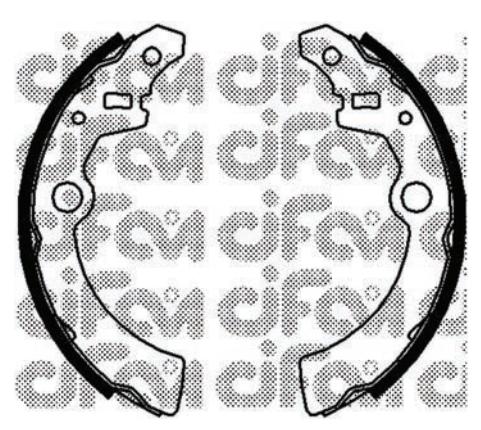

153-385 (Ø 180,0 x 31)

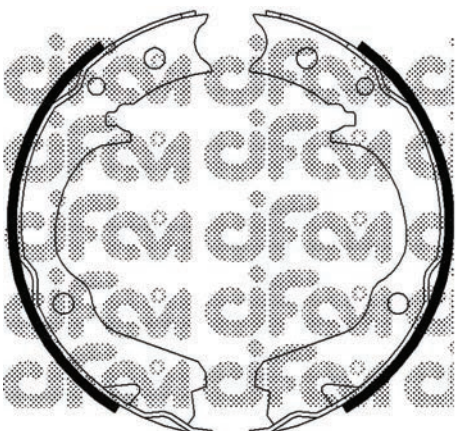

153-386 (Ø 170,0 x 32)

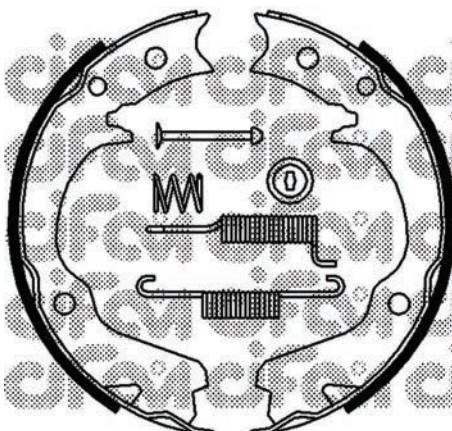

153-386K (Ø 170,0 x 32)

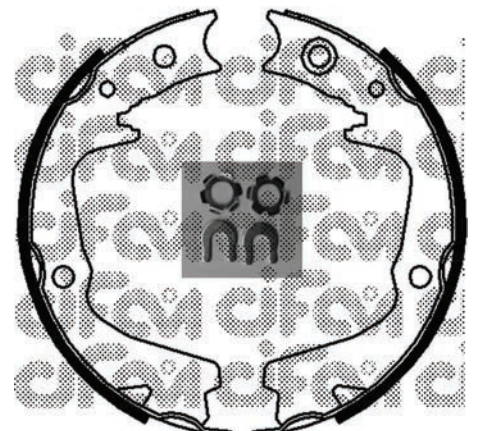

153-387 (Ø 174,0 x 35)

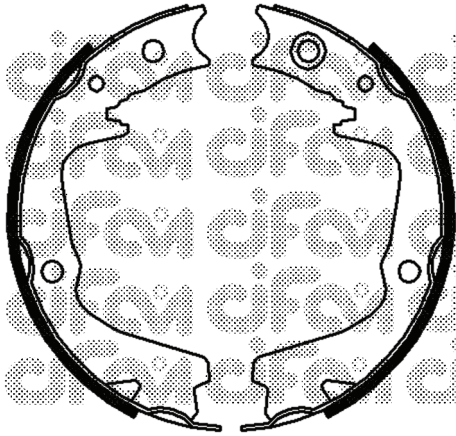

153-387K (Ø 170 x 36)

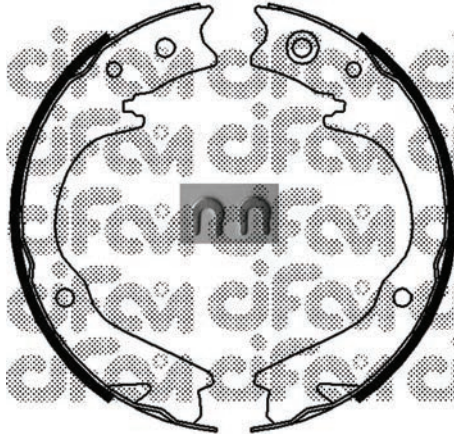

153-388 (Ø 192,0 x 32)

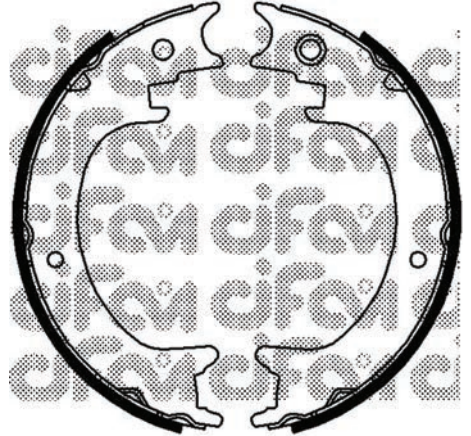

153-389 (Ø 206,0 x 40)

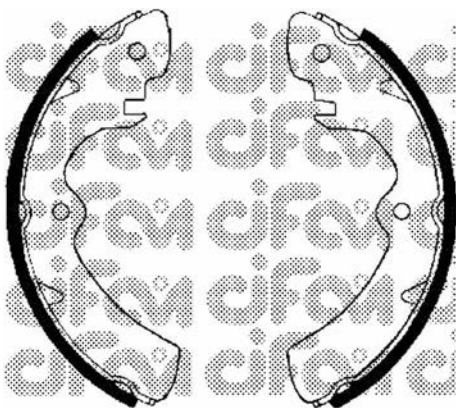

153-390 (Ø 220,0 x 40)

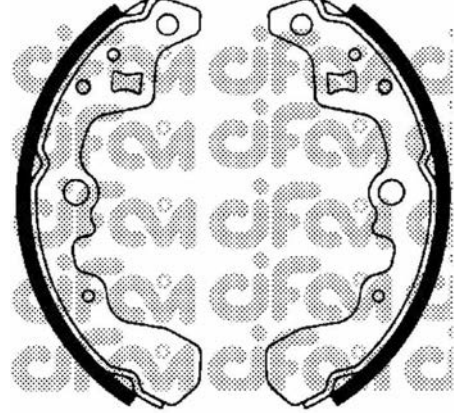

153-391 (Ø 180,0 x 30)

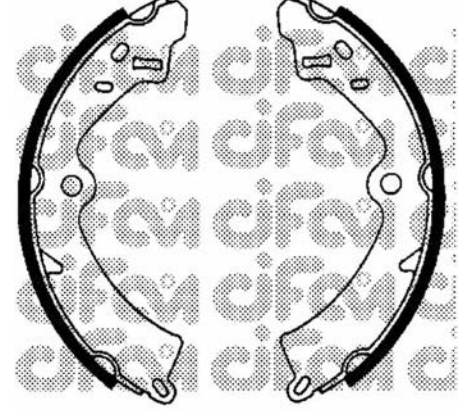

153-392 (Ø 220,0 x 40)

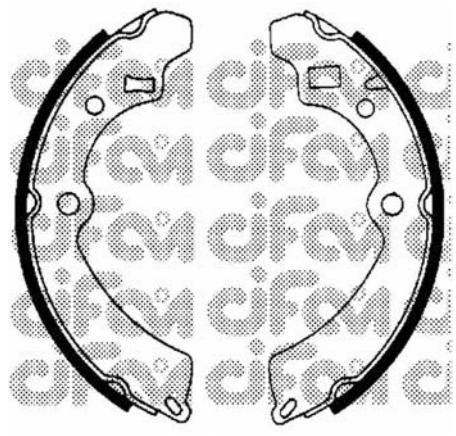

153-393 (Ø 220,0 x 40)

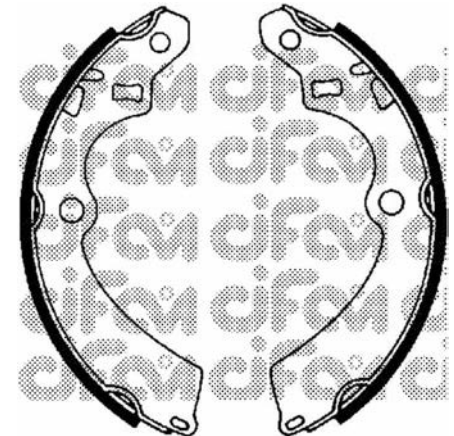

153-394 (Ø 220,0 x 40)

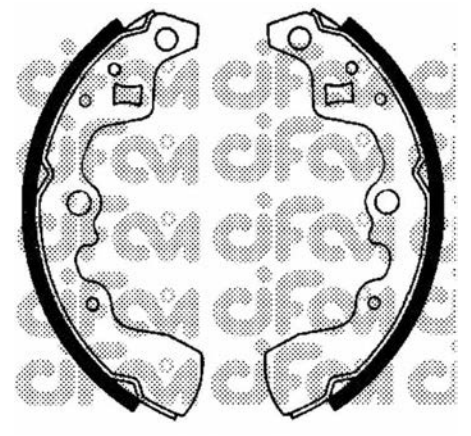

153-395 (Ø 180,0 x 30)

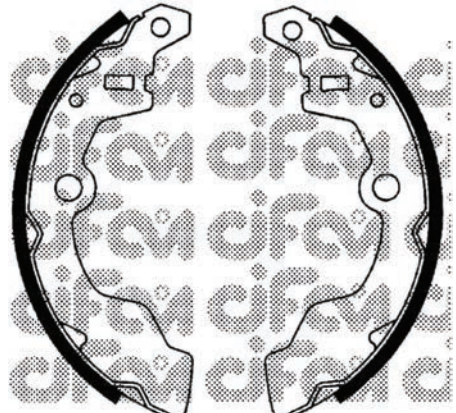

153-396 (Ø 180,0 x 30)

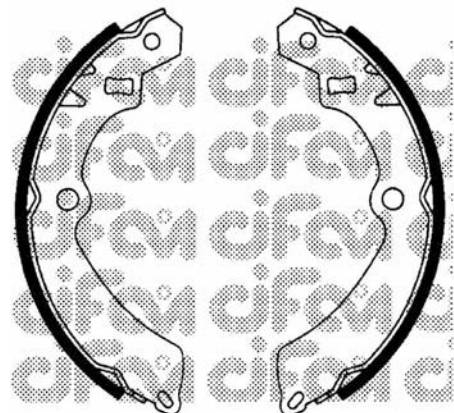

153-397 (Ø 220,0 x 36)

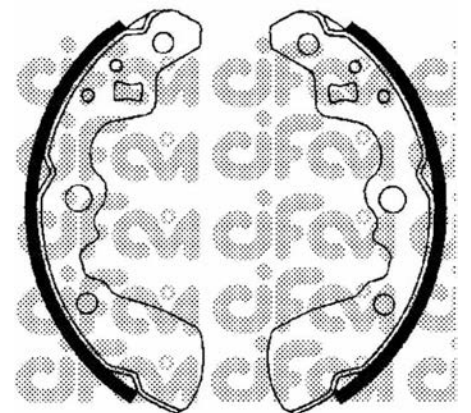

153-398 (Ø 180,0 x 25)

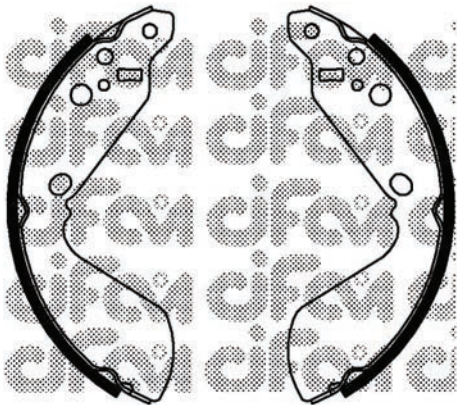

153-399 (Ø 254,0 x 45)

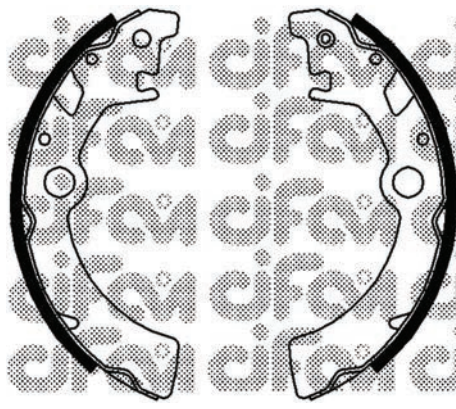

153-400 (Ø 180,0 x 25)

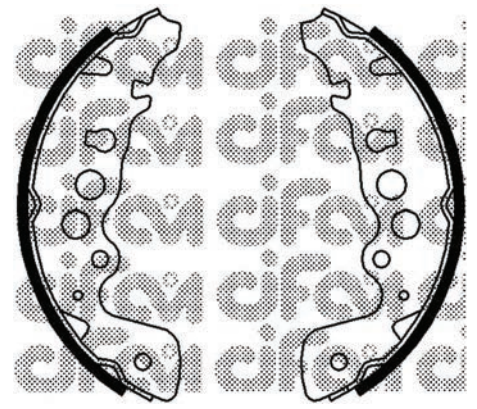

153-401 (Ø 220,0 x 42)

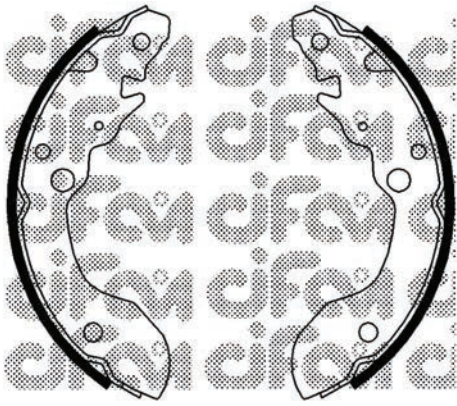

153-402 (Ø 220,0 x 36)

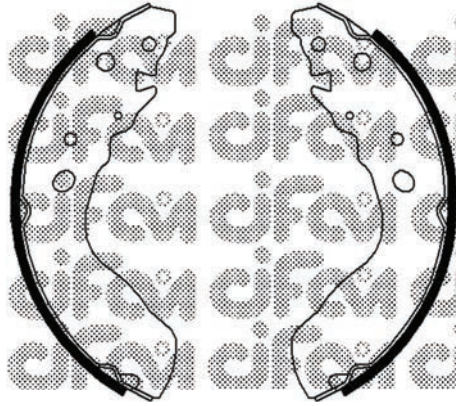

153-403 (Ø 254,0 x 47)

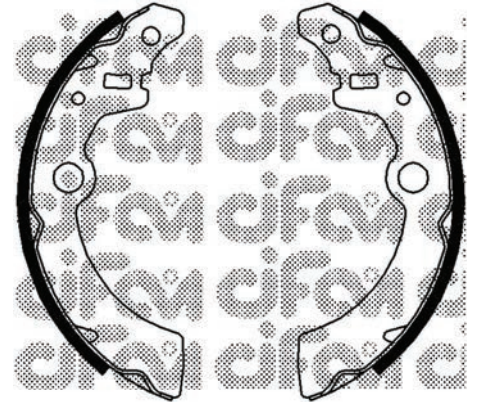

153-404 (Ø 180,0 x 26)

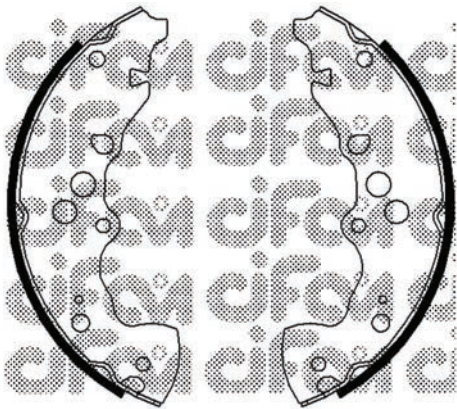

153-405 (Ø 254,0 x 57)

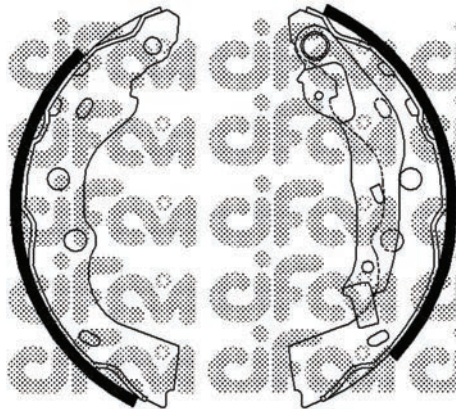

153-406 (Ø 203,2 x 32)

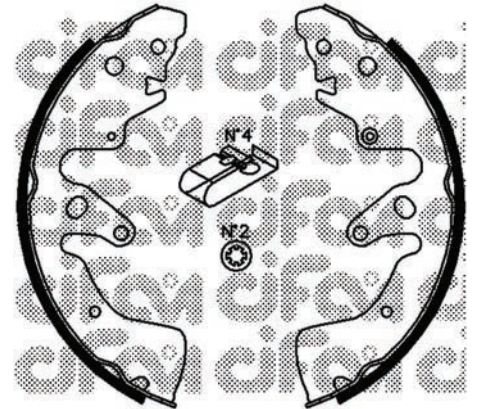

153-407 (Ø 254,0 x 42)

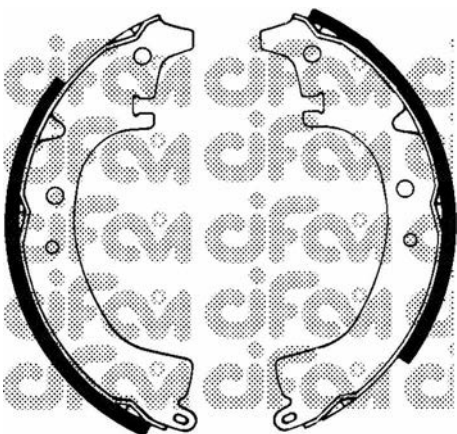

153-408 (Ø 228,6 x 41)

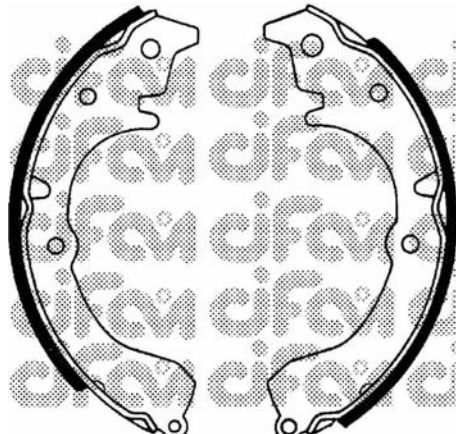

153-409 (Ø 200,0 x 36)

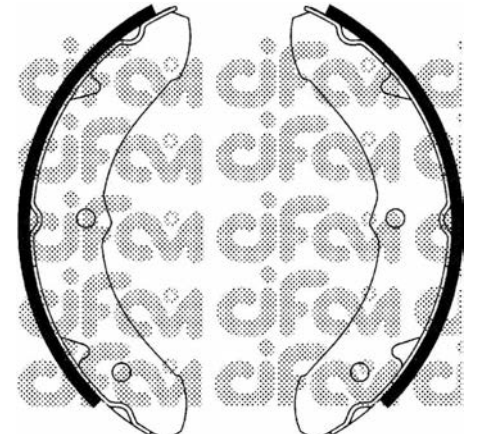

153-411 (Ø 295,0 x 78)



153-412 (Ø 254,0 x 58)

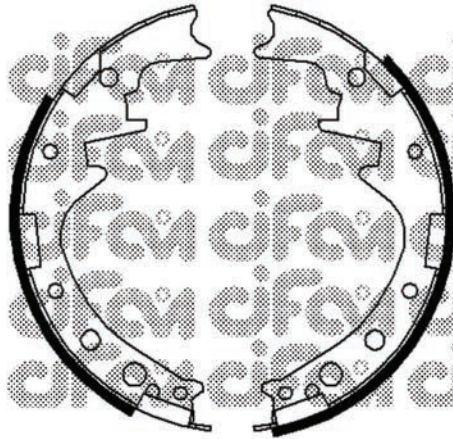

153-413 (Ø 254,0 x 58)

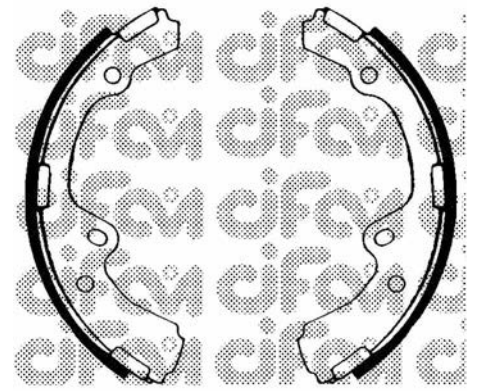

153-414 (Ø 254,0 x 50)



153-415 (Ø 295,0 x 60)

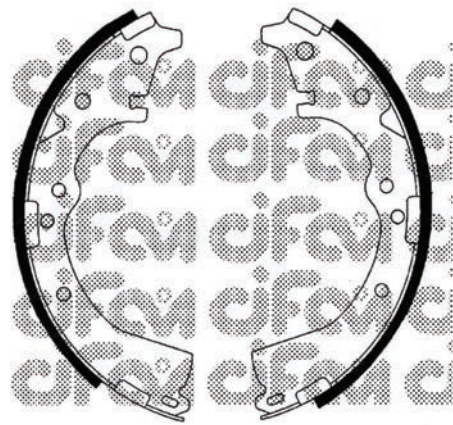

153-416 (Ø 254,0 x 50)

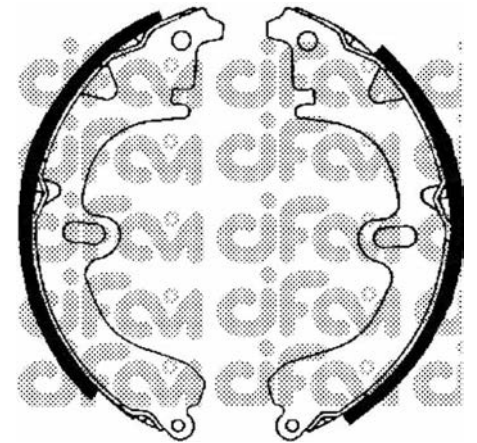

153-417 (Ø 200,0 x 37)

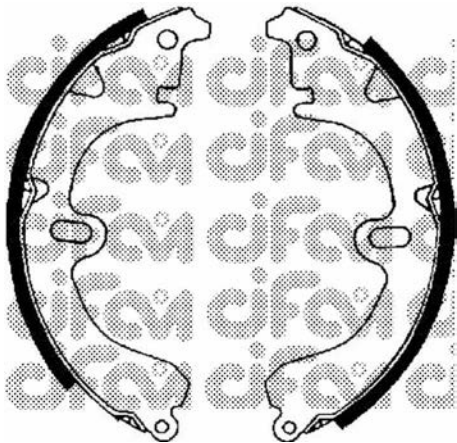

153-419 (Ø 200,0 x 37)

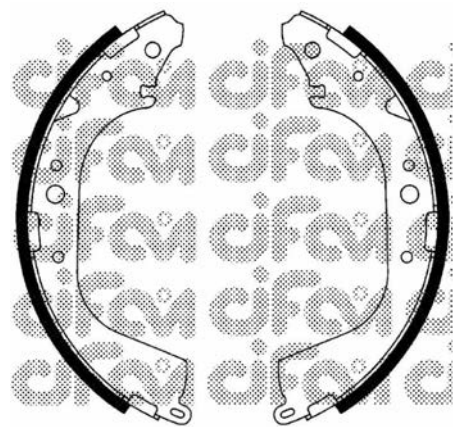

153-421 (Ø 295,0 x 50)

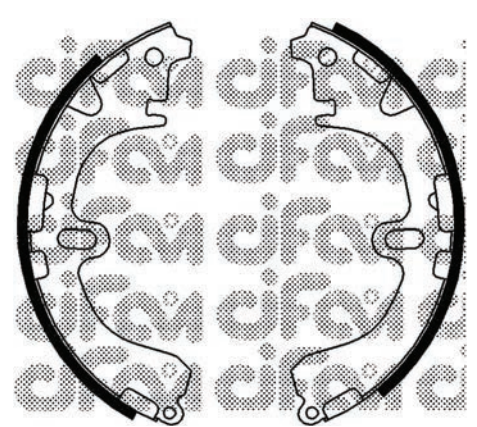

153-422 (Ø 200,0 x 37)

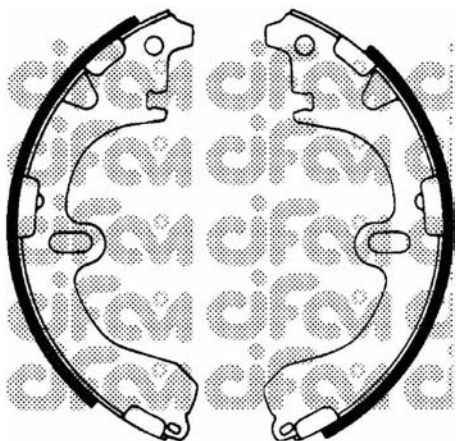

153-423 (Ø 200,0 x 37)

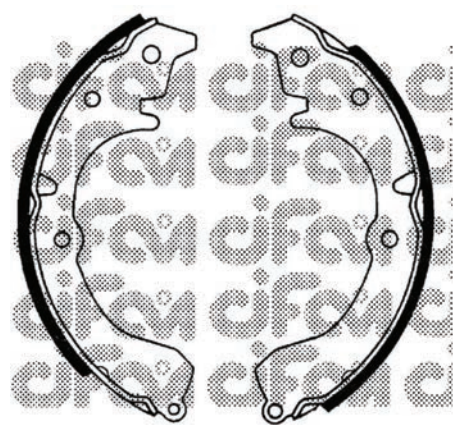

153-424 (Ø 200,0 x 36)

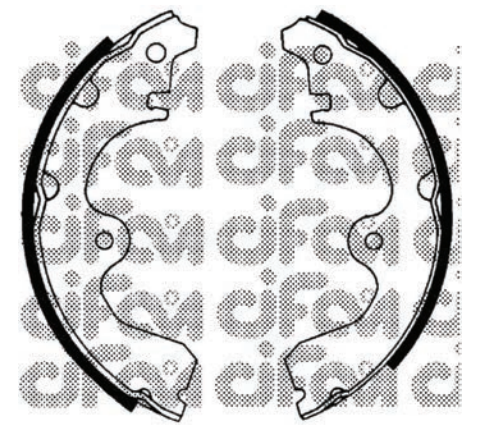

153-425 (Ø 180,0 x 28)

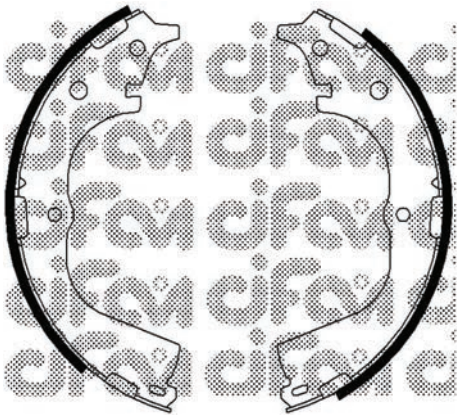

153-426 (Ø 270,0 x 55)

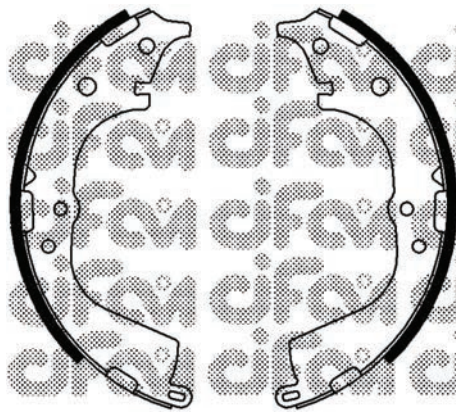

153-428 (Ø 270,0 x 55)

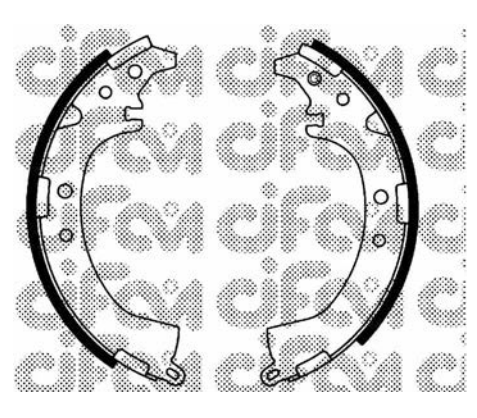

153-429 (Ø 228,6 x 42)

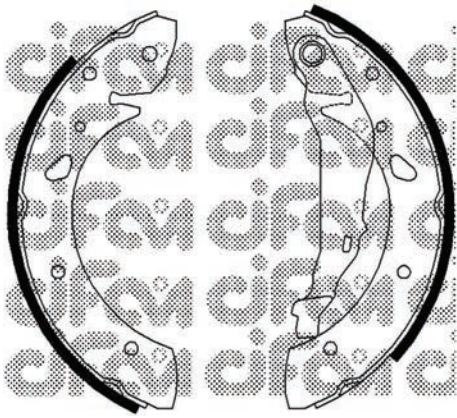

153-430 (Ø 228,6 x 35)

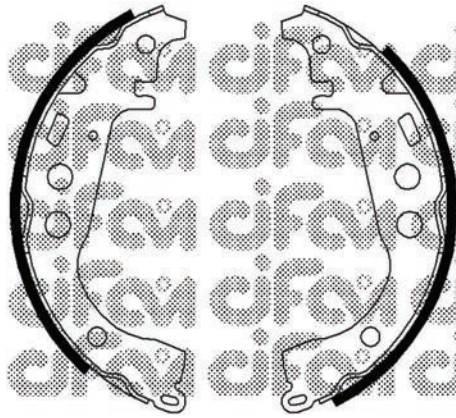

153-431 (Ø 203,0 x 32)

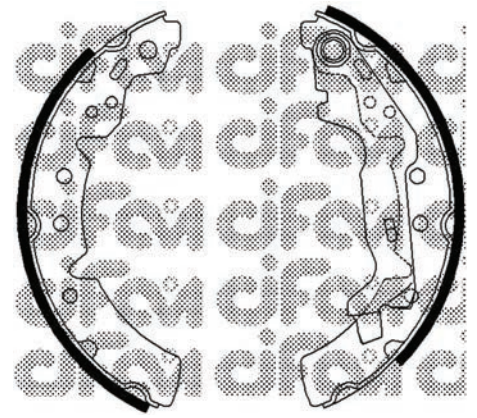

153-432 (Ø 200,0 x 35)

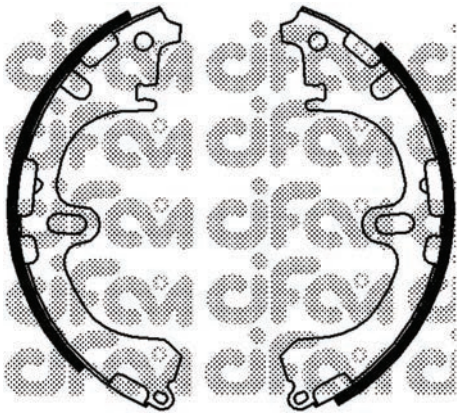

153-433 (Ø 200,0 x 38)

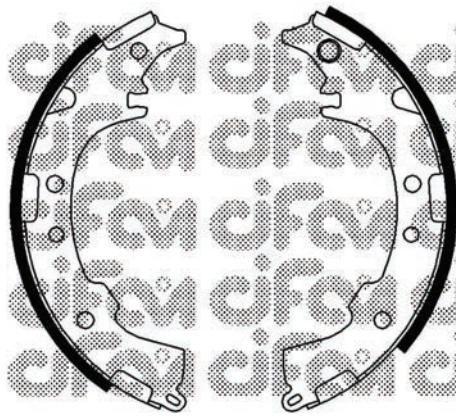

153-434 (Ø 228,6 x 42)

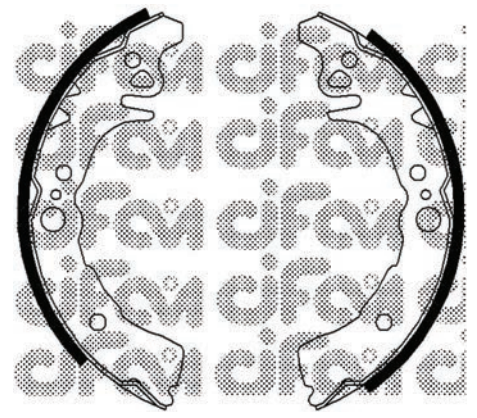

153-435 (Ø 180,0 x 38)

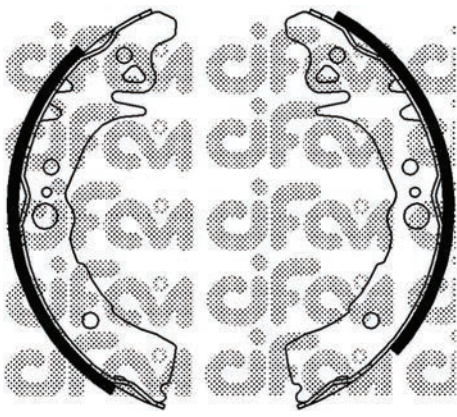

153-436 (Ø 180,0 x 27)

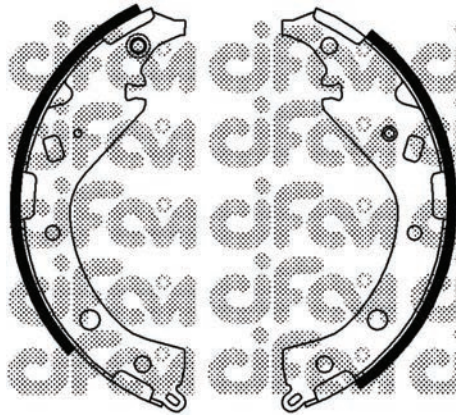

153-437 (Ø 228,6 x 42)



153-438 (Ø 200,0 x 32)

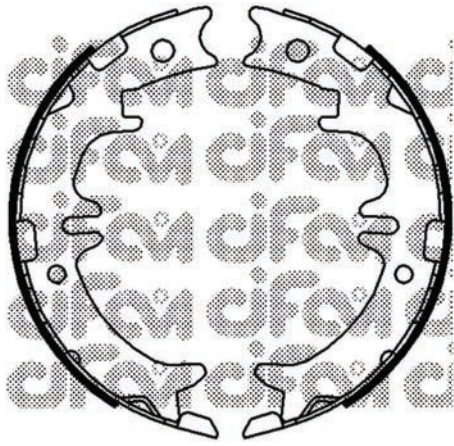

153-439 (Ø 190,0 x 45)

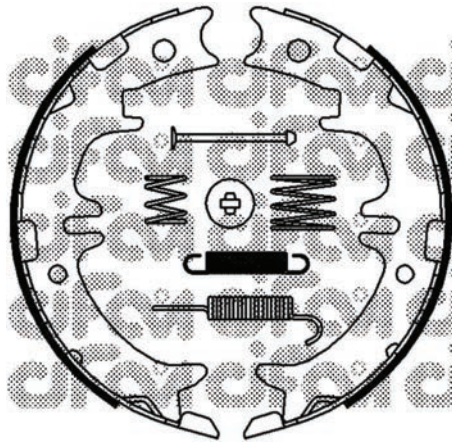

153-439K (Ø 190,0 x 45)

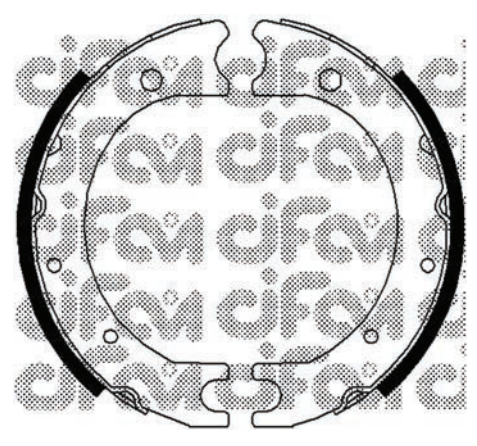

153-440 (Ø 160,0 x 35)

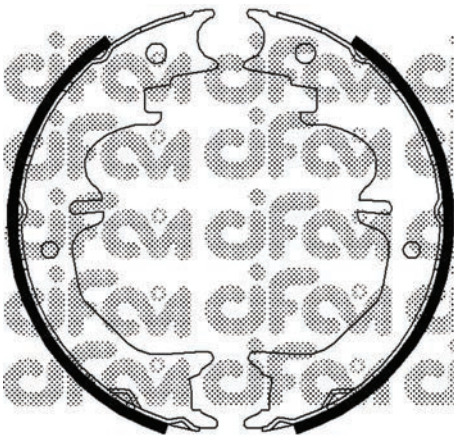

153-441 (Ø 210,0 x 46)

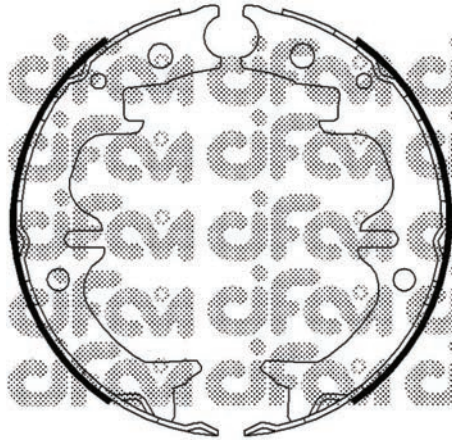

153-442 (Ø 170,0 x 40)

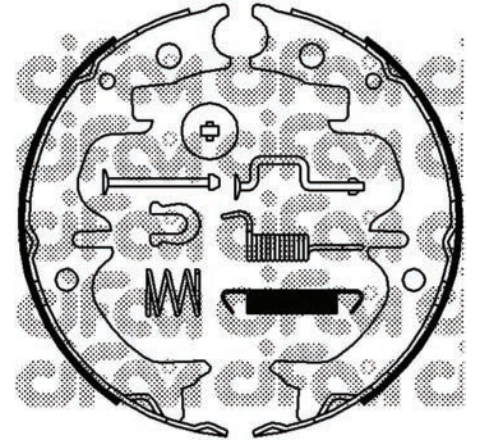

153-442K (Ø 170,0 x 40)

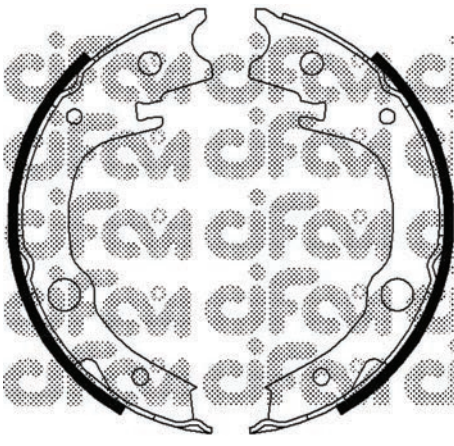

153-443 (Ø 174,0 x 32)

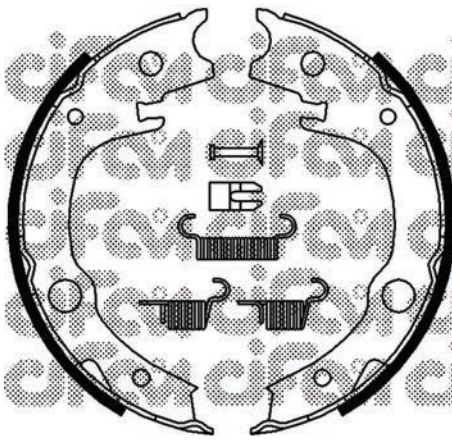

153-443K (Ø 174,0 x 32)

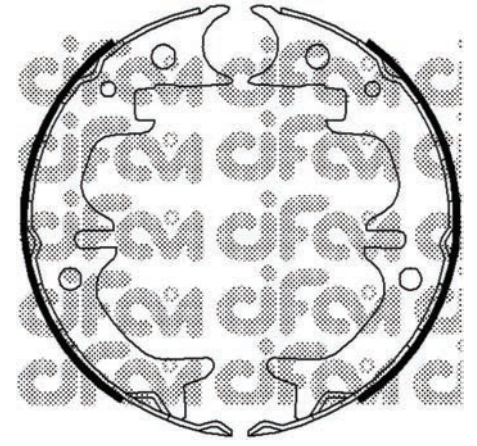

153-444 (Ø 170,0 x 40)

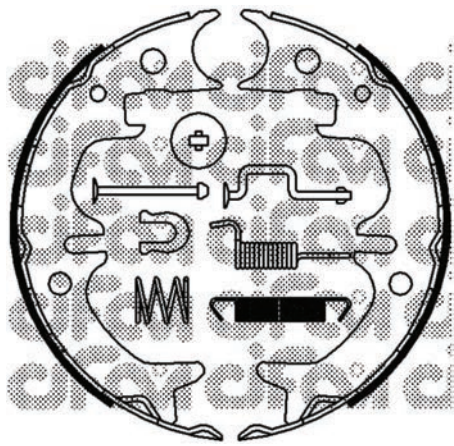

153-444K (Ø 170,0 x 40)

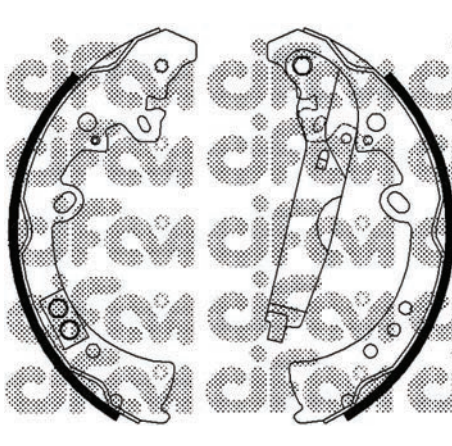

153-445 (Ø 300,0 x 62)

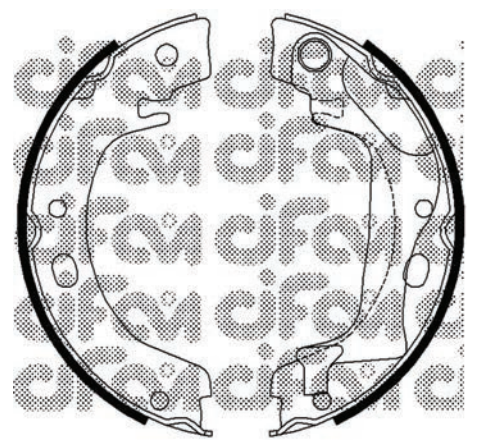

153-446 (Ø 172,0 x 22)

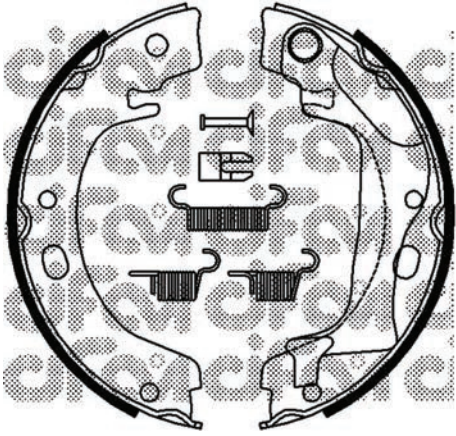

153-446K (Ø 172,0 x 22)

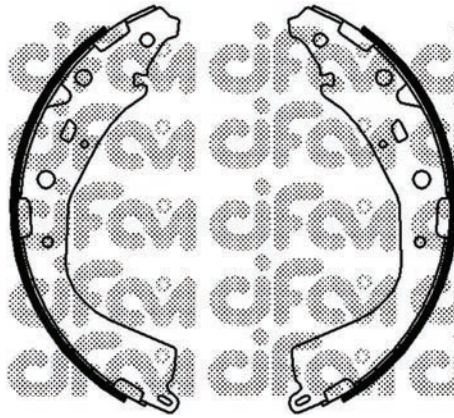

153-447 (Ø 290,0 x 51)

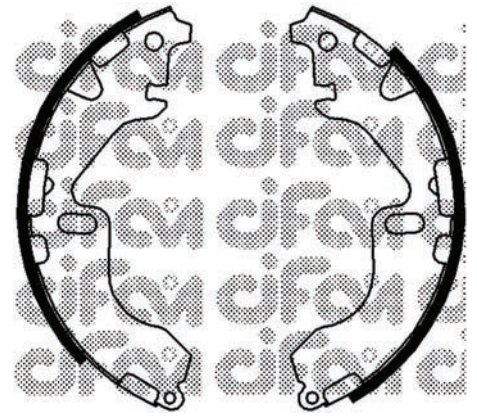

153-448 (Ø 200,0 x 37)

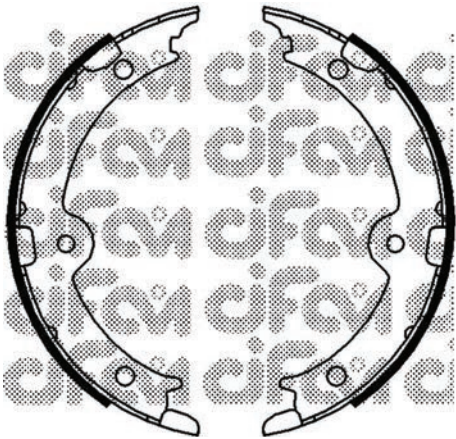

153-449 (Ø 190,0 x 26)

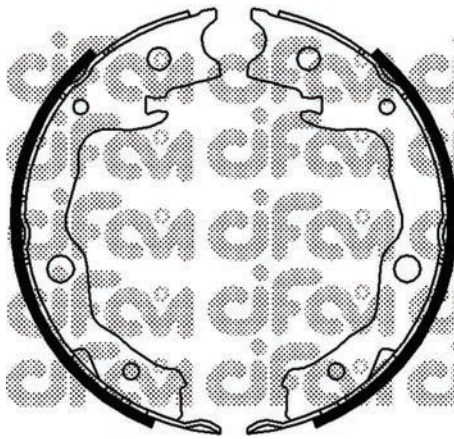

153-450 (Ø 170,0 x 32)

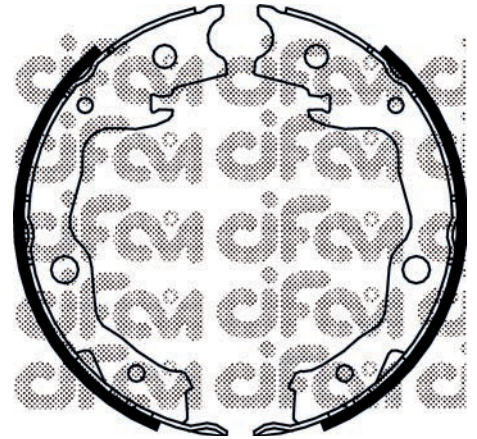

153-450K (Ø 170 x 32)

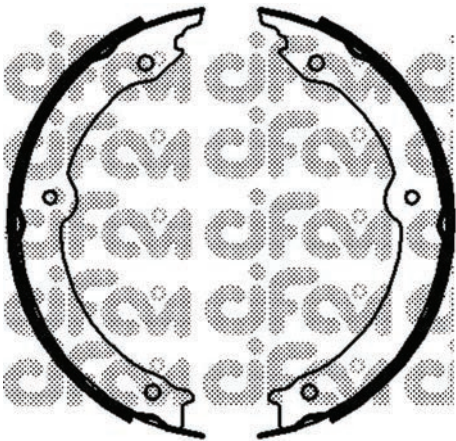

153-451 (Ø 242,0 x 32)

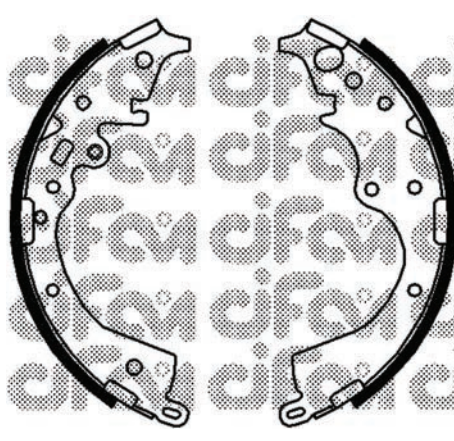

153-452 (Ø 254,0 x 52)

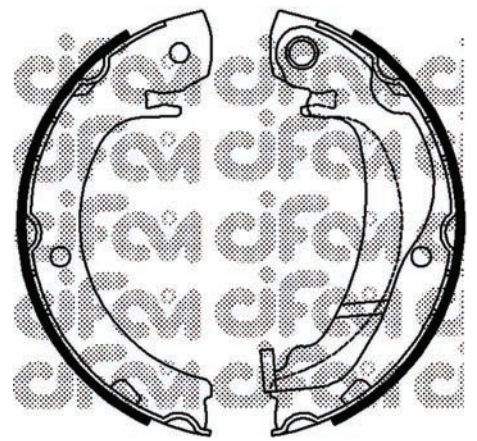

153-453 (Ø 185,0 x 32)

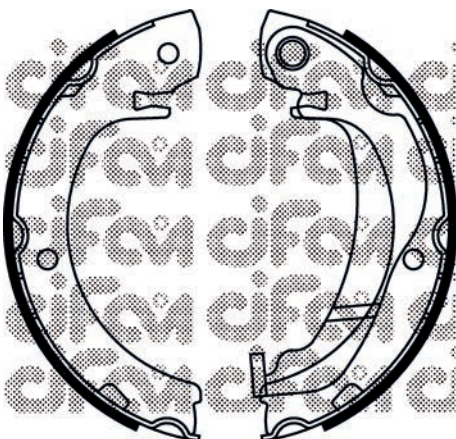

153-453K (Ø 185 x 32)

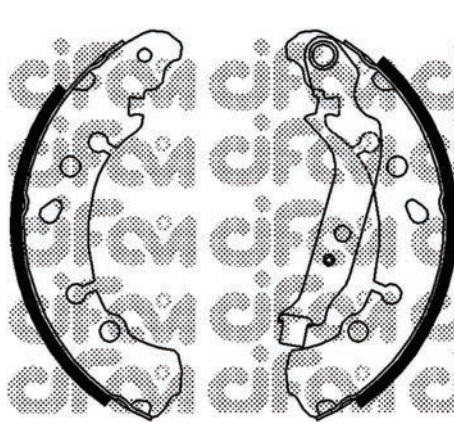

153-454 (Ø 203,0 x 38)

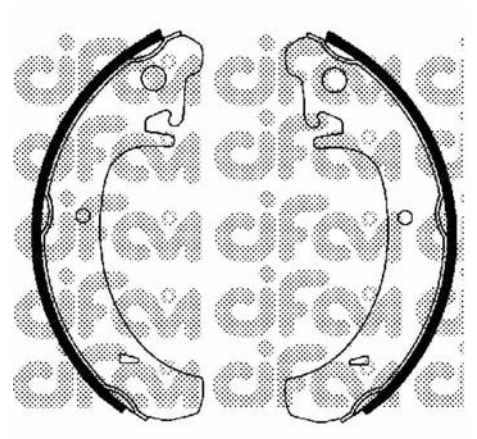

153-456 (Ø 200,0 x 40)

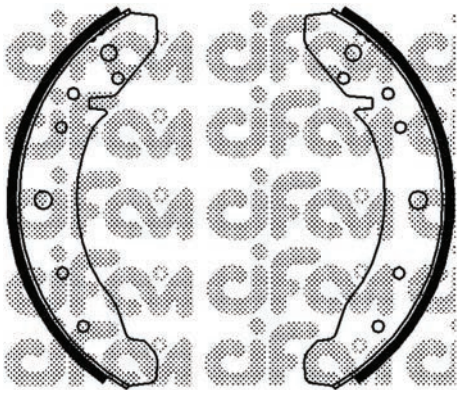

153-457 (Ø 230,0 x 40)

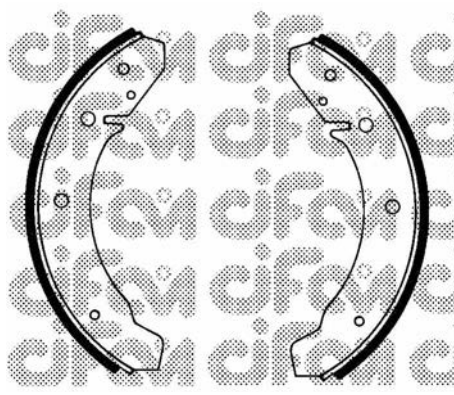

153-458 (Ø 230,0 x 30)

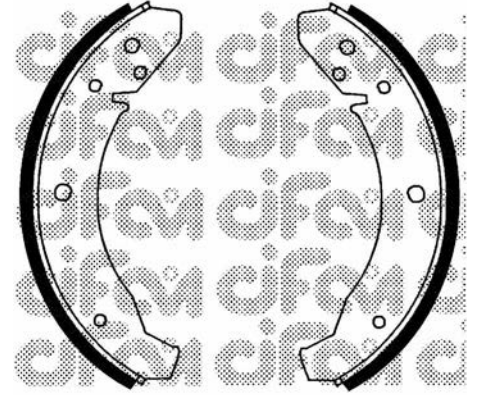

153-459 (Ø 230,0 x 40)

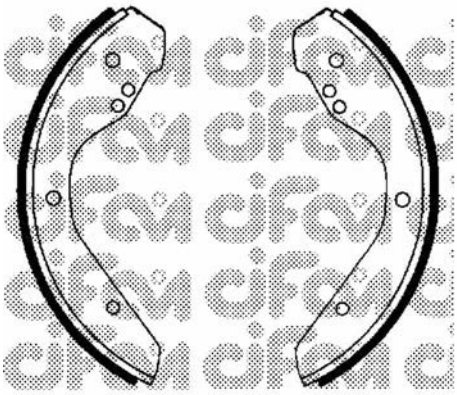

153-460 (Ø 248,0 x 46)

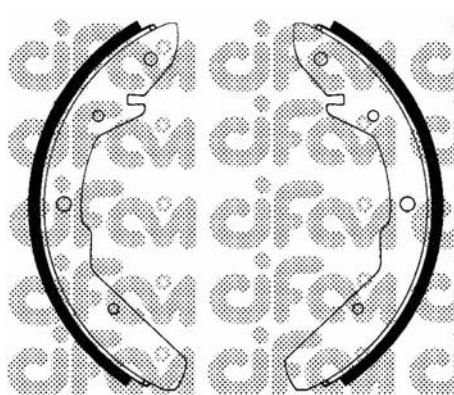

153-461 (Ø 252,0 x 56)



153-462 (Ø 200,0 x 40)

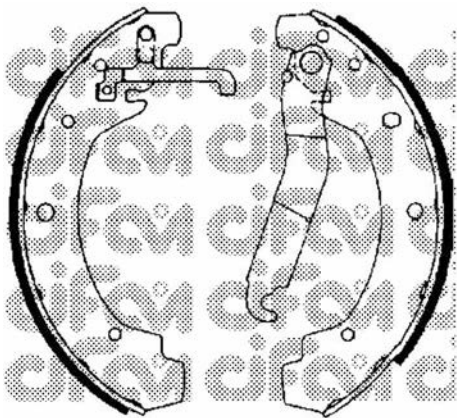

153-463 (Ø 270,0 x 66)

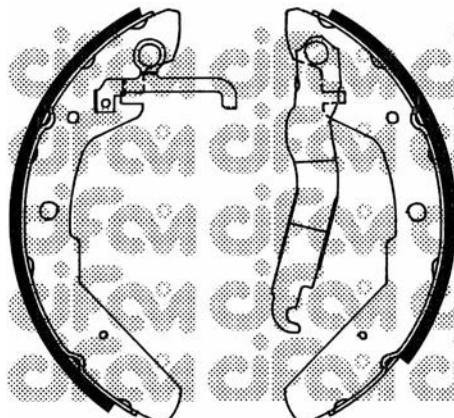

153-464 (Ø 252,0 x 56)

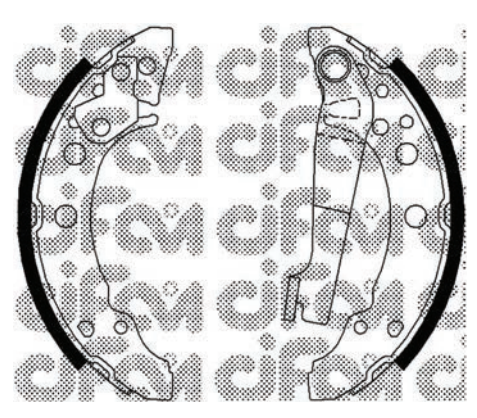

153-465 (Ø 180,0 x 31)

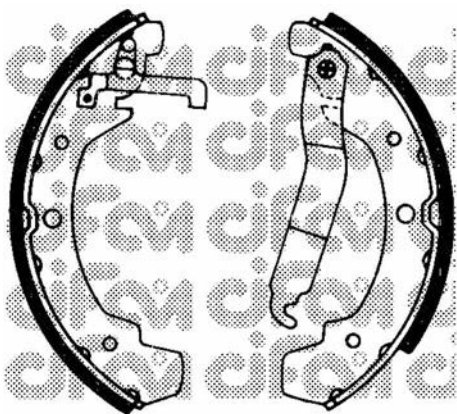

153-466 (Ø 252,0 x 56)

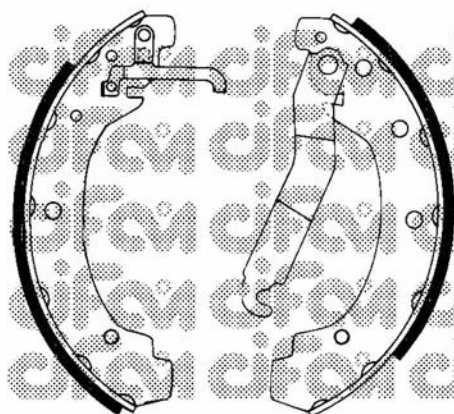

153-467 (Ø 270,0 x 66)

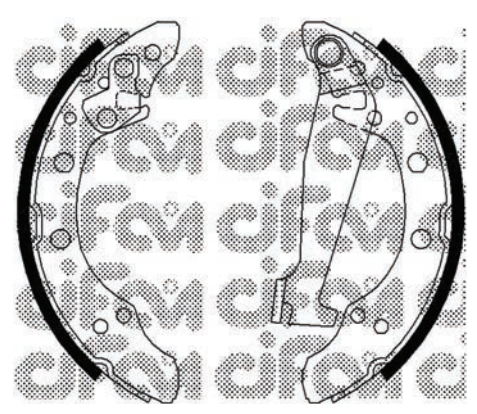

153-468 (Ø 200,0 x 40)

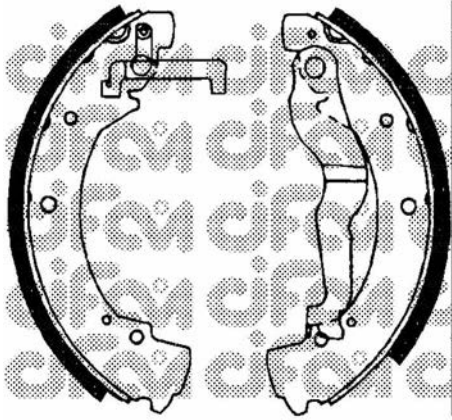

153-469 (Ø 270,0 x 55)

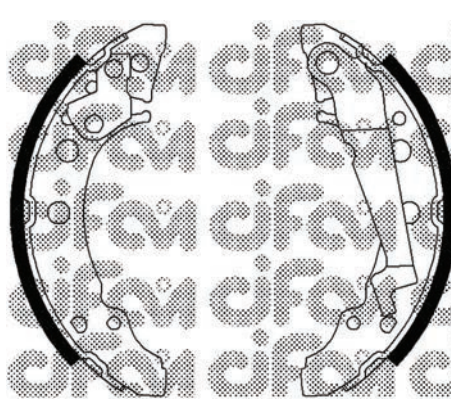

153-470 (Ø 180,0 x 31)

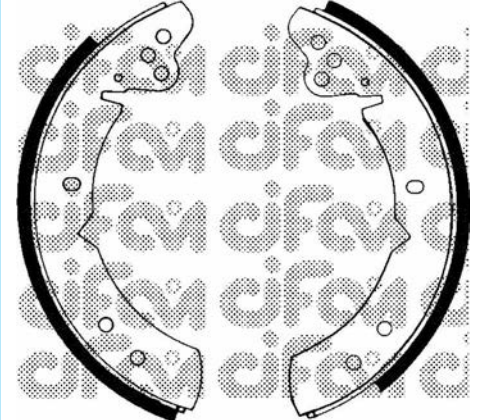

153-471 (Ø 228,6 x 51)

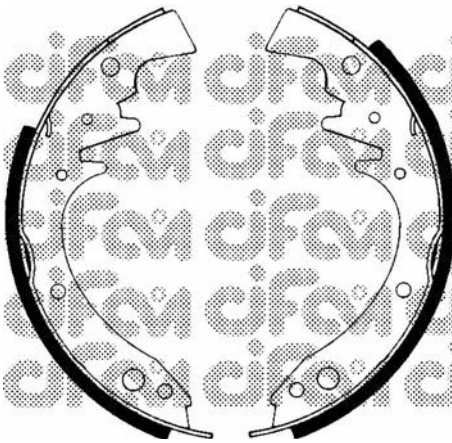

153-472 (Ø 228,6 x 51)

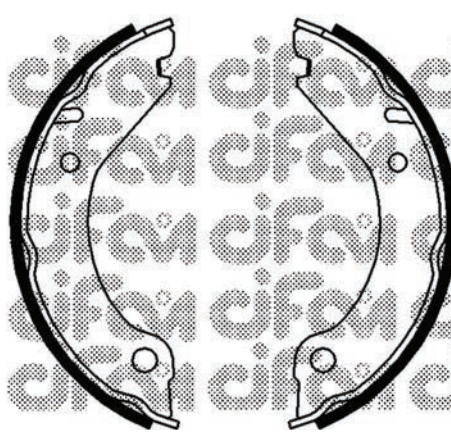

153-473 (Ø 160,0 x 25)

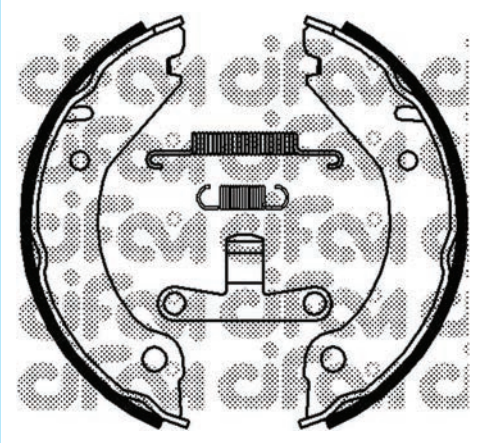

153-473K (Ø 160,0 x 25)

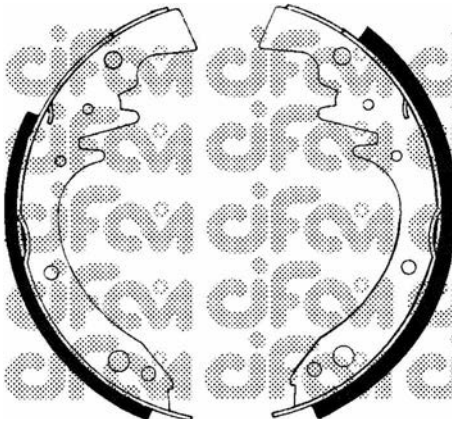

153-474 (Ø 228,6 x 51)

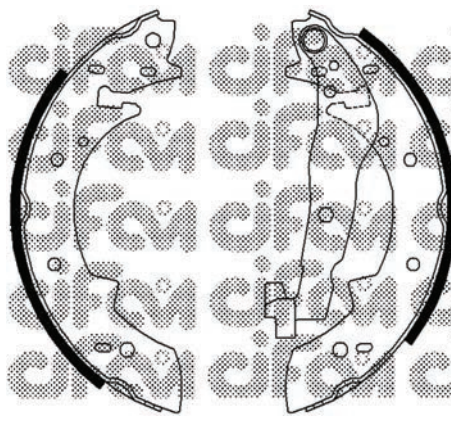

153-475 (Ø 228,6 x 42)

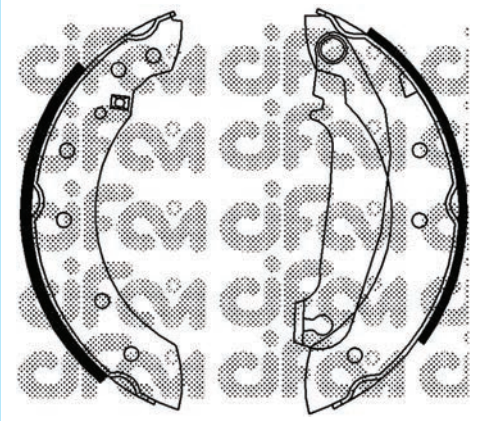

153-476 (Ø 203,0 x 38)

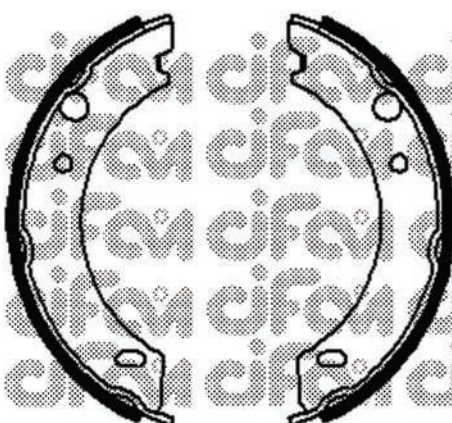

153-477 (Ø 160,0 x 25)

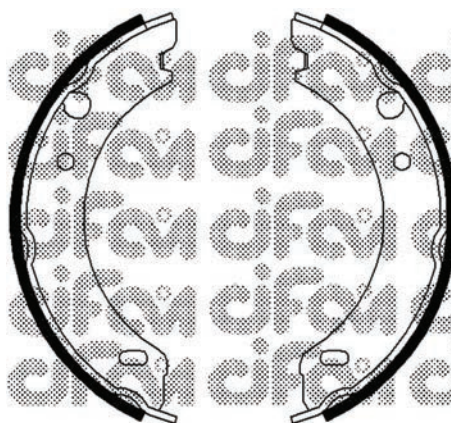

153-477K (Ø 160,0 x 25)

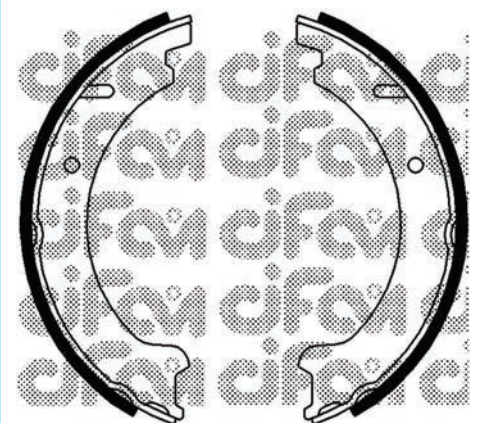

153-478 (Ø 177,8 x 25)

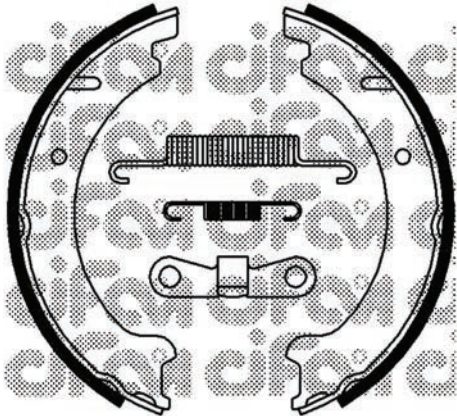

153-478K (Ø 177,8 x 25)

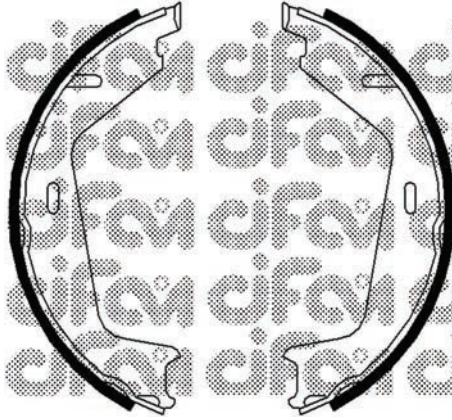

153-479 (Ø 177,8 x 25)

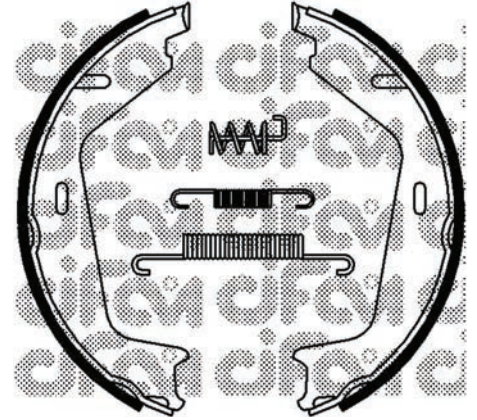

153-479K (Ø 177,8 x 25)

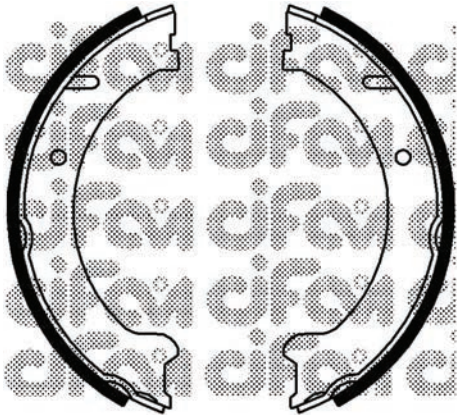

153-480 (Ø 177,8 x 25)

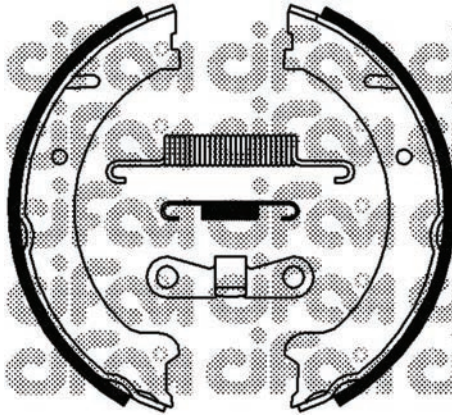

153-480K (Ø 177,8 x 25)

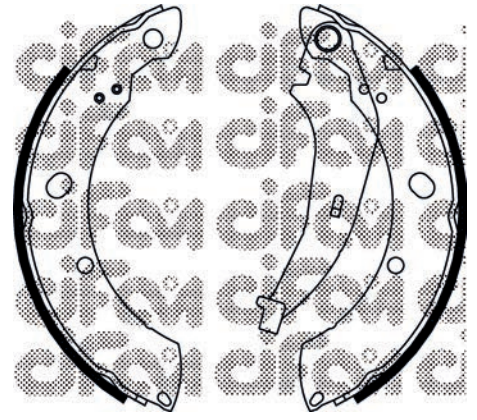

153-481 (Ø 228,6 x 42)

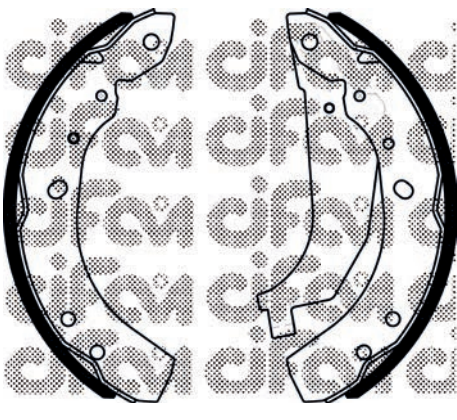

153-482 (Ø 220 x 42)



153-483 (Ø 167 x 25)

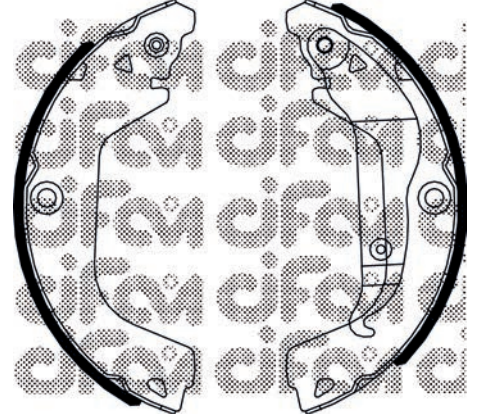

153-484 (Ø 254 x 41)

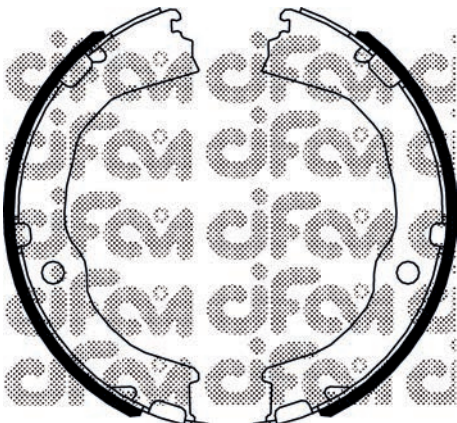

153-485 (Ø 203,2 x 22)

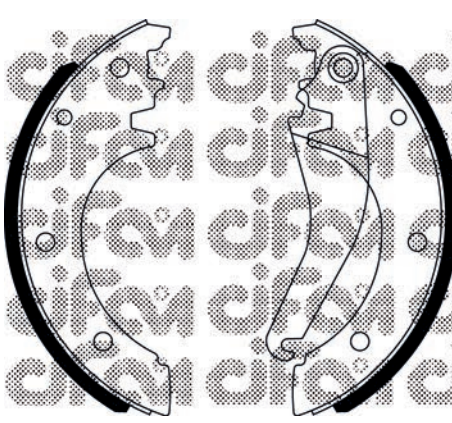

153-486 (Ø 260 x 80)

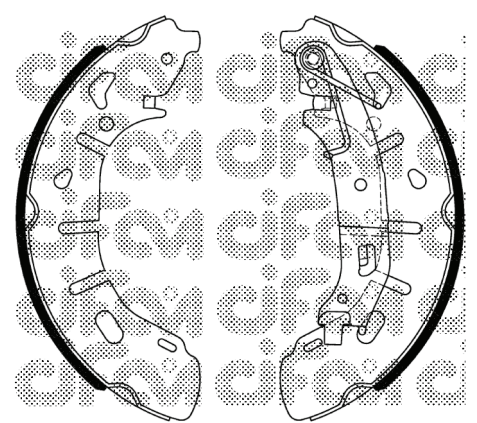

153-487 (Ø 254 x 57)



153-488 (Ø 180 x 30)

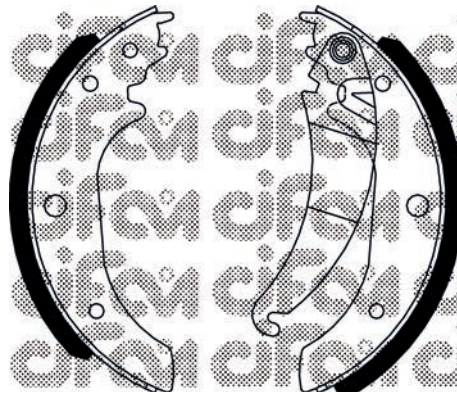

153-489 (Ø 310 x 101)

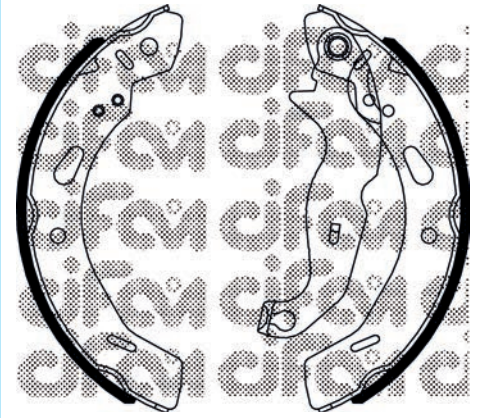

153-490 (Ø 200 x 32)

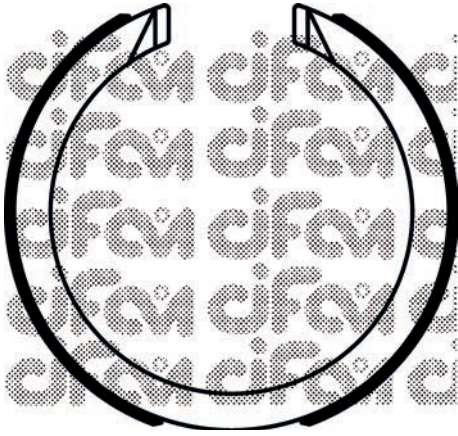

153-491 (Ø 190 x 25)

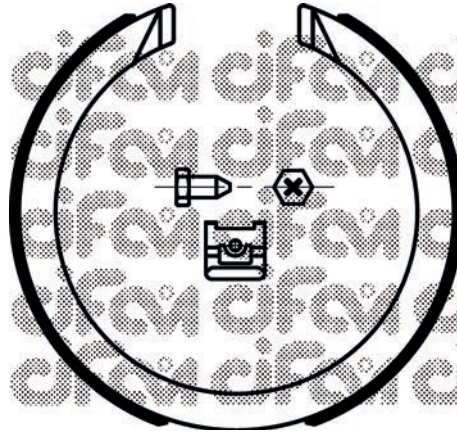

153-491K (Ø 190 x 25)

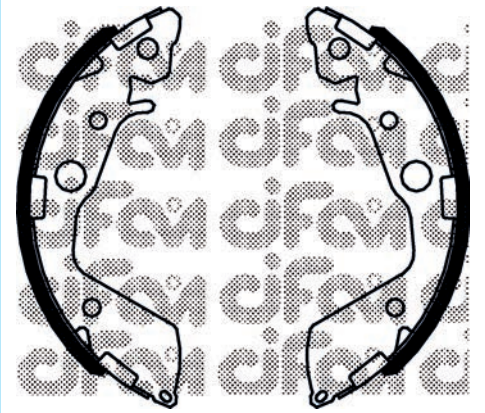

153-492 (Ø 180 x 31)

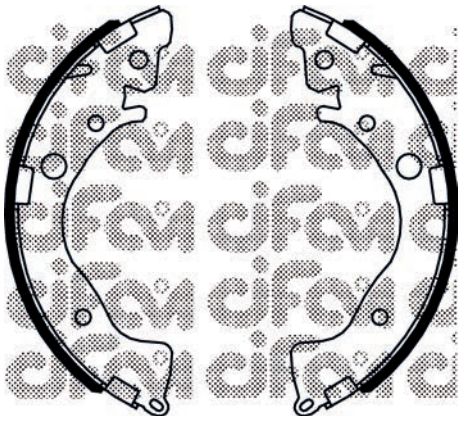

153-493 (Ø 200 x 31)

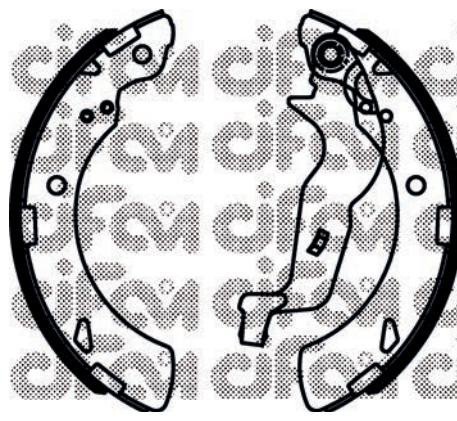

153-494 (Ø 200 x 36)

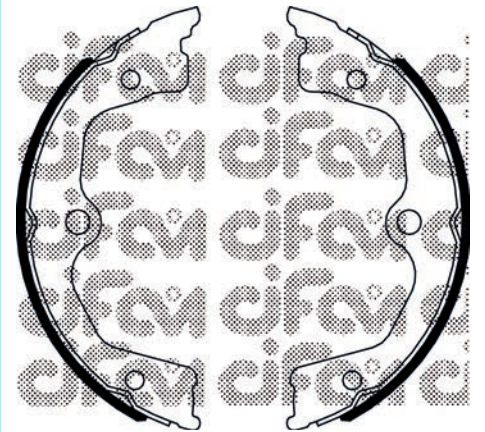

153-495 (Ø 190 x 27)

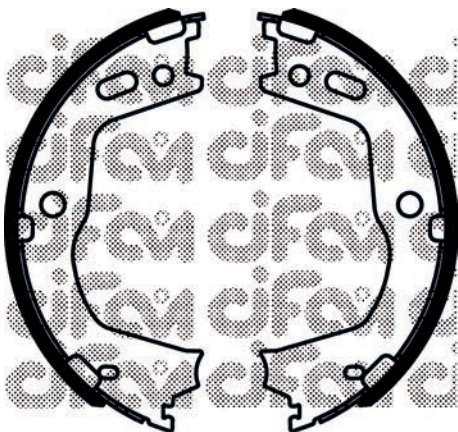



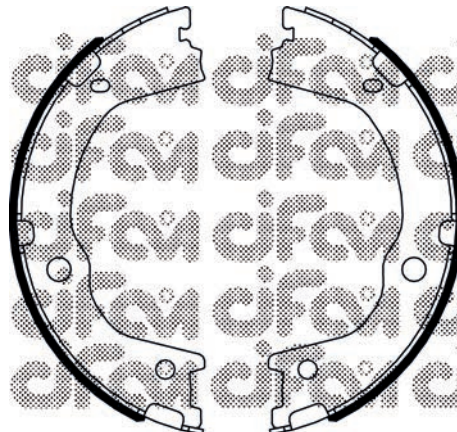

153-497 (Ø 190 x 26)

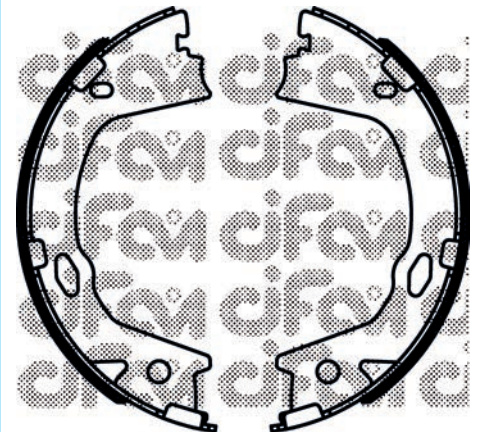

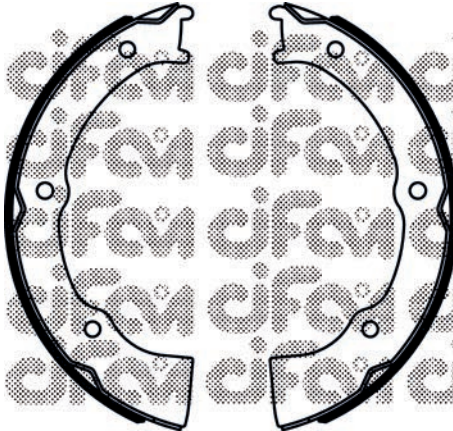

153-498 (Ø 190 x 26)

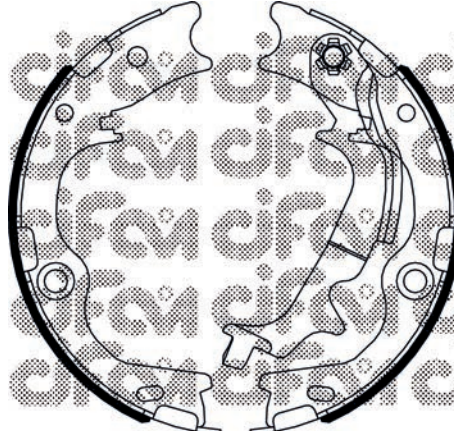
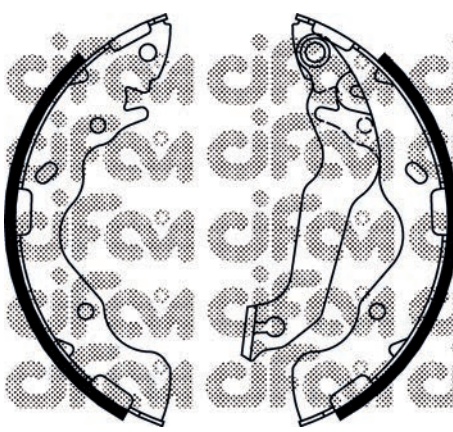
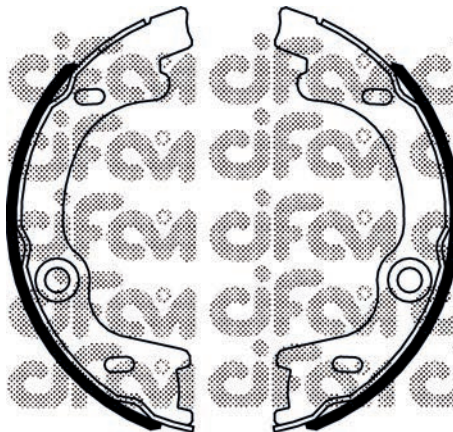
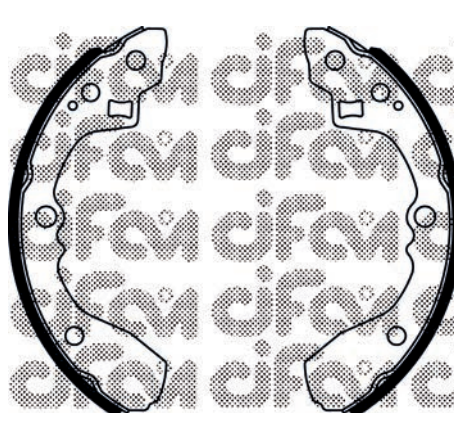
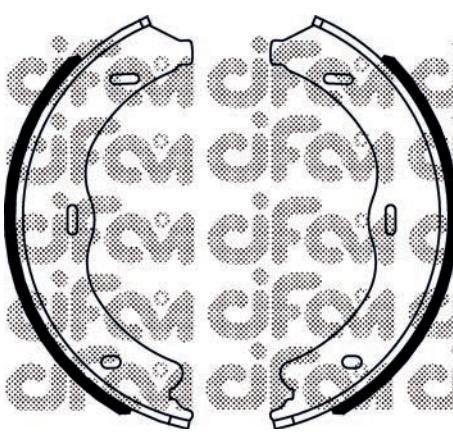
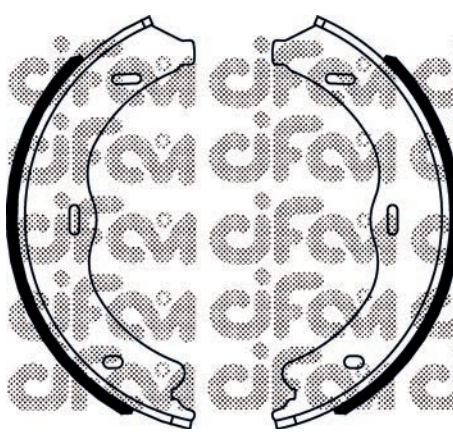
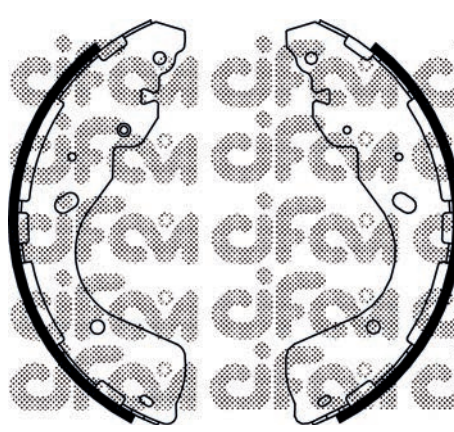
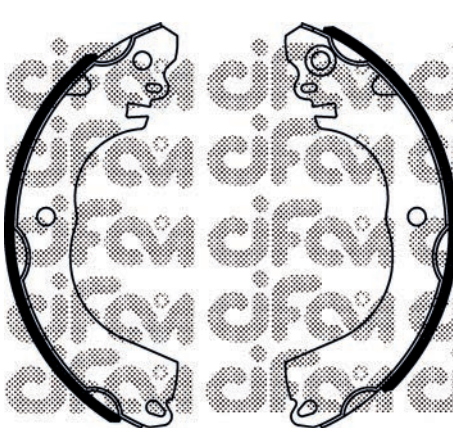
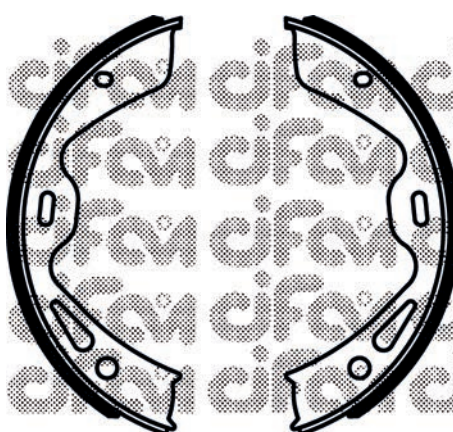

153-499 (Ø 167 x 27)

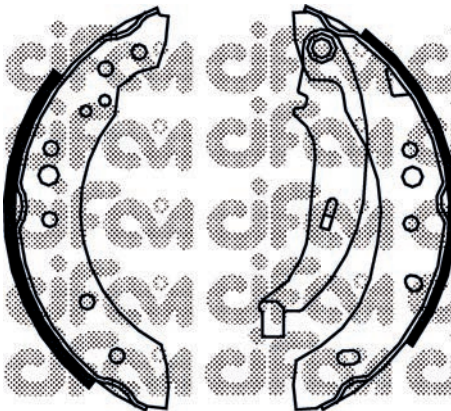
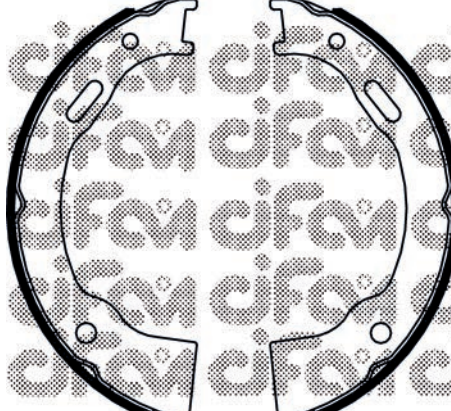
		
<p>153-500 (Ø 184 x 32)</p>	<p>153-501 (Ø 295 x 52)</p>	<p>153-502 (Ø 190 x 40)</p>
		
<p>153-504 (Ø 203,2 x 36)</p>	<p>153-505 (Ø 170 x 32)</p>	<p>153-506 (Ø 200 x 31)</p>
		
<p>153-507 (Ø 186 x 36)</p>	<p>153-507K (Ø 186 x 36)</p>	<p>153-508 (Ø 295 x 57)</p>
		
<p>153-509 (Ø 205 x 30)</p>	<p>153-511 (Ø 180 x 25)</p>	<p>153-512 (Ø 180 x 25)</p>

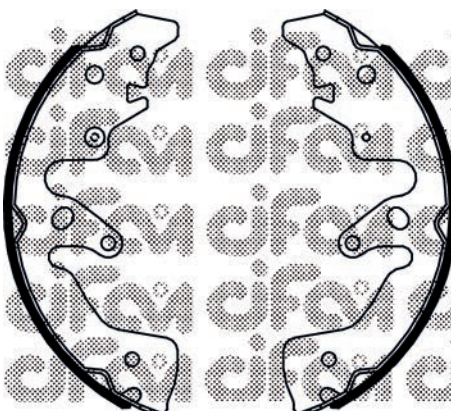
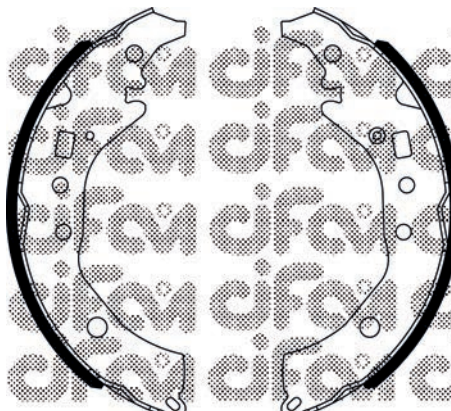
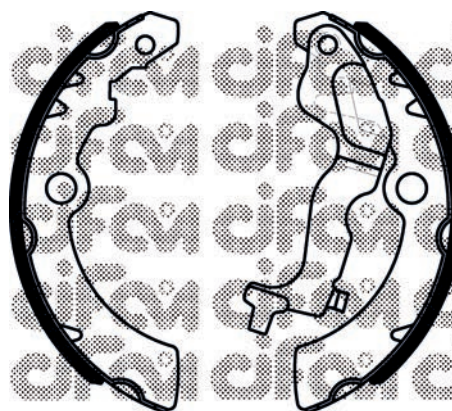
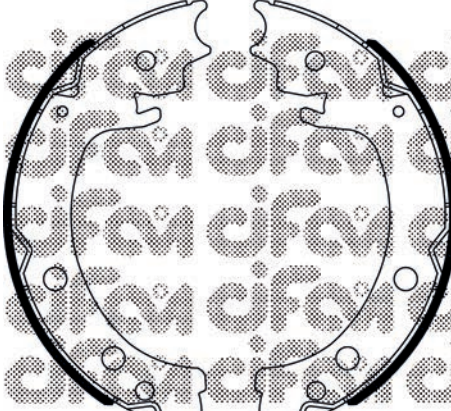
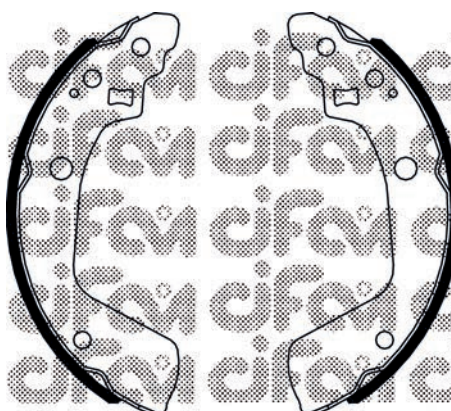
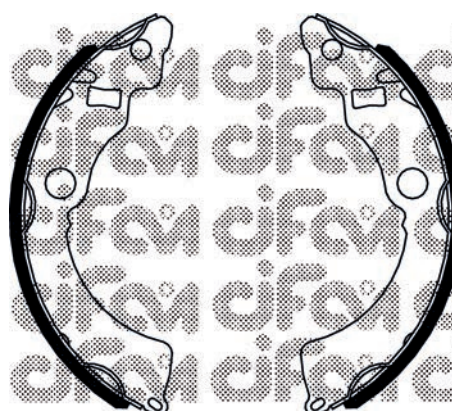
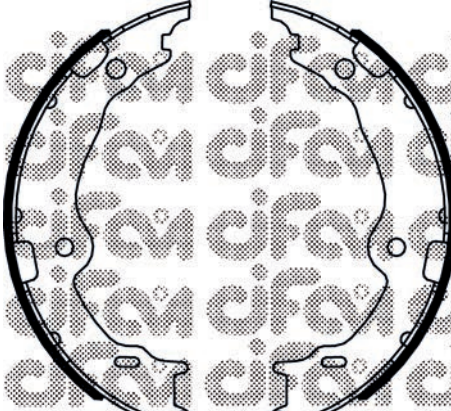
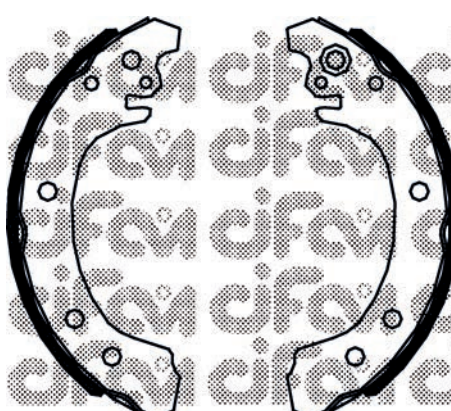
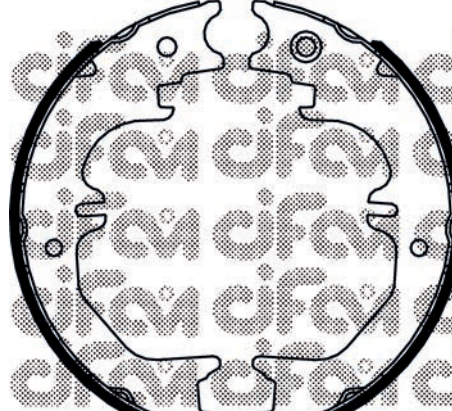
		
<p>153-513 (Ø 203,2 x 39)</p>	<p>153-514 (Ø 185 x 31)</p>	<p>153-515 (Ø 205 x 32)</p>
		
<p>153-516 (Ø 254 x 42)</p>	<p>153-517 (Ø 228,6 x 37)</p>	<p>153-518 (Ø 180 x 26)</p>
		
<p>153-519 (Ø 200 x 37)</p>	<p>153-520 (Ø 200 x 32)</p>	<p>153-521 (Ø 180 x 26)</p>
		
<p>153-522 (Ø 190 x 31)</p>	<p>153-523 (Ø 200 x 32)</p>	<p>153-524 (Ø 228,6 x 45)</p>

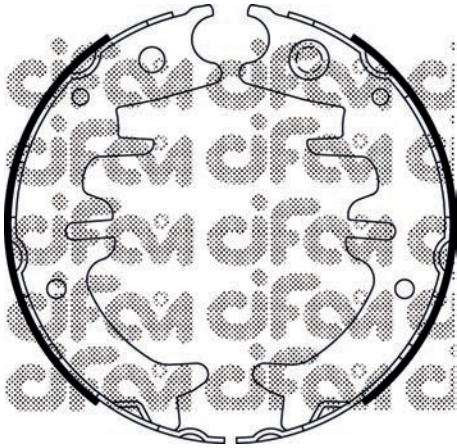

153-525 (Ø 167 x 40)

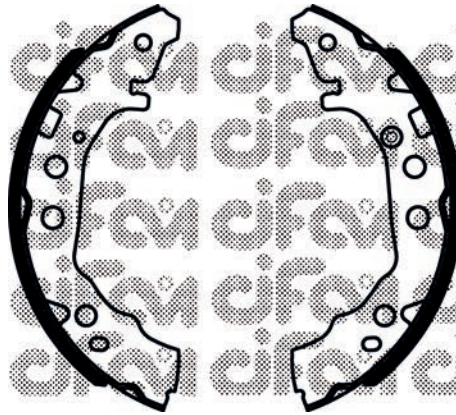

153-526 (Ø 180 x 28)

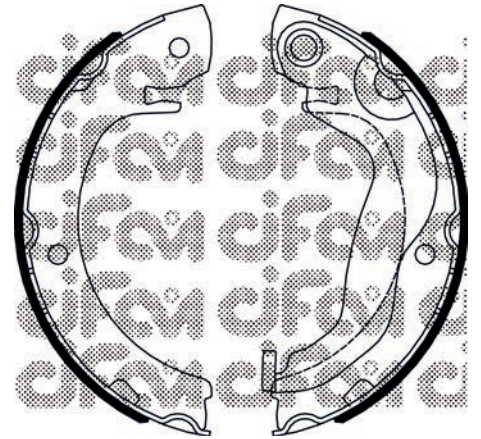

153-527 (Ø 185 x 32)

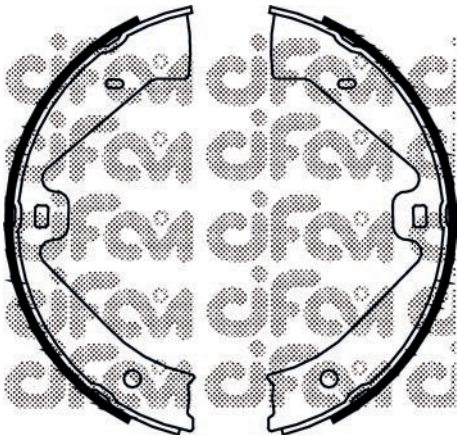

153-528 (Ø 210 x 31)

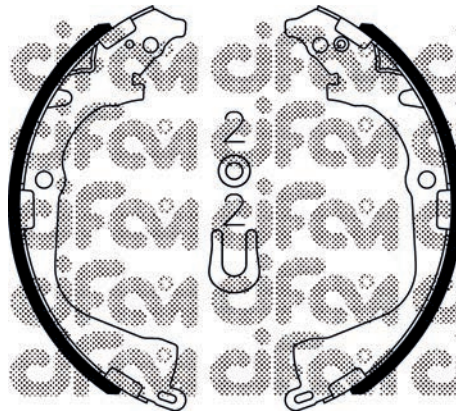

153-529 (Ø 295 x 57)

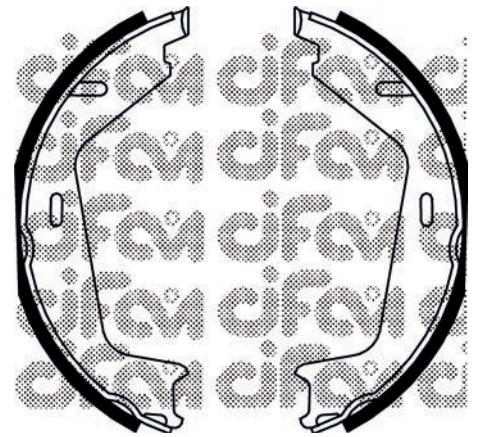

153-530 (Ø 177,8 x 25)

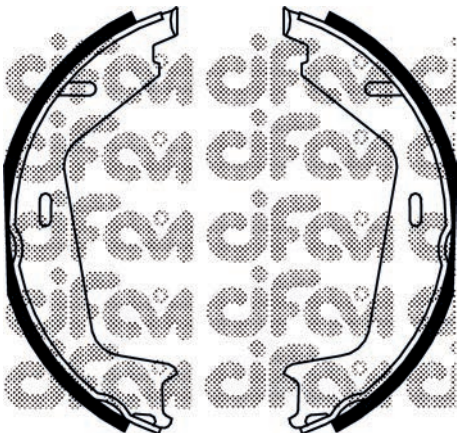

153-530K (Ø 177,8 x 25)