

**AEROTWIN** ★★★★★  
**TWIN** ★★★★★  
**REAR**



de

**Sichere Diagnose.  
 Zeitsparende Reparatur.  
 Bosch-Diagnostics und  
 Ersatzteile.**

Aus einer Hand: Diagnostics, Teile und Services. Bosch bietet der Werkstatt ein Komplettdienstleistungsprogramm zur Steigerung von Effizienz und Qualität in der täglichen Arbeit. Vom weltweit aktiven Entwickler und führenden Hersteller von Kfz-Systemtechnik kommen die Ersatzteile in bekannter Original-Qualität. Kompetenz und Qualität – für die Zukunft Ihrer Werkstatt.

en

**Reliable diagnosis.  
 Time saving repairs.  
 Bosch diagnostics and  
 service parts.**

From a single source: Diagnostics, parts and services. Bosch has a complete program available which increases efficiency and quality in the workshop's daily work. The service parts from the globally active development expert and leading manufacturer of automotive system technology are in renowned Bosch OE quality. Competence and quality: assuring your workshop's future success.

sv

**Säker diagnos. Tids-  
 sparande reparation.  
 Bosch-diagnos och  
 reservdelar.**

Komplett lösning: Diagnostics, delar och tjänster. Bosch erbjuder verkstäderna ett komplett program för att öka effektiviteten och kvaliteten i det dagliga arbetet. Från den globalt aktiva utvecklaren och ledande tillverkaren av systemteknik för fordon kommer reservdelarna i välkänd originalkvalitet. Kompetens och kvalitet – för din verkstads framtid.

fi

**Luotettava diagnoosi.  
 Aikaa säästävä korjaus.  
 Bosch-Diagnostics ja  
 varaosat.**

Kaikki samalta toimittajalta: Diagnoosit, osat ja lisätarvikkeet. Bosch tarjoaa korjaamoille kattavan tuotevalikoiman, jonka tuella tehokkuus ja laatu päivittäisissä töissä saadaan nousemaan. Maa- ja maailmanlaajuisesti aktiiviselta autotekniikan kehittäjältä ja johtavalta valmistajalta varaosat toimitetaan tunnetusti alkuperäislaatuina. Osaamista ja laatua – korjaamonne tulevaisuuden tueksi.

it

**Diagnosi sicure.  
 Riparazioni rapide.  
 Diagnostica, ricambi  
 e formazione.**

Tutto da un unico fornitore: diagnostics, componenti e service. Bosch offre all'officina un programma completo per migliorare l'efficienza e la qualità nel lavoro quotidiano. Lo sviluppatore attivo a livello mondiale e costruttore leader di sistemi automobilistici offre ricambi di comprovata qualità originale. Competenza e qualità, quindi, per il futuro dell'officina.



2014

**Scheibenwischer  
 Wiper blades  
 Torkarblad  
 Pyyhkimensulat  
 Tergicristalli**



Bosch parts fast and easy on:  
[www.bosch-automotive-catalog.com](http://www.bosch-automotive-catalog.com)



**BOSCH**

☎ 1 987 720 619/201311

AA/MK12 – 11.2013 – Int

© 2013 Robert Bosch GmbH  
 Automotive Aftermarket  
 Postfach 41 09 60  
 76225 Karlsruhe

Token fee: € 5,00

[www.bosch.de/aa](http://www.bosch.de/aa)

Editorial closing: 15.09.2013

Subject to change without notice.  
 Please direct questions and  
 comments to our Authorized  
 Representative in your country.  
 This edition supersedes all  
 previous editions.

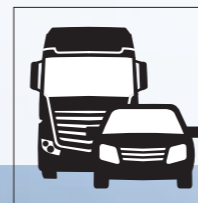

**BOSCH**



de

Produktlinien  
im Vergleich

en

Product line  
comparison

sv

Produktlinjerna  
i jämförelse

fi

Tuotesarjat  
vertailussa

it

Confronto tra le linee  
di prodotto

	<b>AEROTWIN</b> (A) Original program	<b>AEROTWIN</b> (AM) (AP) Universal program	<b>AEROTWIN</b> (AR) Upgrade program	<b>TWIN</b> <b>POILER</b>	<b>TWIN</b>
Wischqualität Wiping quality Torkkvalitet Pyyhinteho Qualità di tergiture	★★★★★	★★★★★	★★★★★	★★★★★	★★★★★
Lebensdauer Service life Livslängd Käyttöikä Durata	★★★★★	★★★★★	★★★★★	★★★★★	★★★★★
Laufruhe Smooth running Jämn gång Tasainen käynti Silenziosità	★★★★★	★★★★★	★★★★★	★★★★★	★★★★★
Hochgeschwindigkeitsverhalten High-speed performance Egenskaper vid hög hastighet Ominaisuudet suurilla nopeuksilla Performance alle velocità elevate	★★★★★	★★★★★	★★★★★	★★★★★	★★★★★
Montagezeit Fitting time Monteringstid Asennusaika Tempo di montaggio	★★★★★	★★★★★	★★★★★	★★★★★	★★★★★
Gesamtbewertung Overall assessment Total utvärdering Kokonaispisteet Valutazione complessiva	★★★★★	★★★★★	★★★★★	★★★★★	★★★★★

Wie in vielen Bereichen der Automobiltechnik ist Bosch auch bei der Scheibenreinigung Vorreiter des Fortschritts: Zum Beispiel mit dem ersten elektrischen Scheibenwischer, dem Spoilerwischer, der Scheibenwaschanlage oder dem Einsatz von synthetischem Wischgummi. Bosch leistet mit den Fahrzeugherstellern technologische Entwicklungsarbeit und zeigt mit dem Aerotwin klare Perspektiven für die Zukunft.

Windshield and rear window cleaning is one of the many automotive engineering sectors in which Bosch plays a pioneering role: Examples include the first electric windshield wiper, spoiler-type wipers, windshield and rear window washer systems and the use of a synthetic wiper blade element. Bosch joins forces with vehicle manufacturers to develop advanced technology for innovative products such as the Aerotwin.

Som inom många områden inom fordonstekniken leder Bosch utvecklingen även vad gäller rengöring av fordonsrutor: till exempel med den första elektriska vindrutetorkaren, torkarblad med spoiler, vindrutespolare och användningen av syntetiskt torkgummi. Bosch realiserar tillsammans med fordons-tillverkarna teknologiskt utvecklingsarbete och visar med Aerotwin klara perspektiv för framtiden.

Kuten monilla muilla autotekniikan alueilla Bosch on edelläkävijä myös lasinpyyhkimien ja pesulaitteiden kehittäjänä. Esimerkkejä ovat ensimmäinen sähkötoiminen lasinpyyhin, spoilersulka, lasinpesulaite sekä syntetisen kumin soveltaminen sulkakumissa. Bosch panostaa yhdessä autotehtaiden kanssa teknologiseen kehittäelyöhön ja varmistaa Aerotwin-sarjalla selkeät näkömät tulevaisuudessakin.

Come in molti ambiti della tecnica automobilistica, Bosch riveste il ruolo di precursore anche per quanto riguarda la tergiture dei cristalli: esempi sono il primo tergicristallo elettrico, il tergicristallo con spoiler, l'impianto lavavetri o l'impiego di gomma tergente sintetica. In collaborazione con i costruttori automobilistici, Bosch svolge un importante lavoro di sviluppo tecnologico e con i tergicristalli Aerotwin fa intravedere le prospettive per il futuro.

de

„Online“-Katalog  
für Kraftfahrzeug-  
Ausrüstung

en

“Online” Catalog  
for Automotive Parts

sv

”Online”-katalog  
för fordonsutrustning

fi

Online-kuvasto  
autotuotevarusteiden  
valikoimista

it

Catalogo “online”  
per ricambi di  
automobili

**75 Countries  
28 Languages**

[www.bosch-automotive-catalog.com](http://www.bosch-automotive-catalog.com)

Einfacher und schneller  
Zugriff auf Kfz-Ausrüs-  
tungsdaten von Bosch.

Easy and quick access to  
vehicle application data  
from Bosch.

Enklare och snabbare  
tillgång till utrustnings-  
data för fordon genom  
Bosch.

Helppo ja nopea pääsy  
Boschin autotuotevarus-  
teiden tietoihin.

Ricerca semplice e  
veloce dei dati Bosch di  
equipaggiamento veicoli.

de

Inhalt

en

Contents

sv

Innehåll

fi

Sisältö

it

Contenuto

Angebot	Offer	Erbjudande	Tarjous	Offerta	
<b>Bosch Aerotwin für Pkw</b>	<b>Bosch Aerotwin for passenger cars</b>	<b>Bosch Aerotwin för personbilar</b>	<b>Bosch Aerotwin henkilöautoihin</b>	<b>Bosch Aerotwin per autovettura</b>	<b>A 2</b>
Aerotwin Sets – Original-Programm	Aerotwin Sets – Original program	Aerotwin Sets – Original Program	Aerotwin Sets – Alkuperäinen ohjelma	Set Aerotwin – programma originale	<b>A 4</b>
Aerotwin Singles – Universal-Programm	Aerotwin Singles – Universal program	Aerotwin Singles – Universalprogram	Aerotwin Singles – yleisvalikoima	Aerotwin confezione singola – Multi-Clip	<b>A 7</b>
Aerotwin Plus Singles für PKW	Aerotwin Plus Singles for passenger cars	Aerotwin Plus Singles för personbilar	Aerotwin Plus Singles henkilöautoihin	Aerotwin Plus confezione singola per autovettura	<b>A 8</b>
Aerotwin Plus Singles – Programm	Aerotwin Plus Singles – Program	Aerotwin Plus Singles – Program	Aerotwin Plus Singles – Ohjelma	Aerotwin Plus confezione singola – programma	<b>A 9</b>
Aerotwin Sets – Upgrade-Programm	Aerotwin Sets – Upgrade program	Aerotwin Sets – Uppgraderingsprogram	Aerotwin Sets – Päivitetty valikoima	Set Aerotwin – programma Retrofit	<b>A 10</b>
Aerotwin Singles – Upgrade-Programm	Aerotwin Singles – Upgrade program	Aerotwin Singles – Uppgraderingsprogram	Aerotwin Singles – Päivitetty valikoima	Aerotwin confezione singola – programma Retrofit	<b>A 11</b>
<b>Bosch Twin für Pkw</b>	<b>Bosch Twin for passenger cars</b>	<b>Bosch Twin för personbilar</b>	<b>Bosch Twin henkilöautoihin</b>	<b>Bosch Twin per autovettura</b>	<b>A 12</b>
nach Suchnummer geordnet	by search number	sorterat efter söknummer	järjestys hakunumeron mukaan	in ordine dei numeri di ricerca	<b>A 14</b>
im Großpack	Bumper pack	i storförpackning	Suurpakkauksessa	in confezione Maxi	<b>A 17</b>
Adapterübersicht	Adapter overview	Adapteröversikt	Sovitinvalikoima	Codici di ordinazione adattatori	<b>A 19</b>
<b>Bosch Rear Heckscheibenwischer-Programm</b>	<b>Bosch Rear Rear window wipers program</b>	<b>Bosch Rear Bakrutetorkare Program</b>	<b>Bosch Rear Takalasin pyyhkimet – Ohjelma</b>	<b>Bosch Rear Gamma tergilonotto – Programma</b>	<b>A 20</b> <b>A 22</b>
<b>Aerotwin Flachblatt-Wischer für Nkw</b>	<b>Aerotwin flat wiper blades for commercial vehicles</b>	<b>Aerotwin torkarblad med låg profil för kommersiell</b>	<b>Aerotwin matalprofiilisulka, hyötyajoneuvojen</b>	<b>Tergicristalli Aerotwin a spazzola piatta per veicoli commerciali</b>	<b>A 24</b>
Programm	Program	Program	Ohjelma	Programma	<b>A 25</b>
<b>Twin Metallbügel-Wischer für Nkw</b>	<b>Twin standard wiper blades for commercial vehicles</b>	<b>Torkarblad för nyttofordon Twin torkare med metallbygel</b>	<b>Hyötyajoneuvojen pyyhkimet Twin sulkiin metallikaarella</b>	<b>Tergicristalli Twin con staffa metallica per veicoli commerciali</b>	<b>A 26</b>
Programm	Program	Program	Ohjelma	Programma	<b>A 27</b>
Adapterübersicht	Adapter overview	Adapteröversikt	Sovitinvalikoima	Codici di ordinazione adattatori	<b>A 28</b>
Wischgummi/ Refill Programm	Wiper blade element/ refill program	Torkargummi/ Päfteyllning program	Pyyhkimen kumi/ Refill-Ohjelma	Profili tergenti/ Programma refill	<b>A 29</b>
Aerotwin-Verpackung	Aerotwin packaging	Aerotwin förpackning	Aerotwin-pakkaus	Aerotwin confezione	<b>A 30</b>

Verwendung	Applications	Användning	Käyttö	Impiegi	
Hinweise zur Benutzung	Instructions for use	Anvisningar för användning	Käyttöön liittyviä vihjeitä	Istruzioni d'uso	<b>B 1.1</b>
Wischblätter für Pkw, Transporter	Wiper blades for passenger cars, transporters	Torkarblad för personbilar, transporter	Pyyhinsulat henkilöautoihin, pakettiautoihin	Spazzole per autovetture, furgoni	<b>B 2</b>
Wischblätter für Lkw, Busse	Wiper blades for trucks, buses	Torkarblad för lastbilar, bussar	Pyyhinsulat hyötyajoneuvoihin, busseihin	Spazzole per autocarri, autobus	<b>B 81</b>

de

**Aerotwin Flachblatt-Wischer für Pkw mit Vorschau auf das neue globale Verpackungsdesign**

en

**Aerotwin flat wiper blades for passenger cars with preview on new global packaging design**

sv

**Aerotwin torkarblad med låg profil för personbilar med förhandsvisning av förpackningens nya globala design**

fi

**Aerotwin matalaprofiilisulka, ha katsaus uuteen globaaliin pakkausmuotoiluun**

it

**Tergicristalli Aerotwin a spazzola piatta per autovetture con anteprima del nuovo layout delle confezioni**



# AEROTWIN



- ① Perfekte Reinigung durch Leichtlaufbeschichtung
- ② Leises Wischen durch flexiblen Gummirücken
- ③ Lange Lebensdauer durch verschleißfeste Mikro-doppelkante

- ① Perfect cleaning due to smooth running coating
- ② Quiet wiping due to flexible rubber back
- ③ Long service life due to wear resistant double microedge

- ① Perfekt rengöring tack vare lågfriktionsbeläggning
- ② Tyst torkning genom flexibel gummiskena
- ③ Lång livslängd tack vare slitstark mikrodubbelkant

- ① Puhdistaa tehokkaasti kevyesti liukuvan pinnoitteen ansiosta
- ② Hiljainen käynti joustavan kumisen selkäpuolen ansiosta
- ③ Pitkän käyttöiän takaa kulumisen kestävä mikro-kaksoisreuna

- ① Pulizia perfetta grazie al rivestimento ultrascorrevole
- ② Tergitura silenziosa grazie al dorso flessibile in gomma
- ③ Lunga durata grazie al Microspigolo doppio resistente all'usura

#### Höchste Wischqualität

- ▶ An jedem Punkt der Scheibe durch maßgeschneiderte Federschiene
- ▶ Sicherer Durchblick auch bei hohen Geschwindigkeiten durch aerodynamischen Spoiler

#### Top quality wiper action

- ▶ Right across the windshield or rear window thanks to a custom-made spring strip
- ▶ Aerodynamic spoiler for clear vision even at high speeds

#### Högsta torkkvalitet

- ▶ På varje punkt på rutan genom skräddarsydd fjäderskena
- ▶ Säker sikt även vid höga hastigheter tack vare aerodynamisk spoiler

#### Huippulaadukkaat pyyhkimet

- ▶ Pyyhkii tehokkaasti koko lasipinnan kiitos tarkkaan mitoitettun joustavan kiskon
- ▶ Aerodynaaminen spoileri huolehtii hyvästä näkyvyydestä korkeilla nopeuksilla

#### Massima qualità di tergiture

- ▶ In ogni punto del cristallo, grazie all'impiego di una guida elastica progettata su misura
- ▶ Visibilità sicura anche alle alte velocità, grazie allo spoiler aerodinamico

#### Mehr Komfort

- ▶ Minimale Windgeräusche durch weniger Strömungsangriffsfläche
- ▶ Verbesserte Wintertauglichkeit, da Eis nicht mehr an Metallrahmen und Gelenken anfrieren kann

#### Improved features and greater convenience

- ▶ A reduced surface area minimizes wind noise
- ▶ Better equipped for winter conditions, as ice can no longer form on the metal frame and joints

#### Mer komfort

- ▶ Minimala vindljud tack vare mindre angreppsytta för luftströmmar
- ▶ Förbättrade vinteregenskaper, då ingen is längre kan frysa fast på metallramar och leder

#### Lisää mukavuutta

- ▶ Kavennettu pinta minimoi viiman aiheuttaman melun
- ▶ Tehokkaampi talvikelillä, koska jää ei enää pääse tarttumaan metallikehykseen ja niveliin

#### Più comfort

- ▶ Silenziosità, grazie ad un profilo altamente aerodinamico
- ▶ Migliorata efficacia anche nella stagione invernale, in quanto è esclusa la formazione di ghiaccio in corrispondenza di parti metalliche e snodi



#### Bosch-Qualität

- ▶ Längere Lebensdauer durch gleichmäßig starke Anpresskraft, die Verschleißspitzen vermeidet
- ▶ Höhere Resistenz gegen Insekten und hartnäckigen Schmutz durch konstante Kraftverteilung
- ▶ Bewährtes Twin-Zweistoff-Wischgummi

#### (A) Aerotwin Original-Programm

- ▶ Flachblatt-Wischer mit fahrzeugspezifischem Original-Adapter

#### (AM) Aerotwin Universal-Programm

- ▶ Flachblatt-Wischer mit Multi-Clip-Adapter - passend für die wichtigsten Wischarm-Schnittstellen
- ▶ Einfacher Wischerwechsel durch vormontierten Multi-Clip-Adapter

#### (AP) Aerotwin Plus Universal-Programm

- ▶ Innovatives Adaptersystem - pro Wischblatt passen 10 unterschiedliche Wischarm (6 mehr als beim Multi-Clip-Adapter)

#### (AR) Aerotwin Upgrade-Programm

- ▶ Flachblatt-Wischer zum Nachrüsten für Pkw mit konventionellem Metallbügel-System und für Hybrid-Wischer

#### Bosch quality

- ▶ Longer service life on account of uniform contact pressure, thus avoiding worn areas
- ▶ Fewer problems with insects and stubborn dirt thanks to constant force distribution
- ▶ Renowned Twin compound wiper blade element

#### (A) Aerotwin original program

- ▶ Flat wiper blade with vehicle-specific original adapter

#### (AM) Aerotwin universal program

- ▶ Flat wiper blade with Multi-Clip adapter - suitable for the most important wiper arm connections
- ▶ Simple replacement of wiper blades thanks to pre-mounted Multi-Clip adapter

#### (AP) Aerotwin Plus universal-program

- ▶ Innovative adapter system - each wiper blade fits 10 different wiper arms (6 more than is the case with the existing Multi-Clip)

#### (AR) Aerotwin upgrade program

- ▶ Flat wiper blade for retrofitting in passenger cars with conventional standard wiper system and for hybrid wipers

#### Bosch-kvalitet

- ▶ Längre livslängd genom jämn anliggningskraft, som förhindrar slitagetoppar
- ▶ Högre motståndskraft mot insekter och fastsittande smuts genom konstant kraftfördelning
- ▶ Beprövat Twin tvåkomponents torkargummi

#### (A) Aerotwin originalprogram

- ▶ Metallbygeltorkare med fordonsspecifik original-adapter

#### (AM) Aerotwin universalprogram

- ▶ Metallbygeltorkare med multi-clip-adapter - anpassad för de viktigaste torkarmgränssnitt
- ▶ Enkel torkarbyte genom förmonterad multi-clip-adapter

#### (AP) Aerotwin Plus universalprogram

- ▶ Nyttänkande adapter system - per torkarblad kan 10 olika torkararmar kombineras (6 fler än vid traditionella multi-clip)

#### (AR) Aerotwin uppgraderingsprogram

- ▶ Metallbygeltorkare för eftermontering för personbilar med konventionellt metallbygelsystem och för hybrid-torkare

#### Bosch-laatu

- ▶ Pitempi käyttöikä kiitos tasaisen puristusvoiman, ei pisteittäistä kulumista
- ▶ Koska pyyhinvoima jakautuu tasaisesti, hyönteiset ja muu itsepäinen lika poistuu tehokkaasti
- ▶ Hyväksi havaittu Twin-yhdistelmäkumi

#### (A) Aerotwin-alkuperäisvalikoima

- ▶ Matalaprofiilisulat mallikohtaisella alkuperäissovittimella

#### (AM) Aerotwin yleisvalikoima

- ▶ Matalaprofiilisulat mallikohtaisella multi-clip-sovittimella - sopii tärkeimpiin pyyhinvarsin liittimiin
- ▶ Pyyhin on helppo vaihtaa esiasennetun multi-clip-sovittimen ansiosta

#### (AP) Aerotwin Plus yleisvalikoima

- ▶ Innovatiivinen sovitinjärjestelmä - pyyhinsulkaan sopii 10 eri pyyhinvarrtta (6 enemmän kuin tähänastisessa multi-clip - kiinnityksessä)

#### (AR) Aerotwin Upgrade-Programm

- ▶ Matalaprofiilisulat jälkiasennukseen henkilöautoihin, joissa perinteiset sulat metallikaarella sekä hybridimallien sulat

#### Qualità Bosch

- ▶ Grazie alla pressione uniforme distribuita, il cristallo beneficia di una tergitura omogenea per tutta la durata
- ▶ Maggiore resistenza contro gli agenti atmosferici, gli insetti e i residui di sporco, grazie ad una distribuzione uniforme della forza
- ▶ Collaudata tecnologia Twin: profilo tergente a doppia mescola

#### (A) Aerotwin

- ▶ le migliori spazzole tergicristallo, specifiche per ogni veicolo

#### (AM) Aerotwin Multiclip

- ▶ Spazzole Aerotwin dotate di adattatore Multi-Clip premontato compatibile con 4 diversi attacchi OE per bracci tergicristallo
- ▶ Individuare la spazzola giusta diventa semplice e veloce

#### (AP) Aerotwin Plus Multiclip

- ▶ Sistema innovativo di adattatori - ogni spazzola è compatibile con 10 diversi bracci tergicristallo (6 più delle attuali Multi-clip)

#### (AR) Aerotwin Retrofit

- ▶ Spazzole Aerotwin compatibili con bracci tergicristallo di autovetture dotate originariamente di spazzole tradizionali





de	en	sv	fi	it
Aerotwin Sets – Original-Programm	Aerotwin Sets – original program	Aerotwin Sets – Original Program	Aerotwin Sets – Alkuperäinen ohjelma	Set Aerotwin – programma originale



AEROTWIN



A 034 S	3 397 009 034	650/650	LLE	②
A 051 S	3 397 009 051	530/530	LLE	③ (19 mm)
A 053 S	3 397 009 053	600/600	LLE	②
A 072 S	3 397 007 072	600/475	LLE	② Special
A 079 S	3 397 007 079	650/650	LLE/RLE	②
A 084 S	3 397 007 084	575/450	LLE	②
A 088 S	3 397 007 088	650/500	LLE	③ (19 mm)
A 093 S	3 397 007 093	700/530	LLE	⑥
A 094 S	3 397 007 094	625/425	LLE	②
A 096 S	3 397 007 096	600/450	LLE	②
A 099 S	3 397 007 099	650/650	LLE/RLE	⑥
A 100 S	3 397 007 100	700/650	LLE/RLE	⑥
A 115 S	3 397 007 115	600/450	LLE	⑦
A 116 S	3 397 007 116	600/400	LLE	⑦
A 117 S	3 397 007 117	650/550	LLE/RLE	⑦
A 119 S	3 397 007 502	750/650	LLE	⑦
A 120 S	3 397 007 120	750/650	LLE/RLE	③ (19 mm)
A 187 S	3 397 007 187	600/450	LLE	③ (19 mm)
A 215 S	3 397 007 215	650/600	LLE	⑥
A 225 S	3 397 007 225	650/530	LLE	③ (19 mm)
A 256 S	3 397 007 256	700/550	LLE	⑥
A 290 S	3 397 007 290	550/530	LLE	⑥
A 292 S	3 397 007 292	600/380	LLE	③ (19 mm), ⑥
A 294 S	3 397 007 294	600/550	LLE/RLE	⑥
A 295 S	3 397 007 295	600/400	LLE	③ (19 mm)
A 296 S	3 397 007 296	600/500	LLE/RLE	③ (19 mm)
A 297 S	3 397 007 297	600/500	LLE	③ (16 mm)
A 299 S	3 397 007 299	600/350	LLE	③ (19 mm)
A 307 S	3 397 007 307	530/475	LLE	③ (19 mm)
A 309 S	3 397 007 309	650/475	LLE	③ (19 mm)
A 311 S	3 397 007 311	700/650	LLE/RLE	⑥
A 313 S	3 397 007 313	800/750	LLE	②
A 385 S	3 397 007 385	750/650	LLE/RLE	③ (19 mm)
A 392 S	3 397 007 392	700/575	LLE	① Special
A 408 S	3 397 007 408	550/475	LLE	⑥
A 410 S	3 397 007 410	600/550	LLE	⑥
A 414 S	3 397 007 414	650/400	LLE	③ (19 mm)
A 416 S	3 397 007 416	600/575	LLE	⑥
A 420 S	3 397 007 420	575/380	LLE	③ (19 mm)
A 422 S	3 397 007 422	650/400	LLE	⑦
A 424 S	3 397 007 424	600/550	LLE	⑦
A 426 S	3 397 007 426	650/475	LLE	⑦
A 428 S	3 397 007 428	800/750	LLE/RLE	⑦
A 430 S	3 397 007 430	600/530	LLE	③ (19 mm)
A 432 S	3 397 007 432	650/380	LLE	③ (19 mm)
A 452 S	3 397 007 452 <sup>1)</sup>	600/450	LLE	② Special
A 501 S	3 397 007 501	800/680	LLE	③ (19 mm)
A 523 S	3 397 007 523	650/450	LLE	②
A 538 S	3 397 007 538	650/400	LLE	③ (19 mm) Special
A 540 S	3 397 007 540	680/625	LLE	③ (19 mm)
A 555 S	3 397 007 555	600/400	LLE	③ (16 mm)
A 557 S	3 397 007 557	700/400	LLE	③ (16 mm)
A 579 S	3 397 007 579	600/400	LLE	⑥
A 580 S	3 397 007 580 <sup>4)</sup>	575/450	LLE	③ (19 mm)
A 581 S	3 397 007 581	680/575	LLE	③ (19 mm)

 №	AEROTWIN 	 ← mm →		
A 582 S	3 397 007 582	600/530	LLE	② Special
A 583 S	3 397 007 583	650/340	LLE	③ (19 mm)
A 586 S	3 397 007 586	680/515	LLE	③ (16 mm)
A 620 S	3 397 007 620	600/475	LLE	③ (16 mm)
A 636 S	3 397 007 636	650/650	LLE/RLE	③ (19 mm)
A 637 S	3 397 007 637	475/500	LLE	⑥
A 638 S	3 397 007 638	650/530	LLE	③ (16 mm)
A 640 S	3 397 007 640	725/725	LLE/RLE	③ (19 mm)
A 641 S	3 397 007 644	725/625	LLE	⑥
A 653 S	3 397 007 653	650/425	LLE	②
A 692 S	3 397 007 692	500/450	LLE	⑦
A 696 S	3 397 007 696	550/450	LLE	⑥
A 697 S <b>NEW</b>	3 397 007 697 <sup>2)</sup>	550/450	LLE	③ (16 mm)
A 798 S	3 397 009 798	530/530	LLE	③ (16 mm)
A 821 S <b>NEW</b>	3 397 009 821 <sup>2)</sup>	600/600	LLE	③ (16 mm)
A 825 S <b>NEW</b>	3 397 009 825 <sup>2)</sup>	600/600	LLE	③ (19 mm)
A 854 S <b>NEW</b>	3 397 007 854 <sup>2)</sup>	650/575	LLE	③ (19 mm) Special
A 856 S	3 397 007 856 <sup>3)</sup>	450/475	LLE	⑦
A 862 S <b>NEW</b>	3 397 007 862 <sup>2)</sup>	600/530	LLE	③ (16 mm)
A 863 S <b>NEW</b>	3 397 007 863 <sup>2)</sup>	650/450	LLE	③ (16 mm)
A 865 S <b>NEW</b>	3 397 007 865 <sup>2)</sup>	800/700	LLE	③ (19 mm)
A 868 S <b>NEW</b>	3 397 007 868 <sup>2)</sup>	650/340	LLE	⑦
A 916 S	3 397 118 916 <sup>1)</sup>	475/475	LLE	②
A 922 S	3 397 118 922	500/500	LLE	⑥
A 923 S	3 397 118 923	530/530	LLE	②
A 925 S	3 397 118 925 <sup>1)</sup>	530/530	LLE	②
A 927 S	3 397 118 927 <sup>1)</sup>	530/475	LLE	②
A 929 S	3 397 118 929	600/475	LLE	⑥
A 931 S	3 397 118 931	550/450	LLE	②
A 933 S	3 397 118 933	550/550	LLE	④
A 934 S	3 397 118 934	555/555	LLE	⑧
A 936 S	3 397 118 936	600/475	LLE	②
A 938 S	3 397 118 938	600/600	LLE	② Special
A 942 S	3 397 118 942	650/650	LLE	② Special
A 944 S	3 397 007 944 <sup>3)</sup>	800/750	LLE	③ (19 mm)
A 945 S	3 397 007 945 <sup>3)</sup>	650/400	LLE	③ (16 mm)
A 946 S	3 397 118 946	680/680	LLE	② Special
A 948 S	3 397 118 948	650/650	LLE	② Special
A 950 S	3 397 118 950	700/700	LLE/RLE	②
A 951 S	3 397 118 951 <sup>1)</sup>	650/475	LLE	②
A 953 S	3 397 118 953	650/500	LLE	②
A 955 S	3 397 118 955	600/575	LLE/RLE	②
A 957 S	3 397 118 957	650/550	LLE/RLE	⑥
A 958 S	3 397 118 958	650/650	LLE/RLE	⑧
A 960 S	3 397 018 960	750	LLE	②
A 962 S	3 397 118 962	700/625	LLE	②
A 963 S	3 397 118 963	746/646	LLE/RLE	② Special



1) Asymmetrische Länge  
auf Beifahrerseite

1) Asymmetrical length  
on passenger's side

1) Asymmetrisk längd  
på passagerarsidan

1) Epäsymmetrinen pituus  
etumatkustajan puolella

1) Lunghezza asimmetrica  
sul lato passeggero

2) Neu

2) New

2) Ny

2) Uutuus

2) Nuovo

3) In Vorbereitung

3) In preparation

3) Under förberedelse

3) Valmistumassa

3) In fase di preparazione

4) Abgekündigt

4) to be discontinued



4) föråldrad

4) vanhentunut

4) Fuori produzione

A6

<b>de</b>	<b>en</b>	<b>sv</b>	<b>fi</b>	<b>it</b>
<b>Aerotwin Sets – Original-Programm</b> (Fortsetzung)	<b>Aerotwin Sets – original program</b> (continued)	<b>Aerotwin Sets – Original Program</b> (sorterat efter söknummer)	<b>Aerotwin Sets – Alkuperäinen ohjelma</b> (jatkoa)	<b>Set Aerotwin – programma originale</b> (seguito)

	 №	<b>AEROTWIN</b> 	 ← mm →		
---	---	--	---	---	--

<b>A 964 S</b>	<b>3 397 118 964</b>	750/680	LLE/RLE	② Special
<b>A 965 S</b>	<b>3 397 118 965</b>	700/600	LLE/RLE	⑥
<b>A 966 S</b>	<b>3 397 118 966</b>	600/530	LLE	③ (19 mm), ⑥
<b>A 967 S</b>	<b>3 397 118 967</b>	650/575	LLE/RLE	⑥
<b>A 969 S</b>	<b>3 397 118 969</b>	550/550	LLE	⑥
<b>A 970 S</b>	<b>3 397 118 970</b>	600/500	LLE	②
<b>A 972 S</b>	<b>3 397 118 972</b>	550/400	LLE	②
<b>A 974 S</b>	<b>3 397 118 974</b>	530/475	LLE	③ (19 mm)
<b>A 976 S</b>	<b>3 397 118 976</b>	700/700	LLE	②
<b>A 977 S</b>	<b>3 397 118 977</b>	650/425	LLE	②
<b>A 979 S</b>	<b>3 397 118 979</b>	600/475	LLE	③ (19 mm)
<b>AM 460 S</b>	<b>3 397 007 460<sup>1)</sup></b>	530/450	LLE	②, ③ (19 mm), ⑥
<b>AM 462 S</b>	<b>3 397 007 462</b>	600/475	LLE	②, ③ (19 mm), ⑥
<b>AM 466 S</b>	<b>3 397 007 466</b>	650/380	LLE	③ (19 mm), ⑥
<b>AM 467 S</b>	<b>3 397 007 467</b>	650/475	LLE	②, ③ (19 mm), ⑥



<sup>1)</sup> Asymmetrische Länge auf Beifahrerseite	<sup>1)</sup> Asymmetrical length on passenger's side	<sup>1)</sup> Asymmetrisk längd på passagerarsidan	<sup>1)</sup> Epäsymmetrinen pituus etumatkustajan puolella	<sup>1)</sup> Lunghezza asimmetrica sul lato passeggero
--	---	--	---	---



de

**Aerotwin Singles –  
Universal-Programm  
mit Multi-Clip-Adapter**

en

**Aerotwin Singles –  
Universal program  
with Multi-Clip adapter**

sv





**Aerotwin Singles –  
Universalprogram  
med Multi-Clip adapter**

fi

**Aerotwin Singles –  
yleisvalikoima vain  
Multi-Clip sovitin**

it

**Aerotwin confezione  
singola – Multi-Clip**

 №	<b>AEROTWIN</b> 	 ← mm →		
<b>AM 13 U</b>	<b>3 397 008 794</b>	340	LLE/RLE	③, ⑥,
<b>AM 15 U</b>	<b>3 397 008 562</b>	380	LLE/RLE	③, ⑥,
<b>AM 16 U</b>	<b>3 397 008 563</b>	400	LLE/RLE	②, ③, ⑥,
<b>AM 18 U</b>	<b>3 397 008 565</b>	450	LLE/RLE	②, ③, ⑥,
<b>AM 19 U</b>	<b>3 397 008 566</b>	475	LLE/RLE	②, ③, ⑥,
<b>AM 20 U</b>	<b>3 397 008 567</b>	500	LLE/RLE	②, ③, ⑥,
<b>AM 21 U</b>	<b>3 397 008 568</b>	530	LLE/RLE	②, ③, ⑥,
<b>AM 22 U</b>	<b>3 397 008 569</b>	550	LLE/RLE	②, ③, ⑥,
<b>AM 23 U</b>	<b>3 397 008 570</b>	575	LLE/RLE	②, ③, ⑥,
<b>AM 24 U</b>	<b>3 397 008 571</b>	600	LLE/RLE	②, ③, ⑥,
<b>AM 26 U</b>	<b>3 397 008 573</b>	650	LLE/RLE	②, ③, ⑥,
<b>AM 28 U</b>	<b>3 397 008 574</b>	700	LLE/RLE	②, ③, ⑥,
<b>AM 30 U</b>	<b>3 397 008 928</b>	750	LLE/RLE	②, ③, ⑥,
<b>AM 32 U</b>	<b>3 397 008 926</b>	800	LLE/RLE	②, ③, ⑥,



(AM) Flachblatt-Wischer mit Multi-Clip-Adapter - passend für die wichtigsten Wischarm-Schnittstellen

(AM) Flat wiper blade with Multi-Clip adapter - suitable for the most important wiper arm connections

(AM) Metallbygeltorkare med multi-clip-adapter - anpassad för de viktigaste torkarm-gränssnitt

(AM) Matalaprofiilisulat mallikohtaisella multi-clip-sovittimella - sopii tärkeimpiin pyyhinvarsien liittimiin

(AM) Programma universale Aerotwin tergicristalli a spazzola piatta con adattatore Multi-Clip – adatti alle più importanti interfacce di attacco per spazzole tergicristallo



de

## Aerotwin Plus Singles für PKW

en

## Aerotwin Plus Singles for passenger cars

sv

## Aerotwin Plus Singles för personbilar

fi

## Aerotwin Plus Singles henkilöautoihin

it

## Aerotwin Plus in confezione singola per autovetture



**P.P.P.** Power  
Protection Plus

### Vorteile:

#### Neues, cleveres Adaptersystem

- ▶ Innovatives System durch die Kombination von 15 Wischerlängen und 4 Adaptern
- ▶ Pro Wischblatt passen 10 unterschiedliche Wischerarme – 6 mehr als bei dem bisherigen Multi-Clip
- ▶ Einfache und schnelle Abdeckung für neue Fahrzeugmodelle

#### Höhere Rentabilität pro Sachnummer

- ▶ Mit nur 15 Aerotwin Plus Singles können über 100 OE-Sets ersetzt werden
- ▶ Weniger Lagerhaltungskosten, schnellerer Abverkauf, höhere Rentabilität

#### Rasche und sichere Montage durch übersichtliche Montageanleitung

#### Schneller und einfacher Wischerwechsel nach dem 1-2-3-Prinzip

1. Aus den 4 spezifischen Adaptern den passenden auswählen
2. Auf Basis an Wischblatt aufklipsen
3. Wischblatt montieren – fertig!

### Benefits:

#### New, clever adapter system

- ▶ Innovative system combining 15 wiper lengths and 4 adapters
- ▶ Each wiper blade fits 10 different wiper arms – 6 more than is the case with the existing Multi-Clip
- ▶ Straightforward and fast coverage for new vehicle models

#### Making each part number more profitable

- ▶ More than 100 OE sets can be replaced with just 15 Aerotwin Plus singles
- ▶ Warehousing costs are reduced, sales can be processed more quickly, profitability increases

#### Clear and concise assembly instructions for rapid and safe assembly

#### Quick and easy wiper replacement based on the principle of 1-2-3

1. Make appropriate selection from 4 specific adapters
2. Clip onto wiper blade
3. Assemble wiper blade – ready to go!

### Fördelar:

#### Nytt och smart adaptersystem

- ▶ Nyttänkande system genom kombinationen av 15 torkarlängder och 4 adapterar
- ▶ Per torkarblad kan 10 olika torkararmar kombineras – 6 fler än vid traditionella multi-clip
- ▶ Nya bilmodeller täcks enkelt och snabbt

#### Högre lönsamhet per artikelnummer

- ▶ Med bara 15 Aerotwin Plus Singles kan över 100 OE-set ersättas
- ▶ Lägre lagerhållningskostnader, snabbare försäljning, högre lönsamhet

#### Snabb och säker montering tack vare överskådlig monteringsanvisning

#### Snabbt och enkelt torkarbyte enligt 1-2-3-principen

1. Välj rätt adapter bland de 4 specifika adapterarna
2. Klicka fast på torkbladets bas
3. Montera torkarbladet – klart!

### Edut:

#### Uusi, älykäs sovitinjärjestelmä

- ▶ Innovatiivinen järjestelmä - yhteensä 15 sulkapituutta ja 4 sovitinta
- ▶ Pyyhinsulkaan sopii 10 eri pyyhinvartta – 6 enemmän kuin tähänastisessa multi-clip-kiinnityksessä
- ▶ Nopea ja kätevä kattavuus myös uusiin ajoneuvomalleihin

#### Korkeampi kannattavuus viitenumeroa kohti

- ▶ Vain 15 Aerotwin Plus Singles korvaa yli 100 alkuperäisarjaa
- ▶ Alhaisemmat varastointikustannukset, nopeuttaa myyntiä, korkeampi kannattavuus

#### Nopea ja pitävä asennus, selkeä asennusohje

#### Nopeampi ja helpompi pyyhkimien vaihto 1-2-3-periaatteella

1. Valitse 4 sovitinmallista tapaukseen sopiva
2. Kiinnitä se pyyhinsulkaan
3. Asenna sulka – valmis!

### Vantaggi:

#### Nuovo sistema di adattatori intelligente

- ▶ Sistema innovativo che unisce 15 lunghezze di tergicristalli e 4 adattatori
- ▶ Ogni spazzola è compatibile con 10 diversi bracci tergicristallo, 6 più delle attuali Multi-clip
- ▶ Copertura semplice e veloce anche per nuovi modelli

#### Rendere ogni codice prodotto più redditizio

- ▶ Più di 100 set di primo equipaggiamento possono essere sostituiti con appena 15 Aerotwin Plus in confezione singola

- ▶ Costi di magazzino ridotti, le vendite possono essere effettuate più rapidamente, la redditività aumenta

#### Chiaro e concise istruzioni di montaggio istruzioni per una rapida e sicura installazione

#### Sostituzione della spazzola rapida e semplice basata sul principio di 1-2-3

1. Effettuare la selezione appropriata tra 4 adattatori specifici
2. Fissare l'adattatore alla spazzola
3. Montare la spazzola tergicristallo - pronto per partire!

<b>de</b>	<b>en</b>	<b>sv</b>	<b>fi</b>	<b>it</b>
<b>Aerotwin Plus Singles – Programm</b>	<b>Aerotwin Plus Singles – Program</b>	<b>Aerotwin Plus Singles – Program</b>	<b>Aerotwin Plus Singles – Ohjelma</b>	<b>Aerotwin Plus Singles – Programma</b>

	<b>AEROTWIN</b> 		<b>Adapter Adapter Adapter Sovitin Adattatore</b>
--	---------------------	--	---

<b>AP 13 U</b> <b>NEW</b>	<b>3 397 006 827</b> <sup>1)</sup>	340	③ (16 mm), ③ (19 mm), ⑥, ⑦	②, ③, ④
<b>AP 15 U</b> <b>NEW</b>	<b>3 397 006 828</b> <sup>1)</sup>	380	③ (16 mm), ③ (19 mm), ⑥, ⑦	②, ③, ④
<b>AP 16 U</b> <b>NEW</b>	<b>3 397 006 829</b> <sup>1)</sup>	400	②, ③ (16 mm), ③ (19 mm), ⑥, ⑦	①, ②, ③, ④
<b>AP 17 U</b> <b>NEW</b>	<b>3 397 006 830</b> <sup>1)</sup>	425	②, ③ (16 mm), ③ (19 mm), ⑥, ⑦	①, ②, ③, ④
<b>AP 18 U</b> <b>NEW</b>	<b>3 397 006 831</b> <sup>1)</sup>	450	②, ③ (16 mm), ③ (19 mm), ⑥, ⑦	①, ②, ③, ④
<b>AP 19 U</b> <b>NEW</b>	<b>3 397 006 832</b> <sup>1)</sup>	475	②, ③ (16 mm), ③ (19 mm), ⑥, ⑦	①, ②, ③, ④
<b>AP 20 U</b> <b>NEW</b>	<b>3 397 006 833</b> <sup>1)</sup>	500	②, ③ (16 mm), ③ (19 mm), ⑥, ⑦	①, ②, ③, ④
<b>AP 21 U</b> <b>NEW</b>	<b>3 397 006 834</b> <sup>1)</sup>	530	②, ③ (16 mm), ③ (19 mm), ⑥, ⑦	①, ②, ③, ④
<b>AP 22 U</b> <b>NEW</b>	<b>3 397 006 835</b> <sup>1)</sup>	550	②, ③ (16 mm), ③ (19 mm), ⑥, ⑦	①, ②, ③, ④
<b>AP 23 U</b> <b>NEW</b>	<b>3 397 006 836</b> <sup>1)</sup>	575	②, ③ (16 mm), ③ (19 mm), ⑥, ⑦	①, ②, ③, ④
<b>AP 24 U</b> <b>NEW</b>	<b>3 397 006 837</b> <sup>1)</sup>	600	②, ③ (16 mm), ③ (19 mm), ⑥, ⑦	①, ②, ③, ④
<b>AP 26 U</b> <b>NEW</b>	<b>3 397 006 838</b> <sup>1)</sup>	650	②, ③ (16 mm), ③ (19 mm), ⑥, ⑦	①, ②, ③, ④
<b>AP 28 U</b> <b>NEW</b>	<b>3 397 006 839</b> <sup>1)</sup>	700	②, ③ (16 mm), ③ (19 mm), ⑥, ⑦	①, ②, ③, ④
<b>AP 30 U</b> <b>NEW</b>	<b>3 397 006 840</b> <sup>1)</sup>	750	②, ③ (16 mm), ③ (19 mm), ⑥, ⑦	①, ②, ③, ④
<b>AP 32 U</b> <b>NEW</b>	<b>3 397 006 841</b> <sup>1)</sup>	800	②, ③ (16 mm), ③ (19 mm), ⑥, ⑦	①, ②, ③, ④

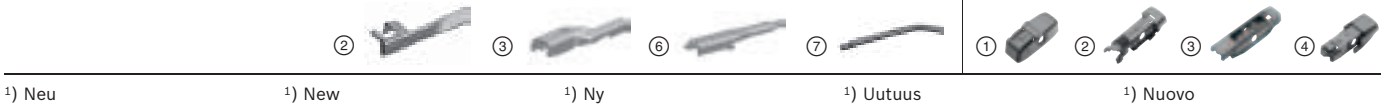

<b>Adapter Adapter Adapter Sovitin Adattatore</b>	<b>Passend für Wischarme Suitable for wiper arms Anpassad för torkarmar Sopii pyyhinvarsiin Bracci tergicristallo compatibili</b>		
1			
2	19 mm		
3			
4	16 mm		

de	en	sv	fi	it
Aerotwin Sets – Upgrade-Programm (zum Nachrüsten)	Aerotwin Sets – Upgrade program (for retrofitting)	Aerotwin Sets – Uppgraderingsprogram (för eftermontering)	Aerotwin Sets – Päivitetty valikoima (jälkiasennukseen)	Aerotwin Sets – Programma Retrofit per il post-equipaggiamento



AR 450 S	3 397 118 994	450/450	LLE	9x3/9x4	①
AR 480 S	3 397 118 900	475/475	LLE	9x3/9x4	①
AR 500 S	3 397 009 081	500/500	LLE	9x3/9x4	①
AR 502 S	3 397 118 995	500/450	LLE	9x3/9x4	①
AR 503 S	3 397 118 993	500/475	LLE	9x3/9x4	①
AR 530 S	3 397 118 903	530/530	LLE/RLE	9x3/9x4	①
AR 531 S	3 397 118 901	530/450	LLE	9x3/9x4	①
AR 532 S	3 397 118 986	530/500	LLE	9x3/9x4	①
AR 533 S	3 397 118 902	530/475	LLE	9x3/9x4	①
AR 534 S	3 397 007 503	530/380	LLE	9x3/9x4	①
AR 550 S	3 397 118 906	550/530	LLE	9x3/9x4	①
AR 551 S	3 397 118 905	550/500	LLE	9x3/9x4	①
AR 552 S	3 397 118 984	550/400	LLE	9x3/9x4	①
AR 553 S	3 397 007 589	550/340	LLE	9x3/9x4	①
AR 566 S	3 397 118 990	475/425	LLE	9x3/9x4	①
AR 601 S	3 397 118 907	600/400	LLE	9x3/9x4	①
AR 604 S	3 397 118 908	600/450	LLE	9x3/9x4	①
AR 605 S	3 397 007 504	600/350	LLE	9x3/9x4	①
AR 606 S	3 397 118 910	600/500	LLE	9x3/9x4	①
AR 607 S	3 397 118 909	600/475	LLE	9x3/9x4	①
AR 608 S	3 397 007 654 <sup>1)</sup>	600/475	LLE/RLE	9x3/9x4	①
AR 609 S	3 397 009 776 <sup>1)</sup>	600/600	LLE/RLE	9x3/9x4	①
AR 644 S	3 397 004 644 <sup>2)</sup>	700	LLE	9x3/9x4	①
AR 650 S	3 397 018 913	650	LLE	9x3/9x4	①
AR 651 S	3 397 118 913	650/650	LLE/RLE	9x3/9x4	①
AR 652 S	3 397 007 566 <sup>1)</sup>	650/450	LLE/RLE	9x3/9x4	①
AR 653 S	3 397 118 911	650/400	LLE	9x3/9x4	①
AR 654 S	3 397 007 570	650/350	LLE	9x3/9x4	①
AR 655 S	3 397 007 584	650/550	LLE	9x3/9x4	①
AR 657 S	3 397 009 777 <sup>1)</sup>	650/650	LLE/RLE	9x3/9x4	①
AR 701 S	3 397 007 706	650/500	LLE	9x3/9x4	①
AR 704 S	3 397 007 565	700/650	LLE/RLE	12x4	①
AR 728 S	3 397 118 904	550/475	LLE	9x3/9x4	①
AR 801 S	3 397 118 996	600/530	LLE	9x3/9x4	①
AR 813 S	3 397 118 912	650/450	LLE	9x3/9x4	①
AR 989 S	3 397 118 989	575/400	LLE	9x3/9x4	①
AR 991 S	3 397 118 991	650/575	LLE/RLE	9x3/9x4	①
AR 992 S	3 397 118 992	530/530	LLE/RLE	9x3/9x4	①
AR 997 S	3 397 118 997	600/550	LLE/RLE	9x3/9x4	①

①

(AR) Flachblatt-Wischer zum Nachrüsten für Pkw mit konventionellem Metallbügel-System und für Hybrid-Wischer

(AR) Flat wiper blade for retrofitting in passenger cars with conventional standard wiper system and for hybrid wipers

(AR) Metallbygeltorkare för eftermontering för personbilar med konventionellt metallbygelsystem och för hybrid-torkare

(AR) Matalaprofiillisulat jälkiasennukseen henkilöautoihin, joissa perinteiset sulat metallikaarella sekä hybridimallien sulat

(AR) Spazzole Aerotwin compatibili con bracci tergitristallo di autovetture dotate originariamente di spazzole tradizionali

<sup>1)</sup> Inkl. Spritzdüse  
<sup>2)</sup> Abgekündigt

<sup>1)</sup> Incl. spray nozzle  
<sup>2)</sup> to be discontinued

<sup>1)</sup> Original skyddskåpa kan inte längre monteras  
<sup>2)</sup> föråldrad

<sup>1)</sup> sis. pesuuttimen  
<sup>2)</sup> vanhentunut

<sup>1)</sup> Incl. spruzzatore  
<sup>2)</sup> Fuori produzione

<b>de</b> Aerotwin Singles – Upgrade-Programm (zum Nachrüsten)	<b>en</b> Aerotwin Singles – Upgrade program (for retrofitting)	<b>sv</b> Aerotwin Singles – Uppgraderingsprogram (för eftermontering)	<b>fi</b> Aerotwin Singles – Päivitetty valikoima (jälkiasennukseen)	<b>it</b> Aerotwin Singles – Programma Retrofit per il post-equipaggiamento
---	--	---	---	--

№ mm

AR 340 U	3 397 008 930	340	LLE	9x3/9x4	①
AR 380 U	3 397 008 931	380	LLE	9x3/9x4	①
AR 400 U	3 397 008 932	400	LLE	9x3/9x4	①
AR 450 U	3 397 008 933	450	LLE	9x3/9x4	①
AR 480 U	3 397 008 934	475	LLE	9x3/9x4	①
AR 500 U	3 397 008 935	500	LLE	9x3/9x4	①
AR 530 U	3 397 008 936	530	LLE	9x3/9x4	①
AR 550 U	3 397 008 937	550	LLE	9x3/9x4	①
AR 575 U	3 397 008 940	575	LLE	9x3/9x4	①
AR 600 U	3 397 008 938	600	LLE	9x3/9x4	①
AR 650 U	3 397 008 939	650	LLE	9x3/9x4	①
AR 707 U <b>NEW</b>	3 397 006 803 <sup>1)</sup>	700	LLE	9x3/9x4	①

	Blister <sup>2)</sup>				
AR 13 U	3 397 008 638	340	LLE/RLE	9x3/9x4	①
AR 15 U	3 397 008 639	380	LLE/RLE	9x3/9x4	①
AR 16 U	3 397 008 530	400	LLE/RLE	9x3/9x4	①
AR 17 U	3 397 008 531	425	LLE/RLE	9x3/9x4	①
AR 18 U	3 397 008 532	450	LLE/RLE	9x3/9x4	①
AR 19 U	3 397 008 533	475	LLE/RLE	9x3/9x4	①
AR 20 U	3 397 008 534	500	LLE/RLE	9x3/9x4	①
AR 21 U	3 397 008 536	530	LLE/RLE	9x3/9x4	①
AR 22 U	3 397 008 537	550	LLE/RLE	9x3/9x4	①
AR 24 U	3 397 008 538	600	LLE/RLE	9x3/9x4	①
AR 26 U	3 397 008 539	650	LLE/RLE	9x3/9x4	①

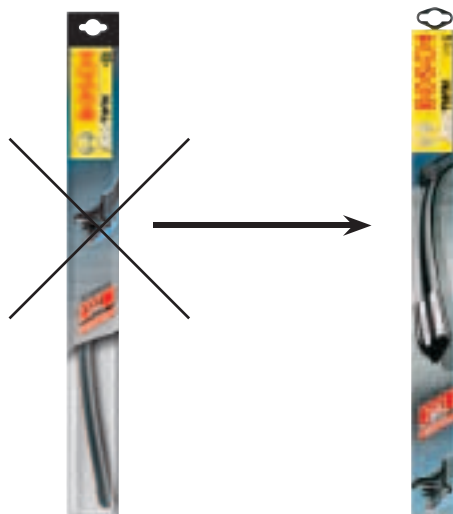

<sup>1)</sup> Neu  
<sup>2)</sup> Abgekündigt

<sup>1)</sup> New  
<sup>2)</sup> to be discontinued

<sup>1)</sup> Ny  
<sup>2)</sup> föråldrad

<sup>1)</sup> Uutuus  
<sup>2)</sup> vanhentunut

<sup>1)</sup> Nuovo  
<sup>2)</sup> Fuori produzione

de

**Twin Metallbügel-  
Wischer für Pkw**

en

**Twin standard wiper  
blades for passenger  
cars**

sv

**Twin torkarblad med  
metallbygel för  
personbilar**

fi

**Twin perinteinen  
sulka metallikaarella,  
ha**

it

**Tergicristalli Twin  
con staffa metallica  
per autovetture**



**TWIN**



- ① Perfekte Reinigung durch Leichtlaufbeschichtung
- ② Leises Wischen durch flexiblen Gummirücken
- ③ Lange Lebensdauer durch verschleißfeste Mikrodoppelkante

- ① Perfect cleaning due to smooth running coating
- ② Quiet wiping due to flexible rubber back
- ③ Long service life due to wear resistant double microedge

- ① Perfekt rengöring tack vare lågfriktionsbeläggning
- ② Tyst torkning genom flexibel gummiskena
- ③ Lång livslängd tack vare slitstark mikrodubbelkant

- ① Puhdistaa tehokkaasti kevyesti liukuvan pinnoitteen ansiosta
- ② Hiljainen käynti joustavan kumisen selkäpuolen ansiosta
- ③ Pitkän käyttöiän takaa kulumisen kestävä mikro-kaksoisreuna

- ① Pulizia perfetta grazie al rivestimento ultrascorrevole
- ② Tergitura silenziosa grazie al dorso flessibile in gomma
- ③ Lunga durata grazie al Microspigolo doppio resistente all'usura

#### Langlebige Sicherheit

- Das robuste Vollmetall-Bügelssystem ist extrem widerstandsfähig bei jeder Witterung durch zweifachen Korrosionsschutz

#### Lasting safety

- Double corrosion protection enables the robust all-metal bracket system to withstand any weather conditions

#### Långlivad säkerhet

- Det robusta bygel-systemet helt i metall är extremt motståndskraftigt vid varje väderlek tack vare det dubbla korrosionsskyddet

#### Kestävä ja luotettava

- Vankka täysmetallinen kiinnityskaari kestää sitkeästi sään vaihtelut kiitos kaksinkertaisen korroosiosuojan

#### Sicuri nel tempo

- Grazie alla doppia protezione contro la corrosione, il robusto sistema di staffe interamente in metallo risulta estremamente resistente ad ogni tipo di condizione atmosferica

#### Mehr Leistung auf der Scheibe

- Die bewährte Twin-Zweistoff-Technologie erzielt perfekte Wischleistung

#### Even better performance

- Renowned Twin compound technology guarantees optimum wiper action

#### Bättre resultat på rutan

- Den beprövade Twin-tvåkomponentstekniken ger perfekta torkarprestanda

#### Lisää tehoa lasin pintaan

- Tuttu Twin-yhdistelmäkumi takaa optimaalisen pyyhintehon

#### Più forza sul cristallo

- La collaudata tecnologia Twin a doppia mescola garantisce una tergitura perfetta



► Besonders wirkungsvoll ist die speziell auf schwierige Umweltbedingungen optimierte Leichtlaufbeschichtung. Selbst bei einer teilweise trockenen Scheibe wird eine perfekte Reinigung garantiert

► A particularly effective feature is the coating specially designed to ensure smooth operation under adverse ambient conditions. Perfect cleaning action is assured even if the glass is dry in places

► Speciellt effektiv låg-friktionsbeläggning som har optimerats för svåra förhållanden. Till och med vid en delvis torr ruta kan en perfekt rengöring garanteras

► Erityisen tehokas, jonka kevyesti liukuva pinnoite on suunniteltu nimenomaan ongelmallisiin sääolosuhteisiin. Silloinkin, kun lasi on osittain kuiva, pyyhintulos on taattu.

► Particolarmente efficace è il rivestimento che agevola la corsa delle spazzole, ottimizzato in modo specifico per l'impiego in condizioni ambientali avverse. Persino con un cristallo parzialmente asciutto è garantita una tergitura perfetta

#### Vorzüge des Twin Spoiler

► Durch erhöhten Andruck noch besseres Hochgeschwindigkeitsverhalten

#### Advantages of Twin spoiler

► Even better performance at high speeds thanks to increased contact pressure

#### Fördelar med Twin Spoiler

► Genom det högre trycket mot rutan fungerar den ännu bättre vid höga hastigheter

#### Twin-spoilerin edut

► Korkeampi puristusaine takaa hyvän tuloksen korkeillakin nopeuksilla

#### Vantaggi di Twin Spoiler

► Grazie alla maggiore pressione di contatto comportamento ulteriormente migliorato alle velocità elevate

#### Sekundenschneller Wischerwechsel

► Der Universaladapter Quick-Clip erspart langes Suchen und umständliches Hantieren bei der Wischer-Montage. Der Quick-Clip ist vormontiert, passt zu jedem Wischarm und bietet Sicherheit in Sekunden

#### Instant wiper replacement

► The Quick-Clip universal adapter speeds up and simplifies the business of fitting wipers. The Quick-Clip is pre-assembled, fits any wiper arm and stands for instant reliability

#### Sekundsnabbt byte av torkarblad

► Universaladaptern Quick-Clip sparar letande och omständig hantering vid torkarmonteringen. Quick-Clip är förmonterad, passar till varje torkararm och ger säkerhet på några sekunder

#### Pyyhkimen vaihto parissa sekunnissa

► Yleismallinen Quick-Clip kiinnike säästää aikaa ja vaivalloista kiinnitysosien soveltamista pyyhkimä vaihdettaessa. Esiasennettu Quick-Clip kiinnitys on luotettava ja sopii useimpiin varsimalleihin.

#### Rapidissima sostituzione del tergicristallo

► L'adattatore universale Quick-Clip evita lunghe ricerche e manovre complicate durante il montaggio dei tergicristalli. L'adattatore Quick-Clip è pre-montato, si adatta a qualunque braccio tergicristallo e offre sicurezza in pochi secondi

de

**Twin Sets  
und Singles**(nach Suchnummer  
geordnet)

en

**Twin Sets  
and Singles**

(by search number)

sv

**Twin satser  
och Singles**(sorterat efter  
söknummer)

fi

**Twin Set & Singles**  
(järjestys hakunumeron  
mukaan)

it

**Confezioni doppie  
e singole**(in ordine dei  
numeri di ricerca)

<b>041</b>	<b>3 397 110 041</b> <sup>4)</sup>	450/450	3 391 250 244				Special	
<b>046 S</b>	<b>3 397 005 046</b>	680/680	3 391 250 230				12x4	①
<b>109</b>	<b>3 397 033 109</b>	500/500						Refill
<b>260</b>	<b>3 397 118 800</b>	260/260	3 391 250 085	3 391 390 079	3 391 390 496			①
<b>280</b>	<b>3 397 118 801</b>	280/280	3 391 250 247				7x2,5, 9x3	①
<b>291 S</b>	<b>3 397 010 291</b>	600/450	3 391 250 142				9x4,2	①
<b>340</b>	<b>3 397 118 700</b>	340/340	3 391 250 247				7x2,5, 9x3	①
<b>340 U</b>	<b>3 397 004 578</b>	340	3 391 250 246				8x3, 9x3, 9x4	①
<b>359 S</b>	<b>3 397 001 359</b>	705/628	3 391 250 161	3 391 250 182			12x4	①
<b>361</b>	<b>3 397 001 361</b>	500/400	3 391 250 246				8x3, 9x3, 9x4	①
<b>367 S</b>	<b>3 397 001 367</b>	600/625	3 391 250 151				9x4	①
<b>380 U</b>	<b>3 397 011 353</b>	380	3 391 250 246				8x3, 9x3, 9x4	①
<b>394 S</b>	<b>3 397 001 394</b>	580/500	3 391 250 234				9x4	①
<b>400</b>	<b>3 397 118 610</b>	400/400	3 391 250 246				8x3, 9x3, 9x4	①
<b>400 S</b>	<b>3 397 118 611</b> <sup>4)</sup>	400/400	3 391 250 246				8x3, 9x3, 9x4	①
<b>400 U</b>	<b>3 397 004 579</b>	400	3 391 250 246				8x3, 9x3, 9x4	①
<b>405</b>	<b>3 397 005 800</b> <sup>2)</sup>	550/550	3 391 250 246				8x3, 9x3, 9x4	①
<b>408</b>	<b>3 397 118 408</b> <sup>1)</sup>	530/530	3 391 250 193				9x4	①
<b>420</b>	<b>3 397 118 500</b>	420/420	3 391 250 246				8x3, 9x3, 9x4	①
<b>420 U</b>	<b>3 397 011 354</b>	420	3 391 250 246				8x3, 9x3, 9x4	①
<b>450</b>	<b>3 397 118 505</b>	450/450	3 391 250 246				8x3, 9x3, 9x4	①
<b>450 S</b>	<b>3 397 118 506</b>	450/450	3 391 250 246				8x3, 9x3, 9x4	①
<b>450 U</b>	<b>3 397 004 581</b>	450	3 391 250 246				8x3, 9x3, 9x4	①
<b>450 US</b>	<b>3 397 004 588</b>	450	3 391 250 246				8x3, 9x3, 9x4	①
<b>455</b>	<b>3 397 012 455</b>	640	3 391 250 209				9x3	①
<b>465 S</b>	<b>3 397 001 465</b> <sup>1)</sup>	475/475	3 391 250 193				9x4	①
<b>472</b>	<b>3 397 001 472</b>	450/400	3 391 250 247				7x2,5, 9x3	①
<b>480</b>	<b>3 397 118 540</b>	475/475	3 391 250 246				8x3, 9x3, 9x4	①
<b>480 S</b>	<b>3 397 118 541</b>	475/475	3 391 250 246				8x3, 9x3, 9x4	①
<b>480 U</b>	<b>3 397 004 582</b>	475	3 391 250 246				8x3, 9x3, 9x4	①
<b>481</b>	<b>3 397 118 542</b>	475/450	3 391 250 246				8x3, 9x3, 9x4	①
<b>481 S</b>	<b>3 397 118 543</b>	475/450	3 391 250 246				8x3, 9x3, 9x4	①
<b>500</b>	<b>3 397 118 560</b>	500/500	3 391 250 246				8x3, 9x3, 9x4	①
<b>500 S</b>	<b>3 397 118 561</b>	500/500	3 391 250 246				8x3, 9x3, 9x4	①
<b>500 U</b>	<b>3 397 004 583</b>	500	3 391 250 246				8x3, 9x3, 9x4	①
<b>500 US</b>	<b>3 397 004 590</b>	500	3 391 250 246				8x3, 9x3, 9x4	①
<b>502</b>	<b>3 397 118 563</b>	500/450	3 391 250 246				8x3, 9x3, 9x4	①
<b>502 S</b>	<b>3 397 118 564</b>	500/450	3 391 250 246				8x3, 9x3, 9x4	①
<b>503</b>	<b>3 397 118 565</b>	500/475	3 391 250 246				8x3, 9x3, 9x4	①
<b>503 S</b>	<b>3 397 118 566</b>	500/475	3 391 250 246				8x3, 9x3, 9x4	①
<b>530</b>	<b>3 397 118 400</b>	530/530	3 391 250 246				8x3, 9x3, 9x4	①
<b>530 S</b>	<b>3 397 118 401</b>	530/530	3 391 250 246				8x3, 9x3, 9x4	①
<b>530 U</b>	<b>3 397 004 584</b>	530	3 391 250 246				8x3, 9x3, 9x4	①
<b>530 US</b>	<b>3 397 011 352</b>	530	3 391 250 246				8x3, 9x3, 9x4	①
<b>531</b>	<b>3 397 118 402</b>	530/450	3 391 250 246				8x3, 9x3, 9x4	①
<b>531 S</b>	<b>3 397 118 403</b>	530/450	3 391 250 246				8x3, 9x3, 9x4	①
<b>532</b>	<b>3 397 001 532</b> <sup>1)</sup>	700/700	3 391 250 127				12x4	①
<b>532 S</b>	<b>3 397 118 404</b>	530/500	3 391 250 246				8x3, 9x3, 9x4	①
<b>533</b>	<b>3 397 118 405</b>	530/475	3 391 250 246				8x3, 9x3, 9x4	①
<b>533 S</b>	<b>3 397 118 406</b>	530/475	3 391 250 246				8x3, 9x3, 9x4	①
<b>534</b>	<b>3 397 010 271</b>	530/380	3 391 250 246				8x3, 9x3, 9x4	①
<b>539</b>	<b>3 397 001 539</b>	650/550					Special	
<b>543</b>	<b>3 397 001 543</b>	600/500	3 391 250 246				8x3, 9x3, 9x4	①
<b>550</b>	<b>3 397 118 420</b>	550/550	3 391 250 246				8x3, 9x3, 9x4	①
<b>550 S</b>	<b>3 397 118 421</b>	550/550	3 391 250 246				8x3, 9x3, 9x4	①





550 U	3 397 004 585		550	3 391 250 246			8x3, 9x3, 9x4	①
550 US		3 397 004 591	550	3 391 250 246			8x3, 9x3, 9x4	①
551	3 397 118 422		550/500	3 391 250 246			8x3, 9x3, 9x4	①
551 S		3 397 118 423	550/500	3 391 250 246			8x3, 9x3, 9x4	①
552 S		3 397 118 427	550/400	3 391 250 246			8x3, 9x3, 9x4	①
553	3 397 010 274		550/340	3 391 250 246			8x3, 9x3, 9x4	①
575 S		3 397 118 451	575/575	3 391 250 246			8x3, 9x3, 9x4	①
575 U	3 397 011 351		575	3 391 250 246			8x3, 9x3, 9x4	①
576	3 397 118 452		575/450	3 391 250 246			8x3, 9x3, 9x4	①
577	3 397 010 298		575/380	3 391 250 246			8x3, 9x3, 9x4	①
582 S		3 397 001 582 <sup>1)</sup>	550/530	3 391 250 193	3 391 250 246		9x4	①
583 S		3 397 001 583 <sup>1)</sup>	530/530	3 391 250 193	3 391 250 246		9x4	①
584 S		3 397 001 584 <sup>1)</sup>	530/475	3 391 250 193	3 391 250 246		9x4	①
600	3 397 018 300		600	3 391 250 209			9x3	①
600 U	3 397 004 586		600	3 391 250 246			8x3, 9x3, 9x4	①
600 US		3 397 004 592	600	3 391 250 246			8x3, 9x3, 9x4	①
601	3 397 118 304		575/400	3 391 250 246			8x3, 9x3, 9x4	①
601 S		3 397 010 297	600/400	3 391 250 246			8x3, 9x3, 9x4	①
602 S		3 397 118 302	600/600	3 391 250 151			9x4	①
603	3 397 118 301		600/600	3 391 250 246			8x3, 9x3, 9x4	①
604 S		3 397 118 303	600/450	3 391 250 246			8x3, 9x3, 9x4	①
605	3 397 010 270		600/340	3 391 250 246			8x3, 9x3, 9x4	①
606 S		3 397 118 305	600/500	3 391 250 211			9x4	①
607 S		3 397 118 306	600/475	3 391 250 246			8x3, 9x3, 9x4	①
608	3 397 118 307		600/550	3 391 250 246			8x3, 9x3, 9x4	①
608 S		3 397 118 308	600/550	3 391 250 211			9x4	①
609	3 397 118 309 <sup>2)</sup>		600/600	3 391 250 246			8x3, 9x3, 9x4	①
610 S		3 397 010 280 <sup>1)</sup>	600/575	3 391 250 220	3 391 250 193		9x4	①
611 S		3 397 010 300	600/530	3 391 250 246			8x3, 9x3, 9x4	①
650	3 397 118 320		650/650	3 391 250 246			8x3, 9x3, 9x4	①
650 U	3 397 004 587		650	3 391 250 246			8x3, 9x3, 9x4	①
650 US		3 397 004 593	650	3 391 250 246			8x3, 9x3, 9x4	①
651	3 397 118 321 <sup>2)</sup>		650/450	3 391 250 246			8x3, 9x3, 9x4	①
651 U	3 397 011 641 <sup>3)</sup>	<b>NEW</b>	650	3 391 250 211			9x4	①
652 S		3 397 118 327	650/575	3 391 250 246			8x3, 9x3, 9x4	①
653	3 397 118 324		650/400	3 391 250 246			8x3, 9x3, 9x4	①
653 S		3 397 118 325	650/400	3 391 250 246			8x3, 9x3, 9x4	①
654	3 397 010 299		650/340	3 391 250 246			8x3, 9x3, 9x4	①
655	3 397 010 302		650/550	3 391 250 246			8x3, 9x3, 9x4	①
657 S		3 397 118 334 <sup>2)</sup>	650/650	3 391 250 246			8x3, 9x3, 9x4	①
682	3 397 001 682 <sup>1)</sup>		550/530	3 391 250 193			9x4	①
700 U	3 397 004 489		700	3 391 250 246			8x3, 9x3, 9x4	①
701	3 397 118 202		650/500	3 391 250 246			8x3, 9x3, 9x4	①
702	3 397 118 203		700/650	3 391 250 246			8x3, 9x3, 9x4	①
702 S		3 397 118 204	700/650	3 391 250 246			8x3, 9x3, 9x4	①
703 S		3 397 118 205 <sup>2)</sup>	700/650	3 391 250 246			8x3, 9x3, 9x4	①

①

1) Beifahrerseite gebogen

1) Passenger's side angled

1) Passagerarsida böjd

1) Etumatkustajan puoli

1) Lato passeggero curva

2) Mit vormontierter Spritzdüse

2) With already fitted nozzle

2) Med förmonterat spolarmunstycke

2) Esiasennetulla suuttimella

2) Con spruzzatore

3) Neu

3) New

3) Ny

3) Uutuus

3) Nuovo

4) Abgekündigt

4) to be discontinued

4) föråldrad

4) vanhentunut

4) Fuori produzione

de

**Twin Sets  
und Singles**(nach Suchnummer  
geordnet)  
(Fortsetzung)

en

**Twin Sets  
and Singles**(by search number)  
(continued)

sv

**Twin satser  
och Singles**(sorterat efter  
söknummer)  
(fortsättning)

fi

**Twin Set & Singles**(järjestys hakunumeron  
mukaan) (jatkoa)

it

**Confezioni doppie  
e singole**(in ordine dei  
numeri di ricerca)  
(seguito)

<b>704</b>	<b>3 397 010 211</b>		700/650	3 391 250 230			12x4	①
<b>706 S</b>		<b>3 397 010 301</b>	700/500	3 391 250 246			8x3, 9x3, 9x4	①
<b>707 U</b>	<b>3 397 011 543</b>		700	3 391 250 247			7x2,5, 9x3	①
<b>725</b>	<b>3 397 001 725</b> <sup>2)</sup>		650/550	3 391 250 246			8x3, 9x3, 9x4	①
<b>727</b>	<b>3 397 001 727</b>		550/475	3 391 250 246			8x3, 9x3, 9x4	①
<b>728 S</b>		<b>3 397 001 728</b>	550/475	3 391 250 246			8x3, 9x3, 9x4	①
<b>801</b>	<b>3 397 001 801</b> <sup>1)</sup>		600/530	3 391 250 246	3 391 250 193	3 391 250 151	8x3, 9x3, 9x4	①
<b>801 S</b>		<b>3 397 001 802</b> <sup>1)</sup>	600/530	3 391 250 246	3 391 250 193	3 391 250 151	8x3, 9x3, 9x4	①
<b>803</b>	<b>3 397 001 803</b>		650/450	3 391 250 246			8x3, 9x3, 9x4	①
<b>807</b>	<b>3 397 005 807</b>		530/530				Special	
<b>808</b>	<b>3 397 005 808</b>		650/650				Special	
<b>813 S</b>		<b>3 397 001 813</b>	650/475	3 391 250 239			9x4	①
<b>814 S</b>		<b>3 397 001 814</b>	625/625	3 391 250 241			Special	
<b>866</b>	<b>3 397 001 866</b>		650/530				Special	
<b>909</b>	<b>3 397 001 909</b>		550/550				Special	

①

1) Beifahrerseite gebogen

1) Passenger's side angled

1) Passagerarsida böjd

1) Etumatkustajan puoli  
sivuttain taivutettu

1) Lato passeggero curva

2) Mit vormontierter  
Spritzdüse

2) With already fitted nozzle

2) Med förmonterat  
spolarmunstycke

2) Esiasennetulla suuttimella

2) Con spruzzatore  
premontato

3) Neu

3) New

3) Ny

3) Uutuus

3) Nuovo

4) Abgekündigt

4) to be discontinued

4) föråldrad

4) vanhentunut

4) Fuori produzione

de

**Twin –  
im Großpack.**  
Die wichtigsten Typen  
zum Vorteilspreis

en

**Twin –  
bumper pack.**  
The main types at  
a bargain price

sv

**Twin –  
i storförpackning.**  
De viktigaste typerna  
till specialpris

fi

**Twin –  
suurpakkaus:**  
Kysytyimmät mallit  
edulliseen hintaan

it

**Twin  
in confezione Maxi.**  
I codici prodotto  
principali ad un  
prezzo più  
vantaggioso

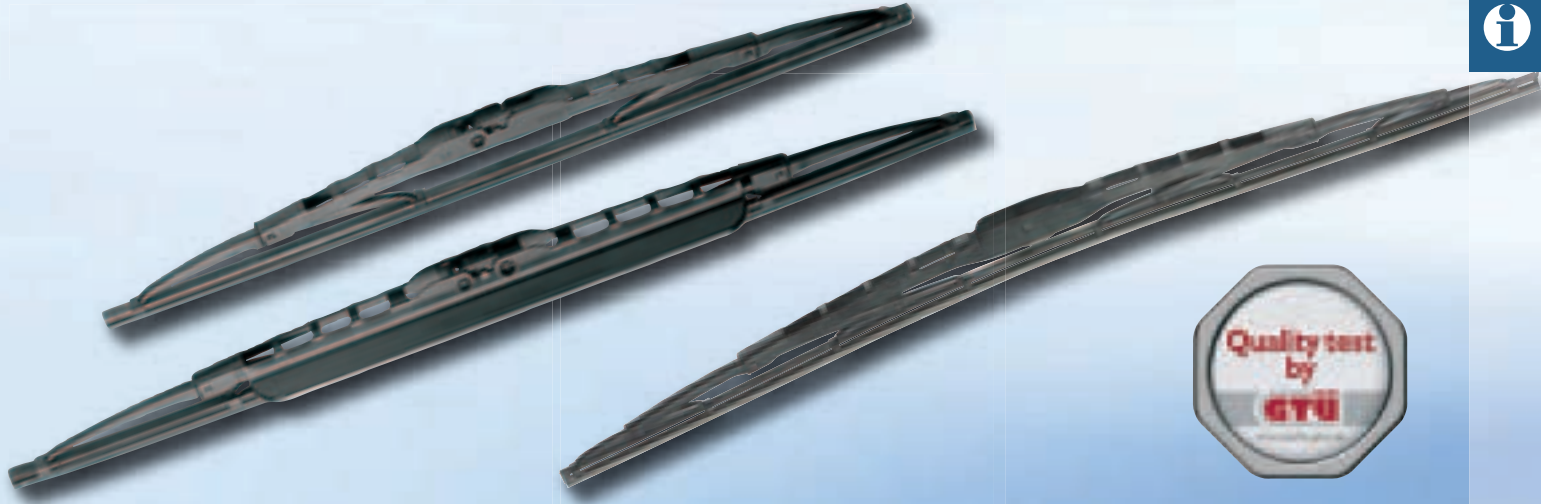

- ▶ Für Pkw, Kleintransporter und Nkw
- ▶ Preisvorteil durch einfache, neutrale Verpackung
- ▶ Marktgerechte Packungsgrößen: 10 Wischer pro Packung
- ▶ 19 verschiedene Wischertypen für die gängigsten Fahrzeuge
- ▶ Perfekte Reinigung durch Leichtlaufbeschichtung
- ▶ Leises Wischen durch flexiblen Gummirücken
- ▶ Lange Lebensdauer durch verschleißfeste Wischkante

- ▶ For passenger cars, transporters and commercial vehicles
- ▶ Simple, neutral packaging cuts costs
- ▶ Practical pack sizes: 10 wipers per pack
- ▶ 19 different types of wiper for the most common vehicle models
- ▶ Perfect cleaning action thanks to special coating for smooth operation
- ▶ Blade element with flexible back for less wiper noise
- ▶ Long service life on account of wear resistant wiper blade edge

- ▶ För personbilar, mindre transportbilar och nyttofordon
- ▶ Prisfördel genom enkel, neutral förpackning
- ▶ Marknadsanpassade förpackningsstorlekar: 10 torkare per förpackning
- ▶ 19 olika torkartyper för de vanligaste fordonen
- ▶ Perfekt rengöring tack vare lågfriktionsbeläggning
- ▶ Tyst torkning genom fl exibel gummiskena
- ▶ Lång livslängd tack vare slitstark torkarkant

- ▶ Henkilöautoihin, paketti ja hyötyajoneuvoihin
- ▶ Hintaeu pelkistetyn neutraalin pakkauksen ansiosta
- ▶ Edulliset pakkauskoot: 10 pyyhintä / pakkaus
- ▶ 19 eri pyyhintyyppiä yleisimpiin ajoneuvomalleihin
- ▶ Puhdistaa tehokkaasti kevyesti liukuvan pinnoitteen ansiosta
- ▶ Hiljainen käynti joustavan kumisen selkäpuolen ansiosta
- ▶ Kulumista hyvin kestävä pyyhinosa takaa pitkän käyttöiän

- ▶ Per autovetture, piccoli furgoni e veicoli commerciali
- ▶ Prezzo vantaggioso grazie ad una confezione semplice e neutra
- ▶ Confezioni di dimensioni adatte per il mercato: 10 tergicristalli per confezione
- ▶ 19 diversi tipi di tergicristalli per i veicoli più diffusi
- ▶ Pulizia perfetta grazie al rivestimento ultrascorrevole
- ▶ Tergitura silenziosa grazie al dorso flessibile in gomma
- ▶ Lunga durata grazie al profilo tergente resistente all'usura



400	400	3 397 001 741	3 391 250 246	8x3, 9x3, 9x4
400	450 S	3 397 001 742	3 391 250 246	8x3, 9x3, 9x4
420	420	3 397 001 743	3 391 250 246	8x3, 9x3, 9x4
450	450	3 397 001 744	3 391 250 246	8x3, 9x3, 9x4
450	450 S	3 397 001 745	3 391 250 246	8x3, 9x3, 9x4
475	480	3 397 001 746	3 391 250 246	8x3, 9x3, 9x4
475	480 S	3 397 001 747	3 391 250 246	8x3, 9x3, 9x4
500	500	3 397 001 748	3 391 250 246	8x3, 9x3, 9x4
500	500 S	3 397 001 749	3 391 250 246	8x3, 9x3, 9x4
530	530	3 397 001 750	3 391 250 246	8x3, 9x3, 9x4



530	530 S	3 397 001 751	3 391 250 246	8x3, 9x3, 9x4
550	550	3 397 001 752	3 391 250 246	8x3, 9x3, 9x4
550	550 S	3 397 001 753	3 391 250 246	8x3, 9x3, 9x4
600	600	3 397 001 754	3 391 250 209	9x3
600	601	3 397 010 266	3 391 250 215	12x4
600	602	3 397 011 552	3 391 250 246	8x3, 9x3, 9x4
650	650	3 397 010 267	3 391 250 289	9x3, 9x4
650	652	3 397 011 553	3 391 250 246	8x3, 9x3, 9x4
700	701	3 397 010 014	3 391 250 246	8x3, 9x3, 9x4



de

Adapterübersicht  
für Pkw

en

Adapter overview  
for passenger cars

sv

Adapteröversikt  
för personbilar

fi

Kiinnikevalikoima  
henkilöautoihin

it

Codici di ordinazione  
per adattatori auto

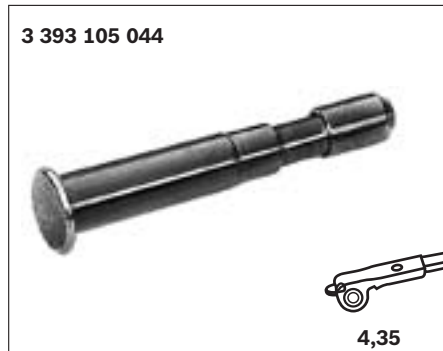
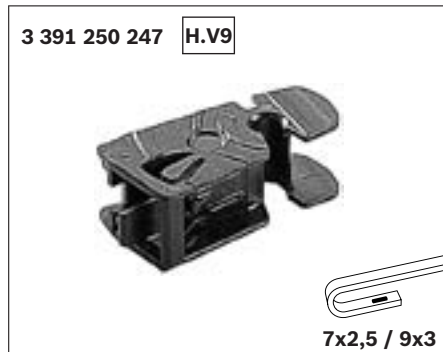
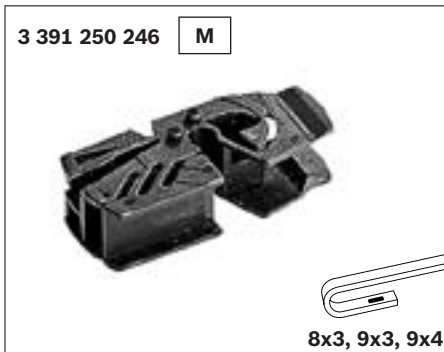
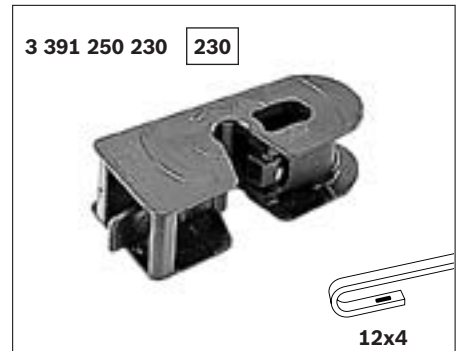
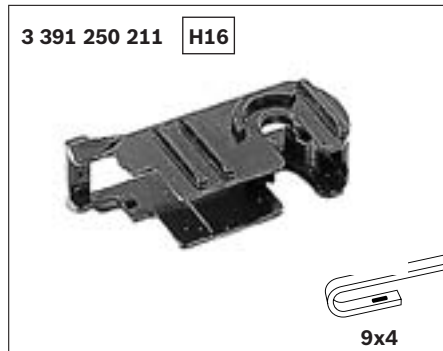
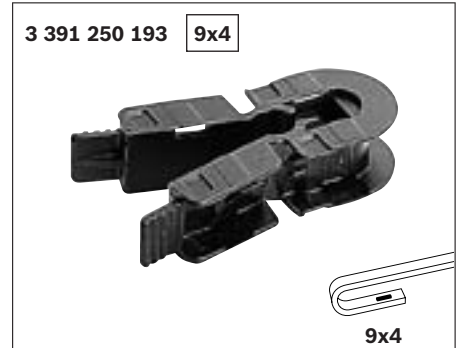
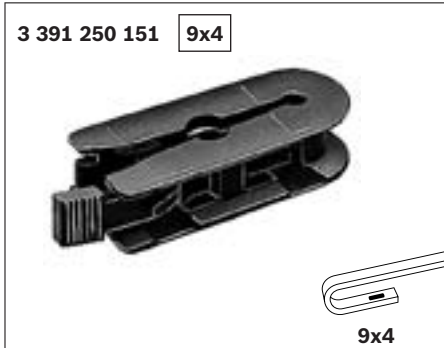

de

Rear Heckscheiben-  
Wischer für PKW

en

Rear wiper blades  
for passenger cars

sv

Torkarblad för  
bakrutetorkare  
till personbilar

fi

Rear takalasin  
pyyhkimet, ha

it

Tergilunotti Rear per  
autovetture



# DEAD

**Bosch Heckscheiben-  
Wischer für alle Fahr-  
zeuge, für alle Ansprüche.**

**Komplett.** Wer einen Heckscheiben-Wischer sucht, der wird im großen Bosch-Programm fündig. Es bietet eine einzigartige Marktdeckung für rund 95% aller Fahrzeuge, die mit einem Heckscheiben-Wischer ausgerüstet sind.

Das Programm besteht aus:

- ▶ Aerotwin Flachblatt-Wischern
- ▶ Konventionellen Metallbügel-Wischern
- ▶ Design-Kunststoff-Wischern
- ▶ Ersatz-Wischgummis

**Beste Sicht auch nach hinten: Bosch Heckscheiben-Wischer.**

**Bosch rear wiper blades for all vehicles and all requirements.**

**Complete.** Whatever the type of rear wiper blade required, the extensive Bosch range will have the answer. It provides unique market coverage for around 95% of all vehicles fitted with a rear wiper.

The range includes:

- ▶ Aerotwin flat wiper blades
- ▶ Conventional standard wiper blades
- ▶ Design plastic wiper blades
- ▶ Replacement wiper blade element

**All clear at the back: Bosch rear wiper blades.**

**Bosch bakrute-torkare för alla fordon, för alla anspråk.**

**Komplett.** Den som söker en bakrutetorkare hittar det han behöver i det stora Bosch-programmet. Det erbjuder en exklusiv marknadstäckning av ungefär 95% av alla fordon som är utrustade med en bakrutetorkare.

Programmet består av:

- ▶ Aerotwin torkarblad med låg profil
- ▶ Konventionella metall-bygeltorkare
- ▶ Designade torkarblad av plast
- ▶ Lösa torkargummi

**Bästa sikt även bakåt: Bosch bak-rutetorkare.**

**Boschin takalasin pyyhkimet kaikkiin malleihin, kaikkiin tarpeisiin.**

**Kattava valikoima.** Kun tarvitset uuden takalasin pyyhkimen, sellainen löytyy laajasta Bosch-valikoimasta. Valikoiman laaja markkinakattavuus on noin 95% kaikista automalleista, joissa on varusteena takalasin pyyhkin.

Valikoiman sisältö:

- ▶ Aerotwin matala-profiilisulka
- ▶ Perinteiset sulat metallikaarella
- ▶ Muoviset design-pyyhinsulat
- ▶ Varasulkakumit

**Taattu näkyvyys myös taakspäin. Boschin taka-lasin pyyhkimet.**

**Tergilunotti Bosch per tutti i veicoli e tutte le esigenze.**

**Completo.** Chi è alla ricerca di un tergilunotto troverà sicuramente il prodotto giusto nella vasta gamma Bosch. Essa offre infatti una copertura del mercato unica, pari a circa il 95% di tutti i veicoli dotati di tergilunotto.

Il programma comprende:

- ▶ tergicristalli Aerotwin a spazzola piatta
- ▶ Tergicristalli con staffa metallica
- ▶ tergicristalli design in materiale sintetico
- ▶ Profili tergenti in gomma

**Ottima visibilità anche all'indietro: tergilunotti Bosch.**



#### Alle Vorteile auf einen Blick:

- ▶ Zuverlässige Sicherheit durch perfekte Scheibenreinigung
- ▶ Lange Lebensdauer durch verschleißfeste Wischkante
- ▶ Beste Sicht auch bei extremer Witterung durch Leichtlaufbeschichtung

#### Markanter und übersichtlicher: Die selbst-erklärende Verpackung.

Einfacher, schneller und sicherer den richtigen Heckwischer finden. Die Kennzeichnung „REAR“ steht für das gesamte Bosch Heckscheiben-Wischer-Programm, der Zusatz H xxx bzw. A xxx H für Aerotwin steht bei der Kundensuchnummer.

#### All the advantages at a glance:

- ▶ Perfect cleaning action for dependable safety
- ▶ Long service life thanks to wear-resistant wiper blade edge
- ▶ Special coating ensures smooth operation and optimum vision even in adverse weather conditions

#### More eye-catching and even clearer: The self-explanatory packaging.

Finding the right rear wiper blade is now even easier, quicker and more reliable. „REAR“ stands for the entire Bosch rear wiper blade range and the code H xxx or A xxx H for Aerotwin is given with the customer ID number.

#### Alla fördelar med en blick:

- ▶ Tillförlitlig säkerhet genom perfekt rut rengöring
- ▶ Lång livslängd tack vare slitstark torkarkant
- ▶ Bästa sikt även i extrem väderlek genom lågfrikionsbeläggning

#### Iögonfallande och översiktligare: Den självförklarande förpackningen.

Hitta rätt bakrutetorkare enklare, snabbare och säkrare. Markeringen ”REAR” är gemensam för hela bakrutetorkarprogrammet från Bosch, tillägget H xxx resp. A xxx H för Aerotwin står vid kundens söknummer.

#### Kaikki edut yhdellä silmäyksellä:

- ▶ Luotettava ja turvallinen, puhdistaa lasit tehokkaasti
- ▶ Kulumista hyvin kestävä kumin reuna takaa pitkän käyttöiän
- ▶ Näkyvyys on taattu myös huonolla säällä, kiitos kevyesti liukuvan pinnoitteen

#### Näkyvämpi ja selkeämpi: yksiselitteinen pakkaus.

Oikeantyyppinen takalasin pyyhin löytyy helposti ja hetkessä. Tunnus REAR merkitsee Boschin koko takalasin pyyhinvalikoimaa, lisätunnus H xxx tai A xxx H = Aerotwin löytyy asiakkaalle tarkoitettusta hakunumerosta.

#### Ecco una panoramica di tutti i vantaggi:

- ▶ Sicurezza affidabile grazie ad una perfetta tergiture del cristallo
- ▶ Lunga durata grazie al profilo tergente resistente all'usura
- ▶ Ottima visibilità anche in condizioni meteorologiche estreme grazie al rivestimento ultras-correvole

#### Più appariscente e più chiara: la confezione che si spiega da sé.

Trovare il tergilunotto giusto in modo più semplice, rapido e sicuro. Il contrassegno “REAR” sta per l'intera gamma di tergilunotti Bosch, la sigla aggiuntiva H xxx o rispettivamente A xxx H per Aerotwin viene indicata vicino al codice breve.

de

Rear –  
Heckscheibenwischer-  
Programm

en

Rear –  
rear window wipers  
program

sv

Rear –  
Bakrutetorkare  
program

fi







Rear –  
takalasin pyyhkimet  
ohjelma

it

Rear –  
Tergicristallo lunotto  
posteriore programma

A 250 H	3 397 008 056	250			Aerotwin
A 251 H	3 397 008 058	250			Aerotwin
A 280 H	3 397 008 005	280			Aerotwin
A 281 H	3 397 008 045	280			Aerotwin
A 282 H	3 397 008 634	280			Aerotwin
A 330 H	3 397 008 006	330			Aerotwin
A 331 H	3 397 008 713	330			Aerotwin
A 332 H	3 397 008 635	330			Aerotwin
A 333 H	3 397 008 995	330			Aerotwin
A 340 H	3 397 008 004	340			Aerotwin
A 350 H	3 397 008 054	350			Aerotwin-Retro
A 351 H	3 397 008 192	350			Aerotwin
A 360 H	3 397 008 997	360			Aerotwin
A 380 H	3 397 008 050	380			Aerotwin
A 381 H	3 397 008 996	380			Aerotwin
A 382 H <b>NEW</b>	3 397 006 865 <sup>1)</sup>	380			Aerotwin
A 400 H	3 397 008 009	400			Aerotwin
A 401 H	3 397 008 047	400			Aerotwin
A 402 H	3 397 008 057	400			Aerotwin
A 403 H	3 397 008 998	400			Aerotwin
A 425 H	3 397 008 051	425			Aerotwin
A 475 H	3 397 008 055	475			Aerotwin
H 230	3 397 004 560	230			plastic design
H 250 <b>NEW</b>	3 397 011 629 <sup>1)</sup>	250			plastic design
H 261 <b>NEW</b>	3 397 011 676 <sup>1)</sup>	260			plastic design
H 280	3 397 018 802	280	3 391 250 247	7x2,5, 9x3	①
H 281	3 397 011 428	280			plastic design
H 300	3 397 004 628	300			plastic design
H 301	3 397 004 629	300			plastic design
H 304	3 397 004 990	300			plastic design
H 305	3 397 011 239	300			special metal
H 306	3 397 011 432	300			plastic design
H 307 <b>NEW</b>	3 397 011 429 <sup>1)</sup>	300			plastic design
H 308 <b>NEW</b>	3 397 011 628 <sup>1)</sup>	300			special metal
H 309 <b>NEW</b>	3 397 011 630 <sup>1)</sup>	300			plastic design
H 310 <b>NEW</b>	3 397 011 654 <sup>1)</sup>	300			special metal
H 311	3 397 011 666 <sup>2)</sup>	300			plastic design
H 330	3 397 011 306	330			plastic design
H 340	3 397 004 754	340	3 391 250 247	7x2,5, 9x3	①
H 341	3 397 004 755	340	3 391 250 247	7x2,5, 9x3	①
H 351	3 397 004 559	350			plastic design
H 352	3 397 011 430	350			plastic design
H 353	3 397 004 631	350			plastic design
H 354	3 397 011 433	350			plastic design
H 355	3 397 011 435	350			plastic design
H 356 <b>NEW</b>	3 397 011 655 <sup>1)</sup>	350			special metal
H 357	3 397 011 667 <sup>2)</sup>	350			plastic design
H 358	3 397 011 668 <sup>2)</sup>	350			plastic design
H 370	3 397 011 022	370			plastic design
H 375	3 397 004 558	375			plastic design
H 380	3 397 004 756	380	3 391 250 246	8x3, 9x3, 9x4	①
H 381	3 397 011 135	380			special metal
H 382	3 397 011 412	380	3 391 250 247	7x2,5, 9x3	①
H 383	3 397 011 551	380			special metal
H 400	3 397 004 757	400	3 391 250 246	8x3, 9x3, 9x4	①



 №		 mm			 mm	
H 402	3 397 004 632	400				plastic design
H 403	3 397 011 592	400				special metal
H 405	3 397 004 764	400	3 391 250 247	7x2,5, 9x3		①
H 406	3 397 011 134	400				plastic design
H 407	3 397 011 401	400				special metal
H 408	3 397 011 410	400				special metal
H 409	3 397 011 431 <sup>1)</sup>	400				plastic design
H 410	3 397 011 434 <sup>1)</sup>	400				plastic design
H 420	3 397 004 758	425	3 391 250 246	7x2,5, 8x3, 9x3		①
H 425	3 397 004 561	425				special metal
H 450	3 397 004 763	450	3 391 250 246	8x3, 9x3, 9x4		①
H 480	3 397 004 759	475	3 391 250 246	8x3, 9x3, 9x4		①
H 500	3 397 004 760	500	3 391 250 246	8x3, 9x3, 9x4		①
H 502	3 397 004 633	500				plastic design
H 503	3 397 004 660	500				plastic design
H 530	3 397 004 761	530	3 391 250 246	8x3, 9x3, 9x4		①
H 550	3 397 004 762	550	3 391 250 246	8x3, 9x3, 9x4		①
H 595	3 397 004 595	280	3 391 250 256	7x2,5		①
H 753	3 397 004 753	380				special metal
H 772	3 397 004 772	340				special metal
H 801	3 397 004 801	260				plastic design
H 840	3 397 004 802	290				plastic design
H 874	3 397 004 874	340				special metal
Z 361	3 397 033 361	450/450				refill
Z 362	3 397 033 362	500/500				refill

①



<sup>1)</sup> Neu  
<sup>2)</sup> In Vorbereitung

<sup>1)</sup> New  
<sup>2)</sup> In preparation

<sup>1)</sup> Ny  
<sup>2)</sup> Under förberedelse

<sup>1)</sup> Uutuus  
<sup>2)</sup> Valmistumassa

<sup>1)</sup> Nuovo  
<sup>2)</sup> In fase di preparazione

de

**Aerotwin Flachblatt-  
Wischer für Nkw**

en

**Aerotwin flat wiper  
blades for commercial  
vehicles**

sv

**Aerotwin torkarblad  
med låg profil för  
kommersiell**

fi

**Aerotwin  
matalaprofiilisulka,  
hyötyajoneuvojen**

it

**Tergicristalli Aerotwin  
a spazzola piatta per  
veicoli commerciali**



**Aerotwin für Nkw:  
Flachblatt-Wischer von  
450 bis 800 mm Länge**

- ▶ Bis zu 30 % höhere Lebensdauer
- ▶ Bestes Wischergebnis über die gesamte Wischblattlänge
- ▶ Bestmögliche Reinigung
- ▶ Extrem geräuscharmes Wischen
- ▶ Einfacher Wechsel mit vormontiertem Universaladapter und Kombi-Schnittstelle, passend für die Haken 9 x 3, 9 x 4 und 12 x 4
- ▶ Neue Schnittstelle (Screw type) für Überfallbefestigung bei Wischblattlänge 800 mm

**Aerotwin for commercial  
vehicles:  
Flat wiper blades in  
lengths of between  
450 and 800 mm**

- ▶ Up to 30 % longer service life
- ▶ Optimum wiper action over the full length of the blade
- ▶ Excellent cleaning effect
- ▶ Extremely quiet wiping
- ▶ Easy to replace thanks to pre-assembled universal adapter and combi interface, suitable for hook sizes 9 x 3, 9 x 4 and 12 x 4
- ▶ New (screw-type) interface for hasp fastening with 800 mm wiper blade length

**Aerotwin för nyttofordon:  
Metallbygeltorkare från  
450 till 800 mm längd**

- ▶ Upp till 30 % längre livslängd
- ▶ Bästa torkresultat över torkarbladets hela längd
- ▶ Bästa möjliga rengöring
- ▶ Extremt tyst torkning
- ▶ Enkelt byte med förmonterad universaladapter och kombifäste, passande till krokarna 9 x 3, 9 x 4 och 12 x 4
- ▶ Nytt fäste (skruvad typ) för överfallsfastsättning vid torkabladsängd 800 mm







**Aerotwin  
hyötyajoneuvoihin:  
Matalaprofiilisulat,  
pituus 450 ... 800 mm**

- ▶ Jopa 30 % pitempi käyttöikä
- ▶ Paras pyyhintulos pyyhinsulan koko pituudelta
- ▶ Paras puhdistusteho
- ▶ Erittäin hiljainen käyntiääni
- ▶ Helppo vaihtaa yleiskiinnikkeen ja yhdistelmäkiinnikkeen avulla koukkumalleihin 9 x 3, 9 x 4 ja 12 x 4
- ▶ Uusi kiinnike (malli ruuvi) pyyhkimen lisäkiinnikkeeseen 800 mm sulille

**Aerotwin per veicoli  
commerciali: lunghezze  
da 450 a 800 mm**

- ▶ Durata più lunga fino al 30 %
- ▶ Ottimo risultato di tergiture sull'intera lunghezza della spazzola tergcristallo
- ▶ Migliore pulizia possibile
- ▶ Tergitura estremamente silenziosa
- ▶ Sostituzione semplice grazie all'adattatore universale premontato e all'interfaccia multipla, adatta per i ganci 9 x 3, 9 x 4 e 12 x 4
- ▶ Nuova interfaccia (screw type) per fissaggio speciale per spazzole con lunghezza 800 mm

<b>de</b>	<b>en</b>	<b>sv</b>	<b>fi</b>	<b>it</b>
<b>Aerotwin Flachblatt- Wischer für Nkw – Programm</b>	<b>Aerotwin flat wiper blades for commercial vehicles – program</b>	<b>Aerotwin torkarblad med låg profil för kommersiell – program</b>	<b>Aerotwin matalaprofiilisulka, hyötyajoneuvojen – Ohjelma</b>	<b>Tergicristalli Aerotwin a spazzola piatta per veicoli commerciali – Programma</b>

 №	 AEROTWIN	 mm			 mm	
<b>A 215 S</b>	<b>3 397 007 215</b>	650/600	LLE			⑥
<b>A 225 S</b>	<b>3 397 007 225</b>	650/530	LLE			③
<b>A 311 S</b>	<b>3 397 007 311</b>	700/650	LLE/RLE			⑥
<b>AR 609 S</b>	<b>3 397 009 776 <sup>1)</sup></b>	600/600	LLE/RLE	M2	9x3, 9x4	①
<b>AR 644 S</b>	<b>3 397 004 644 <sup>2)</sup></b>	700	LLE	M1	9x3, 9x4	①
<b>AR 650 S</b>	<b>3 397 018 913</b>	650	LLE	M1	9x3, 9x4	①
<b>AR 703 S</b>	<b>3 397 007 568 <sup>1)</sup></b>	700/650	LLE/RLE	M2	9x3, 9x4	①
<b>AR 725 S</b>	<b>3 397 007 567 <sup>1)</sup></b>	650/550	LLE/RLE	M2	9x3, 9x4	①
<b>AR 45 N</b>	<b>3 397 008 840</b>	450	LLE/RLE	M2	9x3, 9x4	①
<b>AR 50 N</b>	<b>3 397 008 841</b>	500	LLE/RLE	M2	9x3, 9x4	①
<b>AR 55 N</b>	<b>3 397 008 842</b>	550	LLE/RLE	M2	9x3, 9x4	①
<b>AR 60 N</b>	<b>3 397 008 843</b>	600	LLE/RLE	M5	9x3, 9x4, 12x4	①
<b>AR 61 N</b>	<b>3 397 008 847 <sup>1)</sup></b>	600	LLE/RLE	M2	9x3, 9x4	①
<b>AR 65 N</b>	<b>3 397 008 844</b>	650	LLE/RLE	M5	9x3, 9x4, 12x4	①
<b>AR 66 N</b>	<b>3 397 008 848 <sup>1)</sup></b>	650	LLE/RLE	M2	9x3, 9x4	①
<b>AR 70 N</b>	<b>3 397 008 845</b>	700	LLE/RLE	M5	9x3, 9x4, 12x4	①
<b>AR 71 N</b>	<b>3 397 008 849 <sup>1)</sup></b>	700	LLE/RLE	M5	9x3, 9x4, 12x4	①
<b>AR 81 N</b>	<b>3 397 008 846</b>	800	LLE/RLE			⑨



<sup>1)</sup> Inkl. Spritzdüse  
<sup>2)</sup> Abgekündigt

<sup>1)</sup> Incl. spray nozzle  
<sup>2)</sup> to be discontinued

<sup>1)</sup> Inkl. sprutmunstycke  
<sup>2)</sup> föråldrad

<sup>1)</sup> sis. pesusuuttimen  
<sup>2)</sup> vanhentunut

<sup>1)</sup> Incl. spruzzatore  
<sup>2)</sup> Fuori produzione

de

**Twin Metallbügel-  
Wischer für Nkw**

en

**Twin standard wiper  
blades for commercial  
vehicles**

sv

**Torkarblad för  
nyttfordon  
Twin torkare med  
metallbygel**

fi

**Hyötyajoneuvojen  
pyyhkimetTwin  
sulkiin metalli-  
kaarella**

it

**Tergicristalli Twin con  
staffa metallica per  
veicoli commerciali**



**Twin für Nkw:  
Metallbügel-Wischer von  
400 bis 1000 mm Länge**

- ▶ Besonders robuste Bügelkonstruktion, die für höchste Gleichlaufstabilität bei Längen bis 1000 mm sorgt
- ▶ Perfekte Reinigung ohne Schlieren
- ▶ Leises, ruhiges Wischen
- ▶ Kein Abheben und Flattern
- ▶ Verschleißfeste Mikro-Doppelkante
- ▶ Robustheit und Langlebigkeit

**Twin for commercial  
vehicles:  
Standard wiper blades in  
lengths of between  
400 and 1000 mm**

- ▶ Extremely robust bracket structure guarantees maximum tandem pattern stability for lengths up to 1000 mm
- ▶ Perfect cleaning action with no smearing
- ▶ Smooth, quiet wiping
- ▶ No lift or flutter
- ▶ Wear-resistant double microedge
- ▶ Sturdy and durable

**Twin för nyttfordon:  
Metallbygeltorkare från  
400 till 1 000 mm längd**

- ▶ Speciellt robust bygelkonstruktion som ger högsta stabilitet och jämn torkning vid längder upp till 1000 mm
- ▶ Perfekt rengöring utan smutsränder
- ▶ Tyst, lugn torkning
- ▶ Bladen varken lyfter eller fladdrar
- ▶ Slitstark mikro-dubbelkant
- ▶ Robust och långlivad







**Twin hyötyajoneuvoihin:  
Pyyhkimet metallikaarella,  
pituus 400 ... 1000 mm**

- ▶ Sulan erityisen tukevan rakenteen ansiosta myös 1000 mm pitkät sulat pyyhkivät vakaasti
- ▶ Puhdistaa tehokkaasti
- ▶ Pyyhkii hiljaa ja tasaisesti
- ▶ Ei nouse irti lasista eikä lepata
- ▶ Kulutusta kestävä mikro-kaksoisreuna
- ▶ Vankka ja pitkäikäinen

**Spazzole Twin per veicoli  
commerciali: lunghezze  
da 400 a 1000 mm**

- ▶ Struttura a staffe particolarmente robusta che assicura la massima uniformità di scorrimento per lunghezze fino a 1000 mm
- ▶ Pulizia perfetta senza aloni o striature
- ▶ Tergitura regolare e silenziosa
- ▶ Nessun sollevamento o sfarfallio delle spazzole
- ▶ Microspigolo doppio resistente all'usura
- ▶ Robustezza e lunga durata

de	en	sv	fi	it
<b>Twin Metallbügel- Wischer für Nkw - Programm</b>	<b>Twin standard wiper blades for commercial vehicles - program</b>	<b>Torkarblad för nyttfordon Twin torkare med metallbygel - program</b>	<b>Hyötyajoneuvojen pyyhkimetTwin sulkiin metalli- kaarella - Ohjelma</b>	<b>Tergicristalli Twin con staffa metallica per veicoli commerciali - programma</b>

		 N <sup>o</sup>		 mm			 mm	
<b>543</b>	<b>3 397 001 543</b>		600/550		M	3 391 250 246	8x3, 9x3, 9x4	①
<b>609</b>	<b>3 397 118 309<sup>1)</sup></b>		600/600		M	3 391 250 246	8x3, 9x3, 9x4	①
<b>650 U</b>	<b>3 397 004 587</b>		650		M	3 391 250 246	8x3, 9x3, 9x4	①
<b>703 S</b>	<b>3 397 118 205<sup>1)</sup></b>		700/650		M	3 391 250 246	8x3, 9x3, 9x4	①
<b>725</b>	<b>3 397 001 725<sup>1)</sup></b>		650/550		M	3 391 250 246	8x3, 9x3, 9x4	①
<b>N 40</b>	<b>3 397 018 140</b>		400	3 397 033 322	M	3 391 250 246	8x3, 9x3, 9x4	①
					S 13	3 392 390 382	8x3	②
<b>N 45</b>	<b>3 397 018 145</b>		450	3 397 033 323	M	3 391 250 246	8x3, 9x3, 9x4	①
					S 13	3 392 390 382	8x3	②
<b>N 53</b>	<b>3 397 018 964<sup>2)</sup></b>		500	3 397 033 323	M	3 391 250 246	8x3, 9x3, 9x4	①
<b>N 55</b>	<b>3 397 018 965<sup>2)</sup></b>		550	3 397 033 327	M	3 392 390 246	8x3, 9x3, 9x4	①
<b>N 56</b>	<b>3 397 018 962</b>		550	3 397 033 327	230	3 391 250 230	12x4	①
<b>N 63</b>	<b>3 397 018 966<sup>2)</sup></b>		600	3 397 033 327		3 391 250 215	12x4	①
<b>N 65</b>	<b>3 397 018 963<sup>2)</sup></b>		650		230	3 391 250 230	12x4	①
<b>N 66</b>	<b>3 397 011 310<sup>1)</sup></b>		650		M	3 392 390 246	8x3, 9x3, 9x4	①
<b>N 70</b>	<b>3 397 018 170<sup>2)</sup></b>		700	3 397 033 324	230	3 391 250 230	12x4	①
<b>N 71</b>	<b>3 397 011 238<sup>1)</sup></b>		700	3 397 033 324	230	3 391 250 230	12x4	①
<b>N 72</b>	<b>3 397 002 918</b>		700	3 397 033 371		3 391 321 484	16,2 (L)	③
						3 391 321 485	16,4 (K)	③
<b>N 73</b>	<b>3 397 018 173</b>		700	3 397 033 324	T8	3 391 250 289	9x4 (L)	①
<b>N 74</b>	<b>3 397 004 080<sup>1)</sup></b>		700	3 397 033 324	M	3 391 250 246	9x4	①
<b>N 80</b>	<b>3 397 018 180</b>		800	3 397 033 372		3 391 321 482	25/6	③
						3 391 325 278	25/8	③
<b>N 81</b>	<b>3 397 018 181</b>		800	3 397 033 372		3 391 325 684	16/6	③
						3 391 325 685	25/8	③
						3 391 325 688	25/6	③
<b>N 82</b>	<b>3 397 011 425</b>		800	3 397 033 372			16/6	③
							25/6	③
							25/8	③
							27/8	③
<b>N 90</b>	<b>3 397 018 190</b>		900	3 397 033 373		3 391 321 482	25/6	③
<b>N 91</b>	<b>3 397 018 191</b>		900	3 397 033 373			16x6	④
<b>N 92</b>	<b>3 397 011 426</b>		900	3 397 033 373			25/6	③
							16x6	④
<b>N 100</b>	<b>3 397 018 199</b>		1000	3 397 033 374		3 391 325 277	27/8	③
						3 391 321 482	25/6	③
						3 391 325 278	25/8	③
						3 391 321 476	22/6	③
<b>N 101</b>	<b>3 397 018 198</b>		1000	3 397 033 374			16x6	④
<b>N 102</b>	<b>3 397 011 427</b>		1000	3 397 033 374			22/6	③
							25/6	③
							27/8	③
							25/8	③
							16x6	④



<sup>1)</sup> Inkl. Spritzdüse

<sup>2)</sup> Gesonderte Adapter  
entfallen

<sup>1)</sup> Incl. spray nozzle

<sup>2)</sup> Removal of separate  
adapters

<sup>1)</sup> Inkl. sprutmunstycke

<sup>2)</sup> Borttagning av separat  
adapter

<sup>1)</sup> sis. pesusuuttimen

<sup>2)</sup> Erillisten sovittimien poisto

<sup>1)</sup> Incl. spruzzatore

<sup>2)</sup> Eliminazione di adattatori  
separati

de

Bosch Nkw-Wischer – Adapterübersicht

en

Bosch commercial vehicle wipers – adapter overview

sv

Bosch Torkare för nyttofordon – Adapteröversikt

fi

Bosch-pyyhkimet hyötyajoneuvoihin – Sovitinvalikoima

it

Codici di ordinazione adattatori per veicoli commerciali

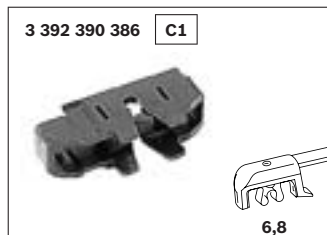
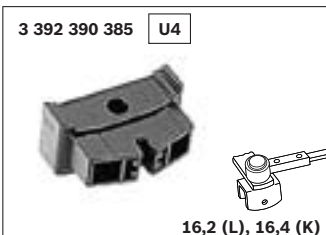
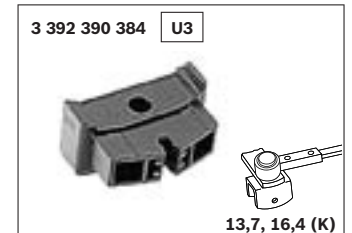
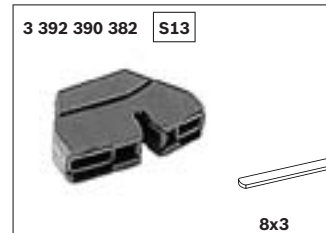
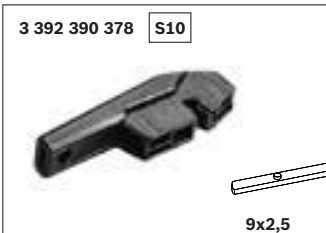
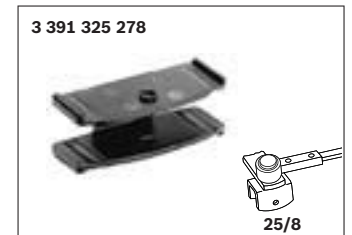
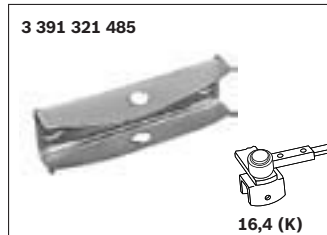
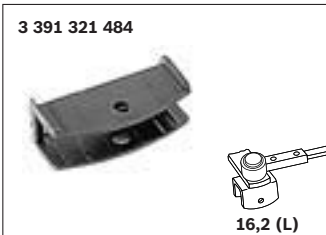
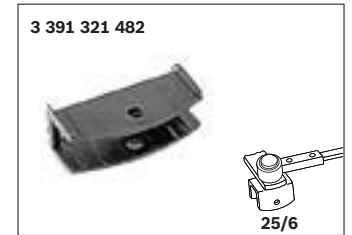
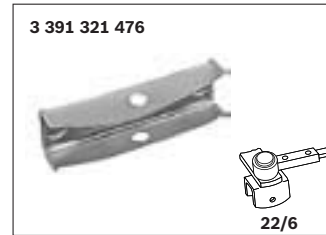
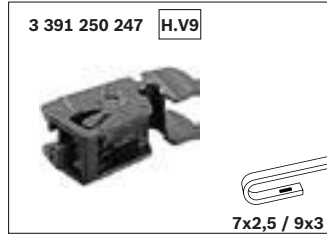
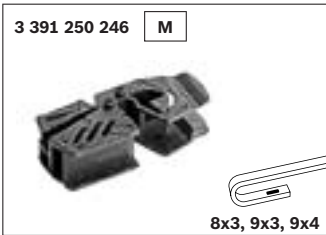
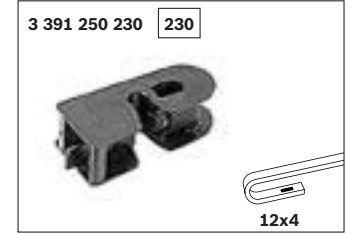
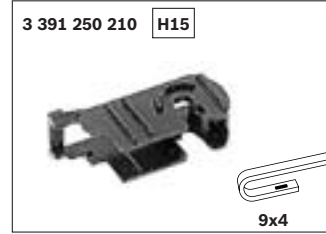
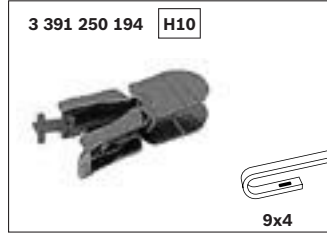
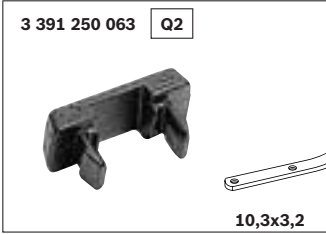

de

**Bosch Wischgummi/  
Refill – Programm**

en

**Bosch Wiper blade  
element/refill –  
program**

sv

**Bosch Torkargummi/  
Påfyllning program**

fi

**Bosch Pyyhkimen  
kumi/Refill-Ohjelma**

it

**Bosch Profili  
tergenti/Programma  
refill**

Federschiene* Spring strip* Fjäderskena* Jousikisko* Guida elastica*	Bestellnummer (neu) Part number (new) Beställningsnummer (nytt) Tilausnumero (uusi) Codice d'ordinazione (nuovo)	Länge Length Längd Pituus Lunghezza	Kurz-Suchnummer Short code Kort söknummer Lyhytnumero Codice breve
--	--	---	--

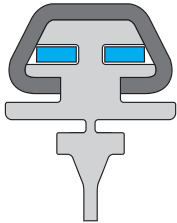

<b>3 391 014 459</b>	500	<b>Z 391</b>
<b>3 391 014 391</b>	600	<b>Z 459</b>
<b>3 391 014 901</b>	612	<b>Z 901</b>
<b>3 391 014 414</b>	705	<b>Z 414</b>
<b>3 397 033 319</b>	400/400	<b>Z 319</b>
<b>3 397 033 361</b>	450/450	<b>Z 361</b>
<b>3 397 033 362</b>	500/500	<b>Z 362</b>
<b>3 397 033 320</b>	530/530	<b>Z 320</b>
<b>3 397 033 363</b>	550/550	<b>Z 363</b>
<b>3 397 033 321</b>	600/600	<b>Z 321</b>
<b>3 397 033 364</b>	630/630	<b>Z 364</b>
<b>3 397 033 365</b>	644/644	<b>Z 365</b>
<b>3 397 033 366</b>	705/705	<b>Z 366</b>

Federschiene* Spring strip* Fjäderskena* Jousikisko* Guida elastica*	Bestellnummer (neu) Part number (new) Beställningsnummer (nytt) Tilausnumero (uusi) Codice d'ordinazione (nuovo)	Länge Length Längd Pituus Lunghezza	Kurz-Suchnummer Short code Kort söknummer Lyhytnumero Codice breve
--	--	---	--

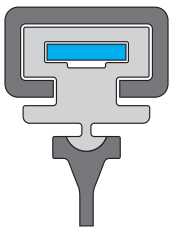

<b>3 397 033 322</b>	400/400	<b>Z 322</b>
<b>3 397 033 323</b>	500/500	<b>Z 323</b>
<b>3 397 033 327</b>	600/600	<b>Z 327</b>
<b>3 397 033 324</b>	700/700	<b>Z 324</b>
<b>3 397 033 232</b>	305	<b>H 303</b>
<b>3 397 033 281</b>	350	<b>H 350</b>
<b>3 397 033 233</b>	410	<b>H 404</b>
<b>3 391 014 955</b>	680/680	<b>Z 955</b>

Federschiene* Spring strip* Fjäderskena* Jousikisko* Guida elastica*	Bestellnummer (neu) Part number (new) Beställningsnummer (nytt) Tilausnumero (uusi) Codice d'ordinazione (nuovo)	Länge Length Längd Pituus Lunghezza	Kurz-Suchnummer Short code Kort söknummer Lyhytnumero Codice breve
--	--	---	--

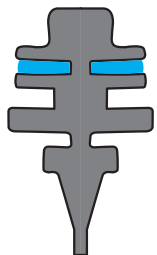

<b>3 397 033 367</b>	480/480	<b>Z 367</b>
<b>3 397 033 368</b>	550/550	<b>Z 368</b>
<b>3 397 033 369</b>	600/600	<b>Z 369</b>
<b>3 397 033 370</b>	650/650	<b>Z 370</b>
<b>3 397 033 371</b>	700/700	<b>Z 371</b>
<b>3 397 033 372</b>	800/800	<b>Z 372</b>
<b>3 397 033 373</b>	900/900	<b>Z 373</b>
<b>3 397 033 374</b>	1000/1000	<b>Z 374</b>
<b>3 397 033 375</b>	640/640	<b>Z 375</b>

\* Vor Austausch des Wischgummis auf außen- oder innenliegende Federschiene achten

\* Before replacing the wiper blade element, check whether spring strip is on outside or inside

\* Ge akt på om fjäderskenan ligger invändigt eller utvändigt innan torkargummit byts

\* Pyyhkimen kumin vaihdossa on katsottava, onko jousikisko ulko- vai sisäpuolinen

\* Prima della sostituzione del profilo tergente in gomma verificare se la guida elastica è all'esterno o all'interno

de

Die innovative  
Aerotwin-  
Verpackung\*

en

Aerotwin  
innovative  
packaging\*

sv

Den innovativa  
Aerotwin-  
förpackningen\*

fi

Innovatiivinen  
Aerotwin-  
pakkaus\*

it

L'innovativa  
confezione Aerotwin\*



**Selbsterklärende,  
SB-gerechte Handels-  
verpackung:**

- ① Kundensuchnummer
- ② Fahrzeug-Feinverwendung: Hersteller, Modell, Baujahr
- ③ Inhaltsangabe
- ④ Dominanter Bosch-Schriftzug als eindeutige Marken-Kennzeichnung
- ⑤ Wischblattlänge
- ⑥ Umweltfreundliche Verpackungsmaterialien
- ⑦ Service Informationen
- ⑧ EAN-Code
- ⑨ Montageanleitung

**Self-explanatory,  
self-service-compatible  
trade packaging:**

- ① Customer search number
- ② Detailed vehicle applications: Manufacturer, model, year of manufacture
- ③ Details of contents
- ④ Dominant Bosch lettering as a unique brand identification
- ⑤ Wiper blade length
- ⑥ Environmentally compatible packaging materials
- ⑦ Service information
- ⑧ Barcode
- ⑨ Fitting instructions

**Självförklarande,  
självbetjädningsanpassad  
handels-förpackning:**

- ① Kundens söknummer
- ② Fordon detaljerad uppgift: tillverkare, modell, årsmodell
- ③ Uppgift om innehåll
- ④ Dominant Bosch logotyp som entydig märkesidentifiering
- ⑤ Torkarbladets längd
- ⑥ Miljövänliga förpackningsmaterial
- ⑦ Serviceinformation
- ⑧ EAN-kod
- ⑨ Monteringsanvisning

**Yksiselitteiset  
itsepalvelu-  
pakkaukset:**

- ① Lyhytnumero
- ② Mallikohtaiset tiedot: valmistaja, malli, vm.
- ③ Sisältötiedot
- ④ Dominoiva Bosch-logo viestii merkituotteesta
- ⑤ Pyyhinsulan pituus
- ⑥ Ympäristöystävällinen pakkausmateriaali
- ⑦ Huoltotiedot
- ⑧ EAN-koodi
- ⑨ Asennusohje

**Confezione con istruzioni  
semplici, adatta per il  
"fai-da-te":**

- ① Codice breve
- ② Applicazioni: marca, modello ed anno di costruzione
- ③ Contenuto
- ④ Scritta Bosch per la chiara identificazione del marchio
- ⑤ Lunghezza di spazzole
- ⑥ Confezione in materiale ecologico
- ⑦ Informazione di servizio
- ⑧ Codice a barre
- ⑨ Istruzioni di montaggio

\* Patentiert

\* Patented

\* Patenterad

\* Patentoitu

\* Brevettato



de

Vorschau auf das neue globale Verpackungsdesign

en

Preview on new global packaging design

sv

Förhandsvisning av förpackningens nya globala design

fi

Katsaus uuteen globaaliin pakkausmuotoiluun

it

Anteprima del layout delle nuove confezioni



### Montage Video





de

Verwendung

en

Applications

sv

Använda

fi

Käyttö

it

Impiego

**Benutzerhinweise**

In diesem Katalog sind die Daten von Fahrzeugen, Motoren und Geräten für den europäischen Markt von Baujahr 1993 bis einschließlich 2013 erfasst. Diese wurden aus Hersteller- und Importeurangaben, aus Fahrzeuguntersuchungen sowie aus Unterlagen von Bosch nach bestem Wissen sorgfältig zusammengestellt und geben den Stand zum Zeitpunkt der Drucklegung wieder.

Zwangsläufige Abweichungen durch länderspezifische technische Änderungen können nie ganz ausgeschlossen werden. Bosch kann daher insoweit nicht für die Vollständigkeit und Fehlerfreiheit der Daten haften. Für Irrtümer und Druckfehler, die zu Schäden am Eigentum oder Vermögen führen, haftet Bosch nur bei grob fahrlässiger Pflichtverletzung und bei Vorsatz für unmittelbare Schäden. Bei Personenschäden haftet Bosch auch bei leichter Fahrlässigkeit.

**Notes for users**

This catalog contains the data from the vehicles, engines, and equipment for the European market from year of manufacture 1993 up to and including the year 2013. This data has been assembled from information provided by manufacturers and importers, and taken from Bosch documentation, as well as from investigations made on vehicles. It has been compiled to the best of our knowledge and belief, and reflects the status at the date of going to print.

It is impossible to avoid deviations caused by technical changes resulting from the conditions and regulations applying in a particular country. Bosch can therefore accept no liability for the completeness and faultlessness of the data. In case of mistakes and misprints which result in damage to property or assets, Bosch is only liable for immediate damages insofar as a gross breach of duty or wrongful intent apply. If personal injury is involved, Bosch is liable also in case of ordinary negligence.

**Användarvägledning**

I denna katalog finns data angivna för fordon, motorer och apparater för den europeiska marknaden från årsmodell 1993 till och med 2013. Uppgifterna kommer från tillverkarna och importörerna, från fordonsundersökningar och från underlag från Bosch och är omsorgsfullt sammanställda enligt tillgänglig kunskap och anger läget vid tryckningstidpunkten.

I vissa länder kan specifika avvikelser förekomma p. g. a. tekniska ändringar varför Bosch ej kan hållas ansvarig för ej komplett information. Vid fel som leder till direkt skada på egendom eller fordon, kan Bosch hållas ansvarig endast om grov oaktsamhet kan påvisas. Vid personskador kan Bosch hållas ansvarig om vårdslöshet kan påvisas..

**Ohjeita käyttäjälle**

Oheiseen esitteeseen on koostettu ajoneuvo-, moottori- ja laitekohtaisia tietoja, jotka kattavat Euroopan maissa markkinoituneet mallit v. 1993 lähtien – v. 2013 mukaan lukien. Tiedot on kerätty valikoiden valmistajien ja maahantuojien laatimista tiedoista, katsastusdokumenteista sekä Boschdokumenteista, ja ne vastaavat painoajankohdan tietoja.

Eriäviä tietoja, jotka johtuvat maakohtaisista teknisistä muutoksista, ei voida em. syistä sulkea kokonaan pois. Bosch ei niin ollen voi taata tietojen täydellistä kattavuutta ja virheettömyyttä. Erehdyksistä ja painovirheistä, jotka johtavat omaisuuden vaurioitumiseen, Bosch vastaa vain, jos kyseessä on törkeä velvollisuuden laiminlyönti ja välillisistä vaurioista tahallisen toiminnan seurauksena. Henkilövahingoista Bosch vastaa myös vähäisen laiminlyönnin seurauksena.

**Avvertenze per la consultazione**

Nella seguente parte di catalogo sono contemplati veicoli, motori ed apparecchi a partire dall'anno di costruzione 1993 fino all'anno 2013. Tali informazioni sono state rilevate dalle documentazioni di Case Auto, Importatori, da verifiche eseguite sui veicoli, così come da documentazione Bosch.

Eventuali discordanze dovute a specifiche esigenze del Paese e variazioni tecniche non possono essere previste. Per questo Bosch non si assume alcuna responsabilità per mancanze ed eventuali errori riferite ai dati. Per danni a cose o danni patrimoniali, dovuti ad errori o refusi di stampa, Bosch è responsabile solo in caso di dolo o colpa grave. Per danni alla persona, Bosch è responsabile anche in caso di colpa meno grave

B2 | ALFA ROMEO



Modell	Zeitraum	Optionen	533S	530US	530	530U	530U	480U	Z361
<b>ALFA ROMEO</b>									
Brera [939]	01.06-12.10	A084S ..007 084 AM23U ..008 570 AM18U ..008 565	AP1	AP23U ..006 836	AP18U ..006 831			WGK	Z361 ..033 361
Giulietta [940]	05.10→	A580S ..007 580 AM23U ..008 570 AM18U ..008 565	2AA	AP23U ..006 836	AP18U ..006 831				H353 ..004 631
GT [937]	10.03-06.05	A187S ..007 187 AR550U ..008 937 AR400U ..008 932				552S ..118 427	550US ..004 591	550U ..004 585	400U ..004 579
Mito [955]	08.08→	A972S ..118 972 AM22U ..008 569 AM16U ..008 563	AP1	AP22U ..006 835	AP16U ..006 829				H301 ..004 629
Spider [115]	01.90-12.94	AM466S ..007 466 AM26U ..008 573 AM15U ..008 562	288	AP26U ..006 838	AP15U ..006 828				
Spider [939]	03.06-12.10	A084S ..007 084 AM23U ..008 570 AM18U ..008 565	AP1	AP23U ..006 836	AP18U ..006 831	450S ..118 506	420 ..118 500	450U ..004 581	450U ..004 581
33 Berlina [907]	01.90-10.94					450S ..118 506	450 ..118 505	450U ..004 581	450U ..004 581
33 Sport Wagon [907]	01.90-10.94					450S ..118 506	450 ..118 505	450U ..004 581	450U ..004 581
145 [930]	04.94-04.97					REF	109 ..033 109		
145 [930]	04.97-12.00	AR728S ..118 904 AR550U ..008 937 AR480U ..008 934		728S ..001 728	550US ..004 591	727 ..001 727	550U ..004 585	480U ..004 582	
146 [930]	12.94-04.97					REF	109 ..033 109		
146 [930]	04.97-12.00	AR728S ..118 904 AR550U ..008 937 AR480U ..008 934		728S ..001 728	550US ..004 591	727 ..001 727	550U ..004 585	480U ..004 582	
147 [937]	11.00-06.05	AR552S ..118 984 AR550U ..008 937 AR400U ..008 932		552S ..118 427	550US ..004 591	550U ..004 585	400U ..004 579	WGK	Z361 ..033 361
147 [937]	04.05-12.10	A972S ..118 972 AM22U ..008 569 AM16U ..008 563	AP1	AP22U ..006 835	AP16U ..006 829			WGK	Z361 ..033 361
155 [167]	02.92-04.96					BO	533S ..118 406	530US ..011 352	530 ..118 405
155 [167]	01.93-04.97					REF	109 ..033 109	530U ..004 584	480U ..004 582
156 Berlina [932]	10.97-12.05	FFB 1 AR551S ..118 905 AR550U ..008 937 AR500U ..008 935		551S ..118 423	550US ..004 591	550U ..004 585	500U ..004 583		
156 Berlina [932]	10.97-12.05	FFB 1 AR551S ..118 905 AR550U ..008 937 AR500U ..008 935		BGO	682 ..001 682				
156 Sport Wagon [932]	06.00-12.05	FFB 1 AR551S ..118 905 AR550U ..008 937 AR500U ..008 935		551S ..118 423	550US ..004 591	550U ..004 585	500U ..004 583	WGK	Z361 ..033 361
156 Sport Wagon [932]	06.00-12.05	FFB 1 AR551S ..118 905 AR550U ..008 937 AR500U ..008 935		BGO	682 ..001 682				
159 Berlina [939]	06.05→	A084S ..007 084 AM23U ..008 570 AM18U ..008 565	AP1	AP23U ..006 836	AP18U ..006 831				
159 Sport Wagon [939]	03.06→	A084S ..007 084 AM23U ..008 570 AM18U ..008 565	AP1	AP23U ..006 836	AP18U ..006 831			WGK	Z361 ..033 361
164 [164]	06.87-10.98					530S ..118 401	530US ..011 352	530 ..118 400	530U ..004 584
164 [164]	06.87-10.98					BO	533S ..118 406	530US ..011 352	530 ..118 405
166 [936]	10.98-10.07	AR533S ..118 902 AR530U ..008 936 AR480U ..008 934		533S ..118 406	530US ..011 352	530 ..118 405	530U ..004 584	480U ..004 582	



A = Aerotwin | AM = Aerotwin Multi-Clip | AP = Aerotwin Plus | AR = Aerotwin Retrofit | S = Spoiler | U = Single Pack

Bosch Automotive Aftermarket

2013 | 2014

① **Fahrzeugmarke**  
Hervorhebung der Hersteller im Graubalken

② **Fahrzeugmodell**  
Alphanumerisch aufsteigend sortiert

③ **Modelldetail**  
Besondere Fahrzeugmerkmale

④ **Einbauezeitraum**  
Erster und letzter Einbauezeitraum des jeweiligen Produktes

⑤ **Bildzeichen-Erläuterung**  
Siehe Katalogende

⑥ **Bestellnummer**  
10-stellige Nummer, zum Nachbestellen für den Handel

⑦ **Suchnummer**  
Einprägsame Kurzbezeichnung. Wiederauffindbar auf der Verpackung

⑧ **Sonderfall**  
Erläuterung siehe Katalogende

⑨ **Wischarme**

**Schnelles Finden der gewünschten Wischblätter durch Einteilung in Spoiler, Standard- und Heckwischblätter. Jeweils mit 10-stelliger Bestellnummer.**

en

## How to use this catalog

sv

## Anvisningar för användning

fi

## Käyttöön liittyviä vihjeitä

it

## Istruzioni d'uso

① <b>Vehicle brand</b> Manufacturer indicated in bold print within gray bar	① <b>Fordonsmärke</b> Markering av tillverkaren i grått fält	① <b>Automerkki</b> Valmistaja on ilmoitettu harmaalla taustalla	① <b>Marca del veicolo</b> Evidenziata con fondo grigio
② <b>Vehicle model</b> in alphabetical order	② <b>Fordonsmodell</b> Sorterat alfanumeriskt i stigande ordning	② <b>Ajoneuvomalli</b> Aakkosnumeerisessa järjestyksessä	② <b>Modello veicolo</b> In ordine alfabetico
③ <b>Model specifics</b> Special vehicle information	③ <b>Modelldetalj</b> Speciella kännetecken för fordonet	③ <b>Mallitiedot</b> Ajoneuvomallin erityispiirteet	③ <b>Dettagli modello</b> Particolari caratteristiche del veicolo
④ <b>Production period</b> Production run initiation and termination dates for each particular model	④ <b>Inbyggnadsperiod</b> Första och sista inbyggnadsperiod för respektive produkt	④ <b>Valmistusajanjakso</b> Kyseisen mallin ensimmäinen ja viimeinen valmistusajankohta	④ <b>Periodo di produzione</b> Prima e ultima data di produzione del rispettivo modello del veicolo
⑤ <b>Explanation of symbols</b> Refer at back of catalogue	⑤ <b>Bildtecken, förklaring</b> Se katalogens slut	⑤ <b>Kuvattunnusten selitys</b> Ks. kuvaston lopusta	⑤ <b>Legenda dei simboli</b> A fine catalogo
⑥ <b>Part number</b> 10-digit aftermarket order number	⑥ <b>Beställningsnummer</b> 10-ställigt nummer, vid nybeställningar för handeln	⑥ <b>Tilausnumero</b> 10-merkkinen numero, myyntiportaan tilauksia varten	⑥ <b>Codice di ordinazione</b> A 10 cifre
⑦ <b>Search number</b> Easily remembered code. Repeated on the packaging	⑦ <b>Söknummer</b> Kortbeteckning lätt att minnas. Återfinns på förpackningen	⑦ <b>Hakunumero</b> Mieleenpainuva lyhenne. Sama lyhenne on pakkauksessa	⑦ <b>Numero di ricerca</b> Codice breve facile da ricordare, riportato sulla confezione
⑧ <b>Special version</b> Refer at back of catalogue for details	⑧ <b>Specialfall</b> Förklaring, se katalogens slut	⑧ <b>Erikoisversio</b> Selitys, ks. kuvaston lopusta	⑧ <b>Caso speciale</b> Vedere legenda a fine catalogo
⑨ <b>Wiper arms</b>  <b>Rapid location or required wiper blades due to subdivision into spoiler wiper blades, standard wiper blades and rear window wiper blades, each with 10-digit part number.</b>	⑨ <b>Torkarmar</b>  <b>Snabbsökning av önskat torkarbald genom indelning i spoiler-, standard- och bakrutetorkarblad. Vardera med 10-ställigt beställningsnummer.</b>	⑩ <b>Pyyhkimen varsi</b>  <b>Oikeat pyyhinsulat löytyvät nopeasti, tuoteryhmät on jaoteltu spoileri- ja vakioalleihin ja takalasin pyyhkiimiin. Kaikilla 10-merkkinen tilausnumero.</b>	⑨ <b>Braccio tergicristallo</b>  <b>Ricerca rapida delle spazzole desiderate mediante suddivisione in spazzole spoiler, standard e tergilunotto. Codice di ordinazione a 10 cifre.</b>



3 397...

ALFA ROMEO														
Brera [939]	01.06-12.10		<b>A084S</b> ..007 084	<b>AM23U</b> ..008 570	<b>AM18U</b> ..008 565	AP1	<b>AP23U</b> ..006 836	<b>AP18U</b> ..006 831					WGK	<b>Z361</b> ..033 361
Giulietta [940]	05.10→	③	<b>A580S</b> ..007 580	<b>AM23U</b> ..008 570	<b>AM18U</b> ..008 565	2AA	<b>AP23U</b> ..006 836	<b>AP18U</b> ..006 831						<b>H353</b> ..004 631
		WW ③	<b>A187S</b> ..007 187											
GT [937]	10.03-06.05	①	<b>AR552S</b> ..118 984	<b>AR550U</b> ..008 937	<b>AR400U</b> ..008 932				<b>552S</b> ..118 427	<b>550US</b> ..004 591	<b>550U</b> ..004 585	<b>400U</b> ..004 579		
	04.05-12.10	②	<b>A972S</b> ..118 972	<b>AM22U</b> ..008 569	<b>AM16U</b> ..008 563	AP1	<b>AP22U</b> ..006 835	<b>AP16U</b> ..006 829						
Mito [955]	08.08→	⑥	<b>AM466S</b> ..007 466	<b>AM26U</b> ..008 573	<b>AM15U</b> ..008 562	2BB	<b>AP26U</b> ..006 838	<b>AP15U</b> ..006 828						<b>H301</b> ..004 629
Spider [115]	01.90-12.94								<b>450S</b> ..118 506	<b>420</b> ..118 500	<b>450U</b> ..004 581	<b>450U</b> ..004 581		
	[939]	03.06-12.10	②	<b>A084S</b> ..007 084	<b>AM23U</b> ..008 570	<b>AM18U</b> ..008 565	AP1	<b>AP23U</b> ..006 836	<b>AP18U</b> ..006 831					
33 Berlina [907]	01.90-10.94								① <b>450S</b> ..118 506	<b>450</b> ..118 505	<b>450U</b> ..004 581	<b>450U</b> ..004 581	①	<b>H400/400U</b> ..004 757
33 Sport Wagon [907]	01.90-10.94								① <b>450S</b> ..118 506	<b>450</b> ..118 505	<b>450U</b> ..004 581	<b>450U</b> ..004 581	①	<b>H400/400U</b> ..004 757
145 [930]	04.94-04.97								REF		<b>109</b> ..033 109			
	04.97-12.00	①	<b>AR728S</b> ..118 904	<b>AR550U</b> ..008 937	<b>AR480U</b> ..008 934				<b>728S</b> ..001 728	<b>550US</b> ..004 591	<b>727</b> ..001 727	<b>550U</b> ..004 585	<b>480U</b> ..004 582	
146 [930]	12.94-04.97								REF		<b>109</b> ..033 109			
	04.97-12.00	①	<b>AR728S</b> ..118 904	<b>AR550U</b> ..008 937	<b>AR480U</b> ..008 934				<b>728S</b> ..001 728	<b>550US</b> ..004 591	<b>727</b> ..001 727	<b>550U</b> ..004 585	<b>480U</b> ..004 582	
147 [937]	11.00-06.05	①	<b>AR552S</b> ..118 984	<b>AR550U</b> ..008 937	<b>AR400U</b> ..008 932				<b>552S</b> ..118 427	<b>550US</b> ..004 591	<b>550U</b> ..004 585	<b>400U</b> ..004 579	WGK	<b>Z361</b> ..033 361
	04.05-12.10	②	<b>A972S</b> ..118 972	<b>AM22U</b> ..008 569	<b>AM16U</b> ..008 563	AP1	<b>AP22U</b> ..006 835	<b>AP16U</b> ..006 829					WGK	<b>Z361</b> ..033 361
155 [167]	02.92-04.96								BO ①	<b>533S</b> ..118 406	<b>530US</b> ..011 352	<b>533</b> ..118 405	<b>530U</b> ..004 584	<b>480U</b> ..004 582
	01.93-04.97								REF		<b>109</b> ..033 109			
156 Berlina [932]	10.97-12.05	FFB ①	<b>AR551S</b> ..118 905	<b>AR550U</b> ..008 937	<b>AR500U</b> ..008 935				<b>551S</b> ..118 423	<b>550US</b> ..004 591	<b>550U</b> ..004 585	<b>500U</b> ..004 583		
									BGO		<b>682</b> ..001 682			
156 Sport Wagon [932]	06.00-12.05	FFB ①	<b>AR551S</b> ..118 905	<b>AR550U</b> ..008 937	<b>AR500U</b> ..008 935				<b>551S</b> ..118 423	<b>550US</b> ..004 591	<b>550U</b> ..004 585	<b>500U</b> ..004 583	WGK	<b>Z361</b> ..033 361
									BGO		<b>682</b> ..001 682			
159 Berlina [939]	06.05→	②	<b>A084S</b> ..007 084	<b>AM23U</b> ..008 570	<b>AM18U</b> ..008 565	AP1	<b>AP23U</b> ..006 836	<b>AP18U</b> ..006 831						
159 Sport Wagon [939]	03.06→	②	<b>A084S</b> ..007 084	<b>AM23U</b> ..008 570	<b>AM18U</b> ..008 565	AP1	<b>AP23U</b> ..006 836	<b>AP18U</b> ..006 831					WGK	<b>Z361</b> ..033 361
164 [164]	06.87-10.98								①	<b>530S</b> ..118 401	<b>530US</b> ..011 352	<b>530</b> ..118 400	<b>530U</b> ..004 584	<b>530U</b> ..004 584
166 [936]	10.98-10.07	①	<b>AR533S</b> ..118 902	<b>AR530U</b> ..008 936	<b>AR480U</b> ..008 934				BO	<b>533S</b> ..118 406	<b>530US</b> ..011 352	<b>533</b> ..118 405	<b>530U</b> ..004 584	<b>480U</b> ..004 582



A = Aerotwin | AM = Aerotwin Multi-Clip | AP = Aerotwin Plus | AR = Aerotwin Retrofit | S = Spoiler | U = Single Pack



3 397...

ASTON MARTIN																
Cygnets	04.11→	①	AR531S ..118 901	AR530U ..008 936	AR450U ..008 933					531S ..118 403	530US ..011 352	531 ..118 402	530U ..004 584	450U ..004 581		
DB9, Volante	07.11→	③	A088S ..007 088													
DBS Vantage, Volante	07.11→	③	A088S ..007 088													
Rapide	07.11→	③	A088S ..007 088													
V8/V12	07.11→	③	A088S ..007 088													
Virage Coupe, Volante	07.11→	③	A088S ..007 088													
AUDI																
A1 [8X1]	05.10→	③	A555S ..007 555			AP4	AP24U ..006 837	AP15U ..006 828							A360H ..008 997	
A1 Sportback [8XA]	09.11→	③	A555S ..007 555			AP4	AP24U ..006 837	AP15U ..006 828							APE	A282H ..008 634
A2 [8Z0]	09.99-06.01	①		AR70N ..008 845									N70 ..018 170			
	07.01-08.05	②	A960S ..018 960	AM30U ..008 928		AP1	AP30U ..006 840									
A3 [8L1]	09.96-06.03	①	AR533S ..118 902	AR530U ..008 936	AR480U ..008 934				GA	533S ..118 406	530US ..011 352	533 ..118 405	530U ..004 584	480U ..004 582	①	H380/380U ..004 756
									BGO	584S ..001 584						
[8P1]	05.03→	②,⑥	AM462S ..007 462	AM24U ..008 571	AM19U ..008 566											H772 ..004 772
	05.03-11.04	②	A936S ..118 936			AP1	AP24U ..006 837	AP19U ..006 832								
	12.04→	⑥	A929S ..118 929			2BB	AP24U ..006 837	AP19U ..006 832								
[8V1]	04.12→	③	A863S ..007 863			AP4	AP26U ..006 838	AP18U ..006 831								A332H ..008 635
A3 Cabriolet [8P7]	04.08→	⑥		AM24U ..008 571	AM18U ..008 565	2BB	AP24U ..006 837	AP18U ..006 831								
A3 Sportback [8PA]	09.04→	②,⑥	AM462S ..007 462	AM24U ..008 571	AM19U ..008 566											
	09.04-11.04	②	A936S ..118 936			AP1	AP24U ..006 837	AP19U ..006 832								
	12.04→	⑥	A929S ..118 929			2BB	AP24U ..006 837	AP19U ..006 832								
[8VA]	09.12→	③	A863S ..007 863			AP4	AP26U ..006 838	AP18U ..006 831								A332H ..008 635
A4 [8D2; B5]	11.94-12.98	①	AR530S ..118 903	AR530U ..008 936	AR530U ..008 936				BGR	530S ..118 401	530US ..011 352	530 ..118 400	530U ..004 584	530U ..004 584		
	08.98-09.01	①	AR530S ..118 903	AR530U ..008 936	AR530U ..008 936				BGO	583S ..001 583	530US ..011 352	682 ..001 682	530U ..004 584	530U ..004 584		
	09.01-10.01								WOB			909 ..001 909				
[8E2; B6]	10.00-03.01	①	AR530S ..118 903	AR530U ..008 936	AR530U ..008 936				BGO	583S ..001 583	530US ..011 352		530U ..004 584	530U ..004 584		



A = Aerotwin | AM = Aerotwin Multi-Clip | AP = Aerotwin Plus | AR = Aerotwin Retrofit | S = Spoiler | U = Single Pack







3 397...

<b>A6 Avant</b> [4B5; C5]	06.01-01.05	④	<b>A933S</b> ..118 933															①	<b>H380/380U</b> ..004 756
[4F5; C6]	03.05→	⑧	<b>A934S</b> ..118 934																<b>H383</b> ..011 551
[4G5; C7]	05.11→	③	<b>A638S</b> ..007 638			AP4	<b>AP26U</b> ..006 838	<b>AP21U</b> ..006 834											<b>A402H</b> ..008 057
<b>A6 Avant Allroad</b> [4BH; C5]	05.00-12.00	①	<b>AR550S</b> ..118 906	<b>AR550U</b> ..008 937	<b>AR530U</b> ..008 936				BGO	<b>582S</b> ..001 582								①	<b>H380/380U</b> ..004 756
	01.01-08.05	④	<b>A933S</b> ..118 933															①	<b>H380/380U</b> ..004 756
[4FH; C6]	05.06→	⑧	<b>A934S</b> ..118 934																<b>H383</b> ..011 551
[4GH; C7]	01.12→	③	<b>A638S</b> ..007 638			AP4	<b>AP26U</b> ..006 838	<b>AP21U</b> ..006 834											<b>A402H</b> ..008 057
<b>A7 Sportback</b> [4GA]	07.10→	③	<b>A862S</b> ..007 862			AP4	<b>AP24U</b> ..006 837	<b>AP21U</b> ..006 834											
		KUR ③	<b>A297S</b> ..007 297																
<b>A8</b> [4D2; D2]	06.94-09.02	FFB ①	<b>AR551S</b> ..118 905	<b>AR550U</b> ..008 937	<b>AR500U</b> ..008 935				BGO	<b>582S</b> ..001 582									
[4H; D4]	11.09→	③	<b>A586S</b> ..007 586			AP4	<b>AP28U</b> ..006 839	<b>AP20U</b> ..006 833											
<b>Cabriolet</b> [8G7; B4]	06.91-08.00	①	<b>AR550S</b> ..118 906	<b>AR550U</b> ..008 937	<b>AR530U</b> ..008 936					<b>550S</b> ..118 421	<b>550US</b> ..004 591	<b>550</b> ..118 420	<b>550U</b> ..004 585	<b>550U</b> ..004 585					
<b>Coupé</b> [89; B3]	11.88-12.95	①	<b>AR550S</b> ..118 906	<b>AR550U</b> ..008 937	<b>AR530U</b> ..008 936					<b>550S</b> ..118 421	<b>550US</b> ..004 591	<b>550</b> ..118 420	<b>550U</b> ..004 585	<b>550U</b> ..004 585				①	<b>H500/500U</b> ..004 760
<b>Q3</b> [8UB]	06.11→	③	<b>A862S</b> ..007 862			AP4	<b>AP24U</b> ..006 837	<b>AP21U</b> ..006 834											<b>A402H</b> ..008 057
		KUR ③	<b>A297S</b> ..007 297																
<b>Q5</b> [8RB]	11.08→	③	<b>A297S</b> ..007 297			AP4	<b>AP24U</b> ..006 837	<b>AP20U</b> ..006 833											<b>A332H</b> ..008 635
<b>Q7</b> [4LB]	03.06→	⑥	<b>A215S</b> ..007 215	<b>AM26U</b> ..008 573	<b>AM24U</b> ..008 571	2BB	<b>AP26U</b> ..006 838	<b>AP24U</b> ..006 837										KUR	<b>H772</b> ..004 772
<b>RS3 Sportback</b> [8PA]	01.11→	⑥	<b>A929S</b> ..118 929	<b>AM24U</b> ..008 571	<b>AM19U</b> ..008 566	2BB	<b>AP24U</b> ..006 837	<b>AP19U</b> ..006 832											
		WW ⑥	<b>AM462S</b> ..007 462																
<b>RS4</b> [8EC; B7]	11.05-06.08	④	<b>A933S</b> ..118 933																
<b>RS4 Avant</b> [8D5; B5]	05.00-09.01	①	<b>AR530S</b> ..118 903	<b>AR530U</b> ..008 936	<b>AR530U</b> ..008 936				BGO	<b>583S</b> ..001 583	<b>530US</b> ..011 352		<b>530U</b> ..004 584					①	<b>H380/380U</b> ..004 756
[8ED; B7]	05.06-06.08	④	<b>A933S</b> ..118 933																<b>H772</b> ..004 772
[8K5; B8]	05.12→	③	<b>A297S</b> ..007 297			AP4	<b>AP24U</b> ..006 837	<b>AP20U</b> ..006 833											<b>A402H</b> ..008 057
<b>RS4 Cabriolet</b> [8HE; B7]	05.06-01.08	④	<b>A933S</b> ..118 933																
<b>RS5 Coupé</b> [8T3]	03.10→	③	<b>A297S</b> ..007 297			AP4	<b>AP24U</b> ..006 837	<b>AP20U</b> ..006 833											
<b>RS5 Cabriolet</b> [8T3]	03.10→	③	<b>A297S</b> ..007 297			AP4	<b>AP24U</b> ..006 837	<b>AP20U</b> ..006 833											
<b>RS6</b> [4B4]	07.02-04.04	①	<b>AR550S</b> ..118 906	<b>AR550U</b> ..008 937	<b>AR550U</b> ..008 937					<b>582S</b> ..001 582									
[4F2; C6]	09.08-08.10	⑧	<b>A934S</b> ..118 934																



A = Aerotwin | AM = Aerotwin Multi-Clip | AP = Aerotwin Plus | AR = Aerotwin Retrofit | S = Spoiler | U = Single Pack





◀ AUDI

3 397...

Model	Period	Icon	AR550S	AR550U	AR550U	AP4	AP26U	AP21U	GA	533S	530US	533	530U	480U	Icon	H380/380U
RS6 Avant [4B6]	07.02-04.04	①	AR550S ..118 906	AR550U ..008 937	AR550U ..008 937					582S ..001 582						H380/380U ..004 756
[4F2; C6]	04.08-08.10	⑧	A934S ..118 934													H383 ..011 551
[4GH; C7]	01.13→	③	A638S ..007 638			AP4	AP26U ..006 838	AP21U ..006 834								A402H ..008 057
S3 [8L1]	08.98-06.03	①	AR533S ..118 902	AR530U ..008 936	AR480U ..008 934				GA	533S ..118 406	530US ..011 352	533 ..118 405	530U ..004 584	480U ..004 582	①	H380/380U ..004 756
	08.98-06.03								BGO	584S ..001 584						
[8P1]	11.06→	⑥	A929S ..118 929	AM24U ..008 571	AM19U ..008 566	2BB	AP24U ..006 837	AP19U ..006 832								H772 ..004 772
		WW	AM462S ..007 462													
[8V1]	11.12→	③	A863S ..007 863			AP4	AP26U ..006 838	AP18U ..006 831								A332H ..008 635
S3 Sportback [8PA]	07.08→	⑥	A929S ..118 929	AM24U ..008 571	AM19U ..008 566	2BB	AP24U ..006 837	AP19U ..006 832								
		WW	AM462S ..007 462													
S4 [4A2; C4]	07.92-07.94	①	AR550S ..118 906	AR550U ..008 937	AR530U ..008 936					550S ..118 421	550US ..004 591	550 ..118 420	550U ..004 585	550U ..004 585	①	H450/450U ..004 763
[8D2; B5]	08.98-09.01	①	AR530S ..118 903	AR530U ..008 936	AR530U ..008 936				BGO	583S ..001 583	530US ..011 352		530U ..004 584			
[8E2; B6]	03.03-10.03								WOB			909 ..001 909				
	11.03-12.04	④	A933S ..118 933													
[8EC; B7]	11.04-06.08	④	A933S ..118 933													
[8K2; B8]	03.09→	③	A297S ..007 297			AP4	AP24U ..006 837	AP20U ..006 833								
S4 Avant [8D5; B5]	10.97-09.01	①	AR530S ..118 903	AR530U ..008 936	AR530U ..008 936				BGO	583S ..001 583	530US ..011 352				①	H380/380U ..004 756
[8E5; B6]	03.03-10.03								WOB			909 ..001 909				H772 ..004 772
	11.03-12.04	④	A933S ..118 933													H772 ..004 772
[8ED; B7]	11.04-06.08	④	A933S ..118 933													H772 ..004 772
[8K2; B8]	03.09→	③	A297S ..007 297			AP4	AP24U ..006 837	AP20U ..006 833								A402H ..008 057
S4 Cabriolet [8HE; B7; 8H7; B7]	02.04-03.09	KUR	A933S ..118 933													
[8F7]	06.09→	③	A297S ..007 297			AP4	AP24U ..006 837	AP20U ..006 833								
S5 Coupé [8T3]	11.07→	③	A297S ..007 297			AP4	AP24U ..006 837	AP20U ..006 833								
S5 Sportback [8TA]	01.10→	③	A297S ..007 297			AP4	AP24U ..006 837	AP20U ..006 833								
S6 [4A2; C4]	06.94-10.97	①	AR550S ..118 906	AR550U ..008 937	AR530U ..008 936					550S ..118 421	550US ..004 591	550 ..118 420	550U ..004 585	550U ..004 585		
[4B; C5]	09.99-05.04	①	AR550S ..118 906	AR550U ..008 937	AR530U ..008 936				BGO	582S ..001 582						
[4F2; C6]	06.06→	⑧	A934S ..118 934													



A = Aerotwin | AM = Aerotwin Multi-Clip | AP = Aerotwin Plus | AR = Aerotwin Retrofit | S = Spoiler | U = Single Pack



3 397...

<b>S6</b> [4G2; C7]	04.12→	③	<b>A638S</b> ..007 638			AP4	<b>AP26U</b> ..006 838	<b>AP21U</b> ..006 834									
<b>S6 Avant</b> [4A5; C4]	06.94-10.97	①	<b>AR550S</b> ..118 906	<b>AR550U</b> ..008 937	<b>AR530U</b> ..008 936					<b>550S</b> ..118 421	<b>550US</b> ..004 591	<b>550</b> ..118 420	<b>550U</b> ..004 585	<b>550U</b> ..004 585	①	<b>H450/450U</b> ..004 763	
[4B; C5]	09.99-01.05	①	<b>AR550S</b> ..118 906	<b>AR550U</b> ..008 937	<b>AR530U</b> ..008 936				BGO	<b>582S</b> ..001 582					①	<b>H380/380U</b> ..004 756	
[4F5; C6]	06.06→	⑧	<b>A934S</b> ..118 934													<b>H383</b> ..011 551	
[4GH; C7]	04.12→	③	<b>A638S</b> ..007 638			AP4	<b>AP26U</b> ..006 838	<b>AP21U</b> ..006 834								<b>A402H</b> ..008 057	
<b>S7 Sportback</b> [4GA]	04.12→	③	<b>A862S</b> ..007 862			AP4	<b>AP24U</b> ..006 837	<b>AP21U</b> ..006 834									
<b>S8</b> [4D2]	09.96-09.02	①	<b>AR550S</b> ..118 906	<b>AR550U</b> ..008 937	<b>AR530U</b> ..008 936				BGO	<b>582S</b> ..001 582							
[4H; D4]	04.12→	③	<b>A586S</b> ..007 586														
<b>SQ5</b> [8RB]	12.12→	③	<b>A297S</b> ..007 297			AP4	<b>AP24U</b> ..006 837	<b>AP20U</b> ..006 833								<b>A332H</b> ..008 635	
<b>TT Coupé</b> [8N3]	07.98-04.03								BGO	<b>550US</b> ..004 591	<b>682</b> ..001 682	<b>550U</b> ..004 585					
	05.03-06.06	②	<b>A923S</b> ..118 923	<b>AM21U</b> ..008 568	<b>AM21U</b> ..008 568	AP1	<b>AP21U</b> ..006 834	<b>AP21U</b> ..006 834									
[8J3]	07.06→	⑥	<b>A290S</b> ..007 290	<b>AM22U</b> ..008 569	<b>AM21U</b> ..008 568	2BB	<b>AP22U</b> ..006 835	<b>AP21U</b> ..006 834									
<b>TT Roadster</b> [8N9]	03.99-04.03								BGO	<b>550US</b> ..004 591	<b>682</b> ..001 682	<b>550U</b> ..004 585					
	05.03-06.06	②	<b>A923S</b> ..118 923	<b>AM21U</b> ..008 568	<b>AM21U</b> ..008 568	AP1	<b>AP21U</b> ..006 834	<b>AP21U</b> ..006 834									
[8J9]	02.07→	⑥	<b>A290S</b> ..007 290	<b>AM22U</b> ..008 569	<b>AM21U</b> ..008 568	2BB	<b>AP22U</b> ..006 835	<b>AP21U</b> ..006 834									
<b>TT RS Coupé</b> [8J3]	07.09→	⑥	<b>A290S</b> ..007 290	<b>AM22U</b> ..008 569	<b>AM21U</b> ..008 568	2BB	<b>AP22U</b> ..006 835	<b>AP21U</b> ..006 834									
<b>TT RS Roadster</b> [8J9]	07.09→	⑥	<b>A290S</b> ..007 290	<b>AM22U</b> ..008 569	<b>AM21U</b> ..008 568	2BB	<b>AP22U</b> ..006 835	<b>AP21U</b> ..006 834									
<b>TTS Coupé</b> [8J3]	05.08→	⑥	<b>A290S</b> ..007 290	<b>AM22U</b> ..008 569	<b>AM21U</b> ..008 568	2BB	<b>AP22U</b> ..006 835	<b>AP21U</b> ..006 834									
<b>TTS Roadster</b> [8J9]	05.08→	⑥	<b>A290S</b> ..007 290	<b>AM22U</b> ..008 569	<b>AM21U</b> ..008 568	2BB	<b>AP22U</b> ..006 835	<b>AP21U</b> ..006 834									
<b>80</b> [8C2; B4]	09.91-05.95	①	<b>AR532S</b> ..118 986	<b>AR530U</b> ..008 936	<b>AR500U</b> ..008 935					<b>530S</b> ..118 401	<b>530US</b> ..011 352	<b>530</b> ..118 400	<b>530U</b> ..004 584	<b>530U</b> ..004 584			
<b>80 Avant</b> [8C5; B4]	03.92-07.95	①	<b>AR532S</b> ..118 986	<b>AR530U</b> ..008 936	<b>AR500U</b> ..008 935					<b>530S</b> ..118 401	<b>530US</b> ..011 352	<b>530</b> ..118 400	<b>530U</b> ..004 584	<b>530U</b> ..004 584	①	<b>H400/400U</b> ..004 757	
<b>100</b> [4A2; C4]	12.90-07.94	①	<b>AR550S</b> ..118 906	<b>AR550U</b> ..008 937	<b>AR530U</b> ..008 936					<b>550S</b> ..118 421	<b>550US</b> ..004 591	<b>550</b> ..118 420	<b>550U</b> ..004 585	<b>550U</b> ..004 585			
<b>100 Avant</b> [4A5; C4]	12.90-07.94	①	<b>AR550S</b> ..118 906	<b>AR550U</b> ..008 937	<b>AR530U</b> ..008 936					<b>550S</b> ..118 421	<b>550US</b> ..004 591	<b>550</b> ..118 420	<b>550U</b> ..004 585	<b>550U</b> ..004 585	①	<b>H450/450U</b> ..004 763	

BMW

<b>Serie 1</b> [E 81; E 87]	09.04-12.11	⑥	<b>A922S</b> ..118 922	<b>AM20U</b> ..008 567	<b>AM20U</b> ..008 567	2BB	<b>AP20U</b> ..006 833	<b>AP20U</b> ..006 833								<b>A280H</b> ..008 005
[F 20; F21]	09.11→	⑥	<b>A696S</b> ..007 696	<b>AM22U</b> ..008 569	<b>AM18U</b> ..008 565	2BB	<b>AP22U</b> ..006 835	<b>AP18U</b> ..006 831								<b>H306</b> ..011 432
<b>Serie 1 Cabrio</b> [E 88]	03.08→	⑥	<b>A922S</b> ..118 922	<b>AM20U</b> ..008 567	<b>AM20U</b> ..008 567	2BB	<b>AP20U</b> ..006 833	<b>AP20U</b> ..006 833								
<b>Serie 1 Coupé</b> [E 82]	10.07→	⑥	<b>A922S</b> ..118 922	<b>AM20U</b> ..008 567	<b>AM20U</b> ..008 567	2BB	<b>AP20U</b> ..006 833	<b>AP20U</b> ..006 833								



A = Aerotwin | AM = Aerotwin Multi-Clip | AP = Aerotwin Plus | AR = Aerotwin Retrofit | S = Spoiler | U = Single Pack





◀ BMW

3 397...

<b>Serie 3 [E 36]</b>	09.90-12.98	①	<b>AR532S</b> ..118 986	<b>AR530U</b> ..008 936	<b>AR500U</b> ..008 935				<b>532S</b> ..118 404	<b>530US</b> ..011 352	<b>530U</b> ..004 584	<b>500U</b> ..004 583		
[E 46]	04.98-03.05	FFB	<b>AR607S</b> ① ..118 909	<b>AR600U</b> ..008 938	<b>AR480U</b> ..008 934				<b>394S</b> ..001 394					
		WW	<b>AR728S</b> ① ..118 904	<b>AR550U</b> ..008 937	<b>AR480U</b> ..008 934									
[E 90]	03.05-08.09	②	<b>A072S</b> ..007 072											
	03.05-08.09	OAM	<b>AM462S</b> ② ..007 462	<b>AM24U</b> ..008 571	<b>AM19U</b> ..008 566	AP1, OAM	<b>AP24U</b> ..006 837	<b>AP19U</b> ..006 832						
	09.09→	⑥	<b>A929S</b> ..118 929	<b>AM24U</b> ..008 571	<b>AM19U</b> ..008 566	2BB	<b>AP24U</b> ..006 837	<b>AP19U</b> ..006 832						
		WW	<b>AM462S</b> ⑥ ..007 462											
[F 30]	02.12→	⑥	<b>A929S</b> ..118 929	<b>AM24U</b> ..008 571	<b>AM19U</b> ..008 566	2BB	<b>AP24U</b> ..006 837	<b>AP19U</b> ..006 832						
		WW	<b>AM462S</b> ⑥ ..007 462											
<b>Serie 3 Cabrio</b>	09.85-12.93								① <b>500S</b> ..118 561	<b>500US</b> ..004 590	<b>500</b> ..118 560	<b>500U</b> ..004 583	<b>500U</b> ..004 583	
[E 30]														
[E 36]	03.93-12.99	①	<b>AR532S</b> ..118 986	<b>AR530U</b> ..008 936	<b>AR500U</b> ..008 935				<b>532S</b> ..118 404	<b>530US</b> ..011 352	<b>530U</b> ..004 584	<b>500U</b> ..004 583		
[E 46]	03.00-08.06	FFB	<b>AR607S</b> ① ..118 909	<b>AR600U</b> ..008 938	<b>AR480U</b> ..008 934				<b>394S</b> ..001 394					
		WW	<b>AR728S</b> ① ..118 904	<b>AR550U</b> ..008 937	<b>AR480U</b> ..008 934									
[E 93]	09.06-08.09	OAM	<b>A452S</b> ② ..007 452	<b>AM24U</b> ..008 571	<b>AM16U</b> ..008 563	AP1, OAM	<b>AP24U</b> ..006 837	<b>AP16U</b> ..006 829						
	09.09→	⑥	<b>A579S</b> ..007 579	<b>AM24U</b> ..008 571	<b>AM16U</b> ..008 563	2BB	<b>AP24U</b> ..006 837	<b>AP17U</b> ..006 830						
<b>Serie 3 Compact</b>	03.94-09.00	①	<b>AR500S</b> ..009 081	<b>AR500U</b> ..008 935	<b>AR500U</b> ..008 935				<b>500S</b> ..118 561	<b>500US</b> ..004 590	<b>500</b> ..118 560	<b>500U</b> ..004 583	<b>500U</b> ..004 583	① <b>H450/450U</b> ..004 763
[E 36]														
[E 46]	06.01-12.04	FFB	<b>AR607S</b> ① ..118 909	<b>AR600U</b> ..008 938	<b>AR480U</b> ..008 934				<b>394S</b> ..001 394					① <b>H450/450U</b> ..004 763
		WW	<b>AR728S</b> ① ..118 904	<b>AR550U</b> ..008 937	<b>AR480U</b> ..008 934									
<b>Serie 3 Coupé</b>	03.92-12.99	①	<b>AR532S</b> ..118 986	<b>AR530U</b> ..008 936	<b>AR500U</b> ..008 935				<b>532S</b> ..118 404	<b>530US</b> ..011 352	<b>530U</b> ..004 584	<b>500U</b> ..004 583		
[E 36]														
[E 46]	04.98-05.06	FFB	<b>AR607S</b> ① ..118 909	<b>AR600U</b> ..008 938	<b>AR480U</b> ..008 934				<b>394S</b> ..001 394					
		WW	<b>AR728S</b> ① ..118 904	<b>AR550U</b> ..008 937	<b>AR480U</b> ..008 934									
[E 92]	09.06-08.09	OAM	<b>A452S</b> ② ..007 452	<b>AM24U</b> ..008 571	<b>AM16U</b> ..008 563	AP1, OAM	<b>AP24U</b> ..006 837	<b>AP16U</b> ..006 829						
	09.09→	⑥	<b>A579S</b> ..007 579	<b>AM24U</b> ..008 571	<b>AM16U</b> ..008 563	2BB	<b>AP24U</b> ..006 837	<b>AP17U</b> ..006 830						
<b>Serie 3 GT [F 34]</b>	06.13→	⑥	<b>A929S</b> ..118 929	<b>AM24U</b> ..008 571	<b>AM19U</b> ..008 566	2BB	<b>AP24U</b> ..006 837	<b>AP19U</b> ..006 832						
		WW	<b>AM462S</b> ⑥ ..007 462											
<b>Serie 3 Touring</b>	07.87-06.94								① <b>500S</b> ..118 561	<b>500US</b> ..004 590	<b>500</b> ..118 560	<b>500U</b> ..004 583	<b>500U</b> ..004 583	<b>H425</b> ..004 561
[E 30]														
[E 36]	03.95-12.99	①	<b>AR532S</b> ..118 986	<b>AR530U</b> ..008 936	<b>AR500U</b> ..008 935				<b>532S</b> ..118 404	<b>530US</b> ..011 352	<b>530U</b> ..004 584	<b>500U</b> ..004 583	① <b>H380/380U</b> ..004 756	
[E 46]	10.99-09.05	FFB	<b>AR607S</b> ① ..118 909	<b>AR600U</b> ..008 938	<b>AR480U</b> ..008 934				<b>394S</b> ..001 394					<b>H305</b> ..011 239



A = Aerotwin | AM = Aerotwin Multi-Clip | AP = Aerotwin Plus | AR = Aerotwin Retrofit | S = Spoiler | U = Single Pack



3 397...

<b>Serie 3 Touring</b>	10.99-09.05	WW	<b>AR728S</b> ..118 904	<b>AR550U</b> ..008 937	<b>AR480U</b> ..008 934														
[E 46]		①																	
[E 91]	09.05-08.09	②	<b>A072S</b> ..007 072																<b>A340H</b> ..008 004
		OAM	<b>AM462S</b> ..007 462	<b>AM24U</b> ..008 571	<b>AM19U</b> ..008 566	AP1, OAM	<b>AP24U</b> ..006 837	<b>AP19U</b> ..006 832											
	09.09→	⑥	<b>A929S</b> ..118 929	<b>AM24U</b> ..008 571	<b>AM19U</b> ..008 566	2BB	<b>AP24U</b> ..006 837	<b>AP19U</b> ..006 832											<b>A340H</b> ..008 004
		WW	<b>AM462S</b> ..007 462																
[F 31]	09.12→	⑥	<b>A929S</b> ..118 929	<b>AM24U</b> ..008 571	<b>AM19U</b> ..008 566	2BB	<b>AP24U</b> ..006 837	<b>AP19U</b> ..006 832										APE, KUR	<b>A281H</b> ..008 045
		WW	<b>AM462S</b> ..007 462															APE, KUR	<b>A280H</b> ..008 005
<b>Serie 5 [E 34]</b>	01.88-12.95											<b>602S</b> ..118 302							
[E 39]	09.95-07.03													<b>539</b> ..001 539					
[E 60]	07.03-02.10	⑥	<b>A955S</b> ..118 955	<b>AM24U</b> ..008 571	<b>AM23U</b> ..008 570	2CC	<b>AP24U</b> ..006 837	<b>AP23U</b> ..006 836											
[F 10]	03.10→	②	<b>A523S</b> ..007 523			AP1	<b>AP26U</b> ..006 838	<b>AP18U</b> ..006 831											
<b>Serie 5 GT [F 07]</b>	10.09→	KUR	<b>A523S</b> ..007 523			AP1	<b>AP26U</b> ..006 838	<b>AP19U</b> ..006 832											
<b>Serie 5 Touring</b>	11.91-12.96											<b>602S</b> ..118 302							<b>H425</b> ..004 561
[E 34]																			
[E 39]	12.96-05.04													<b>539</b> ..001 539					<b>H425</b> ..004 561
[E 61]	05.04-08.10	⑥	<b>A955S</b> ..118 955	<b>AM24U</b> ..008 571	<b>AM23U</b> ..008 570	2CC	<b>AP24U</b> ..006 837	<b>AP23U</b> ..006 836											<b>H753</b> ..004 753
[F 11]	09.10→	②	<b>A523S</b> ..007 523			AP1	<b>AP26U</b> ..006 838	<b>AP18U</b> ..006 831											<b>A351H</b> ..008 192
<b>Serie 6 [E 63]</b>	01.04-07.10	⑥	<b>A955S</b> ..118 955	<b>AM24U</b> ..008 571	<b>AM23U</b> ..008 570	2CC	<b>AP24U</b> ..006 837	<b>AP23U</b> ..006 836											
[F 13]	10.11→	②	<b>A642S</b> ..007 653			AP1	<b>AP26U</b> ..006 838	<b>AP17U</b> ..006 830											
<b>Serie 6 Cabrio</b>	04.04-07.10	⑥	<b>A955S</b> ..118 955	<b>AM24U</b> ..008 571	<b>AM23U</b> ..008 570	2CC	<b>AP24U</b> ..006 837	<b>AP23U</b> ..006 836											
[E 64]																			
[F 12]	03.11→	②	<b>A642S</b> ..007 653			AP1	<b>AP26U</b> ..006 838	<b>AP17U</b> ..006 830											
<b>Serie 6 GC [F 06]</b>	05.12→	②	<b>A642S</b> ..007 653			AP1	<b>AP26U</b> ..006 838	<b>AP17U</b> ..006 830											
<b>Serie 7 [E 32]</b>	09.86-10.94											<b>602S</b> ..118 302							
[E 38]	06.94-12.01											<b>367S</b> ..001 367							
[E 65; E 66]	11.01-10.08											<b>814S</b> ..001 814							
[F 01; F 02; F 04]	11.08→	KUR	<b>A523S</b> ..007 523			AP1	<b>AP26U</b> ..006 838	<b>AP19U</b> ..006 832											
<b>Serie 8 [E 31]</b>	07.89-12.99											<b>602S</b> ..118 302							
<b>X1 [E 84]</b>	10.09→	⑥	<b>A929S</b> ..118 929	<b>AM24U</b> ..008 571	<b>AM19U</b> ..008 566	2BB	<b>AP24U</b> ..006 837	<b>AP19U</b> ..006 832											<b>A333H</b> ..008 995
		WW	<b>AM462S</b> ..007 462																



A = Aerotwin | AM = Aerotwin Multi-Clip | AP = Aerotwin Plus | AR = Aerotwin Retrofit | S = Spoiler | U = Single Pack





◀ BMW

3 397...

X3 [E 83]	01.04-08.10	①	AR551S ..118 905	AR550U ..008 937	AR500U ..008 935					551S ..118 423	550US ..004 591	551 ..118 422	550U ..004 585	500U ..004 583	H351 ..004 559	
	[F 25]	10.10→	②	A953S ..118 953	AM26U ..008 573	AM20U ..008 567	AP1	AP26U ..006 838	AP20U ..006 833							APE A330H ..008 006
X5 [E 53]	03.99-10.06	FFB	AR801S ..118 996	AR600U ..008 938	AR530U ..008 936					608S ..118 308	600US ..004 592	608 ..118 307	600U ..004 586	550U ..004 585	H425 ..004 561	
	[E 70]	11.06→	KUR	AM462S ②,③ ..007 462	AM24U ..008 571	AM20U ..008 567									A380H ..008 050	
		11.06-03.12	②	A970S ..118 970			AP1	AP24U ..006 837	AP20U ..006 833							
		04.12→	③	A296S ..007 296			2AA	AP24U ..006 837	AP20U ..006 833							
X6 [E 71; E 72]	03.08→	KUR	AM462S ②,③ ..007 462	AM24U ..008 571	AM20U ..008 567											
		03.08-03.12	②	A970S ..118 970			AP1	AP24U ..006 837	AP20U ..006 833							
		04.12→	③	A296S ..007 296			2AA	AP24U ..006 837	AP20U ..006 833							
Z1 [E30]	07.88-06.91								①	500S ..118 561	500US ..004 590	500 ..118 560	500U ..004 583	500U ..004 583		
Z3 [E 36/7]	03.95-09.02	①	AR500S ..009 081	AR500U ..008 935	AR500U ..008 935					500S ..118 561	500US ..004 590	500 ..118 560	500U ..004 583	500U ..004 583		
Z3 Coupé [E 36/8]	09.97-06.02	①	AR500S ..009 081	AR500U ..008 935	AR500U ..008 935					500S ..118 561	500US ..004 590	500 ..118 560	500U ..004 583	500U ..004 583	① H280 ..018 802	
Z4 [E 85]	10.02-07.07								①	532S ..118 404	530US ..011 352		530U ..004 584	500U ..004 583		
	[E 89]	04.09→							BGO	① 583S ..001 583	530US ..011 352					
Z4 Coupé [E 86]	03.06-07.07									532S ..118 404	530US ..011 352		530U ..004 584	500U ..004 583		

CADILLAC

ATS	09.12→	①	AR728S ..118 904	AR550U ..008 937	AR450U ..008 933					728S ..001 728	550US ..004 591	727 ..001 727	550U ..004 585	450U ..004 581		
BLS	10.05-01.08								①	575S ..118 451			575U ..011 351	575U ..011 351		
		02.08→	⑥	A416S ..007 416	AM24U ..008 571	AM23U ..008 570	2BB	AP24U ..006 837	AP23U ..006 836							
BLS Wagon	02.08→	⑥	A416S ..007 416	AM24U ..008 571	AM23U ..008 570	2BB	AP24U ..006 837	AP23U ..006 836							H304 ..004 990	
CTS	09.02-08.07	①	AR550S ..118 906	AR550U ..008 937	AR530U ..008 936				KUR	530S ..118 401	550US ..004 591	530 ..118 400	550U ..004 585	530U ..004 584		
		09.07→	①	AR728S ..118 904	AR550U ..008 937	AR480U ..008 934							727 ..001 727	550U ..004 585	480U ..004 582	
Escalade	09.01-08.06	①	AR550S ..118 906	AR550U ..008 937	AR530U ..008 936					550S ..118 421	550US ..004 591	550 ..118 420	550U ..004 585	550U ..004 585		
		09.06-08.08	⑥	A969S ..118 969	AM22U ..008 569	AM22U ..008 569	2BB	AP22U ..006 835	AP22U ..006 835							
		09.09→	①	AR550S ..118 906	AR550U ..008 937	AR530U ..008 936					550S ..118 421	550US ..004 591	550 ..118 420	550U ..004 585	550U ..004 585	
SRX	09.03-08.09	①	AR550S ..118 906	AR550U ..008 937	AR530U ..008 936				KUR				551 ..118 422	550U ..004 585	500U ..004 583	① H340/340U ..004 754
		09.09→	KUR	A414S ③ ..007 414	AM26U ..008 573	AM16U ..008 563										



A = Aerotwin | AM = Aerotwin Multi-Clip | AP = Aerotwin Plus | AR = Aerotwin Retrofit | S = Spoiler | U = Single Pack



3 397...

<b>STS</b>	09.04→	KUR ⑥	<b>A290S</b> ..007 290	<b>AM22U</b> ..008 569	<b>AM21U</b> ..008 568	2BB	<b>AP23U</b> ..006 836	<b>AP21U</b> ..006 834							
<b>STS-V</b>	09.05→	KUR ⑥	<b>A290S</b> ..007 290	<b>AM22U</b> ..008 569	<b>AM21U</b> ..008 568	2BB	<b>AP23U</b> ..006 836	<b>AP21U</b> ..006 834							
<b>XLR</b>	09.03→								①		<b>500</b> ..118 560	<b>500U</b> ..004 583	<b>500U</b> ..004 583		

**CHEVROLET**

<b>Aveo</b> [KL1S, T250; KL1S, T255]	02.06-12.11	①	<b>AR552S</b> ..118 984	<b>AR550U</b> ..008 937	<b>AR400U</b> ..008 932					<b>552S</b> ..118 427	<b>550US</b> ..004 591		<b>550U</b> ..004 585	<b>400U</b> ..004 579	
[KL1T, T300]	06.11→	⑥	<b>AM466S</b> ..007 466	<b>AM26U</b> ..008 573	<b>AM15U</b> ..008 562	2BB	<b>AP26U</b> ..006 838	<b>AP15U</b> ..006 828							
<b>Aveo Hatchback</b> [KL1S, T250; KL1S, T255]	02.06-12.11	①	<b>AR552S</b> ..118 984	<b>AR550U</b> ..008 937	<b>AR400U</b> ..008 932					<b>552S</b> ..118 427	<b>550US</b> ..004 591		<b>550U</b> ..004 585	<b>400U</b> ..004 579	① <b>H382</b> ..011 412
[KL1T, T300]	06.11→	⑥	<b>AM466S</b> ..007 466	<b>AM26U</b> ..008 573	<b>AM15U</b> ..008 562	2BB	<b>AP26U</b> ..006 838	<b>AP15U</b> ..006 828							<b>H801</b> ..004801
<b>Camaro Convertible</b>	09.11→								①	<b>611S</b> ..010 300	<b>600US</b> ..004 592		<b>600U</b> ..004 586	<b>530U</b> ..004 584	
<b>Captiva</b> [KL1C, C100]	10.06-02.11	①	<b>AR601S</b> ..118 907	<b>AR600U</b> ..008 938	<b>AR400U</b> ..008 932					<b>601S</b> ..010 297	<b>600US</b> ..004 592		<b>600U</b> ..004 586	<b>400U</b> ..004 579	<b>H308</b> ..011 628
[KL1C, C140]	04.11→	①	<b>AR601S</b> ..118 907	<b>AR600U</b> ..008 938	<b>AR400U</b> ..008 932					<b>601S</b> ..010 297	<b>600US</b> ..004 592		<b>600U</b> ..004 586	<b>400U</b> ..004 579	<b>H308</b> ..011 628
<b>Corvette Coupé</b>	01.97-08.03								①	<b>575S</b> ..118 451			<b>575U</b> ..011 351	<b>575U</b> ..011 351	
<b>Cruze</b> [KL1J, J300]	05.09→								①	<b>291S</b> ..010 291					
<b>Cruze Hatchback</b> [KL1J, J305]	07.11→								①	<b>291S</b> ..010 291					<b>H358</b> (2014)
<b>Cruze Station Wagon</b> [KL1J, J308]	07.12→								①	<b>291S</b> ..010 291					
<b>Epica</b> [KL1L]	06.06→	①	<b>AR551S</b> ..118 905	<b>AR550U</b> ..008 937	<b>AR500U</b> ..008 935					<b>551S</b> ..118 423	<b>550US</b> ..004 591	<b>551</b> ..118 422	<b>550U</b> ..004 585	<b>500U</b> ..004 583	
<b>Evanda</b> [KL1L, V200]	02.05-09.06	①	<b>AR551S</b> ..118 905	<b>AR550U</b> ..008 937	<b>AR500U</b> ..008 935					<b>551S</b> ..118 423	<b>550US</b> ..004 591	<b>551</b> ..118 422	<b>550U</b> ..004 585	<b>500U</b> ..004 583	
<b>HHR</b>	02.08-05.09	①	<b>AR450S</b> ..118 994	<b>AR450U</b> ..008 933	<b>AR450U</b> ..008 933					<b>450S</b> ..118 506	<b>450US</b> ..004 588	<b>450</b> ..118 505	<b>450U</b> ..004 581	<b>450U</b> ..004 581	
<b>Impala</b>	09.99-08.05								①	<b>575S</b> ..118 451			<b>575U</b> ..011 351	<b>575U</b> ..011 351	
<b>Kalos</b> [KL1S, T200]	02.05-08.06	①	<b>AR552S</b> ..118 984	<b>AR550U</b> ..008 937	<b>AR400U</b> ..008 932					<b>552S</b> ..118 427	<b>550US</b> ..004 591		<b>550U</b> ..004 585	<b>400U</b> ..004 579	
<b>Kalos Hatchback</b> [KL1S, T200]	02.05-04.08	①	<b>AR552S</b> ..118 984	<b>AR550U</b> ..008 937	<b>AR400U</b> ..008 932					<b>552S</b> ..118 427	<b>550US</b> ..004 591		<b>550U</b> ..004 585	<b>400U</b> ..004 579	① <b>H380/380U</b> ..004 756
<b>Lacetti</b> [KL1N, J200]	02.05→	①	<b>AR728S</b> ..118 904	<b>AR550U</b> ..008 937	<b>AR480U</b> ..008 934					<b>728S</b> ..001 728	<b>550US</b> ..004 591	<b>727</b> ..001 727	<b>550U</b> ..004 585	<b>480U</b> ..004 582	① <b>H450/450U</b> ..004 763
<b>Lanos</b>	01.04→	①	<b>AR480S</b> ..118 900	<b>AR480U</b> ..008 934	<b>AR480U</b> ..008 934					<b>480S</b> ..118 541		<b>480</b> ..118 540	<b>480U</b> ..004 582	<b>480U</b> ..004 582	① <b>H480/480U</b> ..004 759
<b>Malibu</b> [KL1G, V300]	03.12→	①	<b>AR607S</b> ..118 909	<b>AR600U</b> ..008 938	<b>AR480U</b> ..008 934					<b>607S</b> ..118 306	<b>600US</b> ..004 592		<b>600U</b> ..004 586	<b>480U</b> ..004 582	
<b>Matiz</b> [KL1K, M200]	02.05-12.10	①	<b>AR553S</b> ..007 589	<b>AR550U</b> ..008 937	<b>AR340U</b> ..008 930							<b>553</b> ..010 274	<b>550U</b> ..004 585	<b>340U</b> ..004 578	
<b>Nubira</b> [KL1N, J200]	02.05→	①	<b>AR728S</b> ..118 904	<b>AR550U</b> ..008 937	<b>AR480U</b> ..008 934					<b>728S</b> ..001 728	<b>550US</b> ..004 591	<b>727</b> ..001 727	<b>550U</b> ..004 585	<b>480U</b> ..004 582	
<b>Nubira Station Wagon</b> [KL1N, J200]	02.05→	①	<b>AR728S</b> ..118 904	<b>AR550U</b> ..008 937	<b>AR480U</b> ..008 934					<b>728S</b> ..001 728	<b>550US</b> ..004 591	<b>727</b> ..001 727	<b>550U</b> ..004 585	<b>480U</b> ..004 582	



A = Aerotwin | AM = Aerotwin Multi-Clip | AP = Aerotwin Plus | AR = Aerotwin Retrofit | S = Spoiler | U = Single Pack



Car Icon	1	AEROTWIN			NEW AEROTWIN			TWIN SPOILER			TWIN			REAR	
		?	SET	↖	↙	?	↖	↙	?	SET	↖	↙	?	↖	↙

◀ CHEVROLET

3 397...

<b>Orlando</b>	10.10→	①	<b>AR607S</b> ..118 909	<b>AR600U</b> ..008 938	<b>AR480U</b> ..008 934					<b>607S</b> ..118 306	<b>600US</b> ..004 592		<b>600U</b> ..004 586	<b>480U</b> ..004 582	
<b>Prizm</b>	01.89-12.97	①	<b>AR502S</b> ..118 995	<b>AR500U</b> ..008 935	<b>AR450U</b> ..008 933					<b>502S</b> ..118 564	<b>500US</b> ..004 590	<b>502</b> ..118 563	<b>500U</b> ..004 583	<b>450U</b> ..004 581	
<b>Rezzo</b> [KL1U, U100]	02.05-05.09	①	<b>AR604S</b> ..118 908	<b>AR600U</b> ..008 938	<b>AR450U</b> ..008 933					<b>607S</b> ..118 306	<b>600US</b> ..004 592		<b>600U</b> ..004 586	<b>480U</b> ..004 582	① <b>H380/380U</b> ..004 756
<b>Spark</b> [KL1K, M200]	02.05-12.10	①	<b>AR553S</b> ..007 589	<b>AR550U</b> ..008 937	<b>AR340U</b> ..008 930							<b>553</b> ..010 274	<b>550U</b> ..004 585	<b>340U</b> ..004 578	
	12.09→	KUR ①	<b>AR553S</b> ..007 589	<b>AR575U</b> ..008 940	<b>AR380U</b> ..008 931							<b>577</b> ..010 298	<b>575U</b> ..011 351	<b>380U</b> ..011 353	
<b>Tahoe</b>	01.06→	①	<b>AR550S</b> ..118 906	<b>AR550U</b> ..008 937	<b>AR530U</b> ..008 936					<b>550S</b> ..118 421	<b>550US</b> ..004 591	<b>550</b> ..118 420	<b>550U</b> ..004 585	<b>550U</b> ..004 585	<b>H 300</b> ..004 628
	09.06-08.08	⑥	<b>A969S</b> ..118 969	<b>AM22U</b> ..008 569	<b>AM22U</b> ..008 569	2BB	<b>AP22U</b> ..006 835	<b>AP22U</b> ..006 835							
<b>TrailBlazer</b>	09.01-08.09	①	<b>AR550S</b> ..118 906	<b>AR550U</b> ..008 937	<b>AR530U</b> ..008 936					<b>550S</b> ..118 421	<b>550US</b> ..004 591	<b>550</b> ..118 420	<b>550U</b> ..004 585	<b>550U</b> ..004 585	
<b>Trans Sport</b>	09.96→	①	<b>AR609S</b> ..009 776	<b>AR600U</b> ..008 938	<b>AR600U</b> ..008 938							<b>603</b> ..118 301	<b>600U</b> ..004 586	<b>600U</b> ..004 586	
<b>Trax</b>	11.12→	③	<b>A583S</b> ..007 583	<b>AM26U</b> ..008 573	<b>AM13U</b> ..008 794	2AA	<b>AP26U</b> ..006 838	<b>AP13U</b> ..006 827							
<b>Volt [1G1]</b>	10.11→	③	<b>A636S</b> ..007 636			2AA	<b>AP26U</b> ..006 838	<b>AP26U</b> ..006 838							

CHRYSLER

<b>Crossfire [ZH]</b>	09.03-08.08	①	<b>AR551S</b> ..118 905	<b>AR550U</b> ..008 937	<b>AR500U</b> ..008 935							<b>551</b> ..118 422	<b>550U</b> ..004 585	<b>500U</b> ..004 583	
<b>Grand Voyager</b> [RS]	09.07-11.09	①	<b>AR701S</b> ..007 706	<b>AR650U</b> ..008 939	<b>AR500U</b> ..008 935					<b>650US</b> ..004 593	<b>701</b> ..118 202	<b>650U</b> ..004 587	<b>500U</b> ..004 583	<b>H 402</b> ..004 632	
	12.09→	①	<b>AR701S</b> ..007 706	<b>AR650U</b> ..008 939	<b>AR500U</b> ..008 935					<b>650US</b> ..004 593	<b>701</b> ..118 202	<b>650U</b> ..004 587	<b>500U</b> ..004 583	① <b>H 403</b> ..011 592	
<b>GTS</b>	09.89-09.98							PBG				<b>041</b> ..110 041			
<b>Neon [PL]</b>	06.94-06.99	①	<b>AR531S</b> ..118 901	<b>AR530U</b> ..008 936	<b>AR450U</b> ..008 933					<b>531S</b> ..118 403	<b>530US</b> ..011 352	<b>531</b> ..118 402	<b>530U</b> ..004 584	<b>450U</b> ..004 581	
	09.99-12.05	①	<b>AR728S</b> ..118 904	<b>AR550U</b> ..008 937	<b>AR480U</b> ..008 934					<b>728S</b> ..001 728	<b>550US</b> ..004 591	<b>727</b> ..001 727	<b>550U</b> ..004 585	<b>480U</b> ..004 582	
<b>Neon Coupé [PL]</b>	09.95-06.99	①	<b>AR531S</b> ..118 901	<b>AR530U</b> ..008 936	<b>AR450U</b> ..008 933					<b>531S</b> ..118 403	<b>530US</b> ..011 352	<b>531</b> ..118 402	<b>530U</b> ..004 584	<b>450U</b> ..004 581	
<b>PT Cruiser [PT]</b>	06.00-12.10	①	<b>AR532S</b> ..118 986	<b>AR530U</b> ..008 936	<b>AR500U</b> ..008 935					<b>530S</b> ..118 401	<b>530US</b> ..011 352	<b>530</b> ..118 400	<b>530U</b> ..004 584	<b>530U</b> ..004 584	
<b>PT Cruiser Cabrio</b> [PT]	09.00-08.08	①	<b>AR532S</b> ..118 986	<b>AR530U</b> ..008 936	<b>AR500U</b> ..008 935					<b>530S</b> ..118 401	<b>530US</b> ..011 352	<b>530</b> ..118 400	<b>530U</b> ..004 584	<b>530U</b> ..004 584	
<b>Sebring [JR]</b>	09.00-08.08	①	<b>AR550S</b> ..118 906	<b>AR550U</b> ..008 937	<b>AR530U</b> ..008 936					<b>550S</b> ..118 421	<b>550US</b> ..004 591	<b>550</b> ..118 420	<b>550U</b> ..004 585	<b>550U</b> ..004 585	
	09.06→	KUR ①	<b>AR801S</b> ..118 996	<b>AR600U</b> ..008 938	<b>AR530U</b> ..008 936										
<b>Sebring</b> <b>Convertible [JR]</b>	01.01-08.08	①	<b>AR550S</b> ..118 906	<b>AR550U</b> ..008 937	<b>AR530U</b> ..008 936					<b>550S</b> ..118 421	<b>550US</b> ..004 591	<b>550</b> ..118 420	<b>550U</b> ..004 585	<b>550U</b> ..004 585	
	09.06→	KUR ①	<b>AR801S</b> ..118 996	<b>AR600U</b> ..008 938	<b>AR530U</b> ..008 936										
<b>Stratus [JA]</b>	08.95-04.01	①	<b>AR550S</b> ..118 906	<b>AR550U</b> ..008 937	<b>AR530U</b> ..008 936					<b>550S</b> ..118 421	<b>550US</b> ..004 591	<b>550</b> ..118 420	<b>550U</b> ..004 585	<b>550U</b> ..004 585	
	08.96-12.99	①	<b>AR550S</b> ..118 906	<b>AR550U</b> ..008 937	<b>AR530U</b> ..008 936					<b>550S</b> ..118 421	<b>550US</b> ..004 591	<b>550</b> ..118 420	<b>550U</b> ..004 585	<b>550U</b> ..004 585	
<b>Stratus Cabrio [JA]</b>	08.95-04.01	①	<b>AR550S</b> ..118 906	<b>AR550U</b> ..008 937	<b>AR530U</b> ..008 936					<b>550S</b> ..118 421	<b>550US</b> ..004 591	<b>550</b> ..118 420	<b>550U</b> ..004 585	<b>550U</b> ..004 585	



A = Aerotwin | AM = Aerotwin Multi-Clip | AP = Aerotwin Plus | AR = Aerotwin Retrofit | S = Spoiler | U = Single Pack





3 397...

<b>Stratus Cabrio [JX]</b>	08.96-12.99	①	<b>AR550S</b> ..118 906	<b>AR550U</b> ..008 937	<b>AR530U</b> ..008 936				<b>550S</b> ..118 421	<b>550US</b> ..004 591	<b>550</b> ..118 420	<b>550U</b> ..004 585	<b>550U</b> ..004 585	
<b>Vision</b>	09.93-12.97							①				<b>600</b> ..018 300		
<b>Voyager [ES]</b>	09.91-12.95							PBG			<b>041</b> ..110 041			① <b>H450/450U</b> ..004 763
[GS]	01.95-12.00	KUR ①	<b>AR651S</b> ..118 913					KUR			<b>650</b> ..118 320	<b>650U</b> ..004 587	<b>650U</b> ..004 587	① <b>H450/450U</b> ..004 763
[RG]	01.01-12.07	KUR ①	<b>AR651S</b> ..118 913					KUR			<b>650</b> ..118 320	<b>650U</b> ..004 587	<b>650U</b> ..004 587	<b>H403</b> ..011 592
[RS]	08.00→	KUR ①	<b>AR651S</b> ..118 913					KUR			<b>650</b> ..118 320	<b>650U</b> ..004 587	<b>650U</b> ..004 587	<b>H400/400U</b> ..004 757
[RT]	01.08-11.09	①	<b>AR701S</b> ..007 706	<b>AR650U</b> ..008 939	<b>AR500U</b> ..008 935					<b>650US</b> ..004 593	<b>701</b> ..118 202	<b>650U</b> ..004 587	<b>500U</b> ..004 583	KWB <b>H402</b> ..004 632
	12.09→	①	<b>AR701S</b> ..007 706	<b>AR650U</b> ..008 939	<b>AR500U</b> ..008 935					<b>650US</b> ..004 593	<b>701</b> ..118 202	<b>650U</b> ..004 587	<b>500U</b> ..004 583	① <b>H403</b> ..011 592
<b>300 [LX]</b>	09.04-08.10							①	<b>550S</b> ..118 421	<b>550US</b> ..004 591	<b>550</b> ..118 420	<b>550U</b> ..004 585	<b>550U</b> ..004 585	
<b>300C [LE]</b>	10.04-08.10							①	<b>550S</b> ..118 421	<b>550US</b> ..004 591	<b>550</b> ..118 420	<b>550U</b> ..004 585	<b>550U</b> ..004 585	
<b>300C [LX]</b>	09.04-08.09							①	<b>550S</b> ..118 421	<b>550US</b> ..004 591	<b>550</b> ..118 420	<b>550U</b> ..004 585	<b>550U</b> ..004 585	
<b>300C Touring [LE]</b>	10.04-08.10							①	<b>550S</b> ..118 421	<b>550US</b> ..004 591	<b>550</b> ..118 420	<b>550U</b> ..004 585	<b>550U</b> ..004 585	
<b>300M [LH]</b>	09.98-08.04	①	<b>AR607S</b> ..118 909	<b>AR600U</b> ..008 938	<b>AR480U</b> ..008 934			KUR ①	<b>607S</b> ..118 306	<b>600US</b> ..004 592		<b>600U</b> ..004 586	<b>480U</b> ..004 582	

## CITROEN

<b>AX</b>	10.86-12.98											<b>550U</b> ..004 585		① <b>H400/400U</b> ..004 757
<b>Berlingo [M49]</b>	07.96-11.02	①	<b>AR550S</b> ..118 906	<b>AR550U</b> ..008 937	<b>AR530U</b> ..008 936						<b>550</b> ..118 420	<b>550U</b> ..004 585	<b>550U</b> ..004 585	MHK <b>H400/400U</b> ① ..004 757
														TU2 ① <b>H341</b> ..004 755
[M59]	11.02-03.10	①	<b>AR550S</b> ..118 906	<b>AR550U</b> ..008 937	<b>AR530U</b> ..008 936						<b>550</b> ..118 420	<b>550U</b> ..004 585	<b>550U</b> ..004 585	MHK <b>H408</b> ① ..011 410
														TU2 ① <b>H341</b> ..004 755
[B9]	05.08→	③	<b>A414S</b> ..007 414	<b>AM26U</b> ..008 573	<b>AM16U</b> ..008 563	2AA	<b>AP26U</b> ..006 838	<b>AP16U</b> ..006 829						<b>H353</b> ..004 631
			KUR ③	<b>AM466S</b> ..007 466										
<b>BX [X56]</b>	07.85-12.94											<b>500U</b> ..004 583		① <b>H500/500U</b> ..004 760
<b>C 15</b>	07.87-12.05											<b>450U</b> ..004 581		① <b>H400/400U</b> ..004 757
<b>C-Crosser [I4]</b>	09.07→	①	<b>AR801S</b> ..118 996	<b>AR600U</b> ..008 938	<b>AR530U</b> ..008 936				<b>611S</b> ..010 300	<b>600US</b> ..004 592		<b>600U</b> ..004 586	<b>530U</b> ..004 584	<b>H306</b> ..011 432
<b>C-Elysee</b>	09.12→	⑦	<b>A116S</b> ..007 116			AP3	<b>AP24U</b> ..006 837	<b>AP16U</b> ..006 829						
<b>C-Zero</b>	10.10→	①		<b>AR70N</b> ..008 845								<b>700U</b> ..004 489		<b>H306</b> ..011 432
<b>C1 [B0]</b>	06.05→	①	<b>AR650S</b> ..018 913	<b>AR650U</b> ..008 939								<b>651U</b> ..011 641		<b>H300</b> ..004 628
<b>C2 [A6]</b>	09.03→	①	<b>AR604S</b> ..118 908	<b>AR600U</b> ..008 938	<b>AR450U</b> ..008 933				<b>604S</b> ..118 303	<b>600US</b> ..004 592		<b>600U</b> ..004 586	<b>450U</b> ..004 581	<b>H840</b> ..004 802



A = Aerotwin | AM = Aerotwin Multi-Clip | AP = Aerotwin Plus | AR = Aerotwin Retrofit | S = Spoiler | U = Single Pack



◀ CITROEN

3 397...

<b>C3</b> [A8; A31]	01.02-08.09	①	<b>AR604S</b> ..118 908	<b>AR600U</b> ..008 938	<b>AR450U</b> ..008 933				<b>604S</b> ..118 303	<b>600US</b> ..004 592	<b>600U</b> ..004 586	<b>450U</b> ..004 581	<b>H353</b> ..004 631
[A51]	09.09→	⑦	<b>A422S</b> ..007 422			AP3	<b>AP26U</b> ..006 838	<b>AP16U</b> ..006 829					<b>H301</b> ..004 629
<b>C3 Picasso</b> [A58]	02.09-03.10	⑤	<b>A295S</b> ..007 295	<b>AM24U</b> ..008 571	<b>AM16U</b> ..008 563	2AA	<b>AP24U</b> ..006 837	<b>AP16U</b> ..006 829					<b>H840</b> ..004 802
	04.10→	⑦	<b>A116S</b> ..007 116			AP3	<b>AP24U</b> ..006 837	<b>AP16U</b> ..006 829					<b>H840</b> ..004 802
<b>C3-Pluriel</b> [A42]	05.03-10.12	KUR ①	<b>AR531S</b> ..118 901	<b>AR550U</b> ..008 937	<b>AR450U</b> ..008 933				KUR <b>531S</b> ..118 403	<b>550US</b> ..004 591	<b>531</b> ..118 402	<b>550U</b> ..004 585	<b>450U</b> ..004 581
<b>C4</b> [B5]	11.04-08.10	⑥	<b>A965S</b> ..118 965	<b>AM28U</b> ..008 574	<b>AM24U</b> ..008 571	2BB	<b>AP28U</b> ..006 839	<b>AP24U</b> ..006 837					<b>H304</b> ..004 990
[B7]	09.10→	③	<b>A120S</b> ..007 120	<b>AM30U</b> ..008 928	<b>AM26U</b> ..008 573	2AA	<b>AP30U</b> ..006 840	<b>AP26U</b> ..006 838					<b>H840</b> ..004 802
<b>C4 Aircross</b>	03.12→	①	<b>AR801S</b> ..118 996	<b>AR600U</b> ..008 938	<b>AR530U</b> ..008 936				<b>611S</b> ..010 300	<b>600US</b> ..004 592	<b>600U</b> ..004 586	<b>530U</b> ..004 584	<b>H250</b> ..011 629
<b>C4 Coupé</b> [B5]	11.04-07.10	⑥	<b>A965S</b> ..118 965	<b>AM28U</b> ..008 574	<b>AM24U</b> ..008 571	2BB	<b>AP28U</b> ..006 839	<b>AP24U</b> ..006 837					
<b>C4 Grand Picasso</b> [B58]	10.06-03.08	②	<b>A313S</b> ..007 313	<b>AM32U</b> ..008 926	<b>AM30U</b> ..008 928	AP1	<b>AP32U</b> ..006 841	<b>AP30U</b> ..006 840					<b>H351</b> ..004 559
	04.08→	⑦	<b>A428S</b> ..007 428			AP3	<b>AP32U</b> ..006 841	<b>AP30U</b> ..006 840					<b>H351</b> ..004 559
<b>C4 Picasso</b> [B58]	02.07-03.08	②	<b>A313S</b> ..007 313	<b>AM32U</b> ..008 926	<b>AM30U</b> ..008 928	AP1	<b>AP32U</b> ..006 841	<b>AP30U</b> ..006 840					<b>H351</b> ..004 559
	04.08→	⑦	<b>A428S</b> ..007 428			AP3	<b>AP32U</b> ..006 841	<b>AP30U</b> ..006 840					<b>H351</b> ..004 559
[B78]	05.13→	③	<b>A944S</b> (2014)	<b>AM32U</b> ..008 926	<b>AM30U</b> ..008 928	2AA	<b>AP32U</b> ..006 841	<b>AP30U</b> ..006 840					
<b>C5</b> [X4]	03.01-03.03												<b>H502</b> ..004 633
	03.01-11.03	①	<b>AR813S</b> ..118 912	<b>AR650U</b> ..008 939	<b>AR450U</b> ..008 933				<b>813S</b> ..001 813	<b>650US</b> ..004 593	<b>650U</b> ..004 587	<b>450U</b> ..004 581	
	04.03-09.04												<b>H402</b> ..004 632
	12.03-09.04	②	<b>A951S</b> ..118 951	<b>AM26U</b> ..008 573	<b>AM18U</b> ..008 565	AP1	<b>AP26U</b> ..006 838	<b>AP18U</b> ..006 831					
[X3]	10.04-03.08	②	<b>A951S</b> ..118 951	<b>AM26U</b> ..008 573	<b>AM18U</b> ..008 565	AP1	<b>AP26U</b> ..006 838	<b>AP18U</b> ..006 831				WOB	<b>A401H</b> ..008 047
[X7]	04.08→	⑥	<b>A256S</b> ..007 256	<b>AM28U</b> ..008 574	<b>AM22U</b> ..008 569	2BB	<b>AP28U</b> ..006 839	<b>AP22U</b> ..006 835					
<b>C5 Break</b> [X4]	06.01-11.03	①	<b>AR813S</b> ..118 912	<b>AR650U</b> ..008 939	<b>AR450U</b> ..008 933				<b>813S</b> ..001 813	<b>650US</b> ..004 593	<b>650U</b> ..004 587	<b>450U</b> ..004 581	<b>H840</b> ..004 802
	12.03-09.04	②	<b>A951S</b> ..118 951	<b>AM26U</b> ..008 573	<b>AM18U</b> ..008 565	AP1	<b>AP26U</b> ..006 838	<b>AP18U</b> ..006 831					<b>H840</b> ..004 802
[X3]	10.04-03.08	②	<b>A951S</b> ..118 951	<b>AM26U</b> ..008 573	<b>AM18U</b> ..008 565	AP1	<b>AP26U</b> ..006 838	<b>AP18U</b> ..006 831					<b>H840</b> ..004 802
<b>C5 Tourer</b> [X7]	04.08→	⑥	<b>A256S</b> ..007 256	<b>AM28U</b> ..008 574	<b>AM22U</b> ..008 569	2BB	<b>AP28U</b> ..006 839	<b>AP22U</b> ..006 835					<b>A250H</b> ..008 056
<b>C6</b> [X6]	11.05→	②	<b>A976S</b> ..118 976	<b>AM28U</b> ..008 574	<b>AM28U</b> ..008 574	AP1	<b>AP28U</b> ..006 839	<b>AP28U</b> ..006 839					
<b>C8</b> [V3]	06.02-07.05	SDV ①	<b>AR657S</b> ..009 777	<b>AR66N</b> ..008 848	<b>AR66N</b> ..008 848				SDV <b>657S</b> ..118 334				<b>H353</b> ..004 631
	08.05→	①	<b>AR651S</b> ..118 913							<b>650US</b> ..004 593	<b>650</b> ..118 320	<b>650U</b> ..004 587	<b>650U</b> ..004 587
<b>DS3</b> [A55]	11.09→	⑦	<b>A116S</b> ..007 116			AP3	<b>AP24U</b> ..006 837	<b>AP16U</b> ..006 829					<b>H840</b> ..004 802



A = Aerotwin | AM = Aerotwin Multi-Clip | AP = Aerotwin Plus | AR = Aerotwin Retrofit | S = Spoiler | U = Single Pack



3 397...

<b>DS3 Cabrio</b> [A56]	07.12→	⑦	<b>A116S</b> ..007 116			AP3	<b>AP24U</b> ..006 837	<b>AP16U</b> ..006 829									
<b>DS4</b> [B75]	03.11→	③	<b>A385S</b> ..007 385	<b>AM30U</b> ..008 928	<b>AM26U</b> ..008 573	2AA	<b>AP30U</b> ..006 840	<b>AP26U</b> ..006 838									
<b>DS5</b> [B81]	09.11→	KUR ③	<b>A641S</b> ..007 644	<b>AM30U</b> ..008 928	<b>AM26U</b> ..008 573	2AA	<b>AP30U</b> ..006 840	<b>AP26U</b> ..006 838									
<b>Evasion</b> [U60]	06.94-07.02	①	<b>AR701S</b> ..007 706	<b>AR650U</b> ..008 939	<b>AR500U</b> ..008 935					<b>650US</b> ..004 593	<b>701</b> ..118 202	<b>650U</b> ..004 587	<b>500U</b> ..004 583	①	<b>H400/400U</b> ..004 757		
<b>Jumper</b> [U5, 23]	02.94-05.06	①	<b>AR550S</b> ..118 906	<b>AR550U</b> ..008 937	<b>AR530U</b> ..008 936					<b>550S</b> ..118 421	<b>550US</b> ..004 591	<b>550</b> ..118 420	<b>550U</b> ..004 585	<b>550U</b> ..004 585			
[U9]	06.06→	③	<b>A225S</b> ..007 225	<b>AM26U</b> ..008 573	<b>AM22U</b> ..008 569	2AA	<b>AP26U</b> ..006 838	<b>AP22U</b> ..006 835									
<b>Jumpy</b> [U64]	10.95-01.07	①	<b>AR701S</b> ..007 706	<b>AR650U</b> ..008 939	<b>AR500U</b> ..008 935						<b>701</b> ..118 202	<b>650U</b> ..004 587	<b>500U</b> ..004 583				
[G9]	02.07→	KUR ①	<b>AR701S</b> ..007 706	<b>AR650U</b> ..008 939	<b>AR500U</b> ..008 935					<b>706S</b> ..010 301	<b>650US</b> ..004 593	<b>701</b> ..118 202	<b>700U</b> ..004 489	<b>500U</b> ..004 583	TU2 ..004 631	<b>H353</b>	
		WW		<b>AR70N</b> ..008 845	<b>AR50N</b> ..008 841										MHK, APE	<b>H380/380U</b> ..004 756	
<b>Nemo</b> [A9]	02.08→	⑦	<b>A426S</b> ..007 426			AP3	<b>AP26U</b> ..006 838	<b>AP19U</b> ..006 832									
<b>Saxo</b> [S8]	02.96-09.99	①	<b>AR502S</b> ..118 995	<b>AR500U</b> ..008 935	<b>AR450U</b> ..008 933					<b>502S</b> ..118 564	<b>500US</b> ..004 590	<b>502</b> ..118 563	<b>500U</b> ..004 583	<b>450U</b> ..004 581	①	<b>H400/400U</b> ..004 757	
	10.99-09.03	①	<b>AR502S</b> ..118 995	<b>AR500U</b> ..008 935	<b>AR450U</b> ..008 933					<b>502S</b> ..118 564	<b>500US</b> ..004 590	<b>502</b> ..118 563	<b>500U</b> ..004 583	<b>450U</b> ..004 581		<b>H353</b> ..004 631	
<b>Xantia</b> [X1]	03.93-12.98	①	<b>AR606S</b> ..118 910	<b>AR600U</b> ..008 938	<b>AR500U</b> ..008 935					<b>606S</b> ..118 305					①	<b>H450/450U</b> ..004 763	
[X2]	10.97-12.01	①	<b>AR606S</b> ..118 910	<b>AR600U</b> ..008 938	<b>AR500U</b> ..008 935					<b>607S</b> ..118 306	<b>600US</b> ..004 592		<b>600U</b> ..004 586	<b>480U</b> ..004 582	①	<b>H450/450U</b> ..004 763	
<b>Xantia Break</b> [X1]	09.95-01.98	①	<b>AR606S</b> ..118 910	<b>AR600U</b> ..008 938	<b>AR500U</b> ..008 935					<b>606S</b> ..118 305					①	<b>H450/450U</b> ..004 763	
[X2]	12.97-11.99	①	<b>AR606S</b> ..118 910	<b>AR600U</b> ..008 938	<b>AR500U</b> ..008 935					<b>607S</b> ..118 306	<b>600US</b> ..004 592		<b>600U</b> ..004 586	<b>480U</b> ..004 582	①	<b>H400/400U</b> ..004 757	
	12.99-12.01	①	<b>AR606S</b> ..118 910	<b>AR600U</b> ..008 938	<b>AR500U</b> ..008 935					<b>607S</b> ..118 306	<b>600US</b> ..004 592		<b>600U</b> ..004 586	<b>480U</b> ..004 582		<b>H353</b> ..004 631	
<b>XM</b> [Y3, Y4]	05.89-10.10	①	<b>AR550S</b> ..118 906	<b>AR550U</b> ..008 937	<b>AR530U</b> ..008 936					<b>550S</b> ..118 421	<b>550US</b> ..004 591	<b>550</b> ..118 420	<b>550U</b> ..004 585	<b>550U</b> ..004 585	KOB ①	<b>H400/400U</b> ..004 757	
<b>Xsara</b> [N6, N7]	07.97-12.05	①	<b>AR551S</b> ..118 905	<b>AR550U</b> ..008 937	<b>AR500U</b> ..008 935					<b>551S</b> ..118 423	<b>550US</b> ..004 591	<b>551</b> ..118 422	<b>550U</b> ..004 585	<b>500U</b> ..004 583	①	<b>H450/450U</b> ..004 763	
<b>Xsara Break</b> [N6, N7]	10.97-03.10	①	<b>AR551S</b> ..118 905	<b>AR550U</b> ..008 937	<b>AR500U</b> ..008 935					<b>551S</b> ..118 423	<b>550US</b> ..004 591	<b>551</b> ..118 422	<b>550U</b> ..004 585	<b>500U</b> ..004 583		<b>H402</b> ..004 632	
<b>Xsara Coupé</b> [N6, N7]	07.97-12.05	①	<b>AR551S</b> ..118 905	<b>AR550U</b> ..008 937	<b>AR500U</b> ..008 935					<b>551S</b> ..118 423	<b>550US</b> ..004 591	<b>551</b> ..118 422	<b>550U</b> ..004 585	<b>500U</b> ..004 583	①	<b>H450/450U</b> ..004 763	
<b>Xsara Picasso</b> [N68]	01.00-09.05	①	<b>AR651S</b> ..118 913									<b>650</b> ..118 320	<b>650U</b> ..004 587	<b>650U</b> ..004 587		<b>H402</b> ..004 632	
	10.05-04.10	②	<b>A079S</b> ..007 079	<b>AM26U</b> ..008 573	<b>AM26U</b> ..008 573	AP1	<b>AP26U</b> ..006 838	<b>AP26U</b> ..006 838								<b>H402</b> ..004 632	
<b>ZX</b> [N20/N21]	03.91-02.98												<b>550U</b> ..004 585		LIM ①	<b>H450/450U</b> ..004 763	

**DACIA**

<b>Dokker</b>	07.12→	①	<b>AR552S</b> ..118 984	<b>AR550U</b> ..008 937	<b>AR400U</b> ..008 932					<b>552S</b> ..118 427	<b>550US</b> ..004 591		<b>550U</b> ..004 585	<b>400U</b> ..004 579		<b>H801</b> ..004 801
<b>Duster</b>	10.09→	①	<b>AR500S</b> ..009 081	<b>AR500U</b> ..008 935	<b>AR500U</b> ..008 935					<b>500S</b> ..118 561	<b>500US</b> ..004 590	<b>500</b> ..118 560	<b>500U</b> ..004 583	<b>500U</b> ..004 583		<b>H301</b> ..004 629
<b>Lodgy</b>	03.12→	①	<b>AR552S</b> ..118 984	<b>AR550U</b> ..008 937	<b>AR400U</b> ..008 932					<b>552S</b> ..118 427	<b>550US</b> ..004 591		<b>550U</b> ..004 585	<b>400U</b> ..004 579		<b>H840</b> ..004 802



A = Aerotwin | AM = Aerotwin Multi-Clip | AP = Aerotwin Plus | AR = Aerotwin Retrofit | S = Spoiler | U = Single Pack





◀ DACIA

3 397...

Logan [LS]	07.04→	①	AR500S ..009 081	AR500U ..008 935	AR500U ..008 935				500S ..118 561	500US ..004 590	500 ..118 560	500U ..004 583	500U ..004 583	
Logan II [L8]	08.12→	①	AR551S ..118 905	AR550U ..008 937	AR500U ..008 935				551S ..118 423	550US ..004 591	551 ..118 422	550U ..004 585	500U ..004 583	
Logan MCV [KS/FS]	01.07→	①	AR500S ..009 081	AR500U ..008 935	AR500U ..008 935				500S ..118 561	500US ..004 590	500 ..118 560	500U ..004 583	500U ..004 583	H 353 ..004 631
Logan Pick-Up [US]	01.07→	①	AR500S ..009 081	AR500U ..008 935	AR500U ..008 935				500S ..118 561	500US ..004 590	500 ..118 560	500U ..004 583	500U ..004 583	
Nova	05.96-09.00								500S ..118 561	500US ..004 590	500 ..118 560	500U ..004 583	500U ..004 583	
Sandero [BS]	06.08→	①	AR500S ..009 081	AR500U ..008 935	AR500U ..008 935				500S ..118 561	500US ..004 590	500 ..118 560	500U ..004 583	500U ..004 583	H 402 ..004 632
Sandero II [L8]	08.12→	①	AR551S ..118 905	AR550U ..008 937	AR500U ..008 935				551S ..118 423	550US ..004 591	551 ..118 422	550U ..004 585	500U ..004 583	H 840 ..004 802
Serie 1300	01.79-06.04							①	400S ..118 611		400 ..118 610	400U ..004 579	400U ..004 579	① H400/400U ..004 757
Solenza	04.03-04.05							①	450S ..118 506		450 ..118 505	450U ..004 581	450U ..004 581	
Super Nova	10.00-09.03							①	500S ..118 561	500US ..004 590	500 ..118 560	500U ..004 583	500U ..004 583	

DAEWOO

Cielo	08.94-08.97	①	AR450S ..118 994	AR450U ..008 933	AR450U ..008 933				450S ..118 506	450US ..004 588	450 ..118 505	450U ..004 581	450U ..004 581	
Damas	10.91-12.02							①	400S ..118 611		400 ..118 610	400U ..004 579	340U ..004 578	① H340/340U ..004 754
Espero [KLEJ]	09.91-10.99	①	AR450S ..118 994	AR450U ..008 933	AR450U ..008 933				450S ..118 506		450 ..118 505	450U ..004 581	450U ..004 581	
Evanda	03.03-01.05	①	AR551S ..118 905	AR550U ..008 937	AR500U ..008 935				551S ..118 423	550US ..004 591	551 ..118 422	550U ..004 585	500U ..004 583	
Kalos [KLAS]	09.02-01.05	①	AR552S ..118 984	AR550U ..008 937	AR500U ..008 935				552S ..118 427	550US ..004 591		550U ..004 585	400U ..004 579	
Kalos Hatchback [KLAS]	09.02-01.05	①	AR552S ..118 984	AR550U ..008 937	AR400U ..008 932				552S ..118 427	550US ..004 591		550U ..004 585	400U ..004 579	① H380/380U ..004 756
Korando [KJ]	07.96-12.00							①	450S ..118 506		450 ..118 505	450U ..004 581	450U ..004 581	
Lacetti [KLAN]	03.04-01.05	①	AR728S ..118 904	AR550U ..008 937	AR480U ..008 934				728S ..001 728	550US ..004 591	727 ..001 727	550U ..004 585	480U ..004 582	① H450/450U ..004 763
Lanos [KLAT]	11.96-09.03	①	AR480S ..118 900	AR480U ..008 934	AR480U ..008 934				480S ..118 541		480 ..118 540	480U ..004 582	480U ..004 582	
Lanos Hatchback [KLAT]	11.96-09.03	①	AR480S ..118 900	AR480U ..008 934	AR480U ..008 934				480S ..118 541		480 ..118 540	480U ..004 582	480U ..004 582	① H480/480U ..004 759
Leganza [KLAV, V100]	03.97-12.02	①	AR551S ..118 905	AR550U ..008 937	AR500U ..008 935				551S ..118 423	550US ..004 591	551 ..118 422	550U ..004 585	500U ..004 583	
LeMans	09.88-10.96	①	AR450S ..118 994	AR450U ..008 933	AR450U ..008 933				450S ..118 506	450US ..004 588	450 ..118 505	450U ..004 581	450U ..004 581	
Matiz [KLYA]	04.98→	①	AR534S ..007 503	AR530U ..008 936	AR380U ..008 931						534 ..010 271	530U ..004 584	380U ..011 353	① H 341 ..004 755
Musso [MJ]	07.93-12.00							①	502S ..118 564	500US ..004 590	502 ..118 563	500U ..004 583	450U ..004 581	
Nexia	11.95→	①	AR450S ..118 994	AR450U ..008 933	AR450U ..008 933				450S ..118 506	450US ..004 588	450 ..118 505	450U ..004 581	450U ..004 581	① H450/450U ..004 763
Nexia Hatchback [KLETN]	11.94-08.97	①	AR450S ..118 994	AR450U ..008 933	AR450U ..008 933				450S ..118 506	450US ..004 588	450 ..118 505	450U ..004 581	450U ..004 581	① H450/450U ..004 763
Nubira [KLAJ, J100]	09.97-09.99	①	AR500S ..009 081	AR500U ..008 935	AR500U ..008 935				500S ..118 561	500US ..004 590	500 ..118 560	500U ..004 583	500U ..004 583	



A = Aerotwin | AM = Aerotwin Multi-Clip | AP = Aerotwin Plus | AR = Aerotwin Retrofit | S = Spoiler | U = Single Pack



3 397...

<b>Nubira</b> [KLAJ, 150, 190]	10.99-06.03	①	<b>AR728S</b> ..118 904	<b>AR550U</b> ..008 937	<b>AR480U</b> ..008 934				<b>728S</b> ..001 728	<b>550US</b> ..004 591	<b>727</b> ..001 727	<b>550U</b> ..004 585	<b>480U</b> ..004 582	KOB	<b>H380/380U</b> ..004 756
[J200, KLAN]	07.03-01.05	①	<b>AR728S</b> ..118 904	<b>AR550U</b> ..008 937	<b>AR480U</b> ..008 934				<b>728S</b> ..001 728	<b>550US</b> ..004 591	<b>727</b> ..001 727	<b>550U</b> ..004 585	<b>480U</b> ..004 582		
<b>Nubira Hatchback</b> [KLAJ, J100]	09.97-09.99	①	<b>AR500S</b> ..009 081	<b>AR500U</b> ..008 935	<b>AR500U</b> ..008 935				<b>500S</b> ..118 561	<b>500US</b> ..004 590	<b>500</b> ..118 560	<b>500U</b> ..004 583	<b>500U</b> ..004 583		
<b>Nubira Station Wagon</b> [KLAJ, J100]	09.97-09.99	①	<b>AR500S</b> ..009 081	<b>AR500U</b> ..008 935	<b>AR500U</b> ..008 935				<b>500S</b> ..118 561	<b>500US</b> ..004 590	<b>500</b> ..118 560	<b>500U</b> ..004 583	<b>500U</b> ..004 583	KOB	<b>H380/380U</b> ..004 756
[KLAJ, 150, 190]	08.99-06.03	①	<b>AR728S</b> ..118 904	<b>AR550U</b> ..008 937	<b>AR480U</b> ..008 934				<b>728S</b> ..001 728	<b>550US</b> ..004 591	<b>727</b> ..001 727	<b>550U</b> ..004 585	<b>480U</b> ..004 582	KOB	<b>H380/380U</b> ..004 756
[J200, KLAN]	03.04-01.05	①	<b>AR728S</b> ..118 904	<b>AR550U</b> ..008 937	<b>AR480U</b> ..008 934				<b>728S</b> ..001 728	<b>550US</b> ..004 591	<b>727</b> ..001 727	<b>550U</b> ..004 585	<b>480U</b> ..004 582		
<b>Rezzo</b> [KLAU]	09.00-01.05	①	<b>AR604S</b> ..118 908	<b>AR600U</b> ..008 938	<b>AR450U</b> ..008 933				<b>607S</b> ..118 306	<b>600US</b> ..004 592		<b>600U</b> ..004 586	<b>480U</b> ..004 582	①	<b>H380/380U</b> ..004 756
<b>Sens</b> [TF698]	01.02→	①	<b>AR480S</b> ..118 900	<b>AR480U</b> ..008 934	<b>AR480U</b> ..008 934				<b>480S</b> ..118 541		<b>480</b> ..118 540	<b>480U</b> ..004 582	<b>480U</b> ..004 582		
<b>Tico</b> [KLY3]	06.91-01.05	①		<b>AR400U</b> ..008 932	<b>AR400U</b> ..008 932						<b>400</b> ..118 610	<b>400U</b> ..004 579	<b>400U</b> ..004 579	①	<b>H340/340U</b> ..004 754

**DAIHATSU**

<b>Charade</b> [G2]	06.94-09.00	①	<b>AR566S</b> ..118 990	<b>AR480U</b> ..008 934	<b>AR400U</b> ..008 932				<b>481S</b> ..118 543		<b>481</b> ..118 542	<b>480U</b> ..004 582	<b>450U</b> ..004 581		
[NSP90]	03.11→	①	<b>AR605S</b> ..007 504	<b>AR600U</b> ..008 938	<b>AR340U</b> ..008 930						<b>605</b> ..010 270	<b>600U</b> ..004 586	<b>340U</b> ..004 578		<b>H304</b> ..004 990
<b>Charade Hatchback</b> [G2]	01.93-09.00	①	<b>AR566S</b> ..118 990	<b>AR480U</b> ..008 934	<b>AR400U</b> ..008 932				<b>481S</b> ..118 543		<b>481</b> ..118 542	<b>480U</b> ..004 582	<b>450U</b> ..004 581		
<b>Cuore</b> [L5]	08.94-12.99							KUR	<b>400S</b> ..118 611		<b>400</b> ..118 610	<b>400U</b> ..004 579	<b>400U</b> ..004 579		
[L7]	10.98-03.03	①		<b>AR450U</b> ..008 933	<b>AR380U</b> ..008 931							<b>450U</b> ..004 581	<b>380U</b> ..011 353	KUR	<b>H280</b> ..018 802
[L2]	03.03→							①				<b>530U</b> ..004 584	<b>H280</b> ..018 802		<b>H309</b> ..011 630
<b>Gran Move</b> [G3]	11.96-07.02	①	<b>AR533S</b> ..118 902	<b>AR530U</b> ..008 936	<b>AR480U</b> ..008 934				<b>533S</b> ..118 406	<b>530US</b> ..011 352	<b>533</b> ..118 405	<b>530U</b> ..004 584	<b>480U</b> ..004 582	①	<b>H380/380U</b> ..004 756
<b>Hijet</b>	12.92→	①		<b>AR400U</b> ..008 932	<b>AR400U</b> ..008 932						<b>400</b> ..118 610	<b>400U</b> ..004 579	<b>400U</b> ..004 579		
<b>Materia</b>	09.06→	①	<b>AR503S</b> ..118 993	<b>AR500U</b> ..008 935	<b>AR480U</b> ..008 934						<b>503</b> ..118 565	<b>500U</b> ..004 583	<b>480U</b> ..004 582		<b>H309</b> ..011 630
<b>Move</b>	08.95-09.02	①		<b>AR400U</b> ..008 932	<b>AR380U</b> ..008 931							<b>420U</b> ..011 354	<b>380U</b> ..011 353		
<b>Rocky</b>	03.93-03.02							①			<b>400</b> ..118 610	<b>400U</b> ..004 579	<b>400U</b> ..004 579		
<b>Sirion I</b> [M1]	04.98-07.04	①	<b>AR566S</b> ..118 990	<b>AR480U</b> ..008 934	<b>AR400U</b> ..008 932				<b>481S</b> ..118 543		<b>481</b> ..118 542	<b>480U</b> ..004 582	<b>450U</b> ..004 581	KUR	<b>H280</b> ..018 802
<b>Sirion II</b> [M3]	10.04→	①		<b>AR500U</b> ..008 935	<b>AR400U</b> ..008 932						<b>361</b> ..001 361	<b>500U</b> ..004 583	<b>400U</b> ..004 579		<b>H352</b> ..011 430
<b>Terios</b> [J1]	03.97-12.05	①		<b>AR500U</b> ..008 935	<b>AR380U</b> ..008 931							<b>500U</b> ..004 583	<b>380U</b> ..011 353	KUR	<b>H280</b> ..018 802
[J2]	01.06→	①	<b>AR531S</b> ..118 901	<b>AR530U</b> ..008 936	<b>AR450U</b> ..008 933				<b>531S</b> ..118 403	<b>530US</b> ..011 352	<b>531</b> ..118 402	<b>530U</b> ..004 584	<b>450U</b> ..004 581		<b>H307</b> ..011 429
<b>Trevis</b> [L6]	08.06→	①		<b>AR500U</b> ..008 935	<b>AR400U</b> ..008 932						<b>361</b> ..001 361	<b>500U</b> ..004 583	<b>400U</b> ..004 579		
<b>YRV</b> [M2]	08.00-07.05	①	<b>AR553S</b> ..007 589	<b>AR550U</b> ..008 937	<b>AR340U</b> ..008 930						<b>553</b> ..010 274	<b>550U</b> ..004 585	<b>340U</b> ..004 578		<b>H309</b> ..011 630



A = Aerotwin | AM = Aerotwin Multi-Clip | AP = Aerotwin Plus | AR = Aerotwin Retrofit | S = Spoiler | U = Single Pack





3 397...

DODGE													
Avenger [JS]	09.07→	KUR	AR801S ..118 996	AR600U ..008 938	AR530U ..008 936								
Caliber [P3]	01.06→	①	AR601S ..118 907	AR600U ..008 938	AR400U ..008 932			601S ..010 297	600US ..004 592		600U ..004 586	400U ..004 579	① H280 ..018 802
Caravan [NS]	01.95-08.03	①	AR651S ..118 913							650 ..118 320	650U ..004 587	650U ..004 587	① H450/450U ..004 763
[RS]	09.00-08.07	①	AR651S ..118 913							650 ..118 320	650U ..004 587	650U ..004 587	① H400/400U ..004 757
Grand Caravan [RT]	09.07-11.09	①	AR701S ..007 706	AR650U ..008 939	AR450U ..008 933					701 ..118 202	650U ..004 587	650U ..004 587	KWB H402 ..004 632
	12.09→	①	AR701S ..007 706	AR650U ..008 939	AR450U ..008 933					701 ..118 202	650U ..004 587	650U ..004 587	① H403 ..011 592
Journey [JC]	05.08→	①	AR604S ..118 908	AR600U ..008 938	AR450U ..008 933			604S ..118 303	600US ..004 592		600U ..004 586	450U ..004 581	H309 ..011 630
Magnum [LX]	09.04→	①	AR550S ..118 906	AR550U ..008 937	AR530U ..008 936			550S ..118 421	550US ..004 591	550 ..118 420	550U ..004 585	550U ..004 585	
Nitro [KA]	09.06→	①	AR480S ..118 900	AR480U ..008 934	AR480U ..008 934			480S ..118 541		480 ..118 540	480U ..004 582	480U ..004 582	
FIAT													
Albea [172..]	01.02→	①		AR575U ..008 940	AR450U ..008 933						576 ..118 452	575U ..011 351	450U ..004 581
Barchetta [183..]	01.95-02.05	①	AR480S ..118 900	AR480U ..008 934	AR480U ..008 934						480 ..118 540	480U ..004 582	480U ..004 582
Brava [182..]	10.95-09.01	FFB	AR551S ..118 905	AR550U ..008 937	AR500U ..008 935					FFB	551 ..118 422	550U ..004 585	500U ..004 583
Bravo [182..]	10.95-09.01	FFB	AR551S ..118 905	AR550U ..008 937	AR500U ..008 935					FFB	551 ..118 422	550U ..004 585	500U ..004 583
[198]	03.07→	③	A187S ..007 187	AM24U ..008 571	AM18U ..008 565	2AA	AP24U ..006 837	AP18U ..006 831					
Cinquecento [170..]	07.91-07.98	①	AR480S ..118 900	AR480U ..008 934	AR480U ..008 934			480S ..118 541		480 ..118 540	480U ..004 582	480U ..004 582	WGK Z361 ..033 361
	07.91-05.95												① H280 ..018 802
Coupé [175..]	02.94-09.00									①	533 ..118 405	530U ..004 584	480U ..004 582
													① H500/500U ..004 760
Croma [154..]	07.90-12.96	KUR	AR503S ..118 993	AR500U ..008 935	AR480U ..008 934			500S ..118 561	500US ..004 590	500 ..118 560	500U ..004 583	500U ..004 583	① H500/500U ..004 760
[194..]	06.05-12.10	②	A094S ..007 094	AM24U ..008 571	AM16U ..008 563	AP1	AP24U ..006 837	AP16U ..006 829					
Doblo [223..]	07.00-12.10	KUR	AR531S ..118 901	AR530U ..008 936	AR450U ..008 933					KUR	531S ..118 403	550US ..004 591	531 ..118 402
													530U ..004 584
[263..]	02.10→	③	A295S ..007 295	AM24U ..008 571	AM16U ..008 563	2AA	AP24U ..006 837	AP16U ..006 829					MHK A381H ..008 996
Doblo Cargo [223..]	07.00-12.10	KUR	AR531S ..118 901	AR530U ..008 936	AR450U ..008 933					KUR	531S ..118 403	550US ..004 591	531 ..118 402
													530U ..004 584
													450U ..004 581
													WGK H356 ..011 655
[263..]	02.10→	③	A295S ..007 295	AM24U ..008 571	AM16U ..008 563	2AA	AP24U ..006 837	AP16U ..006 829					MHK A381H ..008 996
													MGT H400/400U ..004 757
													① H400/400U ..004 757



A = Aerotwin | AM = Aerotwin Multi-Clip | AP = Aerotwin Plus | AR = Aerotwin Retrofit | S = Spoiler | U = Single Pack



3 397...

<b>Ducato</b> [230; 231; 232; 234]	03.94-03.02	①	<b>AR550S</b> ..118 906	<b>AR550U</b> ..008 937	<b>AR530U</b> ..008 936				<b>550S</b> ..118 421	<b>550US</b> ..004 591	<b>550</b> ..118 420	<b>550U</b> ..004 585	<b>550U</b> ..004 585			
[243; 244; 245; 247]	04.02→	①	<b>AR550S</b> ..118 906	<b>AR550U</b> ..008 937	<b>AR530U</b> ..008 936				<b>550S</b> ..118 421	<b>550US</b> ..004 591	<b>550</b> ..118 420	<b>550U</b> ..004 585	<b>550U</b> ..004 585			
[250; 251]	06.06→	③	<b>A225S</b> ..007 225	<b>AM26U</b> ..008 573	<b>AM22U</b> ..008 569	2AA	<b>AP26U</b> ..006 838	<b>AP22U</b> ..006 835								
<b>Fiorino</b> [255..]	01.88-12.01											<b>450U</b> ..004 581				
[225..]	12.07→	⑦	<b>A426S</b> ..007 426			AP3	<b>AP26U</b> ..006 838	<b>AP19U</b> ..006 832								
<b>Freemont</b> [JC]	06.11→	①	<b>AR607S</b> ..118 909	<b>AR600U</b> ..008 938	<b>AR480U</b> ..008 934				<b>607S</b> ..118 306	<b>600US</b> ..004 592		<b>600U</b> ..004 586	<b>480U</b> ..004 582		<b>H309</b> ..011 630	
<b>Idea</b> [350]	01.04-12.05	FFB	<b>AR989S</b> ..118 989	<b>AR575U</b> ..008 940	<b>AR400U</b> ..008 932						<b>601</b> ..118 304	<b>575U</b> ..011 351	<b>400U</b> ..004 579	WGK	<b>Z361</b> ..033 361	
	01.06-03.08	①		<b>AR575U</b> ..008 940	<b>AR380U</b> ..008 931						<b>577</b> ..010 298	<b>575U</b> ..011 351	<b>380U</b> ..011 353	WGK	<b>Z361</b> ..033 361	
	04.08-12.12	③	<b>A420S</b> ..007 420	<b>AM23U</b> ..008 570	<b>AM15U</b> ..008 562	2AA	<b>AP23U</b> ..006 836	<b>AP15U</b> ..006 828						WGK	<b>Z361</b> ..033 361	
[323]	03.07→	⑥	<b>AM466S</b> ..007 466	<b>AM26U</b> ..008 573	<b>AM15U</b> ..008 562	2BB	<b>AP26U</b> ..006 838	<b>AP15U</b> ..006 828								
<b>Marea</b> [185..]	10.96-09.02	FFB	<b>AR728S</b> ..118 904	<b>AR550U</b> ..008 937	<b>AR480U</b> ..008 934				FFB	<b>728S</b> ..001 728	<b>550US</b> ..004 591	<b>727</b> ..001 727	<b>550U</b> ..004 585	<b>480U</b> ..004 582	WGK	<b>Z361</b> ..033 361
<b>Marengo</b> [259..]	02.90-12.96								①	<b>500S</b> ..118 561	<b>500US</b> ..004 590	<b>500</b> ..118 560	<b>500U</b> ..004 583	<b>500U</b> ..004 583	WGK	<b>Z361</b> ..033 361
									REF			<b>109</b> ..033 109				
[285..]	01.97-09.02	FFB	<b>AR728S</b> ..118 904	<b>AR550U</b> ..008 937	<b>AR480U</b> ..008 934				FFB	<b>728S</b> ..001 728	<b>550US</b> ..004 591	<b>727</b> ..001 727	<b>550U</b> ..004 585	<b>480U</b> ..004 582	WGK	<b>Z361</b> ..033 361
<b>Multipla</b> [186..]	01.99-12.05	①	<b>AR801S</b> ..118 996	<b>AR600U</b> ..008 938	<b>AR530U</b> ..008 936						<b>608</b> ..118 307	<b>600U</b> ..004 586	<b>550U</b> ..004 585	WGK	<b>Z361</b> ..033 361	
	01.06-12.10	⑥	<b>A410S</b> ..007 410	<b>AM24U</b> ..008 571	<b>AM22U</b> ..008 569	2BB	<b>AP24U</b> ..006 837	<b>AP22U</b> ..006 835						WGK	<b>Z361</b> ..033 361	
<b>Palio</b> [178..]	03.98→	①		<b>AR575U</b> ..008 940	<b>AR450U</b> ..008 933						<b>576</b> ..118 452	<b>575U</b> ..011 351	<b>450U</b> ..004 581	WGK	<b>Z361</b> ..033 361	
<b>Palio Weekend</b> [178..]	09.97→	①		<b>AR575U</b> ..008 940	<b>AR450U</b> ..008 933						<b>576</b> ..118 452	<b>575U</b> ..011 351	<b>450U</b> ..004 581	WGK	<b>Z361</b> ..033 361	
<b>Panda</b> [141..]	01.93-09.03								①			<b>400U</b> ..004 579		WGK	<b>Z361</b> ..033 361	
[153..]	01.93-09.03								①			<b>400U</b> ..004 579				
[169..]	10.03-12.12	FFB	<b>AR989S</b> ..118 989	<b>AR575U</b> ..008 940	<b>AR400U</b> ..008 932				FFB		<b>601</b> ..118 304	<b>575U</b> ..011 351	<b>400U</b> ..004 579	WGK	<b>Z361</b> ..033 361	
[312..]	02.12→	③	<b>A292S</b> ..007 292	<b>AM24U</b> ..008 571	<b>AM15U</b> ..008 562	2AA	<b>AP24U</b> ..006 837	<b>AP15U</b> ..006 828							<b>H840</b> ..004 802	
<b>Punto</b> [176..]	08.93-08.99	FFB	<b>AR989S</b> ..118 989	<b>AR575U</b> ..008 940	<b>AR400U</b> ..008 932				FFB		<b>601</b> ..118 304	<b>575U</b> ..011 351	<b>400U</b> ..004 579	WGK	<b>Z361</b> ..033 361	
[188..]	07.99-12.10	FFB	<b>AR531S</b> ..118 901	<b>AR530U</b> ..008 936	<b>AR450U</b> ..008 933				KUR	<b>531S</b> ..118 403	<b>550US</b> ..004 591	<b>531</b> ..118 402	<b>530U</b> ..004 584	<b>450U</b> ..004 581	WGK	<b>Z361</b> ..033 361
[199..]	01.12→	⑥	<b>AM466S</b> ..007 466	<b>AM26U</b> ..008 573	<b>AM15U</b> ..008 562	2BB	<b>AP26U</b> ..006 838	<b>AP15U</b> ..006 828							<b>H301</b> ..004 629	
<b>Punto Cabrio</b> [176..]	04.94-08.99	FFB	<b>AR989S</b> ..118 989	<b>AR575U</b> ..008 940	<b>AR400U</b> ..008 932				FFB		<b>601</b> ..118 304	<b>575U</b> ..011 351	<b>400U</b> ..004 579			
<b>Punto Evo</b> [199..]	10.09→	⑥	<b>AM466S</b> ..007 466	<b>AM26U</b> ..008 573	<b>AM15U</b> ..008 562	2BB	<b>AP26U</b> ..006 838	<b>AP15U</b> ..006 828							<b>H301</b> ..004 629	
<b>Punto Grande</b> [199..]	10.05→	⑥	<b>AM466S</b> ..007 466	<b>AM26U</b> ..008 573	<b>AM15U</b> ..008 562	2BB	<b>AP26U</b> ..006 838	<b>AP15U</b> ..006 828							<b>H301</b> ..004 629	



A = Aerotwin | AM = Aerotwin Multi-Clip | AP = Aerotwin Plus | AR = Aerotwin Retrofit | S = Spoiler | U = Single Pack



		<b>AEROTWIN</b>			NEW <b>AEROTWIN</b>			<b>TWIN</b> SPOILER			<b>TWIN</b>			<b>REAR</b>	
		?	SET			?			?	SET		SET			?

◀ FIAT

3 397...

<b>Punto GT</b> [176..]	08.93-08.99	FFB ①	<b>AR989S</b> ..118 989	<b>AR575U</b> ..008 940	<b>AR400U</b> ..008 932				FFB			<b>601</b> ..118 304	<b>575U</b> ..011 351	<b>400U</b> ..004 579	WGK	<b>Z361</b> ..033 361
<b>Punto VAN</b> [276..]	05.97-08.99	FFB ①	<b>AR989S</b> ..118 989	<b>AR575U</b> ..008 940	<b>AR400U</b> ..008 932				FFB			<b>601</b> ..118 304	<b>575U</b> ..011 351	<b>400U</b> ..004 579		
[288..]	05.99-12.10	FFB ①	<b>AR531S</b> ..118 901	<b>AR530U</b> ..008 936	<b>AR450U</b> ..008 933				KUR	<b>531S</b> ..118 403	<b>530US</b> ..011 352	<b>531</b> ..118 402	<b>530U</b> ..004 584	<b>450U</b> ..004 581	WGK	<b>Z361</b> ..033 361
<b>Qubo</b> [300..]	09.08→	⑦	<b>A426S</b> ..007 426			AP3	<b>AP26U</b> ..006 838	<b>AP19U</b> ..006 832								
<b>Scudo</b> [222..]	10.95-01.07	①	<b>AR701S</b> ..007 706	<b>AR650U</b> ..008 939	<b>AR500U</b> ..008 935						<b>650US</b> ..004 593	<b>701</b> ..118 202	<b>650U</b> ..004 587	<b>500U</b> ..004 583		
[272..]	01.07→	KUR ① WW	<b>AR701S</b> ..007 706	<b>AR650U</b> ..008 939	<b>AR500U</b> ..008 935					<b>706S</b> ..010 301	<b>650US</b> ..004 593	<b>701</b> ..118 202	<b>700U</b> ..004 489	<b>500U</b> ..004 583	MGT	<b>H353</b> ..004 631
				<b>AR70N</b> ..008 845	<b>AR50N</b> ..008 841										MHK, APE	<b>H380/380U</b> ..004 756
<b>Sedici</b> [189..]	05.06→	①	<b>AR654S</b> ..007 570	<b>AR650U</b> ..008 939	<b>AR340U</b> ..008 930							<b>654</b> ..010 299	<b>650U</b> ..004 587	<b>340U</b> ..004 578		<b>H250</b> ..011 629
<b>Seicento</b> [187..]	03.98-12.10	①	<b>AR480S</b> ..118 900	<b>AR480U</b> ..008 934	<b>AR480U</b> ..008 934					<b>480S</b> ..118 541		<b>480</b> ..118 540	<b>480U</b> ..004 582	<b>480U</b> ..004 582	WGK	<b>Z361</b> ..033 361
<b>Siena</b> [178..]	04.97-12.01	①		<b>AR575U</b> ..008 940	<b>AR450U</b> ..008 933							<b>576</b> ..118 452	<b>575U</b> ..011 351	<b>450U</b> ..004 581		
<b>Stilo</b> [192..]	10.01-06.05	①	<b>AR531S</b> ..118 901	<b>AR530U</b> ..008 936	<b>AR450U</b> ..008 933				KUR	<b>531S</b> ..118 403	<b>530US</b> ..011 352	<b>531</b> ..118 402	<b>530U</b> ..004 584	<b>450U</b> ..004 581	WGK	<b>Z361</b> ..033 361
									BGO	<b>584S</b> ..001 584						
	07.05-12.07	⑥	<b>A408S</b> ..007 408	<b>AM22U</b> ..008 569	<b>AM19U</b> ..008 566	2BB	<b>AP22U</b> ..006 835	<b>AP19U</b> ..006 832							WGK	<b>Z361</b> ..033 361
<b>Stilo Multi Wagon</b> [192..]	10.02-06.05	①	<b>AR531S</b> ..118 901	<b>AR530U</b> ..008 936	<b>AR450U</b> ..008 933				KUR	<b>531S</b> ..118 403	<b>550US</b> ..004 591	<b>531</b> ..118 402	<b>530U</b> ..004 584	<b>450U</b> ..004 581		<b>H353</b> ..004 631
									BGO	<b>584S</b> ..001 584						
	07.05-12.07	⑥	<b>A408S</b> ..007 408	<b>AM22U</b> ..008 569	<b>AM19U</b> ..008 566	2BB	<b>AP22U</b> ..006 835	<b>AP19U</b> ..006 832								<b>H353</b> ..004 631
<b>Strada</b> [278]	03.99→	①		<b>AR575U</b> ..008 940	<b>AR450U</b> ..008 933							<b>576</b> ..118 452	<b>575U</b> ..011 351	<b>450U</b> ..004 581		
<b>Talento</b>	03.88-12.94								①	<b>500S</b> ..118 561	<b>500US</b> ..004 590	<b>500</b> ..118 560	<b>500U</b> ..004 583	<b>500U</b> ..004 583		
<b>Tempra</b> [159]	02.90-12.98								①	<b>500S</b> ..118 561	<b>500US</b> ..004 590	<b>500</b> ..118 560	<b>500U</b> ..004 583	<b>500U</b> ..004 583	WGK	<b>Z361</b> ..033 361
<b>Tempra SW</b> [159]	02.90-12.98								①	<b>500S</b> ..118 561	<b>500US</b> ..004 590	<b>500</b> ..118 560	<b>500U</b> ..004 583	<b>500U</b> ..004 583	WGK	<b>Z361</b> ..033 361
									REF			<b>109</b> ..033 109				
<b>Tipo</b> [160..]	12.90-10.95								REF			<b>109</b> ..033 109			①	<b>H380/380U</b> ..004 756
<b>Ulysse</b> [121..]	09.94-09.02	①	<b>AR701S</b> ..007 706	<b>AR650U</b> ..008 939	<b>AR500U</b> ..008 935						<b>650US</b> ..004 593	<b>701</b> ..118 202	<b>650U</b> ..004 587	<b>500U</b> ..004 583	①	<b>H400/400U</b> ..004 757
[179..]	10.02-10.05	SDV ①	<b>AR657S</b> ..009 777	<b>AR66N</b> ..008 848	<b>AR66N</b> ..008 848				SDV	<b>657S</b> ..118 334						<b>H353</b> ..004 631
	11.05-12.10	①	<b>AR651S</b> ..118 913								<b>650US</b> ..004 593	<b>650</b> ..118 320	<b>650U</b> ..004 587	<b>650U</b> ..004 587		<b>H353</b> ..004 631
<b>Uno</b> [146..]	09.87-12.00								①				<b>450U</b> ..004 581			
	09.89-03.94														①	<b>H340/340U</b> ..004 754
[158..]	01.96→								①				<b>450U</b> ..004 581		WGK	<b>Z361</b> ..033 361



A = Aerotwin | AM = Aerotwin Multi-Clip | AP = Aerotwin Plus | AR = Aerotwin Retrofit | S = Spoiler | U = Single Pack





3 397...

Uno Van [246..]	09.89-03.94	①															450U ..004 581				
126	09.87-09.00	①		AR340U ..008 930	AR340U ..008 930												340 ..118 700	340U ..004 578	340U ..004 578		
500 [312..]	07.07→	③	A299S ..007 299	AM24U ..008 571	AM13U ..008 794	2AA	AP24U ..006 837	AP13U ..006 827												H840 ..004 802	
500C [312..]	07.09→	③	A299S ..007 299	AM24U ..008 571	AM13U ..008 794	2AA	AP24U ..006 837	AP13U ..006 827													
500 EV [3C3..]	03.12→	①	AR605S ..007 504	AR600U ..008 938	AR340U ..008 930												605 ..010 270	600U ..004 586	340U ..004 578		
500L [199..]	09.12→	③	AM466S ..007 466			2AA	AP26U ..006 838	AP15U ..006 828													H840 ..004 802

FORD

B-MAX	08.12→	KUR ⑥	A641S ..007 644	AM30U ..008 928	AM26U ..008 573	2BB	AP30U ..006 840	AP26U ..006 838													H301 ..004 629	
C-MAX [07]	03.07-07.10	②	A951S ..118 951	AM26U ..008 573	AM19U ..008 566	AP1	AP26U ..006 838	AP19U ..006 832													①	H280 ..018 802
	03.07-07.10	WW ②	AM467S ..007 467																			
[11]	08.10→	⑥	A641S ..007 644			2BB	AP30U ..006 840	AP24U ..006 837													FKR	H301 ..004 629
C-MAX (Grand) [11]	08.10→	⑥	A641S ..007 644			2BB	AP30U ..006 840	AP24U ..006 837													FLR, APE	H400/400U ..004 757
Cougar	08.98-12.00	①	AR551S ..118 905	AR550U ..008 937	AR500U ..008 935					551S ..118 423	550US ..004 591	551 ..118 422	550U ..004 585	500U ..004 583							①	H550/550U ..004 762
Econovan	08.85-12.99																					
Escort VII [95]	01.95-09.01																					
Escort VII Cabrio [95]	01.95-09.01																					
Escort VII Express [95]	01.95-09.01																					
Escort VII Turnier [95]	01.95-09.01																					
Escort V/VI [91]	08.90-12.94																					
Escort V/VI Cabrio [91]	08.90-12.94																					
Escort V/VI [91] Express	08.90-12.94																					
Escort V/VI Turnier [91]	08.90-12.94																					
Explorer	01.91-08.01																					
	09.10→	⑥		AM26U ..008 573	AM22U ..008 569	2BB	AP26U ..006 838	AP22U ..006 835														
Festiva	01.93-10.00	①	AR502S ..118 995	AR500U ..008 935	AR450U ..008 933																	
Fiesta III [89]	03.89-12.96																					
Fiesta III Courier [89]	09.91-08.96																					
Fiesta IV [96]	10.95-12.02	①	AR480S ..118 900	AR480U ..008 934	AR480U ..008 934																	



A = Aerotwin | AM = Aerotwin Multi-Clip | AP = Aerotwin Plus | AR = Aerotwin Retrofit | S = Spoiler | U = Single Pack





◀ FORD

3 397...

Model	Year Range	Icon	SET	AM	AP	AR	S	U	REAR				
Fiesta IV Courier [96]	10.95-12.02	①	AR480S ..118 900	AR480U ..008 934	AR480U ..008 934			480S ..118 541	480 ..118 540	480U ..004 582	480U ..004 582		
Fiesta V [02]	11.01-09.08	①	AR552S ..118 984	AR550U ..008 937	AR400U ..008 932			552S ..118 427	550US ..004 591	550U ..004 585	400U ..004 579	① H280 ..018 802	
												WW ① H595 ..004 595	
Fiesta VI [08, 13]	07.08→	③	A432S ..007 432	AM26U ..008 573	AM15U ..008 562	2AA	AP26U ..006 838	AP15U ..006 828					H304 ..004 990
		WW ⑤	AM466S ..007 466										
Five Hundred	09.05-08.07	②	A970S ..118 970	AM24U ..008 571	AM20U ..008 567	AP1	AP24U ..006 837	AP20U ..006 833					
Focus C-MAX [04]	06.03-03.07	②	A951S ..118 951	AM26U ..008 573	AM19U ..008 566	AP1	AP26U ..006 838	AP19U ..006 832				① H280 ..018 802	
		WW ②	AM467S ..007 467										
Focus I [99]	08.98-05.05	①	AR728S ..118 904	AR550U ..008 937	AR480U ..008 934			728S ..001 728	550US ..004 591	727 ..001 727	550U ..004 585	480U ..004 582	① H382 ..011 412
Focus I Turnier [99]	11.98-05.05	①	AR728S ..118 904	AR550U ..008 937	AR480U ..008 934			728S ..001 728	550US ..004 591	727 ..001 727	550U ..004 585	480U ..004 582	① H280 ..018 802
													WW ① H595 ..004 595
Focus II [04]	07.04-01.06	②	A977S ..118 977	AM26U ..008 573	AM16U ..008 563	AP1	AP26U ..006 838	AP17U ..006 830					H381 ..011 135
[04, 08]	02.06-12.11	②	A977S ..118 977	AM26U ..008 573	AM16U ..008 563	AP1	AP26U ..006 838	AP17U ..006 830				KWB	H351 ..004 559
Focus II Cabriolet [06]	07.06-07.10	②	A977S ..118 977	AM26U ..008 573	AM16U ..008 563	AP1	AP26U ..006 838	AP17U ..006 830					
Focus II Turnier [04, 08]	07.04-10.08	②	A977S ..118 977	AM26U ..008 573	AM16U ..008 563	AP1	AP26U ..006 838	AP17U ..006 830				①	H280 ..018 802
[08]	11.08-12.11	②	A977S ..118 977	AM26U ..008 573	AM16U ..008 563	AP1	AP26U ..006 838	AP17U ..006 830				KWB	H304 ..004 990
Focus III [11]	01.11→	③	A640S ..007 640	AM28U ..008 574	AM28U ..008 574	2AA	AP28U ..006 839	AP28U ..006 839					H304 ..004 990
Focus III Turnier [11]	01.11→	③	A640S ..007 640	AM28U ..008 574	AM28U ..008 574	2AA	AP28U ..006 839	AP28U ..006 839					H304 ..004 990
Fusion [02/05]	10.02-06.12	①	AR552S ..118 984	AR550U ..008 937	AR400U ..008 932			552S ..118 427	550US ..004 591	550U ..004 585	400U ..004 579	① H280 ..018 802	
	10.02-06.12											WW ① H595 ..004 595	
Galaxy [95]	02.95-03.00	①	AR704S ..007 565	AR70N ..008 845	AR60N ..008 843			GA		704 ..010 211		① H400/400U ..004 757	
								GBO		532 ..001 532			
[00]	04.00-04.01	①	AR704S ..007 565	AR70N ..008 845	AR60N ..008 843			GA		704 ..010 211		H405 ..004 764	
								GBO		532 ..001 532			
	04.01-08.06	②	A950S ..118 950	AM28U ..008 574	AM28U ..008 574	AP1	AP28U ..006 839	AP28U ..006 839					H405 ..004 764
[06]	03.06-09.08	③	A120S ..007 120	AM30U ..008 928	AM26U ..008 573	2AA	AP30U ..006 840	AP26U ..006 838					H405 ..004 764
	10.08→	③	A120S ..007 120	AM30U ..008 928	AM26U ..008 573	2AA	AP30U ..006 840	AP26U ..006 838				KWB	H330 ..011 306
Granada III [92]	02.92-09.94							①	500S ..118 561	500US ..004 590	500 ..118 560	500U ..004 583	500U ..004 583



A = Aerotwin | AM = Aerotwin Multi-Clip | AP = Aerotwin Plus | AR = Aerotwin Retrofit | S = Spoiler | U = Single Pack



3 397...

<b>Granada III Estate</b> [92]	02.92-09.94								①	<b>500S</b> ..118 561	<b>500US</b> ..004 590	<b>500</b> ..118 560	<b>500U</b> ..004 583	<b>500U</b> ..004 583		
<b>Ka</b> [97]	09.96-09.08	①	<b>AR566S</b> ..118 990	<b>AR480U</b> ..008 934	<b>AR400U</b> ..008 932					<b>481S</b> ..118 543		<b>481</b> ..118 542	<b>480U</b> ..004 582	<b>450U</b> ..004 581	APE	<b>H382</b> ..011 412
<b>Ka II</b> [08]	09.08-10.10	①	<b>AR605S</b> ..007 504	<b>AR600U</b> ..008 938	<b>AR340U</b> ..008 930							<b>605</b> ..010 270	<b>600U</b> ..004 586	<b>340U</b> ..004 578		<b>H840</b> ..004 802
	11.10→	③	<b>A299S</b> ..007 299	<b>AM24U</b> ..008 571	<b>AM13U</b> ..008 794	2AA	<b>AP24U</b> ..006 837	<b>AP13U</b> ..006 827								<b>H840</b> ..004 802
<b>Kuga</b> [CBV]	02.08→	KUR	<b>A295S</b> ..007 295	<b>AM24U</b> ..008 571	<b>AM16U</b> ..008 563	2AA	<b>AP24U</b> ..006 837	<b>AP17U</b> ..006 830								<b>H330</b> ..011 306
	[CBS]	11.12→	KUR	<b>A100S</b> ..007 100	<b>AM28U</b> ..008 574	<b>AM28U</b> ..008 574	2BB	<b>AP28U</b> ..006 839	<b>AP28U</b> ..006 839						APE	<b>A282H</b> ..008 634
<b>Maverick</b> [1EZ, 1N2]	10.00-01.07	①	<b>AR480S</b> ..118 900	<b>AR480U</b> ..008 934	<b>AR480U</b> ..008 934					<b>480S</b> ..118 541		<b>480</b> ..118 540	<b>480U</b> ..004 582	<b>480U</b> ..004 582	L28	<b>H280</b> ..018 802
	[94]	06.93-04.96	①	<b>AR532S</b> ..118 986	<b>AR530U</b> ..008 936	<b>AR500U</b> ..008 935				<b>532S</b> ..118 404	<b>530US</b> ..011 352		<b>530U</b> ..004 584	<b>500U</b> ..004 583	①	<b>H341</b> ..004 755
<b>Maverick</b> [96]	05.96-12.98	①	<b>AR532S</b> ..118 986	<b>AR530U</b> ..008 936	<b>AR500U</b> ..008 935					<b>532S</b> ..118 404	<b>530US</b> ..011 352		<b>530U</b> ..004 584	<b>500U</b> ..004 583	①	<b>H341</b> ..004 755
<b>Mondeo I</b> [93]	01.93-07.96	①	<b>AR532S</b> ..118 986	<b>AR530U</b> ..008 936	<b>AR500U</b> ..008 935					<b>532S</b> ..118 404	<b>530US</b> ..011 352		<b>530U</b> ..004 584	<b>500U</b> ..004 583	①	<b>H550/550U</b> ..004 762
<b>Mondeo I Turnier</b> [93]	04.93-07.96	①	<b>AR532S</b> ..118 986	<b>AR530U</b> ..008 936	<b>AR500U</b> ..008 935					<b>532S</b> ..118 404	<b>530US</b> ..011 352		<b>530U</b> ..004 584	<b>500U</b> ..004 583	①	<b>H341</b> ..004 755
<b>Mondeo II</b> [97]	08.96-09.00	①	<b>AR532S</b> ..118 986	<b>AR530U</b> ..008 936	<b>AR500U</b> ..008 935					<b>532S</b> ..118 404	<b>530US</b> ..011 352		<b>530U</b> ..004 584	<b>500U</b> ..004 583	LIM	<b>H500/500U</b> ..004 760
															①	<b>H550/550U</b> ..004 762
<b>Mondeo II Turnier</b> [97]	08.96-09.00	①	<b>AR532S</b> ..118 986	<b>AR530U</b> ..008 936	<b>AR500U</b> ..008 935					<b>532S</b> ..118 404	<b>530US</b> ..011 352		<b>530U</b> ..004 584	<b>500U</b> ..004 583	①	<b>H341</b> ..004 755
<b>Mondeo III</b> [01]	10.00-03.07	①	<b>AR551S</b> ..118 905	<b>AR550U</b> ..008 937	<b>AR500U</b> ..008 935					<b>551S</b> ..118 423	<b>550US</b> ..004 591	<b>551</b> ..118 422	<b>550U</b> ..004 585	<b>500U</b> ..004 583	①	<b>H480/480U</b> ..004 759
<b>Mondeo III Turnier</b> [01]	10.00-03.07	①	<b>AR551S</b> ..118 905	<b>AR550U</b> ..008 937	<b>AR500U</b> ..008 935					<b>551S</b> ..118 423	<b>550US</b> ..004 591	<b>551</b> ..118 422	<b>550U</b> ..004 585	<b>500U</b> ..004 583	①	<b>H280</b> ..018 802
															WW	<b>H595</b> ..004 595
<b>Mondeo IV</b> [07]	02.07→	③	<b>A309S</b> ..007 309	<b>AM26U</b> ..008 573	<b>AM19U</b> ..008 566	2AA	<b>AP26U</b> ..006 838	<b>AP19U</b> ..006 832							③	<b>A475H</b> ..008 055
		WW	<b>AM467S</b> ..007 467												WW	<b>AM19U</b> ..008 566
<b>Mondeo IV Turnier</b> [07]	02.07→	③	<b>A309S</b> ..007 309	<b>AM26U</b> ..008 573	<b>AM19U</b> ..008 566	2AA	<b>AP26U</b> ..006 838	<b>AP19U</b> ..006 832								<b>H304</b> ..004 990
		WW	<b>AM467S</b> ..007 467													
<b>Mustang</b>	09.04-08.09	①	<b>AR551S</b> ..118 905	<b>AR550U</b> ..008 937	<b>AR500U</b> ..008 935					<b>551S</b> ..118 423	<b>550US</b> ..004 591	<b>551</b> ..118 422	<b>550U</b> ..004 585	<b>500U</b> ..004 583		
	09.09→	KUR	<b>A408S</b> ..007 408	<b>AM22U</b> ..008 569	<b>AM20U</b> ..008 567	2BB	<b>AP22U</b> ..006 835	<b>AP20U</b> ..006 833								
<b>Probe</b>	09.88-08.97	①	<b>AR500S</b> ..009 081	<b>AR500U</b> ..008 935	<b>AR500U</b> ..008 935					<b>500S</b> ..118 561	<b>500US</b> ..004 590	<b>500</b> ..118 560	<b>500U</b> ..004 583	<b>500U</b> ..004 583	①	<b>H500/500U</b> ..004 760
<b>Puma</b>	06.97-12.01									<b>480S</b> ..118 541		<b>480</b> ..118 540	<b>480U</b> ..004 582	<b>480U</b> ..004 582	①	<b>H480/480U</b> ..004 759
<b>Ranger</b>	06.94-06.09	①	<b>AR450S</b> ..118 994	<b>AR450U</b> ..008 933	<b>AR450U</b> ..008 933					<b>450S</b> ..118 506	<b>450US</b> ..004 588	<b>450</b> ..118 505	<b>450U</b> ..004 581	<b>450U</b> ..004 581		
	[TKE]	09.11→	①	<b>AR601S</b> ..118 907	<b>AR600U</b> ..008 938	<b>AR400U</b> ..008 932							<b>601</b> ..118 304	<b>600U</b> ..004 586	<b>400U</b> ..004 579	
<b>Scorpio I</b> [92]	02.92-09.94								①	<b>500S</b> ..118 561	<b>500US</b> ..004 590	<b>500</b> ..118 560	<b>500U</b> ..004 583	<b>500U</b> ..004 583		



A = Aerotwin | AM = Aerotwin Multi-Clip | AP = Aerotwin Plus | AR = Aerotwin Retrofit | S = Spoiler | U = Single Pack





◀ FORD

3 397...

<b>Scorpio I Turnier</b> [92]	02.92-09.94								①	<b>500S</b> ..118 561	<b>500US</b> ..004 590	<b>500</b> ..118 560	<b>500U</b> ..004 583	<b>500U</b> ..004 583		
<b>Scorpio II</b> [95]	01.95-12.98								①	<b>500S</b> ..118 561	<b>500US</b> ..004 590	<b>500</b> ..118 560	<b>500U</b> ..004 583	<b>500U</b> ..004 583		
<b>Scorpio II Turnier</b> [95]	01.95-12.98								①	<b>500S</b> ..118 561	<b>500US</b> ..004 590	<b>500</b> ..118 560	<b>500U</b> ..004 583	<b>500U</b> ..004 583		
<b>S-MAX</b> [06]	03.06-01.09	③	<b>A 120S</b> ..007 120	<b>AM30U</b> ..008 928	<b>AM26U</b> ..008 573	2AA	<b>AP30U</b> ..006 840	<b>AP26U</b> ..006 838							①	<b>H 341</b> ..004 755
	02.09→	③	<b>A 120S</b> ..007 120	<b>AM30U</b> ..008 928	<b>AM26U</b> ..008 573	2AA	<b>AP30U</b> ..006 840	<b>AP26U</b> ..006 838							KWB	<b>H 330</b> ..011 306
<b>Streetka</b>	12.02-12.05	①	<b>AR480S</b> ..118 900	<b>AR480U</b> ..008 934	<b>AR480U</b> ..008 934					<b>480S</b> ..118 541		<b>480</b> ..118 540	<b>480U</b> ..004 582	<b>480U</b> ..004 582		
<b>Tourneo Connect</b> [02]	05.02→	①	<b>AR551S</b> ..118 905	<b>AR550U</b> ..008 937	<b>AR500U</b> ..008 935					<b>551S</b> ..118 423	<b>550US</b> ..004 591	<b>551</b> ..118 422	<b>550U</b> ..004 585	<b>500U</b> ..004 583	MGT	<b>H340/340U</b> ..004 754
															MHK	<b>H380/380U</b> ..004 756
<b>Transit</b> [92]	08.91-07.94	①	<b>AR550S</b> ..118 906	<b>AR550U</b> ..008 937	<b>AR530U</b> ..008 936					<b>550S</b> ..118 421	<b>550US</b> ..004 591	<b>550</b> ..118 420	<b>550U</b> ..004 585	<b>550U</b> ..004 585	①	<b>H 341</b> ..004 755
	[95]	①	<b>AR550S</b> ..118 906	<b>AR550U</b> ..008 937	<b>AR530U</b> ..008 936					<b>550S</b> ..118 421	<b>550US</b> ..004 591	<b>550</b> ..118 420	<b>550U</b> ..004 585	<b>550U</b> ..004 585	①	<b>H 341</b> ..004 755
	[00, 06, 12]	01.00→	①	<b>AR655S</b> ..007 584	<b>AR650U</b> ..008 939	<b>AR550U</b> ..008 937							<b>655</b> ..010 302	<b>650U</b> ..004 587	<b>550U</b> ..004 585	MGT
									WW				<b>700U</b> ..004 489	<b>575U</b> ..011 351	MHK	<b>H450/450U</b> ..004 763
<b>Transit Connect</b> [02]	05.02→	①	<b>AR551S</b> ..118 905	<b>AR550U</b> ..008 937	<b>AR500U</b> ..008 935					<b>551S</b> ..118 423	<b>550US</b> ..004 591	<b>551</b> ..118 422	<b>550U</b> ..004 585	<b>500U</b> ..004 583	MGT	<b>H 341</b> ..004 755
															MHK	<b>H 280</b> ..018 802
<b>Transit Custom</b> [13]	09.12→	③		<b>AM30U</b> ..008 928	<b>AM28U</b> ..008 574	2AA	<b>AP30U</b> ..006 840	<b>AP28U</b> ..006 839							MGT	<b>H 341</b> ..004 755
<b>Transit Tourneo custom</b> [13]	09.12→	③		<b>AM30U</b> ..008 928	<b>AM28U</b> ..008 574	2AA	<b>AP30U</b> ..006 840	<b>AP28U</b> ..006 839							MGT	<b>H 341</b> ..004 755

**FSM**

<b>126</b>	12.94-12.00								①			<b>340</b> ..118 700	<b>340U</b> ..004 578	<b>340U</b> ..004 578		
------------	-------------	--	--	--	--	--	--	--	---	--	--	-------------------------	--------------------------	--------------------------	--	--

**GREATWALL**

<b>Hover</b>	05.05→	①	<b>AR503S</b> ..118 993	<b>AR500U</b> ..008 935	<b>AR480U</b> ..008 934					<b>503S</b> ..118 566	<b>500US</b> ..004 590	<b>503</b> ..118 565	<b>500U</b> ..004 583	<b>480U</b> ..004 582		
<b>Steed/Wingle</b>	12.06→	①	<b>AR728S</b> ..118 904	<b>AR550U</b> ..008 937	<b>AR480U</b> ..008 934					<b>728S</b> ..001 728	<b>550US</b> ..004 591	<b>727</b> ..001 727	<b>550U</b> ..004 585	<b>480U</b> ..004 582		
<b>Voleex C10</b>	01.12→	①	<b>AR605S</b> ..007 504	<b>AR600U</b> ..008 938	<b>AR380U</b> ..008 931						<b>600US</b> ..004 592	<b>605</b> ..010 270	<b>600U</b> ..004 586	<b>380U</b> ..011 353		<b>H 301</b> ..004 629

**HONDA**

<b>Accord</b> [CL/CN/CM]	02.03-06.08	①	<b>AR653S</b> ..118 911	<b>AR650U</b> ..008 939	<b>AR400U</b> ..008 932							<b>653</b> ..118 324	<b>650U</b> ..004 587	<b>400U</b> ..004 579		
	[CU/CW]	07.08→	①	<b>AR801S</b> ..118 996	<b>AR600U</b> ..008 938	<b>AR530U</b> ..008 936							<b>608</b> ..118 307	<b>600U</b> ..004 586	<b>550U</b> ..004 585	
<b>Accord Aerodeck</b> [CB/CC/CD/CE]	09.93-06.98	①	<b>AR551S</b> ..118 905	<b>AR550U</b> ..008 937	<b>AR500U</b> ..008 935					<b>551S</b> ..118 423	<b>550US</b> ..004 591	<b>551</b> ..118 422	<b>550U</b> ..004 585	<b>500U</b> ..004 583	①	<b>H380/380U</b> ..004 756



A = Aerotwin | AM = Aerotwin Multi-Clip | AP = Aerotwin Plus | AR = Aerotwin Retrofit | S = Spoiler | U = Single Pack



3 397...

			SET			NEW! AEROTWIN			TWIN SPOILER		SET		TWIN			REAR
<b>Accord Coupé</b>	01.92-06.98	①	<b>AR551S</b>	<b>AR550U</b>	<b>AR500U</b>						<b>551S</b>	<b>550US</b>	<b>551</b>	<b>550U</b>	<b>500U</b>	
[CB/CC/CD/CE]			..118 905	..008 937	..008 935						..118 423	..004 591	..118 422	..004 585	..004 583	
[CG]	12.97-12.02	①	<b>AR607S</b>	<b>AR600U</b>	<b>AR480U</b>						<b>607S</b>	<b>600US</b>		<b>600U</b>	<b>480U</b>	
			..118 909	..008 938	..008 934						..118 306	..004 592		..004 586	..004 582	
<b>Accord Hatchback</b>	10.98-11.99	①	<b>AR728S</b>	<b>AR550U</b>	<b>AR480U</b>						<b>728S</b>	<b>550US</b>	<b>727</b>	<b>550U</b>	<b>480U</b>	
[CG/CH/CL]			..118 904	..008 937	..008 934						..001 728	..004 591	..001 727	..004 585	..004 582	
	12.99-02.03	①	<b>AR728S</b>	<b>AR550U</b>	<b>AR480U</b>						<b>728S</b>	<b>550US</b>	<b>727</b>	<b>550U</b>	<b>480U</b>	<b>H402</b>
			..118 904	..008 937	..008 934						..001 728	..004 591	..001 727	..004 585	..004 582	..004 632
<b>Accord Sedan</b>	01.90-12.99	①	<b>AR551S</b>	<b>AR550U</b>	<b>AR500U</b>						<b>551S</b>	<b>550US</b>	<b>551</b>	<b>550U</b>	<b>500U</b>	
[CA/CB/CD]			..118 905	..008 937	..008 935						..118 423	..004 591	..118 422	..004 585	..004 583	
[CC; CE/CF]	03.93-10.98	①	<b>AR551S</b>	<b>AR550U</b>	<b>AR500U</b>						<b>551S</b>	<b>550US</b>	<b>551</b>	<b>550U</b>	<b>500U</b>	
			..118 905	..008 937	..008 935						..118 423	..004 591	..118 422	..004 585	..004 583	
[CG/CH/CL]	10.98-02.03	①	<b>AR728S</b>	<b>AR550U</b>	<b>AR480U</b>						<b>728S</b>	<b>550US</b>	<b>727</b>	<b>550U</b>	<b>480U</b>	
			..118 904	..008 937	..008 934						..001 728	..004 591	..001 727	..004 585	..004 582	
<b>Accord Tourer</b>	02.03-08.08	①	<b>AR653S</b>	<b>AR650U</b>	<b>AR400U</b>								<b>653</b>	<b>650U</b>	<b>400U</b>	<b>H306</b>
[CL/CN/CM]			..118 911	..008 939	..008 932								..118 324	..004 587	..004 579	..011 432
[CU/CW]	09.08→	①	<b>AR801S</b>	<b>AR600U</b>	<b>AR530U</b>								<b>608</b>	<b>600U</b>	<b>550U</b>	<b>H306</b>
			..118 996	..008 938	..008 936								..118 307	..004 586	..004 585	..011 432
<b>Civic Aerodeck</b>	03.98-02.01	①	<b>AR502S</b>	<b>AR500U</b>	<b>AR450U</b>						<b>502S</b>	<b>500US</b>	<b>502</b>	<b>500U</b>	<b>450U</b>	① <b>H380/380U</b>
[MB/MC]			..118 995	..008 935	..008 933						..118 564	..004 590	..118 563	..004 583	..004 581	..004 756
<b>Civic Coupé [EK]</b>	05.01-12.04	①	<b>AR533S</b>	<b>AR530U</b>	<b>AR480U</b>											
			..118 902	..008 936	..008 934											
<b>Civic CRX [EG/EH]</b>	03.92-12.98	①	<b>AR502S</b>	<b>AR500U</b>	<b>AR450U</b>						<b>502S</b>	<b>500US</b>	<b>502</b>	<b>500U</b>	<b>450U</b>	
			..118 995	..008 935	..008 933						..118 564	..004 590	..118 563	..004 583	..004 581	
<b>Civic Fastback</b>	09.94-01.97	①	<b>AR502S</b>	<b>AR500U</b>	<b>AR450U</b>						<b>502S</b>	<b>500US</b>	<b>502</b>	<b>500U</b>	<b>450U</b>	① <b>H450/450U</b>
[MA]			..118 995	..008 935	..008 933						..118 564	..004 590	..118 563	..004 583	..004 581	..004 763
[MB/MC]	09.94-02.01	①	<b>AR502S</b>	<b>AR500U</b>	<b>AR450U</b>						<b>502S</b>	<b>500US</b>	<b>502</b>	<b>500U</b>	<b>450U</b>	① <b>H450/450U</b>
			..118 995	..008 935	..008 933						..118 564	..004 590	..118 563	..004 583	..004 581	..004 763
<b>Civic Hatchback</b>	10.91-09.95	①	<b>AR502S</b>	<b>AR500U</b>	<b>AR450U</b>						<b>502S</b>	<b>500US</b>	<b>502</b>	<b>500U</b>	<b>450U</b>	
[EG/EH]			..118 995	..008 935	..008 933						..118 564	..004 590	..118 563	..004 583	..004 581	
[EJ/EK]	10.95-02.01	①	<b>AR502S</b>	<b>AR500U</b>	<b>AR450U</b>						<b>502S</b>	<b>500US</b>	<b>502</b>	<b>500U</b>	<b>450U</b>	① <b>H380/380U</b>
			..118 995	..008 935	..008 933						..118 564	..004 590	..118 563	..004 583	..004 581	..004 756
[EU/EP]	02.01-12.05	KUR	<b>AR605S</b>	<b>AR600U</b>	<b>AR380U</b>							<b>600US</b>	<b>605</b>	<b>600U</b>	<b>380U</b>	<b>H301</b>
		①	..007 504	..008 938	..008 931							..004 592	..010 270	..004 586	..011 353	..004 629
[FK/FN]	09.05-12.11	①	<b>A392S</b>													
			..007 392													
	09.11→	①	<b>AR813S</b>	<b>AR650U</b>	<b>AR450U</b>								<b>803</b>	<b>650U</b>	<b>450U</b>	OAM <b>H450/450U</b>
			..118 912	..008 939	..008 933								..001 803	..004 587	..004 581	① ..004 763
<b>Civic Hybrid [FD]</b>	01.06-12.07	①	<b>A392S</b>													
			..007 392													
[FA]	01.06-08.11	①	<b>AR991S</b>										<b>655</b>	<b>650U</b>	<b>575U</b>	
			..118 991										..010 302	..004 587	..011 351	
[FD]	01.08→	①	<b>AR991S</b>										<b>655</b>	<b>650U</b>	<b>575U</b>	
			..118 991										..010 302	..004 587	..011 351	
<b>Civic Sedan</b>	10.91-09.95	①	<b>AR502S</b>	<b>AR500U</b>	<b>AR450U</b>						<b>502S</b>	<b>500US</b>	<b>502</b>	<b>500U</b>	<b>450U</b>	
[EG/EH]			..118 995	..008 935	..008 933						..118 564	..004 590	..118 563	..004 583	..004 581	
[EJ/EK]	10.95-02.01	①	<b>AR502S</b>	<b>AR500U</b>	<b>AR450U</b>						<b>502S</b>	<b>500US</b>	<b>502</b>	<b>500U</b>	<b>450U</b>	① <b>H380/380U</b>
			..118 995	..008 935	..008 933						..118 564	..004 590	..118 563	..004 583	..004 581	..004 756
[ES]	02.01-12.06	①	<b>AR531S</b>	<b>AR530U</b>	<b>AR450U</b>						<b>531S</b>	<b>530US</b>	<b>531</b>	<b>530U</b>	<b>450U</b>	
			..118 901	..008 936	..008 933						..118 403	..011 352	..118 402	..004 584	..004 581	
[FD]	09.05-12.11	①	<b>AR991S</b>										<b>655</b>	<b>650U</b>	<b>575U</b>	
			..118 991										..010 302	..004 587	..011 351	
<b>Civic Shuttle</b>	01.88-06.95	①	<b>AR566S</b>	<b>AR480U</b>	<b>AR400U</b>						<b>481S</b>		<b>481</b>	<b>480U</b>	<b>450U</b>	① <b>H450/450U</b>
[EC/ED/EE]			..118 990	..008 934	..008 932						..118 543		..118 542	..004 582	..004 581	..004 763
<b>CR-V [RD]</b>	10.95-07.02	①	<b>AR480S</b>	<b>AR480U</b>	<b>AR480U</b>						<b>480S</b>		<b>480</b>	<b>480U</b>	<b>480U</b>	
			..118 900	..008 934	..008 934						..118 541		..118 540	..004 582	..004 582	



A = Aerotwin | AM = Aerotwin Multi-Clip | AP = Aerotwin Plus | AR = Aerotwin Retrofit | S = Spoiler | U = Single Pack



🚗	📄 1	AEROTWIN			NEW! AEROTWIN			TWIN SPOILER			TWIN			REAR	
		🔍 SET	↙	↘	🔍 SET	↙	↘	🔍 SET	↙	↘	SET	↙	↘	🔍	🚗

◀ HONDA

3 397...

<b>CR-V [RD]</b>	08.02-09.06	①	<b>AR532S</b> ..118 986	<b>AR530U</b> ..008 936	<b>AR500U</b> ..008 935				<b>532S</b> ..118 404	<b>530US</b> ..011 352		<b>530U</b> ..004 584	<b>500U</b> ..004 583	KUR	<b>H280</b> ..018 802
[KL]	07.03→	①	<b>AR533S</b> ..118 902	<b>AR530U</b> ..008 936	<b>AR480U</b> ..008 934						<b>533</b> ..118 405	<b>530U</b> ..004 584	<b>480U</b> ..004 582		
[RE]	01.07→	KUR	<b>AR653S</b> ..118 911	<b>AR650U</b> ..008 939	<b>AR400U</b> ..008 932										<b>H354</b> ..011 433
	10.12→	①	<b>AR653S</b> ..118 911	<b>AR650U</b> ..008 939	<b>AR400U</b> ..008 932										<b>H308</b> ..011 628
<b>CR-Z [ZF]</b>	03.10→	①	<b>AR701S</b> ..007 706	<b>AR650U</b> ..008 939	<b>AR500U</b> ..008 935						<b>701</b> ..118 202	<b>650U</b> ..004 587	<b>500U</b> ..004 583		
<b>Crosstour</b>	09.09→	KUR	<b>AR813S</b> ..118 912	<b>AR650U</b> ..008 939	<b>AR480U</b> ..008 934										
<b>Fit</b>	06.01-10.07										<b>534</b> ..010 271	<b>500U</b> ..004 583	<b>380U</b> ..011 353		
<b>FR-V [BE]</b>	01.05-06.09	KUR	<b>AR813S</b> ..118 912	<b>AR650U</b> ..008 939	<b>AR450U</b> ..008 933			KUR			<b>803</b> ..001 803	<b>650U</b> ..004 587	<b>480U</b> ..004 582		
<b>HR-V [GH]</b>	12.98-12.05	①	<b>AR502S</b> ..118 995	<b>AR500U</b> ..008 935	<b>AR400U</b> ..008 932						<b>361</b> ..001 361	<b>500U</b> ..004 583	<b>400U</b> ..004 579		
<b>Insight Coupé [ZE]</b>	01.00-12.06	①	<b>AR502S</b> ..118 995	<b>AR500U</b> ..008 935	<b>AR450U</b> ..008 933				<b>502S</b> ..118 564	<b>500US</b> ..004 590	<b>502</b> ..118 563	<b>500U</b> ..004 583	<b>450U</b> ..004 581		
<b>Insight Hatchback [ZE]</b>	03.09→	①	<b>AR653S</b> ..118 911	<b>AR650U</b> ..008 939	<b>AR400U</b> ..008 932				<b>653S</b> ..118 325	<b>650US</b> ..004 593	<b>653</b> ..118 324	<b>650U</b> ..004 587	<b>400U</b> ..004 579		
<b>Integra Type R [DC]</b>	01.98-10.01	①	<b>AR502S</b> ..118 995	<b>AR500U</b> ..008 935	<b>AR450U</b> ..008 933				<b>502S</b> ..118 564	<b>500US</b> ..004 590	<b>502</b> ..118 563	<b>500U</b> ..004 583	<b>450U</b> ..004 581		
<b>Jazz [GD]</b>	03.02-12.08	①	<b>AR534S</b> ..007 503	<b>AR530U</b> ..008 936	<b>AR380U</b> ..008 931					<b>530US</b> ..011 352	<b>534</b> ..010 271	<b>530U</b> ..004 584	<b>380U</b> ..011 353		<b>H354</b> ..011 433
[GE/GG/GP]	10.08→	①	<b>AR654S</b> ..007 570	<b>AR650U</b> ..008 939	<b>AR340U</b> ..008 930						<b>654</b> ..010 299	<b>650U</b> ..004 587	<b>340U</b> ..004 578		<b>H354</b> ..011 433
<b>Legend</b>	04.98-12.04	①	<b>AR503S</b> ..118 993	<b>AR500U</b> ..008 935	<b>AR480U</b> ..008 934				<b>503S</b> ..118 566	<b>500US</b> ..004 590	<b>503</b> ..118 565	<b>500U</b> ..004 583	<b>480U</b> ..004 582		
<b>Logo</b>	09.96-06.01	①	<b>AR502S</b> ..118 995	<b>AR500U</b> ..008 935	<b>AR450U</b> ..008 933				<b>502S</b> ..118 564	<b>500US</b> ..004 590	<b>502</b> ..118 563	<b>500U</b> ..004 583	<b>450U</b> ..004 579		
<b>NSX Coupé [NA]</b>	06.90-09.05	①	<b>AR500S</b> ..009 081	<b>AR500U</b> ..008 935	<b>AR500U</b> ..008 935				<b>500S</b> ..118 561	<b>500US</b> ..004 590	<b>500</b> ..118 560	<b>500U</b> ..004 583	<b>500U</b> ..004 583		
<b>Odyssey [RA]</b>	03.00→							①			<b>608</b> ..118 307	<b>600U</b> ..004 586	<b>550U</b> ..004 585		
<b>Pilot [YF]</b>	01.09→	①	<b>AR550S</b> ..118 906	<b>AR550U</b> ..008 937	<b>AR530U</b> ..008 936			KUR	<b>530S</b> ..118 401	<b>550US</b> ..004 591	<b>530</b> ..118 400	<b>550U</b> ..004 585	<b>530U</b> ..004 584		
<b>Prelude [BB]</b>	02.92-09.96	①	<b>AR533S</b> ..118 902	<b>AR530U</b> ..008 936	<b>AR480U</b> ..008 934				<b>533S</b> ..118 406	<b>530US</b> ..011 352	<b>533</b> ..118 405	<b>530U</b> ..004 584	<b>480U</b> ..004 582	①	<b>H480/480U</b> ..004 759
<b>Shuttle</b>	01.95-05.01								<b>550S</b> ..118 421	<b>550US</b> ..004 591	<b>550</b> ..118 420	<b>550U</b> ..004 585	<b>550U</b> ..004 585	①	<b>H380/380U</b> ..004 756
<b>Stream [RN]</b>	10.00-07.06	①	<b>AR605S</b> ..007 504	<b>AR600U</b> ..008 938	<b>AR340U</b> ..008 930						<b>605</b> ..010 270	<b>600U</b> ..004 586	<b>340U</b> ..004 578		
<b>S2000</b>	04.99-06.09	①		<b>AR500U</b> ..008 935	<b>AR400U</b> ..008 932						<b>361</b> ..001 361	<b>500U</b> ..004 583	<b>400U</b> ..004 579		

**HUMMER**

<b>H2</b>	09.02→	①		<b>AR400U</b> ..008 932	<b>AR400U</b> ..008 932							<b>400</b> ..118 610	<b>400U</b> ..004 579	<b>400U</b> ..004 579	
<b>H3</b>	09.06→	①		<b>AR400U</b> ..008 932	<b>AR400U</b> ..008 932							<b>400</b> ..118 610	<b>400U</b> ..004 579	<b>400U</b> ..004 579	



A = Aerotwin | AM = Aerotwin Multi-Clip | AP = Aerotwin Plus | AR = Aerotwin Retrofit | S = Spoiler | U = Single Pack



3 397...

HYUNDAI															
<b>Accent [X3]</b>	07.94-07.99	①	<b>AR502S</b> ..118 995	<b>AR500U</b> ..008 935	<b>AR450U</b> ..008 933				<b>502S</b> ..118 564	<b>500US</b> ..004 590	<b>502</b> ..118 563	<b>500U</b> ..004 583	<b>450U</b> ..004 581	①	<b>H500/500U</b> ..004 760
[LC]	05.99→	①	<b>AR502S</b> ..118 995	<b>AR500U</b> ..008 935	<b>AR450U</b> ..008 933				<b>502S</b> ..118 564	<b>500US</b> ..004 590	<b>502</b> ..118 563	<b>500U</b> ..004 583	<b>450U</b> ..004 581		
[MC]	04.06-02.12	①	<b>AR552S</b> ..118 984	<b>AR550U</b> ..008 937	<b>AR400U</b> ..008 932				<b>552S</b> ..118 427	<b>550US</b> ..004 591		<b>550U</b> ..004 585	<b>400U</b> ..004 579		
<b>Accent Blue [RB]</b>	01.11→	①	<b>AR653S</b> ..118 911	<b>AR650U</b> ..008 939	<b>AR400U</b> ..008 932						<b>653</b> ..118 324	<b>650U</b> ..004 587	<b>400U</b> ..004 579		
<b>Accent Hatchback [X3]</b>	07.94-07.99	①	<b>AR502S</b> ..118 995	<b>AR500U</b> ..008 935	<b>AR450U</b> ..008 933				<b>502S</b> ..118 564	<b>500US</b> ..004 590	<b>502</b> ..118 563	<b>500U</b> ..004 583	<b>450U</b> ..004 581	①	<b>H500/500U</b> ..004 760
[LC]	08.99-06.06	①	<b>AR502S</b> ..118 995	<b>AR500U</b> ..008 935	<b>AR450U</b> ..008 933				<b>502S</b> ..118 564	<b>500US</b> ..004 590	<b>502</b> ..118 563	<b>500U</b> ..004 583	<b>450U</b> ..004 581	①	<b>H450/450U</b> ..004 763
[MC]	04.06-02.12	①	<b>AR552S</b> ..118 984	<b>AR550U</b> ..008 937	<b>AR400U</b> ..008 932				<b>552S</b> ..118 427	<b>550US</b> ..004 591		<b>550U</b> ..004 585	<b>400U</b> ..004 579		<b>H352</b> ..011 430
<b>Atos [MX]</b>	09.97-12.03	①		<b>AR500U</b> ..008 935	<b>AR400U</b> ..008 932						<b>361</b> ..001 361	<b>500U</b> ..004 583	<b>400U</b> ..004 579	①	<b>H341</b> ..004 755
<b>Atos Prime [MX]</b>	09.99-03.08	①		<b>AR500U</b> ..008 935	<b>AR400U</b> ..008 932						<b>361</b> ..001 361	<b>500U</b> ..004 583	<b>400U</b> ..004 579	①	<b>H341</b> ..004 755
<b>Coupé [FX]</b>	07.96→	①	<b>AR531S</b> ..118 901	<b>AR530U</b> ..008 936	<b>AR450U</b> ..008 933										
[RD]	05.96-09.01							KUR	<b>531S</b> ..118 403	<b>530US</b> ..011 352	<b>531</b> ..118 402	<b>530U</b> ..004 584	<b>450U</b> ..004 581	①	<b>H500/500U</b> ..004 760
[GK]	10.01-08.09	①	<b>AR531S</b> ..118 901	<b>AR530U</b> ..008 936	<b>AR450U</b> ..008 933			KUR	<b>531S</b> ..118 403	<b>530US</b> ..011 352	<b>531</b> ..118 402	<b>530U</b> ..004 584	<b>450U</b> ..004 581	①	<b>H500/500U</b> ..004 760
<b>Elantra [J1]</b>	10.90-04.95	①	<b>AR502S</b> ..118 995	<b>AR500U</b> ..008 935	<b>AR450U</b> ..008 933				<b>502S</b> ..118 564	<b>500US</b> ..004 590	<b>502</b> ..118 563	<b>500U</b> ..004 583	<b>450U</b> ..004 581		
[J2]	05.95-09.00	①	<b>AR502S</b> ..118 995	<b>AR500U</b> ..008 935	<b>AR450U</b> ..008 933				<b>502S</b> ..118 564	<b>500US</b> ..004 590	<b>502</b> ..118 563	<b>500U</b> ..004 583	<b>450U</b> ..004 581	①	<b>H500/500U</b> ..004 760
[XD]	06.00-09.06	①	<b>AR502S</b> ..118 995	<b>AR500U</b> ..008 935	<b>AR450U</b> ..008 933				<b>502S</b> ..118 564	<b>500US</b> ..004 590	<b>502</b> ..118 563	<b>500U</b> ..004 583	<b>450U</b> ..004 581		
[HD]	01.06→	①	<b>AR502S</b> ..118 995	<b>AR500U</b> ..008 935	<b>AR450U</b> ..008 933				<b>502S</b> ..118 564	<b>500US</b> ..004 590	<b>502</b> ..118 563	<b>500U</b> ..004 583	<b>450U</b> ..004 581		
[MD]	02.11→	①	<b>AR654S</b> ..007 570	<b>AR650U</b> ..008 939	<b>AR340U</b> ..008 930						<b>654</b> ..010 299	<b>650U</b> ..004 587	<b>340U</b> ..004 578		
<b>Elantra Hatchback [XD]</b>	06.00→	①	<b>AR502S</b> ..118 995	<b>AR500U</b> ..008 935	<b>AR450U</b> ..008 933				<b>502S</b> ..118 564	<b>500US</b> ..004 590	<b>502</b> ..118 563	<b>500U</b> ..004 583	<b>450U</b> ..004 581	①	<b>H500/500U</b> ..004 760
<b>Equus</b>	10.09→	WOB ⑥	<b>A929S</b> ..118 929	<b>AM24U</b> ..008 571	<b>AM19U</b> ..008 566	2BB	<b>AP24U</b> ..006 837	<b>AP19U</b> ..006 832							
<b>Excel [X3]</b>	07.94-07.99	①	<b>AR502S</b> ..118 995	<b>AR500U</b> ..008 935	<b>AR450U</b> ..008 933				<b>502S</b> ..118 564	<b>500US</b> ..004 590	<b>502</b> ..118 563	<b>500U</b> ..004 583	<b>450U</b> ..004 581	①	<b>H500/500U</b> ..004 760
<b>Excel Hatchback [X3]</b>	11.95-07.99	①	<b>AR502S</b> ..118 995	<b>AR500U</b> ..008 935	<b>AR450U</b> ..008 933				<b>502S</b> ..118 564	<b>500US</b> ..004 590	<b>502</b> ..118 563	<b>500U</b> ..004 583	<b>450U</b> ..004 581	①	<b>H500/500U</b> ..004 760
<b>Genesis Coupe [DK]</b>	11.10→	①	<b>AR606S</b> ..118 910	<b>AR600U</b> ..008 938	<b>AR500U</b> ..008 935			KUR	<b>607S</b> ..118 306	<b>600US</b> ..004 592		<b>600U</b> ..004 586	<b>500U</b> ..004 583		
<b>Genesis Sedan</b>	05.08→	KUR ⑥	<b>A929S</b> ..118 929	<b>AM24U</b> ..008 571	<b>AM19U</b> ..008 566	2BB	<b>AP24U</b> ..006 837	<b>AP19U</b> ..006 832							
<b>Getz [TB]</b>	09.02-06.09	①	<b>AR553S</b> ..007 589	<b>AR550U</b> ..008 937	<b>AR340U</b> ..008 930						<b>553</b> ..010 274	<b>550U</b> ..004 585	<b>340U</b> ..004 578	①	<b>H341</b> ..004 755
<b>Grandeur [TG]</b>	07.05→	①	<b>AR606S</b> ..118 910	<b>AR600U</b> ..008 938	<b>AR500U</b> ..008 935			KUR	<b>607S</b> ..118 306	<b>600US</b> ..004 592		<b>600U</b> ..004 586	<b>500U</b> ..004 583		
<b>H 100</b>	09.96→	①	<b>AR450S</b> ..118 994	<b>AR450U</b> ..008 933	<b>AR450U</b> ..008 933				<b>450S</b> ..118 506	<b>450US</b> ..004 588	<b>450</b> ..118 505	<b>450U</b> ..004 581	<b>450U</b> ..004 581	①	<b>H400/400U</b> ..004 757
<b>H-1</b>	10.97-05.07	①	<b>AR701S</b> ..007 706	<b>AR650U</b> ..008 939	<b>AR500U</b> ..008 935					<b>650US</b> ..004 593	<b>701</b> ..118 202	<b>650U</b> ..004 587	<b>500U</b> ..004 583	①	<b>H400/400U</b> ..004 757



A = Aerotwin | AM = Aerotwin Multi-Clip | AP = Aerotwin Plus | AR = Aerotwin Retrofit | S = Spoiler | U = Single Pack



◀ HYUNDAI

3 397...

<b>H-1</b>	03.08→	①	<b>AR606S</b> ..118 910	<b>AR600U</b> ..008 938	<b>AR500U</b> ..008 935					<b>600US</b> ..004 592	<b>600U</b> ..004 586	<b>500U</b> ..004 583	<b>H352</b> ..011 430	
<b>i10 [PA]</b>	10.07→	①	<b>AR552S</b> ..118 984	<b>AR550U</b> ..008 937	<b>AR400U</b> ..008 932				<b>552S</b> ..118 427	<b>550US</b> ..004 591	<b>550U</b> ..004 585	<b>400U</b> ..004 579		
<b>i20 [PB]</b>	12.08→	①	<b>AR601S</b> ..118 907	<b>AR600U</b> ..008 938	<b>AR400U</b> ..008 932				<b>601S</b> ..010 297	<b>600US</b> ..004 592	<b>601</b> ..118 304	<b>600U</b> ..004 586	<b>400U</b> ..004 579	<b>H309</b> ..011 630
<b>i30 [FD]</b>	09.07-03.10	③	<b>A187S</b> ..007 187	<b>AM24U</b> ..008 571	<b>AM18U</b> ..008 565	2AA	<b>AP24U</b> ..006 837	<b>AP18U</b> ..006 831						
	04.10→	①	<b>AR604S</b> ..118 908	<b>AR600U</b> ..008 938	<b>AR450U</b> ..008 933				<b>604S</b> ..118 303	<b>600US</b> ..004 592	<b>600U</b> ..004 586	<b>450U</b> ..004 581		
[GD]	12.11→	①	<b>AR654S</b> ..007 570	<b>AR650U</b> ..008 939	<b>AR340U</b> ..008 930						<b>654</b> ..010 299	<b>650U</b> ..004 587	<b>340U</b> ..004 578	
<b>i30 Coupé [GD]</b>	02.13→	①	<b>AR654S</b> ..007 570	<b>AR650U</b> ..008 939	<b>AR340U</b> ..008 930						<b>654</b> ..010 299	<b>650U</b> ..004 587	<b>340U</b> ..004 578	
<b>i30 CW Kombi [FD]</b>	02.08-03.10	③	<b>A187S</b> ..007 187	<b>AM24U</b> ..008 571	<b>AM18U</b> ..008 565	2AA	<b>AP24U</b> ..006 837	<b>AP18U</b> ..006 831						
	04.10-09.12	①	<b>AR604S</b> ..118 908	<b>AR600U</b> ..008 938	<b>AR450U</b> ..008 933				<b>604S</b> ..118 303	<b>600US</b> ..004 592	<b>600U</b> ..004 586	<b>450U</b> ..004 581		
[GD]	03.12→	①	<b>AR654S</b> ..007 570	<b>AR650U</b> ..008 939	<b>AR340U</b> ..008 930						<b>654</b> ..010 299	<b>650U</b> ..004 587	<b>340U</b> ..004 578	
<b>i40 [VF]</b>	04.11→	①	<b>AR653S</b> ..118 911	<b>AR650U</b> ..008 939	<b>AR400U</b> ..008 932				<b>653S</b> ..118 325	<b>650US</b> ..004 593	<b>653</b> ..118 324	<b>650U</b> ..004 587	<b>400U</b> ..004 579	
<b>i40 CW Kombi [VF]</b>	03.11→	①	<b>AR653S</b> ..118 911	<b>AR650U</b> ..008 939	<b>AR400U</b> ..008 932				<b>653S</b> ..118 325	<b>650US</b> ..004 593	<b>653</b> ..118 324	<b>650U</b> ..004 587	<b>400U</b> ..004 579	<b>H352</b> ..011 430
<b>ix20 [JC]</b>	10.10→	③	<b>A583S</b> ..007 583	<b>AM26U</b> ..008 573	<b>AM13U</b> ..008 794	2AA	<b>AP26U</b> ..006 838	<b>AP13U</b> ..006 827						<b>H301</b> ..004 629
<b>ix35 [TM]</b>	01.10→	①	<b>AR601S</b> ..118 907	<b>AR600U</b> ..008 938	<b>AR400U</b> ..008 932				<b>601S</b> ..010 297	<b>600US</b> ..004 592	<b>600U</b> ..004 586	<b>400U</b> ..004 579		
<b>ix55 [EN]</b>	09.08→	③	<b>A296S</b> ..007 296	<b>AM24U</b> ..008 571	<b>AM20U</b> ..008 567	2AA	<b>AP24U</b> ..006 837	<b>AP20U</b> ..006 833						
<b>Lantra [J1]</b>	10.90-04.95	①	<b>AR502S</b> ..118 995	<b>AR500U</b> ..008 935	<b>AR450U</b> ..008 933				<b>502S</b> ..118 564	<b>500US</b> ..004 590	<b>502</b> ..118 563	<b>500U</b> ..004 583	<b>450U</b> ..004 581	
	[J2]	05.95-09.00	①	<b>AR502S</b> ..118 995	<b>AR500U</b> ..008 935	<b>AR450U</b> ..008 933				<b>502S</b> ..118 564	<b>500US</b> ..004 590	<b>502</b> ..118 563	<b>500U</b> ..004 583	<b>450U</b> ..004 581
<b>Lantra Kombi [J2]</b>	05.95-09.00	①	<b>AR502S</b> ..118 995	<b>AR500U</b> ..008 935	<b>AR450U</b> ..008 933				<b>502S</b> ..118 564	<b>500US</b> ..004 590	<b>502</b> ..118 563	<b>500U</b> ..004 583	<b>450U</b> ..004 581	① <b>H341</b> ..004 755
<b>Matrix [FC]</b>	07.01-04.10	①	<b>AR552S</b> ..118 984	<b>AR550U</b> ..008 937	<b>AR400U</b> ..008 932				<b>552S</b> ..118 427	<b>550US</b> ..004 591	<b>550U</b> ..004 585	<b>400U</b> ..004 579	① <b>H341</b> ..004 755	
<b>New Equus</b>	02.09→	⑥	<b>A929S</b> ..118 929	<b>AM24U</b> ..008 571	<b>AM19U</b> ..008 566	2BB	<b>AP24U</b> ..006 837	<b>AP19U</b> ..006 832						
<b>Pony [X3]</b>	07.94-07.99	①	<b>AR502S</b> ..118 995	<b>AR500U</b> ..008 935	<b>AR450U</b> ..008 933				<b>502S</b> ..118 564	<b>500US</b> ..004 590	<b>502</b> ..118 563	<b>500U</b> ..004 583	<b>450U</b> ..004 581	① <b>H500/500U</b> ..004 760
<b>Porter 507</b>	09.00-12.03	①	<b>AR450S</b> ..118 994	<b>AR450U</b> ..008 933	<b>AR450U</b> ..008 933				<b>450S</b> ..118 506	<b>450US</b> ..004 588	<b>450</b> ..118 505	<b>450U</b> ..004 581	<b>450U</b> ..004 581	
<b>Santa Fe [SM]</b>	09.99-12.05	①	<b>AR551S</b> ..118 905	<b>AR550U</b> ..008 937	<b>AR500U</b> ..008 935				<b>551S</b> ..118 423	<b>550US</b> ..004 591	<b>551</b> ..118 422	<b>550U</b> ..004 585	<b>500U</b> ..004 583	① <b>H340/340U</b> ..004 754
	[CM]	03.06-12.12	①	<b>AR604S</b> ..118 908	<b>AR600U</b> ..008 938	<b>AR450U</b> ..008 933				<b>604S</b> ..118 303	<b>600US</b> ..004 592	<b>600U</b> ..004 586	<b>450U</b> ..004 581	<b>H352</b> ..011 430
[DM]	06.12→	①	<b>AR654S</b> ..007 570	<b>AR650U</b> ..008 939	<b>AR340U</b> ..008 930						<b>654</b> ..010 299	<b>650U</b> ..004 587	<b>340U</b> ..004 578	
<b>Scoupe</b>	02.90-04.95	①	<b>AR566S</b> ..118 990	<b>AR480U</b> ..008 934	<b>AR400U</b> ..008 932				<b>481S</b> ..118 543		<b>481</b> ..118 542	<b>480U</b> ..004 582	<b>450U</b> ..004 581	
<b>Solaris [RB]</b>	01.11→	①	<b>AR653S</b> ..118 911	<b>AR650U</b> ..008 939	<b>AR400U</b> ..008 932						<b>653</b> ..118 324	<b>650U</b> ..004 587	<b>400U</b> ..004 579	
<b>Solaris Hatchback [RB]</b>	01.11→	①	<b>AR653S</b> ..118 911	<b>AR650U</b> ..008 939	<b>AR400U</b> ..008 932						<b>653</b> ..118 324	<b>650U</b> ..004 587	<b>400U</b> ..004 579	<b>H281</b> ..011 428



A = Aerotwin | AM = Aerotwin Multi-Clip | AP = Aerotwin Plus | AR = Aerotwin Retrofit | S = Spoiler | U = Single Pack





3 397...

<b>Sonata I [Y2]</b>	06.88-06.93	①	<b>AR502S</b> ..118 995	<b>AR500U</b> ..008 935	<b>AR450U</b> ..008 933				<b>502S</b> ..118 564	<b>500US</b> ..004 590	<b>502</b> ..118 563	<b>500U</b> ..004 583	<b>450U</b> ..004 581	
<b>Sonata II [Y3]</b>	07.93-06.98	①	<b>AR500S</b> ..009 081	<b>AR500U</b> ..008 935	<b>AR500U</b> ..008 935				<b>500S</b> ..118 561	<b>500US</b> ..004 590	<b>500</b> ..118 560	<b>500U</b> ..004 583	<b>500U</b> ..004 583	
<b>Sonata III [EF]</b>	03.98-03.01	①	<b>AR503S</b> ..118 993	<b>AR500U</b> ..008 935	<b>AR480U</b> ..008 934				<b>500S</b> ..118 561	<b>500US</b> ..004 590	<b>500</b> ..118 560	<b>500U</b> ..004 583	<b>500U</b> ..004 583	
<b>Sonata IV [EF]</b>	04.01-01.05	①	<b>AR551S</b> ..118 905	<b>AR550U</b> ..008 937	<b>AR500U</b> ..008 935				<b>551S</b> ..118 423	<b>550US</b> ..004 591	<b>551</b> ..118 422	<b>550U</b> ..004 585	<b>500U</b> ..004 583	
<b>Sonata V [NF]</b>	08.04-12.10	①	<b>AR606S</b> ..118 910	<b>AR600U</b> ..008 938	<b>AR500U</b> ..008 935									
<b>Sonata [YF]</b>	09.09→	KUR ①	<b>AR813S</b> ..118 912	<b>AR650U</b> ..008 939	<b>AR480U</b> ..008 934			KUR			<b>803</b> ..001 803	<b>650U</b> ..004 587	<b>480U</b> ..004 582	
<b>Starex</b>	10.02-12.07	①	<b>AR701S</b> ..007 706	<b>AR650U</b> ..008 939	<b>AR500U</b> ..008 935					<b>650US</b> ..004 593	<b>701</b> ..118 202	<b>650U</b> ..004 587	<b>500U</b> ..004 583	① H400/400U ..004 757
	05.07→	①	<b>AR606S</b> ..118 910	<b>AR600U</b> ..008 938	<b>AR500U</b> ..008 935									H352 ..011 430
<b>Terracan [HP]</b>	01.01→	①	<b>AR551S</b> ..118 905	<b>AR550U</b> ..008 937	<b>AR500U</b> ..008 935				<b>551S</b> ..118 423	<b>550US</b> ..004 591	<b>551</b> ..118 422	<b>550U</b> ..004 585	<b>500U</b> ..004 583	① H400/400U ..004 757
<b>Trajjet [FO]</b>	01.00-06.07	①	<b>AR655S</b> ..007 584	<b>AR650U</b> ..008 939	<b>AR550U</b> ..008 937						<b>655</b> ..010 302	<b>650U</b> ..004 587	<b>550U</b> ..004 585	① H400/400U ..004 757
<b>Tucson [JM]</b>	08.04-03.10	①	<b>AR601S</b> ..118 907	<b>AR600U</b> ..008 938	<b>AR400U</b> ..008 932				<b>601S</b> ..010 297	<b>600US</b> ..004 592		<b>600U</b> ..004 586	<b>400U</b> ..004 579	H308 ..011 628
<b>Veloster</b>	06.11→	①	<b>AR813S</b> ..118 912	<b>AR650U</b> ..008 939	<b>AR480U</b> ..008 934									
<b>Veracruz</b>	10.06→	③	<b>A296S</b> ..007 296	<b>AM24U</b> ..008 571	<b>AM20U</b> ..008 567	2AA	<b>AP24U</b> ..006 837	<b>AP20U</b> ..006 833						
<b>Verna [MC]</b>	10.06-05.11	①	<b>AR533S</b> ..118 902	<b>AR530U</b> ..008 936	<b>AR480U</b> ..008 934				<b>533S</b> ..118 406	<b>530US</b> ..011 352	<b>533</b> ..118 405	<b>530U</b> ..004 584	<b>480U</b> ..004 582	
<b>XG [F]</b>	12.98-12.05	①	<b>AR551S</b> ..118 905	<b>AR550U</b> ..008 937	<b>AR500U</b> ..008 935				<b>551S</b> ..118 423	<b>550US</b> ..004 591	<b>551</b> ..118 422	<b>550U</b> ..004 585	<b>500U</b> ..004 583	

**INFINITI**

<b>EX [J50]</b>	04.08→	①	<b>AR604S</b> ..118 908	<b>AR600U</b> ..008 938	<b>AR450U</b> ..008 933									H354 ..011 433
<b>FX [S50]</b>	11.02-08.08	①	<b>AR551S</b> ..118 905	<b>AR550U</b> ..008 937	<b>AR500U</b> ..008 935				<b>551S</b> ..118 423	<b>550US</b> ..004 591	<b>551</b> ..118 422	<b>550U</b> ..004 585	<b>500U</b> ..004 583	
[S51]	07.08→	①	<b>AR607S</b> ..118 909	<b>AR600U</b> ..008 938	<b>AR480U</b> ..008 934									H354 ..011 433
<b>Q45 [F50]</b>	01.01→	①	<b>AR813S</b> ..118 912	<b>AR650U</b> ..008 939	<b>AR450U</b> ..008 933			KUR			<b>803</b> ..001 803	<b>650U</b> ..004 587	<b>450U</b> ..004 581	
<b>QX4 [JR50]</b>	09.96-08.03	①	<b>AR550S</b> ..118 906	<b>AR550U</b> ..008 937	<b>AR530U</b> ..008 936			KUR	<b>551S</b> ..118 423	<b>550US</b> ..004 591	<b>551</b> ..118 422	<b>550U</b> ..004 585	<b>500U</b> ..004 583	
<b>QX56 [A60]</b>	04.08→	KUR ①	<b>AR801S</b> ..118 996	<b>AR600U</b> ..008 938	<b>AR550U</b> ..008 937									H250 ..011 629

**INNOCENTI (NUOVA INNOCENTI)**

<b>Elba</b>	09.92-12.96							①				<b>450U</b> ..004 581		
<b>Mille</b>	07.94-11.97							①			<b>450</b> ..118 505	<b>450U</b> ..004 581	<b>450U</b> ..004 581	



A = Aerotwin | AM = Aerotwin Multi-Clip | AP = Aerotwin Plus | AR = Aerotwin Retrofit | S = Spoiler | U = Single Pack





3 397...

ISUZU														
<b>D-MAX</b>	01.07→	①	<b>AR728S</b> ..118 904	<b>AR550U</b> ..008 937	<b>AR480U</b> ..008 934					<b>728S</b> ..001 728	<b>550US</b> ..004 591	<b>727</b> ..001 727	<b>550U</b> ..004 585	<b>480U</b> ..004 582
<b>Serie N</b>	08.98→	①	<b>AR500S</b> ..009 081	<b>AR51N</b> ..008 841	<b>AR51N</b> ..008 841					<b>500S</b> ..118 561	<b>500US</b> ..004 590	<b>500</b> ..118 560	<b>500U</b> ..004 583	<b>500U</b> ..004 583
<b>Trooper [UBS]</b>	08.92-09.04								①	<b>500S</b> ..118 561	<b>500US</b> ..004 590	<b>500</b> ..118 560	<b>500U</b> ..004 583	<b>500U</b> ..004 583

IVECO														
<b>Daily</b> [00/06/09/12]	05.99→	SDV ①	<b>AR609S</b> ..009 776	<b>AR61N</b> ..008 847	<b>AR61N</b> ..008 847				SDV			<b>609</b> ..118 309		
<b>Daily, Grinta</b>	07.89-05.99	L60 ①		<b>AR600U</b> ..008 938	<b>AR600U</b> ..008 938							<b>603</b> ..118 301	<b>600U</b> ..004 586	<b>600U</b> ..004 586
<b>Massif</b>	06.08→	①		<b>AR450U</b> ..008 933	<b>AR400U</b> ..008 932							<b>472</b> ..001 472	<b>450U</b> ..004 581	<b>400U</b> ..004 579

JAGUAR															
<b>Daimler</b>	01.99-08.02								①				<b>530U</b> ..004 584		
<b>F-Type</b>	10.12→								①			<b>530</b> ..118 400	<b>530U</b> ..004 584	<b>530U</b> ..004 584	
<b>S-Type [CCX]</b>	10.98-04.02	KUR ①	<b>AR550S</b> ..118 906	<b>AR550U</b> ..008 937	<b>AR530U</b> ..008 936					<b>550S</b> ..118 421	<b>550US</b> ..004 591	<b>550</b> ..118 420	<b>550U</b> ..004 585	<b>550U</b> ..004 585	
		10.01-03.08	SWO ①	<b>AR604S</b> ..118 908	<b>AR600U</b> ..008 938	<b>AR450U</b> ..008 933									
			SDV ①	<b>AR608S</b> ..007 654											
<b>XF</b>	03.08→	⑥	<b>A929S</b> ..118 929	<b>AM24U</b> ..008 571	<b>AM18U</b> ..008 565	2BB	<b>AP24U</b> ..006 837	<b>AP18U</b> ..006 831							
			WW ⑥	<b>AM462S</b> ..007 462											
<b>XF Sportbrake</b>	09.12→	⑥	<b>A929S</b> ..118 929	<b>AM24U</b> ..008 571	<b>AM18U</b> ..008 565	2BB	<b>AP24U</b> ..006 837	<b>AP18U</b> ..006 831						<b>H301</b> ..004 629	
			WW ⑥	<b>AM462S</b> ..007 462											
<b>XJ</b>	08.10→	⑥	<b>A929S</b> ..118 929	<b>AM24U</b> ..008 571	<b>AM18U</b> ..008 565	2BB	<b>AP24U</b> ..006 837	<b>AP18U</b> ..006 831							
			WW ⑥	<b>AM462S</b> ..007 462											
<b>XJ S Cabrio</b>	09.81-12.97								①				<b>380U</b> ..011 353	<b>380U</b> ..011 353	
<b>XJ S Coupé</b>	09.75-12.97								①				<b>380U</b> ..011 353	<b>380U</b> ..011 353	
<b>XJ 6/2003</b>	02.03-07.10	SDV ①	<b>AR608S</b> ..007 654												
<b>XJ 8</b>	09.97-01.03								①				<b>530U</b> ..004 584		
<b>XJ 8/2003</b>	02.03-07.10	SDV ①	<b>AR608S</b> ..007 654												
<b>XJR 8</b>	09.97-09.02								①				<b>530U</b> ..004 584		



A = Aerotwin | AM = Aerotwin Multi-Clip | AP = Aerotwin Plus | AR = Aerotwin Retrofit | S = Spoiler | U = Single Pack



3 397...

<b>XK [X150]</b>	03.06→								①	<b>530S</b>	<b>530US</b>	<b>530</b>	<b>530U</b>	<b>530U</b>	
										..118 401	..011 352	..118 400	..004 584	..004 584	
<b>XK 8 Convertible [QDV]</b>	01.99-02.09	①	<b>AR530S</b>	<b>AR530U</b>	<b>AR530U</b>					<b>530S</b>	<b>530US</b>	<b>530</b>	<b>530U</b>	<b>530U</b>	
			..118 903	..008 936	..008 936					..118 401	..011 352	..118 400	..004 584	..004 584	
<b>XK 8 Coupé [QEV]</b>	01.99-02.09	①	<b>AR530S</b>	<b>AR530U</b>	<b>AR530U</b>					<b>530S</b>	<b>530US</b>	<b>530</b>	<b>530U</b>	<b>530U</b>	
			..118 903	..008 936	..008 936					..118 401	..011 352	..118 400	..004 584	..004 584	
<b>XKR 8 Convertible [QDV]</b>	01.99-02.09	①	<b>AR530S</b>	<b>AR530U</b>	<b>AR530U</b>					<b>530S</b>	<b>530US</b>	<b>530</b>	<b>530U</b>	<b>530U</b>	
			..118 903	..008 936	..008 936					..118 401	..011 352	..118 400	..004 584	..004 584	
<b>X-Type [CF1]</b>	03.01-11.09	①	<b>AR728S</b>	<b>AR550U</b>	<b>AR480U</b>					<b>728S</b>	<b>550US</b>	<b>727</b>	<b>550U</b>	<b>480U</b>	
			..118 904	..008 937	..008 934					..001 728	..004 591	..001 727	..004 585	..004 582	
<b>X-Type Estate [CF1]</b>	03.03-12.09	①	<b>AR728S</b>	<b>AR550U</b>	<b>AR480U</b>					<b>728S</b>	<b>550US</b>	<b>727</b>	<b>550U</b>	<b>480U</b>	<b>H351</b>
			..118 904	..008 937	..008 934					..001 728	..004 591	..001 727	..004 585	..004 582	..004 559

**JEEP**

<b>Cherokee [XJ]</b>	01.87-09.01								PBG			<b>041</b>			
												..110 041			
[KJ]	03.01-12.07	①	<b>AR480S</b>	<b>AR480U</b>	<b>AR480U</b>					<b>480S</b>		<b>480</b>	<b>480U</b>	<b>480U</b>	
			..118 900	..008 934	..008 934					..118 541		..118 540	..004 582	..004 582	
<b>Commander [XH]</b>	01.06→	①	<b>AR450S</b>	<b>AR450U</b>	<b>AR450U</b>					<b>450S</b>	<b>450US</b>	<b>450</b>	<b>450U</b>	<b>450U</b>	<b>H355</b>
			..118 994	..008 933	..008 933					..118 506	..004 588	..118 505	..004 581	..004 581	..011 435
<b>Compass [MK, PK]</b>	10.06→	①	<b>AR551S</b>	<b>AR550U</b>	<b>AR500U</b>					<b>551S</b>	<b>550US</b>	<b>551</b>	<b>550U</b>	<b>500U</b>	① <b>H280</b>
			..118 905	..008 937	..008 935					..118 423	..004 591	..118 422	..004 585	..004 583	..018 802
<b>Grand Cherokee [ZG]</b>	09.92-04.99	①								<b>500S</b>	<b>500US</b>	<b>500</b>	<b>500U</b>	<b>500U</b>	
										..118 561	..004 590	..118 560	..004 583	..004 583	
[WG]	09.00-12.04	①	<b>AR530S</b>	<b>AR530U</b>	<b>AR530U</b>					<b>530S</b>	<b>530US</b>	<b>530</b>	<b>530U</b>	<b>530U</b>	
			..118 903	..008 936	..008 936					..118 401	..011 352	..118 400	..004 584	..004 584	
[WH]	03.05-10.11	①	<b>AR530S</b>	<b>AR530U</b>	<b>AR530U</b>					<b>530S</b>	<b>530US</b>	<b>530</b>	<b>530U</b>	<b>530U</b>	L34 <b>H355</b>
			..118 903	..008 936	..008 936					..118 401	..011 352	..118 400	..004 584	..004 584	..011 435
[WK]	08.04→	①	<b>AR530S</b>	<b>AR530U</b>	<b>AR530U</b>					<b>530S</b>	<b>530US</b>	<b>530</b>	<b>530U</b>	<b>530U</b>	L30 <b>H307</b>
			..118 903	..008 936	..008 936					..118 401	..011 352	..118 400	..004 584	..004 584	..011 429
[WK2]	10.10→	①	<b>AR550S</b>	<b>AR550U</b>	<b>AR530U</b>				KUR	<b>530S</b>	<b>550US</b>	<b>530</b>	<b>550U</b>	<b>530U</b>	<b>H307</b>
			..118 906	..008 937	..008 936					..118 401	..004 591	..118 400	..004 585	..004 584	..011 429
<b>Liberty [KK]</b>	09.07→	①	<b>AR480S</b>	<b>AR480U</b>	<b>AR480U</b>					<b>480S</b>		<b>480</b>	<b>480U</b>	<b>480U</b>	
			..118 900	..008 934	..008 934					..118 541		..118 540	..004 582	..004 582	
<b>Patriot [MK]</b>	10.06→	①	<b>AR530S</b>	<b>AR530U</b>	<b>AR530U</b>					<b>530S</b>	<b>530US</b>	<b>530</b>	<b>530U</b>	<b>530U</b>	
			..118 903	..008 936	..008 936					..118 401	..011 352	..118 400	..004 584	..004 584	
<b>Wrangler [TJ]</b>	01.97-12.06	①		<b>AR380U</b>	<b>AR380U</b>								<b>380U</b>	<b>380U</b>	
				..008 931	..008 931								..004 579	..004 579	
[JK]	01.07→	①		<b>AR380U</b>	<b>AR380U</b>								<b>380U</b>	<b>380U</b>	<b>H353</b>
				..008 931	..008 931								..004 579	..004 579	..004 631

**KIA**

<b>Carens [FC]</b>	04.99-12.06	①	<b>AR604S</b>	<b>AR600U</b>	<b>AR450U</b>					<b>604S</b>	<b>600US</b>		<b>600U</b>	<b>450U</b>	① <b>H341</b>
			..118 908	..008 938	..008 933					..118 303	..004 592		..004 586	..004 581	..004 755
[FG]	09.06→	①	<b>AR653S</b>	<b>AR650U</b>	<b>AR400U</b>					<b>653S</b>	<b>650US</b>	<b>653</b>	<b>650U</b>	<b>400U</b>	<b>H352</b>
			..118 911	..008 939	..008 932					..118 325	..004 593	..118 324	..004 587	..004 579	..011 430
[RP]	01.13→	①		<b>AR70N</b>	<b>AR70N</b>								<b>700U</b>	<b>700U</b>	
				..008 845	..008 845								..004 489	..004 489	
<b>Carnival [MB]</b>	04.06→	①	<b>AR813S</b>	<b>AR650U</b>	<b>AR450U</b>							<b>803</b>	<b>650U</b>	<b>450U</b>	
			..118 912	..008 939	..008 933							..001 803	..004 587	..004 581	
[UP]	06.98-06.06	①		<b>AR600U</b>	<b>AR600U</b>							<b>603</b>	<b>600U</b>	<b>600U</b>	① <b>H400/400U</b>
				..008 938	..008 938							..118 301	..004 586	..004 586	..004 757
<b>Cee'd [ED/FF2]</b>	11.06-06.09	③	<b>A187S</b>	<b>AM24U</b>	<b>AM18U</b>	2AA	<b>AP24U</b>	<b>AP18U</b>							
			..007 187	..008 571	..008 565		..006 837	..006 831							



A = Aerotwin | AM = Aerotwin Multi-Clip | AP = Aerotwin Plus | AR = Aerotwin Retrofit | S = Spoiler | U = Single Pack





			SET	↖	↙	NEW	SET	↖	↙	SET	↖	↙	SET	↖	↙	REAR
◀ KIA		3 397...														
Cee'd [ED/FF2]	07.09→	①	AR604S ..118 908	AR600U ..008 938	AR450U ..008 933					604S ..118 303	600US ..004 592		600U ..004 586	450U ..004 581		
[JD]	05.12→	①	AR654S ..007 570	AR650U ..008 939	AR340U ..008 930								654 ..010 299	650U ..004 587	340U ..004 578	
Cee'd Sporty Wagon [ED/FF2]	09.07-06.09	⑤	A187S ..007 187	AM24U ..008 571	AM18U ..008 565	2AA	AP24U ..006 837	AP18U ..006 831								
[JD]	07.09→	①	AR604S ..118 908	AR600U ..008 938	AR450U ..008 933					604S ..118 303	600US ..004 592		600U ..004 586	450U ..004 581		
[JD]	08.12→	①	AR654S ..007 570	AR650U ..008 939	AR340U ..008 930								654 ..010 299	650U ..004 587	340U ..004 578	
Cerato [FE]	03.04-11.09	①	AR601S ..118 907	AR600U ..008 938	AR400U ..008 932					601S ..010 297	600US ..004 592		600U ..004 586	400U ..004 579		
Cerato Hatchback [FE]	03.04-11.09	①	AR601S ..118 907	AR600U ..008 938	AR400U ..008 932					601S ..010 297	600US ..004 592		600U ..004 586	400U ..004 579	H352 ..011 430	
Cerato [TD]	12.08→	①	AR606S ..118 910	AR600U ..008 938	AR500U ..008 935				KUR	607S ..118 306	600US ..004 592		600U ..004 586	500U ..004 583		
Cerato Koup [TD]	08.10→	①	AR606S ..118 910	AR600U ..008 938	AR500U ..008 935				KUR	607S ..118 306	600US ..004 592		600U ..004 586	500U ..004 583		
Clarus I [GC]	05.96-05.98	①	AR533S ..118 902	AR530U ..008 936	AR480U ..008 934					533S ..118 406	530US ..011 352	533 ..118 405	530U ..004 584	480U ..004 582		
Clarus II [GC]	06.98-11.01	①	AR533S ..118 902	AR530U ..008 936	AR480U ..008 934					533S ..118 406	530US ..011 352	533 ..118 405	530U ..004 584	480U ..004 582		
Clarus II Kombi [GC]	06.98-11.01	①	AR533S ..118 902	AR530U ..008 936	AR480U ..008 934					533S ..118 406	530US ..011 352	533 ..118 405	530U ..004 584	480U ..004 582		
Joice [MT]	08.99-09.01	KUR	AR531S ..118 901	AR530U ..008 936	AR450U ..008 933				KUR	531S ..118 403	530US ..011 352	531 ..118 402	530U ..004 584	450U ..004 581	①	H400/400U ..004 757
	09.01-03.03	KUR	AR531S ..118 901	AR530U ..008 936	AR450U ..008 933				KUR	531S ..118 403	530US ..011 352	531 ..118 402	530U ..004 584	450U ..004 581		
		①	AR533S ..118 902	AR530U ..008 936	AR480U ..008 934					533S ..118 406	530US ..011 352	533 ..118 405	530U ..004 584	480U ..004 582		
K 2500	09.01→	①	AR533S ..118 902	AR530U ..008 936	AR480U ..008 934					533S ..118 406	530US ..011 352	533 ..118 405	530U ..004 584	480U ..004 582		
K 2700 [SD]	04.98-08.04	①	AR531S ..118 901	AR530U ..008 936	AR450U ..008 933					531S ..118 403	530US ..011 352	531 ..118 402	530U ..004 584	450U ..004 581		
	08.04→	①	AR533S ..118 902	AR530U ..008 936	AR480U ..008 934					533S ..118 406	530US ..011 352	533 ..118 405	530U ..004 584	480U ..004 582		
K 2900	05.07→	①	AR533S ..118 902	AR530U ..008 936	AR480U ..008 934					533S ..118 406	530US ..011 352	533 ..118 405	530U ..004 584	480U ..004 582		
Magentis [GD]	09.00-12.05	①	AR551S ..118 905	AR550U ..008 937	AR500U ..008 935					551S ..118 423	550US ..004 591	551 ..118 422	550U ..004 585	500U ..004 583		
[GE]	02.06→	①	AR604S ..118 908	AR600U ..008 938	AR450U ..008 933					604S ..118 303	600US ..004 592		600U ..004 586	450U ..004 581		
Mentor II [FX]	01.01-08.04	①	AR533S ..118 902	AR530U ..008 936	AR480U ..008 934					533S ..118 406	530US ..011 352	533 ..118 405	530U ..004 584	480U ..004 582		
Mentor II Hatchback [FX]	01.01-08.04	①	AR533S ..118 902	AR530U ..008 936	AR480U ..008 934					533S ..118 406	530US ..011 352	533 ..118 405	530U ..004 584	480U ..004 582		
Mohave	01.09→	①	AR606S ..118 910	AR600U ..008 938	AR500U ..008 935				KUR	607S ..118 306	600US ..004 592		600U ..004 586	500U ..004 583	H352 ..011 430	
Opirus [LD]	09.03→	①	AR604S ..118 908	AR600U ..008 938	AR450U ..008 933					604S ..118 303	600US ..004 592		600U ..004 586	450U ..004 581		
Optima [TF]	09.11→	①	AR604S ..118 908	AR600U ..008 938	AR450U ..008 933					604S ..118 303	600US ..004 592		600U ..004 586	450U ..004 581		
Picanto [BA]	05.04-01.11	①	AR552S ..118 984	AR550U ..008 937	AR400U ..008 932					552S ..118 427	550US ..004 591		550U ..004 585	400U ..004 579	H304 ..004 990	
[TA]	05.11→	①	AR552S ..118 984	AR550U ..008 937	AR400U ..008 932					552S ..118 427	550US ..004 591		550U ..004 585	400U ..004 579		
Pregio [TB]	02.97-04.04	①	AR531S ..118 901	AR530U ..008 936	AR450U ..008 933					531S ..118 403	530US ..011 352	531 ..118 402	530U ..004 584	450U ..004 581		



A = Aerotwin | AM = Aerotwin Multi-Clip | AP = Aerotwin Plus | AR = Aerotwin Retrofit | S = Spoiler | U = Single Pack



3 397...

			AEROTWIN			NEW!	AEROTWIN			TWIN SPOILER			TWIN			REAR	
			SET						SET		SET						
Pregio [TB]	05.04→	①	AR533S ..118 902	AR530U ..008 936	AR480U ..008 934				533S ..118 406	530US ..011 352	533 ..118 405	530U ..004 584	480U ..004 582				
Pride [DA]	05.90-02.00								450S ..118 506	450US ..004 588	450 ..118 505	450U ..004 581	450U ..004 581	①	H380/380U ..004 756		
Pro Cee'd [ED/FF2]	10.07-06.09	③	A187S ..007 187	AM24U ..008 571	AM18U ..008 565	2AA	AP24U ..006 837	AP18U ..006 831									
	07.09→	①	AR604S ..118 908	AR600U ..008 938	AR450U ..008 933				604S ..118 303	600US ..004 592		600U ..004 586	450U ..004 581				
[JD]	01.13→	①	AR654S ..007 570	AR650U ..008 939	AR340U ..008 930							654 ..010 299	650U ..004 587	340U ..004 578			
Retona [CE]	04.98-12.00											340 ..118 700	340U ..004 578	340U ..004 578			
Rio [DC]	07.00-02.05	①	AR531S ..118 901	AR530U ..008 936	AR450U ..008 933				531S ..118 403	530US ..011 352	531 ..118 402	530U ..004 584	450U ..004 581				
[DE]	03.05→	①	AR552S ..118 984	AR550U ..008 937	AR400U ..008 932				552S ..118 427	550US ..004 591		550U ..004 585	400U ..004 579		H352 ..011 430		
[UB]	11.11→	①	AR653S ..118 911	AR650U ..008 939	AR400U ..008 932				653S ..118 325	650US ..004 593	653 ..118 324	650U ..004 587	400U ..004 579				
Rio Hatchback	03.05-09.11	①	AR552S ..118 984	AR550U ..008 937	AR400U ..008 932				552S ..118 427	550US ..004 591		550U ..004 585	400U ..004 579		H352 ..011 430		
[DE]																	
[UB]	06.11→	①	AR653S ..118 911	AR650U ..008 939	AR400U ..008 932				653S ..118 325	650US ..004 593	653 ..118 324	650U ..004 587	400U ..004 579		H281 ..011 428		
Rio Kombi [DC]	09.02-02.05	①	AR531S ..118 901	AR530U ..008 936	AR450U ..008 933				531S ..118 403	530US ..011 352	531 ..118 402	530U ..004 584	450U ..004 581	①	H341 ..004 755		
Sedona	06.98-08.05	①		AR600U ..008 938	AR600U ..008 938							603 ..118 301	600U ..004 586	600U ..004 586			
Sephia I [FA]	01.92-12.00	①	AR533S ..118 902	AR530U ..008 936	AR480U ..008 934				533S ..118 406	530US ..011 352	533 ..118 405	530U ..004 584	480U ..004 582	①	H450/450U ..004 763		
Sephia I Hatchback	09.96-12.00	①	AR533S ..118 902	AR530U ..008 936	AR480U ..008 934				533S ..118 406	530US ..011 352	533 ..118 405	530U ..004 584	480U ..004 582	①	H450/450U ..004 763		
[FA]																	
Shuma I [FB]	01.98-12.00	①	AR533S ..118 902	AR530U ..008 936	AR480U ..008 934				533S ..118 406	530US ..011 352	533 ..118 405	530U ..004 584	480U ..004 582	①	H450/450U ..004 763		
Shuma I Hatchback	01.98-12.00	①	AR533S ..118 902	AR530U ..008 936	AR480U ..008 934				533S ..118 406	530US ..011 352	533 ..118 405	530U ..004 584	480U ..004 582	①	H450/450U ..004 763		
[FB]																	
Shuma II [FB]	01.01-08.04	①	AR533S ..118 902	AR530U ..008 936	AR480U ..008 934				533S ..118 406	530US ..011 352	533 ..118 405	530U ..004 584	480U ..004 582	①	H450/450U ..004 763		
Shuma II Hatchback	01.01-08.04	①	AR533S ..118 902	AR530U ..008 936	AR480U ..008 934				533S ..118 406	530US ..011 352	533 ..118 405	530U ..004 584	480U ..004 582	①	H450/450U ..004 763		
[FB]																	
Sorento [JC]	07.02-08.09	①	AR604S ..118 908	AR600U ..008 938	AR450U ..008 933				604S ..118 303	600US ..004 592		600U ..004 586	450U ..004 581	①	H341 ..004 755		
[XM]	09.09→	①	AR606S ..118 910	AR600U ..008 938	AR500U ..008 935				KUR	607S ..118 306	600US ..004 592	600U ..004 586	500U ..004 583		H281 ..011 428		
Soul [AM]	09.08→	①	AR606S ..118 910	AR600U ..008 938	AR500U ..008 935				607S ..118 306	600US ..004 592		600U ..004 586	480U ..004 582		H281 ..011 428		
Spectra	01.01-12.09	①	AR532S ..118 986	AR530U ..008 936	AR500U ..008 935				532S ..118 404	530US ..011 352		530U ..004 584	500U ..004 583	①	H450/450U ..004 763		
Sportage [JA]	05.93-08.04	①	AR500S ..009 081	AR500U ..008 935	AR500U ..008 935				500S ..118 561	500US ..004 590	500 ..118 560	500U ..004 583	500U ..004 583	①	H400/400U ..004 757		
[JE]	08.08-05.10	①	AR601S ..118 907	AR600U ..008 938	AR400U ..008 932				601S ..010 297	600US ..004 592		600U ..004 586	400U ..004 579				
[SL]	07.10→	①	AR604S ..118 908	AR600U ..008 938	AR450U ..008 933				604S ..118 303	600US ..004 592		600U ..004 586	450U ..004 581				
Sportage New	09.04-08.08	①	AR601S ..118 907	AR600U ..008 938	AR400U ..008 932				601S ..010 297	600US ..004 592		600U ..004 586	400U ..004 579				
Venga	12.09→	③	A583S ..007 583	AM26U ..008 573	AM13U ..008 794	2AA	AP26U ..006 838	AP13U ..006 827							H301 ..004 629		



A = Aerotwin | AM = Aerotwin Multi-Clip | AP = Aerotwin Plus | AR = Aerotwin Retrofit | S = Spoiler | U = Single Pack





3 397...

LADA														
Forma	09.91-12.00							①	500S ..118 561	500US ..004 590	500 ..118 560	500U ..004 583	500U ..004 583	
Granta	01.12→							①	601S ..010 297	600US ..004 592	601 ..118 304	600U ..004 586	400U ..004 579	
Kalina	11.04→							①	601S ..010 297	600US ..004 592	601 ..118 304	600U ..004 586	400U ..004 579	
Kalina Hatchback	07.06→							①	601S ..010 297	600US ..004 592	601 ..118 304	600U ..004 586	400U ..004 579	
Kalina Kombi	07.07→							①	601S ..010 297	600US ..004 592	601 ..118 304	600U ..004 586	400U ..004 579	
Kalina Sport	08.08→							①	601S ..010 297	600US ..004 592	601 ..118 304	600U ..004 586	400U ..004 579	
Largus [R90]	04.12→	①	AR500S ..009 081	AR500U ..008 935	AR500U ..008 935				500S ..118 561	500US ..004 590	500 ..118 560	500U ..004 583	500U ..004 583	H353 ..004 631
Niva (4x4)	12.76→							ADF			340 ..118 700	340U ..004 578	340U ..004 578	
Oka	01.88→							ADF				500U ..004 583		
Priora	11.06→							①			500 ..118 560	500U ..004 583	500U ..004 583	
Priora Coupé	01.10→							①			500 ..118 560	500U ..004 583	500U ..004 583	
Priora Hatchback	01.08→							①			500 ..118 560	500U ..004 583	500U ..004 583	
Priora Kombi	01.08→							①			500 ..118 560	500U ..004 583	500U ..004 583	
Samara	01.84→							①	530S ..118 401	530US ..011 352	530 ..118 400	530U ..004 584	530U ..004 584	
Samara Hatchback	01.84→							①	530S ..118 401	530US ..011 352	530 ..118 400	530U ..004 584	530U ..004 584	
Serie 110	01.96→							①	500S ..118 561	500US ..004 590	500 ..118 560	500U ..004 583	500U ..004 583	① H500/500U ..004 760
Serie 111	01.96→							①	500S ..118 561	500US ..004 590	500 ..118 560	500U ..004 583	500U ..004 583	KUR ① H280 ..018 802
Serie 112	01.96→							①			500 ..118 560	500U ..004 583	500U ..004 583	① H500/500U ..004 760
Serie 114	12.08→							①			500 ..118 560	500U ..004 583	500U ..004 583	
Serie 115	01.98→							①			500 ..118 560	500U ..004 583	500U ..004 583	
Serie 2100	09.75→							ADF			340 ..118 700	340U ..004 578	340U ..004 578	
Serie 2100 Kombi	01.88-12.00							ADF			340 ..118 700	340U ..004 578	340U ..004 578	
Serie 2113	01.07→							①			500 ..118 560	500U ..004 583	500U ..004 583	
Serie 2114	07.01→							①			500 ..118 560	500U ..004 583	500U ..004 583	
Serie 2115	01.07→							①			500 ..118 560	500U ..004 583	500U ..004 583	
Serie 21000	01.82→							ADF			340 ..118 700	340U ..004 578	340U ..004 578	
Serie 21000 Kombi	06.03→							ADF			340 ..118 700	340U ..004 578	340U ..004 578	



A = Aerotwin | AM = Aerotwin Multi-Clip | AP = Aerotwin Plus | AR = Aerotwin Retrofit | S = Spoiler | U = Single Pack



3 397...

Serie 21099	01.90-01.04								①	530S ..118 401	530US ..011 352	530 ..118 400	530U ..004 584	530U ..004 584	
Toscana	01.86-12.00								ADF			340 ..118 700	340U ..004 578	340U ..004 578	
4x4	06.07→								ADF			340 ..118 700	340U ..004 578	340U ..004 578	

**LANCIA**

Dedra Berlina [835]	01.89-10.94								①	533S ..118 406	530US ..011 352	533 ..118 405	530U ..004 584	480U ..004 582	
	10.94-10.99								①	533S ..118 406	530US ..011 352	533 ..118 405	530U ..004 584	480U ..004 582	
Dedra Station Wagon [835]	10.94-10.99								REF			109 ..033 109			WGK Z361 ..033 361
Delta [831]	05.86-12.94								①	450S ..118 506		450 ..118 505	450U ..004 581	450U ..004 581	
	[836]	01.93-12.99							①	533S ..118 406	530US ..011 352	533 ..118 405	530U ..004 584	480U ..004 582	① H450/450U ..004 763
									REF			109 ..033 109			
[844]	07.08→	③	A187S ..007 187	AM24U ..008 571	AM18U ..008 565	2AA	AP24U ..006 837	AP18U ..006 831							H840 ..004 802
Flavia	03.12→	KUR ①	AR801S ..118 996	AR600U ..008 938	AR550U ..008 937							608 ..118 307	600U ..004 586	550U ..004 585	
Kappa Berlina [838]	11.94-12.00	①	AR606S ..118 910	AR600U ..008 938	AR500U ..008 935				KUR	607S ..118 306	600US ..004 592		600U ..004 586	500U ..004 583	
	Kappa Coupé [838]	04.97-06.00	①	AR606S ..118 910	AR600U ..008 938	AR500U ..008 935			KUR	607S ..118 306	600US ..004 592		600U ..004 586	500U ..004 583	
Kappa Station Wagon [838]	11.94-12.00	①	AR606S ..118 910	AR600U ..008 938	AR500U ..008 935				KUR	607S ..118 306	600US ..004 592		600U ..004 586	500U ..004 583	WGK Z361 ..033 361
Lybra Berlina [839]	10.99-11.06								BGO ①			682 ..001 682	550U ..004 585		
Lybra Station Wagon [839]	10.99-11.06								BGO ①			682 ..001 682	550U ..004 585		WGK Z361 ..033 361
Musa [184]	10.04-01.06	FFB ①	AR989S ..118 989	AR575U ..008 940	AR400U ..008 932				FFB			601 ..118 304	575U ..011 351	400U ..004 579	WGK Z361 ..033 361
	01.06-09.07	①		AR575U ..008 940	AR380U ..008 931							577 ..010 298	575U ..011 351	380U ..011 353	WGK Z361 ..033 361
	10.07→	③	A420S ..007 420	AM23U ..008 570	AM15U ..008 562	2AA	AP23U ..006 836	AP15U ..006 828							WGK Z361 ..033 361
Phedra [180]	09.02-09.05	SDV ①	AR657S ..009 777	AR66N ..008 848	AR66N ..008 848				SDV	657S ..118 334					H353 ..004 631
	10.05-12.10	①	AR651S ..118 913								650US ..004 593	650 ..118 320	650U ..004 587	650U ..004 587	H353 ..004 631
Thema	11.11→	①	AR801S ..118 996	AR600U ..008 938	AR530U ..008 936					608S ..118 308	600US ..004 592		600U ..004 586	550U ..004 585	
Thema Berlina [104]	05.92-11.94								①	500S ..118 561	500US ..004 590	500 ..118 560	500U ..004 583	500U ..004 583	① H380/380U ..004 756
Thema Station Wagon [104]	05.92-11.94								①	500S ..118 561	500US ..004 590	500 ..118 560	500U ..004 583	500U ..004 583	① H380/380U ..004 756
Thesis [841]	04.02-12.09	①	AR701S ..007 706	AR650U ..008 939	AR500U ..008 935						650US ..004 593	701 ..118 202	650U ..004 587	500U ..004 583	
Voyager [RT]	09.11→	①	AR701S ..007 706	AR650U ..008 939	AR500U ..008 935						650US ..004 593	701 ..118 202	650U ..004 587	500U ..004 583	H403 ..011 592
Y [840]	01.96-06.03	①	AR989S ..118 989	AR575U ..008 940	AR400U ..008 932							601 ..118 304	575U ..011 351	400U ..004 579	WGK Z361 ..033 361



A = Aerotwin | AM = Aerotwin Multi-Clip | AP = Aerotwin Plus | AR = Aerotwin Retrofit | S = Spoiler | U = Single Pack





◀ LANCIA

3 397...

Ypsilon [843]	06.03-11.11	①	AR601S ..118 907	AR600U ..008 938	AR400U ..008 932					601S ..010 297	600US ..004 592	601 ..118 304	600U ..004 586	400U ..004 579	WGK	Z361 ..033 361
[846]	06.11→	③	A292S ..007 292	AM24U ..008 571	AM15U ..008 562	2AA	AP24U ..006 837	AP15U ..006 828								
ZETA [122]	09.94-06.02	①	AR701S ..007 706	AR650U ..008 939	AR500U ..008 935							701 ..118 202	650U ..004 587	500U ..004 583	①	H400/400U ..004 757

LAND ROVER

Defender 90	08.90→											340 ..118 700	340U ..004 578	340U ..004 578	①	H340/340U ..004 754
Defender 110	08.90→											340 ..118 700	340U ..004 578	340U ..004 578	①	H340/340U ..004 754
Defender 130	08.90→											340 ..118 700	340U ..004 578	340U ..004 578	①	H340/340U ..004 754
Discovery I	09.89-12.98	①	AR450S ..118 994	AR450U ..008 933	AR450U ..008 933					450S ..118 506	450US ..004 588	450 ..118 505	450U ..004 581	450U ..004 581	①	H340/340U ..004 754
Discovery II	10.98-08.04								WOB			807 ..005 807				
Discovery III/IV	09.04→	①	AR550S ..118 906	AR550U ..008 937	AR530U ..008 936											H403 ..011 592
Freelander I [LN]	09.97-03.07	①	AR551S ..118 905	AR550U ..008 937	AR500U ..008 935					530S ..118 401	530US ..011 352	530 ..118 400	530U ..004 584	530U ..004 584		
Freelander II [LF]	10.06→	⑥	A929S ..118 929	AM24U ..008 571	AM19U ..008 566	2BB	AP24U ..006 837	AP19U ..006 832							①	H340/340U ..004 754
		WW	AM462S ..007 462													
Range Rover I	11.88-04.96									450S ..118 506		450 ..118 505	450U ..004 581	450U ..004 581		
Range Rover II	09.94-08.02	①	AR550S ..118 906	AR550U ..008 937	AR530U ..008 936							550 ..118 420	550U ..004 585	550U ..004 585		
Range Rover III [LM]	03.02-01.13								WOB			808 ..005 808				
Range Rover IV [LG]	02.13→	①	AR606S ..118 910	AR600U ..008 938	AR500U ..008 935											
Range Rover Evoque	09.11→	③	A430S ..007 430			2AA	AP23U ..006 836	AP21U ..006 834								
		WW	A966S ..118 966													
Range Rover Sport I [LS]	03.05-08.13	①	AR550S ..118 906	AR550U ..008 937	AR530U ..008 936											H403 ..011 592
Range Rover Sport II [LW]	09.13→	①	AR606S ..118 910	AR600U ..008 938	AR500U ..008 935											

LEXUS

CT200h	12.10→	①	AR813S ..118 912	AR650U ..008 939	AR450U ..008 933							803 ..001 803	650U ..004 587	450U ..004 581		
ES [V1/2/3/4]	03.06→	①	AR607S ..118 909	AR600U ..008 938	AR480U ..008 934					607S ..118 306	600US ..004 592		600U ..004 586	480U ..004 582		
GS [S1]	03.93-08.97	①	AR533S ..118 902	AR530U ..008 936	AR480U ..008 934					533S ..118 406	530US ..011 352	533 ..118 405	530U ..004 584	480U ..004 582		
	08.97-12.12	①	AR606S ..118 910	AR600U ..008 938	AR500U ..008 935											
[L1]	01.12→	①	AR813S ..118 912	AR650U ..008 939	AR450U ..008 933							803 ..001 803	650U ..004 587	450U ..004 581		



A = Aerotwin | AM = Aerotwin Multi-Clip | AP = Aerotwin Plus | AR = Aerotwin Retrofit | S = Spoiler | U = Single Pack





3 397...

<b>GX [J1]</b>	11.02-10.09	①	<b>AR550S</b> ..118 906	<b>AR550U</b> ..008 937	<b>AR530U</b> ..008 936				<b>551S</b> ..118 423	<b>550US</b> ..004 591	<b>551</b> ..118 422	<b>550U</b> ..004 585	<b>500U</b> ..004 583	
	11.09→	①	<b>AR701S</b> ..007 706	<b>AR650U</b> ..008 939	<b>AR500U</b> ..008 935					<b>650US</b> ..004 593	<b>701</b> ..118 202	<b>650U</b> ..004 587	<b>500U</b> ..004 583	
<b>IS [E1]</b>	01.99-07.05	①	<b>AR728S</b> ..118 904	<b>AR550U</b> ..008 937	<b>AR480U</b> ..008 934				<b>728S</b> ..001 728	<b>550US</b> ..004 591	<b>727</b> ..001 727	<b>550U</b> ..004 585	<b>480U</b> ..004 582	
[E2]	08.05→	①	<b>AR551S</b> ..118 905	<b>AR550U</b> ..008 937	<b>AR500U</b> ..008 935				<b>551S</b> ..118 423	<b>550US</b> ..004 591	<b>551</b> ..118 422	<b>550U</b> ..004 585	<b>500U</b> ..004 583	
<b>ISF [E2]</b>	12.07→	①	<b>AR551S</b> ..118 905	<b>AR550U</b> ..008 937	<b>AR500U</b> ..008 935				<b>551S</b> ..118 423	<b>550US</b> ..004 591	<b>551</b> ..118 422	<b>550U</b> ..004 585	<b>500U</b> ..004 583	
<b>IS Wagon [E1]</b>	07.01-07.05	①	<b>AR728S</b> ..118 904	<b>AR550U</b> ..008 937	<b>AR480U</b> ..008 934				<b>728S</b> ..001 728	<b>550US</b> ..004 591	<b>727</b> ..001 727	<b>550U</b> ..004 585	<b>480U</b> ..004 582	<b>H352</b> ..011 430
<b>LX [J1]</b>	01.98-08.07	①	<b>AR500S</b> ..009 081	<b>AR500U</b> ..008 935	<b>AR500U</b> ..008 935				<b>500S</b> ..118 561	<b>500US</b> ..004 590	<b>500</b> ..118 560	<b>500U</b> ..004 583	<b>500U</b> ..004 583	① <b>H400/400U</b> ..004 757
[J2]	11.07→	KUR ①	<b>AR801S</b> ..118 996	<b>AR600U</b> ..008 938	<b>AR550U</b> ..008 937						<b>608</b> ..118 307	<b>600U</b> ..004 586	<b>550U</b> ..004 585	<b>H309</b> ..011 630
<b>RX [U1]</b>	01.98-02.03	①	<b>AR801S</b> ..118 996	<b>AR600U</b> ..008 938	<b>AR530U</b> ..008 936				<b>611S</b> ..010 300	<b>600US</b> ..004 592		<b>600U</b> ..004 586	<b>530U</b> ..004 584	① <b>H400/400U</b> ..004 757
[U3]	02.03-12.08	①	<b>AR655S</b> ..007 584	<b>AR650U</b> ..008 939	<b>AR550U</b> ..008 937									<b>H352</b> ..011 430
[L1]	12.08→	①	<b>AR655S</b> ..007 584	<b>AR650U</b> ..008 939	<b>AR550U</b> ..008 937									
<b>SC Cabrio [Z4]</b>	05.01→	①	<b>AR606S</b> ..118 910	<b>AR600U</b> ..008 938	<b>AR500U</b> ..008 935									

**LOTUS**

<b>Elan</b>	09.89-09.99	①	<b>AR550S</b> ..118 906	<b>AR550U</b> ..008 937	<b>AR530U</b> ..008 936									
<b>Elise Cabrio</b>	09.07→	①	<b>AR650S</b> ..018 913	<b>AR650U</b> ..008 939								<b>650U</b> ..004 587		
<b>Europa</b>	07.06→	①	<b>AR650S</b> ..018 913	<b>AR650U</b> ..008 939								<b>650U</b> ..004 587		
<b>Evora</b>	05.09→	②	<b>A948S</b> ..118 948			AP1	<b>AP26U</b> ..006 838							
<b>Exige</b>	04.06→	①	<b>AR650S</b> ..018 913	<b>AR650U</b> ..008 939								<b>650U</b> ..004 587		

**MASERATI**

<b>Biturbo</b>	03.89-12.01	①	<b>AR500S</b> ..009 081	<b>AR500U</b> ..008 935	<b>AR500U</b> ..008 935			KUR	<b>500S</b> ..118 561	<b>500US</b> ..004 590	<b>500</b> ..118 560	<b>500U</b> ..004 583	<b>500U</b> ..004 583	
<b>Karif</b>	04.88-12.01	①	<b>AR500S</b> ..009 081	<b>AR500U</b> ..008 935	<b>AR500U</b> ..008 935			KUR	<b>500S</b> ..118 561	<b>500US</b> ..004 590	<b>500</b> ..118 560	<b>500U</b> ..004 583	<b>500U</b> ..004 583	
<b>420</b>	01.87-12.01	①	<b>AR500S</b> ..009 081	<b>AR500U</b> ..008 935	<b>AR500U</b> ..008 935				<b>500S</b> ..118 561	<b>500US</b> ..004 590	<b>500</b> ..118 560	<b>500U</b> ..004 583	<b>500U</b> ..004 583	
<b>430</b>	02.88-12.01	①	<b>AR500S</b> ..009 081	<b>AR500U</b> ..008 935	<b>AR500U</b> ..008 935			KUR	<b>500S</b> ..118 561	<b>500US</b> ..004 590	<b>500</b> ..118 560	<b>500U</b> ..004 583	<b>500U</b> ..004 583	

**MAYBACH**

<b>Serie 240</b>	09.02→	②	<b>A946S</b> ..118 946			AP1	<b>AP26U</b> ..006 838	<b>AP26U</b> ..006 838						
------------------	--------	---	---------------------------	--	--	-----	---------------------------	---------------------------	--	--	--	--	--	--



A = Aerotwin | AM = Aerotwin Multi-Clip | AP = Aerotwin Plus | AR = Aerotwin Retrofit | S = Spoiler | U = Single Pack





3 397...

MAZDA																
<b>BT-50</b>	03.06→	①	<b>AR450S</b> ..118 994	<b>AR450U</b> ..008 933	<b>AR450U</b> ..008 933					<b>450S</b> ..118 506	<b>450US</b> ..004 588	<b>450</b> ..118 505	<b>450U</b> ..004 581	<b>450U</b> ..004 581		
<b>CX-5 [KE]</b>	12.11→	①	<b>AR604S</b> ..118 908	<b>AR600U</b> ..008 938	<b>AR450U</b> ..008 933					<b>604S</b> ..118 303	<b>600US</b> ..004 592		<b>600U</b> ..004 586	<b>450U</b> ..004 581	<b>H352</b> ..011 430	
<b>CX-7 [ER]</b>	05.07→	①	<b>AR653S</b> ..118 911	<b>AR650U</b> ..008 939	<b>AR400U</b> ..008 932					<b>653S</b> ..118 325	<b>650US</b> ..004 593	<b>653</b> ..118 324	<b>650U</b> ..004 587	<b>400U</b> ..004 579	<b>H352</b> ..011 430	
<b>CX-9 [TB]</b>	09.06→	KUR ①	<b>AR653S</b> ..118 911	<b>AR650U</b> ..008 939	<b>AR400U</b> ..008 932				KUR	<b>653S</b> ..118 325	<b>650US</b> ..004 593	<b>653</b> ..118 324	<b>650U</b> ..004 587	<b>400U</b> ..004 579	<b>H352</b> ..011 430	
<b>Demio [DW]</b>	07.96-02.03	①		<b>AR500U</b> ..008 935	<b>AR400U</b> ..008 932							<b>361</b> ..001 361	<b>500U</b> ..004 583	<b>400U</b> ..004 579	① <b>H420/420U</b> ..004 758	
<b>MPV [LV]</b>	07.94-04.99	①	<b>AR551S</b> ..118 905	<b>AR550U</b> ..008 937	<b>AR500U</b> ..008 935					<b>551S</b> ..118 423	<b>550US</b> ..004 591	<b>551</b> ..118 422	<b>550U</b> ..004 585	<b>500U</b> ..004 583	① <b>H420/420U</b> ..004 758	
[LW]	05.99-08.04	KUR ①	<b>AR997S</b> ..118 997									<b>603</b> ..118 301	<b>600U</b> ..004 586	<b>600U</b> ..004 586		
<b>MX-3 [EC]</b>	05.91-10.93	①	<b>AR531S</b> ..118 901	<b>AR530U</b> ..008 936	<b>AR450U</b> ..008 933					<b>531S</b> ..118 403	<b>530US</b> ..011 352	<b>531</b> ..118 402	<b>530U</b> ..004 584	<b>450U</b> ..004 581	① <b>H500/500U</b> ..004 760	
	11.93-02.98	①	<b>AR531S</b> ..118 901	<b>AR530U</b> ..008 936	<b>AR450U</b> ..008 933					<b>531S</b> ..118 403	<b>530US</b> ..011 352	<b>531</b> ..118 402	<b>530U</b> ..004 584	<b>450U</b> ..004 581		
<b>MX-5 [NA]</b>	08.89-11.97	①	<b>AR450S</b> ..118 994	<b>AR450U</b> ..008 933	<b>AR450U</b> ..008 933					<b>450S</b> ..118 506	<b>450US</b> ..004 588	<b>450</b> ..118 505	<b>450U</b> ..004 581	<b>450U</b> ..004 581		
[NB]	01.98-07.05	①	<b>AR450S</b> ..118 994	<b>AR450U</b> ..008 933	<b>AR450U</b> ..008 933					<b>450S</b> ..118 506	<b>450US</b> ..004 588	<b>450</b> ..118 505	<b>450U</b> ..004 581	<b>450U</b> ..004 581		
[NC]	07.05→								①	<b>450S</b> ..118 506		<b>450</b> ..118 505	<b>450U</b> ..004 581	<b>450U</b> ..004 581		
<b>MX-6 [GE]</b>	07.91-06.97	①	<b>AR500S</b> ..009 081	<b>AR500U</b> ..008 935	<b>AR500U</b> ..008 935					<b>500S</b> ..118 561	<b>500US</b> ..004 590	<b>500</b> ..118 560	<b>500U</b> ..004 583	<b>500U</b> ..004 583		
<b>Premacy [CP]</b>	03.99-05.05	①	<b>AR601S</b> ..118 907	<b>AR600U</b> ..008 938	<b>AR400U</b> ..008 932					<b>601S</b> ..010 297	<b>600US</b> ..004 592	<b>601</b> ..118 304	<b>600U</b> ..004 586	<b>400U</b> ..004 579	① <b>H341</b> ..004 755	
<b>RX-7 Coupé [FD]</b>	01.92-02.96	①	<b>AR500S</b> ..009 081	<b>AR500U</b> ..008 935	<b>AR500U</b> ..008 935					<b>500S</b> ..118 561	<b>500US</b> ..004 590	<b>500</b> ..118 560	<b>500U</b> ..004 583	<b>500U</b> ..004 583	① <b>H450/450U</b> ..004 763	
<b>RX-8 [FE; SE]</b>	04.03→	①	<b>AR502S</b> ..118 995	<b>AR500U</b> ..008 935	<b>AR450U</b> ..008 933					<b>502S</b> ..118 564	<b>500US</b> ..004 590	<b>502</b> ..118 563	<b>500U</b> ..004 583	<b>450U</b> ..004 581		
<b>Serie B [UF; UN]</b>	03.96-03.06	①	<b>AR450S</b> ..118 994	<b>AR450U</b> ..008 933	<b>AR450U</b> ..008 933					<b>450S</b> ..118 506		<b>450</b> ..118 505	<b>450U</b> ..004 581	<b>450U</b> ..004 581		
<b>Serie E</b>	02.84-12.06								①			<b>400</b> ..118 610	<b>400U</b> ..004 579	<b>400U</b> ..004 579	① <b>H380/380U</b> ..004 756	
<b>Tribute [EP]</b>	02.01→	①	<b>AR480S</b> ..118 900	<b>AR480U</b> ..008 934	<b>AR480U</b> ..008 934					<b>480S</b> ..118 541		<b>480</b> ..118 540	<b>480U</b> ..004 582	<b>480U</b> ..004 582	<b>H280</b> ..018 802	
<b>Xedos-6 [CA]</b>	01.92-02.99	①	<b>AR533S</b> ..118 902	<b>AR530U</b> ..008 936	<b>AR480U</b> ..008 934					<b>533S</b> ..118 406	<b>530US</b> ..011 352	<b>533</b> ..118 405	<b>530U</b> ..004 584	<b>480U</b> ..004 582		
<b>Xedos-9 [TA]</b>	07.93-11.02	①	<b>AR533S</b> ..118 902	<b>AR530U</b> ..008 936	<b>AR480U</b> ..008 934					<b>532S</b> ..118 404	<b>530US</b> ..011 352		<b>530U</b> ..004 584	<b>500U</b> ..004 583		
<b>2 [DY]</b>	02.03-06.07	①	<b>AR601S</b> ..118 907	<b>AR600U</b> ..008 938	<b>AR400U</b> ..008 932					<b>601S</b> ..010 297	<b>600US</b> ..004 592	<b>601</b> ..118 304	<b>600U</b> ..004 586	<b>400U</b> ..004 579	<b>H354</b> ..011 433	
[DE]	06.07→	①	<b>AR605S</b> ..007 504	<b>AR600U</b> ..008 938	<b>AR340U</b> ..008 930							<b>600US</b> ..004 592	<b>605</b> ..010 270	<b>600U</b> ..004 586	<b>340U</b> ..004 578	<b>H354</b> ..011 433
<b>3 [BK]</b>	07.03-12.08	②	<b>A927S</b> ..118 927	<b>AM21U</b> ..008 568	<b>AM19U</b> ..008 566	AP1	<b>AP21U</b> ..006 834	<b>AP19U</b> ..006 832								
			<b>AM460S</b> ..007 460													
[BL]	12.08→	①	<b>AR607S</b> ..118 909	<b>AR600U</b> ..008 938	<b>AR480U</b> ..008 934											
<b>3 Hatchback [BK]</b>	07.03-12.08	②	<b>A927S</b> ..118 927	<b>AM21U</b> ..008 568	<b>AM19U</b> ..008 566	AP1	<b>AP21U</b> ..006 834	<b>AP19U</b> ..006 832							<b>H351</b> ..004 559	



A = Aerotwin | AM = Aerotwin Multi-Clip | AP = Aerotwin Plus | AR = Aerotwin Retrofit | S = Spoiler | U = Single Pack



3 397...

<b>3 Hatchback [BK]</b>	07.03-12.08	WW	<b>AM460S</b> ..007 460																
[BL]	12.08→	①	<b>AR607S</b> ..118 909	<b>AR600U</b> ..008 938	<b>AR480U</b> ..008 934														<b>H352</b> ..011 430
<b>5 [CR;CW]</b>	02.05→	①	<b>AR653S</b> ..118 911	<b>AR650U</b> ..008 939	<b>AR400U</b> ..008 932				<b>653S</b> ..118 325	<b>650US</b> ..004 593	<b>653</b> ..118 324	<b>650U</b> ..004 587	<b>400U</b> ..004 579						
<b>6 [GG/GY]</b>	02.02-07.07	①	<b>AR728S</b> ..118 904	<b>AR550U</b> ..008 937	<b>AR480U</b> ..008 934				<b>531S</b> ..118 403	<b>530US</b> ..011 352	<b>531</b> ..118 402	<b>530U</b> ..004 584	<b>450U</b> ..004 581						
[GH]	08.07→	①	<b>AR601S</b> ..118 907	<b>AR600U</b> ..008 938	<b>AR400U</b> ..008 932				<b>601S</b> ..010 297	<b>600US</b> ..004 592		<b>600U</b> ..004 586	<b>400U</b> ..004 579						
[GJ]	10.12→	①	<b>AR604S</b> ..118 908	<b>AR600U</b> ..008 938	<b>AR450U</b> ..008 933				<b>604S</b> ..118 303	<b>600US</b> ..004 592		<b>600U</b> ..004 586	<b>450U</b> ..004 581						
<b>6 Fastback [GG/GY]</b>	04.02-08.08	①	<b>AR728S</b> ..118 904	<b>AR550U</b> ..008 937	<b>AR480U</b> ..008 934				<b>531S</b> ..118 403	<b>530US</b> ..011 352	<b>531</b> ..118 402	<b>530U</b> ..004 584	<b>450U</b> ..004 581	①					<b>H500/500U</b> ..004 760
[GH]	08.07→	①	<b>AR601S</b> ..118 907	<b>AR600U</b> ..008 938	<b>AR400U</b> ..008 932				<b>601S</b> ..010 297	<b>600US</b> ..004 592		<b>600U</b> ..004 586	<b>400U</b> ..004 579	①					<b>H500/500U</b> ..004 760
<b>6 Sedan [GG/GY]</b>	02.02-08.07	①	<b>AR728S</b> ..118 904	<b>AR550U</b> ..008 937	<b>AR480U</b> ..008 934				<b>531S</b> ..118 403	<b>530US</b> ..011 352	<b>531</b> ..118 402	<b>530U</b> ..004 584	<b>450U</b> ..004 581						
<b>6 Wagon [GG/GY]</b>	06.02-12.07	①	<b>AR728S</b> ..118 904	<b>AR550U</b> ..008 937	<b>AR480U</b> ..008 934				<b>531S</b> ..118 403	<b>530US</b> ..011 352	<b>531</b> ..118 402	<b>530U</b> ..004 584	<b>450U</b> ..004 581						
[GH]	12.07→	①	<b>AR601S</b> ..118 907	<b>AR600U</b> ..008 938	<b>AR400U</b> ..008 932				<b>601S</b> ..010 297	<b>600US</b> ..004 592		<b>600U</b> ..004 586	<b>400U</b> ..004 579						<b>H352</b> ..011 430
[GJ]	10.12→	①	<b>AR604S</b> ..118 908	<b>AR600U</b> ..008 938	<b>AR450U</b> ..008 933				<b>604S</b> ..118 303	<b>600US</b> ..004 592		<b>600U</b> ..004 586	<b>450U</b> ..004 581						<b>H309</b> ..011 630
<b>121 [DB]</b>	11.90-12.95											<b>361</b> ..001 361	<b>500U</b> ..004 583	<b>400U</b> ..004 579					
[JA/JB]	01.96-10.99								① <b>480S</b> ..118 541			<b>480</b> ..118 540	<b>480U</b> ..004 582	<b>480U</b> ..004 582					<b>H503</b> ..004 660
[Soho]	01.97-12.98	①	<b>AR450S</b> ..118 994	<b>AR450U</b> ..008 933	<b>AR450U</b> ..008 933				<b>480S</b> ..118 541			<b>480</b> ..118 540	<b>480U</b> ..004 582	<b>480U</b> ..004 582					
<b>323 [BF]</b>	08.85-06.94								① <b>450S</b> ..118 506			<b>450</b> ..118 505	<b>450U</b> ..004 581	<b>450U</b> ..004 581	①				<b>H450/450U</b> ..004 763
[BJ]	05.98-09.03	①	<b>AR531S</b> ..118 901	<b>AR530U</b> ..008 936	<b>AR450U</b> ..008 933				<b>531S</b> ..118 403	<b>530US</b> ..011 352	<b>531</b> ..118 402	<b>530U</b> ..004 584	<b>450U</b> ..004 581						
<b>323 F Hatchback [BA]</b>	05.94-07.98	①	<b>AR531S</b> ..118 901	<b>AR530U</b> ..008 936	<b>AR450U</b> ..008 933				<b>531S</b> ..118 403	<b>530US</b> ..011 352	<b>531</b> ..118 402	<b>530U</b> ..004 584	<b>450U</b> ..004 581	①					<b>H480/480U</b> ..004 759
<b>323 Hatchback [BA]</b>	06.94-09.00	①	<b>AR531S</b> ..118 901	<b>AR530U</b> ..008 936	<b>AR450U</b> ..008 933				<b>531S</b> ..118 403	<b>530US</b> ..011 352	<b>531</b> ..118 402	<b>530U</b> ..004 584	<b>450U</b> ..004 581	①					<b>H400/400U</b> ..004 757
[BG]	06.89-05.96	①	<b>AR531S</b> ..118 901	<b>AR530U</b> ..008 936	<b>AR450U</b> ..008 933				<b>531S</b> ..118 403	<b>530US</b> ..011 352	<b>531</b> ..118 402	<b>530U</b> ..004 584	<b>450U</b> ..004 581	TU3					<b>H400/400U</b> ..004 757
[BJ]	06.98-09.03	①	<b>AR531S</b> ..118 901	<b>AR530U</b> ..008 936	<b>AR450U</b> ..008 933				<b>531S</b> ..118 403	<b>530US</b> ..011 352	<b>531</b> ..118 402	<b>530U</b> ..004 584	<b>450U</b> ..004 581	①					<b>H341</b> ..004 755
<b>323 Sedan [BA]</b>	06.94-04.98	①	<b>AR531S</b> ..118 901	<b>AR530U</b> ..008 936	<b>AR450U</b> ..008 933				<b>531S</b> ..118 403	<b>530US</b> ..011 352	<b>531</b> ..118 402	<b>530U</b> ..004 584	<b>450U</b> ..004 581						
[BG]	06.89-02.97	①	<b>AR531S</b> ..118 901	<b>AR530U</b> ..008 936	<b>AR450U</b> ..008 933				<b>531S</b> ..118 403	<b>530US</b> ..011 352	<b>531</b> ..118 402	<b>530U</b> ..004 584	<b>450U</b> ..004 581						
<b>323 Wagon [BW]</b>	09.89-10.95	①	<b>AR450S</b> ..118 994	<b>AR450U</b> ..008 933	<b>AR450U</b> ..008 933				<b>450S</b> ..118 506	<b>450US</b> ..004 588	<b>450</b> ..118 505	<b>450U</b> ..004 581	<b>450U</b> ..004 581	①					<b>H341</b> ..004 755
<b>626 [GE]</b>	08.91-03.97	①	<b>AR532S</b> ..118 986	<b>AR530U</b> ..008 936	<b>AR500U</b> ..008 935				<b>532S</b> ..118 404	<b>530US</b> ..011 352		<b>530U</b> ..004 584	<b>500U</b> ..004 583						
[GF]	05.97-09.99	①	<b>AR531S</b> ..118 901	<b>AR530U</b> ..008 936	<b>AR450U</b> ..008 933				<b>531S</b> ..118 403	<b>530US</b> ..011 352	<b>531</b> ..118 402	<b>480U</b> ..004 582	<b>480U</b> ..004 582						
<b>626 Fastback [GF]</b>	08.99-04.02	①	<b>AR531S</b> ..118 901	<b>AR530U</b> ..008 936	<b>AR450U</b> ..008 933				<b>531S</b> ..118 403	<b>530US</b> ..011 352	<b>531</b> ..118 402	<b>530U</b> ..004 584	<b>450U</b> ..004 581	①					<b>H500/500U</b> ..004 760
<b>626 Hatchback [GE]</b>	09.91-03.97	①	<b>AR532S</b> ..118 986	<b>AR530U</b> ..008 936	<b>AR500U</b> ..008 935				<b>532S</b> ..118 404	<b>530US</b> ..011 352		<b>530U</b> ..004 584	<b>500U</b> ..004 583	ADD					<b>H550/550U</b> ..004 762



A = Aerotwin | AM = Aerotwin Multi-Clip | AP = Aerotwin Plus | AR = Aerotwin Retrofit | S = Spoiler | U = Single Pack





◀ MAZDA

3 397...

<b>626 Hatchback</b> [GF]	04.97-07.02	①	<b>AR531S</b> ..118 901	<b>AR530U</b> ..008 936	<b>AR450U</b> ..008 933				<b>531S</b> ..118 403	<b>530US</b> ..011 352	<b>531</b> ..118 402	<b>530U</b> ..004 584	<b>450U</b> ..004 581	①	<b>H530/530U</b> ..004 761
<b>626 Wagon</b> [GV]	03.92-10.97	①	<b>AR480S</b> ..118 900	<b>AR480U</b> ..008 934	<b>AR480U</b> ..008 934				<b>480S</b> ..118 541		<b>480</b> ..118 540	<b>480U</b> ..004 582	<b>480U</b> ..004 582	①	<b>H400/400U</b> ..004 757
[GW]	10.97-04.02	①	<b>AR531S</b> ..118 901	<b>AR530U</b> ..008 936	<b>AR450U</b> ..008 933				<b>531S</b> ..118 403	<b>530US</b> ..011 352	<b>531</b> ..118 402	<b>530U</b> ..004 584	<b>450U</b> ..004 581	①	<b>H341</b> ..004 755

**MERCEDES-BENZ**

<b>Citan</b>	07.12→	①	<b>AR550S</b> ..118 906	<b>AR550U</b> ..008 937	<b>AR530U</b> ..008 936									MHK	<b>H351</b> ..004 559
		⑦	<b>A424S</b> ..007 424			AP3	<b>AP23U</b> ..006 836	<b>AP21U</b> ..006 834						MHT	<b>H341</b> ..004 755
<b>Serie A</b> [168]	10.97-08.04	①	<b>AR991S</b> ..118 991						<b>652S</b> ..118 327	<b>650US</b> ..004 593		<b>650U</b> ..004 587	<b>575U</b> ..011 351	①	<b>H341</b> ..004 755
[169]	09.04-06.12	⑥	<b>A967S</b> ..118 967	<b>AM26U</b> ..008 573	<b>AM23U</b> ..008 570	2BB	<b>AP26U</b> ..006 838	<b>AP23U</b> ..006 836							<b>H301</b> ..004 629
[176]	06.12→	⑥	<b>A929S</b> ..118 929	<b>AM24U</b> ..008 571	<b>AM19U</b> ..008 566	2BB	<b>AP24U</b> ..006 837	<b>AP19U</b> ..006 832							
		WW	<b>AM462S</b> ..007 462												
<b>Serie B</b> [245]	04.05-05.12	⑥	<b>A967S</b> ..118 967	<b>AM26U</b> ..008 573	<b>AM23U</b> ..008 570	2BB	<b>AP26U</b> ..006 838	<b>AP23U</b> ..006 836							<b>H840</b> ..004 802
[246]	09.11→	⑥	<b>AM467S</b> ..007 467	<b>AM26U</b> ..008 573	<b>AM19U</b> ..008 566	2BB	<b>AP26U</b> ..006 838	<b>AP19U</b> ..006 832							<b>H261</b> ..011 676
<b>Serie C</b> [202]	03.93-04.00											<b>600</b> ..018 300			
[203]	05.00-06.03								BGO	<b>801S</b> ..001 802	<b>600US</b> ..004 592	<b>801</b> ..001 801	<b>600U</b> ..004 586		
	07.03-08.07	④	<b>A933S</b> ..118 933												
[204]	01.07-11.08	②	<b>A053S</b> ..009 053			AP1	<b>AP24U</b> ..006 837	<b>AP24U</b> ..006 837							
	12.08→	②	<b>A938S</b> ..118 938			AP1	<b>AP24U</b> ..006 837	<b>AP24U</b> ..006 837							
	01.13→	③	<b>A825S</b> ..009 825			2AA	<b>AP24U</b> ..006 837	<b>AP24U</b> ..006 837							
<b>Serie C Coupé</b> [204]	03.11→	②	<b>A938S</b> ..118 938			AP1	<b>AP24U</b> ..006 837	<b>AP24U</b> ..006 837							
<b>Serie C</b> [203] (Sportcoupe)	01.01-06.03								BGO	<b>801S</b> ..001 802	<b>600US</b> ..004 592	<b>801</b> ..001 801	<b>600U</b> ..004 586		
	07.03-02.08	④	<b>A933S</b> ..118 933												
<b>Serie C (T-Modell)</b> [202]	05.96-02.01											<b>600</b> ..018 300		①	<b>H405</b> ..004 764
[203]	01.01-06.03								BGO	<b>801S</b> ..001 802	<b>600US</b> ..004 592	<b>801</b> ..001 801	<b>600U</b> ..004 586	①	<b>H382</b> ..011 412
	07.03-08.07	④	<b>A933S</b> ..118 933											①	<b>H382</b> ..011 412
[204]	09.07-11.08	②	<b>A053S</b> ..009 053			AP1	<b>AP24U</b> ..006 837	<b>AP24U</b> ..006 837							<b>H840</b> ..004 802
	12.08→	②	<b>A938S</b> ..118 938			AP1	<b>AP24U</b> ..006 837	<b>AP24U</b> ..006 837							<b>H840</b> ..004 802
	01.13→	③	<b>A825S</b> ..009 825			2AA	<b>AP24U</b> ..006 837	<b>AP24U</b> ..006 837							
<b>Serie CL (Coupé)</b> [140]	06.96-08.99	①		<b>AR65N</b> ..008 844	<b>AR65N</b> ..008 844				<b>359S</b> ..001 359						



A = Aerotwin | AM = Aerotwin Multi-Clip | AP = Aerotwin Plus | AR = Aerotwin Retrofit | S = Spoiler | U = Single Pack



3 397...

<b>Serie CL (Coupé)</b> [215]	09.99-02.00								①	<b>046S</b> ..005 046							
	03.00-08.06	②	<b>A946S</b> ..118 946				AP1	<b>AP26U</b> ..006 838	<b>AP26U</b> ..006 838								
[216]	06.06→	②	<b>A946S</b> ..118 946				AP1	<b>AP26U</b> ..006 838	<b>AP26U</b> ..006 838								
<b>Serie CLA</b> [117]	12.12→	⑥	<b>A929S</b> ..118 929	<b>AM24U</b> ..008 571	<b>AM19U</b> ..008 566	2BB	<b>AP24U</b> ..006 837	<b>AP19U</b> ..006 832									
		WW ⑥	<b>AM462S</b> ..007 462														
<b>Serie CLC</b> [203]	03.08-10.10	④	<b>A933S</b> ..118 933														
<b>Serie CLK (Cabrio)</b> [208]	09.96-01.03									①		<b>600</b> ..018 300					
[209]	09.01-12.09	KUR ④	<b>A933S</b> ..118 933														
<b>Serie CLK (Coupé)</b> [208]	01.97-09.02									①		<b>600</b> ..018 300					
[209]	08.01-04.09	KUR ④	<b>A933S</b> ..118 933														
<b>Serie CLS</b> [219]	06.04-02.11	②	<b>A948S</b> ..118 948				AP1	<b>AP26U</b> ..006 838	<b>AP26U</b> ..006 838								
<b>Serie CLS Coupé</b> [218]	10.10→	②	<b>A938S</b> ..118 938				AP1	<b>AP24U</b> ..006 837	<b>AP24U</b> ..006 837								
<b>Serie CLS</b> [218] <b>Shooting Brake</b>	06.12→	②	<b>A938S</b> ..118 938				AP1	<b>AP24U</b> ..006 837	<b>AP24U</b> ..006 837					KUR		<b>A333H</b> ..008 995	
<b>Serie E</b> [124]	02.92-07.95									①		<b>600</b> ..018 300					
[210]	06.95-08.03									①		<b>455</b> ..012455					
[211]	03.02-03.09	②	<b>A948S</b> ..118 948				AP1	<b>AP26U</b> ..006 838	<b>AP26U</b> ..006 838								
[212]	08.08→	②	<b>A938S</b> ..118 938				AP1	<b>AP24U</b> ..006 837	<b>AP24U</b> ..006 837								
<b>Serie E (Cabrio)</b> [124]	05.93-06.98									①		<b>600</b> ..018 300					
[207]	01.10→	②	<b>A938S</b> ..118 938				AP1	<b>AP24U</b> ..006 837	<b>AP24U</b> ..006 837								
	01.13→	③	<b>A825S</b> ..009 825				2AA	<b>AP24U</b> ..006 837	<b>AP24U</b> ..006 837								
<b>Serie E (Coupé)</b> [124]	05.93-06.98									①		<b>600</b> ..018 300					
[207]	02.09→	②	<b>A938S</b> ..118 938				AP1	<b>AP24U</b> ..006 837	<b>AP24U</b> ..006 837								
	01.13→	③	<b>A825S</b> ..009 825				2AA	<b>AP24U</b> ..006 837	<b>AP24U</b> ..006 837								
<b>Serie E (T-Modell)</b> [124]	07.93-05.96									①		<b>600</b> ..018 300		①		<b>H450/450U</b> ..004 763	
[210]	05.96-02.03									①		<b>455</b> ..012455		①		<b>H405</b> ..004 764	
[211]	02.03-08.09	②	<b>A948S</b> ..118 948				AP1	<b>AP26U</b> ..006 838	<b>AP26U</b> ..006 838					①		<b>H420/420U</b> ..004 758	
[212]	08.09→	②	<b>A938S</b> ..118 938				AP1	<b>AP24U</b> ..006 837	<b>AP24U</b> ..006 837							<b>H301</b> ..004 629	
<b>Serie G</b> [463]	09.89→	①		<b>AR400U</b> ..008 932	<b>AR400U</b> ..008 932						<b>400S</b> ..118 611	<b>400</b> ..118 610	<b>400U</b> ..004 579	<b>400U</b> ..004 579	①	<b>H380/380U</b> ..004 756	



A = Aerotwin | AM = Aerotwin Multi-Clip | AP = Aerotwin Plus | AR = Aerotwin Retrofit | S = Spoiler | U = Single Pack





◀ MERCEDES-BENZ

3 397...

<b>Serie GL</b> [164]	02.06→	⑥	<b>A093S</b> ..007 093	<b>AM28U</b> ..008 574	<b>AM21U</b> ..008 568	2BB	<b>AP28U</b> ..006 839	<b>AP21U</b> ..006 834							<b>H301</b> ..004 629
[166]	08.12→	③	<b>A854S</b> ..007 854												<b>H301</b> ..004 629
<b>Serie GLK</b> [204]	06.08→	②	<b>A931S</b> ..118 931	<b>AM22U</b> ..008 569	<b>AM18U</b> ..008 565	AP1	<b>AP22U</b> ..006 835	<b>AP18U</b> ..006 831							<b>H301</b> ..004 629
<b>Serie MB</b>	01.87-01.96	①	<b>AR450S</b> ..118 994	<b>AR450U</b> ..008 933	<b>AR450U</b> ..008 933				<b>450S</b> ..118 506	<b>450</b> ..118 505	<b>450U</b> ..004 581	<b>450U</b> ..004 581			
<b>Serie ML</b> [163]	03.98-06.05	①	<b>AR550S</b> ..118 906	<b>AR550U</b> ..008 937	<b>AR530U</b> ..008 936				<b>550S</b> ..118 421	<b>550US</b> ..004 591	<b>550</b> ..118 420	<b>550U</b> ..004 585	<b>550U</b> ..004 585	①	<b>H420/420U</b> ..004 758
[164]	03.05-07.11	⑥	<b>A093S</b> ..007 093	<b>AM28U</b> ..008 574	<b>AM21U</b> ..008 568	2BB	<b>AP28U</b> ..006 839	<b>AP21U</b> ..006 834							<b>H301</b> ..004 629
[166]	06.11-08.11	⑥	<b>A093S</b> ..007 093	<b>AM28U</b> ..008 574	<b>AM21U</b> ..008 568	2BB	<b>AP28U</b> ..006 839	<b>AP21U</b> ..006 834							<b>H301</b> ..004 629
	09.11→	19M ③	<b>A854S</b> ..007 854												<b>H301</b> ..004 629
<b>Serie R</b> [251]	09.05→	⑥	<b>A093S</b> ..007 093	<b>AM28U</b> ..008 574	<b>AM21U</b> ..008 568	2BB	<b>AP28U</b> ..006 839	<b>AP21U</b> ..006 834							<b>H301</b> ..004 629
<b>Serie S</b> [140]	02.91-09.98	①		<b>AR65N</b> ..008 844	<b>AR65N</b> ..008 844				<b>359S</b> ..001 359						
[220]	10.98-02.00								① <b>046S</b> ..005 046						
	03.00-09.05	②	<b>A946S</b> ..118 946			AP1	<b>AP26U</b> ..006 838	<b>AP26U</b> ..006 838							
[221]	09.05→	②	<b>A946S</b> ..118 946			AP1	<b>AP26U</b> ..006 838	<b>AP26U</b> ..006 838							
<b>Serie S (Coupé)</b> [140]	09.92-09.97	①		<b>AR65N</b> ..008 844	<b>AR65N</b> ..008 844				<b>359S</b> ..001 359						
<b>Serie SL</b> [129]	03.89-08.01								KUR ①			<b>600</b> ..018 300			
[230]	10.01-11.12	②	<b>A948S</b> ..118 948			AP1	<b>AP26U</b> ..006 838	<b>AP26U</b> ..006 838							
<b>Serie SLK</b> [170]	09.96-03.04	①	<b>AR550S</b> ..118 906	<b>AR550U</b> ..008 937	<b>AR530U</b> ..008 936				<b>550S</b> ..118 421	<b>550US</b> ..004 591	<b>550</b> ..118 420	<b>550U</b> ..004 585	<b>550U</b> ..004 585		
[171]	04.04-11.10	⑥	<b>A969S</b> ..118 969	<b>AM22U</b> ..008 569	<b>AM22U</b> ..008 569	2BB	<b>AP22U</b> ..006 835	<b>AP22U</b> ..006 835							
[172]	01.11→	⑥	<b>A969S</b> ..118 969	<b>AM22U</b> ..008 569	<b>AM22U</b> ..008 569	2BB	<b>AP22U</b> ..006 835	<b>AP22U</b> ..006 835							
<b>Serie SLR</b> [199]	04.04-12.09	②	<b>A948S</b> ..118 948			AP1	<b>AP26U</b> ..006 838	<b>AP26U</b> ..006 838							
<b>Serie V</b> [638 TON]	04.96-09.03	SDV ①	<b>AR725S</b> ..007 567						SDV		<b>725</b> ..001 725				
<b>Serie 124</b>	01.88-08.93								①			<b>600</b> ..018 300			
<b>Serie 124 (T-Modell)</b>	01.85-08.93								①			<b>600</b> ..018 300		①	<b>H450/450U</b> ..004 763
<b>Serie 190</b> [201]	09.86-09.93								①			<b>500U</b> ..004 583			
[201]	08.87-09.93								HUW ①			<b>600</b> ..018 300			
<b>Sprinter</b> [T1N]	02.95-05.06	①	<b>AR801S</b> ..118 996	<b>AR600U</b> ..008 938	<b>AR530U</b> ..008 936						<b>543</b> ..001 543	<b>600U</b> ..004 586	<b>530U</b> ..004 584		
[NCV3]	04.06→	⑥	<b>A215S</b> ..007 215	<b>AM26U</b> ..008 573	<b>AM24U</b> ..008 571	2BB	<b>AP26U</b> ..006 838	<b>AP24U</b> ..006 837							<b>A425H</b> ..008 051
<b>Vaneo</b> [414]	02.02-01.04	①	<b>AR991S</b> ..118 991						<b>652S</b> ..118 327	<b>650US</b> ..004 593	<b>650U</b> ..004 587	<b>575U</b> ..011 351	①	<b>H380/380U</b> ..004 756	



A = Aerotwin | AM = Aerotwin Multi-Clip | AP = Aerotwin Plus | AR = Aerotwin Retrofit | S = Spoiler | U = Single Pack



3 397...

<b>Vaneo</b> [414]	02.04-08.05	⑥	<b>A967S</b> ..118 967	<b>AM26U</b> ..008 573	<b>AM23U</b> ..008 570	2BB	<b>AP26U</b> ..006 838	<b>AP23U</b> ..006 836							①	<b>H380/380U</b> ..004 756
<b>Viano</b> [639 TON]	09.03-08.05	SDV ①	<b>AR703S</b> ..007 568	<b>AR71N</b> ..008 849	<b>AR66N</b> ..008 848				SDV	<b>703S</b> ..118 205					MGT ①	<b>H400/400U</b> ..004 757
	09.03-08.05														MHK ①	<b>H340/340U</b> ..004 754
	09.05-08.10	⑥	<b>A311S</b> ..007 311	<b>AM28U</b> ..008 574	<b>AM26U</b> ..008 573	2BB	<b>AP28U</b> ..006 839	<b>AP26U</b> ..006 838							MGT ①	<b>H400/400U</b> ..004 757
															MHK ①	<b>H340/340U</b> ..004 754
	09.10→	⑥	<b>A311S</b> ..007 311	<b>AM28U</b> ..008 574	<b>AM26U</b> ..008 573	2BB	<b>AP28U</b> ..006 839	<b>AP26U</b> ..006 838								<b>A381H</b> ..008 996
<b>Vito</b> [638 TON]	11.95-09.03	SDV ①	<b>AR725S</b> ..007 567						SDV		<b>725</b> ..001 725				①	<b>H450/450U</b> ..004 763
[639 TON]	10.03-08.05	SDV ①	<b>AR703S</b> ..007 568	<b>AR71N</b> ..008 849	<b>AR66N</b> ..008 848				SDV	<b>703S</b> ..118 205					MGT ①	<b>H400/400U</b> ..004 757
															MHK ①	<b>H340/340U</b> ..004 754
	09.05-08.10	⑥	<b>A311S</b> ..007 311	<b>AM28U</b> ..008 574	<b>AM26U</b> ..008 573	2BB	<b>AP28U</b> ..006 839	<b>AP26U</b> ..006 838							MGT ①	<b>H400/400U</b> ..004 757
															MHK ①	<b>H340/340U</b> ..004 754
	09.10→	⑥	<b>A311S</b> ..007 311	<b>AM28U</b> ..008 574	<b>AM26U</b> ..008 573	2BB	<b>AP28U</b> ..006 839	<b>AP26U</b> ..006 838								<b>A381H</b> ..008 996
<b>2t</b> [T1]	10.88-06.95								①		<b>500</b> ..118 560	<b>500U</b> ..004 583	<b>500U</b> ..004 583			
<b>3t</b> [T1]	10.88-06.95								①		<b>500</b> ..118 560	<b>500U</b> ..004 583	<b>500U</b> ..004 583			
<b>4t</b> [T1]	11.88-06.95								①		<b>500</b> ..118 560	<b>500U</b> ..004 583	<b>500U</b> ..004 583			

**MG**

<b>MG 6</b>	11.10→	⑥		<b>AM24U</b> ..008 571	<b>AM18U</b> ..008 565	2BB	<b>AP24U</b> ..006 837	<b>AP18U</b> ..006 831								
<b>MGF</b>	10.95-03.02								①	<b>500S</b> ..118 561	<b>500US</b> ..004 590	<b>500</b> ..118 560	<b>500U</b> ..004 583	<b>500U</b> ..004 583		
<b>MGTF</b>	03.02→	①	<b>AR500S</b> ..009 081	<b>AR500U</b> ..008 935	<b>AR500U</b> ..008 935					<b>500S</b> ..118 561	<b>500US</b> ..004 590	<b>500</b> ..118 560	<b>500U</b> ..004 583	<b>500U</b> ..004 583		
<b>ZR</b>	10.01-05.05								①	<b>450S</b> ..118 506		<b>450</b> ..118 505	<b>450U</b> ..004 581	<b>450U</b> ..004 581	①	<b>H450/450U</b> ..004 763
<b>ZS</b>	10.01-05.05	①	<b>AR502S</b> ..118 995	<b>AR500U</b> ..008 935	<b>AR450U</b> ..008 933					<b>502S</b> ..118 564	<b>500US</b> ..004 590	<b>502</b> ..118 563	<b>500U</b> ..004 583	<b>450U</b> ..004 581	①	<b>H450/450U</b> ..004 763
<b>ZT</b>	10.01-05.05	①	<b>AR550S</b> ..118 906	<b>AR550U</b> ..008 937	<b>AR530U</b> ..008 936					<b>550S</b> ..118 421	<b>550US</b> ..004 591	<b>550</b> ..118 420	<b>550U</b> ..004 585	<b>550U</b> ..004 585		
<b>ZT-Tourer</b>	10.01-05.05	①	<b>AR550S</b> ..118 906	<b>AR550U</b> ..008 937	<b>AR530U</b> ..008 936					<b>550S</b> ..118 421	<b>550US</b> ..004 591	<b>550</b> ..118 420	<b>550U</b> ..004 585	<b>550U</b> ..004 585		<b>H351</b> ..004 559

**MIA Electric**

<b>mia 18 kW</b>	02.12→	①		<b>AR400U</b> ..008 932	<b>AR400U</b> ..008 932							<b>400</b> ..118 610	<b>400U</b> ..004 579	<b>400U</b> ..004 579		
------------------	--------	---	--	----------------------------	----------------------------	--	--	--	--	--	--	-------------------------	--------------------------	--------------------------	--	--



A = Aerotwin | AM = Aerotwin Multi-Clip | AP = Aerotwin Plus | AR = Aerotwin Retrofit | S = Spoiler | U = Single Pack





3 397...

MINI (BMW)															
Mini [R 50, R 53]	06.01-07.04	①	AR450S ..118 994	AR450U ..008 933	AR450U ..008 933					480S ..118 541	450US ..004 588	480 ..118 540	480U ..004 582	480U ..004 582	
	08.04-11.06	①	AR450S ..118 994	AR450U ..008 933	AR450U ..008 933					480S ..118 541	450US ..004 588	480 ..118 540	480U ..004 582	480U ..004 582	H840 ..004 802
[R 56]	11.06-04.12	①	AR450S ..118 994	AR450U ..008 933	AR450U ..008 933					480S ..118 541	450US ..004 588	480 ..118 540	480U ..004 582	480U ..004 582	
	05.12→	⑦	A856S ..007 856			AP3	AP18U ..006 831	AP19U ..006 832							
Mini Cabrio [R 52; R 57]	07.04-04.12	①	AR450S ..118 994	AR450U ..008 933	AR450U ..008 933					480S ..118 541	450US ..004 588	480 ..118 540	480U ..004 582	480U ..004 582	
	05.12→	⑦	A856S ..007 856			AP3	AP18U ..006 831	AP19U ..006 832							
Mini Clubman [R 55]	11.07-04.12	①	AR450S ..118 994	AR450U ..008 933	AR450U ..008 933					480S ..118 541	450US ..004 588	480 ..118 540	480U ..004 582	480U ..004 582	ZE ..008 005
	05.12→	⑦	A856S ..007 856			AP3	AP18U ..006 831	AP19U ..006 832							
Mini Clubvan [R 55]	02.13→	⑦	A856S ..007 856			AP3	AP18U ..006 831	AP19U ..006 832							ZE ..008 005
Mini Countryman [R 60]	09.10→	⑥	A637S ..007 637			2BB	AP19U ..006 832	AP20U ..006 833							
Mini Coupé [R 58]	09.11→	⑥	A922S ..118 922	AM20U ..008 567	AM20U ..008 567	2BB	AP20U ..006 833	AP20U ..006 833							
Mini Coupé [R 59] Roadster	02.12→	⑥	A922S ..118 922	AM20U ..008 567	AM20U ..008 567	2BB	AP20U ..006 833	AP20U ..006 833							
Mini Paceman [R 61]	03.13→	⑥	A637S ..007 637			2BB	AP19U ..006 832	AP20U ..006 833							

MITSUBISHI															
ASX [GA]	04.10→	①	AR801S ..118 996	AR600U ..008 938	AR530U ..008 936					611S ..010 300	600US ..004 592		600U ..004 586	530U ..004 584	H250 ..011 629
Canter [FE]	10.96-10.00	①	AR500S ..009 081	AR500U ..008 935	AR500U ..008 935							500 ..118 560	500U ..004 583	500U ..004 583	
Carisma [DA]	05.96-12.03	①	AR532S ..118 986	AR530U ..008 936	AR500U ..008 935					532S ..118 404	530US ..011 352		530U ..004 584	500U ..004 583	
Carisma [DA] Hatchback	05.95-12.03	①	AR532S ..118 986	AR530U ..008 936	AR500U ..008 935					532S ..118 404	530US ..011 352		530U ..004 584	500U ..004 583	① H500/500U ..004 760
Colt [CA/CC; C5]	04.88-11.95								①	502S ..118 564	500US ..004 590	502 ..118 563	500U ..004 583	450U ..004 581	① H380/380U ..004 756
	[CJ]	11.95-06.03	①	AR533S ..118 902	AR530U ..008 936	AR480U ..008 934				533S ..118 406	530US ..011 352	533 ..118 405	530U ..004 584	480U ..004 582	① H341 ..004 755
	[CZ]	04.04→							①				650U ..004 587	H280 ..018802	
	04.04-09.08														L34 H351 ..004 559
	10.08→	①	AR605S ..007 504	AR600U ..008 938	AR340U ..008 930							605 ..010 270	600U ..004 586	340U ..004 578	L30 H304 ..004 990
Colt Cabrio [CZ]	03.06-07.08								①				650U ..004 587	H280 ..018802	
Eclipse [D2/3]	01.90-03.94	①	AR503S ..118 993	AR500U ..008 935	AR480U ..008 934					500S ..118 561	500US ..004 590	500 ..118 560	500U ..004 583	500U ..004 583	
Galant [EA]	10.96-05.03	①	AR531S ..118 901	AR530U ..008 936	AR450U ..008 933					531S ..118 403	530US ..011 352	531 ..118 402	530U ..004 584	450U ..004 581	



A = Aerotwin | AM = Aerotwin Multi-Clip | AP = Aerotwin Plus | AR = Aerotwin Retrofit | S = Spoiler | U = Single Pack





3 397...

			SET						SET		SET				
<b>Galant</b> [E5...8]	11.92-10.96	①	<b>AR533S</b> ..118 902	<b>AR530U</b> ..008 936	<b>AR480U</b> ..008 934				<b>533S</b> ..118 406	<b>530US</b> ..011 352	<b>533</b> ..118 405	<b>530U</b> ..004 584	<b>480U</b> ..004 582		
<b>Galant Fortis Sportback</b>	12.08-12.09	①	<b>AR601S</b> ..118 907	<b>AR600U</b> ..008 938	<b>AR400U</b> ..008 932				<b>601S</b> ..010 297	<b>600US</b> ..004 592		<b>600U</b> ..004 586	<b>400U</b> ..004 579		<b>H354</b> ..011 433
<b>Galant Hatchback</b> [E5...8]	11.92-10.96	①	<b>AR533S</b> ..118 902	<b>AR530U</b> ..008 936	<b>AR480U</b> ..008 934				<b>533S</b> ..118 406	<b>530US</b> ..011 352	<b>533</b> ..118 405	<b>530U</b> ..004 584	<b>480U</b> ..004 582	①	<b>H550/550U</b> ..004 762
<b>Galant Station Wagon</b> [EA]	10.96-09.02	①	<b>AR531S</b> ..118 901	<b>AR530U</b> ..008 936	<b>AR450U</b> ..008 933				<b>531S</b> ..118 403	<b>530US</b> ..011 352	<b>531</b> ..118 402	<b>530U</b> ..004 584	<b>450U</b> ..004 581	①	<b>H400/400U</b> ..004 757
<b>Galloper</b>	05.98-12.01	①	<b>AR450S</b> ..118 994	<b>AR450U</b> ..008 933	<b>AR450U</b> ..008 933						<b>450</b> ..118 505	<b>450U</b> ..004 581	<b>450U</b> ..004 581		
<b>Grandis</b>	01.04-01.08	①		<b>AR70N</b> ..008 845	<b>AR55N</b> ..008 842							<b>N70</b> ..018 170	<b>550U</b> ..004 585		<b>H307</b> ..011 429
	02.08-11.10	①		<b>AR70N</b> ..008 845	<b>AR55N</b> ..008 842							<b>700U</b> ..004 489	<b>550U</b> ..004 585		<b>H307</b> ..011 429
<b>i-Miev</b>	10.10→	①		<b>AR70N</b> ..008 845								<b>700U</b> ..004 489			<b>H306</b> ..011 432
<b>L 200</b> [K6/K7]	01.96-12.07	①	<b>AR480S</b> ..118 900	<b>AR480U</b> ..008 934	<b>AR480U</b> ..008 934				<b>480S</b> ..118 541		<b>480</b> ..118 540	<b>480U</b> ..004 582	<b>480U</b> ..004 582		
[KB]	12.05-10.09	①	<b>AR533S</b> ..118 902	<b>AR530U</b> ..008 936	<b>AR480U</b> ..008 934				<b>533S</b> ..118 406	<b>530US</b> ..011 352	<b>533</b> ..118 405	<b>530U</b> ..004 584	<b>480U</b> ..004 582		
[KA, KB]	11.09→	KUR ①	<b>AR531S</b> ..118 901	<b>AR550U</b> ..008 937	<b>AR450U</b> ..008 933			KUR	<b>531S</b> ..118 403	<b>550US</b> ..004 591	<b>531</b> ..118 402	<b>550U</b> ..004 585	<b>450U</b> ..004 581		
<b>L 200 Forte</b> [K7]	01.96→	①	<b>AR480S</b> ..118 900	<b>AR480U</b> ..008 934	<b>AR480U</b> ..008 934				<b>480S</b> ..118 541		<b>480</b> ..118 540	<b>480U</b> ..004 582	<b>480U</b> ..004 582		
<b>L 300</b> [P]	12.87-12.01	①	<b>AR450S</b> ..118 994	<b>AR450U</b> ..008 933	<b>AR450U</b> ..008 933				<b>450S</b> ..118 506	<b>450US</b> ..004 588	<b>450</b> ..118 505	<b>450U</b> ..004 581	<b>450U</b> ..004 581		
<b>L 300 Exceed</b>	02.00→							①	<b>400S</b> ..118 611		<b>400</b> ..118 610	<b>400U</b> ..004 579	<b>400U</b> ..004 579		
<b>Lancer</b> [C6/C7]	04.88-07.95	①	<b>AR502S</b> ..118 995	<b>AR500U</b> ..008 935	<b>AR450U</b> ..008 933				<b>502S</b> ..118 564	<b>500US</b> ..004 590	<b>502</b> ..118 563	<b>500U</b> ..004 583	<b>450U</b> ..004 581		
[CA/CB/CD]	05.92-12.96	①	<b>AR502S</b> ..118 995	<b>AR500U</b> ..008 935	<b>AR450U</b> ..008 933				<b>502S</b> ..118 564	<b>500US</b> ..004 590	<b>502</b> ..118 563	<b>500U</b> ..004 583	<b>450U</b> ..004 581		
[CK/CP/CN]	11.95-05.01	①	<b>AR533S</b> ..118 902	<b>AR530U</b> ..008 936	<b>AR480U</b> ..008 934				<b>533S</b> ..118 406	<b>530US</b> ..011 352	<b>533</b> ..118 405	<b>530U</b> ..004 584	<b>480U</b> ..004 582		
[CS/CT]	12.00-04.10	①	<b>AR604S</b> ..118 908	<b>AR600U</b> ..008 938	<b>AR450U</b> ..008 933				<b>604S</b> ..118 303	<b>600US</b> ..004 592		<b>600U</b> ..004 586	<b>450U</b> ..004 581		
[CY/CZ]	03.07→	①	<b>AR601S</b> ..118 907	<b>AR600U</b> ..008 938	<b>AR400U</b> ..008 932				<b>601S</b> ..010 297	<b>600US</b> ..004 592		<b>600U</b> ..004 586	<b>400U</b> ..004 579		
<b>Lancer Hatchback</b> [C6/C7]	06.92-07.95	①	<b>AR502S</b> ..118 995	<b>AR500U</b> ..008 935	<b>AR450U</b> ..008 933				<b>502S</b> ..118 564	<b>500US</b> ..004 590	<b>502</b> ..118 563	<b>500U</b> ..004 583	<b>450U</b> ..004 581	①	<b>H450/450U</b> ..004 763
<b>Lancer Sedan</b> [CA/CB/CD]	01.93-12.96	①	<b>AR502S</b> ..118 995	<b>AR500U</b> ..008 935	<b>AR450U</b> ..008 933				<b>502S</b> ..118 564	<b>500US</b> ..004 590	<b>502</b> ..118 563	<b>500U</b> ..004 583	<b>450U</b> ..004 581		
[CK/CP/CN]	05.96-05.01	①	<b>AR533S</b> ..118 902	<b>AR530U</b> ..008 936	<b>AR480U</b> ..008 934				<b>533S</b> ..118 406	<b>530US</b> ..011 352	<b>533</b> ..118 405	<b>530U</b> ..004 584	<b>480U</b> ..004 582		
<b>Lancer Sportback</b> [CX]	07.08→	①	<b>AR601S</b> ..118 907	<b>AR600U</b> ..008 938	<b>AR400U</b> ..008 932				<b>601S</b> ..010 297	<b>600US</b> ..004 592		<b>600U</b> ..004 586	<b>400U</b> ..004 579		<b>H354</b> ..011 433
<b>Lancer Station Wagon</b> [CA/CB/CD]	06.92-09.00	①	<b>AR502S</b> ..118 995	<b>AR500U</b> ..008 935	<b>AR450U</b> ..008 933				<b>502S</b> ..118 564	<b>500US</b> ..004 590	<b>502</b> ..118 563	<b>500U</b> ..004 583	<b>450U</b> ..004 581	①	<b>H400/400U</b> ..004 757
[CS/CT]	06.03-06.08	①	<b>AR604S</b> ..118 908	<b>AR600U</b> ..008 938	<b>AR450U</b> ..008 933				<b>604S</b> ..118 303	<b>600US</b> ..004 592		<b>600U</b> ..004 586	<b>450U</b> ..004 581		
<b>Mirage</b> [A0]	11.12→	①	<b>AR553S</b> ..007 589	<b>AR550U</b> ..008 937	<b>AR340U</b> ..008 930						<b>553</b> ..010 274	<b>550U</b> ..004 585	<b>340U</b> ..004 578		<b>H309</b> ..011 630
<b>Outlander</b> [CU]	02.03-09.07	①	<b>AR728S</b> ..118 904	<b>AR550U</b> ..008 937	<b>AR480U</b> ..008 934				<b>728S</b> ..001 728	<b>550US</b> ..004 591	<b>727</b> ..001 727	<b>550U</b> ..004 585	<b>480U</b> ..004 582		<b>H352</b> ..011 430
[CW]	02.07→	①	<b>AR801S</b> ..118 996	<b>AR600U</b> ..008 938	<b>AR530U</b> ..008 936				<b>611S</b> ..010 300	<b>600US</b> ..004 592		<b>600U</b> ..004 586	<b>530U</b> ..004 584		<b>H306</b> ..011 432



A = Aerotwin | AM = Aerotwin Multi-Clip | AP = Aerotwin Plus | AR = Aerotwin Retrofit | S = Spoiler | U = Single Pack





◀ MITSUBISHI

3 397...

<b>Outlander [GF]</b>	04.12→	①	<b>AR813S</b> ..118 912	<b>AR650U</b> ..008 939	<b>AR450U</b> ..008 933												<b>H306</b> ..011 432
<b>Pajero [V]</b>	12.90-06.00	①	<b>AR480S</b> ..118 900	<b>AR480U</b> ..008 934	<b>AR480U</b> ..008 934				<b>480S</b> ..118 541		<b>480</b> ..118 540	<b>480U</b> ..004 582	<b>480U</b> ..004 582				
	02.00→	①	<b>AR500S</b> ..009 081	<b>AR500U</b> ..008 935	<b>AR500U</b> ..008 935				<b>500S</b> ..118 561	<b>500US</b> ..004 590	<b>500</b> ..118 560	<b>500U</b> ..004 583	<b>500U</b> ..004 583				
[V80, V90]	09.06→	①	<b>AR551S</b> ..118 905	<b>AR550U</b> ..008 937	<b>AR500U</b> ..008 935				<b>551S</b> ..118 423	<b>550US</b> ..004 591	<b>551</b> ..118 422	<b>550U</b> ..004 585	<b>500U</b> ..004 583				
<b>Pajero Cabrio [V]</b>	12.90-05.01	①	<b>AR480S</b> ..118 900	<b>AR480U</b> ..008 934	<b>AR480U</b> ..008 934				<b>480S</b> ..118 541		<b>480</b> ..118 540	<b>480U</b> ..004 582	<b>480U</b> ..004 582				
<b>Pajero IO</b>	03.98-06.00	①	<b>AR480S</b> ..118 900	<b>AR480U</b> ..008 934	<b>AR480U</b> ..008 934				<b>480S</b> ..118 541		<b>480</b> ..118 540	<b>480U</b> ..004 582	<b>480U</b> ..004 582				
<b>Pajero Pinin [H]</b>	06.98-02.06	①	<b>AR480S</b> ..118 900	<b>AR480U</b> ..008 934	<b>AR480U</b> ..008 934				<b>480S</b> ..118 541		<b>480</b> ..118 540	<b>480U</b> ..004 582	<b>480U</b> ..004 582	①		<b>H400/400U</b> ..004 757	
<b>Pajero Sport [K]</b>	07.96-02.09	①	<b>AR500S</b> ..009 081	<b>AR500U</b> ..008 935	<b>AR500U</b> ..008 935				<b>500S</b> ..118 561	<b>500US</b> ..004 590	<b>500</b> ..118 560	<b>500U</b> ..004 583	<b>500U</b> ..004 583				
[KH]	07.08→	KUR ①	<b>AR531S</b> ..118 901	<b>AR550U</b> ..008 937	<b>AR450U</b> ..008 933			KUR	<b>531S</b> ..118 403	<b>550US</b> ..004 591	<b>531</b> ..118 402	<b>550U</b> ..004 585	<b>450U</b> ..004 581				
<b>Sigma</b>	12.90-03.96							①	<b>533S</b> ..118 406	<b>530US</b> ..011 352	<b>533</b> ..118 405	<b>530U</b> ..004 584	<b>480U</b> ..004 582				
<b>Space Runner</b>	06.91-08.02	KUR ①	<b>AR531S</b> ..118 901	<b>AR530U</b> ..008 936	<b>AR450U</b> ..008 933			KUR	<b>531S</b> ..118 403	<b>530US</b> ..011 352	<b>531</b> ..118 402	<b>530U</b> ..004 584	<b>450U</b> ..004 581				
<b>Space Star [DG]</b>	06.98-12.04	①	<b>AR531S</b> ..118 901	<b>AR530U</b> ..008 936	<b>AR450U</b> ..008 933				<b>531S</b> ..118 403	<b>530US</b> ..011 352	<b>531</b> ..118 402	<b>530U</b> ..004 584	<b>450U</b> ..004 581	①		<b>H341</b> ..004 755	
[A0]	11.12→	①	<b>AR553S</b> ..007 589	<b>AR550U</b> ..008 937	<b>AR340U</b> ..008 930						<b>553</b> ..010 274	<b>550U</b> ..004 585	<b>340U</b> ..004 578			<b>H309</b> ..011 630	
<b>Space Wagon [N]</b>	06.92-11.00							①			<b>551</b> ..118 422	<b>550U</b> ..004 585	<b>500U</b> ..004 583				
	07.98-01.04							ADD			<b>653</b> ..118 324	<b>650U</b> ..004 587	<b>450U</b> ..004 581				
<b>3000 GT</b>	06.92-12.00	①	<b>AR532S</b> ..118 986	<b>AR530U</b> ..008 936	<b>AR500U</b> ..008 935				<b>530S</b> ..118 401	<b>530US</b> ..011 352	<b>530</b> ..118 400	<b>530U</b> ..004 584	<b>530U</b> ..004 584	ZU2 ①		<b>H480/480U</b> ..004 759	

**NISSAN**

<b>Almera (Classic) [B10]</b>	01.06→	①	<b>AR552S</b> ..118 984	<b>AR550U</b> ..008 937	<b>AR400U</b> ..008 932				<b>552S</b> ..118 427	<b>550US</b> ..004 591		<b>550U</b> ..004 585	<b>400U</b> ..004 579				
<b>Almera [G15RA]</b>	11.12→	KUR ①	<b>AR552S</b> ..118 984	<b>AR550U</b> ..008 937	<b>AR400U</b> ..008 932				<b>552S</b> ..118 427	<b>550US</b> ..004 591		<b>550U</b> ..004 585	<b>420U</b> ..011 354			<b>H354</b> ..011 433	
<b>Almera Hatchback [N15]</b>	07.95-04.00	①	<b>AR533S</b> ..118 902	<b>AR530U</b> ..008 936	<b>AR480U</b> ..008 934				<b>533S</b> ..118 406	<b>530US</b> ..011 352	<b>533</b> ..118 405	<b>530U</b> ..004 584	<b>480U</b> ..004 582				
[N16E]	01.00-09.02	①	<b>AR552S</b> ..118 984	<b>AR550U</b> ..008 937	<b>AR400U</b> ..008 932				<b>552S</b> ..118 427	<b>550US</b> ..004 591		<b>550U</b> ..004 585	<b>400U</b> ..004 579				
<b>Almera Hatchback [N16E]</b>	10.02-11.06	①	<b>AR552S</b> ..118 984	<b>AR550U</b> ..008 937	<b>AR400U</b> ..008 932				<b>552S</b> ..118 427	<b>550US</b> ..004 591		<b>550U</b> ..004 585	<b>400U</b> ..004 579			<b>H353</b> ..004 631	
<b>Almera Sedan [N15]</b>	07.95-04.00	①	<b>AR533S</b> ..118 902	<b>AR530U</b> ..008 936	<b>AR480U</b> ..008 934				<b>533S</b> ..118 406	<b>530US</b> ..011 352	<b>533</b> ..118 405	<b>530U</b> ..004 584	<b>480U</b> ..004 582				
[N16; N16E]	04.00-11.06	①	<b>AR552S</b> ..118 984	<b>AR550U</b> ..008 937	<b>AR400U</b> ..008 932				<b>552S</b> ..118 427	<b>550US</b> ..004 591		<b>550U</b> ..004 585	<b>400U</b> ..004 579				
<b>Almera Tino [V10M]</b>	05.00-12.05	①	<b>AR813S</b> ..118 912	<b>AR650U</b> ..008 939	<b>AR450U</b> ..008 933						<b>803</b> ..001 803	<b>650U</b> ..004 587	<b>450U</b> ..004 581	①		<b>H500/500U</b> ..004 760	
<b>Altima [L32]</b>	11.06→	①	<b>AR653S</b> ..118 911	<b>AR650U</b> ..008 939	<b>AR400U</b> ..008 932				<b>653S</b> ..118 325	<b>650US</b> ..004 593	<b>653</b> ..118 324	<b>650U</b> ..004 587	<b>400U</b> ..004 579				
<b>Cabstar [TLO]</b>	10.98-08.06	①	<b>AR450S</b> ..118 994	<b>AR450U</b> ..008 933	<b>AR450U</b> ..008 933						<b>450</b> ..118 505	<b>450U</b> ..004 581	<b>450U</b> ..004 581				
[F24]	09.06→	①	<b>AR500S</b> ..009 081	<b>AR500U</b> ..008 935	<b>AR500U</b> ..008 935						<b>500</b> ..118 560	<b>500U</b> ..004 583	<b>500U</b> ..004 583				



A = Aerotwin | AM = Aerotwin Multi-Clip | AP = Aerotwin Plus | AR = Aerotwin Retrofit | S = Spoiler | U = Single Pack

			AEROTWIN			NEW! AEROTWIN			TWIN SPOILER			TWIN			REAR	
			SET	↖	↙	SET	↖	↙	SET	↖	↙	SET	↖	↙	SET	↖
3 397...																
Cube [Z12]	08.09→	①	AR500S ..009 081	AR500U ..008 935	AR500U ..008 935				500S ..118 561	500US ..004 590	500 ..118 560	500U ..004 583	500U ..004 583			
Evalia [M20M]	01.11→	①	AR552S ..118 984	AR550U ..008 937	AR400U ..008 932				552S ..118 427	550US ..004 591		550U ..004 585	400U ..004 579		H354 ..011 433	
Interstar [X70]	07.02-06.10	SDV ①	AR609S ..009 776	AR61N ..008 847	AR61N ..008 847			SDV			609 ..118 309					
Juke [F15]	07.10→	KUR ①	AR553S ..007 589	AR575U ..008 940	AR340U ..008 930			KUR		550US ..004 591	553 ..010 274	575U ..011 351	340U ..004 578	KWB ①	H301 ..004 629 H280 ..018 802	
Kubistar [X76]	07.03-03.09	①	AR500S ..009 081	AR500U ..008 935	AR500U ..008 935				500S ..118 561	500US ..004 590	500 ..118 560	500U ..004 583	500U ..004 583	MHK ①	H341 ..004 755 H402 ..004 632	
Leaf	10.10→														H250 ..011 629	
Maxima [A34]	02.03-05.08	①	AR653S ..118 911	AR650U ..008 939	AR400U ..008 932				653S ..118 325	650US ..004 593	653 ..118 324	650U ..004 587	400U ..004 579			
[J30]	09.88-06.94	①	AR530S ..118 903	AR530U ..008 936	AR530U ..008 936				530S ..118 401	530US ..011 352	530 ..118 400	530U ..004 584	530U ..004 584			
Maxima QX [A32]	10.94-01.00	①	AR530S ..118 903	AR530U ..008 936	AR530U ..008 936				530S ..118 401	530US ..011 352	530 ..118 400	530U ..004 584	530U ..004 584			
[CA33]	01.00-01.06	①	AR813S ..118 912	AR650U ..008 939	AR450U ..008 933						803 ..001 803	650U ..004 587	450U ..004 581			
Micra [K10]	12.82-07.92							ADF	450S ..118 506		450 ..118 505	450U ..004 581	450U ..004 581	①	H450/450U ..004 763	
[K11E]	08.92-06.00	①	AR502S ..118 995	AR500U ..008 935	AR450U ..008 933				502S ..118 564	500US ..004 590	502 ..118 563	500U ..004 583	450U ..004 581	①	H450/450U ..004 763	
	07.00-10.02	①	AR502S ..118 995	AR500U ..008 935	AR450U ..008 933				502S ..118 564	500US ..004 590	502 ..118 563	500U ..004 583	450U ..004 581		H402 ..004 632	
[K12E]	11.02-05.05	①	AR531S ..118 901	AR530U ..008 936	AR450U ..008 933				531S ..118 403	530US ..011 352	531 ..118 402	530U ..004 584	450U ..004 581		H301 ..004 629	
	06.05-10.10	①	AR531S ..118 901	AR530U ..008 936	AR450U ..008 933				531S ..118 403	530US ..011 352	531 ..118 402	530U ..004 584	450U ..004 581		H402 ..004 632	
[K13K]	07.10→	①		AR530U ..008 936	AR340U ..008 930					530US ..011 352		530U ..004 584	340U ..004 578		H306 ..011 432	
Micra CC [K12E]	09.05-10.10	①	AR531S ..118 901	AR530U ..008 936	AR450U ..008 933				531S ..118 403	530US ..011 352	531 ..118 402	530U ..004 584	450U ..004 581			
Murano [Z50]	11.04-12.08	①	AR813S ..118 912	AR650U ..008 939	AR450U ..008 933										H354 ..011 433	
[Z51]	06.08→	①	AR653S ..118 911	AR650U ..008 939	AR400U ..008 932											
Navara [D22]	06.00→	①	AR480S ..118 900	AR480U ..008 934	AR480U ..008 934				480S ..118 541		480 ..118 540	480U ..004 582	480U ..004 582			
[D40]	05.05→	①	AR607S ..118 909	AR600U ..008 938	AR480U ..008 934				607S ..118 306	600US ..004 592		600U ..004 586	480U ..004 582			
Note [E11; E11E]	01.05→	ORO ①	AR605S ..007 504	AR600U ..008 938	AR340U ..008 930			ORO		600US ..004 592	605 ..010 270	600U ..004 586	340U ..004 578		H306 ..011 432	
NP300 [D22]	05.08→	①	AR480S ..118 900	AR480U ..008 934	AR480U ..008 934				480S ..118 541		480 ..118 540	480U ..004 582	480U ..004 582			
NV200 [M20/M20M]	08.09→	①	AR552S ..118 984	AR550U ..008 937	AR400U ..008 932				552S ..118 427	550US ..004 591		550U ..004 585	400U ..004 579		H354 ..011 433	
NV400 [X62]	09.11→	①		AR650U ..008 939	AR650U ..008 939						650 ..118 320	650U ..004 587	650U ..004 587			
Pathfinder [R50]	10.97-08.03	①	AR551S ..118 905	AR550U ..008 937	AR500U ..008 935				551S ..118 423	550US ..004 591	551 ..118 422	550U ..004 585	500U ..004 583			



A = Aerotwin | AM = Aerotwin Multi-Clip | AP = Aerotwin Plus | AR = Aerotwin Retrofit | S = Spoiler | U = Single Pack





◀ NISSAN

3 397...

			SET			NEW AEROTWIN			TWIN SPOILER		SET			TWIN			REAR
<b>Pathfinder [R51]</b>	01.05→	①	<b>AR607S</b> ..118 909	<b>AR600U</b> ..008 938	<b>AR480U</b> ..008 934						<b>607S</b> ..118 306	<b>600US</b> ..004 592		<b>600U</b> ..004 586	<b>480U</b> ..004 582		<b>H306</b> ..011 432
<b>Patrol [260]</b>	04.89-12.05	①	<b>AR480S</b> ..118 900	<b>AR480U</b> ..008 934	<b>AR480U</b> ..008 934						<b>480S</b> ..118 541		<b>480</b> ..118 540	<b>480U</b> ..004 582	<b>480U</b> ..004 582		
<b>Patrol GR [Y60]</b>	09.88-09.97	①	<b>AR480S</b> ..118 900	<b>AR480U</b> ..008 934	<b>AR480U</b> ..008 934						<b>480S</b> ..118 541		<b>480</b> ..118 540	<b>480U</b> ..004 582	<b>480U</b> ..004 582		
[Y61]	08.97-03.10	①	<b>AR500S</b> ..009 081	<b>AR500U</b> ..008 935	<b>AR500U</b> ..008 935						<b>500S</b> ..118 561	<b>500US</b> ..004 590	<b>500</b> ..118 560	<b>500U</b> ..004 583	<b>500U</b> ..004 583	①	<b>H340/340U</b> ..004 754
<b>Patrol [Y62]</b>	03.10→	①	<b>AR604S</b> ..118 908	<b>AR600U</b> ..008 938	<b>AR450U</b> ..008 933												<b>H306</b> ..011 432
<b>Pickup [D21]</b>	08.87-02.98	①	<b>AR480S</b> ..118 900	<b>AR480U</b> ..008 934	<b>AR480U</b> ..008 934						<b>480S</b> ..118 541		<b>480</b> ..118 540	<b>480U</b> ..004 582	<b>480U</b> ..004 582		
[D22]	02.97→	①	<b>AR480S</b> ..118 900	<b>AR480U</b> ..008 934	<b>AR480U</b> ..008 934						<b>480S</b> ..118 541		<b>480</b> ..118 540	<b>480U</b> ..004 582	<b>480U</b> ..004 582		
<b>Pixo Hatchback [UA0]</b>	03.09→	①	<b>AR553S</b> ..007 589	<b>AR550U</b> ..008 937	<b>AR340U</b> ..008 930								<b>553</b> ..010 274	<b>550U</b> ..004 585	<b>340U</b> ..004 578		
<b>Prairie Pro [M11]</b>	04.92-07.94										<b>550S</b> ..118 421	<b>550US</b> ..004 591	<b>550</b> ..118 420	<b>550U</b> ..004 585	<b>550U</b> ..004 585	①	<b>H400/400U</b> ..004 757
<b>Primastar [X83]</b>	07.02→	①	<b>AR801S</b> ..118 996	<b>AR600U</b> ..008 938	<b>AR530U</b> ..008 936						<b>611S</b> ..010 300	<b>600US</b> ..004 592		<b>600U</b> ..004 586	<b>530U</b> ..004 584	MHK ① MHT	<b>H341</b> ..004 755 <b>H402</b> ..004 632
<b>Primera Hatchback [P10E]</b>	06.90-06.96	①	<b>AR533S</b> ..118 902	<b>AR530U</b> ..008 936	<b>AR480U</b> ..008 934						<b>533S</b> ..118 406	<b>530US</b> ..011 352	<b>533</b> ..118 405	<b>530U</b> ..004 584	<b>480U</b> ..004 582	①	<b>H500/500U</b> ..004 760
[P11E]	06.96-12.01	①	<b>AR532S</b> ..118 986	<b>AR530U</b> ..008 936	<b>AR500U</b> ..008 935						<b>532S</b> ..118 404	<b>530US</b> ..011 352		<b>530U</b> ..004 584	<b>500U</b> ..004 583	①	<b>H500/500U</b> ..004 760
[P12E]	05.02-09.10	①	<b>AR813S</b> ..118 912	<b>AR650U</b> ..008 939	<b>AR450U</b> ..008 933						<b>813S</b> ..001 813	<b>650US</b> ..004 593		<b>650U</b> ..004 587	<b>450U</b> ..004 581	KWB	<b>H502</b> ..004 633
<b>Primera Sedan [P10E]</b>	06.90-06.96	①	<b>AR533S</b> ..118 902	<b>AR530U</b> ..008 936	<b>AR480U</b> ..008 934						<b>533S</b> ..118 406	<b>530US</b> ..011 352	<b>533</b> ..118 405	<b>530U</b> ..004 584	<b>480U</b> ..004 582		
[P11E]	06.96-12.01	①	<b>AR532S</b> ..118 986	<b>AR530U</b> ..008 936	<b>AR500U</b> ..008 935						<b>532S</b> ..118 404	<b>530US</b> ..011 352		<b>530U</b> ..004 584	<b>500U</b> ..004 583	①	<b>H500/500U</b> ..004 760
<b>Primera Sedan [P12E]</b>	12.01-09.10	①	<b>AR813S</b> ..118 912	<b>AR650U</b> ..008 939	<b>AR450U</b> ..008 933						<b>813S</b> ..001 813	<b>650US</b> ..004 593		<b>650U</b> ..004 587	<b>450U</b> ..004 581		
<b>Primera Wagon [W10]</b>	07.90-12.97	①	<b>AR533S</b> ..118 902	<b>AR530U</b> ..008 936	<b>AR480U</b> ..008 934						<b>533S</b> ..118 406	<b>530US</b> ..011 352	<b>533</b> ..118 405	<b>530U</b> ..004 584	<b>480U</b> ..004 582	①	<b>H380/380U</b> ..004 756
[P11E]	01.98-12.01	①	<b>AR532S</b> ..118 986	<b>AR530U</b> ..008 936	<b>AR500U</b> ..008 935						<b>532S</b> ..118 404	<b>530US</b> ..011 352		<b>530U</b> ..004 584	<b>500U</b> ..004 583	①	<b>H400/400U</b> ..004 757
[P12E]	12.01-09.10	①	<b>AR813S</b> ..118 912	<b>AR650U</b> ..008 939	<b>AR450U</b> ..008 933						<b>813S</b> ..001 813	<b>650US</b> ..004 593		<b>650U</b> ..004 587	<b>450U</b> ..004 581		<b>H402</b> ..004 632
<b>Qashqai [J10]</b>	12.06→	⑥	<b>A292S</b> ..007 292	<b>AM24U</b> ..008 571	<b>AM15U</b> ..008 562	2BB	<b>AP24U</b> ..006 837	<b>AP15U</b> ..006 828									<b>H304</b> ..004 990
<b>Qashqai+2 [J10]</b>	08.08→	⑥	<b>A292S</b> ..007 292	<b>AM24U</b> ..008 571	<b>AM15U</b> ..008 562	2BB	<b>AP24U</b> ..006 837	<b>AP15U</b> ..006 828									<b>H304</b> ..004 990
<b>Serena [C23M]</b>	07.92-11.01	SPQ ①		<b>AR600U</b> ..008 938	<b>AR600U</b> ..008 938			SPQ					<b>603</b> ..118 301	<b>600U</b> ..004 586	<b>600U</b> ..004 586	MHK ①	<b>H400/400U</b> ..004 757
<b>Sunny</b>	10.98-10.04	①	<b>AR552S</b> ..118 984	<b>AR550U</b> ..008 937	<b>AR400U</b> ..008 932						<b>552S</b> ..118 427	<b>550US</b> ..004 591		<b>550U</b> ..004 585	<b>400U</b> ..004 579	①	<b>H420/420U</b> ..004 758
<b>Sunny Hatchback [N14]</b>	10.90-05.95	①	<b>AR533S</b> ..118 902	<b>AR530U</b> ..008 936	<b>AR480U</b> ..008 934						<b>533S</b> ..118 406	<b>530US</b> ..011 352	<b>533</b> ..118 405	<b>530U</b> ..004 584	<b>480U</b> ..004 582	①	<b>H341</b> ..004 755
																TU3 ①	<b>H280</b> ..018 802
<b>Sunny Liftback [N14]</b>	10.90-05.95	①	<b>AR533S</b> ..118 902	<b>AR530U</b> ..008 936	<b>AR480U</b> ..008 934						<b>533S</b> ..118 406	<b>530US</b> ..011 352	<b>533</b> ..118 405	<b>530U</b> ..004 584	<b>480U</b> ..004 582		
<b>Sunny Sedan [N14]</b>	10.90-05.95	①	<b>AR533S</b> ..118 902	<b>AR530U</b> ..008 936	<b>AR480U</b> ..008 934						<b>533S</b> ..118 406	<b>530US</b> ..011 352	<b>533</b> ..118 405	<b>530U</b> ..004 584	<b>480U</b> ..004 582		



A = Aerotwin | AM = Aerotwin Multi-Clip | AP = Aerotwin Plus | AR = Aerotwin Retrofit | S = Spoiler | U = Single Pack



3 397...

<b>Sunny Wagon</b> [Y10]	11.90-03.00	①	<b>AR533S</b> ..118 902	<b>AR530U</b> ..008 936	<b>AR480U</b> ..008 934				<b>533S</b> ..118 406	<b>530US</b> ..011 352	<b>533</b> ..118 405	<b>530U</b> ..004 584	<b>480U</b> ..004 582	①	<b>H341</b> ..004 755
<b>Teana</b> [J31]	04.06-02.08	①	<b>AR607S</b> ..118 909	<b>AR600U</b> ..008 938	<b>AR480U</b> ..008 934				<b>607S</b> ..118 306	<b>600US</b> ..004 592		<b>600U</b> ..004 586	<b>480U</b> ..004 582		
[J32, J32R]	06.08→	①	<b>AR653S</b> ..118 911	<b>AR650U</b> ..008 939	<b>AR400U</b> ..008 932				<b>653S</b> ..118 325	<b>650US</b> ..004 593	<b>653</b> ..118 324	<b>650U</b> ..004 587	<b>400U</b> ..004 579		
<b>Terrano I</b>	11.88-08.95	①	<b>AR480S</b> ..118 900	<b>AR480U</b> ..008 934	<b>AR480U</b> ..008 934				<b>480S</b> ..118 541		<b>480</b> ..118 540	<b>480U</b> ..004 582	<b>480U</b> ..004 582		
[WD21]	04.97-12.06	①	<b>AR532S</b> ..118 986	<b>AR530U</b> ..008 936	<b>AR500U</b> ..008 935										
<b>Terrano II</b> [R20]	02.93-10.99	①	<b>AR532S</b> ..118 986	<b>AR530U</b> ..008 936	<b>AR500U</b> ..008 935				<b>532S</b> ..118 404	<b>530US</b> ..011 352		<b>530U</b> ..004 584	<b>500U</b> ..004 583	①	<b>H341</b> ..004 755
	11.99→	①	<b>AR532S</b> ..118 986	<b>AR530U</b> ..008 936	<b>AR500U</b> ..008 935				<b>532S</b> ..118 404	<b>530US</b> ..011 352		<b>530U</b> ..004 584	<b>500U</b> ..004 583	L28	<b>H595</b> ..004 595
<b>Tiida</b> [C11]	02.07→	①	<b>AR605S</b> ..007 504	<b>AR600U</b> ..008 938	<b>AR340U</b> ..008 930					<b>600US</b> ..004 592	<b>605</b> ..010 270	<b>600U</b> ..004 586	<b>340U</b> ..004 578		
<b>Tiida Hatchback</b> [C11]	03.07→	①	<b>AR605S</b> ..007 504	<b>AR600U</b> ..008 938	<b>AR340U</b> ..008 930					<b>600US</b> ..004 592	<b>605</b> ..010 270	<b>600U</b> ..004 586	<b>340U</b> ..004 578		<b>H353</b> ..004 631
<b>Trade</b>	03.87-12.00	①	<b>AR500S</b> ..009 081	<b>AR500U</b> ..008 935	<b>AR500U</b> ..008 935						<b>500</b> ..118 560	<b>500U</b> ..004 583	<b>500U</b> ..004 583		
<b>Urvan</b> [E24]	11.86-06.97							①	<b>480S</b> ..118 541		<b>480</b> ..118 540	<b>480U</b> ..004 582	<b>480U</b> ..004 582	①	<b>H400/400U</b> ..004 757
<b>Vanette</b> [C220]	04.87-11.94							①	<b>450S</b> ..118 506		<b>450</b> ..118 505	<b>450U</b> ..004 581	<b>450U</b> ..004 581		
<b>Vanette Cargo</b> [C23M]	07.92-11.01	①	<b>AR609S</b> ..009 776	<b>AR600U</b> ..008 938	<b>AR600U</b> ..008 938						<b>603</b> ..118 301	<b>600U</b> ..004 586	<b>600U</b> ..004 586	MHK	<b>H400/400U</b> ..004 757
<b>X-Trail</b> [T30]	06.01-08.07	①	<b>AR601S</b> ..118 907	<b>AR600U</b> ..008 938	<b>AR400U</b> ..008 932				<b>601S</b> ..010 297	<b>600US</b> ..004 592		<b>600U</b> ..004 586	<b>400U</b> ..004 579	①	<b>H420/420U</b> ..004 758
[T31]	04.07→	①	<b>AR601S</b> ..118 907	<b>AR600U</b> ..008 938	<b>AR400U</b> ..008 932				<b>601S</b> ..010 297	<b>600US</b> ..004 592		<b>600U</b> ..004 586	<b>400U</b> ..004 579		<b>H354</b> ..011 433
<b>100 NX</b> [B13]	10.90-10.93	①	<b>AR533S</b> ..118 902	<b>AR530U</b> ..008 936	<b>AR480U</b> ..008 934				<b>533S</b> ..118 406	<b>530US</b> ..011 352	<b>533</b> ..118 405	<b>530U</b> ..004 584	<b>480U</b> ..004 582	①	<b>H500/500U</b> ..004 760
<b>200 SX</b> [S13, S14]	09.88-09.99	①	<b>AR503S</b> ..118 993	<b>AR500U</b> ..008 935	<b>AR480U</b> ..008 934				<b>500S</b> ..118 561	<b>500US</b> ..004 590	<b>500</b> ..118 560	<b>500U</b> ..004 583	<b>500U</b> ..004 583	①	<b>H500/500U</b> ..004 760
<b>300 ZX</b> [Z32]	01.90-03.96	①	<b>AR530S</b> ..118 903	<b>AR530U</b> ..008 936	<b>AR530U</b> ..008 936				<b>530S</b> ..118 401	<b>530US</b> ..011 352	<b>530</b> ..118 400	<b>530U</b> ..004 584	<b>530U</b> ..004 584	①	<b>H480/480U</b> ..004 759
<b>350 Z</b> [Z33]	12.03→	①	<b>AR502S</b> ..118 995	<b>AR500U</b> ..008 935	<b>AR450U</b> ..008 933				<b>502S</b> ..118 564	<b>500US</b> ..004 590	<b>502</b> ..118 563	<b>500U</b> ..004 583	<b>450U</b> ..004 581		
<b>350 Z Cabriolet</b> [Z33]	09.03-04.09	①	<b>AR502S</b> ..118 995	<b>AR500U</b> ..008 935	<b>AR450U</b> ..008 933				<b>502S</b> ..118 564	<b>500US</b> ..004 590	<b>502</b> ..118 563	<b>500U</b> ..004 583	<b>450U</b> ..004 581		
<b>350 Z Coupé</b> [Z33]	09.02-04.09	①	<b>AR502S</b> ..118 995	<b>AR500U</b> ..008 935	<b>AR450U</b> ..008 933				<b>502S</b> ..118 564	<b>500US</b> ..004 590	<b>502</b> ..118 563	<b>500U</b> ..004 583	<b>450U</b> ..004 581		

<b>OPEL</b>															
<b>Adam</b>	03.13→	③	<b>A414S</b> ..007 414	<b>AM26U</b> ..008 573	<b>AM16U</b> ..008 563	2AA	<b>AP26U</b> ..006 838	<b>AP16U</b> ..006 829							<b>H351</b> ..004 559
		KUR	<b>AM466S</b> ..007 466												
<b>Agila</b> [A]	06.00-02.08	①	<b>AR502S</b> ..118 995	<b>AR500U</b> ..008 935	<b>AR450U</b> ..008 933				<b>502S</b> ..118 564	<b>500US</b> ..004 590	<b>502</b> ..118 563	<b>500U</b> ..004 583	<b>450U</b> ..004 581	①	<b>H341</b> ..004 755
[B]	03.08→	①	<b>AR552S</b> ..118 984	<b>AR550U</b> ..008 937	<b>AR400U</b> ..008 932				<b>552S</b> ..118 427	<b>550US</b> ..004 591		<b>550U</b> ..004 585	<b>400U</b> ..004 579		<b>H250</b> ..011 629
<b>Ampera</b>	10.11→	③	<b>A636S</b> ..007 636			2AA	<b>AP26U</b> ..006 838	<b>AP26U</b> ..006 838							
<b>Antara</b>	05.06→	①	<b>AR601S</b> ..118 907	<b>AR600U</b> ..008 938	<b>AR400U</b> ..008 932				<b>601S</b> ..010 297	<b>600US</b> ..004 592		<b>600U</b> ..004 586	<b>400U</b> ..004 579		



A = Aerotwin | AM = Aerotwin Multi-Clip | AP = Aerotwin Plus | AR = Aerotwin Retrofit | S = Spoiler | U = Single Pack





◀ OPEL

3 397...

			SET	↳	↳	NEW	SET	↳	↳	SET	↳	SET	↳	↳	REAR	
<b>Arena</b>	03.98-08.01	①	<b>AR500S</b> ..009 081	<b>AR500U</b> ..008 935	<b>AR500U</b> ..008 935					<b>500S</b> ..118 561	<b>500US</b> ..004 590	<b>500</b> ..118 560	<b>500U</b> ..004 583	<b>500U</b> ..004 583		
<b>Astra [F]</b>	09.91-02.98	①	<b>AR450S</b> ..118 994	<b>AR450U</b> ..008 933	<b>AR450U</b> ..008 933					<b>450S</b> ..118 506	<b>450US</b> ..004 588	<b>450</b> ..118 505	<b>450U</b> ..004 581	<b>450U</b> ..004 581	① <b>H450/450U</b> ..004 763	
[G]	09.97-02.98	①	<b>AR503S</b> ..118 993	<b>AR500U</b> ..008 935	<b>AR480U</b> ..008 934					<b>503S</b> ..118 566	<b>500US</b> ..004 590	<b>503</b> ..118 565	<b>500U</b> ..004 583	<b>480U</b> ..004 582	① <b>H400/400U</b> ..004 757	
	03.98-01.05	①	<b>AR503S</b> ..118 993	<b>AR500U</b> ..008 935	<b>AR480U</b> ..008 934					<b>503S</b> ..118 566	<b>500US</b> ..004 590	<b>503</b> ..118 565	<b>500U</b> ..004 583	<b>480U</b> ..004 582	<b>H402</b> ..004 632	
[H]	03.04-03.10	②	<b>A931S</b> ..118 931	<b>AM22U</b> ..008 569	<b>AM18U</b> ..008 565	AP1	<b>AP22U</b> ..006 835	<b>AP18U</b> ..006 831							<b>H304</b> ..004 990	
[J]	09.09→	③	<b>A540S</b> ..007 540	<b>AM28U</b> ..008 574	<b>AM24U</b> ..008 571	2AA	<b>AP28U</b> ..006 839	<b>AP24U</b> ..006 837							<b>H311</b> (2014)	
<b>Astra Cabrio [F]</b>	09.91-08.98	①	<b>AR450S</b> ..118 994	<b>AR450U</b> ..008 933	<b>AR450U</b> ..008 933					<b>450S</b> ..118 506	<b>450US</b> ..004 588	<b>450</b> ..118 505	<b>450U</b> ..004 581	<b>450U</b> ..004 581		
[G]	09.97-08.05	①	<b>AR503S</b> ..118 993	<b>AR500U</b> ..008 935	<b>AR480U</b> ..008 934					<b>503S</b> ..118 566	<b>500US</b> ..004 590	<b>503</b> ..118 565	<b>500U</b> ..004 583	<b>480U</b> ..004 582		
<b>Astra Caravan [F]</b>	09.91-08.98	①	<b>AR450S</b> ..118 994	<b>AR450U</b> ..008 933	<b>AR450U</b> ..008 933					<b>450S</b> ..118 506	<b>450US</b> ..004 588	<b>450</b> ..118 505	<b>450U</b> ..004 581	<b>450U</b> ..004 581	① <b>H341</b> ..004 755	
[G]	09.97-06.04	①	<b>AR503S</b> ..118 993	<b>AR500U</b> ..008 935	<b>AR480U</b> ..008 934					<b>503S</b> ..118 566	<b>500US</b> ..004 590	<b>503</b> ..118 565	<b>500U</b> ..004 583	<b>480U</b> ..004 582	<b>H840</b> ..004 802	
[H]	08.04-03.10	②	<b>A931S</b> ..118 931	<b>AM22U</b> ..008 569	<b>AM18U</b> ..008 565	AP1	<b>AP22U</b> ..006 835	<b>AP18U</b> ..006 831							<b>H304</b> ..004 990	
<b>Astra Classic</b> [F-Classic]	09.97-08.02	①	<b>AR503S</b> ..118 993	<b>AR500U</b> ..008 935	<b>AR480U</b> ..008 934					<b>503S</b> ..118 566	<b>500US</b> ..004 590	<b>503</b> ..118 565	<b>500U</b> ..004 583	<b>480U</b> ..004 582	① <b>H400/400U</b> ..004 757	
<b>Astra Classic</b> <b>Caravan [F-Classic]</b>	09.97-08.02	①	<b>AR503S</b> ..118 993	<b>AR500U</b> ..008 935	<b>AR480U</b> ..008 934					<b>503S</b> ..118 566	<b>500US</b> ..004 590	<b>503</b> ..118 565	<b>500U</b> ..004 583	<b>480U</b> ..004 582	① <b>H400/400U</b> ..004 757	
<b>Astra Coupé [G]</b>	09.97-02.05	①	<b>AR503S</b> ..118 993	<b>AR500U</b> ..008 935	<b>AR480U</b> ..008 934					<b>503S</b> ..118 566	<b>500US</b> ..004 590	<b>503</b> ..118 565	<b>500U</b> ..004 583	<b>480U</b> ..004 582		
<b>Astra GTC [H]</b>	03.05-09.09	②	<b>A931S</b> ..118 931	<b>AM22U</b> ..008 569	<b>AM18U</b> ..008 565	AP1	<b>AP22U</b> ..006 835	<b>AP18U</b> ..006 831							<b>H230</b> ..004 560	
[J]	09.11→	③	<b>A641S</b> ..007 644	<b>AM28U</b> ..008 574	<b>AM24U</b> ..008 571	2AA	<b>AP28U</b> ..006 839	<b>AP24U</b> ..006 837							<b>H311</b> (2014)	
<b>Astra Sedan [J]</b>	09.12→	③	<b>A540S</b> ..007 540	<b>AM28U</b> ..008 574	<b>AM24U</b> ..008 571	2AA	<b>AP28U</b> ..006 839	<b>AP24U</b> ..006 837								
<b>Astra Sports</b> <b>Tourer [J]</b>	09.10→	③	<b>A540S</b> ..007 540	<b>AM28U</b> ..008 574	<b>AM24U</b> ..008 571	2AA	<b>AP28U</b> ..006 839	<b>AP24U</b> ..006 837							<b>H311</b> (2014)	
<b>Astra TwinTop [H]</b>	09.05-10.10	②	<b>A931S</b> ..118 931	<b>AM22U</b> ..008 569	<b>AM18U</b> ..008 565	AP1	<b>AP22U</b> ..006 835	<b>AP18U</b> ..006 831								
<b>Calibra</b>	06.90-03.97	①	<b>AR480S</b> ..118 900	<b>AR480U</b> ..008 934	<b>AR480U</b> ..008 934					<b>480S</b> ..118 541		<b>480</b> ..118 540	<b>480U</b> ..004 582	<b>480U</b> ..004 582	① <b>H480/480U</b> ..004 759	
<b>Cascada</b>	03.13→	③	<b>A540S</b> ..007 540	<b>AM28U</b> ..008 574	<b>AM24U</b> ..008 571	2AA	<b>AP28U</b> ..006 839	<b>AP24U</b> ..006 837								
<b>Combo</b>	09.94-10.01	①	<b>AR450S</b> ..118 994	<b>AR450U</b> ..008 933	<b>AR450U</b> ..008 933					<b>450S</b> ..118 506	<b>450US</b> ..004 588	<b>450</b> ..118 505	<b>450U</b> ..004 581	<b>450U</b> ..004 581	① <b>H341</b> ..004 755	
[Tour]	10.01-01.12	KUR ①	<b>AR566S</b> ..118 990	<b>AR500U</b> ..008 935	<b>AR400U</b> ..008 932							<b>361</b> ..001 361	<b>500U</b> ..004 583	<b>400U</b> ..004 579	MGT ① <b>H341</b> ..004 755 MHK <b>H402</b> ..004 632	
[D]	02.12→	③	<b>A295S</b> ..007 295	<b>AM24U</b> ..008 571	<b>AM16U</b> ..008 563	2AA	<b>AP24U</b> ..006 837	<b>AP16U</b> ..006 829							MHK <b>A381H</b> ..008 996	
<b>Corsa [A]</b>	09.82-08.94											① <b>400S</b> ..118 611	<b>400</b> ..118 610	<b>400U</b> ..004 579	<b>400U</b> ..004 579	① <b>H400/400U</b> ..004 757
[B]	03.93-09.00	①	<b>AR450S</b> ..118 994	<b>AR450U</b> ..008 933	<b>AR450U</b> ..008 933					<b>450S</b> ..118 506	<b>450US</b> ..004 588	<b>450</b> ..118 505	<b>450U</b> ..004 581	<b>450U</b> ..004 581	TU3 ① <b>H400/400U</b> ..004 757 TU5 ① <b>H341</b> ..004 755	



A = Aerotwin | AM = Aerotwin Multi-Clip | AP = Aerotwin Plus | AR = Aerotwin Retrofit | S = Spoiler | U = Single Pack



3 397...

			SET			NEW! AEROTWIN			TWIN SPOILER		SET		TWIN			REAR
Corsa [C]	09.00-09.06	①	AR502S ..118 995	AR500U ..008 935	AR450U ..008 933						502S ..118 564	500US ..004 590	502 ..118 563	500U ..004 583	450U ..004 581	H402 ..004 632
[D]	07.06→	KUR ⑥	AM466S ..007 466	AM26U ..008 573	AM16U ..008 563	2BB	AP26U ..006 838	AP16U ..006 829								H301 ..004 629
Euromidi	09.88-08.96	①	AR450S ..118 994	AR450U ..008 933	AR450U ..008 933						450S ..118 506	450US ..004 588	450 ..118 505	450U ..004 581	450U ..004 581	
Frontera [A; B]	09.91-09.04	①	AR480S ..118 900	AR480U ..008 934	AR480U ..008 934						480S ..118 541		480 ..118 540	480U ..004 582	480U ..004 582	① H341 ..004 755
GT [B]	06.07-12.09	①	AR552S ..118 984	AR550U ..008 937	AR400U ..008 932											
Insignia [68]	09.08→	①	AR604S ..118 908	AR600U ..008 938	AR450U ..008 933									600U ..004 586	450U ..004 581	⑥ AM20U ..008 567
[69]	09.08→	①	AR604S ..118 908	AR600U ..008 938	AR450U ..008 933									600U ..004 586	450U ..004 581	
Insignia Sports Tourer [35]	02.09→	①	AR604S ..118 908	AR600U ..008 938	AR450U ..008 933									600U ..004 586	450U ..004 581	H301 ..004 629
Kadett [E]	09.84-08.93										450S ..118 506		450 ..118 505	450U ..004 581	450U ..004 581	KOB ① H341 ..004 755
																LIM ① H450/450U ..004 763
Konrad [R]	03.12-11.12	①	AR500S ..009 081	AR500U ..008 935	AR500U ..008 935								500 ..118 560	500U ..004 583	500U ..004 583	① H380/380U ..004 756
Meriva [A]	03.03-03.10	KUR ①	AR997S ..118 997						KUR				608 ..118 307	600U ..004 586	550U ..004 585	H402 ..004 632
[B]	04.10→	③	A581S ..007 581	AM28U ..008 574	AM23U ..008 570	2AA	AP28U ..006 839	AP23U ..006 836								H402 ..004 632
Mokka	09.12→	③	A583S ..007 583	AM26U ..008 573	AM13U ..008 794	2AA	AP26U ..006 838	AP13U ..006 827								
Monterey [A]	09.91-12.97	①	AR500S ..009 081	AR500U ..008 935	AR500U ..008 935						500S ..118 561	500US ..004 590	500 ..118 560	500U ..004 583	500U ..004 583	① H380/380U ..004 756
Movano [A]	06.98-03.10	SDV ①	AR609S ..009 776	AR61N ..008 847	AR61N ..008 847				SDV				609 ..118 309			
[B]	04.10→	①		AR650U ..008 939	AR650U ..008 939								650 ..118 320	650U ..004 587	650U ..004 587	
Omega [A]	09.86-03.94	①	AR480S ..118 900	AR480U ..008 934	AR480U ..008 934						480S ..118 541		480 ..118 540	480U ..004 582	480U ..004 582	KOB ① H341 ..004 755
[B]	09.93-09.03								①	607S ..118 306	600US ..004 592		600U ..004 586	480U ..004 582	480U ..004 582	KOB ① H341 ..004 755
Senator [B]	09.87-09.93	①	AR480S ..118 900	AR480U ..008 934	AR480U ..008 934						480S ..118 541		480 ..118 540	480U ..004 582	480U ..004 582	
Signum	05.03-09.08	①	AR607S ..118 909	AR600U ..008 938	AR480U ..008 934						607S ..118 306	600US ..004 592		600U ..004 586	480U ..004 582	KUR H375 ..004 558
Sintra	09.96-09.99	KUR ①	AR997S ..118 997										603 ..118 301	600U ..004 586	600U ..004 586	
Tigra [A]	09.94-08.99	①	AR450S ..118 994	AR450U ..008 933	AR450U ..008 933						450S ..118 506	450US ..004 588	450 ..118 505	450U ..004 581	450U ..004 581	① H500/500U ..004 760
Tigra TwinTop [B]	06.04-12.09	①	AR502S ..118 995	AR500U ..008 935	AR450U ..008 933						502S ..118 564	500US ..004 590	502 ..118 563	500U ..004 583	450U ..004 581	
Vectra [A]	09.88-08.95	①	AR480S ..118 900	AR480U ..008 934	AR480U ..008 934						480S ..118 541		480 ..118 540	480U ..004 582	480U ..004 582	① H480/480U ..004 759
[B]	09.95-09.03	①	AR480S ..118 900	AR480U ..008 934	AR480U ..008 934						480S ..118 541		480 ..118 540	480U ..004 582	480U ..004 582	SCR ① H480/480U ..004 759
[C]	09.01-10.08	①	AR607S ..118 909	AR600U ..008 938	AR480U ..008 934						607S ..118 306	600US ..004 592		600U ..004 586	480U ..004 582	KWB H402 ..004 632
	10.05-10.08															WOB A401H ..008 047



A = Aerotwin | AM = Aerotwin Multi-Clip | AP = Aerotwin Plus | AR = Aerotwin Retrofit | S = Spoiler | U = Single Pack



◀ OPEL

3 397...

<b>Vectra Caravan [B]</b>	09.95-09.03	①	<b>AR480S</b> ..118 900	<b>AR480U</b> ..008 934	<b>AR480U</b> ..008 934				<b>480S</b> ..118 541		<b>480</b> ..118 540	<b>480U</b> ..004 582	<b>480U</b> ..004 582	
[C]	09.03-10.08	①	<b>AR607S</b> ..118 909	<b>AR600U</b> ..008 938	<b>AR480U</b> ..008 934				<b>607S</b> ..118 306	<b>600US</b> ..004 592		<b>600U</b> ..004 586	<b>480U</b> ..004 582	<b>H375</b> ..004 558
<b>Vivaro</b>	03.01→	①	<b>AR801S</b> ..118 996	<b>AR600U</b> ..008 938	<b>AR530U</b> ..008 936				<b>611S</b> ..010 300	<b>600US</b> ..004 592		<b>600U</b> ..004 586	<b>530U</b> ..004 584	MHK ① MHT ..004 755 <b>H341</b> ..004 632
<b>Zafira [A]</b>	03.99-07.05	KUR ①	<b>AR997S</b> ..118 997						KUR		<b>608</b> ..118 307	<b>600U</b> ..004 586	<b>550U</b> ..004 585	<b>H402</b> ..004 632
[B]	07.05→	⑥	<b>A256S</b> ..007 256	<b>AM28U</b> ..008 574	<b>AM22U</b> ..008 569	2BB	<b>AP28U</b> ..006 839	<b>AP22U</b> ..006 835						<b>H353</b> ..004 631
<b>Zafira Tourer [C]</b>	01.12→	③	<b>A865S</b> ..007 865	<b>AM32U</b> ..008 926	<b>AM28U</b> ..008 574	2AA	<b>AP32U</b> ..006 841	<b>AP28U</b> ..006 839						<b>H357</b> (2014)

PEUGEOT

<b>Bipper [A9]</b>	02.08→	⑦	<b>A426S</b> ..007 426			AP3	<b>AP26U</b> ..006 838	<b>AP19U</b> ..006 832						
<b>Boxer [U3]</b>	02.94-02.02	①	<b>AR550S</b> ..118 906	<b>AR550U</b> ..008 937	<b>AR530U</b> ..008 936				<b>550S</b> ..118 421	<b>550US</b> ..004 591	<b>550</b> ..118 420	<b>550U</b> ..004 585	<b>550U</b> ..004 585	
[U5]	02.02-05.06	①	<b>AR550S</b> ..118 906	<b>AR550U</b> ..008 937	<b>AR530U</b> ..008 936				<b>550S</b> ..118 421	<b>550US</b> ..004 591	<b>550</b> ..118 420	<b>550U</b> ..004 585	<b>550U</b> ..004 585	
[U9]	06.06→	③	<b>A225S</b> ..007 225	<b>AM26U</b> ..008 573	<b>AM22U</b> ..008 569	2AA	<b>AP26U</b> ..006 838	<b>AP22U</b> ..006 835						
<b>Expert [U64]</b>	09.95-01.07	KUR ①	<b>AR701S</b> ..007 706	<b>AR650U</b> ..008 939	<b>AR500U</b> ..008 935					<b>650US</b> ..004 593	<b>701</b> ..118 202	<b>650U</b> ..004 587	<b>500U</b> ..004 583	
[G9]	02.07→	①	<b>AR701S</b> ..007 706	<b>AR650U</b> ..008 939	<b>AR500U</b> ..008 935				<b>706S</b> ..010 301	<b>650US</b> ..004 593	<b>701</b> ..118 202	<b>700U</b> ..004 489	<b>500U</b> ..004 583	TU2 ..004 631 <b>H353</b>
		WW		<b>AR70N</b> ..008 845	<b>AR50N</b> ..008 841									MHK, APE <b>H380/380U</b> ..004 756
<b>ION</b>	10.10→	①		<b>AR70N</b> ..008 845								<b>700U</b> ..004 489		<b>H306</b> ..011 432
<b>P4</b>	10.86-12.96							①			<b>340</b> ..118 700	<b>340U</b> ..004 578	<b>340U</b> ..004 578	
<b>Partner [M4]</b>	07.96-08.02	①	<b>AR550S</b> ..118 906	<b>AR550U</b> ..008 937	<b>AR530U</b> ..008 936						<b>550</b> ..118 420	<b>550U</b> ..004 585	<b>550U</b> ..004 585	MHK ① TU2 ① ..004 757 <b>H400/400U</b> ..004 757 <b>H341</b> ..004 755
[M5]	09.02-04.08	①	<b>AR550S</b> ..118 906	<b>AR550U</b> ..008 937	<b>AR530U</b> ..008 936						<b>550</b> ..118 420	<b>550U</b> ..004 585	<b>550U</b> ..004 585	MHK TU2 ① ..011 410 <b>H408</b> ..011 410 <b>H341</b> ..004 755
[B9]	05.08→	③	<b>A414S</b> ..007 414	<b>AM26U</b> ..008 573	<b>AM16U</b> ..008 563	2AA	<b>AP26U</b> ..006 838	<b>AP16U</b> ..006 829						<b>H353</b> ..004 631
		KUR ⑤	<b>AM466S</b> ..007 466											
<b>Ranch [M4]</b>	07.97-08.02	①	<b>AR550S</b> ..118 906	<b>AR550U</b> ..008 937	<b>AR530U</b> ..008 936						<b>550</b> ..118 420	<b>550U</b> ..004 585	<b>550U</b> ..004 585	MHK ① TU2 ① ..004 757 <b>H400/400U</b> ..004 757 <b>H341</b> ..004 755
<b>RCZ [T75]</b>	01.10→	③	<b>A636S</b> ..007 636	<b>AM26U</b> ..008 573	<b>AM26U</b> ..008 573	2AA	<b>AP26U</b> ..006 838	<b>AP26U</b> ..006 838						
<b>106 [S1]</b>	09.91-04.96	①	<b>AR502S</b> ..118 995	<b>AR500U</b> ..008 935	<b>AR450U</b> ..008 933				<b>502S</b> ..118 564	<b>500US</b> ..004 590	<b>502</b> ..118 563	<b>500U</b> ..004 583	<b>450U</b> ..004 581	① ..004 757 <b>H400/400U</b> ..004 757
[S2]	07.95-09.99	①	<b>AR502S</b> ..118 995	<b>AR500U</b> ..008 935	<b>AR450U</b> ..008 933				<b>502S</b> ..118 564	<b>500US</b> ..004 590	<b>502</b> ..118 563	<b>500U</b> ..004 583	<b>450U</b> ..004 581	① ..004 757 <b>H400/400U</b> ..004 757



A = Aerotwin | AM = Aerotwin Multi-Clip | AP = Aerotwin Plus | AR = Aerotwin Retrofit | S = Spoiler | U = Single Pack



			AEROTWIN			NEW! AEROTWIN			TWIN SPOILER			TWIN			REAR	
			SET	↳	↳	?	↳	↳	?	SET	↳	SET	↳	↳	?	↳
3 397...																
106 [S2]	10.99-05.05	①	AR502S ..118 995	AR500U ..008 935	AR450U ..008 933					502S ..118 564	500US ..004 590	502 ..118 563	500U ..004 583	450U ..004 581		H353 ..004 631
107 [B0]	06.05→	①	AR650S ..018 913	AR650U ..008 939									651U ..011 641			H300 ..004 628
205	10.87-09.98	①	AR450S ..118 994	AR450U ..008 933	AR450U ..008 933					450S ..118 506	450US ..004 588	450 ..118 505	450U ..004 581	450U ..004 581	①	H450/450U ..004 763
205 Pickup	05.85-09.98	①	AR450S ..118 994	AR450U ..008 933	AR450U ..008 933					450S ..118 506	450US ..004 588	450 ..118 505	450U ..004 581	450U ..004 581	①	H450/450U ..004 763
206 [T1]	06.98-02.09	①	AR653S ..118 911	AR650U ..008 939	AR400U ..008 932					653S ..118 325	650US ..004 593	653 ..118 324	650U ..004 587	400U ..004 579		H353 ..004 631
206+ [T3]	03.09→	①	AR653S ..118 911	AR650U ..008 939	AR400U ..008 932					653S ..118 325	650US ..004 593	653 ..118 324	650U ..004 587	400U ..004 579		H353 ..004 631
206 CC [T1]	09.00-03.07	①	AR653S ..118 911	AR650U ..008 939	AR400U ..008 932					653S ..118 325	650US ..004 593	653 ..118 324	650U ..004 587	400U ..004 579		
206 SW [T1]	03.02-12.06	①	AR653S ..118 911	AR650U ..008 939	AR400U ..008 932					653S ..118 325	650US ..004 593	653 ..118 324	650U ..004 587	400U ..004 579		H351 ..004 559
207 [A7]	05.06-04.12	②	A977S ..118 977	AM26U ..008 573	AM16U ..008 563	AP1	AP26U ..006 838	AP17U ..006 830								H406 ..011 134
207+ [A7]	11.12→	②	A977S ..118 977	AM26U ..008 573	AM16U ..008 563	AP1	AP26U ..006 838	AP17U ..006 830								H406 ..011 134
207 CC [A7]	03.07→	②	A977S ..118 977	AM26U ..008 573	AM16U ..008 563	AP1	AP26U ..006 838	AP17U ..006 830								
207 SW [A7]	06.07→	②	A977S ..118 977	AM26U ..008 573	AM16U ..008 563	AP1	AP26U ..006 838	AP17U ..006 830								H301 ..004 629
208	01.12→	③	A414S ..007 414			2AA	AP26U ..006 838	AP16U ..006 829								H353 ..004 631
		KUR ③	AM466S ..007 466													
306 [N3]	01.93-04.97	①	AR551S ..118 905	AR550U ..008 937	AR500U ..008 935					551S ..118 423	550US ..004 591	551 ..118 422	550U ..004 585	500U ..004 583	SCR ①	H500/500U ..004 760
	[N5] 05.97-12.98	①	AR551S ..118 905	AR550U ..008 937	AR500U ..008 935					551S ..118 423	550US ..004 591	551 ..118 422	550U ..004 585	500U ..004 583	SCR ①	H500/500U ..004 760
	01.99-10.03	①	AR551S ..118 905	AR550U ..008 937	AR500U ..008 935					551S ..118 423	550US ..004 591	551 ..118 422	550U ..004 585	500U ..004 583		H402 ..004 632
306 Break [N5]	05.97-03.02	①	AR551S ..118 905	AR550U ..008 937	AR500U ..008 935					551S ..118 423	550US ..004 591	551 ..118 422	550U ..004 585	500U ..004 583		
306 Cabriolet [N3; N5]	01.93-10.03	①	AR551S ..118 905	AR550U ..008 937	AR500U ..008 935					551S ..118 423	550US ..004 591	551 ..118 422	550U ..004 585	500U ..004 583		
307 [T5]	08.00-05.05	KUR ①	AR651S ..118 913							702S ..118 204		702 ..118 203	700U ..004 489	650U ..004 587		H353 ..004 631
	10.04-05.05	⑥	A100S ..007 100	AM28U ..008 574	AM26U ..008 573	2BB	AP28U ..006 839	AP26U ..006 838								
[T6]	06.05-08.07	⑥	A100S ..007 100	AM28U ..008 574	AM26U ..008 573	2BB	AP28U ..006 839	AP26U ..006 838								H353 ..004 631
307 Break/SW [T5]	03.02-05.05	KUR ①	AR651S ..118 913							702S ..118 204		702 ..118 203	700U ..004 489	650U ..004 587		H353 ..004 631
	10.04-05.05	⑥	A100S ..007 100	AM28U ..008 574	AM26U ..008 573	2BB	AP28U ..006 839	AP26U ..006 838								
	[T6]	06.05-05.08	⑥	A100S ..007 100	AM28U ..008 574	AM26U ..008 573	2BB	AP28U ..006 839	AP26U ..006 838							H353 ..004 631
307 CC [T5]	10.03-05.05	⑥	A965S ..118 965	AM28U ..008 574	AM24U ..008 571	2BB	AP28U ..006 839	AP24U ..006 837								
	[T6]	06.05-03.09	⑥	A100S ..007 100	AM28U ..008 574	AM26U ..008 573	2BB	AP28U ..006 839	AP26U ..006 838							



A = Aerotwin | AM = Aerotwin Multi-Clip | AP = Aerotwin Plus | AR = Aerotwin Retrofit | S = Spoiler | U = Single Pack





◀ PEUGEOT

3 397...

308 [T7]	09.07→	③	A385S ..007 385	AM30U ..008 928	AM26U ..008 573	2AA	AP30U ..006 840	AP26U ..006 838									H301 ..004 629
308 CC [T7]	03.09→	③	A385S ..007 385	AM30U ..008 928	AM26U ..008 573	2AA	AP30U ..006 840	AP26U ..006 838									
308 SW [T7]	05.08→	③	A385S ..007 385	AM30U ..008 928	AM26U ..008 573	2AA	AP30U ..006 840	AP26U ..006 838									H840 ..004 802
309	10.89-12.93								①	450S ..118 506		450 ..118 505	450U ..004 581	450U ..004 581	①	H500/500U ..004 760	
405 [4; 15]	07.87-04.97								SDV ①			405 ..005 800					
405 Break [4; 15]	07.88-04.97								SDV ①			405 ..005 800			①	H340/340U ..004 754	
406 [D8]	10.95-03.99	①	AR801S ..118 996	AR600U ..008 938	AR530U ..008 936					608S ..118 308	600US ..004 592		600U ..004 586	550U ..004 585	①	H450/450U ..004 763	
[D9]	04.99-06.04	①	AR801S ..118 996	AR600U ..008 938	AR530U ..008 936					608S ..118 308	600US ..004 592		600U ..004 586	550U ..004 585			
406 Break [D8; D9]	10.96-06.04	①	AR801S ..118 996	AR600U ..008 938	AR530U ..008 936					608S ..118 308	600US ..004 592		600U ..004 586	550U ..004 585		H351 ..004 559	
406 Coupé [D8; D9]	03.97-02.05	①	AR701S ..007 706	AR650U ..008 939	AR500U ..008 935												
407 [D2]	05.04-02.11	②	A976S ..118 976	AM28U ..008 574	AM28U ..008 574	AP1	AP28U ..006 839	AP28U ..006 839									
407 Coupé [D2]	10.05→	②	A976S ..118 976	AM28U ..008 574	AM28U ..008 574	AP1	AP28U ..006 839	AP28U ..006 839									
407 SW [D2]	05.04-02.11	②	A976S ..118 976	AM28U ..008 574	AM28U ..008 574	AP1	AP28U ..006 839	AP28U ..006 839								H840 ..004 802	
408	05.10→	③	A385S ..007 385	AM30U ..008 928	AM26U ..008 573	2AA	AP30U ..006 840	AP26U ..006 838									
505	08.83-12.93								①			450 ..118 505	450U ..004 581	450U ..004 581	KOB ①	H450/450U ..004 763	
508	11.10→	③	A636S ..007 636	AM26U ..008 573	AM26U ..008 573	2AA	AP26U ..006 838	AP26U ..006 838									
508 SW	11.10→	③	A636S ..007 636	AM26U ..008 573	AM26U ..008 573	2AA	AP26U ..006 838	AP26U ..006 838								H301 ..004 629	
605 [Y30]	06.89-05.99								①	550S ..118 421	550US ..004 591	550 ..118 420	550U ..004 585	550U ..004 585			
607 [Z8; Z9]	03.00→								WOB			866 ..001 866					
806 [U60]	06.94-08.02	①	AR701S ..007 706	AR650U ..008 939	AR500U ..008 935						650US ..004 593	701 ..118 202	650U ..004 587	500U ..004 583	①	H400/400U ..004 757	
807 [V2]	06.02-07.05	SDV ①	AR657S ..009 777	AR66N ..008 848	AR66N ..008 848				SDV	657S ..118 334						H353 ..004 631	
	08.05→	①	AR651S ..118 913								650US ..004 593	650 ..118 320	650U ..004 587	650U ..004 587		H353 ..004 631	
1007 [A8]	04.05→	①	AR604S ..118 908	AR600U ..008 938	AR450U ..008 933					604S ..118 303	600US ..004 592		600U ..004 586	450U ..004 581		H301 ..004 629	
2008	03.13→	③	A414S ..007 414			2AA	AP26U ..006 838	AP16U ..006 829								H840 ..004 802	
		KUR ③	AM466S ..007 466														
3008 [T8]	05.09→	③	A501S ..007 501	AM32U ..008 926	AM28U ..008 574	2AA	AP32U ..006 841	AP28U ..006 839								H301 ..004 629	
4007 [I3]	09.07→	①	AR801S ..118 996	AR600U ..008 938	AR530U ..008 936					611S ..010 300	600US ..004 592		600U ..004 586	530U ..004 584		H306 ..011 432	
4008	03.12→	①	AR801S ..118 996	AR600U ..008 938	AR530U ..008 936					611S ..010 300	600US ..004 592		600U ..004 586	530U ..004 584		H250 ..011 629	



A = Aerotwin | AM = Aerotwin Multi-Clip | AP = Aerotwin Plus | AR = Aerotwin Retrofit | S = Spoiler | U = Single Pack



3 397...

<b>5008 [T8]</b>	09.09→	③	<b>A501S</b> ..007 501	<b>AM32U</b> ..008 926	<b>AM28U</b> ..008 574	2AA	<b>AP32U</b> ..006 841	<b>AP28U</b> ..006 839								<b>H840</b> ..004 802
------------------	--------	---	---------------------------	---------------------------	---------------------------	-----	---------------------------	---------------------------	--	--	--	--	--	--	--	--------------------------

**PIAGGIO**

<b>Apetruk</b>	05.07→	①		<b>AR400U</b> ..008 932	<b>AR400U</b> ..008 932						<b>400</b> ..118 610	<b>400U</b> ..004 579	<b>400U</b> ..004 579			
<b>Porter</b>	10.94→	①		<b>AR400U</b> ..008 932	<b>AR400U</b> ..008 932						<b>400</b> ..118 610	<b>400U</b> ..004 579	<b>400U</b> ..004 579	①	<b>H340/340U</b> ..004 754	

**PONTIAC**

<b>Montana</b>	09.98-08.05								①		<b>608</b> ..118 307	<b>600U</b> ..004 586	<b>550U</b> ..004 585			
----------------	-------------	--	--	--	--	--	--	--	---	--	-------------------------	--------------------------	--------------------------	--	--	--

**PORSCHE**

<b>Boxster</b> [986; 987] [981]	10.96→								BGO ①	<b>582S</b> ..001 582						
	02.12→	③	<b>A697S</b> ..007 697			AP4	<b>AP21U</b> ..006 834	<b>AP23U</b> ..006 836								
<b>Cayenne [9PA]</b>	09.02-01.07	②	<b>A942S</b> ..118 942													<b>H383</b> ..011 551
	02.07-08.10	②	<b>A034S</b> ..009 034	<b>AM26U</b> ..008 573	<b>AM26U</b> ..008 573	AP1	<b>AP26U</b> ..006 838	<b>AP26U</b> ..006 838								<b>H383</b> ..011 551
[92A]	09.10→	②	<b>A034S</b> ..009 034	<b>AM26U</b> ..008 573	<b>AM26U</b> ..008 573	AP1	<b>AP26U</b> ..006 838	<b>AP26U</b> ..006 838								<b>A360H</b> ..008 997
<b>Cayman [987C]</b>	11.05-12.12								BGO ①	<b>582S</b> ..001 582						
[981C]	03.13→	③	<b>A697S</b> ..007 697			AP4	<b>AP21U</b> ..006 834	<b>AP23U</b> ..006 836								
<b>Panamera [970]</b>	03.09-09.13								BGO ①	<b>801S</b> ..001 802						
<b>911 [964]</b>	09.89-08.93								①		<b>340</b> ..118 700	<b>340U</b> ..004 578	<b>340U</b> ..004 578			
[993]	09.93-08.97								①		<b>472</b> ..001 472					
[996]	09.97-07.04								BGO ①	<b>582S</b> ..001 582				①	<b>H550/550U</b> ..004 762	
[996T/GT2, 3]	06.00-09.05								BGO ①	<b>582S</b> ..001 582				①	<b>H550/550U</b> ..004 762	
[997; 997 GT3]	08.04→								BGO ①	<b>582S</b> ..001 582						
[991]	12.11→	③	<b>A697S</b> ..007 697			AP4	<b>AP21U</b> ..006 834	<b>AP23U</b> ..006 836								
<b>968</b>	08.91-11.95								①		<b>480</b> ..118 540	<b>480U</b> ..004 582	<b>480U</b> ..004 582	①	<b>H500/500U</b> ..004 760	

**RENAULT**

<b>Avantime [XEO]</b>	09.01-12.03	SDV ①	<b>AR652S</b> ..007 566						SDV		<b>651</b> ..118 321					<b>H301</b> ..004 629
<b>Captur [J5]</b>	01.13→	⑦	<b>A868S</b> ..007 868			AP3	<b>AP26U</b> ..006 838	<b>AP13U</b> ..006 827								<b>H840</b> ..004 802



A = Aerotwin | AM = Aerotwin Multi-Clip | AP = Aerotwin Plus | AR = Aerotwin Retrofit | S = Spoiler | U = Single Pack





◀ RENAULT

3 397...

Model	Year Range	Icon	SET	AR	AR	NEW	AP	AP	SET	TWIN	TWIN	TWIN	REAR	Code	
Clio I [X57]	06.90-02.94	①	AR450S	AR450U	AR450U				450S	450US	450	450U	450U	B0	H400/400U
			..118 994	..008 933	..008 933				..118 506	..004 588	..118 505	..004 581	..004 581	①	..004 757
	03.94-02.98	①	AR500S	AR500U	AR500U				500S	500US	500	500U	500U		H402
			..009 081	..008 935	..008 935				..118 561	..004 590	..118 560	..004 583	..004 583		..004 632
Clio II [BB./CB./SB.]	03.98-05.09	①	AR531S	AR530U	AR450U				531S	530US	531	530U	450U		H301
			..118 901	..008 936	..008 933				..118 403	..011 352	..118 402	..004 584	..004 581		..004 629
Clio II (Campus) [BB./CB./SB.]	06.09→	⑦	A692S			AP3	AP20U	AP18U							H301
			..007 692				..006 833	..006 831							..004 629
Clio III [BR/CR]	06.05-05.07	⑦	A116S			AP3	AP24U	AP16U							H353
			..007 116				..006 837	..006 829							..004 631
	06.07→	⑦	A116S			AP3	AP24U	AP16U							H301
			..007 116				..006 837	..006 829							..004 629
Clio III Grandtour [KR]	08.07→	⑦	A116S			AP3	AP24U	AP16U							H301
			..007 116				..006 837	..006 829							..004 629
Clio IV [BH]	05.12→	⑦	A868S			AP3	AP26U	AP13U							A250H
			..007 868				..006 838	..006 827							..008 056
Clio IV Grandtour [KH]	11.12→	⑦	A868S			AP3	AP26U	AP13U							A250H
			..007 868				..006 838	..006 827							..008 056
Duster [HS]	10.09→	①	AR500S	AR500U	AR500U				500S	500US	500	500U	500U		H301
			..009 081	..008 935	..008 935				..118 561	..004 590	..118 560	..004 583	..004 583		..004 629
Espace II [J63]	01.91-09.96	SDV ①	AR609S	AR61N	AR61N						609			①	H400/400U
			..009 776	..008 847	..008 847						..118 309				..004 757
Espace III [JEO]	10.96-10.02	SDV ①	AR652S								651				H402
			..007 566								..118 321				..004 632
Espace IV [JK;JKO]	11.02→	②	A964S			AP1	AP30U	AP26U							H353
			..118 964				..006 840	..006 838							..004 631
Express, Extra, Rapid [F40]	03.86-08.94	①	AR450S	AR450U	AR450U				450S	450US	450	450U	450U	①	H400/400U
			..118 994	..008 933	..008 933				..118 506	..004 588	..118 505	..004 581	..004 581		..004 757
	09.94-10.97	①	AR450S	AR450U	AR450U				450S	450US	450	450U	450U		H402
			..118 994	..008 933	..008 933				..118 506	..004 588	..118 505	..004 581	..004 581		..004 632
Fluence [L38]	11.09→	⑦	A116S			AP3	AP24U	AP16U							
			..007 116				..006 837	..006 829							
		①	AR601S	AR600U	AR400U				601S	600US		600U	400U		
			..118 907	..008 938	..008 932				..010 297	..004 592		..004 586	..004 579		
Kangoo I [FC./KC.]	10.97-12.07	①	AR500S	AR500U	AR500U				500S	500US	500	500U	500U	MHK	H402
			..009 081	..008 935	..008 935				..118 561	..004 590	..118 560	..004 583	..004 583		..004 632
													MHT	H341	
													①	..004 755	
Kangoo II [FW./KW.]	01.08→	①	AR550S	AR550U	AR530U									MHK	H351
			..118 906	..008 937	..008 936										..004 559
		⑦	A424S			AP3	AP23U	AP21U						MHT	H341
			..007 424				..006 836	..006 834						①	..004 755
Koleos [HY.]	09.08→	⑥	A929S	AM24U	AM19U	2BB	AP24U	AP19U							
			..118 929	..008 571	..008 566		..006 837	..006 832							
		WW ⑥	AM462S												
			..007 462												
Laguna I [B56; 556]	01.94-03.01	①	AR604S	AR600U	AR450U				607S	600US		600U	480U	①	H550/550U
			..118 908	..008 938	..008 933				..118 306	..004 592		..004 586	..004 582		..004 762
Laguna I Grandtour [A56; K56; S56]	02.95-02.01	①	AR604S	AR600U	AR450U				607S	600US		600U	480U	WGK	Z361
			..118 908	..008 938	..008 933				..118 306	..004 592		..004 586	..004 582		..033 361
Laguna II [BG.]	03.01-09.07	①	AR606S	AR600U	AR500U				606S						H502
			..118 910	..008 938	..008 935				..118 305						..004 633
Laguna II [KG.] Grandtour	03.01-09.07	①	AR606S	AR600U	AR500U				606S						H353
			..118 910	..008 938	..008 935				..118 305						..004 631
Laguna III [BT.]	07.07→	⑦	A422S			AP3	AP26U	AP16U						①	H480/480U
			..007 422				..006 838	..006 829							..004 759



A = Aerotwin | AM = Aerotwin Multi-Clip | AP = Aerotwin Plus | AR = Aerotwin Retrofit | S = Spoiler | U = Single Pack



3 397...

<b>Laguna III Coupé</b> [DT.]	02.08→	⑦	<b>A422S</b> ..007 422			AP3	<b>AP26U</b> ..006 838	<b>AP16U</b> ..006 829								
<b>Laguna III [KT.]</b> <b>Grandtour</b>	07.07→	⑦	<b>A422S</b> ..007 422			AP3	<b>AP26U</b> ..006 838	<b>AP16U</b> ..006 829								<b>H351</b> ..004 559
<b>Latitude</b>	01.11→	①	<b>AR601S</b> ..118 907	<b>AR600U</b> ..008 938	<b>AR400U</b> ..008 932				<b>601S</b> ..010 297	<b>600US</b> ..004 592		<b>600U</b> ..004 586	<b>400U</b> ..004 579			
<b>Logan [LS]</b>	07.04→	①	<b>AR500S</b> ..009 081	<b>AR500U</b> ..008 935	<b>AR500U</b> ..008 935							<b>500</b> ..118 560	<b>500U</b> ..004 583	<b>500U</b> ..004 583		
<b>Logan MCV</b> [KS/FS]	01.07→	①	<b>AR500S</b> ..009 081	<b>AR500U</b> ..008 935	<b>AR500U</b> ..008 935							<b>500</b> ..118 560	<b>500U</b> ..004 583	<b>500U</b> ..004 583	<b>H353</b> ..004 631	
<b>Master</b>	09.80-09.97	①		<b>AR600U</b> ..008 938	<b>AR600U</b> ..008 938							<b>603</b> ..118 301	<b>600U</b> ..004 586	<b>600U</b> ..004 586		
[X70]	10.97-04.10	SDV ①	<b>AR609S</b> ..009 776	<b>AR61N</b> ..008 847	<b>AR61N</b> ..008 847				SDV			<b>609</b> ..118 309				
	02.10→	ZE ①	<b>AR650S</b> ..018 913	<b>AR650U</b> ..008 939	<b>AR650U</b> ..008 939							<b>650</b> ..118 320	<b>650U</b> ..004 587	<b>650U</b> ..004 587		
<b>Megane I [X64]</b>	01.96-10.02	①	<b>AR551S</b> ..118 905	<b>AR550U</b> ..008 937	<b>AR500U</b> ..008 935				<b>551S</b> ..118 423	<b>550US</b> ..004 591	<b>551</b> ..118 422	<b>550U</b> ..004 585	<b>500U</b> ..004 583		<b>Z362</b> ..033 362	
<b>Megane I Cabrio</b> [X64]	09.96-09.03	①	<b>AR551S</b> ..118 905	<b>AR550U</b> ..008 937	<b>AR500U</b> ..008 935				<b>551S</b> ..118 423	<b>550US</b> ..004 591	<b>551</b> ..118 422	<b>550U</b> ..004 585	<b>500U</b> ..004 583			
<b>Megane I Classic</b> [X64]	09.96-09.03	①	<b>AR551S</b> ..118 905	<b>AR550U</b> ..008 937	<b>AR500U</b> ..008 935				<b>551S</b> ..118 423	<b>550US</b> ..004 591	<b>551</b> ..118 422	<b>550U</b> ..004 585	<b>500U</b> ..004 583			
<b>Megane I Coupé</b> [X64]	01.96-10.02	①	<b>AR551S</b> ..118 905	<b>AR550U</b> ..008 937	<b>AR500U</b> ..008 935				<b>551S</b> ..118 423	<b>550US</b> ..004 591	<b>551</b> ..118 422	<b>550U</b> ..004 585	<b>500U</b> ..004 583		<b>H402</b> ..004 632	
<b>Megane I</b> <b>Grandtour</b> [X64]	07.98-10.01	①	<b>AR551S</b> ..118 905	<b>AR550U</b> ..008 937	<b>AR500U</b> ..008 935				<b>551S</b> ..118 423	<b>550US</b> ..004 591	<b>551</b> ..118 422	<b>550U</b> ..004 585	<b>500U</b> ..004 583	WGK	<b>Z361</b> ..033 361	
	11.01-09.03	①	<b>AR551S</b> ..118 905	<b>AR550U</b> ..008 937	<b>AR500U</b> ..008 935				<b>551S</b> ..118 423	<b>550US</b> ..004 591	<b>551</b> ..118 422	<b>550U</b> ..004 585	<b>500U</b> ..004 583		<b>H353</b> ..004 631	
<b>Megane II [LM]</b>	09.02-01.06	①	<b>AR604S</b> ..118 908	<b>AR600U</b> ..008 938	<b>AR450U</b> ..008 933				<b>604S</b> ..118 303	<b>600US</b> ..004 592		<b>600U</b> ..004 586	<b>450U</b> ..004 581			
	02.06-10.09	⑦	<b>A115S</b> ..007 115			AP3	<b>AP24U</b> ..006 837	<b>AP18U</b> ..006 831								
<b>Megane II Cabrio</b> [EM]	10.03-01.06	①	<b>AR604S</b> ..118 908	<b>AR600U</b> ..008 938	<b>AR450U</b> ..008 933				<b>604S</b> ..118 303	<b>600US</b> ..004 592		<b>600U</b> ..004 586	<b>450U</b> ..004 581			
	02.06-03.10	⑦	<b>A115S</b> ..007 115			AP3	<b>AP24U</b> ..006 837	<b>AP18U</b> ..006 831								
<b>Megane II</b> <b>Grandtour</b> [KM.]	10.03-01.06	①	<b>AR604S</b> ..118 908	<b>AR600U</b> ..008 938	<b>AR450U</b> ..008 933				<b>604S</b> ..118 303	<b>600US</b> ..004 592		<b>600U</b> ..004 586	<b>450U</b> ..004 581		<b>H801</b> ..004 801	
	02.06-05.09	⑦	<b>A115S</b> ..007 115			AP3	<b>AP24U</b> ..006 837	<b>AP18U</b> ..006 831							<b>H801</b> ..004 801	
<b>Megane II</b> <b>Hatchback</b> [BM./CM./ GM./SM.]	11.02-01.06	①	<b>AR604S</b> ..118 908	<b>AR600U</b> ..008 938	<b>AR450U</b> ..008 933				<b>604S</b> ..118 303	<b>600US</b> ..004 592		<b>600U</b> ..004 586	<b>450U</b> ..004 581		<b>H230</b> ..004 560	
	02.06-10.08	⑦	<b>A115S</b> ..007 115			AP3	<b>AP24U</b> ..006 837	<b>AP18U</b> ..006 831							<b>H230</b> ..004 560	
<b>Megane III CC [EZ]</b>	04.10→	⑦	<b>A116S</b> ..007 116			AP3	<b>AP24U</b> ..006 837	<b>AP16U</b> ..006 829								
<b>Megane III Coupé</b> [DZ]	01.09→	⑦	<b>A116S</b> ..007 116			AP3	<b>AP24U</b> ..006 837	<b>AP16U</b> ..006 829							<b>H351</b> ..004 559	
<b>Megane III</b> <b>Grandtour</b> [KZ]	06.09→	⑦	<b>A116S</b> ..007 116			AP3	<b>AP24U</b> ..006 837	<b>AP16U</b> ..006 829							<b>H353</b> ..004 631	
<b>Megane III</b> <b>Hatchback</b> [BZ]	11.08→	⑦	<b>A116S</b> ..007 116			AP3	<b>AP24U</b> ..006 837	<b>AP16U</b> ..006 829							<b>H351</b> ..004 559	
<b>Modus [FP./JP.]</b>	06.04-05.05	②	<b>A962S</b> ..118 962	<b>AM28U</b> ..008 574	<b>AM26U</b> ..008 573	AP1	<b>AP28U</b> ..006 839	<b>AP26U</b> ..006 838							<b>H801</b> ..004 801	
	06.05→	②	<b>A962S</b> ..118 962	<b>AM28U</b> ..008 574	<b>AM26U</b> ..008 573	AP1	<b>AP28U</b> ..006 839	<b>AP26U</b> ..006 838							<b>H301</b> ..004 629	



A = Aerotwin | AM = Aerotwin Multi-Clip | AP = Aerotwin Plus | AR = Aerotwin Retrofit | S = Spoiler | U = Single Pack





◀ RENAULT

3 397...

Model	Year Range	①	SET	②	③	NEW AEROTWIN	TWIN SPOILER	TWIN	REAR				
Safrane [B54]	04.92-01.99												
		①											
	02.99-12.00	①	AR609S ..009 776	AR600U ..008 938	AR600U ..008 938			603 ..118 301	600U ..004 586	600U ..004 586	①	H550/550U ..004 762	
Sandero [BS]	11.10→	①	AR500S ..009 081	AR500U ..008 935	AR500U ..008 935			500S ..118 561	500US ..004 590	500 ..118 560	500U ..004 583	500U ..004 583	H402 ..004 632
Scenic I [JA.]	01.96-04.03	①	AR601S ..118 907	AR600U ..008 938	AR400U ..008 932			601S ..010 297	600US ..004 592	601 ..118 304	600U ..004 586	400U ..004 579	L40 H402 ..004 632
Scenic II [JM.]	05.03-11.04	⑤	A957S ..118 957										H801 ..004 801
	12.04-04.09	⑦	A117S ..007 117			AP3	AP26U ..006 838	AP22U ..006 835					H801 ..004 801
Scenic III [J95]	05.09→	⑦	A119S ..007 502			AP3	AP30U ..006 840	AP26U ..006 838					H304 ..004 990
Symbol [LB]	10.99-10.07	①	AR531S ..118 901	AR530U ..008 936	AR450U ..008 933			531S ..118 403	530US ..011 352	531 ..118 402	530U ..004 584	450U ..004 581	
[LU]	10.08→	⑦	A116S ..007 116			AP3	AP24U ..006 837	AP16U ..006 829					
[L8]	03.13→	①	AR532S ..118 986	AR530U ..008 936	AR500U ..008 935			532S ..118 404	530US ..011 352		530U ..004 584	500U ..004 583	①
Thalia [LB]	10.99-10.07	①	AR531S ..118 901	AR530U ..008 936	AR450U ..008 933			531S ..118 403	530US ..011 352	531 ..118 402	530U ..004 584	450U ..004 581	
[LU]	10.08→	⑦	A116S ..007 116			AP3	AP24U ..006 837	AP16U ..006 829					
Traffic	09.80-05.01	①	AR500S ..009 081	AR500U ..008 935	AR500U ..008 935			500S ..118 561	500US ..004 590	500 ..118 560	500U ..004 583	500U ..004 583	
[EL./FL./JL.]	05.01→	①	AR801S ..118 996	AR600U ..008 938	AR530U ..008 936			611S ..010 300	600US ..004 592		600U ..004 586	530U ..004 584	MHK ① MHT H341 ..004 755 H402 ..004 632
Twingo I [CO./SO.]	03.93-05.07	①	AR650S ..018 913	AR650U ..008 939							650U ..004 587		H300 ..004 628
Twingo II [CN; CN/GN]	04.07→	③	A295S ..007 295	AM24U ..008 571	AM16U ..008 563	2AA	AP24U ..006 837	AP16U ..006 829					H301 ..004 629
Twizy [MA]	03.12→	①		AR450U ..008 933							450U ..004 581		
Vel Satis [BJ.]	04.02-12.09	②	A963S ..118 963										H402 ..004 632
Wind	04.10→	③	A295S ..007 295	AM24U ..008 571	AM16U ..008 563	2AA	AP24U ..006 837	AP16U ..006 829					
ZOE [BF]	01.13→	KUR ③	A299S ..007 299	AM24U ..008 571	AM13U ..008 794	2AA	AP24U ..006 837	AP13U ..006 827					H840 ..004 802
5	03.90-12.96	①	AR450S ..118 994	AR450U ..008 933	AR450U ..008 933			450S ..118 506	450US ..004 588	450 ..118 505	450U ..004 581	450U ..004 581	① H400/400U ..004 757
9 [L42]	01.85-12.95							400S ..118 611		400 ..118 610	400U ..004 579	400U ..004 579	
11 [B37]	01.85-03.95							400S ..118 611		400 ..118 610	400U ..004 579	400U ..004 579	① H450/450U ..004 763
19 [X53]	09.88-12.01	①	AR500S ..009 081	AR500U ..008 935	AR500U ..008 935			500S ..118 561	500US ..004 590	500 ..118 560	500U ..004 583	500U ..004 583	① H480/480U ..004 759 WW ① H340/340U ..004 754
21 [L48]	03.86-12.94							450S ..118 506		450 ..118 505	450U ..004 581	450U ..004 581	



A = Aerotwin | AM = Aerotwin Multi-Clip | AP = Aerotwin Plus | AR = Aerotwin Retrofit | S = Spoiler | U = Single Pack



3 397...

ROLLS-ROYCE															
Silver Spirit	10.80-03.93											340 ..118 700	340U ..004 578	340U ..004 578	
Silver Spur	10.80-03.93											340 ..118 700	340U ..004 578	340U ..004 578	

ROVER

Maestro	09.88-12.93	①	AR503S ..118 993	AR500U ..008 935	AR480U ..008 934							500S ..118 561	500US ..004 590	500 ..118 560	500U ..004 583	500U ..004 583			
Maestro Estate	09.88-12.93	①	AR503S ..118 993	AR500U ..008 935	AR480U ..008 934							500S ..118 561	500US ..004 590	500 ..118 560	500U ..004 583	500U ..004 583			
Mini	09.88-09.00													280 ..118 801	H280 ..018 802	H280 ..018 802			
Montego	09.88-12.93	①	AR503S ..118 993	AR500U ..008 935	AR480U ..008 934							500S ..118 561	500US ..004 590	500 ..118 560	500U ..004 583	500U ..004 583	① H380/380U ..004 756		
Serie 200	10.89-03.00	①	AR450S ..118 994	AR450U ..008 933	AR450U ..008 933							450S ..118 506	450US ..004 588	450 ..118 505	450U ..004 581	450U ..004 581	① H450/450U ..004 763		
Serie 400	09.91-04.95	①	AR502S ..118 995	AR500U ..008 935	AR450U ..008 933							502S ..118 564	500US ..004 590	502 ..118 563	500U ..004 583	450U ..004 581			
Serie 400 Coupé	01.97-12.98	①	AR502S ..118 995	AR500U ..008 935	AR450U ..008 933							502S ..118 564	500US ..004 590	502 ..118 563	500U ..004 583	450U ..004 581			
Serie 400 Tourer	09.91-04.95	①	AR502S ..118 995	AR500U ..008 935	AR450U ..008 933							502S ..118 564	500US ..004 590	502 ..118 563	500U ..004 583	450U ..004 581			
Serie 600	04.93-09.00	①	AR551S ..118 905	AR550U ..008 937	AR500U ..008 935							551S ..118 423	550US ..004 591	551 ..118 422	550U ..004 585	500U ..004 583			
Serie 800	10.91-09.99	①	AR500S ..009 081	AR500U ..008 935	AR500U ..008 935							500S ..118 561	500US ..004 590	500 ..118 560	500U ..004 583	500U ..004 583	① H480/480U ..004 759		
Streetwise	09.03-12.05													450 ..118 505	450U ..004 581	450U ..004 581	H402 ..004 632		
25	02.00-09.04	①	AR450S ..118 994	AR450U ..008 933	AR450U ..008 933							450S ..118 506	450US ..004 588	450 ..118 505	450U ..004 581	450U ..004 581	① H450/450U ..004 763		
	10.04-05.05	①	AR450S ..118 994	AR450U ..008 933	AR450U ..008 933							450S ..118 506	450US ..004 588	450 ..118 505	450U ..004 581	450U ..004 581	H402 ..004 632		
45	02.00-05.05	①	AR502S ..118 995	AR500U ..008 935	AR450U ..008 933							502S ..118 564	500US ..004 590	502 ..118 563	500U ..004 583	450U ..004 581	① H450/450U ..004 763		
75	01.99-05.05	①	AR550S ..118 906	AR550U ..008 937	AR530U ..008 936							550S ..118 421	550US ..004 591	550 ..118 420	550U ..004 585	550U ..004 585			
75 Tourer	01.01-05.05	①	AR550S ..118 906	AR550U ..008 937	AR530U ..008 936							550S ..118 421	550US ..004 591	550 ..118 420	550U ..004 585	550U ..004 585	H351 ..004 559		
100 Metro	05.90-12.98													400S ..118 611		400 ..118 610	400U ..004 579	400U ..004 579	① H400/400U ..004 757
100 Metro Cabrio	09.90-03.98													400S ..118 611		400 ..118 610	400U ..004 579	400U ..004 579	① H400/400U ..004 757

SAAB

9-3 [9400]	03.98-09.02	①	AR532S ..118 986	AR530U ..008 936	AR500U ..008 935							530S ..118 401	530US ..011 352	530 ..118 400	530U ..004 584	530U ..004 584	① H500/500U ..004 760	
	09.02-08.07														575S ..011 351	575U ..011 351	575U ..011 351	① H500/500U ..004 760
	09.07→	⑥	A416S ..007 416	AM24U ..008 571	AM23U ..008 570	2BB	AP24U ..006 837	AP23U ..006 836										① H500/500U ..004 760



A = Aerotwin | AM = Aerotwin Multi-Clip | AP = Aerotwin Plus | AR = Aerotwin Retrofit | S = Spoiler | U = Single Pack



◀ SAAB

3 397...

9-3 Cabriolet [9400]	03.98-08.03	①	AR532S ..118 986	AR530U ..008 936	AR500U ..008 935				530S ..118 401	530US ..011 352	530 ..118 400	530U ..004 584	530U ..004 584	
	08.03-08.07								575S ..118 451			575U ..011 351	575U ..011 351	
	09.07-06.12	⑥	A416S ..007 416	AM24U ..008 571	AM23U ..008 570	2BB	AP24U ..006 837	AP23U ..006 836						
9-3 Coupé [9400]	03.98-08.03	①	AR532S ..118 986	AR530U ..008 936	AR500U ..008 935				530S ..118 401	530US ..011 352	530 ..118 400	530U ..004 584	530U ..004 584	① H500/500U ..004 760
9-3 Kombi [9440]	03.05-08.07								575S ..118 451			575U ..011 351	575U ..011 351	TW H304 ..004 990
	09.07→	⑥	A416S ..007 416	AM24U ..008 571	AM23U ..008 570	2BB	AP24U ..006 837	AP23U ..006 836						TW H304 ..004 990
9-3 X	03.10→	⑥	A416S ..007 416	AM24U ..008 571	AM23U ..008 570	2BB	AP24U ..006 837	AP23U ..006 836						TW H304 ..004 990
9-5 I	06.97-07.07								575S ..118 451			575U ..011 351	575U ..011 351	
	08.07-02.10	⑦	A424S ..007 424			AP3	AP24U ..006 837	AP22U ..006 835						
9-5 II	03.10→	①	AR801S ..118 996	AR600U ..008 938	AR530U ..008 936				611S ..010 300	600US ..004 592		600U ..004 586	530U ..004 584	
9-5 Kombi	06.97-07.07								575S ..118 451			575U ..011 351	575U ..011 351	
	08.07-02.10	⑦	A424S ..007 424			AP3	AP24U ..006 837	AP22U ..006 835						
	09.05-02.10													TW H304 ..004 990
900 I	02.84-08.93										400 ..118 610	400U ..004 579	400U ..004 579	
900 I Cabrio	09.86-08.94											450 ..118 505	450U ..004 581	450U ..004 581
	09.93-08.98											400 ..118 610	400U ..004 579	400U ..004 579
900 I Hatchback	09.90-08.98											400 ..118 610	400U ..004 579	400U ..004 579
900 II	09.93-10.98	①	AR532S ..118 986	AR530U ..008 936	AR500U ..008 935				530S ..118 401	530US ..011 352	530 ..118 400	530U ..004 584	530U ..004 584	① H500/500U ..004 760
900 II Cabrio	03.94-10.98	①	AR532S ..118 986	AR530U ..008 936	AR500U ..008 935				530S ..118 401	530US ..011 352	530 ..118 400	530U ..004 584	530U ..004 584	
900 II Coupé	03.94-10.98	①	AR532S ..118 986	AR530U ..008 936	AR500U ..008 935				530S ..118 401	530US ..011 352	530 ..118 400	530U ..004 584	530U ..004 584	① H500/500U ..004 760
9000	12.85-12.98	①	AR532S ..118 986	AR530U ..008 936	AR500U ..008 935				530S ..118 401	530US ..011 352	530 ..118 400	530U ..004 584	530U ..004 584	① H500/500U ..004 760

SEAT

Alhambra [7V8]	03.96-02.00	①	AR704S ..007 565	AR70N ..008 845	AR60N ..008 843				GA			704 ..010 211		① H400/400U ..004 757
									GBO			532 ..001 532		
[7V9]	06.00-06.01	①	AR704S ..007 565	AR70N ..008 845	AR60N ..008 843				GA			704 ..010 211		① H405 ..004 764
									GBO			532 ..001 532		
	07.01-03.10	②	A950S ..118 950	AM28U ..008 574	AM28U ..008 574	AP1	AP28U ..006 839	AP28U ..006 839						① H405 ..004 764
[710]	07.10→	③	A557S ..007 557			AP4	AP28U ..006 839	AP16U ..006 829						A331H ..008 713



A = Aerotwin | AM = Aerotwin Multi-Clip | AP = Aerotwin Plus | AR = Aerotwin Retrofit | S = Spoiler | U = Single Pack



			AEROTWIN			NEW!	AEROTWIN			TWIN SPOILER			TWIN			REAR		
			SET	↳	↳	?	↳	↳	?	SET	↳	SET	↳	↳	?	↳		
			3 397...															
Altea [5P1]	03.04-02.09	⑧	A958S ..118 958														H772 ..004 772	
	03.09→	⑧	A958S ..118 958														A330H ..008 006	
Altea Freetrack [5P5/5P8]	06.07→	⑧	A958S ..118 958													APE	H595 ..004 595	
Altea XL [5P5]	05.06→	⑧	A958S ..118 958													APE	H595 ..004 595	
Arosa [6H1]	02.97-02.99								BGO ①	465S ..001 465			480U ..004 582			①	H280 ..018 802	
	03.99-06.04								BGO ①	584S ..001 584	530US ..011 352		530U ..004 584			①	H280 ..018 802	
															WW ①	H595 ..004 595		
Cordoba [6K2]	09.93-12.02	①	AR533S ..118 902	AR530U ..008 936	AR480U ..008 934					533S ..118 406	530US ..011 352	533 ..118 405	530U ..004 584	480U ..004 582				
	[6L2]	09.02-02.06	①	AR533S ..118 902	AR530U ..008 936	AR480U ..008 934				BGR	533S ..118 406	530US ..011 352	533 ..118 405	530U ..004 584	480U ..004 582			
			WW ①	AR531S ..118 901	AR530U ..008 936	AR450U ..008 933				BGO	584S ..001 584	530US ..011 352	531 ..118 402	530U ..004 584	450U ..004 581			
	05.06-11.09	③	A307S ..007 307	AM21U ..008 568	AM19U ..008 566	2AA	AP21U ..006 834	AP19U ..006 832										
		KUR ③	AM460S ..007 460															
Cordoba Vario [6K5]	04.97-12.02	①	AR533S ..118 902	AR530U ..008 936	AR480U ..008 934					533S ..118 406	530US ..011 352	533 ..118 405	530U ..004 584	480U ..004 582	APE	H595 ..004 595		
Exeo [3R2]	12.08→	④	A933S ..118 933															
Exeo ST [3R5]	06.09→	④	A933S ..118 933														A330H ..008 006	
Ibiza [Y..]	06.84-05.93								①				450U ..004 581		①	H480/480U ..004 759		
	[6K1]	03.93-05.02	①	AR533S ..118 902	AR530U ..008 936	AR480U ..008 934					533S ..118 406	530US ..011 352	533 ..118 405	530U ..004 584	480U ..004 582	①	H341 ..004 755	
			WW ①	AR531S ..118 901	AR530U ..008 936	AR450U ..008 933				BGO	584S ..001 584	530US ..011 352	531 ..118 402	530U ..004 584	450U ..004 581			
	[6L1]	09.01-02.06	①	AR533S ..118 902	AR530U ..008 936	AR480U ..008 934				BGR	533S ..118 406	530US ..011 352	533 ..118 405	530U ..004 584	480U ..004 582	①	H341 ..004 755	
			WW ①	AR531S ..118 901	AR530U ..008 936	AR450U ..008 933				BGO	584S ..001 584	530US ..011 352	531 ..118 402	530U ..004 584	450U ..004 581			
	02.06-11.09	③	A307S ..007 307	AM21U ..008 568	AM19U ..008 566	2AA	AP21U ..006 834	AP19U ..006 832										H772 ..004 772
		WW ③	AM460S ..007 460															
[6J5]	02.08-08.11	③	A295S ..007 295	AM24U ..008 571	AM16U ..008 563	2AA	AP24U ..006 837	AP16U ..006 829									H772 ..004 772	
	09.11→	③	A295S ..007 295	AM24U ..008 571	AM16U ..008 563	2AA	AP24U ..006 837	AP16U ..006 829									A382H ..006 865	
Ibiza SC [6J1]	02.08-08.11	③	A295S ..007 295	AM24U ..008 571	AM16U ..008 563	2AA	AP24U ..006 837	AP16U ..006 829									H772 ..004 772	
	09.11→	③	A295S ..007 295	AM24U ..008 571	AM16U ..008 563	2AA	AP24U ..006 837	AP16U ..006 829							KUR	A330H ..008 006		
Ibiza ST [6J8]	03.10-08.11	③	A295S ..007 295	AM24U ..008 571	AM16U ..008 563	2AA	AP24U ..006 837	AP16U ..006 829									H772 ..004 772	
	09.11→	③	A295S ..007 295	AM24U ..008 571	AM16U ..008 563	2AA	AP24U ..006 837	AP16U ..006 829									A382H ..006 865	
Inca [6K9]	11.95-06.03	①	AR502S ..118 995	AR500U ..008 935	AR450U ..008 933					502S ..118 564	500US ..004 590	502 ..118 563	500U ..004 583	450U ..004 581	①	H450/450U ..004 763		



A = Aerotwin | AM = Aerotwin Multi-Clip | AP = Aerotwin Plus | AR = Aerotwin Retrofit | S = Spoiler | U = Single Pack



◀ SEAT

3 397...

<b>Leon [1M1]</b>	10.98-06.06	①	<b>AR533S</b> ..118 902	<b>AR530U</b> ..008 936	<b>AR480U</b> ..008 934				BGR	<b>533S</b> ..118 406	<b>530US</b> ..011 352	<b>533</b> ..118 405	<b>530U</b> ..004 584	<b>480U</b> ..004 582		<b>H403</b> ..011 592
									BGO	<b>584S</b> ..001 584						
[1P1]	07.05-02.09	⑥	<b>A099S</b> ..007 099	<b>AM26U</b> ..008 573	<b>AM26U</b> ..008 573	2BB	<b>AP26U</b> ..006 838	<b>AP26U</b> ..006 838							APE	<b>H595</b> ..004 595
	03.09→	⑥	<b>A099S</b> ..007 099	<b>AM26U</b> ..008 573	<b>AM26U</b> ..008 573	2BB	<b>AP26U</b> ..006 838	<b>AP26U</b> ..006 838								<b>A281H</b> ..008 045
[5F1]	09.12→	③	<b>A945S</b> (2014)			AP4	<b>AP26U</b> ..006 838	<b>AP16U</b> ..006 829								<b>A331H</b> ..008 713
		KUR	<b>A555S</b> ..007 555													
<b>Leon SC [5F5]</b>	01.13→	③	<b>A945S</b> (2014)			AP4	<b>AP26U</b> ..006 838	<b>AP16U</b> ..006 829								<b>A403H</b> ..008 998
		KUR	<b>A555S</b> ..007 555													
<b>Malaga</b>	12.89-12.93	①	<b>AR450S</b> ..118 994	<b>AR450U</b> ..008 933	<b>AR450U</b> ..008 933					<b>450S</b> ..118 506	<b>450US</b> ..004 588	<b>450</b> ..118 505	<b>450U</b> ..004 581	<b>450U</b> ..004 581		
<b>Marbella</b>	01.87-05.98								①				<b>400U</b> ..004 579		①	<b>H340/340U</b> ..004 754
<b>Mii [KF1]</b>	10.11→	③	<b>A555S</b> ..007 555			AP4	<b>AP24U</b> ..006 837	<b>AP16U</b> ..006 829								<b>A251H</b> ..008 058
<b>Terra</b>	01.87-12.94								①				<b>400U</b> ..004 579			
<b>Toledo [1L2]</b>	05.91-03.99	①	<b>AR500S</b> ..009 081	<b>AR500U</b> ..008 935	<b>AR500U</b> ..008 935					<b>500S</b> ..118 561	<b>500US</b> ..004 590	<b>500</b> ..118 560	<b>500U</b> ..004 583	<b>500U</b> ..004 583		
[1M2]	04.99-07.04	①	<b>AR533S</b> ..118 902	<b>AR530U</b> ..008 936	<b>AR480U</b> ..008 934				BGO	<b>584S</b> ..001 584	<b>530US</b> ..011 352		<b>530U</b> ..004 584		WGK	<b>Z361</b> ..033 361
[5P2]	09.04-05.09	⑥	<b>A958S</b> ..118 958												APE	<b>H595</b> ..004 595
[KG3]	07.12→	③	<b>A555S</b> ..007 555			AP4	<b>AP24U</b> ..006 837	<b>AP16U</b> ..006 829								

**SKODA**

<b>Citigo</b>	10.11→	③	<b>A555S</b> ..007 555			AP4	<b>AP24U</b> ..006 837	<b>AP16U</b> ..006 829								<b>A251H</b> ..008 058
<b>Fabia [6Y3]</b>	09.99-12.07	①	<b>AR533S</b> ..118 902	<b>AR530U</b> ..008 936	<b>AR480U</b> ..008 934				BGR	<b>533S</b> ..118 406	<b>530US</b> ..011 352	<b>533</b> ..118 405	<b>530U</b> ..004 584	<b>480U</b> ..004 582		<b>A350H</b> ..008 054
									BGO	<b>584S</b> ..001 584						
[5J2]	12.06→	③	<b>A051S</b> ..009 051	<b>AM21U</b> ..008 568	<b>AM21U</b> ..008 568	2AA	<b>AP21U</b> ..006 834	<b>AP21U</b> ..006 834								<b>A330H</b> ..008 006
<b>Fabia Combi [6Y5]</b>	12.99-12.07	①	<b>AR533S</b> ..118 902	<b>AR530U</b> ..008 936	<b>AR480U</b> ..008 934				BGR	<b>533S</b> ..118 406	<b>530US</b> ..011 352	<b>533</b> ..118 405	<b>530U</b> ..004 584	<b>480U</b> ..004 582		<b>A350H</b> ..008 054
									BGO	<b>584S</b> ..001 584						
[5J5]	12.06→	③	<b>A051S</b> ..009 051	<b>AM21U</b> ..008 568	<b>AM21U</b> ..008 568	2AA	<b>AP21U</b> ..006 834	<b>AP21U</b> ..006 834								<b>A400H</b> ..008 009
<b>Fabia Hatchback [6Y2]</b>	09.99-03.08	①	<b>AR533S</b> ..118 902	<b>AR530U</b> ..008 936	<b>AR480U</b> ..008 934				BGR	<b>533S</b> ..118 406	<b>530US</b> ..011 352	<b>533</b> ..118 405	<b>530U</b> ..004 584	<b>480U</b> ..004 582		<b>A350H</b> ..008 054
									BGO	<b>584S</b> ..001 584						
<b>Favorit</b>	09.88-09.94	①	<b>AR450S</b> ..118 994	<b>AR450U</b> ..008 933	<b>AR450U</b> ..008 933					<b>450S</b> ..118 506	<b>450US</b> ..004 588	<b>450</b> ..118 505	<b>450U</b> ..004 581	<b>450U</b> ..004 581	①	<b>H400/400U</b> ..004 757
	10.94-12.98	①	<b>AR500S</b> ..009 081	<b>AR500U</b> ..008 935	<b>AR500U</b> ..008 935					<b>500S</b> ..118 561	<b>500US</b> ..004 590	<b>500</b> ..118 560	<b>500U</b> ..004 583	<b>500U</b> ..004 583	①	<b>H400/400U</b> ..004 757



A = Aerotwin | AM = Aerotwin Multi-Clip | AP = Aerotwin Plus | AR = Aerotwin Retrofit | S = Spoiler | U = Single Pack



3 397...

Model	Period	Icon	AR500S	AR500U	AR500U				500S	500US	500	500U	500U	Icon	H400/400U
Felicia [6U1]	10.94-08.01	①	AR500S ..009 081	AR500U ..008 935	AR500U ..008 935				500S ..118 561	500US ..004 590	500 ..118 560	500U ..004 583	500U ..004 583	①	H400/400U ..004 757
Felicia Combi [6U5]	10.94-08.01	①	AR500S ..009 081	AR500U ..008 935	AR500U ..008 935				500S ..118 561	500US ..004 590	500 ..118 560	500U ..004 583	500U ..004 583	①	H400/400U ..004 757
Felicia Fun [6UF]	08.96-03.01	①	AR531S ..118 901	AR530U ..008 936	AR450U ..008 933				531S ..118 403	530US ..011 352	531 ..118 402	530U ..004 584	450U ..004 581		
Forman	10.90-12.95	①	AR500S ..009 081	AR500U ..008 935	AR500U ..008 935				500S ..118 561	500US ..004 590	500 ..118 560	500U ..004 583	500U ..004 583	①	H400/400U ..004 757
Octavia [1U2]	09.96-12.10	①	AR533S ..118 902	AR530U ..008 936	AR480U ..008 934			BGR	533S ..118 406	530US ..011 352	533 ..118 405	530U ..004 584	480U ..004 582		
								BGO	584S ..001 584						
[1Z3]	05.04→	②	A936S ..118 936	AM24U ..008 571	AM19U ..008 566	AP1	AP24U ..006 837	AP19U ..006 832							A400H ..008 009
			WW	AM462S ..007 462											
[5E3]	11.12→	③	A620S ..007 620			AP4	AP24U ..006 837	AP19U ..006 832							
Octavia Combi [1U5]	10.96-12.10	①	AR533S ..118 902	AR530U ..008 936	AR480U ..008 934			BGR	533S ..118 406	530US ..011 352	533 ..118 405	530U ..004 584	480U ..004 582	WGK	Z361 ..033 361
								BGO	584S ..001 584						
[1Z5]	05.04→	②	A936S ..118 936	AM24U ..008 571	AM19U ..008 566	AP1	AP24U ..006 837	AP19U ..006 832							A400H ..008 009
			WW	AM462S ..007 462											
[5E5]	11.12→	③	A620S ..007 620			AP4	AP24U ..006 837	AP19U ..006 832						KUR	A331H ..008 713
Pick-Up [6U7]	09.91-03.01	①	AR500S ..009 081	AR500U ..008 935	AR500U ..008 935						500 ..118 560	500U ..004 583	500U ..004 583		
Praktik [5J7]	03.07→	③	A051S ..009 051	AM21U ..008 568	AM21U ..008 568	2AA	AP21U ..006 834	AP21U ..006 834							A330H ..008 006
Rapid [NH3]	07.12→	③	A555S ..007 555			AP4	AP24U ..006 837	AP16U ..006 829							A403H ..008 998
Roomster [5J7]	03.06→	③	A051S ..009 051	AM21U ..008 568	AM21U ..008 568	2AA	AP21U ..006 834	AP21U ..006 834							A330H ..008 006
Superb [3U4]	12.01-10.04	②	A925S ..118 925	AM21U ..008 568	AM19U ..008 566	AP1	AP21U ..006 834	AP19U ..006 832							
	11.04-03.08	①	AR532S ..118 986	AR530U ..008 936	AR500U ..008 935			BGR	532S ..118 404	530US ..011 352		530U ..004 584	500U ..004 583		
								BGO	583S ..001 583						
[3T4]	03.08→	③	A187S ..007 187	AM24U ..008 571	AM18U ..008 565	2AA	AP24U ..006 837	AP18U ..006 831							
Superb Combi [3T5]	03.08→	③	A187S ..007 187	AM24U ..008 571	AM18U ..008 565	2AA	AP24U ..006 837	AP18U ..006 831							A403H ..008 998
Yeti [5L7]	05.09→	③	A979S ..118 979	AM24U ..008 571	AM19U ..008 566	2AA	AP24U ..006 837	AP19U ..006 832							A282H ..008 634
			WW	AM462S ..007 462											



A = Aerotwin | AM = Aerotwin Multi-Clip | AP = Aerotwin Plus | AR = Aerotwin Retrofit | S = Spoiler | U = Single Pack





3 397...

SMART (MCC)														
Forfour [454]	01.04-06.07	①	AR813S ..118 912	AR650U ..008 939	AR450U ..008 933						803 ..001 803	650U ..004 587	450U ..004 581	H351 ..004 559
Fortwo Cabrio [450]	02.04-03.07	①	AR992S ..118 992								530 ..118 400	530U ..004 584	530U ..004 584	
	[451]	04.07→	⑥	A294S ..007 294	AM23U ..008 570	AM21U ..008 568	2BB	AP23U ..006 836	AP21U ..006 834					
Fortwo Coupé [450]	02.04-03.07	①	AR992S ..118 992								530 ..118 400	530U ..004 584	530U ..004 584	① H341 ..004 755
	[451]	04.07→	⑥	A294S ..007 294	AM23U ..008 570	AM21U ..008 568	2BB	AP23U ..006 836	AP21U ..006 834					H801 ..004 801
Roadster [452]	04.03-11.05	①	AR502S ..118 995	AR500U ..008 935	AR450U ..008 933					502S ..118 564	500US ..004 590	502 ..118 563	500U ..004 583	450U ..004 581
Roadster Coupé [452]	04.03-11.05	①	AR502S ..118 995	AR500U ..008 935	AR450U ..008 933					502S ..118 564	500US ..004 590	502 ..118 563	500U ..004 583	450U ..004 581
Smart Cabrio [450]	01.01-01.04	①	AR992S ..118 992								530 ..118 400	530U ..004 584	530U ..004 584	
Smart Coupé [450]	07.98-01.04	①	AR992S ..118 992								530 ..118 400	530U ..004 584	530U ..004 584	① H341 ..004 755

SSANGYONG															
Actyon	11.06→	①	AR533S ..118 902	AR530U ..008 936	AR480U ..008 934					533S ..118 406	530US ..011 352	533 ..118 405	530U ..004 584	480U ..004 582	
Actyon Sports	03.07→	①	AR533S ..118 902	AR530U ..008 936	AR480U ..008 934					533S ..118 406	530US ..011 352	533 ..118 405	530U ..004 584	480U ..004 582	
Chairman	09.03-01.08								①				600 ..018 300		
Korando [KJ]	07.96-12.05	①	AR450S ..118 994	AR450U ..008 933	AR450U ..008 933					450S ..118 506	450US ..004 588	450 ..118 505	450U ..004 581	450U ..004 581	
Korando C	03.11→	①	AR601S ..118 907	AR600U ..008 938	AR400U ..008 932					601S ..010 297	600US ..004 592	601 ..118 304	600U ..004 586	400U ..004 579	
Kyron	05.05→	①	AR728S ..118 904	AR550U ..008 937	AR480U ..008 934					728S ..001 728	550US ..004 591	727 ..001 727	550U ..004 585	480U ..004 582	
Musso [MJ]	07.93-12.05	①	AR502S ..118 995	AR500U ..008 935	AR450U ..008 933							502 ..118 563	500U ..004 583	450U ..004 581	① H280 ..018 802
Rexton	05.02→	①	AR500S ..009 081	AR500U ..008 935	AR500U ..008 935							500 ..118 560	500U ..004 583	500U ..004 583	① H340/340U ..004 754
Rexton II	10.08→	①	AR500S ..009 081	AR500U ..008 935	AR500U ..008 935							500 ..118 560	500U ..004 583	500U ..004 583	
Rodius	08.04→	①	AR604S ..118 908	AR600U ..008 938	AR450U ..008 933					604S ..118 303	600US ..004 592		600U ..004 586	450U ..004 581	① H280 ..018 802

STEYR															
G	01.98→	①		AR400U ..008 932	AR400U ..008 932							400 ..118 610	400U ..004 579	400U ..004 579	① H380/380U ..004 756
Pinzgauer	10.86-12.96								①			340 ..118 700	340U ..004 578	340U ..004 578	① H340/340U ..004 754



A = Aerotwin | AM = Aerotwin Multi-Clip | AP = Aerotwin Plus | AR = Aerotwin Retrofit | S = Spoiler | U = Single Pack



3 397...

SUBARU														
<b>BRZ [Z10]</b>	01.12→	①	<b>AR551S</b> ..118 905	<b>AR550U</b> ..008 937	<b>AR500U</b> ..008 935				<b>551S</b> ..118 423	<b>550US</b> ..004 591	<b>551</b> ..118 422	<b>550U</b> ..004 585	<b>500U</b> ..004 583	
<b>Forester [SF]</b>	01.97-05.02	①	<b>AR533S</b> ..118 902	<b>AR530U</b> ..008 936	<b>AR480U</b> ..008 934				<b>533S</b> ..118 406	<b>530US</b> ..011 352	<b>533</b> ..118 405	<b>530U</b> ..004 584	<b>480U</b> ..004 582	① <b>H380/380U</b> ..004 756
[SG]	06.02-05.03	①	<b>AR533S</b> ..118 902	<b>AR530U</b> ..008 936	<b>AR480U</b> ..008 934				<b>533S</b> ..118 406	<b>530US</b> ..011 352	<b>533</b> ..118 405	<b>530U</b> ..004 584	<b>480U</b> ..004 582	① <b>H380/380U</b> ..004 756
	06.03-05.05	①	<b>AR533S</b> ..118 902	<b>AR530U</b> ..008 936	<b>AR480U</b> ..008 934				<b>533S</b> ..118 406	<b>530US</b> ..011 352	<b>533</b> ..118 405	<b>530U</b> ..004 584	<b>480U</b> ..004 582	KWB, L40 <b>H410</b> ..011 434
	06.05-11.07	①	<b>AR533S</b> ..118 902	<b>AR530U</b> ..008 936	<b>AR480U</b> ..008 934				<b>533S</b> ..118 406	<b>530US</b> ..011 352	<b>533</b> ..118 405	<b>530U</b> ..004 584	<b>480U</b> ..004 582	L34 <b>H354</b> ..011 433
[S12]	12.07-12.12	①	<b>AR604S</b> ..118 908	<b>AR600U</b> ..008 938	<b>AR450U</b> ..008 933				<b>604S</b> ..118 303	<b>600US</b> ..004 592		<b>600U</b> ..004 586	<b>450U</b> ..004 581	<b>H354</b> ..011 433
[S13]	11.12→	①	<b>AR653S</b> ..118 911	<b>AR650U</b> ..008 939	<b>AR400U</b> ..008 932						<b>653</b> ..118 324	<b>650U</b> ..004 587	<b>400U</b> ..004 579	<b>H354</b> ..011 433
<b>Impreza [G12/G22]</b>	06.07-12.11	①	<b>AR601S</b> ..118 907	<b>AR600U</b> ..008 938	<b>AR400U</b> ..008 932				<b>601S</b> ..010 297	<b>600US</b> ..004 592		<b>600U</b> ..004 586	<b>400U</b> ..004 579	<b>H410</b> ..011 434
[G13/G23]	10.11→	①	<b>AR653S</b> ..118 911	<b>AR650U</b> ..008 939	<b>AR400U</b> ..008 932						<b>653</b> ..118 324	<b>650U</b> ..004 587	<b>400U</b> ..004 579	<b>H306</b> ..011 432
<b>Impreza Kombi [GC, GF]</b>	01.93-07.98	①	<b>AR531S</b> ..118 901	<b>AR530U</b> ..008 936	<b>AR450U</b> ..008 933				<b>531S</b> ..118 403	<b>530US</b> ..011 352	<b>531</b> ..118 402	<b>530U</b> ..004 584	<b>450U</b> ..004 581	① <b>H380/380U</b> ..004 756
	08.98-09.00	①	<b>AR531S</b> ..118 901	<b>AR530U</b> ..008 936	<b>AR450U</b> ..008 933				<b>531S</b> ..118 403	<b>530US</b> ..011 352	<b>531</b> ..118 402	<b>530U</b> ..004 584	<b>450U</b> ..004 581	
[GD, GG]	10.00-06.07	①	<b>AR552S</b> ..118 984	<b>AR550U</b> ..008 937	<b>AR400U</b> ..008 932				<b>552S</b> ..118 427	<b>550US</b> ..004 591		<b>550U</b> ..004 585	<b>400U</b> ..004 579	① <b>H380/380U</b> ..004 756
<b>Impreza Outback [GD, GG]</b>	10.00-06.07	①	<b>AR552S</b> ..118 984	<b>AR550U</b> ..008 937	<b>AR400U</b> ..008 932				<b>552S</b> ..118 427	<b>550US</b> ..004 591		<b>550U</b> ..004 585	<b>400U</b> ..004 579	① <b>H380/380U</b> ..004 756
<b>Impreza Sedan [GC, GF]</b>	01.93-09.00	①	<b>AR531S</b> ..118 901	<b>AR530U</b> ..008 936	<b>AR450U</b> ..008 933				<b>531S</b> ..118 403	<b>530US</b> ..011 352	<b>531</b> ..118 402	<b>530U</b> ..004 584	<b>450U</b> ..004 581	
[GD, GG]	10.00-06.07	①	<b>AR552S</b> ..118 984	<b>AR550U</b> ..008 937	<b>AR400U</b> ..008 932				<b>552S</b> ..118 427	<b>550US</b> ..004 591		<b>550U</b> ..004 585	<b>400U</b> ..004 579	
[G12]	06.07-12.11	①	<b>AR601S</b> ..118 907	<b>AR600U</b> ..008 938	<b>AR400U</b> ..008 932				<b>601S</b> ..010 297	<b>600US</b> ..004 592		<b>600U</b> ..004 586	<b>400U</b> ..004 579	
[G13]	10.11→	①	<b>AR653S</b> ..118 911	<b>AR650U</b> ..008 939	<b>AR400U</b> ..008 932						<b>653</b> ..118 324	<b>650U</b> ..004 587	<b>400U</b> ..004 579	
<b>Impreza Sports Wagon</b>	11.92-07.00	①	<b>AR531S</b> ..118 901	<b>AR530U</b> ..008 936	<b>AR450U</b> ..008 933				<b>531S</b> ..118 403	<b>530US</b> ..011 352	<b>531</b> ..118 402	<b>530U</b> ..004 584	<b>450U</b> ..004 581	① <b>H380/380U</b> ..004 756
<b>Justy [KA, KD]</b>	05.87-10.95	①	<b>AR450S</b> ..118 994	<b>AR450U</b> ..008 933	<b>AR450U</b> ..008 933				<b>450S</b> ..118 506	<b>450US</b> ..004 588	<b>450</b> ..118 505	<b>450U</b> ..004 581	<b>450U</b> ..004 581	① <b>H400/400U</b> ..004 757
[MA]	10.95-09.96	①	<b>AR531S</b> ..118 901	<b>AR530U</b> ..008 936	<b>AR450U</b> ..008 933				<b>531S</b> ..118 403	<b>530US</b> ..011 352	<b>531</b> ..118 402	<b>530U</b> ..004 584	<b>450U</b> ..004 581	
[MS]	10.96-08.03	①	<b>AR531S</b> ..118 901	<b>AR530U</b> ..008 936	<b>AR450U</b> ..008 933				<b>531S</b> ..118 403	<b>530US</b> ..011 352	<b>531</b> ..118 402	<b>530U</b> ..004 584	<b>450U</b> ..004 581	
[G3X]	09.03-08.07	①	<b>AR566S</b> ..118 990	<b>AR480U</b> ..008 934	<b>AR400U</b> ..008 932				<b>481S</b> ..118 543		<b>481</b> ..118 542	<b>480U</b> ..004 582	<b>450U</b> ..004 581	① <b>H280</b> ..018 802
[M3]	09.07-12.10	①		<b>AR500U</b> ..008 935	<b>AR400U</b> ..008 932						<b>361</b> ..001 361	<b>500U</b> ..004 583	<b>400U</b> ..004 579	
<b>Legacy [BC/BF/BJ]</b>	01.89-08.95	①	<b>AR502S</b> ..118 995	<b>AR500U</b> ..008 935	<b>AR450U</b> ..008 933				<b>502S</b> ..118 564	<b>500US</b> ..004 590	<b>502</b> ..118 563	<b>500U</b> ..004 583	<b>450U</b> ..004 581	① <b>H380/380U</b> ..004 756
[BL/BP]	07.03-05.09	①	<b>AR604S</b> ..118 908	<b>AR600U</b> ..008 938	<b>AR450U</b> ..008 933				<b>604S</b> ..118 303	<b>600US</b> ..004 592		<b>600U</b> ..004 586	<b>450U</b> ..004 581	
[B14]	06.09→	KUR ①	<b>AR813S</b> ..118 912	<b>AR650U</b> ..008 939	<b>AR480U</b> ..008 934									
<b>Legacy Kombi [BD/BG]</b>	01.94-08.98	①	<b>AR533S</b> ..118 902	<b>AR530U</b> ..008 936	<b>AR480U</b> ..008 934				<b>533S</b> ..118 406	<b>530US</b> ..011 352	<b>533</b> ..118 405	<b>530U</b> ..004 584	<b>480U</b> ..004 582	① <b>H380/380U</b> ..004 756



A = Aerotwin | AM = Aerotwin Multi-Clip | AP = Aerotwin Plus | AR = Aerotwin Retrofit | S = Spoiler | U = Single Pack





◀ SUBARU

3 397...

Model	Year Range	Code	AR551S	AR550U	AR500U	551S	550US	551	550U	500U	Code	
Legacy Kombi	[BE/BH]	10.98-06.03	①	..118 905	..008 937	..008 935	..118 423	..004 591	..118 422	..004 585	..004 583	① H380/380U ..004 756
	[BL/BP]	07.03-05.09	①	..118 908	..008 938	..008 933	..118 303	..004 592		..004 586	..004 581	H354 ..011 433
	[B14]	06.09→	KUR ①	..118 912	..008 939	..008 934						H354 ..011 433
Legacy Outback	[BD/BG]	06.96-12.99	①	..118 902	..008 936	..008 934	..118 406	..011 352	..118 405	..004 584	..004 582	① H380/380U ..004 756
	[BE/BH]	10.98-06.03	①	..118 905	..008 937	..008 935	..118 423	..004 591	..118 422	..004 585	..004 583	① H380/380U ..004 756
	[BL/BP]	07.03-05.09	①	..118 908	..008 938	..008 933	..118 303	..004 592		..004 586	..004 581	H354 ..011 433
Legacy Sedan	[BD/BG]	01.94-11.98	①	..118 902	..008 936	..008 934	..118 406	..011 352	..118 405	..004 584	..004 582	
	[BE/BH]	10.98-06.03	①	..118 905	..008 937	..008 935	..118 423	..004 591	..118 422	..004 585	..004 583	
Outback [B14]	06.09→	KUR ①	..118 912	..008 939	..008 934							H354 ..011 433
SVX	09.92-12.96								① 551	550U	500U	
Trezia	11.10→	①		AR707U ..006 803						707U		H309 ..011 630
Tribeca [B9]	04.06→	①		AR65N ..008 844	AR50N ..008 841					N65	500U	
Vivio [R13]	08.93-04.00	①		AR480U ..008 934	AR380U ..008 931					480U	380U	H341 ..004 755
XV [G33]	09.11→	①	AR653S ..118 911	AR650U ..008 939	AR400U ..008 932				653	650U	400U	H306 ..011 432

SUZUKI

Alto [EC]	01.86-11.93									420	420U	420U	① H341 ..004 755
[MA]	02.02-12.06	①		AR450U ..008 933	AR400U ..008 932					472	450U	400U	① H340/340U ..004 754
Alto Hatchback	[EF]	10.94-02.02	①	AR566S ..118 990	AR480U ..008 934	AR400U ..008 932	481S ..118 543			481	480U	450U	① H341 ..004 755
	[AMF]	12.08→	①	AR553S ..007 589	AR550U ..008 937	AR340U ..008 930				553	550U	340U	
Baleno Hatchback	04.95-09.05	①	AR502S ..118 995	AR500U ..008 935	AR450U ..008 933	502S ..118 564	500US ..004 590	502	500U	450U	450U	① H380/380U ..004 756	
Baleno Sedan	04.95-09.05	①	AR502S ..118 995	AR500U ..008 935	AR450U ..008 933	502S ..118 564	500US ..004 590	502	500U	450U	450U		
Baleno Wagon	08.96-09.07	①	AR502S ..118 995	AR500U ..008 935	AR450U ..008 933	502S ..118 564	500US ..004 590	502	500U	450U	450U	① H340/340U ..004 754	
Carry [ED]		10.85-03.99								420	420U	420U	
		10.94-03.99								340	340U	340U	
	[FD]	03.99-03.09	①		AR400U ..008 932	AR400U ..008 932				400	400U	400U	
Escudo	05.05→	①	AR480S ..118 900	AR480U ..008 934	AR480U ..008 934	480S ..118 541		480	480U	480U	480U	KWB H307 ..011 429	
Grand Vitara		03.98-09.05	①	AR480S ..118 900	AR480U ..008 934	AR480U ..008 934	480S ..118 541		480	480U	480U	① H380/380U ..004 756	
	[JT]	10.05→	①	AR480S ..118 900	AR480U ..008 934	AR480U ..008 934	480S ..118 541		480	480U	480U	KWB H307 ..011 429	



A = Aerotwin | AM = Aerotwin Multi-Clip | AP = Aerotwin Plus | AR = Aerotwin Retrofit | S = Spoiler | U = Single Pack

			AEROTWIN			NEW! AEROTWIN			TWIN SPOILER			TWIN			REAR	
			SET	↳	↳	?	↳	↳	?	SET	↳	SET	↳	↳	?	↳
3 397...																
Grand Vitara Cabrio	03.98-03.08	①	AR480S ..118 900	AR480U ..008 934	AR480U ..008 934					480S ..118 541		480 ..118 540	480U ..004 582	480U ..004 582		
Ignis Hatchback	10.00-12.07	①	AR450S ..118 994	AR450U ..008 933	AR450U ..008 933					481S ..118 543		481 ..118 542	480U ..004 582	450U ..004 581	①	H280 ..018 802
Jimny [FJ]	10.98→	①		AR450U ..008 933	AR400U ..008 932							472 ..001 472	450U ..004 581	400U ..004 579	①	H280 ..018 802
Kizashi	06.10→	①	AR606S ..118 910	AR600U ..008 938	AR500U ..008 935					607S ..118 306	600US ..004 592		600U ..004 586	480U ..004 582		
Liana Hatchback	03.01-04.08	①	AR728S ..118 904	AR550U ..008 937	AR480U ..008 934					728S ..001 728	550US ..004 591	727 ..001 727	550U ..004 585	480U ..004 582	①	H341 ..004 755
Liana Sedan	04.02-12.07	①	AR728S ..118 904	AR550U ..008 937	AR480U ..008 934					728S ..001 728	550US ..004 591	727 ..001 727	550U ..004 585	480U ..004 582		
Samurai	03.87-12.04								ADG			280 ..118 801			①	H340/340U ..004 754
Splash [EX]	01.08→	①	AR552S ..118 984	AR550U ..008 937	AR400U ..008 932					552S ..118 427	550US ..004 591		550U ..004 585	400U ..004 579		H250 ..011 629
Swift [MA]	03.96-12.04	①	AR531S ..118 901	AR530U ..008 936	AR450U ..008 933					531S ..118 403	530US ..011 352	531 ..118 402	530U ..004 584	450U ..004 581		
[Z]	11.04→	①	AR531S ..118 901	AR530U ..008 936	AR450U ..008 933					531S ..118 403	530US ..011 352	531 ..118 402	530U ..004 584	450U ..004 581		
Swift Hatchback [EA]	01.89-09.95								①			502 ..118 563	500U ..004 583	450U ..004 581	①	H380/380U ..004 756
[MA]	03.96-12.04	①	AR531S ..118 901	AR530U ..008 936	AR450U ..008 933					531S ..118 403	530US ..011 352	531 ..118 402	530U ..004 584	450U ..004 581	①	H380/380U ..004 756
[MZ/EZ]	11.04→	①	AR531S ..118 901	AR530U ..008 936	AR450U ..008 933					531S ..118 403	530US ..011 352	531 ..118 402	530U ..004 584	450U ..004 581		H250 ..011 629
[AZH, AZG]	09.10→	①	AR531S ..118 901	AR530U ..008 936	AR450U ..008 933					531S ..118 403	530US ..011 352	531 ..118 402	530U ..004 584	450U ..004 581		H250 ..011 629
Swift Sedan [EA]	01.90-09.95	①	AR502S ..118 995	AR500U ..008 935	AR450U ..008 933							502 ..118 563	500U ..004 583	450U ..004 581		
SX4	07.06→	①	AR654S ..007 570	AR650U ..008 939	AR340U ..008 930							654 ..010 299	650U ..004 587	340U ..004 578		
SX4 Hatchback	05.06→	①	AR654S ..007 570	AR650U ..008 939	AR340U ..008 930							654 ..010 299	650U ..004 587	340U ..004 578		H250 ..011 629
SX4 Sedan	07.07→	①	AR654S ..007 570	AR650U ..008 939	AR340U ..008 930							654 ..010 299	650U ..004 587	340U ..004 578		
Vitara	09.95-03.04								①			420 ..118 500	420U ..011 354	420U ..011 354		
[ET]	03.88-03.98														①	H380/380U ..004 756
	01.95-03.98	①	AR450S ..118 994	AR450U ..008 933	AR450U ..008 933					450S ..118 506	450US ..004 588	450 ..118 505	450U ..004 581	450U ..004 581		
Vitara Cabrio [ET]	01.95-03.98	①	AR450S ..118 994	AR450U ..008 933	AR450U ..008 933					450S ..118 506	450US ..004 588	450 ..118 505	450U ..004 581	450U ..004 581		
Wagon R+ [EM]	10.96-05.00	①	AR502S ..118 995	AR500U ..008 935	AR450U ..008 933							502 ..118 563	500U ..004 583	450U ..004 581	①	H280 ..018 802
[MM]	05.00→	①	AR502S ..118 995	AR500U ..008 935	AR450U ..008 933					502S ..118 564	500US ..004 590	502 ..118 563	500U ..004 583	450U ..004 581	①	H341 ..004 755
X-90	09.95→								①			502 ..118 563	500U ..004 583	450U ..004 581		
<b>TATA</b>																
Indica (Vista) [X1]	08.08→	KUR ①	AR605S ..007 504	AR600U ..008 938	AR380U ..008 931							605 ..010 270	600U ..004 586	380U ..011 353		
Indica [T4]	11.06→	①	AR601S ..118 907	AR600U ..008 938	AR400U ..008 932					601S ..010 297	600US ..004 592	601 ..118 304	600U ..004 586	400U ..004 579		



A = Aerotwin | AM = Aerotwin Multi-Clip | AP = Aerotwin Plus | AR = Aerotwin Retrofit | S = Spoiler | U = Single Pack





3 397...

**THINK NORDIC**

<b>THINK City</b>	10.07→	①		<b>AR530U</b> ..008936							<b>530U</b> ..004584		
-------------------	--------	---	--	---------------------------	--	--	--	--	--	--	-------------------------	--	--

**TOFAS**

<b>Dogan [131]</b>	03.81-06.02										<b>400</b> ..118610	<b>400U</b> ..004579	<b>400U</b> ..004579	
<b>Kartal [131]</b>	03.81-06.03										<b>400</b> ..118610	<b>400U</b> ..004579	<b>400U</b> ..004579	
<b>Sahin [131]</b>	02.82→										<b>400</b> ..118610	<b>400U</b> ..004579	<b>400U</b> ..004579	

**TOYOTA**

<b>Alphard</b>	05.08→	KUR ①		<b>AR707U</b> ..006803	<b>AR340U</b> ..008930				KUR			<b>700U</b> ..004489	<b>340U</b> ..004578	
<b>Auris [E15, JTN]</b>	10.06-08.12	①	<b>AR653S</b> ..118911	<b>AR650U</b> ..008939	<b>AR400U</b> ..008932				<b>653S</b> ..118325	<b>650US</b> ..004593	<b>653</b> ..118324	<b>650U</b> ..004587	<b>400U</b> ..004579	<b>H309</b> ..011630
<b>GB</b> [E15,NMT,SB1]	02.07-10.12	①	<b>AR653S</b> ..118911	<b>AR650U</b> ..008939	<b>AR400U</b> ..008932				<b>653S</b> ..118325	<b>650US</b> ..004593	<b>653</b> ..118324	<b>650U</b> ..004587	<b>400U</b> ..004579	<b>H309</b> ..011630
[E18]	10.12→	①	<b>AR654S</b> ..007570	<b>AR650U</b> ..008939	<b>AR340U</b> ..008930						<b>654</b> ..010299	<b>650U</b> ..004587	<b>340U</b> ..004578	
<b>Auris Touring Sports [E18]</b>	07.13→	①	<b>AR654S</b> ..007570	<b>AR650U</b> ..008939	<b>AR340U</b> ..008930						<b>654</b> ..010299	<b>650U</b> ..004587	<b>340U</b> ..004578	
<b>Avalon</b>	09.99-08.04	①	<b>AR601S</b> ..118907	<b>AR600U</b> ..008938	<b>AR400U</b> ..008932				<b>601S</b> ..010297	<b>600US</b> ..004592	<b>601</b> ..118304	<b>600U</b> ..004586	<b>400U</b> ..004579	
<b>Avensis [T22]</b>	10.97-01.03	①	<b>AR531S</b> ..118901	<b>AR530U</b> ..008936	<b>AR450U</b> ..008933				<b>531S</b> ..118403	<b>530US</b> ..011352	<b>531</b> ..118402	<b>530U</b> ..004584	<b>450U</b> ..004581	
[T25]	01.03-11.08	①	<b>AR601S</b> ..118907	<b>AR600U</b> ..008938	<b>AR400U</b> ..008932				<b>601S</b> ..010297	<b>600US</b> ..004592		<b>600U</b> ..004586	<b>400U</b> ..004579	
[T27]	11.08→	③	<b>A538S</b> ..007538											
<b>Avensis Liftback [T22]</b>	10.97-01.03	①	<b>AR531S</b> ..118901	<b>AR530U</b> ..008936	<b>AR450U</b> ..008933				<b>531S</b> ..118403	<b>530US</b> ..011352	<b>531</b> ..118402	<b>530U</b> ..004584	<b>450U</b> ..004581	① <b>H500/500U</b> ..004760
[T25]	01.03-11.08	①	<b>AR601S</b> ..118907	<b>AR600U</b> ..008938	<b>AR400U</b> ..008932				<b>601S</b> ..010297	<b>600US</b> ..004592		<b>600U</b> ..004586	<b>400U</b> ..004579	① <b>H400/400U</b> ..004757
	04.05-11.08													KWB <b>H409</b> ..011431
<b>Avensis Verso [M2]</b>	05.01→	①	<b>AR653S</b> ..118911	<b>AR650U</b> ..008939	<b>AR400U</b> ..008932				<b>653S</b> ..118325	<b>650US</b> ..004593	<b>653</b> ..118324	<b>650U</b> ..004587	<b>400U</b> ..004579	
<b>Avensis Wagon [T22]</b>	10.97-01.03	①	<b>AR531S</b> ..118901	<b>AR530U</b> ..008936	<b>AR450U</b> ..008933				<b>531S</b> ..118403	<b>530US</b> ..011352	<b>531</b> ..118402	<b>530U</b> ..004584	<b>450U</b> ..004581	① <b>H341</b> ..004755
[T25]	01.03-11.08	①	<b>AR601S</b> ..118907	<b>AR600U</b> ..008938	<b>AR400U</b> ..008932				<b>601S</b> ..010297	<b>600US</b> ..004592		<b>600U</b> ..004586	<b>400U</b> ..004579	<b>H309</b> ..011630
[T27]	11.08→	③	<b>A538S</b> ..007538											<b>H309</b> ..011630
<b>Aygo</b>	02.05→	①	<b>AR650S</b> ..018913	<b>AR650U</b> ..008939								<b>651U</b> ..011641		<b>H300</b> ..004628
<b>Camry [V1]</b>	06.91-08.96	①	<b>AR531S</b> ..118901	<b>AR530U</b> ..008936	<b>AR450U</b> ..008933				<b>533S</b> ..118406	<b>530US</b> ..011352	<b>533</b> ..118405	<b>530U</b> ..004584	<b>480U</b> ..004582	
[V2]	06.96-09.01	①	<b>AR531S</b> ..118901	<b>AR530U</b> ..008936	<b>AR450U</b> ..008933				<b>533S</b> ..118406	<b>530US</b> ..011352	<b>533</b> ..118405	<b>530U</b> ..004584	<b>480U</b> ..004582	



A = Aerotwin | AM = Aerotwin Multi-Clip | AP = Aerotwin Plus | AR = Aerotwin Retrofit | S = Spoiler | U = Single Pack





3 397...

<b>Camry [V3]</b>	08.99-01.06	①	<b>AR551S</b> ..118 905	<b>AR550U</b> ..008 937	<b>AR500U</b> ..008 935												
	08.01-01.06	L65 ①	<b>AR813S</b> ..118 912	<b>AR650U</b> ..008 939	<b>AR450U</b> ..008 933												
[V4]	01.06→	①	<b>AR606S</b> ..118 910	<b>AR600U</b> ..008 938	<b>AR500U</b> ..008 935												
[V5]	08.11→	①	<b>AR813S</b> ..118 912	<b>AR650U</b> ..008 939	<b>AR450U</b> ..008 933						<b>650U</b> ..004 587	<b>450U</b> ..004 581					
<b>Camry Wagon [V1]</b>	03.92-07.96	①	<b>AR531S</b> ..118 901	<b>AR530U</b> ..008 936	<b>AR450U</b> ..008 933			<b>533S</b> ..118 406	<b>530US</b> ..011 352	<b>533</b> ..118 405	<b>530U</b> ..004 584	<b>480U</b> ..004 582	<b>ZE</b> ①	<b>H341</b> ..004 755			
<b>Carina E Liftback [T19]</b>	02.92-10.97	①	<b>AR531S</b> ..118 901	<b>AR530U</b> ..008 936	<b>AR450U</b> ..008 933			<b>531S</b> ..118 403	<b>530US</b> ..011 352	<b>531</b> ..118 402	<b>530U</b> ..004 584	<b>450U</b> ..004 581	①	<b>H500/500U</b> ..004 760			
<b>Carina E Sedan [T19]</b>	02.92-10.97	①	<b>AR531S</b> ..118 901	<b>AR530U</b> ..008 936	<b>AR450U</b> ..008 933			<b>531S</b> ..118 403	<b>530US</b> ..011 352	<b>531</b> ..118 402	<b>530U</b> ..004 584	<b>450U</b> ..004 581					
<b>Carina E Wagon [T19]</b>	11.92-10.97	①	<b>AR531S</b> ..118 901	<b>AR530U</b> ..008 936	<b>AR450U</b> ..008 933			<b>531S</b> ..118 403	<b>530US</b> ..011 352	<b>531</b> ..118 402	<b>530U</b> ..004 584	<b>450U</b> ..004 581					
<b>Celica Cabrio [T20]</b>	08.94-05.99	①	<b>AR533S</b> ..118 902	<b>AR530U</b> ..008 936	<b>AR480U</b> ..008 934			<b>533S</b> ..118 406	<b>530US</b> ..011 352	<b>533</b> ..118 405	<b>530U</b> ..004 584	<b>480U</b> ..004 582					
<b>Celica Coupé [T23]</b>	08.99-09.05	①	<b>AR653S</b> ..118 911	<b>AR650U</b> ..008 939	<b>AR400U</b> ..008 932			<b>653S</b> ..118 325	<b>650US</b> ..004 593	<b>653</b> ..118 324	<b>650U</b> ..004 587	<b>400U</b> ..004 579	①	<b>H500/500U</b> ..004 760			
<b>Celica Liftback [T18]</b>	10.89-10.93							<b>502S</b> ..118 564	<b>500US</b> ..004 590	<b>502</b> ..118 563	<b>500U</b> ..004 583	<b>450U</b> ..004 581					
[T20]	11.93-08.99	①	<b>AR533S</b> ..118 902	<b>AR530U</b> ..008 936	<b>AR480U</b> ..008 934			<b>533S</b> ..118 406	<b>530US</b> ..011 352	<b>533</b> ..118 405	<b>530U</b> ..004 584	<b>480U</b> ..004 582					
	11.93-08.95												①	<b>H500/500U</b> ..004 760			
<b>Conquest [Carri]</b>	11.98→	①	<b>AR450S</b> ..118 994	<b>AR450U</b> ..008 933	<b>AR450U</b> ..008 933			<b>450S</b> ..118 506	<b>450US</b> ..004 588	<b>450</b> ..118 505	<b>450U</b> ..004 581	<b>450U</b> ..004 581					
<b>Corolla [E10; E11]</b>	05.92-09.01	①	<b>AR502S</b> ..118 995	<b>AR500U</b> ..008 935	<b>AR450U</b> ..008 933			<b>502S</b> ..118 564	<b>500US</b> ..004 590	<b>502</b> ..118 563	<b>500U</b> ..004 583	<b>450U</b> ..004 581	①	<b>H400/400U</b> ..004 757			
[E12]	08.00-12.07	①	<b>AR728S</b> ..118 904	<b>AR550U</b> ..008 937	<b>AR480U</b> ..008 934			<b>728S</b> ..001 728	<b>550US</b> ..004 591	<b>727</b> ..001 727	<b>550U</b> ..004 585	<b>480U</b> ..004 582					
	10.02-07.07	L60 ①	<b>AR601S</b> ..118 907	<b>AR600U</b> ..008 938	<b>AR400U</b> ..008 932		L60	<b>601S</b> ..010 297	<b>600US</b> ..004 592	<b>601</b> ..118 304	<b>600U</b> ..004 586	<b>400U</b> ..004 579	TU5	<b>H354</b> ..011 433			
[E15]	11.06→	①	<b>AR654S</b> ..007 570	<b>AR650U</b> ..008 939	<b>AR340U</b> ..008 930					<b>654</b> ..010 299	<b>650U</b> ..004 587	<b>340U</b> ..004 578					
<b>Corolla Hatchback [E10]</b>	05.92-04.97	①	<b>AR502S</b> ..118 995	<b>AR500U</b> ..008 935	<b>AR450U</b> ..008 933			<b>502S</b> ..118 564	<b>500US</b> ..004 590	<b>502</b> ..118 563	<b>500U</b> ..004 583	<b>450U</b> ..004 581	①	<b>H450/450U</b> ..004 763			
[E11]	05.97-07.01	①	<b>AR502S</b> ..118 995	<b>AR500U</b> ..008 935	<b>AR450U</b> ..008 933			<b>502S</b> ..118 564	<b>500US</b> ..004 590	<b>502</b> ..118 563	<b>500U</b> ..004 583	<b>450U</b> ..004 581					
[E12]	11.01-12.07	①	<b>AR728S</b> ..118 904	<b>AR550U</b> ..008 937	<b>AR480U</b> ..008 934			<b>728S</b> ..001 728	<b>550US</b> ..004 591	<b>727</b> ..001 727	<b>550U</b> ..004 585	<b>480U</b> ..004 582		<b>H352</b> ..011 430			
	11.01-11.06	L60 ①	<b>AR601S</b> ..118 907	<b>AR600U</b> ..008 938	<b>AR400U</b> ..008 932		L60	<b>601S</b> ..010 297	<b>600US</b> ..004 592	<b>601</b> ..118 304	<b>600U</b> ..004 586	<b>400U</b> ..004 579		<b>H352</b> ..011 430			
<b>Corolla Liftback [E10]</b>	05.92-05.95	①	<b>AR502S</b> ..118 995	<b>AR500U</b> ..008 935	<b>AR450U</b> ..008 933			<b>502S</b> ..118 564	<b>500US</b> ..004 590	<b>502</b> ..118 563	<b>500U</b> ..004 583	<b>450U</b> ..004 581	①	<b>H400/400U</b> ..004 757			
[E11]	05.97-11.01	①	<b>AR502S</b> ..118 995	<b>AR500U</b> ..008 935	<b>AR450U</b> ..008 933			<b>502S</b> ..118 564	<b>500US</b> ..004 590	<b>502</b> ..118 563	<b>500U</b> ..004 583	<b>450U</b> ..004 581	TU5	<b>H500/500U</b> ..004 760			
	05.97-11.01	①	<b>AR502S</b> ..118 995	<b>AR500U</b> ..008 935	<b>AR450U</b> ..008 933			<b>502S</b> ..118 564	<b>500US</b> ..004 590	<b>502</b> ..118 563	<b>500U</b> ..004 583	<b>450U</b> ..004 581	L40 ①	<b>H400/400U</b> ..004 757			
<b>Corolla Sedan [E10]</b>	05.92-04.97	①	<b>AR502S</b> ..118 995	<b>AR500U</b> ..008 935	<b>AR450U</b> ..008 933			<b>502S</b> ..118 564	<b>500US</b> ..004 590	<b>502</b> ..118 563	<b>500U</b> ..004 583	<b>450U</b> ..004 581					
[E11]	04.97-09.01	①	<b>AR502S</b> ..118 995	<b>AR500U</b> ..008 935	<b>AR450U</b> ..008 933			<b>502S</b> ..118 564	<b>500US</b> ..004 590	<b>502</b> ..118 563	<b>500U</b> ..004 583	<b>450U</b> ..004 581					
<b>Corolla Verso [E12]</b>	09.01-01.04	①	<b>AR653S</b> ..118 911	<b>AR650U</b> ..008 939	<b>AR400U</b> ..008 932			<b>653S</b> ..118 325	<b>650US</b> ..004 593	<b>653</b> ..118 324	<b>650U</b> ..004 587	<b>400U</b> ..004 579		<b>H352</b> ..011 430			



A = Aerotwin | AM = Aerotwin Multi-Clip | AP = Aerotwin Plus | AR = Aerotwin Retrofit | S = Spoiler | U = Single Pack





◀ TOYOTA

3 397...

			SET						SET		SET				
<b>Corolla Verso</b> [R2; R10/11]	02.04→	①	AR653S ..118 911	AR650U ..008 939	AR400U ..008 932				653S ..118 325	650US ..004 593	653 ..118 324	650U ..004 587	400U ..004 579		
<b>Corolla Wagon</b> [E10]	05.92-04.97	①	AR502S ..118 995	AR500U ..008 935	AR450U ..008 933				502S ..118 564	500US ..004 590	502 ..118 563	500U ..004 583	450U ..004 581	①	H400/400U ..004 757
[E11]	04.97-09.01	①	AR502S ..118 995	AR500U ..008 935	AR450U ..008 933				502S ..118 564	500US ..004 590	502 ..118 563	500U ..004 583	450U ..004 581	①	H341 ..004 755
[E12]	08.00-12.07	①	AR601S ..118 907	AR600U ..008 938	AR400U ..008 932				601S ..010 297	600US ..004 592	601 ..118 304	600U ..004 586	400U ..004 579		H352 ..011 430
<b>Cressida Sedan</b> [X8]	08.88-08.96							①	400S ..118 611		400 ..118 610	400U ..004 579	400U ..004 579		
<b>Dyna</b>	01.97-04.03							①			420 ..118 500	420U ..011 354	420U ..011 354		
	10.00→	①	AR500S ..009 081	AR500U ..008 935	AR500U ..008 935				500S ..118 561	500US ..004 590	500 ..118 560	500U ..004 583	500U ..004 583		
<b>Echo</b>	09.99→	①	AR534S ..007 503	AR530U ..008 936	AR380U ..008 931						534 ..010 271	530U ..004 584	380U ..011 353		
<b>GT68</b>	04.12→	①	AR551S ..118 905	AR550U ..008 937	AR500U ..008 935				551S ..118 423	550US ..004 591	551 ..118 422	550U ..004 585	500U ..004 583		
<b>Harrier</b>	12.97-02.03							①			608 ..118 307	600U ..004 586	550U ..004 585		
	10.03→	①	AR655S ..007 584	AR650U ..008 939	AR550U ..008 937						655 ..010 302	650U ..004 587	550U ..004 585		
<b>Hiace [LXH, RCH]</b>	08.95-08.96							①	502S ..118 564	500US ..004 590	502 ..118 563	500U ..004 583	450U ..004 581	①	H450/450U ..004 763
	08.96-11.09	①	AR530S ..118 903	AR530U ..008 936	AR530U ..008 936				530S ..118 401	530US ..011 352	530 ..118 400	530U ..004 584	530U ..004 584	①	H450/450U ..004 763
[KLH]	08.01→	①	AR530S ..118 903	AR530U ..008 936	AR530U ..008 936						530 ..118 400	530U ..004 584	530U ..004 584	MUT ①	H450/450U ..004 763
														MGT ①	H400/400U ..004 757
<b>Hiace Van [LH, ZH]</b>	08.89-08.96							①	502S ..118 564	500US ..004 590	502 ..118 563	500U ..004 583	450U ..004 581		
[LH, LXH, ZH]	08.96-02.06	①	AR530S ..118 903	AR530U ..008 936	AR530U ..008 936				530S ..118 401	500US ..004 590	530 ..118 400	530U ..004 584	530U ..004 584		
<b>Hiace Wagon</b> [LH, ZH]	08.89-08.96							①	502S ..118 564	500US ..004 590	502 ..118 563	500U ..004 583	450U ..004 581		
	08.96-02.06	①	AR530S ..118 903	AR530U ..008 936	AR530U ..008 936				530S ..118 401	500US ..004 590	530 ..118 400	530U ..004 584	530U ..004 584		
<b>Highlander</b>	09.00-08.07	①	AR728S ..118 904	AR550U ..008 937	AR480U ..008 934				728S ..001 728	550US ..004 591	727 ..001 727	550U ..004 585	480U ..004 582		
	09.07→	①	AR701S ..007 706	AR650U ..008 939	AR500U ..008 935						701 ..118 202	650U ..004 587	500U ..004 583		
<b>Hilux [N5/N6]</b>	08.84-07.98							①			420 ..118 500	420U ..011 354	420U ..011 354		
[N16/N17]	08.97→							①			420 ..118 500	420U ..011 354	420U ..011 354		
[Raider]	05.05→	①	AR533S ..118 902	AR530U ..008 936	AR480U ..008 934				533S ..118 406	530US ..011 352	533 ..118 405	530U ..004 584	480U ..004 582		
[N15; N25; N26; N35]	07.05→	①	AR533S ..118 902	AR530U ..008 936	AR480U ..008 934				533S ..118 406	530US ..011 352	533 ..118 405	530U ..004 584	480U ..004 582		
<b>Hilux Pickup</b> [N8; N8...13; N14...19]	08.88-08.05							①			420 ..118 500	420U ..011 354	420U ..011 354		
<b>iQ</b>	11.08→	①	AR531S ..118 901	AR530U ..008 936	AR450U ..008 933				531S ..118 403	530US ..011 352	531 ..118 402	530U ..004 584	450U ..004 581		
<b>Land Cruiser [J7]</b>	11.84-08.01							①			420 ..118 500	420U ..011 354	420U ..011 354	①	H341 ..004 755



A = Aerotwin | AM = Aerotwin Multi-Clip | AP = Aerotwin Plus | AR = Aerotwin Retrofit | S = Spoiler | U = Single Pack



3 397...

			SET	↖	↙	NEW! AEROTWIN	↖	↙	TWIN SPOILER	SET	↖	TWIN	↖	↙	REAR	
<b>Land Cruiser [J8]</b>	01.90-01.98	①	AR450S ..118 994	AR450U ..008 933	AR450U ..008 933					450S ..118 506	450US ..004 588	450 ..118 505	450U ..004 581	450U ..004 581	ZE ①	H341 ..004 755
[J9]	04.96-12.06	KUR ①	AR566S ..118 990	AR480U ..008 934	AR450U ..008 933					481S ..118 543		481 ..118 542	480U ..004 582	450U ..004 581		
[J10]	01.98-08.07								①			420 ..118 500	420U ..011 354	420U ..011 354	MHK ①	H400/400U ..004 757
															MGT ①	H341 ..004 755
[J12]	09.02-08.09	①	AR550S ..118 906	AR550U ..008 937	AR530U ..008 936				KUR	530S ..118 401	550US ..004 591	530 ..118 400	550U ..004 585	530U ..004 584		
[J20]	09.07→	KUR ①	AR801S ..118 996	AR600U ..008 938	AR550U ..008 937							608 ..118 307	600U ..004 586	550U ..004 585		H309 ..011 630
[J15]	08.09→	①	AR701S ..007 706	AR650U ..008 939	AR500U ..008 935							701 ..118 202	650U ..004 587	500U ..004 583		H309 ..011 630
<b>Land Cruiser Prado</b>	10.96-09.04	KUR	AR566S ..118 990	AR480U ..008 934	AR450U ..008 933					481S ..118 543		481 ..118 542	480U ..004 582	450U ..004 581		
[J9]		①														
[J12]	01.03→	①	AR550S ..118 906	AR550U ..008 937	AR530U ..008 936					551S ..118 423	550US ..004 591	551 ..118 422	550U ..004 585	500U ..004 583	TOB ①	H450/450U ..004 763
[J15]	09.09→	①	AR701S ..007 706	AR650U ..008 939	AR500U ..008 935							701 ..118 202	650U ..004 587	500U ..004 583		H309 ..011 630
<b>MR2 Cabrio [W3]</b>	12.99-05.06	①	AR503S ..118 993	AR500U ..008 935	AR480U ..008 934					503S ..118 566	500US ..004 590	503 ..118 565	500U ..004 583	480U ..004 582		
<b>Paseo [L5]</b>	08.95-07.99	①	AR502S ..118 995	AR500U ..008 935	AR450U ..008 933					502S ..118 564	500US ..004 590	502 ..118 563	500U ..004 583	450U ..004 581		
<b>Picnic</b>	09.96-05.01	①	AR601S ..118 907	AR600U ..008 938	AR400U ..008 932					601S ..010 297	600US ..004 592	601 ..118 304	600U ..004 586	400U ..004 579	①	H380/380U ..004 756
<b>Previa</b>	05.90-12.99														①	H400/400U ..004 757
	02.00-01.06	①		AR70N ..008 845	AR45N ..008 840								N70 ..018 170	450U ..004 581		
<b>Prius [W11]</b>	09.00-08.03	①	AR601S ..118 907	AR600U ..008 938	AR400U ..008 932					601S ..010 297	600US ..004 592	601 ..118 304	600U ..004 586	400U ..004 579		
[W20]	09.03-03.09	①	AR653S ..118 911	AR650U ..008 939	AR400U ..008 932					653S ..118 325	650US ..004 593	653 ..118 324	650U ..004 587	400U ..004 579	①	H400/400U ..004 757
[W30,W35]	04.09→	①	AR653S ..118 911	AR650U ..008 939	AR400U ..008 932							653 ..118 324	650U ..004 587	400U ..004 579	①	H400/400U ..004 757
<b>Prius + [W40]</b>	03.12→	①		AR650U ..008 939	AR380U ..008 931								650U ..004 587	380U ..011 353		
<b>RAV4 [A1]</b>	04.94-08.00	①	AR502S ..118 995	AR500U ..008 935	AR450U ..008 933					502S ..118 564	500US ..004 590	502 ..118 563	500U ..004 583	450U ..004 581	①	H341 ..004 755
[A2]	05.00-01.06	①	AR607S ..118 909	AR600U ..008 938	AR480U ..008 934					607S ..118 306	600US ..004 592		600U ..004 586	480U ..004 582		H309 ..011 630
[A3]	11.05→	①	AR601S ..118 907	AR600U ..008 938	AR400U ..008 932					601S ..010 297	600US ..004 592		600U ..004 586	400U ..004 579		H309 ..011 630
[A4]	11.12→	①	AR653S ..118 911	AR650U ..008 939	AR400U ..008 932					653S ..118 325	650US ..004 593	653 ..118 324	650U ..004 587	400U ..004 579		
<b>RAV4 Cabrio [A1]</b>	11.95-08.00	①	AR502S ..118 995	AR500U ..008 935	AR450U ..008 933					502S ..118 564	500US ..004 590	502 ..118 563	500U ..004 583	450U ..004 581		
<b>Sequoia</b>	09.07→	①	AR480S ..118 900	AR480U ..008 934	AR480U ..008 934					480S ..118 541		480 ..118 540	480U ..004 582	480U ..004 582		
<b>Sienna</b>	09.06→	KUR ①	AR813S ..118 912	AR650U ..008 939	AR480U ..008 934				KUR			803 ..001 803	650U ..004 587	480U ..004 582		
<b>Solara</b>	09.98-08.03	①	AR550S ..118 906	AR550U ..008 937	AR530U ..008 936				KUR	551S ..118 423	550US ..004 591	551 ..118 422	550U ..004 585	530U ..004 584		
	09.03-08.08	①	AR607S ..118 909	AR600U ..008 938	AR480U ..008 934					607S ..118 306	600US ..004 592		600U ..004 586	480U ..004 582		



A = Aerotwin | AM = Aerotwin Multi-Clip | AP = Aerotwin Plus | AR = Aerotwin Retrofit | S = Spoiler | U = Single Pack





◀ TOYOTA

3 397...

Starlet [P8]	12.89-01.96								①	502S ..118 564	500US ..004 590	502 ..118 563	500U ..004 583	450U ..004 581	①	H420/420U ..004 758
[P9]	01.96-07.99	①	AR502S ..118 995	AR500U ..008 935	AR450U ..008 933					502S ..118 564	500US ..004 590	502 ..118 563	500U ..004 583	450U ..004 581	①	H405 ..004 764
Urban Cruiser [P1]	01.09→	①	AR605S ..007 504	AR600U ..008 938	AR340U ..008 930						600US ..004 592	605 ..010 270	600U ..004 586	340U ..004 578		
Venza	09.08→	①	AR655S ..007 584	AR650U ..008 939	AR550U ..008 937							655 ..010 302	650U ..004 587	550U ..004 585		
Verso [R2/R11]	02.09→	①	AR653S ..118 911	AR650U ..008 939	AR400U ..008 932					653S ..118 325	650US ..004 593	653 ..118 324	650U ..004 587	400U ..004 579		H309 ..011 630
Verso-S	11.10→	①		AR707U ..006 803									707U ..011 543			H309 ..011 630
Yaris [P1]	01.99-08.05	①	AR534S ..007 503	AR530U ..008 936	AR380U ..008 931							534 ..010 271	530U ..004 584	380U ..011 353		
FR	01.01-08.06	①	AR534S ..007 503	AR530U ..008 936	AR380U ..008 931							534 ..010 271	530U ..004 584	380U ..011 353		H300 ..004 628
[P9, JTD]	08.05→	①	AR605S ..007 504	AR600U ..008 938	AR340U ..008 930							605 ..010 270	600U ..004 586	340U ..004 578		H309 ..011 630
[P9, VNK]	11.05→	①	AR605S ..007 504	AR600U ..008 938	AR340U ..008 930							605 ..010 270	600U ..004 586	340U ..004 578		H304 ..004 990
[P13]	07.11→	①		AR707U ..006 803									707U ..011 543			H309 ..011 630
Yaris Verso [P2]	08.99-11.02	①	AR552S ..118 984	AR550U ..008 937	AR400U ..008 932					552S ..118 427	550US ..004 591		550U ..004 585	400U ..004 579		H405 ..004 764

VOLVO

C30	10.06→	③	A088S ..007 088	AM26U ..008 573	AM20U ..008 567	2AA	AP26U ..006 838	AP20U ..006 833								KWB	A401H ..008 047
			KUR ③ ..007 467														
	08.10→															SPA, APE	H380/380U ..004 756
C70 Coupé	01.97-07.02	①	AR530S ..118 903	AR530U ..008 936	AR530U ..008 936					530S ..118 401	530US ..011 352	530 ..118 400	530U ..004 584	530U ..004 584			
C70 I Cabrio	03.98-03.06	①	AR530S ..118 903	AR530U ..008 936	AR530U ..008 936					530S ..118 401	530US ..011 352	530 ..118 400	530U ..004 584	530U ..004 584			
C70 II Cabrio	03.06→	③	A309S ..007 309	AM26U ..008 573	AM19U ..008 566	2AA	AP26U ..006 838	AP19U ..006 832									
			WW ③ ..007 467														
S40 I	09.95-01.04	①	AR500S ..009 081	AR500U ..008 935	AR500U ..008 935					500S ..118 561	500US ..004 590	500 ..118 560	500U ..004 583	500U ..004 583			
S40 II [P 11]	12.03→		KUR ②,③ ..007 467	AM26U ..008 573	AM20U ..008 567												
	12.03-07.05	②	A953S ..118 953			AP1	AP26U ..006 838	AP20U ..006 833									
	08.05→	③	A088S ..007 088			2AA	AP26U ..006 838	AP20U ..006 833									
S60 I	11.00-07.04	①	AR801S ..118 996	AR600U ..008 938	AR530U ..008 936				BGR	611S ..010 300	600US ..004 592		600U ..004 586	530U ..004 584			
									BGO	801S ..001 802		801 ..001 801					
	08.04-07.09	⑥	A966S ..118 966	AM24U ..008 571	AM21U ..008 568	2BB	AP24U ..006 837	AP21U ..006 834									
S60 II	08.10→	③	A088S ..007 088	AM26U ..008 573	AM20U ..008 567	2AA	AP26U ..006 838	AP20U ..006 833									



A = Aerotwin | AM = Aerotwin Multi-Clip | AP = Aerotwin Plus | AR = Aerotwin Retrofit | S = Spoiler | U = Single Pack

			AEROTWIN			NEW!	AEROTWIN			TWIN SPOILER			TWIN			REAR	
			SET						SET			SET					
			3 397...														
S60 II	08.10→	KUR ③	AM467S ..007 467														
S70	01.97-07.00	①	AR530S ..118 903	AR530U ..008 936	AR530U ..008 936					530S ..118 401	530US ..011 352	530 ..118 400	530U ..004 584	530U ..004 584			
S80 I	05.98-07.04	①	AR801S ..118 996	AR600U ..008 938	AR530U ..008 936					BGR 611S ..010 300	600US ..004 592		600U ..004 586	530U ..004 584			
									BGO 801S ..001 802		801 ..001 801						
	08.04-07.06	⑥	A966S ..118 966	AM24U ..008 571	AM21U ..008 568	2BB	AP24U ..006 837	AP21U ..006 834									
S80 II	03.06→	③	A088S ..007 088	AM26U ..008 573	AM20U ..008 567	2AA	AP26U ..006 838	AP20U ..006 833									
	03.06→	KUR ③	AM467S ..007 467														
S90	01.97-05.98	①	AR530S ..118 903	AR530U ..008 936	AR530U ..008 936					530S ..118 401	530US ..011 352	530 ..118 400	530U ..004 584	530U ..004 584			
V40 I	01.95-06.04	①	AR500S ..009 081	AR500U ..008 935	AR500U ..008 935					500S ..118 561	500US ..004 590	500 ..118 560	500U ..004 583	500U ..004 583			
	01.95-04.00														①	H400/400U ..004 757	
	05.00-06.04															H407 ..011 401	
V40 II	08.12→	③	A309S ..007 309	AM26U ..008 573	AM19U ..008 566	2AA	AP26U ..006 838	AP19U ..006 832							APE	A281H ..008 045	
		WW ③	AM467S ..007 467														
V40 Cross Country	01.13→	③	A309S ..007 309	AM26U ..008 573	AM19U ..008 566	2AA	AP26U ..006 838	AP19U ..006 832							APE	A281H ..008 045	
		WW ③	AM467S ..007 467														
V50	04.04→	KUR ②,③	AM467S ..007 467	AM26U ..008 573	AM20U ..008 567											H874 ..004 874	
	04.04-07.05	②	A953S ..118 953			AP1	AP26U ..006 838	AP20U ..006 833									
	08.05-12.12	③	A088S ..007 088			2AA	AP26U ..006 838	AP20U ..006 833									
V60	11.10→	③	A088S ..007 088	AM26U ..008 573	AM20U ..008 567	2AA	AP26U ..006 838	AP20U ..006 833									
		KUR ③	AM467S ..007 467														H305 ..011 239
V70 I	01.97-03.00	①	AR530S ..118 903	AR530U ..008 936	AR530U ..008 936					530S ..118 401	530US ..011 352	530 ..118 400	530U ..004 584	530U ..004 584	①	H420/420U ..004 758	
V70 II	03.00-07.04	①	AR801S ..118 996	AR600U ..008 938	AR530U ..008 936					BGR 611S ..010 300	600US ..004 592		600U ..004 586	530U ..004 584			
								BGO 801S ..001 802		801 ..001 801							
	08.04-07.07	⑥	A966S ..118 966	AM24U ..008 571	AM21U ..008 568	2BB	AP24U ..006 837	AP21U ..006 834									
	03.00-07.03														①	H400/400U ..004 757	
	08.03-07.07														KWB	H370 ..011 022	
V70 III	08.07→	③	A088S ..007 088	AM26U ..008 573	AM20U ..008 567	2AA	AP26U ..006 838	AP20U ..006 833								A351H ..008 192	
		KUR ③	AM467S ..007 467														



A = Aerotwin | AM = Aerotwin Multi-Clip | AP = Aerotwin Plus | AR = Aerotwin Retrofit | S = Spoiler | U = Single Pack



◀ VOLVO

3 397...

<b>V90</b>	01.97-07.98	①	<b>AR530S</b> ..118 903	<b>AR530U</b> ..008 936	<b>AR530U</b> ..008 936					<b>530S</b> ..118 401	<b>530US</b> ..011 352	<b>530</b> ..118 400	<b>530U</b> ..004 584	<b>530U</b> ..004 584	
<b>XC60</b>	03.09→	③	<b>A088S</b> ..007 088	<b>AM26U</b> ..008 573	<b>AM20U</b> ..008 567	2AA	<b>AP26U</b> ..006 838	<b>AP20U</b> ..006 833							
		KUR	<b>AM467S</b> ..007 467												
	03.09-07.11														<b>A380H</b> ..008 050
	08.11→														KWB <b>H353</b> ..004 631
<b>XC70 I</b>	08.02-07.04	①	<b>AR801S</b> ..118 996	<b>AR600U</b> ..008 938	<b>AR530U</b> ..008 936				BGR	<b>611S</b> ..010 300	<b>600US</b> ..004 592		<b>600U</b> ..004 586	<b>530U</b> ..004 584	
									BGO	<b>801S</b> ..001 802		<b>801</b> ..001 801			
	08.04-07.07	⑥	<b>A966S</b> ..118 966	<b>AM24U</b> ..008 571	<b>AM21U</b> ..008 568	2BB	<b>AP24U</b> ..006 837	<b>AP21U</b> ..006 834							
	08.02-07.07														① <b>H400/400U</b> ..004 757
															KWB <b>H370</b> ..011 022
<b>XC70 II</b>	08.07→	③	<b>A088S</b> ..007 088	<b>AM26U</b> ..008 573	<b>AM20U</b> ..008 567	2AA	<b>AP26U</b> ..006 838	<b>AP20U</b> ..006 833							<b>A351H</b> ..008 192
		KUR	<b>AM467S</b> ..007 467												
<b>XC90</b>	10.02-07.04	KUR	<b>AR606S</b> ..118 910	<b>AR600U</b> ..008 938	<b>AR500U</b> ..008 935				BGO	<b>801S</b> ..001 802	<b>600US</b> ..004 592	<b>801</b> ..001 801	<b>600U</b> ..004 586	<b>500U</b> ..004 584	
	08.04→	⑥	<b>A966S</b> ..118 966	<b>AM24U</b> ..008 571	<b>AM21U</b> ..008 568	2BB	<b>AP24U</b> ..006 837	<b>AP21U</b> ..006 834							
	10.02-07.06														KWB <b>H370</b> ..011 022
	08.06-07.11														<b>A380H</b> ..008 050
	08.11→														KWB <b>H353</b> ..004 631
<b>440</b>	09.88-07.97	①	<b>AR530S</b> ..118 903	<b>AR530U</b> ..008 936	<b>AR530U</b> ..008 936					<b>530S</b> ..118 401	<b>530US</b> ..011 352	<b>530</b> ..118 400	<b>530U</b> ..004 584	<b>530U</b> ..004 584	① <b>H500/500U</b> ..004 760
<b>460</b>	03.90-07.97	①	<b>AR530S</b> ..118 903	<b>AR530U</b> ..008 936	<b>AR530U</b> ..008 936					<b>530S</b> ..118 401	<b>530US</b> ..011 352	<b>530</b> ..118 400	<b>530U</b> ..004 584	<b>530U</b> ..004 584	① <b>H500/500U</b> ..004 760
<b>480 [E 12]</b>	08.88-12.96	①	<b>AR530S</b> ..118 903	<b>AR530U</b> ..008 936	<b>AR530U</b> ..008 936					<b>530S</b> ..118 401	<b>530US</b> ..011 352	<b>530</b> ..118 400	<b>530U</b> ..004 584	<b>530U</b> ..004 584	
<b>740</b>	09.90-07.95	①	<b>AR500S</b> ..009 081	<b>AR500U</b> ..008 935	<b>AR500U</b> ..008 935					<b>500S</b> ..118 561	<b>500US</b> ..004 590	<b>500</b> ..118 560	<b>500U</b> ..004 583	<b>500U</b> ..004 583	① <b>H340/340U</b> ..004 754
<b>850</b>	09.91-07.97	①	<b>AR530S</b> ..118 903	<b>AR530U</b> ..008 936	<b>AR530U</b> ..008 936					<b>530S</b> ..118 401	<b>530US</b> ..011 352	<b>530</b> ..118 400	<b>530U</b> ..004 584	<b>530U</b> ..004 584	
<b>850 Kombi</b>	09.91-07.97	①	<b>AR530S</b> ..118 903	<b>AR530U</b> ..008 936	<b>AR530U</b> ..008 936					<b>530S</b> ..118 401	<b>530US</b> ..011 352	<b>530</b> ..118 400	<b>530U</b> ..004 584	<b>530U</b> ..004 584	① <b>H420/420U</b> ..004 758
<b>940</b>	09.90-10.98	①	<b>AR500S</b> ..009 081	<b>AR500U</b> ..008 935	<b>AR500U</b> ..008 935					<b>500S</b> ..118 561	<b>500US</b> ..004 590	<b>500</b> ..118 560	<b>500U</b> ..004 583	<b>500U</b> ..004 583	① <b>H340/340U</b> ..004 754
<b>960</b>	08.90-07.97	①	<b>AR530S</b> ..118 903	<b>AR530U</b> ..008 936	<b>AR530U</b> ..008 936					<b>530S</b> ..118 401	<b>530US</b> ..011 352	<b>530</b> ..118 400	<b>530U</b> ..004 584	<b>530U</b> ..004 584	KOB <b>H340/340U</b> ..004 754

**VW**

<b>Amarok [2H]</b>	09.10-04.12								①	<b>610S</b> ..010 280	<b>600US</b> ..004 592				
									KUR	<b>801S</b> ..001 802		<b>801</b> ..001 801			



A = Aerotwin | AM = Aerotwin Multi-Clip | AP = Aerotwin Plus | AR = Aerotwin Retrofit | S = Spoiler | U = Single Pack



3 397...

<b>Amarok</b> [2H]	05.12→	③	<b>A821S</b> ..009 821			AP4	<b>AP24U</b> ..006 837	<b>AP24U</b> ..006 837									
<b>Beetle</b> [5C1]	04.11→	③	<b>A798S</b> ..009 798			AP4	<b>AP21U</b> ..006 834	<b>AP21U</b> ..006 834									
<b>Beetle Cabriolet</b> [5C7]	01.13→	③	<b>A798S</b> ..009 798			AP4	<b>AP21U</b> ..006 834	<b>AP21U</b> ..006 834									
<b>Bora</b> [1J2]	09.98-05.02	①	<b>AR533S</b> ..118 902	<b>AR530U</b> ..008 936	<b>AR480U</b> ..008 934				BGR	<b>533S</b> ..118 406	<b>530US</b> ..011 352	<b>533</b> ..118 405	<b>530U</b> ..004 584	<b>480U</b> ..004 582			
									BGO	<b>584S</b> ..001 584							
	06.02-05.05	②	<b>A927S</b> ..118 927	<b>AM21U</b> ..008 568	<b>AM18U</b> ..008 565	AP1	<b>AP21U</b> ..006 834	<b>AP18U</b> ..006 831									
		WW	<b>AM460S</b> ..007 460														
<b>Bora Variant</b> [1J6]	09.89-05.02	①	<b>AR533S</b> ..118 902	<b>AR530U</b> ..008 936	<b>AR480U</b> ..008 934				BGR	<b>533S</b> ..118 406	<b>530US</b> ..011 352	<b>533</b> ..118 405	<b>530U</b> ..004 584	<b>480U</b> ..004 582	①	<b>H380/380U</b> ..004 756	
									BGO	<b>584S</b> ..001 584				WW	<b>H382</b> ..011 412		
	06.02-05.05	②	<b>A927S</b> ..118 927	<b>AM21U</b> ..008 568	<b>AM18U</b> ..008 565	AP1	<b>AP21U</b> ..006 834	<b>AP18U</b> ..006 831						①	<b>H382</b> ..011 412		
		WW	<b>AM460S</b> ..007 460											WW	<b>H380/380U</b> ..004 756		
<b>Caddy</b> [9K9]	11.95-06.03	①	<b>AR531S</b> ..118 901	<b>AR530U</b> ..008 936	<b>AR450U</b> ..008 933					<b>531S</b> ..118 403	<b>530US</b> ..011 352	<b>531</b> ..118 402	<b>530U</b> ..004 584	<b>450U</b> ..004 581	①	<b>H450/450U</b> ..004 763	
	[2K]	02.04→	②,③	<b>AM462S</b> ..007 462	<b>AM24U</b> ..008 571	<b>AM18U</b> ..008 565									MHK	<b>A400H</b> ..008 009	
		02.04→													MGT	<b>H405</b> ..004 764	
		02.04-10.06	②	<b>A096S</b> ..007 096			AP1	<b>AP24U</b> ..006 837	<b>AP18U</b> ..006 831								
		11.06→	③	<b>A187S</b> ..007 187			2AA	<b>AP24U</b> ..006 837	<b>AP18U</b> ..006 831								
<b>Caddy Pickup</b> [9U7]	06.96-12.00	①	<b>AR531S</b> ..118 901	<b>AR530U</b> ..008 936	<b>AR450U</b> ..008 933					<b>531S</b> ..118 403	<b>530US</b> ..011 352	<b>531</b> ..118 402	<b>530U</b> ..004 584	<b>450U</b> ..004 581			
<b>California T4</b> [70, 7D]	09.90-06.03	①	<b>AR532S</b> ..118 986	<b>AR530U</b> ..008 936	<b>AR500U</b> ..008 935					<b>530S</b> ..118 401	<b>530US</b> ..011 352	<b>530</b> ..118 400	<b>530U</b> ..004 584	<b>530U</b> ..004 584	①	<b>H400/400U</b> ..004 757	
<b>California T5</b> [7H]	02.03-11.09	②	<b>A938S</b> ..118 938	<b>AM24U</b> ..008 571	<b>AM24U</b> ..008 571	AP1	<b>AP24U</b> ..006 837	<b>AP24U</b> ..006 837	BGO	<b>610S</b> ..010 280	<b>600US</b> ..004 592		<b>600U</b> ..004 586		MHK	<b>A400H</b> ..008 009	
									KUR	<b>801S</b> ..001 802		<b>801</b> ..001 801					
	[7E]	09.09-05.13							BGO	<b>610S</b> ..010 280	<b>600US</b> ..004 592		<b>600U</b> ..004 586		MHK	<b>A400H</b> ..008 009	
								KUR	<b>801S</b> ..001 802		<b>801</b> ..001 801						
<b>Caravelle T4</b> [70, 7D]	09.90-06.03	①	<b>AR532S</b> ..118 986	<b>AR530U</b> ..008 936	<b>AR500U</b> ..008 935					<b>530S</b> ..118 401	<b>530US</b> ..011 352	<b>530</b> ..118 400	<b>530U</b> ..004 584	<b>530U</b> ..004 584	①	<b>H400/400U</b> ..004 757	
<b>Caravelle T5</b> [7H]	02.03-11.09	②	<b>A938S</b> ..118 938	<b>AM24U</b> ..008 571	<b>AM24U</b> ..008 571	AP1	<b>AP24U</b> ..006 837	<b>AP24U</b> ..006 837	BGO	<b>610S</b> ..010 280	<b>600US</b> ..004 592		<b>600U</b> ..004 586		MHK	<b>A400H</b> ..008 009	
									KUR	<b>801S</b> ..001 802		<b>801</b> ..001 801					
	[7E]	09.09-05.13							BGO	<b>610S</b> ..010 280	<b>600US</b> ..004 592		<b>600U</b> ..004 586		MHK	<b>A400H</b> ..008 009	
								KUR	<b>801S</b> ..001 802		<b>801</b> ..001 801						
<b>CC</b> [358]	11.11→	③	<b>A620S</b> ..007 620			AP4	<b>AP24U</b> ..006 837	<b>AP19U</b> ..006 832									



A = Aerotwin | AM = Aerotwin Multi-Clip | AP = Aerotwin Plus | AR = Aerotwin Retrofit | S = Spoiler | U = Single Pack





Model	Year Range	Icon	AR480S	AR480U	AR480U				480S	450US	480	480U	480U		
Corrado [50]	09.88-07.95	①	..118 900	..008 934	..008 934				..118 541	..004 588	..118 540	..004 582	..004 582		
Crafter [2E]	04.06→	⑥	..007 215	..008 573	..008 571	2BB	AP26U	AP24U							A425H ..008 051
Eos [1F7,1F8]	05.06→	③	..118 979	..008 571	..008 566	2AA	AP24U	AP19U							
		WW ③	AM462S ..007 462												
Eurovan [70]	10.02-08.01	①	..118 986	..008 936	..008 935				530S ..118 401	530US ..011 352	530 ..118 400	530U ..004 584	530U ..004 584	①	H400/400U ..004 757
Fox [5Z1]	04.05→	①	..007 503	..008 936	..008 931					530US ..011 352	534 ..010 271	530U ..004 584	380U ..011 353		H310 ..011 654
Golf II [19, 1G1, 1G4]	02.86-07.91	①	..118 994	..008 933	..008 933				450S ..118 506	450US ..004 588	450 ..118 505	450U ..004 581	450U ..004 581	①	H400/400U ..004 757
Golf III [1H1]	11.91-12.97	①	..118 902	..008 936	..008 934				533S ..118 406	530US ..011 352	533 ..118 405	530U ..004 584	480U ..004 582	①	H341 ..004 755
Golf III Cabriolet [1E7]	09.93-04.98	①	..118 902	..008 936	..008 934				533S ..118 406	530US ..011 352	533 ..118 405	530U ..004 584	480U ..004 582		
Golf III Variant [1H5]	07.93-02.99	①	..118 902	..008 936	..008 934				533S ..118 406	530US ..011 352	533 ..118 405	530U ..004 584	480U ..004 582	①	H341 ..004 755
Golf IV [1J1]	10.97-05.02	①	..118 902	..008 936	..008 934			BGR	533S ..118 406	530US ..011 352	533 ..118 405	530U ..004 584	480U ..004 582	①	H341 ..004 755
							BGO	584S ..001 584							
		②	AM460S ..007 460	AM21U ..008 568	AM18U ..008 565	AP1	AP21U ..006 834	AP18U ..006 831							①
	06.02-06.05	②	WW ②	A927S ..118 927											
Golf IV Cabriolet [1E7]	04.98-06.02	①	..118 902	..008 936	..008 934			BGR	533S ..118 406	530US ..011 352	533 ..118 405	530U ..004 584	480U ..004 582		
							BGO	584S ..001 584							
Golf IV Variant [1J5]	05.99-05.02	①	..118 902	..008 936	..008 934			BGR	533S ..118 406	530US ..011 352	533 ..118 405	530U ..004 584	480U ..004 582	①	H382 ..011 412
							BGO	584S ..001 584							WW ①
		②	AM460S ..007 460	AM21U ..008 568	AM18U ..008 565	AP1	AP21U ..006 834	AP18U ..006 831						①	H382 ..011 412
	06.02-06.06	②	WW ②	A927S ..118 927									WW ①	H380/380U ..004 756	
Golf Plus [5M1]	01.05-05.09	②	..118 950	..008 574	..008 574	AP1	AP28U ..006 839	AP28U ..006 839							A330H ..008 006
[521]	01.09→	②	..118 950	..008 574	..008 574	AP1	AP28U ..006 839	AP28U ..006 839							A331H ..008 713
Golf V [1K1]	10.03-11.08	②,③	AM462S ..007 462	AM24U ..008 571	AM19U ..008 566										A330H ..008 006
		②	A936S ..118 936			AP1	AP24U ..006 837	AP19U ..006 832							
		③	A979S ..118 979			2AA	AP24U ..006 837	AP19U ..006 832							
Golf V Variant [1K5]	05.07-07.09	③	..118 979	..008 571	..008 566	2AA	AP24U ..006 837	AP19U ..006 832							A330H ..008 006
		WW ③	AM462S ..007 462												
Golf VI [5K1]	10.08→	③	..118 979	..008 571	..008 566	2AA	AP24U ..006 837	AP19U ..006 832							A282H ..008 634



A = Aerotwin | AM = Aerotwin Multi-Clip | AP = Aerotwin Plus | AR = Aerotwin Retrofit | S = Spoiler | U = Single Pack





3 397...

<b>Golf VI</b> [5K1]	10.08→	WW ③	<b>AM462S</b> ..007 462															
<b>Golf VI Cabriolet</b> [517]	03.11→	③	<b>A620S</b> ..007 620			AP4	<b>AP24U</b> ..006 837	<b>AP19U</b> ..006 832										
<b>Golf VI Variant</b> [AJ5]	06.09→	③	<b>A979S</b> ..118 979	<b>AM24U</b> ..008 571	<b>AM19U</b> ..008 566	2AA	<b>AP24U</b> ..006 837	<b>AP19U</b> ..006 832										<b>A330H</b> ..008 006
		WW ③	<b>AM462S</b> ..007 462															
<b>Golf VII</b> [5G1]	08.12→	③	<b>A863S</b> ..007 863			AP4	<b>AP26U</b> ..006 838	<b>AP18U</b> ..006 831										<b>A282H</b> ..008 634
<b>Golf VII Variant</b> [BA5]	04.13→	③	<b>A863S</b> ..007 863			AP4	<b>AP26U</b> ..006 838	<b>AP18U</b> ..006 831										<b>A282H</b> ..008 634
<b>Jetta</b> [1K2]	01.05-10.10	②,③	<b>AM462S</b> ..007 462	<b>AM24U</b> ..008 571	<b>AM19U</b> ..008 566													
	01.05-11.05	②	<b>A936S</b> ..118 936			AP1	<b>AP24U</b> ..006 837	<b>AP19U</b> ..006 832										
	12.05-10.10	③	<b>A979S</b> ..118 979			2AA	<b>AP24U</b> ..006 837	<b>AP19U</b> ..006 832										
[162]	02.11→	③	<b>A620S</b> ..007 620			AP4	<b>AP24U</b> ..006 837	<b>AP19U</b> ..006 832										
<b>LT</b> [2D, 2H]	05.96-04.06	①	<b>AR801S</b> ..118 996	<b>AR600U</b> ..008 938	<b>AR530U</b> ..008 936						<b>543</b> ..001 543	<b>600U</b> ..004 586	<b>530U</b> ..004 584					
<b>Lupo</b> [6X1]	06.98-05.03						BGO ①	<b>584S</b> ..001 584	<b>530US</b> ..011 352			<b>530U</b> ..004 584					①	<b>H280</b> ..018 802
																	WW ①	<b>H595</b> ..004 595
	06.03-07.05	②	<b>A916S</b> ..118 916	<b>AM19U</b> ..008 566	<b>AM18U</b> ..008 565	AP1	<b>AP19U</b> ..006 832	<b>AP18U</b> ..006 831									①	<b>H280</b> ..018 802
																	WW ①	<b>H595</b> ..004 595
<b>Multivan T4</b> [70, 7D]	09.90-06.03	①	<b>AR532S</b> ..118 986	<b>AR530U</b> ..008 936	<b>AR500U</b> ..008 935					<b>530S</b> ..118 401	<b>530US</b> ..011 352	<b>530</b> ..118 400	<b>530U</b> ..004 584	<b>530U</b> ..004 584			①	<b>H400/400U</b> ..004 757
<b>Multivan T5</b> [7H]	02.03-11.09	②	<b>A938S</b> ..118 938	<b>AM24U</b> ..008 571	<b>AM24U</b> ..008 571	AP1	<b>AP24U</b> ..006 837	<b>AP24U</b> ..006 837	BGO ①	<b>610S</b> ..010 280	<b>600US</b> ..004 592		<b>600U</b> ..004 586				MHK	<b>A400H</b> ..008 009
									KUR ①	<b>801S</b> ..001 802		<b>801</b> ..001 801						
[7E]	09.09-05.13								BGO ①	<b>610S</b> ..010 280	<b>600US</b> ..004 592		<b>600U</b> ..004 586				MHK	<b>A400H</b> ..008 009
									KUR ①	<b>801S</b> ..001 802		<b>801</b> ..001 801						
<b>New Beetle</b> [1C1/9C1]	01.98-12.10								GBO ①			<b>408</b> ..118 408						
<b>New Beetle Cabriolet</b> [1Y7]	01.03-10.10								GBO ①			<b>408</b> ..118 408						
<b>Passat</b> [312/35/3A2]	04.88-03.97	①	<b>AR530S</b> ..118 903	<b>AR530U</b> ..008 936	<b>AR530U</b> ..008 936					<b>530S</b> ..118 401	<b>530US</b> ..011 352	<b>530</b> ..118 400	<b>530U</b> ..004 584	<b>530U</b> ..004 584				
[3B2]	10.96-11.00	①	<b>AR532S</b> ..118 986	<b>AR530U</b> ..008 936	<b>AR500U</b> ..008 935				BGR	<b>532S</b> ..118 404	<b>530US</b> ..011 352		<b>530U</b> ..004 584	<b>500U</b> ..004 583				
									BGO	<b>583S</b> ..001 583								
[3B3]	10.00-10.01	①	<b>AR532S</b> ..118 986	<b>AR530U</b> ..008 936	<b>AR500U</b> ..008 935				BGR	<b>532S</b> ..118 404	<b>530US</b> ..011 352		<b>530U</b> ..004 584	<b>500U</b> ..004 583				
									BGO	<b>583S</b> ..001 583								
	11.01-05.05	②	<b>A925S</b> ..118 925	<b>AM21U</b> ..008 568	<b>AM19U</b> ..008 566	AP1	<b>AP21U</b> ..006 834	<b>AP19U</b> ..006 832										



A = Aerotwin | AM = Aerotwin Multi-Clip | AP = Aerotwin Plus | AR = Aerotwin Retrofit | S = Spoiler | U = Single Pack





			AEROTWIN			NEW AEROTWIN			TWIN SPOILER		TWIN			REAR
			SET						SET		SET			
◀ VW														
		3 397...												
Passat [3C2]	03.05-11.10	③	A979S ..118 979	AM24U ..008 571	AM19U ..008 566	2AA	AP24U ..006 837	AP19U ..006 832						
		WW	AM462S ..007 462											
[362]	08.10-11.11	19M	A979S ..118 979	AM24U ..008 571	AM19U ..008 566	2AA	AP24U ..006 837	AP19U ..006 832						
		19M	AM462S ..007 462											
	08.11→	16M	A620S ..007 620			AP4	AP24U ..006 837	AP19U ..006 832						
Passat Alltrack [365]	01.12→	③	A620S ..007 620			AP4	AP24U ..006 837	AP19U ..006 832						A281H ..008 045
Passat CC [357]	05.08-05.12	③	A979S ..118 979	AM24U ..008 571	AM19U ..008 566	2AA	AP24U ..006 837	AP19U ..006 832						
		WW	AM462S ..007 462											
Passat Variant [315/351/3A5]	04.88-03.97	①	AR530S ..118 903	AR530U ..008 936	AR530U ..008 936				530S ..118 401	530US ..011 352	530 ..118 400	530U ..004 584	530U ..004 584	① H400/400U ..004 757
[3B5]	10.94-11.00	①	AR532S ..118 986	AR530U ..008 936	AR500U ..008 935				532S ..118 404	530US ..011 352		530U ..004 584	500U ..004 583	① H380/380U ..004 756
[3B6]	10.00-10.01	①	AR532S ..118 986	AR530U ..008 936	AR500U ..008 935				BGR 532S ..118 404	530US ..011 352		530U ..004 584	500U ..004 583	① H380/380U ..004 756
									BGO 583S ..001 583					
	11.01-05.05	②	A925S ..118 925	AM21U ..008 568	AM19U ..008 566	AP1	AP21U ..006 834	AP19U ..006 832						① H380/380U ..004 756
[3C5]	08.05-11.10	③	A979S ..118 979	AM24U ..008 571	AM19U ..008 566	2AA	AP24U ..006 837	AP19U ..006 832						A281H ..008 045
		WW	AM462S ..007 462											
[365]	08.10-11.11	19M	A979S ..118 979	AM24U ..008 571	AM19U ..008 566	2AA	AP24U ..006 837	AP19U ..006 832						A281H ..008 045
		19M	AM462S ..007 462											
	08.11→	16M	A620S ..007 620			AP4	AP24U ..006 837	AP19U ..006 832						A281H ..008 045
Phaeton [3D]	05.02→	②	A582S ..007 582											
Polo [80]	10.90-09.94								① 400S ..118 611		400 ..118 610	400U ..004 579	400U ..004 579	① H280 ..018 802
[6N1]	10.94-12.99	①	AR480S ..118 900	AR480U ..008 934	AR480U ..008 934				BGR 480S ..118 541		480 ..118 540	480U ..004 582	480U ..004 582	APE H595 ..004 595
									BGO 465S ..001 465					
[6N2]	07.98-09.01	①	AR480S ..118 900	AR480U ..008 934	AR480U ..008 934				BGR 480S ..118 541		480 ..118 540	480U ..004 582	480U ..004 582	① H280 ..018 802
									BGO 465S ..001 465					WW H595 ..004 595
[9N1]	09.01-05.02	①	AR533S ..118 902	AR530U ..008 936	AR480U ..008 934				BGR 533S ..118 406	530US ..011 352	533 ..118 405	530U ..004 584	480U ..004 582	WGK Z361 ..033 361
									BGO 584S ..001 584					
	06.02-05.05	②	AM460S ..007 460	AM21U ..008 568	AM16U ..008 563	AP1	AP21U ..006 834	AP17U ..006 830						
		WW	A927S ..118 927											



A = Aerotwin | AM = Aerotwin Multi-Clip | AP = Aerotwin Plus | AR = Aerotwin Retrofit | S = Spoiler | U = Single Pack



3 397...

Model	Period	Notes	A974S	AM21U	AM19U	2AA	AP21U	AP19U	531S	530US	531	530U	450U	Notes	Part
Polo [9N1]	10.02-05.05														A330H ..008 006
[9N3]	04.05-12.09	③	A974S ..118 974	AM21U ..008 568	AM19U ..008 566	2AA	AP21U ..006 834	AP19U ..006 832							A330H ..008 006
		WW	AM460S ..007 460											L28	A281H ..008 045
[6R1]	06.09→	③	A555S ..007 555			AP4	AP24U ..006 837	AP16U ..006 829							A282H ..008 634
Polo Classic [6V2]	11.95-09.01	①	AR531S ..118 901	AR530U ..008 936	AR450U ..008 933				531S ..118 403	530US ..011 352	531 ..118 402	530U ..004 584	450U ..004 581		
[9N4]	04.05-02.10	③	A974S ..118 974	AM21U ..008 568	AM19U ..008 566	2AA	AP21U ..006 834	AP19U ..006 832							
[80]	10.90-09.94								① 400S ..118 611		400 ..118 610	400U ..004 579	400U ..004 579		
Polo Coupé [80]	10.90-09.94								① 400S ..118 611		400 ..118 610	400U ..004 579	400U ..004 579	①	H400/400U ..004 757
Polo Playa [9V4]	10.98-10.02	①	AR502S ..118 995	AR500U ..008 935	AR450U ..008 933				502S ..118 564	500US ..004 590	502 ..118 563	500U ..004 583	450U ..004 581		
Polo Variant [6V5]	05.97-09.01	①	AR531S ..118 901	AR530U ..008 936	AR450U ..008 933				531S ..118 403	530US ..011 352	531 ..118 402	530U ..004 584	450U ..004 581	APE	H595 ..004 595
Scirocco [137]	08.08→	③	A979S ..118 979	AM24U ..008 571	AM19U ..008 566	2AA	AP24U ..006 837	AP19U ..006 832							A251H ..008 058
		WW	AM462S ..007 462												
Sharan [7M8]	09.95-02.00	①	AR704S ..007 565	AR70N ..008 845	AR60N ..008 843				GA		704 ..010 211			①	H400/400U ..004 757
									GBO		532 ..001 532				
[7M9, 7M6]	04.00-05.01	①	AR704S ..007 565	AR70N ..008 845	AR60N ..008 843				GA		704 ..010 211			①	H405 ..004 764
									GBO		532 ..001 532				
	06.01-03.10	②	A950S ..118 950	AM28U ..008 574	AM28U ..008 574	AP1	AP28U ..006 839	AP28U ..006 839						①	H405 ..004 764
[7N1]	05.10→	③	A557S ..007 557			AP4	AP28U ..006 839	AP16U ..006 829							A331H ..008 713
Taro [7A]	04.89-03.97								①		420 ..118 500	420U ..011 354	420U ..011 354		
Tiguan [5N1, 5N2]	11.07→	③	A430S ..007 430	AM24U ..008 571	AM21U ..008 568	2AA	AP24U ..006 837	AP21U ..006 834							A330H ..008 006
Touareg [7LA, 7L6]	11.02-05.07	②	A942S ..118 942												A330H ..008 006
[7L6]	06.07-05.10	②	A034S ..009 034	AM26U ..008 573	AM26U ..008 573	AP1	AP26U ..006 838	AP26U ..006 838							A330H ..008 006
[7P5]	01.10→	②	A034S ..009 034	AM26U ..008 573	AM26U ..008 573	AP1	AP26U ..006 838	AP26U ..006 838							A360H ..008 997
Touran [1T1, 1T2]	02.03-05.10	GEG	A950S ..118 950	AM28U ..008 574	AM28U ..008 574	AP1	AP28U ..006 839	AP28U ..006 839						WOB	A400H ..008 009
		②												WOB	A400H ..008 009
		GLF	AM462S ..007 462	AM24U ..008 571	AM18U ..008 565										
[1T1]	02.03-08.03													①	H405 ..004 764
	02.03-10.06	GLF	A096S ..007 096			AP1	AP24U ..006 837	AP18U ..006 831							
[1T2]	11.06-05.10	GLF	A187S ..007 187			2AA	AP24U ..006 837	AP18U ..006 831							



A = Aerotwin | AM = Aerotwin Multi-Clip | AP = Aerotwin Plus | AR = Aerotwin Retrofit | S = Spoiler | U = Single Pack



◀ VW

3 397...

<b>Touran</b> [1T3]	05.10→	③	<b>A187S</b> ..007 187	<b>AM24U</b> ..008 571	<b>AM18U</b> ..008 565	2AA	<b>AP24U</b> ..006 837	<b>AP18U</b> ..006 831							<b>A331H</b> ..008 713
<b>Transporter T4</b> [70, 7D]	09.90-06.03	①	<b>AR532S</b> ..118 986	<b>AR530U</b> ..008 936	<b>AR500U</b> ..008 935					<b>530S</b> ..118 401	<b>530US</b> ..011 352	<b>530</b> ..118 400	<b>530U</b> ..004 584	<b>530U</b> ..004 584	① <b>H400/400U</b> ..004 757
<b>Transporter T5</b> [7H, 7J]	02.03-11.09	②	<b>A938S</b> ..118 938	<b>AM24U</b> ..008 571	<b>AM24U</b> ..008 571	AP1	<b>AP24U</b> ..006 837	<b>AP24U</b> ..006 837	BGO	<b>610S</b> ① ..010 280	<b>600US</b> ..004 592		<b>600U</b> ..004 586		MHK <b>A400H</b> ..008 009
									KUR	<b>801S</b> ① ..001 802		<b>801</b> ..001 801			
	[7E]								BGO	<b>610S</b> ① ..010 280	<b>600US</b> ..004 592		<b>600U</b> ..004 586		MHK <b>A400H</b> ..008 009
									KUR	<b>801S</b> ① ..001 802		<b>801</b> ..001 801			
<b>Up!</b> [121]	12.11→	③	<b>A555S</b> ..007 555			AP4	<b>AP24U</b> ..006 837	<b>AP16U</b> ..006 829							<b>A251H</b> ..008 058
<b>Vento</b> [1H2]	11.91-12.97	①	<b>AR533S</b> ..118 902	<b>AR530U</b> ..008 936	<b>AR480U</b> ..008 934					<b>533S</b> ..118 406	<b>530US</b> ..011 352	<b>533</b> ..118 405	<b>530U</b> ..004 584	<b>480U</b> ..004 582	



A = Aerotwin | AM = Aerotwin Multi-Clip | AP = Aerotwin Plus | AR = Aerotwin Retrofit | S = Spoiler | U = Single Pack

		AEROTWIN				TWIN			
		SET	L	L	SET	L	L		
<b>AUWÄRTER</b>									
Clubstar	09.04→						<b>N 101</b> 3 397 018 198	<b>N 101</b> 3 397 018 198	
						WW	<b>N 102</b> 3 397 011 427	<b>N 102</b> 3 397 011 427	
Teamstar	01.96→						<b>N 101</b> 3 397 018 198	<b>N 101</b> 3 397 018 198	
						WW	<b>N 102</b> 3 397 011 427	<b>N 102</b> 3 397 011 427	
<b>BERKHOF</b>									
Ambassador	07.07→						<b>N 101</b> 3 397 018 198	<b>N 101</b> 3 397 018 198	
						WW	<b>N 102</b> 3 397 011 427	<b>N 102</b> 3 397 011 427	
Axial	01.01→					OE	<b>N 65</b> 3 397 018 963	<b>N 65</b> 3 397 018 963	
						UE	<b>N 100</b> 3 397 018 199	<b>N 100</b> 3 397 018 199	
						UE,WW	<b>N 102</b> 3 397 011 427	<b>N 102</b> 3 397 011 427	
<b>BMC</b>									
Alyos	09.08→		<b>AR 81 N</b> 3 397 008 846	<b>AR 81 N</b> 3 397 008 846			<b>N 80</b> 3 397 018 180	<b>N 80</b> 3 397 018 180	
						WW	<b>N 82</b> 3 397 011 425	<b>N 82</b> 3 397 011 425	
Falcon	02.02→						<b>N 70</b> 3 397 018 170	<b>N 70</b> 3 397 018 170	
Hawk	09.07→	KUR	<b>AR 81 N</b> 3 397 008 846	<b>AR 81 N</b> 3 397 008 846			<b>N 90</b> 3 397 018 190	<b>N 90</b> 3 397 018 190	
							WW	<b>N 92</b> 3 397 011 426	<b>N 92</b> 3 397 011 426
Megastar	09.04→		<b>AR 60 N</b> 3 397 008 843	<b>AR 60 N</b> 3 397 008 843		<b>603</b> 3 397 118 301	<b>600 U</b> 3 397 004 586	<b>600 U</b> 3 397 004 586	
Midilux	03.09→	KUR	<b>AR 81 N</b> 3 397 008 846	<b>AR 81 N</b> 3 397 008 846			<b>N 90</b> 3 397 018 190	<b>N 90</b> 3 397 018 190	
							WW	<b>N 92</b> 3 397 011 426	<b>N 92</b> 3 397 011 426
Probus	02.02→	KUR	<b>AR 81 N</b> 3 397 008 846	<b>AR 81 N</b> 3 397 008 846			<b>N 90</b> 3 397 018 190	<b>N 90</b> 3 397 018 190	
							WW	<b>N 92</b> 3 397 011 426	<b>N 92</b> 3 397 011 426
Procity	10.09→		<b>AR 81 N</b> 3 397 008 846	<b>AR 81 N</b> 3 397 008 846			<b>N 80</b> 3 397 018 180	<b>N 80</b> 3 397 018 180	
						WW	<b>N 82</b> 3 397 011 425	<b>N 82</b> 3 397 011 425	
400MH	09.08→					<b>652 S</b> 3 397 118 327	<b>650 U</b> 3 397 004 587	<b>575 U</b> 3 397 011 351	
<b>BOVA</b>									
Futura	09.01→						<b>N 100</b> 3 397 018 199	<b>N 100</b> 3 397 018 199	
						WW	<b>N 102</b> 3 397 011 427	<b>N 102</b> 3 397 011 427	
Lexio	12.06→						<b>N 101</b> 3 397 018 198	<b>N 101</b> 3 397 018 198	
						WW	<b>N 102</b> 3 397 011 427	<b>N 102</b> 3 397 011 427	





◀ BOVA

Magiq	10.06→							N 100	N 100
								3 397 018 199	3 397 018 199
								N 102	N 102
								3 397 011 427	3 397 011 427
Synergy	09.04→	UE		AR 81 N	AR 81 N	UE		N 80	N 80
								3 397 008 846	3 397 008 846
								3 397 018 180	3 397 018 180
						UE,WW		N 82	N 82
								3 397 011 425	3 397 011 425

**CAETANOBUS**

Optimo	01.06→			AR 81 N	AR 81 N			N 81	N 81
								3 397 008 846	3 397 008 846
						WW		N 82	N 82
								3 397 011 425	3 397 011 425

**CITROEN**

C 25	07.81-03.94					HBG		N 53	N 53
								3 397 018 964	3 397 018 964
Jumper [23]	02.94-02.02		AR 550 S	AR 55 N	AR 55 N		550	550 U	550 U
			3 397 118 906	3 397 008 842	3 397 008 842		3 397 118 420	3 397 004 585	3 397 004 585
[U5]	02.02-05.06		AR 550 S	AR 55 N	AR 55 N		550	550 U	550 U
			3 397 118 906	3 397 008 842	3 397 008 842		3 397 118 420	3 397 004 585	3 397 004 585
[U9]	06.06→		A 225 S	AM 26 U	AM 22 U				
			3 397 007 225	3 397 008 573	3 397 008 569				

**DAF**

CF 65	01.01→			AR 60 N	AR 60 N		603	600 U	600 U
				3 397 008 843	3 397 008 843		3 397 118 301	3 397 004 586	3 397 004 586
CF 75	02.01→			AR 60 N	AR 60 N		603	600 U	600 U
				3 397 008 843	3 397 008 843		3 397 118 301	3 397 004 586	3 397 004 586
CF 85	04.06→			AR 60 N	AR 60 N		603	600 U	600 U
				3 397 008 843	3 397 008 843		3 397 118 301	3 397 004 586	3 397 004 586
LF 45	04.01→	SDV	AR 609 S	AR 61 N	AR 61 N	SDV	609		
			3 397 009 776	3 397 008 847	3 397 008 847		3 397 118 309		
LF 55	04.01→	SDV	AR 609 S	AR 61 N	AR 61 N	SDV	609		
			3 397 009 776	3 397 008 847	3 397 008 847		3 397 118 309		
XF 95	11.01-12.07			AR 50 N	AR 50 N		500	500 U	500 U
				3 397 008 841	3 397 008 841		3 397 118 560	3 397 004 583	3 397 004 583
XF 105	02.04→			AR 50 N	AR 50 N		500	500 U	500 U
				3 397 008 841	3 397 008 841		3 397 118 560	3 397 004 583	3 397 004 583
XF 106	11.12→			AR 50 N	AR 50 N		500	500 U	500 U
				3 397 008 841	3 397 008 841		3 397 118 560	3 397 004 583	3 397 004 583
45	05.91-04.01							N 53	N 53
								3 397 018 964	3 397 018 964
65	01.93-04.02			AR 60 N	AR 60 N		603	600 U	600 U
				3 397 008 843	3 397 008 843		3 397 118 301	3 397 004 586	3 397 004 586
75	01.92-06.02			AR 60 N	AR 60 N		603	600 U	600 U
				3 397 008 843	3 397 008 843		3 397 118 301	3 397 004 586	3 397 004 586
85	02.90-01.08			AR 60 N	AR 60 N		603	600 U	600 U
				3 397 008 843	3 397 008 843		3 397 118 301	3 397 004 586	3 397 004 586
95	01.87-12.98							N 56	N 56
								3 397 018 962	3 397 018 962
95 XF	01.97-09.03							550 U	550 U
								3 397 004 585	3 397 004 585
						WW		N 55	N 55
								3 397 018 965	3 397 018 965





DAIHATSU								
Hijet Pick-up	12.92→					400 3 397 118 610	400 U 3 397 004 579	400 U 3 397 004 579
Hijet Van	12.92→					400 3 397 118 610	400 U 3 397 004 579	400 U 3 397 004 579
FIAT								
Ducato 94 [230, 231, 232, 234..]	03.94-03.02		AR 550 S 3 397 118 906	AR 550 U 3 397 008 937	AR 550 U 3 397 008 937	550 3 397 118 420	550 U 3 397 004 585	550 U 3 397 004 585
		WW		AR 55 N 3 397 008 842	AR 55 N 3 397 008 842		N 55 3 397 018 965	N 55 3 397 018 965
Ducato 02 [243, 244, 245, 247..]	04.02-08.06		AR 550 S 3 397 118 906	AR 550 U 3 397 008 937	AR 550 U 3 397 008 937	550 3 397 118 420	550 U 3 397 004 585	550 U 3 397 004 585
		WW		AR 55 N 3 397 008 842	AR 55 N 3 397 008 842		N 55 3 397 018 965	N 55 3 397 018 965
Ducato 06 [250, 251..]	06.06→		A 225 S 3 397 007 225	AM 26 U 3 397 008 573	AM 22 U 3 397 008 569			
FORD								
Cargo (Ford-Otosan)	12.06→						N 73 3 397 018 173	N 73 3 397 018 173
Econovan	08.85-12.99						N 40 3 397 018 140	N 40 3 397 018 140
Ranger	06.94-06.09		AR 450 S 3 397 118 994	AR 450 U 3 397 008 933	AR 450 U 3 397 008 933	450 3 397 118 505	450 U 3 397 004 581	450 U 3 397 004 581
Transit [92]	08.91-07.94		AR 550 S 3 397 118 906	AR 55 N 3 397 008 842	AR 55 N 3 397 008 842	550 3 397 118 420	550 U 3 397 004 585	550 U 3 397 004 585
	[95]	08.94-08.00	AR 550 S 3 397 118 906	AR 55 N 3 397 008 842	AR 55 N 3 397 008 842	550 3 397 118 420	550 U 3 397 004 585	550 U 3 397 004 585
	[00]	01.00-07.06	AR 655 S 3 397 007 584	AR 70 N 3 397 008 845	AR 55 N 3 397 008 842	655 3 397 010 302	700 U 3 397 004 489	575 U 3 397 011 351
	[06]	04.06→	AR 655 S 3 397 007 584	AR 65 N 3 397 008 844	AR 55 N 3 397 008 842	655 3 397 010 302	650 U 3 397 004 587	550 U 3 397 004 585
Transit Connect [02]	05.02→		AR 551 S 3 397 118 905	AR 550 U 3 397 008 937	AR 500 U 3 397 008 935	551 3 397 118 422	550 U 3 397 004 585	500 U 3 397 004 583
Transit Euroline [95]	08.94-08.00		AR 550 S 3 397 118 906	AR 55 N 3 397 008 842	AR 55 N 3 397 008 842	550 3 397 118 420	550 U 3 397 004 585	550 U 3 397 004 585
	[00]	08.00-07.06	AR 655 S 3 397 007 584	AR 70 N 3 397 008 845	AR 55 N 3 397 008 842	655 3 397 010 302	700 U 3 397 004 489	575 U 3 397 011 351
	[06]	04.06→	AR 655 S 3 397 007 584	AR 65 N 3 397 008 844	AR 55 N 3 397 008 842	655 3 397 010 302	650 U 3 397 004 587	550 U 3 397 004 585
Transit Nugget [95]	08.94-08.00		AR 550 S 3 397 118 906	AR 55 N 3 397 008 842	AR 55 N 3 397 008 842	550 3 397 118 420	550 U 3 397 004 585	550 U 3 397 004 585
	[00]	08.00-07.06	AR 655 S 3 397 007 584	AR 70 N 3 397 008 845	AR 55 N 3 397 008 842	655 3 397 010 302	700 U 3 397 004 489	575 U 3 397 011 351
	[06]	04.06→	AR 655 S 3 397 007 584	AR 65 N 3 397 008 844	AR 55 N 3 397 008 842	655 3 397 010 302	650 U 3 397 004 587	550 U 3 397 004 585
Transit Tourneo [95]	08.94-08.00		AR 550 S 3 397 118 906	AR 55 N 3 397 008 842	AR 55 N 3 397 008 842	550 3 397 118 420	550 U 3 397 004 585	550 U 3 397 004 585
	[00]	08.00-07.06	AR 655 S 3 397 007 584	AR 70 N 3 397 008 845	AR 55 N 3 397 008 842	655 3 397 010 302	700 U 3 397 004 489	575 U 3 397 011 351
GAZ								
Gazel	01.97→					500 3 397 118 560	500 U 3 397 004 583	500 U 3 397 004 583
Valday	02.04→					500 3 397 118 560	500 U 3 397 004 583	500 U 3 397 004 583
	[06]	04.06→	AR 655 S 3 397 007 584	AR 65 N 3 397 008 844	AR 55 N 3 397 008 842	655 3 397 010 302	650 U 3 397 004 587	550 U 3 397 004 585





**HYUNDAI**

H 100	09.96→		<b>AR 450 S</b> 3 397 118 994	<b>AR 450 U</b> 3 397 008 933	<b>AR 450 U</b> 3 397 008 933		<b>450</b> 3 397 118 505	<b>450 U</b> 3 397 004 581	<b>450 U</b> 3 397 004 581
H-1	10.97-05.07			<b>AR 65 N</b> 3 397 008 844	<b>AR 55 N</b> 3 397 008 842		<b>701</b> 3 397 118 202	<b>650 U</b> 3 397 004 587	<b>500 U</b> 3 397 004 583
	03.08→		<b>AR 606 S</b> 3 397 118 910	<b>AR 60 N</b> 3 397 008 843	<b>AR 50 N</b> 3 397 008 841		<b>606 S</b> 3 397 118 305	<b>600 U</b> 3 397 004 586	<b>500 U</b> 3 397 004 583
HD 78	01.06→		<b>AR 500 S</b> 3 397 009 081	<b>AR 50 N</b> 3 397 008 841	<b>AR 50 N</b> 3 397 008 841		<b>500</b> 3 397 118 560	<b>500 U</b> 3 397 004 583	<b>500 U</b> 3 397 004 583
		WW					<b>N 53</b> 3 397 018 964	<b>N 53</b> 3 397 018 964	
HD 120	01.06→			<b>AR 55 N</b> 3 397 008 842	<b>AR 55 N</b> 3 397 008 842		<b>550</b> 3 397 118 420	<b>550 U</b> 3 397 004 585	<b>550 U</b> 3 397 004 585
		WW				<b>N 55</b> 3 397 018 965	<b>N 55</b> 3 397 018 965		
Starex	10.02-12.07			<b>AR 65 N</b> 3 397 008 844	<b>AR 55 N</b> 3 397 008 842		<b>701</b> 3 397 118 202	<b>650 U</b> 3 397 004 587	<b>500 U</b> 3 397 004 583

**IRISBUS**

Agora	01.01-12.06							<b>N 100</b> 3 397 018 199	<b>N 100</b> 3 397 018 199
		WW					<b>N 102</b> 3 397 011 427	<b>N 102</b> 3 397 011 427	
Ares	04.02-12.05							<b>N 100</b> 3 397 018 199	<b>N 100</b> 3 397 018 199
		WW					<b>N 102</b> 3 397 011 427	<b>N 102</b> 3 397 011 427	
Azer	03.05-02.07			<b>AR 81 N</b> 3 397 008 846	<b>AR 81 N</b> 3 397 008 846			<b>N 81</b> 3 397 018 181	<b>N 81</b> 3 397 018 181
		WW					<b>N 82</b> 3 397 011 425	<b>N 82</b> 3 397 011 425	
Citelis	09.05→							<b>N 100</b> 3 397 018 199	<b>N 100</b> 3 397 018 199
		WW					<b>N 102</b> 3 397 011 427	<b>N 102</b> 3 397 011 427	
Crossway	06.06→							<b>N 100</b> 3 397 018 199	<b>N 100</b> 3 397 018 199
		WW					<b>N 102</b> 3 397 011 427	<b>N 102</b> 3 397 011 427	
Domino	10.03→							<b>N 100</b> 3 397 018 199	<b>N 100</b> 3 397 018 199
		WW					<b>N 102</b> 3 397 011 427	<b>N 102</b> 3 397 011 427	
Ecodaily	09.07→	SDV	<b>AR 609 S</b> 3 397 009 776	<b>AR 61 N</b> 3 397 008 847	<b>AR 61 N</b> 3 397 008 847	SDV	<b>609</b> 3 397 118 309		
Evady's	12.06→							<b>N 100</b> 3 397 018 199	<b>N 100</b> 3 397 018 199
		WW					<b>N 102</b> 3 397 011 427	<b>N 102</b> 3 397 011 427	
Heuliex GX	01.02→			<b>AR 81 N</b> 3 397 008 846	<b>AR 81 N</b> 3 397 008 846			<b>N 81</b> 3 397 018 181	<b>N 81</b> 3 397 018 181
		WW					<b>N 82</b> 3 397 011 425	<b>N 82</b> 3 397 011 425	
Iliade	04.02-04.07							<b>N 100</b> 3 397 018 199	<b>N 100</b> 3 397 018 199
		WW					<b>N 102</b> 3 397 011 427	<b>N 102</b> 3 397 011 427	
Magelys	09.08→							<b>N 100</b> 3 397 018 199	<b>N 100</b> 3 397 018 199
		WW					<b>N 102</b> 3 397 011 427	<b>N 102</b> 3 397 011 427	







IRIZAR									
Century	10.05→						N 100 3 397 018 199	N 100 3 397 018 199	
					WW		N 102 3 397 011 427	N 102 3 397 011 427	
i4	09.07→						N 101 3 397 018 198	N 101 3 397 018 198	
					WW		N 102 3 397 011 427	N 102 3 397 011 427	
PB	09.04→						N 101 3 397 018 198	N 101 3 397 018 198	
					WW		N 102 3 397 011 427	N 102 3 397 011 427	
ISUZU									
N-Serie (NQR)	08.98→		AR 500 S 3 397 009 081	AR 500 U 3 397 008 935	AR 500 U 3 397 008 935		500 3 397 118 560	500 U 3 397 004 583	500 U 3 397 004 583
WFR-WFS Serie	02.83-12.96							N 45 3 397 018 145	N 45 3 397 018 145
IVECO									
Daily, Grinta	07.89-05.99	L55		AR 55 N 3 397 008 842	AR 55 N 3 397 008 842	L55		N 55 3 397 018 965	N 55 3 397 018 965
	07.89-07.99	L60		AR 600 U 3 397 008 938	AR 600 U 3 397 008 938	L60	603 3 397 118 301	600 U 3 397 004 586	600 U 3 397 004 586
Daily	05.99→	SDV	AR 609 S 3 397 009 776	AR 61 N 3 397 008 847	AR 61 N 3 397 008 847	SDV	609 3 397 118 309		
EuroCargo	01.83-08.05							N 65 3 397 018 963	N 65 3 397 018 963
	01.91-08.00			AR 45 N 3 397 008 840	AR 45 N 3 397 008 840			N 45 3 397 018 145	N 45 3 397 018 145
EuroCargo 2003	09.03-04.08			AR 65 N 3 397 008 844	AR 65 N 3 397 008 844			N 65 3 397 018 963	N 65 3 397 018 963
	05.08→			AR 65 N 3 397 008 844	AR 65 N 3 397 008 844		650 3 397 118 320	650 U 3 397 004 587	650 U 3 397 004 587
EuroClass	01.93-11.02							N 100 3 397 018 199	N 100 3 397 018 199
					WW		N 102 3 397 011 427	N 102 3 397 011 427	
EuroMover-Cursor	08.00-03.06							N 65 3 397 018 963	N 65 3 397 018 963
EuroStar	04.92-09.04							N 65 3 397 018 963	N 65 3 397 018 963
EuroTech	04.92-09.04							N 65 3 397 018 963	N 65 3 397 018 963
EuroTrakker	04.92-08.04							N 65 3 397 018 963	N 65 3 397 018 963
Stralis	08.02-12.07							N 65 3 397 018 963	N 65 3 397 018 963
	01.08→						650 3 397 118 320	650 U 3 397 004 587	650 U 3 397 004 587
Trakker	09.04-12.07							N 65 3 397 018 963	N 65 3 397 018 963
	01.08→						650 3 397 118 320	650 U 3 397 004 587	650 U 3 397 004 587
TurboStar	03.89-12.00							N 65 3 397 018 963	N 65 3 397 018 963
TurboTech	03.80-01.01							N 65 3 397 018 963	N 65 3 397 018 963
110	11.85-12.99			AR 45 N 3 397 008 840	AR 45 N 3 397 008 840			N 45 3 397 018 145	N 45 3 397 018 145



		AEROTWIN			TWIN		
			SET				SET

◀ IVECO

190	09.87-11.98						N 65 3 397 018 963	N 65 3 397 018 963
260	06.84-12.99						N 65 3 397 018 963	N 65 3 397 018 963
320	01.84-07.96						N 65 3 397 018 963	N 65 3 397 018 963
330	06.84-12.99						N 65 3 397 018 963	N 65 3 397 018 963
	10.87-12.95				HA,HBG		N 63 3 397 018 966	N 63 3 397 018 966
380	09.85-07.01						N 100 3 397 018 199	N 100 3 397 018 199
					WW		N 102 3 397 011 427	N 102 3 397 011 427

**Kässbohrer**

Setra	09.85-07.01						N 100 3 397 018 199	N 100 3 397 018 199
					WW		N 102 3 397 011 427	N 102 3 397 011 427

**KIA**

Besta [TA]	03.90-12.01		AR 45 N 3 397 008 840	AR 45 N 3 397 008 840		450 3 397 118 505	N 45 3 397 018 965	N 45 3 397 018 145
Bongo III	01.04→		AR 55 N 3 397 008 842	AR 45 N 3 397 008 840			N 55 3 397 018 965	N 45 3 397 018 145
K 2700	08.04→	AR 533 S 3 397 118 902	AR 530 U 3 397 008 936	AR 480 U 3 397 008 934		533 3 397 118 405	530 U 3 397 004 584	480 U 3 397 004 582
K 2700 [SD]	04.98-08.04	AR 531 S 3 397 118 901	AR 530 U 3 397 008 936	AR 450 U 3 397 008 933		531 3 397 118 402	530 U 3 397 004 584	450 U 3 397 004 581
K 2900	05.07→	AR 533 S 3 397 118 902	AR 530 U 3 397 008 936	AR 480 U 3 397 008 934		533 3 397 118 405	530 U 3 397 004 584	480 U 3 397 004 582
Pregio [TB]	02.97-04.04	AR 531 S 3 397 118 901	AR 530 U 3 397 008 936	AR 450 U 3 397 008 933		531 3 397 118 402	530 U 3 397 004 584	450 U 3 397 004 581
	05.04→	AR 533 S 3 397 118 902	AR 530 U 3 397 008 936	AR 480 U 3 397 008 934		533 3 397 118 405	530 U 3 397 004 584	480 U 3 397 004 582

**LDV GROUP LIMITED**

Maxus	01.05→		AR 550 S 3 397 118 906	AR 55 N 3 397 008 842	AR 55 N 3 397 008 842		550 3 397 118 420	550 U 3 397 004 585	550 U 3 397 004 585
-------	--------	--	---------------------------	--------------------------	--------------------------	--	----------------------	------------------------	------------------------

**LEYLAND**

Constructor	01.83-10.99						N 63 3 397 018 966	N 63 3 397 018 966
Roadrunner	09.84-10.96						N 55 3 397 018 965	N 55 3 397 018 965

**LEYLAND-DAF**

95	04.89-12.01						N 53 3 397 018 964	N 53 3 397 018 964
----	-------------	--	--	--	--	--	-----------------------	-----------------------





								MAN		
EL-EM Serie	01.93-12.04							N 90	N 90	
								3 397 018 190	3 397 018 190	
E2000 Serie	06.96-12.03			AR 60 N	AR 60 N			N 92	N 92	
								3 397 008 843	3 397 008 843	
	09.95-09.01							N 63	N 63	
								3 397 018 966	3 397 018 966	
F Serie	07.86-06.03			AR 60 N	AR 60 N			N 101	N 101	
								3 397 008 843	3 397 008 843	
Lion's City	07.98→			AR 81 N	AR 81 N	L80		N 63	N 63	
								3 397 008 846	3 397 008 846	
								L80,WW	N 81	N 81
									3 397 018 181	3 397 018 181
								L90	N 82	N 82
									3 397 011 425	3 397 011 425
								L90,WW	N 91	N 91
									3 397 018 191	3 397 018 191
LA1	N 92	N 92								
	3 397 011 426	3 397 011 426								
LA1,WW	N 101	N 101								
	3 397 018 198	3 397 018 198								
Lion's City DD	08.03→							N 102	N 102	
								3 397 011 427	3 397 011 427	
								WW	N 91	N 91
									3 397 018 191	3 397 018 191
Lion's City G	07.98-09.06							N 92	N 92	
								3 397 011 426	3 397 011 426	
								L90	N 91	N 91
									3 397 018 191	3 397 018 191
								L90,WW	N 92	N 92
3 397 011 426	3 397 011 426									
Lion's City G, GL	10.06→							N 101	N 101	
								3 397 018 198	3 397 018 198	
								LA1	N 102	N 102
									3 397 011 427	3 397 011 427
								LA1,WW	N 91	N 91
3 397 018 191	3 397 018 191									
Lion's City LL	08.98-09.06							N 92	N 92	
								3 397 011 426	3 397 011 426	
								L90	N 91	N 91
									3 397 018 191	3 397 018 191
Lion's City M	04.04-08.09							N 92	N 92	
								3 397 018 191	3 397 018 191	
								WW	N 91	N 91
3 397 011 426	3 397 011 426									
Lion's City T, TÜ	06.04-09.06							N 92	N 92	
								3 397 011 426	3 397 011 426	
								WW	N 91	N 91
									3 397 018 191	3 397 018 191
Lion's City Ü	01.01→							N 92	N 92	
								3 397 011 426	3 397 011 426	
								WW	N 91	N 91
									3 397 018 191	3 397 018 191
Lion's City ÜLL	02.98-09.06							N 92	N 92	
								3 397 011 426	3 397 011 426	
								WW	N 91	N 91
									3 397 018 191	3 397 018 191
								N 92	N 92	
								3 397 011 426	3 397 011 426	



		AEROTWIN			TWIN		
		SET			SET		
MAN							
Lion's Classic	06.03-10.06					N 91 3 397 018 191	N 91 3 397 018 191
					WW	N 92 3 397 011 426	N 92 3 397 011 426
Lion's Classic G	06.03-09.06					N 91 3 397 018 191	N 91 3 397 018 191
					WW	N 92 3 397 011 426	N 92 3 397 011 426
Lion's Coach	09.02→					N 100 3 397 018 199	N 100 3 397 018 199
					WW	N 102 3 397 011 427	N 102 3 397 011 427
Lion's Comfort	01.98-12.01					N 101 3 397 018 198	N 101 3 397 018 198
					WW	N 102 3 397 011 427	N 102 3 397 011 427
Lion's Regio	06.04→					N 100 3 397 018 199	N 100 3 397 018 199
					WW	N 102 3 397 011 427	N 102 3 397 011 427
Lion's Star	01.93-09.01					N 101 3 397 018 198	N 101 3 397 018 198
					WW	N 102 3 397 011 427	N 102 3 397 011 427
Lion's Top Coach	06.99-01.04					N 101 3 397 018 198	N 101 3 397 018 198
					WW	N 102 3 397 011 427	N 102 3 397 011 427
L2000	10.93-12.06		AR 50 N 3 397 008 841	AR 50 N 3 397 008 841		N 53 3 397 018 964	N 53 3 397 018 964
M2000	08.95-09.01		AR 60 N 3 397 008 843	AR 60 N 3 397 008 843		N 63 3 397 018 966	N 63 3 397 018 966
M2000L	06.98-09.06		AR 50 N 3 397 008 841	AR 50 N 3 397 008 841		N 53 3 397 018 964	N 53 3 397 018 964
M2000M	06.98-07.05		AR 60 N 3 397 008 843	AR 60 N 3 397 008 843		N 63 3 397 018 966	N 63 3 397 018 966
NG Serie	06.90-11.99					N 90 3 397 018 190	N 90 3 397 018 190
					WW	N 92 3 397 011 426	N 92 3 397 011 426
	07.98-09.06				HBG	N 91 3 397 018 191	N 91 3 397 018 191
					WW	N 92 3 397 011 426	N 92 3 397 011 426
NL	09.89-04.93					N 90 3 397 018 190	N 90 3 397 018 190
					WW	N 92 3 397 011 426	N 92 3 397 011 426
	04.94→				HBG	N 91 3 397 018 191	N 91 3 397 018 191
					WW	N 92 3 397 011 426	N 92 3 397 011 426
	07.98-12.01				L80	N 81 3 397 018 181	N 81 3 397 018 181
					L80,WW	N 82 3 397 011 425	N 82 3 397 011 425
NM	02.96-09.06					N 91 3 397 018 191	N 91 3 397 018 191
					WW	N 92 3 397 011 426	N 92 3 397 011 426
NÜ	09.96→					N 91 3 397 018 191	N 91 3 397 018 191
					WW	N 92 3 397 011 426	N 92 3 397 011 426
RH	07.98-09.01					N 101 3 397 018 198	N 101 3 397 018 198
					WW	N 102 3 397 011 427	N 102 3 397 011 427



			AEROTWIN			TWIN		
			SET	L	L	SET	L	L
SG-Serie	09.85-06.97						<b>N 81</b> 3 397 018 181	<b>N 81</b> 3 397 018 181
		WW					<b>N 82</b> 3 397 011 425	<b>N 82</b> 3 397 011 425
SÜ	01.87-06.97	LA1					<b>N 100</b> 3 397 018 199	<b>N 100</b> 3 397 018 199
		LA1,WW					<b>N 102</b> 3 397 011 427	<b>N 102</b> 3 397 011 427
		L80					<b>N 81</b> 3 397 018 181	<b>N 81</b> 3 397 018 181
		L80,WW					<b>N 82</b> 3 397 011 425	<b>N 82</b> 3 397 011 425
	11.99-09.06	HBG,L90					<b>N 91</b> 3 397 018 191	<b>N 91</b> 3 397 018 191
		HBG,L90, WW					<b>N 92</b> 3 397 011 426	<b>N 92</b> 3 397 011 426
TGA	03.99-03.09		<b>AR 65 N</b> 3 397 008 844	<b>AR 65 N</b> 3 397 008 844			<b>N 65</b> 3 397 018 963	<b>N 65</b> 3 397 018 963
		XXL					<b>N 70</b> 3 397 018 170	<b>N 70</b> 3 397 018 170
TGL	05.05→		<b>AR 65 N</b> 3 397 008 844	<b>AR 65 N</b> 3 397 008 844			<b>N 65</b> 3 397 018 963	<b>N 65</b> 3 397 018 963
		XXL					<b>N 70</b> 3 397 018 170	<b>N 70</b> 3 397 018 170
TGS	09.07→		<b>AR 65 N</b> 3 397 008 844	<b>AR 65 N</b> 3 397 008 844			<b>N 65</b> 3 397 018 963	<b>N 65</b> 3 397 018 963
		XXL					<b>N 70</b> 3 397 018 170	<b>N 70</b> 3 397 018 170
TGX	09.07→		<b>AR 65 N</b> 3 397 008 844	<b>AR 65 N</b> 3 397 008 844			<b>N 65</b> 3 397 018 963	<b>N 65</b> 3 397 018 963
		XXL					<b>N 70</b> 3 397 018 170	<b>N 70</b> 3 397 018 170
ÜL	09.89-09.96						<b>N 100</b> 3 397 018 199	<b>N 100</b> 3 397 018 199
		WW					<b>N 102</b> 3 397 011 427	<b>N 102</b> 3 397 011 427
	09.96-09.06	HBG					<b>N 101</b> 3 397 018 198	<b>N 101</b> 3 397 018 198
		WW					<b>N 102</b> 3 397 011 427	<b>N 102</b> 3 397 011 427
8 t	09.87-05.95				<b>500</b> 3 397 118 560	<b>500 U</b> 3 397 004 583	<b>500 U</b> 3 397 004 583	
		WW				<b>N 53</b> 3 397 018 964	<b>N 53</b> 3 397 018 964	
	02.95-09.01					<b>N 53</b> 3 397 018 964	<b>N 53</b> 3 397 018 964	
9 t	09.87-05.95					<b>N 40</b> 3 397 018 140	<b>N 40</b> 3 397 018 140	
12 t	08.88-06.97					<b>N 63</b> 3 397 018 966	<b>N 63</b> 3 397 018 966	
		07.98-09.06				HBG	<b>N 91</b> 3 397 018 191	<b>N 91</b> 3 397 018 191
14 t	08.88-06.97					<b>N 63</b> 3 397 018 966	<b>N 63</b> 3 397 018 966	
		07.98-10.06				HBG	<b>N 91</b> 3 397 018 191	<b>N 91</b> 3 397 018 191
						HBG,WW	<b>N 92</b> 3 397 011 426	<b>N 92</b> 3 397 011 426
17 t	08.88-06.96					<b>N 63</b> 3 397 018 966	<b>N 63</b> 3 397 018 966	
18 t	09.90-06.96					<b>N 63</b> 3 397 018 966	<b>N 63</b> 3 397 018 966	
41 t	02.90-06.96					<b>N 63</b> 3 397 018 966	<b>N 63</b> 3 397 018 966	





MAZDA									
E-Serie	02.84-12.06					HBG	400 3 397 118 610	400 U 3 397 004 579	400 U 3 397 004 579
MERCEDES-BENZ									
Actros [SKN]	09.96-09.03		AR 70 N 3 397 008 845	AR 70 N 3 397 008 845				N 73 3 397 018 173	N 73 3 397 018 173
Actros II [MP2]	04.03-12.08		AR 70 N 3 397 008 845	AR 70 N 3 397 008 845				N 73 3 397 018 173	N 73 3 397 018 173
Actros III [MP3]	06.08→		AR 70 N 3 397 008 845	AR 70 N 3 397 008 845				N 73 3 397 018 173	N 73 3 397 018 173
Actros [963]	09.11→							N 71 3 397 011 238	N 71 3 397 011 238
Atego [LKN]	01.98-10.04		AR 65 N 3 397 008 844	AR 65 N 3 397 008 844				650 U 3 397 004 587	650 U 3 397 004 587
Atego II	09.04→		AR 65 N 3 397 008 844	AR 65 N 3 397 008 844				650 U 3 397 004 587	650 U 3 397 004 587
Axor	01.02-08.06		AR 65 N 3 397 008 844	AR 65 N 3 397 008 844				650 U 3 397 004 587	650 U 3 397 004 587
Axor II	09.04→		AR 65 N 3 397 008 844	AR 65 N 3 397 008 844				650 U 3 397 004 587	650 U 3 397 004 587
Citaro	01.98→							N 91 3 397 018 191	N 91 3 397 018 191
		WW						N 92 3 397 011 426	N 92 3 397 011 426
Conecto	05.01-08.07							N 101 3 397 018 198	N 101 3 397 018 198
		WW						N 102 3 397 011 427	N 102 3 397 011 427
	09.07→							N 91 3 397 018 191	N 91 3 397 018 191
		WW						N 92 3 397 011 426	N 92 3 397 011 426
Econic	03.98→		AR 60 N 3 397 008 843	AR 60 N 3 397 008 843				N 63 3 397 018 966	N 63 3 397 018 966
Integro I	09.99-09.06							N 101 3 397 018 198	N 101 3 397 018 198
		WW						N 102 3 397 011 427	N 102 3 397 011 427
Integro II	09.06→							N 101 3 397 018 198	N 101 3 397 018 198
		WW						N 102 3 397 011 427	N 102 3 397 011 427
Intouro	01.00-03.07							N 101 3 397 018 198	N 101 3 397 018 198
		WW						N 102 3 397 011 427	N 102 3 397 011 427
MB	01.87-01.96	AR 450 S 3 397 118 994	AR 45 N 3 397 008 840	AR 45 N 3 397 008 840				N 45 3 397 018 145	N 45 3 397 018 145
O 100	01.94→							N 53 3 397 018 964	N 53 3 397 018 964
O 345	10.95→							N 101 3 397 018 198	N 101 3 397 018 198
		WW						N 102 3 397 011 427	N 102 3 397 011 427
O 402	02.86-02.01							N 81 3 397 018 181	N 81 3 397 018 181
		WW						N 82 3 397 011 425	N 82 3 397 011 425
		WW						N 80 3 397 018 180	N 80 3 397 018 180



			AEROTWIN			TWIN			
				SET				SET	
<b>O 404</b>		09.91-10.99						<b>N 101</b> 3 397 018 198	<b>N 101</b> 3 397 018 198
						WW		<b>N 102</b> 3 397 011 427	<b>N 102</b> 3 397 011 427
<b>O 405</b>		01.85-02.01		<b>AR 81 N</b> 3 397 008 846	<b>AR 81 N</b> 3 397 008 846	L80		<b>N 81</b> 3 397 018 181	<b>N 81</b> 3 397 018 181
						L80,WW		<b>N 82</b> 3 397 011 425	<b>N 82</b> 3 397 011 425
		10.89-08.98				L90		<b>N 90</b> 3 397 018 190	<b>N 90</b> 3 397 018 190
						WW,L90		<b>N 92</b> 3 397 011 426	<b>N 92</b> 3 397 011 426
<b>O 560 (Intouro)</b>		01.00-03.07						<b>N 101</b> 3 397 018 198	<b>N 101</b> 3 397 018 198
						WW		<b>N 102</b> 3 397 011 427	<b>N 102</b> 3 397 011 427
<b>Sprinter [T1N]</b>		02.95-05.06	<b>AR 801 S</b> 3 397 118 996	<b>AR 60 N</b> 3 397 008 843	<b>AR 50 N</b> 3 397 008 841		<b>543</b> 3 397 001 543	<b>600 U</b> 3 397 004 586	<b>530 U</b> 3 397 004 584
[NCV3]		04.06→	<b>A 215 S</b> 3 397 007 215	<b>AM 26 U</b> 3 397 008 573	<b>AM 24 U</b> 3 397 008 571				
<b>Tourino</b>		01.04→	KUR	<b>AR 81 N</b> 3 397 008 846	<b>AR 81 N</b> 3 397 008 846	L90		<b>N 90</b> 3 397 018 190	<b>N 90</b> 3 397 018 190
						WW,L90		<b>N 92</b> 3 397 011 426	<b>N 92</b> 3 397 011 426
						LA1		<b>N 100</b> 3 397 018 199	<b>N 100</b> 3 397 018 199
						WW,LA1		<b>N 102</b> 3 397 011 427	<b>N 102</b> 3 397 011 427
<b>Touro</b>		02.02-08.09	KUR	<b>AR 81 N</b> 3 397 008 846	<b>AR 81 N</b> 3 397 008 846	L90		<b>N 90</b> 3 397 018 190	<b>N 90</b> 3 397 018 190
						WW,L90		<b>N 92</b> 3 397 011 426	<b>N 92</b> 3 397 011 426
						LA1		<b>N 100</b> 3 397 018 199	<b>N 100</b> 3 397 018 199
						WW,LA1		<b>N 102</b> 3 397 011 427	<b>N 102</b> 3 397 011 427
<b>Tourismo</b>		10.95→						<b>N 101</b> 3 397 018 198	<b>N 101</b> 3 397 018 198
						WW		<b>N 102</b> 3 397 011 427	<b>N 102</b> 3 397 011 427
<b>Travego</b>		10.99→						<b>N 101</b> 3 397 018 198	<b>N 101</b> 3 397 018 198
						WW		<b>N 102</b> 3 397 011 427	<b>N 102</b> 3 397 011 427
<b>Unimog</b>		11.86→				L50		<b>N 53</b> 3 397 018 964	<b>N 53</b> 3 397 018 964
		05.88-02.01				L45		<b>N 45</b> 3 397 018 145	<b>N 45</b> 3 397 018 145
		04.00→				L80,WOB		<b>N 81</b> 3 397 018 181	<b>N 81</b> 3 397 018 181
						L80, WOB,WW		<b>N 82</b> 3 397 011 425	<b>N 82</b> 3 397 011 425
		10.07→				L60	<b>603</b> 3 397 118 301	<b>600 U</b> 3 397 004 586	<b>600 U</b> 3 397 004 586
		01.08→				HBG,L50		<b>N 53</b> 3 397 018 964	<b>N 53</b> 3 397 018 964
<b>UX-Serie</b>		08.96→						<b>N 65</b> 3 397 018 963	<b>N 65</b> 3 397 018 963
<b>Vario [T2W]</b>		01.96→		<b>AR 60 N</b> 3 397 008 843	<b>AR 60 N</b> 3 397 008 843			<b>N 63</b> 3 397 018 966	<b>N 63</b> 3 397 018 966
<b>Vito [638 TON]</b>		11.95-09.03	SDV	<b>AR 725 S</b> 3 397 007 567		SDV	<b>725</b> 3 397 001 725		
[639 TON]		10.03-08.05	SDV	<b>AR 703 S</b> 3 397 007 568	<b>AR 71 N</b> 3 397 008 849	<b>AR 66 N</b> 3 397 008 848	SDV	<b>703 S</b> 3 397 118 205	
		09.05→	WOB	<b>A 311 S</b> 3 397 007 311	<b>AM 28 U</b> 3 397 008 574	<b>AM 26 U</b> 3 397 008 573			
<b>5 t</b>		03.89-02.01						<b>N 63</b> 3 397 018 966	<b>N 63</b> 3 397 018 966



		AEROTWIN			TWIN		
			SET		L		SET

◀ MERCEDES-BENZ

7t	09.86-02.01							N 63 3 397 018 966	N 63 3 397 018 966
8t [LK]	03.84-12.99							N 63 3 397 018 966	N 63 3 397 018 966
9t [LK]	02.87-12.99					L60		N 63 3 397 018 966	N 63 3 397 018 966
11t [LK]	03.84-12.99							N 63 3 397 018 966	N 63 3 397 018 966
12t [LK]	03.94-12.99							N 63 3 397 018 966	N 63 3 397 018 966
[MK]	07.89→							N 65 3 397 018 963	N 65 3 397 018 963
13t [LK]	07.84-12.99							N 63 3 397 018 966	N 63 3 397 018 966
14t [MK]	06.89→							N 65 3 397 018 963	N 65 3 397 018 963
15t [LK]	10.88-02.01							N 63 3 397 018 966	N 63 3 397 018 966
16t [MK]	02.93-08.94							N 65 3 397 018 963	N 65 3 397 018 963
17t [LK]	01.84-12.98							N 63 3 397 018 966	N 63 3 397 018 966
[MK; SK]	07.88-02.01							N 65 3 397 018 963	N 65 3 397 018 963
18t [MK; SK]	12.90→							N 65 3 397 018 963	N 65 3 397 018 963
19t [MK; SK]	12.87-09.96							N 65 3 397 018 963	N 65 3 397 018 963
20t [LK]	01.84-12.98							N 63 3 397 018 966	N 63 3 397 018 966
[SK]	01.91-02.01							N 65 3 397 018 963	N 65 3 397 018 963
23t [MK]	02.93-09.96							N 65 3 397 018 963	N 65 3 397 018 963
24t [MK]	12.87-09.96							N 65 3 397 018 963	N 65 3 397 018 963
[SK]	07.88-09.96							N 65 3 397 018 963	N 65 3 397 018 963
25t [MK; SK]	12.90→							N 65 3 397 018 963	N 65 3 397 018 963
26t [SK]	07.88-09.96							N 65 3 397 018 963	N 65 3 397 018 963
30t [SK]	02.91-02.01							N 65 3 397 018 963	N 65 3 397 018 963
32t [SK]	07.87-02.01							N 65 3 397 018 963	N 65 3 397 018 963
35t [SK]	09.87-09.96							N 65 3 397 018 963	N 65 3 397 018 963
44t [SK]	10.89-02.01							N 65 3 397 018 963	N 65 3 397 018 963

**MITSUBISHI**

Canter [FB]	05.96-02.05	L55		AR 55 N 3 397 008 842	AR 55 N 3 397 008 842	L55	550 3 397 118 420	550 U 3 397 004 585	550 U 3 397 004 585				
						WW		N 55 3 397 018 965	N 55 3 397 018 965				
[FE]	01.86-09.96			AR 45 N 3 397 008 840	AR 45 N 3 397 008 840			N 45 3 397 018 145	N 45 3 397 018 145				
				05.96-02.05	L55			AR 55 N 3 397 008 842	AR 55 N 3 397 008 842	L55	550 3 397 118 420	550 U 3 397 004 585	550 U 3 397 004 585
								L55,WW		N 55 3 397 018 965	N 55 3 397 018 965		
10.96→	L50			AR 50 N 3 397 008 841	AR 50 N 3 397 008 841	L50	500 3 397 118 560	500 U 3 397 004 583	500 U 3 397 004 583				
						L50,WW		N 53 3 397 018 964	N 53 3 397 018 964				





			AEROTWIN			TWIN			
			SET	L	L	SET	L	L	
L 300 [P]	11.86-12.01	HBG	AR 450 S 3 397 118 994	AR 450 U 3 397 008 933	AR 450 U 3 397 008 933	HBG	450 3 397 118 505	450 U 3 397 004 581	450 U 3 397 004 581
						WW		N 45 3 397 018 145	N 45 3 397 018 145
L300 Exceed	02.00→						400 3 397 118 610	400 U 3 397 004 579	400 U 3 397 004 579
<b>MULTICAR</b>									
Multicar	01.91→							N 65 3 397 018 963	N 65 3 397 018 963
<b>NEOPLAN</b>									
Cityliner	09.85-12.00					UE		N 81 3 397 018 181	N 81 3 397 018 181
						UE,WW		N 82 3 397 011 425	N 82 3 397 011 425
	01.06→			AR 81 N 3 397 008 846	AR 81 N 3 397 008 846			N 81 3 397 018 181	N 81 3 397 018 181
						WW		N 82 3 397 011 425	N 82 3 397 011 425
Clubliner	10.81-09.95					UE		N 100 3 397 018 199	N 100 3 397 018 199
						UE,WW		N 102 3 397 011 427	N 102 3 397 011 427
	02.86-09.95					OE		N 81 3 397 018 181	N 81 3 397 018 181
						OE,WW		N 82 3 397 011 425	N 82 3 397 011 425
						OE,WW		N 80 3 397 018 180	N 80 3 397 018 180
Jetliner	10.81-05.01						N 100 3 397 018 199	N 100 3 397 018 199	
Jumbocruiser	08.83-12.96					UE		N 100 3 397 018 199	N 100 3 397 018 199
						UE,WW		N 102 3 397 011 427	N 102 3 397 011 427
	02.86-12.96					OE		N 81 3 397 018 181	N 81 3 397 018 181
						OE,WW		N 82 3 397 011 425	N 82 3 397 011 425
						OE,WW		N 80 3 397 018 180	N 80 3 397 018 180
Skyliner	02.86-05.10					OE		N 80 3 397 018 180	N 80 3 397 018 180
						OE,WW		N 82 3 397 011 425	N 82 3 397 011 425
						OE,WW		N 81 3 397 018 181	N 81 3 397 018 181
	06.01-05.10					UE		N 72 3 397 002 918	N 72 3 397 002 918
								N 81 3 397 018 181	N 81 3 397 018 181
SL	01.81-12.96							N 81 3 397 018 181	N 81 3 397 018 181
						WW		N 82 3 397 011 425	N 82 3 397 011 425
						WW		N 80 3 397 018 180	N 80 3 397 018 180





◀ NEOPLAN

Spaceliner	08.83-05.01					OE		<b>N 81</b>	<b>N 81</b>
								3 397 018 181	3 397 018 181
						OE,WW		<b>N 82</b>	<b>N 82</b>
								3 397 011 425	3 397 011 425
Starliner	08.96→	UE		<b>AR 81 N</b> 3 397 008 846	<b>AR 81 N</b> 3 397 008 846	UE		<b>N 81</b>	<b>N 81</b>
								3 397 018 181	3 397 018 181
	08.04→					UE,WW		<b>N 82</b>	<b>N 82</b>
								3 397 011 425	3 397 011 425
Tourliner	11.03→							<b>N 90</b>	<b>N 90</b>
						WW		3 397 018 190	3 397 018 190
Transliner	01.91-12.98							<b>N 92</b>	<b>N 92</b>
						WW		3 397 011 426	3 397 011 426
Trendliner	01.06-03.10							<b>N 100</b>	<b>N 100</b>
						WW		3 397 018 199	3 397 018 199

**NISSAN**

Atleon	09.99→			<b>AR 60 N</b> 3 397 008 843	<b>AR 55 N</b> 3 397 008 842		<b>608</b>	<b>600 U</b>	<b>550 U</b>
						WW		3 397 118 307	3 397 004 586
Cabstar [F24]	09.06→			<b>AR 500 S</b> 3 397 009 081	<b>AR 50 N</b> 3 397 008 841	<b>AR 50 N</b> 3 397 008 841		<b>500</b>	<b>500 U</b>
							WW		3 397 118 560
Cabstar E [TLO]	10.98-08.06			<b>AR 450 S</b> 3 397 118 994	<b>AR 45 N</b> 3 397 008 840	<b>AR 45 N</b> 3 397 008 840		<b>450</b>	<b>450 U</b>
							WW		3 397 118 505
Interstar [X70]	07.02→		SDV	<b>AR 609 S</b> 3 397 009 776	<b>AR 61 N</b> 3 397 008 847	<b>AR 61 N</b> 3 397 008 847	SDV	<b>609</b>	
Navara [D22]	06.00→			<b>AR 480 S</b> 3 397 118 900	<b>AR 480 U</b> 3 397 008 934	<b>AR 480 U</b> 3 397 008 934		<b>480</b>	<b>480 U</b>
NV400 [X62]	09.11→				<b>AR 65 N</b> 3 397 008 844	<b>AR 65 N</b> 3 397 008 844		<b>650</b>	<b>650 U</b>
								WW	
Primastar [X83]	07.02→			<b>AR 801 S</b> 3 397 118 996	<b>AR 600 U</b> 3 397 008 938	<b>AR 530 U</b> 3 397 008 936		<b>611 S</b>	<b>600 US</b>
Trade	10.83-12.99			<b>AR 500 S</b> 3 397 009 081	<b>AR 500 U</b> 3 397 008 935	<b>AR 500 U</b> 3 397 008 935		<b>500</b>	<b>500 U</b>
Urvan [E24]	11.86-06.97							<b>480</b>	<b>480 U</b>
Vanette [C220]	04.87-11.94							<b>450</b>	<b>450 U</b>
[GC22]	09.86-12.96							<b>533</b>	<b>530 U</b>
Vanette Cargo [C23M]	07.92-11.01			<b>AR 60 N</b> 3 397 008 843	<b>AR 60 N</b> 3 397 008 843			<b>603</b>	<b>600 U</b>





## OPEL

<b>Arena</b>	03.98-08.01		<b>AR 500 S</b> 3 397 009 081	<b>AR 50 N</b> 3 397 008 841	<b>AR 50 N</b> 3 397 008 841		<b>500</b> 3 397 118 560	<b>500 U</b> 3 397 004 583	<b>500 U</b> 3 397 004 583
<b>Euromidi</b>	09.88-08.96						<b>450</b> 3 397 118 505	<b>450 U</b> 3 397 004 581	<b>450 U</b> 3 397 004 581
<b>Movano [A]</b>	06.98-03.10	SDV	<b>AR 609 S</b> 3 397 009 776	<b>AR 61 N</b> 3 397 008 847	<b>AR 61 N</b> 3 397 008 847	SDV	<b>609</b> 3 397 118 309		
[B]	04.10→			<b>AR 650 U</b> 3 397 008 939	<b>AR 650 U</b> 3 397 008 939		<b>650</b> 3 397 118 320	<b>650 U</b> 3 397 004 587	<b>650 U</b> 3 397 004 587
		WW		<b>AR 65 N</b> 3 397 008 844	<b>AR 65 N</b> 3 397 008 844				
<b>Vivaro</b>	03.01→		<b>AR 801 S</b> 3 397 118 996	<b>AR 600 U</b> 3 397 008 938	<b>AR 530 U</b> 3 397 008 936		<b>611 S</b> 3 397 010 300	<b>600 US</b> 3 397 004 592	<b>530 U</b> 3 397 004 584

## OTOKAR

<b>Centro</b>	09.09→			<b>AR 70 N</b> 3 397 008 845	<b>AR 70 N</b> 3 397 008 845			<b>N 70</b> 3 397 018 170	<b>N 70</b> 3 397 018 170
<b>Kent</b>	09.09→							<b>N 100</b> 3 397 018 199	<b>N 100</b> 3 397 018 199
						WW		<b>N 102</b> 3 397 011 427	<b>N 102</b> 3 397 011 427
<b>Navigo</b>	09.02→			<b>AR 81 N</b> 3 397 008 846	<b>AR 81 N</b> 3 397 008 846			<b>N 80</b> 3 397 018 180	<b>N 80</b> 3 397 018 180
						WW		<b>N 82</b> 3 397 011 425	<b>N 82</b> 3 397 011 425
<b>Vectio</b>	04.07→							<b>N 100</b> 3 397 018 199	<b>N 100</b> 3 397 018 199
						WW		<b>N 102</b> 3 397 011 427	<b>N 102</b> 3 397 011 427

## PEGASO

<b>1200-Serie</b>	04.87→							<b>N 53</b> 3 397 018 964	<b>N 53</b> 3 397 018 964
							<b>500</b> 3 397 118 560	<b>500 U</b> 3 397 004 583	<b>500 U</b> 3 397 004 583

## PEUGEOT

<b>Boxer [U3]</b>	02.94-02.02		<b>AR 550 S</b> 3 397 118 906	<b>AR 55 N</b> 3 397 008 842	<b>AR 55 N</b> 3 397 008 842		<b>550</b> 3 397 118 420	<b>550 U</b> 3 397 004 585	<b>550 U</b> 3 397 004 585
[U5]	02.02-05.06		<b>AR 550 S</b> 3 397 118 906	<b>AR 55 N</b> 3 397 008 842	<b>AR 55 N</b> 3 397 008 842		<b>550</b> 3 397 118 420	<b>550 U</b> 3 397 004 585	<b>550 U</b> 3 397 004 585
[U9]	06.06→		<b>A 225 S</b> 3 397 007 225	<b>AM 26 U</b> 3 397 008 573	<b>AM 22 U</b> 3 397 008 569				

## PIAGGIO

<b>Porter</b>	10.94→			<b>AR 400 U</b> 3 397 008 932	<b>AR 400 U</b> 3 397 008 932		<b>400</b> 3 397 118 610	<b>400 U</b> 3 397 004 579	<b>400 U</b> 3 397 004 579
---------------	--------	--	--	----------------------------------	----------------------------------	--	-----------------------------	-------------------------------	-------------------------------





**RENAULT**

Agora	09.94→					LA1		<b>N 100</b>	<b>N 100</b>
								3 397 018 199	3 397 018 199
						WW		<b>N 102</b>	<b>N 102</b>
								3 397 011 427	3 397 011 427
Ares	04.98→					L70		<b>N 72</b>	<b>N 72</b>
								3 397 002 918	3 397 002 918
						ZUE		<b>N 45</b>	<b>N 45</b>
								3 397 018 145	3 397 018 145
B	01.86-06.94					L70		<b>N 70</b>	<b>N 70</b>
C [Ligne 3]	10.82-10.98							<b>N 53</b>	<b>N 53</b>
								3 397 018 964	3 397 018 964
CBH-Serie	04.86-10.98							<b>N 53</b>	<b>N 53</b>
								3 397 018 964	3 397 018 964
CLM	04.86-10.98							<b>N 53</b>	<b>N 53</b>
								3 397 018 964	3 397 018 964
CLR	05.86-10.98							<b>N 53</b>	<b>N 53</b>
								3 397 018 964	3 397 018 964
FR	01.84-12.96							<b>N 100</b>	<b>N 100</b>
G	03.84-06.97							<b>N 102</b>	<b>N 102</b>
Iliade	10.96-09.01							<b>N 53</b>	<b>N 53</b>
Kerax	06.97-10.05							<b>N 100</b>	<b>N 100</b>
Magnum	09.90→							<b>N 102</b>	<b>N 102</b>
Mascott	01.99→	SDV	AR 609 S 3 397 009 776	AR 61 N 3 397 008 847	AR 61 N 3 397 008 847	SDV	609 3 397 118 309	<b>N 74</b>	<b>N 74</b>
Master	09.80-09.97							<b>N 74</b>	<b>N 74</b>
Master	11.05→							<b>N 66</b>	<b>N 66</b>
Master	10.97-04.10	SDV	AR 609 S 3 397 009 776	AR 61 N 3 397 008 847	AR 61 N 3 397 008 847	SDV	609 3 397 118 309	<b>N 66</b>	<b>N 66</b>
Master	02.10→							<b>N 70</b>	<b>N 70</b>
Master	02.10→	WW		AR 650 U 3 397 008 939	AR 650 U 3 397 008 939		650 3 397 118 320	<b>N 70</b>	<b>N 70</b>
Master	02.10→	WW		AR 65 N 3 397 008 844	AR 65 N 3 397 008 844			<b>600 U</b>	<b>600 U</b>
Master	02.10→	WW		AR 65 N 3 397 008 844	AR 65 N 3 397 008 844			<b>650 U</b>	<b>650 U</b>
Maxity	03.07→		AR 500 S 3 397 009 081	AR 500 U 3 397 008 935	AR 500 U 3 397 008 935		500 3 397 118 560	<b>500 U</b>	<b>500 U</b>
Midliner	10.86-12.01							<b>500 U</b>	<b>500 U</b>
Midliner	06.89-12.01					L60		<b>N 53</b>	<b>N 53</b>
Midlum	03.00-04.06		AR 609 S 3 397 009 776	AR 61 N 3 397 008 847	AR 61 N 3 397 008 847	SDV	609 3 397 118 309	<b>N 63</b>	<b>N 63</b>
Midlum II	05.06→		AR 609 S 3 397 009 776	AR 61 N 3 397 008 847	AR 61 N 3 397 008 847	SDV	609 3 397 118 309	<b>609</b>	<b>609</b>
PR	06.84→							<b>N 70</b>	<b>N 70</b>
Premium	02.96-10.05			AR 71 N 3 397 008 849	AR 71 N 3 397 008 849	SDV		<b>N 74</b>	<b>N 74</b>
Premium	11.05-04.06			AR 66 N 3 397 008 848	AR 66 N 3 397 008 848	SDV		<b>N 66</b>	<b>N 66</b>
Premium II	09.05→			AR 66 N 3 397 008 848	AR 66 N 3 397 008 848	SDV		<b>N 66</b>	<b>N 66</b>





R	01.86-10.96							N 53 3 397 018 964	N 53 3 397 018 964
	11.86-12.03							N 100 3 397 018 199	N 100 3 397 018 199
						WW		N 102 3 397 011 427	N 102 3 397 011 427
	05.88-10.96							N 45 3 397 018 145	N 45 3 397 018 145
S	06.80-10.96						603 3 397 118 301	600 U 3 397 004 586	600 U 3 397 004 586
Trafic	09.80-05.01	HBG	AR 500 S 3 397 009 081	AR 500 U 3 397 008 935	AR 500 U 3 397 008 935	HBG	500 3 397 118 560	500 U 3 397 004 583	500 U 3 397 004 583
	[EL./FL./JL.]	05.01→	AR 801 S 3 397 118 996	AR 600 U 3 397 008 938	AR 530 U 3 397 008 936		611 S 3 397 010 300	600 US 3 397 004 592	530 U 3 397 004 584
Winnebago	03.88-12.00	KUR				KUR	450 3 397 118 505	450 U 3 397 004 581	450 U 3 397 004 581
110	06.80-01.95							N 53 3 397 018 964	N 53 3 397 018 964

SCANIA

G-Serie	09.07→	SDV		AR 71 N 3 397 008 849	AR 71 N 3 397 008 849	SDV		N 71 3 397 011 238	N 71 3 397 011 238
P-Serie	09.04→	SDV		AR 71 N 3 397 008 849	AR 71 N 3 397 008 849	SDV		N 71 3 397 011 238	N 71 3 397 011 238
R-Serie	02.04→	SDV		AR 71 N 3 397 008 849	AR 71 N 3 397 008 849	SDV		N 71 3 397 011 238	N 71 3 397 011 238
T-Serie	09.04-10.05	SDV		AR 71 N 3 397 008 849	AR 71 N 3 397 008 849	SDV		N 71 3 397 011 238	N 71 3 397 011 238
Touring	10.09→					HBG		N 101 3 397 018 198	N 101 3 397 018 198
						WW		N 102 3 397 011 427	N 102 3 397 011 427
93	03.88-08.97			AR 60 N 3 397 008 843	AR 60 N 3 397 008 843		603 3 397 118 301	600 U 3 397 004 586	600 U 3 397 004 586
	[BUS]	06.90-01.98		AR 60 N 3 397 008 843	AR 60 N 3 397 008 843		603 3 397 118 301	600 U 3 397 004 586	600 U 3 397 004 586
94	08.96-09.04			AR 70 N 3 397 008 845	AR 70 N 3 397 008 845	SDA		N 70 3 397 018 170	N 70 3 397 018 170
113	05.88-12.00			AR 60 N 3 397 008 843	AR 60 N 3 397 008 843		603 3 397 118 301	600 U 3 397 004 586	600 U 3 397 004 586
	[BUS]	12.88-08.98		AR 60 N 3 397 008 843	AR 60 N 3 397 008 843		603 3 397 118 301	600 U 3 397 004 586	600 U 3 397 004 586
114	02.96-09.04			AR 70 N 3 397 008 845	AR 70 N 3 397 008 845	SDA		N 70 3 397 018 170	N 70 3 397 018 170
124	03.95-09.04			AR 70 N 3 397 008 845	AR 70 N 3 397 008 845	SDA		N 70 3 397 018 170	N 70 3 397 018 170
143	03.88-06.98			AR 60 N 3 397 008 843	AR 60 N 3 397 008 843		603 3 397 118 301	600 U 3 397 004 586	600 U 3 397 004 586
144	01.96-08.01			AR 70 N 3 397 008 845	AR 70 N 3 397 008 845	SDA		N 70 3 397 018 170	N 70 3 397 018 170
164	04.00-09.04			AR 70 N 3 397 008 845	AR 70 N 3 397 008 845	SDA		N 70 3 397 018 170	N 70 3 397 018 170

SEDDON ATKINSON

Strato	01.01-10.06							N 65 3 397 018 963	N 65 3 397 018 963
--------	-------------	--	--	--	--	--	--	-----------------------	-----------------------





**SEDDON DIESEL**

201	01.80→							<b>N 55</b> 3 397 018 965	<b>N 55</b> 3 397 018 965
301	01.80→							<b>N 55</b> 3 397 018 965	<b>N 55</b> 3 397 018 965
400	01.80→							<b>N 55</b> 3 397 018 965	<b>N 55</b> 3 397 018 965

**SETRA**

ComfortClass 400	02.03→							<b>N 101</b> 3 397 018 198	<b>N 101</b> 3 397 018 198
								WW	<b>N 102</b> 3 397 011 427
MultiClass 400	01.05→							<b>N 101</b> 3 397 018 198	<b>N 101</b> 3 397 018 198
								WW	<b>N 102</b> 3 397 011 427
Setra	03.95-07.01							<b>N 101</b> 3 397 018 198	<b>N 101</b> 3 397 018 198
								WW	<b>N 102</b> 3 397 011 427
TopClass 400	02.03→							<b>N 101</b> 3 397 018 198	<b>N 101</b> 3 397 018 198
								WW	<b>N 102</b> 3 397 011 427

**SISU**

R	05.77→							<b>N 40</b> 3 397 018 140	<b>N 40</b> 3 397 018 140
SK	09.81-12.95							<b>N 63</b> 3 397 018 966	<b>N 63</b> 3 397 018 966
SM	12.82-12.95							<b>N 63</b> 3 397 018 966	<b>N 63</b> 3 397 018 966
SR	04.82-12.95							<b>N 63</b> 3 397 018 966	<b>N 63</b> 3 397 018 966

**SOLARIS**

Urbino	01.99→			<b>AR 81 N</b> 3 397 008 846	<b>AR 81 N</b> 3 397 008 846			<b>N 81</b> 3 397 018 181	<b>N 81</b> 3 397 018 181
								WW	<b>N 82</b> 3 397 011 425
InterUrbino	06.10→			<b>AR 81 N</b> 3 397 008 846	<b>AR 81 N</b> 3 397 008 846			<b>N 81</b> 3 397 018 181	<b>N 81</b> 3 397 018 181
								WW	<b>N 82</b> 3 397 011 425
Vacanza/Vacanza	01.02→							<b>N 100</b> 3 397 018 199	<b>N 100</b> 3 397 018 199
								WW	<b>N 102</b> 3 397 011 427

**SOLBUS**

Soltour	09.07→							<b>N 101</b> 3 397 018 198	<b>N 101</b> 3 397 018 198
								WW	<b>N 102</b> 3 397 011 427



			AEROTWIN			TWIN		
			SET	L	L	SET	L	L
Solway	09.07→						<b>N 101</b>	<b>N 101</b>
						WW	3 397 018 198	3 397 018 198
							<b>N 102</b>	<b>N 102</b>
							3 397 011 427	3 397 011 427
<b>STEYR</b>								
Pinzgauer	10.86-12.96					<b>340</b>	<b>340 U</b>	<b>340 U</b>
						3 397 118 700	3 397 004 578	3 397 004 578
8 S	05.89→						<b>N 53</b>	<b>N 53</b>
							3 397 018 964	3 397 018 964
9 S	04.86→						<b>N 53</b>	<b>N 53</b>
							3 397 018 964	3 397 018 964
10 S	04.86→						<b>N 53</b>	<b>N 53</b>
							3 397 018 964	3 397 018 964
11 S	07.89→						<b>N 53</b>	<b>N 53</b>
							3 397 018 964	3 397 018 964
12 S	04.86→						<b>N 53</b>	<b>N 53</b>
							3 397 018 964	3 397 018 964
13 S	09.88→						<b>N 53</b>	<b>N 53</b>
							3 397 018 964	3 397 018 964
14 S	04.86→						<b>N 53</b>	<b>N 53</b>
							3 397 018 964	3 397 018 964
15 S	04.86→						<b>N 53</b>	<b>N 53</b>
							3 397 018 964	3 397 018 964
16 S	04.86→						<b>N 53</b>	<b>N 53</b>
							3 397 018 964	3 397 018 964
17 S	09.88→						<b>N 53</b>	<b>N 53</b>
							3 397 018 964	3 397 018 964
<b>SUZUKI</b>								
Carry [ED]	10.85-03.99					HBG	<b>420</b>	<b>420 U</b>
							3 397 118 500	3 397 011 354
[FD]	03.99-03.09						<b>400</b>	<b>400 U</b>
							3 397 118 610	3 397 004 579
Carry Van [ED]	10.85-03.99					HBG	<b>420</b>	<b>420 U</b>
							3 397 118 500	3 397 011 354
<b>TATRA</b>								
T 815	03.83→						<b>N 55</b>	<b>N 55</b>
							3 397 018 965	3 397 018 965
						<b>550</b>	<b>550 U</b>	
						3 397 118 420	3 397 004 585	3 397 004 585
<b>TEMSA</b>								
Avenue	01.10→						<b>N 100</b>	<b>N 100</b>
						WW	3 397 018 199	3 397 018 199
							<b>N 102</b>	<b>N 102</b>
							3 397 011 427	3 397 011 427
Diamond	09.04→			<b>AR 81 N</b>	<b>AR 81 N</b>		<b>N 80</b>	<b>N 80</b>
				3 397 008 846	3 397 008 846		3 397 018 180	3 397 018 180
Metropol	10.06→						<b>N 100</b>	<b>N 100</b>
						WW	3 397 018 199	3 397 018 199
							<b>N 102</b>	<b>N 102</b>
							3 397 011 427	3 397 011 427
Opalin	09.05→	KUR		<b>AR 81 N</b>	<b>AR 81 N</b>		<b>N 90</b>	<b>N 90</b>
				3 397 008 846	3 397 008 846		3 397 018 190	3 397 018 190
Prestij	01.07→	KUR					<b>N 90</b>	<b>N 90</b>
						WW	3 397 018 190	3 397 018 190
							<b>N 92</b>	<b>N 92</b>
							3 397 011 426	3 397 011 426



--	--	--	--	--	--	--	--	--

◀ TEMSA

Safari	10.06→						<b>N 100</b>	<b>N 100</b>
						WW	3 397 018 199	3 397 018 199
Safir	01.99→						<b>N 102</b>	<b>N 102</b>
						WW	3 397 011 427	3 397 011 427
Tourmalin	10.06→						<b>N 100</b>	<b>N 100</b>
						WW	3 397 018 199	3 397 018 199

**TOYOTA**

Corolla Van	09.91-06.02		<b>AR 502 S</b> 3 397 118 995	<b>AR 500 U</b> 3 397 008 935	<b>AR 450 U</b> 3 397 008 933		<b>502</b> 3 397 118 563	<b>500 U</b> 3 397 004 583	<b>450 U</b> 3 397 004 581
Dyna	08.87-05.95							<b>N 40</b> 3 397 018 140	<b>N 40</b> 3 397 018 140
	05.95-08.01					HBG	<b>420</b> 3 397 118 500	<b>420 U</b> 3 397 011 354	<b>420 U</b> 3 397 011 354
	10.00→		<b>AR 500 S</b> 3 397 009 081	<b>AR 500 U</b> 3 397 008 935	<b>AR 500 U</b> 3 397 008 935		<b>500</b> 3 397 118 560	<b>500 U</b> 3 397 004 583	<b>500 U</b> 3 397 004 583
Hiace [KLH]	08.01→		<b>AR 530 S</b> 3 397 118 903	<b>AR 530 U</b> 3 397 008 936	<b>AR 530 U</b> 3 397 008 936		<b>530</b> 3 397 118 400	<b>530 U</b> 3 397 004 584	<b>530 U</b> 3 397 004 584
[LXH]	08.95-12.95						<b>502</b> 3 397 118 563	<b>500 U</b> 3 397 004 583	<b>450 U</b> 3 397 004 581
	01.96-08.01		<b>AR 530 S</b> 3 397 118 903	<b>AR 530 U</b> 3 397 008 936	<b>AR 530 U</b> 3 397 008 936		<b>530</b> 3 397 118 400	<b>530 U</b> 3 397 004 584	<b>530 U</b> 3 397 004 584
	08.95-12.95						<b>502</b> 3 397 118 563	<b>500 U</b> 3 397 004 583	<b>450 U</b> 3 397 004 581
[RCH]	01.96-11.09		<b>AR 530 S</b> 3 397 118 903	<b>AR 530 U</b> 3 397 008 936	<b>AR 530 U</b> 3 397 008 936		<b>530</b> 3 397 118 400	<b>530 U</b> 3 397 004 584	<b>530 U</b> 3 397 004 584
Hiace Van [LH; ZH]	08.89-12.95						<b>502</b> 3 397 118 563	<b>500 U</b> 3 397 004 583	<b>450 U</b> 3 397 004 581
[LH, LXH, ZH]	08.96-02.06		<b>AR 530 S</b> 3 397 118 903	<b>AR 530 U</b> 3 397 008 936	<b>AR 530 U</b> 3 397 008 936		<b>530</b> 3 397 118 400	<b>530 U</b> 3 397 004 584	<b>530 U</b> 3 397 004 584
Hiace Wagon [LH; ZH]	08.89-12.95						<b>502</b> 3 397 118 563	<b>500 U</b> 3 397 004 583	<b>450 U</b> 3 397 004 581
[LH; ZH]	08.96-02.06		<b>AR 530 S</b> 3 397 118 903	<b>AR 530 U</b> 3 397 008 936	<b>AR 530 U</b> 3 397 008 936		<b>530</b> 3 397 118 400	<b>530 U</b> 3 397 004 584	<b>530 U</b> 3 397 004 584
Land Cruiser	01.98-06.04		<b>AR 566 S</b> 3 397 118 990	<b>AR 480 U</b> 3 397 008 934	<b>AR 450 U</b> 3 397 008 933		<b>481</b> 3 397 118 542	<b>480 U</b> 3 397 004 582	<b>450 U</b> 3 397 004 581

**VAN HOOL**

A	07.92→	KUR		<b>AR 81 N</b> 3 397 008 846	<b>AR 81 N</b> 3 397 008 846			<b>N 90</b> 3 397 018 190	<b>N 90</b> 3 397 018 190
AG	06.91→	KUR		<b>AR 81 N</b> 3 397 008 846	<b>AR 81 N</b> 3 397 008 846			<b>N 92</b> 3 397 011 426	<b>N 92</b> 3 397 011 426
						WW		<b>N 90</b> 3 397 018 190	<b>N 90</b> 3 397 018 190
AGG	09.09→	KUR		<b>AR 81 N</b> 3 397 008 846	<b>AR 81 N</b> 3 397 008 846			<b>N 92</b> 3 397 011 426	<b>N 92</b> 3 397 011 426
						WW		<b>N 90</b> 3 397 018 190	<b>N 90</b> 3 397 018 190
T9 Acron	10.05→					LA1,UE		<b>N 100</b> 3 397 018 199	<b>N 100</b> 3 397 018 199
						LA1,UE, WW		<b>N 102</b> 3 397 011 427	<b>N 102</b> 3 397 011 427
						L55,OE		<b>N 56</b> 3 397 018 962	<b>N 56</b> 3 397 018 962





			AEROTWIN			TWIN			
			SET	L	L	SET	L	L	
T9 Alicron	10.06→					LA1		<b>N 100</b> 3 397 018 199	<b>N 100</b> 3 397 018 199
						LA1,WW		<b>N 102</b> 3 397 011 427	<b>N 102</b> 3 397 011 427
T9 Astromega	10.08→	UE		<b>AR 81 N</b> 3 397 008 846	<b>AR 81 N</b> 3 397 008 846	L80,UE		<b>N 80</b> 3 397 018 180	<b>N 80</b> 3 397 018 180
						L80,UE, WW		<b>N 82</b> 3 397 011 425	<b>N 82</b> 3 397 011 425
						L60,OE		<b>N 63</b> 3 397 018 966	<b>N 63</b> 3 397 018 966
						L70,OE		<b>N 70</b> 3 397 018 170	<b>N 70</b> 3 397 018 170
<b>VOLVO</b>									
B 10 M	01.94→							<b>N 81</b> 3 397 018 181	<b>N 81</b> 3 397 018 181
						WW		<b>N 82</b> 3 397 011 425	<b>N 82</b> 3 397 011 425
						WW		<b>N 80</b> 3 397 018 180	<b>N 80</b> 3 397 018 180
B 12 B	06.01→					UE		<b>N 100</b> 3 397 018 199	<b>N 100</b> 3 397 018 199
						UE,WW		<b>N 102</b> 3 397 011 427	<b>N 102</b> 3 397 011 427
B 8700	08.02→							<b>N 100</b> 3 397 018 199	<b>N 100</b> 3 397 018 199
						WW		<b>N 102</b> 3 397 011 427	<b>N 102</b> 3 397 011 427
FE	05.06→	SDV		<b>AR 66 N</b> 3 397 008 848	<b>AR 66 N</b> 3 397 008 848	SDV	<b>609</b> 3 397 118 309	<b>N 66</b> 3 397 011 310	<b>N 66</b> 3 397 011 310
FH	09.06→			<b>AR 65 N</b> 3 397 008 844	<b>AR 65 N</b> 3 397 008 844			<b>N 65</b> 3 397 018 963	<b>N 65</b> 3 397 018 963
FH II	03.13→							<b>N 71</b> 3 397 011 238	<b>N 71</b> 3 397 011 238
FH 12	08.93-08.06			<b>AR 65 N</b> 3 397 008 844	<b>AR 65 N</b> 3 397 008 844			<b>N 65</b> 3 397 018 963	<b>N 65</b> 3 397 018 963
FH 16	08.93→			<b>AR 65 N</b> 3 397 008 844	<b>AR 65 N</b> 3 397 008 844			<b>N 65</b> 3 397 018 963	<b>N 65</b> 3 397 018 963
FL	05.06→	SDV	<b>AR 609 S</b> 3 397 009 776	<b>AR 61 N</b> 3 397 008 847	<b>AR 61 N</b> 3 397 008 847	SDV	<b>609</b> 3 397 118 309		
FL 6	05.00-05.06	SDV	<b>AR 609 S</b> 3 397 009 776	<b>AR 61 N</b> 3 397 008 847	<b>AR 61 N</b> 3 397 008 847	SDV	<b>609</b> 3 397 118 309		
FL 7	09.85-01.96							<b>N 72</b> 3 397 002 918	<b>N 72</b> 3 397 002 918
FL 12	09.95-12.01							<b>N 72</b> 3 397 002 918	<b>N 72</b> 3 397 002 918
FM	09.05→			<b>AR 65 N</b> 3 397 008 844	<b>AR 65 N</b> 3 397 008 844			<b>N 65</b> 3 397 018 963	<b>N 65</b> 3 397 018 963
FM 7	09.98-12.01			<b>AR 65 N</b> 3 397 008 844	<b>AR 65 N</b> 3 397 008 844			<b>N 65</b> 3 397 018 963	<b>N 65</b> 3 397 018 963
FM 9	12.01→			<b>AR 65 N</b> 3 397 008 844	<b>AR 65 N</b> 3 397 008 844			<b>N 65</b> 3 397 018 963	<b>N 65</b> 3 397 018 963
FM 10	04.99-12.01			<b>AR 65 N</b> 3 397 008 844	<b>AR 65 N</b> 3 397 008 844			<b>N 65</b> 3 397 018 963	<b>N 65</b> 3 397 018 963
FM 12	09.98-09.05			<b>AR 65 N</b> 3 397 008 844	<b>AR 65 N</b> 3 397 008 844			<b>N 65</b> 3 397 018 963	<b>N 65</b> 3 397 018 963
FMX	03.10→			<b>AR 65 N</b> 3 397 008 844	<b>AR 65 N</b> 3 397 008 844			<b>N 65</b> 3 397 018 963	<b>N 65</b> 3 397 018 963
N 12	09.83-01.96					WW	<b>400</b> 3 397 118 610	<b>400 U</b> 3 397 004 579	<b>400 U</b> 3 397 004 579
								<b>N 40</b> 3 397 018 140	<b>N 40</b> 3 397 018 140
NH 12	05.99→			<b>AR 65 N</b> 3 397 008 844	<b>AR 65 N</b> 3 397 008 844			<b>650 U</b> 3 397 004 587	<b>650 U</b> 3 397 004 587



--	--	--	--	--	--	--	--	--

◀ VOLVO

7700	06.06→						<b>N 100</b> 3 397 018 199	<b>N 100</b> 3 397 018 199
					WW		<b>N 102</b> 3 397 011 427	<b>N 102</b> 3 397 011 427
9700	04.01→						<b>N 101</b> 3 397 018 198	<b>N 101</b> 3 397 018 198
					WW		<b>N 102</b> 3 397 011 427	<b>N 102</b> 3 397 011 427
9900	10.01→						<b>N 101</b> 3 397 018 198	<b>N 101</b> 3 397 018 198
					WW		<b>N 102</b> 3 397 011 427	<b>N 102</b> 3 397 011 427

**VW**

California T4 [70, 7D]	09.90-06.03		<b>AR 532 S</b> 3 397 118 986	<b>AR 530 U</b> 3 397 008 936	<b>AR 500 U</b> 3 397 008 935		<b>530</b> 3 397 118 400	<b>530 U</b> 3 397 004 584	<b>530 U</b> 3 397 004 584
California T5 [7H]	02.03-11.09	SBF	<b>A 938 S</b> 3 397 118 938	<b>AM 24 U</b> 3 397 008 571	<b>AM 24 U</b> 3 397 008 571	BGO, HBG	<b>610 S</b> 3 397 010 280	<b>600 US</b> 3 397 004 592	
[7E]	09.09-05.13					HBG, BGO, HBG,KUR	<b>801 S</b> 3 397 001 802	<b>610 S</b> 3 397 010 280	<b>600 US</b> 3 397 004 592
Caravelle T4 [70, 7D]	09.90-06.03		<b>AR 532 S</b> 3 397 118 986	<b>AR 530 U</b> 3 397 008 936	<b>AR 500 U</b> 3 397 008 935		<b>530</b> 3 397 118 400	<b>530 U</b> 3 397 004 584	<b>530 U</b> 3 397 004 584
Caravelle T5 [7H]	02.03-11.09	SBF	<b>A 938 S</b> 3 397 118 938	<b>AM 24 U</b> 3 397 008 571	<b>AM 24 U</b> 3 397 008 571	BGO, HBG	<b>610 S</b> 3 397 010 280	<b>600 US</b> 3 397 004 592	
[7E]	09.09-05.13					HBG, BGO, HBG,KUR	<b>801 S</b> 3 397 001 802	<b>610 S</b> 3 397 010 280	<b>600 US</b> 3 397 004 592
Crafter [2E]	04.06→		<b>A 215 S</b> 3 397 007 215	<b>AM 26 U</b> 3 397 008 573	<b>AM 24 U</b> 3 397 008 571				
Eurovan [70]	10.92-05.00		<b>AR 532 S</b> 3 397 118 986	<b>AR 530 U</b> 3 397 008 936	<b>AR 500 U</b> 3 397 008 935		<b>530</b> 3 397 118 400	<b>530 U</b> 3 397 004 584	<b>530 U</b> 3 397 004 584
LT [2D, 2H]	05.96-04.06		<b>AR 801 S</b> 3 397 118 996	<b>AR 600 U</b> 3 397 008 938	<b>AR 530 U</b> 3 397 008 936		<b>543</b> 3 397 001 543	<b>600 U</b> 3 397 004 586	<b>530 U</b> 3 397 004 584
Multivan T4 [70, 7D]	09.90-06.03		<b>AR 532 S</b> 3 397 118 986	<b>AR 530 U</b> 3 397 008 936	<b>AR 500 U</b> 3 397 008 935		<b>530</b> 3 397 118 400	<b>530 U</b> 3 397 004 584	<b>530 U</b> 3 397 004 584
Multivan T5 [7H]	02.03-11.09	SBF	<b>A 938 S</b> 3 397 118 938	<b>AM 24 U</b> 3 397 008 571	<b>AM 24 U</b> 3 397 008 571	BGO, HBG	<b>610 S</b> 3 397 010 280	<b>600 US</b> 3 397 004 592	
[7E]	09.09-05.13					HBG, BGO, HBG,KUR	<b>801 S</b> 3 397 001 802	<b>610 S</b> 3 397 010 280	<b>600 US</b> 3 397 004 592
Transporter T3 [24, 25]	08.82-07.92						<b>450</b> 3 397 118 505	<b>450 U</b> 3 397 004 581	<b>450 U</b> 3 397 004 581
Transporter T4 [70, 7D]	09.90-06.03		<b>AR 532 S</b> 3 397 118 986	<b>AR 530 U</b> 3 397 008 936	<b>AR 500 U</b> 3 397 008 935		<b>530</b> 3 397 118 400	<b>530 U</b> 3 397 004 584	<b>530 U</b> 3 397 004 584
Transporter T5 [7H; 7J]	02.03-11.09	SBF	<b>A 938 S</b> 3 397 118 938	<b>AM 24 U</b> 3 397 008 571	<b>AM 24 U</b> 3 397 008 571	BGO, HBG	<b>610 S</b> 3 397 010 280	<b>600 US</b> 3 397 004 592	
[7E]	09.09-05.13					HBG, BGO, HBG,KUR	<b>801 S</b> 3 397 001 802	<b>610 S</b> 3 397 010 280	<b>600 US</b> 3 397 004 592



























<b>16M</b>	Breite der Wischblattaufnahme 16 mm	<b>GLF</b>	Für Fahrzeuge mit gleichlaufenden Wischerarmen	<b>ORO</b>	Für Fahrzeuge ohne Regensensor
<b>19M</b>	Breite der Wischblattaufnahme 19 mm	<b>HA</b>	Für Haubenausführung	<b>PBG</b>	Pinarm-Befestigung
<b>2AA</b>	Adapter 2 verwenden, Montageanleitung A	<b>HBG</b>	Hakenbefestigung	<b>REF</b>	Wischgummi + Schiene, Refill
<b>2AB</b>	Adapter 2 verwenden, Montageanleitung B	<b>HUW</b>	Hubgesteuerte Wischanlage	<b>SBF</b>	Seitliche Befestigung
<b>2CC</b>	Adapter 2 verwenden, Montageanleitung C	<b>KOB</b>	Für Kombiwagen	<b>SCR</b>	Schrägheck
<b>ADD</b>	Wischblatt-Adapter 3 392 390 298 mitverwenden	<b>KUR</b>	Wischblatt geringfügig kürzer als Original	<b>SDA</b>	Spritzdüse am Wischarm
<b>ADF</b>	Bei Steckbefestigung Adapter 3 392 390 335 mitverwenden	<b>KWB</b>	Nur für Kunststoff-Wischblatt	<b>SDV</b>	Mit vormontierter Spritzdüse
<b>ADG</b>	Wischblatt-Adapter 3 392 390 079 mitverwenden	<b>L28</b>	Länge: 280 mm	<b>SPA</b>	Sparausführung
<b>AP1</b>	Adapter 1 verwenden	<b>L30</b>	Länge: 300 mm	<b>SPO</b>	Für Fahrzeuge ohne Spoiler
<b>AP3</b>	Adapter 3 verwenden	<b>L34</b>	Länge: 340 mm	<b>SWO</b>	Nur für Fahrzeuge ohne Spritzdüse am Wischblatt
<b>AP4</b>	Adapter 4 verwenden	<b>L40</b>	Länge: 400 mm	<b>SZS</b>	Sprührohr 3 397 000 669 separat bestellen
<b>APE</b>	Adapter entfernen	<b>L45</b>	Länge: 450 mm	<b>TOB</b>	Für Fahrzeuge mit Ersatzrad an der Hecktür
<b>BEI</b>	Beifahrerseite	<b>L50</b>	Länge: 500 mm	<b>TU2</b>	2 Türen
<b>BGO</b>	Beifahrerseite gebogen	<b>L55</b>	Länge: 550 mm	<b>TU3</b>	3 Türen
<b>BGR</b>	Beifahrerseite gerade	<b>L60</b>	Länge: 600 mm	<b>TU5</b>	5 Türen
<b>BO</b>	Bosch, nur als Ersatz für Bosch-Ausrüstung	<b>L65</b>	Länge: 650 mm	<b>TW</b>	Eingebautes Erzeugnis muss am Fahrzeug oder Motor ermittelt werden.
<b>FAS</b>	Fahrerseite	<b>L70</b>	Länge: 700 mm	<b>UE</b>	Unten eingebaut
<b>FBF</b>	Führungsbügel entfernen	<b>L80</b>	Länge: 800 mm	<b>WGG</b>	Wischgummi gegebenenfalls kürzen
<b>FKR</b>	Für Fahrzeuge mit kurzem Radstand	<b>L90</b>	Länge: 900 mm	<b>WOB</b>	Befestigung von oben
<b>FLR</b>	Für Fahrzeuge mit langem Radstand	<b>LA1</b>	Länge: 1000 mm	<b>WW</b>	Wahlweise
<b>GA</b>	Gerade	<b>LIM</b>	Für Limousine	<b>XXL</b>	Nur für XXL Fahrerhaus
<b>GBO</b>	Wischblatt gebogen	<b>MGT</b>	Für Fahrzeuge mit geteilter Hecktür	<b>ZE</b>	Zwei erforderlich
<b>GEG</b>	Für Fahrzeuge mit gegenlaufenden Wischerarmen	<b>MHK</b>	Für Fahrzeuge mit Heckklappe	<b>ZU2</b>	Zubehör 3 392 390 088 muß mitverwendet werden
		<b>MHT</b>	Für Fahrzeuge mit Hecktür		
		<b>OAM</b>	Original Abdeckkappe nicht mehr montierbar		
		<b>OE</b>	Oben eingebaut		

	Pkw / Kleintransporter		Beifahrerseite
	Nkw / Kleintransporter		Datum / Einbauperiode
	Aerotwin		Sonderfälle
	Wischblatt mit Spoiler		Suchnummer
	Twin		alte Suchnummer
	Standardwischblatt		Maße Wischarm
	Heckwischblatt		Wischblattlänge
	Set		Wischgummi
	Fahrerseite		Wischblattadapter

<b>16M</b>	Width of wiper blade connection 16 mm	<b>GLF</b>	For vehicles with tandem wiper arm pattern	<b>ORO</b>	For vehicles without rain sensor
<b>19M</b>	Width of wiper blade connection 19 mm	<b>HA</b>	For cab-behind-engine version	<b>PBG</b>	Pinarm attachment
<b>2AA</b>	Use adapter 2, mounting A	<b>HBG</b>	Hook-type fastening	<b>REF</b>	Wiper blade element + rail, refill
<b>2BB</b>	Use adapter 2, mounting B	<b>HUW</b>	Eccentric-sweep wiper system	<b>SBF</b>	Side mounting
<b>2CC</b>	Use adapter 2, mounting C	<b>KOB</b>	For station wagon	<b>SCR</b>	Hatchback
<b>ADD</b>	Also use wiper blade adapter 3 392 390 298	<b>KUR</b>	Wiper blade slightly shorter than original	<b>SDA</b>	Nozzle at wiper arm
<b>ADF</b>	Adapter 3392390335 is required for plug-in attachment	<b>KWB</b>	For plastic wiper blade only	<b>SDV</b>	With pre-assembled nozzle
<b>ADG</b>	Also use wiper blade adapter 3 392 390 079	<b>L28</b>	Length: 280 mm	<b>SPA</b>	Economy version
<b>AP1</b>	Use adapter 1	<b>L30</b>	Length: 300 mm	<b>SPO</b>	For vehicles without spoiler
<b>AP3</b>	Use adapter 3	<b>L34</b>	Length: 340 mm	<b>SWO</b>	Only for vehicles with no spray jet at wiper blade
<b>AP4</b>	Use adapter 4	<b>L40</b>	Length: 400 mm	<b>SZS</b>	Order spray pipe 3 397 000 669 separately
<b>APE</b>	Remove adapter	<b>L45</b>	Length: 450 mm	<b>TOB</b>	For vehicles with spare wheel on rear door
<b>BEI</b>	Front passenger side	<b>L50</b>	Length: 500 mm	<b>TU2</b>	2 doors
<b>BGO</b>	Passenger side, curved	<b>L55</b>	Length: 550 mm	<b>TU3</b>	3 doors
<b>BGR</b>	Passenger side, straight	<b>L60</b>	Length: 600 mm	<b>TU5</b>	5 doors
<b>BO</b>	Bosch, only as replacement for Bosch equipment	<b>L65</b>	Length: 650 mm	<b>TW</b>	The product fitted must be identified on the vehicle or engine
<b>FAS</b>	Driver's side	<b>L70</b>	Length: 700 mm	<b>UE</b>	Installed at bottom
<b>FFB</b>	Remove guide bracket	<b>L80</b>	Length: 800 mm	<b>WGK</b>	Shorten wiper blade element if necessary
<b>FKR</b>	For vehicles with short wheelbase	<b>L90</b>	Length: 900 mm	<b>WOB</b>	Attachment from above
<b>FLR</b>	For vehicles with long wheelbase	<b>LA1</b>	Length: 1000 mm	<b>WW</b>	Optional
<b>GA</b>	Straight	<b>LIM</b>	For limousine	<b>XXL</b>	For XXL cab only
<b>GBO</b>	Angled wiper blade	<b>MGT</b>	For vehicles with split rear door	<b>ZE</b>	Two required
<b>GEG</b>	For vehicles with opposed wiper arm pattern	<b>MHK</b>	For vehicles with tailgate	<b>ZU2</b>	Accessory 3 392 390 088 must also be used
		<b>MHT</b>	For vehicles with rear door		
		<b>OAM</b>	The original cap can no longer be fitted		
		<b>OE</b>	Installed at top		

	Passenger cars / small vans		Front passenger's side
	Commercial vehicle / small transporter		Date / Production period
	Aerotwin		Special case
	Wiper blade with spoiler		Search number
	Twin		Old item number
	Wiper blade, standard		Wiper arm dimensions
	Rear-window wiper blade		Wiper blade length
	Set		Wiper blade element
	Driver's side		Wiper blade adapter

<b>16M</b>	Torkarbladsfästets bredd 16 mm	<b>GLF</b>	För bilar med synkront löpande torkararmar	<b>ORO</b>	För bilar utan regnsensor
<b>19M</b>	Torkarbladsfästets bredd 19 mm	<b>HA</b>	För huvutförändel	<b>PBG</b>	Pinnarmsfäste
<b>2AA</b>	Använd adapter 2, monteringsanvisning A	<b>HBG</b>	Krokfastsättning	<b>REF</b>	Torkargummi + skena, utbyte
<b>2BB</b>	Använd adapter 2, monteringsanvisning B	<b>HUW</b>	Slagstyrd vindrutetorkaranläggning	<b>SBF</b>	Sidomontering
<b>2CC</b>	Använd adapter 2, monteringsanvisning C	<b>KOB</b>	För kombibil	<b>SCR</b>	Hatchback
<b>ADD</b>	Använd även torkarbladadapter 3 392 390 298	<b>KUR</b>	Torkarblad något kortare än originalet	<b>SDA</b>	Sprutmunstycke på torkararm
<b>ADF</b>	Vid stickinfästning använd adapter 3 392 390 335	<b>KWB</b>	Endast för plasttorkarblad	<b>SDV</b>	Med förmonterat torkarmunstycke
<b>ADG</b>	Använd även torkarbladsadaptern 3 392 390 079	<b>L28</b>	Längd 280 mm	<b>SPA</b>	Ekonomiutförande
<b>AP1</b>	Använd adapter 1	<b>L30</b>	Längd 300 mm	<b>SPØ</b>	För bilar utan spoiler
<b>AP3</b>	Använd adapter 3	<b>L34</b>	Längd 340 mm	<b>SWO</b>	Endast för bilar utan spolmunstycke på torkarbladet
<b>AP4</b>	Använd adapter 4	<b>L40</b>	Längd 400 mm	<b>SZS</b>	Spritsrör 3 397 000 669 beställs separat
<b>APE</b>	Ta bort adaptern	<b>L45</b>	Längd 450 mm	<b>TOB</b>	För bilar med reservhjul på bakdörren
<b>BEI</b>	Passagerarsidan	<b>L50</b>	Längd 500 mm	<b>TU2</b>	2-dörrar
<b>BGO</b>	Passagerarsida böjd	<b>L55</b>	Längd: 550 mm	<b>TU3</b>	3-dörrar
<b>BGR</b>	Passagerarsida rak	<b>L60</b>	Längd 600 mm	<b>TU5</b>	5 dörrar
<b>BO</b>	Bosch, endast som ersättning för Bosch-utrustning	<b>L65</b>	Längd: 650 mm	<b>TW</b>	Monterad produkt måste identifieras på bilen eller motorn.
<b>FAS</b>	Förarsida	<b>L70</b>	Längd 700 mm	<b>UE</b>	Monterad nedtill
<b>FFB</b>	Ta bort styrbygel	<b>L80</b>	Längd 800 mm	<b>WGG</b>	Vindrutetorkargummi avkortas vid behov
<b>FKR</b>	För bil med kort hjulbas	<b>L90</b>	Längd 900 mm	<b>WOB</b>	Infästning uppifrån
<b>FLR</b>	För bil med lång hjulbas	<b>LA1</b>	Längd 1000 mm	<b>WW</b>	Valfritt
<b>GA</b>	Rak	<b>LIM</b>	För limousine	<b>XXL</b>	Endast för XXL förarhytt
<b>GBO</b>	Böjt torkarblad	<b>MGT</b>	För fordon med delad bakdörr	<b>ZE</b>	2 erfordras
<b>GEG</b>	För bilar med motlöpande torkararmar	<b>MHK</b>	För fordon med baklucka	<b>ZU2</b>	Tillbehör 3 392 390 088 måste också användas
		<b>MHT</b>	För fordon med bakdörr		
		<b>OAM</b>	Original skyddskåpa kan inte längre monteras		
		<b>OE</b>	Monterad upptill		



Personbil / lätt lastbil



Passagerarsida



Nyttfordon / pickup



Datum / monteringsstidpunkt



Aerotwin



Speciellt fall



Torkarblad med spoiler



Söknummer



Twin



Gammalt söknummer



Standard viskerblad



Mått för torkararm



Bakre torkarblad



Torkarbladslängd



Sats



Torkargummi



Förarsida



Torkarbladsadapter











<b>16M</b>	Pyyhinsulan kiinnitysleveys 16 mm
<b>19M</b>	Pyyhinsulan kiinnitysleveys 19 mm
<b>2AA</b>	Käytä adapteria 2, asennusohje A
<b>2BB</b>	Käytä adapteria 2, asennusohje B
<b>2CC</b>	Käytä adapteria 2, asennusohje C
<b>ADD</b>	Käytä pyyhinsulkasovitetta 3 392 390 298
<b>ADF</b>	Käytä pistoliitännässä adapteria 3 392 390 335
<b>ADG</b>	Käytä sulka-adapteri 3 392 390 079 mukana
<b>AP1</b>	Käytä adapteria 1
<b>AP3</b>	Käytä adapteria 3
<b>AP4</b>	Käytä adapteria 4
<b>APE</b>	Poista adapteri
<b>BEI</b>	Etumatkustajan puoli
<b>BGO</b>	Etumatkustajan puoli kaarrettu
<b>BGR</b>	Etumatkustajan puoli suora
<b>BO</b>	Bosch vain Bosch-varusteen korvaamiseksi
<b>FAS</b>	kuljettajan puoli
<b>FFB</b>	Irrota ohjainsanka
<b>FKR</b>	Malleihin, joissa lyhyt akseliväli
<b>FLR</b>	Mallit, joissa pitkä akseliväli
<b>GA</b>	suora
<b>GBO</b>	Kaareva pyyhinsulka
<b>GEG</b>	Malleihin, joissa vastasuunnassa toimivat tuulilasin pyyhkimien varret
<b>GLF</b>	Malleihin, joissa samansuuntaisesti toimivat tuulilasin pyyhkimien varret

<b>HA</b>	Nokalliseen ohjaamomalliin
<b>HBG</b>	koukkukiinnitys
<b>HUW</b>	tahdistettu yksivarsi-pyyhinjärjestelmä
<b>KOB</b>	farmari
<b>KUR</b>	Pyyhinsulka hieman lyhyempi kuin alkuperäisosa
<b>KWB</b>	vain muoviseen pyyhinsulkaan
<b>L28</b>	Pituus 280 mm
<b>L30</b>	Pituus 300 mm
<b>L34</b>	Pituus 340 mm
<b>L40</b>	Pituus 400 mm
<b>L45</b>	Pituus 450 mm
<b>L50</b>	Pituus 500 mm
<b>L55</b>	Pituus: 550 mm
<b>L60</b>	Pituus 600 mm
<b>L65</b>	Pituus: 650 mm
<b>L70</b>	Pituus 700 mm
<b>L80</b>	Pituus 800 mm
<b>L90</b>	Pituus 900 mm
<b>LA1</b>	Pituus 1000 mm
<b>LIM</b>	Limousine-malleihin
<b>MGT</b>	Mallit, joissa kaksiosainen takaovi
<b>MHK</b>	Takaluukullisiin malleihin
<b>MHT</b>	Mallit, joissa takaovi
<b>OAM</b>	Alkuperäiskantta ei voi enää käyttää
<b>OE</b>	asennettu ylös
<b>ORO</b>	Mallit ilman sateentunnistinta

<b>PBG</b>	Pinarm-kiinnitys
<b>REF</b>	pyyhkimenkumi + kisko, refill
<b>SBF</b>	sivukiinnitys
<b>SCR</b>	Viistoperä
<b>SDA</b>	Ruiskutussuutin pyyhkijän varressa
<b>SDV</b>	Esiasennetulla ruiskutussuuttimella
<b>SPA</b>	Säästömalli (Economy)
<b>SPØ</b>	Mallit ilman spoileria
<b>SWO</b>	Vain malleihin ilman suuttimella varustettua pyyhinsulkaa
<b>SZS</b>	sumuteputki 3 397 000 669 tilattava erikseen
<b>TOB</b>	Ajoneuvoja varten, joissa varapyörä on takaovessa
<b>TU2</b>	2 ovinen
<b>TU3</b>	3-ovinen
<b>TU5</b>	5-ovinen
<b>TW</b>	Asennettu tuote on määritettävä ajoneuvoa tai moottoria varten.
<b>UE</b>	asennus alas
<b>WGK</b>	Pyyhkiäkumi lyhennettävä tarvittaessa
<b>WOB</b>	Kiinnitys ylhäältä nähtynä.
<b>WW</b>	Optio
<b>XXL</b>	Vain XXL-ohjaamoihin
<b>ZE</b>	Tarvittava määrä: 2
<b>ZU2</b>	As. käytettävä tarvikesarjaa 3 392 390 088

	HA / pienkuljetusauto
	Hyötyajoneuvo/kevytpakettiauto
	Aerotwin
	Pyyhinsulka jossa spoileri
	Twin
	Vakiopyyhinsulka
	Takalasinpyyhkimen sulkakumi
<b>SET</b>	Poltonesteen tuottomäärä nimellisjännitteellä
	Kuljettajan puoli

	Etumatkustajan puoli
	Päiväys/asennusaikaväli
	Erytistapaus
	Hakunumero
	Vanha hakunumero
	Pyyhinvarren mitat
	Pyyhinsulan pituus
	Pyyhkimen sulkakumi
	Pyyhinsulan adapteri

<b>16M</b>	Larghezza dell'alloggiamento spazzola tergicristallo 16 mm	<b>GEG</b>	Per veicoli con bracci tergicristallo a movimento opposto	<b>OE</b>	Montato in alto
<b>19M</b>	Larghezza dell'alloggiamento spazzola tergicristallo 19 mm	<b>GLF</b>	Per veicoli con bracci tergicristallo a movimento parallelo	<b>ORO</b>	Per veicoli senza sensore pioggia
<b>2AA</b>	Utilizzare l'adattatore 2, istruzioni di montaggio A	<b>HA</b>	Per versione con cabina arretrata	<b>PBG</b>	Fissaggio "Pinarm"
<b>2BB</b>	Utilizzare l'adattatore 2, istruzioni di montaggio B	<b>HBG</b>	Fissaggio a gancio	<b>REF</b>	Spazzola tergicristallo in gomma + guida, refill
<b>2CC</b>	Utilizzare l'adattatore 2, istruzioni di montaggio C	<b>HUW</b>	Tergicristallo a corsa controllata	<b>SBF</b>	Fissaggio laterale
<b>ADD</b>	Per questa spazzola, utilizzare l'adattatore 3 392 390 298	<b>KOB</b>	Per station wagon	<b>SCR</b>	A due volumi
<b>ADF</b>	In caso di fissaggio ad innesto usare anche l'adattatore 3 392 390 335	<b>KUR</b>	Spazzola tergicristallo leggermente più corta di quella originale	<b>SDA</b>	Ugello sul braccio tergicristallo
<b>ADG</b>	Utilizzare anche l'adattatore spazzola tergicristallo 3 392 390 079	<b>KWB</b>	Solo per spazzola tergicristallo in materiale sintetico	<b>SDV</b>	Con ugello premontato
<b>AP1</b>	Utilizzare adattatore 1	<b>L28</b>	Lunghezza 280 mm	<b>SPA</b>	Versione economica
<b>AP3</b>	Utilizzare adattatore 3	<b>L30</b>	Lunghezza 300 mm	<b>SPO</b>	Per veicoli senza spoiler
<b>AP4</b>	Utilizzare adattatore 4	<b>L34</b>	Lunghezza 340 mm	<b>SWO</b>	Solo per veicoli senza ugello sulla spazzola tergicristallo
<b>APE</b>	Rimuovere adattatore	<b>L40</b>	Lunghezza 400 mm	<b>SZS</b>	Ordinare a parte il tubo nebulizzazione 3 397 000 669
<b>BEI</b>	Lato passeggero	<b>L45</b>	Lunghezza 450 mm	<b>TOB</b>	Per veicoli con ruota di scorta sul portellone posteriore
<b>BGO</b>	Curvo lato passeggero	<b>L50</b>	Lunghezza 500 mm	<b>TU2</b>	2 porte
<b>BGR</b>	Diritto lato passeggero	<b>L55</b>	Lunghezza: 550 mm	<b>TU3</b>	3 porte
<b>BO</b>	Solo come ricambio per l'equipaggiamento Bosch	<b>L60</b>	Lunghezza 600 mm	<b>TU5</b>	5 porte
<b>FAS</b>	Lato guida	<b>L65</b>	Lunghezza: 650 mm	<b>TW</b>	Il prodotto montato deve essere rilevato sul veicolo o sul motore.
<b>FFB</b>	Rimuovere la staffa di guida	<b>L70</b>	Lunghezza 700 mm	<b>UE</b>	Montato in basso
<b>FKR</b>	Per veicoli a passo corto	<b>L80</b>	Lunghezza 800 mm	<b>WGK</b>	Se necessario, accorciare la spazzola tergicristallo in gomma
<b>FLR</b>	Per veicoli a passo lungo	<b>L90</b>	Lunghezza 900 mm	<b>WOB</b>	Fissaggio dall'alto
<b>GA</b>	Diritto	<b>LA1</b>	Lunghezza 1000 mm	<b>WW</b>	A scelta
<b>GBO</b>	Spazzola tergicristallo incurvata	<b>LIM</b>	Per berlina	<b>XXL</b>	Solo per cabina di guida XXL
		<b>MGT</b>	Per veicoli con portellone posteriore diviso	<b>ZE</b>	Sono necessari due pezzi
		<b>MHK</b>	Per veicoli con portellone posteriore	<b>ZU2</b>	Utilizzare anche l'accessorio 3 392 390 088
		<b>MHT</b>	Per veicoli con porta posteriore		
		<b>OAM</b>	Cappuccio di copertura originale non più montabile		



Autovettura / furgone



Lato passeggero



Veicoli commerciali / camioncini



Data/Periodo di montaggio



Aerotwin



Caso specifico



Spazzola con spoiler



Numero ricerca



Twin



Numero di ricerca vecchio



Spazzola standard



Misure braccio tergicristallo



Spazzola tergilunotto



Lunghezza spazzola



Set



Gomma tangente



Lato conducente



Adattatore spazzola