



ALFA ROMEO

ALFA ROMEO GTV (916C_)						09.94-
1.8 16V, 2.0 T.SPARK 16V	23033		168			
ALFA ROMEO SPIDER (916S_)						09.94-04.05
1.8 16V, 2.0 T.SPARK 16V	23033		168			
ALFA ROMEO 145 (930)						07.94-01.01
1.7 i.e. 16V	23001		121			
1.8 i.e. 16V, 1.8 i.e. 16V T.S., 2.0 16V Quadrifoglio, 2.0 16V T.S.	23033		168			
ALFA ROMEO 146 (930)						12.94-01.01
1.7 i.e. 16V	23001		121			
1.8 i.e. 16V T.S., 2.0 16V Quadrifoglio, 2.0 16V T.S.	23033		168			
ALFA ROMEO 147 (937)						01.01-
2.0 16V T.SPARK	23033		168			
ALFA ROMEO 155 (167)						01.92-12.97
1.7 T.S. 16V, 2.0 T.S. 16V	23033		168			
ALFA ROMEO 156 Sportwagon (932)						05.00-05.06
1.8 16V T.SPARK, 2.0 16V T.SPARK	23033		168			
ALFA ROMEO 156 (932)						09.97-09.05
1.8 16V T.SPARK, 2.0 16V T.SPARK	23033		168			
ALFA ROMEO 166 (936)						09.98-
2.0 T.Spark	23033		168			
ALFA ROMEO 33 Sportwagon (907B)						01.90-09.94
1.7 16V 4x4, 1.7 16V	23001		121			
ALFA ROMEO 33 (907A)						01.90-09.94
1.7 16V 4x4, 1.7 16V	23001		121			

AUDI

AUDI ALLROAD (4BH)						05.00-08.05
2.7 T quattro	23842		253			
AUDI A2 (8Z0)						02.00-08.05
1.4 TDI	23847		120			...8Z-2-017 000, angetriebene Aggregate: angetr. Agg.: Nockenwelle * Driven Units: Driven unit: camshaft * Périphériques entraînés: Arbre à came
1.4 TDI	41847		120		AMF	...8Z-2-017 000
1.4 TDI	23848		120			...8Z-2-017 000
1.2 TDI	23849		117			
1.4, 1.6 FSI	23838		130	58		
1.4	41838		130	58		
1.6 FSI	41838/2		130	58		
AUDI A3 Sportback (8PA)						09.04-
1.6	23832		138			
AUDI A3 (8L1)						09.96-05.03
1.8 T, 1.8 T quattro	23829		150		ARX	8L-Y-125 001..., wahlweise: * Alternately: * au choix:
1.8 T, 1.8 T quattro	23830		150		ARX	8L-Y-125 001..., wahlweise: * Alternately: * au choix:
1.8 T, 1.8 T quattro	23829		150		ARY	8L-Y-125 001..., wahlweise: * Alternately: * au choix:
1.8 T, 1.8 T quattro	23830		150		ARY	8L-Y-125 001..., wahlweise: * Alternately: * au choix:
S3 quattro	23829		150		APY	8L-Y-125 001..., wahlweise: * Alternately: * au choix:
S3 quattro	23830		150		APY	8L-Y-125 001..., wahlweise: * Alternately: * au choix:
1.8	23829		150			8L-Y-125 001..., wahlweise: * Alternately: * au choix:
1.8	23830		150			8L-Y-125 001..., wahlweise: * Alternately: * au choix:
1.8 T, 1.8 T quattro	23831		150		ARX	8L-Y-125 001...



AUDI

AUDI A3 (8L1)

09.96-05.03

1.8 T, 1.8 T quattro	23831		150		ARY	8L-Y-125 001...
S3 quattro	23831		150		APY	8L-Y-125 001...
1.8	23831		150			8L-Y-125 001...
1.8 T, 1.8 T quattro	23912		150		AGU,AQ A,ARZ,A UM	...8L-Y-125 000
1.8 T, 1.8 T quattro	23913		150		AGU,AQ A,ARZ,A UM	...8L-Y-125 000
1.8 T quattro	41912		150		AGU, AQA	...8L-Y-125 000
1.8 T, 1.8 T quattro	23912		150		AJQ,APP ,AUQ	...8L-Y-125 000
1.8 T, 1.8 T quattro	23913		150		AJQ,APP ,AUQ	...8L-Y-125 000
1.8 T	41912		150		AJQ, APP, AUQ	...8L-Y-125 000
1.8 T quattro	41912		150		AJQ	...8L-Y-125 000
S3 quattro	23912		150		APY	...8L-Y-125 000
S3 quattro	23913		150		APY	...8L-Y-125 000
S3 quattro	41912		150		APY	...8L-Y-125 000
1.8	23912		150			...8L-Y-125 000
1.8	23913		150			...8L-Y-125 000
1.8, 1.8 T	41912		150			...8L-Y-125 000
1.9 TDI, 1.9 TDI quattro	41848		120			...8L-2-150 000, bis Motornummer: 115 000
1.9 TDI	41848		120		ATD	...8L-2-150 000, bis Motornummer: 165 000
1.9 TDI	23844		141		ASV	ab Motornummer: 006 066
1.9 TDI	41844		141		ASV	ab Motornummer: 006 066
1.9 TDI	23844		141		ALH	ab Motornummer: 044 442
1.9 TDI	41844		141		ALH	ab Motornummer: 044 442
1.9 TDI	23845		141		AHF	bis Motornummer: 006 065
1.9 TDI	23845		141		AGR	bis Motornummer: 044 441
1.9 TDI, 1.9 TDI quattro	23847		120			bis Motornummer: 115 000, angetriebene Aggregate: angetr. Agg.: Nockenwelle * Driven Units: Driven unit: camshaft * Périphériques entraînés: Arbre à came
1.9 TDI, 1.9 TDI quattro	23848		120			bis Motornummer: 115 000
1.9 TDI	23847		120		ATD	bis Motornummer: 165 000, angetriebene Aggregate: angetr. Agg.: Nockenwelle * Driven Units: Driven unit: camshaft * Périphériques entraînés: Arbre à came
1.9 TDI	23848		120		ATD	bis Motornummer: 165 000
S3 quattro	23829		150			wahlweise: * Alternatively: * au choix:
S3 quattro	23830		150			wahlweise: * Alternatively: * au choix:
1.6	23832		138			
1.6	41832		138			
S3 quattro	23831		150			

AUDI A3 (8P1)

05.03-

1.6	23832		138			
-----	-------	--	-----	--	--	--

AUDI A4 Avant (8D5, B5)

07.95-09.01



AUDI

AUDI A4 Avant (8D5, B5)

07.95-09.01

1.9 TDI, 1.9 TDI quattro	23847		120			angetriebene Aggregate: angetr. Agg.: Nockenwelle * Driven Units: Driven unit: camshaft * Périphériques entraînés: Arbre à came
1.8 T, 1.8 T quattro	23827		153		ARK	8D-T-155 010..., ab Motornummer: 020 001
1.8 T, 1.8 T quattro	23828		153		ARK	8D-T-155 010..., ab Motornummer: 020 001
1.8 T, 1.8 T quattro	23833		153		ARK	8D-T-155 010..., ab Motornummer: 020 001
1.8, 1.8 quattro	23827		153		APT,AR G,AVV	8D-T-155 010...
1.8, 1.8 quattro	23828		153		APT,AR G,AVV	8D-T-155 010...
1.8, 1.8 quattro	23833		153		APT,AR G,AVV	8D-T-155 010...
1.8, 1.8 quattro	23828		153			8D-T-155 010...
2.8, 2.8 quattro	23842		253		ALG,AM X,APR,A QD	8D-V-205 001...
1.8 T, 1.8 T quattro	23901		150		AWT	8D-1-042 385..., wahlweise: * Alternately: * au choix:
1.8 T, 1.8 T quattro	41901		150		AWT	8D-1-042 385..., wahlweise: * Alternately: * au choix:
1.8 T, 1.8 T quattro	23902		150		AWT	8D-1-042 385...
1.8, 1.8 quattro	23840		153		ADR	...8D-T-155 009, wahlweise: * Alternately: * au choix:
1.8 T, 1.8 T quattro	23840		153		AEB	...8D-T-155 009, wahlweise: * Alternately: * au choix:
1.8, 1.8 quattro	23908		153		ADR	...8D-T-155 009
1.8 T, 1.8 T quattro	23908		153		AEB	...8D-T-155 009
1.8 T, 1.8 T quattro	23829		150		AWT	...8D-1-042 384, wahlweise: * Alternately: * au choix:
1.8 T, 1.8 T quattro	23830		150		AWT	...8D-1-042 384, wahlweise: * Alternately: * au choix:
1.8 T, 1.8 T quattro	23831		150		AWT	...8D-1-042 384
1.8 T, 1.8 T quattro	23828		153			ab Motornummer: 010 001
1.9 TDI, 1.9 TDI quattro	23848		120			
1.9 TDI, 1.9 TDI quattro	41848		120			
1.6	23814		121		ADP	
1.9 TDI	23820		137		1Z,AHU	
1.9 TDI	23821		137		1Z,AHU	
1.9 TDI, 1.9 TDI quattro	23820		137			
1.9 TDI, 1.9 TDI quattro	23821		137			
1.6	23832		138		AHL,ANA ,ARM	
1.6	41832		138		AHL,ANA ,ARM	
1.6	23832		138			
1.6	41832		138			
1.8, 1.8 quattro, 1.8 T, 1.8 T quattro	23827		153			
1.8, 1.8 quattro, 1.8 T, 1.8 T quattro	23833		153			
2.6, 2.6 quattro, 2.8, 2.8 quattro	23817		239			
RS4 quattro, S4 quattro, 2.4, 2.4 quattro	23842		253			

AUDI A4 Avant (8ED)

11.04-

1.8 T, 1.8 T quattro, 2.0	23901		150			wahlweise: * Alternately: * au choix:
---------------------------	-------	--	-----	--	--	---------------------------------------



AUDI

AUDI A4 Avant (8ED)

11.04-

1.8 T, 1.8 T quattro	41901		150			wahlweise: * Alternatively: * au choix:
1.6	23832		138			
1.6	41832		138			
1.8 T, 1.8 T quattro, 2.0	23902		150			

AUDI A4 Avant (8E5, B6)

04.01-12.04

1.9 TDI, 1.9 TDI quattro	41848		120			...8E-2-295 000, angetriebene Aggregate: angetr. Agg.: Wasserpumpe * Driven Units: Driven unit: water pump * Périphériques entraînés: Pompe à eau, angetriebene Aggregate: angetr. Agg.: Nockenwelle * Driven Units: Driven unit: camshaft * Périphériques entraînés: Arbre à came
1.9 TDI, 1.9 TDI quattro	23847		120			...8E-2-297 100, angetriebene Aggregate: angetr. Agg.: Nockenwelle * Driven Units: Driven unit: camshaft * Périphériques entraînés: Arbre à came
1.9 TDI, 1.9 TDI quattro	23848		120			...8E-2-297 100
1.8 T, 1.8 T quattro, 2.0	23901		150			wahlweise: * Alternatively: * au choix:
1.8 T, 1.8 T quattro	41901		150			wahlweise: * Alternatively: * au choix:
1.6	23832		138			
1.6	41832		138			
1.8 T, 1.8 T quattro, 2.0	23902		150			
2.4	23842		253			

AUDI A4 Cabriolet (8H7, 8HE)

04.02-

1.8, 1.8 T, 1.8 T quattro, 2.0	23901		150			wahlweise: * Alternatively: * au choix:
1.8, 1.8 T, 1.8 T quattro	41901		150			wahlweise: * Alternatively: * au choix:
1.8, 1.8 T, 1.8 T quattro, 2.0	23902		150			
2.4	23842		253			

AUDI A4 (8D2, B5)

01.95-11.00

1.9 TDI, 1.9 TDI quattro	23847		120			angetriebene Aggregate: angetr. Agg.: Nockenwelle * Driven Units: Driven unit: camshaft * Périphériques entraînés: Arbre à came
1.9 TDI	41848		120			angetriebene Aggregate: angetr. Agg.: Nockenwelle * Driven Units: Driven unit: camshaft * Périphériques entraînés: Arbre à came
1.8 T quattro	23827		153		ARK	8D-T-155 010..., ab Motonummer: 020 001
1.8 T, 1.8 T quattro	23828		153		ARK	8D-T-155 010..., ab Motonummer: 020 001
1.8 T, 1.8 T quattro	23833		153		ARK	8D-T-155 010..., ab Motonummer: 020 001
1.8 T	23827		153		ARK	8D-T-155 010..., ab Motonummer: 020 001
1.8, 1.8 quattro	23827		153		APT,AR G,AVV	8D-T-155 010...
1.8, 1.8 quattro	23828		153		APT,AR G,AVV	8D-T-155 010...
1.8, 1.8 quattro	23833		153		APT,AR G,AVV	8D-T-155 010...
1.8, 1.8 quattro	23828		153			8D-T-155 010...
2.8, 2.8 quattro	23842		253		ALG,AM X,APR,A QD	8D-V-205 001...
1.8 T, 1.8 T quattro	23901		150		AWT	8D-1-042 385..., wahlweise: * Alternatively: * au choix:
1.8 T, 1.8 T quattro	41901		150		AWT	8D-1-042 385..., wahlweise: * Alternatively: * au choix:
1.8 T, 1.8 T quattro	23902		150		AWT	8D-1-042 385...
1.8, 1.8 quattro	23840		153		ADR	...8D-T-155 009, wahlweise: * Alternatively: * au choix:
1.8 T, 1.8 T quattro	23840		153		AEB	...8D-T-155 009, wahlweise: * Alternatively: * au choix:
1.8, 1.8 quattro	23908		153		ADR	...8D-T-155 009



AUDI

AUDI A4 (8D2, B5)

01.95-11.00

1.8 T, 1.8 T quattro	23908		153		AEB	...8D-T-155 009
1.8 T, 1.8 T quattro	23829		150		AWT	...8D-1-042 384, wahlweise: * Alternatively: * au choix:
1.8 T, 1.8 T quattro	23830		150		AWT	...8D-1-042 384, wahlweise: * Alternatively: * au choix:
1.8 T, 1.8 T quattro	23831		150		AWT	...8D-1-042 384
1.8 T, 1.8 T quattro	23828		153			ab Motornummer: 010 001
1.9 TDI, 1.9 TDI quattro	23848		120			
1.9 TDI quattro	41848		120			
1.6	23814		121		ADP	
1.9 TDI	23820		137		1Z,AHU	
1.9 TDI	23821		137		1Z,AHU	
1.9 TDI, 1.9 TDI quattro	23820		137			
1.9 TDI, 1.9 TDI quattro	23821		137			
1.6	23832		138		AHL,ANA ,ARM	
1.6	41832		138		AHL,ANA ,ARM	
1.6	23832		138			
1.6	41832		138			
1.8, 1.8 quattro, 1.8 T, 1.8 T quattro	23827		153			
1.8, 1.8 quattro, 1.8 T, 1.8 T quattro	23833		153			
2.6, 2.6 quattro, 2.8, 2.8 quattro	23817		239			
S4 quattro, 2.4, 2.4 quattro	23842		253			

AUDI A4 (8EC)

11.04-

1.8 T, 1.8 T quattro, 2.0	23901		150			wahlweise: * Alternatively: * au choix:
1.8 T, 1.8 T quattro	41901		150			wahlweise: * Alternatively: * au choix:
1.6	23832		138			
1.6	41832		138			
1.8 T, 1.8 T quattro, 2.0	23902		150			

AUDI A4 (8E2, B6)

11.00-12.04

1.9 TDI, 1.9 TDI quattro	41848		120			...8E-2-295 000, angetriebene Aggregate: angetr. Agg.: Wasserpumpe * Driven Units: Driven unit: water pump * Périphériques entraînés: Pompe à eau, angetriebene Aggregate: angetr. Agg.: Nockenwelle * Driven Units: Driven unit: camshaft * Périphériques entraînés: Arbre à came
1.9 TDI, 1.9 TDI quattro	23847		120			...8E-2-297 100, angetriebene Aggregate: angetr. Agg.: Nockenwelle * Driven Units: Driven unit: camshaft * Périphériques entraînés: Arbre à came
1.9 TDI, 1.9 TDI quattro	23848		120			...8E-2-297 100
1.8 T, 1.8 T quattro, 2.0	23901		150			wahlweise: * Alternatively: * au choix:
1.8 T, 1.8 T quattro	41901		150			wahlweise: * Alternatively: * au choix:
1.6	23832		138			
1.6	41832		138			
1.8 T, 1.8 T quattro, 2.0	23902		150			
2.4	23842		253			

AUDI A6 Avant (4A, C4)

06.94-12.97

2.6, 2.6 quattro, 2.8, 2.8 quattro	23817		239			4A-S-026 715...
------------------------------------	-------	--	-----	--	--	-----------------



AUDI

AUDI A6 Avant (4A, C4)

06.94-12.97

2.6, 2.6 quattro, 2.8, 2.8 quattro	23813		239			...4A-S-026 714
2.0	23811		124			...4A-S-060 808
2.0 16V, 2.0 16V quattro	23808		147			bis Motornummer: 017 139
2.5 TDI, 2.5 TDI quattro	23834		122			
1.9 TDI	23820		137			
1.9 TDI	23821		137			
1.8, 1.8 quattro	23827		153			
1.8, 1.8 quattro	23828		153			
1.8, 1.8 quattro	23833		153			
2.8, 2.8 quattro	23842		253			

AUDI A6 Avant (4B, C5)

11.97-01.05

1.8 T, 1.8 T quattro	23901		150		AWT	06.01..., wahlweise: * Alternately: * au choix:
1.8 T, 1.8 T quattro	41901		150		AWT	06.01..., wahlweise: * Alternately: * au choix:
1.8 T, 1.8 T quattro	23902		150		AWT	06.01...
1.8 T, 1.8 T quattro	23829		150		AWT	...06.01, wahlweise: * Alternately: * au choix:
1.8 T, 1.8 T quattro	23830		150		AWT	...06.01, wahlweise: * Alternately: * au choix:
1.8 T, 1.8 T quattro	23831		150		AWT	...06.01
1.8 T, 1.8 T quattro	23828		153		AEB,AR K,ANB,A PU	4B-X-140 001...
1.8, 1.8 T, 1.8 T quattro	23828		153			4B-X-140 001...
1.9 TDI	23847		120			...4B-2-120 000, angetriebene Aggregate: angetr. Agg.: Nockenwelle * Driven Units: Driven unit: camshaft * Périphériques entraînés: Arbre à came
1.9 TDI	23848		120			...4B-2-120 000
1.9 TDI	41848		120			...4B-2-120 000
2.0	23901		150			wahlweise: * Alternately: * au choix:
1.9 TDI	23820		137			
1.9 TDI	23821		137			
2.0	23902		150			
1.8	23912		150			
1.8	23913		150			
1.8 T, 1.8 T quattro	23827		153		AEB,AR K,ANB,A PU	
1.8 T, 1.8 T quattro	23833		153		AEB,AR K,ANB,A PU	
1.8, 1.8 T, 1.8 T quattro	23827		153			
1.8, 1.8 T, 1.8 T quattro	23833		153			
2.4, 2.4 quattro, 2.7 T, 2.7 T quattro, 2.8, 2.8 quattro	23842		253			

AUDI A6 (4A, C4)

06.94-10.97

2.6, 2.6 quattro, 2.8, 2.8 quattro	23817		239			4A-S-026 715...
2.6, 2.6 quattro, 2.8, 2.8 quattro	23813		239			...4A-S-026 714
2.0	23811		124			...4A-S-060 808



AUDI

AUDI A6 (4A, C4)						06.94-10.97
2.0 16V, 2.0 16V quattro	23808		147			bis Motornummer: 017 139
2.5 TDI, 2.5 TDI quattro	23834		122			
1.9 TDI	23820		137			
1.9 TDI	23821		137			
1.8, 1.8 quattro	23827		153			
1.8, 1.8 quattro	23828		153			
1.8, 1.8 quattro	23833		153			
2.4	23817		239			
2.8, 2.8 quattro	23842		253			
AUDI A6 (4B, C5)						01.97-01.05
1.8 T, 1.8 T quattro	23901		150		AWT	06.01..., wahlweise: * Alternatively: * au choix:
1.8 T, 1.8 T quattro	41901		150		AWT	06.01..., wahlweise: * Alternatively: * au choix:
1.8 T, 1.8 T quattro	23902		150		AWT	06.01...
1.8 T, 1.8 T quattro	23829		150		AWT	...06.01, wahlweise: * Alternatively: * au choix:
1.8 T, 1.8 T quattro	23830		150		AWT	...06.01, wahlweise: * Alternatively: * au choix:
1.8 T, 1.8 T quattro	23831		150		AWT	...06.01
1.8 T, 1.8 T quattro	23828		153		AEB,AR K,ANB,A PU	4B-X-140 001...
1.8, 1.8 T, 1.8 T quattro	23828		153			4B-X-140 001...
1.9 TDI	23847		120			...4B-2-120 000, angetriebene Aggregate: angetr. Agg.: Nockenwelle * Driven Units: Driven unit: camshaft * Périphériques entraînés: Arbre à came
1.9 TDI	23848		120			...4B-2-120 000
1.9 TDI	41848		120			...4B-2-120 000
2.0	23901		150			wahlweise: * Alternatively: * au choix:
1.9 TDI	23820		137			
1.9 TDI	23821		137			
2.0	23902		150			
1.8	23912		150			
1.8	23913		150			
1.8 T, 1.8 T quattro	23827		153		AEB,AR K,ANB,A PU	
1.8 T, 1.8 T quattro	23833		153		AEB,AR K,ANB,A PU	
1.8, 1.8 T, 1.8 T quattro	23827		153			
1.8, 1.8 T, 1.8 T quattro	23833		153			
2.4, 2.4 quattro, 2.7 T, 2.7 T quattro, 2.8, 2.8 quattro	23842		253			
AUDI A8 (4D2, 4D8)						03.94-12.02
2.8, 2.8 quattro	23817		239			4D-S-000 497...
2.8, 2.8 quattro	23842		253		ALG,AM X,APR,A QD	4D-V-011 001...
2.8, 2.8 quattro	23813		239			...4D-S-000 496
AUDI CABRIOLET (8G7, B4)						05.91-08.00



AUDI

AUDI CABRIOLET (8G7, B4)

05.91-08.00

2.6, 2.8	23817		239		8G-S-001 303...
2.3 E	23810		142		...8B-M-033 000
2.3 E	41810		142		...8B-M-033 000
2.6, 2.8	23813		239		...8G-S-001 302
2.0 E	23811		124		...8G-S-002 743
1.9 TDI	23820		137		
1.9 TDI	23821		137		
1.8	23827		153		
1.8	23828		153		
1.8	23833		153		

AUDI COUPE (81, 85)

07.80-10.88

1.6, 1.8 GT	23801		121		angetriebene Aggregate: angetr. Agg.: Nockenwelle * Driven Units: Driven unit: camshaft * Périphériques entraînés: Arbre à came
2.3, 2.3 quattro	41810		142		08.88..., 89-J-394 743..., ...8B-M-033 000
2.2 quattro, 2.2 GT	41810		142		08.88..., 89-J-394 743...
2.2 quattro, 2.2 GT, 2.3, 2.3 quattro	41805		120		...08.88, ...89-J-934 742
1.9, 2.0, 2.1 GT, 2.2 GT	23805		120		85-E-000001..., angetriebene Aggregate: angetr. Agg.: Nockenwelle * Driven Units: Driven unit: camshaft * Périphériques entraînés: Arbre à came
2.2 quattro, 2.2 GT, 2.3, 2.3 quattro	23810		142		89-J-394 743...
2.2 quattro, 2.2 GT	23805		120		...89-J-394742, angetriebene Aggregate: angetr. Agg.: Nockenwelle * Driven Units: Driven unit: camshaft * Périphériques entraînés: Arbre à came
2.2 quattro, 2.3, 2.3 quattro	23805		120		...89-J-394 742
2.2 quattro	41805		120		...89-J-394 742
2.0, 2.1 GT, 2.2 GT	41805		120		
1.8, 1.8 GT	23801		121		

AUDI COUPE (89, 8B)

10.88-12.96

1.8	23801		121		angetriebene Aggregate: angetr. Agg.: Nockenwelle * Driven Units: Driven unit: camshaft * Périphériques entraînés: Arbre à came
2.6, 2.6 quattro, 2.8, 2.8 quattro	23817		239		8B-S-000 545...
2.3, 2.3 quattro	41810		142		89-J-394 743..., ...8B-M-033 000
2.2 quattro	23810		142		89-J-394 743...
2.2 quattro	41810		142		89-J-394 743...
2.3, 2.3 quattro	23810		142		...8B-M-033 000
2.6, 2.6 quattro, 2.8, 2.8 quattro	23813		239		...8B-S-000 544
2.2 quattro	23805		120		...89-J-394742
2.0 16 V	23808		147		bis Motornummer: 017 139
2.0	23801		121		
2.0 16 V	23808		147		

AUDI QUATTRO (85)

07.80-07.91

2.1 Turbo	23805		120		85-E-900001..., ...85-J-900643, angetriebene Aggregate: angetr. Agg.: Nockenwelle * Driven Units: Driven unit: camshaft * Périphériques entraînés: Arbre à came
2.2 Turbo	41810		142		85-J-900 644..., ab Motornummer: 001 571
2.1 Turbo	23810		142		85-J-900-644...



AUDI

AUDI QUATTRO (85)

07.80-07.91

2.1 Turbo	41810		142			85-J-900-644...
2.2 Turbo	41805		120		MB	...85-J-900 643
2.1 Turbo	41805		120			...85-J-900-643
2.2 Turbo	23810		142			ab Motornummer: 001 571
2.2 Turbo	23805		120			bis Motornummer: 001570

AUDI TT Roadster (8N9)

10.99-06.06

1.8 T, 1.8 T quattro	23829		150			8N-Y-095 001..., wahlweise: * Alternativly: * au choix:
1.8 T, 1.8 T quattro	23830		150			8N-Y-095 001..., wahlweise: * Alternativly: * au choix:
1.8 T, 1.8 T quattro	23831		150			8N-Y-095 001...
1.8 T, 1.8 T quattro	23912		150			...8N-Y-095 000
1.8 T, 1.8 T quattro	23913		150			...8N-Y-095 000
1.8 T, 1.8 T quattro	41912		150			...8N-Y-095 000
1.8 T, 1.8 T quattro	23829		150			wahlweise: * Alternativly: * au choix:
1.8 T, 1.8 T quattro	23830		150			wahlweise: * Alternativly: * au choix:
1.8 T, 1.8 T quattro	23831		150			

AUDI TT (8N3)

10.98-06.06

1.8 T, 1.8 T quattro	23829		150			8N-Y-095 001..., wahlweise: * Alternativly: * au choix:
1.8 T, 1.8 T quattro	23830		150			8N-Y-095 001..., wahlweise: * Alternativly: * au choix:
1.8 T, 1.8 T quattro	23831		150			8N-Y-095 001...
1.8 T, 1.8 T quattro	23912		150			...8N-Y-095 000
1.8 T, 1.8 T quattro	23913		150			...8N-Y-095 000
1.8 T, 1.8 T quattro	41912		150			...8N-Y-095 000
1.8 T, 1.8 T quattro	23829		150			wahlweise: * Alternativly: * au choix:
1.8 T, 1.8 T quattro	23830		150			wahlweise: * Alternativly: * au choix:
1.8 T, 1.8 T quattro	23831		150			

AUDI 100 Avant (4A, C4)

12.90-11.94

2.6, 2.6 quattro, 2.8 E, 2.8 E quattro	23813		239			
----------------------------------------	-------	--	-----	--	--	--

AUDI 100 Avant (43, C2)

07.77-02.83

2.0 D	23806		119			
2.0 D	41806		119			
1.6, 2.0	23801		121			

AUDI 100 Avant (44, 44Q, C3)

08.82-11.90

2.0 D, 2.0 TD	23806		119			angetriebene Aggregate: angetr. Agg.: Nockenwelle * Driven Units: Driven unit: camshaft * Périphériques entraînés: Arbre à came
2.0 E, 2.2, 2.2 KAT, 2.2 quattro, 2.2 quattro KAT, 2.2 Turbo quattro	23805		120			angetriebene Aggregate: angetr. Agg.: Nockenwelle * Driven Units: Driven unit: camshaft * Périphériques entraînés: Arbre à came
1.8, 1.8 quattro, 1.8 quattro KAT	23801		121			angetriebene Aggregate: angetr. Agg.: Nockenwelle * Driven Units: Driven unit: camshaft * Périphériques entraînés: Arbre à came
2.0 E KAT, 2.3, 2.3 E quattro	23805		120			...06.88, angetriebene Aggregate: angetr. Agg.: Nockenwelle * Driven Units: Driven unit: camshaft * Périphériques entraînés: Arbre à came
1.9	23805		120			44-E-000 001..., angetriebene Aggregate: angetr. Agg.: Nockenwelle * Driven Units: Driven unit: camshaft * Périphériques entraînés: Arbre à came
2.1	23805		120			44-E-000 001...
2.1	41805		120			44-E-000 001...
2.0 E KAT	23810		142			ab Motornummer: 010 236



AUDI

AUDI 100 Avant (44, 44Q, C3)

08.82-11.90

2.0 E KAT	41810		142			ab Motornummer: 010 236
2.2 Turbo, 2.2 Turbo quattro	23810		142			ab Motornummer: 039 951
2.2 Turbo, 2.2 Turbo quattro	41810		142			ab Motornummer: 039 951
2.3, 2.3 E quattro	23810		142			ab Motornummer: 063 969
2.3, 2.3 E quattro	41810		142			ab Motornummer: 063 969
2.2, 2.2 KAT, 2.2 quattro, 2.2 quattro KAT	23810		142			ab Motornummer: 077 117
2.2, 2.2 KAT, 2.2 quattro, 2.2 quattro KAT	41810		142			ab Motornummer: 077 117
2.0 E KAT	41805		120			bis Motornummer: 010 235
2.2 Turbo, 2.2 Turbo quattro	41805		120			bis Motornummer: 039 950
2.3, 2.3 E quattro	41805		120			bis Motornummer: 063 968
2.2, 2.2 KAT, 2.2 quattro, 2.2 quattro KAT	41805		120			bis Motornummer: 077 116
2.0 TD	23806		119			
2.0 D, 2.0 TD	41806		119			
2.0, 2.2, 2.2 E quattro, 2.2 Turbo	23805		120			
2.0, 2.0 E, 2.2, 2.2 E quattro	41805		120			
1.8, 1.8 KAT, 1.8 quattro	23801		121			

AUDI 100 (C1)

11.68-07.76

1.6	23801		121			
-----	-------	--	-----	--	--	--

AUDI 100 (4A, C4)

12.90-07.94

2.0 E 16V	23808		147			bis Motornummer: 017 139
2.6, 2.6 quattro, 2.8 E, 2.8 E quattro	23813		239			

AUDI 100 (43, C2)

06.76-07.82

2.0 D	23806		119			
2.0 D	41806		119			
1.6, 2.0	23801		121			

AUDI 100 (44, 44Q, C3)

08.82-11.90

2.0 D, 2.0 D Turbo	23806		119			angetriebene Aggregate: angetr. Agg.: Nockenwelle * Driven Units: Driven unit: camshaft * Périphériques entraînés: Arbre à came
2.0, 2.0 KAT, 2.2 KAT, 2.2 quattro, 2.2 quattro KAT, 2.2 E Turbo quattro, 2.2 Turbo	23805		120			angetriebene Aggregate: angetr. Agg.: Nockenwelle * Driven Units: Driven unit: camshaft * Périphériques entraînés: Arbre à came
1.8, 1.8 KAT, 1.8 quattro, 1.8 quattro KAT	23801		121			angetriebene Aggregate: angetr. Agg.: Nockenwelle * Driven Units: Driven unit: camshaft * Périphériques entraînés: Arbre à came
1.9	23805		120			08.83..., angetriebene Aggregate: angetr. Agg.: Nockenwelle * Driven Units: Units: Driven unit: camshaft * Périphériques entraînés: Arbre à came
2.3 E, 2.3 E quattro	23805		120			...06.88, angetriebene Aggregate: angetr. Agg.: Nockenwelle * Driven Units: Units: Driven unit: camshaft * Périphériques entraînés: Arbre à came
2.1	23805		120			44-E-000 001...
2.1	41805		120			44-E-000 001...
2.0 KAT	23810		142			ab Motornummer: 010 236
2.0 KAT	41810		142			ab Motornummer: 010 236
2.2 E Turbo quattro, 2.2 Turbo	23810		142			ab Motornummer: 039 951
2.2 E Turbo quattro, 2.2 Turbo	41810		142			ab Motornummer: 039 951
2.3 E, 2.3 E quattro	23810		142			ab Motornummer: 063 969
2.3 E, 2.3 E quattro	41810		142			ab Motornummer: 063 969
2.2, 2.2 KAT, 2.2 quattro, 2.2 quattro KAT	23810		142			ab Motornummer: 077 117



AUDI

AUDI 100 (44, 44Q, C3)

08.82-11.90

2.2, 2.2 KAT, 2.2 quattro, 2.2 quattro KAT	41810		142		ab Motornummer: 077 117
2.0 KAT	41805		120		bis Motornummer: 010 235
2.2 E Turbo quattro, 2.2 Turbo	41805		120		bis Motornummer: 039 950
2.3 E, 2.3 E quattro	41805		120		bis Motornummer: 063 968
2.2, 2.2 KAT, 2.2 quattro, 2.2 quattro KAT	41805		120		bis Motornummer: 077 116
2.0 D, 2.0 D Turbo	41806		119		
2.0, 2.2, 2.2 E quattro	23805		120		
2.0, 2.2, 2.2 E quattro	41805		120		
2.0 D Turbo	23807		122		

AUDI 200 Avant (44, 44Q)

09.83-12.91

2.2 Turbo	23805		120		...07.88, 44-E-012 001..., angetriebene Aggregate: angetr. Agg.: Nockenwelle * Driven Units: Driven unit: camshaft * Périphériques entraînés: Arbre à came
2.1 Turbo quattro	23805		120		44-E-012 001..., angetriebene Aggregate: angetr. Agg.: Nockenwelle * Driven Units: Driven unit: camshaft * Périphériques entraînés: Arbre à came
2.1 Turbo quattro	41805		120		44-E-012 001...
2.2 Turbo quattro	23805		120		44J246281..., angetriebene Aggregate: angetr. Agg.: Nockenwelle * Driven Units: Driven unit: camshaft * Périphériques entraînés: Arbre à came
2.2 Turbo quattro	23810		142		ab Motornummer: 001 571
2.2 Turbo quattro	41810		142		ab Motornummer: 001 571
2.2 Turbo, 2.2 Turbo quattro	23810		142		ab Motornummer: 039 951
2.2 Turbo, 2.2 Turbo quattro	41810		142		ab Motornummer: 039 951
2.3	23810		142		ab Motornummer: 063 969
2.3	41810		142		ab Motornummer: 063 969
2.2 Turbo quattro	23805		120		bis Motornummer: 001 570
2.2 Turbo quattro	41805		120		bis Motornummer: 001 570
2.2 Turbo, 2.2 Turbo quattro	41805		120		bis Motornummer: 039 950
2.3	23805		120		bis Motornummer: 063 968
2.3	41805		120		bis Motornummer: 063 968

AUDI 200 (44, 44Q)

06.83-12.91

2.1 Turbo quattro	23805		120		angetriebene Aggregate: angetr. Agg.: Nockenwelle * Driven Units: Driven unit: camshaft * Périphériques entraînés: Arbre à came
2.2 Turbo	23805		120		...07.88, 44E012001..., angetriebene Aggregate: angetr. Agg.: Nockenwelle * Driven Units: Driven unit: camshaft * Périphériques entraînés: Arbre à came
2.1 Turbo, 2.1 Turbo quattro, 2.1 5 E	41805		120		44-E-000 001...
2.1 Turbo, 2.1 5 E, 2.2	23805		120		44E012001..., angetriebene Aggregate: angetr. Agg.: Nockenwelle * Driven Units: Driven unit: camshaft * Périphériques entraînés: Arbre à came
2.2 Turbo quattro	23805		120		...44J246281, angetriebene Aggregate: angetr. Agg.: Nockenwelle * Driven Units: Driven unit: camshaft * Périphériques entraînés: Arbre à came
2.2 Turbo	23810		142		ab Motornummer: 001 069
2.2 Turbo	41810		142		ab Motornummer: 001 069
2.2 Turbo, 2.2 Turbo quattro	23810		142		ab Motornummer: 001 571
2.2 Turbo, 2.2 Turbo quattro	41810		142		ab Motornummer: 001 571
2.2 Turbo, 2.2 Turbo quattro	23810		142		ab Motornummer: 039 951



AUDI

AUDI 200 (44, 44Q)

06.83-12.91

2.2 Turbo, 2.2 Turbo quattro	41810		142		ab Motornummer: 039 951
2.3	23810		142		ab Motornummer: 063 969
2.3	41810		142		ab Motornummer: 063 969
2.2 Turbo	41805		120		bis Motornummer: 001 068
2.2 Turbo	23805		120		bis Motornummer: 001 570
2.2 Turbo, 2.2 Turbo quattro	41805		120		bis Motornummer: 001 570
2.2 Turbo, 2.2 Turbo quattro	41805		120		bis Motornummer: 039 950
2.3	23805		120		bis Motornummer: 063 968
2.3	41805		120		bis Motornummer: 063 968
2.2 Turbo quattro	23805		120		
2.2	41805		120		

AUDI 50 (86)

08.74-07.78

0.8, 1.1, 1.3	41850		108		angetriebene Aggregate: angetr. Agg.: Nockenwelle * Driven Units: Driven unit: camshaft * Périphériques entraînés: Arbre à came
---------------	-------	--	-----	--	------------------------------------------------------------------------------------------------------------------------------------

AUDI 80 Avant (8C, B4)

09.91-01.96

2.6, 2.6 quattro, 2.8, 2.8 quattro	23817		239		8C-S-025 821...
2.3 E, 2.3 E quattro	23810		142		...8B-M-033 000
2.3 E, 2.3 E quattro	41810		142		...8B-M-033 000
2.6, 2.6 quattro, 2.8, 2.8 quattro	23813		239		...8C-S-025 820
2.0, 2.0 E	23811		124		...8C-S-075 037
1.9 TDI	23820		137		ab Motornummer: 289 576
1.9 TDI	23821		137		ab Motornummer: 289576
1.9 TD	23820		137		ab Motornummer: 552 766
2.0 E 16V, 2.0 E 16V quattro	23808		147		bis Motornummer: 017 139
1.9 TDI	23815		137		bis Motornummer: 289 575
1.9 TD	23812		137		bis Motornummer: 552765

AUDI 80 (8C, B4)

09.91-12.94

1.6 E	23801		121		angetriebene Aggregate: angetr. Agg.: Nockenwelle * Driven Units: Driven unit: camshaft * Périphériques entraînés: Arbre à came
2.6, 2.6 quattro, 2.8, 2.8 quattro	23817		239		8C-S-025 821...
2.3 E, 2.3 E quattro	23810		142		...8B-M-033 000
2.3 E, 2.3 E quattro	41810		142		...8B-M-033 000
2.6, 2.6 quattro, 2.8, 2.8 quattro	23813		239		...8C-S-025 820
2.0 E, 2.0 E quattro	23811		124		...8C-S-075 037
1.9 TDI	23820		137		ab Motornummer: 289 576
1.9 TDI	23821		137		ab Motornummer: 289576
1.9 TD	23820		137		ab Motornummer: 552 766
2.0 E 16V, 2.0 E 16V quattro	23808		147		bis Motornummer: 017 139
1.9 TDI	23815		137		bis Motornummer: 289 575
1.9 TD	23812		137		bis Motornummer: 552765
1.6	23801		121		

AUDI 80 (80, 82, B1)

05.72-07.78



AUDI

AUDI 80 (80, 82, B1) 05.72-07.78

1.3, 1.5, 1.6, 1.6 GT, 1.6 GTE	23801		121			
--------------------------------	-------	--	-----	--	--	--

AUDI 80 (81, 85, B2) 08.78-08.86

1.3	41850		108		FY	angetriebene Aggregate: angetr. Agg.: Nockenwelle * Driven Units: Driven unit: camshaft * Périphériques entraînés: Arbre à came
1.3	41850		108		FZ	angetriebene Aggregate: angetr. Agg.: Nockenwelle * Driven Units: Driven unit: camshaft * Périphériques entraînés: Arbre à came
1.3, 1.6, 1.8, 1.8 CC quattro, 1.8 GTE, 1.8 GTE quattro	23801		121			angetriebene Aggregate: angetr. Agg.: Nockenwelle * Driven Units: Driven unit: camshaft * Périphériques entraînés: Arbre à came
2.0, 2.0 quattro, 2.2 quattro	23805		120			
2.0, 2.0 quattro, 2.2 quattro	41805		120			
1.6, 1.6 GLE, 1.8, 1.8 GTE, 1.8 GTE quattro	23801		121			
1.6 D, 1.6 TD	23804		135			

AUDI 80 (89, 89Q, 8A, B3) 06.86-10.91

1.6, 1.8, 1.8 E, 1.8 E quattro, 1.8 S, 1.8 S quattro	23801		121			angetriebene Aggregate: angetr. Agg.: Nockenwelle * Driven Units: Driven unit: camshaft * Périphériques entraînés: Arbre à came
1.8, 1.8 quattro, 2.0 quattro, 2.0 E, 2.0 E quattro	23801		121			
1.6 D, 1.6 TD	23804		135			
1.9 D	23812		137			
2.0 E 16V, 2.0 E 16V quattro	23808		147			

AUDI 90 (81, 85, B2) 08.84-03.87

2.0	23805		120			angetriebene Aggregate: angetr. Agg.: Nockenwelle * Driven Units: Driven unit: camshaft * Périphériques entraînés: Arbre à came
2.2, 2.2 E quattro	23810		142			89-J-394 743...
2.2, 2.2 E quattro	41810		142			89-J-394 743...
2.2, 2.2 E quattro	23805		120			...89-J-394742, angetriebene Aggregate: angetr. Agg.: Nockenwelle * Driven Units: Driven unit: camshaft * Périphériques entraînés: Arbre à came
2.2 E quattro	23805		120			...89-J-394742
2.2, 2.2 E quattro	41805		120			...89-J-394 742
2.0, 2.2	23805		120			
2.0, 2.2, 2.2 E quattro	41805		120			

AUDI 90 (89, 89Q, 8A, B3) 04.87-09.91

2.0, 2.2 E, 2.2 E quattro	23810		142			89-J-394 743...
2.0, 2.2 E, 2.2 E quattro	41810		142			89-J-394 743...
2.3 E, 2.3 E quattro	23810		142			89-J-396 703...
2.3 E, 2.3 E quattro	41810		142			89-J-396 703...
2.2 E, 2.2 E quattro, 2.3 E, 2.3 E quattro	23805		120			...89-J-394742, angetriebene Aggregate: angetr. Agg.: Nockenwelle * Driven Units: Driven unit: camshaft * Périphériques entraînés: Arbre à came
2.0	23805		120			...89-J-394742
2.0, 2.2 E, 2.2 E quattro	41805		120			...89-J-394 742
2.3 E, 2.3 E quattro	41805		120			...89-J-396 702
1.6 TD	23804		135			

BMW

BMW Z1 06.88-06.91

2.5	23600		127			
-----	-------	--	-----	--	--	--

BMW 3 Cabriolet (E30) 12.85-10.93

318 i	23605		110			
320 i, 325 i	23600		127			

BMW 3 (E21) 06.75-03.84



BMW

BMW 3 (E21)						06.75-03.84
320i, 323i	23601		110			angetriebene Aggregate: angetr. Agg.: Nockenwelle * Driven Units: Driven unit: camshaft * Périphériques entraînés: Arbre à came
BMW 3 (E30)						09.82-03.92
323i	23602		128			angetriebene Aggregate: angetr. Agg.: Nockenwelle * Driven Units: Driven unit: camshaft * Périphériques entraînés: Arbre à came
323i, 325 e 2.7, 325i	23600		127			09.85...
320i, 323i	23602		128			...08.85, angetriebene Aggregate: angetr. Agg.: Nockenwelle * Driven Units: Driven unit: camshaft * Périphériques entraînés: Arbre à came
325i	23602		128			...08.85
325 e 2.7	23602		128			bis Motornummer: 08.1985
316i, 318i	23605		110			
320i, 323i, 325 e 2.7, 325i, 325i X	23600		127			
320i	23602		128			
BMW 3 (E36)						09.90-02.98
316i, 318i	23604		110			
BMW 3 Touring (E30)						07.87-10.94
316i, 318i	23605		110			
320i, 325i, 325i X	23600		127			
BMW 5 (E12)						08.72-08.81
520i	23601		110			angetriebene Aggregate: angetr. Agg.: Nockenwelle * Driven Units: Driven unit: camshaft * Périphériques entraînés: Arbre à came
BMW 5 (E28)						06.80-06.90
520i, 525 e 2.7	23600		127			09.85...
525 e 2.7	23602		128			...08.85
520i	23602		128			...12.85, angetriebene Aggregate: angetr. Agg.: Nockenwelle * Driven Units: Driven unit: camshaft * Périphériques entraînés: Arbre à came
520i	23600		127			
BMW 5 (E34)						12.87-11.95
518i	23604		110			10.91...
518i	23605		110			...09.91
520i, 525i	23600		127			
BMW 5 Touring (E34)						11.91-01.97
518i	23604		110			
CHEVROLET						
CHEVROLET AVEO Stufenheck						05.05-
1.2, 1.5	23722		111			
CHEVROLET CORSA						03.94-07.02
1.4 GLS	23722		111			
1.4 GLS	41722		111			
1.6 GS	41735/2		169			
CHEVROLET CORSA Kombi						08.97-07.02
1.6 GS	41735/2		169			
CHEVROLET CORSA PICK UP						08.01-
1.6	23722		111			
CHEVROLET CORSA Pritsche/Fahrgestell						08.94-07.02
1.4 GLS	23722		111			
1.4 GLS	41722		111			
CHEVROLET CORSA Schrägheck						03.94-07.02
1.4 GLS	23722		111			ab Motornummer: 19311739
1.4 GLS	41722		111			
1.6 GS	41735/2		169			



CHEVROLET

CHEVROLET KALOS						03.05-
1.4	23722		111			
1.4 16V	73536		127			
CHEVROLET KALOS Stufenheck						03.05-
1.4 16V	73536		127			
CHEVROLET LACETTI						03.05-
1.4 16V, 1.6	73536		127			
CHEVROLET LOVA						08.05-
1.4	23722		111			
CHEVROLET MATIZ						03.05-
0.8	73537		107			
CHEVROLET NUBIRA Kombi						01.05-
1.6	73536		127			
CHEVROLET NUBIRA Stufenheck						01.05-
1.6	73536		127			
CHEVROLET REZZO						03.05-
1.6	73536		127			

CHRYSLER

CHRYSLER LE BARON						09.86-12.94
3.0 i V6	73510		149			
CHRYSLER LE BARON Cabriolet						09.86-12.96
3.0 i V6	73510		149			
CHRYSLER SARATOGA						09.89-12.95
3.0	73510		149			
CHRYSLER VOYAGER I (ES)						08.84-09.95
3.0, 3.0 i	73510		149			

CITROËN

CITROËN AX (ZA-_)						07.86-12.98
1.4 GTi	23413		101			angetriebene Aggregate: angetr. Agg.: Nockenwelle * Driven Units: Driven unit: camshaft * Périphériques entraînés: Arbre à came
14 D	23403		143			angetriebene Aggregate: angetr. Agg.: Nockenwelle * Driven Units: Driven unit: camshaft * Périphériques entraînés: Arbre à came
14, 14 4x4	23413		101			01.92.... angetriebene Aggregate: angetr. Agg.: Nockenwelle * Driven Units: Driven unit: camshaft * Périphériques entraînés: Arbre à came
14, 14 4x4	41413		101		TU3FM	01.93...
14, 14 4x4	23402		108			...12.91, angetriebene Aggregate: angetr. Agg.: Nockenwelle * Driven Units: Driven unit: camshaft * Périphériques entraînés: Arbre à came
1.4 GTi	23413		101			
1.4 GTi	41413		101			
10, 10 E, 11, 11 KAT, 1.3 Sport	23401		104			
14	23402		108			
15 D	23412		136			
15 D	41412		136			
14 D, 1.4 D 4x4	41403		143			
CITROËN BERLINGO Kasten (M_)						07.96-
1.8 D, 1.9 D	41415		136			Schaufelraddurchmesser [mm]: 71 * Impeller Diameter [mm]: 71 * Diamètre de la roue à aubes [mm]: 71
1.4 i	23402		108			09.97.... angetriebene Aggregate: angetr. Agg.: Nockenwelle * Driven Units: Driven unit: camshaft * Périphériques entraînés: Arbre à came
1.4 i	23411		104			ab Motornummer: 3666767
1.1 i	23401		104			bis Motornummer: 3 762 434
2.0 HDI 90 4WD, 2.0 HDI 90	41426		141			bis Organisationsnummer: 08735 * To RP number: 08735 * jusque n° d'organisation: 08735
1.4 bivalent, 1.4 i bivalent	23411		104		TU3A	



CITROËN

CITROËN BERLINGO Kasten (M_)

07.96-

1.8 i	23414		114			
1.8 D, 1.9 D	23415		136			
1.9 D 70 4WD, 1.9 D 70	23425		140			
2.0 HDI 90 4WD, 2.0 HDI 90	23426		141			

CITROËN BERLINGO (MF)

07.96-

1.8 D	41415		136		XUD7	Schaufelraddurchmesser [mm]: 71 * Impeller Diameter [mm]: 71 * Diamètre de la roue à aubes [mm]: 71
1.9 D	41415		136		XUD9A	Schaufelraddurchmesser [mm]: 71 * Impeller Diameter [mm]: 71 * Diamètre de la roue à aubes [mm]: 71
1.8 D, 1.9 D	41415		136			Schaufelraddurchmesser [mm]: 71 * Impeller Diameter [mm]: 71 * Diamètre de la roue à aubes [mm]: 71
1.4 i	23402		108			09.97...., angetriebene Aggregate: angetr. Agg.: Nockenwelle * Driven Units: Driven unit: camshaft * Périphériques entraînés: Arbre à came
1.4 i	23411		104			ab Motornummer: 3666767
1.1 i	23410		100		TU1JP	ab Motornummer: 3762435
1.1 i	23401		104			bis Motornummer: 3 762 434
2.0 HDi, 2.0 HDi 4x4, 2.0 HDi 90	41426		141			bis Organisationsnummer: 08735 * To RP number: 08735 * jusqu'au n° d'organisation: 08735
1.4 bivalent, 1.4 i bivalent	23411		104		TU3A	
1.8 i, 1.8 i 4WD	23414		114			
1.8 i, 1.8 i 4WD	41414		114			
1.8 D, 1.9 D	23415		136			
1.9 D	23425		140			
2.0 HDI 90	23426		141			

CITROËN BX Break (XB-)

04.83-12.94

14	23402		108			angetriebene Aggregate: angetr. Agg.: Nockenwelle * Driven Units: Driven unit: camshaft * Périphériques entraînés: Arbre à came
14	41413		101			01.92...
15, 16, 19, 19 KAT	41414		114			02.92...., ab Organisationsnummer: 5410 * From RP number: 5410 * à partir de n° d'organisation: 5410
16, 19, 19 KAT	23414		114			02.92...
15, 16, 19, 19 KAT	41404		113			...01.92, bis Organisationsnummer: 5409 * To RP number: 5409 * jusqu'au n° d'organisation: 5409
16, 19, 19 KAT	23404		113			...01.92
19 4x4	41404		113			bis Organisationsnummer: 5409 * To RP number: 5409 * jusqu'au n° d'organisation: 5409
14	23402		108			
15, 19, 19 4x4	23404		113			
16, 19	41404		113			
TRD Turbo, 18 D, 19 D	23405		136			

CITROËN BX (XB-)

10.82-06.94

14	23402		108			angetriebene Aggregate: angetr. Agg.: Nockenwelle * Driven Units: Driven unit: camshaft * Périphériques entraînés: Arbre à came
14 E	23402		108			05.85...., ...12.91
14 E	23402		108			05.85...
14 E	23402		108			05.88...., ...12.91
14 E	23413		101			01.92...
14 E	41413		101			01.92...
16, 16 E, 19 E, 19 E 4x4, 19 GTi, 19 GTi 4x4	41414		114			02.92...., ab Organisationsnummer: 5410 * From RP number: 5410 * à partir de n° d'organisation: 5410



CITROËN

CITROËN BX (XB-)

10.82-06.94

16, 16 E, 19 E, 19 E 4x4, 19 GTi, 19 GTi 4x4	23414		114		02.92...
16, 16 E, 19 E, 19 GTi, 19 GTi 4x4	41404		113		...01.92, bis Organisationsnummer: 5409 * To RP number: 5409 * jusque n° d'organisation: 5409
16, 16 E, 19 E, 19 E 4x4, 19 GTi, 19 GTi 4x4	23404		113		...01.92
19	41404		113		bis Organisationsnummer: 5409 * To RP number: 5409 * jusque n° d'organisation: 5409
11	23401		104		
14	23402		108		
15, 16, 19	23404		113		
1.6, 16, 19	41404		113		
19 GTi 16V	23406		133		
19 GTi 16V	41406		133		
TRD Turbo, 1.8 D, 19 D	23405		136		

CITROËN CX I Break (MA)

09.75-08.85

2000	23118		116		...10.83
2500 D Turbo	23418		62		

CITROËN CX I (MA)

09.74-08.85

2000	23118		116		...10.83
2500 D	23418		62		

CITROËN CX II

07.85-12.92

20 RE	23115		116		01.91...
22 TRS	23114		118		01.91...
25 D, 25 D Turbo	23418		62		

CITROËN CX II Break

07.85-12.92

22 TRS	23114		118		01.91...
25 D, 25 D Turbo 2	23418		62		

CITROËN C15 (VD-)

10.84-12.05

1.4, 1.4 E	23402		108		05.88..., ...12.91, antriebene Aggregate: anetr. Agg.: Nockenwelle * Driven Units: Driven unit: camshaft * Périphériques entraînés: Arbre à came
1.1	23401		104		05.88...
1.4 i	23413		101		01.92..., antriebene Aggregate: anetr. Agg.: Nockenwelle * Driven Units: Driven unit: camshaft * Périphériques entraînés: Arbre à came
1.8 D	23415		136		03.94...
1.4 i	23402		108		...12.91, antriebene Aggregate: anetr. Agg.: Nockenwelle * Driven Units: Driven unit: camshaft * Périphériques entraînés: Arbre à came
1.8 D	23405		136		...02.94
1.1 i	23401		104		

CITROËN C2 (JM-)

09.03-

1.1	23410		100		
1.4	23411		104		

CITROËN C25 Bus (280-, 290-)

07.81-02.94

1.9 D	23405		136		
2.5 D, 2.5 D Turbo, 2.5 D Turbo 4x4, 2.5 D 4x4	23418		62		

CITROËN C3 (FC-)

02.02-

1.1 i	23410		100		
1.4 i Bivalent	23411		104		

CITROËN C3 Pluriel (HB-)

05.03-

1.4	23411		104		
-----	-------	--	-----	--	--



CITROËN

CITROËN						
CITROËN C4 Coupe (LA_)						11.04-
2.0 16V	23408		153			
CITROËN C4 (LC_)						11.04-
2.0 16V	23408		153			
CITROËN C5 Break (DE_)						06.01-08.04
2.0 HDi	41426		141			bis Organisationsnummer: 08756 * To RP number: 08756 * jusque n° d'organisation: 08756
2.2 HDi	23427		146			bis Organisationsnummer: 10010 * To RP number: 10010 * jusque n° d'organisation: 10010
2.0 HDi	23426		141			
2.0 HDi	23428		144			
1.8 16V, 2.0 16V	23408		153			
3.0 V6	23424		259			
CITROËN C5 Break (RE_)						09.04-
2.2 HDi	23427		146			bis Organisationsnummer: 10010 * To RP number: 10010 * jusque n° d'organisation: 10010
1.8 16V	23408		153			
3.0 V6	23424		259			
CITROËN C5 (DC_)						03.01-08.04
2.0 HDi	41426		141			bis Organisationsnummer: 08756 * To RP number: 08756 * jusque n° d'organisation: 08756
2.2 HDi	23427		146			bis Organisationsnummer: 10010 * To RP number: 10010 * jusque n° d'organisation: 10010
2.0 HDi	23426		141			
1.8 16V, 2.0 16V	23408		153			
3.0 V6	23424		259			
CITROËN C5 (RC_)						08.04-
2.2 HDi	23427		146			bis Organisationsnummer: 10010 * To RP number: 10010 * jusque n° d'organisation: 10010
1.8 16V	23408		153			
3.0 V6	23424		259			
CITROËN C6 (TD_)						09.05-
3.0 V6	23424		259			
CITROËN C8 (EA_, EB_)						07.02-
2.2 HDi	23427		146			bis Organisationsnummer: 10010 * To RP number: 10010 * jusque n° d'organisation: 10010
2.0 HDi	23428		144			
2.0 HDi	41428		144			
2.0, 2.2	23408		153			
3.0 V6	23424		259			
CITROËN EVASION (22, U6)						06.94-07.02
1.9 TD	41415		136			Schaufelraddurchmesser [mm]: 71 * Impeller Diameter [mm]: 71 * Diamètre de la roue à aubes [mm]: 71
2.0 HDi	41426		141			bis Organisationsnummer: 08560 * To RP number: 08560 * jusque n° d'organisation: 08560
1.8, 2.0, 2.0 Turbo C.T.	23414		114			
1.8	41414		114			
2.0, 2.0 Turbo C.T.	41414/1		114			
1.9 TD	23415		136			
2.0 HDi	23426		141			
2.0 HDi 16V	41428		144			
2.1 TD	23419		149			



CITROËN

CITROËN EVASION (22, U6)							06.94-07.02
2.1 TD	41419		149				
2.0 16V	23408		153				
CITROËN JUMPER Bus (230P)							02.94-04.02
1.9 D, 1.9 TD, 1.9 TD 4x4	41415		136			Schaufelraddurchmesser [mm]: 71 * Impeller Diameter [mm]: 71 * Diamètre de la roue à aubes [mm]: 71	
1.9 D, 1.9 TD, 1.9 TD 4x4	23415		136				
CITROËN JUMPER Bus (244, Z_)							04.02-
2.2 HDi	23433		143			...04.04	
2.0 HDi	23426		141				
2.0 HDi	41426		141				
CITROËN JUMPER Kasten (230L)							02.94-04.02
1.9 D, 1.9 TD	41415		136			Schaufelraddurchmesser [mm]: 71 * Impeller Diameter [mm]: 71 * Diamètre de la roue à aubes [mm]: 71	
1.9 TD	41415		136			...02.97, Schaufelraddurchmesser [mm]: 71 * Impeller Diameter [mm]: 71 * Diamètre de la roue à aubes [mm]: 71	
1.9 D	23415		136		DJY		
1.9 D, 1.9 TD	23415		136				
2.0 HDi	41426		141				
CITROËN JUMPER Kasten (244)							04.02-
2.2 HDi	23433		143			...04.04	
2.0 HDi	23426		141				
2.0 HDi	41426		141				
CITROËN JUMPER Pritsche/Fahrgestell (230)							03.94-04.02
1.9 TD	41415		136			Schaufelraddurchmesser [mm]: 71 * Impeller Diameter [mm]: 71 * Diamètre de la roue à aubes [mm]: 71	
1.9 TD	23415		136				
CITROËN JUMPER Pritsche/Fahrgestell (244)							02.02-
2.2 HDi 16V	23433		143			...04.04	
2.0 HDi	23426		141				
2.0 HDi	41426		141				
CITROËN JUMPY Kasten (BS_, BT_, BY_, BZ_)							06.94-
1.9 D	41415		136		D9B	Schaufelraddurchmesser [mm]: 71 * Impeller Diameter [mm]: 71 * Diamètre de la roue à aubes [mm]: 71	
1.9 TD	41415		136			Schaufelraddurchmesser [mm]: 71 * Impeller Diameter [mm]: 71 * Diamètre de la roue à aubes [mm]: 71	
2.0 HDi 95	41426		141			ab Organisationsnummer: 09868 * From RP number: 09868 * à partir de n° d'organisation: 09868	
2.0 HDi 110	41426		141			bis Organisationsnummer: 08560 * To RP number: 08560 * jusque n° d'organisation: 08560	
1.9 TD	23415		136				
1.6 i	23003		138				
1.9 D 70	23425		140				
2.0 HDi 95	23426		141		RHY		
2.0 HDi 110	23426		141				
2.0 i 16V	23408		153		RFN		
CITROËN JUMPY Pritsche/Fahrgestell (BU_, BV_, BW_, BX_)							10.99-
1.9 TD	41415		136			Schaufelraddurchmesser [mm]: 71 * Impeller Diameter [mm]: 71 * Diamètre de la roue à aubes [mm]: 71	
2.0 HDi 95	41426		141			ab Organisationsnummer: 09868 * From RP number: 09868 * à partir de n° d'organisation: 09868	
2.0 HDi	41426		141		RHZ	bis Organisationsnummer: 08560 * To RP number: 08560 * jusque n° d'organisation: 08560	
2.0 HDi 95	23426		141		RHY		



CITROËN

CITROËN JUMPY (U6U)						06.94-
1.9 D, 1.9 TD	41415		136			Schaufelraddurchmesser [mm]: 71 * Impeller Diameter [mm]: 71 * Diamètre de la roue à aubes [mm]: 71
2.0 HDi 95	41426		141			ab Organisationsnummer: 09868 * From RP number: 09868 * à partir de n° d'organisation: 09868
2.0 HDi 110	41426		141			bis Organisationsnummer: 08560 * To RP number: 08560 * jusque n° d'organisation: 08560
1.9 D, 1.9 TD	23415		136			
1.6	23003		138			
1.9 D 70	23425		140			
2.0 HDi 95	23426		141		RHY	
2.0 HDi 110	23426		141			
2.0, 2.0 i 16V	23408		153		RFN	
CITROËN SAXO (S0, S1)						02.96-04.04
1.4 VTS	23411		104			ab Motornummer: 3666767
1.1 X,SX	23410		100			ab Motornummer: 3762435
1.4 VTS	23402		108			bis Motornummer: 3666765, angetriebene Aggregate: anetr. Agg.: Nockenwelle * Driven Units: Driven unit: camshaft * Périphériques entraînés: Arbre à came
1.1 X,SX	23401		104			bis Motornummer: 3 762 434
1.6, 1.6 VTS	41413		101		TU5JP	
1.6 VTL,VTR	23413		101			
1.6 VTL,VTR	41413		101			
1.0 X	23401		104			
1.6 VTS	23432		134			
1.6, 1.6 VTS	41432		134			
1.5 D	23412		136		TUD5	
1.5 D	41412		136		TUD5	
1.5 D	23412		136			
1.5 D	41412		136			
CITROËN VISA						09.78-03.91
16 GTI	41404		113			bis Organisationsnummer: 3583 * To RP number: 3583 * jusque n° d'organisation: 3583
16 GTI	23404		113			
17 D	23405		136			
CITROËN XANTIA Break (X1)						06.95-01.98
1.9 SD, 1.9 Turbo D	41415		136			Schaufelraddurchmesser [mm]: 71 * Impeller Diameter [mm]: 71 * Diamètre de la roue à aubes [mm]: 71
1.8 i, 2.0 i, 2.0 Turbo	23414		114			
1.8 i	41414		114			
2.0 i, 2.0 Turbo	41414/1		114			
1.9 SD, 1.9 Turbo D	23415		136			
2.1 Turbo D 12V	23419		149			
2.1 Turbo D 12V	41419		149			
CITROËN XANTIA Break (X2)						01.98-04.03
3.0 V6	23424		259			12.99...
1.9 Turbo D	41415		136			ab Organisationsnummer: 06265 * From RP number: 06265 * à partir de n° d'organisation: 06265, Schaufelraddurchmesser [mm]: 71 * Impeller Diameter [mm]: 71 * Diamètre de la roue à aubes [mm]: 71



CITROËN

CITROËN XANTIA Break (X2)

01.98-04.03

1.9 SD	41415		136			bis Organisationsnummer: 07389 * To RP number: 07389 * jusque n° d'organisation: 07389, Schaufelraddurchmesser [mm]: 71 * Impeller Diameter [mm]: 71 * Diamètre de la roue à aubes [mm]: 71
1.8 i, 2.0 i, 2.0 Turbo	23414		114			
1.8 i	41414		114			
2.0 i, 2.0 Turbo	41414/1		114			
1.9 SD, 1.9 Turbo D	23415		136			
2.0 HDI 90	23426		141		RHY	
2.0 HDI 109	23426		141			
2.0 HDI 109, 2.0 HDI 90	41426		141			
2.1 Turbo D 12V	23419		149			
2.1 Turbo D 12V	41419		149			

CITROËN XANTIA (X1)

03.93-01.98

1.9 SD, 1.9 Turbo D	41415		136			Schaufelraddurchmesser [mm]: 71 * Impeller Diameter [mm]: 71 * Diamètre de la roue à aubes [mm]: 71
1.9 D	41415		136			ab Organisationsnummer: 06265 * From RP number: 06265 * à partir de n° d'organisation: 06265, Schaufelraddurchmesser [mm]: 71 * Impeller Diameter [mm]: 71 * Diamètre de la roue à aubes [mm]: 71
1.6 i, 1.8 i, 2.0 i, 2.0 Turbo	23414		114			
1.6 i, 1.8 i	41414		114			
2.0 i, 2.0 Turbo	41414/1		114			
1.9 D, 1.9 SD, 1.9 Turbo D	23415		136			
2.1 Turbo D 12V	23419		149			
2.1 Turbo D 12V	41419		149			

CITROËN XANTIA (X2)

01.98-04.03

1.9 Turbo D	41415		136			Schaufelraddurchmesser [mm]: 71 * Impeller Diameter [mm]: 71 * Diamètre de la roue à aubes [mm]: 71
3.0 V6	23424		259			12.99...
1.9 SD	41415		136			bis Organisationsnummer: 07389 * To RP number: 07389 * jusque n° d'organisation: 07389, Schaufelraddurchmesser [mm]: 71 * Impeller Diameter [mm]: 71 * Diamètre de la roue à aubes [mm]: 71
1.8 i, 2.0 i, 2.0 Turbo	23414		114			
1.8 i	41414		114			
2.0 i, 2.0 Turbo	41414/1		114			
1.9 SD, 1.9 Turbo D	23415		136			
2.0 HDI 109, 2.0 HDI 90	23426		141			
2.0 HDI 109, 2.0 HDI 90	41426		141			
2.1 Turbo D 12V	23419		149			
2.1 Turbo D 12V	41419		149			

CITROËN XM Break (Y3)

05.89-07.94

2.0 i	41414/1		114		XU102C	07.93...
2.0 i	23414		114			07.93...
2.0 i	41414/1		114			07.93...
2.0 i	41416		114		XU102C	...06.93
2.0 i	23416		114			...06.93
2.0 i	41416		114			...06.93



CITROËN

CITROËN XM Break (Y3)

05.89-07.94

2.0 Turbo	23414		114		
2.0 Turbo	41414/1		114		
2.1 D 12V	23417		144		
2.1 D 12V	41417		144		
2.1 TD 12V	23419		149		
2.1 TD 12V	41419		149		

CITROËN XM Break (Y4)

05.94-10.00

3.0 V6	23424		259		12.99...
2.0 Turbo	23414		114		
2.0 Turbo	41414/1		114		
2.1 D12	23417		144		
2.1 D12	41417		144		
2.1 TD 12V	23419		149		
2.1 TD 12V	41419		149		

CITROËN XM (Y3)

05.89-10.94

2.0 i	23414		114		07.93...
2.0 i	41414/1		114		07.93...
2.0 i	23416		114		...06.93
2.0 i	41416		114		...06.93
2.0 i Turbo	23414		114		
2.0 i Turbo	41414/1		114		
2.1 D 12V	23417		144		
2.1 D 12V	41417		144		
2.1 TD 12V	23419		149		
2.1 TD 12V	41419		149		

CITROËN XM (Y4)

05.94-10.00

3.0 V6	23424		259		12.99...
2.0 Turbo	23414		114		
2.0 Turbo	41414/1		114		
2.1 D12 VSX	41417		144		
2.1 TD 12V	23419		149		
2.1 TD 12V	41419		149		

CITROËN XSARA Break (N2)

10.97-08.05

1.9 TD	41415		136		Schaufelraddurchmesser [mm]: 71 * Impeller Diameter [mm]: 71 * Diamètre de la roue à aubes [mm]: 71
1.4 i	23402		108		09.00.... angetriebene Aggregate: angetr. Agg.: Nockenwelle * Driven Units: Driven unit: camshaft * Périphériques entraînés: Arbre à came
1.9 D	41415		136		...09.98, Schaufelraddurchmesser [mm]: 71 * Impeller Diameter [mm]: 71 * Diamètre de la roue à aubes [mm]: 71
2.0 HDi 109, 2.0 HDi 90	41426		141		bis Organisationsnummer: 08735 * To RP number: 08735 * jusque n° d'organisation: 08735
1.6 i	23413		101		
1.6 i	41413		101		
1.8 i, 1.8 i Aut.	23414		114		



CITROËN

CITROËN XSARA Break (N2)

10.97-08.05

1.8 i, 1.8 i Aut.	41414		114			
1.5 D	23412		136			
1.8 D, 1.9 D, 1.9 TD	23415		136			
1.5 D	41412		136			
1.9 D	23425		140			
2.0 HDi 109, 2.0 HDi 90	23426		141			
2.0 16V	23408		153			

CITROËN XSARA Coupe (N0)

02.98-04.05

1.9 TD	41415		136			Schaufelraddurchmesser [mm]: 71 * Impeller Diameter [mm]: 71 * Diamètre de la roue à aubes [mm]: 71
1.4 i	23402		108			09.00..., angetriebene Aggregate: angetr. Agg.: Nockenwelle * Driven Units: Driven unit: camshaft * Périphériques entraînés: Arbre à came
1.9 D	41415		136			...09.98, Schaufelraddurchmesser [mm]: 71 * Impeller Diameter [mm]: 71 * Diamètre de la roue à aubes [mm]: 71
2.0 HDi 109, 2.0 HDi 90	41426		141			bis Organisationsnummer: 08735 * To RP number: 08735 * jusque n° d'organisation: 08735
1.8 i	23414		114			
1.8 i	41414		114			
1.9 D, 1.9 TD	23415		136			
1.9 D	23425		140			
2.0 HDi 109, 2.0 HDi 90	23426		141			
2.0 16V	23408		153			

CITROËN XSARA (N1)

04.97-04.05

1.9 TD	41415		136			Schaufelraddurchmesser [mm]: 71 * Impeller Diameter [mm]: 71 * Diamètre de la roue à aubes [mm]: 71
1.4 i	23402		108			09.00..., angetriebene Aggregate: angetr. Agg.: Nockenwelle * Driven Units: Driven unit: camshaft * Périphériques entraînés: Arbre à came
1.9 D	41415		136			...09.98, Schaufelraddurchmesser [mm]: 71 * Impeller Diameter [mm]: 71 * Diamètre de la roue à aubes [mm]: 71
2.0 HDi 109, 2.0 HDi 90	41426		141			bis Organisationsnummer: 08735 * To RP number: 08735 * jusque n° d'organisation: 08735
1.6 i	23413		101			
1.6 i	41413		101			
1.8 i, 1.8 i Aut.	23414		114			
1.8 i, 1.8 i Aut.	41414		114			
1.8 TD	23415		136		A8A,AJZ	
1.5 D	23412		136			
1.8 D, 1.9 D, 1.9 SD, 1.9 TD	23415		136			
1.5 D	41412		136			
1.9 D	23425		140			
2.0 HDi 109, 2.0 HDi 90	23426		141			
2.0 16V	23408		153			

CITROËN XSARA PICASSO (N68)

12.99-

2.0 HDi	41426		141			bis Organisationsnummer: 08735 * To RP number: 08735 * jusque n° d'organisation: 08735
1.6	41413		101		TU5JP	
1.6	23413		101			
1.6	41413		101			



CITROËN

CITROËN XSARA PICASSO (N68)

12.99-

2.0 HDi	23426		141			
1.8 16V	23408		153		6FZ	

CITROËN ZX Break (N2)

10.93-02.98

1.9 D	41415		136		XUD9A	Schaufelraddurchmesser [mm]: 71 * Impeller Diameter [mm]: 71 * Diamètre de la roue à aubes [mm]: 71
1.9 TD	41415		136		XUD9TE	03.94..., Schaufelraddurchmesser [mm]: 71 * Impeller Diameter [mm]: 71 * Diamètre de la roue à aubes [mm]: 71
1.9 D	41415		136			03.94..., ab Organisationsnummer: 06171 * From RP number: 06171 * à partir de n° d'organisation: 06171, bis Organisationsnummer: 07389 * To RP number: 07389 * jusqu'à n° d'organisation: 07389, Schaufelraddurchmesser [mm]: 71 * Impeller Diameter [mm]: 71 * Diamètre de la roue à aubes [mm]: 71
1.8 D, 1.9 TD	23415		136			03.94...
1.8 D, 1.9 TD	23405		136			...02.94
1.8 i	41414		114			ab Organisationsnummer: 5410 * From RP number: 5410 * à partir de n° d'organisation: 5410
1.4 i	23402		108			
1.6 i, 1.8 i	23414		114			
1.9 D	23415		136			

CITROËN ZX (N2)

03.91-10.97

1.6 i	23414		114			01.92...
1.9, 1.9 i	41414		114			02.92...
1.9 TD	41415		136			03.94..., bis Organisationsnummer: 07389 * To RP number: 07389 * jusqu'à n° d'organisation: 07389, Schaufelraddurchmesser [mm]: 71 * Impeller Diameter [mm]: 71 * Diamètre de la roue à aubes [mm]: 71
1.8 D, 1.9 D, 1.9 TD	23415		136			03.94...
1.6 i	23404		113			...01.92
1.6 i, 1.9, 1.9 i	41404		113			...01.92
1.8 D, 1.9 D, 1.9 TD	23405		136			...02.94
1.9 D	41415		136			ab Organisationsnummer: 06171 * From RP number: 06171 * à partir de n° d'organisation: 06171, bis Organisationsnummer: 07389 * To RP number: 07389 * jusqu'à n° d'organisation: 07389, Schaufelraddurchmesser [mm]: 71 * Impeller Diameter [mm]: 71 * Diamètre de la roue à aubes [mm]: 71
1.9 D	41415		136			bis Organisationsnummer: 07389 * To RP number: 07389 * jusqu'à n° d'organisation: 07389, Schaufelraddurchmesser [mm]: 71 * Impeller Diameter [mm]: 71 * Diamètre de la roue à aubes [mm]: 71
1.1	23401		104			
1.4, 1.4 i	23402		108			
1.9 i	23404		113			
1.8 i, 1.9 i, 2.0 i	23414		114			
1.8 i	41414		114			
2.0 i	41414/1		114			
1.9 D	23415		136			

DACIA

DACIA LOGAN EXPRESS (FS_)

03.09-

1.4	23122		96		K7J 710	...10.09
1.6	23122		96		K7M 718	...10.09

DACIA LOGAN (LS_)

09.04-

1.4	23122		96		K7J 714	...10.09
1.6	23122		96		K7M 732	...10.09
1.5 dCi	23132		123		K9K	



DACIA

DACIA LOGAN (LS_)						09.04-
1.5 dCi	23132		123			
1.6 16V	41129		132			
DACIA LOGAN MCV (KS_)						02.07-
1.4	23122		96		K7J 710	...10.09
1.6	23122		96		K7M 718	...10.09
1.5 dCi	23132		123		K9K	
1.5 dCi	23132		123			
1.6 16V	41129		132			
DACIA LOGAN Pick-up (US_)						03.08-
1.6	23122		96		K7M 710	...10.09
DACIA SANDERO						06.08-
1.4	23122		96		K7J 714	...10.09
1.6	23122		96		K7M 732	...10.09
DAEWOO						
DAEWOO AVEO						11.02-04.05
1.5 SE	23722		111		F15S3	
DAEWOO ESPERO (KLEJ)						10.91-09.99
1.5	23722		111		A15SMS	
1.8, 2.0	73535		125			
1.5 16V	41536		127		A15MF	
1.5 16V	73536		127			
1.5 16V	41536		127			
DAEWOO GENTRA Stufenheck						11.02-04.05
1.4 SR	41536/1		127		L14	...12.04
1.5 SE	23722		111		F15S3	
DAEWOO KALOS (KLAS)						09.02-
1.4 16V	41536/1		127		L14	...12.04
1.4	23722		111		F14S3	
1.5	23722		111		F15S3	
1.4 16V	73536		127			
DAEWOO KALOS Stufenheck (KLAS)						11.02-12.04
1.4	23722		111		F14S3	
1.5	23722		111		F15S3	
1.4	41536/1		127		L14	
DAEWOO LACETTI Kombi						04.97-05.99
1.5 SX	23722		111			
DAEWOO LACETTI Schrägheck (KLAN)						02.04-
1.4, 1.6	73536		127			
1.4	41536/1		127			
DAEWOO LACETTI Stufenheck						04.97-05.99
1.5 SX	23722		111			
1.6	41536		127		A16DMS	
DAEWOO LACETTI Stufenheck (J200)						08.03-12.04
1.5	23722		111			
DAEWOO LANOS (KLAT)						05.97-
1.4, 1.5	23722		111			



DAEWOO

DAEWOO LANOS (KLAT)						05.97-
1.6 16V	73536		127			
1.6 16V	41536		127			
DAEWOO LANOS Stufenheck (KLAT)						05.97-
1.4, 1.5	23722		111			
1.6 16V	73536		127			
1.6 16V	41536		127			
DAEWOO LEGANZA (KLAV)						06.97-04.04
2.0 16V	23725		169			
2.0 16V	41725		169			
DAEWOO MATIZ (KLYA)						09.98-
0.8	73537		107			
DAEWOO NEXIA (KLETN)						02.95-08.97
1.5	23722		111			
1.5	41722		111			
1.5 16V	73536		127			
1.5 16V	41536		127			
DAEWOO NEXIA Stufenheck (KLETN)						02.95-08.97
1.5	23722		111			
1.5	41722		111			
1.5 16V	73536		127			
1.5 16V	41536		127			
DAEWOO NUBIRA (KLAJ)						04.97-
1.6 16V	73536		127			
1.6, 1.6 16V	41536/1		127			
2.0 16V	23725		169			
2.0 16V	41725		169			
DAEWOO NUBIRA Stufenheck (KLAJ)						04.97-
1.6 16V	73536		127			
1.6 16V	41536/1		127			
2.0 16V	23725		169			
2.0 16V	41725		169			
DAEWOO NUBIRA Stufenheck (KLAN)						07.03-
1.6	73536		127			
DAEWOO NUBIRA Wagon (KLAJ)						04.97-
1.6 16V	41536/1		127		A16DMS	
1.6 16V	41536/1		127		616L	
1.6 16V	73536		127			
1.6 16V	41536/1		127			
2.0 16V	23725		169			
2.0 16V	41725		169			
DAEWOO REZZO (KLAU)						09.00-
1.6	73536		127			
1.6	41536/1		127			
2.0	23725		169			
DAEWOO TICO (KLY3)						02.95-12.00



DAEWOO

DAEWOO TICO (KLY3)							02.95-12.00
0.8	73537		107				
FIAT							
FIAT BARCHETTA (183)							03.95-
1.8 16V	23033		168		183A1.0 00	...05.98	
FIAT CINQUECENTO (170)							07.91-07.99
1.1 Sporting	23005		125			ab Motornummer: 9042884	
1.1 Sporting	23002		104			bis Motornummer: 9042883	
1.1 Sporting	41002		104			bis Motornummer: 9042883	
FIAT COUPE (FA/175)							11.93-08.00
1.8 16V	23033		168			...05.98	
FIAT DOBLO Cargo (223)							03.01-
1.2	41006		129			bis Motornummer: 2533528	
1.2	23006		129				
FIAT DOBLO (119)							03.01-
1.2	41006		129			bis Motornummer: 2533528	
1.2	23006		129				
FIAT DUCATO Bus (230)							03.94-04.02
2.5 TDI Combinato, 2.5 TDI Panorama/Combinato, 2.5 TDI 4x4, 2.8 D	23027		153			angetriebene Aggregate: angetr. Agg.: Nockenwelle * Driven Units: Driven unit: camshaft * Périphériques entraînés: Arbre à came	
2.8 TDI 4x4	23028		154			angetriebene Aggregate: angetr. Agg.: Nockenwelle * Driven Units: Driven unit: camshaft * Périphériques entraînés: Arbre à came	
2.8 TDI	23028		154			01.98..., angetriebene Aggregate: angetr. Agg.: Nockenwelle * Driven Units: Driven unit: camshaft * Périphériques entraînés: Arbre à came	
1.9 D, 1.9 TD	23415		136				
2.0 JTD	23426		141				
2.0 JTD	41426		141				
FIAT DUCATO Bus (244, Z_)							04.02-
2.0 JTD	23426		141				
2.0 JTD	41426		141				
FIAT DUCATO Kasten (230L)							03.94-04.02
2.5 TDI, 2.5 TDI Maxi, 2.5 TDI 4x4, 2.8 D, 2.8 D 4x4	23027		153			angetriebene Aggregate: angetr. Agg.: Nockenwelle * Driven Units: Driven unit: camshaft * Périphériques entraînés: Arbre à came	
2.8 TDI 4x4	23028		154			angetriebene Aggregate: angetr. Agg.: Nockenwelle * Driven Units: Driven unit: camshaft * Périphériques entraînés: Arbre à came	
2.8 TDI	23028		154			01.98..., angetriebene Aggregate: angetr. Agg.: Nockenwelle * Driven Units: Driven unit: camshaft * Périphériques entraînés: Arbre à came	
1.9 D, 1.9 TD	23415		136				
2.0 JTD	23426		141				
2.0 JTD	41426		141				
FIAT DUCATO Kasten (244)							04.02-
2.0 JTD	23426		141				
2.0 JTD	41426		141				
FIAT DUCATO Kasten (280)							01.82-08.90
2.5 D, 2.5 D 4x4	23418		62				
FIAT DUCATO Kasten (290)							03.89-05.94
2.5 TD, 2.5 TD 4x4	23027		153			angetriebene Aggregate: angetr. Agg.: Nockenwelle * Driven Units: Driven unit: camshaft * Périphériques entraînés: Arbre à came	
FIAT DUCATO Panorama (280)							07.82-08.90
2.4 TD 4x4	23026		153			...12.88, angetriebene Aggregate: angetr. Agg.: Nockenwelle * Driven Units: Driven unit: camshaft * Périphériques entraînés: Arbre à came	
2.4 TD	23026		153				
2.5 D, 2.5 D 4x4	23418		62				
FIAT DUCATO Panorama (290)							01.90-05.94



FIAT

FIAT DUCATO Panorama (290)							01.90-05.94
2.5 TD, 2.5 TD 4x4	23027		153			angetriebene Aggregate: angetr. Agg.: Nockenwelle * Driven Units: Driven unit: camshaft * Périphériques entraînés: Arbre à came	
FIAT DUCATO Pritsche/Fahrgestell (230)							03.94-04.02
2.5 TDI, 2.5 TDI 4x4, 2.8 D	23027		153			angetriebene Aggregate: angetr. Agg.: Nockenwelle * Driven Units: Driven unit: camshaft * Périphériques entraînés: Arbre à came	
2.8 TDI	23028		154			angetriebene Aggregate: angetr. Agg.: Nockenwelle * Driven Units: Driven unit: camshaft * Périphériques entraînés: Arbre à came	
1.9 D, 1.9 TD	23415		136				
FIAT DUCATO Pritsche/Fahrgestell (244)							04.02-
2.0 JTD	23426		141				
2.0 JTD	41426		141				
FIAT DUCATO Pritsche/Fahrgestell (280)							07.82-08.90
2.4 TD	23026		153			...12.88, angetriebene Aggregate: angetr. Agg.: Nockenwelle * Driven Units: Driven unit: camshaft * Périphériques entraînés: Arbre à came	
2.5 D, 2.5 D 4x4	23418		62				
FIAT DUCATO Pritsche/Fahrgestell (290)							03.89-05.94
2.5 TD, 2.5 TD 4x4	23027		153			angetriebene Aggregate: angetr. Agg.: Nockenwelle * Driven Units: Driven unit: camshaft * Périphériques entraînés: Arbre à came	
FIAT FIORINO Kasten (146 Uno)							01.88-05.01
70 i.e. 1.4, 75 i.e. 1.6	23003		138				
FIAT FIORINO Pick up (146)							01.88-05.01
1.6	23003		138		146D6.0 00		
FIAT FIORINO (147)							01.80-04.88
1.3	23007		120		146A5.0 00	8220597...	
FIAT PALIO Weekend (178DX)							04.96-
1.2	41004		108			...03.99, bis Motornummer: 9042883	
1.2	23006		129			ab Motornummer: 9042884	
1.2	41006		129			ab Motornummer: 9042884	
1.2	23004		108			bis Motornummer: 9042883	
1.2	23006		129				
FIAT PANDA Van (141_)							01.86-02.04
1000, 1000 i.e	23005		125			ab Motornummer: 9042884	
1000, 1000 i.e	23002		104			bis Motornummer: 9042883	
1000, 1000 i.e	41002		104			bis Motornummer: 9042883	
FIAT PANDA Van (169)							03.04-
1.2, 1.2 4x4	41006		129		188A4.0 00	bis Motornummer: 2533528	
FIAT PANDA (141A_)							03.80-07.04
1100 4x4	41005		125			04.99..., ab Motornummer: 9042883	
1100	41005		125		187A1.0 00	04.99..., ab Motornummer: 9042884	
1100, 1100 Trekking 4x4	41005		125			04.99..., ab Motornummer: 9042884	
1100	41002		104		176B2.0 00	...03.99, bis Motornummer: 9042883	
1100, 1100 Trekking 4x4, 1100 4x4	41002		104			...03.99, bis Motornummer: 9042883	
1000 i.e. KAT, 1000 4x4, 1100, 1100 Trekking 4x4, 1100 4x4, 750	23005		125			ab Motornummer: 9042884	
1000 i.e. KAT, 1000 4x4, 1100, 1100 Trekking 4x4, 1100 4x4, 750	23002		104			bis Motornummer: 9042883	
1000, 1000 i.e. KAT, 1000 4x4, 750	41002		104			bis Motornummer: 9042883	
1000	23002		104		156A2.1 00		
900	23003		138				
FIAT PANDA (169)							09.03-
1.1	41005		125			bis Motornummer: 2533528	



FIAT

FIAT PANDA (169)

09.03-

1.2, 1.2 4x4, 1.2 Bi-Power / Natural Power	41006		129			bis Motornummer: 2533528
1.1, 1.2, 1.2 4x4	23005		125			

FIAT PUNTO Cabriolet (176C)

04.94-06.00

60 1.2	41006		129		176B4.0 00	04.99..., ab Motornummer: 9042884
60 1.2	41004		108		176B4.0 00	...03.99, bis Motornummer: 9042883
60 1.2	41004		108			...03.99
60 1.2	23006		129		176B4.0 00	ab Motornummer: 9042884
60 1.2	23004		108		176B4.0 00	bis Motornummer: 9042883
60 1.2	23004		108			
90 1.6	23003		138			

FIAT PUNTO Van (176L)

04.96-02.00

1.1	41005		125			04.99..., ab Motornummer: 9042884
1.1	41002		104			...03.99, bis Motornummer: 9042883
1.1	23005		125			ab Motornummer: 9042884
1.1	23002		104			bis Motornummer: 9042883

FIAT PUNTO Van (188AX)

02.00-

1.2 60	23006		129			ab Motornummer: 9042884
1.2 60	41006		129			bis Motornummer: 2533528

FIAT PUNTO (176)

09.93-09.99

60 1.2	41006		129		176 B4.000	04.99..., ab Motornummer: 9042883
55 1.1	41005		125			04.99..., ab Motornummer: 9042884
75 1.2	41006		129			04.99..., ab Motornummer: 9042884
55 1.1	41002		104			...03.99, bis Motornummer: 9042883
60 1.2	41004		108		176B4.0 00	...03.99, bis Motornummer: 9042883
75 1.2	41004		108			...03.99, bis Motornummer: 9042883
60 1.2	41004		108			...03.99
55 1.1	23005		125			ab Motornummer: 9042884
60 1.2	23006		129		176B4.0 00	ab Motornummer: 9042884
75 1.2	23006		129			ab Motornummer: 9042884
55 1.1	23002		104			bis Motornummer: 9042883
60 1.2	23004		108		176B4.0 00	bis Motornummer: 9042883
60 1.2, 75 1.2	23004		108			bis Motornummer: 9042883
1.4 GT Turbo, 90 1.6	23003		138			

FIAT PUNTO (188)

09.99-

1.2 60	23006		129			ab Motornummer: 9042884
1.2 Natural Power, 1.2 60	41006		129			bis Motornummer: 2533528

FIAT SCUDO Combinato (220P)

02.96-

1.9 D, 1.9 TD, 1.9 TD Eco	41415		136			...03.97, Schaufelraddurchmesser [mm]: 71 * Impeller Diameter [mm]: 71 * Diamètre de la roue à aubes [mm]: 71
2.0 JTD	41426		141			...04.00
1.9 D, 1.9 TD, 1.9 TD Eco	23415		136			
1.6	23003		138			



FIAT

FIAT						
FIAT SCUDO Combinato (220P)						02.96-
1.9 D	23425		140			
2.0 JTD	23426		141			
2.0 16V	23408		153			
FIAT SCUDO Kasten (220L)						02.96-
1.9 D, 1.9 TD	41415		136			...03.97, Schaufelraddurchmesser [mm]: 71 * Impeller Diameter [mm]: 71 * Diamètre de la roue à aubes [mm]: 71
2.0 JTD	41426		141			...04.00
1.9 D, 1.9 TD	23415		136			
1.6	23003		138			
1.9 D	23425		140			
2.0 JTD	23426		141			
2.0 JTD	23428		144		RHW	
2.0	23408		153			
FIAT SEICENTO Van (187)						01.98-
1.1	41005		125			04.99...., ab Motornummer: 9042883
1.1	41002		104			...03.99, bis Motornummer: 9042882
FIAT SEICENTO (187)						01.98-
1.1	41005		125	187A1.0 00		04.99...., ab Motornummer: 9042884
1.1	41002		104	176B2.0 00		...03.99, bis Motornummer: 9042882
1.1	23005		125			ab Motornummer: 9042884
1.1	23002		104			bis Motornummer: 9042883
FIAT STRADA (178E)						06.99-
1.2	23006		129			ab Motornummer: 9042884
1.2	23004		108			bis Motornummer: 9042883
FIAT TEMPRA S.W. (159)						03.90-08.97
1.4 i.e., 1.6, 1.6 i.e.	23003		138			
FIAT TEMPRA (159)						03.90-08.97
1.4 i.e., 1.6, 1.6 i.e.	23003		138			
FIAT TIPO (160)						07.87-04.95
1.1	23002		104			
1.1	41002		104			
1.4 i.e.	23003		138	159A2.0 00		
1.4, 1.4 i.e., 1.6, 1.6 i.e.	23003		138			
FIAT ULYSSE (179AX)						08.02-
2.0 JTD	23428		144			
2.0 JTD	41428		144			
2.2 JTD	23427		146			
2.0	23408		153			
3.0 V6	23424		259			
FIAT ULYSSE (220)						06.94-08.02
1.9 TD	41415		136			...03.97, Schaufelraddurchmesser [mm]: 71 * Impeller Diameter [mm]: 71 * Diamètre de la roue à aubes [mm]: 71
2.0 JTD	41426		141			...04.00
1.8, 2.0, 2.0 Turbo	23414		114			



FIAT

FIAT						
FIAT ULYSSE (220)						06.94-08.02
1.8	41414		114			
2.0, 2.0 Turbo	41414/1		114			
1.9 TD	23415		136			
2.0 JTD	23426		141			
2.1 TD	23419		149			
2.1 TD	41419		149			
2.0 16V	23408		153			
FIAT UNO (146A/E)						01.83-08.00
45 i.e. 1.0, 45 1.0, 50 1.1	23005		125			ab Motornummer: 9042884
50 1.1	41002		104	160A 3.000		bis Motornummer: 9042883
45 i.e. 1.0, 45 1.0, 50 1.1	23002		104			bis Motornummer: 9042883
45 i.e. 1.0, 45 1.0	41002		104			bis Motornummer: 9042883
50 i.e. 1.1, 50 1.1	23002		104			
50 i.e. 1.1, 50 1.1	41002		104			
1.4 Turbo i.e., 70 i.e. 1.4	23003		138			
FORD						
FORD CAPRI (ECJ)						12.68-02.74
1300, 1600	23628		119			
FORD CAPRI II (GECF)						02.74-12.77
1.3, 1.6	23628		119			
FORD CAPRI III (GECF)						01.78-04.87
1.3, 1.6	23628		119			
2.0	23627		122			
FORD CONSUL Coupe (GGCL)						01.72-12.75
2000	23627		122			
FORD CONSUL Turnier (GGNL)						01.72-12.75
2000	23627		122			
FORD COURIER Kasten (F3L, F5L)						07.91-02.96
1.8 D	23633		85			10.95...
1.8 D	23704		85			...10.95
FORD COURIER Kasten (J5_, J3_)						02.96-
1.8 D	23712		85			09.96...
1.8 D	41712		85			09.96...
1.4 i	23629		117			03.97...
1.4 i	41629		117			03.97...
1.8 D	23633		85			...09.96
1.8 DI	23636		91			
FORD COURIER Pick-up						06.99-02.02
1.8 D	41712		85		RTK	
FORD ESCORT CLASSIC (AAL, ABL)						10.98-07.00
1.8 TD	23712		85			
1.6 16V	23710		131			
FORD ESCORT CLASSIC Turnier (ANL)						02.99-07.00
1.8 TD	23712		85			
1.6 16V	23710		131			



FORD

FORD ESCORT II (ATH)						03.73-07.81
2.0 RS Heckantrieb	23627		122			
FORD ESCORT III Cabriolet (ALD)						09.83-12.85
1.6, 1.6 i	23701		97		HL 16 CVH	
FORD ESCORT III (GAA)						09.80-07.86
RS 1600i, 1.6, 1.6 XR3i	23701		97		HL 16 CVH	06.83...
1.6, 1.6 i, 1.6 RS Turbo	23701		97		HL 16 CVH	
FORD ESCORT III Kombi (AWA)						09.80-12.85
1.6	23701		97		HL 16 CVH	06.83...
FORD ESCORT IV Cabriolet (ALF)						01.86-07.90
1.4	23701		97		HL 14 CVH	
1.4	41701		97		HL14 CVH	
1.6 i, 1.6 XR3i	23701		97		HL 16 CVH	
1.6 i, 1.6 XR3i	41701		97		HL16 CVH	
FORD ESCORT IV (GAF, AWF, ABFT)						10.85-10.90
1.8 D	23704		85			
1.4	23701		97		HL 14 CVH	
1.4	41701		97		HL14 CVH	
1.6, 1.6 i, 1.6 Turbo RS, 1.6 XR3i	23701		97		HL 16 CVH	
1.6, 1.6 i, 1.6 Turbo RS, 1.6 XR3i	41701		97		HL16 CVH	
FORD ESCORT IV Kombi (AWF, AVF)						10.85-10.90
1.8 D	23704		85			
1.4	23701		97		HL 14 CVH	
1.4	41701		97		HL14 CVH	
1.6, 1.6 i	23701		97		HL 16 CVH	
1.6, 1.6 i	41701		97		HL16 CVH	
FORD ESCORT V Cabriolet (ALL)						07.90-12.92
1.4	23702		97			05.92...
1.4	41702		97			05.92...
1.4	23701		97			...04.92
1.4	41701		97			...04.92
1.8 16V XR3i	23710		131		ZH18 ZETEC E	
1.6	23701		97		HL 16 CVH	
1.6	41701		97		HL16 CVH	
FORD ESCORT V (GAL)						07.90-12.92
1.4, 1.6	23702		97			05.92...
1.4, 1.6	41702		97			05.92...
1.4, 1.6	23701		97			...04.92
1.4, 1.6	41701		97			...04.92
1.8 D	23704		85			
1.8 16V XR3i	23710		131		ZH18 ZETEC E	



FORD

FORD ESCORT V (GAL)							07.90-12.92
1.6	23701		97		HL 16 CVH		
1.6	41701		97		HL16 CVH		
FORD ESCORT V Kombi (GAL, AVL)							07.90-12.92
1.4, 1.6	23702		97			05.92...	
1.4, 1.6	41702		97			05.92...	
1.4	23701		97			...04.92	
1.4, 1.6	41701		97			...04.92	
1.8 D	23704		85				
1.8 16V	23710		131		ZH18 ZETEC E		
1.6	23701		97		HL 16 CVH		
1.6	41701		97		HL16 CVH		
FORD ESCORT VI Cabriolet (ALL)							12.92-01.95
1.6 16V XR3i	23710		131		ZH16 ZETEC E		
1.6 i 16V, 1.8 16V XR3i	23710		131				
1.4, 1.4 i	23702		97		HL 14 CVH		
1.4, 1.4 i	41702		97		HL14 CVH		
FORD ESCORT VI (GAL)							09.92-01.95
1.8 D, 1.8 TD	23704		85				
1.6 i 16V, 1.8 i 16V, 1.8 XR3i 16V 4x4, 1.8 16V XR3i	23710		131				
1.4	23702		97		HL 14 CVH		
1.4	41702		97		HL14 CVH		
FORD ESCORT VI Kombi (GAL)							09.92-01.95
1.8 D, 1.8 TD	23704		85				
1.6 i 16V, 1.8 i 16V	23710		131				
1.4	23702		97		HL 14 CVH		
1.4	41702		97		HL14 CVH		
FORD ESCORT VI Stufenheck (GAL)							08.93-01.95
1.8 D, 1.8 TD	23704		85				
1.6 i 16V, 1.8 i 16V	23710		131				
1.4	23702		97		HL 14 CVH		
1.4	41702		97		HL14 CVH		
FORD ESCORT VII Cabriolet (ALL)							02.95-08.00
1.8 TD	23633		85			10.95..., ...09.96	
1.8 TD	23712		85			10.96...	
1.8 TD	23704		85			...09.95	
1.8 Turbo D	23712		85				
1.6 16V XR3i	23710		131		ZH16 ZETEC E		
1.8 16V XR3i	23710		131		ZH18 ZETEC E		
1.4	23702		97		HL 14 CVH		
1.4	41702		97		HL14 CVH		



FORD

FORD ESCORT VII (GAL, AAL, ABL) 01.95-10.98

1.8 D	23633		85			09.95...
1.8 TD	23633		85			10.95..., ...09.96
1.8 Turbo D	23712		85			09.96...
1.8 TD	23712		85			10.96...
1.8 TD	23704		85			...09.95
1.8 D	23704		85			...10.95
1.8 Turbo D	23633		85			...09.96
1.6 i 16V, 1.6 16V, 1.6 16V 4x4, 1.8 16V	23710		131		ZH16 ZETEC E	
1.4	23702		97		HL 14 CVH	
1.4	41702		97		HL14 CVH	

FORD ESCORT VII Kombi (GAL, ANL) 01.95-02.99

1.8 TD	23633		85			10.95..., ...09.96
1.8 D, 1.8 Turbo D	23712		85			09.96...
1.8 D	41712		85			09.96...
1.8 TD	23712		85			10.96...
1.8 TD	23704		85			...09.95
1.8 D, 1.8 Turbo D	23633		85			...09.96
1.6 i 16V, 1.6 16V	23710		131		ZH16 ZETEC E	
1.8 16V	23710		131		ZH18 ZETEC E	
1.4	41702		97		HL14 CVH	
1.4	23702		97		HL 16 CVH	

FORD ESCORT VII Stufenheck (GAL, AFL) 01.95-02.99

1.8 D	23633		85			09.95...
1.8 TD	23633		85			10.95..., ...09.96
1.8 Turbo D	23712		85			09.96...
1.8 TD	23712		85			10.96...
1.8 TD	23704		85			...09.95
1.8 D	23704		85			...10.95
1.8 Turbo D	23633		85			...09.96
1.6 i 16V, 1.8 16V	23710		131		ZH16 ZETEC E	
1.8 16V	23710		131		ZH18 ZETEC E	
1.4	23702		97		HL 14 CVH	
1.4	41702		97		HL14 CVH	

FORD ESCORT `86 Express (AVF) 02.86-07.90

1.8 D	23704		85			
1.4 i	23701		97		HL 14 CVH	
1.4 i	41701		97		HL14 CVH	
1.6	23701		97		HL 16 CVH	



FORD

FORD ESCORT `86 Express (AVF)						02.86-07.90
1.6	41701		97		HL16 CVH	
FORD ESCORT `91 Express (AVL)						07.90-12.94
1.4	23702		97			05.92...
1.4	41702		97			05.92...
1.4	23701		97			...04.92
1.4	41701		97			...04.92
1.8 D	23704		85			
FORD ESCORT `95 Express (AVL)						01.95-
1.8 D	23633		85			10.95..., ...09.96
1.8 D, 1.8 Turbo D	23712		85			10.96...
1.8 D	41712		85			10.96...
1.8 D	23704		85			...09.95
1.8 Turbo D	23633		85			...09.96
1.4	23702		97		HL 14 CVH	
1.4	41702		97		HL14 CVH	
FORD FIESTA II (FBD)						09.83-11.89
1.6 XR2	41701		97		HL16 CVH	02.86...
1.4	23701		97		HL 14 CVH	
1.4	41701		97		HL14 CVH	
1.6 XR2	23701		97		HL 16 CVH	
FORD FIESTA III (GFJ)						01.89-01.97
1.4, 1.4 KAT	23702		97		HL 14 CVH	05.92...
1.4, 1.4 KAT	41702		97		HL14 CVH	05.92...
1.6	23702		97		HL 16 CVH	05.92...
1.6	41702		97		HL16 CVH	05.92...
1.8 D	23633		85			10.95...
1.4, 1.4 KAT	23701		97		HL 14 CVH	...04.92
1.4, 1.4 KAT	41701		97		HL14 CVH	...04.92
1.6	23701		97		HL 16 CVH	...04.92
1.6	41701		97		HL16 CVH	...04.92
1.8 D	23704		85			...10.95
1.6 i 16V, 1.8 XR2i 16V, 1.8 16V	23710		131			
1.6 Turbo, 1.6 XR2i	23701		97		HL 16 CVH	
1.6 Turbo, 1.6 XR2i	41701		97		HL16 CVH	
FORD FIESTA IV (JA_, JB_)						08.95-01.02
1.8 D	23633		85			10.95..., ...09.96
1.8 D	23712		85			09.96...
1.8 D	41712		85			09.96...
1.25 i 16V, 1.4 i 16V	23629		117			03.97...



FORD

FORD FIESTA IV (JA_, JB_)						08.95-01.02
1.25 i 16V, 1.4 i 16V	41629		117			03.97...
1.8 DI	23636		91			09.00...
1.8 D	23704		85			...10.95
1.8 DI	23630		91			...09.00
1.6 16V Sport	23629		117			
1.6 16V Sport	41629		117			
FORD FIESTA Kasten (FVD)						03.83-12.95
1.8 D	23633		85			10.95...
1.8 D	23704		85			...10.95
FORD FIESTA Kasten (JV_)						05.98-
D 1.8	23712		85			
D 1.8	41712		85			
TD 1.8	23636		91			
FORD FIESTA V (JH_, JD_)						11.01-
1.25 16V, 1.4 16V, 1.6 16V	23629		117			...04.05
1.25 16V, 1.4 16V, 1.6 16V	41629		117			...04.05
FORD FOCUS C-MAX						10.03-03.07
1.6, 1.6 Ti	23629		117			...04.05
1.6, 1.6 Ti	41629		117			...04.05
1.8 TDCi	23636		91			
FORD FOCUS (DAW, DBW)						10.98-11.04
1.8 DI / TDDi, 1.8 Turbo DI / TDDi	23636		91			09.00...
1.8 DI / TDDi, 1.8 Turbo DI / TDDi	23630		91			...09.00
1.4 16V, 1.6 16V, 1.6 16V Flexifuel	23629		117			
1.4 16V, 1.6 16V	41629		117			
1.8 TDCi	23636		91			
FORD FOCUS II (DA_)						11.04-
1.4, 1.6, 1.6 Ti	23629		117			...04.05
1.4, 1.6, 1.6 Ti	41629		117			...04.05
1.8 TDCi	23636		91			
FORD FOCUS II Kombi (DAW_)						11.04-
1.4, 1.6, 1.6 Ti	23629		117			...04.05
1.4, 1.6, 1.6 Ti	41629		117			...04.05
1.8 TDCi	23636		91			
FORD FOCUS II Stufenheck (DA_)						04.05-
1.8 TDCi	23636		91			
FORD FOCUS Kombi (DNW)						02.99-11.04
1.8 DI / TDDi, 1.8 Turbo DI / TDDi	23636		91			09.00...
1.8 DI / TDDi, 1.8 Turbo DI / TDDi	23630		91			...09.00
1.4 16V, 1.6 16V, 1.6 16V Flexifuel	23629		117			
1.4 16V, 1.6 16V	41629		117			
1.8 TDCi	23636		91			
FORD FOCUS Stufenheck (DFW)						02.99-03.05
1.8 Turbo DI / TDDi	23636		91			09.00...



FORD

FORD FOCUS Stufenheck (DFW)							02.99-03.05
1.8 Turbo DI / TDDi	23630		91			...09.00	
1.4 16V, 1.6 16V	23629		117				
1.4 16V, 1.6 16V	41629		117				
1.8 TDCi	23636		91				
FORD FUSION (JU_)							08.02-
1.25, 1.4, 1.6	23629		117			...04.05	
1.25, 1.4, 1.6	41629		117			...04.05	
FORD GALAXY							05.06-
1.8 TDCi	23636		91				
FORD GALAXY (WGR)							03.95-05.06
1.9 TDI	23847		120		ANU	04.00..., angetriebene Aggregate: angetr. Agg.: Nockenwelle * Driven Units: Driven unit: camshaft * Périphériques entraînés: Arbre à came	
1.9 TDI	23848		120		ANU	04.00...	
1.9 TDI	41848		120			...03.02, angetriebene Aggregate: angetr. Agg.: Wasserpumpe * Driven Units: Driven unit: water pump * Périphériques entraînés: Pompe à eau, angetriebene Aggregate: angetr. Agg.: Nockenwelle * Driven Units: Driven unit: camshaft * Périphériques entraînés: Arbre à came	
1.9 TDI	23847		120			...03.02, angetriebene Aggregate: angetr. Agg.: Nockenwelle * Driven Units: Driven unit: camshaft * Périphériques entraînés: Arbre à came	
1.9 TDI	23848		120			...03.02	
1.9 TDI	41848		120		ANU	...12.02, ab Motornummer: 005 001, angetriebene Aggregate: angetr. Agg.: Wasserpumpe * Driven Units: Driven unit: water pump * Périphériques entraînés: Pompe à eau, angetriebene Aggregate: angetr. Agg.: Nockenwelle * Driven Units: Driven unit: camshaft * Périphériques entraînés: Arbre à came	
1.9 TDI	23821		137		1Z,AHU		
1.9 TDI	73808		137		1Z, AHU		
1.9 TDI	23821		137				
1.9 TDI	73808		137				
FORD GRANADA (GU)							08.77-08.85
2.0	23627		122		TL20 OHC		
FORD GRANADA Kombi (GNU)							08.77-08.85
2.0	23627		122		TL20 OHC		
FORD MONDEO I (GBP)							02.93-08.96
1.8 TD	23633		85			10.95...	
1.8 TD	23704		85			...09.95	
1.8 TD	23633		85				
1.6 i 16V, 1.8 i 16V, 1.8 i 16V 4x4, 2.0 i 16V, 2.0 i 16V 4x4	23710		131				
FORD MONDEO I Kombi (BNP)							01.93-08.96
1.8 TD	23633		85			10.95...	
1.8 TD	23704		85			...09.95	
1.8 TD	23633		85				
1.6 i 16V, 1.8 i 16V, 1.8 i 16V 4x4, 2.0 i 16V, 2.0 i 16V 4x4	23710		131				
FORD MONDEO I Stufenheck (GBP)							02.93-08.96
1.8 TD	23633		85			10.95...	
1.8 TD	23704		85			...09.95	
1.8 TD	23633		85				
1.6 i 16V, 1.8 i 16V, 2.0 i 16V, 2.0 i 16V 4x4	23710		131				
FORD MONDEO II (BAP)							09.96-11.00
1.6 i, 1.8 i, 2.0 i	23710		131			...04.98	



FORD

FORD							09.96-11.00
FORD MONDEO II (BAP)							09.96-11.00
1.8 TD	41712/2		85		RFN		
1.8 TD	23712		85				
FORD MONDEO II Kombi (BNP)							09.96-11.00
1.6 i, 1.8 i, 2.0 i	23710		131			...04.98	
1.8 TD	41712/2		85		RFN		
1.8 TD	23712		85				
FORD MONDEO II Stufenheck (BFP)							09.96-11.00
1.6 i, 1.8 i, 2.0 i	23710		131			...04.98	
1.8 TD	41712/2		85		RFN		
1.8 TD	23712		85				
FORD ORION I (AFD)							07.83-03.86
1.6, 1.6 i	23701		97		HL 16 CVH		
FORD ORION II (AFF)							12.85-07.90
1.8 D	23704		85				
1.4, 1.4 KAT, 1.6, 1.6 i KAT	23701		97				
1.4, 1.4 KAT, 1.6, 1.6 i, 1.6 i KAT	41701		97				
FORD ORION III (GAL)							07.90-12.93
1.4	23702		97			05.92...	
1.4	41702		97			05.92...	
1.4	23701		97			...04.92	
1.4	41701		97			...04.92	
1.8 D, 1.8 TD	23704		85				
1.6 i 16V	23710		131		ZH16 ZETEC E		
1.8 i 16V	23710		131		ZH18 ZETEC E		
1.8 i 16V	23710		131				
1.6 i	23701		97		HL 16 CVH		
1.6 i	41701		97		HL16 CVH		
FORD PUMA (EC_)							03.97-06.02
1.4 16V, 1.6 16V	23629		117				
1.4 16V, 1.6 16V	41629		117				
FORD SIERRA (GBG, GB4)							01.87-02.93
1.6, 1.6 i	23702		97		HL 16 CVH	05.92...	
1.6, 1.6 i	23701		97		HL 16 CVH	...04.92	
1.8 TD	23704		85				
1.6, 1.6 i	23628		119		TL 16 OHC		
1.8	23627		122		TL18 OHC		
2.0, 2.0 4x4, 2.0 i, 2.0 i KAT	23627		122		TL20 OHC		
1.8	23627		122				
FORD SIERRA Kombi (BNC)							08.82-12.86
1.6	23628		119		TL 16 OHC		
1.8	23627		122		TL18 OHC		



FORD

FORD SIERRA Kombi (BNC)							08.82-12.86
2.0	23627		122		TL20 OHC		
FORD SIERRA Kombi (BNG)							01.87-02.93
1.6, 1.6 i	23702		97		HL 16 CVH	05.92...	
1.6, 1.6 i	23701		97		HL 16 CVH	...04.92	
1.8 TD	23704		85				
1.6, 1.6 i	23628		119		TL 16 OHC		
1.8	23627		122		TL18 OHC		
2.0, 2.0 4x4, 2.0 i, 2.0 i KAT	23627		122		TL20 OHC		
FORD SIERRA Schrägheck (GBC)							08.82-02.87
1.3	23628		119		TL 13 OHC		
1.6	23628		119		TL 16 OHC		
1.8	23627		122		TL18 OHC		
2.0, 2.0 i	23627		122		TL20 OHC		
FORD SIERRA Schrägheck (GBC, GBG)							01.87-03.93
1.6, 1.6 i	23702		97		HL 16 CVH	05.92...	
1.6, 1.6 i	23701		97		HL 16 CVH	...04.92	
1.8 TD	23704		85				
1.6, 1.6 i	23628		119		TL 16 OHC		
1.8	23627		122		TL18 OHC		
1.8, 2.0, 2.0 i, 2.0 i KAT	23627		122		TL20 OHC		
FORD S-MAX							05.06-
1.8 TDCi	23636		91				
FORD TAUNUS '80 (GBS, GBNS)							07.79-07.82
2.0	23627		122		TL20 OHC		
FORD TAUNUS '80 Turnier (GBNS)							07.79-07.82
2.0	23627		122		TL20 OHC		
FORD TOURNEO CONNECT							06.02-
1.8 Di, 1.8 Turbo Di	23636		91				
FORD TRANSIT Bus (E_ _)							01.91-07.94
2.5 DI, 2.5 TD	23709		130			angetriebene Aggregate: angetr. Agg.: Nockenwelle * Driven Units: Driven unit: camshaft * Périphériques entraînés: Arbre à came	
2.5 DI	23709		130			07.97...., angetriebene Aggregate: angetr. Agg.: Nockenwelle * Driven Units: Driven unit: camshaft * Périphériques entraînés: Arbre à came	
2.5 DI	23708		130,0			07.97...	
2.5 DI, 2.5 TD	23632		130			07.97...	
2.5 TD	23709		130			09.97...., angetriebene Aggregate: angetr. Agg.: Nockenwelle * Driven Units: Driven unit: camshaft * Périphériques entraînés: Arbre à came	
2.5 TD	23708		130,0			09.97...	
2.5 DI, 2.5 TD	23631		130			...07.97	
2.5 DI	23707		130			...07.97	
2.5 TD	23707		130			...09.97	
2.0, 2.0 i	23627		122		TL20 OHC		
2.5 DI, 2.5 TD	23708		130,0				



FORD

FORD TRANSIT Bus (E_)						01.91-07.94
2.5 DI, 2.5 TD	23631		130			
2.5 DI	23632		130			
2.5 DI, 2.5 TD	23707		130			
FORD TRANSIT Bus (FD_ , FB_ , FS_ , FZ_ , FC_)						01.00-05.06
2.4 DI [RWD]	23628		119			
FORD TRANSIT Bus (T_)						10.85-09.92
2.5 D	23707		130			08.91...
1.6	23628		119		TL 16 OHC	
2.0	23627		122		TL20 OHC	
FORD TRANSIT Bus (V_)						11.77-10.86
1.6	23628		119		TL 16 OHC	
2.0	23627		122		TL20 OHC	
2.0	23627		122			
FORD TRANSIT CONNECT (P65_ , P70_ , P80_)						06.02-
1.8 Di, 1.8 TDCi	23636		91			
FORD TRANSIT Kasten (E_)						05.91-06.94
2.5 DI, 2.5 TD	23709		130			angetriebene Aggregate: angetr. Agg.: Nockenwelle * Driven Units: Driven unit: camshaft * Périphériques entraînés: Arbre à came
2.5 DI	23709		130			07.97..., angetriebene Aggregate: angetr. Agg.: Nockenwelle * Driven Units: Driven unit: camshaft * Périphériques entraînés: Arbre à came
2.5 DI	23708		130,0			07.97...
2.5 DI, 2.5 TD, 2.5 TDI	23632		130			07.97...
2.5 TD, 2.5 TDI	23709		130			09.97..., angetriebene Aggregate: angetr. Agg.: Nockenwelle * Driven Units: Driven unit: camshaft * Périphériques entraînés: Arbre à came
2.5 TD, 2.5 TDI	23708		130,0			09.97...
2.5 DI, 2.5 TD, 2.5 TDI	23631		130			...07.97
2.5 DI	23707		130			...07.97
2.5 TD, 2.5 TDI	23707		130			...09.97
2.0, 2.0 i	23627		122		TL20 OHC	
2.5 DI, 2.5 TD	23708		130,0			
2.5 DI, 2.5 TD	23631		130			
2.5 DI, 2.5 TD	23632		130			
2.5 DI, 2.5 TD	23707		130			
FORD TRANSIT Kasten (T_)						09.85-09.92
1.6	23628		119		TL 16 OHC	
2.0	23627		122		TL20 OHC	
FORD TRANSIT Kasten (V_)						01.77-10.86
1.6	23628		119		TL 16 OHC	
2.0	23627		122		TL20 OHC	
FORD TRANSIT Pritsche/Fahrgestell (E_)						09.91-08.94
2.5 DI, 2.5 TD	23709		130			angetriebene Aggregate: angetr. Agg.: Nockenwelle * Driven Units: Driven unit: camshaft * Périphériques entraînés: Arbre à came
2.5 DI	23709		130			07.97..., angetriebene Aggregate: angetr. Agg.: Nockenwelle * Driven Units: Driven unit: camshaft * Périphériques entraînés: Arbre à came
2.5 DI	23708		130,0			07.97...
2.5 DI, 2.5 TD	23632		130			07.97...



FORD

FORD TRANSIT Pritsche/Fahrgestell (E_ _)						09.91-08.94
2.5 TD	23709		130			09.97.... angetriebene Aggregate: angetr. Agg.: Nockenwelle * Driven Units: Driven unit: camshaft * Périphériques entraînés: Arbre à came
2.5 TD	23708		130,0			09.97...
2.5 DI, 2.5 TD	23631		130			...07.97
2.5 DI	23707		130			...07.97
2.5 TD	23707		130			...09.97
2.0	23627		122		TL20 OHC	
2.5 DI, 2.5 TD	23708		130,0			
2.5 DI, 2.5 TD	23631		130			
2.5 DI, 2.5 TD	23632		130			
2.5 DI, 2.5 TD	23707		130			
FORD TRANSIT Pritsche/Fahrgestell (T_ _)						11.85-09.92
2.5 DI	23707		130			08.91...
2.0	23627		122		TL20 OHC	
FORD TRANSIT Pritsche/Fahrgestell (V_ _)						11.77-10.86
1.6	23628		119		TL 16 OHC	
2.0	23627		122		TL20 OHC	
HONDA						
HONDA ACCORD IV Aerodeck (CB8, CB9)						01.91-12.93
2.0 i 16V, 2.2 i 16V	23507		113			
HONDA ACCORD IV (CB3, CB7)						11.89-10.93
2.0 i 16V, 2.0 16V, 2.2 i 16V Automatik, 2.2 i 16V	23507		113			
HONDA ACCORD IV Coupe (CC1)						01.92-09.93
2.0 i 16V	23507		113			
HONDA ACCORD V Aerodeck (CE)						09.93-02.98
2.0 i LS 16V, 2.2 i ES	23507		113			
HONDA ACCORD V (CC7, CD)						03.93-12.97
2.0 i, 2.0 i S	23507		113			
HONDA ACCORD V Coupe (CD7, CD9)						09.93-02.98
2.2 i ES	23507		113			
HONDA ACCORD VI (CE, CF)						02.96-10.98
1.9 i, 2.0 i LS	23507		113			
HONDA CIVIC II Shuttle (EE)						01.88-02.95
1.5 i 16V	23501		106			
1.6 i 16V 4WD	23502		107			
HONDA CIVIC IV Hatchback (EC, ED, EE)						09.87-10.93
1.3, 1.3 16 V, 1.4 L, 1.5 i 16V	23501		106			
1.6 i 16V	23502		107			
HONDA CIVIC IV Hatchback (EG)						10.91-11.95
1.3 16V, 1.5 i 16V	23501		106			
HONDA CIVIC IV Stufenheck (ED)						09.87-10.93
1.4 L, 1.5 i 16V	23501		106			
1.6 i 16V, 1.6 i 16V 4x4	23502		107			
HONDA CIVIC V Coupe (EJ)						08.93-03.96
1.5 i LSi	23501		106			
HONDA CIVIC V Stufenheck (EG, EH)						10.91-12.95
1.5 i 16V	23501		106			
HONDA CIVIC VI Fastback (MA)						09.94-01.97
1.4 i	23501		106			



HONDA

HONDA CONCERTO (HW)						08.89-10.96
1.4, 1.5 i 16V	23501		106			
1.6 i 16V	23502		107			
1.6 i 16V	23503		124			
1.8 TD	23415		136			
HONDA CONCERTO Stufenheck (HWW)						08.89-05.95
1.4	23501		106			
HONDA CRX II (ED, EE)						10.87-02.92
1.6 i 16V	23503		124			
HONDA PRELUDE IV (BB)						12.91-02.97
2.0 i 16V	23507		113			
HONDA PRELUDE V (BB)						10.96-10.00
2.0 16V	23507		113			
HONDA SHUTTLE (RA)						06.94-06.02
2.2 16V	23507		113			

HYUNDAI

HYUNDAI ACCENT I (X-3)						10.94-01.00
1.3, 1.3 i 12V, 1.5 i 12V	73533		92			
HYUNDAI ACCENT II (LC)						01.00-
1.5, 1.6	73539		105			
1.3, 1.5	73538		110			
HYUNDAI ACCENT III (MC)						11.05-
1.4 GL	73539		105			
HYUNDAI ACCENT Stufenheck (LC)						09.99-10.02
1.6	73539		105			
1.3, 1.5	73538		110			
HYUNDAI ACCENT Stufenheck (MC)						11.05-
1.4 GL, 1.6 GLS	73539		105			
HYUNDAI ACCENT Stufenheck (X-3)						10.94-01.00
1.3, 1.3 i 12V, 1.5 i 12V	73533		92			
HYUNDAI COUPE (GK)						08.01-
1.6 16V	73539		105			
2.7 V6	23530		207			
HYUNDAI COUPE (RD)						06.96-04.02
1.6 i 16V, 1.6 16V	73539		105			05.00...
HYUNDAI ELANTRA Stufenheck (XD)						06.00-
1.6	73539		105			
HYUNDAI ELANTRA (XD)						06.00-
1.6	73539		105		G4GR,G 4ED-L	
1.6	73539		105			
HYUNDAI GALLOPER II (JK-01)						08.98-
3.0 V6	73510		149			
HYUNDAI GETZ (TB)						08.02-
1.4 i, 1.6	73539		105			
1.3, 1.3 i	73538		110			
HYUNDAI HIGHWAY VAN						03.00-
2.0 16V	73540		173			
2.7 V6 24V	23530		207		G6BA-G	
HYUNDAI LANTRA I (J-1)						10.90-11.95
1.6 i.e. 16V, 1.8 i.e. 16V	73501		65			angetriebene Aggregate: angetr. Agg.: Ausgleichwelle * Driven Units: Driven unit: balance shaft * Périphériques entraînés: Arbre de différentiel



HYUNDAI

HYUNDAI LANTRA I (J-1)							10.90-11.95
1.5 i.e.	23541		92				
1.5 i.e.	23542		92				
HYUNDAI LANTRA II (J-2)							11.95-10.00
1.9 D	23415		136		XUD9		
1.5 12V	73533		92				
HYUNDAI LANTRA II Wagon (J-2)							02.96-
1.9 D	23415		136		XUD9		
1.5 12V	73533		92				
HYUNDAI MATRIX (FC)							06.01-12.05
1.6	73539		105				
HYUNDAI PONY (X-2)							10.89-01.95
1.3, 1.5, 1.5 i	73533		92			08.94...	
1.3	23541		92		G4DG	...07.94	
1.3	23542		92		G4DG	...07.94	
1.5, 1.5 i	23541		92			...07.94	
1.5, 1.5 i	23542		92			...07.94	
HYUNDAI PONY/EXCEL Stufenheck (X-2)							01.90-01.95
1.3, 1.5, 1.5 i	73533		92			08.94...	
1.5, 1.5 i	23541		92			...07.94	
1.5, 1.5 i	23542		92			...07.94	
HYUNDAI S COUPE (SLC)							02.90-05.96
1.5 i	23541		92				
1.5 i	23542		92				
1.5 i, 1.5 i Turbo	73533		92				
HYUNDAI SANTA FÉ (SM)							11.00-03.06
2.0	73540		173				
2.7 V6 4x4	23530		207				
HYUNDAI SONATA II (Y-2)							09.88-10.93
2.0 i 16V	73501		65			angetriebene Aggregate: angetr. Agg.: Ausgleichwelle * Driven Units: Driven unit: balance shaft * Périphériques entraînés: Arbre de différentiel	
3.0 i V6	73510		149				
HYUNDAI SONATA III (Y-3)							05.93-08.98
2.0 i 16V	73501		65			angetriebene Aggregate: angetr. Agg.: Ausgleichwelle * Driven Units: Driven unit: balance shaft * Périphériques entraînés: Arbre de différentiel	
3.0 i V6	73510		149				
HYUNDAI SONATA IV (EF)							03.98-05.05
2.0 16V	73540		173				
2.5 V6 24V, 2.7 V6	23530		207				
HYUNDAI TRAJET (FO)							03.00-
2.0	73540		173				
2.7 V6	23530		207				
HYUNDAI TUCSON (JM)							08.04-
2.7 Allrad	23530		207				
HYUNDAI XG (XG)							12.98-
2.5	23530		207		G6BA-G		
KIA							
KIA CLARUS Kombi (GC)							05.98-
2.0 i 16V	23534		168				



KIA

KIA CLARUS (K9A)							07.96-
2.0 i 16V	23534		168				
KIA MAGENTIS (GD)							05.01-
2.0	73540		173				
2.7 V6	23530		207		G6BA-G		
2.5 V6	23530		207				
KIA PRIDE (DA)							01.90-
1.1 i, 1.3 i, 1.3 16V	23539		107				
KIA PRIDE Kombi							08.99-
1.3	23539		107				
KIA RETONA (CE)							06.99-
2.0 16V	23534		168				
KIA RIO Kombi (DC)							08.00-02.05
1.3	23539		107				
KIA SEPHIA (FA)							01.95-10.97
1.6 i	23539		107				
KIA SEPHIA Stufenheck (FA)							09.93-10.97
1.6 i	23539		107				
KIA SPORTAGE (JE_)							09.04-
2.7 V6 4WD	23530		207				
KIA SPORTAGE (K00)							04.94-04.04
2.0 i 4WD	23536		108				
2.0, 2.0 4WD, 2.0 i 16V, 2.0 i 16V 4WD	23534		168				

LADA

LADA KALINA Schrägheck (1119)							10.04-
1.6	73080		136		11194	angetriebene Aggregate: angetr. Agg.: Nockenwelle * Driven Units: Driven unit: camshaft * Périphériques entraînés: Arbre à came	
1.6 16V	73080		136			angetriebene Aggregate: angetr. Agg.: Nockenwelle * Driven Units: Driven unit: camshaft * Périphériques entraînés: Arbre à came	
LADA KALINA Stufenheck (1118)							10.04-
1.6	73080		136		11194	angetriebene Aggregate: angetr. Agg.: Nockenwelle * Driven Units: Driven unit: camshaft * Périphériques entraînés: Arbre à came	
1.6 16V	73080		136			angetriebene Aggregate: angetr. Agg.: Nockenwelle * Driven Units: Driven unit: camshaft * Périphériques entraînés: Arbre à came	
LADA NIVA (2121)							12.76-
1900 Diesel	23415		136				01.94...
1900 Diesel	23405		136				...01.94
1900 Diesel	23415		136				
LADA SAMARA FORMA (21099)							09.87-
1100, 1300, 1500	23080		111				
1.5, 1500	73081		111				
LADA SAMARA (2108, 2109)							01.86-
1100, 1300, 1500	23080		111				
1.5, 1500	73081		111				
LADA 110							01.95-
1.5 16V	73080		136			angetriebene Aggregate: angetr. Agg.: Nockenwelle * Driven Units: Driven unit: camshaft * Périphériques entraînés: Arbre à came	
1.5 16V	73080		136			06.96..., angetriebene Aggregate: angetr. Agg.: Nockenwelle * Driven Units: Driven unit: camshaft * Périphériques entraînés: Arbre à came	
1.5	73081		111				
LADA 111							01.95-
1.5 16V	73080		136			angetriebene Aggregate: angetr. Agg.: Nockenwelle * Driven Units: Driven unit: camshaft * Périphériques entraînés: Arbre à came	
1.5 16V	73080		136			11.96..., angetriebene Aggregate: angetr. Agg.: Nockenwelle * Driven Units: Driven unit: camshaft * Périphériques entraînés: Arbre à came	
1.6	73080		136			09.06..., angetriebene Aggregate: angetr. Agg.: Nockenwelle * Driven Units: Driven unit: camshaft * Périphériques entraînés: Arbre à came	



LADA

LADA 111						01.95-
1.5	73081		111			

LADA 112						01.95-
1.5 16V	73080		136			02.01.... angetriebene Aggregate: angetr. Agg.: Nockenwelle * Driven Units: Driven unit: camshaft * Périphériques entraînés: Arbre à came
1.5	73081		111			

LANCIA

LANCIA DEDRA SW (835)						07.94-07.99
1.8 GT 16V	23033		168			...04.98
1.6	23003		138			
1.8 16V LE	23033		168			

LANCIA DEDRA (835)						01.89-07.99
1.8 GT 16V	23033		168			...04.98
1.6 i.e., 1.6 LE	23003		138			
1.8 16V LE	23033		168			

LANCIA DELTA II (836)						06.93-09.99
1.8 i.e. 16V GT	23033		168			...04.98
1.4 i.e., 1.6 i.e.	23003		138			
1.8 i.e. 16V	23033		168			

LANCIA PHEDRA (179)						09.02-
2.0 JTD	23428		144			
2.0 JTD	41428		144			
2.2 JTD	23427		146			
2.0	23408		153			
3.0 V6	23424		259			

LANCIA Y (840A)						11.95-09.03
1.1	41005		125			04.99...., ab Motornummer: 9042884
1.1	41002		104			...04.99, bis Motornummer: 9042883
1.2	41004		108	840 A3.000		...04.99, bis Motornummer: 9042883
1.2	41006		129	840 A3.000		...07.02, ab Motornummer: 9042884
1.1	23005		125			ab Motornummer: 9042884
1.2	23006		129			ab Motornummer: 9042884
1.1	23002		104			bis Motornummer: 9042883
1.2	23004		108			bis Motornummer: 9042883

LANCIA YPSILON (843)						10.03-
1.2	41006		129			bis Motornummer: 2533528
1.2	23005		125			

LANCIA Y10 (156)						03.85-12.95
1.3 i.e. Fire	23007		120			03.92...
1.0 Fire, 1.0 Fire 4WD, 1.1 Avenue, 1.1 Avenue 4WD, 1.1 i.e. Fire, 1.1 i.e. Fire 4WD	23002		104			
1.0 Fire, 1.0 Fire 4WD, 1.1 Avenue, 1.1 Avenue 4WD, 1.1 i.e. Fire, 1.1 i.e. Fire 4WD	41002		104			

LANCIA ZETA (220)						05.95-09.02
2.0 Turbo	23414		114			
2.0 Turbo	41414/1		114			
2.0 JTD	23426		141			



LANCIA

LANCIA ZETA (220)							05.95-09.02
2.0 JTD	23428		144		RHW		
2.0 JTD	41428		144		RHW		
2.1 TD	23419		149				
2.1 TD	41419		149				
2.0 16V	23408		153				

MAZDA

MAZDA DEMIO (DW)							10.96-12.02
1.2	23629		117			...02.05	
1.2	41629		117			...02.05	
1.3 i 16V, 1.3 16V, 1.5 16V	23539		107				
MAZDA E-SERIE Bus (SR1)							01.84-05.94
E2000, E2000 4WD	23536		108				
MAZDA E-SERIE Kasten (SR2)							01.84-07.04
E2000	23536		108			12.87...	
E2000	23536		108				
MAZDA MX-3 (EC)							07.91-10.97
1.6 i	23539		107				
MAZDA MX-5 I (NA)							09.89-04.98
1.6	23539		107				
MAZDA 121 I (DA)							03.87-11.90
1.1	23539		107			01.90...	
1.1	23538		107			...12.89	
1.3	23539		107			124779...	
1.3	23538		107			...124778	
MAZDA 121 II (DB)							11.90-05.97
1.3 i 16V, 1.3 16V	23539		107				
MAZDA 121 III (JASM, JBSM)							03.96-
1.8 D	23712		85			01.98...	
1.8 D	41712		85			01.98...	
1.8 D	23633		85			...12.97	
1.25	23629		117			ab Motornummer: 7204	
1.25	41629		117			ab Motornummer: 7204	
MAZDA 2 (DY)							04.03-
1.25, 1.4, 1.6	23629		117			...02.05	
1.25, 1.4, 1.6	41629		117			...02.05	
MAZDA 323 C IV (BG)							06.89-10.94
1.3, 1.3 16V, 1.6, 1.6 16V, 1.8 16V 4WD	23539		107				
MAZDA 323 C V (BA)							08.94-09.98
1.3 16V	23539		107				
MAZDA 323 F IV (BG)							06.89-10.94
1.6, 1.6 16V, 1.8 4WD, 1.8 16V	23539		107				
MAZDA 323 F VI (BJ)							09.98-05.04
1.4, 1.4 16V	23539		107				
MAZDA 323 III (BF)							08.85-04.90
1.5, 1.5 i, 1.6 GT	23539		107			BF563074...	
1.5, 1.5 i, 1.6 GT	23538		107			...BF563073	
MAZDA 323 III Hatchback (BF)							08.85-11.91



MAZDA

MAZDA 323 III Hatchback (BF)						08.85-11.91
1.4, 1.5, 1.5 i, 1.6, 1.6 GT	23539		107			BF563074...
1.4, 1.5, 1.5 i, 1.6, 1.6 GT	23538		107			...BF563073
MAZDA 323 III Station Wagon (BW)						01.86-10.95
1.5, 1.6	23539		107			BF563074...
1.5, 1.6	23538		107			...BF563073
1.5, 1.6 4x4	23539		107			
MAZDA 323 P V (BA)						10.96-09.98
1.3 16V	23539		107			
MAZDA 323 S IV (BG)						06.89-10.94
1.3, 1.3 16V, 1.6, 1.6 16V, 1.8 16V	23539		107			
MAZDA 323 S V (BA)						05.94-09.98
1.3 16V	23539		107			
MAZDA 323 S VI (BJ)						05.98-05.04
1.4, 1.4 16V	23539		107			
MAZDA 626 III Coupe (GD)						06.87-05.92
2.2 12V	23535		110			...10.91
2.0, 2.0 12V	23536		108			
2.0 16V	23534		168			
MAZDA 626 III (GD)						06.87-05.92
2.0, 2.0 12V	23536		108			
2.2 12V	23535		110			
2.0 16V	23534		168			
MAZDA 626 III Hatchback (GD)						06.87-05.92
2.2 12V	23535		110			...10.91
2.0, 2.0 12V	23536		108			
2.0 16V	23534		168			
MAZDA 626 III Station Wagon (GV)						09.87-09.97
2.2 12V	23535		110			10.89...
2.0	23536		108			
2.2 12V 4WD	23535		110			
2.0 16V	23534		168			
MAZDA 929 III (HC)						05.87-06.91
2.2 12V	23535		110			...12.89
2.0	23536		108			
2.2 i, 2.2 12V	23535		110			
MG						
MG MG TF						03.02-
115, 120, 135	23938		143			
MG MG ZR						06.01-
105, 120	23938		143			
MG MG ZS						07.01-
1.6	23938		143			
MG MG ZS Hatchback						07.01-
1.6	23938		143			
MG MG ZT- T						10.01-
1.8 16V	23938		143			
MG MGF (RD)						03.95-03.02
1.6, 1.8 i 16V	23938		143			



MITSUBISHI

MITSUBISHI COLT II (C1_A)							10.82-04.88
1.2 EL, GL, 1.5 GLX	23541		92			06.87...	
1.2 EL, GL, 1.5 GLX	23542		92			06.87...	
MITSUBISHI COLT III (C5_A)							10.86-05.92
1.8 GTi 16V	73501		65			angetriebene Aggregate: angetr. Agg.: Ausgleichwelle * Driven Units: Driven unit: balance shaft * Périphériques entraînés: Arbre de différentiel	
1.5 GLXi	23541		92			...05.90	
1.5 GLXi	23542		92			...05.90	
1.3 GL	23541		92				
1.3 GL	23542		92				
MITSUBISHI DEBONAIR							09.92-10.97
3.0	73510		149		6G72		
3.0	73510		149				
MITSUBISHI ECLIPSE I (D2_A)							12.89-12.95
2.0 i 16V, 2.0 i 16V 4x4	73501		65			angetriebene Aggregate: angetr. Agg.: Ausgleichwelle * Driven Units: Driven unit: balance shaft * Périphériques entraînés: Arbre de différentiel	
MITSUBISHI GALANT IV (E3_A)							11.88-12.92
2.0 GTi 16V, 2.0 GTi 16V 4x4	73501		65			angetriebene Aggregate: angetr. Agg.: Ausgleichwelle * Driven Units: Driven unit: balance shaft * Périphériques entraînés: Arbre de différentiel	
MITSUBISHI GALANT IV Stufenheck (E3_A)							11.87-03.93
2.0 GTi 16V, 2.0 GTi 16V 4x4, 2.0 GTi 16V 4x4	73501		65			angetriebene Aggregate: angetr. Agg.: Ausgleichwelle * Driven Units: Driven unit: balance shaft * Périphériques entraînés: Arbre de différentiel	
MITSUBISHI GALANT V (E5_A, E7_A, E8_A)							11.92-10.96
2.0 GLSi, 2.0 GLSi 4x4, 2.0 GLSTD	73501		65			angetriebene Aggregate: angetr. Agg.: Ausgleichwelle * Driven Units: Driven unit: balance shaft * Périphériques entraînés: Arbre de différentiel	
2.0 GLSi, 2.0 GLSi 4x4	73508		123				
MITSUBISHI GALANT V Stufenheck (E5_A, E7_A, E8_A)							11.92-08.96
2.0 GLSi, 2.0 GLSi 4x4, 2.0 GLSTD	73501		65			angetriebene Aggregate: angetr. Agg.: Ausgleichwelle * Driven Units: Driven unit: balance shaft * Périphériques entraînés: Arbre de différentiel	
2.0 GLSi, 2.0 GLSi 4x4	73508		123				
MITSUBISHI GALANT VI (EA_)							09.96-10.04
2.0 TDI	73501		65			angetriebene Aggregate: angetr. Agg.: Ausgleichwelle * Driven Units: Driven unit: balance shaft * Périphériques entraînés: Arbre de différentiel	
2.0	23520		122		4G63		
MITSUBISHI GALANT VI Station Wagon (EA_)							09.96-10.03
2.0 TDI	73501		65			angetriebene Aggregate: angetr. Agg.: Ausgleichwelle * Driven Units: Driven unit: balance shaft * Périphériques entraînés: Arbre de différentiel	
2.0	23520		122		4G63		
MITSUBISHI GALLOPER (JK-01)							02.99-
3.0 V6	73510		149				
MITSUBISHI L 200 (KAOT)							11.05-
2.4 i	73509		124				
MITSUBISHI L 200 (K_T)							06.96-
2.0	73501		65		4G63, G6 3B	angetriebene Aggregate: angetr. Agg.: Ausgleichwelle * Driven Units: Driven unit: balance shaft * Périphériques entraînés: Arbre de différentiel	
2.0	73508		123		4G63, G6 3B		
2.4 4x4, 2.4 i	73509		124		4G64		
3.0, 3.0 i 4x4	73510		149				
MITSUBISHI L 300 Bus (P0_W, P1_W, P2_W)							11.86-
2.0 i	73501		65		4G63, G6 3B	angetriebene Aggregate: angetr. Agg.: Ausgleichwelle * Driven Units: Driven unit: balance shaft * Périphériques entraînés: Arbre de différentiel	
2.0, 2.0 4WD, 2.4, 2.4 4WD	73501		65			05.92..., angetriebene Aggregate: angetr. Agg.: Ausgleichwelle * Driven Units: Driven unit: balance shaft * Périphériques entraînés: Arbre de différentiel	



MITSUBISHI

MITSUBISHI L 300 Bus (P0_W, P1_W, P2_W)							11.86-
2.0 i	73508		123		4G63, G6 3B		
MITSUBISHI L 300 Kasten (P0_W, P1_W)							11.86-08.97
2.0	73501		65			05.92..., angetriebene Aggregate: angetr. Agg.: Ausgleichswelle * Driven Units: Driven unit: balance shaft * Périphériques entraînés: Arbre de différentiel	
MITSUBISHI L 300 Pritsche/Fahrgestell (P1_T)							04.94-
2.0	73501		65			angetriebene Aggregate: angetr. Agg.: Ausgleichswelle * Driven Units: Driven unit: balance shaft * Périphériques entraînés: Arbre de différentiel	
2.0	73508		123				
MITSUBISHI LANCER III (C1_A, C6_A)							11.83-06.90
1.2, 1.5 GLX	23541		92			06.87...	
1.2, 1.5 GLX	23542		92			06.87...	
MITSUBISHI LANCER III Station Wagon (C1_V, C3_V)							09.85-06.92
1.5	23541		92			06.87...	
1.5	23542		92			06.87...	
1.5	23541		92				
1.5	23542		92				
MITSUBISHI LANCER IV (C6_A, C7_A)							04.88-05.94
1.8 GTi 16V	73501		65			angetriebene Aggregate: angetr. Agg.: Ausgleichswelle * Driven Units: Driven unit: balance shaft * Périphériques entraînés: Arbre de différentiel	
MITSUBISHI LANCER IV Stufenheck (C6_A)							04.88-09.92
1.3	23541		92		4G13	...05.90	
1.3	23542		92		4G13	...05.90	
1.3, 1.5	23541		92			...05.90	
1.3, 1.5	23542		92			...05.90	
MITSUBISHI LANCER V (CB/D_A)							06.92-07.96
2.0 Diesel	73501		65			angetriebene Aggregate: angetr. Agg.: Ausgleichswelle * Driven Units: Driven unit: balance shaft * Périphériques entraînés: Arbre de différentiel	
MITSUBISHI LANCER V Station Wagon (CB_W, CD_W)							12.92-10.03
2.0 D	73501		65			angetriebene Aggregate: angetr. Agg.: Ausgleichswelle * Driven Units: Driven unit: balance shaft * Périphériques entraînés: Arbre de différentiel	
MITSUBISHI PAJERO I (L04_G, L14_G)							12.82-12.91
3.0 i 4x4	73510		149		6G72		
3.0 V6	73510		149				
MITSUBISHI PAJERO II Canvas Top (V2_W, V4_W)							12.90-04.00
2.4	73501		65			05.92..., angetriebene Aggregate: angetr. Agg.: Ausgleichswelle * Driven Units: Driven unit: balance shaft * Périphériques entraînés: Arbre de différentiel	
3.0 V6	73510		149				
MITSUBISHI PAJERO II (V2_W, V4_W)							12.90-06.00
2.4	73501		65			05.92..., angetriebene Aggregate: angetr. Agg.: Ausgleichswelle * Driven Units: Driven unit: balance shaft * Périphériques entraînés: Arbre de différentiel	
3.0 V6 4x4	73510		149				
MITSUBISHI SANTAMO							03.99-
2.0 16V, 2.0 16V 4x4	73501		65			angetriebene Aggregate: angetr. Agg.: Ausgleichswelle * Driven Units: Driven unit: balance shaft * Périphériques entraînés: Arbre de différentiel	
MITSUBISHI SIGMA (F16A)							12.90-07.96
3.0 V6	73510		149				
MITSUBISHI SIGMA Station Wagon (F07W)							01.93-07.96
3.0	73510		149				
MITSUBISHI SPACE GEAR (PA/B/D_V/W)							05.95-05.00
2.0 16V, 2.4 i, 2.4 i 4x4	73501		65			angetriebene Aggregate: angetr. Agg.: Ausgleichswelle * Driven Units: Driven unit: balance shaft * Périphériques entraînés: Arbre de différentiel	
2.0 16V	73508		123				



MITSUBISHI

MITSUBISHI SPACE GEAR (PA/B/D V/W)						05.95-05.00
2.4 i, 2.4 i 4x4	73509		124			
MITSUBISHI SPACE RUNNER (N1_W, N2_W)						10.91-08.99
2.0 TD, 2.0 16V	73501		65			angetriebene Aggregate: angetr. Agg.: Ausgleichwelle * Driven Units: Driven unit: balance shaft * Périphériques entraînés: Arbre de différentiel
2.0 16V	73508		123			
MITSUBISHI SPACE RUNNER (N50)						08.99-
2.0	23520		122		4G63	
MITSUBISHI SPACE WAGON (N3_W, N4_W)						05.91-11.98
2.0, 2.0 4x4, 2.0 TD	73501		65			angetriebene Aggregate: angetr. Agg.: Ausgleichwelle * Driven Units: Driven unit: balance shaft * Périphériques entraînés: Arbre de différentiel
2.0, 2.0 4x4	73508		123			
MITSUBISHI TRITON						07.06-
2.4 i	73509		124			
MITSUBISHI TRITON (MJ)						10.86-10.96
3.0 i 4x4	73510		149			

NISSAN

NISSAN ALMERA II Hatchback (N16)						01.00-
1.5 dCi	23132		123			
NISSAN KUBISTAR (X76)						08.03-
1.5 dCi, 1.5 dCi 70, 1.5 dCi 85	23132		123		K9K	
1.5 dCi	23132		123			
1.6 16V	23129		132			
1.2	23100		87		D7F 764	
NISSAN MICRA II (K11)						01.92-02.03
1.5 D	23412		136		VJZ (TUD5)	
1.5 D	41412		136		VJZ (TUD5)	
NISSAN MICRA III (K12)						01.03-05.10
1.5 dCi	23132		123		K9K	
1.5 dCi	23132		123			
NISSAN PRIMASTAR Kasten (X83)						09.02-
dCi 100	23132		123			

OPEL

OPEL ARENA Combi (THB)						03.98-08.01
1.9 D	23110		153			
OPEL ARENA Kasten (TB, TF)						03.98-08.01
1.9 D	23110		153			
OPEL ASCONA C CC (84_, 89_)						09.81-08.88
1.6 D	23721		146		16DA	
OPEL ASCONA C (81_, 86_, 87_, 88_)						09.81-10.88
1.6 D	23721		146		16DA	
OPEL ASTRA F Cabriolet (53_B)						03.93-03.01
2.0 i	23731		146			ab Motornummer: 14608701
2.0 i	41731/1		146			ab Motornummer: 14608701
1.4 Si, 1.6 i	23722		111			
1.4 Si, 1.6 i	41722		111			
1.8 i 16V	23725		169			
1.4 i 16V	23735		169			
1.8 i 16V	41725		169			
1.4 i 16V	41735/2		169			



OPEL

OPEL ASTRA F Caravan (51_, 52_)						09.91-01.98
1.8 i	23731		146			ab Motornummer: 14142839
1.8 i	41731/1		146			ab Motornummer: 14254439
1.7 D, 1.7 TD	41724		176			ab Motornummer: 1436352
2.0 i	23731		146			ab Motornummer: 14608701
2.0 i	41731/1		146			ab Motornummer: 14608701
1.4 i	23722		111			ab Motornummer: 19311739
1.4 i	41722		111			ab Motornummer: 19311739
1.4 Si, 1.6 i, 1.6 Si	23722		111			
1.4 Si, 1.6 i, 1.6 Si	41722		111			
1.7 D	23721		146			
1.8 i 16V, 2.0 i 16V	23725		169			
1.4 i 16V, 1.6 i 16V	23735		169			
1.8 i 16V, 2.0 i 16V	41725		169			
1.4 i 16V, 1.6 i 16V	41735/2		169			
1.7 D, 1.7 TD	23724		176			
OPEL ASTRA F CC (53_, 54_, 58_, 59_)						09.91-01.98
1.8 i	23731		146			ab Motornummer: 14142839
1.8 i	41731/1		146			ab Motornummer: 14254439
1.7 D	41724		176			ab Motornummer: 1436352
2.0 i	23731		146			ab Motornummer: 14608701
2.0 i	41731/1		146			ab Motornummer: 14608701
1.4 i	23722		111			ab Motornummer: 19311739
1.4 i	41722		111			ab Motornummer: 19311739
1.4 Si, 1.6 i, 1.6 Si	23722		111			
1.4 Si, 1.6 i, 1.6 Si	41722		111			
1.7 D	23721		146			
1.8 i 16V, 2.0 i 16V	23725		169			
1.4 i 16V, 1.6 i 16V	23735		169			
1.8 i 16V, 2.0 i 16V	41725		169			
1.4 i 16V, 1.6 i 16V	41735/2		169			
1.7 D, 1.7 TD	23724		176			
1.7 TD	41724		176			
OPEL ASTRA F CLASSIC Caravan						01.98-01.05
1.8	23734		162			ab Motornummer: 02HL5118, ab Motornummer: 20041691
1.8	41739/1		162			bis Motornummer: 02HL5117, bis Motornummer: 20041690
OPEL ASTRA F CLASSIC CC						01.98-08.02
1.8 i	23734		162			ab Motornummer: 02HL5118, ab Motornummer: 20041691
1.8 i	41739/1		162			bis Motornummer: 02HL5117, bis Motornummer: 20041690
1.4 i	41735/2		169			
1.7 TD	23724		176			



OPEL

OPEL ASTRA F CLASSIC CC						01.98-08.02
1.7 TD	41724		176			
OPEL ASTRA F Van (55_)						10.91-01.99
1.7 D	41724		176			ab Motornummer: 1436352
1.4 i	23722		111			ab Motornummer: 19311739
1.4 i	41722		111			ab Motornummer: 19311739
1.6 i	23722		111			
1.6 i	41722		111			
1.7 D	23721		146			
1.7 D, 1.7 TD	23724		176			
1.7 TD	41724		176			
OPEL ASTRA F (56_, 57_)						09.91-09.98
1.8 i	23731		146			ab Motornummer: 14142839
1.8 i	41731/1		146			ab Motornummer: 14254439
1.7 D	41724		176			ab Motornummer: 1436352
2.0 i	23731		146			ab Motornummer: 14608701
2.0 i	41731/1		146			ab Motornummer: 14608701
1.4 i	23722		111			ab Motornummer: 19311739
1.4 i	41722		111			ab Motornummer: 19311739
1.4 Si, 1.6 i, 1.6 Si	23722		111			
1.4 Si, 1.6 i, 1.6 Si	41722		111			
1.7 D	23721		146			
1.8 i 16V, 2.0 i 16V	23725		169			
1.4 i 16V, 1.6 i 16V	23735		169			
1.8 i 16V, 2.0 i 16V	41725		169			
1.4 i 16V, 1.6 i 16V	41735/2		169			
1.7 D, 1.7 TD	23724		176			
1.7 TD	41724		176			
OPEL ASTRA G Cabriolet						03.01-10.05
1.6 16V, 1.8 16V	23734		162			ab Motornummer: 02HL5118, ab Motornummer: 20041691
1.6 16V, 1.8 16V	23739		162			bis Motornummer: 02HL5117, bis Motornummer: 20041690
1.6 16V	41739		162			bis Motornummer: 02HL5117, bis Motornummer: 20041690
1.8 16V	41739/1		162			bis Motornummer: 02HL5117, bis Motornummer: 20041690
OPEL ASTRA G Caravan (F35_)						02.98-07.04
1.4 16V, 1.6 16V, 1.8, 1.8 16V	23734		162			ab Motornummer: 02HL5118, ab Motornummer: 20041691
1.6	41722/1		111			ab Motornummer: 02MZ5254, ab Motornummer: 20U75999
1.6	41722/1		111			ab Motornummer: 02MZ5254
1.4 16V, 1.6 16V, 1.8 16V	23739		162			bis Motornummer: 02HL5117, bis Motornummer: 20041690
1.4 16V, 1.6 16V	41739		162			bis Motornummer: 02HL5117, bis Motornummer: 20041690
1.8, 1.8 16V	41739/1		162			bis Motornummer: 02HL5117, bis Motornummer: 20041690
1.6	41722		111			bis Motornummer: 02MZ5253, bis Motornummer: 20U75998
1.6	41722		111			bis Motornummer: 02MZ5253



OPEL

OPEL ASTRA G Caravan (F35_)						02.98-07.04
1.6	23722		111			
1.6 CNG	23734		162			
1.7 TD	23724		176			
1.7 TD	41724		176			
OPEL ASTRA G CC (F48_ , F08_)						02.98-01.05
1.4 16V, 1.6 16V, 1.8, 1.8 16V	23734		162			ab Motornummer: 02HL5118, ab Motornummer: 20041691
1.6	41722/1		111			ab Motornummer: 02MZ5254, ab Motornummer: 20U75999
1.6	41722/1		111			ab Motornummer: 02MZ5254
1.4 16V, 1.6 16V, 1.8 16V	23739		162			bis Motornummer: 02HL5117, bis Motornummer: 20041690
1.4 16V, 1.6 16V	41739		162			bis Motornummer: 02HL5117, bis Motornummer: 20041690
1.8, 1.8 16V	41739/1		162			bis Motornummer: 02HL5117, bis Motornummer: 20041690
1.6	41722		111			bis Motornummer: 02MZ5253, bis Motornummer: 20U75998
1.6	41722		111			bis Motornummer: 02MZ5253
1.6	23722		111			
1.7 TD	23724		176			
1.7 TD	41724		176			
OPEL ASTRA G Coupe (F07_)						03.00-05.05
1.8 16V	23734		162			ab Motornummer: 02HL5118, ab Motornummer: 20041691
1.8 16V	23739		162			bis Motornummer: 02HL5117, bis Motornummer: 20041690
1.8 16V	41739/1		162			bis Motornummer: 02HL5117, bis Motornummer: 20041690
OPEL ASTRA G Kasten (F70)						01.99-04.05
1.6	41722/1		111			ab Motornummer: 02MZ5254, ab Motornummer: 20U75999
1.6	41722/1		111			ab Motornummer: 02MZ5254
1.6	41722		111			bis Motornummer: 02MZ5253, bis Motornummer: 20U75998
1.6	41722		111			bis Motornummer: 02MZ5253
1.6	23722		111			
1.7 TD	23724		176			
1.7 TD	41724		176			
OPEL ASTRA G Stufenheck (F69_)						09.98-01.05
1.4 16V, 1.6 16V, 1.8, 1.8 16V	23734		162			ab Motornummer: 02HL5118, ab Motornummer: 20041691
1.6	41722/1		111			ab Motornummer: 02MZ5254, ab Motornummer: 20U75999
1.6	41722/1		111			ab Motornummer: 02MZ5254
1.4 16V, 1.6 16V, 1.8 16V	23739		162			bis Motornummer: 02HL5117, bis Motornummer: 20041690
1.4 16V, 1.6 16V	41739		162			bis Motornummer: 02HL5117, bis Motornummer: 20041690
1.8, 1.8 16V	41739/1		162			bis Motornummer: 02HL5117, bis Motornummer: 20041690
1.6	41722		111			bis Motornummer: 02MZ5253, bis Motornummer: 20U75998
1.6	41722		111			bis Motornummer: 02MZ5253
1.6	23722		111			
1.7 TD	23724		176			
1.7 TD	41724		176			
OPEL ASTRA H						03.04-



OPEL

OPEL						
OPEL ASTRA H						03.04-
1.6 CNG, 1.8	23734		162			
OPEL ASTRA H Caravan						08.04-
1.6 CNG, 1.8	23734		162			
OPEL ASTRA H GTC						03.05-
1.6 CNG, 1.8	23734		162			
OPEL ASTRA H TwinTop						09.05-
1.8	23734		162			
OPEL CALIBRA A (85_)						06.90-07.97
2.0 i, 2.0 i 4x4	23731		146			ab Motonummer: 14608701
2.0 i, 2.0 i 4x4	41731/1		146			ab Motonummer: 14608701
2.0 i 16V, 2.0 i 16V 4x4	23725		169			
2.0 i 16V, 2.0 i 16V 4x4	41725		169			
2.5 i V6	23733		225			
OPEL COMBO Kasten/Kombi						10.01-
1.6	23722		111			
1.6	41722/1		111			
1.6 CNG 16V	23734		162			
OPEL COMBO Tour						10.01-
1.6	23722		111			
1.6	41722/1		111			
1.6 CNG	23734		162			
OPEL COMBO (71_)						07.94-10.01
1.2, 1.4	23722		111			
1.2, 1.4	41722		111			
1.4 16V	41735/2		169			
OPEL CORSA A CC (93_, 94_, 98_, 99_)						09.82-03.93
1.4 Si, 1.6 GSI, 1.6 GSI KAT	23722		111			ab Motonummer: 02J22350
1.4 Si, 1.6 GSI, 1.6 GSI KAT	41722		111			ab Motonummer: 02J22350
1.4 S	23722		111			ab Motonummer: 19307806
1.4 S	41722		111			ab Motonummer: 19307806
1.4 i	23722		111			ab Motonummer: 19311739
1.4 i	41722		111			ab Motonummer: 19311739
1.2 i	23722		111			
1.2 i	41722		111			
OPEL CORSA B Kasten (73_)						08.99-09.00
1.4 i	23722		111			
1.4 i	41722		111			
OPEL CORSA B Kombi (F35)						01.99-
1.4 i 16V	41735/2		169			
OPEL CORSA B (73_, 78_, 79_)						03.93-09.00
1.2 i, 1.4 i, 1.4 Si	23722		111			
1.2 i, 1.4 i, 1.4 Si	41722		111			
1.4 i 16V, 1.6 GSI 16V, 1.6 i 16V	23735		169			
1.4 i 16V, 1.6 GSI 16V, 1.6 i 16V	41735/2		169			
OPEL CORSA C (F08, F68)						09.00-



OPEL

OPEL							
OPEL CORSA C (F08, F68)							09.00-
1.6	23734		162		Z16YNG		
1.4, 1.8	23734		162				
OPEL CORSA C Kasten (F08, W5L)							09.00-
1.6	23734		162		Z16YNG		
OPEL FRONTERA A Sport (5_SUD2)							03.92-10.98
2.0 i	23731		146		X20SE	ab Motornummer: 14608701	
2.0 i	41731/1		146		X20SE	ab Motornummer: 14608701	
OPEL FRONTERA A (5_MWL4)							03.92-10.98
2.2 i	23738		171				
OPEL FRONTERA B (6B_)							10.98-
2.2 i	23738		171				
OPEL KADETT E Cabriolet (43B_)							10.86-02.93
1.4 i	41722		111			ab Motornummer: 02J22350, ab Motornummer: 19311738	
1.6 i, 1.6 i KAT	23722		111			ab Motornummer: 02J22350	
1.6 i, 1.6 i KAT	41722		111			ab Motornummer: 02J22350	
2.0 i KAT	23731		146			ab Motornummer: 14608701	
1.4 S	23722		111			ab Motornummer: 19307806.	
1.4 S	41722		111			ab Motornummer: 19307806	
1.4 i	23722		111			ab Motornummer: 19311739	
OPEL KADETT E Caravan (35_, 36_, 45_, 46_)							09.84-08.91
1.4 i	41722		111			ab Motornummer: 02J22350, ab Motornummer: 19311738	
1.6, 1.6 i, 1.6 i KAT	23722		111			ab Motornummer: 02J22350	
1.6, 1.6 i, 1.6 i KAT	41722		111			ab Motornummer: 02J22350	
1.8 i	23731		146		C18NZ	ab Motornummer: 14142839	
1.8 i	41731/1		146		C18NZ	ab Motornummer: 14142839	
1.4 S	23722		111			ab Motornummer: 19307806.	
1.4 S	41722		111			ab Motornummer: 19307806	
1.4 i	23722		111			ab Motornummer: 19311739	
1.6 D	23721		146		16DA		
1.7 D	23721		146				
OPEL KADETT E CC (33_, 34_, 43_, 44_)							09.84-08.91
1.4 i	41722		111			ab Motornummer: 02J22350, ab Motornummer: 19311738	
1.6 i, 1.6 i KAT, 1.6 S	23722		111			ab Motornummer: 02J22350	
1.6 i, 1.6 i KAT, 1.6 S	41722		111			ab Motornummer: 02J22350	
1.8 i	23731		146		C18NZ	ab Motornummer: 14142839	
1.8 i	41731/1		146		C18NZ	ab Motornummer: 14142839	
1.4 S	23722		111			ab Motornummer: 19307806.	
1.4 S	41722		111			ab Motornummer: 19307806	
1.4 i	23722		111			ab Motornummer: 19311739	
1.6 D	23721		146		16DA		
1.7 D	23721		146				
OPEL KADETT E Combo (38_, 48_)							01.86-07.94
1.4 i	41722		111			ab Motornummer: 02J22350, ab Motornummer: 19311738	



OPEL

OPEL						
OPEL KADETT E Combo (38_, 48_)						01.86-07.94
1.6, 1.6 i	23722		111			ab Motornummer: 02J22350
1.6, 1.6 i	41722		111			ab Motornummer: 02J22350
1.7 D	41724		176			ab Motornummer: 14363650
1.4 S	23722		111			ab Motornummer: 19307806.
1.4 S	41722		111			ab Motornummer: 19307806
1.4 i	23722		111			ab Motornummer: 19311739
1.6 D, 1.7 D	23721		146			
1.7 D	23724		176			
OPEL KADETT E Kasten (37_, 47_)						08.84-09.92
1.4 i	41722		111			ab Motornummer: 02J22350, ab Motornummer: 19311738
1.6 i	23722		111			ab Motornummer: 02J22350
1.6 i	41722		111			ab Motornummer: 02J22350
1.4 i	23722		111			ab Motornummer: 19311739
1.6 D	23721		146		16DA	
1.7 D	23721		146			
OPEL KADETT E (39_, 49_)						09.84-08.91
1.4 i	41722		111			ab Motornummer: 02J22350, ab Motornummer: 19311738
1.6 i, 1.6 i KAT, 1.6 S	23722		111			ab Motornummer: 02J22350
1.6 i, 1.6 i KAT, 1.6 S	41722		111			ab Motornummer: 02J22350
1.8 i	23731		146		C18NZ	ab Motornummer: 14142839
1.8 i	41731/1		146		C18NZ	ab Motornummer: 14142839
1.4 S	23722		111			ab Motornummer: 19307806.
1.4 S	41722		111			ab Motornummer: 19307806
1.4 i	23722		111			ab Motornummer: 19311739
1.6 D	23721		146		16DA	
1.7 D	23721		146			
OPEL MERIVA						05.03-05.10
1.6	23722		111			
1.6	41722/1		111			
1.6 16V, 1.8	23734		162			
OPEL MOVANO Combi (J9)						07.98-
2.8 DTI	23028		154			01.99.... angetriebene Aggregate: angetr. Agg.: Nockenwelle * Driven Units: Driven unit: camshaft * Périphériques entraînés: Arbre à came
OPEL MOVANO Kasten (F9)						01.99-
2.8 DTI	23028		154			angetriebene Aggregate: angetr. Agg.: Nockenwelle * Driven Units: Driven unit: camshaft * Périphériques entraînés: Arbre à came
OPEL MOVANO Kipper (H9)						01.99-
2.8 DTI	23028		154			angetriebene Aggregate: angetr. Agg.: Nockenwelle * Driven Units: Driven unit: camshaft * Périphériques entraînés: Arbre à came
OPEL MOVANO Pritsche/Fahrgestell (U9, E9)						07.98-
2.8 DTI	23028		154			01.99.... angetriebene Aggregate: angetr. Agg.: Nockenwelle * Driven Units: Driven unit: camshaft * Périphériques entraînés: Arbre à came
OPEL OMEGA A Caravan (66_, 67_)						09.86-05.94
2.0, 2.0 i	23731		146			ab Motornummer: 14608701
2.0, 2.0 i	41731/1		146			ab Motornummer: 14608701
OPEL OMEGA A (16_, 17_, 19_)						09.86-05.94
2.0, 2.0 i	23731		146			ab Motornummer: 14608701



OPEL

OPEL OMEGA A (16_, 17_, 19_)						09.86-05.94
2.0, 2.0 i	41731/1		146			ab Motornummer: 14608701
OPEL OMEGA B Caravan (21_, 22_, 23_)						03.94-07.03
2.5 V6, 3.0 V6	23733		225			bis Motornummer: 08300418
2.0	23731		146			
2.0	41731/1		146			
2.0 16V	23725		169			
2.0 16V	41725		169			
2.2 16V	23738		171			
OPEL OMEGA B (25_, 26_, 27_)						03.94-07.03
2.5 V6, 3.0 V6	23733		225			bis Motornummer: 08300418
2.0	23731		146			
2.0	41731/1		146			
2.0 16V	23725		169			
2.0 16V	41725		169			
2.2 16V	23738		171			
OPEL SIGNUM						05.03-
1.8	23734		162			
OPEL SINTRA						11.96-04.99
3.0 i 24V	23733		225			bis Motornummer: 08300000
2.2 i 16V	23738		171			
OPEL TIGRA TwinTop						06.04-
1.8	23734		162			
OPEL TIGRA (95_)						07.94-12.00
1.4 16V, 1.6 16V	23735		169			
1.4 16V, 1.6 16V	41735/2		169			
OPEL VECTRA A CC (88_, 89_)						04.88-11.95
1.6 i KAT	41722		111		C16NZ	ab Motornummer: 02J22350, ab Motornummer: 19307806
1.6 S	41722		111			ab Motornummer: 02J22350, ab Motornummer: 19307806
1.6 i	41722		111			ab Motornummer: 02J22350, ab Motornummer: 19311738
1.6 i KAT	23722		111		C16NZ	ab Motornummer: 02J22350
1.6 i, 1.6 S	23722		111			ab Motornummer: 02J22350
1.8 i KAT	23731		146			ab Motornummer: 14142839
1.8 i KAT	41731/1		146			ab Motornummer: 14142839
1.7 D	41724		176			ab Motornummer: 14363650
2.0 i KAT	23731		146			ab Motornummer: 14608701
2.0 i, 2.0 i KAT	41731/1		146			ab Motornummer: 14608701
1.6 i KAT	23731		146		C16NZ2	
1.6 i KAT	41731/1		146		C16NZ2	
1.7 D	23721		146			
2.0 i 16V	23725		169			
2.0 i 16V	41725		169			
1.7 D	23724		176			



OPEL

OPEL VECTRA A CC (88_, 89_) 04.88-11.95						
2.5 V6	23733		225			
OPEL VECTRA A (86_, 87_) 08.88-11.95						
1.6 i KAT	41722		111		C16NZ	ab Motornummer: 02J22350, ab Motornummer: 19307806
1.6, 1.6 i	41722		111			ab Motornummer: 02J22350, ab Motornummer: 19307806
1.6 i	41722		111			ab Motornummer: 02J22350, ab Motornummer: 19311738
1.6 i KAT	23722		111		C16NZ	ab Motornummer: 02J22350
1.6, 1.6 i	23722		111			ab Motornummer: 02J22350
1.8 i KAT	23731		146			ab Motornummer: 14142839
1.8 i KAT	41731/1		146			ab Motornummer: 14142839
1.7 D	41724		176			ab Motornummer: 14363651
2.0 i KAT, 2.0 i 4x4 KAT	23731		146			ab Motornummer: 14608701
2.0 i, 2.0 i KAT, 2.0 i 4x4 KAT	41731/1		146			ab Motornummer: 14608701
1.6 i KAT	23731		146		C16NZ2	
1.7 D	23721		146			
2.0 i 16V, 2.0 i 16V 4x4	23725		169			
2.0 i 16V, 2.0 i 16V 4x4	41725		169			
1.7 D	23724		176			
2.5 CD 4x4, 2.5 V6	23733		225			
OPEL VECTRA B Caravan (31_) 11.96-07.03						
1.6 i 16V	41735		169			ab Motornummer: 02MZ5254, ab Motornummer: 20U75999
1.6 i 16V	41735/2		169			bis Motornummer: 02MZ5253, bis Motornummer: 20U75998
2.5 i V6	23733		225			bis Motornummer: 08300418
1.6 i	23722		111			
1.6 i	41722		111			
1.8 i 16V	23735		169		X18XE1	
1.8 i 16V	41735/1		169		X18XE1	
1.8 i 16V	23725		169		X18XE	
1.8 i 16V	41725		169		X 18 XE	
2.0 i 16V	23725		169			
1.6 i 16V, 1.8 i 16V	23735		169			
2.0 i 16V	41725		169			
1.8 i 16V	41735/1		169			
OPEL VECTRA B CC (38_) 10.95-07.03						
1.8 i 16V	23725		169			ab Motornummer: X18XE
1.6 i 16V	41735		169			ab Motornummer: 02MZ5254, ab Motornummer: 20U75999
1.6 i 16V	41735/2		169			bis Motornummer: 02MZ5253, bis Motornummer: 20U75998
2.5 i V6	23733		225			bis Motornummer: 08300418
1.6 i	23722		111			
1.6 i	41722		111			
1.8 i 16V	23735		169		X18XE1	



OPEL

OPEL VECTRA B CC (38_) 10.95-07.03

1.8 i 16V	41735/1		169		X18XE1	
1.8 i 16V	41725		169		X 18 XE	
2.0 i 16V	23725		169			
1.6 i 16V, 1.8 i 16V	23735		169			
2.0 i 16V	41725		169			
1.8 i 16V	41735/1		169			

OPEL VECTRA B (36_) 09.95-04.02

1.6 i 16V	41735		169			ab Motornummer: 02MZ5254, ab Motornummer: 20U75999
1.6 i 16V	41735/2		169			bis Motornummer: 02MZ5253, bis Motornummer: 20U75998
2.5 i V6	23733		225			bis Motornummer: 08300418
1.6 i	23722		111			
1.6 i	41722		111			
1.8 i 16V	23735		169		X18XE1	
1.8 i 16V	41735/1		169		X18XE1	
1.8 i 16V	23725		169		X18XE	
1.8 i 16V	41725		169		X 18 XE	
2.0 i 16V	23725		169			
1.6 i 16V, 1.8 i 16V	23735		169			
2.0 i 16V	41725		169			
1.8 i 16V	41735/1		169			

OPEL VECTRA C 04.02-

1.6 16V, 1.8, 1.8 16V	23734		162			
-----------------------	-------	--	-----	--	--	--

OPEL VECTRA C Caravan 10.03-

1.6 16V, 1.8	23734		162			
--------------	-------	--	-----	--	--	--

OPEL VECTRA C GTS 08.02-

1.6, 1.8 16V	23734		162			
--------------	-------	--	-----	--	--	--

OPEL ZAFIRA 07.05-

1.6, 1.6 CNG Turbo	23734		162			
--------------------	-------	--	-----	--	--	--

OPEL ZAFIRA (F75_) 04.99-06.05

1.6 16V, 1.8, 1.8 16V	23734		162			ab Motornummer: 02HL5118, ab Motornummer: 20041691
1.6 16V, 1.8 16V	23739		162			bis Motornummer: 02HL5117, bis Motornummer: 20041690
1.6 16V	41739		162			bis Motornummer: 02HL5117, bis Motornummer: 20041690
1.8, 1.8 16V	41739/1		162			bis Motornummer: 02HL5117, bis Motornummer: 20041690
1.6, 1.6 CNG	23734		162			

PEUGEOT

PEUGEOT BOXER Bus (230P) 03.94-04.02

1.9 TD, 1.9 TD 4x4	41415		136			Schaufelraddurchmesser [mm]: 71 * Impeller Diameter [mm]: 71 * Diamètre de la roue à aubes [mm]: 71
1.9 TD	41415		136			...02.97, Schaufelraddurchmesser [mm]: 71 * Impeller Diameter [mm]: 71 * Diamètre de la roue à aubes [mm]: 71
1.9 D, 1.9 TD, 1.9 TD 4x4	23415		136			

PEUGEOT BOXER Bus (244, Z_) 04.02-

2.2 HDi	23433		143			...04.04
2.0 HDi	23426		141			
2.0 HDi	41426		141			



PEUGEOT

PEUGEOT BOXER Kasten (230L)						03.94-04.02
1.9 TD	41415		136			Schaufelraddurchmesser [mm]: 71 * Impeller Diameter [mm]: 71 * Diamètre de la roue à aubes [mm]: 71
1.9 D, 1.9 TD	23415		136			
PEUGEOT BOXER Kasten (244)						04.02-
2.2 HDi	23433		143			...04.04
2.0 HDi	23426		141			
2.0 HDi	41426		141			
PEUGEOT BOXER Pritsche/Fahrgestell (ZCT)						03.94-04.02
1.9 TD	23415		136			angetriebene Aggregate: angetr. Agg.: Nockenwelle * Driven Units: Driven unit: camshaft * Périphériques entraînés: Arbre à came
1.9 TD	41415		136			Schaufelraddurchmesser [mm]: 71 * Impeller Diameter [mm]: 71 * Diamètre de la roue à aubes [mm]: 71
1.9 TD	23415		136			
PEUGEOT BOXER Pritsche/Fahrgestell (244)						12.01-
2.2 HDi	23433		143			...04.04
2.0 HDi	23426		141			
2.0 HDi	41426		141			
PEUGEOT EXPERT Kasten (222)						07.95-
1.9 D, 1.9 TD	41415		136			Schaufelraddurchmesser [mm]: 71 * Impeller Diameter [mm]: 71 * Diamètre de la roue à aubes [mm]: 71
2.0 HDi	41426		141			ab Organisationsnummer: 09868 * From RP number: 09868 * à partir de n° d'organisation: 09868
2.0 HDi	41426		141			bis Organisationsnummer: 08560 * To RP number: 08560 * jusque n° d'organisation: 08560
2.0 HDi	41428		144			bis Organisationsnummer: 10010 * To RP number: 10010 * jusque n° d'organisation: 10010
1.9 D, 1.9 TD	23415		136			
1.6	23003		138			
2.0 HDi	23426		141			
2.0 HDi	23428		144			
PEUGEOT EXPERT Pritsche/Fahrgestell (223)						12.95-
1.9 D, 1.9 TD	41415		136			Schaufelraddurchmesser [mm]: 71 * Impeller Diameter [mm]: 71 * Diamètre de la roue à aubes [mm]: 71
2.0 HDi	41426		141			ab Organisationsnummer: 09868 * From RP number: 09868 * à partir de n° d'organisation: 09868
2.0 HDi	41426		141		RHZ	bis Organisationsnummer: 08560 * To RP number: 08560 * jusque n° d'organisation: 08560
1.9 D, 1.9 TD	23415		136			
1.6	23003		138			
PEUGEOT EXPERT (224)						12.95-
1.9 D, 1.9 TD	41415		136			Schaufelraddurchmesser [mm]: 71 * Impeller Diameter [mm]: 71 * Diamètre de la roue à aubes [mm]: 71
2.0 HDi	41426		141			ab Organisationsnummer: 09868 * From RP number: 09868 * à partir de n° d'organisation: 09868
2.0 HDi	41426		141			bis Organisationsnummer: 08560 * To RP number: 08560 * jusque n° d'organisation: 08560
2.0 HDi	41428		144			bis Organisationsnummer: 10010 * To RP number: 10010 * jusque n° d'organisation: 10010
1.9 D, 1.9 TD	23415		136			
1.6	23003		138			
2.0 HDi	23426		141			
2.0 HDi	23428		144			
2.0	23408		153			
PEUGEOT J5 Bus (280P)						09.81-09.90
2.5 D	23418		62			
PEUGEOT J5 Bus (290P)						09.90-03.94



PEUGEOT

PEUGEOT J5 Bus (290P)						09.90-03.94
1.9 D	23415		136			02.94...
1.9 D	23405		136			...01.94
2.5 D, 2.5 D 4x4, 2.5 TD, 2.5 TD 4x4	23418		62			
PEUGEOT J5 Kasten (290L)						09.90-03.94
1.9 D	23415		136			02.94...
1.9 D	23405		136			...01.94
2.5 D 4x4, 2.5 TD 4x4	23418		62			
PEUGEOT J5 Pritsche/Fahrgestell (280L)						09.81-09.90
2.5 D	23418		62			
PEUGEOT J5 Pritsche/Fahrgestell (290L)						09.90-03.94
1.9 D	23415		136			02.94...
1.9 D	23405		136			...01.94
2.5 D, 2.5 D 4x4, 2.5 TD, 2.5 TD 4x4	23418		62			
PEUGEOT PARTNER Combispace (5F)						05.96-
1.4	23402		108			angetriebene Aggregate: angetr. Agg.: Nockenwelle * Driven Units: Driven unit: camshaft * Périphériques entraînés: Arbre à came
1.9 D	41415		136		XUD9	Schaufelraddurchmesser [mm]: 71 * Impeller Diameter [mm]: 71 * Diamètre de la roue à aubes [mm]: 71
1.9 D	41415		136			Schaufelraddurchmesser [mm]: 71 * Impeller Diameter [mm]: 71 * Diamètre de la roue à aubes [mm]: 71
1.4	23411		104			ab Motornummer: 3666767
1.1	23410		100		TU1JP	ab Motornummer: 3762435
2.0 HDI, 2.0 HDI 4x4	41426		141			bis Organisationsnummer: 08735 * To RP number: 08735 * jusque n° d'organisation: 08735
1.1	23401		104			
1.8	23414		114			
1.8	41414		114			
1.9 D	23415		136			
1.9 D	23425		140			
2.0 HDI	23426		141			
PEUGEOT PARTNER Kasten (5)						04.96-
1.4	23402		108			angetriebene Aggregate: angetr. Agg.: Nockenwelle * Driven Units: Driven unit: camshaft * Périphériques entraînés: Arbre à came
1.8 D	41415		136		XUD7	Schaufelraddurchmesser [mm]: 71 * Impeller Diameter [mm]: 71 * Diamètre de la roue à aubes [mm]: 71
1.9 D	41415		136		XUD9A	Schaufelraddurchmesser [mm]: 71 * Impeller Diameter [mm]: 71 * Diamètre de la roue à aubes [mm]: 71
1.9 D	41415		136		XUD9	Schaufelraddurchmesser [mm]: 71 * Impeller Diameter [mm]: 71 * Diamètre de la roue à aubes [mm]: 71
1.8 D	41415		136			Schaufelraddurchmesser [mm]: 71 * Impeller Diameter [mm]: 71 * Diamètre de la roue à aubes [mm]: 71
1.4	23411		104			ab Motornummer: 3666767
1.1	23401		104			bis Motornummer: 3 762 434
2.0 HDi, 2.0 HDi 4x4	41426		141			bis Organisationsnummer: 08735 * To RP number: 08735 * jusque n° d'organisation: 08735
1.8	41414		114		XU7JB	
1.8 D, 1.9 D	23415		136			
1.9 D	23425		140			
2.0 HDi	23426		141			
PEUGEOT 1007 (KM_)						04.05-
1.4	23411		104			



PEUGEOT

PEUGEOT 106 I (1A, 1C)

08.91-04.96

1.6	23413		101			angetriebene Aggregate: angetr. Agg.: Nockenwelle * Driven Units: Driven unit: camshaft * Périphériques entraînés: Arbre à came
1.4 D	23403		143			angetriebene Aggregate: angetr. Agg.: Nockenwelle * Driven Units: Driven unit: camshaft * Périphériques entraînés: Arbre à came
1.6	23413		101			01.94...., angetriebene Aggregate: angetr. Agg.: Nockenwelle * Driven Units: Driven unit: camshaft * Périphériques entraînés: Arbre à came
1.4	23413		101			50355043...., angetriebene Aggregate: angetr. Agg.: Nockenwelle * Driven Units: Driven unit: camshaft * Périphériques entraînés: Arbre à came
1.4	23402		108			...50355042, angetriebene Aggregate: angetr. Agg.: Nockenwelle * Driven Units: Driven unit: camshaft * Périphériques entraînés: Arbre à came
1.4	23413		101			ab Motonummer: 50355043
1.1	23401		104			bis Motonummer: 3 762 434
1.4	23402		108			bis Motonummer: 50355042
1.4, 1.6	41413		101			
1.0	23401		104			
1.3	23402		108			
1.5 D	23412		136		TUD5	
1.5 D	41412		136		TUD5	
1.5 D	23412		136			
1.5 D	41412		136			
1.4 D	41403		143			

PEUGEOT 106 II (1)

04.96-

1.6 i	23413		101			angetriebene Aggregate: angetr. Agg.: Nockenwelle * Driven Units: Driven unit: camshaft * Périphériques entraînés: Arbre à came
1.4 i	23411		104			ab Motonummer: 3666767
1.1 i	23410		100		TU1JP	ab Motonummer: 3762435
1.4 i	23402		108			bis Motonummer: 3666766
1.1 i	23401		104			bis Motonummer: 3 762 434
1.6 i	41413		101			
1.0 i	23401		104			
1.6 S16	23432		134			
1.6 S16	41432		134			
1.5 D	23412		136			
1.5 D	41412		136			

PEUGEOT 205 I Cabriolet (741B, 20D)

04.86-12.94

1.9 CTI	23414		114			02.92...
1.9 CTI	41414		114			02.92...
1.9 CTI	23404		113			...01.92
1.9 CTI	41404		113			...01.92
1.4 CJ	23413		101			ab Motonummer: 50355043
1.4 CJ	23402		108			bis Motonummer: 50355042
1.1 CJ	23401		104			
1.4 CJ, 1.4 CJ KAT	23402		108			
1.6	41404		113		XU5	



PEUGEOT

PEUGEOT 205 I Cabriolet (741B, 20D)

04.86-12.94

1.9, 1.9 CTI	41404		113		XU9	
1.6 CTI	23404		113			
1.6 CTI	41404		113			
1.6 CJ	23414		114			
1.6 CJ	41414		114			

PEUGEOT 205 I (741A/C)

02.83-10.87

1.7 Diesel	23415		136			angetriebene Aggregate: angetr. Agg.: Nockenwelle * Driven Units: Driven unit: camshaft * Périphériques entraînés: Arbre à came
1.6, 1.6 GTI, 1.9 GTI	23404		113			
1.6, 1.6 GTI, 1.9 GTI	41404		113			
1.7 Diesel	23405		136			

PEUGEOT 205 II (20A/C)

01.87-09.98

1.4, 1.4 KAT	23402		108			angetriebene Aggregate: angetr. Agg.: Nockenwelle * Driven Units: Driven unit: camshaft * Périphériques entraînés: Arbre à came
1.6, 1.6 Aut.	41414		114		XU5	02.92...
1.9	41414		114		XU9	02.92...
1.6, 1.6 Aut., 1.9 GTI, 1.9 GTI KAT	23414		114			02.92...
1.6, 1.6 Aut., 1.9 GTI, 1.9 GTI KAT	41414		114			02.92...
1.7 Diesel	23415		136			01.94..., angetriebene Aggregate: angetr. Agg.: Nockenwelle * Driven Units: Driven unit: camshaft * Périphériques entraînés: Arbre à came
1.7 TD, 1.9 Diesel	41415		136			01.94..., Schaufelraddurchmesser [mm]: 71 * Impeller Diameter [mm]: 71 * Diamètre de la roue à aubes [mm]: 71
1.7 TD, 1.9 Diesel	23415		136			02.94...
1.6, 1.6 Aut.	41404		113		XU5	...01.92
1.9	41404		113		XU9	...01.92
1.6, 1.6 Aut., 1.9 GTI, 1.9 GTI KAT	23404		113			...01.92
1.6, 1.6 Aut., 1.9 GTI, 1.9 GTI KAT	41404		113			...01.92
1.7 TD, 1.9 Diesel	23405		136			...01.94
1.4	23413		101		TU3M	ab Motornummer: 50355043
1.4	23402		108		TU3M	bis Motornummer: 50355042
1.4	41413		101		TU3M	
1.1	23401		104		TU9/TU1	
1.0, 1.1	23401		104			
1.4	23402		108		TU3, TU3F	
1.4	23402		108			
1.6 GTI, 1.6 GTX	41404		113		XU5	
1.6, 1.6 GTI, 1.9 GTI	23404		113			
1.6 GTI, 1.9 GTI	41404		113			
1.9	41414		114			
1.7 Diesel	23405		136			

PEUGEOT 205 Kasten

03.94-

1.7 Diesel	41415		136			Schaufelraddurchmesser [mm]: 71 * Impeller Diameter [mm]: 71 * Diamètre de la roue à aubes [mm]: 71
1.7 Diesel	23415		136			

PEUGEOT 206 CC (2D)

09.00-



PEUGEOT

PEUGEOT 206 CC (2D)						09.00-
2.0 S16	23408		153			
PEUGEOT 206 Schrägheck (2A/C)						08.98-
1.6 i	23413		101			angetriebene Aggregate: angetr. Agg.: Nockenwelle * Driven Units: Driven unit: camshaft * Périphériques entraînés: Arbre à came
1.4 i	23402		108			...08.99, angetriebene Aggregate: angetr. Agg.: Nockenwelle * Driven Units: Driven unit: camshaft * Périphériques entraînés: Arbre à came
1.4 i	23411		104			ab Motornummer: 3666767
1.1	23410		100	TU1JP		ab Motornummer: 3762435
1.1 i	23410		100			ab Motornummer: 3762435
1.1 i	23401		104			bis Motornummer: 3 762 434
2.0 HDI 90	41426		141			bis Organisationsnummer: 08735 * To RP number: 08735 * jusque n° d'organisation: 08735
1.6 i	41413		101			
1.9 D	23425		140			
2.0 HDI 90	23426		141			
2.0 S16	23408		153			
PEUGEOT 206 SW (2E/K)						07.02-
1.4	23411		104			ab Motornummer: 3666767
1.1	23410		100			ab Motornummer: 3762435
2.0 HDi	41426		141			bis Organisationsnummer: 08735 * To RP number: 08735 * jusque n° d'organisation: 08735
2.0 HDi	23426		141			
2.0 16V	23408		153			
PEUGEOT 207 (WA_, WC_)						02.06-
1.4	23411		104	TU3A		
PEUGEOT 305 II Break (581E)						10.82-07.90
1.6, 1.9	23404		113			
1.6, 1.9	41404		113			
1.9 Diesel	23405		136			
PEUGEOT 305 II (581M)						10.82-07.90
1.6, 1.9	23404		113			
1.6, 1.9	41404		113			
1.9 D	23405		136			
PEUGEOT 306 Break (7E, N3, N5)						06.94-04.02
1.6	23413		101			angetriebene Aggregate: angetr. Agg.: Nockenwelle * Driven Units: Driven unit: camshaft * Périphériques entraînés: Arbre à came
1.8 D	41415		136	XUD7		Schaufelraddurchmesser [mm]: 71 * Impeller Diameter [mm]: 71 * Diamètre de la roue à aubes [mm]: 71
1.9 D	41415		136	XUD9A		Schaufelraddurchmesser [mm]: 71 * Impeller Diameter [mm]: 71 * Diamètre de la roue à aubes [mm]: 71
1.9 D, 1.9 TD	41415		136			Schaufelraddurchmesser [mm]: 71 * Impeller Diameter [mm]: 71 * Diamètre de la roue à aubes [mm]: 71
1.4	23411		104			ab Motornummer: 3666767
1.4	23402		108			bis Motornummer: 3666766
2.0 HDI 90	41426		141			bis Organisationsnummer: 09065 * To RP number: 09065 * jusque n° d'organisation: 09065
1.6	41413		101	TU5JP		
1.6	41413		101			
1.8	23414		114			
1.8	41414		114			



PEUGEOT

PEUGEOT 306 Break (7E, N3, N5)

06.94-04.02

1.9 D, 1.9 TD	23415		136			
1.9 D	23425		140			
2.0 HDI 90	23426		141			

PEUGEOT 306 Cabriolet (7D, N3, N5)

03.94-04.02

1.6	23413		101			angetriebene Aggregate: angetr. Agg.: Nockenwelle * Driven Units: Driven unit: camshaft * Périphériques entraînés: Arbre à came
1.6	41413		101		TU5JP	
1.6	41413		101			
1.8	41414		114		XU7JP	
1.8, 2.0	23414		114			
1.8	41414		114			
2.0	41414/1		114			

PEUGEOT 306 Schrägheck (7A, 7C, N3, N5)

04.93-08.01

1.6	23413		101			angetriebene Aggregate: angetr. Agg.: Nockenwelle * Driven Units: Driven unit: camshaft * Périphériques entraînés: Arbre à came
1.9 D	41415		136		XUD9A	Schaufelraddurchmesser [mm]: 71 * Impeller Diameter [mm]: 71 * Diamètre de la roue à aubes [mm]: 71
1.9 D	41415		136			Schaufelraddurchmesser [mm]: 71 * Impeller Diameter [mm]: 71 * Diamètre de la roue à aubes [mm]: 71
1.9 D, 1.9 DT	23415		136			01.94.... angetriebene Aggregate: angetr. Agg.: Nockenwelle * Driven Units: Driven unit: camshaft * Périphériques entraînés: Arbre à came
1.9 DT	41415		136			02.94.... Schaufelraddurchmesser [mm]: 71 * Impeller Diameter [mm]: 71 * Diamètre de la roue à aubes [mm]: 71
1.9 D	41415		136			01.96.... Schaufelraddurchmesser [mm]: 71 * Impeller Diameter [mm]: 71 * Diamètre de la roue à aubes [mm]: 71
1.8 D	41415		136		XUD7	02.96.... Schaufelraddurchmesser [mm]: 71 * Impeller Diameter [mm]: 71 * Diamètre de la roue à aubes [mm]: 71
1.8 D	41415		136			02.96.... Schaufelraddurchmesser [mm]: 71 * Impeller Diameter [mm]: 71 * Diamètre de la roue à aubes [mm]: 71
1.9 D, 1.9 DT	23405		136			...01.94
1.4	23402		108			...08.99, angetriebene Aggregate: angetr. Agg.: Nockenwelle * Driven Units: Driven unit: camshaft * Périphériques entraînés: Arbre à came
1.4	23411		104			ab Motornummer: 3666767
1.1	23401		104			bis Motornummer: 3 762 434
2.0 HDI 90	41426		141			bis Organisationsnummer: 09065 * To RP number: 09065 * jusque n° d'organisation: 09065
1.6	41413		101		TU5JP	
1.6	41413		101			
1.8	41414		114		XU7JP	
1.8, 2.0 XSi	23414		114			
1.8	41414		114			
2.0 XSi	41414/1		114			
1.8 D, 1.9 D	23415		136			
1.9 D	23425		140			
2.0 HDI 90	23426		141			

PEUGEOT 306 (7B, N3, N5)

04.93-05.01

1.6 SR	23413		101			angetriebene Aggregate: angetr. Agg.: Nockenwelle * Driven Units: Driven unit: camshaft * Périphériques entraînés: Arbre à came
1.8 D	41415		136		XUD7	Schaufelraddurchmesser [mm]: 71 * Impeller Diameter [mm]: 71 * Diamètre de la roue à aubes [mm]: 71
1.9 STD	41415		136		XUD9A	Schaufelraddurchmesser [mm]: 71 * Impeller Diameter [mm]: 71 * Diamètre de la roue à aubes [mm]: 71
1.9 D, 1.9 SRDT	41415		136			Schaufelraddurchmesser [mm]: 71 * Impeller Diameter [mm]: 71 * Diamètre de la roue à aubes [mm]: 71



PEUGEOT

PEUGEOT 306 (7B, N3, N5)						04.93-05.01
1.4 SL	23402		108		TU3-2/TU 3JP	01.96.... angetriebene Aggregate: angetr. Agg.: Nockenwelle * Driven Units: Driven unit: camshaft * Périphériques entraînés: Arbre à came
1.9 SLD	41415		136			01.96.... Schaufelraddurchmesser [mm]: 71 * Impeller Diameter [mm]: 71 * Diamètre de la roue à aubes [mm]: 71
1.4 SL	23411		104			ab Motornummer: 3 666 767
1.1	23401		104			bis Motornummer: 3 762 434
2.0 HDI 90	41426		141			bis Organisationsnummer: 09065 * To RP number: 09065 * jusqu'à n° d'organisation: 09065
1.6	41413		101		TU5JP	
1.6 SR	41413		101			
1.8	41414		114		XU7JP	
1.8 ST, 2.0 ST	23414		114			
1.8 ST	41414		114			
2.0 ST	41414/1		114			
1.9 D, 1.9 SLD, 1.9 SRDT	23415		136			
1.9 D	23425		140			
2.0 HDI 90	23426		141			
PEUGEOT 307 Break (3E)						03.02-
2.0 HDI 90	23426		141			
2.0	23408		153			
PEUGEOT 307 CC (3B)						10.03-
2.0 16V	23408		153			
PEUGEOT 307 SW (3H)						03.02-
2.0 HDI 90	23426		141			
2.0 HDI 110	23428		144			
2.0 16V	23408		153			
PEUGEOT 307 (3A/C)						08.00-
1.4	23411		104			ab Motornummer: 3666767
2.0 HDI 90	23426		141			
2.0 HDI 110	23428		144			
2.0 16V	23408		153			
PEUGEOT 309 I (10C, 10A)						10.85-12.89
1.4	23402		108			angetriebene Aggregate: angetr. Agg.: Nockenwelle * Driven Units: Driven unit: camshaft * Périphériques entraînés: Arbre à came
1.3	23413		101			
1.1	23401		104			
1.6, 1.6 KAT, 1.9, 1.9 GTI	23404		113			
1.6, 1.6 KAT, 1.9	41404		113			
1.9 D	23405		136			
PEUGEOT 309 II (3C, 3A)						07.89-12.93
1.4	23413		101			angetriebene Aggregate: angetr. Agg.: Nockenwelle * Driven Units: Driven unit: camshaft * Périphériques entraînés: Arbre à came
1.4	23402		108			angetriebene Aggregate: angetr. Agg.: Nockenwelle * Driven Units: Driven unit: camshaft * Périphériques entraînés: Arbre à came
1.6, 1.9, 1.9 GTI	23414		114			02.92...
1.6, 1.9	41414		114			02.92...
1.9 GTI	41404		113		XU9J1	...01.92



PEUGEOT

PEUGEOT 309 II (3C, 3A)

07.89-12.93

1.6, 1.9, 1.9 GTI	23404		113		...01.92
1.6, 1.9	41404		113		...01.92
1.1	23401		104		bis Motornummer: 3 762 434
1.4	23402		108		bis Motornummer: 50355042, angetriebene Aggregate: angetr. Agg.: Nockenwelle * Driven Units: Driven unit: camshaft * Périphériques entraînés: Arbre à came
1.9 GTI 16V	23406		133	XU9J4	
1.9 GTI 16V	23406		133		
1.9 GTI 16V	41406		133		
1.8 Diesel, 1.8 TD, 1.9 Diesel	23405		136		

PEUGEOT 405 I Break (15E)

06.87-08.92

1.6, 1.9, 1.9 4x4	23414		114		02.92...
1.6, 1.9, 1.9 4x4	23404		113		...01.92
1.6, 1.9, 1.9 4x4	41404		113		...01.92
1.8 TD, 1.9 D	23405		136		

PEUGEOT 405 I (15B)

01.87-12.93

1.6, 1.9, 1.9 4x4, 1.9 Injection	23414		114		02.92...
1.6, 1.9, 1.9 4x4, 1.9 Injection	23404		113		...01.92
1.6, 1.9, 1.9 4x4, 1.9 Injection	41404		113		...01.92
1.6	23404		113		
1.6	41404		113		
1.9 Sport MI-16, 1.9 Sport MI-16 4x4	23406		133		
1.9 Sport MI-16, 1.9 Sport MI-16 4x4	41406		133		
1.8 Turbo Diesel, 1.9 Diesel	23405		136		

PEUGEOT 405 II Break (4E)

08.92-10.96

1.9 D	41415		136		Schaufelraddurchmesser [mm]: 71 * Impeller Diameter [mm]: 71 * Diamètre de la roue à aubes [mm]: 71
2.0, 2.0 4x4	23414		114		07.93...
2.0, 2.0 4x4	41414/1		114		07.93...
1.9 TD	41415		136		02.94..., Schaufelraddurchmesser [mm]: 71 * Impeller Diameter [mm]: 71 * Diamètre de la roue à aubes [mm]: 71
1.9 D, 1.9 TD	23415		136		02.94...
2.0, 2.0 4x4	23416		114		...06.93
2.0, 2.0 4x4	41416		114		...06.93
1.9 D, 1.9 TD	23405		136		...01.94
1.4	23402		108		
1.6, 1.8	23414		114		
1.6, 1.8	41414		114		
1.9 D	23415		136		

PEUGEOT 405 II (4B)

08.92-10.95

1.9 D	41415		136		Schaufelraddurchmesser [mm]: 71 * Impeller Diameter [mm]: 71 * Diamètre de la roue à aubes [mm]: 71
2.0, 2.0 X4	23414		114		07.93...
2.0, 2.0 X4	41414/1		114		07.93...
1.9 TD	41415		136		02.94..., Schaufelraddurchmesser [mm]: 71 * Impeller Diameter [mm]: 71 * Diamètre de la roue à aubes [mm]: 71



PEUGEOT

PEUGEOT 405 II (4B)

08.92-10.95

1.9 D, 1.9 TD	23415		136			02.94...
2.0, 2.0 X4	23416		114			...06.93
2.0, 2.0 X4	41416		114			...06.93
1.9 D, 1.9 TD	23405		136			...01.94
1.4	23402		108			
1.6, 1.8	23414		114			
1.6, 1.8	41414		114			
1.9 D	23415		136			

PEUGEOT 406 Break (8E/F)

10.96-10.04

1.9 D	41415		136			Schaufelraddurchmesser [mm]: 71 * Impeller Diameter [mm]: 71 * Diamètre de la roue à aubes [mm]: 71
1.9 TD	41415		136			11.96..., Schaufelraddurchmesser [mm]: 71 * Impeller Diameter [mm]: 71 * Diamètre de la roue à aubes [mm]: 71
3.0 24V	23424		259			12.99...
2.0 HDi 110, 2.0 HDI 110, 2.0 HDI 90	41426		141			bis Organisationsnummer: 08735 * To RP number: 08735 * jusque n° d'organisation: 08735
2.2 HDI	23427		146			bis Organisationsnummer: 10010 * To RP number: 10010 * jusque n° d'organisation: 10010
1.8	41414		114		XU7JP	
1.8, 2.0 Turbo	23414		114			
1.8	41414		114			
2.0 Turbo	41414/1		114			
1.9 D, 1.9 TD	23415		136			
2.0 HDI 110, 2.0 HDI 90	23426		141			
2.0 HDI 110	23428		144			
2.1 TD 12V	23419		149			
2.1 TD 12V	41419		149			
1.8 16V, 2.0 16V, 2.2	23408		153			
3.0 V6	23424		259			

PEUGEOT 406 Coupe (8C)

03.97-12.04

3.0 V6 24V	23424		259			12.99...
2.2 HDI	23427		146			bis Organisationsnummer: 10010 * To RP number: 10010 * jusque n° d'organisation: 10010
2.0 16V, 2.2	23408		153			
3.0 V6	23424		259			

PEUGEOT 406 (8B)

10.95-05.04

1.9 TD	41415		136			11.96..., Schaufelraddurchmesser [mm]: 71 * Impeller Diameter [mm]: 71 * Diamètre de la roue à aubes [mm]: 71
3.0 24V	23424		259			12.99...
2.0 HDi 110, 2.0 HDI 110, 2.0 HDI 90	41426		141			bis Organisationsnummer: 08735 * To RP number: 08735 * jusque n° d'organisation: 08735
2.2 HDi	23427		146			bis Organisationsnummer: 10010 * To RP number: 10010 * jusque n° d'organisation: 10010
1.8	41414		114		XU7JP	
1.6, 1.8, 2.0 Turbo	23414		114			
1.6, 1.8	41414		114			
2.0 Turbo	41414/1		114			



PEUGEOT

PEUGEOT 406 (8B)							10.95-05.04
1.9 TD	23415		136				
2.0 HDI 110, 2.0 HDI 90	23426		141				
2.0 HDi 110	23428		144				
2.1 TD 12V	23419		149				
2.1 TD 12V	41419		149				
1.8 16V, 2.0 16V, 2.2	23408		153				
3.0 V6	23424		259				
PEUGEOT 407 Coupe (6C_)							10.05-
3.0 V6	23424		259				
PEUGEOT 407 SW (6E_)							05.04-
1.8, 2.0, 2.2	23408		153				
3.0	23424		259				
PEUGEOT 407 (6D_)							05.04-
1.8, 2.0, 2.2	23408		153				
3.0	23424		259				
PEUGEOT 505 (551A)							05.79-12.93
2.0 TI,STI	23118		116			bis Motornummer: 53472	
PEUGEOT 605 (6B)							06.89-09.99
2.0	41414/1		114		XU	07.93...	
2.0	23414		114			07.93...	
2.0	41414/1		114			07.93...	
2.0	41416		114		XU	...06.93	
2.0	23416		114			...06.93	
2.0	41416		114			...06.93	
2.0 Turbo	23414		114				
2.0 Turbo	41414/1		114				
2.1 D	23417		144				
2.1 D	41417		144				
2.1 TD 12V, 2.1 Turbo Diesel	23419		149				
2.1 TD 12V, 2.1 Turbo Diesel	41419		149				
PEUGEOT 607 (9D, 9U)							01.00-
2.2 HDI	23427		146			bis Organisationsnummer: 10010 * To RP number: 10010 * jusque n° d'organisation: 10010	
2.0 HDI	23426		141				
2.0, 2.2 16V	23408		153				
3.0 V6 24V	23424		259				
PEUGEOT 806 (221)							06.94-08.02
1.9 TD	41415		136			Schaufelraddurchmesser [mm]: 71 * Impeller Diameter [mm]: 71 * Diamètre de la roue à aubes [mm]: 71	
2.0 HDI	41426		141			bis Organisationsnummer: 08560 * To RP number: 08560 * jusque n° d'organisation: 08560	
1.8, 2.0, 2.0 Turbo	23414		114				
2.0, 2.0 Turbo	41414/1		114				
1.9 TD	23415		136				
2.0 HDI	23426		141				



PEUGEOT

PEUGEOT 806 (221)

06.94-08.02

2.0 HDI 16V	23428		144			
2.0 HDI 16V	41428		144			
2.1 td 12V	23419		149			
2.1 td 12V	41419		149			
2.0 16V	23408		153			

PEUGEOT 807 (E)

06.02-

2.0 HDi	41428		144		DW10AT ED4	
2.0 HDi	23428		144			
2.2 HDi	23427		146		10010	
2.0, 2.2	23408		153			
3.0 V6	23424		259			

PROTON

PROTON PERSONA 400 (C9_S)

01.94-

420 GLS D, 420 TD	73501		65			angetriebene Aggregate: angetr. Agg.: Ausgleichwelle * Driven Units: Driven unit: balance shaft * Périphériques entraînés: Arbre de différentiel
-------------------	-------	--	----	--	--	--------------------------------------------------------------------------------------------------------------------------------------------------------

PROTON PERSONA 400 Hatchback (C9_C, C9_S)

01.94-

420 D, 420 GLS D	73501		65			angetriebene Aggregate: angetr. Agg.: Ausgleichwelle * Driven Units: Driven unit: balance shaft * Périphériques entraînés: Arbre de différentiel
------------------	-------	--	----	--	--	--------------------------------------------------------------------------------------------------------------------------------------------------------

RENAULT

RENAULT AVANTIME (DE0_)

09.01-05.03

2.0 16V Turbo	23136		126			
3.0 V6	23424		259			

RENAULT CLIO Grandtour (KR0/1_)

02.08-

1.5 dCi	23132		123		K9K	
---------	-------	--	-----	--	-----	--

RENAULT CLIO I (B/C57_, 5/357_)

05.90-09.98

1.2	23100		87			angetriebene Aggregate: angetr. Agg.: Nockenwelle * Driven Units: Driven unit: camshaft * Périphériques entraînés: Arbre à came
1.9 D	23135		151			...06.96
1.9 D	23112		151		F8Q 732	...09.96
1.8, 1.8 Rsi	23108		125			
Williams, 1.8 16V	23111		148			
1.2	41100		87			
1.2, 1.4	23106		95			
1.2, 1.4	41106/1		95			

RENAULT CLIO I Kasten (S57_)

01.91-09.98

1.9 D	23135		151			...06.96
1.2	23106		95			
1.2	41106/1		95			

RENAULT CLIO II (BB0/1/2_, CB0/1/2_)

09.98-

1.2	23100		87			angetriebene Aggregate: angetr. Agg.: Nockenwelle * Driven Units: Driven unit: camshaft * Périphériques entraînés: Arbre à came
2.0 16V Sport	23124		128			...04.01
1.5 dCi	23132		123			
1.4 16V, 1.6 16V	23129		132			
1.4 16V, 1.6 16V	41129		132			
3.0 V6 Sport	23424		259			



RENAULT

RENAULT CLIO II (BB0/1/2_, CB0/1/2_) 09.98-					
1.2	41100		87		
1.4, 1.6	23122		96		
1.6	41122/1		96		
RENAULT CLIO II Kasten (SB0/1/2_) 09.98-					
1.5 dCi	23132		123		K9K
RENAULT CLIO III (BR0/1, CR0/1) 05.05-					
1.5 dCi	23132		123		K9K
1.5 dCi	23132		123		
2.0 16V, 2.0 16V Sport	23136		126		F4R 830
RENAULT ESPACE I (J11_) 07.84-12.92					
2.0, 2.0 i, 2.0 i Quadra	23115		116		
RENAULT ESPACE II (J/S63_) 01.91-12.96					
2.0	23115		116		
2.2, 2.2 4x4	23114		118		
RENAULT ESPACE III (JE0_) 11.96-10.02					
2.0	23102		127		angetriebene Aggregate: angetr. Agg.: Nockenwelle * Driven Units: Driven unit: camshaft * Périphériques entraînés: Arbre à came
3.0 V6 24V	23424		259		12.99...
2.0 16V	23125		128		04.01...
2.0 16V	23124		128		...04.01
2.0	23125		128		
RENAULT ESPACE IV (JK0/1_) 11.02-					
2.0, 2.0 Turbo	23136		126		
RENAULT FUEGO (136_) 02.80-11.92					
2.0 TX/GTX	23118		116		
RENAULT GRAND SCÉNIC II (JM0/1_) 04.04-					
1.5 dCi	23132		123		K9K
2.0	23136		126		F4R 770,771
2.0	23136		126		F4R 776
RENAULT KANGOO Express (FW0/1_) 02.08-					
1.5 dCi	23132		123		K9K
RENAULT KANGOO (KC0/1_) 08.97-					
1.2	23100		87		angetriebene Aggregate: angetr. Agg.: Nockenwelle * Driven Units: Driven unit: camshaft * Périphériques entraînés: Arbre à came
1.4	23122		96		...06.05
1.5 dCi	23132		123		K9K
1.5 dCi	23132		123		
1.6 16V, 1.6 16V 4x4	23129		132		
1.6 16V, 1.6 16V 4x4	41129		132		
1.2	41100		87		
1.6	23122		96		K7M 744,745
1.6	41122/1		96		K7M 744,745
RENAULT KANGOO (KW0/1_) 02.08-					
1.5 dCi	23132		123		K9K
RENAULT KANGOO Rapid (FC0/1_) 08.97-					
1.2	23100		87		angetriebene Aggregate: angetr. Agg.: Nockenwelle * Driven Units: Driven unit: camshaft * Périphériques entraînés: Arbre à came
1.4	23122		96		...06.05



RENAULT

RENAULT KANGOO Rapid (FC0/1_)						08.97-
1.5 dCi	23132		123		K9K	
1.5 dCi	23132		123			
1.6 16V, 1.6 16V 4x4	23129		132			
1.6 16V, 1.6 16V 4x4	41129		132			
1.2	41100		87			
RENAULT LAGUNA (B56_, 556_)						11.93-03.01
2.0, 2.0 16V	23123		142			12.97...
2.0 16V	41123		142			12.97...
3.0 24V	23424		259			12.99...
2.0, 2.0 16V	23928		148			...12.97
2.0 16V	41928		148			...12.97
2.0	23102		127			...12.98, angetriebene Aggregate: angetr. Agg.: Nockenwelle * Driven Units: Driven unit: camshaft * Périphériques entraînés: Arbre à came
1.8	23108		125			
1.8 16V, 2.0 16V	23124		128			
1.6 16V	23129		132			
1.6 16V	41129		132			
RENAULT LAGUNA Grandtour (K56_)						09.95-03.01
2.0 16V	23123		142			12.97...
2.0 16V	41123		142			12.97...
3.0 24V	23424		259			12.99...
2.0 16V	23928		148			...12.97
2.0 16V	41928		148			...12.97
2.0	23102		127			...12.98, angetriebene Aggregate: angetr. Agg.: Nockenwelle * Driven Units: Driven unit: camshaft * Périphériques entraînés: Arbre à came
1.8	23108		125			
1.8 16V	23124		128			
1.6 16V	23129		132			
1.6 16V	41129		132			
RENAULT LAGUNA II (BG0/1_)						03.01-
1.8 16V	23136		126			04.01...
1.8 16V	23126		126		FAP 770,771	
2.0 16V	23136		126		F4R 784,786, 787	
2.0 16V	23136		126		F4R 886,887	
1.8 16V	23126		126			
2.0 16V, 2.0 16V Turbo	23136		126			
1.6 16V	23129		132			
1.6 16V	41129		132			
3.0 V6 24V	23424		259			
RENAULT LAGUNA II Grandtour (KG0/1_)						03.01-
1.8 16V	23136		126			04.01...



RENAULT

RENAULT LAGUNA II Grandtour (KG0/1_)							03.01-
2.0 16V	23136		126		F4R 784,786, 787		
2.0 16V	23136		126		F4R 886,887		
1.8 16V	23126		126				
2.0 16V, 2.0 16V Turbo	23136		126				
1.6 16V	23129		132				
1.6 16V	41129		132				
3.0 V6 24V	23424		259				
RENAULT LAGUNA III (BT0/1)							10.07-
1.5 dCi	23132		123		K9K		
RENAULT LAGUNA III Grandtour (KT0/1)							10.07-
1.5 dCi	23132		123		K9K		
RENAULT MASTER I Bus (T_)							08.80-07.98
28-35 2.0	23115		116			01.91...	
30 2.2	23114		118			01.91...	
28-35 2,5 TD	23027		153		S9U 702	ab Motornummer: 1307402, angetriebene Aggregate: angetr. Agg.: Nockenwelle * Driven Units: Driven unit: camshaft * Périphériques entraînés: Arbre à came	
35 2,5 TD	23027		153			ab Motornummer: 1307402, angetriebene Aggregate: angetr. Agg.: Nockenwelle * Driven Units: Driven unit: camshaft * Périphériques entraînés: Arbre à came	
28-35 2,5 TD	23026		153		S9U 702	bis Motornummer: 1307401, angetriebene Aggregate: angetr. Agg.: Nockenwelle * Driven Units: Driven unit: camshaft * Périphériques entraînés: Arbre à came	
35 2,5 TD	23026		153			bis Motornummer: 1307401, angetriebene Aggregate: angetr. Agg.: Nockenwelle * Driven Units: Driven unit: camshaft * Périphériques entraînés: Arbre à came	
28-35 2.0	23118		116				
RENAULT MASTER I Kasten (T_)							07.80-07.98
28-35 2.0	23115		116			01.91...	
30 2.2	23114		118			01.91...	
28-35 2,5 TD	23027		153		S9U 702	ab Motornummer: 1307402, angetriebene Aggregate: angetr. Agg.: Nockenwelle * Driven Units: Driven unit: camshaft * Périphériques entraînés: Arbre à came	
35 2,5 TD	23027		153		S9U 714	ab Motornummer: 1307402, angetriebene Aggregate: angetr. Agg.: Nockenwelle * Driven Units: Driven unit: camshaft * Périphériques entraînés: Arbre à came	
28-35 2,5 TD	23026		153		S9U 702	bis Motornummer: 1307401, angetriebene Aggregate: angetr. Agg.: Nockenwelle * Driven Units: Driven unit: camshaft * Périphériques entraînés: Arbre à came	
35 2,5 TD	23026		153			bis Motornummer: 1307401, angetriebene Aggregate: angetr. Agg.: Nockenwelle * Driven Units: Driven unit: camshaft * Périphériques entraînés: Arbre à came	
28-35 2.0	23118		116				
RENAULT MASTER I Pritsche/Fahrgestell (P_)							07.80-07.98
28-35 2.0	23115		116			01.91...	
28-35 2.0	23118		116				
RENAULT MASTER II Bus (JD/ND)							03.98-
2.8 dTI	23028		154			angetriebene Aggregate: angetr. Agg.: Nockenwelle * Driven Units: Driven unit: camshaft * Périphériques entraînés: Arbre à came	
RENAULT MASTER II Kasten (FD)							07.98-
2.8 dTI	23028		154			angetriebene Aggregate: angetr. Agg.: Nockenwelle * Driven Units: Driven unit: camshaft * Périphériques entraînés: Arbre à came	
RENAULT MASTER II Pritsche/Fahrgestell (ED/HD/UD)							07.98-
2.8 dTI	23028		154			angetriebene Aggregate: angetr. Agg.: Nockenwelle * Driven Units: Driven unit: camshaft * Périphériques entraînés: Arbre à came	
RENAULT MEGANE I (BA0/1_)							08.95-08.03
2.0 i	23102		127			angetriebene Aggregate: angetr. Agg.: Nockenwelle * Driven Units: Driven unit: camshaft * Périphériques entraînés: Arbre à came	
1.8 16V	23125		128			04.01...	



RENAULT

RENAULT MEGANE I (BA0/1_)

08.95-08.03

1.8 16V	23124		128			...04.01
1.4 e	23122		96		E7J 626	...06.05
1.4 16V, 1.6 16V	23129		132			
1.4 16V, 1.6 16V	41129		132			
2.0 16V	23111		148			
1.9 D Eco, 1.9 dT	23110		153			
1.4 e	23106		95		E7J 764	
1.4 Eco, 1.6 e	23106		95			
1.6 e	41106		95			
1.6, 1.6 i	23122		96			
1.6 i	41122/1		96			

RENAULT MEGANE I Cabriolet (EA0/1_)

10.96-08.03

2.0, 2.0 i	23102		127			angetriebene Aggregate: angetr. Agg.: Nockenwelle * Driven Units: Driven unit: camshaft * Périphériques entraînés: Arbre à came
1.4 16V, 1.6 16V	23129		132			
1.4 16V, 1.6 16V	41129		132			
2.0 16V	23111		148			
1.6 e	23106		95			
1.6 e	41106		95			

RENAULT MEGANE I Classic (LA0/1_)

09.96-08.03

2.0 i	23102		127			angetriebene Aggregate: angetr. Agg.: Nockenwelle * Driven Units: Driven unit: camshaft * Périphériques entraînés: Arbre à came
1.8 16V	23125		128			04.01...
1.8 16V	23124		128			...04.01
1.4	23122		96		E7J 626	...06.05
1.4 16V, 1.6 16V	23129		132			
1.4 16V, 1.6 16V	41129		132			
1.9 D, 1.9 dT	23110		153			
1.4	23106		95		E7J 764	
1.6 e	23106		95			
1.6 e	41106		95			
1.6 i	23122		96			
1.6 i	41122/1		96			

RENAULT MEGANE I Coach (DA0/1_)

03.96-08.03

2.0 i	23102		127			angetriebene Aggregate: angetr. Agg.: Nockenwelle * Driven Units: Driven unit: camshaft * Périphériques entraînés: Arbre à came
1.4 16V, 1.6 16V	23129		132			
1.4 16V, 1.6 16V	41129		132			
2.0 16V	23111		148			
1.6 e	23106		95			
1.6 e	41106		95			

RENAULT MEGANE I Grandtour (KA0/1_)

03.99-08.03

1.8 16V	23125		128			04.01...
---------	-------	--	-----	--	--	----------



RENAULT

RENAULT MEGANE I Grandtour (KA0/1_)						03.99-08.03
1.8 16V	23124		128			...04.01
1.4 e	23122		96			...06.05
1.4 16V, 1.6 16V	23129		132			
1.4 16V, 1.6 16V	41129		132			
1.6 e	23106		95			
1.6 e	41106		95			
RENAULT MEGANE II (BM0/1_, CM0/1_)						11.02-
1.5 dCi	23132		123		K9K 728, 729	
1.5 dCi	23132		123		K9K	
2.0 16V	23132		123			
2.0 Renault Sport, 2.0 16V Turbo	23136		126		F4R 774,776	
2.0 16V	23136		126			
1.4 16V	23129		132		K4J 730, 732	
1.4 16V	41129		132		K4J 732	
1.4 16V	23129		132			
1.4 16V	41129		132			
RENAULT MEGANE II Coupé-Cabriolet (EM0/1_)						09.03-
1.5 dCi	23132		123		K9K	
2.0 16V Turbo	23136		126		F4R 774,776	
2.0	23136		126			
RENAULT MEGANE II Grandtour (KM0/1_)						08.03-
1.5 dCi	23132		123		K9K	
1.5 dCi	23132		123			
2.0	23136		126			
1.4	23129		132		K4J 730, 732	
1.4	41129		132			
RENAULT MEGANE II Stufenheck (LM0/1_)						09.03-
1.5 dCi	23132		123		K9K	
2.0	23136		126			
1.4	23129		132		K4J 730, 732	
1.4	41129		132		K4J 732	
1.4	41129		132			
RENAULT MEGANE Scenic (JA0/1_)						01.97-10.99
2.0 i	23102		127			angetriebene Aggregate: angetr. Agg.: Nockenwelle * Driven Units: Driven unit: camshaft * Périphériques entraînés: Arbre à came
1.9 dT	23110		153			
1.4 i, 1.6 e	23106		95			
1.6 i	23122		96			
1.6 i	41122/1		96			
RENAULT MODUS (F/JP0_)						12.04-
1.5 dCi	23132		123		K9K	
1.6	23129		132			



RENAULT

RENAULT RAPID Kasten (F40_, G40)						07.85-11.98
1.6 D	23110		153			02.88...
1.9 D	23135		151			...06.96
1.9 D	23112		151		F8Q 776	...08.96
1.4	23106		95			
1.4	41106/1		95			
RENAULT SAFRANE I (B54_)						04.92-07.96
2.0, 2.0 12V	23115		116			
2.2	23114		118			
RENAULT SAFRANE II (B54_)						07.96-12.00
2.0 16V, 2.5 20V	23123		142			12.97...
2.0 16V	41123		142			12.97...
2.9 24V	23424		259			12.99...
2.0 16V, 2.5 20V	23928		148			...12.97
2.0 16V	41928		148			...12.97
RENAULT SCÉNIC I (JA0/1_)						09.99-08.03
1.8 16V, 2.0 16V, 2.0 16V RX4	23125		128			04.01...
1.8 16V, 2.0 16V, 2.0 16V RX4	23124		128			...04.01
2.0 16V IDE	23124		128			
1.4 16V, 1.6 16V	23129		132			
1.4 16V, 1.6 16V	41129		132			
RENAULT SCÉNIC II (JM0/1_)						06.03-
1.5 dCi	23132		123		K9K	
1.5 dCi	23132		123			
2.0 16V Turbo	23136		126		F4R 776	
2.0	23136		126			
1.4	23129		132		K4J 730, 732	
1.4	41129		132		K4J 730,740	
RENAULT SPORT SPIDER (EF0_)						03.95-10.99
2.0 16V	23111		148			
RENAULT SUPER 5 (B/C40_)						10.84-12.96
1.7, 1.7 i	23108		125			02.88...
1.6 D	23110		153			02.88...
1.7	23108		125			ab Motornummer: C016386
RENAULT THALIA (LB0/1/2_)						02.98-
1.4	23122		96			...06.05
1.5 dCi	23132		123		K9K	
1.5 dCi	23132		123			
1.4 16V	41129		132		K4J 700,712, 713	
1.6 16V	41129		132			
1.2	41100		87			
1.6	23122		96		K7M 744,745	



RENAULT

RENAULT THALIA (LB0/1/2_)							02.98-
1.6	41122/1		96		K7M 744,745		
RENAULT TRAFIC Bus (TXW)							03.89-03.01
2.2, 2.2 4x4	23115		116			01.91...	
2.2, 2.2 4x4	23114		118				
1.7	23108		125				
1.9 D	23110		153				
RENAULT TRAFIC Bus (T5, T6, T7)							03.80-04.89
1.7	23108		125			02.88...	
RENAULT TRAFIC Kasten (TXX)							05.89-03.01
2.2, 2.2 4x4	23115		116			01.91...	
2.2, 2.2 4x4	23114		118				
1.7	23108		125				
1.9 D	23110		153				
RENAULT TRAFIC Kasten (T1, T3, T4)							03.80-04.89
1.7	23108		125			02.88...	
RENAULT TRAFIC Pritsche/Fahrgestell (PXX)							03.89-03.01
2.0 [RWD]	23115		116			01.91...	
1.7	23108		125				
RENAULT TRAFIC Pritsche/Fahrgestell (P6)							03.80-04.89
1.7	23108		125			02.88...	
2.0	23115		116			ab Motornummer: 376908	
2.0	23118		116			bis Motornummer: 376907	
RENAULT TWINGO (CN0_)							03.07-
1.5 dCi	23132		123				
RENAULT TWINGO (C06_)							03.93-
1.2	23100		87			angetriebene Aggregate: angetr. Agg.: Nockenwelle * Driven Units: Driven unit: camshaft * Périphériques entraînés: Arbre à came	
1.2	41100		87				
RENAULT TWINGO Kasten (S06_)							03.93-
1.2	41100		87				
RENAULT VEL SATIS (BJ0_)							06.02-
2.0 16V Turbo	23136		126				
RENAULT 11 (B/C37_)							03.83-07.89
1.7	23108		125			02.88...	
1.6 D	23110		153			02.88...	
RENAULT 18 Variable (135_)							02.79-11.93
2.0, 2.0 4x4	23118		116			bis Motornummer: 24261, bis Motornummer: 26767	
RENAULT 18 (134_)							04.78-11.93
2.0	23118		116			bis Motornummer: 24261, bis Motornummer: 26767	
RENAULT 19 I (B/C53_)							01.88-12.92
1.7	23108		125				
1.8 16V	23111		148				
1.9 D	23110		153				
1.2	23106		95		E7F 730		
1.2	41106/1		95		E7F 730		
1.4	23106		95				
1.4	41106/1		95				
RENAULT 19 I Cabriolet (D53_)							07.91-04.92



RENAULT

RENAULT					
RENAULT 19 I Cabriolet (D53_) 07.91-04.92					
1.7	23108		125		
RENAULT 19 I Chamade (L53_) 01.88-12.92					
1.7	23108		125		
1.8 16V	23111		148		
1.9 D	23110		153		
1.2	23106		95		E7F 730
1.2	41106/1		95		E7F 730
1.4	23106		95		
1.4	41106/1		95		
RENAULT 19 I Kasten (S53_) 01.88-12.92					
1.4	23106		95		E6J 700,701
1.2	23106		95		E7F 730
1.2	41106/1		95		E7F 730
1.4	41106/1		95		
RENAULT 19 II (B/C53_) 01.91-12.95					
1.7, 1.8	23108		125		
1.8 16V	23111		148		
1.9 D, 1.9 dT	23110		153		
1.2, 1.4	23106		95		
1.2, 1.4	41106/1		95		
RENAULT 19 II Cabriolet (D53_, 853_) 04.92-02.97					
1.7, 1.8	23108		125		
1.8 16V	23111		148		
RENAULT 19 II Chamade (L53_) 04.92-12.95					
1.7, 1.8	23108		125		
1.8 16V	23111		148		
1.9 D, 1.9 dT	23110		153		
1.4	23106		95		E6J 700,701
1.2, 1.4	23106		95		
1.2, 1.4	41106/1		95		
RENAULT 19 II Kasten (S53_) 03.92-12.95					
1.4	23106		95		E6J 700,701
1.2	23106		95		E7F 730
1.2	41106/1		95		E7F 730
1.4	41106/1		95		
RENAULT 20 (127_) 10.75-12.83					
2.0	23118		116		
RENAULT 21 (B48_) 09.89-06.94					
2.0, 2.2, 2.2 4x4	23115		116		01.91...
2.0, 2.0 4x4	23115		116		
1.7	23108		125		
RENAULT 21 Kombi (K48_) 03.86-08.94					
1.7	23108		125		02.88...



RENAULT

RENAULT 21 Kombi (K48_)							03.86-08.94
2.0, 2.0 4x4, 2.2, 2.2 4x4	23115		116			01.91...	
1.7	23108		125		F2R	...12.87	
2.0	23115		116				
1.7	23108		125				
RENAULT 21 Stufenheck (L48_)							03.86-06.94
1.7	23108		125			02.88...	
2.0 Turbo, 2.0 Turbo 4x4	23116		115			01.91...	
2.0, 2.2, 2.2 4x4	23115		116			01.91...	
2.0, 2.0 4x4	23115		116				
1.7	23108		125				
RENAULT 25 (B29_)							04.84-12.93
2.0, 2.0 12V, 2.2	23115		116			01.91...	
RENAULT 9 (L42_)							09.81-12.89
1.7	23108		125			02.88...	
1.6 D	23110		153			02.88...	
ROVER							
ROVER CABRIOLET (XW)							04.90-11.99
216 1.6i	23503		124				
214 1.4, 214 1.4i 16V, 216 1.6i 16V	23938		143				
ROVER COUPE							03.96-11.99
1.6 16 V	23938		143				
ROVER STREETWISE							08.03-
1.4	23938		143				
ROVER 100 Cabriolet (XP)							04.94-12.98
114	23938		143		14K4		
ROVER 100 (METRO) (XP)							11.89-12.98
114 D	23403		143			angetriebene Aggregate: angetr. Agg.: Nockenwelle * Driven Units: Driven unit: camshaft * Périphériques entraînés: Arbre à came	
114 GSi, 114 GTI 16V, 114 GTI/GT 16V KAT	23938		143				
114 D	41403		143				
ROVER 200 Coupe (XW)							10.92-06.99
216	23503		124				
ROVER 200 Hatchback (XW)							10.89-10.95
218 TD	41415		136		XUD7TE L	11.92..., ab Motornummer: 10CV2L4016154, Schaufelraddurchmesser [mm]: 71 * Impeller Diameter [mm]: 71 * Diamètre de la roue à aubes [mm]: 71	
218 D	23415		136		D9B	11.92...	
218 TD	23415		136			11.92...	
218 D	23405		136		D9B	...10.92	
218 TD	23405		136			...10.92	
216 GSi	23502		107				
216 GTi	23503		124				
214 GSi/Si, 214 Si/Gsi	23938		143				
ROVER 200 (RF)							11.95-03.00
1.4, 214 Si, 216 Si	23938		143				
ROVER 25 (RF)							09.99-
1.4 16V, 1.6 16V, 1.8 16V	23938		143				
ROVER 400 Hatchback (RT)							05.95-03.00
414 Si, 416 Si	23938		143				



ROVER

ROVER 400 (RT)							05.95-03.00
414 Si, 416 Si	23938		143				
ROVER 400 Tourer (XW)							09.93-11.98
1.6 i	23502		107				
1.6 i	23503		124				
1.8 TD	23415		136				
ROVER 400 (XW)							04.90-04.95
418 D	23415		136		D9B	11.92...	
418 TD	23415		136			11.92...	
418 D	23405		136		D9B	...10.92	
418 TD	23405		136			...10.92	
416 GSI	23502		107				
416 GTI	23503		124				
414, 414 GSI/SI, 414 GSI/SI KAT	23938		143				
ROVER 45 (RT)							02.00-
1.4, 1.6	23938		143				
ROVER 45 Stufenheck (RT)							02.00-
1.4, 1.6	23938		143				
ROVER 600 (RH)							08.93-02.99
618 i/SI, 620 i, 620 Si	23507		113				

SAAB

SAAB 900 II							07.93-02.98
2.5 -24 V6	23733		225				
SAAB 900 II Cabriolet							12.93-02.98
2.5 -24 V6	23733		225				
SAAB 900 II Coupe							12.93-02.98
2.5 -24 V6	23733		225				
SAAB 9000							04.85-12.98
3.0 -24 V6 CD/CDE	23733		225				
SAAB 9000 Schrägheck							09.84-12.98
3.0 -24 V6 CS/CSE	23733		225				
SAAB 9-3 Kombi							03.05-
1.8 i	23734		162				
SAAB 9-3 (YS3F)							09.02-
1.8 i	23734		162				
SAAB 9-5 Kombi (YS3E)							10.98-
3.0 V6t	23733		225			bis Motornummer: 300418	
SAAB 9-5 (YS3E)							09.97-
3.0 V6t	23733		225			bis Motornummer: 300418	

SEAT

SEAT ALHAMBRA (7V8, 7V9)							04.96-03.10
1.9 TDI	41848		120		ANU	...07.02, angetriebene Aggregate: angetr. Agg.: Wasserpumpe * Driven Units: Driven unit: water pump * Périphériques entraînés: Pompe à eau, angetriebene Aggregate: angetr. Agg.: Nockenwelle * Driven Units: Driven unit: camshaft * Périphériques entraînés: Arbre à came	
1.9 TDI, 1.9 TDI 4motion	41848		120			...07.02, ...7M-2-530 000, angetriebene Aggregate: angetr. Agg.: Wasserpumpe * Driven Units: Driven unit: water pump * Périphériques entraînés: Pompe à eau, angetriebene Aggregate: angetr. Agg.: Nockenwelle * Driven Units: Driven unit: camshaft * Périphériques entraînés: Arbre à came	
1.9 TDI	23847		120		ANU	...11.02, angetriebene Aggregate: angetr. Agg.: Nockenwelle * Driven Units: Driven unit: camshaft * Périphériques entraînés: Arbre à came	
1.9 TDI, 1.9 TDI 4motion	23847		120			...11.02, angetriebene Aggregate: angetr. Agg.: Nockenwelle * Driven Units: Driven unit: camshaft * Périphériques entraînés: Arbre à came	
1.9 TDI	23848		120		ANU	...11.02	



SEAT

SEAT ALHAMBRA (7V8, 7V9)

04.96-03.10

1.9 TDI, 1.9 TDI 4motion	23848		120			...11.02
1.8 T 20V	23829		150		AWC	wahlweise: * Alternatively: * au choix:
1.8 T 20V	23830		150		AWC	wahlweise: * Alternatively: * au choix:
2.0 i	23802		124			
1.9 TDI	23821		137		1Z, AHU	
1.9 TDI	73808		137		1Z,AHU	
1.9 TDI	23821		137			
1.9 TDI	73808		137			
2.0 i	23832		138		ATM	
1.8 T 20V	23912		150		AJH	
1.8 T 20V	23913		150		AJH	
1.8 T 20V	41912		150		AJH	
1.8 T 20V	23831		150		AWC	

SEAT ALTEA XL (5P5, 5P8)

10.06-

1.4 16V	23838		130	58		
1.4 16V	41838		130	58		
1.6, 1.6 Multifuel	41832		138			

SEAT ALTEA (5P1)

03.04-

1.4 16V	23838		130	58		
1.4 16V	41838		130	58		
1.6	23832		138			
1.6	41832		138			

SEAT AROSA (6H)

05.97-06.04

1.7 SDI	23836		137			angetriebene Aggregate: inkl. Umlenkrolle * Driven Units: incl. of deflection pulley * Périphériques entraînés: Poulie de renvoi incl., wahlweise: * Alternatively: * au choix:
1.0	23823		135		ALD,AUC ,ANV	...6H-Y-014 000
1.0	41823/1		135		AUC	...6H-Y-014 000
1.4	23823		135		AWX,AP Q,AKV	...6H-Y-014 000
1.4	41823/1		135		AUD	...6H-Y-014 000
1.4 TDI	23847		120			...6H-2-023 000, ab Motornummer: 011 495, angetriebene Aggregate: angetr. Agg.: Nockenwelle * Driven Units: Driven unit: camshaft * Périphériques entraînés: Arbre à came
1.4 TDI	23848		120			...6H-2-023 000, ab Motornummer: 011 495
1.4 TDI	41847		120			...6H-2-023 000, ab Motornummer: 011 495
1.4	23838/1		130	58	ANW	2 Riemen: * 2 Belts: * 2 courroies:
1.4 16V	23838		130	58		
1.4 16V	41838		130	58		
1.4	41823		135		APQ	
1.7 SDI	23837		137			

SEAT CORDOBA

05.99-09.02

1.8	23830		150			wahlweise: * Alternatively: * au choix:
1.4	23838		130	58		



SEAT

SEAT CORDOBA

05.99-09.02

1.6	41824		137			
1.6	41832		138			

SEAT CORDOBA Schrägheck (6K2)

06.99-10.02

1.9 SDI	41844		141		AQM	ab Motornummer: 004 132, ab Motornummer: 229 003
1.9 SDI	23844		141		AQM	ab Motornummer: 004 132, ab Motornummer: 229 903
1.9 SDI	23845		141		AQM	bis Motornummer: 004 132, bis Motornummer: 229 902
1.4	23823		135		AKK	bis Motornummer: 127806
1.4	41823/1		135		AKK	bis Motornummer: 127 806
1.8 T 20V Cupra	23829		150			wahlweise: * Alternatively: * au choix:
1.8 T 20V Cupra	23830		150			wahlweise: * Alternatively: * au choix:
1.4 16V	23838		130	58		
1.4 16V	41838		130	58		
1.0	23823		135		ANV	
1.6	23824		137			
1.6	41824		137			
1.6	23832		138			
1.6	41832		138			
1.9 TDI	41844		141		ASV	
1.9 TDI	23844		141			
1.9 TDI	41844		141			
1.8 T 20V Cupra	23831		150			

SEAT CORDOBA Vario (6K5)

06.99-12.02

1.6 i	23801		121			angetriebene Aggregate: angetr. Agg.: Nockenwelle * Driven Units: Driven unit: camshaft * Périphériques entraînés: Arbre à came
1.6 i	23801		121			...12.97, angetriebene Aggregate: angetr. Agg.: Nockenwelle * Driven Units: Driven unit: camshaft * Périphériques entraînés: Arbre à came
1.4	23823		135		AKK	...127806
1.9 SDI	41844		141		AQM	ab Motornummer: 004 132, ab Motornummer: 229 003
1.9 SDI	23844		141		AQM	ab Motornummer: 004 132, ab Motornummer: 229 903
1.9 SDI	23821		137			ab Motornummer: 552766
1.9 SDI	73808		137			ab Motornummer: 552766
1.9 SDI	23845		141		AQM	bis Motornummer: 004 132, bis Motornummer: 229 903
1.4	41823/1		135		AKK	bis Motornummer: 127 806
1.9 SDI	23812		137			bis Motornummer: 552765
1.4, 1.4 16V	23838		130	58		
1.4 16V	41838		130	58		
1.4 i	23823		135			
1.4 i	41823		135			
1.6 i	23824		137		AEE,AL M	



SEAT

SEAT CORDOBA Vario (6K5)

06.99-12.02

1.9 TDI	23820		137			
1.9 TDI	23821		137			
1.6	23824		137			
1.6, 1.6 i	41824		137			
1.6	41832		138		AKL	
1.6	23832		138			
1.9 TDI	41844		141		ASV	
1.9 TDI	23844		141			
1.9 TDI	41844		141			

SEAT CORDOBA (6K2/C2)

02.93-10.99

1.6 i, 1.8 i	23801		121			angetriebene Aggregate: angetr. Agg.: Nockenwelle * Driven Units: Driven unit: camshaft * Périphériques entraînés: Arbre à came
1.9 SDI	23821		137		AEY	ab Motornummer: 552766
1.9 D, 1.9 TD	23820		137			ab Motornummer: 552766
1.9 SDI	73808		137			ab Motornummer: 552766
1.9 SDI	23812		137		AEY	bis Motornummer: 552765
1.9 D, 1.9 TD	23812		137			bis Motornummer: 552765
1.6 i	23801		121			
2.0 i	23802		124			
1.4 i	23823		135		AEX,AK V, ANX, APQ	
1.4 i	41823		135		APQ	
1.0 i	23823		135			
1.0 i	41823/1		135			
1.6 i	23824		137		AEE,AL M	
1.6 i	41824		137		ALM	
1.9 TDI	23820		137			
1.9 TDI	23821		137			

SEAT CORDOBA (6L2)

09.02-

1.4 16V	23838		130	58		
1.4 16V	41838		130	58		

SEAT EXEO ST (3R5)

06.09-

1.8 T	23901		150			
1.8 T	23902		150			

SEAT EXEO (3R2)

12.08-

1.8 T	23901		150			
1.8 T	23902		150			

SEAT IBIZA I (021A)

06.84-12.93

1.2, 1.5 i, 1.7	23800		112			
-----------------	-------	--	-----	--	--	--

SEAT IBIZA II (6K1)

03.93-08.99

1.8 i	23801		121			angetriebene Aggregate: angetr. Agg.: Nockenwelle * Driven Units: Driven unit: camshaft * Périphériques entraînés: Arbre à came
1.6 i	23801		121			01.94..., ...12.97, angetriebene Aggregate: angetr. Agg.: Nockenwelle * Driven Units: Driven unit: camshaft * Périphériques entraînés: Arbre à came



SEAT

SEAT IBIZA II (6K1)

03.93-08.99

1.9 D	23820		137			ab Motornummer: 378365
1.9 TD	23820		137			ab Motornummer: 552 766
1.9 D	23812		137			bis Motornummer: 378364
1.9 TD	23812		137			bis Motornummer: 552765
1.6 i	23801		121			
2.0 i	23802		124			
1.4 i	23823		135		AEX,AK V,APQ	
1.4 i	41823		135		APQ	
1.0 i	23823		135			
1.0 i	41823/1		135			
1.6 i	23824		137		AEE,AL M	
1.6 i	41824		137		ALM	
1.9 SDI	23821		137		AEY	
1.9 TDI	23820		137			
1.9 TDI	23821		137			
1.9 SDI	73808		137			

SEAT IBIZA III (6K1)

08.99-02.02

1.9 SDI	23844		141		AQM	ab Motornummer: 004 132, ab Motornummer: 229 003
1.9 SDI	41844		141		AQM	ab Motornummer: 004 132, ab Motornummer: 229 003
1.9 SDI	23845		141		AQM	bis Motornummer: 004 132, bis Motornummer: 229 003
1.0	23823		135		ALD	bis Motornummer: 037 979
1.4	23823		135		AKK	bis Motornummer: 127806
1.4	41823/1		135		AKK	bis Motornummer: 127 806
1.8 T 20V Cupra	23829		150			wahlweise: * Alternatively: * au choix:
1.8 T 20V Cupra	23830		150			wahlweise: * Alternatively: * au choix:
1.4 16V	23838		130	58		
1.4 16V	41838		130	58		
1.6	23824		137			
1.6	41824		137			
1.6	23832		138			
1.6	41832		138			
1.9 TDI	23844		141			
1.9 TDI	41844		141			
1.8 T 20V Cupra	23831		150			

SEAT IBIZA IV (6L1)

02.02-

1.4 16V	23838		130	58		
1.4 16V	41838		130	58		

SEAT IBIZA V SPORTCOUPE (6J1)

07.08-

1.4	23838		130	58		
1.4	41838		130	58		



SEAT

SEAT IBIZA V ST (6J8)

03.10-

1.4	23838		130	58		
1.4	41838		130	58		

SEAT IBIZA V (6J5)

03.08-

1.4	23838		130	58		
1.4	41838		130	58		

SEAT INCA (6K9)

11.95-06.03

1.6 i	23801		121			...12.97, angetriebene Aggregate: angetr. Agg.: Nockenwelle * Driven Units: Driven unit: camshaft * Périphériques entraînés: Arbre à came
1.4 16V	23838		130	58		
1.4 16V	41838		130	58		
1.4 i	23823		135		AEX,AK V,APQ	
1.4 i	41823		135		APQ	
1.6 i	23824		137		AEE	
1.9 SDI	23821		137		AEY	
1.9 SDI	73808		137		AEY	
1.7 D, 1.9 D	23820		137			
1.7 D	23821		137			
1.6 i	41824		137			
1.9 SDI	23844		141		AYQ	
1.9 SDI	41844		141		AYQ	
1.9 TDI	41844		141			

SEAT LEON (1M1)

11.99-06.06

1.9 TDI	23847		120			angetriebene Aggregate: angetr. Agg.: Nockenwelle * Driven Units: Driven unit: camshaft * Périphériques entraînés: Arbre à came
1.8 20V, 1.8 20V T, 1.8 20V T 4	23829		150			1M-YB088 001..., 1M-YR016 501..., wahlweise: * Alternately: * au choix:
1.8 20V, 1.8 20V T, 1.8 20V T 4	23830		150			1M-YB088 001..., 1M-YR016 501..., wahlweise: * Alternately: * au choix:
1.8 20V, 1.8 20V T, 1.8 20V T 4	23831		150			1M-YB088 001..., 1M-YR016 501...
1.8 20V, 1.8 20V T, 1.8 20V T 4	23913		150			...1M-YB088 000, ...1M-YR016 500
1.8 20V, 1.8 20V T, 1.8 20V T 4	23912		150			...1M-YB088 000, ...1M-YR019 500
1.8 20V, 1.8 20V T, 1.8 20V T 4	41912		150			...1M-YB-088 000, ...1M-YR-019 500
1.9 SDI	41844		141		AQM	ab Motornummer: 030 001
1.4 16V	23838		130	58	APE,AX P,BCA	ab Motornummer: 160 001
1.4 16V	41838		130	58	APE,AX P,BCA	ab Motornummer: 160 001
1.4 16V	23838/1		130	58	AHW	bis Motornummer: 160 000, 2 Riemen: * 2 Belts: * 2 courroies:
1.8 T Cupra R	23829		150			wahlweise: * Alternately: * au choix:
1.8 T Cupra R	23830		150			wahlweise: * Alternately: * au choix:
1.9 TDI	23848		120			
1.6 16 V	23838		130	58		
1.6 16 V	41838/2		130	58		
1.6	23832		138			
1.6	41832		138			



SEAT

SEAT LEON (1M1)							11.99-06.06
1.9 SDI, 1.9 TDI	23844		141				
1.9 TDI	41844		141				
1.8 T Cupra R	23831		150				
SEAT LEON (1P1)							05.05-
1.4 16V	23838		130	58			
1.4 16V	41838		130	58			
1.6, 1.6 LPG	41832		138				
SEAT RONDA (022A)							06.82-11.88
1.2, 1.5	23800		112				
SEAT TOLEDO I (1L)							01.91-10.99
1.6 i, 1.8 i	23801		121				angetriebene Aggregate: angetr. Agg.: Nockenwelle * Driven Units: Driven unit: camshaft * Périphériques entraînés: Arbre à came
1.9 TDI	23821		137		1Z		ab Motornummer: 136386, ab Motornummer: 289577
1.9 TDI	23821		137				ab Motornummer: 136734
1.9 TD	23820		137				ab Motornummer: 634079
1.9 D	23820		137				ab Motornummer: 705903
1.9 TDI	23815		137		1Z		bis Motornummer: 136 385, bis Motornummer: 289 576
1.9 TDI	23815		137				bis Motornummer: 136 733
1.9 TD	23812		137				bis Motornummer: 634078
1.9 D	23812		137				bis Motornummer: 705902
1.6 i	23801		121				
2.0 i	23802		124				
1.8 16V	23808		147				
SEAT TOLEDO II (1M2)							04.99-05.06
1.9 TDI	23847		120				angetriebene Aggregate: angetr. Agg.: Nockenwelle * Driven Units: Driven unit: camshaft * Périphériques entraînés: Arbre à came
1.8 20V, 1.8 20VT	23829		150				1M-YB088 001..., 1M-YR016 501..., wahlweise: * Alternatively: * au choix:
1.8 20V, 1.8 20VT	23830		150				1M-YB088 001..., 1M-YR016 501..., wahlweise: * Alternatively: * au choix:
1.8 20V, 1.8 20VT	23831		150				1M-YB088 001..., 1M-YR016 501...
1.8 20V, 1.8 20VT	23912		150				...1M-YB088 000, ...1M-YR016 500
1.8 20V, 1.8 20VT	23913		150				...1M-YB088 000, ...1M-YR016 500
1.8 20V, 1.8 20VT	41912		150				...1M-YB-088 000, ...1M-YR-019 500
1.4 16V	23838		130	58	AXP		ab Motornummer: 160 001
1.4 16V	41838		130	58	AXP		ab Motornummer: 160 001
1.4 16V	23838/1		130	58	AHW		bis Motornummer: 160 000, 2 Riemen: * 2 Belts: * 2 courroies:
1.9 TDI	23848		120				
1.6 16V	23838		130	58			
1.6 16V	41838/2		130	58			
1.6	23832		138				
1.6	41832		138				
1.9 TDI	23844		141				
1.9 TDI	41844		141				
SEAT TOLEDO III (5P2)							04.04-



SEAT

SEAT TOLEDO III (5P2)							04.04-
1.6	41832		138				

SKODA

SKODA FABIA							12.06-
-------------	--	--	--	--	--	--	--------

1.4	23838		130	58		5J-8-000 001...	
1.4	41838		130	58		...5J-8-000 001	

SKODA FABIA Combi							10.07-
-------------------	--	--	--	--	--	--	--------

1.4	23838		130	58		5J-8-000 001...	
1.4	41838		130	58		5J-8-000 001...	

SKODA FABIA Combi (6Y5)							04.00-12.07
-------------------------	--	--	--	--	--	--	-------------

1.4 16V	23841		130			6Y-7-000 001...	
1.4 16V	41838		130	58		...1Y-1-116 273	
1.4 16V	41838		130	58		...6Y-1-116 273	
1.9 TDI	23847		120			...6Y-3-740 479, angetriebene Aggregate: angetr. Agg.: Nockenwelle * Driven Units: Driven unit: camshaft * Périphériques entraînés: Arbre à came	
1.9 TDI	41847		120		ATD	...6Y-3-740 479	
1.9 TDI	23848		120			...6Y-3-740 479	
1.4 16V	23838		130	58		...6Y-5B050 001, ...6Y-54421 759	
1.4 16V	23838		130	58			
2.0	23832		138				

SKODA FABIA Stufenheck (6Y3)							10.99-12.07
------------------------------	--	--	--	--	--	--	-------------

1.4 16V	23841		130			6Y-7-000 001...	
1.4 16V	41838		130	58		...1Y-1-116 273	
1.4 16V	41838		130	58		...6Y-1-116 273	
1.9 TDI	23847		120			...6Y-3-740 479, angetriebene Aggregate: angetr. Agg.: Nockenwelle * Driven Units: Driven unit: camshaft * Périphériques entraînés: Arbre à came	
1.9 TDI	23848		120			...6Y-3-740 479	
1.9 TDI	41847		120			...6Y-3-740 479	
1.4 16V	23838		130	58		...6Y-5B050 001, ...6Y-54421 759	
1.4 16V	23838		130	58			
2.0	23832		138				

SKODA FABIA (6Y2)							08.99-03.08
-------------------	--	--	--	--	--	--	-------------

1.4	23841		130			6Y-7-000 001...	
1.4 16V	41838		130	58		...1Y-1-116 273	
1.4, 1.4 16V	41838		130	58		...6Y-1-116 273	
1.9 TDI	23847		120			...6Y-3-740 479, angetriebene Aggregate: angetr. Agg.: Nockenwelle * Driven Units: Driven unit: camshaft * Périphériques entraînés: Arbre à came	
1.9 TDI	23848		120			...6Y-3-740 479	
1.9 TDI	41847		120			...6Y-3-740 479	
1.4	23838		130	58		...6Y-5B050 001, ...6Y-54421 759	
1.4 16V	23838		130	58			
2.0	23832		138				

SKODA FELICIA I Fun (797)							06.97-
---------------------------	--	--	--	--	--	--	--------

1.6	23824		137				
1.9 D	23837		137				



SKODA

SKODA FELICIA I Fun (797)						06.97-
1.6	41824		137			
SKODA FELICIA I Kombi (6U5)						07.95-03.98
1.6 GLX	23824		137			02.97...
1.6 GLX	41824		137			02.97...
1.9 D	23837		137			
SKODA FELICIA I (6U1)						10.94-03.98
1.6 LX	23824		137			02.97...
1.9 D	23837		137			
SKODA FELICIA II Kombi (6U5)						01.98-06.01
1.6	23824		137			
1.9 D	23837		137			
1.6	41824		137			
SKODA FELICIA II (6U1)						01.98-06.01
1.6	23824		137			
1.9 D	23837		137			
1.6	41824		137			
SKODA OCTAVIA Combi (1U5)						07.98-
1.9 TDI	23845		141	AHF	...07.01, bis Motornummer: AHF006065, angetriebene Aggregate: angetr. Agg.: Nockenwelle * Driven Units: Driven unit: camshaft * Périphériques entraînés: Arbre à came	
1.8 T, 1.8 T 4x4	23829		150	ARX,AU M	1U-Y-390 001..., wahlweise: * Alternately: * au choix:	
1.8 T, 1.8 T 4x4	23830		150	ARX,AU M	1U-Y-390 001..., wahlweise: * Alternately: * au choix:	
1.8 20V	23829		150		1U-Y-390 001..., wahlweise: * Alternately: * au choix:	
1.8 20V	23830		150		1U-Y-390 001..., wahlweise: * Alternately: * au choix:	
1.8 T, 1.8 T 4x4	23831		150	ARX,AU M	1U-Y-390 001...	
1.8 20V	23831		150		1U-Y-390 001...	
1.8 T, 1.8 T 4x4	23912		150	AGU,AR Z	...1U-Y-390 000	
1.8 T, 1.8 T 4x4	23913		150	AGU,AR Z	...1U-Y-390 000	
1.8 T, 1.8 T 4x4	41912		150	ARZ, AGU	...1U-Y-390 000	
1.8 20V	23912		150		...1U-Y-390 000	
1.8 20V	23913		150		...1U-Y-390 000	
1.8 20V	41912		150		...1U-Y-390 000	
1.9 TDI 4x4	41848		120		...1U-3-634 881, ...1U-38569 351, bis Motornummer: 211 245	
1.9 TDI	23844		141	ASV	ab Motornummer: 006 066	
1.9 TDI	41844		141	ASV	ab Motornummer: 006 066	
1.9 TDI, 1.9 TDI 4x4	23844		141	ALH	ab Motornummer: 044 442	
1.9 TDI, 1.9 TDI 4x4	41844		141	ALH	ab Motornummer: 044 442	
1.9 SDI	23844		141	AQM	ab Motornummer: 400 001	
1.9 SDI	41844		141	AQM	ab Motornummer: 400 001	
1.9 TDI, 1.9 TDI 4x4	23845		141	AGR	bis Motornummer: 044 442	
1.9 TDI 4x4	23847		120		bis Motornummer: 211 245, angetriebene Aggregate: angetr. Agg.: Nockenwelle * Driven Units: Driven unit: camshaft * Périphériques entraînés: Arbre à came	



SKODA

SKODA OCTAVIA Combi (1U5)

07.98-

1.9 TDI 4x4	23848		120			bis Motornummer: 211 245
1.9 SDI	23845		141		AGP	bis Motornummer: 400 000
RS 1.8 T	23829		150			wahlweise: * Alternatively: * au choix:
RS 1.8 T	23830		150			wahlweise: * Alternatively: * au choix:
1.4 16V	23838		130	58		
1.4 16V	41838		130	58		
1.6	23824		137			
1.6	41824		137			
1.6	41832		138		AVU	
1.6, 2.0, 2.0 4x4	23832		138			
1.6	41832		138			
RS 1.8 T	23831		150			

SKODA OCTAVIA Combi (1Z5)

02.04-

1.4	23838		130	58		1Z-5-000 001...
1.6	41832		138			

SKODA OCTAVIA (1U2)

09.96-

1.8 T, 1.8 T 4x4	23829		150		ARX,AU M	1U-Y-390 001..., wahlweise: * Alternatively: * au choix:
1.8 T, 1.8 T 4x4	23830		150		ARX,AU M	1U-Y-390 001..., wahlweise: * Alternatively: * au choix:
1.8	23829		150			1U-Y-390 001..., wahlweise: * Alternatively: * au choix:
1.8	23830		150			1U-Y-390 001..., wahlweise: * Alternatively: * au choix:
1.8 T, 1.8 T 4x4	23831		150		ARX,AU M	1U-Y-390 001...
1.8	23831		150			1U-Y-390 001...
1.8 T, 1.8 T 4x4	23912		150		AGU,AR Z	...1U-Y-390 000
1.8 T, 1.8 T 4x4	23913		150		AGU,AR Z	...1U-Y-390 000
1.8 T, 1.8 T 4x4	41912		150		ARZ, AGU	...1U-Y-390 000
1.8	23912		150			...1U-Y-390 000
1.8	23913		150			...1U-Y-390 000
1.8	41912		150			...1U-Y-390 000
1.9 TDI	23844		141		ASV	ab Motornummer: 006 066
1.9 TDI	41844		141		ASV	ab Motornummer: 006 066
1.9 TDI	23844		141		ALH	ab Motornummer: 044 442
1.9 TDI	41844		141		ALH	ab Motornummer: 044 442
1.9 SDI	23844		141		AQM	ab Motornummer: 400 001
1.9 SDI	41844		141		AQM	ab Motornummer: 400 001
1.9 TDI	23845		141		AHF	bis Motornummer: 006 066
1.9 TDI	23845		141		AGR	bis Motornummer: 044 442
1.9 SDI	23845		141		AGP	bis Motornummer: 400 000
RS 1.8 T	23829		150			wahlweise: * Alternatively: * au choix:
RS 1.8 T	23830		150			wahlweise: * Alternatively: * au choix:



SKODA

SKODA OCTAVIA (1U2) 09.96-

1.4 16V	23838		130	58		
1.4 16V	41838		130	58		
1.6	23824		137			
1.6	41824		137			
1.6, 2.0	23832		138			
1.6	41832		138			
RS 1.8 T	23831		150			

SKODA OCTAVIA (1Z3) 02.04-

1.4	23838		130	58		1Z-5-000 001...
1.4	23838		130	58		
1.4	41838		130	58		
1.6	41832		138			

SKODA PRAKTIK (5J) 03.07-

1.4	23838		130	58		
1.4	41838		130	58		

SKODA ROOMSTER (5J) 05.06-

1.4	23838		130	58		
1.4	41838		130	58		

SKODA SUPERB (3U4) 02.02-03.08

1.9 TDI	41848		120			...3U-29009506
1.9 TDI	23847		120			...3U-3-009 506, angetriebene Aggregate: angetr. Agg.: Nockenwelle * Driven Units: Driven unit: camshaft * Périphériques entraînés: Arbre à came
1.9 TDI	23848		120			...3U-3-009 506
1.8 T	41901		150			...3U-3-033 360, wahlweise: * Alternatively: * au choix:
1.8 T	23901		150			wahlweise: * Alternatively: * au choix:
2.0	23832		138			
1.8 T	23902		150			
2.8 V6	23842		253			

SUZUKI

SUZUKI BALENO (EG) 03.95-05.02

1.9 TD	23415		136		XUD9A	
--------	-------	--	-----	--	-------	--

SUZUKI BALENO Kombi (EG) 08.96-05.02

1.9 TD	23415		136		XUD9A	
--------	-------	--	-----	--	-------	--

SUZUKI BALENO Schrägheck (EG) 03.95-05.02

1.9 TD	23415		136		XUD9A	
--------	-------	--	-----	--	-------	--

SUZUKI GRAND VITARA (FT, GT) 03.98-

2.0 HDI 110 16V	23426		141			
-----------------	-------	--	-----	--	--	--

SUZUKI JIMNY (FJ) 09.98-

1.5 DDIS 4x4	23132		123			
--------------	-------	--	-----	--	--	--

SUZUKI SAMURAI (SJ) 11.88-

1.9 TD	23415		136		XUD9A	angetriebene Aggregate: angetr. Agg.: Nockenwelle * Driven Units: Driven unit: camshaft * Périphériques entraînés: Arbre à came
--------	-------	--	-----	--	-------	---------------------------------------------------------------------------------------------------------------------------------

SUZUKI VITARA Cabrio (ET, TA) 07.88-10.02

1.9 D	23415		136		XUD9A	
-------	-------	--	-----	--	-------	--

SUZUKI VITARA (ET, TA) 07.88-12.98

1.9 D	23415		136		XUD9A	
-------	-------	--	-----	--	-------	--

TALBOT

TALBOT HORIZON 02.78-06.86



TALBOT

TALBOT HORIZON

02.78-06.86

1.9 Diesel	23405		136			
------------	-------	--	-----	--	--	--

TOYOTA

TOYOTA AVENSIS Liftback (_T22_)

09.97-02.03

1.6	23510		117			
1.8	23511		121			
2.0	23512		163			
2.0 TD	23513		177			

TOYOTA AVENSIS Station Wagon (_T22_)

09.97-02.03

1.6	23510		117			
1.8	23511		121			
2.0	23512		163			
2.0 TD	23513		177			

TOYOTA AVENSIS (_T22_)

09.97-02.03

1.6	23510		117			
1.8	23511		121			
2.0	23512		163			
2.0 TD	23513		177			

TOYOTA CAMRY Liftback (V1)

01.83-01.88

1.8 Turbo-D	23513		177			
-------------	-------	--	-----	--	--	--

TOYOTA CAMRY Station Wagon (_V10)

06.91-08.97

2.2	23512		163			
-----	-------	--	-----	--	--	--

TOYOTA CAMRY Station Wagon (_V2_)

11.86-06.91

2.0, 2.0 GLi 16V	23512		163			
2.0 Turbo-D	23513		177			

TOYOTA CAMRY Stufenheck (V1)

02.83-01.88

1.8 Turbo-D	23513		177			
-------------	-------	--	-----	--	--	--

TOYOTA CAMRY (_V1_)

06.91-09.97

2.2	23512		163			
-----	-------	--	-----	--	--	--

TOYOTA CAMRY (_V2_)

10.86-06.91

2.0, 2.0 Gli 16V	23512		163			
2.0 Turbo-D	23513		177			

TOYOTA CAMRY (_V20)

08.96-11.01

2.2	23512		163			
-----	-------	--	-----	--	--	--

TOYOTA CARINA E Sportswagon (_T19_)

01.93-09.97

1.6 GLi, 1.6 i	23510		117			
1.8 i	23511		121			
2.0 GLi, 2.0 i	23512		163			
2.0 D, 2.0 TD	23513		177			

TOYOTA CARINA E Stufenheck (_T19_)

04.92-09.97

1.6, 1.6 16V	23510		117			
1.8 i 16V	23511		121			
2.0, 2.0 i	23512		163			
2.0 D, 2.0 TD	23513		177			

TOYOTA CARINA E (_T19_)

04.92-09.97

1.6, 1.6 GLi, 1.6 16V	23510		117			
1.8	23511		121			



TOYOTA

TOYOTA CARINA E (_T19_)				04.92-09.97	
2.0 GLI, 2.0 i	23512		163		
2.0 D, 2.0 TD	23513		177		
TOYOTA CARINA II Station Wagon (_T17_)				12.87-04.92	
2.0	23512		163		
2.0 D	23513		177		
1.6	23518		94		
TOYOTA CARINA II Stufenheck (_T15_)				08.83-05.88	
2.0 D	23513		177		
1.6	23517		88		
TOYOTA CARINA II Stufenheck (_T17_)				12.87-06.93	
2.0 GLI	23512		163		
2.0 D	23513		177		
1.6	23518		94		
TOYOTA CARINA II (_T15_)				10.83-05.88	
2.0 D	23513		177		
1.6	23517		88		
TOYOTA CARINA II (_T17_)				12.87-06.93	
2.0 GLI	23512		163		
2.0 D	23513		177		
1.6	23518		94		
TOYOTA CELICA Coupe (_T18_)				10.89-03.94	
1.6 STI	23518		94		
TOYOTA CELICA Liftback (T16)				08.85-08.90	
1.6	23517		88		
TOYOTA CELICA (ST16_)				09.85-02.90	
1.6	23517		88		
TOYOTA CELICA (_T20_)				11.93-11.99	
1.8 i 16V	23511		121		
TOYOTA COROLLA Compact (_E10_)				05.92-11.99	
1.6 Si	23510		117		
2.0 D	23513		177		
TOYOTA COROLLA Compact (_E11_)				04.97-01.02	
1.6, 1.6 Aut.	23510		117		
2.0 D	23513		177		
TOYOTA COROLLA Compact (_E9_)				05.87-10.95	
1.8 D	23513		177		
1.6, 1.6 i	23518		94		
TOYOTA COROLLA (_E10_)				05.92-11.99	
1.6 Si	23510		117		
2.0 D	23513		177		
TOYOTA COROLLA (_E11_)				04.97-01.02	
1.6, 1.6 Aut.	23510		117		
2.0 D	23513		177		
TOYOTA COROLLA (_E7_)				09.79-09.85	
1.8 D	23513		177		
TOYOTA COROLLA (_E8_)				06.83-06.89	
1.8 D	23513		177		
1.3, 1.6	23517		88		



TOYOTA

TOYOTA COROLLA (_E9_)						05.87-09.94
1.8 D	23513		177			
1.6, 1.6 i	23518		94			
TOYOTA COROLLA FX Compact (E8B)						08.84-05.88
1.8 D	23513		177			
TOYOTA COROLLA Liftback (_E10_)						05.92-04.97
1.6 GLI	23510		117			
2.0 D	23513		177			
TOYOTA COROLLA Liftback (_E11_)						04.97-01.02
1.6, 1.6 Aut.	23510		117			
2.0 D	23513		177			
TOYOTA COROLLA Liftback (_E7_)						09.79-09.83
1.8 D	23513		177			
TOYOTA COROLLA Liftback (_E8_)						06.83-05.89
1.8 D	23513		177			
1.3, 1.6	23517		88			
TOYOTA COROLLA Liftback (_E9_)						07.87-10.95
1.8 D	23513		177			
1.6	23518		94			
TOYOTA COROLLA Station Wagon (_E7_)						12.79-08.87
1.8 D	23513		177			
TOYOTA COROLLA Station Wagon (_E9_)						12.87-12.92
1.8 D	23513		177			
1.6, 1.6 XLI, 1.6 XLI 4x4	23518		94			
TOYOTA COROLLA Wagon (_E10_)						07.92-04.97
1.6 Si	23510		117			
1.8 16V 4WD	23511		121			
2.0 D	23513		177			
TOYOTA COROLLA Wagon (_E11_)						04.97-01.02
1.6, 1.6 Aut.	23510		117			
1.8 AWD	23511		121			
2.0 D	23513		177			
TOYOTA CRESSIDA Station Wagon (X6K, MX62)						09.80-10.85
2.2 D	23516		130			
TOYOTA CRESSIDA Stufenheck (_X6_)						09.80-09.92
2.2 D	23516		130			
TOYOTA HIACE I Kasten (H10)						02.77-03.83
2.2 D	23516		130			01.82...
TOYOTA HIACE II Kasten (H20)						03.83-11.89
2.2 D	23516		130			
TOYOTA HIACE II Wagon (H20)						03.83-11.89
2.2 D, 2.4 D	23516		130			
TOYOTA LAND CRUISER (_J7_)						03.84-
2.4 D, 2.4 TD	23516		130			
TOYOTA LITEACE Bus (CM30_G, KM30_G)						10.85-01.92
2.0 D	23513		177			
TOYOTA LITEACE Kasten (CM3_V, KM3_V)						01.83-12.92
1.8 D, 2.0 D	23513		177			
TOYOTA PICNIC (_XM10)						05.96-12.01
2.0, 2.0 16V	23512		163			
2.2 D	23513		177			



TOYOTA

TOYOTA RAV 4 I Cabrio (SXA1_)						12.97-06.00
2.0 16V	23512		163			
TOYOTA RAV 4 I (SXA1_)						01.94-09.00
2.0 16V	23512		163			
TOYOTA TERCEL (AL2_)						10.82-01.88
1.5 4WD	23517		88			
TOYOTA TERCEL (_L1_, _L2_)						03.79-01.88
1.3	23517		88			

VAUXHALL

VAUXHALL ARENA Combi						01.97-08.01
1.9 D	23110		153			
VAUXHALL ARENA Van						01.97-08.01
1.9 D	23110		153			
VAUXHALL ASTRA Mk II Belmont						09.85-12.91
1.6 S	41722		111			ab Motornummer: 02J22350, ab Motornummer: 19307806
1.4 i	41722		111			ab Motornummer: 02J22350, ab Motornummer: 19311738
1.4 i	23722		111			ab Motornummer: 19311739
1.6 D, 1.7 D	23721		146			
VAUXHALL ASTRA Mk II CC						09.84-08.91
1.4 S, 1.6	41722		111			ab Motornummer: 02J22350, ab Motornummer: 19307806
1.4 i	41722		111			ab Motornummer: 02J22350, ab Motornummer: 19311738
1.6	23722		111			ab Motornummer: 02122350
1.4 S	23722		111			ab Motornummer: 19307806
1.4 i	23722		111			ab Motornummer: 19311739
1.6 D	23721		146			
1.7 D	23724		176			
VAUXHALL ASTRA Mk II Convertible						01.87-08.93
1.6 i	41722		111			ab Motornummer: 02J22350, ab Motornummer: 19307806
1.6 i, 1.6 i KAT	23722		111			ab Motornummer: 02122350
1.6 i, 1.6 i KAT	41722		111			ab Motornummer: 02122350
2.0 i KAT	23731		146			ab Motornummer: 14608701
2.0 i KAT	41731/1		146			ab Motornummer: 14608701
VAUXHALL ASTRA Mk II Estate						09.84-08.91
1.4 S, 1.6	41722		111			ab Motornummer: 02J22350, ab Motornummer: 19307806
1.6	23722		111			ab Motornummer: 02122350
1.4 S	23722		111			ab Motornummer: 19307806
1.6 D, 1.7 D	23721		146			
VAUXHALL ASTRA Mk III (F)						09.91-09.98
1.6 i	41722		111			ab Motornummer: 02J22350
1.6 i	23722		111			ab Motornummer: 02122350
1.8 i	23731		146			ab Motornummer: 14142839
1.8 i	41731/1		146			ab Motornummer: 14142839
1.7 D	41724		176			ab Motornummer: 14363652
2.0 i	23731		146			ab Motornummer: 14608701
2.0 i	41731/1		146			ab Motornummer: 14608701



VAUXHALL

VAUXHALL ASTRA Mk III (F)

09.91-09.98

1.4 i	23722		111			ab Motornummer: 19311739
1.4 i	41722		111			ab Motornummer: 19311739
1.4 i	41722		111			bis Motornummer: 14254439
1.7 D	23721		146			bis Motornummer: 14363650
1.4 i, 1.6 i	23722		111			
1.6 i	41722		111			
1.8 i 16V, 2.0 i 16V	23725		169			
1.4 i 16V, 1.6 i 16V	23735		169			
1.8 i 16V, 2.0 i 16V	41725		169			
1.4 i 16V, 1.6 i 16V	41735/2		169			
1.7 D, 1.7 TD	23724		176			
1.7 TD	41724		176			

VAUXHALL ASTRA Mk III (F) CC

09.91-02.98

1.4 S	41722		111			ab Motornummer: 02J22350, ab Motornummer: 19307806
1.6 i	41722		111			ab Motornummer: 02J22350
1.6 i	23722		111			ab Motornummer: 02122350
1.8 i	23731		146			ab Motornummer: 14142839
1.8 i	41731/1		146			ab Motornummer: 14142839
1.7 D	41724		176			ab Motornummer: 14363652
2.0 i	23731		146			ab Motornummer: 14608701
2.0 i	41731/1		146			ab Motornummer: 14608701
1.4 S	23722		111			ab Motornummer: 19307806.
1.4 i	23722		111			ab Motornummer: 19311739
1.4 i	41722		111			ab Motornummer: 19311739
1.4 i	41722		111			bis Motornummer: 14254439
1.7 D	23721		146			bis Motornummer: 14363650
1.4 i, 1.6 i	23722		111			
1.6 i	41722		111			
1.8 i 16V, 2.0 i 16V	23725		169			
1.4 i 16V, 1.6 i 16V	23735		169			
1.8 i 16V, 2.0 i 16V	41725		169			
1.4 i 16V, 1.6 i 16V	41735/2		169			
1.7 D, 1.7 TD	23724		176			
1.7 TD	41724		176			

VAUXHALL ASTRA Mk III (F) Convertible

03.93-03.01

2.0 i	23731		146			ab Motornummer: 14608701
2.0 i	41731/1		146			ab Motornummer: 14608701
1.4 i	41722		111			bis Motornummer: 14254439
1.4 i, 1.6 i	23722		111			



VAUXHALL

VAUXHALL ASTRA Mk III (F) Convertible

03.93-03.01

1.6 i	41722		111			
1.8 16V	23725		169			
1.4 i 16V	23735		169			
1.8 16V	41725		169			
1.4 i 16V	41735/2		169			

VAUXHALL ASTRA Mk III (F) Estate

03.91-02.98

1.4 S	41722		111			ab Motornummer: 02J22350, ab Motornummer: 19307806
1.6 i	41722		111			ab Motornummer: 02J22350
1.6 i	23722		111			ab Motornummer: 02122350
1.8 i	23731		146			ab Motornummer: 14142839
1.8 i	41731/1		146			ab Motornummer: 14142839
1.7 D	41724		176			ab Motornummer: 14363652
2.0 i	23731		146			ab Motornummer: 14608701
2.0 i	41731/1		146			ab Motornummer: 14608701
1.4 S	23722		111			ab Motornummer: 19307806.
1.4 i	23722		111			ab Motornummer: 19311739
1.4 i	41722		111			ab Motornummer: 19311739
1.4 i	41722		111			bis Motornummer: 14254439
1.7 D	23721		146			bis Motornummer: 14363650
1.4 i, 1.6 i, 1.6 Si	23722		111			
1.6 i, 1.6 Si	41722		111			
1.8 i 16V, 2.0 i 16V	23725		169			
1.4 i 16V, 1.6 i 16V	23735		169			
1.8 i 16V, 2.0 i 16V	41725		169			
1.4 i 16V, 1.6 i 16V	41735/2		169			
1.7 D, 1.7 TD	23724		176			
1.7 TD	41724		176			

VAUXHALL ASTRA Mk IV (G)

02.98-05.05

1.4 16V, 1.6 Dualfuel, 1.6 16V, 1.8 16V, 1.8 16V Dualfuel	23734		162			ab Motornummer: 02HL5118, ab Motornummer: 20041691
1.6	41722/1		111			ab Motornummer: 02MZ5254, ab Motornummer: 20U75999
1.4 16V, 1.6 16V, 1.8 16V, 1.8 16V Dualfuel	23739		162			bis Motornummer: 02HL5117, bis Motornummer: 20041690
1.4 16V, 1.6 Dualfuel, 1.6 16V	41739		162			bis Motornummer: 02HL5117, bis Motornummer: 20041690
1.8 16V, 1.8 16V Dualfuel	41739/1		162			bis Motornummer: 02HL5117, bis Motornummer: 20041690
1.6	41722		111			bis Motornummer: 02MZ5253, bis Motornummer: 20U75998
1.6	23722		111			
1.6	41722		111			
1.7 TD	23724		176			
1.7 TD	41724		176			

VAUXHALL ASTRA Mk IV (G) CC

02.98-

1.4 16V, 1.6 Dualfuel, 1.6 16V, 1.8 16V, 1.8 16V Dualfuel	23734		162			ab Motornummer: 02HL5118, ab Motornummer: 20041691
-----------------------------------------------------------	-------	--	-----	--	--	----------------------------------------------------



VAUXHALL

VAUXHALL ASTRA Mk IV (G) CC

02.98-

1.6	41722/1		111			ab Motornummer: 02MZ5254, ab Motornummer: 20U75999
1.4 16V, 1.6 16V, 1.8 16V, 1.8 16V Dualfuel	23739		162			bis Motornummer: 02HL5117, bis Motornummer: 20041690
1.4 16V, 1.6 Dualfuel, 1.6 16V	41739		162			bis Motornummer: 02HL5117, bis Motornummer: 20041690
1.8 16V, 1.8 16V Dualfuel	41739/1		162			bis Motornummer: 02HL5117, bis Motornummer: 20041690
1.6	41722		111			bis Motornummer: 02MZ5253, bis Motornummer: 20U75998
1.6	23722		111			
1.6	41722		111			
1.7 TD	23724		176			
1.7 TD	41724		176			

VAUXHALL ASTRA Mk IV (G) Convertible

03.01-

1.6 16V, 1.8 16V	23734		162			ab Motornummer: 02HL5118, ab Motornummer: 20041691
1.6 16V	41739		162			bis Motornummer: 02HL5117, bis Motornummer: 02MV7224, bis Motornummer: 20U75998, bis Motornummer: 20041690
1.6 16V, 1.8 16V	23739		162			bis Motornummer: 02HL5117, bis Motornummer: 20041690
1.8 16V	41739/1		162			bis Motornummer: 02HL5117, bis Motornummer: 20041690

VAUXHALL ASTRA Mk IV (G) Coupe

03.00-

1.8 16V, 1.8 16V Dualfuel	23734		162			ab Motornummer: 02HL5118, ab Motornummer: 20041691
1.8 16V	23739		162			bis Motornummer: 02HL5117, bis Motornummer: 20041690
1.8 16V, 1.8 16V Dualfuel	41739/1		162			bis Motornummer: 02HL5117, bis Motornummer: 20041690

VAUXHALL ASTRA Mk IV (G) Estate

02.98-05.05

1.4 16V, 1.6 Dualfuel, 1.6 16V, 1.8 16V, 1.8 16V Dualfuel	23734		162			ab Motornummer: 02HL5118, ab Motornummer: 20041691
1.6	41722/1		111			ab Motornummer: 02MZ5254, ab Motornummer: 20U75999
1.4 16V, 1.6 16V, 1.8 16V, 1.8 16V Dualfuel	23739		162			bis Motornummer: 02HL5117, bis Motornummer: 20041690
1.4 16V, 1.6 Dualfuel, 1.6 16V	41739		162			bis Motornummer: 02HL5117, bis Motornummer: 20041690
1.8 16V, 1.8 16V Dualfuel	41739/1		162			bis Motornummer: 02HL5117, bis Motornummer: 20041690
1.6	41722		111			bis Motornummer: 02MZ5253, bis Motornummer: 20U75998
1.6	23722		111			
1.6	41722		111			
1.7 TD	23724		176			
1.7 TD	41724		176			

VAUXHALL ASTRA Mk V (H) CC

01.04-05.09

1.8	23734		162			
-----	-------	--	-----	--	--	--

VAUXHALL ASTRA Mk V (H) Estate

08.04-

1.8	23734		162			
-----	-------	--	-----	--	--	--

VAUXHALL ASTRA Mk V (H) Sport Hatch

02.05-

1.8	23734		162			
-----	-------	--	-----	--	--	--

VAUXHALL ASTRAVAN Mk III (F)

01.91-08.98

1.7 D	41724		176			ab Motornummer: 14363652
1.4 i	23722		111			ab Motornummer: 19311739
1.4 i	41722		111			ab Motornummer: 19311739
1.6 i	23722		111			
1.6 i	41722		111			
1.7 D, 1.7 TD	23724		176			



VAUXHALL

VAUXHALL ASTRAVAN Mk III (F)						01.91-08.98
1.7 TD	41724		176			
VAUXHALL ASTRAVAN Mk IV (G)						08.98-
1.6 i	41722/1		111			ab Motornummer: 02MZ5254, ab Motornummer: 20U75999
1.6 i	41722		111			bis Motornummer: 02MZ5253, bis Motornummer: 20U75998
1.6 i	23722		111			
1.6 i	41722		111			
1.7 TD	23724		176			
1.7 TD	41724		176			
VAUXHALL CALIBRA						06.90-07.97
2.0 i, 2.0 i 4x4	23731		146			ab Motornummer: 14608701
2.0 i, 2.0 i 4x4	41731/1		146			ab Motornummer: 14608701
2.0 i 16V, 2.0 i 16V 4x4	23725		169			
2.0 i 16V, 2.0 i 16V 4x4	41725		169			
2.5 i V6	23733		225			
VAUXHALL CARLTON Mk III						09.86-03.94
2.0, 2.0 i	23731		146			ab Motornummer: 14608701
2.0, 2.0 i	41731/1		146			ab Motornummer: 14608701
VAUXHALL CARLTON Mk III Estate						09.86-03.94
2.0, 2.0 i	23731		146			ab Motornummer: 14608701
2.0, 2.0 i	41731/1		146			ab Motornummer: 14608701
VAUXHALL CAVALIER Mk II						09.81-08.88
1.6 D	23721		146		16DA	
VAUXHALL CAVALIER Mk II CC						09.81-08.88
1600D	23721		146		16DA	
VAUXHALL CAVALIER Mk II Estate						09.81-08.88
1.6 D	23721		146		16DA	
VAUXHALL CAVALIER Mk III CC						09.88-11.95
1.8	41731/1		146			ab Motornummer: C18NZ, ab Motornummer: 14142839
1.6, 1.6 i	41722		111			ab Motornummer: 02J22350, ab Motornummer: 19307806
1.6, 1.6 i	23722		111			ab Motornummer: 02122350
1.8	23731		146		C18NZ	ab Motornummer: 14142839
1.8 i KAT	23731		146			ab Motornummer: 14142839
1.8 i KAT	41731/1		146			ab Motornummer: 14142839
1.7 D	41724		176			ab Motornummer: 14363651
2.0 i KAT	23731		146			ab Motornummer: 14608701
2.0 i KAT	41731/1		146			ab Motornummer: 14608701
1.4 S	23722		111			ab Motornummer: 19307806
1.4 S	41722		111			ab Motornummer: 19307806
1.7 D	23721		146			bis Motornummer: 14363650
1.6 i	23722		111			
2.0 i 16V	23725		169			
2.0 i 16V	41725		169			
1.7 D	23724		176			



VAUXHALL

VAUXHALL CAVALIER Mk III CC						09.88-11.95
2.5 V6	23733		225			
VAUXHALL CAVALIER Mk III (87)						09.88-11.95
1.6, 1.6 i	41722		111			ab Motornummer: 02J22350, ab Motornummer: 19307806
1.6, 1.6 i	23722		111			ab Motornummer: 02122350
1.8	23731		146		C18NZ	ab Motornummer: 14142839
1.8	41731/1		146		C18NZ	ab Motornummer: 14142839
1.8 i KAT	23731		146			ab Motornummer: 14142839
1.8 i KAT	41731/1		146			ab Motornummer: 14142839
1.7 D	41724		176			ab Motornummer: 14363651
2.0 i KAT	23731		146			ab Motornummer: 14608701
2.0 i KAT	41731/1		146			ab Motornummer: 14608701
1.4 S	23722		111			ab Motornummer: 19307806
1.4 S	41722		111			ab Motornummer: 19307806
1.7 D	23721		146			bis Motornummer: 14363650
1.6 i	23722		111			
2.0 SRi 16V	23725		169			
2.0 SRi 16V	41725		169			
1.7 D	23724		176			
2.5 V6	23733		225			
VAUXHALL COMBO Mk I (B)						07.94-10.01
1.2, 1.4	23722		111			
1.2, 1.4	41722		111			
VAUXHALL COMBO Mk II (C)						09.01-
1.6	23722		111			
VAUXHALL CORSA Convertible						01.98-
1.4 i 16V	23735		169			
1.4 i 16V	41735/2		169			
VAUXHALL CORSA Mk II (B)						03.93-09.00
1.2i, 1.4i, 1.4i S	23722		111			
1.2i, 1.4i, 1.4i S	41722		111			
1.4 i 16V, 1.6 GSI 16V, 1.6 i 16V	23735		169			
1.4 i 16V, 1.6 GSI 16V, 1.6 i 16V	41735/2		169			
VAUXHALL CORSA Mk III (C)						08.00-09.06
1.4 16V, 1.8 16V	23734		162			
VAUXHALL CORSAVAN Mk II (B)						01.94-09.00
1.4 i	23722		111			
1.4 i	41722		111			
VAUXHALL FRONTERA Mk I (A)						03.92-10.98
2.2 i	23738		171			
VAUXHALL FRONTERA Mk I (A) Sport						03.92-10.98
2.0 i	41731/1		146		X20SE	ab Motornummer: 14608701
2.0 i	23731		146			
VAUXHALL FRONTERA Mk II (B)						10.98-10.04
2.2 i	23738		171			
VAUXHALL MERIVA Mk I (A)						01.03-06.10



VAUXHALL

VAUXHALL MERIVA Mk I (A)						01.03-06.10
1.6 i	23722		111		Z16SE	
1.6 i	41722/1		111		Z16SE	
1.6 i 16V, 1.8 i 16V	23734		162			
VAUXHALL MOVANO Mk I (A) Chassis/Cab (ED, UD, HD)						10.98-
2.8 DTI	23028		154			01.99.... angetriebene Aggregate: angetr. Agg.: Nockenwelle * Driven Units: Driven unit: camshaft * Périphériques entraînés: Arbre à came
VAUXHALL MOVANO Mk I (A) Combi (JD)						10.98-
2.8 DTI	23028		154			01.99.... angetriebene Aggregate: angetr. Agg.: Nockenwelle * Driven Units: Driven unit: camshaft * Périphériques entraînés: Arbre à came
VAUXHALL MOVANO Mk I (A) Van (FD)						10.98-
2.8 TDI	23028		154			01.99.... angetriebene Aggregate: angetr. Agg.: Nockenwelle * Driven Units: Driven unit: camshaft * Périphériques entraînés: Arbre à came
VAUXHALL NOVA						09.82-02.93
1.4 S	23722		111			ab Motornummer: 19307806
1.4 S	41722		111			ab Motornummer: 19307806
VAUXHALL NOVA CC						05.83-03.93
1.6 GSI	23722		111			ab Motornummer: 02J22350
1.6 GSI, 1.6 GSI KAT	41722		111			ab Motornummer: 02J22350
1.4 i S	23722		111			ab Motornummer: 02I22350
1.4 i S	41722		111			ab Motornummer: 02I22350
1.4 S	23722		111			ab Motornummer: 19307806
1.4 S	41722		111			ab Motornummer: 19307806
1.4 i	23722		111			ab Motornummer: 19311739
1.4 i	41722		111			ab Motornummer: 19311739
1.2 i KAT, 1.6 GSI KAT	23722		111			
1.2 i KAT	41722		111			
VAUXHALL OMEGA (B)						12.93-03.04
2.5 V6, 3.0 V6	23733		225			bis Motornummer: 08300418
2.0	23731		146			
2.0	41731/1		146			
2.0 16V	23725		169			
2.0 16V	41725		169			
2.2 16V	23738		171			
VAUXHALL OMEGA (B) Estate						12.93-03.04
2.5 V6, 3.0 V6	23733		225			bis Motornummer: 08300418
2.0	23731		146			
2.0	41731/1		146			
2.0 16V	23725		169			
2.0 16V	41725		169			
2.2 16V	23738		171			
VAUXHALL SIGNUM						04.02-05.08
1.8	23734		162			
VAUXHALL SINTRA						09.96-04.99
3.0 i 24V	23733		225			bis Motornummer: 08300000
2.2 i 16 V	23738		171			
VAUXHALL TIGRA Mk I						07.94-12.00
1.4 16V, 1.6 16V	23735		169			



VAUXHALL

VAUXHALL TIGRA Mk I						07.94-12.00
1.4 16V, 1.6 16V	41735/2		169			
VAUXHALL TIGRA TwinTop						06.04-
1.8	23734		162			
VAUXHALL VECTRA (B)						08.95-03.02
1.6 i 16V	41735		169			ab Motornummer: 02MZ5254, ab Motornummer: 20U75999
1.6 i 16V	41735/2		169			bis Motornummer: 02MZ5253, bis Motornummer: 20U75998
2.5 i GSi, 2.5 i V6	23733		225			bis Motornummer: 08300418
1.6 i	23722		111			
1.6 i	41722		111			
1.8 i 16V	23735		169		X18XE1	
1.8 i 16V	41735/1		169		X18XE1	
1.8 i 16V	23725		169		X18XE	
1.8 i 16V	41725		169		X18XE	
2.0 i 16V	23725		169			
1.6 i 16V, 1.8 i 16V	23735		169			
2.0 i 16V	41725		169			
1.8 i 16V	41735/1		169			
VAUXHALL VECTRA (B) CC						08.95-10.01
1.6 i 16V	41735		169			ab Motornummer: 02MZ5254, ab Motornummer: 20U75999
1.6 i 16V	41735/2		169			bis Motornummer: 02MZ5253, bis Motornummer: 20U75998
2.5 i GSi, 2.5 i V6	23733		225			bis Motornummer: 08300418
1.6 i	23722		111			
1.6 i	41722		111			
1.8 i 16V	23735		169		X18XE1	
1.8 i 16V	41735/1		169		X18XE1	
1.8 i 16V	23725		169		X18XE	
1.8 i 16V	41725		169		X18XE	
2.0 i 16V	23725		169			
1.6 i 16V, 1.8 i 16V	23735		169			
2.0 i 16V	41725		169			
1.8 i 16V	41735/1		169			
VAUXHALL VECTRA (B) Estate						08.95-03.02
1.6 i 16V	41735		169			ab Motornummer: 02MZ5254, ab Motornummer: 20U75999
1.6 i 16V	41735/2		169			bis Motornummer: 02MZ5253, bis Motornummer: 20U75998
2.5 i GSi, 2.5 i V6	23733		225			bis Motornummer: 08300418
1.6 i	23722		111			
1.6 i	41722		111			
1.8 i 16V	23735		169		X18XE1	
1.8 i 16V	41735/1		169		X18XE1	
1.8 i 16V	23725		169		X18XE	
1.8 i 16V	41725		169		X18XE	



VAUXHALL

VAUXHALL VECTRA (B) Estate						08.95-03.02
2.0 i 16V	23725		169			
1.6 i 16V, 1.8 i 16V	23735		169			
2.0 i 16V	41725		169			
1.8 i 16V	41735/1		169			
VAUXHALL VECTRA Mk II (C)						01.00-10.08
1.6 16V, 1.8 16V, 1.8 16V Dualfuel	23734		162			
VAUXHALL VECTRA Mk II (C) Estate						10.03-07.08
1.6 16V, 1.8 16V	23734		162			
VAUXHALL VECTRA Mk II (C) GTS						08.02-07.08
1.6 16V, 1.8 16V, 1.8 16V Dualfuel	23734		162			
VAUXHALL ZAFIRA Mk I (A)						11.98-08.05
1.8 16V	23734		162			ab Motornummer: 02HL5118, ab Motornummer: 20041691
1.6 16V	23734		162			ab Motornummer: 02H5118, ab Motornummer: 20041691
1.6 16V, 1.8 16V	23739		162			bis Motornummer: 02HL5117, bis Motornummer: 20041690
1.6 16V	41739		162			bis Motornummer: 02HL5117, bis Motornummer: 20041690
1.8 16V	41739/1		162			bis Motornummer: 02HL5117, bis Motornummer: 20041690
1.6 CNG	23734		162		Z16YNG	
VOLVO						
VOLVO C70 I Cabriolet						03.98-10.05
2.0, 2.0 T, 2.3 T-5, 2.5, 2.5 T	23123		142			ab Motornummer: 1266128
2.0, 2.0 T, 2.3 T-5, 2.5, 2.5 T	41123		142			ab Motornummer: 1266128
2.0, 2.0 T, 2.3 T-5, 2.5, 2.5 T	23928		148			bis Motornummer: 1266127
2.0, 2.0 T, 2.3 T-5, 2.5, 2.5 T	41928		148			bis Motornummer: 1266127
2.3 T5	23123		142		B5234T9	
2.0 T, 2.4 T	23123		142			
2.0 T, 2.3 T5, 2.4 T	41123		142			
VOLVO C70 I Coupe						03.97-09.02
2.0, 2.0 T, 2.3 T-5, 2.5, 2.5 T	23123		142			ab Motornummer: 1266128
2.0, 2.0 T, 2.3 T-5, 2.5, 2.5 T	41123		142			ab Motornummer: 1266128
2.0, 2.0 T, 2.3 T-5, 2.5, 2.5 T	23928		148			bis Motornummer: 1266127
2.0, 2.0 T, 2.3 T-5, 2.5, 2.5 T	41928		148			bis Motornummer: 1266127
2.0 T	23123		142		B5204T4	
2.0 T	41123		142			
VOLVO S40 I (VS)						07.95-12.03
1.6, 1.8, 1.9 T4, 2.0, 2.0 T	23123		142			ab Motornummer: 1219111
1.6, 1.8, 1.9 T4, 2.0, 2.0 T	41123		142			ab Motornummer: 1219111
1.6, 1.8, 1.9 T4, 2.0, 2.0 T	23928		148			bis Motornummer: 1219110
1.6, 1.8, 1.9 T4, 2.0, 2.0 T	41928		148			bis Motornummer: 1219110
1.6, 1.8, 2.0 T	23123		142			
1.6, 1.8, 2.0 T	41123		142			
1.9 TD	23110		153			
VOLVO S40 II (MS)						01.04-
1.6	23629		117			...115 002



VOLVO

VOLVO S40 II (MS)							01.04-
1.6	41629		117			...115002	
VOLVO S60							07.00-
2.0 T	23123		142		B5204T5	bis Motornummer: 3188688	
2.0 T	41123		142		B5204T5	bis Motornummer: 3188688	
R 2,5 T AWD, T5, 2.3 T5, 2.4, 2.4 AWD, 2.4 Bifuel, 2.4 T, 2.4 T AWD, 2.4 T5, 2.5 T, 2.5 T AWD	23123		142			bis Motornummer: 3188688	
R 2,5 T AWD, T5, 2.3 T5, 2.4, 2.4 AWD, 2.4 Bifuel, 2.4 T, 2.4 T AWD, 2.4 T5, 2.5 T, 2.5 T AWD	41123		142			bis Motornummer: 3188688	
VOLVO S70 (P80_)							11.96-11.00
2.5 TDI	23835		81			angetriebene Aggregate: angetr. Agg.: Einspritzpumpe * Driven Units: Driven unit: injection pump * Périphériques entraînés: Pompe d'injection	
2.4 AWD	23929		144			...1266127	
2.5	23123		142		B5254S	ab Motornummer: 1266128	
2.5	41123		142		B5254S	ab Motornummer: 1266128	
2.0, 2.0 Turbo, 2.3 AWD, 2.3 Turbo, 2.3 T-5, 2.3 T5 AWD, 2.4, 2.4 Turbo, 2.4 T5 AWD	23123		142			ab Motornummer: 1266128	
2.0, 2.0 Turbo, 2.3 T-5, 2.4, 2.4 Turbo, 2.4 T5 AWD	41123		142			ab Motornummer: 1266128	
2.0, 2.5, 2.5 Bifuel	23929		144			bis Motornummer: 1266127	
2.5	23928		148		B5254S	bis Motornummer: 1266127	
2.5	41928		148		B5254S	bis Motornummer: 1266127	
2.0, 2.0 Turbo, 2.3 AWD, 2.3 Turbo, 2.3 T-5, 2.3 T5 AWD, 2.4, 2.4 Turbo, 2.4 T5 AWD	23928		148			bis Motornummer: 1266127	
2.0, 2.0 Turbo, 2.3 T-5, 2.4, 2.4 Turbo, 2.4 T5 AWD	41928		148			bis Motornummer: 1266127	
2.5 TDI	23819		122				
2.5 TDI	23839		122				
2.5 TDI	41819/1		122				
2.5 TDI	41839/1		122				
2.4, 2.5 Bifuel	23123		142				
2.4, 2.5 Bifuel	41123		142				
2.3 T5 AWD, 2.3 T5 R AWD	23928		148				
VOLVO S80 (TS, XY)							05.98-07.06
2.5 TDI	23835		81			angetriebene Aggregate: angetr. Agg.: Einspritzpumpe * Driven Units: Driven unit: injection pump * Périphériques entraînés: Pompe d'injection	
2.0, 2.0 T, 2.3 R, 2.4, 2.4 Bifuel, 2.4 LTP, 2.4 T, 2.4 T5 AWD, 2.5 T, 2.5 T AWD	23123		142			bis Motornummer: 3188688	
2.0, 2.0 T, 2.3 R, 2.4, 2.4 Bifuel, 2.4 LTP, 2.4 T, 2.4 T5 AWD, 2.5 T, 2.5 T AWD	41123		142			bis Motornummer: 3188688	
2.5 TDI	23819		122				
2.5 TDI	23839		122				
2.5 TDI	41819/1		122				
2.5 TDI	41839/1		122				
VOLVO V40 Kombi (VW)							07.95-06.04
1.6, 1.8, 1.9 T4, 2.0, 2.0 T	23123		142			ab Motornummer: 1219111	
1.6, 1.8, 1.9 T4, 2.0, 2.0 T	41123		142			ab Motornummer: 1219111	
1.9 TD	23110		153			ab Motornummer: 20 559	
1.6, 1.8, 1.9 T4, 2.0, 2.0 T	23928		148			bis Motornummer: 1219110	
1.6, 1.8, 1.9 T4, 2.0, 2.0 T	41928		148			bis Motornummer: 1219110	
1.6, 1.8, 1.8 Bi-Fuel, 2.0 T	23123		142				



VOLVO

VOLVO V40 Kombi (VW)						07.95-06.04
1.6, 1.8, 1.8 Bi-Fuel, 2.0 T	41123		142			
VOLVO V50 (MW)						04.04-
1.6	23629		117			...115 449
1.6	41629		117			...115449
VOLVO V70 I Kombi (P80_)						11.96-05.00
2.5 TDI	23835		81			angetriebene Aggregate: angetr. Agg.: Einspritzpumpe * Driven Units: Driven unit: injection pump * Périphériques entraînés: Pompe d'injection
2.4 AWD	23929		144			...1266127
2.5	23123		142	B5254S		ab Motornummer: 1266128
2.5	41123		142	B5254S		ab Motornummer: 1266128
2.0, 2.0 Turbo, 2.0 Turbo AWD, 2.3 AWD, 2.3 T AWD, 2.3 Turbo, 2.3 T-5, 2.3 T-5 AWD, 2.4, 2.4 Turbo, 2.5 Turbo AWD	23123		142			ab Motornummer: 1266128
2.0, 2.0 Turbo, 2.0 Turbo AWD, 2.3 T-5, 2.3 T-5 AWD, 2.4, 2.4 Turbo, 2.5 Turbo AWD	41123		142			ab Motornummer: 1266128
2.0, 2.5, 2.5 Bifuel	23929		144			bis Motornummer: 1266127
2.5	23928		148	B5254S		bis Motornummer: 1266127
2.5	41928		148	B5254S		bis Motornummer: 1266127
2.0, 2.0 Turbo, 2.0 Turbo AWD, 2.3 AWD, 2.3 T AWD, 2.3 Turbo, 2.3 T-5, 2.3 T-5 AWD, 2.4, 2.4 Turbo, 2.5 Turbo AWD	23928		148			bis Motornummer: 1266127
2.0, 2.0 Turbo, 2.0 Turbo AWD, 2.3 T AWD, 2.3 T-5, 2.3 T-5 AWD, 2.4, 2.4 Turbo, 2.5 Turbo AWD	41928		148			bis Motornummer: 1266127
2.5 TDI	23819		122			
2.5 TDI	23839		122			
2.5 TDI	41819/1		122			
2.5 TDI	41839/1		122			
2.4, 2.4 Bifuel	23123		142			
2.4, 2.4 Bifuel	41123		142			
VOLVO V70 II Kombi (P80_)						03.00-
2.5 TDI	23835		81			angetriebene Aggregate: angetr. Agg.: Einspritzpumpe * Driven Units: Driven unit: injection pump * Périphériques entraînés: Pompe d'injection
2.0 T	23123		142	B5204T5		bis Motornummer: 3188688
R 2,5 T AWD, 2.3, 2.3 AWD, 2.3 T5, 2.4, 2.4 Bifuel, 2.4 T, 2.4 T AWD, 2.4 T5, 2.5 R Sport, 2.5 T, 2.5 T AWD	23123		142			bis Motornummer: 3188688
R 2,5 T AWD, 2.0 T, 2.3 T5, 2.4, 2.4 Bifuel, 2.4 T, 2.4 T AWD, 2.4 T5, 2.5 R Sport, 2.5 T, 2.5 T AWD	41123		142			bis Motornummer: 3188688
2.5 TDI	23819		122			
2.5 TDI	23839		122			
2.5 TDI	41819/1		122			
2.5 TDI	41839/1		122			
VOLVO XC 90						10.02-
2.5 T	23123		142			bis Motornummer: 3188688
2.5 T	41123		142			bis Motornummer: 3188688
VOLVO XC70 CROSS COUNTRY						03.00-
2.4 T XC AWD, 2.5 T XC AWD	23123		142			bis Motornummer: 3188688
2.4 T XC AWD, 2.5 T XC AWD	41123		142			bis Motornummer: 3188688
VOLVO 240 Kombi (P245)						08.74-08.93
2.3 iKAT	23926		123			01.93...
2.3 iKAT	23925		123			...12.92



VOLVO

VOLVO 240 Kombi (P245)						08.74-08.93
2.0, 2.1, 2.1 Turbo, 2.3	23925		123			
VOLVO 240 (P242, P244)						08.74-12.93
2.3 i KAT	23926		123			01.93...
2.3 i KAT	23925		123			...12.92
2.0, 2.1, 2.1 Turbo, 2.3	23925		123			
VOLVO 340-360 Stufenheck (344)						08.79-07.91
1.6 Diesel	23110		153			ab Motornummer: 32768
1.7	23108		125			ab Motornummer: 51892
2.0	23925		123			
VOLVO 340-360 (343, 345)						08.75-07.91
1.6 Diesel	23110		153			ab Motornummer: 32768
1.7	23108		125			ab Motornummer: 51892
1.4, 2.0, 2.1	23925		123			
VOLVO 440 K (445)						08.88-12.96
1.7	23108		125			ab Motornummer: 01726
1.6, 1.7, 1.7 Turbo, 1.8	23108		125			
1.9 Turbo-Diesel	23110		153			
VOLVO 460 L (464)						09.88-07.96
1.7, 1.7 Turbo, 1.8	23108		125			
1.9 Turbo-Diesel	23110		153			
VOLVO 480 E						04.86-07.96
1.7 Turbo	23108		125			ab Motornummer: 01456
1.7	23108		125			ab Motornummer: 16530
1.7	23108		125		01726	
1.7	23108		125			
VOLVO 740 Kombi (745)						08.84-08.92
2.0, 2.3, 2.3 Turbo	23925		123			
VOLVO 740 (744)						04.83-08.92
2.3, 2.3 Turbo	23925		123			
VOLVO 760 (704, 764)						08.81-07.92
2.3 Turbo	23925		123			
VOLVO 850 Kombi (LW)						04.92-10.97
2.5 TDI	23835		81			angetriebene Aggregate: angetr. Agg.: Einspritzpumpe * Driven Units: Driven unit: injection pump * Périphériques entraînés: Pompe d'injection
2.0, 2.5	23929		144			ab Motornummer: 131035
2.0 Turbo	41928		148		B 5204 FT	ab Motornummer: 131035
2.0, 2.0 Turbo, 2.3 T5, 2.3 T5-R, 2.5, 2.5 AWD	23928		148			ab Motornummer: 131 035
2.0, 2.3 T5, 2.3 T5-R, 2.5	41928		148			ab Motornummer: 131035
2.5 TDI	23819		122			
2.5 TDI	23839		122			
2.5 TDI	41819/1		122			
2.5 TDI	41839/1		122			
VOLVO 850 (LS)						06.91-10.97
2.5 TDI	23835		81			angetriebene Aggregate: angetr. Agg.: Einspritzpumpe * Driven Units: Driven unit: injection pump * Périphériques entraînés: Pompe d'injection
2.0, 2.5	23929		144			ab Motornummer: 131035



VOLVO

VOLVO 850 (LS)							06.91-10.97
2.0 Turbo	41928		148		B 5204 FT	ab Motornummer: 131035	
2.0, 2.0 Turbo, 2.3 T5, 2.3 T5-R, 2.5	23928		148			ab Motornummer: 131 035	
2.0, 2.3 T5, 2.3 T5-R, 2.5	41928		148			ab Motornummer: 131035	
2.5 TDI	23819		122				
2.5 TDI	23839		122				
2.5 TDI	41819/1		122				
2.5 TDI	41839/1		122				
VOLVO 940 II Kombi (945)							08.94-10.98
2.3, 2.3 ti	23925		123				
2.3, 2.3 Turbo	23926		123				
VOLVO 940 II (944)							08.94-10.98
2.3, 2.3 ti	23925		123				
2.3, 2.3 Turbo	23926		123				
VOLVO 940 Kombi (945)							08.90-10.95
2.0, 2.3, 2.3 Turbo	23926		123			01.93...	
2.0, 2.3, 2.3 Turbo	23925		123			...12.92	
VOLVO 940 (944)							08.90-12.94
2.0, 2.0 Turbo, 2.3, 2.3 Turbo	23926		123			01.93...	
2.0, 2.0 Turbo, 2.3, 2.3 Turbo	23925		123			...12.92	
VW							
VW BORA Kombi (1J6)							05.99-05.05
1.9 TDI, 1.9 TDI 4motion	41848		120		ATD	...07.02	
1.9 TDI, 1.9 TDI 4motion	41848		120			...07.02	
1.9 TDI, 1.9 TDI 4motion	23847		120			...12.02, angetriebene Aggregate: angetr. Agg.: Nockenwelle * Driven Units: Driven unit: camshaft * Périphériques entraînés: Arbre à came	
1.9 TDI, 1.9 TDI 4motion	23848		120			...12.02	
1.8 4motion, 1.8 T	23829		150			1J-Y-850 001..., wahlweise: * Alternatively: * au choix:	
1.8 4motion, 1.8 T	23830		150			1J-Y-850 001..., wahlweise: * Alternatively: * au choix:	
1.8 4motion, 1.8 T	23831		150			1J-Y-850 001...	
1.8 4motion, 1.8 T	23912		150			...1J-Y-850 000	
1.8 4motion, 1.8 T	23913		150			...1J-Y-850 000	
1.8 4motion, 1.8 T	41912		150			...1J-Y-850 000	
1.4 16V	23838		130	58	BCA	ab Motornummer: 160 001, ab Motornummer: 242 001	
1.4 16V	41838		130	58	BCA	ab Motornummer: 160 001, ab Motornummer: 242 001	
1.9 TDI, 1.9 TDI 4motion	23847		120		AUY	ab Motornummer: 185 671, angetriebene Aggregate: angetr. Agg.: Nockenwelle * Driven Units: Driven unit: camshaft * Périphériques entraînés: Arbre à came	
1.9 TDI, 1.9 TDI 4motion	23848		120		AUY	ab Motornummer: 185 671	
1.9 TDI, 1.9 TDI 4motion	41848		120		AJM	ab Motornummer: 185 671	
1.9 TDI, 1.9 TDI 4motion	23847		120		AXR	bis Motornummer: 010 000, angetriebene Aggregate: angetr. Agg.: Nockenwelle * Driven Units: Driven unit: camshaft * Périphériques entraînés: Arbre à came	
1.9 TDI, 1.9 TDI 4motion	23848		120		AXR	bis Motornummer: 010 000	
1.4 16V	23838/1		130	58	AKQ	bis Motornummer: 160 000, bis Motornummer: 242 000, 2 Riemen: * 2 Belts: * 2 courroies:	



VW

VW BORA Kombi (1J6)

05.99-05.05

1.8 T	23829		150			wahlweise: * Alternatively: * au choix:
1.8 T	23830		150			wahlweise: * Alternatively: * au choix:
1.6 FSI, 1.6 16V	23838		130	58		
1.6 FSI, 1.6 16V	41838/2		130	58		
1.6	41832		138		AVU	
1.6, 2.0, 2.0 4motion	23832		138			
1.6	41832		138			
1.9 TDI	23844		141			
1.9 TDI	41844		141			
1.8 T	23831		150			

VW BORA (1J2)

10.98-09.05

1.9 TDI, 1.9 TDI 4motion	41848		120		ATD	...07.02, ...1J-2D352 773, ...1J-2-592 782, angetriebene Aggregate: angetr. Agg.: Wasserpumpe * Driven Units: Driven unit: water pump * Périphériques entraînés: Pompe à eau, angetriebene Aggregate: angetr. Agg.: Nockenwelle * Driven Units: Driven unit: camshaft * Périphériques entraînés: Arbre à came
1.9 TDI, 1.9 TDI 4motion	41848		120			...07.02
1.9 TDI	23847		120		ATD	...12.02, angetriebene Aggregate: angetr. Agg.: Nockenwelle * Driven Units: Driven unit: camshaft * Périphériques entraînés: Arbre à came
1.9 TDI, 1.9 TDI 4motion	23847		120			...12.02, angetriebene Aggregate: angetr. Agg.: Nockenwelle * Driven Units: Driven unit: camshaft * Périphériques entraînés: Arbre à came
1.9 TDI, 1.9 TDI 4motion	23848		120			...12.02
1.8, 1.8 4motion, 1.8 T	23829		150			1J-Y-850 001..., wahlweise: * Alternatively: * au choix:
1.8, 1.8 4motion, 1.8 T	23830		150			1J-Y-850 001..., wahlweise: * Alternatively: * au choix:
1.8, 1.8 4motion, 1.8 T	23831		150			1J-Y-850 001...
1.8, 1.8 4motion, 1.8 T	23912		150			...1J-Y-850 000
1.8, 1.8 4motion, 1.8 T	23913		150			...1J-Y-850 000
1.8, 1.8 4motion, 1.8 T	41912		150			...1J-Y-850 000
1.9 SDI	23844		141		AQM	ab Motornummer: 030 000, ab Motornummer: 400 001
1.9 SDI	41844		141		AQM	ab Motornummer: 030 001, ab Motornummer: 400 001
1.4 16V	23838		130	58	BCA	ab Motornummer: 160 001, ab Motornummer: 242 001
1.4 16V	41838		130	58	BCA	ab Motornummer: 160 001, ab Motornummer: 242 001
1.9 TDI, 1.9 TDI 4motion	23847		120		AUY	ab Motornummer: 185 671, angetriebene Aggregate: angetr. Agg.: Nockenwelle * Driven Units: Driven unit: camshaft * Périphériques entraînés: Arbre à came
1.9 TDI, 1.9 TDI 4motion	23848		120		AUY	ab Motornummer: 185 671
1.9 TDI, 1.9 TDI 4motion	41848		120		AJM	ab Motornummer: 185 671
1.9 TDI 4motion	23847		120		AXR	bis Motornummer: 010 000, angetriebene Aggregate: angetr. Agg.: Nockenwelle * Driven Units: Driven unit: camshaft * Périphériques entraînés: Arbre à came
1.9 TDI, 1.9 TDI 4motion	23848		120		AXR	bis Motornummer: 010 000
1.9 SDI	23845		141		AQM	bis Motornummer: 030 000, bis Motornummer: 400 000
1.4 16V	23838/1		130	58	AKQ	bis Motornummer: 160 000, bis Motornummer: 242 000, 2 Riemen: * 2 Belts: * 2 courroies:
1.8 T	23829		150			wahlweise: * Alternatively: * au choix:
1.8 T	23830		150			wahlweise: * Alternatively: * au choix:
1.6 FSI, 1.6 16V	23838		130	58		



VW

VW BORA (1J2)

10.98-09.05

1.6 FSI, 1.6 16V	41838/2		130	58		
1.6	41832		138		AVU	
1.6, 2.0, 2.0 4motion	23832		138			
1.6	41832		138			
1.9 TDI, 1.9 TDI 4motion	23844		141			
1.9 TDI, 1.9 TDI 4motion	41844		141			
1.8 T	23831		150			

VW CADDY I (14)

08.82-07.92

1.5, 1.6, 1.8	23801		121			angetriebene Aggregate: angetr. Agg.: Nockenwelle * Driven Units: Driven unit: camshaft * Périphériques entraînés: Arbre à came
---------------	-------	--	-----	--	--	------------------------------------------------------------------------------------------------------------------------------------

VW CADDY II Kasten (9K9A)

11.95-01.04

1.4	23838		130	58		
1.4	41838		130	58		
60 1.4	23823		135		AEX,AK V,APQ	
60 1.4	41823		135		APQ	
1.9 SDI	73808		137		AEY	
1.9 TDI	23820		137		1Z,AHU, ALE	
1.9 D	23820		137			
1.9 SDI, 1.9 TDI	23821		137			
75 1.6	23824		137			
1.7 SDI	73808		137			
75 1.6	41824		137			
1.9 TDI	23844		141		ALH	
1.9 TDI	41844		141		ALH	
1.9 SDI	23844		141		AYQ	
1.9 SDI	41844		141		AYQ	

VW CADDY II Kombi (9K9B)

11.95-01.04

1.4 16V	23838		130	58		
1.4 16V	41838		130	58		
1.4	23823		135		AEX,AK V,APQ	
1.4	41823		135		APQ	
1.9 SDI	73808		137		AEY	
1.9 TDI	23820		137		1Z,AHU, ALE	
1.9 TDI	23821		137		1Z,AHU, ALE	
1.9 D	23820		137			
1.6	23824		137			
1.7 SDI	73808		137			
1.6	41824		137			
1.9 TDI	23844		141		ALH	
1.9 TDI	41844		141		ALH	



VW

VW CADDY II Kombi (9K9B)							11.95-01.04
1.9 SDI	23844		141		AYQ		
1.9 SDI	41844		141		AYQ		
VW CADDY II Pick-up (9U7)							06.96-12.00
1.6	23824		137				
1.9 D	23837		137				
1.6	41824		137				
VW CADDY III Kasten (2KA, 2KH, 2CA, 2CH)							03.04-
1.4 16V	23841		130			2K-7-000 001...	
1.4 16V	23838		130	58		...2K-6-150 000	
1.4	23838		130	58			
1.4	41838		130	58			
1.6	23832		138		BGU		
1.6	41832		138		BGU		
VW CADDY III Kombi (2KB, 2KJ)							03.04-
1.4 16V	23841		130			2K-7-000 001...	
1.4 16V	23838		130	58		...2K-6-150 000	
1.4	23838		130	58			
1.4	41838		130	58			
1.6	23832		138		BGU		
1.6	41832		138		BGU		
VW CORRADO (53I)							08.87-12.95
1.8 G60	23801		121			angetriebene Aggregate: angetr. Agg.: Nockenwelle * Driven Units: Driven unit: camshaft * Périphériques entraînés: Arbre à came	
2.0 i	23802		124				
1.8 16V, 2.0 i 16V	23808		147				
VW CRAFTER 30-35 Bus (2E_)							04.06-
2.5 TDI	23818		141				
VW CRAFTER 30-50 Kasten (2E_)							04.06-
2.5 TDI	23818		141				
VW CRAFTER 30-50 Pritsche/Fahrgestell (2F_)							04.06-
2.5 TDI	23818		141				
VW DERBY (86C, 80)							08.81-12.84
1.0, 1.1, 1.3	41850		108			angetriebene Aggregate: angetr. Agg.: Nockenwelle * Driven Units: Driven unit: camshaft * Périphériques entraînés: Arbre à came	
1.3	41850		108			08.83..., angetriebene Aggregate: angetr. Agg.: Nockenwelle * Driven Units: Driven unit: camshaft * Périphériques entraînés: Arbre à came	
1.0	41850		108			bis Motornummer: HZ 786022, angetriebene Aggregate: angetr. Agg.: Nockenwelle * Driven Units: Driven unit: camshaft * Périphériques entraînés: Arbre à came	
VW GOLF I Cabriolet (155)							01.79-08.93
1.3	41850		108			angetriebene Aggregate: angetr. Agg.: Nockenwelle * Driven Units: Driven unit: camshaft * Périphériques entraînés: Arbre à came	
1.6, 1.8	23801		121			angetriebene Aggregate: angetr. Agg.: Nockenwelle * Driven Units: Driven unit: camshaft * Périphériques entraînés: Arbre à came	
1.5, 1.6	23801		121				
VW GOLF I (17)							04.74-12.85
1.1, 1.3	41850		108			angetriebene Aggregate: angetr. Agg.: Nockenwelle * Driven Units: Driven unit: camshaft * Périphériques entraînés: Arbre à came	
1.6 GTI, 1.8 GTI	23801		121				
1.5 D, 1.6 D, 1.6 TD	23804		135				
VW GOLF II (19E, 1G1)							08.83-12.92
1.0, 1.3	41850		108			angetriebene Aggregate: angetr. Agg.: Nockenwelle * Driven Units: Driven unit: camshaft * Périphériques entraînés: Arbre à came	



VW

VW GOLF II (19E, 1G1)

08.83-12.92

1.6, 1.8, 1.8 Syncro, 1.8 GTI G60, 1.8 GTI G60 Syncro, 1.8 i KAT	23801		121			angetriebene Aggregate: angetr. Agg.: Nockenwelle * Driven Units: Driven unit: camshaft * Périphériques entraînés: Arbre à came
1.8 GTI KAT	23801		121			01.89..., angetriebene Aggregate: angetr. Agg.: Nockenwelle * Driven Units: Driven unit: camshaft * Périphériques entraînés: Arbre à came
1.3 KAT	41850		108		NZ	...10.90, bis Motornummer: NZ 200 000, angetriebene Aggregate: angetr. Agg.: Nockenwelle * Driven Units: Driven unit: camshaft * Périphériques entraînés: Arbre à came
1.6	23801		121			...12.91, angetriebene Aggregate: angetr. Agg.: Nockenwelle * Driven Units: Driven unit: camshaft * Périphériques entraînés: Arbre à came
1.0	41850		108			bis Motornummer: HZ 786022, angetriebene Aggregate: angetr. Agg.: Nockenwelle * Driven Units: Driven unit: camshaft * Périphériques entraînés: Arbre à came
1.3	41850		108		NZ	bis Motornummer: NZ 200 000, angetriebene Aggregate: angetr. Agg.: Nockenwelle * Driven Units: Driven unit: camshaft * Périphériques entraînés: Arbre à came
1.8 i Syncro KAT	23801		121			
1.6 D, 1.6 TD	23804		135			
1.8 GTI 16V	23808		147			

VW GOLF III Cabriolet (1E7)

07.93-05.98

1.9 TDI	23820		137		1Z	ab Motornummer: 289 576
1.9 TDI	23815		137		1Z	bis Motornummer: 289 575
1.9 TDI	23821		137		1Z	bis Motornummer: 289576
1.6, 1.8	23803		121			
2.0	23802		124			
1.9 TDI	23820		137			
1.9 TDI	23821		137			

VW GOLF III Variant (1H5)

07.93-04.99

1.9 TDI	23820		137		1Z	ab Motornummer: 289 576
1.9 TDI	23821		137		1Z	ab Motornummer: 289576
1.9 TDI Syncro	23820		137		1Z	ab Motornummer: 289 576
1.9 TDI Syncro	23821		137		1Z	ab Motornummer: 289576
1.9 D	23820		137			ab Motornummer: 378 365
1.9 D	23821		137			ab Motornummer: 378365
1.9 TD	23820		137			ab Motornummer: 552 766
1.9 TDI, 1.9 TDI Syncro	23815		137		1Z	bis Motornummer: 289 575
1.9 D	23812		137			bis Motornummer: 378364
1.9 TD	23812		137			bis Motornummer: 552765
1.6, 1.8, 1.8 Syncro	23803		121			
2.0, 2.0 Syncro	23802		124			
1.4	23823		135		AEX,AP Q	
1.4	41823		135		APQ	
1.6	23824		137		AEA,AE E	
1.6	41824		137		AEE	
1.9 TDI	23820		137			
1.9 SDI, 1.9 TDI	23821		137			

VW GOLF III (1H1)

08.91-09.97

--	--	--	--	--	--	--



VW

VW GOLF III (1H1)

08.91-09.97

1.9 TDI, 1.9 TDI Syncro	23820		137		1Z	ab Motornummer: 289 576
1.9 TDI Syncro	23821		137		1Z	ab Motornummer: 289576
1.9 D	23820		137			ab Motornummer: 378 365
1.9 D	23821		137			ab Motornummer: 378365
1.9 TD,GTD	23820		137			ab Motornummer: 552 766
2.0 GTI 16V	23809		151			bis Motornummer: 020 922
1.9 TDI, 1.9 TDI Syncro	23815		137		1Z	bis Motornummer: 289 575
1.9 TDI	23821		137		1Z	bis Motornummer: 289576
1.9 D	23812		137			bis Motornummer: 378364
1.9 TD,GTD	23812		137			bis Motornummer: 552765
1.6, 1.8, 1.8 Syncro	23803		121			
2.0, 2.0 Syncro	23802		124			
1.4	23823		135		AEX,AP Q	
1.4	41823		135		APQ	
1.4	23823		135		AEX	
1.6	23824		137		AEA,AE E	
1.6	41824		137		AEE	
1.9 TDI	23820		137			
1.9 SDI, 1.9 TDI	23821		137			

VW GOLF IV Cabriolet (1E7)

06.98-06.02

1.6, 1.8	23803		121			
2.0	23802		124		AGG, AKR	
1.9 TDI	23820		137			
1.9 TDI	23821		137			

VW GOLF IV Variant (1J5)

05.99-06.06

1.9 TDI, 1.9 TDI 4motion	41848		120			...07.02, ...1J-2B123 078, ...1J-2D352 773, ...1J-2P394 000, ...1J-2U403 276, ...1J-2W592 782, antriebene Aggregate: angetr. Agg.: Wasserpumpe * Driven Units: Driven unit: water pump * Périphériques entraînés: Pompe à eau, antriebene Aggregate: angetr. Agg.: Nockenwelle * Driven Units: Driven unit: camshaft * Périphériques entraînés: Arbre à came
1.9 TDI	41848		120		AXR	...07.02, ...1J-2B123 078, ...1J-2D352 773, ...1J-2P394 000, ...1J-2U403 276, ...1J-2W592 782, bis Motornummer: AXR 021 000, antriebene Aggregate: angetr. Agg.: Wasserpumpe * Driven Units: Driven unit: water pump * Périphériques entraînés: Pompe à eau, antriebene Aggregate: angetr. Agg.: Nockenwelle * Driven Units: Driven unit: camshaft * Périphériques entraînés: Arbre à came
1.9 TDI	23847		120		ATD	...12.02, antriebene Aggregate: angetr. Agg.: Nockenwelle * Driven Units: Driven unit: camshaft * Périphériques entraînés: Arbre à came
1.9 TDI, 1.9 TDI 4motion	23847		120			...12.02, antriebene Aggregate: angetr. Agg.: Nockenwelle * Driven Units: Driven unit: camshaft * Périphériques entraînés: Arbre à came
1.9 TDI 4motion	41848		120			...12.02, ...1J-2B123 078, ...1J-2D352 773, ...1J-2P394 000, ...1J-2U403 276, ...1J-2W592 782, antriebene Aggregate: angetr. Agg.: Wasserpumpe * Driven Units: Driven unit: water pump * Périphériques entraînés: Pompe à eau, antriebene Aggregate: angetr. Agg.: Nockenwelle * Driven Units: Driven unit: camshaft * Périphériques entraînés: Arbre à came
1.9 TDI, 1.9 TDI 4motion	23848		120			...12.02
1.8 4motion, 1.8 T	23829		150			1J-Y-850 001..., wahlweise: * Alternatively: * au choix:
1.8 4motion, 1.8 T	23830		150			1J-Y-850 001..., wahlweise: * Alternatively: * au choix:
1.8 4motion, 1.8 T	23831		150			1J-Y-850 001...



VW

VW GOLF IV Variant (1J5)

05.99-06.06

1.8 4motion, 1.8 T	23912		150			...1J-Y-850 000
1.8 4motion, 1.8 T	23913		150			...1J-Y-850 000
1.8 4motion, 1.8 T	41912		150			...1J-Y-850 000
1.9 SDI	23844		141		AQM	ab Motornummer: 030 001, ab Motornummer: 400 001
1.4 16V	23838		130	58	APE,AX P,BCA	ab Motornummer: 160 001, ab Motornummer: 242 001
1.4 16V	41838		130	58	BCA	ab Motornummer: 160 001, ab Motornummer: 242 001
1.9 TDI, 1.9 TDI 4motion	23847		120		AUY	ab Motornummer: 185 671, angetriebene Aggregate: angetr. Agg.: Nockenwelle * Driven Units: Driven unit: camshaft * Périphériques entraînés: Arbre à came
1.9 TDI, 1.9 TDI 4motion	23848		120		AUY	ab Motornummer: 185 671
1.9 TDI, 1.9 TDI 4motion	41848		120		AJM	ab Motornummer: 185 671
1.9 SDI	41844		141		AQM	ab Motornummer: 400 001
1.9 TDI 4motion	23847		120		AXR	bis Motornummer: 010 000, angetriebene Aggregate: angetr. Agg.: Nockenwelle * Driven Units: Driven unit: camshaft * Périphériques entraînés: Arbre à came
1.9 TDI, 1.9 TDI 4motion	23848		120		AXR	bis Motornummer: 010 000
1.9 SDI	23845		141		AQM	bis Motornummer: 030 000, bis Motornummer: 400 000
1.4 16V	23838/1		130	58	AKQ	bis Motornummer: 160 000, bis Motornummer: 242 000, 2 Riemen: * 2 Belts: * 2 courroies:
1.6 FSI, 1.6 16V	23838		130	58		
1.6 FSI, 1.6 16V	41838/2		130	58		
1.6, 2.0, 2.0 4motion	23832		138			
1.6	41832		138			
1.9 TDI, 1.9 TDI 4motion	23844		141			
1.9 TDI, 1.9 TDI 4motion	41844		141			

VW GOLF IV (1J1)

08.97-06.05

1.9 TDI, 1.9 TDI 4motion	41848		120			...07.02, ...1J-2B123 078, ...1J-2D352 773, ...1J-2P394 000, ...1J-2U403 276, ...1J-2W592 782, angetriebene Aggregate: angetr. Agg.: Wasserpumpe * Driven Units: Driven unit: water pump * Périphériques entraînés: Pompe à eau, angetriebene Aggregate: angetr. Agg.: Nockenwelle * Driven Units: Driven unit: camshaft * Périphériques entraînés: Arbre à came
1.9 TDI	41848		120		AXR	...07.02, ...1J-2B123 078, ...1J-2D352 773, ...1J-2P394 000, ...1J-2U403 276, ...1J-2W592 782, bis Motornummer: AXR 021 000, angetriebene Aggregate: angetr. Agg.: Wasserpumpe * Driven Units: Driven unit: water pump * Périphériques entraînés: Pompe à eau, angetriebene Aggregate: angetr. Agg.: Nockenwelle * Driven Units: Driven unit: camshaft * Périphériques entraînés: Arbre à came
1.9 TDI, 1.9 TDI 4motion	23847		120			...12.02, angetriebene Aggregate: angetr. Agg.: Nockenwelle * Driven Units: Driven unit: camshaft * Périphériques entraînés: Arbre à came
1.9 TDI, 1.9 TDI 4motion	23848		120			...12.02
1.8, 1.8 4motion, 1.8 T	23829		150			1J-Y-850 001..., wahlweise: * Alternatively: * au choix:
1.8, 1.8 4motion, 1.8 T	23830		150			1J-Y-850 001..., wahlweise: * Alternatively: * au choix:
1.8, 1.8 4motion, 1.8 T	23831		150			1J-Y-850 001...
1.8, 1.8 4motion, 1.8 T	23912		150			...1J-Y-850 000
1.8, 1.8 4motion, 1.8 T	23913		150			...1J-Y-850 000
1.8, 1.8 4motion, 1.8 T	41912		150			...1J-Y-850 000
1.9 SDI	23844		141		AQM	ab Motornummer: 030 001, ab Motornummer: 400 001
1.4 16V	23838		130	58	APE,AX P,BCA	ab Motornummer: 160 001, ab Motornummer: 242 001
1.4 16V	41838		130	58	BCA	ab Motornummer: 160 001, ab Motornummer: 242 001



VW

VW GOLF IV (1J1)

08.97-06.05

1.9 TDI, 1.9 TDI 4motion	23847		120		AUY	ab Motornummer: 185 671, angetriebene Aggregate: anetr. Agg.: Nockenwelle * Driven Units: Driven unit: camshaft * Périphériques entraînés: Arbre à came
1.9 TDI, 1.9 TDI 4motion	23848		120		AUY	ab Motornummer: 185 671
1.9 TDI, 1.9 TDI 4motion	41848		120		AJM	ab Motornummer: 185 671
1.9 SDI	41844		141		AQM	ab Motornummer: 400 001
1.9 TDI, 1.9 TDI 4motion	23847		120		AXR	bis Motornummer: 010 000, angetriebene Aggregate: anetr. Agg.: Nockenwelle * Driven Units: Driven unit: camshaft * Périphériques entraînés: Arbre à came
1.9 TDI, 1.9 TDI 4motion	23848		120		AXR	bis Motornummer: 010 000
1.9 SDI	23845		141		AQM	bis Motornummer: 030 000, bis Motornummer: 400 000
1.4 16V	23838/1		130	58	AKQ	bis Motornummer: 160 000, bis Motornummer: 242 000, 2 Riemen: * 2 Belts: * 2 courroies:
1.8 T GTI	23829		150			wahlweise: * Alternately: * au choix:
1.8 T GTI	23830		150			wahlweise: * Alternately: * au choix:
1.6 FSI, 1.6 16V	23838		130	58		
1.6 FSI, 1.6 16V	41838/2		130	58		
1.6, 2.0, 2.0 4motion	23832		138			
1.6	41832		138			
1.9 TDI, 1.9 TDI 4motion	23844		141			
1.9 TDI, 1.9 TDI 4motion	41844		141			
1.8 T GTI	23831		150			

VW GOLF PLUS (5M1, 521)

01.05-

1.4 16V	23841		130		CGGA	1K-7-500 001...
1.4 16V	23841		130			1K-7-500 001...
1.4 16V	23838		130	58	BUD	...1K-6-650 000
1.4 16V	23838		130	58		...1K-6-650 000
1.4 16V	41838		130	58		
1.6, 1.6 MultiFuel	41832		138			

VW GOLF V Variant (1K5)

06.07-

1.4	23841		130			1K-7-000 001...
1.4	23838		130	58		...1K-6-250 000
1.6	41832		138			

VW GOLF V (1K1)

10.03-

1.4 16V	23841		130			1K-7-000 001...
1.4 16V	23838		130	58		...1K-6-250 000
1.4 16V	23838		130	58		
1.4 16V	41838		130	58		
1.6	23832		138			
1.6	41832		138			

VW GOLF VI Variant (AJ5)

07.09-

1.4	23841		130			
-----	-------	--	-----	--	--	--

VW GOLF VI (5K1)

10.08-

1.4	23841		130			1K-9-400 001...
1.6	41832		138			



VW

VW JETTA I (16)						08.78-02.84
1.3	41850		108			angetriebene Aggregate: angetr. Agg.: Nockenwelle * Driven Units: Driven unit: camshaft * Périphériques entraînés: Arbre à came
1.1	41850		108			08.79...., angetriebene Aggregate: angetr. Agg.: Nockenwelle * Driven Units: Driven unit: camshaft * Périphériques entraînés: Arbre à came
1.5, 1.6, 1.6 GLI	23801		121			
1.6 D, 1.6 TD	23804		135			
VW JETTA II (19E, 1G2)						01.84-12.92
1.3	41850		108			angetriebene Aggregate: angetr. Agg.: Nockenwelle * Driven Units: Driven unit: camshaft * Périphériques entraînés: Arbre à came
1.6, 1.8, 1.8 KAT, 1.8 Syncro	23801		121			angetriebene Aggregate: angetr. Agg.: Nockenwelle * Driven Units: Driven unit: camshaft * Périphériques entraînés: Arbre à came
1.3	41850		108	NZ		08.85...., bis Motonummer: NZ 200000, angetriebene Aggregate: angetr. Agg.: Nockenwelle * Driven Units: Driven unit: camshaft * Périphériques entraînés: Arbre à came
1.3 KAT	41850		108	2G		08.89...., ...10.90, ...12.90, bis Motonummer: NZ 200000, bis Motonummer: 2G 262 739, angetriebene Aggregate: angetr. Agg.: Nockenwelle * Driven Units: Driven unit: camshaft * Périphériques entraînés: Arbre à came
1.6 D, 1.6 TD	23804		135			
VW JETTA III (1K2)						08.05-
1.6	23832		138		BSF	
1.6	41832		138		BSE	
VW LT 28-35 I Bus (281-363)						04.75-06.96
2.4 D	23806		119		1S	
2.4 D	41806		119		1S	
2.4 D, 2.4 TD	23806		119			
2.4 D, 2.4 TD	41806		119			
2.0	23801		121			
VW LT 28-35 I Kasten (281-363)						04.75-06.96
2.4 D, 2.4 TD	23806		119			angetriebene Aggregate: angetr. Agg.: Nockenwelle * Driven Units: Driven unit: camshaft * Périphériques entraînés: Arbre à came
2.4 D	23806		119			01.83...., angetriebene Aggregate: angetr. Agg.: Nockenwelle * Driven Units: Driven unit: camshaft * Périphériques entraînés: Arbre à came
2.4 D	41806		119		1S	
2.4 D, 2.4 TD	41806		119			
VW LT 28-35 I Pritsche/Fahrgestell (281-363)						04.75-06.96
2.4 D	23806		119		1S	angetriebene Aggregate: angetr. Agg.: Nockenwelle * Driven Units: Driven unit: camshaft * Périphériques entraînés: Arbre à came
2.4 D, 2.4 TD	23806		119			angetriebene Aggregate: angetr. Agg.: Nockenwelle * Driven Units: Driven unit: camshaft * Périphériques entraînés: Arbre à came
2.4 D	41806		119		1S	
2.4 D, 2.4 TD	41806		119			
VW LT 28-35 II Bus (2DM)						04.96-07.06
2.5 SDI, 2.5 TDI	23835		81			angetriebene Aggregate: angetr. Agg.: Einspritzpumpe * Driven Units: Driven unit: injection pump * Périphériques entraînés: Pompe d'injection
2.5 TDI	73834		122	81		
2.5 SDI	23819		122			
2.5 TDI	23834		122			
2.5 SDI	23839		122			
2.5 SDI	41819		122			
2.5 SDI	41839		122			
VW LT 28-46 II Kasten (2DX0AE)						04.96-07.06
2.5 SDI, 2.5 TDI	23835		81			angetriebene Aggregate: angetr. Agg.: Einspritzpumpe * Driven Units: Driven unit: injection pump * Périphériques entraînés: Pompe d'injection
2.5 TDI	73834		122	81		



VW

VW LT 28-46 II Kasten (2DX0AE)						04.96-07.06
2.5 SDI	23819		122			
2.5 TDI	23834		122			
2.5 SDI	23839		122			
2.5 SDI	41819		122			
2.5 SDI	41839		122			
VW LT 28-46 II Pritsche/Fahrgestell (2DX0FE)						04.96-07.06
2.5 SDI, 2.5 TDI	23835		81			angetriebene Aggregate: angetr. Agg.: Einspritzpumpe * Driven Units: Driven unit: injection pump * Périphériques entraînés: Pompe d'injection
2.5 TDI	73834		122	81		
2.5 SDI	23819		122			
2.5 TDI	23834		122			
2.5 SDI	23839		122			
2.5 SDI	41819		122			
2.5 SDI	41839		122			
VW LT 40-55 I Kasten (291-512)						04.75-06.96
2.4 D, 2.4 TD	23806		119			angetriebene Aggregate: angetr. Agg.: Nockenwelle * Driven Units: Driven unit: camshaft * Périphériques entraînés: Arbre à came
2.4 D 4WD, 2.4 TD 4WD	41806		119			12.82...
2.4 D, 2.4 D 4WD, 2.4 TD 4WD	23806		119			01.83..., angetriebene Aggregate: angetr. Agg.: Nockenwelle * Driven Units: Driven unit: camshaft * Périphériques entraînés: Arbre à came
2.4 D	41806		119		1S	
2.4 D, 2.4 TD	41806		119			
VW LT 40-55 I Pritsche/Fahrgestell (293-909)						04.75-06.96
2.4 D, 2.4 TD	23806		119			angetriebene Aggregate: angetr. Agg.: Nockenwelle * Driven Units: Driven unit: camshaft * Périphériques entraînés: Arbre à came
2.4 D	23806		119			01.83..., angetriebene Aggregate: angetr. Agg.: Nockenwelle * Driven Units: Driven unit: camshaft * Périphériques entraînés: Arbre à came
2.4 D	41806		119		1S	
2.4 D, 2.4 TD	41806		119			
VW LUPO (6X1, 6E1)						09.98-07.05
1.7 SDI	23836		137			angetriebene Aggregate: inkl. Umlenkrolle * Driven Units: incl. of deflection pulley * Périphériques entraînés: Poulie de renvoie incl., wahlweise: * Alternatively: * au choix:
1.0	23823		135		AER,ALL ,ALD,AN V,AUC	...6X-Y-060 000
1.0	41823/1		135		AUC	...6X-Y-060 000
1.4 TDI	23847		120			...6X-2-015 000, ab Motornummer: 011 495, angetriebene Aggregate: angetr. Agg.: Nockenwelle * Driven Units: Driven unit: camshaft * Périphériques entraînés: Arbre à came
1.4 TDI	23848		120			...6X-2-015 000, ab Motornummer: 011 495
1.4 TDI	41847		120			...6X-2-015 000, ab Motornummer: 011 495
1.4 16V	23838		130	58	APE,AU A,BBY	ab Motornummer: 160 001, ab Motornummer: 242 001
1.4 16V	41838		130	58	BBY	ab Motornummer: 160 001, ab Motornummer: 242 001
1.4 16V	23838/1		130	58	AKQ	bis Motornummer: 160 000, bis Motornummer: 242 000, 2 Riemen: * 2 Belts: * 2 courroies:
1.2 TDI 3L	23849		117			
1.4 FSI, 1.4 16V, 1.6 GTI	23838		130	58		
1.4 FSI, 1.4 16V	41838		130	58		
1.6 GTI	41838/2		130	58		



VW

VW LUPO (6X1, 6E1)							09.98-07.05
1.7 SDI	23837		137				
VW MULTIVAN T5 (7HM, 7HN, 7HF, 7EF, 7EM, 7EN)							04.03-
2.0	23832		138				
VW NEW BEETLE Cabriolet (1Y7)							09.02-
1.8 T	23829		150		AWU,AW V	ab Motornummer: 003 001, ab Motornummer: 028 501, wahlweise: * Alternatively: * au choix:	
1.8 T	23830		150		AWU,AW V	ab Motornummer: 003 001, ab Motornummer: 028 501, wahlweise: * Alternatively: * au choix:	
1.8 T	23831		150		AWU,AW V	ab Motornummer: 003 001, ab Motornummer: 028 501	
1.8 T	23912		150		AVC	bis Motornummer: 003 000, bis Motornummer: 028 500	
1.8 T	23913		150		AVC	bis Motornummer: 003 000, bis Motornummer: 028 500	
1.4	23838		130	58			
1.4	41838		130	58			
1.6	41832		138				
VW NEW BEETLE (9C1, 1C1)							01.98-
1.9 TDI	23847		120			...9C-2-613 920, angetriebene Aggregate: angetr. Agg.: Nockenwelle * Driven Units: Driven unit: camshaft * Périphériques entraînés: Arbre à came	
1.9 TDI	23848		120			...9C-2-613 920	
1.9 TDI	41848		120			...9C-2-613 920	
1.8 T	23829		150		AWU,AW V	ab Motornummer: 003 001, ab Motornummer: 028 501, wahlweise: * Alternatively: * au choix:	
1.8 T	23830		150		AWU,AW V	ab Motornummer: 003 001, ab Motornummer: 028 501, wahlweise: * Alternatively: * au choix:	
1.8 T	23831		150		AWU,AW V	ab Motornummer: 003 001, ab Motornummer: 028 501	
1.8 T	23912		150		AVC	bis Motornummer: 003 000, bis Motornummer: 028 500	
1.8 T	23913		150		AVC	bis Motornummer: 003 000, bis Motornummer: 028 500	
1.8 T	41912		150		AVC	bis Motornummer: 003 000, bis Motornummer: 028 500	
1.4	23838		130	58			
1.4	41838		130	58			
1.6, 2.0	23832		138				
1.6	41832		138				
1.9 TDI	23844		141				
1.9 TDI	41844		141				
VW PARATI							08.02-
1.0	23838		130	58	AZP		
VW PASSAT Stufenheck (32B)							08.84-03.88
1.6	23801		121				
1.6 TD	23804		135				
VW PASSAT Variant (3A5, 35I)							02.88-06.97
1.6, 1.8	23801		121			angetriebene Aggregate: angetr. Agg.: Nockenwelle * Driven Units: Driven unit: camshaft * Périphériques entraînés: Arbre à came	
1.8 G60 Syncro	23801		121			...12.93, angetriebene Aggregate: angetr. Agg.: Nockenwelle * Driven Units: Driven unit: camshaft * Périphériques entraînés: Arbre à came	
1.8	23801		121			...12.96, angetriebene Aggregate: angetr. Agg.: Nockenwelle * Driven Units: Driven unit: camshaft * Périphériques entraînés: Arbre à came	
1.9 TDI	23820		137		1Z	ab Motornummer: 289 576	
1.9 TDI	23821		137		1Z	ab Motornummer: 289576	
1.9 TD	23820		137			ab Motornummer: 552 766	



VW

VW PASSAT Variant (3A5, 35I)

02.88-06.97

2.0 16V	23809		151			bis Motornummer: 020 922
1.9 TDI	23815		137		1Z	bis Motornummer: 289 575
1.9 TD	23812		137			bis Motornummer: 552765
1.8	23803		121		ABS,ADZ	
1.6, 1.8	23803		121			
2.0, 2.0 Syncro	23802		124			
1.6 TD	23804		135			
1.9 D	23812		137			
1.9 TDI	23820		137			
1.9 TDI	23821		137			
1.8 16V, 2.0 16V	23808		147			

VW PASSAT Variant (3B5)

05.97-11.00

1.9 TDI	23847		120			angetriebene Aggregate: angetr. Agg.: Nockenwelle * Driven Units: Driven unit: camshaft * Périphériques entraînés: Arbre à came
1.8	23828		153			ab Motornummer: 010 001
1.9 TDI, 1.9 TDI 4motion	23847		120		ATJ	ab Motornummer: 185 671, angetriebene Aggregate: angetr. Agg.: Nockenwelle * Driven Units: Driven unit: camshaft * Périphériques entraînés: Arbre à came
1.9 TDI, 1.9 TDI 4motion	23848		120		ATJ	ab Motornummer: 185 671
1.9 TDI	41848		120		ATJ	
1.9 TDI	23848		120			
1.9 TDI, 1.9 TDI 4motion	41848		120			
1.6	23814		121		ADP	
1.9 TDI	23821		137		AHU	
1.9 TDI, 1.9 TDI Syncro/4motion	23820		137			
1.9 TDI, 1.9 TDI Syncro/4motion	23821		137			
1.6	23832		138		AHL,ANA ,ARM	
1.6	41832		138		ARM	
1.8, 1.8 Syncro/4motion, 1.8 T	23827		153			
1.8, 1.8 Syncro/4motion, 1.8 T	23828		153			
1.8, 1.8 Syncro/4motion, 1.8 T	23833		153			
2.8 V6, 2.8 V6 Syncro/4motion, 2.8 V6 4motion	23842		253			

VW PASSAT Variant (3B6)

11.00-08.05

1.9 TDI, 1.9 TDI 4motion	41848		120			...04.02, ...3B-2-500000
1.9 TDI, 1.9 TDI 4motion	23847		120			...12.02, angetriebene Aggregate: angetr. Agg.: Nockenwelle * Driven Units: Driven unit: camshaft * Périphériques entraînés: Arbre à came
1.9 TDI, 1.9 TDI 4motion	23848		120			...12.02
1.8 T 20V, 2.0	23901		150			wahlweise: * Alternatively: * au choix:
1.8 T 20V	41901		150			wahlweise: * Alternatively: * au choix:
1.6, 2.0, 2.0 4motion	23832		138			
1.6	41832		138			
1.8 T	23901		150			
1.8 T 20V, 2.0	23902		150			



VW

VW PASSAT Variant (3B6)						11.00-08.05
2.8 4motion	23842		253			
VW PASSAT Variant (32B)						08.80-06.89
2.2, 2.2 Syncro	23805		120			angetriebene Aggregate: angetr. Agg.: Nockenwelle * Driven Units: Driven unit: camshaft * Périphériques entraînés: Arbre à came
1.6, 1.8	23801		121			angetriebene Aggregate: angetr. Agg.: Nockenwelle * Driven Units: Driven unit: camshaft * Périphériques entraînés: Arbre à came
1.3	41850		108		FY/FZ	08.81..., angetriebene Aggregate: angetr. Agg.: Nockenwelle * Driven Units: Driven unit: camshaft * Périphériques entraînés: Arbre à came
1.3	41850		108			08.81..., angetriebene Aggregate: angetr. Agg.: Nockenwelle * Driven Units: Driven unit: camshaft * Périphériques entraînés: Arbre à came
2.0, 2.0 Syncro	23805		120			08.84..., angetriebene Aggregate: angetr. Agg.: Nockenwelle * Driven Units: Driven unit: camshaft * Périphériques entraînés: Arbre à came
1.6 D, 1.6 TD	23804		135			
VW PASSAT Variant (33)						05.73-10.81
1.3	41850		108			02.78..., angetriebene Aggregate: angetr. Agg.: Nockenwelle * Driven Units: Driven unit: camshaft * Périphériques entraînés: Arbre à came
1.5, 1.6	23801		121			
1.5 D	23804		135			
VW PASSAT (3A2, 35I)						02.88-10.96
1.6, 1.8	23801		121			angetriebene Aggregate: angetr. Agg.: Nockenwelle * Driven Units: Driven unit: camshaft * Périphériques entraînés: Arbre à came
1.8 G60 Syncro	23801		121			...12.93, angetriebene Aggregate: angetr. Agg.: Nockenwelle * Driven Units: Driven unit: camshaft * Périphériques entraînés: Arbre à came
1.9 TDI	23820		137		1Z	ab Motornummer: 289 576
1.9 TDI	23821		137			ab Motornummer: 289576
1.9 TD	23820		137			ab Motornummer: 552 766
2.0 16V	23809		151			bis Motornummer: 020 922
1.9 TDI	23815		137		1Z	bis Motornummer: 289 575
1.9 TD	23812		137			bis Motornummer: 552765
1.8	23803		121		ABS,ADZ	
1.6, 1.8	23803		121			
2.0, 2.0 Syncro	23802		124			
1.6 TD	23804		135			
1.9 D	23812		137			
1.9 TDI	23820		137			
1.9 TDI	23821		137			
1.8 16V, 2.0 16V	23808		147			
VW PASSAT (3B2)						08.96-11.00
1.9 TDI	23847		120			angetriebene Aggregate: angetr. Agg.: Nockenwelle * Driven Units: Driven unit: camshaft * Périphériques entraînés: Arbre à came
1.8	23828		153			ab Motornummer: 010 001
1.9 TDI, 1.9 TDI 4motion	23847		120		ATJ	ab Motornummer: 185 671, angetriebene Aggregate: angetr. Agg.: Nockenwelle * Driven Units: Driven unit: camshaft * Périphériques entraînés: Arbre à came
1.9 TDI, 1.9 TDI 4motion	23848		120		ATJ	ab Motornummer: 185 671
1.9 TDI, 1.9 TDI 4motion	41848		120		ATJ	
1.9 TDI	23848		120			
1.9 TDI	41848		120			
1.6	23814		121		ADP	
1.9 TDI	23821		137		AHU	



VW

VW PASSAT (3B2)

08.96-11.00

1.9 TDI, 1.9 TDI Syncro/4motion	23820		137			
1.9 TDI, 1.9 TDI Syncro/4motion	23821		137			
1.6	23832		138		AHL,ANA .ARM	
1.6	41832		138		ARM	
1.8, 1.8 Syncro/4motion, 1.8 T	23827		153			
1.8, 1.8 Syncro/4motion, 1.8 T	23828		153			
1.8, 1.8 Syncro/4motion, 1.8 T	23833		153			
2.8 V6, 2.8 V6 Syncro/4motion, 2.8 V6 4motion	23842		253			

VW PASSAT (3B3)

11.00-05.05

1.9 TDI, 1.9 TDI 4motion	41848		120			...04.02, ...3B-2-500000
1.9 TDI, 1.9 TDI 4motion	23847		120			...12.02, angetriebene Aggregate: angetr. Agg.: Nockenwelle * Driven Units: Driven unit: camshaft * Périphériques entraînés: Arbre à came
1.9 TDI, 1.9 TDI 4motion	23848		120			...12.02
1.8 T, 1.8 T 20V, 2.0	23901		150			wahlweise: * Alternatively: * au choix:
1.8 T 20V	41901		150			wahlweise: * Alternatively: * au choix:
1.6, 2.0, 2.0 4motion	23832		138			
1.6	41832		138			
1.8 T, 1.8 T 20V, 2.0	23902		150			
2.8 4motion	23842		253			

VW PASSAT (32)

05.73-07.80

1.3	41850		108			02.78..., angetriebene Aggregate: angetr. Agg.: Nockenwelle * Driven Units: Driven unit: camshaft * Périphériques entraînés: Arbre à came
1.3, 1.5, 1.6	23801		121			
1.5 D	23804		135			

VW PASSAT (32B)

08.80-12.88

1.3	41850		108		FY/FZ	angetriebene Aggregate: angetr. Agg.: Nockenwelle * Driven Units: Driven unit: camshaft * Périphériques entraînés: Arbre à came
1.3	41850		108			angetriebene Aggregate: angetr. Agg.: Nockenwelle * Driven Units: Driven unit: camshaft * Périphériques entraînés: Arbre à came
2.2	23805		120			angetriebene Aggregate: angetr. Agg.: Nockenwelle * Driven Units: Driven unit: camshaft * Périphériques entraînés: Arbre à came
1.6, 1.8	23801		121			angetriebene Aggregate: angetr. Agg.: Nockenwelle * Driven Units: Driven unit: camshaft * Périphériques entraînés: Arbre à came
2.0	23805		120			08.84..., angetriebene Aggregate: angetr. Agg.: Nockenwelle * Driven Units: Driven unit: camshaft * Périphériques entraînés: Arbre à came
1.6	23801		121			
1.6 D, 1.6 TD	23804		135			

VW POLO CLASSIC (6KV2)

11.95-07.02

68 1.9 SDI	23844		141		AQM	ab Motornummer: 004 132, ab Motornummer: 229 003
68 1.9 SDI	41844		141		AQM	ab Motornummer: 004 132, ab Motornummer: 229 003
68 1.9 SDI	23845		141		AQM	bis Motornummer: 004 132
60 1.4	23823		135		AKK	bis Motornummer: 127806
60 1.4	41823/1		135		AKK	bis Motornummer: 127 806
100 1.6	23803		121		AFT	
90 1.8	23803		121			
75 1.4 16V	23838		130	58		
75 1.4 16V	41838		130	58		



VW

VW POLO CLASSIC (6KV2)

11.95-07.02

60 1.4	41823		135		APQ	
75 1.6	23824		137		AEE,AL M	
64 1.9 SDI	23821		137		AEY	
64 1.9 SDI	73808		137		AEY	
110 1.9 TDI	23820		137		AFN	
110 1.9 TDI	23821		137		AFN	
90 1.9 TDI	23820		137		AHU,ALE	
90 1.9 TDI	23821		137		AHU,ALE	
64 1.9 SDI	23820		137		1Y	
57 1.7 SDI	23821		137			
57 1.7 SDI	73808		137			
75 1.6	41824		137			
100 1.6	23832		138		AEH,AKL ,APF,AU R	
100 1.6	41832		138		AUR	
90 1.9 TDI	23844		141		AGR,AL H	
90 1.9 TDI	41844		141		ALH	
110 1.9 TDI	23844		141		ASV	
110 1.9 TDI	41844		141		ASV	

VW POLO CLASSIC (86C, 80)

01.85-09.94

1.0	41850		108		HZ	bis Motornummer: AAU 015867, bis Motornummer: HZ 786022, angetriebene Aggregate: angetr. Agg.: Nockenwelle * Driven Units: Driven unit: camshaft * Périphériques entraînés: Arbre à came
1.3, 1.3 KAT	41850		108		2G	bis Motornummer: NZ200 000, bis Motornummer: 2G262 739, angetriebene Aggregate: angetr. Agg.: Nockenwelle * Driven Units: Driven unit: camshaft * Périphériques entraînés: Arbre à came

VW POLO Coupe (86C, 80)

10.81-09.94

1.1, 1.3	41850		108			angetriebene Aggregate: angetr. Agg.: Nockenwelle * Driven Units: Driven unit: camshaft * Périphériques entraînés: Arbre à came
1.0, 1.0 KAT	41850		108		HZ	bis Motornummer: AAU 015867, bis Motornummer: HZ 786022, angetriebene Aggregate: angetr. Agg.: Nockenwelle * Driven Units: Driven unit: camshaft * Périphériques entraînés: Arbre à came
1.3, 1.3 KAT	41850		108		2G	bis Motornummer: NZ200 000, bis Motornummer: 2G262 739, angetriebene Aggregate: angetr. Agg.: Nockenwelle * Driven Units: Driven unit: camshaft * Périphériques entraînés: Arbre à came
1.3 G40	41850		108		PY	bis Motornummer: PY002 177, angetriebene Aggregate: angetr. Agg.: Nockenwelle * Driven Units: Driven unit: camshaft * Périphériques entraînés: Arbre à came
1.3 G40	41850		108			bis Motornummer: PY002 177, angetriebene Aggregate: angetr. Agg.: Nockenwelle * Driven Units: Driven unit: camshaft * Périphériques entraînés: Arbre à came
1.3, 1.3 KAT	41850		108		3F	bis Motornummer: 3F008 526, angetriebene Aggregate: angetr. Agg.: Nockenwelle * Driven Units: Driven unit: camshaft * Périphériques entraînés: Arbre à came
1.3	41850		108			bis Motornummer: 3F008 526, angetriebene Aggregate: angetr. Agg.: Nockenwelle * Driven Units: Driven unit: camshaft * Périphériques entraînés: Arbre à came

VW POLO Kasten (6NF)

09.94-12.99

1.7 SDI, 1.9 SDI	23836		137			angetriebene Aggregate: inkl. Umlenkrolle * Driven Units: incl. of deflection pulley * Périphériques entraînés: Poulie de renvoi incl., wahlweise: * Alternately: * au choix:
1.4	23823		135			
1.4	41823		135			
1.7 SDI, 1.9 D, 1.9 SDI	23837		137			

VW POLO Kasten (86CF)

08.92-07.94



VW

VW POLO Kasten (86CF)

08.92-07.94

1.0	41850		108		HZ	bis Motornummer: AAU 015867, bis Motornummer: HZ 786022, angetriebene Aggregate: angetr. Agg.: Nockenwelle * Driven Units: Driven unit: camshaft * Périphériques entraînés: Arbre à came
-----	-------	--	-----	--	----	------------------------------------------------------------------------------------------------------------------------------------------------------------------------------------------

VW POLO Stufenheck

09.02-

1.4 TDI	23847		120			...9N-2-050-000, ab Motornummer: 011 495, angetriebene Aggregate: angetr. Agg.: Nockenwelle * Driven Units: Driven unit: camshaft * Périphériques entraînés: Arbre à came
1.4 TDI	23848		120			...9N-2-050 000, ab Motornummer: 011 495
1.4 TDI	41847		120			...9N-2-050 000, ab Motornummer: 011 495
1.4	23838		130	58		
1.4	41838		130	58		

VW POLO Variant (6KV5)

04.97-09.01

1.4	23823		135			...6N-Y-600 000
1.4	41823/1		135			...6N-Y-600 000
1.9 SDI	23844		141		AQM	ab Motornummer: 004 132, ab Motornummer: 229 003
1.9 SDI	41844		141		AQM	ab Motornummer: 004 132, ab Motornummer: 229 003
1.9 SDI	23845		141		AQM	bis Motornummer: 004 132, bis Motornummer: 229 903
1.4	23823		135		AKK	bis Motornummer: 127806
1.4	41823/1		135		AKK	bis Motornummer: 127 806
1.6	23803		121		AFT	
1.8	23803		121			
1.4 16V	23838		130	58		
1.4 16V	41838		130	58		
1.4	41823		135		APQ	
1.9 TDI	23820		137		AFN	
1.9 TDI	23821		137		AFN	
1.9 TDI	23820		137		AHU,ALE	
1.9 TDI	23821		137		AHU, ALE	
1.7 SDI, 1.9 SDI	23821		137			
1.6	23824		137			
1.7 SDI, 1.9 SDI	73808		137			
1.6	41824		137			
1.6	23832		138		AEH,AKL,APF,AUR	
1.6	41832		138		AUR	
1.9 TDI	41844		141		ALH	
1.9 TDI	23844		141		ALH,AGR	
1.9 TDI	23844		141		ASV	
1.9 TDI	41844		141		ASV	

VW POLO (6N1)

10.94-10.99

60 1.7 SDI, 64 1.9 SDI	23836		137			angetriebene Aggregate: inkl. Umlenkrolle * Driven Units: incl. of deflection pulley * Périphériques entraînés: Poulie de renvoi incl., wahlweise: * Alternatively: * au choix:
120 1.6 16V GTI	23838		130	58		ab Motornummer: 005 001
120 1.6 16V GTI	41838/2		130	58		ab Motornummer: 005001



VW

VW POLO (6N1)						10.94-10.99
120 1.6 16V GTI	23838/1		130	58		bis Motornummer: 005 000, 2 Riemen: * 2 Belts: * 2 courroies:
50 1.0, 55 1.3, 55 1.4, 60 1.4	23823		135			
55 1.3, 55 1.4, 60 1.4	41823		135			
50 1.0	41823/1		135			
75 1.6	23824		137			
1.7 SDI	23836		137			
60 1.7 SDI, 64 1.9 D, 64 1.9 SDI	23837		137			
75 1.6	41824		137			
VW POLO (6N2)						10.99-10.01
1.7 SDI, 1.9 SDI	23836		137			angetriebene Aggregate: inkl. Umlenkrolle * Driven Units: incl. of deflection pulley * Périphériques entraînés: Poulie de renvoi incl., wahlweise: * Alternatively: * au choix:
1.0, 1.4	23823		135			...6N-Y-600 000
1.0, 1.4	41823/1		135			...6N-Y-600 000
1.4 TDI	23847		120			...9N-2-050 000, ab Motornummer: 011 495, angetriebene Aggregate: angetr. Agg.: Nockenwelle * Driven Units: Driven unit: camshaft * Périphériques entraînés: Arbre à came
1.4 TDI	23848		120			...9N-2-050 000, ab Motornummer: 011 495
1.4 TDI	41847		120			...9N-2-050 000, ab Motornummer: 011 495
1.4 16V, 1.6 16V GTI	23838		130	58		
1.4 16V	41838		130	58		
1.6 16V GTI	41838/2		130	58		
1.7 SDI, 1.9 D, 1.9 SDI	23837		137			
VW POLO (6R_)						06.09-
1.4	23841		130			6Y-7-000 001...
VW POLO (86)						03.75-09.81
0.9, 1.1	41850		108			angetriebene Aggregate: angetr. Agg.: Nockenwelle * Driven Units: Driven unit: camshaft * Périphériques entraînés: Arbre à came
0.8	41850		108			01.76..., angetriebene Aggregate: angetr. Agg.: Nockenwelle * Driven Units: Driven unit: camshaft * Périphériques entraînés: Arbre à came
1.3	41850		108			08.77..., angetriebene Aggregate: angetr. Agg.: Nockenwelle * Driven Units: Driven unit: camshaft * Périphériques entraînés: Arbre à came
VW POLO (86C, 80)						10.81-09.94
0.9, 1.1, 1.3	41850		108			angetriebene Aggregate: angetr. Agg.: Nockenwelle * Driven Units: Driven unit: camshaft * Périphériques entraînés: Arbre à came
1.0, 1.0 KAT	41850		108		HZ	bis Motornummer: AAU 015867, bis Motornummer: HZ 786022, angetriebene Aggregate: angetr. Agg.: Nockenwelle * Driven Units: Driven unit: camshaft * Périphériques entraînés: Arbre à came
1.3, 1.3 KAT	41850		108		2G	bis Motornummer: NZ200 000, bis Motornummer: 2G262 739, angetriebene Aggregate: angetr. Agg.: Nockenwelle * Driven Units: Driven unit: camshaft * Périphériques entraînés: Arbre à came
1.3, 1.3 KAT	41850		108		3F	bis Motornummer: 3F008 526, angetriebene Aggregate: angetr. Agg.: Nockenwelle * Driven Units: Driven unit: camshaft * Périphériques entraînés: Arbre à came
VW POLO (9N_)						10.01-
1.4 16V	23841		130			9N-7-000 001...
1.4 TDI	23847		120			...9N-2-050-000, ab Motornummer: 011 495, angetriebene Aggregate: angetr. Agg.: Nockenwelle * Driven Units: Driven unit: camshaft * Périphériques entraînés: Arbre à came
1.4 TDI	23848		120			...9N-2-050 000, ab Motornummer: 011 495
1.4 TDI	41847		120			...9N-2-050 000, ab Motornummer: 011 495
1.4 16V	23838		130	58		...9N-6-300 000
1.4 16V	23838		130	58		
1.4 16V	41838		130	58		



VW

VW SANTANA (32B)						08.81-12.85
1.3	41850		108			angetriebene Aggregate: angetr. Agg.: Nockenwelle * Driven Units: Driven unit: camshaft * Périphériques entraînés: Arbre à came
1.6	23801		121			angetriebene Aggregate: angetr. Agg.: Nockenwelle * Driven Units: Driven unit: camshaft * Périphériques entraînés: Arbre à came
2.0	23805		120			08.84..., angetriebene Aggregate: angetr. Agg.: Nockenwelle * Driven Units: Driven unit: camshaft * Périphériques entraînés: Arbre à came
1.6 D, 1.6 TD	23804		135			
VW SCIROCCO (53)						02.74-07.80
1.1, 1.3	41850		108			angetriebene Aggregate: angetr. Agg.: Nockenwelle * Driven Units: Driven unit: camshaft * Périphériques entraînés: Arbre à came
1.5	23801		121			angetriebene Aggregate: angetr. Agg.: Nockenwelle * Driven Units: Driven unit: camshaft * Périphériques entraînés: Arbre à came
1.6	23801		121			
VW SCIROCCO (53B)						08.80-07.92
1.3	41850		108			angetriebene Aggregate: angetr. Agg.: Nockenwelle * Driven Units: Driven unit: camshaft * Périphériques entraînés: Arbre à came
1.5, 1.6	23801		121			angetriebene Aggregate: angetr. Agg.: Nockenwelle * Driven Units: Driven unit: camshaft * Périphériques entraînés: Arbre à came
1.8	23801		121			...12.91, angetriebene Aggregate: angetr. Agg.: Nockenwelle * Driven Units: Driven unit: camshaft * Périphériques entraînés: Arbre à came
1.8 16V	23808		147			
VW SHARAN (7M8, 7M9, 7M6)						05.95-
1.9 TDI 4motion	41848		120			...07.02, ...7M-2-060 000, angetriebene Aggregate: angetr. Agg.: Wasserpumpe * Driven Units: Driven unit: water pump * Périphériques entraînés: Pompe à eau, angetriebene Aggregate: angetr. Agg.: Nockenwelle * Driven Units: Driven unit: camshaft * Périphériques entraînés: Arbre à came
1.9 TDI, 1.9 TDI 4motion	23847		120			...12.02, angetriebene Aggregate: angetr. Agg.: Nockenwelle * Driven Units: Driven unit: camshaft * Périphériques entraînés: Arbre à came
1.9 TDI	41848		120		ANU	...12.02, ab Motornummer: 005 001, angetriebene Aggregate: angetr. Agg.: Wasserpumpe * Driven Units: Driven unit: water pump * Périphériques entraînés: Pompe à eau, angetriebene Aggregate: angetr. Agg.: Nockenwelle * Driven Units: Driven unit: camshaft * Périphériques entraînés: Arbre à came
1.9 TDI, 1.9 TDI 4motion	23848		120			...12.02
1.9 TDI	23847		120		ANU	ab Motornummer: 005 001, angetriebene Aggregate: angetr. Agg.: Nockenwelle * Driven Units: Driven unit: camshaft * Périphériques entraînés: Arbre à came
1.9 TDI	23848		120		ANU	ab Motornummer: 005 001
1.8 T 20V	23829		150		AWC	wahlweise: * Alternatively: * au choix:
1.8 T 20V	23830		150		AWC	wahlweise: * Alternatively: * au choix:
2.0	23802		124		ADY	
1.9 TDI	23821		137		1Z, AHU	
1.9 TDI	73808		137		1Z, AHU	
1.9 TDI	23821		137			
1.9 TDI	73808		137			
2.0	23832		138		ATM	
1.8 T 20V	23912		150		AJH	
1.8 T 20V	23913		150		AJH	
1.8 T 20V	41912		150		AJH	
1.8 T 20V	23831		150		AWC	
VW TOURAN (1T1, 1T2, 1T3)						02.03-
1.6	23832		138			
1.6	41832		138			
VW TRANSPORTER T3 Bus						05.79-07.92
1.6 D, 1.6 TD, 1.6 TD Syncro, 1.7 D	23804		135			
VW TRANSPORTER T3 Kasten						05.79-12.92



VW

VW TRANSPORTER T3 Kasten						05.79-12.92
2.1	23801		121			angetriebene Aggregate: angetr. Agg.: Nockenwelle * Driven Units: Driven unit: camshaft * Périphériques entraînés: Arbre à came
1.6 TD, 1.6 TD Syncro	23804		135			
VW TRANSPORTER T3 Pritsche/Fahrgestell						05.79-12.92
1.6 TD, 1.6 TD Syncro, 1.7 D	23804		135			
VW TRANSPORTER T4 Bus (70XB, 70XC, 7DB, 7DW)						09.90-04.03
2.5 TDI, 2.5 TDI Syncro	23835		81			angetriebene Aggregate: angetr. Agg.: Einspritzpumpe * Driven Units: Driven unit: injection pump * Périphériques entraînés: Pompe d'injection
1.8	23801		121			angetriebene Aggregate: angetr. Agg.: Nockenwelle * Driven Units: Driven unit: camshaft * Périphériques entraînés: Arbre à came
2.4 D, 2.4 D Syncro	23807		122			01.95...., angetriebene Aggregate: angetr. Agg.: Nockenwelle * Driven Units: Driven unit: camshaft * Périphériques entraînés: Arbre à came
2.4 D, 2.4 D Syncro	41807		122			...06.96, bis Motornummer: 320 126
2.5	23807		122		AAF	...70-N-014000
2.5 Syncro	23807		122		AAF	...70N014000
2.5, 2.5 Syncro	41807		122		AAF	...70-N-014 000
2.5, 2.5 Syncro	41833		122		AEU	ab Motornummer: 019 150
1.9 TD	23820		137			ab Motornummer: 029 320
1.9 D	23820		137			ab Motornummer: 120 078
2.4 D, 2.4 D Syncro	73809		77			ab Motornummer: 320127
2.4 D, 2.4 D Syncro	23834		122			ab Motornummer: 320 127
1.9 TD	23812		137			bis Motornummer: 029319
1.9 D	23812		137			bis Motornummer: 120077
2.5 TDI Syncro	23834		122		ACV	
2.5 TDI Syncro	23819		122		AXL	
2.5 TDI Syncro	23839		122		AXL	
2.5 TDI Syncro	41819		122		AXL	
2.5 TDI Syncro	41839		122		AXL	
2.4 D	73809		77			
2.5 TDI Syncro	73834		122	81	ACV	
2.5 TDI	73834		122	81		
2.5 TDI	23819		122			
2.4 D, 2.5 TDI	23834		122			
2.5 TDI	23839		122			
2.5 TDI	41819		122			
2.5, 2.5 Syncro	41833		122			
2.5 TDI	41839		122			
VW TRANSPORTER T4 Kasten (70XA)						07.90-04.03
2.5 TDI, 2.5 TDI Syncro	23835		81			angetriebene Aggregate: angetr. Agg.: Einspritzpumpe * Driven Units: Driven unit: injection pump * Périphériques entraînés: Pompe d'injection
2.4 D, 2.4 D Syncro	23807		122			01.95...., angetriebene Aggregate: angetr. Agg.: Nockenwelle * Driven Units: Driven unit: camshaft * Périphériques entraînés: Arbre à came
2.4 D, 2.4 D Syncro	41807		122			...06.96, bis Motornummer: 320 126
2.5, 2.5 Syncro	23807		122		AAF	...70N014000
2.5, 2.5 Syncro	41807		122		AAF	...70-N-014 000



VW

VW TRANSPORTER T4 Kasten (70XA)

07.90-04.03

2.5, 2.5 Syncro	41833		122		AEU	ab Motornummer: 019 150
1.9 TD	23820		137			ab Motornummer: 029 320
1.9 D	23820		137			ab Motornummer: 120 078
2.4 D, 2.4 D Syncro	73809		77			ab Motornummer: 320127
2.4 D, 2.4 D Syncro	23834		122			ab Motornummer: 320 127
1.9 TD	23812		137			bis Motornummer: 029319
1.9 D	23812		137			bis Motornummer: 120077
2.5 TDI Syncro	23834		122		ACV	
2.5 TDI Syncro	23819		122		AXL	
2.5 TDI Syncro	23839		122		AXL	
2.5 TDI Syncro	41819		122		AXL	
2.5 TDI Syncro	41839		122		AXL	
2.4 D	73809		77			
2.5 TDI, 2.5 TDI Syncro	73834		122	81		
2.5 TDI	23819		122			
2.4 D, 2.5 TDI	23834		122			
2.5 TDI	23839		122			
2.5 TDI	41819		122			
2.5, 2.5 Syncro	41833		122			
2.5 TDI	41839		122			

VW TRANSPORTER T4 Pritsche/Fahrgestell (70XD)

07.90-04.03

2.5 TDI, 2.5 TDI Syncro	23835		81			angetriebene Aggregate: angetr. Agg.: Einspritzpumpe * Driven Units: Driven unit: injection pump * Périphériques entraînés: Pompe d'injection
2.4 D, 2.4 D Syncro	23807		122			01.95..., angetriebene Aggregate: angetr. Agg.: Nockenwelle * Driven Units: Driven unit: camshaft * Périphériques entraînés: Arbre à came
2.4 D, 2.4 D Syncro	41807		122			...06.96, bis Motornummer: 320 126
2.5	23807		122		AAF	...70N014000
2.5, 2.5 Syncro	41807		122		AAF	...70-N-014 000
2.5, 2.5 Syncro	41833		122		AEU	ab Motornummer: 019 150
1.9 TD	23820		137			ab Motornummer: 029 320
1.9 D	23820		137			ab Motornummer: 120 078
2.4 D, 2.4 D Syncro	73809		77			ab Motornummer: 320127
2.4 D, 2.4 D Syncro	23834		122			ab Motornummer: 320 127
1.9 TD	23812		137			bis Motornummer: 029319
1.9 D	23812		137			bis Motornummer: 120077
2.5 TDI Syncro	23834		122		ACV	
2.5 TDI Syncro	23819		122		AXL	
2.5 TDI Syncro	23839		122		AXL	
2.5 TDI Syncro	41819		122		AXL	
2.5 TDI Syncro	41839		122		AXL	



VW

VW TRANSPORTER T4 Pritsche/Fahrgestell (70XD)						07.90-04.03
2.5 Syncro	23807		122		70N0140 00	
2.4 D	73809		77			
2.5 TDI Syncro	73834		122	81	ACV	
2.5 TDI	73834		122	81		
2.5 TDI	23819		122			
2.4 D, 2.5 TDI	23834		122			
2.5 TDI	23839		122			
2.5 TDI	41819		122			
2.5, 2.5 Syncro	41833		122			
2.5 TDI	41839		122			
VW TRANSPORTER T5 Bus (7HB, 7HJ, 7EB, 7EJ)						04.03-
2.0	23832		138			
VW TRANSPORTER T5 Kasten (7HA, 7HH, 7EA, 7EH)						04.03-
2.0	23832		138			
VW TRANSPORTER T5 Pritsche/Fahrgestell (7JD, 7JE, 7JL, 7JY, 7JZ)						04.03-
2.0	23832		138			
VW VENTO (1H2)						11.91-09.98
1.9 TDI	23820		137			ab Motornummer: 289 576
1.9 TDI	23821		137			ab Motornummer: 289576
1.9 TD	23820		137			ab Motornummer: 552 766
1.9 TDI	23815		137			bis Motornummer: 289 575
1.6, 1.8	23803		121			
2.0	23802		124			
1.4	23823		135		AEX	
1.4	41823		135		AEX	
1.4	23823		135			
1.6	23824		137		AEA,AE E	
1.6	41824		137		AEE	
1.9 TD	23812		137			
1.9 D, 1.9 TDI	23820		137			
1.9 D, 1.9 SDI, 1.9 TDI	23821		137			

Application list - Liste d'affectation

23001	Zahnriemensatz, Timing Belt Kit, Kit de distribution ALFA ROMEO 145 (930),146 (930),33 Sportwagon (907B),33 (907A)
23002	Zahnriemensatz, Timing Belt Kit, Kit de distribution FIAT CINQUECENTO (170),PANDA Van (141_),PANDA (141A_),PUNTO Van (176L),PUNTO (176),SEICENTO (187),TIPO (160),UNO (146A/E),LANCIA Y (840A),Y10 (156)
23003	Zahnriemensatz, Timing Belt Kit, Kit de distribution CITROËN JUMPY Kasten (BS_, BT_, BY_, BZ_),JUMPY (U6U),FIAT FIORINO Kasten (146 Uno),FIORINO Pick up (146),PANDA (141A_),PUNTO Cabriolet (176C),PUNTO (176),SCUDO Combinato (220P),SCUDO Kasten (220L),TEMPRA S.W. (159),TEMPRA (159),TIPO (160),UNO (146A/E),LANCIA DEDRA SW (835),DEDRA (835),DELTA II (836),PEUGEOT EXPERT Kasten (222),EXPERT Pritsche/Fahrgestell (223),EXPERT (224),ZASTAVA YUGO FLORIDA
23004	Zahnriemensatz, Timing Belt Kit, Kit de distribution FIAT PALIO Weekend (178DX),PALIO (178BX),PUNTO Cabriolet (176C),PUNTO (176),SIENA (178_),STRADA (178E),LANCIA Y (840A)
23005	Zahnriemensatz, Timing Belt Kit, Kit de distribution FIAT CINQUECENTO (170),PANDA Van (141_),PANDA (141A_),PANDA (169),PUNTO Van (176L),PUNTO (176),SEICENTO (187),UNO (146A/E),LANCIA Y (840A),YPSILON (843)
23006	Zahnriemensatz, Timing Belt Kit, Kit de distribution FIAT DOBLO Cargo (223),DOBLO (119),PALIO Weekend (178DX),PUNTO Cabriolet (176C),PUNTO Van (188AX),PUNTO (176),PUNTO (188),STRADA (178E),LANCIA Y (840A)
23007	Zahnriemensatz, Timing Belt Kit, Kit de distribution FIAT FIORINO (147),LANCIA Y10 (156)
23026	Zahnriemensatz, Timing Belt Kit, Kit de distribution FIAT DUCATO Panorama (280),DUCATO Pritsche/Fahrgestell (280),RENAULT MASTER I Bus (T_),MASTER I Kasten (T_)
23027	Zahnriemensatz, Timing Belt Kit, Kit de distribution FIAT DUCATO Bus (230),DUCATO Kasten (230L),DUCATO Kasten (290),DUCATO Panorama (290),DUCATO Pritsche/Fahrgestell (230),DUCATO Pritsche/Fahrgestell (290),RENAULT MASTER I Bus (T_),MASTER I Kasten (T_)
23028	Zahnriemensatz, Timing Belt Kit, Kit de distribution FIAT DUCATO Bus (230),DUCATO Kasten (230L),DUCATO Pritsche/Fahrgestell (230),OPEL MOVANO Combi (J9),MOVANO Kasten (F9),MOVANO Kipper (H9),MOVANO Pritsche/Fahrgestell (U9, E9),RENAULT MASTER II Bus (JD/ND),MASTER II Kasten (FD),MASTER II Pritsche/Fahrgestell (ED/HD/UD),VAUXHALL MOVANO Mk I (A) Chassis/Cab (ED, UD, HD),MOVANO Mk I (A) Combi (JD),MOVANO Mk I (A) Van (FD)
23033	Zahnriemensatz, Timing Belt Kit, Kit de distribution ALFA ROMEO GTV (916C_),SPIDER (916S_),145 (930),146 (930),147 (937),155 (167),156 Sportwagon (932),156 (932),166 (936),FIAT BARCHETTA (183),COUPE (FA/175),LANCIA DEDRA SW (835),DEDRA (835),DELTA II (836)
23080	Zahnriemensatz, Timing Belt Kit, Kit de distribution LADA SAMARA FORMA (21099),SAMARA (2108, 2109)
23100	Zahnriemensatz, Timing Belt Kit, Kit de distribution NISSAN KUBISTAR (X76),RENAULT CLIO I (B/C57_, 5/357_),CLIO II (BB0/1/2_, CB0/1/2_),KANGOO (KC0/1_),KANGOO Rapid (FC0/1_),TWINGO (C06_)
23102	Zahnriemensatz, Timing Belt Kit, Kit de distribution RENAULT ESPACE III (JE0_),LAGUNA (B56_, 556_),LAGUNA Grandtour (K56_),MEGANE I (BA0/1_),MEGANE I Cabriolet (EA0/1_),MEGANE I Classic (LA0/1_),MEGANE I Coach (DA0/1_),MEGANE Scenic (JA0/1_)
23106	Zahnriemensatz, Timing Belt Kit, Kit de distribution RENAULT CLIO I (B/C57_, 5/357_),CLIO I Kasten (S57_),MEGANE I (BA0/1_),MEGANE I Cabriolet (EA0/1_),MEGANE I Classic (LA0/1_),MEGANE I Coach (DA0/1_),MEGANE I Grandtour (KA0/1_),MEGANE Scenic (JA0/1_),RAPID Kasten (F40_, G40_),19 I (B/C53_),19 I Chamade (L53_),19 I Kasten (S53_),19 II (B/C53_),19 II Chamade (L53_),19 II Kasten (S53_)
23108	Zahnriemensatz, Timing Belt Kit, Kit de distribution RENAULT CLIO I (B/C57_, 5/357_),LAGUNA (B56_, 556_),LAGUNA Grandtour (K56_),SUPER 5 (B/C40_),TRAFIC Bus (TXW),TRAFIC Bus (T5, T6, T7),TRAFIC Kasten (TXX),TRAFIC Kasten (T1, T3, T4),TRAFIC Pritsche/Fahrgestell (PXX),TRAFIC Pritsche/Fahrgestell (P6),11 (B/C37_),19 I (B/C53_),19 I Cabriolet (D53_),19 I Chamade (L53_),19 II (B/C53_),19 II Cabriolet (D53_, 853_),19 II Chamade (L53_),21 (B48_),21 Kombi (K48_),21 Stufenheck (L48_),9 (L42_),VOLVO 340-360 Stufenheck (344),340-360 (343, 345),440 K (445),460 L (464),480 E
23110	Zahnriemensatz, Timing Belt Kit, Kit de distribution OPEL ARENA Combi (THB),ARENA Kasten (TB, TF),RENAULT MEGANE I (BA0/1_),MEGANE I Classic (LA0/1_),MEGANE Scenic (JA0/1_),RAPID Kasten (F40_, G40_),SUPER 5 (B/C40_),TRAFIC Bus (TXW),TRAFIC Kasten (TXX),11 (B/C37_),19 I (B/C53_),19 I Chamade (L53_),19 II (B/C53_),19 II Chamade (L53_),9 (L42_),VAUXHALL ARENA Combi,ARENA Van,VOLVO S40 I (VS),V40 Kombi (VW),340-360 Stufenheck (344),340-360 (343, 345),440 K (445),460 L (464)
23111	Zahnriemensatz, Timing Belt Kit, Kit de distribution RENAULT CLIO I (B/C57_, 5/357_),MEGANE I (BA0/1_),MEGANE I Cabriolet (EA0/1_),MEGANE I Coach (DA0/1_),SPORT SPIDER (EF0_),19 I (B/C53_),19 I Chamade (L53_),19 II (B/C53_),19 II Cabriolet (D53_, 853_),19 II Chamade (L53_)
23112	Zahnriemensatz, Timing Belt Kit, Kit de distribution RENAULT CLIO I (B/C57_, 5/357_),RAPID Kasten (F40_, G40_)
23114	Zahnriemensatz, Timing Belt Kit, Kit de distribution CITROËN CX II,CX II Break,RENAULT ESPACE II (J/S63_),MASTER I Bus (T_),MASTER I Kasten (T_),SAFRANE I (B54_),TRAFIC Bus (TXW),TRAFIC Kasten (TXX)
23115	Zahnriemensatz, Timing Belt Kit, Kit de distribution CITROËN CX II,RENAULT ESPACE I (J11_),ESPACE II (J/S63_),MASTER I Bus (T_),MASTER I Kasten (T_),MASTER I Pritsche/Fahrgestell (P_),SAFRANE I (B54_),TRAFIC Bus (TXW),TRAFIC Kasten (TXX),TRAFIC Pritsche/Fahrgestell (PXX),TRAFIC Pritsche/Fahrgestell (P6),21 (B48_),21 Kombi (K48_),21 Stufenheck (L48_),25 (B29_)
23116	Zahnriemensatz, Timing Belt Kit, Kit de distribution RENAULT 21 Stufenheck (L48_)
23118	Zahnriemensatz, Timing Belt Kit, Kit de distribution CITROËN CX I Break (MA),CX I (MA),PEUGEOT 505 (551A),RENAULT FUEGO (136_),MASTER I Bus (T_),MASTER I Kasten (T_),MASTER I Pritsche/Fahrgestell (P_),TRAFIC Pritsche/Fahrgestell (P6),18 Variable (135_),18 (134_),20 (127_)
23122	Zahnriemensatz, Timing Belt Kit, Kit de distribution DACIA LOGAN EXPRESS (FS_),LOGAN (LS_),LOGAN MCV (KS_),LOGAN Pick-up (US_),SANDERO,RENAULT CLIO II (BB0/1/2_, CB0/1/2_),KANGOO (KC0/1_),KANGOO Rapid (FC0/1_),MEGANE I (BA0/1_),MEGANE I Classic (LA0/1_),MEGANE I Grandtour (KA0/1_),MEGANE Scenic (JA0/1_),THALIA (LB0/1/2_)
23123	Zahnriemensatz, Timing Belt Kit, Kit de distribution RENAULT LAGUNA (B56_, 556_),LAGUNA Grandtour (K56_),SAFRANE II (B54_),VOLVO C70 I Cabriolet,C70 I Coupe,S40 I (VS),S60,S70 (P80_),S80 (TS, XY),V40 Kombi (VW),V70 I Kombi (P80_),V70 II Kombi (P80_),XC 90,XC70 CROSS COUNTRY

Application list - Liste d'affectation

23124	Zahnriemensatz, Timing Belt Kit, Kit de distribution RENAULT CLIO II (BB0/1/2_, CB0/1/2_), ESPACE III (JE0_), LAGUNA (B56_, 556_), LAGUNA Grandtour (K56_), MEGANE I (BA0/1_), MEGANE I Classic (LA0/1_), MEGANE I Grandtour (KA0/1_), SCÉNIC I (JA0/1_)
23125	Zahnriemensatz, Timing Belt Kit, Kit de distribution RENAULT ESPACE III (JE0_), MEGANE I (BA0/1_), MEGANE I Classic (LA0/1_), MEGANE I Grandtour (KA0/1_), SCÉNIC I (JA0/1_)
23126	Zahnriemensatz, Timing Belt Kit, Kit de distribution RENAULT LAGUNA II (BG0/1_), LAGUNA II Grandtour (KG0/1_)
23129	Zahnriemensatz, Timing Belt Kit, Kit de distribution NISSAN KUBISTAR (X76), RENAULT CLIO II (BB0/1/2_, CB0/1/2_), KANGOO (KC0/1_), KANGOO Rapid (FC0/1_), LAGUNA (B56_, 556_), LAGUNA Grandtour (K56_), LAGUNA II (BG0/1_), LAGUNA II Grandtour (KG0/1_), MEGANE I (BA0/1_), MEGANE I Cabriolet (EA0/1_), MEGANE I Classic (LA0/1_), MEGANE I Coach (DA0/1_), MEGANE I Grandtour (KA0/1_), MEGANE II (BM0/1_, CM0/1_), MEGANE II Grandtour (KM0/1_), MEGANE II Stufenheck (LM0/1_), MODUS (F/JPO_), SCÉNIC I (JA0/1_), SCÉNIC II (JM0/1_)
23132	Zahnriemensatz, Timing Belt Kit, Kit de distribution DACIA LOGAN (LS_), LOGAN MCV (KS_), NISSAN ALMERA II Hatchback (N16), KUBISTAR (X76), MICRA III (K12), PRIMASTAR Kasten (X83), RENAULT CLIO Grandtour (KR0/1_), CLIO II (BB0/1/2_, CB0/1/2_), CLIO II Kasten (SB0/1/2_), CLIO III (BR0/1_, CR0/1_), GRAND SCÉNIC II (JM0/1_), KANGOO Express (FW0/1_), KANGOO (KC0/1_), KANGOO (KW0/1_), KANGOO Rapid (FC0/1_), LAGUNA III (BT0/1_), LAGUNA III Grandtour (KT0/1_), MEGANE II (BM0/1_, CM0/1_), MEGANE II Coupé-Cabriolet (EM0/1_), MEGANE II Grandtour (KM0/1_), MEGANE II Stufenheck (LM0/1_), MODUS (F/JPO_), SCÉNIC II (JM0/1_), THALIA (LB0/1/2_), TWINGO (CN0_), SUZUKI JIMNY (FJ)
23135	Zahnriemensatz, Timing Belt Kit, Kit de distribution RENAULT CLIO I (B/C57_, 5/357_), CLIO I Kasten (S57_), RAPID Kasten (F40_, G40_)
23136	Zahnriemensatz, Timing Belt Kit, Kit de distribution RENAULT AVANTIME (DE0_), CLIO III (BR0/1_, CR0/1_), ESPACE IV (JK0/1_), GRAND SCÉNIC II (JM0/1_), LAGUNA II (BG0/1_), LAGUNA II Grandtour (KG0/1_), MEGANE II (BM0/1_, CM0/1_), MEGANE II Coupé-Cabriolet (EM0/1_), MEGANE II Grandtour (KM0/1_), MEGANE II Stufenheck (LM0/1_), SCÉNIC II (JM0/1_), VEL SATIS (BJ0_)
23401	Zahnriemensatz, Timing Belt Kit, Kit de distribution CITROËN AX (ZA_), BERLINGO Kasten (M_), BERLINGO (MF), BX (XB_), C15 (VD_), SAXO (S0, S1), ZX (N2), PEUGEOT PARTNER Combispacer (5F), PARTNER Kasten (5), 106 I (1A, 1C), 106 II (1), 205 I Cabriolet (741B, 20D), 205 II (20A/C), 206 Schrägheck (2A/C), 306 Schrägheck (7A, 7C, N3, N5), 306 (7B, N3, N5), 309 I (10C, 10A), 309 II (3C, 3A)
23402	Zahnriemensatz, Timing Belt Kit, Kit de distribution CITROËN AX (ZA_), BERLINGO Kasten (M_), BERLINGO (MF), BX Break (XB_), BX (XB_), C15 (VD_), SAXO (S0, S1), XSARA Break (N2), XSARA Coupe (N0), XSARA (N1), ZX Break (N2), ZX (N2), PEUGEOT PARTNER Combispacer (5F), PARTNER Kasten (5), 106 I (1A, 1C), 106 II (1), 205 I Cabriolet (741B, 20D), 205 II (20A/C), 206 Schrägheck (2A/C), 306 Break (7E, N3, N5), 306 Schrägheck (7A, 7C, N3, N5), 306 (7B, N3, N5), 309 I (10C, 10A), 309 II (3C, 3A), 405 II Break (4E), 405 II (4B)
23403	Zahnriemensatz, Timing Belt Kit, Kit de distribution CITROËN AX (ZA_), PEUGEOT 106 I (1A, 1C), ROVER 100 (METRO) (XP)
23404	Zahnriemensatz, Timing Belt Kit, Kit de distribution CITROËN BX Break (XB_), BX (XB_), VISA, ZX (N2), PEUGEOT 205 I Cabriolet (741B, 20D), 205 I (741A/C), 205 II (20A/C), 305 II Break (581E), 305 II (581M), 309 I (10C, 10A), 309 II (3C, 3A), 405 I Break (15E), 405 I (15B)
23405	Zahnriemensatz, Timing Belt Kit, Kit de distribution CITROËN BX Break (XB_), BX (XB_), C15 (VD_), C25 Bus (280_, 290_), VISA, ZX Break (N2), ZX (N2), LADA NIVA (2121), PEUGEOT J5 Bus (290P), J5 Kasten (290L), J5 Pritsche/Fahrgestell (290L), 205 I (741A/C), 205 II (20A/C), 305 II Break (581E), 305 II (581M), 306 Schrägheck (7A, 7C, N3, N5), 309 I (10C, 10A), 309 II (3C, 3A), 405 I Break (15E), 405 I (15B), 405 II Break (4E), 405 II (4B), ROVER 200 Hatchback (XW), 400 (XW), TALBOT HORIZON
23406	Zahnriemensatz, Timing Belt Kit, Kit de distribution CITROËN BX (XB_), PEUGEOT 309 II (3C, 3A), 405 I (15B)
23408	Zahnriemensatz, Timing Belt Kit, Kit de distribution CITROËN C4 Coupe (LA_), C4 (LC_), C5 Break (DE_), C5 Break (RE_), C5 (DC_), C5 (RC_), C8 (EA_, EB_), EVASION (22, U6), JUMPY Kasten (BS_, BT_, BY_, BZ_), JUMPY (U6U), XSARA Break (N2), XSARA Coupe (N0), XSARA (N1), XSARA PICASSO (N68), FIAT SCUDO Combinato (220P), SCUDO Kasten (220L), ULYSSE (179AX), ULYSSE (220), LANCIA PHEDRA (179), ZETA (220), PEUGEOT EXPERT (224), 206 CC (2D), 206 Schrägheck (2A/C), 206 SW (2E/K), 307 Break (3E), 307 CC (3B), 307 SW (3H), 307 (3A/C), 406 Break (8E/F), 406 Coupe (8C), 406 (8B), 407 SW (6E_), 407 (6D_), 607 (9D, 9U), 806 (221), 807 (E)
23410	Zahnriemensatz, Timing Belt Kit, Kit de distribution CITROËN BERLINGO (MF), C2 (JM_), C3 (FC_), SAXO (S0, S1), PEUGEOT PARTNER Combispacer (5F), 106 II (1), 206 Schrägheck (2A/C), 206 SW (2E/K)
23411	Zahnriemensatz, Timing Belt Kit, Kit de distribution CITROËN BERLINGO Kasten (M_), BERLINGO (MF), C2 (JM_), C3 (FC_), C3 Pluriel (HB_), SAXO (S0, S1), PEUGEOT PARTNER Combispacer (5F), PARTNER Kasten (5), 1007 (KM_), 106 II (1), 206 Schrägheck (2A/C), 206 SW (2E/K), 207 (WA_, WC_), 306 Break (7E, N3, N5), 306 Schrägheck (7A, 7C, N3, N5), 306 (7B, N3, N5), 307 (3A/C)
23412	Zahnriemensatz, Timing Belt Kit, Kit de distribution CITROËN AX (ZA_), SAXO (S0, S1), XSARA Break (N2), XSARA (N1), NISSAN MICRA II (K11), PEUGEOT 106 I (1A, 1C), 106 II (1)
23413	Zahnriemensatz, Timing Belt Kit, Kit de distribution CITROËN AX (ZA_), BX (XB_), C15 (VD_), SAXO (S0, S1), XSARA Break (N2), XSARA (N1), XSARA PICASSO (N68), PEUGEOT 106 I (1A, 1C), 106 II (1), 205 I Cabriolet (741B, 20D), 205 II (20A/C), 206 Schrägheck (2A/C), 306 Break (7E, N3, N5), 306 Cabriolet (7D, N3, N5), 306 Schrägheck (7A, 7C, N3, N5), 306 (7B, N3, N5), 309 I (10C, 10A), 309 II (3C, 3A)
23414	Zahnriemensatz, Timing Belt Kit, Kit de distribution CITROËN BERLINGO Kasten (M_), BERLINGO (MF), BX Break (XB_), BX (XB_), EVASION (22, U6), XANTIA Break (X1), XANTIA Break (X2), XANTIA (X1), XANTIA Break (N2), XSARA Coupe (N0), XSARA (N1), ZX Break (N2), ZX (N2), FIAT ULYSSE (220), LANCIA ZETA (220), PEUGEOT PARTNER Combispacer (5F), 205 I Cabriolet (741B, 20D), 205 II (20A/C), 306 Break (7E, N3, N5), 306 Cabriolet (7D, N3, N5), 306 Schrägheck (7A, 7C, N3, N5), 306 (7B, N3, N5), 309 I (3C, 3A), 405 I Break (15E), 405 I (15B), 405 II Break (4E), 405 II (4B), 406 Break (8E/F), 406 (8B), 605 (6B), 806 (221)
23415	Zahnriemensatz, Timing Belt Kit, Kit de distribution CITROËN BERLINGO Kasten (M_), BERLINGO (MF), C15 (VD_), EVASION (22, U6), JUMPER Bus (230P), JUMPER Kasten (230L), JUMPER Pritsche/Fahrgestell (230), JUMPY Kasten (BS_, BT_, BY_, BZ_), JUMPY (U6U), XANTIA Break (X1), XANTIA Break (X2), XANTIA (X1), XANTIA (X2), XSARA Break (N2), XSARA Coupe (N0), XSARA (N1), ZX Break (N2), ZX (N2), FIAT DUCATO Bus (230), DUCATO Kasten (230L), DUCATO Pritsche/Fahrgestell (230), SCUDO Combinato (220P), SCUDO Kasten (220L), ULYSSE (220), HONDA CONCERTO (HW), HYUNDAI LANTRA II (J-2), LANTRA II Wagon (J-2), LADA NIVA (2121), PEUGEOT BOXER Kasten (230P), BOXER Kasten (230L), BOXER Pritsche/Fahrgestell (ZCT_), EXPERT Kasten (222), EXPERT Pritsche/Fahrgestell (223), EXPERT (224), J5 Bus (290P), J5 Kasten (290L), J5 Pritsche/Fahrgestell (290L), PARTNER Combispacer (5F), PARTNER Kasten (5), 205 I (741A/C), 205 II (20A/C), 205 Kasten, 306 Break (7E, N3, N5), 306 Schrägheck (7A, 7C, N3, N5), 306 (7B, N3, N5), 405 II Break (4E), 405 II (4B), 406 Break (8E/F), 406 (8B), 806 (221), ROVER 200 Hatchback (XW), 400 Tourer (XW), 400 (XW), SUZUKI BALENO (EG), BALENO Kombi (EG), BALENO Schrägheck (EG), SAMURAI (SJ), VITARA Cabrio (ET, TA), VITARA (ET, TA)
23416	Zahnriemensatz, Timing Belt Kit, Kit de distribution CITROËN XM Break (Y3), XM (Y3), PEUGEOT 405 II Break (4E), 405 II (4B), 605 (6B)

Application list - Liste d'affectation

23417	Zahnriemensatz, Timing Belt Kit, Kit de distribution CITROËN XM Break (Y3),XM Break (Y4),XM (Y3),PEUGEOT 605 (6B)
23418	Zahnriemensatz, Timing Belt Kit, Kit de distribution CITROËN CX I Break (MA),CX I (MA),CX II,CX II Break,C25 Bus (280_, 290_),FIAT DUCATO Kasten (280),DUCATO Panorama (280),DUCATO Pritsche/Fahrgestell (280),PEUGEOT J5 Bus (280P),J5 Bus (290P),J5 Kasten (290L),J5 Pritsche/Fahrgestell (280L),J5 Pritsche/Fahrgestell (290L)
23419	Zahnriemensatz, Timing Belt Kit, Kit de distribution CITROËN EVASION (22, U6),XANTIA Break (X1),XANTIA Break (X2),XANTIA (X1),XANTIA (X2),XM Break (Y3),XM Break (Y4),XM (Y3),XM (Y4),FIAT ULYSSE (220),LANCIA ZETA (220),PEUGEOT 406 Break (8E/F),406 (8B),605 (6B),806 (221)
23424	Zahnriemensatz, Timing Belt Kit, Kit de distribution CITROËN C5 Break (DE_),C5 Break (RE_),C5 (DC_),C5 (RC_),C6 (TD_),C8 (EA_, EB_),XANTIA Break (X2),XANTIA (X2),XM Break (Y4),XM (Y4),FIAT ULYSSE (179AX),LANCIA PHEDRA (179),PEUGEOT 406 Break (8E/F),406 Coupe (8C),406 (8B),407 Coupe (6C_),407 SW (6E_),407 (6D_),807 (9D, 9U),807 (E),RENAULT AVANTIME (DEO_),CLIO II (BB0/1/2_, CB0/1/2_),ESPACE III (JEO_),LAGUNA (B56_, 556_),LAGUNA Grandtour (K56_),LAGUNA II (BG0/1_),LAGUNA II Grandtour (KG0/1_),SAFRANE II (B54_)
23425	Zahnriemensatz, Timing Belt Kit, Kit de distribution CITROËN BERLINGO Kasten (M_),BERLINGO (MF),JUMPY Kasten (BS_, BT_, BY_, BZ_),JUMPY (U6U),XSARA Break (N2),XSARA Coupe (N0),XSARA (N1),FIAT SCUDO Combinato (220P),SCUDO Kasten (220L),PEUGEOT PARTNER Combispace (5F),PARTNER Kasten (5),206 Schrägheck (2A/C),306 Break (7E, N3, N5),306 Schrägheck (7A, 7C, N3, N5),306 (7B, N3, N5)
23426	Zahnriemensatz, Timing Belt Kit, Kit de distribution CITROËN BERLINGO Kasten (M_),BERLINGO (MF),C5 Break (DE_),C5 (DC_),EVASION (22, U6),JUMPER Bus (244, Z_),JUMPER Kasten (244),JUMPER Pritsche/Fahrgestell (244),JUMPY Kasten (BS_, BT_, BY_, BZ_),JUMPY Pritsche/Fahrgestell (BU_, BV_, BW_, BX_),JUMPY (U6U),XANTIA Break (X2),XANTIA (X2),XSARA Break (N2),XSARA Coupe (N0),XSARA (N1),XSARA PICASSO (N68),FIAT DUCATO Bus (230),DUCATO Bus (244, Z_),DUCATO Kasten (230L),DUCATO Kasten (244),DUCATO Pritsche/Fahrgestell (244),SCUDO Combinato (220P),SCUDO Kasten (220L),ULYSSE (220),LANCIA ZETA (220),PEUGEOT BOXER Bus (244, Z_),BOXER Kasten (244),BOXER Pritsche/Fahrgestell (244),EXPERT Kasten (222),EXPERT (224),PARTNER Combispace (5F),PARTNER Kasten (5),206 Schrägheck (2A/C),206 SW (2E/K),306 Break (7E, N3, N5),306 Schrägheck (7A, 7C, N3, N5),306 (7B, N3, N5),307 Break (3E),307 SW (3H),307 (3A/C),406 Break (8E/F),406 (8B),607 (9D, 9U),806 (221),SUZUKI GRAND VITARA (FT, GT)
23427	Zahnriemensatz, Timing Belt Kit, Kit de distribution CITROËN C5 Break (DE_),C5 Break (RE_),C5 (DC_),C5 (RC_),C8 (EA_, EB_),FIAT ULYSSE (179AX),LANCIA PHEDRA (179),PEUGEOT 406 Break (8E/F),406 Coupe (8C),406 (8B),607 (9D, 9U),807 (E)
23428	Zahnriemensatz, Timing Belt Kit, Kit de distribution CITROËN C5 Break (DE_),C8 (EA_, EB_),FIAT SCUDO Kasten (220L),ULYSSE (179AX),LANCIA PHEDRA (179),ZETA (220),PEUGEOT EXPERT Kasten (222),EXPERT (224),307 SW (3H),307 (3A/C),406 Break (8E/F),406 (8B),806 (221),807 (E)
23432	Zahnriemensatz, Timing Belt Kit, Kit de distribution CITROËN SAXO (S0, S1),PEUGEOT 106 II (1)
23433	Zahnriemensatz, Timing Belt Kit, Kit de distribution CITROËN JUMPER Bus (244, Z_),JUMPER Kasten (244),JUMPER Pritsche/Fahrgestell (244),PEUGEOT BOXER Bus (244, Z_),BOXER Kasten (244),BOXER Pritsche/Fahrgestell (244)
23501	Zahnriemensatz, Timing Belt Kit, Kit de distribution HONDA CIVIC II Shuttle (EE),CIVIC IV Hatchback (EC, ED, EE),CIVIC IV Hatchback (EG),CIVIC IV Stufenheck (ED),CIVIC V Coupe (EJ),CIVIC V Stufenheck (EG, EH),CIVIC VI Fastback (MA),CONCERTO (HW),CONCERTO Stufenheck (HWW)
23502	Zahnriemensatz, Timing Belt Kit, Kit de distribution HONDA CIVIC II Shuttle (EE),CIVIC IV Hatchback (EC, ED, EE),CIVIC IV Stufenheck (ED),CONCERTO (HW),ROVER 200 Hatchback (XW),400 Tourer (XW),400 (XW)
23503	Zahnriemensatz, Timing Belt Kit, Kit de distribution HONDA CONCERTO (HW),CRX II (ED, EE),ROVER CABRIOLET (XW),200 Coupe (XW),200 Hatchback (XW),400 Tourer (XW),400 (XW)
23507	Zahnriemensatz, Timing Belt Kit, Kit de distribution HONDA ACCORD IV Aerodeck (CB8, CB9),ACCORD IV (CB3, CB7),ACCORD IV Coupe (CC1),ACCORD V Aerodeck (CE),ACCORD V (CC7, CD),ACCORD V Coupe (CD7, CD9),ACCORD VI (CE, CF),PRELUDE IV (BB),PRELUDE V (BB),SHUTTLE (RA),ROVER 600 (RH)
23510	Zahnriemensatz, Timing Belt Kit, Kit de distribution TOYOTA AVENSIS Liftback (_T22_),AVENSIS Station Wagon (_T22_),AVENSIS (_T22_),CARINA E Sportswagon (_T19_),CARINA E Stufenheck (_T19_),CARINA E (_T19_),COROLLA Compact (_E10_),COROLLA Compact (_E11_),COROLLA (_E10_),COROLLA (_E11_),COROLLA Liftback (_E10_),COROLLA Liftback (_E11_),COROLLA Wagon (_E10_),COROLLA Wagon (_E11_)
23511	Zahnriemensatz, Timing Belt Kit, Kit de distribution TOYOTA AVENSIS Liftback (_T22_),AVENSIS Station Wagon (_T22_),AVENSIS (_T22_),CARINA E Sportswagon (_T19_),CARINA E Stufenheck (_T19_),CARINA E (_T19_),CELICA (_T20_),COROLLA Wagon (_E10_),COROLLA Wagon (_E11_)
23512	Zahnriemensatz, Timing Belt Kit, Kit de distribution TOYOTA AVENSIS Liftback (_T22_),AVENSIS Station Wagon (_T22_),AVENSIS (_T22_),CAMRY Station Wagon (_V10),CAMRY Station Wagon (_V2_),CAMRY (_V1_),CAMRY (_V2_),CAMRY (_V20),CARINA E Sportswagon (_T19_),CARINA E Stufenheck (_T19_),CARINA E (_T19_),CARINA II Station Wagon (_T17_),CARINA II Stufenheck (_T17_),CARINA II (_T17_),PICNIC (_XM10),RAV 4 I Cabrio (SXA1_),RAV 4 I (SXA1_)
23513	Zahnriemensatz, Timing Belt Kit, Kit de distribution TOYOTA AVENSIS Liftback (_T22_),AVENSIS Station Wagon (_T22_),AVENSIS (_T22_),CAMRY Liftback (V1),CAMRY Station Wagon (_V2_),CAMRY Stufenheck (V1),CAMRY (_V2_),CARINA E Sportswagon (_T19_),CARINA E Stufenheck (_T19_),CARINA E (_T19_),CARINA II Station Wagon (_T17_),CARINA II Stufenheck (_T15_),CARINA II Stufenheck (_T17_),CARINA II (_T15_),CARINA II (_T17_),COROLLA Compact (_E10_),COROLLA Compact (_E11_),COROLLA Compact (_E9_),COROLLA (_E10_),COROLLA (_E11_),COROLLA (_E8_),COROLLA (_E9_),COROLLA FX Compact (E8B),COROLLA Liftback (_E10_),COROLLA Liftback (_E11_),COROLLA Liftback (_E7_),COROLLA Liftback (_E8_),COROLLA Liftback (_E9_),COROLLA Station Wagon (_E7_),COROLLA Station Wagon (_E9_),COROLLA Wagon (_E10_),COROLLA Wagon (_E11_),LITEACE Bus (CM30_G, KM30_G),LITEACE Kasten (CM3_V, KM3_V),PICNIC (_XM10)
23516	Zahnriemensatz, Timing Belt Kit, Kit de distribution TOYOTA CRESSIDA Station Wagon (X6K, MX62),CRESSIDA Stufenheck (_X6_),HIACE I Kasten (H10),HIACE II Kasten (H20),HIACE II Wagon (H20),LAND CRUISER (_J7_)
23517	Zahnriemensatz, Timing Belt Kit, Kit de distribution TOYOTA CARINA II Stufenheck (_T15_),CARINA II (_T15_),CELICA Liftback (T16),CELICA (ST16_),COROLLA (_E8_),COROLLA Liftback (_E8_),TERCEL (AL2_),TERCEL (_L1_, _L2_)
23518	Zahnriemensatz, Timing Belt Kit, Kit de distribution TOYOTA CARINA II Station Wagon (_T17_),CARINA II Stufenheck (_T17_),CARINA II (_T17_),CELICA Coupe (_T18_),COROLLA Compact (_E9_),COROLLA (_E9_),COROLLA Liftback (_E9_),COROLLA Station Wagon (_E9_)
23520	Zahnriemensatz, Timing Belt Kit, Kit de distribution MITSUBISHI GALANT VI (EA_),GALANT VI Station Wagon (EA_),SPACE RUNNER (N50)
23530	Zahnriemensatz, Timing Belt Kit, Kit de distribution HYUNDAI COUPE (GK),HIGHWAY VAN,SANTA FÉ (SM),SONATA IV (EF),TRAJET (FO),TUCSON (JM),XG (XG),KIA MAGENTIS (GD),SPORTAGE (JE_)

Application list - Liste d'affectation

23534	Zahnriemensatz, Timing Belt Kit, Kit de distribution KIA CLARUS Kombi (GC),CLARUS (K9A),RETONA (CE),SPORTAGE (K00),MAZDA 626 III Coupe (GD),626 III (GD),626 III Hatchback (GD),626 III Station Wagon (GV)
23535	Zahnriemensatz, Timing Belt Kit, Kit de distribution MAZDA 626 III Coupe (GD),626 III (GD),626 III Hatchback (GD),626 III Station Wagon (GV),929 III (HC)
23536	Zahnriemensatz, Timing Belt Kit, Kit de distribution KIA SPORTAGE (K00),MAZDA E-SERIE Bus (SR1),E-SERIE Kasten (SR2),626 III Coupe (GD),626 III (GD),626 III Hatchback (GD),626 III Station Wagon (GV),929 III (HC)
23538	Zahnriemensatz, Timing Belt Kit, Kit de distribution MAZDA 121 I (DA),323 III (BF),323 III Hatchback (BF),323 III Station Wagon (BW)
23539	Zahnriemensatz, Timing Belt Kit, Kit de distribution KIA PRIDE (DA),PRIDE Kombi,RIO Kombi (DC),SEPHIA (FA),SEPHIA Stufenheck (FA),MAZDA DEMIO (DW),MX-3 (EC),MX-5 I (NA),121 I (DA),121 II (DB),323 C IV (BG),323 C V (BA),323 F IV (BG),323 F VI (BJ),323 III (BF),323 III Hatchback (BF),323 III Station Wagon (BW),323 P V (BA),323 S IV (BG),323 S V (BA),323 S VI (BJ)
23541	Zahnriemensatz, Timing Belt Kit, Kit de distribution HYUNDAI LANTRA I (J-1),PONY (X-2),PONY/EXCEL Stufenheck (X-2),S COUPE (SLC),MITSUBISHI COLT II (C1_A),COLT III (C5_A),LANCER III (C1_A, C6_A),LANCER III Station Wagon (C1_V, C3_V),LANCER IV Stufenheck (C6_A)
23542	Zahnriemensatz, Timing Belt Kit, Kit de distribution HYUNDAI LANTRA I (J-1),PONY (X-2),PONY/EXCEL Stufenheck (X-2),S COUPE (SLC),MITSUBISHI COLT II (C1_A),COLT III (C5_A),LANCER III (C1_A, C6_A),LANCER III Station Wagon (C1_V, C3_V),LANCER IV Stufenheck (C6_A)
23600	Zahnriemensatz, Timing Belt Kit, Kit de distribution BMW Z1,3 Cabriolet (E30),3 (E30),3 Touring (E30),5 (E28),5 (E34)
23601	Zahnriemensatz, Timing Belt Kit, Kit de distribution BMW 3 (E21),5 (E12)
23602	Zahnriemensatz, Timing Belt Kit, Kit de distribution BMW 3 (E30),5 (E28)
23604	Zahnriemensatz, Timing Belt Kit, Kit de distribution BMW 3 (E36),5 (E34),5 Touring (E34)
23605	Zahnriemensatz, Timing Belt Kit, Kit de distribution BMW 3 Cabriolet (E30),3 (E30),3 Touring (E30),5 (E34)
23627	Zahnriemensatz, Timing Belt Kit, Kit de distribution FORD CAPRI III (GECF),CONSUL Coupe (GGCL),CONSUL Turnier (GGNL),ESCORT II (ATH),GRANADA (GU),GRANADA Kombi (GNU),SIERRA (GBG, GB4),SIERRA Kombi (BNC),SIERRA Kombi (BNG),SIERRA Schrägheck (GBC),SIERRA Schrägheck (GBC, GBG),TAUNUS '80 (GBS, GBNS),TAUNUS '80 Turnier (GBNS),TRANSIT Bus (E_),TRANSIT Bus (T_),TRANSIT Bus (V_),TRANSIT Kasten (E_),TRANSIT Kasten (T_),TRANSIT Kasten (V_),TRANSIT Pritsche/Fahrgestell (E_),TRANSIT Pritsche/Fahrgestell (T_),TRANSIT Pritsche/Fahrgestell (V_)
23628	Zahnriemensatz, Timing Belt Kit, Kit de distribution FORD CAPRI (ECJ),CAPRI II (GECF),CAPRI III (GECF),SIERRA (GBG, GB4),SIERRA Kombi (BNC),SIERRA Kombi (BNG),SIERRA Schrägheck (GBC),SIERRA Schrägheck (GBC, GBG),TRANSIT Bus (FD_ , FB_ , FS_ , FZ_ , FC_),TRANSIT Bus (T_),TRANSIT Bus (V_),TRANSIT Kasten (T_),TRANSIT Kasten (V_),TRANSIT Pritsche/Fahrgestell (V_)
23629	Zahnriemensatz, Timing Belt Kit, Kit de distribution FORD COURIER Kasten (J5_ , J3_),FIESTA IV (JA_ , JB_),FIESTA V (JH_ , JD_),FOCUS C-MAX,FOCUS (DAW, DBW),FOCUS II (DA_),FOCUS II Kombi (DAW_),FOCUS Kombi (DNW),FOCUS Stufenheck (DFW),FUSION (JU_),PUMA (EC_),MAZDA DEMIO (DW),121 III (JASM, JBSM),2 (DY),VOLVO S40 II (MS),V50 (MW)
23630	Zahnriemensatz, Timing Belt Kit, Kit de distribution FORD FIESTA IV (JA_ , JB_),FOCUS (DAW, DBW),FOCUS Kombi (DNW),FOCUS Stufenheck (DFW)
23631	Zahnriemensatz, Timing Belt Kit, Kit de distribution FORD TRANSIT Bus (E_),TRANSIT Kasten (E_),TRANSIT Pritsche/Fahrgestell (E_)
23632	Zahnriemensatz, Timing Belt Kit, Kit de distribution FORD TRANSIT Bus (E_),TRANSIT Kasten (E_),TRANSIT Pritsche/Fahrgestell (E_)
23633	Zahnriemensatz, Timing Belt Kit, Kit de distribution FORD COURIER Kasten (F3L, F5L),COURIER Kasten (J5_ , J3_),ESCORT VII Cabriolet (ALL),ESCORT VII (GAL, AAL, ABL),ESCORT VII Kombi (GAL, ANL),ESCORT VII Stufenheck (GAL, AFL),ESCORT '95 Express (AVL),FIESTA III (GFJ),FIESTA IV (JA_ , JB_),FIESTA Kasten (FVD),MONDEO I (GBP),MONDEO I Kombi (BNP),MONDEO I Stufenheck (GBP),MAZDA 121 III (JASM, JBSM)
23636	Zahnriemensatz, Timing Belt Kit, Kit de distribution FORD COURIER Kasten (J5_ , J3_),FIESTA IV (JA_ , JB_),FIESTA Kasten (JV_),FOCUS C-MAX,FOCUS (DAW, DBW),FOCUS II (DA_),FOCUS II Kombi (DAW_),FOCUS II Stufenheck (DA_),FOCUS Kombi (DNW),FOCUS Stufenheck (DFW),GALAXY,S-MAX,TOURNEO CONNECT,TRANSIT CONNECT (P65_ , P70_ , P80_)
23701	Zahnriemensatz, Timing Belt Kit, Kit de distribution FORD ESCORT III Cabriolet (ALD),ESCORT III (GAA),ESCORT III Kombi (AWA),ESCORT IV Cabriolet (ALF),ESCORT IV (GAF, AWF, ABFT),ESCORT IV Kombi (AWF, AVF),ESCORT V Cabriolet (ALL),ESCORT V (GAL),ESCORT V Kombi (GAL, AVL),ESCORT '81 Express (AVA),ESCORT '86 Express (AVF),ESCORT '91 Express (AVL),FIESTA II (FBD),FIESTA III (GFJ),ORION I (AFD),ORION II (AFF),ORION III (GAL),SIERRA (GBG, GB4),SIERRA Kombi (BNG),SIERRA Schrägheck (GBC, GBG)
23702	Zahnriemensatz, Timing Belt Kit, Kit de distribution FORD ESCORT V Cabriolet (ALL),ESCORT V (GAL),ESCORT V Kombi (GAL, AVL),ESCORT VI Cabriolet (ALL),ESCORT VI (GAL),ESCORT VI Kombi (GAL),ESCORT VII Stufenheck (GAL),ESCORT VII Cabriolet (ALL),ESCORT VII (GAL, AAL, ABL),ESCORT VII Kombi (GAL, ANL),ESCORT VII Stufenheck (GAL, AFL),ESCORT '91 Express (AVL),ESCORT '95 Express (AVL),FIESTA III (GFJ),ORION III (GAL),SIERRA (GBG, GB4),SIERRA Kombi (BNG),SIERRA Schrägheck (GBC, GBG)
23704	Zahnriemensatz, Timing Belt Kit, Kit de distribution FORD COURIER Kasten (F3L, F5L),ESCORT IV (GAF, AWF, ABFT),ESCORT IV Kombi (AWF, AVF),ESCORT V (GAL),ESCORT V Kombi (GAL, AVL),ESCORT VI (GAL),ESCORT VI Kombi (GAL),ESCORT VI Stufenheck (GAL),ESCORT VII Cabriolet (ALL),ESCORT VII (GAL, AAL, ABL),ESCORT VII Kombi (GAL, ANL),ESCORT VII Stufenheck (GAL, AFL),ESCORT '86 Express (AVF),ESCORT '91 Express (AVL),ESCORT '95 Express (AVL),FIESTA III (GFJ),FIESTA IV (JA_ , JB_),FIESTA Kasten (FVD),MONDEO I (GBP),MONDEO I Kombi (BNP),MONDEO I Stufenheck (GBP),ORION II (AFF),ORION III (GAL),P 100 II,SIERRA (GBG, GB4),SIERRA Kombi (BNG),SIERRA Schrägheck (GBC, GBG)
23707	Zahnriemensatz, Timing Belt Kit, Kit de distribution FORD TRANSIT Bus (E_),TRANSIT Bus (T_),TRANSIT Kasten (E_),TRANSIT Pritsche/Fahrgestell (E_),TRANSIT Pritsche/Fahrgestell (T_)
23708	Zahnriemensatz, Timing Belt Kit, Kit de distribution FORD TRANSIT Bus (E_),TRANSIT Kasten (E_),TRANSIT Pritsche/Fahrgestell (E_)

Application list - Liste d'affectation

23709	Zahnriemensatz, Timing Belt Kit, Kit de distribution FORD TRANSIT Bus (E_), TRANSIT Kasten (E_), TRANSIT Pritsche/Fahrgestell (E_)
23710	Zahnriemensatz, Timing Belt Kit, Kit de distribution FORD ESCORT CLASSIC (AAL, ABL), ESCORT CLASSIC Turnier (ANL), ESCORT V Cabriolet (ALL), ESCORT V (GAL), ESCORT V Kombi (GAL, AVL), ESCORT VI Cabriolet (ALL), ESCORT VI (GAL), ESCORT VI Kombi (GAL), ESCORT VI Stufenheck (GAL), ESCORT VII Cabriolet (ALL), ESCORT VII (GAL, AAL, ABL), ESCORT VII Kombi (GAL, ANL), ESCORT VII Stufenheck (GAL, AFL), FIESTA III (GFJ), MONDEO I (GBP), MONDEO I Kombi (BNP), MONDEO I Stufenheck (GBP), MONDEO II (BAP), MONDEO II Kombi (BNP), MONDEO II Stufenheck (BFP), ORION III (GAL)
23712	Zahnriemensatz, Timing Belt Kit, Kit de distribution FORD COURIER Kasten (J5_, J3_), ESCORT CLASSIC (AAL, ABL), ESCORT CLASSIC Turnier (ANL), ESCORT VII Cabriolet (ALL), ESCORT VII (GAL, AAL, ABL), ESCORT VII Kombi (GAL, ANL), ESCORT VII Stufenheck (GAL, AFL), ESCORT '95 Express (AVL), FIESTA IV (JA_, JB_), FIESTA Kasten (JV_), MONDEO II (BAP), MONDEO II Kombi (BNP), MONDEO II Stufenheck (BFP), MAZDA 121 III (JASM, JBSM)
23721	Zahnriemensatz, Timing Belt Kit, Kit de distribution OPEL ASCONA C CC (84_, 89_), ASCONA C (81_, 86_, 87_, 88_), ASTRA F Caravan (51_, 52_), ASTRA F CC (53_, 54_, 58_, 59_), ASTRA F Van (55_), ASTRA F (56_, 57_), KADETT E Caravan (35_, 36_, 45_, 46_), KADETT E CC (33_, 34_, 43_, 44_), KADETT E Combo (38_, 48_), KADETT E Kasten (37_, 47_), KADETT E (39_, 49_), VECTRA A CC (88_, 89_), VECTRA A (86_, 87_), VAUXHALL ASTRA Mk II Belmont, ASTRA Mk II CC, ASTRA Mk II Estate, ASTRA Mk III (F), ASTRA Mk III (F) CC, ASTRA Mk III (F) Estate, CAVALIER Mk II, CAVALIER Mk II CC, CAVALIER Mk II Estate, CAVALIER Mk III CC, CAVALIER Mk III (87)
23722	Zahnriemensatz, Timing Belt Kit, Kit de distribution CHEVROLET AVEO Stufenheck, CORSA, CORSA PICK UP, CORSA Pritsche/Fahrgestell, CORSA Schrägheck, KALOS, LOVA, DAEWOO AVEO, ESPERO (KLEJ), GENTRA Stufenheck, KALOS (KLAS), KALOS Stufenheck (KLAS), LACETTI Kombi, LACETTI Stufenheck, LACETTI Stufenheck (J200), LANOS (KLAT), LANOS Stufenheck (KLAT), NEXIA (KLETN), NEXIA Stufenheck (KLETN), OPEL ASTRA F Cabriolet (53_B), ASTRA F Caravan (51_, 52_), ASTRA F CC (53_, 54_, 58_, 59_), ASTRA F CLASSIC Caravan, ASTRA F CLASSIC CC, ASTRA F CLASSIC Stufenheck, ASTRA F Van (55_), ASTRA F (56_, 57_), ASTRA G Caravan (F35_), ASTRA G CC (F48_, F08_), ASTRA G Kasten (F70), ASTRA G Stufenheck (F69_), COMBO Kasten/Kombi, COMBO Tour, COMBO (71_), CORSA A CC (93_, 94_, 98_, 99_), CORSA A TR (91_, 92_, 96_, 97_), CORSA B Kasten (73_), CORSA B (73_, 78_, 79_), KADETT E Cabriolet (43B), KADETT E Caravan (35_, 36_, 45_, 46_), KADETT E CC (33_, 34_, 43_, 44_), KADETT E Combo (38_, 48_), KADETT E Kasten (37_, 47_), KADETT E (39_, 49_), MERIVA, VECTRA A CC (88_, 89_), VECTRA A (86_, 87_), VECTRA B Caravan (31_), VECTRA B CC (38_), VECTRA B (36_), VAUXHALL ASTRA Mk II Belmont, ASTRA Mk II CC, ASTRA Mk II Convertible, ASTRA Mk II Estate, ASTRA Mk III (F), ASTRA Mk III (F) CC, ASTRA Mk III (F) Convertible, ASTRA Mk III (F) Estate, ASTRA Mk IV (G), ASTRA Mk IV (G) CC, ASTRA Mk IV (G) Estate, ASTRAVAN Mk III (F), ASTRAVAN Mk IV (G), CAVALIER Mk III CC, CAVALIER Mk III (87), COMBO Mk I (B), COMBO Mk II (C), CORSA Mk II (B), CORSAVAN Mk II (B), MERIVA Mk I (A), NOVA, NOVA CC, VECTRA (B), VECTRA (B) CC, VECTRA (B) Estate
23724	Zahnriemensatz, Timing Belt Kit, Kit de distribution OPEL ASTRA F Caravan (51_, 52_), ASTRA F CC (53_, 54_, 58_, 59_), ASTRA F CLASSIC CC, ASTRA F Van (55_), ASTRA F (56_, 57_), ASTRA G Caravan (F35_), ASTRA G CC (F48_, F08_), ASTRA G Kasten (F70), ASTRA G Stufenheck (F69_), KADETT E Combo (38_, 48_), VECTRA A CC (88_, 89_), VECTRA A (86_, 87_), VAUXHALL ASTRA Mk II CC, ASTRA Mk III (F), ASTRA Mk III (F) CC, ASTRA Mk III (F) Estate, ASTRA Mk IV (G), ASTRA Mk IV (G) CC, ASTRA Mk IV (G) Estate, ASTRAVAN Mk III (F), ASTRAVAN Mk IV (G), CAVALIER Mk III CC, CAVALIER Mk III (87)
23725	Zahnriemensatz, Timing Belt Kit, Kit de distribution DAEWOO LEGANZA (KLAJ), NUBIRA (KLAJ), NUBIRA Stufenheck (KLAJ), NUBIRA Wagon (KLAJ), REZZO (KLAU), OPEL ASTRA F Cabriolet (53_B), ASTRA F Caravan (51_, 52_), ASTRA F CC (53_, 54_, 58_, 59_), ASTRA F (56_, 57_), CALIBRA A (85_), OMEGA B Caravan (21_, 22_, 23_), OMEGA B (25_, 26_, 27_), VECTRA A CC (88_, 89_), VECTRA A (86_, 87_), VECTRA B Caravan (31_), VECTRA B CC (38_), VECTRA B (36_), VAUXHALL ASTRA Mk III (F), ASTRA Mk III (F) CC, ASTRA Mk III (F) Convertible, ASTRA Mk III (F) Estate, CALIBRA, CAVALIER Mk III CC, CAVALIER Mk III (87), OMEGA (B), OMEGA (B) Estate, VECTRA (B), VECTRA (B) CC, VECTRA (B) Estate
23731	Zahnriemensatz, Timing Belt Kit, Kit de distribution OPEL ASTRA F Cabriolet (53_B), ASTRA F Caravan (51_, 52_), ASTRA F CC (53_, 54_, 58_, 59_), ASTRA F (56_, 57_), CALIBRA A (85_), FRONTERA A Sport (5_SUD2), KADETT E Cabriolet (43B), KADETT E Caravan (35_, 36_, 45_, 46_), KADETT E CC (33_, 34_, 43_, 44_), KADETT E (39_, 49_), OMEGA A Caravan (66_, 67_), OMEGA A (16_, 17_, 19_), OMEGA B Caravan (21_, 22_, 23_), OMEGA B (25_, 26_, 27_), VECTRA A CC (88_, 89_), VECTRA A (86_, 87_), VAUXHALL ASTRA Mk II Convertible, ASTRA Mk III (F), ASTRA Mk III (F) CC, ASTRA Mk III (F) Convertible, ASTRA Mk III (F) Estate, CALIBRA, CARLTON Mk III, CARLTON Mk III Estate, CAVALIER Mk III CC, CAVALIER Mk III (87), FRONTERA Mk I (A) Sport, OMEGA (B), OMEGA (B) Estate
23733	Zahnriemensatz, Timing Belt Kit, Kit de distribution OPEL CALIBRA A (85_), OMEGA B Caravan (21_, 22_, 23_), OMEGA B (25_, 26_, 27_), SINTRA, VECTRA A CC (88_, 89_), VECTRA A (86_, 87_), VECTRA B Caravan (31_), VECTRA B CC (38_), VECTRA B (36_), SAAB 900 II Cabriolet, 900 II Coupe, 9000, 9000 Schrägheck, 9-5 Kombi (YS3E), 9-5 (YS3E), VAUXHALL CALIBRA, CAVALIER Mk III CC, CAVALIER Mk III (87), OMEGA (B), OMEGA (B) Estate, SINTRA, VECTRA (B), VECTRA (B) CC, VECTRA (B) Estate
23734	Zahnriemensatz, Timing Belt Kit, Kit de distribution OPEL ASTRA F CLASSIC Caravan, ASTRA F CLASSIC CC, ASTRA G Cabriolet, ASTRA G Caravan (F35_), ASTRA G CC (F48_, F08_), ASTRA G Coupe (F07_), ASTRA G Stufenheck (F69_), ASTRA H, ASTRA H Caravan, ASTRA H GTC, ASTRA H TwinTop, COMBO Kasten/Kombi, COMBO Tour, CORSA C (F08, F68), CORSA C Kasten (F08, W5L), MERIVA, SIGNUM, TIGRA TwinTop, VECTRA C, VECTRA C Caravan, VECTRA C GTS, ZAFIRA, ZAFIRA (F75_), SAAB 9-3 Kombi, 9-3 (YS3F), VAUXHALL ASTRA Mk IV (G), ASTRA Mk IV (G) CC, ASTRA Mk IV (G) Convertible, ASTRA Mk IV (G) Coupe, ASTRA Mk IV (G) Estate, ASTRA Mk V (H) CC, ASTRA Mk V (H) Estate, ASTRA Mk V (H) Sport Hatch, CORSA Mk III (C), MERIVA Mk I (A), SIGNUM, TIGRA TwinTop, VECTRA Mk II (C), VECTRA Mk II (C) Estate, VECTRA Mk II (C) GTS, ZAFIRA Mk I (A)
23735	Zahnriemensatz, Timing Belt Kit, Kit de distribution OPEL ASTRA F Cabriolet (53_B), ASTRA F Caravan (51_, 52_), ASTRA F CC (53_, 54_, 58_, 59_), ASTRA F (56_, 57_), CORSA B (73_, 78_, 79_), TIGRA (95_), VECTRA B Caravan (31_), VECTRA B CC (38_), VECTRA B (36_), VAUXHALL ASTRA Mk III (F), ASTRA Mk III (F) CC, ASTRA Mk III (F) Convertible, ASTRA Mk III (F) Estate, CORSA Convertible, CORSA Mk II (B), TIGRA Mk I, VECTRA (B), VECTRA (B) CC, VECTRA (B) Estate
23738	Zahnriemensatz, Timing Belt Kit, Kit de distribution OPEL FRONTERA A (5_MWL4), FRONTERA B (6B_), OMEGA B Caravan (21_, 22_, 23_), OMEGA B (25_, 26_, 27_), SINTRA, VAUXHALL FRONTERA Mk I (A), FRONTERA Mk II (B), OMEGA (B), OMEGA (B) Estate, SINTRA
23739	Zahnriemensatz, Timing Belt Kit, Kit de distribution OPEL ASTRA G Cabriolet, ASTRA G Caravan (F35_), ASTRA G CC (F48_, F08_), ASTRA G Coupe (F07_), ASTRA G Stufenheck (F69_), ZAFIRA (F75_), VAUXHALL ASTRA Mk IV (G), ASTRA Mk IV (G) CC, ASTRA Mk IV (G) Convertible, ASTRA Mk IV (G) Coupe, ASTRA Mk IV (G) Estate, ZAFIRA Mk I (A)
23800	Zahnriemensatz, Timing Belt Kit, Kit de distribution SEAT IBIZA I (021A), RONDA (022A)
23801	Zahnriemensatz, Timing Belt Kit, Kit de distribution AUDI COUPE (81, 85), COUPE (89, 8B), 100 Avant (43, C2), 100 Avant (44, 44Q, C3), 100 (C1), 100 (43, C2), 100 (44, 44Q, C3), 80 (8C, B4), 80 (80, 82, B1), 80 (81, 85, B2), 80 (89, 89Q, 8A, B3), SEAT CORDOBA Vario (6K5), CORDOBA (6K2/C2), IBIZA II (6K1), INCA (6K9), TOLEDO I (1L), VW CADDY I (14), CORRADO (53I), GOLF I Cabriolet (155), GOLF I (17), GOLF II (19E, 1G1), JETTA I (16), JETTA II (19E, 1G2), LT 28-35 I Bus (281-363), PASSAT Stufenheck (32B), PASSAT Variant (3A5, 35I), PASSAT Variant (32B), PASSAT Variant (33), PASSAT (3A2, 35I), PASSAT (32), PASSAT (32B), SANTANA (32B), SCIROCCO (53), SCIROCCO (53B), TRANSPORTER T3 Kasten, TRANSPORTER T4 Bus (70XB, 70XC, 7DB, 7DW)
23802	Zahnriemensatz, Timing Belt Kit, Kit de distribution SEAT ALHAMBRA (7V8, 7V9), CORDOBA (6K2/C2), IBIZA II (6K1), TOLEDO I (1L), VW CORRADO (53I), GOLF III Cabriolet (1E7), GOLF III Variant (1H5), GOLF III (1H1), GOLF IV Cabriolet (1E7), PASSAT Variant (3A5, 35I), PASSAT (3A2, 35I), SHARAN (7M8, 7M9, 7M6), VENTO (1H2)
23803	Zahnriemensatz, Timing Belt Kit, Kit de distribution VW GOLF III Cabriolet (1E7), GOLF III Variant (1H5), GOLF III (1H1), GOLF IV Cabriolet (1E7), PASSAT Variant (3A5, 35I), PASSAT (3A2, 35I), POLO CLASSIC (6KV2), POLO Variant (6KV5), VENTO (1H2)

Application list - Liste d'affectation

23804	Zahnriemensatz, Timing Belt Kit, Kit de distribution AUDI 80 (81, 85, B2),80 (89, 89Q, 8A, B3),90 (89, 89Q, 8A, B3),VW GOLF I (17),GOLF II (19E, 1G1),JETTA I (16),JETTA II (19E, 1G2),PASSAT Stufenheck (32B),PASSAT Variant (3A5, 35I),PASSAT Variant (32B),PASSAT Variant (33),PASSAT (3A2, 35I),PASSAT (32),PASSAT (32B),SANTANA (32B),TRANSPORTER T3 Bus,TRANSPORTER T3 Kasten,TRANSPORTER T3 Pritsche/Fahrgestell
23805	Zahnriemensatz, Timing Belt Kit, Kit de distribution AUDI COUPE (81, 85),COUPE (89, 8B),QUATTRO (85),100 Avant (44, 44Q, C3),100 (44, 44Q, C3),200 Avant (44, 44Q),200 (44, 44Q),80 (81, 85, B2),90 (81, 85, B2),90 (89, 89Q, 8A, B3),VW PASSAT Variant (32B),PASSAT (32B),SANTANA (32B)
23806	Zahnriemensatz, Timing Belt Kit, Kit de distribution AUDI 100 Avant (43, C2),100 Avant (44, 44Q, C3),100 (43, C2),100 (44, 44Q, C3),VW LT 28-35 I Bus (281-363),LT 28-35 I Kasten (281-363),LT 28-35 I Pritsche/Fahrgestell (281-363),LT 40-55 I Kasten (291-512),LT 40-55 I Pritsche/Fahrgestell (293-909)
23807	Zahnriemensatz, Timing Belt Kit, Kit de distribution AUDI 100 (44, 44Q, C3),VW TRANSPORTER T4 Bus (70XB, 70XC, 7DB, 7DW),TRANSPORTER T4 Kasten (70XA),TRANSPORTER T4 Pritsche/Fahrgestell (70XD)
23808	Zahnriemensatz, Timing Belt Kit, Kit de distribution AUDI A6 Avant (4A, C4),A6 (4A, C4),COUPE (89, 8B),100 (4A, C4),80 Avant (8C, B4),80 (8C, B4),80 (89, 89Q, 8A, B3),SEAT TOLEDO I (1L),VW CORRADO (53I),GOLF II (19E, 1G1),PASSAT Variant (3A5, 35I),PASSAT (3A2, 35I),SCIROCCO (53B)
23809	Zahnriemensatz, Timing Belt Kit, Kit de distribution VW GOLF III (1H1),PASSAT Variant (3A5, 35I),PASSAT (3A2, 35I)
23810	Zahnriemensatz, Timing Belt Kit, Kit de distribution AUDI CABRIOLET (8G7, B4),COUPE (81, 85),COUPE (89, 8B),QUATTRO (85),100 Avant (44, 44Q, C3),100 (44, 44Q, C3),200 Avant (44, 44Q),200 (44, 44Q),80 Avant (8C, B4),80 (8C, B4),90 (81, 85, B2),90 (89, 89Q, 8A, B3)
23811	Zahnriemensatz, Timing Belt Kit, Kit de distribution AUDI A6 Avant (4A, C4),A6 (4A, C4),CABRIOLET (8G7, B4),80 Avant (8C, B4),80 (8C, B4)
23812	Zahnriemensatz, Timing Belt Kit, Kit de distribution AUDI 80 Avant (8C, B4),80 (8C, B4),80 (89, 89Q, 8A, B3),SEAT CORDOBA Vario (6K5),CORDOBA (6K2/C2),IBIZA II (6K1),TOLEDO I (1L),VW GOLF III Variant (1H5),GOLF III (1H1),PASSAT Variant (3A5, 35I),PASSAT (3A2, 35I),TRANSPORTER T4 Bus (70XB, 70XC, 7DB, 7DW),TRANSPORTER T4 Kasten (70XA),TRANSPORTER T4 Pritsche/Fahrgestell (70XD),VENTO (1H2)
23813	Zahnriemensatz, Timing Belt Kit, Kit de distribution AUDI A6 Avant (4A, C4),A6 (4A, C4),A8 (4D2, 4D8),CABRIOLET (8G7, B4),COUPE (89, 8B),100 Avant (4A, C4),100 (4A, C4),80 Avant (8C, B4),80 (8C, B4)
23814	Zahnriemensatz, Timing Belt Kit, Kit de distribution AUDI A4 Avant (8D5, B5),A4 (8D2, B5),VW PASSAT Variant (3B5),PASSAT (3B2)
23815	Zahnriemensatz, Timing Belt Kit, Kit de distribution AUDI 80 Avant (8C, B4),80 (8C, B4),SEAT TOLEDO I (1L),VW GOLF III Cabriolet (1E7),GOLF III Variant (1H5),GOLF III (1H1),PASSAT Variant (3A5, 35I),PASSAT (3A2, 35I),VENTO (1H2)
23817	Zahnriemensatz, Timing Belt Kit, Kit de distribution AUDI A4 Avant (8D5, B5),A4 (8D2, B5),A6 Avant (4A, C4),A6 (4A, C4),A8 (4D2, 4D8),CABRIOLET (8G7, B4),COUPE (89, 8B),80 Avant (8C, B4),80 (8C, B4)
23818	Zahnriemensatz, Timing Belt Kit, Kit de distribution VW CRAFTER 30-35 Bus (2E_),CRAFTER 30-50 Kasten (2E_),CRAFTER 30-50 Pritsche/Fahrgestell (2F_)
23819	Zahnriemensatz, Timing Belt Kit, Kit de distribution VOLVO S70 (P80_),S80 (TS, XY),V70 I Kombi (P80_),V70 II Kombi (P80_),850 Kombi (LW),850 (LS),VW LT 28-35 II Bus (2DM),LT 28-46 II Kasten (2DX0AE),LT 28-46 II Pritsche/Fahrgestell (2DX0FE),TRANSPORTER T4 Bus (70XB, 70XC, 7DB, 7DW),TRANSPORTER T4 Kasten (70XA),TRANSPORTER T4 Pritsche/Fahrgestell (70XD)
23820	Zahnriemensatz, Timing Belt Kit, Kit de distribution AUDI A4 Avant (8D5, B5),A4 (8D2, B5),A6 Avant (4A, C4),A6 Avant (4B, C5),A6 (4A, C4),A6 (4B, C5),CABRIOLET (8G7, B4),80 Avant (8C, B4),80 (8C, B4),SEAT CORDOBA Vario (6K5),CORDOBA (6K2/C2),IBIZA II (6K1),INCA (6K9),TOLEDO I (1L),VW CADDY II Kasten (9K9A),CADDY II Kombi (9K9B),GOLF III Cabriolet (1E7),GOLF III Variant (1H5),GOLF III (1H1),GOLF IV Cabriolet (1E7),PASSAT Variant (3A5, 35I),PASSAT Variant (3B5),PASSAT (3A2, 35I),PASSAT (3B2),POLO CLASSIC (6KV2),POLO Variant (6KV5),TRANSPORTER T4 Bus (70XB, 70XC, 7DB, 7DW),TRANSPORTER T4 Kasten (70XA),TRANSPORTER T4 Pritsche/Fahrgestell (70XD),VENTO (1H2)
23821	Zahnriemensatz, Timing Belt Kit, Kit de distribution AUDI A4 Avant (8D5, B5),A4 (8D2, B5),A6 Avant (4A, C4),A6 Avant (4B, C5),A6 (4A, C4),A6 (4B, C5),CABRIOLET (8G7, B4),80 Avant (8C, B4),80 (8C, B4),FORD GALAXY (WGR),SEAT ALHAMBRA (7V8, 7V9),CORDOBA Vario (6K5),CORDOBA (6K2/C2),IBIZA II (6K1),INCA (6K9),TOLEDO I (1L),VW CADDY II Kasten (9K9A),CADDY II Kombi (9K9B),GOLF III Cabriolet (1E7),GOLF III Variant (1H5),GOLF III (1H1),GOLF IV Cabriolet (1E7),PASSAT Variant (3A5, 35I),PASSAT Variant (3B5),PASSAT (3A2, 35I),PASSAT (3B2),POLO CLASSIC (6KV2),POLO Variant (6KV5),SHARAN (7M8, 7M9, 7M6),VENTO (1H2)
23823	Zahnriemensatz, Timing Belt Kit, Kit de distribution SEAT AROSA (6H),CORDOBA Schrägheck (6K2),CORDOBA Vario (6K5),CORDOBA (6K2/C2),IBIZA II (6K1),IBIZA III (6K1),INCA (6K9),VW CADDY II Kasten (9K9A),CADDY II Kombi (9K9B),GOLF III Variant (1H5),GOLF III (1H1),LUPO (6X1, 6E1),POLO CLASSIC (6KV2),POLO Kasten (6NF),POLO Variant (6KV5),POLO (6N1),POLO (6N2),VENTO (1H2)
23824	Zahnriemensatz, Timing Belt Kit, Kit de distribution SEAT CORDOBA Schrägheck (6K2),CORDOBA Vario (6K5),CORDOBA (6K2/C2),IBIZA II (6K1),IBIZA III (6K1),INCA (6K9),SKODA FELICIA I Fun (797),FELICIA I Kombi (6U5),FELICIA I (6U1),FELICIA II Kombi (6U5),FELICIA II (6U1),OCTAVIA Combi (1U5),OCTAVIA (1U2),VW CADDY II Kasten (9K9A),CADDY II Kombi (9K9B),CADDY II Pick-up (9U7),GOLF III Variant (1H5),GOLF III (1H1),POLO CLASSIC (6KV2),POLO Variant (6KV5),POLO (6N1),VENTO (1H2)
23827	Zahnriemensatz, Timing Belt Kit, Kit de distribution AUDI A4 Avant (8D5, B5),A4 (8D2, B5),A6 Avant (4A, C4),A6 Avant (4B, C5),A6 (4A, C4),A6 (4B, C5),CABRIOLET (8G7, B4),VW PASSAT Variant (3B5),PASSAT (3B2)
23828	Zahnriemensatz, Timing Belt Kit, Kit de distribution AUDI A4 Avant (8D5, B5),A4 (8D2, B5),A6 Avant (4A, C4),A6 Avant (4B, C5),A6 (4A, C4),A6 (4B, C5),CABRIOLET (8G7, B4),VW PASSAT Variant (3B5),PASSAT (3B2)
23829	Zahnriemensatz, Timing Belt Kit, Kit de distribution AUDI A3 (8L1),A4 Avant (8D5, B5),A4 (8D2, B5),A6 Avant (4B, C5),A6 (4B, C5),TT Roadster (8N9),TT (8N3),SEAT ALHAMBRA (7V8, 7V9),CORDOBA Schrägheck (6K2),IBIZA III (6K1),LEON (1M1),TOLEDO II (1M2),SKODA OCTAVIA Combi (1U5),OCTAVIA (1U2),VW BORA Kombi (1J6),BORA (1J2),GOLF IV Variant (1J5),GOLF IV (1J1),NEW BEETLE Cabriolet (1Y7),NEW BEETLE (9C1, 1C1),SHARAN (7M8, 7M9, 7M6)
23830	Zahnriemensatz, Timing Belt Kit, Kit de distribution AUDI A3 (8L1),A4 Avant (8D5, B5),A4 (8D2, B5),A6 Avant (4B, C5),A6 (4B, C5),TT Roadster (8N9),TT (8N3),SEAT ALHAMBRA (7V8, 7V9),CORDOBA Schrägheck (6K2),IBIZA III (6K1),LEON (1M1),TOLEDO II (1M2),SKODA OCTAVIA Combi (1U5),OCTAVIA (1U2),VW BORA Kombi (1J6),BORA (1J2),GOLF IV Variant (1J5),GOLF IV (1J1),NEW BEETLE Cabriolet (1Y7),NEW BEETLE (9C1, 1C1),SHARAN (7M8, 7M9, 7M6)

Application list - Liste d'affectation

23831	Zahnriemensatz, Timing Belt Kit, Kit de distribution AUDI A3 (8L1),A4 Avant (8D5, B5),A4 (8D2, B5),A6 Avant (4B, C5),A6 (4B, C5),TT Roadster (8N9),TT (8N3),SEAT ALHAMBRA (7V8, 7V9),CORDOBA Schrägheck (6K2),IBIZA III (6K1),LEON (1M1),TOLEDO II (1M2),SKODA OCTAVIA Combi (1U5),OCTAVIA (1U2),VW BORA Kombi (1J6),BORA (1J2),GOLF IV Variant (1J5),GOLF IV (1J1),NEW BEETLE Cabriolet (1Y7),NEW BEETLE (9C1, 1C1),SHARAN (7M8, 7M9, 7M6)
23832	Zahnriemensatz, Timing Belt Kit, Kit de distribution AUDI A3 Sportback (8PA),A3 (8L1),A3 (8P1),A4 Avant (8D5, B5),A4 Avant (8ED),A4 Avant (8E5, B6),A4 (8D2, B5),A4 (8EC),A4 (8E2, B6),SEAT ALHAMBRA (7V8, 7V9),ALTEA (5P1),CORDOBA Schrägheck (6K2),CORDOBA Vario (6K5),IBIZA III (6K1),LEON (1M1),TOLEDO II (1M2),SKODA FABIA Combi (6Y5),FABIA Stufenheck (6Y3),FABIA (6Y2),OCTAVIA Combi (1U5),OCTAVIA (1U2),SUPERB (3U4),VW BORA Kombi (1J6),BORA (1J2),CADDY III Kasten (2KA, 2KH, 2CA, 2CH),CADDY III Kombi (2KB, 2KJ),GOLF IV Variant (1J5),GOLF IV (1J1),GOLF V (1K1),JETTA III (1K2),MULTIVAN T5 (7HM, 7HN, 7HF, 7EF, 7EM, 7EN),NEW BEETLE (9C1, 1C1),PASSAT Variant (3B5),PASSAT Variant (3B6),PASSAT (3B2),PASSAT (3B3),POLO CLASSIC (6KV2),POLO Variant (6KV5),SHARAN (7M8, 7M9, 7M6),TOURAN (1T1, 1T2, 1T3),TRANSPORTER T5 Bus (7HB, 7HJ, 7EB, 7EJ),TRANSPORTER T5 Kasten (7HA, 7HH, 7EA, 7EH),TRANSPORTER T5 Pritsche/Fahrgestell (7JD, 7JE, 7JL, 7JY, 7JZ)
23833	Zahnriemensatz, Timing Belt Kit, Kit de distribution AUDI A4 Avant (8D5, B5),A4 (8D2, B5),A6 Avant (4A, C4),A6 Avant (4B, C5),A6 (4A, C4),A6 (4B, C5),CABRIOLET (8G7, B4),VW PASSAT Variant (3B5),PASSAT (3B2)
23834	Zahnriemensatz, Timing Belt Kit, Kit de distribution AUDI A6 Avant (4A, C4),A6 (4A, C4),VW LT 28-35 II Bus (2DM),LT 28-46 II Kasten (2DX0AE),LT 28-46 II Pritsche/Fahrgestell (2DX0FE),TRANSPORTER T4 Bus (70XB, 70XC, 7DB, 7DW),TRANSPORTER T4 Kasten (70XA),TRANSPORTER T4 Pritsche/Fahrgestell (70XD)
23835	Zahnriemensatz, Timing Belt Kit, Kit de distribution VOLVO S70 (P80_),S80 (TS, XY),V70 I Kombi (P80_),V70 II Kombi (P80_),850 Kombi (LW),850 (LS),VW LT 28-35 II Bus (2DM),LT 28-46 II Kasten (2DX0AE),LT 28-46 II Pritsche/Fahrgestell (2DX0FE),TRANSPORTER T4 Bus (70XB, 70XC, 7DB, 7DW),TRANSPORTER T4 Kasten (70XA),TRANSPORTER T4 Pritsche/Fahrgestell (70XD)
23836	Zahnriemensatz, Timing Belt Kit, Kit de distribution SEAT AROSA (6H),VW LUPO (6X1, 6E1),POLO Kasten (6NF),POLO (6N1),POLO (6N2)
23837	Zahnriemensatz, Timing Belt Kit, Kit de distribution SEAT AROSA (6H),SKODA FELICIA I Fun (797),FELICIA I Kombi (6U5),FELICIA I (6U1),FELICIA II Kombi (6U5),FELICIA II (6U1),VW CADDY II Pick-up (9U7),LUPO (6X1, 6E1),POLO Kasten (6NF),POLO (6N1),POLO (6N2)
23838	Zahnriemensatz, Timing Belt Kit, Kit de distribution AUDI A2 (8Z0),SEAT ALTEA XL (5P5, 5P8),ALTEA (5P1),AROSA (6H),CORDOBA,CORDOBA Schrägheck (6K2),CORDOBA Vario (6K5),CORDOBA (6L2),IBIZA III (6K1),IBIZA IV (6L1),IBIZA V SPORTCOUPE (6J1),IBIZA V ST (6J8),IBIZA V (6J5),INCA (6K9),LEON (1M1),LEON (1P1),TOLEDO II (1M2),SKODA FABIA,FABIA Combi,FABIA Combi (6Y5),FABIA Stufenheck (6Y3),FABIA (6Y2),OCTAVIA Combi (1U5),OCTAVIA Combi (1Z5),OCTAVIA (1U2),OCTAVIA (1Z3),PRAKTIK (5J),ROOMSTER (5J),VW BORA Kombi (1J6),BORA (1J2),CADDY II Kasten (9K9A),CADDY II Kombi (9K9B),CADDY III Kasten (2KA, 2KH, 2CA, 2CH),CADDY III Kombi (2KB, 2KJ),GOLF IV Variant (1J5),GOLF IV (1J1),GOLF PLUS (5M1, 521),GOLF V Variant (1K5),GOLF V (1K1),LUPO (6X1, 6E1),NEW BEETLE Cabriolet (1Y7),NEW BEETLE (9C1, 1C1),PARATI,POLO CLASSIC (6KV2),POLO Stufenheck,POLO Variant (6KV5),POLO (6N1),POLO (6N2),POLO (9N_)
23838/1	Zahnriemensatz, Timing Belt Kit, Kit de distribution SEAT AROSA (6H),LEON (1M1),TOLEDO II (1M2),VW BORA Kombi (1J6),BORA (1J2),GOLF IV Variant (1J5),GOLF IV (1J1),LUPO (6X1, 6E1),POLO (6N1)
23839	Zahnriemensatz, Timing Belt Kit, Kit de distribution VOLVO S70 (P80_),S80 (TS, XY),V70 I Kombi (P80_),V70 II Kombi (P80_),850 Kombi (LW),850 (LS),VW LT 28-35 II Bus (2DM),LT 28-46 II Kasten (2DX0AE),LT 28-46 II Pritsche/Fahrgestell (2DX0FE),TRANSPORTER T4 Bus (70XB, 70XC, 7DB, 7DW),TRANSPORTER T4 Kasten (70XA),TRANSPORTER T4 Pritsche/Fahrgestell (70XD)
23840	Zahnriemensatz, Timing Belt Kit, Kit de distribution AUDI A4 Avant (8D5, B5),A4 (8D2, B5)
23841	Zahnriemensatz, Timing Belt Kit, Kit de distribution SKODA FABIA Combi (6Y5),FABIA Stufenheck (6Y3),FABIA (6Y2),VW CADDY III Kasten (2KA, 2KH, 2CA, 2CH),CADDY III Kombi (2KB, 2KJ),GOLF PLUS (5M1, 521),GOLF V Variant (1K5),GOLF V (1K1),GOLF VI Variant (AJ5),GOLF VI (5K1),POLO (6R_),POLO (9N_)
23842	Zahnriemensatz, Timing Belt Kit, Kit de distribution AUDI ALLROAD (4BH),A4 Avant (8D5, B5),A4 Avant (8E5, B6),A4 Cabriolet (8H7, 8HE),A4 (8D2, B5),A4 (8E2, B6),A6 Avant (4A, C4),A6 Avant (4B, C5),A6 (4A, C4),A6 (4B, C5),A8 (4D2, 4D8),SKODA SUPERB (3U4),VW PASSAT Variant (3B5),PASSAT Variant (3B6),PASSAT (3B2),PASSAT (3B3)
23844	Zahnriemensatz, Timing Belt Kit, Kit de distribution AUDI A3 (8L1),SEAT CORDOBA Schrägheck (6K2),CORDOBA Vario (6K5),IBIZA III (6K1),INCA (6K9),LEON (1M1),TOLEDO II (1M2),SKODA OCTAVIA Combi (1U5),OCTAVIA (1U2),VW BORA Kombi (1J6),BORA (1J2),CADDY II Kasten (9K9A),CADDY II Kombi (9K9B),GOLF IV Variant (1J5),GOLF IV (1J1),NEW BEETLE (9C1, 1C1),POLO CLASSIC (6KV2),POLO Variant (6KV5)
23845	Zahnriemensatz, Timing Belt Kit, Kit de distribution AUDI A3 (8L1),SEAT CORDOBA Schrägheck (6K2),CORDOBA Vario (6K5),IBIZA III (6K1),SKODA OCTAVIA Combi (1U5),OCTAVIA (1U2),VW BORA (1J2),GOLF IV Variant (1J5),GOLF IV (1J1),POLO CLASSIC (6KV2),POLO Variant (6KV5)
23847	Zahnriemensatz, Timing Belt Kit, Kit de distribution AUDI A2 (8Z0),A3 (8L1),A4 Avant (8D5, B5),A4 Avant (8E5, B6),A4 (8D2, B5),A4 (8E2, B6),A6 Avant (4B, C5),A6 (4B, C5),FORD GALAXY (WGR),SEAT ALHAMBRA (7V8, 7V9),AROSA (6H),LEON (1M1),TOLEDO II (1M2),SKODA FABIA Combi (6Y5),FABIA Stufenheck (6Y3),FABIA (6Y2),OCTAVIA Combi (1U5),SUPERB (3U4),VW BORA Kombi (1J6),BORA (1J2),GOLF IV Variant (1J5),GOLF IV (1J1),LUPO (6X1, 6E1),NEW BEETLE (9C1, 1C1),PASSAT Variant (3B5),PASSAT Variant (3B6),PASSAT (3B2),PASSAT (3B3),POLO Stufenheck,POLO (6N2),POLO (9N_),SHARAN (7M8, 7M9, 7M6)
23848	Zahnriemensatz, Timing Belt Kit, Kit de distribution AUDI A2 (8Z0),A3 (8L1),A4 Avant (8D5, B5),A4 Avant (8E5, B6),A4 (8D2, B5),A4 (8E2, B6),A6 Avant (4B, C5),A6 (4B, C5),FORD GALAXY (WGR),SEAT ALHAMBRA (7V8, 7V9),AROSA (6H),LEON (1M1),TOLEDO II (1M2),SKODA FABIA Combi (6Y5),FABIA Stufenheck (6Y3),FABIA (6Y2),OCTAVIA Combi (1U5),SUPERB (3U4),VW BORA Kombi (1J6),BORA (1J2),GOLF IV Variant (1J5),GOLF IV (1J1),LUPO (6X1, 6E1),NEW BEETLE (9C1, 1C1),PASSAT Variant (3B5),PASSAT Variant (3B6),PASSAT (3B2),PASSAT (3B3),POLO Stufenheck,POLO (6N2),POLO (9N_),SHARAN (7M8, 7M9, 7M6)
23849	Zahnriemensatz, Timing Belt Kit, Kit de distribution AUDI A2 (8Z0),VW LUPO (6X1, 6E1)
23901	Zahnriemensatz, Timing Belt Kit, Kit de distribution AUDI A4 Avant (8D5, B5),A4 Avant (8ED),A4 Avant (8E5, B6),A4 Cabriolet (8H7, 8HE),A4 (8D2, B5),A4 (8EC),A4 (8E2, B6),A6 Avant (4B, C5),A6 (4B, C5),SEAT EXEO ST (3R5),EXEO (3R2),SKODA SUPERB (3U4),VW PASSAT Variant (3B6),PASSAT (3B3)
23902	Zahnriemensatz, Timing Belt Kit, Kit de distribution AUDI A4 Avant (8D5, B5),A4 Avant (8ED),A4 Avant (8E5, B6),A4 Cabriolet (8H7, 8HE),A4 (8D2, B5),A4 (8EC),A4 (8E2, B6),A6 Avant (4B, C5),A6 (4B, C5),SEAT EXEO ST (3R5),EXEO (3R2),SKODA SUPERB (3U4),VW PASSAT Variant (3B6),PASSAT (3B3)
23908	Zahnriemensatz, Timing Belt Kit, Kit de distribution AUDI A4 Avant (8D5, B5),A4 (8D2, B5)
23912	Zahnriemensatz, Timing Belt Kit, Kit de distribution

Application list - Liste d'affectation

	AUDI A3 (8L1),A6 Avant (4B, C5),A6 (4B, C5),TT Roadster (8N9),TT (8N3),SEAT ALHAMBRA (7V8, 7V9),LEON (1M1),TOLEDO II (1M2),SKODA OCTAVIA Combi (1U5),OCTAVIA (1U2),VW BORA Kombi (1J6),BORA (1J2),GOLF IV Variant (1J5),GOLF IV (1J1),NEW BEETLE Cabriolet (1Y7),NEW BEETLE (9C1, 1C1),SHARAN (7M8, 7M9, 7M6)
23913	Zahnriemensatz, Timing Belt Kit, Kit de distribution
	AUDI A3 (8L1),A6 Avant (4B, C5),A6 (4B, C5),TT Roadster (8N9),TT (8N3),SEAT ALHAMBRA (7V8, 7V9),LEON (1M1),TOLEDO II (1M2),SKODA OCTAVIA Combi (1U5),OCTAVIA (1U2),VW BORA Kombi (1J6),BORA (1J2),GOLF IV Variant (1J5),GOLF IV (1J1),NEW BEETLE Cabriolet (1Y7),NEW BEETLE (9C1, 1C1),SHARAN (7M8, 7M9, 7M6)
23925	Zahnriemensatz, Timing Belt Kit, Kit de distribution
	VOLVO 240 Kombi (P245),240 (P242, P244),340-360 Stufenheck (344),340-360 (343, 345),740 Kombi (745),740 (744),760 (704, 764),940 II Kombi (945),940 II (944),940 Kombi (945),940 (944)
23926	Zahnriemensatz, Timing Belt Kit, Kit de distribution
	VOLVO 240 Kombi (P245),240 (P242, P244),940 II Kombi (945),940 II (944),940 Kombi (945),940 (944)
23928	Zahnriemensatz, Timing Belt Kit, Kit de distribution
	RENAULT LAGUNA (B56_, 556_),LAGUNA Grandtour (K56_),SAFRANE II (B54_),VOLVO C70 I Cabriolet,C70 I Coupe,S40 I (VS),S70 (P80_),V40 Kombi (VW),V70 I Kombi (P80_),850 Kombi (LW),850 (LS)
23929	Zahnriemensatz, Timing Belt Kit, Kit de distribution
	VOLVO S70 (P80_),V70 I Kombi (P80_),850 Kombi (LW),850 (LS)
23938	Zahnriemensatz, Timing Belt Kit, Kit de distribution
	MG MG TF,MG ZR,MG ZS,MG ZS Hatchback,MG ZT- T,MGF (RD),ROVER CABRIOLET (XW),COUPE,STREETWISE,100 Cabriolet (XP),100 (METRO) (XP),200 Hatchback (XW),200 (RF),25 (RF),400 Hatchback (RT),400 (RT),400 (XW),45 (RT),45 Stufenheck (RT)
41002	Wasserpumpe + Zahnriemensatz, Water Pump & Timing Belt Kit, Pompe à eau + kit de courroie de distribution
	FIAT CINQUECENTO (170),PANDA Van (141_),PANDA (141A_),PUNTO Van (176L),PUNTO (176),SEICENTO Van (187),SEICENTO (187),TIPO (160),UNO (146A/E),LANCIA Y (840A),Y10 (156)
41004	Wasserpumpe + Zahnriemensatz, Water Pump & Timing Belt Kit, Pompe à eau + kit de courroie de distribution
	FIAT PALIO Weekend (178DX),PALIO (178BX),PUNTO Cabriolet (176C),PUNTO (176),SIENA (178_),LANCIA Y (840A)
41005	Wasserpumpe + Zahnriemensatz, Water Pump & Timing Belt Kit, Pompe à eau + kit de courroie de distribution
	FIAT PANDA (141A_),PANDA (169),PUNTO Van (176L),PUNTO (176),SEICENTO Van (187),SEICENTO (187),LANCIA Y (840A)
41006	Wasserpumpe + Zahnriemensatz, Water Pump & Timing Belt Kit, Pompe à eau + kit de courroie de distribution
	FIAT DOBLO Cargo (223),DOBLO (119),PALIO Weekend (178DX),PALIO (178BX),PANDA Van (169),PANDA (169),PUNTO Cabriolet (176C),PUNTO Van (188AX),PUNTO (176),PUNTO (188),SIENA (178_),LANCIA Y (840A),YPSILON (843)
41100	Wasserpumpe + Zahnriemensatz, Water Pump & Timing Belt Kit, Pompe à eau + kit de courroie de distribution
	RENAULT CLIO I (B/C57_, 5/357_),CLIO II (BB0/1/2_, CB0/1/2_),CLIO II Kasten (SB0/1/2_),KANGOO (KC0/1_),KANGOO Rapid (FC0/1_),THALIA (LB0/1/2_),TWINGO (C06_),TWINGO Kasten (S06_)
41106	Wasserpumpe + Zahnriemensatz, Water Pump & Timing Belt Kit, Pompe à eau + kit de courroie de distribution
	RENAULT MEGANE I (BA0/1_),MEGANE I Cabriolet (EA0/1_),MEGANE I Classic (LA0/1_),MEGANE I Coach (DA0/1_),MEGANE I Grandtour (KA0/1_)
41106/1	Wasserpumpe + Zahnriemensatz, Water Pump & Timing Belt Kit, Pompe à eau + kit de courroie de distribution
	RENAULT CLIO I (B/C57_, 5/357_),CLIO I Kasten (S57_),RAPID Kasten (F40_, G40_),19 I (B/C53_),19 I Chamade (L53_),19 I Kasten (S53_),19 II (B/C53_),19 II Chamade (L53_),19 II Kasten (S53_)
41122/1	Wasserpumpe + Zahnriemensatz, Water Pump & Timing Belt Kit, Pompe à eau + kit de courroie de distribution
	RENAULT CLIO II (BB0/1/2_, CB0/1/2_),KANGOO (KC0/1_),MEGANE I (BA0/1_),MEGANE I Classic (LA0/1_),MEGANE Scenic (JA0/1_),THALIA (LB0/1/2_)
41123	Wasserpumpe + Zahnriemensatz, Water Pump & Timing Belt Kit, Pompe à eau + kit de courroie de distribution
	RENAULT LAGUNA (B56_, 556_),LAGUNA Grandtour (K56_),SAFRANE II (B54_),VOLVO C70 I Cabriolet,C70 I Coupe,S40 I (VS),S60,S70 (P80_),S80 (TS, XY),V40 Kombi (VW),V70 I Kombi (P80_),V70 II Kombi (P80_),XC 90,XC70 CROSS COUNTRY
41129	Wasserpumpe + Zahnriemensatz, Water Pump & Timing Belt Kit, Pompe à eau + kit de courroie de distribution
	DACIA LOGAN (LS_),LOGAN MCV (KS_),RENAULT CLIO II (BB0/1/2_, CB0/1/2_),KANGOO (KC0/1_),KANGOO Rapid (FC0/1_),LAGUNA (B56_, 556_),LAGUNA Grandtour (K56_),LAGUNA II (BG0/1_),LAGUNA II Grandtour (KG0/1_),MEGANE I (BA0/1_),MEGANE I Cabriolet (EA0/1_),MEGANE I Classic (LA0/1_),MEGANE I Coach (DA0/1_),MEGANE I Grandtour (KA0/1_),MEGANE II (BM0/1_, CM0/1_),MEGANE II Grandtour (KM0/1_),MEGANE II Stufenheck (LM0/1_),SCÉNIC I (JA0/1_),SCÉNIC II (JM0/1_),THALIA (LB0/1/2_)
41403	Wasserpumpe + Zahnriemensatz, Water Pump & Timing Belt Kit, Pompe à eau + kit de courroie de distribution
	CITROËN AX (ZA-_),PEUGEOT 106 I (1A, 1C),ROVER 100 (METRO) (XP)
41404	Wasserpumpe + Zahnriemensatz, Water Pump & Timing Belt Kit, Pompe à eau + kit de courroie de distribution
	CITROËN BX Break (XB-_),BX (XB-_),VISA,ZX (N2),PEUGEOT 205 I Cabriolet (741B, 20D),205 I (741A/C),205 II (20A/C),305 II Break (581E),305 II (581M),309 I (10C, 10A),309 II (3C, 3A),405 I Break (15E),405 I (15B)
41406	Wasserpumpe + Zahnriemensatz, Water Pump & Timing Belt Kit, Pompe à eau + kit de courroie de distribution
	CITROËN BX (XB-_),PEUGEOT 309 II (3C, 3A),405 I (15B)
41412	Wasserpumpe + Zahnriemensatz, Water Pump & Timing Belt Kit, Pompe à eau + kit de courroie de distribution
	CITROËN AX (ZA-_),SAXO (S0, S1),XSARA Break (N2),XSARA (N1),NISSAN MICRA II (K11),PEUGEOT 106 I (1A, 1C),106 II (1)
41413	Wasserpumpe + Zahnriemensatz, Water Pump & Timing Belt Kit, Pompe à eau + kit de courroie de distribution
	CITROËN AX (ZA-_),BX Break (XB-_),BX (XB-_),SAXO (S0, S1),XSARA Break (N2),XSARA Coupe (N0),XSARA (N1),XSARA PICASSO (N68),PEUGEOT 106 I (1A, 1C),106 II (1),205 II (20A/C),206 Schrägheck (2A/C),306 Break (7E, N3, N5),306 Cabriolet (7D, N3, N5),306 Schrägheck (7A, 7C, N3, N5),306 (7B, N3, N5)
41414	Wasserpumpe + Zahnriemensatz, Water Pump & Timing Belt Kit, Pompe à eau + kit de courroie de distribution
	CITROËN BERLINGO (MF),BX Break (XB-_),BX (XB-_),EVASION (22, U6),XANTIA Break (X1),XANTIA Break (X2),XANTIA (X1),XANTIA (X2),XSARA Break (N2),XSARA Coupe (N0),XSARA (N1),ZX Break (N2),ZX (N2),FIAT ULYSSE (220),PEUGEOT PARTNER Combispac (5F),PARTNER Kasten (5),205 I Cabriolet (741B, 20D),205 II (20A/C),306 Break (7E, N3, N5),306 Cabriolet (7D, N3, N5),306 Schrägheck (7A, 7C, N3, N5),306 (7B, N3, N5),309 II (3C, 3A),405 II Break (4E),405 II (4B),406 Break (8E/F),406 (8B)
41414/1	Wasserpumpe + Zahnriemensatz, Water Pump & Timing Belt Kit, Pompe à eau + kit de courroie de distribution
	CITROËN EVASION (22, U6),XANTIA Break (X1),XANTIA Break (X2),XANTIA (X1),XANTIA (X2),XM Break (Y3),XM Break (Y4),XM (Y3),XM (Y4),ZX (N2),FIAT ULYSSE (220),LANCIA ZETA (220),PEUGEOT 306 Cabriolet (7D, N3, N5),306 Schrägheck (7A, 7C, N3, N5),306 (7B, N3, N5),405 II Break (4E),405 II (4B),406 Break (8E/F),406 (8B),605 (6B),806 (221)
41415	Wasserpumpe + Zahnriemensatz, Water Pump & Timing Belt Kit, Pompe à eau + kit de courroie de distribution
	CITROËN BERLINGO Kasten (M_),BERLINGO (MF),EVASION (22, U6),JUMPER Bus (230P),JUMPER Kasten (230L),JUMPER Pritsche/Fahrgestell (230),JUMPY Kasten (BS_, BT_, BY_, BZ_),JUMPY Pritsche/Fahrgestell (BU_, BV_, BW_, BX_),JUMPY (U6U),XANTIA Break (X1),XANTIA Break (X2),XANTIA (X1),XANTIA (X2),XSARA Break (N2),XSARA Coupe (N0),XSARA (N1),ZX Break (N2),ZX (N2),FIAT SCUDO Combinato (220P),SCUDO Kasten (220L),ULYSSE (220),PEUGEOT BOXER Bus (230P),BOXER Kasten (230L),BOXER Pritsche/Fahrgestell (ZCT_),EXPERT Kasten (22E),EXPERT Pritsche/Fahrgestell (223),EXPERT (224),PARTNER Combispac (5F),PARTNER Kasten (5),205 II (20A/C),205 Kasten,306 Break (7E, N3, N5),306 Schrägheck (7A, 7C, N3, N5),306 (7B, N3, N5),405 II Break (4E),405 II (4B),406 Break (8E/F),406 (8B),806 (221),ROVER 200 Hatchback (XW)

Application list - Liste d'affectation

41416	Wasserpumpe + Zahnriemensatz, Water Pump & Timing Belt Kit, Pompe à eau + kit de courroie de distribution CITROËN XM Break (Y3),XM (Y3),PEUGEOT 405 II Break (4E),405 II (4B),605 (6B)
41417	Wasserpumpe + Zahnriemensatz, Water Pump & Timing Belt Kit, Pompe à eau + kit de courroie de distribution CITROËN XM Break (Y3),XM Break (Y4),XM (Y3),XM (Y4),PEUGEOT 605 (6B)
41419	Wasserpumpe + Zahnriemensatz, Water Pump & Timing Belt Kit, Pompe à eau + kit de courroie de distribution CITROËN EVASION (22, U6),XANTIA Break (X1),XANTIA Break (X2),XANTIA (X1),XANTIA (X2),XM Break (Y3),XM Break (Y4),XM (Y3),XM (Y4),FIAT ULYSSE (220),LANCIA ZETA (220),PEUGEOT 406 Break (8E/F),406 (8B),605 (6B),806 (221)
41426	Wasserpumpe + Zahnriemensatz, Water Pump & Timing Belt Kit, Pompe à eau + kit de courroie de distribution CITROËN BERLINGO Kasten (M_),BERLINGO (MF),C5 Break (DE_),C5 (DC_),EVASION (22, U6),JUMPER Bus (244, Z_),JUMPER Kasten (230L),JUMPER Kasten (244),JUMPER Pritsche/Fahrgestell (244),JUMPY Kasten (BS_, BT_, BY_, BZ_),JUMPY Pritsche/Fahrgestell (BU_, BV_, BW_, BX_),JUMPY (U6U),XANTIA Break (X2),XANTIA (X2),XSARA Break (N2),XSARA Coupe (N0),XSARA (N1),XSARA PICASSO (N68),FIAT DUCATO Bus (230),DUCATO Bus (244, Z_),DUCATO Kasten (230L),DUCATO Kasten (244),DUCATO Pritsche/Fahrgestell (244),SCUDO Combinato (220P),SCUDO Kasten (220L),ULYSSE (220),PEUGEOT BOXER Bus (244, Z_),BOXER Kasten (244),BOXER Pritsche/Fahrgestell (244),EXPERT Kasten (222),EXPERT Pritsche/Fahrgestell (223),EXPERT (224),PARTNER CombiSpace (5F),PARTNER Kasten (5),206 Schrägheck (2A/C),206 SW (2E/K),306 Break (7E, N3, N5),306 Schrägheck (7A, 7C, N3, N5),306 (7B, N3, N5),406 Break (8E/F),406 (8B),806 (221)
41428	Wasserpumpe + Zahnriemensatz, Water Pump & Timing Belt Kit, Pompe à eau + kit de courroie de distribution CITROËN C8 (EA_, EB_),EVASION (22, U6),FIAT ULYSSE (179AX),LANCIA PHEDRA (179),ZETA (220),PEUGEOT EXPERT Kasten (222),EXPERT (224),806 (221),807 (E)
41432	Wasserpumpe + Zahnriemensatz, Water Pump & Timing Belt Kit, Pompe à eau + kit de courroie de distribution CITROËN SAXO (S0, S1),PEUGEOT 106 II (1)
41536	Wasserpumpe + Zahnriemensatz, Water Pump & Timing Belt Kit, Pompe à eau + kit de courroie de distribution DAEWOO ESPERO (KLEJ),LACETTI Stufenheck,LANOS (KLAT),LANOS Stufenheck (KLAT),NEXIA (KLETN),NEXIA Stufenheck (KLETN)
41536/1	Wasserpumpe + Zahnriemensatz, Water Pump & Timing Belt Kit, Pompe à eau + kit de courroie de distribution DAEWOO GENTRA Stufenheck,KALOS (KLAS),KALOS Stufenheck (KLAS),LACETTI Schrägheck (KLAN),NUBIRA (KLAJ),NUBIRA Stufenheck (KLAJ),NUBIRA Wagon (KLAJ),REZZO (KLAU)
41629	Wasserpumpe + Zahnriemensatz, Water Pump & Timing Belt Kit, Pompe à eau + kit de courroie de distribution FORD COURIER Kasten (J5_, J3_),FIESTA IV (JA_, JB_),FIESTA V (JH_, JD_),FOCUS C-MAX,FOCUS (DAW, DBW),FOCUS II (DA_),FOCUS II Kombi (DAW_),FOCUS Kombi (DNW),FOCUS Stufenheck (DFW),FUSION (JU_),PUMA (EC_),MAZDA DEMIO (DW),121 III (JASM, JBSSM),2 (DY),VOLVO S40 II (MS),V50 (MW)
41701	Wasserpumpe + Zahnriemensatz, Water Pump & Timing Belt Kit, Pompe à eau + kit de courroie de distribution FORD ESCORT IV Cabriolet (ALF),ESCORT IV (GAF, AWF, ABFT),ESCORT IV Kombi (AWF, AVF),ESCORT V Cabriolet (ALL),ESCORT V (GAL),ESCORT V Kombi (GAL, AVL),ESCORT '86 Express (AVF),ESCORT '91 Express (AVL),FIESTA II (FBD),FIESTA III (GFJ),ORION II (AFF),ORION III (GAL)
41702	Wasserpumpe + Zahnriemensatz, Water Pump & Timing Belt Kit, Pompe à eau + kit de courroie de distribution FORD ESCORT V Cabriolet (ALL),ESCORT V (GAL),ESCORT V Kombi (GAL, AVL),ESCORT VI Cabriolet (ALL),ESCORT VI (GAL),ESCORT VI Kombi (GAL),ESCORT VI Stufenheck (GAL),ESCORT VII Cabriolet (ALL),ESCORT VII (GAL, AAL, ABL),ESCORT VII Kombi (GAL, ANL),ESCORT VII Stufenheck (GAL, AFL),ESCORT '91 Express (AVL),ESCORT '95 Express (AVL),FIESTA III (GFJ),ORION III (GAL)
41712	Wasserpumpe + Zahnriemensatz, Water Pump & Timing Belt Kit, Pompe à eau + kit de courroie de distribution FORD COURIER Kasten (J5_, J3_),COURIER Pick-up,ESCORT VII Kombi (GAL, ANL),ESCORT '95 Express (AVL),FIESTA IV (JA_, JB_),FIESTA Kasten (JV_),FORD ASIA / OZEANIA IKON (L),MAZDA 121 III (JASM, JBSSM)
41712/2	Wasserpumpe + Zahnriemensatz, Water Pump & Timing Belt Kit, Pompe à eau + kit de courroie de distribution FORD MONDEO II (BAP),MONDEO II Kombi (BNP),MONDEO II Stufenheck (BFP)
41722	Wasserpumpe + Zahnriemensatz, Water Pump & Timing Belt Kit, Pompe à eau + kit de courroie de distribution CHEVROLET CORSA,CORSA Pritsche/Fahrgestell,CORSA Schrägheck,DAEWOO NEXIA (KLETN),NEXIA Stufenheck (KLETN),OPEL ASTRA F Cabriolet (53_B),ASTRA F Caravan (51_, 52_),ASTRA F CC (53_, 54_, 58_, 59_),ASTRA F CLASSIC Caravan,ASTRA F CLASSIC CC,ASTRA F CLASSIC Stufenheck,ASTRA F Van (55_),ASTRA F (56_, 57_),ASTRA G Caravan (F35_),ASTRA G CC (F48_, F08_),ASTRA G Kasten (F70),ASTRA G Stufenheck (F69_),COMBO (71_),CORSA A CC (93_, 94_, 98_, 99_),CORSA A TR (91_, 92_, 96_, 97_),CORSA B Kasten (73_),CORSA B (73_, 78_, 79_),KADETT E Cabriolet (43B),KADETT E Caravan (35_, 36_, 45_, 46_),KADETT E CC (33_, 34_, 43_, 44_),KADETT E Combo (38_, 48_),KADETT E Kasten (37_, 47_),KADETT E (39_, 49_),VECTRA A CC (88_, 89_),VECTRA A (86_, 87_),VECTRA B Caravan (31_),VECTRA B CC (38_),VECTRA B (36_),VAUXHALL ASTRA Mk II Belmont,ASTRA Mk II CC,ASTRA Mk II Convertible,ASTRA Mk II Estate,ASTRA Mk III (F),ASTRA Mk III (F) CC,ASTRA Mk III (F) Convertible,ASTRA Mk III (F) Estate,ASTRA Mk IV (G),ASTRA Mk IV (G) CC,ASTRA Mk IV (G) Estate,ASTRAVAN Mk III (F),ASTRAVAN Mk IV (G),CAVALIER Mk III CC,CAVALIER Mk III (87),COMBO Mk I (B),CORSA Mk II (B),CORSAVAN Mk II (B),NOVA,NOVA CC,VECTRA (B),VECTRA (B) CC,VECTRA (B) Estate
41722/1	Wasserpumpe + Zahnriemensatz, Water Pump & Timing Belt Kit, Pompe à eau + kit de courroie de distribution OPEL ASTRA G Caravan (F35_),ASTRA G CC (F48_, F08_),ASTRA G Kasten (F70),ASTRA G Stufenheck (F69_),COMBO Kasten/Kombi,COMBO Tour,MERIVA,VAUXHALL ASTRA Mk IV (G),ASTRA Mk IV (G) CC,ASTRA Mk IV (G) Estate,ASTRAVAN Mk IV (G),MERIVA Mk I (A)
41724	Wasserpumpe + Zahnriemensatz, Water Pump & Timing Belt Kit, Pompe à eau + kit de courroie de distribution OPEL ASTRA F Caravan (51_, 52_),ASTRA F CC (53_, 54_, 58_, 59_),ASTRA F CLASSIC CC,ASTRA F Van (55_),ASTRA F (56_, 57_),ASTRA G Caravan (F35_),ASTRA G CC (F48_, F08_),ASTRA G Kasten (F70),ASTRA G Stufenheck (F69_),KADETT E Combo (38_, 48_),VECTRA A CC (88_, 89_),VECTRA A (86_, 87_),VAUXHALL ASTRA Mk III (F),ASTRA Mk III (F) CC,ASTRA Mk III (F) Estate,ASTRA Mk IV (G),ASTRA Mk IV (G) CC,ASTRA Mk IV (G) Estate,ASTRAVAN Mk III (F),ASTRAVAN Mk IV (G),CAVALIER Mk III CC,CAVALIER Mk III (87)
41725	Wasserpumpe + Zahnriemensatz, Water Pump & Timing Belt Kit, Pompe à eau + kit de courroie de distribution DAEWOO LEGANZA (KLAV),NUBIRA (KLAJ),NUBIRA Stufenheck (KLAJ),NUBIRA Wagon (KLAJ),OPEL ASTRA F Cabriolet (53_B),ASTRA F Caravan (51_, 52_),ASTRA F CC (53_, 54_, 58_, 59_),ASTRA F (56_, 57_),CALIBRA A (85_),OMEGA B Caravan (21_, 22_, 23_),OMEGA B (25_, 26_, 27_),VECTRA A CC (88_, 89_),VECTRA A (86_, 87_),VECTRA B Caravan (31_),VECTRA B CC (38_),VECTRA B (36_),VAUXHALL ASTRA Mk III (F),ASTRA Mk III (F) CC,ASTRA Mk III (F) Convertible,ASTRA Mk III (F) Estate,CALIBRA,CAVALIER Mk III CC,CAVALIER Mk III (87),OMEGA (B),OMEGA (B) Estate,VECTRA (B),VECTRA (B) CC,VECTRA (B) Estate
41731/1	Wasserpumpe + Zahnriemensatz, Water Pump & Timing Belt Kit, Pompe à eau + kit de courroie de distribution OPEL ASTRA F Cabriolet (53_B),ASTRA F Caravan (51_, 52_),ASTRA F CC (53_, 54_, 58_, 59_),ASTRA F (56_, 57_),CALIBRA A (85_),FRONTERA A Sport (5_SUD2),KADETT E Caravan (35_, 36_, 45_, 46_),KADETT E CC (33_, 34_, 43_, 44_),KADETT E (39_, 49_),OMEGA A Caravan (66_, 67_),OMEGA A (16_, 17_, 19_),OMEGA B Caravan (21_, 22_, 23_),OMEGA B (25_, 26_, 27_),VECTRA A CC (88_, 89_),VECTRA A (86_, 87_),VECTRA B Caravan (31_),VECTRA B CC (38_),VECTRA B (36_),VAUXHALL ASTRA Mk II Convertible,ASTRA Mk III (F),ASTRA Mk III (F) CC,ASTRA Mk III (F) Convertible,ASTRA Mk III (F) Estate,CALIBRA,CARLTON Mk III,CARLTON Mk III Estate,CAVALIER Mk III CC,CAVALIER Mk III (87),FRONTERA Mk I (A) Sport,OMEGA (B),OMEGA (B) Estate
41735	Wasserpumpe + Zahnriemensatz, Water Pump & Timing Belt Kit, Pompe à eau + kit de courroie de distribution OPEL VECTRA B Caravan (31_),VECTRA B CC (38_),VECTRA B (36_),VAUXHALL VECTRA (B),VECTRA (B) CC,VECTRA (B) Estate
41735/1	Wasserpumpe + Zahnriemensatz, Water Pump & Timing Belt Kit, Pompe à eau + kit de courroie de distribution OPEL VECTRA B Caravan (31_),VECTRA B CC (38_),VECTRA B (36_),VAUXHALL VECTRA (B),VECTRA (B) CC,VECTRA (B) Estate
41735/2	Wasserpumpe + Zahnriemensatz, Water Pump & Timing Belt Kit, Pompe à eau + kit de courroie de distribution

Application list - Liste d'affectation

	CHEVROLET CORSA, CORSA Kombi, CORSA Schrägheck, OPEL ASTRA F Cabriolet (53_B), ASTRA F Caravan (51_ 52_), ASTRA F CC (53_ 54_ 58_ 59_), ASTRA F CLASSIC Caravan, ASTRA F CLASSIC CC, ASTRA F CLASSIC Stufenheck, ASTRA F (56_ 57_), COMBO (71_), CORSA B Kombi (F35), CORSA B (73_ 78_ 79_), TIGRA (95_), VECTRA B Caravan (31_), VECTRA B CC (38_), VECTRA B (36_), VAUXHALL ASTRA Mk III (F), ASTRA Mk III (F) CC, ASTRA Mk III (F) Convertible, ASTRA Mk III (F) Estate, CORSA Convertible, CORSA Mk II (B), TIGRA Mk I, VECTRA (B), VECTRA (B) CC, VECTRA (B) Estate
41739	Wasserpumpe + Zahnriemensatz, Water Pump & Timing Belt Kit, Pompe à eau + kit de courroie de distribution
	OPEL ASTRA G Cabriolet, ASTRA G Caravan (F35_), ASTRA G CC (F48_ F08_), ASTRA G Stufenheck (F69_), ZAFIRA (F75_), VAUXHALL ASTRA Mk IV (G), ASTRA Mk IV (G) CC, ASTRA Mk IV (G) Convertible, ASTRA Mk IV (G) Estate, ZAFIRA Mk I (A)
41739/1	Wasserpumpe + Zahnriemensatz, Water Pump & Timing Belt Kit, Pompe à eau + kit de courroie de distribution
	OPEL ASTRA F CLASSIC Caravan, ASTRA F CLASSIC CC, ASTRA G Cabriolet, ASTRA G Caravan (F35_), ASTRA G CC (F48_ F08_), ASTRA G Coupe (F07_), ASTRA G Stufenheck (F69_), ZAFIRA (F75_), VAUXHALL ASTRA Mk IV (G), ASTRA Mk IV (G) CC, ASTRA Mk IV (G) Convertible, ASTRA Mk IV (G) Coupe, ASTRA Mk IV (G) Estate, ZAFIRA Mk I (A)
41805	Wasserpumpe + Zahnriemensatz, Water Pump & Timing Belt Kit, Pompe à eau + kit de courroie de distribution
	AUDI COUPE (81, 85), QUATTRO (85), 100 Avant (44, 44Q, C3), 100 (44, 44Q, C3), 200 Avant (44, 44Q), 200 (44, 44Q), 80 (81, 85, B2), 90 (81, 85, B2), 90 (89, 89Q, 8A, B3)
41806	Wasserpumpe + Zahnriemensatz, Water Pump & Timing Belt Kit, Pompe à eau + kit de courroie de distribution
	AUDI 100 Avant (43, C2), 100 Avant (44, 44Q, C3), 100 (43, C2), 100 (44, 44Q, C3), VW LT 28-35 I Bus (281-363), LT 28-35 I Kasten (281-363), LT 28-35 I Pritsche/Fahrgestell (281-363), LT 40-55 I Kasten (291-512), LT 40-55 I Pritsche/Fahrgestell (293-909)
41807	Wasserpumpe + Zahnriemensatz, Water Pump & Timing Belt Kit, Pompe à eau + kit de courroie de distribution
	VW TRANSPORTER T4 Bus (70XB, 70XC, 7DB, 7DW), TRANSPORTER T4 Kasten (70XA), TRANSPORTER T4 Pritsche/Fahrgestell (70XD)
41810	Wasserpumpe + Zahnriemensatz, Water Pump & Timing Belt Kit, Pompe à eau + kit de courroie de distribution
	AUDI CABRIOLET (8G7, B4), COUPE (81, 85), COUPE (89, 8B), QUATTRO (85), 100 Avant (44, 44Q, C3), 100 (44, 44Q, C3), 200 Avant (44, 44Q), 200 (44, 44Q), 80 Avant (8C, B4), 80 (8C, B4), 90 (81, 85, B2), 90 (89, 89Q, 8A, B3)
41819	Wasserpumpe + Zahnriemensatz, Water Pump & Timing Belt Kit, Pompe à eau + kit de courroie de distribution
	VW LT 28-35 II Bus (2DM), LT 28-46 II Kasten (2DX0AE), LT 28-46 II Pritsche/Fahrgestell (2DX0FE), TRANSPORTER T4 Bus (70XB, 70XC, 7DB, 7DW), TRANSPORTER T4 Kasten (70XA), TRANSPORTER T4 Pritsche/Fahrgestell (70XD)
41819/1	Wasserpumpe + Zahnriemensatz, Water Pump & Timing Belt Kit, Pompe à eau + kit de courroie de distribution
	VOLVO S70 (P80_), S80 (TS, XY), V70 I Kombi (P80_), V70 II Kombi (P80_), 850 Kombi (LW), 850 (LS)
41823	Wasserpumpe + Zahnriemensatz, Water Pump & Timing Belt Kit, Pompe à eau + kit de courroie de distribution
	SEAT AROSA (6H), CORDOBA Vario (6K5), CORDOBA (6K2/C2), IBIZA II (6K1), INCA (6K9), VW CADDY II Kasten (9K9A), CADDY II Kombi (9K9B), GOLF III Variant (1H5), GOLF III (1H1), POLO CLASSIC (6KV2), POLO Kasten (6NF), POLO Variant (6KV5), POLO (6N1), VENTO (1H2)
41823/1	Wasserpumpe + Zahnriemensatz, Water Pump & Timing Belt Kit, Pompe à eau + kit de courroie de distribution
	SEAT AROSA (6H), CORDOBA Schrägheck (6K2), CORDOBA Vario (6K5), CORDOBA (6K2/C2), IBIZA II (6K1), IBIZA III (6K1), VW LUPO (6X1, 6E1), POLO CLASSIC (6KV2), POLO Variant (6KV5), POLO (6N1), POLO (6N2)
41824	Wasserpumpe + Zahnriemensatz, Water Pump & Timing Belt Kit, Pompe à eau + kit de courroie de distribution
	SEAT CORDOBA, CORDOBA Schrägheck (6K2), CORDOBA Vario (6K5), CORDOBA (6K2/C2), IBIZA II (6K1), IBIZA III (6K1), INCA (6K9), SKODA FELICIA I Fun (797), FELICIA I Kombi (6U5), FELICIA II Kombi (6U5), FELICIA II (6U1), OCTAVIA Combi (1U5), OCTAVIA (1U2), VW CADDY II Kasten (9K9A), CADDY II Kombi (9K9B), CADDY II Pick-up (9U7), GOLF III Variant (1H5), GOLF III (1H1), POLO CLASSIC (6KV2), POLO Variant (6KV5), POLO (6N1), VENTO (1H2)
41832	Wasserpumpe + Zahnriemensatz, Water Pump & Timing Belt Kit, Pompe à eau + kit de courroie de distribution
	AUDI A3 (8L1), A4 Avant (8D5, B5), A4 Avant (8ED), A4 Avant (8E5, B6), A4 (8D2, B5), A4 (8EC), A4 (8E2, B6), SEAT ALTEA XL (5P5, 5P8), ALTEA (5P1), CORDOBA, CORDOBA Schrägheck (6K2), CORDOBA Vario (6K5), IBIZA III (6K1), LEON (1M1), LEON (1P1), TOLEDO II (1M2), TOLEDO III (5P2), SKODA OCTAVIA Combi (1U5), OCTAVIA Combi (1Z5), OCTAVIA (1U2), OCTAVIA (1Z3), VW BORA Kombi (1J6), BORA (1J2), CADDY III Kasten (2KA, 2KH, 2CA, 2CH), CADDY III Kombi (2KB, 2KJ), GOLF IV Variant (1J5), GOLF IV (1J1), GOLF PLUS (5M1, 521), GOLF V Variant (1K5), GOLF V (1K1), GOLF VI (5K1), JETTA III (1K2), NEW BEETLE Cabriolet (1Y7), NEW BEETLE (9C1, 1C1), PASSAT Variant (3B5), PASSAT Variant (3B6), PASSAT (3B2), PASSAT (3B3), POLO CLASSIC (6KV2), POLO Variant (6KV5), TOURAN (1T1, 1T2, 1T3)
41833	Wasserpumpe + Zahnriemensatz, Water Pump & Timing Belt Kit, Pompe à eau + kit de courroie de distribution
	VW TRANSPORTER T4 Bus (70XB, 70XC, 7DB, 7DW), TRANSPORTER T4 Kasten (70XA), TRANSPORTER T4 Pritsche/Fahrgestell (70XD)
41838	Wasserpumpe + Zahnriemensatz, Water Pump & Timing Belt Kit, Pompe à eau + kit de courroie de distribution
	AUDI A2 (8Z0), SEAT ALTEA XL (5P5, 5P8), ALTEA (5P1), AROSA (6H), CORDOBA Schrägheck (6K2), CORDOBA Vario (6K5), CORDOBA (6L2), IBIZA III (6K1), IBIZA IV (6L1), IBIZA V SPORTCOUPE (6J1), IBIZA V ST (6J8), IBIZA V (6J5), INCA (6K9), LEON (1M1), LEON (1P1), TOLEDO II (1M2), SKODA FABIA, FABIA Combi (6Y5), FABIA Stufenheck (6Y3), FABIA (6Y2), OCTAVIA Combi (1U5), OCTAVIA (1U2), OCTAVIA (1Z3), PRAKTIK (5J), ROOMSTER (5J), VW BORA Kombi (1J6), BORA (1J2), CADDY II Kasten (9K9A), CADDY II Kombi (9K9B), CADDY III Kasten (2KA, 2KH, 2CA, 2CH), CADDY III Kombi (2KB, 2KJ), GOLF IV Variant (1J5), GOLF IV (1J1), GOLF PLUS (5M1, 521), GOLF V (1K1), LUPO (6X1, 6E1), NEW BEETLE Cabriolet (1Y7), NEW BEETLE (9C1, 1C1), POLO CLASSIC (6KV2), POLO Stufenheck, POLO Variant (6KV5), POLO (6N2), POLO (9N_)
41838/2	Wasserpumpe + Zahnriemensatz, Water Pump & Timing Belt Kit, Pompe à eau + kit de courroie de distribution
	AUDI A2 (8Z0), SEAT LEON (1M1), TOLEDO II (1M2), VW BORA Kombi (1J6), BORA (1J2), GOLF IV Variant (1J5), GOLF IV (1J1), LUPO (6X1, 6E1), POLO (6N1), POLO (6N2)
41839	Wasserpumpe + Zahnriemensatz, Water Pump & Timing Belt Kit, Pompe à eau + kit de courroie de distribution
	VW LT 28-35 II Bus (2DM), LT 28-46 II Kasten (2DX0AE), LT 28-46 II Pritsche/Fahrgestell (2DX0FE), TRANSPORTER T4 Bus (70XB, 70XC, 7DB, 7DW), TRANSPORTER T4 Kasten (70XA), TRANSPORTER T4 Pritsche/Fahrgestell (70XD)
41839/1	Wasserpumpe + Zahnriemensatz, Water Pump & Timing Belt Kit, Pompe à eau + kit de courroie de distribution
	VOLVO S70 (P80_), S80 (TS, XY), V70 I Kombi (P80_), V70 II Kombi (P80_), 850 Kombi (LW), 850 (LS)
41844	Wasserpumpe + Zahnriemensatz, Water Pump & Timing Belt Kit, Pompe à eau + kit de courroie de distribution
	AUDI A3 (8L1), SEAT CORDOBA Schrägheck (6K2), CORDOBA Vario (6K5), IBIZA III (6K1), INCA (6K9), LEON (1M1), TOLEDO II (1M2), SKODA OCTAVIA Combi (1U5), OCTAVIA (1U2), VW BORA Kombi (1J6), BORA (1J2), CADDY II Kasten (9K9A), CADDY II Kombi (9K9B), GOLF IV Variant (1J5), GOLF IV (1J1), NEW BEETLE (9C1, 1C1), POLO CLASSIC (6KV2), POLO Variant (6KV5)
41847	Wasserpumpe + Zahnriemensatz, Water Pump & Timing Belt Kit, Pompe à eau + kit de courroie de distribution
	AUDI A2 (8Z0), SEAT AROSA (6H), SKODA FABIA Combi (6Y5), FABIA Stufenheck (6Y3), FABIA (6Y2), VW LUPO (6X1, 6E1), POLO Stufenheck, POLO (6N2), POLO (9N_)
41848	Wasserpumpe + Zahnriemensatz, Water Pump & Timing Belt Kit, Pompe à eau + kit de courroie de distribution
	AUDI A3 (8L1), A4 Avant (8D5, B5), A4 Avant (8E5, B6), A4 (8D2, B5), A4 (8E2, B6), A6 Avant (4B, C5), A6 (4B, C5), FORD GALAXY (WGR), SEAT ALHAMBRA (7V8, 7V9), SKODA OCTAVIA Combi (1U5), SUPERB (3U4), VW BORA Kombi (1J6), BORA (1J2), GOLF IV Variant (1J5), GOLF IV (1J1), NEW BEETLE (9C1, 1C1), PASSAT Variant (3B5), PASSAT Variant (3B6), PASSAT (3B2), PASSAT (3B3), SHARAN (7M8, 7M9, 7M6)
41850	Wasserpumpe + Zahnriemensatz, Water Pump & Timing Belt Kit, Pompe à eau + kit de courroie de distribution
	AUDI 50 (86), 80 (81, 85, B2), VW DERBY (86C, 80), GOLF I Cabriolet (155), GOLF I (17), GOLF II (19E, 1G1), JETTA I (16), JETTA II (19E, 1G2), PASSAT Variant (3ZB), PASSAT Variant (33), PASSAT (32), PASSAT (32B), POLO CLASSIC (86C, 80), POLO Coupe (86C, 80), POLO Kasten (86CF), POLO (86), POLO (86C, 80), SANTANA (32B), SCIROCCO (53), SCIROCCO (53B)
41901	Wasserpumpe + Zahnriemensatz, Water Pump & Timing Belt Kit, Pompe à eau + kit de courroie de distribution
	AUDI A4 Avant (8D5, B5), A4 Avant (8ED), A4 Avant (8E5, B6), A4 Cabriolet (8H7, 8HE), A4 (8D2, B5), A4 (8EC), A4 (8E2, B6), A6 Avant (4B, C5), A6 (4B, C5), SKODA SUPERB (3U4), VW PASSAT Variant (3B6), PASSAT (3B3)

Application list - Liste d'affectation

41912	Wasserpumpe + Zahnriemensatz, Water Pump & Timing Belt Kit, Pompe à eau + kit de courroie de distribution AUDI A3 (8L1), TT Roadster (8N9), TT (8N3), SEAT ALHAMBRA (7V8, 7V9), LEON (1M1), TOLEDO II (1M2), SKODA OCTAVIA Combi (1U5), OCTAVIA (1U2), VW BORA Kombi (1J6), BORA (1J2), GOLF IV Variant (1J5), GOLF IV (1J1), NEW BEETLE (9C1, 1C1), SHARAN (7M8, 7M9, 7M6)
41928	Wasserpumpe + Zahnriemensatz, Water Pump & Timing Belt Kit, Pompe à eau + kit de courroie de distribution RENAULT LAGUNA (B56_, 556_), LAGUNA Grandtour (K56_), SAFRANE II (B54_), VOLVO C70 I Cabriolet, C70 I Coupe, S40 I (VS), S70 (P80_), V40 Kombi (VW), V70 I Kombi (P80_), 850 Kombi (LW), 850 (LS)
73080	Zahnriemensatz, Timing Belt Kit, Kit de distribution LADA KALINA Schrägheck (1119), KALINA Stufenheck (1118), 110, 111, 112
73081	Zahnriemensatz, Timing Belt Kit, Kit de distribution LADA SAMARA FORMA (21099), SAMARA (2108, 2109), 110, 111, 112
73501	Zahnriemensatz, Timing Belt Kit, Kit de distribution HYUNDAI LANTRA I (J-1), SANTAMO, SONATA II (Y-2), SONATA III (Y-3), MITSUBISHI COLT III (C5_A), ECLIPSE I (D2_A), GALANT IV (E3_A), GALANT IV Stufenheck (E3_A), GALANT V (E5_A, E7_A, E8_A), GALANT V Stufenheck (E5_A, E7_A, E8_A), GALANT VI (EA_), GALANT VI Station Wagon (EA_), L 200 (K_T), L 300 Bus (P0_W, P1_W, P2_W), L 300 Kasten (P0_W, P1_W), L 300 Pritsche/Fahrgestell (P1_T), LANCER IV (C6_A, C7_A), LANCER V (CB/D_A), LANCER V Station Wagon (CB_W, CD_W), PAJERO II Canvas Top (V2_W, V4_W), PAJERO II (V2_W, V4_W), SANTAMO, SPACE GEAR (PA/B/D_V/W), SPACE RUNNER (N1_W, N2_W), SPACE WAGON (N3_W, N4_W), PROTON PERSONA 400 (C9_S), PERSONA 400 Hatchback (C9_C, C9_S)
73508	Zahnriemensatz, Timing Belt Kit, Kit de distribution MITSUBISHI GALANT V (E5_A, E7_A, E8_A), GALANT V Stufenheck (E5_A, E7_A, E8_A), L 200 (K_T), L 300 Bus (P0_W, P1_W, P2_W), L 300 Pritsche/Fahrgestell (P1_T), SPACE GEAR (PA/B/D_V/W), SPACE RUNNER (N1_W, N2_W), SPACE WAGON (N3_W, N4_W)
73509	Zahnriemensatz, Timing Belt Kit, Kit de distribution MITSUBISHI L 200 (KAOT), L 200 (K_T), SPACE GEAR (PA/B/D_V/W), TRITON
73510	Zahnriemensatz, Timing Belt Kit, Kit de distribution CHRYSLER LE BARON, LE BARON Cabriolet, SARATOGA, VOYAGER I (ES), HYUNDAI GALLOPER I, GALLOPER II (JK-01), SONATA II (Y-2), SONATA III (Y-3), MITSUBISHI DEBONAIR, GALLOPER (JK-01), L 200 (K_T), PAJERO I (L04_G, L14_G), PAJERO II Canvas Top (V2_W, V4_W), PAJERO II (V2_W, V4_W), SIGMA (F16A), SIGMA Station Wagon (F07W), TRITON (MJ)
73533	Zahnriemensatz, Timing Belt Kit, Kit de distribution HYUNDAI ACCENT I (X-3), ACCENT Stufenheck (X-3), LANTRA II (J-2), LANTRA II Wagon (J-2), PONY (X-2), PONY/EXCEL Stufenheck (X-2), S COUPE (SLC)
73535	Zahnriemensatz, Timing Belt Kit, Kit de distribution DAEWOO ESPERO (KLEJ)
73536	Zahnriemensatz, Timing Belt Kit, Kit de distribution CHEVROLET KALOS, KALOS Stufenheck, LACETTI, NUBIRA Kombi, NUBIRA Stufenheck, REZZO, DAEWOO ESPERO (KLEJ), KALOS (KLAS), LACETTI Schrägheck (KLAN), LANOS (KLAT), LANOS Stufenheck (KLAT), NEXIA (KLETN), NEXIA Stufenheck (KLETN), NUBIRA (KLAJ), NUBIRA Stufenheck (KLAJ), NUBIRA Stufenheck (KLAN), NUBIRA Wagon (KLAJ), REZZO (KLAU)
73537	Zahnriemensatz, Timing Belt Kit, Kit de distribution CHEVROLET MATIZ, DAEWOO MATIZ (KLYA), TICO (KLY3)
73538	Zahnriemensatz, Timing Belt Kit, Kit de distribution HYUNDAI ACCENT II (LC), ACCENT Stufenheck (LC), GETZ (TB)
73539	Zahnriemensatz, Timing Belt Kit, Kit de distribution HYUNDAI ACCENT II (LC), ACCENT III (MC), ACCENT Stufenheck (LC), ACCENT Stufenheck (MC), COUPE (GK), COUPE (RD), ELANTRA Stufenheck (XD), ELANTRA (XD), GETZ (TB), MATRIX (FC)
73540	Zahnriemensatz, Timing Belt Kit, Kit de distribution HYUNDAI HIGHWAY VAN, SANTA FÉ (SM), SONATA IV (EF), TRAJET (FO), KIA MAGENTIS (GD)
73808	Zahnriemensatz, Timing Belt Kit, Kit de distribution FORD GALAXY (WGR), SEAT ALHAMBRA (7V8, 7V9), CORDOBA Vario (6K5), CORDOBA (6K2/C2), IBIZA II (6K1), INCA (6K9), VW CADDY II Kasten (9K9A), CADDY II Kombi (9K9B), POLO CLASSIC (6KV2), POLO Variant (6KV5), SHARAN (7M8, 7M9, 7M6)
73809	Zahnriemensatz, Timing Belt Kit, Kit de distribution VW TRANSPORTER T4 Bus (70XB, 70XC, 7DB, 7DW), TRANSPORTER T4 Kasten (70XA), TRANSPORTER T4 Pritsche/Fahrgestell (70XD)
73834	Zahnriemensatz, Timing Belt Kit, Kit de distribution VW LT 28-35 II Bus (2DM), LT 28-46 II Kasten (2DX0AE), LT 28-46 II Pritsche/Fahrgestell (2DX0FE), TRANSPORTER T4 Bus (70XB, 70XC, 7DB, 7DW), TRANSPORTER T4 Kasten (70XA), TRANSPORTER T4 Pritsche/Fahrgestell (70XD)

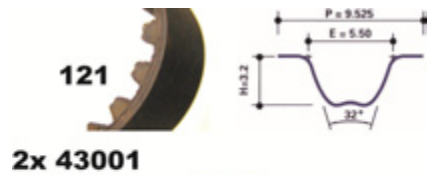

4x 23077
23001

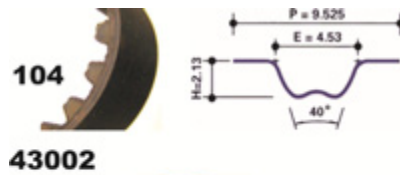

23056
23002

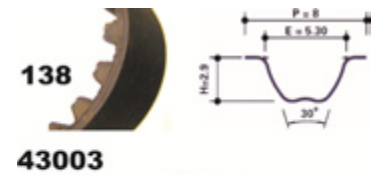

23056
23003

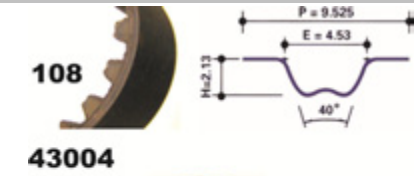

23056
23004

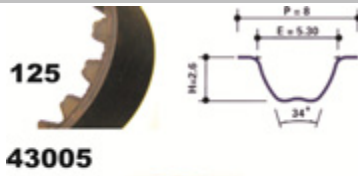

23056
23005

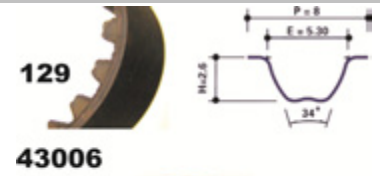

23056
23006

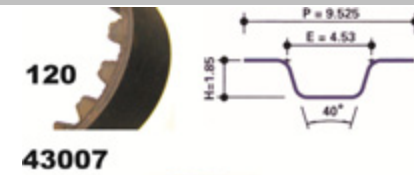

23056
23007

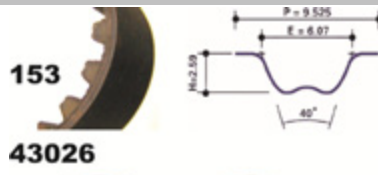

23057 23057
23026

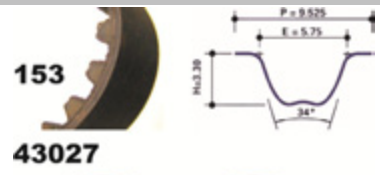

23057 23057
23027

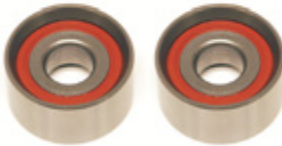
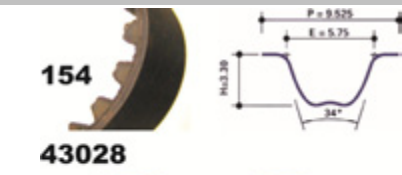

23057 23057
23028

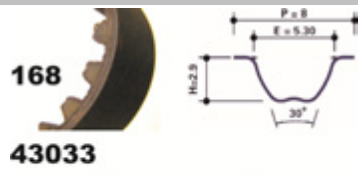

23051 23050
23033

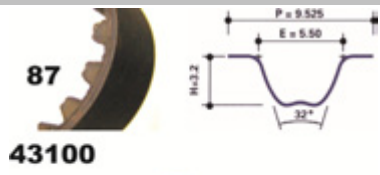

23150
23100

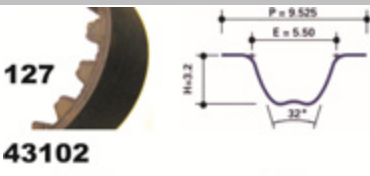

23152 23151
23102

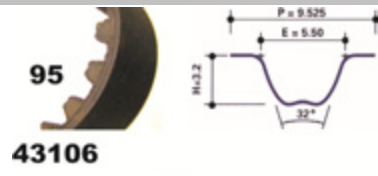

23150
23106

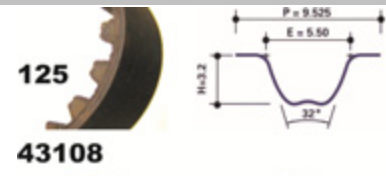

23152 23151
23108

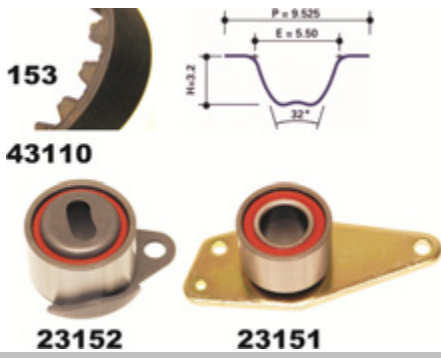

23110

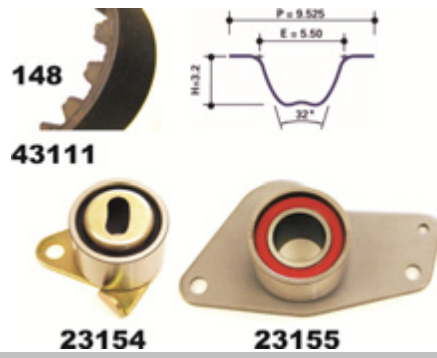

23111

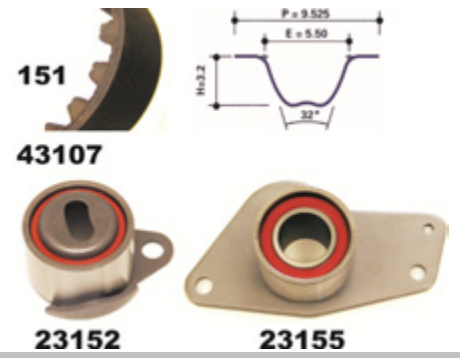

23112

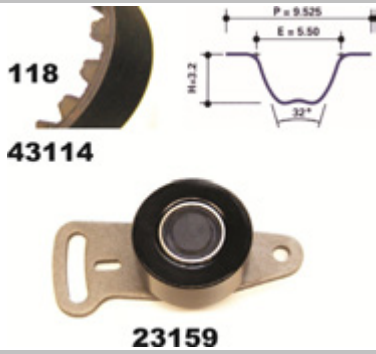

23114

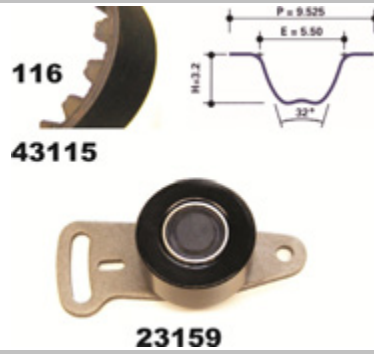

23115

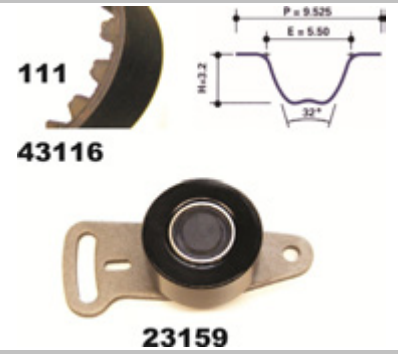

23116

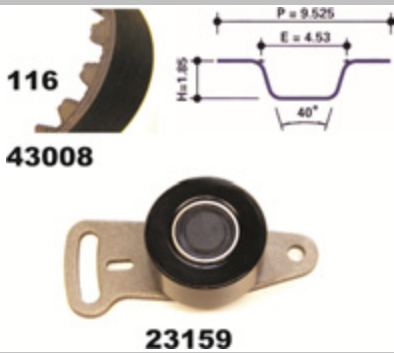

23118

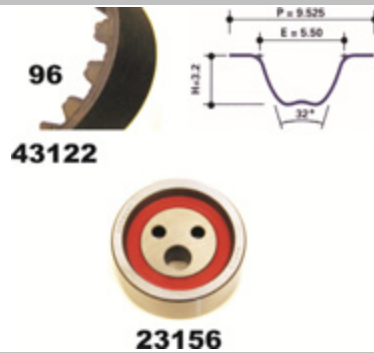

23122

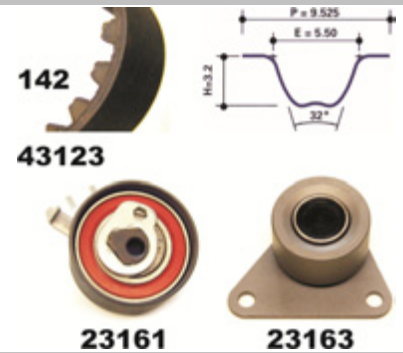

23123



23124



23125



23126



23129



23132

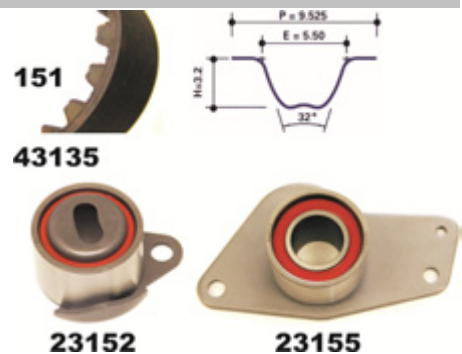

23135

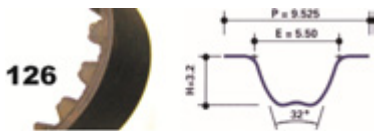

126

43126



23176 24066

23136

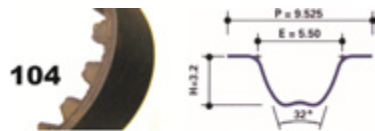

104

43401



23458

23401

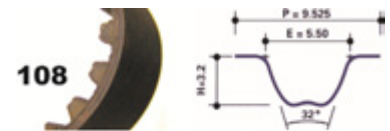

108

43402



23458

23402

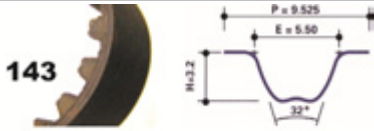

143

43403



23461 23450

23403

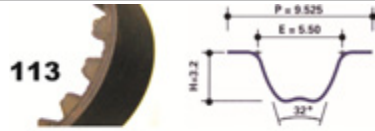

113

43404



23451

23404

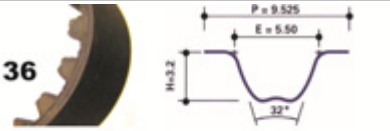

136

43415



23454

23453

23405

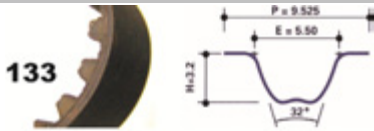

133

43406



2x 23459

23406

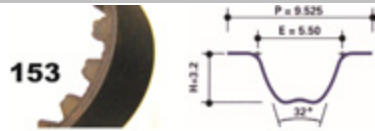

153

43408



24353

24354

23408

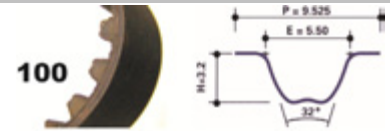

100

43410



23462

23410

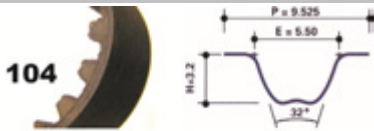

104

43411



23462

23411

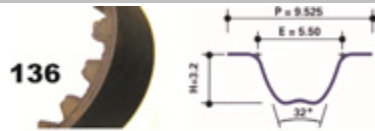

136

43412



23461

23450

23412

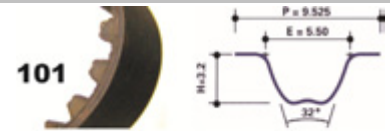

101

43413



23458

23413



114

43414



23452

23414

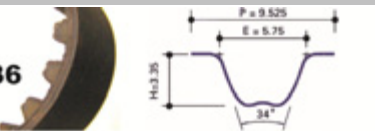

136

43415



23460

23350

23415

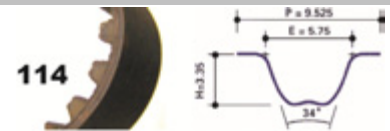

114

43414



23456

23416

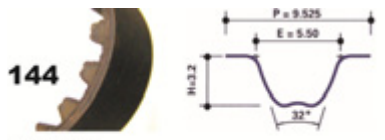

144

43417



23457

23450

23417



62

118

43418

43418/1



23455

23056

23418

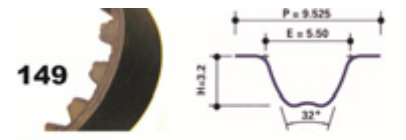

149

43419

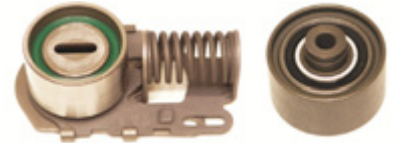

23457

23450

23419



259

43424



24364

2x 24363

24362

23424

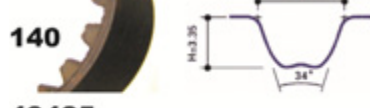

140

43425



23464

23465

23425

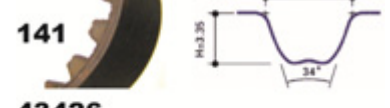

141

43426



23464

23465

23426

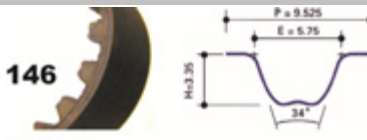

146

43427



23464

23465

23427

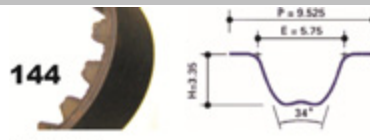

144

43428



23464

23465

23428

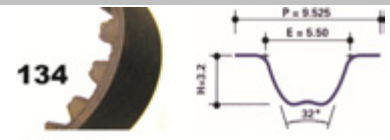

134

43432



23385

23382

23432

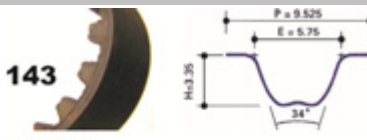

143

43433



23464

23465

23433

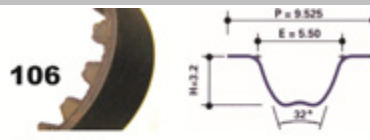

106

43501



23660

23501

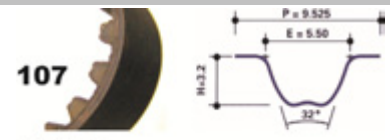

107

43502



23660

23502

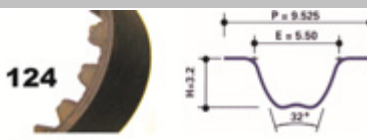

124

43503



23660

23503

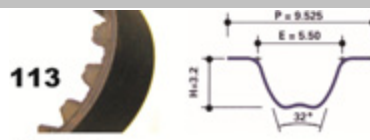

113

43507



23662

23507

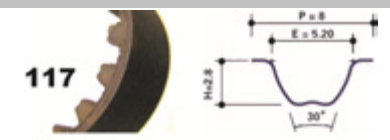

117

43510



23560

23510

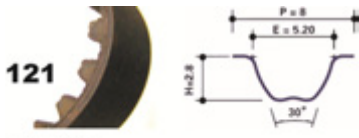

121

43511



23560

23511

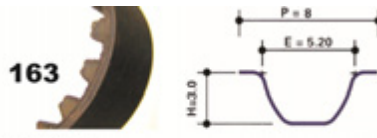

163

43512



23564



23280

23512

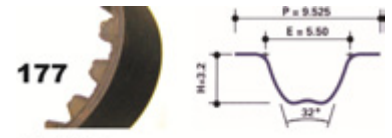

177

43513



24583



24584

23513

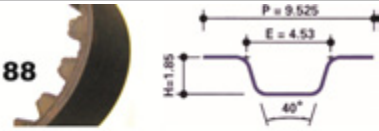

88

43517



24593

23516



88

43517



24593

23517



94

43518



24593

23518

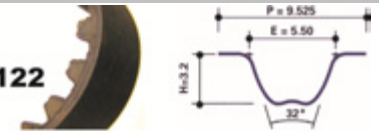

122

43520



23583



23597

23520

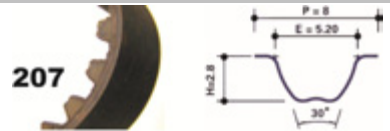

207

43530



23556



23554

23530

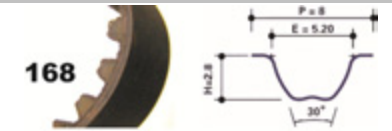

168

43534



23594



23292

23534

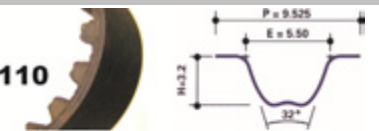

110

43535



23594



23292

23535

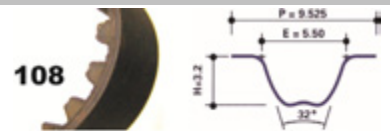

108

43536



23594



23292

23536

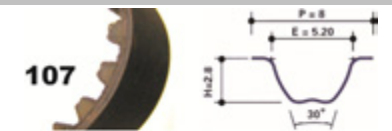

107

43538



23591

23538

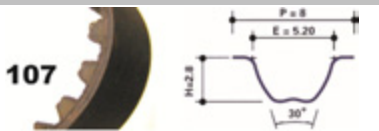

107

43539



23591

23539

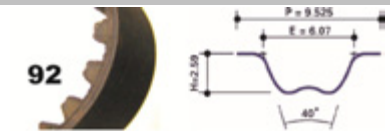

92

43541



23582

23541

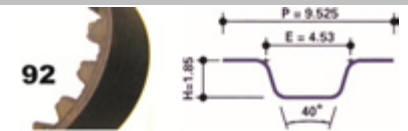

92

43542



23582

23542

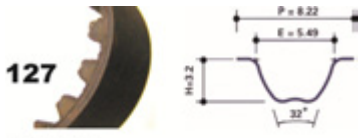

127

43600



23654

23600

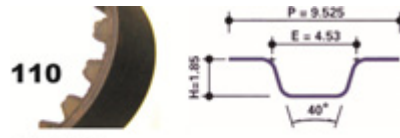

110

43601



23654

23601

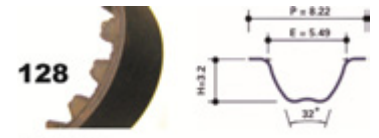

128

43602



23654

23602

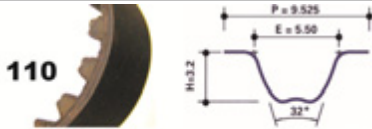

110

43604



23652

23651

23650

23604

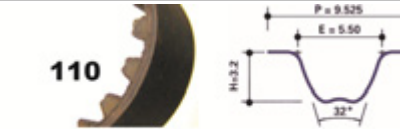

110

43604



23655

23651

23650

23605

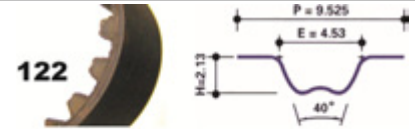

122

43627



23755

23627

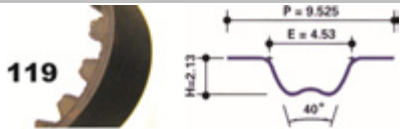

119

43628



23755

23628



117

43629



23759

23629



91

43630



23768

23630



130

43707



24650

23631

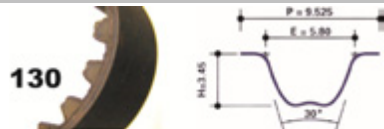

130

43709



24650

23632

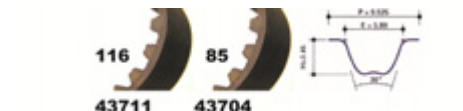

116

43711

85

43704



23761

24756

23762

23633

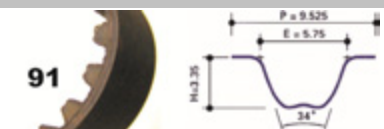

91

43630



24680

23636



97

43701



23753

23701

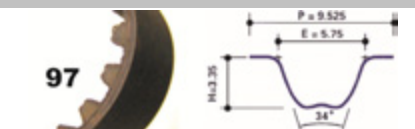

97

43702



23753

23702

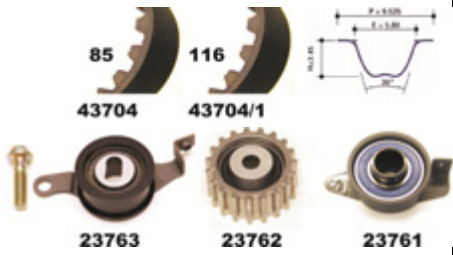

23704

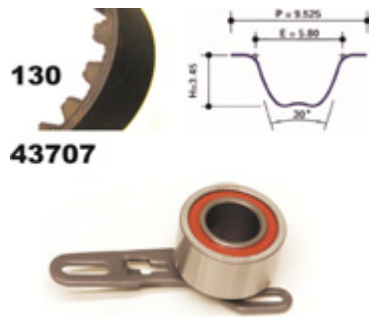

23754
23707

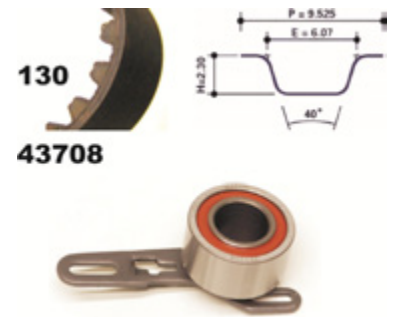

23754
23708

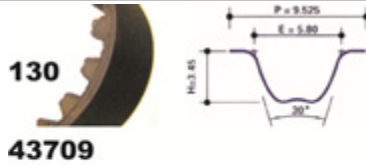

23754
23709



23710

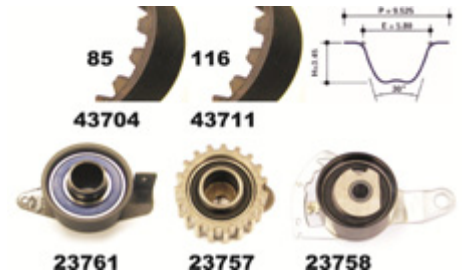

23712

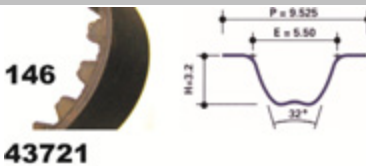

23790
23721

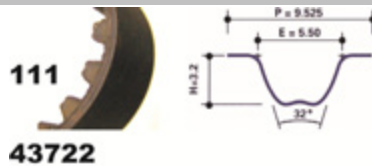

23791
23722

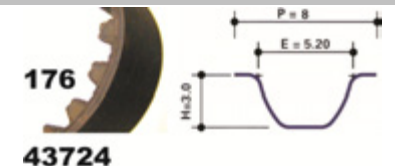

23724

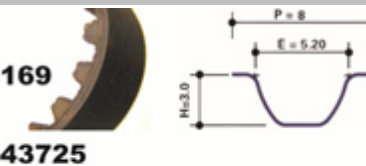

23725

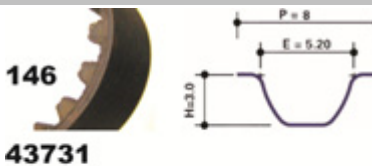

23792
23731

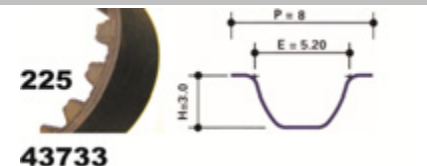

23733

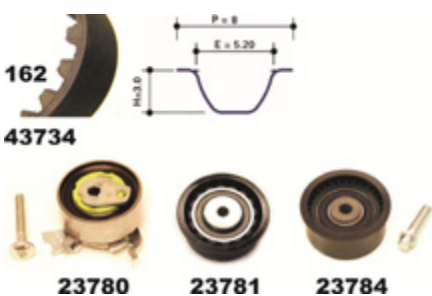

23734

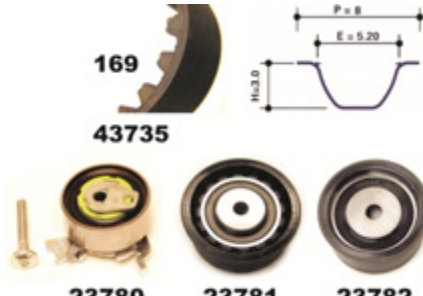

23735



23738

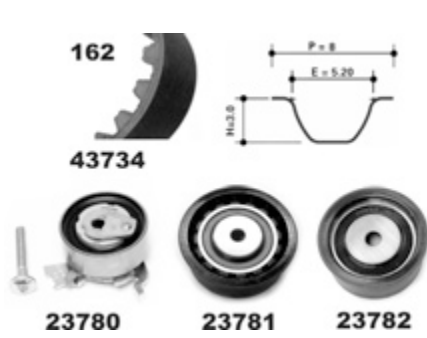

23739

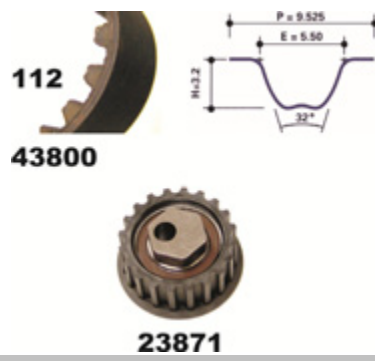

23800

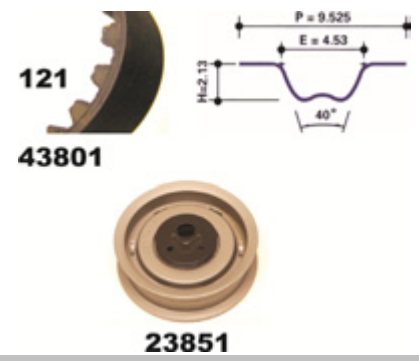

23801

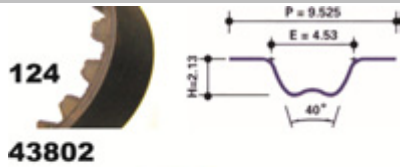

23851

23802

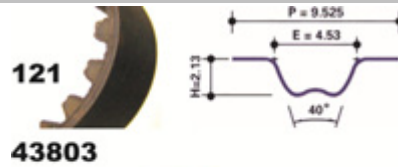

23851

23803

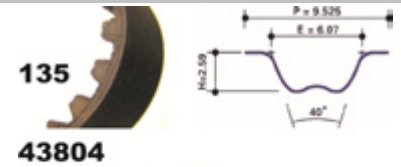

23852

23804

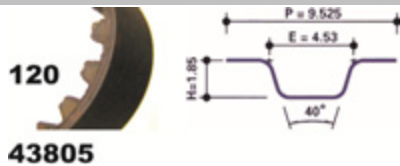

23854

23805

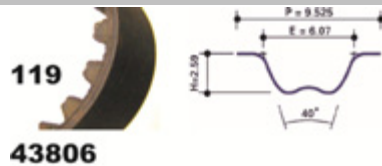

23854

23806

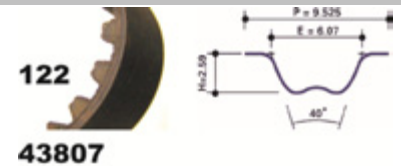

23854

23807

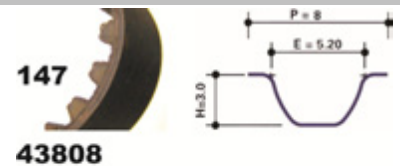

23853

23808

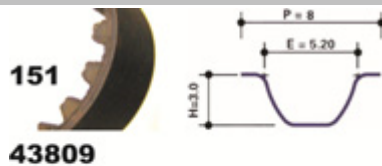

23853

23809

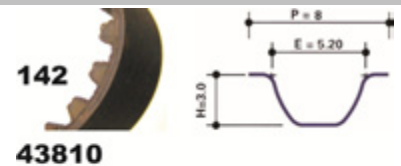

23855

23810

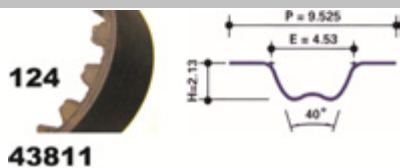

23856

23811

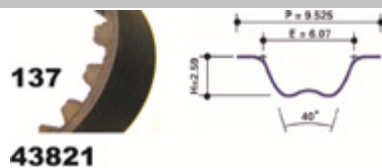

23852

23812

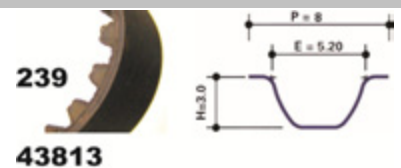

23860



23863

23813

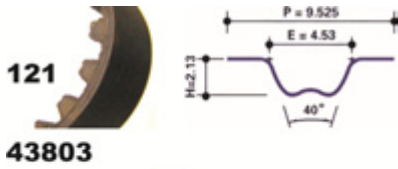

121

43803



23877

23814

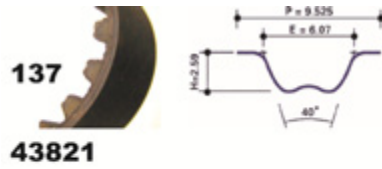

137

43821



23890

23815

23885

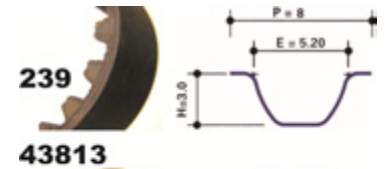

239

43813



23859

23817



23861

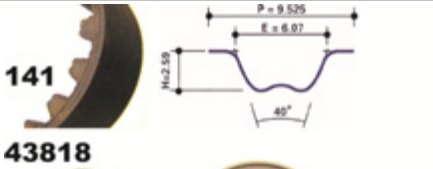

141

43818



23961



23893



23891

23818

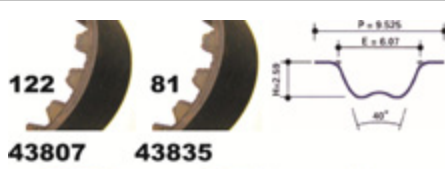

122

43807



23961

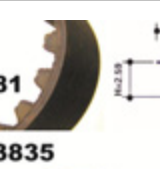

81

43835



23959



23960

23819

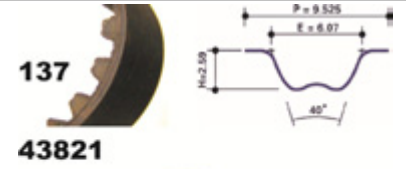

137

43821



23884

23820

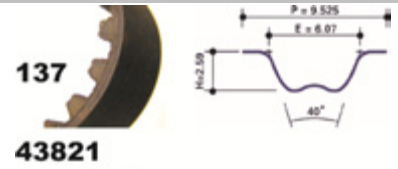

137

43821



23884



23885

23821

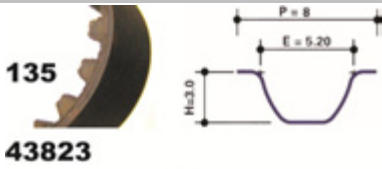

135

43823



23957

23823

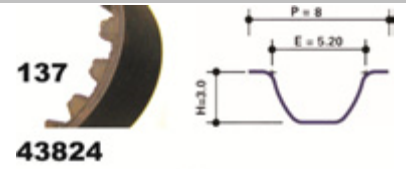

137

43824



23957

23824

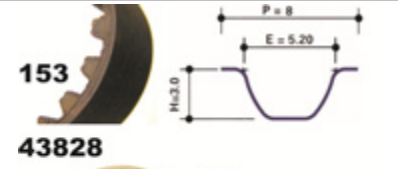

153

43828



23878



24884

23827

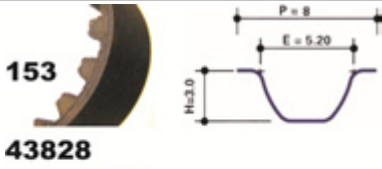

153

43828



23878



23891

23828

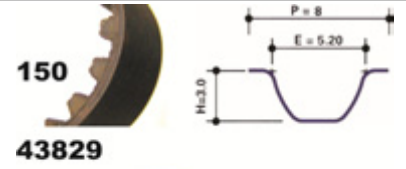

150

43829



24886

23829

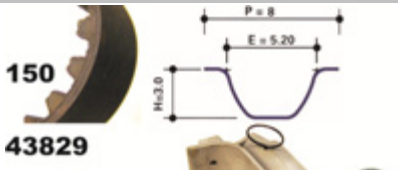

150

43829



24886



43862

23830

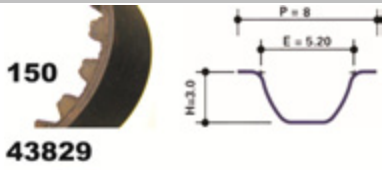

150

43829



24886



24883

23831

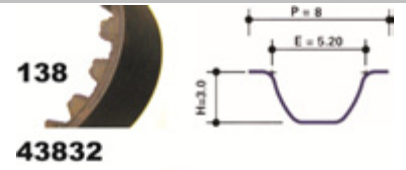

138

43832



23895

23832

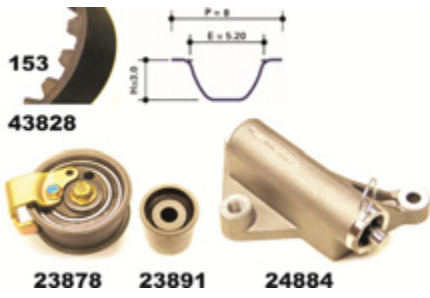

23833

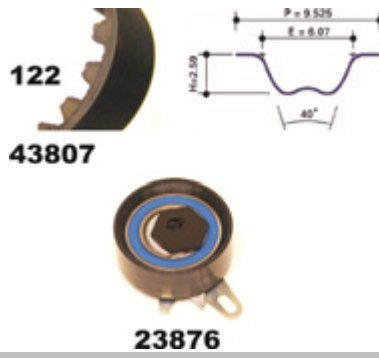

23834



23835



23836

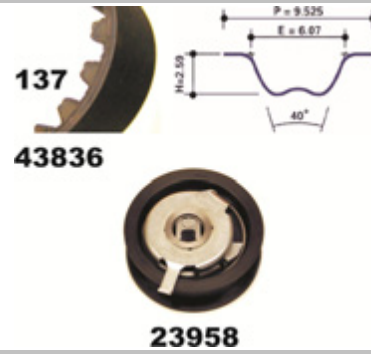

23837



23838



23838/1



23839



23840

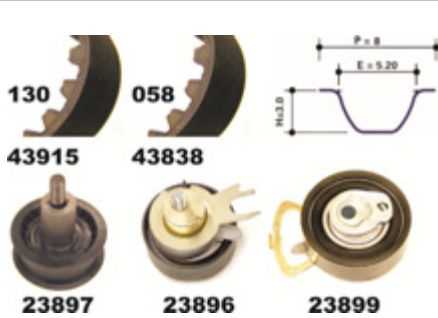

23841



23842

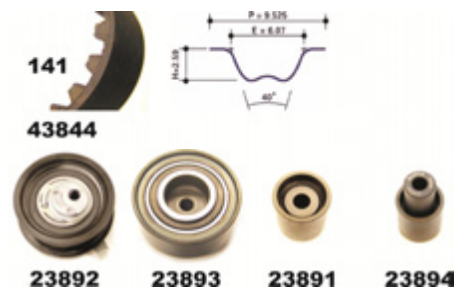

23844



23845



23847



23848

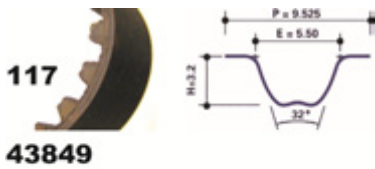

117

43849



23888 23887

23849

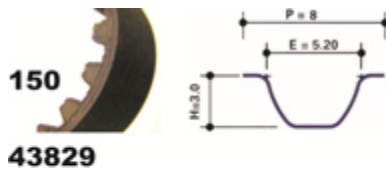

150

43829



43864 24883

23901

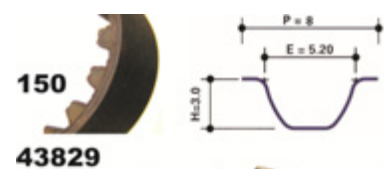

150

43829



43864 24865

23902

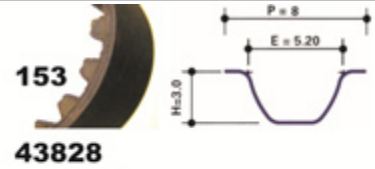

153

43828



24852 24884

23908

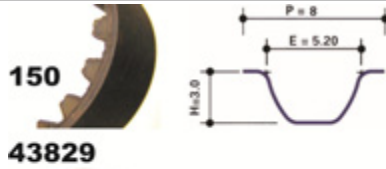

150

43829



24875 24883

23912

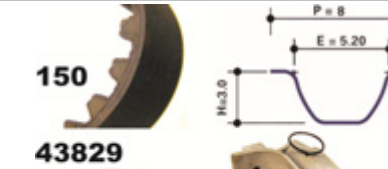

150

43829



24875 43862

23913

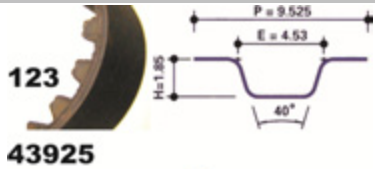

123

43925



23969

23925

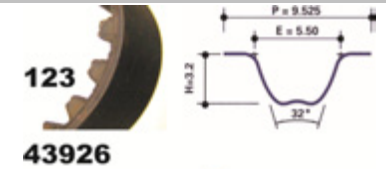

123

43926



23969

23926

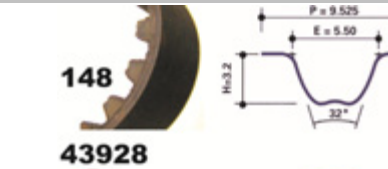

148

43928



23162 23163

23928

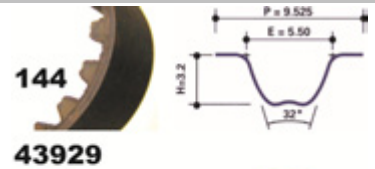

144

43929



23162 23163

23929

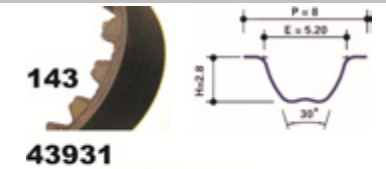

143

43931



23664

23938

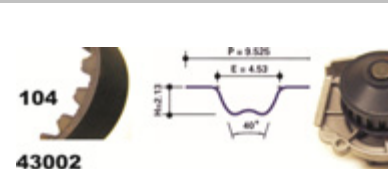

104

43002



23056

21058

41002

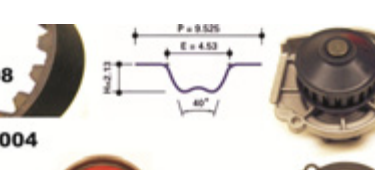

108

43004



23056

21058

41004

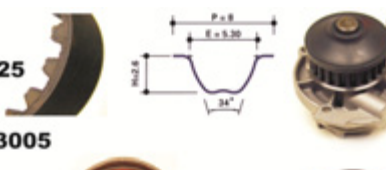

125

43005



23056

21006

41005



129

43006



23056

21006

41006

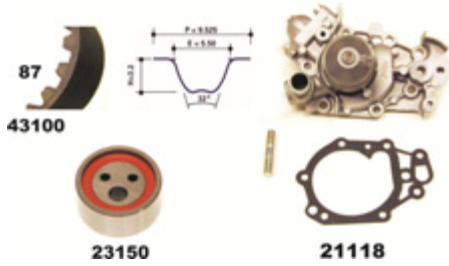

41100

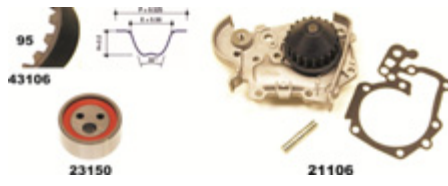

41106

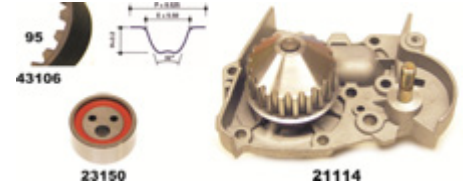

41106/1

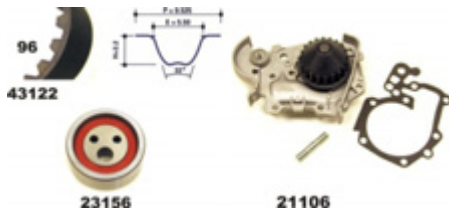

41122/1



41123



41129

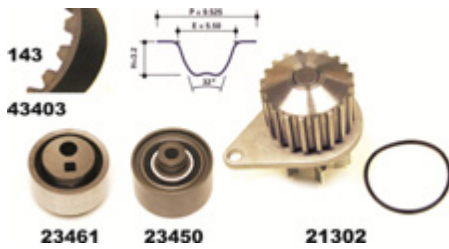

41403



41404

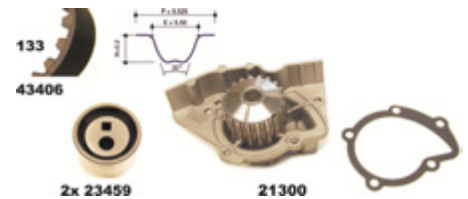

41406



41412

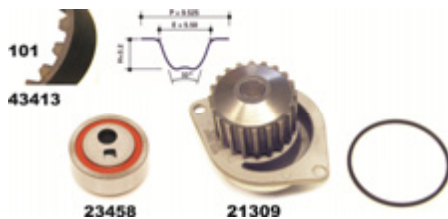

41413

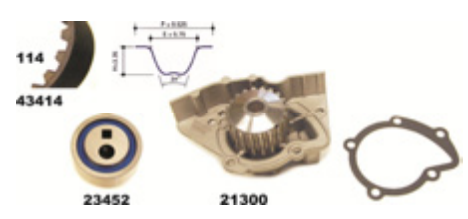

41414



41414/1



41415



41416



41417



41419

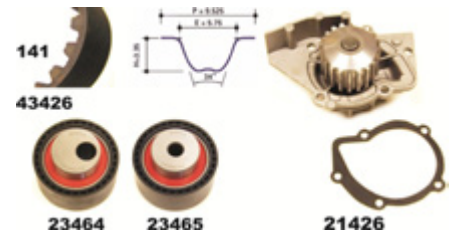

41426

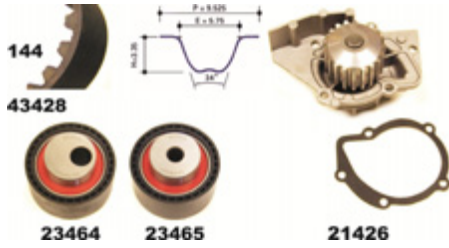

41428

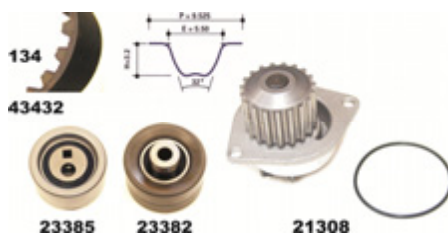

42432

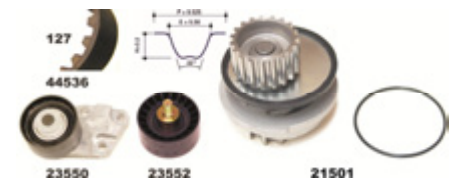

41536

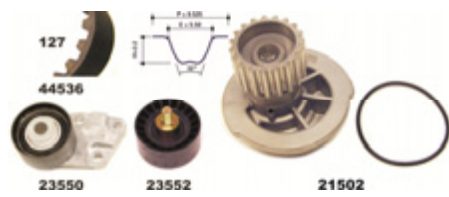

41536/1

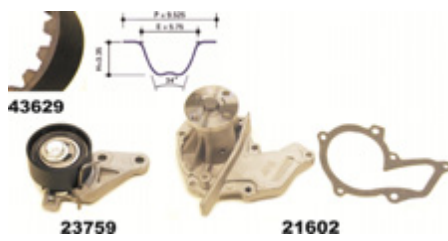

41629

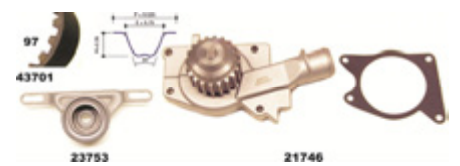

41701

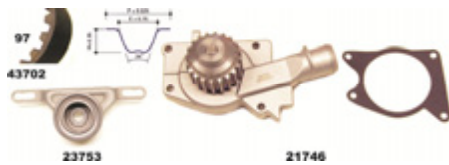

41702



41712



41712/2

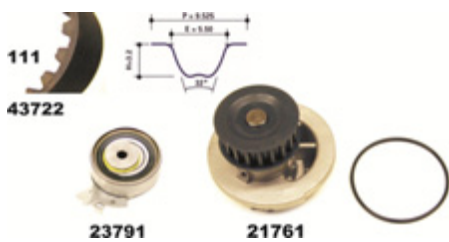

41722

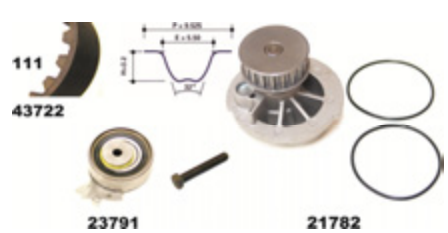

41722/1

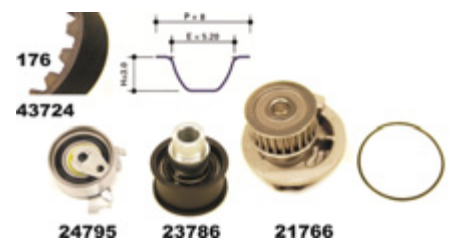

41724

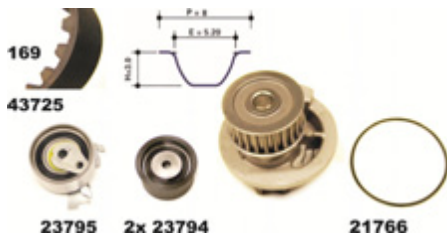

41725

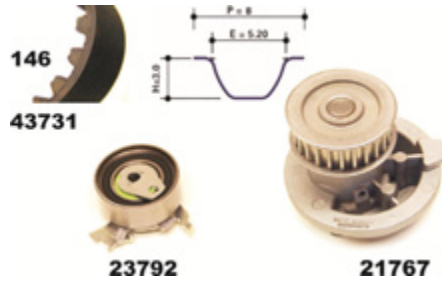

41731/1

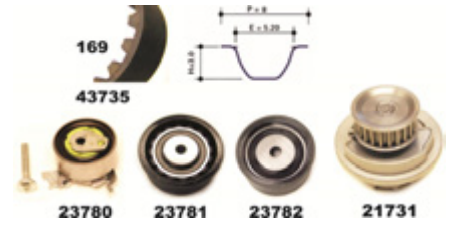

43735

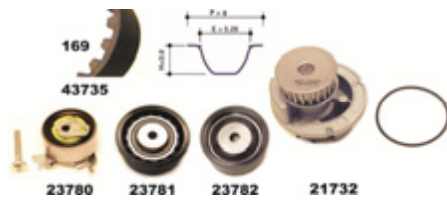

41735/1

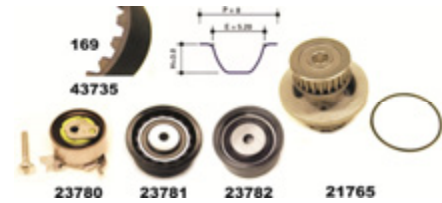

41735/2



41739

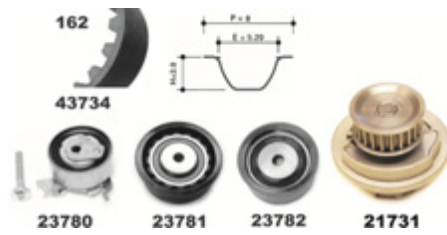

41739/1

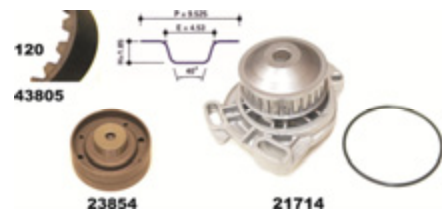

41805

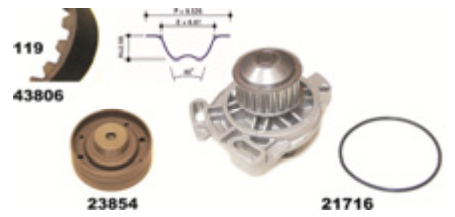

41806

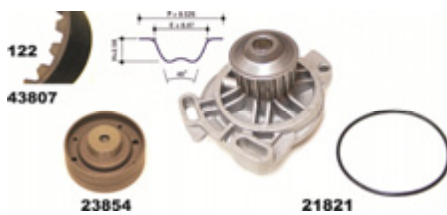

41807

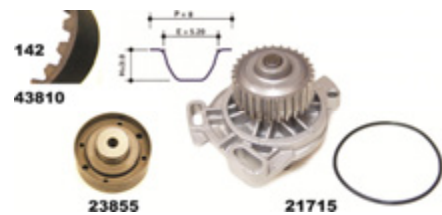

41810

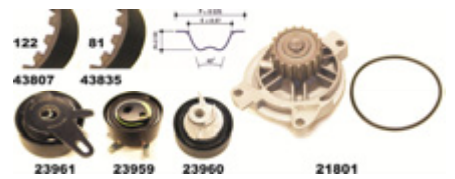

41819



41819/1

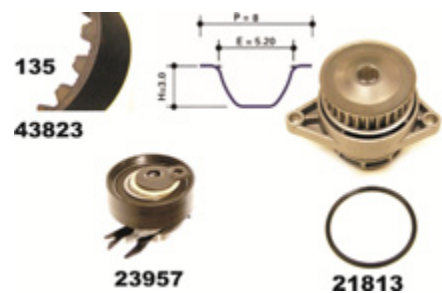

41823

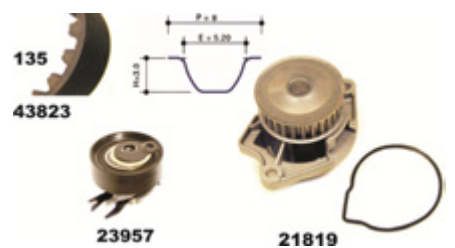

41823/1



41824

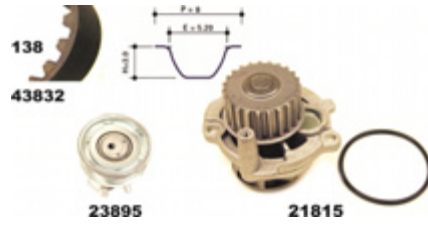

41832



41833

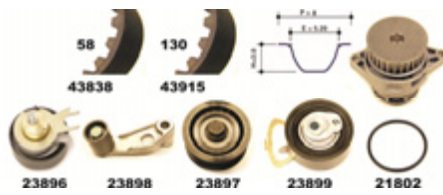

41838/2

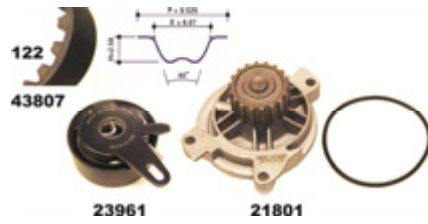

41839

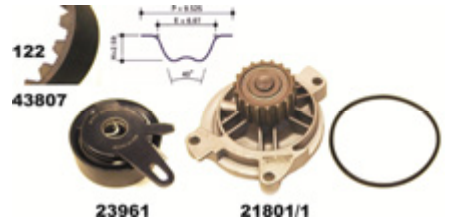

41839/1



41844

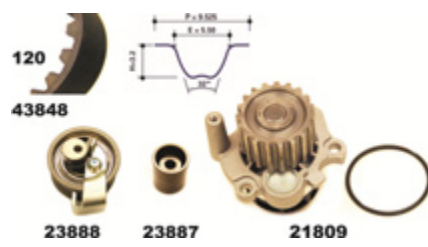

41847

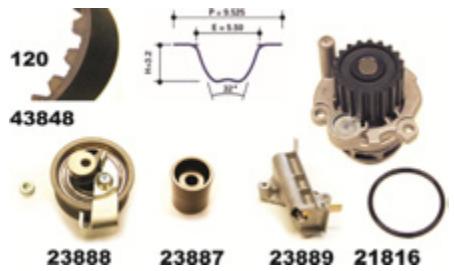

41848



41850

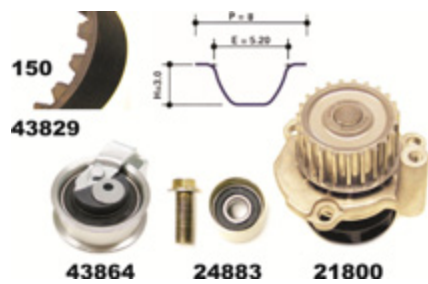

41901

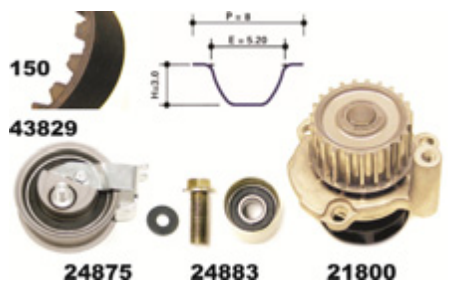

41912

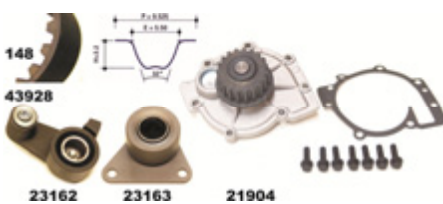

41928

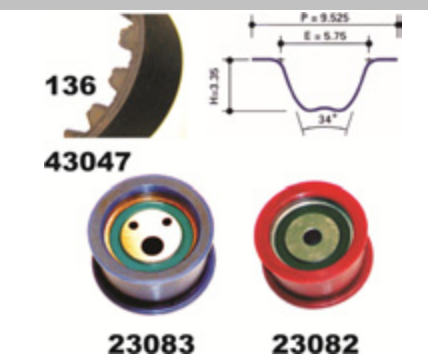

73080

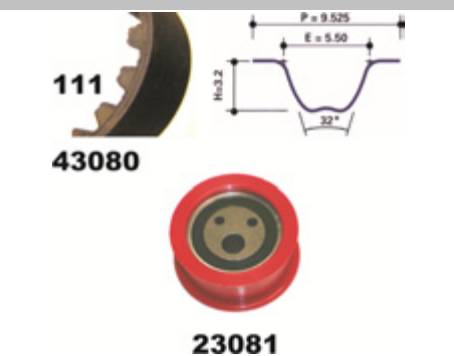

73081

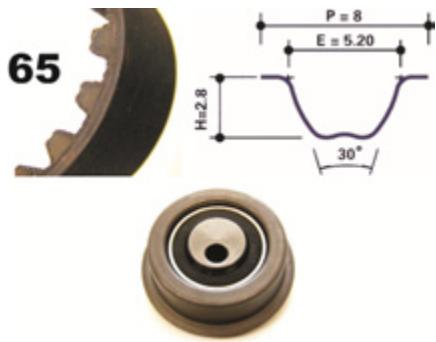

73501



73508



73509

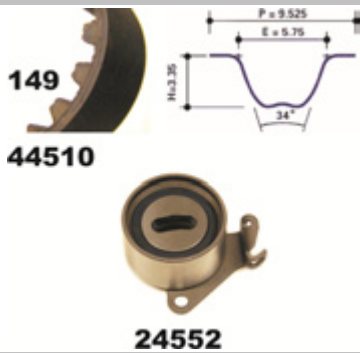

73510

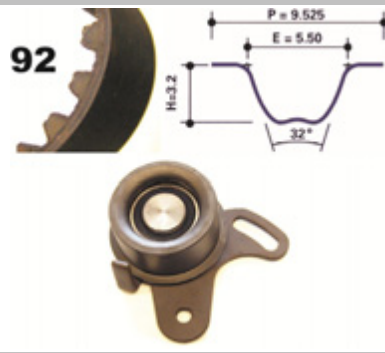

73533



73535



73536

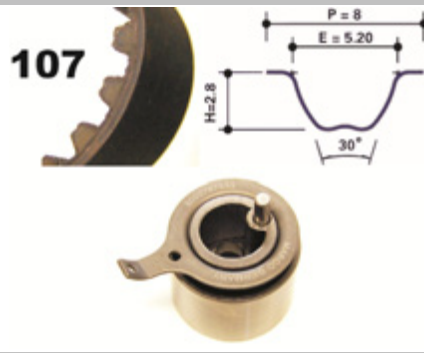

73537

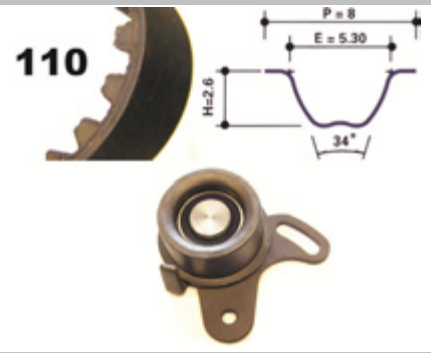

73538



73539

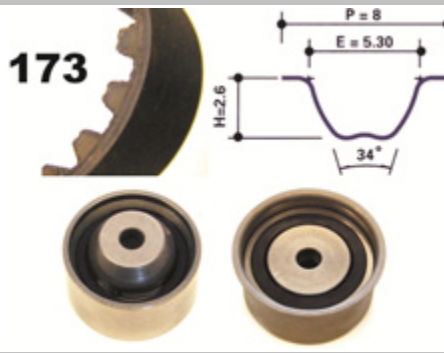

73540



73808

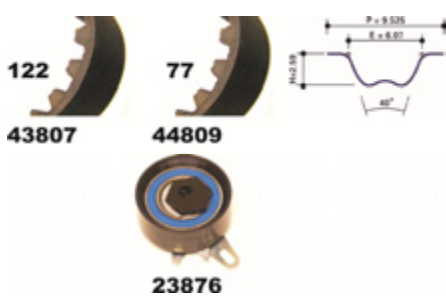

73809



73834