

Dacia

Spare parts for passenger cars



DRIVER'S BEST FRIEND

MEYLE

Sophisticated technology - considerably longer service life.



The MEYLE range of products features a wide variety of components. Spare parts from A to Z, from Alfa Romeo to Volvo, from minicars to top-of-the-range luxury models.



Steering & suspension

Control arms, Stabilizer links, Tie rod assemblies, and many more



Brakes

Brake discs, MEYLE PD, Brake pad sets, Brake drums, and many more



Drive components

C.V. joint kits, Wheel bearings, Belt drives, and many more



Damping parts

Shock absorbers, Strut mounts, Coil springs, and many more



Filters

Oil filters, Air filters, Cabin air filters, Fuel filters, and many more



Cooling components

Water pumps, Expansion tanks, Radiator hoses, and many more



Rubber-to-metal parts

Flex discs, Cardan shaft bearings, Engine mounts, and many more



Electrics and sensors

Crank position sensor, Control units, Glow plugs, and many more



Engine and transmission parts

Oil change kits, V-ribbed belts, Idlers/guide pulleys, and many more



Fluids

Coolant additives, Hydraulic oil, Engine oil, and many more



Complementary product range

Wiper blades, Gas springs, Window lifters, and many more

ORIGINAL, PD and HD – The MEYLE product lines



MEYLE-ORIGINAL: Fit as snugly as the original.

More than 21,000 spare parts for passenger cars, vans and trucks, quality-tested, robust, durable and tried and tested a thousand times over on the roads across the world – that's MEYLE-ORIGINAL. Relying on our comprehensive product portfolio – offering everything from A for axial joint to Z for zinc-coated screw – customers can be sure that they will always have safety on their side.

MEYLE-PD: Safety to the power of two.

Thinking outside the box to make our products better: MEYLE-PD stands for brake discs and pads delivering maximum braking performance and setting new standards in terms of durability, comfort, aesthetics, and ease of installation. Look for the „/PD“ part number extension.

MEYLE-HD: Better than originals.

MEYLE-HD parts simply last longer. Their technically optimised and reinforced designs make them more durable and reliable than OE components. So it is only natural for us to offer extended warranty protection for our MEYLE-HD parts: All parts of the HD range come with a full four-year guarantee. Look for the „/HD“ part number extension.



4-year guarantee on all MEYLE-HD parts!

Robust, high mileage, reliable and better than the original. MEYLE-HD parts simply last longer!

Our three success factors.

The success of the MEYLE brand is based on competence, quality and service.

The development of quality-approved automotive spare parts for the independent aftermarket is our trademark. And MEYLE-HD parts are our specialty: improved parts, developed by our team of engineers at our headquarters in Hamburg. We give a 4-year guarantee on our MEYLE-HD parts which have a far longer service life. Based on information from TÜV (Technical control board), from recall statistics as well as media and market information from workshops and other technical partners, MEYLE engineers identify parts in vehicles which become conspicuous on account of frequent, early wear. On the basis of their findings, they develop technical improvements for the respective weakness. In the end, this work is a

large benefit for all MEYLE parts. Something all reputable automotive manufacturers highly appreciate: MEYLE also develops customized products, for example for Morgan, the legendary sports car manufacturer.

Passing on our know-how to staff and customers is just as much a part of our service as high parts availability and swift delivery. Modern warehouse logistics with space covering 29,000 m² and 56,000 pallet places ensure the reliable supply of our partners.

We have now won the "Top Job Employer" award for the fifth time which confirms our outstanding internal business approach and excellent Human Resources policy. We have been one of Germany's leading SME employers for many years.

MEYLE

Guarantee certificate



A distinguishing feature of MEYLE is our high level of precision, achieved by the application of the most modern manufacturing methods. Our MEYLE articles meet highest quality standards and our supply plants are certified in accordance with ISO 9001:2008 and ISO/TS 16949.

We guarantee perfect material and faultless processing of all our MEYLE articles for a period of 24 months as of the date of installation. For MEYLE-HD articles, this guarantee applies for 48 months as of the date of installation.

Complementing this guarantee, we give an additional 100,000 miles (160,934 kilometres) performance guarantee against defects of material and workmanship for MEYLE passenger car water pumps purchased from 01 May 2016. The guarantee given for MEYLE passenger car water pumps terminates upon expiration of the guarantee period or the guaranteed mileage, whichever occurs later: if the guaranteed mileage has not been reached at the end of the guarantee period of 24 or 48 months respectively, the performance guarantee continues to be valid. Respectively, the guarantee period of 24 or 48 months continues to be valid also in any case where the guaranteed mileage was already exceeded.

During the guarantee period, we perform repair work on claimed MEYLE articles or provide a replacement. The MEYLE guarantee does not apply for normal wear and damage caused by inappropriate handling or inappropriate installation. The guarantee expires if the respective part is modified by third parties or via installation of parts from third parties, or if the part, or vehicle, is used in excess of the appropriate use and purpose. The MEYLE guarantee also expires if MEYLE instructions or vehicle manufacturer instructions, e.g. concerning maintenance and replacement intervals, are not observed. The guarantee only applies for MEYLE water pumps, if the cooling circuit has been flushed prior to installation of the MEYLE water pump. Rights granted by law continue to apply unrestrictedly, irrespective of this guarantee.

The customer must submit a written guarantee claim immediately, or at the latest 30 days after identifying an error in material or processing. This claim is to be submitted to the dealer from which he acquired the MEYLE article part. The customer should return the article, carefully packed. He must enclose the original sales receipt and a description of the error. The customer must also verify the date of installation and the mileage of the vehicle by means of respective documents.

Last amended January 2017

A handwritten signature in white ink, appearing to read 'M. Wunder', is centered on the dark blue background.

Director Quality Assurance
Manfred Wunder

Body/Cabin 1

Body, Interior fittings

Cabin air filter	Windshield washer pump
Window lifter	Wiper Blade

Brakes 7

Disc brake, Drum brake, Hydraulics

Brake disc	Brake hose	Brake shoe kit
Brake drum	Brake pad set	

Drive train/Transmission 24

Drive shafts

Boot kit, C.V. joint
Drive shaft

Electrics 26

Brakes, Engine

ABS wheel sensor	Glow plug	Sender unit, coolant temperature
Crank position sensor	Ignition coil	Sensor, camshaft position

Engine/Cooling/Clutch 32

Belt drive / Engine control, Cooling system, Fuel system, Lubrication system, Mounts

Air filter	Fuel filter	Timing belt kit
Engine mount	Oil filter	Timing belt roller
Expansion tank	Tensioner pulley, timing belt	V-ribbed belt
Expansion tank cap	Thermostat	Water pump

Steering 48

Mounting parts, Tie rod assemblies

Axial rod	Steering boot kit
Steering boot	Tie rod end

Suspension 53

Control arms, Stabilizer, Stub axle, Subframe, Suspension / damping, Wheel hubs / Wheel bearings

Ball joint	Mount, axle rod	Strut mount
Coil spring	Mount, stabilizer	Strut mount bearing
Control arm	Repair kit, strut mount	Stub axle
Control arm bushing	Shock absorber	Wheel bearing
Dust cover kit, shock absorber	Spring seat	Wheel bearing kit
Mount, axle carrier	Stabilizer link	Wheel hub

Window lifter

16-14 909 0000 | MWL0083

Notes

with electric motor
Electric
Left

References

6001547149 8200884403
6001550253 8200901099
8200804290

Counterpart

16-14 909 0001 | MWL0084



Application info

Logan [09/04--]

Logan [09/04--]

Window lifter

16-14 909 0001 | MWL0084

Notes

with electric motor
Electric
Right

References

6001547150 8200804297
6001550254 8200901102

Counterpart

16-14 909 0000 | MWL0083



Application info

Logan [09/04--]

Logan [09/04--]

Windshield washer pump

11-14 870 0001 | MWI0011

Notes

Voltage [V]

Dual Pump
12
Front and Rear

References

8200194414



Application info

Logan [09/04--]

029 290 111 | MBL0062

Wiper Blade



Notes

Length [in]
Length [mm]

Beam wiper blade
Bracket wiper blade
11.5
290
Rear

Application info

Lodgy [06/10--]
Logan II [10/12--]

Sandero II [01/13--]

029 300 121 | MBL0004

Wiper Blade



Notes

Length [in]
Length [mm]

Bracket wiper blade
Beam wiper blade
12
300
Rear

Application info

Duster [04/10--]

029 350 1410 | MBL0014

Wiper Blade



Notes

Length [in]
Length [mm]

Bracket wiper blade
Beam wiper blade
14
350
Rear

Application info

Duster [04/10--]
Logan [09/04--]

Logan [09/04--]

Wiper Blade

029 400 1600 | MBL0021

Notes

Observe service information
Length [in]
Length [mm]

Flat bar wiper blade
Flat wiper blade
16
400
Front



Application info

Dokker (11/12--)

Lodgy (06/10--)

Wiper Blade

029 400 1610 | MBL0022

Notes

Length [in]
Length [mm]

Bracket wiper blade
Beam wiper blade
16
400
Rear



Application info

Sandero (06/08--)

Wiper Blade

029 450 1800 | MBL0027

Notes

Observe service information
Length [in]
Length [mm]

Flat wiper blade
Flat bar wiper blade
18
450
Front



Application info

Duster (04/10--)

029 475 1900 | MBL0028

Wiper Blade



Notes

Observe service information
Length [in]
Length [mm]

Flat bar wiper blade
Flat wiper blade
19
475
Front

Application info

Logan II (10/12--)

Sandero II (01/13--)

029 500 2000 | MBL0029

Wiper Blade



Notes

Observe service information
Length [in]
Length [mm]

Flat bar wiper blade
Flat wiper blade
20
500
Front

Application info

Duster (04/10--)
Logan (09/04--)
Logan II (10/12--)

Sandero (06/08--)
Sandero II (01/13--)
Logan (09/04--)

029 550 2200 | MBL0032

Wiper Blade



Notes

Observe service information
Length [in]
Length [mm]

Flat bar wiper blade
Flat wiper blade
22
550
Front

Application info

Dokker (11/12--)
Lodgy (06/10--)

Logan II (10/12--)
Sandero II (01/13--)

Wiper Blade

029 600 2400 | MBL0034

Notes

Observe service information
Length [in]
Length [mm]

Flat bar wiper blade
Flat wiper blade
24
600
Front



Application info

Duster (04/10--)

Cabin air filter

16-12 319 0003 | MCF0132

Notes

Height [mm]
Width [mm]
Length [mm]

25
182
184
Filter Insert
Particulate Filter

References

272772835R



Application info

Duster (04/10--)
Logan (09/04--)

Sandero (06/08--)

Cabin air filter

16-12 319 0023 | MCF0449

Notes

Height [mm]
Width [mm]
Length [mm]

35
200
216
Filter Insert
Particulate Filter

References

272773016R

272778214R



Application info

Logan II (10/12--)
Sandero (06/08--)

Sandero II (01/13--)

16-12 319 0001 | MCF0131

Cabin air filter

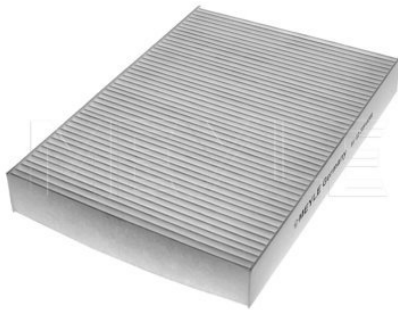

Notes

Height [mm] 30
 Width [mm] 160
 Length [mm] 230
 Filter Insert
 Particulate Filter

References

7700424098

Application info

Logan [09/04--]
 Sandero [06/08--]

Logan [09/04--]

16-12 320 0001 | MCF0153

Cabin air filter

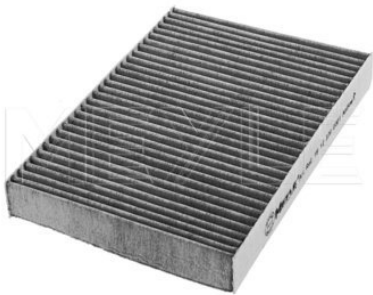

Notes

Height [mm] 30
 Width [mm] 160
 Length [mm] 230
 Filter Insert
 Activated Carbon Filter

References

7711228912

Application info

Logan [09/04--]
 Sandero [06/08--]

Logan [09/04--]



Brake disc

16-15 521 0035 | MBD1822

Notes

Wheel Bolt Bore Ø [mm]	13.5
	Solid
Centering Diameter [mm]	61
Minimum thickness [mm]	10.5
Outer diameter [mm]	238
Height [mm]	41
Bolt Hole Circle Ø [mm]	100
Brake Disc Thickness [mm]	12
Required quantity	2
Number of Holes	4
	Front Axle



References

2677509716	6001549211
6001547684	

Application info

Logan [09/04--]

Sandero [06/08--]

Brake disc

16-15 521 0035/PD | MBD1822PD

Notes

Wheel Bolt Bore Ø [mm]	13.5
	Zink flake coated
	Solid
Centering Diameter [mm]	61
Minimum thickness [mm]	10.5
Outer diameter [mm]	238
Height [mm]	41
Bolt Hole Circle Ø [mm]	100
	with screws
Brake Disc Thickness [mm]	12
Required quantity	2
Number of Holes	4
	Front Axle



References

2677509716	6001549211
6001547684	

Application info

Logan [09/04--]

Sandero [06/08--]

16-15 521 0040 | MBD1827

Brake disc



Notes

Wheel Bolt Bore Ø [mm]	15.8
	Vented
Centering Diameter [mm]	68
Minimum thickness [mm]	21.8
Outer diameter [mm]	280
Height [mm]	44
Bolt Hole Circle Ø [mm]	114.3
Brake Disc Thickness [mm]	24
Required quantity	2
Number of Holes	5
	Front Axle

References

402060010R	402064151R
402063793R	

Application info

Duster [04/10--]

16-15 521 0040/PD | MBD1827PD

Brake disc



Notes

Wheel Bolt Bore Ø [mm]	15.8
	Zink flake coated
	Vented
Centering Diameter [mm]	68
Minimum thickness [mm]	21.8
Outer diameter [mm]	280
Height [mm]	44
Bolt Hole Circle Ø [mm]	114.3
Brake Disc Thickness [mm]	24
Required quantity	2
Number of Holes	5
	Front Axle

References

402060010R	402064151R
402063793R	

Application info

Duster [04/10--]



Brake disc

16-15 521 0034 | MBD1700

Notes

Wheel Bolt Bore Ø [mm]	13.5
	Vented
Centering Diameter [mm]	61
Minimum thickness [mm]	19.8
Outer diameter [mm]	258
Height [mm]	43.9
Bolt Hole Circle Ø [mm]	100
Brake Disc Thickness [mm]	22
Required quantity	2
Number of Holes	5
	Front Axle



References

402063149R

Application info

Logan (09/04--)
Logan II (10/12--)

Sandero II (01/13--)

Brake disc

16-15 521 0034/PD | MBD1700PD

Notes

Wheel Bolt Bore Ø [mm]	13.5
	Zink flake coated
	Vented
Centering Diameter [mm]	61
Minimum thickness [mm]	19.8
Outer diameter [mm]	258
Height [mm]	43.9
Bolt Hole Circle Ø [mm]	100
Brake Disc Thickness [mm]	22
Required quantity	2
Number of Holes	5
	Front Axle



References

402063149R

Application info

Logan (09/04--)
Logan II (10/12--)

Sandero II (01/13--)

2

16-15 521 0028 | MBD0337

Brake disc



Notes

Wheel Bolt Bore Ø [mm]	15.8
	Vented
Centering Diameter [mm]	68
Minimum thickness [mm]	19.8
Outer diameter [mm]	269
Height [mm]	44
Bolt Hole Circle Ø [mm]	114.3
Brake Disc Thickness [mm]	22.5
Required quantity	2
Number of Holes	5
	Front Axle

References

402066300R

Application info

Duster [04/10--]

16-15 521 0017 | MBD0329

Brake disc



Notes

Wheel Bolt Bore Ø [mm]	13.7
	Vented
Centering Diameter [mm]	61
Minimum thickness [mm]	19
Outer diameter [mm]	235.5
Height [mm]	51
Bolt Hole Circle Ø [mm]	100
Brake Disc Thickness [mm]	20
Required quantity	2
Number of Holes	4
	Front Axle

References

6001539659

Application info

Solenza [02/03--]

Brake disc

16-15 521 0036 | MBD1823

Notes

Wheel Bolt Bore Ø [mm]	12.7
	Vented
Centering Diameter [mm]	61
Minimum thickness [mm]	17.7
Outer diameter [mm]	259
Height [mm]	41
Bolt Hole Circle Ø [mm]	100
Brake Disc Thickness [mm]	20.7
Required quantity	2
Number of Holes	4
	Front Axle



References

6001548578	7701206339
7701204304	8201464598
7701205653	

Application info

Logan [09/04--]

Sandero [06/08--]

Brake disc

16-15 521 0036/PD | MBD1823PD

Notes

Wheel Bolt Bore Ø [mm]	12.7
	Zink flake coated
	Vented
Centering Diameter [mm]	61
Minimum thickness [mm]	17.7
Outer diameter [mm]	259
Height [mm]	41
Bolt Hole Circle Ø [mm]	100
	with screws
Brake Disc Thickness [mm]	20.7
Required quantity	2
Number of Holes	4
	Front Axle



References

6001548578	7701206339
7701204304	8201464598
7701205653	

Application info

Logan [09/04--]

Sandero [06/08--]

16-15 521 0039 | MBD1826

Brake disc



Notes

Wheel Bolt Bore Ø [mm]	13.6
	Vented
Centering Diameter [mm]	61
Minimum thickness [mm]	19.8
Outer diameter [mm]	260
Height [mm]	44
Bolt Hole Circle Ø [mm]	100
Brake Disc Thickness [mm]	22
Required quantity	2
Number of Holes	4
	Front Axle

References

7701207795

Application info

Logan [09/04--]

Logan [09/04--]

16-15 521 0039/PD | MBD1826PD

Brake disc



Notes

Wheel Bolt Bore Ø [mm]	13.6
	Zink flake coated
	Vented
Centering Diameter [mm]	61
Minimum thickness [mm]	19.8
Outer diameter [mm]	260
Height [mm]	44
Bolt Hole Circle Ø [mm]	100
	with screws
Brake Disc Thickness [mm]	22
Required quantity	2
Number of Holes	4
	Front Axle

References

7701207795

Application info

Logan [09/04--]

Logan [09/04--]

Brake disc
16-15 521 0005 | MBD0319
Notes

Wheel Bolt Bore Ø [mm]	13.5
	Solid
Centering Diameter [mm]	61
Minimum thickness [mm]	10.6
Outer diameter [mm]	259
Height [mm]	40.9
Bolt Hole Circle Ø [mm]	100
Brake Disc Thickness [mm]	12
Required quantity	2
Number of Holes	4
	Front Axle

References

6001547683	8200123117
7701208252	

Application info

 Logan [09/04--]
 Sandero [06/08--]

Sandero II [01/13--]

Brake disc
16-15 521 0004 | MBD0318
Notes

Wheel Bolt Bore Ø [mm]	13.6
	Vented
Centering Diameter [mm]	61
Minimum thickness [mm]	21.8
Outer diameter [mm]	280
Height [mm]	44
Bolt Hole Circle Ø [mm]	100
Brake Disc Thickness [mm]	24
Required quantity	2
Number of Holes	4
	Front Axle

References

402060540R	8671005975
402069518R	

Application info

Dokker [11/12--]

Lodgy [06/10--]

16-83 521 0004/PD | MBD1832PD

Brake disc

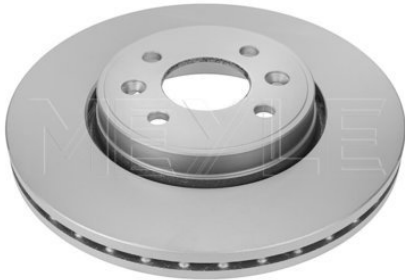

Notes

Wheel Bolt Bore Ø [mm]	13.6
	Zink flake coated
	High-carbon
	Vented
Centering Diameter [mm]	61
Minimum thickness [mm]	21.8
Outer diameter [mm]	280
Height [mm]	44
Bolt Hole Circle Ø [mm]	100
	with screws
Brake Disc Thickness [mm]	24
Required quantity	2
Number of Holes	4
	Front Axle

References

402060540R	8671005975
402069518R	

Application info

Dokker [11/12--]

Lodgy [06/10--]

16-15 521 0027 | MBD0336

Brake disc



Notes

Wheel Bolt Bore Ø [mm]	13.5
	Vented
Centering Diameter [mm]	61
Minimum thickness [mm]	19.8
Outer diameter [mm]	258
Height [mm]	44
Bolt Hole Circle Ø [mm]	100
Brake Disc Thickness [mm]	22
Required quantity	2
Number of Holes	4
	Front Axle

References

40 20 612 00R	40 20 670 16R
---------------	---------------

Application info

Dokker [11/12--]

Lodgy [06/10--]

Brake pad set

025 225 2517 | MBP1745

Notes

not prepared for wear indicator
 Thickness [mm] 16.9
 Height [mm] 49
 Width [mm] 155
 Brake System ATE
 with anti-squeak plate
 Front Axle



References

410605536R

Application info

Logan II [10/12--]

Sandero II [01/13--]

Brake pad set

025 257 0217 | MBP0705

Notes

not prepared for wear indicator
 Thickness [mm] 17.2
 Height 2 [mm] 42
 Height 1 [mm] 40
 Width 1 [mm] 140
 Brake System ATE
 with anti-squeak plate
 Front Axle



References

410602581R

410605612R

Application info

Logan II [10/12--]

Sandero II [01/13--]

Brake pad set

025 257 3817 | MBP1744

Notes

not prepared for wear indicator
 Thickness [mm] 18
 Height [mm] 42
 Width [mm] 140.2
 Brake System ATE
 with anti-squeak plate
 Front Axle



References

41060 9646R

Application info

Sandero II [01/13--]

025 249 1418 | MBP0677

Brake pad set

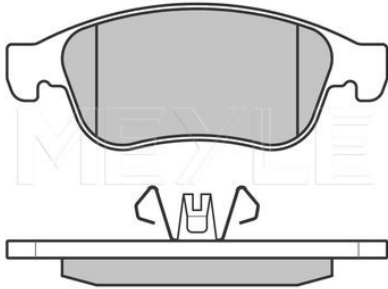

Notes

Thickness [mm]
Height 2 [mm]
Height 1 [mm]
Width 2 [mm]
Width 1 [mm]
Brake System

not prepared for wear indicator
18
64.7
59.4
155.1
155.1
ATE
with anti-squeak plate
Front Axle

References

410607115R

440603905R

Application info

Dokker [11/12--]
Duster [04/10--]

Lodgy [06/10--]

025 249 1418/PD | MBP0677PD

Brake pad set

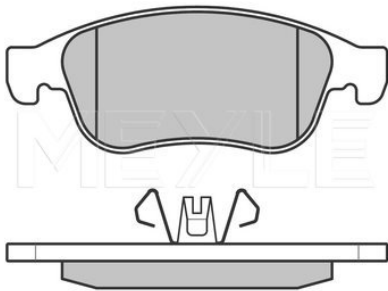

Notes

Quality
Thickness [mm]
Height 2 [mm]
Height 1 [mm]
Width 2 [mm]
Width 1 [mm]
Brake System

not prepared for wear indicator
PREMIUM
18
64.7
59.4
155.1
155.1
ATE
with anti-squeak plate
Front Axle

References

410607115R

440603905R

Application info

Dokker [11/12--]
Duster [04/10--]

Lodgy [06/10--]

Brake pad set

025 214 6318/PD | MBP0767PD

Notes

Quality	incl. wear warning contact
Thickness [mm]	PREMIUM
Height [mm]	18.1
Width [mm]	64.6
Number of wear indicators [per axle]	100
Brake System	2
	TRW
	with anti-squeak plate
	Front Axle

References

410602192R	7701210142
6001547619	7711130036
6001547911	7711130071
7701207066	8671000107
7701208265	8671016173
7701209639	

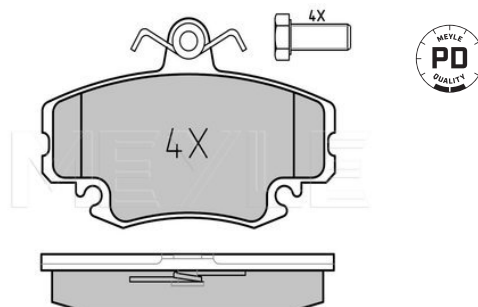

Application info

Logan (09/04--)

Sandero (06/08--)

Brake pad set

025 214 6318/W | MBP0135

Notes

Thickness [mm]	incl. wear warning contact
Height [mm]	18.1
Width [mm]	64.6
Number of wear indicators [per axle]	100
Brake System	2
	TRW
	with anti-squeak plate
	Front Axle

References

410602192R	7701210142
6001547619	7711130036
6001547911	7711130071
7701207066	8671000107
7701208265	8671016173
7701209639	

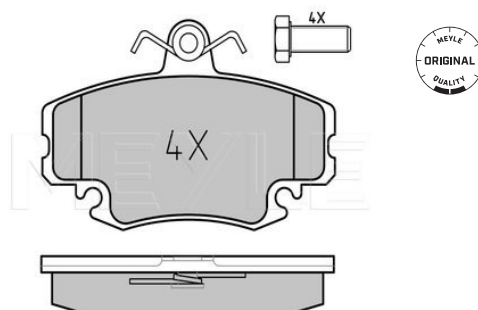

Application info

Logan (09/04--)

Sandero (06/08--)

025 246 7318 | MBP0650

Brake pad set

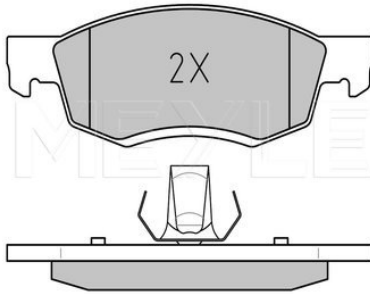

Notes

Thickness [mm]
Height [mm]
Width 2 [mm]
Width 1 [mm]
Brake System

not prepared for wear indicator
18
52.5
151.5
150.1
ATE
with anti-squeak plate
Front Axle

References

6001 549 803

Application info

Logan [09/04--]

Logan [09/04--]

025 239 7317 | MBP0489

Brake pad set

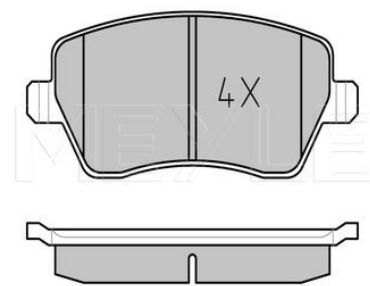

Notes

Thickness [mm]
Height [mm]
Width [mm]
Brake System

excl. wear warning contact
17.3
52.6
116.5
TRW
with anti-squeak plate
Front Axle

References

410604775R
410608481R
7701208422

7701209164
8671016692

Application info

Dokker [11/12--]
Duster [04/10--]
Lodgy [06/10--]

Logan [09/04--]
Logan [09/04--]

025 239 7317/PD | MBP0489PD

Brake pad set

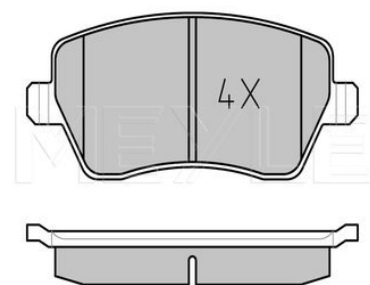

Notes

Quality
Thickness [mm]
Height [mm]
Width [mm]
Brake System

excl. wear warning contact
PREMIUM
17.3
52.6
116.5
TRW
with screws
with anti-squeak plate
Front Axle

References

410604775R
410608481R
7701208422

7701209164
8671016692

Brake pad set

025 239 7317/PD | MBP0489PD

Application info

Dokker [11/12--]
Duster [04/10--]
Lodgy [06/10--]

Logan [09/04--]
Logan [09/04--]

Brake drum

16-15 523 0019 | MDR0021

Notes

Centering Diameter [mm]	52
Inner Brake Drum Height [mm]	53.5
Total Br. Drum Height [mm]	83
Bolt Hole Circle Ø [mm]	100
Max.skimmed drum measure [mm]	181
Br. Drum outer diameter [mm]	208
Inner Br. Drum Diam. [mm]	180
Required quantity	2
Number of Holes	4
	Rear Axle



References

7700419824

Application info

Logan [09/04--]
Sandero [06/08--]

Logan [09/04--]

Brake shoe kit

16-14 533 0012 | MBS0039

Notes

	without spring
	with lever
Diameter [mm]	203
Width [mm]	38
Brake System	Bosch
	Rear Axle



References

440607493R

6001551409

Application info

Duster [04/10--]
Logan [09/04--]

Sandero [06/08--]
Sandero II [01/13--]

16-14 533 0012/K | MBS0271

Brake shoe kit



Notes

without wheel brake cylinder
with lever
with spring
Pre-assembled
203
38
Bosch
Rear Axle

Diameter [mm]
Width [mm]
Brake System

References

440607493R

6001551409

Application info

Duster [04/10--]
Logan [09/04--]

Sandero [06/08--]
Sandero II [01/13--]

16-14 533 0000 | MBS0030

Brake shoe kit



Notes

without spring
with lever
203
39
Lucas Girling
Rear Axle

Diameter [mm]
Width [mm]
Brake System

References

6001547630

Application info

Logan [09/04--]

Sandero [06/08--]

40-14 533 0004/K | MBS0153

Brake shoe kit



Notes

with lever
with accessories
without wheel brake cylinder
Pre-assembled
203
38
Lucas Girling
Rear Axle

Diameter [mm]
Width [mm]
Brake System

References

6001547630

Application info

Logan [09/04--]

Sandero [06/08--]

Brake shoe kit

16-14 533 0003 | MBS0033

Notes

Diameter [mm]
Width [mm]
Brake System

without spring
with lever
180
42
Bendix
Rear Axle

References

7701205758



Application info

Logan [09/04--]

Sandero [06/08--]

Brake shoe kit

16-14 533 0003/K | MBS0269

Notes

Diameter [mm]
Width [mm]
Brake System

without wheel brake cylinder
with lever
with spring
Pre-assembled
180
42
Bendix
Rear Axle

References

7701205758



Application info

Logan [09/04--]

Sandero [06/08--]

Brake shoe kit

16-14 533 0016 | MBS0043

Notes

Diameter [mm]
Width [mm]
Brake System

without spring
with lever
228
42
BOSCH
Rear Axle

References

6001549703

7701210109



Application info

Dokker [11/12--]
Duster [04/10--]
Lodgy [06/10--]
Logan [09/04--]

Logan II [10/12--]
Sandero [06/08--]
Logan [09/04--]

16-14 533 0016/K | MBS0272

Brake shoe kit



Notes

Diameter [mm]
Width [mm]
Brake System

without wheel brake cylinder
with lever
with spring
Pre-assembled
228
42
BOSCH
Rear Axle

References

6001549703

7701210109

Application info

Dokker [11/12--]
Duster [04/10--]
Lodgy [06/10--]
Logan [09/04--]

Logan II [10/12--]
Sandero [06/08--]
Logan [09/04--]

16-14 525 0015 | MBH0242

Brake hose



Notes

Inner thread 2 [mm]
Inner thread 1 [mm]
Length [mm]

M10x1
M10x1
285

References

6001547820

6001551097

Application info

Duster [04/10--]
Logan [09/04--]

Sandero [06/08--]
Logan [09/04--]

16-14 525 0018 | MBH0245

Brake hose



Notes

Inner thread [mm]
Outer thread [mm]
Length [mm]
Required quantity

M10x1
M10x1
300
2

References

6001547819

6001551098

Brake hose

16-14 525 0018 | MBH0245



Application info

Logan [09/04--]
Sandero [06/08--]

Sandero II [01/13--]
Logan [09/04--]

16-14 620 0000 | MBK0138

Boot kit, C.V. joint



Notes

Inner diameter 2 [mm]
Inner diameter 1 [mm]
Length [mm]

Thermoplast
81
34
152
Wheel Side
Front Axle

References

6001547699

Application info

Sandero [06/08--]

16-14 495 0017 | MBK0135

Boot kit, C.V. joint



Notes

Inner diameter 2 [mm]
Inner diameter 1 [mm]
Length [mm]

Thermoplast
69
25
99
Transmission End
Front Axle

References

6001548164

Application info

Logan [09/04--]

16-14 495 0020 | MBK0137

Boot kit, C.V. joint



Notes

Inner diameter 2 [mm]
Inner diameter 1 [mm]
Length [mm]

Thermoplast
69
25.5
97
Transmission End
Front Axle

References

7701209255

Application info

Logan [09/04--]

Logan [09/04--]



Boot kit, C.V. joint

16-14 495 0016 | MBK0134

Notes

Inner diameter 2 [mm]
Inner diameter 1 [mm]
Length [mm]

Elastomer
107
25.7
85
with bearing(s)
Transmission End
Front Axle Left

References

8200017057



Application info

Logan [09/04--]
Sandero [06/08--]

Logan [09/04--]

Drive shaft

16-14 498 0034 | MDS0037

Notes

Tripod Roller Diameter [mm]
Seal Diameter [mm]
Length [mm]
Outer gearing wheel side

29.95
49
681
21
Front Axle Left

References

8200444438

Counterpart

16-14 498 0035 | MDS0038



Application info

Logan [09/04--]

Sandero [06/08--]

Drive shaft

16-14 498 0035 | MDS0038

Notes

Seal Diameter [mm]
Length [mm]
Int. teeth, diff.side, conn.to
transm.
Outer gearing wheel side

49
763
23
21
Front Axle Right

References

8200484373

Counterpart

16-14 498 0034 | MDS0037



Application info

Logan [09/04--]

Sandero [06/08--]

16-14 800 0010 | MAS0298

ABS wheel sensor



Notes

Cable Length [mm]	Hall Sensor
Operating voltage [V]	590
Number of Poles	12
Required quantity	2
	2
	Front Axle left and right

References

479101292R	8200419177
------------	------------

Application info

Logan [09/04--]
Sandero [06/08--]

Logan [09/04--]

16-14 800 0011 | MAS0294

ABS wheel sensor



Notes

Cable Length [mm]	Hall Sensor
Operating voltage [V]	450
Number of Poles	12
Required quantity	2
	1
	Rear Axle Left

References

6040004542	8200254687
------------	------------

Counterpart

16-14 800 0012 | MAS0301

Application info

Logan [09/04--]

16-14 800 0012 | MAS0301

ABS wheel sensor



Notes

Cable Length [mm]	Hall Sensor
Operating voltage [V]	450
Number of Poles	12
Required quantity	2
	1
	Rear Axle Right

References

6040004543	8200254688
------------	------------

Counterpart

16-14 800 0011 | MAS0294

Application info

Logan [09/04--]

Crank position sensor

16-14 899 0006 | MPS0056

Notes

Observe service information

Fitting Depth [mm]
Operating voltage [V]
Number of Poles
Resistance [Ohm]

Blue
with cable set
Passive sensor
24
12
2
250

References

6001548175



Application info

Logan (09/04--)
Logan II (10/12--)

Sandero (06/08--)
Sandero II (01/13--)

Crank position sensor

16-14 800 0023 | MPS0054

Notes

Observe service information

Operating voltage [V]
Fitting Depth [mm]
Number of Poles
Resistance [Ohm]

Blue
with cable set
Passive sensor
12
24
2
250

References

8200468645



Application info

Duster (04/10--)
Logan (09/04--)

Sandero (06/08--)

Crank position sensor

16-14 899 0010 | MPS0057

Notes

Observe service information

Fitting Depth [mm]
Operating voltage [V]
Number of Poles
Resistance [Ohm]

Blue
with cable set
Passive sensor
24
12
2
250

References

8200647556



Application info

Logan (09/04--)

Sandero (06/08--)

4

16-14 800 0025 | MPS0053

Crank position sensor



Notes

Observe service information

Operating voltage [V]
Fitting Depth [mm]
Number of Poles
Resistance [Ohm]

Black
with cable set
Passive sensor
12
24
2
250

References

7700109055
8200439315

8200688406
8201040861

Application info

Logan [09/04--]
Sandero [06/08--]

Logan [09/04--]

16-14 860 0010 | MGP0099

Glow plug



Notes

Rated current [A]

15
after-glow capable
Pencil-type Glow Plug

Spanner Size
Diameter [mm]
Thread Size
Overall Length [mm]
Cone Pitch
Fitting Depth [mm]
Connector type
Voltage [V]

10
5
M10 x 1
88
63°
25
Ø 4 mm
11

References

8200490950

Application info

Duster [04/10--]
Logan [09/04--]

Sandero [06/08--]
Logan [09/04--]



Glow plug

16-14 860 0009 | MGP0034

Notes

Rated current [A]	25
	Euro 5
	after-glow capable
	Pencil-type Glow Plug
Spanner Size	10
Diameter [mm]	4
Thread Size	M10 x 1
Overall Length [mm]	96.5
Cone Pitch	63°
Fitting Depth [mm]	24.5
Connector type	Ø 4 mm
Voltage [V]	4.4

References

8200682592



Application info

Dokker [11/12--]
 Duster [04/10--]
 Logan [09/04--]
 Logan II [10/12--]

Sandero [06/08--]
 Sandero II [01/13--]
 Logan [09/04--]

4

Glow plug

16-14 860 0004 | MGP0030

Notes

Rated current [A]	15
	after-glow capable
	Pencil-type Glow Plug
Spanner Size	10
Diameter [mm]	5.1
Thread Size	M10 x 1
Overall Length [mm]	99
Cone Pitch	63°
Fitting Depth [mm]	25
Connector type	Ø 4 mm
Voltage [V]	11

References

6001545515 8671012308
 8200787721



Application info

Solenza [02/03--]

16-14 885 0001 | MIC0036

Ignition coil



Notes

Oval
for fully electronic ignition (FI)
Coupling Type Saw Tooth
12
4
1

Operating voltage [V]
Number of Poles
Required quantity

References

6001543604

6001544755

Application info

Dokker (11/12--)
Lodgy (06/10--)
Logan (09/04--)

Sandero (06/08--)
Solenza (02/03--)
Logan (09/04--)

16-14 885 0004 | MIC0039

Ignition coil



Notes

for fully electronic ignition (FI)
incl. spark plug connector with ignition cable
Double Ignition Coil

Operating voltage [V]
Cable Length [mm]
Number of Poles
Required quantity

12
470
4
1

References

8200702693

Application info

Logan II (10/12--)
Sandero (06/08--)

Sandero II (01/13--)

16-14 885 0002 | MIC0037

Ignition coil



Notes

for fully electronic ignition (FI)
incl. spark plug connector
Coupling Type SAE
12
2
4
for vehicles without distributor

Operating voltage [V]
Number of Poles
Required quantity

References

8200765882

Ignition coil

16-14 885 0002 | MIC0037

Application info

Duster [04/10--]

Logan [09/04--]

Sender unit, coolant temperature

16-14 899 0011 | MEX0372

Notes

	Black
	NTC Sensor
Spanner Size	--
Thread Size	--
Operating voltage [V]	12
Number of Poles	4

References

6001545356 7700105087



Application info

Logan [09/04--]

Sensor, camshaft position

16-14 800 0000 | MEX0371

Notes

	Black
	Active sensor
Fitting Depth [mm]	28
Operating voltage [V]	12
Number of Poles	3
	without cable
	with seal

References

820033686 8200285798



Application info

Duster [04/10--]

Logan [09/04--]

Sandero [06/08--]

Logan [09/04--]

4

16-51 902 1007 | MMX1674

Tensioner pulley, timing belt



Notes

	Piece
Inner diameter [mm]	8
Outer diameter [mm]	65.5
Width [mm]	32

References

130701192R

Application info

Duster [04/10--]
Logan [09/04--]

Logan II [10/12--]
Sandero [06/08--]

16-51 902 1003 | MMX1671

Tensioner pulley, timing belt



Notes

	Piece
Inner diameter [mm]	8
Outer diameter [mm]	59
Width [mm]	28.5

References

130701564R 8200704394
130705295R

Application info

Logan [09/04--]
Logan II [10/12--]

Sandero [06/08--]
Sandero II [01/13--]

16-51 902 1005 | MMX1633

Tensioner pulley, timing belt



Notes

	Piece
Outer diameter [mm]	73
Width [mm]	22

References

8200908180

Application info

Dokker [11/12--]
Lodgy [06/10--]
Logan [09/04--]

Sandero [06/08--]
Solenza [02/03--]
Logan [09/04--]



Tensioner pulley, timing belt

16-51 902 1001 | MMX1669

Notes

	Piece
Inner diameter [mm]	8
Outer diameter [mm]	60
Width [mm]	32



Application info

Duster [04/10--]	Sandero [06/08--]
Lodgy [06/10--]	Sandero II [01/13--]
Logan [09/04--]	Logan [09/04--]
Logan II [10/12--]	

Tensioner pulley, timing belt

16-51 902 1009 | MMX1676

Notes

	Piece
Outer diameter [mm]	59
Width [mm]	32



References

130705625R	130708047R
------------	------------

Application info

Dokker [11/12--]	Logan II [10/12--]
Duster [04/10--]	Sandero II [01/13--]
Lodgy [06/10--]	

Timing belt kit

36-51 049 0013 | MMX1091

Notes

Number of belts	1
	Driven unit: camshaft
Width [mm]	27
Pulleys contained	1
Length [mm]	1171
Number of Teeth	123



References

7701477012	7701477028
------------	------------

Parts list

16-51 902 1001 MMX1669	Tensioner pulley, timing belt
--------------------------	-------------------------------

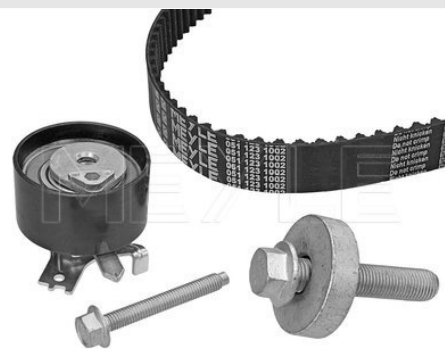

36-51 049 0013 | MMX1091

Timing belt kit

Application info

Duster [04/10--]
Lodgy [06/10--]
Logan [09/04--]

Sandero [06/08--]
Logan [09/04--]

16-51 049 0018 | MMX0740

Timing belt kit



Notes

Number of belts	1
Width [mm]	23
Pulleys contained	1
Length [mm]	905
Number of Teeth	95

References

7701476745

Parts list

16-51 902 1003 MMX1671	Tensioner pulley, timing belt
--------------------------	-------------------------------

Application info

Logan [09/04--]
Logan II [10/12--]

Sandero [06/08--]
Sandero II [01/13--]

16-51 902 2001 | MMX1635

Timing belt roller



Notes

Inner diameter [mm]	10
Outer diameter [mm]	54.5
Width [mm]	32

References

7700107150	8201058069
------------	------------

Application info

Duster [04/10--]
Logan [09/04--]

Logan II [10/12--]
Sandero [06/08--]



Timing belt roller

16-51 902 2003 | MMX1637

Notes

Outer diameter [mm]	50
Width [mm]	31



Application info

Solenza [02/03--]

V-ribbed belt

050 006 1820 | MRB0471

Notes

Number of Ribs	6
Length [mm]	1820

References

8200356268

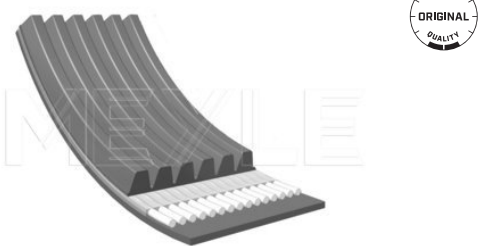

Application info

Logan [09/04--]

V-ribbed belt

050 006 1200 | MRB0377

Notes

Number of Ribs	6
Length [mm]	1200

References

8200243021	8200821813
------------	------------

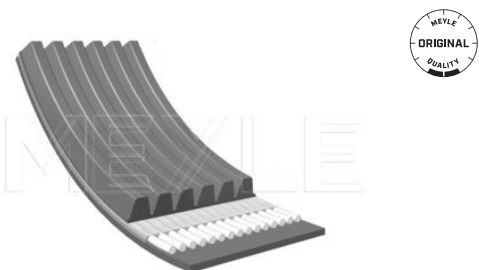

Application info

Dokker [11/12--]
 Duster [04/10--]
 Lodgy [06/10--]
 Logan [09/04--]

Logan II [10/12--]
 Sandero [06/08--]
 Sandero II [01/13--]
 Logan [09/04--]

050 006 1130 | MRB0365

V-ribbed belt

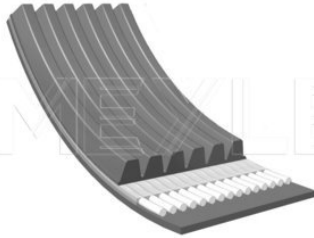

Notes

Number of Ribs 6
Length [mm] 1130

References

117202608R 8200821816

Application info

Dokker [11/12--]
Duster [04/10--]
Lodgy [06/10--]
Logan [09/04--]

Logan II [10/12--]
Sandero [06/08--]
Sandero II [01/13--]
Logan [09/04--]

050 004 1538 | MRB0167

V-ribbed belt

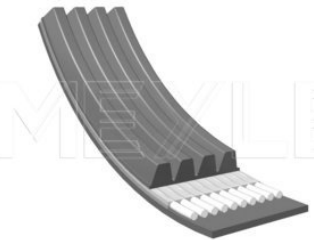

Notes

Number of Ribs 4
Length [mm] 1538

References

8200830192

Application info

Logan [09/04--]

Sandero [06/08--]

050 004 0725 | MRB0065

V-ribbed belt

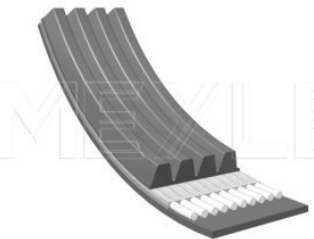

Notes

Number of Ribs 4
Length [mm] 725

References

8200987173 8201060429

Application info

Logan [09/04--]
Sandero [06/08--]

Logan [09/04--]



V-ribbed belt

050 004 0730 | MRB0066

Notes

Number of Ribs 4
Length [mm] 730

References

8200987173 8201060429

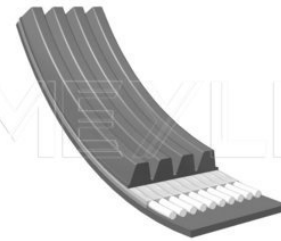

Application info

Logan [09/04--]
Sandero [06/08--]

Logan [09/04--]

V-ribbed belt

050 007 1605 | MRB0605

Notes

Number of Ribs 7
Length [mm] 1605

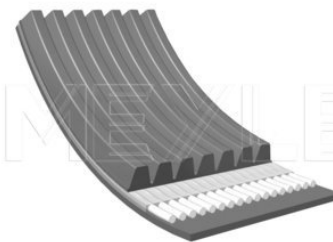

Application info

Lodgy [06/10--]
Logan II [10/12--]

Sandero II [01/13--]

Expansion tank

16-14 223 0000 | MET0044

Notes

with lid

References

7701470460

Parts list

16-14 228 0000 | MMX1314 Expansion tank cap



Application info

Duster [04/10--]
Logan [09/04--]

Sandero [06/08--]
Logan [09/04--]

16-14 228 0000 | MMX1314

Expansion tank cap



References
8200048024*

Application info

Duster [04/10--]
Logan [09/04--]

Sandero [06/08--]
Logan [09/04--]

16-28 228 0001 | MTH0105

Thermostat



Notes

Opening Temperature [°C]

with seal
Synthetic Material Housing
89

References
8200660882

Application info

Logan [09/04--]

Sandero [06/08--]

16-13 220 0015 | MWP0208

Water pump



Notes

Impeller Diameter [mm]

Quality

for toothed belt drive
74
with seal
Sealed with SiC/SiC

References
7701475995

7701478031

Application info

Duster [04/10--]
Logan [09/04--]

Sandero [06/08--]
Logan [09/04--]

Water pump

16-13 220 0023 | MWP0214

Notes

Quality

References

7701478830

for toothed belt drive
with seal
Sealed with SiC/SiC



Application info

Dokker (11/12--)
Duster (04/10--)
Lodgy (06/10--)
Logan (09/04--)

Logan II (10/12--)
Sandero (06/08--)
Sandero II (01/13--)
Logan (09/04--)

Water pump

16-13 220 0021 | MWP0212

Notes

Quality

References

7701478923

for toothed belt drive
with seal
Sealed with SiC/SiC



Application info

Logan (09/04--)
Logan II (10/12--)

Sandero (06/08--)
Sandero II (01/13--)

Water pump

16-13 086 1686 | MWP0191

Notes

Quality
Number of Teeth

References

7700861686
7701478018

for toothed belt drive
with seal
Sealed with SiC/SiC
20

8200146298



16-13 086 1686 | MWP0191

Water pump

Application info

Logan [09/04--]
Sandero [06/08--]

Logan [09/04--]

16-13 027 0001 | MWP0189

Water pump

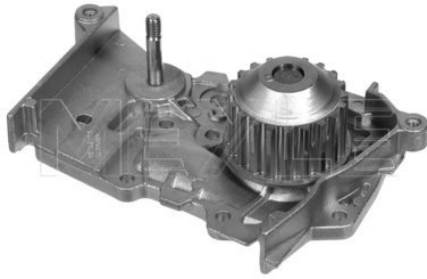

Notes

Quality
Number of Teeth

for toothed belt drive
with seal
Sealed with SiC/SiC
20

References

8200582675

Application info

Duster [04/10--]
Logan [09/04--]

Logan [09/04--]

16-12 321 0018 | MAF0239

Air filter



Notes

Height [mm]
Width [mm]
Length [mm]

56
96
326
Filter Insert

References

165469466R

Application info

Dokker [11/12--]
Lodgy [06/10--]

Logan [09/04--]
Logan [09/04--]

Air filter

16-12 321 0011 | MAF0233

Notes

Height [mm] 50
Width [mm] 153
Length [mm] 286
Filter Insert

References

7701047417

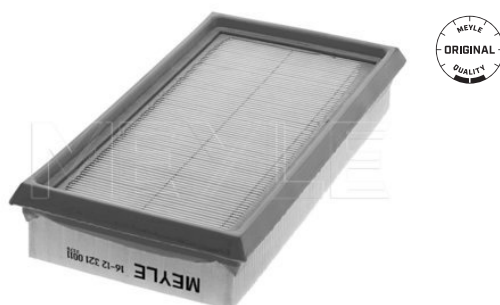

Application info

Solenza [02/03--]

Air filter

16-12 321 0010 | MAF0232

Notes

Height [mm] 58
Width [mm] 82
Length [mm] 356
Filter Insert

References

7701059409



Application info

Logan [09/04--]
Logan II [10/12--]

Sandero [06/08--]
Sandero II [01/13--]

Air filter

16-12 321 0005 | MAF0227

Notes

Inner diameter [mm] 205
Outer diameter [mm] 265
Height [mm] 91
Filter Insert

References

7701070525



Application info

Logan [09/04--]
Sandero [06/08--]

Solenza [02/03--]
Logan [09/04--]

5

16-12 321 0007 | MAF0229

Air filter



Notes

Height [mm] 57
Width [mm] 82
Length [mm] 378
Filter Insert

References

8200023480

Application info

Duster [04/10--]
Logan [09/04--]

Sandero [06/08--]
Logan [09/04--]

16-12 321 0004 | MAF0226

Air filter



Notes

Height [mm] 80
Width [mm] 140
Width 2 [mm] 98
Length [mm] 176
Filter Insert

References

8200431051

Application info

Duster [04/10--]
Logan [09/04--]

Sandero [06/08--]

16-12 321 0020 | MAF0673

Air filter



Notes

Height [mm] 63
Width [mm] 124
Length [mm] 285
Filter Insert

Application info

Dokker [11/12--]
Duster [04/10--]
Lodgy [06/10--]

Logan II [10/12--]
Sandero II [01/13--]



Fuel filter

16-14 323 0010 | MFF0095

Notes

Diameter [mm]
Height [mm]

with seal
71
52
Filter Insert

References

4402894



Application info

Solenza [02/03--]

Fuel filter

614 323 0002 | MFF0208

Notes

Diameter [mm]
Height [mm]

Zinc-coated
Steel
58.8
136.5
In-Line Filter

References

6001543138



Application info

Logan [09/04--]
Sandero [06/08--]

Logan [09/04--]

Fuel filter

16-14 323 0019 | MFF0255

Notes

Outer diameter [mm]
Height [mm]
Inlet Ø [mm]

Metal
89
212.5
10
In-Line Filter

References

8200813237



Application info

Duster [04/10--]
Logan [09/04--]

Sandero [06/08--]
Logan [09/04--]

16-14 322 0000 | MOF0075

Oil filter



Notes

Bypass Valve Opening Pressure [bar]	1
Outer diameter [mm]	76
Height [mm]	50.6
Thread Size	M20x1,5
	Screw-on Filter

References

6001543357

Application info

Duster [04/10--]
Logan [09/04--]
Sandero [06/08--]

Solenza [02/03--]
Logan [09/04--]

16-14 322 0008 | MOF0080

Oil filter



Notes

Bypass Valve Opening Pressure [bar]	1
Outer diameter [mm]	68
Height [mm]	58.5
Thread Size	M20x1,5
	Screw-on Filter

References

8200257642

Application info

Logan [09/04--]
Logan II [10/12--]

Sandero [06/08--]
Sandero II [01/13--]

16-14 322 0005 | MOF0078

Oil filter



Notes

Bypass Valve Opening Pressure [bar]	2.5
Outer diameter [mm]	76.5
Height [mm]	65
Thread Size	M20x1,5
	Screw-on Filter with one anti-return valve

References

8200867980

Application info

Duster [04/10--]
Lodgy [06/10--]
Logan [09/04--]

Sandero [06/08--]
Logan [09/04--]

Oil filter

16-14 322 0011 | MOF0224

Notes

Bypass Valve Opening Pressure [bar] 1
 Outer diameter [mm] 75
 Height [mm] 79
 Thread Size M20x1,5
 Screw-on Filter with one anti-return valve



Application info

Dokker (11/12--)
 Duster (04/10--)
 Lodgy (06/10--)

Logan II (10/12--)
 Sandero II (01/13--)

Oil filter

16-14 322 0012 | MOF0231

Notes

Inner diameter [mm] 20.5
 Outer diameter [mm] 90
 Height [mm] 63.5
 Filter Insert with seal



Application info

Dokker (11/12--)
 Duster (04/10--)
 Lodgy (06/10--)

Logan II (10/12--)
 Sandero II (01/13--)

Engine mount

16-14 030 0025 | MEM0310

Notes

Rubber-metal Bearing for vehicles with air conditioning
 Right

References

112107695R 8200 420 742
 6001 547 893 8200 805 581
 6001 548 157



Application info

Logan (09/04--)
 Sandero (06/08--)

Logan (09/04--)

16-14 030 0105 | MEM0668

Engine mount



Notes

Rubber-metal Bearing
Left
Transmission End

References

112201332R

8200805796

Application info

Duster [04/10--]

16-14 030 0085 | MEM0825

Engine mount



Notes

Rubber-metal Bearing
Rear

References

112383665R
6001549647

8200500928
8200780781

Application info

Logan [09/04--]
Sandero [06/08--]

Logan [09/04--]

16-14 030 0024 | MEM0309

Engine mount



Notes

Rubber-metal Bearing
Manual Transmission, 5-
speed
Left

References

6001548160
8200297939

8200395661

Application info

Logan [09/04--]
Sandero [06/08--]

Logan [09/04--]



Engine mount

16-14 030 0016 | MEM0301

Notes

Rubber-metal Bearing
Left
Rear

References

6001549205

8200575641



Application info

Logan [09/04--]

Sandero [06/08--]

16-14 620 0001 | MSX0077

Steering boot



Notes

Inner diameter 2 [mm]
Inner diameter 1 [mm]
Height [mm]

with accessories
10
10
165
Front Axle Right
Front Axle Left

References

6001547607
6025370231

7701470361

Application info

Logan [09/04--]
Sandero [06/08--]

Logan [09/04--]

16-14 620 0016 | MSK0104

Steering boot kit



Notes

Inner diameter 2 [mm]
Inner diameter 1 [mm]
Height [mm]

with accessories
53
13.5
192
Front Axle Left
Front Axle Right

References

82 01 108 358

Application info

Duster [04/10--]

16-16 031 0026 | MAR0360

Axial rod



Notes

Thread Measurement 2
Thread Measurement 1
Length [mm]

M14x1,5
M14x1,5
190
Front Axle Right
Front Axle Left

References

485211105R

485213172R

Application info

Dokker [11/12--]
Lodgy [06/10--]

Logan II [10/12--]
Sandero II [01/13--]

Axial rod

16-16 031 0040/HD | MAR0504HD

Notes

Thread Measurement 2
Thread Measurement 1
Length [mm]

M14x1,5
M14x1,5
190
Front Axle Left
Front Axle Right

References

485213172R



Application info

Dokker (11/12--)
Lodgy (06/10--)

Logan II (10/12--)
Sandero II (01/13--)

Axial rod

16-16 031 0003/HD | MAR0107HD

Notes

Thread Measurement 2
Thread Measurement 1
Length [mm]

M14x1,5
M12x1
193
Front Axle Right
Front Axle Left

References

6001547606

6001550441



Application info

Logan (09/04--)
Sandero (06/08--)

Logan (09/04--)

Axial rod

16-16 031 0019 | MAR0121

Notes

Thread Measurement 2
Thread Measurement 1
Length [mm]

M14x1,5
M16x1,5
205
Front Axle Right
Front Axle Left

References

8201108350



Application info

Duster (04/10--)

16-16 031 0038/HD | MAR0502HD

Axial rod



Notes

Thread Measurement 2
Thread Measurement 1
Length [mm]

M14x1,5
M16x1,5
205
Front Axle Left
Front Axle Right

Reinforced Version

References

8201108350

Application info

Duster [04/10--]

16-16 020 0012/HD | MTE0193HD

Tie rod end



Notes

Thread Measurement 2
Thread Measurement 1
Length [mm]

M14x1,5
M10x1,25
213
Front Axle Right

Reinforced Version

References

485200410R
6001 547 611

6001550443

Counterpart

16-16 020 0011/HD | MTE0192HD

Application info

Dokker [11/12--]
Lodgy [06/10--]
Logan [09/04--]
Logan II [10/12--]

Sandero [06/08--]
Sandero II [01/13--]
Logan [09/04--]

16-16 020 0011/HD | MTE0192HD

Tie rod end



Notes

Thread Measurement 2
Thread Measurement 1
Length [mm]

M14x1,5
M10x1,25
213
Front Axle Left

Reinforced Version

References

485202867R
6001547610

6001550442

Counterpart

16-16 020 0012/HD | MTE0193HD

Tie rod end

16-16 020 0011/HD | MTE0192HD

Application info

Dokker [11/12--]
Lodgy [06/10--]
Logan [09/04--]
Logan II [10/12--]

Sandero [06/08--]
Sandero II [01/13--]
Logan [09/04--]

Tie rod end

16-16 020 0011 | MTE0192

Notes

Thread Measurement 2	M14x1,5
Thread Measurement 1	M10x1,25
Length [mm]	213
	Front Axle Left

References

6001 547 610	6001550442
--------------	------------

Counterpart

16-16 020 0012 | MTE0193

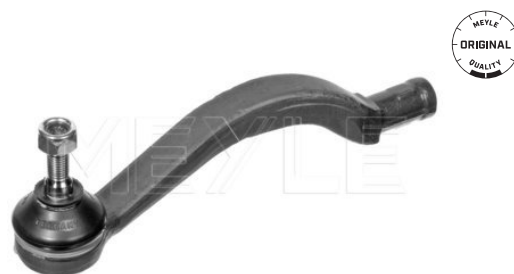

Application info

Logan [09/04--]
Sandero [06/08--]

Logan [09/04--]

Tie rod end

16-16 020 0012 | MTE0193

Notes

Thread Measurement 2	M14x1,5
Thread Measurement 1	M10x1,25
Length [mm]	213
	Front Axle Right

References

6001 547 611	6001550443
--------------	------------

Counterpart

16-16 020 0011 | MTE0192



Application info

Logan [09/04--]
Sandero [06/08--]

Logan [09/04--]

16-16 020 0027 | MTE0208

Tie rod end



Notes

Thread Measurement 2
Thread Measurement 1
Length [mm]

M14x1,5
M10x1,25
220
Front Axle Right

References

82 01 108 332

Counterpart

16-16 020 0028 | MTE0209

Application info

Duster [04/10--]

16-16 020 0028 | MTE0209

Tie rod end



Notes

Thread Measurement 2
Thread Measurement 1
Length [mm]

M14x1,5
M10x1,25
220
Front Axle Left

References

82 01 108 339

Counterpart

16-16 020 0027 | MTE0208

Application info

Duster [04/10--]

Ball joint
16-16 010 0004 | MBJ0104
Notes

 Outer diameter [mm]
 Cone Size [mm]

 with accessories
 38
 18
 Lower
 Front Axle Right
 Front Axle Left

References

401604793R	6001549182*
545000794R*	6001550911*
545001064R	6001550912*
545004529R	8200749459*
545006623R	8200749461*
545007106R	8200792639*
545019294R*	8200792640*
6001547519*	8200910716*
6001547520*	8200910717*
6001549181*	

Application info

 Dokker [11/12--]
 Lodgy [06/10--]
 Logan [09/04--]
 Logan II [10/12--]

 Sandero [06/08--]
 Sandero II [01/13--]
 Logan [09/04--]

Ball joint
16-16 010 0004/S | MBJ0426
Notes

 Outer diameter [mm]
 Cone Size [mm]

 with add-on material
 38
 18
 Front Axle Right
 Front Axle Left
 Lower

References

401604793R	6001550912*
545000794R*	8200749459*
545019294R*	8200749461*
6001547519*	8200792639*
6001547520*	8200792640*
6001549181*	8200910716*
6001549182*	8200910717*
6001550911*	

Application info

 Logan [09/04--]
 Sandero [06/08--]

Logan [09/04--]

16-16 010 0015 | MBJ0115

Ball joint



Notes

Thread Measurement 1

with accessories
M12x1,25
Front Axle Right
Front Axle Left

References

401602308R
545006542R*

545016746R

Application info

Duster [04/10--]

16-16 050 0066 | MCA1114

Control arm



Notes

Sheet Steel
Control Arm
Lower
Outer
Front Axle Right

References

545001064R
545004529R

545006623R
545007106R

Parts list

16-16 010 0004 | MBJ0104
16-14 610 0000 | MCB0147

Ball joint
Control arm bushing

Counterpart

16-16 050 0067 | MCA1115

Application info

Dokker [11/12--]
Lodgy [06/10--]

Logan II [10/12--]
Sandero II [01/13--]

Control arm

16-16 050 0015 | MCA0264

Notes

Sheet Steel
with rubber mounting
with ball joint
Control Arm
Lower
Front Axle Left

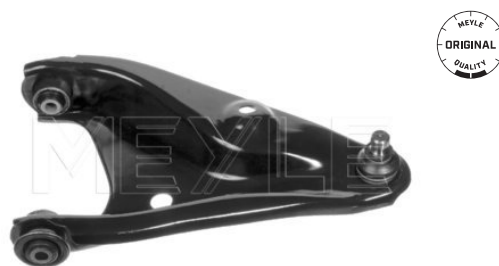

References

545011362R	6001550911
545019294R	8200216376
6001547520	8200749461
6001549181	8200792639
6001550446	8200820930
6001550909	8200910716

Parts list

16-16 010 0004 MBJ0104	Ball joint
16-14 610 0000 MCB0147	Control arm bushing

Counterpart

16-16 050 0016 | MCA0265

Application info

Logan (09/04--)	Logan (09/04--)
Sandero (06/08--)	

Control arm

16-16 050 0049 | MCA0292

Notes

Sheet Steel
with rubber mounting
with ball joint
Control Arm
Front Axle Left



References

545011697R	545016746R
545012815R	545019969R

Parts list

16-16 010 0015 MBJ0115	Ball joint
16-14 610 0026 MCB0169	Control arm bushing

Counterpart

16-16 050 0050 | MCA0293

Application info

Duster (04/10--)

16-16 050 0067 | MCA1115

Control arm



Notes

Sheet Steel
Control Arm
Lower
Outer
Front Axle Left

References

545010294R
545011727R

545017081R
545019811R

Parts list

16-16 010 0004 | MBJ0104
16-14 610 0000 | MCB0147

Ball joint
Control arm bushing

Counterpart

16-16 050 0066 | MCA1114

Application info

Dokker [11/12--]
Lodgy [06/10--]

Logan II [10/12--]
Sandero II [01/13--]

16-16 050 0050 | MCA0293

Control arm



Notes

Sheet Steel
with rubber mounting
with ball joint
Control Arm
Front Axle Right

References

545000138R
545001535R

545006542R
545501225R

Parts list

16-16 010 0015 | MBJ0115
16-14 610 0026 | MCB0169

Ball joint
Control arm bushing

Counterpart

16-16 050 0049 | MCA0292

Application info

Duster [04/10--]

Control arm

16-16 050 0012 | MCA1106

Notes

Steel
with rubber mounting
Trailing Arm
Rear Axle Right



References

551107894R 8200839107



Counterpart

16-16 050 0011 | MCA1105

Application info

Duster [04/10--]

Control arm

16-16 050 0011 | MCA1105

Notes

Steel
with rubber mounting
Trailing Arm
Rear Axle Left



References

551119305R 8200841004



Counterpart

16-16 050 0012 | MCA1106

Application info

Duster [04/10--]

Control arm

16-16 050 0016 | MCA0265

Notes

Sheet Steel
with rubber mounting
with ball joint
Control Arm
Lower
Front Axle Right



References

545000794R	6001550912
545004269R	8200216377
6001547519	8200749459
6001549182	8200792640
6001550447	8200820918
6001550910	8200910717



Parts list

16-16 010 0004 MBJ0104	Ball joint
16-14 610 0000 MCB0147	Control arm bushing

Counterpart

16-16 050 0015 | MCA0264

7



16-16 050 0016 | MCA0265

Control arm

Application info

Logan [09/04--]
Sandero [06/08--]

Logan [09/04--]

16-14 610 0000 | MCB0147

Control arm bushing



Notes

Inner diameter [mm]	12
Outer diameter [mm]	50
Outer diameter [mm]	37
Height [mm]	46
	Lower
	Front Axle Right
	Front Axle Left

References

545000794R	6040002245
545004269R	8200749459
545011362R	8200749461
545019294R	8200792639
6001549181	8200792640
6001549182	8200910716
6001550911	8200910717
6001550912	

Application info

Logan [09/04--]
Sandero [06/08--]

Logan [09/04--]

16-14 610 0026 | MCB0169

Control arm bushing



Notes

Inner diameter [mm]	14
Outer diameter [mm]	37
Height [mm]	45
	Rear
	Front
	Front Axle Right
	Front Axle Left

References

545006542R*	545602788R
545016746R*	

Application info

Duster [04/10--]

Mount, axle rod

16-14 711 0000 | MAM0033

Notes

Inner diameter [mm] 14.1
 Outer diameter [mm] 33.8
 Height [mm] 40
 Front
 Lower
 Rear
 Rear Axle Right
 Rear Axle Left

References

8200839121



Application info

Duster [04/10--]

Mount, stabilizer

16-14 715 0001 | MSB0350

Notes

Inner diameter [mm] 11
 Rear Axle Right
 Rear Axle Left

References

562300111R



Application info

Duster [04/10--]

Mount, stabilizer

16-14 054 0001 | MSB0142

Notes

Inner diameter [mm] 23.5
 inner
 Front Axle Right
 Front Axle Left

References

6001547140



Application info

Logan [09/04--]

Sandero [06/08--]

7

16-14 615 0015 | MSB0407

Mount, stabilizer



Notes

Inner diameter [mm]	24.5
Required quantity	2
	Front Axle Left
	Front Axle Right

References

6001549311

Application info

Dokker [11/12--]
Lodgy [06/10--]
Logan [09/04--]
Logan II [10/12--]

Sandero [06/08--]
Sandero II [01/13--]
Logan [09/04--]

16-14 615 0009 | MSB0148

Mount, stabilizer



Notes

Inner diameter [mm]	19
	inner
	Front Axle Right
	Front Axle Left

References

82 00 852 550

Application info

Duster [04/10--]

16-14 615 0001 | MSL0160

Stabilizer link



Notes

Thread Size	Coupling Rod
Length [mm]	M8x1,25
	74
	Front Axle Right
	Front Axle Left

References

6001 547 138

8200 277 960



Stabilizer link

16-14 615 0001 | MSL0160

Application info

Dokker [11/12--]
Lodgy [06/10--]
Logan [09/04--]
Logan II [10/12--]

Sandero [06/08--]
Sandero II [01/13--]
Logan [09/04--]

Stabilizer link

516 060 0000/HD | MSL0489HD

Notes

Thread Measurement 2
Thread Measurement 1
Length [mm]
Short Version
Reinforced Version

with spanner attachment
Coupling Rod
M10x1,5
M10x1,5
302

References

8200814411



Application info

Duster [04/10--]

Stabilizer link

516 060 0017 | MSL0868

Notes

Thread Measurement 2
Thread Measurement 1
Length [mm]
Short Version

with spanner attachment
Coupling Rod
M10x1,5
M10x1,5
302

References

8200814411



Application info

Duster [04/10--]

7

16-14 501 0000 | MST0008

Stub axle



Notes

Number of Holes

Drum Brake
4
Rear Axle left and right

References

6001 548 299

7700 416 374

Application info

Logan [09/04--]

16-14 710 0002 | MCX0263

Mount, axle carrier



Notes

Inner diameter [mm]
Outer diameter [mm]
Height [mm]

12
66
90
Rear Axle Right
Rear Axle Left

References

6001549988

6001549989

Application info

Duster [04/10--]
Logan [09/04--]

Sandero [06/08--]
Logan [09/04--]

16-14 739 0000 | MCS0251

Coil spring

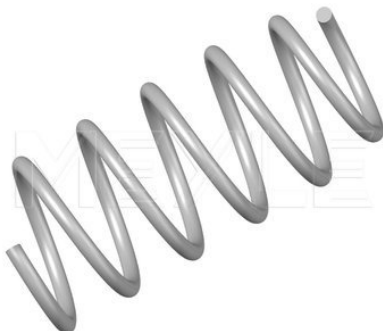

Notes

Required quantity
Replace in pairs only

Coil Spring
2
Rear Axle

References

6001547493

Application info

Logan [09/04--]

Coil spring

16-14 639 0000 | MCS0229

Notes

Required quantity Coil Spring
2
Replace in pairs only Front Axle

References

6001547496 6001548549

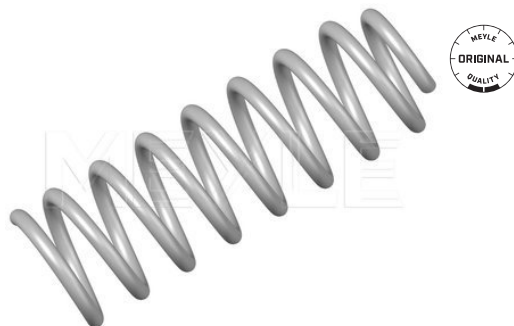

Application info

Logan [09/04--] Sandero [06/08--]

Dust cover kit, shock absorber

16-14 640 0000 | MSC0038

Notes

Kit
Front Axle

References

6001549290



Application info

Logan [09/04--] Logan [09/04--]
Sandero [06/08--]

Repair kit, strut mount

16-14 641 0019/S | MCX0261

Notes

with ball bearing
Front Axle

References

6001547499

Parts list

16-14 641 0019 | MSM0096 Strut mount
16-14 641 0003 | MMB0012 Strut mount bearing



Application info

Dokker [11/12--] Logan II [10/12--]
Duster [04/10--] Sandero [06/08--]
Lodgy [06/10--] Sandero II [01/13--]
Logan [09/04--] Logan [09/04--]

16-26 725 0019 | MSA0706

Shock absorber



Notes

Bottom eye
Top pin
Gas Pressure
Twin-Tube
Rear Axle

References

562105043R

Application info

Duster [04/10--]

16-26 725 0008 | MSA0153

Shock absorber



Notes

Top pin
Bottom eye
Gas Pressure
Twin-Tube
Rear Axle

References

6001547072

Application info

Logan [09/04--]

Sandero [06/08--]

16-26 725 0012 | MSA0156

Shock absorber



Notes

Top pin
Bottom eye
Gas Pressure
Twin-Tube
Rear Axle

References

6001549248

Application info

Logan [09/04--]

Logan [09/04--]

Shock absorber

16-26 623 0003 | MSA0142

Notes

Suspension Strut
Gas Pressure
Twin-Tube
Front Axle

References

6001547071	6001550752
6001547105	8200216267
6001548533	8200238930
6001550751	8200647862



Application info

Logan [09/04--]
Sandero [06/08--]

Logan [09/04--]

Shock absorber

16-26 623 0013 | MSA0695

Notes

Suspension Strut
Gas Pressure
Twin-Tube
Front Axle

References

8200813791



Application info

Duster [04/10--]

Spring seat

16-14 741 0000 | MCX0264

Notes

Thickness [mm]
Inner diameter [mm]
Outer diameter [mm]

Elastomer
35
43
109.5
Upper
Rear Axle

References

6001547495



Application info

Duster [04/10--]
Logan [09/04--]

Sandero [06/08--]
Logan [09/04--]

16-14 641 0019 | MSM0096

Strut mount



Notes

without ball bearing
Front Axle

References

6001547499
6001548403

8200307941

Application info

Dokker [11/12--]
Duster [04/10--]
Lodgy [06/10--]
Logan [09/04--]

Logan II [10/12--]
Sandero [06/08--]
Sandero II [01/13--]
Logan [09/04--]

16-14 641 0000 | MMB0011

Strut mount bearing



Notes

Inner diameter [mm]
Outer diameter [mm]
Height [mm]

Suspension Strut
62.5
99.5
21
Front Axle

References

6001541678

Application info

Solenza [02/03--]

16-14 641 0003 | MMB0012

Strut mount bearing



Notes

Inner diameter [mm]
Outer diameter [mm]
Height [mm]

16
56
9
Front Axle

References

6001025850

8200651172

Application info

Duster [04/10--]
Logan [09/04--]

Sandero [06/08--]
Logan [09/04--]



Wheel bearing

16-14 309 0353 | MWB0039

Notes

Alternative Repair Kit	16-14 146 4049
Inner diameter [mm]	37
Outer diameter [mm]	72
Height [mm]	37
	Front Axle



Application info

Logan [09/04--]

Wheel bearing kit

16-14 650 0100 | MWK0119

Notes

Inner diameter [mm]	with add-on material	42
Outer diameter [mm]		80
Height [mm]		39
	with integrated sensor ring	
	Front Axle left and right	

References

402107049R



Application info

Duster [04/10--]

Wheel bearing kit

16-14 750 0100 | MWK0126

Notes

Inner diameter [mm]	with add-on material	42
Outer diameter [mm]		77
Height [mm]		39.5
	Rear Axle left and right	

References

402109533R



Application info

Duster [04/10--]

7

16-14 650 0007 | MWK0112

Wheel bearing kit



Notes

Inner diameter [mm]
Outer diameter [mm]
Height [mm]

with add-on material
for vehicles with ABS
37
72
37
Front Axle left and right

References

6001547686

Application info

Logan [09/04--]

16-14 146 4049 | MWK0108

Wheel bearing kit



Notes

Inner diameter [mm]
Outer diameter [mm]
Height [mm]

with add-on material
37
72
37
Front Axle left and right

References

6001547696

Parts list

16-14 309 0353 | MWB0039

Wheel bearing

Application info

Logan [09/04--]

16-14 650 0011 | MWK0115

Wheel bearing kit



Notes

Inner diameter [mm]
Outer diameter [mm]
Height [mm]

with add-on material
for vehicles with ABS
37
72
37
Front Axle left and right

References

6001550915

7701207677

Application info

Logan [09/04--]
Sandero [06/08--]

Logan [09/04--]

Wheel bearing kit

16-14 650 0001 | MWK0109

Notes

Inner diameter [mm]
Outer diameter [mm]
Height [mm]

with add-on material
Drum Brake
25
52
37
Rear Axle left and right

References

7701205812



Application info

Logan [09/04--]
Sandero [06/08--]

Logan [09/04--]

Wheel bearing kit

16-14 750 0011 | MWK0215

Notes

Inner diameter [mm]
Outer diameter [mm]
Height [mm]

with add-on material
Drum Brake
25
55
43
Rear Axle left and right

References

6001 550 814

7701 210 004



Application info

Logan [09/04--]
Logan II [10/12--]
Sandero [06/08--]

Sandero II [01/13--]
Logan [09/04--]

Wheel hub

16-14 415 0000 | MWH0067

Notes

Outer diameter [mm]
Bolt Hole Circle Ø [mm]
Rim Hole Number

without add-on material
121
100
4
without wheel bearing
Front Axle left and right

References

402027463R



Application info

Logan [09/04--]
Sandero [06/08--]

Logan [09/04--]

16-14 652 0101 | MWH0071

Wheel hub



Notes

Outer diameter [mm]
Bolt Hole Circle Ø [mm]
Rim Hole Number

without add-on material
121
100
4
without wheel bearing
Front Axle left and right

References

6001547685

Application info

Logan [09/04--]

Sandero [06/08--]

MEYLE no.	Ref. no.	Page
Dacia		
025 214 6318/PD	410602192R	17
	6001547619	
	6001547911	
	7701207066	
	7701208265	
	7701209639	
	7701210142	
	7711130036	
	7711130071	
	8671000107	
8671016173		
025 214 6318/W	410602192R	17
	6001547619	
	6001547911	
	7701207066	
	7701208265	
	7701209639	
	7701210142	
	7711130036	
	7711130071	
	8671000107	
8671016173		
025 225 2517	410605536R	15
025 239 7317	410604775R	18
	410608481R	
	7701208422	
	7701209164	
8671016692		
025 239 7317/PD	410604775R	18
	410608481R	
	7701208422	
	7701209164	
8671016692		
025 246 7318	6001 549 803	18
025 249 1418	410607115R	16
	440603905R	
025 249 1418/PD	410607115R	16
	440603905R	
025 257 0217	410602581R	15
	410605612R	
025 257 3817	41060 9646R	15
029 290 1111	-	2
029 300 1211	-	2
029 350 1410	-	2
029 400 1600	-	3
029 400 1610	-	3

MEYLE no.	Ref. no.	Page
Dacia		
029 450 1800	-	3
029 475 1900	-	4
029 500 2000	-	4
029 550 2200	-	4
029 600 2400	-	5
050 004 0725	8200987173	36
	8201060429	
050 004 0730	8200987173	37
	8201060429	
050 004 1538	8200830192	36
050 006 1130	117202608R	36
	8200821816	
050 006 1200	8200243021	35
	8200821813	
050 006 1820	8200356268	35
050 007 1605	-	37
11-14 870 0001	8200194414	1
16-12 319 0001	7700424098	6
16-12 319 0003	272772835R	5
16-12 319 0023	272773016R	5
	272778214R	
16-12 320 0001	7711228912	6
16-12 321 0004	8200431051	42
16-12 321 0005	7701070525	41
16-12 321 0007	8200023480	42
16-12 321 0010	7701059409	41
16-12 321 0011	7701047417	41
16-12 321 0018	165469466R	40
16-12 321 0020	-	42
16-13 027 0001	8200582675	40
16-13 086 1686	7700861686	39
	7701478018	
	8200146298	
16-13 220 0015	7701475995	38
	7701478031	
16-13 220 0021	7701478923	39
16-13 220 0023	7701478830	39
16-14 030 0016	6001549205	47
	8200575641	
16-14 030 0024	6001548160	46
	8200297939	
	8200395661	
16-14 030 0025	112107695R	45
	6001 547 893	
	6001 548 157	
	8200 420 742	

MEYLE no.	Ref. no.	Page
Dacia		
	8200 805 581	
16-14 030 0085	112383665R 6001549647 8200500928 8200780781	46
16-14 030 0105	112201332R 8200805796	46
16-14 054 0001	6001547140	59
16-14 146 4049	6001547696	68
16-14 223 0000	7701470460	37
16-14 228 0000	8200048024*	38
16-14 309 0353	-	67
16-14 322 0000	6001543357	44
16-14 322 0005	8200867980	44
16-14 322 0008	8200257642	44
16-14 322 0011	-	45
16-14 322 0012	-	45
16-14 323 0010	4402894	43
16-14 323 0019	8200813237	43
16-14 415 0000	402027463R	69
16-14 495 0016	8200017057	25
16-14 495 0017	6001548164	24
16-14 495 0020	7701209255	24
16-14 498 0034	8200444438	25
16-14 498 0035	8200484373	25
16-14 501 0000	6001 548 299 7700 416 374	62
16-14 525 0015	6001547820 6001551097	22
16-14 525 0018	6001547819 6001551098	22
16-14 533 0000	6001547630	20
16-14 533 0003	7701205758	21
16-14 533 0003/K	7701205758	21
16-14 533 0012	440607493R 6001551409	19
16-14 533 0012/K	440607493R 6001551409	20
16-14 533 0016	6001549703 7701210109	21
16-14 533 0016/K	6001549703 7701210109	22
16-14 610 0000	545000794R 545004269R 545011362R 545019294R	58

MEYLE no.	Ref. no.	Page
Dacia		
	6001549181 6001549182 6001550911 6001550912 6040002245 8200749459 8200749461 8200792639 8200792640 8200910716 8200910717	
16-14 610 0026	545006542R* 545016746R* 545602788R	58
16-14 615 0001	6001 547 138 8200 277 960	60
16-14 615 0009	82 00 852 550	60
16-14 615 0015	6001549311	60
16-14 620 0000	6001547699	24
16-14 620 0001	6001547607 6025370231 7701470361	48
16-14 620 0016	82 01 108 358	48
16-14 639 0000	6001547496 6001548549	63
16-14 640 0000	6001549290	63
16-14 641 0000	6001541678	66
16-14 641 0003	6001025850 8200651172	66
16-14 641 0019	6001547499 6001548403 8200307941	66
16-14 641 0019/S	6001547499	63
16-14 650 0001	7701205812	69
16-14 650 0007	6001547686	68
16-14 650 0011	6001550915 7701207677	68
16-14 650 0100	402107049R	67
16-14 652 0101	6001547685	70
16-14 710 0002	6001549988 6001549989	62
16-14 711 0000	8200839121	59
16-14 715 0001	562300111R	59
16-14 739 0000	6001547493	62
16-14 741 0000	6001547495	65
16-14 750 0011	6001 550 814	69

MEYLE no.	Ref. no.	Page
Dacia		
	7701 210 004	
16-14 750 0100	402109533R	67
16-14 800 0000	8200033686 8200285798	31
16-14 800 0010	479101292R 8200419177	26
16-14 800 0011	6040004542 8200254687	26
16-14 800 0012	6040004543 8200254688	26
16-14 800 0023	8200468645	27
16-14 800 0025	7700109055 8200439315 8200688406 8201040861	28
16-14 860 0004	6001545515 8200787721 8671012308	29
16-14 860 0009	8200682592	29
16-14 860 0010	8200490950	28
16-14 885 0001	6001543604 6001544755	30
16-14 885 0002	8200765882	30
16-14 885 0004	8200702693	30
16-14 899 0006	6001548175	27
16-14 899 0010	8200647556	27
16-14 899 0011	6001545356 7700105087	31
16-14 909 0000	6001547149 6001550253 8200804290 8200884403 8200901099	1
16-14 909 0001	6001547150 6001550254 8200804297 8200901102	1
16-15 521 0004	402060540R 402069518R 8671005975	13
16-15 521 0005	6001547683 7701208252 8200123117	13
16-15 521 0017	6001539659	10
16-15 521 0027	40 20 612 00R 40 20 670 16R	14

MEYLE no.	Ref. no.	Page
Dacia		
16-15 521 0028	402066300R	10
16-15 521 0034	402063149R	9
16-15 521 0034/PD	402063149R	9
16-15 521 0035	2677509716 6001547684 6001549211	7
16-15 521 0035/PD	2677509716 6001547684 6001549211	7
16-15 521 0036	6001548578 7701204304 7701205653 7701206339 8201464598	11
16-15 521 0036/PD	6001548578 7701204304 7701205653 7701206339 8201464598	11
16-15 521 0039	7701207795	12
16-15 521 0039/PD	7701207795	12
16-15 521 0040	402060010R 402063793R 402064151R	8
16-15 521 0040/PD	402060010R 402063793R 402064151R	8
16-15 523 0019	7700419824	19
16-16 010 0004	401604793R 545000794R* 545001064R 545004529R 545006623R 545007106R 545019294R* 6001547519* 6001547520* 6001549181* 6001549182* 6001550911* 6001550912* 8200749459* 8200749461* 8200792639* 8200792640* 8200910716*	53

MEYLE no.	Ref. no.	Page
Dacia		
	8200910717*	
16-16 010 0004/S	401604793R 545000794R* 545019294R* 6001547519* 6001547520* 6001549181* 6001549182* 6001550911* 6001550912* 8200749459* 8200749461* 8200792639* 8200792640* 8200910716* 8200910717*	53
16-16 010 0015	401602308R 545006542R* 545016746R	54
16-16 020 0011	6001 547 610 6001550442	51
16-16 020 0011/HD	485202867R 6001547610 6001550442	50
16-16 020 0012	6001 547 611 6001550443	51
16-16 020 0012/HD	485200410R 6001 547 611 6001550443	50
16-16 020 0027	82 01 108 332	52
16-16 020 0028	82 01 108 339	52
16-16 031 0003/HD	6001547606 6001550441	49
16-16 031 0019	8201108350	49
16-16 031 0026	485211105R 485213172R	48
16-16 031 0038/HD	8201108350	50
16-16 031 0040/HD	485213172R	49
16-16 050 0011	551119305R 8200841004	57
16-16 050 0012	551107894R 8200839107	57
16-16 050 0015	545011362R 545019294R 6001547520 6001549181	55

MEYLE no.	Ref. no.	Page
Dacia		
	6001550446 6001550909 6001550911 8200216376 8200749461 8200792639 8200820930 8200910716	
16-16 050 0016	545000794R 545004269R 6001547519 6001549182 6001550447 6001550910 6001550912 8200216377 8200749459 8200792640 8200820918 8200910717	57
16-16 050 0049	545011697R 545012815R 545016746R 545019969R	55
16-16 050 0050	545000138R 545001535R 545006542R 545501225R	56
16-16 050 0066	545001064R 545004529R 545006623R 545007106R	54
16-16 050 0067	545010294R 545011727R 545017081R 545019811R	56
16-26 623 0003	6001547071 6001547105 6001548533 6001550751 6001550752 8200216267 8200238930 8200647862	65
16-26 623 0013	8200813791	65
16-26 725 0008	6001547072	64

MEYLE no.	Ref. no.	Page
Dacia		
16-26 725 0012	6001549248	64
16-26 725 0019	562105043R	64
16-28 228 0001	8200660882	38
16-51 049 0018	7701476745	34
16-51 902 1001	-	33
16-51 902 1003	130701564R 130705295R 8200704394	32
16-51 902 1005	8200908180	32
16-51 902 1007	130701192R	32
16-51 902 1009	130705625R 130708047R	33
16-51 902 2001	7700107150 8201058069	34
16-51 902 2003	-	35
16-83 521 0004/PD	402060540R 402069518R 8671005975	14
36-51 049 0013	7701477012 7701477028	33
40-14 533 0004/K	6001547630	20
516 060 0000/HD	8200814411	61
516 060 0017	8200814411	61
614 323 0002	6001543138	43



Ref. no.	MEYLE no.	Page
Dacia		
4402894	16-14 323 0010	43
112107695R	16-14 030 0025	45
112201332R	16-14 030 0105	46
112383665R	16-14 030 0085	46
117202608R	050 006 1130	36
130701192R	16-51 902 1007	32
130701564R	16-51 902 1003	32
130705295R	16-51 902 1003	32
130705625R	16-51 902 1009	33
130708047R	16-51 902 1009	33
165469466R	16-12 321 0018	40
2677509716	16-15 521 0035 16-15 521 0035/PD	7
272772835R	16-12 319 0003	5
272773016R	16-12 319 0023	5
272778214R	16-12 319 0023	5
401602308R	16-16 010 0015	54
401604793R	16-16 010 0004 16-16 010 0004/S	53
402027463R	16-14 415 0000	69
402060010R	16-15 521 0040 16-15 521 0040/PD	8
402060540R	16-15 521 0004 16-83 521 0004/PD	13-14
40 20 612 00R	16-15 521 0027	14
402063149R	16-15 521 0034 16-15 521 0034/PD	9
402063793R	16-15 521 0040 16-15 521 0040/PD	8
402064151R	16-15 521 0040 16-15 521 0040/PD	8
402066300R	16-15 521 0028	10
40 20 670 16R	16-15 521 0027	14
402069518R	16-15 521 0004 16-83 521 0004/PD	13-14
402107049R	16-14 650 0100	67
402109533R	16-14 750 0100	67
410602192R	025 214 6318/PD 025 214 6318/W	17
410602581R	025 257 0217	15
410604775R	025 239 7317 025 239 7317/PD	18
410605536R	025 225 2517	15
410605612R	025 257 0217	15
410607115R	025 249 1418 025 249 1418/PD	16

Ref. no.	MEYLE no.	Page
Dacia		
410608481R	025 239 7317 025 239 7317/PD	18
41060 9646R	025 257 3817	15
440603905R	025 249 1418 025 249 1418/PD	16
440607493R	16-14 533 0012 16-14 533 0012/K	19-20
479101292R	16-14 800 0010	26
485200410R	16-16 020 0012/HD	50
485202867R	16-16 020 0011/HD	50
485211105R	16-16 031 0026	48
485213172R	16-16 031 0026 16-16 031 0040/HD	48-49
545000138R	16-16 050 0050	56
545000794R	16-14 610 0000 16-16 050 0016	53, 57-58
545000794R*	16-16 010 0004 16-16 010 0004/S	53, 57-58
545001064R	16-16 010 0004 16-16 050 0066	53-54
545001535R	16-16 050 0050	56
545004269R	16-14 610 0000 16-16 050 0016	57-58
545004529R	16-16 010 0004 16-16 050 0066	53-54
545006542R	16-16 050 0050	54, 56, 58
545006542R*	16-14 610 0026 16-16 010 0015	54, 56, 58
545006623R	16-16 010 0004 16-16 050 0066	53-54
545007106R	16-16 010 0004 16-16 050 0066	53-54
545010294R	16-16 050 0067	56
545011362R	16-14 610 0000 16-16 050 0015	55, 58
545011697R	16-16 050 0049	55
545011727R	16-16 050 0067	56
545012815R	16-16 050 0049	55
545016746R	16-16 010 0015 16-16 050 0049	54-55, 58
545016746R*	16-14 610 0026	54-55, 58
545017081R	16-16 050 0067	56
545019294R	16-14 610 0000 16-16 050 0015	53, 55, 58
545019294R*	16-16 010 0004 16-16 010 0004/S	53, 55, 58

Ref. no.	MEYLE no.	Page
Dacia		
545019811R	16-16 050 0067	56
545019969R	16-16 050 0049	55
545501225R	16-16 050 0050	56
545602788R	16-14 610 0026	58
551107894R	16-16 050 0012	57
551119305R	16-16 050 0011	57
562105043R	16-26 725 0019	64
562300111R	16-14 715 0001	59
6001025850	16-14 641 0003	66
6001539659	16-15 521 0017	10
6001541678	16-14 641 0000	66
6001543138	614 323 0002	43
6001543357	16-14 322 0000	44
6001543604	16-14 885 0001	30
6001544755	16-14 885 0001	30
6001545356	16-14 899 0011	31
6001545515	16-14 860 0004	29
6001547071	16-26 623 0003	65
6001547072	16-26 725 0008	64
6001547105	16-26 623 0003	65
6001 547 138	16-14 615 0001	60
6001547140	16-14 054 0001	59
6001547149	16-14 909 0000	1
6001547150	16-14 909 0001	1
6001547493	16-14 739 0000	62
6001547495	16-14 741 0000	65
6001547496	16-14 639 0000	63
6001547499	16-14 641 0019 16-14 641 0019/S	63, 66
6001547519	16-16 050 0016	53, 57
6001547519*	16-16 010 0004 16-16 010 0004/S	53, 57
6001547520	16-16 050 0015	53, 55
6001547520*	16-16 010 0004 16-16 010 0004/S	53, 55
6001547606	16-16 031 0003/HD	49
6001547607	16-14 620 0001	48
6001 547 610	16-16 020 0011	51
6001547610	16-16 020 0011/HD	50
6001 547 611	16-16 020 0012 16-16 020 0012/HD	50-51
6001547619	025 214 6318/PD 025 214 6318/W	17
6001547630	16-14 533 0000 40-14 533 0004/K	20
6001547683	16-15 521 0005	13

Ref. no.	MEYLE no.	Page
Dacia		
6001547684	16-15 521 0035 16-15 521 0035/PD	7
6001547685	16-14 652 0101	70
6001547686	16-14 650 0007	68
6001547696	16-14 146 4049	68
6001547699	16-14 620 0000	24
6001547819	16-14 525 0018	22
6001547820	16-14 525 0015	22
6001 547 893	16-14 030 0025	45
6001547911	025 214 6318/PD 025 214 6318/W	17
6001 548 157	16-14 030 0025	45
6001548160	16-14 030 0024	46
6001548164	16-14 495 0017	24
6001548175	16-14 899 0006	27
6001 548 299	16-14 501 0000	62
6001548403	16-14 641 0019	66
6001548533	16-26 623 0003	65
6001548549	16-14 639 0000	63
6001548578	16-15 521 0036 16-15 521 0036/PD	11
6001549181	16-14 610 0000 16-16 050 0015	53, 55, 58
6001549181*	16-16 010 0004 16-16 010 0004/S	53, 55, 58
6001549182	16-14 610 0000 16-16 050 0016	53, 57-58
6001549182*	16-16 010 0004 16-16 010 0004/S	53, 57-58
6001549205	16-14 030 0016	47
6001549211	16-15 521 0035 16-15 521 0035/PD	7
6001549248	16-26 725 0012	64
6001549290	16-14 640 0000	63
6001549311	16-14 615 0015	60
6001549647	16-14 030 0085	46
6001549703	16-14 533 0016 16-14 533 0016/K	21-22
6001 549 803	025 246 7318	18
6001549988	16-14 710 0002	62
6001549989	16-14 710 0002	62
6001550253	16-14 909 0000	1
6001550254	16-14 909 0001	1
6001550441	16-16 031 0003/HD	49
6001550442	16-16 020 0011 16-16 020 0011/HD	50-51

Ref. no.	MEYLE no.	Page
Dacia		
6001550443	16-16 020 0012 16-16 020 0012/HD	50-51
6001550446	16-16 050 0015	55
6001550447	16-16 050 0016	57
6001550751	16-26 623 0003	65
6001550752	16-26 623 0003	65
6001 550 814	16-14 750 0011	69
6001550909	16-16 050 0015	55
6001550910	16-16 050 0016	57
6001550911	16-14 610 0000 16-16 050 0015	53, 55, 58
6001550911*	16-16 010 0004 16-16 010 0004/S	53, 55, 58
6001550912	16-14 610 0000 16-16 050 0016	53, 57-58
6001550912*	16-16 010 0004 16-16 010 0004/S	53, 57-58
6001550915	16-14 650 0011	68
6001551097	16-14 525 0015	22
6001551098	16-14 525 0018	22
6001551409	16-14 533 0012 16-14 533 0012/K	19-20
6025370231	16-14 620 0001	48
6040002245	16-14 610 0000	58
6040004542	16-14 800 0011	26
6040004543	16-14 800 0012	26
7700105087	16-14 899 0011	31
7700107150	16-51 902 2001	34
7700109055	16-14 800 0025	28
7700 416 374	16-14 501 0000	62
7700419824	16-15 523 0019	19
7700424098	16-12 319 0001	6
7700861686	16-13 086 1686	39
7701047417	16-12 321 0011	41
7701059409	16-12 321 0010	41
7701070525	16-12 321 0005	41
7701204304	16-15 521 0036 16-15 521 0036/PD	11
7701205653	16-15 521 0036 16-15 521 0036/PD	11
7701205758	16-14 533 0003 16-14 533 0003/K	21
7701205812	16-14 650 0001	69
7701206339	16-15 521 0036 16-15 521 0036/PD	11
7701207066	025 214 6318/PD	17

Ref. no.	MEYLE no.	Page
Dacia		
	025 214 6318/W	
7701207677	16-14 650 0011	68
7701207795	16-15 521 0039 16-15 521 0039/PD	12
7701208252	16-15 521 0005	13
7701208265	025 214 6318/PD 025 214 6318/W	17
7701208422	025 239 7317 025 239 7317/PD	18
7701209164	025 239 7317 025 239 7317/PD	18
7701209255	16-14 495 0020	24
7701209639	025 214 6318/PD 025 214 6318/W	17
7701 210 004	16-14 750 0011	69
7701210109	16-14 533 0016 16-14 533 0016/K	21-22
7701210142	025 214 6318/PD 025 214 6318/W	17
7701470361	16-14 620 0001	48
7701470460	16-14 223 0000	37
7701475995	16-13 220 0015	38
7701476745	16-51 049 0018	34
7701477012	36-51 049 0013	33
7701477028	36-51 049 0013	33
7701478018	16-13 086 1686	39
7701478031	16-13 220 0015	38
7701478830	16-13 220 0023	39
7701478923	16-13 220 0021	39
7711130036	025 214 6318/PD 025 214 6318/W	17
7711130071	025 214 6318/PD 025 214 6318/W	17
7711228912	16-12 320 0001	6
8200017057	16-14 495 0016	25
8200023480	16-12 321 0007	42
8200033686	16-14 800 0000	31
8200048024*	16-14 228 0000	38
8200123117	16-15 521 0005	13
8200146298	16-13 086 1686	39
8200194414	11-14 870 0001	1
8200216267	16-26 623 0003	65
8200216376	16-16 050 0015	55
8200216377	16-16 050 0016	57
8200238930	16-26 623 0003	65
8200243021	050 006 1200	35

Ref. no.	MEYLE no.	Page
Dacia		
8200254687	16-14 800 0011	26
8200254688	16-14 800 0012	26
8200257642	16-14 322 0008	44
8200 277 960	16-14 615 0001	60
8200285798	16-14 800 0000	31
8200297939	16-14 030 0024	46
8200307941	16-14 641 0019	66
8200356268	050 006 1820	35
8200395661	16-14 030 0024	46
8200419177	16-14 800 0010	26
8200 420 742	16-14 030 0025	45
8200431051	16-12 321 0004	42
8200439315	16-14 800 0025	28
8200444438	16-14 498 0034	25
8200468645	16-14 800 0023	27
8200484373	16-14 498 0035	25
8200490950	16-14 860 0010	28
8200500928	16-14 030 0085	46
8200575641	16-14 030 0016	47
8200582675	16-13 027 0001	40
8200647556	16-14 899 0010	27
8200647862	16-26 623 0003	65
8200651172	16-14 641 0003	66
8200660882	16-28 228 0001	38
8200682592	16-14 860 0009	29
8200688406	16-14 800 0025	28
8200702693	16-14 885 0004	30
8200704394	16-51 902 1003	32
8200749459	16-14 610 0000 16-16 050 0016	53, 57-58
8200749459*	16-16 010 0004 16-16 010 0004/S	53, 57-58
8200749461	16-14 610 0000 16-16 050 0015	53, 55, 58
8200749461*	16-16 010 0004 16-16 010 0004/S	53, 55, 58
8200765882	16-14 885 0002	30
8200780781	16-14 030 0085	46
8200787721	16-14 860 0004	29
8200792639	16-14 610 0000 16-16 050 0015	53, 55, 58
8200792639*	16-16 010 0004 16-16 010 0004/S	53, 55, 58
8200792640	16-14 610 0000 16-16 050 0016	53, 57-58
8200792640*	16-16 010 0004	53, 57-58

Ref. no.	MEYLE no.	Page
Dacia		
	16-16 010 0004/S	
8200804290	16-14 909 0000	1
8200804297	16-14 909 0001	1
8200 805 581	16-14 030 0025	45
8200805796	16-14 030 0105	46
8200813237	16-14 323 0019	43
8200813791	16-26 623 0013	65
8200814411	516 060 0000/HD 516 060 0017	61
8200820918	16-16 050 0016	57
8200820930	16-16 050 0015	55
8200821813	050 006 1200	35
8200821816	050 006 1130	36
8200830192	050 004 1538	36
8200839107	16-16 050 0012	57
8200839121	16-14 711 0000	59
8200841004	16-16 050 0011	57
82 00 852 550	16-14 615 0009	60
8200867980	16-14 322 0005	44
8200884403	16-14 909 0000	1
8200901099	16-14 909 0000	1
8200901102	16-14 909 0001	1
8200908180	16-51 902 1005	32
8200910716	16-14 610 0000 16-16 050 0015	53, 55, 58
8200910716*	16-16 010 0004 16-16 010 0004/S	53, 55, 58
8200910717	16-14 610 0000 16-16 050 0016	53, 57-58
8200910717*	16-16 010 0004 16-16 010 0004/S	53, 57-58
8200987173	050 004 0725 050 004 0730	36-37
8201040861	16-14 800 0025	28
8201058069	16-51 902 2001	34
8201060429	050 004 0725 050 004 0730	36-37
82 01 108 332	16-16 020 0027	52
82 01 108 339	16-16 020 0028	52
8201108350	16-16 031 0019 16-16 031 0038/HD	49-50
82 01 108 358	16-14 620 0016	48
8201464598	16-15 521 0036 16-15 521 0036/PD	11
8671000107	025 214 6318/PD 025 214 6318/W	17



Ref. no.	MEYLE no.	Page
Dacia		
8671005975	16-15 521 0004 16-83 521 0004/PD	13-14
8671012308	16-14 860 0004	29
8671016173	025 214 6318/PD 025 214 6318/W	17
8671016692	025 239 7317 025 239 7317/PD	18



Short no.	MEYLE no.	Page
Dacia		
MAF0226	16-12 321 0004	42
MAF0227	16-12 321 0005	41
MAF0229	16-12 321 0007	42
MAF0232	16-12 321 0010	41
MAF0233	16-12 321 0011	41
MAF0239	16-12 321 0018	40
MAF0673	16-12 321 0020	42
MAM0033	16-14 711 0000	59
MAR0107HD	16-16 031 0003/HD	49
MAR0121	16-16 031 0019	49
MAR0360	16-16 031 0026	48
MAR0502HD	16-16 031 0038/HD	50
MAR0504HD	16-16 031 0040/HD	49
MAS0294	16-14 800 0011	26
MAS0298	16-14 800 0010	26
MAS0301	16-14 800 0012	26
MBD0318	16-15 521 0004	13
MBD0319	16-15 521 0005	13
MBD0329	16-15 521 0017	10
MBD0336	16-15 521 0027	14
MBD0337	16-15 521 0028	10
MBD1700	16-15 521 0034	9
MBD1700PD	16-15 521 0034/PD	9
MBD1822	16-15 521 0035	7
MBD1822PD	16-15 521 0035/PD	7
MBD1823	16-15 521 0036	11
MBD1823PD	16-15 521 0036/PD	11
MBD1826	16-15 521 0039	12
MBD1826PD	16-15 521 0039/PD	12
MBD1827	16-15 521 0040	8
MBD1827PD	16-15 521 0040/PD	8
MBD1832PD	16-83 521 0004/PD	14
MBH0242	16-14 525 0015	22
MBH0245	16-14 525 0018	22
MBJ0104	16-16 010 0004	53
MBJ0115	16-16 010 0015	54
MBJ0426	16-16 010 0004/S	53
MBK0134	16-14 495 0016	25
MBK0135	16-14 495 0017	24
MBK0137	16-14 495 0020	24
MBK0138	16-14 620 0000	24
MBL0004	029 300 1211	2
MBL0014	029 350 1410	2
MBL0021	029 400 1600	3
MBL0022	029 400 1610	3
MBL0027	029 450 1800	3

Short no.	MEYLE no.	Page
Dacia		
MBL0028	029 475 1900	4
MBL0029	029 500 2000	4
MBL0032	029 550 2200	4
MBL0034	029 600 2400	5
MBL0062	029 290 1111	2
MBP0135	025 214 6318/W	17
MBP0489	025 239 7317	18
MBP0489PD	025 239 7317/PD	18
MBP0650	025 246 7318	18
MBP0677	025 249 1418	16
MBP0677PD	025 249 1418/PD	16
MBP0705	025 257 0217	15
MBP0767PD	025 214 6318/PD	17
MBP1744	025 257 3817	15
MBP1745	025 225 2517	15
MBS0030	16-14 533 0000	20
MBS0033	16-14 533 0003	21
MBS0039	16-14 533 0012	19
MBS0043	16-14 533 0016	21
MBS0153	40-14 533 0004/K	20
MBS0269	16-14 533 0003/K	21
MBS0271	16-14 533 0012/K	20
MBS0272	16-14 533 0016/K	22
MCA0264	16-16 050 0015	55
MCA0265	16-16 050 0016	57
MCA0292	16-16 050 0049	55
MCA0293	16-16 050 0050	56
MCA1105	16-16 050 0011	57
MCA1106	16-16 050 0012	57
MCA1114	16-16 050 0066	54
MCA1115	16-16 050 0067	56
MCB0147	16-14 610 0000	58
MCB0169	16-14 610 0026	58
MCF0131	16-12 319 0001	6
MCF0132	16-12 319 0003	5
MCF0153	16-12 320 0001	6
MCF0449	16-12 319 0023	5
MCS0229	16-14 639 0000	63
MCS0251	16-14 739 0000	62
MCX0261	16-14 641 0019/S	63
MCX0263	16-14 710 0002	62
MCX0264	16-14 741 0000	65
MDR0021	16-15 523 0019	19
MDS0037	16-14 498 0034	25
MDS0038	16-14 498 0035	25
MEM0301	16-14 030 0016	47

Short no.	MEYLE no.	Page
Dacia		
MEM0309	16-14 030 0024	46
MEM0310	16-14 030 0025	45
MEM0668	16-14 030 0105	46
MEM0825	16-14 030 0085	46
MET0044	16-14 223 0000	37
MEX0371	16-14 800 0000	31
MEX0372	16-14 899 0011	31
MFF0095	16-14 323 0010	43
MFF0208	614 323 0002	43
MFF0255	16-14 323 0019	43
MGP0030	16-14 860 0004	29
MGP0034	16-14 860 0009	29
MGP0099	16-14 860 0010	28
MIC0036	16-14 885 0001	30
MIC0037	16-14 885 0002	30
MIC0039	16-14 885 0004	30
MMB0011	16-14 641 0000	66
MMB0012	16-14 641 0003	66
MMX0740	16-51 049 0018	34
MMX1091	36-51 049 0013	33
MMX1314	16-14 228 0000	38
MMX1633	16-51 902 1005	32
MMX1635	16-51 902 2001	34
MMX1637	16-51 902 2003	35
MMX1669	16-51 902 1001	33
MMX1671	16-51 902 1003	32
MMX1674	16-51 902 1007	32
MMX1676	16-51 902 1009	33
MOF0075	16-14 322 0000	44
MOF0078	16-14 322 0005	44
MOF0080	16-14 322 0008	44
MOF0224	16-14 322 0011	45
MOF0231	16-14 322 0012	45
MPS0053	16-14 800 0025	28
MPS0054	16-14 800 0023	27
MPS0056	16-14 899 0006	27
MPS0057	16-14 899 0010	27
MRB0065	050 004 0725	36
MRB0066	050 004 0730	37
MRB0167	050 004 1538	36
MRB0365	050 006 1130	36
MRB0377	050 006 1200	35
MRB0471	050 006 1820	35
MRB0605	050 007 1605	37
MSA0142	16-26 623 0003	65
MSA0153	16-26 725 0008	64

Short no.	MEYLE no.	Page
Dacia		
MSA0156	16-26 725 0012	64
MSA0695	16-26 623 0013	65
MSA0706	16-26 725 0019	64
MSB0142	16-14 054 0001	59
MSB0148	16-14 615 0009	60
MSB0350	16-14 715 0001	59
MSB0407	16-14 615 0015	60
MSC0038	16-14 640 0000	63
MSK0104	16-14 620 0016	48
MSL0160	16-14 615 0001	60
MSL0489HD	516 060 0000/HD	61
MSL0868	516 060 0017	61
MSM0096	16-14 641 0019	66
MST0008	16-14 501 0000	62
MSX0077	16-14 620 0001	48
MTE0192	16-16 020 0011	51
MTE0192HD	16-16 020 0011/HD	50
MTE0193	16-16 020 0012	51
MTE0193HD	16-16 020 0012/HD	50
MTE0208	16-16 020 0027	52
MTE0209	16-16 020 0028	52
MTH0105	16-28 228 0001	38
MWB0039	16-14 309 0353	67
MWH0067	16-14 415 0000	69
MWH0071	16-14 652 0101	70
MWI0011	11-14 870 0001	1
MWK0108	16-14 146 4049	68
MWK0109	16-14 650 0001	69
MWK0112	16-14 650 0007	68
MWK0115	16-14 650 0011	68
MWK0119	16-14 650 0100	67
MWK0126	16-14 750 0100	67
MWK0215	16-14 750 0011	69
MWL0083	16-14 909 0000	1
MWL0084	16-14 909 0001	1
MWP0189	16-13 027 0001	40
MWP0191	16-13 086 1686	39
MWP0208	16-13 220 0015	38
MWP0212	16-13 220 0021	39
MWP0214	16-13 220 0023	39



MEYLE

**You see the pretty
curves, underneath
is what counts.**



The MEYLE brand supplies its customers with more than 21,000 extremely reliable and durable spare parts manufactured at our own production facilities or by trusted production partners. MEYLE boasts a highly diversified product range.

Whether steering and suspension components, rubber-to-metal parts, brakes, damping components, cooling systems, filters, drive components, electric and sensors MEYLE is synonymous with top-grade quality-tested spare parts.

Notes

This catalogue is protected by copyright. Reproduction of text, graphic elements, photographs and/or data, even in part, is prohibited. MEYLE, **MEYLE**, or parts thereof, are registered trademarks of MEYLE AG.

All supplies and services are subject to our General Terms and Conditions. The original spare part numbers shown in this catalogue are for cross-reference purposes only and shall not be disclosed to third parties on invoices and delivery notes. While the information in this catalogue was compiled and edited with utmost care we do not assume responsibility or accept claims arising from errors or inconsistencies. Subject to technical and/or design changes.

This issue of the catalogue supersedes all previous issues.
All rights reserved. © 2017 MEYLE AG



MEYLE parts are available through:

MEYLE AG

Merkurring 111, 22143 Hamburg, Germany
Tel. +49 40 67506 510, Fax +49 40 67506 506
contact@meyle.com

www.meyle.com

MEYLE