

MAN

Spare parts for commercial vehicles



DRIVER'S BEST FRIEND

MEYLE

Robust and reliable components – simply longer on the road.



Trucks are subject to extreme use and require reliable, durable spare parts. MEYLE parts provide outstanding services on roads all over the world, especially for trucks of MAN, Mercedes-Benz, DAF, Volvo, Scania, Renault and Iveco as well as for bus and trailer applications.



Steering & suspension

King pins, Tie rods/tie rod ends, Drag links, and many more



Brakes

Brake discs, Brake pads, Wear indicators, and many more



Drive, clutch and gearbox parts

Clutch discs, Release bearings, Release forks, and many more



Filters

Air filters, Oil filters, Hydraulic oil filters, Cabin air filters, and many more



Engine and cooling parts

Engine mounts, Oil cooler, Fuel pumps, Belt tensioners, and many more



Electrics and sensors

Steering-column switch, ABS sensors, and many more



Cabin and body parts

Cabin tilt pumps, Cabin tilt cylinders, Door handles, and many more

ORIGINAL, PD and HD – The MEYLE product lines



MEYLE-ORIGINAL: Fit as snugly as the original.

More than 21,000 spare parts for passenger cars, vans and trucks, quality-tested, robust, durable and tried and tested a thousand times over on the roads across the world – that's MEYLE-ORIGINAL. Relying on our comprehensive product portfolio – offering everything from A for axial joint to Z for zinc-coated screw – customers can be sure that they will always have safety on their side.

MEYLE-PD: Safety to the power of two.

Thinking outside the box to make our products better: MEYLE-PD stands for brake discs and pads delivering maximum braking performance and setting new standards in terms of durability, comfort, aesthetics, and ease of installation. Look for the „/PD“ part number extension.

MEYLE-HD: Better than originals.

MEYLE-HD parts simply last longer. Their technically optimised and reinforced designs make them more durable and reliable than OE components. So it is only natural for us to offer extended warranty protection for our MEYLE-HD parts: All parts of the HD range come with a full four-year guarantee. Look for the „/HD“ part number extension.



4-year guarantee on all MEYLE-HD parts!

Robust, high mileage, reliable and better than the original. MEYLE-HD parts simply last longer!

Our three success factors.

The success of the MEYLE brand is based on competence, quality and service.

The development of quality-approved automotive spare parts for the independent aftermarket is our trademark. And MEYLE-HD parts are our specialty: improved parts, developed by our team of engineers at our headquarters in Hamburg. We give a 4-year guarantee on our MEYLE-HD parts which have a far longer service life. Based on information from TÜV (Technical control board), from recall statistics as well as media and market information from workshops and other technical partners, MEYLE engineers identify parts in vehicles which become conspicuous on account of frequent, early wear. On the basis of their findings, they develop technical improvements for the respective weakness. In the end, this work is a

large benefit for all MEYLE parts. Something all reputable automotive manufacturers highly appreciate: MEYLE also develops customized products, for example for Morgan, the legendary sports car manufacturer.

Passing on our know-how to staff and customers is just as much a part of our service as high parts availability and swift delivery. Modern warehouse logistics with space covering 29,000 m² and 56,000 pallet places ensure the reliable supply of our partners.

We have now won the “Top Job Employer“ award for the fifth time which confirms our outstanding internal business approach and excellent Human Resources policy. We have been one of Germany’s leading SME employers for many years.

MEYLE

Guarantee certificate



A distinguishing feature of MEYLE is our high level of precision, achieved by the application of the most modern manufacturing methods. Our MEYLE articles meet highest quality standards and our supply plants are certified in accordance with ISO 9001:2008 and ISO/TS 16949.

We guarantee perfect material and faultless processing of all our MEYLE articles for a period of 24 months as of the date of installation. For MEYLE-HD articles, this guarantee applies for 48 months as of the date of installation.

Complementing this guarantee, we give an additional 100,000 miles (160,934 kilometres) performance guarantee against defects of material and workmanship for MEYLE passenger car water pumps purchased from 01 May 2016. The guarantee given for MEYLE passenger car water pumps terminates upon expiration of the guarantee period or the guaranteed mileage, whichever occurs later: if the guaranteed mileage has not been reached at the end of the guarantee period of 24 or 48 months respectively, the performance guarantee continues to be valid. Respectively, the guarantee period of 24 or 48 months continues to be valid also in any case where the guaranteed mileage was already exceeded.

During the guarantee period, we perform repair work on claimed MEYLE articles or provide a replacement. The MEYLE guarantee does not apply for normal wear and damage caused by inappropriate handling or inappropriate installation. The guarantee expires if the respective part is modified by third parties or via installation of parts from third parties, or if the part, or vehicle, is used in excess of the appropriate use and purpose. The MEYLE guarantee also expires if MEYLE instructions or vehicle manufacturer instructions, e.g. concerning maintenance and replacement intervals, are not observed. The guarantee only applies for MEYLE water pumps, if the cooling circuit has been flushed prior to installation of the MEYLE water pump. Rights granted by law continue to apply unrestrictedly, irrespective of this guarantee.

The customer must submit a written guarantee claim immediately, or at the latest 30 days after identifying an error in material or processing. This claim is to be submitted to the dealer from which he acquired the MEYLE article part. The customer should return the article, carefully packed. He must enclose the original sales receipt and a description of the error. The customer must also verify the date of installation and the mileage of the vehicle by means of respective documents.

Last amended January 2017

Handwritten signature of Manfred Wunder

Director Quality Assurance
Manfred Wunder



Engine/Cooling

1

Belt drive / Engine control, Cooling system, Crankshaft drive, Cylinder head, Engine, Exhaust system, Fuel system, Lubrication system, Mounts

Air filter	Gasket set, cylinder head	Sender, oil pressure
Belt tensioner	Gasket, exhaust manifold	Sensor, boost pressure
Crank position sensor	Gasket, intake manifold	Sensor, coolant level
Crankshaft seal	Gasket, oil pan	Sensor, RPM
Cylinder head gasket	Hand primer pump	Tension roller, ribbed belt
Engine mount	Intake air, temperature sensor	Thermostat
Expansion tank	Oil filter	Valve cover gasket
Expansion tank cap	Radiator cap	V-belt
Fan blade	Radiator fan motor	Voltage regulator
Fan clutch	Radiator hose	V-ribbed belt
Fuel filter	Ring gear, crankshaft	Water pump
Fuel pump	Sender unit, coolant temperature	

Brakes

77

Air system, Brakes, Disc brake, Drum brake, Mounting parts

ABS wheel sensor	Cylinder liner, compressor	Repair kit, brake caliper
Air dryer cartridge	Diaphragm, brake cylinder	Repair kit, brake shoe sleeve
Air suspension valve	Line filter, compressor system	Sensor, pneumatic suspension level
Brake disc	Multi-circuit protection valve	Silencer, compressor system
Brake line coupling	Multiway valve	Slave cylinder
Brake pad set	Overflow valve	Valve plate, air compressor
Brake valve, park brake	Pressure limiting valve	Valve, compressor system
Check valve	Quick release valve	Wear sensor
Control valve, trailer	Relay valve	
Cylinder head, compressor	Repair kit, brake adjuster	

Drive train/Transmission/Clutch

115

Axle shafts, Clutch, Transmission

Bolt, release fork	Joint, propeller shaft	Shaft seal, differential
Clutch booster	Neutral safety switch	Shift rod connector
Clutch master cylinder	Release bearing	Switch, differential lock
Drive shaft support	Repair kit, clutch releaser	Switch, splitter gearbox

Suspension

128

Control arms, Stabilizer, Stub axle, Suspension / damping, Wheel hubs / Wheel bearings

Bushing, leaf spring	Mount, stabilizer	Shaft seal, wheel hub
Bushing, stabilizer	Repair kit, control arm	Wheel bearing
Control arm	Repair kit, kingpin	Wheel nut
Gasket set, planetary gear box	Ring, wheel hub	
Mount, leaf spring	Rod/strut, suspension	

Steering

161

Hydraulics, Mounting parts, Tie rod assemblies

Drag link	Hydraulic pump, P/S	Tie rod assembly
Hydraulic filter, steering system	P/S fluid reservoir	Tie rod end

Body/Cabin

176

Body, Cabin, Interior fittings, Lighting

Back up light switch	Door lock	Latch, driver cabine
Bushing, driver cab suspension	Gas spring, front hood	Lock cylinder set
Cabin air filter	Gear shift knob	Repair kit, driver cab mounting
Door handle	Hinge, driver cab	Rubber stop, cabin

Seal, driver cab stabiliser
Side marker
Spacer, driver cab stabiliser

Tilt cylinder, driver cab
Tilt pump, driver cab
Window lifter

Windshield washer pump
Wiper Blade

Auxiliary parts / Miscellaneous

196

Universal parts

Multifunction relay

Gasket, intake manifold

12-34 035 0010 | MMX1482

References

51.08901.0202 51.08902.0202



Application info

TGA [04/00--]

Gasket, intake manifold

12-34 001 0007 | MMX1564

References

51.08902.0115 51.08902.0161
51.08902.0135



Application info

F 2000 [01/94-12/95]
F 90 [07/86-12/97]
NG [--07/98]
NL [--07/98]

SD [04/74-04/94]
SG [07/76-06/97]
ÜL [09/89-09/96]

Gasket, intake manifold

12-34 900 0006 | MMX1485

References

51.08902.0150 51.08902.0194

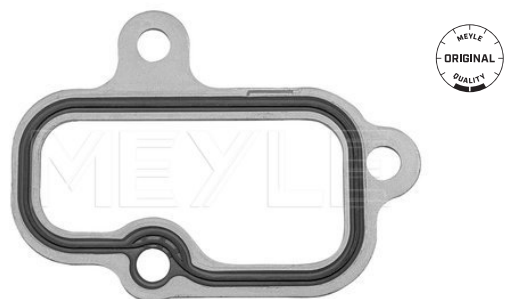

Application info

E 2000 [05/00--]
F 2000 [01/94-12/95]
HOCL [01/85-05/09]

SÜ [--06/97]
TGA [04/00--]
ÜL [09/89-09/96]

12-34 100 6558 | MMX0604

Gasket set, cylinder head

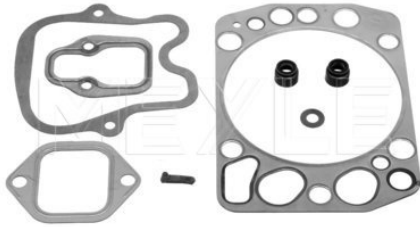

Notes

with valve stem seals
with rocker cover gasket
with cylinder head gasket
Steel Elastomer

References

51.00900.6536
51.00900.6552

51.00900.6558

Application info

EL [01/93-06/97]
F 2000 [01/94-12/95]
F 90 [07/86-12/97]
F 90 Unterflur [07/86-05/94]
LION'S COACH [09/95--]
LION'S COMFORT [09/96--]
LION'S STAR [01/93-09/96]
M 90 [08/88-06/96]
NG [--07/98]

NL [--07/98]
NÜ [09/96-07/98]
R [05/85-01/93]
SG [07/76-06/97]
SL [05/80-04/87]
SL II [--04/94]
SÜ [--06/97]
ÜL [09/89-09/96]

12-34 900 0004 | MMX1483

Gasket set, cylinder head

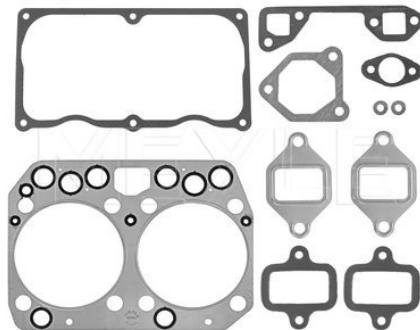

Notes

without valve stem seals
Steel

References

51.00900.6550

51.00900.6628

Application info

CLA [01/06--]
G 90 [09/87-05/95]
HOCL [01/85-05/09]
L 2000 [10/93-07/97]
M 2000 L [08/95--]

M 2000 M [--12/05]
M 90 [08/88-06/96]
NL [--07/98]
NM [--03/97]
SM [11/87-02/95]

Gasket set, cylinder head

12-34 900 6437 | MMX0611

Notes

with valve stem seals
with rocker cover gasket
with cylinder head gasket
Steel Elastomer

References

51.00900.6273
51.00900.6437

51.00900.6570

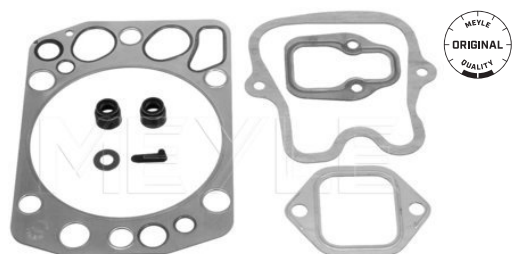

Application info

SD (04/74-04/94)
SG (07/76-06/97)
SL (05/80-04/87)

SR (10/75-11/86)
SÜ (--06/97)

Gasket set, cylinder head

12-34 900 0000 | MMX0609

Notes

with valve stem seals
with rocker cover gasket
with cylinder head gasket
Steel Elastomer

References

51.00900.6630

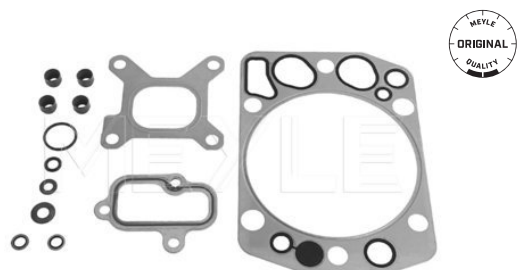

Application info

F 2000 (01/94-12/95)
LION'S COACH (09/95--)
LION'S STAR (01/93-09/96)

SÜ (--06/97)
TGA (04/00--)

Gasket set, cylinder head

12-34 900 0001 | MMX0610

Notes

without valve stem seals
with rocker cover gasket
with cylinder head gasket
Steel Elastomer

References

51.00900.6629

51.00900.6639

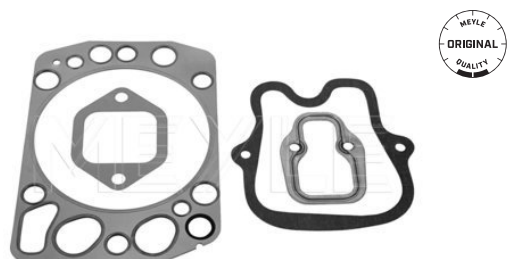

12-34 900 0001 | MMX0610

Gasket set, cylinder head

Application info

E 2000 (05/00--)
F 2000 (01/94-12/95)
F 90 (07/86-12/97)

F 90 Unterflur (07/86-05/94)
TGA (04/00--)
ÜL (09/89-09/96)

12-34 001 0012 | MMX1548

Cylinder head gasket

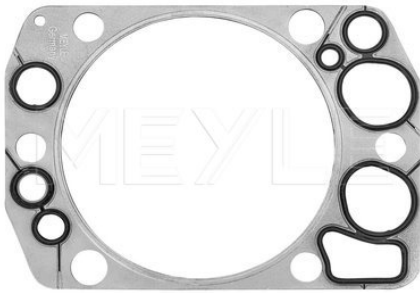

Notes

Thickness [mm]
Width [mm]
Length [mm]

MVQ (Silicone Elastomer)
Sheet Steel
1.1
157
220

References

51.03901.0356

Application info

F 90 (07/86-12/97)
F 90 Unterflur (07/86-05/94)
M 90 (08/88-06/96)
NG (--07/98)

NL (--07/98)
SG (07/76-06/97)
SÜ (--06/97)

12-34 901 0351 | MMX1581

Cylinder head gasket

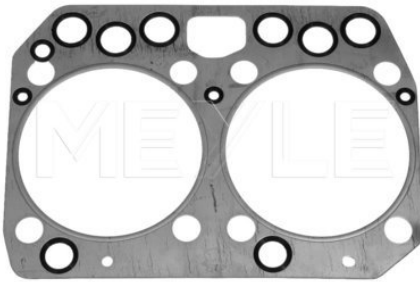

References

51.03901.0351
51.03901.0357
51.03901.0361

51.03901.0378
51.03901.0379

Application info

CLA (01/06--)
EL (01/93-06/97)
EM (08/87-06/97)
G 90 (09/87-05/95)
L 2000 (10/93-07/97)
M 2000 L (08/95--)
M 90 (08/88-06/96)

NL (--07/98)
NM (--03/97)
SM (11/87-02/95)
TGA (04/00--)
TGL (04/05--)
TGM (10/05--)

Cylinder head gasket

12-34 001 0010 | MMX1523

Notes

MVQ (Silicone Elastomer)
Sheet Steel

References

51.03901.0382

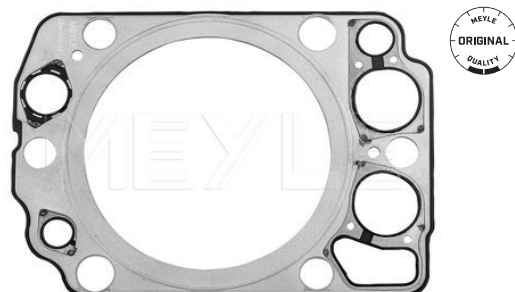

Application info

E 2000 (05/00--)
F 2000 (01/94-12/95)

TGA (04/00--)

Cylinder head gasket

12-34 900 0003 | MMX1566

References

51.03901.0385 51.03901.0387

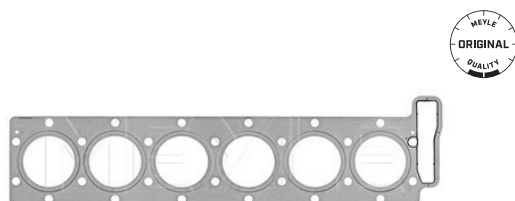

Application info

NL (--07/98)
SÜ (--06/97)
TGA (04/00--)

TGS (09/07--)
TGX (09/07--)

Valve cover gasket

12-34 905 0135 | MMX0615

Notes

Thickness [mm]

Paper
2

References

51.03905.0091 51.03905.0105
51.03905.0094 51.03905.0109
51.03905.0098 51.03905.0123
51.03905.0103 51.03905.0134
51.03905.0104 51.03905.0135



Application info

F 2000 (01/94-12/95)
F 90 (07/86-12/97)

F 90 Unterflur (07/86-05/94)
M 90 (08/88-06/96)

12-34 905 0001 | MMX0613

Valve cover gasket



Notes

Thickness [mm]	1.55
Required quantity	2

References

51.03905.0157

Application info

F 2000 (01/94-12/95)
LION'S COACH (09/95--)
LION'S COMFORT (09/96--)
LION'S STAR (01/93-09/96)
NG (--07/98)

NL (--07/98)
NÜ (09/96-07/98)
SÜ (--06/97)
TGA (04/00--)
ÜL (09/89-09/96)

12-34 905 0002 | MMX0614

Valve cover gasket



Notes

Thickness [mm]	1.5
Required quantity	2

References

51.03905.0161

Application info

F 2000 (01/94-12/95)
LION'S COACH (09/95--)

LION'S STAR (01/93-09/96)
TGA (04/00--)

12-34 905 0004 | MMX1582

Valve cover gasket



References

51.03905.0177

Valve cover gasket
12-34 905 0004 | MMX1582
Application info

 TGA [04/00--]
 TGS [09/07--]

TGX [09/07--]

Ring gear, crankshaft
12-34 130 0032 | MMX0605
Notes

Inner diameter [mm]	99.5
Outer diameter [mm]	105
Height [mm]	17.8
	Front

References

51.02130.0005	51.02130.0012
51.02130.0007	51.02130.0032
51.02130.0008	

Application info

 F 2000 [01/94-12/95]
 F 90 [07/86-12/97]
 F 90 Unterflur [07/86-05/94]
 LION´S COMFORT [09/96--]
 LION´S STAR [01/93-09/96]

 M 90 [08/88-06/96]
 NÜ [09/96-07/98]
 SÜ [--06/97]
 ÜL [09/89-09/96]

Ring gear, crankshaft
034 003 1024 | MMX0191
Notes

Inner diameter [mm]	115
Outer diameter [mm]	120
Height [mm]	21
	Front

References

51.02130.0013	51.93020.0236
---------------	---------------

Application info

F 2000 [01/94-12/95]

F 90 [07/86-12/97]

034 035 0038 | MMX0240

Crankshaft seal



Notes

Inner diameter [mm]
Outer diameter [mm]
Height [mm]

Right-hand Twist
105
130
12
Timing End

References

51.01510.0150

Application info

F 90 Unterflur [07/86-05/94]

12-34 099 0004 | MMX0600

Crankshaft seal



Notes

Inner diameter [mm]
Outer diameter [mm]
Height [mm]

Left-hand Twist
120
140
12
Transmission End

References

51.01510.0133
51.01510.0134
51.01510.0140
51.01510.0141
51.01510.0184

51.01510.0196
51.01510.0206
51.01510.0207
51.01510.0208

Application info

F 2000 [01/94-12/95]
F 90 [07/86-12/97]
F 90 Unterflur [07/86-05/94]
LION'S COACH [09/95--]
LION'S STAR [01/93-09/96]
M 90 [08/88-06/96]
SD [04/74-04/94]

SG [07/76-06/97]
SL [05/80-04/87]
SL II [--04/94]
SR [10/75-11/86]
SÜ [--06/97]
ÜL [09/89-09/96]

12-34 099 0005 | MMX0601

Crankshaft seal



Notes

Inner diameter [mm]
Outer diameter [mm]
Height [mm]

Left-hand Twist
110
130
13
Timing End

References

51.01510.0151

51.01510.0218

Crankshaft seal

12-34 099 0005 | MMX0601

Application info

CLA [01/06--]
EL [01/93-06/97]
EM [08/87-06/97]
G [10/79-08/88]
G 90 [09/87-05/95]
L 2000 [10/93-07/97]
M 2000 L [08/95--]
M 2000 M [--12/05]
M 90 [08/88-06/96]

NG [--07/98]
NL [--07/98]
NM [--03/97]
NÜ [09/96-07/98]
SM [11/87-02/95]
SÜ [--06/97]
TGA [04/00--]
TGL [04/05--]
TGM [10/05--]

Crankshaft seal

12-34 099 0003 | MMX0599

Notes

Inner diameter [mm]
Outer diameter [mm]
Height [mm]

Right-hand Twist
66
90
12
Timing End

References

51.01510.0172
51.01510.0174
51.01510.0179

51.01510.0219
51.01510.0237
51.01510.7000



Application info

EL [01/93-06/97]
EM [08/87-06/97]
G 90 [09/87-05/95]
L 2000 [10/93-07/97]
M 2000 L [08/95--]
M 2000 M [--12/05]
M 90 [08/88-06/96]

NG [--07/98]
NL [--07/98]
NM [--03/97]
SÜ [--06/97]
TGA [04/00--]
TGL [04/05--]
TGM [10/05--]

Crankshaft seal

12-34 099 0007 | MMX0603

Notes

Inner diameter [mm]
Outer diameter [mm]
Height [mm]

Right-hand Twist
100
130
12
Timing End

References

51.01510.0236
51.01510.0273
51.01510.0282

51.01510.6005
51.01510.6008



Application info

TGA [04/00--]
TGS [09/07--]

TGX [09/07--]

12-34 099 0006 | MMX0602

Crankshaft seal



Notes

Inner diameter [mm]
Outer diameter [mm]
Height [mm]

Right-hand Twist
105
130
12
Transmission End

References

51.01510.0197	51.01510.6004
51.01510.0199	51.01510.6006
51.01510.0226	51.01510.6007
51.01510.6003	

Application info

E 2000 (05/00--)
EL (01/93-06/97)
F 2000 (01/94-12/95)
F 90 (07/86-12/97)
F 90 Unterflur (07/86-05/94)
M 90 (08/88-06/96)
NG (--07/98)
NL (--07/98)

NÜ (09/96-07/98)
R (05/85-01/93)
SD (04/74-04/94)
SG (07/76-06/97)
SÜ (--06/97)
TGA (04/00--)
ÜL (09/89-09/96)

12-34 003 0001 | MEX0354

Sensor, RPM



Notes

Cable Length [mm]
Operating voltage [V]
Number of Poles
Resistance [Ohm]

Passive sensor
370
24
2
900

References

51.27120.0005	51.27120.0011
51.27120.0008	

Application info

EL (01/93-06/97)
EM (08/87-06/97)
F 2000 (01/94-12/95)
F 90 (07/86-12/97)
F 90 Unterflur (07/86-05/94)
L 2000 (10/93-07/97)
LION´S COACH (09/95--)
LION´S COMFORT (09/96--)
LION´S STAR (01/93-09/96)
M 2000 L (08/95--)
M 2000 M (--12/05)

M 90 (08/88-06/96)
NG (--07/98)
NL (--07/98)
NM (--03/97)
NÜ (09/96-07/98)
SG (07/76-06/97)
SÜ (--06/97)
TGA (04/00--)
TGS (09/07--)
TGX (09/07--)
ÜL (09/89-09/96)

Sensor, RPM
12-34 003 0002 | MEX0355
Notes

Cable Length [mm]	Passive sensor 420
Number of Poles	2
Resistance [Ohm]	950

References

51.27120.0006	51.27120.0012
51.27120.0009	

Application info

EL (01/93-06/97)
 EM (08/87-06/97)
 F 2000 (01/94-12/95)
 F 90 (07/86-12/97)
 F 90 Unterflur (07/86-05/94)
 L 2000 (10/93-07/97)
 LION'S COACH (09/95--)
 LION'S STAR (01/93-09/96)
 M 2000 L (08/95--)
 M 2000 M (--12/05)
 M 90 (08/88-06/96)

NG (--07/98)
 NL (--07/98)
 NM (--03/97)
 NÜ (09/96-07/98)
 SG (07/76-06/97)
 SÜ (--06/97)
 TGA (04/00--)
 TGS (09/07--)
 TGX (09/07--)
 ÜL (09/89-09/96)

Sensor, RPM
12-34 003 0009 | MEX0575
Notes

Cable Length [mm]	Passive sensor 780
Operating voltage [V]	24
Number of Poles	2
Resistance [Ohm]	1000

References

51.27120.0014

Application info

E 2000 (05/00--)
 F 2000 (01/94-12/95)
 TGA (04/00--)

TGL (04/05--)
 TGM (10/05--)

12-34 003 0010 | MEX0356

Sensor, RPM



Notes

Cable Length [mm]
Number of Poles

Inductive Sensor
905
2

References

51.27120.0015

Application info

E 2000 [05/00--]
F 2000 [01/94-12/95]
TGA [04/00--]

TGL [04/05--]
TGM [10/05--]

034 015 0005 | MEX0143

Voltage regulator



Notes

Number of Poles
Voltage [V]

2
28

References

81.25601.6024

Application info

F 90 [07/86-12/97]
F 90 Unterflur [07/86-05/94]

G 90 [09/87-05/95]

12-34 003 0011 | MPS0016

Crank position sensor



Notes

Operating voltage [V]
Number of Poles

Passive sensor
12
2
with seal
without cable
950

Resistance [Ohm]

References

51.27120.0016
51.27120.7035

51.27120.7037
51.27120.7038

Application info

TGA [04/00--]
TGL [04/05--]
TGM [10/05--]

TGS [09/07--]
TGX [09/07--]

Sender, oil pressure

12-14 820 0000 | MEX0472

Notes

Measuring range from [bar]	5
	Active sensor
Spanner Size	22
Thread Size	M18x1,5
Operating voltage [V]	24
Number of Poles	3

References

81.27421.0098	81.27421.0109
---------------	---------------



Application info

F 2000 (01/94-12/95)
F 90 (07/86-12/97)
F 90 Unterflur (07/86-05/94)
LION'S COMFORT (09/96--)
LION'S STAR (01/93-09/96)

M 90 (08/88-06/96)
NÜ (09/96-07/98)
SÜ (--06/97)
ÜL (09/89-09/96)

Intake air, temperature sensor

12-34 899 0022 | MEX0363

Notes

Operating voltage [V]	24
Number of Poles	2

References

51.27421.0077



Application info

E 2000 (05/00--)
F 2000 (01/94-12/95)
F 90 (07/86-12/97)
G 90 (09/87-05/95)
L 2000 (10/93-07/97)
M 2000 L (08/95--)

M 2000 M (--12/05)
M 90 (08/88-06/96)
SG (07/76-06/97)
SM (11/87-02/95)
SÜ (--06/97)
TGA (04/00--)

Sensor, boost pressure

12-34 899 0004 | MEX0474

Notes

Operating voltage [V]	24
Number of Poles	4

References

51.27421.0179	51.27421.0198
51.27421.0185	51.27421.0216



12-34 899 0004 | MEX0474

Sensor, boost pressure

Application info

LION´S COACH (09/95--)
LION´S STAR (01/93-09/96)
TGA (04/00--)

TGL (04/05--)
TGM (10/05--)
TGS (09/07--)
TGX (09/07--)

12-34 904 0132 | MMX0612

Gasket, oil pan

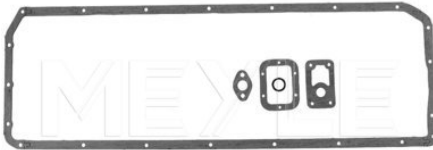

References

51.05904.0132

Application info

F 90 (07/86-12/97)
F 90 Unterflur (07/86-05/94)
LION´S COACH (09/95--)
LION´S STAR (01/93-09/96)
R (05/85-01/93)
SD (04/74-04/94)

SG (07/76-06/97)
SL (05/80-04/87)
SL II (--04/94)
SR (10/75-11/86)
SÜ (--06/97)
ÜL (09/89-09/96)

014 018 0015 | MOF0014

Oil filter



Notes

Inner diameter [mm]
Outer diameter [mm]
Height [mm]

with gaskets/seals
36.5
82
174
Filter Insert

References

51.05500.6073

51.05504.0105

Application info

TGA (04/00--)
TGL (04/05--)

TGM (10/05--)

Oil filter
12-14 322 0003 | MOF0068
Notes

Inner diameter [mm]	with seal
Outer diameter [mm]	91
Height [mm]	109
Thread Size	180
	M30x2
	Screw-on Filter

References

51.05501.7160	51.05501.7166
51.05501.7161	51.05501.7180
51.05501.7163	

Application info

CLA (01/06--)	M 90 (08/88-06/96)
EL (01/93-06/97)	NG (--07/98)
EM (08/87-06/97)	NL (--07/98)
G 90 (09/87-05/95)	NM (--03/97)
L 2000 (10/93-07/97)	NÜ (09/96-07/98)
M 2000 L (08/95--)	SM (11/87-02/95)
M 2000 M (--12/05)	SÜ (--06/97)

Oil filter
12-14 322 0001 | MOF0067
Notes

Inner diameter 2 [mm]	with seal
Inner diameter 1 [mm]	36
Outer diameter [mm]	28
Height [mm]	83
	214
	Filter Insert

References

51.05504.0096	82.05504.6096
---------------	---------------

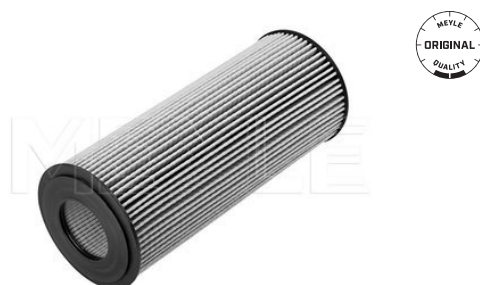
Application info

E 2000 (05/00--)	TGA (04/00--)
F 2000 (01/94-12/95)	TGL (04/05--)
F 90 (07/86-12/97)	TGM (10/05--)

Oil filter
12-14 322 0000 | MOF0066
Notes

Inner diameter [mm]	with seal
Outer diameter [mm]	55
Height [mm]	120
	148
	Filter Insert

References

51.05504.0098	81.05504.0025
---------------	---------------



12-14 322 0000 | MOF0066

Oil filter

Application info

E 2000 (05/00--)
F 2000 (01/94-12/95)
LION'S COACH (09/95--)
LION'S STAR (01/93-09/96)

SG (07/76-06/97)
SL (05/80-04/87)
SÜ (--06/97)
TGA (04/00--)

12-14 322 0004 | MOF0223

Oil filter



Notes

Inner diameter 2 [mm]
Inner diameter 1 [mm]
Outer diameter [mm]
Height [mm]

with seal
57
15
121
204
Filter Insert

References

51.05504.0107
51.05504.0108

51.05504.0122

Application info

HOCL (01/85-05/09)
NG (--07/98)
NL (--07/98)
SL (05/80-04/87)

SÜ (--06/97)
TGA (04/00--)
TGS (09/07--)
TGX (09/07--)

12-34 321 0010 | MAF0199

Air filter



Notes

Inner diameter [mm]
Inner diameter [mm]
Outer diameter [mm]
Height [mm]

191
11
302
473
Filter Insert

References

81.08304.0038
81.08304.0043
81.08304.0044

81.08304.0091
81.08401.6213

Application info

F 90 (07/86-12/97)
F 90 Unterflur (07/86-05/94)
LION'S COACH (09/95--)
LION'S STAR (01/93-09/96)
M 2000 L (08/95--)

M 90 (08/88-06/96)
SG (07/76-06/97)
SR (10/75-11/86)
ÜL (09/89-09/96)

Air filter

034 321 0006 | MAF0064

Notes

Inner diameter [mm] 132
Outer diameter [mm] 241
Height [mm] 485
Filter Insert

References

64.08301.0003 81.08304.0048
81.08205.0005 81.08304.0057
81.08304.0040 81.08304.0060
81.08304.0041



Application info

CLA [01/06--]

Air filter

12-34 321 0011 | MAF0200

Notes

Inner diameter [mm] 132
Inner diameter [mm] 10.5
Outer diameter [mm] 242
Height [mm] 378
Filter Insert

References

81.08304.0074 81.08304.0076



Application info

CLA [01/06--]
EL [01/93-06/97]
EM [08/87-06/97]
M 2000 L [08/95--]
M 2000 M [--12/05]

M 90 [08/88-06/96]
NG [--07/98]
NL [--07/98]
NM [--03/97]
SÜ [--06/97]

Air filter

12-34 321 0002 | MAF0193

Notes

Inner diameter [mm] 134
Outer diameter [mm] 162
Height [mm] 468
Fine Filter
Filter Insert

References

81.08304.0084



12-34 321 0002 | MAF0193

Air filter

Application info

E 2000 (05/00--)
F 2000 (01/94-12/95)

F 90 (07/86-12/97)

812 321 0001 | MAF0649

Air filter



Notes

Inner diameter [mm]	190.5
Outer diameter [mm]	302
Height [mm]	365
	Filter Insert

References

81.08304.0086

Application info

EL (01/93-06/97)
NG (--07/98)

NL (--07/98)
ÜL (09/89-09/96)

034 321 0009 | MAF0067

Air filter

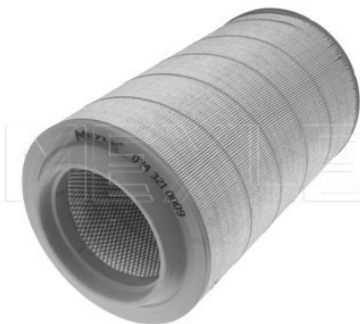

Notes

Inner diameter [mm]	170
Outer diameter [mm]	265
Height [mm]	481
	Filter Insert

References

81.08304.0100

Application info

TGA (04/00--)

12-34 321 0019 | MAF0204

Air filter

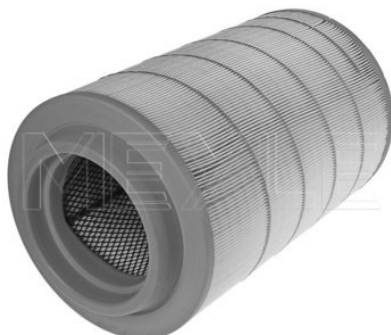

Notes

Inner diameter [mm]	150
Outer diameter [mm]	248
Height [mm]	414.5
	Filter Insert

References

81.08304.0101	81.08405.0031
81.08304.0103	

Air filter

12-34 321 0019 | MAF0204

Application info

LION'S CITY (08/04--)
NM (--03/97)

TGL (04/05--)

Air filter

12-34 321 0006 | MAF0196

Notes

Inner diameter [mm]	119
Outer diameter [mm]	248
Height [mm]	382
	Filter Insert

References

81.08304.0087	81.08405.0015
---------------	---------------



Application info

L 2000 (10/93-07/97)
M 2000 L (08/95--)

M 2000 M (--12/05)

Air filter

12-34 321 0009 | MAF0198

Notes

Inner diameter [mm]	125
Outer diameter [mm]	250
Height [mm]	460
	Filter Insert

References

81.08405.0018



Application info

TGL (04/05--)

TGM (10/05--)

Air filter

12-34 321 0003 | MAF0194

Notes

Inner diameter [mm]	170
Outer diameter [mm]	266
Height [mm]	510
	Filter Insert

References

81.08405.0016	81.08405.0021
81.08405.0020	



12-34 321 0003 | MAF0194

Air filter

Application info

LION´S COACH (09/95--)
TGA (04/00--)

TGS (09/07--)
TGX (09/07--)

12-34 321 0017 | MAF0202

Air filter



Notes

Inner diameter [mm]	150
Outer diameter [mm]	232
Height [mm]	415
	Filter Insert

References

81.08405.0022

Application info

TGL (04/05--)

TGM (10/05--)

12-34 321 0018 | MAF0203

Air filter



Notes

Inner diameter [mm]	130
Outer diameter [mm]	227
Height [mm]	305
	Filter Insert

References

81.08405.0023

Application info

TGL (04/05--)

TGM (10/05--)

12-34 321 0021 | MAF0206

Air filter



Notes

Inner diameter [mm]	170
Outer diameter [mm]	251
Height [mm]	533
	Filter Insert

References

81.08405.0029

Air filter

12-34 321 0021 | MAF0206

Application info

LION´S CITY (08/04--)
NG (--07/98)

NL (--07/98)

Air filter

12-34 321 0022 | MAF0207

Notes

Inner diameter [mm]	199
Outer diameter [mm]	281
Height [mm]	564
	Filter Insert

References

81.08405.0030



Application info

HOCL (01/85-05/09)
SL II (--04/94)

SÜ (--06/97)

Fuel pump

12-34 009 0003 | MFP0026

Notes

Diesel
Manual

References

51.12101.7045	51.12101.7128
51.12101.7046	51.12101.7137
51.12101.7120	



Application info

TGA (04/00--)
TGL (04/05--)

TGM (10/05--)

034 009 0015 | MMX0197

Hand primer pump



Notes

Outer thread [mm]

M16x1,5
Manual

References

51.12150.7003
51.12150.7005

81.12150.6003
81.12150.6013

Application info

E 2000 [05/00--]
F 2000 [01/94-12/95]
F 90 [07/86-12/97]
F 90 Unterflur [07/86-05/94]
L 2000 [10/93-07/97]
LION'S COACH [09/95--]

LION'S STAR [01/93-09/96]
M 2000 L [08/95--]
M 90 [08/88-06/96]
SÜ [--06/97]
TGA [04/00--]

114 323 0001 | MFF0073

Fuel filter



Notes

Diameter [mm]
Height [mm]
Connecting thread

Steel
77
122
M16x1,5
Screw-on Filter

References

51.12503.0004
51.12503.0005
51.12503.0009
51.12503.0010
51.12503.0012
51.12503.0016

51.12503.0018
51.12503.0028
51.12503.0029
51.12503.0030
51.12503.0040

Application info

CLA [01/06--]
F 2000 [01/94-12/95]
F 90 [07/86-12/97]
F 90 Unterflur [07/86-05/94]
G [10/79-08/88]

G 90 [09/87-05/95]
L 2000 [10/93-07/97]
M 2000 L [08/95--]
M 2000 M [--12/05]
M 90 [08/88-06/96]

Fuel filter
12-14 323 0002 | MFF0244
Notes

Outer diameter [mm]	76
Height [mm]	230
	Filter Insert

References

51.12503.0037	51.12503.0056
51.12503.0042	82.12503.0042

Application info

F 2000 (01/94-12/95)
 LION´S COACH (09/95--)
 LION´S STAR (01/93-09/96)

SÜ (--06/97)
 TGA (04/00--)

Fuel filter
12-34 323 0012 | MFF0083
Notes

Outer diameter [mm]	76
Height [mm]	230
	Filter Insert

References

51.12503.0048

Application info

TGA (04/00--)

Fuel filter
12-34 323 0001 | MFF0078
Notes

	Steel
Outer diameter [mm]	76.5
Height [mm]	157
Connecting thread	M16x1,5
	Screw-on Filter

References

51.12503.0059	51.12503.0060
---------------	---------------



12-34 323 0001 | MFF0078

Fuel filter

Application info

EL (01/93-06/97)
EM (08/87-06/97)
L 2000 (10/93-07/97)
LION'S STAR (01/93-09/96)
M 2000 L (08/95--)
M 2000 M (--12/05)
M 90 (08/88-06/96)

NG (--07/98)
NL (--07/98)
NM (--03/97)
NÜ (09/96-07/98)
SM (11/87-02/95)
SÜ (--06/97)
ÜL (09/89-09/96)

12-34 323 0009 | MFF0082

Fuel filter



Notes

Outer diameter [mm]	50
Height [mm]	41
	Filter Insert

References

51.12503.0047	51.12503.0062
---------------	---------------

Application info

L 2000 (10/93-07/97)
M 2000 L (08/95--)
M 2000 M (--12/05)
TGA (04/00--)

TGL (04/05--)
TGM (10/05--)
TGX (09/07--)

12-34 323 0007 | MFF0081

Fuel filter



Notes

Diameter [mm]	46
Diameter [mm]	14
Outer diameter [mm]	95
Height [mm]	174
	Filter Insert

References

51.12503.0061	51.12503.0063
---------------	---------------

Application info

TGA (04/00--)
TGL (04/05--)
TGM (10/05--)

TGS (09/07--)
TGX (09/07--)

Fuel filter
014 323 0008 | MFF0018
Notes

Diameter [mm]	110
Height [mm]	219
Thread Size	1 1/4" UNF
Thread Measurement 1	3.3/4-10 UNF
	Screw-on Filter

References

51.12503.0051	51.12503.6000
---------------	---------------

Application info

EL [01/93-06/97]	NM [--03/97]
EM [08/87-06/97]	NÜ [09/96-07/98]
F 2000 [01/94-12/95]	R [05/85-01/93]
F 90 [07/86-12/97]	SD [04/74-04/94]
F 90 Unterflur [07/86-05/94]	SG [07/76-06/97]
G [10/79-08/88]	SL [05/80-04/87]
G 90 [09/87-05/95]	SL II [--04/94]
L 2000 [10/93-07/97]	SM [11/87-02/95]
LION´S COACH [09/95--]	SR [10/75-11/86]
LION´S COMFORT [09/96--]	SÜ [--06/97]
LION´S STAR [01/93-09/96]	TGA [04/00--]
M 2000 L [08/95--]	TGL [04/05--]
M 2000 M [--12/05]	TGM [10/05--]
M 90 [08/88-06/96]	TGS [09/07--]
NG [--07/98]	TGX [09/07--]
NL [--07/98]	ÜL [09/89-09/96]

Fuel filter
034 009 0003 | MFF0023
Notes

	Plastic
Diameter [mm]	36
Height [mm]	52
Connecting thread	M20x1,5
	Pre-filter

References

81.11101.6012	81.12102.0002
81.11101.6016	

Application info

CLA [01/06--]	NÜ [09/96-07/98]
E 2000 [05/00--]	R [05/85-01/93]
F 2000 [01/94-12/95]	SD [04/74-04/94]
M 2000 L [08/95--]	SG [07/76-06/97]
M 2000 M [--12/05]	SL [05/80-04/87]
M 90 [08/88-06/96]	SL II [--04/94]
NG [--07/98]	SM [11/87-02/95]
NL [--07/98]	SR [10/75-11/86]
NM [--03/97]	SÜ [--06/97]

034 323 0003 | MFF0245

Fuel filter



References

81.11101.6013	81.11101.6151
---------------	---------------

Application info

EM (08/87-06/97)
 F 2000 (01/94-12/95)
 F 90 (07/86-12/97)
 F 90 Unterflur (07/86-05/94)
 L 2000 (10/93-07/97)
 LION'S COACH (09/95--)
 LION'S STAR (01/93-09/96)

M 2000 L (08/95--)
 M 2000 M (--12/05)
 NM (--03/97)
 SM (11/87-02/95)
 SÜ (--06/97)
 TGA (04/00--)
 ÜL (09/89-09/96)

12-34 323 0006 | MFF0080

Fuel filter



Notes

Diameter [mm]	13.8
Outer diameter [mm]	83
Height [mm]	145
	Filter Insert

References

81.00000.0246	81.12503.0048
81.12503.0021	81.12503.0054
81.12503.0022	81.12503.0063
81.12503.0042	

Application info

EL (01/93-06/97)
 F 90 (07/86-12/97)
 F 90 Unterflur (07/86-05/94)
 SD (04/74-04/94)
 SG (07/76-06/97)

SL (05/80-04/87)
 SL II (--04/94)
 SÜ (--06/97)
 ÜL (09/89-09/96)

12-34 323 0005 | MFF0235

Fuel filter



Notes

Height [mm]	54
	Filter Insert

References

81.12501.0031	82.12503.0069
81.12503.0085	

Fuel filter
12-34 323 0005 | MFF0235
Application info

F 2000 (01/94-12/95)

TGA (04/00--)

Fuel filter
12-34 323 0003 | MFF0243
Notes

 Height [mm] 55
 Filter Insert

References

81.12501.0021	81.12503.0033
81.12501.0026	81.12503.0086
81.12501.0030	

Application info

 TGA (04/00--)
 TGS (09/07--)

TBX (09/07--)

Fuel filter
12-34 323 0004 | MFF0079
Notes

 Height [mm] 54
 Filter Insert

References

81.12501.0022	81.12503.0080
81.12501.0032	85.12501.0002
81.12501.0034	

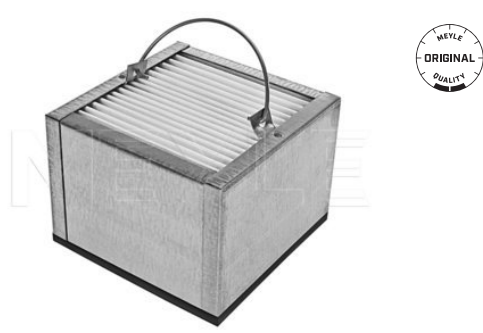
Application info

 CLA (01/06--)
 EM (08/87-06/97)
 L 2000 (10/93-07/97)
 LION'S COACH (09/95--)
 M 2000 L (08/95--)
 M 2000 M (--12/05)
 NG (--07/98)

 NL (--07/98)
 NM (--03/97)
 NÜ (09/96-07/98)
 SM (11/87-02/95)
 TGL (04/05--)
 TGM (10/05--)

12-34 323 0014 | MFF0270

Fuel filter



Notes

Height [mm] 54
Filter Insert

References

81.12501.0004 85.12501.0005
85.12501.0003

Application info

M 2000 L (08/95--)
M 2000 M (--12/05)

TGL (04/05--)

12-34 030 0004 | MEM0623

Engine mount



Notes

Outer diameter [mm] 96
Outer diameter [mm] 82
Height [mm] 91
Thread Size M12x1,5
Required quantity 2

Rubber-metal Bearing
Left and right
Front and Rear

References

81.41506.0096

Application info

HOCL (01/85-05/09)
L 2000 (10/93-07/97)
M 2000 L (08/95--)
M 90 (08/88-06/96)

SL II (--04/94)
SÜ (--06/97)
TGL (04/05--)

12-34 030 0007 | MEM0280

Engine mount



Notes

Inner diameter [mm] 22
Outer diameter [mm] 106
Outer diameter [mm] 70
Height [mm] 85
Required quantity 2

Rubber Bush
Elastomer
Left and right
Front

References

81.96020.0341 81.96020.0408
81.96020.0373

Engine mount

12-34 030 0007 | MEM0280

Application info

F 2000 (01/94-12/95)
F 90 (07/86-12/97)

TGA (04/00--)
TGX (09/07--)

Engine mount

12-34 030 0003 | MEM0278

Notes

Height [mm]
Width [mm]
Thread Size
Thread Size
Length [mm]
Required quantity

Rubber-metal Bearing
Steel Elastomer
174
126
M14X1,5
M18x1,5
180
2
Left and right
Front



References

81.96210.0562
81.96210.0571

81.96210.0575
81.96210.0577

Application info

HOCL (01/85-05/09)
LION´S COACH (09/95--)
TGA (04/00--)

TGS (09/07--)
TGX (09/07--)

Engine mount

12-34 030 0000 | MEM0275

Notes

Thread Size
Thread Size
Required quantity

Rubber-metal Bearing
Aluminium
M16x1,5
M14x1,5
2
Left and right
Front



References

81.96210.0525
81.96210.0553

81.96210.0574

Application info

LION´S COACH (09/95--)
LION´S STAR (01/93-09/96)

TGA (04/00--)

12-34 030 0002 | MEM0277

Engine mount



Notes

Bore Ø [mm]
Height [mm]
Width [mm]
Thread Size
Length [mm]
Required quantity

Rubber-metal Bearing
Steel Elastomer
15
160
120
M18x1,5
230
2
Left and right
Rear

References

81.96210.0572
81.96210.0592

81.96210.0597

Application info

HOCL (01/85-05/09)
LION´S COACH (09/95--)
TGA (04/00--)

TGS (09/07--)
TGX (09/07--)

12-34 030 0001 | MEM0276

Engine mount



Notes

Required quantity

Rubber-metal Bearing
Steel Elastomer
2
Left and right
Rear

References

81.96210.6065
81.96210.6071

81.96210.6072

Application info

LION´S COACH (09/95--)
LION´S STAR (01/93-09/96)

TGA (04/00--)

12-14 234 0027 | MRM0099

Radiator fan motor

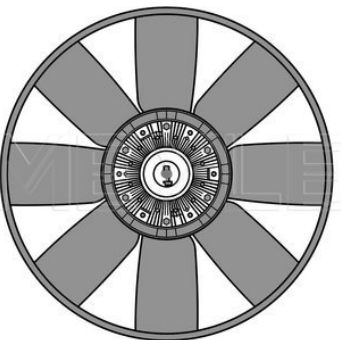

References

51.06600.7006

Radiator fan motor

12-14 234 0027 | MRM0099

Application info

TGA [04/00--]
TGL [04/05--]

TGM [10/05--]

Radiator fan motor

12-14 234 0014 | MRM0094

Notes

Electric

References

51.06600.7017
51.06600.7026
51.06600.7031

51.06600.7033
51.06600.7036
51.06601.7019

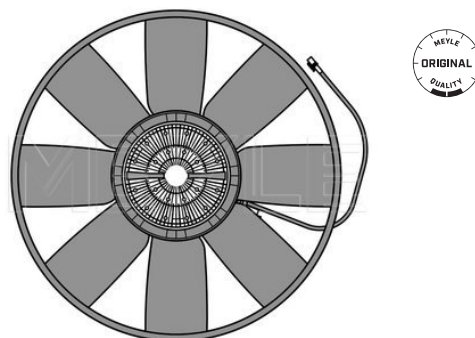

Application info

E 2000 [05/00--]
F 2000 [01/94-12/95]
TGA [04/00--]

TGS [09/07--]
TGX [09/07--]

Radiator fan motor

12-14 234 0029 | MRM0100

References

51.06600.7025

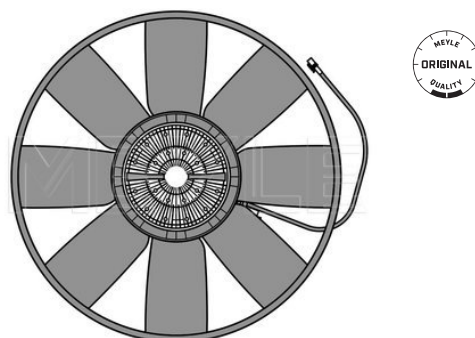

Application info

TGA [04/00--]
TGS [09/07--]

TGX [09/07--]

12-14 234 0025 | MRM0098

Radiator fan motor

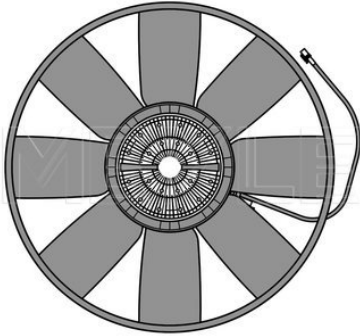

Notes

Number of Wings	9
Outer diameter [mm]	Electric 754

References

51.06600.7008	51.06600.7045
51.06600.7015	51.06600.9045

Application info

LION'S COACH (09/95--)
NG (--07/98)
NL (--07/98)

NÜ (09/96-07/98)
TGA (04/00--)
TGS (09/07--)
TGX (09/07--)

12-14 234 0018 | MRM0097

Radiator fan motor

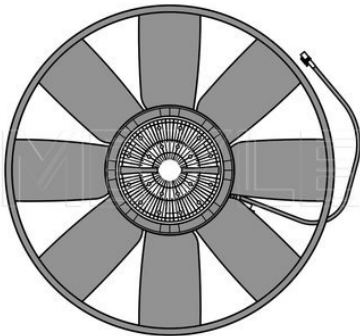

References

51.06601.7015

Application info

F 2000 (01/94-12/95)

TGA (04/00--)

12-14 223 0002 | MMX1451

Radiator cap



Notes

Pressure [bar]	0.7
----------------	-----

References

81.06111.0019	81.06111.0020
---------------	---------------

Radiator cap

12-14 223 0002 | MMX1451

Application info

CLA (01/06--)
EL (01/93-06/97)
EM (08/87-06/97)
F 2000 (01/94-12/95)
F 90 (07/86-12/97)
F 90 Unterflur (07/86-05/94)
L 2000 (10/93-07/97)
LION´S COACH (09/95--)
LION´S STAR (01/93-09/96)
M 2000 L (08/95--)

M 2000 M (--12/05)
M 90 (08/88-06/96)
NG (--07/98)
NL (--07/98)
NM (--03/97)
NÜ (09/96-07/98)
TGA (04/00--)
TGL (04/05--)
TGM (10/05--)
ÜL (09/89-09/96)

Fan clutch

12-14 234 0010 | MFC0068

Notes

Number of mounting bores	4
	Thermic
Diameter [mm]	186
Outer diameter [mm]	186
Depth [mm]	108
Hole Arrangement / Number	4

References

51.06630.0050 51.06630.0067

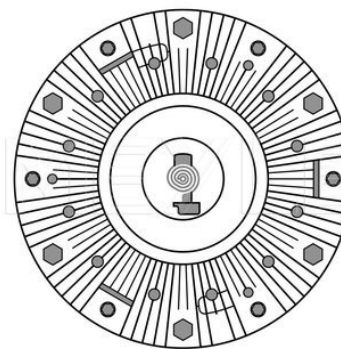

Application info

EM (08/87-06/97)
G 90 (09/87-05/95)
L 2000 (10/93-07/97)

M 90 (08/88-06/96)
TGL (04/05--)
TGM (10/05--)

Fan clutch

12-14 234 0011 | MFC0069

Notes

Number of mounting bores	6
	Thermic
Outer diameter [mm]	185
Depth [mm]	51
Hole Arrangement / Number	6

References

51.06630.0071

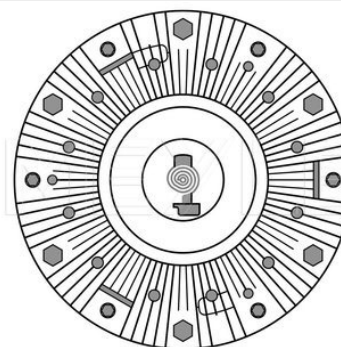

Application info

L 2000 (10/93-07/97)
M 2000 L (08/95--)

TGL (04/05--)

12-14 234 0009 | MFC0067

Fan clutch

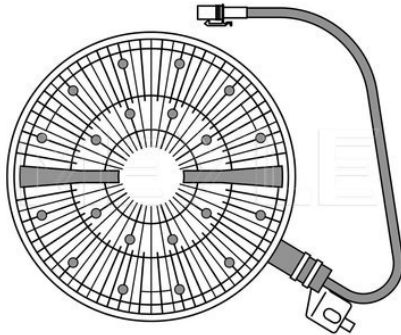

Notes

Number of mounting bores	6
	Electric
Outer diameter [mm]	236
Hole Arrangement / Number	4
Depth [mm]	138
Number of Poles	2

References

51.06630.0073	51.06630.0077
---------------	---------------

Application info

F 2000 [01/94-12/95]
LION'S CITY [08/04--]

LION'S COACH [09/95--]
TGA [04/00--]

12-14 234 0026 | MFC0119

Fan clutch

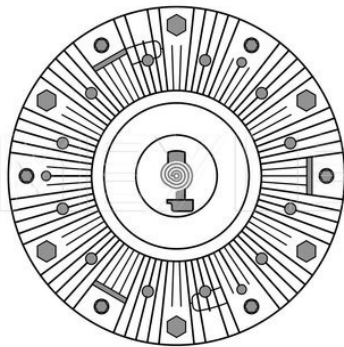

Notes

Number of mounting bores	4
	Thermic
Outer diameter [mm]	205
Depth [mm]	99

References

51.06630.0082

Application info

TGA [04/00--]
TGL [04/05--]

TGM [10/05--]

12-14 234 0030 | MFC0121

Fan clutch

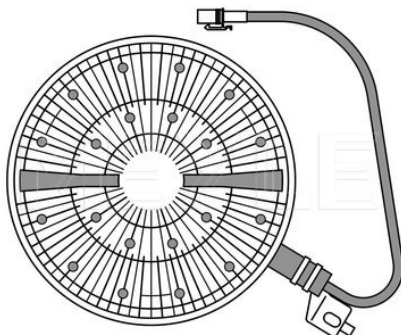

Notes

Number of mounting bores	6
	Electric
Outer diameter [mm]	190
Depth [mm]	128

References

51.06630.0094	51.06630.0117
51.06630.0113	

Application info

TGA [04/00--]
TGS [09/07--]

TGX [09/07--]

Fan clutch
12-14 234 0007 | MFC0063
Notes

Number of mounting bores	6
	Electric
Outer diameter [mm]	232
Hole Arrangement / Number	4
Depth [mm]	144
Number of Poles	2

References

51.06630.0076	51.06630.0115
51.06630.0108	

Application info

 E 2000 [05/00--]
 F 2000 [01/94-12/95]

TGA [04/00--]

Fan clutch
12-14 234 0031 | MFC0122
Notes

Number of mounting bores	6
	Electric
Outer diameter [mm]	240
Depth [mm]	132

References

51.06630.0124	51.06630.0127
---------------	---------------

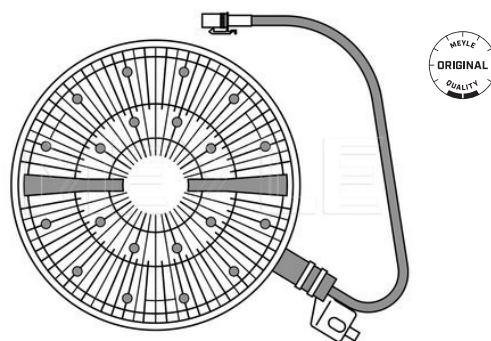
Application info

 TGA [04/00--]
 TGS [09/07--]

TGX [09/07--]

Fan clutch
12-14 234 0004 | MFC0062
Notes

Number of mounting bores	6
	Electric
Outer diameter [mm]	245
Hole Arrangement / Number	4
Depth [mm]	132
Number of Poles	2

References

51.06630.0096	51.06630.0129
---------------	---------------

Application info

TGA [04/00--]

12-14 234 0006 | MFC0049

Fan clutch



Notes

Number of mounting bores	6
	Electric
Outer diameter [mm]	245
Hole Arrangement / Number	4
Depth [mm]	161
Number of Poles	2

References

51.06630.0106	51.06630.0130
---------------	---------------

Application info

LION´S COACH (09/95--)
NG (--07/98)
NL (--07/98)

NÜ (09/96-07/98)
TGA (04/00--)
TGS (09/07--)
TGX (09/07--)

12-14 234 0005 | MFC0050

Fan clutch



Notes

Number of mounting bores	4
	Electric
Outer diameter [mm]	205
Hole Arrangement / Number	4
Depth [mm]	140
Number of Poles	2

References

51.06630.0107	51.06630.0131
---------------	---------------

Application info

TGA (04/00--)
TGS (09/07--)

TGX (09/07--)

12-14 234 0028 | MFC0120

Fan clutch



Notes

Number of mounting bores	4
	Electric
Outer diameter [mm]	246
Depth [mm]	165

References

51.06630.0119	51.06630.0140
51.06630.0136	

Application info

TGA (04/00--)
TGS (09/07--)

TGX (09/07--)

Fan blade

12-34 232 0001 | MMX0606

Notes

Number of Wings 9
Diameter [mm] 704

References

51.06601.0256



Application info

F 2000 [01/94-12/95]
F 90 [07/86-12/97]
F 90 Unterflur [07/86-05/94]
LION'S COACH [09/95--]

NG [--07/98]
NL [--07/98]
NÜ [09/96-07/98]

Fan blade

12-34 232 0002 | MMX0607

Notes

Number of Wings 9
Diameter [mm] 754

References

51.06601.0257



Application info

LION'S COACH [09/95--]
LION'S STAR [01/93-09/96]

TGA [04/00--]

Fan blade

12-34 232 0005 | MMX1388

Notes

Number of Wings 9
Outer diameter [mm] 704

References

51.06601.0263

Parts list

12-14 234 0007 | MFC0063 Fan clutch



12-34 232 0005 | MMX1388

Fan blade

Application info

E 2000 [05/00--]
F 2000 [01/94-12/95]
TGA [04/00--]

TGS [09/07--]
TGX [09/07--]

12-34 232 0014 | MMX1397

Fan blade

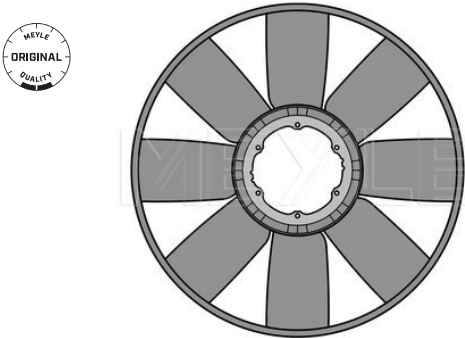

Notes

Number of Wings	8
Outer diameter [mm]	600

References

51.06601.0266

Application info

L 2000 [10/93-07/97]
M 2000 L [08/95--]

M 2000 M [--12/05]
TGL [04/05--]

12-34 232 0006 | MMX1389

Fan blade

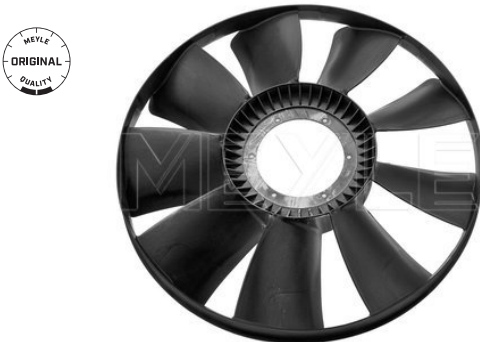

Notes

Number of Wings	9
Outer diameter [mm]	750

References

51.06601.0268

Application info

E 2000 [05/00--]
F 2000 [01/94-12/95]
TGA [04/00--]

TGS [09/07--]
TGX [09/07--]

Fan blade

12-34 020 0001 | MMX0595

Notes

Number of Wings 9
Diameter [mm] 750

References

51.06601.0275



Application info

TGA [04/00--] TGX [09/07--]
TGS [09/07--]

Fan blade

12-34 232 0018 | MMX1401

Notes

Number of Wings 9
Outer diameter [mm] 704

References

51.06601.0273 51.06601.0279



Application info

TGA [04/00--] TGX [09/07--]
TGS [09/07--]

Fan blade

12-34 232 0020 | MMX1403

Notes

Number of Wings 9

References

51.06601.0282

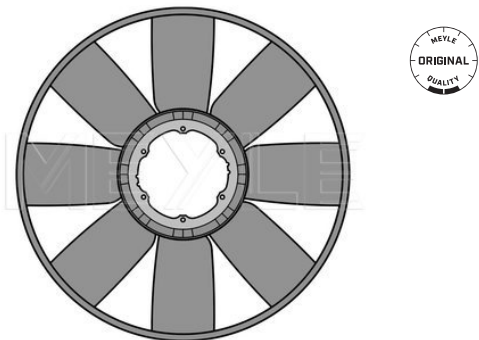

Application info

TGA [04/00--] TGX [09/07--]
TGS [09/07--]

12-34 232 0019 | MMX1402

Fan blade



Notes

Number of Wings 11
Outer diameter [mm] 750

References

51.06601.0283

Application info

TGA [04/00--]
TGS [09/07--]

TGX [09/07--]

14-34 232 0012 | MMX1361

Fan blade

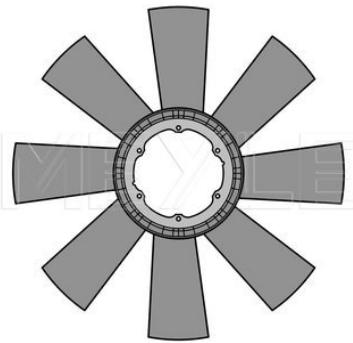

Notes

Number of Wings 7
Outer diameter [mm] 720

References

81.06601.0072

Application info

HOCL [01/85-05/09]
SL II [--04/94]

SÜ [--06/97]

033 020 0022 | MWP0053

Water pump



Notes

Impeller Diameter [mm] 125
Weight [kg] 10.36
for v-ribbed belt use
with seal
1-part housing
Metal impeller
without belt pulley

References

51.06500.6282 51.06500.6387
51.06500.6384 51.06500.9282

Parts list

028 280 0002 | MTH0017 Thermostat
028 283 0000 | MTH0025 Thermostat
12-28 265 0001 | MTH0091 Thermostat
12-28 279 0000 | MTH0049 Thermostat



Water pump

033 020 0022 | MWP0053

Application info

SD (04/74-04/94)
SL (05/80-04/87)

SÜ (--06/97)

Water pump

12-33 500 6408 | MWP0173

Notes

Weight [kg]	10.4 with seal 1-part housing without belt pulley 16
Diameter [mm]	

References

51.06500.6408	51.06500.9408
---------------	---------------

Parts list

028 271 0001 MTH0005	Thermostat
028 280 0002 MTH0017	Thermostat
028 283 0000 MTH0025	Thermostat
12-28 265 0001 MTH0091	Thermostat
12-28 279 0000 MTH0049	Thermostat



Application info

F 2000 (01/94-12/95)
F 90 (07/86-12/97)
F 90 Unterflur (07/86-05/94)

M 90 (08/88-06/96)
SÜ (--06/97)
ÜL (09/89-09/96)

Water pump

033 020 0043 | MWP0056

Notes

Impeller Diameter [mm]	for v-ribbed belt use 135
Weight [kg]	11.2 with seal 1-part housing Metal impeller without belt pulley

References

51.06500.6426

Parts list

028 271 0001 MTH0005	Thermostat
028 280 0002 MTH0017	Thermostat
028 283 0000 MTH0025	Thermostat
12-28 265 0001 MTH0091	Thermostat
12-28 279 0000 MTH0049	Thermostat



Application info

E 2000 (05/00--)
F 2000 (01/94-12/95)

TGA (04/00--)

033 020 0048 | MWP0059

Water pump



Notes

Impeller Diameter [mm]
Weight [kg]

for v-ribbed belt use
135
11.35
with seal
1-part housing
Metal impeller
without belt pulley

References

51.06500.6479

51.06500.9479

Parts list

028 271 0001 | MTH0005
028 280 0002 | MTH0017
028 283 0000 | MTH0025
12-28 265 0001 | MTH0091
12-28 279 0000 | MTH0049

Thermostat
Thermostat
Thermostat
Thermostat
Thermostat

Application info

F 90 [07/86-12/97]
F 90 Unterflur [07/86-05/94]
LION´S COACH [09/95--]
LION´S STAR [01/93-09/96]

NG [--07/98]
NL [--07/98]
SÜ [--06/97]

12-34 500 6495 | MWP0177

Water pump



Notes

Weight [kg]
Belt Pulley Ø [mm]

7.7
with seal
135

References

51.06500.6495

51.06500.9495

Application info

EM [08/87-06/97]
F 2000 [01/94-12/95]
L 2000 [10/93-07/97]
M 2000 L [08/95--]

M 90 [08/88-06/96]
NM [--03/97]
SM [11/87-02/95]

Water pump
12-34 500 6543 | MWP0178
Notes

 Weight [kg] 7.6
 with gaskets/seals
 Height [mm] 79.5

References

51.06500.6543 51.06500.9543

Application info

 EL (01/93-06/97)
 NG (--07/98)
 NL (--07/98)

 NM [--03/97]
 NÜ (09/96-07/98)

Water pump
12-33 500 0001 | MWP0172
Notes

 Weight [kg] 11.8
 with seal
 1-part housing
 Pulley

References

51.06500.6546 51.06500.9546

Parts list

 028 283 0000 | MTH0025 Thermostat
 12-28 279 0000 | MTH0049 Thermostat

Application info

 F 2000 (01/94-12/95)
 F 90 (07/86-12/97)

F 90 Unterflur (07/86-05/94)

Water pump
12-33 500 6547 | MWP0175
Notes

 Weight [kg] 11.7
 with seal
 1-part housing
 with belt pulley

References

 51.06500.6545 51.06500.9545
 51.06500.6547 51.06500.9547

Parts list

 028 283 0000 | MTH0025 Thermostat
 12-28 265 0001 | MTH0091 Thermostat
 12-28 279 0000 | MTH0049 Thermostat

12-33 500 6547 | MWP0175

Water pump

Application info

F 2000 (01/94-12/95)
F 90 (07/86-12/97)

F 90 Unterflur (07/86-05/94)

12-33 500 6548 | MWP0547

Water pump



Notes

Weight [kg]	12
Number of Wings	12 with seal

References

51.06500.6548	51.06500.9548
---------------	---------------

Parts list

028 283 0000 MTH0025	Thermostat
12-28 265 0001 MTH0091	Thermostat
12-28 279 0000 MTH0049	Thermostat

Application info

E 2000 (05/00--)
F 90 (07/86-12/97)
LION'S COACH (09/95--)
NG (--07/98)
NL (--07/98)

NÜ (09/96-07/98)
TGA (04/00--)
TGS (09/07--)
TGX (09/07--)

12-33 220 0003 | MWP0521

Water pump



Notes

Weight [kg]	12.25 with seal
Height [mm]	127

References

51.06500.6616	51.06500.9616
---------------	---------------

Parts list

028 283 0000 MTH0025	Thermostat
12-28 265 0001 MTH0091	Thermostat
12-28 279 0000 MTH0049	Thermostat

Application info

TGA (04/00--)

TGX (09/07--)

Water pump
12-34 500 6646 | MWP0181
Notes

 Weight [kg] 2.85
 Number of Wings 8
 with seal

References

 51.06500.6646 51.06500.9050
 51.06500.6676 51.06500.9646
 51.06500.7050

Application info

 NG [--07/98] NÜ [09/96-07/98]
 NL [--07/98]

Water pump
12-34 500 6612 | MWP0179
Notes

 Weight [kg] 8.1
 with seal
 without belt pulley

References

 51.06500.6606 51.06500.9606
 51.06500.6612 51.06500.9612
 51.06500.6669 51.06500.9669

Application info

 EM [08/87-06/97] M 90 [08/88-06/96]
 L 2000 [10/93-07/97] NM [--03/97]
 M 2000 L [08/95--] SM [11/87-02/95]
 M 2000 M [--12/05]

Water pump
12-34 500 6642 | MWP0180
Notes

 Weight [kg] 3.3
 Number of Wings 8
 with seal

References

 51.06500.6642 51.06500.9642
 51.06500.6675 51.06500.9694
 51.06500.6694

12-34 500 6642 | MWP0180

Water pump

Application info

L 2000 (10/93-07/97)
M 2000 L (08/95--)
M 90 (08/88-06/96)

TGA (04/00--)
TGS (09/07--)
TGX (09/07--)

12-34 220 0004 | MWP0531

Water pump



Notes

Weight [kg] 3.4
with seal

References

51.06500.6587 51.06500.7070
51.06500.6651 51.06500.7079
51.06500.6680 51.06500.9079

Application info

TGL (04/05--)

TGM (10/05--)

12-14 234 0003 | MWP0170

Water pump



Notes

Impeller Diameter [mm] 135
Weight [kg] 4.1
for v-ribbed belt use
with seal
1-part housing
Metal impeller
without belt pulley

References

51.06500.6637 51.06500.9049
51.06500.7049

Application info

TGA (04/00--)
TGS (09/07--)

TGX (09/07--)

Water pump

12-34 500 7064 | MWP0522

Notes

Weight [kg] 3.3
Number of Wings 8
with seal

References

51.06500.6679 51.06500.9078
51.06500.7064 51.06500.9679
51.06500.7078 51.06500.9699
51.06500.9064



Application info

FOCL (---) M 2000 L (08/95--)
HOCL (01/85-05/09) TGA (04/00--)
L 2000 (10/93-07/97)

Water pump

12-33 220 0001 | MWP0171

Notes

Weight [kg] 10.4
with seal
1-part housing
without belt pulley

References

51.06500.7033 51.06500.7065
51.06500.7036 51.06500.7066
51.06500.7043 51.06500.7089
51.06500.7045 51.06500.9048
51.06500.7047 51.06500.9052
51.06500.7048 51.06500.9066
51.06500.7051 51.06500.9089
51.06500.7052 51.06500.9548



Application info

F 2000 (01/94-12/95) TGA (04/00--)

Thermostat

028 283 0000 | MTH0025

Notes

Opening Temperature [°C] with seal
83

References

51.06402.0058 51.06402.0063
51.06402.0060 51.06402.0066



028 283 0000 | MTH0025

Thermostat

Application info

CLA [01/06--]
EL [01/93-06/97]
F 2000 [01/94-12/95]
F 90 [07/86-12/97]
F 90 Unterflur [07/86-05/94]
LION´S COACH [09/95--]
LION´S COMFORT [09/96--]
LION´S STAR [01/93-09/96]
M 90 [08/88-06/96]
NG [--07/98]

NL [--07/98]
NÜ [09/96-07/98]
SD [04/74-04/94]
SG [07/76-06/97]
SL [05/80-04/87]
SR [10/75-11/86]
SÜ [--06/97]
TGA [04/00--]
ÜL [09/89-09/96]

12-28 279 0000 | MTH0049

Thermostat



Notes

Opening Temperature [°C] with seal
79

References

51.06402.0034	51.06402.0061
51.06402.0050	51.06402.0064
51.06402.0056	51.06402.0067

Application info

CLA [01/06--]
EL [01/93-06/97]
EM [08/87-06/97]
F 2000 [01/94-12/95]
F 90 [07/86-12/97]
F 90 Unterflur [07/86-05/94]
G [10/79-08/88]
G 90 [09/87-05/95]
L 2000 [10/93-07/97]
LION´S COACH [09/95--]
LION´S COMFORT [09/96--]
LION´S STAR [01/93-09/96]
M 2000 L [08/95--]

M 2000 M [--12/05]
M 90 [08/88-06/96]
NG [--07/98]
NL [--07/98]
NM [--03/97]
NÜ [09/96-07/98]
R [05/85-01/93]
SG [07/76-06/97]
SM [11/87-02/95]
SR [10/75-11/86]
SÜ [--06/97]
TGA [04/00--]
ÜL [09/89-09/96]

028 271 0011 | MTH0010

Thermostat



Notes

Opening Temperature [°C] with seal
71

References

51.06402.0057	51.06402.0065
51.06402.0062	51.06402.0068

Thermostat

028 271 0011 | MTH0010

Application info

F 90 (07/86-12/97)
LION'S CITY (08/04--)
LION'S COACH (09/95--)

LION'S STAR (01/93-09/96)
M 2000 M (--12/05)

Expansion tank

12-14 223 0001 | MET0037

Notes

Opening Pressure [bar]

Transparent
0.7
PP (Polypropylene)
321
108
743
8
with sensor
with filler cap
Front

Width [mm]
Depth [mm]
Length [mm]
Capacity [Litre]

References

81.06102.6110
81.06102.6112
81.06102.6205

81.06102.6209
81.06102.6222
81.06102.6227

Parts list

12-14 223 0002 | MMX1451
039 238 0001 | MMX0290

Radiator cap
Expansion tank cap



Application info

E 2000 (05/00--)

F 2000 (01/94-12/95)

Expansion tank

12-14 223 0004 | MET0039

Notes

Opening Pressure [bar]

Transparent
0.7
PP (Polypropylene)
321
130
742
8.4
without sensor
with filler cap
Front

Width [mm]
Depth [mm]
Length [mm]
Capacity [Litre]

References

81.06102.6098
81.06102.6099
81.06102.6201

81.06102.6202
81.06102.6218

Parts list

12-14 223 0002 | MMX1451
039 238 0001 | MMX0290

Radiator cap
Expansion tank cap



12-14 223 0004 | MET0039

Expansion tank

Application info

E 2000 (05/00--)
EL (01/93-06/97)
F 2000 (01/94-12/95)
F 90 (07/86-12/97)
F 90 Unterflur (07/86-05/94)
HOCL (01/85-05/09)
LION´S COACH (09/95--)
LION´S STAR (01/93-09/96)

NG (--07/98)
NL (--07/98)
NM (--03/97)
NÜ (09/96-07/98)
SÜ (--06/97)
TGA (04/00--)
ÜL (09/89-09/96)

12-14 223 0005 | MET0040

Expansion tank



Notes

Opening Pressure [bar] 0.7
Width [mm] 321
Depth [mm] 130
Length [mm] 742
Capacity [Litre] 5.6
without sensor
with filler cap
Front

References

81.06102.6109 81.06102.6219
81.06102.6204

Parts list

12-14 223 0002 | MMX1451 Radiator cap
039 238 0001 | MMX0290 Expansion tank cap

Application info

F 90 (07/86-12/97)

F 90 Unterflur (07/86-05/94)

12-14 223 0006 | MET0041

Expansion tank

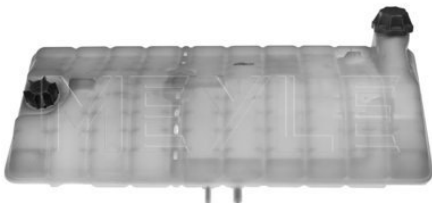

Notes

Opening Pressure [bar] 0.7
Width [mm] 321
Depth [mm] 130
Length [mm] 742
Capacity [Litre] 5.6
without sensor
with filler cap
Front

References

81.06102.6089 81.06102.6203
81.06102.6100 81.06102.6220

Parts list

12-14 223 0002 | MMX1451 Radiator cap
039 238 0001 | MMX0290 Expansion tank cap

Expansion tank

12-14 223 0006 | MET0041

Application info

M 2000 M [--12/05]

Expansion tank

12-14 223 0003 | MET0038

Notes

Opening Pressure [bar]	Black 0.7
Width [mm]	PP (Polypropylene) 321
Depth [mm]	142
Length [mm]	743
Capacity [Litre]	14 without sensor with filler cap Front



References

81.06102.6117	81.06102.6221
81.06102.6206	81.06102.6226
81.06102.6208	

Parts list

12-14 223 0002 MMX1451	Radiator cap
039 238 0001 MMX0290	Expansion tank cap

Application info

E 2000 [05/00--]
F 2000 [01/94-12/95]

TGA [04/00--]

Sender unit, coolant temperature

12-28 279 0002 | MEX0603

Notes

Thread Size	M14 x 1,5
Switch Point [°C]	100

References

51.27420.0074	81.27421.0125
81.27421.0099	



Application info

EL [01/93-06/97]
EM [08/87-06/97]
F 2000 [01/94-12/95]
F 90 [07/86-12/97]
F 90 Unterflur [07/86-05/94]
L 2000 [10/93-07/97]
LION´S COMFORT [09/96--]
M 2000 L [08/95--]
M 2000 M [--12/05]

M 90 [08/88-06/96]
NG [--07/98]
NL [--07/98]
NM [--03/97]
NÜ [09/96-07/98]
SG [07/76-06/97]
SM [11/87-02/95]
SÜ [--06/97]
ÜL [09/89-09/96]

12-34 223 0001 | MEX0358

Sensor, coolant level



Notes

Operating voltage [V]	Passive sensor
Number of Poles	24
	2

References

81.27421.0152	81.27421.0169
---------------	---------------

Application info

F 2000 (01/94-12/95)
L 2000 (10/93-07/97)

LION'S COACH (09/95--)
M 2000 L (08/95--)

12-34 223 0002 | MEX0588

Sensor, coolant level



Notes

Operating voltage [V]	Active sensor
Length [mm]	24
Number of Poles	127
	2

References

81.27421.0195	81.27421.0232
---------------	---------------

Application info

F 2000 (01/94-12/95)
LION'S COACH (09/95--)
LION'S STAR (01/93-09/96)

NL (--07/98)
TGA (04/00--)

039 238 0001 | MMX0290

Expansion tank cap



Notes

Pressure [bar]	Green
Diameter [mm]	Round
	0.45
	76

References

81.06111.0018

Expansion tank cap

039 238 0001 | MMX0290

Application info

E 2000 (05/00--)	TGA (04/00--)
F 2000 (01/94-12/95)	TGL (04/05--)
F 90 (07/86-12/97)	TGM (10/05--)
F 90 Unterflur (07/86-05/94)	TGS (09/07--)
M 90 (08/88-06/96)	TGX (09/07--)

Radiator hose

12-39 222 0026 | MRH0231

Notes

	MVQ (Silicone Elastomer)
Inner diameter [mm]	60
Outer diameter [mm]	68
Length [mm]	1000

References

04.27405.0601	04.27405.9360
04.27405.9160	N1.01100.8494



Application info

F 2000 (01/94-12/95)	TGL (04/05--)
L 2000 (10/93-07/97)	TGM (10/05--)
M 2000 L (08/95--)	TGS (09/07--)
M 2000 M (--12/05)	TGX (09/07--)
TGA (04/00--)	

Radiator hose

12-39 222 0019 | MRH0229

Notes

	Rubber with textile reinforcement
Inner diameter [mm]	10
Outer diameter [mm]	18
Length [mm]	2000

References

04.27405.9502	04.27405.9510
---------------	---------------



Application info

CLA (01/06--)	TGM (10/05--)
F 2000 (01/94-12/95)	TGS (09/07--)
TGA (04/00--)	TGX (09/07--)
TGL (04/05--)	

12-39 222 0014 | MRH0224

Radiator hose



Notes

from engine to engine cooler
Rubber with textile reinforcement

Inner diameter [mm]
Outer diameter [mm]

48
58

References

81.96301.0581

81.96301.0676

Application info

L 2000 [10/93-07/97]

12-39 222 0015 | MRH0225

Radiator hose



Notes

from engine to engine cooler
with angled water pipe
Rubber with textile reinforcement

Inner diameter [mm]
Outer diameter [mm]

55
67

References

81.96301.0582

81.96301.0621

Application info

L 2000 [10/93-07/97]

12-39 222 0001 | MRH0214

Radiator hose



Notes

from expansion tank to water
pipe
Rubber with textile reinforcement

Inner diameter [mm]
Outer diameter [mm]

58
68

References

81.96301.0496
81.96301.0659

82.96301.0008

Application info

F 2000 [01/94-12/95]
F 90 [07/86-12/97]

TGA [04/00--]
TGX [09/07--]

Radiator hose

12-39 222 0005 | MRH0217

Notes

Inner diameter [mm]
Outer diameter [mm]

from engine to engine cooler
Rubber with textile reinforcement
58
68

References

81.96301.0677



Application info

TGA [04/00--]
TGS [09/07--]

TGX [09/07--]

Radiator hose

12-39 222 0018 | MRH0228

Notes

Inner diameter [mm]
Outer diameter [mm]

from engine to engine cooler
Rubber with textile reinforcement
60
70

References

81.96301.0679



Application info

TGA [04/00--]

Radiator hose

12-39 222 0017 | MRH0227

Notes

Inner diameter [mm]
Outer diameter [mm]

from radiator to water pipe
Rubber with textile reinforcement
60
70

References

81.96301.0680



Application info

TGA [04/00--]

12-39 222 0008 | MRH0220

Radiator hose



Notes

Inner diameter [mm]
Outer diameter [mm]

from radiator to intermediate piece
Rubber with textile reinforcement
58
68
Lower

References

81.96301.0892

Application info

TGA [04/00--]
TGS [09/07--]

TGX [09/07--]

12-39 222 0007 | MRH0219

Radiator hose



Notes

Inner diameter [mm]
Outer diameter [mm]

from radiator to water pipe
Rubber with textile reinforcement
58
68
Lower

References

81.96301.0893

81.96301.0961

Application info

F 2000 [01/94-12/95]
TGA [04/00--]

TGS [09/07--]
TGX [09/07--]

12-39 222 0006 | MRH0218

Radiator hose



Notes

Inner diameter [mm]
Outer diameter [mm]

from engine to engine cooler
Rubber with textile reinforcement
58
68
Lower

References

81.96301.0898

82.96301.0006

Application info

TGA [04/00--]

TGX [09/07--]

Radiator hose

12-39 222 0003 | MRH0215

Notes

with angled water pipe
from expansion tank to en-
gine cooler
Rubber with textile reinforce-
ment
50
60
Lower

Inner diameter [mm]
Outer diameter [mm]

References

81.96305.0088



Application info

F 90 [07/86-12/97]

Radiator hose

12-39 222 0004 | MRH0216

Notes

from expansion tank to water
pipe
with angled water pipe
Rubber with textile reinforce-
ment
58
68

Inner diameter [mm]
Outer diameter [mm]

References

81.96305.0129



Application info

F 2000 [01/94-12/95]

Radiator hose

12-39 222 0013 | MRH0223

Notes

from engine to water pipe
FPM [fluoride rubber]/ACM
[polyacrylate rubber]
60
70

Inner diameter [mm]
Outer diameter [mm]

References

51.96305.0018
51.96305.0021
81.96305.0095

81.96305.0134
81.96305.0223
81.96305.0226



12-39 222 0013 | MRH0223

Radiator hose

Application info

F 2000 (01/94-12/95)
F 90 (07/86-12/97)
F 90 Unterflur (07/86-05/94)
LION'S COACH (09/95--)
LION'S STAR (01/93-09/96)
NG (--07/98)

NL (--07/98)
NÜ (09/96-07/98)
TGA (04/00--)
TGX (09/07--)
ÜL (09/89-09/96)

12-39 222 0016 | MRH0226

Radiator hose



Notes

from expansion tank to engine cooler
Rubber with textile reinforcement
21
31

Inner diameter [mm]
Outer diameter [mm]

References

81.96305.0166

Application info

TGA (04/00--)

12-39 222 0020 | MRH0230

Radiator hose



Notes

from expansion tank to distributor
Rubber with textile reinforcement
10
18

Inner diameter [mm]
Outer diameter [mm]

References

81.96305.0130

81.96305.0169

Application info

F 2000 (01/94-12/95)

TGA (04/00--)



Radiator hose

12-39 222 0009 | MRH0221

Notes

Inner diameter [mm]
Outer diameter [mm]

from engine to water pipe
Rubber with textile reinforcement
57
68

References

81.96305.0227



Application info

TGA [04/00--]

TGX [09/07--]

Radiator hose

12-39 222 0011 | MRH0222

Notes

Inner diameter [mm]
Outer diameter [mm]

from connecting pipe to
engine cooler
Rubber with textile reinforcement
58
68
Lower

References

81.96305.0230



Application info

TGA [04/00--]

TGS [09/07--]

TGX [09/07--]

Belt tensioner

12-34 000 1002 | MBT0032

Notes

Outer diameter [mm]
Height [mm]

74
90

References

51.95800.7437

51.95800.7479



Application info

TGA [04/00--]

TGL [04/05--]

TGM [10/05--]

12-34 000 1003 | MBT0033

Belt tensioner



Notes

Outer diameter [mm]	74
Height [mm]	84

References

51.95800.7428	51.95800.7459
51.95800.7429	51.95800.7477
51.95800.7436	

Application info

TGA [04/00--]
TGS [09/07--]

TGX [09/07--]

12-34 000 0003 | MTR0042

Tension roller, ribbed belt



Notes

Outer diameter [mm]	85
Width [mm]	46.5

References

51.95800.5001

Application info

EL [01/93-06/97]
EM [08/87-06/97]
HOCL [01/85-05/09]
LION'S CITY [08/04--]
M 2000 L [08/95--]
NM [--03/97]
NÜ [09/96-07/98]

SL [05/80-04/87]
SÜ [--06/97]
TGA [04/00--]
TGL [04/05--]
TGM [10/05--]
TGS [09/07--]
TGX [09/07--]

12-34 000 1101 | MTR0043

Tension roller, ribbed belt



Notes

Outer diameter [mm]	74
Width [mm]	42

References

51.95800.6061	51.95800.6075
---------------	---------------

Tension roller, ribbed belt

12-34 000 1101 | MTR0043

Application info

LION´S COACH (09/95--)
LION´S STAR (01/93-09/96)
NG (--07/98)

NL (--07/98)
NÜ (09/96-07/98)
ÜL (09/89-09/96)

Tension roller, ribbed belt

12-34 000 1004 | MTR0022

Notes

Inner diameter [mm]	20
Outer diameter [mm]	74
Height [mm]	28.3

References

51.95800.6087



Application info

LION´S COACH (09/95--)

LION´S STAR (01/93-09/96)

Tension roller, ribbed belt

12-34 000 1100 | MTR0023

Notes

Inner diameter [mm]	20
Outer diameter [mm]	74
Height [mm]	34

References

51.95800.6076	51.95800.6099
51.95800.6092	



Application info

TGA (04/00--)
TGL (04/05--)
TGM (10/05--)

TGS (09/07--)
TGX (09/07--)

Ø52 Ø13 1525 | MVB0224

V-belt

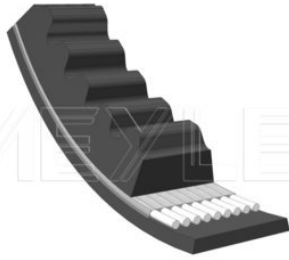

Notes

Width [mm]	13
Length [mm]	1525

References

06.58042.0242	06.58073.2421
06.58043.0242	6.58041.0242
06.58043.2242	6.58043.0242
06.58047.2242	6.58043.2242
06.58072.2422	6.58072.2421

Application info

M 90 [08/88-06/96]

Ø52 Ø13 1050 | MVB0188

V-belt

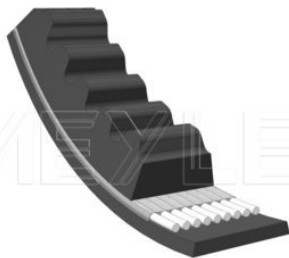

Notes

Width [mm]	13
Length [mm]	1050

References

06.58043.0223	6.58072.2231
06.58072.2231	

Application info

M 90 [08/88-06/96]

Ø52 Ø13 1450 | MVB0221

V-belt

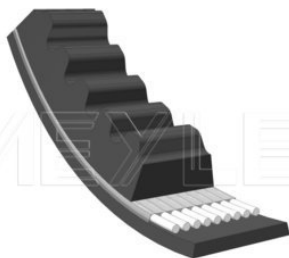

Notes

Width [mm]	13
Length [mm]	1450

References

06.58043.0239	06.58072.2391
06.58043.2239	06.58072.2392
06.58046.0239	06.58073.2391
06.58046.2239	

Application info

F 2000 [01/94-12/95]
F 90 [07/86-12/97]

F 90 Unterflur [07/86-05/94]
M 90 [08/88-06/96]



V-belt

052 010 1250 | MVB0097

Notes

Width [mm]	10
Length [mm]	1250

References

06.58043.2131

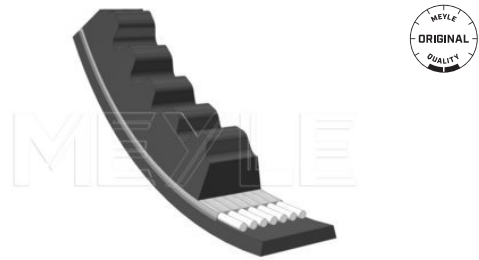

Application info

L 2000 (10/93-07/97)

V-belt

052 013 1600 | MVB0228

Notes

Width [mm]	13
Length [mm]	1600

References

06.58043.2245	51.96820.6001
06.58072.2452	51.96820.6027
51.96820.3001	

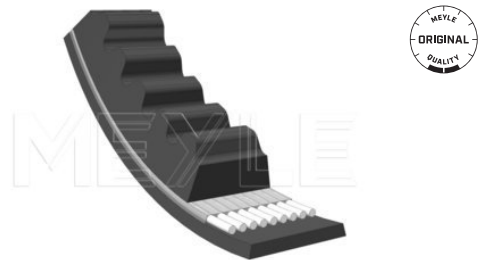

Application info

R (05/85-01/93)
SG (07/76-06/97)

SÜ (--06/97)

V-belt

052 013 1000 | MVB0183

Notes

Width [mm]	13
Length [mm]	1000

References

06.58043.0221	65.80430.221
06.58072.2211	

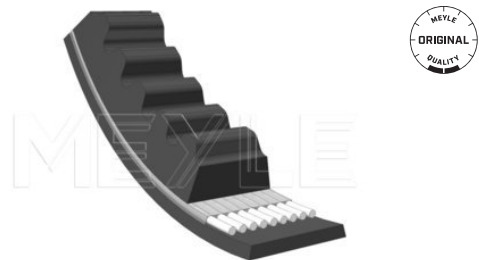

Application info

M 90 (08/88-06/96)

Ø52 Ø10 Ø975 | MVB0063

V-belt

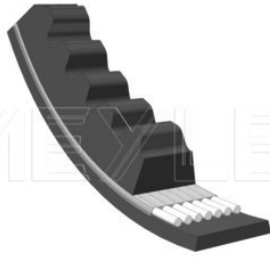

Notes

Width [mm]	10
Length [mm]	975

References

Ø6.58043.0120	6.58043.0120
Ø6.58072.1201	6.58043.2120
Ø6.58073.1201	6.58072.1201

Application info

M 90 [08/88-06/96]

Ø52 Ø10 1075 | MVB0079

V-belt

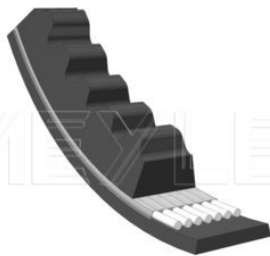

Notes

Width [mm]	10
Length [mm]	1075

References

Ø6.58073.1241	6.58043.2124
6.58043.0124	6.58072.1241

Application info

M 90 [08/88-06/96]

Ø52 Ø10 1100 | MVB0082

V-belt

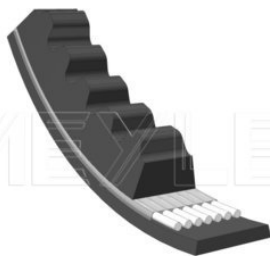

Notes

Width [mm]	10
Length [mm]	1100

References

Ø6.58047.0125	6580 432 125
Ø6.58073.1251	6580 470 125
6580 430 125	6580 721 251

Application info

M 90 [08/88-06/96]



V-belt

052 010 1380 | MVB0108

Notes

Width [mm]	10
Length [mm]	1380

References

06.58073.1361	6.58043.2136
06.58073.1362	6.58072.1361
6.58043.0136	

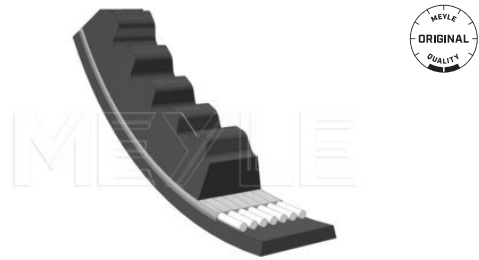

Application info

M 2000 L (08/95--)

M 2000 M (--12/05)

V-belt

052 010 1375 | MVB0107

Notes

Width [mm]	10
Length [mm]	1375

References

06.58073.1361	06.58073.1362
---------------	---------------

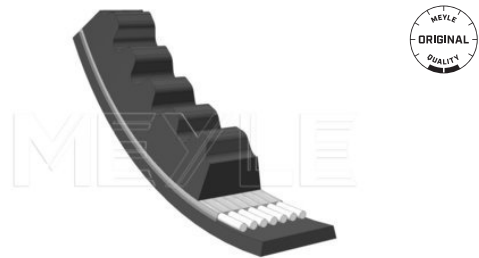

Application info

M 2000 L (08/95--)

M 2000 M (--12/05)

V-belt

052 010 1425 | MVB0110

Notes

Width [mm]	10
Length [mm]	1425

References

06.58072.1361	06.58073.1381
06.58072.1381	51.96820.0132

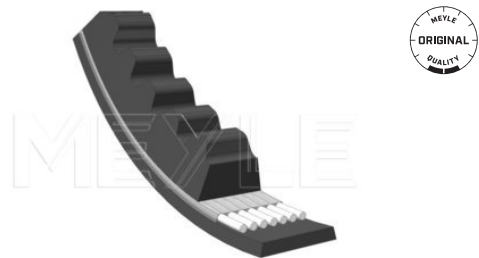

Application info

G (10/79-08/88)

Ø52 Ø10 1500 | MVB0113

V-belt

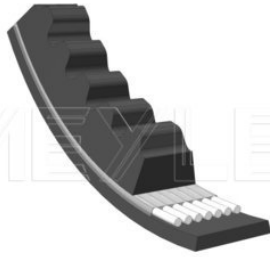

Notes

Width [mm] 10
Length [mm] 1500

References

06.58073.1412

Application info

F 2000 (01/94-12/95)

Ø52 Ø13 1155 | MVB0201

V-belt

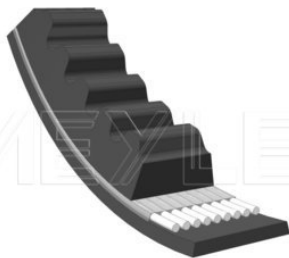

Notes

Width [mm] 13
Length [mm] 1155

References

06.58073.2272

Application info

EL (01/93-06/97)
LION'S COACH (09/95--)
LION'S COMFORT (09/96--)
NG (--07/98)
NL (--07/98)
NÜ (09/96-07/98)

R (05/85-01/93)
SD (04/74-04/94)
SG (07/76-06/97)
SL II (--04/94)
ÜL (09/89-09/96)

Ø52 Ø13 1500 | MVB0223

V-belt

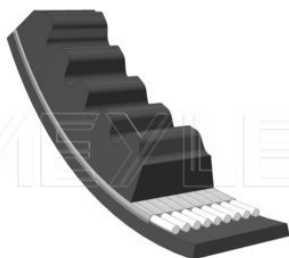

Notes

Width [mm] 13
Length [mm] 1500

References

06.58043.0241 6.58041.0241
06.58045.0241 6.58041.2241
06.58047.2241 6.58043.0241
06.58072.2412 6.58043.2241
06.58073.2411

V-belt

052 013 1500 | MVB0223

Application info

M 90 (08/88-06/96)

V-belt

052 013 1475 | MVB0222

Notes

Width [mm] 13
Length [mm] 1475

References

06.58042.2240	06.58072.2402
06.58045.0240	06.58073.2401
06.58072.2401	51.96820.0128

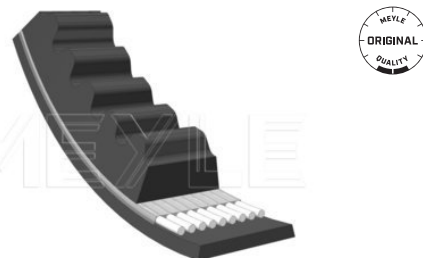

Application info

F 90 (07/86-12/97)
F 90 Unterflur (07/86-05/94)

M 90 (08/88-06/96)

V-belt

052 013 1550 | MVB0226

Notes

Width [mm] 13
Length [mm] 1550

References

06.58043.0243	06.58072.2433
06.58043.2243	06.58073.2431
06.58047.2243	51.96820.0143
06.58072.2431	51.96820.0153
06.58072.2432	

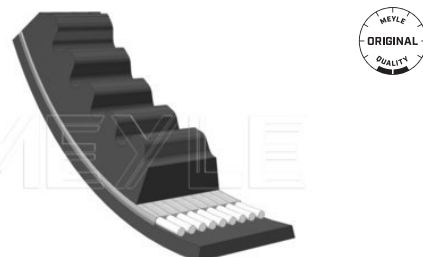

Application info

F 90 (07/86-12/97)

V-ribbed belt

050 008 0880 | MRB0643

Notes

	EPDM (ethylene propylene diene Monomer (M-class) rubber)
Width [mm]	28
Number of Ribs	8
Length [mm]	880
	One-sided

References

51.96820.0238

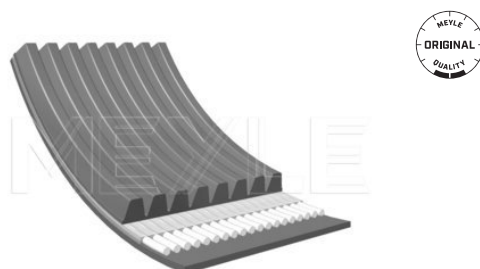

050 008 0880 | MRB0643

V-ribbed belt

Application info

F 2000 [01/94-12/95]
TGA [04/00--]

TGX [09/07--]

050 008 1376 | MRB0656

V-ribbed belt

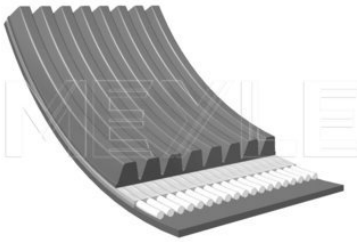

Notes

Width [mm]
Number of Ribs
Length [mm]

EPDM (ethylene propylene diene Monomer [M-class] rubber)
28
8
1376
One-sided

References

51.96820.0239

Application info

E 2000 [05/00--]
F 2000 [01/94-12/95]

TGA [04/00--]

050 008 1275 | MRB0655

V-ribbed belt

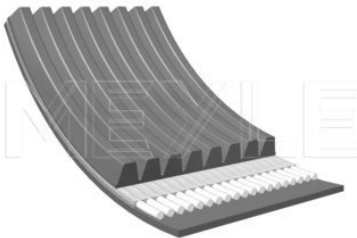

Notes

Width [mm]
Number of Ribs
Length [mm]

EPDM (ethylene propylene diene Monomer [M-class] rubber)
28
8
1275
One-sided

References

51.96820.0243
51.96820.0257

51.96820.0280

Application info

TGA [04/00--]
TGL [04/05--]

TGS [09/07--]
TGX [09/07--]



V-ribbed belt

050 010 1980 | MRB0723

Notes

Width [mm]
Number of Ribs
Length [mm]

EPDM (ethylene propylene diene Monomer [M-class] rubber)
35
10
1980
One-sided

References

51.96820.0248

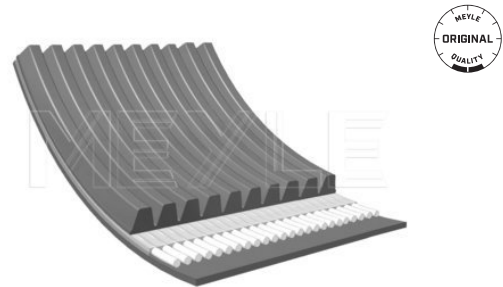

Application info

LION'S CITY (08/04--)
NG (--07/98)
NL (--07/98)

NÜ (09/96-07/98)
SÜ (--06/97)
ÜL (09/89-09/96)

V-ribbed belt

050 012 1515 | MRB0727

Notes

Width [mm]
Number of Ribs
Length [mm]

EPDM (ethylene propylene diene Monomer [M-class] rubber)
42
12
1515
One-sided

References

51.96820.0250

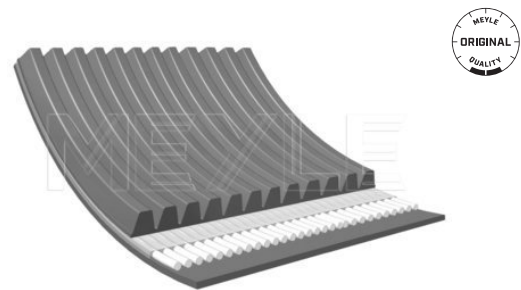

Application info

TGA (04/00--)

TGL (04/05--)

V-ribbed belt

050 004 0790 | MRB0077

Notes

Width [mm]
Number of Ribs
Length [mm]

EPDM (ethylene propylene diene Monomer [M-class] rubber)
14
4
790
One-sided

References

51.96820.0251

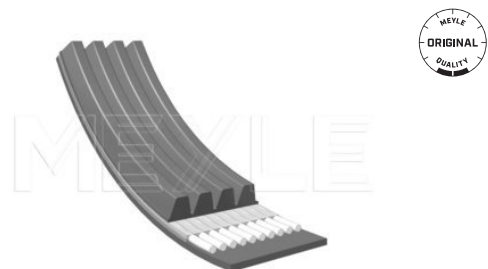

Application info

EL (01/93-06/97)

050 005 1482 | MRB0274

V-ribbed belt

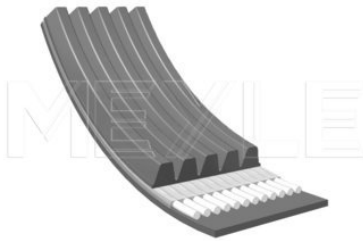

Notes

Width [mm]
Number of Ribs
Length [mm]

EPDM (ethylene propylene diene Monomer [M-class] rubber)
18
5
1482
One-sided

References

51.96820.0271

Application info

TGA [04/00--]

TGX [09/07--]

050 008 1915 | MRB0678

V-ribbed belt

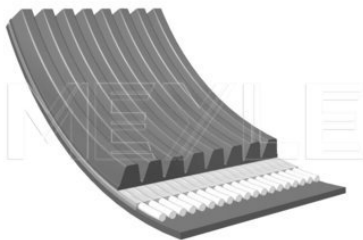

Notes

Width [mm]
Number of Ribs
Length [mm]

EPDM (ethylene propylene diene Monomer [M-class] rubber)
28
8
1915
One-sided

References

51.96820.0273

51.96820.0335

Application info

TGA [04/00--]

050 009 1725 | MRB0699

V-ribbed belt

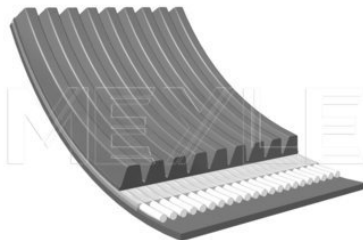

Notes

Width [mm]
Number of Ribs
Length [mm]

EPDM (ethylene propylene diene Monomer [M-class] rubber)
32
9
1725
One-sided

References

51.96820.0308

Application info

TGA [04/00--]



V-ribbed belt

050 004 1390 | MRB0160

Notes

EPDM (ethylene propylene diene Monomer (M-class) rubber)

Width [mm] 14
Number of Ribs 4
Length [mm] 1390
One-sided

References

51.96820.0304
51.96820.0314

51.96820.0317



Application info

TGA [04/00--] TGM [10/05--]
TGL [04/05--]

V-ribbed belt

050 008 1158 | MRB0647

Notes

EPDM (ethylene propylene diene Monomer (M-class) rubber)

Width [mm] 28
Number of Ribs 8
Length [mm] 1158
One-sided

References

51.96820.0322

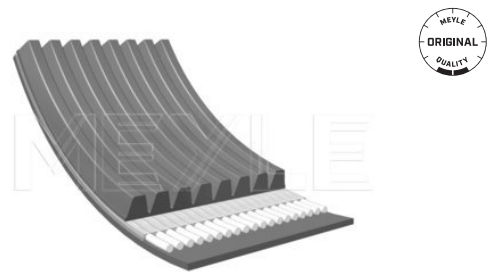

Application info

HOCL [01/85-05/09] NÜ [09/96-07/98]
NG [--07/98] SÜ [--06/97]
NL [--07/98]

V-ribbed belt

050 010 1688 | MRB0720

Notes

EPDM (ethylene propylene diene Monomer (M-class) rubber)

Width [mm] 35
Number of Ribs 10
Length [mm] 1688
One-sided

References

51.96820.0325

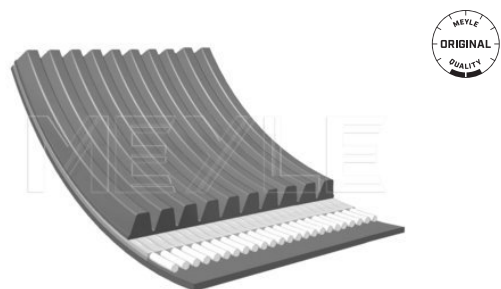

Application info

NG [--07/98] NÜ [09/96-07/98]
NL [--07/98] SÜ [--06/97]

050 005 1530 | MRB0275

V-ribbed belt

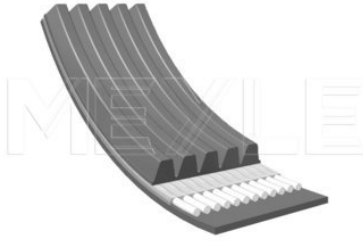

Notes

Width [mm]
Number of Ribs
Length [mm]

EPDM (ethylene propylene diene Monomer [M-class] rubber)
18
5
1530
One-sided

References

51.96820.0332

Application info

LION'S COACH (09/95--)

050 008 1635 | MRB0670

V-ribbed belt

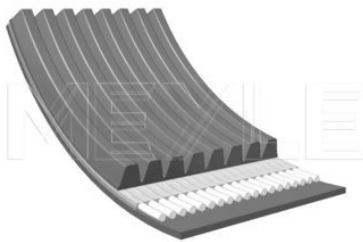

Notes

Width [mm]
Number of Ribs
Length [mm]

EPDM (ethylene propylene diene Monomer [M-class] rubber)
28
8
1635
One-sided

References

51.96820.0272

51.96820.0344

Application info

TGA (04/00--)

050 008 1920 | MRB0679

V-ribbed belt

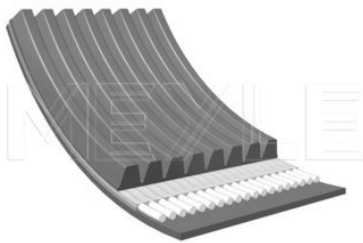

Notes

Width [mm]
Number of Ribs
Length [mm]

EPDM (ethylene propylene diene Monomer [M-class] rubber)
28
8
1920
One-sided

References

51.96820.0345

Application info

TGA (04/00--)



V-ribbed belt

050 008 1655 | MRB0758

Notes

Width [mm]
Number of Ribs
Length [mm]

EPDM (ethylene propylene diene Monomer [M-class] rubber)
28
8
1655
One-sided

References

51.96820.0346

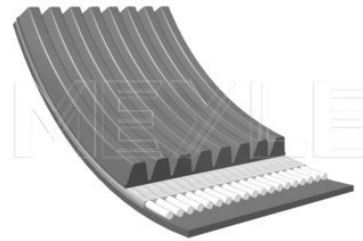

Application info

TGA [04/00--]

V-ribbed belt

050 012 1630 | MRB0769

Notes

Width [mm]
Number of Ribs
Length [mm]

EPDM (ethylene propylene diene Monomer [M-class] rubber)
42
12
1630
One-sided

References

81.96820.0047

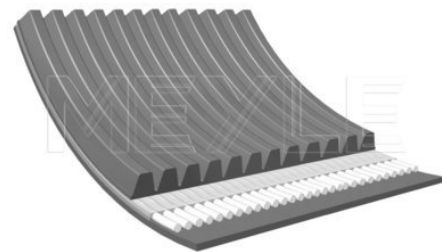

Application info

TGA [04/00--]

V-ribbed belt

050 008 0855 | MRB0642

Notes

Width [mm]
Number of Ribs
Length [mm]

EPDM (ethylene propylene diene Monomer [M-class] rubber)
28
8
855
One-sided

References

81.96820.0051

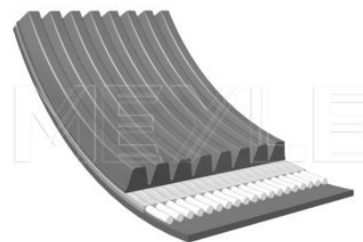

Application info

TGL [04/05--]

050 006 2200 | MRB0530

V-ribbed belt

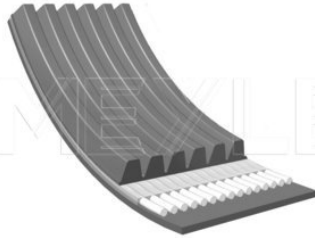

Notes

Width [mm]
Number of Ribs
Length [mm]

EPDM (ethylene propylene diene Monomer [M-class] rubber)
21
6
2200
One-sided

References

88.96820.0001

Application info

EL [01/93-06/97]

NL [--07/98]

050 008 1908 | MRB0677

V-ribbed belt

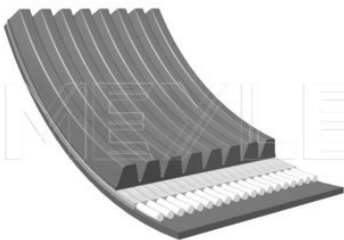

Notes

Width [mm]
Number of Ribs
Length [mm]

EPDM (ethylene propylene diene Monomer [M-class] rubber)
28
8
1908
One-sided

References

N1.01100.1840

Application info

TGA [04/00--]

050 006 1180 | MRB0372

V-ribbed belt

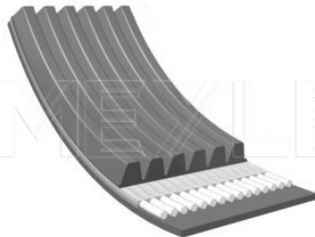

Notes

Width [mm]
Number of Ribs
Length [mm]

EPDM (ethylene propylene diene Monomer [M-class] rubber)
21
6
1180
One-sided

References

N1.01100.1846

Application info

EL [01/93-06/97]

V-ribbed belt

050 008 1398 | MRB0657

Notes

Width [mm]
Number of Ribs
Length [mm]

EPDM (ethylene propylene diene Monomer (M-class) rubber)
28
8
1398
One-sided

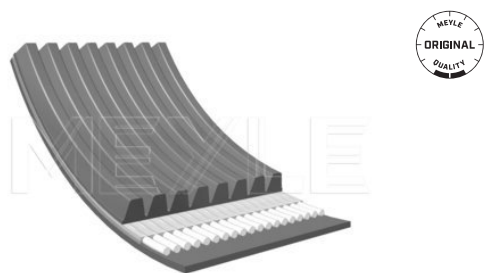

Application info

TGA [04/00--]

Gasket, exhaust manifold

834 900 0005 | MMX1535

References

51.08901.0096	51.15901.0031
51.15901.0009	88.09901.0001
51.15901.0012	

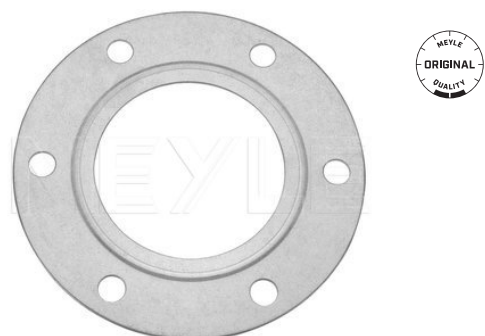

Application info

E 2000 [05/00--]
F 2000 [01/94-12/95]
HOCL [01/85-05/09]
LION'S CITY [08/04--]

LION'S COACH [09/95--]
LION'S STAR [01/93-09/96]
SL II [--04/94]
TGA [04/00--]

Gasket, exhaust manifold

12-34 900 0005 | MMX1484

References

51.08901.0104	51.08901.0152
---------------	---------------





12-34 900 0005 | MMX1484

Gasket, exhaust manifold

Application info

E 2000 (05/00--)
F 2000 (01/94-12/95)
LION'S COACH (09/95--)

LION'S STAR (01/93-09/96)
TGA (04/00--)

1





Repair kit, brake caliper

12-34 042 0014 | MBX0245

Notes

Brake System Elsa 1
Front Axle

References

81.50802.6017
81.50802.6020 81.50802.6021



Application info

F 2000 [01/94-12/95] TGA [04/00--]

Repair kit, brake caliper

12-34 042 0015 | MBX0244

Notes

Rear Axle

References

81.50802.6022



Application info

F 2000 [01/94-12/95]

Repair kit, brake caliper

12-34 042 0017 | MBX0223

Notes

Brake System D-Elsa 2
Rear Axle

References

81.50802.6025



Application info

F 2000 [01/94-12/95] TGA [04/00--]
M 2000 L [08/95--] TGL [04/05--]
M 2000 M [--12/05]

2

12-34 042 0010 | MBX0163

Repair kit, brake caliper



Notes

Front Axle

References

81.50822.6009

Application info

LION´S COACH (09/95--)

M 2000 M (--12/05)

12-34 042 0012 | MBX0164

Repair kit, brake caliper



Notes

Diameter [mm]
Brake System
Brake System
Brake System

69
SK 7000
SN 7000
SN 6000
Rear Axle

References

81.50822.6020

81.50822.6031

Application info

LION´S COACH (09/95--)
TGA (04/00--)

TGM (10/05--)

034 042 0053 | MBX0083

Repair kit, brake caliper



Notes

Diameter [mm]
Brake System
Brake System

74
SB 7000
SB 6000
Front Axle
Rear Axle

References

81.50822.6022

81.50822.6032

Application info

TGA (04/00--)



Repair kit, brake caliper

12-34 042 0021 | MBX0219

Notes

Rear Axle

References

81.50822.6019
81.50822.6034

81.50822.6037



Application info

TGM (10/05--)

Brake disc

12-35 521 0000 | MBD0295

Notes

Centering Diameter [mm]
Minimum thickness [mm]
Outer diameter [mm]
Height [mm]
Bolt Hole Circle Ø [mm]
Brake Disc Thickness [mm]
Required quantity
Number of Holes

Vented
135
24
324
102
158
30
2
10
Front Axle

References

81.50803.0010



Application info

L 2000 (10/93-07/97)

Brake disc

12-35 521 0007 | MBD0300

Notes

Centering Diameter [mm]
Minimum thickness [mm]
Outer diameter [mm]
Height [mm]
Bolt Hole Circle Ø [mm]
Brake System
Brake Disc Thickness [mm]
Number of Holes

Vented
135
26
330
104
135
WABCO PAN17
34
10
Front Axle

References

81.50803.0024

81.50803.0026

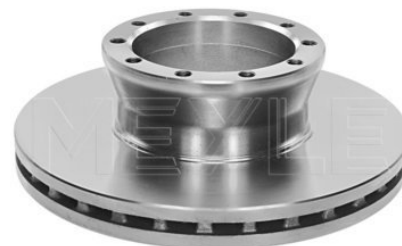

12-35 521 0007 | MBD0300

Brake disc

Application info

L 2000 (10/93-07/97)

M 2000 L (08/95--)

12-35 521 0008 | MBD0301

Brake disc



Notes

Centering Diameter [mm]	Vented
Minimum thickness [mm]	145
Outer diameter [mm]	26
Height [mm]	330
Bolt Hole Circle Ø [mm]	129.5
Brake System	177
Brake Disc Thickness [mm]	MERITOR D-ELSA1
Required quantity	34
Number of Holes	2
	8
	Rear Axle

References

81.50803.0039

Application info

L 2000 (10/93-07/97)

12-35 521 0002 | MBD0296

Brake disc



Notes

Centering Diameter [mm]	Vented
Minimum thickness [mm]	131
Outer diameter [mm]	35
Height [mm]	432
Bolt Hole Circle Ø [mm]	130
Brake System	168
Brake Disc Thickness [mm]	MERITOR D-ELSA2
Number of Holes	45
	12
	Front Axle

References

81.50803.0023	81.50803.0036
81.50803.0031	81.50803.0038
81.50803.0033	81.50803.0040
81.50803.0034	81.50803.0046
81.50803.0035	

Application info

F 2000 (01/94-12/95)
LION'S COACH (09/95--)
LION'S COMFORT (09/96--)
LION'S STAR (01/93-09/96)
M 2000 L (08/95--)

M 2000 M (--12/05)
TGA (04/00--)
TGS (09/07--)
TGX (09/07--)

Brake disc
12-35 521 0004 | MBD0298
Notes

	Vented
Centering Diameter [mm]	208
Minimum thickness [mm]	37
Outer diameter [mm]	432
Height [mm]	135
Bolt Hole Circle Ø [mm]	235
Brake System	MERITOR D-ELSA1
Brake Disc Thickness [mm]	45
Number of Holes	10
	Front Axle

References

81.50803.0021 81.50803.0041

Application info

F 2000 (01/94-12/95)
LION'S COACH (09/95--)
LION'S STAR (01/93-09/96)
NG (--07/98)
NL (--07/98)

NÜ (09/96-07/98)
TGA (04/00--)
TGS (09/07--)
TGX (09/07--)
ÜL (09/89-09/96)

Brake disc
12-35 521 0009 | MBD0302
Notes

	Vented
Centering Diameter [mm]	90
Minimum thickness [mm]	30
Outer diameter [mm]	335
Height [mm]	93
Bolt Hole Circle Ø [mm]	122
Brake System	KNORR SB/SN5
Brake Disc Thickness [mm]	34
Number of Holes	10
	Front Axle

References

81.50803.0042

Application info

TGL (04/05--)

12-35 521 0003 | MBD0297

Brake disc



Notes

Centering Diameter [mm]	Vented 208
Minimum thickness [mm]	35
Outer diameter [mm]	432
Height [mm]	135
Bolt Hole Circle Ø [mm]	235
Brake Disc Thickness [mm]	45
Number of Holes	10 Rear Axle

References

81.50803.0028	81.50803.0048
---------------	---------------

Application info

LION´S COACH (09/95--)
LION´S STAR (01/93-09/96)

ÜL (09/89-09/96)

12-35 521 0005 | MBD0299

Brake disc



Notes

Centering Diameter [mm]	Vented 162
Minimum thickness [mm]	38
Outer diameter [mm]	376
Height [mm]	128
Bolt Hole Circle Ø [mm]	195
Brake System	KNORR SB/SN6
Brake Disc Thickness [mm]	45
Required quantity	2
Number of Holes	10 Front Axle

References

81.50803.0020	81.50803.0057
81.50803.0027	

Application info

M 2000 L (08/95--)
M 2000 M (--12/05)

TGM (10/05--)

Brake disc

12-35 523 0000 | MBD0305

Notes

	Internally Vented
Centering Diameter [mm]	157
Minimum thickness [mm]	28
Outer diameter [mm]	330
Height [mm]	124
Bolt Hole Circle Ø [mm]	180
Brake System	MERITOR
Brake Disc Thickness [mm]	34
Required quantity	2
Number of Holes	12
	Rear Axle



References

81.50803.0022	81.50803.0061
---------------	---------------

Application info

L 2000 (10/93-07/97)

Brake disc

12-35 521 0010 | MBD0303

Notes

	Vented
Centering Diameter [mm]	154
Minimum thickness [mm]	26
Outer diameter [mm]	335
Height [mm]	118
Bolt Hole Circle Ø [mm]	176
Brake System	KNORR SB/SN5
Brake Disc Thickness [mm]	34
Required quantity	2
Number of Holes	10
	Rear Axle



References

81.50803.0054	81.50803.0063
---------------	---------------

Application info

L 2000 (10/93-07/97)

TGA (04/00--)

TGL (04/05--)

TGM (10/05--)

025 290 9530 | MBP0713

Brake pad set



Notes

Thickness [mm]
Height [mm]
Width [mm]
Brake System

without add-on material
prepared for wear indicator
30
92.5
210.7
Knorr
Rear Axle
Front Axle

References

81.50820.5017
81.50820.6008

81.50820.6022

Application info

M 2000 L (08/95--)

M 2000 M (--12/05)

025 291 1428 | MBP0716

Brake pad set

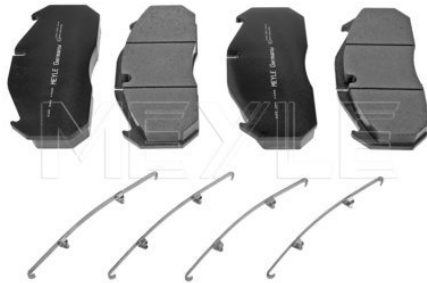

Notes

Thickness [mm]
Height [mm]
Width [mm]
Brake System

prepared for wear indicator
30.2
118.5
249.6
Meritor D-Elsa

References

81.50820.5007
81.50820.5041
81.50820.5048
81.50820.5061
81.50820.5069
81.50820.5092

81.50820.6001
81.50820.6003
81.50820.6005
81.50820.6015
81.50820.6017
81.50820.6026

Application info

EL (01/93-06/97)
F 2000 (01/94-12/95)
F 90 (07/86-12/97)
LION'S COACH (09/95--)
LION'S COMFORT (09/96--)
LION'S STAR (01/93-09/96)
M 2000 L (08/95--)

M 2000 M (--12/05)
NÜ (09/96-07/98)
TGA (04/00--)
TGS (09/07--)
TGX (09/07--)
ÜL (09/89-09/96)

Brake pad set

025 290 8826 | MBP0712

Notes

Thickness [mm]
Height [mm]
Width [mm]
Brake System

without add-on material
prepared for wear indicator
26
85.6
175.5
Wabco PAN 17

References

81.50820.5023	81.50820.6006
81.50820.5025	81.50820.6020
81.50820.5029	81.50820.6042
81.50820.5079	

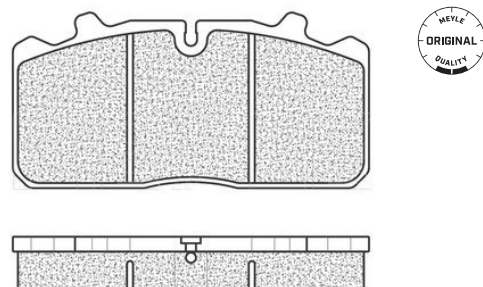

Application info

L 2000 (10/93-07/97)

M 2000 L (08/95--)

Brake pad set

025 290 8826/S | MBP1627

Notes

Thickness [mm]
Height [mm]
Width [mm]
Brake System

with add-on material
prepared for wear indicator
26
85.6
175.5
Wabco PAN 17
Front Axle

References

81.50820.5023	81.50820.6006
81.50820.5025	81.50820.6020
81.50820.5029	81.50820.6042
81.50820.5079	

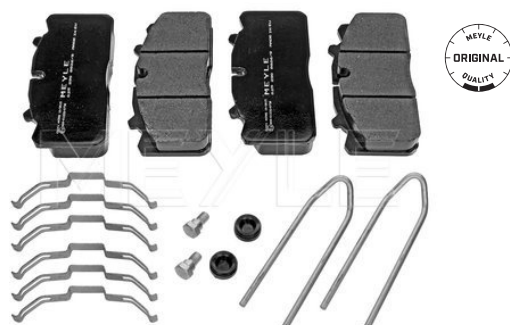

Application info

L 2000 (10/93-07/97)

M 2000 L (08/95--)

Brake pad set

025 290 8730 | MBP0710

Notes

Thickness [mm]
Height [mm]
Width [mm]
Brake System

without accessories
prepared for wear indicator
30
109.5
247.3
KNORR SB 6/7
Rear Axle
Front Axle

References

81.50820.6030	81.50820.6056
---------------	---------------

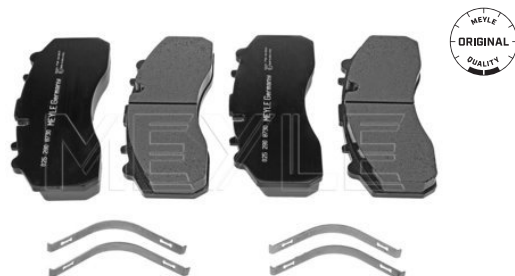

025 290 8730 | MBP0710

Brake pad set

Application info

TGA [04/00--]
TGS [09/07--]

TGX [09/07--]

025 291 1328 | MBP0715

Brake pad set

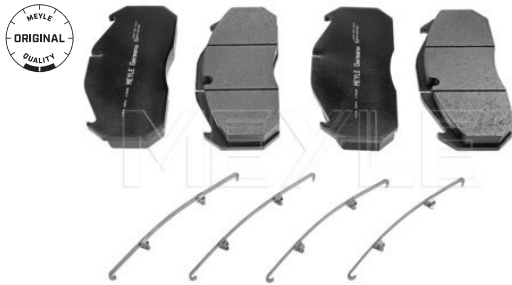

Notes

Thickness [mm]
Height [mm]
Width [mm]
Brake System

without accessories
prepared for wear indicator
28.2
118.5
249.6
TRW
Front Axle

References

81.50820.5006	81.50820.6002
81.50820.5007	81.50820.6004
81.50820.5020	81.50820.6014
81.50820.5040	81.50820.6016
81.50820.5047	81.50820.6017
81.50820.5060	81.50820.6025
81.50820.5066	81.50820.6034
81.50820.5068	81.50820.6035
81.50820.5091	81.50820.6036
81.50820.6000	81.50820.6046

Application info

EL [01/93-06/97]
F 2000 [01/94-12/95]
F 90 [07/86-12/97]
LION'S COACH [09/95--]
LION'S COMFORT [09/96--]
LION'S STAR [01/93-09/96]

M 2000 L [08/95--]
M 2000 M [--12/05]
NÜ [09/96-07/98]
TGA [04/00--]
ÜL [09/89-09/96]

025 291 3130 | MBP0720

Brake pad set



Notes

Thickness [mm]
Height [mm]
Width [mm]
Brake System

with add-on material
prepared for wear indicator
30.2
118.2
249.6
Meritor D-Elsa 2
Front Axle

References

81.50820.5072	81.50820.6041
81.50820.5080	81.50820.6051
81.50820.6031	

Application info

TGA [04/00--]
TGS [09/07--]

TGX [09/07--]

Brake pad set

025 290 8730/S | MBP0711

Notes

with accessories
prepared for wear indicator

Thickness [mm] 30
Height [mm] 109.5
Width [mm] 247.3
Brake System Knorr
Rear Axle
Front Axle

References

81.50820.6030 81.50820.6056

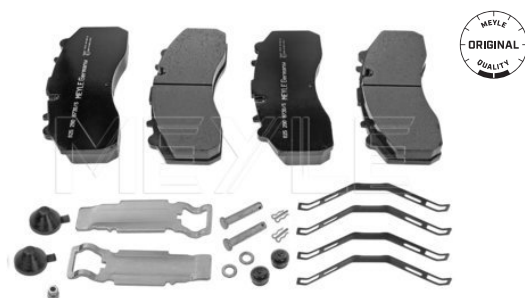

Application info

TGA [04/00--]

Brake pad set

025 290 4827 | MBP0708

Notes

without add-on material
excl. wear warning contact

Thickness [mm] 34
Thickness [mm] 27
Height [mm] 84
Width [mm] 185
Width [mm] 173.5
Brake System Knorr SB 5000
Front Axle

References

81.50820.5074 81.50820.6043
81.50820.5085 81.50820.6054
81.50820.6040 81.50820.6063

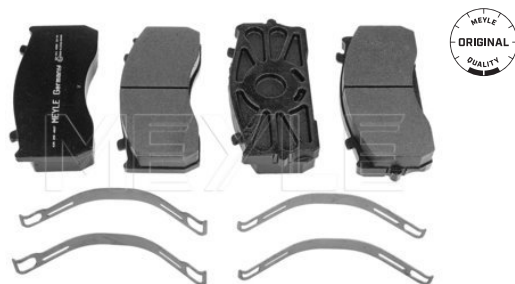

Application info

TGL [04/05--]

Wear sensor

12-34 527 0008 | MWS0133

Notes

Warning Contact Length [mm] 300
Warning Contact Length [mm] 230
Brake System MERITOR D-ELSA 2
Required quantity 2
Front Axle

References

68324072



12-34 527 0008 | MWS0133

Wear sensor

Application info

F 2000 (01/94-12/95)
SÜ (--06/97)

TGA (04/00--)

12-34 527 0004 | MWS0131

Wear sensor



Notes

Warning Contact Length [mm]
Warning Contact Length [mm]
Required quantity

Round Plug
Disc Brake
340
240
2

References

81.50811.0004

Application info

E 2000 (05/00--)
F 2000 (01/94-12/95)
F 90 (07/86-12/97)

M 2000 L (08/95--)
M 2000 M (--12/05)

12-34 527 0000 | MWS0129

Wear sensor



Notes

Warning Contact Length [mm]
Required quantity

Disc Brake
275
2
Left and right
Front Axle

References

81.50822.6013

Application info

F 2000 (01/94-12/95)
F 90 (07/86-12/97)
F 90 Unterflur (07/86-05/94)
LION´S COACH (09/95--)

LION´S STAR (01/93-09/96)
M 2000 L (08/95--)
M 2000 M (--12/05)
ÜL (09/89-09/96)



Wear sensor

12-34 527 0002 | MWS0130

Notes

Warning Contact Length [mm]
Required quantity

Disc Brake
300
4
Left and right

References

81.50822.6014



Application info

L 2000 (10/93-07/97)

M 2000 L (08/95--)

Wear sensor

12-34 527 0001 | MWS0027

Notes

Warning Contact Length [mm]
Required quantity

Disc Brake
380
2
Left and right
Front Axle

References

81.50822.6011

81.50822.6016



Application info

F 2000 (01/94-12/95)
LION'S COACH (09/95--)
LION'S STAR (01/93-09/96)
M 2000 L (08/95--)
M 2000 M (--12/05)

NG (--07/98)
NÜ (09/96-07/98)
TGA (04/00--)
ÜL (09/89-09/96)

Wear sensor

12-34 527 0005 | MWS0132

Notes

Warning Contact Length [mm]
Required quantity

Disc Brake
250
2
Front Axle

References

81.50822.6012

81.50822.6017



2

+

12-34 527 0005 | MWS0132

Wear sensor

Application info

NG [--07/98]
NL [--07/98]

NÜ [09/96-07/98]
TGA [04/00--]

12-34 533 0103 | MAS0093

ABS wheel sensor



Notes

Cable Length [mm]
Operating voltage [V]
Length [mm]
Number of Poles
Required quantity
Resistance [Ohm]

with accessories
Inductive Sensor
for vehicles with ABS
350
24
400
2
2
1150
Rear Axle
Front Axle

References

81.27120.0021

Application info

NG [--07/98]
NL [--07/98]

NM [--03/97]

12-34 899 0016 | MAS0105

ABS wheel sensor



Notes

Cable Length [mm]
Operating voltage [V]
Length [mm]
Number of Poles
Required quantity
Resistance [Ohm]

with accessories
Inductive Sensor
for vehicles with ABS
2940
24
3000
2
1
1150
Rear Axle Right

References

81.27120.6106

Application info

TGL [04/05--]

TGM [10/05--]



ABS wheel sensor

12-34 899 0005 | MAS0094

Notes

Cable Length [mm]
 Operating voltage [V]
 Length [mm]
 Number of Poles
 Required quantity
 Resistance [Ohm]

with accessories
 Inductive Sensor
 for vehicles with ABS
 2000
 24
 2065
 2
 1
 1150
 Rear Axle Left
 Front Axle Left



References

81.27120.6119 81.27120.6182

Application info

LION´S COACH (09/95--)
 LION´S STAR (01/93-09/96)
 NM (--03/97)
 SÜ (--06/97)

TGA (04/00--)
 TGM (10/05--)
 TGS (09/07--)
 TGX (09/07--)

ABS wheel sensor

12-34 899 0017 | MAS0106

Notes

Cable Length [mm]
 Operating voltage [V]
 Length [mm]
 Number of Poles
 Required quantity
 Resistance [Ohm]

with accessories
 Inductive Sensor
 for vehicles with ABS
 2600
 24
 2670
 2
 1
 1150
 Left



References

81.27120.6121 81.27120.6184

Application info

TGA (04/00--)

TGS (09/07--)

2

12-34 899 0009 | MAS0098

ABS wheel sensor



Notes

Cable Length [mm]
Operating voltage [V]
Length [mm]
Number of Poles
Required quantity
Resistance [Ohm]

with accessories
Inductive Sensor
for vehicles with ABS
2240
24
2300
2
1
1150
Rear Axle
Front Axle

References

81.27120.6205

Counterpart

12-34 899 0010 | MAS0099

Application info

TGM [10/05--]

12-34 899 0010 | MAS0099

ABS wheel sensor



Notes

Cable Length [mm]
Operating voltage [V]
Length [mm]
Number of Poles
Required quantity
Resistance [Ohm]

with accessories
Inductive Sensor
for vehicles with ABS
2300
24
2360
2
1
1150
Rear Axle
Front Axle

References

81.27120.6206

Counterpart

12-34 899 0009 | MAS0098

Application info

TGM [10/05--]



ABS wheel sensor

12-34 899 0007 | MAS0096

Notes

	with accessories
	Inductive Sensor
	for vehicles with ABS
Cable Length [mm]	1240
Operating voltage [V]	24
Length [mm]	1300
Number of Poles	2
Required quantity	1
Resistance [Ohm]	1150
	Front Axle Left



References

81.27120.6179	81.27120.6220
---------------	---------------

Counterpart

12-34 899 0008 | MAS0097

Application info

LION'S COACH (09/95--)
LION'S STAR (01/93-09/96)

TGL (04/05--)

ABS wheel sensor

12-34 899 0008 | MAS0097

Notes

	with accessories
	Inductive Sensor
	for vehicles with ABS
Cable Length [mm]	1220
Operating voltage [V]	24
Length [mm]	1300
Number of Poles	2
Required quantity	1
Resistance [Ohm]	1150
	Front Axle Right



References

81.27120.6178	81.27120.6221
---------------	---------------

Counterpart

12-34 899 0007 | MAS0096

Application info

LION'S COACH (09/95--)
LION'S STAR (01/93-09/96)

TGL (04/05--)

034 042 0017 | MBX0061

Repair kit, brake shoe sleeve



References

81.50213.0013
81.50213.6005

81.50213.6006

Application info

F 2000 (01/94-12/95)
F 90 (07/86-12/97)
F 90 Unterflur (07/86-05/94)
M 2000 L (08/95--)
M 2000 M (--12/05)

M 90 (08/88-06/96)
TGL (04/05--)
TGM (10/05--)
TGS (09/07--)
TGX (09/07--)

034 042 0029/C | MBX0064

Repair kit, brake adjuster



References

81.50610.6132

Application info

F 2000 (01/94-12/95)

F 90 (07/86-12/97)

034 013 0006 | MBX0018

Cylinder head, compressor



References

51.54114.6023
51.54114.6024
51.54114.6035
51.54114.6045

51.54114.6047
51.54114.6049
51.54114.6054

Application info

E 2000 (05/00--)

TGA (04/00--)

Valve plate, air compressor

034 013 0008 | MBX0020

References

81.54124.6006



Application info

E 2000 (05/00--)
F 2000 (01/94-12/95)
F 90 (07/86-12/97)
LION'S CITY (08/04--)

NG (--07/98)
NL (--07/98)
TGA (04/00--)

Valve plate, air compressor

12-14 013 0001 | MBX0236

References

81.54124.6013 81.54124.6017



Application info

F 2000 (01/94-12/95)
F 90 (07/86-12/97)
F 90 Unterflur (07/86-05/94)
NG (--07/98)
NL (--07/98)

NÜ (09/96-07/98)
SG (07/76-06/97)
SÜ (--06/97)
TGA (04/00--)
ÜL (09/89-09/96)

Cylinder liner, compressor

034 013 0001 | MBX0016

Notes

Diameter [mm]

with piston rings
with piston
90
Air cooled

References

51.54105.6006



034 013 0001 | MBX0016

Cylinder liner, compressor

Application info

G 90 (09/87-05/95)
L 2000 (10/93-07/97)
M 2000 L (08/95--)

M 2000 M (--12/05)
M 90 (08/88-06/96)

034 013 0005 | MBX0017

Cylinder liner, compressor



Notes

Diameter [mm]

with piston rings
with piston
90
Water-cooled

References

51.54105.6002
51.54105.6004

51.54105.6007
51.54105.6008

Application info

TGA (04/00--)

034 043 0058 | MBX0112

Silencer, compressor system



Notes

Outer diameter [mm]

70

References

81.52101.6152
81.52101.6159
81.52101.6180
81.52101.6240

81.52101.6274
81.52101.6280
81.52101.6288
85.50001.1965

Application info

CLA (01/06--)
TGA (04/00--)
TGL (04/05--)

TGM (10/05--)
TGS (09/07--)
TGX (09/07--)

Silencer, compressor system

034 043 0056 | MBX0111

Notes

Inner diameter [mm] 40
Outer diameter [mm] 69

References

81.52101.6241 81.52101.6275
81.52101.6246



Application info

F 2000 (01/94-12/95)
M 90 (08/88-06/96)
TGA (04/00--)
TGL (04/05--)

TGM (10/05--)
TGS (09/07--)
TGX (09/07--)

Air dryer cartridge

12-34 042 0026 | MBX0165

Notes

Inner thread [mm] M39x1,5
Outer diameter [mm] 141
Height [mm] 165

References

81.52108.6001 81.52155.0040
81.52108.6025 81.52155.0041



Application info

E 2000 (05/00--)
EL (01/93-06/97)
EM (08/87-06/97)
F 2000 (01/94-12/95)
L 2000 (10/93-07/97)
LION'S COACH (09/95--)
LION'S COMFORT (09/96--)
LION'S STAR (01/93-09/96)
M 2000 L (08/95--)
M 2000 M (--12/05)
NG (--07/98)

NL (--07/98)
NM (--03/97)
NÜ (08/96-07/98)
SL II (--04/94)
SM (11/87-02/95)
SÜ (--06/97)
TGA (04/00--)
TGL (04/05--)
TGM (10/05--)
TGS (09/07--)
TGX (09/07--)

034 042 0032 | MBX0066

Air dryer cartridge



Notes

Inner thread [mm]	M39x1,5
Outer diameter [mm]	140
Height [mm]	164

References

81.52102.0008	82.52102.0013
---------------	---------------

Application info

CLA [01/06--]

12-34 032 0000 | MBX0162

Air suspension valve



Notes

Left and right

References

81.43610.6124	81.43610.6129
---------------	---------------

Application info

F 2000 [01/94-12/95]
F 90 [07/86-12/97]
M 90 [08/88-06/96]

TGA [04/00--]
TGS [09/07--]
TGX [09/07--]

12-34 032 0007 | MEX0476

Sensor, pneumatic suspension level



References

81.25937.0010	81.25937.0015
---------------	---------------

Application info

F 90 [07/86-12/97]

M 90 [08/88-06/96]

Sensor, pneumatic suspension level

834 533 0004 | MEX0477

References

81.25937.0016



Application info

F 2000 (01/94-12/95)

M 2000 M [--12/05]

Sensor, pneumatic suspension level

034 032 0115 | MEX0480

References

81.25937.0023

81.25937.0037



Application info

TGA (04/00--)

Brake line coupling

034 042 0033 | MBX0067

Notes

Number of connectors
Connecting thread
Operating Pressure [bar]

Red
1
M22x1,5
8.2

References

81.51220.6024

Counterpart

034 042 0034 | MBX0068

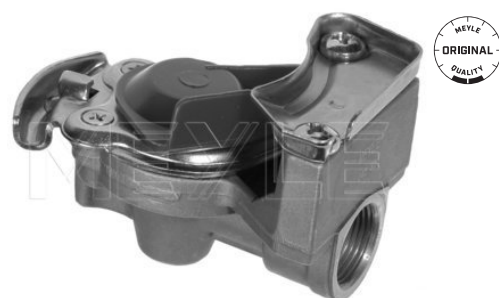

Application info

F 2000 (01/94-12/95)

034 042 0034 | MBX0068

Brake line coupling



Notes

Number of connectors	Yellow
Connecting thread	1
Operating Pressure [bar]	M22x1,5
	8

References

81.51220.6025

Counterpart

034 042 0033 | MBX0067

Application info

F 2000 (01/94-12/95)

034 042 0039 | MBX0073

Brake line coupling



Notes

Number of connectors	Yellow
Connecting thread	1
Operating Pressure [bar]	M16x1,5
	8.1

References

81.51220.6032	81.51220.6093
81.51220.6069	81.51220.6096

Counterpart

034 042 0038 | MBX0072

Application info

F 2000 (01/94-12/95)

12-35 533 0003 | MBX0229

Overflow valve



References

81.52110.6049	81.52110.6095
---------------	---------------

Overflow valve

12-35 533 0003 | MBX0229

Application info

F 2000 (01/94-12/95)
F 90 (07/86-12/97)
L 2000 (10/93-07/97)
M 2000 L (08/95--)
M 2000 M (--12/05)

M 90 (08/88-06/96)
TGA (04/00--)
TGL (04/05--)
TGM (10/05--)

Quick release valve

034 042 0048 | MBX0080

References

81.52115.6009	81.52115.6021
81.52115.6017	90.81011.4192
81.52115.6018	



Application info

G 90 (09/87-05/95)

Pressure limiting valve

12-34 820 0002 | MBX0267

References

51.10304.0291



Application info

HOCL (01/85-05/09)
LION'S CITY (08/04--)
NG (--07/98)
TGA (04/00--)

TGL (04/05--)
TGM (10/05--)
TGS (09/07--)
TGX (09/07--)

12-35 533 0000 | MBX0226

Pressure limiting valve



Notes

Pressure [bar] 3.5

References

81.52101.6153 81.52101.6154

Application info

EL (01/93-06/97)
EM (08/87-06/97)
F 2000 (01/94-12/95)
F 90 (07/86-12/97)
L 2000 (10/93-07/97)
M 2000 L (08/95--)
M 2000 M (--12/05)
NG (--07/98)
NL (--07/98)
NM (--03/97)
NÜ (09/96-07/98)

SG (07/76-06/97)
SL II (--04/94)
SM (11/87-02/95)
SÜ (--06/97)
TGA (04/00--)
TGL (04/05--)
TGM (10/05--)
TGS (09/07--)
TGX (09/07--)
ÜL (09/89-09/96)

12-35 533 0001 | MBX0215

Pressure limiting valve



Notes

Pressure [bar] 8.1

References

81.52101.6269

Application info

F 2000 (01/94-12/95)
L 2000 (10/93-07/97)
LION'S COACH (09/95--)
LION'S STAR (01/93-09/96)
M 2000 L (08/95--)
M 2000 M (--12/05)
NG (--07/98)

NL (--07/98)
NÜ (09/96-07/98)
TGA (04/00--)
TGL (04/05--)
TGM (10/05--)
TGS (09/07--)
TGX (09/07--)



Pressure limiting valve

12-35 533 0002 | MBX0216

References

81.52101.6270



Application info

EM (08/87-06/97)
F 2000 (01/94-12/95)
L 2000 (10/93-07/97)
LION'S COACH (09/95--)
LION'S STAR (01/93-09/96)

M 2000 M (--12/05)
NM (--03/97)
TGA (04/00--)
TGL (04/05--)

Line filter, compressor system

034 042 0024 | MBX0063

Notes

Pressure [bar] 8

References

81.51270.6002



Application info

G (10/79-08/88)
M 2000 L (08/95--)
M 2000 M (--12/05)

M 90 (08/88-06/96)
TGA (04/00--)
TGM (10/05--)

Slave cylinder

034 007 0002 | MBX0013

Notes

Diameter [mm] Black
30
Thread Size M8x1

References

81.11701.6046



2



034 007 0002 | MBX0013

Slave cylinder

Application info

G 90 (09/87-05/95)

034 043 0005 | MBX0090

Slave cylinder



Notes

Diameter [mm]
Thread Size

Black
35
M18x1

References

81.15701.6003

Application info

F 2000 (01/94-12/95)

F 90 (07/86-12/97)

12-34 157 0005 | MBX0168

Slave cylinder



Notes

Diameter [mm]
Thread Size

48
M8x1

References

81.15701.6113

81.15701.6120

Application info

CLA (01/06--)
EL (01/93-06/97)
F 2000 (01/94-12/95)
L 2000 (10/93-07/97)
M 2000 L (08/95--)
M 2000 M (--12/05)

M 90 (08/88-06/96)
NG (--07/98)
NL (--07/98)
NÜ (09/96-07/98)
TGA (04/00--)

Slave cylinder

12-34 157 0004 | MBX0167

Notes

Diameter [mm] Black
45
Thread Size M8x1

References

81.15701.6124



Application info

TGA [04/00--]
TGL [04/05--]
TGM [10/05--]

TGS [09/07--]
TGX [09/07--]

Multi-circuit protection valve

12-35 533 0034 | MBX0230

Notes

Thread Size M18x1,5

References

81.52151.6094



Application info

TGA [04/00--]
TGS [09/07--]

TGX [09/07--]

Multi-circuit protection valve

12-35 533 0005 | MBX0243

Notes

Thread Size M22x1,5
Thread Size M16x1,5

References

81.52151.6093 81.52151.6096



Application info

F 2000 [01/94-12/95]

TGA [04/00--]

2

034 042 0051 | MBX0082

Check valve



Notes

Non-return Valve

References

81.52120.6003	81.52120.6030
81.52120.6004	81.52120.6040
81.52120.6025	81.52120.6075
81.52120.6028	85.30001.6535
81.52120.6029	88.52120.6200

Application info

EL (01/93-06/97)
EM (08/87-06/97)
F 2000 (01/94-12/95)
F 90 (07/86-12/97)
F 90 Unterflur (07/86-05/94)
G (10/79-08/88)
G 90 (09/87-05/95)
L 2000 (10/93-07/97)
LION'S COACH (09/95--)
LION'S STAR (01/93-09/96)
M 2000 L (08/95--)
M 2000 M (--12/05)
M 90 (08/88-06/96)
NG (--07/98)

NL (--07/98)
NM (--03/97)
NÜ (09/96-07/98)
R (05/85-01/93)
SD (04/74-04/94)
SG (07/76-06/97)
SL II (--04/94)
SM (11/87-02/95)
SÜ (--06/97)
TGA (04/00--)
TGL (04/05--)
TGM (10/05--)
ÜL (09/89-09/96)

12-35 533 0007 | MBX0227

Control valve, trailer

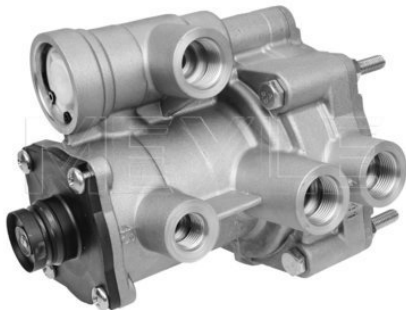

References

81.52301.6183	81.52301.6192
81.52301.6189	

Application info

F 2000 (01/94-12/95)
L 2000 (10/93-07/97)
M 2000 L (08/95--)
M 2000 M (--12/05)

NG (--07/98)
TGA (04/00--)
TGL (04/05--)
TGM (10/05--)



Control valve, trailer

12-35 533 0037 | MBX0239

References

81.52301.6120	81.52310.6165
81.52301.6121	



Application info

F 90 [07/86-12/97]

Brake valve, park brake

12-34 043 0002 | MBX0237

References

81.52301.6148	82.58000.0060
81.52301.9148	



Application info

TGA [04/00--]

Brake valve, park brake

12-35 533 0031 | MBX0228

Notes

Thread Size	M16x1,5
Operating Pressure [bar]	10

References

81.52315.6156	81.52315.6161
81.52315.6160	



Application info

CLA [01/06--]
 F 2000 [01/94-12/95]
 M 2000 M [--12/05]

TGA [04/00--]
 TGL [04/05--]

034 043 0002 | MBX0089

Diaphragm, brake cylinder



Notes

Equipment Variant

T20
Rubber with textile reinforcement
20"

Diameter [in]

References

81.51113.0001

Application info

M 90 [08/88-06/96]

TGA [04/00--]

034 042 0061 | MBX0087

Diaphragm, brake cylinder



Notes

Equipment Variant

T16L
Rubber with textile reinforcement
16"

Diameter [in]

References

81.51113.0012

Application info

F 90 [07/86-12/97]

034 042 0030 | MBX0065

Diaphragm, brake cylinder



Notes

Equipment Variant

T16
Rubber with textile reinforcement
16"

Diameter [in]

References

81.51113.0013

Application info

TGA [04/00--]



Diaphragm, brake cylinder

034 042 0043 | MBX0075

Notes

Equipment Variant	T24L Rubber with textile reinforcement
Diameter [in]	24"

References

81.51113.0014	99.10036.0792
---------------	---------------



Application info

F 90 (07/86-12/97)

TGA (04/00--)

Diaphragm, brake cylinder

034 042 0062 | MBX0088

Notes

Equipment Variant	T20L Rubber with textile reinforcement
Diameter [in]	20"

References

81.51113.0020



Application info

F 90 (07/86-12/97)

Diaphragm, brake cylinder

034 042 0001 | MBX0052

Notes

Equipment Variant	T24 Rubber with textile reinforcement
Diameter [in]	24"

References

90.91157.8013



034 042 0001 | MBX0052

Diaphragm, brake cylinder

Application info

EL (01/93-06/97)
EM (08/87-06/97)
F 2000 (01/94-12/95)
F 90 (07/86-12/97)
F 90 Unterflur (07/86-05/94)
G (10/79-08/88)

G 90 (09/87-05/95)
L 2000 (10/93-07/97)
LION'S COACH (09/95--)
LION'S COMFORT (09/96--)
LION'S STAR (01/93-09/96)
TGA (04/00--)

034 042 0003 | MBX0054

Diaphragm, brake cylinder



Notes

Equipment Variant

T30

Rubber with textile reinforcement
30"

Diameter [in]

References

90.91159.0013

Application info

L 2000 (10/93-07/97)

TGA (04/00--)

034 042 0002 | MBX0053

Diaphragm, brake cylinder



Notes

Equipment Variant

T30L

Rubber with textile reinforcement
30"

Diameter [in]

Application info

TGA (04/00--)

Valve, compressor system
12-34 026 0002 | MBX0161
Notes

Multiport Valve

References

 81.52131.6015
81.52170.6139

81.52170.6151

Application info

 F 2000 [01/94-12/95]
F 90 [07/86-12/97]

 F 90 Unterflur [07/86-05/94]
M 90 [08/88-06/96]

Valve, compressor system
034 026 0027 | MBX0038
Notes

Relay Valve

References

81.52170.6064

81.52170.6128

Application info

 F 2000 [01/94-12/95]
F 90 [07/86-12/97]
M 2000 L [08/95--]

 M 2000 M [--12/05]
M 90 [08/88-06/96]

Relay valve
034 042 0007 | MBX0056
Notes

 Pressure [bar] 10
Thread Size M16x1,5
Thread Size M22x1,5
Number of Inlets / Outlets 3

References

81.52116.6010

81.52116.6037

Application info

 F 90 [07/86-12/97]
F 90 Unterflur [07/86-05/94]

M 90 [08/88-06/96]

12-34 043 0001 | MBX0246

Relay valve



Notes

Pressure [bar]	8
Thread Size	M16x1,5
Thread Size	M22x1,5
Number of Inlets / Outlets	4

References

81.52116.6067	81.52116.6069
81.52116.6068	

Application info

TGA [04/00--]

034 043 0070 | MBX0117

Relay valve



Notes

Pressure [bar]	13
Thread Size	M22x1,5
Thread Size	M16x1,5
Number of Inlets / Outlets	4

References

81.52116.6070

Application info

EM [08/87-06/97]
 F 2000 [01/94-12/95]
 L 2000 [10/93-07/97]
 LION'S COACH [09/95--]
 LION'S STAR [01/93-09/96]
 M 2000 L [08/95--]
 M 2000 M [--12/05]

NG [--07/98]
 NL [--07/98]
 NM [--03/97]
 NÜ [09/96-07/98]
 TGA [04/00--]
 ÜL [09/89-09/96]

12-35 533 0004 | MBX0192

Relay valve



Notes

Pressure [bar]	10
Thread Size	M22x1,5
Thread Size	M16x1,5
Number of Inlets / Outlets	5

References

81.52116.6071

Relay valve

12-35 533 0004 | MBX0192

Application info

F 2000 (01/94-12/95)
L 2000 (10/93-07/97)
LION'S COACH (09/95--)
LION'S STAR (01/93-09/96)
M 2000 M (--12/05)

NG (--07/98)
NL (--07/98)
NÜ (09/96-07/98)
TGA (04/00--)
ÜL (09/89-09/96)

Relay valve

034 043 0066 | MBX0114

Notes

Pressure [bar] 8.5
Thread Size M22x1,5
Number of Inlets / Outlets 5

References

81.52116.6074 81.52116.6076
81.52116.6075 81.52116.9075



Application info

L 2000 (10/93-07/97)
LION'S COACH (09/95--)
LION'S STAR (01/93-09/96)
M 2000 L (08/95--)
M 2000 M (--12/05)
NG (--07/98)

NÜ (09/96-07/98)
TGA (04/00--)
TGL (04/05--)
TGM (10/05--)
TGS (09/07--)
TGX (09/07--)

Multiway valve

034 026 0030 | MBX0039

Notes

Pressure [bar] 8.1

References

81.32734.6001 81.52170.6120



Application info

F 2000 (01/94-12/95)
F 90 (07/86-12/97)

M 90 (08/88-06/96)

12-37 142 0007 | MBX0197

Multiway valve



References

81.52170.6096

81.52170.6156

Application info

F 2000 (01/94-12/95)

F 90 (07/86-12/97)

F 90 Unterflur (07/86-05/94)

LION'S COACH (09/95--)

M 2000 L (08/95--)

M 2000 M (--12/05)

M 90 (08/88-06/96)

Shaft seal, differential
12-34 279 0073 | MTX0062
Notes

	FPM (fluoride rubber)
Inner diameter [mm]	72
Outer diameter [mm]	105
Height [mm]	13

References

06.56279.0027	06.56279.0073
06.56279.0072	81.96501.0907

Application info

F 90 (07/86-12/97)
L 2000 (10/93-07/97)

M 2000 L (08/95--)
M 2000 M (--12/05)

Shaft seal, differential
12-14 753 0001 | MTX0058
Notes

	FPM (fluoride rubber)
Inner diameter [mm]	72
Outer diameter [mm]	105
Height [mm]	13 inner

References

06.56279.0366

Application info

F 2000 (01/94-12/95)
F 90 (07/86-12/97)
G 90 (09/87-05/95)
L 2000 (10/93-07/97)

M 2000 L (08/95--)
M 2000 M (--12/05)
M 90 (08/88-06/96)
TGA (04/00--)

Shaft seal, differential
12-14 753 0013 | MTX0060
Notes

	FPM (fluoride rubber)
Inner diameter [mm]	80
Outer diameter [mm]	154
Outer diameter [mm]	135
Height [mm]	12

References

06.56289.0279	81.96502.6052
06.56289.0280	81.96502.6066
06.56289.0293	

3
+

12-14 753 0013 | MTX0060

Shaft seal, differential

Application info

F 2000 (01/94-12/95)
 F 90 (07/86-12/97)
 L 2000 (10/93-07/97)
 LION'S COACH (09/95--)
 LION'S STAR (01/93-09/96)

M 2000 L (08/95--)
 M 2000 M (--12/05)
 M 90 (08/88-06/96)
 TGA (04/00--)
 ÜL (09/89-09/96)

12-14 753 0014 | MTX0061

Shaft seal, differential



Notes

Inner diameter [mm]
 Outer diameter [mm]
 Height [mm]

FPM (fluoride rubber)/ACM
 (polyacrylate rubber)
 85
 145
 37

References

06.56289.0319 81.35412.6003

Application info

F 2000 (01/94-12/95)
 F 90 (07/86-12/97)
 F 90 Unterflur (07/86-05/94)
 M 2000 L (08/95--)

TGA (04/00--)
 TGS (09/07--)
 TGX (09/07--)

034 753 0021 | MTX0036

Shaft seal, differential



Notes

Inner diameter [mm]
 Outer diameter [mm]
 Height [mm]

NBR (nitrile butadiene rubber)
 85
 105
 13

References

06.56289.0361

Application info

E 2000 (05/00--)
 F 2000 (01/94-12/95)
 F 90 (07/86-12/97)

F 90 Unterflur (07/86-05/94)
 TGA (04/00--)

Shift rod connector
036 026 0016 | MTX0037
Notes

Thread Measurement 2	with right-hand thread
Thread Measurement 1	M14x1,5
Length [mm]	M10x1
Cone Size [mm]	86
	12

References

81.95301.0038	81.95301.6176
81.95301.0045	81.95301.6235
81.95301.6016	81.95301.6266
81.95301.6169	81.95301.6269
81.95301.6172	

Application info

F 90 Unterflur (07/86-05/94)
 M 2000 L (08/95--)
 M 2000 M (--12/05)
 M 90 (08/88-06/96)
 R (05/85-01/93)

SG (07/76-06/97)
 SL (05/80-04/87)
 SR (10/75-11/86)
 SÜ (--06/97)

Shift rod connector
034 026 0018 | MTX0023
Notes

Thread Measurement 2	with right-hand thread
Thread Measurement 1	M12x1,75
Length [mm]	M10x1,5
Cone Size [mm]	55
	10.8

References

81.95301.6064	81.95301.6170
81.95301.6130	81.95301.6173

Counterpart

034 026 0017 | MTX0022

Application info

EL (01/93-06/97)
 EM (08/87-06/97)
 F 2000 (01/94-12/95)
 F 90 (07/86-12/97)
 F 90 Unterflur (07/86-05/94)
 G (10/79-08/88)
 G 90 (09/87-05/95)
 L 2000 (10/93-07/97)
 LION´S COACH (09/95--)
 LION´S COMFORT (09/96--)
 LION´S STAR (01/93-09/96)
 M 2000 L (08/95--)
 M 2000 M (--12/05)
 M 90 (08/88-06/96)

NG (--07/98)
 NL (--07/98)
 NM (--03/97)
 NÜ (09/96-07/98)
 R (05/85-01/93)
 SD (04/74-04/94)
 SG (07/76-06/97)
 SL (05/80-04/87)
 SM (11/87-02/95)
 SR (10/75-11/86)
 SÜ (--06/97)
 TGA (04/00--)
 TGL (04/05--)
 TGM (10/05--)
 ÜL (09/89-09/96)

034 026 0017 | MTX0022

Shift rod connector



Notes

Thread Measurement 2	with left-hand thread
Thread Measurement 1	M12x1,75
Length [mm]	M10x1,5
Cone Size [mm]	55
	12.8

References

81.95301.6063	81.95301.6171
81.95301.6131	81.95301.6174

Counterpart

034 026 0018 | MTX0023

Application info

F 2000 (01/94-12/95)
 F 90 (07/86-12/97)
 F 90 Unterflur (07/86-05/94)
 L 2000 (10/93-07/97)

M 90 (08/88-06/96)
 TGL (04/05--)
 TGM (10/05--)

12-34 899 0026 | MEX0577

Switch, splitter gearbox



Notes

Number of connectors	2
Voltage [V]	24

References

81.25525.0032

Application info

TGA (04/00--)

034 026 0032 | MEX0151

Switch, splitter gearbox



Notes

Number of connectors	3
----------------------	---

References

81.32550.0003

Application info

F 90 (07/86-12/97)



Switch, splitter gearbox

034 026 0029 | MEX0150

Notes

Number of connectors 2

References

81.52170.6095 81.52170.6097



Application info

F 90 (07/86-12/97)

Switch, splitter gearbox

14-34 043 0001 | MEX0567

References

85.30001.9636 85.32734.6001



Application info

F 2000 (01/94-12/95)

Neutral safety switch

034 026 0025 | MEX0148

Notes

Operating Pressure [bar] Pneumatic 8

References

81.32735.6011 81.32735.6039
81.32735.6035 81.32735.6040



Application info

M 90 (08/88-06/96)

3

12-34 029 0001 | MEX0357

Switch, differential lock



Notes

Push control
Rear Axle

References

81.25503.0244

Application info

TGA [04/00--]
TGL [04/05--]
TGM [10/05--]

TGS [09/07--]
TGX [09/07--]

12-34 899 0023 | MEX0488

Switch, differential lock



Notes

Push control
Mechanical

References

81.25525.0033
81.25525.0227

81.25525.0257

Application info

TGA [04/00--]
TGL [04/05--]
TGM [10/05--]

TGS [09/07--]
TGX [09/07--]

12-34 410 0002 | MDM0054

Drive shaft support



Notes

Thickness [mm]	90
Thickness [mm]	70
Inner diameter [mm]	65
Outer diameter [mm]	185
	with ball bearing
	Centre

References

81.39410.6013
81.39410.6017

81.39410.6019

Drive shaft support

12-34 410 0002 | MDM0054

Application info

F 2000 (01/94-12/95)
F 90 (07/86-12/97)
L 2000 (10/93-07/97)
M 2000 L (08/95--)
M 2000 M (--12/05)
M 90 (08/88-06/96)

TGA (04/00--)
TGL (04/05--)
TGM (10/05--)
TGS (09/07--)
TGX (09/07--)

Drive shaft support

12-34 151 0002 | MDM0051

Notes

Thickness [mm]	60
Thickness [mm]	40
Inner diameter [mm]	75
Outer diameter [mm]	180
	with ball bearing
	Centre

References

81.39410.6020



Application info

TGA (04/00--)

Drive shaft support

12-34 151 0003 | MDM0052

Notes

Thickness [mm]	60
Thickness [mm]	40
Inner diameter [mm]	85
Outer diameter [mm]	180
	with ball bearing
	Centre

References

81.39410.6023

81.39410.6031



Application info

F 2000 (01/94-12/95)
F 90 (07/86-12/97)
G 90 (09/87-05/95)
L 2000 (10/93-07/97)
M 2000 L (08/95--)
M 2000 M (--12/05)
M 90 (08/88-06/96)
NG (--07/98)
NL (--07/98)
NM (--03/97)

NÜ (09/96-07/98)
SD (04/74-04/94)
SG (07/76-06/97)
SR (10/75-11/86)
SÜ (--06/97)
TGL (04/05--)
TGM (10/05--)
TGS (09/07--)
TGX (09/07--)
ÜL (09/89-09/96)

034 041 9022 | MPJ0069

Joint, propeller shaft



Notes

Diameter [mm]
Length [mm]

Piece
with add-on material
Universal Joint
57
152
Centre

References

81.39108.6048

81.39374.6003

Application info

F 2000 [01/94-12/95]
LION'S COACH [09/95--]
LION'S STAR [01/93-09/96]

M 2000 L [08/95--]
TGA [04/00--]
TGL [04/05--]
TGM [10/05--]

12-34 126 6017 | MPJ0071

Joint, propeller shaft



Notes

Outer diameter [mm]
Length [mm]

Piece
with add-on material
Universal Joint
57
144
Centre

References

81.39126.6017

81.39200.6015

Application info

F 90 [07/86-12/97]
F 90 Unterflur [07/86-05/94]

L 2000 [10/93-07/97]

12-34 126 6020 | MPJ0072

Joint, propeller shaft



Notes

Outer diameter [mm]
Length [mm]

Piece
with add-on material
Universal Joint
52
148
Centre

References

81.39126.6020
81.39126.6030

81.99917.8470

Joint, propeller shaft

12-34 126 6020 | MPJ0072

Application info

F 2000 (01/94-12/95)
F 90 (07/86-12/97)
TGA (04/00--)

TGS (09/07--)
TGX (09/07--)

Release bearing

12-31 111 0003 | MMX1491

Notes

Parameter KZISZ-5
Height [mm] 112

References

36.30550.0001	81.30550.0104
81.30550.0096	81.30550.0114
81.30550.0101	81.30550.0255
81.30550.0102	



Application info

LION'S COACH (09/95--)
LION'S STAR (01/93-09/96)
TGA (04/00--)

TGL (04/05--)
TGM (10/05--)
TGS (09/07--)
TGX (09/07--)

Repair kit, clutch releaser

12-31 106 0001 | MMX0587

Notes

with pressure pin

References

81.30560.6019	81.30560.6022
---------------	---------------



Application info

CLA (01/06--)
E 2000 (05/00--)
EL (01/93-06/97)
EM (08/87-06/97)
F 2000 (01/94-12/95)
F 90 (07/86-12/97)
M 2000 L (08/95--)

M 2000 M (--12/05)
M 90 (08/88-06/96)
NM (--03/97)
NÜ (09/96-07/98)
TGA (04/00--)
TGL (04/05--)
TGM (10/05--)

12-31 106 0004 | MMX0590

Bolt, release fork



References

81.30530.0037

Application info

FOCL (---)
HOCL (01/85-05/09)
LION'S CITY (08/04--)
LION'S COACH (09/95--)

LION'S STAR (01/93-09/96)
TGA (04/00--)
TGL (04/05--)
TGM (10/05--)

12-34 725 6025 | MBX0189

Clutch booster



Notes

Force output F [N]
Stroke [mm]

Brake Fluid
4000
85

References

81.30725.6007
81.30725.6024
81.30725.6025

81.30725.6026
81.30725.9025

Application info

SL II (--04/94)

SÜ (--06/97)

12-34 725 6027 | MBX0190

Clutch booster



Notes

Force output F [N]
Stroke [mm]

Brake Fluid
4000
85

References

81.30725.6027
81.30725.6028

81.30725.6045
81.30725.6046

Application info

M 90 (08/88-06/96)

Clutch booster
12-34 725 6032 | MBX0191
Notes

Force output F [N]	6000
Operating Pressure [bar]	8.1
Stroke [mm]	85

References

81.30725.6031	81.30725.6053
81.30725.6032	81.30725.6054

Application info

F 90 (07/86-12/97)
 F 90 Unterflur (07/86-05/94)

SÜ (--06/97)

Clutch booster
12-37 142 0003 | MBX0195
Notes

Force output F [N]	6000
Operating Pressure [bar]	8.2
Stroke [mm]	85

References

81.30725.6065	81.30725.6086
---------------	---------------

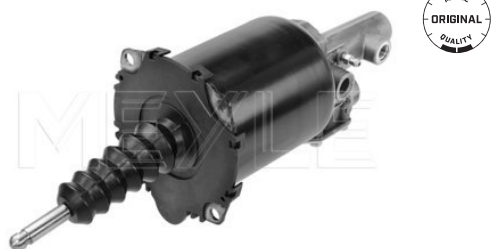
Application info

F 2000 (01/94-12/95)

F 90 (07/86-12/97)

Clutch booster
12-37 142 0004 | MBX0196
Notes

Force output F [N]	6000
Stroke [mm]	85

References

81.30725.6084	81.30725.6107
81.30725.6085	81.30725.6116
81.30725.6092	

Application info

LION´S COACH (09/95--)
 TGA (04/00--)

TGS (09/07--)
 TGX (09/07--)

034 029 0034 | MBX0242

Clutch booster



Notes

Force output F [N]
Operating Pressure [bar]
Stroke [mm]

Mineral Oil
3900
8.4
80

References

81.30725.6104

Application info

HOCL [01/85-05/09]

12-37 142 0001 | MMX1300

Clutch master cylinder



Notes

Bore Ø [mm]

Silver
Grey Cast Iron
23.81

References

81.30715.6111
81.30715.6119

81.30715.6121

Application info

EM [08/87-06/97]
F 2000 [01/94-12/95]
F 90 [07/86-12/97]
F 90 Unterflur [07/86-05/94]
LION'S COACH [09/95--]
LION'S STAR [01/93-09/96]

M 2000 M [--12/05]
M 90 [08/88-06/96]
NG [--07/98]
NM [--03/97]
SM [11/87-02/95]
ÜL [09/89-09/96]

12-37 142 0002 | MMX1301

Clutch master cylinder



Notes

Bore Ø [mm]

Silver
Aluminium
25.4

References

81.30715.6108

81.30715.6120

Clutch master cylinder

12-37 142 0002 | MMX1301

Application info

F 2000 (01/94-12/95)
F 90 (07/86-12/97)

F 90 Unterflur (07/86-05/94)

Clutch master cylinder

12-37 142 0011 | MMX1578

Notes

	Mineral Oil
	Black
Bore Ø [mm]	23.81
Diameter [mm]	40

References

81.30715.6149	81.30715.6156
81.30715.6154	



Application info

TGA (04/00--)
TGS (09/07--)

TGX (09/07--)

3

12-34 205 6013 | MCX0216

Repair kit, kingpin



Notes

Outer diameter [mm] 49.5
Outer diameter [mm] 50
Length [mm] 223
with ball bearing
Front Axle

References

81.44205.6013

Application info

F 2000 (01/94-12/95)
F 90 (07/86-12/97)
F 90 Unterflur (07/86-05/94)
M 2000 L (08/95--)
M 2000 M (--12/05)
M 90 (08/88-06/96)
NG (--07/98)

NL (--07/98)
NM (--03/97)
SD (04/74-04/94)
SG (07/76-06/97)
SÜ (--06/97)
ÜL (09/89-09/96)

12-34 205 0001 | MCX0215

Repair kit, kingpin



Notes

Outer diameter [mm] 50
Outer diameter [mm] 51
Length [mm] 222.5
with ball bearing
Front Axle

References

81.44205.6023

Application info

F 2000 (01/94-12/95)
LION'S COACH (09/95--)
M 2000 L (08/95--)

M 2000 M (--12/05)
NG (--07/98)
NL (--07/98)
NÜ (09/96-07/98)

12-34 798 0001 | MCX0248

Repair kit, kingpin



Notes

Outer diameter [mm] 36
Outer diameter [mm] 35
Length [mm] 172
with ball bearing
Front Axle Right
Front Axle Left

References

81.44205.6025



Repair kit, kingpin

12-34 798 0001 | MCX0248

Application info

L 2000 (10/93-07/97)

M 2000 L (08/95--)

Bushing, leaf spring

12-34 610 0001 | MCX0450

Notes

Inner diameter [mm]	24
Outer diameter [mm]	70
Height [mm]	95
	Front Axle

References

81.43722.0044	83.43722.0001
81.43722.0061	



Application info

E 2000 (05/00--)

F 2000 (01/94-12/95)

Bushing, leaf spring

12-34 032 0003 | MCX0383

Notes

Inner diameter [mm]	20
Outer diameter [mm]	41
Outer diameter 1 [mm]	58
Height [mm]	70
Length [mm]	84
	Rear
	Front

References

81.43722.0051	81.43722.0060
---------------	---------------



Application info

M 2000 L (08/95--)

M 2000 M (--12/05)

Bushing, leaf spring

12-34 032 0002 | MCX0397

Notes

Inner diameter [mm]	16
Outer diameter [mm]	50
Outer diameter 1 [mm]	55
Height [mm]	95
	Left and right
	Rear Axle

References

81.96020.0231	81.96020.0252
81.96020.0250	



12-34 032 0002 | MCX0397

Bushing, leaf spring

Application info

G (10/79-08/88)
G 90 (09/87-05/95)

L 2000 (10/93-07/97)
M 2000 M (--12/05)

12-34 742 0009 | MCX0520

Mount, leaf spring



Notes

Height [mm] 18
Left and right

References

81.43400.6484 81.43407.0110
81.43407.0109 81.43407.5003

Application info

E 2000 (05/00--)
F 2000 (01/94-12/95)
TGA (04/00--)
TGL (04/05--)

TGM (10/05--)
TGS (09/07--)
TGX (09/07--)

12-34 722 0062 | MCX0359

Mount, leaf spring



Notes

Rear Axle

References

81.43722.0062

Application info

F 2000 (01/94-12/95)

Mount, leaf spring

12-34 742 0000 | MCX0243

Notes

Right
Rear Axle

References

81.96210.0554

Counterpart

12-34 742 0001 | MCX0244



Application info

TGA [04/00--]
TGM [10/05--]

TGS [09/07--]
TGX [09/07--]

Mount, leaf spring

12-34 742 0001 | MCX0244

Notes

Left
Rear Axle

References

81.96210.0555

Counterpart

12-34 742 0000 | MCX0243



Application info

TGA [04/00--]
TGM [10/05--]

TGS [09/07--]
TGX [09/07--]

Mount, leaf spring

12-34 742 0006 | MCX0246

Notes

Height [mm]

127
Rear Axle left and right

References

81.96210.5022



Application info

F 2000 [01/94-12/95]

F 90 [07/86-12/97]

4

12-34 742 0005 | MCX0245

Mount, leaf spring



Notes

Rear Axle left and right

References

81.96210.5025
81.96210.5026

81.96210.5027

Application info

F 2000 (01/94-12/95)

036 035 0053 | MCA1122

Control arm



Notes

Hole Pitch 1/ Hole Pitch 2
Pipe Ø [mm]
Length [mm]

Steel Pipe
80
36
330
Trailing Arm
Left and right

References

81.43220.6177
81.43220.6179

81.43220.6224

Application info

LION´S COACH (09/95--)

LION´S STAR (01/93-09/96)

12-36 030 0013 | MCA0767

Control arm



Notes

Hole Pitch 1/ Hole Pitch 2
Bore Ø [mm]
Pipe Ø [mm]
Length [mm]

Steel
130mm/130mm
23
50
414
Trailing Arm
Rear Axle left and right

References

81.43220.6247

Application info

TGA (04/00--)
TGS (09/07--)

TGX (09/07--)



Control arm

12-34 050 0003 | MCA0778

Notes

Hole Pitch 1/ Hole Pitch 2	Steel
Bore Ø [mm]	115mm/115mm
Pipe Ø [mm]	17
Length [mm]	48
	941
	Trailing Arm
	Front Axle

References

81.43220.6222	81.43220.6283
81.43220.6260	81.43220.6284



Application info

TGA [04/00--]	TGX [09/07--]
TGS [09/07--]	

Control arm

12-34 050 0002 | MCA0777

Notes

Hole Pitch 1/ Hole Pitch 2	Steel
Bore Ø [mm]	130mm/130mm
Pipe Ø [mm]	19
Length [mm]	52
	572
	Trailing Arm
	Trailing Axle

References

81.43220.6268	81.43220.6291
---------------	---------------



Application info

TGA [04/00--]	TGX [09/07--]
TGS [09/07--]	

Control arm

12-36 030 0016 | MCA0938

Notes

Pipe Ø [mm]	48
Length [mm]	570
	Trailing Arm
	Rear Axle

References

36.43220.6002	81.43220.6183
36.43220.6043	81.43220.6276
81.43220.6139	81.43220.6277
81.43220.6151	



Application info

LION´S COACH [09/95--]	LION´S STAR [01/93-09/96]
------------------------	---------------------------

12-36 050 0001 | MCA0242

Control arm



Notes

Hole Pitch 1/ Hole Pitch 2
Bore Ø [mm]
Pipe Ø [mm]
Length [mm]

Steel
152mm/152mm
23
58
627
Wishbone [CV]
Rear Axle

References

81.43270.6056
81.43270.6067
81.43270.6075

81.43270.6077
81.43270.6081

Application info

F 2000 (01/94-12/95)

F 90 (07/86-12/97)

12-36 050 0000 | MCA0241

Control arm



Notes

Hole Pitch 1/ Hole Pitch 2
Bore Ø [mm]
Pipe Ø [mm]
Length [mm]

Steel
152mm/152mm
23
50
621
Wishbone [CV]
Rear Axle

References

81.43270.6030
81.43270.6034
81.43270.6054
81.43270.6057
81.43270.6076

81.43270.6078
81.43270.6082
81.43270.9054
81.43270.9078

Parts list

12-34 301 6132 | MCX0237

Repair kit, control arm

Application info

F 2000 (01/94-12/95)

F 90 (07/86-12/97)

F 90 Unterflur (07/86-05/94)

12-36 035 6087 | MCA0240

Control arm



Notes

Hole Pitch 1/ Hole Pitch 2
Bore Ø [mm]
Pipe Ø [mm]
Length [mm]

Steel
130mm/130mm/152mm
25
48
627
Wishbone [CV]
Rear Axle

References

81.43270.6087
81.43270.6088

81.43270.6094
81.43270.6095



Control arm

12-36 035 6087 | MCA0240

Application info

F 2000 (01/94-12/95)
TGA (04/00--)
TGM (10/05--)

TGS (09/07--)
TGX (09/07--)

Control arm

12-34 035 0002 | MCA0237

Notes

Hole Pitch 1/ Hole Pitch 2
Bore Ø [mm]
Pipe Ø [mm]
Length [mm]

Steel
130mm/130mm
23
48
627
Wishbone [CV]
Rear Axle



References

81.43220.6221
81.43270.6096

81.43270.6114

Parts list

12-34 301 6132 | MCX0237

Repair kit, control arm

Application info

TGA (04/00--)
TGS (09/07--)

TGX (09/07--)

Control arm

12-34 050 0001 | MCA0239

Notes

Hole Pitch 1/ Hole Pitch 2
Bore Ø [mm]
Pipe Ø [mm]
Length [mm]

Steel
130mm/152mm
25
48
627
Wishbone [CV]
Rear Axle



References

81.43270.6097
81.43270.6113

81.43270.6135

Application info

TGA (04/00--)
TGS (09/07--)

TGX (09/07--)

4

12-34 035 0006 | MCA0238

Control arm



Notes

Hole Pitch 1/ Hole Pitch 2
Bore Ø [mm]
Pipe Ø [mm]
Length [mm]

Steel
130mm/130mm
25
58
627
Wishbone [CV]
Rear Axle

References

81.43270.6117

Application info

TGA [04/00--]

TGX [09/07--]

12-34 035 0005 | MCA0792

Control arm



Notes

Hole Pitch 1/ Hole Pitch 2
Bore Ø [mm]
Pipe Ø [mm]
Length [mm]

Steel
130mm/130mm/152mm
25
48
627
Wishbone [CV]
Rear Axle

References

81.43270.6116

81.43270.6137

Application info

F 2000 [01/94-12/95]
TGA [04/00--]

TGS [09/07--]

TGX [09/07--]

12-36 035 0002 | MSR0072

Rod/strut, suspension



Notes

Bore Ø 1 [mm]
Bore Ø 2 [mm]

Hole Pitch 1/ Hole Pitch 2
Pipe Ø [mm]
Length [mm]

19
19
Guide Rod
130mm/130mm
48
590
Trailing Arm
Rear Axle

References

81.43220.6067
81.43220.6068
81.43220.6090

81.43220.6092
81.43220.6120
81.43220.9092

Parts list

12-34 220 6055 | MCX0218

Repair kit, control arm



Rod/strut, suspension

12-36 035 0002 | MSR0072

Application info

F 2000 (01/94-12/95)
F 90 (07/86-12/97)

TGA (04/00--)

Rod/strut, suspension

12-36 035 0003 | MSR0073

Notes

Bore Ø 1 [mm]	21
Bore Ø 2 [mm]	21
	Guide Rod
Hole Pitch 1/ Hole Pitch 2	130mm/130mm
Pipe Ø [mm]	58
Length [mm]	585
	Trailing Arm
	Rear Axle



References

81.43220.6070	81.43220.6091
81.43220.6071	81.43220.6093
81.43220.6072	81.43220.6119

Application info

F 2000 (01/94-12/95)
F 90 (07/86-12/97)

TGA (04/00--)

Rod/strut, suspension

12-36 030 0004 | MSR0070

Notes

Bore Ø 1 [mm]	19
Bore Ø 2 [mm]	19
	Guide Rod
Hole Pitch 1/ Hole Pitch 2	130mm/130mm
Pipe Ø [mm]	48
Length [mm]	571
	Trailing Arm
	Rear Axle Lower



References

81.43220.6030	81.43220.6098
81.43220.6096	81.43220.6129
81.43220.6097	81.43230.6014

Parts list

12-34 220 6108 | MCX0219 Repair kit, control arm

Application info

F 90 (07/86-12/97)
F 90 Unterflur (07/86-05/94)
M 90 (08/88-06/96)

TGA (04/00--)
TGS (09/07--)
TGX (09/07--)

4

12-36 050 0002 | MSR0075

Rod/strut, suspension



Notes

Bore Ø 1 [mm]	19
Bore Ø 2 [mm]	19
Guide Rod	
Hole Pitch 1/ Hole Pitch 2	130mm/130mm
Pipe Ø [mm]	48
Length [mm]	531
	Trailing Arm
	Rear Axle

References

81.43220.6161	81.43220.6190
---------------	---------------

Parts list

12-34 220 6055 MCX0218	Repair kit, control arm
--------------------------	-------------------------

Application info

TGA [04/00--]	TGX [09/07--]
TGS [09/07--]	

12-36 035 6196 | MSR0074

Rod/strut, suspension



Notes

Bore Ø 1 [mm]	19
Bore Ø 2 [mm]	19
Guide Rod	
Hole Pitch 1/ Hole Pitch 2	130mm/130mm
Pipe Ø [mm]	48
Length [mm]	596
	Trailing Arm
	Rear Axle

References

81.43220.6196	81.43220.6233
81.43220.6232	

Application info

F 2000 [01/94-12/95]	TGA [04/00--]
----------------------	---------------

4



Rod/strut, suspension

12-34 035 0003 | MSR0069

Notes

Bore Ø 1 [mm]	19
Bore Ø 2 [mm]	19
Hole Pitch 1/ Hole Pitch 2	Guide Rod 130mm/130mm
Pipe Ø [mm]	50
Length [mm]	572
	Trailing Arm Rear Axle



References

81.43220.6229	81.43220.6304
81.43220.6236	81.43220.6305
81.43220.6267	81.43220.6380
81.43220.6272	81.43220.9236

Parts list

12-34 220 6108 MCX0219	Repair kit, control arm
--------------------------	-------------------------

Application info

TGA [04/00--]	TGX [09/07--]
TGS [09/07--]	

4

Repair kit, control arm

12-34 220 6055 | MCX0218

Notes

Hole Pitch 1/ Hole Pitch 2	130,0
Bore Ø [mm]	19
Thickness [mm]	30
Outer diameter [mm]	85
	for wishbone [CV] Rear Axle



References

81.43220.6006	81.43220.6073
81.43220.6055	81.43220.6107

Application info

EL [01/93-06/97]	NL [--07/98]
EM [08/87-06/97]	NM [--03/97]
LION'S COACH [09/95--]	NÜ [09/96-07/98]
LION'S STAR [01/93-09/96]	TGA [04/00--]
NG [--07/98]	ÜL [09/89-09/96]

12-34 220 6108 | MCX0219

Repair kit, control arm



Notes

Thickness [mm]	30
Inner diameter [mm]	19
Outer diameter [mm]	72
Outer diameter [mm]	65
Length [mm]	129.5
	for wishbone (CV)
	Left and right

References

81.43220.6108	81.43220.6132
---------------	---------------

Application info

F 2000 (01/94-12/95)

TGA (04/00--)

036 035 0052 | MCX0519

Repair kit, control arm



Notes

Hole Pitch 1/ Hole Pitch 2	80
Bore Ø [mm]	15
Outer diameter [mm]	67
Width 2 [mm]	115
Width 1 [mm]	35
	Trailing Arm

References

81.43220.6177	81.43220.6224
81.43220.6179	

Application info

LION'S COACH (09/95--)
LION'S STAR (01/93-09/96)

ÜL (09/89-09/96)

16-34 653 0001 | MCX0505

Repair kit, control arm



Notes

Bore Ø [mm]	15
Outer diameter [mm]	67
Length [mm]	129
	for drag link
	Front Axle

References

81.43220.6197	81.95302.0057
81.95302.0038	

Application info

M 2000 L (08/95--)

M 2000 M (--12/05)



Repair kit, control arm

14-36 035 0003 | MCX0492

Notes

Hole Pitch 1/ Hole Pitch 2	130
Thickness [mm]	30
	for drag link
	Rear Axle

References

81.43220.6203



Application info

LION'S COACH (09/95--)
LION'S STAR (01/93-09/96)

ÜL (09/89-09/96)

Repair kit, control arm

12-34 250 6244 | MCX0224

Notes

Hole Pitch 1/ Hole Pitch 2	115
Bore Ø [mm]	17
Thickness [mm]	24
Outer diameter [mm]	75
Length [mm]	149
	for drag link
	Front Axle

References

81.43220.6244



Application info

TGA (04/00--)

Repair kit, control arm

12-34 230 6051 | MCX0221

Notes

Hole Pitch 1/ Hole Pitch 2	115
Bore Ø [mm]	17
Thickness [mm]	24
Outer diameter [mm]	75
Length [mm]	150
	for drag link
	Rear Axle

References

81.43230.6051

81.43230.6068



Application info

F 2000 (01/94-12/95)
F 90 (07/86-12/97)
F 90 Unterflur (07/86-05/94)

M 2000 L (08/95--)
M 2000 M (--12/05)
M 90 (08/88-06/96)

034 035 0029 | MCX0089

Repair kit, control arm



Notes

Hole Pitch 1/ Hole Pitch 2	152
Bore Ø [mm]	21
Thickness [mm]	24
Outer diameter [mm]	95
Length [mm]	190
	for wishbone [CV]
	Front and Rear
	Rear Axle

References

81.43270.6040	81.43270.6045
---------------	---------------

Application info

R [05/85-01/93]
SG [07/76-06/97]
SL [05/80-04/87]

SL II [--04/94]
SÜ [--06/97]

12-34 301 6132 | MCX0237

Repair kit, control arm



Notes

Thickness [mm]	61
Outer diameter [mm]	80
Outer diameter [mm]	90
	for wishbone [CV]
	Left and right

References

81.43270.6080	81.95301.6132
---------------	---------------

Application info

F 2000 [01/94-12/95]
F 90 [07/86-12/97]
F 90 Unterflur [07/86-05/94]

M 2000 M [--12/05]
M 90 [08/88-06/96]
TGA [04/00--]

12-34 301 6133 | MCX0238

Repair kit, control arm



Notes

Thickness [mm]	35
Inner diameter [mm]	23
Outer diameter [mm]	80
Outer diameter [mm]	90
Length [mm]	152
	for wishbone [CV]
	Left and right

References

81.43270.6083	81.95301.6133
---------------	---------------

Repair kit, control arm

12-34 301 6133 | MCX0238

Application info

F 2000 (01/94-12/95)
F 90 (07/86-12/97)
F 90 Unterflur (07/86-05/94)

M 2000 M (--12/05)
M 90 (08/88-06/96)

Bushing, stabilizer

12-34 704 0057 | MCX0239

Notes

Inner diameter [mm]	45
Outer diameter [mm]	69
Height [mm]	60
Required quantity	2
	Front Axle

References

81.43704.0057



Application info

F 2000 (01/94-12/95)
F 90 (07/86-12/97)

F 90 Unterflur (07/86-05/94)
M 90 (08/88-06/96)

Bushing, stabilizer

12-34 704 0061 | MCX0241

Notes

Inner diameter [mm]	59
Outer diameter [mm]	78
Height [mm]	60
Required quantity	2
	Rear Axle

References

81.43704.0061 81.43722.0020



Application info

F 2000 (01/94-12/95)
F 90 (07/86-12/97)

F 90 Unterflur (07/86-05/94)
M 90 (08/88-06/96)

4

12-34 271 0095 | MCX0503

Bushing, stabilizer



Notes

Inner diameter [mm]	50
Outer diameter [mm]	75
Height [mm]	51
	Front Axle

References

81.43704.0077

Application info

L 2000 [10/93-07/97]
LION'S COACH [09/95--]
NG [--07/98]
NL [--07/98]

NÜ [09/96-07/98]
TGA [04/00--]
TGL [04/05--]
TGM [10/05--]

12-34 722 0019 | MCX0242

Bushing, stabilizer



Notes

Inner diameter [mm]	22
Outer diameter [mm]	75
Height [mm]	62
	Rear Axle

References

81.43722.0019 81.43722.6051

Application info

F 2000 [01/94-12/95]
F 90 [07/86-12/97]

F 90 Unterflur [07/86-05/94]
TGA [04/00--]

12-34 271 0101 | MCX0236

Bushing, stabilizer



Notes

Inner diameter [mm]	34.5
Outer diameter [mm]	55
Height [mm]	60
	Left and right Front Axle

References

81.43722.0052





Bushing, stabilizer

12-34 271 0101 | MCX0236

Application info

L 2000 (10/93-07/97)
M 2000 L (08/95--)

M 2000 M (--12/05)

Bushing, stabilizer

12-34 271 0094 | MCX0234

Notes

Inner diameter [mm]	38
Outer diameter [mm]	55
Height [mm]	60
	Rear Axle

References

81.43722.0053	85.93020.0005
---------------	---------------



Application info

L 2000 (10/93-07/97)
M 2000 L (08/95--)

M 2000 M (--12/05)

Bushing, stabilizer

12-34 271 0088 | MCX0229

Notes

Inner diameter [mm]	60
Outer diameter [mm]	89
Height [mm]	62
	Rear Axle

References

81.43722.0083



Application info

TGA (04/00--)
TGM (10/05--)

TGS (09/07--)
TGX (09/07--)

4

12-34 271 0089 | MCX0230

Bushing, stabilizer



Notes

Inner diameter [mm]	31
Outer diameter [mm]	53
Height [mm]	46
	Rear Axle

References

85.43704.0002

Application info

TGL [04/05--]

12-34 271 0090 | MCX0231

Bushing, stabilizer



Notes

Inner diameter [mm]	38.25
Outer diameter [mm]	51.95
Height [mm]	46.2
	Left and right

References

85.43704.0004

Application info

TGL [04/05--]

12-34 271 0092 | MCX0232

Bushing, stabilizer



Notes

Inner diameter [mm]	26
Outer diameter [mm]	46
Height [mm]	66
	Left and right

References

85.43704.0005

Application info

TGL [04/05--]



Bushing, stabilizer

12-34 271 0091 | MCX0398

Notes

Inner diameter [mm]	14
Outer diameter [mm]	42.5
Height [mm]	35
	Left and right
	Rear Axle
	Front Axle

References

85.43722.0007



Application info

TGL [04/05--]

Mount, stabilizer

12-34 271 0082 | MSB0134

Notes

Inner diameter [mm]	21
Outer diameter [mm]	65
	Rear Axle

References

81.43271.0082



Application info

F 2000 [01/94-12/95]
F 90 [07/86-12/97]

F 90 Unterflur [07/86-05/94]
M 2000 L [08/95--]

Mount, stabilizer

12-34 271 0096 | MSB0137

Notes

Inner diameter [mm]	44
Outer diameter [mm]	64
Height [mm]	65
	Front Axle left and right

References

81.43704.0074



Application info

CLA [01/06--]

4

12-34 271 0084 | MSB0243

Mount, stabilizer



Notes

Inner diameter [mm]	45
Outer diameter [mm]	75
Height [mm]	51
	Front Axle

References

81.43704.0078

Application info

LION´S COACH (09/95--)
LION´S STAR (01/93-09/96)
TGA (04/00--)

TGM (10/05--)
TGS (09/07--)
TGX (09/07--)
ÜL (09/89-09/96)

12-34 271 0086 | MSB0358

Mount, stabilizer



Notes

Inner diameter [mm]	16
Outer diameter [mm]	47.5
Height [mm]	47
	Front Axle

References

81.43722.0022	81.96210.0450
81.43722.0038	81.96210.0469

Application info

F 2000 (01/94-12/95)
F 90 (07/86-12/97)
F 90 Unterflur (07/86-05/94)
G 90 (09/87-05/95)
L 2000 (10/93-07/97)
M 2000 L (08/95--)
M 2000 M (--12/05)

M 90 (08/88-06/96)
TGA (04/00--)
TGL (04/05--)
TGM (10/05--)
TGS (09/07--)
TGX (09/07--)

12-34 271 0085 | MSB0136

Mount, stabilizer



Notes

Inner diameter [mm]	16
Outer diameter [mm]	50
Height [mm]	47
	Front Axle

References

81.43722.0059

Mount, stabilizer

12-34 271 0085 | MSB0136

Application info

CLA [01/06--]
F 2000 [01/94-12/95]
F 90 [07/86-12/97]
F 90 Unterflur [07/86-05/94]
L 2000 [10/93-07/97]
LION´S STAR [01/93-09/96]
M 2000 L [08/95--]
M 2000 M [--12/05]

M 90 [08/88-06/96]
NL [--07/98]
TGA [04/00--]
TGL [04/05--]
TGM [10/05--]
TGS [09/07--]
TGX [09/07--]
ÜL [09/89-09/96]

Mount, stabilizer

12-34 722 0021 | MSB0140

Notes

Inner diameter [mm] 22
Outer diameter [mm] 68
Height [mm] 62
Rear Axle left and right

References

81.43722.0021 81.43722.0081
81.43722.0039 81.43722.0082
81.43722.0063



Application info

CLA [01/06--]
EM [08/87-06/97]
F 2000 [01/94-12/95]
F 90 [07/86-12/97]
F 90 Unterflur [07/86-05/94]
L 2000 [10/93-07/97]
M 2000 L [08/95--]

M 2000 M [--12/05]
M 90 [08/88-06/96]
NM [--03/97]
TGA [04/00--]
TGM [10/05--]
TGS [09/07--]
TGX [09/07--]

Mount, stabilizer

12-34 271 0098 | MSB0226

Notes

Inner diameter [mm] 49
Outer diameter [mm] 83
Height [mm] 72
Rear Axle

References

81.43722.0068



Application info

TGA [04/00--]
TGM [10/05--]

TGS [09/07--]
TGX [09/07--]

4

12-34 271 0083 | MSB0135

Mount, stabilizer



Notes

Inner diameter [mm] 15
Outer diameter [mm] 68.5
Rear Axle

References

81.43722.0072

Application info

TGA [04/00--]

TGS [09/07--]

12-14 650 0005 | MWB0049

Wheel bearing



Notes

Inner diameter [mm] 45
Outer diameter [mm] 85
Height [mm] 32.2
Tapered Roller Bearing
Outer
Front Axle

References

06.32489.0003 81.93420.0078
06.32489.0044

Application info

M 2000 L [08/95--]
M 2000 M [--12/05]

M 90 [08/88-06/96]

034 650 0001 | MWB0016

Wheel bearing



Notes

Inner diameter [mm] 50
Outer diameter [mm] 110
Height [mm] 42.25
DIN / ISO 32310 A
Tapered Roller Bearing
Outer
Rear Axle left and right
Front Axle left and right

References

06.32490.3200 81.93420.0131
06.32499.0016 87.52340.0820
06.32499.0034

Wheel bearing
034 650 0001 | MWB0016
Application info

 EL (01/93-06/97)
 F 2000 (01/94-12/95)
 F 90 (07/86-12/97)
 F 90 Unterflur (07/86-05/94)
 LION'S COACH (09/95--)
 LION'S STAR (01/93-09/96)
 M 2000 M (--12/05)

 M 90 (08/88-06/96)
 NG (--07/98)
 NL (--07/98)
 NM (--03/97)
 SL II (--04/94)
 ÜL (09/89-09/96)

Wheel bearing
034 650 0000 | MWB0015
Notes

Inner diameter [mm]	70
Outer diameter [mm]	150
Height [mm]	54
DIN / ISO	32314
	Tapered Roller Bearing
	inner
	Left and right
	Front Axle

References

06.32499.0020	06.32499.0085
06.32499.0082	06.32499.0157
06.32499.0084	87.52340.1240

Application info

 F 2000 (01/94-12/95)
 F 90 (07/86-12/97)
 F 90 Unterflur (07/86-05/94)

 TGS (09/07--)
 TGX (09/07--)

Wheel bearing
300 334 1103 | MWB0046
Notes

Alternative Repair Kit	300 334 1103/S
Inner diameter [mm]	37
Outer diameter [mm]	74
Height [mm]	45
	Rear Axle

References

51.93410.0079

Application info

 F 2000 (01/94-12/95)
 F 90 (07/86-12/97)

 F 90 Unterflur (07/86-05/94)
 M 90 (08/88-06/96)

12-14 751 0006 | MWB0055

Wheel bearing



Notes

Inner diameter [mm]	105
Outer diameter [mm]	160
Height [mm]	140

References

81.93420.0320	81.93420.0376
81.93420.0342	81.93420.6097

Application info

L 2000 (10/93-07/97)
LION'S COACH (09/95--)
LION'S STAR (01/93-09/96)
M 2000 L (08/95--)
M 2000 M (--12/05)
NG (--07/98)

NL (--07/98)
NÜ (09/96-07/98)
TGA (04/00--)
TGM (10/05--)
TGS (09/07--)
TGX (09/07--)

12-14 650 0006 | MWB0054

Wheel bearing



Notes

Inner diameter [mm]	57.8
Outer diameter [mm]	110
Height [mm]	115
	Tapered Roller Bearing
	Front Axle
	Rear Axle

References

81.93420.0288	81.93420.0349
81.93420.0330	

Application info

CLA (01/06--)
E 2000 (05/00--)
F 2000 (01/94-12/95)
LION'S CITY (08/04--)
LION'S COACH (09/95--)
LION'S STAR (01/93-09/96)
M 2000 M (--12/05)
NG (--07/98)

NL (--07/98)
NÜ (09/96-07/98)
SÜ (--06/97)
TGA (04/00--)
TGL (04/05--)
TGM (10/05--)
TGS (09/07--)
TGX (09/07--)

Wheel bearing

12-34 751 0001 | MWB0057

Notes

Inner diameter [mm] 78
Outer diameter [mm] 130
Height [mm] 90
Rear Axle

References

81.93420.0336



Application info

L 2000 (10/93-07/97)
TGL (04/05--)

TGM (10/05--)

Wheel bearing

12-14 751 0007 | MWB0056

Notes

Inner diameter [mm] 110
Outer diameter [mm] 170
Height [mm] 145.8
Rear Axle

References

81.93420.0346



Application info

F 2000 (01/94-12/95)
TGA (04/00--)
TGM (10/05--)

TGS (09/07--)
TGX (09/07--)

Wheel bearing

034 650 0020 | MWB0053

Notes

Inner diameter [mm] 78
Outer diameter [mm] 130
Height [mm] 90

References

81.93420.0379 81.93420.6099
81.93420.6083



Application info

L 2000 (10/93-07/97)

TGL (04/05--)

4

034 035 0013 | MTX0028

Gasket set, planetary gear box



Notes

with seal
with lock ring

References

81.96601.0298

Application info

EL (01/93-06/97)
EM (08/87-06/97)
F 2000 (01/94-12/95)
F 90 (07/86-12/97)
F 90 Unterflur (07/86-05/94)
G 90 (09/87-05/95)
L 2000 (10/93-07/97)
LION'S COACH (09/95--)
LION'S COMFORT (09/96--)
LION'S STAR (01/93-09/96)

M 2000 L (08/95--)
M 2000 M (--12/05)
M 90 (08/88-06/96)
NG (--07/98)
NL (--07/98)
NM (--03/97)
NÜ (09/96-07/98)
TGA (04/00--)
ÜL (09/89-09/96)

034 035 0003 | MCX0083

Ring, wheel hub



Notes

Inner diameter [mm]	115
Outer diameter [mm]	145
Height [mm]	32
Axle Load [t]	13

References

81.35710.0044

Application info

F 2000 (01/94-12/95)
F 90 (07/86-12/97)

F 90 Unterflur (07/86-05/94)
M 90 (08/88-06/96)

034 035 0001 | MCX0082

Ring, wheel hub



Notes

Inner diameter [mm]	110
Outer diameter [mm]	145
Height [mm]	32
Axle Load [t]	10

References

81.35710.0045

Ring, wheel hub

034 035 0001 | MCX0082

Application info

F 2000 (01/94-12/95)
F 90 (07/86-12/97)
F 90 Unterflur (07/86-05/94)
M 2000 L (08/95--)

M 90 (08/88-06/96)
SG (07/76-06/97)
SL (05/80-04/87)
SR (10/75-11/86)

Shaft seal, wheel hub

12-14 753 0000 | MCX0203

Notes

Inner diameter [mm]	145
Outer diameter [mm]	174
Height [mm]	16
	Rear Axle

References

06.56289.0257	06.56289.0308
06.56289.0261	06.56289.0309
06.56289.0272	06.56289.0386
06.56289.0307	



Application info

F 2000 (01/94-12/95)
F 90 (07/86-12/97)
LION´S STAR (01/93-09/96)

M 2000 M (--12/05)
M 90 (08/88-06/96)

Shaft seal, wheel hub

12-34 753 0000 | MCX0247

Notes

Inner diameter [mm]	145
Outer diameter [mm]	175
Height [mm]	13
	Rear Axle

References

06.56279.0033	06.56289.0333
06.56289.0065	06.56289.0334
06.56289.0330	81.96503.0154
06.56289.0331	



Application info

F 2000 (01/94-12/95)
F 90 (07/86-12/97)
F 90 Unterflur (07/86-05/94)
G 90 (09/87-05/95)
L 2000 (10/93-07/97)

M 2000 L (08/95--)
M 2000 M (--12/05)
M 90 (08/88-06/96)
TGA (04/00--)

4

12-14 753 0002 | MCX0204

Shaft seal, wheel hub



Notes

Inner diameter [mm]	85
Outer diameter [mm]	105
Height [mm]	13
	Rear Axle

References

06.56289.0047	06.56289.0357
06.56289.0048	

Application info

F 2000 (01/94-12/95)
F 90 (07/86-12/97)

F 90 Unterflur (07/86-05/94)
TGA (04/00--)

034 753 0020 | MCX0116

Shaft seal, wheel hub



Notes

Inner diameter [mm]	145
Outer diameter [mm]	205
Outer diameter [mm]	175
Height [mm]	9
	Outer Rear Axle Front Axle

References

06.56289.0371

Application info

EL (01/93-06/97)
F 2000 (01/94-12/95)
F 90 (07/86-12/97)
F 90 Unterflur (07/86-05/94)
M 2000 L (08/95--)
M 2000 M (--12/05)

M 90 (08/88-06/96)
NG (--07/98)
NL (--07/98)
TGA (04/00--)
TGS (09/07--)
TGX (09/07--)

12-14 753 0007 | MCX0208

Shaft seal, wheel hub



Notes

Inner diameter [mm]	132
Outer diameter [mm]	160
Height [mm]	10
	Rear Axle

References

06.56289.0387

Shaft seal, wheel hub

12-14 753 0007 | MCX0208

Application info

M 2000 L (08/95--)
M 2000 M (--12/05)
TGA (04/00--)

TGM (10/05--)
TGS (09/07--)
TGX (09/07--)

Shaft seal, wheel hub

12-14 653 0001 | MCX0202

Notes

Inner diameter [mm]	81
Outer diameter [mm]	137
Outer diameter [mm]	100
Height [mm]	15.5

Front Axle

References

81.52403.6001



Application info

L 2000 (10/93-07/97)

M 2000 L (08/95--)

Shaft seal, wheel hub

12-14 753 0004 | MCX0205

Notes

Inner diameter [mm]	145
Outer diameter [mm]	175
Height [mm]	14

Rear Axle
Front Axle

References

06.56289.0027	06.56289.0335
06.56289.0064	81.96501.0861
06.56289.0332	81.96506.0155



Application info

F 2000 (01/94-12/95)
F 90 (07/86-12/97)
M 2000 L (08/95--)

M 2000 M (--12/05)
M 90 (08/88-06/96)
TGA (04/00--)

4

12-14 653 0000 | MCX0201

Shaft seal, wheel hub



Notes

Inner diameter [mm]	100
Outer diameter [mm]	130
Height [mm]	12
	Front Axle

References

81.96502.6081

Application info

F 2000 (01/94-12/95)
 F 90 (07/86-12/97)
 F 90 Unterflur (07/86-05/94)
 LION'S COACH (09/95--)
 LION'S STAR (01/93-09/96)
 M 2000 L (08/95--)

M 2000 M (--12/05)
 NG (--07/98)
 NL (--07/98)
 SG (07/76-06/97)
 SL II (--04/94)
 ÜL (09/89-09/96)

034 753 0017 | MCX0114

Shaft seal, wheel hub



Notes

Inner diameter [mm]	145
Outer diameter [mm]	175
Height [mm]	14
	Rear Axle

References

81.96503.0155

Application info

F 2000 (01/94-12/95)
 F 90 (07/86-12/97)
 M 2000 L (08/95--)

M 2000 M (--12/05)
 M 90 (08/88-06/96)
 TGA (04/00--)

12-14 753 0005 | MCX0206

Shaft seal, wheel hub



Notes

Inner diameter [mm]	87.3
Outer diameter [mm]	120.7
Height [mm]	13
	inner
	Rear Axle

References

81.96503.0161



Shaft seal, wheel hub

12-14 753 0005 | MCX0206

Application info

G 90 (09/87-05/95)

L 2000 (10/93-07/97)

Shaft seal, wheel hub

12-14 753 0008 | MCX0209

Notes

Inner diameter [mm]	132
Outer diameter [mm]	172
Height [mm]	12
	inner
	Rear Axle

References

81.96503.0333

81.96503.0399



Application info

L 2000 (10/93-07/97)

M 2000 L (08/95--)

M 2000 M (--12/05)

TGA (04/00--)

TGM (10/05--)

TGS (09/07--)

TGX (09/07--)

Shaft seal, wheel hub

12-14 753 0006 | MCX0207

Notes

Inner diameter [mm]	135
Outer diameter [mm]	175
Outer diameter [mm]	205
Height [mm]	11
	Rear Axle

References

81.96503.0188

81.96503.0398



Application info

F 2000 (01/94-12/95)

F 90 (07/86-12/97)

F 90 Unterflur (07/86-05/94)

L 2000 (10/93-07/97)

M 2000 L (08/95--)

M 2000 M (--12/05)

M 90 (08/88-06/96)

4

12-14 753 0009 | MCX0210

Shaft seal, wheel hub



Notes

Inner diameter [mm]	139
Outer diameter [mm]	170
Height [mm]	11
	Outer
	Rear Axle

References

81.96503.0339	81.96503.0530
81.96503.0445	

Application info

F 2000 (01/94-12/95)

TGA (04/00--)

12-14 753 0010 | MCX0211

Shaft seal, wheel hub



Notes

Inner diameter [mm]	139
Outer diameter [mm]	175
Outer diameter [mm]	205
Height [mm]	16.3
	Rear Axle

References

81.96503.6000

Application info

F 2000 (01/94-12/95)

TGA (04/00--)

TGM (10/05--)

034 040 0002 | MCX0101

Wheel nut



Notes

Inner thread [mm]	M22x1,5
Spanner Size	32
Quality/ Grade	10

References

81.45503.0049	81.45503.0056
---------------	---------------

Application info

F 2000 (01/94-12/95)

F 90 (07/86-12/97)

G 90 (09/87-05/95)

L 2000 (10/93-07/97)

Hydraulic filter, steering system

12-34 632 0001 | MSX0075

References

81.05504.6001 82.05504.6001
81.47307.0001



Application info

F 2000 (01/94-12/95)
F 90 (07/86-12/97)

TGA (04/00--)

Hydraulic filter, steering system

034 046 0000 | MSX0026

Notes

Thickness [mm] 100
Inner diameter [mm] 17.1
Outer diameter [mm] 59

References

81.47301.6005



Application info

CLA (01/06--)
EL (01/93-06/97)
F 2000 (01/94-12/95)
F 90 (07/86-12/97)
L 2000 (10/93-07/97)
LION'S COACH (09/95--)
LION'S COMFORT (09/96--)
LION'S STAR (01/93-09/96)
M 2000 L (08/95--)
M 2000 M (--12/05)

NG (--07/98)
NL (--07/98)
NÜ (09/96-07/98)
SÜ (--06/97)
TGA (04/00--)
TGL (04/05--)
TGM (10/05--)
TGS (09/07--)
TGX (09/07--)
ÜL (09/89-09/96)

12-36 030 0002 | MTA0130

Tie rod assembly

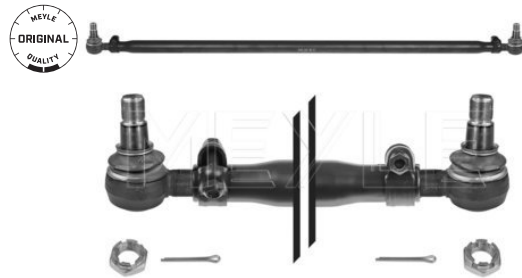

Notes

Pipe Ø [mm]

Thread Measurement 2

Thread Measurement 1

Length [mm]

Cone Size [mm]

Guide Rod
Nut with lateral notches
50
with metric thread
M30x1,5
M24x1,5
1652
30
Front Axle

References

81.46710.6112

81.46710.6163

81.46710.6165

81.46710.6198

81.46710.6353

81.46710.6354

81.46710.6361

81.46711.6725

81.46711.6820

81.46711.6849

Parts list

036 020 0004 | MTE0047

036 020 0005 | MTE0048

Tie rod end

Tie rod end

Application info

F 90 [07/86-12/97]

TGA [04/00--]

TGS [09/07--]

TGX [09/07--]

12-36 030 0002/HD | MTA0130HD

Tie rod assembly

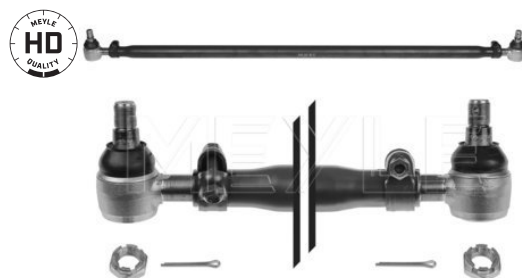

Notes

Pipe Ø [mm]

Thread Measurement 2

Thread Measurement 1

Length [mm]

Cone Size [mm]

Reinforced Version

Guide Rod
Nut with lateral notches
50
with metric thread
M30x1,5
M24x1,5
1652
30
Front Axle

References

81.46710.6112

81.46710.6163

81.46710.6165

81.46710.6198

81.46710.6353

81.46710.6354

81.46711.6725

81.46711.6820

81.46711.6849

Parts list

036 020 0004/HD | MTE0047HD

036 020 0005/HD | MTE0048HD

Tie rod end

Tie rod end

Application info

F 90 [07/86-12/97]

TGA [04/00--]

TGS [09/07--]

TGX [09/07--]



Tie rod assembly

12-34 250 6860 | MTA0129

Notes

Pipe Ø [mm]

Thread Measurement 2

Thread Measurement 1

Length [mm]

Cone Size [mm]

Guide Rod
Self-locking
52
with metric thread
M30x1,5
M24x1,5
1679
30
Front Axle



References

81.46711.6773

81.46711.6791

81.46711.6848

81.46711.6858

81.46711.6859

81.46711.6860

81.46711.6861

81.46711.6862

81.46711.6863

81.46711.6921

Parts list

12-36 020 0041 | MTE0173

Tie rod end

Application info

M 2000 L (08/95--)

M 2000 M (--12/05)

NÜ (09/96-07/98)

TGA (04/00--)

TGM (10/05--)

TGS (09/07--)

TGX (09/07--)

Drag link

12-34 250 6656 | MDL0060

Notes

Pipe Ø [mm]

Thread Measurement 2

Thread Measurement 1

Length [mm]

Cone Size [mm]

Push Rod
Nut with lateral notches
48
with metric thread
M30x1,5
M24x1,5
1070
for left-hand drive vehicles
30
Pitman Arm to track rod



References

81.46610.6656

81.46610.6659

81.46610.6669

Parts list

036 020 0004 | MTE0047

Tie rod end

Application info

F 2000 (01/94-12/95)

F 90 (07/86-12/97)

12-34 250 6197 | MDL0094

Drag link

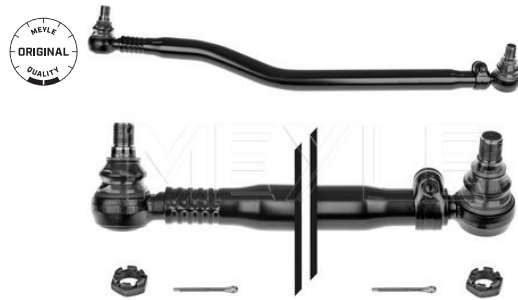

Notes

Pipe Ø [mm]

Thread Measurement 2

Thread Measurement 1

Length [mm]

Cone Size [mm]

Push Rod
Nut with lateral notches
52
with metric thread
M30x1,5
M24x1,5
993
for left-hand drive vehicles
30
at steering arm

References

81.46610.6087	81.46611.6099
81.46610.6808	81.46611.6132
81.46610.6836	81.46611.6133
81.46610.6837	81.46611.6136
81.46611.6088	81.46611.6197
81.46611.6096	81.46611.6198
81.46611.6097	81.46611.6205

Application info

TGA [04/00--]

TGS [09/07--]

TGX [09/07--]

12-34 250 6135 | MDL0057

Drag link



Notes

Pipe Ø [mm]

Thread Measurement 2

Thread Measurement 1

Length [mm]

Cone Size [mm]

Push Rod
Self-locking
52
with metric thread
M30x1,5
M24x1,5
967
for left-hand drive vehicles
30
Pitman arm to 1st front axle

References

81.46610.6809	81.46611.6134
81.46610.6810	81.46611.6135
81.46610.6823	81.46611.6137
81.46610.6839	81.46611.6199
81.46611.6104	81.46611.6200
81.46611.6105	81.46611.6206
81.46611.6107	

Parts list

836 020 0006 MTE0728	Tie rod end
------------------------	-------------

Application info

TGA [04/00--]

TGS [09/07--]

TGX [09/07--]



Drag link

12-36 040 0009 | MDL0062

Notes

	Push Rod
	Nut with lateral notches
Pipe Ø [mm]	48
	with metric thread
Thread Measurement 2	M30x1,5
Thread Measurement 1	M24x1,5
Length [mm]	1040
	for left-hand drive vehicles
Cone Size [mm]	30
	Pitman Arm to track rod



References

81.46610.6333	81.46610.6361
81.46610.6334	81.46610.6721
81.46610.6354	81.46610.6722
81.46610.6355	81.46610.6723
81.46610.6360	81.46611.6216

Parts list

036 020 0004 MTE0047	Tie rod end
------------------------	-------------

Application info

F 2000 (01/94-12/95)
F 90 (07/86-12/97)

F 90 Unterflur (07/86-05/94)

Drag link

12-34 250 6418 | MDL0059

Notes

	Push Rod
	Nut with lateral notches
Pipe Ø [mm]	50
	with metric thread
Thread Measurement 2	M30x1,5
Thread Measurement 1	M24x1,5
Length [mm]	1795
	for left-hand drive vehicles
Cone Size [mm]	30
	Pitman Arm to track rod



References

81.46710.6418

Application info

F 90 (07/86-12/97)

12-34 035 0004 | MDL0055

Drag link



Notes

Pipe Ø [mm]

Thread Measurement 2

Thread Measurement 1

Length [mm]

Cone Size [mm]

Push Rod

Nut with lateral notches

38

with metric thread

M28x1,5

M18x1,5

825

for left-hand drive vehicles

22

Pitman Arm to track rod

References

81.46610.6004

81.46610.6006

81.46610.6753

81.46610.6754

85.46610.6031

85.46610.6104

85.46610.6203

Parts list

036 020 0003 | MTE0046

Tie rod end

Application info

L 2000 [10/93-07/97]

036 020 0008 | MTE0051

Tie rod end



Notes

Thread Measurement 2

Thread Measurement 1

Length [mm]

Cone Size [mm]

Nut with lateral notches

with left-hand thread

M28x1,5L

M18x1,5

106

for left-/right-hand traffic

22

Front Axle

References

81.95301.0079

81.95301.6139

81.95301.6222

81.95301.6315

81.95301.6329

81.95301.6359

Counterpart

036 020 0003 | MTE0046

Application info

G [10/79-08/88]



Tie rod end

036 020 0004 | MTE0047

Notes

Thread Measurement 2
Thread Measurement 1
Length [mm]

Cone Size [mm]

Nut with lateral notches
with right-hand thread
M30x1,5
M24x1,5
125
for left-/right-hand traffic
30
Front Axle

References

81.95301.0016	81.95301.6156
81.95301.0084	81.95301.6194
81.95301.6048	81.95301.6224
81.95301.6049	81.95301.6234
81.95301.6053	81.95301.6242
81.95301.6061	81.95301.6274
81.95301.6090	81.95301.6278
81.95301.6112	81.95301.6308
81.95301.6126	81.95301.6312
81.95301.6143	81.95301.6350
81.95301.6149	81.95301.6352
81.95301.6154	

Counterpart

036 020 0005 | MTE0048



Application info

CLA [01/06--]
F 2000 [01/94-12/95]
F 90 [07/86-12/97]
F 90 Unterflur [07/86-05/94]

M 2000 L [08/95--]
M 90 [08/88-06/96]
TGA [04/00--]

Tie rod end

036 020 0004/HD | MTE0047HD

Notes

Thread Measurement 2
Thread Measurement 1
Length [mm]

Cone Size [mm]

Reinforced Version

Nut with lateral notches
with right-hand thread
M30x1,5
M24x1,5
125
for left-/right-hand traffic
30
Front Axle

References

81.95301.0016	81.95301.6154
81.95301.0084	81.95301.6156
81.95301.6048	81.95301.6194
81.95301.6049	81.95301.6224
81.95301.6053	81.95301.6234
81.95301.6061	81.95301.6242
81.95301.6090	81.95301.6274
81.95301.6112	81.95301.6278
81.95301.6126	81.95301.6308
81.95301.6143	81.95301.6312
81.95301.6149	81.95301.6350

Counterpart

036 020 0005/HD | MTE0048HD



036 020 0004/HD | MTE0047HD

Tie rod end

Application info

CLA [01/06--]
F 2000 [01/94-12/95]
F 90 [07/86-12/97]
F 90 Unterflur [07/86-05/94]

M 2000 L [08/95--]
M 90 [08/88-06/96]
TGA [04/00--]

12-36 020 0032 | MTE0171

Tie rod end



Notes

Thread Measurement 2
Thread Measurement 1
Length [mm]

Cone Size [mm]

Nut with lateral notches
with right-hand thread
M30x1,5
M24x1,5
158
for left-/right-hand traffic
30
Front Axle

References

81.95301.6263

Application info

F 2000 [01/94-12/95]
F 90 [07/86-12/97]

F 90 Unterflur [07/86-05/94]

12-36 020 0039 | MTE0655

Tie rod end



Notes

Thread Measurement 2
Thread Measurement 1
Length [mm]

Cone Size [mm]

Nut with lateral notches
with right-hand thread
M24x1,5
M30x1,5
141
for left-/right-hand traffic
26
Front Axle

References

81.95301.6270

Application info

EL [01/93-06/97]
HOCL [01/85-05/09]
M 2000 L [08/95--]
M 2000 M [--12/05]

NG [--07/98]
NL [--07/98]
NM [--03/97]
TGM [10/05--]

Tie rod end
036 020 0001 | MTE0044
Notes

Thread Measurement 2
Thread Measurement 1
Length [mm]

Cone Size [mm]

Nut with lateral notches
with right-hand thread
M30x1,5
M20x1,5
114
for left-/right-hand traffic
26
Front Axle

References

81.95301.0014
81.95301.0064
81.95301.6067
81.95301.6162

81.95301.6239
81.95301.6272
90.80415.3111

Counterpart

036 020 0002 | MTE0045

Application info

F 2000 [01/94-12/95]
F 90 [07/86-12/97]
F 90 Unterflur [07/86-05/94]

M 2000 L [08/95--]
M 90 [08/88-06/96]

Tie rod end
036 020 0002 | MTE0045
Notes

Thread Measurement 2
Thread Measurement 1
Length [mm]

Cone Size [mm]

Nut with lateral notches
with left-hand thread
M30x1,5
M20x1,5
114
for left-/right-hand traffic
26
Front Axle

References

81.95301.0013
81.95301.0074
81.95301.6068
81.95301.6163

81.95301.6273
90.80415.3107
90.80415.3113

Counterpart

036 020 0001 | MTE0044

Application info

F 2000 [01/94-12/95]
F 90 [07/86-12/97]
F 90 Unterflur [07/86-05/94]

M 2000 L [08/95--]
M 90 [08/88-06/96]

036 020 0005 | MTE0048

Tie rod end



Notes

Thread Measurement 2
Thread Measurement 1
Length [mm]

Cone Size [mm]

Nut with lateral notches
with left-hand thread
M30x1,5
M24x1,5
125
for left-/right-hand traffic
30
Front Axle

References

81.95301.0015	81.95301.6152
81.95301.6030	81.95301.6155
81.95301.6043	81.95301.6167
81.95301.6091	81.95301.6179
81.95301.6120	81.95301.6237
81.95301.6125	81.95301.6275

Counterpart

036 020 0004 | MTE0047

Application info

CLA [01/06--]
F 90 [07/86-12/97]
F 90 Unterflur [07/86-05/94]

M 90 [08/88-06/96]
TGA [04/00--]

036 020 0005/HD | MTE0048HD

Tie rod end



Notes

Thread Measurement 2
Thread Measurement 1
Length [mm]

Cone Size [mm]

Reinforced Version

Nut with lateral notches
with left-hand thread
M30x1,5
M24x1,5
125
for left-/right-hand traffic
30
Front Axle

References

81.95301.0015	81.95301.6152
81.95301.6030	81.95301.6155
81.95301.6043	81.95301.6167
81.95301.6091	81.95301.6179
81.95301.6120	81.95301.6237
81.95301.6125	81.95301.6275

Counterpart

036 020 0004/HD | MTE0047HD

Application info

CLA [01/06--]
F 90 [07/86-12/97]
F 90 Unterflur [07/86-05/94]

M 90 [08/88-06/96]
TGA [04/00--]



Tie rod end

836 020 0006 | MTE0728

Notes

Thread Measurement 2
Thread Measurement 1
Length [mm]

Cone Size [mm]

References

81.95301.6286

Nut with lateral notches
with right-hand thread
M30x1,5
M24x1,5
141
for left-/right-hand traffic
30
Front Axle



Application info

F 2000 (01/94-12/95)
F 90 (07/86-12/97)
TGA (04/00--)

TGS (09/07--)
TGX (09/07--)

Tie rod end

12-36 020 0041 | MTE0173

Notes

Thread Measurement 2
Thread Measurement 1
Length [mm]

Cone Size [mm]

References

81.95301.6288

Nut with lateral notches
with right-hand thread
M30x1,5
M24x1,5
120
for left-/right-hand traffic
30
Steering Rod at steering arm



Application info

NÜ (09/96-07/98)
TGA (04/00--)
TGM (10/05--)

TGS (09/07--)
TGX (09/07--)

Tie rod end

536 020 0009 | MTE0741

Notes

Thread Measurement 2
Thread Measurement 1
Length [mm]
Cone Size [mm]

References

81.95301.6292

Self-locking
with right-hand thread
M30x1,5
M20x1,5
145
28.6
Front Axle



536 020 0009 | MTE0741

Tie rod end

Application info

F 90 (07/86-12/97)

036 020 0015 | MTE0058

Tie rod end



Notes

Thread Measurement 2
Thread Measurement 1
Length [mm]

Cone Size [mm]

Nut with lateral notches
with left-hand thread
M24x1,5
M16x1,5
104
for left-/right-hand traffic
20
Front Axle

References

81.95301.0076
81.95301.0078

81.95301.6141
81.95301.6304

Counterpart

036 020 0016 | MTE0059

Application info

G (10/79-08/88)
G 90 (09/87-05/95)

L 2000 (10/93-07/97)
TGA (04/00--)

036 020 0016 | MTE0059

Tie rod end



Notes

Thread Measurement 2
Thread Measurement 1
Length [mm]

Cone Size [mm]

Nut with lateral notches
with right-hand thread
M24x1,5
M16x1,5
104
for left-/right-hand traffic
20
Front Axle

References

81.95301.0077
81.95301.0388
81.95301.6134

81.95301.6142
81.95301.6303
81.95301.6321

Counterpart

036 020 0015 | MTE0058

Application info

G (10/79-08/88)
G 90 (09/87-05/95)

L 2000 (10/93-07/97)
TGA (04/00--)

Tie rod end

036 020 0003 | MTE0046

Notes

Thread Measurement 2
Thread Measurement 1
Length [mm]

Cone Size [mm]

Nut with lateral notches
with right-hand thread
M28x1,5
M18x1,5
106
for left-/right-hand traffic
22
Front Axle

References

81.95301.6060
81.95301.6135
81.95301.6140

81.95301.6249
81.95301.6328
81.95301.6358

Counterpart

036 020 0008 | MTE0051



Application info

G 10/79-08/88
G 90 [09/87-05/95]

L 2000 [10/93-07/97]
M 2000 L [08/95--]

Hydraulic pump, P/S

12-34 471 0001 | MHP0053

Notes

Thread Measurement 2
Number of connectors
Thread Measurement 1
Operating Pressure [bar]

Hydraulic
Steel
M26x1,5
2
M18x1,5
130
Clockwise rotation

References

81.47101.6000
81.47101.6001
81.47101.6031

81.47101.6040
81.47101.6051
81.47101.6169



Application info

F 2000 [01/94-12/95]
F 90 [07/86-12/97]
F 90 Unterflur [07/86-05/94]

LION'S COACH [09/95--]
LION'S COMFORT [09/96--]
LION'S STAR [01/93-09/96]

Hydraulic pump, P/S

12-34 631 0001 | MHP0055

Notes

Thread Measurement 2
Number of connectors
Thread Measurement 1
Operating Pressure [bar]

Hydraulic
Cast Aluminium
M26x1,5
2
M18x1,5
150
Anti-clockwise rotation

References

81.47101.6121
81.47101.6136

81.47101.6161



12-34 631 0001 | MHP0055

Hydraulic pump, P/S

Application info

SL (05/80-04/87)

TGA (04/00--)

12-34 471 0003 | MHP0054

Hydraulic pump, P/S



Notes

Thread Measurement 2
Number of connectors
Thread Measurement 1
Operating Pressure [bar]

Hydraulic
Cast Aluminium
M26x1,5
2
M18x1,5
150
Clockwise rotation

References

81.47101.6137
81.47101.6162
81.47101.6181

81.47101.9137
81.47101.9162

Application info

F 2000 (01/94-12/95)
F 90 (07/86-12/97)
F 90 Unterflur (07/86-05/94)
LION'S COACH (09/95--)

LION'S COMFORT (09/96--)
LION'S STAR (01/93-09/96)
TGA (04/00--)

12-34 631 0002 | MHP0056

Hydraulic pump, P/S



Notes

Thread Measurement 2
Number of connectors
Thread Measurement 1
Operating Pressure [bar]

Hydraulic
Cast Aluminium
M26x1,5
2
M18x1,5
130
Clockwise rotation

References

81.47101.6102
81.47101.6108

81.47101.6189

Application info

EL (01/93-06/97)
EM (08/87-06/97)
F 90 (07/86-12/97)
LION'S COACH (09/95--)
LION'S STAR (01/93-09/96)

NG (--07/98)
NL (--07/98)
NM (--03/97)
NÜ (09/96-07/98)



P/S fluid reservoir

12-34 632 0002 | MSX0076

Notes

with lid

References

81.47301.6048



Application info

F 2000 [01/94-12/95]
TGA [04/00--]

TGS [09/07--]
TGX [09/07--]

12-34 026 0001 | MIX0161

Gear shift knob



Notes

Width 2 [mm]
Width 1 [mm]
Number of connectors
Length [mm]

Black
ZF Transmission
65
47
6
155

References

81.32620.0039
81.32620.0043

81.32620.0085

Application info

TGA [04/00--]
TGS [09/07--]

TGX [09/07--]

12-34 026 0000 | MIX0160

Gear shift knob



Notes

Width 2 [mm]
Width 1 [mm]
Number of connectors
Length [mm]

Black
Silver
ZF Transmission
65
47
4
150

References

81.32620.0049

Application info

TGA [04/00--]
TGS [09/07--]

TGX [09/07--]

12-34 026 0004 | MIX0163

Gear shift knob



Notes

Number of connectors
Length [mm]

Black
Manual Transmission
2
128

References

81.97010.6010

Application info

F 2000 [01/94-12/95]
F 90 [07/86-12/97]
M 2000 L [08/95--]

M 2000 M [--12/05]
M 90 [08/88-06/96]

Gear shift knob
12-34 026 0003 | MIX0162
Notes

Width 2 [mm]	Black
Width 1 [mm]	67
Number of connectors	50
Length [mm]	3
	115

References

81.97010.6011

Application info

F 2000 (01/94-12/95)
 F 90 (07/86-12/97)
 F 90 Unterflur (07/86-05/94)
 L 2000 (10/93-07/97)

M 2000 L (08/95--)
 M 2000 M (--12/05)
 M 90 (08/88-06/96)

Cabin air filter
12-12 319 0000 | MCF0111
Notes

Height [mm]	31
Width [mm]	187
Length [mm]	401.8
	Filter Insert
	Particulate Filter

References

81.61910.0011

Application info

F 2000 (01/94-12/95)
 F 90 (07/86-12/97)
 F 90 Unterflur (07/86-05/94)
 L 2000 (10/93-07/97)

LION'S COMFORT (09/96--)
 M 2000 L (08/95--)
 M 2000 M (--12/05)
 M 90 (08/88-06/96)

Cabin air filter
12-12 319 0003 | MCF0113
Notes

Height [mm]	70
Width [mm]	177
Length [mm]	466.5
	Filter Insert
	Particulate Filter

References

81.61910.0018



12-12 319 0003 | MCF0113

Cabin air filter

Application info

TGA (04/00--)
TGL (04/05--)

TGS (09/07--)
TGX (09/07--)

12-12 320 0008 | MCF0118

Cabin air filter



Notes

Height [mm]
Width [mm]
Length [mm]

70
177
466.5
Filter Insert
Activated Carbon Filter

References

81.61910.0019

81.61910.0030

Application info

TGA (04/00--)
TGL (04/05--)
TGM (10/05--)

TGS (09/07--)
TGX (09/07--)

12-12 319 0001 | MCF0112

Cabin air filter



Notes

Height [mm]
Width [mm]
Length [mm]

40
159
361
Filter Insert
Particulate Filter

References

85.61950.0025

Application info

CLA (01/06--)

L 2000 (10/93-07/97)



Cabin air filter

12-12 319 0012 | MCF0454

Notes

Height [mm]	20
Width [mm]	150
Length [mm]	223
	Pollen Filter

References

88.77910.0003



Application info

LION´S STAR (01/93-09/96)

Latch, driver cabine

12-14 910 0001 | MIX0157

References

81.61851.6019	81.61851.6029
81.61851.6023	



Application info

F 2000 (01/94-12/95)
 F 90 (07/86-12/97)
 M 2000 M (--12/05)

M 90 (08/88-06/96)
 TGA (04/00--)

Hinge, driver cab

12-34 210 0348 | MIX0166

Notes

Inner diameter [mm]	22
Outer diameter [mm]	58.5
Height [mm]	47.5
	Left and right
	Front

References

81.96210.0340	81.96210.0349
81.96210.0348	



Application info

LION´S COACH (09/95--)
 LION´S STAR (01/93-09/96)
 M 2000 M (--12/05)

M 90 (08/88-06/96)
 TGA (04/00--)

6

12-34 210 0403 | MIX0168

Hinge, driver cab



Notes

Inner diameter [mm]	14
Outer diameter [mm]	38
Outer diameter [mm]	30
Height [mm]	48
	Left and right
	Rear

References

81.96210.0369	81.96210.0462
---------------	---------------

Application info

CLA [01/06--]
 F 2000 [01/94-12/95]
 F 90 [07/86-12/97]
 L 2000 [10/93-07/97]
 M 2000 L [08/95--]
 M 2000 M [--12/05]

TGA [04/00--]
 TGL [04/05--]
 TGM [10/05--]
 TGS [09/07--]
 TGX [09/07--]

12-34 089 0001 | MIX0278

Spacer, driver cab stabiliser



Notes

Thickness [mm]	6
Required quantity	2

References

81.90712.0844	81.90713.0909
---------------	---------------

Application info

F 2000 [01/94-12/95]

F 90 [07/86-12/97]

12-34 210 0401 | MIX0290

Spacer, driver cab stabiliser

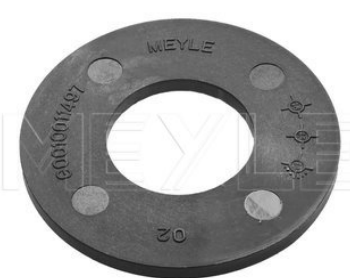

Notes

Thickness [mm]	4
Required quantity	2

References

81.96101.0638

Spacer, driver cab stabiliser

12-34 210 0401 | MIX0290

Application info

F 2000 (01/94-12/95)
F 90 (07/86-12/97)

F 90 Unterflur (07/86-05/94)

Bushing, driver cab suspension

12-34 210 0400 | MIX0167

Notes

Inner diameter 1 [mm]	16
Outer diameter 2 [mm]	64
Outer diameter 1 [mm]	50
Height 1 [mm]	29
	Left and right
	Front

References

81.96210.0400



Application info

F 90 (07/86-12/97)
F 90 Unterflur (07/86-05/94)

M 90 (08/88-06/96)

Bushing, driver cab suspension

12-34 210 0437 | MIX0173

Notes

Inner diameter 1 [mm]	11
Outer diameter 2 [mm]	70
Outer diameter 1 [mm]	63
Height 1 [mm]	68
	Left and right
	Front

References

81.96210.0424 81.96210.0437



Application info

F 2000 (01/94-12/95)

F 90 (07/86-12/97)

Bushing, driver cab suspension

12-34 210 0609 | MIX0327

Notes

Outer diameter [mm]	53.5
	Left and right

References

81.96210.0609



12-34 210 0609 | MIX0327

Bushing, driver cab suspension

Application info

TGA [04/00--]
TGS [09/07--]

TGX [09/07--]

12-34 210 0409 | MIX0223

Bushing, driver cab suspension



Notes

Inner diameter 1 [mm]	17
Outer diameter 1 [mm]	75
Height 1 [mm]	22
	Left and right

References

85.41715.0006

Application info

TGA [04/00--]
TGS [09/07--]

TGX [09/07--]

12-34 210 0404 | MIX0169

Bushing, driver cab suspension



Notes

Inner diameter 1 [mm]	13
Outer diameter 1 [mm]	22
Height 1 [mm]	79.5
	Left and right
	Rear

References

85.94299.0015

Application info

TGA [04/00--]
TGL [04/05--]
TGM [10/05--]

TGS [09/07--]

TGX [09/07--]

Bushing, driver cab suspension

12-34 210 0405 | MIX0170

Notes

Inner diameter 1 [mm]	22
Outer diameter 1 [mm]	53
Height 1 [mm]	42
Required quantity	2
	Left and right
	Rear

References

85.96020.0004



Application info

TGA [04/00--]	TGS [09/07--]
TGL [04/05--]	TGX [09/07--]
TGM [10/05--]	

Bushing, driver cab suspension

12-34 210 0406 | MIX0171

Notes

Inner diameter 1 [mm]	16.5
Outer diameter 1 [mm]	60
Height 2 [mm]	80
Height 1 [mm]	64
	Left and right
	Front

References

85.96210.0019



Application info

TGA [04/00--]	TGX [09/07--]
TGS [09/07--]	

Bushing, driver cab suspension

12-34 210 0408 | MIX0172

References

85.96210.0021



Application info

TGA [04/00--]	TGM [10/05--]
TGL [04/05--]	

12-34 210 0515 | MIX0175

Rubber stop, cabin



Notes

Outer diameter [mm]	50
Height [mm]	36
Thread Size	M10x1,5
Thread Length [mm]	18

References

81.96210.0482	81.96210.0515
---------------	---------------

Application info

E 2000 [05/00--]
F 2000 [01/94-12/95]

M 2000 M [--12/05]
TGA [04/00--]

12-34 210 0402 | MIX0216

Seal, driver cab stabiliser



References

81.96503.0129

Application info

F 2000 [01/94-12/95]
F 90 [07/86-12/97]

F 90 Unterflur [07/86-05/94]

12-34 058 0003 | MIX0217

Repair kit, driver cab mounting



References

81.41700.6095

Application info

F 2000 [01/94-12/95]
F 90 [07/86-12/97]

F 90 Unterflur [07/86-05/94]



Repair kit, driver cab mounting

12-34 058 0001 | MIX0164

Notes

with bush
with gaskets/seals

References

81.41715.6013



Application info

TGA [04/00--]
TGS [09/07--]

TGX [09/07--]

Repair kit, driver cab mounting

12-34 058 0002 | MIX0165

References

81.41715.6014



Application info

TGA [04/00--]

Repair kit, driver cab mounting

12-34 058 0004 | MIX0218

References

81.96210.0362

81.96210.0407



Application info

F 2000 [01/94-12/95]

F 90 [07/86-12/97]

6

12-14 910 0102 | MIX0240

Tilt pump, driver cab



Notes

for left-hand drive vehicles

References

81.41723.6059
81.41723.6103

81.41723.6114
81.41723.9114

Application info

F 2000 (01/94-12/95)
F 90 (07/86-12/97)
L 2000 (10/93-07/97)

M 2000 L (08/95--)
M 2000 M (--12/05)

12-14 910 0100 | MIX0159

Tilt pump, driver cab



Notes

for left-hand drive vehicles

References

85.41723.6011
85.41723.6020

85.41723.6044

Application info

TGA (04/00--)
TGM (10/05--)

TGS (09/07--)
TGX (09/07--)

12-14 910 0005 | MIX0158

Tilt cylinder, driver cab



Notes

Outer thread [mm]	M12x1,5
Pressure [bar]	250
Outer diameter [mm]	50
Length 2 [mm]	1545
Length 1 [mm]	890
Stroke [mm]	655

References

81.41723.6123

83.41723.6123

Application info

TGA (04/00--)



Tilt cylinder, driver cab

12-14 910 0004 | MIX0239

Notes

Outer thread [mm]	M12x1,5
Length 2 [mm]	1160
Length 1 [mm]	940
Stroke [mm]	720

References

81.41723.6124	83.41723.6124
---------------	---------------



Application info

TGA [04/00--]

Gas spring, front hood

12-34 920 1002 | MIX0186

Notes

Eject Force [N]	260
Length [mm]	580
Stroke [mm]	280

References

81.74821.0109



Application info

F 2000 [01/94-12/95]

F 90 [07/86-12/97]

Side marker

12-34 830 0101 | MIX0177

Notes

Yellow
with bulb
Left and right

References

81.25260.6105



Application info

F 2000 [01/94-12/95]
 L 2000 [10/93-07/97]
 M 2000 L [08/95--]
 M 2000 M [--12/05]

TGA [04/00--]
 TGS [09/07--]
 TGX [09/07--]

12-34 533 0200 | MEX0596

Back up light switch



Notes

Spanner Size
Thread Size
Thread Size
Number of Poles

Push control
Mechanical
27
M27x1,5
M18x1,5
2

References

81.25503.6119	81.25505.0636
81.25505.0236	81.25505.6110
81.25505.0239	81.25520.0050
81.25505.0426	

Application info

F 90 (07/86-12/97)
F 90 Unterflur (07/86-05/94)
G (10/79-08/88)
G 90 (09/87-05/95)
L 2000 (10/93-07/97)
M 2000 L (08/95--)
M 2000 M (--12/05)
M 90 (08/88-06/96)

NL (--07/98)
NÜ (09/96-07/98)
TGL (04/05--)
TGM (10/05--)
TGS (09/07--)
TGX (09/07--)
ÜL (09/89-09/96)

12-34 910 0005 | MIX0182

Door handle



Notes

Black
without lock barrel
Left

References

81.62641.0099

Application info

F 2000 (01/94-12/95)

M 2000 M (--12/05)

12-34 910 0006 | MIX0183

Door handle



Notes

Black
Right

References

81.62641.0100



Door handle

12-34 910 0006 | MIX0183

Application info

F 2000 (01/94-12/95)

M 2000 M [--12/05]

Door handle

12-34 910 0001 | MIX0179

Notes

Black
without lock barrel
Left

References

81.62641.6085

Counterpart

12-34 910 0002 | MIX0180



Application info

TGA (04/00--)

TGL (04/05--)

TGM (10/05--)

TGS (09/07--)

TGX (09/07--)

Door handle

12-34 910 0002 | MIX0180

Notes

Black
without lock barrel
Right

References

81.62641.6086

Counterpart

12-34 910 0001 | MIX0179



Application info

TGA (04/00--)

TGL (04/05--)

TGM (10/05--)

TGS (09/07--)

TGX (09/07--)

6

12-34 910 0003 | MIX0181

Door handle



Notes

Black
with key
with lock barrel
Left and right

References

81.97100.6079

81.97100.6099

Application info

F 2000 (01/94-12/95)
F 90 (07/86-12/97)
F 90 Unterflur (07/86-05/94)

M 2000 M (--12/05)
M 90 (08/88-06/96)

12-34 910 0009 | MIX0185

Door lock



Notes

Left

References

81.62680.6095

Counterpart

12-34 910 0008 | MIX0184

Application info

F 2000 (01/94-12/95)
F 90 (07/86-12/97)

F 90 Unterflur (07/86-05/94)
M 90 (08/88-06/96)

12-34 910 0008 | MIX0184

Door lock



Notes

Right

References

81.62680.6096

Counterpart

12-34 910 0009 | MIX0185

Application info

F 2000 (01/94-12/95)
F 90 (07/86-12/97)

F 90 Unterflur (07/86-05/94)
M 90 (08/88-06/96)



Lock cylinder set

12-34 899 0002 | MIX0178

References

81.46433.6006	81.97100.6034
81.46433.6011	81.97100.6095



Application info

CLA [01/06--]
 EL [01/93-06/97]
 EM [08/87-06/97]
 F 2000 [01/94-12/95]
 F 90 [07/86-12/97]
 F 90 Unterflur [07/86-05/94]
 L 2000 [10/93-07/97]
 LION'S COACH [09/95--]
 LION'S STAR [01/93-09/96]
 M 2000 L [08/95--]
 M 2000 M [--12/05]

M 90 [08/88-06/96]
 NG [--07/98]
 NL [--07/98]
 NM [--03/97]
 NÜ [09/96-07/98]
 R [05/85-01/93]
 SG [07/76-06/97]
 SM [11/87-02/95]
 SÜ [--06/97]
 ÜL [09/89-09/96]

Window lifter

12-34 910 0010 | MWL0081

Notes

Electric
Left

References

81.62640.6045	81.62640.6055
81.62640.6049	

Counterpart

12-34 910 0011 | MWL0082



Application info

F 2000 [01/94-12/95]

M 2000 M [--12/05]

Window lifter

12-34 910 0011 | MWL0082

Notes

Electric
Right

References

81.62640.6046	81.62640.6056
81.62640.6050	

Counterpart

12-34 910 0010 | MWL0081

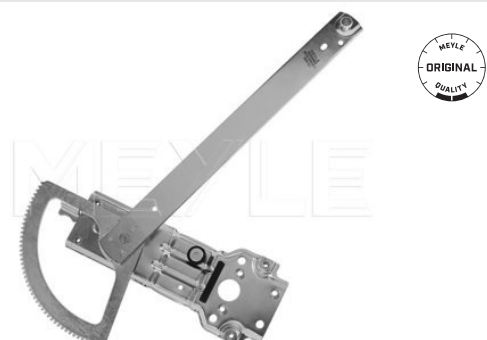

6



12-34 910 0011 | MWL0082

Window lifter

Application info

F 2000 (01/94-12/95)

M 2000 M [--12/05]

12-34 870 0004 | MWI0016

Windshield washer pump



Notes

Voltage [V]

Mono Pump
Electric
24

References

81.26485.6008

Application info

EL (01/93-06/97)
EM (08/87-06/97)
LION'S COACH (09/95--)
LION'S STAR (01/93-09/96)
NG [--07/98]
NM [--03/97]

NÜ (09/96-07/98)
SG (07/76-06/97)
SL (05/80-04/87)
SR (10/75-11/86)
ÜL (09/89-09/96)

12-34 870 0002 | MWI0015

Windshield washer pump



Notes

Voltage [V]

Dual Pump
Grey
Black
Electric
24

References

81.26485.6027

81.26485.6030

Application info

CLA (01/06--)
F 2000 (01/94-12/95)
F 90 (07/86-12/97)
F 90 Unterflur (07/86-05/94)
L 2000 (10/93-07/97)

M 2000 L (08/95--)
M 2000 M [--12/05]
M 90 (08/88-06/96)
NÜ (09/96-07/98)



Windshield washer pump

034 870 0005 | MWI0031

Notes

Voltage [V]

Mono Pump
Electric
24

References

81.26485.6029



Application info

F 2000 (01/94-12/95)
L 2000 (10/93-07/97)
LION'S COACH (09/95--)
LION'S STAR (01/93-09/96)
M 2000 L (08/95--)

M 2000 M (--12/05)
NÜ (09/96-07/98)
TGA (04/00--)
TGL (04/05--)
TGM (10/05--)

Windshield washer pump

12-34 870 0001 | MWI0014

Notes

Voltage [V]

Dual Pump
Black
Electric
24

References

81.26485.6032

81.26485.6033



Application info

NG (--07/98)
NL (--07/98)
NÜ (09/96-07/98)
TGA (04/00--)

TGL (04/05--)
TGM (10/05--)
TGS (09/07--)
TGX (09/07--)

Wiper Blade

029 100 4071 | MBL0063

Notes

Length [in]
Length [mm]

Bracket wiper blade
Beam wiper blade
40
1000
Front

References

81.26440.0049
81.26440.6016

81.26440.6027
83.26440.0001



029 100 4071 | MBL0063

Wiper Blade

Application info

LION´S COACH (09/95--)
R (05/85-01/93)

SR (10/75-11/86)
ÜL (09/89-09/96)

029 600 2470 | MBL0035

Wiper Blade



Notes

Length [in]
Length [mm]

Bracket wiper blade
Beam wiper blade
24
600
Front

References

81.26440.0053
81.26440.0065
81.26440.6034

85.20000.9975
85.26440.0046

Application info

F 2000 (01/94-12/95)
F 90 (07/86-12/97)
F 90 Unterflur (07/86-05/94)

M 2000 M (--12/05)
M 90 (08/88-06/96)
TGA (04/00--)

029 700 2870 | MBL0040

Wiper Blade



Notes

Length [in]
Length [mm]

Bracket wiper blade
Beam wiper blade
28
700
Front

References

81.26440.0029
81.26440.0043
81.26440.6006

81.26440.6035
81.70701.0331
84.26440.0003

Application info

TGA (04/00--)
TGL (04/05--)
TGM (10/05--)

TGS (09/07--)
TGX (09/07--)



Wiper Blade

029 650 2670 | MBL0037

Notes

Length [in]
Length [mm]

Beam wiper blade
Bracket wiper blade
26
650
Front



Application info

TGA [04/00--]
TGL [04/05--]
TGM [10/05--]

TGS [09/07--]
TGX [09/07--]

12-34 830 0006 | MEX0362

Multifunction relay



Notes

Rated current [A]	70
	Clamp 87
	Directional Contact
Height [mm]	42
Width [mm]	27
Operating voltage [V]	24
Length [mm]	27
Number of Poles	4
	with retaining strap

References

81.25902.0155	81.25902.0274
---------------	---------------

Application info

- E 2000 [05/00--]
- F 2000 [01/94-12/95]
- L 2000 [10/93-07/97]

- M 2000 L [08/95--]
- M 2000 M [--12/05]
- TGA [04/00--]

12-34 830 0005 | MEX0361

Multifunction relay

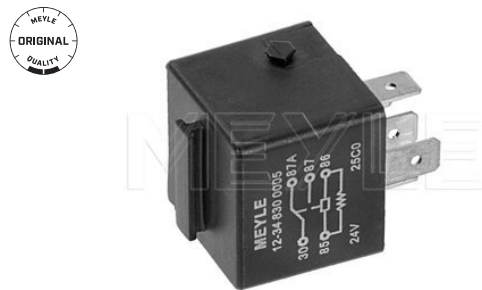

Notes

Rated current [A]	20
	ABS
	Indicator
	with headlight flasher
Height [mm]	40
Width [mm]	27
Operating voltage [V]	24
Length [mm]	27
Number of Poles	5

References

81.25902.0460	81.25902.0474
---------------	---------------

Application info

- E 2000 [05/00--]
- EL [01/93-06/97]
- EM [08/87-06/97]
- F 2000 [01/94-12/95]
- F 90 [07/86-12/97]
- F 90 Unterflur [07/86-05/94]
- G 90 [09/87-05/95]
- L 2000 [10/93-07/97]
- LION'S CITY [08/04--]
- LION'S COACH [09/95--]
- LION'S COMFORT [09/96--]
- LION'S STAR [01/93-09/96]
- M 2000 L [08/95--]

- M 2000 M [--12/05]
- M 90 [08/88-06/96]
- SD [04/74-04/94]
- SL [05/80-04/87]
- SM [11/87-02/95]
- SR [10/75-11/86]
- SÜ [--06/97]
- TGA [04/00--]
- TGL [04/05--]
- TGM [10/05--]
- TGS [09/07--]
- TGX [09/07--]
- ÜL [09/89-09/96]



MEYLE no.	Ref. no.	Page
MAN		
014 018 0015	51.05500.6073 51.05504.0105	14
014 323 0008	51.12503.0051 51.12503.6000	25
025 290 4827	81.50820.5074 81.50820.5085 81.50820.6040 81.50820.6043 81.50820.6054 81.50820.6063	87
025 290 8730	81.50820.6030 81.50820.6056	85
025 290 8730/S	81.50820.6030 81.50820.6056	87
025 290 8826	81.50820.5023 81.50820.5025 81.50820.5029 81.50820.5079 81.50820.6006 81.50820.6020 81.50820.6042	85
025 290 8826/S	81.50820.5023 81.50820.5025 81.50820.5029 81.50820.5079 81.50820.6006 81.50820.6020 81.50820.6042	85
025 290 9530	81.50820.5017 81.50820.6008 81.50820.6022	84
025 291 1328	81.50820.5006 81.50820.5007 81.50820.5020 81.50820.5040 81.50820.5047 81.50820.5060 81.50820.5066 81.50820.5068 81.50820.5091 81.50820.6000 81.50820.6002 81.50820.6004 81.50820.6014 81.50820.6016 81.50820.6017	86

MEYLE no.	Ref. no.	Page
MAN		
	81.50820.6025 81.50820.6034 81.50820.6035 81.50820.6036 81.50820.6046	
025 291 1428	81.50820.5007 81.50820.5041 81.50820.5048 81.50820.5061 81.50820.5069 81.50820.5092 81.50820.6001 81.50820.6003 81.50820.6005 81.50820.6015 81.50820.6017 81.50820.6026	84
025 291 3130	81.50820.5072 81.50820.5080 81.50820.6031 81.50820.6041 81.50820.6051	86
028 271 0011	51.06402.0057 51.06402.0062 51.06402.0065 51.06402.0068	48
028 283 0000	51.06402.0058 51.06402.0060 51.06402.0063 51.06402.0066	47
029 100 4071	81.26440.0049 81.26440.6016 81.26440.6027 83.26440.0001	193
029 600 2470	81.26440.0053 81.26440.0065 81.26440.6034 85.20000.9975 85.26440.0046	194
029 650 2670	-	195
029 700 2870	81.26440.0029 81.26440.0043 81.26440.6006 81.26440.6035 81.70701.0331 84.26440.0003	194



MEYLE no.	Ref. no.	Page
MAN		
033 020 0022	51.06500.6282	40
	51.06500.6384	
	51.06500.6387	
	51.06500.9282	
033 020 0043	51.06500.6426	41
033 020 0048	51.06500.6479	42
	51.06500.9479	
034 003 1024	51.02130.0013	7
	51.93020.0236	
034 007 0002	81.11701.6046	103
034 009 0003	81.11101.6012	25
	81.11101.6016	
	81.12102.0002	
034 009 0015	51.12150.7003	22
	51.12150.7005	
	81.12150.6003	
	81.12150.6013	
034 013 0001	51.54105.6006	95
034 013 0005	51.54105.6002	96
	51.54105.6004	
	51.54105.6007	
	51.54105.6008	
034 013 0006	51.54114.6023	94
	51.54114.6024	
	51.54114.6035	
	51.54114.6045	
	51.54114.6047	
	51.54114.6049	
034 013 0008	51.54114.6054	
034 013 0008	81.54124.6006	95
034 013 0041	51.54119.6002	-
	81.54119.6040	
034 015 0005	81.25601.6024	12
034 026 0017	81.95301.6063	118
	81.95301.6131	
	81.95301.6171	
	81.95301.6174	
034 026 0018	81.95301.6064	117
	81.95301.6130	
	81.95301.6170	
	81.95301.6173	
034 026 0025	81.32735.6011	119
	81.32735.6035	
	81.32735.6039	
	81.32735.6040	
034 026 0027	81.52170.6064	111

MEYLE no.	Ref. no.	Page
MAN		
	81.52170.6128	
034 026 0029	81.52170.6095	119
	81.52170.6097	
034 026 0030	81.32734.6001	113
	81.52170.6120	
034 026 0032	81.32550.0003	118
034 029 0034	81.30725.6104	126
034 032 0115	81.25937.0023	99
	81.25937.0037	
034 035 0001	81.35710.0045	154
034 035 0003	81.35710.0044	154
034 035 0013	81.96601.0298	154
034 035 0029	81.43270.6040	142
	81.43270.6045	
034 035 0038	51.01510.0150	8
034 040 0002	81.45503.0049	160
	81.45503.0056	
034 041 9022	81.39108.6048	122
	81.39374.6003	
034 042 0001	90.91157.8013	109
034 042 0002	-	110
034 042 0003	90.91159.0013	110
034 042 0007	81.52116.6010	111
	81.52116.6037	
034 042 0017	81.50213.0013	94
	81.50213.6005	
	81.50213.6006	
034 042 0024	81.51270.6002	103
034 042 0029/C	81.50610.6132	94
034 042 0030	81.51113.0013	108
034 042 0032	81.52102.0008	98
	82.52102.0013	
034 042 0033	81.51220.6024	99
034 042 0034	81.51220.6025	100
034 042 0039	81.51220.6032	100
	81.51220.6069	
	81.51220.6093	
	81.51220.6096	
034 042 0043	81.51113.0014	109
	99.10036.0792	
034 042 0048	81.52115.6009	101
	81.52115.6017	
	81.52115.6018	
	81.52115.6021	
	90.81011.4192	
034 042 0051	81.52120.6003	106

MEYLE no.	Ref. no.	Page
MAN		
	81.52120.6004 81.52120.6025 81.52120.6028 81.52120.6029 81.52120.6030 81.52120.6040 81.52120.6075 85.30001.6535 88.52120.6200	
034 042 0053	81.50822.6022 81.50822.6032	78
034 042 0061	81.51113.0012	108
034 042 0062	81.51113.0020	109
034 043 0002	81.51113.0001	108
034 043 0005	81.15701.6003	104
034 043 0056	81.52101.6241 81.52101.6246 81.52101.6275	97
034 043 0058	81.52101.6152 81.52101.6159 81.52101.6180 81.52101.6240 81.52101.6274 81.52101.6280 81.52101.6288 85.50001.1965	96
034 043 0066	81.52116.6074 81.52116.6075 81.52116.6076 81.52116.9075	113
034 043 0070	81.52116.6070	112
034 046 0000	81.47301.6005	161
034 321 0006	64.08301.0003 81.08205.0005 81.08304.0040 81.08304.0041 81.08304.0048 81.08304.0057 81.08304.0060	17
034 321 0009	81.08304.0100	18
034 323 0003	81.11101.6013 81.11101.6151	26
034 650 0000	06.32499.0020 06.32499.0082 06.32499.0084 06.32499.0085	151

MEYLE no.	Ref. no.	Page
MAN		
	06.32499.0157 87.52340.1240	
034 650 0001	06.32490.3200 06.32499.0016 06.32499.0034 81.93420.0131 87.52340.0820	150
034 650 0020	81.93420.0379 81.93420.6083 81.93420.6099	153
034 753 0017	81.96503.0155	158
034 753 0020	06.56289.0371	156
034 753 0021	06.56289.0361	116
034 870 0005	81.26485.6029	193
036 020 0001	81.95301.0014 81.95301.0064 81.95301.6067 81.95301.6162 81.95301.6239 81.95301.6272 90.80415.3111	169
036 020 0002	81.95301.0013 81.95301.0074 81.95301.6068 81.95301.6163 81.95301.6273 90.80415.3107 90.80415.3113	169
036 020 0003	81.95301.6060 81.95301.6135 81.95301.6140 81.95301.6249 81.95301.6328 81.95301.6358	173
036 020 0004	81.95301.0016 81.95301.0084 81.95301.6048 81.95301.6049 81.95301.6053 81.95301.6061 81.95301.6090 81.95301.6112 81.95301.6126 81.95301.6143 81.95301.6149 81.95301.6154	167

MEYLE no.	Ref. no.	Page
MAN		
	81.95301.6156 81.95301.6194 81.95301.6224 81.95301.6234 81.95301.6242 81.95301.6274 81.95301.6278 81.95301.6308 81.95301.6312 81.95301.6350 81.95301.6352	
036 020 0004/HD	81.95301.0016 81.95301.0084 81.95301.6048 81.95301.6049 81.95301.6053 81.95301.6061 81.95301.6090 81.95301.6112 81.95301.6126 81.95301.6143 81.95301.6149 81.95301.6154 81.95301.6156 81.95301.6194 81.95301.6224 81.95301.6234 81.95301.6242 81.95301.6274 81.95301.6278 81.95301.6308 81.95301.6312 81.95301.6350	167
036 020 0005	81.95301.0015 81.95301.6030 81.95301.6043 81.95301.6091 81.95301.6120 81.95301.6125 81.95301.6152 81.95301.6155 81.95301.6167 81.95301.6179 81.95301.6237 81.95301.6275	170
036 020 0005/HD	81.95301.0015	170

MEYLE no.	Ref. no.	Page
MAN		
	81.95301.6030 81.95301.6043 81.95301.6091 81.95301.6120 81.95301.6125 81.95301.6152 81.95301.6155 81.95301.6167 81.95301.6179 81.95301.6237 81.95301.6275	
036 020 0008	81.95301.0079 81.95301.6139 81.95301.6222 81.95301.6315 81.95301.6329 81.95301.6359	166
036 020 0015	81.85301.0076 81.95301.0078 81.95301.6141 81.95301.6304	172
036 020 0016	81.95301.0077 81.95301.0388 81.95301.6134 81.95301.6142 81.95301.6303 81.95301.6321	172
036 026 0016	81.95301.0038 81.95301.0045 81.95301.6016 81.95301.6169 81.95301.6172 81.95301.6176 81.95301.6235 81.95301.6266 81.95301.6269	117
036 035 0052	81.43220.6177 81.43220.6179 81.43220.6224	140
036 035 0053	81.43220.6177 81.43220.6179 81.43220.6224	132
039 238 0001	81.06111.0018	52
050 004 0790	51.96820.0251	69
050 004 1390	51.96820.0304 51.96820.0314	71

MEYLE no.	Ref. no.	Page
MAN		
	51.96820.0317	
050 005 1482	51.96820.0271	70
050 005 1530	51.96820.0332	72
050 006 1180	N1.01100.1846	74
050 006 2200	88.96820.0001	74
050 008 0855	81.96820.0051	73
050 008 0880	51.96820.0238	67
050 008 1158	51.96820.0322	71
050 008 1275	51.96820.0243 51.96820.0257 51.96820.0280	68
050 008 1376	51.96820.0239	68
050 008 1398	-	75
050 008 1635	51.96820.0272 51.96820.0344	72
050 008 1655	51.96820.0346	73
050 008 1908	N1.01100.1840	74
050 008 1915	51.96820.0273 51.96820.0335	70
050 008 1920	51.96820.0345	72
050 009 1725	51.96820.0308	70
050 010 1688	51.96820.0325	71
050 010 1980	51.96820.0248	69
050 012 1515	51.96820.0250	69
050 012 1630	81.96820.0047	73
052 010 0975	06.58043.0120 06.58072.1201 06.58073.1201 6.58043.0120 6.58043.2120 6.58072.1201	64
052 010 1075	06.58073.1241 6.58043.0124 6.58043.2124 6.58072.1241	64
052 010 1100	06.58047.0125 06.58073.1251 6580 430 125 6580 432 125 6580 470 125 6580 721 251	64
052 010 1250	06.58043.2131	63
052 010 1375	06.58073.1361 06.58073.1362	65
052 010 1380	06.58073.1361 06.58073.1362	65

MEYLE no.	Ref. no.	Page
MAN		
	6.58043.0136 6.58043.2136 6.58072.1361	
052 010 1425	06.58072.1361 06.58072.1381 06.58073.1381 51.96820.0132	65
052 010 1500	06.58073.1412	66
052 013 1000	06.58043.0221 06.58072.2211 65.80430.221	63
052 013 1050	06.58043.0223 06.58072.2231 6.58072.2231	62
052 013 1155	06.58073.2272	66
052 013 1450	06.58043.0239 06.58043.2239 06.58046.0239 06.58046.2239 06.58072.2391 06.58072.2392 06.58073.2391	62
052 013 1475	06.58042.2240 06.58045.0240 06.58072.2401 06.58072.2402 06.58073.2401 51.96820.0128	67
052 013 1500	06.58043.0241 06.58045.0241 06.58047.2241 06.58072.2412 06.58073.2411 6.58041.0241 6.58041.2241 6.58043.0241 6.58043.2241	66
052 013 1525	06.58042.0242 06.58043.0242 06.58043.2242 06.58047.2242 06.58072.2422 06.58073.2421 6.58041.0242 6.58043.0242 6.58043.2242	62

MEYLE no.	Ref. no.	Page
MAN		
	6.58072.2421	
052 013 1550	06.58043.0243 06.58043.2243 06.58047.2243 06.58072.2431 06.58072.2432 06.58072.2433 06.58073.2431 51.96820.0143 51.96820.0153	67
052 013 1600	06.58043.2245 06.58072.2452 51.96820.3001 51.96820.6001 51.96820.6027	63
114 323 0001	51.12503.0004 51.12503.0005 51.12503.0009 51.12503.0010 51.12503.0012 51.12503.0016 51.12503.0018 51.12503.0028 51.12503.0029 51.12503.0030 51.12503.0040	22
12-12 319 0000	81.61910.0011	177
12-12 319 0001	85.61950.0025	178
12-12 319 0003	81.61910.0018	177
12-12 319 0012	88.77910.0003	179
12-12 320 0008	81.61910.0019 81.61910.0030	178
12-14 013 0001	81.54124.6013 81.54124.6017	95
12-14 223 0001	81.06102.6110 81.06102.6112 81.06102.6205 81.06102.6209 81.06102.6222 81.06102.6227	49
12-14 223 0002	81.06111.0019 81.06111.0020	32
12-14 223 0003	81.06102.6117 81.06102.6206 81.06102.6208 81.06102.6221	51

MEYLE no.	Ref. no.	Page
MAN		
	81.06102.6226	
12-14 223 0004	81.06102.6098 81.06102.6099 81.06102.6201 81.06102.6202 81.06102.6218	49
12-14 223 0005	81.06102.6109 81.06102.6204 81.06102.6219	50
12-14 223 0006	81.06102.6089 81.06102.6100 81.06102.6203 81.06102.6220	50
12-14 234 0003	51.06500.6637 51.06500.7049 51.06500.9049	46
12-14 234 0004	51.06630.0096 51.06630.0129	35
12-14 234 0005	51.06630.0107 51.06630.0131	36
12-14 234 0006	51.06630.0106 51.06630.0130	36
12-14 234 0007	51.06630.0076 51.06630.0108 51.06630.0115	35
12-14 234 0009	51.06630.0073 51.06630.0077	34
12-14 234 0010	51.06630.0050 51.06630.0067	33
12-14 234 0011	51.06630.0071	33
12-14 234 0014	51.06600.7017 51.06600.7026 51.06600.7031 51.06600.7033 51.06600.7036 51.06601.7019	31
12-14 234 0018	51.06601.7015	32
12-14 234 0025	51.06600.7008 51.06600.7015 51.06600.7045 51.06600.9045	32
12-14 234 0026	51.06630.0082	34
12-14 234 0027	51.06600.7006	30
12-14 234 0028	51.06630.0119 51.06630.0136 51.06630.0140	36

MEYLE no.	Ref. no.	Page
MAN		
12-14 234 0029	51.06600.7025	31
12-14 234 0030	51.06630.0094 51.06630.0113 51.06630.0117	34
12-14 234 0031	51.06630.0124 51.06630.0127	35
12-14 322 0000	51.05504.0098 81.05504.0025	15
12-14 322 0001	51.05504.0096 82.05504.6096	15
12-14 322 0003	51.05501.7160 51.05501.7161 51.05501.7163 51.05501.7166 51.05501.7180	15
12-14 322 0004	51.05504.0107 51.05504.0108 51.05504.0122	16
12-14 323 0002	51.12503.0037 51.12503.0042 51.12503.0056 82.12503.0042	23
12-14 650 0005	06.32489.0003 06.32489.0044 81.93420.0078	150
12-14 650 0006	81.93420.0288 81.93420.0330 81.93420.0349	152
12-14 653 0000	81.96502.6081	158
12-14 653 0001	81.52403.6001	157
12-14 751 0006	81.93420.0320 81.93420.0342 81.93420.0376 81.93420.6097	152
12-14 751 0007	81.93420.0346	153
12-14 753 0000	06.56289.0257 06.56289.0261 06.56289.0272 06.56289.0307 06.56289.0308 06.56289.0309 06.56289.0386	155
12-14 753 0001	06.56279.0366	115
12-14 753 0002	06.56289.0047 06.56289.0048 06.56289.0357	156

MEYLE no.	Ref. no.	Page
MAN		
12-14 753 0004	06.56289.0027 06.56289.0064 06.56289.0332 06.56289.0335 81.96501.0861 81.96506.0155	157
12-14 753 0005	81.96503.0161	158
12-14 753 0006	81.96503.0188 81.96503.0398	159
12-14 753 0007	06.56289.0387	156
12-14 753 0008	81.96503.0333 81.96503.0399	159
12-14 753 0009	81.96503.0339 81.96503.0445 81.96503.0530	160
12-14 753 0010	81.96503.6000	160
12-14 753 0013	06.56289.0279 06.56289.0280 06.56289.0293 81.96502.6052 81.96502.6066	115
12-14 753 0014	06.56289.0319 81.35412.6003	116
12-14 820 0000	81.27421.0098 81.27421.0109	13
12-14 910 0001	81.61851.6019 81.61851.6023 81.61851.6029	179
12-14 910 0004	81.41723.6124 83.41723.6124	187
12-14 910 0005	81.41723.6123 83.41723.6123	186
12-14 910 0100	85.41723.6011 85.41723.6020 85.41723.6044	186
12-14 910 0102	81.41723.6059 81.41723.6103 81.41723.6114 81.41723.9114	186
12-28 279 0000	51.06402.0034 51.06402.0050 51.06402.0056 51.06402.0061 51.06402.0064 51.06402.0067	48
12-28 279 0002	51.27420.0074	51

MEYLE no.	Ref. no.	Page
MAN		
	81.27421.0099 81.27421.0125	
12-31 106 0001	81.30560.6019 81.30560.6022	123
12-31 106 0004	81.30530.0037	124
12-31 111 0003	36.30550.0001 81.30550.0096 81.30550.0101 81.30550.0102 81.30550.0104 81.30550.0114 81.30550.0255	123
12-33 220 0001	51.06500.7033 51.06500.7036 51.06500.7043 51.06500.7045 51.06500.7047 51.06500.7048 51.06500.7051 51.06500.7052 51.06500.7065 51.06500.7066 51.06500.7089 51.06500.9048 51.06500.9052 51.06500.9066 51.06500.9089 51.06500.9548	47
12-33 220 0003	51.06500.6616 51.06500.9616	44
12-33 500 0001	51.06500.6546 51.06500.9546	43
12-33 500 6408	51.06500.6408 51.06500.9408	41
12-33 500 6547	51.06500.6545 51.06500.6547 51.06500.9545 51.06500.9547	43
12-33 500 6548	51.06500.6548 51.06500.9548	44
12-34 000 0003	51.95800.5001	60
12-34 000 1002	51.95800.7437 51.95800.7479	59
12-34 000 1003	51.95800.7428 51.95800.7429 51.95800.7436	60

MEYLE no.	Ref. no.	Page
MAN		
	51.95800.7459 51.95800.7477	
12-34 000 1004	51.95800.6087	61
12-34 000 1100	51.95800.6076 51.95800.6092 51.95800.6099	61
12-34 000 1101	51.95800.6061 51.95800.6075	60
12-34 001 0007	51.08902.0115 51.08902.0135 51.08902.0161	1
12-34 001 0010	51.03901.0382	5
12-34 001 0012	51.03901.0356	4
12-34 003 0001	51.27120.0005 51.27120.0008 51.27120.0011	10
12-34 003 0002	51.27120.0006 51.27120.0009 51.27120.0012	11
12-34 003 0009	51.27120.0014	11
12-34 003 0010	51.27120.0015	12
12-34 003 0011	51.27120.0016 51.27120.7035 51.27120.7037 51.27120.7038	12
12-34 009 0003	51.12101.7045 51.12101.7046 51.12101.7120 51.12101.7128 51.12101.7137	21
12-34 020 0001	51.06601.0275	39
12-34 026 0000	81.32620.0049	176
12-34 026 0001	81.32620.0039 81.32620.0043 81.32620.0085	176
12-34 026 0002	81.52131.6015 81.52170.6139 81.52170.6151	111
12-34 026 0003	81.97010.6011	177
12-34 026 0004	81.97010.6010	176
12-34 029 0001	81.25503.0244	120
12-34 030 0000	81.96210.0525 81.96210.0553 81.96210.0574	29
12-34 030 0001	81.96210.6065 81.96210.6071	30

MEYLE no.	Ref. no.	Page
MAN		
	81.96210.6072	
12-34 030 0002	81.96210.0572 81.96210.0592 81.96210.0597	30
12-34 030 0003	81.96210.0562 81.96210.0571 81.96210.0575 81.96210.0577	29
12-34 030 0004	81.41506.0096	28
12-34 030 0007	81.96020.0341 81.96020.0373 81.96020.0408	28
12-34 032 0000	81.43610.6124 81.43610.6129	98
12-34 032 0002	81.96020.0231 81.96020.0250 81.96020.0252	129
12-34 032 0003	81.43722.0051 81.43722.0060	129
12-34 032 0007	81.25937.0010 81.25937.0015	98
12-34 035 0002	81.43220.6221 81.43270.6096 81.43270.6114	135
12-34 035 0003	81.43220.6229 81.43220.6236 81.43220.6267 81.43220.6272 81.43220.6304 81.43220.6305 81.43220.6380 81.43220.9236	139
12-34 035 0004	81.46610.6004 81.46610.6006 81.46610.6753 81.46610.6754 85.46610.6031 85.46610.6104 85.46610.6203	166
12-34 035 0005	81.43270.6116 81.43270.6137	136
12-34 035 0006	81.43270.6117	136
12-34 035 0010	51.08901.0202 51.08902.0202	1
12-34 042 0010	81.50822.6009	78
12-34 042 0012	81.50822.6020	78

MEYLE no.	Ref. no.	Page
MAN		
	81.50822.6031	
12-34 042 0014	81.50802.6017 81.50802.6020 81.50802.6021	77
12-34 042 0015	81.50802.6022	77
12-34 042 0017	81.50802.6025	77
12-34 042 0021	81.50822.6019 81.50822.6034 81.50822.6037	79
12-34 042 0026	81.52108.6001 81.52108.6025 81.52155.0040 81.52155.0041	97
12-34 043 0001	81.52116.6067 81.52116.6068 81.52116.6069	112
12-34 043 0002	81.52301.6148 81.52301.9148 82.58000.0060	107
12-34 050 0001	81.43270.6097 81.43270.6113 81.43270.6135	135
12-34 050 0002	81.43220.6268 81.43220.6291	133
12-34 050 0003	81.43220.6222 81.43220.6260 81.43220.6283 81.43220.6284	133
12-34 058 0001	81.41715.6013	185
12-34 058 0002	81.41715.6014	185
12-34 058 0003	81.41700.6095	184
12-34 058 0004	81.96210.0362 81.96210.0407	185
12-34 089 0001	81.90712.0844 81.90713.0909	180
12-34 099 0003	51.01510.0172 51.01510.0174 51.01510.0179 51.01510.0219 51.01510.0237 51.01510.7000	9
12-34 099 0004	51.01510.0133 51.01510.0134 51.01510.0140 51.01510.0141 51.01510.0184	8

MEYLE no.	Ref. no.	Page
MAN		
	51.01510.0196 51.01510.0206 51.01510.0207 51.01510.0208	
12-34 099 0005	51.01510.0151 51.01510.0218	8
12-34 099 0006	51.01510.0197 51.01510.0199 51.01510.0226 51.01510.6003 51.01510.6004 51.01510.6006 51.01510.6007	10
12-34 099 0007	51.01510.0236 51.01510.0273 51.01510.0282 51.01510.6005 51.01510.6008	9
12-34 100 6558	51.00900.6536 51.00900.6552 51.00900.6558	2
12-34 126 6017	81.39126.6017 81.39200.6015	122
12-34 126 6020	81.39126.6020 81.39126.6030 81.99917.8470	122
12-34 130 0032	51.02130.0005 51.02130.0007 51.02130.0008 51.02130.0012 51.02130.0032	7
12-34 151 0002	81.39410.6020	121
12-34 151 0003	81.39410.6023 81.39410.6031	121
12-34 157 0004	81.15701.6124	105
12-34 157 0005	81.15701.6113 81.15701.6120	104
12-34 205 0001	81.44205.6023	128
12-34 205 6013	81.44205.6013	128
12-34 210 0348	81.96210.0340 81.96210.0348 81.96210.0349	179
12-34 210 0400	81.96210.0400	181
12-34 210 0401	81.96101.0638	180
12-34 210 0402	81.96503.0129	184
12-34 210 0403	81.96210.0369	180

MEYLE no.	Ref. no.	Page
MAN		
	81.96210.0462	
12-34 210 0404	85.94299.0015	182
12-34 210 0405	85.96020.0004	183
12-34 210 0406	85.96210.0019	183
12-34 210 0408	85.96210.0021	183
12-34 210 0409	85.41715.0006	182
12-34 210 0437	81.96210.0424 81.96210.0437	181
12-34 210 0515	81.96210.0482 81.96210.0515	184
12-34 210 0609	81.96210.0609	181
12-34 220 0004	51.06500.6587 51.06500.6651 51.06500.6680 51.06500.7070 51.06500.7079 51.06500.9079	46
12-34 220 6055	81.43220.6006 81.43220.6055 81.43220.6073 81.43220.6107	139
12-34 220 6108	81.43220.6108 81.43220.6132	140
12-34 223 0001	81.27421.0152 81.27421.0169	52
12-34 223 0002	81.27421.0195 81.27421.0232	52
12-34 230 6051	81.43230.6051 81.43230.6068	141
12-34 232 0001	51.06601.0256	37
12-34 232 0002	51.06601.0257	37
12-34 232 0005	51.06601.0263	37
12-34 232 0006	51.06601.0268	38
12-34 232 0014	51.06601.0266	38
12-34 232 0018	51.06601.0273 51.06601.0279	39
12-34 232 0019	51.06601.0283	40
12-34 232 0020	51.06601.0282	39
12-34 250 6135	81.46610.6809 81.46610.6810 81.46610.6823 81.46610.6839 81.46611.6104 81.46611.6105 81.46611.6107 81.46611.6134	164

MEYLE no.	Ref. no.	Page
MAN		
	81.46611.6135 81.46611.6137 81.46611.6199 81.46611.6200 81.46611.6206	
12-34 250 6197	81.46610.6087 81.46610.6808 81.46610.6836 81.46610.6837 81.46611.6088 81.46611.6096 81.46611.6097 81.46611.6099 81.46611.6132 81.46611.6133 81.46611.6136 81.46611.6197 81.46611.6198 81.46611.6205	164
12-34 250 6244	81.43220.6244	141
12-34 250 6418	81.46710.6418	165
12-34 250 6656	81.46610.6656 81.46610.6659 81.46610.6669	163
12-34 250 6860	81.46711.6773 81.46711.6791 81.46711.6848 81.46711.6858 81.46711.6859 81.46711.6860 81.46711.6861 81.46711.6862 81.46711.6863 81.46711.6921	163
12-34 271 0082	81.43271.0082	147
12-34 271 0083	81.43722.0072	150
12-34 271 0084	81.43704.0078	148
12-34 271 0085	81.43722.0059	148
12-34 271 0086	81.43722.0022 81.43722.0038 81.96210.0450 81.96210.0469	148
12-34 271 0088	81.43722.0083	145
12-34 271 0089	85.43704.0002	146
12-34 271 0090	85.43704.0004	146
12-34 271 0091	85.43722.0007	147

MEYLE no.	Ref. no.	Page
MAN		
12-34 271 0092	85.43704.0005	146
12-34 271 0094	81.43722.0053 85.93020.0005	145
12-34 271 0095	81.43704.0077	144
12-34 271 0096	81.43704.0074	147
12-34 271 0098	81.43722.0068	149
12-34 271 0099	81.43722.0070	-
12-34 271 0101	81.43722.0052	144
12-34 279 0073	06.56279.0027 06.56279.0072 06.56279.0073 81.96501.0907	115
12-34 301 6132	81.43270.6080 81.95301.6132	142
12-34 301 6133	81.43270.6083 81.95301.6133	142
12-34 321 0002	81.08304.0084	17
12-34 321 0003	81.08405.0016 81.08405.0020 81.08405.0021	19
12-34 321 0006	81.08304.0087 81.08405.0015	19
12-34 321 0009	81.08405.0018	19
12-34 321 0010	81.08304.0038 81.08304.0043 81.08304.0044 81.08304.0091 81.08401.6213	16
12-34 321 0011	81.08304.0074 81.08304.0076	17
12-34 321 0017	81.08405.0022	20
12-34 321 0018	81.08405.0023	20
12-34 321 0019	81.08304.0101 81.08304.0103 81.08405.0031	18
12-34 321 0021	81.08405.0029	20
12-34 321 0022	81.08405.0030	21
12-34 323 0001	51.12503.0059 51.12503.0060	23
12-34 323 0003	81.12501.0021 81.12501.0026 81.12501.0030 81.12503.0033 81.12503.0086	27
12-34 323 0004	81.12501.0022 81.12501.0032	27

MEYLE no.	Ref. no.	Page
MAN		
	81.12501.0034 81.12503.0080 85.12501.0002	
12-34 323 0005	81.12501.0031 81.12503.0085 82.12503.0069	26
12-34 323 0006	81.00000.0246 81.12503.0021 81.12503.0022 81.12503.0042 81.12503.0048 81.12503.0054 81.12503.0063	26
12-34 323 0007	51.12503.0061 51.12503.0063	24
12-34 323 0009	51.12503.0047 51.12503.0062	24
12-34 323 0012	51.12503.0048	23
12-34 323 0014	81.12501.0004 85.12501.0003 85.12501.0005	28
12-34 410 0002	81.39410.6013 81.39410.6017 81.39410.6019	120
12-34 471 0001	81.47101.6000 81.47101.6001 81.47101.6031 81.47101.6040 81.47101.6051 81.47101.6169	173
12-34 471 0003	81.47101.6137 81.47101.6162 81.47101.6181 81.47101.9137 81.47101.9162	174
12-34 500 5040	51.06330.5040	-
12-34 500 6495	51.06500.6495 51.06500.9495	42
12-34 500 6543	51.06500.6543 51.06500.9543	43
12-34 500 6612	51.06500.6606 51.06500.6612 51.06500.6669 51.06500.9606 51.06500.9612 51.06500.9669	45

MEYLE no.	Ref. no.	Page
MAN		
12-34 500 6642	51.06500.6642 51.06500.6675 51.06500.6694 51.06500.9642 51.06500.9694	45
12-34 500 6646	51.06500.6646 51.06500.6676 51.06500.7050 51.06500.9050 51.06500.9646	45
12-34 500 7064	51.06500.6679 51.06500.7064 51.06500.7078 51.06500.9064 51.06500.9078 51.06500.9679 51.06500.9699	47
12-34 527 0000	81.50822.6013	88
12-34 527 0001	81.50822.6011 81.50822.6016	89
12-34 527 0002	81.50822.6014	89
12-34 527 0004	81.50811.0004	88
12-34 527 0005	81.50822.6012 81.50822.6017	89
12-34 527 0008	68324072	87
12-34 533 0103	81.27120.0021	90
12-34 533 0200	81.25503.6119 81.25505.0236 81.25505.0239 81.25505.0426 81.25505.0636 81.25505.6110 81.25520.0050	188
12-34 610 0001	81.43722.0044 81.43722.0061 83.43722.0001	129
12-34 631 0001	81.47101.6121 81.47101.6136 81.47101.6161	173
12-34 631 0002	81.47101.6102 81.47101.6108 81.47101.6189	174
12-34 632 0001	81.05504.6001 81.47307.0001 82.05504.6001	161
12-34 632 0002	81.47301.6048	175

MEYLE no.	Ref. no.	Page
MAN		
12-34 704 0057	81.43704.0057	143
12-34 704 0061	81.43704.0061 81.43722.0020	143
12-34 722 0019	81.43722.0019 81.43722.6051	144
12-34 722 0021	81.43722.0021 81.43722.0039 81.43722.0063 81.43722.0081 81.43722.0082	149
12-34 722 0062	81.43722.0062	130
12-34 725 6025	81.30725.6007 81.30725.6024 81.30725.6025 81.30725.6026 81.30725.9025	124
12-34 725 6027	81.30725.6027 81.30725.6028 81.30725.6045 81.30725.6046	124
12-34 725 6032	81.30725.6031 81.30725.6032 81.30725.6053 81.30725.6054	125
12-34 742 0000	81.96210.0554	131
12-34 742 0001	81.96210.0555	131
12-34 742 0005	81.96210.5025 81.96210.5026 81.96210.5027	132
12-34 742 0006	81.96210.5022	131
12-34 742 0009	81.43400.6484 81.43407.0109 81.43407.0110 81.43407.5003	130
12-34 751 0001	81.93420.0336	153
12-34 753 0000	06.56279.0033 06.56289.0065 06.56289.0330 06.56289.0331 06.56289.0333 06.56289.0334 81.96503.0154	155
12-34 798 0001	81.44205.6025	128
12-34 820 0001	81.27421.0077	-
12-34 820 0002	51.10304.0291	101
12-34 830 0005	81.25902.0460	196

MEYLE no.	Ref. no.	Page
MAN		
	81.25902.0474	
12-34 830 0006	81.25902.0155 81.25902.0274	196
12-34 830 0101	81.25260.6105	187
12-34 870 0001	81.26485.6032 81.26485.6033	193
12-34 870 0002	81.26485.6027 81.26485.6030	192
12-34 870 0004	81.26485.6008	192
12-34 899 0002	81.46433.6006 81.46433.6011 81.97100.6034 81.97100.6095	191
12-34 899 0004	51.27421.0179 51.27421.0185 51.27421.0198 51.27421.0216	13
12-34 899 0005	81.27120.6119 81.27120.6182	91
12-34 899 0007	81.27120.6179 81.27120.6220	93
12-34 899 0008	81.27120.6178 81.27120.6221	93
12-34 899 0009	81.27120.6205	92
12-34 899 0010	81.27120.6206	92
12-34 899 0016	81.27120.6106	90
12-34 899 0017	81.27120.6121 81.27120.6184	91
12-34 899 0022	51.27421.0077	13
12-34 899 0023	81.25525.0033 81.25525.0227 81.25525.0257	120
12-34 899 0026	81.25525.0032	118
12-34 900 0000	51.00900.6630	3
12-34 900 0001	51.00900.6629 51.00900.6639	3
12-34 900 0003	51.03901.0385 51.03901.0387	5
12-34 900 0004	51.00900.6550 51.00900.6628	2
12-34 900 0005	51.08901.0104 51.08901.0152	75
12-34 900 0006	51.08902.0150 51.08902.0194	1
12-34 900 6437	51.00900.6273 51.00900.6437	3

MEYLE no.	Ref. no.	Page
MAN		
	51.00900.6570	
12-34 901 0351	51.03901.0351 51.03901.0357 51.03901.0361 51.03901.0378 51.03901.0379	4
12-34 904 0132	51.05904.0132	14
12-34 905 0001	51.03905.0157	6
12-34 905 0002	51.03905.0161	6
12-34 905 0004	51.03905.0177	6
12-34 905 0135	51.03905.0091 51.03905.0094 51.03905.0098 51.03905.0103 51.03905.0104 51.03905.0105 51.03905.0109 51.03905.0123 51.03905.0134 51.03905.0135	5
12-34 910 0001	81.62641.6085	189
12-34 910 0002	81.62641.6086	189
12-34 910 0003	81.97100.6079 81.97100.6099	190
12-34 910 0005	81.62641.0099	188
12-34 910 0006	81.62641.0100	188
12-34 910 0008	81.62680.6096	190
12-34 910 0009	81.62680.6095	190
12-34 910 0010	81.62640.6045 81.62640.6049 81.62640.6055	191
12-34 910 0011	81.62640.6046 81.62640.6050 81.62640.6056	191
12-34 920 1002	81.74821.0109	187
12-35 521 0000	81.50803.0010	79
12-35 521 0002	81.50803.0023 81.50803.0031 81.50803.0033 81.50803.0034 81.50803.0035 81.50803.0036 81.50803.0038 81.50803.0040 81.50803.0046	80
12-35 521 0003	81.50803.0028	82

MEYLE no.	Ref. no.	Page
MAN		
	81.50803.0048	
12-35 521 0004	81.50803.0021 81.50803.0041	81
12-35 521 0005	81.50803.0020 81.50803.0027 81.50803.0057	82
12-35 521 0007	81.50803.0024 81.50803.0026	79
12-35 521 0008	81.50803.0039	80
12-35 521 0009	81.50803.0042	81
12-35 521 0010	81.50803.0054 81.50803.0063	83
12-35 523 0000	81.50803.0022 81.50803.0061	83
12-35 533 0000	81.52101.6153 81.52101.6154	102
12-35 533 0001	81.52101.6269	102
12-35 533 0002	81.52101.6270	103
12-35 533 0003	81.52110.6049 81.52110.6095	100
12-35 533 0004	81.52116.6071	112
12-35 533 0005	81.52151.6093 81.52151.6096	105
12-35 533 0007	81.52301.6183 81.52301.6189 81.52301.6192	106
12-35 533 0031	81.52315.6156 81.52315.6160 81.52315.6161	107
12-35 533 0034	81.52151.6094	105
12-35 533 0037	81.52301.6120 81.52301.6121 81.52310.6165	107
12-36 020 0032	81.95301.6263	168
12-36 020 0039	81.95301.6270	168
12-36 020 0041	81.95301.6288	171
12-36 030 0002	81.46710.6112 81.46710.6163 81.46710.6165 81.46710.6198 81.46710.6353 81.46710.6354 81.46710.6361 81.46711.6725 81.46711.6820 81.46711.6849	162

MEYLE no.	Ref. no.	Page
MAN		
12-36 030 0002/HD	81.46710.6112	162
	81.46710.6163	
	81.46710.6165	
	81.46710.6198	
	81.46710.6353	
	81.46710.6354	
	81.46711.6725	
	81.46711.6820	
12-36 030 0004	81.43220.6030	137
	81.43220.6096	
	81.43220.6097	
	81.43220.6098	
	81.43220.6129	
12-36 030 0013	81.43220.6247	132
	81.43230.6014	
12-36 030 0016	36.43220.6002	133
	36.43220.6043	
	81.43220.6139	
	81.43220.6151	
	81.43220.6183	
	81.43220.6276	
12-36 035 0002	81.43220.6067	136
	81.43220.6068	
	81.43220.6090	
	81.43220.6092	
	81.43220.6120	
12-36 035 0003	81.43220.6070	137
	81.43220.6071	
	81.43220.6072	
	81.43220.6091	
	81.43220.6093	
12-36 035 6087	81.43270.6087	134
	81.43270.6088	
	81.43270.6094	
	81.43270.6095	
12-36 035 6196	81.43220.6196	138
	81.43220.6232	
	81.43220.6233	
12-36 040 0009	81.46610.6333	165
	81.46610.6334	
	81.46610.6354	
	81.46610.6355	

MEYLE no.	Ref. no.	Page
MAN		
12-36 050 0000	81.46610.6360	134
	81.46610.6361	
	81.46610.6721	
	81.46610.6722	
	81.46610.6723	
	81.46611.6216	
12-36 050 0001	81.43270.6030	134
	81.43270.6034	
	81.43270.6054	
	81.43270.6057	
	81.43270.6076	
	81.43270.6078	
	81.43270.6082	
	81.43270.9054	
12-36 050 0002	81.43270.6056	134
	81.43270.6067	
	81.43270.6075	
	81.43270.6077	
12-36 050 0003	81.43270.6081	134
	81.43270.6088	
12-36 050 0002	81.43220.6161	138
	81.43220.6190	
12-37 142 0001	81.30715.6111	126
	81.30715.6119	
	81.30715.6121	
12-37 142 0002	81.30715.6108	126
	81.30715.6120	
12-37 142 0003	81.30725.6065	125
	81.30725.6086	
12-37 142 0004	81.30725.6084	125
	81.30725.6085	
	81.30725.6092	
	81.30725.6107	
	81.30725.6116	
12-37 142 0007	81.52170.6096	114
	81.52170.6156	
12-37 142 0011	81.30715.6149	127
	81.30715.6154	
	81.30715.6156	
12-39 222 0001	81.96301.0496	54
	81.96301.0659	
	82.96301.0008	
12-39 222 0003	81.96305.0088	57
12-39 222 0004	81.96305.0129	57
12-39 222 0005	81.96301.0677	55
12-39 222 0006	81.96301.0898	56

MEYLE no.	Ref. no.	Page
MAN		
	82.96301.0006	
12-39 222 0007	81.96301.0893 81.96301.0961	56
12-39 222 0008	81.96301.0892	56
12-39 222 0009	81.96305.0227	59
12-39 222 0011	81.96305.0230	59
12-39 222 0013	51.96305.0018 51.96305.0021 81.96305.0095 81.96305.0134 81.96305.0223 81.96305.0226	57
12-39 222 0014	81.96301.0581 81.96301.0676	54
12-39 222 0015	81.96301.0582 81.96301.0621	54
12-39 222 0016	81.96305.0166	58
12-39 222 0017	81.96301.0680	55
12-39 222 0018	81.96301.0679	55
12-39 222 0019	04.27405.9502 04.27405.9510	53
12-39 222 0020	81.96305.0130 81.96305.0169	58
12-39 222 0026	04.27405.0601 04.27405.9160 04.27405.9360 N1.01100.8494	53
14-34 043 0001	85.30001.9636 85.32734.6001	119
14-34 232 0012	81.06601.0072	40
14-36 035 0003	81.43220.6203	141
16-34 653 0001	81.43220.6197 81.95302.0038 81.95302.0057	140
300 334 1103	51.93410.0079	151
536 020 0009	81.95301.6292	171
812 321 0001	81.08304.0086	18
834 533 0004	81.25937.0016	99
834 900 0005	51.08901.0096 51.15901.0009 51.15901.0012 51.15901.0031 88.09901.0001	75
836 020 0006	81.95301.6286	171

Ref. no.	MEYLE no.	Page
MAN		
04.27405.0601	12-39 222 0026	53
04.27405.9160	12-39 222 0026	53
04.27405.9360	12-39 222 0026	53
04.27405.9502	12-39 222 0019	53
04.27405.9510	12-39 222 0019	53
06.32489.0003	12-14 650 0005	150
06.32489.0044	12-14 650 0005	150
06.32490.3200	034 650 0001	150
06.32499.0016	034 650 0001	150
06.32499.0020	034 650 0000	151
06.32499.0034	034 650 0001	150
06.32499.0082	034 650 0000	151
06.32499.0084	034 650 0000	151
06.32499.0085	034 650 0000	151
06.32499.0157	034 650 0000	151
06.56279.0027	12-34 279 0073	115
06.56279.0033	12-34 753 0000	155
06.56279.0072	12-34 279 0073	115
06.56279.0073	12-34 279 0073	115
06.56279.0366	12-14 753 0001	115
06.56289.0027	12-14 753 0004	157
06.56289.0047	12-14 753 0002	156
06.56289.0048	12-14 753 0002	156
06.56289.0064	12-14 753 0004	157
06.56289.0065	12-34 753 0000	155
06.56289.0257	12-14 753 0000	155
06.56289.0261	12-14 753 0000	155
06.56289.0272	12-14 753 0000	155
06.56289.0279	12-14 753 0013	115
06.56289.0280	12-14 753 0013	115
06.56289.0293	12-14 753 0013	115
06.56289.0307	12-14 753 0000	155
06.56289.0308	12-14 753 0000	155
06.56289.0309	12-14 753 0000	155
06.56289.0319	12-14 753 0014	116
06.56289.0330	12-34 753 0000	155
06.56289.0331	12-34 753 0000	155
06.56289.0332	12-14 753 0004	157
06.56289.0333	12-34 753 0000	155
06.56289.0334	12-34 753 0000	155
06.56289.0335	12-14 753 0004	157
06.56289.0357	12-14 753 0002	156
06.56289.0361	034 753 0021	116
06.56289.0371	034 753 0020	156
06.56289.0386	12-14 753 0000	155
06.56289.0387	12-14 753 0007	156

Ref. no.	MEYLE no.	Page
MAN		
06.58042.0242	052 013 1525	62
06.58042.2240	052 013 1475	67
06.58043.0120	052 010 0975	64
06.58043.0221	052 013 1000	63
06.58043.0223	052 013 1050	62
06.58043.0239	052 013 1450	62
06.58043.0241	052 013 1500	66
06.58043.0242	052 013 1525	62
06.58043.0243	052 013 1550	67
06.58043.2131	052 010 1250	63
06.58043.2239	052 013 1450	62
06.58043.2242	052 013 1525	62
06.58043.2243	052 013 1550	67
06.58043.2245	052 013 1600	63
06.58045.0240	052 013 1475	67
06.58045.0241	052 013 1500	66
06.58046.0239	052 013 1450	62
06.58046.2239	052 013 1450	62
06.58047.0125	052 010 1100	64
06.58047.2241	052 013 1500	66
06.58047.2242	052 013 1525	62
06.58047.2243	052 013 1550	67
06.58072.1201	052 010 0975	64
06.58072.1361	052 010 1425	65
06.58072.1381	052 010 1425	65
06.58072.2211	052 013 1000	63
06.58072.2231	052 013 1050	62
06.58072.2391	052 013 1450	62
06.58072.2392	052 013 1450	62
06.58072.2401	052 013 1475	67
06.58072.2402	052 013 1475	67
06.58072.2412	052 013 1500	66
06.58072.2422	052 013 1525	62
06.58072.2431	052 013 1550	67
06.58072.2432	052 013 1550	67
06.58072.2433	052 013 1550	67
06.58072.2452	052 013 1600	63
06.58073.1201	052 010 0975	64
06.58073.1241	052 010 1075	64
06.58073.1251	052 010 1100	64
06.58073.1361	052 010 1375	65
	052 010 1380	
06.58073.1362	052 010 1375	65
	052 010 1380	
06.58073.1381	052 010 1425	65
06.58073.1412	052 010 1500	66

Ref. no.	MEYLE no.	Page
MAN		
06.58073.2272	052 013 1155	66
06.58073.2391	052 013 1450	62
06.58073.2401	052 013 1475	67
06.58073.2411	052 013 1500	66
06.58073.2421	052 013 1525	62
06.58073.2431	052 013 1550	67
36.30550.0001	12-31 111 0003	123
36.43220.6002	12-36 030 0016	133
36.43220.6043	12-36 030 0016	133
51.00900.6273	12-34 900 6437	3
51.00900.6437	12-34 900 6437	3
51.00900.6536	12-34 100 6558	2
51.00900.6550	12-34 900 0004	2
51.00900.6552	12-34 100 6558	2
51.00900.6558	12-34 100 6558	2
51.00900.6570	12-34 900 6437	3
51.00900.6628	12-34 900 0004	2
51.00900.6629	12-34 900 0001	3
51.00900.6630	12-34 900 0000	3
51.00900.6639	12-34 900 0001	3
51.01510.0133	12-34 099 0004	8
51.01510.0134	12-34 099 0004	8
51.01510.0140	12-34 099 0004	8
51.01510.0141	12-34 099 0004	8
51.01510.0150	034 035 0038	8
51.01510.0151	12-34 099 0005	8
51.01510.0172	12-34 099 0003	9
51.01510.0174	12-34 099 0003	9
51.01510.0179	12-34 099 0003	9
51.01510.0184	12-34 099 0004	8
51.01510.0196	12-34 099 0004	8
51.01510.0197	12-34 099 0006	10
51.01510.0199	12-34 099 0006	10
51.01510.0206	12-34 099 0004	8
51.01510.0207	12-34 099 0004	8
51.01510.0208	12-34 099 0004	8
51.01510.0218	12-34 099 0005	8
51.01510.0219	12-34 099 0003	9
51.01510.0226	12-34 099 0006	10
51.01510.0236	12-34 099 0007	9
51.01510.0237	12-34 099 0003	9
51.01510.0273	12-34 099 0007	9
51.01510.0282	12-34 099 0007	9
51.01510.6003	12-34 099 0006	10
51.01510.6004	12-34 099 0006	10
51.01510.6005	12-34 099 0007	9

Ref. no.	MEYLE no.	Page
MAN		
51.01510.6006	12-34 099 0006	10
51.01510.6007	12-34 099 0006	10
51.01510.6008	12-34 099 0007	9
51.01510.7000	12-34 099 0003	9
51.02130.0005	12-34 130 0032	7
51.02130.0007	12-34 130 0032	7
51.02130.0008	12-34 130 0032	7
51.02130.0012	12-34 130 0032	7
51.02130.0013	034 003 1024	7
51.02130.0032	12-34 130 0032	7
51.03901.0351	12-34 901 0351	4
51.03901.0356	12-34 001 0012	4
51.03901.0357	12-34 901 0351	4
51.03901.0361	12-34 901 0351	4
51.03901.0378	12-34 901 0351	4
51.03901.0379	12-34 901 0351	4
51.03901.0382	12-34 001 0010	5
51.03901.0385	12-34 900 0003	5
51.03901.0387	12-34 900 0003	5
51.03905.0091	12-34 905 0135	5
51.03905.0094	12-34 905 0135	5
51.03905.0098	12-34 905 0135	5
51.03905.0103	12-34 905 0135	5
51.03905.0104	12-34 905 0135	5
51.03905.0105	12-34 905 0135	5
51.03905.0109	12-34 905 0135	5
51.03905.0123	12-34 905 0135	5
51.03905.0134	12-34 905 0135	5
51.03905.0135	12-34 905 0135	5
51.03905.0157	12-34 905 0001	6
51.03905.0161	12-34 905 0002	6
51.03905.0177	12-34 905 0004	6
51.05500.6073	014 018 0015	14
51.05501.7160	12-14 322 0003	15
51.05501.7161	12-14 322 0003	15
51.05501.7163	12-14 322 0003	15
51.05501.7166	12-14 322 0003	15
51.05501.7180	12-14 322 0003	15
51.05504.0096	12-14 322 0001	15
51.05504.0098	12-14 322 0000	15
51.05504.0105	014 018 0015	14
51.05504.0107	12-14 322 0004	16
51.05504.0108	12-14 322 0004	16
51.05504.0122	12-14 322 0004	16
51.05904.0132	12-34 904 0132	14
51.06330.5040	12-34 500 5040	-

Ref. no.	MEYLE no.	Page
MAN		
51.06402.0034	12-28 279 0000	48
51.06402.0050	12-28 279 0000	48
51.06402.0056	12-28 279 0000	48
51.06402.0057	028 271 0011	48
51.06402.0058	028 283 0000	47
51.06402.0060	028 283 0000	47
51.06402.0061	12-28 279 0000	48
51.06402.0062	028 271 0011	48
51.06402.0063	028 283 0000	47
51.06402.0064	12-28 279 0000	48
51.06402.0065	028 271 0011	48
51.06402.0066	028 283 0000	47
51.06402.0067	12-28 279 0000	48
51.06402.0068	028 271 0011	48
51.06500.6282	033 020 0022	40
51.06500.6384	033 020 0022	40
51.06500.6387	033 020 0022	40
51.06500.6408	12-33 500 6408	41
51.06500.6426	033 020 0043	41
51.06500.6479	033 020 0048	42
51.06500.6495	12-34 500 6495	42
51.06500.6543	12-34 500 6543	43
51.06500.6545	12-33 500 6547	43
51.06500.6546	12-33 500 0001	43
51.06500.6547	12-33 500 6547	43
51.06500.6548	12-33 500 6548	44
51.06500.6587	12-34 220 0004	46
51.06500.6606	12-34 500 6612	45
51.06500.6612	12-34 500 6612	45
51.06500.6616	12-33 220 0003	44
51.06500.6637	12-14 234 0003	46
51.06500.6642	12-34 500 6642	45
51.06500.6646	12-34 500 6646	45
51.06500.6651	12-34 220 0004	46
51.06500.6669	12-34 500 6612	45
51.06500.6675	12-34 500 6642	45
51.06500.6676	12-34 500 6646	45
51.06500.6679	12-34 500 7064	47
51.06500.6680	12-34 220 0004	46
51.06500.6694	12-34 500 6642	45
51.06500.7033	12-33 220 0001	47
51.06500.7036	12-33 220 0001	47
51.06500.7043	12-33 220 0001	47
51.06500.7045	12-33 220 0001	47
51.06500.7047	12-33 220 0001	47
51.06500.7048	12-33 220 0001	47

Ref. no.	MEYLE no.	Page
MAN		
51.06500.7049	12-14 234 0003	46
51.06500.7050	12-34 500 6646	45
51.06500.7051	12-33 220 0001	47
51.06500.7052	12-33 220 0001	47
51.06500.7064	12-34 500 7064	47
51.06500.7065	12-33 220 0001	47
51.06500.7066	12-33 220 0001	47
51.06500.7070	12-34 220 0004	46
51.06500.7078	12-34 500 7064	47
51.06500.7079	12-34 220 0004	46
51.06500.7089	12-33 220 0001	47
51.06500.9048	12-33 220 0001	47
51.06500.9049	12-14 234 0003	46
51.06500.9050	12-34 500 6646	45
51.06500.9052	12-33 220 0001	47
51.06500.9064	12-34 500 7064	47
51.06500.9066	12-33 220 0001	47
51.06500.9078	12-34 500 7064	47
51.06500.9079	12-34 220 0004	46
51.06500.9089	12-33 220 0001	47
51.06500.9282	033 020 0022	40
51.06500.9408	12-33 500 6408	41
51.06500.9479	033 020 0048	42
51.06500.9495	12-34 500 6495	42
51.06500.9543	12-34 500 6543	43
51.06500.9545	12-33 500 6547	43
51.06500.9546	12-33 500 0001	43
51.06500.9547	12-33 500 6547	43
51.06500.9548	12-33 220 0001 12-33 500 6548	44, 47
51.06500.9606	12-34 500 6612	45
51.06500.9612	12-34 500 6612	45
51.06500.9616	12-33 220 0003	44
51.06500.9642	12-34 500 6642	45
51.06500.9646	12-34 500 6646	45
51.06500.9669	12-34 500 6612	45
51.06500.9679	12-34 500 7064	47
51.06500.9694	12-34 500 6642	45
51.06500.9699	12-34 500 7064	47
51.06600.7006	12-14 234 0027	30
51.06600.7008	12-14 234 0025	32
51.06600.7015	12-14 234 0025	32
51.06600.7017	12-14 234 0014	31
51.06600.7025	12-14 234 0029	31
51.06600.7026	12-14 234 0014	31
51.06600.7031	12-14 234 0014	31

Ref. no.	MEYLE no.	Page
MAN		
51.06600.7033	12-14 234 0014	31
51.06600.7036	12-14 234 0014	31
51.06600.7045	12-14 234 0025	32
51.06600.9045	12-14 234 0025	32
51.06601.0256	12-34 232 0001	37
51.06601.0257	12-34 232 0002	37
51.06601.0263	12-34 232 0005	37
51.06601.0266	12-34 232 0014	38
51.06601.0268	12-34 232 0006	38
51.06601.0273	12-34 232 0018	39
51.06601.0275	12-34 020 0001	39
51.06601.0279	12-34 232 0018	39
51.06601.0282	12-34 232 0020	39
51.06601.0283	12-34 232 0019	40
51.06601.7015	12-14 234 0018	32
51.06601.7019	12-14 234 0014	31
51.06630.0050	12-14 234 0010	33
51.06630.0067	12-14 234 0010	33
51.06630.0071	12-14 234 0011	33
51.06630.0073	12-14 234 0009	34
51.06630.0076	12-14 234 0007	35
51.06630.0077	12-14 234 0009	34
51.06630.0082	12-14 234 0026	34
51.06630.0094	12-14 234 0030	34
51.06630.0096	12-14 234 0004	35
51.06630.0106	12-14 234 0006	36
51.06630.0107	12-14 234 0005	36
51.06630.0108	12-14 234 0007	35
51.06630.0113	12-14 234 0030	34
51.06630.0115	12-14 234 0007	35
51.06630.0117	12-14 234 0030	34
51.06630.0119	12-14 234 0028	36
51.06630.0124	12-14 234 0031	35
51.06630.0127	12-14 234 0031	35
51.06630.0129	12-14 234 0004	35
51.06630.0130	12-14 234 0006	36
51.06630.0131	12-14 234 0005	36
51.06630.0136	12-14 234 0028	36
51.06630.0140	12-14 234 0028	36
51.08901.0096	834 900 0005	75
51.08901.0104	12-34 900 0005	75
51.08901.0152	12-34 900 0005	75
51.08901.0202	12-34 035 0010	1
51.08902.0115	12-34 001 0007	1
51.08902.0135	12-34 001 0007	1
51.08902.0150	12-34 900 0006	1

Ref. no.	MEYLE no.	Page
MAN		
51.08902.0161	12-34 001 0007	1
51.08902.0194	12-34 900 0006	1
51.08902.0202	12-34 035 0010	1
51.10304.0291	12-34 820 0002	101
51.12101.7045	12-34 009 0003	21
51.12101.7046	12-34 009 0003	21
51.12101.7120	12-34 009 0003	21
51.12101.7128	12-34 009 0003	21
51.12101.7137	12-34 009 0003	21
51.12150.7003	034 009 0015	22
51.12150.7005	034 009 0015	22
51.12503.0004	114 323 0001	22
51.12503.0005	114 323 0001	22
51.12503.0009	114 323 0001	22
51.12503.0010	114 323 0001	22
51.12503.0012	114 323 0001	22
51.12503.0016	114 323 0001	22
51.12503.0018	114 323 0001	22
51.12503.0028	114 323 0001	22
51.12503.0029	114 323 0001	22
51.12503.0030	114 323 0001	22
51.12503.0037	12-14 323 0002	23
51.12503.0040	114 323 0001	22
51.12503.0042	12-14 323 0002	23
51.12503.0047	12-34 323 0009	24
51.12503.0048	12-34 323 0012	23
51.12503.0051	014 323 0008	25
51.12503.0056	12-14 323 0002	23
51.12503.0059	12-34 323 0001	23
51.12503.0060	12-34 323 0001	23
51.12503.0061	12-34 323 0007	24
51.12503.0062	12-34 323 0009	24
51.12503.0063	12-34 323 0007	24
51.12503.6000	014 323 0008	25
51.15901.0009	834 900 0005	75
51.15901.0012	834 900 0005	75
51.15901.0031	834 900 0005	75
51.27120.0005	12-34 003 0001	10
51.27120.0006	12-34 003 0002	11
51.27120.0008	12-34 003 0001	10
51.27120.0009	12-34 003 0002	11
51.27120.0011	12-34 003 0001	10
51.27120.0012	12-34 003 0002	11
51.27120.0014	12-34 003 0009	11
51.27120.0015	12-34 003 0010	12
51.27120.0016	12-34 003 0011	12

Ref. no.	MEYLE no.	Page
MAN		
51.27120.7035	12-34 003 0011	12
51.27120.7037	12-34 003 0011	12
51.27120.7038	12-34 003 0011	12
51.27420.0074	12-28 279 0002	51
51.27421.0077	12-34 899 0022	13
51.27421.0179	12-34 899 0004	13
51.27421.0185	12-34 899 0004	13
51.27421.0198	12-34 899 0004	13
51.27421.0216	12-34 899 0004	13
51.54105.6002	034 013 0005	96
51.54105.6004	034 013 0005	96
51.54105.6006	034 013 0001	95
51.54105.6007	034 013 0005	96
51.54105.6008	034 013 0005	96
51.54114.6023	034 013 0006	94
51.54114.6024	034 013 0006	94
51.54114.6035	034 013 0006	94
51.54114.6045	034 013 0006	94
51.54114.6047	034 013 0006	94
51.54114.6049	034 013 0006	94
51.54114.6054	034 013 0006	94
51.54119.6002	034 013 0041	-
51.93020.0236	034 003 1024	7
51.93410.0079	300 334 1103	151
51.95800.5001	12-34 000 0003	60
51.95800.6061	12-34 000 1101	60
51.95800.6075	12-34 000 1101	60
51.95800.6076	12-34 000 1100	61
51.95800.6087	12-34 000 1004	61
51.95800.6092	12-34 000 1100	61
51.95800.6099	12-34 000 1100	61
51.95800.7428	12-34 000 1003	60
51.95800.7429	12-34 000 1003	60
51.95800.7436	12-34 000 1003	60
51.95800.7437	12-34 000 1002	59
51.95800.7459	12-34 000 1003	60
51.95800.7477	12-34 000 1003	60
51.95800.7479	12-34 000 1002	59
51.96305.0018	12-39 222 0013	57
51.96305.0021	12-39 222 0013	57
51.96820.0128	052 013 1475	67
51.96820.0132	052 010 1425	65
51.96820.0143	052 013 1550	67
51.96820.0153	052 013 1550	67
51.96820.0238	050 008 0880	67
51.96820.0239	050 008 1376	68

Ref. no.	MEYLE no.	Page
MAN		
51.96820.0243	050 008 1275	68
51.96820.0248	050 010 1980	69
51.96820.0250	050 012 1515	69
51.96820.0251	050 004 0790	69
51.96820.0257	050 008 1275	68
51.96820.0271	050 005 1482	70
51.96820.0272	050 008 1635	72
51.96820.0273	050 008 1915	70
51.96820.0280	050 008 1275	68
51.96820.0304	050 004 1390	71
51.96820.0308	050 009 1725	70
51.96820.0314	050 004 1390	71
51.96820.0317	050 004 1390	71
51.96820.0322	050 008 1158	71
51.96820.0325	050 010 1688	71
51.96820.0332	050 005 1530	72
51.96820.0335	050 008 1915	70
51.96820.0344	050 008 1635	72
51.96820.0345	050 008 1920	72
51.96820.0346	050 008 1655	73
51.96820.3001	052 013 1600	63
51.96820.6001	052 013 1600	63
51.96820.6027	052 013 1600	63
64.08301.0003	034 321 0006	17
6.58041.0241	052 013 1500	66
6.58041.0242	052 013 1525	62
6.58041.2241	052 013 1500	66
6.58043.0120	052 010 0975	64
6.58043.0124	052 010 1075	64
6580 430 125	052 010 1100	64
6.58043.0136	052 010 1380	65
65.80430.221	052 013 1000	63
6.58043.0241	052 013 1500	66
6.58043.0242	052 013 1525	62
6.58043.2120	052 010 0975	64
6.58043.2124	052 010 1075	64
6580 432 125	052 010 1100	64
6.58043.2136	052 010 1380	65
6.58043.2241	052 013 1500	66
6.58043.2242	052 013 1525	62
6580 470 125	052 010 1100	64
6.58072.1201	052 010 0975	64
6.58072.1241	052 010 1075	64
6580 721 251	052 010 1100	64
6.58072.1361	052 010 1380	65
6.58072.2231	052 013 1050	62

Ref. no.	MEYLE no.	Page
MAN		
6.58072.2421	052 013 1525	62
68324072	12-34 527 0008	87
81.00000.0246	12-34 323 0006	26
81.05504.0025	12-14 322 0000	15
81.05504.6001	12-34 632 0001	161
81.06102.6089	12-14 223 0006	50
81.06102.6098	12-14 223 0004	49
81.06102.6099	12-14 223 0004	49
81.06102.6100	12-14 223 0006	50
81.06102.6109	12-14 223 0005	50
81.06102.6110	12-14 223 0001	49
81.06102.6112	12-14 223 0001	49
81.06102.6117	12-14 223 0003	51
81.06102.6201	12-14 223 0004	49
81.06102.6202	12-14 223 0004	49
81.06102.6203	12-14 223 0006	50
81.06102.6204	12-14 223 0005	50
81.06102.6205	12-14 223 0001	49
81.06102.6206	12-14 223 0003	51
81.06102.6208	12-14 223 0003	51
81.06102.6209	12-14 223 0001	49
81.06102.6218	12-14 223 0004	49
81.06102.6219	12-14 223 0005	50
81.06102.6220	12-14 223 0006	50
81.06102.6221	12-14 223 0003	51
81.06102.6222	12-14 223 0001	49
81.06102.6226	12-14 223 0003	51
81.06102.6227	12-14 223 0001	49
81.06111.0018	039 238 0001	52
81.06111.0019	12-14 223 0002	32
81.06111.0020	12-14 223 0002	32
81.06601.0072	14-34 232 0012	40
81.08205.0005	034 321 0006	17
81.08304.0038	12-34 321 0010	16
81.08304.0040	034 321 0006	17
81.08304.0041	034 321 0006	17
81.08304.0043	12-34 321 0010	16
81.08304.0044	12-34 321 0010	16
81.08304.0048	034 321 0006	17
81.08304.0057	034 321 0006	17
81.08304.0060	034 321 0006	17
81.08304.0074	12-34 321 0011	17
81.08304.0076	12-34 321 0011	17
81.08304.0084	12-34 321 0002	17
81.08304.0086	812 321 0001	18
81.08304.0087	12-34 321 0006	19

Ref. no.	MEYLE no.	Page
MAN		
81.08304.0091	12-34 321 0010	16
81.08304.0100	034 321 0009	18
81.08304.0101	12-34 321 0019	18
81.08304.0103	12-34 321 0019	18
81.08401.6213	12-34 321 0010	16
81.08405.0015	12-34 321 0006	19
81.08405.0016	12-34 321 0003	19
81.08405.0018	12-34 321 0009	19
81.08405.0020	12-34 321 0003	19
81.08405.0021	12-34 321 0003	19
81.08405.0022	12-34 321 0017	20
81.08405.0023	12-34 321 0018	20
81.08405.0029	12-34 321 0021	20
81.08405.0030	12-34 321 0022	21
81.08405.0031	12-34 321 0019	18
81.11101.6012	034 009 0003	25
81.11101.6013	034 323 0003	26
81.11101.6016	034 009 0003	25
81.11101.6151	034 323 0003	26
81.11701.6046	034 007 0002	103
81.12102.0002	034 009 0003	25
81.12150.6003	034 009 0015	22
81.12150.6013	034 009 0015	22
81.12501.0004	12-34 323 0014	28
81.12501.0021	12-34 323 0003	27
81.12501.0022	12-34 323 0004	27
81.12501.0026	12-34 323 0003	27
81.12501.0030	12-34 323 0003	27
81.12501.0031	12-34 323 0005	26
81.12501.0032	12-34 323 0004	27
81.12501.0034	12-34 323 0004	27
81.12503.0021	12-34 323 0006	26
81.12503.0022	12-34 323 0006	26
81.12503.0033	12-34 323 0003	27
81.12503.0042	12-34 323 0006	26
81.12503.0048	12-34 323 0006	26
81.12503.0054	12-34 323 0006	26
81.12503.0063	12-34 323 0006	26
81.12503.0080	12-34 323 0004	27
81.12503.0085	12-34 323 0005	26
81.12503.0086	12-34 323 0003	27
81.15701.6003	034 043 0005	104
81.15701.6113	12-34 157 0005	104
81.15701.6120	12-34 157 0005	104
81.15701.6124	12-34 157 0004	105
81.25260.6105	12-34 830 0101	187

Ref. no.	MEYLE no.	Page
MAN		
81.25503.0244	12-34 029 0001	120
81.25503.6119	12-34 533 0200	188
81.25505.0236	12-34 533 0200	188
81.25505.0239	12-34 533 0200	188
81.25505.0426	12-34 533 0200	188
81.25505.0636	12-34 533 0200	188
81.25505.6110	12-34 533 0200	188
81.25520.0050	12-34 533 0200	188
81.25525.0032	12-34 899 0026	118
81.25525.0033	12-34 899 0023	120
81.25525.0227	12-34 899 0023	120
81.25525.0257	12-34 899 0023	120
81.25601.6024	034 015 0005	12
81.25902.0155	12-34 830 0006	196
81.25902.0274	12-34 830 0006	196
81.25902.0460	12-34 830 0005	196
81.25902.0474	12-34 830 0005	196
81.25937.0010	12-34 032 0007	98
81.25937.0015	12-34 032 0007	98
81.25937.0016	834 533 0004	99
81.25937.0023	034 032 0115	99
81.25937.0037	034 032 0115	99
81.26440.0029	029 700 2870	194
81.26440.0043	029 700 2870	194
81.26440.0049	029 100 4071	193
81.26440.0053	029 600 2470	194
81.26440.0065	029 600 2470	194
81.26440.6006	029 700 2870	194
81.26440.6016	029 100 4071	193
81.26440.6027	029 100 4071	193
81.26440.6034	029 600 2470	194
81.26440.6035	029 700 2870	194
81.26485.6008	12-34 870 0004	192
81.26485.6027	12-34 870 0002	192
81.26485.6029	034 870 0005	193
81.26485.6030	12-34 870 0002	192
81.26485.6032	12-34 870 0001	193
81.26485.6033	12-34 870 0001	193
81.27120.0021	12-34 533 0103	90
81.27120.6106	12-34 899 0016	90
81.27120.6119	12-34 899 0005	91
81.27120.6121	12-34 899 0017	91
81.27120.6178	12-34 899 0008	93
81.27120.6179	12-34 899 0007	93
81.27120.6182	12-34 899 0005	91
81.27120.6184	12-34 899 0017	91

Ref. no.	MEYLE no.	Page
MAN		
81.27120.6205	12-34 899 0009	92
81.27120.6206	12-34 899 0010	92
81.27120.6220	12-34 899 0007	93
81.27120.6221	12-34 899 0008	93
81.27421.0077	12-34 820 0001	-
81.27421.0098	12-14 820 0000	13
81.27421.0099	12-28 279 0002	51
81.27421.0109	12-14 820 0000	13
81.27421.0125	12-28 279 0002	51
81.27421.0152	12-34 223 0001	52
81.27421.0169	12-34 223 0001	52
81.27421.0195	12-34 223 0002	52
81.27421.0232	12-34 223 0002	52
81.30530.0037	12-31 106 0004	124
81.30550.0096	12-31 111 0003	123
81.30550.0101	12-31 111 0003	123
81.30550.0102	12-31 111 0003	123
81.30550.0104	12-31 111 0003	123
81.30550.0114	12-31 111 0003	123
81.30550.0255	12-31 111 0003	123
81.30560.6019	12-31 106 0001	123
81.30560.6022	12-31 106 0001	123
81.30715.6108	12-37 142 0002	126
81.30715.6111	12-37 142 0001	126
81.30715.6119	12-37 142 0001	126
81.30715.6120	12-37 142 0002	126
81.30715.6121	12-37 142 0001	126
81.30715.6149	12-37 142 0011	127
81.30715.6154	12-37 142 0011	127
81.30715.6156	12-37 142 0011	127
81.30725.6007	12-34 725 6025	124
81.30725.6024	12-34 725 6025	124
81.30725.6025	12-34 725 6025	124
81.30725.6026	12-34 725 6025	124
81.30725.6027	12-34 725 6027	124
81.30725.6028	12-34 725 6027	124
81.30725.6031	12-34 725 6032	125
81.30725.6032	12-34 725 6032	125
81.30725.6045	12-34 725 6027	124
81.30725.6046	12-34 725 6027	124
81.30725.6053	12-34 725 6032	125
81.30725.6054	12-34 725 6032	125
81.30725.6065	12-37 142 0003	125
81.30725.6084	12-37 142 0004	125
81.30725.6085	12-37 142 0004	125
81.30725.6086	12-37 142 0003	125

Ref. no.	MEYLE no.	Page
MAN		
81.30725.6092	12-37 142 0004	125
81.30725.6104	034 029 0034	126
81.30725.6107	12-37 142 0004	125
81.30725.6116	12-37 142 0004	125
81.30725.9025	12-34 725 6025	124
81.32550.0003	034 026 0032	118
81.32620.0039	12-34 026 0001	176
81.32620.0043	12-34 026 0001	176
81.32620.0049	12-34 026 0000	176
81.32620.0085	12-34 026 0001	176
81.32734.6001	034 026 0030	113
81.32735.6011	034 026 0025	119
81.32735.6035	034 026 0025	119
81.32735.6039	034 026 0025	119
81.32735.6040	034 026 0025	119
81.35412.6003	12-14 753 0014	116
81.35710.0044	034 035 0003	154
81.35710.0045	034 035 0001	154
81.39108.6048	034 041 9022	122
81.39126.6017	12-34 126 6017	122
81.39126.6020	12-34 126 6020	122
81.39126.6030	12-34 126 6020	122
81.39200.6015	12-34 126 6017	122
81.39374.6003	034 041 9022	122
81.39410.6013	12-34 410 0002	120
81.39410.6017	12-34 410 0002	120
81.39410.6019	12-34 410 0002	120
81.39410.6020	12-34 151 0002	121
81.39410.6023	12-34 151 0003	121
81.39410.6031	12-34 151 0003	121
81.41506.0096	12-34 030 0004	28
81.41700.6095	12-34 058 0003	184
81.41715.6013	12-34 058 0001	185
81.41715.6014	12-34 058 0002	185
81.41723.6059	12-14 910 0102	186
81.41723.6103	12-14 910 0102	186
81.41723.6114	12-14 910 0102	186
81.41723.6123	12-14 910 0005	186
81.41723.6124	12-14 910 0004	187
81.41723.9114	12-14 910 0102	186
81.43220.6006	12-34 220 6055	139
81.43220.6030	12-36 030 0004	137
81.43220.6055	12-34 220 6055	139
81.43220.6067	12-36 035 0002	136
81.43220.6068	12-36 035 0002	136
81.43220.6070	12-36 035 0003	137

Ref. no.	MEYLE no.	Page
MAN		
81.43220.6071	12-36 035 0003	137
81.43220.6072	12-36 035 0003	137
81.43220.6073	12-34 220 6055	139
81.43220.6090	12-36 035 0002	136
81.43220.6091	12-36 035 0003	137
81.43220.6092	12-36 035 0002	136
81.43220.6093	12-36 035 0003	137
81.43220.6096	12-36 030 0004	137
81.43220.6097	12-36 030 0004	137
81.43220.6098	12-36 030 0004	137
81.43220.6107	12-34 220 6055	139
81.43220.6108	12-34 220 6108	140
81.43220.6119	12-36 035 0003	137
81.43220.6120	12-36 035 0002	136
81.43220.6129	12-36 030 0004	137
81.43220.6132	12-34 220 6108	140
81.43220.6139	12-36 030 0016	133
81.43220.6151	12-36 030 0016	133
81.43220.6161	12-36 050 0002	138
81.43220.6177	036 035 0052 036 035 0053	132, 140
81.43220.6179	036 035 0052 036 035 0053	132, 140
81.43220.6183	12-36 030 0016	133
81.43220.6190	12-36 050 0002	138
81.43220.6196	12-36 035 6196	138
81.43220.6197	16-34 653 0001	140
81.43220.6203	14-36 035 0003	141
81.43220.6221	12-34 035 0002	135
81.43220.6222	12-34 050 0003	133
81.43220.6224	036 035 0052 036 035 0053	132, 140
81.43220.6229	12-34 035 0003	139
81.43220.6232	12-36 035 6196	138
81.43220.6233	12-36 035 6196	138
81.43220.6236	12-34 035 0003	139
81.43220.6244	12-34 250 6244	141
81.43220.6247	12-36 030 0013	132
81.43220.6260	12-34 050 0003	133
81.43220.6267	12-34 035 0003	139
81.43220.6268	12-34 050 0002	133
81.43220.6272	12-34 035 0003	139
81.43220.6276	12-36 030 0016	133
81.43220.6277	12-36 030 0016	133
81.43220.6283	12-34 050 0003	133
81.43220.6284	12-34 050 0003	133

Ref. no.	MEYLE no.	Page
MAN		
81.43220.6291	12-34 050 0002	133
81.43220.6304	12-34 035 0003	139
81.43220.6305	12-34 035 0003	139
81.43220.6380	12-34 035 0003	139
81.43220.9092	12-36 035 0002	136
81.43220.9236	12-34 035 0003	139
81.43230.6014	12-36 030 0004	137
81.43230.6051	12-34 230 6051	141
81.43230.6068	12-34 230 6051	141
81.43270.6030	12-36 050 0000	134
81.43270.6034	12-36 050 0000	134
81.43270.6040	034 035 0029	142
81.43270.6045	034 035 0029	142
81.43270.6054	12-36 050 0000	134
81.43270.6056	12-36 050 0001	134
81.43270.6057	12-36 050 0000	134
81.43270.6067	12-36 050 0001	134
81.43270.6075	12-36 050 0001	134
81.43270.6076	12-36 050 0000	134
81.43270.6077	12-36 050 0001	134
81.43270.6078	12-36 050 0000	134
81.43270.6080	12-34 301 6132	142
81.43270.6081	12-36 050 0001	134
81.43270.6082	12-36 050 0000	134
81.43270.6083	12-34 301 6133	142
81.43270.6087	12-36 035 6087	134
81.43270.6088	12-36 035 6087	134
81.43270.6094	12-36 035 6087	134
81.43270.6095	12-36 035 6087	134
81.43270.6096	12-34 035 0002	135
81.43270.6097	12-34 050 0001	135
81.43270.6113	12-34 050 0001	135
81.43270.6114	12-34 035 0002	135
81.43270.6116	12-34 035 0005	136
81.43270.6117	12-34 035 0006	136
81.43270.6135	12-34 050 0001	135
81.43270.6137	12-34 035 0005	136
81.43270.9054	12-36 050 0000	134
81.43270.9078	12-36 050 0000	134
81.43271.0082	12-34 271 0082	147
81.43400.6484	12-34 742 0009	130
81.43407.0109	12-34 742 0009	130
81.43407.0110	12-34 742 0009	130
81.43407.5003	12-34 742 0009	130
81.43610.6124	12-34 032 0000	98
81.43610.6129	12-34 032 0000	98

Ref. no.	MEYLE no.	Page
MAN		
81.43704.0057	12-34 704 0057	143
81.43704.0061	12-34 704 0061	143
81.43704.0074	12-34 271 0096	147
81.43704.0077	12-34 271 0095	144
81.43704.0078	12-34 271 0084	148
81.43722.0019	12-34 722 0019	144
81.43722.0020	12-34 704 0061	143
81.43722.0021	12-34 722 0021	149
81.43722.0022	12-34 271 0086	148
81.43722.0038	12-34 271 0086	148
81.43722.0039	12-34 722 0021	149
81.43722.0044	12-34 610 0001	129
81.43722.0051	12-34 032 0003	129
81.43722.0052	12-34 271 0101	144
81.43722.0053	12-34 271 0094	145
81.43722.0059	12-34 271 0085	148
81.43722.0060	12-34 032 0003	129
81.43722.0061	12-34 610 0001	129
81.43722.0062	12-34 722 0062	130
81.43722.0063	12-34 722 0021	149
81.43722.0068	12-34 271 0098	149
81.43722.0070	12-34 271 0099	-
81.43722.0072	12-34 271 0083	150
81.43722.0081	12-34 722 0021	149
81.43722.0082	12-34 722 0021	149
81.43722.0083	12-34 271 0088	145
81.43722.6051	12-34 722 0019	144
81.44205.6013	12-34 205 6013	128
81.44205.6023	12-34 205 0001	128
81.44205.6025	12-34 798 0001	128
81.45503.0049	034 040 0002	160
81.45503.0056	034 040 0002	160
81.46433.6006	12-34 899 0002	191
81.46433.6011	12-34 899 0002	191
81.46610.6004	12-34 035 0004	166
81.46610.6006	12-34 035 0004	166
81.46610.6007	12-34 250 6197	164
81.46610.6333	12-36 040 0009	165
81.46610.6334	12-36 040 0009	165
81.46610.6354	12-36 040 0009	165
81.46610.6355	12-36 040 0009	165
81.46610.6360	12-36 040 0009	165
81.46610.6361	12-36 040 0009	165
81.46610.6656	12-34 250 6656	163
81.46610.6659	12-34 250 6656	163
81.46610.6669	12-34 250 6656	163

Ref. no.	MEYLE no.	Page
MAN		
81.46610.6721	12-36 040 0009	165
81.46610.6722	12-36 040 0009	165
81.46610.6723	12-36 040 0009	165
81.46610.6753	12-34 035 0004	166
81.46610.6754	12-34 035 0004	166
81.46610.6808	12-34 250 6197	164
81.46610.6809	12-34 250 6135	164
81.46610.6810	12-34 250 6135	164
81.46610.6823	12-34 250 6135	164
81.46610.6836	12-34 250 6197	164
81.46610.6837	12-34 250 6197	164
81.46610.6839	12-34 250 6135	164
81.46611.6088	12-34 250 6197	164
81.46611.6096	12-34 250 6197	164
81.46611.6097	12-34 250 6197	164
81.46611.6099	12-34 250 6197	164
81.46611.6104	12-34 250 6135	164
81.46611.6105	12-34 250 6135	164
81.46611.6107	12-34 250 6135	164
81.46611.6132	12-34 250 6197	164
81.46611.6133	12-34 250 6197	164
81.46611.6134	12-34 250 6135	164
81.46611.6135	12-34 250 6135	164
81.46611.6136	12-34 250 6197	164
81.46611.6137	12-34 250 6135	164
81.46611.6197	12-34 250 6197	164
81.46611.6198	12-34 250 6197	164
81.46611.6199	12-34 250 6135	164
81.46611.6200	12-34 250 6135	164
81.46611.6205	12-34 250 6197	164
81.46611.6206	12-34 250 6135	164
81.46611.6216	12-36 040 0009	165
81.46710.6112	12-36 030 0002 12-36 030 0002/HD	162
81.46710.6163	12-36 030 0002 12-36 030 0002/HD	162
81.46710.6165	12-36 030 0002 12-36 030 0002/HD	162
81.46710.6198	12-36 030 0002 12-36 030 0002/HD	162
81.46710.6353	12-36 030 0002 12-36 030 0002/HD	162
81.46710.6354	12-36 030 0002 12-36 030 0002/HD	162
81.46710.6361	12-36 030 0002	162
81.46710.6418	12-34 250 6418	165

Ref. no.	MEYLE no.	Page
MAN		
81.46711.6725	12-36 030 0002 12-36 030 0002/HD	162
81.46711.6773	12-34 250 6860	163
81.46711.6791	12-34 250 6860	163
81.46711.6820	12-36 030 0002 12-36 030 0002/HD	162
81.46711.6848	12-34 250 6860	163
81.46711.6849	12-36 030 0002 12-36 030 0002/HD	162
81.46711.6858	12-34 250 6860	163
81.46711.6859	12-34 250 6860	163
81.46711.6860	12-34 250 6860	163
81.46711.6861	12-34 250 6860	163
81.46711.6862	12-34 250 6860	163
81.46711.6863	12-34 250 6860	163
81.46711.6921	12-34 250 6860	163
81.47101.6000	12-34 471 0001	173
81.47101.6001	12-34 471 0001	173
81.47101.6031	12-34 471 0001	173
81.47101.6040	12-34 471 0001	173
81.47101.6051	12-34 471 0001	173
81.47101.6102	12-34 631 0002	174
81.47101.6108	12-34 631 0002	174
81.47101.6121	12-34 631 0001	173
81.47101.6136	12-34 631 0001	173
81.47101.6137	12-34 471 0003	174
81.47101.6161	12-34 631 0001	173
81.47101.6162	12-34 471 0003	174
81.47101.6169	12-34 471 0001	173
81.47101.6181	12-34 471 0003	174
81.47101.6189	12-34 631 0002	174
81.47101.9137	12-34 471 0003	174
81.47101.9162	12-34 471 0003	174
81.47301.6005	034 046 0000	161
81.47301.6048	12-34 632 0002	175
81.47307.0001	12-34 632 0001	161
81.50213.0013	034 042 0017	94
81.50213.6005	034 042 0017	94
81.50213.6006	034 042 0017	94
81.50610.6132	034 042 0029/C	94
81.50802.6017	12-34 042 0014	77
81.50802.6020	12-34 042 0014	77
81.50802.6021	12-34 042 0014	77
81.50802.6022	12-34 042 0015	77
81.50802.6025	12-34 042 0017	77
81.50803.0010	12-35 521 0000	79

Ref. no.	MEYLE no.	Page
MAN		
81.50803.0020	12-35 521 0005	82
81.50803.0021	12-35 521 0004	81
81.50803.0022	12-35 523 0000	83
81.50803.0023	12-35 521 0002	80
81.50803.0024	12-35 521 0007	79
81.50803.0026	12-35 521 0007	79
81.50803.0027	12-35 521 0005	82
81.50803.0028	12-35 521 0003	82
81.50803.0031	12-35 521 0002	80
81.50803.0033	12-35 521 0002	80
81.50803.0034	12-35 521 0002	80
81.50803.0035	12-35 521 0002	80
81.50803.0036	12-35 521 0002	80
81.50803.0038	12-35 521 0002	80
81.50803.0039	12-35 521 0008	80
81.50803.0040	12-35 521 0002	80
81.50803.0041	12-35 521 0004	81
81.50803.0042	12-35 521 0009	81
81.50803.0046	12-35 521 0002	80
81.50803.0048	12-35 521 0003	82
81.50803.0054	12-35 521 0010	83
81.50803.0057	12-35 521 0005	82
81.50803.0061	12-35 523 0000	83
81.50803.0063	12-35 521 0010	83
81.50811.0004	12-34 527 0004	88
81.50820.5006	025 291 1328	86
81.50820.5007	025 291 1328 025 291 1428	84, 86
81.50820.5017	025 290 9530	84
81.50820.5020	025 291 1328	86
81.50820.5023	025 290 8826 025 290 8826/S	85
81.50820.5025	025 290 8826 025 290 8826/S	85
81.50820.5029	025 290 8826 025 290 8826/S	85
81.50820.5040	025 291 1328	86
81.50820.5041	025 291 1428	84
81.50820.5047	025 291 1328	86
81.50820.5048	025 291 1428	84
81.50820.5060	025 291 1328	86
81.50820.5061	025 291 1428	84
81.50820.5066	025 291 1328	86
81.50820.5068	025 291 1328	86
81.50820.5069	025 291 1428	84
81.50820.5072	025 291 3130	86

Ref. no.	MEYLE no.	Page
MAN		
81.50820.5074	025 290 4827	87
81.50820.5079	025 290 8826 025 290 8826/S	85
81.50820.5080	025 291 3130	86
81.50820.5085	025 290 4827	87
81.50820.5091	025 291 1328	86
81.50820.5092	025 291 1428	84
81.50820.6000	025 291 1328	86
81.50820.6001	025 291 1428	84
81.50820.6002	025 291 1328	86
81.50820.6003	025 291 1428	84
81.50820.6004	025 291 1328	86
81.50820.6005	025 291 1428	84
81.50820.6006	025 290 8826 025 290 8826/S	85
81.50820.6008	025 290 9530	84
81.50820.6014	025 291 1328	86
81.50820.6015	025 291 1428	84
81.50820.6016	025 291 1328	86
81.50820.6017	025 291 1328 025 291 1428	84, 86
81.50820.6020	025 290 8826 025 290 8826/S	85
81.50820.6022	025 290 9530	84
81.50820.6025	025 291 1328	86
81.50820.6026	025 291 1428	84
81.50820.6030	025 290 8730 025 290 8730/S	85, 87
81.50820.6031	025 291 3130	86
81.50820.6034	025 291 1328	86
81.50820.6035	025 291 1328	86
81.50820.6036	025 291 1328	86
81.50820.6040	025 290 4827	87
81.50820.6041	025 291 3130	86
81.50820.6042	025 290 8826 025 290 8826/S	85
81.50820.6043	025 290 4827	87
81.50820.6046	025 291 1328	86
81.50820.6051	025 291 3130	86
81.50820.6054	025 290 4827	87
81.50820.6056	025 290 8730 025 290 8730/S	85, 87
81.50820.6063	025 290 4827	87
81.50822.6009	12-34 042 0010	78
81.50822.6011	12-34 527 0001	89
81.50822.6012	12-34 527 0005	89

Ref. no.	MEYLE no.	Page
MAN		
81.50822.6013	12-34 527 0000	88
81.50822.6014	12-34 527 0002	89
81.50822.6016	12-34 527 0001	89
81.50822.6017	12-34 527 0005	89
81.50822.6019	12-34 042 0021	79
81.50822.6020	12-34 042 0012	78
81.50822.6022	034 042 0053	78
81.50822.6031	12-34 042 0012	78
81.50822.6032	034 042 0053	78
81.50822.6034	12-34 042 0021	79
81.50822.6037	12-34 042 0021	79
81.51113.0001	034 043 0002	108
81.51113.0012	034 042 0061	108
81.51113.0013	034 042 0030	108
81.51113.0014	034 042 0043	109
81.51113.0020	034 042 0062	109
81.51220.6024	034 042 0033	99
81.51220.6025	034 042 0034	100
81.51220.6032	034 042 0039	100
81.51220.6069	034 042 0039	100
81.51220.6093	034 042 0039	100
81.51220.6096	034 042 0039	100
81.51270.6002	034 042 0024	103
81.52101.6152	034 043 0058	96
81.52101.6153	12-35 533 0000	102
81.52101.6154	12-35 533 0000	102
81.52101.6159	034 043 0058	96
81.52101.6180	034 043 0058	96
81.52101.6240	034 043 0058	96
81.52101.6241	034 043 0056	97
81.52101.6246	034 043 0056	97
81.52101.6269	12-35 533 0001	102
81.52101.6270	12-35 533 0002	103
81.52101.6274	034 043 0058	96
81.52101.6275	034 043 0056	97
81.52101.6280	034 043 0058	96
81.52101.6288	034 043 0058	96
81.52102.0008	034 042 0032	98
81.52108.6001	12-34 042 0026	97
81.52108.6025	12-34 042 0026	97
81.52110.6049	12-35 533 0003	100
81.52110.6095	12-35 533 0003	100
81.52115.6009	034 042 0048	101
81.52115.6017	034 042 0048	101
81.52115.6018	034 042 0048	101
81.52115.6021	034 042 0048	101

Ref. no.	MEYLE no.	Page
MAN		
81.52116.6010	034 042 0007	111
81.52116.6037	034 042 0007	111
81.52116.6067	12-34 043 0001	112
81.52116.6068	12-34 043 0001	112
81.52116.6069	12-34 043 0001	112
81.52116.6070	034 043 0070	112
81.52116.6071	12-35 533 0004	112
81.52116.6074	034 043 0066	113
81.52116.6075	034 043 0066	113
81.52116.6076	034 043 0066	113
81.52116.9075	034 043 0066	113
81.52120.6003	034 042 0051	106
81.52120.6004	034 042 0051	106
81.52120.6025	034 042 0051	106
81.52120.6028	034 042 0051	106
81.52120.6029	034 042 0051	106
81.52120.6030	034 042 0051	106
81.52120.6040	034 042 0051	106
81.52120.6075	034 042 0051	106
81.52131.6015	12-34 026 0002	111
81.52151.6093	12-35 533 0005	105
81.52151.6094	12-35 533 0034	105
81.52151.6096	12-35 533 0005	105
81.52155.0040	12-34 042 0026	97
81.52155.0041	12-34 042 0026	97
81.52170.6064	034 026 0027	111
81.52170.6095	034 026 0029	119
81.52170.6096	12-37 142 0007	114
81.52170.6097	034 026 0029	119
81.52170.6120	034 026 0030	113
81.52170.6128	034 026 0027	111
81.52170.6139	12-34 026 0002	111
81.52170.6151	12-34 026 0002	111
81.52170.6156	12-37 142 0007	114
81.52301.6120	12-35 533 0037	107
81.52301.6121	12-35 533 0037	107
81.52301.6148	12-34 043 0002	107
81.52301.6183	12-35 533 0007	106
81.52301.6189	12-35 533 0007	106
81.52301.6192	12-35 533 0007	106
81.52301.9148	12-34 043 0002	107
81.52310.6165	12-35 533 0037	107
81.52315.6156	12-35 533 0031	107
81.52315.6160	12-35 533 0031	107
81.52315.6161	12-35 533 0031	107
81.52403.6001	12-14 653 0001	157

Ref. no.	MEYLE no.	Page
MAN		
81.54119.6040	034 013 0041	-
81.54124.6006	034 013 0008	95
81.54124.6013	12-14 013 0001	95
81.54124.6017	12-14 013 0001	95
81.61851.6019	12-14 910 0001	179
81.61851.6023	12-14 910 0001	179
81.61851.6029	12-14 910 0001	179
81.61910.0011	12-12 319 0000	177
81.61910.0018	12-12 319 0003	177
81.61910.0019	12-12 320 0008	178
81.61910.0030	12-12 320 0008	178
81.62640.6045	12-34 910 0010	191
81.62640.6046	12-34 910 0011	191
81.62640.6049	12-34 910 0010	191
81.62640.6050	12-34 910 0011	191
81.62640.6055	12-34 910 0010	191
81.62640.6056	12-34 910 0011	191
81.62641.0099	12-34 910 0005	188
81.62641.0100	12-34 910 0006	188
81.62641.6085	12-34 910 0001	189
81.62641.6086	12-34 910 0002	189
81.62680.6095	12-34 910 0009	190
81.62680.6096	12-34 910 0008	190
81.70701.0331	029 700 2870	194
81.74821.0109	12-34 920 1002	187
81.85301.0076	036 020 0015	172
81.90712.0844	12-34 089 0001	180
81.90713.0909	12-34 089 0001	180
81.93420.0078	12-14 650 0005	150
81.93420.0131	034 650 0001	150
81.93420.0288	12-14 650 0006	152
81.93420.0320	12-14 751 0006	152
81.93420.0330	12-14 650 0006	152
81.93420.0336	12-34 751 0001	153
81.93420.0342	12-14 751 0006	152
81.93420.0346	12-14 751 0007	153
81.93420.0349	12-14 650 0006	152
81.93420.0376	12-14 751 0006	152
81.93420.0379	034 650 0020	153
81.93420.6083	034 650 0020	153
81.93420.6097	12-14 751 0006	152
81.93420.6099	034 650 0020	153
81.95301.0013	036 020 0002	169
81.95301.0014	036 020 0001	169
81.95301.0015	036 020 0005 036 020 0005/HD	170

Ref. no.	MEYLE no.	Page
MAN		
81.95301.0016	036 020 0004 036 020 0004/HD	167
81.95301.0038	036 026 0016	117
81.95301.0045	036 026 0016	117
81.95301.0064	036 020 0001	169
81.95301.0074	036 020 0002	169
81.95301.0077	036 020 0016	172
81.95301.0078	036 020 0015	172
81.95301.0079	036 020 0008	166
81.95301.0084	036 020 0004 036 020 0004/HD	167
81.95301.0388	036 020 0016	172
81.95301.6016	036 026 0016	117
81.95301.6030	036 020 0005 036 020 0005/HD	170
81.95301.6043	036 020 0005 036 020 0005/HD	170
81.95301.6048	036 020 0004 036 020 0004/HD	167
81.95301.6049	036 020 0004 036 020 0004/HD	167
81.95301.6053	036 020 0004 036 020 0004/HD	167
81.95301.6060	036 020 0003	173
81.95301.6061	036 020 0004 036 020 0004/HD	167
81.95301.6063	034 026 0017	118
81.95301.6064	034 026 0018	117
81.95301.6067	036 020 0001	169
81.95301.6068	036 020 0002	169
81.95301.6090	036 020 0004 036 020 0004/HD	167
81.95301.6091	036 020 0005 036 020 0005/HD	170
81.95301.6112	036 020 0004 036 020 0004/HD	167
81.95301.6120	036 020 0005 036 020 0005/HD	170
81.95301.6125	036 020 0005 036 020 0005/HD	170
81.95301.6126	036 020 0004 036 020 0004/HD	167
81.95301.6130	034 026 0018	117
81.95301.6131	034 026 0017	118
81.95301.6132	12-34 301 6132	142
81.95301.6133	12-34 301 6133	142

Ref. no.	MEYLE no.	Page
MAN		
81.95301.6134	036 020 0016	172
81.95301.6135	036 020 0003	173
81.95301.6139	036 020 0008	166
81.95301.6140	036 020 0003	173
81.95301.6141	036 020 0015	172
81.95301.6142	036 020 0016	172
81.95301.6143	036 020 0004 036 020 0004/HD	167
81.95301.6149	036 020 0004 036 020 0004/HD	167
81.95301.6152	036 020 0005 036 020 0005/HD	170
81.95301.6154	036 020 0004 036 020 0004/HD	167
81.95301.6155	036 020 0005 036 020 0005/HD	170
81.95301.6156	036 020 0004 036 020 0004/HD	167
81.95301.6162	036 020 0001	169
81.95301.6163	036 020 0002	169
81.95301.6167	036 020 0005 036 020 0005/HD	170
81.95301.6169	036 026 0016	117
81.95301.6170	034 026 0018	117
81.95301.6171	034 026 0017	118
81.95301.6172	036 026 0016	117
81.95301.6173	034 026 0018	117
81.95301.6174	034 026 0017	118
81.95301.6176	036 026 0016	117
81.95301.6179	036 020 0005 036 020 0005/HD	170
81.95301.6194	036 020 0004 036 020 0004/HD	167
81.95301.6222	036 020 0008	166
81.95301.6224	036 020 0004 036 020 0004/HD	167
81.95301.6234	036 020 0004 036 020 0004/HD	167
81.95301.6235	036 026 0016	117
81.95301.6237	036 020 0005 036 020 0005/HD	170
81.95301.6239	036 020 0001	169
81.95301.6242	036 020 0004 036 020 0004/HD	167
81.95301.6249	036 020 0003	173
81.95301.6263	12-36 020 0032	168

Ref. no.	MEYLE no.	Page
MAN		
81.95301.6266	036 026 0016	117
81.95301.6269	036 026 0016	117
81.95301.6270	12-36 020 0039	168
81.95301.6272	036 020 0001	169
81.95301.6273	036 020 0002	169
81.95301.6274	036 020 0004 036 020 0004/HD	167
81.95301.6275	036 020 0005 036 020 0005/HD	170
81.95301.6278	036 020 0004 036 020 0004/HD	167
81.95301.6286	836 020 0006	171
81.95301.6288	12-36 020 0041	171
81.95301.6292	536 020 0009	171
81.95301.6303	036 020 0016	172
81.95301.6304	036 020 0015	172
81.95301.6308	036 020 0004 036 020 0004/HD	167
81.95301.6312	036 020 0004 036 020 0004/HD	167
81.95301.6315	036 020 0008	166
81.95301.6321	036 020 0016	172
81.95301.6328	036 020 0003	173
81.95301.6329	036 020 0008	166
81.95301.6350	036 020 0004 036 020 0004/HD	167
81.95301.6352	036 020 0004	167
81.95301.6358	036 020 0003	173
81.95301.6359	036 020 0008	166
81.95302.0038	16-34 653 0001	140
81.95302.0057	16-34 653 0001	140
81.96020.0231	12-34 032 0002	129
81.96020.0250	12-34 032 0002	129
81.96020.0252	12-34 032 0002	129
81.96020.0341	12-34 030 0007	28
81.96020.0373	12-34 030 0007	28
81.96020.0408	12-34 030 0007	28
81.96101.0638	12-34 210 0401	180
81.96210.0340	12-34 210 0348	179
81.96210.0348	12-34 210 0348	179
81.96210.0349	12-34 210 0348	179
81.96210.0362	12-34 058 0004	185
81.96210.0369	12-34 210 0403	180
81.96210.0400	12-34 210 0400	181
81.96210.0407	12-34 058 0004	185
81.96210.0424	12-34 210 0437	181

Ref. no.	MEYLE no.	Page
MAN		
81.96210.0437	12-34 210 0437	181
81.96210.0450	12-34 271 0086	148
81.96210.0462	12-34 210 0403	180
81.96210.0469	12-34 271 0086	148
81.96210.0482	12-34 210 0515	184
81.96210.0515	12-34 210 0515	184
81.96210.0525	12-34 030 0000	29
81.96210.0553	12-34 030 0000	29
81.96210.0554	12-34 742 0000	131
81.96210.0555	12-34 742 0001	131
81.96210.0562	12-34 030 0003	29
81.96210.0571	12-34 030 0003	29
81.96210.0572	12-34 030 0002	30
81.96210.0574	12-34 030 0000	29
81.96210.0575	12-34 030 0003	29
81.96210.0577	12-34 030 0003	29
81.96210.0592	12-34 030 0002	30
81.96210.0597	12-34 030 0002	30
81.96210.0609	12-34 210 0609	181
81.96210.5022	12-34 742 0006	131
81.96210.5025	12-34 742 0005	132
81.96210.5026	12-34 742 0005	132
81.96210.5027	12-34 742 0005	132
81.96210.6065	12-34 030 0001	30
81.96210.6071	12-34 030 0001	30
81.96210.6072	12-34 030 0001	30
81.96301.0496	12-39 222 0001	54
81.96301.0581	12-39 222 0014	54
81.96301.0582	12-39 222 0015	54
81.96301.0621	12-39 222 0015	54
81.96301.0659	12-39 222 0001	54
81.96301.0676	12-39 222 0014	54
81.96301.0677	12-39 222 0005	55
81.96301.0679	12-39 222 0018	55
81.96301.0680	12-39 222 0017	55
81.96301.0892	12-39 222 0008	56
81.96301.0893	12-39 222 0007	56
81.96301.0898	12-39 222 0006	56
81.96301.0961	12-39 222 0007	56
81.96305.0088	12-39 222 0003	57
81.96305.0095	12-39 222 0013	57
81.96305.0129	12-39 222 0004	57
81.96305.0130	12-39 222 0020	58
81.96305.0134	12-39 222 0013	57
81.96305.0166	12-39 222 0016	58
81.96305.0169	12-39 222 0020	58

Ref. no.	MEYLE no.	Page
MAN		
81.96305.0223	12-39 222 0013	57
81.96305.0226	12-39 222 0013	57
81.96305.0227	12-39 222 0009	59
81.96305.0230	12-39 222 0011	59
81.96501.0861	12-14 753 0004	157
81.96501.0907	12-34 279 0073	115
81.96502.6052	12-14 753 0013	115
81.96502.6066	12-14 753 0013	115
81.96502.6081	12-14 653 0000	158
81.96503.0129	12-34 210 0402	184
81.96503.0154	12-34 753 0000	155
81.96503.0155	034 753 0017	158
81.96503.0161	12-14 753 0005	158
81.96503.0188	12-14 753 0006	159
81.96503.0333	12-14 753 0008	159
81.96503.0339	12-14 753 0009	160
81.96503.0398	12-14 753 0006	159
81.96503.0399	12-14 753 0008	159
81.96503.0445	12-14 753 0009	160
81.96503.0530	12-14 753 0009	160
81.96503.6000	12-14 753 0010	160
81.96506.0155	12-14 753 0004	157
81.96601.0298	034 035 0013	154
81.96820.0047	050 012 1630	73
81.96820.0051	050 008 0855	73
81.97010.6010	12-34 026 0004	176
81.97010.6011	12-34 026 0003	177
81.97100.6034	12-34 899 0002	191
81.97100.6079	12-34 910 0003	190
81.97100.6095	12-34 899 0002	191
81.97100.6099	12-34 910 0003	190
81.99917.8470	12-34 126 6020	122
82.05504.6001	12-34 632 0001	161
82.05504.6096	12-14 322 0001	15
82.12503.0042	12-14 323 0002	23
82.12503.0069	12-34 323 0005	26
82.52102.0013	034 042 0032	98
82.58000.0060	12-34 043 0002	107
82.96301.0006	12-39 222 0006	56
82.96301.0008	12-39 222 0001	54
83.26440.0001	029 100 4071	193
83.41723.6123	12-14 910 0005	186
83.41723.6124	12-14 910 0004	187
83.43722.0001	12-34 610 0001	129
84.26440.0003	029 700 2870	194
85.12501.0002	12-34 323 0004	27

Ref. no.	MEYLE no.	Page
MAN		
85.12501.0003	12-34 323 0014	28
85.12501.0005	12-34 323 0014	28
85.20000.9975	029 600 2470	194
85.26440.0046	029 600 2470	194
85.30001.6535	034 042 0051	106
85.30001.9636	14-34 043 0001	119
85.32734.6001	14-34 043 0001	119
85.41715.0006	12-34 210 0409	182
85.41723.6011	12-14 910 0100	186
85.41723.6020	12-14 910 0100	186
85.41723.6044	12-14 910 0100	186
85.43704.0002	12-34 271 0089	146
85.43704.0004	12-34 271 0090	146
85.43704.0005	12-34 271 0092	146
85.43722.0007	12-34 271 0091	147
85.46610.6031	12-34 035 0004	166
85.46610.6104	12-34 035 0004	166
85.46610.6203	12-34 035 0004	166
85.50001.1965	034 043 0058	96
85.61950.0025	12-12 319 0001	178
85.93020.0005	12-34 271 0094	145
85.94299.0015	12-34 210 0404	182
85.96020.0004	12-34 210 0405	183
85.96210.0019	12-34 210 0406	183
85.96210.0021	12-34 210 0408	183
87.52340.0820	034 650 0001	150
87.52340.1240	034 650 0000	151
88.09901.0001	834 900 0005	75
88.52120.6200	034 042 0051	106
88.77910.0003	12-12 319 0012	179
88.96820.0001	050 006 2200	74
90.80415.3107	036 020 0002	169
90.80415.3111	036 020 0001	169
90.80415.3113	036 020 0002	169
90.81011.4192	034 042 0048	101
90.91157.8013	034 042 0001	109
90.91159.0013	034 042 0003	110
99.10036.0792	034 042 0043	109
N1.01100.1840	050 008 1908	74
N1.01100.1846	050 006 1180	74
N1.01100.8494	12-39 222 0026	53

Short no.	MEYLE no.	Page
MAN		
MAF0064	034 321 0006	17
MAF0067	034 321 0009	18
MAF0193	12-34 321 0002	17
MAF0194	12-34 321 0003	19
MAF0196	12-34 321 0006	19
MAF0198	12-34 321 0009	19
MAF0199	12-34 321 0010	16
MAF0200	12-34 321 0011	17
MAF0202	12-34 321 0017	20
MAF0203	12-34 321 0018	20
MAF0204	12-34 321 0019	18
MAF0206	12-34 321 0021	20
MAF0207	12-34 321 0022	21
MAF0649	812 321 0001	18
MAS0093	12-34 533 0103	90
MAS0094	12-34 899 0005	91
MAS0096	12-34 899 0007	93
MAS0097	12-34 899 0008	93
MAS0098	12-34 899 0009	92
MAS0099	12-34 899 0010	92
MAS0105	12-34 899 0016	90
MAS0106	12-34 899 0017	91
MBD0295	12-35 521 0000	79
MBD0296	12-35 521 0002	80
MBD0297	12-35 521 0003	82
MBD0298	12-35 521 0004	81
MBD0299	12-35 521 0005	82
MBD0300	12-35 521 0007	79
MBD0301	12-35 521 0008	80
MBD0302	12-35 521 0009	81
MBD0303	12-35 521 0010	83
MBD0305	12-35 523 0000	83
MBL0035	029 600 2470	194
MBL0037	029 650 2670	195
MBL0040	029 700 2870	194
MBL0063	029 100 4071	193
MBP0708	025 290 4827	87
MBP0710	025 290 8730	85
MBP0711	025 290 8730/S	87
MBP0712	025 290 8826	85
MBP0713	025 290 9530	84
MBP0715	025 291 1328	86
MBP0716	025 291 1428	84
MBP0720	025 291 3130	86
MBP1627	025 290 8826/S	85
MBT0032	12-34 000 1002	59

Short no.	MEYLE no.	Page
MAN		
MBT0033	12-34 000 1003	60
MBX0013	034 007 0002	103
MBX0016	034 013 0001	95
MBX0017	034 013 0005	96
MBX0018	034 013 0006	94
MBX0020	034 013 0008	95
MBX0038	034 026 0027	111
MBX0039	034 026 0030	113
MBX0052	034 042 0001	109
MBX0053	034 042 0002	110
MBX0054	034 042 0003	110
MBX0056	034 042 0007	111
MBX0061	034 042 0017	94
MBX0063	034 042 0024	103
MBX0064	034 042 0029/C	94
MBX0065	034 042 0030	108
MBX0066	034 042 0032	98
MBX0067	034 042 0033	99
MBX0068	034 042 0034	100
MBX0073	034 042 0039	100
MBX0075	034 042 0043	109
MBX0080	034 042 0048	101
MBX0082	034 042 0051	106
MBX0083	034 042 0053	78
MBX0087	034 042 0061	108
MBX0088	034 042 0062	109
MBX0089	034 043 0002	108
MBX0090	034 043 0005	104
MBX0111	034 043 0056	97
MBX0112	034 043 0058	96
MBX0114	034 043 0066	113
MBX0117	034 043 0070	112
MBX0161	12-34 026 0002	111
MBX0162	12-34 032 0000	98
MBX0163	12-34 042 0010	78
MBX0164	12-34 042 0012	78
MBX0165	12-34 042 0026	97
MBX0167	12-34 157 0004	105
MBX0168	12-34 157 0005	104
MBX0189	12-34 725 6025	124
MBX0190	12-34 725 6027	124
MBX0191	12-34 725 6032	125
MBX0192	12-35 533 0004	112
MBX0195	12-37 142 0003	125
MBX0196	12-37 142 0004	125
MBX0197	12-37 142 0007	114

Short no.	MEYLE no.	Page
MAN		
MBX0215	12-35 533 0001	102
MBX0216	12-35 533 0002	103
MBX0219	12-34 042 0021	79
MBX0223	12-34 042 0017	77
MBX0226	12-35 533 0000	102
MBX0227	12-35 533 0007	106
MBX0228	12-35 533 0031	107
MBX0229	12-35 533 0003	100
MBX0230	12-35 533 0034	105
MBX0236	12-14 013 0001	95
MBX0237	12-34 043 0002	107
MBX0239	12-35 533 0037	107
MBX0242	034 029 0034	126
MBX0243	12-35 533 0005	105
MBX0244	12-34 042 0015	77
MBX0245	12-34 042 0014	77
MBX0246	12-34 043 0001	112
MBX0267	12-34 820 0002	101
MCA0237	12-34 035 0002	135
MCA0238	12-34 035 0006	136
MCA0239	12-34 050 0001	135
MCA0240	12-36 035 6087	134
MCA0241	12-36 050 0000	134
MCA0242	12-36 050 0001	134
MCA0767	12-36 030 0013	132
MCA0777	12-34 050 0002	133
MCA0778	12-34 050 0003	133
MCA0792	12-34 035 0005	136
MCA0938	12-36 030 0016	133
MCA1122	036 035 0053	132
MCF0111	12-12 319 0000	177
MCF0112	12-12 319 0001	178
MCF0113	12-12 319 0003	177
MCF0118	12-12 320 0008	178
MCF0454	12-12 319 0012	179
MCX0082	034 035 0001	154
MCX0083	034 035 0003	154
MCX0089	034 035 0029	142
MCX0101	034 040 0002	160
MCX0114	034 753 0017	158
MCX0116	034 753 0020	156
MCX0201	12-14 653 0000	158
MCX0202	12-14 653 0001	157
MCX0203	12-14 753 0000	155
MCX0204	12-14 753 0002	156
MCX0205	12-14 753 0004	157

Short no.	MEYLE no.	Page
MAN		
MCX0206	12-14 753 0005	158
MCX0207	12-14 753 0006	159
MCX0208	12-14 753 0007	156
MCX0209	12-14 753 0008	159
MCX0210	12-14 753 0009	160
MCX0211	12-14 753 0010	160
MCX0215	12-34 205 0001	128
MCX0216	12-34 205 6013	128
MCX0218	12-34 220 6055	139
MCX0219	12-34 220 6108	140
MCX0221	12-34 230 6051	141
MCX0224	12-34 250 6244	141
MCX0229	12-34 271 0088	145
MCX0230	12-34 271 0089	146
MCX0231	12-34 271 0090	146
MCX0232	12-34 271 0092	146
MCX0234	12-34 271 0094	145
MCX0236	12-34 271 0101	144
MCX0237	12-34 301 6132	142
MCX0238	12-34 301 6133	142
MCX0239	12-34 704 0057	143
MCX0241	12-34 704 0061	143
MCX0242	12-34 722 0019	144
MCX0243	12-34 742 0000	131
MCX0244	12-34 742 0001	131
MCX0245	12-34 742 0005	132
MCX0246	12-34 742 0006	131
MCX0247	12-34 753 0000	155
MCX0248	12-34 798 0001	128
MCX0358	12-34 271 0099	-
MCX0359	12-34 722 0062	130
MCX0383	12-34 032 0003	129
MCX0397	12-34 032 0002	129
MCX0398	12-34 271 0091	147
MCX0450	12-34 610 0001	129
MCX0492	14-36 035 0003	141
MCX0503	12-34 271 0095	144
MCX0505	16-34 653 0001	140
MCX0519	036 035 0052	140
MCX0520	12-34 742 0009	130
MDL0055	12-34 035 0004	166
MDL0057	12-34 250 6135	164
MDL0059	12-34 250 6418	165
MDL0060	12-34 250 6656	163
MDL0062	12-36 040 0009	165
MDL0094	12-34 250 6197	164

Short no.	MEYLE no.	Page
MAN		
MDM0051	12-34 151 0002	121
MDM0052	12-34 151 0003	121
MDM0054	12-34 410 0002	120
MEM0275	12-34 030 0000	29
MEM0276	12-34 030 0001	30
MEM0277	12-34 030 0002	30
MEM0278	12-34 030 0003	29
MEM0280	12-34 030 0007	28
MEM0623	12-34 030 0004	28
MET0037	12-14 223 0001	49
MET0038	12-14 223 0003	51
MET0039	12-14 223 0004	49
MET0040	12-14 223 0005	50
MET0041	12-14 223 0006	50
MEX0143	034 015 0005	12
MEX0148	034 026 0025	119
MEX0150	034 026 0029	119
MEX0151	034 026 0032	118
MEX0354	12-34 003 0001	10
MEX0355	12-34 003 0002	11
MEX0356	12-34 003 0010	12
MEX0357	12-34 029 0001	120
MEX0358	12-34 223 0001	52
MEX0361	12-34 830 0005	196
MEX0362	12-34 830 0006	196
MEX0363	12-34 899 0022	13
MEX0472	12-14 820 0000	13
MEX0474	12-34 899 0004	13
MEX0476	12-34 032 0007	98
MEX0477	834 533 0004	99
MEX0480	034 032 0115	99
MEX0488	12-34 899 0023	120
MEX0567	14-34 043 0001	119
MEX0575	12-34 003 0009	11
MEX0577	12-34 899 0026	118
MEX0588	12-34 223 0002	52
MEX0596	12-34 533 0200	188
MEX0602	12-34 820 0001	-
MEX0603	12-28 279 0002	51
MFC0049	12-14 234 0006	36
MFC0050	12-14 234 0005	36
MFC0062	12-14 234 0004	35
MFC0063	12-14 234 0007	35
MFC0067	12-14 234 0009	34
MFC0068	12-14 234 0010	33
MFC0069	12-14 234 0011	33

Short no.	MEYLE no.	Page
MAN		
MFC0119	12-14 234 0026	34
MFC0120	12-14 234 0028	36
MFC0121	12-14 234 0030	34
MFC0122	12-14 234 0031	35
MFF0018	014 323 0008	25
MFF0023	034 009 0003	25
MFF0073	114 323 0001	22
MFF0078	12-34 323 0001	23
MFF0079	12-34 323 0004	27
MFF0080	12-34 323 0006	26
MFF0081	12-34 323 0007	24
MFF0082	12-34 323 0009	24
MFF0083	12-34 323 0012	23
MFF0235	12-34 323 0005	26
MFF0243	12-34 323 0003	27
MFF0244	12-14 323 0002	23
MFF0245	034 323 0003	26
MFF0270	12-34 323 0014	28
MFP0026	12-34 009 0003	21
MHP0053	12-34 471 0001	173
MHP0054	12-34 471 0003	174
MHP0055	12-34 631 0001	173
MHP0056	12-34 631 0002	174
MIX0157	12-14 910 0001	179
MIX0158	12-14 910 0005	186
MIX0159	12-14 910 0100	186
MIX0160	12-34 026 0000	176
MIX0161	12-34 026 0001	176
MIX0162	12-34 026 0003	177
MIX0163	12-34 026 0004	176
MIX0164	12-34 058 0001	185
MIX0165	12-34 058 0002	185
MIX0166	12-34 210 0348	179
MIX0167	12-34 210 0400	181
MIX0168	12-34 210 0403	180
MIX0169	12-34 210 0404	182
MIX0170	12-34 210 0405	183
MIX0171	12-34 210 0406	183
MIX0172	12-34 210 0408	183
MIX0173	12-34 210 0437	181
MIX0175	12-34 210 0515	184
MIX0177	12-34 830 0101	187
MIX0178	12-34 899 0002	191
MIX0179	12-34 910 0001	189
MIX0180	12-34 910 0002	189
MIX0181	12-34 910 0003	190

Short no.	MEYLE no.	Page
MAN		
MIX0182	12-34 910 0005	188
MIX0183	12-34 910 0006	188
MIX0184	12-34 910 0008	190
MIX0185	12-34 910 0009	190
MIX0186	12-34 920 1002	187
MIX0216	12-34 210 0402	184
MIX0217	12-34 058 0003	184
MIX0218	12-34 058 0004	185
MIX0223	12-34 210 0409	182
MIX0239	12-14 910 0004	187
MIX0240	12-14 910 0102	186
MIX0278	12-34 089 0001	180
MIX0290	12-34 210 0401	180
MIX0327	12-34 210 0609	181
MMX0191	034 003 1024	7
MMX0197	034 009 0015	22
MMX0240	034 035 0038	8
MMX0290	039 238 0001	52
MMX0587	12-31 106 0001	123
MMX0590	12-31 106 0004	124
MMX0595	12-34 020 0001	39
MMX0599	12-34 099 0003	9
MMX0600	12-34 099 0004	8
MMX0601	12-34 099 0005	8
MMX0602	12-34 099 0006	10
MMX0603	12-34 099 0007	9
MMX0604	12-34 100 6558	2
MMX0605	12-34 130 0032	7
MMX0606	12-34 232 0001	37
MMX0607	12-34 232 0002	37
MMX0609	12-34 900 0000	3
MMX0610	12-34 900 0001	3
MMX0611	12-34 900 6437	3
MMX0612	12-34 904 0132	14
MMX0613	12-34 905 0001	6
MMX0614	12-34 905 0002	6
MMX0615	12-34 905 0135	5
MMX1300	12-37 142 0001	126
MMX1301	12-37 142 0002	126
MMX1303	034 013 0041	-
MMX1361	14-34 232 0012	40
MMX1388	12-34 232 0005	37
MMX1389	12-34 232 0006	38
MMX1397	12-34 232 0014	38
MMX1401	12-34 232 0018	39
MMX1402	12-34 232 0019	40

Short no.	MEYLE no.	Page
MAN		
MMX1403	12-34 232 0020	39
MMX1451	12-14 223 0002	32
MMX1475	12-34 500 5040	-
MMX1482	12-34 035 0010	1
MMX1483	12-34 900 0004	2
MMX1484	12-34 900 0005	75
MMX1485	12-34 900 0006	1
MMX1491	12-31 111 0003	123
MMX1523	12-34 001 0010	5
MMX1535	834 900 0005	75
MMX1548	12-34 001 0012	4
MMX1564	12-34 001 0007	1
MMX1566	12-34 900 0003	5
MMX1578	12-37 142 0011	127
MMX1581	12-34 901 0351	4
MMX1582	12-34 905 0004	6
MOF0014	014 018 0015	14
MOF0066	12-14 322 0000	15
MOF0067	12-14 322 0001	15
MOF0068	12-14 322 0003	15
MOF0223	12-14 322 0004	16
MPJ0069	034 041 9022	122
MPJ0071	12-34 126 6017	122
MPJ0072	12-34 126 6020	122
MPS0016	12-34 003 0011	12
MRB0077	050 004 0790	69
MRB0160	050 004 1390	71
MRB0274	050 005 1482	70
MRB0275	050 005 1530	72
MRB0372	050 006 1180	74
MRB0530	050 006 2200	74
MRB0642	050 008 0855	73
MRB0643	050 008 0880	67
MRB0647	050 008 1158	71
MRB0655	050 008 1275	68
MRB0656	050 008 1376	68
MRB0657	050 008 1398	75
MRB0670	050 008 1635	72
MRB0677	050 008 1908	74
MRB0678	050 008 1915	70
MRB0679	050 008 1920	72
MRB0699	050 009 1725	70
MRB0720	050 010 1688	71
MRB0723	050 010 1980	69
MRB0727	050 012 1515	69
MRB0758	050 008 1655	73

Short no.	MEYLE no.	Page
MAN		
MRB0769	050 012 1630	73
MRH0214	12-39 222 0001	54
MRH0215	12-39 222 0003	57
MRH0216	12-39 222 0004	57
MRH0217	12-39 222 0005	55
MRH0218	12-39 222 0006	56
MRH0219	12-39 222 0007	56
MRH0220	12-39 222 0008	56
MRH0221	12-39 222 0009	59
MRH0222	12-39 222 0011	59
MRH0223	12-39 222 0013	57
MRH0224	12-39 222 0014	54
MRH0225	12-39 222 0015	54
MRH0226	12-39 222 0016	58
MRH0227	12-39 222 0017	55
MRH0228	12-39 222 0018	55
MRH0229	12-39 222 0019	53
MRH0230	12-39 222 0020	58
MRH0231	12-39 222 0026	53
MRM0094	12-14 234 0014	31
MRM0097	12-14 234 0018	32
MRM0098	12-14 234 0025	32
MRM0099	12-14 234 0027	30
MRM0100	12-14 234 0029	31
MSB0134	12-34 271 0082	147
MSB0135	12-34 271 0083	150
MSB0136	12-34 271 0085	148
MSB0137	12-34 271 0096	147
MSB0140	12-34 722 0021	149
MSB0226	12-34 271 0098	149
MSB0243	12-34 271 0084	148
MSB0358	12-34 271 0086	148
MSR0069	12-34 035 0003	139
MSR0070	12-36 030 0004	137
MSR0072	12-36 035 0002	136
MSR0073	12-36 035 0003	137
MSR0074	12-36 035 6196	138
MSR0075	12-36 050 0002	138
MSX0026	034 046 0000	161
MSX0075	12-34 632 0001	161
MSX0076	12-34 632 0002	175
MTA0129	12-34 250 6860	163
MTA0130	12-36 030 0002	162
MTA0130HD	12-36 030 0002/HD	162
MTE0044	036 020 0001	169
MTE0045	036 020 0002	169

Short no.	MEYLE no.	Page
MAN		
MTE0046	036 020 0003	173
MTE0047	036 020 0004	167
MTE0047HD	036 020 0004/HD	167
MTE0048	036 020 0005	170
MTE0048HD	036 020 0005/HD	170
MTE0051	036 020 0008	166
MTE0058	036 020 0015	172
MTE0059	036 020 0016	172
MTE0171	12-36 020 0032	168
MTE0173	12-36 020 0041	171
MTE0655	12-36 020 0039	168
MTE0728	836 020 0006	171
MTE0741	536 020 0009	171
MTH0010	028 271 0011	48
MTH0025	028 283 0000	47
MTH0049	12-28 279 0000	48
MTR0022	12-34 000 1004	61
MTR0023	12-34 000 1100	61
MTR0042	12-34 000 0003	60
MTR0043	12-34 000 1101	60
MTX0022	034 026 0017	118
MTX0023	034 026 0018	117
MTX0028	034 035 0013	154
MTX0036	034 753 0021	116
MTX0037	036 026 0016	117
MTX0058	12-14 753 0001	115
MTX0060	12-14 753 0013	115
MTX0061	12-14 753 0014	116
MTX0062	12-34 279 0073	115
MVB0063	052 010 0975	64
MVB0079	052 010 1075	64
MVB0082	052 010 1100	64
MVB0097	052 010 1250	63
MVB0107	052 010 1375	65
MVB0108	052 010 1380	65
MVB0110	052 010 1425	65
MVB0113	052 010 1500	66
MVB0183	052 013 1000	63
MVB0188	052 013 1050	62
MVB0201	052 013 1155	66
MVB0221	052 013 1450	62
MVB0222	052 013 1475	67
MVB0223	052 013 1500	66
MVB0224	052 013 1525	62
MVB0226	052 013 1550	67
MVB0228	052 013 1600	63

Short no.	MEYLE no.	Page
MAN		
MWB0015	034 650 0000	151
MWB0016	034 650 0001	150
MWB0046	300 334 1103	151
MWB0049	12-14 650 0005	150
MWB0053	034 650 0020	153
MWB0054	12-14 650 0006	152
MWB0055	12-14 751 0006	152
MWB0056	12-14 751 0007	153
MWB0057	12-34 751 0001	153
MWI0014	12-34 870 0001	193
MWI0015	12-34 870 0002	192
MWI0016	12-34 870 0004	192
MWI0031	034 870 0005	193
MWL0081	12-34 910 0010	191
MWL0082	12-34 910 0011	191
MWP0053	033 020 0022	40
MWP0056	033 020 0043	41
MWP0059	033 020 0048	42
MWP0170	12-14 234 0003	46
MWP0171	12-33 220 0001	47
MWP0172	12-33 500 0001	43
MWP0173	12-33 500 6408	41
MWP0175	12-33 500 6547	43
MWP0177	12-34 500 6495	42
MWP0178	12-34 500 6543	43
MWP0179	12-34 500 6612	45
MWP0180	12-34 500 6642	45
MWP0181	12-34 500 6646	45
MWP0521	12-33 220 0003	44
MWP0522	12-34 500 7064	47
MWP0531	12-34 220 0004	46
MWP0547	12-33 500 6548	44
MWS0027	12-34 527 0001	89
MWS0129	12-34 527 0000	88
MWS0130	12-34 527 0002	89
MWS0131	12-34 527 0004	88
MWS0132	12-34 527 0005	89
MWS0133	12-34 527 0008	87



MEYLE

**My longest relationship?
The one with my truck.**



The MEYLE brand supplies its customers with more than 21,000 extremely reliable and durable spare parts manufactured at our own production facilities or by trusted production partners. MEYLE boasts a highly diversified product range.

Whether steering and suspension components, rubber-to-metal parts, brakes, damping components, cooling systems, filters, drive components, electric and sensors MEYLE is synonymous with top-grade quality-tested spare parts.

Notes

This catalogue is protected by copyright. Reproduction of text, graphic elements, photographs and/or data, even in part, is prohibited. MEYLE, **MEYLE**, or parts thereof, are registered trademarks of MEYLE AG.

All supplies and services are subject to our General Terms and Conditions. The original spare part numbers shown in this catalogue are for cross-reference purposes only and shall not be disclosed to third parties on invoices and delivery notes. While the information in this catalogue was compiled and edited with utmost care we do not assume responsibility or accept claims arising from errors or inconsistencies. Subject to technical and/or design changes.

This issue of the catalogue supersedes all previous issues.
All rights reserved. © 2017 MEYLE AG



MEYLE parts are available through:

MEYLE AG

Merkurring 111, 22143 Hamburg, Germany
Tel. +49 40 67506 510, Fax +49 40 67506 506
contact@meyle.com

www.meyle.com

MEYLE