



**VEHÍCULO INDUSTRIAL Y COMERCIAL**  
**TRUCKS & COMMERCIAL VEHICLE**  
**LKW UND NKW**

# PICTOGRAMAS - PICTOGRAMS - PICTOGRAMMES - PIKTOGRAMME

## GENERAL - GENERAL - GÉNÉRAL - ALLGEMEIN

IZQUIERDO LEFT GAUCHE LINKS	DERECHO RIGHT DROIT RECHTS	REVERSIBLE REVERSIBLE REVERSIBLE UMKEHRBAR	IZQ+DCHO LEFT+ RIGHT GAUCHE+DROIT LINKS+RECHTS	ELÉCTRICO ELECTRIC ÉLECTRIQUE ELEKTRISCH	MANUAL MANUAL MANUEL MANUELL
MANUAL ELÉC. ELEC. MANUAL MANUEL ELEC. MANUEL ELEK.	MECÁNICO MECHANICAL MÉCANIQUE MECHANISCH	1.2 WATTS WATTS WATT	10 Volts VOLTAGE VOLTAGE SPANNUNG	7 PINS PINS PINS	NÚM. PUERTAS NUM. DOORS NOM. PORTES ANZAHL TÜREN
AMBAR ORANGE ORANGE ORANGE	AZUL BLUE BLEU BLAU	BLANCO WHITE BLANC WEISS	CROMADO CHROMED CHROME VERCHROMUNG	SMOKED FUMÉ SMOKED FUMÉ RAUCHGRAU	GRIS GREY GRIS GRAU
NEGRO BLACK NOIR SCHWARZ	ROJO RED ROUGE ROT	TRANSPARENTE TRANSPARENT TRANSPARENT TRANSPARENT	CUADRADO SQUARE CARRÉ VIERECKIG	REDONDO ROUND ROND RUND	EXTERIOR EXTERIOR EXTÉRIEUR AUSSEN
INTERIOR INTERIOR INTÉRIEUR INNEN	LHD	LHD + RHD	RHD		

## ESPEJOS - MIRRORS - RÉTROVISEURS - SPIEGEL

ASFÉRICO ASPHÉRIQUE ASPHÄRISCH	CONVEXO CONVEX CONVEX KONVEX	PLANO FLAT PLAT FLACH	ABATIBLE ELEC. ELEC. FOLDABLE RABBATABLE ELEC. ELEC. ABKLAPPBAR	IMPRIMADO PRIMED A PEINDRE LACKIERBAR	ESPEJO ÁNGULO MUERTO BLIND SPOT POINT AVEUGLE TOTERWINKEL
Sonda TEMP. TEMP. SENSOR SONDE TEMP. TEMP. MESSER	SOPORTE HOLDER SOUTIEN HALTEFUSS	TÉRMICO HEATED CHAUFFANT BEHEIZBAR	SOP. CUADRADO SQUARE HOLDER SUPPORT CARRÉ HALTER VIERECKIG	SOP. REDONDO ROUND HOLDER SUPPORT ROND HALTER RUND	CARCASA CON GUÑO HOUSING WITH LIGHT GAP BOITIER AVEC ESPACE FEU GEHÄUSE FÜR BLINKER
PILOTO RETROVISOR BLINKER INDICATEUR BLINKLEUCHTE	CON INTERMITENTE WITH BLINKER AVEC INDICATEUR MIT BINKER				
CRISTAL GLASS GLACE SPIEGELGLAS	CRISTAL+SOPORTE GLASS+HOLDER GLACE+SUPPORT GLAS+HALTEFUSS	CRISTAL+CARCASA GLASS+HOUSING GLACE+BOITIER GLAS+GEHÄUSE	CARCASA HOUSING BOITIER GEHÄUSE	BRAZO ARM BRAS ARM	RESISTENCIA HEATING CHAUFFAGE BEHEIZBAR
BRAZO CORTO SHORT ARM BRAS COURT KURZER ARM	BRAZO MEDIO MEDIUM ARM BRAS MOYEN MITLERER ARM	BRAZO LARGO LONG ARM BRAS LONG LANGER ARM			
COMPLETO COMPLETE COMPLÉT KOMPLÉTT	CUERPO BODY CORPS RUMPFSPIEGEL	CARCASA HOUSING BOITIER GEHÄUSE	CRISTAL GLASS GLACE SPIEGELGLAS	CRISTAL+SOPORTE GLASS+HOLDER GLACE+SUPPORT GLAS+HALTEFUSS	CRISTAL+CARCASA GLASS+HOUSING GLACE+BOITIER GLAS+GEHÄUSE
ESPEJO INTERIOR INTERIOR MIRROR RÉTROVISEUR INT. INNENSPIEGEL	BRAZO CORTO SHORT ARM BRAS COURT KURZER ARM	BRAZO MEDIO MEDIUM ARM BRAS MOYEN MITLERER ARM	BRAZO LARGO LONG ARM BRAS LONG LANGER ARM		

## ILUMINACIÓN - LIGHTING - ÉCLAIRAGE - BELEUCHTUNG

LUZ DE DÍA DAY LIGHT FEUX DE JOUR TAGFAHRLICHT	ANTINEBLA DELANT. FRONT FOG LIGHT ANTI-BROUILLARD AV. NEBELLEUCHTEN	ANTINEBLA TRASERO REAR FOG LIGHT ANTI-BROUILLARD AR. NEBELLEUCHTEN HIN.	CON BOMBILLA WITH BULB AVEC AMPOULES MIT GLÜHBIRNE	SIN BOMBILLA WITHOUT BULB SANS AMPOULE OHNE BIRNE	CARCASA EXT. NEGRA BLACK HOUSING BOITIER NOIRE KAPPE SCHWARZ
TULIPA LENS CABOCHON STREUGLAS	LENTE CON PILOTO LENS W/INDICATOR CABOCHON A/FEU LEUCHTE M/BLINKER	MARCO FRAME CADRE RAHMEN	CERQUILLO RIM CADRE RAHMEN	CON PORTALÁMPARA WITH BULB HOLDER AVEC PORTE LAMPE MIT LAMPENTRÄGER	SIN PORTALÁMPARA WITHOUT BULB HOLDER SANS PORTER LAMPE OHNE LAMPENTRÄGER
CON MOTOR WITH ENGINE MOTORISÉ MIT MOTOR	NEUMÁTICO PNEUMATIC PNEUMATIQUE PNEUMATISCH	REFLECTANTE REFLECTANT REFLÉCHISSANTE REFLEKTIEREND	BEEP!! CON ALARMA WITH ALARM AVEC ALARME MIT ALARM	LÁMPARA ASIMÉTRICA ASYMETRICAL LAMP LAMPE ASYMETRIQUE LEUCHTE ASYMETR.	
FARO HEADLAMP PHARE SCHEINWERFER	FARO ANTINEBLA FOG LAMP P. ANTI-BROUILLARD NEBELSCHEINWERFER	PILOTO DELANTERO FRONT INDICATOR FEU AVANT BLINKLEUCHTE	PILOTO LATERAL SIDE LAMP FEU LATERAL SEITENBLINKER	PILOTO TRASERO TAIL LAMP REAR FEU ARRIERE HECKLEUCHTE	PILOTO POSICIÓN SIDE MARKER FEU LATERAL BEGRENZUNGSLEUCHTE
PIL. MARCHA ATRÁS REVERSING LAMP FEU MARCHÉ ARRIERE RÜCKFAHRTLEUCHTE	LUZ MATRÍCULA NUMBERPLATE LIGHT ÉCLAIRAGE D'IMMATRICULATION KENNZEICHENLEUCHTE				
FARO HEADLAMP PHARE SCHEINWERFER	FARO ANTINEBLA FOG LAMP P. ANTI-BROUILLARD NEBELSCHEINWERFER	PILOTO DELANTERO FRONT INDICATOR FEU AVANT BLINKLEUCHTE	PILOTO PARACHOQUE BUMPER LAMP FEU PARA-CHOC STOSSTANGENBLINKER	PILOTO LATERAL SIDE LAMP FEU LATERAL SEITENBLINKER	PILOTO TRASERO ANTINEBLA TAIL LAMP REAR FOG LAMP FEU ARRIERE ANTI-BROUILLARD NEBELSCHLUSSLEUCHTE
PILOTO TRASERO TAIL LAMP REAR FEU ARRIERE HECKLEUCHTE	PIL. MARCHA ATRÁS REVERSING LAMP FEU MARCHÉ ARRIERE RÜCKFAHRTLEUCHTE	LUZ MATRÍCULA NUMBERPLATE LIGHT ÉCLAIRAGE D'IMMATRICULATION KENNZEICHENLEUCHTE			



Las piezas referenciadas en este catálogo no son originales, pero son perfectamente adaptables a los vehículos a los que van destinadas. El uso de las marcas de fabricantes y de las referencias originales se hace exclusivamente con el propósito de indicar el modelo al que va destinada cada pieza.

*Die in diesem Katalog aufgeführten Produkte sind keine Originalteile, aber sie passen alle perfekt auf die angegebenen Fahrzeuge. Die Herstellermarken und Ursprungsreferenzen werden nur dazu angegeben, um die richtige Zuordnung aller Teile auf die entsprechenden Fahrzeugmodelle zu gewährleisten.*

All references listed in this catalogue are not original, but they are perfectly adaptable to the vehicles to which they are assigned. The manufacturers' brands and the original references are used with the sole purpose of indicating the model on which every piece has to be assembled.

*Les pièces référenciées sur ce catalogue ne sont pas originales, mais elles sont parfaitement adaptables aux véhicules auxquels elles sont destinées. L'utilisation des marques de fabricants et des références originales se fait exclusivement avec le but d'indiquer le modèle auquel est destinée chaque pièce.*



## LOGÍSTICA Y SERVICIO - LOGISTICS AND SERVICE

ALKAR AUTOMOTIVE es actualmente el referente indiscutible del sector en cuanto a Servicio, pudiendo asegurar que la entrega de nuestros productos se realice en casa del cliente en menos de 24 horas. El compromiso de Alkar con el servicio llega hasta el punto de garantizar como mínimo la entrega del 95 % de cada pedido.

A estos efectos, Alkar cuenta con un almacén logístico de 24.000 m<sup>2</sup> donde tienen cabida mas de 1.000.000 piezas listas para ser preparadas inmediatamente.

ALKAR AUTOMOTIVE is currently the unquestionable leader of the sector due to his service, being able to assure our clients that they can pick up their goods in less than a week from the order confirmation.

Alkar's service commitment is to guarantee a minimum service level of 95 % on every order.

For this purpose, Alkar has a 24.000 m<sup>2</sup> logistic warehouse in Boroa where more than 1.000.000 parts can be stocked ready for service.

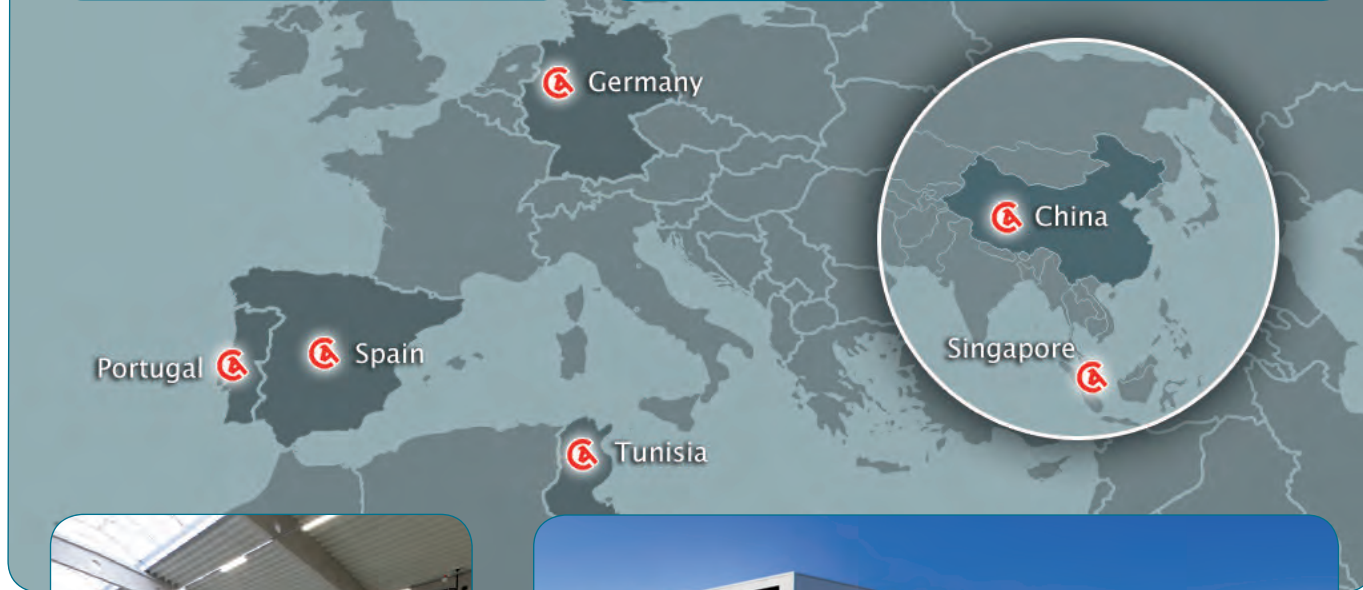

## BUSINESS TO BUSINESS



Alkar es consciente de la capital importancia que tiene para nuestros clientes el disponer de una manera exacta y rápida de la información necesaria para identificar correctamente la pieza.

Por ello somos parte de TecDoc desde el año 2008 y de TecCom desde el año 2012. Así mismo, contamos con una potente Base de Datos con la que poder proveer a nuestros clientes de toda la información que necesitan para realizar correctamente su trabajo.

ALKAR is aware of the importance that for our customers has the reliability of the information concerning the spare parts.

In order to offer an accurate and quick information Alkar is part of TecDoc from 2008 and part of TecCom from 2012. We work, as well, with a powerful DataBase in order to supply our client all the needed information to correctly identify the piece.



## CALIDAD / QUALITY

La prioridad máxima de ALKAR AUTOMOTIVE es garantizar la calidad de todos nuestros productos.

Para ello contamos con un Departamento de Calidad compuesto por 5 técnicos de contrastada experiencia en el sector de la automoción, que siguiendo el Procedimiento de Homologación de Producto en Alkar verifican todas las piezas que pasan a formar parte de nuestra gama. Verificamos la funcionalidad, adaptabilidad y correcto acabado del producto e incluimos una prueba dinámica de carretera que homologa el correcto comportamiento de la pieza.

ALKAR AUTOMOTIVE'S highest priority is to warrant the quality of all our products.

Our Quality Department is composed by 5 technicians with big experience in the Automotive sector. Following the Product Homologation Procedure, they check all the pieces that are introduced in our range.

We check the functionality, adaptability and the appearance of the product, including a road test that homologates the correct performance of the product.

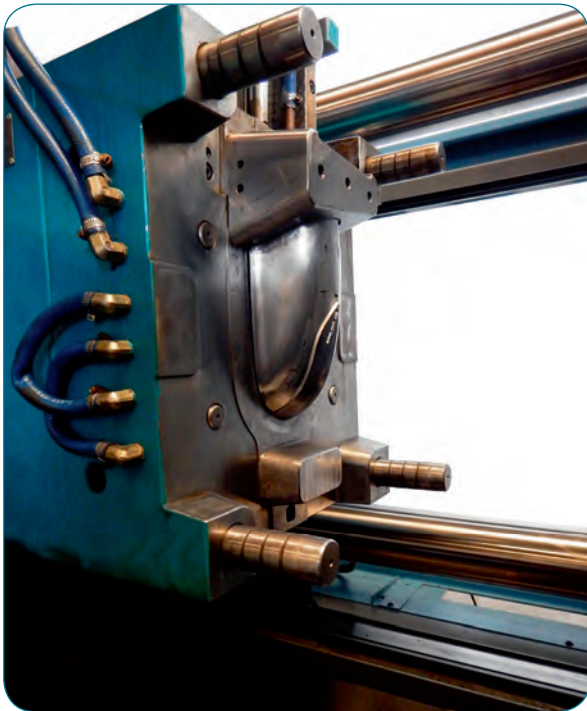

ALKAR AUTOMOTIVE dispone de un Laboratorio de ensayos con todos los instrumentos necesarios para realizar los tests que garanticen a nuestro cliente la fiabilidad del producto que recibe.

ALKAR AUTOMOTIVE has a test Laboratory with all the necessary instruments to make the tests that ensure our clients the reliability of the product.

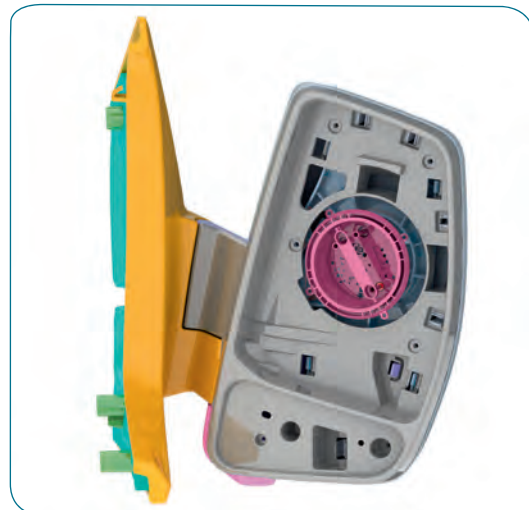
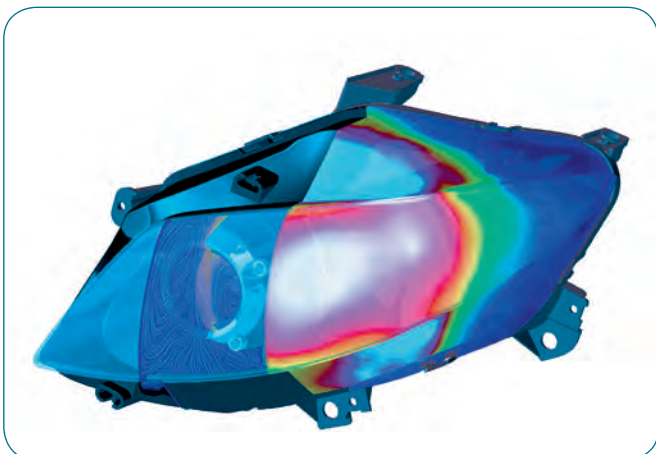



CATÁLOGO GENERAL - 1ª EDICIÓN - 2017.

ALKAR AUTOMOTIVE S.A. veta la reproducción total o parcial del texto, ilustraciones, esquema y diseño del presente catálogo de camión.

ALKAR AUTOMOTIVE S.A. puts a veto on the total or partial reproduction of text, illustration, outline and design of the present truck catalogue.

Depósito Legal: BI-1341-2017



## CAMIÓN - TRUCK - POIDS-LOURDS - LKW

<u>DAF</u>	<u>Pág. 10</u>	<u>MITSUBISHI</u>	<u>Pág. 114</u>
<u>FORD</u>	<u>Pág. 38</u>	<u>NISSAN</u>	<u>Pág. 117</u>
<u>HINO</u>	<u>Pág. 40</u>	<u>RENAULT</u>	<u>Pág. 119</u>
<u>ISUZU</u>	<u>Pág. 41</u>	<u>SCANIA</u>	<u>Pág. 140</u>
<u>IVECO</u>	<u>Pág. 41</u>	<u>VOLVO</u>	<u>Pág. 154</u>
<u>MAN</u>	<u>Pág. 65</u>	<u>UNIVERSAL</u>	<u>Pág. 179</u>
<u>MERCEDES</u>	<u>Pág. 82</u>	<u>LÁMPARAS - LAMPS</u>	<u>Pág. 199</u>

## V. COMERCIAL - COMMERCIAL VEHICLE - VÉHICULE UTILITAIRE - NKW

<u>CITROËN - FIAT - PEUGEOT</u>	<u>Pág. 204</u>	<u>MITSUBISHI</u>	<u>Pág. 279</u>
<u>DACIA</u>	<u>Pág. 236</u>	<u>NISSAN - OPEL - RENAULT</u>	<u>Pág. 280</u>
<u>FORD</u>	<u>Pág. 238</u>	<u>PIAGGIO</u>	<u>Pág. 315</u>
<u>HYUNDAI</u>	<u>Pág. 253</u>	<u>SEAT</u>	<u>Pág. 315</u>
<u>IVECO</u>	<u>Pág. 254</u>	<u>TOYOTA</u>	<u>Pág. 317</u>
<u>KIA</u>	<u>Pág. 262</u>	<u>VOLKSWAGEN</u>	<u>Pág. 319</u>
<u>MERCEDES</u>	<u>Pág. 263</u>	<u>LÁMPARAS - LAMPS</u>	<u>Pág. 337</u>

<u>LISTADO DE REFERENCIAS OE - OE REFERENCES LIST</u> <u>LISTE DES RÉFÉRENCES OE - VERZEICHNIS DER OE REFERENZEN</u>	<u>Pág. 347</u>
---	-----------------







**CAMIÓN**

**TRUCK**

**POIDS-LOURDS**

**LKW**

## DAF 75/85/95



Ref.	Fecha-Date	OE	Caract.	Ø
9401140	1992-00	1232016	392x205	16-22
9403140	1992-00	1232017	392x205	16-22



Ref.	Fecha-Date	Caract.
7303140	1992-00	318x175



Ref.	Fecha-Date	OE	Caract.
7401140	1992-00	05589436; 0699856; 0699956	374X190
7413140	1992-00	1345552	374X190
7403140	1992-00	0589435; 0699857; 1305462	374X190



Ref.	Fecha-Date	OE	Caract.	Ø
9421140	1992-00	1232014	173x218	16-22



Ref.	Fecha-Date		Caract.
7323140	1992-00		138x173

Ref.	Fecha-Date		OE	Caract.
7421140	1992-00		0589438; 0699853	156X190
7423140	1992-00		0589437; 0699854	156X190

## DAF 65CF/75CF/85CF



Ref.	Fecha-Date		OE	Caract.	Ø
9401142	2001-06		1425106	384X205	28
9403142	2001-06		1425104; 1610186	384X205	28
9413142	2001-06		1425105; 1610184	384X205	28
7301142	2001-06		1425113	367X187	



Ref.	Fecha-Date		OE	Caract.
7401142	2001-06		1425109; 1610190	368X189
7403142	2001-06		1425109; 1610190	368X189



## DAF CF65/CF75/CF85



Ref.	Fecha-Date	Icons	OE	Caract.	Ø
9421142	2001-06	IV Class, 300, ABS, Hand, 300	1425108; 1610187	219X170	28
9423142	2001-06	IV Class, 24 Volts, 300, ABS, Hand, 300	1670877	219X170	28
9433142	2001-06	IV Class, 24 Volts, 300, ABS, Hand, 300	1425108; 1610187; 1610189; 1670877	219X170	28
7321142	2001-06	IV Class, 300, ABS, Hand, 300	1670888	194x202	

Ref.	Fecha-Date	Icons	OE	Caract.	Ø
9431142	2001-06	IV Class, 300, ABS, Hand, 300	1425108; 1610187; 1610189; 1670877	170X219	28
9432142	2001-06	IV Class, 24 Volts, 300, ABS, Hand, 300	1425108; 1610187; 1610189; 1670877	170x219	28
7331142	2001-06	IV Class, 300, ABS, Hand, 300	1425114; 1670888	154x203	

Ref.	Fecha-Date	Icons	OE	Caract.	Ø
7421142	2001-06	IV Class, 300, 300, ABS, Hand, 300	1670878	154x203	
7423142	2001-06	IV Class, 24 Volts, 300, 24 Volts, ABS, Hand, 300	1425111; 1610191; 1670878	154x203	

Ref.	Fecha-Date	Icons	OE	Caract.	Ø
9476144	2006-	II Class, 24 Volts, 1200, ABS, Hand, 1200	1692557	228X411	40
9423144	2006-	II Class, 24 Volts, 1200, ABS, Hand, 1200	1689348; 1812862	228X411	40
7394144	2006-	II Class, 300, ABS, Hand, 300	1644325	228X411	



Ref.	Fecha-Date	OE	Caract.
7423144	2006-	1685330	177X363



Ref.	Fecha-Date	OE	Caract.
9481144	2006-	1685324; 1788972; 1812859; 1812867	818X40
9482144	2006-	1686325; 1788487; 1812862; 1818353	818X40



Ref.	Fecha-Date	OE	Caract.	Ø
9479144	2006-	1692556	239x221	40
9469144	2006-	1689347; 1817860	228X411	40
7304144	2006-	1644326	221X239	



Ref.	Fecha-Date	OE	Caract.
7457144	2006-	1685331	161X207



Ref.	Fecha-Date	OE	Caract.
9441144	2006-	1614021; 1614022; 1669573	187x319



Ref.	Fecha-Date	Icons				
7441144	2006-					

## DAF FA1700/3300



Ref.	Fecha-Date	Icons					OE	Caract.	Ø
9401140	1987-						1232016	392x205	16-22
9403140	1987-						1232017	392x205	16-22



Ref.	Fecha-Date	Icons					Caract.
7303140	1987-						318x175



Ref.	Fecha-Date	Icons					OE	Caract.
7401140	1987-						05589436; 0699856; 0699956	374X190
7403140	1987-						0589435; 0699857; 1305462	374X190
7413140	1987-						1345552	374X190

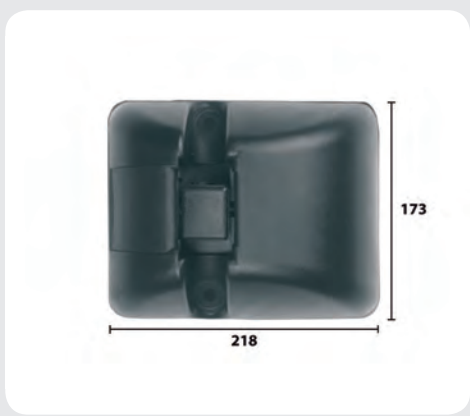

Ref.	Fecha-Date	OE	Caract.	Ø
9421140	1987-	1232014	173x218	16-22

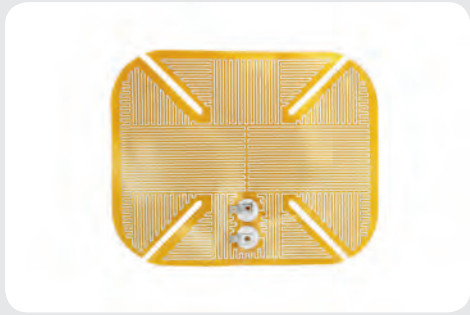

Ref.	Fecha-Date	Caract.
7323140	1987-	138x173



Ref.	Fecha-Date	OE	Caract.
7421140	1987-	0589438; 0699853	156X190
7423140	1987-	0589437; 0699854	156X190

## DAF LF45/LF55



Ref.	Fecha-Date	OE	Caract.	Ø
9475282	2000-06		395X205	22
9476282	2000-06	1620023	395X205	22
9477282	2000-06	1405601; 1805714	395X205	22



Ref.	Fecha-Date	OE	Caract.
7472282	2000-06		382x193
7473282	2000-06	1805717	382x193



Ref.	Fecha-Date	OE	Caract.	Ø
9401141	2000-06	1405295	382x193	22
9403141	2000-06	1404871; 1405295; 1805712	382x193	22



Ref.	Fecha-Date	Caract.
7303141	2000-06	300X150



Ref.	Fecha-Date	OE	Caract.
7401141	2000-06	1404872; 1805713	375x190
7403141	2000-06	1805713	375x190



Ref.	Fecha-Date	OE	Caract.	Ø
9421141	2000-06		199x199	22
9423141	2000-06	1404868; 1405350; 1796324	199x199	22





Ref.	Fecha-Date				Caract.
7323140	2000-06				138x173



Ref.	Fecha-Date				OE	Caract.
7421141	2000-06					191x191
7423141	2000-06				1404849; 1796325	191x191



Ref.	Fecha-Date						Caract.	Ø
9470282	2000-06						170x290	22
9471282	2000-06						170x290	22



Ref.	Fecha-Date				Caract.
7470282	2000-06				156x255

# DAF LF45/LF55



Ref.	Fecha-Date	OE	Caract.	Ø
9441141	2006-	1700961	880x340X155	28
9443141	2006-	1700963	880x340X155	28
9445141	2006-	1700303	880x340X155- C.IV MANUAL	28
9446141	2006-	1700306; 1704604	880x340X155- C.IV MANUAL	28



Ref.	Fecha-Date	OE	Caract.	Ø
9451141	2006-	1700304	880x440X155	28
9452141	2006-	1700307	880x440X155	28
9455141	2006-	1700265	880x340X155- C.IV MANUAL	28
9456141	2006-	1700269; 1704605	880x340X155- C.IV MANUAL	28



Ref.	Fecha-Date	OE	Caract.	Ø
9413141	2006-	1735521	370X245	28
9416141	2006-	1735519	370X245	28



Ref.	Fecha-Date	OE	Caract.
7301141	2006-	1736884	370X247X80



Ref.	Fecha-Date	OE	Caract.
7413141	2006- 	1737933; 20862795	337X202



Ref.	Fecha-Date	OE	Caract.	Ø
9431141	2006- 	1735522	230X245	28
9432141	2006- 	1735523	230X245	28



Ref.	Fecha-Date	OE	Caract.
7431141	2006- 	1736879	197x200
7432141	2006- 	1736865	197x200



Ref.	Fecha-Date	OE	Caract.
9442141	2006- 	1409570; 1409962; 1526649	228x260



Ref.	Fecha-Date	Caract.
7413282	2006- 	152x260



Ref.	Fecha-Date								Caract.
9456144	2006-							187x319	
9459144	2006-							187x319	



Ref.	Fecha-Date						OE	Caract.
9453144	2006-						1701288; 1704627	725X126X319

**NEW**



Ref.	Fecha-Date				
9480144	2006-				

**NEW**



Ref.	Fecha-Date				
7330144	2006-				

**NEW**



Ref.	Fecha-Date					
7430144	2006-					
7433144	2006-					

## DAF XF95



Ref.	Fecha-Date	Icons	OE	Caract.	Ø
9401142	2002-06	Class II, 1200, ABS, Hand, 24 Volts	1425106	384X205	28
9403142	2002-06	Class II, 24 Volts, 1200, ABS, Hand, 300	1425104; 1610186	384X205	28
9413142	2002-06	Class II, 24 Volts, 1200, ABS, Hand, 300	1425105; 1610184	384X205	28
7301142	2002-06	Class II, ABS, Hand, 1200	1425113	367X187	



Ref.	Fecha-Date	Icons	OE	Caract.
7401142	2002-06	Class II, 1200, ABS, Hand, 24 Volts	1425109; 1610190	368X189
7403142	2002-06	Class II, 1200, 24 Volts, ABS, Hand	1425109; 1610190	368X189



Ref.	Fecha-Date	Icons	OE	Caract.	Ø
9421142	2002-06	Class IV, 300, ABS, Hand, 24 Volts	1425108; 1610187	219X170	28
9423142	2002-06	Class IV, 24 Volts, 300, ABS, Hand	1670877	219X170	28
9433142	2002-06	Class IV, 24 Volts, 300, ABS, Hand, 300	1425108; 1610187; 1610189; 1670877	219X170	28
7321142	2002-06	Class IV, ABS, Hand, 1200	1670888	194x202	



Ref.	Fecha-Date	Icons	OE	Caract.	Ø
9431142	2002-06	Class IV, 300, ABS, Hand, 24 Volts	1425108; 1610187; 1610189; 1670877	170X219	28
9432142	2002-06	Class IV, 24 Volts, 300, ABS, Hand	1425108; 1610187; 1610189; 1670877	170X219	28
7331142	2002-06	Class IV, ABS, Hand, 1200	1425114; 1670888	154x203	



Ref.	Fecha-Date	OE	Caract.
7421142	2002-06	1670878	154x203
7423142	2002-06	1425111; 1610191; 1670878	154x203



Ref.	Fecha-Date	OE	Caract.
9466144	2006-		

## DAF XF 105



Ref.	Fecha-Date	OE	Caract.	Ø
9476144	2006-	1692557	228X411	40
9423144	2006-	1689348; 1812862	228X411	40
7394144	2006-	1644325	228X411	



Ref.	Fecha-Date	OE	Caract.
7423144	2006-	1685330	177X363



Ref.	Fecha-Date	OE	Caract.
9481144	2006-		1685324; 1788972; 1812859; 1812867 818X40
9482144	2006-		1686325; 1788487; 1812862; 1818353 818X40



Ref.	Fecha-Date	OE	Caract.	Ø
9479144	2006-		1692556	239x221 40
9469144	2006-		1689347; 1817860	228X411 40
7304144	2006-		1644326	221X239



Ref.	Fecha-Date	OE	Caract.
7457144	2006-		1685331 161X207



Ref.	Fecha-Date	OE	Caract.
9442144	2006-		1614022; 1669573 187x319



Ref.	Fecha-Date	OE	Caract.
7441144	2006-		

## DAF 65CF/75CF/85CF



Ref.	Fecha-Date									OE
9801144	1998-01	◀			H4	WSW	24 Volts			1293364; 1293360
9802144	1998-01	▶			H4	WSW	24 Volts			1293365; 1293361
9845144	1998-01	◀			H4	WSW	24 Volts			1293370
9846144	1998-01	▶			H4	WSW	24 Volts			1293371



Ref.	Fecha-Date									OE
9601144	1998-01	◀				H1	H3	24 Volts		1328860
9602144	1998-01	▶				H1	H3	24 Volts		1328861
9611144	1998-01	◀				H1	H3	24 Volts		1328860
9612144	1998-01	▶				H1	H3	24 Volts		1328861

**NEW**



Ref.	Fecha-Date									OE
9631144	1998-01	◀				H1	H3	24 Volts		
9632144	1998-01	▶				H1	H3	24 Volts		



Ref.	Fecha-Date					OE	
3103970	1998-01	◀			WSW		500308514; 5010306792





Ref.	Fecha-Date		OE	Caract.
9701142	1998-01			1284211; 1304788 T.VIGN
9702142	1998-01			1284212; 1304789 T.VIGN
9711142	1998-01			1272653
9712142	1998-01			152 5177



Ref.	Fecha-Date		OE	Caract.
9841142	2001-08			1641742; 1699300; 1743684
9842142	2001-08			1399903; 1641743; 1699301



Ref.	Fecha-Date		OE	Caract.
9703016	2001-08			CONECTOR 152MM
9704016	2001-08			CONECTOR 152MM



Ref.	Fecha-Date		OE	Caract.
9709016	2001-08			1401713 152MM
9710016	2001-08			1401731 152MM



Ref.	Fecha-Date		OE	Caract.
9723016	2001-08			350 x 131 x 85



Ref.	Fecha-Date							OE
9621144	2007-08	◀				H3	H3	1660960; 1725270; 1725272
9622144	2007-08	▶				H3	H3	1660961; 1725271; 1725273

## DAF 95XF



Ref.	Fecha-Date							OE	
9801144	1998-02	◀				H4	WSW	24 Volts	1293364; 1293360
9802144	1998-02	▶				H4	WSW	24 Volts	1293365; 1293361
9845144	1998-02	◀				H4	WSW	24 Volts	1293370
9846144	1998-02	▶				H4	WSW	24 Volts	1293371



Ref.	Fecha-Date							OE	
9601144	1998-02	◀				H1	H3	24 Volts	1328860
9602144	1998-02	▶				H1	H3	24 Volts	1328861
9611144	1998-02	◀				H1	H3	24 Volts	1328860
9612144	1998-02	▶				H1	H3	24 Volts	1328861



Ref.	Fecha-Date								OE	
9631144	1998-02	◀					H1	H3	24 Volts	
9632144	1998-02	▶					H1	H3	24 Volts	



Ref.	Fecha-Date		OE
3103970	1998-02		500308514; 5010306792



Ref.	Fecha-Date		OE	Caract.
9701142	1998-02		1284211; 1304788	T.VIGN
9702142	1998-02		1284212; 1304789	T.VIGN
9711142	1998-02		1272653	
9712142	1998-02		152 5177	

## DAF CF85



Ref.	Fecha-Date		OE
9841144	2009-		1743690
9842144	2009-		1743691



Ref.	Fecha-Date		OE
9603142	2009-		1735355



Ref.	Fecha-Date		OE
3103970	2009-		500308514; 5010306792



Ref.	Fecha-Date		OE	Caract.
9701142	2009-		1284211; 1304788	T.VIGN
9702142	2009-		1284212; 1304789	T.VIGN
9711142	2009-		1272653	
9712142	2009-		152 5177	



Ref.	Fecha-Date		Caract.
9703016	2009-		CONECTOR 152MM
9704016	2009-		CONECTOR 152MM



Ref.	Fecha-Date		OE	Caract.
9709016	2009-		1401713	152MM
9710016	2009-		1401731	152MM



Ref.	Fecha-Date		OE	Caract.
9723016	2009-			350 x 131 x 85

## DAF CF



**NEW**



Ref.	Fecha-Date		OE	Caract.
9731189	2013-	◀	1875577	CONECTOR LATERAL
9732189	2013-	▶	1875576	CONECTOR LATERAL
9721189	2013-	◀	1914690	
9722189	2013-	▶	1914691	

## DAF LF45/LF55



**NEW**



Ref.	Fecha-Date		OE
9841142	2002-08	◀	1641742; 1699300; 1743684
9842142	2002-08	▶	1399903; 1641743; 1699301



Ref.	Fecha-Date		OE
3103970	2002-08	◀▶	500308514; 5010306792

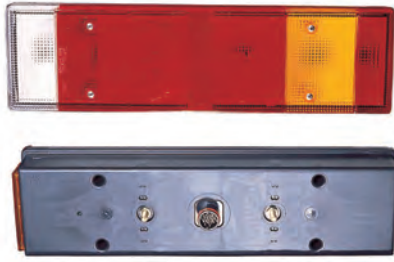

Ref.	Fecha-Date		OE	Caract.
9701142	2002-08		    	1284211; 1304788 T.VIGN
9702142	2002-08		    	1284212; 1304789 T.VIGN
9711142	2002-08		 	1272653
9712142	2002-08		 	152 5177



Ref.	Fecha-Date		Caract.
9703016	2002-08	  	       CONECTOR 152MM
9704016	2002-08	  	       CONECTOR 152MM



Ref.	Fecha-Date		OE	Caract.
9709016	2002-08	  	    	1401713 152MM
9710016	2002-08	  	    	1401731 152MM



Ref.	Fecha-Date		OE	Caract.
9723016	2002-08		 	350 x 131 x 85

**DAF LF45/LF55**



Ref.	Fecha-Date							OE
9621144	2007-08	◀				H3	H3	1660960; 1725270; 1725272
9622144	2007-08	▶				H3	H3	1660961; 1725271; 1725273

**DAF LF**



Ref.	Fecha-Date							OE
9811144	2013-	◀				H1	H7	1706996
9812144	2013-	▶				H1	H7	1706997



Ref.	Fecha-Date							OE
9601143	2013-	◀				H11		1892913
9602143	2013-	▶				H11		1892914

**NEW**



Ref.	Fecha-Date					OE	Caract.
9605143	2013-	◀				1892911	T.HELL
9606143	2013-	▶				1892912	T.HELL

## DAF XF95



**NEW**



Ref.	Fecha-Date							OE	
9841142	2002-08	◀							1641742; 1699300; 1743684
9842142	2002-08	▶							1399903; 1641743; 1699301



Ref.	Fecha-Date				OE
3103970	2002-08	◀▶			500308514; 5010306792



Ref.	Fecha-Date					OE	Caract.
9701142	2002-08	◀					1284211; 1304788
9702142	2002-08	▶					1284212; 1304789





Ref.	Fecha-Date									Caract.	
9703016	2002-08									<b>P21 W4</b>	CONECTOR 152MM
		<b>R10 W2</b>	<b>24 Volts</b>								
9704016	2002-08									<b>P21 W4</b>	CONECTOR 152MM
		<b>R10 W2</b>	<b>24 Volts</b>								



Ref.	Fecha-Date									OE	Caract.	
9709016	2002-08									<b>P21 W4</b>	1401713	152MM
		<b>R10 W2</b>	<b>24 Volts</b>									
9710016	2002-08									<b>P21 W4</b>	1401731	152MM
		<b>R10 W2</b>	<b>24 Volts</b>									



Ref.	Fecha-Date									OE	Caract.
9723016	2002-08										350 x 131 x 85



Ref.	Fecha-Date									OE	
9621144	2007-08									<b>H3 H3</b>	1660960; 1725270; 1725272
9622144	2007-08									<b>H3 H3</b>	1660961; 1725271; 1725273

## DAF XF 105



Ref.	Fecha-Date								OE	
9841144	2006-	▶			H1	D2S	PY 21W	W5W	24 Volts	1743690
9842144	2006-	▶			H1	D2S	PY 21W	W5W	24 Volts	1743691



Ref.	Fecha-Date								OE	
9603142	2006-	▶					P21W	24 Volts		1735355



Ref.	Fecha-Date								OE	
3103970	2006-	▶					W5W			500308514; 5010306792



Ref.	Fecha-Date								OE	Caract.
9701142	2006-	▶			P21 W4	R5 W4	24 Volts		1284211; 1304788	T.VIGN
9702142	2006-	▶			P21 W4	R5 W4	24 Volts		1284212; 1304789	T.VIGN
9711142	2006-	▶							1272653	
9712142	2006-	▶							152 5177	



Ref.	Fecha-Date									Caract.	
9703016	2006-									P21 W4	CONECTOR 152MM
		R10 W2	24 Volts								
9704016	2006-									P21 W4	CONECTOR 152MM
		R10 W2	24 Volts								



Ref.	Fecha-Date									OE	Caract.	
9709016	2006-									P21 W4	1401713	152MM
		R10 W2	24 Volts									
9710016	2006-									P21 W4	1401731	152MM
		R10 W2	24 Volts									



Ref.	Fecha-Date									OE	Caract.	
9723016	2006-											350 x 131 x 85

**NEW**



Ref.	Fecha-Date									OE	
9601142	2006-									H3 H3	1660960; 1725270
9602142	2006-									H3 H3	1660961; 1725271

## DAF XF



**NEW**



Ref.	Fecha-Date						OE	Caract.
9811189	2012-	◀		LED		H1	1857526	
9812189	2012-	▶		LED		H1	1857527	
9801189	2012-	◀		LED		H7 H1	1835874	T.HELL
9802189	2012-	▶		LED		H7 H1	1835875	T.HELL
9841189	2012-	◀		LED		H7 H1	1939777	
9842189	2012-	▶		LED		H7 H1		

**NEW**



Ref.	Fecha-Date						OE	Caract.
9601189	2012-	◀				H11	1835886	T.HELL
9602189	2012-	▶				H11	1835887	T.HELL

**NEW**



Ref.	Fecha-Date						OE	Caract.
9611189	2012-	◀					1846491	T.VIGN
9612189	2012-	▶					1846492	T.VIGN

**NEW**



Ref.	Fecha-Date						OE	Caract.
9701189	2012-	◀					1875577	T.VIGN
9702189	2012-	▶					1875576	T.VIGN

**NEW**



Ref.	Fecha-Date		OE	Caract.
9731189	2012-	◀	1875577	CONECTOR LATERAL
9732189	2012-	▶	1875576	CONECTOR LATERAL

**NEW**



Ref.	Fecha-Date		OE
9721189	2012-	◀	1914690
9722189	2012-	▶	1914691

## DAF UNIVERSAL

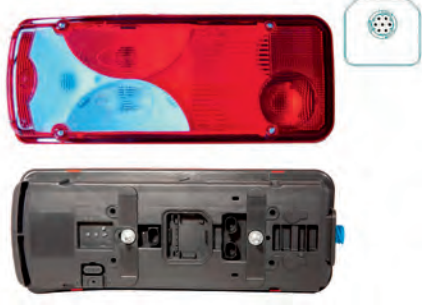

Ref.	Fecha-Date											
9739009		◀	24 Volts							PY 21W	R5W	P21 W3
9740009		▶	24 Volts							PY 21W	R5W	P21 W3



Ref.	Fecha-Date		OE	Caract.
9727009		◀	1284211	CONECT.REN/TGA/DAF 466x130x85
9728009		▶	1284212; 1304788	CONECT.REN/TGA/DAF 466x130x85



Ref.	Fecha-Date		Caract.
9793009		◀▶	466X130X85

**NEW**



Ref.	Fecha-Date	Caract.
9731183		CONECTOR LATERAL
9732183		CONECTOR LATERAL
9741183		CONECTOR TRASERO
9742183		CONECTOR TRASERO

**NEW**



Ref.	Fecha-Date	Caract.
9751183		
9752183		

## FORD CARGO



Ref.	Fecha-Date	OE	Caract.
9401140	1982-92	1232016	392x205
9403140	1982-92	1232017	392x205



Ref.	Fecha-Date	Caract.
7303140	1982-92	318x175



Ref.	Fecha-Date	OE	Caract.
7401140	1982-92	0699956; 1279531; 1589436	374X190
7403140	1982-92	0589435; 0699857; 1305462	374X190



Ref.	Fecha-Date	OE	Caract.
7413140	1982-92	1345552	374X190



Ref.	Fecha-Date	OE	Caract.
9421140	1982-92	1232014	173x218



Ref.	Fecha-Date	OE	Caract.
7421140	1982-92	0589438; 0699853	156X190
7423140	1982-92	0589437; 0699854	156X190



Ref.	Fecha-Date	Caract.
7323140	1982-92	138x173

## HINO 300



Ref.	Fecha-Date	Class	Hand	1200	ABS	24 Voits	Caract.	Ø
9401142	2007-	II	Hand	1200	ABS		384X205	28
9403142	2007-	II	Hand	1200	ABS	24 Voits	384X205	28
9413142	2007-	II	Hand	1200	ABS	24 Voits	384X205	28



Ref.	Fecha-Date	Class	Hand	ABS	OE	Caract.
7301142	2007-	II	Hand	ABS	1425113	367X187



Ref.	Fecha-Date	Class	Hand	1200	24 Voits	OE	Caract.
7401142	2007-	II	Hand	1200		1425109; 1610190	368X189
7403142	2007-	II	Hand	1200	24 Voits	87902007G	368X189



Ref.	Fecha-Date	Class	Hand	300	ABS	24 Voits	Caract.	Ø
9421142	2007-	IV	Hand	300	ABS		219X170	28
9423142	2007-	IV	Hand	300	ABS	24 Voits	219X170	28
9433142	2007-	IV	Hand	300	ABS	24 Voits	219X170	28
7331142	2007-	IV	Hand	ABS			154x203	





Ref.	Fecha-Date		OE	Caract.
7421142	2007-	IV Class, 300, 300	87902008G	154x203
7423142	2007-	IV Class, 300, 24 Volts	87902008G	154x203

## ISUZU NHR/NPR



Ref.	Fecha-Date		OE
9801041	2004-05	H4, 300	8973768982
9802041	2004-05	H4, 300	8973768972

## IVECO EUROCARGO I-III



Ref.	Fecha-Date		OE	Caract.	Ø
9470246	1991-00	II Class, PP, 1200	98424105; 99457906	340X160	18
9471246	1991-00	II Class, PP, 1200, 24 Volts	98424109	340X160	18
9475246	1991-00	II Class, PP, 1800	98424107; 98424108; 99457908	360X210	18
9476246	1991-00	II Class, PP, 1800, 24 Volts	29972111; 98424110; 99457911	360X210	18



Ref.	Fecha-Date	OE	Caract.
7470246	1991-00		330X152
7471246	1991-00		330X152
7475246	1991-00	4723936	345X194
7476246	1991-00	92934662	345X194



Ref.	Fecha-Date	Caract.	Ø
9481246	1991-00	793 X 290	18
9482246	1991-00	793 X 350	18
9487246	1991-00	793X385	18
9486246	1991-00	793X462	18



Ref.	Fecha-Date	OE	Caract.	Ø
9451246	1991-00	98424102; 42209232; 42209233; 42345780; 42350421; 42345783	160X272	18

IVECO EUROCARGO I-III / STRALIS



Ref.	Fecha-Date	OE	Caract.	Ø
9401247	2003-06	98472976	MUELLE 355X215	22
9492247	2003-06	98472977	MUELLE 355X215	22
9498247	2003-06	98472979	MUELLE 355X215	22

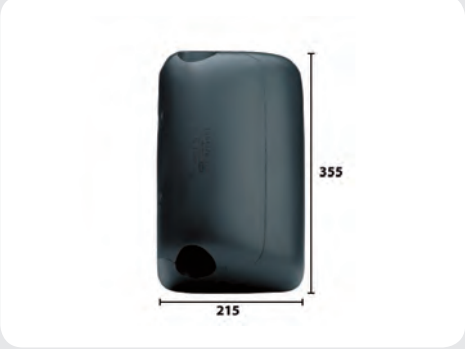

Ref.	Fecha-Date	OE	Caract.
7303144	2003-06	93193202	327x152x45

Ref.	Fecha-Date	OE	Caract.	Ø
9406247	2003-06	98473007; 98472976	ANILLO 355x215	22
9409247	2003-06	98409215	ANILLO 355x215	22
9410247	2003-06	2997159; 98409216; 98473007; 98472979	ANILLO 355x215	22

Ref.	Fecha-Date	OE
7343247	2003-06	93190971

Ref.	Fecha-Date	OE	Caract.
7401247	2003-06	93190983	MUELLE 340 X 200
7492247	2003-06	93190970	MUELLE 340 X 200

Ref.	Fecha-Date	OE	Caract.
7405247	2003-06	93190983	ANILLO 340X200
7497247	2003-06	93190976	ANILLO 340X200



Ref.	Fecha-Date	Icons	OE	Caract.	Ø
9402247	2003-06	Class, ABS, 1800, 24 Volts, Hand, 1800	98472981; 98473008	MUELLE 457X215	22
9493247	2003-06	Class, ABS, 1800, 24 Volts, Hand, 1800	8143121; 98472982; 98472982; 98473010	MUELLE 457X215	22
9499247	2003-06	Class, ABS, 1800, 24 Volts, Hand, 1800	2997157; 8143122; 98472983; 98473011	MUELLE 457X215	22
9416247	2003-06	Class, ABS, 1200, Hand, 1200	98473011	ANILLO 457x215	22
9419247	2003-06	Class, ABS, 1200, 24 Volts, Hand, 1800	8143121	ANILLO 457x215	22
9423247	2003-06	Class, ABS, 1200, 24 Volts, Hand, 1800	2997157; 8143122; 98473011; 98472983	ANILLO 457x215	22

Ref.	Fecha-Date	Icons	OE	Caract.
7344247	2003-06	Class, ABS, 1800	93190977	MUELLE 425x152x50
7354247	2003-06	Class, ABS, 1800	93193161	ANILLO 425x152x50

Ref.	Fecha-Date	Icons	OE	Caract.
7402247	2003-06	Class, 1800, 24 Volts	93190981	MUELLE 440 X 200
7493247	2003-06	Class, 1800, 24 Volts	93190976	MUELLE 440 X 200

Ref.	Fecha-Date	Icons	OE	Caract.
7406247	2003-06	Class, 1200, 24 Volts	93190981	ANILLO 440X200
7498247	2003-06	Class, 1200, 24 Volts	93193198	ANILLO 440X200



Ref.	Fecha-Date						Caract.	Ø
9485247	2003-06	◀	IV Class	ABS	300	793X240	22	
9486247	2003-06	▶	IV Class	ABS	300	793X300	22	



Ref.	Fecha-Date					OE	Caract.	Ø
9451247	2003-06	▶	IV Class	ABS	300	504077949; 98409117; 98472986; 98473012; 99457905	MUELLE 189 X 215	22
9473247	2003-06	▶	IV Class	ABS	24 Volts	2996670; 504132248; 8143172; 98472987	MUELLE 189 X 215	22
9445247	2003-06	▶	IV Class	ABS	24 Volts	2996671; 504096982; 504132249; 8143173; 98409119; 98472989	MUELLE 189 X 215	22



Ref.	Fecha-Date					OE	Caract.	Ø
9456247	2003-06	▶	IV Class	ABS	300	98473012; 98472986; 98473012; 99457905	ANILLO 189X215	22
9459247	2003-06	▶	IV Class	ABS	24 Volts	8143172; 98473013; 98472987	ANILLO 189X215	22
9460247	2003-06	▶	IV Class	ABS	24 Volts	504076894; 8143173; 98473014; 98472989	ANILLO 189X215	22



Ref.	Fecha-Date					OE	Caract.
7346247	2003-06	▶	IV Class	ABS	300	93190974	154X157

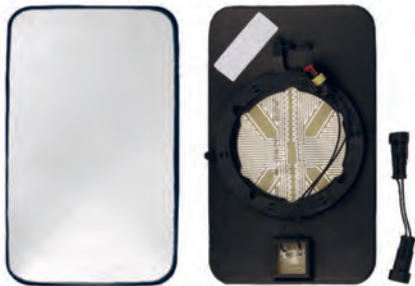
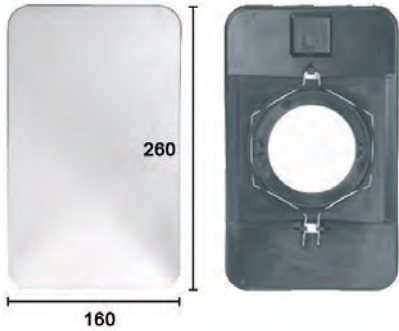
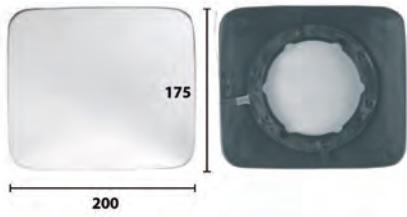

Ref.	Fecha-Date	OE	Caract.
7455247	2003-06	2997254	ANILLO 175X200
7477247	2003-06	93193199	ANILLO 175X200

Ref.	Fecha-Date	OE	Caract.	Ø
9441247	2003-06	504132242; 8143112; 8143113; 98472973	185X284	22
9443247	2003-06	504132243; 98472974; 98472938	185X284	22
9453247	2003-06	504111394; 504132244; 504132245; 98472975; 98409111	185X284	22

Ref.	Fecha-Date	OE	Caract.
7441247	2003-06	93193201	MUELLE 160 X 260
7443247	2003-06	93190985; 98487460	MUELLE 160 X 260

Ref.	Fecha-Date	OE	Caract.
7453246	2003-06	93193201	ANILLO 160X260
7454246	2003-06	93190985; 98487465	ANILLO 160X260

# IVECO EUROCARGO I-III / EUROTRAKKER / STRALIS / TECTOR



Ref.	Fecha-Date	Icons: 1200, 300, ABS, Class II, Class IV, Hand, 24 Volts, etc.								OE	Caract.
9401244	2007-	1200	300	ABS	Class II	Class IV	Hand	24 Volts	504150524	799X370	
9402244	2007-	300	ABS	Class II	Class IV	Hand	1200	504150525; 504150523	799X370		
9461244	2007-	1200	300	ABS	Class II	Class IV	Hand	24 Volts	504150524	799X370	
9462244	2007-	1200	300	ABS	Class II	Class IV	Hand	24 Volts	504150525; 504150523	799X370	
9425244	2007-	1200	300	ABS	Class II	Class IV	Hand	24 Volts	504150526; 504369910; 5801334614	799X370	
9426244	2007-	1200	300	ABS	Class II	Class IV	Hand	24 Volts	504150527; 504369961; 5801334610	799X370	



Ref.	Fecha-Date	Icons: 1200, 300, ABS, Class II, Class IV, Hand, 24 Volts, etc.								OE	Caract.
9411244	2007-	1200	300	ABS	Class II	Class IV	Hand	24 Volts	504150534	799X424	
9412244	2007-	300	ABS	Class II	Class IV	Hand	1200	504150535; 504150537; 504370054	799X424		
9471244	2007-	1200	300	ABS	Class II	Class IV	Hand	24 Volts	504150534; 504150536	799X424	
9472244	2007-	1200	300	ABS	Class II	Class IV	Hand	24 Volts	504150535; 504150537; 504370054	799X424	
9465244	2007-	1200	300	ABS	Class II	Class IV	Hand	24 Volts	504150538; 504370048; 5801336285	799X424	
9466244	2007-	1200	300	ABS	Class II	Class IV	Hand	24 Volts	5801336298; 504150539; 504370055	799X424	

IVECO V.I./I.V./LKW



Ref.	Fecha-Date									OE	Caract.
9421244	2007-									5801341206; 504150551; 504369979	811x520
9422244	2007-									504150552; 504369995; 5801341207	811x520
9481244	2007-									504150549	811x520
9482244	2007-									504150550; 504150547	811x520
9498248	2007-									504150551; 504369979; 5801341206	811x520
9499248	2007-									504150552; 504369995; 5801341207	811x520
9475244	2007-									504150551; 504369979; 5801341206	811x520
9476244	2007-									504150552; 504369995; 5801341207	811x520



Ref.	Fecha-Date									OE
7301244	2007-									504158976
7302244	2007-									504158977



Ref.	Fecha-Date									OE	Caract.
7474244	2007-									504197878	371X181

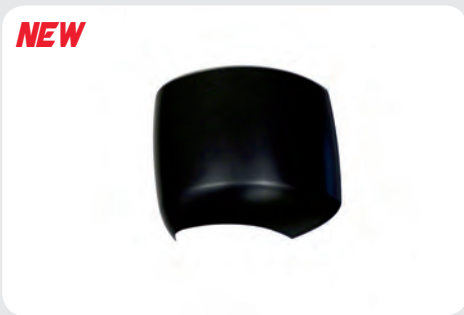

Ref.	Fecha-Date									OE
7305244	2007-									504158974
7306244	2007-									504158975





Ref.	Fecha-Date	Icons	OE	Caract.
7479244	2007-		2997668; 504197879	192X206

Ref.	Fecha-Date	Icons
9431244	2007-	
9432244	2007-	
9435244	2007-	
9436244	2007-	
9437244	2007-	
9438244	2007-	

Ref.	Fecha-Date	Icons	OE	Caract.
9493244	2007-		504168235	175X275
9496244	2007-		504168236	175X275
7393244	2007-		504168244	

Ref.	Fecha-Date	Icons	Caract.
7493244	2007-		175X275
7496244	2007-		175X275

Ref.	Fecha-Date	Icons	OE	Caract.
9477244	2007-		504224427	150x230
9478244	2007-		505224428	150x230

# IVECO EUROSTAR / EUROTECH / EUROTRAKKER

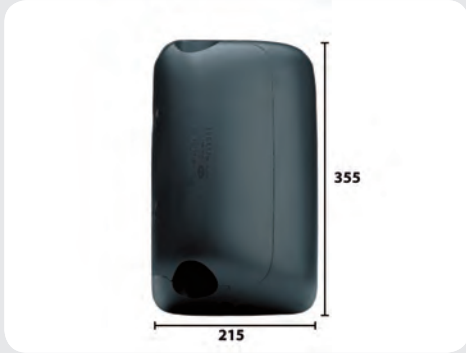

Ref.	Fecha-Date	Icons	OE	Caract.	Ø
9401247	1993-06	Class, ABS, 1800, Hand, 24 Volts	98472976	MUELLE 355X215	22
9492247	1993-06	Class, ABS, 1800, Hand, 24 Volts, 3 Persons	98472977	MUELLE 355X215	22
9498247	1993-06	Class, ABS, 1800, Hand, 24 Volts, 3 Persons	98472979	MUELLE 355X215	22
9406247	1993-06	Class, ABS, 1200, Hand	98473007; 98472976	ANILLO 355x215	22
9409247	1993-06	Class, ABS, 1200, Hand, 24 Volts, 3 Persons	98409215	ANILLO 355x215	22
9410247	1993-06	Class, ABS, 1200, Hand, 24 Volts, 3 Persons	2997159; 98409216; 98473007; 98472979	ANILLO 355x215	22

Ref.	Fecha-Date	Icons	OE	Caract.
7303144	1993-06	Class, ABS, 1200	93193202	327x152x45

Ref.	Fecha-Date	Icons	OE
7343247	1993-06	Class, ABS, 1200	93190971

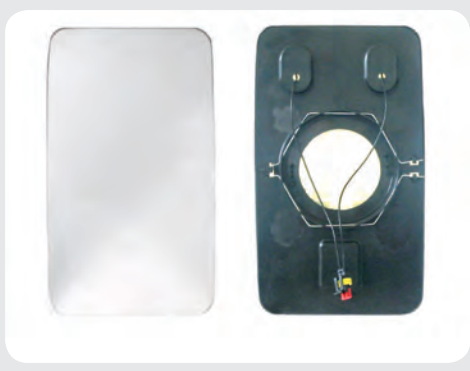

Ref.	Fecha-Date	OE	Caract.
7401247	1993-06	93190983	MUELLE 340 X 200
7492247	1993-06	93190970	MUELLE 340 X 200

Ref.	Fecha-Date	OE	Caract.
7405247	1993-06	93190983	ANILLO 340X200
7497247	1993-06	93190976	ANILLO 340X200

Ref.	Fecha-Date	OE	Caract.	Ø
9402247	1993-06	98472981; 98473008	MUELLE 457X215	22
9493247	1993-06	8143121; 98472982; 98472982; 98473010	MUELLE 457X215	22
9499247	1993-06	2997157; 8143122; 98472983; 98473011	MUELLE 457X215	22
9416247	1993-06	98473011	ANILLO 457x215	22
9419247	1993-06	8143121	ANILLO 457x215	22
9423247	1993-06	2997157; 8143122; 98473011; 98472983	ANILLO 457x215	22

Ref.	Fecha-Date	OE	Caract.
7344247	1993-06	93190977	MUELLE 425x152x50
7354247	1993-06	93193161	ANILLO 425x152x50



Ref.	Fecha-Date		OE	Caract.
7402247	1993-06		93190981	MUELLE 440 X 200
7493247	1993-06		93190976	MUELLE 440 X 200



Ref.	Fecha-Date		OE	Caract.
7406247	1993-06		93190981	ANILLO 440X200
7498247	1993-06		93193198	ANILLO 440X200



Ref.	Fecha-Date		Caract.	Ø
9485247	1993-06		793X240	22
9486247	1993-06		793X300	22



Ref.	Fecha-Date		OE	Caract.	Ø
9451247	1993-06		504077949; 98409117; 98472986; 98473012; 99457905	MUELLE 189 X 215	22
9473247	1993-06		2996670; 504132248; 8143172; 98472987	MUELLE 189 X 215	22
9445247	1993-06		2996671; 504096982; 504132249; 8143173; 98409119; 98472989	MUELLE 189 X 215	22



Ref.	Fecha-Date	OE	Caract.	Ø
9456247	1993-06	98473012; 98472986; 98473012; 99457905	ANILLO 189X215	22
9459247	1993-06	8143172; 98473013; 98472987	ANILLO 189X215	22
9460247	1993-06	504076894; 8143173; 98473014; 98472989	ANILLO 189X215	22



Ref.	Fecha-Date	OE	Caract.
7346247	1993-06	93190974	154X157

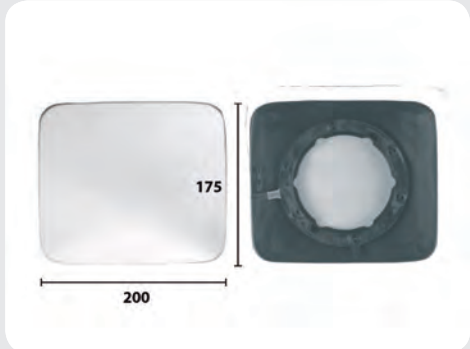

Ref.	Fecha-Date	OE	Caract.
7455247	1993-06	2997254	ANILLO 175X200
7477247	1993-06	93193199	ANILLO 175X200



Ref.	Fecha-Date	OE	Caract.	Ø
9441247	1993-06	504132242; 8143112; 8143113; 98472973	185X284	22
9443247	1993-06	504132243; 98472974; 98472938	185X284	22
9453247	1993-06	50411394; 504132244; 504132245; 98472975; 98409111	185X284	22



Ref.	Fecha-Date	OE	Caract.
7441247	1993-06	93193201	MUELLE 160 X 260
7443247	1993-06	93190985; 98487460	MUELLE 160 X 260



Ref.	Fecha-Date		OE	Caract.
7453246	1993-06		93193201	ANILLO 160X260
7454246	1993-06		93190985; 98487465	ANILLO 160X260

## IVECO TURBOSTAR 190



Ref.	Fecha-Date		OE	Caract.
9405241	1984-93			435 X 235
9407241	1984-93		98472979	435 X 235



Ref.	Fecha-Date		OE	Caract.
7405241	1984-93		93156901	ANILLO 403 X 201
7407241	1984-93		93156901	ANILLO 403 X 201



Ref.	Fecha-Date		OE	Caract.
7401241	1984-93		93160537	MUELLE 403 X 201
7403241	1984-93		93160537	MUELLE 403 X 201



Ref.	Fecha-Date	OE	Caract.	Ø
9451246	1984-93		98424102; 42209232; 42209233; 42345780; 42350421; 42345783	18



Ref.	Fecha-Date	OE	Caract.	Ø
9441246	1984-93		42329121; 423455 22; 42345523; 42350425; 42345778	150x230

## IVECO UNIVERSAL



Ref.	Fecha-Date	OE	Caract.	Ø
9470235			98424107; 98424108; 999457908	18
9473235			29972111; 98424110; 99457911	18



Ref.	Fecha-Date	OE	Caract.	Ø
7475246			4723936	345X194
7476246			92934662	345X194



Ref.	Fecha-Date	OE	Caract.	Ø
9470245		98424105; 99457906	346X162	18



Ref.	Fecha-Date	OE	Caract.	Ø
9470240		4755582; 99457910	439 X 209	18
9471240		98424111	439 X 209	18



Ref.	Fecha-Date	OE	Caract.
7470240		4755585	427X197
7471240		92934663	427X197



Ref.	Fecha-Date	Caract.
7371240		427X197



Ref.	Fecha-Date	OE	Caract.	Ø
9470285		02601417	375x183	14-20
9471285		2628191	375x183	14-20





Ref.	Fecha-Date	OE	Caract.
7401261		2612573	366X176
7403261		2628194	366X176

## IVECO 697



Ref.	Fecha-Date	OE
9803243	1969-89	

## IVECO EUROCARGO I-III



Ref.	Fecha-Date	OE
9801246	1996-02	500340543; 712390731129
9802246	1996-02	500340503; 712930631129
9841246	1996-02	500340408; 712390741129
9842246	1996-02	500340361; 712390641129



Ref.	Fecha-Date							OE
9601246	1996-02	◀				P21W	24 Volts	2997253; 93193199
9602246	1996-02	▶				P21W	24 Volts	98409119 ; LLC761



Ref.	Fecha-Date							OE
9621246	1996-02	◀				H3	H3	712350901120; 98437476
9622246	1996-02	▶				H3	H3	712350801120; 98437475



Ref.	Fecha-Date							OE	
9701246	1996-02	◀				P21 W3	R5 W2	24 Volts	500382616
9702246	1996-02	▶				P21 W3	R5 W2	24 Volts	500382617



Ref.	Fecha-Date								OE		
9841248	2003-	◀				MOTOR	H7	H7	W5W	24 Volts	41221036; 504020193
9842248	2003-	▶				MOTOR	H7	H7	W5W	24 Volts	41221015; 504020189



Ref.	Fecha-Date							OE
9601245	2003-	◀				H1	24 Volts	504052353
9602245	2003-	▶				H1	24 Volts	504052352



Ref.	Fecha-Date	OE	Caract.
9603245	2003-	504047573	CON CONECTOR



Ref.	Fecha-Date	OE
9611245	2003-	504107550
9612245	2003-	504133023



Ref.	Fecha-Date	OE
9701246	2003-	500382616
9702246	2003-	500382617



Ref.	Fecha-Date	OE
9701248	2003-	37653000; 99463244
9702248	2003-	37650000; 99463242

# IVECO EUROSTAR / EUROTECH



Ref.	Fecha-Date					OE
9801247	1993-06	◀	24 Volts	Hand icon	H3 H4 T4W	4861794; 98424105
9802247	1993-06	▶	24 Volts	Hand icon	H3 H4 T4W	42209232; 42209233; 4861793

**NEW**



Ref.	Fecha-Date					OE
9811247	1993-06	◀		Hand icon		
9812247	1993-06	▶		Hand icon		



Ref.	Fecha-Date						OE
9621246	1993-06	◀		Hand icon	H3 H3		712350901120; 98437476
9622246	1993-06	▶		Hand icon	H3 H3		712350801120; 98437475



Ref.	Fecha-Date						OE
9601247	1993-06	◀	24 Volts	Hand icon	P21W		98460038
9602247	1993-06	▶	24 Volts	Hand icon	P21W		98460036



Ref.	Fecha-Date		OE
3103970	1993-06		98472976

## IVECO STRALIS



Ref.	Fecha-Date		OE
9841248	2003-06		41221036; 504020193
9842248	2003-06		41221015; 504020189



Ref.	Fecha-Date		OE
9621248	2003-		504032145; 504032148



Ref.	Fecha-Date		OE
9653248	2003-		504032148



Ref.	Fecha-Date	OE
9601248	2003-	42555023
9602248	2003-	41221040; 42555022; 93190977



Ref.	Fecha-Date	OE
9641248	2003-	42555042; 93190982
9642248	2003-	42555041



Ref.	Fecha-Date	OE
9605248	2003-	98473011; 41221029; 8143122
9606248	2003-	41221039; 8143121



Ref.	Fecha-Date	OE
9701248	2003-	37653000; 99463244
9702248	2003-	37650000; 99463242



Ref.	Fecha-Date	OE
9845248	2007-	504238213; 712452511129
9846248	2007-	504238203; 712452411129

**NEW**



Ref.	Fecha-Date		OE	Caract.
9811248	2013-		5801639118; 5801745449	T.AL
9812248	2013-		5801639122; 5801745452	T.AL



Ref.	Fecha-Date		OE
9611248	2013-		41221029; 504098245; 5801572080; 5801754886
9612248	2013-		5801572074; 5801754885



Ref.	Fecha-Date		OE
9631248	2013-		5801572024
9632248	2013-		5801572018

## IVECO UNIVERSAL



Ref.	Fecha-Date		OE	Caract.
9791008			42471137; 7984016; 7984797	303x130x80
9792008			7984796	303x130x80
9795008			7984794	303x130x80
9796008			42471138; 7984015; 7984794; 7984796	303x130x80



Ref.	Fecha-Date	OE	Caract.
9707008		500356783; 734808775	CONNECT.IVECO FIAT OM 303x130x80
9708008		1907700; 4808772; 4808774; 724808774	CONNECT.IVECO FIAT OM 303x130x80



Ref.	Fecha-Date	OE	Caract.
9709008		4809193; 98409216	CONNECT.IVECO FIAT OM 303x130x80
9710008			CONNECT.IVECO FIAT OM 303x130x80



Ref.	Fecha-Date	Caract.
9793009		466X130X85



Ref.	Fecha-Date	OE	Caract.
9711008		98424052	CONNECT.EUROCARGO 303x130x80
9712008		98424051	CONNECT.EUROCARGO 303x130x80
9715008			CONNECT.EUROCARGO 303x130x80
9716008			CONNECT.EUROCARGO 303x130x80



Ref.	Fecha-Date	Caract.
9721008		CONNECT.DAILY(00-) 303x130x80
9722008		CONNECT.DAILY(00-) 303x130x80







Ref.	Fecha-Date	OE	Caract.	Ø
9421261	1988-94	8163730622; 81637306235	165x215	14-20

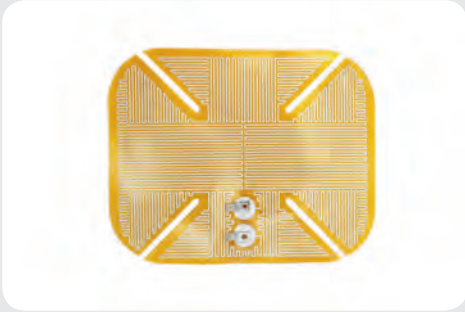

Ref.	Fecha-Date	Caract.
7323140	1988-94	138x173



Ref.	Fecha-Date	OE	Caract.
9441261	1988-94	81637306224	157X247



Ref.	Fecha-Date	Caract.
7441261	1988-94	150X241
7443261	1988-94	150X241



Ref.	Fecha-Date	Caract.	Ø
9413261	1994-00	380x190	18-30



Ref.	Fecha-Date	OE	Caract.
7416261	1994-00	81637330036	366x176

## MAN F2000 / L2000 / M2000



Ref.	Fecha-Date	OE	Caract.	Ø
9401262	1993-04	81637306365; 81637306002; 81637306303; 81637306314; 82637306001	384X205	22
9403262	1993-04	81637306315; 81637306361; 81637306365; 82637306015; 82637306016	384X205	22
7301262	1993-04	81637320044		



Ref.	Fecha-Date	OE	Caract.
7401142	1993-04	81637330093	368X189
7403142	1993-04	81637330095	368X189
7403262	1993-04	81637330095	312X172

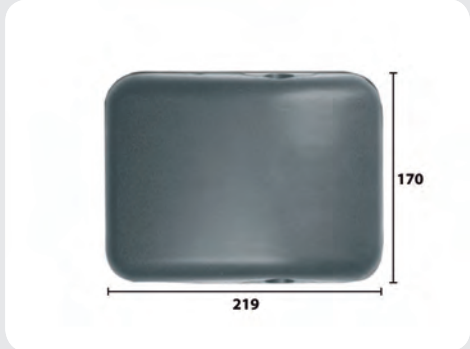

Ref.	Fecha-Date	OE	Caract.	Ø
9421262	1993-04	82637306022; 82637306021	170X219	22
7321262	1993-04	81637320078; 81637320045	159X219	



Ref.	Fecha-Date	OE	Caract.
7421142	1993-04	81637330097	154x203
7423142	1993-04	81637330097	154x203



Ref.	Fecha-Date	OE	Caract.
9476263	1993-04	82637306033; 81637306294	184x324
9443262	1993-04	81637306034; 81637306294; 82637306033	184x324
9478263	1993-04	81637306035; 81637306296	184x324



Ref.	Fecha-Date	OE	Caract.
7443262	1993-04	81637330100	184x324

## MAN G90



Ref.	Fecha-Date	OE	Caract.	Ø
9401286	1975-88	81637306127; 81637306167	308X176	14-20
9402286	1975-88	81637306128; 81637306148	308X176	14-20



Ref.	Fecha-Date	Caract.
7303286	1975-88	280 X 160

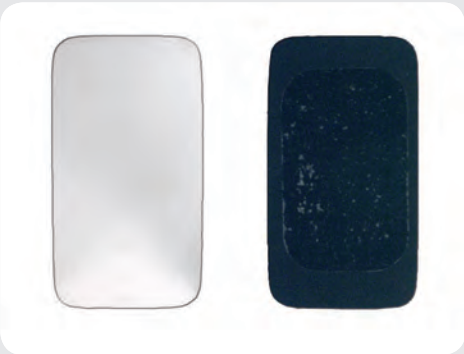

Ref.	Fecha-Date	OE	Caract.
7470286	1975-88	81637330032	308X176
7471286	1975-88	81637336001	308X176

## MAN L2000



Ref.	Fecha-Date	OE	Caract.	Ø
9476261	2004-	81637306478; 85637306030	426x200	22
9479261	2004-	85637306033	426x200	22
9480263	2004-	85637306035; 85637306036	426x200	22



Ref.	Fecha-Date	OE	Caract.
7483263	2004-	81637330101	412x188
7486263	2004-	81637330103	412x188



Ref.	Fecha-Date	OE	Caract.	Ø
9480261	2004-	85637306037; 85637306508	198x202	22
9481261	2004-	85637306039	198x202	22



Ref.	Fecha-Date	OE	Caract.	Ø
7489263	2004-	81637330104	184x190	
7490263	2004-	81637330106	184x190	

MAN TGA / TGL/TGM



Ref.	Fecha-Date	OE	Caract.	Ø
9471263	2000-14	399x222	28	
9473263	2000-14	81637306345; 81637306395; 81637306430; 81637306432; 81637306447	399x207	28
7373263	2000-14	81637320059; 81637320054; 81637320063		



Ref.	Fecha-Date	OE	Caract.	Ø
7473263	2000-14	81637306480; 81637306482	379x176	
7474263	2000-14	81637336034; 81637306482; 81637306483; 81637330082; 81637336033; 81637336049	379x176	



Ref.	Fecha-Date			
7303263	2000-14			



Ref.	Fecha-Date				OE	Caract.	Ø			
9461263	2000-14							81637306511	188X207	28
9462263	2000-14							81637306513	188X207	28
7363263	2000-14							81637320056; 81637320062; 81637320066	187x197	



Ref.	Fecha-Date					OE	Caract.
7463263	2000-14					81637336057	167X177
7464263	2000-14					81637336057; 81637330085	167X177

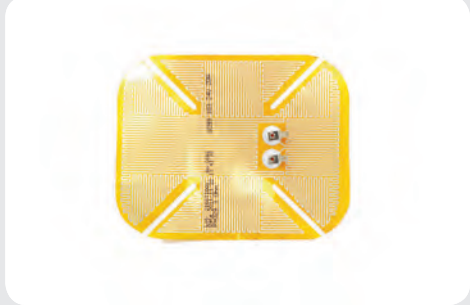

Ref.	Fecha-Date				Caract.
7313263	2000-14				187x197



Ref.	Fecha-Date			OE	Caract.
9401263	2000-14			81637306572; 81637306656; 81637306660	173X218



Ref.	Fecha-Date	Icons	OE	Caract.
9451263	2000-14	▶ V Class, Hand, 300, ABS	81637306449; 81637306522; 81637306573	324x185
9452263	2000-14	▶ V Class, Hand, 300, ABS, 24 Volts	81637306523; 81637306574; 81637306734	324x185
9455263	2000-14	▶ V Class, Hand, 300, ABS, 24 Volts	81637306523; 81637306574	324x185



Ref.	Fecha-Date	Icons	OE	Caract.
7453263	2000-14	◀ V Class, Hand, 300, ABS	81637336061; 81637336067	324x185
7454263	2000-14	◀ V Class, Hand, 300, 24 Volts, ABS	81637336062; 81637336068	324x185

**MAN TGS/TGX**



Ref.	Fecha-Date	Icons	OE	Caract.
9433263	2008-	◀ II Class, IV Class, Hand, 1200, 300, ABS, 24 Volts	81637306529	943x382 C.IV MANUAL
9434263	2008-	▶ II Class, IV Class, Hand, 1200, 300, ABS, 24 Volts	81637306531	943x382 C.IV MANUAL
9431263	2008-	◀ II Class, IV Class, Hand, 1200, 300, ABS, 24 Volts	81637306560	943x382
9432263	2008-	▶ II Class, IV Class, Hand, 1200, 300, ABS, 24 Volts	81637306561	943x382





Ref.	Fecha-Date	OE	Caract.
9443263	2008-	81637306533	943x437 C.IV MANUAL
9444263	2008-	81637306534	943x437 C.IV MANUAL
9441263	2008-	81637306549	943x437
9442263	2008-	81637306550	943x437



Ref.	Fecha-Date	OE	Caract.
7421263	2008-	81637336071	381x201



Ref.	Fecha-Date	OE	Caract.
7431263	2008-	81637336073	197X181
7432263	2008-	81637336072	197X181



Ref.	Fecha-Date	OE	Caract.
7323263	2008-	81637310356	631X237



Ref.	Fecha-Date	OE	Caract.
9401263	2008-	81637306572; 81637306656; 81637306660	173X218

# MAN UNIVERSAL



Ref.	Fecha-Date	OE	Caract.	Ø
9401286		81637306127; 81637306167	308X176	14-20
9402286		81637306128; 81637306148	308X176	14-20

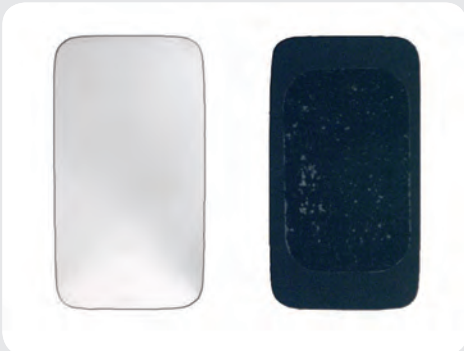

Ref.	Fecha-Date	OE	Caract.
7470286		81637330032	308X176
7471286		81637336001	308X176



Ref.	Fecha-Date	Caract.
7303286		280 X 160



Ref.	Fecha-Date	OE	Caract.	Ø
9470260		81637306147	375X183	19
9471260		81637306001; 81637306151	375X183	19



Ref.	Fecha-Date					Caract.
7303141		◀	Class			300X150

**MAN F2000/M2000M**



Ref.	Fecha-Date									OE
9641009	1994-	◀	Bus	Headlight	H3	70 Watts	24 Volts			81251016339
9642009	1994-	▶	Bus	Headlight	H3	70 Watts	24 Volts			81251016338



Ref.	Fecha-Date									OE
9757009	1994-	◀	Bus	Light		PY 21W	P21 W4			81252286034
9758009	1994-	▶	Bus	Light		PY 21W	P21 W4			81252286033

MAN TGA



Ref.	Fecha-Date					OE
9801009	2000-07	◀			H7 H7 W5W5	81251016379; 81251016435; 81251016449; 81251016457; 81251016449
9802009	2000-07	▶			H7 H7 W5W5	81251016456; 81251016448
9841009	2000-07	◀			MOTOR H7 H7	81251016357; 81251016421; 81251016427; 81251016451
9842009	2000-07	▶			MOTOR H7 H7	81251016356; 81251016422; 81251016428; 81251016450

NEW



Ref.	Fecha-Date					OE
9831009	2000-07	◀				
9832009	2000-07	▶				



Ref.	Fecha-Date						OE	
9625009	2000-07	◀					H4 PY 21W	81253206113; 81253206113
9626009	2000-07	▶					H4 PY 21W	81253206114; 81253206114



Ref.	Fecha-Date						OE	
9621009	2000-07	◀					H4 P21W	81253206091; 81253206111
9622009	2000-07	▶					H4 P21W	81253206092; 81253206112

**NEW**



Ref.	Fecha-Date			
9613009	2000-07	◀▶		

**NEW**



Ref.	Fecha-Date							OE	
9601009	2000-07	▶				21 Watts	24 Volts		81253206089
9602009	2000-07	▶				21 Watts	24 Volts		81253206090

**NEW**



Ref.	Fecha-Date							OE	
9603009	2000-07	▶				PY 21W	24 Volts		8125320610; 81253206118; 81253206116

**NEW**



Ref.	Fecha-Date							OE	
9605009	2000-07	▶				P21W	24 Volts		81253206101; 81253206115

**NEW**



Ref.	Fecha-Date					OE	Caract.
9623009	2000-07	▶			LED		81252606104 CONECTOR CUADRADO HEMBRA

NEW



Ref.	Fecha-Date		OE	Caract.
9609009	2000-07			81252606105 CONECTOR CUADRADO MACHO



Ref.	Fecha-Date		OE	Caract.
9607009	2000-07			81252606101 CONECTOR HEMBRA



Ref.	Fecha-Date		OE
9775009	2000-07		
9776009	2000-07		



Ref.	Fecha-Date		OE	Caract.
9793009	2000-07			81252296051 466X130X85



Ref.	Fecha-Date		OE	Caract.
9727009	2000-07			81252256524; 81252256465 CONECT.REN/TGA/DAF 466x130x85
9728009	2000-07			81252256523; 81252256466 CONECT.REN/TGA/DAF 466x130x85



Ref.	Fecha-Date								OE
9739009	2000-07	◀	▶	LED	24 Volts	W3	P21	R5W	81252256544
9740009	2000-07	▶	◀	LED	24 Volts	W3	P21	R5W	81252256545



Ref.	Fecha-Date					OE	Caract.
9749009	2000-07	◀	▶	LED		81252256059	466X130X85
9750009	2000-07	▶	◀	LED		81252256060	466X130X85

**MAN TGX**



Ref.	Fecha-Date							OE	Caract.
9811009	2008-	◀	▶	LED	MOTOR	H7	H7	81251016661	T. ZKW
9812009	2008-	▶	◀	LED	MOTOR	H7	H7	81251016662	T. ZKW
9861009	2008-	◀	▶	LED	MOTOR	H7		81251016663	T. ZKW
9862009	2008-	▶	◀	LED	MOTOR	H7		81251016664	T. ZKW



Ref.	Fecha-Date							OE
9871009	2008-	◀	▶	LED	MOTOR	H7	D1R	81251016513
9872009	2008-	▶	◀	LED	MOTOR	H7	D1R	81251016514



Ref.	Fecha-Date								OE
9851009	2008-	◀		LED		H7	H7	PY 21W	81251016503
9852009	2008-	▶		LED		H7	H7	PY 21W	81251016504
9845009	2008-	◀		LED		MOTOR	H7	H7	PY 21W
9846009	2008-	▶		LED		MOTOR	H7	H7	PY 21W

**NEW**



Ref.	Fecha-Date							OE
9821009	2008-	◀						81251100083
9822009	2008-	▶						81251100084



Ref.	Fecha-Date								OE
9631009	2008-	◀				H3	H4	24 Volts	81251016521
9632009	2008-	▶				H3	H4	24 Volts	81251016522

**NEW**



Ref.	Fecha-Date							OE
9651009	2008-	◀						81251100085
9652009	2008-	▶						81251100086



Ref.	Fecha-Date							OE
9603009	2008-	◀				PY 21W	24 Volts	8125320610; 81253206116; 81253206118





Ref.	Fecha-Date							OE
9739009	2008-							81252256544
9740009	2008-							81252256545



Ref.	Fecha-Date			OE	Caract.
9749009	2008-			81252256059	466X130X85
9750009	2008-			81252256060	466X130X85

**MAN UNIVERSAL**



Ref.	Fecha-Date				OE	Caract.
9741009						81252296523 CONECTOR MAN 466x130x85
9742009						81252256523; 81252256530; 81252296524 CONECTOR MAN 466x130x85
9729009						81252286030 CONECTOR MAN 466x130x85
9793009					81252296051 466X130X85	

# MERCEDES 1013-2644



Ref.	Fecha-Date	OE	Caract.	Ø	
9470151	1973-86		0008102716;	370X182	18
			0008106216;		
			0008111233;		
			2818107116;		
			3148102616;		
			3818102516;		
			3818107116;		
			6638100816;		
			67381		
			0008102316;		
9473151	1973-86		3018102116;	370X182	18
			3148102616;		
			3818102616;		
			3818107316;		
			3818102616;		
			3818107316;		
			3818102616;		
			6738104216		



Ref.	Fecha-Date	OE	Caract.
7470151	1973-86		0008118733; 0008112033;
			0008113333; 0008116433



Ref.	Fecha-Date	Caract.
7373151	1973-86	350X160

# MERCEDES 1422-2633



Ref.	Fecha-Date	Icons	OE	Caract.	Ø
9470275	1982-94		0008112833; 3818103716	423X203	18
9472275	1982-94		3818103816	423X203	18



Ref.	Fecha-Date	Icons	OE	Caract.
7470275	1982-94		0008103433; 0008113433; 0008119933	408X186
7471275	1982-94		0008118133	408X186

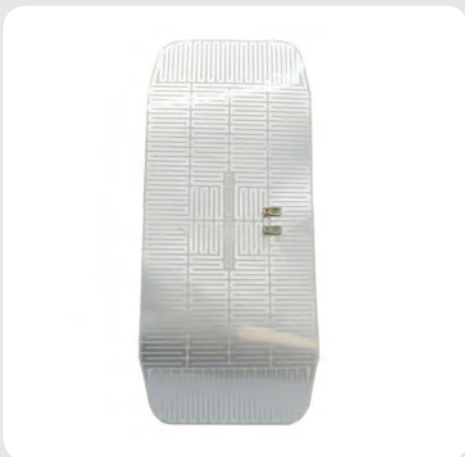

Ref.	Fecha-Date	Icons	Caract.
7371275	1982-94		385x165

MERCEDES V.I./I.V./LKW

## MERCEDES 303



Ref.	Fecha-Date					OE	Caract.	Ø	
9401271	1987-						6738104616	184X184	18



Ref.	Fecha-Date					Caract.
7303271	1987-					140X175

## MERCEDES ACTROS



Ref.	Fecha-Date						OE	Caract.	Ø
9403273	1996-						0018112033; 0008109516; 0018109016	433X188	28
9409273	1996-						0018109116	433X188	28



Ref.	Fecha-Date	OE	Caract.
7403273	1996-	0018112033; 0028110433	433X188



Ref.	Fecha-Date	OE	Caract.	Ø
9421272	1996-	8109616	200X200	28
9423272	1996-	18109216	200X200	28
7319272	1996-	8111307	SOPORTE 74X65X14	



Ref.	Fecha-Date	OE	Caract.
7423272	1996-	18112133	200X200



Ref.	Fecha-Date	OE	Caract.	Ø
9426272	1996-	0028103716; 9408102616; 9418101016; 9418102116	170X310	28



Ref.	Fecha-Date	OE	Caract.
7491273	1996-	0018116933	250X45

# MERCEDES ACTROS MP2



Ref.	Fecha-Date											Caract.
9471274	2003-08	▲	II Class	IV Class	Hand	People	Grey	1200	300	ABS	24 Volts	890x330
9472274	2003-08	▶	II Class	IV Class	Hand	People	Grey	1200	300	ABS	24 Volts	890x330
9478274	2003-08	▲	II Class	IV Class	Hand	People	Grey	1200	300	ABS	24 Volts	890x330
9479274	2003-08	▶	II Class	IV Class	Hand	People	Grey	1200	300	ABS	24 Volts	890x330



Ref.	Fecha-Date											OE	Caract.
7361274	2003-08	▲	II Class	IV Class	Hand	People	Grey	ABS				9438110307	890x330
7362274	2003-08	▶	II Class	IV Class	Hand	People	Grey	ABS				9438110407	890x330



Ref.	Fecha-Date											OE	Caract.
7461274	2003-08	▲	II Class	IV Class	Hand	People	1200	24 Volts				0028110933	401x200
7462274	2003-08	▶	II Class	IV Class	Hand	People	1200	24 Volts				0028111033	401x200



Ref.	Fecha-Date											OE	Caract.
7463274	2003-08	▲	IV Class	IV Class	Hand	People	300	24 Volts				0028110633	191x193
7464274	2003-08	▶	IV Class	IV Class	Hand	People	300	24 Volts				0028110733	191x193

# MERCEDES ACTROS MP3



Ref.	Fecha-Date	Caract.									
9491274	2008-										890x330
9492274	2008-										890x330
9498274	2008-										890x330
9496274	2008-										890x330



Ref.	Fecha-Date	OE										Caract.
7371274	2008-										9438110307	520X170
7372274	2008-										9438110407	520X170



Ref.	Fecha-Date	OE										Caract.
7471274	2008-										28113333	401x200
7472274	2008-										28113433	401x200



Ref.	Fecha-Date	OE										Caract.
7473274	2008-										28113733	191x193
7474274	2008-										28113833	191x193

MERCEDES V.I./I.V./LKW

## MERCEDES ACTROS MP4



**NEW**



Ref.	Fecha-Date		OE	Caract.
7411274	2011-	◀ II Class	0028116333	430X193
7412274	2011-	▶ II Class	0028116433	430X193

**NEW**



Ref.	Fecha-Date		OE	Caract.
7421274	2011-	◀ IV Class	0028116533	204X236
7422274	2011-	▶ IV Class	0028116633	204X236

**NEW**



Ref.	Fecha-Date		OE	Caract.
9462274	2011-	▶ V Class	0028103716	313X255

**NEW**



Ref.	Fecha-Date		OE	Caract.
7443274	2011-	▶ V Class	0028114833	305X158



**NEW**



Ref.	Fecha-Date		OE	Caract.
9452274	2011-	▶ VI Class ABS	9608103016	666X319X249

**NEW**



Ref.	Fecha-Date		OE	Caract.
7433274	2011-	▶ VI Class	0028116233	243X182

**MERCEDES ATEGO / AXOR**



Ref.	Fecha-Date		OE	Caract.	Ø
9401272	1997-04	▶ II Class	8100279	380X170	28



Ref.	Fecha-Date		OE	Caract.
7403272	1997-04	▶ II Class 24 Volts	0008117333; 0018113433; 0018117333	380X170



Ref.	Fecha-Date	OE	Caract.	Ø
9421272	1997-04	8109616	200X200	28
9423272	1997-04	18109216	200X200	28
7319272	1997-04	8111307	SOPORTE 74X65X14	



Ref.	Fecha-Date	OE	Caract.
7423272	1997-04	18112133	200X200



Ref.	Fecha-Date	OE	Caract.	Ø
9426272	1997-04	0028103716; 9408102616; 9418101016; 9418102116	170X310	28



Ref.	Fecha-Date	OE	Caract.
9490272	1997-04	0008111307; 0008100879	130X250



Ref.	Fecha-Date	OE	Caract.
7491272	1997-04	0018116933	250X45



Ref.	Fecha-Date	Icons	OE	Caract.	Ø
9411272	2004-	Class II, 1200, ABS, Hand, 1200	8101779	435x215	28
9412272	2004-	Class II, 1200, ABS, Hand, 1200	0008101479	435x215	28
9431272	2004-	Class II, 24 Volts, 1200, ABS, Hand, 1200	0008101779; 0008102279	435x215	28
9432272	2004-	Class II, 24 Volts, 1200, ABS, Hand, 1200	0008101479; 0008102379	435x215	28
9451272	2004-	Class II, 24 Volts, 1200, ABS, Hand, 1200	0008101879; 0008102079	435x215	28
9452272	2004-	Class II, 24 Volts, 1200, ABS, Hand, 1200	0008102179; 0008101579	435x215	28
7303272	2004-	Class II, ABS, 1200	0008112007	435x215	



Ref.	Fecha-Date	Icons	OE	Caract.	Ø
7413272	2004-	Class II, 1200, ABS, Hand, 1200	0018119933	431x186	
7416272	2004-	Class II, 24 Volts, 1200, ABS, Hand, 1200	0018119933; 0028114633	431x186	



Ref.	Fecha-Date	Icons	OE	Caract.	Ø
9403272	2004-	Class IV, 300, ABS, Hand, 300	0008101679; 0008102479; 28114633	199X215	28
9406272	2004-	Class IV, 24 Volts, 300, ABS, Hand, 300	0008101679; 0008102479	199X215	28
7306272	2004-	Class IV, ABS, 300	0008112007	199X215	



Ref.	Fecha-Date	Icons	OE	Caract.	Ø
7406272	2004-	Class IV, 300, ABS, Hand, 300	18110033	186X192	
7409272	2004-	Class IV, 24 Volts, 300, ABS, Hand, 300	0028110033	186X192	



Ref.	Fecha-Date	OE	Caract.	Ø
9426274	2004-	0028103716; 9408102616; 9418100816	163X303	28



Ref.	Fecha-Date	OE	Caract.
7426274	2004-	0018112233	163X303



Ref.	Fecha-Date	OE	Caract.
9490274	2004-	130X250	



Ref.	Fecha-Date	OE	Caract.
7491274	2004-	0018116933	45X250

## MERCEDES AXOR



Ref.	Fecha-Date		OE	Caract.
7429272	2008-			431X186
7433272	2008-		0028114633	431X186



Ref.	Fecha-Date		OE	Caract.
7436272	2008-			192X186
7439272	2008-		28114733	192X186

## MERCEDES ECONIC



Ref.	Fecha-Date		OE	Caract.	Ø
9403273	1998-		0018112033; 0008109516; 0018109016	433X188	28
9409273	1998-		0018109116	433X188	28



Ref.	Fecha-Date	OE	Caract.
7403273	1998-	0018112033; 0028110433	433X188



Ref.	Fecha-Date	OE	Caract.	Ø
9421272	1998-	8109616	200X200	28
9423272	1998-	18109216	200X200	28
7319272	1998-	8111307	SOPORTE 74X65X14	



Ref.	Fecha-Date	OE	Caract.
7423272	1998-	18112133	200X200



Ref.	Fecha-Date	OE	Caract.	Ø
9426272	1998-	0028103716; 9408102616; 9418101016; 9418102116	170X310	28



Ref.	Fecha-Date	OE	Caract.
7491273	1998-	0018116933	250X45

## MERCEDES LK 814



Ref.	Fecha-Date	OE	Caract.	Ø
9401271	1987-	6738104616	184X184	18



Ref.	Fecha-Date	Caract.
7303271	1987-	140X175

## MERCEDES LP 608-1113



Ref.	Fecha-Date	OE	Caract.	Ø
9401270	1981-95	3148101316	305X183	18
9403270	1981-95	0008100616; 0008102016; 3148101916	305X183	18



Ref.	Fecha-Date		OE	Caract.
7401270	1981-95		0008111933; 00018119033; 0008113533	293X172

**MERCEDES NG 90 I/SK**



Ref.	Fecha-Date		OE	Caract.
7401276	1988-90		0008117033; 0018118533	417X195
7403276	1988-90		0008117033; 0008210029; 0018118533	417X195



Ref.	Fecha-Date		Caract.
7371275	1988-90		385x165



Ref.	Fecha-Date		OE	Caract.
7421276	1988-90		0008118533; 0018118133	188X204





Ref.	Fecha-Date					Caract.
7323140	1988-90	◀▶	IV Class	☐	🚚	138x173



Ref.	Fecha-Date					OE	Caract.
7441276	1988-90	▶	V Class	☐	300 🚚	0008117233	163X319

**MERCEDES NG 90 II/1729-3350 SK**



Ref.	Fecha-Date							OE	Caract.	Ø
9470277	1991-	◀▶	II Class	☐	👤	1800	ABS	6418104216	440X182	28
9471277	1991-	◀▶	II Class	☐	👤	1800	ABS	6418106816; 6418104216	440X182	28



Ref.	Fecha-Date					OE	Caract.
7470277	1991-	◀▶	II Class	☐	1800 🚚	0008118433; 0008118633	427X169



Ref.	Fecha-Date		OE
7371277	1991-		0008210129

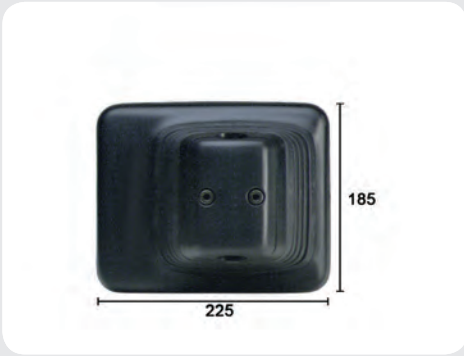

Ref.	Fecha-Date		OE	Caract.	Ø
9471278	1991-		0008107016; 6418104616	185X225	28



Ref.	Fecha-Date		OE	Caract.
7471278	1991-		0008118533; 0018118133	169X209



Ref.	Fecha-Date		OE	Caract.
7371278	1991-		0008210229	140X175



Ref.	Fecha-Date		OE	Caract.	Ø
9473278	1991-		6418104716; 6418106316	164X294	28



Ref.	Fecha-Date		OE	Caract.
7473278	1991-		8118633	152X282

## MERCEDES ACTROS



**NEW**



Ref.	Fecha-Date		OE
9845013	1996-02		A0028208456
9846013	1996-02		A0028208556



Ref.	Fecha-Date		OE
9851013	1996-02		9418205761
9852013	1996-02		9418206261; 9418204461; 9418205861



Ref.	Fecha-Date		OE
9855013	1996-02		301081119; 9418205361; 9418202961
9856013	1996-02		301081114; 9418205461; 9418203061

MERCEDES V.I./I.V./LKW

**NEW**



Ref.	Fecha-Date			
9811013	1996-02	◀		
9812013	1996-02	▶		



Ref.	Fecha-Date						OE	Caract.
9601273	1996-02	◀					A0028208656; 28205656	T.ZKW
9602273	1996-02	▶					A0028208756; 28205756	T.ZKW

**NEW**



Ref.	Fecha-Date				
9829013	1996-02	◀			
9830013	1996-02	▶			

**NEW**



Ref.	Fecha-Date						OE	Caract.
9709013	1996-02	◀					A0015406270	CONECTOR LATERAL
9710013	1996-02	▶					A0015406370	CONECTOR LATERAL



Ref.	Fecha-Date				OE
9711013	1996-02	◀			0025444790; 0025441390; 0025441290
9712013	1996-02	▶			0025444790; 0025441290; 0025441390

# MERCEDES ACTROS MP2



Ref.	Fecha-Date							OE
9831013	2003-08	◀				H1 H7 PY 21W W5W	24 Volts	A9438200161
9832013	2003-08	▶				H1 H7 PY 21W W5W	24 Volts	A9438200261
9841013	2003-08	◀				H1 H7 PY 21W W5W	24 Volts	9438200361; A9438200361
9842013	2003-08	▶				H1 H7 PY 21W W5W	24 Volts	9438200461; A9438200461



Ref.	Fecha-Date							OE
9819013	2003-08	◀				H1 D2S PY 21W		A9438200961
9820013	2003-08	▶				H1 D2S PY 21W		A9438201061



Ref.	Fecha-Date							OE
9827013	2003-08	◀						
9828013	2003-08	▶						



Ref.	Fecha-Date							OE
9801274	2003-08	◀				H3 70 Watts 24 Volts		9438200056
9802274	2003-08	▶				H3 70 Watts 24 Volts		9438200156

**NEW**



Ref.	Fecha-Date			
9611274	2003-08	◀		
9612274	2003-08	▶		



Ref.	Fecha-Date							OE
9601274	2003-08	◀			5 Watts	P21	24 Volts	9418200521
9602274	2003-08	▶			5 Watts	P21	24 Volts	9418200921



Ref.	Fecha-Date				OE
9711013	2003-	◀			0025444790; 0025441390; 0025441290
9712013	2003-	▶			0025444790; 0025441290; 0025441390

## MERCEDES ACTROS MP3



Ref.	Fecha-Date								OE		
9867013	2008-	◀			H1	H7	PY 21W	W5W	9438201461		
9868013	2008-	▶			H1	H7	PY 21W	W5W	9438201561		
9861013	2008-	◀			H1	H7	PY 21W	W5W	24 Volts	9438201461; 9438201661	
9862013	2008-	▶			H1	H7	PY 21W	W5W	24 Volts	9438201561; 9438201761	
9885013	2008-	◀			MOTOR	H1	H7	PY 21W	W5W	24 Volts	A9438201661
9886013	2008-	▶			MOTOR	H1	H7	PY 21W	W5W	24 Volts	A9438201761



Ref.	Fecha-Date		OE
9865013	2008-		9438202261; 9438201461
9866013	2008-		9438202361; 9438201561



Ref.	Fecha-Date		OE
9835013	2008-		
9836013	2008-		



Ref.	Fecha-Date		OE
9651013	2008-		A9438200756
9652013	2008-		A9438200856



Ref.	Fecha-Date		OE	Caract.
9661013	2008-		A9608201021; A9608200421	T. ZKW
9662013	2008-		A9608201121; A9608200521	T. ZKW

# MERCEDES ACTROS MP4



Ref.	Fecha-Date						OE	Caract.	
9815013	2010-	◀			H1	D1S	PY 21W	9608200739	
9816013	2010-	▶			H1	D1S	PY 21W	9608200639	
9801013	2010-	◀				H1	D1S	9608200839; A9608200839	T. KOITO
9802013	2010-	▶				H1	D1S	9608200939; A9608200939	T. KOITO



Ref.	Fecha-Date							OE	
9875013	2010-	◀			H1	H7	PY 21W	W5W	9608200339
9876013	2010-	▶			H1	H7	PY 21W	W5W	9608200239
9839013	2010-	◀				H1	H7		A9608200439
9840013	2010-	▶				H1	H7		A960820539



Ref.	Fecha-Date							OE	
9641013	2010-	◀				H11	24 Volts		9608200456
9642013	2010-	▶				H11	24 Volts		9608200556



Ref.	Fecha-Date							OE
9615013	2010-	◀				LED		A9608200956
9616013	2010-	▶				LED		A9608201056





Ref.	Fecha-Date	OE
9703013	2010-	5445411



Ref.	Fecha-Date	OE	Caract.
9701013	2010-	35440903	525MM
9702013	2010-	35440803	525MM



Ref.	Fecha-Date	OE	Caract.
9705013	2010-	A0035441003	T. RUBBLITE



Ref.	Fecha-Date	OE
9713013	2010-	

## MERCEDES ANTOS



Ref.	Fecha-Date								OE	
9891013	2012-	▶			H1	H7	PY 21W	W5W	24 Volts	9608201939
9892013	2012-	▶			H1	H7	PY 21W	W5W	24 Volts	9618201839



Ref.	Fecha-Date							OE	Caract.
9705013	2012-	▶						A0035441003	T. RUBBLITE

## MERCEDES ATEGO



Ref.	Fecha-Date								OE
9821272	1997-04	▶			H4	W5W			9738200161
9822272	1997-04	▶			H4	W5W			9738200261
9841272	1997-04	▶			MOTOR	H4	W5W		9738200561
9842272	1997-04	▶			MOTOR	H4	W5W		9738200661
9831272	1997-04	▶			H1	H4	W5W		9738200561
9832272	1997-04	▶			H1	H4	W5W		9738200661
9851272	1997-04	▶			MOTOR	H1	H4	W5W	
9852272	1997-04	▶			MOTOR	H1	H4	W5W	



Ref.	Fecha-Date					OE
9711272	1997-04	◀			P21W	9738200121
9712272	1997-04	▶			P21W	9738200221



Ref.	Fecha-Date					OE
9611272	1997-04	◀			P21W 24 Volts	9738200321
9612272	1997-04	▶			P21W 24 Volts	9738200421



Ref.	Fecha-Date					OE	Caract.	
9753009	1997-04	◀			R5 W4 24 Volts	P21 W4	0035445303; 15406270	464MM
9754009	1997-04	▶			R5 W3 24 Volts	P21 W4	0025445403; 0035445703; 15406370	464MM
9755009	1997-04	◀			P21 W4 R5 W4 24 Volts		0035445603; 0035445303; 25440790; 25441290;	464MM
9756009	1997-04	▶			P21 W4 R5 W3 24 Volts		A0025449803 0025445403; 0035445703; 25440690; 25441691; A0025449703	464MM



Ref.	Fecha-Date					OE	Caract.	
9797009	1997-04	◀▶					25441390	464MM



Ref.	Fecha-Date									OE
9845019	2004-					H1	H7	H1	W5W	9738202661
		24 Volts								
9846019	2004-					H1	H7	H1	W5W	9738202761
		24 Volts								



Ref.	Fecha-Date				OE
9825019	2004-				
9826019	2004-				



Ref.	Fecha-Date									OE
9611272	2004-					P21W	24 Volts			9738200321
9612272	2004-					P21W	24 Volts			9738200421



Ref.	Fecha-Date									OE
9611019	2004-12					PY 21W	24 Volts			9738200521
9612019	2004-12					PY 21W	24 Volts			9738200621



Ref.	Fecha-Date									OE
9701019	2004-12				R10W	R5W	P21 W4			0025446803; 0025447003
9702019	2004-12				R10W	R5W	P21 W4			0025446903; 0025447103

**NEW**



Ref.	Fecha-Date			
9703019	2004-12	◀▶		

**NEW**



Ref.	Fecha-Date				OE	Caract.
9631019	2013-	▶				A9678200121 T. FARBA
9632019	2013-	▶				A9678200221 T. FARBA

**NEW**



Ref.	Fecha-Date				OE	Caract.
9651019	2013-	▶				A9678201121 T. ZKW
9652019	2013-	▶				A9678201221 T. ZKW

**NEW**



Ref.	Fecha-Date				OE	Caract.
9705013	2013-	▶				A0035441003 T. RUBBLITE

# MERCEDES AXOR



**NEW**



Ref.	Fecha-Date		OE
9845013	1996-02	◀ H3	A0028208456
9846013	1996-02	▶ H3	A0028208556



Ref.	Fecha-Date		OE
9851013	1996-02	◀ W5W 24 Volts H1 H4	9418205761
9852013	1996-02	▶ W5W 24 Volts H1 H4	9418206261; 9418204461; 9418205861



Ref.	Fecha-Date		OE
9855013	1996-02	◀ H4 P21W W5W	301081119; 9418205361; 9418202961
9856013	1996-02	▶ H4 P21W W5W	301081114; 9418205461; 9418203061

**NEW**



Ref.	Fecha-Date		OE
9811013	1996-02	◀ H3	
9812013	1996-02	▶ H3	
9829013	1996-02	◀ H4	
9830013	1996-02	▶ H4	



Ref.	Fecha-Date		OE	Caract.
9601273	1996-02		A0028208656; 28205656	T.ZKW
9602273	1996-02		A0028208756; 28205756	T.ZKW

NEW



Ref.	Fecha-Date		OE	Caract.
9709013	1996-02		A0015406270	CONECTOR LATERAL
9710013	1996-02		A0015406370	CONECTOR LATERAL



Ref.	Fecha-Date		OE
9711013	1996-02		0025444790; 0025441390; 0025441290
9712013	1996-02		0025444790; 0025441290; 0025441390



Ref.	Fecha-Date		OE
9821013	2004-		9408200161
9822013	2004-		9408200261
9871013	2004-		9408200161; 9408200361
9872013	2004-		9408200261; 9408200461



Ref.	Fecha-Date		OE
9825013	2004-		9408200161; A9408200961
9826013	2004-		9408200261; A9408201061

**NEW**



Ref.	Fecha-Date			
9805013	2004-	◀		
9806013	2004-	▶		



Ref.	Fecha-Date							OE
9601013	2004-	◀						9408200056
9602013	2004-	▶						9408200156



Ref.	Fecha-Date						OE
9631013	2004-	◀					9408200321
9632013	2004-	▶					9408200421



Ref.	Fecha-Date						OE	
9703013	2004-	◀▶						5445411



Ref.	Fecha-Date						OE	
9833013	2004-	◀▶						9408200777; 9418200221



## MERCEDES ECONIC



Ref.	Fecha-Date							OE
9606013	2008-						A005447806	



Ref.	Fecha-Date						OE
9711272	2008-					9738200121	
9712272	2008-					9738200221	

## MERCEDES SK



Ref.	Fecha-Date				OE
9711013	1987-				0025444790; 0025441390; 0025441290
9712013	1987-				0025444790; 0025441290; 0025441390

# MITSUBISHI CANTER



Ref.	Fecha-Date	Icons	OE	Caract.	Ø
9401005	2005-		84044000	355X173	19



Ref.	Fecha-Date	Icons	OE	Caract.
7403005	2005-		MK580133	330X155



Ref.	Fecha-Date	Icons	OE
9701004	1993-04		MC856559
9702004	1993-04		MC856557
9795004	1993-04		MC856557
9796004	1993-04		MC856559



Ref.	Fecha-Date		OE	Caract.
9801005	2005-	    	MK353636	T. KOITO
9802005	2005-	    	MK353635	T. KOITO
9841005	2005-	    	MK486505; MK548497; MK548498	T. KOITO
9842005	2005-	    	MK486506; MK548497; MK548498	T. KOITO
9845005	2005-	     		
9846006	2005-	     		



Ref.	Fecha-Date		OE	Caract.
9605005	2005-	   	MK427117; MK486509; MK548503	T. KOITO
9606005	2005-	   	MK4271118; MK486510; MK548501	T. KOITO



Ref.	Fecha-Date			
9711005	2005-	    		
9712005	2005-	    		
9721005	2005-	    		
9722005	2005-	    		



Ref.	Fecha-Date		OE	Caract.
9793005	2005-	  	A0035444790; MK485413	485x124x85

## MITSUBISHI FUSO CANTER



Ref.	Fecha-Date						OE
9841026	2012-	◀			H4	W5W	MK581216
9842026	2012-	▶			H4	W5W	MK581215



Ref.	Fecha-Date						OE
9611026	2012-	◀			H3		MK580561
9612026	2012-	▶			H3		MK580562



Ref.	Fecha-Date						OE
9601026	2012-	◀				P21W	MK581219
9602026	2012-	▶				P21W	MK581220

## NISSAN ATLEON



Ref.	Fecha-Date	Class	Hand	1200	24 Volts	OE	Caract.
7401545	2000-	II	Hand	1200	24 Volts	93193201	395X195
7439545	2000-	II	Hand	1200	24 Volts	93190985	395X195



Ref.	Fecha-Date	Class	Hand	300	24 Volts	OE	Caract.
7453545	2000-	IV	Hand	300	24 Volts	963659X026	265 X 205
7473545	2000-	IV	Hand	300	24 Volts	963659X126	265 X 205

## NISSAN CABSTAR



Ref.	Fecha-Date	Class	Hand	1200	ABS	24 Volts	Caract.	Ø
9401544	1992-	II	Hand	1200	ABS	24 Volts	310X200	18
9403544	1992-	II	Hand	1200	ABS	24 Volts	310X200	18



Ref.	Fecha-Date						Caract.
7401544	1992-						295X175

**NISSAN ATLEON / CABSTAR**



Ref.	Fecha-Date						OE	Caract.
9703016	1992-						265559X126	CONECTOR 152MM
9704016	1992-						265559X125	CONECTOR 152MM



Ref.	Fecha-Date						OE	Caract.
9709016	1992-						1401713	152MM
9710016	1992-						1401731	152MM



Ref.	Fecha-Date				OE	Caract.
9723016	1992-					350 x 131 x 85

## NISSAN CABSTAR



Ref.	Fecha-Date						OE
9861016	2006-	◀					26060MB400; 26060MB41A
9862016	2006-	▶					26010MB400; 26010MB41A



Ref.	Fecha-Date					
9865016	2006-	◀				
9866016	2006-	▶				

## RENAULT MAGNUM



Ref.	Fecha-Date						OE	Caract.	
9475281	1992-	◀						5001838474	482X205
9476281	1992-	◀						5001838474	482X205
9477281	1992-	◀						5001873670	482X205
9478281	1992-	▶						5001842202; 5001873671; 5010646156	482X205



Ref.	Fecha-Date	OE	Caract.
7475281	1992-	5000289377; 5001873674	460X183



Ref.	Fecha-Date	OE	Caract.
9471281	1992-	5000296871; 5001873672; 5001873673	215X240



Ref.	Fecha-Date	OE	Caract.
7421142	1992-		154x203
7423142	1992-		154x203



Ref.	Fecha-Date	OE	Caract.
9443281	1992-	5000939145; 5001646159	215X310



# RENAULT MIDLINER/MIDLUM /PREMIUM



Ref.	Fecha-Date	OE	Caract.	Ø
9475282	1983-05	5001853675	395X205	22
9476282	1983-05		395X205	22
9477282	1983-05	5001856290	395X205	22



Ref.	Fecha-Date	OE	Caract.
7472282	1983-05	5000295475	382x193
7473282	1983-05		382x193



Ref.	Fecha-Date	OE	Caract.	Ø
9421141	1983-05	5001853673	199x199	22
9423141	1983-05	7421276373	199x199	22



Ref.	Fecha-Date	OE	Caract.
7421141	1983-05	5001853332; 5001832947	191x191
7423141	1983-05		191x191

RENAULT V.I./I.V./LKW

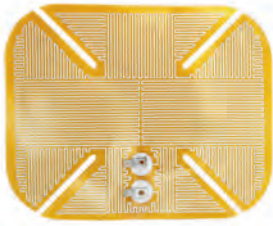

Ref.	Fecha-Date	Caract.
7323140	1983-05	138x173



Ref.	Fecha-Date	OE	Caract.	Ø
9470282	1983-05	5000296397	170x290	22
9471282	1983-05		170x290	22



Ref.	Fecha-Date	Caract.
7470282	1983-05	156x255



Ref.	Fecha-Date	OE	Caract.	Ø
9441141	2006-	5010623225	880x340X155	28
9443141	2006-	5010623226	880x340X155	28
9445141	2006-	5010623231	880x340X155 C.IV MANUAL	28
9446141	2006-	5010623232; 7421326527	880x340X155 C.IV MANUAL	28



Ref.	Fecha-Date	OE	Caract.
9411141	2006-	5010623225; 7420812551	880x340X155
9412141	2006-	5010623226; 7420812555	880x340X155
9461141	2006-	5010578503; 5010623689	880x340X155 C.IV MANUAL
9462141	2006-	5010578504; 5010623690; 7421326558; 7421326550	880x340X155 C.IV MANUAL



Ref.	Fecha-Date	OE	Caract.	Ø
9451141	2006-	5010623240	880x440X155	28
9452141	2006-	5010623241	880x440X155	28
9455141	2006-	5010623246	880x340X155 C.IV MANUAL	28
9456141	2006-	5010623247; 7421326526	880x340X155 C.IV MANUAL	28



Ref.	Fecha-Date	OE	Caract.
9425141	2006-	5010623240; 7420812581	880x440X155
9426141	2006-	5010623241; 7420812580	880x440X155
9465141	2006-	5010623697	880x340X155 C.IV MANUAL
9466141	2006-	7421326554; 5010623698	880x340X155 C.IV MANUAL



Ref.	Fecha-Date	OE	Caract.
9493282	2006-	7420903723	800X350X28
9494282	2006-	7420903724	800X350X28



Ref.	Fecha-Date	OE	Caract.	Ø
9403282	2006-	7420862782	370x245	28
9406282	2006-	7420862795; 7420866665; 7420903881; 7420913815	370x245	28



Ref.	Fecha-Date	OE	Caract.
7303282	2006-	7420862779	370x245



Ref.	Fecha-Date	OE	Caract.
7403282	2006-	7420862795	337x202



Ref.	Fecha-Date	OE	Caract.	Ø
9411282	2006-	7420862809	230x245	28
9412282	2006-	7420862813	230x245	28
9421282	2006-	7420862809	230x245	28
9422282	2006-	7420862813	230x245	28
7306282	2006-	7420862800	225X244	

**NEW**



Ref.	Fecha-Date		OE	Caract.
9431282	2006-			230X245
9432282	2006-			230X245
9451282	2006-			230X245
9452282	2006-			230X245
7313282	2006-		7420903736	244X225X75



Ref.	Fecha-Date		OE	Caract.
7431141	2006-		7420862810	197x200
7432141	2006-		7420862815	197x200



Ref.	Fecha-Date		OE	Caract.
9442141	2006-		5010578511	228x260



Ref.	Fecha-Date		Caract.
7413282	2006-		152x260

**RENAULT V.I./I.V./LKW**



Ref.	Fecha-Date								Caract.
9456144	2006-								187x319



Ref.	Fecha-Date								Caract.
9453144	2006-								725X126X319



Ref.	Fecha-Date								OE	Caract.
9402282	2006-							7420849835; 7421595513; 7482226027	437X319X103	
9404282	2006-								437X319X103	



Ref.	Fecha-Date					
7330144	2006-					



Ref.	Fecha-Date						
7433144	2006-						

**NEW**



Ref.	Fecha-Date	Icons				
9480144	2006-	▶	VI Class	▶	PP	▶

**RENAULT PREMIUM ROUTE 2711**



Ref.	Fecha-Date	Icons							OE	Caract.
9441282	2005-	▶	II Class	IV Class	▶	▶	▶	▶	5010578503	880x340X155 C.IV MANUAL
9442282	2005-	▶	II Class	IV Class	▶	▶	▶	▶	5010578504; 7421326550	880x340X155 C.IV MANUAL
9445282	2005-	▶	II Class	IV Class	▶	▶	▶	▶	5010578503	880x340X155 C.IV MANUAL
9446282	2005-	▶	II Class	IV Class	▶	▶	▶	▶	5010578506; 7421326550	880x340X155 C.IV MANUAL



Ref.	Fecha-Date	Icons							OE	Caract.	Ø
9403282	2005-	▶	II Class	▶	▶	▶	▶	▶	7420862782	370x245	28
9406282	2005-	▶	II Class	▶	▶	▶	▶	▶	7420862795; 7420866665; 7420903881; 7420913815	370x245	28



Ref.	Fecha-Date	Icons				OE	Caract.
7303282	2005-	▶	II Class	▶	▶	7420862779	370x245

**RENAULT V.I./I.V./LKW**



Ref.	Fecha-Date	OE	Caract.
7403282	2005-	7420862795	337x202



Ref.	Fecha-Date	OE	Caract.	Ø
9471283	2005-	7420862809	300X230	28
9472283	2005-	7420862813	300X230	28
9477283	2005-	7420904268	300X230	28
9478283	2005-	7420904269	300X230	28

NEW



Ref.	Fecha-Date	Caract.
9431282	2005-	230X245
9432282	2005-	230X245
9451282	2005-	230X245
9452282	2005-	230X245



Ref.	Fecha-Date	OE	Caract.
7311282	2005-	7420903882	303x244
7312282	2005-	7420903883	303x244



**NEW**



Ref.	Fecha-Date					OE	Caract.
7313282	2005-					7420903736	244X225X75



Ref.	Fecha-Date						OE	Caract.
7441283	2005-						1736879; 7420903745	203x189
7442283	2005-						1736865; 7420903746	203x189



Ref.	Fecha-Date						OE	Caract.
9442141	2005-						5010578511	228x260



Ref.	Fecha-Date					Caract.
7413282	2005-					152x260



Ref.	Fecha-Date						Caract.
9456144	2005-						187x319



Ref.	Fecha-Date							Caract.
9453144	2005-							725X126X319



Ref.	Fecha-Date							OE	Caract.
9402282	2005-						7420849835; 7421595513; 7482226027	437X319X103	
9404282	2005-							437X319X103	



Ref.	Fecha-Date					
7330144	2005-					



Ref.	Fecha-Date						
7433144	2005-						



Ref.	Fecha-Date					
9480144	2005-					

## RENAULT UNIVERSAL



Ref.	Fecha-Date	OE	Caract.	Ø
9470280			421X220	18
9471280		5000296871	421X220	18

## RENAULT D-SERIE



**NEW**



Ref.	Fecha-Date	OE
9701279	2013-	7420862038
9702279	2013-	7420862041

## RENAULT MAGNUM



Ref.	Fecha-Date	OE
9841755	2001-	5010623620
9842755	2001-	5010623619



Ref.	Fecha-Date	OE
2903750	2001-     	5010312972















Ref.	Fecha-Date	OE
9603750	2001-     	5010271807



Ref.	Fecha-Date	OE
3103970	2001-     	500308514 ; 5010306792

**RENAULT MASCOTT**



Ref.	Fecha-Date	OE	Caract.
9703016	1999-10      	7420862035	CONECTOR 152MM
9704016	1999-10      	7420862035	CONECTOR 152MM



Ref.	Fecha-Date							Caract.
9709016	1999-10	◀					P21 W4 R10 W2 24 Volts	152MM
9710016	1999-10	▶					P21 W4 R10 W2 24 Volts	152MM



Ref.	Fecha-Date		OE	Caract.
9723016	1999-10	◀▶	5001847153; 5010392231	350 x 131 x 85

## RENAULT MAXITY



Ref.	Fecha-Date		OE
9865016	2007-	◀	5001872439
9866016	2007-	▶	5001872437



Ref.	Fecha-Date		OE	Caract.
9703016	2007-	◀	7420862035	CONECTOR 152MM
9704016	2007-	▶	7420862035	CONECTOR 152MM



Ref.	Fecha-Date									Caract.
9709016	2007-									152MM
9710016	2007-									152MM



Ref.	Fecha-Date			OE	Caract.
9723016	2007-			5001847153; 5010392231	350 x 131 x 85

RENAULT MIDLINER / MIDLUM / PREMIUM



Ref.	Fecha-Date									OE
9841750	1983-05									5010468976; 5010468980; 5010089181
9842750	1983-05									5010468977; 5010468981; 5010089180



Ref.	Fecha-Date									OE
9801750	1983-05									5010231860; 5010086974; 5010379325
9802750	1983-05									5010231861; 5010379321; 5010379324
9841016	1983-05									5010231860; 5010231669
9842016	1983-05									5010231861; 5010379321; 5010231670



Ref.	Fecha-Date		OE	Caract.
9801016	1996-05		5010468976; 5010468980	PREMIUM
9802016	1996-05		5010468977; 5010468981	PREMIUM



Ref.	Fecha-Date		OE	Caract.
9611016	1996-05		5010231849	PREMIUM
9612016	1996-05		5010231850	PREMIUM



Ref.	Fecha-Date		OE
9601016	1983-05		5001834560
9602016	1983-05		5001834559



Ref.	Fecha-Date		OE
3103970	1983-05		500308514 ; 5010306792



Ref.	Fecha-Date		OE
9607016	1983-05		5001834565



Ref.	Fecha-Date	OE	Caract.
9703016	1983-05	7420862035	CONECTOR 152MM
9704016	1983-05	7420862035	CONECTOR 152MM



Ref.	Fecha-Date	OE	Caract.
9709016	1983-05		152MM
9710016	1983-05		152MM



Ref.	Fecha-Date	OE	Caract.
9723016	1983-05	5001847153; 5010392231	350 x 131 x 85



Ref.	Fecha-Date	OE	Caract.
9741016	1996-	5001847886	PREMIUM
9742016	1996-	5010847583; 5001847887	PREMIUM



# RENAULT PREMIUM



Ref.	Fecha-Date											OE			
9701024	1996-													P21 W4	5010847582; 5001847584; 5001864535
9702024	1996-													P21 W4	5001847585; 5001864536



Ref.	Fecha-Date											OE				
9815024	2006-													H1 H7	7482588678	
9816024	2006-													H1 H7	7482588692	
9841024	2006-													H1 H3 H7	5010578451; 5010578476; 5010578452; 7421636295	
9842024	2006-													H1 H3 H7	5010578452; 5010578475; 5010578476	



Ref.	Fecha-Date											OE				
9801024	2006-													H1 H3 D2S	5010578476; 5010578451; 7421636295	
9802024	2006-													H1 H3 D2S	5010578452; 5010578475	
9831024	2006-													H1 H7	5010578453	
9832024	2006-													H1 H7	5010578477	
9851024	2006-													H1 H3 H7	5010578452	
9852024	2006-													H1 H3 H7	5010578476	

**NEW**



Ref.	Fecha-Date											OE
9821024	2006-	▲	24 Volts	▲	▲	▲	▲	▲	H1	H7	PY 21W	5010578442
9822024	2006-	▲	24 Volts	▲	▲	▲	▲	▲	H1	H7	PY 21W	5010578466
9845024	2006-	▲	▲	▲	▲	▲	▲	▲	H1	H3		5010578452
9846024	2006-	▲	▲	▲	▲	▲	▲	▲	H1	H3		5010578451; 5010578476; 7421636295



Ref.	Fecha-Date											OE	
9811024	2006-	▲	24 Volts	▲	▲	▲	▲	▲	H1	H7	PY 21W	W5W	5010578454
9812024	2006-	▲	▲	▲	▲	▲	▲	▲	H1	H7	PY 21W	W5W	5010578478
9861024	2006-	▲	▲	▲	▲	▲	▲	▲	H1	H3	H7		5010578460
9862024	2006-	▲	▲	▲	▲	▲	▲	▲	H1	H3	H7		5010578484



Ref.	Fecha-Date											OE
3103970	2006-	▲	▲	▲	▲	▲	▲	▲	W5W	▲		500308514 ; 5010306792



Ref.	Fecha-Date											OE
9607016	2006-	▲	▲	▲	▲	▲	▲	▲	RSW	▲		5001834565

**RENAULT V.I./I.V./LKW**

## RENAULT T-SERIE



**NEW**



Ref.	Fecha-Date						OE
9871016	2013-	◀					748262242
9872016	2013-	▶					748262240

## RENAULT UNIVERSAL



Ref.	Fecha-Date									
9739009		◀								
		24 Volts								
9740009		▶								
		24 Volts								



Ref.	Fecha-Date						Caract.
9727009		◀					CONNECT.REN/TGA/DAF /466x130x85
9728009		▶					CONNECT.REN/TGA/DAF /466x130x85

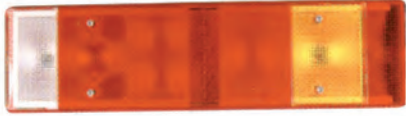

Ref.	Fecha-Date		Caract.
9793009			466X130X85

## SCANIA 93/113/143



Ref.	Fecha-Date		OE	Caract.	Ø
9470100	1981-96		1106950; 1106953; ; 316623	426X231	22
9471100	1981-96		1106955; 316624; 356495; 367624	426X231	22



Ref.	Fecha-Date		OE	Caract.
7470100	1981-96		296538	417X221
7471100	1981-96		376243; 296538	417X221



Ref.	Fecha-Date		OE	Caract.
7371275	1981-96		8211129	385x165



Ref.	Fecha-Date	OE	Caract.
7421100	1981-96	316918	150X253
7423100	1981-96		150X253

## SCANIA 94/124/144



Ref.	Fecha-Date	OE	Caract.
9405001	1996-07	1765808	650X290
9426001	1996-07	1765808+1723519	650X290
9406001	1996-07	1765813	650X290
9443102	1996-07	1765809+1723518	650X290



Ref.	Fecha-Date	OE	Caract.
9452001	1996-07		650X290
9455001	1996-07	1723519; 1765808	650X290
9427001	1996-07	1765812	650X290



Ref.	Fecha-Date	OE	Caract.
9404001	1996-07	1723518	530x340
9425001	1996-07	1723518	530x340
9407001	1996-07	1765811	530x340
9428001	1996-07	1765814	530x340



Ref.	Fecha-Date	OE	Caract.
9451001	1996-07	1406628; 1406633	530x340
9454001	1996-07	1732776	460X270



Ref.	Fecha-Date	OE	Caract.
7403001	1996-07	1745369; 1749684; 1765985	440 X 210



Ref.	Fecha-Date	OE	Caract.
7475102	1996-07	1346377	440X210
7476102	1996-07	1346378	440X210



Ref.	Fecha-Date								Caract.
9404102	1996-07	◀	IV Class				ABS		195X270
9405102	1996-07	▶	IV Class				ABS		195X270



Ref.	Fecha-Date						OE	Caract.
7421001	1996-07	◀	IV Class			300	1346379; 1767265	160X184
7423001	1996-07	◀	IV Class			300	1346379; 1767265	160X184



Ref.	Fecha-Date							Caract.
7465102	1996-07	◀	IV Class			300		160X184
7466102	1996-07	◀	IV Class			300		160X184



Ref.	Fecha-Date							Caract.
9441142	1996-07	◀	V Class			300	ABS	229x260



Ref.	Fecha-Date							
9421001	1996-07	▶	V Class			300	ABS	

**NEW**



Ref.	Fecha-Date	Icons: V Class, Hand, 300, ABS, etc.						
9411001	1996-07	▶ V Class, Hand, 300, ABS, etc.						

## SCANIA 4/R/P/T



Ref.	Fecha-Date	Icons: 1200, 300, ABS, 24 Volts, etc.							OE	Caract.
9461001	2007-	▶ 1200, 300, ABS, 24 Volts, etc.							1765809+1723518	650X290
9462001	2007-	▶ 1200, 300, ABS, 24 Volts, etc.							1723519+1765808	650X290
9465001	2007-	▶ 1200, 300, ABS, 24 Volts, etc.								650X290
9466001	2007-	▶ 1200, 300, ABS, 24 Volts, etc.								650X290



Ref.	Fecha-Date	Icons: 1200, 300, ABS, 24 Volts, etc.							Caract.
9471001	2007-	▶ 1200, 300, ABS, 24 Volts, etc.							650X290
9472001	2007-	▶ 1200, 300, ABS, 24 Volts, etc.							650X290
9475001	2007-	▶ 1200, 300, ABS, 24 Volts, etc.							650X290
9476001	2007-	▶ 1200, 300, ABS, 24 Volts, etc.							650X290





Ref.	Fecha-Date	OE	Caract.
9481001	2007-	1346381; 1732782; 1765809	190X250
9482001	2007-	1346382; 1732783; 1765808	190X250



Ref.	Fecha-Date	OE	Caract.
7301001	2007-		
7302001	2007-		



Ref.	Fecha-Date	OE	Caract.
7433001	2007-	1767265	160X184



Ref.	Fecha-Date	OE	Caract.
9422001	2007-	1484076; 1757155	319X187
9424001	2007-		319X187

# SCANIA112



Ref.	Fecha-Date								OE
9721100	1980-88	◀							1365963
9722100	1980-88	▶							1365964



Ref.	Fecha-Date								OE	Caract.
9731016	1980-88	◀							5001847582	T.VAL
			P21 W4	R5 W4	24 Volts					
9732016	1980-88	▶							5001847583	T.VAL
			P21 W4	R5 W3	24 Volts					



Ref.	Fecha-Date							OE	Caract.
9793009	1980-88	◀▶						1272653	466X130X85

## SCANIA 93/113/143



Ref.	Fecha-Date		OE
9721100	1988-96	◀ [Icons]	1365963
9722100	1988-96	▶ [Icons]	1365964



Ref.	Fecha-Date		OE	Caract.
9731016	1988-96	◀ [Icons] P21 W4 R5 W4 24 Volts	5001847582	T.VAL
9732016	1988-96	▶ [Icons] P21 W4 R5 W3 24 Volts	5001847583	T.VAL



Ref.	Fecha-Date		OE	Caract.
9793009	1988-96	◀▶ [Icons]	1272653	466X130X85

## SCANIA 94/124/144



Ref.	Fecha-Date		OE
2705100	1996-04	◀ [Icons] H4	144434021; 1446587; 1EG00715009
2706100	1996-04	▶ [Icons] H4	144433021; 1446588; 1EG007150101

**NEW**



Ref.	Fecha-Date			
9801100	1996-04	◀		
9802100	1996-04	▶		



Ref.	Fecha-Date					OE	
9841101	1996-04	◀					144434021+1385410; 1467000; 1732509
9842101	1996-04	▶					144433021+1387155; 1467003; 1732510



Ref.	Fecha-Date					OE	
9821101	1996-04	◀					1E6007150101
9822101	1996-04	▶					1E6007150091



Ref.	Fecha-Date						OE	
9621101	1996-04	◀						1358831; 1422991; 1529070
9622101	1996-04	▶						1358832; 1422992; 1529071



Ref.	Fecha-Date						OE	
9601101	1996-04	◀						1385410; 1524093
9602101	1996-04	▶						1337250; 1387155



Ref.	Fecha-Date						OE
9603101	1996-04	◀▶			<b>LED</b>		1471599



Ref.	Fecha-Date						OE
9606101	1996-04	◀▶			<b>R5W</b>	<b>24 Volts</b>	1362707; 1363578



Ref.	Fecha-Date						OE	Caract.
9711003	1996-04	◀▶					1371974; 1371976; 1371978; 1371980; 1387877; 1414366; 1414368; 1436867; 1504608	152MM
9712003	1996-04	▶					1371975; 1371977; 1371979; 1371981; 1387878; 1414367; 1414369; 1436868; 1504609	152MM
9717003	1996-04	◀▶					1436867	152MM
9718003	1996-04	▶					1436868	152MM
9793003	1996-04	◀▶					1380819	

## SCANIA 4/R/P/T



Ref.	Fecha-Date						OE
2705100	2004-12	◀▶			<b>H4</b>		144434021; 1446587; 1EG00715009
2706100	2004-12	▶			<b>H4</b>		144433021; 1446588; 1EG007150101



Ref.	Fecha-Date							OE
9801019	2004-12	◀				INT	H1	1446353; 1852569
9802019	2004-12	▶				INT	H1	1446354; 1852570



Ref.	Fecha-Date							OE
9601019	2004-12	◀				EXT	H1	1446355; 1511542; 1852572
9602019	2004-12	▶				EXT	H1	1446356; 1511543; 1852573



Ref.	Fecha-Date							OE	
9641019	2004-12	◀			H7	D2R	T4W	24 Volts	1760551
9642019	2004-12	▶			H7	D2R	T4W	24 Volts	1760554; 1892324



Ref.	Fecha-Date							OE
9603100	2004-12	◀▶			LED			1798980; 1910437

**NEW**



Ref.	Fecha-Date						OE
9643101	2004-12	◀▶		LED			1941323



Ref.	Fecha-Date								OE
9623101	2004-12					1.4 Watts	24 Volts		1362707; 1737413



Ref.	Fecha-Date								OE
9613101	2004-12					P21W	24 Volts		1747981



Ref.	Fecha-Date								OE	Caract.
9717003	2004-12								1436867	152MM
9718003	2004-12								1436868	152MM



Ref.	Fecha-Date				
9721003	2004-12				
9722003	2004-12				



Ref.	Fecha-Date								OE
9633101	2007-13					P21W	24 Volts		1770301



Ref.	Fecha-Date						OE
9611101	2009-13	◀					1931613
9612101	2009-13	▶					1931614



Ref.	Fecha-Date						OE	Caract.
9811019	2014-	◀			H7	H1	1949906	T.ZKW
9812019	2014-	▶			H7	H1	1949908	T.ZKW



Ref.	Fecha-Date						OE
9815019	2014-	◀		LED		H1 H7	2241826
9816019	2014-	▶		LED		H1 H7	2241827



Ref.	Fecha-Date						OE	Caract.
9821019	2014-	◀		LED		H7 D1R	1949890	T.ZKW
9822019	2014-	▶		LED		H7 D1R	1949894	T.ZKW



Ref.	Fecha-Date						OE
9851019	2014-	◀		LED		H1 H7	
9852019	2014-	▶		LED		H1 H7	2241829



**NEW**



Ref.	Fecha-Date		OE
9831019	2014-	◀ [Truck] [Headlight]	1549814
9832019	2014-	▶ [Truck] [Headlight]	1549815

**NEW**



Ref.	Fecha-Date		OE
9603019	2014-	◀▶ [Truck] [LED] [H21W]	2241544

**NEW**



Ref.	Fecha-Date		OE	Caract.
9741019	2014-	◀ [Truck] [Headlight]	2241860; 2380955	CONECTOR LATERAL
9742019	2014-	▶ [Truck] [Headlight]	2241859	CONECTOR LATERAL

## SCANIA UNIVERSAL



Ref.	Fecha-Date		OE
9611101		◀ [Truck] [LED] [H21W]	1931613
9612101		▶ [Truck] [LED] [H21W]	1931614

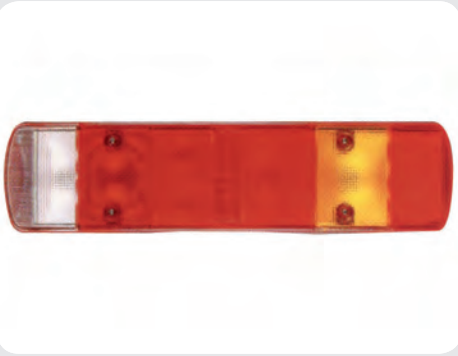

Ref.	Fecha-Date	OE
9793003		1380819

**NEW**



Ref.	Fecha-Date	OE
9741100		

## VOLVO F7/F10/F12



Ref.	Fecha-Date	OE	Caract.	Ø
9470285	1977-85		1581550; 2601417	375x183 14-20
9471285	1977-86		1581616; 1594411; 1594412	375x183 14-20



Ref.	Fecha-Date	OE	Caract.
7401261	1977-87		1581599 366X176
7403261	1977-88		1581602; 1594415 366X176

## VOLVO FL4/FL6



Ref.	Fecha-Date	Class	PP	ABS	1800	24 Volts	OE	Caract.	Ø
9470151	1985-93	Class	PP	ABS	1800		6793879	370X182	18
9473151	1985-93	Class	PP	ABS	1800	24 Volts	6794880	370X182	18



Ref.	Fecha-Date	Class	PP	ABS	1800 <th>OE</th> <th>Caract.</th>	OE	Caract.
7470151	1985-93	Class	PP	ABS	1800	1697926	356X170

## VOLVO FL4/FL6/FL7/FL10/ F10/F12/F16



Ref.	Fecha-Date	Class	PP	ABS	1200	24 Volts	OE	Caract.
9483151	1985-94	Class	PP	ABS	1200		1599462; 3090395	444x208
9486151	1985-94	Class	PP	ABS	1200	24 Volts	1195934; 1594902; 1621353; 1621353; 3090396	444x208



Ref.	Fecha-Date	OE	Caract.
7470150	1985-94	1697007; 20854576	430x191
7473150	1985-94	1697008; 3093519	430x191

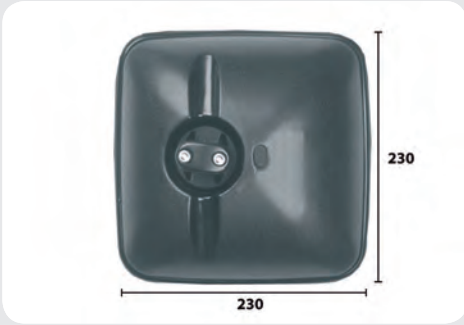

Ref.	Fecha-Date	OE	Caract.	Ø
9421150	1985-94	1618973; 20854621	230 X 230	16-22
9423150	1985-94	1618769; 1621354; 20854626	230 X 230	16-22



Ref.	Fecha-Date	OE	Caract.
7421150	1985-94	1697862; 1697984	213 X 213



Ref.	Fecha-Date	Caract.
7323150	1985-94	213 X 213

**VOLVO F/FL**



Ref.	Fecha-Date	OE	Caract.	Ø
9401140	1991-06	1232016	392x205	16-22
9403140	1991-06	1232017	392x205	16-22



Ref.	Fecha-Date	OE	Caract.
7413140	1991-06	1345552	374X190
7401140	1991-06	1279531; 0699956; 1589436	374X190
7403140	1991-06	0589435; 0699857; 1305462	374X190



Ref.	Fecha-Date	Caract.
7303140	1991-06	318x175



Ref.	Fecha-Date	OE	Caract.	Ø
9421140	1991-06	1232014	173x218	16-22



Ref.	Fecha-Date	OE	Caract.
7421140	1991-06	0589438; 0699853	156X190
7423140	1991-06	0589437; 0699854	156X190



Ref.	Fecha-Date	Caract.
7323140	1991-06	138x173



Ref.	Fecha-Date	Caract.						
9441142	1991-06							229x260

**VOLVO FE/FL**



Ref.	Fecha-Date	OE							Caract.	Ø
9441141	2006-							20903722; 20207881; 20707881	880x340X155	28
9443141	2006-							20217883; 21326527	880x340X155	28
9445141	2006-							20903722; 20207881; 20707881	880x340X155 C.IV MANUAL	28
9446141	2006-							20217883; 21326527	880x340X155 C.IV MANUAL	28



Ref.	Fecha-Date	OE							Caract.	Ø
9451141	2006-							20707874	880x440X155	28
9452141	2006-							20708303; 21326526; 21475603	880x440X155	28
9455141	2006-							20707874	880x340X155 C.IV MANUAL	28
9456141	2006-							21326526; 20708303; 21475603	880x340X155 C.IV MANUAL	28



Ref.	Fecha-Date	OE	Caract.	Ø
9413141	2006-	85120820	370X245	28
9416141	2006-	20866665	370X245	28



Ref.	Fecha-Date	OE	Caract.
7301141	2006-	20862779	370X247X80



Ref.	Fecha-Date	OE	Caract.
7413141	2006-	20862795	337X202



Ref.	Fecha-Date	OE	Caract.	Ø
9431141	2006-	20862809	230X245	28
9432141	2006-	20862813	230X245	28
7306141	2006-	20862800		



Ref.	Fecha-Date	OE	Caract.
7431141	2006-	20862810	197x200
7432141	2006-	20872815	197x200



Ref.	Fecha-Date	OE	Caract.
9442141	2006-	20707812	228x260



Ref.	Fecha-Date	Caract.
7413282	2006-	152x260



Ref.	Fecha-Date	OE	Caract.
9456144	2006-	1484076; 1746678; 7421020285	187x319
9459144	2006-		187x319



Ref.	Fecha-Date	Caract.
9453144	2006-	725X126X319
9460144	2006-	725x126x319



Ref.	Fecha-Date	Caract.
7330144	2006-	



**NEW**



Ref.	Fecha-Date						
7430144	2006-	▶	VI Class	☐	300	👤	🚚
7433144	2006-	▶	VI Class	☐	300	👤	🚚

**NEW**



Ref.	Fecha-Date						
9480144	2006-	▶	VI Class	👤	PP	🚚	

**VOLVO FH / FM**



Ref.	Fecha-Date						OE	Caract.
9401285	1993-02	▶	II Class	☐	👤	1200	ABS	3091256 469 X 249
9403285	1993-02	▶	II Class	☐	👤	24 Volts	👤	3980924; 3980932 469 X 249
9413285	1993-02	▶	II Class	☐	👤	24 Volts	👤	3980926; 3980935 469 X 249



Ref.	Fecha-Date							OE	Caract.
9406285	1993-02	▶	II Class	IV Class	☐	👤	👤	3091261; 3980924; 3980933 665 X 251	
9405285	1993-02	▶	II Class	IV Class	☐	👤	👤	3080935 665 X 251	

**VOLVO V.I./I.V./LKW**



Ref.	Fecha-Date	OE	Caract.
9493285	1993-02	3091258	665X251



Ref.	Fecha-Date	OE	Caract.
7473285	1993-02	20854555; 3090736	433X198
7474285	1993-02	20854564; 3090737; 3091756; 3092854	433X198



Ref.	Fecha-Date	OE	Caract.
7402285	1993-02	3090738	175X181
7465285	1993-02	21203311; 3090739; 3091757	175X181



Ref.	Fecha-Date	OE	Caract.
9441285	1993-02	21203313	174X284



Ref.	Fecha-Date	OE	Caract.
7441285	1993-02	3090734	162X272



Ref.	Fecha-Date	OE	Caract.
9490285	1993-02	3091750	240X250X45
9491285	1993-02	3091751	240X250X45

**VOLVO FH II/FM II**



Ref.	Fecha-Date	OE	Caract.
9427288	2002-07	20455982; 20567633	670x260
9428288	2002-07	20455981; 20567635	670x260



Ref.	Fecha-Date	OE	Caract.
9490287	2002-07		670x260
9491287	2002-07	20767635; 20841078	670x260
9496287	2002-07	20567637	670x260
9497287	2002-07	20567647	670x260



Ref.	Fecha-Date	OE	Caract.
9411288	2002-07		530X420
9441288	2002-07	20567651	530X420



Ref.	Fecha-Date		OE	Caract.
7394288	2002-07		20746401	250X190



Ref.	Fecha-Date		OE	Caract.
7393287	2002-07		20360810; 20746401	430X195



Ref.	Fecha-Date		OE	Caract.
7475288	2002-07			435X200
7401286	2002-07		20567670	435X200
7476288	2002-07		20455986; 20567670; 20589788; 21320383	435X200
7403286	2002-07		20455986; 20567670; 20589788; 21320383	435X200



Ref.	Fecha-Date		OE	Caract.
9462287	2002-07		21070768; 21070768+20360807; 20589819; 20841081	200X250
9463287	2002-07		20841078; 21070768; 21070768+20360806	200X250



Ref.	Fecha-Date		OE	Caract.
9402288	2002-07		20841081	200X250
9401288	2002-07		20841078	200X250



Ref.	Fecha-Date		OE	Caract.
7421286	2002-07		IV Class, 300,	1699016 170X188
7423286	2002-07	 24 Volts	IV Class, , 300	20360807; 21070768; 21320365 170X188



Ref.	Fecha-Date		OE	Caract.
7341287	2002-07		IV Class,	20589831 200X250



Ref.	Fecha-Date		OE	Caract.
7483287	2002-07		IV Class, , 300	21070768; 21320365 199x189



Ref.	Fecha-Date		OE	Caract.
9451287	2002-07		V Class, 300,	20716739 170X290
9452287	2002-07	 24 Volts	V Class, , 300	20716954; 20854644; 21203313 170X290

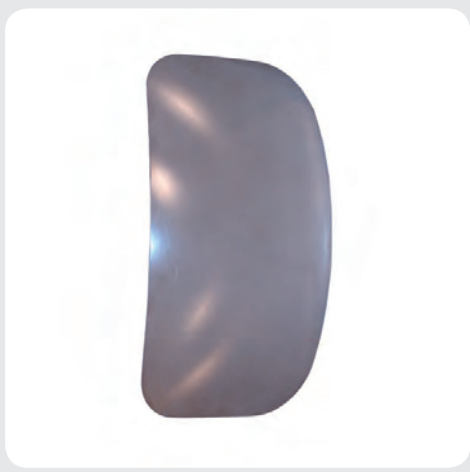

Ref.	Fecha-Date		OE	Caract.
7401287	2002-07		V Class, 300,	170X290
7403287	2002-07	 	V Class, , 300, 24 Volts	20854644; 21203313 170X290



Ref.	Fecha-Date											Caract.
9495287	2007-											670x260
9493287	2007-											670x260
9477287	2007-											670x260
9478287	2007-											670x260



Ref.	Fecha-Date											OE	Caract.
7493287	2007-											20455986; 20567670; 21320383	435x200



Ref.	Fecha-Date										
9481287	2002-07										
9482287	2002-07										



Ref.	Fecha-Date											OE	Caract.
9402287	2007-											20360807	200X250
9401287	2007-											20360806	200X250



Ref.	Fecha-Date											OE	Caract.
9451287	2007-											20716739	170X290
9452287	2007-											20716954; 20854644; 21203313	170X290



Ref.	Fecha-Date	OE	Caract.
7401287	2007-		170X290
7403287	2007-		20854644; 21203313 170X290

## VOLVO FH 16



Ref.	Fecha-Date	Caract.
9461287	2012-	1015,5X399
9464287	2012-	1015,5X399
9411287	2012-	1015,5X399 C.IV MANUAL
9412287	2012-	1015,5X399 C.IV MANUAL



Ref.	Fecha-Date	OE
7301287	2012-	82356808
7302287	2012-	82359213



Ref.	Fecha-Date	OE	Caract.
7406287	2012-	82356810	385,4X206,3

**NEW**



Ref.	Fecha-Date		OE
7303287	2012-	◀▶ IV Class ABS	82356819

**NEW**



Ref.	Fecha-Date		OE	Caract.
7409287	2012-	◀▶ IV Class 300	82356824	206,1X204,2

**NEW**



Ref.	Fecha-Date		OE
9421287	2012-	▶◀ ABS	82356797
9422287	2012-	▶◀ ABS	82359208

**NEW**



Ref.	Fecha-Date		OE
9431287	2012-	▶ V Class 300 ABS	84004929

**NEW**



Ref.	Fecha-Date		OE
7431287	2012-	◀▶ V Class 300	21578244



**NEW**



Ref.	Fecha-Date							OE
9441287	2012-	▶	VI Class	Hand	300	ABS	Truck	84004927

**NEW**



Ref.	Fecha-Date						OE
7441287	2012-	◀▶	VI Class	300	Truck	Truck	21578293

## VOLVO FMX



Ref.	Fecha-Date						OE	Caract.	Ø
9476261	2010-	◀▶	II Class	Hand	1200	ABS		426x200	22
9479261	2010-	◀▶	II Class	Hand	24 Volts	Truck	82417041; 82417042; 82471688; 82471690; 82472612	426x200	22
9480263	2010-	◀▶	II Class	Hand	24 Volts	Truck	82417041; 82417042; 82471688; 82472612	426x200	22



Ref.	Fecha-Date						OE	Caract.
7483263	2010-	◀▶	II Class	Hand	1200	Truck		412x188
7486263	2010-	◀▶	II Class	Hand	24 Volts	Truck	82417041	412x188



Ref.	Fecha-Date	OE	Caract.	Ø
9480261	2010-		198x202	22
9481261	2010-		82417044; 82417045; 82471689; 82472612	198x202 22



Ref.	Fecha-Date	Caract.	
7489263	2010-		184x190
7490263	2010-		184x190



Ref.	Fecha-Date	Caract.	
9476263	2010-		184X324
9443262	2010-		184x324
9478263	2010-		184X324



Ref.	Fecha-Date	Caract.	
7443262	2010-		184x324

## VOLVO FL4/FL6/FL7/FL10/ F10/F12/F16



Ref.	Fecha-Date	OE	Caract.
9705007	1985-94		
9706007	1985-94		
9702007	1985-94		10850793
9793007	1985-94		10850793 430X125X90

# VOLVO FH / FM



Ref.	Fecha-Date						OE
9823285	1993-02	▶			H4	12 Volts	3981594; 8144286
9833285	1993-02	▶					



Ref.	Fecha-Date						OE
9606285	1993-02	▶			R5W		3981666



Ref.	Fecha-Date						OE
9615285	1993-02	▶			H3		20360273
9616285	1993-02	▶			H3		20360274



Ref.	Fecha-Date						OE
9609285	1993-02	▶			H3	24 Volts	1062190



Ref.	Fecha-Date						OE
9613016	1993-02	▶				24 Volts	8191146



Ref.	Fecha-Date						OE
9701285	1993-02	▶					1365963; 3981460; 8191747
9702285	1993-02	▶					1365964; 3981461; 8191748



Ref.	Fecha-Date	OE	Caract.
9711285	1993-02	1365963; 21063887; 3981455; 3981460; 8191747	
9712285	1993-02	3981456; 1365964; 21063895; 3981464; 8191748	
9793009	1993-02	1272653	466X130X85

**NEW**



Ref.	Fecha-Date	OE
9721285	1993-02	20425728; 20507623; 20892384; 21097448
9722285	1993-02	20425729; 20507624; 20892386; 21097449

## VOLVO FE/FL



Ref.	Fecha-Date	OE
3103970	2006-12	500308514 ; 5010306792



Ref.	Fecha-Date	Caract.
9703016	2006-12	CONECTOR 152MM
9704016	2006-12	CONECTOR 152MM

## VOLVO FL



Ref.	Fecha-Date	OE
9831144	2013-	82526640
9832144	2013-	82532284

# VOLVO FH II/FM II



Ref.	Fecha-Date		OE
9801025	2002-07		20360898; 20762992; 20861583; 20862575
9802025	2002-07		20360899; 2086158; 21001668
9841025	2002-07		20861573; 21001645
9842025	2002-07		20861574; 21001649



Ref.	Fecha-Date		OE	Caract.
9811025	2002-07			CONECTOR
9812025	2002-07			CONECTOR
9851025	2002-07			CONECTOR
9852025	2002-07		21001649	CONECTOR



Ref.	Fecha-Date		OE
9804025	2002-07		21001650
9805025	2002-07		21001651



Ref.	Fecha-Date	
9821025	2002-07	
9822025	2002-07	



Ref.	Fecha-Date						OE
9601025	2002-07	◀			H21W	24 Volts	20409874; 20826211
9602025	2002-07	▶			H21W	24 Volts	20409875; 20826213



Ref.	Fecha-Date						OE	Caract.
9621025	2002-07	◀			H21W	24 Volts	20826211; 20826227	C-CARCASA
9622025	2002-07	▶			H21W	24 Volts	20826213; 20826231	C-CARCASA



Ref.	Fecha-Date						OE
9611025	2002-07	◀					20826227
9612025	2002-07	▶					20826231



Ref.	Fecha-Date						OE	Caract.
9701003	2002-07	◀						152MM
9702003	2002-07	▶					3981458	152MM
9705003	2002-07	◀						160MM
9706003	2002-07	▶					1498103; 1792374; 39811464	160MM



Ref.	Fecha-Date						OE	Caract.
9707003	2002-07	◀					3981456	152MM
9708003	2002-07	▶					1436868	152MM
9709003	2002-07	◀					3981459	160MM



Ref.	Fecha-Date						OE
9793003	2002-07	◀					1380819



Ref.	Fecha-Date	OE	Caract.
9701025	2002-07	20565103; 20892367	T. RUBBLITE
9704025	2002-07	21761261	T. RUBBLITE
9702025	2002-07	20565104; 20565106; 20892368; 21063895	T. RUBBLITE



Ref.	Fecha-Date	OE	Caract.
9703025	2002-07		

## VOLVO FH 16



Ref.	Fecha-Date	OE
9821285	2008-12	21035638; 21123523; 21323108
9822285	2008-12	21123589
9801285	2008-12	21035645; 21323114
9802285	2008-12	21035644; 21323113



Ref.	Fecha-Date	OE
9815285	2008-12	21035652
9816285	2008-12	21035651
9811285	2008-12	21035638; 21035652; 21323108
9812285	2008-12	21035637; 21035651; 21323106



Ref.	Fecha-Date		OE
9601285	2008-12	◀ [Truck] [Headlight] [H3] [H7]	21035692
9602285	2008-12	▶ [Truck] [Headlight] [H3] [H7]	21035690; 21297909



Ref.	Fecha-Date		OE	Caract.
9621285	2008-12	◀ [Truck] [Headlight] [H3] [H7]	21035701	T.VIGN
9622285	2008-12	▶ [Truck] [Headlight] [H3] [H7]	21035700	T.VIGN



Ref.	Fecha-Date		OE
9635285	2008-12	◀ [Truck] [Headlight] [H3] [H7]	21297914(21035694)
9636285	2008-12	▶ [Truck] [Headlight] [H3] [H7]	21297913(21035693)



Ref.	Fecha-Date		OE
9625285	2008-12	◀ [Truck] [Headlight] [H3] [H7]	21297902
9626285	2008-12	▶ [Truck] [Headlight] [H3] [H7]	21297901



Ref.	Fecha-Date		OE
9671285	2008-12	◀ [Truck] [Headlight] [H3] [H7]	
9672285	2008-12	▶ [Truck] [Headlight] [H3] [H7]	



Ref.	Fecha-Date		OE
9661285	2008-12	◀ [Truck] [Headlight] [H3] [H7]	21297918
9662285	2008-12	▶ [Truck] [Headlight] [H3] [H7]	21297917



Ref.	Fecha-Date		OE
9681285	2008-12	◀ [Truck] [Headlight] [H3] [H7]	21118550
9682285	2008-12	▶ [Truck] [Headlight] [H3] [H7]	21120482





Ref.	Fecha-Date						OE	Caract.
9611285	2008-12	◀					82114506	
9612285	2008-12	▶					82114500	
9631285	2008-12	◀					82114506	T.VIGN
9632285	2008-12	▶					82114500	T.VIGN



Ref.	Fecha-Date						OE	
9613285	2008-12	◀▶					20398660; 20789440	

## VOLVO FH



Ref.	Fecha-Date						OE	
9841285	2013-	◀					21221134	
9842285	2013-	▶						



Ref.	Fecha-Date						OE	
9851285	2013-	◀						
9852285	2013-	▶					21608666	

**NEW**



Ref.	Fecha-Date	OE	Caract.
9835285	2013-	21221130	T.ZKW
9836285	2013-	21221129	T.ZKW

**NEW**



Ref.	Fecha-Date	OE	Caract.
9831285	2013-	21608663	T.ZKW
9832285	2013-	21608661	T.ZKW
9825285	2013-	21221142; 21221146	T.ZKW
9826285	2013-	21221145; 22239248	T.ZKW

**NEW**



Ref.	Fecha-Date	OE
9641285	2013-	82151157
9642285	2013-	82151205

**NEW**



Ref.	Fecha-Date	OE
9651285	2013-	21346521
9652285	2013-	21346522

**NEW**



Ref.	Fecha-Date	OE
9731285	2013-	82849894
9732285	2013-	82849923
9711100	2013-	
9734285	2013-	82849925

# RETROVISORES / MIRRORS / RETROVISEUR / SPIEGEL



Ref.	Caract.	Ø
<b>9401286</b>	308X176	14-20

Icons: Left turn, Class II, Hand, 1800, ABS, Right turn



Ref.	Caract.	Ø
<b>9476200</b>	147X262	14-22

Icons: Left turn, Class II, Hand, 1200, ABS, Right turn



Ref.	Caract.	Ø
<b>9473200</b>	147X262	14-22

Icons: Left turn, Class II, Hand, 300, ABS, Right turn



Ref.	Caract.	Ø
<b>9470200</b>	147X262	14-22

Icons: Left turn, Class II, Hand, 1200, ABS, Right turn



Ref.	Caract.	Ø
<b>9470201</b>	258 X 167	16-18

Icons: Left turn, Class II, Hand, 1200, ABS, Right turn



Ref.	Caract.	Ø
<b>7470201</b>	250X160	

Icons: Left turn, Class II, Hand, 1800, Right turn



Ref.	Caract.	Ø
<b>9470205</b>	352X170	14-22

Icons: Left turn, Class II, Hand, 1200, ABS, Right turn



Ref.	Caract.	Ø
<b>9470210</b>	403X203	14-22

Icons: Left turn, Class II, Hand, 1200, ABS, Right turn

UNIVERSAL V.I./I.V./LKW



Ref.	Caract.	Ø
9470300		REDONDO CON ROTULA 125 10



Ref.	Caract.	Ø
9470305		RECTANGULAR CON ROTULA 175X125 10



Ref.	Caract.	Ø
9470500		237X180 14-22



Ref.	Caract.	Ø
9470260		375X183 19
9471260		375X183 19



Ref.	Caract.	Ø
9475282		395X205 22
9476282		395X205 22
9477282		395X205 22



Ref.	Caract.
7473282	382x193
7472282	382x193



Ref.	Caract.
9483201	245X155



Ref.	Caract.
9473201	190x140



Ref. 9401200      Caract. 235 X 155

▶ IV Class    ✎    300    ABS    🚗



Ref. 9401271      Caract. 184X184      Ø 18

◀ IV Class    ✎    ✎    300    PP    🚗



Ref. 9421261      Caract. 165x215      Ø 14-20

◀ IV Class    ✎    ✎    300    ABS    🚗



Ref. 9451246      Caract. 160X272      Ø 18

◀ IV Class    ✎    ✎    300    ABS    🚗



Ref. 9470215      Caract. 143X238      Ø 14-22

◀ IV Class    ✎    ✎    300    ABS    🚗



Ref. 9441142      Caract. 229x260

◀ V Class    ✎    ✎    300    ABS    🚗



Ref. 9441246      Caract. 150x230

▶ V Class    ✎    ✎    300    ABS    🚗

**NEW**



Ref. 72414052      🚗



Ref. 9441261      Caract. 157X247

▶ V Class    ✎    ✎    300    PP    🚗



Ref.	Caract.
7441261	150X241
7443261	150X241



Ref.	Ø
9401001	17
9402001	17



Ref.	Ø
9401006	17

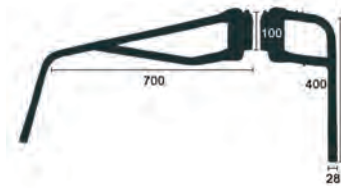

Ref.	Ø
9402003	17



Ref.	Ø
9403008	17



Ref.	Caract.
9403009	300 X 350



Ref.	Caract.
9403010	240 X 370

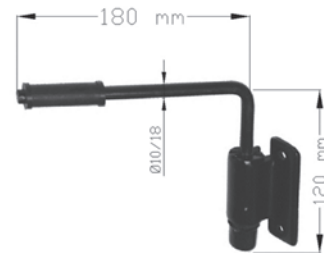

Ref.	Ø
9403011	10-18

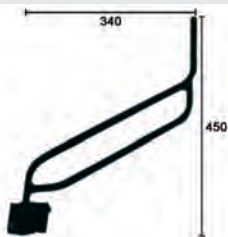

Ref.	Ø
9405008	17

## FARO DE TRABAJO / WORK LAMP / FEU TRAVAIL / SCHEINWERFER

**NEW**



Ref.	Caract.	Ø
2596025	8 LED; CABLE 280 MM.	115

**NEW**



Ref.	Caract.
2596026	3 LED; CABLE 300 MM.

**NEW**



Ref.	Caract.
2596030	3 LED; CABLE 250 MM.

**NEW**



Ref.	Caract.
2596027	9 LED; CABLE 300 MM.

**NEW**



Ref.	Caract.
2596028	9 LED

**NEW**



Ref.	Caract.
2596029	9 LED

## PILOTO TRASERO / REAR LAMP / FEU ARRIERE / HECKLEUCHE



Ref.	Caract.
9737009	466X130X85
9738009	466X130X85
9793009	466X130X85



Ref.	Caract.
9709007	CABLE 300 MM / 430x125x90
9710007	CABLE 300 MM / 430x125x90
9707007	CABLE 300 MM / 430x125x90
9708007	CABLE 300 MM / 430x125x90
9793007	430X125 X90

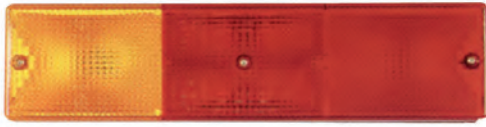

Ref.	Caract.
9705005	466X130X85
9706005	466X130X85
9701005	466X130X85
9702005	466X130X85
9793005	466X130X85

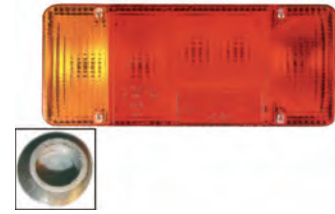

Ref.	Caract.
9701008	CABLE 400 MM / 303x130x80
9706008	CABLE 400 / 303x130x80
9705008	CABLE 400 / 303x130x80
9702008	CABLE 400 MM / 303x130x80

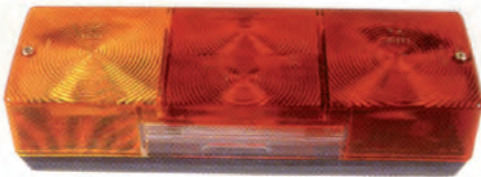

Ref.	Caract.
9705010	345 X 115 X 90
9701010	345 X 115 X 90
9706010	345 X 115 X 90
9791010	345 X 115 X 90



Ref.	Caract.
9796010	345 X 115 X 90
9792010	345 X 115 X 90
9795010	345 X 115 X 90



Ref.	Caract.
9793006	



Ref.	Caract.
9701015	466X130X85
9702015	466X130X85
9705015	466X130X85
9706015	466X130X85
9791015	466X130X85
9792015	466X130X85





Ref.	Caract.
9707001	440x130x92
9708001	440x130x92
9705001	440x130x92
9706001	440x130x92
9793001	



Ref.	Caract.
9721010	535x178x120
9722010	535x178x120
9725010	
9726010	



Ref.	Caract.
9731010	430x158x115
9732010	430x158x115
9723010	



Ref.	Caract.
9761015	CONEC.REDONDO / 348x140x105
9762015	348x140x105



Ref.	Caract.
9751015	CONEC.REDONDO / 540x130x170
9752015	190x160x85

**NEW**



Ref.	Caract.
971102	
971202	

**NEW**



Ref.	Caract.
971101	
971201	



Ref.	Caract.
71513903	10,2x9,5x4,7CM



Ref.		Ø
9753002		140
9792002		140



Ref.		Ø
9713002		142
9703002		142



Ref.		Caract.	Ø
9763002		3 FUNCIONES	140
9794002			140



Ref.		Ø
9773002		140



Ref.		Ø
9783002		140



Ref.		Ø
9774002		140

**NEW**



Ref.		Caract.
2596043		CABLE 300 MM

**NEW**



Ref.		Caract.
2596044		CABLE 300 MM

**NEW**



Ref.

2596036



2596037



**NEW**



Ref.

2596038



2596039



**NEW**



Ref.

2596046



CABLE 300 MM

Caract.

**NEW**



Ref.

2596080



CABLE 2.000 MM.

Caract.

2596081



CABLE 2.000 MM.

**NEW**



Ref.

2596082



2596083



**NEW**



Ref.

2596084



CABLE 500 MM.

Caract.

**NEW**



Ref.

2596085



2596086



**NEW**



Ref.

2596087



2596088



**NEW**



Ref.

2596089 **LED** 12 Volts 24 Volts

2596090 **LED** 12 Volts 24 Volts

**NEW**



Ref.

71513907 **LED** 12 Volts 24 Volts

71513906 **LED** 12 Volts 24 Volts

**NEW**



Ref.

Caract.

71513905 **LED**

ANCHO 2100 MM.

**TERCERA LUZ DE FRENO / 3RD STOP LIGHT / 3EME FEU FREINAGE-BREMSEN L**



Ref.

6901304 **LED** 12 Volts

6901305 **LED** 24 Volts

**KIT ILUMINACION / LIGHTING KIT / KIT ECLAIRAGE / BELEUCHTUNG KIT**



Ref.

Caract.

70404101 **LED**

CABLE 1,4 + 7,5m.



Ref.

9698002 **LED**

9698006

9698010 **LED**

**NEW**



Ref.

Caract.

**2596074**

12 Volts

24 Volts

7 PINS



CABLE 7500 MM

**NEW**



Ref.

Caract.

**2597014**

5 PINS

CONECTOR - 3M

**2597015**

5 PINS

CONECTOR - 5M

**2597016**

5 PINS

CONECTOR - 7M

**NEW**



Ref.

Caract.

**2597018**

7 PINS

CONECTOR

**NEW**



Ref.

**71513915**



LED

12 Volts

24 Volts



**71513914**



LED

12 Volts

24 Volts



**NEW**



Ref.

Caract.

**71513913**



LED



ANCHO 2100 MM.

**LUZ MATRICU / LICENSE PLATE LIGHT / F.IMMATR. / KENNZEICHENLEUCHTEN**



Ref.

Caract.

**9753011**



73x39x60



Ref.

**9755011**





Ref.	Caract.
9723011	120x59x45



Ref.	Caract.
9703011	100x59
9743011	100x59-C-TUERCAS
9745011	100x59



Ref.	Caract.
9698062	CABLE 450 MM



Ref.	Caract.
9773012	95x55x75

## PILOTO GALIBO / WARNING LIGHT / FEU POSITION / POSITIONSLICHT



Ref.	Caract.
9607013	103x41x29
9603013	103x41x29
9611013	103x41x29
9617013	
9613013	
9621013	



Ref.	Caract.
9623014	190x160x85



Ref.	Caract.
9653012	



Ref.	Caract.
9663012	



**NEW**



Ref.

Caract.

Ref.

Caract.

9698056



3 LED; CABLE 500 MM

2596060



3 LED; CABLE 500 MM.



Ref.

Caract.

Ref.

Caract.

9666012



103x75x36

9769012



95x55x75



**NEW**



**NEW**



Ref.

Caract.

Ø

Ref.

Caract.

Ø

2596001



3 LED; CABLE 1000 MM 48

2596002



2 LED; CABLE 500 MM 48

**NEW**



Ref.

Caract.

Ref.

Caract.

2596005



CABLE 300 MM.



9698064



CABLE 500 MM

9698066



CABLE 500 MM

9698068



CABLE 500 MM



Ref.

Ref.

Caract.

9698070



9698080

CLIP TERMINAL



Ref. **2596003** Caract. 7,4 CM. ENTRE AGUJEROS

**NEW**



Ref. **2596048** Caract. CABLE 130 MM.

**NEW**



Ref. **2596050** Caract. CABLE 130 MM.

**NEW**



Ref. **2596056** Caract. CABLE 140 MM.

**NEW**



Ref. **2596057** Caract. CABLE 140 MM.

**NEW**



Ref. **2596058** Caract. CABLE 140 MM.

**NEW**



Ref. **2596061** Caract. 3 LED; CABLE 500 MM.

**NEW**



Ref. **2596062** Caract.

**NEW**



Ref. **2596064** Caract. CABLE 3500 MM.

**NEW**



Ref. **2596066** Caract. CABLE 3500 MM.



**PILOTO ANCHURA / BUMPER LIGHT / FEU PARE-CHOCS / PUFFER LIGHT**



Ref.  
**9698050**   
**9698052**



Ref.  
**9698054**



Ref. Caract.  
**2596016** **12 Volts** **24 Volts** CABLE 220 MM.



Ref. Caract.  
**2596070** **12 Volts** **24 Volts** CABLE 500 MM.



Ref. Caract.  
**2596071** **12 Volts** **24 Volts** CABLE 500 MM.



Ref. Caract.  
**2599010** **12 Volts** 10 LED; CABLE 150 MM



Ref. Caract.  
**2596022** **12 Volts** **36 Volts** 6 LED; CABLE 280 MM.



Ref. Caract.  
**2596021** **12 Volts** **36 Volts** 3 LED; CABLE 280 MM.

**UNIVERSAL V.I./I.V./LKW**

**NEW**



Ref.

Caract.

2596023



8 LED; CABLE 500 MM.

**NEW**



Ref.

Caract.

2596020



9 LED; CABLE 280 MM.

**NEW**



Ref.

Caract.

2596012



CABLE 500 MM.

**NEW**



Ref.

Caract.

2596040



CABLE 2.000 MM.

**NEW**



Ref.

Caract.

2596042



CABLE 2.000 MM.

**NEW**



Ref.

Caract.

2596024



CABLE 190 MM.

**NEW**



Ref.

Caract.

2596011



CABLE 500 MM.

2596007



CABLE 500 MM.

2596009



CABLE 500 MM.

**ROTATIVO / ROTARY / GYROPHARE / DREHWARNLICHT**

**NEW**



Ref. Caract. Ø

**2596032** LED 12 24 12 Volts 24 Volts 12 LED; CABLE 340 MM 161

**NEW**



Ref. Caract. Ø

**2596034** LED 12 36 12 Volts 36 Volts 12 LED; CABLE 340 MM 122

**NEW**



Ref. Caract.

**9700001** 12 24 12 Volts 24 Volts MAGNETICO

**NEW**



Ref. Caract.

**9700002** 24 24 Volts H21

**NEW**



Ref.

**9700003** 12 24 12 Volts 24 Volts

**NEW**



Ref. Caract.

**9700004** LED 12 24 12 Volts 24 Volts 10-30V MAGNETICO

**NEW**



Ref. Caract.

**9700005** LED 12 24 12 Volts 24 Volts 10-30V

**NEW**



Ref.

**9700006** 12 24 12 Volts 24 Volts

**NEW**



Ref. ACCESORIES

**9700007**

**NEW**



Ref. ACCESORIES

**9700008**

**UNIVERSAL V.I./I.V./LKW**

**NEW**



Ref.

9700009

ACCESORIES

**PLAFON / CEILING LIGHT / PLAFONIER ENCAST / INNENL DACHLAMPE**



Ref.

6901310

24  
Volts

21  
Watts

6901312

12  
Volts

21  
Watts



Ref.

Caract.

6901316

LED

12  
Volts

24  
Volts

CABLE 180 MM.

**NEW**



Ref.

Caract.

2569001

LED

12  
Volts

24  
Volts

CABLE 180 MM.

2569005

LED

12  
Volts

24  
Volts

CABLE 180 MM.



Ref.

Caract.

6901317

EMBELLECEDOR / CAP



Ref.

Caract.

6901318

ARO / RING



Ref.

Caract.

Ø

2569002

LED

24  
Volts

2 AGUJEROS. 11,4 CM.ENTRE AGUJEROS

5



Ref.

Caract.

Ø

2569004

LED

EXT

24  
Volts

3 AGUJEROS. 10,7 CM.ENTRE AGUJEROS

5



**NEW**



Ref.	Caract.	Ø
<b>2569006</b>	11,4 CM.ENTRE AGUJEROS	5

Ref.	Caract.	Ø
<b>2569014</b>	12 LED. CABLE 160 MM	90

**NEW**



**NEW**



Ref.	Caract.	Ø
<b>2569015</b>	18 LED. CABLE 160 MM	11,4

Ref.	Caract.	Ø
<b>2569008</b>	39 LED. CABLE 180 MM.	177

## REGLETA LED / LED INTERIOR LAMP / LAMPE LED



Ref.	Caract.
<b>6901306</b>	18LED. CABLE 100 MM
<b>6901308</b>	9 LED. CABLE 180 MM.

Ref.	Caract.
<b>2569007</b>	CABLE 100 MM.

## KIT PROTECTOR FARO / KIT PROTECTOR HEADLAMP / JEU PROTECTION PHARE / SCHEINWERFERSCHUTZ SCHEINWERFER

7301014 - SCANIA SERIE R



7301033 - IVECO STRALIS



7301046 - M-B ACTROS (2003)



7301060 - MAN TG-A



Ref.	Caract.	MODELO
<b>7301021</b>	PLAST.	DAF XF
<b>7301023</b>	PLAST.	DAF CF
<b>7301025</b>	PLAST.	DAF LF
<b>7301030</b>	PLAST.	IVECO EUROSTAR
<b>7301033</b>	PLAST.	IVECO STRALIS
<b>7301036</b>	PLAST.	IVECO EUROCARGO
<b>7301061</b>	PLAST.	MAN TGX-TGS (07-)
<b>7301040</b>	PLAST.	M-B ACTROS 98
<b>7301048</b>	PLAST.	M-B AXOR 05
<b>7301046</b>	PLAST.	M-B ACTROS 03
<b>7301012</b>	PLAST.	SCANIA SERIE 4
<b>7301051</b>	PLAST.	VOLVO FH
<b>7301065</b>	PLAST.	NISSAN CABSTAR

## KIT PROTECTOR ANTINEBLA / KIT PROTECTOR FOG LAMP / JEU PROTECTION ANTIBROUILLARD / SCHEINWERFERSCHUTZ NEBELSCHEINWERFER

7301013 - SCANIA SERIE R



7301035 - IVECO STRALIS



7301047 - M-B ACTROS 2003)



7301062 - MAN TG-A



Ref.	MODELO
<b>7301020</b>	DAF XF/LF/CF
<b>7301032</b>	IVECO EUROSTAR
<b>7301034</b>	IVECO EUROCARGO
<b>7301035</b>	IVECO STRALIS
<b>7301062</b>	MAN TG-A
<b>7301068</b>	MAN TGX-TGS (07-)
<b>7301047</b>	M-B ACTROS 03
<b>7301013</b>	SCANIA SERIE R
<b>7301050</b>	VOLVO FH/FM

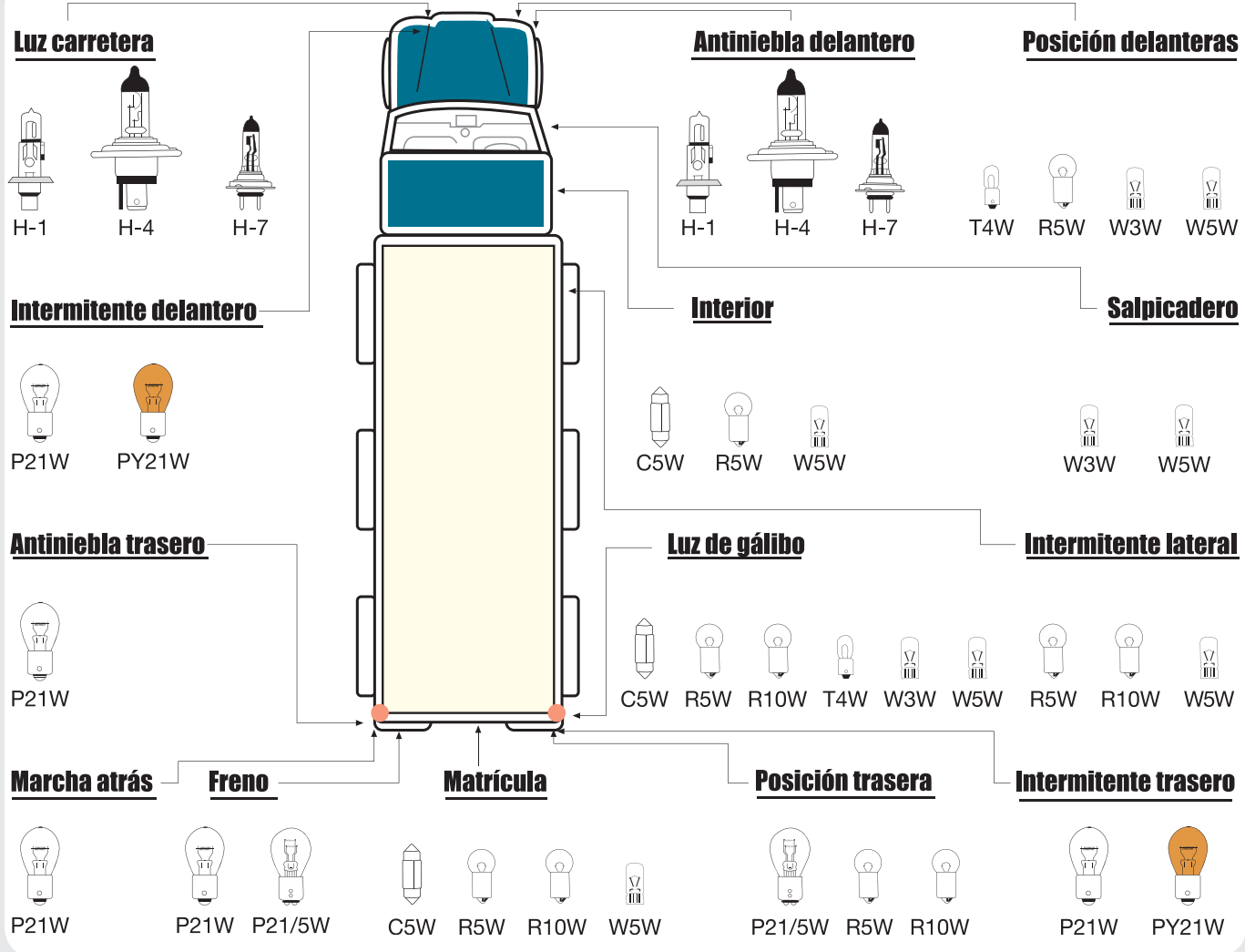

### ICONOS - PICTOGRAMS

<b>Transparente</b> Transparent	<b>Ambar</b> Orange	<b>Blister Doble</b> Double Blister	<b>Estuche Transparente</b> Showbox	<b>Caja</b> Box
<b>Marca Carpriss</b> Carpriss Brand	<b>Novedad</b> New	<b>EMARK</b>	<b>Un. por Embalaje</b> Pack Quantity	<b>Lote Obligatorio</b> Minimum sale Lot
<b>16 Watts</b> Watts	<b>3 Voltaje</b> Voltage	<b>10 Lote</b> Lot		

### ESTUCHE SURTIDO - BULB SET



Ref.	Marca Brand	Homologación Approval	Medidas Measure	Presentación Display	Uds. Embalaje QTY per item	Lot	V	Color	Tipo Vehículo Vehicle type
79780207	CARPRISS	E <sub>1</sub>	H1		9	10	24 VOLTS		
79780212	CARPRISS	E <sub>4</sub>	H4		9	10	24 VOLTS		
79780217	CARPRISS	E <sub>4</sub>	H7		9	10	24 VOLTS		

P21/5W, PY21W, R5W, W5W, 4 Fus.

## H1

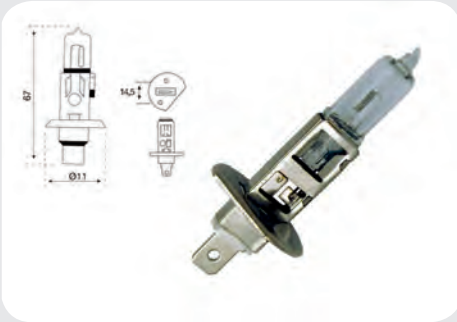

Ref.	Marca Brand	Novedad New	Homol Approval	Medidas Measure	Present Display	Uds. Emb QTY item	Lot	V	W	Color	Tipo Vehiculo Vehicle type
79780231	ALKAR		E4	H1xP14.5s	B	1	10	24 VOLTS	75 WATTS	Blue	Truck
79780233	ALKAR	NEW	E4	H1xP14.5s	Box	1	10	24 VOLTS	75 WATTS	Blue	Truck

## H4

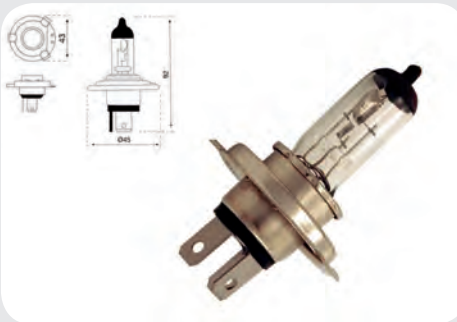

Ref.	Marca Brand	Novedad New	Homol Approval	Medidas Measure	Present Display	Uds. Emb QTY item	Lot	V	W	Color	Tipo Vehiculo Vehicle type
79780236	ALKAR		E4	H4xP43t	B	1	10	24 VOLTS	75/70 WATTS	Blue	Truck
79780238	ALKAR	NEW	E4	H4xP43t	Box	1	10	24 VOLTS	75/70 WATTS	Blue	Truck

## H7

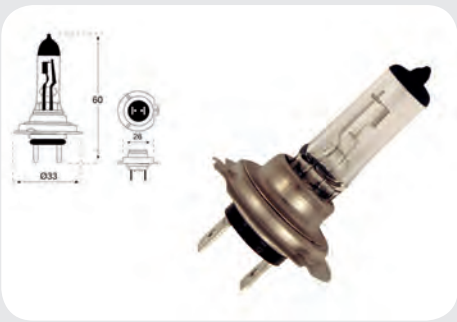

Ref.	Marca Brand	Novedad New	Homol Approval	Medidas Measure	Present Display	Uds. Emb QTY item	Lot	V	W	Color	Tipo Vehiculo Vehicle type
79780241	ALKAR		E4	H7xPX26d	B	1	10	24 VOLTS	70 WATTS	Blue	Truck
79780239	ALKAR	NEW	E4	H7xPX26d	Box	1	10	24 VOLTS	70 WATTS	Blue	Truck

## P21W



Ref.	Marca Brand	Novedad New	Homol Approval	Medidas Measure	Present Display	Uds. Emb QTY item	Lot	V	W	Color	Tipo Vehiculo Vehicle type
79780251	ALKAR		E4	P21WxBA15s	B	2	10	24 VOLTS	21 WATTS	Blue	Truck
79780253	ALKAR	NEW	E4	P21WxBA15s	Box	10	100	24 VOLTS	21 WATTS	Blue	Truck



## PY21W



Ref.	Marca	Novedad	Medidas	Present	Uds. Emb	Lot	V	W	Color	Tipo Vehiculo
	Brand	New	Measure	Display	QTY item		VOLTS	WATTS		Vehicle type
79780256	ALKAR		PY21WxBAU15s		2	10	24	21		
79780258	ALKAR	NEW	PY21WxBAU15s		10	100	24	21		

## P21/5W



Ref.	Marca	Novedad	Homol	Medidas	Present	Uds. Emb	Lot	V	W	Color	Tipo Vehiculo
	Brand	New	Approval	Measure	Display	QTY item		VOLTS	WATTS		Vehicle type
79780261	ALKAR		E <sub>4</sub>	P21/5WxBAY15d		2	10	24	21/5		
79780259	ALKAR	NEW	E <sub>4</sub>	P21/5WxBAY15d		10	100	24	21/5		

## R5W



Ref.	Marca	Novedad	Homologación	Medidas	Present	Uds. Emb	Lot	V	W	Color	Tipo Vehiculo
	Brand	New	Approval	Measure	Display	QTY item		VOLTS	WATTS		Vehicle type
79780266	ALKAR		E <sub>4</sub>	R5WxBA15s		2	10	24	5		
79780281	ALKAR	NEW	E <sub>4</sub>	R5WxBA15s		10	100	24	5		

## R10W



Ref.	Marca	Novedad	Homol	Medidas	Present	Uds. Emb	Lot	V	W	Color	Tipo Vehiculo
	Brand	New	Approval	Measure	Display	QTY item		VOLTS	WATTS		Vehicle type
79780269	ALKAR	NEW	E <sub>4</sub>	R10WxBA15s		2	10	24	10		
79780282	ALKAR	NEW	E <sub>4</sub>	R10WxBA15s		10	100	24	10		

## T4W

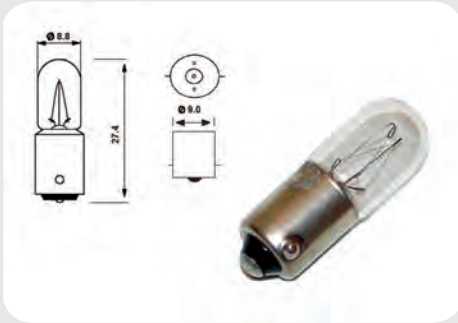

Ref.	Marca Brand	Novedad New	Homol Approval	Medidas Measure	Present Display	Uds. Emb QTY item	Lot	V	W	Color	Tipo Vehiculo Vehicle type
79780288	ALKAR	NEW	E4	T4WxBA9s	B	2	10	24 VOLTS	4 WATTS	Light Blue	Truck
79780286	ALKAR	NEW	E4	T4WxBA9s	Box	10	100	24 VOLTS	4 WATTS	Light Blue	Truck

## W3W

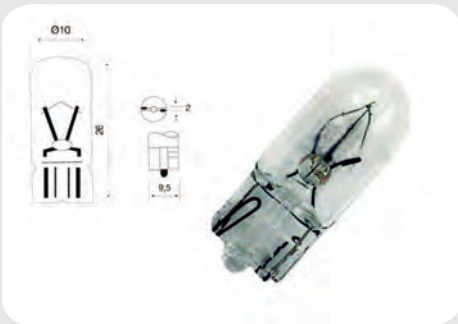

Ref.	Marca Brand	Novedad New	Homol Approval	Medidas Measure	Present Display	Uds. Emb QTY item	Lot	V	W	Color	Tipo Vehiculo Vehicle type
79780274	ALKAR	NEW	E4	W3WxW2,1x9,5d	B	2	10	24 VOLTS	3 WATTS	Light Blue	Truck
79780284	ALKAR	NEW	E4	W3WxW2,1x9,5d	Box	10	100	24 VOLTS	3 WATTS	Light Blue	Truck

## W5W T10

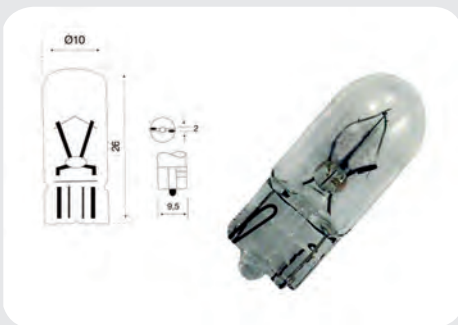

Ref.	Marca Brand	Novedad New	Homol Approval	Medidas Measure	Present Display	Uds. Emb QTY item	Lot	V	W	Color	Tipo Vehiculo Vehicle type
79780271	ALKAR		E4	W5WxW2,1x9,5d	B	2	10	24 VOLTS	5 WATTS	Light Blue	Truck
79780283	ALKAR	NEW	E4	W5WxW2,1x9,5d	Box	10	100	24 VOLTS	5 WATTS	Light Blue	Truck

## C5W



Ref.	Marca Brand	Novedad New	Homol Approval	Medidas Measure	Present Display	Uds. Emb QTY item	Lot	V	W	Color	Tipo Vehiculo Vehicle type
79780276	ALKAR		E4	C5WxSV8,5-38x11mm.	B	2	10	24 VOLTS	5 WATTS	Light Blue	Truck
79780285	ALKAR	NEW	E4	C5WxSV8,5-38x11mm.	Box	10	100	24 VOLTS	5 WATTS	Light Blue	Truck



# VEHÍCULO COMERCIAL

# COMMERCIAL VEHICLE

# VÉHICULE UTILITAIRE

# NKW

## CITROËN BERLINGO / PEUGEOT PARTNER



Ref.	Fecha-Date	OE
9264974	1996-08	8153HL
9265974	1996-08	8153HR
9233974	1996-08	8153HN
9234974	1996-08	8153HW



Ref.	Fecha-Date	OE
9237974	1996-08	8153JJ
9238974	1996-08	8149E5(C); 8153JN(P)
9253974	1996-08	8153JK
9254974	1996-08	8149C9(C); 8153JL(P)



Ref.	Fecha-Date	OE
9228974	1996-08	8148PC
9225974	1996-08	8148PL
9226974	1996-08	8148PP(C); 8153HS(P)



Ref.	Fecha-Date	OE
9239974	1996-08	8149E1(C); 8148E1(P)
9240974	1996-08	8153JN(C); 8149E6(P)



Ref.	Fecha-Date	OE
6341974	1996-08	8149C4
6342974	1996-08	8149C5



Ref.	Fecha-Date	OE
6401974	1996-08	8151V9
6402974	1996-08	8151W0
6425974	1996-08	8151W3(C); 5181W3(P)
6426974	1996-08	8151W4

# CITROËN BERLINGO / PEUGEOT PARTNER



Ref.	Fecha-Date	Icons	OE
9264998	2008-12	◀ ◁ ▷ ▶	8153HL(C); 8153TL(P)
9265998	2008-12	▶ ◁ ▷ ▶	8153HR(C); 8153TN(P)
9227998	2008-12	◀ ◁ ▷ ▶	
9228998	2008-12	▶ ◁ ▷ ▶	
9225998	2008-12	◀ ◁ ▷ ▶	8153TP
9226998	2008-12	▶ ◁ ▷ ▶	8153TQ



Ref.	Fecha-Date	Icons	OE
9237998	2008-12	◀ ◁ ▷ ▶	8153JJ
9238998	2008-12	▶ ◁ ▷ ▶	8149E5(C); 8149C6(P)
9239998	2008-12	◀ ◁ ▷ ▶	8153TR
9240998	2008-12	▶ ◁ ▷ ▶	8153TT
9229998	2008-12	◀ ◁ ▷ ▶	8153TS
9230998	2008-12	▶ ◁ ▷ ▶	8153TV



Ref.	Fecha-Date	Icons	OE
6341998	2008-12	◀ ◁ ▷ ▶	8149 C4
6342998	2008-12	▶ ◁ ▷ ▶	8149 C5



Ref.	Fecha-Date	Icons	OE
6401998	2008-12	◀ ◁ ▷ ▶	8151NP
6402998	2008-12	▶ ◁ ▷ ▶	8151NQ
6431998	2008-12	◀ ◁ ▷ ▶	8151W3(C); 8151W4(P)
6432998	2008-12	▶ ◁ ▷ ▶	8151W4(C); 8151W3(P)

## CITROËN BERLINGO / PEUGEOT PARTNER



Ref.	Fecha-Date	Icons	OE
9264867	2012-		96777503XT
9265867	2012-		96777548XT
9237867	2012-		8154TG; 96777503XT
9238867	2012-		8154 RZ; 96777548XT



Ref.	Fecha-Date	Icons	OE
9225867	2012-		96777523XT
9226867	2012-		96777550XT
9239867	2012-		8154 TE; 96777523XT
9240867	2012-		8154SZ; 96777550XT
9243867	2012-		1608177880
9244867	2012-		1608177980



Ref.	Fecha-Date	Icons	OE
6343867	2012-		1608750880
6344867	2012-		1608751180
6341867	2012-		1608180980
6342867	2012-		1608181079



Ref.	Fecha-Date	Icons	OE
6431867	2012-		1608181280
6432867	2012-		1608181380

## CITROËN C15



Ref.	Fecha-Date	Icons	OE
8102327	1981-90		96029034YB
6102327	1981-90		96029034YB

## CITROËN C25 / FIAT DUCATO / PEUGEOT J5



Ref.	Fecha-Date	Icons	OE
9291961	1981-90		95651072(C); 5920892(F); 814804(P)
9292961	1981-90		95651073(C); 5920891(F); 814805(P)



Ref.	Fecha-Date	Icons	OE	Caract.
6101982	1990-94		ZF07684289(C); 7684289(F); 8148P8(P)	90 X 280 X 175
6102982	1990-94		ZF07684288(C); 7684288(F); 8148P9(P)	90 X 280 X 175



Ref.	Fecha-Date	Icons	OE	Caract.
6403961	1990-94		8151H4	C25 260 X 169
6433961	1990-94		8151S4	C25 260 X 169

## CITROËN JUMPER / FIAT DUCATO / PEUGEOT BOXER

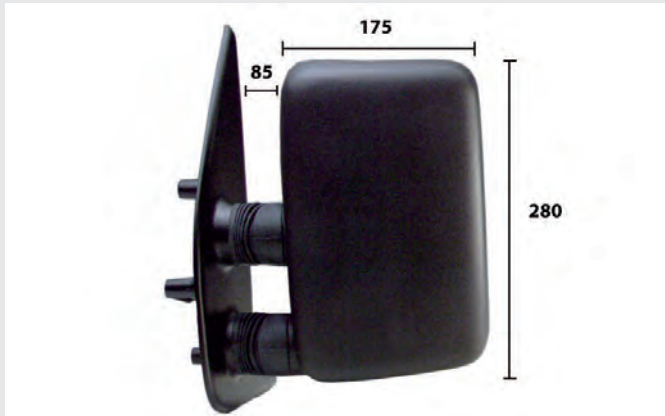

Ref.	Fecha-Date	OE	Caract.
9250961	1994-02	8148EQ(C; P); 1312467080(F)	85 X 280 X 175
9251961	1994-02	8148ER(C; P); 1312468080(F)	85 X 280 X 175
9225920	1994-02	8148ES(C; P); 1314489080(F)	85 X 280 X 175

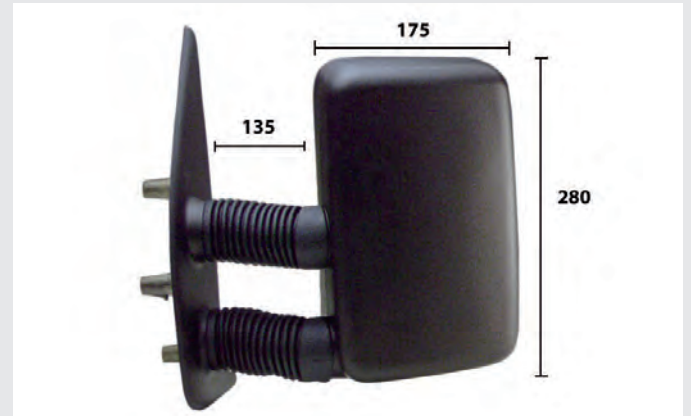

Ref.	Fecha-Date	OE	Caract.
9252961	1994-02	8148GF(C); 7684292(F); 8153JS(P)	135 X 280 X 175
9253961	1994-02	8148GG(C); 7684291(F); 8153JR(P)	135 X 280 X 175
9239920	1994-02	8153BB(C; P); 8153BM(P)	135 X 280 X 175



Ref.	Fecha-Date	OE	Caract.
6403961	1994-02	8151H4(C; P); 7750625(F) 8151S4(C);	260 X 169
6433961	1994-02	93160518(F); 8151ES; 8151ET; 8151S5(P)	260 X 169



# CITROËN JUMPER / FIAT DUCATO / PEUGEOT BOXER

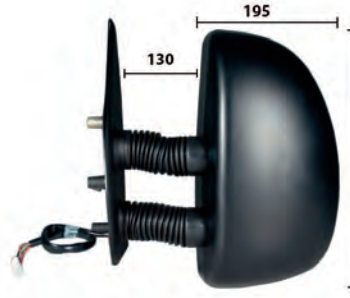

Ref.	Fecha-Date	OE	Caract.
9254961	2002-06	8149H8(C); 1325627080(F); 8153JS(P)	80 X 360 X 195
9255961	2002-06	8149H6(C); 1325626080(F); 8153JR(P)	80 X 360 X 195
9225921	2002-06	8149J2(C); 735326499(F); 8153CL(P)	80 X 360 X 195
9226921	2002-06	8149J0(C); 735326494(F); 8153CK(P)	80 X 360 X 195

Ref.	Fecha-Date	OE	Caract.
9256961	2002-06	8149J7(C; P); 1325629080(F)	130 X 360 X 195
9257961	2002-06	8149J5(C; P); 1325628080(F)	130 X 360 X 195
9239921	2002-06	8149K0	130 X 360 X 195
9240921	2002-06	8149J8	130 X 360 X 195



Ref.	Fecha-Date	OE
6401921	2002-06	8151 ES(C; P); 71716702; 7750625(F)
6402921	2002-06	8151 ET(C; P); 71716701; 7750626(F)
6431921	2002-06	8151 ET(C; P); 71716702(F)
6432921	2002-06	8151 ES(C; P); 71716701(F)

Ref.	Fecha-Date	OE
6451921	2002-06	8151EP(C; P); 71716698(F)
6452921	2002-06	8151EN(C; P); 71716697(F)
6471921	2002-06	8151ER(C; P); 71716702(F)
6472921	2002-06	8151EQ(C; P); 71716701(F)



Ref.	Fecha-Date	OE	Caract.
9201984	2002-	7353188540	DUCATO CHASSIS
9202984	2002-	7353188480	DUCATO CHASSIS



Ref.	Fecha-Date	OE	Caract.
9225984	2002-	7353188560	DUCATO CHASSIS
9226984	2002-	7353188500	DUCATO CHASSIS

## CITROËN JUMPER / FIAT DUCATO / PEUGEOT BOXER



Ref.	Fecha-Date	OE	Caract.
9201922	2006-	735424420; 8153 Y7 (C; P); 735517070(F)	80 X 320 X 400
9202922	2006-	735424394; 8153 Y5 (C; P); 735517038(F)	80 X 320 X 400
9233922	2006-	735424438(C; P); 8153Y2(P)	80 X 320 X 400

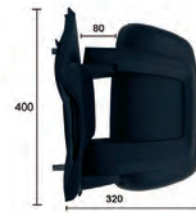

Ref.	Fecha-Date	OE
9203922	2006-	8154NV
9204922	2006-	8153NL; 815425; 8154LQ; 8154NQ
9237922	2006-	815454



Ref.	Fecha-Date	OE
9211922	2006-	735424421
9212922	2006-	735424395
9213922	2006-	

**NEW**



Ref.	Fecha-Date	OE
9215922	2006-	8153S2
9216922	2006-	8153W0
9217922	2006-	

**NEW**



Ref.	Fecha-Date	OE
9223922	2006-	1613692480(C; P); 0000735620745; 735517072(F)
9224922	2006-	1613689180(C; P); 0000735620706; 735517040(F)



Ref.	Fecha-Date	OE
9263922	2006-	735424440; 8153Y4
9257922	2006-	



Ref.	Fecha-Date	OE	Caract.
9225922	2006-	735424423 ; 8153 Y8 (C; P); 735517073(F)	80 X 320 X 400
9226922	2006-	735424397 ; 8153 Y6(C; P); 735517041(F)	80 X 320 X 400
9235922	2006-	735424431(C; P); 8153X8(P)	80 X 320 X 400



Ref.	Fecha-Date	OE
9227922	2006-	8153PJ; 815457; 8154NW
9228922	2006-	8153NQ; 815428; 8154LR
9239922	2006-	735517079

**NEW**



Ref.	Fecha-Date	OE
9229922	2006-	1613692680(C; P); 0000735620748(F)
9230922	2006-	1613689380(C; P); 0000735620709(F)
9231922	2006-	1613692680(C; P); 0000735620748(F)

**NEW**



Ref.	Fecha-Date	OE
9251922	2006-	1613694380(C; P) ; 0000735620748(F)
9252922	2006-	1613689480(C; P) ; 0000735620709(F)
9253922	2006-	1613694380(C; P) ; 0000735620748(F)

**NEW**



Ref.	Fecha-Date		OE
9254922	2006-		8153X6
9255922	2006-		8153W3
9277922	2006-		735424433; 8153Y0

**NEW**



Ref.	Fecha-Date		OE
6343922	2006-		2507070066
6344922	2006-		2507070011

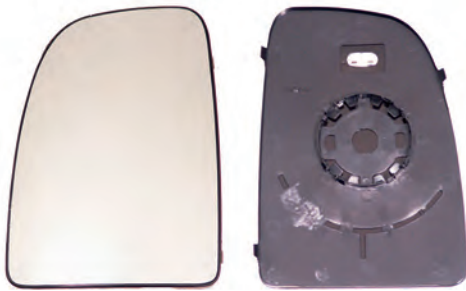

Ref.	Fecha-Date		OE
6401922	2006-		8151LG(C; P); 71748244(F)
6402922	2006-		8151LH(C; P); 71748245(F)
6431922	2006-		8151LJ(C; P); 71748246(F)
6432922	2006-		8151LK(C; P); 71748247(F)



Ref.	Fecha-Date		OE
6411922	2006-		8151LL(C; P); 71748248(F)
6412922	2006-		8151LN(C; P); 71748249(F)
6441922	2006-		8151LP(C; P); 71748250(F)
6442922	2006-		8151LQ(C; P); 71748251(F)



Ref.	Fecha-Date		OE
6201922	2006-		6325H0(C; F); 71748252(P)
6202922	2006-		6325H1(C; F); 71748253(P)



Ref.	Fecha-Date		OE
6203922	2006-		6325H3
6204922	2006-		6325H4

# CITROËN JUMPY / FIAT SCUDO / PEUGEOT EXPERT



Ref.	Fecha-Date	OE
9201973	1995-06	8153HE(C); 1484825089(F); 8148NP(P)
9202973	1995-06	8153HF(C); 1484826899(F); 8148NQ(P)



Ref.	Fecha-Date	OE
9264973	1995-06	8148NP(C); 9790417889(F); 8153HE(P) 8148NQ(C);
9265973	1995-06	9790417989(F); 8153HF(P)



Ref.	Fecha-Date	OE
9225973	1995-06	8153HZ(C; P); 1484829089(F)
9226973	1995-06	8153JA(C; P); 1484830899(F)

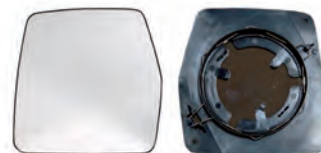

Ref.	Fecha-Date	OE
6401973	1995-06	8151V5(C; P); 9790414180(F)
6402973	1995-06	8151V2(C; P); 9790419180(F)



Ref.	Fecha-Date	OE
6464973	1995-06	8151 V5(C; P); 9790418680(F)
6465973	1995-06	8151 V6(C; P); 9790418780(F)



Ref.	Fecha-Date	OE
6425973	1995-06	8151AT(C; P); 9790460680(F)
6426973	1995-06	8151AV(C; P); 9790460780(F)













Ref.	Fecha-Date	OE
6106217	1995-06  	814842











Ref.	Fecha-Date	OE	Caract.
6106219	1995-06  	814842	CON PLOMO

## CITROËN JUMPY / FIAT SCUDO / PEUGEOT EXPERT





























Ref.	Fecha-Date	OE
9264955	2007-     	8153GC(C; P); 1488681898(F)
9265955	2007-     	8153GA(C; P); 1488681898(F)





























Ref.	Fecha-Date	OE
9274955	2007-    	8153K1
9275955	2007-    	8153J9



Ref.	Fecha-Date	OE
9225955	2007-      	8153L7(C; P); 9467193088(F)
9221955	2007-      	8153L5(C; P); 9467192088(F)
9229955	2007-       	8153N9
9230955	2007-       	8153N7(C; P); 9467188088(F)



Ref.	Fecha-Date	OE
9239955	2007-      	8153L7(C); 8153K9(P)
9240955	2007-      	8153L5(C); 8153K7(P)
9215955	2007-       	8153GJ(C; P); 1498689898(F)
9222955	2007-       	8153GH(C; P); 9467194088(F)



Ref.	Fecha-Date	OE
9245955	2007-	8153K9(C; P); 9467187088(F)
9251955	2007-	8153K7(C; P); 9467186088(F)
9259955	2007-	8153K9(C; P); 9467189088(F)
9250955	2007-	8153L9(C; P); 9467192088(F)



Ref.	Fecha-Date	OE
9269955	2007-	8153K1(C; P); 9467193088(F)
9260955	2007-	8153J9
9255955	2007-	8153GE(C; P); 9467197088(F)
9252955	2007-	8153GK(C; P); 9467196088(F)



Ref.	Fecha-Date	OE
6343955	2007-	8152C3(C; P); 9467047877(F)
6344955	2007-	8152C2(C; P); 9467047777(F)



Ref.	Fecha-Date	OE
6401955	2007-	8151KG(C); 8151KE(C; P); 9467048380(F)
6402955	2007-	8151KF(C); 8151KC(C; P); 9467048280(F)
6431955	2007-	8151KE(C); 8151KG(P)
6432955	2007-	8151KC(C); 8151KF(P)



Ref.	Fecha-Date	OE	Caract.
6411955	2007-	8151KE(C; P); 9467051880(F)	135 X 155
6412955	2007-	8151KC(C; P); 9467051780(F)	135 X 155
6441955	2007-	8151LJ(C)	135 X 155
6442955	2007-	8151LK(C)	135 X 155

## CITROËN NEMO / FIAT FIORINO-QUBO / PEUGEOT BIPPER



Ref.	Fecha-Date	OE
9264351	2007-	8153VG(C; P); 735460570(F)
9265351	2007-	8153VF(C; P); 735460566(F)
9231351	2007-	735460570
9232351	2007-	735460566



Ref.	Fecha-Date	OE
9225351	2007-	8153VJ(C; P); 735460571(F)
9236351	2007-	8153VH(C; P); 735460567(F)
9239351	2007-	735460571
9240351	2007-	735460567



Ref.	Fecha-Date	OE
6343351	2007-	8153VL(C; P); 735462099(F)
6344351	2007-	8153VK(C; P); 735462098(F)
6345351	2007-	8154RX(C; P); 735480200(F)
6346351	2007-	8154RW(C; P); 735480199(F)



Ref.	Fecha-Date	OE
6451351	2007-	8151QW(C; P); 71765392(F)
6402351	2007-	8151QV(C; P); 71765391(F)
6471351	2007-	8151QY(C; P); 71765390(F)
6432351	2007-	8151QX(C; P); 71765389(F)



# FIAT DOBLO



Ref.	Fecha-Date	Icons	OE
9201930	2000-10	◀ ◻ ◻ ◻ ◻	735394524
9202930	2000-10	▶ ◻ ◻ ◻ ◻	735394266
9261930	2000-10	◀ ◻ ◻ ◻ ◻	735419582
9262930	2000-10	▶ ◻ ◻ ◻ ◻	735419592
9227930	2000-10	◀ ◻ ◻ ◻ ◻	735325159
9228930	2000-10	▶ ◻ ◻ ◻ ◻	735325166



Ref.	Fecha-Date	Icons	OE
9264930	2000-10	◀ ◻ ◻ ◻ ◻	735296233
9265930	2000-10	▶ ◻ ◻ ◻ ◻	735296225
9225930	2000-10	◀ ◻ ◻ ◻ ◻	735325159
9226930	2000-10	▶ ◻ ◻ ◻ ◻	735296227



Ref.	Fecha-Date	Icons	OE
6346930	2000-10	◀ ◻ ◻	735296869
6345930	2000-10	▶ ◻ ◻	0735296869; 0735419600



Ref.	Fecha-Date	Icons	OE
6403930	2000-10	◀ ◻ ◻ ◻	71718326
6433930	2000-10	▶ ◻ ◻ ◻	71718326

FIAT DOBLO



Ref.	Fecha-Date	OE
9264929	2010-	735497882
9265929	2010-	735497881
9225929	2010-	735528049
9226929	2010-	735528034
9236929	2010-	735528041



Ref.	Fecha-Date	OE
9237929	2010-	735528050
9238929	2010-	735528038
9239929	2010-	
9240929	2010-	
9246929	2010-	



Ref.	Fecha-Date	OE
9254929	2010-	735497885
9255929	2010-	735497873
9275929	2010-	735497890
9276929	2010-	735497871
9256929	2010-	735497878



Ref.	Fecha-Date	OE
9257929	2010-	735528050
9258929	2010-	735528038
9259929	2010-	
9250929	2010-	
9253929	2010-	735528034



Ref.	Fecha-Date	OE
6343929	2010-	735497928
6344929	2010-	735497926
6341929	2010-	735512765
6342929	2010-	735512764



Ref.	Fecha-Date	OE
6401929	2010-	71765379
6402929	2010-	71765378
6431929	2010-	71765471
6432929	2010-	71765470



Ref.	Fecha-Date	OE
6441929	2010-	71765381
6442929	2010-	71765380



Ref.	Fecha-Date	OE
6201929	2010-	71765449
6202929	2010-	71765377

**FIAT FIORINO**



Ref.	Fecha-Date	OE
6164490	1988-90	5892125
6165490	1988-90	5892126



Ref.	Fecha-Date	OE
6401348	1997-	
6402348	1997-	

CITROËN BERLINGO / PEUGEOT PARTNER



Ref.	Fecha-Date	OE	Caract.
2741974	1996-02	6204P6	BERLINGO
2742974	1996-02	6205P6	BERLINGO



Ref.	Fecha-Date	OE	Caract.
2745974	1996-02	6204P8	PARTNER
2746974	1996-02	6205P8	PARTNER



Ref.	Fecha-Date	OE	Caract.
2901974	1996-02	9682F2	BERLINGO
2902974	1996-02	9682F2	BERLINGO



Ref.	Fecha-Date	OE	Caract.
2903364	1996-02	00006205W4	PARTNER



Ref.	Fecha-Date	OE
2101974	1996-02	630379(C); 630381(P)
2102974	1996-02	630380(C); 630382(P)



Ref.	Fecha-Date	OE
3103339	1996-02	632545; 632562(C); 632567(P)



Ref.	Fecha-Date	OE
3103338	1996-02	632545(C; P)



Ref.	Fecha-Date	OE	Caract.
2201974	1996-02	6350EE; 6350J1(C); 6350J0(P)	T.YORKA
2202974	1996-02	6351EE; 6351J1(C); 6351J0(P)	T.YORKA



Ref.	Fecha-Date	OE	Caract.
2211974	1996-02	6350EC; 6350H2	T.YORKA
2212974	1996-02	6351EC; 6351H2	T.YORKA

**CITROËN BERLINGO / PEUGEOT PARTNER**



Ref.	Fecha-Date	OE
2751974	2002-08	6204AX(C; P)
2752974	2002-08	6205AW(C; P)



Ref.	Fecha-Date	OE
2903364	2002-08	6204AA(C); 00006205W4(P)



Ref.	Fecha-Date	OE
3040974	2002-08	6325G3(C); 6325G4(P)



Ref.	Fecha-Date	OE	Caract.
2211975	2002-08	6350EE(C); 6350Y9(P)	T.YORKA
2212975	2002-08	6351EE(C); 6351Y9(P)	T.YORKA



Ref.	Fecha-Date	OE	Caract.
2201975	2002-08	6350EC(C); 6350Y8(P)	T.YORKA
2202975	2002-08	6351EC(C); 6351Y8(P)	T.YORKA

**CITROËN BERLINGO / PEUGEOT PARTNER**



Ref.	Fecha-Date	OE	Caract.
2741975	2008-11	6208K6	BERLINGO
2742975	2008-11	6206K6	BERLINGO



Ref.	Fecha-Date	OE	Caract.
2745975	2008-12	6208K4	PARTNER
2746975	2008-12	6206K4	PARTNER



Ref.	Fecha-Date	OE
3040974	2008-11	6325G3(C); 6325G4(P)



Ref.	Fecha-Date	OE
2231975	2008-11	6350FH(C); 6350FH(P)
2232975	2008-11	6351FH(C); 6351FH(P)



Ref.	Fecha-Date	OE	Caract.
2221975	2008-11	6350FJ(C); 6350FJ(P)	T.AL
2222975	2008-11	6351FJ(C); 6351FJ(P)	T.AL

**NEW**



Ref.	Fecha-Date	OE
2403975	2008-11	6340G7



Ref.	Fecha-Date	OE	Caract.
2751975	2012-	9677202080 (C); 9677202480 (P)	BERLINGO
2752975	2012-	9677201980(C); 9677202380 (P)	BERLINGO



Ref.	Fecha-Date	OE	Caract.
2755975	2012-	9677202480	PARTNER
2756975	2012-	9677202380	PARTNER

**NEW**



Ref.	Fecha-Date	OE	Caract.
1913975	2012-	9812662280	T.VAL



Ref.	Fecha-Date	OE
2251975	2012-	9677205180 (C); 9812662280 (P)
2252975	2012-	9677205080 (C)



Ref.	Fecha-Date		OE
2241975	2012-		9677205580(C; P)
2242975	2012-		9677205580(C; P)

## CITROËN C15



Ref.	Fecha-Date		OE
2705326	1989-95		95535308
2706326	1989-95		95535309



Ref.	Fecha-Date		OE
2705327	1989-95		95535308
2706327	1989-95		95535309



Ref.	Fecha-Date		OE
3305327	1989-95		95614884
3306327	1989-95		95614885



Ref.	Fecha-Date		OE	Caract.
2201326	1989-95		95630219	T. YORKA
2202326	1989-95		95630217	T. YORKA



## CITROËN C25 / FIAT DUCATO / PEUGEOT J5

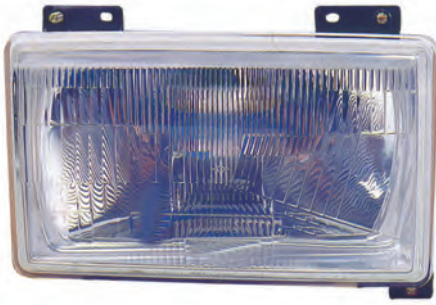

Ref.	Fecha-Date	Icons	OE
2711961	1990-94	Left arrow, Car, Hand, ASIM, H4	7543659(C); 0007660574(F); 6204AC(P)
2712961	1990-94	Right arrow, Car, Hand, ASIM, H4	7536658(C); 0007660573(F); 6205AA(P)
3701961	1990-94	Left arrow, Car, Hand, ASIM, H4	7660574(C); 0007660574(F); 6204AC(P)
3702961	1990-94	Right arrow, Car, Hand, ASIM, H4	7660573(C); 0007660573(F); 6205AA(P)



Ref.	Fecha-Date	Icons	OE
2205982	1990-94	Left arrow, Car, ASIM, H4, Stop	7567805(C); 7567805(F); 6350AT(P)
2206982	1990-94	Right arrow, Car, ASIM, H4, Stop	7567804(C); 7567804(F); 6351AX(P)

## CITROËN JUMPER / FIAT DUCATO / PEUGEOT BOXER



Ref.	Fecha-Date	Icons	OE
2741920	1994-02	Left arrow, Car, ASIM, H4, Stop	6204AF(C; P); 1301150080(F)
2742920	1994-02	Right arrow, Car, ASIM, H4, Stop	6205AE(C; P); 1301149080(F)



Ref.	Fecha-Date	Icons	OE
2101920	1994-02	Left arrow, Car, ASIM, H4, Stop	630396(C; P); 1303854080(F)
2102920	1994-02	Right arrow, Car, ASIM, H4, Stop	630395(C; P); 1303853080(F)



Ref.	Fecha-Date	OE
<b>3117920</b>	1994-02	6325G1(C; P); 0001341674080(F)



Ref.	Fecha-Date	OE	Caract.
<b>2205920</b>	1994-02	6350AL(C; P); 132635908(F)	BUS/VAN T. YORKA
<b>2206920</b>	1994-02	6351AL(C; P); 132635808(F)	BUS/VAN T. YORKA



Ref.	Fecha-Date	OE	Caract.
<b>2215973</b>	1994-02	6350AL(C; P); 0001326358080(F)	CHASSIS T. SIEM
<b>2216973</b>	1994-02	6351AL(C; P); 0001326359080(F)	CHASSIS T. SIEM
<b>2225973</b>	1994-02	6350AL(C; P); 0001326358080(F)	CHASSIS
<b>2226973</b>	1994-02	6351AL(C; P); 0001326359080(F)	CHASSIS

**CITROËN JUMPER / FIAT DUCATO / PEUGEOT BOXER**



Ref.	Fecha-Date	OE
<b>2741921</b>	2002-06	6208E3(C; P); 0001328426080(F)
<b>2742921</b>	2002-06	6206E2(C; P); 0001328425080(F)



Ref.	Fecha-Date	OE
<b>2903532</b>	2002-06	6206C8(C; P); 0000469309999(F)



Ref.	Fecha-Date	OE
<b>3117920</b>	<b>2002-06</b>	6325G1(C; P); 0001341674080(F)



Ref.	Fecha-Date	OE	Caract.
<b>2201921</b>	<b>2002-06</b>	6350AR(C; P); 0001328428080(F)	BUS/VAN T. SEIMA/M.MARELLI
<b>2202921</b>	<b>2002-06</b>	6351AV(C; P); 0001328427080(F)	BUS/VAN T. SEIMA/M.MARELLI



Ref.	Fecha-Date	OE	Caract.
<b>2215973</b>	<b>2002-06</b>	6350AL(C; P); 0001326358080(F)	CHASSIS T. SIEM
<b>2216973</b>	<b>2002-06</b>	6351AL(C; P); 0001326359080(F)	CHASSIS T. SIEM
<b>2225973</b>	<b>2002-06</b>	6350AL(C; P); 0001326358080(F)	CHASSIS
<b>2226973</b>	<b>2002-06</b>	6351AL(C; P); 0001326359080(F)	CHASSIS

**CITROËN JUMPER / FIAT DUCATO / PEUGEOT BOXER**



Ref.	Fecha-Date	OE
<b>2741922</b>	<b>2006-</b>	6208A5(C; P); 0001340664080(F)
<b>2742922</b>	<b>2006-</b>	6206A5(C; P); 0001340663080(F)



Ref.	Fecha-Date	OE
<b>2903474</b>	<b>2006-</b>	620862(C; P); 0046823269(F)

**NEW**



Ref.	Fecha-Date				
2405922	2006-				

**NEW**



Ref.	Fecha-Date					OE
2413922	2006-					735430904
2403922	2006-					735430904



Ref.	Fecha-Date	OE	Caract.
2201856	2006-	1606664080(C); 0001365774080(F); 6350AV(P)	BUS/VAN T. AL
2202856	2006-	1606664180(C); 0001365775080(F); 6351AY(P)	BUS/VAN T. AL



Ref.	Fecha-Date	OE	Caract.
2215973	2006-	6350AL(C; P); 0001326358080(F)	CHASSIS T. SIEM
2216973	2006-	6351AL(C; P); 0001326359080(F)	CHASSIS T. SIEM
2225973	2006-	6350AL(C; P); 0001326358080(F)	CHASSIS
2226973	2006-	6351AL(C; P); 0001326359080(F)	CHASSIS

**CITROËN JUMPER / FIAT DUCATO**



**NEW**



Ref.	Fecha-Date	OE	Caract.
2751922	2014-	1612041780 (C); 1374296080 (F)	T.AL
2752922	2014-	1612040980 (C); 1374292080 (F)	T.AL

**NEW**



Ref.	Fecha-Date	OE	Caract.
2755922	2014-	1612041880 (C); 1374297080 (F)	T.AL
2756922	2014-	1612041080 (C); 1374293080 (F)	T.AL

## FIAT DUCATO / PEUGEOT BOXER



**NEW**



Ref.	Fecha-Date	OE	Caract.
2745922	2014-		T.AL
2746922	2014-		1374292080 T.AL

**NEW**



Ref.	Fecha-Date	OE	Caract.
2741856	2014-		1612041380 BOXER
2742856	2014-		1612040580 BOXER

## CITROËN JUMPY / FIAT SCUDO / PEUGEOT EXPERT



Ref.	Fecha-Date	OE
2741973	1995-06	6204AL(C; P); 1474268080(F)
2742973	1995-06	6205AK(C; P); 1474267080(F)



Ref.	Fecha-Date	OE
2901354	1995-06	6204J4(C); 1471312080(F); 6204J3(P); 6205J4(C);
2902354	1995-06	1471313080(F); 6205J3(P)



Ref.	Fecha-Date	OE
2101973	1995-06	630356(C); 9406303547(F); 630354(P)
2102973	1995-06	630355(C); 9406303537(F); 630353(P)



Ref.	Fecha-Date	OE
3103338	1995-06	632545(C; P); 9613702180(F)



Ref.	Fecha-Date	OE
3103339	1995-06	632545; 632562(C); 9613702180(F); 632567(P)



Ref.	Fecha-Date	OE	Caract.
2205973	1995-06	6350E7(C); 9790384780(F); 6350E6(P)	T.VAL
2206973	1995-06	6351E7(C); 9730384880(F); 6351E6(P)	T.VAL



Ref.	Fecha-Date	OE
2745973	2004-06	6208E8(C); 9467119588(F); 620630(P)
2746973	2004-06	6206E8(C); 9467119688(F); 620830(P)



Ref.	Fecha-Date	OE
2903363	2004-06	6206E1(C); 620400; 9648947780(F); 6208E1(P)



Ref.	Fecha-Date	OE
2741971	2007-	6208C5(C; P); 6208C5(F)
2742971	2007-	6206C5(C; P); 6206C5(F)



Ref.	Fecha-Date	OE
2903363	2007-	9206E1(C); 620400; 9648947780(F); 6208E1(P)



Ref.	Fecha-Date	OE
3040974	2007-	6325G4



Ref.	Fecha-Date	OE	Caract.
2201971	2007-	6350AH(C; P); 9467069888(F)	T.VAL
2202971	2007-	6351AH(C; P); 9467069988(F)	T.VAL

**NEW**



Ref.	Fecha-Date	OE
2403975	2007-	6340G7

**CITROËN NEMO / FIAT FIORINO-QUBO / PEUGEOT BIPPER**



Ref.	Fecha-Date	OE
2741351	2007-	6205AZ(C; P); 1353198080(F)
2742351	2007-	6205AY(C; P); 1353197080(F)



Ref.	Fecha-Date	OE
2901351	2007-	6206K2(C); 1356651080(F); 6206K0(P) 6206K3(C);
2902351	2007-	1356651080(F); 6206K0(P)



Ref.	Fecha-Date	OE
3103931	2007-	6326H7



Ref.	Fecha-Date	OE	Caract.
2211351	2007-	6350EV(C); 1355724080(F); 8503QA(P)	
2212351	2007-	6350ET(C); 1355727080(F); 8503PZ(P)	
2201351	2007-	6350EV(C; P); 1353355080(F)	T. FARBA
2202351	2007-	6350ET(C; P); 1353356080(F)	T. FARBA

**NEW**



Ref.	Fecha-Date	OE
2413351	2007-	6340G5
2403351	2007-	6340G5

**NEW**



Ref.	Fecha-Date	OE
2433351	2009-	6340H0
2423351	2009-	6340H0

**FIAT DOBLO**



Ref.	Fecha-Date	OE
2741961	2000-05	46807765
2742961	2000-05	46807766
2751961	2000-05	46807768
2752961	2000-05	46807769

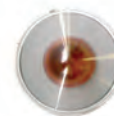

Ref.	Fecha-Date	OE
3107961	2000-05	000007734499; 0046522717; 46803094





Ref.	Fecha-Date	OE
2241961	2000-05	51735979
2242961	2000-05	51735978



Ref.	Fecha-Date	OE
2745961	2005-10	51755051
2746961	2005-10	51755054



Ref.	Fecha-Date	OE
2903474	2005-10	46823269



Ref.	Fecha-Date	OE
3103931	2005-10	0046758821



Ref.	Fecha-Date	OE	Caract.
2211961	2005-10	51755145	T.(AL)MAKO
2212961	2005-10	51755144	T.(AL)MAKO

**FIAT DOBLO**



Ref.	Fecha-Date	OE
2761961	2010-	51810672
2762961	2010-	51810671



Ref.	Fecha-Date	OE	Caract.
2231961	2010-	51830565	T.AL
2232961	2010-	51830564	T.AL
2221961	2010-	51810674	T.AL
2222961	2010-	51810673	T.AL

**FIAT FIORINO**



Ref.	Fecha-Date	OE
3107492	1991-96	0007566759; 0007626742; 5953696

**FIAT MULTIPLA**



Ref.	Fecha-Date	OE
2105367	1999-04	0046512542
2106367	1999-04	0046512541



Ref.	Fecha-Date	OE
3003011	1999-04	0046769163; 46769163



Ref.	Fecha-Date	OE
3007011	1999-04	46511360



Ref.	Fecha-Date	OE
2751006	2004-05	0000051708730; 0051780722
2752006	2004-05	0000051708729; 0051780718



Ref.	Fecha-Date	OE
2745006	2004-05	0051708732
2746006	2004-05	0051708731



Ref.	Fecha-Date	OE
3103931	2004-05	0046758821

# DACIA DOKKER / LODGY



Ref.	Fecha-Date	OE
6164646	2012-	963026216R; 963736608R; 963023379R
6165646	2012-	963011786R; 8200947383; 963659141R



Ref.	Fecha-Date	OE
6137646	2012-	963026216R; 963737245R; 963023379R
6138646	2012-	963011786R; 963740290R; 963659141R



Ref.	Fecha-Date	OE
6125646	2012-	963025005R; 963736608R; 963661HB0B
6126646	2012-	8200947383; 963019902R; 963651HB0B
6139646	2012-	963025005R; 963737245R; 963661HB0B
6140646	2012-	963019902R; 963740290R; 963651HB0B

## DACIA LOGAN EXPRESS



Ref.	Fecha-Date	OE
6101594	2009-12	963025718R
6102594	2009-12	963015334R



Ref.	Fecha-Date	OE
6164594	2009-12	6001549674
6165594	2009-12	6001549675



Ref.	Fecha-Date	OE
6125594	2009-12	963023520R
6126594	2009-12	963017247R



Ref.	Fecha-Date	OE
6139594	2009-12	963028631R
6140594	2009-12	963013709R



Ref.	Fecha-Date	OE
6341594	2009-12	963736915R
6342594	2009-12	963747198R



Ref.	Fecha-Date	OE
6401594	2009-12	6001549716
6402594	2009-12	6001549717
6431594	2009-12	963664166R
6432594	2009-12	963654759R

# FORD TRANSIT CONNECT / TOURNEO CONNECT



Ref.	Fecha-Date	OE
9264390	2002-09	4460950
9265390	2002-09	4460947
9225390	2002-09	4571615
9226390	2002-09	4571614



Ref.	Fecha-Date	OE
6401390	2002-09	4440216
6402390	2002-09	4440212
6431390	2002-09	4440217
6432390	2002-09	4440214



Ref.	Fecha-Date	OE	Caract.
6481390	2002-09	4440216	135 X 50
6482390	2002-09	4440212	135 X 50



Ref.	Fecha-Date	OE
9201396	2009-12	5016562
9202396	2009-12	5091561
9225396	2009-12	5091601
9226396	2009-12	5091589; 5211697



Ref.	Fecha-Date	OE
9239396	2009-12	5211706
9240396	2009-12	5211589

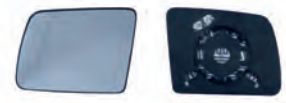

Ref.	Fecha-Date	OE
6343396	2009-12	5091564; 5211714
6344396	2009-12	5091563; 5211715
6341396	2009-12	5016549
6342396	2009-12	5016550

Ref.	Fecha-Date	OE
6451396	2009-12	4973827
6402396	2009-12	4973826
6471396	2009-12	4973823
6432396	2009-12	4973822

## FORD TRANSIT CONNECT / TOURNEO CONNECT / GRAND TOURNEO CONNECT



**NEW**



Ref.	Fecha-Date	OE
9201341	2013-	1819841; 1828728; 1845989
9202341	2013-	1819836; 1828722; 1845983
9225341	2013-	1819843; 1828730; 1845991
9226341	2013-	1819838; 1828724; 1845985

Ref.	Fecha-Date	OE
9231341	2013-	1828728; 1845989
9232341	2013-	1828722; 1845983
9239341	2013-	1828730; 1845991
9240341	2013-	1828724; 1845985
9229341	2013-	1828732; 1845993
9230341	2013-	1828726; 1845987

**NEW**



Ref.	Fecha-Date	OE
6343341	2013-	1824875
6344341	2013-	1825609
6341341	2013-	1824875
6342341	2013-	1825609



Ref.	Fecha-Date	OE
6431341	2013-	1815170
6432341	2013-	1815172

## FORD TRANSIT COURIER / TOURNEO COURIER



Ref.	Fecha-Date	OE
9201668	2013-	ET7617683AF5JA; ET7617K747AD-5JA
9202668	2013-	ET7617682AF5JA; ET7617K746AD-5JA



Ref.	Fecha-Date	OE
9231668	2013-	ET7617683AF5JA; ET7617K747AD-5JA
9232668	2013-	ET7317682AF5JA; ET7617K746AD-5JA



Ref.	Fecha-Date	OE
9227668	2013-	ET7617683A-F5JA6; ET7617K747AD-5JA6
9228668	2013-	ET7617683A-F5JA6; ET7617K747AD-5JA6
9230668	2013-	ET7617682A-F5JA6; ET7617K746AD-5JA6

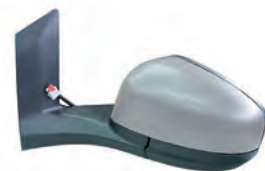

Ref.	Fecha-Date	OE
9237668	2013-	ET7617683AF-5JA6
9238668	2013-	ET7617682AF5JA6; ET7617K746AD5JA6
9236668	2013-	ET7617683AF5JA6; ET7617K747AD5JA6





Ref.	Fecha-Date	OE
9225668	2013-	ET7617683BF5JA; ET7617K747BD57V
9226668	2013-	ET7617682BF5JA; ET7617K746BD57V
9242668	2013-	ET7617682BF5JA6; ET7617K746AD5JA6

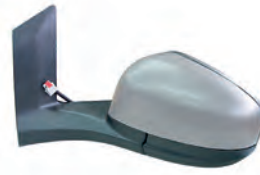

Ref.	Fecha-Date	OE
9239668	2013-	ET7617683BF5JA; ET7617K747BD57V
9240668	2013-	ET7617682BF5JA; ET7617K746BD57V
9243668	2013-	ET7617683BF5JA6
9244668	2013-	ET7617682BF5JA6; ET7617K746AD5JA6



Ref.	Fecha-Date	OE
6343668	2013-	ET7617K747AD5JA
6344668	2013-	ET7617K746AD5JA
6341668	2013-	ET7617K747BD57V
6342668	2013-	ET7617K746BD57V



Ref.	Fecha-Date	OE
6451668	2013-	1766586; ET7617K741CAYP
6452668	2013-	1766583; ET7617K740AAYP
6471668	2013-	ET7617K741BA
6472668	2013-	ET7617K740BA

# FORD TRANSIT CUSTOM / TOURNEO CUSTOM



FORD



Ref.	Fecha-Date	OE
9201381	2012-	1805837; 1776500; 1766587
9202381	2012-	1805825; 1776499; 1766584
9225381	2012-	1911143; 2013061; 1776500; 1766587
9226381	2012-	1932576; 2013054; 1776499; 1766584
9229381	2012-	BK2117683RE5JAE; BK2117K747ABW
9230381	2012-	BK2117682RE5JAE; BK2117K746ABW



Ref.	Fecha-Date	OE
9231381	2012-	1805837; 1809085; 1766587
9232381	2012-	1805825; 1809084; 1766584
9239381	2012-	1805832; 2013061; 1809085; 1766587
9240381	2012-	1805826; 2013054; 1809084; 1766584
9243381	2012-	1805835; 2013068; 1809085; 1766587
9244381	2012-	1805829; 2013057; 1809084; 1766584



Ref.	Fecha-Date	OE
6343381	2012-	1776500
6344381	2012-	1776499
6341381	2012-	1809085
6342381	2012-	1809084

**NEW**



Ref.	Fecha-Date	OE
6411381	2012-	
6412381	2012-	
6431381	2012-	1766587
6432381	2012-	1766584



Ref.	Fecha-Date		OE
6201381	2012-		1766580
6202381	2012-		1766579

## FORD TRANSIT



Ref.	Fecha-Date		OE	Caract.
9261961	1985-92		6831697	110 MM
9262961	1985-92		6831642	110 MM

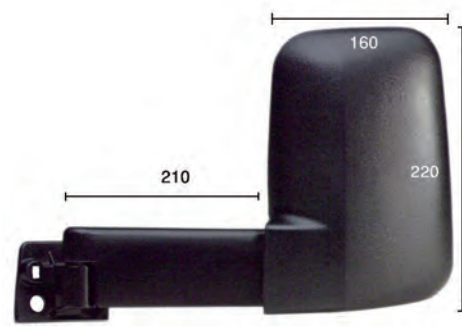

Ref.	Fecha-Date		OE	Caract.
9263961	1985-92		6831705	210 MM
9264961	1985-92		6831650	210 MM

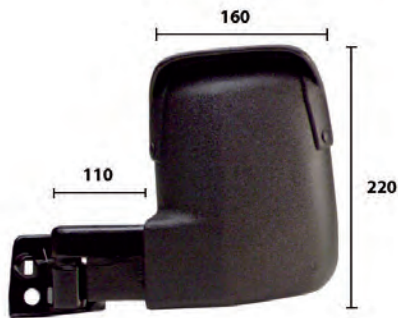

Ref.	Fecha-Date		OE	Caract.
9265961	1991-94		6831697	110 MM
9266961	1991-94		6831642	110 MM



Ref.	Fecha-Date		OE	Caract.
9267961	1991-94		6831650; 6831705	210 MM
9268961	1991-94		6831642; 6831650	210 MM



Ref.	Fecha-Date	OE	Caract.
9201959	1994-00	1053418	70 X 280 X 180
9202959	1994-00	1053410	70 X 280 X 180



Ref.	Fecha-Date	OE
9207959	1994-00	1026893; 94VB- 17683CL
9208959	1994-00	1053412; 94VB17682GN
9227959	1994-00	94VB17683DN
9228959	1994-00	94VB17682HP



Ref.	Fecha-Date	OE
9225959	1994-00	1053419; 94VB17683BN
9226959	1994-00	1053411; 94VB- 17682FP



Ref.	Fecha-Date	OE
6401959	1994-00	7194188
6402959	1994-00	7194185
6411959	1994-00	5211712
6412959	1994-00	4460947



Ref.	Fecha-Date	OE
6431959	1994-00	1048711; 7194189; 94VB17K741BC; 94VB17K741BD
6432959	1994-00	1048710; 7194186; 94VB17K740BC; 94VB17K740BD



Ref.	Fecha-Date	OE
6481959	1994-00	1026990
6482959	1994-00	1026997



Ref.	Fecha-Date	OE	Caract.
9201960	2000-14	4643771	110 X 300 X 170
9202960	2000-14	4643476	110 X 300 X 170
9227960	2000-14	4643782	110 X 300 X 170
9228960	2000-14	4643479	110 X 300 X 170

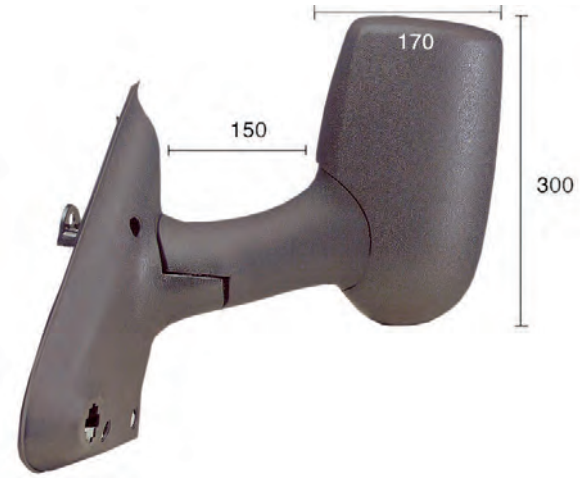

Ref.	Fecha-Date	OE	Caract.
9209960	2000-14	4643787	150 X 300 X 170
9210960	2000-14	4643360	150 X 300 X 170
9237960	2000-14	4643788	150 X 300 X 170
9238960	2000-14	4643394	150 X 300 X 170



Ref.	Fecha-Date	OE
6343960	2000-14	4458067
6344960	2000-14	4458064



Ref.	Fecha-Date	OE	Caract.
6401960	2000-14	4059969	147 X 210
6402960	2000-14	4059965	147 X 210
6431960	2000-14	4059968	147 X 210
6432960	2000-14	4059964	147 X 210



Ref.	Fecha-Date	OE
6481960	2000-14	4458063
6482960	2000-14	4458055



Ref.	Fecha-Date	OE
6201960	2000-14	4474148
6202960	2000-14	4474148



Ref.	Fecha-Date	OE
9225666	2013-	1911145; BK3117683EA-5JA
9226666	2013-	
9229666	2013-	1911148; 1932573
9230666	2013-	1911130; 1932580



Ref.	Fecha-Date	OE
9211666	2013-	1911143; BK3117683J-5J6A
9212666	2013-	1911132; BK3117682J-5J6A
9235666	2013-	1911152; BK-3117683NA-5JA
9236666	2013-	1911125; BK-3117682NA-5JA
9249666	2013-	1911154; BK3117683R-H5J6A
9250666	2013-	1911136; 1932579



Ref.	Fecha-Date	OE
6343666	2013-	1823808
6344666	2013-	1823809



Ref.	Fecha-Date	OE
6431666	2013-	1823985; BK3117K740AAW
6432666	2013-	1823994; BK3117K741AAW
6401666	2013-	1823986
6402666	2013-	1823995



Ref.	Fecha-Date	OE
6201666	2013-	1847387
6202666	2013-	1847389



Ref.	Fecha-Date	OE
6203666	2013-	1847388
6204666	2013-	1847390

## FORD TRANSIT CONNECT / TOURNEO CONNECT



Ref.	Fecha-Date	OE
2751960	2002-12	1346495
2752960	2002-12	1346497



Ref.	Fecha-Date	OE
2903960	2002-12	1097474



Ref.	Fecha-Date	OE
3105960	2002-12	1353531



Ref.	Fecha-Date	OE
3103960	2010-	4972773



Ref.	Fecha-Date	OE	Caract.
2205960	2002-09	1369222	T.VAL
2206960	2002-09	1369221	T.VAL



Ref.	Fecha-Date	OE
2201962	2006-	1435881
2202962	2006-	1435880



Ref.	Fecha-Date	OE
2211960	2010-	4974083; 5177813
2212960	2010-	4974082; 5177810

**NEW**



Ref.	Fecha-Date	OE
2413962	2002-12	1732840
2403962	2002-12	1732840

**FORD TRANSIT CONNECT / TOURNEO CONNECT / GRAND TOURNEO CONNECT**



**NEW**



Ref.	Fecha-Date	OE
2761960	2013-	1827690; 1827692; DT1113W030AC
2762960	2013-	1827686; 1827688; DT1113W029AC

**NEW**



Ref.	Fecha-Date	OE
2231960	2013-	1778456
2232960	2013-	1778457



Ref.	Fecha-Date	OE	Caract.
2221960	2013-	1827837; 1849468; 1908969	T.VAL
2222960	2013-	1824731; 1827836; 1908967	T.VAL



## FORD TRANSIT COURIER / TOURNEO COURIER



Ref.	Fecha-Date	OE
<b>2761960</b>	2014- H15	1827690; 1827692; DT1113W030AC
<b>2762960</b>	2014- H15	1827686; 1827688; DT1113W029AC



Ref.	Fecha-Date	OE
<b>2201388</b>	2014-	ET7613404AB
<b>2202388</b>	2014-	ET7613405AB

## FORD TRANSIT



Ref.	Fecha-Date	OE
<b>2709961</b>	1985-91	6639650
<b>2710961</b>	1985-91	6639646



Ref.	Fecha-Date	OE
<b>2105961</b>	1985-91	6166918
<b>2106961</b>	1985-91	6166917



Ref.	Fecha-Date	OE
<b>3007380</b>	1985-91	6156783
<b>3107380</b>	1985-91	6156783



Ref.	Fecha-Date	OE
<b>3007386</b>	1985-91	4474148; 6859846
<b>3107386</b>	1985-91	1058079; 4474148



Ref.	Fecha-Date	OE
<b>3103386</b>	1985-91	1034275; 4474148; 6166302



Ref.	Fecha-Date	OE
<b>2201961</b>	1985-91	1063538; 4505432
<b>2202961</b>	1985-91	1063537; 4505431



Ref.	Fecha-Date	OE	Caract.
<b>2701958</b>	1991-94	6677256	
<b>2702958</b>	1991-94	6677253	
<b>2741958</b>	1991-94	7242053	
<b>2742958</b>	1991-94	7242047	
<b>2741959</b>	1991-94	7242051	LENTE POLICARBONATO
<b>2742959</b>	1991-94	7242045	LENTE POLICARBONATO



Ref.	Fecha-Date	OE
<b>2101958</b>	1991-94	1054241
<b>2102958</b>	1991-94	1C0941700B



Ref.	Fecha-Date	OE
<b>2105958</b>	1991-94	1063534
<b>2106958</b>	1991-94	1063533



Ref.	Fecha-Date	OE
<b>3103386</b>	1991-94	1034275; 4474148; 6166302



Ref.	Fecha-Date	OE	Caract.
<b>2201961</b>	1991-94	1063538; 4505432	BUS/VAN
<b>2202961</b>	1991-94	1063537; 4505431	BUS/VAN



Ref.	Fecha-Date	OE	Caract.
<b>2741959</b>	1994-00	7242051	LENTE POLICARBONATO
<b>2742959</b>	1994-00	7242045	LENTE POLICARBONATO



Ref.	Fecha-Date	OE
<b>2105959</b>	1994-00	1063534
<b>2106959</b>	1994-00	1063533



Ref.	Fecha-Date	OE
<b>3103386</b>	1994-00	1034275; 4474148; 6166302



Ref.	Fecha-Date	OE	Caract.
<b>2201961</b>	1994-00	1063538; 4505432	BUS/VAN
<b>2202961</b>	1994-00	1063537; 4505431	BUS/VAN



Ref.	Fecha-Date	OE
<b>2745960</b>	2000-06	4696778
<b>2746960</b>	2000-06	4696752



Ref.	Fecha-Date	OE
<b>2741960</b>	2000-06	4696778
<b>2742960</b>	2000-06	4696752



Ref.	Fecha-Date	OE
<b>2901398</b>	2000-06	1135996; 4377433
<b>2902398</b>	2000-06	1135998; 4395813



Ref.	Fecha-Date	OE
3007386	2000-06	4474148; 6859846
3107386	2000-06	1058079; 4474148



Ref.	Fecha-Date	OE
3103386	2000-06	1034275; 4474148; 6166302



Ref.	Fecha-Date	OE
2201960	2000-06	1205706
2202960	2000-06	1205701



Ref.	Fecha-Date	OE
2745962	2006-13	1537774
2746962	2006-13	1537773



Ref.	Fecha-Date	OE
2903228	2006-13	1209177



Ref.	Fecha-Date	OE
2201962	2006-	1435881
2202962	2006-	1435880

**NEW**



Ref.	Fecha-Date	OE
2413962	2006-	1732840
2403962	2006-	1732840

**NEW**



Ref.	Fecha-Date	OE
<b>2765960</b>	2013-	1815696; 1817487; 1819826; 1830357; 1865207; 1865209; 1877027
<b>2766960</b>	2013-	1815694; 1817485; 1819824; 1830355; 1865207; 1877025



Ref.	Fecha-Date	OE
<b>2201983</b>	2013-	BK13404AG
<b>2202983</b>	2013-	BK13405AG

**HYUNDAI H-1**



Ref.	Fecha-Date	OE
<b>2751626</b>	2005-07	92101-4H020
<b>2752626</b>	2005-07	92102-4H020

Ref.	Fecha-Date	OE
<b>2911626</b>	2005-07	922014A600
<b>2912626</b>	2005-07	922024A600

## HYUNDAI H100



Ref.	Fecha-Date				
2741624	2005-07	◀			
2742624	2005-07	▶			



Ref.	Fecha-Date				
2901624	2005-07	◀			
2902624	2005-07	▶			



Ref.	Fecha-Date			OE
1901624	2005-07	◀		92301-43810
1902624	2005-07	▶		92302-43810



Ref.	Fecha-Date			OE	Caract.
2209624	2005-07	◀		92401-43810	T.HMC
2210624	2005-07	▶		92402-43800	T.HMC

## IVECO DAILY I/II



Ref.	Fecha-Date			OE	Caract.
9297961	1978-99	◀		93908147	30 X 230 X 210
9298961	1978-99	▶		93908146	30 X 230 X 210



Ref.	Fecha-Date			OE	Caract.
6101972	1989-95	◀		93924654	90 X 280 X 180
6102972	1989-95	▶		85B507021001; 93924653	90 X 280 X 180



Ref.	Fecha-Date	OE	Caract.
<b>6109972</b>	<b>1989-95</b>	8SB507022001; 93936850	160 X 280 X 180
<b>6110972</b>	<b>1989-95</b>	8SB507023001; 93936851	160 X 280 X 180



Ref.	Fecha-Date	OE	Caract.
<b>9201975</b>	<b>1996-99</b>	93936852	90 X 280 X 180
<b>9202975</b>	<b>1996-99</b>	93936853	90 X 280 X 180

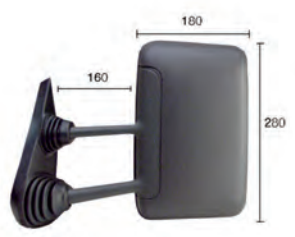

Ref.	Fecha-Date	OE	Caract.
<b>9201976</b>	<b>1996-99</b>	93936854	160 X 280 X 180
<b>9202976</b>	<b>1996-99</b>	93936855	160 X 280 X 180
<b>9227976</b>	<b>1996-99</b>	93936844	160 X 280 X 180
<b>9228976</b>	<b>1996-99</b>	93936845	160 X 280 X 180

# IVECO DAILY III



Ref.	Fecha-Date	OE	Caract.
9201977	1999-06	500325706	100 X 340 X 180
9202977	1999-06	98473012	100 X 340 X 180
9227977	1999-06	504056864	100 X 340 X 180
9228977	1999-06	504056878	100 X 340 X 180



Ref.	Fecha-Date	OE	Caract.
9209977	1999-06	98473011	130 X 340 X 180
9210977	1999-06	98472986; 98409117	130 X 340 X 180
9237977	1999-06	500325729	130 X 340 X 180
9238977	1999-06	500325730	130 X 340 X 180

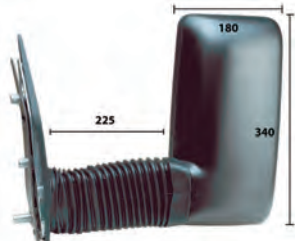

Ref.	Fecha-Date	OE	Caract.
9219977	1999-06	500325743	225 X 340 X 180
9220977	1999-06	500325744	225 X 340 X 180
9247977	1999-06	500325747	225 X 340 X 180
9248977	1999-06	500325748	225 X 340 X 180



Ref.	Fecha-Date	OE
6403977	1999-06	500371327
6433977	1999-06	98472973; 8143112



Ref.	Fecha-Date	OE
6453977	1999-06	500371329



# IVECO DAILY IV



Ref.	Fecha-Date	OE	Caract.
9201249	2006-10	3800401	80 X 350 X 320
9202249	2006-10	3800414	80 X 350 X 320
9225249	2006-10	3800404	80 X 350 X 320
9226249	2006-10	3800416	80 X 350 X 320

Ref.	Fecha-Date	OE
9251249	2006-10	3800423
9252249	2006-10	3800423
9235249	2006-10	3800429
9228249	2006-10	3800425



Ref.	Fecha-Date	OE
6401249	2006-10	3801926
6402249	2006-10	3801927
6431249	2006-10	3801926
6432249	2006-10	3801927

Ref.	Fecha-Date	OE
6411249	2006-10	3801928
6412249	2006-10	3801929
6441249	2006-10	3801928
6442249	2006-10	3801929

# IVECO DAILY V



Ref.	Fecha-Date	OE
9204249	2011-14	5801755695
9205249	2011-14	5801755747
9238249	2011-14	3800415; 5801367640



Ref.	Fecha-Date	OE
9254249	2011-14	5801736702
9255249	2011-14	5801736697
9229249	2011-14	3800429; 5801367573
9230249	2011-14	3800424; 5801367568



Ref.	Fecha-Date	OE
6201249	2011-14	3801914
6202249	2011-14	3801915

**IVECO DAILY II**



Ref.	Fecha-Date		OE
2741972	1989-99		98433940
2742972	1989-99		98433939
2701972	1989-99		94433944
2702972	1989-99		94433943



Ref.	Fecha-Date		OE
1901972	1989-99		98433912
1902972	1989-99		98433913



Ref.	Fecha-Date		OE
2201972	1989-99		370830004
2202972	1989-99		1904639

# IVECO DAILY III



Ref.	Fecha-Date	OE
2741977	1999-06	710301160201
2742977	1999-06	710301160202



Ref.	Fecha-Date	OE
2901977	1999-06	98424109
2902977	1999-06	98424107



Ref.	Fecha-Date	OE
2101977	1999-06	50410467
2102977	1999-06	50410465



Ref.	Fecha-Date	OE
2105977	1999-06	98472982
2106977	1999-06	98472981



Ref.	Fecha-Date	OE	Caract.
2201977	1999-06	98472977	T.HELL
2202977	1999-06	98472979	T.HELL

## IVECO DAILY IV



Ref.	Fecha-Date	OE
2741970	2006-11	69500013
2742970	2006-11	69500010



Ref.	Fecha-Date	OE
3103970	2006-11	98472976



Ref.	Fecha-Date	OE	Caract.
2211970	2006-11	69500591	T.COBO
2212970	2006-11	69500591	T.COBO



Ref.	Fecha-Date	OE	Caract.
2201970	2006-11	69500032	CHASSIS T.COBO
2202970	2006-11	69500026	CHASSIS T.COBO
2301970	2006-11	93190983	CHASSIS
2302970	2006-11	93190983	CHASSIS

## IVECO DAILY V / VI



Ref.	Fecha-Date	OE
2745970	2011-14	5801375416
2746970	2011-14	5801375415

**NEW**



Ref.	Fecha-Date	OE	Caract.
2751970	2014-	5801473750	T.AL
2752970	2014-	5801473749	T.AL

**NEW**



Ref.	Fecha-Date	OE
2101970	2014-	5801585146
2102970	2014-	5801585151

**NEW**



Ref.	Fecha-Date	OE	Caract.
2231970	2014-	5801523220	T.AGES
2232970	2014-	5801523221	T.AGES

## KIA PREGIO



Ref.	Fecha-Date
2005967	1997-04
2006967	1997-04

## MERCEDES 100



Ref.	Fecha-Date	OE	Caract.
6164967	1988-91	A6318101816	75 X 210 X 155
6165967	1988-91	A6318101916	75 X 210 X 155



Ref.	Fecha-Date	OE
6433965	1991-96	A6318110930

## MERCEDES CITAN



Ref.	Fecha-Date	OE
9264698	2012-	A4158110507; A4158110033; A4158100316
9265698	2012-	A4158110607; A4158110333; A4158100016
9237698	2012-	A4158110307; A4158110033; A4158100316
9238698	2012-	A4158110107; A4158110333; A4158100016



Ref.	Fecha-Date	OE
9225698	2012-	A4158110507; A4158110033; A4158100416
9226698	2012-	A4158110607; A4158110333; A4158100116
9239698	2012-	A4158110307; A4158110033; A4158100416
9240698	2012-	A4158110107; A4158110333; A4158100116



Ref.	Fecha-Date	OE
9243698	2012-	A4158110307; A4158110033; A4158100516
9244698	2012-	A4158110107; A4158110333; A4158100216



Ref.	Fecha-Date	OE
6343698	2012-	A4158110507
6344698	2012-	A4158110607
6341698	2012-	A4158110307
6342698	2012-	A4158110107

**NEW**



Ref.	Fecha-Date	OE
6481698	2012-	
6482698	2012-	
6471698	2012-	MA4158110033
6472698	2012-	MA4158110333

## MERCEDES SPRINTER



Ref.	Fecha-Date	OE	Caract.
9201966	1995-06	9018105516	130 X 270 X 170
9202966	1995-06	9018106116	130 X 270 X 170



Ref.	Fecha-Date	OE	Caract.
9225966	1995-06	9018105716	130 X 270 X 170
9226966	1995-06	9018106616	130 X 270 X 170





Ref.	Fecha-Date	OE
6401966	1995-06	A0018110533
6402966	1995-06	A0018110433

Ref.	Fecha-Date	OE
6431966	1995-06	181105331
6432966	1995-06	18110433
6423966	1995-06	A0018115133
6424966	1995-06	A0018115233

## MERCEDES SPRINTER PK1 / PK2

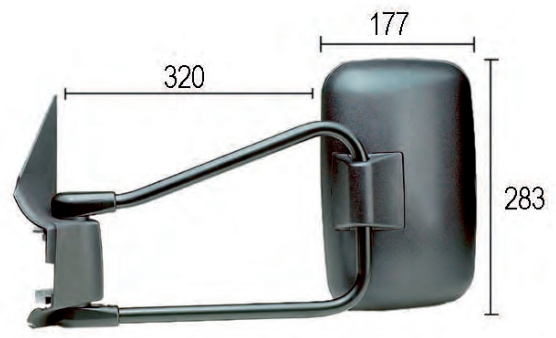
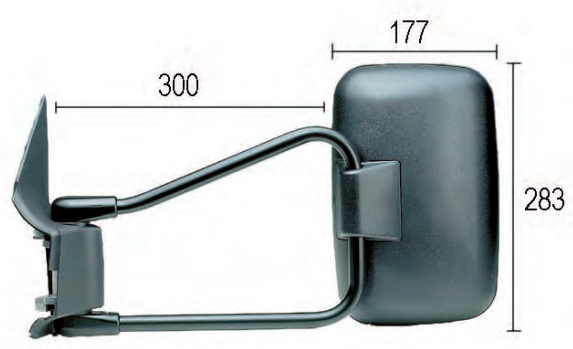

Ref.	Fecha-Date	OE	Caract.
9201962	1995-06	A0008114830; A0018110533	320 X 270 X 170
9202962	1995-06	A0008115430; A0018110433	320 X 270 X 170
9225962	1995-06	A0008114930; A0018110633	320 X 270 X 170

Ref.	Fecha-Date	OE	Caract.
9201963	1995-06	9018105816	340 X 280 X 170
9202963	1995-06	9018106716	340 X 280 X 170

# MERCEDES SPRINTER



Ref.	Fecha-Date	OE
9201994	2006-12	A0018100019
9202994	2006-12	A0018100319



Ref.	Fecha-Date	OE	Caract.
9225994	2006-12	A0018101219	ÁNGULO MUERTO NO TÉRMICO
9226994	2006-12	A0018101519	ÁNGULO MUERTO NO TÉRMICO
9239994	2006-12	A0008111022; A0008205708; A0028111533; A0028113933; A0008105819; A0008105919; A0018228920; A0008130436 A0008111122;	ÁNGULO MUERTO TÉRMICO
9240994	2006-12	A0008205708; A0028111633; A0028114033; A0008106219; A0008106819; A0018229020; A0008130536	ÁNGULO MUERTO TÉRMICO



Ref.	Fecha-Date	OE
6343994	2006-12	A0008111122
6344994	2006-12	A0008111022



Ref.	Fecha-Date	OE
6401994	2006-12	A0028111533
6402994	2006-12	A0028111633
6431994	2006-12	A0028111733
6432994	2006-12	A0028111833



Ref.	Fecha-Date	OE
6421994	2006-12	28111533
6422994	2006-12	28111633
6441994	2006-12	A0028115233
6442994	2006-12	A0028115333



Ref.	Fecha-Date	OE
6411994	2006-12	0028111933; A0028111933
6412994	2006-12	0028112033; A0028112033



Ref.	Fecha-Date	OE
6413994	2006-12	28111933
6414994	2006-12	28112033
6415994	2006-12	A0028113933
6416994	2006-12	A0028114033



Ref.	Fecha-Date	OE
6201994	2006-12	2E0953049A
6202994	2006-12	2E0953050A

## MERCEDES T1-TN / 207



Ref.	Fecha-Date	OE	Caract.
9203959	1982-95	6038110030; 6038110033	245 X 155



Ref.	Fecha-Date	OE	Caract.	Ø
<b>9473275</b>	<b>1981-95</b>	6118100116; 6128100166	247x157	13

## MERCEDES VIANO



Ref.	Fecha-Date	OE
<b>9225704</b>	<b>2003-11</b>	6398104516
<b>9226704</b>	<b>2003-11</b>	6398104616



Ref.	Fecha-Date	OE
<b>6341704</b>	<b>2003-11</b>	6398110461
<b>6342704</b>	<b>2003-11</b>	6398110561



Ref.	Fecha-Date	OE
<b>6471704</b>	<b>2003-11</b>	8100919
<b>6472704</b>	<b>2003-11</b>	8101019

## MERCEDES VITO



Ref.	Fecha-Date	OE
9201969	1996-03	A6388100016
9202969	1996-03	A6388100116



Ref.	Fecha-Date	OE
9225969	1996-03	A6388100616
9226969	1996-03	A6388100716



Ref.	Fecha-Date	OE	Caract.
6403969	1996-03	A0018112633	158 X 250
6443969	1996-03	A0018112633	152 X 200



Ref.	Fecha-Date	OE
9231969	2003-11	6398100116
9232969	2003-11	6398100216



Ref.	Fecha-Date	OE
9227969	2003-11	A6398109816
9228969	2003-11	A6398109916
9229969	2003-11	A6398106316
9230969	2003-11	A6398106416



Ref.	Fecha-Date	OE
6343969	2003-11	A0008110522
6344969	2003-11	A0008110622



Ref.	Fecha-Date		OE
6401969	2003-11		A0008100519
6402969	2003-11		A0008100619
6471969	2003-11		A0008100719
6472969	2003-11		A0008100819

## MERCEDES VITO / VIANO



Ref.	Fecha-Date		OE
9201710	2011-		A63981006197C45; MA6398100619
9202710	2011-		A63981007197C45; MA6398100719



Ref.	Fecha-Date		OE
9225710	2011-		A63981008197C45
9226710	2011-		A63981009197C45
9229710	2011-		A63981010197C45; A63981015197C45
9230710	2011-		A63981011197C45; A63981016197C45



Ref.	Fecha-Date	OE
9239710	2011-	A63981089167C45
9240710	2011-	A63981090167C45
9249710	2011-	A63981013197C45; A63981091167C45
9250710	2011-	A63981014197C45; A63981092167C45



Ref.	Fecha-Date	OE
6343710	2011-	A0008111422
6344710	2011-	A0008111522
6341710	2011-	A0008111222
6342710	2011-	A0008111322



Ref.	Fecha-Date	OE
6451710	2011-	A0028114133
6452710	2011-	A0028114233
6471710	2011-	A0028114133; A6398100617
6472710	2011-	A0028114233; A6398100719

## MERCEDES V-CLASS / VITO



Ref.	Fecha-Date	OE
6471711	2014-	A4478111700
6472711	2014-	A4478111600

## MERCEDES 410 L207



Ref.	Fecha-Date	OE
2701709	1977-96	8209161
2702709	1977-96	8209261



Ref.	Fecha-Date	OE
2105709	1977-96	18226720
2106709	1977-96	18226820

## MERCEDES CITAN



Ref.	Fecha-Date	OE
2103708	2012-	A4158201259



Ref.	Fecha-Date	OE
2215708	2012-	A4159062900
2216708	2012-	A4159062600



Ref.	Fecha-Date	OE
2211708	2012-	A4159062800
2212708	2012-	A4159062700



## MERCEDES SPRINTER



Ref.	Fecha-Date	OE
2741966	1995-00	9018200161
2742966	1995-00	9018200261
2745966	1995-00	9018200561
2746966	1995-00	9018200661



Ref.	Fecha-Date	OE
1901966	1995-00	9018200121
1902966	1995-00	9018200221
2101966	1995-00	9018200121
2102966	1995-00	9018200221



Ref.	Fecha-Date	OE
3103969	1995-00	2108200921
3003969	1995-00	2108200921



Ref.	Fecha-Date	OE
3007969	1995-00	18203321
3107969	1995-00	18203321



Ref.	Fecha-Date	OE
3009969	1995-00	18203321



Ref.	Fecha-Date	OE
2751966	2000-02	9018201061
2752966	2000-02	9018201161
2753966	2000-02	9018201461
2754966	2000-02	9018201561



Ref.	Fecha-Date	OE
2755966	2003-04	9018202461
2756966	2003-04	9018202561
2757966	2003-04	9018202661
2758966	2003-04	9018202761



Ref.	Fecha-Date	OE	Caract.
2201966	1995-02	8260756	T. CARELLO
2202966	1995-02	8260856	T. CARELLO



Ref.	Fecha-Date	OE	Caract.
2211966	2002-06	8261856	T. AL
2212966	2002-06	8261956	T. AL

**NEW**



Ref.	Fecha-Date	Caract.
9765009	1995-06	CHASSIS
9766009	1995-06	CHASSIS
9797009	1995-06	CHASSIS 464MM

**NEW**



Ref.	Fecha-Date	OE
2405966	1995-06	
2413966	1995-06	9018200156
2403966	1995-06	9018200156

## MERCEDES SPRINTER



Ref.	Fecha-Date	OE
2761966	2006-12	9068200161
2762966	2006-12	9068200261
2765966	2006-12	9068200561
2766966	2006-12	9068200661



Ref.	Fecha-Date	OE
2769966	2006-12	9068200961
2770966	2006-12	9068201061



Ref.	Fecha-Date	OE
2901702	2006-12	2118200556
2902702	2006-12	2118200656

**NEW**



Ref.	Fecha-Date	OE	Caract.
2911966	2006-12	9068200856	T.HELL
2912966	2006-12	9068200956	T.HELL



Ref.	Fecha-Date	OE	Caract.
2771966	2013-	A9068202361	T.HELL
2772966	2013-	A9068202461	T.HELL



Ref.	Fecha-Date	OE
2902966	2013-	9068200956



Ref.	Fecha-Date	OE	Caract.
2221966	2006-12	9068200164	T.VAL
2222966	2006-12	9068200264	T.VAL

**NEW**



Ref.	Fecha-Date	OE	Caract.
9771009	2006-12		PY 21W R10W P21 W4
9772009	2006-12		PY 21W R10W P21 W4



Ref.	Fecha-Date	OE
2901966	2013-	9068200856

## MERCEDES CLASE V



Ref.	Fecha-Date	OE
3003969	1996-03	2108200921
3103969	1996-03	2108200921



Ref.	Fecha-Date	OE
2001969	1996-03	4148200364
2002969	1996-03	4148200464

## MERCEDES VIANO



Ref.	Fecha-Date	OE	Caract.
2755969	2010-13	6398201861	
2756969	2010-13	6398201961	



Ref.	Fecha-Date	OE	Caract.
2731969	2010-13	6398202861	
2732969	2010-13	6398202961	
2751969	2010-13	6398202861	
2752969	2010-13	6398202961	

## MERCEDES VITO



Ref.	Fecha-Date	OE	Caract.
2701969	1996-03	6388201961	
2702969	1996-03	6388202061	
2745969	1996-03	6388200061	
2746969	1996-03	6388200161	



Ref.	Fecha-Date	OE	Caract.
1901969	1996-03	6388200821	
1902969	1996-03	6388200921	
2101969	1996-03	6388200821	
2102969	1996-03	6388200921	



Ref.	Fecha-Date	OE
1905969	1996-03	6388200021
1906969	1996-03	6388200121



Ref.	Fecha-Date	OE
3003969	1996-03	2108200921
3103969	1996-03	2108200921



Ref.	Fecha-Date	OE	Caract.
2205969	1996-03	6388201264	T.YORKA
2206969	1996-03	6388201764	T.YORKA



Ref.	Fecha-Date	OE	Caract.
2209969	1996-03	6388201264	T.YORKA
2210969	1996-03	6388201764	T.YORKA



Ref.	Fecha-Date	OE
2741969	2003-09	6398200161
2742969	2003-09	6398200261



Ref.	Fecha-Date	OE	Caract.
2201969	2003-09	6398200164	T.HELL
2202969	2003-09	6398200264	T.HELL

# MITSUBISHI L 300



Ref.	Fecha-Date	OE	Caract.
9247023	1986-95		VERTICAL
9204023	1986-95	MB565821	VERTICAL
9205023	1986-95	MB565822	VERTICAL



Ref.	Fecha-Date	OE	Caract.
9201023	1986-95	MB417031	HORIZONTAL
9202023	1986-95	MB417032	HORIZONTAL



Ref.	Fecha-Date	OE
2105022	2001-06	MB831287
2106022	2001-06	MB831288

## NISSAN INTERSTAR / OPEL MOVANO / RENAULT TRAFFIC



Ref.	Fecha-Date	OE
9201751	2002-	9630200QAG
9202751	2002-	9630100QAE



Ref.	Fecha-Date	OE
6401751	2002-	9636500QAF

## NISSAN INTERSTAR / OPEL MOVANO / RENAULT MASTER



Ref.	Fecha-Date	OE
9201905	2002-	
9202905	2002-	
9225905	2002-	
9226905	2002-	
9246905	2002-	
9236905	2002-	



Ref.	Fecha-Date	OE
6343905	2002-	
6344905	2002-	





Ref.	Fecha-Date	OE
6401905	2002-	9636600QAF
6402905	2002-	9636500QAF
6431905	2002-	9636600QAF
6432905	2002-	9636500QAF



Ref.	Fecha-Date	OE
6481905	2002-	9636600QAF
6482905	2002-	9636500QAF

## NISSAN KUBISTAR



Ref.	Fecha-Date	OE
9264174	2002-08	96302-00QAT(N)
9265174	2002-08	96301-00QAR(N)



Ref.	Fecha-Date	OE
9225174	2002-08	96354-00Q0B(N); 8200245171
9226174	2002-08	96953-00QAF(N); 8200245172















Ref.	Fecha-Date	OE
9239174	2002-08	82002-53492(N)
9240174	2002-08	82002-53494(N)





Ref.	Fecha-Date	OE
6343174	2002-08	96374-00QAD(N)
6344174	2002-08	96373-00QAD(N)
6341174	2002-08	96374-00QAE(N)
6342174	2002-08	96373-00QAE(N)



Ref.	Fecha-Date		OE	Caract.
6453174	2002-08	  	77010-39896(N); 7701048400	166 X 127
6403174	2002-08	  	9636600QAM(N); 7701039896; 7701041941; 7701048400	
6473174	2002-08	  	9636600QAN(N)	166 X 127
6433174	2002-08	  	9636500QAR(N)	166 X 127

## NISSAN NV200 EVALIA



Ref.	Fecha-Date		OE
6431579	2010-	  	96366JX30B
6432579	2010-	  	96365JX30B

## NISSAN NV300 / OPEL VIVARO / RENAULT TRAFIC



Ref.	Fecha-Date	OE
9201645	2014-	95517317; 4422962; 4422997 (O); 963027954R; 93451848; 963739461R; 963660940R (R) 4422987; 4422961;
9202645	2014-	4422999 (O); 963019473R; 93451847; 963745863R; 963651699R (R) 95517317; 4422963;
9231645	2014-	4422997 (O); 963027954R; 963731115R; 963739461R; 963660940R (R) 4422987; 95517319; 4422964; 4422999 (O); 963019473R; 963745863R; 963746264R; 963651699R (R)



Ref.	Fecha-Date	OE
9225645	2014-	4422988; 95517318; 4422962; 4422997 (O); 963025418R; 93451848; 963666705R; 963739461R; 963660940R (R) 4422989; 95517320;
9226645	2014-	4422961; 4422999 (O); 963019124R; 93451847; 963745863R; 963651588R; 963651699R (R) 4422988; 95517318;
9239645	2014-	4422963; 4422997 (O); 963025418R; 963731115R; 963739461R; 963660940R; 963666705R (R) 4422989; 95517320; 4422964; 4422999 (O);
9240645	2014-	963019124R; 963745863R ; 963746264R; 963651588R; 963651699R (R)



Ref.	Fecha-Date	OE
6343645	2014-	4422962 (O); 93451848; 963739461R (R) 4422961 (O); 93451847; 963745863R (R) 4422963 (O); 93451849;
6344645	2014-	963731115R; 963739461R (R) 4422964 (O); 93452218; 963745863R; 963746264R (R)



Ref.	Fecha-Date	OE
6471645	2014-	4422997 (O); 95517329; 963666705R (R)
6472645	2014-	4422999 (O); 95517331; 963651588R (R)

# NISSAN NV400 / OPEL MOVANO / RENAULT MASTER



Ref.	Fecha-Date	OE
9201907	2010-16	963662420R(N) ; 4419420(O); 963020624R(R)
9202907	2010-16	963012653R(N) ; 4419422(O); 963012653R(R)
9225907	2010-16	4419408(O); 963021976R(N/R)
9226907	2010-16	4419412(O); 963016903R(N/R)



Ref.	Fecha-Date	OE
9203907	2010-16	4419416; 4419994(O); 963020624R; 963662420R; 261652475R(R)
9204907	2010-16	4419417; 4419995(O); 9963012653R; 963655132R; 261603141R (R)
9227907	2010-16	4419416; 4419994(O); 963021976R; 963655132R; 261652475R(R)
9228907	2010-16	4406886; 4419417; 4419995 (O); 963016903R; 963655132R; 261603141R(R)

**NEW**



Ref.	Fecha-Date	OE
9271907	2010-16	963027041 R; 963662420R; 261650223R
9281907	2010-16	963026988R; 963655132R; 261650223R

**NEW**



Ref.	Fecha-Date	OE
6343907	2010-16	1887729(O)
6344907	2010-16	1887728(O)

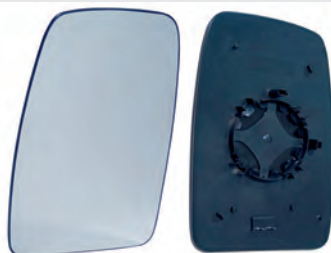

Ref.	Fecha-Date	OE
6401755	2010-16	4419416(O); 963662420R(R)
6402755	2010-16	4419417(O); 963655132R(R)
6431755	2010-16	4419416(O); 963655132R(R)
6432755	2010-16	4419417(O); 963655132R(R)



Ref.	Fecha-Date	OE
6201907	2010-	261650223R(O; R)
6202907	2010-	261603141R(O; R)



Ref.	Fecha-Date	OE
6203907	2010-	261652475R(O); 21982857(R)
6204907	2010-	261609635R(O); 21982857(R)

## NISSAN PRIMASTAR / OPEL VIVARO / RENAULT TRAFIC



Ref.	Fecha-Date	OE
9201750	2001-	9630200QAN(N); 4408525(O); 7701050267; 7701473241(R)
9202750	2001-	9630100QAL(N); 4408527(O); 7701052624; 7701473243(R)



Ref.	Fecha-Date	OE
9225750	2001-	9630200QAP(N); 4408529(O); 7701050267; 7701473245(R)
9226750	2001-	9630100QAM(N); 4408531(O); 7701052624; 7701473247(R)
9236750	2001-	7700773858; 7701052624; 7701473247(N); 4408533(O); (R)



Ref.	Fecha-Date	OE
6401750	2001-	9636600QAH(N); 4408323(O); 7701050267(R)
6402750	2001-	9636500QAK(N); 4410618(O); 7701052624(R)
6431750	2001-	7701050267(N); 4451618(O)
6432750	2001-	7701052624(N); 4410618(O)



Ref.	Fecha-Date	OE
6481750	2001-	9636600QAJ(N); 4408325(O); 7701050269(R)
6482750	2001-	9636500QAL(N); 4410641(O); 7701052626(R)

## NISSAN TRADE



Ref.	Fecha-Date		OE
6101970	1986-01	◀	16110103
6102970	1986-01	▶	16110113

## NISSAN VANETTE



Ref.	Fecha-Date		OE	Caract.
9241961	1986-01	◀	963027C976	150 X 215
9242961	1986-01	▶	963017C976	150 X 215



Ref.	Fecha-Date		OE
9245961	1994-01	◀	963028C800
9246961	1994-01	▶	963017C976



Ref.	Fecha-Date		OE	Caract.
6106218	1994-01		735245999	CON PLOMO

# OPEL COMBO



Ref.	Fecha-Date	OE
9201418	1994-95	1427439
9202418	1994-95	1427449



Ref.	Fecha-Date	OE
6140418	1994-95	1427553



Ref.	Fecha-Date	OE
6101418	1995-01	14227509; 14227554
6102418	1995-01	14227508; 14227554



Ref.	Fecha-Date	OE
6141418	1995-01	1427554



Ref.	Fecha-Date	OE
9264421	2001-11	6428116
9265421	2001-11	6428119



Ref.	Fecha-Date	OE
9239421	2001-11	6428116
9237421	2001-11	6428116
9238421	2001-11	6428119



Ref.	Fecha-Date	OE
9245421	2001-11	6428190
9246421	2001-11	6428193



Ref.	Fecha-Date	OE
6343421	2001-11	1428860
6344421	2001-11	1428861



Ref.	Fecha-Date	OE
6401421	2001-11	6428768
6402421	2001-11	6428769
6411421	2001-11	6428781
6412421	2001-11	6428782



Ref.	Fecha-Date	OE
9264429	2012-	1426582
9265429	2012-	1426581



Ref.	Fecha-Date	OE
9237929	2012-	
9238429	2012-	1426581



Ref.	Fecha-Date	OE
9239929	2012-	
9240929	2012-	
9246929	2012-	





Ref.	Fecha-Date	OE
9254929	2012-	735497885
9275429	2012-	1426575



Ref.	Fecha-Date	OE
9257929	2012-	735528050
9248429	2012-	1426575



Ref.	Fecha-Date	OE
9259929	2012-	1426595
9250929	2012-	1426593



Ref.	Fecha-Date	OE
6401929	2012-	1426595
6402929	2012-	1426593
6431929	2012-	1426596
6432929	2012-	1426594



Ref.	Fecha-Date	OE
6441929	2012-	1426596
6442929	2012-	1426594

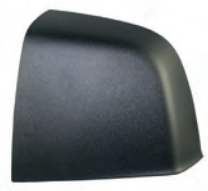

Ref.	Fecha-Date	OE
6343929	2012-	735497928
6344929	2012-	735497926
6341929	2012-	735512765
6342929	2012-	735512764



Ref.	Fecha-Date	OE
6201929	2012-	71765449
6202929	2012-	71765377

**RENAULT EXPRESS / RAPID**



Ref.	Fecha-Date	OE
6164152	1985-91	7700400127
6165152	1985-91	7700400129



Ref.	Fecha-Date	OE
6101153	1991-01	6001030130
6102153	1991-01	6001030197



Ref.	Fecha-Date	OE
6164153	1991-01	7700808132
6165153	1991-01	7700808133



Ref.	Fecha-Date	OE
9264155	1995-01	6001030130
9265155	1995-01	6001030197
9201155	1995-01	6001030130

**RENAULT KANGOO**



Ref.	Fecha-Date	OE
9264156	1997-01	7700304830; 963029461R
9265156	1997-01	7700304831
9201156	1997-01	7700304830



Ref.	Fecha-Date	OE
9227156	1997-01	7700304834; 7700354638R
9228156	1997-01	7700304835
9225156	1997-01	7700304834
9226156	1997-01	7700304835



Ref.	Fecha-Date	OE
6464156	1997-01	7701039896; 7701048401
6402156	1997-01	7701041941
6401156	1997-01	7701039896



Ref.	Fecha-Date	OE
6431156	1997-01	7701044083; 7701048401
6432156	1997-01	7701044085; 7701048400
6423156	1997-01	7701044083
6424156	1997-01	7701044085



Ref.	Fecha-Date	Caract.
6106219	1997-01	CON PLOMO



Ref.	Fecha-Date
6106217	1997-01



Ref.	Fecha-Date	OE
9264174	2002-08	7700354636(R)
9265174	2002-08	7700354637(R)



Ref.	Fecha-Date	OE
9225174	2002-08	96354-00Q0B(N); 8200245171; 8200253492(R)
9226174	2002-08	96953-00QA- F(N); 8200245172; 8200253494(R)



Ref.	Fecha-Date	OE
9239174	2002-08	82002-53492(N); 8200253492(R)
9240174	2002-08	82002-53494(N); 8200253494(R)



Ref.	Fecha-Date	OE
6343174	2002-08	96374-00QAD(N); 8200245171(R)
6344174	2002-08	96373-00QAD(N); 8200245172(R)
6341174	2002-08	96374-00QAE(N); 8200245174(R)
6342174	2002-08	96373-00QAE(N); 8200245177(R)



Ref.	Fecha-Date	OE	Caract.
6453174	2002-08	77010-39896(N); 7701048400; 7701048401(R)	166 X 127
6403174	2002-08	9636600QAM(N); 7701039896; 7701041941; 7701048400; 7701048401(R)	
6473174	2002-08	9636600QAN(N); 7701048401(R)	166 X 127
6433174	2002-08	9636500QAR(N); 7701044083(R)	166 X 127

# RENAULT KANGOO / GRAND KANGOO



Ref.	Fecha-Date	OE
9201160	2008-12	7701068838
9202160	2008-12	7701068834
9264160	2008-12	7701068839
9265160	2008-12	7701068835
9225160	2008-12	7701068840
9226160	2008-12	7701068836



Ref.	Fecha-Date	OE
9231160	2008-12	7701068838
9232160	2008-12	7701068834
9237160	2008-12	7701068839
9238160	2008-12	7701068835



Ref.	Fecha-Date	OE
9239160	2008-12	7701068840
9240160	2008-12	7701068836
9229160	2008-12	7701068841
9230160	2008-12	7701068837



Ref.	Fecha-Date	OE
6343160	2008-12	7701068844
6344160	2008-12	7701068842
6341160	2008-12	7701068845
6342160	2008-12	7701068843



Ref.	Fecha-Date	OE
6403160	2008-12	7701068848
6433160	2008-12	7701068848



Ref.	Fecha-Date	OE
9264698	2012-	963029296R; 963735075R; 963664943R
9265698	2012-	963016348R; 963742880R; 963656392R
9237698	2012-	963029296R; 963733548R; 963664943R
9238698	2012-	963016348R; 963742374R; 963656392R



Ref.	Fecha-Date	OE
9225698	2012-	963027201R; 963735075R; 963664943R
9226698	2012-	963010714R; 963742880R; 963656392R



Ref.	Fecha-Date	OE
9239698	2012-	963027201R; 963733548R; 963664943R
9240698	2012-	963010714R; 963742374R; 963656392R
9243698	2012-	963028506R; 963733548R; 963664943R
9244698	2012-	963018644R; 963742374R; 963656392R



Ref.	Fecha-Date	OE
6343698	2012-	963735075R
6344698	2012-	963742880R
6341698	2012-	963733548R
6342698	2012-	963742374R

**NEW**



Ref.	Fecha-Date	OE
6481698	2012-	963664943R
6482698	2012-	963656392R

**RENAULT MASTER I**



Ref.	Fecha-Date						
9245095	1980-98	◀▶	👁️	👤	🔄	🚗	🚚
9241095	1980-98	◀▶	👁️	👤	🔄	🚗	🚚



Ref.	Fecha-Date					Caract.
9040025	1980-98	◀▶	👁️	👤	🔄	215 X 142



Ref.	Fecha-Date		
6106217	1980-98	🚗	🚚



Ref.	Fecha-Date			Caract.
6106219	1980-98	🚗	🚚	CON PLOMO

**RENAULT MASTER II**



Ref.	Fecha-Date	OE	Caract.
9264902	1998-03	7700354140	60 X 300 X 177
9265902	1998-03	7700354141	60 X 300 X 177
9225902	1998-03	7700354142	60 X 300 X 177
9226902	1998-03	7700353143	60 X 300 X 177



Ref.	Fecha-Date	OE	Caract.
9201902	1998-03	8200024459	130 X 300 X 177
9202902	1998-03	8200024460	130 X 300 X 177
9227902	1998-03	8200032374	130 X 300 X 177
9228902	1998-03	8200285571	130 X 300 X 177



Ref.	Fecha-Date	OE
6401751	1998-03	7701044515; 7701046190



Ref.	Fecha-Date
6106217	1998-03



Ref.	Fecha-Date	Caract.
6106219	1998-03	CON PLOMO



Ref.	Fecha-Date	OE
9201905	2003-09	8200163752
9202905	2003-09	8200163753
9225905	2003-09	8200163449
9226905	2003-09	8200255776





Ref.	Fecha-Date	Icons
9246905	2003-09	[Icons: Right arrow, Headlight, Fog light, Mirror, 5 PINS]
9236905	2003-09	[Icons: Right arrow, Headlight, Fog light, Mirror, 12 Volts, 5 PINS]



Ref.	Fecha-Date	Icons
6343905	2003-09	[Icons: Left arrow, Headlight, Fog light]
6344905	2003-09	[Icons: Right arrow, Headlight, Fog light]



Ref.	Fecha-Date	OE	Icons
6401905	2003-09	7701046190	[Icons: Left arrow, Headlight, Fog light]
6402905	2003-09	7701046190	[Icons: Right arrow, Headlight, Fog light]
6431905	2003-09		[Icons: Left arrow, Headlight, Fog light, Mirror, 5 PINS]
6432905	2003-09		[Icons: Right arrow, Headlight, Fog light, Mirror, 5 PINS]



Ref.	Fecha-Date	OE	Icons
6481905	2003-09	7701050269	[Icons: Left arrow, Headlight, Fog light, Mirror, 5 PINS]
6482905	2003-09	7701052626	[Icons: Right arrow, Headlight, Fog light, Mirror, 5 PINS]

## RENAULT MASTER III



Ref.	Fecha-Date	OE	Icons
9201907	2010-16	963020624R(R)	[Icons: Left arrow, Headlight, Fog light, Mirror, 5 Watts]
9202907	2010-16	963012653R(R)	[Icons: Right arrow, Headlight, Fog light, Mirror, 5 Watts]
9225907	2010-16	963021976R(N/R)	[Icons: Left arrow, Headlight, Fog light, Mirror, 5 Watts]
9226907	2010-16	963016903R(N/R)	[Icons: Right arrow, Headlight, Fog light, Mirror, 5 Watts]



Ref.	Fecha-Date	OE	Icons
9203907	2010-16	963020624R; 963662420R; 261652475R(R)	[Icons: Left arrow, Headlight, Fog light, Mirror, 2 PINS, W16 W]
9204907	2010-16	9963012653R; 963655132R; 261603141R (R)	[Icons: Right arrow, Headlight, Fog light, Mirror, 2 PINS, W16 W]
9227907	2010-16	963021976R; 963655132R; 261652475R(R)	[Icons: Left arrow, Headlight, Fog light, Mirror, 7 PINS, W16 W]
9228907	2010-16	4406886; 4419417; 4419995 (O); 963016903R; 963655132R; 261603141R(R)	[Icons: Right arrow, Headlight, Fog light, Mirror, 9 PINS, W16 W]

**NEW**



Ref.	Fecha-Date	OE
9271907	2010-16	963027041R; 963662420R; 261650223R
9281907	2010-16	963026988R; 963655132R; 261650223R

**NEW**



Ref.	Fecha-Date	OE
6343907	2010-16	1887729(O)
6344907	2010-16	1887728(O)



Ref.	Fecha-Date	OE
6401755	2010-16	4419416(O); 963662420R(R)
6402755	2010-16	4419417(O); 963655132R(R)
6431755	2010-16	4419416(O); 963655132R(R)
6432755	2010-16	4419417(O); 963655132R(R)



Ref.	Fecha-Date	OE
6203907	2010-	261652475R(O); 21982857(R)
6204907	2010-	261609635R(O); 21982857(R)



Ref.	Fecha-Date	OE
6201907	2010-	261650223R(O; R)
6202907	2010-	261603141R(O; R)

**NISSAN INTERSTAR/ OPEL MOVANO / RENAULT MASTER**



Ref.	Fecha-Date	OE
2741751	2004-10	8200163516(N; O; R)
2742751	2004-10	8200163518(N; O; R)



Ref.	Fecha-Date	OE
2901164	2004-10	2615500Q02(N); 4501195(O); 7701205665(R)
2902164	2004-10	2615000Q02(N); 4501194(O); 7701205664(R)



Ref.	Fecha-Date	OE
3107218	2004-10	7700822136(N); 4500736(O); 7701047516(R)



Ref.	Fecha-Date	OE
3117218	2004-10	7700822136(N); 8200257685(R)



Ref.	Fecha-Date	OE	Caract.
2221751	2004-10	2655500QAB(N); 8200171472 ( R ); 7700352700(O)	T. YORKA
2222751	2004-10	2655000QAB(N); 8200171478(R)	T. YORKA

# NISSAN KUBISTAR



NISSAN/OPEL/RENAULT



Ref.	Fecha-Date	OE
2741174	2003-07	2606000Q0L(N); 8200236591(R)
2742174	2003-07	2601000Q0L(N); 8200236590(R)



Ref.	Fecha-Date	OE
2745174	2003-07	2606000Q0L(N); 8200150617(R)
2746174	2003-07	2601000Q0L(N); 8200150614(R)



Ref.	Fecha-Date	OE
2751174	2003-07	2606000Q0L(N); 8200183917(R)
2752174	2003-07	2601000Q0L(N); 8200183921(R)



Ref.	Fecha-Date	OE
2901227	2003-07	2615500Q03(N); 7701040680; 7701045718(R)
2902227	2003-07	2615000Q03(N); 7701040681; 7701045717(R)



Ref.	Fecha-Date	OE
3103218	2003-09	2616000QAA



Ref.	Fecha-Date	OE
3107218	2003-09	7700822136(N); 4500736(O); 7701047516(R)



Ref.	Fecha-Date	OE
3117218	2003-09	7700822136(N); 8200257685(R)



Ref.	Fecha-Date	OE	Caract.
2211176	2003-	2655500QAM	T.VAL
2212176	2003-	2655000QAM	T.VAL



Ref.	Fecha-Date	OE	Caract.
2201176	2003-	2655500QAN	T.VAL
2202176	2003-	2655000QAN	T.VAL

## NISSAN NV200 / EVALIA



Ref.	Fecha-Date	OE
2741964	2010-	26060JX30A
2742964	2010-	26010JX30A



Ref.	Fecha-Date	OE
2211964	2010-	26555BJ00A
2212964	2010-	26550BJ00A

## NISSAN PRIMASTAR / OPEL VIVARO / RENAULT TRAFIC



Ref.	Fecha-Date	OE
2745751	2001-05	2606000QAE(N); 4414032(O); 7700311371(R)
2746751	2001-05	2600000QAD(N); 4408723(O); 7700311372(R)



Ref.	Fecha-Date	OE
2901227	2001-05	2615500Q03(N); 4408447(O); 7701040680; 7701045718(R)
2902227	2001-05	2615000Q03(N); 4408448(O); 7701040681; 7701045717(R)



Ref.	Fecha-Date	OE
2101751	2001-05	2613500Q0A(N); 4408521(R)
2102751	2001-05	2613000Q0A(N); 4408520(R)



Ref.	Fecha-Date	OE
2105751	2001-05	2613500QAC(N); 8200007031(R)
2106751	2001-05	2613000QAC(N); 8200007030(R)



Ref.	Fecha-Date	OE
3117218	2001-05	7700822136(N); 8200257685(R)



Ref.	Fecha-Date	OE
3107218	2001-05	7700822136(N); 4500736(O); 7701047516(R)



Ref.	Fecha-Date	OE	Caract.
2241751	2001-05	26545-00Q0A (N); 4419132 (O); 8200968070 (R)	T.AL



Ref.	Fecha-Date	OE	Caract.
2242751	2001-05	26540-00Q0A (N); 44193130(O); 8200968063 (R)	T.AL



Ref.	Fecha-Date	OE
2741754	2006-13	2606000QAE(N)4414032(O); 8200701354(R)
2742754	2006-13	2600000QA-D(N); 4408723(O); 8200701356(R)



Ref.	Fecha-Date	OE
2751754	2006-13	2606000QAE(N); 4414032(O); 8200701352(R)
2752754	2006-13	2600000QA-D(N); 4408723(O); 8200701353(R)



Ref.	Fecha-Date	OE	Caract.
2201754	2006-13	2654500Q0A(N); 4449448(O); 8200415250(R)	T.VAL
2202754	2006-13	2654000Q0A(N); 4449447(O); 8200415251(R)	T.VAL

## NISSAN VANETTE



Ref.	Fecha-Date	OE
1905961	1987-11	B61259C000
1906961	1987-11	B61209C000



Ref.	Fecha-Date	OE
2011961	1987-11	1220832
2012961	1987-11	26555-G2701

## OPEL COMBO



Ref.	Fecha-Date	OE
2701417	1994-01	1216488
2702417	1994-01	1216489
2741417	1994-01	1216486
2742417	1994-01	1216487



Ref.	Fecha-Date	OE
3107417	1994-01	1713013; 1713411; 1713501; 1713542; 90487599



Ref.	Fecha-Date	OE	Caract.
2221417	1994-01	1223530	T.VAL
2222417	1994-01	1223531	T.VAL





Ref.	Fecha-Date	OE	Caract.
2741420	2001-	1216000	T.VAL
2742420	2001-	1216093	T.VAL
2741441	2001-	1216096	T. MAGNETI MARELLI
2742441	2001-	1216097	T. MAGNETI MARELLI



Ref.	Fecha-Date	OE
2901441	2001-	1710372
2902441	2001-	1710373



Ref.	Fecha-Date	OE
3103420	2001-	1713013; 1713240; 1713411



Ref.	Fecha-Date	OE
3107417	2001-	1713013; 1713411; 1713501; 1713542; 90487599



Ref.	Fecha-Date	OE	Caract.
2201441	2001-	1222061	T. YORKA
2202441	2001-	1222062	T. YORKA



Ref.	Fecha-Date	OE
2761961	2012-	
2762961	2012-	

## OPEL MOVANO / RENAULT MASTER



Ref.	Fecha-Date	OE
2751751	1998-03	4500915(O); 7701044518(R)
2752751	1998-03	4500917(O); 7701044520(R)



Ref.	Fecha-Date	OE
2901164	1998-03	4501195(O); 7701205665(R)
2902164	1998-03	4501194(O); 7701205664(R)



Ref.	Fecha-Date	OE
2101902	1998-03	4500919(O); 7701044522(R)
2102902	1998-03	4500920(O); 7701044523(R)



Ref.	Fecha-Date	OE
2105902	1998-03	4500919(O); 7701044522(R)
2106902	1998-03	4500920(O); 7701044523(R)



Ref.	Fecha-Date	OE	Caract.
2211751	1998-03	4500516(O); 7705352700(R)	T.VAL
2212751	1998-03	4500517(O); 7705352703(R)	T.VAL

## OPEL MOVANO



Ref.	Fecha-Date	OE
2121751	2003-09	93184008
2122751	2003-09	93184007



Ref.	Fecha-Date	OE
2755751	2010-	260608210R; 4419525
2756751	2010-	260106869R

## OPEL MOVANO / RENAULT MASTER



Ref.	Fecha-Date	OE
2761751	2010-	260606702R(O; R)
2762751	2010-	260606869R(O; R)



Ref.	Fecha-Date	OE
2231751	2010-	4419378(O); 265550023R(R)
2232751	2010-	4419379(O); 265500023R(R)

**OPEL VIVARO**



Ref.	Fecha-Date	OE
1901751	2001-06	4408521
1902751	2001-06	4408520



Ref.	Fecha-Date	OE
2761754	2014-	4422458
2762754	2014-	4422459; 95517042



Ref.	Fecha-Date	OE
2231754	2014-	4422466 (O); 265556737R (R)
2232754	2014-	4422465 (O); 265504656R (R)

**RENAULT EXPRESS I / II**



Ref.	Fecha-Date	OE
2701152	1985-92	7701366413
2702152	1985-92	7701366413



Ref.	Fecha-Date	OE
2703152	1985-92	7701031920



Ref.	Fecha-Date	OE
3103218	1985-98	2616000QAA



Ref.	Fecha-Date	OE
3107218	1985-94	7700822136(N); 4500736(O); 7701047516(R)



Ref.	Fecha-Date	OE
3117218	1985-94	7700822136(N); 8200257685(R)



Ref.	Fecha-Date	OE
3207152	1985-92	7701029282



Ref.	Fecha-Date	OE
2701153	1993-94	7701035230
2702153	1993-94	7701035231



Ref.	Fecha-Date	OE
3103218	1993-94	7700822136; 7701047516; 820019458; 8200257684; 8200257685



Ref.	Fecha-Date	OE
2201153	1993-94	7701035363
2202153	1993-94	7701035364



Ref.	Fecha-Date	OE
3701155	1995-01	7701035238
3702155	1995-01	7701035239



Ref.	Fecha-Date		OE
2201155	1995-01	◀ [Car] [Truck] [Truck]	7701039728
2202155	1995-01	▶ [Car] [Truck] [Truck]	7701039729

**RENAULT KANGOO**



Ref.	Fecha-Date		OE
2741156	1997-03	◀ [Car] [Truck] [Truck] H4	7701044037
2742156	1997-03	▶ [Car] [Truck] [Truck] H4	7701044038



Ref.	Fecha-Date		OE
2901164	1997-03	◀ [Car] [Truck] [Truck] H1	7701205665
2902164	1997-03	▶ [Car] [Truck] [Truck] H1	7701205664



Ref.	Fecha-Date		OE
3103218	1997-07	◀▶ [Car] [Truck] [Truck]	2616000QAA



Ref.	Fecha-Date		OE
3107218	1997-07	◀▶ [Car] [Truck] [Truck]	7701047516



Ref.	Fecha-Date		OE
3117218	1997-07	◀▶ [Car] [Truck] [Truck]	8200257685



Ref.	Fecha-Date	OE	Caract.
2201156	1997-03	7700308715	T.VAL
2202156	1997-03	7700308716	T.VAL



Ref.	Fecha-Date	OE	Caract.
2211156	1997-03	8200103284	T.VAL
2212156	1997-03	8200103292	T.VAL



Ref.	Fecha-Date	OE
2741174	2003-07	8200236591
2742174	2003-07	8200236590



Ref.	Fecha-Date	OE
2745174	2003-07	8200150617
2746174	2003-07	8200150614



Ref.	Fecha-Date	OE
2751174	2003-07	8200183917
2752174	2003-07	8200183921



Ref.	Fecha-Date	OE
2903228	2003-07	8200074008



Ref.	Fecha-Date	OE
2901227	2003-07	7701040680; 7701045718
2902227	2003-07	7701040681; 7701045717



Ref.	Fecha-Date	OE	Caract.
2201174	2003-07	8200150619	T.VAL
2202174	2003-07	8200150621	T.VAL



Ref.	Fecha-Date	OE	Caract.
2211174	2003-07	8200150623	T.VAL
2212174	2003-07	8200150625	T.VAL

**RENAULT KANGOO / GRAND KANGOO**



Ref.	Fecha-Date	OE
2741188	2008-12	7701068181
2742188	2008-12	7701068178
2751188	2008-12	7701068181
2752188	2008-12	7701068178



Ref.	Fecha-Date	OE
2745188	2008-12	7701071596
2746188	2008-12	7701071595



Ref.	Fecha-Date	OE
3103188	2008-12	8200439492



Ref.	Fecha-Date	OE	Caract.
2201188	2008-12	8200419941	T.VAL
2202188	2008-12	8200419945	T.VAL





Ref.	Fecha-Date	OE	Caract.
2211188	2008-12	8200419949	T.VAL
2212188	2008-12	8200419952	T.VAL



Ref.	Fecha-Date	OE	Caract.
2221188	2008-12	8200419906	
2222188	2008-12	8200419908	

**NEW**



Ref.	Fecha-Date	OE	Caract.
2751168	2013-	260607949R	T.KOITO
2752168	2013-	260103948R	T.KOITO

**NEW**



Ref.	Fecha-Date	OE	Caract.
2741168	2013-	260602665R	T.KOITO
2742168	2013-	260109958R	T.KOITO

**NEW**



Ref.	Fecha-Date	OE	Caract.
3103168	2013-	8200257684	T.PRETTL

**NEW**



Ref.	Fecha-Date	OE	Caract.
2211168	2013-	265557352R	T.KOITO
2212168	2013-	265506145R	T.KOITO

**NEW**



Ref.	Fecha-Date	OE	Caract.
2201168	2013-	265559212R	T.KOITO
2202168	2013-	265506747R	T.KOITO

**RENAULT MASTER II**



Ref.	Fecha-Date	OE
2113751	2003-09	8200263356
2114751	2003-09	8200263364

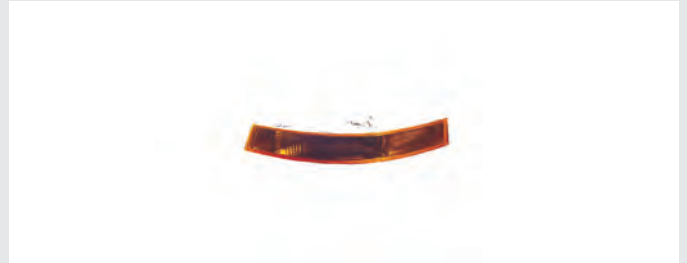

Ref.	Fecha-Date	OE
2111751	2003-09	8200163914
2112751	2003-09	8200163918



Ref.	Fecha-Date	OE	Caract.
2201753	2005-08	8200228394	T. YORKA
2202753	2005-08	8200228395	T. YORKA

**RENAULT TRAFIC**



Ref.	Fecha-Date	OE
2201902	1989-01	7701025919
2202902	1989-01	7701025921



Ref.	Fecha-Date	OE
2771754	2014-	260601784R
2772754	2014-	260108724R

**NEW**



Ref.	Fecha-Date		OE
2231754	2014-	◀	265556737R
2232754	2014-	▶	265504656R

## PIAGGIO PORTER



Ref.	Fecha-Date		OE
9201403	1992-99	◀	8794087Z010
9202403	1992-99	▶	8791087Z010

## SEAT INCA



Ref.	Fecha-Date		OE
6164154	1995-03	◀	6K9857501F
6165154	1995-03	▶	6K9857502C01C
6137154	1995-03	◀	6K9857501G



Ref.	Fecha-Date		OE
6401154	1995-03		6K9857521D
6402154	1995-03		6K9857522C
6451154	1995-03		6K9857521E
6471154	1995-03		6K9857521H
6432154	1995-03		6K9857522G



Ref.	Fecha-Date		OE
3701064	1995-00		6K5941015L
3702064	1995-00		6K5941016L
2741064	1995-00		6K1941015L
2742064	1995-00		6K1941016L



Ref.	Fecha-Date		OE
2901064	1995-00		6K0941701
2902064	1995-00		6K0941702



Ref.	Fecha-Date		OE
2101064	1995-00		6K5953049A
2102064	1995-00		6K5953050A



Ref.	Fecha-Date		OE
3007126	1995-00		3A0949101A



Ref.	Fecha-Date		OE
3003126	1995-00		3A0949101B



Ref.	Fecha-Date		OE	Caract.
2211154	1995-00		6K9945111	T.VAL
2212154	1995-00		6K9945112	T.VAL

**TOYOTA DYNA Pick-up**



Ref.	Fecha-Date		OE
9203995	1977-1987		8791025061(d); 8794025081(l)

**TOYOTA HIACE II**



Ref.	Fecha-Date		OE
9201995	1982-1989		8794095325
9202995	1982-1989		8791095J25

## TOYOTA HIACE IV



Ref.	Fecha-Date	OE
9201955	2004-08	8794026612CO
9202955	2004-08	8794026492CO

**NEW**



Ref.	Fecha-Date	OE	Caract.
2701036	1997-03	81150-26100	T. ICHIKOH
2702036	1997-03	81110-26100	T. ICHIKOH

## TOYOTA HIACE V / COMMUTER V



**NEW**



Ref.	Fecha-Date	OE	Caract.
2731036	2008-	81170-26500	T. ICHIKOH
2732036	2008-	81130-26500	T. ICHIKOH

**NEW**



Ref.	Fecha-Date	OE
3101036	2008-	81743-26030
3102036	2008-	81733-26030



Ref.	Fecha-Date	Icons	OE	Caract.
2251036	2013-		81560-26440	T.KOITO
2252036	2013-		81550-26440	T.KOITO

## VOLKSWAGEN CADDY II



Ref.	Fecha-Date	Icons	OE
6164154	1995-04		6K9857501F
6165154	1995-04		6K985750102C01C
6137154	1995-04		6K9857501G01C



Ref.	Fecha-Date	Icons	OE
6401154	1995-04		357857521; 6K9857521D
6402154	1995-04		357857522; 6K9857522C
6451154	1995-04		357857521A; 6K9857521E
6471154	1995-04		357857521C; 6K9857521J
6432154	1995-04		357857522A

# VOLKSWAGEN CADDY III



Ref.	Fecha-Date	OE
9201154	2004-15	2K5857507AB9B9
9202154	2004-15	2K5857508AD9B9



Ref.	Fecha-Date	OE
9225154	2004-15	2K5857507AC9B9
9226154	2004-15	2K5857508AE9B9



Ref.	Fecha-Date	OE
9227154	2004-15	2K1857508A9B9
9228154	2004-15	2K1857507A9B9



Ref.	Fecha-Date	OE
6343985	2004-15	7H1857527A9B9
6344985	2004-15	7H1857528A9B9
6341985	2004-15	7H1857527GRU
6342985	2004-15	7H1857528CGRU





Ref.	Fecha-Date	OE
6401985	2004-15	7H1857521M
6402985	2004-15	7H1857522R
6403985	2004-15	7E1857522



Ref.	Fecha-Date	OE
6431985	2004-15	7H1857521A; 7H1857521N
6432985	2004-15	7H1857522R; 7H1857522S
6433985	2004-15	7E1857522A; 7H1857522J

## VOLKSWAGEN CADDY IV



**NEW**



Ref.	Fecha-Date	OE
9201877	2015-	2K58574079B9; 2K5857521B; 2K58575279B9; 2K58585539B9
9202877	2015-	2K58574089B9; 2K5857522; 2K58575289B9; 2K58585549B9

**NEW**



Ref.	Fecha-Date	OE
6343877	2015-	2K58575279B9
6344877	2015-	2K58575289B9

**NEW**



Ref.	Fecha-Date	OE
6451877	2015-	2K5857521B
6402877	2015-	2K5857522
6471877	2015-	2K5857521C
6432877	2015-	2K5857522A

## VOLKSWAGEN LT40



Ref.	Fecha-Date	OE	Caract.
9201910	1996-99	2D1857501A	130X270X170
9202910	1996-99	2D1857502A	130X270X170



Ref.	Fecha-Date	OE	Caract.
9225910	1996-99	2D1857501C	130X270X170
9226910	1996-99	2D1857502C	130X270X170

## VOLKSWAGEN CRAFTER



Ref.	Fecha-Date	OE
9201994	2006-12	2E1857501AD
9202994	2006-12	2E1857502AC



Ref.	Fecha-Date	OE	Caract.
9225994	2006-12	2E1857501Q	ÁNGULO MUERTO NO TÉRMICO
9226994	2006-12	2E1857502P	ÁNGULO MUERTO NO TÉRMICO
9239994	2006-12		ÁNGULO MUERTO TÉRMICO
9240994	2006-12		ÁNGULO MUERTO TÉRMICO



Ref.	Fecha-Date			
6343994	2006-12	◀	◻	⊕
6344994	2006-12	▶	◻	⊕



Ref.	Fecha-Date							OE
6401994	2006-12	◀	◻	◡	⊕	⊗	⊕	2E0857587A
6402994	2006-12	▶	◻	◡	⊕	⊗	⊕	2E0857588A
6431994	2006-12	◀	◻	◡	⊕	⊗	⊕	2E0857587B
6432994	2006-12	▶	◻	◡	⊕	⊗	⊕	2E0857588B



Ref.	Fecha-Date							OE
6421994	2006-12	◀	◻	◡	⊕	⊗	⊕	
6422994	2006-12	▶	◻	◡	⊕	⊗	⊕	
6441994	2006-12	◀	◻	◡	⊕	⊗	⊕	2E0857587A
6442994	2006-12	▶	◻	◡	⊕	⊗	⊕	2E0857588A



Ref.	Fecha-Date							OE
6411994	2006-12	◀	◻	◡	⊕	⊗	⊕	28111933
6412994	2006-12	▶	◻	◡	⊕	⊗	⊕	28112033



Ref.	Fecha-Date							OE
6413994	2006-12	◀	◻	◡	⊕	⊗	⊕	
6414994	2006-12	▶	◻	◡	⊕	⊗	⊕	
6415994	2006-12	◀	◻	◡	⊕	⊗	⊕	2E1857587E
6416994	2006-12	▶	◻	◡	⊕	⊗	⊕	2E1857588E



Ref.	Fecha-Date							OE
6201994	2006-12	◀	◻	◡	⊕	⊗	⊕	2E0953049A
6202994	2006-12	▶	◻	◡	⊕	⊗	⊕	2E0953050A

## VOLKSWAGEN TRANSPORTER III



Ref.	Fecha-Date		OE
6101983	1979-92		251857513A
6102983	1979-92		251857514A

## VOLKSWAGEN TRANSPORTER IV



Ref.	Fecha-Date		OE
6101986	1990-03		701857507C; 701857521J
6125986	1990-03		701857507E; 701857521A
6127986	1990-03		701857507H01C



Ref.	Fecha-Date		OE
6102986	1990-03		701857508F; 701857522L
6126986	1990-03		701857508H; 701857522G
6128986	1990-03		701857508H01C



Ref.	Fecha-Date	OE
6401986	1990-03	701857521J
6402986	1990-03	701857522L
6431986	1990-03	701857521A
6432986	1990-03	701857522G



Ref.	Fecha-Date	OE
6106986	1990-03	701857511AFKZ

## VOLKSWAGEN TRANSPORTER V



Ref.	Fecha-Date	OE
9201985	2003-09	7E18575079B9; 7H1857521
9202985	2003-09	7E18575089B9; 7E1857522A
9231985	2003-09	7E18575089B9
9232985	2003-09	7H1857507A9B9



Ref.	Fecha-Date	OE
9225985	2003-09	7H1857507A9B9; 7H1857521A
9226985	2003-09	7E1857522A; 7H1857508A9B9
9239985	2003-09	7H1857507A9B9; 7H1857521A
9240985	2003-09	7E1857522A; 7H1857508A9B9



Ref.	Fecha-Date	OE
6343985	2003-09	7H1857527A9B9
6344985	2003-09	7H1857528A9B9
6341985	2003-09	7H1857527GRU
6342985	2003-09	7H1857528CGRU

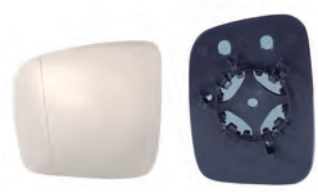

Ref.	Fecha-Date	OE
6401985	2003-09	7H1857521M
6402985	2003-09	7H1857522R
6403985	2003-09	7E1857522



Ref.	Fecha-Date	OE
6431985	2003-09	7H1857521A; 7H1857521N
6432985	2003-09	7H1857522R; 7H1857522S
6433985	2003-09	7E1857522A; 7H1857522J



Ref.	Fecha-Date	OE
9201928	2009-	7E1857507DJ9B9
9202928	2009-	7E1857508DS9B9
9225928	2009-	7E1857507DK9B9
9226928	2009-	7E1857508DT9B9
9229928	2009-	7E1858553B9B9
9230928	2009-	7E1858554B9B9



Ref.	Fecha-Date	OE
9231928	2009-	7E1858553B9B9
9232928	2009-	7E1857508DS9B9
9239928	2009-	7E1858553B9B9
9240928	2009-	7E1858554B9B9
9243928	2009-	7E1858553B9B9
9244928	2009-	7E1857508EB9B9



Ref.	Fecha-Date	OE
6343928	2009-	2H08575279B9
6344928	2009-	2H08575289B9
6341928	2009-	2H0857527CGRU
6342928	2009-	2H0857528CGRU



Ref.	Fecha-Date	OE	Ø
6401948	2009-	2H0857521B; 7E1857521E	84
6402948	2009-	2H0857522B; 7E1857522H	84
6451948	2009-	2H0857521B	84
6431948	2009-	7E1857521M	84
6471948	2009-	7E1857521J; 7H1857521N	84
6432948	2009-	7E1857522C; 7E1857522J	84

Ref.	Fecha-Date	OE	Ø
6441948	2009-	7E1857521H	108
6442948	2009-	7E1857522H	108
6461948	2009-	7E1857521K	108
6462948	2009-	7E1857522K	108

## VOLKSWAGEN TRANSPORTER VI



**NEW**



**NEW**



Ref.	Fecha-Date	OE
9201912	2015-	7E18574079B9; 7E1857521H; 7E1857527F9B9
9202912	2015-	7E18574089B9; 7E1857522H; 7E1857528F9B9

Ref.	Fecha-Date	OE
9225912	2015-	7E1857407A9B9; 7E1857521J; 7E1857527F9B9
9226912	2015-	7E1857408A9B9; 7E1857522J; 7E1857528F9B9
9229912	2015-	7E1857407E9B9; 7E1857521J; 7E1857527F9B9
9230912	2015-	7E1857408E9B9; 7E1857522J; 7E1857528F9B9

**NEW**



Ref.	Fecha-Date		OE
9239912	2015-		7E1857407A9B9; 7E1857521J; 7E1857527GGRU
9240912	2015-		7E1857408A9B9; 7E1857522J; 7E1857528GGRU
9243912	2015-		7E1857407E9B9; 7E1857521J; 7E1857527GGRU
9244912	2015-		7E1857408E9B9; 7E1857522J; 7E1857528GGRU

## VOLKSWAGEN CADDY II



Ref.	Fecha-Date		OE
2741154	1995-04		6K5941015
2742154	1995-04		6K5941016



Ref.	Fecha-Date		OE
2901064	1995-04		6K5941701A
2902064	1995-04		6K5941702A



Ref.	Fecha-Date		OE
2101062	1995-04		6K5953049C
2102062	1995-04		6K5953050C



Ref.	Fecha-Date		OE
2105108	1995-04		6K5953049B
2106108	1995-04		6K5953050B





Ref.	Fecha-Date	OE
3007126	1995-04	1H0949101A
3107126	1995-04	1H0949101A



Ref.	Fecha-Date	OE
3003126	1995-04	1H0949101B; 3A0949101A
3103126	1995-04	1H0949101B; 3A0949101A; 3A0949101B



Ref.	Fecha-Date	OE	Caract.
2211154	1995-04	6K9945111	T.VAL
2212154	1995-04	6K9945112	T.VAL

## VOLKSWAGEN CADDY III



Ref.	Fecha-Date	OE
2745154	2004-10	2K0941005D
2746154	2004-10	2K0941006D



Ref.	Fecha-Date	OE
2901124	2004-10	1T0941699C
2902124	2004-10	1T0941700C



Ref.	Fecha-Date	OE
3103127	2004-10	1J5949117A; 3B0949117C



Ref.	Fecha-Date	OE
<b>3107127</b>	2004-10	1J5949117B; 2K0949117B; 3B0949117C



Ref.	Fecha-Date	OE
<b>3111127</b>	2004-10	3B0949117C



Ref.	Fecha-Date	OE
<b>3103802</b>	2004-10	1J0949117



Ref.	Fecha-Date	OE	Caract.
<b>2201154</b>	2004-10	2K0945095N	T.VISTEON
<b>2202154</b>	2004-10	2K0945096N	T.VISTEON



Ref.	Fecha-Date	OE
<b>2755154</b>	2010-15	2K5941005
<b>2756154</b>	2010-15	2K5941006



Ref.	Fecha-Date	OE	Caract.
<b>2751154</b>	2010-15	1T1941005G	DOBLE
<b>2752154</b>	2010-15	1T1941006G	DOBLE



Ref.	Fecha-Date	OE
<b>2231154</b>	2010-15	2K5945095B
<b>2232154</b>	2010-15	2K5945096B



Ref.	Fecha-Date	OE
<b>2241154</b>	2010-15	2K5945095C
<b>2242154</b>	2010-15	2K5945096C

**NEW**



Ref.	Fecha-Date	OE	Caract.
2251154	2010-15	2K5945095F; 2K5945095M	T.VARROC
2252154	2010-15	2K5945096F; 2K5945096M	T.VARROC

**NEW**



Ref.	Fecha-Date	OE	Caract.
2255154	2010-15	2K5945095G; 2K5945095N	T.VARROC
2256154	2010-15	2K5945096G; 2K5945096N	T.VARROC

## VOLKSWAGEN CRAFTER



Ref.	Fecha-Date	OE
2761110	2006-16	2E1941015
2762110	2006-16	2E1941016



Ref.	Fecha-Date	OE
2911110	2006-16	6Q0941699; 6Q0941699C
2912110	2006-16	6Q0941700; 6Q0941700C



Ref.	Fecha-Date	OE	Caract.
2250910	2006-16	2E0945095	T.VAL
2251910	2006-16	2E0945096	T.VAL

# VOLKSWAGEN LT28-35 II



Ref.	Fecha-Date	OE	Caract.
2741910	1996-06	2D1941015	NEUMÁTICO
2742910	1996-06	2D1941016	NEUMÁTICO
2745910	1996-06	2D1941015A	
2746910	1996-06	2D1941016A	



Ref.	Fecha-Date	OE
1901910	1996-06	2D0953041A
1902910	1996-06	2D0953042A



Ref.	Fecha-Date	OE
1905910	1996-06	2D0953041
1906910	1996-06	2D0953042



Ref.	Fecha-Date	OE
2001910	1996-06	2D0945095
2002910	1996-06	2D0945096C
2201910	1996-06	2D0945095A
2202910	1996-06	2D0945096D

**NEW**



Ref.	Fecha-Date	OE
2405966	1996-06	2D0943021A
2413966	1996-06	2D0943021A
2403966	1996-06	2D0943021A

**VOLKSWAGEN TRANSPORTER IV**



Ref.	Fecha-Date	OE
2701986	1990-03	701941017
2702986	1990-03	701941018



Ref.	Fecha-Date	OE
1905986	1990-03	701953049
1906986	1990-03	701953050
2105986	1990-03	701953049
2106986	1990-03	701953050



Ref.	Fecha-Date	OE
2101986	1990-03	701953049
2102986	1990-03	701953050



Ref.	Fecha-Date	OE	Caract.
2201986	1990-03	70194509501C	BUS/VAN
2202986	1990-03	70194509601C	BUS/VAN



Ref.	Fecha-Date	OE	Caract.
2209986	1990-03	70194509501C	BUS/VAN
2210986	1990-03	70194509601C	BUS/VAN



Ref.	Fecha-Date	OE
2413986	1990-03	701943021
2403986	1990-03	701943021



Ref.	Fecha-Date	OE
2705984	1997-03	7D1941009H
2706984	1997-03	7D1941010H



Ref.	Fecha-Date	OE
2901984	1997-03	7D0941699C
2902984	1997-03	7D0941700C



Ref.	Fecha-Date	OE
2101984	1997-03	7D0953041F
2102984	1997-03	7D0953042F

**VOLKSWAGEN TRANSPORTER V**



Ref.	Fecha-Date	OE
2705985	2003-09	7H1941017L
2706985	2003-09	7H1941018L



Ref.	Fecha-Date	OE
2701985	2003-09	7H1941017N
2702985	2003-09	7H1941018N



Ref.	Fecha-Date	OE
2909522	2003-09	7E0941699
2910522	2003-09	7E0941700



Ref.	Fecha-Date	OE
2201985	2003-09	7H5945095M
2202985	2003-09	7H5945096M
2211985	2003-09	7H5945095H
2212985	2003-09	7H5945096H



Ref.	Fecha-Date	OE
2205985	2003-09	7H0945095J
2206985	2003-09	7H0945096J



Ref.	Fecha-Date	OE	Caract.
2215985	2003-09	7H0945095F	T.HELL
2216985	2003-09	7H0945096F	T.HELL



Ref.	Fecha-Date	OE
2225985	2003-09	7H5945095N
2226985	2003-09	7H5945096N

## VOLKSWAGEN TRANSPORTER V / MULTIVAN V



Ref.	Fecha-Date	OE
2745985	2010-15	7E1941015H
2746985	2010-15	7E1941016H



Ref.	Fecha-Date	OE
2741985	2010-15	7E1941015J
2742985	2010-15	7E1941016J

**NEW**



Ref.	Fecha-Date	OE	Caract.
2751985	2010-15	7E5941017	T.AL
2752985	2010-15	7E5941018	T.AL



Ref.	Fecha-Date	OE
2901985	2010-15	7E0941699A
2902985	2010-15	7E0941700A



Ref.	Fecha-Date	OE
3105110	2010-15	1Z0949101C; 7H0949117A



Ref.	Fecha-Date	OE
2241110	2010-15	7E5945095C
2242110	2010-15	7E5945096C



Ref.	Fecha-Date	OE
2251110	2010-15	7E5945095D
2252110	2010-15	7E5945096D



### Luz carretera

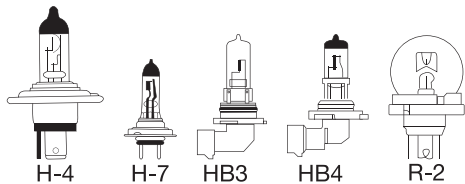
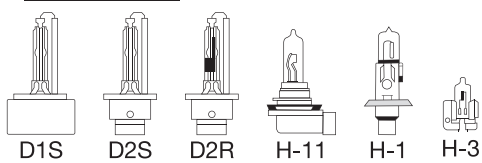

### Intermitente delantero

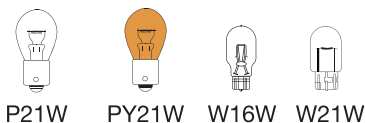

### Salpicadero



### Interior



### Maletero



### Posición trasera

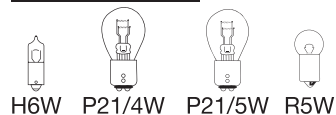

### Antiniebla trasero

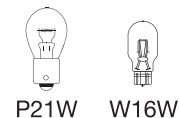

### Matrícula



### Posición delanteras

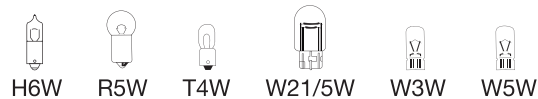

### Antiniebla delantero

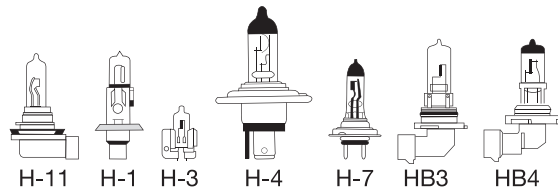

### Intermitente lateral

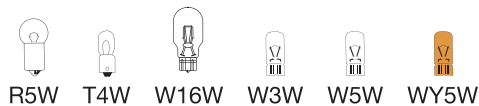

### Guantera



### 3ª luz de freno

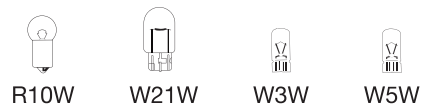

### Intermitente trasero

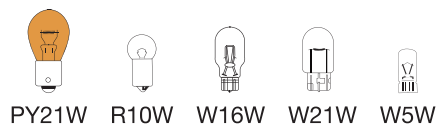

### Freno

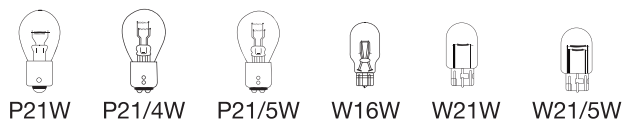

### Marcha atrás

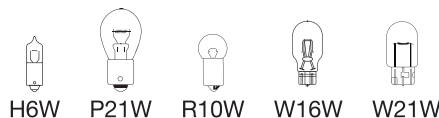

## ICONOS - PICTOGRAMS



Transparente  
Transparent



Ambar  
Orange



Blister Doble  
Double Blister



Estuche Transparente  
Showbox



Caja  
Box



Azul  
Blue



Blanco  
White



EMARK



Un. por Embalaje  
Pack Quantity



Lote Obligatorio  
Minimum sale Lot



16  
Watts



3  
Voltage



10  
Lot



Marca Carpriss  
Carpriss Brand



Novedad  
New

## D1S XENON



Ref.	Marca Brand	Novedad New	Homol Approv	Medidas Measure	Present Display	Uds. Emb QTY item	Lot	V	W	Color	Tipo Vehiculo Vehicle type
70721101	CARPRISS	NEW	E4	D1SxPK32d-2		2	5	85 VOLTS	35 WATTS		

## D2S XENON



Ref.	Marca Brand	Novedad New	Homol Approv	Medidas Measure	Present Display	Uds. Emb QTY item	Lot	V	W	Color	Tipo Vehiculo Vehicle type
70721103	CARPRISS	NEW	E4	D2SxP32d-2		2	5	85 VOLTS	35 WATTS		

## D2R XENON

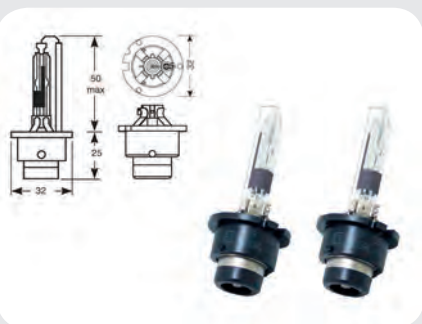

Ref.	Marca Brand	Novedad New	Homol Approv	Medidas Measure	Present Display	Uds. Emb QTY item	Lot	V	W	Color	Tipo Vehiculo Vehicle type
70721104	CARPRISS	NEW	E4	D2RxP32d-3		2	5	85 VOLTS	35 WATTS		

## Estuche Lámparas Tipo XENÓN - XENON like Lamp Set



Ref.	Marca Brand	Homologación Approval	Medidas Measure	Present Display	Uds. Emb QTY item	Lot	V	W	Color	Tipo Vehículo Vehicle type
70721012	CARPRISS	E <sub>4</sub>	H1xP14.5s	B	2	10	12 VOLTS	55 WATTS		
70721013	CARPRISS	E <sub>4</sub>	H4xP43t	B	2	10	12 VOLTS	60/55 WATTS		
70721014	CARPRISS	E <sub>4</sub>	H7xPX26d	B	2	10	12 VOLTS	55 WATTS		
70721021	CARPRISS	E <sub>4</sub>	H1xP14.5s	B	2	10	12 VOLTS	55 WATTS		
70721023	CARPRISS	E <sub>4</sub>	H4xP43t	B	2	10	12 VOLTS	60/55 WATTS		
70721024	CARPRISS	E <sub>4</sub>	H7xPX26d	B	2	10	12 VOLTS	55 WATTS		

## Estuche Lámparas SUPREME WHITE Lamp Set



Ref.	Marca Brand	Novedad New	Homol. Approval	Medidas Measure	Present Display	Uds. Emb QTY item	Lot	V	W	Color	Tipo Vehículo Vehicle type
70721055	CARPRISS	NEW	E <sub>4</sub>	H1xP14.5s	B	2	10	12 VOLTS	55 WATTS		
70721056	CARPRISS	NEW	E <sub>4</sub>	H4xP43t	B	2	10	12 VOLTS	60/55 WATTS		
70721057	CARPRISS	NEW	E <sub>4</sub>	H7xPX26d	B	2	10	12 VOLTS	55 WATTS		

30% más visibilidad - 30% more visibility

## Estuche Lámparas SUPREME WHITE PLUS Lamp Set



Ref.	Marca Brand	Novedad New	Homol. Approval	Medidas Measure	Present Display	Uds. Emb QTY item	Lot	V	W	Color	Tipo Vehículo Vehicle type
70721055	CARPRISS	NEW	E <sub>4</sub>	H1xP14.5s	B	2	10	12 VOLTS	55 WATTS		
70721056	CARPRISS	NEW	E <sub>4</sub>	H4xP43t	B	2	10	12 VOLTS	60/55 WATTS		
70721057	CARPRISS	NEW	E <sub>4</sub>	H7xPX26d	B	2	10	12 VOLTS	55 WATTS		

60% más visibilidad - 60% more visibility

## H1

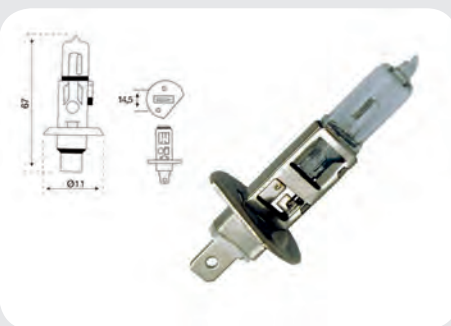

Ref.	Marca Brand	Novedad New	Homol. Approval	Medidas Measure	Present Display	Uds. Emb QTY item	Lot	V	W	Color	Tipo Vehículo Vehicle type
79780230	CARPRISS		E <sub>4</sub>	H1xP14.5s	B	1	10	12 VOLTS	55 WATTS		
79780232	CARPRISS		E <sub>4</sub>	H1xP14.5s	B	1	10	12 VOLTS	55 WATTS		

## H3

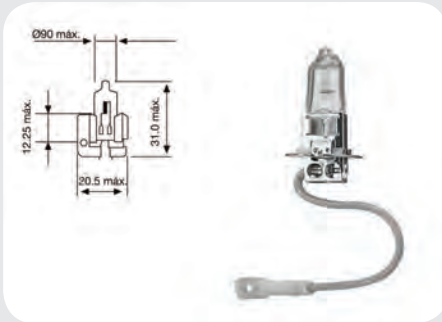

Ref.	Marca Brand	Novedad New	Homol Approval	Medidas Measure	Present Display	Uds. Emb QTY item	Lot	V	W	Color	Tipo Vehículo Vehicle type
79780246	ALKAR		E <sub>4</sub>	H3xPK22s	B	1	10	12 VOLTS	55 WATTS	Blue	Car, Motorcycle, 4x4
79780247	ALKAR	NEW	E <sub>4</sub>	H3xPK22s	B	1	10	12 VOLTS	55 WATTS	Blue	Car, Motorcycle, 4x4

## H4

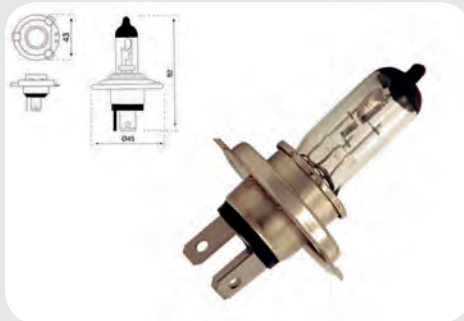

Ref.	Marca Brand	Novedad New	Homol Approval	Medidas Measure	Present Display	Uds. Emb QTY item	Lot	V	W	Color	Tipo Vehículo Vehicle type
79780235	ALKAR		E <sub>4</sub>	H4xP43t	B	1	10	12 VOLTS	60/55 WATTS	Blue	Car, Motorcycle, 4x4
79780237	ALKAR		E <sub>4</sub>	H4xP43t	B	1	10	12 VOLTS	60/55 WATTS	Blue	Car, Motorcycle, 4x4

## H7

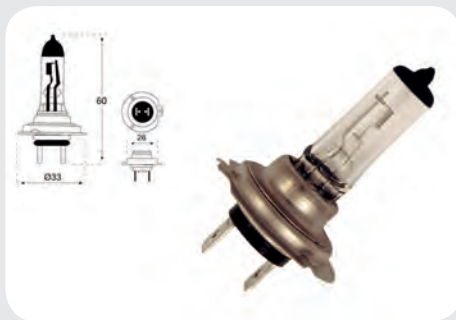

Ref.	Marca Brand	Novedad New	Homol Approval	Medidas Measure	Present Display	Uds. Emb QTY item	Lot	V	W	Color	Tipo Vehículo Vehicle type
79780240	ALKAR		E <sub>4</sub>	H7xPX26d	B	1	10	12 VOLTS	55 WATTS	Blue	Car, Motorcycle, 4x4
79780242	ALKAR		E <sub>4</sub>	H7xPX26d	B	1	10	12 VOLTS	55 WATTS	Blue	Car, Motorcycle, 4x4

## H11



Ref.	Marca Brand	Novedad New	Homol Approval	Medidas Measure	Present Display	Uds. Emb QTY item	Lot	V	W	Color	Tipo Vehículo Vehicle type
79780243	ALKAR	NEW	E <sub>4</sub>	H11xPGJ19	B	1	10	12 VOLTS	55 WATTS	Blue	Car, Motorcycle, 4x4
79780245	ALKAR	NEW	E <sub>4</sub>	H11xPGJ19	B	1	10	12 VOLTS	55 WATTS	Blue	Car, Motorcycle, 4x4

## HB3

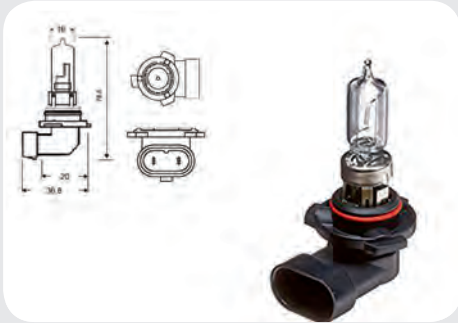

Ref.	Marca	Novedad	Medidas	Present	Uds. Emb	Lot	V	W	Color	Tipo Vehiculo
	Brand	New	Measure	Display	QTY item					Vehicle type
79780248		NEW	HB3xP20d90°		1	10	12 VOLTS	55 WATTS		

## HB4



Ref.	Marca	Novedad	Medidas	Present	Uds. Emb	Lot	V	W	Color	Tipo Vehiculo
	Brand	New	Measure	Display	QTY item					Vehicle type
79780249		NEW	HB4xP22d90°		1	10	12 VOLTS	51 WATTS		

## R2

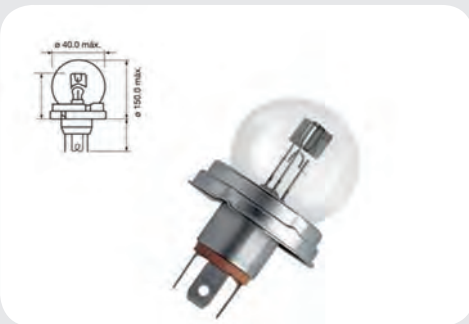

Ref.	Marca	Homologación	Medidas	Present	Uds. Emb	Lot	V	W	Color	Tipo Vehiculo
	Brand	Approval	Measure	Display	QTY item					Vehicle type
79780225			R2xP45t		1	10	12 VOLTS	40/45 WATTS		

## P21W



Ref.	Marca	Novedad	Homol	Medidas	Present	Uds. Emb	Lot	V	W	Color	Tipo Vehiculo
	Brand	New	Approval	Measure	Display	QTY item					Vehicle type
79780250				P21WxBA15s		2	10	12 VOLTS	21 WATTS		
79780252				P21WxBA15s		10	100	12 VOLTS	21 WATTS		

## PY21W



Ref.	Marca Brand	Novedad New	Homol Approval	Medidas Measure	Present Display	Uds. Emb QTY item	Lot	V	W	Color	Tipo Vehiculo Vehicle type
79780255	ALKAR		E4	PY21WxBAU15s	B	2	10	12 VOLTS	21 WATTS	Orange	Car, Motorcycle, 4x4
79780257	ALKAR		E4	PY21WxBAU15s	B	10	100	12 VOLTS	21 WATTS	Orange	Car, Motorcycle, 4x4

## P21 / 5W



Ref.	Marca Brand	Novedad New	Homol Approval	Medidas Measure	Present Display	Uds. Emb QTY item	Lot	V	W	Color	Tipo Vehiculo Vehicle type
79780260	ALKAR		E4	P21/5WxBAY15d	B	2	10	12 VOLTS	21/5 WATTS	Blue	Car, Motorcycle, 4x4
79780262	ALKAR		E4	P21/5WxBAY15d	B	10	100	12 VOLTS	21/5 WATTS	Blue	Car, Motorcycle, 4x4

## P21 / 4W



Ref.	Marca Brand	Novedad New	Homol Approval	Medidas Measure	Present Display	Uds. Emb QTY item	Lot	V	W	Color	Tipo Vehiculo Vehicle type
79780263	ALKAR		E4	P21/4WxBAZ15d	B	2	10	12 VOLTS	21/4 WATTS	Blue	Car, Motorcycle, 4x4
79780264	ALKAR	NEW	E4	P21/4WxBAZ15d	B	10	100	12 VOLTS	21/4 WATTS	Blue	Car, Motorcycle, 4x4

## R5W

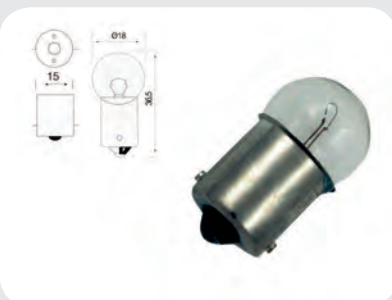

Ref.	Marca Brand	Novedad New	Homologación Approval	Medidas Measure	Present Display	Uds. Emb QTY item	Lot	V	W	Color	Tipo Vehiculo Vehicle type
79780265	ALKAR		E4	R5WxBA15s	B	2	10	12 VOLTS	5 WATTS	Blue	Car, Motorcycle, 4x4
79780267	ALKAR		E4	R5WxBA15s	B	10	100	12 VOLTS	5 WATTS	Blue	Car, Motorcycle, 4x4

## R10W

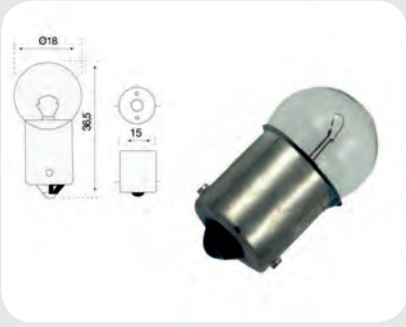

Ref.	Marca	Novedad	Homol	Medidas	Present	Uds. Emb	Lot	V	W	Color	Tipo Vehículo
	Brand	New	Approval	Measure	Display	QTY item					Vehicle type
79780268	ALPKAR		E4	R10WxBA15s	B	2	10	12 VOLTS	10 WATTS	Blue	Car, Motorcycle, 4x4
79780278	ALPKAR	NEW	E4	R10WxBA15s	B	10	100	12 VOLTS	10 WATTS	Blue	Car, Motorcycle, 4x4

## T4W



Ref.	Marca	Novedad	Homol	Medidas	Present	Uds. Emb	Lot	V	W	Color	Tipo Vehículo
	Brand	New	Approval	Measure	Display	QTY item					Vehicle type
79780287	ALPKAR		E4	T4WxBAGs	B	2	10	12 VOLTS	4 WATTS	Blue	Car, Motorcycle, 4x4
79780289	ALPKAR	NEW	E4	T4WxBAGs	B	10	100	12 VOLTS	4 WATTS	Blue	Car, Motorcycle, 4x4

## H6W



Ref.	Marca	Novedad	Homologación	Medidas	Present	Uds. Emb	Lot	V	W	Color	Tipo Vehículo
	Brand	New	Approval	Measure	Display	QTY item					Vehicle type
79780244	ALPKAR	NEW	E4	H6WxBAX9s	B	2	10	12 VOLTS	6 WATTS	Blue	Car, Motorcycle, 4x4
79780254	ALPKAR	NEW	E4	H6WxBAX9s	B	10	100	12 VOLTS	6 WATTS	Blue	Car, Motorcycle, 4x4

## W3W

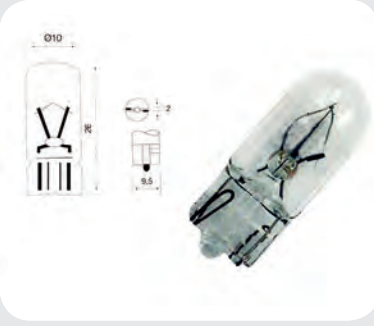

Ref.	Marca	Novedad	Homol	Medidas	Present	Uds. Emb	Lot	V	W	Color	Tipo Vehículo
	Brand	New	Approval	Measure	Display	QTY item					Vehicle type
79780273	ALPKAR		E4	W3WxW2,1x9,5d	B	2	10	12 VOLTS	3 WATTS	Blue	Car, Motorcycle, 4x4
79780279	ALPKAR	NEW	E4	W3WxW2,1x9,5d	B	10	100	12 VOLTS	3 WATTS	Blue	Car, Motorcycle, 4x4

## WY5W T10



Ref.	Marca Brand	Novedad New	Homol Approval	Medidas Measure	Present Display	Uds. Emb QTY item	Lot	V	W	Color	Tipo Vehículo Vehicle type
79780292	ALKAR PRESS	NEW	E4	WY5WxW2.1x9.5d	B	2	10	12 VOLTS	5 WATTS	Orange	Car, Motorcycle, 4x4
79780297	ALKAR PRESS	NEW	E4	WY5WxW2.1x9.5d	Box	10	100	12 VOLTS	5 WATTS	Orange	Car, Motorcycle, 4x4

## W5W T10

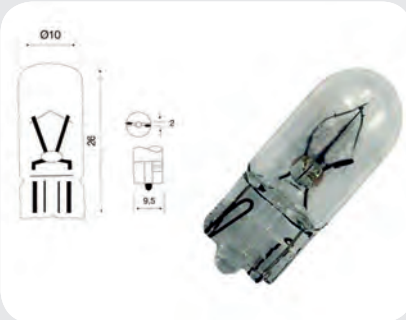

Ref.	Marca Brand	Novedad New	Homol Approval	Medidas Measure	Present Display	Uds. Emb QTY item	Lot	V	W	Color	Tipo Vehículo Vehicle type
79780270	ALKAR PRESS		E4	W5WxW2.1x9.5d	B	2	10	12 VOLTS	5 WATTS	Clear	Car, Motorcycle, 4x4
79780272	ALKAR PRESS		E4	W5WxW2.1x9.5d	Box	10	100	12 VOLTS	5 WATTS	Clear	Car, Motorcycle, 4x4

## W16W T15

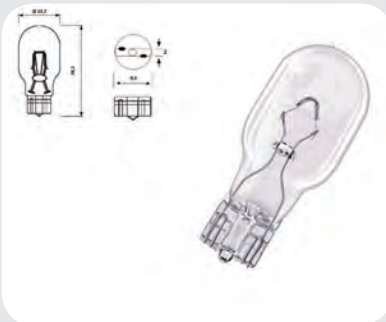

Ref.	Marca Brand	Novedad New	Homol Approval	Medidas Measure	Present Display	Uds. Emb QTY item	Lot	V	W	Color	Tipo Vehículo Vehicle type
79780234	ALKAR PRESS	NEW	E4	W16WxW2.1x9.5d	B	2	10	12 VOLTS	16 WATTS	Clear	Car, Motorcycle, 4x4
79780280	ALKAR PRESS	NEW	E4	W16WxW2.1x9.5d	Box	10	100	12 VOLTS	16 WATTS	Clear	Car, Motorcycle, 4x4

## W21W T20

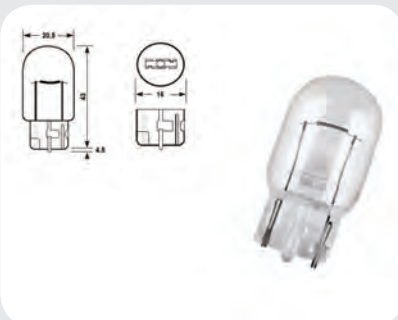

Ref.	Marca Brand	Novedad New	Homol Approval	Medidas Measure	Present Display	Uds. Emb QTY item	Lot	V	W	Color	Tipo Vehículo Vehicle type
79780293	ALKAR PRESS	NEW	E4	W21WxW3x16d	B	2	10	12 VOLTS	21 WATTS	Clear	Car, Motorcycle, 4x4
79780298	ALKAR PRESS	NEW	E4	W21WxW3x16d	Box	10	100	12 VOLTS	21 WATTS	Clear	Car, Motorcycle, 4x4



## W21 / 5W T20 LED



Ref.	Marca	Novedad	Homol	Medidas	Present	Uds. Emb	Lot	V	W	Color	Tipo Vehiculo
	Brand	New	Approval	Measure	Display	QTY item					Vehicle type
79780294	CAR PRISS	NEW	E4	W21/5WxW3x16q	B	2	10	12 VOLTS	21/5 WATTS		Car, Motorcycle, 4x4
79780299	CAR PRISS	NEW	E4	W21/5WxW3x16q		10	100	12 VOLTS	21/5 WATTS		Car, Motorcycle, 4x4

## C5W



Ref.	Marca	Novedad	Homol	Medidas	Present	Uds. Emb	Lot	V	W	Color	Tipo Vehiculo
	Brand	New	Approval	Measure	Display	QTY item					Vehicle type
79780275	CAR PRISS		E4	C5WxSV8,5-38x11mm.	B	2	10	12 VOLTS	5 WATTS		Car, Motorcycle, 4x4
79780277	CAR PRISS		E4	C5WxSV8,5-38x11mm.		10	100	12 VOLTS	5 WATTS		Car, Motorcycle, 4x4

## ESTUCHE SURTIDO - BULB SET



Ref.	Marca	Homologación	Medidas	Presentación	Uds. Embalaje	Lot	V	Color	Tipo Vehiculo
	Brand	Approval	Measure	Display	QTY per item				Vehicle type
79780205	CAR PRISS	E4	H1	B	9	10	12 VOLTS		Car, Motorcycle, 4x4
79780210	CAR PRISS	E4	H4	B	9	10	12 VOLTS		Car, Motorcycle, 4x4
79780215	CAR PRISS	E4	H7	B	9	10	12 VOLTS		Car, Motorcycle, 4x4
79780220	CAR PRISS	E4	H1+H7	B	10	10	12 VOLTS		Car, Motorcycle, 4x4





**LISTADO DE REFERENCIAS OE**

**OE REFERENCES LIST**

**LISTE DES RÉFÉRENCES OE**

**VERZEICHNIS DER OE REFERENZEN**

Ref.	OE	PAG.	Ref.	OE	PAG.
1901624	92301-43810	254	2121751	93184008	307
1901751	4408521	308	2122751	93184007	307
1901910	2D0953041A	332	2201153	7701035363	309
1901966	9018200121	273	2201154	2K0945095N	330
1901969	6388200821	277	2201155	7701039728	310
1901972	98433912	259	2201156	7700308715	311
1902624	92302-43810	254	2201168	265559212R	313
1902751	4408520	308	2201174	8200150619	311
1902910	2D0953042A	332	2201176	2655500QAN	301
1902966	9018200221	273	2201188	8200419941	312
1902969	6388200921	277	2201326	95630219	224
1902972	98433913	259	2201351	6350EV(C; P); 1353355080(F)	232
1905910	2D0953041	332	2201388	ET7613404AB	249
1905961	B61259C000	304	2201441	1222061	305
1905969	6388200021	278	2201753	8200228394	314
1905986	701953049	333	2201754	2654500QDA(N); 4449448(O); 8200415250(R)	303
1906910	2D0953042	332	2201856	1606664080(C); 0001365774080(F); 6350AV(P)	228
1906961	B61209C000	304	2201902	7701025919	314
1906969	6388200121	278	2201910	2D0945095A	332
1906986	701953050	333	2201921	6350AR(C; P); 0001328428080(F)	227
1913975	9812662280	223	2201960	1205706	252
2001910	2D0945095	332	2201961	1063538; 4505432; 1063538; 4505432	250;251
2001969	4148200364	276	2201962	1435881; 1435881	247;252
2002910	2D0945096C	332	2201966	8260756	274
2002969	4148200464	276	2201969	6398200164	278
2005967		262	2201970	69500032	261
2006967		262	2201971	6350AH(C; P); 9467069888(F)	231
2011961	1220832	304	2201972	370830004	259
2012961	26555-G2701	304	2201974	6350EE; 6350J1(C); 6350JO(P)	221
2101062	6K5953049C	328	2201975	6350EC(C); 6350Y8(P)	222
2101064	6K5953049A	316	2201977	98472977	260
2101751	2613500QDA(N); 4408521(R)	302	2201983	BK13404AG	253
2101902	4500919(O); 7701044522(R)	306	2201985	7H5945095M	335
2101920	630396(C; P); 1303854080(F)	225	2201986	70194509501C	333
2101958	1054241	250	2202153	7701035364	309
2101966	9018200121	273	2202154	2K0945096N	330
2101969	6388200821	277	2202155	7701039729	310
2101970	5801585146	262	2202156	7700308716	311
2101973	630356(C); 9406303547(F); 630354(P)	230	2202168	265506747R	313
2101974	630379(C); 630381(P)	220	2202174	8200150621	311
2101977	50410467	260	2202176	2655000QAN	301
2101984	7D0953041F	334	2202188	8200419945	312
2101986	701953049	333	2202326	95630217	224
2102062	6K5953050C	328	2202351	6350ET(C; P); 1353356080(F)	232
2102064	6K5953050A	316	2202388	ET7613405AB	249
2102751	2613000QDA(N); 4408520(R)	302	2202441	1222062	305
2102902	4500920(O); 7701044523(R)	306	2202753	8200228395	314
2102920	630395(C; P); 1303853080(F)	225	2202754	2654000QDA(N); 4449447(O); 8200415251(R)	303
2102958	1C0941700B	250	2202856	1606664180(C); 0001365775080(F); 6351AY(P)	228
2102966	9018200221	273	2202902	7701025921	314
2102969	6388200921	277	2202910	2D0945096D	332
2102970	5801585151	262	2202921	6351AV(C; P); 0001328427080(F)	227
2102973	630355(C); 9406303537(F); 630353(P)	230	2202960	1205701	252
2102974	630380(C); 630382(P)	220	2202961	1063537; 4505431; 1063537; 4505431	250;251
2102977	50410465	260	2202962	1435880; 1435880	247;252
2102984	7D0953042F	334	2202966	8260856	274
2102986	701953050	333	2202969	6398200264	278
2103708	A4158201259	272	2202970	69500026	261
2105022	MB831287	279	2202971	6351AH(C; P); 9467069988(F)	231
2105108	6K5953049B	328	2202972	1904639	259
2105367	0046512542	235	2202974	6351EE; 6351J1(C); 6351JO(P)	221
2105709	18226720	272	2202975	6351EC(C); 6351Y8(P)	222
2105751	2613500QAC(N); 8200007031(R)	302	2202977	98472979	260
2105902	4500919(O); 7701044522(R)	306	2202983	BK13405AG	253
2105958	1063534	250	2202985	7H5945096M	335
2105959	1063534	251	2202986	70194509601C	333
2105961	6166918	249	2205920	6350AL(C; P); 132635908(F)	226
2105977	98472982	260	2205960	1369222	247
2105986	701953049	333	2205969	6388201264	278
2106022	MB831288	279	2205973	6350E7(C); 9790384780(F); 6350E6(P)	230
2106108	6K5953050B	328	2205982	7567805(C); 7567805(F); 6350AT(P)	225
2106367	0046512541	235	2205985	7H0945095J	335
2106709	18226820	272	2206920	6351AL(C; P); 132635808(F)	226
2106751	2613000QAC(N); 8200007030(R)	302	2206960	1369221	247
2106902	4500920(O); 7701044523(R)	306	2206969	6388201764	278
2106958	1063533	250	2206973	6351E7(C); 9730384880(F); 6351E6(P)	230
2106959	1063533	251	2206982	7567804(C); 7567804(F); 6351AX(P)	225
2106961	6166917	249	2206985	7H0945096J	335
2106977	98472981	260	2209624	92401-43810	254
2106986	701953050	333	2209969	6388201264	278
2111751	8200163914	314	2209986	70194509501C	333
2112751	8200163918	314	2210624	92402-43800	254
2113751	8200263356	314	2210969	6388201764	278
2114751	8200263364	314	2210986	70194509601C	333

Ref.	OE	PAG.
2211154	6K9945111	316;329
2211156	8200103284	311
2211168	265557352R	313
2211174	8200150623	312
2211176	2655500QAM	301
2211188	8200419949	313
2211351	6350EV(C); 1355724080(F); 8503QA(P)	232
2211708	A4159062800	272
2211751	4500516(O); 7705352700(R)	306
2211960	4974083; 5177813	248
2211961	51755145	233
2211964	26555BJ00A	301
2211966	8261856	274
2211970	69500591	261
2211974	6350EC; 6350H2	221
2211975	6350EE(C); 6350Y9(P)	222
2211985	7H5945095H	335
2212154	6K9945112	316;329
2212156	8200103292	311
2212168	265506145R	313
2212174	8200150625	312
2212176	2655000QAM	301
2212188	8200419952	313
2212351	6350ET(C); 1355727080(F); 8503PZ(P)	232
2212708	A4159062700	272
2212751	4500517(O); 7705352703(R)	306
2212960	4974082; 5177810	248
2212961	51755144	233
2212964	26550BJ00A	301
2212966	8261956	274
2212970	69500591	261
2212974	6351EC; 6351H2	221
2212975	6351EE(C); 6351Y9(P)	222
2212985	7H5945096H	335
2215708	A4159062900	272
2215973	6350AL(C; P); 0001326358080(F)	226;227;228
2215985	7H0945095F	335
2216708	A4159062600	272
2216973	6351AL(C; P); 0001326359080(F)	226;227;228
2216985	7H0945096F	335
2221188	8200419906	313
2221417	1223530	304
2221751	2655500QAB(N); 8200171472 ( R ); 7700352700(O)	299
2221960	1827837; 1849468; 1908969	248
2221961	51810674	234
2221966	9068200164	276
2221975	6350FJ(C); 6350FJ(P)	223
2222188	8200419908	313
2222417	1223531	304
2222751	2655000QAB(N); 8200171478(R)	299
2222960	1824731; 1827836; 1908967	248
2222961	51810673	234
2222966	9068200264	276
2222975	6351FJ(C); 6351FJ(P)	223
2225973	6350AL(C; P); 0001326358080(F)	226;227;228
2225985	7H5945095N	335
2226973	6351AL(C; P); 0001326359080(F)	226;227;228
2226985	7H5945096N	335
2231154	2K5945095B	330
2231751	4419378(O); 265550023R(R)	307
2231754	4422466 (O); 265556737R ®	308;315
2231960	1778456	248
2231961	51830565	234
2231970	5801523220	262
2231975	6350FH(C); 6350FH(P)	223
2232154	2K5945096B	330
2232751	4419379(O); 265500023R(R)	307
2232754	4422465 (O); 265504656R ®	308;315
2232960	1778457	248
2232961	51830564	234
2232970	5801523221	262
2232975	6351FH(C); 6351FH(P)	223
2241110	7E5945095C	336
2241154	2K5945095C	330
2241751	26545-00Q0A (N); 4419132 (O); 8200968070 (R)	303
2241961	51735979	233
2241975	9677205580(C; P)	224
2242110	7E5945096C	336
2242154	2K5945096C	330
2242751	26540-00Q0A (N); 44193130(O); 8200968063 (R)	303
2242961	51735978	233
2242975	9677205580(C; P)	224
2250910	2E0945095	331
2251036	81560-26440	319

Ref.	OE	PAG.
2251110	7E5945095D	336
2251154	2K5945095F; 2K5945095M	331
2251910	2E0945096	331
2251975	9677205180 (C); 9812662280 (P)	223
2252036	81550-26440	319
2252110	7E5945096D	336
2252154	2K5945096F; 2K5945096M	331
2252975	9677205080 (C)	223
2255154	2K5945095G; 2K5945095N	331
2256154	2K5945096G; 2K5945096N	331
2301970	93190983	261
2302970	93190983	261
2403351	6340G5	232
2403922	735430904	228
2403962	1732840	252;248
2403966	9018200156 ; 2D0943021A	274;332
2403975	6340G7	223;231
2403986	701943021	333
2405922		228
2405966		274;332
2413351	6340G5	232
2413922	735430904	228
2413962	1732840	252;248
2413966	9018200156 ; 2D0943021A	274;332
2413986	701943021	333
2423351	6340H0	232
2433351	6340H0	232
2569001		196
2569002		196
2569004		196
2569005		196
2569006		197
2569007		197
2569008		197
2569010		193
2569014		197
2569015		197
2596001		191
2596002		191
2596003		192
2596005		191
2596007		194
2596009		194
2596011		194
2596012		194
2596016		193
2596020		194
2596021		193
2596022		193
2596023		194
2596024		194
2596025		183
2596026		183
2596027		183
2596028		183
2596029		183
2596030		183
2596032		195
2596034		195
2596036		187
2596037		187
2596038		187
2596039		187
2596040		194
2596042		194
2596043		186
2596044		186
2596046		187
2596048		192
2596050		192
2596056		192
2596057		192
2596058		192
2596060		191
2596061		192
2596062		192
2596064		192
2596066		192
2596070		193
2596071		193
2596074		189
2596080		187
2596081		187
2596082		187

Ref.	OE	PAG.
2596083		187
2596084		187
2596085		187
2596086		187
2596087		187
2596088		187
2596089		188
2596090		188
2597014		189
2597015		189
2597016		189
2597018		189
2701036	81150-26100	318
2701152	7701366413	308
2701153	7701035230	309
2701417	1216488	304
2701709	8209161	272
2701958	6677256	250
2701969	6388201961	277
2701972	94433944	259
2701985	7H1941017N	334
2701986	701941017	333
2702036	81110-26100	318
2702152	7701366413	308
2702153	7701035231	309
2702417	1216489	304
2702709	8209261	272
2702958	6677253	250
2702969	6388202061	277
2702972	94433943	259
2702985	7H1941018N	334
2702986	701941018	333
2703152	7701031920	308
2705100	144434021; 1446587; 1EG00715009	147;149
2705326	95535308	224
2705327	95535308	224
2705984	7D1941009H	334
2705985	7H1941017L	334
2706100	144433021; 1446588; 1EG007150101	147;149
2706326	95535309	224
2706327	95535309	224
2706984	7D1941010H	334
2706985	7H1941018L	334
2709961	6639650	249
2710961	6639646	249
2711961	7543659(C); 0007660574(F); 6204AC(P)	225
2712961	7536658(C); 0007660573(F); 6205AA(P)	225
2731036	81170-26500	318
2731969	6398202861	277
2732036	81130-26500	318
2732969	6398202961	277
2741064	6K1941015L	316
2741154	6K5941015	328
2741156	7701044037	310
2741168	260602665R	313
2741174	2606000QOL(N); 8200236591(R)	300;311
2741188	7701068181	312
2741351	6205AZ(C; P); 1353198080(F)	231
2741417	1216486	304
2741420	1216000	305
2741441	1216096	305
2741624		254
2741751	8200163516(N; O; R)	299
2741754	2606000QAE(N)4414032(O); 8200701354(R)	303
2741856	1612041380	229
2741910	2D1941015	332
2741920	6204AF(C; P); 1301150080(F)	225
2741921	6208E3(C; P); 0001328426080(F)	226
2741922	6208A5(C; P); 0001340664080(F)	227
2741958	7242053	250
2741959	7242051	250;251
2741960	4696778	251
2741961	46807765	232
2741964	26060JX30A	301
2741966	9018200161	273
2741969	6398200161	278
2741970	69500013	261
2741971	6208C5(C; P); 6208C5(F)	230
2741972	98433940	259
2741973	6204AL(C; P); 1474268080(F)	229
2741974	6204P6	220
2741975	6208K6	222
2741977	710301160201	260
2741985	7E1941015J	335

Ref.	OE	PAG.
2742064	6K1941016L	316
2742154	6K5941016	328
2742156	7701044038	310
2742168	260109958R	313
2742174	2601000QOL(N); 8200236590(R)	300;311
2742188	7701068178	312
2742351	6205AY(C; P); 1353197080(F)	231
2742417	1216487	304
2742420	1216093	305
2742441	1216097	305
2742624		254
2742751	8200163518(N; O; R)	299
2742754	2600000QAD(N); 4408723(O); 8200701356(R)	303
2742856	1612040580	229
2742910	2D1941016	332
2742920	6205AE(C; P); 1301149080(F)	225
2742921	6206E2(C; P); 0001328425080(F)	226
2742922	6206A5(C; P); 0001340663080(F)	227
2742958	7242047	250
2742959	7242045	250;251
2742960	4696752	251
2742961	46807766	232
2742964	26010JX30A	301
2742966	9018200261	273
2742969	6398200261	278
2742970	69500010	261
2742971	6206C5(C; P); 6206C5(F)	230
2742972	98433939	259
2742973	6205AK(C; P); 1474267080(F)	229
2742974	6205P6	220
2742975	6206K6	222
2742977	710301160202	260
2742985	7E1941016J	335
2745006	0051708732	235
2745154	2K0941005D	329
2745174	2606000QOL(N); 8200150617(R)	300;311
2745188	7701071596	312
2745751	2606000QAE(N); 4414032(O); 7700311371(R)	302
2745910	2D1941015A	332
2745922		229
2745960	4696778	251
2745961	51755051	233
2745962	1537774	252
2745966	9018200561	273
2745969	6388200061	277
2745970	5801375416	262
2745973	6208E8(C); 9467119588(F); 620630(P)	230
2745974	6204P8	220
2745975	6208K4	222
2745985	7E1941015H	335
2746006	0051708731	235
2746154	2K0941006D	329
2746174	2601000QOL(N); 8200150614(R)	300;311
2746188	7701071595	312
2746751	2600000QAD(N); 4408723(O); 7700311372(R)	302
2746910	2D1941016A	332
2746922	1374292080	229
2746960	4696752	251
2746961	51755054	233
2746962	1537773	252
2746966	9018200661	273
2746969	6388200161	277
2746970	5801375415	262
2746973	6206E8(C); 9467119688(F); 620830(P)	230
2746974	6205P8	220
2746975	6206K4	222
2746985	7E1941016H	335
2751006	0000051708730; 0051780722	235
2751154	1T1941005G	330
2751168	260607949R	313
2751174	2606000QOL(N); 8200183917(R)	300;311
2751188	7701068181	312
2751626	92101-4H020	253
2751751	4500915(O); 7701044518(R)	306
2751754	2606000QAE(N); 4414032(O); 8200701352(R)	303
2751922	1612041780 (C); 1374296080 (F)	228
2751960	1346495	247
2751961	46807768	232
2751966	9018201061	273
2751969	6398202861	277
2751970	5801473750	262
2751974	6204AX(C; P)	221
2751975	9677202080 (C); 9677202480 (P)	223
2751985	7E5941017	336

Ref.	OE	PAG.
2752006	000051708729; 0051780718	235
2752154	1T1941006G	330
2752168	260103948R	313
2752174	2601000QOL(N); 8200183921(R)	300,311
2752188	7701068178	312
2752626	92102-4H020	253
2752751	4500917(O); 7701044520(R)	306
2752754	2600000QAD(N); 4408723(O); 8200701353(R)	303
2752922	1612040980 (C); 1374292080 (F)	228
2752960	1346497	247
2752961	46807769	232
2752966	9018201161	273
2752969	6398202961	277
2752970	5801473749	262
2752974	6205AW(C; P)	221
2752975	9677201980(C); 9677202380 (P)	223
2752985	7E5941018	336
2753966	9018201461	273
2754966	9018201561	273
2755154	2K5941005	330
2755751	260608210R; 4419525	307
2755922	1612041880 (C); 1374297080 (F)	228
2755966	9018202461	274
2755969	6398201861	277
2755975	9677202480	223
2756154	2K5941006	330
2756751	260106869R	307
2756922	1612041080 (C); 1374293080 (F)	228
2756966	9018202561	274
2756969	6398201961	277
2756975	9677202380	223
2757966	9018202661	274
2758966	9018202761	274
2761110	2E1941015	331
2761751	260606702R(O; R)	307
2761754	4422458	308
2761960	1827690; 1827692; DT11113W030AC	248;249
2761961	51810672	234;305
2761966	9068200161	275
2762110	2E1941016	331
2762751	260606869R(O; R)	307
2762754	4422459; 95517042	308
2762960	1827686; 1827688; DT11113W029AC	248;249
2762961	51810671	234;305
2762966	9068200261	275
2765960	1815696; 1817487; 1819826; 1830357; 1865207; 1865209; 1877027	253
2765966	9068200561	275
2766960	1815694; 1817485; 1819824; 1830355; 1865207; 1877025	253
2766966	9068200661	275
2769966	9068200961	275
2770966	9068201061	275
2771754	260601784R	314
2771966	A9068202361	275
2772754	260108724R	314
2772966	A9068202461	275
2901064	6K0941701; 6K5941701A	316;328
2901124	1T0941699C	329
2901164	2615500Q02(N); 4501195(O); 7701205665(R)	299;306;310
2901227	2615500Q03(N); 7701040680; 7701045718(R)	300;302;311
2901351	6206K2(C); 1356651080(F); 6206K0(P)	231
2901354	6204J4(C); 1471312080(F); 6204J3(P)	229
2901398	1135996; 4377433	251
2901441	1710372	305
2901624		254
2901702	2118200556	275
2901966	9068200856	276
2901974	9682F2	220
2901977	98424109	260
2901984	7D0941699C	334
2901985	7E0941699A	336
2902064	6K0941702; 6K5941702A	316;328
2902124	1T0941700C	329
2902164	2615000Q02(N); 4501194(O); 7701205664(R)	299;306;310
2902227	2615000Q03(N); 7701040681; 7701045717(R); 4408448(O)	300;302;311
2902351	6206K3(C); 1356651080(F); 6206K0(P)	231
2902354	6205J4(C); 1471313080(F); 6205J3(P)	229
2902398	1135998; 4395813	251
2902441	1710373	305
2902624		254
2902702	2118200656	275
2902966	9068200956	275
2902974	9682F2	220
2902977	98424107	260

Ref.	OE	PAG.
2902984	7D0941700C	334
2902985	7E0941700A	336
2903228	1209177; 8200074008	252;311
2903363	6206E1(C); 6204Q0; 9648947780(F); 6208E1(P)	230;230
2903364	6204AA(C); 00006205W4(P)	220;221
2903474	620862(C; P); 0046823269(F); 46823269	227;233
2903532	6206C8(C; P); 0000469309999(F)	226
2903750	5010312972	132
2903960	1097474	247
2909522	7E0941699	334
2910522	7E0941700	334
2911110	6Q0941699; 6Q0941699C	331
2911626	922014A600	253
2911966	9068200856	275
2912110	6Q0941700; 6Q0941700C	331
2912626	922024A600	253
2912966	9068200956	275
3003011	0046769163; 46769163	235
3003126	3A0949101B; 1H0949101B; 3A0949101A	316;329
3003969	2108200921	276;273;278
3007011	46511360	235
3007126	3A0949101A; 1H0949101A	316;329
3007380	6156783	249
3007386	4474148; 6859846	249;252
3007969	18203321	273
3009969	18203321	273
3040974	6325G3(C); 6325G4(P)	222;223;231
3101036	81743-26030	318
3102036	81733-26030	318
3103126	1H0949101B; 3A0949101A; 3A0949101B	329
3103127	1J5949117A; 3B0949117C	329
3103168	8200257684	313
3103188	8200439492	312
3103218	2616000QAA; 7700822136; 7701047516; 820019458; 8200257684;	300; 309;
	8200257685; 2616000QAA	309; 310
3103338	632545(C; P); 9613702180(F)	221;230
3103339	632545; 632562(C); 632567(P); 9613702180(F)	220;230
3103386	1034275; 4474148; 6166302	250; 251; 252
3103420	1713013; 1713240; 1713411	305
3103802	1J0949117	330
3103931	6326H7; 0046758821	232;233;235
3103960	4972773	247
3103969	2108200921	276;273;278
		24;27;28;29;
3103970	500308514; 5010306792; 98472976	32;34;132;13
		8;172;61;13
		5;261
3105110	1Z0949101C; 7H0949117A	336
3105960	1353531	247
3107126	1H0949101A	329
3107127	1J5949117B; 2K0949117B; 3B0949117C	330
		299; 300; 302;
3107218	7700822136(N); 4500736(O); 7701047516	309; 310
3107380	6156783	249
3107386	1058079; 4474148	249;252
3107417	1713013; 1713411; 1713501; 1713542; 90487599	305;304
3107492	0007566759; 0007626742; 5953696	234
3107961	000007734499; 0046522717; 46803094	232
3107969	18203321	273
3111127	3B0949117C	330
		299; 301; 302;
3117218	7700822136(N); 8200257685	309; 310
		226;227
3117920	6325G1(C; P); 0001341674080(F)	226;227
3207152	7701029282	309
3305327	95614884	224
3306327	95614885	224
3701064	6K5941015L	316
3701155	7701035238	309
3701961	7660574(C); 0007660574(F); 6204AC(P)	225
3702064	6K5941016L	316
3702155	7701035239	309
3702961	7660573(C); 0007660573(F); 6205AA(P)	225
6101153	6001030130	290
6101418	14227509; 14227554	287
6101594	963025718R	237
6101970	16110103	286
6101972	93924654	254
6101982	ZF07684289(C); 7684289(F); 8148P8(P)	207
6101983	251857513A	324
6101986	701857507C; 701857521J	324
6102153	6001030197	290
6102327	96029034YB	207
6102418	14227508; 14227554	287

Ref.	OE	PAG.
6102594	963015334R	237
6102970	16110113	286
6102972	8SB507021001; 93924653	254
6102982	ZF07684288(C); 7684288(F); 8148P9(P)	207
6102983	251857514A	324
6102986	701857508F; 701857522L	324
6106217	814842	291; 214; 295; 296
6106218	735245999	286
6106219	814842	291; 214; 295; 296
6106986	701857511AFKZ	325
6109972	8SB507022001; 93936850	255
6110972	8SB507023001; 93936851	255
6125594	963023520R	237
6125646	963025005R; 963736608R; 963661HB0B	236
6125986	701857507E; 701857521A	324
6126594	963017247R	237
6126646	8200947383; 963019902R; 963651HB0B	236
6126986	701857508H; 701857522G	324
6127986	701857507H01C	324
6128986	701857508H01C	324
6137154	6K9857501G; 6K9857501G01C	315; 319
6137646	963026216R; 963737245R; 963023379R	236
6138646	963011786R; 963740290R; 963659141R	236
6139594	963028631R	237
6139646	963025005R; 963737245R; 963661HB0B	236
6140418	1427553	287
6140594	963013709R	237
6140646	963019902R; 963740290R; 963651HB0B	236
6141418	1427554	287
6164152	7700400127	290
6164153	7700808132	290
6164154	6K9857501F	315; 319
6164490	5892125	219
6164594	6001549674	237
6164646	963026216R; 963736608R; 963023379R	236
6164967	A6318101816	263
6165152	7700400129	290
6165153	7700808133	290
6165154	6K9857502C01C	315; 319
6165490	5892126	219
6165594	6001549675	237
6165646	963011786R; 8200947383; 963659141R	236
6165967	A6318101916	263
6201249	3801914	258
6201381	1766580	243
6201666	1847387	246
6201907	261650223R(O; R)	284; 298
6201922	6325H0(C; F); 71748252(P)	212
6201929	71765449	219; 289
6201960	4474148	245
6201994	2E0953049A	323; 267
6202249	3801915	258
6202381	1766579	243
6202666	1847389	246
6202907	261603141R(O; R)	284; 298
6202922	6325H1(C; F); 71748253(P)	212
6202929	71765377	219; 289
6202960	4474148	245
6202994	2E0953050A	323; 267
6203666	1847388	246
6203907	261652475R(O); 21982857(R)	285; 298
6203922	6325H3	212
6204666	1847390	246
6204907	261609635R(O); 21982857(R)	285; 298
6204922	6325H4	212
6341160	7701068845	293
6341174	96374-00QAE(N); 8200245174(R)	281; 292
6341341	1824875	240
6341381	1809085	242
6341396	5016549	239
6341594	963736915R	237
6341645	4422963 (O); 93451849; 963731115R; 963739461R (R)	283
6341668	ET7617K747BD57V	241
6341698	A4158110307; 963733548R	264; 294
6341704	6398110461	268
6341710	A0008111222	271
6341867	1608180980	206
6341928	2H0857527CGRU	326
6341929	735512765	219; 289
6341974	8149C4	204
6341985	7H1857527GRU	325; 320
6341998	8149 C4	205

Ref.	OE	PAG.
6342160	7701068843	293
6342174	96373-00QAE(N); 8200245177(R)	281; 292
6342341	1825609	240
6342381	1809084	242
6342396	5016550	239
6342594	963747198R	237
6342645	4422964 (O); 93452218; 963745863R; 963746264R (R)	283
6342668	ET7617K746BD57V	241
6342698	A4158110107; 963742374R	264; 294
6342704	6398110561	268
6342710	A0008111322	271
6342867	1608181079	206
6342928	2H0857528CGRU	326
6342929	735512764	219; 289
6342974	8149C5	204
6342985	7H1857528CGRU	325; 320
6342998	8149 C5	205
6343160	7701068844	293
6343174	96374-00QAD(N); 8200245171(R)	281; 292
6343341	1824875	240
6343351	8153VL(C; P); 735462099(F)	216
6343381	1776500	242
6343396	5091564; 5211714	239
6343421	1428860	288
6343645	4422962 (O); 93451848; 963739461R (R)	283
6343666	1823808	246
6343668	ET7617K747AD5JA	241
6343698	A4158110507; 963735075R	264; 294
6343710	A0008111422	271
6343867	1608750880	206
6343877	2K58575279B9	321
6343905		280; 297
6343907	1887729(O)	284; 298
6343922	2507070066	212
6343928	2H08575279B9	326
6343929	735497928	219; 289
6343955	8152C3(C; P); 9467047877(F)	215
6343960	4458067	245
6343969	A0008110522	269
6343985	7H1857527A9B9	325; 320
6343994	A0008111122	323; 266
6344160	7701068842	293
6344174	96373-00QAD(N); 8200245172(R)	281; 292
6344341	1825609	240
6344351	8153VK(C; P); 735462098(F)	216
6344381	1776499	242
6344396	5091563; 5211715	239
6344421	1428861	288
6344645	4422961 (O); 93451847; 963745863R (R)	283
6344666	1823809	246
6344668	ET7617K746AD5JA	241
6344698	A4158110607; 963742880R	264; 294
6344710	A0008111522	271
6344867	1608751180	206
6344877	2K58575289B9	321
6344905		280; 297
6344907	1887728(O)	284; 298
6344922	2507070011	212
6344928	2H08575289B9	326
6344929	735497926	219; 289
6344955	8152C2(C; P); 9467047777(F)	215
6344960	4458064	245
6344969	A0008110622	269
6344985	7H1857528A9B9	325; 320
6344994	A0008111022	323; 266
6345351	8154RX(C; P); 735480200(F)	216
6345930	0735296869; 0735419600	217
6346351	8154RW(C; P); 735480199(F)	216
6346930	735296869	217
6401154	6K9857521D; 357857521	316; 319
6401156	7701039896	291
6401249	3801926	257
6401348		219
6401390	4440216	238
6401421	6428768	288
6401594	6001549716	237
6401666	1823986	246
6401750	9636600QAH(N); 4408323(O); 7701050267(R)	285
6401751	9636500QAF; 7701044515; 7701046190	280; 296
6401755	4419416(O); 963662420R(R)	284; 298
6401905	9636600QAF; 7701046190	281; 297
6401921	8151 ES(C; P); 71716702; 7750625(F)	209
6401922	8151LG(C; P); 71748244(F)	212
6401929	71765379; 1426595	219; 289



Ref.	OE	PAG.
6401948	2H0857521B; 7E1857521E	327
6401955	8151KG(C); 8151KE(C; P); 9467048380(F)	215
6401959	7194188	244
6401960	4059969	245
6401966	A0018110533	265
6401969	A0008100519	270
6401973	8151V5(C; P); 9790414180(F)	213
6401974	8151V9	204
6401985	7H1857521M	325;321
6401986	701857521J	325
6401994	2E0857587A; A0028111533	323;266
6401998	8151NP	205
6402154	6K9857522C; 357857522	316;319
6402156	7701041941	291
6402249	3801927	257
6402348		219
6402351	8151QV(C; P); 71765391(F)	216
6402390	4440212	238
6402396	4973826	239
6402421	6428769	288
6402594	6001549717	237
6402666	1823995	246
6402750	9636500QAK(N); 4410618(O); 7701052624(R)	285
6402755	4419417(O); 963655132R(R)	284;298
6402877	2K5857522	321
6402905	9636500QAF; 7701046190	281;297
6402921	8151 ET(C; P); 71716701; 7750626(F)	209
6402922	8151LH(C; P); 71748245(F)	212
6402929	71765378; 1426593	219;289
6402948	2H0857522B; 7E1857522H	327
6402955	8151KF(C); 8151KC(C; P); 9467048280(F)	215
6402959	7194185	244
6402960	4059965	245
6402966	A0018110433	265
6402969	A0008100619	270
6402973	8151V2(C; P); 9790419180(F)	213
6402974	8151W0	204
6402985	7H1857522R	325;321
6402986	701857522L	325
6402994	2E0857588A; A0028111633	323;266
6402998	8151NQ	205
6403160	7701068848	294
6403174	9636600QAM(N); 7701039896; 7701041941; 7701048400; 7701048401(R)	282;292
6403930	71718326	217
6403961	8151H4; 7750625(F)	207;208
6403969	A0018112633	269
6403977	500371327	256
6403985	7E1857522	325;321
6411249	3801928	257
6411381		242
6411421	6428781	288
6411922	8151LL(C; P); 71748248(F)	212
6411955	8151KE(C; P); 9467051880(F)	215
6411959	5211712	244
6411994	28111933; 0028111933; A0028111933	323;267
6412249	3801929	257
6412381		242
6412421	6428782	288
6412922	8151LN(C; P); 71748249(F)	212
6412955	8151KC(C; P); 9467051780(F)	215
6412959	4460947	244
6412994	28112033; 0028112033	323;267
6413994	28111933	323;267
6414994	28112033	323;267
6415994	2E1857587E; A0028113933	323;267
6416994	2E1857588E; A0028114033	323;267
6421994	28111533	323;267
6422994	28111633	323;267
6423156	7701044083	291
6423966	A0018115133	265
6424156	7701044085	291
6424966	A0018115233	265
6425973	8151AT(C; P); 9790460680(F)	213
6425974	8151W3(C); 5181W3(P)	204
6426973	8151AV(C; P); 9790460780(F)	213
6426974	8151W4	204
6431156	7701044083; 7701048401	291
6431249	3801926	257
6431341	1815170	240
6431381	1766587	242
6431390	4440217	238
6431579	96366JX30B	282
6431594	963664166R	237

Ref.	OE	PAG.
6431666	1823985; BK3117K740AAW	246
6431750	7701050267(N); 4451618(O)	285
6431755	4419416(O); 963655132R(R)	284;298
6431867	1608181280	206
6431905	9636600QAF	281;297
6431921	8151 ET(C; P); 71716702(F)	209
6431922	8151LJ(C; P); 71748246(F)	212
6431929	71765471; 1426596	219;289
6431948	7E1857521M	327
6431955	8151KE(C); 8151KG(P)	215
6431959	1048711; 7194189; 94VB17K741BC; 94VB17K741BD	244
6431960	4059968	245
6431966	181105331	265
6431985	7H1857521A; 7H1857521N	326;321
6431986	701857521A	325
6431994	2E0857587B; A0028111733	323;266
6431998	8151W3(C); 8151W4(P)	205
6432154	6K9857522G; 357857522A	316;319
6432156	7701044085; 7701048400	291
6432249	3801927	257
6432341	1815172	240
6432351	8151QX(C; P); 71765389(F)	216
6432381	1766584	242
6432390	4440214	238
6432396	4973822	239
6432579	96365JX30B	282
6432594	963654759R	237
6432666	1823994; BK3117K741AAW	246
6432750	7701052624(N); 4410618(O)	285
6432755	4419417(O); 963655132R(R)	284;298
6432867	1608181380	206
6432877	2K5857522A	321
6432905	9636500QAF	281;297
6432921	8151 ES(C; P); 71716701(F)	209
6432922	8151LK(C; P); 71748247(F)	212
6432929	71765470; 1426594	219;289
6432948	7E1857522C; 7E1857522J	327
6432955	8151KC(C); 8151KF(P)	215
6432959	1048710; 7194186; 94VB17K740BC; 94VB17K740BD	244
6432966	4059964	245
6432966	18110433	265
6432985	7H1857522R; 7H1857522S	326;321
6432986	701857522G	325
6432994	2E0857588B; A0028111833	323;266
6432998	8151W4(C); 8151W3(P)	205
6433160	7701068848	294
6433174	9636500QAR(N); 7701044083(R)	282;292
6433930	71718326	217
6433961	8151S4(C); 93160518(F); 8151ES; 8151ET; 8151S5(P)	207;208
6433965	A6318110930	263
6433977	98472973; 8143112	256
6433985	7E1857522A; 7H1857522J	326;321
6441249	3801928	257
6441922	8151LP(C; P); 71748250(F)	212
6441929	71765381	219;289
6441948	7E1857521H	327
6441955	8151LJ(C)	215
6441994	2E0857587A; A0028115233	323;267
6442249	3801929	257
6442922	8151LQ(C; P); 71748251(F)	212
6442929	71765380	219;289
6442948	7E1857522H	327
6442955	8151LK(C)	215
6442994	2E0857588A; A0028115333	323;267
6443969	A0018112633	269
6451154	357857521A; 6K9857521E	316;319
6451351	8151QW(C; P); 71765392(F)	216
6451396	4973827	239
6451668	1766586; ET7617K741CAYP	241
6451710	A0028114133	271
6451877	2K5857521B	321
6451921	8151EP(C; P); 71716698(F)	209
6451948	2H0857521B	327
6452668	1766583; ET7617K740AAYP	241
6452710	A0028114233	271
6452921	8151EN(C; P); 71716697(F)	209
6453174	7701039896(N); 7701048400; 7701048401(R); 7701039896(N); 7701048400; 7701048401(R)	282;292
6453977	500371329	256
6461948	7E1857521K	327
6462948	7E1857522K	327
6464156	7701039896; 7701048401	291
6464973	8151 V5(C; P); 9790418680(F)	213
6465973	8151 V6(C; P); 9790418780(F)	213

Ref.	OE	PAG.
6471154	6K9857521H;357857521C; 6K9857521J	316;319
6471351	8151QY(C; P); 71765390(F)	216
6471396	4973823	239
6471645	4422997 (O); 95517329; 963666705R (R)	283
6471668	ET7617K741BA	241
6471698	MA4158110033	264
6471704	8100919	268
6471710	A0028114133; A6398100617	271
6471711	A4478111700	271
6471877	2K5857521C	321
6471921	8151ER(C; P); 71716702(F)	209
6471948	7E1857521J; 7H1857521N	327
6471969	A0008100719	270
6472645	4422999 (O); 95517331; 963651588R (R)	283
6472668	ET7617K740BA	241
6472698	MA4158110333	264
6472704	8101019	268
6472710	A0028114233; A6398100719	271
6472711	A4478111600	271
6472921	8151EQ(C; P); 71716701(F)	209
6472969	A0008100819	270
6473174	9636600QAN(N); 7701048401(R)	282;292
6481390	4440216	238
6481698	963664943R	264;294
6481750	9636600QAJ(N); 4408325(O); 7701050269(R)	285
6481905	7701050269	281;297
6481959	1026990	244
6481960	4458063	245
6482390	4440212	238
6482698	963656392R	264;294
6482750	9636500QAL(N); 4410641(O); 7701052626(R)	285
6482905	7701052626	281;297
6482959	1026997	244
6482960	4458055	245
6901304		188
6901305		188
6901306		197
6901308		197
6901310		196
6901312		196
6901316		196
6901317		196
6901318		196
70404101		188
71513903		185
71513905		188
71513906		188
71513907		188
71513913		189
71513914		189
71513915		189
72414052		181
7301001		145
7301012		198
7301013		198
7301020		198
7301021		198
7301023		198
7301025		198
7301030		198
7301032		198
7301033		198
7301034		198
7301035		198
7301036		198
7301040		198
7301046		198
7301047		198
7301048		198
7301050		198
7301051		198
7301061		198
7301062		198
7301065		198
7301068		198
7301141	1736884 ;20862779	18;159
7301142	1425113	11;21;40
7301244	504158976	48
7301262	81637320044	67
7301287	82356808	167
7302001		145
7302244	504158977	48
7302287	82359213	167
7303140		10;14;38;157

Ref.	OE	PAG.
7303141		16;65;75;153
7303144	93193202	43;50
7303263		71
7303271		84;95
7303272	0008112007	91
7303282	7420862779	124;127
7303286		69;74
7303287	82356819	168
7304144	1644326	13;23
7305244	504158974	48
7306141	20862800	159
7306244	504158975	48
7306272	0008112007	91
7306282	7420862800	124
7311282	7420903882	128
7312282	7420903883	128
7313263		71
7313282	7420903736	125;129
7319272	8111307	85;94;90
7321142	1670888	12;21
7321262	81637320078; 81637320045	67
7323140		11;15;17; 39;66;97; 157;122
7323150		156
7323263	81637310356	73
7330144		20;126; 130;160
7331142	1425114; 1670888	12;21;40
7341287	20589831	165
7343247	93190971	43;50
7344247	93190977	44;51
7346247	93190974	45;53
7354247	93193161	44;51
7361274	9438110307	86
7362274	9438110407	86
7363263	81637320056; 81637320062; 81637320066	71
7371240		56
7371274	9438110307	87
7371275	8211129	83;96;140
7371277	0008210129	98
7371278	0008210229	98
7372274	9438110407	87
7373151		82
7373263	81637320059; 81637320054; 81637320063	70
7393244	504168244	49
7393287	20360810; 20746401	164
7394144	1644325	12;22
7394288	20746401	164
7401140	05589436; 0699856; 0699956; 1279531; 1589436 ;1279531	10;14;39;157
7401141	1404872; 1805713	16
7401142	1425109; 1610190 ;81637330093	11;21;40;67
7401241	93160537	54
7401247	93190983	43;51
7401261	2612573 ;1581599	57;154
7401270	0008111933; 00018119033; 0008113533	96
7401276	0008117033; 0018118533	96
7401286	20567670	164
7401287		165;167
7401544		118
7401545	93193201	117
7402247	93190981	44;52
7402285	3090738	162
7403001	1745369; 1749684; 1765985	142
7403005	MK580133	114
7403140	0589435; 0699857; 1305462	10;14;39;157
7403141	1805713	16
7403142	1425109; 1610190 ;87902007G ;81637330095	11;21;40;67
7403241	93160537	54
7403261	2628194 ;1581602; 1594415	57;154
7403262	81637330095	67
7403272	0008117333; 0018113433; 0018117333	89
7403273	0018112033; 0028110433	85;94
7403276	0008117033; 0008210029; 0018118533	96
7403282	7420862795	124;128
7403286	20455986; 20567670; 20589788; 21320383	164
7403287	20854644; 21203313	165;167
7405241	93156901	54
7405247	93190983	43;51
7406247	93190981	44;52
7406272	18110033	91
7406287	82356810	167
7407241	93156901	54

Ref.	OE	PAG.
7409261	81637330025; 81637330060; 81637330030	65
7409272	0028110033	91
7409287	82356824	168
7411274	0028116333	88
7412274	0028116433	88
7413140	1345552	10;14;39;157
7413141	1737933; 20862795	19;159
7413272	0018119933	91
7413282		19;125; 129;160
7416261	81637330036	67
7416272	0018119933; 0028114633	91
7421001	1346379; 1767265	143
7421100	316918	141
7421140	0589438; 0699853	11;15;39;157
7421141	5001853332; 5001832947	17;121
7421142	1670878 ;87902008G ;81637330097	12;22;41; 120;68
7421150	1697862; 1697984	156
7421263	81637336071	73
7421274	0028116533	88
7421276	0008118533; 0018118133	96
7421286	1699016	165
7422274	0028116633	88
7423001	1346379; 1767265	143
7423100		141
7423140	0589437; 0699854	11;15;39;157
7423141	1404849; 1796325	17;121
7423142	1425111; 1610191; 1670878 ;87902008G ;81637330097	12;22;41; 120;68
7423144	1685330	13;22
7423272	18112133	85;94;90
7423286	20360807; 21070768; 21320365	165
7426274	0018112233	92
7429272		93
7430144		20;161
7431141	1736879 ;7420862810 ;20862810	19;125;159
7431263	81637336073	73
7431287	21578244	168
7432141	1736865 ;7420862815 ;20872815	19;125;159
7432263	81637336072	73
7433001	1767265	145
7433144		20;126; 130;161
7433272	0028114633	93
7433274	0028116233	89
7436272		93
7439272	28114733	93
7439545	93190985	117
7441144		14;23
7441247	93193201	46;53
7441261		66;182
7441276	0008117233	97
7441283	1736879; 7420903745	129
7441285	3090734	162
7441287	21578293	169
7442283	1736865; 7420903746	129
7443247	93190985; 98487460	46;53
7443261		66;182
7443262	81637330100	170;68
7443274	0028114833	88
7453246	93193201	46;54
7453263	81637336061; 81637336067	72
7453545	963659X026	117
7454246	93190985; 98487465	46;54
7454263	81637336062; 81637336068	72
7455247	2997254	46;53
7457144	1685331	13;23
7461274	0028110933	86
7462274	0028111033	86
7463263	81637336057	71
7463274	0028110633	86
7464263	81637336057; 81637330085	71
7464274	0028110733	86
7465102		143
7465285	21203311; 3090739; 3091757	162
7466102		143
7470100	296538	140
7470150	1697007; 20854576	156
7470151	0008118733; 0008112033; 0008113333; 0008116433	82;155
7470201		179
7470240	4755585	56
7470246		42

Ref.	OE	PAG.
7470275	0008103433; 0008113433; 0008119933	83
7470277	0008118433; 0008118633	97
7470282		17;122
7470286	81637330032	69;74
7471100	376243; 296538	140
7471240	92934663	56
7471246		42
7471274	28113333	87
7471275	0008118133	83
7471278	0008118533; 0018118133	98
7471286	81637336001	69;74
7472274	28113433	87
7472282		16
7473150	1697008; 3093519	156
7473263	81637306480; 81637306482	70
7473274	28113733	87
7473278	8118633	99
7473282	1805717	16;180;121
7473285	20854555; 3090736	162
7473545	963659X126	117
7474244	504197878	48
7474263	81637336034; 81637306482; 81637306483; 81637330082; 81637336033; 81637336049	70
7474274	28113833	87
7474285	20854564; 3090737; 3091756; 3092854	162
7475102	1346377	142
7475246	4723936	42;55
7475281	5000289377; 5001873674	120
7475288		164
7476102	1346378	142
7476246	92934662	42;55
7476288	20455986; 20567670; 20589788; 21320383	164
7477247	93193199	46;53
7479244	2997668; 504197879	49
7483263	81637330101	69;169
7483287	21070768; 21320365	165
7486263	81637330103 ;82417041	69;169
7489263	81637330104	70;170
7490263	81637330106	70;170
7491272	0018116933	90
7491273	0018116933 ;0018116933	85;94
7491274	0018116933	92
7492247	93190970	43;51
7493244		49
7493247	93190976	44;52
7493287	20455986; 20567670; 21320383	166
7496244		49
7497247	93190976	43;51
7498247	93193198	44;52
8102327	96029034YB	207
9040025		295
9201023	MB417031	279
9201154	2K5857507AB9B9	320
9201155	6001030130	290
9201156	7700304830	290
9201160	7701068838	293
9201249	3800401	257
9201341	1819841; 1828728; 1845989	239
9201381	1805837; 1776500; 1766587	242
9201396	5016562	238
9201403	8794087Z010	315
9201418	1427439	287
9201645	95517317; 4422962; 4422997 (O); 963027954R; 93451848; 963739461R; 963660940R (R)	283
9201668	ET7617683AF5JA; ET7617K747AD5JA	240
9201710	A63981006197C45; MA6398100619	270
9201750	9630200QAN(N); 4408525(O); 7701050267; 7701473241(R)	285
9201751	9630200QAG	280
9201877	2K58574079B9; 2K5857521B; 2K58575279B9; 2K58585539B9	321
9201902	8200024459	296
9201905	8200163752	280;296
9201907	963662420R(N); 4419420(O); 963020624R(R)	284;297
9201910	2D1857501A	322
9201912	7E18574079B9; 7E1857521H; 7E1857527F9B9	327
9201922	735424420; 8153 Y7 (C; P); 735517070(F)	210
9201928	7E1857507D.J9B9	326
9201930	735394524	217
9201955	8794026612CO	318
9201959	1053418	244
9201960	4643771	245
9201962	A0008114830; A0018110533	265
9201963	9018105816	265
9201966	9018105516	264
9201969	A6388100016	269



Ref.	OE	PAG.
9227960	4643782	245
9227969	A6398109816	269
9227976	93936844	255
9227977	504056864	256
9227998		205
9228154	2K1857507A9B9	320
9228156	7700304835	291
9228249	3800425	257
9228668	ET7617683AF5JA6; ET7617K747AD5JA6	240
9228902	8200285571	296
9228907	4406886; 4419417; 4419995 (O); 963016903R; 963655132R; 261603141R(R)	284;297
9228922	8153NQ; 815428; 8154LR	211
9228930	735325166	217
9228959	94VB17682HP	244
9228960	4643479	245
9228969	A6398109916	269
9228974	8148PC	204
9228976	93936845	255
9228977	504056878	256
9228998		205
9229160	7701068841	293
9229249	3800429; 5801367573	258
9229341	1828732; 1845993	239
9229381	BK2117683RE5JAE; BK2117K747ABW	242
9229666	1911148; 1932573	246
9229710	A63981010197C45; A63981015197C45	270
9229912	7E1857407E9B9; 7E1857521J; 7E1857527F9B9	327
9229922	1613692680(C; P); 0000735620748(F)	211
9229928	7E1858553B9B9	326
9229955	8153N9	214
9229969	A6398106316	269
9229998	8153TS	205
9230160	7701068837	293
9230249	3800424; 5801367568	258
9230341	1828726; 1845987	239
9230381	BK2117682RE5JAE; BK2117K746ABW	242
9230666	1911130; 1932580	246
9230668	ET7617682AF5JA6; ET7617K746AD5JA6	240
9230710	A63981011197C45; A63981016197C45	270
9230912	7E1857408E9B9; 7E1857522J; 7E1857528F9B9	327
9230922	161369380(C; P); 0000735620709(F)	211
9230928	7E1858554B9B9	326
9230955	8153N7(C; P); 9467188088(F)	214
9230969	A6398106416	269
9230998	8153TV	205
9231160	7701068838	293
9231341	1828728; 1845989	239
9231351	735460570	216
9231381	1805837; 1809085; 1766587	242
9231645	95517317; 4422963; 4422997 (O); 963027954R; 963731115R; 963739461R; 963660940R (R)	283
9231668	ET7617683AF5JA; ET7617K747AD5JA	240
9231922	1613692680(C; P); 0000735620748(F)	211
9231928	7E1858553B9B9	326
9231969	6398100116	269
9231985	7E18575089B9	325
9232160	7701068834	293
9232341	1828722; 1845983	239
9232351	735460566	216
9232381	1805825; 1809084; 1766584	242
9232645	4422987; 95517319; 4422964; 4422999 (O); 963019473R; 963745863R; 963746264R; 963651699R (R)	283
9232668	ET7317682AF5JA; ET7617K746AD5JA	240
9232928	7E1857508DS9B9	326
9232969	6398100216	269
9232985	7H1857507A9B9	325
9233922	735424438(C; P); 8153Y2(P)	210
9233974	8153HN	204
9234974	8153HW	204
9235249	3800429	257
9235666	1911152; BK3117683NA5JA	246
9235922	735424431(C; P); 8153X8(P)	211
9236351	8153VH(C; P); 735460567(F)	216
9236666	1911125; BK3117682NA5JA	246
9236668	ET7617683AF5JA6; ET7617K747AD5JA6	240
9236750	7700773858; 7701052624; 7701473247(N); 4408533(O); (R)	285
9236905		280;297
9236929	735528041	218
9237160	7701068839	293
9237421	6428116	287
9237668	ET7617683AF5JA6	240

Ref.	OE	PAG.
9237698	A4158110307; A4158110033; A4158100316; 963029296R; 963733548R; 963664943R	263;294
9237867	8154TG; 96777503XT	206
9237922	815454	210
9237929	735528050	218;288
9237960	4643788	245
9237974	8153JJ	204
9237977	500325729	256
9237998	8153JJ	205
9238160	7701068835	293
9238249	3800415; 5801367640	258
9238421	6428119	287
9238429	1426581	288
9238668	ET7617682AF5JA6; ET7617K746AD5JA6 A4158110107; A4158110333; A4158100016; 963016348R;	240
9238698	963742374R; 963656392R	263;294
9238867	8154 RZ; 96777548XT	206
9238929	735528038	218
9238960	4643394	245
9238974	8149E5(C); 8153JN(P)	204
9238977	500325730	256
9238998	8149E5(C); 8149C6(P)	205
9239160	7701068840	293
9239174	82002-53492(N); 8200253492(R)	281;292
9239341	1828730; 1845991	239
9239351	735460571	216
9239381	1805832; 2013061; 1809085; 1766587	242
9239396	5211706	238
9239421	6428116	287
9239645	4422988; 95517318; 4422963; 4422997 (O); 963025418R; 963731115R; 963739461R; 963660940R; 963666705R (R)	283
9239668	ET7617683BF5JA; ET7617K747BD57V A4158110307; A4158110033; A4158100416; 963027201R;	241
9239698	963733548R; 963664943R	263;294
9239710	A63981089167C45	271
9239867	8154 TE; 96777523XT	206
9239912	7E1857407A9B9; 7E1857521J; 7E1857527GGRU	328
9239920	8153BB(C; P); 8153BM(P)	208
9239921	8149K0	209
9239922	735517079	211
9239928	7E1858553B9B9	326
9239929		218;288
9239955	8153L7(C); 8153K9(P)	214
9239974	8149E1(C); 8148E1(P)	204
9239985	7H1857507A9B9; 7H1857521A	325
9239994	A0008111022; A0008205708; A0028111533; A0028113933; A0008105819; A0008105919; A0018228920; A0008130436	322;266
9239998	8153TR	205
9240160	7701068836	293
9240174	82002-53494(N); 8200253494(R)	281;292
9240341	1828724; 1845985	239
9240351	735460567	216
9240381	1805826; 2013054; 1809084; 1766584	242
9240396	5211589	238
9240645	4422989; 95517320; 4422964; 4422999 (O); 963019124R; 963745863R; 963746264R; 963651588R; 963651699R (R)	283
9240668	ET7617682BF5JA; ET7617K746BD57V A4158110107; A4158110333; A4158100116; 963010714R;	241
9240698	963742374R; 963656392R	263;294
9240710	A63981090167C45	271
9240867	8154SZ; 96777550XT	206
9240912	7E1857408A9B9; 7E1857522J; 7E1857528GGRU	328
9240921	8149J8	209
9240928	7E1858554B9B9	326
9240929		218;288
9240955	8153L5(C); 8153K7(P)	214
9240974	8153JN(C); 8149E6(P)	204
9240985	7E1857522A; 7H1857508A9B9	325
9240994	A0008111122; A0008205708; A0028111633; A0028114033; A0008106219; A0008106819; A0018229020; A0008130536	322;266
9240998	8153TT	205
9241095		295
9241961	963027C976	286
9242668	ET7617682BF5JA6; ET7617K746AD5JA6	241
9242961	963017C976	286
9243381	1805835; 2013068; 1809085; 1766587	242
9243668	ET7617683BF5JA6 A4158110307; A4158110033; A4158100516; 963028506R;	241
9243698	963733548R; 963664943R	264;294
9243867	1608177880	206
9243912	7E1857407E9B9; 7E1857521J; 7E1857527GGRU	328
9243928	7E1858553B9B9	326

Ref.	OE	PAG.
9244381	1805829; 2013057; 1809084; 1766584	242
9244668	ET7617682BF5JA6; ET7617K746AD5JA6	241
9244698	A4158110107; A4158110333; A4158100216; 963018644R; 963742374R; 963656392R	264;294
9244867	1608177980	206
9244912	7E1857408E9B9; 7E1857522J; 7E1857528GGRU	328
9244928	7E1857508EB9B9	326
9245095		295
9245421	6428190	288
9245955	8153K9(C; P); 9467187088(F)	215
9245961	963028C800	286
9246421	6428193	288
9246905		280;297
9246929		218;288
9246961	963017C976	286
9247023		279
9247977	500325747	256
9248429	1426575	289
9248977	500325748	256
9249666	1911154; BK3117683RH5J6A	246
9249710	A63981013197C45; A63981091167C45	271
9250666	1911136; 1932579	246
9250710	A63981014197C45; A63981092167C45	271
9250929		218;289
9250955	8153L9(C; P); 9467192088(F)	215
9250961	8148EQ(C; P); 1312467080(F)	208
9251249		257
9251922	1613694380(C; P); 0000735620748(F)	211
9251955	8153K7(C; P); 9467186088(F)	215
9251961	8148ER(C; P); 1312468080(F)	208
9252249	3800423	257
9252922	1613689480(C; P); 0000735620709(F)	211
9252955	8153GK(C; P); 9467196088(F)	215
9252961	8148GF(C; P); 7684292(F); 8153JS(P)	208
9253922	1613694380(C; P); 0000735620748(F)	211
9253929	735528034	218
9253961	8148GG(C); 7684291(F); 8153JR(P)	208
9253974	8153JK	204
9254249	5801736702	258
9254922	8153X6	212
9254929	735497885	218;289
9254961	8149H8(C); 1325627080(F); 8153JS(P)	209
9254974	8149C9(C); 8153JL(P)	204
9255249	5801736697	258
9255922	8153W3	212
9255929	735497873	218
9255955	8153GE(C; P); 9467197088(F)	215
9255961	8149H6(C); 1325626080(F); 8153JR(P)	209
9256929	735497878	218
9256961	8149J7(C; P); 1325629080(F)	209
9257922		211
9257929	735528050	218;289
9257961	8149J5(C; P); 1325628080(F)	209
9258929	735528038	218
9259929		218;289
9259955	8153K9(C; P); 9467189088(F)	215
9260955	8153J9	215
9261930	735419582	217
9261961	6831697	243
9262930	735419592	217
9262961	6831642	243
9263922	735424440; 8153Y4	211
9263961	6831705	243
9264155	6001030130	290
9264156	7700304830; 963029461R	290
9264160	7701068839	293
9264174	96302-00QAT(N); 7700354636(R)	281;291
9264351	8153VG(C; P); 735460570(F)	216
9264390	4460950	238
9264421	6428116	287
9264429	1426582	288
9264698	A4158110507; A4158110033; A4158100316; 963029296R; 963735075R; 963664943R	263;294
9264867	96777503XT	206
9264902	7700354140	296
9264929	735497882	218
9264930	735296233	217
9264955	8153GC(C; P); 1488681898(F)	214
9264961	6831650	243
9264973	8148NP(C); 9790417889(F); 8153HE(P)	213
9264974	8153HL	204
9264998	8153HL(C); 8153TL(P)	205
9265155	6001030197	290
9265156	7700304831	290

Ref.	OE	PAG.
9265160	7701068835	293
9265174	96301-00QAR(N); 7700354637(R)	281;291
9265351	8153VF(C; P); 735460566(F)	216
9265390	4460947	238
9265421	6428119	287
9265429	1426581	288
9265698	A4158110607; A4158110333; A4158100016; 963016348R; 963742880R; 963656392R	263;294
9265867	96777548XT	206
9265902	7700354141	296
9265929	735497881	218
9265930	735296225	217
9265955	8153GA(C; P); 1488681898(F)	214
9265961	6831697	243
9265973	8148NQ(C); 9790417989(F); 8153HF(P)	213
9265974	8153HR	204
9265998	8153HR(C); 8153TN(P)	205
9266961	6831642	243
9267961	6831650; 6831705	243
9268961	6831642; 6831650	243
9269955	8153K1(C; P); 9467193088(F)	215
9271907	963027041R; 963662420R; 261650223R	284;298
9274955	8153K1	214
9275429	1426575	289
9275929	735497890	218
9275955	8153J9	214
9276929	735497871	218
9277922	735424433; 8153Y0	212
9281907	963026988R; 963655132R; 261650223R	284;298
9291961	95651072(C); 5920892(F); 814804(P)	207
9292961	95651073(C); 5920891(F); 814805(P)	207
9297961	93908147	254
9298961	93908146	254
9401001		182
9401005	84044000	114
9401006		182
9401140	1232016	10;14;38;156
9401141	1405295	16
9401142	1425106	11;21;40
9401200		181
9401244	504150524	47
9401247	98472976	42;50
9401261	81637306220; 81637306233	65
9401262	81637306365; 81637306002; 81637306303; 81637306314;	67
9401263	81637306572; 81637306656; 81637306660	73;71
9401270	3148101316	95
9401271	6738104616	84;95;181
9401272	8100279	89
9401285	3091256	161
9401286	81637306127; 81637306167	68;74;179
9401287	20360806	166
9401288	20841078	164
9401544		117
9402001		182
9402003		182
9402244	504150525; 504150523	47
9402247	98472981; 98473008	44;51
9402282	7420849835; 7421595513; 7482226027	126;130
9402286	81637306128; 81637306148	68;74
9402287	20360807	166
9402288	20841081	164
9403008		182
9403009		182
9403010		182
9403011		182
9403140	1232017	10;14;38;156
9403141	1404871; 1405295; 1805712	16
9403142	1425104; 1610186	11;21;40
9403261	81637306221; 81637306234	65
9403262	81637306315; 81637306361; 81637306365; 82637306015;	67
9403270	82637306016	95
9403272	0008100616; 0008102016; 3148101916	91
9403273	0008101679; 0008102479; 28114633	84;93
9403282	0018112033; 0008109516; 0018109016	124;127
9403285	7420862782	161
9403285	3980924; 3980932	117
9403544		142
9404001	1723518	143
9404102		126;130
9404282		141
9405001	1765808	182
9405008		143
9405102		143



Ref.	OE	PAG.
9470205		179
9470210		179
9470215		181
9470235	98424107; 98424108; 999457908	55
9470240	4755582; 99457910	56
9470245	98424105; 99457906	56
9470246	98424105; 99457906	41
9470260	81637306147	74;180
9470275	0008112833; 3818103716	83
9470277	6418104216	97
9470280		131
9470282	5000296397	17;122
9470285	02601417;1581550;	56;154
9470300		180
9470305		180
9470500		180
9471001		144
9471100	1106955; 316624; 356495; 367624	140
9471240	98424111	56
9471244	504150534; 504150536	47
9471246	98424109	41
9471260	81637306001; 81637306151	74;180
9471263		70
9471274		86
9471277	6418106816; 6418104216	97
9471278	0008107016; 6418104616	98
9471280	5000296871	131
9471281	5000296871; 5001873672; 5001873673	120
9471282		17;122
9471283	7420862809	128
9471285	2628191;1581616; 1594411; 1594412	56;154
9472001		144
9472244	504150535; 504150537; 504370054	47
9472274		86
9472275	3818103816	83
9472283	7420862813	128
9473151	0008102316; 3018102116; 3148102616; 3818102616; 3818107316; 3818102616; 3818107316; 6738104216	82;155
9473200		179
9473201		180
9473235	29972111; 98424110; 99457911	55
9473247	2996670; 504132248; 8143172; 98472987	45;52
9473263	81637306345; 81637306395; 81637306430; 81637306432; 81637306447	70
9473275	6118100116; 6128100166	268
9473278	6418104716; 6418106316	98
9475001		144
9475244	504150551; 504369979; 5801341206	48
9475246	98424107; 98424108; 99457908	41
9475281	5001838474	119
9475282	5001853675	15;180;121
9476001		144
9476144	1692557	12;22
9476200		179
9476244	504150552; 504369995; 5801341207	48
9476246	29972111; 98424110; 99457911	41
9476261	81637306478; 85637306030	69;169
9476263	82637306033; 81637306294	170;68
9476281	5001838474	119
9476282	1620023	15;180;121
9477244	504224427	49
9477281	5001873670	119
9477282	1405601; 1805714; 5001856290	15;180;121
9477283	7420904268	128
9477287		166
9478244	505224428	49
9478263	81637306035; 81637306296	170;68
9478274		86
9478281	5001842202; 5001873671; 5010646156	119
9478283	7420904269	128
9478287		166
9479144	1692556	13;23
9479261	85637306033; 82417041; 82417042; 82471688; 82471690; 82472612	69;169
9479274		86
9480144		20;127;130;161
9480261	85637306037; 85637306508	70;170
9480263	85637306035; 85637306036; 82417041; 82417042; 82471688; 82472612	69;169
9481001	1346381; 1732782; 1765809	145
9481144	1685324; 1788972; 1812859; 1812867	13;23
9481244	504150549	48
9481246		42

Ref.	OE	PAG.
9481261	85637306039; 82417044; 82417045; 82471689; 82472612	70;170
9481287		166
9482001	1346382; 1732783; 1765808	145
9482144	1686325; 1788487; 1812862; 1818353	13;23
9482244	504150550; 504150547	48
9482246		42
9482287		166
9483151	1599462; 3090395	155
9483201		180
9485247		45;52
9486151	1195934; 1594902; 1621353; 1621353; 3090396	155
9486246		42
9486247		45;52
9487246		42
9490272	0008111307; 0008100879	90
9490274		92
9490285	3091750	163
9490287		163
9491274		87
9491285	3091751	163
9491287	20767635; 20841078	163
9492247	98472977	42;50
9492274		87
9493244	504168235	49
9493247	8143121; 98472982; 98472982; 98473010	44;51
9493282	7420903723	123
9493285	3091258	162
9493287		166
9494282	7420903724	123
9495287		166
9496244	504168236	49
9496274		87
9496287	20567637	163
9497287	20567647	163
9498247	98472979	42;50
9498248	504150551; 504369979; 5801341206	48
9498274		87
9499247	2997157; 8143122; 98472983; 98473011	44;51
9499248	504150552; 504369995; 5801341207	48
9601009	81253206089	77
9601013	9408200056	112
9601016	5001834560	135
9601019	1446355; 1511542; 1852572	150
9601025	20409874; 20826211	174
9601026	MK581219	116
9601101	1385410; 1524093	148
9601142	1660960; 1725270	35
9601143	1892913	31
9601144	1328860	24;26
9601189	1835886	36
9601245	504052353	58
9601246	2997253; 93193199	58
9601247	98460038	60
9601248	42555023	62
9601273	A0028208656; 28205656	100;111
9601274	9418200521	102
9601285	21035692	176
9602009	81253206090	77
9602013	9408200156	112
9602016	5001834559	135
9602019	1446356; 1511543; 1852573	150
9602025	20409875; 20826213	174
9602026	MK581220	116
9602101	1337250; 1387155	148
9602142	1660961; 1725271	35
9602143	1892914	31
9602144	1328861	24;26
9602189	1835887	36
9602245	504052352	58
9602246	98409119; LLC761	58
9602247	98460036	60
9602248	41221040; 42555022; 93190977	62
9602273	A0028208756; 28205756	100;111
9602274	9418200921	102
9602285	21035690; 21297909	176
9603009	8125320610; 81253206118; 81253206116	77;80
9603013		190
9603019	2241544	153
9603100	1798980; 1910437	150
9603101	1471599	149
9603142	1735355	27;34
9603245	504047573	59
9603750	5010271807	132
9605005	MK427117; MK486509; MK548503	115



Ref.	OE	PAG.
9605009	81253206101; 81253206115	77
9605143	1892911	32
9605248	98473011; 41221029; 8143122	62
9606005	MK4271118; MK486510; MK548501	115
9606013	A0005447806	113
9606101	1362707; 1363578	149
9606143	1892912	32
9606248	41221039; 8143121	62
9606285	3981666	171
9607009	81252606101	78
9607013		190
9607016	5001834565	138;135
9609009	81252606105	78
9609285	1062190	171
9611013		190
9611016	5010231849	135
9611019	9738200521	108
9611025	20826227	174
9611026	MK580561	116
9611101	1931613	153;152
9611144	1328860	24;26
9611189	1846491	36
9611245	504107550	59
9611248	41221029; 504098245; 5801572080; 5801754886	63
9611272	9738200321	107;108
9611274		102
9611285	82114506	177
9612016	5010231850	135
9612019	9738200621	108
9612025	20826231	174
9612026	MK580562	116
9612101	1931614	153;152
9612144	1328861	24;26
9612189	1846492	36
9612245	504133023	59
9612248	5801572074; 5801754885	63
9612272	9738200421	107;108
9612274		102
9612285	82114500	177
9613009		77
9613013		190
9613016	8191146	171
9613101	1747981	151
9613285	20398660; 20789440	177
9615013	A9608200956	104
9615285	20360273	171
9616013	A9608201056	104
9616285	20360274	171
9617013		190
9621009	81253206091; 81253206111	76
9621013		190
9621025	20826211; 20826227	174
9621101	1358831; 1422991; 1529070	148
9621144	1660960; 1725270; 1725272	26;31;33
9621246	712350901120; 98437476	58;60
9621248	504032145; 504032148	61
9621285	21035701	176
9622009	81253206092; 81253206112	76
9622025	20826213; 20826231	174
9622101	1358832; 1422992; 1529071	148
9622144	1660961; 1725271; 1725273	26;31;33
9622246	712350801120; 98437475	58;60
9622285	21035700	176
9623009	81252606104	77
9623014		190
9623101	1362707; 1737413	151
9625009	81253206113; 81253206113	76
9625285	21297902	176
9626009	81253206114; 81253206114	76
9626285	21297901	176
9631009	81251016521	80
9631013	9408200321	112
9631019	A9678200121	109
9631144		24;26
9631248	5801572024	63
9631285	82114506	177
9632009	81251016522	80
9632013	9408200421	112
9632019	A9678200221	109
9632144		24;26
9632248	5801572018	63
9632285	82114500	177
9633101	1770301	151
9635285	21297914(21035694)	176

Ref.	OE	PAG.
9636285	21297913(21035693)	176
9641009	81251016339	75
9641013	9608200456	104
9641019	1760551	150
9641248	42555042; 93190982	62
9641285	82151157	178
9642009	81251016338	75
9642013	9608200556	104
9642019	1760554; 1892324	150
9642248	42555041	62
9642285	82151205	178
9643101	1941323	150
9651009	81251100085	80
9651013	A9438200756	103
9651019	A9678201121	109
9651285	21346521	178
9652009	81251100086	80
9652013	A9438200856	103
9652019	A9678201221	109
9652285	21346522	178
9653012		190
9653248	504032148	61
9661013	A9608201021; A9608200421	103
9661285	21297918	176
9662013	A9608201121; A9608200521	103
9662285	21297917	176
9663012		190
9666012		191
9671285		176
9672285		176
9681285	21118550	176
9682285	21120482	176
9698002		188
9698006		188
9698010		188
9698050		193
9698052		193
9698054		193
9698056		191
9698062		190
9698064		191
9698066		191
9698068		191
9698070		191
9698080		191
9700001		195
9700002		195
9700003		195
9700004		195
9700005		195
9700006		195
9700007		195
9700008		195
9700009		196
9701003		174
9701004	MC856559	114
9701005		184
9701008		184
9701010		184
9701013	35440903	105
9701015		184
9701019	0025446803; 0025447003	108
9701024	5010847582; 5001847584; 5001864535	137
9701025	20565103; 20892367	175
9701142	1284211; 1304788	25;27;28; 30;32;34
9701189	1875577	36
9701246	500382616	58;59
9701248	37653000; 99463244	59;62
9701279	7420862038	131
9701285	1365963; 3981460; 8191747	171
9702003	3981458	174
9702004	MC856557	114
9702005		184
9702007	10850793	170
9702008		184
9702013	35440803	105
9702015		184
9702019	0025446903; 0025447103	108
9702024	5001847585; 5001864536	137
9702025	20565104; 20565106; 20892368; 21063895	175
9702142	1284212; 1304789	25;27;28; 30;32;34
9702189	1875576	36

Ref.	OE	PAG.
9702246	500382617	58;59
9702248	37650000; 99463242	59;62
9702279	7420862041	131
9702285	1365964; 3981461; 8191748	171
9703002		186
9703011		190
9703013	5445411	105;112 25;28;30;33;3
9703016	7420862035 ;265559X126	5;132;133;17 2;118;136
9703019		109
9703025		175 25;28;30;33;3
9704016	265559X125 ;7420862035	5;132;133;17 2;118;136
9704025	21761261	175
9705001		185
9705003		174
9705005		184
9705007		170
9705008		184
9705010		184
9705013	A0035441003	105;106;109
9705015		184
9706001		185
9706003	1498103; 1792374; 39811464	174
9706005		184
9706007		170
9706008		184
9706010		184
9706015		184
9707001		185
9707003	3981456	174
9707007		183
9707008	500356783; 734808775	64
9708001		185
9708003	1436868	174
9708007		183
9708008	1907700; 4808772; 4808774; 724808774	64
9709003	3981459	174
9709007		183
9709008	4809193; 98409216	64
9709013	A0015406270	100;111 25;28;30;
9709016	1401713	33;35;133; 134;118;136
9710007		183
9710008		64
9710013	A0015406370	100;111 25;28;30;
9710016	1401731	33;35;133; 134;118;136
9711003	1371974; 1371976; 1371978; 1371980; 1387877; 1414366; 1414368; 1436867; 1504608	149
9711005		115
9711008	98424052	64
9711013	0025444790; 0025441390; 0025441290	100;102; 111;113
9711100		178
9711101		185
9711102		185
9711142	1272653	25;27;28; 30;34
9711272	9738200121	107;113
9711285	1365963; 21063887; 3981455; 3981460; 8191747 1371975; 1371977; 1371979; 1371981; 1387878; 1414367;	172
9712003	1414369; 1436868; 1504609	149
9712005		115
9712008	98424051	64
9712013	0025444790; 0025441290; 0025441390	100;102; 111;113
9712101		185
9712102		185
9712142	152 5177	25;27;28; 30;34
9712272	9738200221	107;113
9712285	3981456; 1365964; 21063895; 3981464; 8191748	172
9713002		186
9713013		105
9715008		64
9716008		64

Ref.	OE	PAG.
9717003	1436867	149;151
9718003	1436868	149;151
9721003		151
9721005		115
9721008		64
9721010		185
9721100	1365963	146;147
9721189	1914690	29;37
9721285	20425728; 20507623; 20892384; 21097448	172
9722003		151
9722005		115
9722008		64
9722010		185
9722100	1365964	146;147
9722189	1914691	29;37
9722285	20425729; 20507624; 20892386; 21097449	172
9723010		185
9723011		190 25;28;30; 33;35;133; 134;118;136
9723016	5001847153; 5010392231	
9725010		185
9726010		185
9727009	1284211 ;81252256524; 81252256465	37;78;139
9728009	1284212; 1304788 ;81252256523; 81252256466	37;78;139
9729009	81252286030	81
9731009	99463243; 99463244	65
9731010		185
9731016	5001847582	146;147
9731183		38
9731189	1875577	29;37
9731285	82849894	178
9732009	37650000; 99463242	65
9732010		185
9732016	5001847583	146;147
9732183		38
9732189	1875576	29;37
9732285	82849923	178
9734285	82849925	178
9737009		183
9738009		183
9739009	81252256544	37;79;81;139
9740009	81252256545	37;79;81;139
9741009	81252296523	81
9741016	5001847886	136
9741019	2241860; 2380955	153
9741100		154
9741183		38
9742009	81252256523; 81252256530; 81252296524	81
9742016	5010847583; 5001847887	136
9742019	2241859	153
9742183		38
9743011		190
9745009	37653000; 99463242; 99463244	65
9745011		190
9746009	37650000; 99463242; 99463244	65
9749009	81252256059	79;81
9750009	81252256060	79;81
9751015		185
9751183		38
9752015		185
9752183		38
9753002		186
9753009	0035445303; 15406270	107
9753011		189
9754009	0025445403; 0035445703; 15406370	107
9755009	0035445603; 0035445303; 25440790; 25441290; A0025449803	107
9755011		189
9756009	0025445403; 0035445703; 25440690; 25441691; A0025449703	107
9757009	81252286034	75
9758009	81252286033	75
9761015		185
9762015		185
9763002		186
9765009		274
9766009		274
9769012		191
9771009		276
9772009		276
9773002		186
9773012		190
9774002		186
9775009	81252256531	78
9776009	81252256532	78

Ref.	OE	PAG.
9783002		186
9791008	42471137; 7984016; 7984797	63
9791010		184
9791015		184
9792002		186
9792008	7984796	63
9792010		184
9792015		184
9793001		185
9793003	1380819	154;174;149
9793005	A0035444790; MK485413	115;184
9793006		184
9793007	10850793	170;183
		37;64;78;
9793009	81252296051 ;1272653	81;140;146;
		183;147;172
9794002		186
9795004	MC856557	114
9795008	7984794	63
9795010		184
9796004	MC856559	114
9796008	42471138; 7984015; 7984794; 7984796	63
9796010		184
9797009	25441390	107;274
9801005	MK353636	115
9801009	81251016379; 81251016435; 81251016449; 81251016457;	76
	81251016449	
9801013	9608200839; A9608200839	104
9801016	5010468976; 5010468980	134
9801019	1446353; 1852569	150
9801024	5010578476; 5010578451; 7421636295	137
9801025	20360898; 20762992; 20861583; 20862575	173
9801041	8973768982	41
9801100		148
9801144	1293364; 1293360	24;26
9801189	1835874	36
9801246	500340543; 712390731129	57
9801247	4861794; 98424105	60
9801274	9438200056	101
9801285	21035645; 21323114	175
9801750	5010231860; 5010086974; 5010379325	134
9802005	MK353635	115
9802009	81251016456; 81251016448	76
9802013	9608200939; A9608200939	104
9802016	5010468977; 5010468981	134
9802019	1446354; 1852570	150
9802024	5010578452; 5010578475	137
9802025	20360899; 2086158; 21001668	173
9802041	8973768972	41
9802100		148
9802144	1293365; 1293361	24;26
9802189	1835875	36
9802246	500340503; 712930631129	57
9802247	42209232; 42209233; 4861793	60
9802274	9438200156	101
9802285	21035644; 21323113	175
9802750	5010231861; 5010379321; 5010379324	134
9803243		57
9804025	21001650	173
9805013		112
9805025	21001651	173
9806013		112
9811009	81251016661	79
9811013		100;110
9811019	1949906	152
9811024	5010578454	138
9811025		173
9811144	1706996	31
9811189	1857526	36
9811247		60
9811248	5801639118; 5801745449	63
9811285	21035638; 21035652; 21323108	175
9812009	81251016662	79
9812013		100;110
9812019	1949908	152
9812024	5010578478	138
9812025		173
9812144	1706997	31
9812189	1857527	36
9812247		60
9812248	5801639122; 5801745452	63
9812285	21035637; 21035651; 21323106	175
9815013	9608200739	104
9815019	2241826	152

Ref.	OE	PAG.
9815024	7482588678	137
9815285	21035652	175
9816013	9608200639	104
9816019	2241827	152
9816024	7482588692	137
9816285	21035651	175
9819013	A9438200961	101
9820013	A9438201061	101
9821009	81251100083	80
9821013	9408200161	111
9821019	1949890	152
9821024	5010578442	138
9821025		173
9821101	1EG007150101	148
9821272	9738200161	106
9821285	21035638; 21123523; 21323108	175
9822009	81251100084	80
9822013	9408200261	111
9822019	1949894	152
9822024	5010578466	138
9822025		173
9822101	1EG007150091	148
9822272	9738200261	106
9822285	21123589	175
9823285	3981594; 8144286	171
9825013	9408200161; A9408200961	111
9825019		108
9825285	21221142; 21221146	178
9826013	9408200261; A9408201061	111
9826019		108
9826285	21221145; 22239248	178
9827013		101
9828013		101
9829013		100;110
9830013		100;110
9831009		76
9831013	A9438200161	101
9831019	1549814	153
9831024	5010578453	137
9831144	82526640	172
9831272	9738200561	106
9831285	21608663	178
9832009		76
9832013	A9438200261	101
9832019	1549815	153
9832024	5010578477	137
9832144	82532284	172
9832272	9738200661	106
9832285	21608661	178
9833013	9408200777; 9418200221	112
9833285		171
9835013		103
9835285	21221130	178
9836013		103
9836285	21221129	178
9839013	A9608200439	104
9840013	A960820539	104
9841005	MK486505; MK548497; MK548498	115
9841009	81251016357; 81251016421; 81251016427; 81251016451	76
9841013	9438200361; A9438200361	101
9841016	5010231860; 5010231669	134
9841024	5010578451; 5010578476; 5010578452; 7421636295	137
9841025	20861573; 21001645	173
9841026	MK581216	116
9841101	144434021+1385410; 1467000; 1732509	148
9841142	1641742; 1699300; 1743684	25;29;32
9841144	1743690	27;34
9841189	1939777	36
9841246	500340408; 712390741129	57
9841248	41221036; 504020193	58;61
9841272	9738200561	106
9841285	21221134	177
9841750	5010468976; 5010468980; 5010089181	135
9841755	5010623620	131
9842005	MK486506; MK548497; MK548498	115
9842009	81251016356; 81251016422; 81251016428; 81251016450	76
9842013	9438200461; A9438200461	101
9842016	5010231861; 5010379321; 5010231670	134
9842024	5010578452; 5010578475; 5010578476	137
9842025	20861574; 21001649	173
9842026	MK581215	116
9842101	144433021+1387155; 1467003; 1732510	148
9842142	1399903; 1641743; 1699301	25;29;32
9842144	1743691	27;34

Ref.	OE	PAG.
9842189		36
9842246	500340361; 712390641129	57
9842248	41221015; 504020189	58;61
9842272	9738200661	106
9842285		177
9842750	5010468977; 5010468981; 5010089180	135
9842755	5010623619	131
9845005		115
9845009	81251016503; 81251016499	80
9845013	A0028208456	99;110
9845019	9738202661	108
9845024	5010578452	138
9845144	1293370	24;26
9845248	504238213; 712452511129	62
9846006		115
9846009	81251016504; 81251016498	80
9846013	A0028208556	99;110
9846019	9738202761	108
9846024	5010578451; 5010578476; 7421636295	138
9846144	1293371	24;26
9846248	504238203; 712452411129	62
9851009	81251016503	80
9851013	9418205761	99;110
9851019		152
9851024	5010578452	137
9851025		173
9851272		106
9851285		177
9852009	81251016504	80
9852013	9418206261; 9418204461; 9418205861	99;110
9852019	2241829	152
9852024	5101578476	137
9852025	21001649	173
9852272		106
9852285	21608666	177
9855013	301081119; 9418205361; 9418202961	99;110
9856013	301081114; 9418205461; 9418203061	99;110
9861009	81251016663	79
9861013	9438201461; 9438201661	102
9861016	26060MB400; 26060MB41A	119
9861024	5010578460	138
9862009	81251016664	79
9862013	9438201561; 9438201761	102
9862016	26010MB400; 26010MB41A	119
9862024	5010578484	138
9865013	9438202261; 9438201461	103
9865016	5001872439	119;133
9866013	9438202361; 9438201561	103
9866016	5001872437	119;133
9867013	9438201461	102
9868013	9438201561	102
9871009	81251016513	79
9871013	9408200161; 9408200361	111
9871016	748262242	139
9872009	81251016514	79
9872013	9408200261; 9408200461	111
9872016	748262240	139
9875013	9608200339	104
9876013	9608200239	104
9885013	A9438201661	102
9886013	A9438201761	102
9891013	9608201939	106
9892013	9618201839	106







AUTOSPIEGEL GmbH

KAHRWEG, 25  
59590 GESEKE- DEUTSCHLAND

Tel. + 49 (0) - 2942 978670  
Fax. + 49 (0) - 2942 9786710  
info@alkar-autospiegel.de

Hamburg  
316 km.

51°37'58.9"N 8°31'15.6"E



Düsseldorf  
148 km.

Berlin  
458 km.

München  
556 km.

Frankfurt am Main  
275 km.



43°14'24.4"N 2°44'58.6"W



Santander  
96 km.

France  
137 km.

Barcelona  
586 km.

Madrid  
381 km.



Poligono Industrial Boroa parcelas 2B4-5  
48340 AMOREBIETA - VIZCAYA - ESPAÑA - SPAIN

NACIONAL  
Tel. + 34 - 944 544 017  
Fax. + 34 - 944 541 552  
alkar@alkar.es

EXPORT  
Tel. + 34 - 944 544 142  
Fax. + 34 - 944 544 250  
alkar@alkar.es

# PICTOGRAMAS - PICTOGRAMS - PICTOGRAMMES - PIKTOGRAMME

## GENERAL - GENERAL - GÉNÉRAL - ALLGEMEIN

IZQUIERDO LEFT GAUCHE LINKS	DERECHO RIGHT DROIT RECHTS	REVERSIBLE REVERSIBLE RÉVERSIBLE UMKEHRBAR	IZQ+DCHO LEFT+ RIGHT GAUCHE+DROIT LINKS+RECHTS	ELÉCTRICO ELECTRIC ÉLECTRIQUE ELEKTRISCH	MANUAL MANUAL MANUEL MANUELL
MANUAL ELÉC. ELEC. MANUAL MANUEL ÉLEC. MANUEL ELEK.	MECÁNICO MECHANICAL MÉCANIQUE MECHANISCH	1.2 Watts WATTS WATTS WATT	10 Volts VOLTAGE VOLTAGE SPANNUNG	7 PINS PINS PINS	NÚM. PUERTAS NUM. DOORS NOM. PORTES ANZAHL TÜREN
AMBAR ORANGE ORANGE	AZUL BLUE BLEU BLAU	BLANCO WHITE BLANC WEISS	CROMADO CHROMED CHROME VERCHROMUNG	FUMÉ SMOKED FUME RAUCHGRAU	GRIS GREY GRIS GRAU
NEGRO BLACK NOIR SCHWARZ	ROJO RED ROUGE ROT	TRANSPARENTE TRANSPARENT TRANSPARENT TRANSPARENT	CUADRADO SQUARE CARRÉ VIERECKIG	REDONDO ROUND ROND RUND	EXTERIOR EXTERIOR EXTÉRIEUR AUSSEN
INTERIOR INTERIOR INTÉRIEUR INNEN	LHD	LHD + RHD	RHD		

## ESPEJOS - MIRRORS - RÉTROVISEURS - SPIEGEL

ASFÉRICO ASPHERICAL ASPHERIQUE ASPHERISCH	CONVEXO CONVEX CONVEX KONVEX	PLANO FLAT PLAT FLACH	ABATIBLE ELEC. ELEC. FOLDABLE RABBATTABLE ELEC. ELEK. ABKLAPPBAR	IMPRIMADO PRIMED À PEINDRE LACKIERBAR	ESPEJO ÁNGULO MUERTO POINT SPOT BLIND AVEUGLE TOTERWINKEL
SONDA TEMP. TEMP. SENSOR SONDE TEMP. TEMP. MESSER	SOPORTE HOLDER SOUTIEN HALTEFUSS	TÉRMICO HEATED CHAUFFANT BEHEIZBAR	SOP. CUADRADO SQUARE HOLDER SUPPORT CARRÉ HALTER VIERECKIG	SOP. REDONDO ROUND HOLDER SUPPORT ROND HALTER RUND	CARCASA CON GUÑO HOUSING WITH LIGHT CAP BOITIER AVEC ESPACE FEU GEHÄUSE FÜR BLINKER
PILOTO RETROVISOR BLINKER INDICATEUR BLINKLEUCHTE	CON INTERMITENTE WITH BLINKER AVEC INDICATEUR MIT BINKER				
CRISTAL GLASS GLACE SPIEGELGLAS	CRISTAL+SOPORTE GLASS+HOLDER GLACE+SUPPORT GLAS+HALTEFUSS	CRISTAL+CARCASA GLASS+HOUSING GLACE+BOITIER GLAS+GEHÄUSE	CARCASA HOUSING BOITIER GEHÄUSE	BRAZO ARM BRAS ARM	RESISTENCIA HEATING CHAUFFAGE BEHEIZBAR
BRAZO CORTO SHORT ARM BRAS COURT KÜRZER ARM	BRAZO MEDIO MEDIUM ARM BRAS MOYEN MITLERER ARM	BRAZO LARGO LONG ARM BRAS LONG LANGER ARM			
COMPLETO COMPLETE COMPLÉT KOMPLETT	CUERPO BODY CORPS RUMPFSPIEGEL	CARCASA HOUSING BOITIER GEHÄUSE	CRISTAL GLASS GLACE SPIEGELGLAS	CRISTAL+SOPORTE GLASS+HOLDER GLACE+SUPPORT GLAS+HALTEFUSS	CRISTAL+CARCASA GLASS+HOUSING GLACE+BOITIER GLAS+GEHÄUSE
ESPEJO INTERIOR INTERIOR MIRROR RÉTROVISEUR INT. INNENSPIEGEL	BRAZO CORTO SHORT ARM BRAS COURT KÜRZER ARM	BRAZO MEDIO MEDIUM ARM BRAS MOYEN MITLERER ARM	BRAZO LARGO LONG ARM BRAS LONG LANGER ARM		

## ILUMINACIÓN - LIGHTING - ÉCLAIRAGE - BELEUCHTUNG

LUZ DE DÍA DAY LIGHT FEUX DE JOUR TAGFAHRLICHT	ANTINEBLA DELANT. FRONT FOG LIGHT ANTI-BROUILLARD AV. NEBELLEUCHTEN	ANTINEBLA TRASERO REAR FOG LIGHT ANTI-BROUILLARD AR. NEBELLEUCHTEN HIN.	CON BOMBILLA WITH BULB AVEC AMPOULES MIT GLÜHBIRNE	SIN BOMBILLA WITHOUT BULB SANS AMPOULE OHNE BIRNE	CARCASA EXT. NEGRA BLACK HOUSING BOITIER NOIRE KAPPE SCHWARZ
TULIPA LENS CABOCHON STREUGLAS	LENTE CON PILOTO LENS W/INDICATOR CABOCHON A/FEU LEUCHTE M/BLINKER	MARCO FRAME CADRE RAHMEN	CERQUILLO RIM CADRE RAHMEN	CON PORTALÁMPARA WITH BULB HOLDER AVEC PORTE LAMPE MIT LAMPENTRÄGER	SIN PORTALÁMPARA WITHOUT BULB HOLDER SANS PORTE LAMPE OHNE LAMPENTRÄGER
CON MOTOR WITH ENGINE MOTORISÉ MIT MOTOR	NEUMÁTICO PNEUMATIC PNEUMATIQUE PNEUMATISCH	REFLECTANTE REFLECTANT REFLÉCHISSANTE REFLEKTIEREND	BEEP!! CON ALARMA WITH ALARM AVEC ALARME MIT ALARM	LÁMPARA ASIMÉTRICA ASYMMETRICAL LAMP LAMPE ASYMÉTRIQUE LEUCHTE ASYMETR.	
FARO HEADLAMP PHARE SCHEINWERFER	FARO ANTINEBLA FOG LAMP P. ANTI-BROUILLARD NEBELSCHEINWERFER	PILOTO DELANTERO FRONT INDICATOR FEU AVANT BLINKLEUCHTE	PILOTO LATERAL SIDE LAMP FEU LATERAL SEITENBLINKER	PILOTO TRASERO TAIL LAMP REAR FEU ARRIERE HECKLEUCHTE	PILOTO POSICIÓN SIDE MARKER FEU LATERAL BEGRENZUNGSLEUCHTE
PIL. MARCHA ATRÁS REVERSING LAMP FEU MARCHÉ ARRIERE RÜCKFAHRTLEUCHTE	LUZ MATRÍCULA NUMBERPLATE LIGHT ÉCLAIRAGE D'IMMATICULATION KENNZEICHENLEUCHTE				
FARO HEADLAMP PHARE SCHEINWERFER	FARO ANTINEBLA FOG LAMP P. ANTI-BROUILLARD NEBELSCHEINWERFER	PILOTO DELANTERO FRONT INDICATOR FEU AVANT BLINKLEUCHTE	PILOTO PARACHOQUE BUMPER LAMP FEU PARA-CHOC STOSSSTANGENBLINKER	PILOTO LATERAL SIDE LAMP FEU LATERAL SEITENBLINKER	PILOTO TRASERO ANTINEBLA TAIL LAMP REAR FOG LAMP FEU ARRIERE ANTI-BROUILLARD NEBELSCHLUSSLEUCHTE
PILOTO TRASERO TAIL LAMP REAR FEU ARRIERE HECKLEUCHTE	PIL. MARCHA ATRÁS REVERSING LAMP FEU MARCHÉ ARRIERE RÜCKFAHRTLEUCHTE	LUZ MATRÍCULA NUMBERPLATE LIGHT ÉCLAIRAGE D'IMMATICULATION KENNZEICHENLEUCHTE			





Poligono Industrial Boroa Parcela 2B4-5  
48340 AMOREBIETA - VIZCAYA - ESPAÑA - SPAIN

**NACIONAL**

tel. 34 - 944 544 017  
fax. 34 - 944 541 552  
alkar@alkar.es

**EXPORT**

tel. 34 - 944 544 142  
fax. 34 - 944 544 250  
alkar@alkar.es



AUTOSPIEGEL GmbH

Kahrweg, 25

59590 GESEKE- DEUTSCHLAND

tel. + 49 (0) - 02942 / 97867- 0  
fax. + 49 (0) - 02942 / 97867-10  
info@alkar-autospiegel.de

**ILUMINACIÓN - LIGHTING - BELEUCHTUNG - ECLAIRAGE -  
ILLUMINAZIONE - ILUMINAÇÃO - ОСВЕЩЕНИЕ -  
OŚWIETLENIE - إضاءة**

**ESPEJOS - MIRRORS - SPIEGEL - RETROVISEUR -  
SPECCHI - ESPELHOS - ЗЕРКАЛА - LUSTERKA - ايرملا**



[www.alkar.es](http://www.alkar.es)