

2012 | 2013



BOSCH



de

Vom Spezialisten für Diesel- und Benzineinspritzung:
Kraftstofffilter von Bosch

Bosch-Kraftstofffilter sind optimal abgestimmt auf moderne Benzin- und Dieselmotoren, dies schon seit 1930.

en

From specialists for diesel and gasoline injection:
fuel filters from Bosch

Bosch fuel filters are ideally matched to state-of-the-art gasoline and diesel engines, and that's the way it's been since 1930.

fr

Du spécialiste de l'injection diesel et essence:
les filtres à carburant Bosch

Les filtres à carburant Bosch sont parfaitement optimisés en fonction des moteurs essence et diesel modernes, ce depuis 1930.

it

Dallo specialista per iniezione diesel e benzina:
filtri carburante di Bosch

I filtri carburante Bosch sono concepiti su misura per i moderni motori diesel e a benzina e ciò fin dal 1930.

es

Construidos por especialistas para la inyección diésel y de gasolina:
filtros de combustible de Bosch

Los filtros de combustible Bosch están adaptados óptimamente a los motores de gasolina y diésel modernos, y esto ya desde 1930.

nl

Van de specialist op het gebied van diesel- en benzine-injectie:
Brandstoffilters van Bosch

De brandstoffilters van Bosch zijn al sinds 1930 optimaal afgestemd op moderne benzine- en dieselmotoren.

sv

Från specialisten för diesel- och bensininsprutning:
Bränslefilter från Bosch

Bosch-bränslefilter är optimalt anpassade till moderna bensin- och dieselmotorer allt sedan 1930.

cs

Od specialisty v oboru vstřikování nafty a benzínu:
palivové filtry Bosch

Palivové filtry Bosch jsou optimálně přizpůsobeny moderním zážehovým a vznětovým motorům, a to již od roku 1930.

pl

Stworzone przez specjalistę od wtrysku oleju napędowego i benzyny:
filtry paliwa firmy Bosch

Filtry paliwa Bosch są optymalnie dostosowane do nowoczesnych silników benzynowych i wysokoprężnych, i to już od roku 1930.

ru

От специалиста по системам впрыска дизельного топлива и бензина:
топливные фильтры Bosch

Топливные фильтры Bosch оптимально согласованы с современными бензиновыми и дизельными двигателями, уже с 1930 года.

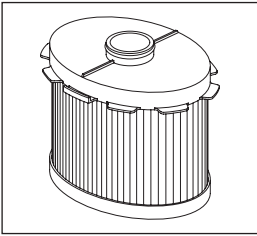

picture 1

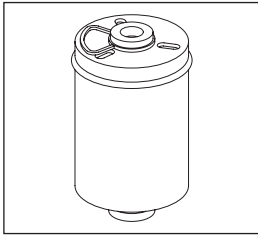

picture 2

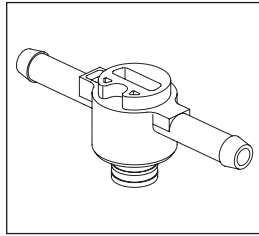

picture 3

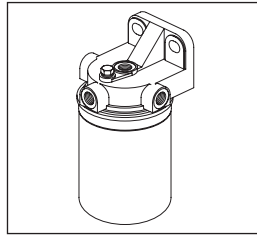

picture 4

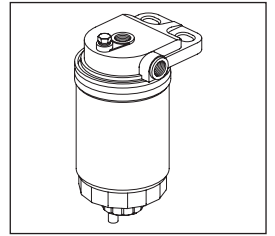

picture 5

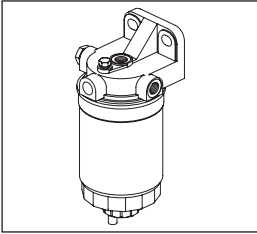

picture 6

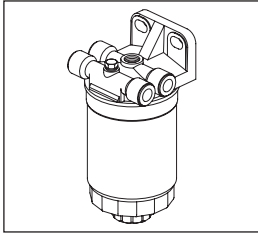

picture 7

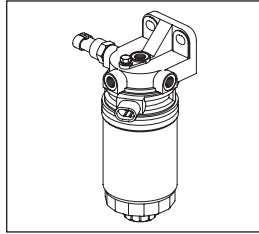

picture 8

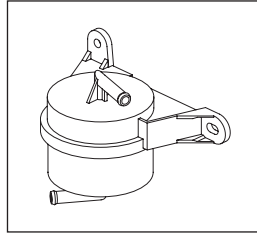

picture 9

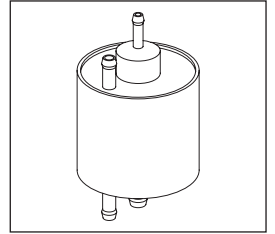

picture 10

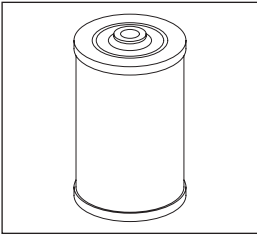

picture 11

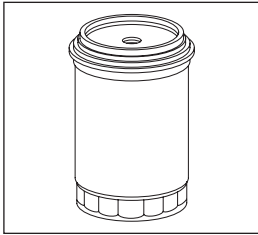

picture 12

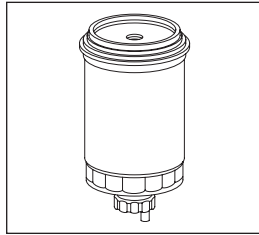

picture 13

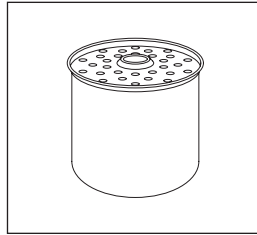

picture 14

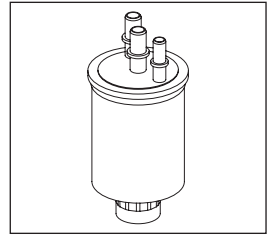

picture 15

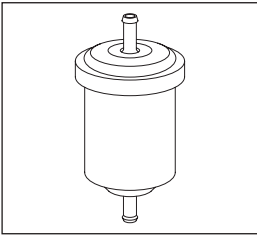

picture 16

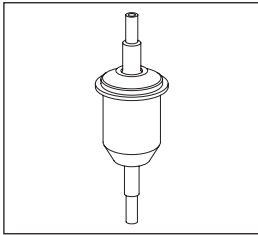

picture 17

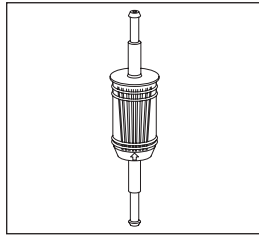

picture 18

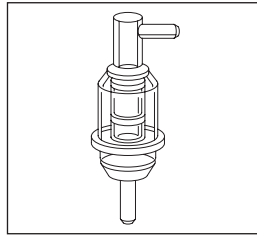

picture 19

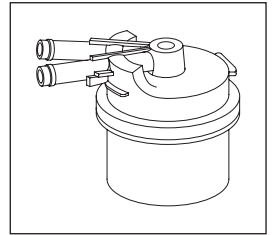

picture 20

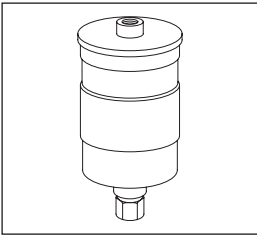

picture 21

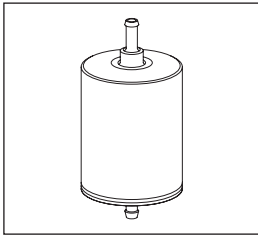

picture 22

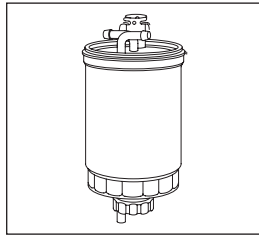

picture 23

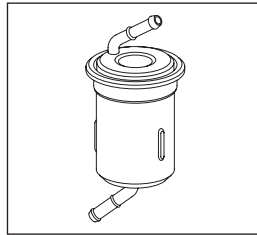

picture 24

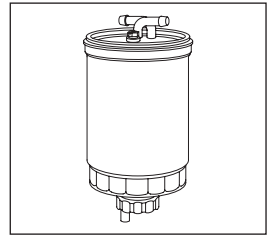

picture 25

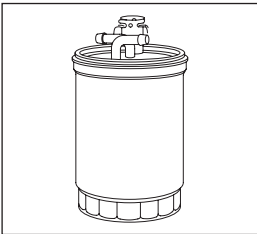

picture 26

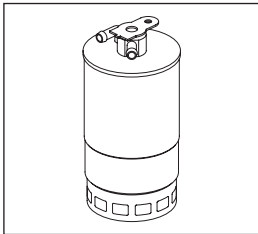

picture 27

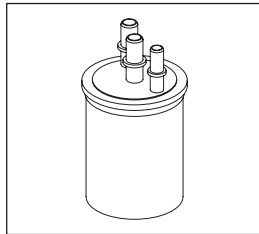

picture 28

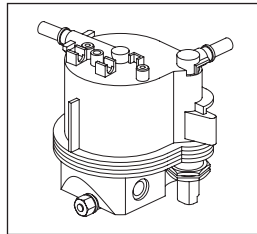

picture 29

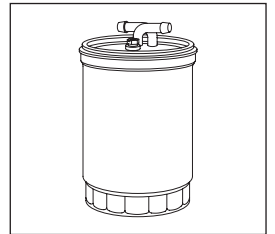

picture 30

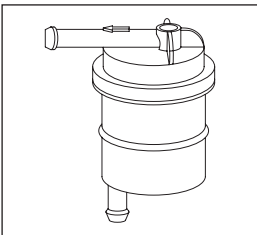

picture 31

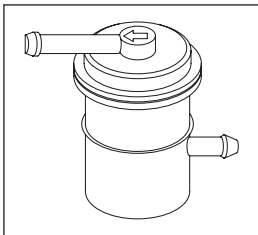

picture 32

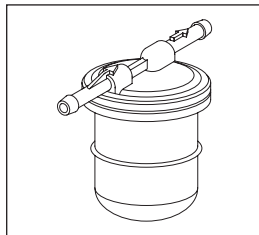

picture 33

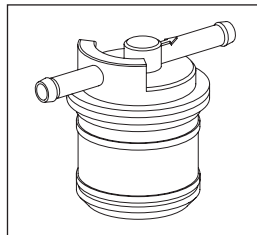

picture 34

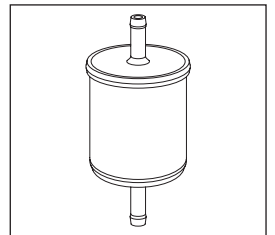

picture 35

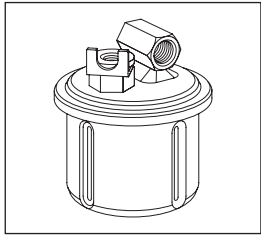

picture 36

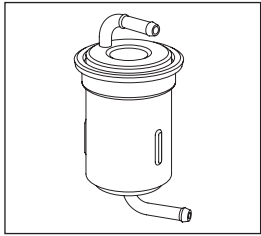

picture 37

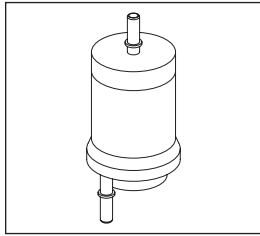

picture 38

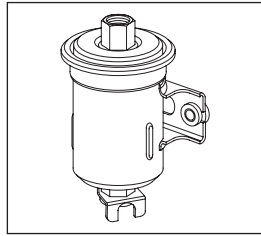

picture 39

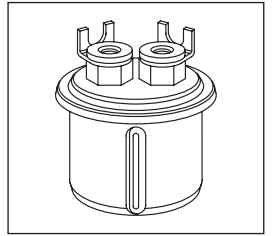

picture 40

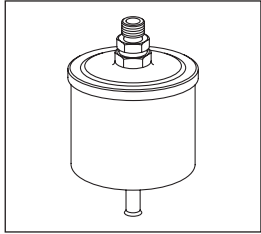

picture 41

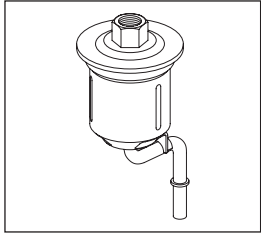

picture 42

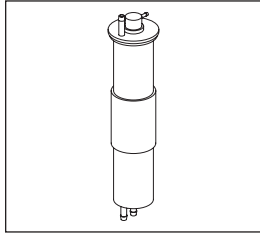

picture 43

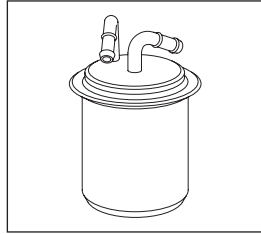

picture 44

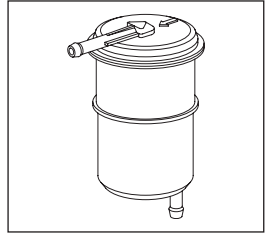

picture 45

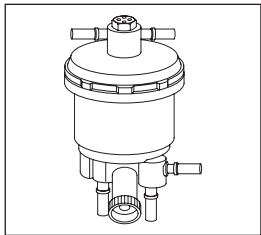

picture 46

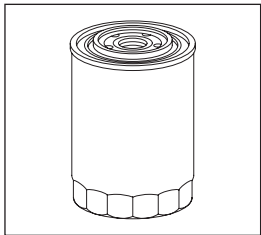

picture 47

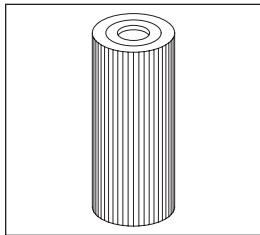

picture 48

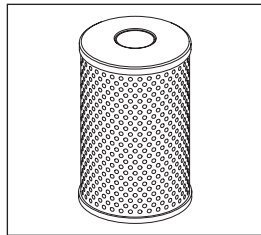

picture 49

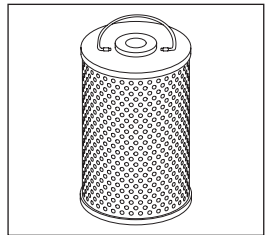

picture 50

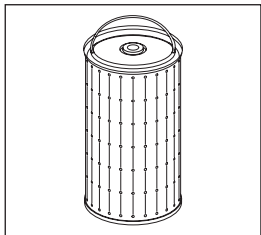

picture 51

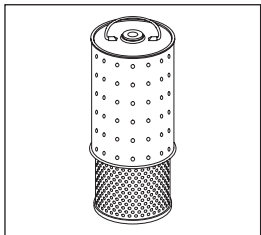

picture 52

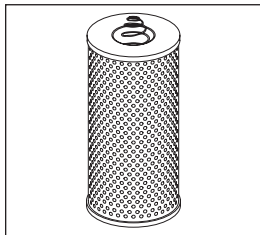

picture 53

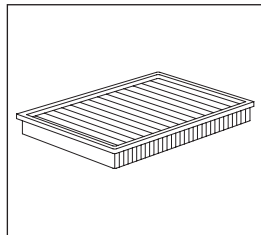

picture 54

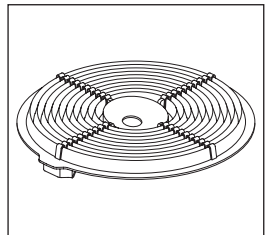

picture 55

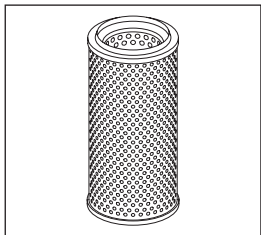

picture 56

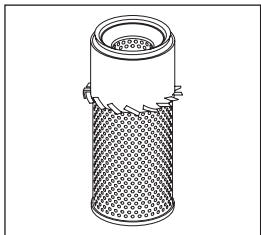

picture 57

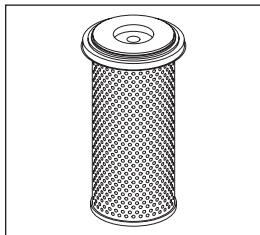

picture 58

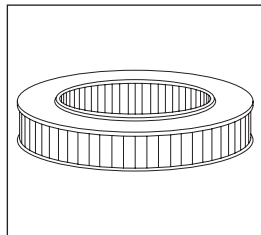

picture 59

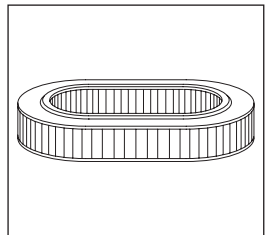

picture 60

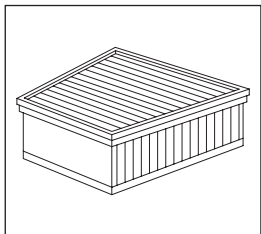

picture 61

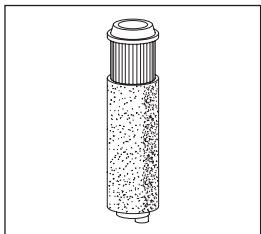

picture 62

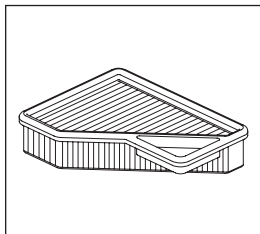

picture 63

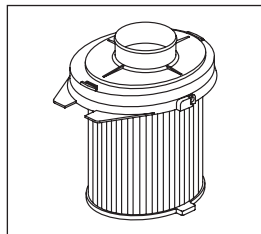

picture 64

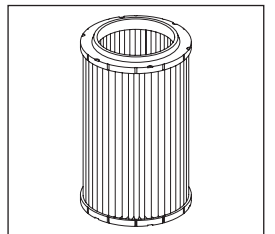

picture 65

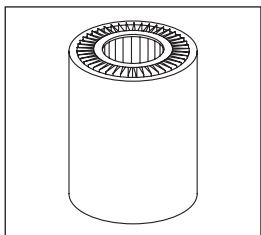

picture 66

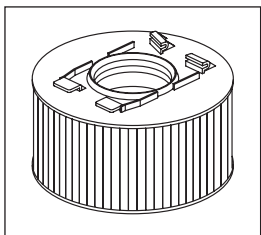

picture 67

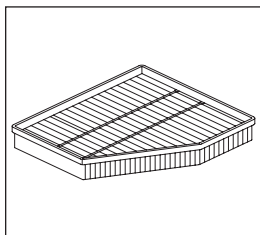

picture 68

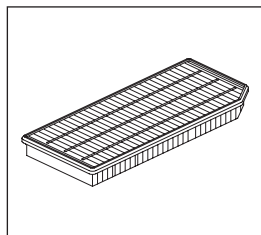

picture 69

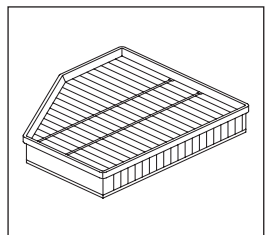

picture 70

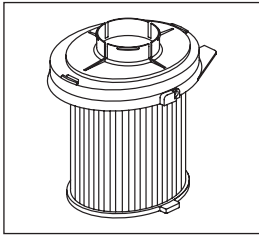

picture 71

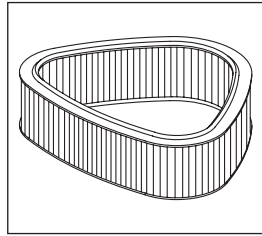

picture 72

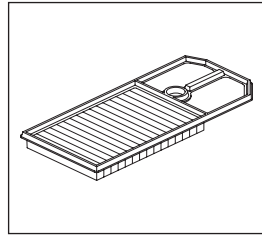

picture 73

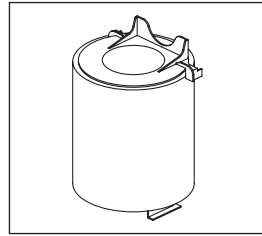

picture 74

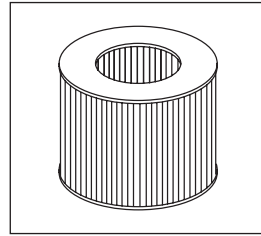

picture 75

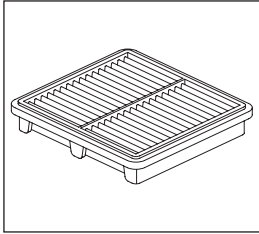

picture 76

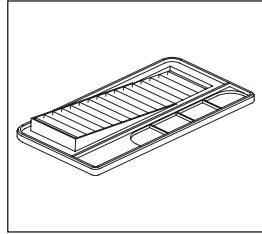

picture 77

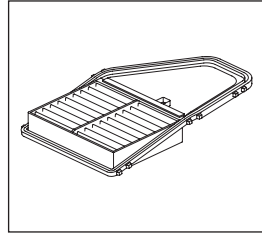

picture 78

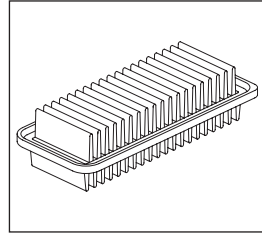

picture 79

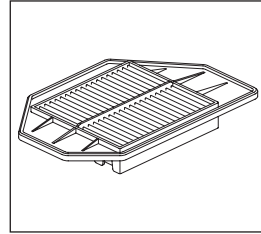

picture 80

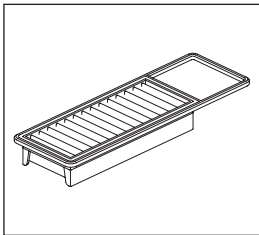

picture 81

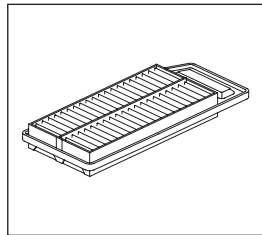

picture 82

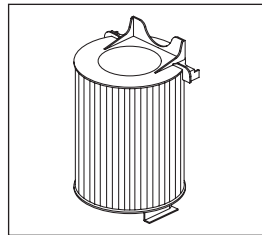

picture 83

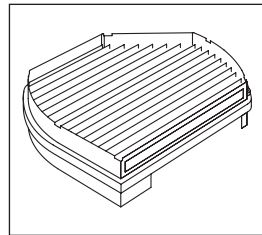

picture 84

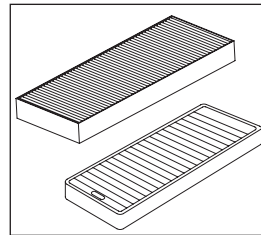

picture 85

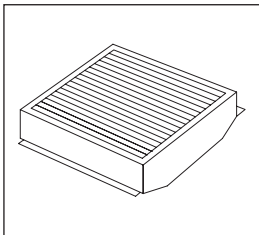

picture 86

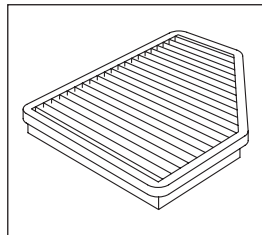

picture 87

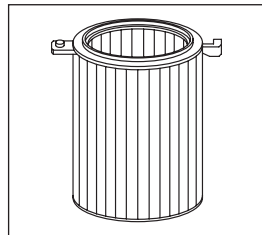

picture 88

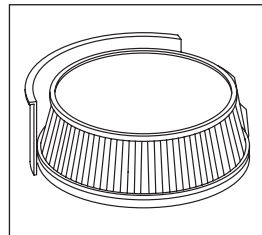

picture 89

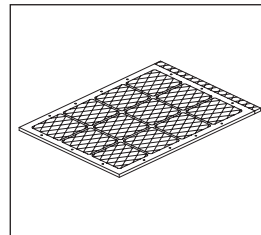

picture 90

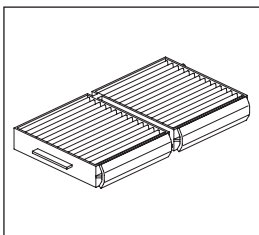

picture 91

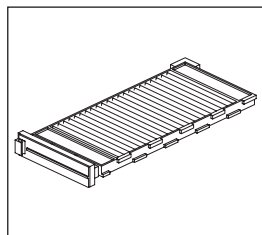

picture 92

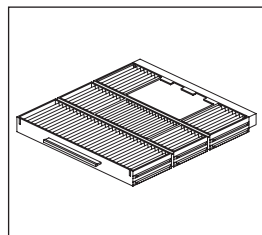

picture 93

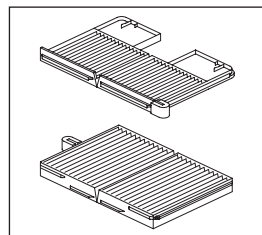

picture 94

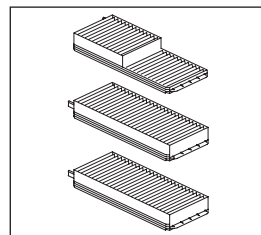

picture 95

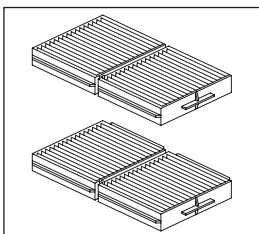

picture 96

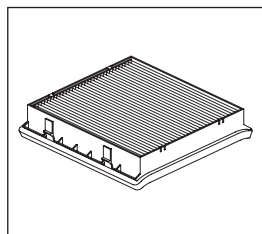

picture 97

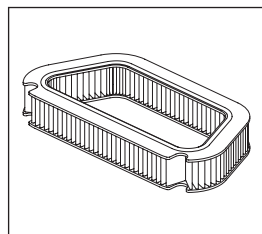

picture 98

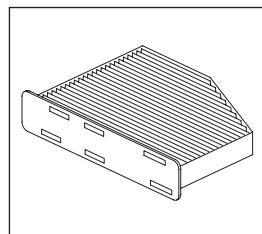

picture 99

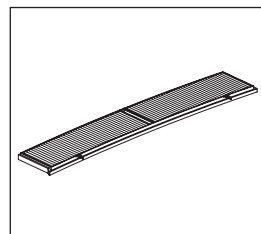

picture 100

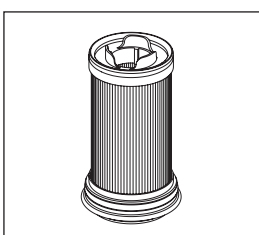

picture 101

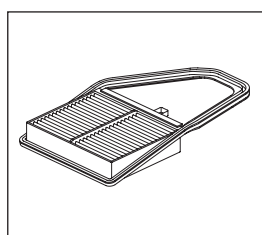

picture 102

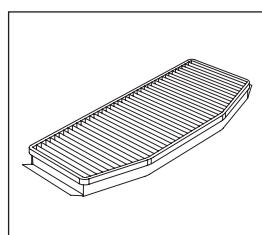

picture 103

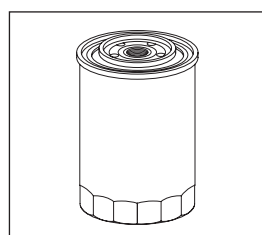

picture 104

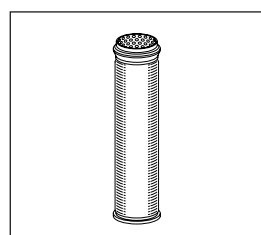

picture 105

de

Prima Klima mit Innenraumfiltern von Bosch

en

Good climate with cabin filters from Bosch

fr

Un air parfait avec les filtres d'habitacle Bosch



Regelmäßiger Filterwechsel: Vier gute Gründe

1. Mehr Sicherheit durch gute Luft und dadurch verbessertes Konzentrationsvermögen.
2. Bessere Sicht, da das Absetzen von Kondenswasser an den Fenstern verhindert wird.
3. Gesundere Atemluft durch das effektive Filtern von Schmutz, Pollen und Bakterienstämmen.
4. Schutz der Klimaanlage, denn Partikel und Mikroorganismen können nicht in den Verdampfer gelangen und die Leistungsfähigkeit der Klimaanlage ist gewährleistet.

Enhance safety with better air and therefore better driver's concentration.

Improve visibility, because no deposit of condensation on the windows.

Breathe healthier air with effective filtration of dirt, pollen and bacteria.

Protect the air-conditioning system, because no particles and micro organisms can penetrate the vaporizer and its performance is assured.

Quatre bonnes raisons pour remplacer régulièrement le filtre

1. En favorisant la concentration, l'air filtré est source de sécurité accrue.
2. L'absence de condensation sur les vitres améliore la visibilité.
3. Efficacement débarrassé des impuretés, pollens et bactéries, l'air respiré est plus sain.
4. Les particules et les microorganismes ne peuvent pas pénétrer dans l'évaporateur, ce qui protège le climatiseur et garantit ses performances.

it

Un clima interno ottimale, grazie a filtri abitacolo di Bosch

es

Un ambiente magnífico con los filtros para el habitáculo de Bosch

pl

Doskonały klimat dzięki filtrom powietrza firmy Bosch



BOSCH

Sostituzione del filtro ad intervalli regolari: ecco quattro buoni motivi

1. Più sicurezza, grazie ad una buona qualità dell'aria interna e quindi una migliore capacità di concentrazione.
2. Migliore visibilità, in quanto viene impedita la deposizione di condensa sui finestrini.
3. Aria più salutare da respirare, grazie al filtraggio efficace che elimina impurità, pollini e batteri.
4. Protezione del climatizzatore, in quanto particelle e microrganismi non possono penetrare nell'evaporatore e in questo modo viene garantita la perfetta funzionalità del climatizzatore a lungo termine.

Cambio regular del filtro: cuatro buenas razones

1. Más seguridad gracias al aire limpio, que mejora la capacidad de concentración.
2. Mejor visibilidad, ya que se evita la condensación de humedad en los cristales.
3. Aire más sano para respirar, gracias a la retención eficaz de partículas de suciedad, polen y bacterias en el filtro.
4. Protección del sistema de aire acondicionado, ya que no pueden llegar partículas ni microorganismos al evaporador, quedando garantizado así el rendimiento del aire acondicionado.

Cztery ważne powody do regularnej wymiany filtrów

1. Czyste powietrze umożliwia lepszą koncentrację, a tym samym większe bezpieczeństwo.
2. Lepsza widoczność, ponieważ klimatyzacja zapobiega zaparowywaniu szyb.
3. Zdrowsze powietrze dzięki skutecznemu filtrowaniu zanieczyszczeń, pyłków i bakterii.
4. Ochrona klimatyzacji, ponieważ cząsteczki i mikroorganizmy nie mogą przedostać się do parownika, co zapewnia wydajną pracę klimatyzacji.

← **Fig.**

de

Filter

en

Filters

fr

Filtres

it

Filtri

es

Filtros

nl

Filters

sv

Filter

cs

Filtry

pl

Filtry

ru

Фильтры

Angebot · Offer · Offre · Offerta · Oferta ·
Assortiment · Offert · Nabídka · Oferta · Ассортимент

NEW

A 2

DENOX

A 8



A 10



A 15



A 22



A 34



A 38



A 40



A 52



A 62

Verwendung · Applications · Affectations · Impiego · Aplicaciones ·
Gebruiksdeel · Användningsdel · Použití · Zastosowanie · Применение

B 2



B 602



B 811



B 818



B 821



Gegenüberstellung · Cross-reference · Table de correspondance · Comparazione ·
Equivalencias · Opzoektabel · Jämförelse · Převod · Zamienniki · Сопоставления

A...Z → Bosch

C 2

→ Bosch

C 76





de

**Leibwächter
für den Motor –**
Filter von Bosch

en

**Bodyguard
for the engine –**
Filters from Bosch

fr

**Les gardes du corps
du moteur :**
les filtres Bosch

it

**Guardie del corpo
per il motore –**
Filtri Bosch

es

**Guardianes
para el motor –**
Filtros de Bosch

nl

**Lijfwacht
voor de motor –**
Filters van Bosch

sv

**Livvakt
för motorn –**
filter från Bosch

cs

Ochránce motoru –
filtr od fy Bosch

pl

**Ochrona
dla silnika –**
filtry Bosch

ru

**Предохранительное
устройство
для двигателя –**
Фильтр производства
Bosch

de	en	fr	it	es
Kombiniertes Bestellnummernsystem	Combined part number system	Système combiné de références	Sistema di codice combinato	Sistema combinado de referencias
nl	sv	cs	pl	ru
Een gecombineerd bestelnummersysteem	Kombinerat ordernummersystem	Kombinovaný systém objednacích čísel	Nowy system numerów katalogowych	Комбинируемая система нумерации артикулов

Typ				Type
3.2 V6				
176 936A000 <M10>	10.03→	0 451 10 P 3351	O	
		1 457 43 S 3791	L	
	2FE	1 987 43 R 2386 ^B	I	
V				
V 1.8 T.S. 16V				
106 AR 32201 <M1>	05.98-12.00	0 451 10 P 3300	O	
	KL	1 987 43 M 2014	I	
V 2.0 JTS				
121 937A1.000 <M8>	04.03-07.04	0 451 10 P 3336	O	
	04.03-12.05 KL	1 987 43 M 2014	I	
V 2.0 T.S. 16V				
110 AR 16201 <M1>	04.95-04.98	0 451 10 P 3300	O	
		0 450 90 F 5087 ¹	K	
110 AR 32310 <M6>	08.00-12.05	0 451 10 P 3300	O	
		1 987 43 M 2014	I	
114 AR 32301 <M2>	05.98-07.00	0 451 10 P 3300	O	
		0 450 90 F 5087 ¹	K	
		1 987 43 M 2014	I	

A Trockenmittelbox	A Desiccant box
C Kühlwasserfilter	C Coolant filter
D Denox Filter Service Set	D Denox filter Service set
H Hydraulikfilter	H Hydraulic filter
I Innenraumfilter	I Filter for vehicle interior
K Kraftstofffilter	K Fuel filter
L Luftfilter	L Air filter
O Ölfilter	O Oil filter
P Filter, Lenkhilfepumpe	P Filter, power steering pump
S Ölabscheider	S Oil separator
A Cartouche de déshydratant	A Box essiccante
C Filtre à liquide de refroidissement	C Filtro liquido di raffreddamento
D Kit d'entretien filtre Denox	D Kit di manutenzione filtro Denox
H Filtre hydraulique	H Filtro idraulico
I Filtre d'habitacle	I Filtro per l'abitacolo
K Filtre à carburant	K Filtro carburante
L Filtre à air	L Filtro dell'aria
O Filtre à huile	O Filtro olio
P Filtre, pompe d'assistance de direction	P Filtro, pompa servosterzo
S Séparateur d'huile	S Separatore d'olio
A Caja de agente desecante	A Droogmiddelbox
C Filtro de agua de refrigeración	C Koelwaterfilter
D Set de servicio de filtro Denox	D Denox-filterserviciset
H Filtro hidráulico	H Hydraulisch filter
I Filtro de habitáculo interior	I Interieurfilter
K Filtro de combustible	K Brandstofffilter
L Filtro de aire	L Luchtfilter
O Filtro de aceite	O Oliefilter
P Filtro, dirección asistida	P Filter, stuurbe-krachtigingspomp
S Separador de aceite	S Olieaafscheider
A Torkmedelsbox	A Krabice s vysoušecím prostředkem
C Kylvätskefilter	C Filtir chladicí vody
D Denox filter servicesats	D Servisní sada filtru Denox
H Hydraulfilter	H Hydraulický filtr
I Kupéfilter	I Filtr pro vnitřní prostor
K Bränslefilter	K Čistič paliva
L Luftfilter	L Čistič vzduchu
O Oljefilter	O Čistič oleje
P Filter, styrservopump	P Filtr, čerpadlo posilovače řízení
S Oljeavskiljare	S Odlučovač oleje
A Skrzynka osuszająca	A Коробка с сушильным агентом
C Filtr wody chłodzącej	C Фильтр охлаждающей жидкости
D Zestaw serwisowy filtra denox	D Сервисный комплект для фильтров Denox
H Filtr cieczy hydraulicznej	H Гидравлический фильтр
I Filtr wnętrza pojazdu	I Фильтр для салона
K Filtr paliwa	K Топливный фильтр
L Filtr powietrza	L Воздушный фильтр
O Filtr oleju	O Масляный фильтр
P Filtr, pompa wspomagania kierownicy	P Фильтр, насос усилителя рулевого привода
S odolejacz	S Маслоотделитель

0 451 10**P3300**

=



№

P3300

+



0 451 103 300



F 026 402 063	Hyundai	Elantra, i30
	KIA	Cee'd
F 026 402 065	Mercedes	E 200 CDI, E220 CDI, E250 CDI, E350 CDI, E350 Bluetec, GLK 220 CDI
F 026 402 066	Audi	A6 2.0 TDI
	Seat	Exeo 2.0 TDI
F 026 402 067	Renault	Megane III Grandtour DCI, Megane III Coupe DCI
F 026 402 068	Audi	A4 TDI, A5 TDI
F 026 402 072	Suzuki	Jimny
F 026 402 078	Volvo	XC 60; S80 II; V70 III; XC70 II
F 026 402 081	Renault	Laguna III dCi, Kangoo II dCi, Twingo II dCi
F 026 402 084	Audi	A2
F 026 402 086	Mitsubishi	Grandis, Lancer, Outlander
F 026 403 012	Audi	R8 5.2 Quattro,
	Seat	Exeo 2.0 TFSI
F 026 403 013	VW	Golf Plus 1.6
F 026 403 014	Volvo	XC60, S80 II
	Seat	Cordoba, Ibiza
	VW	Golf IV 2.0, Polo



F 026 400 046	Hyundai	Starex; Satellite; H-1, H100
F 026 400 054	Honda	Jazz
F 026 400 112	Volvo	S40 1.9,2.0 , V40 1.9, 2.0
F 026 400 113	KIA	Carnival, Sedona
F 026 400 114	Toyota	Corolla Verso, Auris
F 026 400 119	BMW	116d, 330d
F 026 400 120	Citroen	C4
F 026 400 121	Toyota	Corolla Verso
F 026 400 123	Hyundai	Santa Fe
F 026 400 125	Suzuki	Escudo, Grand Vitara
F 026 400 126	Nissan	Qashqai, X-Trail
	Renault	Koleos
F 026 400 127	Hyundai	i10
F 026 400 129	Mazda	MZR-CD
F 026 400 130	Nissan	370 Z 3.7 Coupé
F 026 400 131	Porsche	Cayman
F 026 400 132	Honda	Civic
F 026 400 133	Mercedes	E 200 CDI, E220 CDI, E250 CDI, GLK 220 CDI
F 026 400 134	Mercedes	E 200 CGI, E250 CGI, C 200 CGI
F 026 400 135	Ford	Fiesta VII
F 026 400 136	Ford	Focus II 2.5i
F 026 400 137	Hyundai	i20
F 026 400 138	Renault	Megane III Grandtour/ Coupe 16V/CDI
F 026 400 139	Renault	Megane III Grandtour/Coupe 2.0
F 026 400 140	Toyota	Urban Cruiser
F 026 400 141	Volvo	C30, S40, S40 II, V50



F 026 400 143	Toyota	Yaris
F 026 400 144	Smart	Fortwo
F 026 400 146	Volvo	XC60
F 026 400 147	BMW	X 3 xDrive 18d
F 026 400 148	BMW	Z4 sDrive 35i
F 026 400 149	BMW	Z4 sDrive 23i, Z4 sDrive 30i
F 026 400 150	Peugeot	308 CC 2.0 HDI; 3008 2.0 HDI
F 026 400 151	Peugeot	308 1.6i CC; 3008 1.6i
F 026 400 153	Toyota	Prius 1.8i
F 026 400 154	Toyota	iQ 1.3 VVT-i
F 026 400 156	Seat	Ibiza 1.4 FSI
	VW	Polo 1.6 TDI
F 026 400 157	Audi	A4 1.8 TFSI, A4 2.0 TDI, A5 1.8 TFSI, A5 2.0 TDI
F 026 400 158	Lexus	IS 200
	Toyota	Altezza, Cresta, Crown, Mark, RAV 4, Chaser
F 026 400 159	Honda	CR-V, FR-V
F 026 400 160	Honda	Civic 2.2 CDTi
F 026 400 161	Honda	Civic 1.4
F 026 400 162	Lexus	GS 300, GS 350, GS430, GS450, SC 430
F 026 400 163	Chevrolet	Lacetti, Nubira
F 026 400 164	Hyundai	Trajet, Sonata
	KIA	Magnetis
F 026 400 165	Ford	Ranger
	Mazda	B 2500
F 026 400 167	Chevrolet	Matiz 0.8, spark 0.8 ,1.0
F 026 400 168	Hyundai	Atos prime 1.1i
F 026 400 169	KIA	Picanto
F 026 400 170	Toyota	Prius 1.5i
F 026 400 171	Toyota	Auris 2.0 , Avensis 2.0, 2.2, Corolla Verso
F 026 400 172	Audi	A3, Q3,TT
	Seat	Alhambra , Altea, Leon, Toledo
	Skoda	Octavia, Yeti,
	VW	Caddy, Eos, Golf Plus, Golf V, Golf VI, Jetta, Passat, Tiguan, Touran
F 026 400 173	VW	fox 1.4
F 026 400 174	citroen	C4 1.4i,
	Peugeot	206+ 1.1,1.4, 307 1.4
F 026 400 175	Nissan	Primera 1.9
F 026 400 176	Lexus	IS 220
	Toyota	RAV 4
F 026 400 177	BMW	mini cooper , mini one 1.4D, 1.6i,
F 026 400 178	VW	Golf VI 2.0 TSI; Scirocco 2.0 TSI
F 026 400 180	Audi	A3 3.2, TT 3.2, TTS 2.0,
	Skoda	Superb 3.6
	VW	Eos , Golf V 3.2 , Passat 3.2,3.6
F 026 400 181	Volvo	XC60, XC70II. S80 II, V70 III
F 026 400 182	Audi	Q7 3.0,
	VW	Touareg 2.5, 3.0,3.2, 3.5, 3.6,4.2
F 026 400 183	Nissan	Cabster 2.5,3.0

nl

Nieuwe opnamen

sv

Nya produkter

cs



Nové produkty



pl



Nowe produkty

ru

Новинки

		
F 026 400 186	Hyundai	Galloper 2.5 , H100 2.5 , H100 2.6.
F 026 400 187	KIA	cerato 1.6i, 2.0i
F 026 400 188	Lexus	ES 350
	Toyota	Aurion, Avensis, Camry, RAV4
F 026 400 198	Audi	A6
F 026 400 199	Nissan	NP300, Pickup
F 026 400 191	Suzuki	swift 1.3, Liana 1.6
F 026 400 192	Toyota	crown 2.5, 3.0 , Mark X 2.5,3.0, Reiz 2.5,3.0
	Lexus	GS 300, GS 350, GS430, IS250, IS 350
F 026 400 193	Toyota	Hilux 2.4, 2.5, 3.0,
F 026 400 194	Fiat	Bravo 1.4, 1.6, 2.0
	Lancia	Delta 1.4, 1.6, 1.8
F 026 400 200	Mitsubishi	Lancer 1.5,1.6,1.8,2.0, Outlander 2.0,2.4,3.0
F 026 400 201	Fiat	Sedici
	Suzuki	SX4
F 026 400 202	Ford	Transit FT 300/330/350/430/460
F 026 400 203	Chevrolet	captiva 2.0, 2.4
	Opel	Antara 2.0
F 026 400 204	Saab	9-5 1.9 , 9-5 3.0
F 026 400 205	Mercedes	E200 CDI, E220 CDI
F 026 400 206	Subaru	Forester 2.0 , Impreza 1.5,2.0,2.5, Legacy 2.0,2.5
F 026 400 212	Hyundai	Sonata
F 026 400 213	Porsche	911
F 026 400 214	Mercedes	C 200CDI, C220 CDI
F 026 400 215	Mercedes	E 280CDI/300 CDI/320 CDI / 350 CDI, GL 320 CDI/350 CDI, ML 300 CDI/350 CDI, C 320 CDI, R 300CDI/350CDI, S 320 CDI
F 026 400 216	Mercedes	E 280CDI/300 CDI/320 CDI / 350 CDI, GL 320 CDI/350 CDI, ML 300 CDI/350 CDI, C 320 CDI, R 300CDI/350CDI, S 320 CDI

		
F 026 407 023	Audi	A3 TDI
	VW	Golf VI TDI, Polo TDI, Transporter T5, California, Caravelle, Multivan
F 026 407 024	Hyundai	i20 1.2i
F 026 407 025	Hyundai	i10, i20, Atos
F 026 407 066	Audi	A5 TDI, Q7 TDI
	VW	Touareg 3.0 TDI
F 026 407 069	Chrysler	Voyager
	Hyundai	Tucson, Santa Fe, Carens, Sportage, Elantra
F 026 407 071	Opel	Antara 2.0
	Chevrolet	Lacetti 2.0, Nubira 2.0 ,Captive 2.0, Epica 2.0
F 026 407 072	BMW	116d, X3 xDrive 18d

		
F 026 407 073	Opel	Astra 1.7, Corsa 1.7, Meriva 1.7, Zafira 1.7,
F 026 407 075	Volvo	XC60
F 026 407 076	Mercedes	E 420, GL 420, GL 450, ML 420, ML 450, S 420, S 450
F 026 407 078	Ford	Fiesta II
F 026 407 083	Citroen	Jumper
	Fiat	Ducato
	Iveco	Daily
	Peugeot	Boxer
F 026 407 089	Smart	Fortwo
F 026 407 090	Toyota	Corolla Verso
F 026 407 091	Toyota	Corolla Verso. Prius, Auris
F 026 407 092	Toyota	Urban Cruiser 1.3 VVT, iQ
F 026 407 093	Toyota	Urban Cruiser 1.4 D
F 026 407 094	BMW	330d, 730Ld
F 026 407 097	Volvo	S80 II, V70 III, XC70 II
F 026 407 096	Fiat	Grand punto1.6, Linea 1.6, Bravo 1.6, Bravo 2.0, Sedici 2.0, Doblo 1.6, Punto Evo 1.6., Lancia Delta 1.8, 1.9, 2.0, Musa 1.6
	Opel	Astra 1.3, Corsa 1.3, Meriva 1.3
	Alfa Romeo	Alfa Mito 1.6, Alfa 159, Brera 2.0, Spider 1.8
F 026 407 098	Toyota	Lexus ES 350, Lexus RS 270, 350, 450h, Camry 2.5, Estima 3.5, Aurion 3.5
F 026 407 099	Ford	Transit
F 026 407 102	Porsche	Cayenne, Panamera, 911
F 026 407 104	Subaru	Forester 2.0, Impreza 2.0, Legacy 2.0, Outback 2.0

		
1 987 432 034	Mitsubishi	Colt VI/VII
1 987 432 041	Peugeot	306 o. Klima
1 987 432 055	Hyundai	i30
1 987 432 065	Citroen	Jumper
	Fiat	Ducato
	Peugeot	Boxer
1 987 432 068	BMW	Z4
1 987 432 077	Citroen	Xsara
1 987 432 078	Renault	Kangoo II; Master IV
1 987 432 086	Mitsubishi	Charisma; Colt V; Pajero Sport; Space Star
1 987 432 109	Ford	Focus; C-Max; Focus II; Galaxy; Kuga; Mondeo IV; S-Max
1 987 432 122	Audi	A6
1 987 432 132	Hyundai	i20
1 987 432 137	Citroen	Berlingo; C4 Picasso; C4 Grand Picasso
	Peugeot	3008; 5008; Partner
1 987 432 200	Porsche	Boxster; Cayman; 911;

nl

Nieuwe opnamen
(vervolg)

sv

Nya produkter
(fortsättning)

cs

Nové produkty
(pokračování)

pl

Nowe produkty
(continuação)

ru

Новинки
(продолжение)



F 026 402 099	Iveco	Daily
F 026 402 100	Scania	K 124; P,R 124; T124
F 026 402 101	VW	Crafter
F 026 402 070	Renault	Midlum, Premium,
F 026 402 071	Renault	Mascott
F 026 402 082	Renault	Laguna III dCi,Kangoo II 1.5, dCi
F 026 402 092	VW	Transporter TDI, Multivan TDI
F 026 402 095	Land Rover	Freelander 2.0
F 026 402 096	Nissan	Navara 2.5, pathfinder 2.5
F 026 402 097	Ford	Ranger 2.5



F 026 400 152	Mercedes	E63 AMG
F 026 400 117	Volvo	FM 330, 370, 380, 410, 420, 460, 500
F 026 400 122	Mercedes	Viano, Vito
F 026 400 124	Volvo	BL 70,71,86
	Liebherr	R/A 300
	Deutz	Agroton
	Massey-Ferguson	4200,4300,6200, 8100,8200 series
	Evobus	Cito
	John Deere	3000 series
F 026 400 145	Renault	480, 520 Magnum
	Volvo	FE 240, FE 260, FE 300, FE340
F 026 400 166	Nissan	Interstar
	Opel	Movano
	Renault	Master
F 026 400 179	Volvo	FH 16 540/600/700
F 026 400 184	MAN	Lion's City, NG, NL, NÜ, EM
F 026 400 189	Mercedes	O 5820, Travego
F 026 400 197	Volvo	FH12, FH16, FH 380, FH 400, FH 420, FH 440, FH 460, FH 480, FH 500, FH 520, FH 540, FM 12
F 026 400 207	Volvo	FH12
F 026 400 209	MAN	TGL
F 026 400 210	MAN	TG, TGA, TGS, TGX
F 026 400 211	MAN	TGL, TGM



F 026 407 100	Scania	G230, G280, G320, G360, G400, G440, G480, P230, P280, P320, P360, P400, R440, R480,
F 026 407 101	Iveco	Eurocargo 65,75,80,90,100,120,130, 140,150,160,180,230
F 026 407 105	Iveco	Turbostar ,Eurostar, Eurotech
F 026 400 190	Scania	D series , R series , T series , G series , P series
F 026 400 195	Volvo	FH 16 540/600/550
F 026 400 196	Volvo	FH 16 540/600/550



1 987 431 170	Renault	Premium DXi7
1 987 431 171	Renault	Magnum MIDR 06.24.65
1 987 431 172	Scania	Motorcode DC9-01/04/13-230 Eur
1 987 431 175	Mercedes	SK OM 442.907,926 ab BJ 02.95
1 987 432 213	Mercedes	Sprinter (906)
	VW	Crafter

de

DENOX-Filter von Bosch:
Weniger Emissionen,
weniger Verbrauch

en

Bosch DENOX-Filter:
Reduced emissions,
lower consumption

fr

Filtres DENOX de Bosch:
réduit les émissions,
baisse la consommation

it

Filtri DENOX di Bosch:
Meno emissioni,
meno consumi

es

Filtro DENOX de Bosch:
Menos emisiones,
menos consumo



DENOX 2.0

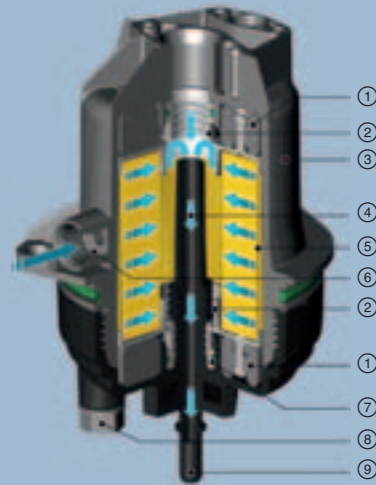

Alles spricht für DENOX-Filter von Bosch:

- ▶ langjährige Erfahrung mit AdBlue, der Filter passt perfekt zum Denoxtronic-System
- ▶ Hochwertige Materialien, die besonders resistent gegen das aggressive AdBlue sind – für sicheren Schutz des Denoxtronic-Systems
- ▶ regelmäßiger Filterwechsel gewährleistet die exakte Dosierung von AdBlue und damit die Einhaltung der EU-Abgasnormen

Strong arguments for Bosch DENOX filters:

- ▶ Years of experience with AdBlue; the filter is perfectly compatible with the Denoxtronic system
- ▶ High-quality materials offering exceptional resistance against the aggressive AdBlue – for a reliable protection of the Denoxtronic system
- ▶ regular filter replacement guarantees precise metering of AdBlue and thus compliance with EU emission standards

Des arguments forts pour les filtres DENOX de Bosch:

- ▶ une forte et longue expérience l'AdBlue, le filtre convient parfaitement au système Denoxtronic
- ▶ des matériaux de grande qualité résistant particulièrement bien à l'agressivité de la solution AdBlue assurent la protection fiable du système Denoxtronic
- ▶ le changement régulier du filtre garantit le dosage exact de la solution AdBlue et ainsi le respect des normes UE en matière de gaz d'échappement

Sono tanti i motivi per scegliere i filtri DENOX di Bosch:

- ▶ Esperienza pluriennale con AdBlue, il filtro si adatta perfettamente al sistema Denoxtronic
- ▶ Materiali di alta qualità, particolarmente resistenti all'aggressività dell'AdBlue - a garanzia di una protezione totale del sistema Denoxtronic
- ▶ La sostituzione ad intervalli regolari del filtro garantisce il dosaggio preciso di AdBlue e quindi il rispetto delle norme antinquinamento dell'UE

Argumentos a favor del filtro DENOX de Bosch:

- ▶ Muchos años de experiencia con AdBlue, el filtro es perfectamente adecuado para el sistema Denoxtronic
- ▶ Materiales de gran calidad especialmente resistentes al agresivo AdBlue – para una protección segura del sistema Denoxtronic
- ▶ Un cambio regular del filtro garantiza una dosificación exacta de AdBlue y, con ello, el respeto de las normas de gases de escape de la UE

Type/KIT										
DENOX 1 Service	F 00B H40 230	●	●	●	●	●				DAF, MAN, IVECO, Scania, Volvo
DENOX 1 Repair	F 00B H40 025			●		●	●			DAF, MAN, IVECO, Scania, Volvo
DENOX 2.0 Service	1 457 436 006	●		●	●					Case, IVECO, KHD, Renault
DENOX 2.0 Repair	1 457 030 020						●			Case, IVECO, KHD, Renault
DENOX 2.2 Service	1 457 436 033	●	●						●	Cummins, Mack, Nissan, Renault, Volvo

nl	sv	cs	pl	ru
DENOX-filter van Bosch: Minder uitstoot, minder verbruik	DENOX-filter från Bosch: Mindre emissioner, mindre förbrukning	DENOX-Filtr od fy Bosch: Méně emisí, nižší spotřeba	Filtry DENOX firmy Bosch: Mniej emisji, niższe zużycie paliwa	Фильтр DENOX производ- ства Bosch: Меньше вы- бросов, меньше расход

1 = Oberes/unteres
Ausgleichselement
2 = Endscheibe
3 = Gehäuse
4 = Gefiltertes AdBlue
5 = Filtermedium
6 = AdBlue Zuleitung
7 = O-Ring
8 = AdBlue Ablassschraube
9 = AdBlue Auslass

1 = Compensation supérieure/
inférieure
2 = Rondelle d'extrémité
3 = Boîtier
4 = AdBlue filtrée
5 = Matière filtrante
6 = Entrée AdBlue
7 = Joint torique
8 = Vis de vidange AdBlue
9 = Sortie AdBlue

1 = elemento de compensa-
ción superior/inferior
2 = disco final
3 = carcasa
4 = AdBlue filtrado
5 = medio filtrante
6 = tubería de alimentación
de AdBlue
7 = anillo toroidal
8 = tornillo de purga de AdBlue
9 = salida de AdBlue

1 = övre/undre
utjämningselement
2 = slutskiva
3 = hus
4 = filterrad AdBlue
5 = filtermedium
6 = AdBlue matarledning
7 = O-ring
8 = AdBlue avtappningskruv
9 = AdBlue utlopp

1 = Górný/dolný element
wyrównawczy
2 = Zašlepka
3 = Obudowa
4 = Przefiltrowany dodatek
AdBlue
5 = Medium filtrujące
6 = Przewód zasilający AdBlue
7 = Pierścień uszczelniający
8 = Śruba spustowa AdBlue
9 = Spust AdBlue

1 = Compensation element
2 = Lid
3 = Housing
4 = Filtered AdBlue
5 = Cellulose
6 = AdBlue Inlet
7 = O-ring
8 = AdBlue drain screw
9 = AdBlue outlet

1 = elementi di compensazione
superiore/inferiore
2 = rondella
3 = corpo
4 = AdBlue filtrato
5 = materiale filtrante
6 = ingresso AdBlue
7 = O-Ring
8 = vite di scarico AdBlue
9 = uscita AdBlue

1 = bovenste/onderste
compensatie-element
2 = eindschijf
3 = behuizing
4 = gefilterd AdBlue
5 = filtermedium
6 = AdBlue-toevoer
7 = O-ring
8 = AdBlue-aftapschroef
9 = AdBlue-afvoer

1 = Horní/dolní vyrovnávací
prvek
2 = Víko
3 = Pouzdro
4 = Filtrované AdBlue
5 = Filtrační médium
6 = Přívod AdBlue
7 = O-kroužek
8 = Výpustný šroub AdBlue
9 = Výpust AdBlue

1 = Верхний/нижний
компенсатор
2 = Концевая шайба
3 = Корпус
4 = Отфильтрованный AdBlue
5 = Фильтрующая среда
6 = Подводящая линия
AdBlue
7 = Кольцо круглого сечения
8 = Резьбовая пробка слив-
ного отверстия AdBlue
9 = Выпуск AdBlue

Alles pleit voor DENOX-filters van Bosch:

- ▶ langjarige ervaring met AdBlue, het filter past perfect bij het Denoxtronic-systeem
- ▶ Hoogwaardige materialen die bijzonder resistent tegen het agressieve AdBlue zijn – voor een veilige bescherming van het Denoxtronic-systeem
- ▶ regelmatige het filter vervangen garandeert de exacte dosering van AdBlue en daarmee naleving van de EU-uitlaatgasnormen

Allt talar för DENOX- filtret från Bosch:

- ▶ mångåriga erfarenheter med AdBlue, filtret passar perfekt till Denoxtronic-systemet
- ▶ Högvärdiga material, vilka är speciellt resistent mot det aggressiva AdBlue – för säkert skydd av Denoxtronic-systemet
- ▶ regelmässigt filterbyte garanterar exakt dosering av AdBlue och därmed även att EU-avgasstandarderna uppfylls

Vše svědčí pro DENOX- Filtr od fy Bosch:

- ▶ mnohaleté zkušenosti s AdBlue, filtr se perfektně hodí k systému Denoxtronic
- ▶ vysoce kvalitní materiály, které jsou mimořádně odolné vůči agresivnímu AdBlue - pro bezpečnou ochranu systému Denoxtronic
- ▶ pravidelná výměna filtru zabezpečuje přesné dávkování AdBlue a tím také dodržení emisních EU norem

Wszystko przemawia za filtrami DENOX firmy Bosch:

- ▶ długoletnie doświadczenie w zakresie stosowania AdBlue, filtr pasuje doskonale do systemu Denoxtronic;
- ▶ wysokogatunkowe materiały, szczególnie odporne na agresywny chemicznie dodatek AdBlue, zapewniają właściwą ochronę systemu Denoxtronic;
- ▶ regularna wymiana filtra zapewnia dokładne dawkowanie dodatku AdBlue, a tym samym spełnienie europejskich norm czystości spalin.

Все говорит в пользу фильтра DENOX производства Bosch:

- ▶ многолетний опыт успешной эксплуатации с AdBlue; этот фильтр идеально подходит для системы Denoxtronic
- ▶ высококачественные материалы, обладающие повышенной стойкостью к агрессивной среде AdBlue, обеспечивают защиту системы Denoxtronic
- ▶ регулярная замена фильтра гарантирует точную дозировку AdBlue и соблюдение европейских норм токсичности ОГ

de	en	fr	it	es
Öl-Wechselfilter	Easy-change oil filters	Filtres à huile à rechange rapide	Filtro olio a cambio rapido	Filtros de aceite intercambiables

	Fig.	H mm	Ø mm	A	p_{1-} bar	p_{1+} bar
0 451 ...						
0 451 102 056	47	79	80	3/4" 16 UNF	-	-
0 451 103 004	47	95	96	3/4" 16 UNF	0,12	1,20
0 451 103 028	47	114	96	3/4" 16 UNF	0,12	2,50
0 451 103 029	47	100	96	3/4" 16 UNF	0,12	1,10
0 451 103 033	47	123	80	3/4" 16 UNF	0,12	2,20
0 451 103 050	47	89	78	3/4" 16 UNF	-	1,40
0 451 103 060	47	69	96	3/4" 16 UNF	0,12	1,20
0 451 103 062	47	102	96	3/4" 16 UNF	0,12	2,50
0 451 103 074	47	123	80	3/4" 16 UNF	0,12	1,00
0 451 103 079	47	89	76	M 18 x 1,5	-	-
0 451 103 086	47	123	80	3/4" 16 UNF	0,12	2,50
0 451 103 093	47	69	96	3/4" 16 UNF	-	-
0 451 103 096	47	100	80	3/4" 16 UNF	0,12	1,20
0 451 103 105	47	123	76	3/4" 16 UNF	0,12	-
0 451 103 109	47	114	90	M 20 x 1,5	0,12	1,00
0 451 103 111	47	100	76	M 20 x 1,5	0,12	1,20
0 451 103 139	47	73	78	M 16 x 1,5	0,12	1,50
0 451 103 141	47	56	78	3/4" 16 UNF	0,12	0,90
0 451 103 144	47	119	80	M 20 x 1,5	-	0,59
0 451 103 145	47	94	80	M 18 x 1,5	0,12	1,00
0 451 103 170	47	100	96	3/4" 16 UNF	0,12	1,40
0 451 103 189	47	86	85	3/4" 16 UNF	0,12	1,00
0 451 103 213	47	123	80	M 20 x 1,5	0,12	2,20
0 451 103 215	47	170	80	M 20 x 1,5	-	2,20
0 451 103 217	47	114	96	3/4" 16 UNF	-	-
0 451 103 219	47	85	96	3/4" 16 UNF	0,12	1,10
0 451 103 221						
0 451 103 224	47	85	96	M 20 x 1,5	0,12	1,10
0 451 103 227	47	100	80	3/4" 16 UNF	0,12	1,00
0 451 103 232	47	100	76	M 18 x 1,5	-	-
0 451 103 235	47	55	78	M 20 x 1,5	-	-
0 451 103 238	47	139	93	M 20 x 1,5	x	x
0 451 103 240	47	119	90	M 20 x 1,5	0,12	0,70
0 451 103 249	47	170	80	3/4" 16 UNF	0,12	2,50
0 451 103 251	47	96	93	3/4" 16 UNF	0,12	1,00
0 451 103 252	47	95	97	M 22 x 1,5	0,12	0,80
0 451 103 253	47	142	94	3/4" 16 UNF	0,12	2,50
0 451 103 257	47	128	110	3/4" 16 UNF	0,12	2,50
0 451 103 258	47	123	80	3/4" 16 UNF	0,12	2,50
0 451 103 259	47	123	80	3/4" 16 UNF	0,12	1,00
0 451 103 260	47	100	96	M 20 x 1,5	0,12	1,50
0 451 103 261	47	89	80	M 20 x 1,5	0,12	1,50
0 451 103 266	47	115	84	M 22 x 1,5	0,12	1,00

	Fig.	H mm	Ø mm	A	p_{1-} bar	p_{1+} bar
0 451 103 270	47	82	104	M 20 x 1,5	-	-
0 451 103 271	47	80	76	3/4" 16 UNF	x	0,59
0 451 103 274	47	69	96	3/4" 16 UNF	0,12	1,20
0 451 103 275	47	74	82	M 20 x 1,5	-	1,00
0 451 103 276	47	90	68	3/4" 16 UNF	0,12	1,00
0 451 103 278	47	121	93	1" 12 UNF	x	1,00
0 451 103 280	47	136	80	3/4" 16 UNF	0,12	2,50
0 451 103 289	47	102	96	3/4" 16 UNF	0,12	2,50
0 451 103 290	47	119	90	3/4" 16 UNF	0,12	2,50
0 451 103 292	47	75	68	M 20 x 1,5	0,12	1,50
0 451 103 297	47	79	80	M 18 x 1,5	-	-
0 451 103 298	47	79	80	3/4" 16 UNF	0,12	1,00
0 451 103 299	47	89	80	M 20 x 1,5	0,12	0,80
0 451 103 300	47	67	76	M 20 x 1,5	x	1,20
0 451 103 311	47	77	96	1 3/16" 16 UN	-	1,00
0 451 103 313	47	114	96	3/4" 16 UNF	0,12	3,00
0 451 103 314	47	123	80	3/4" 16 UNF	0,12	2,50
0 451 103 316	47	74	84	M 20 x 1,5	0,12	1,00
0 451 103 318	47	92	80	3/4" 16 UNF	0,12	2,50
0 451 103 330	47	114	96	M 23 x 1,5	0,12	1,60
0 451 103 333	47	100	96	M 22 x 1,5	0,12	1,20
0 451 103 335	47	119	80	1" 12 UNF	0,12	1,00
0 451 103 336	47	50	80	M 20 x 1,5	0,12	1,50
0 451 103 337	47	93	80	3/4" 16 UNF	0,12	1,00
0 451 103 338	47	203	80	M 24 x 2	0,12	2,50
0 451 103 340	47	124	78	1 3/16" 16 UN	-	1,00
0 451 103 341	47	76	93	1 3/16" 16 UN	-	1,00
0 451 103 342	47	100	80	3/4" 16 UNF	0,12	0,80
0 451 103 343	47	260	110	1 1/8" 16 UNF	-	-
0 451 103 344	47	120	78	3/4" 16 UNF	0,08	2,50
0 451 103 346	47	142	96	3/4" 16 UNF	0,12	2,50
0 451 103 347	47	139	90	3/4" 16 UNF	0,12	2,50
0 451 103 348	47	190	80	M 24 x 2	0,12	2,50
0 451 103 349	47	79	80	3/4" 16 UNF	0,12	1,50
0 451 103 350	47	100	80	3/4" 16 UNF	0,12	1,50
0 451 103 351	47	79	80	3/4" 16 UNF	0,12	1,50
0 451 103 352	47	100	76	3/4" 16 UNF	0,12	1,50
0 451 103 353	47	89	90	M 20 x 1,5	0,12	1,20
0 451 103 354	47	79	80	M 20 x 1,5	0,12	1,20
0 451 103 355	47	89	80	M 20 x 1,5	0,12	1,50
0 451 103 357	47	121	94	3/4" 16 UNF	1,20	-
0 451 103 360	47	121	78	3/4" 16 UNF	-	2,30
0 451 103 363	47	93	79			
0 451 103 364	47	90	68	M 20 x 1,5		
0 451 103 365	47	98	103	M 24 x 1,5	x	x

nl

Oliefilters box

sv

Oljefilter

cs

Olejový filtr

pl

Wymienne filtry oleju

ru

Сменный масляный
фильтр

	Fig.	H mm	Ø mm	A	p ₁ bar	p ₂ bar
0 451 103 366	47	118	94	M 26 x 1,5	x	1,00
0 451 103 367	47	100	76		1,00	1,00
0 451 103 368		91	140		x	x
0 451 103 369	47	120	78	¾" 16 UNF		
0 451 103 370	47	80	78	M 18 x 1,5		
0 451 103 371	47	120	79	¾" 16 UNF		
0 451 103 372	47	85	71	M 20 x 1,5	0,12	1,20
0 451 104 005	47	142	96	1 ³ / ₁₆ " 16 UNF	1,00	1,20
0 451 104 013	47	302	140	M 42 x 1,5		2,50
0 451 104 014	47	114	96	¾" 16 UNF	0,12	1,00
0 451 104 015	47					
0 451 104 025	47	60	66	M 20 x 1,5		1,50
0 451 104 026	47	93	80	1 ³ / ₁₆ " 16 UN	x	1,00
0 451 104 063	47	141	96	¾" 16 UNF	0,12	1,20
0 451 104 064	47	138	93	1 ³ / ₁₆ " 16 UNF	0,12	-
0 451 104 065	47	140	93	¾" 16 UNF	0,12	2,50
0 451 104 066	47	142	96	1" 12 UNF	0,12	2,50
0 451 104 067	47	142	96	¾" 16 UNF	x	1,20
0 451 105 067	47	210	95	1" 12 UNF	0,12	2,50
0 451 105 188	47	217	96	1" 12 UNF	0,12	2,50
0 451 203 002	47	177	93	1" X 12 UNF-2B	0,12	1,20
0 451 203 005	47	142	96	¾" 16 UNF	-	-
0 451 203 010	47	177	96	¾" 16 UNF	0,12	0,70
0 451 203 012	47	142	96	¾" 16 UNF	0,12	2,50
0 451 203 087	47	183	96	¾" 16 UNF	0,12	2,50
0 451 203 108	47	114	96	M 20 x 1,5	0,12	1,20
0 451 203 152	47	139	107	¾" 16 UNF	0,12	1,40
0 451 203 154	47	95	96	¾" 16 UNF	-	1,00
0 451 203 194	47	139	93	¾" 16 UNF	0,12	1,00
0 451 203 197	47					
0 451 203 201	47	145	110	¾" 16 UNF	0,12	2,50
0 451 203 218	47	142	96	1" 12 UNF	2,50	-
0 451 203 220	47	175	95	1" 12 UNF	0,12	2,50
0 451 203 223	47	122	110	¾" 16 UNF	0,12	2,50
0 451 203 226	47	180	98	1" 12 UNF	-	-

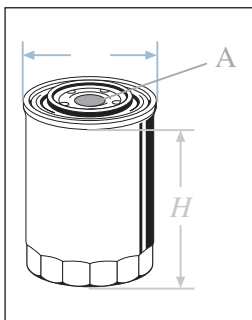

- x Rücklaufsperr/Umgehungsventil eingebaut, jedoch Druck nicht bekannt.
 Integrated check valve/bypass valve, but pressure not defined.
 Clapet anti-retour intégré/soupape de dérivation, mais seuil de pression inconnu.
 Valvola antiritorno incorporata/valvola di bypass, pressione non nota.
 Bloqueo de retorno incorporado/valvula de derivación, pero presión desconocida.
 Terugstroomblokkering ingebouwd/bypassklep, maar druk niet bekend.
 Inbyggd returspär/förbilendigsventil, men trycket obekant.
 Zpětný ventil je vestavěn/obtok. ventilu, tlak však není definován.
 Zamontowany zawór jednokierunkowy/zaworu obejściowego, ale nie określono ciśnienia.
 Блокировка обратного потока установлена/перепускного клапана, но давление неизвестно.

* Neu / New / Nouveau / Nuovo / Nuevo / Nieuwe / Ny / Nové / Nowe / Новые

	Fig.	H mm	Ø mm	A	p ₁ bar	p ₂ bar
0 451 203 231	47	170	110	1½" 16 UNF	-	-
0 451 300 003	47	260	110	1¾" 16 UN	-	-
0 451 300 004	47	181	110	1½" 16 UN	x	x
0 451 300 007	47	186	108	¾" 16 UNF	-	1,00
0 451 300 008	47	178	110	1½" 16 UN	-	-
0 451 301 156	47	230	109	1" 12 UNF	-	2,50
0 451 301 207	47	185	110	M 30 x 2	-	2,50
0 451 403 001	47	273	110	1½" 16 UNF	0,12	2,50
0 451 403 077	47	260	110	1½" 16 UNF	-	-
0 451 403 208	47	308	140	1½" 16 UN	-	1,00
0 451 403 210	47	302	136	1½" 16 UN	-	2,50
0 986 ...						
0 986 450 108	47	171	70			
0 986 452 000	47	122	85	¾" 16 UNF	0,12	-
0 986 452 001	47	140	95	¾" 16 UNF	-	1,00
0 986 452 003	47	97	95	¾" 16 UNF	0,12	1,00
0 986 452 005	47	132	96	¾" 16 UNF	-	-
0 986 452 015	47	92	84	M 22 x 1,5	0,12	1,00
0 986 452 016	47	74	84	M 20 x 1,5	0,12	1,00
0 986 452 019	47	74	84	¾" 16 UNF	0,12	1,00
0 986 452 020	47	120	86	M 20 x 1,5	0,12	1,00
0 986 452 023	47	100	82	¾" 16 UNF	-	1,00
0 986 452 024	47	98	95	¾" 16 UNF	-	1,00
0 986 452 028	47	76	68	¾" 16 UNF	-	1,00
0 986 452 030	47	83	103	M 24 x 1,5	0,12	1,00
0 986 452 035	47	74	84	¾" 16 UNF	0,12	-
0 986 452 036	47	92	84	M 20 x 1,5	0,12	1,00
0 986 452 041	47	90	68	M 20 x 1,5	0,12	1,00
0 986 452 042	47	127	103	M 26 x 1,5	0,12	1,00
0 986 452 044	47	89	77	¾" 16 UNF	0,12	1,00

de Öl-Wechselfilter (Fortsetzung)	en Easy-change oil filters (continued)	fr Filtres à huile à recharge rapide (suite)	it Filtro olio a cambio rapido (seguito)	es Filtros de aceite intercambiables (continuación)
nl Oliefilters box (vervolg)	sv Oljefilter (fortsättning)	cs Olejový filtr (pokračování)	pl Wymienne filtry oleju (ciąg dalszy)	ru Сменный масляный фильтр (продолжение)

	Fig.	H mm	Ø mm	A	p ₁ bar	p ₂ bar
0 986 452 046	47	140	94	1" X 12 UNF-2B	0,12	-
0 986 452 058	47	66	69	¾" 16 UNF	0,12	1,00
0 986 452 060	47	90	68	¾" 16 UNF	0,12	-
0 986 452 061	47	66	70	M 20 x 1,5	0,12	1,00
0 986 452 062	47	127	103	M 24 x 1,5	x	1,00
0 986 452 063	47	152	103	M 26 x 1,56 H	-	1,00
0 986 452 064	47	122	94	M 26 x 1,56 H	0,12	1,00
0 986 452 066	47	125	103	M 26 x 1,56 H	0,12	1,00
0 986 452 068	47	89	76	¾" 16 UNF	-	x
0 986 452 400	47	142	96	¾" 16 UNF	0,12	2,50

1 457 ...						
1 457 429 192		141	70			
1 457 429 239	75	53	91			
1 457 429 249	48	69	64			
1 457 429 256	65	77	65			
1 457 429 307		151	89			

F 026 ...						
F 026 407 001	47	72	63		x	x
F 026 407 004		149	95	¾" 16 UNF	x	x
F 026 407 005		80	80	¾" 16 UNF	x	x
F 026 407 016		89	61			
F 026 407 017	47	93	78	M 20 x 1,5	x	x
F 026 407 018	47	116	89			
F 026 407 022	47	63	78	M 20 x 1,5		2,50
F 026 407 024 *	47	75	96	M 22 x 1,5	x	x
F 026 407 025 *	47	85	69	M 20 x 1,5	x	x
F 026 407 027	47		78	M 20 x 1,5	-	1,20
F 026 407 043	47	260	108			
F 026 407 044	47	81	77			
F 026 407 048	47	228	108			
F 026 407 049	47	213	110	M 30 x 2	x	x
F 026 407 053	47	142	93			

	Fig.	H mm	Ø mm	A	p ₁ bar	p ₂ bar
F 026 407 057	47	171	96			
F 026 407 058		124	97			
F 026 407 059		116	93			
F 026 407 060		116	93			
F 026 407 061	65	110	72			
F 026 407 077	47	90	68	M 20 x 1,5	x	x
F 026 407 078 *	47	74	76	¾" 16 UNF	x	x
F 026 407 079	47	79	78	¾" 16 UNF	x	x
F 026 407 080	75	142	78		x	x
F 026 407 083 *	47	142	96	M 22 x 1,5	x	x
F 026 407 084	47	130	95	M 26 x 1,56 H	x	x
F 026 407 089 *	47	48	68	M 20 x 1,5	x	x
F 026 407 090 *	65	82	70			
F 026 407 091 *	65	57	61			
F 026 407 105 *	47	262	109	M 30 x 2	x	x
F 026 407 106	47	97	98			

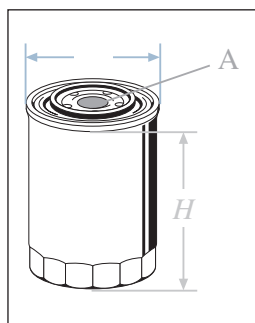

- x Rücklaufsperr-/Umgehungsventil eingebaut, jedoch Druck nicht bekannt.
Integrated check valve/bypass valve, but pressure not defined.
- Clapet anti-retour intégré/soupape de dérivation, mais seuil de pression inconnu.
- Valvola antiritorno incorporata/valvola di bypass, pressione non nota.
- Bloqueo de retorno incorporado/valvula de derivación, pero presión desconocida.
- Terugstroomblokkering ingebouwd/bypasklep, maar druk niet bekend.
- Inbyggd returspärr/förbilendigsventil, men trycket obekant.
- Zpětný ventil je vestavěn/obtok. ventilu, tlak však není definován.
- Zamontowany zawór jednokierunkowy/zaworu obejściowego, ale nie określono ciśnienia.
- Блокировка обратного потока установлена/перепускного клапана, но давление неизвестно.

* Neu / New / Nouveau / Nuovo / Nuevo / Nieuwe / Ny / Nové / Nowe / Новые

de

Ölfiltereinsätze

en

Oil-filter elements

fr

Cartouches de filtres
à huile

it

Cartucce filtranti
per filtri olio

es

Cartuchos filtrantes
para filtros de aceite

nl

Oliefilterpatronen

sv

Oljefilterinsatser

cs

Vložky olejového filtru

pl

Wkłady filtra oleju

ru

Элементы масляного
фильтра

	Fig.	H mm	Ø mm
---	------	---------	---------

0 451 ...

0 451 103 364	47	90	68
0 451 104 010	47	260	110

0 986 ...

0 986 452 005	47	132	96
----------------------	----	-----	----

1 457 ...

1 457 429 102	48	104	83
1 457 429 103	49	105	84
1 457 429 104	49	192	82

1 457 429 105	49	101	59
1 457 429 107	48	214	83
1 457 429 108	48	103	65
1 457 429 116	49	115	64
1 457 429 117	49	117	73

1 457 429 118	48	79	68
1 457 429 119	49	115	64
1 457 429 121	49	162	83
1 457 429 122	48	160	62
1 457 429 123	49	158	89

1 457 429 126	49	135	64
1 457 429 127	48	55	53
1 457 429 128	48	313	118
1 457 429 130	49	196	117
1 457 429 137	49	146	121

1 457 429 139	48	160	82
1 457 429 141	48	162	83
1 457 429 142	48	110	83
1 457 429 144	48	113	61
1 457 429 147	48	78	53

1 457 429 152	48	195	70
1 457 429 153	49	210	62
1 457 429 154	49	99	70
1 457 429 157	48	115	64
1 457 429 165	49	120	81

1 457 429 167	56	86	118
1 457 429 174	50	107	84
1 457 429 175	49	125	110
1 457 429 178	49	72	61
1 457 429 184	49	87	53

	Fig.	H mm	Ø mm
---	------	---------	---------

1 457 429 185	49	155	63
1 457 429 192		141	70
1 457 429 193		141	59
1 457 429 194	56	62	64
1 457 429 196	49	115	63

1 457 429 197	49	82	72
1 457 429 198	49	87	92
1 457 429 199	48	92	72
1 457 429 238	48	82	65
1 457 429 239	75	53	91

1 457 429 243	48	125	64
1 457 429 244	48	125	64
1 457 429 248	48	74	64
1 457 429 249	48	69	64
1 457 429 251	49	221	90

1 457 429 252	48	153	64
1 457 429 256	65	77	65
1 457 429 257	48	73	62
1 457 429 261	48	154	46
1 457 429 262	48	79	72

1 457 429 263	48	115	64
1 457 429 264	49	110	82
1 457 429 265	52	196	92
1 457 429 267	52	196	92
1 457 429 268	48	155	64

1 457 429 269	48	79	74
1 457 429 271	48	101	73
1 457 429 272	48	116	52
1 457 429 274	52	169	92
1 457 429 275	49	124	82

1 457 429 276	49	134	84
1 457 429 277	50	196	84
1 457 429 278	49	169	83
1 457 429 284	48	75	73
1 457 429 301	48	73	65

1 457 429 302	48	123	91
1 457 429 306	48	89	57
1 457 429 307		151	89
1 457 429 308		85	65
1 457 429 413	49	134	84

1 457 429 416	49	26	81
1 457 429 493	49	140	69
1 457 429 546	49		
1 457 429 559	49	120	94
1 457 429 600	49	243	100

	Fig.	H mm	Ø mm
---	------	---------	---------

1 457 429 605	50	106	59
1 457 429 610	50	121	83
1 457 429 616	50	153	71
1 457 429 619	48	155	64
1 457 429 629	49	196	117

1 457 429 631	53	211	128
1 457 429 636	56	183	91
1 457 429 638	49	110	81
1 457 429 646	49	196	84
1 457 429 647	49	134	84

1 457 429 648	49	151	121
1 457 429 649	49	120	59
1 457 429 732	49	196	78
1 457 429 735	49	171	120
1 457 429 740	49	248	120

1 457 429 755	49	130	81
1 457 429 760	49	89	83
1 457 429 762	49	79	76
1 457 429 820	49	101	59

F 026 ...

F 026 404 004	48	149	64
F 026 407 002		200	76
F 026 407 003	48	150	83

F 026 407 006		105	57
F 026 407 007		144	73
F 026 407 008	65	95	71
F 026 407 010		101	69
F 026 407 011		120	69

F 026 407 014	654	112	58
F 026 407 015		87	62
F 026 407 016		89	61
F 026 407 021	48	155	63
F 026 407 023 *	66	101	65

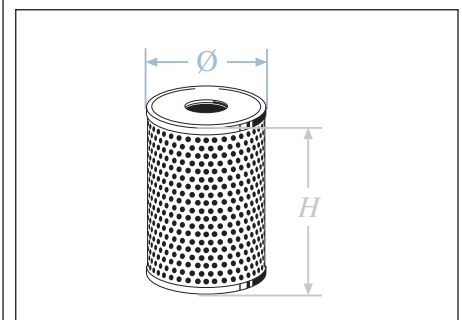

* Neu / New / Nouveau / Nuovo / Nuevo / Nieuwe / Ny / Nové / Nowe / Новые

de

Luftfiltereinsätze

en

Air-filter elements

fr

Cartouches de filtres
à air

it

Cartucce filtranti
per filtri aria

es

Cartuchos filtrantes
para filtros de aire

nl

Luchtfilterpatronen

sv

Luftfilterinsatser

cs

Vložky vzduchového filtru

pl

Wkłady filtra powietrza

ru

Элементы воздушного
фильтра

	Fig.	$a \times b \times c$ $H \times \varnothing$ mm
---	------	---

0 451 ...		
0 451 103 364	47	90x68

1 457 ...		
1 457 429 030	54	200x94x50
1 457 429 050	59	47x243
1 457 429 053	59	53x272

1 457 429 054	59	62x279
1 457 429 056	56	222x152
1 457 429 061	54	213x213x58
1 457 429 064	59	58x257
1 457 429 066	59	62x302

1 457 429 076	54	334x134x41
1 457 429 078	54	254x214x42
1 457 429 079	54	381x115x58
1 457 429 080	59	87x300
1 457 429 085	54	335x165x38

1 457 429 775	59	48x291
1 457 429 777	54	308x184x57
1 457 429 778	54	315x150x57
1 457 429 781	54	323x289x51
1 457 429 782	54	333x107x37

1 457 429 783	54	379x171x59
1 457 429 785	54	381x150x50
1 457 429 786	72	312x150x57
1 457 429 787	59	56x408
1 457 429 789	59	49x245

1 457 429 791	54	257x184x57
1 457 429 792	54	308x184x69
1 457 429 793	54	575x166x41
1 457 429 794	57	392x200
1 457 429 795	56	237x165

	Fig.	$a \times b \times c$ $H \times \varnothing$ mm
---	------	---

1 457 429 800	59	61x261
1 457 429 801	59	50x234
1 457 429 806	59	56x281
1 457 429 810	59	51x260
1 457 429 814	54	325x150x57

1 457 429 817	56	211x165
1 457 429 818	59	53x257
1 457 429 819	59	52x293
1 457 429 839	56	200x118
1 457 429 840	56	164x154

1 457 429 841	56	130x176
1 457 429 842	54	198x150x49
1 457 429 844	54	246x184x57
1 457 429 845	59	95x244
1 457 429 846	54	260x143x50

1 457 429 854	56	255x198
1 457 429 869	54	381x150x58
1 457 429 870	54	254x213x58
1 457 429 871	59	52x331
1 457 429 873	54	254x214x42

1 457 429 874	58	476x302
1 457 429 875	54	288x171x58
1 457 429 876	59	53x273
1 457 429 877	54	254x213x58
1 457 429 882	56	70x98

1 457 429 890	59	103x182
1 457 429 893	59	62x287
1 457 429 894	54	285x166x34
1 457 429 895	54	285x184x41
1 457 429 896	54	286x184x41

1 457 429 898	54	285x184x41
1 457 429 899	56	476x303
1 457 429 900	56	150x150
1 457 429 908	64	200x170
1 457 429 915	59	61x275

	Fig.	$a \times b \times c$ $H \times \varnothing$ mm
---	------	---

1 457 429 920	59	50x231
1 457 429 923	59	63x264
1 457 429 928	54	326x183x39
1 457 429 932	56	295x127
1 457 429 933	57	290x134

1 457 429 934		29x348
1 457 429 941	56	337x150
1 457 429 942	54	210x165
1 457 429 944	56	238x165
1 457 429 946	56	350x165

1 457 429 948	59	64x408
1 457 429 949	60	282x192x131
1 457 429 950	56	378x198
1 457 429 953	59	49x240
1 457 429 954	59	52x282

1 457 429 955	59	53x290
1 457 429 957	54	273x134x42
1 457 429 959	59	49x241
1 457 429 964	54	256x150x58
1 457 429 966	56	382x227

1 457 429 969	56	476x303
1 457 429 970	59	84x408
1 457 429 975	56	498x243
1 457 429 979	58	287x213
1 457 429 980	58	222x210

1 457 429 983	54	355x245x50
1 457 429 987	54	289x214x46
1 457 429 988	54	472x158x61
1 457 429 991	58	259x383
1 457 429 992	59	60x363

1 457 429 993	59	80x389
1 457 429 994	54	337x134x57
1 457 429 998		356x387
1 457 432 100	59	80x202
1 457 432 106	56	175x127

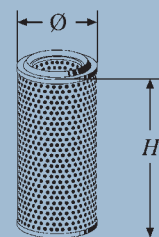
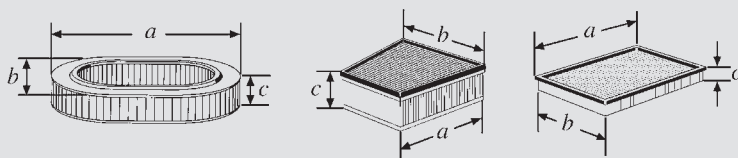

* Neu / New / Nouveau / Nuovo / Nuevo / Nieuwe / Ny / Nové / Nowe / Новые

de

Luftfiltereinsätze
(Fortsetzung)

en

Air-filter elements
(continued)

fr

**Cartouches de filtres
à air**
(suite)

it

**Cartucce filtranti
per filtri aria**
(seguito)

es

**Cartuchos filtrantes
para filtros de aire**
(continuación)

	Fig.	$a \times b \times c$	
		$H \times \emptyset$ mm	
1 457 432 108	59	62x233	
1 457 432 109	59	50x205	
1 457 432 111	59	58x235	
1 457 432 124	56	219x127	
1 457 432 128	59	52x218	
1 457 432 134	59	63x248	
1 457 432 138	56	178x160	
1 457 432 146	54	225x135x36	
1 457 432 149	56	157x132	
1 457 432 150	54	302x171x35	
1 457 432 154	56	124x168	
1 457 432 172	54	300x198x49	
1 457 432 173	54	177x90x49	
1 457 432 174	54	302x170x36	
1 457 432 178	54	248x169x38	
1 457 432 180	54	235x86x48	
1 457 432 183	54	242x131x59	
1 457 432 185	54	350x148x37	
1 457 432 188	56	381x303	
1 457 432 192	58	230x332	
1 457 432 193	57		
1 457 432 200	54	325x156x57	
1 457 432 202	54	336x230x27	
1 457 432 203	54	333x241x57	
1 457 432 204	59	91x317	
1 457 432 205	54		
1 457 432 208	54	212x171x57	
1 457 432 210	56		
1 457 432 212	56		
1 457 433 002	54	221x228x58	
1 457 433 003	54	246x213x42	
1 457 433 004	54	243x178x58	
1 457 433 005	58	309x186	
1 457 433 006	60	378x278x62	
1 457 433 007	54	308x230x27	
1 457 433 008	54	275x185x57	
1 457 433 023	54	268x228x58	
1 457 433 032	59	110x215	
1 457 433 036	54	281x160x47	
1 457 433 037	54	256x210x43	
1 457 433 042	56	465x310	
1 457 433 043	54	520x86x58	
1 457 433 044	56	135x91	
1 457 433 045	54	239x188x58	
1 457 433 046	54	267x213x70	

	Fig.	$a \times b \times c$	
		$H \times \emptyset$ mm	
1 457 433 047	54	340x143x50	
1 457 433 049	54	272x118x50	
1 457 433 052	54	363x142x58	
1 457 433 053	54	260x233x38	
1 457 433 054	54	211x166x37	
1 457 433 055	54	293x206x42	
1 457 433 056	54	234x177x41	
1 457 433 058	54	370x135x58	
1 457 433 059	54	288x188x42	
1 457 433 060	54	312x150x70	
1 457 433 061	612	272x202x58	
1 457 433 062	57	219x129	
1 457 433 065	87	378x156x58	
1 457 433 066	54	287x167x36	
1 457 433 067	54	286x150x58	
1 457 433 069	62	332x106	
1 457 433 070	54	282x180x57	
1 457 433 071	54	355x135x50	
1 457 433 072	54	259x164x38	
1 457 433 073	54	260x180x40	
1 457 433 075	54	231x193x58	
1 457 433 076	78	382x140x49	
1 457 433 077	56	214x114	
1 457 433 078	54	186x78x58	
1 457 433 079	54	298x223x42	
1 457 433 080	54	258x143x58	
1 457 433 081	54	364x184x55	
1 457 433 083	54	268x168x34	
1 457 433 084	66	135x106	
1 457 433 085	54	245x178x57	
1 457 433 086	54	298x165x53	
1 457 433 087	54	340x206x48	
1 457 433 088	54	320x138x42	
1 457 433 089	54	306x212x45	
1 457 433 090	54	246x168x50	
1 457 433 091	54	295x182x62	
1 457 433 093	67	85x171	
1 457 433 094	61	294x231x47	
1 457 433 095	54	179x254x58	
1 457 433 096	54	172x280x52	
1 457 433 097	54	255x125x46	
1 457 433 098	54	170x243x69	
1 457 433 099	54	173x266x52	
1 457 433 100	63	165x215x47	
1 457 433 101	68	273x313x42	

	Fig.	$a \times b \times c$	
		$H \times \emptyset$ mm	
1 457 433 102	69	405x173x37	
1 457 433 150	54	244x169x68	
1 457 433 152	54	271x261x55	
1 457 433 153	54	245x156x45	
1 457 433 154	56	231x136	
1 457 433 155	54	280x266x49	
1 457 433 156	54	306x292x63	
1 457 433 158	54	336x102x41	
1 457 433 159	54	336x102x70	
1 457 433 160	54	318x114x58	
1 457 433 161	56	207x130	
1 457 433 163	54	377x83x57	
1 457 433 164	70	273x313x47	
1 457 433 200	57	261x131	
1 457 433 201	57	391x160	
1 457 433 227	56	164x140	
1 457 433 228	71	185x130	
1 457 433 229	56	243x114	
1 457 433 230	56	255x127	
1 457 433 231	56	311x128	
1 457 433 232	56	75x360	
1 457 433 233	56	177x160	
1 457 433 234	56	210x138	
1 457 433 250	54	341x177x51	
1 457 433 251	54	342x230x24	
1 457 433 252	54	356x189x49	
1 457 433 253	54	247x180x39	
1 457 433 255	54	230x90x48	
1 457 433 256	54	258x105x60	
1 457 433 257	54	379x141x42	
1 457 433 258	56	250x149	
1 457 433 259	54	298x158x37	
1 457 433 260	54	323x100x57	
1 457 433 261	54	211x184x57	
1 457 433 263	54	282x159x58	
1 457 433 264	54	275x185x57	
1 457 433 265	54	246x169x57	
1 457 433 266	54	265x154x58	
1 457 433 268	54	287x157x47	
1 457 433 269	54	247x153x36	
1 457 433 270	56	345x154	
1 457 433 272	54	345x170x39	
1 457 433 273	54	157x171x33	
1 457 433 274	54	227x170x35	
1 457 433 275	56	176x134	

nl

Luchtfilterpatronen
(vervolg)

sv

Luftfilterinsatser
(fortsättning)

cs

Vložky vzduchového filtru
(pokračování)

pl

Wkłady filtra powietrza
(ciąg dalszy)

ru

Элементы воздушного
фильтра
(продолжение)

	Fig.	$a \times b \times c$	
		$H \times \emptyset$	mm
1 457 433 276	54	345x170x48	
1 457 433 279	54	229x140x40	
1 457 433 280	54	210x169x57	
1 457 433 281	54	293x236x42	
1 457 433 282	54	290x124x57	
1 457 433 285	54	302x117x46	
1 457 433 286	54	288x135x47	
1 457 433 289	54	232x191x50	
1 457 433 290	54	249x159x40	
1 457 433 292	54	500x327	
1 457 433 294	72	253x210x65	
1 457 433 297	54	314x112x63	
1 457 433 298	54	347x174x41	
1 457 433 299	54	341x56x115	
1 457 433 300	54	327x217x57	
1 457 433 303	54	247x197x37	
1 457 433 306	54	217x168x34	
1 457 433 307	56	270x109	
1 457 433 308	54	341x111x40	
1 457 433 309	54	213x167x37	
1 457 433 310	54	254x213x57	
1 457 433 311	54	202x91x255	
1 457 433 314	54	248x150x49	
1 457 433 315	54	300x155x42	
1 457 433 316	54	282x123x50	
1 457 433 317	54	320x151x40	
1 457 433 319	54	300x155x46	
1 457 433 320	61	279x201x48	
1 457 433 322	102	318x199x42	
1 457 433 323	54	281x190x57	
1 457 433 324	54	232x191x62	
1 457 433 325	54	336x102x57	
1 457 433 326	54	204x164x38	
1 457 433 327	54	250x133x66	
1 457 433 329	65	257x150	

	Fig.	$a \times b \times c$	
		$H \times \emptyset$	mm
1 457 433 330	59	67x294	
1 457 433 331	54	315x190x58	
1 457 433 332	49	350x164	
1 457 433 333		434x120	
1 457 433 334		433x120	
1 457 433 339	54	362x237x48	
1 457 433 520	54	325x135x42	
1 457 433 521	59	70x294	
1 457 433 522	54	462x86x70	
1 457 433 523	54	316x190x48	
1 457 433 524	54	340x100x58	
1 457 433 526	54	211x170x42	
1 457 433 527	61	318x175x58	
1 457 433 529	61	176x142x70	
1 457 433 531	54	313x102x42	
1 457 433 532	61	213x220x58	
1 457 433 533	54	279x161x35	
1 457 433 534	59	145x216	
1 457 433 535	54	343x169x58	
1 457 433 536	54	350x217x58	
1 457 433 537	54	258x287x58	
1 457 433 538	56	263x119	
1 457 433 539	54	186x140x50	
1 457 433 540	59	62x278	
1 457 433 541	54	257x124x47	
1 457 433 542	59	59x293	
1 457 433 543	61	318x175x58	
1 457 433 544	56	123x170	
1 457 433 545	54	443x134x33	
1 457 433 546	54	308x184x49	
1 457 433 547	54	260x203x57	
1 457 433 548	54	235x176x57	
1 457 433 549	54	248x207x57	
1 457 433 550	54	249x228x50	
1 457 433 553	56	274x115	

	Fig.	$a \times b \times c$	
		$H \times \emptyset$	mm
1 457 433 555	61	272x202x58	
1 457 433 560	58	344x346	
1 457 433 564	56	420x243	
1 457 433 566	56	322x197	
1 457 433 568	56	404x220	
1 457 433 571	54	262x246x58	
1 457 433 573	61	243x192x58	
1 457 433 574	81	360x226x33	
1 457 433 575	61	213x220x70	
1 457 433 576	74	221x136	
1 457 433 577	54	280x158x50	
1 457 433 578	54	326x252x50	
1 457 433 579	54	326x252x50	
1 457 433 580	54	246x210x44	
1 457 433 581	54	307x120x42	
1 457 433 583	54	236x207x64	
1 457 433 584	54	242x193x32	
1 457 433 585	54	174x207x50	
1 457 433 587	61	327x215x58	
1 457 433 588		377x89	
1 457 433 589	62	464x145	
1 457 433 590	75	139x176	
1 457 433 591	82	358x152x59	
1 457 433 592	54	354x103x50	
1 457 433 593	54	217x168x34	
1 457 433 594	54	395x182x46	
1 457 433 595	54	239x141x58	
1 457 433 596	54	321x152x40	
1 457 433 599	54	250x104x48	
1 457 433 601	54	598x171x61	
1 457 433 603	54	211x166x37	
1 457 433 605	54	256x177x41	
1 457 433 606	54	297x102x49	
1 457 433 607	54	283x171x58	
1 457 433 608	54	369x150x57	

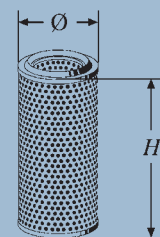
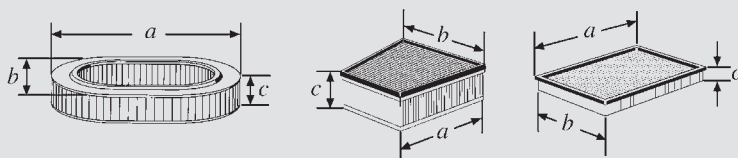

* Neu / New / Nouveau / Nuovo / Nuevo / Nieuwe / Ny / Nové / Nowe / Новые

nl

Luchtfilterpatronen
(vervolg)

sv

Luftfilterinsatser
(fortsättning)

cs

Vložky vzduchového filtru
(pokračování)

pl

Wkłady filtra powietrza
(ciąg dalszy)

ru

Элементы воздушного
фильтра
(продолжение)

	Fig.	$a \times b \times c$	
		$H \times \emptyset$	mm
1 987 429 150	60	284x222x46	
1 987 429 151	54	308x185x42	
1 987 429 152	54	312x150x45	
1 987 429 154	58	162x158	
1 987 429 155	58	290x133	
1 987 429 156	56	292x132	
1 987 429 157	59	145x219	
1 987 429 158	56	145x197	
1 987 429 159	55	45x259	
1 987 429 160	54	310x166x42	
1 987 429 161	54	60x268	
1 987 429 162	54	310x200x51	
1 987 429 163	54	375x135x54	
1 987 429 164	54	185x170x53	
1 987 429 166	76	203x190x35	
1 987 429 167	54	264x135x28	
1 987 429 169	54	196x158	
1 987 429 170	60	342x245x37	
1 987 429 171	54	306x120x44	
1 987 429 172	59	46x215	
1 987 429 173	77	160x307	
1 987 429 174	54	268x188x37	
1 987 429 175	54	179x162x61	
1 987 429 176	78	312x194x44	
1 987 429 177	79	266x116x63	
1 987 429 178	80	323x214x42	
1 987 429 179	54	340x171x35	
1 987 429 180	54	298x237x34	
1 987 429 181	54	274x165x32	
1 987 429 182	54	207x168x80	
1 987 429 183	54	317x163x58	
1 987 429 184	54	315x200x37	
1 987 429 185	54	274x167x42	
1 987 429 186	54	200x155	
1 987 429 187	54	318x193x43	

	Fig.	$a \times b \times c$	
		$H \times \emptyset$	mm
1 987 429 188	54	319x176x48	
1 987 429 189	54	291x211x41	
1 987 429 190	54	392x186x61	
1 987 429 191	81	332x109x41	
1 987 429 192	82	339x151x45	
1 987 429 193	54	296x235x48	
1 987 429 194	54	237x214x40	
1 987 429 400	56	185x152	
1 987 429 401	62	249x133	
1 987 429 402	54	249x211x40	
1 987 429 403	54	300x155x42	
1 987 429 404	54	345x136x70	
1 987 429 405	83	221x136	
1 987 429 406	61	243x192x58	
F 026 ...			
F 026 400 001	54	265x172x32	
F 026 400 002		380x149x53	
F 026 400 004	54	288x247x39	
F 026 400 006	54	249x116x62	
F 026 400 007	54	312x188x67	
F 026 400 010	54	206x170x92	
F 026 400 011		179x107	
F 026 400 012	54	292x224x52	
F 026 400 013		292x234x42	
F 026 400 014		316x262x42	
F 026 400 015	54	289x154x50	
F 026 400 016		254x124x45	
F 026 400 017		289x150x51	
F 026 400 018		200x142	
F 026 400 019	73	420x188x32	
F 026 400 020		329x248x42	
F 026 400 022	105	461x211	
F 026 400 023	87	187x170x70	

	Fig.	$a \times b \times c$	
		$H \times \emptyset$	mm
F 026 400 024		338x120	
F 026 400 025	54	237x192x50	
F 026 400 026	70	225x211x72	
F 026 400 027	75	167x151	
F 026 400 028		192x166	
F 026 400 029		174x176	
F 026 400 030		268x265x50	
F 026 400 033	54	282x180x57	
F 026 400 034	49	410x352	
F 026 400 035		372x190x42	
F 026 400 036		279x97x60	
F 026 400 037	54	231x144x43	
F 026 400 038		309x155x52	
F 026 400 039	66	246x141	
F 026 400 040	75	121x214	
F 026 400 041	54	272x172x54	
F 026 400 042		225x188x37	
F 026 400 043		224x180x46	
F 026 400 044		252x172x46	
F 026 400 045	54	253x149x37	
F 026 400 046 *		228x188	
F 026 400 047	54	238x141x58	
F 026 400 048		266x132x56	
F 026 400 049		212x202x58	
F 026 400 050		495x85x56	
F 026 400 051		377x83x80	
F 026 400 052	54	247x197x58	
F 026 400 053	54	317x152x31	
F 026 400 054 *		170x147x54	
F 026 400 055		355x265x58	
F 026 400 056	54	183x170x57	
F 026 400 057	54	212x202x58	
F 026 400 058		345x147x70	
F 026 400 059	65	303x169	
F 026 400 060		252x114x39	

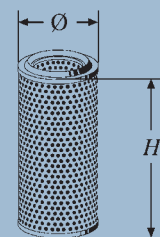
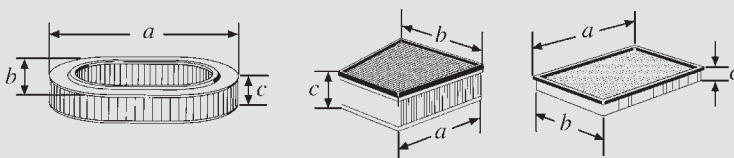

* Neu / New / Nouveau / Nuovo / Nuevo / Nieuwe / Ny / Nové / Nowe / Новые

de

Luftfiltereinsätze
(Fortsetzung)

en

Air-filter elements
(continued)

fr

**Cartouches de filtres
à air**
(suite)

it

**Cartucce filtranti
per filtri aria**
(seguito)

es

**Cartuchos filtrantes
para filtros de aire**
(continuación)

	Fig.	$a \times b \times c$
		$H \times \emptyset$ mm

F 026 400 061	75	175x140
F 026 400 062		248x167x37
F 026 400 063		190x200x50
F 026 400 064		510x267
F 026 400 065	56	512x161

F 026 400 067		383x249
F 026 400 068		486x267
F 026 400 069	56	339x214
F 026 400 070	56	417x214
F 026 400 071		481x265

F 026 400 072		419x267
F 026 400 074		310x248
F 026 400 075		391x248
F 026 400 077	56	500x328
F 026 400 078		468x327

F 026 400 079		606x575
F 026 400 080		421x314
F 026 400 082	56	345x82
F 026 400 083	65	463x310
F 026 400 084	65	505x281

F 026 400 085		592x206
F 026 400 086	65	556x310
F 026 400 087	65	281x480
F 026 400 088		346x520
F 026 400 090		242x163x55

F 026 400 091		270x174x60
F 026 400 092	56	280x145
F 026 400 093		262x132x48
F 026 400 094		626x563x78
F 026 400 095		197x144

F 026 400 096	54	257x222x46
F 026 400 097	54	212x200x58
F 026 400 098	87	230x197x44
F 026 400 099	54	303x224x55
F 026 400 101	54	232x137x34
F 026 400 102		454x89x50
F 026 400 103	54	280x296x57
F 026 400 104	54	270x182x58

	Fig.	$a \times b \times c$
		$H \times \emptyset$ mm

F 026 400 105	54	294x171x50
F 026 400 106	54	271x249x47
F 026 400 107	54	268x144x44
F 026 400 108	54	323x152x59
F 026 400 109		300x240x70

F 026 400 110	61	199x172x38
F 026 400 111		290x258x43
F 026 400 112 *	54	340x170x45
F 026 400 113 *	54	304x196x60
F 026 400 114 *		239x175x54

F 026 400 117 *	58	411x303
F 026 400 119 *	87	299x234x50
F 026 400 120 *	54	245x186x62
F 026 400 121 *	54	305x144x85
F 026 400 122 *	54	419x227x42

F 026 400 123 *	54	260x180x39
F 026 400 125 *		228x178x53
F 026 400 126 *	61	232x163x58
F 026 400 127 *	76	234x178x30
F 026 400 129 *	76	276x187x53

F 026 400 130 *	54	183x169x33
F 026 400 131 *		306x195
F 026 400 132 *	87	199x168x46
F 026 400 133 *		350x176x96
F 026 400 134 *		314x146x48

F 026 400 135 *	54	197x166x71
F 026 400 136 *	65	211x157
F 026 400 137 *		249x130x55
F 026 400 138 *	61	247x192x56
F 026 400 139 *	61	207x192x58

F 026 400 140 *	54	304x144x62
F 026 400 141 *	54	267x172x50
F 026 400 143 *		314x149x76
F 026 400 144 *	54	269x111x36
F 026 400 145 *		461x312
F 026 400 146 *	70	238x209x56
F 026 400 147 *		674x134x45
F 026 400 148 *		353x287x35

	Fig.	$a \times b \times c$
		$H \times \emptyset$ mm

F 026 400 149 *	61	271x251x48
F 026 400 150 *	54	279x167x70
F 026 400 151 *	54	360x145x44
F 026 400 152 *	54	310x156x25
F 026 400 153 *	54	222x187x36

F 026 400 154 *		332x136x36
F 026 400 156 *		170x149
F 026 400 157 *	54	322x128x58
F 026 400 158 *		335x174x53
F 026 400 159 *	68	292x199x46

F 026 400 160 *		306x182x44
F 026 400 161 *	68	195x135x44
F 026 400 162 *	70	280x232x51
F 026 400 163 *		288x223x36
F 026 400 164 *	54	234x188x41

F 026 400 165 *	76	248x199x52
F 026 400 166 *	54	285x249x51
F 026 400 176 *		240x236x86
F 026 400 178 *		405x174x33
F 026 400 179 *		416x356

F 026 400 181 *	70	350x223x47
F 026 400 184 *		500x250
F 026 400 188 *		252x238x56
F 026 400 189 *	56	357x186
F 026 400 197	105	448x203

F 026 400 198 *		192x166
F 026 400 199 *	58	228x145
F 026 400 201 *		226x127x35
F 026 400 205 *		435x119
F 026 400 207 *		416x332

F 026 400 209 *	65	305x227
F 026 400 210	105	456x155
F 026 400 211 *	65	414x232
F 026 400 212 *	54	235x192x58
F 026 400 213 *		167x162
F 026 400 215 *		250x209x35
F 026 400 216 *		273x195x33

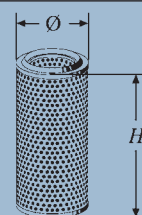
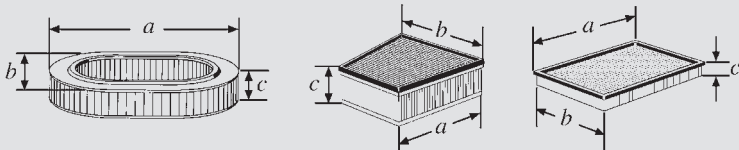

* Neu / New / Nouveau / Nuovo / Nuevo / Nieuwe / Ny / Nové / Nowe / Новые

de

**Darauf schwören Profis:
Nutzfahrzeug-Filter
von Bosch**

nl

**Daarbij zweren profession-
als: Bedrijfswagenfilters
van Bosch**

en

**Trusted by Professionals:
Commercial Vehicle Filters
from Bosch**

sv

**Proffsens favorit:
nyttfordonsfilter
från Bosch**

fr

**Les professionnels leur font
parfaitement confiance: filtres
Bosch pour véhicules utilitaires**

cs

**Na to přísahají profes-
ionálové: Filtr pro užitková
vozidla od fy Bosch**

it

**La prima scelta dei professi-
onisti del settore: filtri Bosch
per veicoli industriali**

pl

**Gwarantowane przez spec-
jalistów: Filtry firmy Bosch
do pojazdów użytkowych**

es

**Filtros Bosch
La mejor protección
del automóvil**

ru

**Профессионалы ручаются за него:
Фильтр для грузовых автомобилей
производства Bosch**



de

Kraftstofffilter für Diesel-
motoren – Filterboxen

en

Fuel filters for diesel
engines – Box-type filters

fr

Filtres à carburant
pour moteurs diesel –
Filtres-box

it

Filtri carburante
per motori diesel –
Cartucce filtranti

es

Filtros de combustible
para motores diesel –
Filtros-caja

Fig.

H
mmØ
mm

A

0 450 ...

0 450 906 174	23	0,5	175	89	
----------------------	----	-----	-----	----	--

0 986 ...

0 986 450 505	47	0,5	138	98	M 20 x 1,5
0 986 450 508	47	0,5	135	98	M 20 x 1,5

1 457 ...

1 457 070 001	48		105	67	
1 457 429 675	47	0,8	142	96	M 16 x 1,5
1 457 429 676	47	1,2	210	96	M 16 x 1,5

1 457 429 681	47	0,8	186	108	¾" 16 UNF
1 457 431 703	1	0,2	106	80	
1 457 434 050	47	0,5	123	83	M 16 x 1,5
1 457 434 051	47	0,4	92	88	M 16 x 1,5
1 457 434 103	13	0,5	130	85	M 16 x 1,5

1 457 434 105	13	0,5	155	83	M 16 x 1,5
1 457 434 106	13	0,5	157	83	M 16 x 1,5
1 457 434 123	47	0,5	100	84	M 12 x 1,5
1 457 434 150	13	0,8	184	83	M 16 x 1,5
1 457 434 153	47	0,4	92	84	M 14 x 1,5

1 457 434 154	47	0,5	123	83	M 16 x 1,5
1 457 434 165	47				
1 457 434 174	13	0,8	163	83	M 16 x 1,5
1 457 434 184	13	0,8	183	84	M 16 x 1,5
1 457 434 186	47	0,9	136	109	M 10 x 1,5

1 457 434 187	13	1,0	185	84	
1 457 434 189	47	0,5	120	80	¾" 16 UNF
1 457 434 192	47	0,5	144	83	M 16 x 1,5
1 457 434 194	13	0,5	157	83	M 16 x 1,5
1 457 434 198	47	0,8	169	81	M 16 x 1,5

1 457 434 200	14	0,8	112	87	
1 457 434 201	14	0,5	71	87	
1 457 434 250	14	0,5	73	87	
1 457 434 251	14	0,5	104	96	
1 457 434 252	14	0,5	103	87	

1 457 434 281	12	0,9	146	100	¾" 16 UNF
1 457 434 291	13	0,5	111	80	M 16 x 1,5
1 457 434 293	13	0,8	182	83	M 16 x 1,5
1 457 434 294	47	0,8	212	93	M 18 x 1,5
1 457 434 295	47	0,5	123	81	M 16 x 1,5



Fig.

H
mmØ
mm

A

1 457 434 296	12	0,5	130	83	M 16 x 1,5
1 457 434 302	12	0,9	135	95	M 20 x 1,5
1 457 434 306	12	0,5	145	83	M 16 x 1,5
1 457 434 310	47	0,8	169	83	M 16 x 1,5
1 457 434 314	47	0,5	142	83	

1 457 434 321	13	0,4	130	83	M 16 x 1,5
1 457 434 324	47	0,8	182	83	M 16 x 1,5
1 457 434 329	13	0,5	155	80	M 16 x 1,5
1 457 434 331			71	81	
1 457 434 400	13	0,5	128	90	M 14 x 1,5

1 457 434 402	13	0,8	195	99	M 14 x 1,5
1 457 434 405	12	0,8	186	83	M 16 x 1,5
1 457 434 408	13	0,5	162	89	
1 457 434 409	47	0,8	144	93	M 16 x 1,5
1 457 434 419	47	1,0	144	96	M 16 x 1,5

1 457 434 421	47	1,0	144	96	M 18 x 1,5
1 457 434 423	47	1,4	210	93	1" 14 UNF
1 457 434 428	47	1,0	142	96	M 24 x 1,5
1 457 434 429	47	1,4	212	96	M 16 x 1,5
1 457 434 430	13	0,5	155	83	M 16 x 1,5

1 457 434 432	12	0,4	119	73	M 16 x 1,5
1 457 434 435	47	0,5	122	84	M 20 x 1,5
1 457 434 436	13	0,5	132	84	
1 457 434 438	47	0,4	129	93	¾" 16 UNF
1 457 434 439	12		141	96	¾" 16 UNF

1 457 434 440	12		122	73	
1 457 434 443	12		97	84	M 16 x 1,5
1 457 434 447	13		146	80	M 16 x 1,5
1 457 434 448	11		107	97	
1 457 434 450	12		108	72	

1 457 434 451	13		153	95	
1 457 434 452	47		97	94	
1 457 434 453	47		127	94	
1 457 434 454	12		102	80	M 20 x 1,5
1 457 434 455	47		149	84	M 16 x 1,5

1 457 434 456	12		126	88	M 20 x 1,5
1 457 434 459	12		143	98	M 22 x 1,5
1 457 434 460	13		178	84	M 16 x 1,5

F 026 ...

F 026 402 002	12		161	81	
F 026 402 013	13		171	87	
F 026 402 017	14		264	113	

de **Filtereinsätze**
 en **Filter elements**
 fr **Cartouches de filtre**
 it **Cartucce filtranti**
 es **Cartuchos filtrantes**

nl **Filterpatronen**
 sv **Filterinsatser**
 cs **Vložky filtrů**
 pl **Wkłady filtra**
 ru **Фильтрующие элементы**

	Fig.		H mm	Ø mm
---	------	---	---------	---------

0 986 ...				
0 986 450 508	47	0,5	135	98

1 457 ...				
1 457 030 013	48	0,5	76	84
1 457 070 000	48		76	84
1 457 070 001	48		105	67

1 457 070 007	48			
1 457 429 230	49	0,2	68	51
1 457 429 289	49	0,5	100	65
1 457 429 291	49	0,4	60	80
1 457 429 354	11	1,0	145	84

1 457 429 359	50	0,5	115	70
1 457 429 621	14	0,4	87	71
1 457 429 655	49	1,2	203	106
1 457 429 656	49	0,5	92	71
1 457 429 657	49	0,2	51	70

1 457 431 028	49	0,5	53	65
1 457 431 158	48	0,5	115	61
1 457 431 159	48	1,1	147	83
1 457 431 261	50	0,5	116	65
1 457 431 270	49	1,1	145	85

1 457 431 325	2	0,5	116	65
1 457 431 326	2	1,1	212	85
1 457 431 702	49	0,4	87	78
1 457 431 703	1	0,2	106	80
1 457 431 704	48	0,4	90	77

1 457 431 705	48	0,4	92	70
1 457 431 707	48	0,7	103	91
1 457 431 708	48	1,0	123	82
1 457 431 710	49	1,1	230	78
1 457 431 712	48	0,2	78	78

1 457 431 713	48	0,2	80	60
1 457 431 715	48		142	83
1 457 431 718			115	75

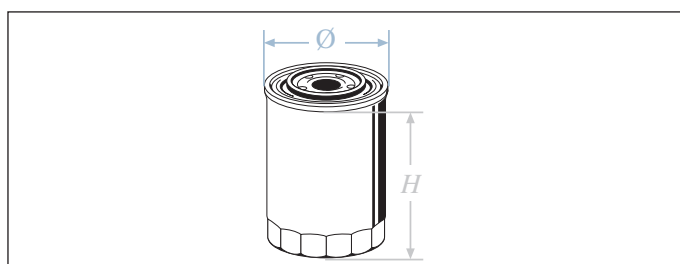

	Fig.		H mm	Ø mm
---	------	---	---------	---------

1 457 431 720	48		96	65
1 457 431 723	48		73	91
1 457 431 724	48		120	71
1 457 431 729	51		90	102
1 457 434 156	47		142	83

1 457 434 187	13	1,0	185	84
1 457 434 281	12	0,9	146	100
1 457 434 438	47	0,4	129	93
1 457 434 440	12		122	73
1 457 434 448	14		107	97

F 026 ...				
F 026 402 002	47		161	81
F 026 402 004	48		118	83
F 026 402 005			111	71

F 026 402 006			136	78
F 026 402 007	58		113	65
F 026 402 008	48		116	84
F 026 402 015	50		84	102
F 026 402 025			157	111





F 026 402 028			173	95
F 026 402 029			230	77
F 026 402 031			219	90
F 026 402 032			250	105
F 026 402 033			205	105

F 026 402 043	13		141	85
F 026 402 047	48		90	69
F 026 402 062			91	79
F 026 402 078 *	48		112	81
F 026 402 100			187	85

F 026 402 101			120	71
---------------	--	--	-----	----

* Neu / New / Nouveau / Nuovo / Nuevo / Nieuwe / Ny / Nové / Nowe / Новые



de Leitungsfilter	en In-line filters	fr Filtres de conduite	it Filtri per tubazioni	es Filtros de tubería
nl Leidingfilters	sv Ledningsfilter	cs Filtr na vedení	pl Filtry przewodów	ru Прямоточные фильтры

	Fig.		H mm	\varnothing mm	B \varnothing mm		B \varnothing mm		
0 450 ...									
0 450 902 161	16	0,2	143	62	-	-	-	-	
0 450 904 058	17	0,1	104	30	-	-	-	-	
0 450 904 060	18	0,1	104	30	-	-	-	-	
0 450 904 077	19	0,1	99	37	-	-	-	-	
0 450 904 149	17	0,1	142	31	-	-	-	-	
0 450 904 158	18		108	50	-	-	-	-	
0 450 904 159	17	0,1	107	50	-	-	-	-	
0 450 904 161	20	0,1	65	44	-	-	-	-	
0 450 904 163	18		134	47	-	-	-	-	
0 450 905 200	21	0,5	152	81	-	-	-	-	
0 450 905 273	22	0,2	162	60	-	-	-	-	
0 450 905 316	22	0,2	156	55	-	-	-	-	
0 450 905 326	35	0,2	73	62	-	-	-	-	
0 450 905 601	21	0,5	152	88	-	-	-	-	
0 450 905 912	21	0,2	116	70	-	-	-	-	
0 450 905 915	24	0,2	111	70	-	-	-	-	
0 450 905 921	35	0,5	165	87	-	-	-	-	
0 450 905 930	23	0,2	127	92	-	-	-	-	
0 450 905 978	42		152	65	-	-	-	-	
0 450 905 982			150	82	-	-	-	-	
0 450 905 990	39		104	65	-	-	-	-	
0 450 906 172	25	0,5	166	89	-	-	-	-	
0 450 906 174	23	0,5	175	89	-	-	-	-	
0 450 906 261	25	0,5	168	81	-	-	-	-	
0 450 906 267	23	0,5	178	81	-	-	-	-	
0 450 906 274	23	0,5	168	89	-	-	-	-	
0 450 906 281	23	0,5	102	89	-	-	-	-	
0 450 906 295	23	0,5	200	89	-	-	-	-	
0 450 906 308	23	0,5	201	89	-	-	-	-	
0 450 906 318	23	0,5	153	89	-	-	-	-	
0 450 906 322	23	0,5	200	89	-	-	-	-	
0 450 906 334	23	0,5	174	89	-	-	-	-	
0 450 906 357	23	0,5	175	89	-	-	-	-	
0 450 906 373	23	0,5	172	89	-	-	-	-	

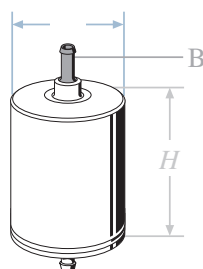
Schlauchanschluss
Hose connection
Raccord de flexible
Raccordo tubo
Racor para tubo flexible
Slangaansluiting
Slanganslutning
Hadicové připojení
Przyłącze wężyka
Подсоединение шланга



de	en	fr	it	es
Leitungsfiler (Fortsetzung)	In-line filters (continued)	Filtres de conduite (suite)	Filtri per tubazioni (seguito)	Filtros de tubería (continuación)

		Fig.		H mm	Ø mm	B Ø mm ↓	B Ø mm ↑
0 450 906 374	23		0,5	200	89	-	-
0 450 906 376	23		0,8	201	89	-	-
0 450 906 406	23		0,5	190	100	-	-
0 450 906 407	23		0,5	190	89	-	-
0 450 906 409	23		0,5	131	89	-	-
0 450 906 426	30			125	88	-	-
0 450 906 429	30			134	80	-	-
0 450 906 431				167	80	-	-
0 450 906 437	23			167	80	-	-
0 450 906 442	25		0,8	177	89	-	-
0 450 906 450	22		0,7	274	55	-	-
0 450 906 451	27		0,7	178	84	-	-
0 450 906 452	23		0,7	182	88	-	-
0 450 906 453	23		0,7	179	88	-	-
0 450 906 457	21			251	55	-	-
0 450 906 458	30		0,4	110	108	-	-
0 450 906 459	30		0,7	207	86	-	-
0 450 906 460	29			135	107	-	-
0 450 906 461				168	104	-	-
0 450 906 462	22		0,7	274	55	-	-
0 450 906 463	22		0,7	274	56	-	-
0 450 906 464	25		0,2	122	91	-	-
0 450 906 467	28			276	80	-	-
0 450 906 468				187	95	-	-
0 450 906 469				187	95	-	-
0 450 906 471				120	110	-	-
0 450 906 473				130	121	-	-
0 450 906 500	44			109	89	-	-
0 450 906 503	25			182	90	-	-
0 450 906 508	15					-	-
0 986 ...							
0 986 450 018	20		0,1	86	44	-	-
0 986 450 030	32		0,1	76	58	-	-
0 986 450 037	34		0,1	66	84	-	-
0 986 450 039	20		0,1	59	49	-	-
0 986 450 120	24		0,2	109	55	-	-
0 986 450 212	31		0,2	108	57	-	-
0 986 450 221	24		0,2	123	88	-	-
0 986 450 222			0,2	151	70	-	-
0 986 450 509	30		0,5	164	88	-	-

nl

Leidingfilters
(vervolg)

sv

Ledningsfilter
(fortsättning)

cs

Filtr na vedení
(pokračování)

pl

Filtry przewodów
(ciąg dalszy)

ru

Прямоточные фильтры
(продолжение)

Fig.

H
mmØ
mm

B Ø ↓

B Ø ↑



1 457 ...

1 457 434 329	13	0,5	155	80	-	-
1 457 434 416		0,7	127	91	-	-
1 457 434 437	25	0,4	125	92	-	-
1 457 434 457			110	86	-	-

F 026 ...





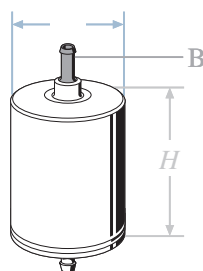



F 026 402 000	44				-	-
F 026 402 001	35		136	55	-	-
F 026 402 002	47		161	81	-	-
F 026 402 003	27		120	92	-	-
F 026 402 016			122	93	-	-
F 026 402 019	23		122	93	-	-
F 026 402 044			120	92	-	-
F 026 402 046			125	127	-	-
F 026 402 049			205	90	-	-
F 026 402 051			193	90	-	-
F 026 402 054			205	90	-	-
F 026 402 056	23		100	90	-	-
F 026 402 059			138	98	-	-
F 026 402 061			120	98	-	-
F 026 402 065 *	30		125	92	-	-
F 026 402 066 *	22		250	55	-	-
F 026 402 067 *			177	98	-	-
F 026 402 068 *	35		250	55	-	-
F 026 402 072 *			122	98	-	-
F 026 402 081 *	13		143	95	-	-
F 026 402 084 *			98	74	-	-
F 026 402 086 *			157	81	-	-
F 026 403 001					-	-
F 026 403 009	35				-	-
F 026 403 014 *			139	55	-	-

Schlauchanschluss
Hose connection
Raccord de flexible
Raccordo tubo
Racor para tubo flexible
Slangaansluiting
Slanganslutning
Hadicové připojení
Przyłącze wężyka
Подсоединение шланга



* Neu / New / Nouveau / Nuovo / Nuevo / Nieuwe / Ny / Nové / Nowe / Новые

de	en	fr	it	es
Ersatzteile für Kraftstoff- filter/-aggregate	Spare parts for fuel filter/ assemblies	Pièces de rechange pour filtres à carburant/unités	Ricambi per filtri carburante/gruppi filtro	Repuestos para filtros Combustible/ Filtros Completos

								
0 450 106 010								
0 450 117 003								
0 450 117 007								
0 450 126 001	1 457 434 051				2 916 710 602	1 453 453 017	1 455 523 009	1 450 508 009
0 450 126 002	1 457 434 051					1 453 453 017	1 455 522 014	1 450 508 009
0 450 126 006	1 457 434 106					1 453 465 017	1 455 523 345	
0 450 126 010								
0 450 126 111	1 457 434 150					1 453 465 017	1 455 522 052	
0 450 126 190	1 457 434 105	1 455 711 006			1 450 206 005	1 453 453 017		
					2 916 710 602			
0 450 126 246								
0 450 126 266	1 457 434 105					1 453 465 009	1 455 523 345	1 450 508 009
0 450 126 267 ^{1) 2)}	1 457 434 310	1 455 711 005	1 457 202 004		1 450 206 005	1 453 453 017	1 455 523 059	1 450 508 014
					2 916 710 609			
0 450 126 268 ^{1) 2)}	1 457 434 310	1 455 711 005	1 457 202 004				1 455 523 059	1 450 508 014
0 450 126 269 ^{1) 2)}	1 457 434 310	1 455 711 005	1 457 202 004				1 455 523 059	1 450 508 014
0 450 132 001	1 457 434 154				2 916 710 602	1 453 453 017	1 455 523 009	1 450 508 009
0 450 132 002	1 457 434 154				2 916 710 602	1 453 453 017	1 455 522 014	1 450 508 009
0 450 132 074	1 457 434 051				2 916 710 602	1 453 453 017	1 455 523 027	1 450 508 009
0 450 132 220								1 450 508 009
0 450 133 007	1 457 434 106					1 453 465 017		1 450 508 009
0 450 133 009	1 457 434 106					1 453 465 017		1 450 508 009
0 450 133 012	1 457 434 099				2 916 710 602	1 453 453 017		1 450 508 009
0 450 133 013	1 457 434 105					1 453 465 009		1 450 508 009
0 450 133 071	1 457 434 105					1 453 465 009		1 450 508 009
0 450 133 075	1 457 434 099				2 916 710 602	1 453 453 017		1 450 508 009
0 450 133 154	1 457 434 105	1 455 711 001	1 457 202 002			1 453 465 009	1 455 522 014	1 450 508 009
0 450 133 171	1 457 434 322						1 455 522 014	1 450 508 009
0 450 133 176	1 457 434 105					1 453 465 009		1 450 508 009
0 450 133 186	1 457 434 105	1 455 711 006	1 457 202 004			1 453 465 009		1 450 508 009
0 450 133 197	1 457 434 322							
0 450 133 211	1 457 434 106					1 453 465 017		
0 450 133 213	1 457 434 105	1 455 711 006	1 457 202 004			1 453 465 009		
0 450 133 255	1 457 434 194	1 455 711 006	1 457 202 004			1 453 465 009	1 455 522 090	1 450 508 009
0 450 133 256	1 457 434 105	1 455 711 006	1 457 202 004			1 453 465 009	1 455 522 071	1 450 508 009
0 450 133 270								
0 450 133 272	1 457 434 293	1 455 711 005	1 457 202 004	1 417 413 061		1 453 465 017	1 455 522 101	1 450 508 014
0 450 133 275	1 457 434 105	1 455 711 006	1 457 202 004			1 453 465 009		1 450 508 009
0 450 133 278	1 457 434 322		1 457 202 004			1 453 465 009	1 455 522 113	1 450 508 025
0 450 133 280	1 457 434 293	1 455 711 005	1 457 202 004	1 417 413 061		1 453 465 017	1 455 522 101	1 450 508 009
0 450 133 281	1 457 434 293	1 455 711 005	1 457 202 004	1 417 413 061		1 453 465 017	1 455 522 127	1 450 508 014
0 450 133 283	1 457 434 293	1 455 711 005	1 457 202 004	1 417 413 061		1 453 465 017	1 455 522 101	
0 450 133 288 ²⁾	1 457 434 306	1 455 711 005	1 457 202 004	1 417 413 061			1 455 522 101	1 450 510 001
0 450 133 289 ²⁾	1 457 434 306	1 455 711 005	1 457 202 004	1 417 413 061			1 455 522 101	1 450 508 014
0 450 133 290 ²⁾	1 457 434 198	1 455 711 005	1 457 202 004	1 417 413 061			1 455 522 101	1 450 508 014
	1 457 434 293					1 453 465 017		1 450 508 009
0 450 133 300 ^{1) 2)}	1 457 434 314	1 455 711 005	1 457 202 004	1 417 413 061			1 455 522 101	1 450 508 014
0 450 133 301 ²⁾	1 457 434 198	1 455 711 005	1 457 202 004	1 417 413 061			1 455 522 101	1 450 508 014
0 450 133 302 ^{1) 2)}	1 457 434 310	1 455 711 005	1 457 202 004				1 455 522 154	1 450 508 014
0 450 134 014	1 457 434 106				2 916 710 602	1 453 465 017	1 455 525 041	1 450 508 009
0 450 134 073	1 457 434 106				2 916 710 602	1 453 465 017	1 455 525 044	1 450 508 009
0 450 136 005	1 457 434 105				2 916 710 602	1 453 465 009	1 455 525 043	1 450 508 009
0 450 136 007	1 457 434 154				2 916 710 602	1 453 465 017	1 455 525 043	1 450 508 009
0 450 136 167	1 457 434 159				2 916 710 602	1 453 465 009	1 455 525 043	1 450 508 009
0 450 136 205	1 457 434 295				2 916 710 602			

nl	sv	cs	pl	ru
Onderdelen voor brandstoftilters/-aggregaten	Reservdelar för bränslefilter/-aggregat	Náhradní díly pro palivové filtry/agregáty	Części zamienne do filtrów/pomp paliwa	Запчасти к топливным фильтрам/агрегатам



0 450 136 212	1 457 434 105	1 455 711 006	1 457 202 004					
0 450 136 214	1 457 434 154	1 455 711 006	1 457 202 004					
0 450 138 002								
0 450 198 169						1 453 465 017		1 450 508 025
0 450 226 023	1 457 434 159							
0 450 907 001	1 457 030 013 ³⁾							
0 450 907 002	1 457 030 013 ³⁾							

- | | | |
|----------------|-------------------|------------------------|
| 1) Common Rail | 2) Wassersensor | 3) Filterelement |
| 1) Common Rail | 2) Water sensor | 3) Filter element |
| 1) Common Rail | 2) Capteur d'eau | 3) Élément filtrant |
| 1) Common Rail | 2) Sensore acqua | 3) Elemento filtrante |
| 1) Common Rail | 2) Sensor de agua | 3) Elemento filtrante |
| 1) Common Rail | 2) Wassersensor | 3) Filterelement |
| 1) Common Rail | 2) Vattensensor | 3) Filterelement |
| 1) Common Rail | 2) Čidlo vody | 3) Element filtru |
| 1) Common Rail | 2) Czujnik wody | 3) Element filtrujący |
| 1) Common Rail | 2) Датчик воды | 3) Фильтрующий элемент |

de

Jetronicfilter
für Einspritzanlagen

en

Jetronic filters for
fuel-injection systems

fr

Filtres Jetronic
pour systèmes d'injection

it

Filtri Jetronic per
impianti d'inezione

es

Filtros Jetronic para
sistemas de Inyección



Fig.

H
mmØ
mm

A ↓

A ↑







B ↓

B ↑

0 450 ...

0 450 901 005			90	45				
0 450 902 151	16	0,2	123	65			8	8
0 450 902 161	16	0,2	143	62			8	8
0 450 902 162	9	0,2	135	90			8	8
0 450 904 058	17	0,1	104	30			8	8
0 450 904 163	18		134	47			7	7
0 450 905 002	22	0,2	138	61			8	8
0 450 905 005	21	0,2	130	64	M 14 x 1,5	M 12 x 1,5		
0 450 905 016	21	0,1	89	72			7,2	7,2
0 450 905 021	21	0,2	135	62	M 12 x 1,5	M 14 x 1,5		
0 450 905 030	22	0,4	140	74			8	8
0 450 905 066	21	0,5	173	81	M 14 x 1,5	M 14 x 1,5		
0 450 905 087	21	0,2	140	74	M 12 x 1,5	M 14 x 1,5		
0 450 905 091	21	0,5	172	88	M 12 x 1,5	M 14 x 1,5		
0 450 905 095	26	0,2	158	81			8	8
0 450 905 104	21	0,4	129	81	M 12 x 1,5	M 14 x 1,5		
0 450 905 133	21	0,5	172	89	M 12 x 1,5	M 14 x 1,5		
0 450 905 143	21	0,5	172	88	M 14 x 1,5	M 14 x 1,5		
0 450 905 145	21	0,5	152	89	M 12 x 1,5	M 14 x 1,5		
0 450 905 177	21	0,5	169	86	M 12 x 1,5	M 14 x 1,5		
0 450 905 195	22	0,5	195	88			8	8
0 450 905 200	21	0,5	152	81	M 14 x 1,5	M 12 x 1,5		
0 450 905 201	22	0,4	151	74			9	9
0 450 905 203	21	0,4	148	80	M 14 x 1,5	M 12 x 1,5		
0 450 905 215	13		135	62				
0 450 905 216	22	0,5	195	88			8	8
0 450 905 264	22	0,4	164	75			8	8
0 450 905 273	22	0,2	162	60			8	8
0 450 905 275	22	0,4	151	75			8	8
0 450 905 280	22	0,2	140	56			8	8
0 450 905 281	21	0,7	165	80	M 14 x 1,5	M 14 x 1,5		
0 450 905 287	22	0,2	137	61			8	8
0 450 905 316	22	0,2	156	55			8	8
0 450 905 318	22	0,4	174	81			8	8
0 450 905 320	16	0,4	162	60			8	8
0 450 905 324	35	0,2	138	80			8	8
0 450 905 326	35	0,2	73	62			8	8
0 450 905 401	21	0,4	129	81	M 14 x 1,5	M 12 x 1,5		
0 450 905 601	21	0,5	152	88	M 14 x 1,5	M 12 x 1,5		
0 450 905 901	22	0,4	206	55			8	8
0 450 905 903	22	0,8	158	81			8	8
0 450 905 904	22	0,2	128	62			8	8
0 450 905 905	22	0,7	300	55			8	8

nl	sv	cs	pl	ru
Jetronicfilters voor injectie-systemen	Jetronic-filter för insprutningsanläggningar	Filtr Jetronic pro vstřikovací soustavy	Filtr Jetronic do układów wtryskowych	Фильтры для систем впрыска Jetronic

	Fig.		$\frac{H}{\text{mm}}$	$\frac{\varnothing}{\text{mm}}$	A 	A 	B $\frac{\varnothing}{\text{mm}}$ 	B $\frac{\varnothing}{\text{mm}}$ 
0 450 905 906	21	0,4	125	75	M 14 x 1,5	M 12 x 1,5		
0 450 905 908	16	0,5	210	88			8	8
0 450 905 909	36	0,2	94	86	M 14 x 1,5	M 14 x 1,25		
0 450 905 911	21	0,2	114	56	M 14 x 1,5	M 14 x 1,5		
0 450 905 912	21	0,2	116	70	M 14 x 1,5	M 14 x 1,5		
0 450 905 914	24	0,4	114	70	M 14 x 1,5	M 14 x 1,25		
0 450 905 915	24	0,2	111	70	M 14 x 1,5	M 12 x 1,2		
0 450 905 916	24	0,4	104	75	M 14 x 1,5	M 12 x 1,25		
0 450 905 920	24	0,2	110	75			9	9
0 450 905 922	20	0,4	68	50			9	9
0 450 905 923	33	0,1	58	49			8,5	8,5
0 450 905 924	24	0,1	104	65	M 14 x 1,5	M 12 x 1,25		
0 450 905 925	38	0,1	150	61			8	8
0 450 905 926	17	0,2	206	55			8	8
0 450 905 927	35	0,2	165	75			8	8
0 450 905 928	17	0,1	125	65			8	8
0 450 905 929	24	0,2	113	70	M 12 x 1,25	M 12 x 1,25		
0 450 905 937	40	0,2	94	70	M 14 x 1,5	M 12 x 1,25		
0 450 905 939	35	0,2	180	51			8	8
0 450 905 940	35	0,2	167	75			8	8
0 450 905 942	22	0,4	340	60			8	8
0 450 905 943	40	0,2	170	88	M 12 x 1,25	M 12 x 1,25		
0 450 905 950	41	0,5	324	56		M 12 x 1,5	8	
0 450 905 951	42		152	65	M 14 x 1,5			8
0 450 905 952	43			55			8	8
0 450 905 953	41		123	65		M 14 x 1,5	8	
0 450 905 954							8	8
0 450 905 955	24		122	70	M 14 x 1,5	M 12 x 1,25		
0 450 905 956	24						8	8
0 450 905 957	24						8	8
0 450 905 958	17		159	65			8	8
0 450 905 959			163	62			8	8
0 450 905 960	43		310	75			8	8
0 450 905 962	24		154	70		M 12 x 1,25	8	
0 450 905 963	24		109	64				

Gewindeanschluss
Threaded connection
Orifice taraudé
Raccordo filettato
Rosca de conexión
Schroefdraadaansluiting
Gånganslutning
Závitové připojení
Przyłącze gwintowane
Резьбовое соединение

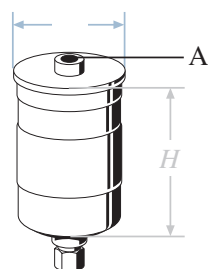

Schlauchanschluss
Hose connection
Raccord de flexible
Raccordo per tubazione
Racor para tubo flexible
Slangaansluiting
Slanganslutning
Hadicové připojení
Przyłącze wężyka
Подсоединение шланга

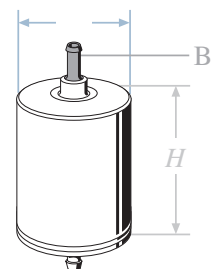

de

Jetronicfilter
für Einspritzanlagen
(Fortsetzung)

en

Jetronic filters for
fuel-injection systems
(continued)

fr

Filtres Jetronic
pour systèmes d'injection
(suite)

it

Filtri Jetronic per
impianti d'inezione
(seguito)

es

Filtros Jetronic para
sistemas de Inyección
(continuación)



		Fig.		$\frac{H}{\text{mm}}$	$\frac{\varnothing}{\text{mm}}$	A	A	B $\frac{\varnothing}{\text{mm}}$	B $\frac{\varnothing}{\text{mm}}$
0 450 905 964	21			155	88	M 14 x 1,5	M 12 x 1,5		
0 450 905 966	35							8	8
0 450 905 967	24							8	8
0 450 905 968				157	75			8	8
0 450 905 969	35							8	8
0 450 905 970								8	8
0 450 905 971								8	8
0 450 905 972	24			130	70	M 12 x 1,25	M 12 x 1,25		
0 450 905 973								8	8
0 450 905 974	17			129	65			8	8
0 450 905 975	35			155	55			8	8
0 450 905 976	35			147	59			8	8
0 450 905 977				131	70	M 12 x 1,25			8
0 450 905 978	42			152	65	M 14 x 1,5			8
0 450 905 979				149	54			9,5	
0 450 905 980	41			173	70	M 14 x 1,5			
0 450 905 981				125	70	M 14 x 1,5	M 12 x 1,25		
0 450 905 982				150	82			8	8
0 450 905 983	35			135	70			8	8
0 450 905 984				130	70	M 12 x 1,25	M 12 x 1,25		
0 450 905 985	22			151	73			9,5	8
0 450 905 986				136	70			8	8
0 450 905 987	42			173	70	M 14 x 1,5			8
0 450 905 988				122	65	M 14 x 1,5			8
0 450 905 989	24			175	70			8	8
0 450 905 990				104	65	M 14 x 1,5	M 12 x 1,25		
0 450 915 001	10	0,1		131	75			8	8
0 450 915 003		0,2		160	75			8	8

0 986 ...

0 986 450 100	40	0,4		95	70	M 12 x 1,5	M 12 x 1,5		
0 986 450 102	24	0,4		181	70			8	8
0 986 450 103	24	0,4		123	70	M 14 x 1,5	M 12 x 1,5		
0 986 450 104	40	0,4		94	70	M 14 x 1,5	M 12 x 1,5		
0 986 450 105	24	0,4		135	70			8	8
0 986 450 106	24	0,4		135	70			8	8
0 986 450 107	24	0,4		123	70	M 14 x 1,5	M 12 x 1,25		
0 986 450 108	24	0,4		171	70			8	8
0 986 450 109	24	0,4		130	70	M 12 x 1,5	M 12 x 1,5		
0 986 450 110	39	0,4		123	70	M 14 x 1,5	M 12 x 1,5		
0 986 450 111	24	0,4		123	70	M 14 x 1,5	M 12 x 1,5		
0 986 450 113	24	0,4		123	70	M 14 x 1,5	M 12 x 1,25		
0 986 450 114	44	0,5		120	90			8	8

nl

**Jetronicfilters voor
injectie-systemen**
(vervolg)

sv

**Jetronic-filter för
insprutningsanläggningar**
(fortsättning)

cs







**Filtr Jetronic pro
vstříkovací soustavy**
(pokračování)

pl

**Filtr Jetronic do układów
wtryskowych**
(ciąg dalszy)

ru

**Фильтры для систем
впрыска Jetronic**
(продолжение)

	Fig.		$\frac{H}{\text{mm}}$	$\frac{\varnothing}{\text{mm}}$	A 	A 	B $\frac{\varnothing}{\text{mm}}$ 	B $\frac{\varnothing}{\text{mm}}$ 
0 986 450 115	24	0,4	114	55	M 14 x 1,5	M 12 x 1,25		
0 986 450 117	33	0,2	60	92			8	8
0 986 450 119	24	0,2	108	55	M 16 x 1,5	M 16 x 1,5		
0 986 450 120	24	0,2	109	55	M 12 x 1,25	M 12 x 1,25		
0 986 450 121	24	0,4	132	55			8	8
0 986 450 123	24	0,2	123	70	M 14 x 1,5	M 12 x 1,25		
0 986 450 124	39	0,2	113	56	M 14 x 1,5	M 14 x 1,5		
0 986 450 137	32	0,1	96	58			8	8
0 986 450 138	31	0,2	86	44			8	8
0 986 450 143								
0 986 450 212	31	0,2	108	57			7	8
0 986 450 220	22	0,1	175	58			9,5	9,5
0 986 450 221	24	0,2	123	88	M 14 x 1,5	M 14 x 1,25		
0 986 450 222	24	0,2	151	70			8	8
0 986 450 225	24	0,2	122	70	M 14 x 1,5	M 14 x 1,5		
0 986 450 226	24	0,2	101	86			8	8
0 986 450 510	37	0,2	135	70			8	8
0 986 450 604	24	0,2	123	70	M 14 x 1,5	M 12 x 1,25		
0 986 450 624	24	0,2	123	70	M 14 x 1,5	M 12 x 1,25		

F 026 ...

F 026 403 000								
F 026 403 001								
F 026 403 002	35							
F 026 403 003								
F 026 403 006			164	61				
F 026 403 008			164	61				
F 026 403 009	35							
F 026 403 012 *			176	82			9,9	7,9
F 026 403 013 *			164	61				

Gewindeanschluss
Threaded connection
Orifice taraudé
Raccordo filettato
Rosca de conexión
Schroefdraadaansluiting
Gånganslutning
Závitové připojení
Przyłącze gwintowane
Резьбовое соединение

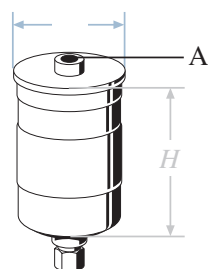

Schlauchanschluss
Hose connection
Raccord de flexible
Raccordo per tubazione
Racor para tubo flexible
Slangaansluiting
Slanganslutning
Hadicové připojení
Przyłącze wężyka
Подсоединение шланга

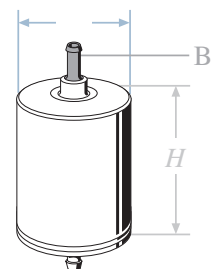

* Neu / New / Nouveau / Nuovo / Nuevo / Nieuwe / Ny / Nové / Nowe / Новые

de

Innenraumfilter -
Standard

en

Cabin filter -
Standard

fr



Filtres d'habitable -
Standard



it

Filtri abitacolo -
Standard

es

Filtros para el habitáculo -
Estándar

	Fig.	$a \times b \times c$		 N°
		$H \times \varnothing$ mm		
1 987 431 154	85	385x128x40	M 1154	
1 987 431 155	85	438x181x56	M 1155	
1 987 431 156	85	571x158x47	M 1156	
1 987 431 157	85	571x158x37	M 1157	
1 987 431 159	85	269x188x36	M 1159	
1 987 431 162	85	361x159x40	M 1162	
1 987 431 163	85	466x182x70	M 1163	
1 987 431 164	85	417x156x25	M 1164	
1 987 431 165	85	440x99x38	M 1165	
1 987 431 166	85	450x206x25	M 1166	
1 987 431 167	97	210x210x50	M 1167	
1 987 431 168	85	439x181x32	M 1168	
1 987 431 169	85	2505x150x45	M 1169	
1 987 431 172	100	199x178x17	M 1172	
1 987 431 174	85	324x162x27	M 1174	
1 987 431 175		326x163x29	M 1175	
1 987 432 001	84	275x219x54	M 2001	
1 987 432 002	85	296x159x26	M 2002	
1 987 432 003	85	290x160x30	M 2003	
1 987 432 004	85	240x204x35	M 2004	
1 987 432 005	85	288x225x13	M 2005	
1 987 432 006	85	336x147x27	M 2006	
1 987 432 007	85	312x156x30	M 2007	
1 987 432 009	85	292x184x18	M 2009	
1 987 432 010	85	411x145x18	M 2010	
1 987 432 011	97	184x170x42	M 2011	
1 987 432 012	85	279x206x25	M 2012	
1 987 432 013	85	261x181x30	M 2013	
1 987 432 014	85	384x170x17	M 2014	
1 987 432 015	85	330x201x18	M 2015	
1 987 432 016	85	290x226x18	M 2016	
1 987 432 017	85	387x147x33	M 2017	
1 987 432 018	85	510x108x36	M 2018	
1 987 432 019	85	309x140x17	M 2019	
1 987 432 020	85	255x122x40	M 2020	
1 987 432 021	85	218x211x19	M 2021	
1 987 432 022	85	271x189x29	M 2022	
1 987 432 024	85	312x193x36	M 2024	
1 987 432 026	85	210x211x30	M 2026	
1 987 432 027	87	240x181x19	M 2027	
1 987 432 028	85	536x110x25	M 2028	
1 987 432 030	85	413x146x25	M 2030	
1 987 432 032	85	327x163x28	M 2032	
1 987 432 033	85	346x214x20	M 2033	
1 987 432 034 *	85	203x178x40	M 2034	

	Fig.	$a \times b \times c$		 N°
		$H \times \varnothing$ mm		
1 987 432 036	85	661x95x20	M 2036	
1 987 432 037	85	354x244x30	M 2037	
1 987 432 038	85	258x233x30	M 2038	
1 987 432 039	85	231x160x30	M 2039	
1 987 432 040	85	292x199x30	M 2040	
1 987 432 042	85	438x144x18	M 2042	
1 987 432 043	85	366x161x29	M 2043	
1 987 432 044	85	366x210x28	M 2044	
1 987 432 045	85	350x160x30	M 2045	
1 987 432 048	87	337x157x30	M 2048	
1 987 432 049	85	184x181x30	M 2049	
1 987 432 050	87	240x185x19	M 2050	
1 987 432 051	85	372x73x24	M 2051	
1 987 432 052	85	230x110x60	M 2052	
1 987 432 053	85	222x199x30	M 2053	
1 987 432 055 *	85	250x172x20	M 2055	
1 987 432 056	88	102x168	M 2056	
1 987 432 057	85	252x216x32	M 2057	
1 987 432 058	85	250x193x20	M 2058	
1 987 432 059	85	265x160x30	M 2059	
1 987 432 060	85	184x92x34	M 2060	
1 987 432 061	85	263x193x17	M 2061	
1 987 432 062	85	253x160x30	M 2062	
1 987 432 063	85	202x220x21	M 2063	
1 987 432 064	85	270x240x25	M 2064	
1 987 432 065 *	85	250x235x25	M 2065	
1 987 432 066	85	230x191x34	M 2066	
1 987 432 068 *	85	233x247x32	M 2068	
1 987 432 069	85	228x195x30	M 2069	
1 987 432 070	87	332x189x25	M 2070	
1 987 432 071	85	300x205x30	M 2071	
1 987 432 072	85	216x163x25	M 2072	
1 987 432 073	85	509x101x35	M 2073	
1 987 432 074	85	225x112x30	M 2074	
1 987 432 075	85	221x201x30	M 2075	
1 987 432 076	85	331x165x30	M 2076	
1 987 432 077 *	85	267x198x21	M 2077	
1 987 432 078 *	85	240x108x20	M 2078	
1 987 432 079	85	285x175x36	M 2079	
1 987 432 081	87	310x258x34	M 2081	
1 987 432 082	85	460x118x30	M 2082	
1 987 432 083	85	220x224x33	M 2083	
1 987 432 084	85	206x186x17	M 2084	
1 987 432 085	85	206x206x17	M 2085	
1 987 432 086 *	92	228x37x13	M 2086	

nl

Standaard
interieurfilters

sv

Kupéfilter -
standard

cs



Filtr vnitřního prostoru -
standardní



pl

Filtr wnętrza
pojazdu - standard

ru

Фильтр салона -
стандарт

	Fig.	$a \times b \times c$		 №
		$H \times \varnothing$ mm		
1 987 432 087	85	240x190x34	M 2087	
1 987 432 088	85	219x200x20	M 2088	
1 987 432 089	85	257x230x20	M 2089	
1 987 432 090	85	234x223x18	M 2090	
1 987 432 091	85	405x164x33	M 2091	
1 987 432 092	85	196x216x25	M 2092	
1 987 432 093	85	261x187x41	M 2093	
1 987 432 094	86	239x238x47	M 2094	
1 987 432 095	85	265x119x30	M 2095	
1 987 432 096	85	441x126x30	M 2096	
1 987 432 097	87	211x272x33	M 2097	
1 987 432 102	85	316x170x30	M 2102	
1 987 432 103	85	314x164x30	M 2103	
1 987 432 104	89	73x164	M 2104	
1 987 432 105	87	215x187x25	M 2105	
1 987 432 106	85	203x178x17	M 2106	
1 987 432 107	85	230x213x12	M 2107	
1 987 432 108	90	230x170x4	M 2108	
1 987 432 111	85	210x240x32	M 2111	
1 987 432 113	85	235x209x35	M 2113	
1 987 432 114	85	278x219x30	M 2114	
1 987 432 115	86	178x183x28	M 2115	
1 987 432 116	86	244x219x75	M 2116	
1 987 432 117	91	198x108x22	M 2117	
1 987 432 118	92	244x102x24	M 2118	
1 987 432 119	86	242x205x21	M 2119	
1 987 432 120	86	226x189x43	M 2120	
1 987 432 121	85	222x198x30	M 2121	
1 987 432 122 *	85	307x100x30	M 2122	
1 987 432 124	100	832x123x20	M 2124	
1 987 432 136	85	201x157x30	M 2136	
1 987 432 137 *	85	290x96x30	M 2137	
1 987 432 150	85	380x134x37	M 2150	
1 987 432 151	85	396x182x40	M 2151	
1 987 432 152	85	311x225x25	M 2152	
1 987 432 153	85	165x223x68	M 2153	
1 987 432 154		120x114x10	M 2154	
1 987 432 155	93	197x200x20	M 2155	
1 987 432 156	85	213x108x17	M 2156	
1 987 432 157	92	187x156x42	M 2157	
1 987 432 158		227x263x34	M 2158	
1 987 432 159	94	202x288x19	M 2159	
1 987 432 160	95	248x194x38	M 2160	
1 987 432 161	85	239x196x12	M 2161	
1 987 432 162	95	178x216x24	M 2162	

	Fig.	$a \times b \times c$		 №
		$H \times \varnothing$ mm		
1 987 432 163	92	216x173x22	M 2163	
1 987 432 164	94	174x175x12	M 2164	
1 987 432 166	85	224x234x30	M 2166	
1 987 432 167	85	181x93x29	M 2167	
1 987 432 169		217x196x25	M 2169	
1 987 432 170	85	227x201x17	M 2170	
1 987 432 171	85	189x196x10	M 2171	
1 987 432 172	85	199x178x17	M 2172	
1 987 432 173	85	178x186x30	M 2173	
1 987 432 175	99	259x198x25	M 2175	
1 987 432 176	95	225x200x25	M 2176	
1 987 432 179	92	222x204x12	M 2179	
1 987 432 182	92	386x248x30	M 2182	
1 987 432 183	85	257x164x21	M 2183	
1 987 432 184	85	224x114x30	M 2184	
1 987 432 188	85	219x265x21	M 2188	
1 987 432 189	92	43x163x214	M 2189	
1 987 432 190	85	192x213x30	M 2190	
1 987 432 192	86	355x129x25	M 2192	
1 987 432 193	88	179x145	M 2193	
1 987 432 194	85	260x100x25	M 2194	
1 987 432 195	85	347x206x33	M 2195	
1 987 432 200 *	85	315x153x34	M 2200	
1 987 432 203	86	240x198x30	M 2203	
1 987 432 204	85	238x197x20	M 2204	
1 987 432 205	85	272x196x35	M 2205	
1 987 432 206	85	376x176x48	M 2206	
1 987 432 207	92	185x109x42	M 2207	
1 987 432 208	92	330x192x45	M 2208	
1 987 432 213	85	354x235x34	M 2213	
1 987 432 214	85	200x142x30	M 2214	
1 987 432 215	85	236x191x22	M 2215	
1 987 432 216		216x200x30	M 2216	
1 987 432 218	85	219x173x20	M 2218	
1 987 432 219	85	293x138x34	M 2219	

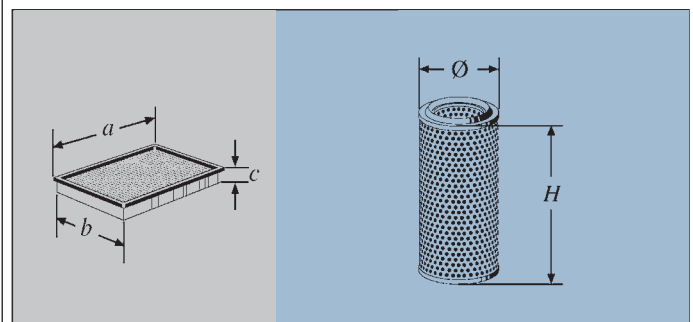

* Neu / New / Nouveau / Nuovo / Nuevo / Nieuwe / Ny / Nové / Nowe / Новые



0 451 102 056	0 451 103 901	AUSTIN, BEDFORD, BKS, FORD, INNOCENTI-LEYLAND, LEYLAND, LOTUS, MG, MINI, MORRIS, OPEL, PRINCESS, ROVER, STEYR, VAUXHALL
0 451 103 029	0 451 103 903	ALFA ROMEO, CHRYSLER, DAVID BROWN, FAUN, FORD, HILLMAN, LINDE, MERCURISER, O & K, RELIANT, SAAB, SEAT, STEINBOCK, STILL, SUNBEAM
0 451 103 033	0 451 103 904	AGRIA, ATLAS COPCO, AUDI, BOMAG, FLOTTMANN WERKE, FORD, JW, KHD, NISSAN, NSU, PORSCHE, REFORMWERKE BAUER, SEAT, SULLAIR, TRABANT, VW, WARTBURG
0 451 103 079	0 451 103 204	BUICK, CHEVROLET, DAEWOO, HOLDEN, NISSAN, OPEL, ROVER, SAAB, TOYOTA, VAUXHALL
0 451 103 219	0 451 103 221	ATLAS COPCO, OPEL, VOLVO
0 451 103 298	0 451 103 907	AUSTIN, FORD, MAZDA, ROVER, SKODA, STEINBOCK
0 451 203 012	0 451 103 906	AUDI, LINDE, NISSAN, SEAT, VOLVO, VW
0 451 103 261	F 026 408 900	CITROËN, FIAT, LANCIA, NISSAN, PEUGEOT, ROVER, SUZUKI
0 451 103 086	F 026 408 901	BMW
0 451 103 314	F 026 408 902	AUDI, SEAT, SKODA, VW
0 451 203 154	F 026 408 903	ABG, AHLMANN, AIFO, AKERMANS VERKSTAD AB, ATLAS, ATLAS COPCO, BAUER, BKS, BOMAG, CASE IH, CLAAS, CLARK, CLAYSON, COLES, DEMAG, DEUTZ-FAHR, DRESSER, EDER, FAHR, FAUN, FENDT, FIAT, FLOTTMANN WERKE, FRISCH, FUCHS, GOTTWALD, HAMM, HANOMAG, HATRA, HOES, HY-MAC, IH, INGERSOLL-RAND, IRMER U. ELZE, IVECO, JW, KAEUBLE, KAEUBLE-GMEINDER, KHD, KOCKUM, KRAMER, KÄSSBOHRER, LAMBORGHINI, LIEBHERR, LINDE, LMV, LOMBARDINI, LOSENHAUSEN, MAGIRUS-DEUTZ, MAN, MASSEY-FERGUSON-HANOMAG, MENCK U. HAMBROCK, MENGELE, MIAG, MWM-DIESEL, O & K, POCLAIN, RENAULT, RUTHEMEYER, SAURER, SCANIA, SCHOPF, SENNEBOGEN, SOYLAND, STEINBOCK, STILL, SULLAIR, VALMET, VOLVO, WELLER, WESERHÜTTE
0 451 104 066	F 026 408 904	ABG, AHLMANN, ATLAS, ATLAS COPCO, BAUER, BKS, BOMAG, CLAAS, CLARK, DEMAG, DEUTZ-FAHR, DYNAPAC, EDER, FAHR, FENDT, FLOTTMANN WERKE, FRISCH, FUCHS, HAMM, HANOMAG, HATRA, HOES, INGERSOLL-RAND, IRMER U. ELZE, IVECO, KAEUBLE, KHD, KRAMER, KÄSSBOHRER, LIEBHERR, LINDE, LOSENHAUSEN, MAGIRUS-DEUTZ, MASSEY-FERGUSON-HANOMAG, MIAG, MWM-DIESEL, O & K, POCLAIN, PORSCHE, RUTHEMEYER, SCHOPF, SENNEBOGEN, STEINBOCK, STILL, SULLAIR, VALMET, WELLER, WESERHÜTTE



nl

Filters-groot-
verpakkingen

sv

Filter-
Storförpackningar

cs

Velké balení
filtru

pl

Duże opakowania
filtrów

ru

Оптовые упаковки
фильтров



0 450 904 058 **F 026 403 900** AUTOBIANCHI, BMW, CITROËN, DAEWOO, FIAT, FORD, HOLDEN, INNOCENTI,
LANCIA, MOSKWITSCH, NISSAN, PEUGEOT, RENAULT, TALBOT, TOYOTA, ZAZ



1 987 432 012 **1 987 432 808** AUDI, SEAT, SKODA, VW

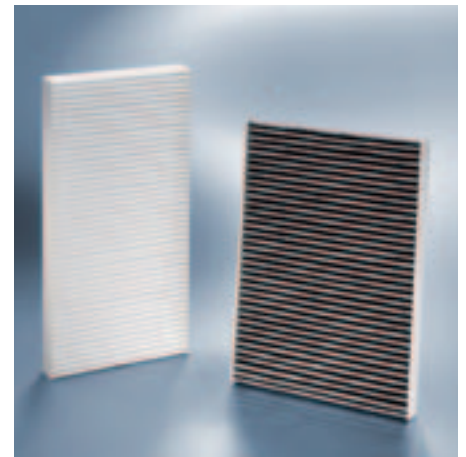

de

SB-Verpackung →
Werkstattverpackung

en

Self-service pack →
workshop packs

fr

Emballage libre-service →
emballage atelier

it

Confezione self-service →
confezione per officina

es

Envase de autoservicio →
envase de taller

1 457 030 813	D 760	1 457 030 013
1 457 070 800	D 756	1 457 070 000
1 457 070 801	D 801	1 457 070 001
1 457 431 891	D 891	1 457 429 291
1 457 434 107	D 701	1 457 434 106

1 457 434 803	D 803	1 457 434 103
1 457 434 824	D 824	1 457 434 324
1 457 434 881	D 881	1 457 434 281
1 457 434 884	D 884	1 457 434 184
1 457 434 893	D 893	1 457 434 293

0 450 902 861	B 861	0 450 902 161
0 450 904 059	B 002	0 450 904 058
0 450 904 150	B 003	0 450 904 149
0 450 905 802	B 002	0 450 905 002
0 450 905 816	B 316	0 450 905 316

0 450 905 818	B 318	0 450 905 318
0 450 905 824	B 324	0 450 905 324
0 450 905 830	B 830	0 450 905 030
0 450 905 873	B 873	0 450 905 273
0 450 905 880	B 880	0 450 905 280

0 450 905 887	B 887	0 450 905 287
0 450 906 804	D 804	0 450 906 274
0 450 906 809	D 809	0 450 906 409
0 450 906 822	D 822	0 450 906 322
0 450 906 829	D 829	0 450 906 429

0 450 906 834	D 834	0 450 906 334
0 450 906 857	D 857	0 450 906 357
0 450 906 861	D 861	0 450 906 261
0 450 906 867	D 867	0 450 906 267
0 450 906 872	D 872	0 450 906 172

0 450 906 873	D 873	0 450 906 373
0 450 906 874	D 761	0 450 906 374
0 450 906 895	D 895	0 450 906 295
1 457 434 810	D 810	1 457 434 310
1 457 434 814	D 814	1 457 434 314

1 457 434 821	D 821	1 457 434 321
1 457 434 898	D 898	1 457 434 198
F 026 402 750	D 750	1 457 431 715
F 026 402 754	D 754	0 450 906 460
F 026 402 759	D 759	1 457 434 442



F 026 402 762	D 762	1 457 431 703
F 026 402 763	D 763	0 450 905 930
F 026 402 764	D 764	1 457 434 437
F 026 402 765	D 765	1 457 431 704
F 026 402 766	D 766	1 457 434 187

F 026 402 767	D 767	1 457 434 416
F 026 402 768	D 768	1 457 434 438
F 026 402 769	D 769	1 457 434 453
F 026 402 770	D 770	1 457 431 708
F 026 402 771	D 771	0 450 906 461

F 026 402 772	D 772	1 457 431 723
F 026 402 773	D 773	0 450 906 469
F 026 402 774	D 774	0 450 906 457
F 026 402 775	D 775	1 457 434 201
F 026 402 776	D 776	1 457 431 705

F 026 402 777	D 777	1 457 429 656
F 026 402 778	D 778	0 450 906 468
F 026 402 779	D 779	0 450 906 471
F 026 402 780	D 780	0 450 906 473
F 026 402 781	D 781	0 450 904 077

F 026 402 782	D 782	1 457 434 440
F 026 402 783	D 783	0 450 906 451
F 026 402 784	D 784	1 457 429 621
F 026 402 785	D 785	1 457 429 657
F 026 402 786	D 786	1 457 434 200

F 026 402 787	D 787	1 457 431 712
F 026 402 788	D 788	1 457 434 291
F 026 403 750	D 705	0 986 450 509



1 457 429 089	L 302	1 457 429 050
1 457 429 091	L 413	1 457 429 053
1 457 429 092	L 403	1 457 429 054
1 457 429 099	L 090	1 457 429 030
1 457 429 828	L 203	1 457 429 875

1 457 429 831	L 311	1 457 429 920
1 457 429 832	L 204	1 457 429 964
1 457 429 974	L 307	1 457 432 111
1 457 429 997	L 103	1 457 429 994
1 457 433 028	L 333	1 457 433 008

1 457 433 030	L 291	F 026 400 011
1 457 433 305	L 415	1 457 433 281
1 457 433 401	L 338	1 457 433 234
1 457 433 411	L 390	1 457 432 134
1 457 433 419	L 254	1 457 432 154

1 457 433 424	L 255	1 457 433 227
1 457 433 430	L 279	1 457 433 233
1 457 433 431	L 510	1 457 433 229
1 457 433 432	L 350	1 457 432 124
1 457 433 433	L 509	1 457 433 624

1 457 433 434	L 512	1 457 433 231
1 457 433 435	L 277	1 457 429 841
1 457 433 442	L 106	1 457 433 606
1 457 433 443	L 108	1 457 433 623
1 457 433 460	L 211	1 457 433 257

1 457 433 461	L 316	1 457 433 265
1 457 433 464	L 249	1 457 433 280
1 457 433 612	L 340	1 457 433 023
1 457 433 613	L 240	1 457 433 007
1 457 433 614	L 345	1 457 429 896

1 457 433 691	L 289	1 457 433 686
1 457 433 704	L 236	1 457 429 777
1 457 433 706	L 086	1 457 432 173
1 457 433 707	L 085	1 457 432 180
1 457 433 708	L 235	1 457 433 253

1 457 433 709	L 087	1 457 433 255
1 457 433 710	L 201	1 457 433 259
1 457 433 754	L 210	1 457 432 200
1 457 433 755	L 270	1 457 429 908
1 457 433 756	L 410	1 457 429 775

nl

Zelfbedieningsverpakking
→ werkplaatsverpakking

sv

SB-förpackning →
verkstadsförpackning

cs

Samoobslužné balení →
Servisní balení

pl

Opakowanie
samoobsługowe →
opakowanie warsztatowe

ru

Упаковка для
самообслуживания →
Упаковка для СТО

1 457 433 757	L 245	1 457 433 603
1 457 433 758	L 260	1 457 429 791
1 457 433 759	L 450	1 457 429 923
1 457 433 760	L 250	1 457 433 004
1 457 433 761	L 470	1 457 429 819

1 457 433 763	L 213	1 457 429 870
1 457 433 765	L 135	1 457 432 183
1 457 433 768	L 110	1 457 433 256
1 457 433 803	L 252	1 457 433 713
1 457 433 804	L 313	1 457 433 714

1 457 433 808	L 318	1 457 433 716
1 457 433 811	L 335	1 457 433 605
1 457 433 819	L 109	1 457 433 773
1 457 433 825	L 225	1 457 433 526
F 026 401 700	L 800	1 457 433 076

F 026 401 701	L 701	1 457 433 521
F 026 401 702	L 702	1 457 433 531
F 026 401 703	L 703	1 457 433 540
F 026 401 704	L 704	1 457 433 575
F 026 401 705	L 705	1 987 429 404

F 026 401 706	L 706	1 457 433 264
F 026 401 708	L 708	1 457 433 055
F 026 401 709	L 709	1 457 433 058
F 026 401 710	L 810	1 457 433 059
F 026 401 711	L 711	1 457 433 791

F 026 401 712	L 712	1 457 432 146
F 026 401 713	L 713	1 457 433 971
F 026 401 714	L 714	1 457 433 553
F 026 401 715	L 715	1 457 433 268
F 026 401 716	L 716	1 457 433 712

F 026 401 717	L 717	1 457 429 079
F 026 401 718	L 718	1 457 433 282
F 026 401 719	L 719	1 457 433 520
F 026 401 720	L 720	1 457 433 077
F 026 401 721	L 721	1 457 432 138

F 026 401 722	L 722	1 457 433 260
F 026 401 723	L 723	1 457 433 266
F 026 401 724	L 724	F 026 400 010
F 026 401 725	L 725	F 026 400 015
F 026 401 726	L 726	F 026 400 016



F 026 401 727	L 727	1 457 433 099
F 026 401 728	L 728	1 457 433 046
F 026 401 729	L 729	1 457 433 529
F 026 401 730	L 730	1 457 433 573
F 026 401 731	L 731	1 457 433 069

F 026 401 732	L 732	1 457 433 588
F 026 401 733	L 733	1 457 433 589
F 026 401 734	L 734	1 457 433 075
F 026 401 735	L 735	1 987 429 406
F 026 401 736	L 736	1 457 433 748

F 026 401 737	L 737	1 457 433 065
F 026 401 738	L 738	1 457 433 539
F 026 401 739	L 739	1 457 429 793
F 026 401 740	L 740	1 457 433 078
F 026 401 741	L 741	1 457 433 772

F 026 401 742	L 742	1 457 433 752
F 026 401 743	L 743	1 987 429 135
F 026 401 744	L 744	1 457 433 608
F 026 401 745	L 745	1 457 433 595
F 026 401 746	L 746	1 457 433 555

F 026 401 747	L 747	1 457 433 047
F 026 401 748	L 748	1 457 433 061
F 026 401 749	L 749	1 457 433 781
F 026 401 750	L 750	1 457 433 535
F 026 401 751	L 751	1 457 433 090

F 026 401 752	L 752	F 026 400 038
F 026 401 753	L 753	1 457 433 163
F 026 401 754	L 754	1 457 433 160
F 026 401 755	L 755	1 457 433 150
F 026 401 756	L 756	1 457 433 544

F 026 401 757	L 757	1 457 433 158
F 026 401 758	L 758	1 457 433 769
F 026 401 759	L 759	1 457 433 273
F 026 401 760	L 760	1 987 429 182
F 026 401 761	L 761	1 987 429 051

F 026 401 762	L 762	1 457 433 081
F 026 401 763	L 763	1 987 429 177
F 026 401 764	L 764	1 987 429 190
F 026 401 765	L 765	1 457 433 161
F 026 401 766	L 766	1 457 433 309



F 026 401 767	L 767	1 457 429 894
----------------------	-------	----------------------

de

SB-Verpackung →
Werkstattverpackung

en

Self-service pack →
workshop packs

fr

Emballage libre-service →
emballage atelier

it

Confezione self-service →
confezione per officina

es

Envase de autoservicio →
envase de taller



0 451 103 044	0 231	0 451 103 029
0 451 103 046	0 530	0 451 103 033
0 451 103 049	0 133	0 451 102 056
0 451 103 070	0 550	0 451 103 314
0 451 103 071	0 105	0 451 103 300

0 451 103 091	0 502	0 451 103 086
0 451 103 097	0 122	0 451 103 079
0 451 103 098	0 403	0 451 103 232
0 451 103 190	0 503	0 451 103 105
0 451 103 222	0 136	0 451 103 219

0 451 103 283	0 306	0 451 103 111
0 451 103 301	0 304	0 451 103 227
0 451 103 303	0 201	0 451 103 261
0 451 103 304	0 508	0 451 103 259
0 451 103 306	0 505	0 451 103 290

0 451 103 307	0 110	0 451 103 298
0 451 103 345	0 002	0 451 103 336
0 451 103 356	0 010	0 451 103 351
0 451 103 359	0 203	0 986 452 036
0 451 104 069	0 301	0 451 103 318

0 451 203 061	0 626	0 451 203 012
0 986 452 067	0 009	0 986 452 061
0 986 452 906	0 315	0 986 452 006
0 986 452 916	0 126	0 986 452 016
0 986 452 928	0 004	0 986 452 028

0 986 452 929	0 318	0 986 452 023
1 457 429 109	0 115	1 457 429 147
1 457 429 124	0 636	1 457 429 122
1 457 429 140	0 710	1 457 429 619
1 457 429 266	0 810	1 457 429 265

1 457 429 273	0 702	1 457 429 274
1 457 429 617	0 507	1 457 429 610
1 457 429 618	0 410	1 457 429 638
1 457 429 756	0 527	1 457 429 755
1 457 429 761	0 205	1 457 429 760

F 026 408 700	0 700	0 451 103 346
F 026 408 701	0 701	0 451 103 354
F 026 408 702	0 870	1 457 429 152
F 026 408 703	0 703	1 457 429 184
F 026 408 704	0 704	1 457 429 192



F 026 408 705	0 705	1 457 429 194
F 026 408 706	0 706	1 457 429 199
F 026 408 707	0 707	1 457 429 249
F 026 408 708	0 708	1 457 429 193
F 026 408 709	0 709	0 451 103 352

F 026 408 710	0 871	1 457 429 123
F 026 408 711	0 711	0 451 103 316
F 026 408 712	0 712	0 986 452 044
F 026 408 713	0 713	0 451 103 276
F 026 408 714	0 714	0 451 103 309

F 026 408 715	0 715	0 986 452 058
F 026 408 716	0 716	1 457 429 127
F 026 408 717	0 717	1 457 429 238
F 026 408 718	0 718	1 457 429 239
F 026 408 719	0 719	1 457 429 256

F 026 408 720	0 720	0 451 103 235
F 026 408 721	0 721	0 986 452 041
F 026 408 722	0 722	F 026 407 015
F 026 408 723	0 723	1 457 429 198
F 026 408 725	0 725	1 457 429 272

F 026 408 726	0 726	0 451 103 349
F 026 408 727	0 727	0 451 103 353
F 026 408 728	0 728	1 457 429 118
F 026 408 729	0 729	0 451 103 289
F 026 408 730	0 730	1 457 429 252

F 026 408 731	0 731	1 457 429 102
F 026 408 732	0 732	1 457 429 185
F 026 408 733	0 733	1 457 429 119
F 026 408 734	0 734	0 451 103 347
F 026 408 735	0 735	0 986 452 062

F 026 408 736	0 736	0 986 452 060
F 026 408 737	0 737	0 451 103 365
F 026 408 738	0 738	0 451 103 341
F 026 408 739	0 739	0 986 452 046
F 026 408 741	0 741	1 457 429 157

F 026 408 743	0 743	0 451 103 299
F 026 408 744	0 744	0 451 103 240
F 026 408 745	0 745	0 451 103 252
F 026 408 771	0 771	0 451 103 355



nl

Zelfbedieningsverpakking
→ werkplaatsverpakking

sv

SB-förpackning →
verkstadsförpackning

cs

Samoobslužné balení →
Servisní balení

pl

Opakowanie
samoobsługowe →
opakowanie warsztatowe

ru

Упаковка для
самообслуживания →
Упаковка для СТО

1 987 431 003	A 310	1 987 432 003
1 987 431 006	A 304	1 987 432 006
1 987 431 007	A 325	1 987 432 007
1 987 431 012	A 501	1 987 432 012
1 987 431 015	A 500	1 987 432 015

1 987 431 017	A 302	1 987 432 017
1 987 431 018	A 100	1 987 432 018
1 987 431 019	A 505	1 987 432 019
1 987 431 021	A 503	1 987 432 021
1 987 431 027	A 507	1 987 432 027

1 987 431 028	A 102	1 987 432 028
1 987 431 030	A 250	1 987 432 030
1 987 431 038	A 603	1 987 432 038
1 987 431 039	A 551	1 987 432 039
1 987 431 045	A 575	1 987 432 045

1 987 431 048	A 570	1 987 432 048
1 987 431 057	A 509	1 987 432 057
1 987 431 061	A 513	1 987 432 061
1 987 431 069	A 538	1 987 432 069
1 987 431 070	A 539	1 987 432 070

1 987 431 071	A 576	1 987 432 071
1 987 431 072	A 578	1 987 432 072
1 987 431 079	A 609	1 987 432 079
1 987 431 300	K 525	1 987 432 300
1 987 431 371	K 576	1 987 432 371

1 987 432 700	A 700	1 987 432 093
1 987 432 701	A 701	1 987 432 010
1 987 432 702	A 702	1 987 432 060
1 987 432 703	A 703	1 987 432 097
1 987 432 704	A 704	1 987 432 036

1 987 432 705	A 705	1 987 432 076
1 987 432 706	A 706	1 987 432 094
1 987 432 707	A 707	1 987 432 083
1 987 432 708	A 708	1 987 432 084
1 987 432 709	A 709	1 987 432 040

1 987 432 710	A 710	1 987 432 120
1 987 432 815	K 815	1 987 432 354
1 987 432 816	K 816	1 987 432 361
1 987 432 817	K 817	1 987 432 386
1 987 432 818	K 818	1 987 432 387



1 987 432 820	K 820	1 987 432 380
----------------------	-------	----------------------



de

Werkstattverpackung →
SB-Verpackung

en

Workshop packs →
self-service pack

fr

Emballage atelier →
emballage libre-service

it

Confezione per officina →
confezione self-service

es

Envase de taller →
envase de autoservicio



0 450 902 161	0 450 902 861	B 861
0 450 904 058	0 450 904 059	B 002
0 450 904 077	F 026 402 781	D 781
0 450 904 149	0 450 904 150	B 003
0 450 905 002	0 450 905 802	B 002
0 450 905 030	0 450 905 830	B 830
0 450 905 273	0 450 905 873	B 873
0 450 905 280	0 450 905 880	B 880
0 450 905 287	0 450 905 887	B 887
0 450 905 316	0 450 905 816	B 316
0 450 905 318	0 450 905 818	B 318
0 450 905 324	0 450 905 824	B 324
0 450 905 930	F 026 402 763	D 763
0 450 906 172	0 450 906 872	D 872
0 450 906 261	0 450 906 861	D 861
0 450 906 267	0 450 906 867	D 867
0 450 906 274	0 450 906 804	D 874
0 450 906 295	0 450 906 895	D 895
0 450 906 322	0 450 906 822	D 822
0 450 906 334	0 450 906 834	D 834
0 450 906 357	0 450 906 857	D 857
0 450 906 373	0 450 906 873	D 873
0 450 906 374	0 450 906 874	D 761
0 450 906 409	0 450 906 809	D 809
0 450 906 429	0 450 906 829	D 829
0 450 906 451	F 026 402 783	D 783
0 450 906 457	F 026 402 774	D 774
0 450 906 460	F 026 402 754	D 754
0 450 906 461	F 026 402 771	D 771
0 450 906 468	F 026 402 778	D 778
0 450 906 469	F 026 402 773	D 773
0 450 906 471	F 026 402 779	D 779
0 450 906 473	F 026 402 780	D 780
0 986 450 509	F 026 403 750	D 705
1 457 030 013	1 457 030 813	D 760
1 457 070 000	1 457 070 800	D 756
1 457 070 001	1 457 070 801	D 801
1 457 429 291	1 457 431 891	D 891
1 457 429 621	F 026 402 784	D 784
1 457 429 656	F 026 402 777	D 777



1 457 429 657	F 026 402 785	D 785
1 457 431 703	F 026 402 762	D 762
1 457 431 704	F 026 402 765	D 765
1 457 431 705	F 026 402 776	D 776
1 457 431 708	F 026 402 770	D 770
1 457 431 712	F 026 402 787	D 787
1 457 431 715	F 026 402 750	D 750
1 457 431 723	F 026 402 772	D 772
1 457 434 103	1 457 434 803	D 803
1 457 434 106	1 457 434 107	D 701
1 457 434 184	1 457 434 884	D 884
1 457 434 187	F 026 402 766	D 766
1 457 434 198	1 457 434 898	D 898
1 457 434 200	F 026 402 786	D 786
1 457 434 201	F 026 402 775	D 775
1 457 434 281	1 457 434 881	D 881
1 457 434 291	F 026 402 788	D 788
1 457 434 293	1 457 434 893	D 893
1 457 434 310	1 457 434 810	D 810
1 457 434 314	1 457 434 814	D 814
1 457 434 321	1 457 434 821	D 821
1 457 434 324	1 457 434 824	D 824
1 457 434 416	F 026 402 767	D 767
1 457 434 437	F 026 402 764	D 764
1 457 434 438	F 026 402 768	D 768
1 457 434 440	F 026 402 782	D 782
1 457 434 442	F 026 402 759	D 759
1 457 434 453	F 026 402 769	D 769



1 457 429 030	1 457 429 099	L 090
1 457 429 050	1 457 429 089	L 302
1 457 429 053	1 457 429 091	L 413
1 457 429 054	1 457 429 092	L 403
1 457 429 079	F 026 401 717	L 717
1 457 429 775	1 457 433 756	L 410
1 457 429 777	1 457 433 704	L 236
1 457 429 791	1 457 433 758	L 260
1 457 429 793	F 026 401 739	L 739
1 457 429 819	1 457 433 761	L 470
1 457 429 841	1 457 433 435	L 277
1 457 429 870	1 457 433 763	L 213
1 457 429 875	1 457 429 828	L 203
1 457 429 894	F 026 401 767	L 767
1 457 429 896	1 457 433 614	L 345
1 457 429 908	1 457 433 755	L 270
1 457 429 920	1 457 429 831	L 311
1 457 429 923	1 457 433 759	L 450
1 457 429 964	1 457 429 832	L 204
1 457 429 994	1 457 429 997	L 103
1 457 432 111	1 457 429 974	L 307
1 457 432 124	1 457 433 432	L 350
1 457 432 134	1 457 433 411	L 390
1 457 432 138	F 026 401 721	L 721
1 457 432 146	F 026 401 712	L 712
1 457 432 154	1 457 433 419	L 254
1 457 432 173	1 457 433 706	L 086
1 457 432 180	1 457 433 707	L 085
1 457 432 183	1 457 433 765	L 135
1 457 432 200	1 457 433 754	L 210
1 457 433 004	1 457 433 760	L 250
1 457 433 007	1 457 433 613	L 240
1 457 433 008	1 457 433 028	L 333
1 457 433 023	1 457 433 612	L 340
1 457 433 046	F 026 401 728	L 728
1 457 433 047	F 026 401 747	L 747
1 457 433 055	F 026 401 708	L 708
1 457 433 058	F 026 401 709	L 709
1 457 433 059	F 026 401 710	L 810
1 457 433 061	F 026 401 748	L 748

nl

Werkplaatsverpakking →
Zelfbedieningsverpakking

sv

Verkstadsförpackning →
SB-förpackning

cs

Servisní balení →
Samoobslužné balení

pl

Opakowanie warsztatu → opakowanie
samoobsługowe

ru

Упаковка для СТО →
Упаковка для
самообслуживания

№

1 457 433 065	F 026 401 737	L 737
1 457 433 069	F 026 401 731	L 731
1 457 433 075	F 026 401 734	L 734
1 457 433 076	F 026 401 700	L 800
1 457 433 077	F 026 401 720	L 720

1 457 433 078	F 026 401 740	L 740
1 457 433 081	F 026 401 762	L 762
1 457 433 090	F 026 401 751	L 751
1 457 433 099	F 026 401 727	L 727
1 457 433 150	F 026 401 755	L 755

1 457 433 158	F 026 401 757	L 757
1 457 433 160	F 026 401 754	L 754
1 457 433 161	F 026 401 765	L 765
1 457 433 163	F 026 401 753	L 753
1 457 433 227	1 457 433 424	L 255

1 457 433 229	1 457 433 431	L 510
1 457 433 231	1 457 433 434	L 512
1 457 433 233	1 457 433 430	L 279
1 457 433 234	1 457 433 401	L 338
1 457 433 253	1 457 433 708	L 235

1 457 433 255	1 457 433 709	L 087
1 457 433 256	1 457 433 768	L 110
1 457 433 257	1 457 433 460	L 211
1 457 433 259	1 457 433 710	L 201
1 457 433 260	F 026 401 722	L 722

1 457 433 264	F 026 401 706	L 706
1 457 433 265	1 457 433 461	L 316
1 457 433 266	F 026 401 723	L 723
1 457 433 268	F 026 401 715	L 715
1 457 433 273	F 026 401 759	L 759

1 457 433 280	1 457 433 464	L 249
1 457 433 281	1 457 433 305	L 415
1 457 433 282	F 026 401 718	L 718
1 457 433 309	F 026 401 766	L 766
1 457 433 520	F 026 401 719	L 719

1 457 433 521	F 026 401 701	L 701
1 457 433 526	1 457 433 825	L 225
1 457 433 529	F 026 401 729	L 729
1 457 433 531	F 026 401 702	L 702
1 457 433 535	F 026 401 750	L 750



№

1 457 433 539	F 026 401 738	L 738
1 457 433 540	F 026 401 703	L 703
1 457 433 544	F 026 401 756	L 756
1 457 433 553	F 026 401 714	L 714
1 457 433 555	F 026 401 746	L 746

1 457 433 573	F 026 401 730	L 730
1 457 433 575	F 026 401 704	L 704
1 457 433 588	F 026 401 732	L 732
1 457 433 589	F 026 401 733	L 733
1 457 433 595	F 026 401 745	L 745

1 457 433 603	1 457 433 757	L 245
1 457 433 605	1 457 433 811	L 335
1 457 433 606	1 457 433 442	L 106
1 457 433 608	F 026 401 744	L 744
1 457 433 623	1 457 433 443	L 108

1 457 433 624	1 457 433 433	L 509
1 457 433 686	1 457 433 691	L 289
1 457 433 712	F 026 401 716	L 716
1 457 433 713	1 457 433 803	L 252
1 457 433 714	1 457 433 804	L 313

1 457 433 716	1 457 433 808	L 318
1 457 433 748	F 026 401 736	L 736
1 457 433 752	F 026 401 742	L 742
1 457 433 769	F 026 401 758	L 758
1 457 433 772	F 026 401 741	L 741

1 457 433 773	1 457 433 819	L 109
1 457 433 781	F 026 401 749	L 749
1 457 433 791	F 026 401 711	L 711
1 457 433 971	F 026 401 713	L 713
1 987 429 051	F 026 401 761	L 761

1 987 429 135	F 026 401 743	L 743
1 987 429 177	F 026 401 763	L 763
1 987 429 182	F 026 401 760	L 760
1 987 429 190	F 026 401 764	L 764
1 987 429 404	F 026 401 705	L 705

1 987 429 406	F 026 401 735	L 735
F 026 400 010	F 026 401 724	L 724
F 026 400 011	1 457 433 030	L 291
F 026 400 015	F 026 401 725	L 725
F 026 400 016	F 026 401 726	L 726



№

F 026 400 038	F 026 401 752	L 752
----------------------	---------------	-------

nl

Werkplaatsverpakking →
Zelfbedieningsverpakking

sv

Verkstadsförpackning →
SB-förpackning

cs

Servisní balení →
Samoobslužné balení

pl

Opakowanie warsztatu → opakowanie
samoobsługowe

ru

Упаковка для СТО →
Упаковка для
самообслуживания

№

1 987 432 003	1 987 431 003	A 310
1 987 432 006	1 987 431 006	A 304
1 987 432 007	1 987 431 007	A 325
1 987 432 010	1 987 432 701	A 701
1 987 432 012	1 987 431 012	A 501

1 987 432 015	1 987 431 015	A 500
1 987 432 017	1 987 431 017	A 302
1 987 432 018	1 987 431 018	A 100
1 987 432 019	1 987 431 019	A 505
1 987 432 021	1 987 431 021	A 503

1 987 432 027	1 987 431 027	A 507
1 987 432 028	1 987 431 028	A 102
1 987 432 030	1 987 431 030	A 250
1 987 432 036	1 987 432 704	A 704
1 987 432 038	1 987 431 038	A 603

1 987 432 039	1 987 431 039	A 551
1 987 432 040	1 987 432 709	A 709
1 987 432 045	1 987 431 045	A 575
1 987 432 048	1 987 431 048	A 570
1 987 432 057	1 987 431 057	A 509

1 987 432 060	1 987 432 702	A 702
1 987 432 061	1 987 431 061	A 513
1 987 432 069	1 987 431 069	A 538
1 987 432 070	1 987 431 070	A 539
1 987 432 071	1 987 431 071	A 576

1 987 432 072	1 987 431 072	A 578
1 987 432 076	1 987 432 705	A 705
1 987 432 079	1 987 431 079	A 609
1 987 432 083	1 987 432 707	A 707
1 987 432 084	1 987 432 708	A 708

1 987 432 093	1 987 432 700	A 700
1 987 432 094	1 987 432 706	A 706
1 987 432 097	1 987 432 703	A 703
1 987 432 120	1 987 432 710	A 710
1 987 432 300	1 987 431 300	K 525

1 987 432 354	1 987 432 815	K 815
1 987 432 361	1 987 432 816	K 816
1 987 432 371	1 987 431 371	K 576
1 987 432 380	1 987 432 820	K 820
1 987 432 386	1 987 432 817	K 817



№

1 987 432 387	1 987 432 818	K 818
----------------------	---------------	-------



№

de

Suchnummer →
SB-/Werkstattverpackung

en

Search number →
self-service/
workshop packs

fr

Code d'identification
→ emballage libre-
service de atelier

it

Numero di ricerca →
confezione self-service
per officina

es

Referencia comercial →
envase de autoservicio/
taller



B 002	0 450 904 059	0 450 904 058
B 002	0 450 905 802	0 450 905 002
B 003	0 450 904 150	0 450 904 149
B 316	0 450 905 816	0 450 905 316
B 318	0 450 905 818	0 450 905 318
B 324	0 450 905 824	0 450 905 324
B 830	0 450 905 830	0 450 905 030
B 861	0 450 902 861	0 450 902 161
B 873	0 450 905 873	0 450 905 273
B 880	0 450 905 880	0 450 905 280
B 887	0 450 905 887	0 450 905 287
D 701	1 457 434 107	1 457 434 106
D 705	F 026 403 750	0 986 450 509
D 750	F 026 402 750	1 457 431 715
D 754	F 026 402 754	0 450 906 460
D 756	1 457 070 800	1 457 070 000
D 759	F 026 402 759	1 457 434 442
D 760	1 457 030 813	1 457 030 013
D 761	0 450 906 874	0 450 906 374
D 762	F 026 402 762	1 457 431 703
D 763	F 026 402 763	0 450 905 930
D 764	F 026 402 764	1 457 434 437
D 765	F 026 402 765	1 457 431 704
D 766	F 026 402 766	1 457 434 187
D 767	F 026 402 767	1 457 434 416
D 768	F 026 402 768	1 457 434 438
D 769	F 026 402 769	1 457 434 453
D 770	F 026 402 770	1 457 431 708
D 771	F 026 402 771	0 450 906 461
D 772	F 026 402 772	1 457 431 723
D 773	F 026 402 773	0 450 906 469
D 774	F 026 402 774	0 450 906 457
D 775	F 026 402 775	1 457 434 201
D 776	F 026 402 776	1 457 431 705
D 777	F 026 402 777	1 457 429 656
D 778	F 026 402 778	0 450 906 468
D 779	F 026 402 779	0 450 906 471
D 780	F 026 402 780	0 450 906 473
D 781	F 026 402 781	0 450 904 077
D 782	F 026 402 782	1 457 434 440



D 783	F 026 402 783	0 450 906 451
D 784	F 026 402 784	1 457 429 621
D 785	F 026 402 785	1 457 429 657
D 786	F 026 402 786	1 457 434 200
D 787	F 026 402 787	1 457 431 712
D 788	F 026 402 788	1 457 434 291
D 801	1 457 070 801	1 457 070 001
D 803	1 457 434 803	1 457 434 103
D 804	0 450 906 804	0 450 906 274
D 809	0 450 906 809	0 450 906 409
D 810	1 457 434 810	1 457 434 310
D 814	1 457 434 814	1 457 434 314
D 821	1 457 434 821	1 457 434 321
D 822	0 450 906 822	0 450 906 322
D 824	1 457 434 824	1 457 434 324
D 829	0 450 906 829	0 450 906 429
D 834	0 450 906 834	0 450 906 334
D 857	0 450 906 857	0 450 906 357
D 861	0 450 906 861	0 450 906 261
D 867	0 450 906 867	0 450 906 267
D 872	0 450 906 872	0 450 906 172
D 873	0 450 906 873	0 450 906 373
D 881	1 457 434 881	1 457 434 281
D 884	1 457 434 884	1 457 434 184
D 891	1 457 431 891	1 457 429 291
D 893	1 457 434 893	1 457 434 293
D 895	0 450 906 895	0 450 906 295
D 898	1 457 434 898	1 457 434 198



L 085	1 457 433 707	1 457 432 180
L 086	1 457 433 706	1 457 432 173
L 087	1 457 433 709	1 457 433 255
L 090	1 457 429 099	1 457 429 030
L 103	1 457 429 997	1 457 429 994
L 106	1 457 433 442	1 457 433 606
L 108	1 457 433 443	1 457 433 623
L 109	1 457 433 819	1 457 433 773
L 110	1 457 433 768	1 457 433 256
L 135	1 457 433 765	1 457 432 183
L 201	1 457 433 710	1 457 433 259
L 203	1 457 429 828	1 457 429 875
L 204	1 457 429 832	1 457 429 964
L 210	1 457 433 754	1 457 432 200
L 211	1 457 433 460	1 457 433 257
L 213	1 457 433 763	1 457 429 870
L 225	1 457 433 825	1 457 433 526
L 235	1 457 433 708	1 457 433 253
L 236	1 457 433 704	1 457 429 777
L 240	1 457 433 613	1 457 433 007
L 245	1 457 433 757	1 457 433 603
L 249	1 457 433 464	1 457 433 280
L 250	1 457 433 760	1 457 433 004
L 252	1 457 433 803	1 457 433 713
L 254	1 457 433 419	1 457 432 154
L 255	1 457 433 424	1 457 433 227
L 260	1 457 433 758	1 457 429 791
L 270	1 457 433 755	1 457 429 908
L 277	1 457 433 435	1 457 429 841
L 279	1 457 433 430	1 457 433 233
L 289	1 457 433 691	1 457 433 686
L 291	1 457 433 030	F 026 400 011
L 302	1 457 429 089	1 457 429 050
L 307	1 457 429 974	1 457 432 111
L 311	1 457 429 831	1 457 429 920
L 313	1 457 433 804	1 457 433 714
L 316	1 457 433 461	1 457 433 265
L 318	1 457 433 808	1 457 433 716
L 333	1 457 433 028	1 457 433 008
L 335	1 457 433 811	1 457 433 605

de

Gegenüberstellung
Bestellnummer →
Suchnummer

en

Cross references
part number →
search number

fr

Table de correspon-
dance référence →
code d'identification

it

Confronto codice di
ordinazione → codice
breve

es

Confrontación refe-
rencia de pedido →
referencia comercial



0 450 ...

0 450 901 005	F 1005
0 450 902 151	F 2151
0 450 902 161	F 2161
0 450 902 162	F 2162
0 450 904 058	F 4058
0 450 904 060	F 4060
0 450 904 077	N 4077
0 450 904 149	F 4149
0 450 904 158	N 4158
0 450 904 159	F 4159
0 450 904 161	N 4161
0 450 904 163	F 4163
0 450 905 002	F 5002
0 450 905 005	F 5005
0 450 905 016	F 5016
0 450 905 021	F 5021
0 450 905 030	F 5030
0 450 905 066	F 5066
0 450 905 087	F 5087
0 450 905 091	F 5091
0 450 905 095	F 5095
0 450 905 104	F 5104
0 450 905 133	F 5133
0 450 905 143	F 5143
0 450 905 145	F 5145
0 450 905 177	F 5177
0 450 905 195	F 5195
0 450 905 200	F 5200
0 450 905 201	F 5201
0 450 905 203	F 5203
0 450 905 215	F 5215
0 450 905 216	F 5216
0 450 905 264	F 5264
0 450 905 273	F 5273
0 450 905 275	F 5275
0 450 905 280	F 5280
0 450 905 281	F 5281
0 450 905 287	F 5287
0 450 905 316	F 5316
0 450 905 318	F 5318
0 450 905 320	F 5320
0 450 905 324	F 5324
0 450 905 326	F 5326



0 450 905 401	F 5401
0 450 905 601	F 5601
0 450 905 901	F 5901
0 450 905 903	F 5903
0 450 905 904	F 5904
0 450 905 905	F 5905
0 450 905 906	F 5906
0 450 905 908	F 5908
0 450 905 909	F 5909
0 450 905 911	F 5911
0 450 905 912	F 5912
0 450 905 914	F 5914
0 450 905 915	F 5915
0 450 905 916	F 5916
0 450 905 920	F 5920
0 450 905 921	F 5921
0 450 905 922	F 5922
0 450 905 923	F 5923
0 450 905 924	F 5924
0 450 905 925	F 5925
0 450 905 926	F 5926
0 450 905 927	F 5927
0 450 905 928	F 5928
0 450 905 929	F 5929
0 450 905 930	N 5930
0 450 905 937	F 5937
0 450 905 939	F 5939
0 450 905 940	F 5940
0 450 905 942	N 5942
0 450 905 943	F 5943
0 450 905 950	F 5950
0 450 905 951	F 5951
0 450 905 952	F 5952
0 450 905 953	F 5953
0 450 905 954	F 5954
0 450 905 955	F 5955
0 450 905 956	F 5956
0 450 905 957	F 5957
0 450 905 958	F 5958
0 450 905 959	F 5959
0 450 905 960	F 5960
0 450 905 962	F 5962
0 450 905 963	F 5963
0 450 905 964	F 5964
0 450 905 966	F 5966



0 450 905 967	F 5967
0 450 905 968	F 5968
0 450 905 969	F 5969
0 450 905 970	F 5970
0 450 905 971	F 5971
0 450 905 972	F 5972
0 450 905 973	F 5973
0 450 905 974	F 5974
0 450 905 975	F 5975
0 450 905 976	F 5976
0 450 905 977	F 5977
0 450 905 978	F 5978
0 450 905 979	F 5979
0 450 905 980	F 5980
0 450 905 981	F 5981
0 450 905 982	F 5982
0 450 905 983	F 5983
0 450 905 984	F 5984
0 450 905 985	F 5985
0 450 905 986	F 5986
0 450 905 987	F 5987
0 450 905 988	F 5988
0 450 905 989	F 5989
0 450 905 990	F 5990
0 450 906 172	N 6172
0 450 906 174	N 6174
0 450 906 261	N 6261
0 450 906 267	N 6267
0 450 906 274	N 6274
0 450 906 281	N 6281
0 450 906 295	N 6295
0 450 906 308	N 6308
0 450 906 318	N 6318
0 450 906 322	N 6322
0 450 906 334	N 6334
0 450 906 357	N 6357
0 450 906 373	N 6373
0 450 906 374	N 6374
0 450 906 376	N 6376
0 450 906 406	N 6406
0 450 906 407	N 6407
0 450 906 409	N 6409
0 450 906 426	N 6426
0 450 906 429	N 6429
0 450 906 431	N 6431



0 450 906 437	N 6437
0 450 906 442	N 6442
0 450 906 450	N 6450
0 450 906 451	N 6451
0 450 906 452	N 6452
0 450 906 453	N 6453
0 450 906 457	N 6457
0 450 906 458	N 6458
0 450 906 459	N 6459
0 450 906 460	N 6460
0 450 906 461	N 6461
0 450 906 462	N 6462
0 450 906 463	N 6463
0 450 906 464	N 6464
0 450 906 467	N 6467
0 450 906 468	N 6468
0 450 906 469	N 6469
0 450 906 471	N 6471
0 450 906 473	N 6473
0 450 906 500	N 6500
0 450 906 503	N 6503
0 450 906 508	N 6508
0 450 915 001	F 5001
0 450 915 003	F 5003
0 451 102 056	P 2056
0 451 103 004	P 3004
0 451 103 028	P 3028
0 451 103 029	P 3029
0 451 103 033	P 3033
0 451 103 050	P 3050
0 451 103 060	P 3060
0 451 103 062	P 3062
0 451 103 074	P 3074
0 451 103 079	P 3079
0 451 103 086	P 3086
0 451 103 093	P 3093
0 451 103 096	P 3096
0 451 103 105	P 3105
0 451 103 109	P 3109
0 451 103 111	P 3111
0 451 103 139	P 3139
0 451 103 141	P 3141

0 451 ...

nl

Omzettingslijst
Bestelnummer →
Opzoeknummer

sv

Artikelnummer →
Söknummer

cs









Převod objednáací číslo →
vyhledávací číslo

pl

Zestawienie
numer katalogowy →
numer identyfikacyjny

ru

Соответствие Номер
артикула →
Поисковый номер

	 №		 №		 №		 №
0 451 103 144	P 3144	0 451 103 333	P 3333	0 451 105 188	P 5188	0 986 450 110	F 0110
0 451 103 145	P 3145	0 451 103 335	P 3335	0 451 203 002	P 3002	0 986 450 111	F 0111
0 451 103 170	P 3170	0 451 103 336	P 3336	0 451 203 005	P 3005	0 986 450 113	F 0113
0 451 103 189	P 3189	0 451 103 337	P 3337	0 451 203 010	P 3010	0 986 450 114	F 0114
0 451 103 213	P 3213	0 451 103 338	P 3338	0 451 203 012	P 3012	0 986 450 115	F 0115
0 451 103 215	P 3215	0 451 103 340	P 3340	0 451 203 087	P 3087	0 986 450 117	F 0117
0 451 103 217	P 3217	0 451 103 341	P 3341	0 451 203 108	P 3108	0 986 450 119	F 0119
0 451 103 219	P 3219	0 451 103 342	P 3342	0 451 203 152	P 3152	0 986 450 120	F 0120
0 451 103 221	P 3221	0 451 103 343	P 3343	0 451 203 154	P 3154	0 986 450 121	F 0121
0 451 103 224	P 3224	0 451 103 344	P 3344	0 451 203 194	P 3194	0 986 450 123	F 0123
0 451 103 227	P 3227	0 451 103 346	P 3346	0 451 203 197	P 3197	0 986 450 124	F 0124
0 451 103 232	P 3232	0 451 103 347	P 3347	0 451 203 201	P 3201	0 986 450 137	F 0137
0 451 103 235	P 3235	0 451 103 348	P 3348	0 451 203 218	P 3218	0 986 450 138	F 0138
0 451 103 238	P 3238	0 451 103 349	P 3349	0 451 203 218	P 3220	0 986 450 143	F 0143
0 451 103 240	P 3240	0 451 103 350	P 3350	0 451 203 223	P 3223	0 986 450 212	F 0212
0 451 103 249	P 3249	0 451 103 351	P 3351	0 451 203 226	P 3226	0 986 450 220	F 0220
0 451 103 251	P 3251	0 451 103 352	P 3352	0 451 203 231	P 3231	0 986 450 221	F 0221
0 451 103 252	P 3252	0 451 103 353	P 3353	0 451 300 003	P 0003	0 986 450 222	F 0222
0 451 103 253	P 3253	0 451 103 354	P 3354	0 451 300 004	P 0004	0 986 450 225	F 0225
0 451 103 257	P 3257	0 451 103 355	P 3355	0 451 300 007	P 0007	0 986 450 226	F 0226
0 451 103 258	P 3258	0 451 103 357	P 3357	0 451 300 008	P 0008	0 986 450 505	N 0505
0 451 103 259	P 3259	0 451 103 360	P 3360	0 451 301 156	P 1156	0 986 450 508	N 0508
0 451 103 260	P 3260	0 451 103 363	P 3363	0 451 301 207	P 1207	0 986 450 509	N 0509
0 451 103 261	P 3261	0 451 103 364	P 3364	0 451 403 001	P 3001	0 986 450 510	F 0510
0 451 103 266	P 3266	0 451 103 365	P 3365	0 451 403 077	P 3077	0 986 450 604	F 0604
0 451 103 270	P 3270	0 451 103 366	P 3366	0 451 403 208	P 3208	0 986 450 624	F 0624
0 451 103 271	P 3271	0 451 103 367	P 3367	0 451 403 210	P 3210	0 986 452 000	P 2000
0 451 103 274	P 3274	0 451 103 368	P 3368			0 986 452 001	P 2001
0 451 103 275	P 3275	0 451 103 369	P 3369			0 986 452 003	P 2003
0 451 103 276	P 3276	0 451 103 370	P 3370			0 986 452 005	P 2005
0 451 103 278	P 3278	0 451 103 371	P 3371			0 986 452 015	P 2015
0 451 103 280	P 3280	0 451 103 372	P 3372	0 986 ...		0 986 452 016	P 2016
0 451 103 289	P 3289	0 451 104 005	P 4005	0 986 450 018	F 0018	0 986 452 019	P 2019
0 451 103 290	P 3290	0 451 104 010	P 4010	0 986 450 030	F 0030	0 986 452 020	P 2020
0 451 103 292	P 3292	0 451 104 013	P 4013	0 986 450 037	F 0037	0 986 452 023	P 2023
0 451 103 297	P 3297	0 451 104 014	P 4014	0 986 450 039	F 0039	0 986 452 024	P 2024
0 451 103 298	P 3298	0 451 104 015	P 4015	0 986 450 100	F 0100	0 986 452 028	P 2028
0 451 103 299	P 3299	0 451 104 025	P 4025	0 986 450 102	F 0102	0 986 452 030	P 2030
0 451 103 300	P 3300	0 451 104 026	P 4026	0 986 450 103	F 0103	0 986 452 035	P 2035
0 451 103 311	P 3311	0 451 104 063	P 4063	0 986 450 104	F 0104	0 986 452 036	P 2036
0 451 103 313	P 3313	0 451 104 064	P 4064	0 986 450 105	F 0105	0 986 452 041	P 2041
0 451 103 314	P 3314	0 451 104 065	P 4065	0 986 450 106	F 0106	0 986 452 042	P 2042
0 451 103 316	P 3316	0 451 104 066	P 4066	0 986 450 107	F 0107	0 986 452 044	P 2044
0 451 103 318	P 3318	0 451 104 067	P 4067	0 986 450 108	F 0108	0 986 452 046	P 2046
0 451 103 330	P 3330	0 451 105 067	P 5067	0 986 450 109	F 0109	0 986 452 058	P 2058

de

**Gegenüberstellung
Bestellnummer →
Suchnummer**
(Fortsetzung)

en

**Cross references
part number →
search number**
(continued)

fr

**Table de correspon-
dance référence →
code d'identification**
(suite)

it

**Confronto codice di
ordinazione → codice
breve**
(seguito)

es

**Confrontación refe-
rencia de pedido →
referencia comercial**
(continuación)



0 986 452 060	P 2060
0 986 452 061	P 2061
0 986 452 062	P 2062
0 986 452 063	P 2063
0 986 452 064	P 2064

0 986 452 066	P 2066
0 986 452 068	P 2068
0 986 452 400	P 2400

1 457 ...

1 457 030 013	N 0013
1 457 070 000	N 0000
1 457 070 001	N 0001

1 457 070 007	N 0007
1 457 429 030	S 9030
1 457 429 050	S 9050
1 457 429 053	S 9053
1 457 429 054	S 9054

1 457 429 056	S 9056
1 457 429 061	S 9061
1 457 429 064	S 9064
1 457 429 066	S 9066
1 457 429 076	S 9076

1 457 429 078	S 9078
1 457 429 079	S 9079
1 457 429 080	S 9080
1 457 429 085	S 9085
1 457 429 102	P 9102

1 457 429 103	P 9103
1 457 429 104	P 9104
1 457 429 105	P 9105
1 457 429 107	P 9107
1 457 429 108	P 9108

1 457 429 116	P 9116
1 457 429 117	P 9117
1 457 429 118	P 9118
1 457 429 119	P 9119
1 457 429 121	P 9121

1 457 429 122	P 9122
1 457 429 123	P 9123
1 457 429 126	P 9126
1 457 429 127	P 9127
1 457 429 128	P 9128



1 457 429 130	P 9130
1 457 429 137	P 9137
1 457 429 139	P 9139
1 457 429 141	P 9141
1 457 429 142	P 9142

1 457 429 144	P 9144
1 457 429 147	P 9147
1 457 429 152	P 9152
1 457 429 153	P 9153
1 457 429 154	P 9154

1 457 429 157	P 9157
1 457 429 165	P 9165
1 457 429 167	P 9167
1 457 429 174	P 9174
1 457 429 175	P 9175

1 457 429 178	P 9178
1 457 429 184	P 9184
1 457 429 185	P 9185
1 457 429 192	P 9192
1 457 429 193	P 9193

1 457 429 194	P 9194
1 457 429 196	P 9196
1 457 429 197	P 9197
1 457 429 198	P 9198
1 457 429 199	P 9199

1 457 429 230	N 9230
1 457 429 238	P 9238
1 457 429 239	P 9239
1 457 429 243	P 9243
1 457 429 244	P 9244

1 457 429 248	P 9248
1 457 429 249	P 9249
1 457 429 251	P 9251
1 457 429 252	P 9252
1 457 429 256	P 9256

1 457 429 257	P 9257
1 457 429 261	P 9261
1 457 429 262	P 9262
1 457 429 263	P 9263
1 457 429 264	P 9264

1 457 429 265	P 9265
1 457 429 267	P 9267
1 457 429 268	P 9268
1 457 429 269	P 9269
1 457 429 271	P 9271



1 457 429 272	P 9272
1 457 429 274	P 9274
1 457 429 275	P 9275
1 457 429 276	P 9276
1 457 429 277	P 9277

1 457 429 278	P 9278
1 457 429 284	P 9284
1 457 429 289	N 9289
1 457 429 291	N 9291
1 457 429 301	P 9301

1 457 429 302	P 9302
1 457 429 306	P 9306
1 457 429 307	P 9307
1 457 429 308	P 9308
1 457 429 354	N 9354

1 457 429 359	N 9359
1 457 429 413	P 9413
1 457 429 416	P 9416
1 457 429 493	P 9493
1 457 429 546	P 9546

1 457 429 559	P 9559
1 457 429 600	P 9600
1 457 429 605	P 9605
1 457 429 610	P 9610
1 457 429 616	P 9616

1 457 429 619	P 9619
1 457 429 621	N 9621
1 457 429 629	P 9629
1 457 429 631	P 9631
1 457 429 636	P 9636

1 457 429 638	P 9638
1 457 429 646	P 9646
1 457 429 647	P 9647
1 457 429 648	P 9648
1 457 429 649	P 9649

1 457 429 655	N 9655
1 457 429 656	N 9656
1 457 429 657	N 9657
1 457 429 675	N 9675
1 457 429 676	N 9676

1 457 429 681	N 9681
1 457 429 732	P 9732
1 457 429 735	P 9735
1 457 429 740	P 9740
1 457 429 755	P 9755



1 457 429 760	P 9760
1 457 429 762	P 9762
1 457 429 775	S 9775
1 457 429 777	S 9777
1 457 429 778	S 9778

1 457 429 781	S 9781
1 457 429 782	S 9782
1 457 429 783	S 9783
1 457 429 785	S 9785
1 457 429 786	S 9786

1 457 429 787	S 9787
1 457 429 789	S 9789
1 457 429 791	S 9791
1 457 429 792	S 9792
1 457 429 793	S 9793

1 457 429 794	S 9794
1 457 429 795	S 9795
1 457 429 800	S 9800
1 457 429 801	S 9801
1 457 429 806	S 9806

1 457 429 810	S 9810
1 457 429 814	S 9814
1 457 429 817	S 9817
1 457 429 818	S 9818
1 457 429 819	S 9819

1 457 429 820	P 9820
1 457 429 839	S 9839
1 457 429 840	S 9840
1 457 429 841	S 9841
1 457 429 842	S 9842

1 457 429 844	S 9844
1 457 429 845	S 9845
1 457 429 846	S 9846
1 457 429 854	S 9854
1 457 429 869	S 9869

1 457 429 870	S 9870
1 457 429 871	S 9871
1 457 429 873	S 9873
1 457 429 874	S 9874
1 457 429 875	S 9875

1 457 429 876	S 9876
1 457 429 877	S 9877
1 457 429 882	S 9882
1 457 429 890	S 9890
1 457 429 893	S 9893

nl

Omzettingslijst
Bestelnummer →
Opzoeknummer
 (vervolg)

sv

Artikelnummer →
Söknummer
 (fortsättning)

cs









Převod objednáací číslo →
vyhledávací číslo
 (pokračování)

pl

Zestawienie
numer katalogowy →
numer identyfikacyjny
 (ciąg dalszy)

ru

Соответствие Номер
артикула →
Поисковый номер
 (продолжение)

	 №		 №		 №		 №	
1 457 429 894	S 9894	1 457 431 270	N 1270	1 457 432 205	S 2205	1 457 433 080	S 3080	
1 457 429 895	S 9895	1 457 431 325	N 1325	1 457 432 208	S 2208	1 457 433 081	S 3081	
1 457 429 896	S 9896	1 457 431 326	N 1326	1 457 432 210	S 2210	1 457 433 083	S 3083	
1 457 429 898	S 9898	1 457 431 702	N 1702	1 457 432 212	S 2212	1 457 433 084	S 3084	
1 457 429 899	S 9899	1 457 431 703	N 1703	1 457 433 002	S 3002	1 457 433 085	S 3085	
1 457 429 900	S 9900	1 457 431 704	N 1704	1 457 433 003	S 3003	1 457 433 086	S 3086	
1 457 429 908	S 9908	1 457 431 705	N 1705	1 457 433 004	S 3004	1 457 433 087	S 3087	
1 457 429 915	S 9915	1 457 431 707	N 1707	1 457 433 005	S 3005	1 457 433 088	S 3088	
1 457 429 920	S 9920	1 457 431 708	N 1708	1 457 433 006	S 3006	1 457 433 089	S 3089	
1 457 429 923	S 9923	1 457 431 710	N 1710	1 457 433 007	S 3007	1 457 433 090	S 3090	
1 457 429 928	S 9928	1 457 431 712	N 1712	1 457 433 008	S 3008	1 457 433 091	S 3091	
1 457 429 932	S 9932	1 457 431 713	N 1713	1 457 433 023	S 3023	1 457 433 093	S 3093	
1 457 429 933	S 9933	1 457 431 715	N 1715	1 457 433 032	S 3032	1 457 433 094	S 3094	
1 457 429 934	S 9934	1 457 431 718	N 1718	1 457 433 036	S 3036	1 457 433 095	S 3095	
1 457 429 941	S 9941	1 457 431 720	N 1720	1 457 433 037	S 3037	1 457 433 096	S 3096	
1 457 429 942	S 9942	1 457 431 723	N 1723	1 457 433 042	S 3042	1 457 433 097	S 3097	
1 457 429 944	S 9944	1 457 431 724	N 1724	1 457 433 043	S 3043	1 457 433 098	S 3098	
1 457 429 946	S 9946	1 457 431 729	N 1729	1 457 433 044	S 3044	1 457 433 099	S 3099	
1 457 429 948	S 9948	1 457 432 100	S 2100	1 457 433 045	S 3045	1 457 433 100	S 3100	
1 457 429 949	S 9949	1 457 432 106	S 2106	1 457 433 046	S 3046	1 457 433 101	S 3101	
1 457 429 950	S 9950	1 457 432 108	S 2108	1 457 433 047	S 3047	1 457 433 102	S 3102	
1 457 429 953	S 9953	1 457 432 109	S 2109	1 457 433 049	S 3049	1 457 433 150	S 3150	
1 457 429 954	S 9954	1 457 432 111	S 2111	1 457 433 052	S 3052	1 457 433 152	S 3152	
1 457 429 955	S 9955	1 457 432 124	S 2124	1 457 433 053	S 3053	1 457 433 153	S 3153	
1 457 429 957	S 9957	1 457 432 128	S 2128	1 457 433 054	S 3054	1 457 433 154	S 3154	
1 457 429 959	S 9959	1 457 432 134	S 2134	1 457 433 055	S 3055	1 457 433 155	S 3155	
1 457 429 964	S 9964	1 457 432 138	S 2138	1 457 433 056	S 3056	1 457 433 156	S 3156	
1 457 429 966	S 9966	1 457 432 146	S 2146	1 457 433 058	S 3058	1 457 433 158	S 3158	
1 457 429 969	S 9969	1 457 432 149	S 2149	1 457 433 059	S 3059	1 457 433 159	S 3159	
1 457 429 970	S 9970	1 457 432 150	S 2150	1 457 433 060	S 3060	1 457 433 160	S 3160	
1 457 429 975	S 9975	1 457 432 154	S 2154	1 457 433 061	S 3061	1 457 433 161	S 3161	
1 457 429 979	S 9979	1 457 432 172	S 2172	1 457 433 062	S 3062	1 457 433 163	S 3163	
1 457 429 980	S 9980	1 457 432 173	S 2173	1 457 433 065	S 3065	1 457 433 164	S 3164	
1 457 429 983	S 9983	1 457 432 174	S 2174	1 457 433 066	S 3066	1 457 433 200	S 3200	
1 457 429 987	S 9987	1 457 432 178	S 2178	1 457 433 067	S 3067	1 457 433 201	S 3201	
1 457 429 988	S 9988	1 457 432 180	S 2180	1 457 433 069	S 3069	1 457 433 227	S 3227	
1 457 429 991	S 9991	1 457 432 183	S 2183	1 457 433 070	S 3070	1 457 433 228	S 3228	
1 457 429 992	S 9992	1 457 432 185	S 2185	1 457 433 071	S 3071	1 457 433 229	S 3229	
1 457 429 993	S 9993	1 457 432 188	S 2188	1 457 433 072	S 3072	1 457 433 230	S 3230	
1 457 429 994	S 9994	1 457 432 192	S 2192	1 457 433 073	S 3073	1 457 433 231	S 3231	
1 457 429 998	S 9998	1 457 432 193	S 2193	1 457 433 075	S 3075	1 457 433 232	S 3232	
1 457 431 028	N 1028	1 457 432 200	S 2200	1 457 433 076	S 3076	1 457 433 233	S 3233	
1 457 431 158	N 1158	1 457 432 202	S 2202	1 457 433 077	S 3077	1 457 433 234	S 3234	
1 457 431 159	N 1159	1 457 432 203	S 2203	1 457 433 078	S 3078	1 457 433 250	S 3250	
1 457 431 261	N 1261	1 457 432 204	S 2204	1 457 433 079	S 3079	1 457 433 251	S 3251	

de

Gegenüberstellung
Bestellnummer →
Suchnummer
(Fortsetzung)

en

Cross references
part number →
search number
(continued)

fr

Table de correspon-
dance référence →
code d'identification
(suite)



it



Confronto codice di
ordinazione → codice
breve
(seguito)



es

Confrontación refe-
rencia de pedido →
referencia comercial
(continuación)

	 N°
1 457 433 252	S 3252
1 457 433 253	S 3253
1 457 433 255	S 3255
1 457 433 256	S 3256
1 457 433 257	S 3257
1 457 433 258	S 3258
1 457 433 259	S 3259
1 457 433 260	S 3260
1 457 433 261	S 3261
1 457 433 263	S 3263
1 457 433 264	S 3264
1 457 433 265	S 3265
1 457 433 266	S 3266
1 457 433 268	S 3268
1 457 433 269	S 3269
1 457 433 270	S 3270
1 457 433 272	S 3272
1 457 433 273	S 3273
1 457 433 274	S 3274
1 457 433 275	S 3275
1 457 433 276	S 3276
1 457 433 279	S 3279
1 457 433 280	S 3280
1 457 433 281	S 3281
1 457 433 282	S 3282
1 457 433 285	S 3285
1 457 433 286	S 3286
1 457 433 289	S 3289
1 457 433 290	S 3290
1 457 433 292	S 3292
1 457 433 294	S 3294
1 457 433 297	S 3297
1 457 433 298	S 3298
1 457 433 299	S 3299
1 457 433 300	S 3300
1 457 433 303	S 3303
1 457 433 306	S 3306
1 457 433 307	S 3307
1 457 433 308	S 3308
1 457 433 309	S 3309
1 457 433 310	S 3310
1 457 433 311	S 3311
1 457 433 314	S 3314
1 457 433 315	S 3315
1 457 433 316	S 3316

	 N°
1 457 433 317	S 3317
1 457 433 319	S 3319
1 457 433 320	S 3320
1 457 433 322	S 3322
1 457 433 323	S 3323
1 457 433 324	S 3324
1 457 433 325	S 3325
1 457 433 326	S 3326
1 457 433 327	S 3327
1 457 433 329	S 3329
1 457 433 330	S 3330
1 457 433 331	S 3331
1 457 433 332	S 3332
1 457 433 333	S 3333
1 457 433 334	S 3334
1 457 433 339	S 3339
1 457 433 520	S 3520
1 457 433 521	S 3521
1 457 433 522	S 3522
1 457 433 523	S 3523
1 457 433 524	S 3524
1 457 433 526	S 3526
1 457 433 527	S 3527
1 457 433 529	S 3529
1 457 433 531	S 3531
1 457 433 532	S 3532
1 457 433 533	S 3533
1 457 433 534	S 3534
1 457 433 535	S 3535
1 457 433 536	S 3536
1 457 433 537	S 3537
1 457 433 538	S 3538
1 457 433 539	S 3539
1 457 433 540	S 3540
1 457 433 541	S 3541
1 457 433 542	S 3542
1 457 433 543	S 3543
1 457 433 544	S 3544
1 457 433 545	S 3545
1 457 433 546	S 3546
1 457 433 547	S 3547
1 457 433 548	S 3548
1 457 433 549	S 3549
1 457 433 550	S 3550
1 457 433 553	S 3553

	 N°
1 457 433 555	S 3555
1 457 433 560	S 3560
1 457 433 564	S 3564
1 457 433 566	S 3566
1 457 433 568	S 3568
1 457 433 571	S 3571
1 457 433 573	S 3573
1 457 433 574	S 3574
1 457 433 575	S 3575
1 457 433 576	S 3576
1 457 433 577	S 3577
1 457 433 578	S 3578
1 457 433 579	S 3579
1 457 433 580	S 3580
1 457 433 581	S 3581
1 457 433 583	S 3583
1 457 433 584	S 3584
1 457 433 585	S 3585
1 457 433 587	S 3587
1 457 433 588	S 3588
1 457 433 589	S 3589
1 457 433 590	S 3590
1 457 433 591	S 3591
1 457 433 592	S 3592
1 457 433 593	S 3593
1 457 433 594	S 3594
1 457 433 595	S 3595
1 457 433 596	S 3596
1 457 433 599	S 3599
1 457 433 601	S 3601
1 457 433 603	S 3603
1 457 433 605	S 3605
1 457 433 606	S 3606
1 457 433 607	S 3607
1 457 433 608	S 3608
1 457 433 609	S 3609
1 457 433 611	S 3611
1 457 433 616	S 3616
1 457 433 617	S 3617
1 457 433 620	S 3620
1 457 433 623	S 3623
1 457 433 624	S 3624
1 457 433 626	S 3626
1 457 433 627	S 3627
1 457 433 637	S 3637

	 N°
1 457 433 642	S 3642
1 457 433 646	S 3646
1 457 433 650	S 3650
1 457 433 651	S 3651
1 457 433 652	S 3652
1 457 433 654	S 3654
1 457 433 655	S 3655
1 457 433 658	S 3658
1 457 433 659	S 3659
1 457 433 660	S 3660
1 457 433 670	S 3670
1 457 433 671	S 3671
1 457 433 677	S 3677
1 457 433 682	S 3682
1 457 433 686	S 3686
1 457 433 688	S 3688
1 457 433 690	S 3690
1 457 433 697	S 3697
1 457 433 698	S 3698
1 457 433 699	S 3699
1 457 433 700	S 3700
1 457 433 701	S 3701
1 457 433 702	S 3702
1 457 433 703	S 3703
1 457 433 711	S 3711
1 457 433 712	S 3712
1 457 433 713	S 3713
1 457 433 714	S 3714
1 457 433 715	S 3715
1 457 433 716	S 3716
1 457 433 722	S 3722
1 457 433 726	S 3726
1 457 433 728	S 3728
1 457 433 729	S 3729
1 457 433 730	S 3730
1 457 433 731	S 3731
1 457 433 732	S 3732
1 457 433 734	S 3734
1 457 433 735	S 3735
1 457 433 736	S 3736
1 457 433 739	S 3739
1 457 433 740	S 3740
1 457 433 741	S 3741
1 457 433 742	S 3742
1 457 433 743	S 3743

nl

Omzettingslijst
Bestelnummer →
Opzoeknummer
(vervolg)

sv

Artikelnummer →
Söknummer
(fortsättning)

cs

Převod objednáací číslo →
vyhledávací číslo
(pokračování)

pl

Zestawienie
numer katalogowy →
numer identyfikacyjny
(ciąg dalszy)

ru

Соответствие Номер
артикула →
Поисковый номер
(продолжение)



1 457 433 745	S 3745
1 457 433 747	S 3747
1 457 433 748	S 3748
1 457 433 749	S 3749
1 457 433 750	S 3750

1 457 433 751	S 3751
1 457 433 752	S 3752
1 457 433 753	S 3753
1 457 433 769	S 3769
1 457 433 771	S 3771

1 457 433 772	S 3772
1 457 433 773	S 3773
1 457 433 775	S 3775
1 457 433 781	S 3781
1 457 433 784	S 3784

1 457 433 785	S 3785
1 457 433 786	S 3786
1 457 433 788	S 3788
1 457 433 789	S 3789
1 457 433 790	S 3790

1 457 433 791	S 3791
1 457 433 792	S 3792
1 457 433 795	S 3795
1 457 433 796	S 3796
1 457 433 797	S 3797

1 457 433 799	S 3799
1 457 433 800	S 3800
1 457 433 900	S 3900
1 457 433 901	S 3901
1 457 433 903	S 3903

1 457 433 904	S 3904
1 457 433 950	S 3950
1 457 433 951	S 3951
1 457 433 952	S 3952
1 457 433 953	S 3953

1 457 433 954	S 3954
1 457 433 955	S 3955
1 457 433 956	S 3956
1 457 433 957	S 3957
1 457 433 958	S 3958

1 457 433 959	S 3959
1 457 433 961	S 3961
1 457 433 962	S 3962
1 457 433 963	S 3963
1 457 433 965	S 3965



1 457 433 966	S 3966
1 457 433 968	S 3968
1 457 433 969	S 3969
1 457 433 970	S 3970
1 457 433 971	S 3971

1 457 433 972	S 3972
1 457 434 050	N 4050
1 457 434 051	N 4051
1 457 434 103	N 4103
1 457 434 105	N 4105

1 457 434 106	N 4106
1 457 434 123	N 4123
1 457 434 150	N 4150
1 457 434 153	N 4153
1 457 434 154	N 4154

1 457 434 156	N 4156
1 457 434 165	N 4165
1 457 434 174	N 4174
1 457 434 184	N 4184
1 457 434 186	N 4186

1 457 434 187	N 4187
1 457 434 189	N 4189
1 457 434 192	N 4192
1 457 434 194	N 4194
1 457 434 198	N 4198

1 457 434 200	N 4200
1 457 434 201	N 4201
1 457 434 250	N 4250
1 457 434 251	N 4251
1 457 434 252	N 4252

1 457 434 281	N 4281
1 457 434 291	N 4291
1 457 434 293	N 4293
1 457 434 294	N 4294
1 457 434 295	N 4295

1 457 434 296	N 4296
1 457 434 302	N 4302
1 457 434 306	N 4306
1 457 434 310	N 4310
1 457 434 314	N 4314

1 457 434 321	N 4321
1 457 434 324	N 4324
1 457 434 329	N 4329
1 457 434 331	N 4331
1 457 434 400	N 4400



1 457 434 402	N 4402
1 457 434 405	N 4405
1 457 434 408	N 4408
1 457 434 409	N 4409
1 457 434 416	N 4416

1 457 434 419	N 4419
1 457 434 421	N 4421
1 457 434 423	N 4423
1 457 434 428	N 4428
1 457 434 429	N 4429

1 457 434 432	N 4432
1 457 434 435	N 4435
1 457 434 436	N 4436
1 457 434 437	N 4437
1 457 434 438	N 4438

1 457 434 439	N 4439
1 457 434 440	N 4440
1 457 434 443	N 4443
1 457 434 447	N 4447
1 457 434 448	N 4448

1 457 434 450	N 4450
1 457 434 451	N 4451
1 457 434 452	N 4452
1 457 434 453	N 4453
1 457 434 454	N 4454

1 457 434 455	N 4455
1 457 434 456	N 4456
1 457 434 457	N 4457
1 457 434 459	N 4459
1 457 434 460	N 4460

1 987 ...	
1 987 429 036	S 9036
1 987 429 042	S 9042/1
1 987 429 046	S 9046

1 987 429 051	S 9051
1 987 429 107	S 9107
1 987 429 109	S 9109
1 987 429 115	S 9115
1 987 429 117	S 9117

1 987 429 120	S 9120
1 987 429 121	S 9121
1 987 429 122	S 9122
1 987 429 123	S 9123
1 987 429 125	S 9125



1 987 429 127	S 9127
1 987 429 128	S 9128
1 987 429 132	S 9132
1 987 429 133	S 9133
1 987 429 135	S 9135

1 987 429 136	S 9136
1 987 429 137	S 9137
1 987 429 146	S 9146
1 987 429 148	S 9148
1 987 429 149	S 9149

1 987 429 150	S 9150
1 987 429 151	S 9151
1 987 429 152	S 9152
1 987 429 154	S 9154
1 987 429 155	S 9155

1 987 429 156	S 9156
1 987 429 157	S 9157
1 987 429 158	S 9158
1 987 429 159	S 9159
1 987 429 160	S 9160

1 987 429 161	S 9161
1 987 429 162	S 9162
1 987 429 163	S 9163
1 987 429 164	S 9164
1 987 429 166	S 9166

1 987 429 167	S 9167
1 987 429 169	S 9169
1 987 429 170	S 9170
1 987 429 171	S 9171
1 987 429 172	S 9172

1 987 429 173	S 9173
1 987 429 174	S 9174
1 987 429 175	S 9175
1 987 429 176	S 9176
1 987 429 177	S 9177

1 987 429 178	S 9178
1 987 429 179	S 9179
1 987 429 180	S 9180
1 987 429 181	S 9181
1 987 429 182	S 9182

1 987 429 183	S 9183
1 987 429 184	S 9184
1 987 429 185	S 9185
1 987 429 186	S 9186
1 987 429 187	S 9187

de

**Gegenüberstellung
Bestellnummer →
Suchnummer**
(Fortsetzung)

en

**Cross references
part number →
search number**
(continued)

fr

**Table de correspon-
dance référence →
code d'identification**
(suite)



it

**Confronto codice di
ordinazione → codice
breve**
(seguito)



es

**Confrontación refe-
rencia de pedido →
referencia comercial**
(continuación)

	 N°
1 987 429 188	S 9188
1 987 429 189	S 9189
1 987 429 190	S 9190
1 987 429 191	S 9191
1 987 429 192	S 9192
1 987 429 193	S 9193
1 987 429 194	S 9194
1 987 429 400	S 9400
1 987 429 401	S 9401
1 987 429 402	S 9402
1 987 429 403	S 9403
1 987 429 404	S 9404
1 987 429 405	S 9405
1 987 429 406	S 9406
1 987 431 154	M 1154
1 987 431 155	M 1155
1 987 431 156	M 1156
1 987 431 157	M 1157
1 987 431 159	M 1159
1 987 431 162	M 1162
1 987 431 163	M 1163
1 987 431 164	M 1164
1 987 431 165	M 1165
1 987 431 166	M 1166
1 987 431 167	M 1167
1 987 431 168	M 1168
1 987 431 169	M 1169
1 987 431 172	M 1172
1 987 431 174	M 1174
1 987 431 175	M 1175
1 987 431 451	R 1451
1 987 431 452	R 1452
1 987 431 454	R 1454
1 987 431 455	R 1455
1 987 431 456	R 1456
1 987 431 457	R 1457
1 987 431 458	R 1458
1 987 432 001	M 2001
1 987 432 002	M 2002
1 987 432 003	M 2003
1 987 432 004	M 2004
1 987 432 005	M 2005
1 987 432 006	M 2006
1 987 432 007	M 2007
1 987 432 009	M 2009

	 N°
1 987 432 010	M 2010
1 987 432 011	M 2011
1 987 432 012	M 2012
1 987 432 013	M 2013
1 987 432 014	M 2014
1 987 432 015	M 2015
1 987 432 016	M 2016
1 987 432 017	M 2017
1 987 432 018	M 2018
1 987 432 019	M 2019
1 987 432 020	M 2020
1 987 432 021	M 2021
1 987 432 022	M 2022
1 987 432 024	M 2024
1 987 432 026	M 2026
1 987 432 027	M 2027
1 987 432 028	M 2028
1 987 432 030	M 2030
1 987 432 032	M 2032
1 987 432 033	M 2033
1 987 432 034	M 2034
1 987 432 036	M 2036
1 987 432 037	M 2037
1 987 432 038	M 2038
1 987 432 039	M 2039
1 987 432 040	M 2040
1 987 432 042	M 2042
1 987 432 043	M 2043
1 987 432 044	M 2044
1 987 432 045	M 2045
1 987 432 048	M 2048
1 987 432 049	M 2049
1 987 432 050	M 2050
1 987 432 051	M 2051
1 987 432 052	M 2052
1 987 432 053	M 2053
1 987 432 055	M 2055
1 987 432 056	M 2056
1 987 432 057	M 2057
1 987 432 058	M 2058
1 987 432 059	M 2059
1 987 432 060	M 2060
1 987 432 061	M 2061
1 987 432 062	M 2062
1 987 432 063	M 2063

	 N°
1 987 432 064	M 2064
1 987 432 065	M 2065
1 987 432 066	M 2066
1 987 432 068	M 2068
1 987 432 069	M 2069
1 987 432 070	M 2070
1 987 432 071	M 2071
1 987 432 072	M 2072
1 987 432 073	M 2073
1 987 432 074	M 2074
1 987 432 075	M 2075
1 987 432 076	M 2076
1 987 432 077	M 2077
1 987 432 078	M 2078
1 987 432 079	M 2079
1 987 432 081	M 2081
1 987 432 082	M 2082
1 987 432 083	M 2083
1 987 432 084	M 2084
1 987 432 085	M 2085
1 987 432 086	M 2086
1 987 432 087	M 2087
1 987 432 088	M 2088
1 987 432 089	M 2089
1 987 432 090	M 2090
1 987 432 091	M 2091
1 987 432 092	M 2092
1 987 432 093	M 2093
1 987 432 094	M 2094
1 987 432 095	M 2095
1 987 432 096	M 2096
1 987 432 097	M 2097
1 987 432 102	M 2102
1 987 432 103	M 2103
1 987 432 104	M 2104
1 987 432 105	M 2105
1 987 432 106	M 2106
1 987 432 107	M 2107
1 987 432 108	M 2108
1 987 432 111	M 2111
1 987 432 113	M 2113
1 987 432 114	M 2114
1 987 432 115	M 2115
1 987 432 116	M 2116
1 987 432 117	M 2117

	 N°
1 987 432 118	M 2118
1 987 432 119	M 2119
1 987 432 120	M 2120
1 987 432 121	M 2121
1 987 432 122	M 2122
1 987 432 124	M 2124
1 987 432 136	M 2136
1 987 432 137	M 2137
1 987 432 150	M 2150
1 987 432 151	M 2151
1 987 432 152	M 2152
1 987 432 153	M 2153
1 987 432 154	M 2154
1 987 432 155	M 2155
1 987 432 156	M 2156
1 987 432 157	M 2157
1 987 432 158	M 2158
1 987 432 159	M 2159
1 987 432 160	M 2160
1 987 432 161	M 2161
1 987 432 162	M 2162
1 987 432 163	M 2163
1 987 432 164	M 2164
1 987 432 166	M 2166
1 987 432 167	M 2167
1 987 432 169	M 2169
1 987 432 170	M 2170
1 987 432 171	M 2171
1 987 432 172	M 2172
1 987 432 173	M 2173
1 987 432 175	M 2175
1 987 432 176	M 2176
1 987 432 179	M 2179
1 987 432 182	M 2182
1 987 432 183	M 2183
1 987 432 184	M 2184
1 987 432 188	M 2188
1 987 432 189	M 2189
1 987 432 190	M 2190
1 987 432 192	M 2192
1 987 432 193	M 2193
1 987 432 194	M 2194
1 987 432 195	M 2195
1 987 432 197	R 2197
1 987 432 200	M 2200

nl

Omzettingslijst
Bestelnummer →
Opzoeknummer
(vervolg)

sv

Artikelnummer →
Söknummer
(fortsättning)

cs









Převod objednáací číslo →
vyhledávací číslo
(pokračování)

pl

Zestawienie
numer katalogowy →
numer identyfikacyjny
(ciąg dalszy)

ru

Соответствие Номер
артикула →
Поисковый номер
(продолжение)

  №		  №		  №		  №	
1 987 432 203	M 2203	1 987 432 345	R 2345	1 987 432 424	R 2424	F 026 400 024	S 0024
1 987 432 204	M 2204	1 987 432 348	R 2348	1 987 432 425	R 2425	F 026 400 025	S 0025
1 987 432 205	M 2205	1 987 432 354	R 2354	1 987 432 426	R 2426	F 026 400 026	S 0026
1 987 432 206	M 2206	1 987 432 357	R 2357	1 987 432 428	R 2428	F 026 400 027	S 0027
1 987 432 207	M 2207	1 987 432 360	R 2360	1 987 432 431	R 2431	F 026 400 028	S 0028
1 987 432 208	M 2208	1 987 432 361	R 2361	1 987 432 433	R 2433	F 026 400 029	S 0029
1 987 432 213	M 2213	1 987 432 362	R 2362	1 987 432 434	R 2434	F 026 400 030	S 0030
1 987 432 214	M 2214	1 987 432 364	R 2364	1 987 432 435	R 2435	F 026 400 033	S 0033
1 987 432 215	M 2215	1 987 432 365	R 2365	1 987 432 437	R 2437	F 026 400 034	S 0034
1 987 432 216	M 2216	1 987 432 366	R 2366	1 987 432 438	R 2438	F 026 400 035	S 0035
1 987 432 218	M 2218	1 987 432 367	R 2367	1 987 432 468	R 2468	F 026 400 036	S 0036
1 987 432 219	M 2219	1 987 432 368	R 2368	1 987 432 482	R 2482	F 026 400 037	S 0037
1 987 432 221	M 2221	1 987 432 369	R 2369	1 987 432 488	R 2488	F 026 400 038	S 0038
1 987 432 227	M 2227	1 987 432 370	R 2370	1 987 432 495	R 2495	F 026 400 039	S 0039
1 987 432 230	M 2230	1 987 432 371	R 2371	1 987 432 497	R 2497	F 026 400 040	S 0040
1 987 432 235	M 2235	1 987 432 373	R 2373	1 987 432 498	R 2498	F 026 400 041	S 0041
1 987 432 236	M 2236	1 987 432 376	R 2376	1 987 432 499	R 2499	F 026 400 042	S 0042
1 987 432 238	M 2238	1 987 432 377	R 2377	1 987 432 500	R 2500	F 026 400 043	S 0043
1 987 432 281	M 2281	1 987 432 378	R 2378	1 987 432 512	R 2512	F 026 400 044	S 0044
1 987 432 296	M 2296	1 987 432 379	R 2379	1 987 432 513	R 2513	F 026 400 045	S 0045
1 987 432 299	M 2299	1 987 432 380	R 2380	1 987 432 597	R 2597	F 026 400 046	S 0046
1 987 432 300	R 2300	1 987 432 381	R 2381			F 026 400 047	S 0047
1 987 432 301	R 2301	1 987 432 382	R 2382			F 026 400 048	S 0048
1 987 432 303	R 2303	1 987 432 386	R 2386			F 026 400 049	S 0049
1 987 432 304	R 2304	1 987 432 387	R 2387			F 026 400 050	S 0050
1 987 432 306	R 2306	1 987 432 393	R 2393	F 026 ...		F 026 400 051	S 0051
1 987 432 307	R 2307	1 987 432 397	R 2397	F 026 400 001	S 0001	F 026 400 052	S 0052
1 987 432 309	R 2309	1 987 432 398	R 2398	F 026 400 002	S 0002	F 026 400 053	S 0053
1 987 432 310	R 2310	1 987 432 399	R 2399	F 026 400 004	S 0004	F 026 400 054	S 0054
1 987 432 311	R 2311	1 987 432 400	R 2400	F 026 400 006	S 0006	F 026 400 055	S 0055
1 987 432 312	R 2312	1 987 432 401	R 2401	F 026 400 007	S 0007	F 026 400 056	S 0056
1 987 432 313	R 2313	1 987 432 402	R 2402	F 026 400 010	S 0010	F 026 400 057	S 0057
1 987 432 315	R 2315	1 987 432 405	R 2405	F 026 400 011	S 0011	F 026 400 058	S 0058
1 987 432 317	R 2317	1 987 432 406	R 2406	F 026 400 012	S 0012	F 026 400 059	S 0059
1 987 432 318	R 2318	1 987 432 407	R 2407	F 026 400 013	S 0013	F 026 400 060	S 0060
1 987 432 319	R 2319	1 987 432 409	R 2409	F 026 400 014	S 0014	F 026 400 061	S 0061
1 987 432 320	R 2320	1 987 432 410	R 2410	F 026 400 015	S 0015	F 026 400 062	S 0062
1 987 432 324	R 2324	1 987 432 411	R 2411	F 026 400 016	S 0016	F 026 400 063	S 0063
1 987 432 326	R 2326	1 987 432 412	R 2412	F 026 400 017	S 0017	F 026 400 064	S 0064
1 987 432 327	R 2327	1 987 432 413	R 2413	F 026 400 018	S 0018	F 026 400 065	S 0065
1 987 432 328	R 2328	1 987 432 415	R 2415	F 026 400 019	S 0019	F 026 400 067	S 0067
1 987 432 330	R 2330	1 987 432 416	R 2416	F 026 400 020	S 0020	F 026 400 068	S 0068
1 987 432 333	R 2333	1 987 432 419	R 2419	F 026 400 022	S 0022	F 026 400 069	S 0069
1 987 432 336	R 2336	1 987 432 422	R 2422	F 026 400 023	S 0023	F 026 400 070	S 0070
1 987 432 337	R 2337	1 987 432 423	R 2423			F 026 400 071	S 0071

de

Gegenüberstellung
Bestellnummer →
Suchnummer
(Fortsetzung)

en

Cross references
part number →
search number
(continued)

fr

Table de correspon-
dance référence →
code d'identification
(suite)

it

Confronto codice di
ordinazione → codice
breve
(seguito)

es

Confrontación refe-
rencia de pedido →
referencia comercial
(continuación)



F 026 400 072	S 0072
F 026 400 074	S 0074
F 026 400 075	S 0075
F 026 400 077	S 0077
F 026 400 078	S 0078
F 026 400 079	S 0079
F 026 400 080	S 0080
F 026 400 082	S 0082
F 026 400 083	S 0083
F 026 400 084	S 0084
F 026 400 085	S 0085
F 026 400 086	S 0086
F 026 400 087	S 0087
F 026 400 088	S 0088
F 026 400 090	S 0090
F 026 400 091	S 0091
F 026 400 092	S 0092
F 026 400 093	S 0093
F 026 400 094	S 0094
F 026 400 095	S 0095
F 026 400 096	S 0096
F 026 400 097	S 0097
F 026 400 098	S 0098
F 026 400 099	S 0099
F 026 400 101	S 0101
F 026 400 102	S 0102
F 026 400 103	S 0103
F 026 400 104	S 0104
F 026 400 105	S 0105
F 026 400 106	S 0106
F 026 400 107	S 0107
F 026 400 108	S 0108
F 026 400 109	S 0109
F 026 400 110	S 0110
F 026 400 111	S 0111
F 026 400 112	S 0112
F 026 400 113	S 0113
F 026 400 114	S 0114
F 026 400 117	S 0117
F 026 400 119	S 0119
F 026 400 120	S 0120
F 026 400 121	S 0121
F 026 400 122	S 0122
F 026 400 123	S 0123
F 026 400 125	S 0125



F 026 400 126	S 0126
F 026 400 127	S 0127
F 026 400 129	S 0129
F 026 400 130	S 0130
F 026 400 131	S 0131
F 026 400 132	S 0132
F 026 400 133	S 0133
F 026 400 134	S 0134
F 026 400 135	S 0135
F 026 400 136	S 0136
F 026 400 137	S 0137
F 026 400 138	S 0138
F 026 400 139	S 0139
F 026 400 140	S 0140
F 026 400 141	S 0141
F 026 400 143	S 0143
F 026 400 144	S 0144
F 026 400 145	S 0145
F 026 400 146	S 0146
F 026 400 147	S 0147
F 026 400 148	S 0148
F 026 400 149	S 0149
F 026 400 150	S 0150
F 026 400 151	S 0151
F 026 400 152	S 0152
F 026 400 153	S 0153
F 026 400 154	S 0154
F 026 400 156	S 0156
F 026 400 157	S 0157
F 026 400 158	S 0158
F 026 400 159	S 0159
F 026 400 160	S 0160
F 026 400 161	S 0161
F 026 400 162	S 0162
F 026 400 163	S 0163
F 026 400 164	S 0164
F 026 400 165	S 0165
F 026 400 166	S 0166
F 026 400 176	S 0176
F 026 400 178	S 0178
F 026 400 179	S 0179
F 026 400 181	S 0181
F 026 400 184	S 0184
F 026 400 188	S 0188
F 026 400 189	S 0189



F 026 400 197	S 0197
F 026 400 198	S 0198
F 026 400 199	S 0199
F 026 400 201	S 0201
F 026 400 205	S 0205
F 026 400 207	S 0207
F 026 400 209	S 0209
F 026 400 210	S 0210
F 026 400 211	S 0211
F 026 400 212	S 0212
F 026 400 213	S 0213
F 026 400 215	S 0215
F 026 400 216	S 0216
F 026 402 000	N 2000
F 026 402 001	N 2001
F 026 402 002	N 2002
F 026 402 003	N 2003
F 026 402 004	N 2004
F 026 402 005	N 2005
F 026 402 006	N 2006
F 026 402 007	N 2007
F 026 402 008	N 2008
F 026 402 013	N 2013
F 026 402 015	N 2015
F 026 402 016	N 2016
F 026 402 017	N 2017
F 026 402 019	N 2019
F 026 402 025	N 2025
F 026 402 028	N 2028
F 026 402 029	N 2029
F 026 402 030	N 2030
F 026 402 031	N 2031
F 026 402 032	N 2032
F 026 402 033	N 2033
F 026 402 034	N 2034
F 026 402 035	N 2035
F 026 402 036	N 2036
F 026 402 037	N 2037
F 026 402 038	N 2038
F 026 402 043	N 2043
F 026 402 044	N 2044
F 026 402 046	N 2046
F 026 402 047	N 2047
F 026 402 048	N 2048
F 026 402 049	N 2049



F 026 402 051	N 2051
F 026 402 054	N 2054
F 026 402 056	N 2056
F 026 402 059	N 2059
F 026 402 061	N 2061
F 026 402 062	N 2062
F 026 402 063	N 2063
F 026 402 065	N 2065
F 026 402 066	N 2066
F 026 402 067	N 2067
F 026 402 068	N 2068
F 026 402 072	N 2072
F 026 402 078	N 2078
F 026 402 081	N 2081
F 026 402 084	N 2084
F 026 402 086	N 2086
F 026 402 100	N 2100
F 026 402 101	N 2101
F 026 403 000	F 3000
F 026 403 001	F 3001
F 026 403 002	F 3002
F 026 403 003	F 3003
F 026 403 006	F 3006
F 026 403 008	F 3008
F 026 403 009	F 3009
F 026 403 012	F 3012
F 026 403 013	F 3013
F 026 403 014	F 3014
F 026 404 004	Z 4004
F 026 407 001	P 7001
F 026 407 002	P 7002
F 026 407 003	P 7003
F 026 407 004	P 7004
F 026 407 005	P 7005
F 026 407 006	P 7006
F 026 407 007	P 7007
F 026 407 008	P 7008
F 026 407 010	P 7010
F 026 407 011	P 7011
F 026 407 014	P 7014
F 026 407 015	P 7015
F 026 407 016	P 7016
F 026 407 017	P 7017
F 026 407 018	P 7018
F 026 407 021	P 7021

nl

Omzettingslijst
Bestelnummer →
Opzoeknummer
(vervolg)

sv

Artikelnummer →
Söknummer
(fortsättning)

cs







Převod objednáací číslo →
vyhledávací číslo
(pokračování)

pl

Zestawienie
numer katalogowy →
numer identyfikacyjny
(ciąg dalszy)

ru

Соответствие Номер
артикула →
Поисковый номер
(продолжение)

  №		  №		  №		  №	
F 026 407 022	P 7022	F 026 407 102	P 7102				
F 026 407 023	P 7023	F 026 407 105	P 7105				
F 026 407 024	P 7024	F 026 407 106	P 7106				
F 026 407 025	P 7025						
F 026 407 026	P 7026						
F 026 407 027	P 7027						
F 026 407 040	P 7040						
F 026 407 042	P 7042						
F 026 407 043	P 7043						
F 026 407 044	P 7044						
F 026 407 045	P 7045						
F 026 407 046	P 7046						
F 026 407 047	P 7047						
F 026 407 048	P 7048						
F 026 407 049	P 7049						
F 026 407 051	P 7051						
F 026 407 053	P 7053						
F 026 407 054	P 7054						
F 026 407 057	P 7057						
F 026 407 058	P 7058						
F 026 407 059	P 7059						
F 026 407 060	P 7060						
F 026 407 061	P 7061						
F 026 407 062	P 7062						
F 026 407 066	P 7066						
F 026 407 067	P 7067						
F 026 407 068	P 7068						
F 026 407 069	P 7069						
F 026 407 070	P 7070						
F 026 407 072	P 7072						
F 026 407 073	P 7073						
F 026 407 075	P 7075						
F 026 407 076	P 7076						
F 026 407 077	P 7077						
F 026 407 078	P 7078						
F 026 407 079	P 7079						
F 026 407 080	P 7080						
F 026 407 083	P 7083						
F 026 407 084	P 7084						
F 026 407 087	P 7087						
F 026 407 089	P 7089						
F 026 407 090	P 7090						
F 026 407 091	P 7091						
F 026 407 097	P 7097						
F 026 407 100	P 7100						

de

Gegenüberstellung
Suchnummer →
Bestellnummer

en

Cross references
search number →
part number

fr

Table de correspon-
dance code d'identi-
fication → référence

it

Confronto codice breve →
codice di ordinazione

es

Confrontación refe-
rencia comercial →
referencia de pedido



F ...	
F 0018	0 986 450 018
F 0030	0 986 450 030
F 0037	0 986 450 037
F 0039	0 986 450 039
F 0100	0 986 450 100
F 0102	0 986 450 102
F 0103	0 986 450 103
F 0104	0 986 450 104
F 0105	0 986 450 105
F 0106	0 986 450 106
F 0107	0 986 450 107
F 0108	0 986 450 108
F 0109	0 986 450 109
F 0110	0 986 450 110
F 0111	0 986 450 111
F 0113	0 986 450 113
F 0114	0 986 450 114
F 0115	0 986 450 115
F 0117	0 986 450 117
F 0119	0 986 450 119
F 0120	0 986 450 120
F 0121	0 986 450 121
F 0123	0 986 450 123
F 0124	0 986 450 124
F 0137	0 986 450 137
F 0138	0 986 450 138
F 0143	0 986 450 143
F 0212	0 986 450 212
F 0220	0 986 450 220
F 0221	0 986 450 221
F 0222	0 986 450 222
F 0225	0 986 450 225
F 0226	0 986 450 226
F 0510	0 986 450 510
F 0604	0 986 450 604
F 0624	0 986 450 624
F 1005	0 450 901 005
F 2151	0 450 902 151
F 2161	0 450 902 161
F 2162	0 450 902 162
F 3000	F 026 403 000
F 3001	F 026 403 001
F 3002	F 026 403 002



F 3003	F 026 403 003
F 3006	F 026 403 006
F 3008	F 026 403 008
F 3009	F 026 403 009
F 3012	F 026 403 012
F 3013	F 026 403 013
F 3014	F 026 403 014
F 4058	0 450 904 058
F 4060	0 450 904 060
F 4149	0 450 904 149
F 4159	0 450 904 159
F 4163	0 450 904 163
F 5001	0 450 915 001
F 5002	0 450 905 002
F 5003	0 450 915 003
F 5005	0 450 905 005
F 5016	0 450 905 016
F 5021	0 450 905 021
F 5030	0 450 905 030
F 5066	0 450 905 066
F 5087	0 450 905 087
F 5091	0 450 905 091
F 5095	0 450 905 095
F 5104	0 450 905 104
F 5133	0 450 905 133
F 5143	0 450 905 143
F 5145	0 450 905 145
F 5177	0 450 905 177
F 5195	0 450 905 195
F 5200	0 450 905 200
F 5201	0 450 905 201
F 5203	0 450 905 203
F 5215	0 450 905 215
F 5216	0 450 905 216
F 5264	0 450 905 264
F 5273	0 450 905 273
F 5275	0 450 905 275
F 5280	0 450 905 280
F 5281	0 450 905 281
F 5287	0 450 905 287
F 5316	0 450 905 316
F 5318	0 450 905 318
F 5320	0 450 905 320
F 5324	0 450 905 324
F 5326	0 450 905 326



F 5401	0 450 905 401
F 5601	0 450 905 601
F 5901	0 450 905 901
F 5903	0 450 905 903
F 5904	0 450 905 904
F 5905	0 450 905 905
F 5906	0 450 905 906
F 5908	0 450 905 908
F 5909	0 450 905 909
F 5911	0 450 905 911
F 5912	0 450 905 912
F 5914	0 450 905 914
F 5915	0 450 905 915
F 5916	0 450 905 916
F 5920	0 450 905 920
F 5921	0 450 905 921
F 5922	0 450 905 922
F 5923	0 450 905 923
F 5924	0 450 905 924
F 5925	0 450 905 925
F 5926	0 450 905 926
F 5927	0 450 905 927
F 5928	0 450 905 928
F 5929	0 450 905 929
F 5937	0 450 905 937
F 5939	0 450 905 939
F 5940	0 450 905 940
F 5943	0 450 905 943
F 5950	0 450 905 950
F 5951	0 450 905 951
F 5952	0 450 905 952
F 5953	0 450 905 953
F 5954	0 450 905 954
F 5955	0 450 905 955
F 5956	0 450 905 956
F 5957	0 450 905 957
F 5958	0 450 905 958
F 5959	0 450 905 959
F 5960	0 450 905 960
F 5962	0 450 905 962
F 5963	0 450 905 963
F 5964	0 450 905 964
F 5966	0 450 905 966
F 5967	0 450 905 967
F 5968	0 450 905 968



F 5969	0 450 905 969
F 5970	0 450 905 970
F 5971	0 450 905 971
F 5972	0 450 905 972
F 5973	0 450 905 973
F 5974	0 450 905 974
F 5975	0 450 905 975
F 5976	0 450 905 976
F 5977	0 450 905 977
F 5978	0 450 905 978
F 5979	0 450 905 979
F 5980	0 450 905 980
F 5981	0 450 905 981
F 5982	0 450 905 982
F 5983	0 450 905 983
F 5984	0 450 905 984
F 5985	0 450 905 985
F 5986	0 450 905 986
F 5987	0 450 905 987
F 5988	0 450 905 988
F 5989	0 450 905 989
F 5990	0 450 905 990
M ...	
M 1154	1 987 431 154
M 1155	1 987 431 155
M 1156	1 987 431 156
M 1157	1 987 431 157
M 1159	1 987 431 159
M 1162	1 987 431 162
M 1163	1 987 431 163
M 1164	1 987 431 164
M 1165	1 987 431 165
M 1166	1 987 431 166
M 1167	1 987 431 167
M 1168	1 987 431 168
M 1169	1 987 431 169
M 1172	1 987 431 172
M 1174	1 987 431 174
M 1175	1 987 431 175
M 2001	1 987 432 001
M 2002	1 987 432 002

nl	sv	cs	pl	ru
Omzettingslijst Opzoeknummer → Bestelnummer (vervolg)	Söknummer → Artikelnummer (fortsättning)	Převod vyhledávací číslo → objednáací číslo (pokračování)	Zestawienie numer identyfikacyjny → numer katalogowy (ciąg dalszy)	Соответствие Поисковый номер → Номер артикула (продолжение)



M 2003	1 987 432 003
M 2004	1 987 432 004
M 2005	1 987 432 005
M 2006	1 987 432 006
M 2007	1 987 432 007

M 2009	1 987 432 009
M 2010	1 987 432 010
M 2011	1 987 432 011
M 2012	1 987 432 012
M 2013	1 987 432 013

M 2014	1 987 432 014
M 2015	1 987 432 015
M 2016	1 987 432 016
M 2017	1 987 432 017
M 2018	1 987 432 018

M 2019	1 987 432 019
M 2020	1 987 432 020
M 2021	1 987 432 021
M 2022	1 987 432 022
M 2024	1 987 432 024

M 2026	1 987 432 026
M 2027	1 987 432 027
M 2028	1 987 432 028
M 2030	1 987 432 030
M 2032	1 987 432 032

M 2033	1 987 432 033
M 2034	1 987 432 034
M 2036	1 987 432 036
M 2037	1 987 432 037
M 2038	1 987 432 038

M 2039	1 987 432 039
M 2040	1 987 432 040
M 2042	1 987 432 042
M 2043	1 987 432 043
M 2044	1 987 432 044

M 2045	1 987 432 045
M 2048	1 987 432 048
M 2049	1 987 432 049
M 2050	1 987 432 050
M 2051	1 987 432 051

M 2052	1 987 432 052
M 2053	1 987 432 053
M 2055	1 987 432 055
M 2056	1 987 432 056
M 2057	1 987 432 057



M 2058	1 987 432 058
M 2059	1 987 432 059
M 2060	1 987 432 060
M 2061	1 987 432 061
M 2062	1 987 432 062

M 2063	1 987 432 063
M 2064	1 987 432 064
M 2065	1 987 432 065
M 2066	1 987 432 066
M 2068	1 987 432 068

M 2069	1 987 432 069
M 2070	1 987 432 070
M 2071	1 987 432 071
M 2072	1 987 432 072
M 2073	1 987 432 073

M 2074	1 987 432 074
M 2075	1 987 432 075
M 2076	1 987 432 076
M 2077	1 987 432 077
M 2078	1 987 432 078

M 2079	1 987 432 079
M 2081	1 987 432 081
M 2082	1 987 432 082
M 2083	1 987 432 083
M 2084	1 987 432 084

M 2085	1 987 432 085
M 2086	1 987 432 086
M 2087	1 987 432 087
M 2088	1 987 432 088
M 2089	1 987 432 089

M 2090	1 987 432 090
M 2091	1 987 432 091
M 2092	1 987 432 092
M 2093	1 987 432 093
M 2094	1 987 432 094

M 2095	1 987 432 095
M 2096	1 987 432 096
M 2097	1 987 432 097
M 2102	1 987 432 102
M 2103	1 987 432 103

M 2104	1 987 432 104
M 2105	1 987 432 105
M 2106	1 987 432 106
M 2107	1 987 432 107
M 2108	1 987 432 108



M 2111	1 987 432 111
M 2113	1 987 432 113
M 2114	1 987 432 114
M 2115	1 987 432 115
M 2116	1 987 432 116

M 2117	1 987 432 117
M 2118	1 987 432 118
M 2119	1 987 432 119
M 2120	1 987 432 120
M 2121	1 987 432 121

M 2122	1 987 432 122
M 2124	1 987 432 124
M 2136	1 987 432 136
M 2137	1 987 432 137
M 2150	1 987 432 150

M 2151	1 987 432 151
M 2152	1 987 432 152
M 2153	1 987 432 153
M 2154	1 987 432 154
M 2155	1 987 432 155

M 2156	1 987 432 156
M 2157	1 987 432 157
M 2158	1 987 432 158
M 2159	1 987 432 159
M 2160	1 987 432 160

M 2161	1 987 432 161
M 2162	1 987 432 162
M 2163	1 987 432 163
M 2164	1 987 432 164
M 2166	1 987 432 166

M 2167	1 987 432 167
M 2169	1 987 432 169
M 2170	1 987 432 170
M 2171	1 987 432 171
M 2172	1 987 432 172

M 2173	1 987 432 173
M 2175	1 987 432 175
M 2176	1 987 432 176
M 2179	1 987 432 179
M 2182	1 987 432 182

M 2183	1 987 432 183
M 2184	1 987 432 184
M 2188	1 987 432 188
M 2189	1 987 432 189
M 2190	1 987 432 190



M 2192	1 987 432 192
M 2193	1 987 432 193
M 2194	1 987 432 194
M 2195	1 987 432 195
M 2200	1 987 432 200

M 2203	1 987 432 203
M 2204	1 987 432 204
M 2205	1 987 432 205
M 2206	1 987 432 206
M 2207	1 987 432 207

M 2208	1 987 432 208
M 2213	1 987 432 213
M 2214	1 987 432 214
M 2215	1 987 432 215
M 2216	1 987 432 216

M 2218	1 987 432 218
M 2219	1 987 432 219
M 2221	1 987 432 221
M 2227	1 987 432 227
M 2230	1 987 432 230

M 2235	1 987 432 235
M 2236	1 987 432 236
M 2238	1 987 432 238
M 2281	1 987 432 281
M 2296	1 987 432 296

M 2299	1 987 432 299

N ...	
N 0000	1 457 070 000
N 0001	1 457 070 001
N 0007	1 457 070 007

N 0013	1 457 030 013
N 0505	0 986 450 505
N 0508	0 986 450 508
N 0509	0 986 450 509
N 1028	1 457 431 028

N 1158	1 457 431 158
N 1159	1 457 431 159
N 1261	1 457 431 261
N 1270	1 457 431 270
N 1325	1 457 431 325

de

**Gegenüberstellung
Suchnummer →
Bestellnummer**
(Fortsetzung)

en

**Cross references
search number →
part number**
(continued)

fr

**Table de correspon-
dance code d'identi-
fication → référence**
(suite)

it

**Confronto codice breve →
codice di ordinazione**
(seguito)

es

**Confrontación refe-
rencia comercial →
referencia de pedido**
(continuación)



N 1326	1 457 431 326
N 1702	1 457 431 702
N 1703	1 457 431 703
N 1704	1 457 431 704
N 1705	1 457 431 705
N 1707	1 457 431 707
N 1708	1 457 431 708
N 1710	1 457 431 710
N 1712	1 457 431 712
N 1713	1 457 431 713
N 1715	1 457 431 715
N 1718	1 457 431 718
N 1720	1 457 431 720
N 1723	1 457 431 723
N 1724	1 457 431 724
N 1729	1 457 431 729
N 2000	F 026 402 000
N 2001	F 026 402 001
N 2002	F 026 402 002
N 2003	F 026 402 003
N 2004	F 026 402 004
N 2005	F 026 402 005
N 2006	F 026 402 006
N 2007	F 026 402 007
N 2008	F 026 402 008
N 2013	F 026 402 013
N 2015	F 026 402 015
N 2016	F 026 402 016
N 2017	F 026 402 017
N 2019	F 026 402 019
N 2025	F 026 402 025
N 2028	F 026 402 028
N 2029	F 026 402 029
N 2030	F 026 402 030
N 2031	F 026 402 031
N 2032	F 026 402 032
N 2033	F 026 402 033
N 2034	F 026 402 034
N 2035	F 026 402 035
N 2036	F 026 402 036
N 2037	F 026 402 037
N 2038	F 026 402 038
N 2043	F 026 402 043
N 2044	F 026 402 044
N 2046	F 026 402 046



N 2047	F 026 402 047
N 2048	F 026 402 048
N 2049	F 026 402 049
N 2051	F 026 402 051
N 2054	F 026 402 054
N 2056	F 026 402 056
N 2059	F 026 402 059
N 2061	F 026 402 061
N 2062	F 026 402 062
N 2063	F 026 402 063
N 2065	F 026 402 065
N 2066	F 026 402 066
N 2067	F 026 402 067
N 2068	F 026 402 068
N 2072	F 026 402 072
N 2078	F 026 402 078
N 2081	F 026 402 081
N 2084	F 026 402 084
N 2086	F 026 402 086
N 2100	F 026 402 100
N 2101	F 026 402 101
N 4050	1 457 434 050
N 4051	1 457 434 051
N 4077	0 450 904 077
N 4103	1 457 434 103
N 4105	1 457 434 105
N 4106	1 457 434 106
N 4123	1 457 434 123
N 4150	1 457 434 150
N 4153	1 457 434 153
N 4154	1 457 434 154
N 4156	1 457 434 156
N 4158	0 450 904 158
N 4161	0 450 904 161
N 4165	1 457 434 165
N 4174	1 457 434 174
N 4184	1 457 434 184
N 4186	1 457 434 186
N 4187	1 457 434 187
N 4189	1 457 434 189
N 4192	1 457 434 192
N 4194	1 457 434 194
N 4198	1 457 434 198
N 4200	1 457 434 200
N 4201	1 457 434 201



N 4250	1 457 434 250
N 4251	1 457 434 251
N 4252	1 457 434 252
N 4281	1 457 434 281
N 4291	1 457 434 291
N 4293	1 457 434 293
N 4294	1 457 434 294
N 4295	1 457 434 295
N 4296	1 457 434 296
N 4302	1 457 434 302
N 4306	1 457 434 306
N 4310	1 457 434 310
N 4314	1 457 434 314
N 4321	1 457 434 321
N 4324	1 457 434 324
N 4329	1 457 434 329
N 4331	1 457 434 331
N 4400	1 457 434 400
N 4402	1 457 434 402
N 4405	1 457 434 405
N 4408	1 457 434 408
N 4409	1 457 434 409
N 4416	1 457 434 416
N 4419	1 457 434 419
N 4421	1 457 434 421
N 4423	1 457 434 423
N 4428	1 457 434 428
N 4429	1 457 434 429
N 4432	1 457 434 432
N 4435	1 457 434 435
N 4436	1 457 434 436
N 4437	1 457 434 437
N 4438	1 457 434 438
N 4439	1 457 434 439
N 4440	1 457 434 440
N 4443	1 457 434 443
N 4447	1 457 434 447
N 4448	1 457 434 448
N 4450	1 457 434 450
N 4451	1 457 434 451
N 4452	1 457 434 452
N 4453	1 457 434 453
N 4454	1 457 434 454
N 4455	1 457 434 455
N 4456	1 457 434 456



N 4457	1 457 434 457
N 4459	1 457 434 459
N 4460	1 457 434 460
N 5930	0 450 905 930
N 5942	0 450 905 942
N 6172	0 450 906 172
N 6174	0 450 906 174
N 6261	0 450 906 261
N 6267	0 450 906 267
N 6274	0 450 906 274
N 6281	0 450 906 281
N 6295	0 450 906 295
N 6308	0 450 906 308
N 6318	0 450 906 318
N 6322	0 450 906 322
N 6334	0 450 906 334
N 6357	0 450 906 357
N 6373	0 450 906 373
N 6374	0 450 906 374
N 6376	0 450 906 376
N 6406	0 450 906 406
N 6407	0 450 906 407
N 6409	0 450 906 409
N 6426	0 450 906 426
N 6429	0 450 906 429
N 6431	0 450 906 431
N 6437	0 450 906 437
N 6442	0 450 906 442
N 6450	0 450 906 450
N 6451	0 450 906 451
N 6452	0 450 906 452
N 6453	0 450 906 453
N 6457	0 450 906 457
N 6458	0 450 906 458
N 6459	0 450 906 459
N 6460	0 450 906 460
N 6461	0 450 906 461
N 6462	0 450 906 462
N 6463	0 450 906 463
N 6464	0 450 906 464
N 6467	0 450 906 467
N 6468	0 450 906 468
N 6469	0 450 906 469
N 6471	0 450 906 471
N 6473	0 450 906 473

nl	sv	cs	pl	ru
Omzettingslijst Opzoeknummer → Bestelnummer (vervolg)	Söknummer → Artikelnummer (fortsättning)	Převod vyhledávací číslo → objednáací číslo (pokračování)	Zestawienie numer identyfikacyjny → numer katalogowy (ciąg dalszy)	Соответствие Поисковый номер → Номер артикула (продолжение)



N 6500	0 450 906 500
N 6503	0 450 906 503
N 6508	0 450 906 508
N 9230	1 457 429 230
N 9289	1 457 429 289

N 9291	1 457 429 291
N 9354	1 457 429 354
N 9359	1 457 429 359
N 9621	1 457 429 621
N 9655	1 457 429 655

N 9656	1 457 429 656
N 9657	1 457 429 657
N 9675	1 457 429 675
N 9676	1 457 429 676
N 9681	1 457 429 681

P ...	
P 0003	0 451 300 003
P 0004	0 451 300 004
P 0007	0 451 300 007

P 0008	0 451 300 008
P 1156	0 451 301 156
P 1207	0 451 301 207
P 2000	0 986 452 000
P 2001	0 986 452 001

P 2003	0 986 452 003
P 2005	0 986 452 005
P 2015	0 986 452 015
P 2016	0 986 452 016
P 2019	0 986 452 019

P 2020	0 986 452 020
P 2023	0 986 452 023
P 2024	0 986 452 024
P 2028	0 986 452 028
P 2030	0 986 452 030

P 2035	0 986 452 035
P 2036	0 986 452 036
P 2041	0 986 452 041
P 2042	0 986 452 042
P 2044	0 986 452 044

P 2046	0 986 452 046
P 2056	0 451 102 056
P 2058	0 986 452 058
P 2060	0 986 452 060
P 2061	0 986 452 061



P 2062	0 986 452 062
P 2063	0 986 452 063
P 2064	0 986 452 064
P 2066	0 986 452 066
P 2068	0 986 452 068

P 2400	0 986 452 400
P 3001	0 451 403 001
P 3002	0 451 203 002
P 3004	0 451 103 004
P 3005	0 451 203 005

P 3010	0 451 203 010
P 3012	0 451 203 012
P 3028	0 451 103 028
P 3029	0 451 103 029
P 3033	0 451 103 033

P 3050	0 451 103 050
P 3060	0 451 103 060
P 3062	0 451 103 062
P 3074	0 451 103 074
P 3077	0 451 403 077

P 3079	0 451 103 079
P 3086	0 451 103 086
P 3087	0 451 203 087
P 3093	0 451 103 093
P 3096	0 451 103 096

P 3105	0 451 103 105
P 3108	0 451 203 108
P 3109	0 451 103 109
P 3111	0 451 103 111
P 3139	0 451 103 139

P 3141	0 451 103 141
P 3144	0 451 103 144
P 3145	0 451 103 145
P 3152	0 451 203 152
P 3154	0 451 203 154

P 3170	0 451 103 170
P 3189	0 451 103 189
P 3194	0 451 203 194
P 3197	0 451 203 197
P 3201	0 451 203 201

P 3208	0 451 403 208
P 3210	0 451 403 210
P 3213	0 451 103 213
P 3215	0 451 103 215
P 3217	0 451 103 217



P 3218	0 451 203 218
P 3219	0 451 103 219
P 3220	0 451 203 220
P 3221	0 451 103 221
P 3223	0 451 203 223

P 3224	0 451 103 224
P 3226	0 451 203 226
P 3227	0 451 103 227
P 3231	0 451 203 231
P 3232	0 451 103 232

P 3235	0 451 103 235
P 3238	0 451 103 238
P 3240	0 451 103 240
P 3249	0 451 103 249
P 3251	0 451 103 251

P 3252	0 451 103 252
P 3253	0 451 103 253
P 3257	0 451 103 257
P 3258	0 451 103 258
P 3259	0 451 103 259

P 3260	0 451 103 260
P 3261	0 451 103 261
P 3266	0 451 103 266
P 3270	0 451 103 270
P 3271	0 451 103 271

P 3274	0 451 103 274
P 3275	0 451 103 275
P 3276	0 451 103 276
P 3278	0 451 103 278
P 3280	0 451 103 280

P 3289	0 451 103 289
P 3290	0 451 103 290
P 3292	0 451 103 292
P 3297	0 451 103 297
P 3298	0 451 103 298

P 3299	0 451 103 299
P 3300	0 451 103 300
P 3311	0 451 103 311
P 3313	0 451 103 313
P 3314	0 451 103 314

P 3316	0 451 103 316
P 3318	0 451 103 318
P 3330	0 451 103 330
P 3333	0 451 103 333
P 3335	0 451 103 335



P 3336	0 451 103 336
P 3337	0 451 103 337
P 3338	0 451 103 338
P 3340	0 451 103 340
P 3341	0 451 103 341

P 3342	0 451 103 342
P 3343	0 451 103 343
P 3344	0 451 103 344
P 3346	0 451 103 346
P 3347	0 451 103 347

P 3348	0 451 103 348
P 3349	0 451 103 349
P 3350	0 451 103 350
P 3351	0 451 103 351
P 3352	0 451 103 352

P 3353	0 451 103 353
P 3354	0 451 103 354
P 3355	0 451 103 355
P 3357	0 451 103 357
P 3360	0 451 103 360

P 3363	0 451 103 363
P 3364	0 451 103 364
P 3365	0 451 103 365
P 3366	0 451 103 366
P 3367	0 451 103 367

P 3368	0 451 103 368
P 3369	0 451 103 369
P 3370	0 451 103 370
P 3371	0 451 103 371
P 3372	0 451 103 372

P 4005	0 451 104 005
P 4010	0 451 104 010
P 4013	0 451 104 013
P 4014	0 451 104 014
P 4015	0 451 104 015

P 4025	0 451 104 025
P 4026	0 451 104 026
P 4063	0 451 104 063
P 4064	0 451 104 064
P 4065	0 451 104 065

P 4066	0 451 104 066
P 4067	0 451 104 067
P 5067	0 451 105 067
P 5188	0 451 105 188
P 7001	F 026 407 001

de

**Gegenüberstellung
Suchnummer →
Bestellnummer**
(Fortsetzung)

en

**Cross references
search number →
part number**
(continued)

fr

**Table de correspon-
dance code d'identi-
fication → référence**
(suite)

it

**Confronto codice breve →
codice di ordinazione**
(seguito)

es

**Confrontación refe-
rencia comercial →
referencia de pedido**
(continuación)



P 7002	F 026 407 002
P 7003	F 026 407 003
P 7004	F 026 407 004
P 7005	F 026 407 005
P 7006	F 026 407 006
P 7007	F 026 407 007
P 7008	F 026 407 008
P 7010	F 026 407 010
P 7011	F 026 407 011
P 7014	F 026 407 014
P 7015	F 026 407 015
P 7016	F 026 407 016
P 7017	F 026 407 017
P 7018	F 026 407 018
P 7021	F 026 407 021
P 7022	F 026 407 022
P 7023	F 026 407 023
P 7024	F 026 407 024
P 7025	F 026 407 025
P 7026	F 026 407 026
P 7027	F 026 407 027
P 7040	F 026 407 040
P 7042	F 026 407 042
P 7043	F 026 407 043
P 7044	F 026 407 044
P 7045	F 026 407 045
P 7046	F 026 407 046
P 7047	F 026 407 047
P 7048	F 026 407 048
P 7049	F 026 407 049
P 7051	F 026 407 051
P 7053	F 026 407 053
P 7054	F 026 407 054
P 7057	F 026 407 057
P 7058	F 026 407 058
P 7059	F 026 407 059
P 7060	F 026 407 060
P 7061	F 026 407 061
P 7062	F 026 407 062
P 7066	F 026 407 066
P 7067	F 026 407 067
P 7068	F 026 407 068
P 7069	F 026 407 069
P 7070	F 026 407 070
P 7072	F 026 407 072



P 7073	F 026 407 073
P 7075	F 026 407 075
P 7076	F 026 407 076
P 7077	F 026 407 077
P 7078	F 026 407 078
P 7079	F 026 407 079
P 7080	F 026 407 080
P 7083	F 026 407 083
P 7084	F 026 407 084
P 7087	F 026 407 087
P 7089	F 026 407 089
P 7090	F 026 407 090
P 7091	F 026 407 091
P 7097	F 026 407 097
P 7100	F 026 407 100
P 7102	F 026 407 102
P 7105	F 026 407 105
P 7106	F 026 407 106
P 9102	1 457 429 102
P 9103	1 457 429 103
P 9104	1 457 429 104
P 9105	1 457 429 105
P 9107	1 457 429 107
P 9108	1 457 429 108
P 9116	1 457 429 116
P 9117	1 457 429 117
P 9118	1 457 429 118
P 9119	1 457 429 119
P 9121	1 457 429 121
P 9122	1 457 429 122
P 9123	1 457 429 123
P 9126	1 457 429 126
P 9127	1 457 429 127
P 9128	1 457 429 128
P 9130	1 457 429 130
P 9137	1 457 429 137
P 9139	1 457 429 139
P 9141	1 457 429 141
P 9142	1 457 429 142
P 9144	1 457 429 144
P 9147	1 457 429 147
P 9152	1 457 429 152
P 9153	1 457 429 153
P 9154	1 457 429 154
P 9157	1 457 429 157



P 9165	1 457 429 165
P 9167	1 457 429 167
P 9174	1 457 429 174
P 9175	1 457 429 175
P 9178	1 457 429 178
P 9184	1 457 429 184
P 9185	1 457 429 185
P 9192	1 457 429 192
P 9193	1 457 429 193
P 9194	1 457 429 194
P 9196	1 457 429 196
P 9197	1 457 429 197
P 9198	1 457 429 198
P 9199	1 457 429 199
P 9238	1 457 429 238
P 9239	1 457 429 239
P 9243	1 457 429 243
P 9244	1 457 429 244
P 9248	1 457 429 248
P 9249	1 457 429 249
P 9251	1 457 429 251
P 9252	1 457 429 252
P 9256	1 457 429 256
P 9257	1 457 429 257
P 9261	1 457 429 261
P 9262	1 457 429 262
P 9263	1 457 429 263
P 9264	1 457 429 264
P 9265	1 457 429 265
P 9267	1 457 429 267
P 9268	1 457 429 268
P 9269	1 457 429 269
P 9271	1 457 429 271
P 9272	1 457 429 272
P 9274	1 457 429 274
P 9275	1 457 429 275
P 9276	1 457 429 276
P 9277	1 457 429 277
P 9278	1 457 429 278
P 9284	1 457 429 284
P 9301	1 457 429 301
P 9302	1 457 429 302
P 9306	1 457 429 306
P 9307	1 457 429 307
P 9308	1 457 429 308



P 9413	1 457 429 413
P 9416	1 457 429 416
P 9493	1 457 429 493
P 9546	1 457 429 546
P 9559	1 457 429 559
P 9600	1 457 429 600
P 9605	1 457 429 605
P 9610	1 457 429 610
P 9616	1 457 429 616
P 9619	1 457 429 619
P 9629	1 457 429 629
P 9631	1 457 429 631
P 9636	1 457 429 636
P 9638	1 457 429 638
P 9646	1 457 429 646
P 9647	1 457 429 647
P 9648	1 457 429 648
P 9649	1 457 429 649
P 9732	1 457 429 732
P 9735	1 457 429 735
P 9740	1 457 429 740
P 9755	1 457 429 755
P 9760	1 457 429 760
P 9762	1 457 429 762
P 9820	1 457 429 820
R ...	
R 1451	1 987 431 451
R 1452	1 987 431 452
R 1454	1 987 431 454
R 1455	1 987 431 455
R 1456	1 987 431 456
R 1457	1 987 431 457
R 1458	1 987 431 458
R 2197	1 987 432 197
R 2300	1 987 432 300
R 2301	1 987 432 301
R 2303	1 987 432 303
R 2304	1 987 432 304
R 2306	1 987 432 306
R 2307	1 987 432 307
R 2309	1 987 432 309
R 2310	1 987 432 310
R 2311	1 987 432 311
R 2312	1 987 432 312

nl	sv	cs	pl	ru
Omzettingslijst Opzoeknummer → Bestelnummer (vervolg)	Söknummer → Artikelnummer (fortsättning)	Převod vyhledávací číslo → objednáací číslo (pokračování)	Zestawienie numer identyfikacyjny → numer katalogowy (ciąg dalszy)	Соответствие Поисковый номер → Номер артикула (продолжение)



R 2313	1 987 432 313
R 2315	1 987 432 315
R 2317	1 987 432 317
R 2318	1 987 432 318
R 2319	1 987 432 319

R 2320	1 987 432 320
R 2324	1 987 432 324
R 2326	1 987 432 326
R 2327	1 987 432 327
R 2328	1 987 432 328

R 2330	1 987 432 330
R 2333	1 987 432 333
R 2336	1 987 432 336
R 2337	1 987 432 337
R 2345	1 987 432 345

R 2348	1 987 432 348
R 2354	1 987 432 354
R 2357	1 987 432 357
R 2360	1 987 432 360
R 2361	1 987 432 361

R 2362	1 987 432 362
R 2364	1 987 432 364
R 2365	1 987 432 365
R 2366	1 987 432 366
R 2367	1 987 432 367

R 2368	1 987 432 368
R 2369	1 987 432 369
R 2370	1 987 432 370
R 2371	1 987 432 371
R 2373	1 987 432 373

R 2376	1 987 432 376
R 2377	1 987 432 377
R 2378	1 987 432 378
R 2379	1 987 432 379
R 2380	1 987 432 380

R 2381	1 987 432 381
R 2382	1 987 432 382
R 2386	1 987 432 386
R 2387	1 987 432 387
R 2393	1 987 432 393

R 2397	1 987 432 397
R 2398	1 987 432 398
R 2399	1 987 432 399
R 2400	1 987 432 400
R 2401	1 987 432 401



R 2402	1 987 432 402
R 2405	1 987 432 405
R 2406	1 987 432 406
R 2407	1 987 432 407
R 2409	1 987 432 409

R 2410	1 987 432 410
R 2411	1 987 432 411
R 2412	1 987 432 412
R 2413	1 987 432 413
R 2415	1 987 432 415

R 2416	1 987 432 416
R 2419	1 987 432 419
R 2422	1 987 432 422
R 2423	1 987 432 423
R 2424	1 987 432 424

R 2425	1 987 432 425
R 2426	1 987 432 426
R 2428	1 987 432 428
R 2431	1 987 432 431
R 2433	1 987 432 433

R 2434	1 987 432 434
R 2435	1 987 432 435
R 2437	1 987 432 437
R 2438	1 987 432 438
R 2468	1 987 432 468

R 2482	1 987 432 482
R 2488	1 987 432 488
R 2495	1 987 432 495
R 2497	1 987 432 497
R 2498	1 987 432 498

R 2499	1 987 432 499
R 2500	1 987 432 500
R 2512	1 987 432 512
R 2513	1 987 432 513
R 2597	1 987 432 597

S ...	
S 0001	F 026 400 001
S 0002	F 026 400 002
S 0004	F 026 400 004

S 0006	F 026 400 006
S 0007	F 026 400 007
S 0010	F 026 400 010
S 0011	F 026 400 011
S 0012	F 026 400 012



S 0013	F 026 400 013
S 0014	F 026 400 014
S 0015	F 026 400 015
S 0016	F 026 400 016
S 0017	F 026 400 017

S 0018	F 026 400 018
S 0019	F 026 400 019
S 0020	F 026 400 020
S 0022	F 026 400 022
S 0023	F 026 400 023

S 0024	F 026 400 024
S 0025	F 026 400 025
S 0026	F 026 400 026
S 0027	F 026 400 027
S 0028	F 026 400 028

S 0029	F 026 400 029
S 0030	F 026 400 030
S 0033	F 026 400 033
S 0034	F 026 400 034
S 0035	F 026 400 035

S 0036	F 026 400 036
S 0037	F 026 400 037
S 0038	F 026 400 038
S 0039	F 026 400 039
S 0040	F 026 400 040

S 0041	F 026 400 041
S 0042	F 026 400 042
S 0043	F 026 400 043
S 0044	F 026 400 044
S 0045	F 026 400 045

S 0046	F 026 400 046
S 0047	F 026 400 047
S 0048	F 026 400 048
S 0049	F 026 400 049
S 0050	F 026 400 050

S 0051	F 026 400 051
S 0052	F 026 400 052
S 0053	F 026 400 053
S 0054	F 026 400 054
S 0055	F 026 400 055

S 0056	F 026 400 056
S 0057	F 026 400 057
S 0058	F 026 400 058
S 0059	F 026 400 059
S 0060	F 026 400 060



S 0061	F 026 400 061
S 0062	F 026 400 062
S 0063	F 026 400 063
S 0064	F 026 400 064
S 0065	F 026 400 065

S 0067	F 026 400 067
S 0068	F 026 400 068
S 0069	F 026 400 069
S 0070	F 026 400 070
S 0071	F 026 400 071

S 0072	F 026 400 072
S 0074	F 026 400 074
S 0075	F 026 400 075
S 0077	F 026 400 077
S 0078	F 026 400 078

S 0079	F 026 400 079
S 0080	F 026 400 080
S 0082	F 026 400 082
S 0083	F 026 400 083
S 0084	F 026 400 084

S 0085	F 026 400 085
S 0086	F 026 400 086
S 0087	F 026 400 087
S 0088	F 026 400 088
S 0090	F 026 400 090

S 0091	F 026 400 091
S 0092	F 026 400 092
S 0093	F 026 400 093
S 0094	F 026 400 094
S 0095	F 026 400 095

S 0096	F 026 400 096
S 0097	F 026 400 097
S 0098	F 026 400 098
S 0099	F 026 400 099
S 0101	F 026 400 101

S 0102	F 026 400 102
S 0103	F 026 400 103
S 0104	F 026 400 104
S 0105	F 026 400 105
S 0106	F 026 400 106

S 0107	F 026 400 107
S 0108	F 026 400 108
S 0109	F 026 400 109
S 0110	F 026 400 110
S 0111	F 026 400 111

de

**Gegenüberstellung
Suchnummer →
Bestellnummer**
(Fortsetzung)

en

**Cross references
search number →
part number**
(continued)

fr

**Table de correspon-
dance code d'identi-
fication → référence**
(suite)

it

**Confronto codice breve →
codice di ordinazione**
(seguito)

es

**Confrontación refe-
rencia comercial →
referencia de pedido**
(continuación)



S 0112	F 026 400 112
S 0113	F 026 400 113
S 0114	F 026 400 114
S 0117	F 026 400 117
S 0119	F 026 400 119

S 0120	F 026 400 120
S 0121	F 026 400 121
S 0122	F 026 400 122
S 0123	F 026 400 123
S 0125	F 026 400 125

S 0126	F 026 400 126
S 0127	F 026 400 127
S 0129	F 026 400 129
S 0130	F 026 400 130
S 0131	F 026 400 131

S 0132	F 026 400 132
S 0133	F 026 400 133
S 0134	F 026 400 134
S 0135	F 026 400 135
S 0136	F 026 400 136

S 0137	F 026 400 137
S 0138	F 026 400 138
S 0139	F 026 400 139
S 0140	F 026 400 140
S 0141	F 026 400 141

S 0143	F 026 400 143
S 0144	F 026 400 144
S 0145	F 026 400 145
S 0146	F 026 400 146
S 0147	F 026 400 147

S 0148	F 026 400 148
S 0149	F 026 400 149
S 0150	F 026 400 150
S 0151	F 026 400 151
S 0152	F 026 400 152

S 0153	F 026 400 153
S 0154	F 026 400 154
S 0156	F 026 400 156
S 0157	F 026 400 157
S 0158	F 026 400 158

S 0159	F 026 400 159
S 0160	F 026 400 160
S 0161	F 026 400 161
S 0162	F 026 400 162
S 0163	F 026 400 163



S 0164	F 026 400 164
S 0165	F 026 400 165
S 0166	F 026 400 166
S 0176	F 026 400 176
S 0178	F 026 400 178

S 0179	F 026 400 179
S 0181	F 026 400 181
S 0184	F 026 400 184
S 0188	F 026 400 188
S 0189	F 026 400 189

S 0197	F 026 400 197
S 0198	F 026 400 198
S 0199	F 026 400 199
S 0201	F 026 400 201
S 0205	F 026 400 205

S 0207	F 026 400 207
S 0209	F 026 400 209
S 0210	F 026 400 210
S 0211	F 026 400 211
S 0212	F 026 400 212

S 0213	F 026 400 213
S 0215	F 026 400 215
S 0216	F 026 400 216
S 2100	1 457 432 100
S 2106	1 457 432 106

S 2108	1 457 432 108
S 2109	1 457 432 109
S 2111	1 457 432 111
S 2124	1 457 432 124
S 2128	1 457 432 128

S 2134	1 457 432 134
S 2138	1 457 432 138
S 2146	1 457 432 146
S 2149	1 457 432 149
S 2150	1 457 432 150

S 2154	1 457 432 154
S 2172	1 457 432 172
S 2173	1 457 432 173
S 2174	1 457 432 174
S 2178	1 457 432 178

S 2180	1 457 432 180
S 2183	1 457 432 183
S 2185	1 457 432 185
S 2188	1 457 432 188
S 2192	1 457 432 192



S 2193	1 457 432 193
S 2200	1 457 432 200
S 2202	1 457 432 202
S 2203	1 457 432 203
S 2204	1 457 432 204

S 2205	1 457 432 205
S 2208	1 457 432 208
S 2210	1 457 432 210
S 2212	1 457 432 212
S 3002	1 457 433 002

S 3003	1 457 433 003
S 3004	1 457 433 004
S 3005	1 457 433 005
S 3006	1 457 433 006
S 3007	1 457 433 007

S 3008	1 457 433 008
S 3023	1 457 433 023
S 3032	1 457 433 032
S 3036	1 457 433 036
S 3037	1 457 433 037

S 3042	1 457 433 042
S 3043	1 457 433 043
S 3044	1 457 433 044
S 3045	1 457 433 045
S 3046	1 457 433 046

S 3047	1 457 433 047
S 3049	1 457 433 049
S 3052	1 457 433 052
S 3053	1 457 433 053
S 3054	1 457 433 054

S 3055	1 457 433 055
S 3056	1 457 433 056
S 3058	1 457 433 058
S 3059	1 457 433 059
S 3060	1 457 433 060

S 3061	1 457 433 061
S 3062	1 457 433 062
S 3065	1 457 433 065
S 3066	1 457 433 066
S 3067	1 457 433 067

S 3069	1 457 433 069
S 3070	1 457 433 070
S 3071	1 457 433 071
S 3072	1 457 433 072
S 3073	1 457 433 073



S 3075	1 457 433 075
S 3076	1 457 433 076
S 3077	1 457 433 077
S 3078	1 457 433 078
S 3079	1 457 433 079

S 3080	1 457 433 080
S 3081	1 457 433 081
S 3083	1 457 433 083
S 3084	1 457 433 084
S 3085	1 457 433 085

S 3086	1 457 433 086
S 3087	1 457 433 087
S 3088	1 457 433 088
S 3089	1 457 433 089
S 3090	1 457 433 090

S 3091	1 457 433 091
S 3093	1 457 433 093
S 3094	1 457 433 094
S 3095	1 457 433 095
S 3096	1 457 433 096

S 3097	1 457 433 097
S 3098	1 457 433 098
S 3099	1 457 433 099
S 3100	1 457 433 100
S 3101	1 457 433 101

S 3102	1 457 433 102
S 3150	1 457 433 150
S 3152	1 457 433 152
S 3153	1 457 433 153
S 3154	1 457 433 154

S 3155	1 457 433 155
S 3156	1 457 433 156
S 3158	1 457 433 158
S 3159	1 457 433 159
S 3160	1 457 433 160

S 3161	1 457 433 161
S 3163	1 457 433 163
S 3164	1 457 433 164
S 3200	1 457 433 200
S 3201	1 457 433 201

S 3227	1 457 433 227
S 3228	1 457 433 228
S 3229	1 457 433 229
S 3230	1 457 433 230
S 3231	1 457 433 231

nl	sv	cs	pl	ru
Omzettingslijst Opzoeknummer → Bestelnummer (vervolg)	Söknummer → Artikelnummer (fortsättning)	Převod vyhledávací číslo → objednáací číslo (pokračování)	Zestawienie numer identyfikacyjny → numer katalogowy (ciąg dalszy)	Соответствие Поисковый номер → Номер артикула (продолжение)



S 3232	1 457 433 232
S 3233	1 457 433 233
S 3234	1 457 433 234
S 3250	1 457 433 250
S 3251	1 457 433 251

S 3252	1 457 433 252
S 3253	1 457 433 253
S 3255	1 457 433 255
S 3256	1 457 433 256
S 3257	1 457 433 257

S 3258	1 457 433 258
S 3259	1 457 433 259
S 3260	1 457 433 260
S 3261	1 457 433 261
S 3263	1 457 433 263

S 3264	1 457 433 264
S 3265	1 457 433 265
S 3266	1 457 433 266
S 3268	1 457 433 268
S 3269	1 457 433 269

S 3270	1 457 433 270
S 3272	1 457 433 272
S 3273	1 457 433 273
S 3274	1 457 433 274
S 3275	1 457 433 275

S 3276	1 457 433 276
S 3279	1 457 433 279
S 3280	1 457 433 280
S 3281	1 457 433 281
S 3282	1 457 433 282

S 3285	1 457 433 285
S 3286	1 457 433 286
S 3289	1 457 433 289
S 3290	1 457 433 290
S 3292	1 457 433 292

S 3294	1 457 433 294
S 3297	1 457 433 297
S 3298	1 457 433 298
S 3299	1 457 433 299
S 3300	1 457 433 300

S 3303	1 457 433 303
S 3306	1 457 433 306
S 3307	1 457 433 307
S 3308	1 457 433 308
S 3309	1 457 433 309



S 3310	1 457 433 310
S 3311	1 457 433 311
S 3314	1 457 433 314
S 3315	1 457 433 315
S 3316	1 457 433 316

S 3317	1 457 433 317
S 3319	1 457 433 319
S 3320	1 457 433 320
S 3322	1 457 433 322
S 3323	1 457 433 323

S 3324	1 457 433 324
S 3325	1 457 433 325
S 3326	1 457 433 326
S 3327	1 457 433 327
S 3329	1 457 433 329

S 3330	1 457 433 330
S 3331	1 457 433 331
S 3332	1 457 433 332
S 3333	1 457 433 333
S 3334	1 457 433 334

S 3339	1 457 433 339
S 3520	1 457 433 520
S 3521	1 457 433 521
S 3522	1 457 433 522
S 3523	1 457 433 523

S 3524	1 457 433 524
S 3526	1 457 433 526
S 3527	1 457 433 527
S 3529	1 457 433 529
S 3531	1 457 433 531

S 3532	1 457 433 532
S 3533	1 457 433 533
S 3534	1 457 433 534
S 3535	1 457 433 535
S 3536	1 457 433 536

S 3537	1 457 433 537
S 3538	1 457 433 538
S 3539	1 457 433 539
S 3540	1 457 433 540
S 3541	1 457 433 541

S 3542	1 457 433 542
S 3543	1 457 433 543
S 3544	1 457 433 544
S 3545	1 457 433 545
S 3546	1 457 433 546



S 3547	1 457 433 547
S 3548	1 457 433 548
S 3549	1 457 433 549
S 3550	1 457 433 550
S 3553	1 457 433 553

S 3555	1 457 433 555
S 3560	1 457 433 560
S 3564	1 457 433 564
S 3566	1 457 433 566
S 3568	1 457 433 568

S 3571	1 457 433 571
S 3573	1 457 433 573
S 3574	1 457 433 574
S 3575	1 457 433 575
S 3576	1 457 433 576

S 3577	1 457 433 577
S 3578	1 457 433 578
S 3579	1 457 433 579
S 3580	1 457 433 580
S 3581	1 457 433 581

S 3583	1 457 433 583
S 3584	1 457 433 584
S 3585	1 457 433 585
S 3587	1 457 433 587
S 3588	1 457 433 588

S 3589	1 457 433 589
S 3590	1 457 433 590
S 3591	1 457 433 591
S 3592	1 457 433 592
S 3593	1 457 433 593

S 3594	1 457 433 594
S 3595	1 457 433 595
S 3596	1 457 433 596
S 3599	1 457 433 599
S 3601	1 457 433 601

S 3603	1 457 433 603
S 3605	1 457 433 605
S 3606	1 457 433 606
S 3607	1 457 433 607
S 3608	1 457 433 608

S 3609	1 457 433 609
S 3611	1 457 433 611
S 3616	1 457 433 616
S 3617	1 457 433 617
S 3620	1 457 433 620



S 3623	1 457 433 623
S 3624	1 457 433 624
S 3626	1 457 433 626
S 3627	1 457 433 627
S 3637	1 457 433 637

S 3642	1 457 433 642
S 3646	1 457 433 646
S 3650	1 457 433 650
S 3651	1 457 433 651
S 3652	1 457 433 652

S 3654	1 457 433 654
S 3655	1 457 433 655
S 3658	1 457 433 658
S 3659	1 457 433 659
S 3660	1 457 433 660

S 3670	1 457 433 670
S 3671	1 457 433 671
S 3677	1 457 433 677
S 3682	1 457 433 682
S 3686	1 457 433 686

S 3688	1 457 433 688
S 3690	1 457 433 690
S 3697	1 457 433 697
S 3698	1 457 433 698
S 3699	1 457 433 699

S 3700	1 457 433 700
S 3701	1 457 433 701
S 3702	1 457 433 702
S 3703	1 457 433 703
S 3711	1 457 433 711

S 3712	1 457 433 712
S 3713	1 457 433 713
S 3714	1 457 433 714
S 3715	1 457 433 715
S 3716	1 457 433 716

S 3722	1 457 433 722
S 3726	1 457 433 726
S 3728	1 457 433 728
S 3729	1 457 433 729
S 3730	1 457 433 730

S 3731	1 457 433 731
S 3732	1 457 433 732
S 3734	1 457 433 734
S 3735	1 457 433 735
S 3736	1 457 433 736

de

**Gegenüberstellung
Suchnummer →
Bestellnummer**
(Fortsetzung)

en

**Cross references
search number →
part number**
(continued)

fr

**Table de correspon-
dance code d'identi-
fication → référence**
(suite)

it

**Confronto codice breve →
codice di ordinazione**
(seguito)

es

**Confrontación refe-
rencia comercial →
referencia de pedido**
(continuación)



S 3739	1 457 433 739
S 3740	1 457 433 740
S 3741	1 457 433 741
S 3742	1 457 433 742
S 3743	1 457 433 743
S 3745	1 457 433 745
S 3747	1 457 433 747
S 3748	1 457 433 748
S 3749	1 457 433 749
S 3750	1 457 433 750
S 3751	1 457 433 751
S 3752	1 457 433 752
S 3753	1 457 433 753
S 3769	1 457 433 769
S 3771	1 457 433 771
S 3772	1 457 433 772
S 3773	1 457 433 773
S 3775	1 457 433 775
S 3781	1 457 433 781
S 3784	1 457 433 784
S 3785	1 457 433 785
S 3786	1 457 433 786
S 3788	1 457 433 788
S 3789	1 457 433 789
S 3790	1 457 433 790
S 3791	1 457 433 791
S 3792	1 457 433 792
S 3795	1 457 433 795
S 3796	1 457 433 796
S 3797	1 457 433 797
S 3799	1 457 433 799
S 3800	1 457 433 800
S 3900	1 457 433 900
S 3901	1 457 433 901
S 3903	1 457 433 903
S 3904	1 457 433 904
S 3950	1 457 433 950
S 3951	1 457 433 951
S 3952	1 457 433 952
S 3953	1 457 433 953
S 3954	1 457 433 954
S 3955	1 457 433 955
S 3956	1 457 433 956
S 3957	1 457 433 957
S 3958	1 457 433 958

S 3959	1 457 433 959
S 3961	1 457 433 961
S 3962	1 457 433 962
S 3963	1 457 433 963
S 3965	1 457 433 965
S 3966	1 457 433 966
S 3968	1 457 433 968
S 3969	1 457 433 969
S 3970	1 457 433 970
S 3971	1 457 433 971
S 3972	1 457 433 972
S 9030	1 457 429 030
S 9036	1 987 429 036
S 9042/1	1 987 429 042
S 9046	1 987 429 046
S 9050	1 457 429 050
S 9051	1 987 429 051
S 9053	1 457 429 053
S 9054	1 457 429 054
S 9056	1 457 429 056
S 9061	1 457 429 061
S 9064	1 457 429 064
S 9066	1 457 429 066
S 9076	1 457 429 076
S 9078	1 457 429 078
S 9079	1 457 429 079
S 9080	1 457 429 080
S 9085	1 457 429 085
S 9107	1 987 429 107
S 9109	1 987 429 109
S 9115	1 987 429 115
S 9117	1 987 429 117
S 9120	1 987 429 120
S 9121	1 987 429 121
S 9122	1 987 429 122
S 9123	1 987 429 123
S 9125	1 987 429 125
S 9127	1 987 429 127
S 9128	1 987 429 128
S 9132	1 987 429 132
S 9133	1 987 429 133
S 9135	1 987 429 135
S 9136	1 987 429 136
S 9137	1 987 429 137
S 9146	1 987 429 146

S 9148	1 987 429 148
S 9149	1 987 429 149
S 9150	1 987 429 150
S 9151	1 987 429 151
S 9152	1 987 429 152
S 9154	1 987 429 154
S 9155	1 987 429 155
S 9156	1 987 429 156
S 9157	1 987 429 157
S 9158	1 987 429 158
S 9159	1 987 429 159
S 9160	1 987 429 160
S 9161	1 987 429 161
S 9162	1 987 429 162
S 9163	1 987 429 163
S 9164	1 987 429 164
S 9166	1 987 429 166
S 9167	1 987 429 167
S 9169	1 987 429 169
S 9170	1 987 429 170
S 9171	1 987 429 171
S 9172	1 987 429 172
S 9173	1 987 429 173
S 9174	1 987 429 174
S 9175	1 987 429 175
S 9176	1 987 429 176
S 9177	1 987 429 177
S 9178	1 987 429 178
S 9179	1 987 429 179
S 9180	1 987 429 180
S 9181	1 987 429 181
S 9182	1 987 429 182
S 9183	1 987 429 183
S 9184	1 987 429 184
S 9185	1 987 429 185
S 9186	1 987 429 186
S 9187	1 987 429 187
S 9188	1 987 429 188
S 9189	1 987 429 189
S 9190	1 987 429 190
S 9191	1 987 429 191
S 9192	1 987 429 192
S 9193	1 987 429 193
S 9194	1 987 429 194
S 9400	1 987 429 400

S 9401	1 987 429 401
S 9402	1 987 429 402
S 9403	1 987 429 403
S 9404	1 987 429 404
S 9405	1 987 429 405
S 9406	1 987 429 406
S 9775	1 457 429 775
S 9777	1 457 429 777
S 9778	1 457 429 778
S 9781	1 457 429 781
S 9782	1 457 429 782
S 9783	1 457 429 783
S 9785	1 457 429 785
S 9786	1 457 429 786
S 9787	1 457 429 787
S 9789	1 457 429 789
S 9791	1 457 429 791
S 9792	1 457 429 792
S 9793	1 457 429 793
S 9794	1 457 429 794
S 9795	1 457 429 795
S 9800	1 457 429 800
S 9801	1 457 429 801
S 9806	1 457 429 806
S 9810	1 457 429 810
S 9814	1 457 429 814
S 9817	1 457 429 817
S 9818	1 457 429 818
S 9819	1 457 429 819
S 9839	1 457 429 839
S 9840	1 457 429 840
S 9841	1 457 429 841
S 9842	1 457 429 842
S 9844	1 457 429 844
S 9845	1 457 429 845
S 9846	1 457 429 846
S 9854	1 457 429 854
S 9869	1 457 429 869
S 9870	1 457 429 870
S 9871	1 457 429 871
S 9873	1 457 429 873
S 9874	1 457 429 874
S 9875	1 457 429 875
S 9876	1 457 429 876
S 9877	1 457 429 877

nl

Omzettingslijst
Opzoeknummer →
Bestelnummer
 (vervolg)

sv

Söknummer →
Artikelnummer
 (fortsättning)

cs

Převod vyhledávací číslo
→ objednáací číslo
 (pokračování)

pl

Zestawienie
numer identyfikacyjny →
numer katalogowy
 (ciąg dalszy)

ru

Соответствие Поисковый
номер → Номер артикула
 (продолжение)

nl		sv		cs		pl		ru	
S 9882	1 457 429 882								
S 9890	1 457 429 890								
S 9893	1 457 429 893								
S 9894	1 457 429 894								
S 9895	1 457 429 895								
S 9896	1 457 429 896								
S 9898	1 457 429 898								
S 9899	1 457 429 899								
S 9900	1 457 429 900								
S 9908	1 457 429 908								
S 9915	1 457 429 915								
S 9920	1 457 429 920								
S 9923	1 457 429 923								
S 9928	1 457 429 928								
S 9932	1 457 429 932								
S 9933	1 457 429 933								
S 9934	1 457 429 934								
S 9941	1 457 429 941								
S 9942	1 457 429 942								
S 9944	1 457 429 944								
S 9946	1 457 429 946								
S 9948	1 457 429 948								
S 9949	1 457 429 949								
S 9950	1 457 429 950								
S 9953	1 457 429 953								
S 9954	1 457 429 954								
S 9955	1 457 429 955								
S 9957	1 457 429 957								
S 9959	1 457 429 959								
S 9964	1 457 429 964								
S 9966	1 457 429 966								
S 9969	1 457 429 969								
S 9970	1 457 429 970								
S 9975	1 457 429 975								
S 9979	1 457 429 979								
S 9980	1 457 429 980								
S 9983	1 457 429 983								
S 9987	1 457 429 987								
S 9988	1 457 429 988								
S 9991	1 457 429 991								
S 9992	1 457 429 992								
S 9993	1 457 429 993								
S 9994	1 457 429 994								
S 9998	1 457 429 998								

de	en	fr	it	es
<p>Verwendungsteil</p> <p>Benutzerhinweise</p> <p>In diesem Katalog sind die Daten von Fahrzeugen, Motoren und Geräten für den europäischen Markt von Baujahr 1991 bis einschließlich 2011 erfasst. Diese wurden aus Hersteller- und Importeurangaben, aus Fahrzeuguntersuchungen sowie aus Unterlagen von Bosch nach bestem Wissen sorgfältig zusammengestellt und geben den Stand zum Zeitpunkt der Drucklegung wieder.</p> <p>Zwangsläufige Abweichungen durch länderspezifische technische Änderungen können nie ganz ausgeschlossen werden. Bosch kann daher insoweit nicht für die Vollständigkeit und Fehlerfreiheit der Daten haften. Für Irrtümer und Druckfehler, die zu Schäden am Eigentum oder Vermögen führen, haftet Bosch nur bei grob fahrlässiger Pflichtverletzung und bei Vorsatz für unmittelbare Schäden. Bei Personenschäden haftet Bosch auch bei leichter Fahrlässigkeit.</p>	<p>Applications</p> <p>Notes for users</p> <p>This catalog contains the data from the vehicles, engines, and equipment for the European market from year of manufacture 1991 up to and including the year 2011. This data has been assembled from information provided by manufacturers and importers, and taken from Bosch documentation, as well as from investigations made on vehicles. It has been compiled to the best of our knowledge and belief, and reflects the status at the date of going to print.</p> <p>Inevitable deviations due to country-specific technical changes can never be completely excluded. Therefore, Bosch in this respect cannot be responsible for the completeness and accuracy of the data. For mistakes and misprint, which lead to damage of property or fortune, Bosch is responsible only in case of grossly negligent violation of duties and in case of intention for direct damage. In case of personal injury, Bosch is also liable concerning slight negligence.</p>	<p>Affectations</p> <p>A l'attention de l'utilisateur</p> <p>Le présent catalogue mentionne les données spécifiques de véhicules, moteurs et appareils pour le marché européen depuis l'année de fabrication 1991 jusqu'au millésime 2011 inclus. Ces informations ont été rassemblées soigneusement et en toute impartialité à partir des indications des constructeurs et importateurs, des contrôles techniques des véhicules et de la documentation Bosch, et matérialisent le stade des connaissances au moment de la mise sous presse.</p> <p>Des écarts inévitables ne peuvent jamais être complètement exclus en raison des différences spécifiques à chaque pays. Bosch ne peut donc pas à cet égard être tenu responsable de l'exactitude des données. Pour des erreurs et fautes d'impression, qui causeraient des dégâts matériels, Bosch est responsable seulement en cas de violation de ses obligations par faute lourde intentionnelle en ce qui concerne les dommages matériels. En cas de dommages corporels, Bosch peut être également tenu pour responsable dans les cas de faute légère.</p>	<p>Impiego</p> <p>Avvertenze per la consultazione</p> <p>Nella seguente parte di catalogo sono contemplati veicoli, motori ed apparecchi a partire dall'anno di costruzione 1991 fino all'anno 2011. Tali informazioni sono state rilevate dalle documentazioni di Case Auto, Importatori, da verifiche eseguite sui veicoli, così come da documentazione Bosch.</p> <p>Eventuali discordanze, dovute a variazioni delle caratteristiche tecniche per specifici Paesi, non possono essere contemplate. Bosch non potrà quindi essere considerata responsabile per mancanze o inesattezze dei dati. Per eventuali danni a cose o danni patrimoniali, dovuti ad errori o refusi di stampa, Bosch è responsabile solo in caso di dolo o colpa grave. In caso di danni alla persona, Bosch è responsabile anche in caso di colpa meno grave.</p>	<p>Aplicación</p> <p>Instrucciones para el usuario</p> <p>Los datos de este catálogo para vehículos, motores y utensilios del mercado europeo comprenden los años de construcción desde 1991 hasta 2011 inclusive. Éstos son creados para la edición indicada sobre la base de documentos de Bosch, exámenes o inspecciones de vehículos así como datos de fabricantes e importadores.</p> <p>Las diferentes especificaciones técnicas propias de cada país nunca pueden ser excluidas completamente. Por lo tanto, Bosch en este aspecto, no puede ser responsable de la absoluta exactitud de los datos. En el caso de errores, incluidos los de imprenta, que generen daños ó pérdidas de la propiedad o posesiones, Bosch es responsable únicamente en los casos de violación negligente de sus obligaciones y en el supuesto de intención o dolo para el daño directo. Bosch está también obligado a responder en casos de injurias personales por negligencia.</p>
<p>nl</p> <p>Gebruiksdeel</p> <p>Gebruikersinstructies</p> <p>In deze catalogus zijn de gegevens van voertuigen, motoren en apparaten voor de Europese markt vanaf bouwjaar 1991 tot en met bouwjaar 2011 opgenomen. Deze zijn naar eer en geweten zorgvuldig samengesteld uit fabrikant- en importeursgegevens, voertuig-onderzoek alsmede informatie van Bosch en geven de stand op het tijdstip van publicatie weer.</p> <p>Landspecifieke afwijkingen zijn echter onvermijdelijk en niet geheel uit te sluiten. Derhalve kan Bosch niet verantwoordelijk worden gehouden voor de volledigheid en het foutloos zijn van deze gegevens. Indien aperte onjuistheden of drukfouten leiden tot directe vermogensschade of directe schade aan eigendommen is Bosch slechts aansprakelijk in geval van grove nalatigheid of opzettelijk handelen. Indien aperte onjuistheden of drukfouten leiden tot letselschade is Bosch aansprakelijk in geval van toerekenbare tekortkoming, die zowel verwijtbaar is als voor haar risico komt.</p>	<p>sv</p> <p>Användningsdel</p> <p>Användarvägledning</p> <p>I denna katalog finns data angivna för fordon, motorer och apparater för den europeiska marknaden från årsmodell 1991 till och med 2011. Uppgifterna kommer från tillverkarna och importörerna, från fordonsundersökningar och från underlag från Bosch och är omsorgsfullt sammanställda enligt tillgänglig kunskap och anger läget vid tryckningstidpunkten.</p> <p>I vissa länder kan specifika avvikelser förekomma p. g. a. tekniska ändringar varför Bosch ej kan hållas ansvarig för ej komplett information. Vid fel som leder till direkt skada på egendom eller fordon, kan Bosch hållas ansvarig endast om grov oaksamhet kan påvisas. Vid personskador kan Bosch hållas ansvarig om vårdslöshet kan påvisas.</p>	<p>cs</p> <p>Použití</p> <p>Pokyny pro uživatele</p> <p>V tomto katalogu jsou obsaženy údaje vozidel, motorů a přístrojů pro evropský trh od roku výroby 1991 do roku 2011 včetně. Tyto údaje byly pečlivě sestaveny podle nejlepšího vědomí z údajů výrobců a dovozců automobilů a zachycují stav k datu předání do tisku.</p> <p>Odchyly, způsobené technickými změnami specifickými pro některé země, není možné vyloučit. Proto nemůže firma Bosch ručit za úplnost a bezchybnost těchto údajů. Za omyly a chyby tisku, které by způsobily škodu na vlastnictví nebo majetku, ručí firma Bosch jen v případě hrubého a nedbalého porušení povinností a úmyslu bezprostřední škody. Pokud by měly za následek škody na zdraví osob, nese firma Bosch odpovědnost i v případě mírné nedbalosti.</p>	<p>pl</p> <p>Zastosowanie</p> <p>Wskazówki dla użytkownika</p> <p>Katalog zawiera dane pojazdów, silników i urządzeń na rynek europejski od roku produkcji 1991 do 2011 włącznie. Zostały one starannie zestawione na podstawie danych producentów i importerów, badań pojazdów oraz dokumentacji firmy Bosch zgodnie z aktualnym stanem wiedzy w momencie oddania do druku.</p> <p>W katalogu mogą występować różnice w stosunku do poszczególnych pojazdów w związku ze specyficznymi dla poszczególnych krajów wersjami wyposażenia i specyfikacji technicznej. Bosch nie ponosi odpowiedzialności za kompletność i dokładność danych. Za błędy i nieścisłości w druku, które mogą prowadzić do szkód mienia Bosch jest odpowiedzialny jedynie w przypadkach rażącego zaniedbania obowiązków oraz w przypadku bezpośredniego zamiaru spowodowania szkód. Bosch jest odpowiedzialny za uszkodzenia ciała jedynie w przypadkach zaniedbania z własnej strony.</p>	<p>ru</p> <p>Применение</p> <p>Вниманию пользователей</p> <p>В настоящем каталоге приводятся данные по автомобилям, двигателям и прочему оборудованию на европейском рынке с 1991 по 2011 год выпуска включительно. Они были тщательно подобраны из информации, предоставленной производителями и импортерами, по результатам тестирования автомобилей, а также из документации компании Bosch и отражают состояние на момент подписания в печать. Неизбежные расхождения из-за специфических для каждой страны технических модификаций не могут быть полностью исключены. Поэтому компания Bosch не несет ответственность за полноту и точность предоставленных данных. В случае, если ошибки или опечатки привели к ущербу для собственности или повлекли материальные затраты, компания Bosch принимает на себя ответственность только если это является преднамеренным вредом или грубой небрежностью со стороны фирмы Bosch. Если по! страдало физическое лицо, фирма Bosch несет ответственность даже при допущении незначительной небрежности.</p>

B2 | ALFA ROMEO

1 ALFA ROMEO *

2 Brera

Brera 1.8 TBI

1.8 | 147 | 939B1000 <M56>

05.09 → F 026 40 S 0039 L
1 987 43 R 2433 I

3 Brera 2.2 JTS

2.2 | 136 | 939A5000 <M50>

01.06 → F 026 40 P 7016 O
F 026 40 S 0039 L

Brera 2.4 JTDM 20V

2.4 | 147/154 | 939A3000 <M95>; 939A9000 <M105>

04.06 → F 026 40 P 7021 O
F 026 40 S 0039 L
TW 1 987 43 R 2433 I

4 Brera 3.2 JTS 24V, JTS 24V Q4

3.2 | 191/195 | 939A000 <M61>; 939A000 <M62>

01.06 → F 026 40 S 0039 L
1 987 43 R 2433 I

5 Giulietta

Giulietta 1.4 TB

1.4 | (88/125) | 198A4000; 940A2000 <MultiAir>

05.10 → 1 457 42 P 9256 O

6 GT

GT 1.8 TS

1.8 | 106 | (AR32205 <M1>

10.03 → 0 451 10 P 3300 O
1 457 43 S 3156 L
2FE 1 987 43 R 2386⁹ I

GT 1.9 JTD 16V

1.9 | 103/110 | 937A5000 <M15>; 937A5000 <M92>

10.03 → 0 451 10 P 3300 O
1 457 43 S 3086 L
2FE 1 987 43 R 2386⁹ I

1.9 | 125 | 937A6000 <M94>

10.07 → 0 451 10 P 3300 O
1 457 43 S 3086 L

GT 2.0 JTS

2.0 | 120/121 | 932A2000 <M6>; 937A1000 <M5>

10.03-07.04 0 451 10 P 3336 O
10.03 → 1 457 43 S 3156 L
2FE 1 987 43 R 2386⁹ I

GT 3.2 V6

3.2 | 176 | 936A000 <M10>

10.03 → 0 451 10 P 3351 O
1 457 43 S 3791 L
2FE 1 987 43 R 2386⁹ I

GTV

GTV 1.8 T.S. 16V

1.8 | 106 | AR 32201 <M1>

05.98-12.00 0 451 10 P 3300 O
KL 1 987 43 M 2014 I

GTV 2.0 JTS

2.0 | 121 | 937A1.000 <M8>

04.03-07.04 0 451 10 P 3336 O
04.03-12.05 KL 1 987 43 M 2014 I

GTV 2.0 T.S. 16V

2.0 | 110 | AR 16201 <M1>

04.95-04.98 0 451 10 P 3300 O
0 450 90 F 5087¹ K

2.0 | 110 | AR 32310 <M6>

08.00-12.05 0 451 10 P 3300 O
(KL) 1 987 43 M 2014 I

2.0 | 114 | AR 32301 <M2>

05.98-07.00 0 451 10 P 3300 O
0 450 90 F 5087¹ K
KL 1 987 43 M 2014 I

GTV 2.0 V6 Turbo

2.0 | 148 | AR 16202 <M2>

04.95-04.98 0 451 10 P 3351 O

2.0 | 148 | AR 16202 <M3>

05.98-07.00 0 451 10 P 3351 O
1 457 43 S 3253 L
0 450 90 F 5087¹ K
KL 1 987 43 M 2014 I

GTV 3.0 V6 24V

3.0 | 160 | AR 16105 <M7>

08.00-12.05 0 451 10 P 3351 O
KL 1 987 43 M 2014 I

3.0 | 162 | AR 16102 <M3>

11.96-04.98 0 451 10 P 3351 O

3.0 | 162 | AR 16102 <M4/M7>

05.98-07.00 0 451 10 P 3351 O
0 450 90 F 5087¹ K
KL 1 987 43 M 2014 I

GTV 3.2 V6 24V

3.2 | 176 | 936A6.000 <M9>

04.03-12.05 0 451 10 P 3351 O
KL 1 987 43 M 2014 I

Bosch Automotive Aftermarket 2011 | 2012

- 1 Fahrzeugmarke**
Hervorhebung der Hersteller im Graubalken
- 2 Fahrzeugmodell**
Alphanumerisch aufsteigend
- 3 Modelldetail**
Besondere Fahrzeugmerkmale
- 4 Hubraum**
in l
- 5 Motorleistung**
in kW
- 6 Motortyp**
Siehe spezieller Hinweis in den Fahrzeugpapieren
- 7 Export-Land**
Gilt nur für spezielle Exportfahrzeuge
- 8 Bildzeichen-Erläuterung**
Erläuterungen siehe Katalogende.
- 9 Filterarten**
- 10 Bestellnummer**
zum Nachbestellen für den Handel
- 11 Sonderfall**
Erläuterung siehe Katalogende.
- 12 Fußnote**
Erläuterung siehe Katalogende.
- 13 Einbauzeitraum**
Einbauzeitraum des jeweiligen Produktes

en

fr

it

es

① Vehicle brand

Manufacturer highlighted
in gray bar

② Vehicle model

In ascending alphanumerical
order

③ Model detail

Special vehicle features

④ Engine capacity

in l

⑤ Engine power

in kW

⑥ Engine type

See special note in vehicle
documents

⑦ Export country

Only applies to special export
vehicles

⑧ Pictogram explanation

See end of catalog
for explanation.

⑨ Filter types**⑩ Order number**

For aftermarket orders

⑪ Special case

See end of catalog for
explanation.

⑫ Footnote

See end of catalog for
explanation.

⑬ Installation period

Installation period for relevant
product

① Marque de véhicules

Mise en valeur des construc-
teurs dans la barre grise

② Modèle de véhicule

en ordre alphanumérique
croissant

③ Détail du modèle

Particularités du véhicule

④ Cylindrée

en l

⑤ Puissance du moteur

en kW

⑥ Type de moteur

Voir remarque spécifique
dans les papiers du véhicule

⑦ Pays d'exportation

Ne concerne que des véhicules
d'exportation spécifiques

⑧ Explication des pictogrammes

Explication, voir la fin du
catalogue.

⑨ Types de filtres**⑩ Référence**

pour le réapprovisionnement
des revendeurs

⑪ Cas particulier

Explication, voir la fin du
catalogue.

⑫ Note

Explication, voir la fin du
catalogue.

⑬ Période de montage

Période de montage du
produit considéré

① Marca del veicolo

Evidenziazione del costruttore
su sfondo grigio

② Modello del veicolo

In ordine alfanumerico
crescente

③ Dettagli del modello

Caratteristiche particolari
del veicolo

④ Cilindrata

in l

⑤ Potenza motore

in kW

⑥ Tipo motore

Vedere indicazioni specifiche
nei documenti veicolo

⑦ Paese di esportazione

Vale solo per veicoli oggetto
di esportazioni speciali

⑧ Legenda dei simboli

Indicazioni a fine catalogo.

⑨ Tipi di filtri**⑩ Codice ordinazione**

Per il riordino da parte di
rivenditori

⑪ Casi particolari

Indicazioni a fine catalogo.

⑫ Note a fondo pagina

Indicazioni a fine catalogo.

⑬ Periodo di montaggio

Del rispettivo ricambio

① Marca del vehículo

Fabricantes resaltados con
una barra gris

② Modelo del vehículo

Alfanumérico ascendente

③ Detalle de modelo

Características particulares
del vehículo

④ Cilindrada

en l

⑤ Potencia del motor

en kW

⑥ Tipo de motor

Véase la indicación especial en
la documentación del vehículo

⑦ País de exportación

Válido sólo para vehículos
de exportación especiales

⑧ Explicación de símbolos gráficos

Explicación véase la parte final
del catálogo.

⑨ Tipos de filtros**⑩ Referencia de pedido**

para pedidos posteriores por
el comercio

⑪ Caso especial

Explicación, véase la parte final
del catálogo.

⑫ Nota al pie

Explicación, véase la parte final
del catálogo.

⑬ Periodo de instalación

Periodo durante el que se
instala el producto en cuestión

B2 | ALFA ROMEO

Typ ? ⊖ Type Typ ? ⊖ Type

ALFA ROMEO *

Brera

Brera 1.8 TBI

1.8 | 147 | 939B1000 <M56>

05.09 → F 026 40 S 0039 L
1 987 43 R 2433 I

Brera 2.2 JTS

2.2 | 136 | 939A5000 <M50>

01.06 → F 026 40 P 7016 O
F 026 40 S 0039 L

Brera 2.4 JTDM 20V

2.4 | 147/154 | 939A3000 <M95>; 939A9000 <M105>

04.06 → F 026 40 P 7021 O
F 026 40 S 0039 L
TW 1 987 43 R 2433 I

Brera 3.2 JTS 24V, JTS 24V Q4

3.2 | 191/195 | 939A000 <M61>; 939A000 <M62>

01.06 → F 026 40 S 0039 L
1 987 43 R 2433 I

Giulietta

Giulietta 1.4 TB

1.4 | (88/125) | 198A4000; 940A2000 <MultiAir>

05.10 → 1 457 42 P 9256 O

GT

GT 1.8 TS

1.8 | 106 | (AR32205 <M1>)

10.03 → 0 451 10 P 3300 O
1 457 43 S 3156 L
2FE 1 987 43 R 2386⁹ I

GT 1.9 JTD 16V

1.9 | 103/110 | 937A5000 <M15>; 937A5000 <M92>

10.03 → 0 451 10 P 3300 O
1 457 43 S 3086 L
2FE 1 987 43 R 2386⁹ I

1.9 | 125 | 937A6000 <M94>

10.07 → 0 451 10 P 3300 O
1 457 43 S 3086 L

GT 2.0 JTS

2.0 | 120/121 | 932A2000 <M6>; 937A1000 <M5>

10.03 → 0 451 10 P 3336 O
1 457 43 S 3156 L
2FE 1 987 43 R 2386⁹ I

GT 3.2 V6

3.2 | 176 | 936A000 <M10>

10.03 → 0 451 10 P 3351 O
1 457 43 S 3791 L
2FE 1 987 43 R 2386⁹ I

GTV

GTV 1.8 T.S. 16V

1.8 | 106 | AR 32201 <M1>

05.98-12.00 0 451 10 P 3300 O
KL 1 987 43 M 2014 I

GTV 2.0 JTS

2.0 | 121 | 937A1.000 <M8>

04.03-07.04 0 451 10 P 3336 O
04.03-12.05 KL 1 987 43 M 2014 I

GTV 2.0 T.S. 16V

2.0 | 110 | AR 16201 <M1>

04.95-04.98 0 451 10 P 3300 O
0 450 90 F 5087¹ K

2.0 | 110 | AR 32310 <M6>

08.00-12.05 0 451 10 P 3300 O
(KL) 1 987 43 M 2014 I

2.0 | 114 | AR 32301 <M2>

05.98-07.00 0 451 10 P 3300 O
0 450 90 F 5087¹ K
KL 1 987 43 M 2014 I

GTV 2.0 V6 Turbo

2.0 | 148 | AR 16202 <M2>

04.95-04.98 0 451 10 P 3351 O

2.0 | 148 | AR 16202 <M3>

05.98-07.00 0 451 10 P 3351 O
1 457 43 S 3253 L
0 450 90 F 5087¹ K
KL 1 987 43 M 2014 I

GTV 3.0 V6 24V

3.0 | 160 | AR 16105 <M7>

08.00-12.05 0 451 10 P 3351 O
KL 1 987 43 M 2014 I

3.0 | 162 | AR 16102 <M3>

11.96-04.98 0 451 10 P 3351 O

3.0 | 162 | AR 16102 <M4/M7>

05.98-07.00 0 451 10 P 3351 O
0 450 90 F 5087¹ K
KL 1 987 43 M 2014 I

GTV 3.2 V6 24V

3.2 | 176 | 936A6.000 <M9>

04.03-12.05 0 451 10 P 3351 O
KL 1 987 43 M 2014 I

Bosch Automotive Aftermarket 2011 | 2012

- ① **Voertuigmerk**
Accentuering van de fabrikanten in de grijze balk
- ② **Voertuigmodel**
Alfanumeriek oplopend
- ③ **Modeldetail**
Bijzondere voertuigkenmerken
- ④ **Cilinderinhoud**
in l
- ⑤ **Motorvermogen**
in kW
- ⑥ **Motortype**
Zie speciale opmerking in de voertuigpapieren
- ⑦ **Exportland**
Alleen geldig voor speciale exportvoertuigen
- ⑧ **Toelichting van de symbolen**
Toelichting zie einde van de catalogus.
- ⑨ **Filtersoorten**
- ⑩ **Bestelnummer**
Voor nabestellingen voor de handel
- ⑪ **Speciale gevallen**
Toelichting zie einde van de catalogus.
- ⑫ **Voetnoot**
Toelichting zie einde van de catalogus.
- ⑬ **Inbouwperiode**
Inbouwperiode van het betreffende product

sv

cs

pl

ru

① Fabrikat

Tillverkaren markerad i det grå fältet

② Fordonsmodell

Alfanumeriskt stigande

③ Modelldetalj

Speciella fordonskännetecken

④ Slagvolym

i l

⑤ Motoreffekt

i kW

⑥ Motortyp

Se speciell anteckning i fordonshandlingarna

⑦ Exportland

Gäller för speciella exportfordon

⑧ Bildsymbolernas förklaring

Se förklaring i slutet av katalogen.

⑨ Filtertyper**⑩ Ordernummer**

För efterbeställning för handeln

⑪ Specialfall

Se förklaring i slutet av katalogen.

⑫ Fotnot

Se förklaring i slutet av katalogen.

⑬ Monteringsperiod

Monteringsperiod för respektive produkt

① Značka vozidla

Zvýraznění výrobce šedým pruhem

② Model vozidla

Alfanumericky vzestupně

③ Detail modelu

Zvláštní charakteristiky vozidla

④ Obsah motoru

v litrech

⑤ Výkon motoru

v kW

⑥ Typ motoru

Viz speciální pokyny v dokladech vozidla

⑦ Země exportu

Platí jen pro speciální exportní vozidla

⑧ Vysvětlení grafických značek

Vysvětlení viz konec katalogu.

⑨ Druhy filtrů**⑩ Objednací číslo**

k doobjednání pro obchod

⑪ Speciální případ

Vysvětlení viz konec katalogu.

⑫ Poznámka pod čarou

Vysvětlení viz konec katalogu.

⑬ Časový interval montáže

Časový interval montáže příslušného produktu

① Marka pojazdu

producent podany na szarym tle

② Model pojazdu

alfanumerycznie, rosnaço

③ Szczegóły modelu

cechy szczególnie pojazdu

④ Pojemność skokowa

w l

⑤ Moc silnika

w kW

⑥ Typ silnika

patrz wskazówka w dokumentach pojazdu

⑦ Kraj eksportu

dotyczy tylko specjalnych pojazdów eksportowych

⑧ Objaśnienie symboli

Objaśnienie patrz koniec katalogu.

⑨ Rodzaje filtrów**⑩ Numer katalogowy**

do zamówień dla handlu

⑪ Przypadek szczególny

Objaśnienie patrz koniec katalogu.

⑫ Przypis

Objaśnienie patrz koniec katalogu.

⑬ Okres montażu

okres, w którym montowany był dany produkt

① Марка автомобиля

Выделение производителей серыми полосками

② Модель автомобиля

В алфавитно-цифровом порядке

③ Особенность модели

Особые характеристики автомобиля

④ Объем двигателя

в литрах

⑤ Мощность двигателя

в кВт

⑥ Тип двигателя

См. специальное указание в документах на автомобиль

⑦ Страна-экспортер

Действительно только для специальных экспортных автомобилей

⑧ Разъяснение пиктограмм

См. разъяснения в конце каталога.

⑨ Виды фильтров**⑩ Номер артикула**

Для оформления заказа см.

⑪ Особые случаи

См. разъяснения в конце каталога.

⑫ Сноска

См. разъяснения в конце каталога.

⑬ Время установки

Время установки соответствующего изделия



ALFA ROMEO *

Brera

Brera 1.8 TBI

1,8 147 939B1000 <M66>	05.09→	F 026 40 S 0039	L
		1 987 43 R 2433 ⁸	I

Brera 2.0 JTDM

2,0 125 939B3000 <M120>	05.09→	F 026 40 S 0039	L
		MKL 1 987 43 R 2433 ⁸	I

Brera 2.2 JTS

2,2 136 939A5000 <M50>	01.06→	F 026 40 P 7016	O
		F 026 40 S 0039	L

Brera 2.4 JTDM 20V

2,4 147/154 939A3000 <M95>; 939A9000 <M105>	04.06→	F 026 40 P 7021	O
		F 026 40 S 0039	L
		TW 1 987 43 R 2433 ⁸	I

Brera 3.2 JTS 24V, JTS 24V Q4

3,2 191/195 939A000 <M61>; 939A000 <M62>	01.06→	F 026 40 S 0039	L
		1 987 43 R 2433 ⁸	I

Giulietta

Giulietta 1.4 TB

1,4 88/125 198A4000; 940A2000 <MultiAir>	05.10→	1 457 42 P 9256	O
--	--------	------------------------	----------

GT

GT 1.8 TS

1,8 106 AR32205 <M1>	10.03→	0 451 10 P 3300	O
		1 457 43 S 3156	L
		2FE 1 987 43 R 2386 ⁸	I

GT 1.9 JTD 16V

1,9 103/110 937A5000 <M15>; 937A5000 <M92>	10.03→	0 451 10 P 3300	O
		1 457 43 S 3086	L
		F 026 40 N 2048 ²	K
		2FE 1 987 43 R 2386 ⁸	I

GT 1.9 JTD 16V

1,9 125 937A6000 <M94>	10.07→	0 451 10 P 3300	O
		1 457 43 S 3086	L
		F 026 40 N 2048 ²	K



GT 2.0 JTS

2,0 120/121 932A2000 <M6>; 937A1000 <M5>	10.03-07.04	0 451 10 P 3336	O
	10.03→	1 457 43 S 3156	L
		2FE 1 987 43 R 2386 ⁸	I

GT 3.2 V6

3,2 176 936A000 <M10>	10.03→	0 451 10 P 3351	O
		1 457 43 S 3791	L
		2FE 1 987 43 R 2386 ⁸	I

GTV

GTV 1.8 T.S. 16V

1,8 106 AR 32201 <M1>	05.98-12.00	0 451 10 P 3300	O
		KL 1 987 43 M 2014	I

GTV 2.0 JTS

2,0 121 937A1.000 <M8>	04.03-07.04	0 451 10 P 3336	O
	04.03-12.05	KL 1 987 43 M 2014	I

GTV 2.0 T.S. 16V

2,0 110 AR 16201 <M1>	04.95-04.98	0 451 10 P 3300	O
		0 450 90 F 5087 ¹	K

2,0 110 AR 32310 <M6>	08.00-12.05	0 451 10 P 3300	O
		KL 1 987 43 M 2014	I

2,0 114 AR 32301 <M2>	05.98-07.00	0 451 10 P 3300	O
		0 450 90 F 5087 ¹	K
		KL 1 987 43 M 2014	I

GTV 2.0 V6 Turbo

2,0 148 AR 16202 <M2>	04.95-04.98	0 451 10 P 3351	O
---------------------------	-------------	------------------------	----------

2,0 148 AR 16202 <M3>	05.98-07.00	0 451 10 P 3351	O
		1 457 43 S 3253	L
		0 450 90 F 5087 ¹	K
		KL 1 987 43 M 2014	I

GTV 3.0 V6 24V

3,0 160 AR 16105 <M7>	08.00-12.05	0 451 10 P 3351	O
		KL 1 987 43 M 2014	I

3,0 162 AR 16102 <M3>	11.96-04.98	0 451 10 P 3351	O
---------------------------	-------------	------------------------	----------

3,0 162 AR 16102 <M4/M7>	05.98-07.00	0 451 10 P 3351	O
		0 450 90 F 5087 ¹	K
		KL 1 987 43 M 2014	I



**GTV 3.2 V6 24V**

3,2 176 936A6.000 <M9>	04.03-12.05	0 451 10 P 3351	O
	KL	1 987 43 M 2014	I

Mito**Mito 1.3 JTD**

1,3 66 199A3000 <M72>	10.08→	1 457 42 P 9256	O
		F 026 40 S 0002	L
		1 987 43 M 2188	I

1,3 70 199B1000 <M95>	10.08→	F 026 40 S 0002	L
		1 987 43 M 2188	I

Mito 1.4

1,4 51 955A9000	05.11→	0 451 10 P 3364	O
		F 026 40 S 0036	L
		1 987 43 M 2188	I

1,4 77 955A6000 <M16>	10.09→	1 457 42 P 9256	O
		1 987 43 M 2188	I

Mito 1.4 i.e.

1,4 57 955A1000 <M14>	08.08→	0 986 45 P 2041	O
		1 457 43 S 3317	L
		1 987 43 M 2188	I

Mito 1.4 i.e. Turbo, LPG, 16V Turbo

1,4 88/114/125 198A4000 <M20>; 199 A 8.000 <M21>; 940A2000	08.08→	1 457 42 P 9256	O
		F 026 40 S 0057	L
		1 987 43 M 2188	I

Mito 1.4 16V Turbo

1,4 99 955A2000 <M22>	10.09→	1 457 42 P 9256	O
		F 026 40 S 0057	L
		1 987 43 M 2188	I

Mito 1.6 JTD

1,6 84/88 955A3000 <M88>; 955A4000 <M87>	08.08→	F 026 40 S 0057	L
		1 987 43 M 2188	I

RZ**RZ 3.0 V6 Zagato**

3,0 154 AR 61501	01.92-12.93	0 451 10 P 3352	O
		0 450 90 F 5030 ¹	K

Spider**Spider 1.6**

1,6 78 AR 01563 <M1>	01.90-12.94	0 451 10 P 3352	O
----------------------	-------------	-----------------	----------

Spider 1.8 TBi

1,8 147 939B1000 <M66>	05.09-12.10	F 026 40 S 0039	L
		1 987 43 R 2433 ⁸	I

Spider 1.8 T.S. 16V

1,8 106 AR 32201 <M1>	05.98-07.00	0 451 10 P 3300	O
	KL	1 987 43 M 2014	I

Spider 2.0 i.e.

2,0 88/93 AR 01588 <M3>; AR 01590 <M2>	01.90-12.94	0 451 10 P 3352	O
		1 457 43 S 3251	L
		0 450 90 F 5030 ¹	K

Spider 2.0 JTDm

2,0 125 939B3000 <M120>	05.09-12.10	F 026 40 S 0039	L
		1 987 43 R 2433 ⁸	I

Spider 2.0 JTS

2,0 121 937A1.000 <M8>	04.03-07.04	0 451 10 P 3336	O
	04.03-02.06 KL	1 987 43 M 2014	I

Spider 2.0 T.S. 16V

2,0 110 AR 16201 <M1>	04.95-04.98	0 451 10 P 3300	O
	KL	0 450 90 F 5087 ¹	K
		1 987 43 M 2014	I

2,0 110 AR 32310 CF3 <M6>	08.00-02.06	0 451 10 P 3300	O
	KL	1 987 43 M 2014	I

2,0 114 AR 32301 <M2>	05.98-07.00	0 451 10 P 3300	O
		0 450 90 F 5087 ¹	K
	KL	1 987 43 M 2014	I

Spider 2.0 V6 Turbo

2,0 147 AR 16202 <M3>	04.98-12.00	0 451 10 P 3351	O
		1 457 43 S 3253	L
		0 450 90 F 5087 ¹	K
	KL	1 987 43 M 2014	I





Spider 2.2 JTS

2,2 136 939A5000 <M50>	03.06-12.10	F 026 40 P 7016	O
		F 026 40 S 0039	L
	TW	1 987 43 R 2433 ⁸	I

Spider 2.4 JTDM 20V

2,4 147/154 939A3000 <M95>; 939A3000 <M105>	03.07-12.10	F 026 40 P 7021	O
		F 026 40 S 0039	L
	TW	1 987 43 R 2433 ⁸	I

Spider 3.0 V6 12V

3,0 141 AR 16101 <M2>	04.95-04.98	0 451 10 P 3351	O
		0 450 90 F 5087 ¹	K
	KL	1 987 43 M 2014	I

3,0 141 AR 16101 <M4>	05.98-08.00	0 451 10 P 3351	O
		1 457 43 S 3791	L
	KL	1 987 43 M 2014	I

3,0 141 AR 16199 <M3>	04.95-04.98	0 451 10 P 3351	O
		1 987 43 M 2014	I

3,0 141 AR 16199 <M5>	05.98-02.06	0 451 10 P 3351	O
		1 457 43 S 3791	L
	KL	1 987 43 M 2014	I

Spider 3.0 V6 24V

3,0 162 AR 16105 CF3 <M7>	08.00-03.03	0 451 10 P 3351	O
		1 987 43 M 2014	I

Spider 3.2 JTS 24V, JTS 24V Q4

3,2 191/195 939A000 <M61>; 939A000 <M62>	09.06-12.10	F 026 40 S 0039	L
		1 987 43 R 2433 ⁸	I

Spider 3.2 V6 24V

3,2 176 936A6.000 <M9>	04.03-02.06	0 451 10 P 3351	O
		1 987 43 M 2014	I

SZ

SZ 3.0 V6

3,0 154 AR 61501	03.89-12.91	0 451 10 P 3352	O
		0 450 90 F 5030 ¹	K

33

33 1.2

1,2 57 AR30743 <W5 M1>	01.90-08.91	0 451 10 P 3349	O
		1 457 43 S 2150	L



33 1.3

1,3 66 AR30732 <W5 M2>	02.90-10.94	0 451 10 P 3349	O
		1 457 43 S 2150	L

33 1.3 , 4x4

1,3 66 AR30732 <M2>	01.90-10.94	0 451 10 P 3350	O
		1 457 43 S 2150	L

33 1.3 I.E.

1,3 65 AR30753 MPI-Weber <M1>	09.91-10.94	0 451 10 P 3350	O
		1 457 43 S 2150	L

33 1.4 I.E.

1,4 64 AR30755 KAT <M10>	09.91-09.94	0 451 10 P 3350	O
		1 457 43 S 2150	L
		0 450 90 F 5005 ¹	K

33 1.5

1,5 77 AR30734 <W5 M3>	02.90-03.92	0 451 10 P 3349	O
		1 457 43 S 2150	L

33 1.5 I.E., I.E. 4x4

1,5 71/74 AR30738 <M4>; AR30750 <M2>; AR30751 KAT <M3>; AR30751 <M3>	06.90-10.94	0 451 10 P 3350	O
		1 457 43 S 2150	L
		0 450 90 F 5005 ¹	K

33 1.7 I.E., I.E. 4x4

1,7 77/79 AR30736 <M5>; AR30737 KAT <M6>; AR30737 <M6>; AR30740 <M7>	01.90-10.94	0 451 10 P 3350	O
		1 457 43 S 2150	L
		0 450 90 F 5005 ¹	K

33 1.7 I.E. 16V, I.E. 16V 4x4

1,7 95-97/98 AR30746 <M8>; AR30747 <M9>	01.90-10.94	0 451 10 P 3349	O
		1 457 43 S 2150	L
		0 450 90 F 5005 ¹	K

33 1.8 D Turbo

1,8 62 VM 96 A <M4>	01.90-10.94	0 451 10 P 3350	O
		1 457 43 S 2150	L

75

75 1.6 I.E.

1,6 79 AR 61101 <M3>	08.89-02.92	0 451 10 P 3352	O
		1 457 43 S 3251	L
		0 450 90 F 5030 ¹	K



**75 1.8 I.E.**

1,8 | 88 | AR 06168 <M5>; AR 61201 <M6>

09.88-02.92	0 451 10 P 3352	O
	1 457 43 S 3251	L
	0 450 90 F 5030 ¹	K

75 2.0 TD

2,0 | 70 | VM80A <M5>

05.85-02.92	0 451 20 P 3194	O
	1 457 43 S 3252	L

75 2.0 Twin Spark

2,0 | 106 | AR 06166 KAT <M11>

09.87-02.92	0 451 10 P 3352	O
	1 457 43 S 3251	L
	0 450 90 F 5030 ¹	K

2,0 | 109 | AR 06224 <M10>

01.87-02.92	0 451 10 P 3352	O
	1 457 43 S 3251	L
	0 450 90 F 5002 ¹	K

75 2.4 TD

2,4 | 81 | VM81A <M6>

09.88-02.92	0 451 20 P 3194	O
	1 457 43 S 3252	L

75 2.5 V6

2,5 | 110-113 | AR 01911 KAT <M1>

02.86-02.92	0 451 10 P 3170	O
	1 457 43 S 3251	L
	0 450 90 F 5030 ¹	K

75 3.0

3,0 | 152 | AR 61501

03.89-02.92	0 451 10 P 3170	O
	1 457 43 S 3251	L
	0 450 90 F 5030 ¹	K

75 3.0 V6

3,0 | 133-136 | AR 06120 <M2>

01.87-02.92	0 451 10 P 3352	O
	1 457 43 S 3251	L
	0 450 90 F 5030 ¹	K

3,0 | 139-141 | AR 61503 <M4>

02.90-02.92	0 451 10 P 3352	O
	1 457 43 S 3251	L
	0 450 90 F 5030 ¹	K

145**145 1.3 i.e.**

1,3 | 68 | AR 33501 MPI-Weber <M1>

04.94-11.96	0 451 10 P 3349	O
	1 457 43 S 2150	L
	0 450 90 F 5005 ¹	K
KL	1 987 43 M 2014	I

145 1.4 i.e. 16V T.S.

1,4 | 76 | AR 33503 <M1>

11.96-12.00	0 451 10 P 3300	O
11.96-05.98	1 457 43 S 3265	L
02.99-12.00	1 457 43 S 3265	L
11.96-02.99	0 450 90 F 5273 ¹	K
KL	1 987 43 M 2014	I

145 1.6 i.e.

1,6 | 78 | AR 33201 MPI-Bosch <M2>

04.94-12.94	0 451 10 P 3349	O
	1 457 43 S 2150	L
	0 450 90 F 5005 ¹	K
KL	1 987 43 M 2014	I

1,6 | 78 | AR 33201 MPI-Roch. <M2>

01.95-11.96	0 451 10 P 3349	O
	1 457 43 S 2150	L
	0 450 90 F 5273 ¹	K
KL	1 987 43 M 2014	I

145 1.6 i.e. 16V T.S.

1,6 | 88 | AR 32102 <M6>

02.99-12.00	0 451 10 P 3300	O
	1 457 43 S 3265	L

1,6 | 88 | AR 67601 <M2>

11.96-02.99	0 451 10 P 3300	O
11.96-05.98	1 457 43 S 3265	L
11.96-02.99	0 450 90 F 5273 ¹	K
KL	1 987 43 M 2014	I

1,6 | 88 | AR 67601 <M5>

02.99-12.00	0 451 10 P 3300	O
	1 457 43 S 3265	L

145 1.7 i.e. 16V

1,7 | 96 | AR 33401 <M3>

04.94-11.96	0 451 10 P 3349	O
	1 457 43 S 2150	L
	0 450 90 F 5005 ¹	K
KL	1 987 43 M 2014	I

145 1.8 i.e. 16V T.S.

1,8 | 103 | AR 32201 <M10>

02.99-12.00	0 451 10 P 3300	O
	1 457 43 S 3265	L

1,8 | 103 | AR 32201 <M11>

05.98-02.99	0 451 10 P 3300	O
	1 457 43 S 3265	L
	0 450 90 F 5273 ¹	K

1,8 | 103 | AR 67106 <M3>; AR 67199 <M8>

11.96-04.98	0 451 10 P 3300	O
	1 457 43 S 3265	L
	0 450 90 F 5273 ¹	K
KL	1 987 43 M 2014	I





145 1.9 JTD

1,9 76 AR 32302 <M20>			
05.98-12.00		0 451 10 P 3111	O
		1 457 43 S 3265	L
05.98-02.99	MW8	1 457 43 N 4198 ²	K
02.99-12.00		1 457 43 N 4198 ²	K
05.98-12.00	KL	1 987 43 M 2014	I

145 1.9 TD

1,9 66 AR 33601 <M5>			
11.96-05.98		0 451 10 P 3352	O
		1 457 43 S 2183	L
	MW8	1 457 43 N 4198 ²	K
	KL	1 987 43 M 2014	I

1,9 66 AR 33601 <M7>			
10.94-11.96		0 451 10 P 3352	O
		1 457 43 S 2183	L
		1 457 43 N 4105 ²	K
	KL	1 987 43 M 2014	I

1,9 66 AR 67501 <M6>			
04.94-05.98		0 451 10 P 3352	O
		1 457 43 S 2183	L
04.94-11.96		1 457 43 N 4105 ²	K
11.96-05.98	MW8	1 457 43 N 4198 ²	K
04.94-05.98	KL	1 987 43 M 2014	I

145 2.0 i.e. 16V T.S.

2,0 110 AR 32301 <M15>			
02.99-12.00		0 451 10 P 3300	O
		1 457 43 S 3265	L

2,0 110 AR 32301 Step A <M12>			
05.98-02.99		0 451 10 P 3300	O
		1 457 43 S 3265	L
		0 450 90 F 5273 ¹	K

2,0 110 AR 67204 <M4>; AR 67299 <M5>; AR 67299 <M7>			
10.94-02.99		0 451 10 P 3300	O
		1 457 43 S 3265	L
		0 450 90 F 5273 ¹	K
	KL	1 987 43 M 2014	I

146

146 1.3 i.e.

1,3 68 AR 33501 MPI-Weber <U2 M1>			
12.94-11.96		0 451 10 P 3349	O
		1 457 43 S 2150	L
		0 450 90 F 5273 ¹	K
	KL	1 987 43 M 2014	I

146 1.4 i.e. 16V T.S.

1,4 76 AR 33503 <M1>			
11.96-02.99		0 451 10 P 3300	O
11.96-05.98		1 457 43 S 3265	L
11.96-02.99		0 450 90 F 5273 ¹	K

1,4 76 AR 33503 <W4 M1>			
02.99-12.00		0 451 10 P 3300	O
		1 457 43 S 3265	L



146 1.6 i.e.

1,6 76-78 AR 33201 MPI-Roch. <U2 M2>			
05.95-11.96		0 451 10 P 3349	O
		1 457 43 S 2150	L
		0 450 90 F 5273 ¹	K
	KL	1 987 43 M 2014	I

146 1.6 i.e. 16V T.S.

1,6 88 AR 32102 <W4 M6>			
02.99-12.00		0 451 10 P 3300	O
		1 457 43 S 3265	L

1,6 88 AR 67601 <M2>			
11.96-02.99		0 451 10 P 3300	O
11.96-05.98		1 457 43 S 3265	L
11.96-02.99		0 450 90 F 5273 ¹	K
	KL	1 987 43 M 2014	I

1,6 88 AR 67601 <W4 M5>			
02.99-12.00		0 451 10 P 3300	O
		1 457 43 S 3265	L

146 1.7 i.e. 16V

1,7 96 AR 33401 <U2 M3>			
12.94-11.96		0 451 10 P 3349	O
		1 457 43 S 2150	L
		0 450 90 F 5273 ¹	K
	KL	1 987 43 M 2014	I

146 1.8 i.e. 16V T.S.

1,8 103 AR 32201 <M11>			
05.98-02.99		0 451 10 P 3300	O
		1 457 43 S 3265	L
		0 450 90 F 5273 ¹	K

1,8 103 AR 32201 <W4 M10>			
02.99-12.00		0 451 10 P 3300	O
		1 457 43 S 3265	L

1,8 103 AR 67106 <M3>			
11.96-04.98		0 451 10 P 3300	O
		1 457 43 S 3265	L
		0 450 90 F 5273 ¹	K

146 1.9 JTD

1,9 76 AR 32302 <M13>			
05.98-02.99		0 451 10 P 3111	O
		1 457 43 S 3265	L
	MW8	1 457 43 N 4198 ²	K
	KL	1 987 43 M 2014	I

1,9 76 AR 32302 <W4 M20>			
02.99-12.00		0 451 10 P 3111	O
		1 457 43 S 3265	L
		1 457 43 N 4198 ²	K
	KL	1 987 43 M 2014	I

146 1.9 TD

1,9 66 AR 33601 <M5>			
11.96-05.98		0 451 10 P 3352	O
		1 457 43 S 2183	L
	MW8	1 457 43 N 4198 ²	K
	KL	1 987 43 M 2014	I



1,9 66 AR 33601 <U2 M6 CF2>	12.94-11.96	0 451 10 P 3352	O
		1 457 43 S 2183	L
		1 457 43 N 4105 ²	K

1,9 66 AR 67501 <M6>	11.96-05.98	0 451 10 P 3352	O
		1 457 43 S 2183	L
		MW8 1 457 43 N 4198 ²	K
		KL 1 987 43 M 2014	I

1,9 66 AR 67501 <U2 M5>	12.94-11.96	0 451 10 P 3352	O
		1 457 43 S 2183	L
		1 457 43 N 4105 ²	K
		KL 1 987 43 M 2014	I

146 2.0 ti 16V T.S.

2,0 110 AR 32301 <M12>	05.98-02.99	0 451 10 P 3300	O
		1 457 43 S 3265	L
		0 450 90 F 5273 ¹	K

2,0 110 AR 32301 <W4 M15>	02.99-12.00	0 451 10 P 3300	O
		1 457 43 S 3265	L

2,0 110 AR 67204 <M4>	10.95-04.98	0 451 10 P 3300	O
		1 457 43 S 3265	L
		0 450 90 F 5273 ¹	K
		KL 1 987 43 M 2014	I

147**147 1.6 TS 16V, TS 16V ECO**

1,6 77/88 AR 32104 <M5>; AR 37203 <M1>	11.00-12.10	0 451 10 P 3300	O
		1 457 43 S 3156	L
		2FE 1 987 43 R 2386 ⁸	I

147 1.9 JTD

1,9 74 182B9000 <M14>	06.03-10.06	0 451 10 P 3300	O
		1 457 43 S 3086	L
		F 026 40 N 2048 ²	K
		2FE 1 987 43 R 2386 ⁸	I

1,9 81-85 937A2000 <M15>	11.00-03.05	0 451 10 P 3300	O
		1 457 43 S 3086	L
	11.00-12.02	1 457 43 N 4314 ²	K
		F 026 40 N 2048 ²	K
	11.00-03.05 2FE	1 987 43 R 2386 ⁸	I

147 1.9 JTDM, JTDM 16V

1,9 85/125 937A6000 <M94>; 939A7000 <M87>	01.06-12.10	0 451 10 P 3300	O
		1 457 43 S 3086	L
		F 026 40 N 2048 ²	K
		2FE 1 987 43 R 2386 ⁸	I



1,9 88/93/110 937A3000 <M88>; 937A4000 <M16>; 937A5000 <M19>	06.03-12.10	0 451 10 P 3300	O
		1 457 43 S 3086	L
		F 026 40 N 2048 ²	K
		2FE 1 987 43 R 2386 ⁸	I

147 1.9 JTDM 16V

1,9 100 192B1000 <M18>	02.04-12.05	0 451 10 P 3300	O
		1 457 43 S 3086	L
		F 026 40 N 2048 ²	K
		2FE 1 987 43 R 2386 ⁸	I

1,9 100 192B1000 <M91>	01.06-12.10	0 451 10 P 3300	O
		1 457 43 S 3086	L
		F 026 40 N 2048 ²	K
		2FE 1 987 43 R 2386 ⁸	I

1,9 103 192A5000 <M17>	10.02-09.03	0 451 10 P 3300	O
		1 457 43 S 3086	L
	10.02-01.03	1 457 43 N 4460 ²	K
		F 026 40 N 2048 ²	K
10.02-09.03 2FE	1 987 43 R 2386 ⁸	I	

1,9 110 937A5000 <M92>	06.05-12.10	0 451 10 P 3300	O
		1 457 43 S 3086	L
		F 026 40 N 2048 ²	K
		2FE 1 987 43 R 2386 ⁸	I

147 2.0 TS 16V

2,0 110 AR 32310 <M10>	11.00-12.10	0 451 10 P 3300	O
		1 457 43 S 3156	L
		2FE 1 987 43 R 2386 ⁸	I

147 3.2 GTA

3,2 184 932A000 <M20>	01.03-12.10	0 451 10 P 3351	O
		1 457 43 S 3791	L
		2FE 1 987 43 R 2386 ⁸	I

155**155 1.6 i 16V T.S.**

1,6 85 AR 67601 <M1>	05.96-10.97	0 451 10 P 3300	O
		1 457 43 S 3265	L
		0 450 90 F 5005 ¹	K
		KL 1 987 43 M 2014	I

155 1.7 T.S.

1,7 85/95 AR 67103 <M1>; AR 67105 <M1>	02.92-04.96	0 451 10 P 3352	O
		1 457 43 S 3253	L
		0 450 90 F 5005 ¹	K
	01.93-04.96 KL	1 987 43 M 2014	I



155 1.8 i 16V T.S.

1,8 100 AR 67106 <M2>			
05.96-10.97	0 451 10 P 3300	O	
	1 457 43 S 3265	L	
	0 450 90 F 5005 ¹	K	
KL	1 987 43 M 2014	I	

155 1.8 T.S.

1,8 93 AR 67101/67102 <M2>			
02.92-04.96	0 451 10 P 3352	O	
	1 457 43 S 3253	L	
	0 450 90 F 5005 ¹	K	
01.93-04.96 KL	1 987 43 M 2014	I	

155 1.9 TD

1,9 66 AR 33601 <M1>			
05.96-10.97	0 451 10 P 3352	O	
	1 457 43 S 2183	L	
	1 457 43 N 4105 ²	K	
KL	1 987 43 M 2014	I	

1,9 66 AR 67501 <U6 M1>			
04.93-04.96	0 451 10 P 3170	O	
	1 457 43 S 2183	L	
	1 457 43 N 4105 ²	K	
KL	1 987 43 M 2014	I	

155 2.0 i 16V T.S.

2,0 110 AR 67204 <M3>			
05.96-10.97	0 451 10 P 3300	O	
	1 457 43 S 3265	L	
	0 450 90 F 5005 ¹	K	
KL	1 987 43 M 2014	I	

2,0 110 AR 67299 <M5>			
05.96-10.97	0 451 10 P 3300	O	
	1 457 43 S 3265	L	
	0 450 90 F 5273 ¹	K	
KL	1 987 43 M 2014	I	

155 2.0 T.S.

2,0 104/106 AR 67201 <M3>; AR 67202 <M3>			
02.92-02.95	0 451 10 P 3352	O	
	1 457 43 S 3253	L	
	0 450 90 F 5005 ¹	K	
01.93-02.95 KL	1 987 43 M 2014	I	

155 2.0 T.S. 16V

2,0 110 AR 67204 <M4>			
03.95-04.96	0 451 10 P 3300	O	
	1 457 43 S 3265	L	
	0 450 90 F 5087 ¹	K	

155 2.0 Turbo 4x4

2,0 140 AR 67203 <U6 M4>			
02.92-04.96	0 451 10 P 3352	O	
	1 457 43 S 3253	L	
01.93-04.96 KL	1 987 43 M 2014	I	



155 2.5 i V6

2,5 121 AR 67303 <M4>			
05.96-10.97	0 451 10 P 3351	O	
	1 457 43 S 3253	L	
	0 450 90 F 5005 ¹	K	
KL	1 987 43 M 2014	I	

155 2.5 TD

2,5 92 VM07B / VM31B <M2/M3>			
04.93-04.96	0 451 10 P 3350	O	
	1 457 43 S 3253	L	
KL	1 987 43 M 2014	I	

2,5 92 VM31B <M2>			
05.96-10.97	0 451 10 P 3350	O	
	1 457 43 S 3253	L	
	1 457 43 N 4174 ²	K	
KL	1 987 43 M 2014	I	

155 2.5 V6

2,5 120 AR 67301 <M6>			
02.92-04.96	0 451 10 P 3352	O	
	1 457 43 S 3253	L	
	0 450 90 F 5005 ¹	K	
01.93-04.96 KL	1 987 43 M 2014	I	

156

156 1.6 TS 16V

1,6 88 AR32102 <M7>			
04.98-09.00	0 451 10 P 3300	O	
	1 457 43 S 3791	L	
	1 987 43 M 2003	I	
	1 987 43 R 2303 ⁸	I	

1,6 88 AR32103 <M2>			
01.02-10.05	0 451 10 P 3300	O	
	1 457 43 S 3791	L	
	0 450 90 F 5320 ¹	K	
2FE	1 987 43 R 2386 ⁸	I	

1,6 88 AR32103 <M11>; AR32104 CF3 <M10>			
09.00-12.01	0 451 10 P 3300	O	
	1 457 43 S 3791	L	
	1 987 43 M 2003	I	
	1 987 43 R 2303 ⁸	I	

1,6 88 AR32104 <M1>			
01.02-12.05	0 451 10 P 3300	O	
	1 457 43 S 3791	L	
	0 450 90 F 5320 ¹	K	
2FE	1 987 43 R 2386 ⁸	I	

1,6 88 AR32104 <M10>; AR67601 CF2 <M1>; AR67601 <M1>			
10.97-12.01	0 451 10 P 3300	O	
	1 457 43 S 3791	L	
	1 987 43 M 2003	I	
	1 987 43 R 2303 ⁸	I	



**156 1.8 TS 16V**

1,8 106 AR32201 CF2 <M2>; AR32201 <M2>; AR32205 CF3 <M15>			
10.97-12.01	0 451 10 P 3300	O	
	1 457 43 S 3791	L	
	1 987 43 M 2003	I	
	1 987 43 R 2303 ⁸	I	

1,8 | 106 | AR32205 <M5>

01.02-12.05	0 451 10 P 3300	O	
	1 457 43 S 3791	L	
	0 450 90 F 5320 ¹	K	
2FE	1 987 43 R 2386 ⁸	I	

1,8 | 106 | AR32205 <M15>

09.00-12.01	0 451 10 P 3300	O	
	1 457 43 S 3791	L	
	1 987 43 M 2003	I	
	1 987 43 R 2303 ⁸	I	

156 1.9 JTD**1,9 | 74 | 182B9.000 <M24>**

06.03-12.04	0 451 10 P 3300	O	
	1 457 43 S 3791	L	
	F 026 40 N 2048 ²	K	
2FE	1 987 43 R 2386 ⁸	I	

1,9 | 76 | AR32302 CF2 <M1>

06.00-09.00	0 451 10 P 3354	O	
	1 457 43 S 3791	L	
MW8	1 457 43 N 4198 ²	K	
	1 987 43 M 2003	I	
	1 987 43 R 2303 ⁸	I	

1,9 | 76 | AR32302 <M1>

10.97-09.00	0 451 10 P 3111	O	
	1 457 43 S 3791	L	
MW8	1 457 43 N 4198 ²	K	
	1 987 43 M 2003	I	
	1 987 43 R 2303 ⁸	I	

1,9 | 80-85 | AR37101 / 937A2.000 <M3/M5>; AR37101 / 937A2.000 <M3/M5 CF3>

Ricam.Nr →00434142	09.00-12.01	0 451 10 P 3354	O
Ricam.Nr 00434143→	09.00-12.01	0 451 10 P 3300	O
	09.00-12.01	1 457 43 S 3791	L
		1 457 43 N 4314 ²	K
		1 987 43 M 2003	I
		1 987 43 R 2303 ⁸	I

1,9 | 85 | 937A2.000 <M25>

01.02-12.05	0 451 10 P 3300	O	
	1 457 43 S 3791	L	
01.02-12.02	1 457 43 N 4314 ²	K	
01.03-12.05	F 026 40 N 2048 ²	K	
01.02-12.05	2FE,TW 1 987 43 R 2386 ⁸	I	

156 1.9 JTD 4x4**1,9 | 110 | 937A5000 <M28 / M92>**

10.04-12.05	0 451 10 P 3300	O	
	1 457 43 S 3791	L	
	F 026 40 N 2048 ²	K	
2FE,TW	1 987 43 R 2386 ⁸	I	

**156 1.9 JTD 16V****1,9 | 93 | 937A4.000 <M26>; 937A4.000 <M26/M90>**

06.03-10.05	0 451 10 P 3300	O	
	1 457 43 S 3791	L	
Ricam.Nr →00585017	06.03-11.03	F 026 40 N 2048 ²	K
Ricam.Nr 00585018→	11.03-10.05	F 026 40 N 2048 ²	K
	06.03-10.05	2FE,TW 1 987 43 R 2386 ⁸	I

1,9 | 93 | 937A4000 <M90>

10.03-12.05	0 451 10 P 3300	O	
	1 457 43 S 3791	L	
	F 026 40 N 2048 ²	K	
2FE,TW	1 987 43 R 2386 ⁸	I	

1,9 | 100 | 192B1000 <M29>

10.04-10.05	0 451 10 P 3300	O	
	1 457 43 S 3791	L	
	F 026 40 N 2048 ²	K	
Ricam.Nr 00585018→	10.04-10.05	F 026 40 N 2048 ²	K
	10.04-10.05	2FE,TW 1 987 43 R 2386 ⁸	I

1,9 | 103 | 192A5.000 <M27>

10.02-12.05	0 451 10 P 3300	O	
	1 457 43 S 3791	L	
Ricam.Nr →00585017	01.03-11.03	F 026 40 N 2048 ²	K
Ricam.Nr 00585018→	11.03-12.05	F 026 40 N 2048 ²	K
	10.02-12.05	2FE,TW 1 987 43 R 2386 ⁸	I

1,9 | 110 | 937A5000 <M82 E4>

10.03-12.05	0 451 10 P 3300	O	
	1 457 43 S 3791	L	
	F 026 40 N 2048 ²	K	
2FE,TW	1 987 43 R 2386 ⁸	I	

156 1.9 JTD 16V 4x4**1,9 | 110 | 937A5000 <M28 / M92>**

10.04-12.05	0 451 10 P 3300	O	
	1 457 43 S 3791	L	
	F 026 40 N 2048 ²	K	
2FE,TW	1 987 43 R 2386 ⁸	I	

156 2.0 JTS 16V**2,0 | 119/121 | 932A2.000 <M12>; 937A1.000 <M10>**

01.02-07.04	0 451 10 P 3336	O	
01.02-12.05	1 457 43 S 3791	L	
	0 450 90 F 5320 ¹	K	
2FE	1 987 43 R 2386 ⁸	I	

156 2.0 TS 16V**2,0 | 114 | AR32301 CF2 <M3>; AR32301 <M3>; AR32303 <M5>**

10.97-12.01	0 451 10 P 3300	O	
	1 457 43 S 3791	L	
	1 987 43 M 2003	I	
	1 987 43 R 2303 ⁸	I	

2,0 | 114 | AR32310 CF3 <M20>

09.00-12.01	0 451 10 P 3300	O	
	1 457 43 S 3791	L	
	1 987 43 M 2003	I	
	1 987 43 R 2303 ⁸	I	



◀ 156 2.0 TS 16V

2,0 114 AR32310 <M20>	09.00-12.01	0 451 10 P 3300	O
		1 457 43 S 3791	L
		1 987 43 M 2003	I
		1 987 43 R 2303 ⁸	I

2,0 121 AR32310 CF3 <M11>	01.02-10.05	0 451 10 P 3300	O
		1 457 43 S 3791	L
	2FE	1 987 43 R 2386 ⁸	I

2,0 121 AR32310 <M11>	01.02-10.05	0 451 10 P 3300	O
		1 457 43 S 3791	L
	2FE	1 987 43 R 2386 ⁸	I

156 2.4 JTD

2,4 100 AR32501 CF2 <M2>	06.00-09.00	0 451 10 P 3224	O
		1 457 43 S 3791	L
Mot.Nr. →2140329	06.00-09.00 MW1	1 457 43 N 4293 ²	K
Mot.Nr. 2140330→	06.00-09.00 MW1,XXX	1 457 43 N 4306 ²	K
	06.00-09.00	1 987 43 M 2003	I
		1 987 43 R 2303 ⁸	I

2,4 100 AR32501 <M2>	10.97-09.00	0 451 10 P 3224	O
		1 457 43 S 3791	L
Mot.Nr. →1930904	10.97-03.00 MW8	1 457 43 N 4198 ²	K
Mot.Nr. 1930905→2140329	03.00-09.00 MW1	1 457 43 N 4293 ²	K
Mot.Nr. 2140330→	03.00-09.00 MW1,XXX	1 457 43 N 4306 ²	K
	10.97-09.00	1 987 43 M 2003	I
		1 987 43 R 2303 ⁸	I

2,4 100 839A6.000 CF3 <M4>; 839A6.000 <M4>	09.00-12.01	0 451 10 P 3224	O
		1 457 43 S 3791	L
		1 457 43 N 4314 ²	K
		1 987 43 M 2003	I
		1 987 43 R 2303 ⁸	I

2,4 110 841C000 <M30>	01.02-10.05	0 451 10 P 3354	O
		1 457 43 S 3791	L
	01.02-12.02	1 457 43 N 4314 ²	K
	01.03-10.05	F 026 40 N 2048 ²	K
	01.02-10.05 2FE,TW	1 987 43 R 2386 ⁸	I

156 2.4 JTD, JTD 20V

2,4 120/129 841G.000 <M31>; 841G000 <M31>; 841M000 <M33>	06.03-12.05	0 451 10 P 3354	O
		1 457 43 S 3791	L
		F 026 40 N 2048 ²	K
	2FE,TW	1 987 43 R 2386 ⁸	I

156 2.5 24V

2,5 140 AR32401 CF2 <M4>; AR32401 <M4>; AR32402 <M6>; AR32405 CF3 <M25>	10.97-12.01	0 451 10 P 3300	O
		1 457 43 S 3791	L
		1 987 43 M 2003	I
		1 987 43 R 2303 ⁸	I



2,5 140 AR32405 <M25>	09.00-12.01	0 451 10 P 3300	O
		1 457 43 S 3791	L
		1 987 43 M 2003	I
		1 987 43 R 2303 ⁸	I

2,5 141 AR32405 <M15>	01.02-10.05	0 451 10 P 3300	O
		1 457 43 S 3791	L
	2FE	1 987 43 R 2386 ⁸	I

156 3.2 GTA

3,2 184 932A000 <M20>	03.02-10.05	0 451 10 P 3351	O
		1 457 43 S 3791	L
	2FE	1 987 43 R 2386 ⁸	I

159

159 1.8 i

1,8 96 939A4000 <M41 E4>	03.06-12.08	F 026 40 P 7006	O
		F 026 40 S 0039	L
	MKL	1 987 43 R 2433 ⁸	I

159 1.8 TBi

1,8 147 939B1000 <M66>	05.09-12.10	F 026 40 S 0039	L
		MKL	1 987 43 R 2433 ⁸

159 1.9 JTDM 8V, JTDM 16V

1,9 85/88/100/110 937A7000 <M87 E4>; 937A8000 <M91>; 939A1000 <M88 E4>; 939A2000 <M92 E4>	06.05-12.08	1 457 42 P 9248	O
		F 026 40 S 0039	L
	MKL	1 987 43 R 2433 ⁸	I

159 1.9 JTS

1,9 118 939A6000 <M47 E4>	06.05-12.08	F 026 40 P 7016	O
		F 026 40 S 0039	L
	MKL	1 987 43 R 2433 ⁸	I

159 2.0 JTDM 16V

2,0 100/125 939B3000 <M120>	05.09→	F 026 40 S 0039	L
		MKL	1 987 43 R 2433 ⁸

159 2.2 JTS

2,2 136 939A5000 <M50 E4>	06.05-12.08	F 026 40 P 7016	O
		F 026 40 S 0039	L
	MKL	1 987 43 R 2433 ⁸	I

159 2.4 JTD 20V, JTDM 20V

2,4 147/154 939A3000 <M95 E4>; 939A9000 <M105>; 939A9000 <M110>	06.05-12.08	F 026 40 P 7021	O
		F 026 40 S 0039	L
	MKL	1 987 43 R 2433 ⁸	I



**159 3.2 JTS**

3,2 191-195 939A000 <M61>; 939A000 <M62>			
	01.06-12.08	F 026 40 S 0039	L
		MKL 1 987 43 R 2433 ⁸	I

164**164 2.0 T.S.**

2,0 106 AR 64103 <M1>			
	09.92-10.98	0 451 10 P 3352	O
		1 457 43 S 2202	L
		0 450 90 F 5087 ¹	K
	KL	1 987 43 M 2005	I

164 2.0 Turbo i.e.

2,0 128 AR 06476 <M1>			
	01.88-09.92	0 451 10 P 3352	O
		1 457 43 S 2202	L
		0 450 90 F 5005 ¹	K
	KL	1 987 43 M 2005	I

164 2.0 Twin Spark

2,0 102/107 AR 06416 <M2>; AR 06420 <M1>			
	06.87-09.92	0 451 10 P 3352	O
		1 457 43 S 2202	L
		0 450 90 F 5087 ¹	K
	KL	1 987 43 M 2005	I

164 2.0 V6 Turbo

2,0 148 AR 64102 <M2>			
	09.92-10.98	0 451 10 P 3351	O
		1 457 43 S 2202	L
		0 450 90 F 5087 ¹	K
	KL	1 987 43 M 2005	I

164 2.0 V6 Turbo i.e.

2,0 148 AR 64102 <M3>			
	03.91-09.92	0 451 10 P 3349	O
		1 457 43 S 2202	L
		0 450 90 F 5087 ¹	K
	KL	1 987 43 M 2005	I

164 2.5 D Turbo

2,5 85 VM84A <M7>			
	06.87-09.92	0 451 20 P 3194	O
		MOK 0 451 20 P 3197	O
		1 457 43 S 2202	L
	KL	1 987 43 M 2005	I

2,5 | 92 | VM08B / VM32B <M8/M9>

	09.92-10.98	0 451 10 P 3350	O
		1 457 43 S 2202	L
		1 457 43 N 4174 ²	K
	KL	1 987 43 M 2005	I

164 3.0 i.e., i.e.Q.V.

3,0 132/136-140/147 AR 06410 <M3>; AR 06412 <M4>; AR 64301 <M5>; AR 64303 <M6>			
	06.87-09.92	0 451 10 P 3352	O
		1 457 43 S 2202	L
		0 450 90 F 5087 ¹	K
	KL	1 987 43 M 2005	I

164 3.0 Q4 4x4, V6 12V, V6 24V, V6 24V Q.V. G.D.

3,0 132/155/170/171 AR 64307 / 66304 <M6/M7>; AR 64308 <M4>; AR 64399 <M5>; AR 66301 / 66302 <M3/M6>			
	09.92-10.98	0 451 10 P 3351	O
		1 457 43 S 2202	L
		0 450 90 F 5087 ¹	K
	KL	1 987 43 M 2005	I

164 3.0 V6 12V, V6 24V Q.V.

3,0 132/169-171 AR 64304 <M3>; AR 64305 <M2>			
	09.92-10.98	0 451 10 P 3351	O
		1 457 43 S 2202	L
		0 450 90 F 5087 ¹	K
	KL	1 987 43 M 2005	I

164 3.0 V6 24V

3,0 155 AR 64306 <M7>			
	09.92-10.98	1 457 43 S 2202	L
	KL	1 987 43 M 2005	I

166**166 2.0 T.S. 16V**

2,0 114 AR 34103 <M1>			
	10.98-09.00	0 451 10 P 3300	O
		KL 1 987 43 R 2360 ⁸	I

2,0 | 114 | AR 36301 <M2>

	09.00-10.07	0 451 10 P 3300	O
		AG 1 457 43 S 3791	L
		GS 1 457 43 S 3329	L
		KL 1 987 43 R 2360 ⁸	I

166 2.0 Turbo V6

2,0 151 AR 34102 <M5>			
	10.98-12.04	0 451 10 P 3351	O
		AG 1 457 43 S 3791	L
		GS 1 457 43 S 3329	L
		KL 1 987 43 R 2360 ⁸	I

166 2.4 JTD

2,4 100 AR 34202 <M20>			
	10.98-09.00	0 451 10 P 3224	O
Mot.Nr. →1930904	10.98-03.00	MW8 1 457 43 N 4198 ²	K
Ricam.Nr →0052106	03.00-09.00	MW1 1 457 43 N 4293 ²	K
Ricam.Nr 0052107→	03.00-09.00	MW1,XXX 1 457 43 N 4306 ²	K
		1 457 43 N 4306	K
	10.98-09.00	KL 1 987 43 R 2360 ⁸	I





◀ 166 2.4 JTD

2,4 100-110 839A6000 / 841C000 <M21/M22>				
09.00-10.07	TW	0 451 10	P 3300	O
		0 451 10	P 3354	O
	AG	1 457 43	S 3791	L
	GS	1 457 43	S 3329	L
09.00-11.02		1 457 43	N 4314²	K
12.02-10.07		F 026 40	N 2048²	K
09.00-10.07	KL	1 987 43	R 2360⁸	I

166 2.4 JTD 20V

2,4 120/128/129 841G000 / 841H000 <M25/M26>; 841M000 <M27>; 841N000 <M28>				
06.03-10.07		0 451 10	P 3300	O
	AG	1 457 43	S 3791	L
	GS	1 457 43	S 3329	L
		F 026 40	N 2048²	K
	KL	1 987 43	R 2360⁸	I

166 2.4 JTDM 20V

2,4 132-136 936B000 <M99>				
10.05-10.07		0 451 10	P 3300	O
	AG	1 457 43	S 3791	L
	GS	1 457 43	S 3329	L
		F 026 40	N 2048²	K
	KL	1 987 43	R 2360⁸	I

166 2.5 V6 24V

2,5 140 AR 34201 <M10>				
10.98-09.00		0 451 10	P 3351	O
	KL	1 987 43	R 2360⁸	I

2,5 140 AR 36201 <M11>				
09.00-10.07		0 451 10	P 3351	O
	AG	1 457 43	S 3791	L
	GS	1 457 43	S 3329	L
	KL	1 987 43	R 2360⁸	I

166 3.0 V6 24V

3,0 166 AR 34301 <M15>				
10.98-09.00		0 451 10	P 3351	O
	KL	1 987 43	R 2360⁸	I

3,0 166 AR 34302 <M16>				
10.98-09.00	KL	1 987 43	R 2360⁸	I

3,0 166 AR 36101 <M17>; AR 36101 <M18>				
09.00-10.07		0 451 10	P 3351	O
	AG	1 457 43	S 3791	L
	GS	1 457 43	S 3329	L
	KL	1 987 43	R 2360⁸	I

166 3.2 V6 24V

3,2 166 936A000 <M19>				
06.03-10.07		0 451 10	P 3351	O
	AG	1 457 43	S 3791	L
	GS	1 457 43	S 3329	L
	KL	1 987 43	R 2360⁸	I



ALPINA (B.BOVENSIEPEN KG)

B7

B7 4.4

4,4 368 N62 B44A <H1>				
	12.03-06.08	F 026 40	P 7010	O
	2FE	1 987 43	M 2103	I

Roadster

Roadster V8

4,8 280 F 5/1				
	06.02-10.03	1 457 42	P 9141	O
		1 457 43	S 3698	L
		0 450 90	F 5950¹	K

ASIA (ASIA MOTORS)

Rocsta

Rocsta 1.8 i

1,8 57 SOHC				
	02.94-12.98	1 457 42	S 9806	L

Rocsta 2.2 D, D R2

2,2 45 R2 <SOHC>				
	08.94-12.98	PRI,VO	0 451 10	P 3270
			1 457 43	N 4453²
				K

AUDI **

A1

A1 1.2 TFSI

1,2 63 CBZA <DB1>				
	05.10→	F 026 40	S 0156	L
		0 450 90	F 5959¹	K
	05.10-06.10	1 987 43	M 2057	I
		1 987 43	R 2357⁸	I

A1 1.4 TFSI

1,4 90 CAXA				
	05.10→	F 026 40	S 0156	L
		0 450 90	F 5959¹	K
	05.10-06.10	1 987 43	M 2057	I
		1 987 43	R 2357⁸	I

A1 1.6 TDI

1,6 66 CAYB <D36>				
	03.11→	F 026 40	P 7023	O
		F 026 40	S 0156	L



**1,6|77|CAYC<TF3>**

05.10→	F 026 40 P 7023	O
	F 026 40 S 0156	L
	F 026 40 N 2000 ¹	K
05.10-06.10	1987 43 M 2057	I
	1987 43 R 2357 ⁸	I

A2**A2 1.2 TDI 3L****1,2|45|ANY**

03.01-08.05	1 457 42 P 9192	O
	1 457 43 S 3538	L
Fg.Nr. →8Z..2..070 000	0 450 90 N 6453 ¹	K
Fg.Nr. 8Z..3..000 001→	F 026 40 N 2084 ¹	K
03.01-08.05	1987 43 M 2057	I
	1987 43 R 2357 ⁸	I

A2 1.4**1,4|55|AUA**

09.99-04.02	0 451 10 P 3318	O
	1 457 43 S 3538	L
	0 450 90 F 5316 ¹	K
	1987 43 M 2057	I
	1987 43 R 2357 ⁸	I

1,4|55|BBY

11.01-08.05	0 451 10 P 3318	O
	1 457 43 S 3538	L
Fg.Nr. →8Z..2..700 000	0 450 90 F 5316 ¹	K
Fg.Nr. 8Z..3..000 001→	05.02-08.05 DRR F 026 40 F 3008 ¹	K
	DRR 0 450 90 F 5925 ¹	K
11.01-08.05	1987 43 M 2057	I
	1987 43 R 2357 ⁸	I

A2 1.4 TDI**1,4|55|AMF**

09.99-08.03	1 457 42 P 9192	O
	1 457 43 S 3538	L
Fg.Nr. →8Z..2..070 000	0 450 90 N 6453 ¹	K
Fg.Nr. 8Z..3..000 001→	05.02-08.03 F 026 40 N 2084 ¹	K
09.99-08.03	1987 43 M 2057	I
	1987 43 R 2357 ⁸	I

1,4|55|BHC

05.03-08.05	1 457 42 P 9192	O
	1 457 43 S 3538	L
	F 026 40 N 2084 ¹	K
	1987 43 M 2057	I
	1987 43 R 2357 ⁸	I

1,4|66|ATL

11.03-08.05	1 457 42 P 9192	O
	1 457 43 S 3538	L
	F 026 40 N 2084 ¹	K
	1987 43 M 2057	I
	1987 43 R 2357 ⁸	I

A2 1.6 FSI**1,6|81|BAD**

01.02-08.05	0 451 10 P 3318	O
	1 457 43 S 3538	L
	0 450 90 F 5316 ¹	K
	1987 43 M 2057	I
	1987 43 R 2357 ⁸	I

A3**A3 1.2 TFSI****1,2|77|CBZB<DB0>**

04.10→	1 987 42 S 9405	L
	0 450 90 F 5959 ¹	K
	1987 43 M 2097	I
	1987 43 R 2397 ⁸	I
	RLE 1987 43 R 2597 ⁸	I

A3 1.4 TFSI**1,4|92|CAXC<D33>**

09.07-06.08	1 457 42 P 9301	O
07.08-05.10	F 026 40 P 7079	O
09.07→	1 987 42 S 9405	L
	0 450 90 F 5959 ¹	K
	1987 43 M 2097	I
	1987 43 R 2397 ⁸	I
	RLE 1987 43 R 2597 ⁸	I

1,4|92|CMSA<D33>

04.10-05.10	F 026 40 P 7079	O
06.10→	1 457 42 P 9301	O
04.10→	1 987 42 S 9405	L
	0 450 90 F 5959 ¹	K
	1987 43 M 2097	I
	1987 43 R 2397 ⁸	I
	RLE 1987 43 R 2597 ⁸	I

A3 1.6**1,6|74|AEH**

09.96-06.01	0 451 10 P 3314	O
	1 457 43 S 3714	L
	0 450 90 F 5318 ¹	K
	H25 1987 43 R 2312 ⁸	I
Fg.Nr. →8L..V..090 450	09.96-04.97 H25 1987 43 M 2012	I
Fg.Nr. 8L..V..090 451→	04.97-06.01 H30 1987 43 R 2300 ⁸	I

1,6|74|AKL

08.97-06.01	0 451 10 P 3314	O
	1 457 43 S 3714	L
	0 450 90 F 5318 ¹	K
	H25 1987 43 R 2312 ⁸	I
Fg.Nr. 8L..V..090 451→	08.97-06.01 H30 1987 43 R 2300 ⁸	I

1,6|74|AKL<EA 113>

05.99-09.06	0 451 10 P 3314	O
	1 457 43 S 3714	L
	0 450 90 F 5318 ¹	K
	1987 43 R 2312 ⁸	I





◀ A3 1.6

1,6 74 BAH <EA 111>	09.00-09.06	0 451 10 P 3314	O
		1 457 43 S 3714	L
		0 450 90 F 5318 ¹	K
		1 987 43 R 2312 ⁸	I

1,6 74/75 APF; AVU	08.98-04.02	0 451 10 P 3314	O
		1 457 43 S 3714	L
		0 450 90 F 5318 ¹	K
	H25	1 987 43 R 2312 ⁸	I

Fg.Nr. 8L..V..090 451→ 08.98-04.02 H30 1 987 43 **R 2300**⁸ **I**

1,6 75 BFQ	05.02-06.03	0 451 10 P 3314	O
		1 457 43 S 3714	L
		0 450 90 F 5318 ¹	K
	H30	1 987 43 R 2300 ⁸	I

Fg.Nr. 8L..V..090 451→ 05.02-06.03 H30 1 987 43 **R 2300**⁸ **I**

1,6 75 BGU	05.03-05.05	0 451 10 P 3314	O
		KZO 1 987 42 S 9405	L
		KZO 1 457 43 S 3576	L

PR-Nr. 1A1 05.03-05.05 F 026 40 **F 3006**¹ **K**

PR-Nr. 1A5 05.03-05.05 0 450 90 **F 5959**¹ **K**

05.03-05.05 1 987 43 **M 2097** **I**

1 987 43 **R 2397**⁸ **I**

RLE 1 987 43 **R 2597**⁸ **I**

1,6 75 BSE <MW6>; BSF <MW6>	06.05→	0 451 10 P 3314	O
		KZO 1 987 42 S 9405	L
		KZO 1 457 43 S 3576	L
		F 026 40 F 3006 ¹	K
		1 987 43 M 2097	I
		1 987 43 R 2397 ⁸	I
	RLE	1 987 43 R 2597 ⁸	I

1,6 75 CCSA <MW6>; CMXA <MW6>	07.08→	0 451 10 P 3314	O
		1 987 42 S 9405	L
		F 026 40 F 3006 ¹	K
		1 987 43 M 2097	I
		1 987 43 R 2397 ⁸	I
	RLE	1 987 43 R 2597 ⁸	I

A3 1.6 FSI

1,6 85 BAG	08.03-05.04	1 457 42 P 9301	O
		1 457 43 S 3315	L
		0 450 90 F 5959 ¹	K
		1 987 43 M 2097	I
		1 987 43 R 2397 ⁸	I
	RLE	1 987 43 R 2597 ⁸	I

1,6 85 BLF; BLP	06.04-09.07	1 457 42 P 9301	O
		1 457 43 S 3315	L
		0 450 90 F 5316 ¹	K
		1 987 43 M 2097	I
		1 987 43 R 2397 ⁸	I
	RLE	1 987 43 R 2597 ⁸	I



A3 1.6 TDI

1,6 66/77 CAYB <D36>; CAYC <D38>	05.09→	F 026 40 P 7023	O
		KZO 1 987 42 S 9404	L
		F 026 40 N 2006	K
		1 987 43 M 2097	I
		1 987 43 R 2397 ⁸	I
	RLE	1 987 43 R 2597 ⁸	I

A3 1.8

1,8 92 APG	08.98-04.03	0 451 10 P 3314	O
		1 457 43 S 3714	L
		0 450 90 F 5318 ¹	K
	H25	1 987 43 R 2312 ⁸	I
	H30	1 987 43 R 2300 ⁸	I

1,8 92/110 AGN; AGU	09.96-09.06	0 451 10 P 3314	O
		1 457 43 S 3714	L
		0 450 90 F 5318 ¹	K
	H25	1 987 43 R 2312 ⁸	I
	H30	1 987 43 R 2312 ⁸	I
	H25	1 987 43 M 2012	I
	H30	1 987 43 R 2300 ⁸	I

A3 1.8 quattro

1,8 92/110 AGN; AGU	08.98-06.99	0 451 10 P 3314	O
		1 457 43 S 3714	L
		0 450 90 F 5318 ¹	K
	H25	1 987 43 R 2312 ⁸	I
	H30	1 987 43 R 2300 ⁸	I

A3 1.8 T

1,8 92/110 AGN; AGU	12.96-09.06	0 451 10 P 3314	O
		1 457 43 S 3714	L
		0 450 90 F 5318 ¹	K
	H25	1 987 43 R 2312 ⁸	I
	H30	1 987 43 R 2312 ⁸	I
	H25	1 987 43 M 2012	I
	H30	1 987 43 R 2300 ⁸	I

1,8 110 AQA	08.98-06.99	0 451 10 P 3314	O
		1 457 43 S 3714	L
		0 450 90 F 5318 ¹	K
	H25	1 987 43 R 2312 ⁸	I
	H30	1 987 43 R 2300 ⁸	I

1,8 110 ARZ; AUM	07.99-06.03	0 451 10 P 3314	O
		1 457 43 S 3714	L
		0 450 90 F 5318 ¹	K
	H25	1 987 43 R 2312 ⁸	I
	H30	1 987 43 R 2300 ⁸	I

1,8 132 AJQ	08.98-08.00	0 451 10 P 3314	O
		1 457 43 S 3714	L
		0 450 90 F 5318 ¹	K
	H25	1 987 43 R 2312 ⁸	I





Fg.Nr. 8L..V..090 451→ 08.98-08.00 H30 1 987 43 **R 2300**⁸ I

1,8 | 132 | APP

08.98-09.06 0 451 10 **P 3314** O
 1 457 43 **S 3714** L
 0 450 90 **F 5318**¹ K
 08.98-05.00 H25 1 987 43 **R 2312**⁸ I
 03.00-09.06 1 987 43 **R 2312**⁸ I

Fg.Nr. 8L..V..090 451→ 08.98-05.00 H30 1 987 43 **R 2300**⁸ I

1,8 | 132 | ARY

09.00-06.01 0 451 10 **P 3314** O
 1 457 43 **S 3714** L
 0 450 90 **F 5318**¹ K
 H25 1 987 43 **R 2312**⁸ I

Fg.Nr. 8L..V..090 451→ 09.00-06.01 H30 1 987 43 **R 2300**⁸ I

1,8 | 132 | AUQ

05.00-09.06 0 451 10 **P 3314** O
 1 457 43 **S 3714** L
 0 450 90 **F 5318**¹ K
 05.00-06.03 H25 1 987 43 **R 2312**⁸ I
 10.00-09.06 1 987 43 **R 2312**⁸ I

Fg.Nr. 8L..V..090 451→ 05.00-06.03 H30 1 987 43 **R 2300**⁸ I

A3 1.8 T quattro

1,8 | 92/110 | AGN; AGU

08.97-08.00 0 451 10 **P 3314** O
 1 457 43 **S 3714** L
 0 450 90 **F 5318**¹ K
 H25 1 987 43 **R 2312**⁸ I
 H30 1 987 43 **R 2300**⁸ I

1,8 | 110 | AQA

08.98-04.01 0 451 10 **P 3314** O
 1 457 43 **S 3714** L
 0 450 90 **F 5318**¹ K
 H25 1 987 43 **R 2312**⁸ I
 H30 1 987 43 **R 2300**⁸ I

1,8 | 110 | ARX

10.99-06.03 0 451 10 **P 3314** O
 1 457 43 **S 3714** L
 0 450 90 **F 5318**¹ K
 H25 1 987 43 **R 2312**⁸ I
 H30 1 987 43 **R 2300**⁸ I

1,8 | 132 | AJQ

08.98-08.00 0 451 10 **P 3314** O
 1 457 43 **S 3714** L
 0 450 90 **F 5318**¹ K
 H25 1 987 43 **R 2312**⁸ I
 H30 1 987 43 **R 2300**⁸ I

1,8 | 132 | ARY

09.00-06.03 0 451 10 **P 3314** O
 1 457 43 **S 3714** L
 0 450 90 **F 5318**¹ K
 H25 1 987 43 **R 2312**⁸ I
 H30 1 987 43 **R 2300**⁸ I

A3 1.8 TFSI

1,8 | 118 | BYT; BZB

11.06-05.08 F 026 40 **P 7080** O
 1 987 42 **S 9404** L
 0 450 90 **F 5316**¹ K
 1 987 43 **M 2097** I
 1 987 43 **R 2397**⁸ I
 RLE 1 987 43 **R 2597**⁸ I

A3 1.8 TFSI, TFSI quattro

1,8 | 118 | CDA <D67>

07.08→ F 026 40 **P 7080** O
 1 987 42 **S 9404** L
 0 450 90 **F 5959**¹ K
 1 987 43 **M 2097** I
 1 987 43 **R 2397**⁸ I
 RLE 1 987 43 **R 2597**⁸ I

A3 1.9 TDI

1,9 | 66/81 | AGR; AHF

09.96-09.06 1 457 42 **P 9619** O
 1 457 43 **S 3714** L
 0 450 90 **N 6374**¹ K
 09.96-08.00 H25 1 987 43 **R 2312**⁸ I

Fg.Nr. →8L..V..090 450

09.96-04.97 H25 1 987 43 **M 2012** I

Fg.Nr. 8L..V..090 451→

04.97-08.00 H30 1 987 43 **R 2300**⁸ I

1,9 | 66/81 | ALH; ASV

08.97-06.01 1 457 42 **P 9619** O
 1 457 43 **S 3714** L
 0 450 90 **N 6374**¹ K
 H25 1 987 43 **R 2312**⁸ I

Fg.Nr. 8L..V..090 451→

08.97-06.01 H30 1 987 43 **R 2300**⁸ I

1,9 | 74 | ATD

09.00-06.03 1 457 42 **P 9619** O
~~KZO~~ 1 457 43 **S 3714** L
 KZO 1 457 43 **S 3081** L
 0 450 90 **N 6374**¹ K
 H25 1 987 43 **R 2312**⁸ I

Fg.Nr. 8L..V..090 451→

09.00-06.03 H30 1 987 43 **R 2300**⁸ I

1,9 | 74 | AXR

11.01-06.03 1 457 42 **P 9619** O
~~KZO~~ 1 457 43 **S 3714** L
 KZO 1 457 43 **S 3081** L
 0 450 90 **N 6374**¹ K

Fg.Nr. 8L..V..090 451→

11.01-06.03 H30 1 987 43 **R 2300**⁸ I

1,9 | 77 | BKC; BLS

06.03-05.10 1 457 42 **P 9192** O
~~KZO~~ 1 987 42 **S 9404** L

Fg.Nr. →8P..6..176 000

06.03-02.06 1 457 07 **N0007** K

Fg.Nr. 8P..6..176 001→

03.06-05.10 F 026 40 **N 2006** K

06.03-05.10 1 987 43 **M 2097** I

1 987 43 **R 2397**⁸ I

RLE 1 987 43 **R 2597**⁸ I





◀ A3 1.9 TDI

1,9 77 BXE				
	06.06-05.10	1 457 42	P 9192	O
		KZO	1 987 42 S 9404	L
			F 026 40 N 2006	K
			1 987 43 M 2097	I
			1 987 43 R 2397 ⁸	I
		RLE	1 987 43 R 2597 ⁸	I

1,9 96 ASZ				
	05.00-06.03	1 457 42	P 9619	O
		KZO	1 457 43 S 3714	L
		KZO	1 457 43 S 3081	L
			0 450 90 N 6374 ¹	K
		H25	1 987 43 R 2312 ⁸	I
Fg.Nr. 8L..V..090 451→	05.00-06.03	H30	1 987 43 R 2300 ⁸	I

A3 1.9 TDI quattro

1,9 96 ASZ				
	05.00-06.03	1 457 42	P 9619	O
		KZO	1 457 43 S 3714	L
		KZO	1 457 43 S 3081	L
			0 450 90 N 6374 ¹	K
		H25	1 987 43 R 2312 ⁸	I
		H30	1 987 43 R 2300 ⁸	I

A3 2.0 FSI

2,0 110 AXW				
	05.03-05.04	1 457 42	P 9243	O
		KZO	1 987 42 S 9405	L
		KZO	1 457 43 S 3576	L
			0 450 90 F 5316 ¹	K
			1 987 43 M 2097	I
			1 987 43 R 2397 ⁸	I
		RLE	1 987 43 R 2597 ⁸	I

2,0 110 BHD				
	10.03-01.04	1 457 42	P 9243	O
		KZO	1 987 42 S 9405	L
		KZO	1 457 43 S 3576	L
			0 450 90 F 5316 ¹	K
			1 987 43 M 2097	I
			1 987 43 R 2397 ⁸	I
		RLE	1 987 43 R 2597 ⁸	I

2,0 110 BLR; BLX; BLY; BMB				
	01.04-10.05	1 457 42	P 9243	O
		KZO	1 987 42 S 9405	L
		KZO	1 457 43 S 3576	L
			0 450 90 F 5316 ¹	K
			1 987 43 M 2097	I
			1 987 43 R 2397 ⁸	I
		RLE	1 987 43 R 2597 ⁸	I

2,0 110 BVY; BVZ				
	11.05-06.08	1 457 42	P 9243	O
		KZO	1 987 42 S 9405	L
		KZO	1 457 43 S 3576	L
			0 450 90 F 5316 ¹	K
			1 987 43 M 2097	I
			1 987 43 R 2397 ⁸	I
		RLE	1 987 43 R 2597 ⁸	I



A3 2.0 TDI, TDI quattro

2,0 100 AZV				
	05.03-06.08	1 457 42	P 9192	O
		KZO	1 987 42 S 9404	L
Fg.Nr. →8P..6..176 000	05.03-02.06	1 457 07	N 0007	K
Fg.Nr. 8P..6..176 001→	03.06-06.08	F 026 40	N 2006	K
	05.03-06.08	1 987 43	M 2097	I
			1 987 43 R 2397 ⁸	I
		RLE	1 987 43 R 2597 ⁸	I

2,0 100/103/125 CBAA; CBAB; CBAB <D91>; CBBB <D93>				
	07.08-05.10	1 457 42	P 9192	O
		KZO	1 987 42 S 9404	L
			F 026 40 N 2006	K
			1 987 43 M 2097	I
			1 987 43 R 2397 ⁸	I
		RLE	1 987 43 R 2597 ⁸	I

2,0 100/103/125 CFFA <D94>; CFFB <D91>; CFGB <D93>; CLJA <D91>				
	11.09→	F 026 40	P 7023	O
		KZO	1 987 42 S 9404	L
			F 026 40 N 2006	K
			1 987 43 M 2097	I
			1 987 43 R 2397 ⁸	I
		RLE	1 987 43 R 2597 ⁸	I

2,0 103 BKD				
	05.03-06.08	1 457 42	P 9192	O
		KZO	1 987 42 S 9404	L
Fg.Nr. →8P..6..176 000	05.03-02.06	1 457 07	N 0007	K
Fg.Nr. 8P..6..176 001→	03.06-06.08	F 026 40	N 2006	K
	05.03-06.08	1 987 43	M 2097	I
			1 987 43 R 2397 ⁸	I
		RLE	1 987 43 R 2597 ⁸	I

2,0 103 BMM				
	01.05-06.08	1 457 42	P 9192	O
		KZO	1 987 42 S 9404	L
Fg.Nr. →8P..6..176 000	01.05-02.06	1 457 07	N 0007	K
Fg.Nr. 8P..6..176 001→	03.06-06.08	F 026 40	N 2006	K
	01.05-06.08	1 987 43	M 2097	I
			1 987 43 R 2397 ⁸	I
		RLE	1 987 43 R 2597 ⁸	I

2,0 120/125 BMN; BUY				
	03.06-06.08	1 457 42	P 9192	O
		KZO	1 987 42 S 9404	L
			F 026 40 N 2006	K
			1 987 43 M 2097	I
			1 987 43 R 2397 ⁸	I
		RLE	1 987 43 R 2597 ⁸	I

A3 2.0 TFSI

2,0 147 CAWB				
	10.07-06.08	F 026 40	P 7080	O
			1 987 42 S 9404	L
			0 450 90 F 5316 ¹	K
			1 987 43 M 2097	I
			1 987 43 R 2397 ⁸	I
		RLE	1 987 43 R 2597 ⁸	I





A3 2.0 TFSI, TFSI quattro

2,0 147 AXX			
	09.04-10.05	1 457 42 P 9243	O
		1 457 43 S 3102	L
		0 450 90 F 5316 ¹	K
		1 987 43 M 2097	I
		1 987 43 R 2397 ⁸	I
	RLE	1 987 43 R 2597 ⁸	I

2,0 147 BWA			
	09.05-06.08	1 457 42 P 9243	O
		1 457 43 S 3102	L
		0 450 90 F 5316 ¹	K
		1 987 43 M 2097	I
		1 987 43 R 2397 ⁸	I
	RLE	1 987 43 R 2597 ⁸	I

2,0 147 CCZA <D2L>			
	07.08->	F 026 40 P 7080	O
		1 987 42 S 9404	L
		0 450 90 F 5959 ¹	K
		1 987 43 M 2097	I
		1 987 43 R 2397 ⁸	I
	RLE	1 987 43 R 2597 ⁸	I

A3 3.2 quattro

3,2 184 BDB; BMJ; BUB <D6D>			
	07.03-05.09	1 457 42 P 9192	O
PR-Nr. 1A1	07.03-05.09	F 026 40 F 3006 ¹	K
PR-Nr. 1A5	07.03-05.09	0 450 90 F 5959 ¹	K
	07.03-05.09	1 987 43 M 2097	I
		1 987 43 R 2397 ⁸	I
	RLE	1 987 43 R 2597 ⁸	I

A3 Sportback/Cabriolet

A3 Sportback/Cabriolet 1.2 TFSI

1,2 77 CBZB; CBZB <DB0>			
	11.09->	1 987 42 S 9405	L
		0 450 90 F 5959 ¹	K
		1 987 43 M 2097	I
		1 987 43 R 2397 ⁸	I
	RLE	1 987 43 R 2597 ⁸	I

A3 Sportback/Cabriolet 1.4 TFSI

1,4 92 CAXC <D33>			
	06.07-06.08	1 457 42 P 9301	O
	07.08-05.10	F 026 40 P 7079	O
	06.07->	1 987 42 S 9405	L
		0 450 90 F 5959 ¹	K
		1 987 43 M 2097	I
		1 987 43 R 2397 ⁸	I
	RLE	1 987 43 R 2597 ⁸	I



1,4 | 92 | CMSA <D33>

	04.10-05.10	F 026 40 P 7079	O
	06.10->	1 457 42 P 9301	O
	04.10->	1 987 42 S 9405	L
		0 450 90 F 5959 ¹	K
		1 987 43 M 2097	I
		1 987 43 R 2397 ⁸	I
	RLE	1 987 43 R 2597 ⁸	I

A3 Sportback/Cabriolet 1.6

1,6 75 BGU			
	09.04-05.05	0 451 10 P 3314	O
		KZ0 1 987 42 S 9405	L
		KZO 1 457 43 S 3576	L
PR-Nr. 1A1	09.04-05.05	F 026 40 F 3006 ¹	K
	09.04-05.05	1 987 43 M 2097	I
		1 987 43 R 2397 ⁸	I
	RLE	1 987 43 R 2597 ⁸	I

1,6 75 BSE			
	09.08-05.10	0 451 10 P 3314	O
		1 987 42 S 9405	L
		F 026 40 F 3006 ¹	K
		1 987 43 M 2097	I
		1 987 43 R 2397 ⁸	I
	RLE	1 987 43 R 2597 ⁸	I

1,6 75 BSE <MW6>; BSF <MW6>			
	06.05->	0 451 10 P 3314	O
		KZ0 1 987 42 S 9405	L
		KZO 1 457 43 S 3576	L
		F 026 40 F 3006 ¹	K
		1 987 43 M 2097	I
		1 987 43 R 2397 ⁸	I
	RLE	1 987 43 R 2597 ⁸	I

1,6 75 CCSA <MW6>; CMXA <MW6>			
	07.08->	0 451 10 P 3314	O
		1 987 42 S 9405	L
		F 026 40 F 3006 ¹	K
		1 987 43 M 2097	I
		1 987 43 R 2397 ⁸	I
	RLE	1 987 43 R 2597 ⁸	I

A3 Sportback/Cabriolet 1.6 FSI

1,6 85 BLF; BLP			
	09.04-09.07	1 457 42 P 9301	O
		1 457 43 S 3315	L
		0 450 90 F 5316 ¹	K
		1 987 43 M 2097	I
		1 987 43 R 2397 ⁸	I
	RLE	1 987 43 R 2597 ⁸	I





A3 Sportback/Cabriolet 1.6 TDI

1,6 | 66/77 | CAYB <D36>; CAYC; CAYC <D38>

05.09→	F 026 40 P 7023	O
KZO	1987 42 S 9404	L
	F 026 40 N 2006	K
	1987 43 M 2097	I
	1987 43 R 2397 ⁸	I
RLE	1987 43 R 2597 ⁸	I

A3 Sportback/Cabriolet 1.8 TFSI

1,8 | 118 | BYT

11.06-06.07	F 026 40 P 7080	O
	1987 42 S 9404	L
	0 450 90 F 5316 ¹	K
	1987 43 M 2097	I
	1987 43 R 2397 ⁸	I
RLE	1987 43 R 2597 ⁸	I

1,8 | 118 | BZB

06.07-01.09	F 026 40 P 7080	O
	1987 42 S 9404	L
06.07-06.08	0 450 90 F 5316 ¹	K
04.08-01.09	0 450 90 F 5959 ¹	K
06.07-01.09	1987 43 M 2097	I
	1987 43 R 2397 ⁸	I
RLE	1987 43 R 2597 ⁸	I

1,8 | 118 | CDAA

01.09→	F 026 40 P 7080	O
	1987 42 S 9404	L
PR-Nr. 1A4	01.09-05.10 NFV F 026 40 F 3013 ¹	K
PR-Nr. 1A5	01.09→ NFV 0 450 90 F 5959 ¹	K
01.09→	1987 43 M 2097	I
	1987 43 R 2397 ⁸	I
RLE	1987 43 R 2597 ⁸	I

A3 Sportback/Cabriolet 1.8 TFSI, TFSI quattro

1,8 | 118 | CDAA <D67>

07.08→	F 026 40 P 7080	O
	1987 42 S 9404	L
	0 450 90 F 5959 ¹	K
	1987 43 M 2097	I
	1987 43 R 2397 ⁸	I
RLE	1987 43 R 2597 ⁸	I

A3 Sportback/Cabriolet 1.9 TDI

1,9 | 77 | BKC

09.04-05.06	1457 42 P 9192	O
KZO	1987 42 S 9404	L
Fg.Nr. →8P..6..176 000	09.04-02.06 1457 07 N0007	K
Fg.Nr. 8P..6..176 001→	03.06-05.06 F 026 40 N 2006	K
09.04-05.06	1987 43 M 2097	I
	1987 43 R 2397 ⁸	I
RLE	1987 43 R 2597 ⁸	I



1,9 | 77 | BLS <D3W>

11.05-05.10	1457 42 P 9192	O
KZO	1987 42 S 9404	L
04.08-05.09	F 026 40 N 2006	K
Fg.Nr. →8P..6..176 000	11.05-02.06 1457 07 N0007	K
Fg.Nr. 8P..6..176 001→	03.06-05.10 F 026 40 N 2006	K
11.05-05.10	1987 43 M 2097	I
	1987 43 R 2397 ⁸	I
RLE	1987 43 R 2597 ⁸	I

1,9 | 77 | BXE <D3W>

06.06-05.10	1457 42 P 9192	O
KZO	1987 42 S 9404	L
	F 026 40 N 2006	K
	1987 43 M 2097	I
	1987 43 R 2397 ⁸	I
RLE	1987 43 R 2597 ⁸	I

A3 Sportback/Cabriolet 2.0 FSI

2,0 | 110 | BLR; BLX; BLY; BMB

09.04-10.05	1457 42 P 9243	O
KZO	1987 42 S 9405	L
KZO	1457 43 S 3576	L
	0 450 90 F 5316 ¹	K
	1987 43 M 2097	I
	1987 43 R 2397 ⁸	I
RLE	1987 43 R 2597 ⁸	I

2,0 | 110 | BVY; BVZ

11.05-06.08	1457 42 P 9243	O
KZO	1987 42 S 9405	L
KZO	1457 43 S 3576	L
	0 450 90 F 5316 ¹	K
	1987 43 M 2097	I
	1987 43 R 2397 ⁸	I
RLE	1987 43 R 2597 ⁸	I

A3 Sportback/Cabriolet 2.0 TDI

2,0 | 103 | CBEA

09.09→	1987 43 M 2097	I
	1987 43 R 2397 ⁸	I
RLE	1987 43 R 2597 ⁸	I

2,0 | 120 | BUY

06.06-06.08	1457 42 P 9192	O
KZO	1987 42 S 9404	L
	F 026 40 N 2006	K
	1987 43 M 2097	I
	1987 43 R 2397 ⁸	I
RLE	1987 43 R 2597 ⁸	I

A3 Sportback/Cabriolet 2.0 TDI, TDI quattro

2,0 | 100/103 | AZV; BKD

09.04-06.08	1457 42 P 9192	O
KZO	1987 42 S 9404	L
Fg.Nr. →8P..6..176 000	09.04-02.06 1457 07 N0007	K
Fg.Nr. 8P..6..176 001→	03.06-06.08 F 026 40 N 2006	K
09.04-06.08	1987 43 M 2097	I
	1987 43 R 2397 ⁸	I
RLE	1987 43 R 2597 ⁸	I



**2,0 | 100/103/125 | CBAA <D94>; CBAB <D91>; CBBB <D93>**

04.08-05.10	1 457 42	P 9192	O
KZO	1 987 42	S 9404	L
	F 026 40	N 2006	K
	1 987 43	M 2097	I
	1 987 43	R 2397 ⁸	I
RLE	1 987 43	R 2597 ⁸	I

2,0 | 100/103/125 | CFFA; CFFA <D94>; CFFB; CFFB <D91>; CFFB <D93>; CLJA <D91>

11.09→	F 026 40	P 7023	O
KZO	1 987 42	S 9404	L
	F 026 40	N 2006	K
	1 987 43	M 2097	I
	1 987 43	R 2397 ⁸	I
RLE	1 987 43	R 2597 ⁸	I

2,0 | 103 | BMM

02.05-06.08	1 457 42	P 9192	O
KZO	1 987 42	S 9404	L
Fg.Nr. →8P..6..176 000	02.05-02.06	1 457 07	N0007 K
Fg.Nr. 8P..6..176 001→	03.06-06.08	F 026 40	N 2006 K
	02.05-06.08	1 987 43	M 2097 I
		1 987 43	R 2397 ⁸ I
RLE		1 987 43	R 2597 ⁸ I

2,0 | 125 | BMN

03.06-06.08	1 457 42	P 9192	O
KZO	1 987 42	S 9404	L
	F 026 40	N 2006	K
	1 987 43	M 2097	I
	1 987 43	R 2397 ⁸	I
RLE	1 987 43	R 2597 ⁸	I

A3 Sportback/Cabriolet 2.0 TFSI**2,0 | 147 | AXX**

09.04-10.05	1 457 42	P 9243	O
	1 457 43	S 3102	L
	0 450 90	F 5316 ¹	K
	1 987 43	M 2097	I
	1 987 43	R 2397 ⁸	I
RLE	1 987 43	R 2597 ⁸	I

2,0 | 147 | BPY

04.05-09.07	1 457 42	P 9243	O
	1 457 43	S 3102	L
	0 450 90	F 5959 ¹	K
	1 987 43	M 2097	I
	1 987 43	R 2397 ⁸	I
RLE	1 987 43	R 2597 ⁸	I

2,0 | 147 | BWA

09.05-05.09	1 457 42	P 9243	O
	1 457 43	S 3102	L
	0 450 90	F 5316 ¹	K
	1 987 43	M 2097	I
	1 987 43	R 2397 ⁸	I
RLE	1 987 43	R 2597 ⁸	I

2,0 | 147 | CAWB

06.07-01.09	F 026 40	P 7080	O
	1 987 42	S 9404	L
06.07-06.08	0 450 90	F 5316 ¹	K
04.08-01.09	0 450 90	F 5959 ¹	K
06.07-01.09	1 987 43	M 2097	I
	1 987 43	R 2397 ⁸	I
RLE	1 987 43	R 2597 ⁸	I

2,0 | 147 | CBFA <D2L>

07.08→	F 026 40	P 7080	O
	1 987 42	S 9404	L
	0 450 90	F 5959 ¹	K
	1 987 43	M 2097	I
	1 987 43	R 2397 ⁸	I
RLE	1 987 43	R 2597 ⁸	I

2,0 | 147 | CCZA

01.09→	F 026 40	P 7080	O
	1 987 42	S 9404	L
PR-Nr. 1A4	01.09-05.10	NFV	F 026 40 F 3013 ¹ K
PR-Nr. 1A5	01.09→	NFV	0 450 90 F 5959 ¹ K
	01.09→		1 987 43 M 2097 I
			1 987 43 R 2397 ⁸ I
RLE			1 987 43 R 2597 ⁸ I

A3 Sportback/Cabriolet 2.0 TFSI quattro**2,0 | 147 | AXX**

09.04-10.05	1 457 42	P 9243	O
	1 457 43	S 3102	L
	0 450 90	F 5959 ¹	K
	1 987 43	M 2097	I
	1 987 43	R 2397 ⁸	I
RLE	1 987 43	R 2597 ⁸	I

2,0 | 147 | BWA

11.05-05.09	1 457 42	P 9192	O
	1 457 43	S 3102	L
	0 450 90	F 5959 ¹	K
	1 987 43	M 2097	I
	1 987 43	R 2397 ⁸	I
RLE	1 987 43	R 2597 ⁸	I

2,0 | 147 | CCTA

07.08→	0 450 90	F 5959 ¹	K
	1 987 43	M 2097	I
	1 987 43	R 2397 ⁸	I
RLE	1 987 43	R 2597 ⁸	I

A3 Sportback/Cabriolet 2.0 TFSI, TFSI quattro**2,0 | 147 | CCZA <D2L>**

07.08→	F 026 40	P 7080	O
	1 987 42	S 9404	L
	0 450 90	F 5959 ¹	K
	1 987 43	M 2097	I
	1 987 43	R 2397 ⁸	I
RLE	1 987 43	R 2597 ⁸	I





A3 Sportback/Cabriolet 3.2 quattro

3,2 184 BMJ; BUB <D6D>			
	09.04-05.09	1 457 42 P 9192	O
PR-Nr. 1A1	09.04-05.09	F 026 40 F 3006 ¹	K
	09.04-05.09	1 987 43 M 2097	I
		1 987 43 R 2397 ⁸	I
	RLE	1 987 43 R 2597 ⁸	I
3,2 184 CBRA			
	06.07→	1 457 42 P 9192	O
		1 987 43 M 2097	I
		1 987 43 R 2397 ⁸	I
	RLE	1 987 43 R 2597 ⁸	I

A4

A4 2.6

2,6 110 ABC			
	11.94-07.98	0 451 10 P 3313	O
		1 457 42 S 9870	L
		0 450 90 F 5264 ¹	K
		1 987 43 M 2017	I
		1 987 43 R 2317 ⁸	I

A4 Allroad (8KH)

A4 Allroad (8KH) 2.0 TDI

2,0 100/105/120/125 CAGA <D92>; CAGB <D94>; CAHA <D93>; CAHB <D95>			
	04.09→	1 457 42 P 9192	O
		F 026 40 N 2068 ¹	K
		1 987 43 R 2369 ⁸	I

A4 Allroad (8KH) 2.0 TFSI

2,0 155 CDNC <D2D>			
	04.09→	F 026 40 P 7080	O
		1 987 43 R 2369 ⁸	I

A4 Allroad (8KH) 3.0 TDI

3,0 176 CCWA <D50>			
	04.09→	F 026 40 P 7066	O
		F 026 40 N 2068 ¹	K
		1 987 43 R 2369 ⁸	I

A4 (B5)

A4 (B5) 1.6

1,6 74/75 ADP; AHL; ALZ; ANA; ARM			
	11.94-09.01	0 451 10 P 3314	O
		1 457 42 S 9870	L
		0 450 90 F 5264 ¹	K
		1 987 43 M 2017	I
		1 987 43 R 2317 ⁸	I

A4 (B5) 1.8

1,8 85/92/110/132 ADR; AEB; AFY; AJL; ANB; APT; APU; ARG; ARK			
	11.94-10.00	0 451 10 P 3314	O
		1 457 42 S 9870	L
		0 450 90 F 5264 ¹	K
		1 987 43 M 2017	I
		1 987 43 R 2317 ⁸	I



1,8 92 AVV			
	06.00-09.01	0 451 10 P 3314	O
		1 457 42 S 9870	L
		0 450 90 F 5264 ¹	K
		1 987 43 M 2017	I
		1 987 43 R 2317 ⁸	I

A4 (B5) 1.8 quattro

1,8 85/92/110/132 ADR; AEB; AFY; AJL; ANB; APT; APU; ARG; ARK			
	11.94-10.01	0 451 10 P 3314	O
		1 457 42 S 9870	L
		0 450 90 F 5906 ¹	K
		1 987 43 M 2017	I
		1 987 43 R 2317 ⁸	I

A4 (B5) 1.8 T

1,8 85/92/110/132 ADR; AEB; AFY; AJL; ANB; APT; APU; ARG; ARK			
	11.94-09.01	0 451 10 P 3314	O
		1 457 42 S 9870	L
		0 450 90 F 5264 ¹	K
		1 987 43 M 2017	I
		1 987 43 R 2317 ⁸	I

1,8 | 110 | ATW

	08.99-08.01	0 451 20 P 3012	O
		KZO 1 457 42 S 9870	L
		0 450 90 F 5264 ¹	K
		1 987 43 M 2017	I

1,8 | 110 | AWT

	06.00-09.01	F 026 40 P 7004	O
		1 457 42 S 9870	L
		0 450 90 F 5264 ¹	K
		1 987 43 M 2017	I
		1 987 43 R 2317 ⁸	I

1,8 | 125 | AWM

	05.00-08.01	F 026 40 P 7004	O
		KZO 1 457 42 S 9870	L
		0 450 90 F 5264 ¹	K
		1 987 43 M 2017	I

A4 (B5) 1.8 T quattro

1,8 85/92/110/132 ADR; AEB; AFY; AJL; ANB; APT; APU; ARG; ARK			
	11.94-09.01	0 451 10 P 3314	O
		1 457 42 S 9870	L
		0 450 90 F 5906 ¹	K
		1 987 43 M 2017	I
		1 987 43 R 2317 ⁸	I

1,8 | 110 | ATW

	08.99-12.01	0 451 20 P 3012	O
		KZO 1 457 42 S 9870	L
		0 450 90 F 5906 ¹	K
		1 987 43 M 2017	I

1,8 | 110 | AWT

	06.00-09.01	F 026 40 P 7004	O
		1 457 42 S 9870	L
		0 450 90 F 5906 ¹	K
		1 987 43 M 2017	I
		1 987 43 R 2317 ⁸	I



**1,8 | 125 | AWM**

05.00-09.01	F 026 40 P 7004	O
KZO	1 457 42 S 9870	L
	0 450 90 F 5906 ¹	K
	1 987 43 M 2017	I

A4 (B5) 1.9 TDI**1,9 | 55 | AFF**

Fg.Nr. →8D-X 400 000	03.96-06.99	0 451 10 P 3346	O
Fg.Nr. 8D-Y 000 001→	07.99-06.00	0 986 45 P 2400	O
	03.96-06.00	1 457 42 S 9870	L
Fg.Nr. →8D..Y...160 000	03.96-02.00	1 457 43 N 4184 ²	K
Fg.Nr. 8D..Y...160 001→	02.00-06.00	0 450 90 N 6374 ¹	K
	03.96-06.00	1 987 43 M 2017	I
		1 987 43 R 2317 ⁸	I

1,9 | 66 | AHU

08.96-06.00	0 451 10 P 3346	O
	1 457 42 S 9870	L
02.00-06.00	0 450 90 N 6374 ¹	K
08.96-06.00	1 987 43 M 2017	I
	1 987 43 R 2317 ⁸	I

1,9 | 66 | 1Z

11.94-07.96	0 451 10 P 3346	O
	1 457 42 S 9870	L
	1 987 43 M 2017	I
	1 987 43 R 2317 ⁸	I

1,9 | 81 | AVG

08.99-06.00	0 986 45 P 2400	O	
	1 457 42 S 9870	L	
Fg.Nr. →8D..Y...160 000	08.99-02.00	1 457 43 N 4184 ²	K
Fg.Nr. 8D..Y...160 001→	02.00-06.00	0 450 90 N 6374 ¹	K
	08.99-06.00	1 987 43 M 2017	I
		1 987 43 R 2317 ⁸	I

A4 (B5) 1.9 TDI quattro**1,9 | 81 | AVG**

08.99-01.00	0 986 45 P 2400	O
	1 457 42 S 9870	L
	1 987 43 M 2017	I
	1 987 43 R 2317 ⁸	I

A4 (B5) 1.9 TDI, TDI quattro**1,9 | 66/81 | AFN; AHH**

02.96-09.01	0 451 10 P 3346	O
	1 457 42 S 9870	L
	1 987 43 M 2017	I
	1 987 43 R 2317 ⁸	I

1,9 | 85 | AJM; ATJ

08.98-09.01	1 457 42 P 9619	O
	1 457 42 S 9870	L
	1 987 43 M 2017	I
	1 987 43 R 2317 ⁸	I

A4 (B5) 2.4**2,4 | 110 | AFM**

07.95-07.97	0 451 10 P 3313	O
	1 457 42 S 9870	L
	0 450 90 F 5264 ¹	K
	1 987 43 M 2017	I
	1 987 43 R 2317 ⁸	I

2,4 | 120 | AMM

06.00-09.01	0 451 10 P 3313	O
	1 457 42 S 9870	L
	0 450 90 F 5264 ¹	K
	1 987 43 M 2017	I
	1 987 43 R 2317 ⁸	I

2,4 | 120/121 | AGA; AJG; ALF; AML

08.97-09.01	0 451 10 P 3313	O
	1 457 42 S 9870	L
	0 450 90 F 5264 ¹	K
	1 987 43 M 2017	I
	1 987 43 R 2317 ⁸	I

2,4 | 120/121 | APS; APZ; ARJ

08.98-06.00	0 451 10 P 3313	O
	1 457 42 S 9870	L
	0 450 90 F 5264 ¹	K
	1 987 43 M 2017	I
	1 987 43 R 2317 ⁸	I

A4 (B5) 2.4 quattro**2,4 | 120/121 | AGA; AJG; ALF; AML**

08.97-12.98	0 451 10 P 3313	O
	1 457 42 S 9870	L
	0 450 90 F 5906 ¹	K
	1 987 43 M 2017	I
	1 987 43 R 2317 ⁸	I

2,4 | 120/121 | APS; APZ; ARJ

08.98-09.01	0 451 10 P 3313	O
	1 457 42 S 9870	L
	0 450 90 F 5906 ¹	K
	1 987 43 M 2017	I
	1 987 43 R 2317 ⁸	I

A4 (B5) 2.5 TDI, TDI quattro**2,5 | 110 | AFB; AKN**

08.97-09.01	1 457 42 P 9152	O
	1 457 43 S 3772	L
	0 986 45 N 0509 ¹	K
	1 987 43 M 2017	I
	1 987 43 R 2317 ⁸	I

A4 (B5) 2.6**2,6 | 102/110 | ABC; ACZ**

11.94-07.98	0 451 10 P 3313	O
	1 457 42 S 9870	L
	0 450 90 F 5264 ¹	K
	1 987 43 M 2017	I
	1 987 43 R 2317 ⁸	I





A4 (B5) 2.6 quattro

2,6 102/110 ABC; ACZ	11.94-07.98	0 451 10 P 3313	O
		1 457 42 S 9870	L
		0 450 90 F 5906 ¹	K
		1 987 43 M 2017	I
		1 987 43 R 2317 ⁸	I

A4 (B5) 2.8

2,8 128/142 AAH; ACK	11.94-12.98	0 451 10 P 3313	O
		1 457 42 S 9870	L
		0 450 90 F 5264 ¹	K
		1 987 43 M 2017	I
		1 987 43 R 2317 ⁸	I

2,8 140 ATX	03.99-09.01	0 451 10 P 3313	O
		1 457 42 S 9870	L
		0 450 90 F 5264 ¹	K
		1 987 43 M 2017	I
		1 987 43 R 2317 ⁸	I

2,8 142 AHA	10.96-08.99	0 451 10 P 3313	O
		KZO 1 457 42 S 9870	L
		0 450 90 F 5264 ¹	K
		1 987 43 M 2017	I

2,8 142 ALG; AMX; APR; AQD	08.97-06.00	0 451 10 P 3313	O
		1 457 42 S 9870	L
		0 450 90 F 5264 ¹	K
		1 987 43 M 2017	I
		1 987 43 R 2317 ⁸	I

A4 (B5) 2.8 , quattro

2,8 128 AFC	08.95-04.97	0 451 10 P 3313	O
		1 457 42 S 9870	L
		0 450 90 F 5264 ¹	K
		1 987 43 M 2017	I

2,8 142 ATQ	08.99-09.01	0 451 10 P 3313	O
		KZO 1 457 42 S 9870	L
		0 450 90 F 5264 ¹	K
		1 987 43 M 2017	I

A4 (B5) 2.8 quattro

2,8 128/142 AAH; ACK	11.94-07.98	0 451 10 P 3313	O
		1 457 42 S 9870	L
		0 450 90 F 5906 ¹	K
		1 987 43 M 2017	I
		1 987 43 R 2317 ⁸	I

2,8 140 ATX	09.99-09.01	0 451 10 P 3313	O
		1 457 42 S 9870	L
		0 450 90 F 5906 ¹	K
		1 987 43 M 2017	I
		1 987 43 R 2317 ⁸	I



2,8 142 AHA	06.97-12.98	0 451 10 P 3313	O
		KZO 1 457 42 S 9870	L
		0 450 90 F 5906 ¹	K
		1 987 43 M 2017	I

2,8 142 ALG; AMX; APR; AQD	05.97-09.01	0 451 10 P 3313	O
		1 457 42 S 9870	L
		0 450 90 F 5906 ¹	K
		1 987 43 M 2017	I
		1 987 43 R 2317 ⁸	I

A4 (B6)

A4 (B6) 1.6

1,6 75 ALZ	10.00-12.04	0 451 10 P 3314	O
		1 457 43 S 3046	L
		0 450 90 F 5318 ¹	K
		1 987 43 M 2071	I
		1 987 43 R 2371 ⁸	I

A4 (B6) 1.8 i Turbo

1,8 120 BFB	01.03-08.08	0 451 20 P 3012	O
		1 457 43 S 3046	L
		1 987 43 R 2371 ⁸	I

A4 (B6) 1.8 T

1,8 120 BFB	04.02-12.05	F 026 40 P 7004	O
		1 457 43 S 3046	L
		1 987 43 M 2071	I
		1 987 43 R 2371 ⁸	I

1,8 | 125 | AMB

	07.01-12.04	F 026 40 P 7004	O
	10.02-06.06	0 451 20 P 3012	O
	07.01-06.06	1 457 43 S 3046	L
		1 987 43 M 2071	I
		1 987 43 R 2371 ⁸	I

1,8 | 140 | BEX

	11.02-12.04	F 026 40 P 7004	O
		1 457 43 S 3046	L
		1 987 43 M 2071	I
		1 987 43 R 2371 ⁸	I

A4 (B6) 1.8 T quattro

1,8 120 BFB	07.02-12.05	F 026 40 P 7004	O
		1 457 43 S 3046	L
Fg.Nr. 8E..5..065 001→	08.04-12.04	F 026 40 F 3003 ¹	K
	07.02-12.05	1 987 43 M 2071	I
		1 987 43 R 2371 ⁸	I

1,8 | 125 | AMB

	07.01-12.04	F 026 40 P 7004	O
	09.01-12.04	0 451 10 P 3314	O
	07.01-12.04	1 457 43 S 3046	L
		1 987 43 M 2071	I
		1 987 43 R 2371 ⁸	I





1,8 140 BEX	11.02-12.04	F 026 40 P 7004	O
		1 457 43 S 3046	L
Fg.Nr. 8E..5..065 001→	08.04-12.04	F 026 40 F 3003 ¹	K
	11.02-12.04	1 987 43 M 2071	I
		1 987 43 R 2371 ⁸	I

A4 (B6) 1.8 T, T quattro

1,8 110 AVJ	12.00-06.02	F 026 40 P 7004	O
		1 457 43 S 3046	L
		1 987 43 M 2071	I
		1 987 43 R 2371 ⁸	I

A4 (B6) 1.9 TDI, TDI quattro

1,9 74/85/96 AVB; AVF; AWX; BKE	12.00-12.04	1 457 42 P 9619	O
		1 457 43 S 3046	L
		0 450 90 N 6374 ¹	K
		1 987 43 M 2071	I
		1 987 43 R 2371 ⁸	I

A4 (B6) 2.0

2,0 96 ALT	12.00-12.05	0 451 10 P 3314	O
		1 457 43 S 3046	L
		0 450 90 F 5318 ¹	K
		1 987 43 M 2071	I
		1 987 43 R 2371 ⁸	I

A4 (B6) 2.0 FSI

2,0 105/110 AWA	09.01-12.04	0 451 10 P 3314	O
		1 457 43 S 3046	L
		1 987 43 M 2071	I
		1 987 43 R 2371 ⁸	I

A4 (B6) 2.4

2,4 120/125 AMM; BDV	04.01-12.05	0 451 10 P 3313	O
		1 457 43 S 3046	L
		0 450 90 F 5318 ¹	K
		1 987 43 M 2071	I
		1 987 43 R 2371 ⁸	I

A4 (B6) 2.5 TDI, TDI quattro

2,5 114/120/132 AKE; AYM; BAU; BCZ; BDG; BDH; BFC	12.00-12.05	1 457 42 P 9152	O
		1 457 43 S 3046	L
	04.01-12.05	0 986 45 N 0509 ¹	K
	12.00-12.05	1 987 43 M 2071	I
		1 987 43 R 2371 ⁸	I

A4 (B6) 3.0 , quattro

3,0 160/162 ASN; AVK; BBJ	12.00-12.05	0 451 10 P 3313	O
		1 457 43 S 3046	L
		0 450 90 F 5318 ¹	K
		1 987 43 M 2071	I
		1 987 43 R 2371 ⁸	I

A4 (B6) 3.0 quattro

3,0 162 BGN	06.04-06.06	0 451 10 P 3313	O
		1 457 43 S 3046	L
		0 450 90 F 5318 ¹	K

A4 (B6) 4.2 quattro

4,2 253 BBK	02.04-12.05	F 026 40 P 7007	O
		1 987 43 M 2071	I
		1 987 43 R 2371 ⁸	I

A4 (B7)**A4 (B7) 1.6**

1,6 75 ALZ	11.04-06.08	0 451 10 P 3314	O
		1 457 43 S 3046	L
		0 450 90 F 5318 ¹	K
		1 987 43 M 2071	I
		1 987 43 R 2371 ⁸	I

A4 (B7) 1.8 T

1,8 120 BFB	11.04-06.08	F 026 40 P 7004	O
	01.06-03.09	0 451 20 P 3012	O
	11.04-03.09	1 457 43 S 3046	L
		1 987 43 M 2071	I
		1 987 43 R 2371 ⁸	I

A4 (B7) 1.8 T quattro

1,8 120 BFB	11.04-06.08	F 026 40 P 7004	O
		1 457 43 S 3046	L
		1 987 43 M 2071	I
		1 987 43 R 2371 ⁸	I

A4 (B7) 1.9 TDI

1,9 85 BKE; BRB	11.04-06.08	1 457 42 P 9619	O
		1 457 43 S 3046	L
		0 450 90 N 6374 ¹	K
		1 987 43 M 2071	I
		1 987 43 R 2371 ⁸	I





A4 (B7) 2.0

2,0 96 ALT	11.04-06.08	0 451 10 P 3314	O
		1 457 43 S 3046	L
		0 450 90 F 5318 ¹	K
		1 987 43 M 2071	I
		1 987 43 R 2371 ⁸	I

A4 (B7) 2.0 TDI

2,0 100/103 BLB; BNA	11.04-11.05	1 457 42 P 9192	O
		1 457 43 S 3046	L
		0 450 90 N 6429 ¹	K
		1 987 43 M 2071	I
		1 987 43 R 2371 ⁸	I

A4 (B7) 2.0 TDI, TDI quattro

2,0 89/93/120 BVA; BVF; BVG	11.05-06.08	1 457 42 P 9192	O
		1 457 43 S 3046	L
		0 450 90 N 6429 ¹	K
		1 987 43 M 2071	I
		1 987 43 R 2371 ⁸	I

2,0 | 100/103 | BPW; BRC

	11.04-03.09	1 457 42 P 9619	O
		1 457 43 S 3046	L
		0 450 90 N 6374 ¹	K
		1 987 43 M 2071	I
		1 987 43 R 2371 ⁸	I

2,0 | 100/103/125 | BRD; BRE; BRF

	06.05-06.08	1 457 42 P 9192	O
		1 457 43 S 3046	L
		0 450 90 N 6429 ¹	K
		1 987 43 M 2071	I
		1 987 43 R 2371 ⁸	I

A4 (B7) 2.0 TFSI

2,0 125 BYK	10.06-06.08	1 457 42 P 9243	O
		1 457 43 S 3046	L
		1 987 43 M 2071	I
		1 987 43 R 2371 ⁸	I

A4 (B7) 2.0 TFSI, TFSI quattro

2,0 125/147 BPG; BPJ	01.05-06.08	1 457 42 P 9243	O
		1 457 43 S 3046	L
		F 026 40 F 3012 ¹	K
		1 987 43 M 2071	I
		1 987 43 R 2371 ⁸	I

2,0 | 147 | BGB

	11.04-08.05	1 457 42 P 9243	O
		1 457 43 S 3046	L
		F 026 40 F 3012 ¹	K
		1 987 43 M 2071	I
		1 987 43 R 2371 ⁸	I



2,0 | 147 | BWE; BWT

	09.05-03.09	1 457 42 P 9243	O
		1 457 43 S 3046	L
		F 026 40 F 3012 ¹	K
		1 987 43 M 2071	I
		1 987 43 R 2371 ⁸	I

2,0 | 162 | BUL

	06.05-06.08	1 457 42 P 9243	O
		1 457 43 S 3046	L
		F 026 40 F 3012 ¹	K
		1 987 43 M 2071	I
		1 987 43 R 2371 ⁸	I

A4 (B7) 2.5 TDI

2,5 | 120 | BDG

	11.04-05.06	1 457 42 P 9152	O
		1 457 43 S 3046	L
		0 986 45 N 0509 ¹	K
		1 987 43 M 2071	I
		1 987 43 R 2371 ⁸	I

A4 (B7) 2.7 TDI

2,7 | 120/132 | BPP; BSG

	11.05-03.09	F 026 40 P 7002	O
		1 457 43 S 3046	L
		0 450 90 N 6431 ¹	K
		1 987 43 M 2071	I
		1 987 43 R 2371 ⁸	I

A4 (B7) 3.0 , quattro

3,0 | 160 | BBJ

	11.04-05.06	0 451 10 P 3313	O
		1 457 43 S 3046	L
		0 450 90 F 5318 ¹	K
		1 987 43 M 2071	I
		1 987 43 R 2371 ⁸	I

A4 (B7) 3.0 TDI quattro

3,0 | 150 | BKN

	01.05-03.09	F 026 40 P 7002	O
		1 457 43 S 3046	L
		0 450 90 N 6431 ¹	K
		1 987 43 M 2071	I
		1 987 43 R 2371 ⁸	I

3,0 | 171 | ASB

	01.06-03.09	F 026 40 P 7002	O
		1 457 43 S 3046	L
		0 450 90 N 6431 ¹	K
		1 987 43 M 2071	I
		1 987 43 R 2371 ⁸	I

A4 (B7) 3.2 FSI, FSI quattro

3,2 | 188 | AUK; BKH

	01.05-03.09	1 457 42 P 9268	O
		1 457 43 S 3046	L
		F 026 40 F 3012 ¹	K
		1 987 43 M 2071	I
		1 987 43 R 2371 ⁸	I



**A4 (B8)****A4 (B8) 1.8 TFSI, TFSI quattro**

1,8 88/118 CABA <D2S>; CABB <D67>; CDHA <D2S>; CDHB <D67>			
11.07→	F 026 40 P 7080	0	
	1987 43 R 2369 ⁸	I	

A4 (B8) 2.0 TDI

2,0 100 CJC B <D94>			
11.10→	F 026 40 P 7023	0	
	F 026 40 N2068 ¹	K	
	1987 43 R 2369 ⁸	I	

2,0 | 105 | CMEA <D92>

05.10→	1 457 42 P 9192	0	
	F 026 40 N2068 ¹	K	
	1987 43 R 2369 ⁸	I	

A4 (B8) 2.0 TDI, TDI quattro

2,0 88/100/105/120/125 CAGA <D92>; CAGB <D94>; CAGC <D90>; CAHA <D93>; CAHB <D95>			
11.07→	1 457 42 P 9192	0	
	F 026 40 N2068 ¹	K	
	1987 43 R 2369 ⁸	I	

A4 (B8) 2.0 TFSI

2,0 132 CAEA <D64>			
09.08→	F 026 40 P 7080	0	
	1987 43 R 2369 ⁸	I	

A4 (B8) 2.0 TFSI, TFSI flexible fuel, TFSI quattro, TFSI quattro flexible fuel

2,0 132/155 CDNB <D64>; CDNC <D2D>; CFKA <D64>			
06.08→	F 026 40 P 7080	0	
	1987 43 R 2369 ⁸	I	

A4 (B8) 2.0 TFSI, TFSI quattro

2,0 155 CAEB			
05.08→	F 026 40 P 7080	0	

A4 (B8) 2.7 TDI

2,7 120/140 CAMA <D4V>; CAMB <D4V>			
04.08-05.08	F 026 40 P 7066	0	
Fg.Nr. →8K..8A021 989→8K..8N009 060	11.07-03.08	F 026 40 P 7002	0
Fg.Nr. 8K..8A021 990→8K..8N009 060→	04.08-05.08	F 026 40 P 7066	0
	11.07-05.08	F 026 40 N2068 ¹	K
		1987 43 R 2369 ⁸	I

2,7 | 120/140 | CGKA; CGKA <D4V>; CGKB

06.08→	F 026 40 P 7066	0	
	F 026 40 N2068 ¹	K	
	1987 43 R 2369 ⁸	I	

A4 (B8) 3.0 TDI quattro

3,0 155/176 CAPA <D50>; CCLA; CCWA <D50>; CCWB <D1V>			
04.08→	F 026 40 P 7066	0	
	F 026 40 N2068 ¹	K	
	1987 43 R 2369 ⁸	I	

3,0 | 176 | CAPA

Fg.Nr. →8K..8A021 989→8K..8N009 060	11.07-03.08	F 026 40 P 7002	0
Fg.Nr. 8K..8A021 990→8K..8N009 060→	04.08-05.08	F 026 40 P 7066	0
	11.07-05.08	F 026 40 N2068 ¹	K
		1987 43 R 2369 ⁸	I

A4 (B8) 3.2 FSI, FSI quattro

3,2 195 CALA			
01.08→	1 457 42 P 9268	0	
	1987 43 R 2369 ⁸	I	

A5 (8F7,8TA,8T3)**A5 (8F7,8TA,8T3) 1.8 TFSI**

1,8 118 CDHB <D67>			
05.09→	F 026 40 P 7080	0	
	F 026 40 S0157	L	
	1987 43 R 2369 ⁸	I	

1,8 | 125 | CABD <D6J>

10.07-11.08	F 026 40 P 7080	0	
	F 026 40 S0157	L	
	1987 43 R 2369 ⁸	I	

A5 (8F7,8TA,8T3) 2.0 TDI

2,0 105 CAGA <D92>			
09.09→	1 457 42 P 9192	0	
	F 026 40 N2068 ¹	K	
	1987 43 R 2369 ⁸	I	

2,0 | 105 | CMEA <D92>

05.10→	1 457 42 P 9192	0	
	F 026 40 S0157	L	
	F 026 40 N2068 ¹	K	
	1987 43 R 2369 ⁸	I	

A5 (8F7,8TA,8T3) 2.0 TDI, TDI quattro

2,0 100/120/125 CAGB <D94>; CAHA <D93>; CAHB <D95>			
01.08→	1 457 42 P 9192	0	
	F 026 40 S0157	L	
	F 026 40 N2068 ¹	K	
	1987 43 R 2369 ⁸	I	

A5 (8F7,8TA,8T3) 2.0 TFSI quattro

2,0 155 CAEB <TG6>			
06.08→	F 026 40 P 7080	0	
	F 026 40 S0157	L	
	1987 43 R 2369 ⁸	I	

A5 (8F7,8TA,8T3) 2.0 TFSI, TFSI quattro

2,0 132/155 CAEA <D64>; CAEB <D2D>			
05.09→	F 026 40 P 7080	0	
	1987 43 R 2369 ⁸	I	

2,0 | 132/155 | CDNB <D64>; CDNC <D2D>

06.08→	F 026 40 P 7080	0	
	F 026 40 S0157	L	
	1987 43 R 2369 ⁸	I	





A5 (8F7,8TA,8T3) 2.7 TDI

2,7 120/140 CAMA <D4V>; CAME <D1W>			
Fg.Nr. →8T..8..032 149	07.07-01.08	F 026 40 P 7002	O
Fg.Nr. 8T..8..032 149→	02.08-05.08	F 026 40 P 7066	O
	07.07-05.08	F 026 40 N2068 ¹	K
		1987 43 R 2369 ⁸	I

2,7 120/140 CGKA <D4V>; CGKB <D1W>			
	05.08→	F 026 40 P 7066	O
		F 026 40 N2068 ¹	K
		1987 43 R 2369 ⁸	I

A5 (8F7,8TA,8T3) 3.0 TDI quattro

3,0 155/176 CCWA <D50>; CCWB <D1V>			
	03.08→	F 026 40 P 7066	O
		F 026 40 N2068 ¹	K
		1987 43 R 2369 ⁸	I

3,0 176 CAPA <D50>			
	06.07-05.08	F 026 40 P 7002	O
		F 026 40 N2068 ¹	K
		1987 43 R 2369 ⁸	I

A5 (8F7,8TA,8T3) 3.2 FSI, FSI quattro

3,2 195 CALA <D6W>			
	06.07→	1457 42 P 9268	O
		1987 43 R 2369 ⁸	I

A6

A6 1.9 TDI

1,9 66 AHU			
	07.96-10.97	0451 10 P 3346	O
		1457 42 S 9777	L
		1457 43 N 4184 ²	K
		KL 1987 43 M 2033	I
		1987 43 R 2333 ⁸	I
		KL 1987 43 M 2024	I
		1987 43 R 2324 ⁸	I

A6 2.6 , i

2,6 102/110 ABC; ACZ			
Fg.Nr. →4A..S..026 713	06.94-07.94	0451 10 P 3314	O
Fg.Nr. 4A..S..026 714→	08.94-12.97	0451 10 P 3313	O
	06.94-12.97	1457 42 S 9777	L
		0450 90 F 5145 ¹	K
		KL 1987 43 M 2033	I
		1987 43 R 2333 ⁸	I
		KL 1987 43 M 2024	I
		1987 43 R 2324 ⁸	I

A6 2.8

2,8 120 AEJ			
	09.94-10.97	0451 10 P 3313	O
		1457 42 S 9777	L
		0450 90 F 5145 ¹	K
		KL 1987 43 M 2033	I
		1987 43 R 2333 ⁸	I
		KL 1987 43 M 2024	I
		1987 43 R 2324 ⁸	I



2,8 | 128 | AFC

	08.94-10.97	0451 10 P 3313	O
--	-------------	----------------	----------

2,8 | 142 | ACK

	10.95-10.97	0451 10 P 3313	O
		1457 42 S 9777	L
	10.95-03.97	0450 90 F 5145 ¹	K
	04.97-10.97	0450 90 F 5264 ¹	K
	10.95-10.97	KL 1987 43 M 2033	I
		1987 43 R 2333 ⁸	I
		KL 1987 43 M 2024	I
		1987 43 R 2324 ⁸	I

A6 2.8 i

2,8 | 128 | AAH

Fg.Nr. →4A..S..026 713	06.94-07.94	0451 10 P 3314	O
Fg.Nr. 4A..S..026 714→	08.94-12.97	0451 10 P 3313	O
	06.94-12.97	1457 42 S 9777	L
		0450 90 F 5145 ¹	K
		KL 1987 43 M 2033	I
		1987 43 R 2333 ⁸	I
		KL 1987 43 M 2024	I
		1987 43 R 2324 ⁸	I

A6 2.8 quattro

2,8 | 128 | AFC

	08.94-10.97	0451 10 P 3313	O
		0450 90 F 5145 ¹	K
		KL 1987 43 M 2033	I
		1987 43 R 2333 ⁸	I
		KL 1987 43 M 2024	I
		1987 43 R 2324 ⁸	I

A6 Allroad (C5,C6)

A6 Allroad (C5,C6) 2.5 TDI

2,5 120/132 AKE; BAU; BCZ			
	05.00-08.05	1457 42 P 9152	O
		KL 1457 43 S 3772	L
		0986 45 N 0509 ¹	K
		1987 43 R 2371 ⁸	I

A6 Allroad (C5,C6) 2.7 T

2,7 | 184/187 | APB; ARE; BEL; BES

	05.00-08.05	0451 10 P 3313	O
		1457 42 S 9870	L
		0450 90 F 5906 ¹	K
		1987 43 R 2371 ⁸	I

A6 Allroad (C5,C6) 2.7 TDI

2,7 | 120/132 | BPP <D1N>; BSG <D1W>

Fg.Nr. →4F..8..112 000	05.06-02.08	F 026 40 P 7002	O
Fg.Nr. 4F..8..112 001→	03.08-10.08	F 026 40 P 7066	O
	05.06-10.08	F 026 40 S 0028	L
Fg.Nr. →4F..8..176 910	05.06-08.08	0450 90 N 6459 ¹	K
	05.06-10.08	1987 43 M 2122	I
		1987 43 R 2422 ⁸	I

**2,7 | 120/140 | CANC <D4V>; CAND <D1W>**

10.08→	F 026 40 P 7066	O
	F 026 40 S 0028	L
	1 987 43 M 2122	I
	1 987 43 R 2422 ⁸	I

A6 Allroad (C5,C6) 3.0 TDI**3,0 | 155 | BNG <D1V>**

05.06-05.07	F 026 40 P 7002	O
	F 026 40 S 0028	L
	0 450 90 N 6459 ¹	K
	1 987 43 M 2122	I
	1 987 43 R 2422 ⁸	I

3,0 | 155/176 | CDYA <D50>; CDYB <D1V>; CDYC <D50>

10.08→	F 026 40 P 7066	O
	F 026 40 S 0028	L
	1 987 43 M 2122	I
	1 987 43 R 2422 ⁸	I

3,0 | 171 | ASB <D1D>

Fg.Nr. →4F..8..112 000	05.06-02.08	F 026 40 P 7002	O
Fg.Nr. 4F..8..112 001→	03.08-10.08	F 026 40 P 7066	O
	05.06-10.08	F 026 40 S 0028	L
Fg.Nr. →4F..8..176 910	05.06-08.08	0 450 90 N 6459 ¹	K
	05.06-10.08	1 987 43 M 2122	I
		1 987 43 R 2422 ⁸	I

A6 Allroad (C5,C6) 3.0 TFSI**3,0 | 213 | CAJA <D12>**

10.08→	1 457 42 P 9268	O
	F 026 40 S 0198	L
	F 026 40 F3012 ¹	K
	1 987 43 M 2122	I
	1 987 43 R 2422 ⁸	I

A6 Allroad (C5,C6) 3.2 FSI**3,2 | 188 | AUK <D2G>**

05.06-10.08	1 457 42 P 9268	O
	F 026 40 S 0198	L
	F 026 40 F3012 ¹	K
	1 987 43 M 2122	I
	1 987 43 R 2422 ⁸	I

A6 Allroad (C5,C6) 4.2**4,2 | 220 | BAS**

07.02-08.05	F 026 40 P 7007	O
	1 457 42 S 9870	L
	0 450 90 F 5906 ¹	K
	1 987 43 R 2371 ⁸	I

A6 Allroad (C5,C6) 4.2 FSI**4,2 | 257 | BVJ <MN5>**

05.06-12.10	F 026 40 P 7011	O
	F 026 40 S 0198	L
	F 026 40 F3012 ¹	K
	1 987 43 R 2422 ⁸	I

A6 (C4,C5)**A6 (C4,C5) 1.8****1,8 | 85 | AFY**

05.97-05.00	0 451 10 P 3314	O
	KZ0 1 457 42 S 9870	L
	0 450 90 F 5264 ¹	K

Fg.Nr. →4B..X..045 000	05.97-10.98	1 987 43 R 2324 ⁸	I
Fg.Nr. 4B..X..045 001→	11.98-05.00	1 987 43 R 2371 ⁸	I

1,8 | 92 | AJP

12.97-07.99	0 451 10 P 3314	O
	KZ0 1 457 42 S 9870	L
	0 450 90 F 5264 ¹	K

Fg.Nr. →4B..X..045 000	12.97-10.98	1 987 43 R 2324 ⁸	I
Fg.Nr. 4B..X..045 001→	11.98-07.99	1 987 43 R 2371 ⁸	I

1,8 | 92 | AQE; ARH

01.99-04.01	0 451 10 P 3314	O
	KZ0 1 457 42 S 9870	L
	0 450 90 F 5264 ¹	K
	1 987 43 M 2071	I
	1 987 43 R 2371 ⁸	I

A6 (C4,C5) 1.8 , quattro**1,8 | 92 | ADR**

06.94-10.97	0 451 10 P 3314	O
	1 457 42 S 9777	L
	0 450 90 F 5145 ¹	K
	KL 1 987 43 M 2033	I
	1 987 43 R 2333 ⁸	I
	KL 1 987 43 M 2024	I
	1 987 43 R 2324 ⁸	I

A6 (C4,C5) 1.8 T**1,8 | 110 | AEB**

04.97-01.99	0 451 10 P 3314	O
	KZ0 1 457 42 S 9870	L
	0 450 90 F 5264 ¹	K

Fg.Nr. →4B..X..045 000	04.97-10.98	1 987 43 R 2324 ⁸	I
Fg.Nr. 4B..X..045 001→	11.98-01.99	1 987 43 R 2371 ⁸	I

1,8 | 110 | ANB; APU

11.98-04.01	0 451 10 P 3314	O
	KZ0 1 457 42 S 9870	L
	0 450 90 F 5264 ¹	K
	1 987 43 M 2071	I
	1 987 43 R 2371 ⁸	I

1,8 | 110 | ARK

01.99-05.99	0 451 10 P 3314	O
	KZ0 1 457 42 S 9870	L
	0 450 90 F 5264 ¹	K
	1 987 43 M 2071	I
	1 987 43 R 2371 ⁸	I





◀ A6 (C4,C5) 1.8 T

1,8 110 AWT	05.00-04.01	F 026 40 P 7004	O
	KZO	1 457 42 S 9870	L
		0 450 90 F 5264 ¹	K
		1 987 43 M 2071	I
		1 987 43 R 2371 ⁸	I

1,8 132 AJL	11.97-10.00	0 451 10 P 3314	O
	KZO	1 457 42 S 9870	L
		0 450 90 F 5264 ¹	K
Fg.Nr. →4B..X..045 000	11.97-10.98	1 987 43 R 2324 ⁸	I
Fg.Nr. 4B..X..045 001→	11.98-10.00	1 987 43 R 2371 ⁸	I

A6 (C4,C5) 1.8 T quattro

1,8 110 AEB	04.97-01.99	0 451 10 P 3314	O
	KZO	1 457 42 S 9870	L
		0 450 90 F 5906 ¹	K
Fg.Nr. →4B..X..045 000	04.97-10.98	1 987 43 R 2324 ⁸	I
Fg.Nr. 4B..X..045 001→	11.98-01.99	1 987 43 R 2371 ⁸	I

1,8 110 ANB; APU	11.98-05.01	0 451 10 P 3314	O
	KZO	1 457 42 S 9870	L
		0 450 90 F 5906 ¹	K
		1 987 43 M 2071	I
		1 987 43 R 2371 ⁸	I

1,8 110 ARK	01.99-05.99	0 451 10 P 3314	O
	KZO	1 457 42 S 9870	L
		0 450 90 F 5906 ¹	K
		1 987 43 M 2071	I
		1 987 43 R 2371 ⁸	I

1,8 110 AWT	05.00-01.05	F 026 40 P 7004	O
	KZO	1 457 42 S 9870	L
		0 450 90 F 5906 ¹	K
		1 987 43 M 2071	I
		1 987 43 R 2371 ⁸	I

1,8 132 AJL	06.97-10.00	0 451 10 P 3314	O
	KZO	1 457 42 S 9870	L
		0 450 90 F 5906 ¹	K
Fg.Nr. →4B..X..045 000	06.97-10.98	1 987 43 R 2324 ⁸	I
Fg.Nr. 4B..X..045 001→	11.98-10.00	1 987 43 R 2371 ⁸	I

A6 (C4,C5) 1.9 TDI

1,9 66 AHU	07.96-10.97	0 451 10 P 3346	O
		1 457 42 S 9777	L
		1 457 43 N 4184 ²	K
	KL	1 987 43 M 2033	I
		1 987 43 R 2333 ⁸	I
	KL	1 987 43 M 2024	I
		1 987 43 R 2324 ⁸	I



1,9 66 1Z	06.94-09.96	0 451 20 P 3012	O
		1 457 42 S 9777	L
		1 457 43 N 4184 ²	K
	KL	1 987 43 M 2033	I
		1 987 43 R 2333 ⁸	I
	KL	1 987 43 M 2024	I
		1 987 43 R 2324 ⁸	I

1,9 81 AFN	04.97-04.01	0 451 10 P 3346	O
	KZO	1 457 42 S 9870	L
		1 457 43 N 4184 ²	K
Fg.Nr. →4B..X..045 000	04.97-10.98	1 987 43 R 2324 ⁸	I
Fg.Nr. 4B..X..045 001→	11.98-04.01	1 987 43 R 2371 ⁸	I

1,9 81 AVG	08.99-10.00	0 451 10 P 3346	O
	KZO	1 457 42 S 9870	L
		1 457 43 N 4184 ²	K
Fg.Nr. →4B..1..000 000	08.99-04.00	1 457 43 N 4184 ²	K
Fg.Nr. 4B..1..000 001→	04.00-10.00	0 450 90 N 6374 ¹	K
	08.99-10.00	1 987 43 M 2071	I
		1 987 43 R 2371 ⁸	I

1,9 85 AJM	02.98-04.01	1 457 42 P 9619	O
	KZO	1 457 42 S 9870	L
	05.99-04.01	1 987 43 M 2071	I
		1 987 43 R 2371 ⁸	I
Fg.Nr. →4B..X..045 000	02.98-10.98	1 987 43 R 2324 ⁸	I
Fg.Nr. 4B..X..045 001→	11.98-04.01	1 987 43 R 2371 ⁸	I

1,9 96 AVF	06.01-01.05	1 457 42 P 9619	O
	KZO	1 457 42 S 9870	L
		0 450 90 N 6374 ¹	K
		1 987 43 M 2071	I
		1 987 43 R 2371 ⁸	I

1,9 96 AWX	06.01-01.05	1 457 42 P 9619	O
	KZO	1 457 42 S 9870	L
		0 450 90 N 6374 ¹	K
		1 987 43 M 2071	I
		1 987 43 R 2371 ⁸	I

A6 (C4,C5) 2.0

2,0 74/85 AAE; ABK	06.94-07.95	0 451 10 P 3033	O
	08.95-08.96	0 451 10 P 3314	O
	06.94-08.96	1 457 42 S 9777	L
		0 450 90 F 5145 ¹	K
	KL	1 987 43 M 2033	I
		1 987 43 R 2333 ⁸	I
	KL	1 987 43 M 2024	I
		1 987 43 R 2324 ⁸	I





2,0|79|ADW

06.94-07.95	0 451 10 P 3033	O
08.95-10.97	0 451 10 P 3314	O
06.94-10.97	1 457 42 S 9777	L
	0 450 90 F 5145 ¹	K
KL	1 987 43 M 2033	I
	1 987 43 R 2333 ⁸	I
KL	1 987 43 M 2024	I
	1 987 43 R 2324 ⁸	I

2,0|96|ALT

06.01-01.05	0 451 10 P 3314	O
KZO	1 457 42 S 9870	L
	0 450 90 F 5264 ¹	K
	1 987 43 M 2071	I
	1 987 43 R 2371 ⁸	I

A6 (C4,C5) 2.0 , quattro

2,0|103|ACE

06.94-10.97	0 451 10 P 3314	O
	1 457 42 S 9777	L
	0 450 90 F 5145 ¹	K
KL	1 987 43 M 2033	I
	1 987 43 R 2333 ⁸	I
KL	1 987 43 M 2024	I
	1 987 43 R 2324 ⁸	I

A6 (C4,C5) 2.3 , quattro

2,3|98|AAR

06.94-10.97	0 451 10 P 3033	O
	1 457 42 S 9777	L
	0 450 90 F 5145 ¹	K
KL	1 987 43 M 2033	I
	1 987 43 R 2333 ⁸	I
KL	1 987 43 M 2024	I
	1 987 43 R 2324 ⁸	I

A6 (C4,C5) 2.4

2,4|100|ALW

08.97-01.99	0 451 10 P 3313	O
KZO	1 457 42 S 9870	L
	0 450 90 F 5264 ¹	K
Fg.Nr. →4B..X..045 000	08.97-10.98	1 987 43 R 2324 ⁸ I
Fg.Nr. 4B..X..045 001→	11.98-01.99	1 987 43 R 2371 ⁸ I

2,4|100|ARN

02.99-05.00	0 451 10 P 3313	O
KZO	1 457 42 S 9870	L
	0 450 90 F 5264 ¹	K
	1 987 43 M 2071	I
	1 987 43 R 2371 ⁸	I

2,4|100|ASM

06.01-01.05	0 451 10 P 3313	O
KZO	1 457 42 S 9870	L
	0 450 90 F 5264 ¹	K
	1 987 43 M 2071	I
	1 987 43 R 2371 ⁸	I

2,4|110|AFM

07.95-10.97	0 451 10 P 3313	O
	1 457 42 S 9777	L
	0 450 90 F 5145 ¹	K
KL	1 987 43 M 2033	I
	1 987 43 R 2333 ⁸	I
KL	1 987 43 M 2024	I
	1 987 43 R 2324 ⁸	I

2,4|115|APC

04.98-04.01	0 451 10 P 3313	O
KZO	1 457 42 S 9870	L
	0 450 90 F 5264 ¹	K
	1 987 43 R 2324 ⁸	I
Fg.Nr. →4B..X..045 000	04.98-10.98	1 987 43 R 2324 ⁸ I
Fg.Nr. 4B..X..045 001→	11.98-04.01	1 987 43 R 2371 ⁸ I

2,4|120|AJG

04.97-07.98	0 451 10 P 3313	O
KZO	1 457 42 S 9870	L
	0 450 90 F 5264 ¹	K
	1 987 43 R 2324 ⁸	I

2,4|120|ALF

06.97-01.99	0 451 10 P 3313	O
KZO	1 457 42 S 9870	L
	0 450 90 F 5264 ¹	K
Fg.Nr. →4B..X..045 000	06.97-10.98	1 987 43 R 2324 ⁸ I
Fg.Nr. 4B..X..045 001→	11.98-01.99	1 987 43 R 2371 ⁸ I

2,4|120|AMM

06.00-04.01	0 451 10 P 3313	O
06.01-05.04	0 451 10 P 3313	O
06.00-04.01	KZO 1 457 42 S 9870	L
06.01-05.04	KZO 1 457 42 S 9870	L
06.00-04.01	0 450 90 F 5264 ¹	K
06.01-05.04	0 450 90 F 5264 ¹	K
06.00-04.01	1 987 43 M 2071	I
	1 987 43 R 2371 ⁸	I
06.01-05.04	1 987 43 M 2071	I
	1 987 43 R 2371 ⁸	I

2,4|120/121|APS; APZ; ARJ

11.98-04.01	0 451 10 P 3313	O
KZO	1 457 42 S 9870	L
	0 450 90 F 5264 ¹	K
	1 987 43 M 2071	I
	1 987 43 R 2371 ⁸	I

2,4|121|AGA

04.97-01.99	0 451 10 P 3313	O
KZO	1 457 42 S 9870	L
	0 450 90 F 5264 ¹	K
Fg.Nr. →4B..X..045 000	04.97-10.98	1 987 43 R 2324 ⁸ I
Fg.Nr. 4B..X..045 001→	11.98-01.99	1 987 43 R 2371 ⁸ I

2,4|121|ALF

02.98-01.99	0 451 10 P 3313	O
KZO	1 457 42 S 9870	L
	0 450 90 F 5264 ¹	K
Fg.Nr. →4B..X..045 000	02.98-10.98	1 987 43 R 2324 ⁸ I
Fg.Nr. 4B..X..045 001→	11.98-01.99	1 987 43 R 2371 ⁸ I





◀ A6 (C4,C5) 2.4

2,4 121 AML			
06.00-04.01	0 451 10 P 3313	O	
	KZO 1 457 42 S 9870	L	
	0 450 90 F 5264 ¹	K	
	1 987 43 M 2071	I	
	1 987 43 R 2371 ⁸	I	

2,4 125 BDV			
06.01-01.05	0 451 10 P 3313	O	
	KZO 1 457 42 S 9870	L	
	0 450 90 F 5264 ¹	K	
	1 987 43 M 2071	I	
	1 987 43 R 2371 ⁸	I	

A6 (C4,C5) 2.4 quattro

2,4 115 APC			
08.98-05.01	0 451 10 P 3313	O	
	KZO 1 457 42 S 9870	L	
	0 450 90 F 5906 ¹	K	
Fg.Nr. →4B..X..045 000	08.98-10.98	1 987 43 R 2324 ⁸	I
Fg.Nr. 4B..X..045 001→	11.98-05.01	1 987 43 R 2371 ⁸	I

2,4 120 AJG			
06.97-01.99	0 451 10 P 3313	O	
	KZO 1 457 42 S 9870	L	
	0 450 90 F 5906 ¹	K	
Fg.Nr. →4B..X..045 000	06.97-10.98	1 987 43 R 2324 ⁸	I
Fg.Nr. 4B..X..045 001→	11.98-01.99	1 987 43 R 2371 ⁸	I

2,4 120/121 APS; APZ; ARJ			
11.98-09.01	0 451 10 P 3313	O	
	KZO 1 457 42 S 9870	L	
	0 450 90 F 5906 ¹	K	
	1 987 43 M 2071	I	
	1 987 43 R 2371 ⁸	I	

2,4 121 AGA			
04.97-01.99	0 451 10 P 3313	O	
	KZO 1 457 42 S 9870	L	
	0 450 90 F 5906 ¹	K	
Fg.Nr. →4B..X..045 000	04.97-10.98	1 987 43 R 2324 ⁸	I
Fg.Nr. 4B..X..045 001→	11.98-01.99	1 987 43 R 2371 ⁸	I

2,4 121 ALF			
06.97-01.99	0 451 10 P 3313	O	
	KZO 1 457 42 S 9870	L	
	0 450 90 F 5906 ¹	K	
Fg.Nr. →4B..X..045 000	06.97-10.98	1 987 43 R 2324 ⁸	I
Fg.Nr. 4B..X..045 001→	11.98-01.99	1 987 43 R 2371 ⁸	I

2,4 121 AML			
06.00-05.01	0 451 10 P 3313	O	
	KZO 1 457 42 S 9870	L	
	0 450 90 F 5906 ¹	K	
	1 987 43 M 2071	I	
	1 987 43 R 2371 ⁸	I	

2,4 125 BDV			
06.01-01.05	0 451 10 P 3313	O	
	KZO 1 457 42 S 9870	L	
	0 450 90 F 5906 ¹	K	
	1 987 43 M 2071	I	
	1 987 43 R 2371 ⁸	I	



A6 (C4,C5) 2.5 TDI

2,5 85 AAT			
06.94-10.97	AG	0 451 10 P 3257	O
07.96-10.97	GS	0 451 10 P 3347	O
06.94-10.97		1 457 42 S 9792	L
		1 457 43 N 4184 ²	K
	KL	1 987 43 M 2033	I
		1 987 43 R 2333 ⁸	I
	KL	1 987 43 M 2024	I
		1 987 43 R 2324 ⁸	I

2,5 110 AFB			
04.97-05.00		1 457 42 P 9152	O
	KZO	1 457 43 S 3772	L
		0 986 45 N 0509 ¹	K
Fg.Nr. →4B..X..045 000	04.97-10.98	1 987 43 R 2324 ⁸	I
Fg.Nr. 4B..X..045 001→	11.98-05.00	1 987 43 R 2371 ⁸	I

2,5 110 AKN			
11.98-04.01		1 457 42 P 9152	O
	KZO	1 457 43 S 3772	L
		0 986 45 N 0509 ¹	K
		1 987 43 M 2071	I
		1 987 43 R 2371 ⁸	I

2,5 114 AYM			
06.01-06.02		1 457 42 P 9152	O
	KZO	1 457 43 S 3772	L
		0 986 45 N 0509 ¹	K
		1 987 43 M 2071	I
		1 987 43 R 2371 ⁸	I

2,5 120 BFC			
07.02-08.03		1 457 42 P 9152	O
	KZO	1 457 43 S 3772	L
		0 986 45 N 0509 ¹	K
		1 987 43 M 2071	I
		1 987 43 R 2371 ⁸	I

2,5 120/132 BCZ; BDG			
11.02-01.05		1 457 42 P 9152	O
	KZO	1 457 43 S 3772	L
		0 986 45 N 0509 ¹	K
		1 987 43 M 2071	I
		1 987 43 R 2371 ⁸	I

2,5 132 AKE			
10.99-08.03		1 457 42 P 9152	O
	KZO	1 457 43 S 3772	L
		0 986 45 N 0509 ¹	K
		1 987 43 M 2071	I
		1 987 43 R 2371 ⁸	I

2,5 132 BAU			
11.02-01.05		1 457 42 P 9152	O
	KZO	1 457 43 S 3772	L
		0 986 45 N 0509 ¹	K
		1 987 43 M 2071	I
		1 987 43 R 2371 ⁸	I

2,5 132 BDH			
11.02-01.05		1 457 42 P 9152	O
	KZO	1 457 43 S 3772	L
		0 986 45 N 0509 ¹	K
		1 987 43 M 2071	I
		1 987 43 R 2371 ⁸	I



**A6 (C4,C5) 2.5 TDI quattro**

2,5 110 AFB				
	07.97-05.00	1 457 42 P 9152	O	
		1 457 43 S 3772	L	
		0 986 45 N 0509 ¹	K	
Fg.Nr. →4B..X..045 000	07.97-10.98	1 987 43 R 2324 ⁸	I	
Fg.Nr. 4B..X..045 001→	11.98-05.00	1 987 43 R 2371 ⁸	I	

2,5|110|AKN

	11.98-04.01	1 457 42 P 9152	O	
		1 457 43 S 3772	L	
		0 986 45 N 0509 ¹	K	
		1 987 43 M 2071	I	
		1 987 43 R 2371 ⁸	I	

2,5|132|AKE

	10.99-08.03	1 457 42 P 9152	O	
		1 457 43 S 3772	L	
		0 986 45 N 0509 ¹	K	
		1 987 43 M 2071	I	
		1 987 43 R 2371 ⁸	I	

2,5|132|BAU

	02.03-01.05	1 457 42 P 9152	O	
		1 457 43 S 3772	L	
		0 986 45 N 0509 ¹	K	
		1 987 43 M 2071	I	
		1 987 43 R 2371 ⁸	I	

2,5|132|BDH

	02.03-01.05	1 457 42 P 9152	O	
		1 457 43 S 3772	L	
		0 986 45 N 0509 ¹	K	
		1 987 43 M 2071	I	
		1 987 43 R 2371 ⁸	I	

A6 (C4,C5) 2.5 TDI, TDI quattro**2,5|103|AEL**

	10.94-10.97	0 451 20 P 3223	O	
		1 457 42 S 9792	L	
		1 457 43 N 4184 ²	K	
		KL 1 987 43 M 2033	I	
		1 987 43 R 2333 ⁸	I	
		KL 1 987 43 M 2024	I	
		1 987 43 R 2324 ⁸	I	

A6 (C4,C5) 2.6 , quattro**2,6|102/110|ABC; ACZ**

Fg.Nr. →4A..S..026 713	06.94-07.94	0 451 10 P 3314	O	
Fg.Nr. 4A..S..026 714→	08.94-10.97	0 451 10 P 3313	O	
	06.94-10.97	1 457 42 S 9777	L	
		0 450 90 F 5145 ¹	K	
		KL 1 987 43 M 2033	I	
		1 987 43 R 2333 ⁸	I	
		KL 1 987 43 M 2024	I	
		1 987 43 R 2324 ⁸	I	

A6 (C4,C5) 2.7 Biturbo

2,7 169 AJK				
	02.99-05.01	0 451 10 P 3313	O	
		KZ0 1 457 42 S 9870	L	
		0 450 90 F 5264 ¹	K	
		1 987 43 M 2071	I	
		1 987 43 R 2371 ⁸	I	

A6 (C4,C5) 2.7 Biturbo quattro

2,7 169 AJK				
	10.97-08.00	0 451 10 P 3313	O	
		KZ0 1 457 42 S 9870	L	
		0 450 90 F 5906 ¹	K	
		1 987 43 M 2071	I	
		1 987 43 R 2371 ⁸	I	
Fg.Nr. →4B..X..045 000	10.97-10.98	1 987 43 R 2324 ⁸	I	
Fg.Nr. 4B..X..045 001→	11.98-08.00	1 987 43 R 2371 ⁸	I	

2,7|169/184|ARE; AZA

	09.00-06.02	0 451 10 P 3313	O	
		KZ0 1 457 42 S 9870	L	
		0 450 90 F 5906 ¹	K	
		1 987 43 M 2071	I	
		1 987 43 R 2371 ⁸	I	

2,7|184|BES

	07.02-01.05	0 451 10 P 3313	O	
		KZ0 1 457 42 S 9870	L	
		0 450 90 F 5906 ¹	K	
		1 987 43 M 2071	I	
		1 987 43 R 2371 ⁸	I	

2,7|187|BEL

	07.02-07.04	0 451 10 P 3313	O	
		1 457 42 S 9870	L	
		0 450 90 F 5906 ¹	K	
		1 987 43 R 2371 ⁸	I	

A6 (C4,C5) 2.7 quattro

2,7 187 APB				
	09.99-06.02	0 451 10 P 3313	O	
		1 457 42 S 9870	L	
		0 450 90 F 5906 ¹	K	
		1 987 43 R 2371 ⁸	I	

A6 (C4,C5) 2.8

2,8 128 AAH				
	09.94-07.96	0 451 10 P 3313	O	
Fg.Nr. →4A..S..026 713	06.94-07.94	0 451 10 P 3314	O	
Fg.Nr. 4A..S..026 714→	08.94-10.97	0 451 10 P 3313	O	
	06.94-10.97	1 457 42 S 9777	L	
		0 450 90 F 5145 ¹	K	
		KL 1 987 43 M 2033	I	
		1 987 43 R 2333 ⁸	I	
		KL 1 987 43 M 2024	I	
		1 987 43 R 2324 ⁸	I	





◀ A6 (C4,C5) 2.8

2,8 | 132 | AGE

	10.97-05.00	0 451 10 P 3313	O
		KZO 1 457 42 S 9870	L
		0 450 90 F 5264 ¹	K
Fg.Nr. →4B..X..045 000	10.97-10.98	1 987 43 R 2324 ⁸	I
Fg.Nr. 4B..X..045 001→	11.98-05.00	1 987 43 R 2371 ⁸	I

2,8 | 140 | ATX

	07.99-04.01	0 451 10 P 3313	O
		KZO 1 457 42 S 9870	L
		0 450 90 F 5264 ¹	K
		1 987 43 M 2071	I
		1 987 43 R 2371 ⁸	I

2,8 | 142 | ACK

	10.95-07.98	0 451 10 P 3313	O
	10.95-10.97	1 457 42 S 9777	L
	04.97-07.98	KZO 1 457 42 S 9870	L
	10.95-03.97	0 450 90 F 5145 ¹	K
	04.97-07.98	0 450 90 F 5264 ¹	K
	10.95-10.97	KL 1 987 43 M 2033	I
		1 987 43 R 2333 ⁸	I
		KL 1 987 43 M 2024	I
		1 987 43 R 2324 ⁸	I
	04.97-07.98	1 987 43 R 2324 ⁸	I

2,8 | 142 | AHA

	08.97-07.99	0 451 10 P 3313	O
		KZO 1 457 42 S 9870	L
		0 450 90 F 5264 ¹	K
		1 987 43 R 2324 ⁸	I

2,8 | 142 | ALG

	06.97-01.99	0 451 10 P 3313	O
		KZO 1 457 42 S 9870	L
		0 450 90 F 5264 ¹	K
Fg.Nr. →4B..X..045 000	06.97-10.98	1 987 43 R 2324 ⁸	I
Fg.Nr. 4B..X..045 001→	11.98-01.99	1 987 43 R 2371 ⁸	I

2,8 | 142 | APR; AQD

	11.98-04.01	0 451 10 P 3313	O
		KZO 1 457 42 S 9870	L
		0 450 90 F 5264 ¹	K
		1 987 43 M 2071	I
		1 987 43 R 2371 ⁸	I

2,8 | 142 | ATQ

	08.99-04.01	0 451 10 P 3313	O
		KZO 1 457 42 S 9870	L
		0 450 90 F 5264 ¹	K
		1 987 43 R 2371 ⁸	I

A6 (C4,C5) 2.8 , quattro

2,8 | 120 | AEJ

	06.94-10.97	0 451 10 P 3313	O
		1 457 42 S 9777	L
		0 450 90 F 5145 ¹	K
		KL 1 987 43 M 2033	I
		1 987 43 R 2333 ⁸	I
		KL 1 987 43 M 2024	I
		1 987 43 R 2324 ⁸	I



2,8 | 142 | AMX

	06.00-05.01	0 451 10 P 3313	O
		KZO 1 457 42 S 9870	L
		0 450 90 F 5264 ¹	K
		1 987 43 M 2071	I
		1 987 43 R 2371 ⁸	I

A6 (C4,C5) 2.8 quattro

2,8 | 128 | AAH

Fg.Nr. →4A..S..026 713	06.94-07.94	0 451 10 P 3314	O
Fg.Nr. 4A..S..026 714→	08.94-10.97	0 451 10 P 3313	O
	06.94-10.97	1 457 42 S 9777	L
		0 450 90 F 5145 ¹	K
		KL 1 987 43 M 2033	I
		1 987 43 R 2333 ⁸	I
		KL 1 987 43 M 2024	I
		1 987 43 R 2324 ⁸	I

2,8 | 128 | AFC

	08.94-12.98	0 451 10 P 3313	O
		0 450 90 F 5145 ¹	K
		KL 1 987 43 M 2033	I
		1 987 43 R 2333 ⁸	I
		KL 1 987 43 M 2024	I
		1 987 43 R 2324 ⁸	I

2,8 | 132 | AGE

	04.98-05.01	0 451 10 P 3313	O
		KZO 1 457 42 S 9870	L
		0 450 90 F 5906 ¹	K
Fg.Nr. →4B..X..045 000	04.98-10.98	1 987 43 R 2324 ⁸	I
Fg.Nr. 4B..X..045 001→	11.98-05.01	1 987 43 R 2371 ⁸	I

2,8 | 140 | ATX

	07.99-05.01	0 451 10 P 3313	O
		KZO 1 457 42 S 9870	L
		0 450 90 F 5906 ¹	K
		1 987 43 M 2071	I
		1 987 43 R 2371 ⁸	I

2,8 | 142 | ACK

	10.95-12.98	0 451 10 P 3313	O
	10.95-10.97	1 457 42 S 9777	L
	04.97-12.98	KZO 1 457 42 S 9870	L
	10.95-03.97	0 450 90 F 5145 ¹	K
	04.97-10.97	0 450 90 F 5264 ¹	K
	04.97-12.98	0 450 90 F 5906 ¹	K
	10.95-10.97	KL 1 987 43 M 2033	I
		1 987 43 R 2333 ⁸	I
		KL 1 987 43 M 2024	I
		1 987 43 R 2324 ⁸	I
	04.97-12.98	1 987 43 R 2324 ⁸	I

2,8 | 142 | ALG

	06.97-01.99	0 451 10 P 3313	O
		KZO 1 457 42 S 9870	L
		0 450 90 F 5906 ¹	K
Fg.Nr. →4B..X..045 000	06.97-10.98	1 987 43 R 2324 ⁸	I
Fg.Nr. 4B..X..045 001→	11.98-01.99	1 987 43 R 2371 ⁸	I

**2,8 | 142 | APR; AQD**

11.98-05.01	0 451 10 P 3313	O
KZO	1 457 42 S 9870	L
	0 450 90 F 5906 ¹	K
	1 987 43 M 2071	I
	1 987 43 R 2371 ⁸	I

A6 (C4,C5) 3.0**3,0 | 160 | BBJ**

06.01-01.05	0 451 10 P 3313	O
KZO	1 457 42 S 9870	L
	0 450 90 F 5264 ¹	K
	1 987 43 M 2071	I
	1 987 43 R 2371 ⁸	I

3,0 | 162 | ASN

06.01-01.05	0 451 10 P 3313	O
KZO	1 457 42 S 9870	L
	0 450 90 F 5264 ¹	K
	1 987 43 M 2071	I
	1 987 43 R 2371 ⁸	I

3,0 | 162 | AVK

06.01-07.04	0 451 10 P 3313	O
	1 457 42 S 9870	L
	0 450 90 F 5264 ¹	K
	1 987 43 R 2371 ⁸	I

A6 (C4,C5) 3.0 quattro**3,0 | 160 | BBJ**

06.01-01.05	0 451 10 P 3313	O
KZO	1 457 42 S 9870	L
	0 450 90 F 5906 ¹	K
	1 987 43 M 2071	I
	1 987 43 R 2371 ⁸	I

3,0 | 162 | ASN

06.01-01.05	0 451 10 P 3313	O
KZO	1 457 42 S 9870	L
	0 450 90 F 5906 ¹	K
	1 987 43 M 2071	I
	1 987 43 R 2371 ⁸	I

3,0 | 162 | AVK

06.01-07.04	0 451 10 P 3313	O
	1 457 42 S 9870	L
	0 450 90 F 5906 ¹	K
	1 987 43 R 2371 ⁸	I

A6 (C4,C5) 4.2 quattro**4,2 | 220 | ARS; ASG; AWW**

04.99-01.05	0 451 10 P 3348	O
	1 457 42 S 9870	L
	0 450 90 F 5906 ¹	K
	1 987 43 R 2371 ⁸	I

A6 (C6)**A6 (C6) 2.0 TDI****2,0 | 89/100/103 | BRE; BRF; BVG**

06.05-10.08	1 457 42 P 9192	O
	F 026 40 S 0027	L
	0 450 90 N 6429 ¹	K
	1 987 43 M 2122	I
	1 987 43 R 2422 ⁸	I

2,0 | 100/103 | BLB; BNA

07.04-11.05	1 457 42 P 9192	O
	F 026 40 S 0027	L
	0 450 90 N 6429 ¹	K
	1 987 43 M 2122	I
	1 987 43 R 2422 ⁸	I

A6 (C6) 2.0 TDI, TDI e**2,0 | 100/120/125 | CAGB <D94>; CAHA <D93>; CAHB <D95>**

10.08→	1 457 42 P 9192	O
	F 026 40 S 0027	L
	F 026 40 N 2066 ¹	K
	1 987 43 M 2122	I
	1 987 43 R 2422 ⁸	I

A6 (C6) 2.0 TFSI**2,0 | 125 | BPJ <D6G>**

06.05→	1 457 42 P 9243	O
	F 026 40 S 0027	L
	F 026 40 F 3012 ¹	K
	1 987 43 R 2422 ⁸	I

2,0 | 125 | BYK <D6G>

01.07→	1 457 42 P 9243	O
	F 026 40 S 0027	L
	F 026 40 F 3012 ¹	K
	1 987 43 R 2422 ⁸	I

A6 (C6) 2.4 , quattro**2,4 | 130 | BDW**

04.04-10.08	1 457 42 P 9268	O
	F 026 40 S 0198	L
	F 026 40 F 3003 ¹	K
	1 987 43 M 2122	I
	1 987 43 R 2422 ⁸	I

A6 (C6) 2.7 TDI**2,7 | 120/132 | BPP; BSG**

11.04-10.08	F 026 40 P 7002	O
	F 026 40 S 0028	L
	0 450 90 N 6459 ¹	K
	1 987 43 M 2122	I
	1 987 43 R 2422 ⁸	I





A6 (C6) 2.7 TDI quattro

2,7 120/132 BPP; BSG			
	06.05-10.08	F 026 40 P 7002	O
Fg.Nr. →4F..6..250 000	06.05-05.06	F 026 40 S 0028	L
Fg.Nr. 4F..7..000 001→	06.06-10.08	F 026 40 S 0198	L
	06.05-10.08	0 450 90 N 6459 ¹	K
		1 987 43 M 2122	I
		1 987 43 R 2422 ⁸	I

A6 (C6) 2.7 TDI, TDI quattro

2,7 120/140 CANA <D4V>; CANB; CANC <D4V>; CAND <D1W>			
	10.08→	F 026 40 P 7066	O
		F 026 40 S 0028	L
		1 987 43 M 2122	I
		1 987 43 R 2422 ⁸	I

A6 (C6) 2.8 FSI, FSI quattro

2,8 140/154/162 BDY; CCDA <DB2>; CCEA <DB3>			
	11.06→	1 457 42 P 9268	O
		F 026 40 S 0198	L
		F 026 40 F 3012 ¹	K
		1 987 43 M 2122	I
		1 987 43 R 2422 ⁸	I

A6 (C6) 3.0 , quattro

3,0 160 BBJ			
	04.04-05.06	0 451 10 P 3313	O
		F 026 40 S 0198	L
		F 026 40 F 3003 ¹	K
		1 987 43 M 2122	I
		1 987 43 R 2422 ⁸	I

A6 (C6) 3.0 TDI quattro

3,0 155 BNG			
	04.04-10.08	F 026 40 P 7002	O
Fg.Nr. →4F..6..250 000	04.04-05.06	F 026 40 S 0028	L
Fg.Nr. 4F..7..000 001→	06.06-10.08	F 026 40 S 0198	L
	04.04-10.08	0 450 90 N 6459 ¹	K
		1 987 43 M 2122	I
		1 987 43 R 2422 ⁸	I

3,0 | 155/176 | CDYA <D50>; CDYB <D1V>; CDYC <D50>

	10.08→	F 026 40 P 7066	O
		F 026 40 S 0028	L
		1 987 43 M 2122	I
		1 987 43 R 2422 ⁸	I

3,0 | 165 | BMK

	04.04-05.06	F 026 40 P 7002	O
		F 026 40 S 0028	L
		0 450 90 N 6459 ¹	K
		1 987 43 M 2122	I
		1 987 43 R 2422 ⁸	I

3,0 | 171 | ASB

	06.06-10.08	F 026 40 P 7002	O
		F 026 40 S 0198	L
		0 450 90 N 6459 ¹	K
		1 987 43 M 2122	I
		1 987 43 R 2422 ⁸	I



A6 (C6) 3.0 TFSI quattro

3,0 213/220 CAJA <D12>; CCAA <D13>			
	10.08→	1 457 42 P 9268	O
		F 026 40 S 0198	L
		F 026 40 F 3012 ¹	K
		1 987 43 M 2122	I
		1 987 43 R 2422 ⁸	I

A6 (C6) 3.2 FSI

3,2 188 BKH			
	06.06-05.09	1 457 42 P 9268	O
		F 026 40 S 0198	L
		F 026 40 F 3012 ¹	K
		1 987 43 M 2122	I
		1 987 43 R 2422 ⁸	I

3,2 | 195 | CALA <D6W>

	03.09→	1 457 42 P 9268	O
		F 026 40 S 0198	L
		F 026 40 F 3012 ¹	K
		1 987 43 M 2122	I
		1 987 43 R 2422 ⁸	I

A6 (C6) 3.2 FSI, FSI quattro

3,2 188 AUK			
	04.04-10.08	1 457 42 P 9268	O
		F 026 40 S 0198	L
		F 026 40 F 3012 ¹	K
		1 987 43 M 2122	I
		1 987 43 R 2422 ⁸	I

A6 (C6) 3.2 FSI quattro

3,2 183 BYU			
	09.06-10.08	1 457 42 P 9268	O
		F 026 40 S 0198	L
		F 026 40 F 3012 ¹	K
		1 987 43 M 2122	I
		1 987 43 R 2422 ⁸	I

3,2 | 188 | BKH

	07.05-10.08	1 457 42 P 9268	O
		F 026 40 S 0198	L
		F 026 40 F 3012 ¹	K
		1 987 43 M 2122	I
		1 987 43 R 2422 ⁸	I

A6 (C6) 4.2 FSI quattro

4,2 257 BVJ <MN5>			
	06.06→	F 026 40 P 7011	O
		F 026 40 S 0198	L
		F 026 40 F 3012 ¹	K
		1 987 43 R 2422 ⁸	I

A6 (C6) 4.2 quattro

4,2 246 BAT; BNK			
	04.04-10.08	F 026 40 P 7007	O
		F 026 40 S 0198	L
		F 026 40 F 3003 ¹	K
		1 987 43 M 2122	I
		1 987 43 R 2422 ⁸	I



**A6 (C7)****A6 (C7) 2.0 FSI**

2,0 | 132/155 | CAEB <D2D>; CDNB <D64>
03.11→ F 026 40 P 7080 0

A6 (C7) 2.0 TDI

2,0 | 120/130 | CGLC <DE2>; CGLD <D95>; CMGB <DE2>
02.11→ F 026 40 P 7023 0

A6 (C7) 2.8 FSI, FSI quattro

2,8 | 150 | CHVA <D05>
11.10→ 1 457 42 P 9268 0

A6 (C7) 3.0 TFSI quattro

3,0 | 220/228 | CGWB <D13>; CGXB <D18>
11.10→ 1 457 42 P 9268 0

A7**A7 2.8 FSI, FSI quattro**

2,8 | 150 | CHVA <D05>
10.10→ 1 457 42 P 9268 0

A7 3.0 TFSI quattro

3,0 | 220/228 | CGWB <D13>; CGXB <D18>
07.10→ 1 457 42 P 9268 0

A8**A8 2.5 TDI**

2,5 | 110 | AFB
06.97-04.00 1 457 42 P 9152 0
1 457 43 S 3537 L
0 986 45 N 0509¹ K
ZE 1 987 43 R 2367⁸ I

A8 (D2,D3,D4)**A8 (D2,D3,D4) 2.5 TDI, TDI quattro**

2,5 | 110/132 | AFB; AKE; AKN
06.97-09.02 1 457 42 P 9152 0
1 457 43 S 3537 L
0 986 45 N 0509¹ K
ZE 1 987 43 R 2367⁸ I

A8 (D2,D3,D4) 2.8 , quattro

2,8 | 120/128/142 | AAH; ACK; AEJ; ALG; AMX; APR; AQD
06.94-09.02 0 451 10 P 3313 0
1 457 43 S 3537 L
0 450 90 F 5906¹ K
ZE 1 987 43 R 2367⁸ I

A8 (D2,D3,D4) 2.8 FSI

2,8 | 154 | BDX
09.07-07.10 1 457 42 P 9268 0
1 987 42 S 9400 L
F 026 40 F 3012¹ K
1 987 43 R 2423⁸ I

2,8 | 170 | CJBA

01.09-07.10 1 457 42 P 9268 0
1 987 42 S 9400 L
1 987 43 R 2423⁸ I

A8 (D2,D3,D4) 3.0

3,0 | 162 | ASN
07.03-05.05 0 451 10 P 3313 0
1 987 42 S 9400 L
0 450 90 F 5318¹ K
1 987 43 R 2423⁸ I

A8 (D2,D3,D4) 3.0 , quattro

3,0 | 160 | BBJ
07.03-05.06 0 451 10 P 3313 0
1 987 42 S 9400 L
Fg.Nr. →4E..6..014980 07.03-10.05 0 450 90 F 5318¹ K
07.03-05.06 1 987 43 R 2423⁸ I

A8 (D2,D3,D4) 3.0 TDI quattro

3,0 | 150 | CLAB <D1Q>
09.11→ F 026 40 N 2068¹ K

3,0 | 155 | BNG

Fg.Nr. →4E..8..011 500 11.03-02.08 F 026 40 P 7002 0
Fg.Nr. 4E..8..011 501→ 03.08-07.10 F 026 40 P 7066 0
11.03-07.10 0 450 90 N 6458¹ K
1 987 43 R 2423⁸ I

3,0 | 155/184 | CDTA; CDTB <D1V>

07.10→ F 026 40 N 2068¹ K

3,0 | 171 | ASB

Fg.Nr. →4E..8..011 500 01.04-02.08 F 026 40 P 7002 0
Fg.Nr. 4E..8..011 501→ 03.08-07.10 F 026 40 P 7066 0
01.04-07.10 0 450 90 N 6458¹ K
1 987 43 R 2423⁸ I

A8 (D2,D3,D4) 3.0 TFSI quattro

3,0 | 213/245 | CGWA; CGXC <D11>
07.10→ 1 457 42 P 9268 0

3,0 | 245 | CMDA <D11>

06.10→ 1 457 42 P 9268 0

A8 (D2,D3,D4) 3.2 FSI, FSI quattro

3,2 | 191 | BPK
06.05-07.10 1 457 42 P 9268 0
1 987 42 S 9400 L
F 026 40 F 3012¹ K
1 987 43 R 2423⁸ I





A8 (D2,D3,D4) 3.3 TDI quattro

3,3 165 AKF	12.99-08.02	1 457 43 S 3537 L	
		0 986 45 N 0509 ¹ K	
	ZE	1 987 43 R 2367 ⁸ I	

A8 (D2,D3,D4) 3.7 , quattro

3,7 169 AEW	07.95-12.98	1 457 43 S 3537 L	
		0 450 90 F 5906 ¹ K	
	ZE	1 987 43 R 2367 ⁸ I	

3,7 169 AKJ	05.97-12.98	1 457 43 S 3537 L	
		0 450 90 F 5906 ¹ K	
	ZE	1 987 43 R 2367 ⁸ I	

3,7 191 AKC	05.00-09.02	1 457 42 P 9142 O	
		1 457 43 S 3537 L	
		0 450 90 F 5906 ¹ K	
	ZE	1 987 43 R 2367 ⁸ I	

3,7 191 AQQ	10.98-02.01	1 457 42 P 9142 O	
		1 457 43 S 3537 L	
		0 450 90 F 5906 ¹ K	
	ZE	1 987 43 R 2367 ⁸ I	

A8 (D2,D3,D4) 3.7 quattro

3,7 206 BFL	11.02-05.06	F 026 40 P 7007 O	
		1 987 42 S 9400 L	
Fg.Nr. →4E..6..014 980	11.02-10.05	0 450 90 F 5318 ¹ K	
	11.02-05.06	1 987 43 R 2423 ⁸ I	

A8 (D2,D3,D4) 4.0 TDI quattro

4,0 202 ASE	05.03-07.05	F 026 40 P 7002 O	
	ZE	1 987 42 S 9400 L	
		0 450 90 N 6458 ¹ K	
		1 987 43 R 2423 ⁸ I	

A8 (D2,D3,D4) 4.2 FSI quattro

4,2 257 BVJ	06.06-07.10	F 026 40 P 7011 O	
		1 987 42 S 9400 L	
		F 026 40 F 3012 ¹ K	
		1 987 43 R 2423 ⁸ I	

4,2 273 CDRA	11.09→	F 026 40 P 7011 O	
--------------	--------	--------------------------	--

A8 (D2,D3,D4) 4.2 quattro

4,2 175/228 AQF; ARU; AUW	10.98-09.02	1 457 42 P 9142 O	
		1 457 43 S 3537 L	
		0 450 90 F 5906 ¹ K	
	ZE	1 987 43 R 2367 ⁸ I	

4,2 180/210/220 ABZ; AEM; AGH	06.94-12.98	1 457 43 S 3537 L	
		0 450 90 F 5906 ¹ K	
	ZE	1 987 43 R 2367 ⁸ I	



4,2 220 AKG	04.97-12.98	1 457 43 S 3537 L	
		0 450 90 F 5906 ¹ K	
	ZE	1 987 43 R 2367 ⁸ I	

4,2 228 AKB	05.99-05.03	1 457 42 P 9142 O	
-------------	-------------	--------------------------	--

4,2 228 AUX	05.00-09.02	1 457 42 P 9142 O	
-------------	-------------	--------------------------	--

4,2 246 BFM	11.02-05.06	F 026 40 P 7007 O	
		1 987 42 S 9400 L	
Fg.Nr. →4E..6..014 980	11.02-10.05	0 450 90 F 5318 ¹ K	
	11.02-05.06	1 987 43 R 2423 ⁸ I	

A8 (D2,D3,D4) 4.2 TDI quattro

4,2 235 BMC	01.05-06.05	F 026 40 P 7002 O	
		1 987 42 S 9400 L	
		0 450 90 N 6458 ¹ K	
		1 987 43 R 2423 ⁸ I	

4,2 240 BVN		F 026 40 P 7002 O	
Fg.Nr. →4E..8..011 500	07.05-02.08	F 026 40 P 7002 O	
Fg.Nr. 4E..8..011 501→	03.08-07.10	F 026 40 P 7066 O	
	07.05-07.10	0 450 90 N 6458 ¹ K	
		1 987 43 R 2423 ⁸ I	

4,2 258 CDSB	11.09→	F 026 40 P 7066 O	
		F 026 40 N 2068 ¹ K	

A8 (D2,D3,D4) 6.0 quattro

6,0 309 AZC	03.01-08.02	0 450 90 F 5906 ¹ K	
	ZE	1 987 43 R 2367 ⁸ I	

6,0 331 BHT		0 450 90 F 5318 ¹ K	
Fg.Nr. →4E..6..014 980	02.04-10.05	0 450 90 F 5318 ¹ K	
	02.04-07.10	1 987 43 R 2423 ⁸ I	

6,0 331 BSB	10.04-07.10	F 026 40 F 3003 ¹ K	
		1 987 43 R 2423 ⁸ I	

6,0 331 BTE		0 450 90 F 5318 ¹ K	
Fg.Nr. →4E..6..014 980	02.05-10.05	0 450 90 F 5318 ¹ K	
	02.05-07.10	1 987 43 R 2423 ⁸ I	

Cabriolet

Cabriolet 1.8

1,8 92 ADR	01.97-08.00	0 451 10 P 3314 O	
		1 457 42 S 9777 L	
		0 450 90 F 5145 ¹ K	
		1 987 43 M 2017 I	
		1 987 43 R 2317 ⁸ I	



**Cabriolet 1.9 TDI****1,9|66|AHU; 1Z**

07.96-08.00	0 451 10 P 3346	O
07.95-08.00	1 457 42 S 9777	L
	1 457 43 N 4184 ²	K
	1 987 43 M 2017	I
	1 987 43 R 2317 ⁸	I

Cabriolet 2.0**2,0|85|ABK**

01.93-09.98	0 451 10 P 3314	O
	1 457 42 S 9777	L
	0 450 90 F 5145 ¹	K
	1 987 43 M 2017	I
	1 987 43 R 2317 ⁸	I

2,0|103|ACE

05.95-07.96	0 451 10 P 3314	O
	1 457 42 S 9994	L
	0 450 90 F 5145 ¹	K
	1 987 43 M 2017	I
	1 987 43 R 2317 ⁸	I

Cabriolet 2.3**2,3|98|NG**

06.91-07.94	0 451 10 P 3033	O
	1 457 42 S 9994	L
	0 450 90 F 5145 ¹	K
	1 987 43 M 2017	I
	1 987 43 R 2317 ⁸	I

Cabriolet 2.6**2,6|102|ACZ**

05.95-12.99	0 451 10 P 3313	O
	1 457 42 S 9777	L
	0 450 90 F 5145 ¹	K
	1 987 43 M 2017	I
	1 987 43 R 2317 ⁸	I

2,6|110|ABC

Fg.Nr. →8G..S..001 302	01.94-09.94	0 451 10 P 3314	O
Fg.Nr. 8G..S..001 303→	09.94-08.00	0 451 10 P 3313	O
	01.94-08.00	1 457 42 S 9777	L
		0 450 90 F 5145 ¹	K
		1 987 43 M 2017	I
		1 987 43 R 2317 ⁸	I

Cabriolet 2.8**2,8|128|AAH**

Fg.Nr. →8G..S..001 302	11.92-09.94	0 451 10 P 3314	O
Fg.Nr. 8G..S..001 303→	09.94-08.00	0 451 10 P 3313	O
	11.92-08.00	1 457 42 S 9777	L
		0 450 90 F 5145 ¹	K
		1 987 43 M 2017	I
		1 987 43 R 2317 ⁸	I

**Coupe (B2,B3)****Coupe (B2,B3) 1.8****1,8|82|DZ**

08.89-07.91	0 451 10 P 3033	O
	1 457 42 S 9994	L
	0 450 90 F 5145 ¹	K
	1 987 43 M 2017	I
	1 987 43 R 2317 ⁸	I

Coupe (B2,B3) 2.0**2,0|85|AAD**

08.90-07.91	0 451 10 P 3033	O
	1 457 42 S 9994	L
	0 450 90 F 5145 ¹	K
	1 987 43 M 2017	I
	1 987 43 R 2317 ⁸	I

2,0|85|ABK

09.91-12.95	0 451 10 P 3033	O
	1 457 42 S 9777	L
	0 450 90 F 5145 ¹	K
	1 987 43 M 2017	I
	1 987 43 R 2317 ⁸	I

2,0|101|6A

01.92-07.92	0 451 10 P 3314	O
	1 457 42 S 9994	L
	0 450 90 F 5145 ¹	K
	1 987 43 M 2017	I
	1 987 43 R 2317 ⁸	I

2,0|103|ACE

08.92-12.95	1 457 42 S 9994	L
	0 450 90 F 5145 ¹	K
	1 987 43 M 2017	I
	1 987 43 R 2317 ⁸	I

Coupe (B2,B3) 2.0 , quattro**2,0|118|NM**

11.88-07.91	0 451 10 P 3033	O
	1 457 42 S 9994	L
	0 450 90 F 5145 ¹	K
	1 987 43 M 2017	I
	1 987 43 R 2317 ⁸	I

Coupe (B2,B3) 2.2 , quattro**2,2|98|KV**

11.88-07.91	0 451 10 P 3033	O
	1 457 42 S 9994	L
	0 450 90 F 5145 ¹	K
	1 987 43 M 2017	I
	1 987 43 R 2317 ⁸	I





Coupe (B2,B3) 2.2 S2 T quattro

2,2 162 3B	09.90-09.92	0 451 10 P 3314	O
		1 457 42 S 9994	L
		0 450 90 F 5145 ¹	K
		1 987 43 M 2017	I
		1 987 43 R 2317 ⁸	I

2,2 169 ABY	10.92-12.95	0 451 10 P 3314	O
		1 457 42 S 9777	L
		0 450 90 F 5145 ¹	K
		1 987 43 M 2017	I
		1 987 43 R 2317 ⁸	I

Coupe (B2,B3) 2.3 , quattro

2,3 98/125 NG; 7A	11.88-07.94	0 451 10 P 3033	O
		1 457 42 S 9994	L
		0 450 90 F 5145 ¹	K
		1 987 43 M 2017	I
		1 987 43 R 2317 ⁸	I

Coupe (B2,B3) 2.6

2,6 110 ABC			
Fg.Nr. →8B..S..000 544	08.92-05.95	0 451 10 P 3314	O
Fg.Nr. 8B..S..000 545→	05.95-12.95	0 451 10 P 3313	O
	08.92-12.95	1 457 42 S 9777	L
		0 450 90 F 5145 ¹	K
		1 987 43 M 2017	I
		1 987 43 R 2317 ⁸	I

Coupe (B2,B3) 2.6 quattro

2,6 110 ABC			
Fg.Nr. →8B..S..000 544	08.92-08.94	0 451 10 P 3314	O
Fg.Nr. 8B..S..000 545→	08.94-12.95	0 451 10 P 3313	O
	08.92-12.95	1 457 42 S 9777	L
		0 450 90 F 5145 ¹	K
		1 987 43 M 2017	I
		1 987 43 R 2317 ⁸	I

Coupe (B2,B3) 2.8

2,8 128 AAH			
Fg.Nr. →8B..S..000 544	09.91-05.95	0 451 10 P 3314	O
Fg.Nr. 8B..S..000 545→	05.95-12.95	0 451 10 P 3313	O
	09.91-12.95	1 457 42 S 9777	L
		0 450 90 F 5145 ¹	K
		1 987 43 M 2017	I
		1 987 43 R 2317 ⁸	I

Coupe (B2,B3) 2.8 quattro

2,8 128 AAH			
Fg.Nr. →8B..S..000 544	08.91-08.94	0 451 10 P 3314	O
Fg.Nr. 8B..S..000 545→	08.94-12.95	0 451 10 P 3313	O
	08.91-12.95	1 457 42 S 9777	L
		0 450 90 F 5145 ¹	K
		1 987 43 M 2017	I
		1 987 43 R 2317 ⁸	I



Quattro

Quattro 2.2 Turbo

2,2 162 RR	08.89-07.91	0 451 10 P 3314	O
		0 450 90 F 5145 ¹	K

Q3

Q3 2.0 TDI, TDI quattro

2,0 100/103/120/130 CFFA <D94>; CFFB <D91>; CFGC <DE2>; CFGD <D95>; CLLB <DE2>	06.11→	F 026 40 P 7023	O
		KZQ 1 987 42 S 9404	L
		1 987 43 M 2097	I
		1 987 43 R 2397 ⁸	I
	RLE	1 987 43 R 2597 ⁸	I

Q3 2.0 TFSI quattro

2,0 125 CCZC <D6G>	06.11-08.11	F 026 40 P 7080	O
	06.11→	KZQ 1 987 42 S 9404	L
		1 987 43 M 2097	I
		1 987 43 R 2397 ⁸	I
	RLE	1 987 43 R 2597 ⁸	I

2,0 | 155 | CPSA <D2D>

	06.11-08.11	F 026 40 P 7080	O
	06.11→	KZQ 1 987 42 S 9404	L
		1 987 43 M 2097	I
		1 987 43 R 2397 ⁸	I
	RLE	1 987 43 R 2597 ⁸	I

Q5 (8RB,8R7)

Q5 (8RB,8R7) 2.0 TDI quattro

2,0 100/105/120/125 CAGA <D92>; CAGB <D94>; CAHA <D93>; CAHB <D95>	11.08-09.10	1 457 42 P 9192	O
		1 987 43 R 2369 ⁸	I

2,0 | 120/125 | CGLA <D95>; CGLB <D93>

	05.10→	F 026 40 P 7023	O
		1 987 43 R 2369 ⁸	I

Q5 (8RB,8R7) 2.0 TDI, TDI quattro

2,0 100/105 CJCA <D92>; CJCB <D94>	05.10→	F 026 40 P 7023	O
		F 026 40 N 2068 ¹	K
		1 987 43 R 2369 ⁸	I

Q5 (8RB,8R7) 2.0 TFSI Hybrid quattro

2,0 155-180 CHJA <D69>	06.11-08.11	F 026 40 P 7080	O
	06.11→	1 987 43 R 2369 ⁸	I

Q5 (8RB,8R7) 2.0 TFSI quattro

2,0 132/155 CDNB <D64>; CDNC <D2D>	11.08→	F 026 40 P 7080	O
		1 987 43 R 2369 ⁸	I





2,0 155 CAEB <D2D>	05.10→	F 026 40 P 7080	O
		1987 43 R 2369 ⁸	I

Q5 (8RB,8R7) 3.0 TDI quattro

3,0 155/176 CCWA <D50>; CCWB <D1V>	11.08→	F 026 40 P 7002	O
		1987 43 R 2369 ⁸	I

Q5 (8RB,8R7) 3.2 FSI quattro

3,2 199 CALB <DC0>	11.08→	1457 42 P 9268	O
		1987 43 R 2369 ⁸	I

Q7**Q7 3.0 TDI**

3,0 150/176/180 CJGA <D50>; CJGC <D1Q>; CJGD <D43>; CJMA <D1Q>	05.10→	STZ 1987 42 S 9190	L
		F 026 40 N 2068 ¹	K
		1987 43 R 2431 ⁸	I

3,0 | 155 | BUN <D1V>

03.06-11.07	F 026 40 P 7002	O
	STZ 1987 42 S 9190	L
	F 026 40 N 2015	K
	1987 43 R 2431 ⁸	I

3,0 | 155/176 | CASA <D50>; CASB <D1V>

Fg.Nr. →4L..8..050 765	09.07-05.10	F 026 40 P 7002	O
Fg.Nr. 4L..8..050 766→	09.07-05.10	F 026 40 P 7066	O
	09.07-05.10	STZ 1987 42 S 9190	L
		F 026 40 N 2015	K
		1987 43 R 2431 ⁸	I

3,0 | 165/176 | CATA <D1T>; CCMA <D50>

11.08→	F 026 40 P 7066	O
	STZ 1987 42 S 9190	L
	F 026 40 N 2015	K
	1987 43 R 2431 ⁸	I

3,0 | 171 | BUG <D1D>

08.06-02.08	F 026 40 P 7002	O
03.08-05.08	F 026 40 P 7066	O
08.06-05.08	STZ 1987 42 S 9190	L
	F 026 40 N 2015	K
	1987 43 R 2431 ⁸	I

3,0 | 180 | CLZB <D43>

05.11→	STZ 1987 42 S 9190	L
	F 026 40 N 2068 ¹	K
	1987 43 R 2431 ⁸	I

3,0 | 180 | CRCA <D43>

05.11→	STZ 1987 42 S 9190	L
	F 026 40 N 2068 ¹	K
	1987 43 R 2431 ⁸	I

Q7 3.0 TFSI

3,0 200/206/245 CJTB <G1G>; CJTC <D08>; CJWB <G1G>; CJWC <D08>; CJWE <DC3>	05.10→	1457 42 P 9268	O
		STZ 1987 42 S 9190	L
		1987 43 R 2431 ⁸	I

3,0 | 245 | CNAA <D11>

05.10→	1457 42 P 9268	O
	STZ 1987 42 S 9190	L
	1987 43 R 2431 ⁸	I

Q7 3.6 FSI

3,6 206 BHK <D3B>	03.07-05.10	1457 42 P 9142	O
		STZ 1987 42 S 9190	L
		1987 43 R 2431 ⁸	I

Q7 4.2 FSI

4,2 257 BAR <T8T>	03.06-05.10	F 026 40 P 7011	O
		STZ 1987 42 S 9190	L
		1987 43 R 2431 ⁸	I

Q7 4.2 TDI

4,1 250 CCFC <D57>	05.10→	F 026 40 P 7066	O
		STZ 1987 42 S 9190	L
		F 026 40 N 2068 ¹	K
		1987 43 R 2431 ⁸	I

4,2 | 240 | BTR <D1S>

03.07-06.09	F 026 40 P 7002	O
	STZ 1987 42 S 9190	L
	F 026 40 N 2015	K
	1987 43 R 2431 ⁸	I

4,2 | 250 | CCFA <D57>

06.09-05.10	F 026 40 P 7066	O
	STZ 1987 42 S 9190	L
	F 026 40 N 2015	K
	1987 43 R 2431 ⁸	I

Q7 6.0 TDI

6,0 368 CCGA <D56>	09.08→	F 026 40 P 7066	O
		1987 43 R 2431 ⁸	I

RS3**RS3 2.5 TFSI quattro**

2,5 250 CEPA <D07>	01.11→	1457 42 P 9243	O
		0450 90 F 5959 ¹	K
		1987 43 R 2397 ⁸	I
	RLE	1987 43 R 2597 ⁸	I





RS4 (B5,B7)

RS4 (B5,B7) 2.7 quattro

2,7 280 ASJ; AZR	05.00-09.01	0 451 10 P 3314	O
		1 457 42 S 9870	L
		0 450 90 F 5906 ¹	K
		1 987 43 M 2017	I

RS4 (B5,B7) 4.2 quattro

4,2 309 BNS	11.05-06.08	F 026 40 P 7011	O
		F 026 40 F 3012 ¹	K
		1 987 43 M 2071	I
		1 987 43 R 2371 ⁸	I

RS5

RS5 4.2 FSI quattro

4,2 331 CFSA	03.10→	F 026 40 P 7011	O
		1 987 43 R 2369 ⁸	I

RS6

RS6 4.2 quattro

4,2 331/353 BCY; BRV	05.02-09.04	0 451 10 P 3314	O
		0 450 90 F 5002 ¹	K
		1 987 43 R 2371 ⁸	I

RS6 5.0 TFSI quattro

5,0 426 BUH	04.08→	F 026 40 P 7011	O
		F 026 40 F 3012 ¹	K

R8 (422,423,429)

R8 (422,423,429) 4.2 quattro

4,2 309 BYH	04.07-09.10	F 026 40 P 7011	O
		F 026 40 F 3012 ¹	K
		1 987 43 R 2422 ⁸	I

R8 (422,423,429) 4.2 quattro, Spyder quattro

4,2 316 CNDA	09.10→	F 026 40 P 7011	O
		F 026 40 F 3012 ¹	K

R8 (422,423,429) 5.2 GT quattro

5,2 412 CMPA <D85>	11.10→	F 026 40 P 7011	O
		1 987 43 M 2122	I
		1 987 43 R 2422 ⁸	I

R8 (422,423,429) 5.2 quattro, Spyder quattro

5,2 386 BUJ	04.09-05.12	F 026 40 P 7011	O
		F 026 40 F 3012 ¹	K
		1 987 43 R 2422 ⁸	I



S1

S1 1.4 TFSI

1,4 136 CAVG <DP4>	01.11→	F 026 40 S 0156	L
		0 450 90 F 5959 ¹	K

S1 2.0 TDI

2,0 100/105 CFHB <D92>; CFHD <D92>	09.11→	F 026 40 P 7023	O
--	--------	------------------------	----------

S3

S3 1.8 quattro

1,8 154/165 AMK; APY; AUL; BAM	08.98-06.03	0 451 10 P 3314	O
		1 457 43 S 3714	L
		0 450 90 F 5318 ¹	K
		H25 1 987 43 R 2312 ⁸	I
		H30 1 987 43 R 2300 ⁸	I

S3 2.0 TFSI quattro

2,0 188/195 BHZ; BZC	11.06-06.08	1 457 42 P 9243	O
		F 026 40 S 0178	L
PR-Nr. 1A2	11.06-06.08	0 450 90 F 5316 ¹	K
PR-Nr. 1A5	11.06-06.08	0 450 90 F 5959 ¹	K
	11.06-06.08	1 987 43 M 2097	I
		1 987 43 R 2397 ⁸	I
		RLE 1 987 43 R 2597 ⁸	I

2,0 | 188/195 | CDLA <D3Q>; CDLC <D81>

	07.08→	1 457 42 P 9243	O
		F 026 40 S 0178	L
		0 450 90 F 5959 ¹	K
		1 987 43 M 2097	I
		1 987 43 R 2397 ⁸	I
		RLE 1 987 43 R 2597 ⁸	I

S4 (B5,B6,B7,B8)

S4 (B5,B6,B7,B8) 2.7 Biturbo quattro

2,7 187 APB	10.97-09.01	1 987 43 M 2017	I
2,7 195 AGB	10.97-09.01	0 451 10 P 3313	O
		1 457 42 S 9870	L
		0 450 90 F 5906 ¹	K
		1 987 43 M 2017	I

2,7 195 AZB	11.00-09.01	0 451 10 P 3313	O
		1 457 42 S 9870	L
		0 450 90 F 5906 ¹	K
		1 987 43 M 2017	I

S4 (B5,B6,B7,B8) 3.0 TFSI quattro

3,0 245 CAKA <D11>; CCBA	03.09→	1 457 42 P 9268	O
		1 987 43 R 2369 ⁸	I



**S4 (B5,B6,B7,B8) 4.2 quattro**

4,2 253 BBK; BHF	03.03-03.09	F 026 40 P 7007	O
		0 450 90 F 5318 ¹	K
		1 987 43 M 2071	I
		1 987 43 R 2371 ⁸	I

S4 (C4)**S4 (C4) 2.2 quattro**

2,2 169 AAN	07.92-07.94	0 451 10 P 3314	O
		0 450 90 F 5145 ¹	K
	ZNE	1 987 43 M 2024	I
		1 987 43 R 2324 ⁸	I

S4 (C4) 4.2 quattro

4,2 206 ABH	07.92-07.94	0 451 10 P 3338	O
		1 457 42 S 9785	L
		0 450 90 F 5145 ¹	K
	ZNE	1 987 43 M 2024	I
		1 987 43 R 2324 ⁸	I

S5**S5 3.0 quattro, TFSI quattro**

3,0 245 CAKA <D11>; CCBA <D11>	05.09→	1 457 42 P 9268	O
		1 987 43 R 2369 ⁸	I

S5 4.2 quattro

4,2 260 CAUA <D0A>	06.07→	F 026 40 P 7011	O
		1 987 43 R 2369 ⁸	I

S6 (C4,C5)**S6 (C4,C5) 2.2 T quattro**

2,2 169 AAN	06.94-07.97	0 451 10 P 3314	O
		1 457 42 S 9777	L
		0 450 90 F 5145 ¹	K
	KL	1 987 43 M 2033	I
		1 987 43 R 2333 ⁸	I
	KL	1 987 43 M 2024	I
		1 987 43 R 2324 ⁸	I

S6 (C4,C5) 4.2 Plus quattro

4,2 240 AHK	06.96-10.97	0 451 10 P 3338	O
		1 457 43 S 3537	L
	08.96-10.97	0 450 90 F 5906 ¹	K
	06.96-10.97	KL 1 987 43 M 2033	I
		1 987 43 R 2333 ⁸	I
	KL	1 987 43 M 2024	I
		1 987 43 R 2324 ⁸	I

**S6 (C4,C5) 4.2 quattro**

4,2 213 AEC	09.94-07.97	0 451 10 P 3338	O
		1 457 42 S 9785	L
		0 450 90 F 5145 ¹	K
	KL	1 987 43 M 2033	I
		1 987 43 R 2333 ⁸	I
	KL	1 987 43 M 2024	I
		1 987 43 R 2324 ⁸	I

4,2 | 250 | ANK; AQJ; BBD

09.99-01.05	0 451 10 P 3348	O
	1 457 42 S 9870	L
	0 450 90 F 5906 ¹	K
	1 987 43 R 2371 ⁸	I

S6 (C4,C5) 5.2 FSI quattro

5,2 320 BXA <D75>	06.06→	F 026 40 P 7011	O
		F 026 40 F 3012 ¹	K
		1 987 43 R 2422 ⁸	I

S8**S8 4.2 quattro**

4,2 250 AHC; AKH	09.96-12.98	1 457 43 S 3537	L
	ZE	1 987 43 R 2367 ⁸	I

4,2 | 265 | AQH; AVP; AYS; BCS

05.99-09.02	1 457 42 P 9142	O
	1 457 43 S 3537	L
	ZE 1 987 43 R 2367 ⁸	I

S8 5.2 FSI quattro

5,2 331 BSM	06.06-07.10	F 026 40 P 7011	O
		F 026 40 F 3012 ¹	K
		1 987 43 M 2122	I
		1 987 43 R 2422 ⁸	I

TT**TT 1.8 T**

1,8 110 AUM	01.01-06.06	0 451 10 P 3314	O
		1 457 43 S 3714	L
		0 450 90 F 5318 ¹	K
		1 987 43 R 2300 ⁸	I

1,8 | 132 | APP

09.99-10.01	0 451 10 P 3314	O	
	1 457 43 S 3714	L	
	0 450 90 F 5318 ¹	K	
	11.99-09.00	1 987 43 M 2012	I
Fg.Nr. →8N..1..014 000	09.99-09.00	1 987 43 M 2012	I
Fg.Nr. 8N..1..014 001→	10.00-10.01	1 987 43 R 2300 ⁸	I





◀ TT 1.8 T

1,8 132 AUQ	08.00-06.06	0 451 10 P 3314 O
		1 457 43 S 3714 L
		0 450 90 F 5318 ¹ K
	09.00-06.06	1 987 43 R 2300 ⁸ I
Fg.Nr. →8N..1..014 000	08.00-09.00	1 987 43 M 2012 I
Fg.Nr. 8N..1..014 001→	10.00-06.06	1 987 43 R 2300 ⁸ I

TT 1.8 T quattro

1,8 132 ARY	09.00-05.05	0 451 10 P 3314 O
		1 457 43 S 3714 L
		0 450 90 F 5318 ¹ K
		1 987 43 R 2300 ⁸ I

1,8 132 AUQ	06.05-06.06	0 451 10 P 3314 O
		1 457 43 S 3714 L
		0 450 90 F 5318 ¹ K
		1 987 43 R 2300 ⁸ I

1,8 165 AMU	03.00-08.02	0 451 10 P 3314 O
		1 457 43 S 3714 L
		0 450 90 F 5318 ¹ K
Fg.Nr. →8N..1..014 000	03.00-09.00	1 987 43 M 2012 I
Fg.Nr. 8N..1..014 001→	10.00-08.02	1 987 43 R 2300 ⁸ I

1,8 165 APX	07.98-08.01	0 451 10 P 3314 O
		1 457 43 S 3714 L
		0 450 90 F 5318 ¹ K
Fg.Nr. →8N..1..014 000	07.98-09.00	1 987 43 M 2012 I
Fg.Nr. 8N..1..014 001→	10.00-08.01	1 987 43 R 2300 ⁸ I

TT 1.8 T, T quattro

1,8 120/132/140/165/180 AUQ <MQ7>; AWP; BAM; BEA; BFV <D7D>; BVP; BVR	09.00-06.06	0 451 10 P 3314 O
		1 457 43 S 3714 L
		0 450 90 F 5318 ¹ K
		1 987 43 R 2300 ⁸ I

1,8 132 AJQ	07.98-08.00	0 451 10 P 3314 O
		1 457 43 S 3714 L
		0 450 90 F 5318 ¹ K
		1 987 43 M 2012 I

1,8 132 ATC	03.99-08.00	0 451 10 P 3314 O
		1 457 43 S 3714 L
		0 450 90 F 5318 ¹ K
		1 987 43 M 2012 I

TT 1.8 TFSI

1,8 118 CDAA	06.08→	F 026 40 P 7080 O
		1 987 42 S 9404 L
		0 450 90 F 5959 ¹ K
		1 987 43 R 2397 ⁸ I
	RLE	1 987 43 R 2597 ⁸ I



TT 2.0 TDI quattro

2,0 125 CBBB	06.08-06.10	1 457 42 P 9192 O
		KZØ 1 987 42 S 9404 L
		F 026 40 N 2006 K
		1 987 43 R 2397 ⁸ I
	RLE	1 987 43 R 2597 ⁸ I

2,0 125 CFGB	05.10→	F 026 40 P 7023 O
		1 987 42 S 9404 L
		F 026 40 N 2006 K
		1 987 43 R 2397 ⁸ I
	RLE	1 987 43 R 2597 ⁸ I

TT 2.0 TFSI

2,0 147 BPY	03.07-05.09	1 457 42 P 9243 O
		1 457 43 S 3102 L
		0 450 90 F 5959 ¹ K
		1 987 43 R 2397 ⁸ I

2,0 147 BWA	07.06-06.10	1 457 42 P 9243 O
		1 457 43 S 3102 L
		0 450 90 F 5959 ¹ K
		1 987 43 R 2397 ⁸ I
	RLE	1 987 43 R 2597 ⁸ I

TT 2.0 TFSI quattro

2,0 147 CCZA	06.08-06.10	F 026 40 P 7080 O
		1 987 42 S 9404 L
		0 450 90 F 5959 ¹ K
		1 987 43 R 2397 ⁸ I
	RLE	1 987 43 R 2597 ⁸ I

2,0 195 CDMA	10.08→	1 457 42 P 9243 O
		0 450 90 F 5959 ¹ K
		1 987 43 R 2397 ⁸ I

2,0 195/200 CDLA; CDLB	05.08→	1 457 42 P 9243 O
		0 450 90 F 5959 ¹ K
		1 987 43 R 2397 ⁸ I
	RLE	1 987 43 R 2597 ⁸ I

TT 2.0 TFSI, TFSI quattro

2,0 147 CCTA	06.08-06.10	F 026 40 P 7080 O
		1 987 42 S 9404 L
		0 450 90 F 5959 ¹ K
		1 987 43 R 2397 ⁸ I

2,0 155 CESA; CETA <D2D>	05.10→	F 026 40 P 7080 O
		1 987 42 S 9404 L
		0 450 90 F 5959 ¹ K
		1 987 43 R 2397 ⁸ I
	RLE	1 987 43 R 2597 ⁸ I



**TT 2.5 TFSI quattro**

2,5 | 250/265 | CEPA; CEPA <D07>; CEPB <D06>

07.09→	1 457 42	P 9243	O
	0 450 90	F 5959 ¹	K
	1 987 43	R 2397 ⁸	I
RLE	1 987 43	R 2597 ⁸	I

TT 3.2 quattro

3,2 | 184 | BHE

07.03-06.06	1 457 42	P 9192	O
	1 457 43	S 3081	L
	0 450 90	F 5318 ¹	K
	1 987 43	R 2300 ⁸	I

3,2 | 184 | BUB

07.06-06.10	1 457 42	P 9192	O
	F 026 40	F 3006 ¹	K
	1 987 43	R 2397 ⁸	I
RLE	1 987 43	R 2597 ⁸	I

3,2 | 184 | CBRA

03.07→	1 457 42	P 9192	O
	F 026 40	F 3006 ¹	K
	1 987 43	R 2397 ⁸	I

V8**V8 3.6 quattro**

3,6 | 184 | PT

10.88-11.93	0 451 10	P 3338	O
	1 457 42	S 9785	L
	0 450 90	F 5906 ¹	K

Fg.Nr. →4C..N..000 000

10.88-07.91	1 987 43	M 2024	I
-------------	----------	---------------	----------

V8 4.2 quattro

4,2 | 206 | ABH

10.91-11.93	0 451 10	P 3338	O
	1 457 42	S 9785	L
	0 450 90	F 5906 ¹	K

80**80 1.6**

1,6 | 51/55 | PP; RN

09.86-12.91	0 451 10	P 3033	O
	1 457 42	S 9054	L
CSA	0 450 90	F 4149 ¹	K

1,6 | 52 | ABM

01.92-08.94	0 451 10	P 3033	O
	1 457 42	S 9054	L
	0 450 90	F 5906 ¹	K
	1 987 43	M 2017	I
	1 987 43	R 2317 ⁸	I

1,6 | 74 | ADA

06.93-07.95	0 451 10	P 3033	O
	1 457 42	S 9777	L
	0 450 90	F 5906 ¹	K
	1 987 43	M 2017	I
	1 987 43	R 2317 ⁸	I

1,6 | 75 | ABB

08.90-12.91	0 451 10	P 3033	O
03.92-08.93	0 451 10	P 3033	O
08.90-12.91	1 457 42	S 9994	L
03.92-08.93	1 457 42	S 9994	L
08.90-12.91	0 450 90	F 5145 ¹	K
03.92-08.93	0 450 90	F 5906 ¹	K
	1 987 43	M 2017	I
	1 987 43	R 2317 ⁸	I

80 1.6 TD

1,6 | 59 | SB

04.89-12.91	0 451 20	P 3012	O
	1 457 42	S 9994	L

80 1.8 E

1,8 | 82 | DZ

09.86-12.91	0 451 10	P 3033	O
	1 457 42	S 9994	L
	0 450 90	F 5145 ¹	K

80 1.8 quattro

1,8 | 82 | DZ

09.86-09.91	0 451 10	P 3033	O
	1 457 42	S 9994	L

Fg.Nr. 89..H..300 001→

02.87-09.91	0 450 90	F 5145 ¹	K
-------------	----------	----------------------------	----------

80 1.8 S

1,8 | 66 | JN

09.86-12.91	0 451 10	P 3033	O
	1 457 42	S 9994	L
	0 450 90	F 5145 ¹	K

1,8 | 66 | NE

08.86-12.91	0 451 10	P 3033	O
	1 457 42	S 9054	L
CSA	0 450 90	F 4149 ¹	K

80 1.8 S, S quattro

1,8 | 66 | PM

03.88-12.91	0 451 10	P 3033	O
	1 457 42	S 9054	L
	0 450 90	F 5145 ¹	K

80 1.9 D

1,9 | 47 | 1Y

08.89-12.91	0 451 20	P 3012	O
	1 457 42	S 9777	L
	1 457 43	N 4184 ²	K





80 1.9 TD

1,9 55 AAZ	09.91-07.95	0 451 10 P 3249 O
		1 457 42 S 9777 L
	G10	1 457 43 N 4184 ² K
		1 987 43 M 2017 I
		1 987 43 R 2317 ⁸ I

80 1.9 TDI

1,9 66 1Z	09.91-07.95	0 451 10 P 3249 O
		1 457 42 S 9777 L
	G10	1 457 43 N 4184 ² K
		1 987 43 M 2017 I
		1 987 43 R 2317 ⁸ I

80 2.0

2,0 66 ABT	09.91-06.95	0 451 10 P 3033 O
		1 457 42 S 9054 L
		0 450 90 F 5906 ¹ K
		1 987 43 M 2017 I
		1 987 43 R 2317 ⁸ I

2,0 101 6A	03.90-07.92	0 451 10 P 3314 O
		1 457 42 S 9994 L
	03.90-12.91	0 450 90 F 5145 ¹ K
	09.91-07.92	0 450 90 F 5906 ¹ K
		1 987 43 M 2017 I
		1 987 43 R 2317 ⁸ I

80 2.0 , quattro

2,0 85 AAD	08.90-12.91	0 451 10 P 3033 O
		1 457 42 S 9994 L
		0 450 90 F 5145 ¹ K

2,0 103 ACE	08.92-07.95	0 451 10 P 3314 O
		1 457 42 S 9994 L
		0 450 90 F 5906 ¹ K
		1 987 43 M 2017 I
		1 987 43 R 2317 ⁸ I

80 2.0 E

2,0 79 ADW	11.93-06.95	0 451 10 P 3033 O
		1 457 42 S 9777 L
		0 450 90 F 5906 ¹ K
		1 987 43 M 2017 I
		1 987 43 R 2317 ⁸ I

2,0 85 ABK	09.91-07.95	0 451 10 P 3033 O
		1 457 42 S 9777 L
		0 450 90 F 5906 ¹ K
		1 987 43 M 2017 I
		1 987 43 R 2317 ⁸ I



80 2.0 quattro

2,0 79 ADW	11.93-07.95	0 451 10 P 3314 O
		1 457 42 S 9777 L
		0 450 90 F 5906 ¹ K
		1 987 43 M 2017 I
		1 987 43 R 2317 ⁸ I

2,0 85 ABK	09.91-12.94	0 451 10 P 3314 O
		1 457 42 S 9777 L
		0 450 90 F 5906 ¹ K
		1 987 43 M 2017 I
		1 987 43 R 2317 ⁸ I

2,0 101 6A	09.91-07.92	0 451 10 P 3314 O
		1 457 42 S 9994 L
		0 450 90 F 5906 ¹ K
		1 987 43 M 2017 I
		1 987 43 R 2317 ⁸ I

80 2.0 16V quattro

2,0 101 6A	03.90-08.91	0 451 10 P 3314 O
		1 457 42 S 9994 L
		0 450 90 F 5145 ¹ K

80 2.2 RS2 quattro, S2 quattro

2,2 169/232 ABY;ADU	02.93-07.95	0 451 10 P 3314 O
		1 457 42 S 9777 L
		0 450 90 F 5906 ¹ K
		1 987 43 M 2017 I
		1 987 43 R 2317 ⁸ I

80 2.3 , E

2,3 98 NG	09.91-11.94	0 451 10 P 3033 O
		1 457 42 S 9994 L
		0 450 90 F 5906 ¹ K
		1 987 43 M 2017 I
		1 987 43 R 2317 ⁸ I

80 2.3 quattro

2,3 98 NG	04.87-11.94	0 451 10 P 3033 O
		1 457 42 S 9994 L
	04.87-08.91	0 450 90 F 5145 ¹ K
	09.91-11.94	0 450 90 F 5906 ¹ K
		1 987 43 M 2017 I
		1 987 43 R 2317 ⁸ I

80 2.6 E, quattro

2,6 102/110 ABC;ACZ		
Fg.Nr. →8C..S..025 820	07.92-08.94	0 451 10 P 3314 O
Fg.Nr. 8C..S..025 821→	09.94-07.95	0 451 10 P 3313 O
	07.92-07.95	1 457 42 S 9777 L
		0 450 90 F 5906 ¹ K
		1 987 43 M 2017 I
		1 987 43 R 2317 ⁸ I



**80 2.8 E, quattro****2,8|128|AAH**

Fg.Nr. →8C..S..025 820	09.91-08.94	0 451 10 P 3314	O
Fg.Nr. 8C..S..025 821→	09.94-07.95	0 451 10 P 3313	O
	09.91-07.95	1 457 42 S 9777	L
		0 450 90 F 5906 ¹	K
		1 987 43 M 2017	I
		1 987 43 R 2317 ⁸	I

90**90 1.6 TD****1,6|59|SB**

04.89-12.91	0 451 20 P 3012	O
	1 457 42 S 9994	L
08.89-12.91	1 457 43 N 4184 ²	K

90 1.8 E**1,8|82|DZ**

08.89-12.91	0 451 10 P 3033	O
	1 457 42 S 9994	L
	0 450 90 F 5145 ¹	K

90 2.0 , quattro**2,0|85/118|NM; PS**

05.87-12.91	0 451 10 P 3033	O
	1 457 42 S 9994	L
	0 450 90 F 5145 ¹	K

90 2.2 E, quattro**2,2|98|KV**

04.87-12.91	0 451 10 P 3033	O
	1 457 42 S 9994	L
	0 450 90 F 5145 ¹	K

90 2.3 , E, quattro**2,3|98/125|NG; 7A**

04.87-12.91	0 451 10 P 3033	O
	1 457 42 S 9994	L
	0 450 90 F 5145 ¹	K

90 2.8**2,8|128|AAH**

01.92-05.95	0 451 10 P 3314	O
	1 457 42 S 9777	L
	0 450 90 F 5906 ¹	K

100**100 1.6****1,6|75|ABB**

03.92-01.94	0 451 10 P 3033	O
	1 457 42 S 9777	L
	0 450 90 F 5145 ¹	K
ZNE	1 987 43 M 2024	I
	1 987 43 R 2324 ⁸	I

**100 1.8****1,8|66|JW**

12.93-07.98	0 451 10 P 3033	O	
	1 457 42 S 9054	L	
Fg.Nr. 44..J..200 100→	12.93-07.98 CSA	0 450 90 F 4149 ¹	K
	12.93-07.98	1 987 43 M 2024	I
		1 987 43 R 2324 ⁸	I

100 2.0**2,0|74/85|AAD; AAE; ABK**

12.90-07.94	0 451 10 P 3033	O
	1 457 42 S 9777	L
	0 450 90 F 5145 ¹	K
ZNE	1 987 43 M 2024	I
	1 987 43 R 2324 ⁸	I

2,0|79|ADW

12.93-07.94	0 451 10 P 3033	O
	1 457 42 S 9777	L
ZNE	1 987 43 M 2024	I
	1 987 43 R 2324 ⁸	I

2,0|103|ACE

01.92-07.94	0 451 10 P 3314	O
	1 457 42 S 9777	L
	0 450 90 F 5145 ¹	K
ZNE	1 987 43 M 2024	I
	1 987 43 R 2324 ⁸	I

100 2.0 quattro**2,0|74/85|AAD; AAE; ABK**

12.90-07.92	0 451 10 P 3033	O
	1 457 42 S 9777	L
	0 450 90 F 5145 ¹	K
ZNE	1 987 43 M 2024	I

2,0|103|ACE

01.92-07.94	0 451 10 P 3314	O
	1 457 42 S 9777	L
	0 450 90 F 5145 ¹	K
ZNE	1 987 43 M 2024	I

100 2.2 E**2,2|96|PR**

01.92-12.98	0 451 10 P 3033	O
	1 457 42 S 9061	L
	0 450 90 F 5091 ¹	K

100 2.3**2,3|98|AAR**

12.90-07.94	0 451 10 P 3033	O
	1 457 42 S 9777	L
	0 450 90 F 5145 ¹	K
ZNE	1 987 43 M 2024	I
	1 987 43 R 2324 ⁸	I





100 2.3 quattro

2,3 98 AAR			
	12.90-07.94	0 451 10 P 3033	O
		1 457 42 S 9777	L
		0 450 90 F 5145 ¹	K
	ZNE	1 987 43 M 2024	I

2,3 100 NF			
	08.86-08.91	0 451 10 P 3033	O
		1 457 42 S 9061	L
		0 450 90 F 5145 ¹	K
	08.89-08.91	ZNE	1 987 43 M 2024
			I

100 2.4 D

2,4 60 AAS			
	05.91-07.94	0 451 20 P 3223	O
		1 457 42 S 9792	L
		1 457 43 N 4184 ²	K
	ZNE	1 987 43 M 2024	I
		1 987 43 R 2324 ⁸	I

100 2.5 TDI

2,5 85 AAT			
	08.91-07.94	AG	0 451 10 P 3257
		GS	0 451 10 P 3253
			1 457 42 S 9792
		MWA	1 457 43 N 4405 ²
		ZNE	1 987 43 M 2024
			1 987 43 R 2324 ⁸

2,5 85 ABP			
	06.91-07.92	0 451 20 P 3012	O
		1 457 42 S 9792	L
		1 457 43 N 4405 ²	K
	ZNE	1 987 43 M 2024	I
		1 987 43 R 2324 ⁸	I

100 2.6

2,6 102 ACZ			
	01.93-07.94	0 451 10 P 3314	O
		1 457 42 S 9777	L
		0 450 90 F 5145 ¹	K
	ZNE	1 987 43 M 2024	I
		1 987 43 R 2324 ⁸	I

2,6 110 ABC			
	04.92-07.94	0 451 10 P 3314	O
		1 457 42 S 9777	L
		0 450 90 F 5145 ¹	K
	ZNE	1 987 43 M 2024	I
		1 987 43 R 2324 ⁸	I

100 2.6 E

2,6 110 ACZ			
	01.92-12.98	0 451 10 P 3313	O
		1 457 42 S 9777	L
		0 450 90 F 5091 ¹	K

100 2.6 quattro

2,6 102 ACZ			
	01.93-07.94	ZNE	1 987 43 M 2024
			I



2,6 110 ABC			
	03.92-07.94	0 451 10 P 3314	O
		1 457 42 S 9777	L
		0 450 90 F 5145 ¹	K
	ZNE	1 987 43 M 2024	I

100 2.8

2,8 128 AAH			
	12.90-07.94	0 451 10 P 3314	O
	09.93-07.94	0 451 10 P 3033	O
	12.90-07.94	1 457 42 S 9777	L
		0 450 90 F 5145 ¹	K
	ZNE	1 987 43 M 2024	I
		1 987 43 R 2324 ⁸	I

100 2.8 quattro

2,8 128 AAH			
	12.90-07.94	0 451 10 P 3314	O
		1 457 42 S 9777	L
		0 450 90 F 5145 ¹	K
	ZNE	1 987 43 M 2024	I

200

200 2.2 Turbo

2,2 121/140/147 MC;1B;2B			
	08.85-12.91	0 451 10 P 3033	O
		1 457 42 S 9061	L
		0 450 90 F 5145 ¹	K
	02.88-12.91	ZNE	1 987 43 M 2024
			I

AUSTIN

Maestro

Maestro 1.3 , City L, LS

1,3 45-49/50-51 A Plus; 12 H			
	03.83-09.92	MOK	0 451 10 P 4026
			O

Maestro 1.6

1,6 63/72 S Series			
	03.83-09.92	0 451 10 P 3298	O
	Fg.Nr. 367395→	01.86-09.92	1 457 43 S 3652
			L

Maestro 1.6 City L

1,6 63 16 H			
	Fg.Nr. (V) 367395→	01.86-09.92	0 451 10 P 3298
	Fg.Nr. 367395→	01.86-09.92	1 457 43 S 3652
			L

Maestro 1.6 MG

1,6 63/72 S Series			
	10.84-09.92	0 451 10 P 3298	O

Maestro 2.0 City L

2,0 45 MDI			
	Fg.Nr. (V) 367395→	01.86-09.92	0 451 10 P 3311
			1 457 43 N 4106 ²
			K





Maestro 2.0 i			
2,0 83 EFI O Series			
	10.84-09.92	0 451 10 P 4026	O
Fg.Nr. →367394	10.84-09.92	1 457 43 S 3652	L
	10.84-09.92	0 450 90 F 5030 ¹	K

Mini			
Mini 1.0 City			
1,0 29/31/33 A Plus			
	01.82-09.92	0 451 10 P 2056	O

AUTOBIANCHI *

Y 10			
Y 10 1.0 fire			
1,0 32 156 A 2.100 Ecotr.			
	03.89-09.92	0 451 10 P 3111	O
		1 457 43 S 2173	L
		0 450 90 F 4058 ¹	K

Y 10 1.0 fire i.e.			
1,0 33 156 A 2.246; 156 A 2.256 KAT			
	01.89-09.92	0 451 10 P 3111	O
		1 457 43 S 2173	L
		0 450 90 F 2151 ¹	K

Y 10 1.1 fire i.e., fire i.e. 4x4, i.e., i.e. ECVT, i.e. Selectronic, i.e. 4x4			
1,1 37/40/41/43 156 C 046 <ZM M1>; 156 C.000; 156 C.000 KAT; 156 C.046 KAT; 176 B 2.000 <ZM M3>			
	01.89-12.95	0 451 10 P 3111	O
		1 457 43 S 2173	L
		0 450 90 F 2151 ¹	K

Y 10 1.3 GT i.e., i.e.			
1,3 53/57 146 A 5.046 KAT; 146 A 5.046 MPI <ZM M2>; 146 B.000 <M6>			
	01.89-12.95	0 451 10 P 3351	O
		1 457 43 S 2205	L
		0 450 90 F 5005 ¹	K

BEDFORD

MIDI			
MIDI 2.0			
2,0 62 20 PET			
	03.88-08.92	0 451 10 P 3316	O

MIDI 2.0 D Turbo			
2,0 50 Isuzu 4 FG1 T			
	03.88-08.92	1 457 43 N 4435 ²	K

☐☐

MIDI 2.2 D			
2,2 45 22 DIE			
	03.88-08.92	AA	0 451 10 P 3316
			1 457 43 N 4435 ²
			O
			K

Rascal			
Rascal 99170, 99180			
1,0 34 FA 10 A			
	02.86-06.93	0 986 45 P 2019	O
		1 987 42 S 9042/1	L

BENTLEY

Brooklands			
Brooklands 6.8			
6,8 182 L 410 MN 1T			
	07.93-07.98	0 450 90 F 5200 ¹	K

Continental			
Continental 6.8 R			
6,8 286 L 410 MT 1T			
	05.94-12.95	0 450 90 F 5200 ¹	K

Turbo R, S			
Turbo R, S R			
6,8 265/286 L 410 MT; L 410 MT 1T			
	04.93-07.99	0 450 90 F 5200 ¹	K

BMW *

Serie X1 (E84)			
Serie X1 (E84) X 1 18 d sDrive, 18 d xDrive			
2,0 100-105 N47 D20C; N47 D20D			
	11.09→	F 026 40 P 7072	O
		F 026 40 S 0119	L
		1 987 43 M 2124	I
		1 987 43 R 2424 ⁸	I

Serie X1 (E84) X 1 18i sDrive			
2,0 100-110 N46 B20B			
	03.10→	1 457 42 P 9262	O
		F 026 40 S 0018	L

Serie X1 (E84) X 1 20 d ed sDrive			
2,0 120 N47 D20C; N47 D20D			
	09.11→	F 026 40 S 0119	L
		1 987 43 M 2124	I
		1 987 43 R 2424 ⁸	I





Serie X1 (E84) X 1 20 d sDrive, 20 d xDrive, 23 d xDrive

2,0 120-130/150 N47 D20C; N47 D20D	10.09→	F 026 40 P 7072	O
		F 026 40 S 0119	L
		1 987 43 M 2124	I
		1 987 43 R 2424⁸	I

Serie X1 (E84) X 1 25i xDrive, 28i xDrive

3,0 160/190 N20 B20A; N52 B30A <N52N>	10.09→	1 457 42 P 9269	O
		F 026 40 S 0029	L
		1 987 43 M 2124	I
		1 987 43 R 2424⁸	I

Serie X1 (E84) X 1 28i xDrive

2,0 180 N20 B20A	03.11→	F 026 40 S 0149	L
		1 987 43 M 2124	I
		1 987 43 R 2424⁸	I

Serie X3 (E83)

Serie X3 (E83) X 3 2.0 d

2,0 110 20 4D 4 <M 47N>	10.04-09.07	1 457 42 P 9185	O
		1 457 43 S 3588	L
		0 450 90 N 6457¹	K
		1 987 43 M 2036	I
		1 987 43 R 2336⁸	I

Serie X3 (E83) X 3 2.0 d, 18 d xDrive, 20 d xDrive

2,0 105/120-130 N47 D20...; N47 D20A; N47 D20C	09.07-08.10	F 026 40 P 7072	O
		F 026 40 S 0147	L
		0 450 90 N 6457¹	K
		1 987 43 M 2036	I
		1 987 43 R 2336⁸	I

Serie X3 (E83) X 3 2.0i, 20i xDrive

2,0 110 N46 B20B <NG4>	09.05-08.10	1 457 42 P 9262	O
		1 987 43 M 2036	I
		1 987 43 R 2336⁸	I

Serie X3 (E83) X 3 2.5 si, 25i xDrive

2,5 160 N52 B25... <NG6>	09.06-08.10	1 457 42 P 9269	O
		1 987 43 M 2036	I
		1 987 43 R 2336⁸	I

Serie X3 (E83) X 3 2.5i

2,5 141 25 6S 5 <M 54>	03.04-08.06	1 457 42 P 9102	O
		TRQ 1 457 43 S 3004	L
		1 987 43 M 2036	I
		1 987 43 R 2336⁸	I



Serie X3 (E83) X 3 3.0 d

3,0 150 30 6D 2 <M 57N>	01.04-09.05	1 457 42 P 9252	O
		1 457 43 S 3589	L
		0 450 90 N 6457¹	K
		1 987 43 M 2036	I
		1 987 43 R 2336⁸	I

Serie X3 (E83) X 3 3.0 d

3,0 160 30 6D 3 <M 57N2>	09.05-08.08	1 457 42 P 9252	O
	09.05-08.06	1 457 43 S 3589	L
	09.06-08.08	F 026 40 S 0147	L
	09.05-08.08	0 450 90 N 6457¹	K
		1 987 43 M 2036	I
		1 987 43 R 2336⁸	I

Serie X3 (E83) X 3 3.0 sd, 35 d xDrive

3,0 210 30 6D 5	09.06-08.10	1 457 42 P 9252	O
		F 026 40 S 0147	L
		0 450 90 N 6457¹	K
		1 987 43 M 2036	I
		1 987 43 R 2336⁸	I

Serie X3 (E83) X 3 3.0 si, 3.0i, 30i xDrive

3,0 160/200 N52 B30... <NG6>; N52 B30A <NG6>	09.06-08.10	1 457 42 P 9269	O
		1 987 43 M 2036	I
		1 987 43 R 2336⁸	I

Serie X3 (E83) X 3 3.0i

3,0 170 30 6S 3 <M 54>	01.04-08.06	1 457 42 P 9102	O
		TRQ 1 457 43 S 3004	L
		1 987 43 M 2036	I
		1 987 43 R 2336⁸	I

Serie X3 (E83) X 3 30 d xDrive

3,0 155-160 30 6D 3 <M 57N2>	09.08-08.10	1 457 42 P 9252	O
		F 026 40 S 0147	L
		0 450 90 N 6457¹	K
		1 987 43 M 2036	I
		1 987 43 R 2336⁸	I

Serie X3 (F25)

Serie X3 (F25) X 3 28i xDrive, 35i xDrive

3,0 190/225 N52 B30...; N55 B30A	10.10→	1 457 42 P 9269	O
--------------------------------------	--------	------------------------	----------

Serie X5 (E53)

Serie X5 (E53) X 5 3.0 d

3,0 135 30 6D 1 <M 57 D 30>	03.01-09.03	1 457 42 P 9118	O
		1 457 43 S 3589	L
		0 450 90 N 6451¹	K
		1 987 43 R 2425⁸	I





3,0 155-160 30 6D 2 <M 57N>			
10.03-10.06	1 457 42	P 9252	O
	1 457 43	S 3589	L
	0 450 90	N 6463 ¹	K
	1 987 43	R 2425 ⁸	I

Serie X5 (E53) X 5 3.0i

3,0 170 30 6S 3 <M 54>			
10.99-09.06	1 457 42	P 9102	O
	1 457 43	S 3067	L
10.99-04.02 DRR	0 450 90	F 5960 ¹	K
05.02-09.06 DRR	F 026 40	F 3000 ¹	K
10.99-09.06	1 987 43	R 2425 ⁸	I

Serie X5 (E53) X 5 4.4i

4,4 210 44 8S 2 <M 62 B 44>			
03.99-09.03	1 457 42	P 9141	O
	1 457 43	S 3698	L
03.99-04.02 DRR	0 450 90	F 5960 ¹	K
05.02-09.03 DRR	F 026 40	F 3000 ¹	K
03.99-09.03	1 987 43	R 2425 ⁸	I

4,4 235 N62 B44A <NGV8>			
10.03-10.06	F 026 40	P 7010	O
	1 457 43	S 3698	L
	DRR	F 026 40	F 3000 ¹
	1 987 43	R 2425 ⁸	I

Serie X5 (E53) X 5 4.6 is

4,6 255 46 8S 1 <M 62 B 46>			
02.02-09.03	1 457 42	P 9141	O
	1 457 43	S 3698	L
02.02-04.02 DRR	0 450 90	F 5960 ¹	K
05.02-09.03 DRR	F 026 40	F 3000 ¹	K
02.02-09.03	1 987 43	R 2425 ⁸	I

Serie X5 (E53) X 5 4.8 is

4,8 265 N62 B48A <NGV8>			
03.04-10.06	F 026 40	P 7010	O
	1 457 43	S 3698	L
	DRR	F 026 40	F 3000 ¹
	1 987 43	R 2425 ⁸	I

Serie X5 (E70)

Serie X5 (E70) X 5 M, 50i xDrive

4,4 300/408 N63 B44A; S63 B44A			
09.09→	2FE	1 987 43	M 2219
		1 987 43	R 2419 ⁸

Serie X5 (E70) X 5 3.0 d, 30 d xDrive

3,0 155-173 30 6D 3 <M 57N2>			
03.07-03.10	1 457 42	P 9252	O
	1 457 43	S 3589	L
	0 450 90	N 6457 ¹	K
	2FE	1 987 43	M 2219
		1 987 43	R 2419 ⁸

Serie X5 (E70) X 5 3.0 sd, 35 d xDrive

3,0 210 30 6D 5			
10.07-03.10	1 457 42	P 9252	O
	0 450 90	N 6457 ¹	K
	2FE	1 987 43	M 2219
		1 987 43	R 2419 ⁸

Serie X5 (E70) X 5 3.0 si, 30i xDrive, 35i xDrive

3,0 200/225 N52 B30... <NG6>; N55 B30A			
11.06→	1 457 42	P 9269	O
	2FE	1 987 43	M 2219
		1 987 43	R 2419 ⁸

Serie X5 (E70) X 5 4.8i, 48i xDrive

4,8 261 N62 B48B <NGV8>			
11.06-03.10	2FE	1 987 43	M 2219
		1 987 43	R 2419 ⁸

Serie X5 (E70) X 5 30 d xDrive

3,0 180 N57 D30A			
04.10→	EU6	0 450 90	N 6457 ¹
	2FE	1 987 43	M 2219
		1 987 43	R 2419 ⁸

Serie X5 (E70) X 5 40 d xDrive

3,0 225 N57 D30B			
04.10→		0 450 90	N 6457 ¹
	2FE	1 987 43	M 2219
		1 987 43	R 2419 ⁸

Serie X6 (E71)

Serie X6 (E71) X 6 M, 50i xDrive

4,4 300/408 N63 B44A; S63 B44A			
05.08→	2FE	1 987 43	M 2219
		1 987 43	R 2419 ⁸

Serie X6 (E71) X 6 30 d xDrive

3,0 173 30 6D 3 <M 57N2>			
05.08-03.10	1 457 42	P 9252	O
	1 457 43	S 3589	L
	0 450 90	N 6457 ¹	K
	2FE	1 987 43	M 2219
		1 987 43	R 2419 ⁸

Serie X6 (E71) X 6 35 d xDrive

3,0 180 N57 D30A			
04.10→	EU6	0 450 90	N 6457 ¹
	2FE	1 987 43	M 2219
		1 987 43	R 2419 ⁸

Serie X6 (E71) X 6 35 d xDrive

3,0 210 30 6D 5			
05.08-03.10	1 457 42	P 9252	O
	0 450 90	N 6457 ¹	K
	2FE	1 987 43	M 2219
		1 987 43	R 2419 ⁸





Serie X6 (E71) X 6 35i xDrive

3,0 225 N54 B30A; N55 B30A	03.08→		1 457 42 P 9269	O
		2FE	1 987 43 M 2219	I
			1 987 43 R 2419⁸	I

Serie X6 (E71) X 6 40 d xDrive

3,0 225 N57 D30B	04.10→		0 450 90 N 6457¹	K
		2FE	1 987 43 M 2219	I
			1 987 43 R 2419⁸	I

Serie X6 (E72)

Serie X6 (E72) X 6 Active Hybrid

4,4 357 N63 B44A	12.09→	2FE	1 987 43 M 2219	I
			1 987 43 R 2419⁸	I

Serie Z1

Serie Z1 Z 1

2,5 125 25 6K 1 <M 20 B 25>	07.88-06.91		0 451 10 P 3086	O
			1 457 42 S 9964	L
			0 450 90 F 5901¹	K

Serie Z3 (E36/7;E36/8)

Serie Z3 (E36/7;E36/8) Z 3 M 3.2

3,2 179 32 6S 2 <S 52 B 32>	09.97-07.00		1 457 42 P 9264	O
			1 457 43 S 3004	L
			0 450 90 F 5905¹	K

3,2 236 32 6S 1 <S 50 B 32>; 32 6S 1/3 <S 50 B 32>	11.96-12.00		1 457 42 P 9264	O
			1 457 43 S 3004	L
		XXX	0 450 90 N 5942¹	K

3,2 239 32 6S 4 <S 54 B 32>	02.01-09.02		1 457 42 P 9264	O
			1 457 43 S 3004	L

Serie Z3 (E36/7;E36/8) Z 3 1.8

1,8 85 18 4E 2 <M 43 B 18>	03.95-12.98	KSF	1 457 42 P 9108	O
			1 457 43 S 3697	L
			0 450 90 F 5905¹	K

Serie Z3 (E36/7;E36/8) Z 3 1.9

1,9 87/103 19 4E 1 <M 43 B 19>; 19 4S 1 <M 44 B 19>	09.95-09.02	KSF	1 457 42 P 9108	O
			1 457 43 S 3697	L
			0 450 90 F 5905¹	K

Serie Z3 (E36/7;E36/8) Z 3 2.0

2,0 110 20 6S 4 <M 52 B 20>	04.99-12.00		1 457 42 P 9102	O
		TRQ	1 457 43 S 3004	L
			0 450 90 F 5905¹	K



Serie Z3 (E36/7;E36/8) Z 3 2.2i

2,2 125 22 6S 1 <M 54>	09.00-09.02		1 457 42 P 9102	O
		TRQ	1 457 43 S 3004	L
		DRR	0 450 90 F 5952¹	K

Serie Z3 (E36/7;E36/8) Z 3 2.5

2,5 125 25 6S 4 <M 52 B 25>	09.98-09.00		1 457 42 P 9102	O
			1 457 43 S 3004	L
			0 450 90 F 5905¹	K

Serie Z3 (E36/7;E36/8) Z 3 2.5i

2,5 141 25 6S 5 <M 54>	09.00-06.02		1 457 42 P 9102	O
			1 457 43 S 3085	L
		DRR	0 450 90 F 5952¹	K

Serie Z3 (E36/7;E36/8) Z 3 2.8

2,8 142 28 6S 1/2 <M 52 B 28>	11.96-09.00		1 457 42 P 9102	O
		TRQ	1 457 43 S 3004	L
			0 450 90 F 5905¹	K

Serie Z3 (E36/7;E36/8) Z 3 3.0i

3,0 170 30 6S 3 <M 54>	05.00-06.02		1 457 42 P 9102	O
		TRQ	1 457 43 S 3004	L
		DRR	0 450 90 F 5952¹	K

Serie Z4 (E85;E86;E89)

Serie Z4 (E85;E86;E89) Z 4 M 3.2

3,2 252 32 6S 4 <S 54>	02.06-08.08		1 457 42 P 9264	O
			1 457 43 S 3094	L
			1 987 43 M 2068	I
			1 987 43 R 2368⁸	I

Serie Z4 (E85;E86;E89) Z 4 2.0i

2,0 110 N46 B20... <NG4>	03.05-03.09		1 457 42 P 9262	O
			1 987 43 M 2068	I
			1 987 43 R 2368⁸	I

Serie Z4 (E85;E86;E89) Z 4 2.2i

2,2 125 22 6S 1	10.03-11.05		1 457 42 P 9102	O
		TRQ	1 457 43 S 3004	L
			1 987 43 M 2068	I
			1 987 43 R 2368⁸	I

Serie Z4 (E85;E86;E89) Z 4 2.5 si, 2.5i

2,5 130/160 N52 B25... <NG6>	02.06-03.09		1 457 42 P 9269	O
			1 987 43 M 2068	I
			1 987 43 R 2368⁸	I





Serie Z4 (E85;E86;E89) Z 4 2.5i

2,5 141 25 6S5 <M 54>			
	10.02-01.06	1 457 42 P 9102	O
		FR 1 457 43 S 3004	L
		1 987 43 M 2068	I
		1 987 43 R 2368 ⁸	I

Serie Z4 (E85;E86;E89) Z 4 3.0 si

3,0 195 N52 B30... <NG6>			
	02.06-08.08	1 457 42 P 9269	O
		1 987 43 M 2068	I
		1 987 43 R 2368 ⁸	I

Serie Z4 (E85;E86;E89) Z 4 3.0i

3,0 160 N52 B30A <NG6>			
	02.06-08.08	1 457 42 P 9269	O

3,0 170 30 6S3 <M 54>			
	10.02-01.06	1 457 42 P 9102	O
		FR 1 457 43 S 3004	L
		1 987 43 M 2068	I
		1 987 43 R 2368 ⁸	I

Serie Z4 (E85;E86;E89) Z 4 20i sDrive, 28i sDrive

2,0 135/180 N20 B20A			
	09.11→	F 026 40 S0149	L
		1 987 43 M 2068	I
		1 987 43 R 2368 ⁸	I

Serie Z4 (E85;E86;E89) Z 4 23i sDrive

2,5 150 N52 B25...			
	04.09→	1 457 42 P 9269	O
		F 026 40 S0149	L
		1 987 43 M 2068	I
		1 987 43 R 2368 ⁸	I

Serie Z4 (E85;E86;E89) Z 4 30i sDrive

3,0 190 N52 B30...			
	04.09→	1 457 42 P 9269	O
		F 026 40 S0149	L
		1 987 43 M 2068	I
		1 987 43 R 2368 ⁸	I

Serie Z4 (E85;E86;E89) Z 4 35i sDrive, 35is sDrive

3,0 225/250 N54 B30A			
	04.09→	1 457 42 P 9269	O
		F 026 40 S0148	L
		1 987 43 M 2068	I
		1 987 43 R 2368 ⁸	I

Serie Z8

Serie Z8 Z 8

5,0 294 50 8S1 <S 62 B 50>			
	03.00-07.03	1 457 42 P 9141	O
		ZE 1 457 43 S 3698	L
		0 450 90 F 5950 ¹	K



Serie 1 (E81;E82;E87;E88)

Serie 1 (E81;E82;E87;E88) M

3,0 250 N54 B30A <NG6>			
	04.11→	1 457 42 P 9269	O
		F 026 40 S0148	L
		1 987 43 M 2124	I
		1 987 43 R 2424 ⁸	I

Serie 1 (E81;E82;E87;E88) 116 d

2,0 85 N47 D20...			
	03.09→	F 026 40 P 7072	O
		F 026 40 S0119	L
		0 450 90 N 6457 ¹	K
		1 987 43 M 2124	I
		1 987 43 R 2424 ⁸	I

Serie 1 (E81;E82;E87;E88) 116 i

1,6 85 N45 B16A <NG4>			
	09.04→	1 457 42 P 9262	O
	09.04-02.07	F 026 40 S 0095	L
	03.07→	F 026 40 S 0018	L
	09.04→	1 987 43 M 2124	I
		1 987 43 R 2424 ⁸	I

1,6 90 N43 B16A <NG4>			
	09.07→	1 457 42 P 9262	O
		F 026 40 S 0095	L
		1 987 43 M 2124	I
		1 987 43 R 2424 ⁸	I

2,0 90 N43 B20A <NG4>			
	03.09→	1 457 42 P 9262	O
		F 026 40 S 0018	L
		1 987 43 M 2124	I
		1 987 43 R 2424 ⁸	I

Serie 1 (E81;E82;E87;E88) 118 d

2,0 90 20 4D 4 <M 47N>			
	09.04-03.07	1 457 42 P 9185	O
		1 457 43 S 3588	L
		0 450 90 N 6457 ¹	K
		1 987 43 M 2124	I
		1 987 43 R 2424 ⁸	I

2,0 100-105 N47 D20...; N47 D20C			
	03.07→	F 026 40 P 7072	O
		F 026 40 S0119	L
		0 450 90 N 6457 ¹	K
		1 987 43 M 2124	I
		1 987 43 R 2424 ⁸	I

Serie 1 (E81;E82;E87;E88) 118 i

2,0 95/100/105 N43 B20A <NG4>; N46 B20B <NG4>			
	11.04→	1 457 42 P 9262	O
		F 026 40 S 0018	L
		1 987 43 M 2124	I
		1 987 43 R 2424 ⁸	I





Serie 1 (E81;E82;E87;E88) 120 d

2,0 120 20 4D 4 <M 47N>	09.04-03.07	1 457 42 P 9185	O
		1 457 43 S 3588	L
		0 450 90 N 6457 ¹	K
		1 987 43 M 2124	I
		1 987 43 R 2424 ⁸	I

2,0 120-130 N47 D20...	03.07→	F 026 40 P 7072	O
		F 026 40 S 0119	L
		0 450 90 N 6457 ¹	K
		1 987 43 M 2124	I
		1 987 43 R 2424 ⁸	I

Serie 1 (E81;E82;E87;E88) 120 i

2,0 110/115/120-125 N43 B20A <NG4>; N46 B20... <NG4>	09.04→	1 457 42 P 9262	O
		F 026 40 S 0018	L
		1 987 43 M 2124	I
		1 987 43 R 2424 ⁸	I

Serie 1 (E81;E82;E87;E88) 123 d

2,0 150 N47 D20B	09.07→	F 026 40 P 7072	O
		F 026 40 S 0119	L
		0 450 90 N 6457 ¹	K
		1 987 43 M 2124	I
		1 987 43 R 2424 ⁸	I

Serie 1 (E81;E82;E87;E88) 125 i

3,0 160 N52 B30... <NG6>	03.08→	1 457 42 P 9269	O
		F 026 40 S 0029	L
		1 987 43 M 2124	I
		1 987 43 R 2424 ⁸	I

Serie 1 (E81;E82;E87;E88) 130 i

3,0 190/195 N52 B30... <NG6>	09.05→	1 457 42 P 9269	O
		F 026 40 S 0029	L
		1 987 43 M 2124	I
		1 987 43 R 2424 ⁸	I

Serie 1 (E81;E82;E87;E88) 135 i

3,0 225 N54 B30A <NG6>	10.07-02.10	1 457 42 P 9269	O
		F 026 40 S 0148	L
		1 987 43 M 2124	I
		1 987 43 R 2424 ⁸	I

3,0 225 N55 B30A <NG6>	03.10→	1 457 42 P 9269	O
		1 987 43 M 2124	I
		1 987 43 R 2424 ⁸	I



Serie 3 (E30)

Serie 3 (E30) M 3

2,3 143-158 23 4E A/S 2 <S 14 B 23...>	03.88-09.91	0 451 10 P 3050	O
		1 457 42 S 9928	L
		0 450 90 F 5201 ¹	K

Serie 3 (E30) 316 i

1,6 73-75 16 4E 1 <M 40 B 16>	09.88-06.94	ALD	1 457 42 P 9760	O
		KSF	1 457 42 P 9108	O
			1 457 42 S 9964	L
	10.89-06.94		0 450 90 F 5901 ¹	K

Serie 3 (E30) 318 i

1,8 83-85 18 4E 1 <M 40 B 18>	09.87-06.94	ALD	1 457 42 P 9760	O
		KSF	1 457 42 P 9108	O
			1 457 42 S 9964	L
	10.89-06.94		0 450 90 F 5901 ¹	K

1,8 103 18 4S 1 <M 42 B 18>	07.90-12.92	ALD	1 457 42 P 9760	O
		KSF	1 457 42 P 9108	O
			1 457 42 S 9964	L
			0 450 90 F 5201 ¹	K

Serie 3 (E30) 318 is

1,8 100 18 4S 1 <M 42 B 18>	09.89-12.91	ALD	1 457 42 P 9760	O
		KSF	1 457 42 P 9108	O
			1 457 42 S 9964	L
			0 450 90 F 5901 ¹	K

Serie 3 (E30) 320 i

2,0 90-95 20 6E E/20 6K A <M 20 B 20>	12.85-12.93	0 451 10 P 3086	O
		1 457 42 S 9964	L
	10.89-12.93		0 450 90 F 5901 ¹

Serie 3 (E30) 324 td

2,4 85 24 6T B <M 21 D 24>	01.88-12.93	1 457 42 P 9636	O
		1 457 42 S 9983	L
	01.89-12.93		1 457 43 N 4186 ²

Serie 3 (E30) 325 i, iX

2,5 125 25 6K 1 <M 20 B 25 Kat.>	12.86-12.93	0 451 10 P 3086	O	
		12.86-01.93	BAN	1 457 42 S 9928
		KAD	1 457 42 S 9964	L
	07.87-12.93		1 457 42 S 9964	L
	10.89-12.93		0 450 90 F 5901 ¹	K

2,5 126 25 6E 1/2 <M 20 B 25>	09.85-01.93	0 451 10 P 3086	O	
		BAN	1 457 42 S 9928	L
		KAD	1 457 42 S 9964	L
			0 450 90 F 5201 ¹	K





Serie 3 (E36)

Serie 3 (E36) M 3

3,0|179|30 6S 2

09.93-12.96	1 457 42	P 9264	O
	1 457 43	S 3004	L
09.93-09.94	0 450 90	F 5201 ¹	K
10.94-12.96	0 450 90	F 5905 ¹	K
09.93-12.96	1 987 43	M 2002	I

3,0|210|30 6S 1 <S 50 B 30..>

09.92-12.95	1 457 42	P 9264	O
	1 457 43	S 3004	L
09.92-09.94	0 450 90	F 5901 ¹	K
01.94-12.95	0 450 90	F 5905 ¹	K
09.92-12.95	KL	1 987 43	M 2002
	2FE, KL	1 987 43	M 2104

3,0|210|30 6S 1 <S50 B30>

09.92-12.94	1 457 43	S 3004	L
	0 450 90	F 5901 ¹	K

Serie 3 (E36) M 3 3.2

3,2|179|32 6S 2 <S 52 B 32>

10.95-05.99	1 457 42	P 9264	O
	1 457 43	S 3004	L
	0 450 90	F 5905 ¹	K
	1 987 43	M 2002	I

3,2|236|32 6S 1 <S 50 B 32..>; 32 6S 1/3 <S 50 B 32..>

10.95-12.99	1 457 42	P 9264	O
	1 457 43	S 3004	L
	XXX	0 450 90	N 5942 ¹
	KL	1 987 43	M 2002
	2FE, KL	1 987 43	M 2104

Serie 3 (E36) 316 g

1,6|64-75|16 4E 2 <M 43 B 16..Gas CNG>

11.95-09.00	KSF	1 457 42	P 9108	O
		1 457 43	S 3697	L
		0 450 90	F 5905 ¹	K
	2FE, KL	1 987 43	M 2104	I

Serie 3 (E36) 316 i

1,6|73-75|16 4E 1 <M 40 B 16>

09.90-02.94	ALD	1 457 42	P 9760	O
	KSF	1 457 42	P 9108	O
		1 457 42	S 9964	L
		0 450 90	F 5901 ¹	K
	KL	1 987 43	M 2002	I
	2FE, KL	1 987 43	M 2104	I

1,6|75|16 4E 2 <M 43 B 16>

09.93-09.95	ALD	1 457 42	P 9760	O
09.93-09.00	KSF	1 457 42	P 9108	O
09.93-09.95		1 457 42	S 9964	L
10.95-09.00		1 457 43	S 3697	L
09.93-09.94		0 450 90	F 5901 ¹	K
10.94-09.00		0 450 90	F 5905 ¹	K
09.93-12.99	KL	1 987 43	M 2002	I
09.93-09.00	2FE, KL	1 987 43	M 2104	I

1,8|85|18 4E 1 <M40 B18>

10.91-10.94	ALD	1 457 42	P 9760	O
	KSF	1 457 42	P 9108	O
		1 457 42	S 9964	L
		0 450 90	F 5901 ¹	K

1,9|77|19 4E 1 <M 43 B 19>

12.98-09.00	KSF	1 457 42	P 9108	O
		1 457 43	S 3697	L
		0 450 90	F 5905 ¹	K
	2FE, KL	1 987 43	M 2104	I

Serie 3 (E36) 318 i

1,8|83-85|18 4E 1 <M 40 B 18>

12.90-02.94	ALD	1 457 42	P 9760	O
	KSF	1 457 42	P 9108	O
		1 457 42	S 9964	L
		0 450 90	F 5901 ¹	K
	KL	1 987 43	M 2002	I
	2FE, KL	1 987 43	M 2104	I

1,8|85|18 4E 2 <M 43 B 18>

11.92-09.95	ALD	1 457 42	P 9760	O
11.92-12.99	KSF	1 457 42	P 9108	O
11.92-09.95		1 457 42	S 9964	L
10.95-12.99		1 457 43	S 3697	L
09.93-09.94		0 450 90	F 5901 ¹	K
10.94-12.99		0 450 90	F 5905 ¹	K
09.93-12.99	KL	1 987 43	M 2002	I
	2FE, KL	1 987 43	M 2104	I

1,8|103|18 4S 1 <M 42 B 18>

03.92-09.95	ALD	1 457 42	P 9760	O
03.92-10.96	KSF	1 457 42	P 9108	O
03.92-03.94		1 457 42	S 9964	L
04.94-10.96		1 457 43	S 3697	L
03.92-09.94		0 450 90	F 5901 ¹	K
10.94-10.96		0 450 90	F 5905 ¹	K
09.93-09.96		1 987 43	M 2002	I

1,9|103|19 4S 1 <M 44 B 19>

09.95-12.98	KSF	1 457 42	P 9108	O
		1 457 43	S 3697	L
		0 450 90	F 5905 ¹	K
		1 987 43	M 2002	I





Serie 3 (E36) 318 is

1,8 103 18 4S 1 <M 42 B 18>				
03.92-09.95	ALD	1 457 42	P 9760	O
03.92-12.96	KSF	1 457 42	P 9108	O
03.92-06.94	TRQ	1 457 42	S 9964	L
07.94-12.96		1 457 43	S 3697	L
03.92-09.94		0 450 90	F 5901 ¹	K
10.94-12.96		0 450 90	F 5905 ¹	K
03.92-12.96	KL	1 987 43	M 2002	I
	2FE, KL	1 987 43	M 2104	I

1,9 103 19 4S 1 <M 44 B 19>				
03.95-08.99	KSF	1 457 42	P 9108	O
		1 457 43	S 3697	L
		0 450 90	F 5905 ¹	K
	KL	1 987 43	M 2002	I
	2FE, KL	1 987 43	M 2104	I

Serie 3 (E36) 318 tds

1,7 66 17 4T 1 <M 41 D 18>				
10.94-09.00		1 457 42	P 9275	O
		1 457 43	S 3616	L
		1 457 43	N 4324 ²	K
10.94-12.99	KL	1 987 43	M 2002	I
10.94-09.00	2FE, KL	1 987 43	M 2104	I

Serie 3 (E36) 318 ti

1,8 103 18 4S 1 <M 42 B 18>				
09.94-09.95	ALD	1 457 42	P 9760	O
09.94-09.96	KSF	1 457 42	P 9108	O
		1 457 43	S 3697	L
		0 450 90	F 5905 ¹	K
	2FE, KL	1 987 43	M 2104	I

1,9 103 19 4S 1 <M 44 B 19>				
12.95-09.00	KSF	1 457 42	P 9108	O
		1 457 43	S 3697	L
		0 450 90	F 5905 ¹	K
	2FE, KL	1 987 43	M 2104	I

Serie 3 (E36) 320 i

2,0 95 20 6S 1/2 <M 50 B 20>				
10.91-10.96		1 457 42	P 9638	O
		1 457 43	S 3004	L
10.94-10.96		0 450 90	F 5905 ¹	K

2,0 109 20 6S 1/2 <M 50 B 20>				
09.93-03.95		1 457 42	P 9638	O

2,0 110 20 6S 1/2 <M 50 B 20>				
09.90-12.95		1 457 42	P 9638	O
		1 457 43	S 3004	L
09.90-09.94		0 450 90	F 5201 ¹	K
10.94-12.95		0 450 90	F 5905 ¹	K
09.90-12.95	KL	1 987 43	M 2002	I
	2FE, KL	1 987 43	M 2104	I

2,0 110 20 6S 2 <M 50 B 20>				
03.93-12.95		1 457 42	P 9638	O
	TRQ	1 457 43	S 3004	L
03.93-09.94		0 450 90	F 5201 ¹	K
10.94-12.95		0 450 90	F 5905 ¹	K
03.93-12.95	KL	1 987 43	M 2002	I
	2FE, KL	1 987 43	M 2104	I



2,0 110 20 6S 2 <M 52 B 20>				
04.95-08.96		1 457 42	P 9638	O

2,0 110 20 6S 3 <M 52 B 20>				
09.94-09.95	ALD	1 457 42	P 9638	O
10.95-12.99	KSF	1 457 42	P 9102	O
09.94-12.99	TRQ	1 457 43	S 3004	L
		0 450 90	F 5905 ¹	K
	KL	1 987 43	M 2002	I
	2FE, KL	1 987 43	M 2104	I

Serie 3 (E36) 323 i

2,4 140 24 6S 2 <M 52>				
03.96-04.99		1 457 42	P 9102	O
	TRQ	1 457 43	S 3004	L
		0 450 90	F 5905 ¹	K
	KL	1 987 43	M 2002	I
	2FE, KL	1 987 43	M 2104	I

2,5 125 25 6S 3 <M 52 B 25>				
10.94-09.95	ALD	1 457 42	P 9638	O
10.95-06.99		1 457 42	P 9102	O
10.95-09.99	KSF	1 457 42	P 9102	O
10.94-09.99	TRQ	1 457 43	S 3004	L
		0 450 90	F 5905 ¹	K
	KL	1 987 43	M 2002	I
	2FE, KL	1 987 43	M 2104	I

2,5 125 25 6S 3 <M 52 B 25>				
10.96-10.98		1 457 42	P 9102	O
		1 457 43	S 3004	L
		0 450 90	F 5905 ¹	K

Serie 3 (E36) 323 ti

2,5 125 25 6S 3 <M 52 B 25>				
06.97-09.00		1 457 42	P 9102	O
	TRQ	1 457 43	S 3004	L
		0 450 90	F 5905 ¹	K
	2FE, KL	1 987 43	M 2104	I

Serie 3 (E36) 325 i

2,5 138 25 6S 1/2 <M 50 B 25>				
04.91-08.95		1 457 42	P 9638	O
		1 457 43	S 3004	L
04.91-03.94		0 450 90	F 5201 ¹	K

2,5 141 25 6S 1/2 <M 50 B 25>				
09.90-12.95		1 457 42	P 9638	O
		1 457 43	S 3004	L
09.90-09.94		0 450 90	F 5201 ¹	K
10.94-12.95		0 450 90	F 5905 ¹	K
09.90-12.95	KL	1 987 43	M 2002	I
	2FE, KL	1 987 43	M 2104	I

2,5 141 25 6S 2 <M 50 B 25>				
03.93-12.95		1 457 42	P 9638	O
		1 457 43	S 3004	L
03.93-09.94		0 450 90	F 5201 ¹	K
10.94-12.95		0 450 90	F 5905 ¹	K
03.93-12.95	KL	1 987 43	M 2002	I
	2FE, KL	1 987 43	M 2104	I



Serie 3 (E36) 325 is

2,5 141 25 6S 1/2 <M 50 B 25>				
03.91-09.95		1 457 42	P 9638	O
		1 457 43	S 3004	L
03.91-09.94		0 450 90	F 5201 ¹	K
10.94-09.95		0 450 90	F 5905 ¹	K
03.91-09.95		1 987 43	M 2002	I

Serie 3 (E36) 325 td

2,5 85 25 6T 1 <M 51 D 25>				
09.91-12.98	ALD	1 457 42	P 9123	O
	KSF	1 457 42	P 9139	O
		1 457 42	S 9793	L
09.91-01.95		1 457 43	N 4187 ²	K
02.95-12.98		1 457 43	N 4324 ²	K
09.91-12.98	KL	1 987 43	M 2002	I
	2FE, KL	1 987 43	M 2104	I

Serie 3 (E36) 325 tds

2,5 105 25 6T 1 <M 51 D 25>				
05.93-12.99	ALD	1 457 42	P 9123	O
	KSF	1 457 42	P 9139	O
		1 457 42	S 9793	L
		1 457 43	N 4324 ²	K
	KL	1 987 43	M 2002	I
	2FE, KL	1 987 43	M 2104	I

Serie 3 (E36) 328 i

2,8 142 28 6S 1 <M 52 B 28>				
10.94-09.95	ALD	1 457 42	P 9638	O
10.95-12.99	KSF	1 457 42	P 9102	O
10.94-12.99	TRQ	1 457 43	S 3004	L
		0 450 90	F 5905 ¹	K
	KL	1 987 43	M 2002	I
	2FE, KL	1 987 43	M 2104	I

Serie 3 (E46)

Serie 3 (E46) M 3

3,2 252 32 6S 4 <S 54 B 32>				
09.00-08.06		1 457 42	P 9264	O
		1 457 43	S 3004	L
		1 987 43	M 2036	I
		1 987 43	R 2336 ⁸	I

Serie 3 (E46) M 3 CSL

3,2 265 32 6S 4 <S 54 B 32>				
03.03-12.03		1 457 42	P 9264	O
		1 987 43	M 2036	I
		1 987 43	R 2336 ⁸	I



Serie 3 (E46) 316 i

1,6 75 16 4E 3 <M 43 B 16>				
04.98-09.02	KSF	1 457 42	P 9108	O
		1 457 43	S 3004	L
10.99-09.02	TRQ	1 457 43	S 3004	L
04.98-09.02		0 450 90	F 5905 ¹	K
		1 987 43	M 2036	I
		1 987 43	R 2336 ⁸	I

1,9|77|19 4E 1 <M 43 B 19>

04.98-09.02	KSF	1 457 42	P 9108	O
	TRQ	1 457 43	S 3004	L
		0 450 90	F 5905 ¹	K
		1 987 43	M 2036	I
		1 987 43	R 2336 ⁸	I

Serie 3 (E46) 316 i, ti

1,6 85 N40 B16A <NG4>; N45 B16A <NG4>				
03.02-05.06		1 457 42	P 9262	O
	TRQ	1 457 43	S 3093	L
	DRR	0 450 90	F 5952 ¹	K
		1 987 43	M 2036	I
		1 987 43	R 2336 ⁸	I

1,8|85|N42 B18A <NG4>; N46 B18A <NG4>

06.01-09.05		1 457 42	P 9262	O
	TRQ	1 457 43	S 3093	L
	DRR	0 450 90	F 5952 ¹	K
		1 987 43	M 2036	I
		1 987 43	R 2336 ⁸	I

Serie 3 (E46) 318 d

2,0 85 20 4D 1 <M 47 D 20>				
09.01-03.03		1 457 42	P 9119	O
		1 457 43	S 3588	L
		1 457 43	N 1708	K
		1 987 43	M 2036	I
		1 987 43	R 2336 ⁸	I

Serie 3 (E46) 318 d, td

2,0 85 20 4D 4 <M 47N>				
03.03-09.05		1 457 42	P 9185	O
		1 457 43	S 3588	L
		0 450 90	N 6450 ¹	K
		1 987 43	M 2036	I
		1 987 43	R 2336 ⁸	I

Serie 3 (E46) 318 i

1,9 87 19 4E 1 <M 43 B 19>				
04.98-09.01	KSF	1 457 42	P 9108	O
	TRQ	1 457 43	S 3004	L
		0 450 90	F 5905 ¹	K
		1 987 43	M 2036	I
		1 987 43	R 2336 ⁸	I

Serie 3 (E46) 318 i A

1,9 88 M43TU				
10.01→		1 457 43	S 3093	L
		1 987 43	M 2036	I





Serie 3 (E46) 318 i, ti

2,0 105-110 N42 B20A <NG4>; N46 B20... <NG4>			
09.01-08.06	1 457 42	P 9262	O
	TRQ 1 457 43	S 3093	L
	DRR 0 450 90	F 5952¹	K
		1 987 43	M 2036 I
		1 987 43	R 2336⁸ I

Serie 3 (E46) 320 d

2,0 100 20 4D 1 <M 47 D 20>			
04.98-09.01	1 457 42	P 9119	O
	1 457 43	S 3588	L
	1 457 43	N 1708	K
	1 987 43	M 2036	I
	1 987 43	R 2336⁸	I

Serie 3 (E46) 320 d, td

2,0 110 20 4D 4 <M 47N>			
09.01-08.06	1 457 42	P 9185	O
	1 457 43	S 3588	L
	0 450 90	N 6450¹	K
	1 987 43	M 2036	I
	1 987 43	R 2336⁸	I

Serie 3 (E46) 320 i

2,0 100 20 6S 4			
04.98-09.00	1 457 42	P 9102	O
	0 450 90	F 5905¹	K

2,0 110 20 6S 4 <M 52 B 20>			
04.98-09.01	1 457 42	P 9102	O
	TRQ 1 457 43	S 3004	L
	0 450 90	F 5905¹	K
	1 987 43	M 2036	I
	1 987 43	R 2336⁸	I

2,2 120-125 22 6S 1 <M 54>			
09.00-08.06	1 457 42	P 9102	O
	TRQ 1 457 43	S 3004	L
	DRR 0 450 90	F 5952¹	K
	1 987 43	M 2036	I
	1 987 43	R 2336⁸	I

Serie 3 (E46) 323 i

2,4 135 24 6S 3			
03.99-12.03	1 457 42	P 9102	O
	TRQ 1 457 43	S 3004	L
	0 450 90	F 5905¹	K
	1 987 43	M 2036	I
	1 987 43	R 2336⁸	I

2,5 125 25 6S 4 <M 52 B 25>			
04.98-09.00	1 457 42	P 9102	O
	TRQ 1 457 43	S 3004	L
10.98-09.00	1 457 43	S 3085	L
04.98-09.00	0 450 90	F 5905¹	K
	1 987 43	M 2036	I
	1 987 43	R 2336⁸	I



Serie 3 (E46) 325 i

2,5 137 25 6S 6 <M 56>			
09.02-05.06	1 457 42	P 9102	O
	1 457 43	S 3085	L
	1 987 43	M 2036	I
	1 987 43	R 2336⁸	I

Serie 3 (E46) 325 i, ti, xi

2,5 141 25 6S 5 <M 54>			
09.00-08.06	1 457 42	P 9102	O
	TRQ 1 457 43	S 3004	L
	DRR 0 450 90	F 5952¹	K
	1 987 43	M 2036	I
	1 987 43	R 2336⁸	I

Serie 3 (E46) 328 i

2,8 142 28 6S 2 <M 52 B 28>			
04.98-09.00	1 457 42	P 9102	O
	TRQ 1 457 43	S 3004	L
	0 450 90	F 5905¹	K
	1 987 43	M 2036	I
	1 987 43	R 2336⁸	I

Serie 3 (E46) 330 d, xd

3,0 135 30 6D 1 <M 57 D 30>			
10.99-04.03	1 457 42	P 9118	O
	1 457 43	S 3589	L
	0 450 90	N 6451¹	K
	1 987 43	M 2036	I
	1 987 43	R 2336⁸	I

3,0 150 30 6D 2 <M 57N>			
03.03-08.06	1 457 42	P 9252	O
	1 457 43	S 3589	L
	0 450 90	N 6450¹	K
	1 987 43	M 2036	I
	1 987 43	R 2336⁸	I

Serie 3 (E46) 330 i, xi

3,0 170 30 6S 3 <M 54>			
05.00-08.06	1 457 42	P 9102	O
	TRQ 1 457 43	S 3004	L
	DRR 0 450 90	F 5952¹	K
	1 987 43	M 2036	I
	1 987 43	R 2336⁸	I

Serie 3 (E90;E91;E92;E93)

Serie 3 (E90;E91;E92;E93) 316 d

2,0 85 N47 D20C			
09.09-02.10	F 026 40	P 7072	O
09.09-→	F 026 40	S 0119	L
	1 987 43	M 2124	I
	1 987 43	R 2424⁸	I

2,0 85 N47 D20C <N47N>			
03.10-→	F 026 40	S 0119	L
	1 987 43	M 2124	I
	1 987 43	R 2424⁸	I





Serie 3 (E90;E91;E92;E93) 316 i

1,6 85 N45 B16A <NG4>			
09.05→	1 457 42	P 9262	O
09.05-08.07	F 026 40	S 0095	L
09.07→	F 026 40	S 0018	L
09.05→	1 987 43	M 2124	I
	1 987 43	R 2424⁸	I

1,6 90 N43 B16A <NG4>			
09.07→	1 457 42	P 9262	O
	F 026 40	S 0095	L
	1 987 43	M 2124	I
	1 987 43	R 2424⁸	I

Serie 3 (E90;E91;E92;E93) 318 d

2,0 90 20 4D 4 <M 47N>			
09.05-09.07	1 457 42	P 9185	O
	1 457 43	S 3588	L
	1 987 43	M 2124	I
	1 987 43	R 2424⁸	I

2,0 100-105 N47 D20...			
09.07-02.10	F 026 40	P 7072	O
09.07→	F 026 40	S 0119	L
	1 987 43	M 2124	I
	1 987 43	R 2424⁸	I

Serie 3 (E90;E91;E92;E93) 318 i

2,0 95-100 N46 B20... <NG4>; N46 B20B <NG4>			
09.05→	1 457 42	P 9262	O
	F 026 40	S 0018	L
	1 987 43	M 2124	I
	1 987 43	R 2424⁸	I

2,0 100-105 N43 B20A <NG4>			
09.07→	1 457 42	P 9262	O
	F 026 40	S 0018	L
	1 987 43	M 2124	I
	1 987 43	R 2424⁸	I

2,0 105 N43 B20A <NG4>			
03.10→	1 457 42	P 9262	O
	F 026 40	S 0018	L
	F 026 40	S 0095	L
	1 987 43	M 2124	I
	1 987 43	R 2424⁸	I

Serie 3 (E90;E91;E92;E93) 320 d

2,0 110/120 20 4D 4 <M 47N>			
03.05-09.07	1 457 42	P 9185	O
	1 457 43	S 3588	L
	1 987 43	M 2124	I
	1 987 43	R 2424⁸	I

Serie 3 (E90;E91;E92;E93) 320 d, d ed, d xDrive

2,0 120-135 N47 D20C <N47N>			
03.10→	F 026 40	S 0119	L
	1 987 43	M 2124	I
	1 987 43	R 2424⁸	I



Serie 3 (E90;E91;E92;E93) 320 d, d xDrive

2,0 130 N47 D20...; N47 D20C			
03.07-03.10	F 026 40	P 7072	O
	F 026 40	S 0119	L
	1 987 43	M 2124	I
	1 987 43	R 2424⁸	I

Serie 3 (E90;E91;E92;E93) 320 i, si

2,0 110-115/120-125/127 N43 B20A <NG4>; N45 B20A <NG4>; N46 B20... <NG4>; N46 B20B <NG4>			
03.05→	1 457 42	P 9262	O
	F 026 40	S 0018	L
	1 987 43	M 2124	I
	1 987 43	R 2424⁸	I

Serie 3 (E90;E91;E92;E93) 323 i

2,5 130 N52 B25... <NG6>; N52 B25A <NG6>			
09.05→	1 457 42	P 9269	O
	F 026 40	S 0029	L
	1 987 43	M 2124	I
	1 987 43	R 2424⁸	I

Serie 3 (E90;E91;E92;E93) 325 d

3,0 145 30 6D 3 <M 57N2>			
09.06-02.10	1 457 42	P 9252	O
	1 457 43	S 3589	L
	1 987 43	M 2124	I
	1 987 43	R 2424⁸	I

3,0 150 N57 D30A			
03.10→	F 026 40	S 0119	L
	1 987 43	M 2124	I
	1 987 43	R 2424⁸	I

Serie 3 (E90;E91;E92;E93) 325 i, i xDrive, xi

2,5 160 N52 B25... <NG6>; N52 B25A <NG6>			
03.05→	1 457 42	P 9269	O
	F 026 40	S 0029	L
	1 987 43	M 2124	I
	1 987 43	R 2424⁸	I

3,0 155-160 N53 B30A <NG6>			
03.07→	1 457 42	P 9269	O
	F 026 40	S 0029	L
	1 987 43	M 2124	I
	1 987 43	R 2424⁸	I

Serie 3 (E90;E91;E92;E93) 325 i, xi

3,0 160 N52 B30A <NG6>			
09.05-08.06	1 457 42	P 9269	O
	F 026 40	S 0030	L
	1 987 43	M 2124	I
	1 987 43	R 2424⁸	I





Serie 3 (E90;E91;E92;E93) 328 i

3,0 170-172 N51 B30A <NG6>	09.06→	1 457 42 P 9269	O
		F 026 40 S 0030	L
		1 987 43 M 2124	I
		1 987 43 R 2424 ⁸	I

Serie 3 (E90;E91;E92;E93) 330 d, d xDrive

3,0 180 N57 D30A	09.08→	F 026 40 S 0119	L
		1 987 43 M 2124	I
		1 987 43 R 2424 ⁸	I

Serie 3 (E90;E91;E92;E93) 330 d, xd

3,0 170 30 6D 3 <M 57N2>	09.05-02.09	1 457 42 P 9252	O
		1 457 43 S 3589	L
		1 987 43 M 2124	I
		1 987 43 R 2424 ⁸	I

Serie 3 (E90;E91;E92;E93) 330 i, i xDrive, xi

3,0 190-200 N52 B30... <NG6>; N52 B30A <NG6>; N53 B30A <NG6>	03.05→	1 457 42 P 9269	O
		F 026 40 S 0029	L
		1 987 43 M 2124	I
		1 987 43 R 2424 ⁸	I

Serie 3 (E90;E91;E92;E93) 335 d

3,0 210 30 6D 5; 30 6D 5 <M 57...>	09.06→	1 457 42 P 9252	O
		F 026 40 S 0119	L
		1 987 43 M 2124	I
		1 987 43 R 2424 ⁸	I

Serie 3 (E90;E91;E92;E93) 335 i, i xDrive

3,0 225 N55 B30A <NG6>	03.10→	1 457 42 P 9269	O
		1 987 43 M 2124	I
		1 987 43 R 2424 ⁸	I

Serie 3 (E90;E91;E92;E93) 335 i, i xDrive, xi

3,0 225 N54 B30A <NG6>	09.06-02.10	1 457 42 P 9269	O
		F 026 40 S 0148	L
		1 987 43 M 2124	I
		1 987 43 R 2424 ⁸	I

Serie 5 (E34)

Serie 5 (E34) M 5 , 3.8

3,8 240-250 38 6S 1 <S 38 B 38...>	03.92-12.95	1 457 42 P 9755	O
		1 457 42 S 9814	L
		0 450 90 F 5201 ¹	K
	KL	1 987 43 M 2032	I



Serie 5 (E34) M 5 3.6

3,6 232 36 6S 1 <S 38 B 36...>	10.88-12.94	1 457 42 P 9755	O
		1 457 42 S 9814	L
		0 450 90 F 5201 ¹	K
	06.90-12.93 KL	1 987 43 M 2032	I

Serie 5 (E34) 518 g

1,8 75-85 18 4E 2 <M 43 B 18...Gas CNG>	11.95-06.96	KSF	1 457 42 P 9108	O
			1 457 42 S 9964	L
			0 450 90 F 5201 ¹	K
		KL	1 987 43 M 2032	I

Serie 5 (E34) 518 i

1,8 83-85 18 4E 1 <M 40 B 18>; 18 4E 2 <M 43 B 18>	09.89-09.95	ALD	1 457 42 P 9760	O
	09.89-12.96	KSF	1 457 42 P 9108	O
			1 457 42 S 9964	L
			0 450 90 F 5201 ¹	K
	06.90-12.96	KL	1 987 43 M 2032	I

Serie 5 (E34) 520 i

2,0 100 20 6S 1/2 <M 50 B 20>	10.90-12.94		1 457 42 S 9814	L
			0 450 90 F 5201 ¹	K

Serie 5 (E34) 520 i

2,0 110 20 6S 1/2 <M 50 B 20>	09.89-12.96		1 457 42 P 9638	O
			1 457 42 S 9814	L
			0 450 90 F 5201 ¹	K
	06.90-12.96	KL	1 987 43 M 2032	I

Serie 5 (E34) 524 td

2,4 85 24 6T B <M 21 D 24>	03.88-12.91		1 457 42 P 9251	O
		RLE	1 457 42 S 9781	L
	11.88-12.91		1 457 43 N 4186 ²	K
	03.88-12.91	KL	1 987 43 M 2032	I

Serie 5 (E34) 525 i

2,5 141 25 6S 1 <M 50 B 25>	10.90-01.93		1 457 42 S 9814	L
			0 450 90 F 5201 ¹	K

Serie 5 (E34) 525 i

2,5 141 25 6S 2 <M 50 B 25>	01.93-12.96		1 457 42 S 9814	L
			0 450 90 F 5201 ¹	K

Serie 5 (E34) 525 i, ix

2,5 141 25 6S 1/2 <M 50 B 25>	09.89-12.96		1 457 42 P 9638	O
			1 457 42 S 9814	L
			0 450 90 F 5201 ¹	K
	06.90-12.96	KL	1 987 43 M 2032	I





Serie 5 (E34) 525 td, tds

2,5 85/105 25 6T 1 <M 51 D 25>				
09.91-12.96	ALD	1 457 42	P 9123	O
	KSF	1 457 42	P 9139	O
		1 457 42	S 9793	L
	RLE	1 457 42	S 9781	L
09.91-01.95		1 457 43	N 4187²	K
02.95-12.96		1 457 43	N 4324²	K
09.91-12.96	KL	1 987 43	M 2032	I

Serie 5 (E34) 530 i

3,0 160 30 8S 1 <M 60 B 30>				
09.92-09.95	I27	1 457 42	P 9121	O
09.92-12.96	I36	1 457 42	P 9141	O
		1 457 43	S 3698	L
09.92-03.94		0 450 90	F 5201¹	K
04.94-12.96		0 450 90	F 5905¹	K
09.92-12.96	KL	1 987 43	M 2032	I

Serie 5 (E34) 535 i

3,5 155 34 6K B <M 30 B 35>				
01.88-12.94		1 457 42	P 9755	O
		1 457 42	S 9869	L
		0 450 90	F 5201¹	K
06.90-04.93	KL	1 987 43	M 2032	I

Serie 5 (E34) 540 i

4,0 210 40 8S 1 <M 60 B 40>				
09.92-09.95	I27	1 457 42	P 9121	O
09.92-12.96	I36	1 457 42	P 9141	O
		1 457 43	S 3698	L
09.92-04.95	ZE	0 450 90	F 5901¹	K
05.95-12.96		0 450 90	F 5905¹	K
09.92-12.96	KL	1 987 43	M 2032	I

Serie 5 (E39)

Serie 5 (E39) M 5

5,0 294 50 8S 1 <S 62 B 50>				
10.98-07.03		1 457 42	P 9141	O
	ZE	1 457 43	S 3698	L
01.99-12.02		1 457 43	S 3698	L
10.98-07.03		0 450 90	F 5950¹	K
	2FE	1 987 43	R 2361⁸	I

Serie 5 (E39) 520 d

2,0 100 20 4D 1 <M 47 D 20>				
04.00-07.03		1 457 42	P 9119	O
		1 457 43	S 3588	L
		0 450 90	N 6451¹	K
	2FE	1 987 43	R 2361⁸	I

Serie 5 (E39) 520 i

2,0 100-110 20 6S 3/4 <M 52 B 20>				
09.95-06.03		1 457 42	P 9102	O
	TRQ	1 457 43	S 3004	L
		0 450 90	F 5905¹	K
	2FE	1 987 43	R 2361⁸	I



2,2 120-125 22 6S 1 <M 54>				
09.00-05.04		1 457 42	P 9102	O
	TRQ	1 457 43	S 3004	L
	DRR	0 450 90	F 5960¹	K
	2FE	1 987 43	R 2361⁸	I

Serie 5 (E39) 523 i

2,4 135 24 6S 3 <M 52>				
03.99-12.02		1 457 42	P 9102	O
		1 457 43	S 3085	L
		0 450 90	F 5905¹	K
	2FE	1 987 43	R 2361⁸	I

2,4|140|24 6S 2 <M 52>

03.97-09.98		1 457 42	P 9102	O
	TRQ	1 457 43	S 3004	L
		0 450 90	F 5905¹	K
	2FE	1 987 43	R 2361⁸	I

2,5|125|25 6S 3/4 <M 52 B 25>

09.95-09.00		1 457 42	P 9102	O
	TRQ	1 457 43	S 3004	L
		0 450 90	F 5905¹	K
	2FE	1 987 43	R 2361⁸	I

2,5|125|25 6S 4

09.98-08.00		1 457 42	P 9102	O
		1 457 43	S 3004	L
		0 450 90	F 5905¹	K
	2FE	1 987 43	R 2361⁸	I

Serie 5 (E39) 525 d

2,5 120 25 6D 1				
04.00-05.04		1 457 42	P 9118	O
		1 457 43	S 3589	L
		0 450 90	N 6451¹	K
	2FE	1 987 43	R 2361⁸	I

Serie 5 (E39) 525 i

2,5 141 25 6S 5 <M 54>				
09.00-05.04		1 457 42	P 9102	O
	TRQ	1 457 43	S 3004	L
	DRR	0 450 90	F 5960¹	K
	2FE	1 987 43	R 2361⁸	I

Serie 5 (E39) 525 td, tds

2,5 85/105 25 6T 1 <M 51 D 25>				
01.96-09.00		1 457 42	P 9139	O
		1 457 42	S 9793	L
		1 457 43	N 4324²	K
	2FE	1 987 43	R 2361⁸	I

Serie 5 (E39) 528 i

2,8 142 28 6S 1 <M 52 B 28>				
06.96-09.98		1 457 42	P 9102	O
		1 457 43	S 3004	L
		0 450 90	F 5905¹	K
	2FE	1 987 43	R 2361⁸	I





◀ Serie 5 (E39) 528 i

2,8 142 28 6S 1/2 <M 52 B 28>			
09.95-09.00	1 457 42	P 9102	O
	TRQ	1 457 43 S 3004	L
		0 450 90 F 5905 ¹	K
	2FE	1 987 43 R 2361 ⁸	I

2,8 142 28 6S 2 <M 52 B 28>			
09.98-01.00	1 457 42	P 9102	O

Serie 5 (E39) 530 d

3,0 135-142 30 6D 1 <M 57 D 30>			
08.98-05.04	1 457 42	P 9118	O
		1 457 43 S 3589	L
08.98-03.00	1 457 43	N 4324 ²	K
04.00-05.04	0 450 90	N 6451 ¹	K
08.98-05.04	2FE	1 987 43 R 2361 ⁸	I

Serie 5 (E39) 530 i

3,0 170 30 6S 3 <M 54>			
09.00-05.04	1 457 42	P 9102	O
	TRQ	1 457 43 S 3004	L
	DRR	0 450 90 F 5960 ¹	K
	2FE	1 987 43 R 2361 ⁸	I

Serie 5 (E39) 535 i

3,5 173-180 35 8S 1/2 <M 62 B 35>			
01.96-07.03	1 457 42	P 9141	O
		1 457 43 S 3698	L
01.96-09.98	0 450 90	F 5905 ¹	K
10.98-07.03	DRR	0 450 90 F 5960 ¹	K
01.96-07.03	2FE	1 987 43 R 2361 ⁸	I

Serie 5 (E39) 540 i

4,4 210 44 8S 1/2 <M 62 B 44>			
01.96-05.04	1 457 42	P 9141	O
		1 457 43 S 3698	L
01.96-09.98	0 450 90	F 5905 ¹	K
10.98-05.04	DRR	0 450 90 F 5960 ¹	K
01.96-05.04	2FE	1 987 43 R 2361 ⁸	I

Serie 5 (E60;E61)

Serie 5 (E60;E61) M 5

5,0 373 S85 B50A			
11.04-08.10	2FE	1 987 43 M 2102	I
		1 987 43 R 2402 ⁸	I

Serie 5 (E60;E61) 520 d

2,0 110/120 20 4D 4 <M 47N>			
09.05-02.08	1 457 42	P 9185	O
		1 457 43 S 3588	L
		0 450 90 N 6457 ¹	K
	2FE	1 987 43 M 2102	I
		1 987 43 R 2402 ⁸	I

2,0 | 130 | N47 D20...

09.07-08.10	F 026 40	P 7072	O
		1 457 43 S 3164	L
		0 450 90 N 6457 ¹	K
	2FE	1 987 43 M 2102	I
		1 987 43 R 2402 ⁸	I



Serie 5 (E60;E61) 520 i

2,0 115/125 N43 B20A <NG4>; N46 B20B <NG4>			
09.07-08.10	1 457 42	P 9262	O
		1 457 43 S 3101	L
	2FE	1 987 43 M 2102	I
		1 987 43 R 2402 ⁸	I

2,2 | 125 | 22 6S 1 <M 54>

07.03-03.05	1 457 42	P 9102	O
		1 457 43 S 3094	L
		0 450 90 F 5960 ¹	K
	2FE	1 987 43 M 2102	I
		1 987 43 R 2402 ⁸	I

Serie 5 (E60;E61) 523 i

2,5 130/140 N52 B25... <NG6>; N53 B25A <NG6>			
03.05-08.10	1 457 42	P 9269	O
		1 457 43 S 3094	L
	2FE	1 987 43 M 2102	I
		1 987 43 R 2402 ⁸	I

Serie 5 (E60;E61) 525 d

2,5 120/130 25 6D 2			
05.04-03.07	1 457 42	P 9252	O
		1 457 43 S 3589	L
		0 450 90 N 6457 ¹	K
	2FE	1 987 43 M 2102	I
		1 987 43 R 2402 ⁸	I

Serie 5 (E60;E61) 525 d, d xDrive, xd

3,0 145 30 6D 3 <M 57N2>			
03.07-08.10	1 457 42	P 9252	O
		1 457 43 S 3589	L
		0 450 90 N 6457 ¹	K
	2FE	1 987 43 M 2102	I
		1 987 43 R 2402 ⁸	I

Serie 5 (E60;E61) 525 i

2,5 141 25 6S 5 <M 54>			
09.03-03.05	1 457 42	P 9102	O
		1 457 43 S 3094	L
	2FE	1 987 43 M 2102	I
		1 987 43 R 2402 ⁸	I

Serie 5 (E60;E61) 525 i, i xDrive, xi

3,0 160 N52 B30A <NG6>; N53 B30A <NG6>			
09.05-08.10	1 457 42	P 9269	O
		1 457 43 S 3094	L
	2FE	1 987 43 M 2102	I
		1 987 43 R 2402 ⁸	I

Serie 5 (E60;E61) 525 i, Li, xi

2,5 160 N52 B25... <NG6>; N52 B25A <NG6>			
03.05-08.10	1 457 42	P 9269	O
		1 457 43 S 3094	L
	2FE	1 987 43 M 2102	I
		1 987 43 R 2402 ⁸	I



Serie 5 (E60;E61) 528 i

3,0 172 N52 B30A <NG6>	03.07-02.10	1 457 42 P 9269	O
		1 457 43 S 3094	L
	2FE	1 987 43 M 2102	I
		1 987 43 R 2402 ⁸	I

Serie 5 (E60;E61) 530 d, d xDrive, xd

3,0 160/170/173 30 6D 2 <M 57N>; 30 6D 3 <M 57N2>	07.03-08.10	1 457 42 P 9252	O
		1 457 43 S 3589	L
		0 450 90 N 6457 ¹	K
	2FE	1 987 43 M 2102	I
1 987 43 R 2402 ⁸		I	

Serie 5 (E60;E61) 530 i

3,0 170 30 6S 3 <M 54>	07.03-03.05	1 457 42 P 9102	O
		1 457 43 S 3094	L
	2FE	1 987 43 M 2102	I
		1 987 43 R 2402 ⁸	I

Serie 5 (E60;E61) 530 i, i xDrive, xi

3,0 190/200 N52 B30... <NG6>; N52 B30A <NG6>; N53 B30A <NG6>	03.05-08.10	1 457 42 P 9269	O
		1 457 43 S 3094	L
	2FE	1 987 43 M 2102	I
		1 987 43 R 2402 ⁸	I

Serie 5 (E60;E61) 535 d

3,0 200/210 30 6D 4; 30 6D 5	09.04-08.10	1 457 42 P 9252	O
		1 457 43 S 3164	L
		0 450 90 N 6457 ¹	K
	2FE	1 987 43 M 2102	I
1 987 43 R 2402 ⁸		I	

Serie 5 (E60;E61) 535 i

3,0 225 N54 B30A <NG6>	03.07-02.10	1 457 42 P 9269	O
		F 026 40 S 0148	L
	2FE	1 987 43 M 2102	I
		1 987 43 R 2402 ⁸	I

Serie 5 (E60;E61) 540 i

4,0 225 N62 B40A <NGV8>	09.05-02.10	1 457 43 S 3101	L
		1 987 43 M 2102	I
	2FE	1 987 43 R 2402 ⁸	I

Serie 5 (E60;E61) 545 i

4,4 245 N62 B44A <NGV8>	09.03-09.05	F 026 40 P 7010	O
		1 457 43 S 3101	L
		1 987 43 M 2102	I
	2FE	1 987 43 R 2402 ⁸	I



Serie 5 (E60;E61) 550 i

4,8 270 N62 B48B <NGV8>	09.05-08.10	1 457 43 S 3101	L
		1 987 43 M 2102	I
	2FE	1 987 43 R 2402 ⁸	I

Serie 5 (F07)

Serie 5 (F07) 530 d, d xDrive

3,0 155/180 N57 D30A	10.09→	0 450 90 N 6457 ¹	K
		1 987 43 R 2315 ⁸	I

Serie 5 (F07) 535 i, i xDrive

3,0 225 N55 B30A	10.09→	1 457 42 P 9269	O
		1 987 43 R 2315 ⁸	I

Serie 5 (F10;F11)

Serie 5 (F10;F11) M 5

4,4 412 S63 B44B	09.11→	2FE	1 987 43 R 2315 ⁸	I
------------------	--------	-----	------------------------------	---

Serie 5 (F10;F11) 520 d

2,0 135 N47 D20C <N47N>	05.10→	0 450 90 N 6457 ¹	K
		1 987 43 R 2315 ⁸	I

Serie 5 (F10;F11) 523 i

2,5 150 N52 B25... <N52N>	03.10→	1 457 42 P 9269	O
		1 987 43 R 2315 ⁸	I

3,0 150 N53 B30A	03.10→	1 457 42 P 9269	O
		1 987 43 R 2315 ⁸	I

Serie 5 (F10;F11) 525 d

3,0 150 N57 D30A	03.10→	0 450 90 N 6457 ¹	K
		1 987 43 R 2315 ⁸	I

Serie 5 (F10;F11) 528 i

3,0 190 N52 B30... <N52N>; N52 B30A <N52N>; N53 B30A	03.10→	1 457 42 P 9269	O
		1 987 43 R 2315 ⁸	I

Serie 5 (F10;F11) 530 d, d xDrive

3,0 180/190 N57 D30A	03.10→	0 450 90 N 6457 ¹	K
		1 987 43 R 2315 ⁸	I

Serie 5 (F10;F11) 535 d

3,0 220 N57 D30B <N57S>	09.10→	0 450 90 N 6457 ¹	K
		1 987 43 R 2315 ⁸	I





Serie 5 (F10;F11) 535 i

3,0 225 N55 B30A	03.10→	1 457 42 P 9269	0
	2FE	1 987 43 R 2315 ⁸	I

Serie 5 (F10;F11) 535 i xDrive

3,0 225 N55 B30A	09.10→	1 457 42 P 9269	0
----------------------	--------	-----------------	---

Serie 5 (F10;F11) 550 i, i xDrive

4,4 300 N63 B44A	03.10→	2FE	1 987 43 R 2315 ⁸	I
----------------------	--------	-----	------------------------------	---

Serie 5 GT (F07)

Serie 5 GT (F07) 535 d, d xDrive

3,0 220 N57 D30B	03.10→	0 450 90 N 6457 ¹	K
	2FE	1 987 43 R 2315 ⁸	I

Serie 5 GT (F07) 550 i, i xDrive

4,4 300 N63 B44A	10.09→	2FE	1 987 43 R 2315 ⁸	I
----------------------	--------	-----	------------------------------	---

Serie 6 (E63;E64)

Serie 6 (E63;E64) M 6

5,0 373 S85 B50A	03.05-07.10	2FE	1 987 43 M 2102	I
			1 987 43 R 2402 ⁸	I

Serie 6 (E63;E64) 630 i

3,0 190/200 N52 B30... <NG6>; N53 B30A <NG6>	09.04-07.10	1 457 42 P 9269	0
		1 457 43 S 3094	L
	2FE	1 987 43 M 2102	I
		1 987 43 R 2402 ⁸	I

Serie 6 (E63;E64) 635 d

3,0 210 30 6D 5	09.07-07.10	1 457 42 P 9252	0
		1 457 43 S 3164	L
		0 450 90 N 6457 ¹	K
	2FE	1 987 43 M 2102	I
		1 987 43 R 2402 ⁸	I

Serie 6 (E63;E64) 645 i

4,4 245 N62 B44A <NGV8>	01.04-09.05	F 026 40 P 7010	0
		1 457 43 S 3101	L
	2FE	1 987 43 M 2102	I
		1 987 43 R 2402 ⁸	I

Serie 6 (E63;E64) 650 i

4,8 270 N62 B48B <NGV8>	09.05-07.10	1 457 43 S 3101	L
	2FE	1 987 43 M 2102	I
		1 987 43 R 2402 ⁸	I



Serie 6 (F12;F13)

Serie 6 (F12;F13) 640 d

3,0 230 N57 D30B	09.11→	0 450 90 N 6457 ¹	K
	2FE	1 987 43 R 2315 ⁸	I

Serie 6 (F12;F13) 640 i

3,0 235 N55 B30A <NG6>	03.11→	1 457 42 P 9269	0
	2FE	1 987 43 R 2315 ⁸	I

Serie 6 (F12;F13) 650 i

4,4 300 N63 B44A <NGV8>	03.11→	2FE	1 987 43 R 2315 ⁸	I
-----------------------------	--------	-----	------------------------------	---

Serie 7 (E32)

Serie 7 (E32) 730 i, iL

3,0 136-145 30 6KA <M 30 B 30>	09.86-06.94	1 457 42 P 9755	0
		1 457 42 S 9869	L
		0 450 90 F 5201 ¹	K
	KL	1 987 43 M 2032	I

Serie 7 (E32) 735 i, iL

3,0 160 30 8S 1 <M 60 B 30>	09.91-10.94	I27	1 457 42 P 9121	0
		I36	1 457 42 P 9141	0
			1 457 43 S 3698	L
			0 450 90 F 5201 ¹	K
	KL		1 987 43 M 2032	I

Serie 7 (E32) 735 i, iL

3,4 155-162 34 6E C/K B <M 30 B 35>	09.86-12.92	1 457 42 P 9755	0
		1 457 42 S 9869	L
		0 450 90 F 5201 ¹	K
	KL	1 987 43 M 2032	I

Serie 7 (E32) 740 i, iL

4,0 210 40 8S 1 <M 60 B 40>	09.91-10.94	I27	1 457 42 P 9121	0
		I36	1 457 42 P 9141	0
			1 457 43 S 3698	L
		ZE	0 450 90 F 5901 ¹	K
	KL		1 987 43 M 2032	I

Serie 7 (E32) 750 i, iL

5,0 220 50 12 A <M 70 B 50>	09.87-09.91	1 457 42 P 9104	0	
	10.91-10.94	I27	1 457 42 P 9121	0
		I36	1 457 42 P 9141	0
	09.87-10.94	ZE	1 457 42 S 9964	L
			0 450 90 F 5901 ¹	K
	KL		1 987 43 M 2032	I





Serie 7 (E38)

Serie 7 (E38) 725 tds

2,5 | 105 | 25 6T 1 <M 51 D 25>

01.96-12.00	1 457 42	P 9139	O
	1 457 42	S 9793	L
	1 457 43	N 4324 ²	K
2FE	1 987 43	R 2362 ⁸	I

Serie 7 (E38) 728 i, iL

2,8 | 142 | 28 6S 1/2 <M 52 B 28>

09.95-10.01	1 457 42	P 9102	O
FRØ	1 457 43	S 3004	L
	0 450 90	F 5905 ¹	K
2FE	1 987 43	R 2362 ⁸	I

Serie 7 (E38) 730 d

3,0 | 135-142 | 30 6D 1 <M 57 D 30>

08.98-12.01	1 457 42	P 9118	O
	1 457 43	S 3589	L
	1 457 43	N 4324 ²	K
2FE	1 987 43	R 2362 ⁸	I

Serie 7 (E38) 730 i, iL

3,0 | 155-160 | 30 8S 1 <M 60 B 30>

06.94-09.95	I27	1 457 42	P 9121	O
06.94-12.96	I36	1 457 42	P 9141	O
		1 457 43	S 3698	L
		0 450 90	F 5905 ¹	K
2FE		1 987 43	R 2362 ⁸	I

Serie 7 (E38) 735 i, iL

3,5 | 173-175 | 35 8S 1/2 <M 62 B 35>

09.94-10.01		1 457 42	P 9141	O
		1 457 43	S 3698	L
09.94-09.98		0 450 90	F 5905 ¹	K
10.98-10.01	DRR	0 450 90	F 5960 ¹	K
09.94-10.01	2FE	1 987 43	R 2362 ⁸	I

Serie 7 (E38) 740 d

3,9 | 180 | 39 8D 1 <M 67>

10.98-12.01		1 457 42	P 9102	O
		1 457 43	N 4324 ²	K
2FE		1 987 43	R 2362 ⁸	I

Serie 7 (E38) 740 i, iL

4,0 | 210 | 40 8S 1 <M 60 B 40>

06.94-09.95	I27	1 457 42	P 9121	O
06.94-06.96	I36	1 457 42	P 9141	O
		1 457 43	S 3698	L
		0 450 90	F 5905 ¹	K
2FE		1 987 43	R 2362 ⁸	I

4,4 | 210 | 44 8S 1/2 <M 62 B 44>

01.96-08.01		1 457 42	P 9141	O
		1 457 43	S 3698	L
01.96-09.98		0 450 90	F 5905 ¹	K
10.98-08.01	DRR	0 450 90	F 5960 ¹	K
01.96-08.01	2FE	1 987 43	R 2362 ⁸	I

Serie 7 (E38) 750 i, iL

5,4 | 240 | 54 12 1/2 <M 73 B 54>

06.94-09.95	I27	1 457 42	P 9121	O
06.94-06.01	I36	1 457 42	P 9141	O
	ZE	1 457 43	S 3067	L
		0 450 90	F 5905 ¹	K
	2FE	1 987 43	R 2362 ⁸	I

Serie 7 (E65;E66)

Serie 7 (E65;E66) 730 d, Ld

3,0 | 160/170 | 30 6D 2 <M 57N>; 30 6D 3 <M 57N2>

10.02-10.08		1 457 42	P 9252	O
		1 457 43	S 3589	L
		0 450 90	N 6457 ¹	K
2FE		1 987 43	M 2103	I

Serie 7 (E65;E66) 730 i, Li

3,0 | 170 | 30 6S 3 <M 54>

03.03-03.05		1 457 42	P 9102	O
2FE		1 987 43	M 2103	I

3,0 | 190 | N52 B30... <NG6>

04.05-10.08		1 457 42	P 9269	O
2FE		1 987 43	M 2103	I

Serie 7 (E65;E66) 735 i, Li

3,6 | 200 | N62 B36A <NGV8>

11.01-03.05		F 026 40	P 7010	O
2FE		1 987 43	M 2103	I

Serie 7 (E65;E66) 740 d

3,9 | 190 | 39 8D 1

10.02-03.05		1 457 42	P 9102	O
	ZE	1 457 43	S 3091	L
		0 450 90	N 6457 ¹	K
2FE		1 987 43	M 2103	I

Serie 7 (E65;E66) 740 i, Li

4,0 | 225 | N62 B40A <NGV8>

04.05-10.08	2FE	1 987 43	M 2103	I
-------------	-----	----------	---------------	----------

Serie 7 (E65;E66) 745 d

4,4 | 220/242 | 44 8D 1

03.05-10.08		1 457 42	P 9185	O
	ZE	1 457 43	S 3091	L
		0 450 90	N 6457 ¹	K
2FE		1 987 43	M 2103	I





Serie 7 (E65;E66) 745 i, Li				
4,4 245 N62 B44A <NGV8>				
	11.01-03.05		F 026 40 P 7010	O
		2FE	1 987 43 M 2103	I

Serie 7 (E65;E66) 750 i, Li				
4,8 270 N62 B48B <NGV8>				
	04.05-10.08	2FE	1 987 43 M 2103	I

Serie 7 (E65;E66) 760 i, Li				
6,0 327 N73 B60... <NGV12>				
	12.02-10.08	RUL	F 026 40 F 3002 ¹	K
		2FE	1 987 43 M 2103	I

Serie 7 (F01;F02)

Serie 7 (F01;F02) 730 d, Ld				
3,0 180 N57 D30A				
	11.08→		0 450 90 N 6457 ¹	K
		2FE	1 987 43 R 2315 ⁸	I

Serie 7 (F01;F02) 730 i, Li				
3,0 190 N52 B30...				
	05.09→		1 457 42 P 9269	O
		2FE	1 987 43 R 2315 ⁸	I

Serie 7 (F01;F02) 740 d, d xDrive				
3,0 225 N57 D30B				
	09.09→		0 450 90 N 6457 ¹	K
		2FE	1 987 43 R 2315 ⁸	I

Serie 7 (F01;F02) 740 i, Li				
3,0 240 N54 B30A				
	11.08→		1 457 42 P 9269	O
		2FE	1 987 43 R 2315 ⁸	I

Serie 7 (F01;F02) 750 i, i xDrive, Li, Li xDrive				
4,4 300 N63 B44A				
	11.08→	2FE	1 987 43 R 2315 ⁸	I

Serie 7 (F01;F02) 760 i, Li				
6,0 400 N74 B60A				
	09.09→	2FE	1 987 43 R 2315 ⁸	I

Serie 7 (F04)

Serie 7 (F04) Active Hybrid				
4,4 342 N63 B44A				
	04.10→	2FE	1 987 43 R 2315 ⁸	I

Serie 8 (E31)

Serie 8 (E31) 840 i				
4,0 210 40 8S 1 <M 60 B 40>				
	04.93-09.95	I27	1 457 42 P 9121	O
	04.93-03.96	I36	1 457 42 P 9141	O
			1 457 43 S 3698	L
	04.93-03.94	ZE	0 450 90 F 5901 ¹	K
	04.94-03.96		0 450 90 F 5905 ¹	K



4,4 210 44 8S 1 <M 62 B 44>				
	09.94-12.99		1 457 42 P 9141	O
			1 457 43 S 3698	L
			0 450 90 F 5905 ¹	K

Serie 8 (E31) 850 i

5,0 220 50 12 A <M 70 B 50>				
	07.89-12.94	I27	1 457 42 P 9121	O
		I36	1 457 42 P 9141	O
		ZE	1 457 42 S 9964	L
			0 450 90 F 5901 ¹	K

5,4 240 54 12 1 <M 73 B 54>				
	03.94-09.95	I27	1 457 42 P 9121	O
	03.94-12.99	I36	1 457 42 P 9141	O
		ZE	1 457 42 S 9964	L
			0 450 90 F 5901 ¹	K

Serie 8 (E31) 850 Si

5,6 280 56 12 1 <M 70 B 56>				
	08.92-09.95	I27	1 457 42 P 9121	O
	08.92-10.96	I36	1 457 42 P 9141	O
		ZE	1 457 42 S 9964	L
			0 450 90 F 5901 ¹	K

BUICK

Century

Century 2.2

2,2 86-89 LN2				
	09.92-08.93	W50	0 451 10 P 3079	O

Century 3.1

3,1 119 LG7				
	09.93-08.98	W50	0 451 10 P 3079	O

3,1 130 LG8				
	09.99-08.05	W50	0 451 10 P 3079	O

Century 3.3

3,3 119 LG7				
	09.88-08.93	W50	0 451 10 P 3079	O

Excelle

Excelle 1.6 i

1,6 78 F16D3				
	09.03-01.08		0 451 10 P 3079	O
			0 450 90 F 5969 ¹	K

LeSabre

LeSabre 3.8

3,8 127 L27				
	09.91-08.95	W50	0 451 10 P 3079	O

3,8 142				
	09.95-08.99	W50	0 451 10 P 3079	O





3,8 | 153 09.87-08.91 W50 0 451 10 P 3079 0

Park Avenue

Park Avenue 3.8 , i

3,8 | 153/179 | L36; L67 09.95-08.05 W50 0 451 10 P 3079 0

Park Avenue 3.8 i

3,8 | 127 | L27 09.90-08.94 W50 0 451 10 P 3079 0

Regal

Regal 3.8

3,8 | 127 | L27 09.89-08.95 W50 0 451 10 P 3079 0

3,8 | 153 | L36 09.95-08.04 W50 0 451 10 P 3079 0

3,8 | 179 | L67 09.96-08.04 W50 0 451 10 P 3079 0

Rendezvous

Rendezvous 3.4 , 4x4

3,4 | 138 | LA1 09.01-08.05 W50 0 451 10 P 3079 0

Rendezvous 3.5

3,5 | 146 | LX9 09.05-08.07 W50 0 451 10 P 3079 0

Riviera

Riviera 3.8

3,8 | 127 | L27 09.90-08.93 W50 0 451 10 P 3079 0

3,8 | 153 09.95-08.97 W50 0 451 10 P 3079 0

3,8 | 179 | L27 09.94-08.99 W50 0 451 10 P 3079 0

Skylark

Skylark 2.3

2,3 | 86-90/112 09.87-08.95 W50 0 451 10 P 3079 0

Skylark 3.1

3,1 | 118 09.93-08.98 W50 0 451 10 P 3079 0



Skylark 3.3

3,3 | 119 09.88-08.93 W50 0 451 10 P 3079 0

CADILLAC

BLS

BLS 1.9

1,9 | 110 | Z19DTH 10.05→ 1987 43 M 2076 I
1987 43 R 2376⁸ I

BLS 2.0

2,0 | 129 | B207L 10.05→ 1987 43 M 2076 I
1987 43 R 2376⁸ I

Catera

Catera 3.0

3,0 | 149 | X30... 10.96-12.01 0 450 90 F 5021¹ K

CHERY

A516

A516 1.6 i

1,6 | 87,5 | SQR481F 02.06→ 0 986 B0 OB 0006 0

Tiggo

Tiggo 2.0 i

2,0 | 95 | SQR484F 04.05→ 0 986 B0 OB 0006 0

CHEVROLET

Aveo

Aveo 1.2

1,2 | 51/63 | A 12 XEL <Ecotec Euro 5>; A 12 XER <Ecotec Euro 5> 06.11→ 1987 43 M 2004 I
1987 43 R 2304⁸ I

1,2 | 55/62 | B12D1 04.08→ F 026 40 S 0043 L
0 450 90 F 5976¹ K





Aveo 1.2 i

1,2 53 F12S3	02.06-10.08	0 986 45 P 2058	O
		F 026 40 S 0043	L
		0 450 90 F 5976 ¹	K

Aveo 1.3 D

1,2 55/70	09.11→	1 987 43 M 2004	I
		1 987 43 R 2304 ⁸	I

Aveo 1.4

1,4 74 A 14 XER <Ecotec Euro 5>	06.11→	1 987 43 M 2004	I
		1 987 43 R 2304 ⁸	I

1,4 74 F14D4	04.08→	F 026 40 S 0043	L
		0 450 90 F 5976 ¹	K

Aveo 1.4 i

1,4 69 F14D3	02.06→	0 451 10 P 3079	O
	02.06-10.08	F 026 40 S 0043	L
	02.06→	0 450 90 F 5976 ¹	K
1,4 69 L95	07.05→	0 450 90 F 5976 ¹	K

Aveo 1.5 i

1,5 63 F15S3 <SOHC>	02.03→	0 451 10 P 3079	O
		1 457 43 S 3568	L
		0 450 90 F 5969 ¹	K

Aveo 1.6

1,6 85 F16D4 <Ecotec Euro 5>	06.11→	1 987 43 M 2004	I
		1 987 43 R 2304 ⁸	I

Aveo 1.6 i

1,6 75 A16DMS	03.06→	0 451 10 P 3079	O
-------------------	--------	-----------------	---

Blazer

Blazer 4.3

4,3 142 L35	09.94-08.02	0 986 45 F 0119 ¹	K
-----------------	-------------	------------------------------	---

Captiva

Captiva 2.0 CDRI, CDRI 4x4

2,0 93/110 Z20S	10.06-02.11	1 457 07 N 0001	K
---------------------	-------------	-----------------	---

Captiva 2.4 , 4x4

2,4 100-104 Z24S...	10.06-02.11	0 451 10 P 3370	O
-------------------------	-------------	-----------------	---



2,4 123 LE5	04.11→	F 026 40 P 7016	O
-----------------	--------	-----------------	---

Cavalier

Cavalier 2.2 i

2,2 104 L61	09.01-08.05	F 026 40 P 7016	O
-----------------	-------------	-----------------	---

Chevy

Chevy 1.6 i

1,6 74 A16DMS	05.06→	0 451 10 P 3079	O
-------------------	--------	-----------------	---

Cobalt

Cobalt 2.0

2,0 194 LSJ	09.04-08.07	F 026 40 P 7016	O
-----------------	-------------	-----------------	---

Cobalt 2.2

2,2 116 L61	09.04-08.08	F 026 40 P 7016	O
-----------------	-------------	-----------------	---

Corvette

Corvette 5.7

5,7 179-183 L98	08.85-08.91	0 451 10 P 4064	O
---------------------	-------------	-----------------	---

Cruze

Cruze 1.6

1,6 80 F16D3	05.09→	0 451 10 P 3079	O
		1 987 43 M 2004	I
		1 987 43 R 2304 ⁸	I

1,6 83/91/91,2 F16D4; F16D4 <Euro 5>	05.09→	1 987 43 M 2004	I
		1 987 43 R 2304 ⁸	I

Cruze 1.8

1,8 104 F18D4; F18D4 <Euro 5>	05.09→	1 987 43 M 2004	I
		1 987 43 R 2304 ⁸	I

Cruze 2.0 CDI

2,0 110/120 Z20D1 <Euro 5>; Z20S1	05.09→	F 026 40 N 2062	K
		1 987 43 M 2004	I
		1 987 43 R 2304 ⁸	I





Epica

Epica 2.0

2,0 105 X20D1	06.06→	0 451 10 P 3355 O 0 450 90 F 5969 ¹ K
---------------	--------	---

Epica 2.0 CDRI

2,0 110 Z20S	09.06→	1 457 07 N 0001 K
--------------	--------	---------------------------------

Epica 2.0 16V

2,0 93 L88 <DOHC>	01.04→	0 451 10 P 3079 O 0 450 90 F 5969 ¹ K
-------------------	--------	---

Epica 2.5

2,5 115 X25D1	06.06→	0 451 10 P 3355 O
---------------	--------	---------------------------------

Evanda

Evanda 2.0 i

2,0 96 X20SED	02.05-09.06	EDO 0 451 10 P 3079 O 0 450 90 F 5969 ¹ K
---------------	-------------	---

HHR

HHR 2.0

2,0LNF	09.07-08.09	F 026 40 P 7016 O
--------	-------------	---------------------------------

HHR 2.2

2,2 107-111 L61	09.05-08.08	F 026 40 P 7016 O
-----------------	-------------	---------------------------------

HHR 2.4

2,4 125/127-131 LE5	09.05→	F 026 40 P 7016 O
---------------------	--------	---------------------------------

Kalos

Kalos 1.2

1,2 53 B12S1	02.05-04.08	0 986 45 P 2058 O F 026 40 S 0043 L 0 450 90 F 5976 ¹ K
--------------	-------------	--

Kalos 1.4

1,4 61/69 F14D3;F14S3	02.05-04.08	0 451 10 P 3079 O F 026 40 S 0043 L 0 450 90 F 5976 ¹ K
-----------------------	-------------	--



Lacetti

Lacetti 1.4

1,4 70 F14D3	02.05→	0 451 10 P 3079 O F 026 40 S 0163 L 0 450 90 F 5969 ¹ K
--------------	--------	--

Lacetti 1.6

1,6 80 F16D3	02.05→	0 451 10 P 3079 O F 026 40 S 0163 L 0 450 90 F 5969 ¹ K
--------------	--------	--

Lacetti 1.8

1,8 89/90 F18D3;T18SED	02.05→	0 451 10 P 3079 O F 026 40 S 0163 L 0 450 90 F 5969 ¹ K
------------------------	--------	--

Lacetti 2.0 D

2,0 89 Z20S	09.06→	1 457 07 N 0001 K
-------------	--------	---------------------------------

Lanos

Lanos 1.5 i

1,5 63 A15SMS <E-TEC>	01.04→	0 451 10 P 3079 O 1 457 43 S 3963 L
Fg.Nr. →278290	01.04→	0 450 90 F 5273 ¹ K
Fg.Nr. 278291→	01.04→	0 450 90 F 5969 ¹ K

Lanos 1.6 i

1,6 78 A16DMS	01.04→	0 451 10 P 3079 O 1 457 43 S 3963 L
Fg.Nr. →278290	01.04→	0 450 90 F 5273 ¹ K
Fg.Nr. 278291→	01.04→	0 450 90 F 5969 ¹ K

Malibu

Malibu 2.2

2,2 104-108 L61	09.03-08.08	F 026 40 P 7016 O
-----------------	-------------	---------------------------------

Matiz

Matiz 0.8 i

0,8 38 F8CV	02.05-12.10	0 986 45 P 2058 O 0 450 90 F 5969 ¹ K 1 987 43 M 2171 I
-------------	-------------	--





Matiz 1.0 i

1,0 48 B10S1	02.05-12.10	0 986 45 P 2058	O
		0 450 90 F 5969 ¹	K
		1 987 43 M 2171	I

Niva

Niva 1.7 i

1,7 58,5 2123 <Euro 2>	09.02→	0 451 10 P 3093	O
		1 457 42 S 9061	L
		1 987 43 M 2230	I

Nubira

Nubira 1.4 i

1,4 70 F14D3	02.05→	0 451 10 P 3079	O
		F 026 40 S 0163	L
		0 450 90 F 5969 ¹	K

Nubira 1.6 i

1,6 80 F16D3	02.05→	0 451 10 P 3079	O
		F 026 40 S 0163	L
		0 450 90 F 5969 ¹	K

Nubira 1.8 i

1,8 89/90 F18D3; T18SED	02.05→	0 451 10 P 3079	O
		F 026 40 S 0163	L
		0 450 90 F 5969 ¹	K

Nubira 2.0 D

2,0 89 Z20S	09.06→	1 457 07 N 0001	K
-----------------	--------	-----------------	---

Optra

Optra 1.6 i 16V

1,6 77-80 A16DMS <DOHC>	01.04→	0 451 10 P 3079	O
-----------------------------	--------	-----------------	---

Orlando

Orlando 1.8

1,8 104 F18D4 <Euro 5>	10.10→	1 987 43 M 2004	I
		1 987 43 R 2304 ⁸	I

Orlando 2.0 CRDi

2,0 120 Z20D1 <Euro 5>	10.10→	F 026 40 N 2062	K
		1 987 43 M 2004	I
		1 987 43 R 2304 ⁸	I



Rezzo

Rezzo 1.6 i

1,6 74-79 A16DMS	02.05-05.09	0 451 10 P 3079	O
		0 450 90 F 5969 ¹	K

Rezzo 2.0 i

2,0 88-90 T20SED	02.05-05.09	0 451 10 P 3079	O
		0 450 90 F 5969 ¹	K

Spark

Spark 0.8 i

0,8 37,5 M-TEC (F8CV)	06.03→	0 986 45 P 2058	O
		1 987 42 S 9166	L
		0 450 90 F 5969 ¹	K

0,8 38 F8CV	02.05-12.10	0 986 45 P 2058	O
		0 450 90 F 5969 ¹	K
		1 987 43 M 2171	I

Spark 1.0

1,0 46 LQ4 <SOHC>	07.04→	0 986 45 P 2058	O
		1 987 42 S 9166	L
		0 450 90 F 5969 ¹	K

Spark 1.0 i

1,0 47 B10S1	01.98→	0 986 45 P 2058	O
		1 987 42 S 9166	L
		0 450 90 F 5969 ¹	K

1,0 48 B10S1	02.05-12.10	0 986 45 P 2058	O
		0 450 90 F 5969 ¹	K
		1 987 43 M 2171	I

Tahoe

Tahoe 5.3 4x4

5,3 220 LM7	09.99-08.06	0 986 45 F 0119 ¹	K
-----------------	-------------	------------------------------	---

Tracker

Tracker 2.0 16V 4x4

2,0 94	11.06-12.08	1 457 43 S 3956	L
		0 986 BF CB 0563	I





CHRYSLER *

Cirrus

Cirrus 2.0

2,0 96 ECB	09.98-08.00	0 451 10 P 3271	0
		F 026 40 S 0042	L

Cirrus 2.4

2,4 112 EDZ	09.94-08.00	0 451 10 P 3271	0
		F 026 40 S 0042	L

Cirrus 2.5 i 24V

2,5 118 EEB	01.99-08.00	0 451 10 P 3251	0
	09.94-08.00	F 026 40 S 0042	L

Concorde

Concorde 2.7 i 24V

2,7 149 EER; EES	09.97-08.04	0 451 10 P 3251	0
------------------	-------------	-----------------	---

Concorde 3.2 i 24V

3,2 168 EGW	09.97-08.01	0 451 10 P 3251	0
-------------	-------------	-----------------	---

Concorde 3.3

3,3 114-120 EGB	09.92-08.96	0 451 10 P 3251	0
-----------------	-------------	-----------------	---

Concorde 3.3 i

3,3 120 EGB <EGD MPI>	01.97-12.97	0 451 10 P 3251	0
-----------------------	-------------	-----------------	---

Concorde 3.5 , i

3,5 160 EGE; EGE <EGE MPI>	09.92-12.04	0 451 10 P 3251	0
----------------------------	-------------	-----------------	---

Convertible

Convertible 2.0 i 16V

2,0 96 ECB,ECO <C MPI SOHC>	09.96-12.00	0 451 10 P 3271	0
		F 026 40 S 0042	L

Convertible 2.4 i 16V

2,4 112 EDZ,EDO <X MPI DOHC>	09.96-12.99	0 451 10 P 3271	0
		F 026 40 S 0042	L



Convertible 2.5 i 24V

2,5 118 EEB,EEO <H MPI SOHC>	01.99-12.00	0 451 10 P 3251	0
	09.96-12.00	F 026 40 S 0042	L

Crossfire

Crossfire 3.2

3,2 163-167 EGX	09.03-08.08	XXX	1 457 42 P 9196	0
			1 457 43 S 3049	L
			1 987 43 M 2001	I
		RLE	1 987 43 M 2001	I

Crossfire 3.2 SRT-6

3,2 264 EGZ	09.04-08.06		1 987 43 M 2001	I
		RLE	1 987 43 M 2001	I

ES

ES 2.2 i Turbo

2,2 109 EDR	08.90-09.98	0 451 10 P 3251	0
-------------	-------------	-----------------	---

ES 2.5 i, i Turbo

2,5 72/110 EDM <EFI>; EDT <K>	08.90-09.98	0 451 10 P 3251	0
-------------------------------	-------------	-----------------	---

GS/GTS

GS/GTS 2.2 i Turbo

2,2 109/130 EDR; TCII <EDG>; TCII <EDR>	08.90-09.98	0 451 10 P 3251	0
---	-------------	-----------------	---

GS/GTS 2.5 i Turbo

2,5 110 KEFI <EDT>	08.90-09.98	0 451 10 P 3251	0
--------------------	-------------	-----------------	---

Intrepid

Intrepid 2.7

2,7 149 EER	09.97-08.04	0 451 10 P 3251	0
-------------	-------------	-----------------	---

Intrepid 3.2

3,2 168 EGW	09.97-08.01	0 451 10 P 3251	0
-------------	-------------	-----------------	---

Intrepid 3.3

3,3 120/160 EGB	09.92-08.97	0 451 10 P 3251	0
-----------------	-------------	-----------------	---

Intrepid 3.5

3,5 160 EGW	01.96-12.97	0 451 10 P 3251	0
-------------	-------------	-----------------	---





Le Baron

Le Baron 2.2 i, i Turbo

2,2 72/109 EDG	08.90-08.95	0 451 10 P 3251	0
--------------------	-------------	-----------------	---

Le Baron 2.5 i, i Town & Country

2,5 72 EDM	08.90-08.93	0 451 10 P 3251	0
----------------	-------------	-----------------	---

Le Baron 3.0 i

3,0 100-106 EFA <6G72>	08.90-08.95	0 451 10 P 3251	0
	05.89-08.95	1 457 42 S 9957	L

LHS

LHS 3.5 i 24V

3,5 155/189 EGE; EGG	09.93-08.01	0 451 10 P 3251	0
--------------------------	-------------	-----------------	---

Neon

Neon 1.6 i 4x4

1,6 85 EJD	01.01-12.05 TW	1 457 42 P 9197	0
----------------	----------------	-----------------	---

Neon 1.8 i 16V

1,8 85 EBD	09.97-12.00	0 451 10 P 3271	0
	09.97-12.99	1 457 42 S 9957	L

Neon 2.0 i 16V

2,0 98/104/112 ECB; ECC	06.94-12.05	0 451 10 P 3271	0
	06.94-08.99	1 457 42 S 9957	L

2,0 112 ECH	09.00-12.05	0 451 10 P 3271	0
-----------------	-------------	-----------------	---

Neon 2.4 i

2,4 172 EDV	01.03-12.05	0 451 10 P 3363	0
-----------------	-------------	-----------------	---

New Yorker

New Yorker 3.0 i

3,0 101-105 EFA	08.90-08.92	0 451 10 P 3251	0
---------------------	-------------	-----------------	---

Pacifica

Pacifica 3.5 , 4x4

3,5 186 EGN	09.02-08.06	0 451 10 P 3251	0
		1 987 43 R 2497 ⁸	I



Pacifica 3.8 , 4x4

3,8 157 EGH	09.03-08.08	0 451 10 P 3251	0
		1 987 43 R 2497 ⁸	I

Prowler

Prowler 3.5

3,5 189 EGG	09.00-08.02	0 451 10 P 3251	0
		1 457 42 S 9957	L

PT Cruiser

PT Cruiser 1.6

1,6 85 EJD	10.02-12.04 TW	1 457 42 P 9197	0
	10.02-12.07	1 987 43 M 2184	I

PT Cruiser 2.0

2,0 100-104 ECC	06.00-12.05	0 451 10 P 3271	0
		1 987 43 M 2184	I

PT Cruiser 2.2 CRD

2,2 89-112 EDJ	09.02-12.09	1 457 42 P 9263	0
		1 987 43 M 2184	I

PT Cruiser 2.4

2,4 105-112 EDZ	06.00-12.10	0 451 10 P 3271	0
		1 987 43 M 2184	I

PT Cruiser 2.4 Turbo

2,4 134/164 ED...	09.02-12.09	0 451 10 P 3363	0
		1 987 43 M 2184	I

2,4 160 EDT	09.03→	0 451 10 P 3074	0
-----------------	--------	-----------------	---

Saratoga

Saratoga 3.0 i

3,0 104 6G72 <EFA>	09.89-12.95	0 451 10 P 3251	0
		1 457 42 S 9957	L

Sebring

Sebring 2.0

2,0 104 ECC	09.00-08.06	0 451 10 P 3271	0
-----------------	-------------	-----------------	---

2,0 104 ECF	09.94-08.00	0 451 10 P 3271	0
-----------------	-------------	-----------------	---





Sebring 2.0 CRD

2,0 103 ECD	09.06→	1 457 42 P9192	0
-------------	--------	----------------	---

Sebring 2.4

2,4 104-110 EY7 <2>	01.01-12.05	0 986 45 P2041	0
		1 457 43 S3968	L

2,4 111/112 EDZ	09.95-08.06	0 451 10 P3271	0
-----------------	-------------	----------------	---

Sebring 2.5

2,5 122-125 EEB	09.95-08.00	0 451 10 P3251	0
		F 026 40 S0042	L

2,5 122-125 EEB <H>	01.99-08.00	0 451 10 P3251	0
---------------------	-------------	----------------	---

Sebring 2.7

2,7 141 EER	09.06-08.07	0 986 45 P2003	0
-------------	-------------	----------------	---

2,7 149 EER	09.00-08.07	0 986 45 P2003	0
	09.01-08.08	0 451 10 P3251	0

2,7 149 EES	09.00-08.01	0 451 10 P3251	0
-------------	-------------	----------------	---

Sebring 3.0

3,0 149 EF7	09.00-08.05	1 457 43 S3968	L
-------------	-------------	----------------	---

Stratus

Stratus 2.0 i 16V

2,0 96-98 ECB,ECO <C MPI>	08.95-04.01	0 451 10 P3271	0
		F 026 40 S0042	L

Stratus 2.4 i 16V

2,4 118 EDZ; EDZ <X MPI>; EDZ,EDO <X MPI>	08.95-04.01	0 451 10 P3271	0
		F 026 40 S0042	L

Stratus 2.5 i 24V

2,5 118/120 EEB <H MPI>; EEB,EEO <H MPI>	01.99-04.01	0 451 10 P3251	0
	08.95-04.01	F 026 40 S0042	L

TC Maserati

TC Maserati 2.2 i

2,2 149 EDR	09.88-08.92	0 451 10 P3251	0
-------------	-------------	----------------	---

☐☐

TC Maserati 3.0 i

3,0 105 6G72	09.89-08.91	0 451 10 P3251	0
		1 457 42 S9957	L

Viper

Viper 8.0 GTS, GTS Lemans, RT/10

8,0 283/290-294/335 EWB	08.92→	0 451 10 P3251	0
-------------------------	--------	----------------	---

Vision

Vision 3.3 i

3,3 120 EGB, MPI	09.93-12.97	0 451 10 P3251	0
------------------	-------------	----------------	---

Vision 3.5 i

3,5 155 EGE	09.93-12.97	0 451 10 P3251	0
-------------	-------------	----------------	---

Voyager

Voyager 2.0 i

2,0 98 ECO,ECB	08.96-12.00	0 451 10 P3271	0
	01.97-12.00	1 457 42 S9957	L

Voyager 2.4

2,4 110 EDZ	08.96-12.00	0 986 45 P2044	0
	01.97-12.00	1 457 42 S9957	L

Voyager 2.4 , i, i 4x4

2,4 108 EDZ	08.00→	0 451 10 P3271	0
		1 987 42 S9194	L
		1 987 43 R2497 ⁸	I

Voyager 2.4 i

2,4 110 EDZ,EDO <DOHC>	01.96-12.00	0 451 10 P3271	0
		1 457 42 S9957	L

Voyager 2.5 CRD

2,5 105 ENC	09.00-08.01	F 026 40 P7069	0
		1 987 42 S9194	L
		1 457 43 N4457 ¹	K
		1 987 43 R2497 ⁸	I





Voyager 2.5 CRD, CRD 4x4

2,5 105 ENJ	01.02-08.07	0 451 10 P 3258	O
	09.01-08.07	1 987 42 S 9194	L
		1 457 43 N 4457 ¹	K
		1 987 43 R 2497 ⁸	I

Voyager 2.5 CRD 4x4

2,5 105 ENC	09.00-08.01	1 987 42 S 9194	L
		1 457 43 N 4457 ¹	K
		1 987 43 R 2497 ⁸	I

Voyager 2.5 i

2,5 72 EDM <EFI>	08.90-08.94	0 451 10 P 3251	O
----------------------	-------------	-----------------	---

Voyager 2.5 TD

2,5 85 VM HR 425 CLIEE	04.92-12.95	0 451 10 P 3258	O
		1 457 43 S 3231	L
		1 457 43 N 4448 ²	K

2,5 85 VM HR 425 CLIEE <ENC>	01.95-12.00	0 451 10 P 3258	O
		TW 1 457 43 S 3231	L
	01.97-12.00	1 457 42 S 9957	L
		01.95-12.00	1 457 43 N 4450 ²

2,5 85-87 VM HR 425 CLIEE <ENC>	04.92-12.95	0 451 10 P 3258	O
		1 457 43 S 3231	L
		1 457 43 N 4448 ²	K

Voyager 2.8 CRD, CRD 4x4

2,8 110 ENR	08.04-12.07	0 451 10 P 3258	O
		1 987 42 S 9194	L
		1 457 43 N 4457 ¹	K
		1 987 43 R 2497 ⁸	I

Voyager 3.0

3,0 112 EFA	01.96-12.00	0 451 10 P 3251	O
		1 457 42 S 9957	L

Voyager 3.0 i

3,0 104-108 A EFI <EFA>	09.88-09.93	0 451 10 P 3251	O
	01.88-09.93	1 457 42 S 9957	L

Voyager 3.3

3,3 116 EGM	01.96-12.00	0 451 10 P 3251	O
		1 457 42 S 9957	L

3,3 128 EGV <H>	01.08→	0 986 45 P 2036	O
---------------------	--------	-----------------	---

3,3 128-134 EGA GAS	08.00→	0 451 10 P 3251	O
		1 987 42 S 9194	L
		1 987 43 R 2497 ⁸	I



Voyager 3.3 i

3,3 110/120 EFI <EGA>	09.90-12.95	0 451 10 P 3251	O
---------------------------	-------------	-----------------	---

3,3 116 EGA,EGM	01.95-12.99	0 451 10 P 3251	O
	01.97-12.99	1 457 42 S 9957	L

3,3 128-134 EGA	01.01-12.07	0 451 10 P 3251	O
		1 987 42 S 9194	L
		1 987 43 R 2497 ⁸	I

Voyager 3.3 i, i AWD

3,3 110/120 EGA	09.90-12.95	0 451 10 P 3251	O
---------------------	-------------	-----------------	---

Voyager 3.3 i 4x4

3,3 128-134 EGA	01.01-12.07	0 451 10 P 3251	O
		1 987 42 S 9194	L

Voyager 3.8

3,8 142 EGL	09.07→	0 986 45 P 2036	O
-----------------	--------	-----------------	---

Voyager 3.8 i AWD

3,8 122/131 EGH,EGO	01.97-12.00	0 451 10 P 3251	O
		1 457 42 S 9957	L

3,8 122/131 EGO,EGH; EGO,EGH <OHV>	01.96-12.00	0 451 10 P 3251	O
		1 457 42 S 9957	L

Voyager 3.8 i, i AWD

3,8 160 EGH,EGO	02.02→	0 451 10 P 3251	O
		1 987 42 S 9194	L
		1 987 43 R 2497 ⁸	I

Voyager 3.8 i V6, i V6 AWD

3,8 160 EGH	03.01→	0 451 10 P 3251	O
		1 987 42 S 9194	L
		1 987 43 R 2497 ⁸	I

300, 300C, 300M

300, 300C, 300M 2.7

2,7 142-149 EER	09.04-08.08	0 451 10 P 3251	O
---------------------	-------------	-----------------	---

2,7 150 ERR <R>	06.98-12.04	0 451 10 P 3251	O
---------------------	-------------	-----------------	---

300, 300C, 300M 3.0 CRD

3,0 160 EXL	10.05→	F 026 40 P 7008	O
		1 457 43 N 4437 ¹	K



**300, 300C, 300M 3.5**

3,5|183-187|EGG
09.04-08.08 0 451 10 P 3251 0

3,5|185|EGG
09.98-08.04 0 451 10 P 3251 0

300, 300C, 300M 3.5 4x4

3,5|183-187|EGG
10.04-08.07 0 451 10 P 3251 0

300, 300C, 300M 5.7

5,7|250-254|EZB
09.04-08.08 0 451 10 P 3251 0

300, 300C, 300M 5.7 , 4x4

5,7|250-254|EZ...
10.04-08.07 0 451 10 P 3251 0

300, 300C, 300M 6.1

6,1|312-318|ESF
01.05-08.07 0 451 10 P 3251 0

300, 300C, 300M 6.1 SRT-8

6,1|312-318|ESF
09.04→ 0 451 10 P 3251 0

CITROEN ***AX****AX 1.0**

1,0|32-34|C1A <TU9>
10.86-06.92 0 451 10 P 3261 0
1457 42 S 9908 L
0450 90 F 5002¹ K

AX 1.0 i

1,0|31-33/37|CDY Kat. <TU9M>; CDZ Kat. <TU9M>
07.92-12.98 0 451 10 P 3261 0
1457 42 S 9908 L
0450 90 F 5002¹ K

AX 1.1

1,1|40|H1A <TU1>
10.86-05.92 0 451 10 P 3261 0
1457 42 S 9908 L
0450 90 F 4058¹ K

AX 1.1 i

1,1|40-44|HDZ Kat. <TU1M>
10.89-05.92 0 451 10 P 3261 0
1457 42 S 9908 L
0450 90 F 5002¹ K



1,1|44|HDY Kat. <TU1M>
06.92-06.98 0 451 10 P 3261 0
1457 43 S 3227 L
0450 90 F 5002¹ K

AX 1.3 Sport

1,3|69|M4A <TU2/4>
04.87-01.91 0 451 10 P 3261 0
1457 43 S 2212 L
0450 90 F 4058¹ K

AX 1.4

1,4|55|K2D (Gußmot.) <TU3F2>
05.91-08.93 0 451 10 P 3261 0
1457 43 S 3227 L
0450 90 F 4058¹ K

AX 1.4 , GT

1,4|51-55/62-65|K1G <TU3A>; K2A <TU3S>; K2B <TU3S>
10.87-12.92 0 451 10 P 3261 0
Org.Nr. →5283 10.87-04.91 1457 42 S 9908 L
Org.Nr. 5284→ 04.91-12.92 1457 43 S 3227 L
10.87-12.92 0 450 90 F 4058¹ K

AX 1.4 D

1,4|37-39|K9A <TUD3>; K9Y <TUD3Y>
09.88-12.97 0 451 10 P 3261 0
1457 43 S 2200 L
1457 43 N 4321² K

AX 1.4 i

1,4|55|KDX Kat.(Gußmot.) <TU3FM>
01.93-12.96 0 451 10 P 3261 0
1457 43 S 3227 L
0450 90 F 5002¹ K

1,4|55-58|KDY Kat. <TU3M>; KDY Kat.(Gußmot.) <TU3FM>
06.90-12.96 0 451 10 P 3261 0
Org.Nr. →5901 06.90-12.92 1457 42 S 9908 L
Org.Nr. 5902→ 01.93-12.96 1457 43 S 3227 L
06.90-12.96 0 450 90 F 5002¹ K

1,4|66/69-70|KFY Kat. <TU3FJ>; KFZ Kat. <TU3FJ>
05.91-12.96 0 451 10 P 3261 0
04.92-12.96 1457 43 S 3227 L
05.91-12.96 0 450 90 F 5002¹ K

1,4|70-74|K6B <TU3FJ2>
05.91-12.96 0 451 10 P 3261 0
04.92-12.96 1457 43 S 3227 L
05.91-12.96 0 450 90 F 5002¹ K

AX 1.5 D

1,5|40-41/42-43|VJY <TUD5>; VJZ <TUD5>
08.94-12.97 0 451 10 P 3261 0
1457 43 S 3234 L
1457 43 N 4321² K





Axel

Axel 11

1,1 42 G11/631	07.84-03.91	0 451 10 P 3145	O
--------------------	-------------	-----------------	---

Axel 12

1,3 45 T13/653; T13/654	07.84-03.91	0 451 10 P 3145	O
-----------------------------	-------------	-----------------	---

Berlingo

Berlingo 1.1 i

1,1 44 HDY <TU1M+>; HDZ <TU1M+>	07.96-11.02	0 451 10 P 3261	O
		1 457 43 S 3227	L
		0 450 90 F 2161 ¹	K
		RLE 1 987 43 M 2021	I
Org.Nr. →8805	07.96-12.00	1 987 43 M 2021	I
Org.Nr. 8806→	01.01-11.02	1 987 43 M 2083	I

1,1 | 44 | HFX <TU1JP>

	06.00-11.02	1 457 42 P 9193	O
Mot.Nr. →4413114	11.02-04.08	1 457 42 P 9193	O
Mot.Nr. 4413115→	11.02-04.08	1 457 42 P 9249	O
	06.00-11.02	1 457 43 S 3769	L
	11.02-04.08	LBE 1 457 43 S 3158	L
		SBE 1 457 43 S 3159	L
	06.00-04.08	0 450 90 F 2161 ¹	K
		RLE 1 987 43 M 2021	I
	11.02-04.08	1 987 43 M 2083	I
Org.Nr. →8805	06.00-12.00	1 987 43 M 2021	I
Org.Nr. 8806→	01.01-11.02	1 987 43 M 2083	I

Berlingo 1.4

1,4 51 K5A <TU3.2TR/K>	10.96-11.02	0 451 10 P 3261	O
		1 457 43 S 3227	L
		0 450 90 F 2161 ¹	K
		RLE 1 987 43 M 2021	I
Org.Nr. →8805	10.96-12.00	1 987 43 M 2021	I
Org.Nr. 8806→	01.01-11.02	1 987 43 M 2083	I

Berlingo 1.4 i

1,4 55 KFW <TU3JP/L4>	06.00-11.02	1 457 42 P 9193	O
		1 457 43 S 3769	L
		0 450 90 F 2161 ¹	K
		RLE 1 987 43 M 2021	I
Org.Nr. →8805	06.00-12.00	1 987 43 M 2021	I
Org.Nr. 8806→	01.01-11.02	1 987 43 M 2083	I

1,4 | 55 | KFW <TU3JP/TU3A>

Mot.Nr. →4717577	11.02-03.10	1 457 42 P 9193	O
Mot.Nr. 4717578→	11.02-03.10	1 457 42 P 9249	O
	11.02-03.10	LBE 1 457 43 S 3158	L
		SBE 1 457 43 S 3159	L
		0 450 90 F 2161 ¹	K
		1 987 43 M 2083	I
		RLE 1 987 43 M 2021	I



1,4 | 55 | KFX <TU3JP>

	07.96-11.02	0 451 10 P 3261	O
		1 457 43 S 3769	L
		0 450 90 F 2161 ¹	K
		RLE 1 987 43 M 2021	I
Org.Nr. →8805	07.96-12.00	1 987 43 M 2021	I
Org.Nr. 8806→	01.01-11.02	1 987 43 M 2083	I

Berlingo 1.6 HDi

1,6 55/66 9HS <DV6TED4BU/FAP>; 9HT <DV6B/DV6BUTED4>; 9HV <DV6TED4/FAP>	05.08→	1 457 42 P 9238	O
		1 457 43 S 3160	L
		0 450 90 N 6471 ¹	K
		1 987 43 M 2137	I
		1 987 43 R 2437 ⁸	I

1,6 | 55/66 | 9HW <DV6B>; 9HX <DV6ATED4>

	09.05-04.08	1 457 42 P 9238	O
		1 457 43 S 3160	L
		0 450 90 N 6471 ¹	K
		1 987 43 M 2083	I
		RLE 1 987 43 M 2021	I

1,6 | 55/66/68/82 | 9HF <DV6DTEDE>; 9HJ <DV6DTEDE M>; 9HK <DV6ETED M>; 9HL <DV6C>; 9HN <DV6ETED4>; 9HP <DV6DTEDE>

	03.10→	1 457 42 P 9238	O
		1 987 43 M 2137	I
		1 987 43 R 2437 ⁸	I

1,6 | 66/80 | 9HX <DV6ATED4/DV6AUTED4>; 9HZ <DV6TED4>

	05.08→	1 457 42 P 9238	O
		1 457 43 S 3160	L
		0 450 90 N 6471 ¹	K
		1 987 43 M 2137	I
		1 987 43 R 2437 ⁸	I

Berlingo 1.6 i VTi, i 16V VTi

1,6 72/88 5FK <EP6C DTR>; 5FS <EP6C>	11.09→	1 457 42 P 9249	O
		F026 40 S 0050	L
		0 450 90 F 2161 ¹	K
		1 987 43 M 2137	I
		1 987 43 R 2437 ⁸	I

Berlingo 1.6 i 16V

1,6 66 NFR <TU5JP4B>	05.08→	1 457 42 P 9249	O
		0 450 90 F 2161 ¹	K
		1 987 43 M 2137	I
		1 987 43 R 2437 ⁸	I

1,6 | 80 | NFU <TU5JP4>

	06.00-11.02	1 457 42 P 9193	O
	05.08→	1 457 42 P 9249	O
Org.Nr. →10072	11.02-06.04	1 457 42 P 9193	O
Org.Nr. 10073→	07.04-04.08	1 457 42 P 9249	O
	06.00-11.02	FMV F 026 40 S 0023	L
	11.02-04.08	LBE 1 457 43 S 3325	L
		SBE 1 457 43 S 3159	L
	06.00→	0 450 90 F 2161 ¹	K
	06.00-04.08	RLE 1 987 43 M 2021	I
	11.02-04.08	1 987 43 M 2083	I
	05.08→	1 987 43 M 2137	I
		1 987 43 R 2437 ⁸	I





Org.Nr. →8805	06.00-12.00	1 987 43 M 2021	I
Org.Nr. 8806→	01.01-11.02	1 987 43 M 2083	I
1,6 81 <TU5JP4>			
	08.05→	1 457 42 P 9249	O
		1 457 43 S 3325	L
		SBE 1 457 43 S 3159	L
		0 450 90 F 2161 ¹	K
		1 987 43 M 2083	I

Berlingo 1.8 D**1,8 | 43-44 | A9A-161A <XUD7>**

	07.96-11.02	0 451 10 P 3261	O
Org.Nr. →7300	07.96-11.96	1 457 43 S 2154	L
Org.Nr. 7301→	12.96-11.02	1 457 43 S 3544	L
	07.96-11.02	1 457 42 N 9291	K
		RLE 1 987 43 M 2021	I
Org.Nr. →8805	07.96-12.00	1 987 43 M 2021	I
Org.Nr. 8806→	01.01-11.02	1 987 43 M 2083	I

Berlingo 1.8 i**1,8 | 66 | LFX <XU7JB>**

	03.97-11.02	0 451 10 P 3261	O
		1 457 43 S 3606	L
		0 450 90 F 2161 ¹	K
		RLE 1 987 43 M 2021	I
Org.Nr. →8805	03.97-12.00	1 987 43 M 2021	I
Org.Nr. 8806→	01.01-11.02	1 987 43 M 2083	I

Berlingo 1.9 D**1,9 | 50-51 | DJY <XUD9>**

	07.96-11.02	0 451 10 P 3261	O
Org.Nr. →7300	07.96-11.96	1 457 43 S 2154	L
Org.Nr. 7301→	12.96-11.02	1 457 43 S 3544	L
	07.96-11.02	1 457 42 N 9291	K
		RLE 1 987 43 M 2021	I
Org.Nr. →8805	07.96-12.00	1 987 43 M 2021	I
Org.Nr. 8806→	01.01-11.02	1 987 43 M 2083	I

1,9 | 50-51 | D9B <XUD9>

	07.96-11.02	0 451 10 P 3261	O
Org.Nr. →7300	07.96-11.96	1 457 43 S 2154	L
Org.Nr. 7301→	12.96-11.02	1 457 43 S 3544	L
	07.96-11.02	1 457 42 N 9291	K
		RLE 1 987 43 M 2021	I
Org.Nr. →8805	07.96-12.00	1 987 43 M 2021	I
Org.Nr. 8806→	01.01-11.02	1 987 43 M 2083	I

1,9 | 51 | DW8

	10.99→	1 457 43 S 3544	L
		1 457 43 N 1703	K

1,9 | 52 | WJC/WJZ <DW8/W3>

	07.98-11.02	0 451 10 P 3355	O
		1 457 43 S 3544	L
		1 457 43 N 1703	K
		RLE 1 987 43 M 2021	I
Org.Nr. →8805	07.98-12.00	1 987 43 M 2021	I
Org.Nr. 8806→	01.01-11.02	1 987 43 M 2083	I

**1,9 | 52 | WJY <DW8B>**

	09.00-04.08	0 451 10 P 3355	O
	09.00-11.02	1 457 43 S 3544	L
	11.02-04.08	1 987 42 S 9182	L
	09.00-04.08	1 457 43 N 1703	K
		RLE 1 987 43 M 2021	I
	11.02-04.08	1 987 43 M 2083	I
Org.Nr. →8805	09.00-12.00	1 987 43 M 2021	I
Org.Nr. 8806→	01.01-11.02	1 987 43 M 2083	I

Berlingo 2.0 HDi**2,0 | 66 | RHY <DW10TD>**

	12.99-04.08	0 451 10 P 3355	O
	12.99-11.02	LBE 1 457 43 S 3555	L
		SBE 1 457 43 S 3061	L
	11.02-04.08	1 987 42 S 9182	L
	12.99-11.02	1 457 03 N 0013	K
	11.02-04.08	1 457 07 N 0000	K
	12.99-04.08	RLE 1 987 43 M 2021	I
	11.02-04.08	1 987 43 M 2083	I
Org.Nr. →8805	12.99-12.00	1 987 43 M 2021	I
Org.Nr. 8806→	01.01-11.02	1 987 43 M 2083	I

Berlingo 2.0 HDi**2,0 | 66 | DW10TD**

	10.00→	1 457 43 S 3061	L
		BO 1 457 03 N 0013	K
		SIE 1 457 07 N 0000	K
		1 987 43 M 2083	I

BX**BX 11****1,1 | 40 | H1A <TU1/K>**

	06.88-06.91	0 451 10 P 3261	O
		1 457 43 S 3732	L
		0 450 90 F 4058 ¹	K

BX 14**1,4 | 49-52 | K1F <TU3A/N>; K1G <TU3A/K>**

Org.Nr. 4193→	05.88-12.94	0 451 10 P 3261	O
Org.Nr. 4193→5439	05.88-09.91	1 457 42 S 9908	L
Org.Nr. 5440→	09.91-12.94	1 457 43 S 3227	L
	07.86-12.94	0 450 90 F 4058 ¹	K

1,4 | 55 | K2D <TU3.2/K>

	09.91-09.93	0 451 10 P 3261	O
Org.Nr. →5439	09.91-09.91	1 457 42 S 9908	L
Org.Nr. 5440→	09.91-09.93	1 457 43 S 3227	L
	09.91-09.93	0 450 90 F 4058 ¹	K

BX 14 i**1,4 | 55 | KDY Kat. <TU3M/Z>**

	06.90-09.93	0 451 10 P 3261	O
		1 457 42 S 9908	L
		0 450 90 F 5002 ¹	K





BX 15			
1,6 53 B1E <XU51C/W>	09.87-12.94	0 451 10 P 3261	O
		0 450 90 F 4058 ¹	K

BX 16			
1,6 58/67 B1A/E,B1F <XU51C/K>; B2C <XU52C/K>	03.87-12.94	0 451 10 P 3261	O
Org.Nr. 4158→	04.88-12.94	1 457 43 S 2200	L
	03.87-12.94	0 450 90 F 4058 ¹	K

1,6 64 171D <XU5STR>	07.85-12.94	0 451 10 P 3261	O
Org.Nr. 4158→	04.88-12.94	1 457 43 S 2200	L
	07.85-12.94	0 450 90 F 4058 ¹	K

BX 16 i			
1,6 65 BDY Kat. <XU5M>; BDZ Kat. <XU5MZ>	05.89-12.94	0 451 10 P 3261	O
		1 457 43 S 2200	L
		0 450 90 F 5002 ¹	K

1,6 76 180Z <XU5J>	03.86-12.94	0 451 10 P 3261	O
A,CH, S	03.86-12.94	1 457 43 S 2154	L
A,CH, S	03.86-12.94	1 457 43 S 2200	L
	03.86-12.94	0 450 90 F 5002 ¹	K

1,6 83-85 B6D,B6E <XU5JA/K>	09.87-02.93	0 451 10 P 3261	O
		1 457 43 S 2200	L
		0 450 90 F 5002 ¹	K

BX 17 D			
1,8 44 161A <XUD7>	07.85-09.93	0 451 10 P 3261	O
		1 457 43 S 2154	L
	CAV	1 457 43 N 4200 ²	K
	PRF	1 457 42 N 9289	K

BX 17 D Turbo			
1,8 66 AJZ <XUD7TE/Y>; A8A <XUD7TE>	02.88-12.94	0 451 10 P 3261	O
		1 457 43 S 2200	L
	CAV	1 457 43 N 4200 ²	K
	PRF	1 457 42 N 9289	K

BX 19			
1,9 79 D2E,D2F <XU92C>	09.86-09.93	0 451 10 P 3261	O
		1 457 43 S 2154	L
	AA	1 457 43 S 2200	L
		0 450 90 F 4058 ¹	K

BX 19 D			
1,9 47 DJZ <XUD9Y>	01.89-12.94	0 451 10 P 3261	O
		1 457 43 S 2200	L
	CAV	1 457 43 N 4200 ²	K
	PRF	1 457 42 N 9289	K



1,9 51 D9B <XUD9A>	03.87-12.94	0 451 10 P 3261	O
Org.Nr. 3796→	09.87-12.94	1 457 43 S 2200	L
	03.87-12.94	CAV 1 457 43 N 4200 ²	K
		PRF 1 457 42 N 9289	K

BX 19 i			
1,9 88 DKZ Kat. <XU9JAZ>	06.88-03.93	0 451 10 P 3261	O
		1 457 43 S 2200	L
		0 450 90 F 5002 ¹	K

BX 19 i, i 16S			
1,9 75-77/80/108 DDZ Kat. <XU9M/Z>; DFW Kat. <XU9J4/Z>; DFZ Kat. <XU9J1/Z>	03.86-12.94	0 451 10 P 3261	O
		1 457 43 S 2200	L
		0 450 90 F 5002 ¹	K

1,9 90/116 D6C <XU9J4/K>; D6D <XU9J2/K>	07.87-09.93	0 451 10 P 3261	O
		1 457 43 S 2200	L
		0 450 90 F 5002 ¹	K

C 15

C 15 E 1.0			
1,0 32 C1A <TU9>	07.88-12.97	0 451 10 P 3261	O
Org.Nr. 4196→	07.88-12.97	1 457 42 S 9908	L

C 15 E 1.1			
1,1 44 H1A <TU1>	07.88-12.96	0 451 10 P 3261	O
Org.Nr. 4196→	07.88-12.96	1 457 42 S 9908	L

C 15 E 1.1 i			
1,1 44 HDZ Kat. <TU1M>	06.89-12.96	0 451 10 P 3261	O
Org.Nr. 4196→	06.89-12.96	1 457 42 S 9908	L
		0 450 90 F 5002 ¹	K

C 15 E 1.4			
1,4 40-46 K3A	07.87-12.96	0 451 10 P 3261	O
Org.Nr. 4196→	07.87-12.96	1 457 42 S 9908	L
Org.Nr. →5201	07.87-12.96	1 457 43 S 3227	L
Org.Nr. 5201→	07.87-12.96	1 457 43 S 3227	L

1,4 51 K1G <TU3A>	07.87-12.96	0 451 10 P 3261	O
Org.Nr. 4196→	07.87-12.96	1 457 42 S 9908	L
Org.Nr. →5201	07.87-12.96	1 457 43 S 3227	L
Org.Nr. 5201→	07.87-12.96	1 457 43 S 3227	L

1,4 55 K2D (Gußmot.)	05.91-12.96	0 451 10 P 3261	O
Org.Nr. 5201→	05.91-12.96	1 457 43 S 3227	L

C 15 E 1.4 i			
1,4 55-58 KDY Kat.(Gußmot.) <TU3FM>	01.92-12.96	0 451 10 P 3261	O
Org.Nr. 5201→	01.92-12.96	1 457 43 S 3227	L
	01.92-12.96	0 450 90 F 5002 ¹	K



**C 15 1.8 D**

1,8 44 161A <XUD7>				
	07.86-05.00	0 451 10 P 3261	O	
		1 457 43 S 2154	L	
Org.Nr. → 5653	07.86-04.92	1 457 43 N 4200 ²	K	
Org.Nr. 5654→	04.92-05.00	1 457 42 N 9291	K	

C 15 1.9 D

1,9 52 WJX <DW8B>				
	06.00-12.05	0 451 10 P 3355	O	
		1 457 43 S 3544	L	
		1 457 43 N 1703	K	

C-Crosser**C-Crosser 2.0 i, i 4x4**

2,0 108 AFZ <4B11 MMC>				
	11.10→	0 451 10 P 3364	O	
		1 987 43 R 2416 ⁸	I	

C-Crosser 2.2 HDi 4x4

2,2 115 4HK <DW12ME5>; 4HN <DW12METED4/FAP>				
	09.07→	1 457 42 P 9249	O	
		1 987 43 R 2416 ⁸	I	

C-Crosser 2.4 i 4x4

2,4 125 SF... <4B12 MMC>				
	11.07→	0 451 10 P 3364	O	
		1 987 43 R 2416 ⁸	I	

CX**CX 20**

2,0 74-78 829 A5, J6RA500				
	07.82-12.92	0 451 10 P 3261	O	
	07.85-12.92	1 457 43 S 2124	L	
	07.82-12.92	0 450 90 F 4058 ¹	K	

CX 22

2,2 83-85 J6TA500				
	07.85-12.92	0 451 10 P 3261	O	
		1 457 43 S 2124	L	
		0 450 90 F 4058 ¹	K	

CX 25 D

2,5 54 M25-660				
	02.84-12.92	0 451 10 P 3109	O	
	04.83-12.92	CAV 1 457 43 N 4200 ²	K	
		PRF 1 457 42 N 9289	K	

CX 25 D Turbo 2

2,5 78/88 M25-669; M25-671				
	01.87-12.92	0 451 10 P 3109	O	
		CAV 1 457 43 N 4200 ²	K	
		PRF 1 457 42 N 9289	K	
Org.Nr. 3766→	A,CH 01.87-12.92	CAV 1 457 43 N 4156	K	

**CX 25 Injection**

2,5 89-98 M25-668 Kat. <EN5L>				
	05.86-12.92	0 451 10 P 3261	O	
		0 450 90 F 5002 ¹	K	

2,5 | 96-100 | M25-659 <EN5L>

	07.83-12.92	0 451 10 P 3261	O	
		0 450 90 F 5002 ¹	K	

CX 25 Injection Turbo 2

2,5 116 M25-667 Kat. <EN5TE>				
	09.86-12.92	0 451 10 P 3261	O	
		0 450 90 F 5021 ¹	K	

2,5 | 122 | M25-666 <EN5TE>

	05.86-12.92	0 451 10 P 3261	O	
		0 450 90 F 5002 ¹	K	

C1**C1 1.0 i**

1,0 50 CFA <384F Euro 4>; <384F Euro 5>				
	06.05→	0 986 45 P 2028	O	
		1 457 43 S 3971	L	
		1 987 43 M 2189	I	

C1 1.4 HDi

1,4 40 8HT <DV4TD>				
	06.05→	1 457 42 P 9238	O	
		1 457 43 S 3076	L	
		0 450 90 N 6460 ¹	K	
		1 987 43 M 2189	I	

C2**C2 1.1 i**

1,1 44 HFX <TU1JP/TU1A>				
Mot.Nr. →4413114	09.03-12.09	1 457 42 P 9193	O	
Mot.Nr. 4413115→	09.03-12.09	1 457 42 P 9249	O	
	09.03-12.09	LBE 1 457 43 S 3158	L	
		SBE 1 457 43 S 3159	L	
		0 450 90 F 2161 ¹	K	
		1 987 43 M 2079	I	
		1 987 43 R 2379 ⁸	I	

C2 1.4 HDi

1,4 50 8H... <DV4TD>				
	09.03-12.09	1 457 42 P 9238	O	
		LBE 1 457 43 S 3076	L	
		SBE 1 457 43 S 3076	L	
		0 450 90 N 6460 ¹	K	
		1 987 43 M 2079	I	
		1 987 43 R 2379 ⁸	I	





C2 1.4 i

1,4 | 55 | KfV <TU3JP/TU3A>

Mot.Nr. →4717577	09.03-12.09	1 457 42	P 9193	O
Mot.Nr. 4717578→	09.03-12.09	1 457 42	P 9249	O
	09.03-12.09	LBE	1 457 43 S 3158	L
		SBE	1 457 43 S 3159	L
			0 450 90 F 2161 ¹	K
			1 987 43 M 2079	I
			1 987 43 R 2379 ⁸	I

C2 1.4 i 16V

1,4 | 65 | KfU <ET3J4>

	12.05-12.08	1 457 42	P 9249	O
		LBE	1 457 43 S 3158	L
		SBE	1 457 43 S 3159	L
			0 450 90 F 2161 ¹	K
			1 987 43 M 2079	I
			1 987 43 R 2379 ⁸	I

C2 1.6 HDi

1,6 | 80 | 9HZ <DV6TED4>

	07.07-05.09	1 457 42	P 9238	O
			1 457 43 S 3160	L
			0 450 90 N 6471 ¹	K
			1 987 43 M 2079	I
			1 987 43 R 2379 ⁸	I

C2 1.6 i

1,6 | 80 | NFU <TU5JP4>

Org.Nr. →10072	09.03-06.04	1 457 42	P 9193	O
Org.Nr. 10073→	07.04-12.09	1 457 42	P 9249	O
	09.03-12.09	LBE	1 457 43 S 3325	L
		SBE	1 457 43 S 3159	L
			0 450 90 F 2161 ¹	K
			1 987 43 M 2079	I
			1 987 43 R 2379 ⁸	I

C2 1.6 i VTS

1,6 | 90 | NFS <TU5JP4S>

	10.04-05.09	1 457 42	P 9249	O
Org.Nr. →11794	10.04-03.09	LBE	1 457 43 S 3325	L
		SBE	1 457 43 S 3159	L
Org.Nr. 11795→	04.09-05.09	1 457 43	S 3325	L
	10.04-05.09		0 450 90 F 2161 ¹	K
			1 987 43 M 2079	I
			1 987 43 R 2379 ⁸	I

C3

C3 1.1 i

1,1 | 44 | HFV <TU1AE5>

	09.09→	1 457 42	P 9249	O
			1 457 43 S 3158	L
		2FE	1 987 43 M 2136	I

1,1 | 44 | HFX <TU1A>

	09.05-09.09	1 457 42	P 9249	O
Org.Nr. →11794	09.05-03.09	LBE	1 457 43 S 3158	L
		SBE	1 457 43 S 3159	L



Org.Nr. 11795→	04.09-09.09	1 457 43	S 3158	L
	09.05-09.09	0 450 90	F 2161 ¹	K
		1 987 43	M 2079	I
		1 987 43	R 2379 ⁸	I

1,1 | 44 | HFX <TU1JP>

Mot.Nr. →4413114	01.02-08.05	1 457 42	P 9193	O
Mot.Nr. 4413115→	01.02-08.05	1 457 42	P 9249	O
	01.02-08.05	LBE	1 457 43 S 3158	L
		SBE	1 457 43 S 3159	L
			0 450 90 F 2161 ¹	K
			1 987 43 M 2079	I
			1 987 43 R 2379 ⁸	I

C3 1.4 HdI

1,4 | 52 | 8HW <DV4TD>

	07.03→	1 457 42	P 9238	O
		1 457 43	S 3076	L
		0 450 90	N 6460 ¹	K
		1 987 43	M 2079	I

C3 1.4 HDi

1,4 | 50 | 8HR <DV4C>

	06.10→	1 457 42	P 9238	O
		2FE	1 987 43 M 2136	I

1,4 | 50 | 8HX <DV4TD>

	01.02-08.05	1 457 42	P 9238	O
		LBE	1 457 43 S 3076	L
		SBE	1 457 43 S 3076	L
			0 450 90 N 6460 ¹	K
			1 987 43 M 2079	I
			1 987 43 R 2379 ⁸	I

1,4 | 50 | 8HZ <DV4TD>

	09.05-09.09	1 457 42	P 9238	O
	11.09→	1 457 42	P 9238	O
	09.05-09.09	LBE	1 457 43 S 3076	L
		SBE	1 457 43 S 3076	L
	11.09→	LBE	1 457 43 S 3076	L
		SBE	1 457 43 S 3076	L
	09.05-09.09	0 450 90	N 6460 ¹	K
	11.09→	0 450 90	N 6460 ¹	K
	09.05-09.09	1 987 43	M 2079	I
		1 987 43	R 2379 ⁸	I
	11.09→	2FE	1 987 43 M 2136	I

C3 1.4 HDi 16V

1,4 | 66 | 8HY <DV4TED4>

	01.02-08.05	1 457 42	P 9238	O
		1 457 43	S 3160	L
		0 450 90	N 6471 ¹	K
		1 987 43	M 2079	I
		1 987 43	R 2379 ⁸	I

C3 1.4 i

1,4 | 54 | KFT <TU3AE5>

	11.09→	1 457 42	P 9249	O
		1 457 43	S 3158	L
		2FE	1 987 43 M 2136	I



1,4 54 KFU <TU3A/TU3JP>				
	09.05-09.09		1 457 42 P 9249	O
Org.Nr. →11794	09.05-03.09	LBE	1 457 43 S 3158	L
		SBE	1 457 43 S 3159	L
Org.Nr. 11795→	04.09-09.09		1 457 43 S 3158	L
	09.05-09.09		0 450 90 F 2161 ¹	K
			1 987 43 M 2079	I
			1 987 43 R 2379 ⁸	I

1,4 55 KFU <TU3JP>				
Mot.Nr. →4717577	01.02-08.05		1 457 42 P 9193	O
Mot.Nr. 4717578→	01.02-08.05		1 457 42 P 9249	O
	01.02-08.05	LBE	1 457 43 S 3158	L
		SBE	1 457 43 S 3159	L
			0 450 90 F 2161 ¹	K
			1 987 43 M 2079	I
			1 987 43 R 2379 ⁸	I

C3 1.4 i 16V

1,4 65 KFU <ET3J4>				
	10.03-09.09		1 457 42 P 9249	O
	10.03-08.05		1 457 43 S 3158	L
	09.05-09.09	LBE	1 457 43 S 3158	L
		SBE	1 457 43 S 3159	L
	10.03-09.09		0 450 90 F 2161 ¹	K
			1 987 43 M 2079	I
			1 987 43 R 2379 ⁸	I

C3 1.4 VTi

1,4 70-72 8F... <EP3C>				
	11.09→		1 457 42 P 9249	O
			F 026 40 S 0050	L
			0 450 90 F 2161 ¹	K
		2FE	1 987 43 M 2136	I

C3 1.4 8V

1,4 54 <TU3JP>				
Mot.Nr. →4717577	07.03→		1 457 42 P 9193	O
Mot.Nr. 4717578→	07.03→		1 457 42 P 9249	O
	07.03→		0 450 90 F 2161 ¹	K
			1 987 43 M 2079	I
			1 987 43 R 2379 ⁸	I

C3 1.6 HDi

1,6 66 9HX <DV6ATED4>				
	09.05→		1 457 42 P 9238	O
			1 457 43 S 3160	L
			0 450 90 N 6471 ¹	K
	09.05-12.09		1 987 43 M 2079	I
			1 987 43 R 2379 ⁸	I
	11.09→	2FE	1 987 43 M 2136	I

1,6 68/82 9HP <DV6DTE4>; 9HR <DV6C>				
	09.09→		1 457 42 P 9238	O
		2FE	1 987 43 M 2136	I

1,6 80 9HZ <DV6TED4>				
	09.05-05.09		1 457 42 P 9238	O
			1 457 43 S 3160	L
			0 450 90 N 6471 ¹	K
			1 987 43 M 2079	I
			1 987 43 R 2379 ⁸	I

C3 1.6 i

1,6 80 NFU <TU5JP4>				
	09.05-05.09		1 457 42 P 9249	O
Org.Nr. →10072	01.02-06.04		1 457 42 P 9193	O
Org.Nr. 10073→	07.04-08.05		1 457 42 P 9249	O
	01.02-05.09	LBE	1 457 43 S 3325	L
		SBE	1 457 43 S 3159	L
	09.05-05.09		1 457 43 S 3076	L
	01.02-05.09		0 450 90 F 2161 ¹	K
			1 987 43 M 2079	I
			1 987 43 R 2379 ⁸	I

C3 1.6 i 16V VTi

1,6 88 5FS <EP6C>				
	11.09→		1 457 42 P 9249	O
			F 026 40 S 0050	L
			0 450 90 F 2161 ¹	K
		2FE	1 987 43 M 2136	I

C3 1.6 16V

1,6 81 TU5JP4				
Org.Nr. →10072	05.03-06.04		1 457 42 P 9193	O
Org.Nr. 10073→	07.04→		1 457 42 P 9249	O
	05.03→		0 450 90 F 2161 ¹	K
			1 987 43 M 2079	I
			1 987 43 R 2379 ⁸	I

C3 Picasso

C3 Picasso 1.4 i

1,4 70 8FS <EP3>				
	02.09→		1 457 42 P 9249	O
			F 026 40 S 0050	L
			1 987 43 M 2079	I
			1 987 43 R 2379 ⁸	I

C3 Picasso 1.4 VTi

1,4 70 8FP <EP3C>				
	01.10→		1 457 42 P 9249	O
			F 026 40 S 0050	L
			0 450 90 F 2161 ¹	K
			1 987 43 M 2079	I
			1 987 43 R 2379 ⁸	I

C3 Picasso 1.6 HDi

1,6 66/80 9HX <DV6ATED4>; 9HZ <DV6TED4>				
	02.09→		1 457 42 P 9238	O
			1 457 43 S 3160	L
			0 450 90 N 6471 ¹	K
			1 987 43 M 2079	I
			1 987 43 R 2379 ⁸	I





◀ C3 Picasso 1.6 HDi

1,6 68/82 9HP <DV6DTEd>; 9HR <DV6C>			
03.10→	1 457 42	P 9238	O
	1 987 43	M 2079	I
	1 987 43	R 2379⁸	I

C3 Picasso 1.6 i

1,6 84-88 5F... <EP6>; 5FS <EP6C>			
02.09→	1 457 42	P 9249	O
	F 026 40	S 0050	L
	0 450 90	F 2161¹	K
	1 987 43	M 2079	I
	1 987 43	R 2379⁸	I

C3 Pluriel

C3 Pluriel 1.4 HDi

1,4 50 8H... <DV4TD>			
10.03-01.10	1 457 42	P 9238	O
	LBE	1 457 43 S 3076	L
	SBE	1 457 43 S 3076	L
	0 450 90	N 6460¹	K
	1 987 43	M 2079	I
	1 987 43	R 2379⁸	I

C3 Pluriel 1.4 i

1,4 54 KfV <TU3A/L5>			
10.05→	1 457 42	P 9249	O
05.09→	1 457 43	S 3158	L
Org.Nr. →11829	10.05-04.09	LBE 1 457 43 S 3158	L
		SBE 1 457 43 S 3159	L
	10.05→	0 450 90 F 2161¹	K
		1 987 43 M 2079	I
		1 987 43 R 2379⁸	I

1,4 | 55 | KfV <TU3JP>

Mot.Nr. →4717577	05.03→	1 457 42	P 9193	O
Mot.Nr. 4717578→	05.03→	1 457 42	P 9249	O
	05.03→	LBE	1 457 43 S 3158	L
		SBE	1 457 43 S 3159	L
		0 450 90	F 2161¹	K
		1 987 43	M 2079	I
		1 987 43	R 2379⁸	I

C3 Pluriel 1.6 i 16V

1,6 80 NFU <TU5JP4>				
Org.Nr. →10072	05.03-06.04	1 457 42	P 9193	O
Org.Nr. 10073→	07.04→	1 457 42	P 9249	O
Org.Nr. →11829	05.03-04.09	LBE	1 457 43 S 3325	L
		SBE	1 457 43 S 3159	L
Org.Nr. 11830→	05.09→	1 457 43	S 3325	L
	05.03→	0 450 90	F 2161¹	K
		1 987 43	M 2079	I
		1 987 43	R 2379⁸	I



C4

C4 1.4 i

1,4 65 KfV <ET3J4>			
11.04→	1 457 42	P 9249	O
	LBE	1 457 43 S 3592	L
	0 450 90	F 2161¹	K
	1 987 43	M 2079	I
	1 987 43	R 2379⁸	I

1,4 | 70 | 8F... <EP3C>

09.10→	1 457 42	P 9249	O
	F 026 40	S 0050	L
	0 450 90	F 2161¹	K
	1 987 43	M 2079	I
	1 987 43	R 2379⁸	I

C4 1.6 HDi

1,6 66 9HV <DV6TED4/FAP>			
05.07-07.09	1 457 42	P 9238	O
	1 457 43	S 3160	L
	0 450 90	N 6471¹	K
	1 987 43	M 2079	I
	1 987 43	R 2379⁸	I

1,6 | 66 | 9HX <DV6ATED4>

11.04-07.05	1 457 42	P 9238	O
	1 457 43	S 3160	L
	0 450 90	N 6471¹	K
	1 987 43	M 2079	I
	1 987 43	R 2379⁸	I

1,6 | 68/80/82 | 9HG <DV6C M>; 9HJ <DV6DTEd M>; 9HP <DV6DTEd>; 9HR <DV6C>

04.10→	1 457 42	P 9238	O
	1 987 43	M 2079	I
	1 987 43	R 2379⁸	I

1,6 | 80 | 9H... <DV6TED4>

11.04→	1 457 42	P 9238	O
	1 457 43	S 3160	L
	0 450 90	N 6471¹	K
	1 987 43	M 2079	I
	1 987 43	R 2379⁸	I

C4 1.6 i

1,6 80 NFU <TU5JP4>			
11.04-07.08	1 457 42	P 9249	O
	0 450 90	F 2161¹	K
	1 987 43	M 2079	I
	1 987 43	R 2379⁸	I

1,6 | 88 | 5FS <EP6C>

09.10→	1 457 42	P 9249	O
	F 026 40	S 0050	L
	0 450 90	F 2161¹	K
	1 987 43	M 2079	I
	1 987 43	R 2379⁸	I

1,6 | 88 | 5FW <EP6>

07.08→	1 457 42	P 9249	O
	F 026 40	S 0050	L
	0 450 90	F 2161¹	K
	1 987 43	M 2079	I
	1 987 43	R 2379⁸	I





1,6 103 5FT <EP6DT>	07.08-07.09	1 457 42 P 9249	O
		F 026 40 S0151	L
		0 450 90 F 2161 ¹	K
		1 987 43 M 2079	I
		1 987 43 R 2379 ⁸	I

1,6 110 5FX <EP6DT>	07.08→	1 457 42 P 9249	O
Org.Nr. →11920	07.08-07.09	F 026 40 S0151	L
	07.08→	0 450 90 F 2161 ¹	K
		1 987 43 M 2079	I
		1 987 43 R 2379 ⁸	I

C4 1.6 i BioFlex

1,6 80 N6A <TU5JP4>	09.07-07.08	1 457 42 P 9249	O
		1 987 43 M 2079	I
		1 987 43 R 2379 ⁸	I

C4 1.6 i THP

1,6 115 5FV <EP6CDT>	09.10→	1 457 42 P 9249	O
		0 450 90 F 2161 ¹	K
		1 987 43 M 2079	I
		1 987 43 R 2379 ⁸	I

C4 1.6 i 16V

1,6 80 NFU <TU5JP4>	11.10→	1 457 42 P 9249	O
		0 450 90 F 2161 ¹	K
		1 987 43 M 2079	I
		1 987 43 R 2379 ⁸	I

C4 2.0 , i

2,0 103/105 <EW10A>; RFJ <EW10A>	11.04→	1 457 42 P 9249	O
		F 026 40 S0120	L
		0 450 90 F 2161 ¹	K
		1 987 43 M 2079	I
		1 987 43 R 2379 ⁸	I

C4 2.0 HDi

2,0 100 RHR <DW10BTD4>	11.04-01.10	1 457 42 P 9249	O
		AG F 026 40 S0150	L
		GS 1 457 43 S 3098	L
		1 457 43 N 1723	K
		1 987 43 M 2079	I
		1 987 43 R 2379 ⁸	I

2,0 103 RHF <DW10BTD4>	07.08→	1 457 42 P 9249	O
		AG F 026 40 S0150	L
		GS 1 457 43 S 3098	L
		1 457 43 N 1723	K
		1 987 43 M 2079	I
		1 987 43 R 2379 ⁸	I

2,0 110 RHE <DW10CTED4/DTR>	09.10→	1 457 42 P 9249	O
		F 026 40 S0150	L
		1 987 43 M 2079	I
		1 987 43 R 2379 ⁸	I

2,0 120 RHH <DW10CTED4/DTR>	10.10→	1 457 42 P 9249	O
		F 026 40 S0150	L
		1 987 43 M 2079	I
		1 987 43 R 2379 ⁸	I

C4 2.0 i

2,0 100 RFN <EW10J4>	11.04-10.05	0 451 10 P 3355	O
		LBE 1 457 43 S 3090	L
		0 450 90 F 2161 ¹	K
		1 987 43 M 2079	I
		1 987 43 R 2379 ⁸	I

2,0 130 RFK <EW10J4S>	11.04-03.08	0 451 10 P 3355	O
		0 450 90 F 2161 ¹	K
		1 987 43 M 2079	I
		1 987 43 R 2379 ⁸	I

C4 Picasso**C4 Picasso 1.6 HDi**

1,6 80 9H... <DV6TED4>	10.06→	1 457 42 P 9238	O
		1 457 43 S 3160	L
		0 450 90 N 6471 ¹	K
		1 987 43 M 2137	I
		1 987 43 R 2437 ⁸	I

1,6 82 9H... <DV6C>	05.10→	1 457 42 P 9238	O
		1 987 43 M 2137	I
		1 987 43 R 2437 ⁸	I

C4 Picasso 1.6 i

1,6 88 5FS <EP6C>	04.10→	1 457 42 P 9249	O
		F 026 40 S 0050	L
		0 450 90 F 2161 ¹	K
		1 987 43 M 2137	I
		1 987 43 R 2437 ⁸	I

1,6 88 5FW <EP6>	07.08→	1 457 42 P 9249	O
		F 026 40 S 0050	L
		0 450 90 F 2161 ¹	K
		1 987 43 M 2137	I
		1 987 43 R 2437 ⁸	I





◀ C4 Picasso 1.6 i

1,6 103 5FT <EP6DT>	07.08-11.09	1 457 42 P 9249	O
Org.Nr. →11920	07.08-07.09	F 026 40 S 0151	L
	07.08-11.09	0 450 90 F 2161 ¹	K
		1 987 43 M 2137	I
		1 987 43 R 2437 ⁸	I

1,6 110 5FX <EP6DT>	07.08→	1 457 42 P 9249	O
Org.Nr. →11920	07.08-07.09	F 026 40 S 0151	L
	07.08→	0 450 90 F 2161 ¹	K
		1 987 43 M 2137	I
		1 987 43 R 2437 ⁸	I

C4 Picasso 1.6 i THP

1,6 115 5FV <EP6CDT>	07.10→	1 457 42 P 9249	O
		0 450 90 F 2161 ¹	K
		1 987 43 M 2137	I
		1 987 43 R 2437 ⁸	I

C4 Picasso 1.8 i

1,8 92 6FY <EW7A>	10.06-07.08	1 457 42 P 9249	O
		F 026 40 S 0120	L
		0 450 90 F 2161 ¹	K
		1 987 43 M 2137	I
		1 987 43 R 2437 ⁸	I

C4 Picasso 2.0 HDi

2,0 100 RHJ <DW10BTED4>; RHR <DW10BTED4>	10.06→	1 457 42 P 9249	O
		F 026 40 S 0150	L
		1 457 43 N 1723	K
		1 987 43 M 2137	I
		1 987 43 R 2437 ⁸	I

2,0 110/120 RHE <DW10CTED4/FAP>; RHH <DW10CTED4/FAP>	07.09→	1 457 42 P 9249	O
		F 026 40 S 0150	L
		1 987 43 M 2137	I
		1 987 43 R 2437 ⁸	I

C4 Picasso 2.0 i

2,0 103 RFJ <EW10A>	10.06-10.08	1 457 42 P 9249	O
		F 026 40 S 0120	L
		0 450 90 F 2161 ¹	K
		1 987 43 M 2137	I
		1 987 43 R 2437 ⁸	I

C5

C5 1.6 HDi

1,6 80 9H... <DV6TED4>	10.04-03.08	1 457 42 P 9238	O
		1 457 43 S 3327	L
		0 450 90 N 6471 ¹	K
		1 987 43 R 2412 ⁸	I



1,6 80 9HZ <DV6TED4>	04.08-07.10	1 457 42 P 9238	O
		1 457 43 S 3327	L
		0 450 90 N 6471 ¹	K
		1 987 43 R 2311 ⁸	I

1,6 82 9H... <DV6C>	03.10→	1 457 42 P 9238	O
		1 987 43 R 2311 ⁸	I

C5 1.6 i

1,6 88 5FS <EP6C>	09.10→	F 026 40 S 0050	L
		0 450 90 F 2161 ¹	K
		1 987 43 R 2311 ⁸	I

C5 1.6 i THP

1,6 110 5FN <EP6CDT>	09.09→	1 457 42 P 9249	O
		0 450 90 F 2161 ¹	K
		1 987 43 R 2311 ⁸	I

1,6 115 5FV <EP6CDT>	09.09→	1 457 42 P 9249	O
		0 450 90 F 2161 ¹	K
		1 987 43 R 2311 ⁸	I

C5 1.8 i

1,8 85 6FZ <EW7J4>	10.04-09.05	0 451 10 P 3355	O
		1 457 43 S 3591	L
		0 450 90 F 2161 ¹	K
		1 987 43 R 2412 ⁸	I

1,8 92 6FY <EW7A>	09.05→	1 457 42 P 9249	O
		1 457 43 S 3591	L
		0 450 90 F 2161 ¹	K
	09.05-03.08	1 987 43 R 2412 ⁸	I
	04.08→	1 987 43 R 2311 ⁸	I

C5 1.8 i 16V

1,8 85 6FZ <EW7J4>	03.01-09.04	0 451 10 P 3355	O
		1 457 43 S 2200	L
		0 450 90 F 2161 ¹	K
		1 987 43 R 2398 ⁸	I

C5 2.0 HDi

2,0 66 RHY <DW10TD>	03.01-09.04	0 451 10 P 3355	O
		1 457 43 S 2200	L
		BO 1 457 03 N 0013	K
		SIE 1 457 07 N 0000	K
		1 987 43 R 2398 ⁸	I

2,0 79 RHS <DW10ATED/FAP>	03.01-09.04	0 451 10 P 3355	O
		1 457 43 S 2200	L
		1 457 07 N 0000	K
		1 987 43 R 2398 ⁸	I



2,0 80 RHZ <DW10ATED>				
	03.01-09.04	0 451 10	P 3355	O
		1 457 43	S 2200	L
	06.01-09.04	GS	1 457 07	N 0000
Org.Nr. →8940	03.01-05.01	GS	1 457 03	N 0013
Org.Nr. →9248	03.01-03.02	AG	1 457 03	N 0013
Org.Nr. 8941→	06.01-09.04	GS	1 457 07	N 0000
Org.Nr. 9248→	04.02-09.04	AG	1 457 07	N 0000
	03.01-09.04	1 987 43	R 2398	I

2,0 100 RH... <DW10BTED4>				
	10.04-03.08	1 457 42	P 9249	O
		LBE	1 457 43	S 3596
		SBE	F 026 40	S 0108
			1 457 43	N 1723
			1 987 43	R 2412

2,0 100-103 RH... <DW10BTED4>				
	04.08→	1 457 42	P 9249	O
		1 457 43	S 3596	L
		1 457 43	N 1723	K
		1 987 43	R 2311	I

2,0 100/110/120 RHD <DW10CTED4>; RHE <DW10CTED4>; RHH <DW10CTED4>				
	09.09→	1 457 42	P 9249	O
		1 987 43	R 2311	I

C5 2.0 HPi

2,0 103 RLZ <EW10D>				
	03.01-09.04	0 451 10	P 3355	O
		1 457 43	S 2200	L
		0 450 90	F 2161	K
		1 987 43	R 2398	I

C5 2.0 i

2,0 103 RFJ <EW10A>				
	10.04-01.10	1 457 42	P 9249	O
		1 457 43	S 3591	L
		0 450 90	F 2161	K
	10.04-03.08	1 987 43	R 2412	I
	04.08-01.10	1 987 43	R 2311	I

C5 2.0 i 16V

2,0 100 RFN <EW10J4>				
	03.01-09.04	0 451 10	P 3355	O
		1 457 43	S 2200	L
		0 450 90	F 2161	K
		1 987 43	R 2398	I

C5 2.2 HDi

2,2 98 4HX <DW12TED4>				
	03.01-09.05	0 451 10	P 3355	O
	03.01-09.04	1 457 43	S 2200	L
	10.04-09.05	F 026 40	S 0108	L
	06.01-09.05	1 457 07	N 0000	K
Org.Nr. →8945	03.01-05.01	1 457 03	N 0013	K
Org.Nr. 8946→	06.01-09.04	1 457 07	N 0000	K
	03.01-09.04	1 987 43	R 2398	I
	10.04-09.05	1 987 43	R 2412	I



2,2 125 4H... <DW12BTED4>				
	03.06-03.08	1 457 42	P 9249	O
		1 987 43	R 2412	I

2,2 125 4H... <DW12BTED4>				
	04.08-09.09	1 457 42	P 9249	O
		1 987 43	R 2311	I

2,2 150 4HL <DW12C>				
	07.10→	1 987 43	R 2311	I

C5 2.7 HDi

2,7 150 UHZ <DT17TED4>				
	04.08-07.09	1 457 42	P 9307	O
		F 026 40	N 2004	K
		1 987 43	R 2311	I

C5 3.0 HDi 24V

3,0 177 X8Z <DT20C>				
	07.09→	1 987 43	R 2311	I

C5 3.0 i

3,0 150 XFX <ES9J4S>				
	03.01-09.04	0 451 10	P 3261	O
		1 457 43	S 2200	L
		0 450 90	F 2161	K
		1 987 43	R 2398	I

3,0 155 XFU <ES9A>				
	10.04-04.07	0 451 10	P 3355	O
		LBE	1 457 43	S 3591
			0 450 90	F 2161
			1 987 43	R 2412

3,0 155 XFF <ES9A>				
	04.08-04.09	0 451 10	P 3355	O
		LBE	1 457 43	S 3591
			0 450 90	F 2161
			1 987 43	R 2311

C6**C6 2.2 HDi**

2,2 125 4H... <DW12BTED4>				
	06.06-07.10	1 457 42	P 9249	O
Org.Nr. →11556	06.06-07.08	1 987 43	R 2412	I
Org.Nr. 11557→	08.08-07.10	1 987 43	R 2311	I

C6 2.7 HDi

2,7 150 UHZ <DT17TED4>				
	11.05-07.09	1 457 42	P 9307	O
		F 026 40	N 2004	K
Org.Nr. →11556	11.05-07.08	1 987 43	R 2412	I
Org.Nr. 11557→	08.08-07.09	1 987 43	R 2311	I

C6 3.0 HDi 24V

3,0 177 X8Z <DT20C>				
	07.09→	1 987 43	R 2311	I





C6 3.0 i

3,0 155 XFV <ES9A>			
	11.05-02.09	0 451 10 P 3355	O
		LBE 1 457 43 S 3591	L
		0 450 90 F 2161 ¹	K
Org.Nr. →11556	11.05-07.08	1 987 43 R 2412 ⁸	I
Org.Nr. 11557→	08.08-02.09	1 987 43 R 2311 ⁸	I

C8

C8 2.0 HDi

2,0 81 RH... <DW10ATED4/FAP>			
	06.02-12.06	0 451 10 P 3355	O
Org.Nr. →10121	06.02-08.04	1 457 43 S 2200	L
	06.02-12.06	1 457 07 N 0000	K
		1 987 43 M 2091	I

2,0 81 RHW <DW10ATED4>			
	06.02-12.06	0 451 10 P 3355	O
		1 457 43 S 2200	L
		1 457 07 N 0000	K
		1 987 43 M 2091	I

2,0 88/100 RHK <DW10UTED4>; RHR <DW10BTED4>			
	03.06-05.10	1 457 42 P 9249	O
		F 026 40 S 0058	L
		1 457 43 N 1723	K
		1 987 43 M 2091	I

2,0 100/120 RHD <DW10CB DTR>; RHH <DW10CTED4>			
	06.10→	1 457 42 P 9249	O
		F 026 40 S 0058	L
		1 987 43 M 2091	I

C8 2.0 i 16V

2,0 100 RFN <EW10J4>			
	06.02-05.06	0 451 10 P 3355	O
		LBE 1 457 43 S 2200	L
		0 450 90 F 2161 ¹	K
		1 987 43 M 2091	I

2,0 103 RFJ <EW10A>			
	10.05-05.10	1 457 42 P 9249	O
		1 457 43 S 2200	L
		1 987 43 M 2091	I

C8 2.2 HDi

2,2 94 4HW <DW12TED4/FAP>			
	06.02-07.06	0 451 10 P 3355	O
		1 457 43 S 2200	L
		1 457 07 N 0000	K
		1 987 43 M 2091	I

2,2 125 4H ... <DW12BTED4>			
	09.07-05.10	1 457 42 P 9249	O
		F 026 40 S 0058	L
		1 987 43 M 2091	I



C8 2.2 i 16V

2,2 116 3FZ <EW12J4>			
	06.02-05.06	0 451 10 P 3355	O
		LBE 1 457 43 S 2200	L
		0 450 90 F 2161 ¹	K
		1 987 43 M 2091	I

C8 3.0 i

2,9 150 XFW <ES9J4S>			
	10.02-05.06	0 451 10 P 3261	O
		1 457 43 S 2200	L
		0 450 90 F 2161 ¹	K
		1 987 43 M 2091	I

C25

C25 25 E 1.8

1,8 49-51 XM7T <169B>			
	11.81-03.94	0 451 10 P 3261	O
		LAT,XXX 1 457 43 S 2149	L

C25 25 E 2.0

2,0 55-63 XN1T <170A/B>; XN1TA <170C/D>			
	09.81-03.94	0 451 10 P 3261	O
		LAT,XXX 1 457 43 S 2149	L

C25 25 1.9 D

1,9 51 D9B <XUD9A>			
	07.87-03.94	0 451 10 P 3261	O
		1 457 43 S 2138	L
Org.Nr. →121750	07.87-03.94	ROD 1 457 43 N 4201 ²	K
Org.Nr. 121751→	07.87-03.94	ROD 1 457 43 N 4200 ²	K

C25 25 1.9 D Turbo

1,9 60 <M705>			
	04.92-03.94	1 457 43 S 2138	L

C25 25 2.5 D, 2.5 D Turbo

2,5 54-55/70 CRD93L <U 25/651, 661>; CRD93LS <U25/673>			
	07.81-03.94	0 451 10 P 3109	O
Org.Nr. 121750→	07.81-03.94	XXX 1 457 43 S 3800	L
Org.Nr. →121750	07.81-03.94	ROD 1 457 43 N 4201 ²	K
Org.Nr. 121751→	07.81-03.94	ROD 1 457 43 N 4200 ²	K

C35

C35 35 E 2.0

2,0 65 B20/614			
	11.73-12.92	0 451 10 P 3144	O

C35 35 2.5 D

2,5 50 CRD93B <B 25/637>			
	08.86-12.92	0 451 10 P 3261	O
	10.83-12.92	PRF 1 457 42 N 9289	K
	11.83-12.92	ROD 1 457 43 N 4200 ²	K



**C45****C45 45 2.5 D**

2,5 50 CRD93B <B25/637>	06.82-12.92	1 457 43 N 1028	K
-----------------------------	-------------	-----------------	---

DS3**DS3 1.4 HDi**

1,4 50 8HR <DV4C>	03.10→	1 457 42 P 9238	O
	2FE	1 987 43 M 2136	I

DS3 1.4 VTi

1,4 70-72 8F... <EP3C>	01.10→	1 457 42 P 9249	O
		F 026 40 S 0050	L
		0 450 90 F 5287 ¹	K
	2FE	1 987 43 M 2136	I

DS3 1.6 HDi

1,6 68/82 9HP <DV6DTE>; 9HR <DV6C>	11.09→	1 457 42 P 9238	O
	2FE	1 987 43 M 2136	I

DS3 1.6 i THP

1,6 110 5FX <EP6DT/EU5>	01.10→	1 457 42 P 9249	O
		0 450 90 F 5287 ¹	K
	2FE	1 987 43 M 2136	I

1,6 | 115 | 5FR <EP6DT/EU5>

01.10→	1 457 42 P 9249	O
	0 450 90 F 5287 ¹	K
2FE	1 987 43 M 2136	I

DS3 1.6 i THP Racing

1,6 149/152 5FD <EP6DTS>; 5FF <EP6DTS>	10.10→	1 457 42 P 9249	O
		0 450 90 F 2161 ¹	K
	2FE	1 987 43 M 2136	I

DS3 1.6 i 16V VTi

1,6 88 5FS <EP6C>	01.10→	1 457 42 P 9249	O
		F 026 40 S 0050	L
		0 450 90 F 5287 ¹	K
	2FE	1 987 43 M 2136	I

DS4**DS4 1.6 HDi**

1,6 82 9HR <DV6C>	03.11→	1 457 42 P 9238	O
		1 987 43 M 2079	I
		1 987 43 R 2379 ⁸	I

DS4 1.6 HDi 16V, i, i THP

1,6 68/88/115/147 5FS <EP6C>; 5FU <EP6CDTX>; 5FV <EP6CDT>; 9HP <DV6DTE>	03.11→	1 987 43 M 2079	I
		1 987 43 R 2379 ⁸	I

DS4 1.6 i THP

1,6 110 5FE <EP6CDT M>	03.11→	1 987 43 M 2079	I
		1 987 43 R 2379 ⁸	I

1,6 | 120 | 5FM <EP6CDT M>

03.11→	1 457 42 P 9249	O
	1 987 43 M 2079	I
	1 987 43 R 2379 ⁸	I

DS4 2.0 HDi 16V

2,0 120 RHH <DW10CTED4>	03.11→	1 987 43 M 2079	I
		1 987 43 R 2379 ⁸	I

DS5**DS5 1.6 HDi**

1,6 82 9HR <DV6C>	09.11→	1 457 42 P 9238	O
-----------------------	--------	-----------------	---

DS5 1.6 i THP

1,6 110/115/120/147 5FE <EP6CDT M>; 5FM <EP6CDT M>; 5FU <EP6CDTX>; 5FV <EP6CDT>	09.11→	1 457 42 P 9249	O
		0 450 90 F 2161 ¹	K

DS5 2.0 HDi

2,0 100/120 RH... <DW10CTED4>; RHD <DW10CB>	09.11→	1 457 42 P 9249	O
		F 026 40 S 0150	L

DS5 2.0 HDi HYbrid4 4x4

2,0 120 <DW10CTED4/HYbrid>	09.11→	F 026 40 S 0150	L
--------------------------------	--------	-----------------	---

Evasion**Evasion 1.8 i**

1,8 72-74 LFW <XU7JP>	09.96-07.02	0 451 10 P 3261	O
		1 457 43 S 2200	L
		0 450 90 F 2161 ¹	K
	3FE	1 987 43 M 2060	I

Evasion 1.9 D Turbo

1,9 66/67-68 DHX <XUD9TE>; D8B <XUD9TE>	10.94-07.02	0 451 10 P 3261	O
		1 457 43 S 2200	L
		1 457 42 N 9291	K
	3FE	1 987 43 M 2060	I





Evasion 2.0 HDi

2,0 80 RHZ <DW10ATED/L3>			
01.99-07.02	0451 10	P 3355	O
	1457 43	S 2200	L
	1457 03	N 0013	K
3FE	1987 43	M 2060	I

2,0 | 81 | RHW <DW10ATED4/L4>

06.00-07.02	0451 10	P 3355	O
	1457 43	S 2200	L
Org.Nr. →8910	06.00-04.01	1457 03	N 0013 K
Org.Nr. 8911→	05.01-07.02	1457 07	N 0000 K
	06.00-07.02	3FE 1987 43	M 2060 I

Evasion 2.0 i

2,0 | 89-90 | RFU <XU10J2>

06.94-07.02	0451 10	P 3261	O
	1457 43	S 2200	L
Org.Nr. →7160	06.94-08.96	0450 90	F 5201 ¹ K
Org.Nr. 7161→	09.96-07.02	0450 90	F 2161 ¹ K
	06.94-07.02	3FE 1987 43	M 2060 I

Evasion 2.0 i Turbo

2,0 | 108-110 | RGX <XU10J2TE>

06.94-07.02	0451 10	P 3261	O
	1457 43	S 2200	L
Org.Nr. →7160	06.94-08.96	0450 90	F 5201 ¹ K
Org.Nr. 7161→	09.96-07.02	0450 90	F 2161 ¹ K
	06.94-07.02	3FE 1987 43	M 2060 I

Evasion 2.0 i 16V

2,0 | 97-99 | RFV <XU10J4R>

05.98-04.00	0451 10	P 3261	O
	1457 43	S 2200	L
	0450 90	F 2161 ¹	K
3FE	1987 43	M 2060	I

2,0 | 100 | RFN <EW10J4>

04.00-07.02	0451 10	P 3355	O
	1457 43	S 2200	L
	0450 90	F 2161 ¹	K
3FE	1987 43	M 2060	I

Evasion 2.1 D Turbo

2,1 | 80-81 | P8C <XUD11BTE>

04.96-07.02	0451 10	P 3261	O
	1457 43	S 2200	L
Org.Nr. →7302	04.96-11.96	1457 42	N 9291 K
Org.Nr. 7302→	12.96-07.02	1457 43	N 1702 K
	04.96-07.02	3FE 1987 43	M 2060 I

Jumper

Jumper 1.9 D

1,9 | 51 | DJY <XUD9>

01.99-02.02	0451 10	P 3261	O
	1457 43	S 2138	L
Fg.Nr. →15707154	01.99-02.02	LUC 1457 43	N 4201 ² K
Fg.Nr. 15707155→	01.99-02.02	BO,MW1 1457 43	N 4106 ² K
		BO,MW8 1457 43	N 4105 ² K
	01.99-02.02	KL 1987 43	M 2042 I



1,9 | 51 | D9B <XUD9AU>

02.94-02.02	0451 10	P 3261	O
	1457 43	S 2138	L
Fg.Nr. →15707154	02.94-02.02	LUC 1457 43	N 4201 ² K
Fg.Nr. 15707155→	02.94-02.02	BO,MW1 1457 43	N 4106 ² K
		BO,MW8 1457 43	N 4105 ² K
	02.94-02.02	KL 1987 43	M 2042 I

Jumper 1.9 D Turbo

1,9 | 66-68 | DHX <XUD9UTF>

02.94-02.02	0451 10	P 3261	O
	1457 43	S 3790	L
Fg.Nr. →15707154	02.94-02.02	LUC 1457 43	N 4201 ² K
Fg.Nr. 15707155→	02.94-02.02	BO,MW1 1457 43	N 4106 ² K
		BO,MW8 1457 43	N 4105 ² K
	02.94-02.02	KL 1987 43	M 2042 I

1,9 | 66-68 | D8C <XUD9UTF>

02.94-02.02	0451 10	P 3261	O
	1457 43	S 3790	L
Fg.Nr. →15707154	02.94-02.02	LUC 1457 43	N 4201 ² K
Fg.Nr. 15707155→	02.94-02.02	BO,MW1 1457 43	N 4106 ² K
		BO,MW8 1457 43	N 4105 ² K
	02.94-02.02	KL 1987 43	M 2042 I

Jumper 2.0

2,0 | 79 | R5B <XU102C>

02.94-02.02	0451 10	P 3261	O
	1457 43	S 3790	L

Jumper 2.0 HDi

2,0 | 62 | RHV <DW10TD>

03.01-05.06	0451 10	P 3355	O
	1457 43	S 3790	L
	10.02-05.06	F 026 40	N 2013 ² K
	11.02-12.04	Y45 F 026 40	N 2013 ² K
	01.05-05.06	1457 07	N 0001 K
	03.01-02.02	KL 1987 43	M 2042 I
	02.02-05.06	1987 43	M 2042 I

Jumper 2.0 i

2,0 | 80 | RFL <XU10J2>

02.02-05.06	0451 10	P 3261	O
	1457 43	S 3790	L
	0450 90	F 5273 ¹	K
	1987 43	M 2042	I

2,0 | 80 | RFW <XU10J2U>

02.94-02.02	0451 10	P 3261	O
	1457 43	S 3790	L
Fg.Nr. 15408416→	02.94-02.02	0450 90	F 5273 ¹ K
	02.94-02.02	KL 1987 43	M 2042 I

Jumper 2.2 HDi

2,2 | 74 | 4HY <DW12TED>

02.02-05.06	0451 10	P 3355	O
	1457 43	S 3790	L
	10.02-11.04	F 026 40	N 2013 ² K
	12.04-05.06	1457 07	N 0001 K
	02.02-05.06	1987 43	M 2042 I



**2,2 | 74/88 | 4HU <22DT>; 4HV <22DT>**

06.06→		1 457 42	P 9249	O
	Y45	F 026 40	S 0059	L
		1 457 07	N 0001	K
		1 987 43	M 2065	I

Jumper 2.5 D**2,5 | 63 | T9A <DJ5>**

Mot.Nr. →263225	02.94-02.02	0 451 10	P 3238	O
Mot.Nr. 263226→	02.94-02.02	0 451 10	P 3261	O
	02.94-02.02	LBE	1 457 43	S 2138
		SBE	1 457 43	S 3790
Fg.Nr. →15707204	02.94-02.02	LUC	1 457 43	N 4201 ²
Fg.Nr. 15707205→	02.94-02.02	BO,MW1	1 457 43	N 4106 ²
		BO,MW8	1 457 43	N 4105 ²
	02.94-02.02	KL	1 987 43	M 2042

Jumper 2.5 D Turbo**2,5 | 76 | THZ <DJ5T>; T8A <DJ5T>**

Mot.Nr. →263225	02.94-02.02	0 451 10	P 3238	O
Mot.Nr. 263226→	02.94-02.02	0 451 10	P 3261	O
	02.94-02.02		1 457 43	S 3790
		LUC	1 457 43	N 4201 ²
		KL	1 987 43	M 2042

Jumper 2.5 TDi**2,5 | 79 | THX <DJ5TED>**

Mot.Nr. →263225	10.96-02.02	0 451 10	P 3238	O
Mot.Nr. 263226→	10.96-02.02	0 451 10	P 3261	O
	10.96-02.02		1 457 43	S 3790
Fg.Nr. →15707704	10.96-02.02	LUC	1 457 43	N 4201 ²
Fg.Nr. 15707705→	10.96-02.02	BO,MW1	1 457 43	N 4106 ²
		BO,MW8	1 457 43	N 4105 ²
	10.96-02.02	KL	1 987 43	M 2042

Jumper 2.8 D**2,8 | 64 | 8140 63 <SOFIM 2800>**

01.99-02.02		0 451 20	P 3201	O
			1 457 43	S 3790
			1 457 43	N 4194 ²
	KL	1 987 43	M 2042	I

Jumper 2.8 D Turbo**2,8 | 90 | 8140 43 <SOFIM 2800 TD>**

10.99-02.02		0 451 20	P 3201	O
Mot.Nr. →4006625	02.02-05.06	0 451 20	P 3201	O
Mot.Nr. 4006626→	02.02-05.06	F 026 40	P 7053	O
	10.99-05.06		1 457 43	S 3790
			1 457 43	N 4194 ²
	10.99-02.02	KL	1 987 43	M 2042
	02.02-05.06		1 987 43	M 2042

Jumper 2.8 HDi**2,8 | 94 | 8140 43s <SOFIM 2800 HDi>**

09.00-02.02		0 451 20	P 3201	O
Mot.Nr. →4006625	02.02-05.06	0 451 20	P 3201	O
Mot.Nr. 4006626→	02.02-05.06	F 026 40	P 7053	O
	09.00-05.06		1 457 43	S 3790
	11.02-12.04	Y45	F 026 40	N 2013 ²
	01.05-05.06		1 457 07	N 0001
	09.00-02.02	KL	1 987 43	M 2042
	02.02-05.06		1 987 43	M 2042

2,8 | 107 | 8140 43N <SOFIM 2800 HDi>

Mot.Nr. →4006625	08.04-05.06	0 451 20	P 3201	O
Mot.Nr. 4006626→	08.04-05.06	F 026 40	P 7053	O
	08.04-05.06	TW	1 457 43	S 3790
	08.04-12.04	Y45	F 026 40	N 2013 ²
	01.05-05.06		1 457 07	N 0001
	08.04-05.06		1 987 43	M 2042

Jumper 2.8 HDi**2,8 | 93 | 8140 43s**

09.05-09.09		0 451 20	P 3201	O
			1 457 43	S 3790

Jumper 2.8 T**2,8 | 77 | 8140 43**

12.01-08.05		0 451 20	P 3201	O
			1 457 43	S 3790
			1 457 43	N 4194 ²

Jumper 3.0 HDi**3,0 | 107/115/116 | F1CE... <SOFIM F 30DT/PEF>; F1CE348ID <30 DT PEF EURO5 155>; F1CE348IN <30 DT PEF EURO5 145>**

06.06→		F 026 40	P 7083	O
	Y45	F 026 40	S 0059	L
			1 457 07	N 0001
			1 987 43	M 2065

Jumpy**Jumpy 1.6 HDi****1,6 | 66 | 9HH <DV6DU M>**

09.11→		1 987 43	M 2206	I
			1 987 43	R 2406 ⁸

1,6 | 66 | 9HM <DV6U C>

12.10→		1 457 42	P 9238	O
			1 987 43	M 2206
			1 987 43	R 2406 ⁸

1,6 | 66 | 9HU <DV6UTED4>

02.07→		1 457 42	P 9238	O
			1 457 43	S 3327
			0 450 90	N 6471 ¹
			1 987 43	M 2206
			1 987 43	R 2406 ⁸





Jumpy 1.6 i

1,6 58 220 A2.000 <1580 SPI>			
10.95-01.07	0 451 10 P 3261	O	
	1 457 43 S 2200	L	
Org.Nr. →7160	10.95-07.96	0 450 90 F 5201 ¹	K
Org.Nr. 7161→	08.96-01.07	0 450 90 F 2161 ¹	K
	10.95-01.07	3FE 1 987 43 M 2060	I

Jumpy 1.9 D

1,9 51/52 WJY <DW8B>; WJZ <DW8>			
10.98-01.07	0 451 10 P 3355	O	
	1 457 43 S 2200	L	
	1 457 43 N 1703	K	
	3FE 1 987 43 M 2060	I	

Jumpy 1.9 D, D Turbo

1,9 50-52/66/67-68 DHX <XUD9TE>; D8B <XUD9TF>; D9B <XUD9A>			
10.95-01.07	0 451 10 P 3261	O	
	1 457 43 S 2200	L	
	1 457 42 N 9291	K	
	3FE 1 987 43 M 2060	I	

Jumpy 2.0 HDi

2,0 70 RHX <DW10BTED>			
10.99-01.07	0 451 10 P 3355	O	
	1 457 43 S 2200	L	
	NW4 1 457 07 N 0000	K	
	N13 1 457 03 N 0013	K	
	3FE 1 987 43 M 2060	I	

2,0 72/94 AHY <DW10CE>; AHZ <DW10CD>			
07.11→	1 987 43 M 2206	I	
	1 987 43 R 2406 ⁸	I	

2,0 80 RHZ <DW10ATED>			
10.99-01.07	0 451 10 P 3355	O	
	1 457 43 S 2200	L	
	1 457 03 N 0013	K	
	3FE 1 987 43 M 2060	I	

2,0 81 RHW <DW10ATED4>			
06.00-01.07	0 451 10 P 3355	O	
	1 457 43 S 2200	L	
Org.Nr. →8910	06.00-04.01	1 457 03 N 0013	K
Org.Nr. 8911→	05.01-01.07	1 457 07 N 0000	K
	06.00-01.07	3FE 1 987 43 M 2060	I

2,0 88 RH... <DW10UTED4>			
02.07→	1 457 42 P 9249	O	
	F 026 40 S 0058	L	
	1 457 43 N 1723	K	
	1 987 43 M 2206	I	
	1 987 43 R 2406 ⁸	I	

2,0 100 RHR <DW10BTED4>			
02.07→	1 457 42 P 9249	O	
	F 026 40 S 0058	L	
	1 457 43 N 1723	K	
	1 987 43 M 2206	I	
	1 987 43 R 2406 ⁸	I	



2,0 120 RHH <DW10CTED4>			
04.10→	1 457 42 P 9249	O	
	1 987 43 M 2206	I	
	1 987 43 R 2406 ⁸	I	

Jumpy 2.0 i

2,0 100 RFN <EW10J4>			
04.00-01.07	0 451 10 P 3355	O	
	1 457 43 S 2200	L	
	0 450 90 F 2161 ¹	K	
	3FE 1 987 43 M 2060	I	

Jumpy 2.0 i 16V

2,0 103 RFH <EW10A>			
02.07→	1 457 42 P 9249	O	
	1 457 43 S 2200	L	
	0 450 90 F 2161 ¹	K	
	1 987 43 M 2206	I	
	1 987 43 R 2406 ⁸	I	

Nemo

Nemo 1.4 HDi

1,4 50 8HS <DV4TED>			
02.08→	1 457 42 P 9238	O	
	1 457 43 S 3076	L	
	0 450 90 N 6460 ¹	K	

Nemo 1.4 i

1,4 54 KFT <TU3AE5>; KfV <TU3A>			
02.08→	1 457 42 P 9249	O	

Picasso

Picasso 1.6 i

1,6 78 N6A10XA3APSA <TU5JP>			
06.02-02.07	1 457 42 P 9193	O	
	F 026 40 S 0010	L	
	0 450 90 F 2161 ¹	K	

Saxo

Saxo Electricque

11-20 SA13			
01.97-09.03	1 987 43 M 2154	I	

Saxo 1.0 i

1,0 33/37 CDY <TU9M>; CDZ <TU9M>			
02.96-09.03	0 451 10 P 3261	O	
	1 457 42 S 9908	L	
	0 450 90 F 2161 ¹	K	
	1 987 43 M 2154	I	

Saxo 1.1 i

1,1 40-44 HDY <TU1M+>; HDZ <TU1M+>			
02.96-09.03	0 451 10 P 3261	O	
	1 457 43 S 3227	L	
	0 450 90 F 2161 ¹	K	
	1 987 43 M 2154	I	





1,1 44 HFX <TU1JP>	03.00-09.03	1 457 42 P 9193	O
		1 457 43 S 3769	L
		0 450 90 F 2161 ¹	K
		1 987 43 M 2154	I

Saxo 1.4 i

1,4 55 KFW <TU3JP/L4>	06.00-09.03	1 457 42 P 9193	O
		1 457 43 S 3769	L
		0 450 90 F 2161 ¹	K
		1 987 43 M 2154	I

1,4 55 KFX <TU3JP>	02.96-09.03	0 451 10 P 3261	O
		1 457 43 S 3769	L
		0 450 90 F 2161 ¹	K
		1 987 43 M 2154	I

Saxo 1.5 D

1,5 40/42 VJX <TUD5B>; VJY <TUD5Y>; VJZ <TUD5L>	07.96-09.03	0 451 10 P 3261	O
		1 457 43 S 3234	L
		1 457 43 N 4103 ²	K
		1 987 43 M 2154	I

Saxo 1.6 i

1,6 65-66 NFZ <TU5JP>	02.96-09.03	0 451 10 P 3261	O
		1 457 43 S 3227	L
		0 450 90 F 2161 ¹	K
		1 987 43 M 2154	I

1,6 74 NFT <TU5JP/L4>	06.00-09.03	1 457 42 P 9193	O
		F 026 40 S 0025	L
		0 450 90 F 2161 ¹	K
		1 987 43 M 2154	I

Saxo 1.6 i 16V

1,6 87-88 NFX <TU5J4>	07.96-09.03	0 451 10 P 3261	O
		1 457 43 S 3297	L
		0 450 90 F 2161 ¹	K
		1 987 43 M 2154	I

Visa**Visa 0.6**

0,6 24/25/26 V06/630; V06/644; V06/665	07.82-03.91	0 451 10 P 3139	O
		1 457 42 S 9915	L

Visa 1.0

1,0 32 108/5C	02.84-03.91	0 451 10 P 3189	O
		1 457 43 S 3732	L

**Visa 1.1**

1,1 35/36-42 109/5; 109/5F; 109/5K; 109/5L; 109/5P; 109/5X; 109/5Z	09.78-03.91	0 451 10 P 3189	O
		1 457 43 S 3732	L

Visa 1.4

1,4 44/53/55/58 KAZ; 150B <XY8>; 150D Kat. <XY7>; 150G; 150/5Z	07.82-03.91	0 451 10 P 3189	O
		1 457 43 S 3732	L

Visa 1.6 i

1,6 83 B6D	06.86-03.91	0 451 10 P 3261	O
		0 450 90 F 5002 ¹	K

Visa 1.8 D

1,8 44 161A <XUD7>	04.84-03.91	0 451 10 P 3261	O
		1 457 43 S 2154	L
		CAV 1 457 43 N 4201 ²	K
		PRF 1 457 43 N 1028	K

Xantia**Xantia 1.6 i**

1,6 65-66 BFZ <XU5JP/Z, L3>	03.93-01.98	0 451 10 P 3261	O
		1 457 43 S 3606	L
Org.Nr. →7306	03.93-11.96	0 450 90 F 5002 ¹	K
Org.Nr. 7307→	12.96-01.98	0 450 90 F 2161 ¹	K
	03.93-01.98	KL 1 987 43 M 2021	I

1,6 66 BFZ <XU5JP/L3>	03.98-12.01	0 451 10 P 3261	O
		1 457 43 S 3606	L
		0 450 90 F 2161 ¹	K
	KL	1 987 43 M 2021	I

Xantia 1.8 i

1,8 66 LFX <XU7JB>; LFX <XU7JB/L3>	04.97-12.01	0 451 10 P 3261	O
		1 457 43 S 3606	L
		0 450 90 F 2161 ¹	K
	KL	1 987 43 M 2021	I

1,8 70-71/74-76 LFZ Kat. <XU7JP/Z, L3>; L6A <XU7JP/K>	03.93-01.98	0 451 10 P 3261	O
		1 457 43 S 3606	L
Org.Nr. →7306	03.93-11.96	0 450 90 F 5002 ¹	K
Org.Nr. 7307→	12.96-01.98	0 450 90 F 2161 ¹	K
	03.93-01.98	KL 1 987 43 M 2021	I





Xantia 1.8 i 16V

1,8 81 LFY Kat. <XU7JP4/L3>			
	05.95-01.98	0 451 10 P 3261	O
		1 457 43 S 2200	L
	04.97-01.98	0 450 90 F 2161 ¹	K
Org.Nr. →7306	05.95-11.96	0 450 90 F 5002 ¹	K
Org.Nr. 7307→	12.96-01.98	0 450 90 F 2161 ¹	K
	05.95-01.98 KL	1 987 43 M 2021	I

1,8 81 LFY <XU7JP4>			
	12.97-12.01	0 451 10 P 3261	O
		1 457 43 S 2200	L
		0 450 90 F 2161 ¹	K
	KL	1 987 43 M 2021	I

Xantia 1.9 D, D Turbo

1,9 50-52/55/66/67-68 DHW <XUD9SD>; DHX, DHY <XUD9BTF/L3>; DHX, DHY <XUD9BTF/Y, L3>; DHX <XUD9BTF/L3>; DJY/DJZ <XUD9A/Y>; D8B <XUD9TF/L>; D9B <XUD9A/L>			
	07.93-12.01	0 451 10 P 3261	O
		1 457 43 S 2200	L
		1 457 42 N 9291	K
	KL	1 987 43 M 2021	I

Xantia 2.0 HDi

2,0 66/81 RHY <DW10TD>; RHZ <DW10ATED>			
	10.98-12.01	0 451 10 P 3355	O
		1 457 43 S 2200	L
Org.Nr. 8071→	10.98-12.01	1 457 03 N 0013	K
	10.98-12.01 KL	1 987 43 M 2021	I

Xantia 2.0 i

2,0 89-90 RFX Kat. <XU10J2C/Z, L3>			
	03.93-01.98	0 451 10 P 3261	O
		1 457 43 S 3606	L
Org.Nr. →7306	03.93-11.96	0 450 90 F 5002 ¹	K
Org.Nr. 7307→	12.96-01.98	0 450 90 F 2161 ¹	K
	03.93-01.98 KL	1 987 43 M 2021	I

2,0 89-90 RFX <XU10J2C/L3>			
	12.97-12.01	0 451 10 P 3261	O
		1 457 43 S 3606	L
		0 450 90 F 2161 ¹	K
	KL	1 987 43 M 2021	I

2,0 91-92 R6D <XU10J2C/K>			
	03.93-01.98	0 451 10 P 3261	O
		1 457 43 S 3606	L
Org.Nr. →7306	03.93-11.96	0 450 90 F 5002 ¹	K
Org.Nr. 7307→	12.96-01.98	0 450 90 F 2161 ¹	K
	03.93-01.98 KL	1 987 43 M 2021	I

Xantia 2.0 i Turbo

2,0 108-110 RGX <XU10J2CTE>			
	05.95-01.98	0 451 10 P 3261	O
		1 457 43 S 2200	L
Org.Nr. →7306	05.95-11.96	0 450 90 F 5002 ¹	K
Org.Nr. 7307→	12.96-01.98	0 450 90 F 2161 ¹	K
	05.95-01.98 KL	1 987 43 M 2021	I



2,0 | 108-110 | RGX <XU10J2TE>

	12.97-12.01	0 451 10 P 3261	O
		1 457 43 S 2200	L
		0 450 90 F 2161 ¹	K
	KL	1 987 43 M 2021	I

Xantia 2.0 i 16V

2,0 97 RFV <XU10J4R>			
	12.94-01.98	0 451 10 P 3261	O
		1 457 43 S 2200	L
Org.Nr. →7306	12.94-11.96	0 450 90 F 5002 ¹	K
Org.Nr. 7307→	12.96-01.98	0 450 90 F 2161 ¹	K
	12.94-01.98 KL	1 987 43 M 2021	I

2,0 97-99 RFV <XU10J4R>			
	12.97-12.01	0 451 10 P 3261	O
		1 457 43 S 2200	L
		0 450 90 F 2161 ¹	K
	KL	1 987 43 M 2021	I

2,0 110-114 RFY, RFT <XU10J4/Z, L3>			
	03.93-12.98	0 451 10 P 3261	O
		1 457 43 S 3229	L
		0 450 90 F 5002 ¹	K
	KL	1 987 43 M 2021	I

Xantia 2.1 D Turbo

2,1 80-81 P8C <XUD11BTE/L, L3>			
	05.95-01.98	0 451 10 P 3261	O
		1 457 43 S 2200	L
		1 457 42 N 9291	K
	KL	1 987 43 M 2021	I

2,1 80-81 P8C <XUD11BTE/L3>			
	12.97-12.01	0 451 10 P 3261	O
		1 457 43 S 2200	L
		1 457 43 N 1702	K
	KL	1 987 43 M 2021	I

Xantia 3.0 i

3,0 140 XFZ <ES9J4>			
	10.96-12.01	0 451 10 P 3261	O
		1 457 43 S 2200	L
		0 450 90 F 2161 ¹	K
	KL	1 987 43 M 2021	I

XM

XM 2.0

2,0 85 R2A <XU102C>			
	05.89-06.94	0 451 10 P 3261	O
		1 457 43 S 3250	L

XM 2.0 i

2,0 79-81 RDZ Kat. <XU10MZ>			
	05.89-06.94	0 451 10 P 3261	O
		1 457 43 S 3250	L
		0 450 90 F 5030 ¹	K

2,0 89-90 RFZ Kat. <XU10J2Z>			
	05.89-06.94	0 451 10 P 3261	O
		1 457 43 S 3250	L
		0 450 90 F 5030 ¹	K



2,0 90-96 R6A <XU10J2>	07.94-10.00	0 451 10 P 3261	O
		1 457 43 S 3250	L
		0 450 90 F 5201 ¹	K

2,0 90-96 R6A <XU10J2K>	05.89-06.94	0 451 10 P 3261	O
		1 457 43 S 3250	L
		0 450 90 F 5030 ¹	K

XM 2.0 i Turbo

2,0 104-107 RGY <XU10J2TE/Z>	09.92-06.94	0 451 10 P 3261	O
		1 457 43 S 3250	L
		0 450 90 F 5030 ¹	K

2,0 108 RGX <XU10J2TE>	04.95-10.00	0 451 10 P 3261	O
		1 457 43 S 3250	L
		Org.Nr. →7814	0 450 90 F 5201 ¹ K
Org.Nr. 7815→	05.98-10.00	0 450 90 F 2161 ¹	K

2,0 108-110 RGY <XU10J2TE>	07.94-09.95	0 451 10 P 3261	O
		1 457 43 S 3250	L
		0 450 90 F 5201 ¹	K

XM 2.0 i 16V

2,0 97-99 RFV <XU10J4R>	07.94-10.00	0 451 10 P 3261	O
		1 457 43 S 3250	L
		Org.Nr. →7814	0 450 90 F 5201 ¹ K
Org.Nr. 7815→	05.98-10.00	0 450 90 F 2161 ¹	K

XM 2.1 D

2,1 60-61 PJZ <XUD11A>	07.94-12.96	0 451 10 P 3261	O
		1 457 43 S 3250	L
		PRF	1 457 42 N 9289 K

2,1 60-61 P9A <XUD11A>	05.89-12.96	0 451 10 P 3261	O	
		1 457 43 S 3250	L	
	05.89-06.94	CAV	1 457 43 N 4200 ²	K
		PRF	1 457 42 N 9289	K

XM 2.1 D, D Turbo

2,1 60-61/80-81 PJZ <XUD11A/L>; P8A <XUD11ATE>	05.89-06.94	0 451 10 P 3261	O
		1 457 43 S 3250	L
		CAV	1 457 43 N 4200 ² K
		PRF	1 457 42 N 9289 K

XM 2.1 D Turbo

2,1 80-81 PHZ <XUD11ATE>	07.94-10.00	0 451 10 P 3261	O
		1 457 43 S 3250	L
		PRF	1 457 42 N 9289 K

2,1 80-81 PHZ <XUD11ATE/L>	05.89-06.94	0 451 10 P 3261	O
		1 457 43 S 3250	L
		CAV	1 457 43 N 4200 ² K
		PRF	1 457 42 N 9289 K

2,1 80-81 P8B <XUD11ATE>	07.94-10.00	0 451 10 P 3261	O
		1 457 43 S 3250	L
		PRF	1 457 42 N 9289 K

2,1 80-81 P8B <XUD11ATE/L>	10.92-06.94	0 451 10 P 3261	O
		1 457 43 S 3250	L
		CAV	1 457 43 N 4200 ² K
		PRF	1 457 42 N 9289 K

2,1 80-81 P8C <XUD11BTE>	07.94-10.00	0 451 10 P 3261	O
		1 457 43 S 3250	L
		PRF	1 457 42 N 9291 K

Org.Nr. →7302	07.94-12.96	LUC	1 457 42 N 9291 K
Org.Nr. 7303→	01.97-10.00	LUC	1 457 43 N 1702 K

XM 2.5 D Turbo

2,5 94-96 THY <DK5ATE>	07.94-10.00	0 451 10 P 3238	O
		1 457 43 S 3250	L
		Org.Nr. →7874	07.94-06.98
Org.Nr. 7875→	07.98-10.00	1 457 43 N 1705	K

XM 3.0 i

3,0 123-125 UFY <ZPJ>	07.94-12.97	0 451 10 P 3238	O
		1 457 43 S 3250	L
		0 450 90 F 5201 ¹	K

3,0 140-143 XFZ <ES9J4>	09.97-10.00	0 451 10 P 3261	O
		1 457 43 S 3250	L
		Org.Nr. →7814	09.97-04.98
Org.Nr. 7815→	05.98-10.00	0 450 90 F 2161 ¹	K

XM 3.0 i, i 24V

3,0 123-125/147 SFZ,S6A <ZPJ>; SKZ <ZPJ4>	05.89-06.93	0 451 10 P 3238	O
		1 457 43 S 3250	L
		0 450 90 F 5030 ¹	K

3,0 123-125/147 UFZ <ZPJ>; UKZ <ZPJ4>	06.93-12.97	0 451 10 P 3238	O
		1 457 43 S 3250	L
	06.93-06.94	0 450 90 F 5030 ¹	K
		07.94-12.97	0 450 90 F 5201 ¹





Xsara

Xsara 1.4 HDi

1,4 50 8HZ <DV4TD>	01.03-12.05	1 457 42 P 9238	O
	LBE	1 457 43 S 3076	L
	SBE	1 457 43 S 3076	L
		0 450 90 N 6460 ¹	K
	KL,MKL	1 987 43 M 2083	I
	KL,MKL,	1 987 43 M 2021	I
	RLE		
	MKL	1 987 43 M 2077	I

Xsara 1.4 i

1,4 55 KFW <TU3JP>			
Mot.Nr. 4717578→	09.00-12.05	1 457 42 P 9249	O
Mot.Nr. →4717577	09.00-12.05	1 457 42 P 9193	O
	09.00-12.05	LBE 1 457 43 S 3526	L
		SBE F 026 40 S 0010	L
		0 450 90 F 2161 ¹	K
		KL,MKL 1 987 43 M 2083	I
		KL,MKL, 1 987 43 M 2021	I
		RLE	
		KL 1 987 43 M 2021	I
		MKL 1 987 43 M 2083	I
		MKL,RLE 1 987 43 M 2021	I
		MKL 1 987 43 M 2077	I
Org.Nr. →8863	09.00-02.01	KL,MKL 1 987 43 M 2021	I

1,4 55 KFX <TU3JP>	07.97-08.00	0 451 10 P 3261	O
		1 457 43 S 3769	L
		0 450 90 F 2161 ¹	K
		KL,MKL 1 987 43 M 2021	I
		MKL 1 987 43 M 2077	I

Xsara 1.5 D

1,5 42 VJY <TUD5>; VJZ <TUD5>	07.97-08.00	0 451 10 P 3261	O
		1 457 43 S 3234	L
		1 457 43 N 4103 ²	K
		KL,MKL 1 987 43 M 2021	I
		MKL 1 987 43 M 2077	I

Xsara 1.6 i

1,6 65-66 NFZ <TU5JP>	07.97-08.00	0 451 10 P 3261	O
		1 457 43 S 3227	L
		0 450 90 F 2161 ¹	K
		KL,MKL 1 987 43 M 2021	I
		MKL 1 987 43 M 2077	I



Xsara 1.6 i 16V

1,6 80 NFU <TU5JP4>			
Org.Nr. →10072	09.00-06.04	1 457 42 P 9193	O
Org.Nr. 10073→	07.04-03.10	1 457 42 P 9249	O
	09.00-03.10	LBE 1 457 43 S 3526	L
		SBE F 026 40 S 0010	L
		0 450 90 F 2161 ¹	K
	09.00-12.05	KL 1 987 43 M 2021	I
		MKL 1 987 43 M 2083	I
		MKL,RLE 1 987 43 M 2021	I
	09.00-03.10	KL,MKL 1 987 43 M 2083	I
		KL,MKL, 1 987 43 M 2021	I
		RLE	
		MKL 1 987 43 M 2077	I
Org.Nr. →8863	09.00-02.01	KL,MKL 1 987 43 M 2021	I

Xsara 1.8 D

1,8 44 A9A,161A <XUD7>	07.97-08.00	0 451 10 P 3261	O
		1 457 43 S 2154	L
		1 457 42 N 9291	K
		KL,MKL 1 987 43 M 2021	I
		MKL 1 987 43 M 2077	I

Xsara 1.8 i

1,8 66 LFX <XU7JB>	07.97-08.00	0 451 10 P 3261	O
		1 457 43 S 3606	L
		0 450 90 F 2161 ¹	K
		KL,MKL 1 987 43 M 2021	I
		MKL 1 987 43 M 2077	I

Xsara 1.8 i 16V

1,8 74-75 LFZ <XU7JP>; L6A <XU7JP>	07.97-08.00	0 451 10 P 3261	O
		1 457 43 S 3606	L
		0 450 90 F 2161 ¹	K
		KL,MKL 1 987 43 M 2021	I
		MKL 1 987 43 M 2077	I

Xsara 1.8 i 16V

1,8 81-82 LFY <XU7JP4>	07.97-08.00	0 451 10 P 3261	O
		LBE 1 457 43 S 3543	L
		SBE 1 457 43 S 3527	L
		0 450 90 F 2161 ¹	K
		KL,MKL 1 987 43 M 2021	I
		MKL 1 987 43 M 2077	I

Xsara 1.9 D

1,9 50 DJY <XUD9A>	07.97-08.00	0 451 10 P 3261	O
Org.Nr. →7972	07.97-09.98	1 457 43 S 2154	L
Org.Nr. 7973→	10.98-08.00	1 457 43 S 3544	L
	07.97-08.00	1 457 42 N 9291	K
		KL,MKL 1 987 43 M 2021	I
		MKL 1 987 43 M 2077	I



**1,9 | 51 | WJZ <DW8>**

04.98-08.00	0 451 10 P 3355	O
	1 457 43 S 3544	L
	1 457 43 N 1703	K
KL , MKL	1 987 43 M 2021	I
MKL	1 987 43 M 2077	I

1,9 | 51-52 | WJY <DW8B>

09.00-12.05	0 451 10 P 3355	O
	LBE 1 457 43 S 3280	L
	SBE F 026 40 S 0010	L
	1 457 43 N 1703	K
	KL, MKL 1 987 43 M 2083	I
	KL, MKL, 1 987 43 M 2021	I
	RLE	
	MKL 1 987 43 M 2077	I

Org.Nr. →8863	09.00-02.01	KL , MKL	1 987 43 M 2021	I
---------------	-------------	---------------------	-----------------	---

1,9 | 52 | WJY <DW8B>

09.00-12.05	0 451 10 P 3355	O
	LBE 1 457 43 S 3280	L
	SBE F 026 40 S 0010	L
	1 457 43 N 1703	K
	KL, MKL 1 987 43 M 2083	I
	KL, MKL, 1 987 43 M 2021	I
	RLE	
	KL 1 987 43 M 2021	I
	MKL 1 987 43 M 2083	I
	MKL, RLE 1 987 43 M 2021	I
	MKL 1 987 43 M 2077	I

Org.Nr. →8863	09.00-02.01	KL , MKL	1 987 43 M 2021	I
---------------	-------------	---------------------	-----------------	---

Xsara 1.9 D Turbo**1,9 | 55 | DHV <XUD9BSD>**

01.98-08.00	0 451 10 P 3261	O
	1 457 43 S 2154	L
	1 457 42 N 9291	K
	KL , MKL 1 987 43 M 2021	I
	MKL 1 987 43 M 2077	I

1,9 | 66 | DHY <XUD9TE>

07.97-08.00	0 451 10 P 3261	O	
Org.Nr. →7685	07.97-12.97	1 457 43 S 3229	L
Org.Nr. 7686→	01.98-08.00	1 457 43 S 3077	L
	07.97-08.00	1 457 42 N 9291	K
		KL , MKL 1 987 43 M 2021	I
		MKL 1 987 43 M 2077	I

1,9 | 66 | D8A <XUD9TE>

07.97-08.00	0 451 10 P 3261	O	
Org.Nr. →7685	07.97-12.97	1 457 43 S 3229	L
Org.Nr. 7686→	01.98-08.00	1 457 43 S 3077	L
	07.97-08.00	1 457 42 N 9291	K
		KL , MKL 1 987 43 M 2021	I
		MKL 1 987 43 M 2077	I

Xsara 2.0 HDi**2,0 | 66 | RHY <DW10TD>**

02.99-03.10	0 451 10 P 3355	O
02.99-08.00	1 457 43 S 3061	L
	LBE 1 457 43 S 3555	L
	SBE 1 457 43 S 3061	L

09.00-03.10	F 026 40 S 0010	L
02.99-08.00	1 457 03 N 0013	K
09.00-12.05	BO 1 457 03 N 0013	K
09.00-03.10	SIE 1 457 07 N 0000	K

Org.Nr. →9337	09.00-06.02	BO	1 457 03 N 0013	K
---------------	-------------	----	-----------------	---

Org.Nr. 9338→	07.02-03.10	BO	1 457 07 N 0000	K
---------------	-------------	----	-----------------	---

02.99-08.00	KL , MKL	1 987 43 M 2021	I
	MKL	1 987 43 M 2021	I

02.99-03.10	MKL	1 987 43 M 2077	I
-------------	----------------	-----------------	---

09.00-12.05	KL	1 987 43 M 2021	I
-------------	---------------	-----------------	---

	MKL	1 987 43 M 2083	I
--	-----	-----------------	---

	MKL, RLE	1 987 43 M 2021	I
--	----------	-----------------	---

09.00-03.10	KL, MKL	1 987 43 M 2083	I
-------------	---------	-----------------	---

	KL, MKL, 1 987 43 M 2021	I
--	--------------------------	---

	RLE	
--	-----	--

Org.Nr. →8863	09.00-02.01	KL , MKL	1 987 43 M 2021	I
---------------	-------------	---------------------	-----------------	---

2,0 | 80 | RHZ <DW10ATED>

09.00-03.10	0 451 10 P 3355	O
	F 026 40 S 0010	L

Org.Nr. →9337	09.00-06.02	1 457 03 N 0013	K
---------------	-------------	-----------------	---

Org.Nr. 9338→	07.02-03.10	1 457 07 N 0000	K
---------------	-------------	-----------------	---

09.00-12.05	KL, MKL	1 987 43 M 2083	I
-------------	---------	-----------------	---

	KL, MKL, 1 987 43 M 2021	I
--	--------------------------	---

	RLE	
--	-----	--

09.00-03.10	KL	1 987 43 M 2021	I
-------------	---------------	-----------------	---

	MKL	1 987 43 M 2083	I
--	-----	-----------------	---

	MKL, RLE	1 987 43 M 2021	I
--	----------	-----------------	---

	MKL	1 987 43 M 2077	I
--	----------------	-----------------	---

Org.Nr. →8863	09.00-02.01	KL , MKL	1 987 43 M 2021	I
---------------	-------------	---------------------	-----------------	---

Xsara 2.0 i**2,0 | 99 | PSARFN10LH46 <10LH46/47>**

03.03-02.07	0 451 10 P 3355	O
	F 026 40 S 0010	L
	0 450 90 F 2161 ¹	K
	1 987 43 M 2083	I

Xsara 2.0 i 16V**2,0 | 97 | RFV <XU10J4R>**

07.97-08.00	0 451 10 P 3261	O
-------------	-----------------	---

	LBE 1 457 43 S 3543	L
--	---------------------	---

	SBE 1 457 43 S 3527	L
--	---------------------	---

	0 450 90 F 2161 ¹	K
--	------------------------------	---

	KL , MKL 1 987 43 M 2021	I
--	-------------------------------------	---

	MKL 1 987 43 M 2077	I
--	--------------------------------	---





◀ Xsara 2.0 i 16V

2,0 100 RFN <EW10J4>			
09.00-01.07		0 451 10 P 3355	O
	LBE	1 457 43 S 3280	L
	SBE	F 026 40 S 0010	L
		0 450 90 F 2161 ¹	K
09.00-12.05	KL,MKL	1 987 43 M 2083	I
	KL,MKL,	1 987 43 M 2021	I
	RLE		
09.00-01.07	KL	1 987 43 M 2021	I
	MKL	1 987 43 M 2083	I
	MKL,RLE	1 987 43 M 2021	I
	MKL	1 987 43 M 2077	I
Org.Nr. →8863	09.00-02.01	KL ,MKL	1 987 43 M 2021 I
2,0 120 RFS <XU10J4RS>			
09.00-12.05		0 451 10 P 3261	O
		1 457 43 S 3229	L
		0 450 90 F 2161 ¹	K
	KL	1 987 43 M 2021	I
	MKL	1 987 43 M 2083	I
	MKL,RLE	1 987 43 M 2021	I
	MKL	1 987 43 M 2077	I
2,0 120-123 RFS <XU10J4RS>			
07.97-08.00		0 451 10 P 3261	O
		1 457 43 S 3229	L
		0 450 90 F 2161 ¹	K
	KL ,MKL	1 987 43 M 2021	I
	MKL	1 987 43 M 2077	I

Xsara Picasso

Xsara Picasso 1.6 HDi

1,6 66/80 9H... <DV6TED4>; 9HX <DV6ATED4>			
05.04→		1 457 42 P 9238	O
		1 457 43 S 3160	L
		0 450 90 N 6471 ¹	K
		1 987 43 R 2354 ⁸	I

Xsara Picasso 1.6 i

1,6 66 NFZ <TU5JP/L3>			
01.00→		0 451 10 P 3355	O
	LBE	1 457 43 S 3526	L
	SBE	F 026 40 S 0010	L
		0 450 90 F 2161 ¹	K
		1 987 43 R 2354 ⁸	I

1,6 | 74 | NFV <TU5JP/L4>

Org.Nr. →10096	01.00-07.04	1 457 42 P 9193	O
Org.Nr. 10097→	08.04→	1 457 42 P 9249	O
	01.00→	LBE 1 457 43 S 3526	L
		SBE F 026 40 S 0010	L
		0 450 90 F 2161 ¹	K
		1 987 43 R 2354 ⁸	I

Xsara Picasso 1.6 i 16V

1,6 80 NFU <TU5JP4>			
09.05→		1 457 42 P 9249	O
		0 450 90 F 2161 ¹	K
		1 987 43 R 2354 ⁸	I



1,6 80 N6A <TU5JP4>			
03.05→		1 457 42 P 9249	O
		0 450 90 F 2161 ¹	K
		1 987 43 R 2354 ⁸	I

1,6 81 <TU5JP4>			
06.05→		1 457 42 P 9193	O
		1 457 42 P 9249	O
		0 450 90 F 2161 ¹	K
		1 987 43 R 2354 ⁸	I

Xsara Picasso 1.8 i

1,8 85 6FZ <EW7J4>			
01.00→		0 451 10 P 3355	O
	LBE	1 457 43 S 3280	L
	SBE	F 026 40 S 0010	L
		0 450 90 F 2161 ¹	K
		1 987 43 R 2354 ⁸	I

Xsara Picasso 2.0 HDi

2,0 66 RHY <DW10TD>			
01.00→		0 451 10 P 3355	O
		F 026 40 S 0010	L
Org.Nr. →8973	01.00-06.01	1 457 03 N 0013	K
Org.Nr. 8974→	07.01→	1 457 07 N 0000	K
	01.00→	1 987 43 R 2354 ⁸	I

2,0 80 <DW10>			
10.00→		1 457 03 N 0013	K

Xsara Picasso 2.0 i 16V

2,0 100 <EW10JP4>			
10.00→		0 451 10 P 3355	O
		1 457 43 S 3229	L
	LBE	1 457 43 S 3280	L
		0 450 90 F 2161 ¹	K
		1 987 43 R 2354 ⁸	I

2,0 100 RF... <EW10J4>			
03.01→		0 451 10 P 3355	O
	LBE	1 457 43 S 3280	L
	SBE	F 026 40 S 0010	L
		0 450 90 F 2161 ¹	K
		1 987 43 R 2354 ⁸	I

ZX

ZX 1.1

1,1 40-44 H1A,H1B <TU1/K>			
03.91-08.96		0 451 10 P 3261	O
		1 457 43 S 3227	L
		0 450 90 F 4058 ¹	K

ZX 1.1 i

1,1 44 HDY Kat. <TU1M>			
04.94-08.96		0 451 10 P 3261	O
		1 457 43 S 3227	L
Org.Nr. →7147	04.94-06.96	0 450 90 F 5002 ¹	K
Org.Nr. 7148→	07.96-08.96	0 450 90 F 2161 ¹	K



1,1 44 HDY <TU1M+>	09.96-06.97	0 451 10 P 3261	O
		1 457 43 S 3227	L
		0 450 90 F 2161 ¹	K

1,1 44 HDZ Kat. <TU1M>	10.91-03.94	0 451 10 P 3261	O
		1 457 43 S 3227	L

Org.Nr. →7147	10.91-03.94	0 450 90 F 5002 ¹	K
---------------	-------------	-------------------------------------	----------

1,1 44 HDZ <TU1M+>	09.96-06.97	0 451 10 P 3261	O
		1 457 43 S 3227	L
		0 450 90 F 2161 ¹	K

ZX 1.4

1,4 55 K2D <TU3.2/K>; K5A <TU3.2/Z>	03.91-12.95	0 451 10 P 3261	O
		1 457 43 S 3227	L
		0 450 90 F 4058 ¹	K

ZX 1.4 D

1,4 37-39 K9Y <TUD3Y>	06.94-06.97	0 451 10 P 3261	O
		1 457 43 S 2200	L
		1 457 43 N 4103 ²	K

ZX 1.4 i

1,4 55 KDX Kat. <TU3MC/Z>	08.92-08.96	0 451 10 P 3261	O
		1 457 43 S 3227	L

Org.Nr. →7147	08.92-06.96	0 450 90 F 5002 ¹	K
---------------	-------------	-------------------------------------	----------

Org.Nr. 7148→	07.96-08.96	0 450 90 F 2161 ¹	K
---------------	-------------	-------------------------------------	----------

1,4 55 KDY,HDY Kat. <TU3M/Z>	03.91-08.92	0 451 10 P 3261	O
		1 457 43 S 3227	L

Org.Nr. →7147	03.91-08.92	0 450 90 F 5002 ¹	K
---------------	-------------	-------------------------------------	----------

1,4 55 KFX <TU3JP>	05.96-10.97	0 451 10 P 3261	O
		1 457 43 S 3769	L
		0 450 90 F 2161 ¹	K

ZX 1.5 D

1,5 42 VJY <TUD5>; VJZ <TUD5>	09.96-10.97	0 451 10 P 3261	O
		1 457 43 S 3077	L
		1 457 43 N 4103 ²	K

ZX 1.6 i

1,6 65 BFZ Kat. <XU5JP>	07.93-10.97	0 451 10 P 3261	O
		1 457 43 S 3606	L

Org.Nr. →7146	07.93-06.96	0 450 90 F 5002 ¹	K
---------------	-------------	-------------------------------------	----------

Org.Nr. 7147→	07.96-10.97	0 450 90 F 2161 ¹	K
---------------	-------------	-------------------------------------	----------

1,6 65-66 BDY Kat. <XU5M/4Z>	03.91-12.94	0 451 10 P 3261	O
		1 457 43 S 3228	L
		0 450 90 F 5002 ¹	K

1,6 65-66 B4A <XU5M/4K>	03.91-12.94	0 451 10 P 3261	O
		1 457 43 S 3228	L
		0 450 90 F 5002 ¹	K

ZX 1.6 i, i 8V

1,6 65-66 NFZ <TU5JP>	02.96→	0 451 10 P 3261	O
		1 457 43 S 3227	L
		0 450 90 F 5002 ¹	K

ZX 1.6 i 8V

1,6 78 N6A10FX3APSA <TU3.2>	04.92-12.99	0 451 10 P 3261	O
		1 457 43 S 3227	L
		0 450 90 F 4058 ¹	K

ZX 1.8 D

1,8 44 A9A,161A <XUD7>	03.91-10.97	0 451 10 P 3261	O
		1 457 43 S 2154	L
		1 457 42 N 9291	K

ZX 1.8 i

1,8 74-76 LFZ Kat. <XU7JP>; L6A <XU7JP>	07.92-10.97	0 451 10 P 3261	O
		1 457 43 S 3606	L
Org.Nr. →7146	07.92-06.96	0 450 90 F 5002 ¹	K
Org.Nr. 7147→	07.96-10.97	0 450 90 F 2161 ¹	K

ZX 1.8 i 16V

1,8 81 LFY <XU7JP4>	01.96-02.98	0 451 10 P 3261	O
		LBE 1 457 43 S 3543	L
		SBE 1 457 43 S 3527	L
		0 450 90 F 2161 ¹	K

ZX 1.9 D

1,9 47-48/50 DJY <XUD9Y>; DJZ <XUD9Y>	03.91-10.97	0 451 10 P 3261	O
		1 457 43 S 2154	L
		1 457 42 N 9291	K

1,9 51-52 D9B <XUD9A>	03.91-10.97	0 451 10 P 3261	O
		1 457 43 S 2154	L
		1 457 42 N 9291	K

ZX 1.9 D Turbo

1,9 66 DHY <XUD9TE/Y>	07.92-10.97	0 451 10 P 3261	O
		1 457 43 S 3077	L
		1 457 42 N 9291	K

1,9 68 D8A <XUD9TE>	07.92-10.97	0 451 10 P 3261	O
		1 457 43 S 3077	L
		1 457 42 N 9291	K





ZX 1.9 i

1,9 88-90/93-96 DKZ,DFY Kat. <XU9JAZ>; D6E <XU9JA/K>	03.91-10.97	0 451 10 P 3261	O
		1 457 43 S 3077	L
		0 450 90 F 5002 ¹	K

ZX 2.0 i

2,0 89 RFX Kat. <XU10J2CZ>	07.92-10.97	0 451 10 P 3261	O
		1 457 43 S 3606	L
Org.Nr. →7146	07.92-06.96	0 450 90 F 5002 ¹	K
Org.Nr. 7147→	07.96-10.97	0 450 90 F 2161 ¹	K

2,0 89-90 R6D <XU10J2>	07.93-10.97	0 451 10 P 3261	O
		1 457 43 S 3606	L
Org.Nr. →7146	07.93-06.96	0 450 90 F 5002 ¹	K
Org.Nr. 7147→	07.96-10.97	0 450 90 F 2161 ¹	K

ZX 2.0 i 16V

2,0 110-114 RFY,RFT Kat. <XU10J4Z>	07.92-10.97	0 451 10 P 3261	O
		1 457 43 S 3077	L
		0 450 90 F 5002 ¹	K

2,0 120-122 RFS <XU10J4RS>	09.96-10.97	0 451 10 P 3261	O
		1 457 43 S 3229	L
		0 450 90 F 2161 ¹	K

DACIA

Duster

Duster 1.5 dCi

1,5 63 K9K796	10.09→	F 026 40 P 7022	O
		F 026 40 S 0051	L
		1 987 43 M 2120	I

Duster 1.5 dCi, dCi 4x4

1,5 66/79/81 K9K892; K9K894; K9K896; K9K898	10.09→	F 026 40 P 7022	O
		1 987 43 M 2120	I

Duster 1.6 , 4x4

1,6 77 K4M606; K4M690	10.09→	0 451 10 P 3336	O
		1 457 43 S 3529	L
		1 987 43 M 2120	I

Logan

Logan 1.2

1,1 55 D4F732	07.04→	0 451 10 P 4025	O
		1 987 43 M 2120	I



Logan 1.4

1,4 55 K7J710	07.04→	0 451 10 P 3336	O
		1 457 43 S 3311	L
		0 450 90 F 2161 ¹	K
		1 987 43 M 2120	I

Logan 1.5 dCi

1,5 48 K9K790	06.05→	0 451 10 P 3336	O
	05.07→	F 026 40 S 0051	L
	06.05→	SWA F 026 40 N 2072 ¹	K
		SWA F 026 40 N 2019 ¹	K
		1 987 43 M 2120	I

1,5 | 50 | K9K792

	10.05-09.07	0 451 10 P 3336	O
	10.07→	F 026 40 P 7022	O
	10.05→	F 026 40 S 0051	L
		SWA F 026 40 N 2072 ¹	K
		SWA F 026 40 N 2019 ¹	K
		1 987 43 M 2120	I

1,5 | 63 | K9K796

	10.05→	F 026 40 P 7022	O
		F 026 40 S 0051	L
		1 987 43 M 2120	I

Logan 1.6

1,6 64 K7M710	07.04→	0 451 10 P 3336	O
		1 457 43 S 3311	L
		0 450 90 F 2161 ¹	K
		1 987 43 M 2120	I

Logan 1.6 16V

1,6 77 K4M690	12.05→	0 451 10 P 3336	O
		1 457 43 S 3529	L
		1 987 43 M 2120	I

Nova

Nova 1.4

1,4 47,8 1.4	05.96-09.00	0 451 10 P 3274	O
------------------	-------------	------------------------	----------

Nova 1.6 i

1,6 53 1.6	05.96-09.00	0 451 10 P 3274	O
		1 457 43 S 2134	L
		0 450 90 F 2151 ¹	K

Sandero

Sandero 1.2

1,1 55 D4F732	06.08→	0 451 10 P 4025	O
		1 987 43 M 2120	I



Sandero 1.4

1,4 55 K7J710	06.08→	0 451 10 P 3336	O
		1 457 43 S 3311	L
		1 987 43 M 2120	I

Sandero 1.5 dCi

1,5 50 K9K792	06.08→	F 026 40 P 7022	O
		F 026 40 S 0051	L
		SWA F 026 40 N2072 ¹	K
		SWA F 026 40 N2019 ¹	K
		1 987 43 M 2120	I

1,5 63 K9K796	06.08→	F 026 40 P 7022	O
		F 026 40 S 0051	L
		1 987 43 M 2120	I

Sandero 1.6

1,6 64 K7M710	06.08→	0 451 10 P 3336	O
		1 457 43 S 3311	L
		1 987 43 M 2120	I

Serie 1300

Serie 1300 1304 1.4 Pick Up

1,4 48 102-14	12.88-12.96	0 451 10 P 3274	O
		1 457 43 S 2106	L

Serie 1300 1305 1.4 Pick Up

1,4 48 102-14	12.88-12.96	0 451 10 P 3274	O
		1 457 43 S 2106	L

Serie 1300 1307 1.4 Double Cabin

1,4 48 102-14	12.88-12.96	0 451 10 P 3274	O
		1 457 43 S 2106	L

Serie 1300 1309 1.4 Pick Up

1,4 48 102-14	12.88-12.96	0 451 10 P 3274	O
		1 457 43 S 2106	L

Serie 1300 1310 1.3

1,3 40 810-99	01.79-12.98	0 451 10 P 3274	O
		1 457 43 S 2106	L

Serie 1300 1310 1.4

1,4 40/48 102-01;102-13	01.84-12.96	0 451 10 P 3274	O
		1 457 43 S 2106	L



Serie 1300 1310 1.6

1,6 53	02.97-06.04	0 450 90 F 2151 ¹	K
--------	-------------	------------------------------	---

1,6 53 106	01.94-12.98	0 451 10 P 3274	O
------------	-------------	-----------------	---

Serie 1300 1325 1.4 Liberta

1,4 48 102-13	12.88-12.96	0 451 10 P 3274	O
		1 457 43 S 2106	L

Solenza

Solenza 1.4 i

1,4 55 E7J-A262	04.03-04.05	0 451 10 P 3336	O
		1 457 43 S 3311	L
		0 450 90 F 2161 ¹	K

Solenza 1.9 D

1,9 45 F8Q-636	04.03-04.05	0 451 10 P 3336	O
		1 457 43 S 3773	L
		1 457 42 N 9657	K

Super Nova

Super Nova 1.4 i

1,4 55 E7J-A2	10.00-09.03	0 451 10 P 3336	O
		1 457 43 S 3311	L
		0 450 90 F 2161 ¹	K

DAEWOO

Brougham

Brougham 2.0 i

2,0 85 Holden-C 20 LE	09.91-12.95	0 451 10 P 3079	O
		1 457 43 S 3003	L
		0 450 90 F 5002 ¹	K

Brougham 2.0 LPG

2,0 83-85 Holden-C 20 LE	09.91-12.95	0 451 10 P 3079	O
		1 457 43 S 3003	L

Cielo

Cielo 1.5 i

1,5 55 G15MF	03.96-12.99	0 451 10 P 3079	O
--------------	-------------	-----------------	---





◀ Cielo 1.5 i

1,5 57 G15MF <SOHC>	08.94-08.97	0 451 10 P 3079	O
		1 987 42 S 9121	L
		0 450 90 F 5002 ¹	K

1,5 59 G15MF	01.95-11.01	0 451 10 P 3079	O
		0 986 45 F 0119 ¹	K

1,5 66 <SOHC Family I>	05.94-11.96	0 451 10 P 3079	O
		1 457 43 S 3003	L
		XXX 0 450 90 F 5928 ¹	K

1,5 74 A15MF <DOHC>	08.94-08.97	0 451 10 P 3079	O
		0 450 90 F 5002 ¹	K

Damas

Damas 0.8

0,8 28 F8CB	05.93-12.02	1 457 43 S 3963	L
-----------------	-------------	-----------------	---

Espero

Espero 1.5 i, i 16V

1,5 66/74 A15MF; A15MF <DOHC>; <SOHC Family I>	10.90-10.99	0 451 10 P 3079	O
		1 457 43 S 3003	L
		0 986 45 F 0119 ¹	K

Espero 1.8 i

1,8 66-70 C18LE	01.95-10.99	0 451 10 P 3079	O
		1 457 43 S 3003	L
		0 986 45 F 0119 ¹	K

1,8 81 <SOHC Family I>	10.90-05.95	0 451 10 P 3079	O
		0 986 45 F 0119 ¹	K

Espero 2.0 i

2,0 77 C20LE	01.95-10.99	0 451 10 P 3079	O
		1 457 43 S 3003	L
		0 986 45 F 0119 ¹	K

2,0 81 C20LE	09.93-10.94	0 451 10 P 3079	O
		0 450 90 F 5002 ¹	K

Evanda

Evanda 2.0 i

2,0 96 T20SED	03.03-01.05	0 451 10 P 3079	O
		0 450 90 F 5969 ¹	K



Kalos

Kalos 1.2

1,2 53 B12S1 <LQ5>	04.03-01.05	F 026 40 S 0043	L
		0 450 90 F 5976 ¹	K

Kalos 1.2 i

1,2 52 <SOHC T4>	05.02→	0 451 10 P 3079	O
		1 457 43 S 3568	L
		0 450 90 F 5969 ¹	K

Kalos 1.4

1,4 61/69 F14D3; F14S3	09.02-01.05	0 451 10 P 3079	O
		F 026 40 S 0043	L
		0 450 90 F 5976 ¹	K

Kalos 1.5 i

1,5 63 F15S3 <SOHC Family I>	05.02→	0 451 10 P 3079	O
		1 457 43 S 3568	L
		0 450 90 F 5969 ¹	K
		0 450 90 F 5976 ¹	K

Korando

Korando 2.0 i 16V

2,0 94 M161 E20 <MB-M 111.940>	07.96-12.00	1 457 42 P 9122	O
		0 450 90 F 5281 ¹	K

Korando 2.3 D

2,3 57 OM661 D23 <MB-OM 601.990>	07.96-12.00	1 457 42 P 9274	O
		0 450 90 N 4077 ¹	K
		1 457 43 N 4331 ²	K

Korando 2.3 i 16V

2,3 103-105 M161 E23 <MB-M 111.>	07.96-12.00	1 457 42 P 9122	O
		0 450 90 F 5281 ¹	K

Korando 2.9 D, TD Intercooler

2,9 70-73/95 OM662 D29 <MB-OM 601.>; OM662 D29 <MB-OM 602.910>	07.96-12.00	1 457 42 P 9274	O
--	-------------	-----------------	---

Korando 3.2 i 24V

3,2 162 M162 E32 <MB-M 104.>	07.96-12.00	1 457 42 P 9122	O
		0 450 90 F 5281 ¹	K

Lacetti

Lacetti 1.4 i

1,4 70 F14D3	03.04-01.05	0 451 10 P 3079	O
		F 026 40 S 0163	L
		0 450 90 F 5969 ¹	K



**Lacetti 1.5 i**

1,5 | 78 | <DOHC Family I>

11.02-07.05	0 451 10 P 3079	O
	F 026 40 S 0163	L
	0 450 90 F 5969 ¹	K

Lacetti 1.6 i

1,6 | 80 | F16D3

03.04-01.05	0 451 10 P 3079	O
	F 026 40 S 0163	L
	0 450 90 F 5969 ¹	K

Lacetti 1.8 i

1,8 | 90 | T18SED

03.04-01.05	0 451 10 P 3079	O
	F 026 40 S 0163	L
	0 450 90 F 5969 ¹	K

Lanos**Lanos 1.4 i**

1,4 | 55 | A14SMS <E-TEC>

04.97-09.03	0 451 10 P 3079	O
	1 457 43 S 3963	L
Fg.Nr. →278290	0 450 90 F 5273 ¹	K
Fg.Nr. 278291→	0 450 90 F 5969 ¹	K
	1 987 43 M 2105	I

Lanos 1.5 i

1,5 | 63 | A15SMS <E-TEC>

11.96-09.03	0 451 10 P 3079	O
	1 457 43 S 3963	L
Fg.Nr. →278290	0 450 90 F 5273 ¹	K
Fg.Nr. 278291→	0 450 90 F 5969 ¹	K
	1 987 43 M 2105	I

1,5 | 71 | A15SMS <SOHC Family I>; <SOHC Family I>

11.96-05.03	0 451 10 P 3079	O
	1 457 43 S 3963	L
	0 450 90 F 5969 ¹	K

1,5 | 74 | A15SMS

11.96-09.03	0 451 10 P 3079	O
	1 457 43 S 3963	L
Fg.Nr. →278290	0 450 90 F 5273 ¹	K
Fg.Nr. 278291→	0 450 90 F 5969 ¹	K

Lanos 1.6 i

1,6 | 78 | A16DMS; A16DMS <E-TEC>

04.97-09.03	0 451 10 P 3079	O
	1 457 43 S 3963	L
Fg.Nr. →278290	0 450 90 F 5273 ¹	K
Fg.Nr. 278291→	0 450 90 F 5969 ¹	K

**Leganza****Leganza 1.8 i**

1,8 | 66-70/77/96/100 | <DOHC Family II>; D-TEC; E-TEC; <SOHC Family II>

03.97-12.02	0 451 10 P 3079	O
	0 450 90 F 5273 ¹	K
	1 987 43 M 2175	I

Leganza 2.0 i

2,0 | 81/93/98-107 | <SOHC Family II>; T20SED; X20SED

03.97-12.02	0 451 10 P 3079	O
	0 450 90 F 5273 ¹	K
	1 987 43 M 2175	I

Leganza 2.2 i

2,2 | 100 | T22SED

09.98-12.02	0 451 10 P 3079	O
	0 450 90 F 5273 ¹	K
	1 987 43 M 2175	I

LeMans**LeMans 1.5 i**

1,5 | 65 | <SOHC Family I>

07.86-02.97	0 451 10 P 3079	O
	0 986 45 F 0119 ¹	K

1,5 | 66 | Opel-G 15 MF

06.92-03.94	0 986 45 F 0119 ¹	K
-------------	------------------------------	---

Magnus**Magnus 2.0 i**

2,0 | 85/109 | <DOHC Family II>; <SOHC Family II>

12.99-01.06	0 451 10 P 3079	O
	0 450 90 F 5969 ¹	K

Matiz**Matiz 0.8**

0,8 | 37,5 | F8CV

01.01→	0 986 45 P 2058	O
	1 987 42 S 9166	L
	0 450 90 F 5969 ¹	K

Matiz 0.8 i

0,8 | 38 | F8CV

04.98-01.05	0 986 45 P 2058	O
11.98-07.02	0 986 45 P 2019	O
04.98-01.05	1 987 42 S 9166	L
	0 450 90 F 5969 ¹	K
11.98-07.02	0 450 90 F 5273 ¹	K

0,8 | 38 | M-TEC II <SOHCT3>

03.06→	0 450 90 F 5273 ¹	K
--------	------------------------------	---





◀ Matiz 0.8 i

0,8 38 <SOHC T3>	04.98→	1 987 42 S 9166	L
	07.00→	0 450 90 F 5273 ¹	K
Fg.Nr. →090117	04.98-08.00	0 450 90 F 5273 ¹	K

Matiz 1.0 , i

1,0 47 B10S	01.01→	0 986 45 P 2058	O
		1 987 42 S 9166	L
		0 450 90 F 5969 ¹	K

Musso

Musso 2.0 i 16V

2,0 100 M161 E20 <MB-M 111.970>	05.96-12.00	1 457 42 P 9122	O
		0 450 90 F 5281 ¹	K

Musso 2.3 D

2,3 57 OM661 D23 <MB-OM 601.910>	07.93-12.00	1 457 42 P 9274	O
		0 450 90 N 4077 ¹	K
		1 457 43 N 4331 ²	K

Musso 2.3 i 16V

2,3 103 M161 E23 <MB-M 111.970>	05.96-12.00	1 457 42 P 9122	O
		0 450 90 F 5281 ¹	K

Musso 2.9 D, TD Intercooler

2,9 72/88 OM 662 D29 <OM 602.910>; OM662 D29 <MB-OM 602>	07.93-12.00	1 457 42 P 9274	O
		0 450 90 N 4077 ¹	K

Musso 3.2 i 24V

3,2 162 M162 E32 <MB-M 104.992>	01.96-12.00	1 457 42 P 9122	O
		0 450 90 F 5281 ¹	K

New Prince

New Prince 2.0 i, LPG

2,0 83-85	04.96-02.97	0 451 10 P 3079	O
		1 457 43 S 3003	L

Nexia

Nexia 1.5 i

1,5 44/52/55-57 G15MF	12.94→	0 451 10 P 3079	O
		1 457 43 S 3003	L
		0 986 45 F 0119 ¹	K

1,5 | 58,9 | A15SMS

01.95→	0 451 10 P 3079	O
	1 457 43 S 3963	L



1,5 62,5/66-67 A15MF	11.94→	0 451 10 P 3079	O
		1 457 43 S 3003	L
		0 986 45 F 0119 ¹	K

Nexia 1.6

1,6 80 F16D3	01.95→	0 451 10 P 3079	O
		F 026 40 S 0163	L
		0 450 90 F 5969 ¹	K

Nubira

Nubira 1.5 i

1,5 66 <SOHC>	02.97-02.99	0 451 10 P 3079	O
		1 457 43 S 3962	L
		0 450 90 F 5273 ¹	K
		1 987 43 M 2105	I

1,5 | 79/81 | <DOHC E-TEC>; <DOHC family I>

02.97-11.02	0 451 10 P 3079	O
	1 457 43 S 3962	L
	0 450 90 F 5969 ¹	K
	1 987 43 M 2105	I

Nubira 1.6 i

1,6 76-78 A16DMS <L44>	10.99-06.03	0 451 10 P 3079	O
		1 457 43 S 3962	L
Fg.Nr. →682031	10.99-06.03	0 450 90 F 5969 ¹	K
Fg.Nr. 682032→	10.99-06.03	0 450 90 F 5969 ¹	K
	10.99-06.03	1 987 43 M 2105	I

1,6 | 78 | A16DMS <L44>

09.97-09.99	0 451 10 P 3079	O
	1 457 43 S 3962	L
	0 450 90 F 5969 ¹	K
	1 987 43 M 2105	I

1,6 | 80 | F16D3 <L44>

07.03-01.05	0 451 10 P 3079	O
	F 026 40 S 0163	L
	0 450 90 F 5969 ¹	K

Nubira 1.8 i

1,8 90 T18SED <L84>	07.03-01.05	0 451 10 P 3079	O
		F 026 40 S 0163	L
		0 450 90 F 5969 ¹	K

1,8 | 96 | <DOHC>

06.96-02.99	0 451 10 P 3079	O
	1 457 43 S 3962	L
	0 450 90 F 5969 ¹	K
	1 987 43 M 2105	I





Nubira 2.0 i

2,0 79 <L76>	10.99-06.03	0 451 10 P 3079 O 1 457 43 S 3962 L
Fg.Nr. →682031	10.99-06.03	0 450 90 F 5969 ¹ K
Fg.Nr. 682032→	10.99-06.03	0 450 90 F 5969 ¹ K
	10.99-06.03	1 987 43 M 2105 I

2,0 79 <SOHC>	03.99-11.02	1 457 43 S 3962 L 0 450 90 F 5969 ¹ K
----------------------------	-------------	---

2,0 98 X20SED	10.99-06.03	0 451 10 P 3079 O 1 457 43 S 3962 L
Fg.Nr. →682031	10.99-06.03	0 450 90 F 5969 ¹ K
Fg.Nr. 682032→	10.99-06.03	0 450 90 F 5969 ¹ K
	10.99-06.03	1 987 43 M 2105 I

2,0 98 X20SED <L88>	09.97-06.03	0 451 10 P 3079 O 1 457 43 S 3962 L
	09.97-09.99	0 450 90 F 5969 ¹ K
Fg.Nr. →682031	08.99-06.03	0 450 90 F 5969 ¹ K
Fg.Nr. 682032→	08.99-06.03	0 450 90 F 5969 ¹ K
	09.97-06.03	1 987 43 M 2105 I

2,0 104 C20SED <DOHC>	02.97-02.99	1 457 43 S 3962 L 0 450 90 F 5969 ¹ K
------------------------------------	-------------	---

Prince

Prince 1.8 i

1,8 78 Holden-C 18 LE	09.92-03.96	0 451 10 P 3079 O 1 457 43 S 3003 L 0 450 90 F 5002 ¹ K
------------------------------	-------------	--

1,8 81 <SOHC Family II>	06.91-12.95	0 451 10 P 3079 O 1 457 43 S 3003 L 0 986 45 F 0119 ¹ K
--------------------------------------	-------------	--

Prince 2.0 i

2,0 85 Holden-C 20 LE <SOHC>	01.91-03.96	0 451 10 P 3079 O 1 457 43 S 3003 L
	09.91-03.96	0 450 90 F 5002 ¹ K

Prince 2.0 LPG

2,0 83-85 Holden-C 20 LE <SOHC>	01.91-03.96	0 451 10 P 3079 O 1 457 43 S 3003 L
--	-------------	--

Racer

Racer 1.5 i

1,5 51 G15L	06.93-12.99	0 451 10 P 3079 O
--------------------	-------------	---------------------------------



Racer 1500

1,5	01.88-02.93	0 986 45 F 0119 ¹ K
------------	-------------	--

Rezzo

Rezzo 1.6 i

1,6 74-77 A16DMS	09.00-01.05	0 451 10 P 3079 O 0 450 90 F 5969 ¹ K
-------------------------	-------------	---

Rezzo 1.8 i

1,8 71-77 A18DMS	09.00-01.05	0 451 10 P 3079 O 0 450 90 F 5969 ¹ K
-------------------------	-------------	---

Rezzo 2.0 i

2,0 88-89 T20SED	09.00-01.05	0 451 10 P 3079 O 0 450 90 F 5969 ¹ K
-------------------------	-------------	---

Rezzo 2.0 i 16V

2,0 94 T 20 SED <DOHC Family II>	01.00→	0 451 10 P 3079 O
---	--------	---------------------------------

Super Salon

Super Salon 2.0 i

2,0 81-85 C 20 LE	09.91-12.95	0 451 10 P 3079 O 1 457 43 S 3003 L
--------------------------	-------------	--

Tico

Tico 0.8

0,8 30-35 F8C	06.91-01.05	0 986 45 P 2019 O 1 457 43 S 3227 L
----------------------	-------------	--

0,8 38 F8CV	01.96-01.05	0 986 45 P 2058 O 1 987 42 S 9166 L
--------------------	-------------	--

DAIHATSU

Applause

Applause 1.6

1,6 66-67 HDCF	06.89-07.97	0 986 45 P 2058 O XXX 0 986 45 F 0212 ¹ K
-----------------------	-------------	---

Applause 1.6 i

1,6 73 HDE <Kat.>	09.97-04.00	0 986 45 P 2058 O 1 987 42 S 9123 L
--------------------------------	-------------	--





◀ Applause 1.6 i

1,6 88 HDE	06.89-05.00	1 987 42	S 9123	L
----------------	-------------	----------	--------	---

Applause 1.6 i, i 4WD

1,6 77 HDE <Kat.>	06.89-07.97	0 986 45	P 2058	O
		1 987 42	S 9123	L
		0 450 90	F 5962 ¹	K

Charade

Charade 1.0

1,0 38 CB	11.90-12.92	0 986 45	P 2058	O
	05.95-10.95	0 986 45	P 2058	O
	11.90-12.92	1 457 43	S 3688	L
	05.93-10.95	1 457 43	S 3688	L
	11.90-12.92 XXX	0 986 45	F 0212 ¹	K
	05.93-10.95 XXX	0 986 45	F 0212 ¹	K

1,0 40 CB	01.87-01.93	1 457 43	S 3688	L
---------------	-------------	----------	--------	---

Charade 1.0 D

1,0 27 CL; CL61	11.90-12.92	0 986 45	P 2019	O
---------------------	-------------	----------	--------	---

Charade 1.0 D Turbo

1,0 35 CL; CL61	11.90-12.92	0 986 45	P 2019	O
		1 987 42	S 9123	L

1,0 37 CL; CL61	01.87-01.93	1 987 42	S 9123	L
---------------------	-------------	----------	--------	---

Charade 1.0 i, i Turbo

1,0 40/74 CB <Kat.>; CB80 <GTI Kat.>	11.90-12.92	0 986 45	P 2058	O
		1 987 42	S 9123	L
		0 450 90	F 5963 ¹	K

Charade 1.0 i Turbo

1,0 77 CB	01.87-01.93	1 987 42	S 9123	L
---------------	-------------	----------	--------	---

Charade 1.3

1,3 60-66 HCC	11.90-12.92	0 986 45	P 2058	O
	XXX	0 986 45	F 0212 ¹	K

Charade 1.3 i

1,3 44 HC <Kat.>	09.96-04.00	0 986 45	P 2058	O
		1 987 42	S 9123	L

1,3 62 HCE	11.90-12.92	0 986 45	F 0103 ¹	K
----------------	-------------	----------	---------------------	---

1,3 62 HCE <Kat.>	01.93-09.00	0 986 45	P 2058	O
		1 987 42	S 9123	L
	01.93-03.95	0 986 45	F 0107 ¹	K



1,3 66 HCE <Kat.>	11.90-12.92	0 986 45	P 2058	O
		0 986 45	F 0103 ¹	K

1,3 67 HCE	01.93-03.00	1 987 42	S 9123	L
----------------	-------------	----------	--------	---

Charade 1.3 i, i 4WD

1,3 69 HCE	01.88-01.93	1 987 42	S 9123	L
		0 986 45	F 0103 ¹	K

Charade 1.3 VVT

1,3 73 1NRFE	03.11→	1 457 43	S 3972	L
		1 987 43	M 2190	I

Charade 1.5 i

1,5 55/66 HEEG	06.94-09.00	0 986 45	P 2058	O
		1 987 42	S 9123	L
	06.94-03.95	0 986 45	F 0107 ¹	K

1,5 66 HEE <Kat.>	01.97-04.00	0 986 45	P 2058	O
		1 987 42	S 9123	L

1,5 71-74 HEEG	07.93-03.00	1 987 42	S 9123	L
--------------------	-------------	----------	--------	---

Charade 1.6 i

1,6 77 HDE <Kat.>	01.93-09.00	0 986 45	P 2058	O
		1 987 42	S 9123	L
	01.93-03.95	0 986 45	F 0107 ¹	K

1,6 92 HDEG	07.93-07.98	1 987 42	S 9123	L
-----------------	-------------	----------	--------	---

Copen

Copen 1.3

1,3 64 K3VE	10.05→	0 986 45	P 2058	O
-----------------	--------	----------	--------	---

Cuore

Cuore 1.0 i

1,0 43 EJ	03.03-12.07	0 986 45	P 2058	O
---------------	-------------	----------	--------	---

1,0 51 1KRFE	04.07→	0 986 45	P 2058	O
------------------	--------	----------	--------	---

Cuore 1.0 i 12V

1,0 40-41 EJDE; EJVE	10.98-03.03	0 986 45	P 2058	O
		1 987 42	S 9164	L

Cuore 850

0,8 31-32 ED20	08.94-12.99	0 986 45	P 2058	O
--------------------	-------------	----------	--------	---



**Delta****Delta 2.8 D**

2,8 60 DL	09.84-04.95	0 986 45 N 0508	K
-----------	-------------	-----------------	---

Delta Wide**Delta Wide 1.8**

1,8 58 2YU	11.82-12.91	0 986 45 P 2000	O
------------	-------------	-----------------	---

Delta Wide 2.0 D Turbo

2,0 63 2CT	08.85-09.93	0 986 45 P 2030	O
------------	-------------	-----------------	---

Extol**Extol 1.3**

1,3 63 K3	07.00-11.04	0 986 45 P 2058	O
-----------	-------------	-----------------	---

Feroza**Feroza 1.6 i 16V 4WD**

1,6 70 HDE	10.88-10.99	0 986 45 P 2058	O
		1 457 43 S 2210	L
		0 450 90 F 5977 ¹	K

1,6|70|HDE <Kat.>

05.92-10.99	0 986 45 P 2019	O
	0 986 45 P 2058	O
	1 457 43 S 2210	L
	0 450 90 F 5977 ¹	K

Feroza 1.6 4WD

1,6 63 HDC	10.88-10.99	0 986 45 P 2019	O
		0 986 45 P 2058	O

Gran Move**Gran Move 1.5 i 16V**

1,5 66 HEEG	11.96-03.00	0 986 45 P 2058	O
		1 987 42 S 9123	L

Gran Move 1.6

1,6 67 HDEP	05.98-07.02	0 986 45 P 2058	O
		1 987 42 S 9123	L

**Hijet****Hijet 1.0 , i**

1,0 33/35 CB41;CB42	12.92-05.98	0 986 45 P 2058	O
---------------------	-------------	-----------------	---

Hijet 1.0 , 4WD

1,0 33 CB	05.86-11.92	0 986 45 P 2019	O
		07.86-11.92	BUS
		1 457 43 S 2208	L

Hijet 1.3 16V

1,3 48 HCE;HCE SOHC	05.98→	0 986 45 P 2058	O
---------------------	--------	-----------------	---

Hijet 850

0,9CD	05.86-11.92	0 986 45 P 2019	O
		07.86-11.92	BUS
		1 457 43 S 2208	L

Move**Move CX 660 12V**

0,7 41 EFZL	08.95→	0 986 45 P 2058	O
-------------	--------	-----------------	---

Move SR 660 16V Turbo

0,7 47 JB JL	08.95→	0 986 45 P 2058	O
--------------	--------	-----------------	---

Move 1.0 i 12V

1,0 40,5 EJDE;EJVE	10.98-09.02	0 986 45 P 2058	O
		1 987 42 S 9164	L

Move 850

0,9 31 ED20	01.97-09.98	0 986 45 P 2058	O
-------------	-------------	-----------------	---

Pyzar**Pyzar 1.5 i**

1,5 74 HEEG	08.96-07.02	1 987 42 S 9123	L
-------------	-------------	-----------------	---

Rocky**Rocky 1.6 i 4x4**

1,6 77 HDE	07.90-05.97	1 457 43 S 2210	L
------------	-------------	-----------------	---

Rocky 2.0 4WD

2,0 67 3Y	04.84-04.93	0 986 45 P 2023	O
-----------	-------------	-----------------	---





Rocky 2.2 4WD

2,2 67-69 4Y	05.93-06.01	0 986 45 P 2003	O
--------------	-------------	-----------------	---

Rocky 2.8 D Turbo 4WD

2,8 67-75 DL	04.84-07.93	0 986 45 P 2020	O
	04.84-04.93	1 457 43 S 3646	L
	08.86-04.93	1 457 43 N 4453 ²	K

2,8 72-75 DL	05.93-03.02	1 457 43 S 3646	L
		1 457 43 N 4453 ²	K

Rocky 2.8 D 4WD

2,8 54 DL	04.84→	0 986 45 P 2020	O
		1 457 43 S 3646	L
	08.86→	1 457 43 N 4453 ²	K

Rugger

Rugger 2.8 D Turbo 4WD

2,8 85 DL	05.93-05.97	1 457 43 S 3646	L
		0 986 45 N 0508	K

Sirion I

Sirion I 1.0 12V, 12V 4WD

1,0 41/43 EJDE; EJVE	04.98-07.04	0 986 45 P 2058	O
		1 987 42 S 9164	L

Sirion I 1.3 16V 4WD, 16V 4x4

1,3 75 K3VE	08.00-07.04	0 986 45 P 2058	O
		1 987 42 S 9164	L

Sirion II

Sirion II 1.0

1,0 51 1KRFE	10.04→	1 457 43 S 3971	L
--------------	--------	-----------------	---

Storia

Storia 1.0 i

1,0 47 EJVE	05.00-05.04	1 987 42 S 9164	L
-------------	-------------	-----------------	---

Terios

Terios 1.3 i, i 4WD

1,3 63 K3VE	05.00→	0 986 45 P 2058	O
-------------	--------	-----------------	---



Terios 1.3 i Turbo 4WD

1,3 103 K3VET	08.00-12.05	1 987 42 S 9123	L
---------------	-------------	-----------------	---

Terios 1.3 i 4WD

1,3 61 HCEJ	03.97-05.00	0 986 45 P 2058	O
		1 987 42 S 9137	L

1,3 68 HCEJ	03.97-05.00	1 987 42 S 9137	L
-------------	-------------	-----------------	---

Terios 1.5 i, i 4WD

1,5 77 3SZVE	01.06→	0 986 45 P 2058	O
--------------	--------	-----------------	---

Trevis

Trevis 1.0

1,0 43 EJVE	08.06→	0 986 45 P 2058	O
-------------	--------	-----------------	---

YRV

YRV 1.0 , 4WD

1,0 47 EJ	08.00-07.05	0 986 45 P 2058	O
		1 987 42 S 9164	L

YRV 1.0 i

1,0 47 EJVE	08.00-12.02	1 987 42 S 9164	L
-------------	-------------	-----------------	---

YRV 1.3 , Turbo, 4WD

1,3 64/95 K3; K3VET	08.00-07.05	0 986 45 P 2058	O
---------------------	-------------	-----------------	---

DODGE

Avenger

Avenger 2.0 CRD

2,0 103 ECD	09.07→	1 457 42 P 9192	O
-------------	--------	-----------------	---

Avenger 2.0 i

2,0 104 ECF	01.95-12.00	0 451 10 P 3251	O
		1 457 43 S 3968	L

Avenger 2.5

2,5 116-122 EEB	01.95-08.00	1 457 43 S 3968	L
-----------------	-------------	-----------------	---

Avenger 2.7 FlexFuel

2,7 139 EER	09.07-08.08 Z34	0 451 10 P 3219	O
-------------	-----------------	-----------------	---





Avenger 3.5 , 4x4

3,5 173 EGF	09.07-08.08	Z34	0 451 10 P 3219	0
-------------	-------------	-----	-----------------	---

Caliber

Caliber 2.0 CRD

2,0 88/103 ECD;ECE	09.06-08.09		1 457 42 P 9192	0
--------------------	-------------	--	-----------------	---

Caravan

Caravan 2.0

2,0 98	01.95-03.01		0 451 10 P 3271	0
	01.97-03.01		1 457 42 S 9957	L

Caravan 2.4

2,4 111 EDZ	09.94-08.07		0 451 10 P 3271	0
	09.94-08.00		1 457 42 S 9957	L
	09.00-08.07		1 987 42 S 9194	L
			1 987 43 R 2497 ⁸	I

Caravan 2.5

2,5 72 EDM	08.90-08.95		0 451 10 P 3251	0
------------	-------------	--	-----------------	---

Caravan 2.5 TD

2,5 85 VM HR 425 CLIEE <ENC>	01.95-08.03		0 451 10 P 3258	0
		TW	1 457 43 S 3231	L
	01.97-08.03		1 457 42 S 9957	L
	01.95-08.03		1 457 43 N 4450 ²	K

Caravan 3.0

3,0 112 EFA	01.95-03.01		1 457 42 S 9957	L
-------------	-------------	--	-----------------	---

Caravan 3.0 i

3,0 107 EFA	08.90-09.94		0 451 10 P 3251	0
	09.91-09.94		0 451 10 P 3219	0
	01.88-09.94		1 457 42 S 9957	L

Caravan 3.3

3,3 121 EG...	09.93-08.01		0 451 10 P 3251	0
			1 457 42 S 9957	L

3,3 128-134 EGA	09.00-08.06		0 451 10 P 3219	0
			0 451 10 P 3251	0
	09.06-08.07		0 986 45 P 2036	0
	09.00-08.07		1 987 42 S 9194	L
			1 987 43 R 2497 ⁸	I



Caravan 3.3 FFV

3,3 131 EGV	09.07→		0 986 45 P 2036	0
-------------	--------	--	-----------------	---

Caravan 3.3 i

3,3 134 EGA	09.00-08.06		0 451 10 P 3219	0
-------------	-------------	--	-----------------	---

Caravan 3.3 4x4

3,3 128-134 EGA	01.01-08.06		0 451 10 P 3251	0
	09.06-08.07		0 986 45 P 2036	0
	01.01-08.07		1 987 42 S 9194	L
			1 987 43 R 2497 ⁸	I

3,3 134 EGA	09.00-08.02		0 451 10 P 3219	0
-------------	-------------	--	-----------------	---

Caravan 3.5

3,5 128-132 EGF <High Output,V6>	01.01-12.01		0 451 10 P 3251	0
			1 987 42 S 9194	L
			1 987 43 R 2497 ⁸	I

Caravan 3.8

3,8 124 EGH	09.94-08.00		0 451 10 P 3251	0
	09.95-08.99		0 451 10 P 3219	0
	09.94-08.00		1 457 42 S 9957	L

3,8 145 EGL	09.07→		0 986 45 P 2036	0
-------------	--------	--	-----------------	---

Caravan 3.8 , AWD

3,8 130/131 EGH	01.95-03.01		0 451 10 P 3251	0
			1 457 42 S 9957	L

Caravan 3.8 , 4x4

3,8 160 EGH	09.01-08.06		0 451 10 P 3251	0
	09.06-08.07		0 986 45 P 2036	0
	09.01-08.07		1 987 42 S 9194	L
			1 987 43 R 2497 ⁸	I

Caravan 3.8 AWD

3,8 122 EGH	01.95-03.01		0 451 10 P 3251	0
			1 457 42 S 9957	L

Caravan 3.8 i

3,8 154-160 EGH	09.00-08.06		0 451 10 P 3219	0
-----------------	-------------	--	-----------------	---





Caravan 3.8 4x4

3,8 153 EGH				
	04.01-08.06	0 451 10 P 3251	0	
	09.06-08.07	0 986 45 P 2036	0	
	04.01-08.07	1 987 42 S 9194	L	
		1 987 43 R 2497 ⁸	I	

Caravan 4.0

4,0 187 EGQ	09.07→	0 986 45 P 2036	0	
-----------------	--------	-----------------	---	--

Charger

Charger 2.7 4x4

2,7 142 EER	09.06-08.07	0 451 10 P 3219	0	
-----------------	-------------	-----------------	---	--

Dakota

Dakota 2.5

2,5 74 EDA	09.90-08.95	0 451 10 P 3219	0	
----------------	-------------	-----------------	---	--

2,5 89 EPE	09.95-08.02	0 451 10 P 3219	0	
	09.95-08.03	0 451 10 P 3251	0	
		1 457 43 S 3298	L	

Dakota 3.7

3,7 157 EKG	09.03→	0 451 10 P 3074	0	
		1 457 43 S 3298	L	

Dakota 3.9

3,9 131-134 EHC	09.96-08.03	0 451 10 P 3251	0	
		1 457 43 S 3298	L	

Dakota 4.7

4,7 172-175 EVA	09.99-08.08	0 451 10 P 3251	0	
		1 457 43 S 3298	L	

Dakota 4.7 H.O., H.O. 4x4

4,7 194 EVC	09.06-08.07	0 451 10 P 3219	0	
-----------------	-------------	-----------------	---	--

Dakota 4.7 4x4

4,7 172-175 EVA	09.04-08.07	0 451 10 P 3219	0	
	09.04-08.08	0 451 10 P 3251	0	
		1 457 43 S 3298	L	

Dakota 5.2

5,2 164-172 ELF, ELG	09.91-08.99	0 451 10 P 3251	0	
		1 457 43 S 3298	L	



Dakota 5.9

5,9 183-187 EML	09.96-08.03	0 451 10 P 3251	0	
	09.97-08.03	0 451 10 P 3219	0	
	09.96-08.03	1 457 43 S 3298	L	

Daytona

Daytona 2.2

2,2 164-168 EDS	09.89-08.92	0 451 10 P 3251	0	
---------------------	-------------	-----------------	---	--

Daytona 2.5

2,5 71-82 EDC	09.90-08.93	0 451 10 P 3219	0	
-------------------	-------------	-----------------	---	--

2,5 | 112-116 | EDT

	09.88-08.92	0 451 10 P 3251	0	
	09.90-08.92	0 451 10 P 3219	0	

Durango

Durango 3.7

3,7 157 EKG	09.03→	0 451 10 P 3074	0	
-----------------	--------	-----------------	---	--

Durango 3.9

3,9 130 EHC	09.97-08.00	0 451 10 P 3251	0	
	09.98-08.99	0 451 10 P 3219	0	
	09.97-08.00	1 457 43 S 3298	L	

Durango 3.9 4x4

3,9 130 EHC	09.97-08.99	0 451 10 P 3219	0	
-----------------	-------------	-----------------	---	--

Durango 4.7

4,7 172-175 EVA	09.99-08.08	0 451 10 P 3251	0	
	09.99-08.04	1 457 43 S 3298	L	

Durango 4.7 4x4

4,7 172-175 EVA	09.04-08.07	0 451 10 P 3219	0	
	09.04→	0 451 10 P 3251	0	

Durango 5.2

5,2 172 ELF	09.97-08.00	0 451 10 P 3251	0	
	09.98-08.00	0 451 10 P 3219	0	
	09.97-08.00	1 457 43 S 3298	L	

Durango 5.7

5,7 250-257 EZA	09.03-08.05	0 451 10 P 3219	0	
	09.03-08.06	0 451 10 P 3251	0	

Durango 5.7 4x4

5,7 250-257 EZA	09.03-08.05	0 451 10 P 3219	0	
---------------------	-------------	-----------------	---	--





Durango 5.9

5,9 184 EML	09.97-08.03	0 451 10 P 3251	0
	09.98-08.03	0 451 10 P 3219	0
	09.97-08.03	1 457 43 S 3298	L

Dynasty

Dynasty 2.5 i

2,5 74 TBI	09.90-08.93	0 451 10 P 3219	0
------------	-------------	-----------------	---

Dynasty 3.0 i

3,0 104 EFA	08.90-08.93	0 451 10 P 3251	0
	09.90-08.93	0 451 10 P 3219	0
	09.87-08.93	1 457 42 S 9957	L

Dynasty 3.3 i

3,3 109 MPI	09.90-08.93	0 451 10 P 3219	0
-------------	-------------	-----------------	---

Intrepid

Intrepid 2.7

2,7 149 EES	10.99-08.01	0 451 10 P 3219	0
-------------	-------------	-----------------	---

Intrepid 2.7 FFV

2,7 138 EER	09.97-08.04	0 451 10 P 3251	0
-------------	-------------	-----------------	---

Intrepid 3.2

3,2 164-168 EGW	09.97-08.01	0 451 10 P 3251	0
-----------------	-------------	-----------------	---

Intrepid 3.3 i

3,3 114-120 EGB	09.93-08.97	0 451 10 P 3251	0
-----------------	-------------	-----------------	---

Intrepid 3.3 i FFV

3,3 125	09.94-08.95	0 451 10 P 3219	0
---------	-------------	-----------------	---

Intrepid 3.5

3,5 160 EGG	09.97-08.04	0 451 10 P 3251	0
	09.00-08.04	0 451 10 P 3219	0

3,5 174-182 EGC	09.99-08.04	0 451 10 P 3251	0
-----------------	-------------	-----------------	---

Intrepid 3.5 i

3,5 160 EGE	01.93-08.97	0 451 10 P 3219	0
	01.93-08.01	0 451 10 P 3251	0



Journey

Journey 2.0 CRD

2,0 103 ECE	05.08→	1 457 42 P 9192	0
-------------	--------	-----------------	---

Magnum

Magnum 2.7 , 4x4

2,7 138 EER	09.04→	0 451 10 P 3251	0
-------------	--------	-----------------	---

Magnum 3.5 , 4x4

3,5 187 EGG	09.04-08.08	0 451 10 P 3251	0
-------------	-------------	-----------------	---

Magnum 5.7 , 4x4

5,7 254 EZB	09.04-08.07	0 451 10 P 3219	0
	09.04-08.08	0 451 10 P 3251	0

Neon

Neon 1.6

1,6 85 EJD	09.00-08.05	1 457 42 P 9197	0
------------	-------------	-----------------	---

Neon 2.0

2,0 98/112 ECB;ECH	09.99-08.05	0 451 10 P 3271	0
--------------------	-------------	-----------------	---

Neon 2.4 SRT-4

2,4 160 EDV	09.02-08.05	0 451 10 P 3074	0
-------------	-------------	-----------------	---

Nitro

Nitro 3.7 , 4x4

3,7 151 EKG	09.06-08.08	0 451 10 P 3074	0
-------------	-------------	-----------------	---

Nitro 4.0 , 4x4

4,0 191 EGS	09.06-08.08	0 451 10 P 3251	0
-------------	-------------	-----------------	---

Ram

Ram 3.7 4x4

3,7 160 EKG	09.01→	0 451 10 P 3074	0
-------------	--------	-----------------	---

Ram 4.7

4,7 175 EVA	09.01-08.07	0 451 10 P 3219	0
-------------	-------------	-----------------	---





Ram 4.7 4x4

4,7 175 EVA	09.01-08.07	0 451 10 P 3219	0
	09.01-08.08	0 451 10 P 3251	0

Ram 5.2

5,2 162 ELF	09.93-08.96	0 451 10 P 3219	0
-----------------	-------------	-----------------	---

Ram 5.7 , 4x4

5,7 257 EZA	09.02-08.07	0 451 10 P 3219	0
	09.02-08.08	0 451 10 P 3251	0

Ram 8.0 , 4x4

8,0 220 EWA	09.99-08.03	0 451 10 P 3219	0
-----------------	-------------	-----------------	---

Ram 8.3 SRT-10 4x4

8,3 380-392 EWC	09.03-08.06	0 451 10 P 3219	0
	09.03-08.08	0 451 10 P 3251	0

Shadow

Shadow 2.2

2,2 69 EDF	09.86-08.94	0 451 10 P 3251	0
	09.90-08.94	0 451 10 P 3219	0

Shadow 2.5

2,5 74/113 EDM; EDT	09.90-08.94	0 451 10 P 3219	0
-------------------------	-------------	-----------------	---

Spirit

Spirit 2.5 i LE

2,5 74 EDM	08.90-08.93	0 451 10 P 3251	0
----------------	-------------	-----------------	---

Spirit 2.5 i Turbo

2,5 107	08.90-08.92	0 451 10 P 3251	0
	09.90-08.92	0 451 10 P 3219	0

Spirit 3.0 i

3,0 104 EFA	08.90-08.95	0 451 10 P 3251	0
	09.90-08.95	0 451 10 P 3219	0
	10.88-08.95	1 457 42 S 9957	L

Sprinter

Sprinter 2.7

2,7 115 OM 612	01.03-12.03	XXX	1 457 42 P 9196	0
			1 457 43 S 3703	L
			1 987 43 M 2043	I



Sprinter 3.0 CDI

3,0 115 EXM	09.06-08.08	1 987 43 M 2213	8	I
-----------------	-------------	-----------------	---	---

Sprinter 3.5

3,5 189 EG1	01.07-08.07	1 987 43 M 2213	8	I
-----------------	-------------	-----------------	---	---

Stratus

Stratus 2.0 CRD

2,0 103 ECD <A>	09.06-08.07	1 457 42 P 9192	0
---------------------	-------------	-----------------	---

Stratus 2.0 i

2,0 98 ECB	09.94-08.00	0 451 10 P 3271	0
		F 026 40 S 0042	L

Stratus 2.0 i 16V

2,0 104 ECC	09.00-08.06	0 451 10 P 3271	0
-----------------	-------------	-----------------	---

Stratus 2.4

2,4 103-112 EDZ	09.94-08.06	0 451 10 P 3271	0
---------------------	-------------	-----------------	---

2,4 110 EY7	09.00-08.05	0 986 45 P 2041	0
		1 457 43 S 3968	L

Stratus 2.4 i

2,4 112 EDZ	09.94-12.00	0 451 10 P 3271	0
		F 026 40 S 0042	L

2,4 | 160 | EDV

	09.00-08.06	0 451 10 P 3251	0
--	-------------	-----------------	---

Stratus 2.5 i

2,5 125 EEB	09.94-08.00	F 026 40 S 0042	L
-----------------	-------------	-----------------	---

Stratus 2.7

2,7 150 EER	09.01-08.06	0 451 10 P 3251	0
-----------------	-------------	-----------------	---

Stratus 3.0 i

3,0 151-157 EF7	09.00-08.05	1 457 43 S 3968	L
---------------------	-------------	-----------------	---

Viper

Viper 8.0 GTS, GTS-R

8,0 306/331-336 EWB	09.90-08.02	0 451 10 P 3251	0
-------------------------	-------------	-----------------	---

Viper 8.3 SRT-10

8,3 372 EWC	09.03-08.06	0 451 10 P 3251	0
-----------------	-------------	-----------------	---





FERRARI

F 50

F 50 V12

4,7 | 383
07.95→ 0 450 90 **F 5087**¹ **K**

F 355

F 355 Spider

3,5 | 280 | F129C/40
10.95→ 0 450 90 **F 5601**¹ **K**

F 355 3.5

3,5 | 280 | F129B/40
05.94-10.95 0 450 90 **F 5601**¹ **K**

Mondial

Mondial T

3,4 | 213/221 | F 119 D; F 119 DL; F 119 DL 000-40
11.88-02.94 0 450 90 **F 5601**¹ **K**

Testarossa

Testarossa 4.9

4,9 | 272/287 | F 113 A../B../; F 113 B..Kat.
01.86-10.91 0 450 90 **F 5601**¹ **K**

348

348 TB

3,4 | 217-221 | F 119 F 000
02.90-04.94 0 450 90 **F 5601**¹ **K**

348 TS

3,4 | 217-221 | F 119 F 000
08.90-04.94 0 450 90 **F 5601**¹ **K**

456

456 GT 2+2

5,5 | 325 | F 116 B 00
01.93-03.96 0 450 90 **F 5087**¹ **K**

456 GT/GTR 48V

5,5 | 325 | F 116 V12
03.96-12.04 0 450 90 **F 5087**¹ **K**



512

512 TR

5,0 | 315 | F 113 D 00/40
01.92-10.94 0 450 90 **F 5087**¹ **K**

550

550 Maranello

5,5 | 357 | F 133
10.96→ 0 450 90 **F 5087**¹ **K**

FIAT *

Albea

Albea 1.2 i.e. 8V, i.e. 16V, i.e. 16V LPG

1,2 | 44/57-59 | 188 A 4.000 <M6>; 188 A 5.000 <M10>
01.02→
0 986 45 **P 2041** **O**
1 457 43 **S 3303** **L**
0 986 45 **F 0220**¹ **K**
1 987 43 **M 2183** **I**

Albea 1.3 JTD 16V

1,3 | 52 | 188 A 9.000 <M40>
07.03→ PRF
1 457 42 **P 9256** **O**
F 026 40 **S 0002** **L**
1 457 07 **N 0001** **K**
1 987 43 **M 2183** **I**

Albea 1.4 i.e. 8V

1,4 | 57 | 350 A 1.000 <M13>
07.06→
0 986 45 **P 2041** **O**
F 026 40 **S 0036** **L**
0 986 45 **F 0220**¹ **K**
1 987 43 **M 2183** **I**

Albea 1.6 i.e. 16V

1,6 | 76 | 182 B 6.000 <M21>
01.02→
0 451 10 **P 3111** **O**
1 457 43 **S 3303** **L**
0 986 45 **F 0220**¹ **K**
1 987 43 **M 2183** **I**

Barchetta

Barchetta 1.8 i.e. 16V

1,8 | 96 | 183 A 1.000 <M1>
01.95-02.96 0 451 10 **P 3111** **O**
03.96-09.00 0 451 10 **P 3300** **O**
Ricom.Nr →37640 01.95-05.98 0 450 90 **F 5273**¹ **K**

1,8 | 96 | 188 A 6.000 <M2>
10.00-02.05 0 451 10 **P 3300** **O**





Brava

Brava 1.2 16V

1,2 60 182 B 2.000 <M1>			
Mot.Nr. →140454	11.98-09.01	0 451 10 P 3111	O
Mot.Nr. 140455→	11.98-09.01	0 986 45 P 2041	O
	11.98-09.01	1 457 43 S 3265	L
		1 987 43 M 2003	I
		1 987 43 R 2303 ⁸	I

1,2 | 60 | 188 A 5.000 <M2>

Mot.Nr. 140455→	08.00-09.01	0 986 45 P 2041	O
	08.00-09.01	1 457 43 S 3265	L
		1 987 43 M 2003	I
		1 987 43 R 2303 ⁸	I

Brava 1.4 12V

1,4 55/59 182 A 3.000 <M1>; 182 A 5.000 <M2>			
	10.95-10.98	0 451 10 P 3111	O
		1 457 43 S 3265	L
		0 450 90 F 5273 ¹	K
		1 987 43 M 2003	I
		1 987 43 R 2303 ⁸	I

Brava 1.6 MPI 16V

1,6 78 178 A 8.011 <FIASA Step A>			
	08.99-03.00	0 450 90 F 5273 ¹	K
1,6 78 182 B 6.000 <FIASA Step B>			
	04.00-06.01	0 450 90 F 5273 ¹	K

Brava 1.6 16V

1,6 66/76/77 182 A 4.027 <M5>; 182 A 4.027 <M6>; 182 A 6.000 <M4>			
	10.95-09.01	0 451 10 P 3111	O
		1 457 43 S 3265	L
		0 450 90 F 5273 ¹	K
		1 987 43 M 2003	I
		1 987 43 R 2303 ⁸	I

1,6 | 75 | 182 A 4.000 <M3>

	10.95-10.98	0 451 10 P 3111	O
		1 457 43 S 3265	L
		0 450 90 F 5273 ¹	K
		1 987 43 M 2003	I
		1 987 43 R 2303 ⁸	I

1,6 | 75 | 182 A 4.000 <M5>

	11.98-09.01	0 451 10 P 3111	O
		1 457 43 S 3265	L
		1 987 43 M 2003	I
		1 987 43 R 2303 ⁸	I

1,6 | 75 | 182 B 6.000 <M8>

	01.99-12.01	0 451 10 P 3111	O
		1 457 43 S 3265	L
		1 987 43 M 2003	I
		1 987 43 R 2303 ⁸	I

1,6 | 77 | 182 B 6.000 <M8>

	08.00-09.01	0 451 10 P 3111	O
		1 987 43 M 2003	I
		1 987 43 R 2303 ⁸	I



Brava 1.8 16V

1,8 83 182 A 2.000 <M6>			
	10.95-10.98	0 451 10 P 3111	O
		1 457 43 S 3265	L
		0 450 90 F 5273 ¹	K
		1 987 43 M 2003	I
		1 987 43 R 2303 ⁸	I

1,8 | 83 | 182 A 2.000 <M10>

	11.98-09.01	0 451 10 P 3300	O
		1 457 43 S 3265	L
Ricam.Nr →4873621	11.98-07.99	0 450 90 F 5273 ¹	K
	11.98-09.01	1 987 43 M 2003	I
		1 987 43 R 2303 ⁸	I

Brava 1.9 D

1,9 48 160 A 7.000 <M7>			
	10.95-10.98	0 451 10 P 3352	O
		1 457 43 S 3265	L
		SWA 1 457 43 N 4106 ²	K
		SWA 1 457 43 N 4105 ²	K
		1 987 43 M 2003	I
		1 987 43 R 2303 ⁸	I

Brava 1.9 JTD

1,9 76 182 B 4.000 <M25>			
	11.98-09.01	0 451 10 P 3354	O
		1 457 43 S 3265	L
Ricam.Nr →4978724	11.98-02.00	MW8 1 457 43 N 4198 ²	K
Ricam.Nr 4978725→	03.00-09.01	MW1 1 457 43 N 4293 ²	K
Ricam.Nr 50289924→	07.00-09.01	1 457 43 N 4293 ²	K
	11.98-09.01	1 987 43 M 2003	I
		1 987 43 R 2303 ⁸	I

1,9 | 76 | 182 B 9.000 <M26>

	08.00-09.01	0 451 10 P 3354	O
		1 457 43 S 3265	L
		1 457 43 N 4314 ²	K
		1 987 43 M 2003	I
		1 987 43 R 2303 ⁸	I

Brava 1.9 TD

1,9 55 182 A 8.000 <M9>			
	03.96-10.98	0 451 10 P 3354	O
		1 457 43 S 3265	L
		1 457 43 N 4106 ²	K
		1 987 43 M 2003	I
		1 987 43 R 2303 ⁸	I

1,9 | 55 | 182 A 8.000 <M20>

	11.98-09.01	0 451 10 P 3354	O
		1 457 43 S 3265	L
Ricam.Nr →4824954	11.98-04.99	1 457 43 N 4106 ²	K
Ricam.Nr 4824955→	05.99-07.00	0 450 90 N 6308 ¹	K
	11.98-09.01	1 987 43 M 2003	I
		1 987 43 R 2303 ⁸	I





1,9 73/73,6 182 A 7.000 <M8>; 182 A 7.000 <M21>			
	03.96-09.01	0 451 10 P 3354	O
		1 457 43 S 3265	L
SWA		1 457 43 N 4106 ²	K
SWA		1 457 43 N 4105 ²	K
		1 987 43 M 2003	I
		1 987 43 R 2303 ⁸	I

Bravo

Bravo 1.2 16V

1,2 60 182 B 2.000 <M1>; 188 A 5.000 <M2>			
Mot.Nr. →140454	11.98-09.01	0 451 10 P 3111	O
Mot.Nr. 140455 →	11.98-09.01	0 986 45 P 2041	O
	11.98-09.01	1 457 43 S 3265	L
		1 987 43 M 2003	I
		1 987 43 R 2303 ⁸	I

Bravo 1.4 , LPG

1,4 66 192 B 2.000			
	03.10-05.10	0 986 45 P 2041	O
	06.10 →	0 451 10 P 3364	O
	03.10 →	STZ 1 457 43 S 3317	L
		STZ 1 457 43 S 3317	L
		1 987 43 R 2377 ⁸	I

Bravo 1.4 Turbo

1,4 88 198 A 4.000			
	03.10 →	1 457 42 P 9256	O
		1 987 43 R 2377 ⁸	I
1,4 103 198 A 7.000			
	03.10 →	1 457 42 P 9256	O
		1 987 43 R 2377 ⁸	I
1,4 110 198 A 1.000			
	03.10 →	1 457 42 P 9256	O
		1 987 43 R 2377 ⁸	I

Bravo 1.4 Turbo 16V

1,4 88 198 A 4.000 <M20>			
	10.07-12.09	PRF 1 457 42 P 9256	O
		1 987 43 R 2377 ⁸	I
1,4 110 198 A 1.000 <M21>			
	07.07-12.09	PRF 1 457 42 P 9256	O
		1 987 43 R 2377 ⁸	I

Bravo 1.4 12V

1,4 55/59 182 A 3.000 <M1>; 182 A 5.000 <M2>			
	10.95-10.98	0 451 10 P 3111	O
		1 457 43 S 3265	L
		0 450 90 F 5273 ¹	K
		1 987 43 M 2003	I
		1 987 43 R 2303 ⁸	I

Bravo 1.4 16V, 16V LPG

1,4 66 192 B 2.000 <M5>; 192 B 2.000 <M7>			
	03.07-12.09	0 986 45 P 2041	O
		STZ 1 457 43 S 3317	L
		STZ 1 457 43 S 3317	L
		1 987 43 R 2377 ⁸	I

Bravo 1.6 JTD

1,6 66 198 A 6.000			
	03.10 →	1 987 43 R 2377 ⁸	I
1,6 77 198 A 3.000			
	03.10 →	1 987 43 R 2377 ⁸	I
1,6 88 198 A 2.000			
	03.10 →	1 987 43 R 2377 ⁸	I

Bravo 1.6 JTD 8V

1,6 77 198 A 3.000 <M76>			
	10.07-12.09	1 987 43 R 2377 ⁸	I

Bravo 1.6 JTD 16V

1,6 88 198 A 2.000 <M78>			
	03.08-12.09	1 987 43 R 2377 ⁸	I

Bravo 1.6 16V

1,6 66 182 A 6.000 <M4>			
	10.95-04.98	0 451 10 P 3111	O
		1 457 43 S 3265	L
		0 450 90 F 5273 ¹	K
		1 987 43 M 2003	I
		1 987 43 R 2303 ⁸	I
1,6 75 178 A 8.011 <M6>; 182 A 4.000 <M3>			
	10.95-09.01	0 451 10 P 3111	O
		1 457 43 S 3265	L
		0 450 90 F 5273 ¹	K
		1 987 43 M 2003	I
		1 987 43 R 2303 ⁸	I

1,6 | 75 | 182 A 4.000 <M5>

	11.98-09.01	0 451 10 P 3111	O
		1 457 43 S 3265	L
		1 987 43 M 2003	I
		1 987 43 R 2303 ⁸	I

1,6 | 75 | 182 B 6.000 <M8>

	08.00-09.01	0 451 10 P 3111	O
		1 457 43 S 3265	L
		1 987 43 M 2003	I
		1 987 43 R 2303 ⁸	I

Bravo 1.8 16V

1,8 83 182 A 2.000 <M5>			
	10.95-10.98	0 451 10 P 3111	O
		1 457 43 S 3265	L
		0 450 90 F 5273 ¹	K
		1 987 43 M 2003	I
		1 987 43 R 2303 ⁸	I





◀ Bravo 1.8 16V

1,8 83 182 A 2.000 <M10>			
	11.98-09.01	0 451 10 P 3300	O
		1 457 43 S 3265	L
Ricam.Nr →4873621	11.98-07.99	0 450 90 F 5273 ¹	K
	11.98-09.01	1 987 43 M 2003	I
		1 987 43 R 2303 ⁸	I

Bravo 1.9 D

1,9 48 160 A 7.000 <M7>			
	10.95-10.98	0 451 10 P 3352	O
		1 457 43 S 3265	L
		SWA 1 457 43 N 4106 ²	K
		SWA 1 457 43 N 4105 ²	K
		1 987 43 M 2003	I
		1 987 43 R 2303 ⁸	I

Bravo 1.9 JTD

1,9 76 182 B 4.000 <M25>			
	11.98-09.01	0 451 10 P 3354	O
		1 457 43 S 3265	L
Ricam.Nr →4978761	11.98-02.00	MW8 1 457 43 N 4198 ²	K
Ricam.Nr 4978762→	03.00-09.01	MW1 1 457 43 N 4293 ²	K
Ricam.Nr 50289924→	07.00-09.01	1 457 43 N 4293 ²	K
	11.98-09.01	1 987 43 M 2003	I
		1 987 43 R 2303 ⁸	I

1,9 | 76 | 182 B 9.000 <M26>

	08.00-09.01	0 451 10 P 3354	O
		1 457 43 S 3265	L
		1 457 43 N 4314 ²	K
		1 987 43 M 2003	I
		1 987 43 R 2303 ⁸	I

Bravo 1.9 JTD 8V, JTD 16V

1,9 66/85/88/110 192 A 8.000 <M88>; 192 B 4.000 <M87>; 192 B 5.000 <M83>; 937 A 5.000 <M92>			
	03.07-12.09	0 451 10 P 3300	O
		F 026 40 S 0041	L
		1 987 43 R 2377 ⁸	I

Bravo 1.9 TD

1,9 55 182 A 8.000 <M9>			
	03.96-10.98	0 451 10 P 3354	O
		1 457 43 S 3265	L
		1 457 43 N 4106 ²	K
		1 987 43 M 2003	I
		1 987 43 R 2303 ⁸	I

1,9 | 55 | 182 A 8.000 <M20>

	11.98-09.01	0 451 10 P 3354	O
		1 457 43 S 3265	L
Ricam.Nr →4824954	11.98-04.99	1 457 43 N 4106 ²	K
Ricam.Nr 4824955→	05.99-07.00	0 450 90 N 6308 ¹	K
	11.98-09.01	1 987 43 M 2003	I
		1 987 43 R 2303 ⁸	I

1,9 | 73/73,6 | 182 A 7.000 <M8>; 182 A 7.000 <M21>

	03.96-09.01	0 451 10 P 3354	O
		1 457 43 S 3265	L
		SWA 1 457 43 N 4106 ²	K
		SWA 1 457 43 N 4105 ²	K
		1 987 43 M 2003	I
		1 987 43 R 2303 ⁸	I



Bravo 2.0 JTD

2,0 121 198 A 5.000			
	03.10→	1 987 43 R 2377 ⁸	I

Bravo 2.0 JTD 16V

2,0 120 198 A 5.000 <M120>			
	10.08-12.09	1 987 43 R 2377 ⁸	I

Bravo 2.0 20V

2,0 108 182 A 1.000 <M6>			
	10.95-10.98	0 451 10 P 3300	O
		1 457 43 S 3265	L
		0 450 90 F 5273 ¹	K
		1 987 43 M 2003	I
		1 987 43 R 2303 ⁸	I

2,0 | 113 | 182 B 7.000 <M15>

	11.98-09.01	0 451 10 P 3354	O
		1 457 43 S 3265	L
		1 987 43 M 2003	I
		1 987 43 R 2303 ⁸	I

Cinquecento

Cinquecento 1.1 i.e

1,1 40 176 B 2.000 <M6>			
	10.94-07.98	0 451 10 P 3111	O
		1 457 43 S 3255	L
		0 450 90 F 5002 ¹	K

Cinquecento 700

0,7 22/23 170 A .000 <M1>; 170 A .046 <M4>			
	07.91-07.98	0 451 10 P 3141	O
		1 457 43 S 2146	L
		0 450 90 F 4058 ¹	K

Cinquecento 900

0,9 29 1170 A 1.000 <M7>			
	07.91-07.98	0 451 10 P 3349	O
		1 457 43 S 2146	L
		0 450 90 F 4058 ¹	K

0,9 | 31 | 170 A 1.000 <M2>

	10.91-07.98	0 451 10 P 3349	O
		1 457 43 S 2146	L
		0 450 90 F 4058 ¹	K

Cinquecento 900 i.e

0,9 30 170 A 1.046 <M3>			
	10.91-07.98	0 451 10 P 3349	O
		1 457 43 S 2146	L
		0 450 90 F 5002 ¹	K

0,9 | 30 | 1170 A 1.046 <M5>

	07.91-07.98	0 451 10 P 3349	O
		1 457 43 S 2146	L
		0 450 90 F 5002 ¹	K





Coupé

Coupé 1.8 i 16V

1,8 96 183 A 1.000 <M4>	03.96-09.96	0 451 10 P 3300	O
		1 457 43 S 3253	L
		0 450 90 F 5273 ¹	K
	KL	1 987 43 M 2014	I

Coupé 1.8 16V

1,8 96 183 A 1.000 <M1>	10.96-09.00	0 451 10 P 3300	O
		1 457 43 S 3253	L
Mot.Nr. ->1070426	10.96-05.98	0 450 90 F 5273 ¹	K

Coupé 2.0 i 16V

2,0 104 836 A 3.000 <M1>	04.94-09.96	0 451 10 P 3350	O
		1 457 43 S 3253	L
		0 450 90 F 5021 ¹	K
	KL	1 987 43 M 2014	I

2,0|104|836 A 3.011 <M3>

04.94-09.96	0 451 10 P 3350	O
	1 457 43 S 3253	L
KL	1 987 43 M 2014	I

Coupé 2.0 i 16V Turbo

2,0 143 175 A 1.000 <M2>	04.94-09.96	0 451 10 P 3350	O
		1 457 43 S 3253	L
	02.94-09.96	0 450 90 F 5021 ¹	K
	04.94-09.96	KL 1 987 43 M 2014	I

Coupé 2.0 20V

2,0 113 182 B 3.000 <M4>	04.98-09.00	0 451 10 P 3354	O
		1 457 43 S 3253	L

Coupé 2.0 20V, 20V Turbo

2,0 108/162 175 A 3.000 <M3>; 182 A 1.000 <M2>	10.96-09.00	0 451 10 P 3354	O
		1 457 43 S 3253	L
		0 450 90 F 5273 ¹	K

Croma

Croma 1.8 i.e.

1,8 103 939 A 4.000 <M41>	06.05-12.10	F 026 40 P 7006	O
		1 457 43 S 3578	L
		1 987 43 R 2376 ⁸	I

Croma 1.9 JTD 8V, JTD 16V

1,9 85/88/100/110 939 A 1.000 <M87>; 939 A 1.000 <M88>; 939 A 1.000 <M91>; 939 A 2.000 <M92>	06.05-12.10	1 457 42 P 9248	O
		1 457 43 S 3579	L
		1 987 43 R 2376 ⁸	I

Croma 1.9 TD i.d.

1,9 69 154 C 6.000 <M1>	07.90-10.92	0 451 10 P 3352	O
		1 457 43 S 3745	L
		1 457 43 N 4105 ²	K
	KL	1 987 43 M 2005	I

1,9|69|154 D 1.000 <M2>

11.92-12.96	0 451 10 P 3352	O
	1 457 43 S 3745	L
	1 457 43 N 4105 ²	K

Croma 2.0

2,0 74 154 C 5.000 CHT	07.90-11.92	0 451 10 P 3350	O
	KL	1 987 43 M 2005	I

Croma 2.0 i.e.

2,0 85 154 C 3.046 <M2>	10.90-12.96	0 451 10 P 3350	O
		1 457 43 S 2172	L
		0 450 90 F 5401 ¹	K
	10.90-10.92	KL 1 987 43 M 2005	I

2,0|85|834 B.146 <M6>

11.92-12.96	0 451 10 P 3350	O
	1 457 43 S 2172	L
	0 450 90 F 5401 ¹	K

2,0|86|154 C 3.000 <M1>

07.90-12.96	0 451 10 P 3350	O
07.90-11.92	0 450 90 F 5021 ¹	K
KL	1 987 43 M 2005	I

2,0|86|154 C 3.000 <M7>

05.91-12.96	0 451 10 P 3350	O
	1 457 43 S 2172	L
	0 450 90 F 5021 ¹	K
05.91-11.92	KL 1 987 43 M 2005	I

2,0|86|834 B.146 <M8>

11.92-12.96	0 451 10 P 3350	O
	0 450 90 F 5401 ¹	K

Croma 2.0 i.e. Turbo

2,0 110 154 C 4.046 <M4>	10.90-12.96	0 451 10 P 3350	O
		1 457 43 S 2172	L
		0 450 90 F 5401 ¹	K
	10.90-11.92	KL 1 987 43 M 2005	I





◀ Croma 2.0 i.e. Turbo

2,0 116 154 C 4.000 <M3>	07.90-11.92	0 451 10 P 3350	O
		1 457 43 S 2172	L
		0 450 90 F 5021 ¹	K
		KL 1 987 43 M 2005	I

2,0 117 154 C 4.000 <M3>	11.92-12.96	0 451 10 P 3350	O
		1 457 43 S 2172	L
		0 450 90 F 5021 ¹	K

Croma 2.0 i.e. 16V

2,0 101 154 E 1.000 <M5>	11.92-12.96	0 451 10 P 3350	O
		1 457 43 S 2172	L
		0 450 90 F 5401 ¹	K

2,0 101 154 E 1.027 <M9>	03.95-12.96	0 451 10 P 3350	O
		1 457 43 S 2172	L

Croma 2.2 i.e.

2,2 108 194 A 1.000 <M49>	06.05-12.10	F 026 40 P 7016	O
		1 457 43 S 3579	L
		1 987 43 R 2376 ⁸	I

Croma 2.4 JTD

2,4 147 939 A 3.000 <M95>	06.05-12.10	F 026 40 P 7021	O
		1 987 43 R 2376 ⁸	I

Croma 2.5 i.e.

2,5 117 834 G.000	06.93-12.96	0 451 10 P 3349	O
		1 457 43 S 3258	L
		0 450 90 F 5401 ¹	K

Croma 2.5 TD

2,5 77/86 8144.97 <M3>; 8144.97 S <M4>	07.90-11.92	0 451 20 P 3201	O
		1 457 43 S 2172	L
		1 457 43 N 4105 ²	K
		1 457 43 N 4106 ²	K
		KL 1 987 43 M 2005	I

Croma 2.5 TD, TDI

2,5 85 8144.97Y (EM.04) <M5>; 8144.97Y (US87) <M5>	11.92-12.96	0 451 20 P 3201	O
		1 457 43 S 2172	L

Doblo

Doblo 1.2 i.e. 8V

1,2 48 223 A 5.000 <M1>	07.00-08.03	0 451 10 P 3300	O
	09.03-01.04	0 451 10 P 3364	O
	02.04-09.05	0 986 45 P 2041	O
	07.00-01.04 TRQ	1 457 43 S 3521	L
	02.04-09.05	1 457 43 S 3521	L
	07.00-02.01 KL	1 987 43 R 2365 ⁸	I
	03.01-09.05 KL	1 987 43 M 2072	I



Doblo 1.3 JTD

1,3 55/62 199 A 2.000 <M73>; 223 A 9.000 <M71>	10.05-12.10	PRF 1 457 42 P 9256	O
		UFI F 026 40 P 7067	O
		F 026 40 S 0002	L
		1 457 07 N 0001	K
		1 987 43 R 2365 ⁸	I

1,3 66 199 A 2.000 <M72>	10.09→	EU5,SSJ F 026 40 S 0002	L

Doblo 1.3 JTD 16V

1,3 51 188 A 9.000 <M20>	02.04-09.05	PRF 1 457 42 P 9256	O
		F 026 40 S 0002	L
		1 457 07 N 0001	K
		KL 1 987 43 M 2072	I

Doblo 1.3 MPI 16V

1,3 59 178 D 6.011 <Fire>	11.01-01.06	1 987 43 M 2072	I
		1 987 43 R 2365 ⁸	I

Doblo 1.4

1,4 70 350 A 1.000 <M10>	10.09→	0 986 45 P 2041	O
		KZO 1 457 43 S 3317	L
		KZO 1 457 43 S 3317	L

Doblo 1.4 i.e.

1,4 55 350 A 1.000 <M11>	10.05-05.10	0 986 45 P 2041	O
	06.10-12.10	0 451 10 P 3364	O
	10.05-12.10	F 026 40 S 0036	L
		1 987 43 R 2365 ⁸	I

Doblo 1.4 Natural Power

1,4 88 350 A 1.000	06.10→	1 457 42 P 9256	O

Doblo 1.6 i.e. 16V

1,6 76 182 B 6.000 <M5/M10>	10.01-09.05	0 451 10 P 3111	O
	10.01-01.04 TRQ	1 457 43 S 3307	L
	02.04-09.05	1 457 43 S 3307	L
	10.01-09.05 KL	1 987 43 M 2072	I

Doblo 1.6 i.e. 16V Bipower

1,6 68-76 182 B 6.000 <M6/M11>	01.03-09.05	0 451 10 P 3111	O
		1 457 43 S 3307	L
		KL 1 987 43 M 2072	I

1,6 76 182 B 6.000 <M26>	10.05-12.10	0 451 10 P 3111	O
		1 457 43 S 3307	L
		1 987 43 R 2365 ⁸	I

Doblo 1.6 JTD

1,6 66	10.09→	F 026 40 S 0057	L



1,6 | 77 | 182 B 6.000 <M76>
10.09→ F 026 40 S 0057 L

Doblo 1.6 MPI 16V

1,6 | 78 | 182 B 6.000 <FIASA Step B>
11.01-08.03 1987 43 M 2072 I
1987 43 R 2365⁸ I

Doblo 1.9 D

1,9 | 46
11.03-01.06 0451 10 P 3354 O
0450 90 N 6452¹ K
1987 43 M 2072 I
1987 43 R 2365⁸ I

1,9 | 46 | 223 A 6.000 <M10/M25>
07.00-09.05 0451 10 P 3354 O
~~TR~~ 1457 43 S 3307 L
0450 90 N 6452¹ K
07.00-02.01 KL 1987 43 R 2365⁸ I
03.01-09.05 KL 1987 43 M 2072 I

Doblo 1.9 JTD

1,9 | 74 | 182 B 9.000 <M15>
10.01-01.04 0451 10 P 3354 O
1457 43 S 3307 L
Fg.Nr. →5184879 10.01-12.02 1457 43 N 4314² K
Fg.Nr. 5184880→ 01.03-01.04 F 026 40 N 2048² K
10.01-01.04 KL 1987 43 M 2072 I

1,9 | 74/77 | 223 B 1.000 <M84>; 223 B 2.000 <M86>
10.05-12.10 0451 10 P 3300 O
1457 43 S 3307 L
F 026 40 N 2049¹ K
1987 43 R 2365⁸ I

1,9 | 77 | 223 A 7.000 <M16/M30>
11.02-09.04 0451 10 P 3354 O
~~TR~~ 10.04-09.05 0451 10 P 3354 O
TR 10.04-09.05 0451 10 P 3300 O
11.02-09.05 1457 43 S 3307 L
F 026 40 N 2048² K
KL 1987 43 M 2072 I

1,9 | 88 | 186 A 9.000 <M88>
10.05-12.10 0451 10 P 3300 O
1457 43 S 3307 L
1987 43 R 2365⁸ I

Doblo 2.0 JTD

2,0 | 100 | <M120>
10.09→ F 026 40 S 0057 L

Doblo Cargo

Doblo Cargo 1.2 i.e. 8V

1,2 | 47 | 223 A 5.000 <M1>
07.00-08.03 0451 10 P 3300 O
09.03-01.04 0451 10 P 3364 O
02.04-09.05 0986 45 P 2041 O
07.00-01.04 ~~TR~~ 1457 43 S 3521 L
02.04-09.05 1457 43 S 3521 L
07.00-02.01 KL 1987 43 R 2365⁸ I
03.01-09.05 KL 1987 43 M 2072 I

Doblo Cargo 1.3 JTD

1,3 | 55/62 | 199 A 2.000 <M73>; 223 A 9.000 <M71>
10.05-12.10 PRF 1457 42 P 9256 O
UFI F 026 40 P 7067 O
F 026 40 S 0002 L
1457 07 N 0001 K
1987 43 R 2365⁸ I

1,3 | 66 | <M72>
10.09→ EU5,SSJ F 026 40 S 0002 L

Doblo Cargo 1.3 JTD 16V

1,3 | 51 | 188 A 9.000 <M20>
02.04-09.05 PRF 1457 42 P 9256 O
F 026 40 S 0002 L
1457 07 N 0001 K
KL 1987 43 M 2072 I

Doblo Cargo 1.4

1,4 | 70 | 350 A 1.000 <M10>
10.09→ 0986 45 P 2041 O
~~KZO~~ 1457 43 S 3317 L
KZO 1457 43 S 3317 L

Doblo Cargo 1.4 i.e.

1,4 | 57 | 350 A 1.000 <M11>
10.05-12.10 0986 45 P 2041 O
F 026 40 S 0036 L
1987 43 R 2365⁸ I

Doblo Cargo 1.4 Natural Power

1,4 | 88 | 350 A 1.000
06.10→ 1457 42 P 9256 O

Doblo Cargo 1.6 i.e. 16V

1,6 | 76 | 182 B 6.000 <M5/M10>
10.01-09.05 0451 10 P 3111 O
10.01-01.04 ~~TR~~ 1457 43 S 3307 L
02.04-09.05 1457 43 S 3307 L
10.01-09.05 KL 1987 43 M 2072 I

Doblo Cargo 1.6 i.e. 16V Bipower

1,6 | 68-76 | 182 B 6.000 <M6/M11>
01.03-09.05 0451 10 P 3111 O
1457 43 S 3307 L
KL 1987 43 M 2072 I





◀ Doblo Cargo 1.6 i.e. 16V Bipower

1,6 76 182 B 6.000 <M26>	10.05-12.10	0 451 10 P 3111	O
		1 457 43 S 3307	L
		1 987 43 R 2365 ⁸	I

Doblo Cargo 1.6 JTD

1,6 66	10.09→	F 026 40 S 0057	L
1,6 77 182 B 6.000 <M76>	10.09→	F 026 40 S 0057	L

Doblo Cargo 1.9 D

1,9 46 223 A 6.000 <M10/M25>	07.00-09.05	0 451 10 P 3354	O
		TRQ 1 457 43 S 3307	L
		0 450 90 N 6452 ¹	K
	07.00-02.01	KL 1 987 43 R 2365 ⁸	I
	03.01-09.05	KL 1 987 43 M 2072	I

Doblo Cargo 1.9 JTD

1,9 74 182 B 9.000 <M15>	10.01-01.04	0 451 10 P 3354	O
		1 457 43 S 3307	L
Fg.Nr. →5184879	10.01-12.02	1 457 43 N 4314 ²	K
Fg.Nr. 5184880→	01.03-01.04	F 026 40 N 2048 ²	K
	10.01-01.04	KL 1 987 43 M 2072	I

1,9 74/77 223 B 2.000 <M86>; 223 B 1000 <M84>	10.05-12.10	0 451 10 P 3300	O
		1 457 43 S 3307	L
		F 026 40 N 2049 ¹	K
		1 987 43 R 2365 ⁸	I

1,9 77 223 A 7.000 <M16/M30>	11.02-09.04	0 451 10 P 3354	O
	TR 10.04-09.05	0 451 10 P 3354	O
	TR 10.04-09.05	0 451 10 P 3300	O
	11.02-09.05	1 457 43 S 3307	L
		F 026 40 N 2048 ²	K
		KL 1 987 43 M 2072	I

1,9 88 186 A 9.000 <M88>	10.05-12.10	0 451 10 P 3300	O
		1 457 43 S 3307	L
		1 987 43 R 2365 ⁸	I

Doblo Cargo 2.0 JTD

2,0 100 <M120>	10.09→	F 026 40 S 0057	L
--------------------	--------	-----------------	---

Ducato

Ducato 1.9 D

1,9 50 DJY <M11>	04.98-10.01	0 451 10 P 3261	O
		LBE 1 457 43 S 2138	L
Fg.Nr. 5707174→	04.98-10.01	BO 1 457 43 N 4106 ²	K
Fg.Nr. →5690280	04.98-12.98	KL 1 987 43 M 2042	I

1,9 51 230 A 2.000 <M1>	03.94-03.98	0 451 10 P 3352	O
		LBE 1 457 43 S 2138	L
		1 457 43 N 4106 ²	K



Fg.Nr. →5690280	03.94-03.98	KL 1 987 43 M 2042	I
-----------------	-------------	--------------------	---

1,9 52 149 B 1.000 <M1>	07.90-02.94	0 451 10 P 3354	O
		1 457 43 S 2138	L
		1 457 43 N 4105 ²	K
		1 457 43 N 4106 ²	K

Ducato 1.9 TD

1,9 60 230 A 3.000 <M2>	03.94-03.98	0 451 10 P 3352	O
		1 457 43 S 3790	L
		1 457 43 N 4105 ²	K

Fg.Nr. →5690280	03.94-03.98	KL 1 987 43 M 2042	I
-----------------	-------------	--------------------	---

1,9 60 280 A 1.000 <M2>	07.90-02.94	0 451 10 P 3352	O
		0 451 10 P 3354	O
		1 457 43 S 2138	L
		1 457 43 N 4105 ²	K
		1 457 43 N 4106 ²	K

1,9 66 DHX <M12>	04.98-10.01	0 451 10 P 3261	O
		1 457 43 S 3790	L

Fg.Nr. 5707174→	04.98-10.01	BO 1 457 43 N 4106 ²	K
-----------------	-------------	---------------------------------	---

Fg.Nr. →5690280	04.98-12.98	KL 1 987 43 M 2042	I
-----------------	-------------	--------------------	---

Ducato 1.9 TD CAT

1,9 59 230 A 4.000 <M3>	03.94-03.98	0 451 10 P 3352	O
		1 457 43 S 3790	L
		1 457 43 N 4105 ²	K

Fg.Nr. →5690280	03.94-03.98	KL 1 987 43 M 2042	I
-----------------	-------------	--------------------	---

Ducato 2.0

2,0 79 R5B <M2>	03.94-07.94	0 451 10 P 3354	O
	08.94-03.02	0 451 10 P 3261	O
	03.94-03.02	1 457 43 S 3790	L
		0 450 90 F 4058 ¹	K
		KL 1 987 43 M 2042	I

Fg.Nr. →5690280	03.94-12.98	KL 1 987 43 M 2042	I
-----------------	-------------	--------------------	---

Ducato 2.0 , Maxi

2,0 55/63 170 B (XN1T) <M1>; 170 C (XN1TA) <M2>	07.90-02.94	0 451 10 P 3144	O
		XXX 1 457 43 S 2149	L

Ducato 2.0 , 4x4

2,0 63 170 D (XN1TA) <M3>; 170D <M3>	07.90-02.94	0 451 10 P 3144	O
		XXX 1 457 43 S 2149	L

Ducato 2.0 i.e., i.e. Bipower CNG, i.e. Bipower CNG 4x4

2,0 80 RFW <M1>	03.94-07.94	0 451 10 P 3354	O
	08.94-03.02	0 451 10 P 3261	O
	03.94-03.02	1 457 43 S 3790	L
Fg.Nr. →5408416	03.94-04.97	0 450 90 F 5021 ¹	K
Fg.Nr. 5408417→	05.97-03.02	0 450 90 F 5273 ¹	K
Fg.Nr. →5690280	03.94-12.98	KL 1 987 43 M 2042	I



Ducato 2.0 i.e., i.e. Bipower CNG, i.e. Bipower CNG 4x4, i.e. Bipower LPG, i.e. Bipower LPG 4x4, i.e. 4x4

2,0 | 71-81 | RFL <M1>; RFL <M2/DECAT.>

04.02-08.06	0 451 10 P 3355	O
	1 457 43 S 3790	L
KL	1 987 43 M 2042	I

Ducato 2.0 JTD

2,0 | 62 | RHV <M5>

04.02-08.06	0 451 10 P 3355	O
	1 457 43 S 3790	L
Fg.Nr. →7150162	04.02-10.02 TRQ	1 457 43 N 4314 ² K
Fg.Nr. 7150163→7388646	11.02-01.04 TRQ	F 026 40 N 2013 ² K
Fg.Nr. 7388647→7544619	02.04-11.04 TRQ	F 026 40 N 2013 ² K
Fg.Nr. 7544620→	12.04-08.06 TRQ	1 457 07 N 0001 K
	04.02-08.06 KL	1 987 43 M 2042 I

2,0 | 63 | RHV <M15>

10.01-03.02	0 451 10 P 3355	O
	1 457 43 S 3790	L
	1 457 43 N 4314 ²	K

2,0 | 85

06.11→	STZ F 026 40 S 0059	L
	1 987 43 M 2065	I

Ducato 2.0 Maxi

2,0 | 63 | 170 D <M3>

07.90-02.94	XXX	1 457 43 S 2149	L
-------------	-----	-----------------	---

Ducato 2.2 JTD

2,2 | 74 | 4HV <M93>

06.06→	1 457 42 P 9249	O
	TRQ F 026 40 S 0059	L
	1 457 07 N 0001	K
	1 987 43 M 2065	I

Ducato 2.3 JTD

2,3 | 81 | F1AE0481C <M10>

01.08→	F 026 40 P 7024	O
Mot.Nr. →240403	04.02-08.06	F 026 40 P 7053 O
Mot.Nr. 240404→	04.02-08.06	F 026 40 P 7024 O
	04.02-08.06	1 457 43 S 3790 L
	01.08→	1 457 43 S 3790 L
		1 457 07 N 0001 K
Fg.Nr. →7150162	04.02-09.02	1 457 43 N 4455 ² K
Fg.Nr. →7150163	04.02-10.02	1 457 43 N 4455 ² K
Fg.Nr. 7150163→7544619	10.02-11.04	F 026 40 N 2013 ² K
Fg.Nr. 7150164→7544620	11.02-12.04	F 026 40 N 2013 ² K
Fg.Nr. 7544621→	12.04-08.06	1 457 07 N 0001 K
	04.02-08.06 KL	1 987 43 M 2042 I
	01.08→ KL	1 987 43 M 2042 I

2,3 | 96/109

06.11→	F 026 40 P 7024	O
	STZ F 026 40 S 0059	L
	1 987 43 M 2065	I

Ducato 2.3 JTD EGR

2,3 | 81 | F1AE0481C <M11>

01.08→	F 026 40 P 7024	O
Mot.Nr. →240403	04.02-08.06	F 026 40 P 7053 O
Mot.Nr. 240404→	04.02-08.06	F 026 40 P 7024 O
	04.02-08.06	1 457 43 S 3790 L
	01.08→	1 457 43 S 3790 L
		1 457 07 N 0001 K
Fg.Nr. →7150162	04.02-09.02	1 457 43 N 4455 ² K
Fg.Nr. →7150163	04.02-10.02	1 457 43 N 4455 ² K
Fg.Nr. 7150163→7544619	10.02-11.04	F 026 40 N 2013 ² K
Fg.Nr. 7150164→7544620	11.02-12.04	F 026 40 N 2013 ² K
Fg.Nr. 7544621→	12.04-08.06	1 457 07 N 0001 K
	04.02-08.06 KL	1 987 43 M 2042 I
	01.08→ KL	1 987 43 M 2042 I

Ducato 2.3 JTD, JTD Maxi

2,3 | 88/96 | F1AE0481D <M94>; F1AE0481N <M95>

06.06→	F 026 40 P 7024	O
	TRQ F 026 40 S 0059	L
	1 457 07 N 0001	K
	1 987 43 M 2065	I

Ducato 2.5 D

2,5 | 62 | 8140.67.2200

11.97-05.05	0 451 20 P 3201	O
	1 457 43 N 4106 ²	K

Ducato 2.5 D, D Maxi

2,5 | 55 | 8144.67 <M3>

07.90-02.94	0 451 20 P 3201	O
	1 457 43 S 2138	L
	1 457 43 N 4105 ²	K
	1 457 43 N 4106 ²	K

Ducato 2.5 D, D 4x4

2,5 | 62 | 8140.67 <M4>

03.94-03.98	0 451 20 P 3201	O
	LBE 1 457 43 S 2138	L
	1 457 43 N 4106 ²	K
Fg.Nr. →5690280	03.94-03.98 KL	1 987 43 M 2042 I

Ducato 2.5 D 4x4

2,5 | 55 | 8144.67 <M1>

07.90-02.94	0 451 20 P 3201	O
	1 457 43 N 4105 ²	K
	1 457 43 N 4106 ²	K

Ducato 2.5 TD ECO

2,5 | 80 | 8140.47R <M7>

03.94-03.98	0 451 20 P 3201	O
	1 457 43 S 3790	L
	1 457 43 N 4105 ²	K
Fg.Nr. →5690280	03.94-03.98 KL	1 987 43 M 2042 I





Ducato 2.5 TD ECO 4x4

2,5 80 8140.47R <M7>			
	03.94-03.98	0 451 20 P 3201	O
		1 457 43 S 3790	L
		1 457 43 N 4106 ²	K
Fg.Nr. →5690280	03.94-03.98 KL	1 987 43 M 2042	I

Ducato 2.5 TD, TD EGR, TD EGR 4x4, TD 4x4

2,5 85 8140.47 <M5>; 8140.47 <M6>			
	03.94-03.98	0 451 20 P 3201	O
		1 457 43 S 3790	L
		1 457 43 N 4106 ²	K
Fg.Nr. →5690280	03.94-03.98 KL	1 987 43 M 2042	I

Ducato 2.5 TD, TD Maxi

2,5 70 8140.27 <M4>			
	07.90-02.94	0 451 20 P 3201	O
		1 457 43 S 2138	L
		1 457 43 N 4105 ²	K
		1 457 43 N 4106 ²	K

Ducato 2.5 TD 4x4

2,5 70 8140.27 <M2>			
	07.90-02.94	0 451 20 P 3201	O
		1 457 43 N 4105 ²	K
		1 457 43 N 4106 ²	K

Ducato 2.8 D

2,8 63 8140.63.22.60 <PC/NA>			
	04.99-05.05	0 451 20 P 3201	O
		1 457 43 N 4194 ²	K

Ducato 2.8 D, D 4x4

2,8 64 8140.63 <M10>			
	04.98-03.02	0 451 20 P 3201	O
		1 457 43 S 3790	L
		1 457 43 N 4106 ²	K
Fg.Nr. →5690280	04.98-12.98 KL	1 987 43 M 2042	I

Ducato 2.8 D Turbo

2,8 90 8140.43.22.00 <ID/TCA>			
	04.99-05.05	0 451 20 P 3201	O
		VOW 1 457 43 N 4106 ²	K
		VOW 1 457 43 N 4194 ²	K

Ducato 2.8 D Turbo Interc.

2,8 103,3 8140.23.22.00 <ID/TC>			
	10.99-05.05	0 451 20 P 3201	O
		VOW 1 457 43 N 4106 ²	K
		VOW 1 457 43 N 4194 ²	K

Ducato 2.8 JTD

2,8 93 8140.43S			
	06.05-08.09	F 026 40 P 7053	O
		1 457 43 N 4314 ²	K



2,8 | 94 | 8140.43S <M15>

Mot.Nr. →4006625	04.02-08.06	0 451 20 P 3201	O
Mot.Nr. 4006626→	04.02-08.06	F 026 40 P 7053	O
	04.02-08.06	1 457 43 S 3790	L
Fg.Nr. →7150162	04.02-09.02 TRQ	1 457 43 N 4314 ²	K
Fg.Nr. 7150163→7388646	10.02-01.04 TRQ	F 026 40 N 2013 ²	K
Fg.Nr. 7544620→	12.04-08.06 TRQ	1 457 07 N 0001	K
	04.02-08.06 KL	1 987 43 M 2042	I

Ducato 2.8 JTD CGV

2,8 107 8140.43S <M22>			
Mot.Nr. →4006625	04.04-08.06	0 451 20 P 3201	O
Mot.Nr. 4006626→	04.04-08.06	F 026 40 P 7053	O
	04.04-08.06	1 457 43 S 3790	L
Fg.Nr. 7544620→	12.04-08.06 TRQ	1 457 07 N 0001	K
	04.04-08.06 KL	1 987 43 M 2042	I

Ducato 2.8 JTD EGR, JTD EGR 4x4

2,8 94 8140.43S <M20>			
Mot.Nr. →4006625	04.02-08.06	0 451 20 P 3201	O
Mot.Nr. 4006626→	04.02-08.06	F 026 40 P 7053	O
	04.02-08.06	1 457 43 S 3790	L
Fg.Nr. →7150162	04.02-09.02 TRQ	1 457 43 N 4314 ²	K
Fg.Nr. 7150163→7388646	10.02-01.04 TRQ	F 026 40 N 2013 ²	K
Fg.Nr. 7544620→	12.04-08.06 TRQ	1 457 07 N 0001	K
	04.02-08.06 KL	1 987 43 M 2042	I

Ducato 2.8 JTD, JTD EGR, JTD EGR 4x4, JTD 4x4

2,8 94 8140.43S <M13>; 8140.43S <M14>			
	08.00-03.02	0 451 20 P 3201	O
		1 457 43 S 3790	L
		1 457 43 N 4314 ²	K

Ducato 2.8 JTD 4x4

2,8 94 8140.43S <M15>			
	04.02-08.06	0 451 20 P 3201	O
Mot.Nr. →4006625	04.02-08.06	0 451 20 P 3201	O
Mot.Nr. 4006626→	04.02-08.06	F 026 40 P 7053	O
	04.02-08.06	1 457 43 S 3790	L
		1 457 43 N 4314 ²	K
Fg.Nr. →7150162	04.02-09.02 TRQ	1 457 43 N 4314 ²	K
Fg.Nr. 7150163→7388646	10.02-01.04 TRQ	F 026 40 N 2013 ²	K
Fg.Nr. 7544620→	12.04-08.06 TRQ	1 457 07 N 0001	K
	04.02-08.06 KL	1 987 43 M 2042	I

Ducato 2.8 TD, TD EGR, TD EGR 4x4, TD 4x4

2,8 90 8140.43 <M8>; 8140.43 <M9>			
	10.97-03.02	0 451 20 P 3201	O
		1 457 43 S 3790	L
		1 457 43 N 4194 ²	K
Fg.Nr. →5690280	10.97-12.98 KL	1 987 43 M 2042	I

2,8 | 90 | 8140.43 <M25>; 8140.43 <M26>

Mot.Nr. →4006625	10.02-08.06	0 451 20 P 3201	O
Mot.Nr. 4006626→	10.02-08.06	F 026 40 P 7053	O
	10.02-08.06	1 457 43 S 3790	L
Fg.Nr. →7388646	10.02-01.04	1 457 43 N 4194 ²	K
Fg.Nr. 7388647→	02.04-08.06	1 457 43 N 4194 ²	K
	10.02-08.06 KL	1 987 43 M 2042	I



Ducato 3.0 Bipower CNG

3,0 100 F1CE0441A <M90>			
06.06→	F 026 40 P 7083	O	
	F 026 40 S 0059	L	
	1 457 07 N 0001	K	
	1 987 43 M 2065	I	

Ducato 3.0 JTD

3,0 107/115 F1CE3481M <M99>; F1CE3481N <M97>			
09.10→	F 026 40 P 7083	O	
	FRØ F 026 40 S 0059	L	
	1 457 07 N 0001	K	

3,0 130 F1CE348IE			
06.11→	F 026 40 P 7083	O	
	STZ F 026 40 S 0059	L	
	1 987 43 M 2065	I	

Ducato 3.0 JTD, JTD Maxi

3,0 116 F1CE0481D <M96>			
06.06→	F 026 40 P 7083	O	
	FRØ F 026 40 S 0059	L	
	1 457 07 N 0001	K	
	1 987 43 M 2065	I	

Fiorino

Fiorino 1.1

1,1 40 146 A 9.000 <M1>			
01.88-08.93	0 451 10 P 3351	O	
	XXX 1 457 43 S 2109	L	
	0 450 90 F 4058 ¹	K	

Fiorino 1.3

1,3 49 146 A 5.000 <M2>			
01.88-08.93	0 451 10 P 3351	O	
	0 450 90 F 4058 ¹	K	

1,3 49 146 A 5.000 <M3>			
09.93-12.01	0 451 10 P 3351	O	
	1 457 43 S 3253	L	

Fiorino 1.3 D

1,3 33 127 A 5.000 <M4>			
01.88-08.93	0 451 10 P 3351	O	
	1 457 43 S 3308	L	
	BO 1 457 43 D 701 ²	K	
	1 457 43 N 4106 ²	K	

Fiorino 1.3 MJTD

1,3 55 199 A2.000 <M73>			
12.07→	PRF 1 457 42 P 9256	O	
	F 026 40 S 0002	L	
	F 026 40 N 2049 ¹	K	
	KL,RLE 1 987 43 M 2188	I	



Fiorino 1.4 i.e.

1,4 49 146 D 5.000 <M4>			
06.95-12.01	0 451 10 P 3111	O	
	1 457 43 S 3253	L	
	0 450 90 F 2151 ¹	K	

1,4 52 146 C 5.000 <M1>			
09.93-10.94	0 451 10 P 3351	O	
11.94-06.95	0 451 10 P 3111	O	
09.93-06.95	1 457 43 S 3253	L	
	0 450 90 F 2151 ¹	K	

1,4 55 KFV <M11>			
12.07→	1 457 42 P 9249	O	
	KL,RLE 1 987 43 M 2188	I	

Fiorino 1.4 Natural Power

1,4 57-59 <M18>			
10.09→	0 986 45 P 2041	O	
	F 026 40 S 0036	L	

Fiorino 1.5 i.e.

1,5 55 149 C 1.000 <M3>			
01.88-08.93	0 451 10 P 3351	O	
	0 450 90 F 5002 ¹	K	

Fiorino 1.6 i.e.

1,6 59 146 C 6.000 <M2>			
09.93-10.94	0 451 10 P 3351	O	
11.94-06.95	0 451 10 P 3111	O	
09.93-06.95	1 457 43 S 3253	L	
	0 450 90 F 2151 ¹	K	

1,6 59 146 D 6.000 <M5>			
06.95-12.01	0 451 10 P 3111	O	
	1 457 43 S 3253	L	
	0 450 90 F 2151 ¹	K	

Fiorino 1.7 D

1,7 42 149 B 4.046 <M7>			
01.88-08.93	0 451 10 P 3352	O	
03.88-08.93	BO 1 457 43 D 701 ²	K	
	1 457 43 N 4106 ²	K	

1,7 43 146 B 2.000 <M6>			
01.88-08.93	0 451 10 P 3352	O	
Mot.Nr. →2404557	09.93-06.99	0 451 10 P 3352	O
Mot.Nr. 2404559→	07.99-12.01	0 451 10 P 3354	O
Mot.Nr. →1872202	01.88-12.01	1 457 43 S 3285	L
Mot.Nr. 1872203→	01.88-12.01	1 457 43 S 3286	L
	03.88-12.01	BO 1 457 43 D 701 ²	K
		1 457 43 N 4106 ²	K
	09.93-12.01	LUC,SWA 1 457 43 N 4105 ²	K

1,7 52 146 B 2.000			
01.04-12.08	0 451 10 P 3354	O	





Fiorino 1.7 TDS

1,7 46 146 D 7.000 <M7>			
02.97-12.01	0 451 10	P 3354	O
	1 457 43	S 3253	L
BO	1 457 43	D 701²	K
	1 457 43	N 4106²	K
LUC,SWA	1 457 43	N 4105²	K

Idea

Idea 1.2 i.e. 16V

1,2 59 188 A 5.000 <M6>; 843 A 1.000 <M10>			
01.04→	0 986 45	P 2041	O
	1 457 43	S 3317	L
KL	1 987 43	M 2072	I

Idea 1.3 JTD 16V

1,3 52/66 188 A 9.000 <M30>; 199 A 3.000 <M72>			
01.04→	PRF	1 457 42	P 9256 O
		F 026 40	S 0002 L
		1 457 07	N 0001 K
KL		1 987 43	M 2072 I

Idea 1.4 i.e. 8V, i.e. 8V LPG

1,4 57 350 A 1.000 <M7>; 350 A 1.000 <M11>			
11.04→	0 986 45	P 2041	O
	F 026 40	S 0036	L
KL	1 987 43	M 2072	I

Idea 1.4 i.e. 16V

1,4 66 192 B 2.000 <M15>			
01.04→	0 986 45	P 2041	O
	1 457 43	S 3317	L
KL	1 987 43	M 2072	I

Idea 1.6 JTD 16V

1,6 88 350 A 2.000 <M78>			
04.08→	1 457 43	S 3553	L
KL	1 987 43	M 2072	I

Idea 1.9 JTD 8V

1,9 74 188 B 2.000 <M40>			
01.04→	0 451 10	P 3300	O
	1 457 43	S 3553	L
	1 457 07	N 0001	K
KL	1 987 43	M 2072	I

Linea

Linea 1.3 JTD

1,3 66 199 A 3.000 <M72>			
03.07→	PRF	1 457 42	P 9256 O
	UFI	F 026 40	P 7067 O
		F 026 40	S 0002 L

Linea 1.4 Turbo 16V

1,4 88 198 A 4.000 <M20>			
03.07→	PRF	1 457 42	P 9256 O
		F 026 40	S 0057 L



Linea 1.4 8V

1,4 57 350 A 1.000 <M13>			
03.07→	0 986 45	P 2041	O
	F 026 40	S 0036	L

Linea 1.4 16V

1,4 66 199 A 6.000 <M14>			
11.08→	0 986 45	P 2041	O
	1 457 43	S 3317	L

Linea 1.6 JTD

1,6 77 198 A 3.000 <M76>			
10.08→	F 026 40	S 0057	L

Marea

Marea 1.2 i 16V

1,2 60 182 B 2.000 <M1>			
Mot.Nr. 140455→	03.99-09.02	0 986 45	P 2041 O
	03.99-09.02	1 457 43	S 3265 L
		1 987 43	M 2003 I
		1 987 43	R 2303⁸ I

Marea 1.4 i 12V

1,4 59 182 A 3.000 <M1>			
10.96-02.99	0 451 10	P 3111	O
	1 457 43	S 3265	L
	0 450 90	F 5273¹	K
	1 987 43	M 2003	I
	1 987 43	R 2303⁸	I

Marea 1.6 i 16V

1,6 76 182 A 4.000 <M2>			
10.96-02.99	0 451 10	P 3111	O
	1 457 43	S 3265	L
Ricam.Nr →0176690→5054799	10.96-02.99	0 450 90	F 5273¹ K
	10.96-02.99	1 987 43	M 2003 I
		1 987 43	R 2303⁸ I

1,6 76 182 A 4.000 <M5>			
03.99-12.02	0 451 10	P 3111	O
	1 457 43	S 3265	L
	1 987 43	M 2003	I
	1 987 43	R 2303⁸	I

1,6 76 182 B 5.098 <M6>; 182 B 5.098 <M7>			
10.98-09.02	1 457 43	S 3265	L
	0 450 90	F 5273¹	K
	1 987 43	M 2003	I
	1 987 43	R 2303⁸	I

1,6 76 182 B 6.000 <M8>			
08.00-12.02	0 451 10	P 3111	O
	1 457 43	S 3265	L
	1 987 43	M 2003	I
	1 987 43	R 2303⁸	I





Marea 1.6 i 16V BI-Power

1,6 68-76 185 A 3.000 <M5>; 185 A 3.000 <M7>			
	10.97-09.02	0 451 10 P 3111	O
		1 457 43 S 3265	L
	10.97-11.99	0 450 90 F 5273 ¹	K
	10.97-09.02	1 987 43 M 2003	I
		1 987 43 R 2303 ⁸	I

Marea 1.8 i 16V

1,8 83 182 A 2.000 <M3>			
	10.96-02.99	0 451 10 P 3300	O
		1 457 43 S 3265	L
		0 450 90 F 5273 ¹	K
		1 987 43 M 2003	I
		1 987 43 R 2303 ⁸	I

1,8|83|182 A 2.000 <M10>

	03.99-09.02	0 451 10 P 3300	O
		1 457 43 S 3265	L
Ricam.Nr →2018321→0270957	03.99-09.02	0 450 90 F 5273 ¹	K
→2022837	03.99-09.02	1 987 43 M 2003	I
		1 987 43 R 2303 ⁸	I

Marea 1.9 JTD

1,9 77 182 B 4.000 <M1>			
	03.99-09.02	0 451 10 P 3354	O
		1 457 43 S 3265	L
Ricam.Nr →2044602	03.99-02.00	MW8	1 457 43 N 4198 ²
Ricam.Nr 2044603→	03.00-09.02	MW1	1 457 43 N 4293 ²
Ricam.Nr 2049978→2052140→	03.99-09.02		1 457 43 N 4293 ²
	03.99-09.02	1 987 43 M 2003	I
		1 987 43 R 2303 ⁸	I

1,9|79|182 B 9.000

	01.01-12.07	0 451 10 P 3354	O
		1 457 43 S 3265	L
		1 457 43 N 4293 ²	K
		1 987 43 M 2003	I
		1 987 43 R 2303 ⁸	I

1,9|81|186 A 6.000 <M4>

Ricam.Nr →0361133	08.00-10.01	0 451 10 P 3354	O
Ricam.Nr 0361134→	11.01-09.02	0 451 10 P 3300	O
	08.00-09.02	1 457 43 S 3265	L
		1 457 43 N 4314 ²	K
		1 987 43 M 2003	I
		1 987 43 R 2303 ⁸	I

Marea 1.9 JTD S.W.

1,9 74 182 B 9.000 <M5>			
	10.01-09.02	0 451 10 P 3354	O
		1 457 43 S 3265	L
		1 457 43 N 4314 ²	K
		1 987 43 M 2003	I
		1 987 43 R 2303 ⁸	I



Marea 1.9 TD

1,9 55,1 182 A 8.000 <M2>			
	10.96-09.02	0 451 10 P 3354	O
		1 457 43 S 3265	L
	10.96-02.99	1 457 43 N 4106 ²	K
	03.99-09.02	0 450 90 N 6308 ¹	K
	10.96-09.02	1 987 43 M 2003	I
		1 987 43 R 2303 ⁸	I

1,9|73,6|182 A 7.000 <M1>

	10.96-02.99	0 451 10 P 3354	O
		1 457 43 S 3265	L
	SWA	1 457 43 N 4106 ²	K
	SWA	1 457 43 N 4105 ²	K
		1 987 43 M 2003	I
		1 987 43 R 2303 ⁸	I

Marea 2.0 i 20V

2,0 108 182 A 1.000 <M4>			
	10.96-02.99	0 451 10 P 3300	O
		1 457 43 S 3265	L
		0 450 90 F 5273 ¹	K
		1 987 43 M 2003	I
		1 987 43 R 2303 ⁸	I

2,0|110|185 A 8.000 <M16>

	08.00-12.02	0 451 10 P 3300	O
		1 457 43 S 3265	L
		1 987 43 M 2003	I
		1 987 43 R 2303 ⁸	I

2,0|113|182 B 7.000 <M15>

	03.99-12.02	0 451 10 P 3300	O
		1 457 43 S 3265	L
		1 987 43 M 2003	I
		1 987 43 R 2303 ⁸	I

Marea 2.0 MPI 20V, MPI 20V Turbo

2,0 104/134 185 A 4.011 <Turbo>; 185 A 5.011			
	05.98-03.07	0 450 90 F 5273 ¹	K

Marea 2.4 JTD

2,4 100 185 A 6.000 <M3>			
	03.99-09.02	0 451 10 P 3354	O
		1 457 43 S 3265	L
Mot.Nr. 1930906→	04.00-09.02	MW1	1 457 43 N 4293 ²
Ricam.Nr 2032532→279451			
Ricam.Nr →1930905	03.99-03.00	MW8	1 457 43 N 4198 ²
Ricam.Nr →2032532	03.99-09.02		1 457 43 N 4293 ²
Ricam.Nr 2032533→279452→	03.99-09.02	XXX	1 457 43 N 4306 ²
	03.99-09.02		1 987 43 M 2003
			1 987 43 R 2303 ⁸





Marea 2.4 TD

2,4 91 185 A 2.000 <M3>			
	10.96-02.99	0 451 10 P 3354	O
		1 457 43 S 3265	L
Mot.Nr. →0446111	10.96-02.99	1 457 43 N 4192 ²	K
Mot.Nr. 0446112→	10.96-02.99	1 457 43 N 4194 ²	K
	10.96-02.99	1 987 43 M 2003	I
		1 987 43 R 2303 ⁸	I

Marengo

Marengo 1.9 D

1,9 48 160 A 7.000 <M1>			
	02.90-12.96	0 451 10 P 3352	O
		1 457 43 S 2183	L
	02.90-03.93	BO,SWA 1 457 43 N 4106 ²	K
	02.90-12.96	LUC,SWA 1 457 43 N 4105 ²	K
Mot.Nr. →1360563	02.90-12.96	BO,SWA 1 457 43 N 4105 ²	K
	02.90-12.96	KL 1 987 43 M 2014	I

Marengo 1.9 D Turbo

1,9 66 160 A 6.000 <M2>			
	02.90-12.96	0 451 10 P 3352	O
		1 457 43 S 2183	L
	02.90-03.93	BO,SWA 1 457 43 N 4106 ²	K
		LUC,SWA 1 457 43 N 4105 ²	K
	02.90-12.96	BO,SWA 1 457 43 N 4105 ²	K
		KL 1 987 43 M 2014	I

Marengo 1.9 JTD

1,9 77 182 B 4.000 <M1>			
	03.99-09.02	0 451 10 P 3354	O
		1 457 43 S 3265	L
Ricam.Nr →2044602	03.99-02.00	MW8 1 457 43 N 4198 ²	K
Ricam.Nr 2044603→	03.00-09.02	MW1 1 457 43 N 4293 ²	K
Ricam.Nr 2049978→2052140→	03.99-09.02	1 457 43 N 4293 ²	K
	03.99-09.02	1 987 43 M 2003	I
		1 987 43 R 2303 ⁸	I

1,9 | 81 | 186 A 6.000 <M4>

Ricam.Nr →0361133	08.00-10.01	0 451 10 P 3354	O
Ricam.Nr 0361134→	11.01-09.02	0 451 10 P 3300	O
	08.00-09.02	1 457 43 S 3265	L
		1 457 43 N 4314 ²	K
		1 987 43 M 2003	I
		1 987 43 R 2303 ⁸	I

Marengo 1.9 TD

1,9 55 182 A 8.000 <M2>			
	03.99-09.02	0 451 10 P 3354	O
		1 457 43 S 3265	L
		0 450 90 N 6308 ¹	K
		1 987 43 M 2003	I
		1 987 43 R 2303 ⁸	I

1,9 | 55,1 | 182 A 8.000 <M2>

	01.97-09.02	0 451 10 P 3354	O
		1 457 43 S 3265	L
	01.97-02.99	1 457 43 N 4106 ²	K
	03.99-09.02	0 450 90 N 6308 ¹	K
	01.97-09.02	1 987 43 M 2003	I
		1 987 43 R 2303 ⁸	I



1,9 | 73,6 | 182 A 7.000 <M1>

	01.97-02.99	0 451 10 P 3354	O
		1 457 43 S 3265	L
		SWA 1 457 43 N 4106 ²	K
		SWA 1 457 43 N 4105 ²	K
		1 987 43 M 2003	I
		1 987 43 R 2303 ⁸	I

Multipla

Multipla 1.6 Blupower, 16V, 16V Bipower CNG, 16V LPG

1,6 68-76 182 A 4.000 <M1>; 182 B 6.000 <M3>; 182 B 6.000 <M4>; 182 B 6.000 <M8>; 182 B 6.000 <M9>; 186 A 3.000 <M3>; 186 A 4.000 <M2>			
	01.99-12.10	0 451 10 P 3111	O
		1 457 43 S 3289	L
		1 987 43 M 2059	I

Multipla 1.9 JTD

1,9 77 182 B 4.000 <M5>			
	01.99-12.00	0 451 10 P 3354	O
		1 457 43 S 3289	L
		1 457 43 N 4293 ²	K
		1 987 43 M 2059	I

1,9 | 81 | 186 A 6.000 <M6>

Ricam.Nr →2104790	08.00-05.01	0 451 10 P 3354	O
Ricam.Nr 2104791→	06.01-03.02	0 451 10 P 3300	O
	08.00-03.02	1 457 43 S 3324	L
		1 457 43 N 4310 ²	K
		1 987 43 M 2059	I

1,9 | 85 | 186 A 8.000 <M7/EU3>

	04.02-12.10	0 451 10 P 3300	O
		1 457 43 S 3324	L
Ricam.Nr →21552225	04.02-02.03	1 457 43 N 4310 ²	K
Ricam.Nr 2199653→	04.02-12.10	1 457 07 N 0001	K
Ricam.Nr 21552226→2199652	03.03-12.10	F 026 40 N 2048 ²	K
	04.02-12.10	1 987 43 M 2059	I

1,9 | 85/88 | 186 A 8.000 <M87/EU4>; 186 A 9.000 <M88/EU4>

	10.03-12.10	0 451 10 P 3300	O
		1 457 43 S 3324	L
		1 457 07 N 0001	K
		1 987 43 M 2059	I

Palio

Palio 1.2 i.e.

1,2 44 178 C 4.066 <M6>			
	08.00-02.02	0 451 10 P 3300	O
		STZ 1 457 43 S 3303	L
		0 986 45 F 0220 ¹	K
Fg.Nr. →0596832	08.00-02.02	KL 1 987 43 M 2107	I
Fg.Nr. 0596833→	08.00-02.02	KL 1 987 43 M 2108	I

Palio 1.2 i.e. 8V

1,2 44 178 B 5.000 <M5>			
	09.00-08.02	0 451 10 P 3300	O
		STZ 1 457 43 S 3303	L
		0 986 45 F 0220 ¹	K
Fg.Nr. →0596832	09.00-08.02	KL 1 987 43 M 2107	I
Fg.Nr. 0596833→	09.00-08.02	KL 1 987 43 M 2108	I



1,2 | 44 | 178 B 5.000 <M7>

	03.99-09.01	0 451 10	P 3111	O
	10.99-09.01	0 451 10	P 3300	O
	03.99-09.01	1 457 43	S 3303	L
	10.99-09.01	STZ 1 457 43	S 3303	L
	03.99-09.01	0 986 45	F 0220 ¹	K
Fg.Nr. →0596832	03.99-09.01	KL	1 987 43	M 2107 I
Fg.Nr. 0596833→	03.99-09.01	KL	1 987 43	M 2108 I

1,2 | 44 | 178 B 5.000 <M11>

	01.01-09.01	0 451 10	P 3300	O
		1 457 43	S 3303	L
		STZ 1 457 43	S 3303	L
		0 986 45	F 0220 ¹	K
Fg.Nr. →0596832	01.01-09.01	KL	1 987 43	M 2107 I
Fg.Nr. 0596833→	01.01-09.01	KL	1 987 43	M 2108 I

1,2 | 44 | 188 A 4.000 <M6>

	10.01→	0 986 45	P 2041	O
		1 457 43	S 3303	L
		0 986 45	F 0220 ¹	K
		1 987 43	M 2183	I

1,2 | 44 | 188 A 4.000 <M10>

	01.01-09.01	0 986 45	P 2041	O
		STZ 1 457 43	S 3303	L
		0 986 45	F 0220 ¹	K
		1 987 43	M 2108	I

1,2 | 46 | 178 C 4.066 <M5>

	07.01-09.03	0 451 10	P 3111	O
	10.03→	0 986 45	P 2041	O
	07.01→	KL	1 987 43	M 2108 I

1,2 | 54 | 178 B 7.045 <M8>

	03.00-09.01	0 451 10	P 3111	O
		STZ 1 457 43	S 3303	L
Fg.Nr. →0596832	03.00-09.01	KL	1 987 43	M 2107 I
Fg.Nr. 0596833→	03.00-09.01	KL	1 987 43	M 2108 I

1,2 | 54 | 178 E 2.000 <M4>

	11.99-09.01	0 451 10	P 3111	O
		STZ 1 457 43	S 3303	L
		0 986 45	F 0220 ¹	K
		1 987 43	M 2108	I

Palio 1.2 i.e. 16V

1,2 | 59 | 188 A 5.000 <M10>

	10.01→	0 986 45	P 2041	O
		1 457 43	S 3303	L
		0 986 45	F 0220 ¹	K
		1 987 43	M 2183	I

Palio 1.3 JTD 16V

1,3 | 52 | 188 A 9.000 <M40>

	07.03→	PRF 1 457 42	P 9256	O
		F 026 40	S 0002	L
		1 457 07	N 0001	K
		1 987 43	M 2183	I



Palio 1.4 i.e.

1,4 | 51 | 178 B 2.000 <M15>; 178 B 2.000 <M17>; 178 B 2.016 <M16>

	11.97-09.01	0 451 10	P 3111	O
		1 457 43	S 3303	L
		0 986 45	F 0220 ¹	K
Fg.Nr. →0596832	11.97-09.01	KL	1 987 43	M 2107 I
Fg.Nr. 0596833→	11.97-09.01	KL	1 987 43	M 2108 I

1,4 | 57 | 350 A 1.000 <M13>

	07.03→	0 986 45	P 2041	O
		F 026 40	S 0036	L
		0 986 45	F 0220 ¹	K
		1 987 43	M 2183	I

Palio 1.6 i.e. 8V, i.e. 16V

1,6 | 69/76 | 178 C 7.098 <M7>; 178 C 8.098 <M20>

	07.00→	1 457 43	S 3303	L
		0 986 45	F 0220 ¹	K
Fg.Nr. →0596832	07.00→	KL	1 987 43	M 2107 I
Fg.Nr. 0596833→	07.00→	KL	1 987 43	M 2108 I

Palio 1.6 i.e. 16V

1,6 | 74 | 182 B 6.000 <M20>

	07.01-02.04	0 451 10	P 3111	O
	07.01-02.04	KL	1 987 43	M 2108 I

1,6 | 76 | 176 D 2.011 <M27>

	01.01-02.02	0 451 10	P 3111	O
		STZ 1 457 43	S 3303	L
		0 986 45	F 0220 ¹	K
Fg.Nr. →0596832	01.01-02.02	KL	1 987 43	M 2107 I
Fg.Nr. 0596833→	01.01-02.02	KL	1 987 43	M 2108 I

1,6 | 76 | 178 B 3.000 <M25>

	11.97-09.01	0 451 10	P 3111	O
		1 457 43	S 3303	L
		0 986 45	F 0220 ¹	K
Fg.Nr. →0596832	11.97-09.01	KL	1 987 43	M 2107 I
Fg.Nr. 0596833→	11.97-09.01	KL	1 987 43	M 2108 I

1,6 | 76 | 182 B 6.000 <M20>

	03.02-02.04	0 451 10	P 3111	O
		0 986 45	F 0220 ¹	K
		KL	1 987 43	M 2108 I

1,6 | 76 | 182 B 6.000 <M21>

	10.01→	0 451 10	P 3111	O
		1 457 43	S 3303	L
		0 986 45	F 0220 ¹	K
		1 987 43	M 2183	I

1,6 | 76 | 182 B 6.000 <M28>

	01.01-09.01	0 451 10	P 3111	O
		1 457 43	S 3303	L
		STZ 1 457 43	S 3303	L
		0 986 45	F 0220 ¹	K
Fg.Nr. →0596832	01.01-09.01	KL	1 987 43	M 2107 I
Fg.Nr. 0596833→	01.01-09.01	KL	1 987 43	M 2108 I





Palio 1.6 i.e. 16V Sport

1,6 76 178 E 7.000 <M22>			
10.01→	0 451 10 P 3111	O	
	1 457 43 S 3303	L	
	0 986 45 F 0220 ¹	K	
	1 987 43 M 2183	I	

Palio 1.6 MPI 16V

1,6 78 178 D 2.011 <FIASA Step A>			
05.97-02.03	0 986 45 F 0220 ¹	K	

Palio 1.7 D

1,7 52 M 708 N7 17L			
09.97-08.01	0 451 10 P 3354	O	
	1 457 43 N 4105 ²	K	

Palio 1.7 D Turbo

1,7 52			
01.04-12.08	0 451 10 P 3354	O	
	1 457 43 N 4105 ²	K	

Palio 1.7 TD

1,7 46 178 C 9.066 <M40>			
08.00-02.02	0 451 10 P 3354	O	
	1 457 43 S 3303	L	
	1 457 43 N 4106 ²	K	
Fg.Nr. →0596832	08.00-02.02	KL	1 987 43 M 2107 I
Fg.Nr. 0596833→	08.00-02.02	KL	1 987 43 M 2108 I

1,7 | 51 | 176 A 3.000 <M3>

Mot.Nr. →2404558	09.97-06.99	0 451 10 P 3352	O
Mot.Nr. 2404559→	07.99-10.00	0 451 10 P 3354	O
	09.97-10.00	1 457 43 S 3303	L
		1 457 43 N 4105 ²	K
Fg.Nr. →0596832	09.97-10.00	KL	1 987 43 M 2107 I
Fg.Nr. 0596833→	09.97-10.00	KL	1 987 43 M 2108 I

1,7 | 51 | 176 B 7.000 <M41>

08.00-02.02	0 451 10 P 3354	O	
	1 457 43 S 3303	L	
	1 457 43 N 4106 ²	K	
Fg.Nr. →0596832	08.00-02.02	KL	1 987 43 M 2107 I
Fg.Nr. 0596833→	08.00-02.02	KL	1 987 43 M 2108 I

1,7 | 52 | 176A3000

02.97-08.01	0 451 10 P 3354	O	
	1 457 43 S 3303	L	
07.97-08.01	1 457 43 N 4105 ²	K	

Palio 1.9 D

1,9 46 223 A 6.000 <M45>			
11.00-09.01	0 451 10 P 3354	O	
	STZ 1 457 43 S 3303	L	
	0 450 90 N 6452 ¹	K	
Fg.Nr. →0596832	11.00-09.01	KL	1 987 43 M 2107 I
Fg.Nr. 0596833→	11.00-09.01	KL	1 987 43 M 2108 I

1,9 | 48 | 223 A 6.000 <M26>

01.03-06.05	0 451 10 P 3354	O	
	KL 1 987 43 M 2108	I	



1,9 | 51 | 188 A 2.000 <M25>

04.03-09.04	0 451 10 P 3354	O	
	1 457 43 S 3303	L	
	0 450 90 N 6452 ¹	K	
	1 987 43 M 2183	I	

Palio 1.9 JTD

1,9 | 57/80 | 188 A 2.000 <M30>

10.01→	0 451 10 P 3354	O	
	1 457 43 S 3303	L	
	1 457 43 N 4314 ²	K	
	1 987 43 M 2183	I	

Palio 75 1.2 i.e.

1,2 | 54 | 178 B 5.000 <M1>

09.97-09.01	0 451 10 P 3111	O	
	STZ 1 457 43 S 3303	L	
	0 986 45 F 0220 ¹	K	
Fg.Nr. →0596832	09.97-09.01	KL	1 987 43 M 2107 I
Fg.Nr. 0596833→	09.97-09.01	KL	1 987 43 M 2108 I

1,2 | 54 | 188 A 4.000 <M9>

08.00-09.01	0 451 10 P 3300	O	
	STZ 1 457 43 S 3303	L	
	0 986 45 F 0220 ¹	K	
Fg.Nr. →0596832	08.00-09.01	KL	1 987 43 M 2107 I
Fg.Nr. 0596833→	08.00-09.01	KL	1 987 43 M 2108 I

Palio 75 1.2 i.e. 8V

1,2 | 54 | 188 A 4.000 <M6>

10.01-09.04	0 986 45 P 2041	O	
	1 457 43 S 3303	L	
	0 986 45 F 0220 ¹	K	
	1 987 43 M 2183	I	

Palio 85 1.2 i.e. 16V

1,2 | 63 | 188 A 5.000 <M10>

10.01-09.04	0 986 45 P 2041	O	
	1 457 43 S 3303	L	
	0 986 45 F 0220 ¹	K	
	1 987 43 M 2183	I	

Palio 100 1.6 i.e. 16V

1,6 | 76 | 178 B 3.000 <M2>

09.97-09.01	0 451 10 P 3111	O	
	1 457 43 S 3303	L	
	0 986 45 F 0220 ¹	K	
Fg.Nr. →0596832	09.97-09.01	KL	1 987 43 M 2107 I
Fg.Nr. 0596833→	09.97-09.01	KL	1 987 43 M 2108 I

1,6 | 76 | 182 B 6.000 <M21>

10.01-09.04	0 451 10 P 3111	O	
	1 457 43 S 3303	L	
	0 986 45 F 0220 ¹	K	
	1 987 43 M 2183	I	

1,6 | 76 | 182 B 6.000 <M28>

08.00-09.01	0 451 10 P 3111	O	
	1 457 43 S 3303	L	
	0 986 45 F 0220 ¹	K	
Fg.Nr. →0596832	08.00-09.01	KL	1 987 43 M 2107 I
Fg.Nr. 0596833→	08.00-09.01	KL	1 987 43 M 2108 I





Panda

Panda 1.1

1,1 39	01.09→	0 986 45 P 2041	0
		1 457 43 S 3316	L

Panda 1.1 i.e.

1,1 40 187 A 1.000 <M1>			
Mot.Nr. →1890665	10.03-12.09	0 451 10 P 3300	0
Mot.Nr. 1890666→	10.03-12.09	0 986 45 P 2041	0
	10.03-12.09	1 457 43 S 3316	L
		1 987 43 M 2106	I

Panda 1.2 i.e., i.e. 4x4

1,2 44 188 A 4.000 <M5>			
Mot.Nr. →1890665	10.03-12.09	0 451 10 P 3300	0
Mot.Nr. 1890666→	10.03-12.09	0 986 45 P 2041	0
	10.03-12.09	1 457 43 S 3316	L
		1 987 43 M 2106	I

Panda 1.2 i.e. LPG

1,2 38-44 188 A 4.000 <M6>			
	12.06-12.09	0 986 45 P 2041	0
		1 457 43 S 3316	L

Panda 1.2 i.e. Natural Power

1,2 38-44 188 A 4.000 <M4>			
	12.06-12.09	0 986 45 P 2041	0
		1 457 43 S 3316	L
		1 987 43 M 2106	I

Panda 1.2 LPG, Natural Power, 4x4

1,2 44 188 A 4.000			
	01.09→	0 986 45 P 2041	0
		1 457 43 S 3316	L

Panda 1.3 , 4x4

1,3 52 188 A 8.000			
	01.09→	EU4,PRF 1 457 42 P 9256	0
		EU4,UFI F 026 40 P 7067	0
		F 026 40 S 0002	L
		1 457 07 N 0001	K

Panda 1.3 D

1,3 27 156 A 5.000			
	07.90-08.92	0 451 10 P 3351	0
		XXX 1 457 43 S 2149	L
		BO 1 457 43 D 701 ²	K
		1 457 43 N 4106 ²	K

Panda 1.3 JTD

1,3 55 169 A 1.000 <M73>			
	05.06-12.09	PRF 1 457 42 P 9256	0
		F 026 40 S 0002	L
		1 457 07 N 0001	K
		1 987 43 M 2106	I



Panda 1.3 JTD, JTD 4x4

1,3 52 188 A 8.000 <M10>			
	01.04-12.09	PRF 1 457 42 P 9256	0
		F 026 40 S 0002	L
		1 457 07 N 0001	K
		1 987 43 M 2106	I

Panda 1.4 , Natural Power

1,4 57/74			
	01.09→	0 986 45 P 2041	0
		F 026 40 S 0053	L

Panda 1.4 i.e. 16V

1,4 74 169 A 3.000 <M17>			
	10.06-12.09	0 986 45 P 2041	0
		F 026 40 S 0053	L
		1 987 43 M 2106	I

Panda 750

0,8 25 141 B.000 <M1>			
	07.90-07.92	0 451 10 P 3349	0
		1 457 43 S 2111	L
		0 450 90 F 4058 ¹	K

Panda 750 fire

0,8 25 156 A 4.000 <M2>; 156 A 4.048 Ecotr. <M3>			
	07.90-12.92	0 451 10 P 3111	0
		1 457 43 S 2173	L
		0 450 90 F 4058 ¹	K

Panda 900

0,9 33 146 A .048 <M4>			
	07.90-03.92	0 451 10 P 3349	0
		1 457 43 S 2111	L
		0 450 90 F 4058 ¹	K

Panda 900 i.e.

0,9 29 1170 A 1.046 <M10>			
	04.92-09.03	0 451 10 P 3349	0
		1 457 43 S 3269	L
		0 450 90 F 2151 ¹	K

Panda 1000 , ACT

1,0 33 156 A 2.000 <M5>; 156 A 2.100 Ecotr. <M6>; 156 A 2.146 <M10>			
	10.87-03.97	0 451 10 P 3111	0
		1 457 43 S 2173	L
		0 450 90 F 4058 ¹	K

Panda 1000 i.e.

1,0 33 141 C 2.000 <M11>			
	01.95-09.03	0 451 10 P 3111	0
Ricam.Nr →0015234	01.95-09.03	1 457 43 S 2173	L
Ricam.Nr 15235→	01.95-09.03	1 457 43 S 3255	L
	01.95-09.03	0 450 90 F 2151 ¹	K





Panda 1000 i.e., i.e. 4x4

1,0 33 156 A 2.246 <M2>; 156 A 2.246 <M7/M16>			
	07.90-03.97	0 451 10 P 3111	O
Ricam.Nr →0015234	07.90-03.97	1 457 43 S 2173	L
Ricam.Nr 15235 →	07.90-03.97	1 457 43 S 3255	L
	07.90-03.97	0 450 90 F 2151 ¹	K

Panda 1000 Selecta

1,0 35 156 A 2.000 <M5>; 156 A 2.100 Ecotr. <M6>; 156 A 2.146 <M10>			
	07.90-03.97	0 451 10 P 3111	O
		1 457 43 S 2173	L

Panda 1000 4x4

1,0 37 156 A 3.000 <M1>			
	07.90-12.95	0 451 10 P 3111	O
		1 457 43 S 2173	L
		0 450 90 F 4058 ¹	K

Panda 1100 i.e., i.e. Selecta

1,1 37 156 C.046 <M9>			
	07.90-03.97	0 451 10 P 3111	O
Ricam.Nr →0015234	07.90-03.97	1 457 43 S 2173	L
Ricam.Nr 15235 →	07.90-03.97	1 457 43 S 3255	L
Mot.Nr. →4599749	07.90-12.92	0 450 90 F 2151 ¹	K
Mot.Nr. 4599750 →	01.93-03.97	0 450 90 F 2151 ¹	K

1,1 | 40 | 176 B 2.000 <M12>

	01.95-09.03	0 451 10 P 3111	O
Ricam.Nr →0015234	01.95-09.03	1 457 43 S 2173	L
Ricam.Nr 15235 →	01.95-09.03	1 457 43 S 3255	L
	01.95-09.03	0 450 90 F 2151 ¹	K

Panda 1100 i.e., i.e. 4x4

1,1 37 187 A 1.000 <M15>			
	12.00-09.03	0 451 10 P 3300	O
		1 457 43 S 3255	L

Panda 1100 i.e. 4x4

1,1 37 156 C.046 <M3>			
	03.92-12.94	0 451 10 P 3111	O
Ricam.Nr →0015234	03.92-12.94	1 457 43 S 2173	L
Ricam.Nr 15235 →	03.92-12.94	1 457 43 S 3255	L
	03.92-12.94	0 450 90 F 2151 ¹	K

1,1 | 40 | 176 B 2.000 <M4>

	01.95-09.03	0 451 10 P 3111	O
Fg.Nr. →1256022	01.95-09.03	1 457 43 S 2173	L
Fg.Nr. 1256023 →	01.95-09.03	1 457 43 S 3255	L
Ricam.Nr 15235 →			
	01.95-09.03	0 450 90 F 2151 ¹	K

Punto

Punto 1.1 i.e.

1,1 40 176 B 2.000 <M1>			
	05.97-08.99	0 451 10 P 3111	O
		1 457 43 S 3255	L
		0 450 90 F 5273 ¹	K
		1 987 43 M 2019	I



Punto 1.2 i 8V

1,2 44 188 A 4.000 <M1/M2/M3>			
	10.00-06.03	EU3	0 986 45 P 2041 O
Mot.Nr. →266044	07.99-09.00	EU3	0 451 10 P 3111 O
Ricam.Nr 266045 →	10.00-06.03	EU3	0 451 10 P 3300 O
	07.99-06.03		1 457 43 S 3521 L
	07.99-02.01	KL	1 987 43 R 2365 ⁸ I
	03.01-06.03	KL	1 987 43 M 2072 I

Punto 1.2 i 8V Bipower

1,2 59 188 A 4.000 <M4/CF3>			
	11.02-06.03		0 451 10 P 3300 O
			1 457 43 S 3521 L
		KL	1 987 43 M 2072 I

Punto 1.2 i 8V Bipower, i.e. 8V Bipower

1,2 44 188 A 4.000 <M4>			
	07.03-09.03		0 451 10 P 3300 O
	10.03 →		0 986 45 P 2041 O
	07.03-05.06		1 457 43 S 3521 L
	06.06 →		1 457 43 S 3316 L
	07.03 →	KL	1 987 43 M 2072 I

Punto 1.2 i 8V, i.e. 8V

1,2 44 188 A 4.000 <M1>; 188 A 4.000 <M1/M2>			
	07.03-09.03		0 451 10 P 3300 O
	10.03 →		0 986 45 P 2041 O
	07.03 →	AG	1 457 43 S 3316 L
Mot.Nr. →2935743	07.03 →	GS	1 457 43 S 3521 L
	07.03 →	KL	1 987 43 M 2072 I

Punto 1.2 i 16V

1,2 59 188 A 5.000 <M5/CF2>			
	07.99-06.03		0 986 45 P 2041 O
			1 457 43 S 3520 L
	07.99-02.01	KL	1 987 43 R 2365 ⁸ I
	03.01-06.03	KL	1 987 43 M 2072 I

1,2 | 59 | 188 A 5.000 <M6/CF3>

	10.00-06.03		0 986 45 P 2041 O
			1 457 43 S 3520 L
	10.00-02.01	KL	1 987 43 R 2365 ⁸ I
	03.01-06.03	KL	1 987 43 M 2072 I

Punto 1.2 i.e. 16V

1,2 59 188 A 5.000 <M6>			
	07.03-12.10		0 986 45 P 2041 O
			1 457 43 S 3520 L
		KL	1 987 43 M 2072 I

Punto 1.2 8V

1,2 48 199 A 4.000 <M4>			
	10.09 →		0 986 45 P 2041 O
			F 026 40 S 0036 L
		KL	1 987 43 M 2188 I





Punto 1.3 JTD

1,3 55 199 A 2.000 <M73>	10.09→	EU4,PRF	1 457 42	P 9256	O
		EU4,UFI	F 026 40	P 7067	O
		EU5	F 026 40	S 0002	L
		EU4	F 026 40	N 2049 ¹	K
		KL	1 987 43	M 2188	I

1,3 66 199 A 3.000 <M72>	10.09→	PRF	1 457 42	P 9256	O
		UFI	F 026 40	P 7067	O
		EU5	F 026 40	S 0002	L
		KL	1 987 43	M 2188	I

1,3 70 199 B 1.000	10.09→	EU5	F 026 40	S 0002	L
		KL	1 987 43	M 2188	I

Punto 1.3 MJTD 16V

1,3 52 188 A 9.000 <M20>	07.03→	PRF	1 457 42	P 9256	O
			F 026 40	S 0002	L
			1 457 07	N 0001	K
		KL	1 987 43	M 2072	I

Punto 1.4 i.e. Turbo

1,4 96 176 B 6.000 <M2>	Mot.Nr. →9039157	03.96-04.97	0 451 10	P 3351	O
	Mot.Nr. 9039158→	03.96-04.97	0 451 10	P 3111	O
		03.96-04.97	1 457 43	S 3257	L
			0 450 90	F 5273 ¹	K

1,4 96 176 B 6.000 <M5>	05.97-08.99	0 451 10	P 3111	O
		1 457 43	S 3257	L
		0 450 90	F 5273 ¹	K
		1 987 43	M 2019	I

1,4 98 176 A 4.000 <M1>	Mot.Nr. →9039157	08.93-04.97	0 451 10	P 3351	O
	Mot.Nr. 9039158→	08.93-04.97	0 451 10	P 3111	O
		08.93-04.97	1 457 43	S 3257	L
		08.93-10.95	0 450 90	F 5021 ¹	K
		11.95-04.97	0 450 90	F 5273 ¹	K

Punto 1.4 i.e. 16V

1,4 70 843 A 1.000 <M10>	07.03-12.10	0 986 45	P 2041	O	
		1 457 43	S 3317	L	
		KL	1 987 43	M 2072	I

Punto 1.4 8V, 8V LPG, 8V Natural Power

1,4 56/57 199 A 7.000; 350 A 1.000 <M7>; 350 A 1.000 <M11>; 350 A 1.000 <M18>	10.09→	0 986 45	P 2041	O	
		F 026 40	S 0036	L	
		KL	1 987 43	M 2188	I



Punto 1.4 16V

1,4 77 955 A 6.000	10.09→	1 457 42	P 9256	O	
		KL	1 987 43	M 2188	I

1,4 99 955 A 2.000	12.09→	1 457 42	P 9256	O	
		F 026 40	S 0057	L	
		KL	1 987 43	M 2188	I

Punto 1.4 16V Abarth

1,4 120	06.10→	1 457 42	P 9256	O	
		F 026 40	S 0057	L	
		KL	1 987 43	M 2188	I

Punto 1.6 JTD

1,6 88 955 A 3.000 <M78>	10.09→	F 026 40	S 0057	L	
		KL	1 987 43	M 2188	I

Punto 1.7 D

1,7 42 176 B 3.000 <M3>; 176 B 3.000 <M4>	08.93-08.99	0 451 10	P 3352	O
		1 457 43	S 3286	L
		1 457 43	N 4105 ²	K
		1 987 43	M 2019	I

Punto 1.7 TD

1,7 46 176 B 7.000 <M3>	Mot.Nr. →2404557	05.97-06.99	0 451 10	P 3352	O
	Mot.Nr. 2404559→	07.99-08.99	0 451 10	P 3354	O
		05.97-08.99	1 457 43	S 3259	L
			VOW	0 450 90	N 6374 ¹
			VOW	0 450 90	N 6295 ¹
			1 987 43	M 2019	I

1,7 46 176 B 7.000 <M4>	06.96-04.97	0 451 10	P 3352	O
		1 457 43	S 3259	L
		1 457 43	N 4105 ²	K
		1 987 43	M 2019	I

1,7|51|176 A 3.000 <M2>; 176 A 5.000 <M1>

	08.93-04.97	0 451 10	P 3352	O
Mot.Nr. →2404557	05.97-06.99	0 451 10	P 3352	O
Mot.Nr. 2404559→	07.99-08.99	0 451 10	P 3354	O
	08.93-08.99	1 457 43	S 3259	L
	08.93-04.97	1 457 43	N 4105 ²	K
	05.97-08.99	VOW	0 450 90	N 6374 ¹
		VOW	0 450 90	N 6295 ¹
	08.93-08.99	1 987 43	M 2019	I

1,7 51-53 176 A 3.000 <M2>; 176 A 5.000 <M1>	08.93-04.97	0 451 10	P 3352	O
		1 457 43	S 3259	L
		1 457 43	N 4105 ²	K
		1 987 43	M 2019	I





◀ Punto 1.7 TD

1,7 | 53 | 176 A 3.000 <M2>; 176 A 5.000 <M1>

Mot.Nr. →2404557	05.97-06.99	0 451 10 P 3352	O
Mot.Nr. 2404559→	07.99-08.99	0 451 10 P 3354	O
	05.97-08.99	1 457 43 S 3259	L
	VOW	0 450 90 N 6374 ¹	K
	VOW	0 450 90 N 6295 ¹	K
		1 987 43 M 2019	I

Punto 1.7 TD SOFT

1,7 | 46 | 176 B7.000 <M3>

Mot.Nr. →2404557	05.97-06.99	0 451 10 P 3352	O
Mot.Nr. 2404559→	07.99-08.99	0 451 10 P 3354	O
	05.97-08.99	1 457 43 S 3259	L
	VOW	0 450 90 N 6374 ¹	K
	VOW	0 450 90 N 6295 ¹	K
		1 987 43 M 2019	I

Punto 1.8 i 16V

1,8 | 96 | 183 A 1.000 <M10>; 188 A 6.000 <M11>

	07.99-06.03	0 451 10 P 3300	O
		1 457 43 S 3553	L
	07.99-02.01 KL	1 987 43 R 2365 ⁸	I
	03.01-06.03 KL	1 987 43 M 2072	I

Punto 1.8 i.e. 16V

1,8 | 96 | 188 A 6.000 <M15>

	07.03-12.10	0 451 10 P 3300	O
		1 457 43 S 3553	L
	KL	1 987 43 M 2072	I

Punto 1.9 D

1,9 | 44 | 188 A 3.000 <M1>

	05.99-06.03	0 451 10 P 3354	O
		1 457 43 S 3553	L
		0 450 90 N 6452 ¹	K
	05.99-02.01 KL	1 987 43 R 2365 ⁸	I
	03.01-06.03 KL	1 987 43 M 2072	I

Punto 1.9 JTD

1,9 | 59 | 188 A 2.000 <M5>

	07.99-06.03	0 451 10 P 3354	O
		1 457 43 S 3553	L
Ricam.Nr →2041613	07.99-04.00 MW8	1 457 43 N 4198 ²	K
Ricam.Nr 2041614→	05.00-06.03 MW1	1 457 43 N 4293 ²	K
	07.99-02.01 KL	1 987 43 R 2365 ⁸	I
	03.01-06.03 KL	1 987 43 M 2072	I

1,9 | 62,5 | 188 A 7.000 <M6>

	06.01-06.03	0 451 10 P 3354	O
		1 457 43 S 3553	L
		1 457 43 N 4310 ²	K
	KL	1 987 43 M 2072	I

1,9 | 85 | 188 A 7.000 <M6>

	05.99-06.03	0 451 10 P 3354	O
		1 457 43 S 3553	L
		1 457 43 N 4310 ²	K
	05.99-02.01 KL	1 987 43 R 2365 ⁸	I
	03.01-06.03 KL	1 987 43 M 2072	I



Punto 1.9 JTD 8V

1,9 | 63 | 188 A 7.000 <M25>

	07.03→	0 451 10 P 3354	O
		1 457 43 S 3553	L
		1 457 07 N 0001	K
	KL	1 987 43 M 2072	I

1,9 | 74 | 188 B 2.000 <M30>

	07.03-12.10	0 451 10 P 3300	O
		1 457 43 S 3553	L
		1 457 07 N 0001	K
	KL	1 987 43 M 2072	I

Punto 55 1.1 i.e.

1,1 | 40 | 176 A 6.000 <M1>

	08.93-04.97	0 451 10 P 3111	O
		NOR 1 457 43 S 3255	L
		SBE 1 457 43 S 3257	L
	08.93-10.95	0 450 90 F 2151 ¹	K
	11.95-04.97	0 450 90 F 5273 ¹	K
	08.93-04.97	1 987 43 M 2019	I

1,1 | 40 | 176 A 6.000 <M6>

	05.97-08.99	0 451 10 P 3111	O
		1 457 43 S 3257	L
		0 450 90 F 5273 ¹	K
		1 987 43 M 2019	I

1,1 | 40 | 176 B 2.000 <M1>

	05.97-08.99	0 451 10 P 3111	O
		1 457 43 S 3255	L
		0 450 90 F 5273 ¹	K
		1 987 43 M 2019	I

1,1 | 40 | 176 B 2.000 <M6>

	01.95-04.97	0 451 10 P 3111	O
		1 457 43 S 3255	L
	01.95-10.95	0 450 90 F 2151 ¹	K
	11.95-04.97	0 450 90 F 5273 ¹	K
	01.95-04.97	1 987 43 M 2019	I

Punto 60 1.2 i.e.

1,2 | 43 | 176 A 7.000 <M2>; 176 B 1.000 <M5>

	08.93-05.94	0 451 10 P 3111	O
		1 457 43 S 3255	L
		0 450 90 F 2151 ¹	K
		1 987 43 M 2019	I

1,2 | 43 | 176 B 4.000 <M7>

	05.95-04.97	0 451 10 P 3111	O
		1 457 43 S 3255	L
	05.95-10.95 AG	0 450 90 F 5273 ¹	K
		GS 0 450 90 F 2151 ¹	K
	11.95-04.97	0 450 90 F 5273 ¹	K
	05.95-04.97 EHX	1 987 43 M 2019	I

1,2 | 44 | 176 A 7.000 <M2>; 176 B 1.000 <M5>

	04.94-04.97	0 451 10 P 3111	O
		1 457 43 S 3255	L
	04.94-10.95	0 450 90 F 2151 ¹	K
	11.95-04.97	0 450 90 F 5273 ¹	K



1,2 44 176 B 4.000 <M2>			
05.97-08.99	0 451 10	P 3111	O
	1 457 43	S 3255	L
	0 450 90	F 5273 ¹	K
	1 987 43	M 2019	I
EHX	1 987 43	M 2019	I

1,2 44 176 B 4.000 <M7>			
06.95-04.97	0 451 10	P 3111	O
	1 457 43	S 3255	L
06.95-10.95	0 450 90	F 2151 ¹	K
11.95-04.97	0 450 90	F 5273 ¹	K
06.95-04.97	1 987 43	M 2019	I

Punto 60 1.2 i.e. Selecta			
1,2 44 176 A 7.000 <M2>; 176 B 1.000 <M5>			
06.94-04.97	0 451 10	P 3111	O
	1 457 43	S 3255	L
06.94-10.95	0 450 90	F 2151 ¹	K
11.95-04.97	0 450 90	F 5273 ¹	K
06.94-04.97	1 987 43	M 2019	I

Punto 75 1.2 i.e.			
1,2 54 176 A 8.000 <M3>			
08.93-08.99	0 451 10	P 3111	O
	1 457 43	S 3256	L
08.93-10.95	0 450 90	F 5021 ¹	K
11.95-01.98	0 450 90	F 5273 ¹	K
08.93-08.99	1 987 43	M 2019	I

Punto 85 1.2 i.e. 16V			
1,2 63 176 B 9.000 <M4>			
Mot.Nr. →140454	05.97-08.99	0 451 10	P 3111 O
Mot.Nr. 140455→	05.97-08.99	0 986 45	P 2041 O
	05.97-08.99	1 457 43	S 3257 L
		0 450 90	F 5273 ¹ K
		1 987 43	M 2019 I
	EHX	1 987 43	M 2019 I

Punto 90 1.6 i.e.			
1,6 65 176 A 9.000 <M4>			
01.94-10.94	0 451 10	P 3351	O
11.94-04.97	0 451 10	P 3111	O
01.94-04.97	1 457 43	S 3257	L
	0 450 90	F 5273 ¹	K
	1 987 43	M 2019	I
04.94-04.97	EHX	1 987 43	M 2019 I

Punto Grande			
Punto Grande 1.2			
1,2 49			
09.10→	0 451 10	P 3364	O
	F 026 40	S 0036	L
	KL	1 987 43	M 2188 I

Punto Grande 1.2 i.e.			
1,2 48 199 A 4.000 <M4>			
10.05→	0 986 45	P 2041	O
	F 026 40	S 0036	L
	KL	1 987 43	M 2188 I

Punto Grande 1.3 MJTD			
1,3 55 199 A 2.000 <M73>			
10.05→	PRF	1 457 42	P 9256 O
		F 026 40	S 0002 L
		F 026 40	N 2049 ¹ K
	KL	1 987 43	M 2188 I

1,3 66 199 A 3.000 <M72>			
10.05→	PRF	1 457 42	P 9256 O
		F 026 40	S 0002 L
	KL	1 987 43	M 2188 I

Punto Grande 1.4 i.e. Turbo 16V			
1,4 88 198 A 4.000 <M20>			
06.07→	PRF	1 457 42	P 9256 O
		F 026 40	S 0057 L
	KL	1 987 43	M 2188 I

Punto Grande 1.4 i.e. Turbo 16V Abarth			
1,4 114 199 A 8.000			
10.07→	PRF	1 457 42	P 9256 O
		F 026 40	S 0057 L
	KL	1 987 43	M 2188 I

Punto Grande 1.4 i.e. Turbo 16V Abarth SS			
1,4 132 199 A 8.000			
10.07→	PRF	1 457 42	P 9256 O
	KL	1 987 43	M 2188 I

Punto Grande 1.4 i.e. 8V			
1,4 55 199 A 7.000 <M12>			
06.06→	0 986 45	P 2041	O
	F 026 40	S 0036	L
	KL	1 987 43	M 2188 I

Punto Grande 1.4 i.e. 8V, i.e. 8V CNG, i.e. 8V LPG			
1,4 56/57 350 A 1.000 <M7>; 350 A 1.000 <M11>; 350 A 1.000 <M18>			
10.05→	0 986 45	P 2041	O
	F 026 40	S 0036	L
	KL	1 987 43	M 2188 I

Punto Grande 1.4 i.e. 16V			
1,4 70 199 A 6.000 <M14>			
03.06→	0 986 45	P 2041	O
	1 457 43	S 3317	L
	KL	1 987 43	M 2188 I

Punto Grande 1.6 JTD			
1,6 88 955 A 3.000 <M78>			
08.08→	F 026 40	S 0057	L
	KL	1 987 43	M 2188 I





Punto Grande 1.9 JTD

1,9 85/88/96 199 A 5.000 <M89>; 939 A 1.000 <M88>; 939 A 7.000 <M87>				
	10.05→		1 457 42 P 9248	O
			F 026 40 S 0057	L
		KL	1 987 43 M 2188	I

Qubo

Qubo 1.3 MJTD

1,3 55 199 A2.000 <M73>				
	09.08→	PRF	1 457 42 P 9256	O
		UFI	F 026 40 P 7067	O
			F 026 40 S 0002	L
			F 026 40 N 2049 ¹	K
		KL,RLE	1 987 43 M 2188	I

1,3 70				
	09.10→	EU5	F 026 40 S 0002	L
			F 026 40 N 2049 ¹	K
		KL,RLE	1 987 43 M 2188	I

Qubo 1.4 i.e.

1,4 55 KFV <M11>				
	09.08→		1 457 42 P 9249	O
		KL,RLE	1 987 43 M 2188	I

Qubo 1.4 Natural Power

1,4 57-59 350 A 1.000 <M18>				
	10.09→		0 986 45 P 2041	O
			F 026 40 S 0036	L

Scudo

Scudo 1.6 D Multijet

1,6 66 9HU <M1>				
	01.07→		1 457 42 P 9238	O
			1 457 43 S 3327	L
		KL	1 987 43 R 2406	I
		KL	1 987 43 M 2206	I

Scudo 1.6 i

1,6 58 220 A 2.000 <M1>				
	10.95-05.00		0 451 10 P 3111	O
			1 457 43 S 2200	L
Ricam.Nr →7161	10.95-06.96		0 450 90 F 5095 ¹	K
Ricam.Nr 7162→	07.96-05.98		0 450 90 F 5287 ¹	K
	10.95-05.00	3FE	1 987 43 M 2060	I

Scudo 1.9 D

1,9 51 D9B <M2>				
Ricam.Nr →7875	10.95-06.99		0 451 10 P 3261	O
Ricam.Nr 7876→	07.98-05.00		0 451 10 P 3355	O
	10.95-05.00		1 457 43 S 2200	L
			1 457 42 N 9291	K
		3FE	1 987 43 M 2060	I

1,9 51/52 WJY <M12>; WJZ <M5>				
	06.98-01.07		0 451 10 P 3355	O
			1 457 43 S 2200	L
			1 457 43 N 1703	K
		3FE	1 987 43 M 2060	I



Scudo 1.9 TD

1,9 66/68 DHX <M4>; D8B <M3>				
Ricam.Nr →7875	04.96-06.98		0 451 10 P 3261	O
Ricam.Nr 7876→	07.98-05.00		0 451 10 P 3355	O
	10.95-05.00		1 457 43 S 2200	L
			1 457 42 N 9291	K
		3FE	1 987 43 M 2060	I

Scudo 2.0 D

2,0 94 <M7>				
	04.11→		1 457 42 P 9249	O
			F 026 40 S 0058	L
		KL	1 987 43 M 2206	I

Scudo 2.0 D Multijet

2,0 88 RHK <M5>				
	01.07→		1 457 42 P 9249	O
			F 026 40 S 0058	L
			1 457 43 N 1723	K
		KL	1 987 43 R 2406	I
		KL	1 987 43 M 2206	I

2,0 | 103 | RHR <M10>

	01.07→		1 457 42 P 9249	O
			F 026 40 S 0058	L
			1 457 43 N 1723	K
		KL	1 987 43 R 2406	I
		KL	1 987 43 M 2206	I

2,0 | 121 | RHH <M15>

	01.07→		1 457 42 P 9249	O
			F 026 40 S 0058	L
		KL	1 987 43 R 2406	I

Scudo 2.0 D Multijet FAP

2,0 88 RHG <M6>				
	10.08→		1 457 42 P 9249	O
			F 026 40 S 0058	L
			1 457 43 N 1723	K
		KL	1 987 43 R 2406	I
		KL	1 987 43 M 2206	I

Scudo 2.0 8V JTD

2,0 70 RHX <M7/M14>				
	10.99-05.04		0 451 10 P 3355	O
			1 457 43 S 2200	L
		EU2	1 457 03 N 0013	K
Ricam.Nr →9155	10.99-11.01	EU3	1 457 03 N 0013	K
Ricam.Nr 9156→	12.01-05.04	EU3	1 457 07 N 0000	K
	10.99-05.04	3FE	1 987 43 M 2060	I

2,0 | 70 | RHX <M14>

	06.04-01.07		0 451 10 P 3355	O
			1 457 43 S 2200	L
			1 457 07 N 0000	K
		3FE	1 987 43 M 2060	I

2,0 | 81 | RHZ <M6/M13>

	10.99-05.04		0 451 10 P 3355	O
			1 457 43 S 2200	L
		EU2	1 457 03 N 0013	K
	01.02-05.04	EU3	1 457 07 N 0000	K
	10.99-05.04	3FE	1 987 43 M 2060	I



2,0 81 RHZ <M13>	06.04-01.07	0 451 10 P 3355	O
		1 457 43 S 2200	L
		1 457 07 N 0000	K
	3FE	1 987 43 M 2060	I

Scudo 2.0 16V

2,0 100 RFN <M10>	05.00-01.07	0 451 10 P 3355	O
		1 457 43 S 2200	L
	05.00-05.04	0 450 90 F 5287	K
	05.00-01.07 3FE	1 987 43 M 2060	I

Scudo 2.0 16V JTD

2,0 81 RHM <M11>	06.04-01.07	0 451 10 P 3355	O
		1 457 43 S 2200	L
		1 457 07 N 0000	K
	3FE	1 987 43 M 2060	I

2,0 81 RHW <M11>	09.00-05.04	0 451 10 P 3355	O
		1 457 43 S 2200	L
Ricam.Nr →8911	09.00-04.01	1 457 03 N 0013	K
Ricam.Nr 8912→	05.01-05.04	1 457 07 N 0000	K
	09.00-05.04 3FE	1 987 43 M 2060	I

Sedici

Sedici 1.6

1,6 79 M16A <M40>	09.06→	0 451 10 P 3276	O
		F 026 40 S 0201	L
		1 987 43 M 2173	I

Sedici 1.6 , 4x4

1,6 88 M16A <M40>	08.09→	0 451 10 P 3276	O
		1 987 43 M 2173	I

Sedici 1.6 4x4

1,6 79 M16A <M40>	05.06→	0 451 10 P 3276	O
		F 026 40 S 0201	L
		1 987 43 M 2173	I

Sedici 1.9 JTD, JTD 4x4

1,9 88 D19AA <M88>	05.06→	1 457 42 P 9248	O
		F 026 40 S 0056	L
	RLE	1 457 07 N 0001	K
		1 987 43 M 2173	I

Sedici 2.0 JTD, JTD 4x4

2,0 99 D20AA <M120>	08.09→	1 457 07 N 0001	K
		RLE 1 457 07 N 0001	K
		1 987 43 M 2173	I



Seicento

Seicento 900

0,9 29 1170 A 1.046 <M1>	03.98-12.03	0 451 10 P 3349	O
		1 457 43 S 2146	L
		0 986 45 F 0220	K

Seicento 1100

1,1 40 176 B 2.000 <M2-SPI>			
Fg.Nr. →01051576	03.98-12.03	0 451 10 P 3300	O
Fg.Nr. 01051577→	03.98-12.03	0 986 45 P 2041	O
	03.98-12.03	1 457 43 S 3255	L
		0 986 45 F 0220	K

1,1|40|187 A 1.000 <M3-MPI>

Fg.Nr. →01051576	09.00-12.10	0 451 10 P 3300	O
Fg.Nr. 01051577→	09.00-12.10	0 986 45 P 2041	O
	09.00-12.10	1 457 43 S 3330	L

Siena

Siena 1.2 i.e. 8V

1,2 44 178 B 5.000 <M5>; 178 B 5.000 <M7>; 178 B 5.000 <M11>	01.98-12.01	0 451 10 P 3300	O
		STZ 1 457 43 S 3303	L
		0 986 45 F 0220	K
Fg.Nr. →0596832	01.98-12.01 KL	1 987 43 M 2107	I
Fg.Nr. 0596833→	01.98-12.01 KL	1 987 43 M 2108	I

1,2|44|178 C 4.066 <M5>

	01.02-03.04	0 451 10 P 3111	O
		0 986 45 F 0220	K
		1 987 43 M 2108	I

1,2|44|178 C 4.066 <M6>

	05.99-12.01	0 451 10 P 3300	O
		KL 1 987 43 M 2108	I

1,2|54|178 B 7.045 <M8>

	01.00-12.01	0 451 10 P 3300	O
	01.05→	0 986 45 P 2041	O
	01.00-12.01 STZ	1 457 43 S 3303	L
	01.05→	1 457 43 S 3303	L
	01.00-12.01 KL	1 987 43 M 2108	I

Siena 1.3 MPI 8V

1,3 55	10.98-03.01	0 451 10 P 3111	O
		1 457 43 S 3303	L

Siena 1.4 i.e.

1,4 51 178 B 2.000 <M15>	04.97-02.99	0 451 10 P 3111	O
		STZ 1 457 43 S 3303	L
		0 986 45 F 0220	K





◀ Siena 1.4 i.e.

1,4 51 178 B 2.000 <M17>	03.00-06.01		0 451 10 P 3111	O
			1 457 43 S 3303	L
			0 986 45 F 0220 ¹	K
1,4 51 178 B 2.016 <M16>	05.98-06.01		0 451 10 P 3111	O
		STZ	1 457 43 S 3303	L
			0 986 45 F 0220 ¹	K
Fg.Nr. →0596832	05.98-06.01	KL	1 987 43 M 2107	I
Fg.Nr. 0596833→	05.98-06.01	KL	1 987 43 M 2108	I

Siena 1.6 i.e. 16V

1,6 76 178 B 3.000 <M25>	04.97-12.01		0 451 10 P 3111	O
		STZ	1 457 43 S 3303	L
			0 986 45 F 0220 ¹	K
Fg.Nr. →0596832	04.97-12.01	KL	1 987 43 M 2107	I
Fg.Nr. 0596833→	04.97-12.01	KL	1 987 43 M 2108	I
1,6 76 178 D 2.011 <M27>	01.01-12.01		0 451 10 P 3111	O
	01.01-12.01	KL	1 987 43 M 2108	I

1,6 76 182 B 6.000 <M20>	01.02-03.04		0 451 10 P 3111	O
			0 986 45 F 0220 ¹	K
			1 987 43 M 2108	I

1,6 76 182 B 6.000 <M28>	01.00-12.01		0 451 10 P 3111	O
		STZ	1 457 43 S 3303	L
			0 986 45 F 0220 ¹	K
Fg.Nr. →0596832	01.00-12.01	KL	1 987 43 M 2107	I
Fg.Nr. 0596833→	01.00-12.01	KL	1 987 43 M 2108	I

Siena 1.9 D

1,9 48 223 A 6.000 <M26>	01.02-03.04		0 451 10 P 3354	O
			1 457 43 S 3303	L
			1 987 43 M 2108	I

Stilo

Stilo 1.2 16V

1,2 59 188 A 5.000 <M1>	10.01-12.03		0 986 45 P 2041	O
			1 457 43 S 3317	L
			1 987 43 R 2377 ⁸	I

Stilo 1.4 16V

1,4 66/70 192 B 2.000 <M6>; 843 A 1.000 <M5>	01.04-12.07		0 986 45 P 2041	O
			1 457 43 S 3317	L
			1 987 43 R 2377 ⁸	I

Stilo 1.6 16V

1,6 77/100 192 B 3.000 <M55>	07.05-12.07		1 457 43 S 3152	L
			1 987 43 R 2377 ⁸	I



Stilo 1.6 16V, 16V Natural Power

1,6 76 182 B 6.000 <M8>; 182 B 6.000 <M10>	10.01-12.07		0 451 10 P 3111	O
			1 457 43 S 3155	L
			1 987 43 R 2377 ⁸	I

Stilo 1.8 MPI 16V

1,8 97	01.04-12.07		0 451 10 P 3300	O
			1 457 43 S 3152	L

Stilo 1.8 16V

1,8 98 192 A 4.000 <M20>	10.01-12.07		0 451 10 P 3300	O
			1 457 43 S 3152	L
			1 987 43 R 2377 ⁸	I

Stilo 1.9 JTD

1,9 85	06.02-12.07		0 451 10 P 3300	O
			F 026 40 S 0041	L
			1 457 43 N 4314 ²	K

Stilo 1.9 JTD 8V

1,9 59 192 A 3.000 <M40>	10.01-12.07		0 451 10 P 3300	O
	10.01-01.03		1 457 43 S 3152	L
	02.03-12.03		F 026 40 S 0041	L
	01.04-12.07		1 457 43 S 3152	L
			F 026 40 N 2048 ²	K
Ricam.Nr →0252018	10.01-12.07		1 457 43 N 4314 ²	K
Ricam.Nr 0252019→	10.01-12.07		F 026 40 N 2048 ²	K
	10.01-12.07		1 987 43 R 2377 ⁸	I

1,9 66 192 B 5.000 <M83>	10.05-12.07		0 451 10 P 3300	O
			F 026 40 S 0041	L
			1 987 43 R 2377 ⁸	I

1,9 85 192 A 1.000 <M50>	10.01-12.07		0 451 10 P 3300	O
	10.01-01.03		1 457 43 S 3152	L
	02.03-12.07		F 026 40 S 0041	L
	01.04-12.07		F 026 40 N 2048 ²	K
Ricam.Nr →0252018	10.01-12.07		1 457 43 N 4314 ²	K
Ricam.Nr 0252019→	10.01-12.07		F 026 40 N 2048 ²	K
	10.01-12.07		1 987 43 R 2377 ⁸	I

1,9 88 192 A 8.000 <M88>	07.05-12.07		0 451 10 P 3300	O
			F 026 40 S 0041	L
			1 987 43 R 2377 ⁸	I

Stilo 1.9 JTD 8V, JTD 16V

1,9 74/100 192 A 9.000 <M45>; 192 B 1.000 <M62>	01.04-12.07		0 451 10 P 3300	O
			F 026 40 S 0041	L
			F 026 40 N 2048 ²	K
			1 987 43 R 2377 ⁸	I



1,9 85 110 937 A 5.000 <M92>; 937 A 7.000 <M87>			
07.05-12.07	0 451 10	P 3300	O
	F 026 40	S 0041	L
	1 987 43	R 2377⁸	I

Stilo 1.9 JTD 16V

1,9 93 937 A 4.000 <M61>			
01.04-12.07	0 451 10	P 3300	O
	F 026 40	S 0041	L
	F 026 40	N 2048²	K
	1 987 43	R 2377⁸	I

1,9 | 103 | 192 A 5.000 <M60>

01.04-12.07	0 451 10	P 3300	O
	F 026 40	S 0041	L
	F 026 40	N 2048²	K
	1 987 43	R 2377⁸	I

Stilo 2.4 MPI 20V

2,4 123 192 A 7.011 <Abarth>			
06.02-12.08	1 457 43	S 3152	L

Stilo 2.4 20V

2,4 125 192 A 2.000 <M30>			
10.01-12.07	0 451 10	P 3300	O
	1 457 43	S 3152	L
	1 987 43	R 2377⁸	I

Strada**Strada 1.2 MPI 8V**

1,2 44 178 B 5.000 <M1>			
03.99-03.05	0 451 10	P 3111	O
	ATN, STZ	1 457 43	S 3303
	KL	1 987 43	M 2108
			I

1,2 | 54 | 178 B 7.045 <M7>

07.05→	0 986 45	P 2041	O
	STZ	1 457 43	S 3303
			L

1,2 | 54 | 188 A 4.000 <M2>

05.01-03.03	0 986 45	P 2041	O
	STZ	1 457 43	S 3303
		0 986 45	F 0220¹
	KL	1 987 43	M 2108
			I

1,2 | 54 | 188 A 4.000 <M3>

04.03-06.05	0 986 45	P 2041	O
	STZ	1 457 43	S 3303
		0 986 45	F 0220¹
		1 987 43	M 2183
			I

Strada 1.3 JTD

1,3 63 223 A 9.000 <M71>			
07.05→	PRF	1 457 42	P 9256
		F 026 40	S 0002
		1 457 07	N 0001
		1 987 43	M 2183
			I

Strada 1.7 D Turbo

1,7 52			
07.99-12.08	0 451 10	P 3354	O
	1 457 43	N 4105²	K

Strada 1.7 TDS

1,7 51 176 A 3.000 <M10>			
03.99-03.03	0 451 10	P 3354	O
	STZ	1 457 43	S 3303
		1 457 43	N 4105²
	KL	1 987 43	M 2108
			I

Strada 1.9 D

1,9 46 223 A 6.000 <M45>			
11.00-06.05	0 451 10	P 3354	O
11.00-03.03	1 457 43	S 3303	L
04.03-06.05	STZ	1 457 43	S 3303
		0 450 90	N 6452¹
			K
11.00-06.05	KL	1 987 43	M 2108
		1 987 43	M 2183
			I

Strada 1.9 JTD

1,9 59 188 A 2.000 <M50>			
04.03-06.05	0 451 10	P 3354	O
	STZ	1 457 43	S 3303
		1 457 43	N 4314²
		1 987 43	M 2183
			I

Talento**Talento 1.9 D**

1,9 51 149 B 1.000 <M1>			
03.88-12.94	0 451 10	P 3354	O
	1 457 43	S 2138	L
	1 457 43	N 4106²	K

Talento 2.0

2,0 55 170 B XN1T <M2>			
07.90-12.94	0 451 10	P 3261	O
	XXX	1 457 43	S 2149
			L

Tempra**Tempra 1.4**

1,4 56 159 A 2.000 <M1>			
02.90-03.93	0 451 10	P 3351	O
	1 457 43	S 2183	L
	KL	1 987 43	M 2014
			I

1,4 | 56 | 159 A 2.000 <M6>

04.93-10.94	0 451 10	P 3351	O
11.94-12.96	0 451 10	P 3111	O
04.93-12.96	1 457 43	S 2183	L
	KL	1 987 43	M 2014
			I





Tempra 1.4 i.e.

1,4 51 160 A 1.046 <M1>			
04.93-10.94	0 451 10 P 3351	O	
11.94-12.96	0 451 10 P 3111	O	
04.93-12.96	1 457 43 S 2180	L	
	0 450 90 F 2151 ¹	K	
KL	1 987 43 M 2014	I	

1,4 51 160 A 1.046 <M2>			
03.92-03.93	0 451 10 P 3350	O	
	1 457 43 S 2180	L	
	0 450 90 F 2151 ¹	K	
KL	1 987 43 M 2014	I	

1,4 51 836 A 4.000 <M7>			
03.95-12.96	0 451 10 P 3111	O	
	1 457 43 S 2180	L	
	0 450 90 F 2151 ¹	K	
KL	1 987 43 M 2014	I	

Tempra 1.6

1,6 62 159 A 3.000 <M3>			
02.90-03.93	0 451 10 P 3350	O	
	1 457 43 S 2183	L	
KL	1 987 43 M 2014	I	

1,6 62 159 A 3.000 <M4>			
04.93-10.94	0 451 10 P 3351	O	
11.94-12.96	0 451 10 P 3111	O	
04.93-12.96	1 457 43 S 2183	L	
KL	1 987 43 M 2014	I	

1,6 62 159 A 3.098 <M8>			
04.93-12.96	0 451 10 P 3111	O	
	1 457 43 S 2183	L	
KL	1 987 43 M 2014	I	

Tempra 1.6 i.e.

1,6 55 159 A 3.048 <M5>			
06.92-03.93	0 451 10 P 3351	O	
	1 457 43 S 2180	L	
	0 450 90 F 2151 ¹	K	
KL	1 987 43 M 2014	I	

1,6 55 835 C 1.000 <M2>			
04.93-10.94	0 451 10 P 3351	O	
11.94-12.96	0 451 10 P 3111	O	
04.93-12.96	1 457 43 S 3541	L	
	0 450 90 F 2151 ¹	K	
KL	1 987 43 M 2014	I	

1,6 57 159 A 3.046 <M4>			
06.90-07.92	0 451 10 P 3351	O	
	1 457 43 S 2180	L	
	0 450 90 F 2151 ¹	K	
KL	1 987 43 M 2014	I	

1,6 66 159 B 9.000 <M5>			
05.94-12.96	0 451 10 P 3111	O	
	1 457 43 S 2183	L	
	0 450 90 F 5273 ¹	K	
KL	1 987 43 M 2014	I	



Tempra 1.6 i.e. Selecta

1,6 55 159 A 3.048 <M3>			
11.94-12.96	0 451 10 P 3111	O	
04.93-12.96	1 457 43 S 2180	L	
	0 450 90 F 2151 ¹	K	
KL	1 987 43 M 2014	I	

Tempra 1.8 i.e.

1,8 66/71/76/77/80 159 A 4.000 <M1>; 159 A 4.046 <M1>; 159 A 4.046 <M2>; 835 C 2.000 <M3>; 835 C 4.000 <M4>; 836 A 5.000 <M5>			
02.90-12.96	0 451 10 P 3350	O	
	1 457 43 S 2183	L	
	0 450 90 F 5021 ¹	K	
KL	1 987 43 M 2014	I	

Tempra 1.9 D

1,9 48 160 A 7.000 <M1>			
02.90-12.96	0 451 10 P 3352	O	
	1 457 43 S 2183	L	
02.90-03.93	BO,SWA 1 457 43 N 4106 ²	K	
	BO,SWA 1 457 43 N 4105 ²	K	
	LUC,SWA 1 457 43 N 4105 ²	K	
Mot.Nr. →1360563	04.93-12.96	BO,SWA 1 457 43 N 4105 ²	K
Mot.Nr. 1360564→	04.93-12.96	LUC,SWA 1 457 43 N 4105 ²	K
02.90-12.96	KL 1 987 43 M 2014	I	

Tempra 1.9 TD

1,9 60 160 B 6.046 <M3>			
07.90-03.93	0 451 10 P 3352	O	
	1 457 43 S 2183	L	
	BO,SWA 1 457 43 N 4106 ²	K	
	BO,SWA 1 457 43 N 4105 ²	K	
	LUC,SWA 1 457 43 N 4105 ²	K	
KL	1 987 43 M 2014	I	

1,9 | 66 | 160 D 1.000 <M3>

04.93-12.96	0 451 10 P 3352	O	
	1 457 43 S 2183	L	
	BO,SWA 1 457 43 N 4105 ²	K	
KL	1 987 43 M 2014	I	

1,9 | 66/68 | 160 A 6.000 <M2>; 160 A 6.046 <M4>

02.90-12.96	0 451 10 P 3352	O	
	1 457 43 S 2183	L	
02.90-03.93	BO,SWA 1 457 43 N 4106 ²	K	
	LUC,SWA 1 457 43 N 4105 ²	K	
02.90-12.96	BO,SWA 1 457 43 N 4105 ²	K	
KL	1 987 43 M 2014	I	

Tempra 2.0 i.e., i.e. 4x4

2,0 83-85 159 A 6.046 <M2>; 159 A 6.046 <M3>			
02.90-12.96	0 451 10 P 3350	O	
	1 457 43 S 2183	L	
	0 450 90 F 5021 ¹	K	
KL	1 987 43 M 2014	I	

Tempra 2.0 SPI 8V

2,0 76/81 159 B 1.011 <SPI>; 159 B 2.011 <SPI>			
05.94-12.96	1 987 43 M 2014 ⁸	I	





Tipo

Tipo 1.1

1,1 41 160 A 3.000 <M1>	07.87-03.93	0 451 10 P 3111	O
		1 457 43 S 2173	L

Tipo 1.1 i.e.

1,1 37 156 C.046 <M6>	10.94-10.95	0 451 10 P 3111	O
		1 457 43 S 2173	L

Tipo 1.4

1,4 52 159 A 2.000 <M2>	03.93-09.94	0 451 10 P 3351	O
	10.94-10.95	0 451 10 P 3111	O
	03.93-10.95	1 457 43 S 2183	L
	KL	1 987 43 M 2014	I

1,4|56|159 A 2.000 <M3>

	01.90-03.93	0 451 10 P 3351	O
Mot.Nr. →7647601	01.90-03.93	1 457 43 S 2180	L
Mot.Nr. 7548187→	04.90-03.93	1 457 43 S 2183	L
	01.90-03.93	KL 1 987 43 M 2014	I

Tipo 1.4 i.e.

1,4 51 160 A 1.046 <M5>	05.89-03.93	0 451 10 P 3351	O
		1 457 43 S 2180	L
		0 450 90 F 2151 ¹	K
	KL	1 987 43 M 2014	I

1,4|51|836 A 4.000 <M7>

	10.94-10.95	0 451 10 P 3111	O
	10.93-10.95	1 457 43 S 2180	L
	KL	1 987 43 M 2014	I

1,4|52|160 A 1.046 <M1>

	03.93-09.94	0 451 10 P 3351	O
	10.94-10.95	0 451 10 P 3111	O
	03.93-10.95	1 457 43 S 2180	L
		0 450 90 F 2151 ¹	K
	KL	1 987 43 M 2014	I

Tipo 1.6

1,6 58 159 A 3.000 <M5>	03.93-09.94	0 451 10 P 3351	O
	10.94-10.95	0 451 10 P 3111	O
	03.93-10.95	1 457 43 S 2183	L
	KL	1 987 43 M 2014	I

1,6|62|159 A 3.000 <M7>

	04.90-12.92	0 451 10 P 3351	O
Mot.Nr. →7647601	04.90-12.92	1 457 43 S 2180	L
Mot.Nr. 7647602→	04.90-12.92	1 457 43 S 2183	L
	04.90-12.92	KL 1 987 43 M 2014	I



Tipo 1.6 i.e.

1,6 55 159 A 3.048 <M9>	01.92-03.93	0 451 10 P 3351	O
		1 457 43 S 2180	L
		0 450 90 F 2151 ¹	K
	KL	1 987 43 M 2014	I

1,6|56|160 E 2.011 <M3>

	10.94-10.95	0 451 10 P 3111	O
	03.93-10.95	KL 1 987 43 M 2014	I

1,6|56|835 C 1.000 <M3>

	03.93-09.94	0 451 10 P 3351	O
	10.94-10.95	0 451 10 P 3111	O
	03.93-10.95	1 457 43 S 3541	L
		0 450 90 F 2151 ¹	K
	KL	1 987 43 M 2014	I

1,6|57|159 A 3.046 <M8>

	03.90-03.93	0 451 10 P 3351	O
		1 457 43 S 2180	L
		0 450 90 F 2151 ¹	K
	KL	1 987 43 M 2014	I

Tipo 1.6 i.e. Selecta

1,6 56 159 A 3.048 <M4>	03.93-09.94	0 451 10 P 3351	O
	10.94-10.95	0 451 10 P 3111	O
	03.93-10.95	1 457 43 S 2180	L
		0 450 90 F 2151 ¹	K
	KL	1 987 43 M 2014	I

Tipo 1.6 MPI 8V

1,6 66 160 E 1.011 <Sevel MPI>	12.95-05.97	1 987 43 M 2014 ⁸	I
---	-------------	-------------------------------------	----------

Tipo 1.7 D

1,7 42 149 B 4.000 <M1>	07.87-10.95	0 451 10 P 3352	O
		1 457 43 S 2185	L
	07.87-03.93	BO,LUC, 1 457 43 N 4106 ²	K
		SWA	
		BO,LUC, 1 457 43 N 4105 ²	K
		SWA	
	07.87-10.95	KL 1 987 43 M 2014	I

Tipo 1.8 i.e., i.e. GT, i.e. 16V

1,8 66/71/77/80/101 159 A 4.000 <M1>; 159 A 4.046 <M2>; 160 A 5.000 <M2>; 835 C 2.000 <M1>; 835 C 4.000 <M4>; 836 A 5.000 <M7>; 836 A 6.000 <M8>	06.89-10.95	0 451 10 P 3350	O
		1 457 43 S 2183	L
		0 450 90 F 5021 ¹	K
	KL	1 987 43 M 2014	I





Tipo 1.9 D

1,9 48 160 A 7.000 <M2>			
	07.89-10.95	0 451 10 P 3352	O
		1 457 43 S 2183	L
	07.89-03.93	BO,SWA 1 457 43 N 4106 ²	K
		BO,SWA 1 457 43 N 4105 ²	K
Mot.Nr. →1360563	03.93-10.95	BO,SWA 1 457 43 N 4106 ²	K
		BO,SWA 1 457 43 N 4105 ²	K
Mot.Nr. 1360564→	03.93-10.95	LUC,SWA 1 457 43 N 4105 ²	K
	07.89-10.95	KL 1 987 43 M 2014	I

Tipo 1.9 D Turbo

1,9 65 160 D 1.000 <M4>			
	03.93-10.95	0 451 10 P 3352	O
		1 457 43 S 2183	L
		KL 1 987 43 M 2014	I
1,9 67,6/68 160 A 6.000 <M3>; 160 A 6.046 <M5>			
	03.93-10.95	0 451 10 P 3352	O
		1 457 43 S 2183	L
		BO,SWA 1 457 43 N 4106 ²	K
		KL 1 987 43 M 2014	I

Tipo 1.9 TD

1,9 59 160 B 6.046 <M4>			
	06.90-03.93	0 451 10 P 3352	O
		1 457 43 S 2183	L
		BO,SWA 1 457 43 N 4106 ²	K
		BO,SWA 1 457 43 N 4105 ²	K
		KL 1 987 43 M 2014	I
1,9 67,6/68 160 A 6.000 <M3>; 160 A 6.046 <M5>			
	07.87-03.93	0 451 10 P 3352	O
		1 457 43 S 2183	L
		BO,SWA 1 457 43 N 4106 ²	K
		BO,SWA 1 457 43 N 4105 ²	K
		KL 1 987 43 M 2014	I

Tipo 2.0 i.e., i.e. 16V

2,0 83/85/104/107 159 A 5.046/6.046 <M3>; 159 A 6.046 <M2>; 160 A 8.046 <M1>; 836 A 3.000 <M3>			
	03.90-10.95	0 451 10 P 3350	O
		1 457 43 S 2183	L
		0 450 90 F 5021 ¹	K
		KL 1 987 43 M 2014	I

Tipo 2.0 i.e. 16V

2,0 104 836 A 3.011 <M6>			
	03.93-10.95	0 451 10 P 3350	O
		1 457 43 S 2183	L
		KL 1 987 43 M 2014	I

Ulysse

Ulysse 1.8 i.e.

1,8 75 LFW <M5>			
Ricam.Nr →8240	05.96-06.99	0 451 10 P 3261	O
Ricam.Nr 8241→	07.99-05.00	0 451 10 P 3355	O
	05.96-05.00	1 457 43 S 2200	L
Ricam.Nr →7844	05.96-05.98	0 450 90 F 5287 ¹	K
	05.96-05.00	3FE 1 987 43 M 2060	I



Ulysse 1.9 TD

1,9 66 DHX <M4>			
	01.95-05.98	0 451 10 P 3261	O
		1 457 43 S 2200	L
		1 457 42 N 9291	K
		3FE 1 987 43 M 2060	I

1,9 | 66 | DHX <M7>

Ricam.Nr 7083→8240	10.96-06.99	0 451 10 P 3261	O
Ricam.Nr 8241→	07.99-12.99	0 451 10 P 3355	O
	10.96-12.99	1 457 43 S 2200	L
		1 457 42 N 9291	K
		3FE 1 987 43 M 2060	I

1,9 | 66 | D8B <M3>

	01.95-05.98	0 451 10 P 3261	O
		1 457 43 S 2200	L
		1 457 42 N 9291	K
		3FE 1 987 43 M 2060	I

Ulysse 2.0 i.e.

2,0 | 90 | RFU <M1>

Ricam.Nr →8240	09.94-06.99	0 451 10 P 3261	O
Ricam.Nr 8241→	07.99-05.00	0 451 10 P 3355	O
	09.94-05.00	1 457 43 S 2200	L
Ricam.Nr →7160	09.94-05.96	0 450 90 F 5030 ¹	K
Ricam.Nr 7161→7844	06.96-05.98	0 450 90 F 5287 ¹	K
	09.94-05.00	3FE 1 987 43 M 2060	I

Ulysse 2.0 i.e. Turbo

2,0 | 110 | RGX <M2>

Ricam.Nr →8240	09.94-06.99	0 451 10 P 3261	O
Ricam.Nr 8241→	07.99-05.00	0 451 10 P 3355	O
	09.94-05.00	1 457 43 S 2200	L
Ricam.Nr →7160	09.94-05.96	0 450 90 F 5030 ¹	K
Ricam.Nr 7161→7844	06.96-05.98	0 450 90 F 5287 ¹	K
	09.94-05.00	3FE 1 987 43 M 2060	I

Ulysse 2.0 i.e. 16V

2,0 | 97 | RFV <M8>

Ricam.Nr 7083→8240	05.98-06.99	0 451 10 P 3261	O
Ricam.Nr 8241→	07.99-05.00	0 451 10 P 3355	O
	05.98-05.00	1 457 43 S 2200	L
Ricam.Nr 8574→	05.98-05.00	0 450 90 F 5287 ¹	K
	05.98-05.00	3FE 1 987 43 M 2060	I

2,0 | 100 | RFN <M10>

	03.00-09.02	0 451 10 P 3355	O
		1 457 43 S 2200	L
		0 450 90 F 5287 ¹	K
		3FE 1 987 43 M 2060	I

Ulysse 2.0 JTD 8V

2,0 | 80 | RHZ <M9>

	07.99-09.02	0 451 10 P 3355	O
		1 457 43 S 2200	L
		1 457 03 N 0013	K
		3FE 1 987 43 M 2060	I



Ulysse 2.0 JTD 16V

2,0 80 RHW <M11>				
	11.00-09.02	0 451 10 P 3355	O	
		1 457 43 S 2200	L	
Ricam.Nr →8911	11.00-04.01	1 457 03 N 0013	K	
	11.00-09.02	3FE 1 987 43 M 2060	I	

Ulysse 2.0 16V

2,0 100 RFN <M1>				
	10.02-10.05	0 451 10 P 3355	O	
		1 457 43 S 2200	L	
		1 987 43 M 2091	I	

Ulysse 2.0 16V JTD

2,0 79 RHM <M7>				
	06.03-01.06	0 451 10 P 3355	O	
Ricam.Nr →10122	06.03-07.04	1 457 43 S 2200	L	
	06.03-01.06	1 457 07 N 0000	K	
		1 987 43 M 2091	I	

2,0 80 RHW <M5>				
	10.02-01.06	0 451 10 P 3355	O	
		1 457 43 S 2200	L	
		1 457 07 N 0000	K	
		1 987 43 M 2091	I	

2,0 88 RHK <M8>				
	02.06-12.10	1 457 42 P 9249	O	
		F 026 40 S 0058	L	
		1 457 43 N 1723	K	
		1 987 43 M 2091	I	

2,0 100 RHR <M9>				
	02.06-12.10	1 457 42 P 9249	O	
		F 026 40 S 0058	L	
		1 457 43 N 1723	K	
		1 987 43 M 2091	I	

Ulysse 2.1 TD

2,1 80 P8C <M6>				
Ricam.Nr 7083→8240	05.96-06.99	0 451 10 P 3261	O	
Ricam.Nr 8241→	07.99-10.99	0 451 10 P 3355	O	
	05.96-10.99	1 457 43 S 2200	L	
Ricam.Nr →7302	05.96-10.96	PRF 1 457 42 N 9291	K	
Ricam.Nr 7303→	11.96-10.99	LUC 1 457 43 N 1702	K	
	05.96-10.99	3FE 1 987 43 M 2060	I	

Ulysse 2.2 16V JTD

2,2 94 4HW <M10>				
	10.02-09.07	0 451 10 P 3355	O	
Ricam.Nr →9428	10.02-09.07	1 457 43 S 2200	L	
	10.02-09.07	1 457 07 N 0000	K	
		1 987 43 M 2091	I	
2,2 125 4HT <M11>				
	10.07-12.10	1 457 42 P 9249	O	
		F 026 40 S 0058	L	
		1 987 43 M 2091	I	



2,2 125 4H01 <M12/M13>				
	10.07-12.10	1 457 42 P 9249	O	
		F 026 40 S 0058	L	
		1 987 43 M 2091	I	

Ulysse 3.0 V6 24V

3,0 150 XFW <M15>				
	01.03-10.05	0 451 10 P 3355	O	
		1 457 43 S 2200	L	
		1 987 43 M 2091	I	

Uno

Uno 0.9

0,9 33 146 A.048 <M1>				
	09.89-03.94	0 451 10 P 3349	O	
		1 457 43 S 2111	L	

Uno 1.0

1,0 32/33 156 A 2.000 <M3>; 156 A 2.048				
	09.89-09.92	0 451 10 P 3111	O	
		1 457 43 S 2173	L	

1,0 33 146 A 2.166 <M1>				
	01.98-05.00	1 457 43 S 3269	L	
		0 450 90 F 2151 ¹	K	

1,0 33 146 A 2.166 <M10>				
	09.89-03.94	0 451 10 P 3111	O	
		1 457 43 S 2173	L	

Uno 1.0 Base

1,0 33 146 C 7.000 <M9>				
	09.89-03.94	1 457 43 S 3269	L	
		0 450 90 F 5005 ¹	K	

Uno 1.0 Cento

1,0 33 146 A.2.166				
Fg.Nr. →1242568	10.96-12.98	1 457 43 S 2173	L	

Uno 1.0 DAV-15

1,0 32 156 A 2.100 <M5>				
	09.89-03.94	0 451 10 P 3111	O	
		1 457 43 S 2173	L	
		0 450 90 F 4058 ¹	K	

Uno 1.0 i.e.

1,0 33 146 D 8.000 <M3>				
	01.96-12.02	0 451 10 P 3111	O	
		1 457 43 S 2173	L	
		0 450 90 F 2151 ¹	K	

1,0 33 156 A 2.246 <M2>				
	01.96-12.02	0 451 10 P 3111	O	
		1 457 43 S 2173	L	
		0 450 90 F 2151 ¹	K	





◀ Uno 1.0 i.e.

1,0 33 156 A 2.246 <M6>	09.89-03.94	0 451 10 P 3111	O
		1 457 43 S 2173	L
		0 450 90 F 2151 ¹	K

Uno 1.0 Trend

1,0 32 146 B 4.000 <M2>	07.90-03.94	0 451 10 P 3351	O
		1 457 43 S 3269	L

Uno 1.1

1,1 40 160 A 3.000 <M6>			
Mot.Nr. →2048106	01.98-12.03	0 451 10 P 3300	O
Mot.Nr. 2048107→	01.98-12.03	0 986 45 P 2041	O
	01.98-12.03	1 457 43 S 2173	L
		0 450 90 F 4058 ¹	K

1,1 41 160 A 3.000 <M4>	09.89-12.00	0 451 10 P 3111	O
		1 457 43 S 2173	L
	09.90-12.98	0 450 90 F 4058 ¹	K

1,1 43 146 A 6.000 <M2>			
Fg.Nr. →9194147	09.89-09.92	0 451 10 P 3351	O
	09.89-09.92	1 457 43 S 3269	L

Uno 1.1 CS

1,1 42 146 A 6.000 <M1>	09.87-09.91	0 451 10 P 3351	O
		0 450 90 F 4058 ¹	K

Uno 1.1 Espresso

1,1 41 160 A 3.000 <M4>	09.90-05.96	0 451 10 P 3111	O
		1 457 43 S 2173	L

Uno 1.1 i.e.

1,1 36/37,5 146 C 3.000 <M8>; 156 C.046 <M7>	09.89-03.94	0 451 10 P 3111	O
		1 457 43 S 2173	L
		0 450 90 F 2151 ¹	K

Uno 1.1 Selecta

1,1 43 146 A 4.048 <M1>			
Fg.Nr. →9194147	09.89-09.92	0 451 10 P 3351	O
Fg.Nr. 9194148→	09.89-09.92	0 451 10 P 3111	O
	09.89-09.92	1 457 42 S 9953	L
		0 450 90 F 4058 ¹	K

Uno 1.2 i

1,2 44 178 D 5.066 <M5>	04.00-03.04	0 451 10 P 3111	O
		1 457 43 S 3255	L
		0 450 90 F 2151 ¹	K

Uno 1.3 D

1,3 33 146 B 1.000 <M1>	09.89-03.92	0 451 10 P 3351	O
		1 457 43 S 3308	L
	BO	1 457 43 D 701 ²	K
		1 457 43 N 4106 ²	K



Uno 1.3 Turbo i.e.

1,3 74 146 A 2.246 <M3>	09.89-03.91	0 451 10 P 3351	O
		1 457 43 S 2178	L
		0 450 90 F 5005 ¹	K

Uno 1.4

1,4 51 146 C 2.028 <M4>	01.98→	0 451 10 P 3111	O
		1 457 43 S 2180	L
		0 450 90 F 4058 ¹	K

1,4 | 51 | 146 C 2.028 <M7>

Fg.Nr. →9194147	09.89-09.92	0 451 10 P 3351	O
Fg.Nr. 9194148→	09.89-09.92	0 451 10 P 3111	O
	09.89-09.92	1 457 43 S 2180	L

Uno 1.4 D Turbo

1,4 52 146 B 3.000 <M2>	09.89-09.92	0 451 10 P 3352	O
		1 457 43 S 3259	L
	BO	1 457 43 D 701 ²	K
		1 457 43 N 4106 ²	K

Uno 1.4 DAV-15

1,4 52 160 A 1.048 <M5>			
Fg.Nr. →9194147	09.89-03.94	0 451 10 P 3351	O
Fg.Nr. 9194148→	09.89-03.94	0 451 10 P 3111	O
	09.89-03.94	1 457 43 S 2180	L

Uno 1.4 i

1,4 52 146 A 4.045			
Mot.Nr. →9039157	08.93-12.98	0 451 10 P 3351	O
	05.90-12.98	1 457 43 S 2180	L

1,4 | 52 | 146 C 1.000

Mot.Nr. →9039157	08.93-05.96	0 451 10 P 3351	O
	05.90-12.00	1 457 43 S 2180	L
	05.90-05.96	0 450 90 F 5002 ¹	K

Uno 1.4 i.e.

1,4 51 160 A 1.046 <M4>			
Fg.Nr. →9194147	09.89-03.94	0 451 10 P 3351	O
Fg.Nr. 9194148→	09.89-03.94	0 451 10 P 3111	O
	09.89-03.94	1 457 43 S 2180	L
		0 450 90 F 2151 ¹	K

1,4 | 52 | 146 C 1.000 <M3>

Fg.Nr. →9194147	09.89-09.92	0 451 10 P 3351	O
Fg.Nr. 9194148→	09.89-09.92	0 451 10 P 3111	O
	09.89-09.92	1 457 43 S 2180	L
		0 450 90 F 2151 ¹	K

Uno 1.4 Turbo i.e.

1,4 84 146 A 8.046 <M2>	10.90-12.93	0 451 10 P 3351	O
		1 457 43 S 2178	L
		0 450 90 F 5005 ¹	K

1,4 | 85 | 146 A 8.000 <M1>

	04.94-12.98	0 451 10 P 3300	O
	05.90-12.98	1 457 43 S 2178	L
Ricam.Nr →0170974	05.90-12.98	0 450 90 F 5005 ¹	K





1,4 87 146 A 8.000 <M1>	09.89-09.92	0 451 10 P 3351	O
		1 457 43 S 2178	L
		0 450 90 F 5005	¹ K

Uno 1.5 i.e., i.e. Selecta

1,5 55 149 C 1.000 <M6>			
Fg.Nr. →9194147	09.89-03.94	0 451 10 P 3351	O
Fg.Nr. 9194148→	09.89-03.94	0 451 10 P 3111	O
	09.89-03.94	1 457 42 S 9953	L
		0 450 90 F 2151	¹ K

Uno 1.7 D

1,7 42 146 B 2.000 <M3>	09.89-03.94	0 451 10 P 3352	O
Mot.Nr. →1872201	09.89-03.94	1 457 43 S 3285	L
Mot.Nr. 1872202→	09.89-03.94	1 457 43 S 3286	L
Ricam.Nr →1028734	09.89-03.94	BO 1 457 43 D 701	² K
		1 457 43 N 4106	² K
Ricam.Nr 1028735→	09.89-03.94	LUC 1 457 43 N 4105	² K

1,7 42 146 B 2.000 <M10>	01.98-06.99	0 451 10 P 3352	O
Mot.Nr. →2404558	07.99-03.04	0 451 10 P 3354	O
Mot.Nr. 2404559→	01.98-03.04	1 457 43 S 3286	L
	01.98-12.03	SWA 1 457 43 N 4106	² K
		SWA 1 457 43 N 4105	² K

1,7 46 146 B 2.000 <M10>	01.96-04.99	0 451 10 P 3352	O
Mot.Nr. →2404557	01.96-04.99	1 457 43 S 3286	L

Uno 1.9 D

1,9 44 149 B 5.046 <M4>	09.89-03.94	0 451 10 P 3352	O
	BO	1 457 43 D 701	² K
		1 457 43 N 4106	² K

126

126 BIS

0,7 20 126 A 2.000/2.048 <M1/M2>	09.87-09.00	0 450 90 F 4058	¹ K
---	-------------	------------------------	-----------------------

147

147 1.3 CLD Spazio

1,3 33 146B000	02.84-11.97	0 451 10 P 3351	O
		1 457 43 N 4106	² K

500

500 1.2

1,2 51 169 A 4.000	07.09-05.10	0 986 45 P 2041	O
	06.10→	0 451 10 P 3364	O
	07.09→	F 026 40 S 0036	L

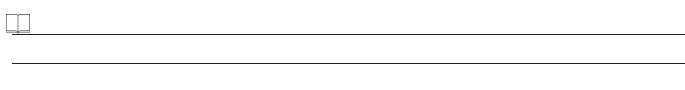

1,2 51 169 A 4.000 <M8>	07.07→	0 986 45 P 2041	O
		F 026 40 S 0036	L
	MKL	1 987 43 M 2106	I

500 1.2 LPG

1,2 51	09.10→	0 451 10 P 3364	O
		F 026 40 S 0036	L

500 1.3 MJTD

1,3 55 169 A 1.000	07.09→	PRF 1 457 42 P 9256	O
		F 026 40 S 0002	L
		1 457 07 N 0001	K

1,3 55 169 A 1.000 <M73>	07.07→	PRF 1 457 42 P 9256	O
		F 026 40 S 0002	L
		1 457 07 N 0001	K
		KL 1 987 43 M 2106	I
		MKL 1 987 43 M 2106	I

500 1.4

1,4 74 169 A 3.000	07.09→	0 986 45 P 2041	O
		F 026 40 S 0053	L

1,4 74 169 A 3.000 <M17>	07.07→	0 986 45 P 2041	O
		F 026 40 S 0053	L
		KL 1 987 43 M 2106	I
		MKL 1 987 43 M 2106	I

500 1.4 Abarth

1,4 99/132 312 A 1.000; 312 A 1.000 <M20>; 312 A 3.000	05.08→	1 457 42 P 9256	O
---	--------	------------------------	----------

FISSORE

Rayton

Rayton 2.4 D Turbo 4x4

2,4 82 HR 492 HIM	03.88-12.01	1 457 43 D 701	² K
------------------------------	-------------	-----------------------	-----------------------





FORD *

A

A 0407

2,0 57 NAT <OHC VV LC>	01.86-12.99	0 451 10 P 3029	O
----------------------------	-------------	-----------------	----------

C-MAX

C-MAX 1.6

1,6 74 <Duratec-16V SFI>	03.07-07.10	F 026 40 P 7078	O
		F 026 40 S 0136	L
		1 987 43 R 2409 ⁸	I

C-MAX 1.6 EcoBoost, Ti-VCT

1,6 77/88-92/110/132-134	08.10→	F 026 40 P 7078	O
----------------------------	--------	-----------------	----------

C-MAX 1.6 TDCi

1,6 66/80 <Duratorq>; <Duratorq-TDCi>	03.07-07.10	1 457 42 P 9238	O
		F 026 40 S 0136	L
		F 026 40 N 2046 ¹	K
		1 987 43 R 2409 ⁸	I

1,6 70/85 T1D...; T3D...	08.10→	1 457 42 P 9238	O
------------------------------	--------	-----------------	----------

C-MAX 1.8 , FFV

1,8 92 <Duratec-HE SFI>	03.07-07.10	0 451 10 P 3363	O
		F 026 40 S 0136	L
		1 987 43 R 2409 ⁸	I

C-MAX 1.8 TDCi

1,8 85 KKDA <Duratorq-TDCi>	03.07-07.10	F 026 40 P 7017	O
		F 026 40 S 0136	L
		F 026 40 N 2007	K
		1 987 43 R 2409 ⁸	I

C-MAX 2.0 , CNG, LPG

2,0 93-107 <Duratec BI-FUEL CNG>; <Duratec BI-FUEL LPG>; <Duratec-HE SFI>	03.07-07.10	0 451 10 P 3363	O
		F 026 40 S 0136	L
		1 987 43 R 2409 ⁸	I

C-MAX 2.0 TDCi

2,0 81/100 <Duratorq-TDCi>	03.07-07.10	1 457 42 P 9249	O
		F 026 40 S 0136	L
		1 457 43 N 1723	K
		1 987 43 R 2409 ⁸	I

2,0 85/100-103/120	08.10→	1 457 42 P 9249	O
----------------------	--------	-----------------	----------



Corsair

Corsair 2.0 i

2,0 83 CA20E	09.88-08.92	0 986 45 P 2023	O
		1 987 42 S 9051	L
		0 450 90 F 5030 ¹	K

Cougar

Cougar 2.0 i

2,0 96 EDDB <ZH20 Zetec E DOHC>; EDDB <ZH20 Zetec E DOHC>; EDDB <ZH20 Zetec E DOHC>; EDDB <ZH20 Zetec E DOHC>	08.98-12.00	0 451 10 P 3259	O
		1 457 43 S 3609	L
		1 987 43 M 2018	I
		1 987 43 R 2318 ⁸	I

Cougar 2.5 i

2,5 125 LCBA <MP25 Duratec-VE SEFI>; LCBB <MP25 Duratec-VE SEFI>	08.98-12.00	0 451 10 P 3333	O
		1 457 43 S 3088	L
		1 987 43 M 2018	I
		1 987 43 R 2318 ⁸	I

2,5 125 LCBC <MP25 Duratec-VE SEFI>	08.98-12.00	0 451 10 P 3333	O
		1 457 43 S 3088	L
		0 450 90 F 5324 ¹	K
		1 987 43 M 2018	I
		1 987 43 R 2318 ⁸	I

Cougar 2.5 i, i ST200

2,5 125/147-151 LCBE <MP25 Duratec-VE SEFI>; MABB <MP25 Duratec-VE SEFI>	08.98-12.00	0 451 10 P 3333	O
		1 457 43 S 3088	L
		1 987 43 M 2018	I
		1 987 43 R 2318 ⁸	I

Courier

Courier 1.4 i 16V

1,4 66 FVKB <Zetec-S>	07.97-08.99	F 026 40 P 7078	O
---------------------------	-------------	-----------------	----------

Courier 2.6 i, i 4x4

2,6 92 G6	09.90-10.02	0 986 45 P 2041	O
---------------	-------------	-----------------	----------

Econovan

Econovan 1.8

1,8 59 F8	01.84-02.97	0 451 10 P 3336	O
		0 986 45 F 0117 ¹	K

Econovan 2.0

2,0 63 FE	02.97-09.99	0 986 45 F 0117 ¹	K
---------------	-------------	------------------------------	----------





Econovan 2.0 D

2,0 41 RF <Mazda>	02.86-12.99	HAU	0 451 10 P 3316	0
		NEB	0 451 10 P 3270	0
			1 457 43 N 4452 ²	K

Escape

Escape 2.0 i

2,0 95 YF	04.02→		0 451 10 P 3371	0

Escape 2.3 i

2,3 98 Duratec-HEd-VIT <U204>	03.04→		0 451 10 P 3033	0
2,3 116 L3	08.04→		1 457 42 P 9257	0

Escape 2.3 i 4x4

2,3 108 L3 <L3 MZR>	01.04→		1 457 42 P 9257	0
			1 987 42 S 9188	L
			0 450 90 F 5324 ¹	K

Escape 3.0 i

3,0 152 Duratec	09.00-08.08		0 986 45 P 2001	0

Escort

Escort 1.6 i 16V

1,6 65 <ZETEC, CFI>	12.97-01.00		0 451 10 P 3259	0
			1 457 42 S 9791	L

Escort RS

Escort RS 2.0 i Cosworth

2,0 162 N5E <CH20 Cosworth>	01.95-12.95		0 451 10 P 3029	0
			0 450 90 F 5964 ¹	K
2,0 162 N5E <DOHC Cosworth>; N5F <DOHC Cosworth>	04.92-12.94		0 451 10 P 3029	0
			0 450 90 F 5200 ¹	K

Escort RS 2000

2,0 110 N7A <DOHC-16V EFI>	05.91-12.94		0 451 10 P 3029	0
			1 457 42 S 9791	L
			0 450 90 F 5195 ¹	K
			0 450 90 F 5324 ¹	K



Escort RS 2000 , 4x4

2,0 110 N7A <DOHC 16V EFI>	01.95-08.96		0 451 10 P 3029	0
			1 457 42 S 9791	L
			0 450 90 F 5324 ¹	K

Escort VII

Escort VII 1.3 i

1,3 44 J4B <Endura-E SEFI>	01.95-09.01		0 451 10 P 3298	0
			1 457 42 S 9791	L
			0 450 90 F 5324 ¹	K

Escort VII 1.3 i

1,3 44 J6A <BL13 HCS CFI>	01.95-09.01		0 451 10 P 3298	0
			1 457 42 S 9791	L
			1 457 42 S 9819	L
			0 450 90 F 5324 ¹	K

Escort VII 1.4 i

1,4 54 F4B <HL14 CVH, PTE/SEFI>	01.95-09.01		0 451 10 P 3298	0
			1 457 42 S 9791	L
			0 450 90 F 5324 ¹	K

Escort VII 1.6 i 16V

1,6 65/66 L1E <ZH16, ZETEC-E>; L1H <ZH16, ZETEC-E>; L1K <ZH16, ZETEC-E>	01.95-09.01		0 451 10 P 3259	0
			1 457 42 S 9791	L
			0 450 90 F 5324 ¹	K

Escort VII 1.6 i 16V

1,6 66 L1E <ZH16 ZETEC>	01.95-09.01		0 451 10 P 3259	0
			1 457 42 S 9791	L
			0 450 90 F 5324 ¹	K
			1 987 43 M 2084	I

Escort VII 1.6 i 16V

1,6 66 L7 <ZETEC, CFI>	08.96-01.00		1 457 42 S 9791	L
------------------------	-------------	--	-----------------	---

Escort VII 1.6 i 16V 4x4

1,6 66 L1E <ZH16 ZETEC>	01.95-09.01		0 451 10 P 3259	0
			1 457 42 S 9791	L
			0 450 90 F 5324 ¹	K

Escort VII 1.8 D

1,8 44 RT... <D18NA>; RTF <D18NA>; RTH <D18NA>	01.95-09.01		0 451 10 P 3227	0
			1 457 42 S 9791	L
		BO	0 450 90 N 6261 ¹	K
		LUC	1 457 43 N 4201 ²	K

Escort VII 1.8 i 16V

1,8 77 RDA <ZH18, ZETEC>	01.95-09.01		0 451 10 P 3259	0
			1 457 42 S 9791	L
			0 450 90 F 5324 ¹	K





◀ Escort VII 1.8 i 16V

1,8 85 RKC <ZETEC>	09.96-01.00	0 451 10 P 3259	O
		1 457 42 S 9791	L
1,8 85 RKC <ZH18, ZETEC-E>	09.95-09.01	0 451 10 P 3259	O
		1 457 42 S 9791	L
		0 450 90 F 5324 ¹	K
1,8 85 <ZETEC>	09.96-01.00	0 451 10 P 3259	O
		1 457 42 S 9791	L

Escort VII 1.8 TD

1,8 51 RVA <D18TC>	10.95-09.01	0 451 10 P 3227	O
		1 457 42 S 9791	L
		1 457 43 N 4201 ²	K
1,8 66 RF... <D18TI>; RFD <D18TI>; RFK <D18TI>	01.95-09.01	0 451 10 P 3227	O
		1 457 42 S 9791	L
		1 457 43 N 4201 ²	K

Escort VII Express

Escort VII Express 1.4 i 55, i 75

1,4 54 F4B <HL14 CVH, PTE/SEFI>	01.95-09.01	0 451 10 P 3298	O
		1 457 42 S 9791	L
		0 450 90 F 5324 ¹	K

Escort VII Express 1.8 D 55, D 75

1,8 44 RTF <D18NA>; RTH <D18NA>	01.95-09.01	0 451 10 P 3227	O
		1 457 42 S 9791	L
	BO	0 450 90 N 6261 ¹	K
	LUC	1 457 43 N 4201 ²	K

Escort VII Express 1.8 TD

1,8 51 RVA <D18TC>	10.95-09.01	0 451 10 P 3227	O
		1 457 42 S 9791	L
		1 457 43 N 4201 ²	K

Escort V/VI

Escort V/VI 1.1

1,1 40 GUF <HCS 2V HC>	08.90-12.94	0 451 10 P 3298	O
		1 457 42 S 9920	L

Escort V/VI 1.3

1,3 44/46 JBD <HCS 2V HS>; JBE <HCS 2V HC>	08.90-12.94	0 451 10 P 3298	O
		1 457 42 S 9819	L



Escort V/VI 1.3 i

1,3 44 J6A <HCS CFI HC>	08.90-12.94	0 451 10 P 3298	O
		1 457 42 S 9819	L
	08.90-12.91	0 450 90 F 5195 ¹	K
	01.92-12.94	0 450 90 F 5324 ¹	K

Escort V/VI 1.4

1,4 54 FUH <CVH 2V LC>	08.90-12.94	0 451 10 P 3298	O
		1 457 42 S 9775	L
	08.90-09.92	0 450 90 F 5324 ¹	K

Escort V/VI 1.4 i

1,4 52 F6F <CVH CFI LC>; F6G <CVH CFI LC>	08.90-12.94	0 451 10 P 3298	O
		1 457 42 S 9775	L
	08.90-12.91	0 450 90 F 5195 ¹	K
	01.92-12.94	0 450 90 F 5324 ¹	K

1,4 | 54-55 | F4B <CVH, PTE/SEFI>

	07.93-12.94	0 451 10 P 3298	O
	01.94-12.94	1 457 42 S 9791	L
	07.93-12.94	0 450 90 F 5324 ¹	K

Escort V/VI 1.6

1,6 65/66 LUJ <CVH 2V HC>; LUK <CVH 2V HC>	08.90-12.94	0 451 10 P 3298	O
		1 457 42 S 9775	L
		0 450 90 F 5324 ¹	K

Escort V/VI 1.6 i

1,6 77/79 LJE <CVH EFI HC>; LJF <CVH EFI HC>	08.90-09.92	0 451 10 P 3298	O
		1 457 42 S 9791	L
	08.90-12.91	0 450 90 F 5195 ¹	K
	01.92-09.92	0 450 90 F 5324 ¹	K

Escort V/VI 1.6 i 16V

1,6 65/66 L1E <ZETEC>; L1H <ZETEC>	09.92-12.94	0 451 10 P 3259	O
		1 457 42 S 9791	L
		0 450 90 F 5324 ¹	K

Escort V/VI 1.8 D

1,8 44 RT... <D18NA>; RTH <D18NA>	08.90-12.94	0 451 10 P 3227	O
		1 457 42 S 9791	L
	08.90-05.93	BO, VOW 0 450 90 N 6172 ¹	K
	08.90-12.94	CAV 1 457 43 N 4201 ²	K
	07.93-12.94	BO, VOW 0 450 90 N 6261 ¹	K

Escort V/VI 1.8 i 16V

1,8 77 RDA <ZETEC>	03.92-12.94	0 451 10 P 3259	O
		1 457 42 S 9791	L
		0 450 90 F 5324 ¹	K

1,8 | 96 | RQB <ZETEC>

	02.92-12.94	0 451 10 P 3259	O
		1 457 42 S 9791	L
		0 450 90 F 5324 ¹	K





Escort V/VI 1.8 TD

1,8 66 RF... <D18T>			
	06.93-12.94	0 451 10 P 3227	O
		1 457 42 S 9791	L
	CAV	1 457 43 N 4201 ²	K

Escort V/VI Express

Escort V/VI Express 1.3

1,3 46 JBD <HCS 2VHC>			
	08.90-12.94	0 451 10 P 3298	O
		1 457 42 S 9819	L

Escort V/VI Express 1.4 i

1,4 52 F6F <CVH CFILC>; F6G <CVH CFILC>			
	08.90-12.94	0 451 10 P 3298	O
		1 457 42 S 9775	L
	08.90-12.91	0 450 90 F 5195 ¹	K
	01.92-12.94	0 450 90 F 5324 ¹	K

Escort V/VI Express 1.8 D

1,8 44 RTH <D18NA>			
	08.90-12.94	0 451 10 P 3227	O
		1 457 42 S 9791	L
	08.90-05.93	BO,VOW 0 450 90 N 6172 ¹	K
	08.90-12.94	CAV 1 457 43 N 4201 ²	K
	07.93-12.94	BO,VOW 0 450 90 N 6261 ¹	K

Escort XR3/XR3i

Escort XR3/XR3i 1.6 i

1,6 65-66 L1E <ZH16, ZETEC-E>; L1H <ZH16, ZETEC-E>; L1K <ZH16, ZETEC-E>			
	01.95-09.01	0 451 10 P 3259	O
		1 457 42 S 9791	L
		0 450 90 F 5324 ¹	K

Escort XR3/XR3i 1.8 i

1,8 77/85/96 RDA <ZETEC>; RDA <ZH18, ZETEC>; RKC <ZH18, ZETEC-E>; RQB <ZETEC>; RQB <ZH18, ZETEC>			
	02.92-09.01	0 451 10 P 3259	O
		1 457 42 S 9791	L
		0 450 90 F 5324 ¹	K

Explorer

Explorer 2.3 i

2,3A <MPI>			
	10.98-12.99	0 450 90 F 5939 ¹	K

Explorer 3.0 i

3,0 108 U <MPI>			
	10.98-12.99	0 450 90 F 5939 ¹	K

Explorer 4.0

4,0 153			
	10.98-09.00	0 450 90 F 5939 ¹	K



Explorer 4.0 , 4x4

4,0 108-119			
	01.91-08.96	0 451 10 P 3357	O

Explorer 4.0 4x4

4,0 119			
	09.96-08.00	0 451 10 P 4063	O
	10.98-08.00	0 450 90 F 5939 ¹	K

4,0 153			
	09.96-08.01	0 451 10 P 3357	O
	10.98-09.00	0 450 90 F 5939 ¹	K

Explorer 5.0 i

5,0 160			
	10.98-09.00	0 450 90 F 5939 ¹	K

Fairlane

Fairlane 3.9 i

3,9 139 P			
	10.89-02.92	0 986 45 P 2001	O
		1 457 42 S 9898	L
	10.89-06.91	0 450 90 F 5002 ¹	K

Fairlane 4.0 i

4,0 148 H			
	03.92-02.95	0 986 45 P 2001	O
		1 457 42 S 9898	L

4,0|157|H

	03.95-08.96	0 986 45 P 2001	O
--	-------------	-----------------	----------

4,0|162|X

	09.96-02.99	0 451 10 P 4063	O
--	-------------	-----------------	----------

4,0|182|H <Barra 182>

	07.03-02.05	0 451 10 P 4063	O
--	-------------	-----------------	----------

Fairlane 5.0 i

5,0 165 Z			
	07.91-02.92	0 986 45 P 2001	O

5,0|175|Z

	02.99-06.00	0 451 10 P 4063	O
--	-------------	-----------------	----------

Falcon

Falcon 4.0

4,0 148 H			
	03.97→	1 457 42 S 9898	L

4,0|157|X

	03.97→	1 457 42 S 9898	L
--	--------	-----------------	----------

Falcon 4.0 i

4,0 148 H			
	03.93-03.96	0 986 45 P 2001	O
		SSZ 1 457 42 S 9898	L
		SSZ 1 457 42 S 9933	L





◀ Falcon 4.0 i

4,0 157 H	09.94-09.95	0 986 45 P 2001	O
4,0 157 H <Intech 6 cyl OHC>	04.96→	0 986 45 P 2001	O
4,0 161 X	10.92-07.93	0 986 45 P 2001 1 457 42 S 9898	O L

Falcon 4.0 LPG

4,0 143 S	04.01-09.02	0 451 10 P 4063	O
-----------	-------------	-----------------	---

Festiva

Festiva 1.3

1,3 46 U	06.91-03.94	0 451 10 P 3316 1 987 42 S 9172 0 986 45 F 0117 ¹	O L K
----------	-------------	--	-------------

Festiva 1.3 i

1,3 47 U	04.94-12.96	0 451 10 P 3316 1 457 43 S 3961	O L
----------	-------------	------------------------------------	--------

1,3|56| Mazda-B3-MI

01.93-10.00	1 987 42 S 9146	L
-------------	-----------------	---

Fiesta

Fiesta 1.3 i

1,3 44 J6B <HCS>	05.97-12.99	1 457 43 S 3605 0 450 90 F 5324 ¹	L K
------------------	-------------	---	--------

1,3|55| <Rocam>

03.03-12.04	0 451 10 P 3259	O
-------------	-----------------	---

Fiesta 1.4 i

1,4 55 <CVH14/PTE>	10.98-02.00	1 457 43 S 3605 0 450 90 F 5324 ¹	L K
---------------------	-------------	---	--------

Fiesta 1.4 i 16V

1,4 66 FHC <Zetec-SE>	04.96-08.99	F 026 40 P 7078	O
-----------------------	-------------	-----------------	---

Fiesta 1.6 i

1,6 72 CCJA <Zetec Rocam>	05.02→	0986B0B7TOP3/4-S	O
---------------------------	--------	------------------	---

Fiesta III

Fiesta III 1.0

1,0 33 TLB <HCS 1V HC>	03.89-12.96	0 451 10 P 3298 1 457 42 S 9920 1 987 43 M 2006	O L I
------------------------	-------------	---	-------------



Fiesta III 1.1

1,1 40 GU... <HCS 2V HC>	03.89-12.96	0 451 10 P 3298 1 457 42 S 9920 1 987 43 M 2006	O L I
--------------------------	-------------	---	-------------

Fiesta III 1.1 i

1,1 36-37 G6A <HCS CFI HC>	03.89-12.96	0 451 10 P 3298 1 457 42 S 9920	O L
	03.89-02.92	0 450 90 F 5200 ¹	K
	03.92-12.96	0 450 90 F 5324 ¹	K
	03.89-12.96	1 987 43 M 2006	I

Fiesta III 1.3

1,3 44 JBC <HCS 2V HC>	06.91-12.96	0 451 10 P 3298 1 457 42 S 9819 1 987 43 M 2006	O L I
------------------------	-------------	---	-------------

Fiesta III 1.3 i

1,3 43-44 J6B <HCS CFI HC>	06.91-12.96	0 451 10 P 3298 1 457 42 S 9819	O L
	06.91-02.92	0 450 90 F 5200 ¹	K
	03.92-12.96	0 450 90 F 5324 ¹	K
	06.91-12.96	SAZ 1 987 43 M 2006	I

Fiesta III 1.4

1,4 54/55 FU... <CVH 2V LC>; FUF <CVH 2V HC>	03.89-12.96	0 451 10 P 3298 1 457 42 S 9775 1 987 43 M 2006	O L I
--	-------------	---	-------------

Fiesta III 1.4 i

1,4 52 F6E <CVH CFI HC>	03.89-12.96	0 451 10 P 3298 1 457 42 S 9775	O L
	03.89-02.92	0 450 90 F 5200 ¹	K
	03.92-12.96	0 450 90 F 5324 ¹	K
	03.89-12.96	SAZ 1 987 43 M 2006	I

1,4|54-55|F4A <CVH EFI HC>

01.94-12.96	0 451 10 P 3298 1 457 43 S 3617	O L
SAZ	1 987 43 M 2006	I

Fiesta III 1.6

1,6 66 LUH <CVH 2V HC>	03.89-12.96	0 451 10 P 3298 1 457 42 S 9775 1 987 43 M 2006	O L I
------------------------	-------------	---	-------------

Fiesta III 1.6 i 16V

1,6 65-66 L1G <ZH SEFI>	02.94-12.96	0 451 10 P 3259 XXX 1 457 43 S 3036 0 450 90 F 5324 ¹ 1 987 43 M 2006	O L K I
-------------------------	-------------	---	------------------





Fiesta III 1.6 Turbo, XR2i

1,6 76/81/96-98 LHA <CVH EFI HC>; LJC <CVH EFI HC>; LJD <CVH EFI HC>			
03.89-12.96	0 451 10 P 3298	O	
	1 457 42 S 9842	L	
03.89-02.92	0 450 90 F 5964 ¹	K	
03.92-12.96	0 450 90 F 5324 ¹	K	
03.89-12.96	1 987 43 M 2006	I	

Fiesta III 1.8 D

1,8 44 RT... <DSL>			
03.89-12.96	0 451 10 P 3227	O	
03.89-01.94	1 457 42 S 9842	L	
02.94-12.96	1 457 43 S 3711	L	
03.89-05.93	BO,VOW 0 450 90 N 6172 ¹	K	
10.90-12.96	CAV 1 457 43 N 4201 ²	K	
06.93-12.96	BO,VOW 0 450 90 N 6261 ¹	K	
03.89-12.96	SAZ 1 987 43 M 2006	I	

Fiesta III 1.8 i 16V, XR2i 16V

1,8 77/93-96 RDA <ZH SEFI>; RDB <ZH SEFI>; RQC <ZH SEFI>			
02.92-12.96	0 451 10 P 3259	O	
	XXX 1 457 43 S 3036	L	
03.92-12.96	0 450 90 F 5324 ¹	K	
02.92-12.96	1 987 43 M 2006	I	

Fiesta III Courier

Fiesta III Courier 1.3

1,3 44 JBC <HCS 2V>; JBC <HCS 2V HC>			
09.91-08.96	0 451 10 P 3298	O	
	1 457 42 S 9819	L	
	SAZ 1 987 43 M 2006	I	

Fiesta III Courier 1.3 i

1,3 44 J6B <HCS CFI>			
09.91-08.96	0 451 10 P 3298	O	
	1 457 42 S 9819	L	
09.91-02.92	0 450 90 F 5200 ¹	K	
03.92-08.96	0 450 90 F 5324 ¹	K	
09.91-08.96	SAZ 1 987 43 M 2006	I	

Fiesta III Courier 1.8 D

1,8 44 RT... <D18NA>			
09.91-08.96	0 451 10 P 3227	O	
09.91-02.94	1 457 42 S 9842	L	
03.94-08.96	1 457 43 S 3711	L	
09.91-08.96	0 450 90 N 6172 ¹	K	
	CAV 1 457 43 N 4200 ²	K	
	SAZ 1 987 43 M 2006	I	

Fiesta IV

Fiesta IV 1.25 i 16V

1,2 55 DH... <ZH12, Zetec-SE>			
11.95-12.02	F 026 40 P 7078	O	
11.95-12.99	1 457 43 S 3605	L	
01.00-12.02	1 457 43 S 3083	L	
11.95-12.02	0 450 90 F 5324 ¹	K	
	1 987 43 M 2006	I	

Fiesta IV 1.3 i

1,3 37/44 JJ... <BL13, Endura-E, SEFI>; J4... <BL13, Endura-E, SEFI>			
11.95-12.02	0 451 10 P 3298	O	
	1 457 43 S 3605	L	
	0 450 90 F 5324 ¹	K	
	1 987 43 M 2006	I	
	1 987 43 R 2306 ⁸	I	

Fiesta IV 1.4 i 16V

1,4 66 FH... <ZH14, Zetec-SE, SEFI>			
01.96-12.00	F 026 40 P 7078	O	
	1 457 43 S 3605	L	
	0 450 90 F 5324 ¹	K	
	1 987 43 M 2006	I	
	1 987 43 R 2306 ⁸	I	

Fiesta IV 1.6 i 16V

1,6 76 L1... <ZH16 Zetec-SE, SEFI>			
02.00-12.02	0 451 10 P 3259	O	
	1 457 43 S 3605	L	
	0 450 90 F 5324 ¹	K	
	1 987 43 M 2006	I	
	1 987 43 R 2306 ⁸	I	

Fiesta IV 1.8 D

1,8 44 RT... <D18, Endura-DE>			
10.95-06.01	0 451 10 P 3227	O	
	1 457 43 S 3605	L	
	BO 0 450 90 N 6261 ¹	K	
	LUC 1 457 43 N 4201 ²	K	
	1 987 43 M 2006	I	
	1 987 43 R 2306 ⁸	I	

Fiesta IV 1.8 TD

1,8 55 RT... <LD18, Endura-DI>			
02.00-12.02	0 451 10 P 3252	O	
	1 457 43 S 3605	L	
	0 450 90 N 6357 ¹	K	
	1 987 43 M 2006	I	
	1 987 43 R 2306 ⁸	I	





Fiesta IV Courier

Fiesta IV Courier 1.3 i

1,3 44 J4... <BL13, Endura-E, SEFI>			
11.95-12.02	0451 10	P 3298	O
	1457 43	S 3605	L
	0450 90	F 5324 ¹	K
	1987 43	M 2006	I
	1987 43	R 2306 ⁸	I

Fiesta IV Courier 1.4 i

1,4 66 FH... <ZH14, Zetec-SE, SEFI>			
01.96-12.00	F 026 40	P 7078	O
	1457 43	S 3605	L
	0450 90	F 5324 ¹	K
	1987 43	M 2006	I
	1987 43	R 2306 ⁸	I

Fiesta IV Courier 1.8 D

1,8 44 RT... <D18, Endura-DE>			
10.95-06.01	0451 10	P 3227	O
	1457 43	S 3605	L
	BO	0450 90	N 6261 ¹ K
	LUC	1457 43	N 4201 ² K
		1987 43	M 2006 I
		1987 43	R 2306 ⁸ I

Fiesta IV Courier 1.8 TD

1,8 55 RT... <LD18, Endura-DI>			
02.00-12.02	0451 10	P 3252	O
	1457 43	S 3605	L
	0450 90	N 6357 ¹	K
	1987 43	M 2006	I
	1987 43	R 2306 ⁸	I

Fiesta V

Fiesta V 1.25 i

1,2 51/55 FUJ... <Duratec 16V SFI>; M7J... <Duratec 16V SFI>			
12.02-09.08	F 026 40	P 7078	O
	1457 43	S 3593	L
	0450 90	F 5926 ¹	K
	1987 43	M 2087	I
	1987 43	R 2387 ⁸	I

Fiesta V 1.3 i

1,3 44/51 A9J... <Duratec EFI>; BAJA <Duratec 8V SFI>			
11.01-09.08	0451 10	P 3259	O
	1457 43	S 3593	L
	0450 90	F 5926 ¹	K
	1987 43	M 2087	I
	1987 43	R 2387 ⁸	I

Fiesta V 1.4 i

1,4 59 FXJ... <Duratec 16V SFI>			
11.01-09.08	F 026 40	P 7078	O
	1457 43	S 3593	L
	0450 90	F 5926 ¹	K
	1987 43	M 2087	I
	1987 43	R 2387 ⁸	I



Fiesta V 1.4 TDCi

1,4 50 F6J... <Duratorq TDCi>			
11.01-09.08	1457 42	P 9238	O
	1457 43	S 3076	L
	0450 90	N 6460 ¹	K
	1987 43	M 2087	I
	1987 43	R 2387 ⁸	I

Fiesta V 1.6 i

1,6 74 FYJ... <Duratec 16V SFI>			
11.01-09.08	F 026 40	P 7078	O
	WW	0451 10	P 3259 O
		1457 43	S 3593 L
		0450 90	F 5926 ¹ K
		1987 43	M 2087 I
		1987 43	R 2387 ⁸ I

Fiesta V 1.6 TDCi

1,6 66 HHJ... <Duratorq TDCi>			
11.04-09.08	1457 42	P 9238	O
11.04-07.06	F 026 40	S 0110	L
11.04-09.08	TW	0450 90	N 6471 ¹ K
10.05-09.08	TW	F 026 40	N 2046 ¹ K
11.04-09.08		1987 43	M 2087 I
		1987 43	R 2387 ⁸ I

Fiesta V 2.0 i ST150

2,0 110 N4JB <Duratec 16V SFI>			
11.04-09.08	0451 10	P 3363	O
	0450 90	F 5926 ¹	K
	1987 43	M 2087	I
	1987 43	R 2387 ⁸	I

Fiesta VI

Fiesta VI 1.25 i

1,2 44/60 SNJ... <Euro4/Euro5>; ST... <Euro4/Euro5>			
07.08→	F 026 40	P 7078	O
	F 026 40	S 0135	L
	1987 43	M 2215	I
	1987 43	R 2415 ⁸	I

Fiesta VI 1.4 i, LPG

1,4 68-71 RTJ... <Euro4/Euro5>; SPJ... <Euro4/Euro5>			
07.08→	F 026 40	P 7078	O
	F 026 40	S 0135	L
	1987 43	M 2215	I
	1987 43	R 2415 ⁸	I

Fiesta VI 1.4 TDCi

1,4 50 F6J... <Euro4>			
07.08→	1457 42	P 9238	O
	1457 43	S 3076	L
	0450 90	N 6460 ¹	K
	1987 43	M 2215	I
	1987 43	R 2415 ⁸	I





1,4 51 KVJA <Euro5>			
09.10→	1 457 42	P 9238	O
	F 026 40	S0135	L
	1 987 43	M 2215	I
	1 987 43	R 2415⁸	I

Fiesta VI 1.6 TDCi

1,6 55/66 HHJ... <Euro4>; HHJF <Euro4>			
07.08→	1 457 42	P 9238	O
	F 026 40	S0135	L
	F 026 40	N 2046¹	K
	1 987 43	M 2215	I
	1 987 43	R 2415⁸	I

1,6 55/70 TZJ... <Euro5>; UBJA <Euro5>			
03.10→	1 457 42	P 9238	O
	F 026 40	S0135	L
	1 987 43	M 2215	I
	1 987 43	R 2415⁸	I

Fiesta VI 1.6 Ti-VCT

1,6 88 HXJ... <Euro4/Euro5>			
07.08→	F 026 40	P 7078	O
	F 026 40	S0135	L
	1 987 43	M 2215	I
	1 987 43	R 2415⁸	I

Fiesta VI 1.6 Ti-VCT Sport S

1,6 99 U5JA			
01.11→	F 026 40	P 7078	O
	F 026 40	S0135	L
	1 987 43	M 2215	I
	1 987 43	R 2415⁸	I

Focus

Focus 1.6 i 8V

1,6 75 FYDA <Zetec Rocam>			
09.03→	1 457 43	S 3686	L
	0 450 90	F 5939¹	K
	1 987 43	M 2045	I

1,6 75 <Zetec Rocam>			
03.04→	1 457 43	S 3686	L
	0 450 90	F 5939¹	K
	1 987 43	M 2045	I

Focus 1.6 i 8V Flex

1,6 77-83 <Zetec Rocam>			
04.07-11.09	1 457 43	S 3686	L
	1 987 43	M 2045	I
	1 987 43	R 2345⁸	I

Focus 1.6 i 16V Flex

1,6 80-85 <Sigma>			
01.10→	F 026 40	S0136	L

Focus 1.8 D Turbo

1,8 66 C9DC			
09.00→	0 451 10	P 3252	O
	1 457 43	S 3686	L
	0 450 90	N 6357¹	K
	1 987 43	M 2045	I

Focus 1.8 i

1,8 132 Zetec			
08.04→	0 451 10	P 2056	O

Focus 1.8 i 16V

1,8 85 <Zetec S SOHC>			
09.00-07.04	1 457 43	S 3686	L
	0 450 90	F 5939¹	K
	1 987 43	M 2045	I

Focus 2.0 i

2,0 96 EDDC <ZH20,Zetec E SFI 16v>			
10.98-05.04	0 451 10	P 3259	O
	1 457 43	S 3686	L

Focus 2.0 i 16V

2,0 96-97 <Zetec S DOHC>			
07.00-05.05	1 457 43	S 3686	L
	0 450 90	F 5939¹	K
	1 987 43	M 2045	I

2,0 | 103-108 | <Duratec HE>

06.05-09.08	1 457 43	S 3686	L
	0 450 90	F 5939¹	K
	1 987 43	M 2045	I
	1 987 43	R 2345⁸	I

2,0 | 107 | <Duratec HE>

10.08→	1 987 43	R 2413⁸	I
--------	----------	---------------------------	----------

Focus C-Max

Focus C-Max 1.6 , Ti-VCT

1,6 74/85 HWD... <Duratec-16V SFI>; HXDA <Duratec-16V PFI VCT>			
09.03-03.07	F 026 40	P 7078	O
	1 457 43	S 3323	L
11.04-03.07	F 026 40	F 3009¹	K
09.03-03.07	1 987 43	R 2409⁸	I

Focus C-Max 1.6 TDCi

1,6 66/80 G8D... <Duratorq-TDCi>; HHD... <Duratorq>			
06.03-03.07	1 457 42	P 9238	O
	1 457 43	S 3099	L
06.03-10.05	0 450 90	N 6471¹	K
11.05-03.07	F 026 40	N 2046¹	K
06.03-03.07	1 987 43	R 2409⁸	I





Focus C-Max 1.8

1,8 88 CSDA <Duratec-HE SFI>; CSDB <Duratec-HE SFI>			
06.03-05.04	0 451 10 P 3363	O	
	1 457 43 S 3323	L	
	1 987 43 R 2409 ⁸	I	

Focus C-Max 1.8 , FFV

1,8 90-92 Q... <Duratec-HE SFI>; Q7DA <Duratec-HE SFI>			
04.04-03.07	0 451 10 P 3363	O	
	1 457 43 S 3323	L	
11.04-03.07	F 026 40 F 3009 ¹	K	
04.04-03.07	1 987 43 R 2409 ⁸	I	

Focus C-Max 1.8 TDCi

1,8 85 KKDA <Duratorq>			
04.05-03.07	F 026 40 P 7017	O	
	1 457 43 S 3096	L	
	F 026 40 N 2007	K	
	1 987 43 R 2409 ⁸	I	

Focus C-Max 2.0 , CNG

2,0 93-107 AOD... <Duratec-HE SFI>; <Duratec-HE CNG>			
04.04-03.07	0 451 10 P 3363	O	
	1 457 43 S 3323	L	
	1 987 43 R 2409 ⁸	I	

Focus C-Max 2.0 TDCi

2,0 98-100 G6D... <Duratorq 2.0>			
06.03-03.07	1 457 42 P 9249	O	
	FIR 1 457 43 S 3096	L	
	1 457 43 N 1723	K	
	1 987 43 R 2409 ⁸	I	

Focus I

Focus I 1.4 i

1,4 55 FXD... <ZH14,Zetec-SE,SFI>; FXDA <ZH14,Zetec-SE,SFI>; FXDB <ZH14,Zetec-SE,SFI>; FXDC <ZH14,Zetec-SE,SFI>; FXDD <ZH14,Zetec-SE,SFI>			
08.98-05.05	F 026 40 P 7078	O	
	1 457 43 S 3686	L	
	F 026 40 F 3009 ¹	K	
	1 987 43 M 2045	I	
	1 987 43 R 2345 ⁸	I	

Focus I 1.6 i

1,6 72 CDDA <Duratec-8V SFI>			
09.02-05.05	WW 1 457 43 S 3686	L	
	F 026 40 F 3009 ¹	K	
	1 987 43 M 2045	I	
	1 987 43 R 2345 ⁸	I	

1,6 74 FYD... <ZH16,Zetec-SE,SFI>; FYDA <ZH16,Zetec-SE,SFI>; FYDB <ZH16,Zetec-SE,SFI>; FYDC <ZH16,Zetec-SE,SFI>; FYDD <ZH16,Zetec-SE,SFI>			
08.98-05.05	ABM F 026 40 P 7078	O	
	0 451 10 P 3259	O	
	1 457 43 S 3686	L	
	F 026 40 F 3009 ¹	K	
	1 987 43 M 2045	I	
	1 987 43 R 2345 ⁸	I	



Focus I 1.6 i FFV

1,6 74-77 FYDH <ZH16 (FLEXFUEL)>			
10.01-05.05	ABM F 026 40 P 7078	O	
	0 451 10 P 3259	O	
	1 457 43 S 3686	L	
	1 987 43 M 2045	I	
	1 987 43 R 2345 ⁸	I	

Focus I 1.8 i

1,8 85 EYD... <ZH18,Zetec-E,SFI>; EYDB <ZH18,Zetec-E,SFI>; EYDC <ZH18,Zetec-E,SFI>; EYDD <ZH18,Zetec-E,BI-FUEL>; EYDE <ZH18,Zetec-E,SFI>; EYDF <ZH18,Zetec-E,SFI>; EYDG <ZH18,Zetec-E,BI-FUEL>; EYDI <ZH18,Zetec-E,BI-FUEL>; EYDJ <ZH18,Zetec-E,BI-FUEL>; EYDL <ZH18,Zetec-E,BI-FUEL>			
08.98-05.05	0 451 10 P 3259	O	
	1 457 43 S 3686	L	
	F 026 40 F 3009 ¹	K	
	1 987 43 M 2045	I	
	1 987 43 R 2345 ⁸	I	

Focus I 1.8 TDCi

1,8 74/85 FFDA <Duratorq-TDCi>; F9D... <Duratorq-TDCi>; F9DA <Duratorq-TDCi>; F9DB <Duratorq-TDCi>			
05.01-05.05	0 451 10 P 3252	O	
	1 457 43 S 3686	L	
	0 450 90 N 6508 ¹	K	
	1 987 43 M 2045	I	
	1 987 43 R 2345 ⁸	I	

Focus I 1.8 TDDi

1,8 55/66 BHD... <LD18,Endura-DI>; BHDA <LD18,Endura-DI>; BHDB <LD18,Endura-DI>; C9D... <LD18,Endura-DI>; C9DA <LD18,Endura-DI>; C9DB <LD18,Endura-DI>; C9DC <LD18,Endura-DI>			
01.99-05.05	0 451 10 P 3252	O	
	1 457 43 S 3686	L	
01.99-09.01	MIH 0 450 90 N 6357 ¹	K	
01.99-05.05	MIH 0 450 90 N 6406 ¹	K	
10.01-05.05	MIH 0 450 90 N 6407 ¹	K	
01.99-05.05	1 987 43 M 2045	I	
	1 987 43 R 2345 ⁸	I	

Focus I 2.0 i, i ST170

2,0 96/127 ALDA <Duratec-ST>; EDD... <ZH20,Zetec-E,SFI>; EDDB <ZH20,Zetec-E,SFI>; EDDC <ZH20,Zetec-E,SFI>; EDDD <ZH20,Zetec-E,SFI>; EDDF <ZH20,Zetec-E,SFI>			
08.98-05.05	0 451 10 P 3259	O	
	1 457 43 S 3686	L	
	F 026 40 F 3009 ¹	K	
	1 987 43 M 2045	I	
	1 987 43 R 2345 ⁸	I	

Focus I 2.0 i RS

2,0 158 HMDA <Duratec-RS>			
09.02-05.05	0 451 10 P 3259	O	
	F 026 40 F 3009 ¹	K	
	1 987 43 M 2045	I	
	1 987 43 R 2345 ⁸	I	





Focus II

Focus II 1.4 i

1,4 | 59 | ASD... <ZH14,Zetec-SE,SFI>

07.04-01.08	F 026 40	P 7078	O
	FIR	1 457 43 S 3323	L
03.07-01.08	FIZ	F 026 40 S0136	L
11.04-01.08	F 026 40	F 3009 ¹	K
07.04-01.08		1 987 43 M 2113	I
		1 987 43 R 2413 ⁸	I

Focus II 1.6 i

1,6 | 74 | ...

07.06-07.10	F 026 40	P 7078	O
	FIR	1 457 43 S 3323	L
03.07-07.10	FIZ	F 026 40 S0136	L
07.06-07.10		1 987 43 M 2113	I
		1 987 43 R 2413 ⁸	I

Focus II 1.6 i, Ti-VCT

1,6 | 74/85 | HWD... <ZH16,Zetec-SE,SFI>; HXD... <ZH16,Zetec-SE,TI-VCT>; SHDA <ZH16,Zetec-SE,HPDC>

07.04-01.08	F 026 40	P 7078	O
07.04-03.07		1 457 43 S 3323	L
04.07-01.08	F 026 40	S0136	L
11.04-01.08	F 026 40	F 3009 ¹	K
07.04-01.08		1 987 43 M 2113	I
		1 987 43 R 2413 ⁸	I

Focus II 1.6 TDCi

1,6 | 66/80 | G8D... <Duratorq>; HHD... <Duratorq>

07.04-01.08		1 457 42 P 9238	O
	FIR	1 457 43 S 3099	L
03.07-01.08	FIZ	F 026 40 S0136	L
07.04-10.05		0 450 90 N 6471 ¹	K
11.05-01.08		F 026 40 N 2046 ¹	K
07.04-01.08		1 987 43 M 2113	I
		1 987 43 R 2413 ⁸	I

Focus II 1.8 FFV, i

1,8 | 92 | QQDB <Duratec-HE SFI>; Q7DA <Duratec-HE SFI>

07.04-01.08		0 451 10 P 3363	O
	FIR	1 457 43 S 3323	L
03.07-01.08	FIZ	F 026 40 S0136	L
11.04-01.08		F 026 40 F 3009 ¹	K
07.04-01.08		1 987 43 M 2113	I
		1 987 43 R 2413 ⁸	I

Focus II 1.8 TDCi

1,8 | 85 | KKD... <Duratorq>

04.05-01.08	F 026 40	P 7017	O
	FIR	1 457 43 S 3096	L
03.07-01.08	FIZ	F 026 40 S0136	L
04.05-01.08		F 026 40 N 2007	K
		1 987 43 M 2113	I
		1 987 43 R 2413 ⁸	I

Focus II 2.0 i

2,0 | 107 | ... <Duratec-HE>

07.06-07.10		0 451 10 P 3363	O
	FIR	1 457 43 S 3323	L
03.07-07.10	FIZ	F 026 40 S0136	L
07.06-07.10		F 026 40 F 3009 ¹	K
		1 987 43 M 2113	I
		1 987 43 R 2413 ⁸	I

2,0 | 107 | AOD... <Duratec-HE>

07.04-01.08		0 451 10 P 3363	O
07.04-03.07		1 457 43 S 3323	L
04.07-01.08		F 026 40 S0136	L
07.04-01.08		1 987 43 M 2113	I
		1 987 43 R 2413 ⁸	I

2,0 | 107 | Duratec HE <DOHC 16v>

06.04-12.08		0 986 45 P 2068	O
		1 987 43 M 2045	I
		1 987 43 R 2345 ⁸	I

Focus II 2.0 TDCi

2,0 | 98-100 | G6D... <Duratorq>

07.04-07.10		1 457 42 P 9249	O
	FIR	1 457 43 S 3096	L
03.07-07.10	FIZ	F 026 40 S0136	L
07.04-07.10		1 457 43 N 1723	K
		1 987 43 M 2113	I
		1 987 43 R 2413 ⁸	I

Focus II 2.5 i ST

2,5 | 166 | HYDA <Duratec-ST>

10.05-01.08		1 457 42 P 9244	O
		1 457 43 S 3583	L
		1 987 43 M 2113	I
		1 987 43 R 2413 ⁸	I

Focus III

Focus III 1.4 i

1,4 | 59 | ASDA <ZH14,Zetec-SE,SFI>

12.07→		F 026 40 P 7078	O
		F 026 40 S0136	L
		1 987 43 R 2413 ⁸	I

Focus III 1.6 i, Ti-VCT

1,6 | 74/85-88 | HXD... <ZH16,Zetec-SE,TI-VCT>; SHDA <ZH16,Zetec-SE,SFI>

12.07→		F 026 40 P 7078	O
		F 026 40 S0136	L
		1 987 43 R 2413 ⁸	I

Focus III 1.6 TDCi

1,6 | 66/80 | ... <Duratorq>; G8D... <Duratorq>

12.07→		1 457 42 P 9238	O
		F 026 40 S0136	L
12.07-04.08	MPR	F 026 40 N 2046 ¹	K
05.08→		F 026 40 N 2046 ¹	K
12.07→		1 987 43 R 2413 ⁸	I





Focus III 1.8 Flexifuel, i

1,8 92 QQDB <Duratec-HE SFI>; Q7DA <Duratec-HE SFI>	12.07→	0 451 10 P 3363	O
		F 026 40 S0136	L
		1 987 43 R 2413 ⁸	I

Focus III 1.8 TDCi

1,8 85 KKD... <Duratorq>	12.07→	F 026 40 P 7017	O
		F 026 40 S0136	L
		F 026 40 N 2007	K
		1 987 43 R 2413 ⁸	I

Focus III 2.0 CNG, i, LPG

2,0 93-107 AODA <Duratec-HE>; <Duratec-HE>	12.07→	0 451 10 P 3363	O
		F 026 40 S0136	L
		1 987 43 R 2413 ⁸	I

Focus III 2.0 TDCi

2,0 81/100 <Duratorq>; G6D... <Duratorq>	12.07→	1 457 42 P 9249	O
		F 026 40 S0136	L
		1 457 43 N 1723	K
		1 987 43 R 2413 ⁸	I

Focus III 2.5 i RS

2,5 224 JZDA <Duratec-ST>	01.09→	1 457 42 P 9244	O
		F 026 40 S0136	L
		1 987 43 R 2413 ⁸	I

Focus III 2.5 i ST

2,5 166 HYDA <Duratec-ST>	12.07→	1 457 42 P 9244	O
		1 457 43 S 3583	L
		1 987 43 R 2413 ⁸	I

Focus IV

Focus IV 1.6 EcoBoost, Ti-VCT, Ti-VCT FlexiFuel

1,6 77/88/92/110/134 IQD... <Euro5>; JQD... <Euro5>; JTD... <Euro5>; MUDA <Euro5>; PND A <Euro5>	01.11→	F 026 40 P 7078	O
--	--------	-----------------	---

Focus IV 1.6 TDCi

1,6 70/85 T1D... <Euro5>; T3D... <Euro5>	01.11→	1 457 42 P 9238	O
--	--------	-----------------	---

Focus IV 2.0 TDCi

2,0 85/100/103/120 TXDB <Euro5>; TYDA <Euro5>; UFDB <Euro5>; UKDB <Euro5>	01.11→	1 457 42 P 9249	O
---	--------	-----------------	---



Fusion

Fusion 1.25 i

1,2 55 FUJ... <Duratec 16V SFI>	03.05→	F 026 40 P 7078	O
		1 457 43 S 3593	L
		0 450 90 F 5926 ¹	K
		1 987 43 M 2087	I
		1 987 43 R 2387 ⁸	I

Fusion 1.4 i

1,4 59 FXJ... <Duratec 16V SFI>	10.02→	F 026 40 P 7078	O
		1 457 43 S 3593	L
		0 450 90 F 5926 ¹	K
		1 987 43 M 2087	I
		1 987 43 R 2387 ⁸	I

Fusion 1.4 TDCi

1,4 50 F6J... <Duratorq TDCi>	10.02→	1 457 42 P 9238	O
		1 457 43 S 3076	L
		0 450 90 N 6460 ¹	K
		1 987 43 M 2087	I
		1 987 43 R 2387 ⁸	I

Fusion 1.6 i, i 16V

1,6 74 FYJ... <Duratec 16V SFI>; FYJA	10.02→	F 026 40 P 7078	O
		WW 0 451 10 P 3259	O
		1 457 43 S 3593	L
		0 450 90 F 5926 ¹	K
		1 987 43 M 2087	I
		1 987 43 R 2387 ⁸	I

Fusion 1.6 TDCi

1,6 66 HHJ... <Duratorq TDCi>	11.04→	1 457 42 P 9238	O
	11.04-07.06	F 026 40 S 0110	L
	11.04→ TW	0 450 90 N 6471 ¹	K
	10.05→ TW	F 026 40 N 2046 ¹	K
	11.04→	1 987 43 M 2087	I
		1 987 43 R 2387 ⁸	I

Galaxy

Galaxy 1.6 EcoBoost

1,6 118 JTW... <Euro5>	11.10→	F 026 40 P 7078	O
		F 026 40 S 0109	L
		1 987 43 R 2409 ⁸	I

Galaxy 1.6 TDCi

1,6 85 T1W... <Euro5>	02.11→	1 457 42 P 9238	O
		1 987 43 R 2409 ⁸	I





Galaxy 1.8 TDCi

1,8 74/92 FFWA <Euro4>; QYWA <Euro4>			
03.06-03.10	F 026 40 P 7017	O	
	F 026 40 S 0109	L	
	F 026 40 N 2007	K	
	1987 43 R 2409 ⁸	I	

Galaxy 1.9 TDI

1,9 66 ANU <D19TI (VW 19N PD)>			
09.99-03.00	1 457 42 P 9619	O	
	1 457 43 S 3742	L	
	0 450 90 N 6334 ¹	K	
	1 987 43 M 2028	I	
	1 987 43 R 2328 ⁸	I	

1,9 66 ANU <19NPD>			
04.00-08.06	1 457 42 P 9619	O	
	1 457 43 S 3089	L	
	0 450 90 N 6334 ¹	K	
	1 987 43 M 2028	I	
	1 987 43 R 2328 ⁸	I	

1,9 66 1Z <D19N (VW 19N)>			
11.95-09.96	0 451 10 P 3290	O	
02.95-09.96	1 457 43 S 3742	L	
	0 450 90 N 6267 ¹	K	
	1 987 43 M 2028	I	
	1 987 43 R 2328 ⁸	I	

1,9 66/81 AFN <D19P (VW 19P)>; AHU <D19N (VW 19N)>			
09.96-03.00	0 451 10 P 3290	O	
	1 457 43 S 3742	L	
	0 450 90 N 6267 ¹	K	
	1 987 43 M 2028	I	
	1 987 43 R 2328 ⁸	I	

1,9 81 AVG <D19P (VW 19P)>			
06.99-03.00	0 451 10 P 3290	O	
	1 457 43 S 3742	L	
	0 450 90 N 6267 ¹	K	
	1 987 43 M 2028	I	
	1 987 43 R 2328 ⁸	I	

1,9 85 AUY <19PPD>			
04.00-08.06	1 457 42 P 9619	O	
	1 457 43 S 3089	L	
	0 450 90 N 6334 ¹	K	
	1 987 43 M 2028	I	
	1 987 43 R 2328 ⁸	I	

1,9 96 ASZ <19PPD>			
01.03-08.06	1 457 42 P 9192	O	
	1 457 43 S 3089	L	
	0 450 90 N 6334 ¹	K	
	1 987 43 M 2028	I	
	1 987 43 R 2328 ⁸	I	



1,9 110 BTB <19PPD>			
01.05-08.06	1 457 42 P 9192	O	
	1 457 43 S 3089	L	
	0 450 90 N 6334 ¹	K	
	1 987 43 M 2028	I	
	1 987 43 R 2328 ⁸	I	

Galaxy 2.0

2,0 107 AOW... <Euro4/Euro5>			
03.06→	0 451 10 P 3363	O	
	F 026 40 S 0109	L	
	1 987 43 R 2409 ⁸	I	

Galaxy 2.0 EcoBoost SCTi

2,0 147-149 TNW... <Euro5>			
03.10→	F 026 40 S 0109	L	
	1 987 43 R 2409 ⁸	I	

Galaxy 2.0 FlexiFuel

2,0 107 TBW... <Euro4/Euro5>			
03.08→	0 451 10 P 3363	O	
	F 026 40 S 0109	L	
	1 987 43 R 2409 ⁸	I	

Galaxy 2.0 i

2,0 85 NSE <DL20 DOHC,SEFI>			
02.95-03.00	0 451 10 P 3259	O	
	1 457 43 S 3742	L	
	0 450 90 F 5264 ¹	K	
	1 987 43 M 2028	I	
	1 987 43 R 2328 ⁸	I	

2,0 85 ZVSA <DL20 DOHC,SEFI>			
01.01-08.06	0 451 10 P 3259	O	
	1 457 43 S 3089	L	
	0 450 90 F 5264 ¹	K	
	1 987 43 M 2028	I	
	1 987 43 R 2328 ⁸	I	

Galaxy 2.0 TDCi

2,0 85 KLWA <Euro4>			
11.07→	1 457 42 P 9249	O	
	F 026 40 S 0109	L	
	1 457 43 N 1723	K	
	1 987 43 R 2409 ⁸	I	

2,0 85/100/103/120 TXWA <Euro5>; TYWA <Euro5>; UFWA <Euro5>; UKWA <Euro5>			
03.10→	1 457 42 P 9249	O	
	F 026 40 S 0109	L	
	1 987 43 R 2409 ⁸	I	

2,0 96 AZWA <Euro4>			
03.06-02.10	1 457 42 P 9249	O	
	F 026 40 S 0109	L	
	1 457 43 N 1723	K	
	1 987 43 R 2409 ⁸	I	





◀ Galaxy 2.0 TDCi

2,0 100 AZWC <Euro4>	09.08→	F 026 40 S 0109 L 1 457 43 N 1723 K 1 987 43 R 2409 ⁸ I
---------------------------------------	--------	---

2,0 103 QXW... <Euro3/Euro4>	03.06→	1 457 42 P 9249 O F 026 40 S 0109 L 1 457 43 N 1723 K 1 987 43 R 2409 ⁸ I
---	--------	---

Galaxy 2.2 TDCi

2,2 129/147 KNWA <Euro5>; Q4BA <Euro4>	03.08→	1 457 42 P 9249 O 1 987 43 R 2409 ⁸ I
---	--------	---

Galaxy 2.3

2,3 118 SEWA <Euro4>	09.07→	0 986 45 P 2068 O 1 457 42 P 9257 O F 026 40 S 0109 L 1 987 43 R 2409 ⁸ I
---------------------------------------	--------	---

Galaxy 2.3 i

2,3 103/107 E5SA <DH23 DOHC, 16V-SEFI>; E5SB <DH23 DOHC, 16V-SEFI>	04.00-08.06	0 451 10 P 3259 O 1 457 43 S 3089 L 0 450 90 F 5264 ¹ K 1 987 43 M 2028 I 1 987 43 R 2328 ⁸ I
---	-------------	--

Galaxy 2.3 i 16V

2,3 107 Y5B <DH23 DOHC, 16V-SEFI>	01.97-03.00	0 451 10 P 3259 O 1 457 43 S 3742 L 0 450 90 F 5264 ¹ K 1 987 43 M 2028 I 1 987 43 R 2328 ⁸ I
--	-------------	--

Galaxy 2.8 i

2,8 128 AAA <VV28, CD-VR6 SEFI>	Mot.Nr. AAA 176890→ 11.95-04.98	1 457 42 P 9142 O
	Mot.Nr. →AAA 176889 02.95-10.95	1 457 42 P 9103 O
	02.95-04.98	1 457 43 S 3742 L 0 450 90 F 5264 ¹ K 1 987 43 M 2028 I 1 987 43 R 2328 ⁸ I

2,8 150 AYL <VV28, CD-VR6 SEFI>	04.00-08.06	1 457 42 P 9192 O 1 457 43 S 3089 L 0 450 90 F 5264 ¹ K 1 987 43 M 2028 I 1 987 43 R 2328 ⁸ I
--	-------------	--

Galaxy 2.8 i, i 4x4

2,8 128 AMY <VV28, CD-VR6 SEFI>	04.98-03.00	1 457 42 P 9142 O 1 457 43 S 3742 L 0 450 90 F 5264 ¹ K 1 987 43 M 2028 I 1 987 43 R 2328 ⁸ I
--	-------------	--



Galaxy 2.8 i 4x4

2,8 128 AAA <VV28, CD-VR6 SEFI>	07.96-04.98	1 457 42 P 9142 O 1 457 43 S 3742 L 0 450 90 F 5264 ¹ K 1 987 43 M 2028 I 1 987 43 R 2328 ⁸ I
--	-------------	--

Granada

Granada 1.8

1,8 66 REC <TL-OHC 2V HC>	05.85-01.92	0 451 10 P 3029 O 1 457 42 S 9066 L
--	-------------	--

Granada 2.0

2,0 77-80 N8... <DL-DOHC 2V HC>; N8D <DL-DOHC 2V HC>	05.89-01.92	0 451 10 P 3029 O 1 457 42 S 9954 L
---	-------------	--

Granada 2.0 i

2,0 85 NR... <TL-OHC EFI HC>	05.85-01.92	0 451 10 P 3029 O 1 457 42 S 9078 L
	01.91-01.92	0 450 90 F 5200 ¹ K

2,0 85 N9F <DL20 DOHC EFI H, C>; N9F <DL20 DOHC EFI HC>	02.92-09.94	0 451 10 P 3259 O 1 457 42 S 9078 L 0 450 90 F 5964 ¹ K
--	-------------	---

2,0 88-93 N9... <DL-DOHC EFI HC>; N9D <DL-DOHC EFI HC>	05.89-01.92	0 451 10 P 3029 O 1 457 42 S 9078 L 0 450 90 F 5964 ¹ K
---	-------------	---

Granada 2.4 i

2,4 92 ARD <TV24 V6 EFI HC>	02.92-09.94	0 451 10 P 3029 O 1 457 42 S 9078 L 0 450 90 F 5964 ¹ K
--	-------------	---

Granada 2.5 D

2,5 51 STR <PD25>	05.85-01.92	0 451 20 P 3108 O 1 457 43 S 3006 L 1 457 43 N 4200 ² K
------------------------------------	-------------	---

Granada 2.5 D Turbo

2,5 68 SF... <PD25T>	06.88-07.93	0 451 20 P 3108 O
	06.88-09.94	1 457 42 S 9078 L
	06.88-04.93	1 457 43 N 4200 ² K

Granada 2.9 i

2,9 107 BRF <TV29 V6 EFI MC>	02.92-09.94	0 451 10 P 3029 O 1 457 42 S 9078 L 0 450 90 F 5964 ¹ K
---	-------------	---





2,9 110 BRC <TV29 EFI HC>	09.86-01.92	0 451 10 P 3029	O
		1 457 42 S 9078	L
	01.91-01.92	0 450 90 F 5200 ¹	K

Granada 2.9 i 4x4

2,9 107 BR... <TV29 V6 EFI MC>	02.92-09.94	0 451 10 P 3029	O
		1 457 42 S 9078	L
		0 450 90 F 5964 ¹	K

Granada 2.9 i 24V

2,9 143 BOA <CP29 DOHC 24V>	02.92-09.94	0 451 10 P 3029	O
		1 457 43 S 3659	L
		0 450 90 F 5964 ¹	K

Ka

Ka 1.0 i

1,0 48 C4C <Zetec Rocam>	08.99-12.07	F 026 40 S 0096	L
------------------------------	-------------	-----------------	---

Ka 1.2 i

1,2 51 169 A 4.000 <Euro4/Euro5>	09.08→	0 451 10 P 3364	O
		F 026 40 S 0036	L
		1 987 43 M 2106	I

Ka 1.3 i

1,3 36/37 JJB <HCS,Endura-E SEFI>; JJD <HCS,Endura-E SEFI>; JJF <HCS,Endura-E SEFI>; JJG <HCS,Endura-E SEFI>; JJH <HCS,Endura-E SEFI>; JJJ <HCS,Endura-E SEFI>	09.96-10.02	0 451 10 P 3298	O
		1 457 43 S 3268	L
		0 450 90 F 5324 ¹	K
		1 987 43 M 2006	I
		1 987 43 R 2306 ⁸	I

1,3 44 BAA <Duratec 8V SFI>	10.02-09.08	0 451 10 P 3259	O
		F 026 40 S 0096	L
		0 450 90 F 5324 ¹	K
		1 987 43 M 2006	I

1,3 44 J4D <HCS,Endura-E SEFI>	09.96-10.02	0 451 10 P 3298	O
		1 457 43 S 3268	L
		0 450 90 F 5324 ¹	K
		1 987 43 M 2006	I

1,3 44 J4K <HCS,Endura-E SEFI>	09.96-10.02	0 451 10 P 3298	O
		1 457 43 S 3268	L
		0 450 90 F 5324 ¹	K
		1 987 43 M 2006	I
		1 987 43 R 2306 ⁸	I

1,3 44 J4M <HCS,Endura-E SEFI>	09.96-10.02	0 451 10 P 3298	O
		1 457 43 S 3268	L
		0 450 90 F 5324 ¹	K
		1 987 43 M 2006	I

1,3 44 J4N <HCS,Endura-E SEFI>; J4P <HCS,Endura-E SEFI>; J4S <HCS,Endura-E SEFI>	09.96-10.02	0 451 10 P 3298	O
		1 457 43 S 3268	L
		0 450 90 F 5324 ¹	K
		1 987 43 M 2006	I
		1 987 43 R 2306 ⁸	I

1,3 51 A9A <Duratec 8V SFI>; A9B <Duratec 8V SFI>	10.02-09.08	0 451 10 P 3259	O
		F 026 40 S 0096	L
		0 450 90 F 5324 ¹	K
		1 987 43 M 2006	I
		1 987 43 R 2306 ⁸	I

Ka 1.3 TDCi

1,3 55 169 A... <Euro4/Euro5>	09.08-10.10	UFI	F 026 40 P 7067	O
	09.08→		1 987 43 M 2106	I

Ka 1.6 i

1,6 70 CCA <Zetec Rocam>	02.01-12.07	F 026 40 S 0096	L
------------------------------	-------------	-----------------	---

1,6 70 CD... <ZH, ZETEC ROCAM>	07.03-09.08	0 451 10 P 3259	O
		F 026 40 S 0096	L
		0 450 90 F 5324 ¹	K
		1 987 43 M 2006	I
		1 987 43 R 2306 ⁸	I

Kuga

Kuga 2.0 TDCi, TDCi 4x4

2,0 100-103 <DURATORQ 2.0 TDCi>	02.08→	1 457 42 P 9249	O
		F 026 40 S 0136	L
		1 457 43 N 1723	K
		1 987 43 R 2409 ⁸	I

Kuga 2.0 TDCi 4x4

2,0 120-123 TXDA <DURATORQ DIESEL 2.0>	04.10→	1 457 42 P 9249	O
		1 987 43 R 2409 ⁸	I

Kuga 2.5 i 4x4

2,5 147 HYD... <Duratec VCT>	12.08→	1 457 42 P 9244	O
		1 457 43 S 3583	L
		1 987 43 R 2409 ⁸	I





Maverick

Maverick 2.0 i, i 4x4

2,0 91-95 YF <Zetec-E SEFI>	10.00-12.03	0451 10 P 3371	0
		1457 43 S 3095	L

Maverick 2.3 i, i 4x4

2,3 112-116 GZ <Duratec SEFI>	12.03-01.07	0451 10 P 3363	0
		1457 43 S 3095	L

Maverick 2.4 i

2,4 85/87 KA24 <OHC>	05.96-12.98	0986 45 P 2023	0
--------------------------	-------------	----------------	---

2,4 91 KA24 <OHC 12V SEFI>	06.93-04.96	0986 45 P 2023	0
		1987 43 M 2058	I

Maverick 2.7 TD

2,7 74 TD27	06.93-04.96	1457 43 S 3275	L
		1457 43 N 4281	K
		1987 43 M 2058	I

2,7 92 TD27E	05.96-12.98	0451 10 P 3357	0
		1457 43 S 3154	L
		1457 43 N 4439 ²	K

Maverick 3.0 i, i 4x4

3,0 145-154 AJ <Duratec-VE SEFI>	07.01-01.07	0451 10 P 3333	0
		1457 43 S 3095	L

Mondeo

Mondeo 1.8 D Turbo

1,8 66 RFN <D18TI/TCI, ENDURA-DE>	11.97-12.98	0451 10 P 3227	0
		1457 43 S 3608	L
		CAV 1457 43 N 4201 ²	K

Mondeo 2.0 i

2,0 107 CJBB Duratec-HE <GE>	08.01→	1457 42 P 9257	0
		1457 43 S 3047	L

Mondeo 2.0 i Ghia

2,0 105 D6BA	04.05→	1457 42 P 9239	0
		1457 43 S 3047	L
		0450 90 N 6376 ¹	K

Mondeo 2.5 i

2,5 125 SEA V6 <MP25, DURATEC-VE>	02.98-12.01	0451 10 P 3333	0
---------------------------------------	-------------	----------------	---



2,5 127 Duratec-V6	06.04-11.07	0451 10 P 3333	0
		0450 90 F 5927 ¹	K
		1987 43 R 2373 ⁸	I

Mondeo I

Mondeo I 1.6 i

1,6 65/66 L1... <ZH16,ZETEC>; L1... <ZH16,ZETEC-E>; L1F <ZH16,ZETEC>; L1J <ZH16,ZETEC-E>	01.93-07.96	0451 10 P 3259	0
		1457 43 S 3609	L
		0450 90 F 5324 ¹	K
		1987 43 M 2018	I
		1987 43 R 2318 ⁸	I

Mondeo I 1.8 i, i 4x4

1,8 82/85 RKA <ZH18,ZETEC>; RKB <ZH18,ZETEC-E>; RKB <ZH18,ZETEC-E>	01.93-07.96	0451 10 P 3259	0
		1457 43 S 3609	L
		0450 90 F 5324 ¹	K
		1987 43 M 2018	I
		1987 43 R 2318 ⁸	I

Mondeo I 1.8 TD

1,8 65 RF... <D18TI/TCI>	06.93-07.96	0451 10 P 3227	0
		1457 43 S 3608	L
	CAV	1457 43 N 4201 ²	K
		1987 43 M 2018	I
		1987 43 R 2318 ⁸	I

Mondeo I 2.0 i, i 4x4

2,0 97-100 NGA <ZH20,ZETEC>	01.93-07.96	0451 10 P 3259	0
		1457 43 S 3609	L
		0450 90 F 5324 ¹	K
		1987 43 M 2018	I
		1987 43 R 2318 ⁸	I

Mondeo I 2.5 i

2,5 125 SEA <MP25, DURATEC-VE>	08.94-07.96	0451 10 P 3333	0
		1457 43 S 3088	L
		0450 90 F 5324 ¹	K
		1987 43 M 2018	I
		1987 43 R 2318 ⁸	I

Mondeo II

Mondeo II 1.6 i

1,6 65-66/70 L1... <ZH16, ZETEC-E>; L1J <ZH16, ZETEC-E>; L1L <ZH16, ZETEC-E>; L1N <ZH16, ZETEC-E>; L1Q <ZH16, ZETEC-E>	08.96-09.00	0451 10 P 3259	0
		1457 43 S 3609	L
		0450 90 F 5324 ¹	K
		1987 43 M 2018	I
		1987 43 R 2318 ⁸	I





Mondeo II 1.8 i

1,8 | 85 | RK... <ZH18, ZETEC-E>; RKB <ZH18, ZETEC-E>; RKF <ZH18, ZETEC-E>; RKH <ZH18, ZETEC-E>; RKJ <ZH18, ZETEC-E>; RKK <ZH18, ZETEC-E>

08.96-09.00	0 451 10 P 3259	O
	1 457 43 S 3609	L
	0 450 90 F 5324 ¹	K
	1 987 43 M 2018	I
	1 987 43 R 2318 ⁸	I

Mondeo II 1.8 TD

1,8 | 65-66 | RFN <D18TI/TCI, ENDURA-DE>

08.96-09.00	0 451 10 P 3227	O
	1 457 43 S 3608	L
	1 457 43 N 4201 ²	K
	1 987 43 M 2018	I
	1 987 43 R 2318 ⁸	I

Mondeo II 2.0 i

2,0 | 96 | NG... <ZH20, ZETEC-E>; NGA <ZH20, ZETEC-E>; NGB <ZH20, ZETEC-E>; NGC <ZH20, ZETEC-E>; NGD <ZH20, ZETEC-E>

08.96-09.00	0 451 10 P 3259	O
	1 457 43 S 3609	L
	0 450 90 F 5324 ¹	K
	1 987 43 M 2018	I
	1 987 43 R 2318 ⁸	I

Mondeo II 2.5 i, i ST200

2,5 | 125/151 | SE... <MP25, DURATEC-VE>; SEA <MP25, DURATEC-VE>; SEB <MP25, DURATEC-VE>; SEC <MP25, DURATEC-VE>; SGA <MP25, DURATEC-VE>

08.96-09.00	0 451 10 P 3333	O
	1 457 43 S 3088	L
	0 450 90 F 5324 ¹	K
	1 987 43 M 2018	I
	1 987 43 R 2318 ⁸	I

Mondeo III

Mondeo III 1.8 i

1,8 | 81/92 | CGB... <Duratec-HE SFI>; CGBA <Duratec-HE SFI>; CGBB <Duratec-HE SFI>; CHB... <Duratec-HE SFI>; CHBA <Duratec-HE SFI>; CHBB <Duratec-HE SFI>

10.00-10.02	1 457 42 P 9257	O
11.02-03.07	0 451 10 P 3363	O
10.00-03.07	1 457 43 S 3047	L
	0 450 90 F 5927 ¹	K
	1 987 43 M 2073	I
	1 987 43 R 2373 ⁸	I
WW	1 987 43 M 2018	I

1,8 | 96 | CFBA <Duratec-Sci PDI>

06.03-03.07	0 451 10 P 3363	O
	1 457 42 P 9257	O
	1 457 43 S 3047	L
	0 450 90 F 5927 ¹	K
	1 987 43 M 2073	I
	1 987 43 R 2373 ⁸	I
WW	1 987 43 M 2018	I



Mondeo III 2.0 i

2,0 | 107 | CJB... <Duratec-HE SFI>; CJBA <Duratec-HE SFI>; CJBB <Duratec-HE SFI>

10.00-10.02	GS	1 457 42 P 9257	O
10.00-03.07	AG	1 457 42 P 9257	O
11.02-03.07	GS	0 451 10 P 3363	O
10.00-03.07		1 457 43 S 3047	L
		0 450 90 F 5927 ¹	K
		1 987 43 M 2073	I
		1 987 43 R 2373 ⁸	I
WW		1 987 43 M 2018	I

Mondeo III 2.0 TDCi

2,0 | 66/85/96 | FMBA <Duratorq-TDCi>; HJB... <Duratorq-TDCi>; HJBA <Duratorq-TDCi>; HJBB <Duratorq-TDCi>; HJBC <Duratorq-TDCi>; N7B... <Duratorq-TDCi>; SDBA <Duratorq-TDCi>

10.01-03.07		1 457 42 P 9239	O
		1 457 43 S 3047	L
		1 987 43 M 2073	I
		1 987 43 R 2373 ⁸	I
WW		1 987 43 M 2018	I

Mondeo III 2.0 TDDi

2,0 | 66 | D5BA <Duratorq-DI>

10.00-03.07		1 457 42 P 9239	O
		1 457 43 S 3047	L
10.00-08.01		0 450 90 N 6376 ¹	K
09.01-03.07		0 450 90 N 6508 ¹	K
10.00-03.07		1 987 43 M 2073	I
		1 987 43 R 2373 ⁸	I
WW		1 987 43 M 2018	I

2,0 | 85 | D6BA <Duratorq-DI>

10.00-08.02		1 457 42 P 9239	O
		1 457 43 S 3047	L
		0 450 90 N 6376 ¹	K
		1 987 43 M 2073	I
		1 987 43 R 2373 ⁸	I
WW		1 987 43 M 2018	I

Mondeo III 2.2 TDCi

2,2 | 110-114 | QJB... <Duratorq-TDCi>

08.04-03.07		1 457 42 P 9239	O
		1 457 43 S 3047	L
		1 987 43 M 2073	I
		1 987 43 R 2373 ⁸	I
WW		1 987 43 M 2018	I

Mondeo III 2.5 i

2,5 | 125 | LCBD <Duratec-VE SFI>

10.00-03.07		0 451 10 P 3333	O
		1 457 43 S 3047	L
		0 450 90 F 5927 ¹	K
		1 987 43 M 2073	I
		1 987 43 R 2373 ⁸	I
WW		1 987 43 M 2018	I





Mondeo III 3.0 i, i ST220

3,0 150/166 MEBA <Duratec-ST SFI>; REBA <Duratec-SE EFI>			
02.02-03.07	0 451 10	P 3333	O
	1 457 43	S 3047	L
	0 450 90	F 5927 ¹	K
	1 987 43	M 2073	I
	1 987 43	R 2373 ⁸	I
WW	1 987 43	M 2018	I

Mondeo IV

Mondeo IV 1.6 EcoBoost

1,6 118			
11.10→	F 026 40	P 7078	O
	F 026 40	S 0109	L
	1 987 43	R 2409 ⁸	I

Mondeo IV 1.6 TDCi

1,6 85			
02.11→	1 457 42	P 9238	O
	1 987 43	R 2409 ⁸	I

Mondeo IV 1.6 Ti-VCT

1,6 81 RHBA <DURATEC TI VCT>			
02.07-08.10	F 026 40	P 7078	O
	F 026 40	S 0109	L
	1 987 43	R 2409 ⁸	I

1,6 88-92 ... <DURATEC TI VCT>			
02.07→	F 026 40	P 7078	O
WW	F 026 40	P 7078	O
	F 026 40	S 0109	L
	1 987 43	R 2409 ⁸	I

Mondeo IV 1.8 TDCi

1,8 74/92 ... <LD18>; FFBA <LD18>			
02.07-11.10	F 026 40	P 7017	O
	F 026 40	S 0109	L
	F 026 40	N 2007	K
	1 987 43	R 2409 ⁸	I

Mondeo IV 2.0 , Flexifuel, LPG

2,0 104-107 AOB... <DURATEC HE PFI>; TBB... <DURATEC HE PFI>; TBBA <DURATEC HE PFI>			
02.07→	0 451 10	P 3363	O
	F 026 40	S 0109	L
	1 987 43	R 2409 ⁸	I

Mondeo IV 2.0 EcoBoost SCTi

2,0 149/176,5 TNBA; TPBA			
03.10→	F 026 40	S 0109	L
	1 987 43	R 2409 ⁸	I

Mondeo IV 2.0 TDCi

2,0 85 ... <DURAORQ TDCi>			
11.07→	1 457 42	P 9249	O
	F 026 40	S 0109	L
	F 026 40	N2078	K
03.10→	EU5	F 026 40	N2078
11.07→	1 987 43	R 2409 ⁸	I



2,0 96 ... <DURAORQ TDCi>			
02.07-02.10	1 457 42	P 9249	O
	F 026 40	S 0109	L
	F 026 40	N2078	K
	1 987 43	R 2409 ⁸	I

2,0 100-103 ... <DURAORQ TDCi>			
02.07→	1 457 42	P 9249	O
	F 026 40	S 0109	L
	F 026 40	N2078	K
03.10→	EU5	F 026 40	N2078
02.07→	1 987 43	R 2409 ⁸	I

2,0 120 TXBA <DURATORQ DIESEL 2.0>			
03.10→	1 457 42	P 9249	O
	F 026 40	S 0109	L
	F 026 40	N2078	K
	1 987 43	R 2409 ⁸	I

Mondeo IV 2.2 TDCi

2,2 129/147 ; Q4BA			
03.08→	1 457 42	P 9249	O
	1 987 43	R 2409 ⁸	I

Mondeo IV 2.3

2,3 118 SEBA <DURATEC HE MI4>			
09.07→	0 986 45	P 2068	O
	1 457 42	P 9257	O
	F 026 40	S 0109	L
	1 987 43	R 2409 ⁸	I

Mondeo IV 2.5

2,5 162 HU... <DURATEC-ST>			
02.07-03.10	1 457 42	P 9244	O
	1 457 43	S 3583	L
	1 987 43	R 2409 ⁸	I

Orion III

Orion III 1.3

1,3 44/46 JBD <HCS 2V HC>; JBE <HCS 2V HC>			
07.90-12.93	0 451 10	P 3298	O
	1 457 42	S 9819	L

Orion III 1.3 i

1,3 44 J6A <HCS CFI HC>			
05.91-12.93	0 451 10	P 3298	O
	1 457 42	S 9819	L
05.91-12.91	0 450 90	F 5195 ¹	K
01.92-12.93	0 450 90	F 5324 ¹	K

Orion III 1.4

1,4 54 FUH <CVH 2V LC>			
07.90-12.93	0 451 10	P 3298	O
	1 457 42	S 9775	L

Orion III 1.4 i

1,4 52 F6F <CVH CFI LC>			
07.90-12.93	0 451 10	P 3298	O
	1 457 42	S 9775	L
07.90-12.91	0 450 90	F 5195 ¹	K
01.92-12.93	0 450 90	F 5324 ¹	K



Orion III 1.6

1,6 66 LUJ <CVH 2V HC>; LUK <CVH 2V HC>			
	07.90-12.93	0 451 10 P 3298	O
		1 457 42 S 9775	L

Orion III 1.6 i

1,6 77/79 LJE <CVH EFI HC>; LJF <CVH EFI HC>			
	07.90-09.92	0 451 10 P 3298	O
		1 457 42 S 9791	L
	07.90-12.91	0 450 90 F 5195 ¹	K
	01.92-09.92	0 450 90 F 5324 ¹	K

Orion III 1.6 i 16V

1,6 66 L1E <ZETEC>			
	09.92-12.93	0 451 10 P 3259	O
		1 457 42 S 9791	L
		0 450 90 F 5324 ¹	K

Orion III 1.8 D

1,8 44 RT... <IDI>			
	07.90-12.93	0 451 10 P 3227	O
		1 457 42 S 9791	L
	07.90-05.93	BO,VOW 0 450 90 N 6172 ¹	K
	07.90-12.93	CAV 1 457 43 N 4201 ²	K
	06.93-12.93	BO,VOW 0 450 90 N 6261 ¹	K

Orion III 1.8 i 16V

1,8 77 RDA <ZETEC>			
	02.92-12.93	0 451 10 P 3259	O
		1 457 42 S 9791	L
		0 450 90 F 5324 ¹	K

1,8 96 RQB <ZETEC>			
	02.92-12.93	0 451 10 P 3259	O
		1 457 42 S 9791	L
		0 450 90 F 5324 ¹	K

Orion III 1.8 TD

1,8 66 RF... <D18T>			
	03.93-12.93	0 451 10 P 3227	O
		1 457 42 S 9791	L
		CAV 1 457 43 N 4201 ²	K

P 100

P 100 1.8 L TD

1,8 55 RFA <D18T>			
	02.89-12.92	0 451 10 P 3227	O
		1 457 42 S 9078	L
		1 457 43 N 4200 ²	K

P 100 2.0 L

2,0 57 NAE <OHC VVLC>			
	01.88-12.92	0 451 10 P 3029	O
		1 457 42 S 9954	L



Probe

Probe 2.0 i 16V

2,0 85-88 FS			
	09.92-01.96	0 451 10 P 3111	O
	02.96-08.97	0 986 45 P 2041	O
	09.92-08.97	0 450 90 F 5982 ¹	K

Probe 2.5 i 24V

2,5 120 KL			
	09.92-08.97	0 986 45 P 2041	O
		0 450 90 F 5982 ¹	K

Puma

Puma 1.4 i

1,4 66 FHD <ZH14,Zetec-SE,SEFI>; FHF <ZH14,Zetec-SE,SEFI>			
	01.98-11.00	F 026 40 P 7078	O
		1 457 43 S 3605	L
		0 450 90 F 5324 ¹	K
		1 987 43 M 2006	I
		1 987 43 R 2306 ⁸	I

Puma 1.6 i

1,6 75 L1W <ZH16,Zetec-SE SFI>			
	08.00-12.01	0 451 10 P 3259	O
		1 457 43 S 3605	L
		0 450 90 F 5324 ¹	K
		1 987 43 M 2006	I
		1 987 43 R 2306 ⁸	I

Puma 1.7 i

1,7 92 MHA <ZH17,Zetec-S,VCT>; MHB <ZH17,Zetec-S,VCT>			
	06.97-12.01	0 451 10 P 3259	O
		1 457 43 S 3605	L
		0 450 90 F 5324 ¹	K
		1 987 43 M 2006	I
		1 987 43 R 2306 ⁸	I

Ranger

Ranger 2.5 D, D 4x4

2,5 57 WL <MD25NA>			
	01.99-10.07	0 986 45 P 2062	O
		F 026 40 S 0165	L
		1 457 43 N 4438 ²	K

Ranger 2.5 TD

2,5 62 WL-T <MD25TI(NP)>			
	04.02-10.07	0 451 10 P 4063	O
		F 026 40 S 0165	L
		1 457 43 N 4438 ²	K





Ranger 2.5 TD, TD 4x4

2,5 80 WL-T <MD25TI(HP)>	01.99-06.00	0 986 45 P 2062	O
	07.00-10.07	0 451 10 P 4063	O
	01.99-10.07	F 026 40 S 0165	L
		1 457 43 N 4438 ²	K

Ranger 2.5 TD 4x4

2,5 62 WL-T <MD25TI(NP)>	04.02-10.07	0 451 10 P 4063	O
		F 026 40 S 0165	L
	WW	F 026 40 S 0165	L
		1 457 43 N 4438 ²	K

Ranger 3.0

3,0 108	09.90-08.92	0 451 10 P 3298	O

Scorpio I

Scorpio I 1.8

1,8 66 REC <TL-OHC 2V HC>	09.87-01.92	0 451 10 P 3029	O
		1 457 42 S 9066	L

Scorpio I 2.0

2,0 77-80 N8... <DL-DOHC 2V HC>	05.89-01.92	0 451 10 P 3029	O
		1 457 43 S 3654	L

Scorpio I 2.0 i

2,0 85 NRA <TL-OHC EFI HC>; NRI <TL-OHC EFI HC>	05.85-01.92	0 451 10 P 3029	O
		1 457 42 S 9078	L
		0 450 90 F 5964 ¹	K

2,0 85/88-90 N9... <DL-DOHC EFI>; N9B <DL-DOHC EFI>; N9D <DL-DOHC EFI>; N9F <DL20 DOHC EFI>	05.89-09.94	0 451 10 P 3029	O
		1 457 42 S 9078	L
		0 450 90 F 5964 ¹	K

Scorpio I 2.4 i

2,4 92 ARD <TV24 EFI HC>	10.88-01.92	0 451 10 P 3259	O
		RLE 0 451 10 P 3029	O
		1 457 42 S 9078	L
		0 450 90 F 5964 ¹	K

2,4 92 ARD <TV24 V6 EFI EC>	02.92-09.94	0 451 10 P 3029	O
		1 457 42 S 9078	L
		0 450 90 F 5964 ¹	K

Scorpio I 2.5 D

2,5 51 STR <PD25>	12.85-01.92	0 451 20 P 3108	O
		1 457 43 S 3006	L
		1 457 43 N 4200 ²	K



Scorpio I 2.5 TD

2,5 68 SF... <PD25T>	06.88-01.92	0 451 20 P 3108	O
		03.92-07.93	0 451 20 P 3108
	06.88-01.92	1 457 42 S 9078	L
		03.92-07.93	1 457 42 S 9078
	06.88-01.92	1 457 43 N 4200 ²	K
		03.92-04.93	1 457 43 N 4200 ²

2,5 85 SCB <VM25T>	08.93-09.94	0 451 20 P 3194	O
		1 457 42 S 9078	L
		1 457 43 N 4201 ²	K

Scorpio I 2.9 i, i 4x4

2,9 107/110 BR... <TV29 EFI MC>; BRC <TV29 EFI HC>; BRE <TV29 EFI MC>; BRF <TV29 V6 EFI MC>	09.86-09.94	0 451 10 P 3259	O
		RLE 0 451 10 P 3029	O
		1 457 42 S 9078	L
		0 450 90 F 5964 ¹	K

Scorpio I 2.9 i 24V

2,9 143 BOA <CP29 DOHC 24V>	04.91-09.94	0 451 10 P 3029	O
		1 457 43 S 3659	L
		0 450 90 F 5964 ¹	K

Scorpio II

Scorpio II 2.0 i, i 16V

2,0 85/100 NSD <DL20 DOHC SEFI>; N3A <DH20 DOHC SEFI>	10.94-12.98	0 451 10 P 3259	O	
		01.95-12.98	1 457 43 S 3659	L
		10.94-12.98	0 450 90 F 5324 ¹	K

Scorpio II 2.3 i 16V

2,3 108 Y5A <DH23 DOHC SEFI>	05.96-12.98	0 451 10 P 3259	O
		1 457 43 S 3659	L
		0 450 90 F 5324 ¹	K

Scorpio II 2.5 TD

2,5 85/92 SCC <VM25-TCI>; SCD <VM25-TCI>	01.95-12.98	0 451 20 P 3194	O
		1 457 42 S 9078	L
		10.94-12.98	1 457 43 N 4201 ²

Scorpio II 2.9 i

2,9 110 BRG <TV29>	10.94-08.96	0 451 10 P 3259	O
		RLE 0 451 10 P 3029	O
	01.95-08.96	1 457 42 S 9078	L
		10.94-08.96	0 450 90 F 5324 ¹

Scorpio II 2.9 i 24V

2,9 152 BOB <CP29>	01.95-07.98	1 457 43 S 3659	L
		10.94-07.98	0 450 90 F 5324 ¹





Sierra II

Sierra II 1.6 , Sapphire

1,6 53/55 LSE <TL-OHC 2V HC>; LSF <TL-OHC 2V HC>	01.87-02.93	0 451 10 P 3259	O
		1 457 42 S 9954	L

Sierra II 1.6 i

1,6 59 L6B <HL-CVH CFI HC>	10.89-02.93	0 451 10 P 3298	O
	XXX	1 457 42 S 9893	L
		0 450 90 F 5964 ¹	K

Sierra II 1.8

1,8 64-66 R2... <HL-CVH 2V HC>	05.88-02.93	0 451 10 P 3298	O
	XXX	1 457 42 S 9893	L

Sierra II 1.8 i

1,8 63 R6A <HL-CVH CFI>	04.92-02.93	0 451 10 P 3298	O
		0 450 90 F 5964 ¹	K

Sierra II 1.8 Sapphire

1,8 65-66 RED <TL-OHC 2V HC>	03.87-02.93	0 451 10 P 3259	O
		1 457 42 S 9066	L

Sierra II 1.8 TD

1,8 55 RF... <D18T>	08.88-02.93	0 451 10 P 3227	O
		1 457 42 S 9078	L
		1 457 43 N 4200 ²	K

Sierra II 2.0

2,0 74/77 NE... <TL-OHC 2V HC>; NES <TL-OHC 2V HC>	01.87-02.93	0 451 10 P 3259	O
		1 457 42 S 9954	L

Sierra II 2.0 , Sapphire

2,0 75/77-80 N8... <DL-DOHC 2V HC>; N8A <DL-DOHC 2V HC>; N8C <DL-DOHC 2V HC>	05.89-02.93	0 451 10 P 3259	O
		1 457 43 S 3654	L

Sierra II 2.0 i

2,0 74/85 N4A <TL-OHC EFI HC>; N4B <TL-OHC EFI LC>	01.87-02.93	0 451 10 P 3259	O
		1 457 42 S 9078	L
		0 450 90 F 5964 ¹	K

Sierra II 2.0 i, i 4x4, Sapphire, XR4i

2,0 85/87/88/90/92 N9A <DL-DOHC EFI HC>; N9C <DL-DOHC EFI HC>; N9E <DL-DOHC EFI HC>	05.89-02.93	0 451 10 P 3259	O
		1 457 42 S 9078	L
		0 450 90 F 5964 ¹	K

Sierra II 2.0 RS Cosworth 4x4

2,0 162 N5... <CH-DOHC HC>; N5C <CH-DOHC HC>; N5D <CH-DOHC HC>	02.90-02.93	0 451 10 P 3029	O
--	-------------	-----------------	---

Sierra II 2.9 i

2,9 107/110 B4... <TV-V6 EFI HC>; B4A <TV-V6 EFI HC>	08.88-02.93	0 451 10 P 3259	O
	RLE	0 451 10 P 3029	O
		1 457 42 S 9078	L
		0 450 90 F 5964 ¹	K
	WW	0 450 90 F 5601 ¹	K

Sierra II 2.9 i XR 4x4

2,9 107/110 B4... <TV-V6 EFI HC>; B4A <TV-V6 EFI HC>	08.88-02.93	0 451 10 P 3259	O
	RLE	0 451 10 P 3029	O
		1 457 42 S 9078	L
		0 450 90 F 5964 ¹	K

Sierra II 2.9 i 4x4

2,9 107/110 B4... <TV-V6 EFI HC>; B4A <TV-V6 EFI HC>	08.88-02.93	0 451 10 P 3259	O
	RLE	0 451 10 P 3029	O
		1 457 42 S 9078	L
		0 450 90 F 5964 ¹	K
	WW	0 450 90 F 5601 ¹	K

S-MAX

S-MAX 1.6 EcoBoost

1,6 118 JTW... <Euro5>	11.10→	F 026 40 P 7078	O
		F 026 40 S 0109	L
		1 987 43 R 2409 ⁸	I

S-MAX 1.6 TDCi

1,6 85 T1W... <Euro5>	02.11→	1 457 42 P 9238	O
		1 987 43 R 2409 ⁸	I

S-MAX 1.8 TDCi

1,8 74/92 FFWA <Euro4>; QYWA <Euro4>	03.06-03.10	F 026 40 P 7017	O
		F 026 40 S 0109	L
		F 026 40 N 2007	K
		1 987 43 R 2409 ⁸	I

S-MAX 2.0

2,0 107 AOW... <Euro4/Euro5>	03.06→	0 451 10 P 3363	O
		F 026 40 S 0109	L
		1 987 43 R 2409 ⁸	I

S-MAX 2.0 EcoBoost SCTi

2,0 147-149/176 TNW... <Euro5>; TPWA <Euro5>	03.10→	F 026 40 S 0109	L
		1 987 43 R 2409 ⁸	I





S-MAX 2.0 FlexiFuel

2,0 107 TBW... <Euro4/Euro5>			
03.08→	0 451 10	P 3363	O
	F 026 40	S 0109	L
	1 987 43	R 2409⁸	I

S-MAX 2.0 TDCi

2,0 85/100/103/120 TXWA <Euro5>; TYWA <Euro5>; UFWA <Euro5>; UKWA <Euro5>			
03.10→	1 457 42	P 9249	O
	F 026 40	S 0109	L
	1 987 43	R 2409⁸	I

2,0 85/103 KLWA <Euro4>; QXW... <Euro3/Euro4>			
03.06→	1 457 42	P 9249	O
	F 026 40	S 0109	L
	1 457 43	N 1723	K
	1 987 43	R 2409⁸	I

2,0 96 AZWA <Euro4>			
03.06-02.10	1 457 42	P 9249	O
	F 026 40	S 0109	L
	1 457 43	N 1723	K
	1 987 43	R 2409⁸	I

2,0 100 AZWC <Euro4>			
03.06→	F 026 40	S 0109	L
	1 457 43	N 1723	K
	1 987 43	R 2409⁸	I

S-MAX 2.2 TDCi

2,2 129/147 KNWA <Euro4>; Q4BA <Euro4>			
03.08→	1 457 42	P 9249	O
	1 987 43	R 2409⁸	I

S-MAX 2.3

2,3 118 SEWA <Euro4>			
09.07→	0 986 45	P 2068	O
	1 457 42	P 9257	O
	F 026 40	S 0109	L
	1 987 43	R 2409⁸	I

S-MAX 2.5

2,5 162 HUWA <Euro4>			
03.06-03.10	1 457 42	P 9244	O
	1 457 43	S 3583	L
	1 987 43	R 2409⁸	I

Streetka

Streetka 1.6 i

1,6 70 CDR... <ZH, ZETEC ROCAM>			
12.02-12.05	0 451 10	P 3259	O
	F 026 40	S 0096	L
	0 450 90	F 5324¹	K
	1 987 43	M 2006	I
	1 987 43	R 2306⁸	I

Taurus

Taurus 3.0 24V

3,0 149 Duratec 30			
09.95-08.99	0 450 90	F 5324¹	K



Telstar

Telstar 2.0 i

2,0 85 N			
12.92-11.96	1 457 43	S 3072	L
	0 986 45	F 0106¹	K

Tourneo Connect

Tourneo Connect 1.8 i, LPG

1,8 81-85 EYPA <ZH18 EFI>; EYPC <ZH18 BI-FUEL>			
05.02-06.10	0 451 10	P 3259	O
	1 457 43	S 3686	L
	0 450 90	F 5939¹	K
	1 987 43	M 2045	I
	1 987 43	R 2345⁸	I

Tourneo Connect 1.8 TDCi

1,8 66/81 HCP... <LD18 Ci>; HCPC <LD18 Ci>; RWPA <LD18 Ci>			
05.02→	0 451 10	P 3252	O
	1 457 43	S 3686	L
	0 450 90	N 6508¹	K
	1 987 43	M 2045	I
	1 987 43	R 2345⁸	I

Tourneo Connect 1.8 TDDi

1,8 55 BHPA <LD18 Di>; BHPB <LD18 Di>			
05.02-06.10	0 451 10	P 3252	O
	1 457 43	S 3686	L
05.02-10.05	MIH	0 450 90	N 6406¹
	MIH	0 450 90	N 6407¹
11.05-06.10		0 450 90	N 6508¹
05.02-06.10		1 987 43	M 2045
		1 987 43	R 2345⁸

Transit

Transit FT 080 2.0i

2,0 84 NSF <DOHC 8V SEFI>; NSG <DOHC 8V SEFI>			
08.94-07.00	KL	0 451 10	P 3029
	KL	0 451 10	P 3259
		1 457 43	S 3750
		0 450 90	F 5324¹

Transit FT 080 2.5 D

2,5 51 4FA <D25N>; 4FB <D25N>; 4FC <D25N>; 4FD <D25N>			
08.94-08.00		0 451 10	P 3252
		1 457 43	S 3750
		1 457 43	N 4400²

Transit FT 080 2.5 DI

2,5 56 4HB <D25P>; 4HC <D25P>			
08.94-08.00		0 451 10	P 3252
	LBF	1 457 43	S 3750
03.98-08.00	LBF	1 457 43	S 3792
08.94-08.00		1 457 43	N 4400²



Transit FT 080 2.5 TD

2,5 55 4HD <TD25N>			
08.94-08.00		0 451 10 P 3252	O
	LBF	1 457 43 S 3750	L
08.97-08.00	LBF	1 457 43 S 3792	L
08.94-08.00		1 457 43 N 4400 ²	K

2,5 74 4EB <D25TP>; 4EC <D25TP>			
08.94-08.00		0 451 10 P 3252	O
	LBF	1 457 43 S 3750	L
		1 457 43 N 4400 ²	K

Transit FT 080 2.5 TD, 2.5 TDI

2,5 55/63 4GA <D25TN>; 4GB <D25TN>; 4GC <D25TN>; 4GD <D25TN>; 4GE <D25TN>; 4GF <D25TN>; 4HA <TD25N>			
08.94-08.00		0 451 10 P 3252	O
	LBF	1 457 43 S 3750	L
08.97-08.00	LBF	1 457 43 S 3792	L
08.94-08.00		1 457 43 N 4400 ²	K

Transit FT 080 2.5 TDI

2,5 85 4ED <D25TP>			
03.99-08.00		0 451 10 P 3252	O
	LBF	1 457 43 S 3792	L
	LBF	1 457 43 S 3750	L
		1 457 43 N 4400 ²	K

Transit FT 100 2.0i

2,0 84 NSF <DOHC 8V SEFI>; NSG <DOHC 8V SEFI>			
08.94-07.00	KL	0 451 10 P 3029	O
	KL	0 451 10 P 3259	O
		1 457 43 S 3750	L
		0 450 90 F 5324 ¹	K

Transit FT 100 2.5 D

2,5 51 4FA <D25N>; 4FB <D25N>; 4FC <D25N>; 4FD <D25N>			
08.94-08.00		0 451 10 P 3252	O
		1 457 43 S 3750	L
		1 457 43 N 4400 ²	K

Transit FT 100 2.5 DI

2,5 56 4HB <D25P>; 4HC <D25P>			
08.94-08.00		0 451 10 P 3252	O
	LBF	1 457 43 S 3750	L
03.98-08.00	LBF	1 457 43 S 3792	L
08.94-08.00		1 457 43 N 4400 ²	K

Transit FT 100 2.5 TD

2,5 74 4EB <D25TP>; 4EC <D25TP>			
08.94-08.00		0 451 10 P 3252	O
		1 457 43 S 3750	L
		1 457 43 N 4400 ²	K



Transit FT 100 2.5 TD, 2.5 TDI

2,5 63 4GA <D25TN>; 4GB <D25TN>; 4GC <D25TN>; 4GD <D25TN>; 4GE <D25TN>; 4GF <D25TN>			
08.94-08.00		0 451 10 P 3252	O
	LBF	1 457 43 S 3750	L
08.97-08.00	LBF	1 457 43 S 3792	L
08.94-08.00		1 457 43 N 4400 ²	K

Transit FT 100 2.5 TDI

2,5 85 4ED <D25TPI>			
03.99-08.00		0 451 10 P 3252	O
	LBF	1 457 43 S 3792	L
	LBF	1 457 43 S 3750	L
		1 457 43 N 4400 ²	K

Transit FT 120 2.0i

2,0 84 NSF <DOHC 8V SEFI>; NSG <DOHC 8V SEFI>			
08.94-07.00	KL	0 451 10 P 3029	O
	KL	0 451 10 P 3259	O
		1 457 43 S 3750	L
		0 450 90 F 5324 ¹	K

Transit FT 120 2.5 D

2,5 51 4FA <D25N>; 4FB <D25N>; 4FC <D25N>; 4FD <D25N>			
08.94-08.00		0 451 10 P 3252	O
		1 457 43 S 3750	L
		1 457 43 N 4400 ²	K

Transit FT 120 2.5 DI

2,5 56 4HB <D25P>; 4HC <D25P>			
08.94-08.00		0 451 10 P 3252	O
	LBF	1 457 43 S 3750	L
03.98-08.00	LBF	1 457 43 S 3792	L
08.94-08.00		1 457 43 N 4400 ²	K

Transit FT 120 2.5 TD

2,5 63 4GA <D25TN>; 4GB <D25TN>; 4GC <D25TN>			
08.94-08.00		0 451 10 P 3252	O
	LBF	1 457 43 S 3750	L
08.97-08.00	LBF	1 457 43 S 3792	L
08.94-08.00		1 457 43 N 4400 ²	K

2,5 | 74 | 4EB <D25TP>; 4EC <D25TP>

08.94-08.00		0 451 10 P 3252	O
		1 457 43 S 3750	L
		1 457 43 N 4400 ²	K

Transit FT 120 2.5 TDI

2,5 85 4ED <D25TP>			
03.99-08.00		0 451 10 P 3252	O
	LBF	1 457 43 S 3792	L
	LBF	1 457 43 S 3750	L
		1 457 43 N 4400 ²	K





Transit FT 150 2.0i

2,0 84 NSF <DOHC 8V SEFI>; NSG <DOHC 8V SEFI>				
08.94-07.00	KL	0 451 10 P 3029	O	
	KL	0 451 10 P 3259	O	
		1 457 43 S 3750	L	
		0 450 90 F 5324 ¹	K	

Transit FT 150 2.5 DI

2,5 56 4HB <D25P>; 4HC <D25P>				
08.94-08.00		0 451 10 P 3252	O	
	LBF	1 457 43 S 3750	L	
03.98-08.00	LBF	1 457 43 S 3792	L	
08.94-08.00		1 457 43 N 4400 ²	K	

Transit FT 150 2.5 TD

2,5 74 4EB <D25TP>; 4EC <D25TP>				
08.94-08.00		0 451 10 P 3252	O	
		1 457 43 S 3750	L	
		1 457 43 N 4400 ²	K	

Transit FT 150 2.5 TD, 2.5 TDI

2,5 63/85 4ED <D25TP>; 4GA <D25TN>; 4GB <D25TN>; 4GC <D25TN>; 4GD <D25TN>; 4GE <D25TN>; 4GF <D25TN>				
08.94-08.00		0 451 10 P 3252	O	
	LBF	1 457 43 S 3750	L	
08.97-08.00	LBF	1 457 43 S 3792	L	
08.94-08.00		1 457 43 N 4400 ²	K	

Transit FT 190 2.0i

2,0 84 NSF <DOHC 8V SEFI>; NSG <DOHC 8V SEFI>				
08.94-07.00	KL	0 451 10 P 3029	O	
	KL	0 451 10 P 3259	O	
		1 457 43 S 3750	L	
		0 450 90 F 5324 ¹	K	

Transit FT 190 2.5 DI

2,5 56 4HB <D25P>; 4HC <D25P>				
08.94-08.00		0 451 10 P 3252	O	
	LBF	1 457 43 S 3750	L	
03.98-08.00	LBF	1 457 43 S 3792	L	
08.94-08.00		1 457 43 N 4400 ²	K	

Transit FT 190 2.5 TD

2,5 74 4EB <D25TP>; 4EC <D25TP>				
08.94-08.00		0 451 10 P 3252	O	
		1 457 43 S 3750	L	
		1 457 43 N 4400 ²	K	

Transit FT 190 2.5 TD, 2.5 TDI

2,5 63/85 4ED <D25TP>; 4GA <D25TN>; 4GB <D25TN>; 4GC <D25TN>; 4GD <D25TN>; 4GE <D25TN>; 4GF <D25TN>				
08.94-08.00		0 451 10 P 3252	O	
	LBF	1 457 43 S 3750	L	
08.97-08.00	LBF	1 457 43 S 3792	L	
08.94-08.00		1 457 43 N 4400 ²	K	



Transit FT 240 K/S 2.0 TD, 2.0 TDE

2,0 55/63 D3FA <PD20>; F3FA <PD20>				
08.00-07.06		1 457 42 P 9239	O	
		1 457 43 S 3070	L	
		1 987 43 M 2192	I	

Transit FT 260 2.2 TDCi

2,2 63/81/103 PGF... <PD22>; P8F... <PD22>; QVFA <PD22>				
04.06→		1 457 42 P 9249	O	
04.06-12.07	WW	1 457 43 S 3070	L	
04.06-11.10		F 026 40 S 0106	L	

2,2 85 SRF... <PD22>				
10.08→		1 457 42 P 9249	O	
10.08-11.10		F 026 40 S 0106	L	

2,2 96-96 QWF... <PD22>				
04.06-08.07		1 457 42 P 9249	O	
		F 026 40 S 0106	L	

Transit FT 260 K/S 2.0 TD, 2.0 TDCi, 2.0 TDE

2,0 55/63/74/92 ABFA <PD20>; D3FA <PD20>; F1FA <PD20 Ci>; F3FA <PD20>				
08.00-07.06		1 457 42 P 9239	O	
		1 457 43 S 3070	L	
		1 987 43 M 2192	I	

Transit FT 260 K/S 2.3i

2,3 103-107 E5FC <DOHC 16V BI-FUEL>				
08.01-07.06		0 451 10 P 3259	O	
		1 457 43 S 3070	L	
		0 450 90 F 5981 ¹	K	
		1 987 43 M 2192	I	

Transit FT 260 K/S 2.4 TDE

2,4 66 D2F... <PD24P>				
04.01-07.06		1 457 42 P 9239	O	
		1 457 43 S 3070	L	
		1 987 43 M 2192	I	

Transit FT 280 2.2 TDCi

2,2 63/81/103 PGF... <PD22>; P8F... <PD22>; QVFA <PD22>				
04.06→		1 457 42 P 9249	O	
04.06-12.07	WW	1 457 43 S 3070	L	
04.06-11.10		F 026 40 S 0106	L	

2,2 85 SRF... <PD22>				
10.08→		1 457 42 P 9249	O	
10.08-11.10		F 026 40 S 0106	L	

2,2 96-96 QWF... <PD22>				
04.06-08.07		1 457 42 P 9249	O	
		F 026 40 S 0106	L	

Transit FT 280 K/S 2.0 TD, 2.0 TDCi, 2.0 TDE

2,0 55/63/74/92 ABFA <PD20>; D3FA <PD20>; F1FA <PD20 Ci>; F3FA <PD20>				
08.00-07.06		1 457 42 P 9239	O	
		1 457 43 S 3070	L	
		1 987 43 M 2192	I	





Transit FT 280 K/S 2.3i			
2,3 103-107 E5FC <DOHC 16V BI-FUEL>			
08.01-07.06	0 451 10 P 3259	O	
	1 457 43 S 3070	L	
	0 450 90 F 5981 ¹	K	
	1 987 43 M 2192	I	

Transit FT 280 K/S 2.4 TDE			
2,4 66 D2F... <PD24P>			
04.01-07.06	1 457 42 P 9239	O	
	1 457 43 S 3070	L	
	1 987 43 M 2192	I	

Transit FT 280 L 2.3i			
2,3 103-107 E5FC <DOHC 16V BI-FUEL>			
08.01-07.06	0 451 10 P 3259	O	
	1 457 43 S 3070	L	
	0 450 90 F 5981 ¹	K	
	1 987 43 M 2192	I	

Transit FT 280 L 2.4 TDE			
2,4 55/66/85/92 DOFA <PD24PP>; D2F... <PD24P>; FXFA <DuraTorq DI>; F4FA <PD24>			
01.00-07.06	1 457 42 P 9239	O	
	1 457 43 S 3070	L	
	1 987 43 M 2192	I	

Transit FT 280 M 2.0 TD, 2.0 TDCi, 2.0 TDE			
2,0 55/63/74/92 ABFA <PD20>; D3FA <PD20>; FIFA <PD20 Ci>; F3FA <PD20>			
08.00-07.06	1 457 42 P 9239	O	
	1 457 43 S 3070	L	
	1 987 43 M 2192	I	

Transit FT 280 M 2.3i			
2,3 103-107 E5FC <DOHC 16V BI-FUEL>			
08.01-07.06	0 451 10 P 3259	O	
	1 457 43 S 3070	L	
	0 450 90 F 5981 ¹	K	
	1 987 43 M 2192	I	

Transit FT 280 M 2.4 TDE			
2,4 66 D2F... <PD24P>			
04.01-07.06	1 457 42 P 9239	O	
	1 457 43 S 3070	L	
	1 987 43 M 2192	I	

Transit FT 280 S 2.4 TDI			
2,4 66 <IDI24>			
01.01-05.06	1 457 42 P 9239	O	
	1 457 43 S 3070	L	
	1 987 43 M 2192	I	

Transit FT 300 2.2 TDCi			
2,2 63/81/103 PGF... <PD22>; P8F... <PD22>; QVFA <PD22>			
04.06->	1 457 42 P 9249	O	
04.06-12.07 WW	1 457 43 S 3070	L	
04.06-11.10	F 026 40 S 0106	L	



2,2 85 SRF... <PD22>			
10.08->	1 457 42 P 9249	O	
10.08-11.10	F 026 40 S 0106	L	

2,2 96 QWF... <PD22>			
04.06-08.07	1 457 42 P 9249	O	
	F 026 40 S 0106	L	

Transit FT 300 2.3i			
2,3 107 GZF... <DOHC 16V SEFI>			
04.06->	0 451 10 P 3363	O	
	1 457 43 S 3070	L	
	0 450 90 F 5927 ¹	K	

Transit FT 300 2.4 TDCi			
2,4 74-74/85 JXF... <PD24>; PHF... <PD24>			
07.06->	1 457 42 P 9249	O	
	1 457 43 S 3070	L	

Transit FT 300 K/S 2.0 TD, 2.0 TDCi, 2.0 TDE			
2,0 55/63/74/92 ABFA <PD20>; D3FA <PD20>; FIFA <PD20 Ci>; F3FA <PD20>			
08.00-07.06	1 457 42 P 9239	O	
	1 457 43 S 3070	L	
	1 987 43 M 2192	I	

Transit FT 300 K/S 2.3i			
2,3 107 E5FA <DOHC 16V SEFI>			
08.00-07.06	0 451 10 P 3259	O	
	1 457 43 S 3070	L	
	0 450 90 F 5981 ¹	K	
	1 987 43 M 2192	I	

Transit FT 300 L 2.0 TD, 2.0 TDCi, 2.0 TDE			
2,0 55/63/74/92 ABFA <PD20>; D3FA <PD20>; FIFA <PD20 Ci>; F3FA <PD20>			
08.00-07.06	1 457 42 P 9239	O	
	1 457 43 S 3070	L	
	1 987 43 M 2192	I	

Transit FT 300 L 2.3i			
2,3 107 E5FA <DOHC 16V SEFI>			
08.00-07.06	0 451 10 P 3259	O	
	1 457 43 S 3070	L	
	0 450 90 F 5981 ¹	K	
	1 987 43 M 2192	I	

Transit FT 300 M 2.0 TD, 2.0 TDCi, 2.0 TDE			
2,0 55/63/74/92 ABFA <PD20>; D3FA <PD20>; FIFA <PD20 Ci>; F3FA <PD20>			
08.00-07.06	1 457 42 P 9239	O	
	1 457 43 S 3070	L	
	1 987 43 M 2192	I	

Transit FT 300 M 2.3i			
2,3 107 E5FA <DOHC 16V SEFI>			
08.00-07.06	0 451 10 P 3259	O	
	1 457 43 S 3070	L	
	0 450 90 F 5981 ¹	K	
	1 987 43 M 2192	I	





Transit FT 300 S 2.0 TDCi

2,0 92 FIFA <PD20 Ci>			
05.02-05.06	1 457 42	P 9239	O
	<u>STZ</u>	1 457 43	S 3070 L
		1 987 43	M 2192 I

Transit FT 300 S 2.4 TDI

2,4 66/74 <IDI24>			
01.01-05.06	1 457 42	P 9239	O
	<u>STZ</u>	1 457 43	S 3070 L
		1 987 43	M 2192 I

Transit FT 310 S 2.4 TDI

2,4 88 <IDI24>			
01.01-05.06	1 457 42	P 9239	O
	<u>STZ</u>	1 457 43	S 3070 L
		1 987 43	M 2192 I

Transit FT 330 2.2 TDCi

2,2 81/103 PGF... <PD22>; QVFA <PD22>			
04.06->	1 457 42	P 9249	O
04.06-12.07	WW	1 457 43	S 3070 L
04.06-11.10		F 026 40	S 0106 L

2,2 85 SRF... <PD22>			
10.08->	1 457 42	P 9249	O
10.08-11.10		F 026 40	S 0106 L

2,2 96 QWF... <PD22>			
04.06-08.07	1 457 42	P 9249	O
		F 026 40	S 0106 L

Transit FT 330 2.3i, 2.3i CNG, 2.3i LPG

2,3 100-107 <Duratec>; GZF... <DOHC 16V SEFI>; GZFA <Duratec>			
04.06->	0 451 10	P 3263	O
		1 457 43	S 3070 L
		0 450 90	F 5927 ¹ K

Transit FT 330 2.4 TDCi, 2.4 TDCi 4x4

2,4 74-74/85-85/103 H... <PD24>; JXF... <PD24>; PHF... <PD24>			
07.06->	1 457 42	P 9249	O
		1 457 43	S 3070 L

Transit FT 330 K/S 2.0 TDCi, 2.0 TDE

2,0 74/92 ABFA <PD20>; FIFA <PD20 Ci>			
05.02-07.06	1 457 42	P 9239	O
		1 457 43	S 3070 L
		1 987 43	M 2192 I

Transit FT 330 K/S 2.3i

2,3 103-107 E5FA <DOHC 16V SEFI>; E5FC <DOHC 16V BI-FUEL>			
12.00-07.06	0 451 10	P 3259	O
		1 457 43	S 3070 L
		0 450 90	F 5981 ¹ K
		1 987 43	M 2192 I



Transit FT 330 K/S 2.4 TD, 2.4 TDCi, 2.4 TDE

2,4 55/66/85/88/92/101 DOFA <PD24PP>; D2F... <PD24P>; D4FA <PD24>; FXFA <DuraTorq DI>; F4FA <PD24N>; H9FA <DuraTorq TDCi>			
01.00-07.06	1 457 42	P 9239	O
		1 457 43	S 3070 L
		1 987 43	M 2192 I

Transit FT 330 L 2.0 TDCi, 2.0 TDE

2,0 74/92 ABFA <PD20>; FIFA <PD20 Ci>			
05.02-07.06	1 457 42	P 9239	O
		1 457 43	S 3070 L
		1 987 43	M 2192 I

Transit FT 330 L 2.3i

2,3 103-107 E5FA <DOHC 16V SEFI>; E5FC <DOHC 16V BI-FUEL>			
12.00-07.06	0 451 10	P 3259	O
		1 457 43	S 3070 L
		0 450 90	F 5981 ¹ K
		1 987 43	M 2192 I

Transit FT 330 L 2.4 TD, 2.4 TDCi, 2.4 TDE

2,4 55/66/85/88/92/101 DOFA <PD24PP>; D2F... <PD24P>; D4FA <PD24>; FXFA <DuraTorq DI>; F4FA <PD24N>; H9FA <DuraTorq TDCi>			
01.00-07.06	1 457 42	P 9239	O
		1 457 43	S 3070 L
		1 987 43	M 2192 I

Transit FT 330 L 2.4 TDI

2,4 66/88 <IDI24>			
01.01-05.06	1 457 42	P 9239	O
	<u>STZ</u>	1 457 43	S 3070 L
		1 987 43	M 2192 I

Transit FT 330 M 2.0 TDCi, 2.0 TDE

2,0 74/92 ABFA <PD20>; FIFA <PD20 Ci>			
05.02-07.06	1 457 42	P 9239	O
		1 457 43	S 3070 L
		1 987 43	M 2192 I

Transit FT 330 M 2.3i

2,3 103-107 E5FA <DOHC 16V SEFI>; E5FC <DOHC 16V BI-FUEL>			
12.00-07.06	0 451 10	P 3259	O
		1 457 43	S 3070 L
		0 450 90	F 5981 ¹ K
		1 987 43	M 2192 I

Transit FT 330 M 2.4 TD, 2.4 TDCi, 2.4 TDE

2,4 55/66/85/88/92/101 DOFA <PD24PP>; D2F... <PD24P>; D4FA <PD24>; FXFA <DuraTorq DI>; F4FA <PD24N>; H9FA <DuraTorq TDCi>			
01.00-07.06	1 457 42	P 9239	O
		1 457 43	S 3070 L
		1 987 43	M 2192 I

Transit FT 330 M 2.4 TDI

2,4 66/88 <IDI24>			
01.01-05.06	1 457 42	P 9239	O
	<u>STZ</u>	1 457 43	S 3070 L
		1 987 43	M 2192 I





Transit FT 330 S 2.4 TDI

2,4 66/74/88 <IDI24>	01.01-05.06	1 457 42 P 9239	O
	STZ	1 457 43 S 3070	L
		1 987 43 M 2192	I

Transit FT 350 2.2 TDCi

2,2 81/103 PGF... <PD22>; QVFA <PD22>	04.06->	1 457 42 P 9249	O
	04.06-12.07 WW	1 457 43 S 3070	L
	04.06-11.10	F 026 40 S 0106	L

2,2 85 SRF... <PD22>	10.08->	1 457 42 P 9249	O
	10.08-11.10	F 026 40 S 0106	L

2,2 96 QWF... <PD22>	04.06-08.07	1 457 42 P 9249	O
		F 026 40 S 0106	L

Transit FT 350 2.3i, 2.3i CNG, 2.3i LPG

2,3 100-107 <Duratec>; GZF... <DOHC 16V SEFI>; GZFA <Duratec>	04.06->	0 451 10 P 3363	O
		1 457 43 S 3070	L
		0 450 90 F 5927 ¹	K

Transit FT 350 2.4 TDCi, 2.4 TDCi 4x4

2,4 74-74/85-85/103 H... <PD24>; JXF... <PD24>; PHF... <PD24>	07.06->	1 457 42 P 9249	O
		1 457 43 S 3070	L

Transit FT 350 3.2 TDCi

3,2 147 SAF... <PD32>	08.07->	1 457 42 P 9249	O
---------------------------	---------	-----------------	---

Transit FT 350 E 2.4 TDI

2,4 66/88/96 <IDI24>	01.01-05.06	1 457 42 P 9239	O
	STZ	1 457 43 S 3070	L
		1 987 43 M 2192	I

Transit FT 350 EL 2.0 TDCi, 2.0 TDE

2,0 74/92 ABFA <PD20>; FIFA <PD20 Ci>	05.02-07.06	1 457 42 P 9239	O
		1 457 43 S 3070	L
		1 987 43 M 2192	I

Transit FT 350 EL 2.3i

2,3 103-107 E5FA <DOHC 16V SEFI>; E5FC <DOHC 16V BI-FUEL>	12.00-07.06	0 451 10 P 3259	O
		1 457 43 S 3070	L
		0 450 90 F 5981 ¹	K
		1 987 43 M 2192	I



Transit FT 350 EL 2.4 TD, 2.4 TDCi, 2.4 TDE

2,4 55/66/85/92/101 DOFA <PD24PP>; D2F... <PD24P>; FXFA <DuraTorq DI>; F4FA <PD24N>; H9FA <Duratorq TDCi>	01.00-07.06	1 457 42 P 9239	O
		1 457 43 S 3070	L
		1 987 43 M 2192	I

Transit FT 350 L 2.0 TDCi, 2.0 TDE

2,0 74/92 ABFA <PD20>; FIFA <PD20 Ci>	05.02-07.06	1 457 42 P 9239	O
		1 457 43 S 3070	L
		1 987 43 M 2192	I

Transit FT 350 L 2.3i

2,3 103-107 E5FA <DOHC 16V SEFI>; E5FC <DOHC 16V BI-FUEL>	12.00-07.06	0 451 10 P 3259	O
		1 457 43 S 3070	L
		0 450 90 F 5981 ¹	K
		1 987 43 M 2192	I

Transit FT 350 L 2.4 TD, 2.4 TDCi, 2.4 TDE

2,4 55/66/85/88/92/101 DOFA <PD24PP>; D2F... <PD24P>; D4FA <PD24>; FXFA <DuraTorq DI>; F4FA <PD24N>; H9FA <Duratorq TDCi>	01.00-07.06	1 457 42 P 9239	O
		1 457 43 S 3070	L
		1 987 43 M 2192	I

Transit FT 350 L 2.4 TDI

2,4 66/88/96 <IDI24>	01.01-05.06	1 457 42 P 9239	O
	STZ	1 457 43 S 3070	L
		1 987 43 M 2192	I

Transit FT 350 M 2.0 TDCi, 2.0 TDE

2,0 74/92 ABFA <PD20>; FIFA <PD20 Ci>	05.02-07.06	1 457 42 P 9239	O
		1 457 43 S 3070	L
		1 987 43 M 2192	I

Transit FT 350 M 2.3i

2,3 103-107 E5FA <DOHC 16V SEFI>; E5FC <DOHC 16V BI-FUEL>	12.00-07.06	0 451 10 P 3259	O
		1 457 43 S 3070	L
		0 450 90 F 5981 ¹	K
		1 987 43 M 2192	I

Transit FT 350 M 2.4 TD, 2.4 TDCi, 2.4 TDE

2,4 55/66/85/88/92/101 DOFA <PD24PP>; D2F... <PD24P>; D4FA <PD24>; FXFA <DuraTorq DI>; F4FA <PD24N>; H9FA <Duratorq TDCi>	01.00-07.06	1 457 42 P 9239	O
		1 457 43 S 3070	L
		1 987 43 M 2192	I





Transit FT 350 M 2.4 TDI

2,4 66/88/96 <IDI24>	01.01-05.06	1 457 42 P 9239	O
		1 457 43 S 3070	L
		1 987 43 M 2192	I

Transit FT 430 2.4 TDCi

2,4 74-74/85-85/103 H... <PD24>; JXF... <PD24>; PHF... <PD24>	07.06->	1 457 42 P 9249	O
		1 457 43 S 3070	L

Transit FT 430 E 2.4 TDI

2,4 96 <IDI24>	06.04-05.06	1 457 42 P 9239	O
		1 457 43 S 3070	L
		1 987 43 M 2192	I

Transit FT 430 EL 2.4 TD, 2.4 TDCi, 2.4 TDE

2,4 55/66/85/92/101 DOFA <PD24PP>; D2F... <PD24P>; FXFA <DuraTorq DI>; F4FA <PD24N>; H9FA <Duratorq TDCi>	08.02-07.06	1 457 42 P 9239	O
		1 457 43 S 3070	L
		1 987 43 M 2192	I

Transit FT 430 M 2.4 TD, 2.4 TDCi, 2.4 TDE

2,4 55/85/92/101 DOFA <PD24PP>; FXFA <DuraTorq DI>; F4FA <PD24N>; H9FA <Duratorq TDCi>	08.02-07.06	1 457 42 P 9239	O
		1 457 43 S 3070	L
		1 987 43 M 2192	I

Transit FT 460 2.4 TDCi

2,4 85/103 H... <PD24>; JXF... <PD24>	07.06->	1 457 42 P 9249	O
		1 457 43 S 3070	L

Transit FT 460 3.2 TDCi

3,2 147 SAF... <PD32>	08.07->	1 457 42 P 9249	O
---------------------------	---------	-----------------	---

Transit 1.6 80-120, 100 L, 130-190

1,6 46 LA... <TL16 OHC VV LC>	01.86-07.91	0 451 10 P 3259	O
		1 457 42 S 9845	L

Transit 1.8 i, LPG

1,8 81-85 EYPA <ZH18 EFI>; EYPC <ZH18 BI-FUEL>	05.02-06.10	0 451 10 P 3259	O
		1 457 43 S 3686	L
		0 450 90 F 5939 ¹	K
		1 987 43 M 2045	I
		1 987 43 R 2345 ⁸	I

Transit 1.8 TDCi

1,8 55/66/81 HCPA <LD18 Ci>; HCPB <LD18 Ci>; P7P... <LD18 Ci>; RWPA <LD18 Ci>	05.02->	0 451 10 P 3252	O
		1 457 43 S 3686	L
		0 450 90 N 6508 ¹	K
		1 987 43 M 2045	I
		1 987 43 R 2345 ⁸	I



Transit 1.8 TDDi

1,8 55 BHPA <LD18 Di>; BHPB <LD18 Di>	05.02-06.10	0 451 10 P 3252	O
		1 457 43 S 3686	L
	05.02-10.05	MIH 0 450 90 N 6406 ¹	K
		MIH 0 450 90 N 6407 ¹	K
	11.05-06.10	0 450 90 N 6508 ¹	K
	05.02-06.10	1 987 43 M 2045	I
		1 987 43 R 2345 ⁸	I

Transit 2.0 i

2,0 84 NSF <DOHC 8V SEFI>; NSG <DOHC 8V SEFI>	08.94-07.00	KL 0 451 10 P 3029	O
		KL 0 451 10 P 3259	O
		1 457 43 S 3750	L
		0 450 90 F 5324 ¹	K

Transit 2.0 i LWB 100-190, i SWB 80-150

2,0 72 NCA <TL20EFI OHC EFI>; NCA <TL20EFI OHC EFI HC>	08.91-07.94	0 451 10 P 3259	O
		1 457 43 S 3789	L
	08.91-12.91	0 450 90 F 5195 ¹	K

Transit 2.0 i 80-120, i 100 L, i 130-190

2,0 57 N6T <TL20CFI OHC LC>	10.88-07.91	0 451 10 P 3259	O
		1 457 43 S 3789	L
		0 450 90 F 5964 ¹	K

Transit 2.0 LWB 100-190, SWB 80-150, 80-120, 100 L, 130-190

2,0 55-57/66 NAT <TL20 OHC VV LC>; NAV <TL20 OHC VV LC>; NBA <TL20 OHC 2V HC>	01.86-07.94	0 451 10 P 3259	O
		1 457 42 S 9845	L

Transit 2.0 TDCi, TDE

2,0 74/92 ABFA <PD20>; F1FA <PD20 Ci>; F1FA <PD20 Ci>	08.00-07.06	1 457 42 P 9239	O
		1 457 43 S 3070	L
		1 987 43 M 2192	I

Transit 2.2 TDCi

2,2 81/103 PGF... <PD22>; PGFA <PD22>; QVFA <PD22>	04.06->	1 457 42 P 9249	O
	04.06-12.07	WW 1 457 43 S 3070	L
	04.06-11.10	F 026 40 S 0106	L

2,2 85 <PD22>	10.08->	1 457 42 P 9249	O
	10.08-11.10	F 026 40 S 0106	L

2,2 85 SRF... <PD22>	10.08->	1 457 42 P 9249	O
	10.08-11.10	F 026 40 S 0106	L

2,2 96-96 QWF... <PD22>	04.06-08.07	1 457 42 P 9249	O
		F 026 40 S 0106	L



Transit 2.5 D

2,5 51 4FA <D25N>			
08.94-08.00	0 451 10 P 3252	O	
	1 457 43 S 3750	L	
	1 457 43 N 4400 ²	K	

2,5 51 4FB <D25N>; 4FC <D25N>; 4FD <D25N>			
08.94-08.00	0 451 10 P 3252	O	
	1 457 43 S 3750	L	
	1 457 43 N 4400 ²	K	

Transit 2.5 D 80-120

2,5 52 4CA <D25N>			
10.88-07.91	0 451 10 P 3252	O	
	SFZ 0 451 10 P 3252	O	
	AGF 1 457 43 S 3690	L	
	AGF 1 457 42 S 9845	L	
	1 457 43 N 4400 ²	K	

Transit 2.5 D 80-120, D 100 L, D 130-190

2,5 50-52 4... <D25N>; 4AB <D25N>			
01.86-07.91	0 451 10 P 3252	O	
	SFZ 0 451 10 P 3252	O	
	AGF 1 457 42 S 9845	L	
A,CH, 10.88-07.91	AGF 1 457 43 S 3690	L	
D			
01.86-07.91	1 457 43 N 4400 ²	K	

Transit 2.5 DI

2,5 56 4HB <D25P>; 4HC <D25P>			
08.94-08.00	0 451 10 P 3252	O	
	LBF 1 457 43 S 3750	L	
03.98-08.00	LBF 1 457 43 S 3792	L	
08.94-08.00	1 457 43 N 4400 ²	K	

Transit 2.5 DI LWB 100 L, DI SWB 80-120

2,5 52 4BC <D25N>			
08.91-07.94	0 451 10 P 3252	O	
	EAB 1 457 43 S 3690	L	
	ECC 1 457 42 S 9845	L	
	1 457 43 N 4400 ²	K	

2,5 52 4CC <D25N>			
08.91-07.94	0 451 10 P 3252	O	
	EAB 1 457 43 S 3690	L	
	ECC 1 457 42 S 9845	L	
	1 457 43 N 4400 ²	K	

Transit 2.5 DI LWB 100-190, DI SWB 80-150

2,5 59 4DA <D25P>			
08.91-07.94	0 451 10 P 3252	O	
	1 457 43 S 3750	L	
	1 457 43 N 4400 ²	K	



Transit 2.5 DI SWB 80-120

2,5 51-52 4FA <D25N>			
08.91-07.94	0 451 10 P 3252	O	
	EAB 1 457 43 S 3690	L	
	ECC 1 457 42 S 9845	L	
	1 457 43 N 4400 ²	K	

Transit 2.5 DI Turbo LWB 100-190, DI Turbo SWB 80-150

2,5 63 4GA <D25TN>			
10.92-07.94	0 451 10 P 3252	O	
	1 457 43 S 3690	L	
	1 457 43 N 4400 ²	K	

Transit 2.5 DI Turbo LWB 150+190 L, DI Turbo SWB 150 S

2,5 74 4EA <D25TP T/C>			
08.91-07.94	0 451 10 P 3252	O	
	1 457 43 S 3690	L	
	1 457 43 N 4400 ²	K	

Transit 2.5 TD

2,5 63 4GA <D25TN>			
08.94-08.00	0 451 10 P 3252	O	
	LBF 1 457 43 S 3750	L	
08.97-08.00	LBF 1 457 43 S 3792	L	
08.94-08.00	1 457 43 N 4400 ²	K	

Transit 2.5 TD, TDI

2,5 63 4GB <D25TN>; 4GC <D25TN>; 4GD <D25TN>; 4GE <D25TN>; 4GF <D25TN>			
08.94-08.00	0 451 10 P 3252	O	
	LBF 1 457 43 S 3750	L	
08.97-08.00	LBF 1 457 43 S 3792	L	
08.94-08.00	1 457 43 N 4400 ²	K	

Transit 2.5 TDI

2,5 85 4ED <D25TN>; 4ED <D25TPI>			
03.99-08.00	0 451 10 P 3252	O	
	LBF 1 457 43 S 3792	L	
	LBF 1 457 43 S 3750	L	
	1 457 43 N 4400 ²	K	

Transit 2.9 V6

2,9 110 B4T <TV29 V6 EFI HC>			
05.88-07.91	0 451 10 P 3029	O	
	0 450 90 F 5964 ¹	K	

Transit 2.9 V6 LWB 100 L-190

2,9 104 BRT <TV29 EFI OHV>			
08.91-07.94	0 451 10 P 3029	O	
	1 457 43 S 3750	L	
08.91-12.91	0 450 90 F 5195 ¹	K	

Transit 3.0 V6

3,0 73-78 HXC <V6 ESSEX 1V LC>			
01.86-07.91	0 451 10 P 3029	O	





Windstar

Windstar 3.0 i

3,0 109-112	10.94-12.00	0 451 10 P 3259	O
	12.98-12.00	F 026 40 F 3009 ¹	K

Windstar 3.8

3,8 115	12.98-12.98	F 026 40 F 3009 ¹	K
-----------	-------------	------------------------------	---

FSO

Polonez

Polonez 1.5

1,5 55/60	01.89-06.95	1 457 43 S 2108	L
-------------	-------------	-----------------	---

Polonez 1.6

1,6 56-60 CE; CE/CF	01.92-12.02	0 451 20 P 3154	O
		1 457 43 S 2108	L

Polonez 1.9 D

1,9 51 XUD 9A	01.93-12.02	0 451 10 P 3189	O
		1 457 43 N 4200 ²	K

1,9 51 XUD 9L	10.94-12.02	0 451 10 P 3189	O
-------------------	-------------	-----------------	---

125

125 1.5

1,5 55	10.67-02.91	0 451 20 P 3154	O
		1 457 43 S 2108	L

1,5 60	10.67-02.91	1 457 43 S 2108	L
----------	-------------	-----------------	---

GAZ

Gazel

Gazel 2.1 TD

2,1 70/81 560 <Euro 1>; 5601 <Euro 2>; 5602 <Euro 3>; 5603 <Euro 4>	09.97→	0 451 20 P 3194	O
		1 457 43 N 4105 ²	K

Gazel 2.3

2,3 80,9 4063.10	11.97→	0 451 20 P 3154	O
		TW 0 450 90 F 5030 ¹	K
		0 450 90 F 5200 ¹	K



Gazel 2.3 16V

2,3 73,5 4061.10 <DOHC>	01.97→	0 451 20 P 3154	O
-----------------------------	--------	-----------------	---

Gazel 2.4

2,4 66,2/73,5 4025.10; 4026.10	09.97→	0 451 20 P 3154	O
		1 457 42 S 9080	L

Gazel 2.4 L DOHC

2,4 112 <DOHC>	07.05→	0 451 10 P 3271	O
		0 450 90 F 5200 ¹	K

Gazel 2.5

2,4 73,5 4026.10	01.97→	1 457 42 S 9080	L
----------------------	--------	-----------------	---

Gazel 2.5 i, i 4x4

2,5 98/111,8 40522.10 <Euro 2>; 40524.10 <Euro 3>	09.01→	0 451 20 P 3154	O
		TW 0 450 90 F 5030 ¹	K
		0 450 90 F 5200 ¹	K

Gazel 2.7 TD

2,7 80 ADCR110 <Euro 4>	01.07→	1 457 43 N 4310 ²	K
		1 457 43 N 4310	K

Gazel 2.9 i, i 16V

2,9 85 4216	04.99→	0 451 20 P 3154	O
-----------------	--------	-----------------	---

Sobol

Sobol 2.1 TD

2,1 70/81 560 <Euro 1>; 5601 <Euro 2>; 5602 <Euro 3>	09.97→	0 451 20 P 3194	O
		1 457 43 N 4105 ²	K

Sobol 2.3

2,3 80,9 4063.10	09.97→	0 451 20 P 3154	O
		TW 0 450 90 F 5030 ¹	K
		0 450 90 F 5200 ¹	K

Sobol 2.4 L DOHC

2,4 112 <DOHC>	01.94→	0 451 10 P 3271	O
		0 450 90 F 5200 ¹	K

Sobol 2.5 i, i 4x4

2,5 98/111,8 40522 <Euro 2>; 40524.10 <Euro 3>	09.01→	0 451 20 P 3154	O
		TW 0 450 90 F 5030 ¹	K
		0 450 90 F 5200 ¹	K





Volga

Volga 2.1 TD

2,1 70/81 560; 560 <Euro 2>; 5601 <Euro 2>; 5602 <Euro 3>	09.97→	0 451 20 P 3194	O
		1 457 43 N 4105 ²	K

Volga 2.3

2,3 73,5 4061.10; 4061.10 <DOHC>	01.97→	0 451 20 P 3154	O
		0 450 90 F 5030 ¹	K
		0 450 90 F 5200 ¹	K

Volga 2.3 i

2,3 110 4062	01.89-12.03	0 451 20 P 3154	O
	01.89-12.99 TW	0 450 90 F 5030 ¹	K
		0 450 90 F 5200 ¹	K
	01.99-12.03	0 450 90 F 5601 ¹	K

Volga 2.3 i, i 16V, 16V

2,3 106/106,6/110 4062.10; 40621; 40621.10 <Euro 2>	01.97→	0 451 20 P 3154	O
		0 450 90 F 5030 ¹	K
		0 450 90 F 5200 ¹	K

Volga 2.3 i 16V

2,3 96 4062.10; 40621; 40621.10 <Euro 2>	01.97→	0 451 20 P 3154	O
		0 450 90 F 5200 ¹	K

Volga 2.4

2,4 66/66,2/73/73,5 402; 402.10; 4021; 4021.10	01.86-01.08	1 457 42 S 9080	L
--	-------------	-----------------	---

Volga 2.4 L

2,4 112 EDZ <DOHC Euro 2>	07.05→	0 451 10 P 3271	O
		0 450 90 F 5200 ¹	K

Volga 2.5

2,5 60/73,5 402.10	01.92-01.08	1 457 42 S 9080	L
------------------------	-------------	-----------------	---

GMC (GENERAL MOTORS CORP.)

GMC

GMC 3500 HD

4,2 110 6.07T <Sprint 6.07T>	08.96-12.01	0 986 B0 AB 3004	L
----------------------------------	-------------	------------------	---

Jimmy

Jimmy 4.3

4,3 131-134 L35	09.99-08.01	0 451 10 P 3079	O
	09.01-08.02 NAA	0 451 10 P 3079	O

Jimmy 4.3 4x4

4,3 131-134 L35	09.99-08.02	0 451 10 P 3079	O
4,3 145-149 LU3	09.04-08.05	0 451 10 P 3079	O

Savana

Savana 4.3 , 4x4

4,3 142-149 LU3; L35	09.99-08.09	0 451 10 P 3079	O
--------------------------	-------------	-----------------	---

Sierra

Sierra 4.3 , 4x4

4,3 146-149 LU3; L35	09.99-08.06	0 451 10 P 3079	O
--------------------------	-------------	-----------------	---

Sonoma

Sonoma 2.2

2,2 88-90 LN2	09.93-08.00	0 451 10 P 3079	O
-------------------	-------------	-----------------	---

Sonoma 2.5

2,5 78 L38	09.90-08.93	0 451 10 P 3079	O
----------------	-------------	-----------------	---

GREATWALL

Hover

Hover 2.8 D CUV Turbo

2,8 85 GW2.8TCI_EU3	02.07→	0 451 10 P 3270	O
		1 457 43 N 4310 ²	K
		1 457 43 N 4310	K

Wingle

Wingle 2.8 D 4X4 CC1031

2,8 70 GW2.8TC_EU3	12.06→	1 457 43 N 4310 ²	K
------------------------	--------	------------------------------	---





HOLDEN

Astra

Astra 1.8 i

1,8 92 Z18XE			
Mot.Nr. →20V00604	09.00-08.09	1 457 42 P 9178	O
Mot.Nr. 20V00605→	09.00-08.09	0 451 10 P 3079	O
	09.00-08.09	1 457 43 S 3281	L
		0 450 90 F 5273 ¹	K
	BHR	1 987 43 M 2038	I
	DHI,ELH	1 987 43 M 2040	I

Astra 2.2 i

2,2 108 Z 22 SE; Z22SE			
	09.00-08.09	0 450 90 F 5273 ¹	K

Barina

Barina 1.8 i 16V

1,8 92 Z18XE <GSI/ Ecotec>			
	09.01-10.05	0 451 10 P 3079	O
		1 457 43 S 3055	L
		0 450 90 F 5273 ¹	K

Rodeo

Rodeo 3.2

3,2 140 6VD1			
	01.01-02.03	0 451 10 P 3316	O
		0 450 90 F 5002 ¹	K

Suburban

Suburban 1500

5,7 190 L31			
	01.98-08.05	0 451 10 P 3079	O
		0 986 45 F 0119 ¹	K

HONDA

Accord

Accord 1.6 i

1,6 85 D16B6			
	10.98-02.03	F 026 40 P 7077	O

Accord 1.8

1,8 77 F18A			
	09.89-09.93	F 026 40 P 7077	O

Accord 1.8 i

1,8 92 F18B			
	09.93-09.97	F 026 40 P 7077	O
		1 457 43 S 3970	L



1,8 100 F18B2			
	10.98-02.03	F 026 40 P 7077	O
		1 987 42 S 9185	L

1,8 103 F18B			
	08.97-10.02	F 026 40 P 7077	O

Accord 1.8 i 16V

1,8 85 F18A3 <iES/iLS>; F18A3 <i/iS>			
	09.95-10.98	F 026 40 P 7077	O
		1 457 43 S 3950	L
		0 450 90 F 5916 ¹	K

1,8 85 F18A3 SOHC Kat. <iS/iES>			
	09.93-09.95	F 026 40 P 7077	O
		1 457 43 S 3950	L
		0 986 45 F 0104 ¹	K

Accord 2.0

2,0 81 F20A (DOHC)			
	09.89-09.93	F 026 40 P 7077	O

2,0 114 K20A6			
	02.03-12.05	0 986 45 P 2041	O
	01.06-08.08	F 026 40 P 7077	O
Fg.Nr. →3009053	02.03-06.08	0 986 45 P 2041	O
Fg.Nr. 3009054→	01.06-06.08	F 026 40 P 7077	O
	02.03-08.08	1 987 42 S 9192	L
	02.03-06.08	0 450 90 F 5916 ¹	K
	02.03-08.08	1 987 43 M 2166	I

2,0 114 K20Z2			
	01.06-08.08	NOR F 026 40 P 7077	O
		1 987 42 S 9192	L
	01.06-06.08	0 450 90 F 5916 ¹	K
	01.06-08.08	1 987 43 M 2166	I

2,0 115 R20A3			
	07.08→	F 026 40 P 7077	O
		1 987 43 M 2166	I

Accord 2.0 D Turbo

2,0 77 20T2N			
	09.95-10.98	0 451 10 P 3311	O
		1 457 43 S 3781	L
		0 450 90 N 6172 ¹	K

Accord 2.0 i

2,0 99 F20B (SOHC)			
	09.93-09.97	F 026 40 P 7077	O
		1 457 43 S 3970	L

2,0 108 F20B6			
	10.98-02.03	F 026 40 P 7077	O
		1 987 42 S 9185	L

2,0 110 F20A (DOHC)			
	09.89-02.94	F 026 40 P 7077	O
		1 457 43 S 3950	L

2,0 132/147 F20B (DOHC)			
	08.97-10.02	F 026 40 P 7077	O





Accord 2.0 i, i 4WD

2,0 107-110 F20B(SOHC)	08.97-10.02	F 026 40 P 7077	O
2,0 112/114/162 K20A	10.02-11.08	F 026 40 P 7077 1987 42 S 9192	O L

Accord 2.0 i 16V

2,0 85 F20Z2	03.93-09.95	F 026 40 P 7077 1457 43 S 3950 0986 45 F 0104 ¹	O L K
2,0 96 F20Z1	03.93-10.98 09.93-10.98 03.93-09.95 09.95-10.98	F 026 40 P 7077 1457 43 S 3950 0986 45 F 0104 ¹ 0450 90 F 5916 ¹	O L K K
2,0 98 F20A7	01.92-08.93	F 026 40 P 7077 1457 43 S 3950 0986 45 F 0104 ¹	O L K
2,0 99 F20A4	01.90-05.93	F 026 40 P 7077 1457 43 S 3950 0986 45 F 0104 ¹	O L K
2,0 100 F20B3 <iES>; F20B3 <iLS>	09.93-12.97	0986 45 P 2036 1457 43 S 3970 0450 90 F 5916 ¹	O L K
2,0 110 F20B2	10.99-12.00	F 026 40 P 7077	O
2,0 110 F20B5	12.97-12.02	0986 45 P 2036	O
2,0 110 <i-VTEC DOHC>	01.06->	1987 42 S 9192 0450 90 F 5916 ¹	L K

Accord 2.0 TDi

2,0 77 20T2N	01.99-02.03	1457 43 S 3781 0450 90 N 6172 ¹	L K
--------------	-------------	---	--------

Accord 2.0 16V

2,0 66 F20A6	01.90-05.93	F 026 40 P 7077 1987 42 S 9192 XXX 0986 45 F 0037 ¹	O L K
2,0 81 F20A2	01.90-05.93	F 026 40 P 7077 XXX 0986 45 F 0037 ¹	O K



Accord 2.2 CTDI

2,2 103 N22A1	01.04-08.08 01.04-12.05 01.06-08.08 01.04-08.08	F 026 40 P 7070 0450 90 N 6442 ¹ F 026 40 N 2063 ² 1987 43 M 2166	O K K I
---------------	--	--	------------------

Accord 2.2 i

2,2 94 F22A5	11.89-09.93	0451 10 P 3316 0986 45 F 0104 ¹	O K
2,2 103 F22A	04.91-02.94 04.91-01.92 04.91-02.94 TW,XXX 02.93-02.94 TW	F 026 40 P 7077 1457 43 S 3950 0986 45 F 0104 ¹ 0450 90 F 5937 ¹ 0986 45 F 0104 ¹	O L K K K
Fg.Nr. 1300001->			

2,2 107 F22B(SOHC)	09.93-09.97	F 026 40 P 7077 1457 43 S 3970	O L
--------------------	-------------	-----------------------------------	--------

2,2 107 F22B1(SOHC)	02.94-09.97 02.94-08.96 09.96-09.97 TW	F 026 40 P 7077 1457 43 S 3970 0450 90 F 5916 ¹ 0450 90 F 5916 ¹	O L K K
---------------------	--	---	------------------

2,2 140 H22A	09.93-09.97	F 026 40 P 7077 1457 43 S 3970	O L
--------------	-------------	-----------------------------------	--------

2,2 162 H22A	06.00-10.02	F 026 40 P 7077	O
--------------	-------------	-----------------	---

Accord 2.2 i Typ R

2,2 156 H22A7	01.99-02.03	F 026 40 P 7077 1987 42 S 9185	O L
---------------	-------------	-----------------------------------	--------

Accord 2.2 i 16V

2,2 103 F22B3	01.93-01.02	0451 10 P 3316 0450 90 F 5916 ¹	O K
---------------	-------------	---	--------

2,2 107 F22B1	01.93-01.02	0986 45 P 2036 0450 90 F 5916 ¹	O K
---------------	-------------	---	--------

2,2 108-110 F22A3	01.90-05.93	F 026 40 P 7077 1457 43 S 3950 0986 45 F 0104 ¹	O L K
-------------------	-------------	--	-------------

2,2 110 F22B5	09.93-06.98	0986 45 P 2036 1457 43 S 3970 0450 90 F 5916 ¹	O L K
---------------	-------------	---	-------------





◀ Accord 2.2 i 16V

2,2 110 F222Z	09.95-10.98	F 026 40 P 7077	0
		1 457 43 S 3950	L
		0 450 90 F 5916 ¹	K

Accord 2.2 i-DTEC, i-DTEC Type S

2,2 110/132 N22B1; N22B2	07.08→	F 026 40 P 7068	0
		1 987 43 M 2166	I

Accord 2.2 16V

2,2 107 F22B1	10.93-12.97	0 451 10 P 3316	0
		0 450 90 F 5916 ¹	K

Accord 2.3 i

2,3 110 F23A	02.98-02.03	0 451 10 P 3316	0
------------------	-------------	-----------------	---

2,3 113 F23Z5	12.99-02.03	F 026 40 P 7077	0
		1 987 42 S 9185	L

2,3 147 H23A	12.98-11.02	F 026 40 P 7077	0
------------------	-------------	-----------------	---

Accord 2.3 i, i 4WD

2,3 116/118 F23A	10.97-11.02	F 026 40 P 7077	0
----------------------	-------------	-----------------	---

Accord 2.3 i 16V

2,3 116 H23A3	03.93-09.95	F 026 40 P 7077	0
		1 457 43 S 3950	L
		0 986 45 F 0104 ¹	K

Accord 2.3 16V

2,3 110 F23A1	12.97→	0 451 10 P 3316	0
-------------------	--------	-----------------	---

Accord 2.4

2,4 140 K24A3	02.03-08.08	0 986 45 P 2041	0
	01.06-08.08	F 026 40 P 7077	0
Fg.Nr. →3011298	02.03-12.05	0 986 45 P 2041	0
Fg.Nr. 3011299→	01.05-06.08	F 026 40 P 7077	0
	02.03-08.08	1 987 42 S 9192	L
	02.03-06.08	0 450 90 F 5916 ¹	K
	02.03-08.08	1 987 43 M 2166	I

2,4 148 K24Z3	07.08→	F 026 40 P 7077	0
		1 987 43 M 2166	I

Accord 2.4 i

2,4 118 K24A	11.02-11.08	F 026 40 P 7077	0
	11.02-11.05	1 987 42 S 9192	L



Accord 2.4 i, i 4WD

2,4 140/147 K24A	10.02-11.08	F 026 40 P 7077	0
		1 987 42 S 9192	L

Accord 2.4 i V-Tec

2,4 119 K24A4	01.00-10.06	TOR 0 986 45 P 2041	0
		TW 0 451 10 P 3316	0

Accord 2.4 i 4WD

2,4 118 K24A	02.03-11.08	F 026 40 P 7077	0
		1 987 42 S 9192	L

Accord 2.4 i 16V

2,4 105 iVTEC	07.01→	0 451 10 P 3316	0
-------------------	--------	-----------------	---

Accord 3.0 i

3,0 147 J30A1	12.97→	0 451 10 P 3316	0
-------------------	--------	-----------------	---

3,0 177 J30A4	01.98-11.06	0 986 45 P 2041	0
-------------------	-------------	-----------------	---

Accord 3.0 i 24V

3,0 147-149 J30A1	09.97-08.02	0 986 45 P 2036	0
-----------------------	-------------	-----------------	---

Accord Aerodeck

Accord Aerodeck 2.0 i 16V

2,0 98-100 F20B3 <iES>; F20B3 <iLS>	09.93-06.98	0 986 45 P 2036	0
		1 457 43 S 3970	L
		0 450 90 F 5916 ¹	K

Accord Aerodeck 2.2 i

2,2 107 F22B1	06.93-01.97	0 451 10 P 3316	0
		0 450 90 F 5916 ¹	K

Accord Aerodeck 2.2 i, i 16V

2,2 110 F22B5 <iES>; F22B5 <iLS>	09.93-09.97	0 986 45 P 2036	0
		1 457 43 S 3970	L
		0 450 90 F 5916 ¹	K

Accord Aerodeck 2.2 i 16V

2,2 108-110 F22A7/8	01.91-06.94	F 026 40 P 7077	0
		1 457 43 S 3950	L
		0 986 45 F 0104 ¹	K

Acty

Acty 0.7

0,7 28 E07A	02.90-07.99	0 986 45 P 2061	0
-----------------	-------------	-----------------	---





Acty 0.7 i

0,7 32 E07A	12.95-06.99	0 450 90	F 5916 ¹	K
-------------	-------------	----------	----------------------------	----------

Airwave

Airwave 1.5 i

1,5 81 L15A	04.05-08.10	0 986 45	P 2041	O
-------------	-------------	----------	---------------	----------

Ascot

Ascot 2.0 i

2,0 110 F20A (DOHC)	03.92-02.97	F 026 40	P 7077	O
		1 457 43	S 3950	L

Beat

Beat 0.7 i

0,7 47 E07A	05.91-01.96	0 986 45	P 2061	O
-------------	-------------	----------	---------------	----------

City

City 1.2

1,2 56 D12A	09.86-06.94	0 986 45	P 2061	O
-------------	-------------	----------	---------------	----------

City 1.3 i

1,3 60 D13B4	10.00-08.02	0 986 45	P 2036	O
--------------	-------------	----------	---------------	----------

1,3 71 D13B4	06.96→	0 451 10	P 3316	O
--------------	--------	----------	---------------	----------

City 1.3 i DSi

1,3 60 D13B4	09.03→	0 986 45	P 2036	O
--------------	--------	----------	---------------	----------

City 1.5 i CVT

1,5 82 L15A1	06.03→	F 026 40	P 7077	O
--------------	--------	----------	---------------	----------

City 1.5 i i-DSi

1,5 66 L15A2 <i-DSi>	11.02-01.09	0 451 10	P 3316	O
----------------------	-------------	----------	---------------	----------

Civic

Civic 1.3

1,3 55 D13B1	10.87-09.91	0 986 45	P 2036	O
		1 987 42	S 9150	L
		XXX	0 986 45	F 0037 ¹
				K



1,3 60 D13B	09.87-03.96	0 986 45	P 2061	O
	09.87-08.91	1 987 42	S 9150	L

1,3 61 LDA1	01.02-12.05	0 986 45	P 2036	O
		1 987 43	M 2074	I

1,3 63 D13B	08.91-09.95	F 026 40	P 7077	O
		1 987 42	S 9150	L

1,3 70-85 LDA2	01.06→	F 026 40	P 7077	O
	01.06-08.09	1 987 43	M 2166	I

Civic 1.3 i

1,3 63 LDA1	11.01-03.05	F 026 40	P 7077	O
-------------	-------------	----------	---------------	----------

1,3 67 D13B	08.95-09.00	F 026 40	P 7077	O
		1 457 43	S 3274	L
		0 450 90	F 5916 ¹	K

Civic 1.3 16V

1,3 55 D13B2	09.89-09.95	0 986 45	P 2036	O
		1 987 42	S 9150	L
	10.91-09.95	XXX	0 450 90	F 5922 ¹
				K

Civic 1.4

1,3 61 L13A7	01.06-10.08	F 026 40	P 7077	O
		F 026 40	S0161	L
		1 987 43	M 2203	I

1,3 73 L13Z1	10.08→	F 026 40	P 7077	O
		F 026 40	S0132	L
		1 987 43	M 2203	I

1,4 55-66 D14Z6	02.01-12.05	0 986 45	P 2041	O
		1 457 43	S 3322	L
		ZE	1 987 43	M 2074
				I

1,4 66 D14A1	10.87-09.91	0 986 45	P 2036	O
		XXX	0 986 45	F 0037 ¹
				K

1,4 66 D14Z5	02.01-12.02	PRF,TEN	0 986 45	P 2036
		TOR	0 986 45	P 2041
			1 987 42	S 9176
			1 987 43	M 2074
				I





Civic 1.4 i 16V

1,4 55 D14A3			
09.95-01.97	0 986 45	P 2036	O
10.95-09.98	F 026 40	P 7077	O
09.95-01.97	1 457 43	S 3951	L
10.95-09.98	1 457 43	S 3274	L
	0 450 90	F 5916 ¹	K
09.95-01.97	KL 1 987 43	M 2053	I
	KL 1 987 43	M 2026	I
10.95-09.98	1 987 43	M 2026	I

1,4 55 D14Z1			
10.98-02.01	F 026 40	P 7077	O
	1 457 43	S 3274	L
	0 450 90	F 5916 ¹	K
	1 987 43	M 2026	I

1,4 55/66 D14A7; D14A8			
03.97-02.01	0 986 45	P 2036	O
03.98-02.01	F 026 40	P 7077	O
03.97-02.01	1 457 43	S 3951	L
03.98-02.01	0 450 90	F 5916 ¹	K
03.97-02.01	KL 1 987 43	M 2053	I
	KL 1 987 43	M 2026	I

1,4 55/66 D14Z3; D14Z4			
01.99-12.00	F 026 40	P 7077	O
	1 457 43	S 3951	L
	0 450 90	F 5916 ¹	K
	KL 1 987 43	M 2053	I
	KL 1 987 43	M 2026	I

1,4 66 D14A2			
09.94-01.97	F 026 40	P 7077	O
	1 457 43	S 3951	L
	0 450 90	F 5916 ¹	K
	1 987 43	M 2026	I

1,4 66 D14A4			
10.95-10.98	0 986 45	P 2036	O
	1 457 43	S 3274	L
	0 450 90	F 5916 ¹	K
	1 987 43	M 2026	I

1,4 66 D14Z2			
10.95-02.01	0 986 45	P 2036	O
10.98-02.01	F 026 40	P 7077	O
10.95-02.01	1 457 43	S 3274	L
	0 450 90	F 5916 ¹	K
	1 987 43	M 2026	I

Civic 1.5

1,5 66 D15Z1			
02.93-09.95	0 986 45	F 0104 ¹	K

1,5 67 D15B			
09.87-08.91	0 986 45	P 2061	O
10.92-03.96	0 986 45	P 2061	O
09.87-08.91	1 987 42	S 9150	L

1,5 67-74 D15B			
09.87-08.91	0 986 45	P 2061	O
	TW 1 457 43	S 3955	L
	1 987 42	S 9150	L

1,5 72/73/74 D15B4			
11.87-09.93	0 451 10	P 3316	O

1,5 74 D15B			
08.91-09.95	F 026 40	P 7077	O

1,5 74 D15B7			
10.93-09.95	0 451 10	P 3316	O
01.94-08.95	F 026 40	P 7077	O
	1 457 43	S 3951	L
10.93-09.95	0 986 45	F 0104 ¹	K
01.95-08.95	0 450 90	F 5916 ¹	K

1,5 77 D15B			
09.87-08.91	0 986 45	P 2061	O

Civic 1.5 Breeze

1,5 67 D15Z2			
10.93-09.95	0 986 45	F 0104 ¹	K

Civic 1.5 i

1,5 66 D15B1/2			
10.87-09.91	0 986 45	P 2036	O
	1 987 42	S 9136	L
	0 986 45	F 0100 ¹	K

1,5 66 D15B2			
10.88-09.91	0 986 45	P 2036	O
	1 987 42	S 9136	L
	0 986 45	F 0100 ¹	K

1,5 69 D15B			
08.91-09.95	F 026 40	P 7077	O
	1 457 43	S 3951	L

1,5 77 D15B			
08.95-09.03	F 026 40	P 7077	O
08.95-09.00	1 457 43	S 3274	L
09.00-09.03	1 457 43	S 3322	L
08.95-09.00	0 450 90	F 5916 ¹	K

1,5 82 L15A1			
03.95-12.04	0 986 45	P 2036	O

1,5 96 D15B			
08.91-09.00	F 026 40	P 7077	O
08.91-09.95	1 457 43	S 3951	L
10.93-09.95	0 986 45	F 0104 ¹	K
08.95-07.97	0 450 90	F 5916 ¹	K
08.98-09.00	0 450 90	F 5316 ¹	K

Civic 1.5 i, i 4WD

1,5 85 D15B			
09.00-09.03	F 026 40	P 7077	O
	1 457 43	S 3322	L

Civic 1.5 i 16V

1,5 66 D15B2			
10.91-09.95	0 986 45	P 2036	O
	1 457 43	S 3951	L
	0 986 45	F 0104 ¹	K

1,5 66 D15Z1			
10.91-09.95	0 986 45	P 2036	O
	1 457 43	S 3951	L
	0 986 45	F 0104 ¹	K





1,5 66 D15Z3; D15Z3 <iLS>	09.94-01.97	F 026 40 P 7077 O 1 457 43 S 3951 L 0 450 90 F 5916 ¹ K KL 1 987 43 M 2053 I KL 1 987 43 M 2026 I
--	-------------	--

1,5 69 D15B2	01.88-11.91	0 986 45 P 2036 O
-------------------------	-------------	---------------------------------

1,5 84 D15Z6	10.95-12.98	0 986 45 P 2036 O
	10.95-02.01	F 026 40 P 7077 O 1 457 43 S 3955 L 0 450 90 F 5916 ¹ K 1 987 43 M 2026 I

1,5 84 D15Z8	03.97-02.01	0 986 45 P 2036 O
	03.98-02.01	F 026 40 P 7077 O
	03.97-02.01	1 457 43 S 3951 L
	03.98-02.01	0 450 90 F 5916 ¹ K
	03.97-02.01	KL 1 987 43 M 2053 I KL 1 987 43 M 2026 I

Civic 1.6

1,6 59 D16Y7	09.95-08.00	F 026 40 P 7077 O 1 457 43 S 3274 L 0 450 90 F 5916 ¹ K 1 987 43 M 2026 I
-------------------------	-------------	---

1,6 77 ZC (SOHC)	10.92-03.96	F 026 40 P 7077 O
-----------------------------	-------------	---------------------------------

1,6 81 D16V1	02.01-12.02	TW F 026 40 P 7077 O 0 986 45 P 2036 O 1 987 42 S 9176 L 1 987 43 M 2074 I
-------------------------	-------------	---

1,6 88 D16Y4	10.95-09.00	0 451 10 P 3316 O 1 457 43 S 3955 L 0 450 90 F 5916 ¹ K
-------------------------	-------------	--

1,6 92 D16Y8	09.95-08.00	F 026 40 P 7077 O 0 450 90 F 5916 ¹ K 1 987 43 M 2026 I
-------------------------	-------------	--

1,6 92 R16A1	09.06→	F 026 40 P 7077 O F 026 40 S 0098 L
	09.06-08.09	TW 1 987 43 M 2166 I

1,6 96 D16A6	11.91-09.93	0 451 10 P 3316 O
-------------------------	-------------	---------------------------------

Civic 1.6 i

1,6 81 D16V1	02.01-12.05	0 986 45 P 2041 O 1 457 43 S 3322 L ZE 1 987 43 M 2074 I
-------------------------	-------------	--



1,6 81 D16V3	02.01-12.05	0 986 45 P 2041 O 1 457 43 S 3322 L ZE 1 987 43 M 2074 I
-------------------------	-------------	--

1,6 88 ZC (SOHC)	09.87-08.91	0 986 45 P 2061 O 1 987 42 S 9136 L
-----------------------------	-------------	--

1,6 90 D16Y4	03.95-11.01	0 451 10 P 3316 O 0 450 90 F 5916 ¹ K
-------------------------	-------------	---

1,6 93 D16Y5	10.95-09.98	1 457 43 S 3955 L 0 450 90 F 5916 ¹ K
-------------------------	-------------	---

1,6 94 D16Y8	10.95-02.01	1 457 43 S 3955 L
-------------------------	-------------	---------------------------------

1,6 96 D16A7	10.87-09.91	0 986 45 P 2036 O 0 986 45 F 0100 ¹ K
-------------------------	-------------	---

1,6 96 ZC (DOHC)	09.87-08.91	F 026 40 P 7077 O 0 986 45 P 2061 O
	05.92-09.95	F 026 40 P 7077 O
	09.87-08.91	1 987 42 S 9136 L
	05.92-09.95	1 457 43 S 3951 L

1,6 114 B16A	07.98-09.00	F 026 40 P 7077 O 1 457 43 S 3955 L 0 450 90 F 5316 ¹ K
-------------------------	-------------	--

1,6 118 B16A	09.89-09.91	F 026 40 P 7077 O
-------------------------	-------------	---------------------------------

1,6 118 B16A2	04.96-02.01	0 451 10 P 3316 O
--------------------------	-------------	---------------------------------

1,6 125 B16A	08.91-07.98	F 026 40 P 7077 O
	08.91-09.95	1 457 43 S 3951 L
	08.95-07.98	1 457 43 S 3955 L 0 450 90 F 5916 ¹ K

Fg.Nr. →1300000	09.92-08.94	0 986 45 F 0104 ¹ K
Fg.Nr. 1300001→	09.94-09.95	0 450 90 F 5916 ¹ K

1,6 136 B16B	07.97-09.00	F 026 40 P 7077 O 1 457 43 S 3955 L 0 450 90 F 5916 ¹ K
-------------------------	-------------	--

Civic 1.6 i Genio

1,6 88 D16Y4	01.92-12.95	0 451 10 P 3316 O
-------------------------	-------------	---------------------------------

Civic 1.6 i, i 4WD, i 16V 4WD

1,6 79-81 D16Z2	10.89-06.95	0 986 45 P 2036 O 1 987 42 S 9136 L 0 986 45 F 0100 ¹ K
----------------------------	-------------	--





Civic 1.6 i VTEC

1,6 92 R16A2	06.06-08.10	F 026 40 P 7077 O 1 987 43 M 2166 I
---------------------	-------------	--

Civic 1.6 i Vti

1,6 95 D16Y8	03.95-11.01	0 986 45 P 2036 O 0 450 90 F 5916 ¹ K
---------------------	-------------	---

Civic 1.6 i 4WD

1,6 77 ZC(SOHC)	08.89-08.91	F 026 40 P 7077 O 1 457 43 S 3955 L
------------------------	-------------	--

1,6 88 ZC(SOHC)	09.87-08.91	F 026 40 P 7077 O 1 987 42 S 9136 L
------------------------	-------------	--

Civic 1.6 i 16V

1,6 81	02.01-12.04 ZE	1 987 43 M 2074 I
---------------	----------------	---------------------------------

1,6 81 D16Y6	01.96-04.00	F 026 40 P 7077 O 0 450 90 F 5916 ¹ K 1 987 43 M 2026 I
---------------------	-------------	--

1,6 83/93 D16Y2;D16Y3	09.94-01.97	F 026 40 P 7077 O 1 457 43 S 3951 L 0 450 90 F 5916 ¹ K KL 1 987 43 M 2053 I KL 1 987 43 M 2026 I
------------------------------	-------------	--

1,6 84 D16Y5	10.95-02.01	0 986 45 P 2036 O 1 457 43 S 3955 L 0 450 90 F 5916 ¹ K 10.99-02.01 1 987 43 M 2026 I
---------------------	-------------	---

1,6 85 D16B2	03.97-02.01 0 986 45 P 2036 O 03.98-12.98 F 026 40 P 7077 O 03.97-02.01 1 457 43 S 3951 L 03.98-12.98 0 450 90 F 5916 ¹ K 03.97-02.01 KL 1 987 43 M 2053 I KL 1 987 43 M 2026 I
---------------------	---

1,6 85 D16W3;D16W4	01.99-02.01 F 026 40 P 7077 O 1 457 43 S 3951 L 01.99-12.00 0 450 90 F 5316 ¹ K 03.99-02.01 0 450 90 F 5916 ¹ K 01.99-02.01 KL 1 987 43 M 2053 I KL 1 987 43 M 2026 I
---------------------------	--

1,6 92 D16Z9	01.94-12.95	F 026 40 P 7077 O 1 457 43 S 3951 L 0 986 45 F 0104 ¹ K
---------------------	-------------	--



1,6 93 D16W3;D16W4	03.99-12.00	F 026 40 P 7077 O 1 457 43 S 3951 L 0 450 90 F 5916 ¹ K KL 1 987 43 M 2053 I KL 1 987 43 M 2026 I
---------------------------	-------------	--

1,6 110 B16A	10.89-09.91	F 026 40 P 7077 O
---------------------	-------------	---------------------------------

1,6 117 B16A2	10.95-02.01	0 451 10 P 3316 O
----------------------	-------------	---------------------------------

1,6 118 B16A2	10.91-02.01 0 986 45 P 2036 O 10.95-10.98 WW 0 451 10 P 3316 O 09.98-08.00 F 026 40 P 7077 O 10.91-09.95 1 457 43 S 3951 L 10.95-02.01 1 457 43 S 3955 L 10.91-09.95 0 986 45 F 0104 ¹ K 10.95-02.01 0 450 90 F 5916 ¹ K 01.98-10.98 0 450 90 F 5316 ¹ K 10.95-02.01 1 987 43 M 2026 I
----------------------	---

1,6 118 D16B2	01.97-02.01	F 026 40 P 7077 O 1 457 43 S 3955 L 0 450 90 F 5916 ¹ K 1 987 43 M 2026 I
----------------------	-------------	---

1,6 118 D16W3;D16W4	01.99-12.00	F 026 40 P 7077 O 0 450 90 F 5316 ¹ K KL 1 987 43 M 2053 I KL 1 987 43 M 2026 I
----------------------------	-------------	---

1,6 118 D16Y8 <Kat. VTEC VTi>	01.96-04.00	F 026 40 P 7077 O 0 450 90 F 5916 ¹ K 1 987 43 M 2026 I
--	-------------	--

Civic 1.6 i 16V EX

1,6 93 D16Y8	10.95-12.00	1 457 43 S 3951 L 0 450 90 F 5916 ¹ K
---------------------	-------------	---

Civic 1.6 i 16V, i 16V 4WD

1,6 80-81 D16A6	10.87-06.95	0 986 45 P 2036 O 1 987 42 S 9136 L 0 986 45 F 0100 ¹ K
------------------------	-------------	--

1,6 88/92 D16Z6;D16Z7	10.91-09.95	0 986 45 P 2036 O 1 457 43 S 3951 L 0 986 45 F 0104 ¹ K
------------------------------	-------------	--

Civic 1.6 i 16V LX

1,6 78 B16Y7	10.97-12.00	0 450 90 F 5916 ¹ K
---------------------	-------------	--





Civic 1.6 i 16V 4WD

1,6 85 D16A7	01.88-06.95	0 986 45 P 2036 O	
		1 987 42 S 9136 L	
		0 986 45 F 0100 ¹ K	

Civic 1.7

1,7 88 D17Z1	10.00→	0 986 45 P 2041 O	
--------------	--------	---------------------------------	--

Civic 1.7 CTDi

1,7 74 4EE2	01.02-12.05	1 457 42 P 9199 O	
		1 987 42 S 9178 L	
		0 450 90 N 6442 ¹ K	
	ZE	1 987 43 M 2074 I	

Civic 1.7 i

1,7 85 D17A6	02.01-01.06	1 987 43 M 2074 I	
--------------	-------------	---------------------------------	--

1,7 96 D17A	09.00-09.05	F 026 40 P 7077 O	
		1 457 43 S 3322 L	
		1 987 42 S 9176 L	

1,7 97 D17Z1	12.00-10.04	0 451 10 P 3316 O	
		1 987 42 S 9176 L	

Civic 1.7 i, i VTEC

1,7 88/92 D17A8;D17A9	05.01-12.05	0 986 45 P 2036 O	
		1 987 42 S 9176 L	
	ZE	1 987 43 M 2074 I	

Civic 1.7 i Vtec

1,7 97 D17A2	12.00-12.05	0 451 10 P 3316 O	
		1 987 42 S 9176 L	

Civic 1.7 i 4WD

1,7 96 D17A	09.00-09.05	F 026 40 P 7077 O	
		1 457 43 S 3322 L	

Civic 1.8

1,8 103 R18A1	10.08→	F 026 40 P 7077 O	
		F 026 40 S 0098 L	
	10.08-08.09 TW	1 987 43 M 2166 I	

1,8 103 R18A2	09.05→	F 026 40 P 7077 O	
		F 026 40 S 0098 L	
		1 987 43 M 2203 I	



Civic 1.8 i

1,8 108 B18B4	06.99-03.00	0 986 45 P 2036 O	
		0 450 90 F 5916 ¹ K	

Civic 1.8 i 16V

1,8 124 B18C4	03.97-02.01	F 026 40 P 7077 O	
		1 457 43 S 3951 L	
	03.98-02.01	0 450 90 F 5916 ¹ K	
	03.97-02.01 KL	1 987 43 M 2053 I	
	KL	1 987 43 M 2026 I	

Civic 2.0 D

2,0 63 20T2N	03.97-02.01	0 451 10 P 3311 O	
		0 450 90 N 6172 ¹ K	
	KL	1 987 43 M 2026 I	

Civic 2.0 D Turbo

2,0 77 20T2N	04.98-02.01	0 451 10 P 3311 O	
		1 457 43 S 3781 L	
		0 450 90 N 6172 ¹ K	
	KL	1 987 43 M 2026 I	

Civic 2.0 i

2,0 116 K20A3	05.03→	0 451 10 P 3316 O	
		1 987 42 S 9176 L	

Civic 2.0 Type R

2,0 147 K20A2	09.01-12.05 TW	F 026 40 P 7077 O	
		0 986 45 P 2041 O	
		F 026 40 S 0061 L	
	ZE	1 987 43 M 2074 I	

2,0 148 K20Z4	01.07→	F 026 40 P 7077 O	
		1 987 43 M 2203 I	

Civic 2.0 VSA

2,0 118 K20A2	01.04-12.05	0 986 45 P 2036 O	
		F 026 40 S 0061 L	
	ZE	1 987 43 M 2074 I	

Civic 2.2 CTDi

2,2 103 N22A2	09.05→	F 026 40 P 7068 O	
		F 026 40 S 0160 L	
		F 026 40 N 2063 ² K	
		1 987 43 M 2203 I	





Civic CRX

Civic CRX 1.6 i

1,6 80 D16A	10.87-02.92	1 987 42 S 9136	L
		0 986 45 F 0100 ¹	K

Civic CRX 1.6 i 16V

1,6 88 D16A	10.87-02.92	1 987 42 S 9136	L
-------------	-------------	------------------------	---

1,6 91-96 D16Z	10.89-02.92	F 026 40 P 7077	O
	10.88-02.92	1 987 42 S 9136	L
		0 986 45 F 0100 ¹	K

1,6 92 D16Y	01.96-12.98	0 986 45 P 2036	O
		1 457 43 S 3951	L
		0 450 90 F 5916 ¹	K

1,6 92 D16Z	03.92-12.95	0 986 45 P 2036	O
		1 457 43 S 3951	L
	03.92-12.94	0 986 45 F 0104 ¹	K
		01.95-12.95	0 450 90 F 5916 ¹

1,6 96 D16A8	11.87-05.92	0 451 10 P 3316	O
--------------	-------------	------------------------	---

1,6 110 B16A	10.89-02.92	F 026 40 P 7077	O
		0 986 45 F 0100 ¹	K

1,6 118 B16A	03.92-12.98	0 986 45 P 2036	O
		1 457 43 S 3951	L
		0 986 45 F 0104 ¹	K
		01.95-12.98	0 450 90 F 5916 ¹

Civic Shuttle

Civic Shuttle 1.3

1,3 60 D13B	08.89-10.92	0 986 45 P 2061	O
		1 987 42 S 9150	L

Civic Shuttle 1.5

1,5 74 D15B	09.87-03.96	0 986 45 P 2061	O
		1 457 43 S 3955	L

Civic Shuttle 1.6 i

1,6 88 ZC(SOHC)	09.87-10.92	0 986 45 P 2061	O
		1 987 42 S 9136	L

Civic Shuttle 1.6 i 4WD

1,6 88 ZC(SOHC)	09.87-03.96	F 026 40 P 7077	O
		1 987 42 S 9136	L
		0 986 45 F 0100 ¹	K



Civic Shuttle 1.6 4WD

1,6 77 ZC(SOHC)	08.89-10.92	F 026 40 P 7077	O
		1 457 43 S 3955	L

Concerto

Concerto 1.4 GL 16V

1,4 65 D14A1	08.89-10.91	0 986 45 P 2036	O

Concerto 1.5

1,5 67 D15B	06.88-09.92	0 986 45 P 2061	O
		1 987 42 S 9150	L

Concerto 1.5 i 16V

1,5 66 D15B2	08.89-03.95	0 986 45 P 2036	O
		1 457 43 S 3279	L
		0 450 90 F 5909 ¹	K

Concerto 1.6

1,6 77 ZC(SOHC)	06.88-09.92	F 026 40 P 7077	O
		1 457 43 S 3955	L

Concerto 1.6 i

1,6 85 D16A6	11.88-07.93	0 451 10 P 3316	O
--------------	-------------	------------------------	---

1,6 88 ZC(SOHC)	06.88-09.92	F 026 40 P 7077	O
		1 987 42 S 9136	L

Concerto 1.6 i 16V

1,6 82/90-96 D16A8;D16Z2	08.89-03.95	0 986 45 P 2036	O
		1 457 43 S 3279	L
		0 450 90 F 5909 ¹	K

CR-V

CR-V 2.0 i, i 4WD

2,0 96-110 B20B	10.95-08.01	F 026 40 P 7077	O
		1 457 43 S 3955	L
		0 450 90 F 5916 ¹	K

2,0 116 K20A	08.01-09.04	F 026 40 P 7077	O
		F 026 40 S 0061	L

CR-V 2.0 i Vtec

2,0 112 K20A4	05.02→	0 451 10 P 3316	O
		0 986 45 P 2036	O
		F 026 40 S 0061	L





CR-V 2.0 i 4WD

2,0 110 K20A4	07.02-12.05	0 986 45	P 2036	O
	01.06-09.06	F 026 40	P 7077	O
	07.02-09.06	0 450 90	F 5916 ¹	K
	ZE	1 987 43	M 2074	I

CR-V 2.0 i 4WD, i 16V

2,0 102 <i>VTEC</i>; K20 A4-A5	07.03→	1 987 43	M 2053	I
--------------------------------	--------	----------	---------------	----------

CR-V 2.0 i 16V 4WD

2,0 94-96 B20B4	10.95-01.99	F 026 40	P 7077	O
		1 457 43	S 3955	L
		0 450 90	F 5916 ¹	K
		1 987 43	M 2053	I

2,0 96 B20B	10.95-01.99	0 450 90	F 5916 ¹	K
-------------	-------------	----------	----------------------------	----------

2,0 97 B20B3	09.96-11.00	F 026 40	P 7077	O
		1 457 43	S 3955	L
		0 450 90	F 5916 ¹	K
		0 450 90	F 5316 ¹	K

2,0 97 B20Z1	11.00→	F 026 40	P 7077	O
		0 450 90	F 5316 ¹	K

2,0 108 B20B3	02.99-12.01	0 451 10	P 3316	O
		1 457 43	S 3955	L
		0 450 90	F 5916 ¹	K

2,0 108 B20Z1	01.99-07.02	F 026 40	P 7077	O
		1 457 43	S 3955	L
		0 450 90	F 5916 ¹	K
		1 987 43	M 2053	I

CR-V 2.0 4x4

2,0 110 R20A2	01.07→	F 026 40	P 7077	O
		1 987 43	M 2166	I

CR-V 2.2 CTDi 4x4

2,2 103 N22A2	02.05-09.06	F 026 40	P 7070	O	
	01.07-12.09	F 026 40	P 7068	O	
	02.05-09.06	F 026 40	S0159	L	
	01.07-12.09	F 026 40	S0159	L	
	02.05-09.06	F 026 40	N 2063 ²	K	
	01.07-12.09	F 026 40	N 2063 ²	K	
	02.05-09.06	ZE	1 987 43	M 2074	I
	01.07-12.09		1 987 43	M 2166	I



CR-V 2.2 i-DTEC 4x4

2,2 110 N22B3	01.10→	F 026 40	P 7068	O
		1 987 43	M 2166	I

CR-V 2.4 i

2,4 119 K24A1	01.02-10.06	F 026 40	P 7077	O
		TW	F 026 40	S 0061

CR-V 2.4 i 4WD

2,4 111 <i>VTEC</i>	11.04→	1 987 43	M 2053	I
---------------------	--------	----------	---------------	----------

2,4 119 K24A1	05.04→	TOR	0 986 45	P 2041	O
		TW	0 451 10	P 3316	O

CR-V 2.4 i 4x4

2,4 119 K24A1	08.02-10.06	TOR	F 026 40	P 7077	O
		TW	0 986 45	P 2041	O
			F 026 40	S 0061	L

CR-X

CR-X 1.5

1,5 73 D15B	09.87-02.92	0 986 45	P 2061	O
		1 457 43	S 3955	L

CR-X 1.6 i

1,6 96 D16A	09.95-07.97	F 026 40	P 7077	O
		1 457 43	S 3951	L
		0 450 90	F 5916 ¹	K

1,6 96 ZC (DOHC)	09.87-02.92	F 026 40	P 7077	O
		1 987 42	S 9136	L

1,6 118 B16A	09.89-02.92	F 026 40	P 7077	O
--------------	-------------	----------	---------------	----------

1,6 125 B16A	02.92-07.97	F 026 40	P 7077	O
		1 457 43	S 3951	L

CR-Z

CR-Z 1.5 Hybrid

1,5 84-91 LEA1	03.10→	F 026 40	P 7077	O
----------------	--------	----------	---------------	----------





Domani

Domani 1.6 i

1,6 88 D16A	01.97-08.00	F 026 40 P 7077	O
	NOR	1 457 43 S 3955	L
	01.98-10.99	AGA,SGA 1 457 43 S 3274	L
	01.97-08.00	0 450 90 F 5916 ¹	K

Edix

Edix 1.7 i

1,7 96 D17A	07.04-12.06	F 026 40 P 7077	O
		1 457 43 S 3322	L

Edix 2.0 i

2,0 115 K20A	07.04-08.09	F 026 40 P 7077	O
		F 026 40 S 0061	L

Element

Element 2.4 i 4WD

2,4 118 K24A4	04.03→	F 026 40 P 7077	O

ElySION

ElySION 2.4 i

2,4 118 K24A	05.04→	F 026 40 P 7077	O

Fit

Fit 1.3 i

1,3 63 L13A	06.01-06.04	1 987 42 S 9191	L
	07.04-10.07	F 026 40 S 0054	L

1,3 73 L13A	10.07→	F 026 40 P 7077	O

Fit 1.3 i 4WD

1,3 63 L13A	11.02-10.05	F 026 40 P 7077	O

Fit 1.4 i 16V Flex

1,4 74-74	11.08→	F 026 40 P 7077	O
		0 986 BF CB 0554	I

Fit 1.5 i

1,5 81 L15A	09.02-10.07	0 986 45 P 2041	O	
	Fg.Nr. 1900001→2000000	09.02-10.07	F 026 40 S 0054	L
	Org.Nr. CBA-GD3			
	Fg.Nr. 2000001→			
Org.Nr. DBA-GD3				



Fg.Nr. 1800001→1900000	09.02-11.05	1 987 42 S 9191	L
Org.Nr. CBA-GD3			
Fg.Nr. 1700001→1800000			
Org.Nr. UA-GD3			
Fg.Nr. 1500001→1700000			
Org.Nr. LA-GD3			

Fit 1.5 i 4WD

1,5 66 L15A	11.02-01.09	F 026 40 P 7077	O

Fit 1.5 i 16V

1,5 77 <VTEC DOHC>	02.05-10.06	1 987 42 S 9191	L
	11.06-10.08	F 026 40 S 0054	L

FR-V

FR-V 1.7 i

1,7 92 D17A2	01.05-12.06	F 026 40 P 7077	O
		STZ 1 457 43 S 3322	L
		1 987 43 M 2074	I

FR-V 1.8

1,8 103 R18A1	01.07-06.09	F 026 40 P 7077	O
		STZ F 026 40 S 0098	L
		1 987 43 M 2074	I

FR-V 2.0 i

2,0 110 K20A9	01.05-12.06	F 026 40 P 7077	O
		1 987 43 M 2074	I

FR-V 2.2 CTDi

2,2 103 N22A1	07.05-06.09	F 026 40 P 7070	O
		F 026 40 S 0159	L
		F 026 40 N 2063 ²	K
		1 987 43 M 2074	I

HR-V

HR-V 1.6 i, i 4WD

1,6 77 D16A	09.98-02.06	F 026 40 P 7077	O
		1 457 43 S 3955	L

1,6 92 D16A	09.98-02.06	F 026 40 P 7077	O

HR-V 1.6 i 16V, i 16V VTEC 4WD, i 16V 4WD

1,6 77/92 D16W1; D16W2; D16W5	12.98-12.05	F 026 40 P 7077	O
		1 457 43 S 3955	L
		0 450 90 F 5916 ¹	K
		ZE 1 987 43 M 2167	I





Insight

Insight 1.0 i

1,0 56 ECA1	01.00-12.06	F 026 40 P 7077	O
		1 987 43 M 2026	I

Insight 1.3 Hybrid

1,3 65 LDA3 <MF6>	03.09→	F 026 40 P 7077	O
-------------------	--------	-----------------	---

Inspire

Inspire 2.5 i

2,5 132 G25A	02.95-10.98	F 026 40 P 7077	O
		0 450 90 F 5916 ¹	K

2,5 147 J25A	10.98-06.03	F 026 40 P 7077	O
--------------	-------------	-----------------	---

Inspire 3.0 i

3,0 184 J30A	06.03-12.07	0 986 45 P 2041	O
--------------	-------------	-----------------	---

Inspire 3.2 i

3,2 165/191 J32A	10.98-06.03	F 026 40 P 7077	O
------------------	-------------	-----------------	---

Integra

Integra 1.5 i

1,5 77 D15B	02.96-08.00	F 026 40 P 7077	O
		1 457 43 S 3274	L
		0 450 90 F 5916 ¹	K

1,5 96 D15B	02.96-08.00	F 026 40 P 7077	O
		1 457 43 S 3955	L
		0 450 90 F 5916 ¹	K

Integra 1.6

1,6 77 ZC (SOHC)	04.89-07.93	0 986 45 P 2061	O
	05.93-09.95	F 026 40 P 7077	O
	04.89-09.95	1 457 43 S 3955	L

Integra 1.6 i

1,6 88 ZC (SOHC)	04.89-07.93	0 986 45 P 2061	O
	05.93-09.00	F 026 40 P 7077	O
		0 450 90 F 5916 ¹	K

1,6 118 B16A	04.89-07.93	F 026 40 P 7077	O
--------------	-------------	-----------------	---



Integra 1.8 i

1,8 103 B18B	10.91-07.93	F 026 40 P 7077	O
--------------	-------------	-----------------	---

1,8 107 B18B	07.93-09.95	F 026 40 P 7077	O
		0 450 90 F 5916 ¹	K

1,8 125 B18C	07.99-09.00	F 026 40 P 7077	O
		0 450 90 F 5316 ¹	K
		0 450 90 F 5916 ¹	K

1,8 132 B18C	05.93-07.99	F 026 40 P 7077	O
		0 450 90 F 5916 ¹	K

Integra 1.8 i 16V

1,8 107 B18B2	08.93-10.99	0 451 10 P 3316	O
---------------	-------------	-----------------	---

1,8 125 B18C2	08.93-10.99	0 451 10 P 3316	O
		0 450 90 F 5916 ¹	K

1,8 140 B18C6	01.98-10.01	F 026 40 P 7077	O
		0 450 90 F 5916 ¹	K

Integra 2.0 i

2,0 118 K20A	07.01-07.06	F 026 40 P 7077	O
		F 026 40 S 0061	L

2,0 162 K20A	07.01-07.06	F 026 40 P 7077	O
	02.02→	0 986 45 P 2041	O
	07.01-07.06	F 026 40 S 0061	L
	02.02→	0 450 90 F 5916 ¹	K

Jazz

Jazz 1.2

1,2 55-57 L12A1	03.02-12.08	F 026 40 P 7077	O
Mot.Nr. →4000000	03.02-12.08	1 987 42 S 9191	L
Mot.Nr. 4000001→	03.02-12.08	F 026 40 S 0054	L
	03.02-12.08	1 987 43 M 2115	I

1,2 66 L12B1; L12B2	10.08→	F 026 40 P 7077	O
---------------------	--------	-----------------	---

Jazz 1.3 Hybrid

1,3 65 LDA3 <MF6>	09.10→	F 026 40 P 7077	O
-------------------	--------	-----------------	---

Jazz 1.4

1,3 61 L13A1	03.02-12.08	F 026 40 P 7077	O
		F 026 40 S 0054	L
		1 987 43 M 2115	I





◀ Jazz 1.4

1,3 73 L13Z1; L13Z2	10.08 →	F 026 40 P 7077	0
-------------------------	---------	-----------------	---

Jazz 1.5 i 16V

1,5 66 L15A2	01.04-09.08	TEN	F 026 40 P 7077	0
------------------	-------------	-----	-----------------	---

Lagreat

Lagreat 3.5 i

3,5 177 J35A	11.01-04.04	F 026 40 P 7077	0
------------------	-------------	-----------------	---

Legend

Legend 2.7 i

2,7 128 C27A1	01.87-02.91	0 986 45 P 2015	0
-------------------	-------------	-----------------	---

Legend 3.2 i 24V

3,2 151 C32A2	01.91-02.96	0 451 10 P 3266	0
		0 450 90 F 5215 ¹	K

3,2 | 151 | C32A2 <Kat.>

01.91-12.95	0 451 10 P 3266	0
-------------	-----------------	---

Legend 3.5 i

3,5 158 C35A	01.96-10.04	TW	F 026 40 P 7077	0
		XXX	1 457 43 S 3966	L
			0 450 90 F 5916 ¹	K

Legend 3.5 i 4WD

3,5 217-221 J35A8	10.04-09.08	F 026 40 P 7077	0
		1 987 43 M 2166	I

Legend 3.5 i 24V

3,5 147-151 C35A2; C35A5	01.96-12.04	0 986 45 P 2036	0	
		XXX	1 457 43 S 3966	L
		01.96-12.98	0 450 90 F 5916 ¹	K

Legend 3.7 4WD

3,7 217 J37A3	09.08 →	F 026 40 P 7077	0
		1 987 43 M 2166	I

Life

Life 0.7 i

0,7 37-38 E07Z	10.98-09.03	F 026 40 P 7077	0
--------------------	-------------	-----------------	---



Logo

Logo 1.3 i

1,3 48 D13B7	02.99-03.02	F 026 40 P 7077	0
		0 450 90 F 5316 ¹	K

1,3 | 49 | D13B

09.96-06.01	F 026 40 P 7077	0
	0 450 90 F 5916 ¹	K

MDX

MDX 3.5 i 4WD

3,5 191-195 J35A	03.03-06.06	0 986 45 P 2041	0
----------------------	-------------	-----------------	---

Mobilio

Mobilio 1.5 i

1,5 66 L15A	12.01-12.05	1 987 42 S 9191	L
	01.06-06.08	F 026 40 S 0054	L

NSX

NSX 3.0 i

3,0 195/206 C30A	09.90-12.05	0 451 10 P 3266	0
----------------------	-------------	-----------------	---

NSX 3.0 i 24V

3,0 188/201 C30A3; C30A4	06.90-01.05	0 451 10 P 3266	0
	06.90-12.96	XXX	0 450 90 F 5943 ¹

NSX 3.2 i, i 24V

3,2 206 C32B; C32B2	01.97-12.05	0 451 10 P 3266	0
-------------------------	-------------	-----------------	---

Odyssey

Odyssey 2.2 i

2,2 107 F22B (SOHC)	09.94-09.97	F 026 40 P 7077	0
		1 457 43 S 3970	L
		0 450 90 F 5916 ¹	K

Odyssey 2.3 i

2,3 110 F23A	07.97-10.03	F 026 40 P 7077	0	
		07.97-12.99	1 457 43 S 3970	L
			0 450 90 F 5916 ¹	K

Odyssey 2.4 i, i 4WD

2,4 118/140/147 K24A	10.03-10.08	F 026 40 P 7077	0
--------------------------	-------------	-----------------	---





Odyssey 3.0 i

3,0 147 J30A	10.97-01.00	F 026 40 P 7077 O 0 450 90 F 5916 ¹ K
3,0 154 J30A	01.00-10.03	F 026 40 P 7077 O

Orthia

Orthia 2.0 i

2,0 107-110 B20B	02.96-01.02	F 026 40 P 7077 O 1 457 43 S 3955 L 0 450 90 F 5916 ¹ K
------------------	-------------	--

Partner

Partner 1.5 i

1,5 77 D15B	02.96-03.06	0 986 45 P 2036 O 1 457 43 S 3274 L 0 450 90 F 5916 ¹ K
-------------	-------------	--

Prelude

Prelude 2.0

2,0 80/81-84 B20A3;B20A4	04.87-01.92	0 986 45 P 2036 O XXX 0 986 45 F 0037 ¹ K
--------------------------	-------------	---

Prelude 2.0 , i

2,0 81/103 B20A (DOHC); B20A (SOHC)	04.87-09.91	F 026 40 P 7077 O
-------------------------------------	-------------	-------------------

Prelude 2.0 i 16V

2,0 98 F20A4	02.92-09.96	F 026 40 P 7077 O
	10.96-12.99	0 986 45 P 2036 O
	02.92-09.96	0 986 45 F 0104 ¹ K
	10.96-12.99	0 450 90 F 5916 ¹ K

2,0 101/107 B20A5;B20A9	04.87-01.92	0 986 45 P 2036 O
-------------------------	-------------	-------------------

Prelude 2.0 i 16V 4WS

2,0 101/107 B20A	04.87-01.92	0 986 45 P 2036 O
------------------	-------------	-------------------

Prelude 2.0 4WS

2,0 80/81-84 B20A	10.87-01.92	XXX 0 986 45 F 0037 ¹ K
-------------------	-------------	------------------------------------

Prelude 2.1 i

2,1 107 B21A	10.90-09.91	F 026 40 P 7077 O
--------------	-------------	-------------------



Prelude 2.2 i

2,2 99/118 F22B (DOHC); F22B (SOHC)	09.91-08.00	F 026 40 P 7077 O
	10.96-08.00	0 450 90 F 5916 ¹ K

2,2 147 H22A	09.91-08.00	F 026 40 P 7077 O
	09.91-09.92	0 986 45 F 0104 ¹ K
	10.96-08.00	0 450 90 F 5916 ¹ K

2,2 162 H22A	09.98-08.00	F 026 40 P 7077 O 0 450 90 F 5316 ¹ K
--------------	-------------	---

Prelude 2.2 i 16V

2,2 96/118 F22A1;F22A6	12.91→	0 451 10 P 3316 O
------------------------	--------	-------------------

2,2 136 H22A2	02.93-09.96	0 986 45 P 2036 O
---------------	-------------	-------------------

2,2 142 H22A1	01.94-12.96	0 451 10 P 3316 O
---------------	-------------	-------------------

2,2 147 H22A5	10.96-12.98	0 986 45 P 2036 O
	01.99-12.01	F 026 40 P 7077 O
	10.96-12.01	0 450 90 F 5916 ¹ K

Prelude 2.2 i 16V, i 16V 4WS

2,2 136 H22A5	10.96-08.01	F 026 40 P 7077 O 0 450 90 F 5916 ¹ K
---------------	-------------	---

2,2 147 H22A8	10.99-12.01	F 026 40 P 7077 O 0 450 90 F 5916 ¹ K
---------------	-------------	---

Prelude 2.3 i 16V

2,3 118 H23A1	09.91-12.96	0 451 10 P 3316 O
---------------	-------------	-------------------

Prelude 2.3 i 16V 4WD

2,3 118 H23A2	02.92-09.96	F 026 40 P 7077 O 0 986 45 F 0104 ¹ K
---------------	-------------	---

Shuttle

Shuttle 2.2 i 16V

2,2 107 F22B8	01.95-12.97	F 026 40 P 7077 O 1 457 43 S 3970 L
	01.97-12.97	0 450 90 F 5916 ¹ K

Shuttle 2.3 i 16V

2,3 110 F23A7	01.98-05.01	F 026 40 P 7077 O 1 457 43 S 3970 L 0 450 90 F 5916 ¹ K
---------------	-------------	--





Step WGN

Step WGN 2.0 i

2,0 92-99 B20B	04.96-04.01	F 026 40 P 7077	O
		0 450 90 F 5916 ¹	K
2,0 118 K20A	04.01-05.05	F 026 40 P 7077	O
		F 026 40 S 0061	L

Step WGN 2.4 i

2,4 119 K24A	06.03-05.05	F 026 40 P 7077	O
		F 026 40 S 0061	L

Stream

Stream 1.7 i

1,7 96 D17A	10.00-07.06	F 026 40 P 7077	O
		TW 1 457 43 S 3322	L
Org.Nr. CBA-RN1	01.04-07.06	TW F 026 40 S 0061	L

Stream 1.7 i 4WD

1,7 96 D17A	10.00-07.06	F 026 40 P 7077	O
		1 457 43 S 3322	L

Stream 1.7 i 16V

1,7 92 D17A2	05.01→	0 986 45 P 2036	O
		1 457 43 S 3322	L

Stream 1.8 i

1,8 103 R18A	07.06→	F 026 40 P 7077	O
------------------	--------	-----------------	---

Stream 2.0 i

2,0 113 K20A	10.00-07.06	F 026 40 P 7077	O
		F 026 40 S 0061	L
2,0 115 K20B	12.03-07.06	F 026 40 P 7077	O
		F 026 40 S 0061	L

Stream 2.0 i 16V

2,0 115 K20A1	05.01→	0 986 45 P 2036	O
		F 026 40 S 0061	L

Street

Street 0.7 4WD

0,7 28 E07A	02.90-06.99	0 986 45 P 2061	O
-----------------	-------------	-----------------	---



Today

Today 0.7 i

0,7 35 E07A	01.93-10.98	0 986 45 P 2061	O
Fg.Nr. 3300001→3400000	01.93-10.98	0 450 90 F 5916 ¹	K
Fg.Nr. 3400001→	01.93-10.98	0 450 90 F 5316 ¹	K

Z

Z 0.7 i Turbo 4WD

0,7 47 E07Z	10.98-01.02	F 026 40 P 7077	O
-----------------	-------------	-----------------	---

HYUNDAI

Accent

Accent 1.3 i

1,3 43 G4EH; G4EH <Kat.>; G4EH <SOHC>	07.94-07.99	0 451 10 P 3316	O
		1 457 43 S 3326	L

1,3 44 G4AH	05.99-09.02	0 451 10 P 3316	O
-----------------	-------------	-----------------	---

1,3 44/55/62/67 G4EH; G4EH <Kat.>; G4EH <SOHC>	04.94-07.99	0 451 10 P 3316	O
		1 457 43 S 3326	L
		0 986 45 F 0624 ¹	K

1,3 53/55/61-63 G4E-A	08.99-03.06	0 451 10 P 3316	O
	02.05-03.06	XXX 0 450 90 F 5928 ¹	K
	12.01-03.06	1 987 43 M 2161	I

1,3 62 G4N	08.99→	1 987 43 M 2161	I
----------------	--------	-----------------	---

Accent 1.4 i

1,4 71 G4EE <1.4L-ALPHA>	04.06-12.10	0 451 10 P 3316	O
		F 026 40 S 0048	L
		TW 1 987 43 M 2204	I

Accent 1.5 CDRi

1,5 81 D4FA <1.5L-U>	04.06→	F 026 40 P 7062	O
	04.06-01.07	TW F 026 40 S 0048	L
	04.06→	TW F 026 40 S 0093	L
		1 987 43 M 2204	I

Accent 1.5 CRDi

1,5 57-60 D3-EA	01.02-06.06	1 457 42 P 9308	O
		F 026 40 S 0062	L
	01.02-03.04	1 457 43 N 4443 ²	K
	01.02-06.06	1 987 43 M 2161	I





Accent 1.5 i

1,5 66 G4EB <SOHC Alpha>			
	08.99-03.06	0 451 10 P 3316	O
	02.05-03.06 XXX	0 450 90 F 5928 ¹	K
	08.99-03.06	1 987 43 M 2161	I

1,5 75 G4EC-G <DOHC Alpha>			
	08.99-03.06	0 451 10 P 3316	O
	08.99-02.05	0 450 90 F 2161 ¹	K
	02.05-03.06 XXX	0 450 90 F 5928 ¹	K
	08.99-03.06	1 987 43 M 2161	I

1,5 79 <DOHC Alpha>			
	04.94-05.99	0 451 10 P 3316	O
		1 457 43 S 3290	L
		0 986 45 F 0624 ¹	K

Accent 1.5 i, i 16V

1,5 63/65-68/71/73 G4EK; G4FK; <SOHC Alpha>			
	04.94-07.99	0 451 10 P 3316	O
		1 457 43 S 3290	L
		0 986 45 F 0624 ¹	K

Accent 1.5 i 12V

1,5 69 Alpha			
	11.99→	0 450 90 F 2161 ¹	K

Accent 1.5 L DLS

1,5 42 TUD5			
	08.00-01.02	F 026 40 P 7018	O

Accent 1.6 i

1,6 77 G4ED-G			
	08.02-03.06	0 451 10 P 3316	O
	02.05-03.06 XXX	0 450 90 F 5928 ¹	K
	08.02-03.06	1 987 43 M 2161	I

1,6 82 G4ED <1.6L-ALPHA>			
	04.06-12.10	0 451 10 P 3316	O
		F 026 40 S 0048	L
	TW	1 987 43 M 2204	I

Accent 1.6 i 16V

1,6 76 Alpha			
	10.01→	0 451 10 P 3316	O
		0 450 90 F 2161 ¹	K

Atos

Atos 0.8 i

0,8 39-42 G4HA <Epsilon>			
	09.97-06.01	0 986 45 P 2061	O
		1 987 42 S 9167	L
		0 986 45 F 0225 ¹	K



Atos 1.0 i

1,0 40 G4HC <Epsilon>			
	12.97-06.01	0 986 45 P 2061	O
		WW F 026 40 P 7025	O
		1 987 42 S 9167	L
		0 986 45 F 0225 ¹	K

1,0 43 G4HC-E			
	07.01-12.03	0 986 45 P 2061	O
		1 987 42 S 9167	L
		0 986 45 F 0225 ¹	K

Atos 1.1 i

1,1 43-46 G4H...			
	06.03-03.08	F 026 40 P 7025	O

Atoz

Atoz 0.8 i

0,8 40 <SOHC Epsilon>			
	09.97-10.02	1 987 42 S 9167	L
		0 986 45 F 0225 ¹	K

Avante

Avante 1.5 i

1,5 65-68/77 <DOHC Alpha>; <SOHC Alpha>			
	03.95→	0 451 10 P 3316	O
		1 457 43 S 3290	L
		0 450 90 F 5915 ¹	K

Avante 1.8 i 16V

1,8 102 <DOHC Beta>			
	03.95-08.00	0 451 10 P 3316	O
		1 457 43 S 3073	L
		0 450 90 F 5915 ¹	K

Centennial

Centennial JL 350

3,5 155			
	08.00-03.05	0 451 10 P 3316	O

Centennial JS 350

3,5 155			
	08.00-03.05	0 451 10 P 3316	O

Centennial VL 450

4,5 195 8A80			
	08.00-07.06	0 451 10 P 3316	O

Centennial VS 450

4,5 195 8A80			
	08.00-07.06	0 451 10 P 3316	O





Click

Click 1.3 i

1,3 60 <SOHC Alpha>	05.02-06.05	1 457 43	S 3097	L
	XXX	0 450 90	F 5928 ¹	K

Coupé

Coupé 1.6 i 16V

1,6 76-79 G4ED-G	03.02-07.03	0 451 10	P 3316	O
	03.02-08.09	1 987 43	M 2158	I

1,6 84-85 G4GR <Beta>	05.96-09.01	0 451 10	P 3316	O
		1 457 43	S 3073	L
		0 450 90	F 5915 ¹	K

Coupé 1.8 i 16V

1,8 94 G4GM <Beta>	07.97-09.01	0 451 10	P 3316	O
		1 457 43	S 3073	L
		0 450 90	F 5915 ¹	K

Coupé 2.0 i

2,0 102 Beta	07.96→	0 451 10	P 3316	O
------------------	--------	----------	---------------	----------

Coupé 2.0 i 16V

2,0 100-102 G4GF <Beta>	05.96-09.01	0 451 10	P 3316	O
		1 457 43	S 3073	L
		0 450 90	F 5915 ¹	K

2,0 101-105 G4GC-G	10.01-07.03	0 451 10	P 3316	O
	10.01-08.09	1 987 43	M 2158	I

Coupé 2.7 i V6

2,7 121-123 G6BA-G	10.01-07.03	0 451 10	P 3316	O
	10.01-08.09	1 987 43	M 2158	I

Elantra

Elantra 1.5 i

1,5 53 G4DJ <New Orion>	10.90-04.95	0 451 10	P 3316	O
	CSA	1 457 42	S 9810	L

1,5 63-66 G4DJ	10.90-04.95	0 451 10	P 3316	O
	10.90-11.92	1 987 42	S 9127	L
	12.92-04.95	1 457 43	S 3314	L
	10.90-04.95	XXX	0 450 90	F 5929 ¹

1,5 65-68 G4EK <Alpha>	07.96-09.00	0 451 10	P 3316	O
		1 457 43	S 3290	L
		0 450 90	F 5915 ¹	K



Elantra 1.6 CRDi

1,6 85 D4FB <1C 1,6L-U>	08.06-02.08	F 026 40	P 7062	O
	08.06→	F 026 40	S 0063	L

Elantra 1.6 i

1,6G4CR <DOHC Sirius>	10.90-03.95	1 987 42	S 9127	L
-----------------------	-------------	----------	---------------	----------

1,6 80 G4DR	10.96-12.03	0 451 10	P 3316	O
-----------------	-------------	----------	---------------	----------

1,6 82 G4GA	04.04→	0 451 10	P 3316	O
		F 026 40	S 0044	L
		1 987 43	M 2158	I

Elantra 1.6 i 16V

1,6 77-79 G4ED-G	06.00-08.06	0 451 10	P 3316	O
		1 987 43	M 2158	I

1,6 78-84 G4CR	04.91-04.95	0 451 10	P 3316	O
	04.91-08.95	1 987 42	S 9127	L
	XXX	0 450 90	F 5929 ¹	K

1,6 78-84 G4DJ <New Sirius>	10.90-04.95	0 451 10	P 3316	O
		1 987 42	S 9127	L
	XXX	0 450 90	F 5929 ¹	K

1,6 84 4G61	05.95-09.00	0 451 10	P 3316	O
		1 457 43	S 3073	L
		0 450 90	F 5915 ¹	K

1,6 90 G4ED-G <D2 1.6 Gamma>	08.06→	0 451 10	P 3316	O
		F 026 40	S 0063	L

Elantra 1.8 i

1,8 94-97 G4GM	08.95-02.01	0 451 10	P 3316	O
		1 457 43	S 3073	L
		1 987 43	M 2158	I

1,8 97 Sirius	08.95-12.03	0 451 10	P 3316	O
-------------------	-------------	----------	---------------	----------

Elantra 1.8 i 16V

1,8 93-93 G4CN	06.92-04.95	0 451 10	P 3316	O
		1 987 42	S 9127	L
	XXX	0 450 90	F 5929 ¹	K

1,8 97 G4GB	06.00-08.06	0 451 10	P 3316	O
		1 987 43	M 2158	I

1,8 101 G4GM <Beta>	05.95-09.00	0 451 10	P 3316	O
		1 457 43	S 3073	L
		0 450 90	F 5915 ¹	K





Elantra 1.9 D

1,9 50 DJY10	05.95-09.00	0 451 10 P 3316	O
		1 457 43 S 3073	L
	11.97-09.00	1 457 43 N 1713	K

Elantra 2.0 CRDi

2,0 83 D4EA	06.04→	F 026 40 P 7018	O
2,0 83 D4EA <2.0L TCI>	06.01-08.06	F 026 40 P 7069	O
		RLE F 026 40 P 7018	O
		1 457 43 N 4198 ²	K
	06.01-12.03	1 987 43 M 2158	I

Elantra 2.0 i 16V

2,0 102-105 G4GC... <2.0L MPI DOHC>	06.00-09.06	0 451 10 P 3316	O
	TW	1 987 43 M 2158	I

Excel

Excel 1.3 i

1,3 43 G4DG <New Orion>; G4DG <SOHC New Orion>	04.89-07.94	0 451 10 P 3316	O
		1 987 42 S 9121	L
1,3 49/53 SOHC New Orion <G4DG>; 4G 13	04.89-07.94	0 451 10 P 3316	O
	CSA	1 457 42 S 9810	L
1,3 55 G4EH	07.94-07.99	0 451 10 P 3316	O
		1 457 43 S 3326	L
		0 986 45 F 0624 ¹	K

Excel 1.5 i

1,5 53 G4DJ	04.89-07.94	0 451 10 P 3316	O
	04.89-06.92	1 987 42 S 9127	L
	04.89-07.94	CSA 1 457 42 S 9810	L
	07.92-07.94	1 457 43 S 3314	L
1,5 59 4G 15	04.89-07.94	0 451 10 P 3316	O
		SIM 1 987 42 S 9127	L
	07.92-07.94	SIM 1 457 43 S 3314	L
	04.89-07.94	XXX 0 986 45 F 0120 ¹	K
1,5 61 G4DJ	04.89-07.94	0 451 10 P 3316	O
	04.89-06.92	1 987 42 S 9127	L
	07.92-07.94	1 457 43 S 3314	L
	04.89-07.94	XXX 0 986 45 F 0120 ¹	K
1,5 62 4G 15	04.89-07.94	0 451 10 P 3316	O
		CSA 1 457 42 S 9810	L



Excel 1.5 i, i 16V

1,5 65-68/73 G4EK; G4FK	07.94-07.99	0 451 10 P 3316	O
		1 457 43 S 3290	L
		0 986 45 F 0624 ¹	K

Galopper

Galopper 2.5 D

2,5 59 D4BA <T-E/G>	02.97-08.01	0 986 45 P 2066	O
		1 457 43 N 4453 ²	K
2,5 74 D4BA <T1>	08.91-02.97	WW 0 986 45 P 2066	O
		1 457 43 N 4453 ²	K

Galopper 2.5 D, D Interc.

2,5 54/70 D4BH <4D56TCI>; D4BX <4D56>	02.91-01.97	0 986 45 P 2066	O
		1 457 43 N 4453 ²	K

Galopper 2.5 D Turbo

2,5 63 D4BF <4D56TC>	09.91-01.97	WW 0 986 45 P 2066	O
		1 457 43 N 4453 ²	K
2,5 63-65 D4BF <4D56TC>	02.97-08.01	0 451 10 P 3366	O
		1 457 43 N 4453 ²	K
2,5 77-78 D4BH <QA-4TCI>	02.97-09.02	0 451 10 P 3366	O
		1 457 43 N 4453 ²	K

Galopper 2.5 TCI

2,5 74 D4BH	09.91-11.04	0 986 45 P 2066	O
-------------	-------------	-----------------	---

Galopper 3.0 i V6

3,0 104/118 G6AT	09.91-08.01	0 451 10 P 3316	O
		1 987 42 S 9127	L

Getz

Getz 1.1 i

1,1 43-49 G4HD	09.02-06.09	0 986 45 P 2061	O
		1 457 43 S 3097	L
		1 987 43 M 2161	I

Getz 1.3 i

1,3 60-63 G4E-A	09.02→	0 451 10 P 3316	O
	09.02-08.05	1 457 43 S 3097	L
		1 987 43 M 2161	I





Getz 1.4 i

1,4 71 G4EE-G	09.05-06.09	0 451 10 P 3316	O
		1 457 43 S 3097	L
		1 987 43 M 2161	I

Getz 1.5 CRDi

1,5 60 D3-EA <TCI>	05.03-08.05	1 457 42 P 9308	O
		F 026 40 S 0016	L
	05.03-10.04	1 457 43 N 4443 ²	K
	05.03-08.05	1 987 43 M 2161	I

1,5 65/81 D4FA <TDI>; D4FA-L <TDI>	09.05-06.09	F 026 40 P 7062	O
		F 026 40 S 0016	L
	TW	1 987 43 M 2161	I

Getz 1.6 i

1,6 77-78 G4ED-G	09.02-06.09	0 451 10 P 3316	O
		1 457 43 S 3097	L
		1 987 43 M 2161	I

Grace

Grace 2.4 i Super

2,4 90 G4CS <New Sirius>	10.95→	0 451 10 P 3316	O
------------------------------	--------	------------------------	----------

Grace 2.5 D, Intercooler

2,5 59/63 D4BA <T1 NA>; D4BF <4D56 TC>	10.95→	0 986 45 P 2066	O
		1 457 43 N 4453 ²	K

Grandeur

Grandeur 2.0 i

2,0 107 <DOHC Sirius II>	09.92-09.98	1 987 42 S 9127	L
------------------------------	-------------	------------------------	----------

Grandeur 2.2 CRDi

2,2 110-114 D4EB	07.06→	F 026 40 P 7061	O
		1 987 43 M 2160	I
	TW	1 987 43 M 2227	I

Grandeur 2.7 i

2,7 141 <DOHC>	05.06-10.07	0 451 10 P 3316	O
	05.06→	1 987 43 M 2160	I
		1 987 43 M 2227	I

Grandeur 3.0 i

3,0 141 Sigma	02.00→	0 450 90 F 5912 ¹	K
-------------------	--------	-------------------------------------	----------

3,0 151 <DOHC>	09.92-03.99	0 451 10 P 3316	O
--------------------	-------------	------------------------	----------



Grandeur 3.3 i

3,3 173 G6DB	07.05-10.10	TW	1 987 43 M 2160	I
			1 987 43 M 2227	I

H 100

H 100 2.4 i

2,4 90 G4CS Kat. <New Sirius>; G4CS <New Sirius>	07.93-03.00	0 451 10 P 3316	O
--	-------------	------------------------	----------

H 100 2.5 CRDi

2,5 92 D4CB <2.5L-A>	01.09→	F 026 40 P 7084	O
--------------------------	--------	------------------------	----------

H 100 2.5 D

2,5 55 D4BX <4D56 NA>	02.93-12.94	0 986 45 P 2066	O
		1 457 43 N 4453 ²	K

2,5 57 D4BB <T2NA>	07.94-03.00	0 986 45 P 2066	O
		1 457 43 N 4453 ²	K

2,5 59 D4BA	07.93-03.00	0 986 45 P 2066	O
	10.97-09.00	0 451 10 P 3366	O
	07.93-02.07	1 457 43 N 4453 ²	K

H 100 2.5 Intercooler

2,5 57 D4BA	07.94-03.00	0 986 45 P 2066	O
		1 457 43 N 4453 ²	K

H 100 2.5 TCI

2,5 63/70 D4BF <4D56>; D4BH <2.5L-5D56 TCI>	09.96-11.07	0 451 10 P 3366	O
	09.96→	1 457 43 N 4453 ²	K

H 100 2.5 TD

2,5 59 D4BF	07.93-03.00	0 986 45 P 2066	O
	05.05→	0 986 45 P 2066	O
	07.93-03.00	1 457 43 N 4453 ²	K

H 100 2.6 D

2,6 59 D4BB	01.03-02.07	1 457 43 N 4453 ²	K
-----------------	-------------	-------------------------------------	----------

H-1

H-1 2.4 i

2,4 82 G4CS	10.97-05.07	0 451 10 P 3316	O
		1 987 42 S 9127	L
		0 450 90 F 5912 ¹	K

H-1 2.5 CRDi

2,5 103 D4CB	08.03-12.06	F 026 40 P 7084	O
		F 026 40 S 0046	L





H-1 2.5 CRDi Cargo, CRDi Travel

2,5 | 81-85/100/125 | D4CB <2.5L A>; D4CB <2.5L A/2.5L A2>
 03.08→ F 026 40 P 7084 O

H-1 2.5 D, TCI

2,5 | 57/73-74 | D4BB; D4BH <4D56>
 10.97-12.06 0 451 10 P 3366 O
 F 026 40 S 0046 L
 1 457 43 N 4453² K

ix35

ix35 2.0 CRDi, CRDi 4x4

2,0 | 100/135 | D4HA <2.0L-R>
 01.10→ TW 1 987 43 M 2170 I

ix35 2.0 i, i 4x4

2,0 | 120 | G4KD <2.0L Theta II>
 01.10→ TW 0 451 10 P 3316 O
 1 987 43 M 2170 I

i10

i10 1.0 i

1,0 | 49 | G3LA <1L-Kappa>
 10.10→ 0 986 45 P 2061 O
 1 987 43 M 2164 I

i10 1.1 CRDi

1,1 | 55 | D3FA <1.1L-U>
 03.08-12.10 F 026 40 P 7062 O
 1 987 43 M 2164 I

i10 1.1 i

1,1 | 49/51 | G4HG <1.1L Epsilon>; G4HG-5 <1.1L-Epsilon>
 03.08-01.11 F 026 40 P 7025 O
 03.08→ F 026 40 S0127 L
 1 987 43 M 2164 I

i10 1.1 LPG

1,1 | 47 | <1.1L Epsilon>
 03.09-02.11 F 026 40 P 7025 O
 F 026 40 S0127 L
 1 987 43 M 2164 I

i10 1.2 i

1,2 | 57/63 | G4LA <1.2L Kappa>
 08.08-01.11 F 026 40 P 7025 O
 08.08→ 1 987 43 M 2164 I

i10 1.2 LPG

1,2 | 54 | <1.2L Kappa>
 03.09-02.11 F 026 40 P 7025 O
 1 987 43 M 2164 I

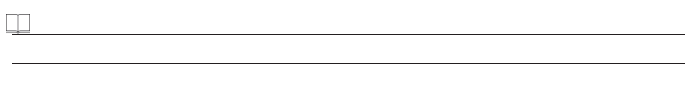

i20

i20 1.2 i

1,2 | 57 | G4LA <1.2L Kappa>
 01.09→ F 026 40 P 7025 O
 F 026 40 S0137 L

i20 1.4 CRDi

1,4 | 55/66 | D4FC <1.4L-U>; D4FC <1.4L-U2>
 10.08→ F 026 40 S0137 L

i20 1.4 i

1,4 | 74 | G4FA <1.4L-Gamma>
 01.09→ 0 451 10 P 3316 O
 F 026 40 S0137 L

i20 1.6 CRDi

1,6 | 85/94 | D4FB <1.6L-U2>
 01.09→ F 026 40 S0137 L

i20 1.6 i

1,6 | 93 | G4FC <1.6L-Gamma>
 01.09→ 0 451 10 P 3316 O
 F 026 40 S0137 L

i30

i30 1.4 i, LPG

1,4 | 76/77-80 | G4FA <1.4 Gamma>
 09.07→ 0 451 10 P 3316 O
 F 026 40 S 0063 L
 1 987 43 M 2055 I

i30 1.6 CRDi

1,6 | 66/85 | D4FB <1.6L-U/U2>
 09.07-05.09 F 026 40 P 7062 O
 09.07→ F 026 40 S 0063 L
 1 987 43 M 2055 I

i30 1.6 i, LPG

1,6 | 94 | D4FB <1.6L-U2>
 11.08→ F 026 40 S 0063 L
 1 987 43 M 2055 I

i30 1.6 i, LPG

1,6 | 85-93 | G4FC <1.6 Gamma>
 09.07→ 0 451 10 P 3316 O
 F 026 40 S 0063 L
 1 987 43 M 2055 I

i30 2.0 CRDi

2,0 | 100-103 | D4EA <2.0L-D>
 09.07→ F 026 40 P 7061 O
 F 026 40 S 0063 L
 1 987 43 M 2055 I

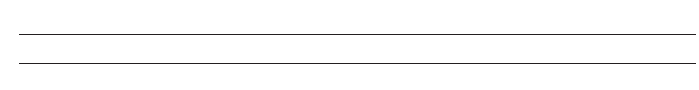



i30 2.0 i, LPG

2,0 100/105 G4GC... <2.0L-Beta>; G4GC <2.0L-Beta>			
09.07→	0 451 10	P 3316	O
	F 026 40	S 0063	L
	1 987 43	M 2055	I

i40

i40 1.6 GDI

1,6 99 G4FD <1.6L Gamma>			
04.11→	1 987 43	M 2170	I

i40 1.7 CRDi

1,7 85/100 <1.7L-U>			
04.11→	1 987 43	M 2170	I

i40 2.0 GDI

2,0 130 <2L-NU>			
04.11→	1 987 43	M 2170	I

Lantra

Lantra 1.5 i

1,5 53 G4DJ <New Orion>			
10.90-04.95	0 451 10	P 3316	O
CSA	1 457 42	S 9810	L

1,5 | 63 | G4DJ <New Orion>

10.90-04.95	0 451 10	P 3316	O
10.90-11.92	1 987 42	S 9127	L
12.92-04.95	1 457 43	S 3314	L
10.90-04.95 XXX	0 450 90	F 5929 ¹	K

1,5 | 65-68 | G4EK <Alpha>

07.96-09.00	0 451 10	P 3316	O
	1 457 43	S 3290	L
	0 450 90	F 5915 ¹	K

Lantra 1.6 i, i 16V

1,6 66/84 G4DJ <Beta>; G4GR <Beta>			
05.95-09.00	0 451 10	P 3316	O
	1 457 43	S 3073	L
	0 450 90	F 5915 ¹	K

Lantra 1.6 i 16V

1,6 78-84 G4CR <New Sirius>			
10.90-04.95	0 451 10	P 3316	O
	1 987 42	S 9127	L
XXX	0 450 90	F 5929 ¹	K

Lantra 1.8 i, i 16V

1,8 94 G4GM <Beta>			
05.95-09.00	0 451 10	P 3316	O
	1 457 43	S 3073	L
	0 450 90	F 5915 ¹	K

Lantra 1.8 i 16V

1,8 93 G4CN <New Sirius>			
06.92-04.95	0 451 10	P 3316	O
	1 987 42	S 9127	L
XXX	0 450 90	F 5929 ¹	K



Lantra 2.0 i, i 16V

2,0 102 G4GF <Beta>			
08.96-09.00	0 451 10	P 3316	O
	1 457 43	S 3073	L
	0 450 90	F 5915 ¹	K

Lavita

Lavita 1.5 i

1,5 74 <DOHC Alpha II>			
04.01→	1 457 43	S 3584	L
	1 987 43	M 2158	I

Lavita 1.8 i

1,8 91 <DOHC Beta>			
04.01→	1 457 43	S 3584	L
	1 987 43	M 2158	I

Matrix

Matrix 1.5 CRDi

1,5 60 D3-EA <TCI>			
07.01-01.06	1 457 42	P 9308	O
	1 457 43	S 3584	L
07.01-02.04	1 457 43	N 4443 ²	K
07.01-01.06	1 987 43	M 2158	I

1,5 | 75/81 | D4FA <TDI>; D4FA-G <TDI>

02.05-06.08	F 026 40	P 7062	O
02.05-04.10	1 457 43	S 3584	L
	1 987 43	M 2158	I

Matrix 1.6 i

1,6 66 G4ED-L			
01.02-12.05	0 451 10	P 3316	O
	1 457 43	S 3584	L
	1 987 43	M 2158	I

1,6 | 76 | G4ED-G <Alpha>

08.01-04.10	0 451 10	P 3316	O
	1 457 43	S 3584	L
	1 987 43	M 2158	I

Matrix 1.8 i

1,8 90 G4GB-G <Beta>			
08.01-04.10	0 451 10	P 3316	O
	1 457 43	S 3584	L
	1 987 43	M 2158	I

Pony

Pony 1.3 i

1,3 43 G4DG <New Orion>			
04.89-07.94	0 451 10	P 3316	O
	1 987 42	S 9121	L

1,3 | 45-49 | New Orion <G4DG>

04.89-07.94	0 451 10	P 3316	O
CSA	1 457 42	S 9810	L





1,3 62 G4EH	07.94-07.99	0 451 10 P 3316	O
		1 457 43 S 3326	L
		0 986 45 F 0624 ¹	K

Pony 1.5 i

1,5 53 G4DJ	04.89-07.94	0 451 10 P 3316	O
		1 987 42 S 9121	L
	CSA	1 457 42 S 9810	L

1,5 61-62 G4DJ	04.89-07.94	0 451 10 P 3316	O
		SIM 1 987 42 S 9127	L
	07.92-07.94	SIM 1 457 43 S 3314	L
	04.89-07.94	XXX 0 986 45 F 0120 ¹	K

Santa Fe

Santa Fe 2.0 CRDi

2,0 83 <DOHC>	06.00-08.03	F 026 40 P 7018	O
		F 026 40 S 0123	L
	06.00-07.02	1 457 43 N 4198 ²	K

2,0 83 D4EA	04.01-12.05	F 026 40 P 7069	O
		F 026 40 S 0123	L
	04.01-07.02	1 457 43 N 4198 ²	K
	04.01-12.05	1 987 43 M 2160	I
		LAB 1 987 43 M 2160 ⁸	I
		RAB 1 987 43 M 2160 ⁸	I

Santa Fe 2.0 CRDi 4x4

2,0 83 D4EA	01.01-12.05	F 026 40 P 7018	O
		F 026 40 P 7069	O
		F 026 40 S 0123	L
	01.01-07.02	1 457 43 N 4198 ²	K
	04.03-12.05	1 987 43 M 2160	I

Santa Fe 2.0 CRDi-VGT

2,0 83 D4EA	08.03→	F 026 40 P 7018	O
		F 026 40 S 0123	L

Santa Fe 2.0 CRDi-VGT 4x4

2,0 92 D4EA-V	08.03-12.05	F 026 40 P 7069	O
		F 026 40 S 0123	L
		1 987 43 M 2160	I

Santa Fe 2.0 i

2,0 99 G4BP <D>	04.01-12.05	0 451 10 P 3316	O
		F 026 40 S 0123	L
	04.03-12.05	1 987 43 M 2160	I

Santa Fe 2.2 CRDi, CRDi 4x4

2,2 110-114 D4EB <2.2L-D>	03.06-11.09	F 026 40 P 7061	O
		F 026 40 S 0091	L
	TW	1 987 43 M 2160	I
		1 987 43 M 2227	I

Santa Fe 2.2 VGT CRDi

2,2 153 HTI	11.05→	1 457 43 N 4105 ²	K
-------------	--------	------------------------------	---

Santa Fe 2.4 i, i 4x4

2,4 100/107 G4JS-G; G4JSX	02.00-12.05	0 451 10 P 3316	O
		F 026 40 S 0123	L
	04.03-12.05	1 987 43 M 2160	I

2,4 128 G4KE <2.4 Theta II>	11.09→	0 451 10 P 3316	O
-----------------------------	--------	-----------------	---

Santa Fe 2.7 i, i 4x4

2,7 125-139 G6EA <2.7L-MU>	03.06-10.07	0 451 10 P 3316	O
	03.06-11.09	F 026 40 S 0091	L
	TW	1 987 43 M 2160	I
		1 987 43 M 2227	I

Santa Fe 2.7 i 4x4

2,7 127 G6BA	09.99-12.05	0 451 10 P 3316	O
		F 026 40 S 0123	L
	04.03-12.05	1 987 43 M 2160	I

Santamo

Santamo 2.0 i

2,0 102 G4CP	05.99-12.02	0 451 10 P 3316	O
		1 987 42 S 9127	L

Satellite

Satellite 2.4 i, i 4WD

2,4 82 G4CS <New Sirius>	10.97-05.07	0 451 10 P 3316	O
		1 987 42 S 9127	L
		0 450 90 F 5912 ¹	K

Satellite 2.5 D Turbo, D Turbo 4WD

2,5 63 4D56 TC <D4BF>	10.97-06.00	KZO 0 986 45 P 2066	O
	10.97-09.00	KZO 0 986 45 P 2066	O
	07.00-09.00	KZO 0 451 10 P 3366	O
	10.00-08.02	0 451 10 P 3366	O
	10.97-08.02	F 026 40 S 0046	L
		1 457 43 N 4453 ²	K





Scoupe

Scoupe 1.5

1,5 53 G4DJ	02.90-06.92	0451 10 P 3316	O
	CSA	1457 42 S 9810	L

Scoupe 1.5 i

1,5 60/71 New Orion <G4DJ>	02.90-07.92	0451 10 P 3316	O
		1987 42 S 9127	L
	XXX	0986 45 F 0120 ¹	K

1,5 62 G4DJ <New Orion>	02.90-06.92	0451 10 P 3316	O
		1987 42 S 9127	L
	XXX	0986 45 F 0120 ¹	K

Scoupe 1.5 i, i Turbo GT

1,5 65-68/84-85 Alpha	09.92-04.95	0451 10 P 3316	O
		0986 45 F 0624 ¹	K

1,5 65-68/84-85 G4EK <Alpha>; G4EK-TC <Alpha>	04.91-04.95	0451 10 P 3316	O
	06.92-04.95	0986 45 F 0624 ¹	K

Sonata

Sonata 1.8 i

1,8 70 G4G2 <G4CM>	06.88-06.93	0986 45 P 2016	O
		1987 42 S 9127	L

1,8 72 G4CM <New Sirius>	07.93-06.98	0451 10 P 3316	O
		1987 42 S 9127	L
		0450 90 F 5912 ¹	K

1,8 77 G4CM <SOHC Sirius>	10.85-12.93	0451 10 P 3316	O
		1987 42 S 9127	L

1,8 98 G4CM <New Sirius>	03.98-03.01	0451 10 P 3316	O
		F026 40 S0164	L

Sonata 1.8 i GLS

1,8 63 G4DM	07.96-05.98	0451 10 P 3316	O
		1987 42 S 9127	L
		0450 90 F 5912 ¹	K

Sonata 1.8 i, i 16V

1,8 99 <DOHC Sirius>	05.93-03.98	1987 42 S 9127	L
		0450 90 F 5912 ¹	K

Sonata 1.8 i 8V

1,8 81 <Sirius>	05.93-02.96	1987 42 S 9127	L
		0450 90 F 5912 ¹	K



Sonata 1.8 i 16V

1,8 96 <DOHC Sirius II>	01.01-09.04	0450 90 F 5912 ¹	K
-----------------------------	-------------	-----------------------------	---

Sonata 2.0 CRDi

2,0 100-103/110 D4EA <2L-D TCI SOHC>	01.06-12.10	F026 40 P 7061	O
	TW	1987 43 M 2160	I
		1987 43 M 2227	I

Sonata 2.0 i

2,0 74-80 G4CP <New Sirius 4G63>	06.88-06.93	0986 45 P 2016	O
		1987 42 S 9127	L

2,0 77 G4CP	07.92-06.98	0451 10 P 3316	O
		1987 42 S 9127	L
	07.93-06.98	0450 90 F 5912 ¹	K

2,0 77 G4CP <New Sirius 4G63>	06.88-08.92	0986 45 P 2016	O
	06.88-10.93	1987 42 S 9127	L

2,0 82 G4CM <SOHC Sirius>	10.85-12.93	1987 42 S 9127	L
-------------------------------	-------------	----------------	---

2,0 89,7 L4GC	09.05-10.06	0451 10 P 3316	O
-------------------	-------------	----------------	---

2,0 96-98 G4JP	04.01-11.04	0451 10 P 3316	O
		F026 40 S0164	L
	04.03-11.04	1987 43 M 2160	I

2,0 100/108 G4CP	03.98-03.01	0451 10 P 3316	O
		F026 40 S0164	L
		0450 90 F 5912 ¹	K

2,0 101 G4GC	01.02→	0451 10 P 3316	O
		1987 43 M 2160	I
		LAB 1987 43 M 2160 ⁸	I
		RAB 1987 43 M 2160 ⁸	I

2,0 102 G4P <DOHC Sirius II>	01.01-09.04	0451 10 P 3316	O
		0450 90 F 5912 ¹	K

2,0 106/121 G4KA <2L Theta>; G4KD <Theta 2>	12.05-12.10	0451 10 P 3316	O
		F026 40 S0212	L
	TW	1987 43 M 2160	I
		1987 43 M 2227	I

2,0 110 <Theta II 2.0 DOHC>	09.10→	0451 10 P 3316	O
---------------------------------	--------	----------------	---

Sonata 2.0 i, i 16V

2,0 92/102/107 G4CP <New Sirius>	07.93-06.98	0451 10 P 3316	O
		1987 42 S 9127	L
		0450 90 F 5912 ¹	K



Sonata 2.0 i 8V, i 16V

2,0 85/107 <Sirius>	05.93-02.96	1 987 42 S 9127 L	
		0 450 90 F 5912 ¹ K	

Sonata 2.0 i 16V

2,0 96 G4CP <New Sirius 4G63>	09.90-06.93	0 986 45 P 2016 O	
		1 987 42 S 9127 L	

Sonata 2.0 LPG

2,0	03.98-07.01	0 451 10 P 3316 O	
		F 026 40 S 0164 L	

Sonata 2.4 i

2,4 80-82 G4CS VIN-S <New Sirius 4G64>	01.89-10.93	0 986 45 P 2016 O	
		1 987 42 S 9127 L	

2,4 82-86 G4CS <New Sirius 4G64>	01.89-08.92	0 986 45 P 2016 O	
	01.89-10.93	1 987 42 S 9127 L	

2,4 86 G4CS	05.98-03.01	0 451 10 P 3316 O	
		F 026 40 S 0164 L	
		0 450 90 F 5912 ¹ K	

2,4 119 G4KC	08.04-01.09	0 451 10 P 3316 O	
		F 026 40 S 0212 L	
	TW	1 987 43 M 2160 I	
		1 987 43 M 2227 I	

2,4 131 <Theta II 2.4 DOHC>	09.10→	0 451 10 P 3316 O	
---------------------------------	--------	--------------------------	--

Sonata 2.5 i

2,5 118/129 G6AV	03.98-03.01	0 451 10 P 3316 O	
		F 026 40 S 0164 L	
		0 450 90 F 5912 ¹ K	

2,5 121 G6BV	06.05→	0 451 10 P 3316 O	
------------------	--------	--------------------------	--

2,5 129 DOHC	03.98-01.01	0 450 90 F 5912 ¹ K	
------------------	-------------	---------------------------------------	--

Sonata 2.7 i

2,7 127 G6BA	01.02→	0 451 10 P 3316 O	
		1 987 43 M 2160 I	
		LAB 1 987 43 M 2160 ⁸ I	
		RAB 1 987 43 M 2160 ⁸ I	

2,7 127-132 G6BA	04.01-01.05	0 451 10 P 3316 O	
		F 026 40 S 0164 L	
	04.03-01.05	1 987 43 M 2160 I	



Sonata 3.0 i

3,0 105/107 G6AT <6G72>	09.89-10.93	0 451 10 P 3316 O	
		1 987 42 S 9127 L	

3,0 106/107 G6AT	07.93-06.98	0 451 10 P 3316 O	
		1 987 42 S 9127 L	
		0 450 90 F 5912 ¹ K	

Sonata 3.3 i

3,3 171-173/184 G6DB; G6DB <3.3L Lambda>	12.04-12.10 TW	1 987 43 M 2160 I	
		1 987 43 M 2227 I	

Starex

Starex 2.4 i, i 4WD

2,4 82-99 G4CS <New Sirius>	10.97-05.07	0 451 10 P 3316 O	
		1 987 42 S 9127 L	
		0 450 90 F 5912 ¹ K	

Starex 2.5 CRDi

2,5 103 D4CB	10.02-01.07	F 026 40 P 7084 O	
		F 026 40 S 0046 L	

2,5 107 <A2,51Gen>	12.02→	F 026 40 P 7084 O	
		F 026 40 S 0046 L	
		1 457 43 N 4105 ² K	

Starex 2.5 D, D Turbo

2,5 57/59 D4BB <T2 NA>; D4BF <4D56>	10.97-06.00 KZO	0 986 45 P 2066 O	
	10.97-09.00 KZO	0 986 45 P 2066 O	
	07.00-09.00 KZO	0 451 10 P 3366 O	
	10.00-08.02	0 451 10 P 3366 O	
	10.97-08.02	F 026 40 S 0046 L	
		1 457 43 N 4453 ² K	

Starex 2.5 D TCI

2,5 76 D4BH	01.00-02.04	0 986 45 P 2061 O	
		F 026 40 S 0046 L	

Starex 2.5 D Turbo 4WD

2,5 59 4D56 TC <D4BF>	10.97-06.00 KZO	0 986 45 P 2066 O	
	10.97-09.00 KZO	0 986 45 P 2066 O	
	07.00-09.00 KZO	0 451 10 P 3366 O	
	10.00-08.02	0 451 10 P 3366 O	
	10.97-08.02	F 026 40 S 0046 L	
		1 457 43 N 4453 ² K	





Starex 2.5 TCI

2,5 74 D4BH <D56TC>	10.02-12.07	0 451 10 P 3366 O	
		F 026 40 S 0046 L	
		1 457 43 N 4453 ² K	

Starex 2.6 D

2,6 76 D4BB <T2>	03.97-09.00	0 986 45 P 2061 O	
		F 026 40 S 0046 L	

Terracan

Terracan 2.5 D Turbo

2,5 74 D4BH	02.01-12.04	0 451 10 P 3366 O	
		1 457 43 S 3580 L	
		1 457 43 N 4453 ² K	

Terracan 2.9 CRDi

2,9 110	08.03-09.06	0 450 90 N6508 ¹ K	
-----------	-------------	---	--

2,9 110/120 J3	11.01-10.06	0 451 10 P 3366 O	
		1 457 43 S 3580 L	
		0 450 90 N6508 ¹ K	

2,9 128 J3	02.01→	0 986 45 P 2061 O	
		1 457 43 S 3580 L	
		0 450 90 N6508 ¹ K	

Terracan 3.5 i

3,5 152 G6CU <DOHC Sigma>	01.01→	1 457 43 S 3580 L	
-------------------------------	--------	---------------------------------	--

Terracan 3.5 i V6

3,5 143-147 G6CU1 <Sigma>	07.01-10.06	0 451 10 P 3316 O	
		1 457 43 S 3580 L	

Terracan 3.5 i 4WD

3,5 140 G6CU	03.03→	0 451 10 P 3316 O	
		1 457 43 S 3580 L	

Tiburon

Tiburon 1.5 i

1,5 74-76 G4EK <DOHC Alpha>	04.96→	0 451 10 P 3316 O	
		1 457 43 S 3290 L	
		0 450 90 F 5915 ¹ K	

Tiburon 2.0 i

2,0 98 <DOHC Beta>	04.96-11.99	1 457 43 S 3073 L	
		0 450 90 F 5915 ¹ K	



2,0 | 102-103 | G4GF <Beta>

09.96-08.01	0 451 10 P 3316 O	
	1 457 43 S 3073 L	
	0 450 90 F 5915 ¹ K	

Trajat

Trajat 2.0 CRDi

2,0 83 D	10.99→	F 026 40 P 7018 O	
	10.99-07.02	1 457 43 N 4198 ² K	

2,0 | 83 | D4EA

01.01-06.07	F 026 40 P 7018 O	
	F 026 40 P 7069 O	
01.01-02.04	F 026 40 S0164 L	
01.01-02.02	1 457 43 N 4198 ² K	
01.01-06.07	1 987 43 M 2160 I	
04.03-06.07	LAB 1 987 43 M 2160 ⁸ I	
	RAB 1 987 43 M 2160 ⁸ I	

Trajat 2.0 i

2,0 | 100 | G4JP-G

01.00-06.07	0 451 10 P 3316 O	
01.00-02.04	F 026 40 S0164 L	
	0 450 90 F 5974 ¹ K	
03.04-06.07	0 450 90 F 5958 ¹ K	
01.00-06.07	1 987 43 M 2160 I	
04.03-06.07	LAB 1 987 43 M 2160 ⁸ I	
	RAB 1 987 43 M 2160 ⁸ I	

2,0 | 104 | <DOHC Sirius II>

10.99→	0 451 10 P 3316 O	
10.99-02.04	0 450 90 F 5974 ¹ K	
03.04→	0 450 90 F 5958 ¹ K	
10.99→	1 987 43 M 2160 I	
	LAB 1 987 43 M 2160 ⁸ I	
	RAB 1 987 43 M 2160 ⁸ I	

Trajat 2.0 VGT CRDi

2,0 93 D	01.03→	F 026 40 P 7018 O	
		1 457 43 N 4198 ² K	

Trajat 2.7 i

2,7 | 127 | DOHC Delta

10.99-06.07	0 451 10 P 3316 O	
10.99-02.04	F 026 40 S0164 L	
	0 450 90 F 5974 ¹ K	
03.04-06.07	0 450 90 F 5958 ¹ K	
04.03-06.07	1 987 43 M 2160 I	

2,7 | 127 | G6BA...

01.00-06.07	0 451 10 P 3316 O	
01.00-02.04	F 026 40 S0164 L	
	0 450 90 F 5974 ¹ K	
03.04-06.07	0 450 90 F 5958 ¹ K	
01.00-06.07	1 987 43 M 2160 I	
	RAB 1 987 43 M 2160 ⁸ I	
04.03-06.07	LAB 1 987 43 M 2160 ⁸ I	





Tucson

Tucson 2.0 CRDi

2,0 85 D<D2,01 Gen>	04.04→	F 026 40 P 7018	O
		F 026 40 S 0044	L

Tucson 2.0 CRDi, CRDi 4x4

2,0 83 D4EA	08.04-12.06	N25 F 026 40 P 7061	O
		N25 F 026 40 P 7069	O
		F 026 40 S 0044	L

2,0 103 D4EA...	09.05-12.06	N25 F 026 40 P 7069	O
	09.05-10.08	N25 F 026 40 P 7061	O
		F 026 40 S 0044	L
		TW 1987 43 M 2170	I

2,0 110	01.09-03.10	N25 F 026 40 P 7061	O
		F 026 40 S 0044	L
		TW 1987 43 M 2170	I

Tucson 2.0 D 4WD

2,0 82 D4EA	04.05→	F 026 40 P 7018	O
-------------	--------	-----------------	---

Tucson 2.0 i, i 4x4

2,0 104 G4GC	08.04-03.10	0 451 10 P 3316	O
		F 026 40 S 0044	L
		TW 1987 43 M 2170	I

Tucson 2.0 VGT CRDi

2,0 115	12.05→	1 457 43 N 4198 ²	K
---------	--------	------------------------------	---

Tucson 2.7 i 4x4

2,7 129 G6BA...	09.04-03.10	0 451 10 P 3316	O
		F 026 40 S 0044	L
		TW 1987 43 M 2170	I

Verna

Verna 1.3 i 8V

1,3 63 <SOHC New Alpha>	06.99-08.05	XXX 0 450 90 F 5928 ¹	K
-------------------------	-------------	----------------------------------	---

Verna 1.5 CRDi 16V

1,5 81	10.06→	1 987 43 M 2160	I
--------	--------	-----------------	---

Verna 1.5 i

1,5 75 <DOHC Alpha II>	07.02-09.05	XXX 0 450 90 F 5928 ¹	K
------------------------	-------------	----------------------------------	---

□□

Verna 1.5 i Lean Burn

1,5 70 <SOHC Alpha>	07.99-03.06	0 451 10 P 3316	O
	02.05-03.06	XXX 0 450 90 F 5928 ¹	K
	12.01-03.06	1 987 43 M 2161	I

Verna 1.5 i 8V

1,5 71 <SOHC New Alpha>	06.99-07.02	XXX 0 450 90 F 5928 ¹	K
-------------------------	-------------	----------------------------------	---

Verna 1.6 i 16V

1,6 76	10.06→	1 987 43 M 2160	I
--------	--------	-----------------	---

XG

XG 25 2.5i

2,5 120 G6BV<Delta>	12.98-12.05	0 451 10 P 3316	O
		F 026 40 S 0164	L
		0 450 90 F 5912 ¹	K
	04.03-12.05	1 987 43 M 2160	I

XG 30 3.0i

3,0 138 G6CT<Sigma>	12.98-12.05	0 451 10 P 3316	O
		0 450 90 F 5912 ¹	K
	04.03-12.05	1 987 43 M 2160	I

XG 35 3.5i

3,5 145 G6CU	08.02-12.05	0 451 10 P 3316	O
		0 450 90 F 5912 ¹	K
	04.03-12.05	1 987 43 M 2160	I

INFINITI

EX

EX 35 4x4

3,5 222 VQ35HR	12.08-01.10	F 026 40 P 7001	O
	04.08-01.10	F 026 40 S 0130	L

EX 37 4x4

3,7 228-235 VQ37VHR	12.08→	F 026 40 P 7001	O
	06.08→	F 026 40 S 0130	L

FX

FX 35 i, 4x4

3,5 206/226 VQ35DE	11.02→	F 026 40 P 7001	O
		1 987 42 S 9051	L





FX 35 4x4

3,5 228 VQ35HR	09.08-01.10	F 026 40 P 7001	O
		1 457 43 S 3274	L

FX 37 4x4

3,7 235 VQ37VHR	07.08→	F 026 40 P 7001	O
		1 457 43 S 3274	L

FX 45 4x4

4,5 233-241 VK45DE	07.06→	0 986 45 P 2041	O
------------------------	--------	------------------------	----------

FX 50 4x4

5,0 287 VK50VE	07.08→	0 986 45 P 2041	O
		1 457 43 S 3274	L

G

G 35 4x4

3,5 232 VQ35HR	12.06→	F 026 40 P 7001	O
		F 026 40 S 0130	L

G 37 , 4x4

3,7 235-243 VQ37VHR	10.07→	F 026 40 P 7001	O
		F 026 40 S 0130	L

M

M 35 , 4x4

3,5 206/226 VQ35DE; VQ35HR	07.06-05.10	F 026 40 P 7001	O
--------------------------------	-------------	------------------------	----------

M 37

3,7 235 VQ37VHR	05.10→	F 026 40 P 7001	O
---------------------	--------	------------------------	----------

M 45

4,5 250 VK45DE	07.06-05.10	0 986 45 P 2041	O
--------------------	-------------	------------------------	----------

QX

QX 56 4x4

5,6 239 VK56DE	04.08→	F 026 40 S 0004	L
--------------------	--------	------------------------	----------



INNOCENTI (NUOVA INNOCENTI)

Elba

Elba 1.3

1,3 37,7 146 A 5.000 <M1>	03.91-09.93	XXX	0 451 10 P 3096	O
			0 450 90 F 4058 ¹	K

Elba 1.4 i.e.

1,4 49 146 C 5.000 SPI-RB <M2>	09.93-09.94	XXX	0 451 10 P 3096	O
	10.94-06.95		0 451 10 P 3111	O
	09.93-06.95		1 457 43 S 3253	L
			0 450 90 F 2151 ¹	K

1,4 | 49 | 146 D 5.000 SPI-RB <M6>

06.95-12.96	0 451 10 P 3111	O
	1 457 43 S 3253	L
	0 450 90 F 2151 ¹	K

Elba 1.5 i.e.

1,5 55 149 C 1.000	03.92-08.93	XXX	0 451 10 P 3096	O
			0 450 90 F 5002 ¹	K

Elba 1.6 i.e.

1,6 55 146 C 6.000 SPI-RB <M4>	09.93-09.94	XXX	0 451 10 P 3096	O
	10.94-03.96		0 451 10 P 3111	O
	09.93-03.96		1 457 43 S 3253	L
			0 450 90 F 2151 ¹	K

1,6 | 55 | 146 D 6.000 SPI-RB <M7>

03.95-12.96	0 451 10 P 3111	O
	1 457 43 S 3253	L
	0 450 90 F 2151 ¹	K

1,6 | 60 | 149 C 1.000 SPI-RB <M3>

03.91-09.93	XXX	0 451 10 P 3096	O
		0 450 90 F 5002 ¹	K

Elba 1.7 D

1,7 42 146 B 2.000	09.92-12.96	XXX	1 457 43 D 701 ²	K
1,7 42 146 B 2.000 <M5>	09.92-12.96		0 451 10 P 3170	O
			1 457 43 S 3286	L
			1 457 43 D 701 ²	K
			1 457 43 N 4106 ²	K

Mille

Mille 1.0 i.e.

1,0 35 146 C 7.000 SPI-Web.	07.94-11.97		1 457 43 S 3253	L
---------------------------------	-------------	--	------------------------	----------



**Mille 1.7 D**

1,7|43|146 B 2.000

07.94-11.97	0 451 10 P 3170	0
	1 457 43 S 3285	L
SWA	1 457 43 N 4106 ²	K

ISUZU**Bighorn****Bighorn 3.2 i 4WD**

3,2|147|6VD1

12.91-03.98 0 451 10 P 3316 0

Bighorn 3.5 i 4WD

3,5|169|6VE1

02.98-12.02 0 986 45 P 2036 0

Gemini**Gemini 1.5**

1,5|52-54|4XC1

05.87-12.93	0 986 45 P 2036	0
	0 450 90 N 4158 ¹	K

Gemini 1.5 D, D Turbo

1,5|37/49|4EC1;4EC1T

02.88-12.93	0 986 45 P 2041	0
	1 457 42 S 9894	L

Gemini 1.6 GTI

1,6|84-85|4XE1

08.88-12.93 0 986 45 P 2036 0

Gemini 1.6 i

1,6|103|4XE1

01.91-10.92 0 451 10 P 3316 0

Gemini 1.6 i Turbo

1,6|132|4XE1T

01.91-10.92 0 451 10 P 3316 0

Mu**Mu 3.1 D Turbo**

3,1|88|4JG2

12.95-07.98 0 986 45 P 2064 0

Mu 3.2 i 4WD

3,2|158|6VD1

05.00-05.02 0 986 45 P 2036 0

**Piazza****Piazza 1.8 i**

1,8|110|4XF1

07.91-09.93 0 986 45 P 2036 0

Pick-Up**Pick-Up 3.1 4x4**

3,1|90

09.90-08.94 0 451 10 P 3079 0

Rodeo**Rodeo 3.1 i, i 4x4**

3,1|88-90|LG6 <Kat.>

09.90-08.92 0 451 10 P 3079 0

Serie N**Serie N NPR300 4.3**

4,3|78|4HF1

09.08→ 0 986 45 F 0108 0

Serie N NPR400 5.2

5,2|110|4HK1-TCN

09.08→ 0 986 45 F 0108 0

Serie N NPS300 5.2 4x4

5,2|110|4HK1-TCN

09.08→ 0 986 45 F 0108 0

Serie N NQR75 R 5.2

5,2|129|4HK1-TCS

02.06-12.08 0 986 45 F 0108 0

Serie N NQR75-R 5.2 TD

5,2|129|4HK1-TCS

02.06-12.08 0 986 45 F 0108 0

Trooper**Trooper 2.6 i**

2,6|90|4ZE1

10.87-08.91 0 451 10 P 3316 0

Trooper 2.8 D Turbo

2,8|71|4JB1T

10.87-12.91	0 451 10 P 3079	0
	XXX 0 986 45 N 0505 ²	K

Trooper 2.8 D Turbo Interc.

2,8|78|4JB1TC

10.88-12.91 XXX 0 986 45 N 0505² K



Trooper 3.2 i 24V 4WD

3,2 130 6VDI				
	04.92-04.93	0 986 45	P 2016	O
	05.93-09.04	0 986 45	P 2036	O
	04.92-09.04	SBE	1 987 42	S 9162 L

VehiCROSS

VehiCROSS 3.2 i 4WD

3,2 158 6VD1				
	03.97-02.99	0 986 45	P 2036	O

IVECO

Massif

Massif 3.0

3,0 107/130 F1CE0481F*...; F1CE0481H*...				
	06.08→	F 026 40	P 7083	O
		1 457 43	S 3332	L
		1 457 43	N 4310 ²	K

JAGUAR

Daimler

Daimler 4.2

4,2 123/131				
Fg.Nr. 200038→400041	01.84-10.95	0 451 10	P 3278	O
	01.84-10.95	0 450 90	F 5030 ¹	K

4,2 151				
Fg.Nr. 200038→400041	10.83-10.95	0 451 10	P 3278	O

Sovereign

Sovereign 3.2 24V

3,2 149 AJ6				
	09.90-08.99	0 451 10	P 3335	O
		1 457 43	S 3546	L
		0 986 45	F 0119 ¹	K

Sovereign 4.0

4,0 175 AJ6				
	09.89-08.99	0 451 10	P 3278	O

S-Type

S-Type 2.5 24V

2,5 147 JB				
	10.01-07.05	0 451 10	P 3344	O
Fg.Nr. M45255→	10.01-07.05	F 026 40	S 0105	L
Fg.Nr. →M45254	10.01-07.05	1 987 42	S 9160	L
	10.01-07.05	0 450 90	F 5939 ¹	K
Fg.Nr. M45255→	10.01-07.05	1 987 43	R 2428 ⁸	I



S-Type 2.7 D

2,7 152 276DT 7B/7G				
	06.04-03.08	1 457 42	P 9307	O
		F 026 40	S 0105	L
Fg.Nr. M45255→	06.04-03.08	1 987 43	R 2428 ⁸	I

S-Type 3.0 24V

3,0 175-179 FC FB				
	10.98-03.08	0 451 10	P 3344	O
Fg.Nr. M45255→	10.98-03.08	F 026 40	S 0105	L
Fg.Nr. →M45254	10.98-03.08	1 987 42	S 9160	L
	10.98-03.08	0 450 90	F 5939 ¹	K
Fg.Nr. M45255→	10.98-03.08	1 987 43	R 2428 ⁸	I

S-Type 4.0 32V

4,0 203 GC GB				
Fg.Nr. M45255→	10.98-04.02	0 451 10	P 3367	O
Fg.Nr. →M45254	10.98-04.02	0 451 10	P 3335	O
Fg.Nr. M45255→	10.98-04.02	F 026 40	S 0105	L
Fg.Nr. →M45254	10.98-04.02	1 987 42	S 9160	L
	10.98-04.02	0 450 90	F 5939 ¹	K
Fg.Nr. M45255→	10.98-04.02	1 987 43	R 2428 ⁸	I

S-Type 4.2 V8 32V, V8 32V R

4,2 219/291 HB; 1B				
	10.01-03.08	0 451 10	P 3367	O
Fg.Nr. M45255→	10.01-03.08	F 026 40	S 0105	L
Fg.Nr. →M45254	10.01-03.08	1 987 42	S 9160	L
	10.01-03.08	0 450 90	F 5939 ¹	K
Fg.Nr. M45255→	10.01-03.08	1 987 43	R 2428 ⁸	I

XF

XF 2.2 D

2,2 120-140 AJ-14D				
	09.11→	F 026 40	S 0105	L

XF 2.7 D

2,7 152 7G				
	03.08-02.09	1 457 42	P 9307	O
		F 026 40	S 0105	L

XF 3.0 D, V6 SD

3,0 155/177/202				
	03.09→	F 026 40	S 0105	L

XF 3.0 V6

3,0 175-179 FG				
	03.08→	0 451 10	P 3369	O
		F 026 40	S 0105	L

XF 4.2 SV8, V8

4,2 219/306 HG; 1G				
	03.08-10.09	0 451 10	P 3367	O
		F 026 40	S 0105	L

XF 5.0 V8

5,0 283/346-375 508PN; 508PS				
	02.09→	F 026 40	S 0105	L



XJ

XJ 3.0 D V6

3,0 202	08.10→	F 026 40 S 0105	L
---------	--------	-----------------	---

XJ 3.0 V6

3,0 175	08.11→	0 451 10 P 3369	O
		F 026 40 S 0105	L

XJ 5.0 V8, V8 Kompressor

5,0 283/346/375 508PN;508PS	08.10→	F 026 40 S 0105	L
-----------------------------	--------	-----------------	---

XJ S

XJ S 3.6

3,6 149/156/168 AJ6;AJ6<Kat.>			
Fg.Nr. 139052→226645	10.83-12.92	0 451 10 P 3278	O
Fg.Nr. 139052→179736	10.83-09.91	1 457 43 S 3658	L
		0 450 90 F 5030 ¹	K

XJ S 4.0

4,0 163-166/175/177 AJ6;9 JPF RB <AJ16>;9EPCNA <AJ6>			
Fg.Nr. 179737→226645	05.91-12.97	0 451 10 P 3278	O
		0 986 45 F 0119 ¹	K

XJ S 5.3

5,3 207-209 <Kat.>			
Fg.Nr. 139052→226645	09.81-09.91	0 451 10 P 3278	O
Fg.Nr. 139052→179736	09.81-09.91	0 450 90 F 5030 ¹	K

5,3 224			
Fg.Nr. 139052→226645	09.75-09.91	0 451 10 P 3278	O
Fg.Nr. 139052→179736	09.75-09.91	0 450 90 F 5030 ¹	K

XJ S 5.3 , V12

5,3 222-227			
Fg.Nr. 179737→226645	03.90-12.97	0 451 10 P 3278	O
		1 457 43 S 3545	L
Fg.Nr. →188104	03.90-12.97	0 986 45 F 0119 ¹	K

5,3 238			
Fg.Nr. 179737→226645	03.90-12.97	0 451 10 P 3278	O
		1 457 43 S 3545	L
Fg.Nr. →188104	03.90-12.97	0 986 45 F 0119 ¹	K

XJ S 5.3 , V12 HE

5,3 182/194-196/198/207-209/213/217/220			
Fg.Nr. 139052→226645	09.75-09.91	0 451 10 P 3278	O
Fg.Nr. 139052→179736	09.75-09.91	0 450 90 F 5030 ¹	K

XJ S 6.0

6,0 222-227/231-234/243-248			
Fg.Nr. 179737→226645	03.92-09.97	0 451 10 P 3278	O
		1 457 43 S 3545	L
		0 986 45 F 0119 ¹	K

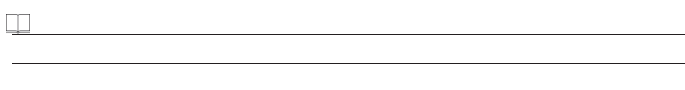

XJ 6

XJ 6 2.5 32V

2,5 147 AJ-V6	03.03-03.05	F 026 40 S 0105	L
---------------	-------------	-----------------	---

XJ 6 2.7 D V6

2,7 152	10.05-07.10	1 457 42 P 9307	O
		F 026 40 S 0105	L

XJ 6 3.0 24V

3,0 175 AJ-V6	03.03-07.10	0 451 10 P 3369	O
		F 026 40 S 0105	L

XJ 6 3.2 , 24V

3,2 155-161 9 JPGRB <AJ16>			
	09.94-12.98	0 451 10 P 3278	O
		1 457 42 S 9061	L
		0 986 45 F 0119 ¹	K

XJ 6 3.2 24V

3,2 146-149 9BPMNA <AJ6>			
Fg.Nr. 500001→667828	10.90-09.94	0 451 10 P 3278	O
	10.90-09.94	1 457 42 S 9061	L
		0 986 45 F 0119 ¹	K

XJ 6 3.6

3,6 149/165 AJ6			
Fg.Nr. 500001→667828	10.86-09.97	0 451 10 P 3278	O

XJ 6 4.0

4,0 163 9EPCNA			
Fg.Nr. 500001→667828	10.87-09.94	0 451 10 P 3278	O
	10.87-09.94	1 457 42 S 9061	L
		0 986 45 F 0119 ¹	K

4,0 166/175-177/185/187 ;AJ6;AJ6<Kat.>			
Fg.Nr. 500001→667828	10.87-09.97	0 451 10 P 3278	O
	10.87-09.97	1 457 42 S 9061	L
		0 986 45 F 0119 ¹	K

XJ 6 4.0 Kompressor, 24V Kompressor

4,0 235-240 9 KPDRB; 9 KPDRB <AJ16>			
	09.94-12.98	0 451 10 P 3278	O
		1 457 42 S 9061	L
		0 986 45 F 0119 ¹	K

XJ 6 4.0 24V

4,0 177-183 AJ16			
	10.94-12.98	0 451 10 P 3278	O
		1 457 42 S 9061	L
		0 986 45 F 0119 ¹	K

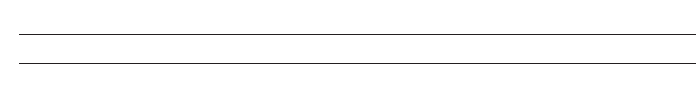



XJ 6 4.2 32V V8 S/C

4,2 291 AJ-V8	03.03-07.10	0 451 10 P 3367	0
		F 026 40 S 0105	L

XJ 8

XJ 8 3.2 V8 32V

3,2 174 AC <AJV8>	09.97-01.03	0 451 10 P 3335	0
		1 457 43 S 3546	L
		0 986 45 F 0119 ¹	K

XJ 8 3.5 32V

3,5 190 AJ-V8	03.03-07.10	0 451 10 P 3367	0
		F 026 40 S 0105	L

XJ 8 4.0 V8 32V

4,0 209 BC <AJV8>	09.97-09.00	0 451 10 P 3335	0
		1 457 43 S 3546	L
		0 986 45 F 0119 ¹	K

XJ 8 4.2 32V

4,2 219 AJ-V8	03.03-07.10	0 451 10 P 3367	0
		F 026 40 S 0105	L

XJ 12

XJ 12 5.3 HE

5,3 183/194/197-198 <Kat.>	07.81-09.94	0 451 10 P 3278	0
--------------------------------	-------------	-----------------	---

XJ 12 6.0

6,0 225-234 8C; 8D	02.93-12.99	0 451 10 P 3278	0
Fg.Nr. 667829→708757		1 457 42 S 9061	L
		0 986 45 F 0119 ¹	K

XJR

XJR 4.2 32V V8 S/C

4,2 291 AJ-V8	03.03→	0 451 10 P 3367	0
		F 026 40 S 0105	L

XJR 8

XJR 8 4.0 V8 32V Kompressor

4,0 267 DC <AJV8>	09.97-09.02	0 451 10 P 3335	0
		1 457 43 S 3546	L
		0 986 45 F 0119 ¹	K



XK

XK 3.5

3,5 190 AJ-V8	07.07-02.09	0 451 10 P 3367	0
Fg.Nr. →B40012			

XK 3.5 AWD

3,6 190 <AJ-V8>	03.08-02.09	0 451 10 P 3367	0
Fg.Nr. →B40012			

XK 4.2 R 32V

4,2 306-313 (A34) <AJ-V8>	03.06-02.09	0 451 10 P 3367	0
Fg.Nr. →B40012	03.06-02.09	1 457 43 S 3546	L

XK 4.2 32V

4,2 219 5G <AJ-V8>	03.06→	0 451 10 P 3367	0
Fg.Nr. →B40012			

XK 8

XK 8 4.0 R 32V, 32V

4,0 209/267 CE,CC,NC,NB <AJV8>; EC <AJV8>	03.96-09.02	0 451 10 P 3335	0
		1 457 43 S 3546	L
		0 986 45 F 0119 ¹	K

XK 8 4.2 R 32V

4,2 291/306 (A34) <AJ-V8>; 3B PC <AJ-V8>	03.03-02.09	0 451 10 P 3367	0
		1 457 43 S 3546	L

XK 8 4.2 32V

4,2 219 5G <AJ-V8>	03.03-02.09	0 451 10 P 3367	0
Fg.Nr. →B00378	03.03-02.09	1 457 43 S 3546	L

X-Type

X-Type 2.0

2,0 115 YB	03.02-10.05	0 451 10 P 3369	0
		0 450 90 F 5273 ¹	K
		MKL 1 987 43 M 2073 ⁸	I
		MKL 1 987 43 R 2373 ⁸	I

X-Type 2.0 D

2,0 96 FMBA/B 6B	09.03-10.05	1 457 42 P 9239	0
		F 026 40 S 0102	L
		0 450 90 N 6508 ¹	K
		MKL 1 987 43 M 2073 ⁸	I
		MKL 1 987 43 R 2373 ⁸	I





X-Type 2.2 D

2,2 107-114 QJBABG			
09.05→	1 457 42	P 9239	O
	F 026 40	S 0102	L
	0 450 90	N6508 ¹	K
MKL	1 987 43	M 2073 ⁸	I
MKL	1 987 43	R 2373 ⁸	I

X-Type 2.5

2,5 144 XB			
03.01→	0 451 10	P 3369	O
	0 450 90	F 5273 ¹	K
MKL	1 987 43	M 2073 ⁸	I
MKL	1 987 43	R 2373 ⁸	I

X-Type 3.0

3,0 169-172 WB			
03.01→	0 451 10	P 3369	O
	0 450 90	F 5273 ¹	K
MKL	1 987 43	M 2073 ⁸	I
MKL	1 987 43	R 2373 ⁸	I

JEEP

Cherokee

Cherokee 2.1 D Turbo

2,1 65 Renault J8S-814; Renault J8S-890			
01.87-08.95	0 451 10	P 3336	O
01.88-08.95	1 457 43	S 3231	L

Cherokee 2.4 4x4

2,4 110-112 ED1,EDO			
03.01-12.07	0 451 10	P 3271	O

Cherokee 2.5 CRD 4x4

2,5 105 ENJ, ENO			
03.01-12.04	0 451 10	P 3258	O
	1 987 42	S 9189	L

Cherokee 2.5 D Turbo

2,5 85-89 ENC, ENO <VM HR 425 CLIRX>			
10.95-12.01	0 451 10	P 3258	O
	1 457 43	N 4448 ²	K

Cherokee 2.5 i

2,5 78 C498QA1			
01.94-07.04	0 451 10	P 3251	O
	1 457 43	S 3298	L
	0 450 90	F 5985 ¹	K

Cherokee 2.5 i 4x4

2,5 90			
09.90-08.96	0 450 90	F 5985 ¹	K



2,5 90 EPE			
09.90-09.01	0 451 10	P 3251	O
01.00-09.01	1 457 43	S 3298	L

Cherokee 2.8 CRD

2,8 112-120 ENR			
03.03-12.07	0 451 10	P 3258	O
	1 987 42	S 9189	L
01.05-12.07	1 457 43	N 4310 ²	K

Cherokee 3.7 4x4

3,7 150-157 EKG <K>			
03.01-12.07	0 451 10	P 3074	O
	1 987 42	S 9189	L

Cherokee 4.0

4,0 127-131/135 ERH			
09.93-12.01	0 451 10	P 3251	O
01.00-12.01	1 457 43	S 3298	L

4,0 136 ERH			
09.90-08.93	0 451 10	P 3251	O

Cherokee 4.0 i

4,0 127 C698QA			
01.97-04.04	0 986 B0	OB 0006	O
01.90-04.04	1 457 43	S 3298	L
	0 450 90	F 5985 ¹	K

Commander

Commander 3.0 CRD 4x4

3,0 160-165 EXL			
01.06→	F 026 40	P 7008	O
	1 987 42	S 9189	L
	F 026 40	N 2056 ¹	K

Commander 3.7 4x4

3,7 157 EKG			
09.05→	0 451 10	P 3074	O
	1 987 42	S 9189	L

Commander 4.7 4x4

4,7 170-175 EVA			
09.05→	0 451 10	P 3251	O
	1 987 42	S 9189	L

Commander 4.7 4x4

4,7 170-175 EVA <N>			
01.06-12.07	0 986 45	P 2003	O
01.06→	1 987 42	S 9189	L

Commander 5.7 4x4

5,7 240-246 EZ... <2>			
01.06-12.07	0 986 45	P 2003	O
01.06→	1 987 42	S 9189	L

5,7 240-246 EZB			
09.05-08.08	0 451 10	P 3251	O
	1 987 42	S 9189	L





Compass

Compass 2.0 CRD, CRD 4x4

2,0 103 ECD	10.06 →	1 457 42 P 9192	O
-----------------	---------	-----------------	---

Grand Cherokee

Grand Cherokee 2.5 TD

2,5 85-87 ENC, ENO	01.96-04.99	F 026 40 S 0004	L
------------------------	-------------	-----------------	---

Grand Cherokee 2.7 CRD

2,7 120 ENF	10.01-12.04	1 457 42 P 9116 F 026 40 S 0004	O L
-----------------	-------------	------------------------------------	--------

Grand Cherokee 3.0

3,0 165 EXL	09.06-08.09	F 026 40 N 2056 ¹	K
-----------------	-------------	------------------------------	---

Grand Cherokee 3.0 CRD

3,0 160-165 EXL	03.05 →	F 026 40 P 7008 1 987 42 S 9189 F 026 40 N 2056 ¹	O L K
---------------------	---------	--	-------------

Grand Cherokee 3.0 CRDi AWD

3,0 140 VM-23D	04.11 →	F 026 40 N 2056 ¹	K
--------------------	---------	------------------------------	---

Grand Cherokee 3.1 TD

3,1 103 EXA <VM-Diesel>; EXA, EXO, VM-Diesel	01.99-12.02	F 026 40 S 0004 1 457 43 N 4448	L K
--	-------------	------------------------------------	--------

Grand Cherokee 3.7

3,7 149-157 EKG	09.04 →	0 451 10 P 3074 1 987 42 S 9189	O L
---------------------	---------	------------------------------------	--------

Grand Cherokee 4.0

4,0 142-145 ERH	09.92-08.04 09.92-12.96 01.97-08.04	0 451 10 P 3251 1 457 43 S 3298 F 026 40 S 0004	O L L
---------------------	---	---	-------------

Grand Cherokee 4.0 i

4,0 130-135 ERH <6L <S MPI>>	09.92-04.99	0 451 10 P 3251 F 026 40 S 0004	O L
----------------------------------	-------------	------------------------------------	--------

4,0 140-144 ERH, ERO <Power Tech>	09.00-12.04	0 451 10 P 3251 F 026 40 S 0004	O L
---------------------------------------	-------------	------------------------------------	--------



Grand Cherokee 4.7

4,7 172 EVA	09.98 → 09.98-08.04 09.04 →	0 451 10 P 3251 F 026 40 S 0004 1 987 42 S 9189	O L L
-----------------	-----------------------------------	---	-------------

4,7 175 EVA, EVO <Power Tech V8>	03.05 →	0 451 10 P 3251 1 987 42 S 9189	O L
--------------------------------------	---------	------------------------------------	--------

4,7 190 EVC	09.00-08.04 09.00-12.01	0 451 10 P 3251 F 026 40 S 0004	O L
-----------------	----------------------------	------------------------------------	--------

Grand Cherokee 4.7 i

4,7 162-164 EVA <Power Tech>	09.00-12.04	0 451 10 P 3251 F 026 40 S 0004	O L
----------------------------------	-------------	------------------------------------	--------

Grand Cherokee 4.7 i Overland

4,7 190 EVC-HO, V8, MPI <High-Output>	10.01-12.04	0 451 10 P 3251	O
---	-------------	-----------------	---

Grand Cherokee 4.7 i 4WD

4,7 175 C8V93Q	12.03-03.07	0 451 10 P 3251 F 026 40 S 0004	O L
--------------------	-------------	------------------------------------	--------

Grand Cherokee 5.2 , i

5,2 156 ELF; ELF, ELO <<Y MPI>>	09.92-04.99 01.97-04.99	0 451 10 P 3251 F 026 40 S 0004	O L
-------------------------------------	----------------------------	------------------------------------	--------

Grand Cherokee 5.7 , V8

5,7 239-250 EZB; EZB, EZO <Hemi V8>	09.04 →	0 451 10 P 3251 1 987 42 S 9189	O L
---	---------	------------------------------------	--------

Grand Cherokee 5.9 , i

5,9 177 EML <Z>; EML, EMO <Z MPI>	10.96-04.99 01.97-04.99	0 451 10 P 3251 F 026 40 S 0004	O L
---------------------------------------	----------------------------	------------------------------------	--------

Grand Cherokee 6.1 SRT-8 4x4

6,1 313 ESF	01.06 →	0 451 10 P 3251 1 987 42 S 9189	O L
-----------------	---------	------------------------------------	--------

Liberty

Liberty 2.4 4x4

2,4 112 ED1	10.00-12.07	0 451 10 P 3271	O
-----------------	-------------	-----------------	---

Liberty 2.8 CRD 4x4

2,8 112-120 ENR	10.05-12.07	0 451 10 P 3258 1 987 42 S 9189	O L
---------------------	-------------	------------------------------------	--------



**Liberty 3.7**

3,7 155 EKG	09.07-08.08	0 451 10 P 3369	0
-------------	-------------	-----------------	---

Liberty 3.7 4x4

3,7 157 EKG	09.01-08.07	0 451 10 P 3074	0
		1 987 42 S 9189	L

Patriot**Patriot 2.0 CRD, CRD 4x4**

2,0 103 ECD	10.06→	1 457 42 P 9192	0
-------------	--------	-----------------	---

Wagoneer**Wagoneer 2.1 D Turbo**

2,1 64 J8S-814	01.88-12.94	0 451 10 P 3336	0
		1 457 43 S 3231	L

Wagoneer 4.0 i

4,0 125 6L <SMPI>	08.90-12.95	0 451 10 P 3251	0
-------------------	-------------	-----------------	---

Wrangler**Wrangler 2.4**

2,4 105-110 ED1	01.03-12.06	0 451 10 P 3271	0
-----------------	-------------	-----------------	---

Wrangler 2.5

2,5 87-90 EPE	09.96-08.02	0 451 10 P 3251	0
---------------	-------------	-----------------	---

Wrangler 2.5 i 4x4

2,5 76/89 4L	10.90-08.96	0 451 10 P 3251	0
	01.87-08.96 TW	1 457 42 S 9076	L

Wrangler 4.0

4,0 130/142 ERH	01.97-12.07	0 451 10 P 3251	0
-----------------	-------------	-----------------	---

Wrangler 4.0 4x4

4,0 126-131 6L	08.87-08.95	0 451 10 P 3251	0
----------------	-------------	-----------------	---

KIA**Avella****Avella 1.3 i, i Delta**

1,3 52/54 B3; B3E <SOHC>	03.94→	0 986 45 P 2061	0
		1 457 43 S 3961	L

Avella 1.5 i Delta

1,5 66 B5E <SOHC>	03.94-10.99	0 986 45 P 2061	0
		1 457 43 S 3961	L

Besta**Besta 2.2 D, D 2WD, D 4WD**

2,2 48/52 HW; R2	08.94-07.00 HAU	0 451 10 P 3316	0
	01.87-11.94	0 986 45 N 0508 ²	K
	12.94-07.00	1 457 43 N 4435 ²	K

Besta 2.7 D Coach, D 2WD

2,7 59-60 VN	01.87-12.93	1 457 43 N 4435 ²	K
--------------	-------------	------------------------------	---

Bongo**Bongo 2.5 D Truck**

2,5 69 D4BH	02.04→	0 450 90 N 6508 ¹	K
-------------	--------	------------------------------	---

Bongo 2.9 CRDI Coach, CRDI Truck

2,9 91 ; D4BH <CRDI>	01.04→	0 450 90 N 6508 ¹	K
----------------------	--------	------------------------------	---

Carens**Carens 1.6**

1,6 91-97 G4FC <GAMMA>	02.09→	0 451 10 P 3316	0
------------------------	--------	-----------------	---

Carens 1.6 i

1,6 77 S6D	09.02-12.06	0 986 45 P 2061	0
		1 987 42 S 9179	L
		0 450 90 F 5973 ¹	K

Carens 1.8 i

1,8 81/93 TB <TED>	04.99-10.00	0 986 45 P 2061	0
	04.99-05.02	1 987 42 S 9179	L
		0 450 90 F 5973 ¹	K





◀ Carens 1.8 i

1,8 93 TB	09.02-12.06	0 986 45 P 2061 O 1 987 42 S 9179 L 0 450 90 F 5973 ¹ K
-----------	-------------	--

1,8 123 T8D	01.01→	0 986 45 P 2041 O
-------------	--------	---------------------------------

Carens 2.0 CRDi

2,0 83 D4EA	04.02-12.06	F 026 40 P 7069 O 1 987 42 S 9179 L 1 457 43 N 4314 ² K
-------------	-------------	--

2,0 85	02.02-04.06	F 026 40 P 7018 O 1 457 43 N 4314 ² K
--------	-------------	---

2,0 85/100 D4EA-L;D4EA-W	09.06-08.10	F 026 40 P 7018 O
--------------------------	-------------	---------------------------------

Carens 2.0 CRDi VGT

2,0 103 D4EA	09.06→ 09.05-12.06	F 026 40 P 7018 O 1 987 42 S 9179 L 1 457 43 N 4314 ² K
--------------	-----------------------	--

Carens 2.0 CVVT

2,0 106 G4KA	09.06→	0 451 10 P 3316 O
--------------	--------	---------------------------------

Carens 2.0 i

2,0 102 G4GC	08.04-12.06	0 451 10 P 3316 O 1 987 42 S 9179 L 0 450 90 F 5973 ¹ K
--------------	-------------	--

Carens 2.0 LPI

2,0 100 <DOHC>	04.06→	F 026 40 S 0048 L
----------------	--------	---------------------------------

Carens 2.0 VGT CRDi

2,0 146	04.06→	1 457 43 N 4105 ² K
---------	--------	--

Carnival

Carnival 2.5 V6

2,5 110 K5	10.01-06.06	0 451 10 P 3316 O 1 987 42 S 9174 L
------------	-------------	--

2,5 121 K5	06.98-09.01	0 986 45 P 2041 O F 026 40 S 0113 L
------------	-------------	--

Carnival 2.7 V6

2,7 139 G6EA <2.7L-MU>	04.06→	0 451 10 P 3316 O
------------------------	--------	---------------------------------



Carnival 2.9 CRDi

2,9 106 J3	10.01-06.06	0 451 10 P 3366 O F 026 40 S 0113 L 0 450 90 N 6508 ¹ K
------------	-------------	--

2,9 136 J3	04.06→	0 451 10 P 3366 O
------------	--------	---------------------------------

Carnival 2.9 CRDi, WGT CRDi

2,9 107/125 J3	01.02-10.07	0 450 90 N 6508 ¹ K
----------------	-------------	--

Carnival 2.9 D Turbo

2,9 92 JRTCI	03.00-03.03 03.00-12.00 01.01-03.03	0 451 10 P 3366 O F 026 40 S 0113 L 1 457 43 N 4435 ² K 1 457 43 N 4453 ² K
--------------	---	--

2,9 93 J3	06.98-09.01 06.98-12.00 01.01-09.01	F 026 40 S 0113 L 1 457 43 N 4435 ² K 1 457 43 N 4453 ² K
-----------	---	---

2,9 99 J3	01.01-12.04 02.98-12.00 01.01-02.01 01.01-12.04	0 451 10 P 3366 O 1 457 43 N 4435 ² K 1 457 43 N 4453 ² K 0 450 90 N 6508 ¹ K
-----------	--	---

Carnival 2.9 VGT CRDi

2,9 141,2 J3	11.07→	0 450 90 N 6508 ¹ K
--------------	--------	--

Carnival 3.5 i

3,5 140 G6CU	07.04-07.06	0 451 10 P 3316 O 1 987 42 S 9174 L
--------------	-------------	--

Cee'd

Cee'd 1.4

1,4 66/77 G4FA	09.09→	0 451 10 P 3316 O F 026 40 S 0063 L 1 987 43 M 2055 I
----------------	--------	---

1,4 80 G4FA	11.06-08.09	0 451 10 P 3316 O F 026 40 S 0063 L 1 987 43 M 2055 I
-------------	-------------	---

Cee'd 1.6

1,6 90-93 G4FC	11.06→	0 451 10 P 3316 O F 026 40 S 0063 L 1 987 43 M 2055 I
----------------	--------	---



**Cee'd 1.6 CRDi**

1,6|66/85|D4FB;D4FB-L

11.06-04.08	F 026 40 P 7062	0
11.06→	F 026 40 S 0063	L
	1 987 43 M 2055	I

1,6|94|D4FB;D4FB-L

09.10→	F 026 40 S 0063	L
	1 987 43 M 2055	I

Cee'd 2.0

2,0|105|G4GC

11.06→	0 451 10 P 3316	0
	F 026 40 S 0063	L
	1 987 43 M 2055	I

Cee'd 2.0 CRDi

2,0|103|D4EA-F

09.07→	F 026 40 S 0063	L
	1 987 43 M 2055	I

Cerato**Cerato 1.5 CRDi**

1,5|75|D4FA

03.04-11.09	F 026 40 P 7062	0
-------------	-----------------	---

Cerato 1.5 i

1,5|79|<DOHC>

11.03-12.05	0 451 10 P 3316	0
-------------	-----------------	---

Cerato 1.5 VGT CRDi

1,5|75

06.05→	F 026 40 P 7062	0
--------	-----------------	---

Cerato 1.6 , i

1,6|77/90|G4ED;G4FC

03.04-11.09	0 451 10 P 3316	0
-------------	-----------------	---

Cerato 1.6 CRDi

1,6|85|D4FB

06.05-04.08	F 026 40 P 7062	0
-------------	-----------------	---

Cerato 2.0

2,0|115|<2.0 THETA II>

12.08→	0 451 10 P 3316	0
	F 026 40 S 0063	L

Cerato 2.0 CRDi

2,0|83|D4EA

03.04-11.09	F 026 40 P 7069	0
-------------	-----------------	---

Cerato 2.0 i

2,0|105|<DOHC Beta>

11.03→	0 451 10 P 3316	0
--------	-----------------	---

2,0|105|G4GC

03.04-11.09	0 451 10 P 3316	0
-------------	-----------------	---

**Clarus****Clarus 1.8 i, i 16V**

1,8|85-86|T8

06.98-11.01	0 986 45 P 2061	0
	1 987 43 M 2176	I

Clarus 1.8 i 16V

1,8|85|T8D

05.96-05.98	0 986 45 P 2061	0
-------------	-----------------	---

Clarus 2.0 i, i 16V

2,0|98|FE

05.96-11.01	0 986 45 P 2041	0
06.98-11.01	1 987 43 M 2176	I

Clarus 2.0 i 16V

2,0|109|FE

05.96-05.98	0 986 45 P 2041	0
-------------	-----------------	---

Credos**Credos 2.0 i 16V**

2,0|109|<DOHC FED>

06.95-02.98	0 986 45 P 2041	0
-------------	-----------------	---

Elan**Elan 1.8 i**

1,8|111|T8D <DOHC>

07.96-11.98	0 986 45 P 2041	0
-------------	-----------------	---

Joice**Joice 2.0 i**

2,0|88/102|;G4CP

08.99-03.03	0 451 10 P 3316	0
	1 987 42 S 9127	L

K 2500**K 2500 Tci**

2,5|69|D4BH

09.01→	0 451 10 P 3366	0
	1 457 43 N 4453 ²	K

K 2700**K 2700**

2,7|59|J2

04.98→	0 451 10 P 3366	0
04.98-03.00	1 457 43 N 4435 ²	K
04.00→	1 457 43 N 4453 ²	K





Magentis

Magentis 2.0

2,0 121 G4KD	07.08→	0 451 10 P 3316	0
		TW 1 987 43 M 2160	I
		1 987 43 M 2227	I

Magentis 2.0 CRDi

2,0 103 D4EA	02.06-04.07	F 026 40 P 7061	0
	02.06-08.08	1 987 43 M 2227	I
		TW 1 987 43 M 2160	I
		1 987 43 M 2227	I

2,0 110 D4EA	07.08→	TW 1 987 43 M 2160	I
		1 987 43 M 2227	I

Magentis 2.0 i

2,0 100 G4JP	09.00-12.05	0 451 10 P 3316	0
		F 026 40 S 0164	L
		0 450 90 F 5912 ¹	K

2,0 106 G4KA	02.06-08.08	0 451 10 P 3316	0
		F 026 40 S 0048	L
		1 987 43 M 2227	I
		TW 1 987 43 M 2160	I
		1 987 43 M 2227	I

Magentis 2.5 i

2,5 124 G6BV	09.00-12.05	0 451 10 P 3316	0
		F 026 40 S 0164	L
		0 450 90 F 5912 ¹	K

Magentis 2.7

2,7 138 G6EA	09.06-10.07	0 451 10 P 3316	0
	09.06-08.08	1 987 43 M 2227	I
		TW 1 987 43 M 2160	I
		1 987 43 M 2227	I

2,7 142 G6EA	07.08→	TW 1 987 43 M 2160	I
		1 987 43 M 2227	I

Mentor

Mentor 1.5 i

1,5 65 B5D	01.98-12.00	0 986 45 P 2061	0
		1 987 42 S 9179	L
		0 450 90 F 5973 ¹	K

Mentor 1.6 i

1,6 74 GA6D	01.01-08.04	0 986 45 P 2061	0
		1 987 42 S 9179	L
		0 450 90 F 5973 ¹	K



Mentor 1.8 i

1,8 82 TE <B5D>; TE <T8D>	01.98-08.04	0 986 45 P 2061	0
		1 987 42 S 9179	L
		0 450 90 F 5973 ¹	K

Morning

Morning 1.0 i

1,0 45 <SOHC>	02.04→	0 986 45 P 2061	0
		F 026 40 S 0060	L

Opirus

Opirus 2.7 i

2,7 130 GV6 <DOHC Delta>	03.03→	0 451 10 P 3316	0
------------------------------	--------	-----------------	---

Opirus 3.0 i

3,0 138 G6CT <DOHC>	03.03→	0 451 10 P 3316	0
-------------------------	--------	-----------------	---

Opirus 3.5 i, i V6

3,5 149 <DOHC>; G6CU	03.03→	0 451 10 P 3316	0
--------------------------	--------	-----------------	---

Optima

Optima 2.0 i 16V

2,0 102 <DOHC Sirius II>	07.00-04.02	0 451 10 P 3316	0
------------------------------	-------------	-----------------	---

Optima 2.5 i

2,5 131 G6B <DOHC>	07.00-04.02	0 451 10 P 3316	0
------------------------	-------------	-----------------	---

Picanto

Picanto 1.0 , Bi-Fuel

1,0 51/60 B3LA; G3LA	05.11→	0 986 45 P 2061	0
		1 987 43 M 2164	I

Picanto 1.0 i

1,0 45-46 G4HE	05.04→	0 986 45 P 2061	0
		F 026 40 S 0060	L
		1 987 43 M 2164	I

Picanto 1.1 CRDi

1,1 55 D3FA	11.05→	F 026 40 P 7062	0
		1 987 43 M 2164	I



**Picanto 1.1 i**

1,1 48 G4HG	05.04→	0 986 45 P 2061	O
		F 026 40 S 0060	L
		1 987 43 M 2164	I

Picanto 1.2

1,2 63 G4LA	05.11→	1 987 43 M 2164	I
-------------	--------	------------------------	----------

Pregio**Pregio 2.5 TCi**

2,5 69 D4BH	08.01→	EDO	0 451 10 P 3366	O
-------------	--------	-----	------------------------	----------

Pregio 2.7 D

2,7 60 J2	08.00→	0 451 10 P 3366	O
	02.97-09.00	1 457 43 N 4435 ²	K
	10.00→	1 457 43 N 4453 ²	K

Pregio 3.0 D

3,0 63 JT	02.97-12.03	1 457 43 N 4435 ²	K
-----------	-------------	-------------------------------------	----------

Pride**Pride 1.1 i**

1,1 38/48 B1	01.91-12.03	0 986 45 P 2061	O
--------------	-------------	------------------------	----------

Pride 1.3 i

1,3 44-47 B3	12.95-01.00	0 986 45 P 2061	O
		1 457 43 S 3961	L
		0 986 45 F 0222 ¹	K

1,3|51|B3

01.90-05.96	0 986 45 P 2061	O
-------------	------------------------	----------

1,3|54|B3

01.90-02.00	0 986 45 P 2061	O
05.90-02.00	1 457 43 S 3961	L
01.90-02.00	0 986 45 F 0222 ¹	K

1,3|54|B3E <SOHC>

12.86-02.00	0 986 45 P 2061	O
	0 986 45 F 0222 ¹	K

1,3|54|SOHC <B3E>

12.86-02.00	0 986 45 P 2061	O
	1 457 43 S 3961	L
	0 986 45 F 0222 ¹	K

**Pride 1.4 i**

1,4 55,4 XG4710E	01.98-03.04	0 986 45 P 2061	O
		1 457 43 S 3961	L
		0 986 45 F 0222 ¹	K

Pride 1.5 VGT CRDI

1,5 112	05.05→	1 457 43 N 4105 ²	K
---------	--------	-------------------------------------	----------

Pro Cee'd**Pro Cee'd 1.4**

1,4 66/77/80 G4FA	10.07→	0 451 10 P 3316	O
		F 026 40 S 0063	L
		1 987 43 M 2055	I

Pro Cee'd 1.6

1,6 90-93 G4FC	03.08→	0 451 10 P 3316	O
		F 026 40 S 0063	L
		1 987 43 M 2055	I

Pro Cee'd 1.6 CRDi

1,6 66/85 D4FB;D4FB-FL	03.08-04.08	F 026 40 P 7062	O
	03.08→	F 026 40 S 0063	L
		1 987 43 M 2055	I

1,6|94|D4FB;D4FB-FL

09.10→	F 026 40 S 0063	L
	1 987 43 M 2055	I

Pro Cee'd 2.0

2,0 105 G4GC	03.08→	0 451 10 P 3316	O
		F 026 40 S 0063	L
		1 987 43 M 2055	I

Pro Cee'd 2.0 CRDi

2,0 103 D4EA	03.08→	F 026 40 S 0063	L
		1 987 43 M 2055	I

Retona**Retona 2.0 i**

2,0 61 <DOHC>	06.98-10.03	0 986 45 P 2041	O
---------------	-------------	------------------------	----------

Retona 2.0 TD

2,0 61 RF-TCI	04.98-12.00	0 451 10 P 3316	O
		1 457 43 N 4454 ²	K





Rio

Rio 1.3 i

1,3 55/60/62 A3E	07.00-02.05	0 986 45 P 2061	O
		F 026 40 S 0107	L
		0 450 90 F 5970 ¹	K
		1 987 43 M 2176	I

1,3 62 A3E <SOHC>	07.99-04.01	0 986 45 P 2061	O
		0 450 90 F 5970 ¹	K

Rio 1.4

1,4 55 G4EE	03.09→	0 451 10 P 3316	O
		F 026 40 S 0048	L

Rio 1.4 i

1,4 71 G4EE	03.05→	0 451 10 P 3316	O
		F 026 40 S 0048	L
		03.05-12.08	1 987 43 M 2170

Rio 1.5 CRDi

1,5 81 D4FA	03.05-04.08	F 026 40 P 7062	O	
		03.05→ TW	F 026 40 S 0048	L
			F 026 40 S 0093	L
		03.05-12.08	1 987 43 M 2170	I

Rio 1.5 i

1,5 71-72 A5D	07.00-02.05	0 986 45 P 2061	O
		F 026 40 S 0107	L
		0 450 90 F 5970 ¹	K
		1 987 43 M 2176	I

1,5 73 A5D <DOHC>	07.99-04.05	0 986 45 P 2041	O
		0 450 90 F 5970 ¹	K

Rio 1.6 i

1,6 82 G4ED	03.05→	0 451 10 P 3316	O
		F 026 40 S 0048	L
		03.05-12.08	1 987 43 M 2170

Sedona

Sedona 2.5 i V6

2,5 121 <K5>	06.98-09.05	0 986 45 P 2041	O
		F 026 40 S 0113	L

Sedona 2.9 D Turbo

2,9 93 J3	06.98-09.01	F 026 40 S 0113	L
	06.98-12.00	1 457 43 N 4435 ²	K
	01.01-09.01	1 457 43 N 4453 ²	K



Sephia

Sephia 1.5 i

1,5 59/68 B5	09.96-12.97	0 986 45 P 2061	O
		0 450 90 F 5957 ¹	K

1,5 66 B5E	10.97-12.00	0 986 45 P 2061	O
		1 987 42 S 9179	L

Sephia 1.5 i 8V

1,5 66 B5E <SOHC>	08.97-05.00	0 986 45 P 2061	O
-----------------------	-------------	-----------------	---

Sephia 1.5 i 8V, i 16V

1,5 68/77 <DOHC B5>; <SOHC B5>	09.92-08.97	0 986 45 P 2061	O
		0 450 90 F 5957 ¹	K

Sephia 1.5 i 16V

1,5 65 B5D	01.98-10.00	0 986 45 P 2061	O	
		01.98-12.00	1 987 42 S 9179	L
		0 450 90 F 5973 ¹	K	

1,5 74 B5D	10.97-12.00	0 986 45 P 2061	O
		1 987 42 S 9179	L

1,5 74 B5D <DOHC>	08.97-05.00	0 986 45 P 2041	O
-----------------------	-------------	-----------------	---

1,5 77 B5	01.92-10.94	0 986 45 P 2061	O	
		09.96-09.97	0 986 45 P 2061	O
		01.92-10.94	1 987 42 S 9179	L
			0 450 90 F 5973 ¹	K
	09.96-09.97	0 450 90 F 5957 ¹	K	

Sephia 1.6 i

1,6 59 B6	07.93-12.97	0 986 45 P 2061	O	
		07.93-06.95	1 987 42 S 9179	L
		07.93-12.97	0 450 90 F 5957 ¹	K

Sephia 1.6 i 16V

1,6 74 GA6D	01.98-10.00	0 986 45 P 2061	O	
		01.98-12.00	1 987 42 S 9179	L
		0 450 90 F 5973 ¹	K	

Sephia 1.8 i 16V

1,8 82 TE <T8D>	09.96-12.00	0 986 45 P 2061	O
		1 987 42 S 9179	L
		0 450 90 F 5973 ¹	K

1,8 93 T8D	01.98-12.00	0 986 45 P 2061	O
		1 987 42 S 9179	L

1,8 96 T8D <DOHC>	08.97-05.00	0 986 45 P 2041	O
-----------------------	-------------	-----------------	---





1,8 104 T8D	09.96-09.97	0 986 45 P 2061	O
		0 450 90 F 5957 ¹	K

Shuma

Shuma 1.5 i

1,5 66 B5E <SOHC>	12.97-05.00	0 986 45 P 2061	O
1,5 74 B5D <DOHC>	12.97-05.00	0 986 45 P 2041	O

Shuma 1.5 i 16V

1,5 65 B5D	01.98-10.00	0 986 45 P 2061	O
	01.98-12.00	1 987 42 S 9179	L
		0 450 90 F 5973 ¹	K

Shuma 1.6 i 16V

1,6 74 GA6D	01.98-10.00	0 986 45 P 2061	O
	01.01-08.04	0 986 45 P 2061	O
	01.98-08.04	1 987 42 S 9179	L
		0 450 90 F 5973 ¹	K

1,6 74-74 GA6D	01.01-08.04	0 986 45 P 2061	O
		1 987 42 S 9179	L
		0 450 90 F 5973 ¹	K

Shuma 1.8 i

1,8 96 <DOHC>	12.97-05.00	0 986 45 P 2061	O
		1 987 42 S 9179	L

Shuma 1.8 i 16V

1,8 82 TE <T8D>	01.98-08.04	0 986 45 P 2061	O
		1 987 42 S 9179	L
		0 450 90 F 5973 ¹	K

Sorento

Sorento 2.4 , 4x4

2,4 128 G4KE	09.09→	0 451 10 P 3316	O
------------------	--------	-----------------	---

Sorento 2.4 i

2,4 102 G4JS	03.03-04.06	0 451 10 P 3316	O
		1 987 42 S 9180	L

Sorento 2.5 CRDi

2,5 103 D4CB	07.02-08.09	F 026 40 P 7084	O
		1 987 42 S 9180	L
	07.02-05.06	1 457 43 N 4310 ²	K

2,5 107 <A2,51Gen>	05.00→	F 026 40 P 7084	O
	05.00-12.05	1 987 42 S 9180	L
	05.00→	1 457 43 N 4310 ²	K

2,5 125 D4CB	03.06-08.09	F 026 40 P 7084	O
------------------	-------------	-----------------	---

Sorento 3.5 i

3,5 144 G6CU	03.03-08.09	0 451 10 P 3316	O
		1 987 42 S 9180	L

Soul

Soul 1.6 CRDi

1,6 85/94 D4FB <Euro 4>	01.09→	F 026 40 S 0137	L
-----------------------------	--------	-----------------	---

Soul 1.6 i CVVT

1,6 77/91-93 G4FC <Euro 4>	01.09→	0 451 10 P 3316	O
		F 026 40 S 0137	L

Spectra

Spectra 1.5 i

1,5 75 A5D <DOHC>	05.00-12.03	0 986 45 P 2041	O
		0 450 90 F 5973 ¹	K

Spectra 1.5 i 16V

1,5 65	01.01-12.09	0 986 45 P 2061	O
		1 987 42 S 9179	L
		0 450 90 F 5973 ¹	K

Spectra 1.6 i 16V

1,6 75 S6D	01.01-12.09	0 986 45 P 2061	O
		1 987 42 S 9179	L
		0 450 90 F 5973 ¹	K

Spectra 1.8 i

1,8 93 A5D <DOHC>	04.00-03.03	0 986 45 P 2041	O
		0 450 90 F 5973 ¹	K

Spectra 1.8 i 16V

1,8 93	01.01-12.06	0 986 45 P 2061	O
		1 987 42 S 9179	L
		0 450 90 F 5973 ¹	K

1,8 93 TE	01.01-12.09	0 986 45 P 2061	O
		1 987 42 S 9179	L
		0 450 90 F 5973 ¹	K





Sportage

Sportage 2.0

2,0 104 G4GC	08.08-05.10	0 451 10 P 3316	O
		F 026 40 S 0044	L

Sportage 2.0 CRDi

2,0 100 <D2,0 Gen 1>	08.04→	F 026 40 P 7018	O
		F 026 40 S 0044	L

Sportage 2.0 CRDi, CRDi 4x4

2,0 83 D4EA	09.04-07.08	F 026 40 P 7069	O
		F 026 40 S 0044	L
		1 987 43 M 2170	I

2,0 100-103 D4EA-V	01.06-07.08	F 026 40 P 7061	O
		F 026 40 S 0044	L
		1 987 43 M 2170	I

2,0 110 D4EA	08.08-05.10	TW F 026 40 P 7061	O
		F 026 40 S 0044	L

Sportage 2.0 i

2,0 105 <DOHC Beta>	08.04→	0 451 10 P 3316	O
-------------------------	--------	-----------------	---

Sportage 2.0 i, i 4x4

2,0 104 G4GC	09.04-07.08	0 451 10 P 3316	O
		F 026 40 S 0044	L
		1 987 43 M 2170	I

Sportage 2.0 i 4x4

2,0 70 FED	04.95-09.98	0 450 90 F 5981 ¹	K
----------------	-------------	------------------------------	---

2,0 73 FED	05.96-08.04	0 450 90 F 5981 ¹	K
----------------	-------------	------------------------------	---

2,0 94 FED	04.94-10.98	0 450 90 F 5981 ¹	K
----------------	-------------	------------------------------	---

Sportage 2.0 TD 4x4

2,0 61 RF	11.96-08.04	HAU 0 451 10 P 3316	O
		1 457 43 N 4454 ²	K

Sportage 2.0 4x4

2,0 104 G4GC	08.08-05.10	0 451 10 P 3316	O
		F 026 40 S 0044	L

Sportage 2.2 4x4

2,2 46 HW	05.93-04.95	1 457 43 N 4435 ²	K
---------------	-------------	------------------------------	---



Sportage 2.7

2,7 129 G6BA	08.08-05.10	0 451 10 P 3316	O
		F 026 40 S 0044	L

Sportage 2.7 i 4x4

2,7 129 G6BA	09.04-08.08	0 451 10 P 3316	O
		F 026 40 S 0044	L
		1 987 43 M 2170	I

Sportage 2.7 4x4

2,7 129 G6BA	08.08-05.10	0 451 10 P 3316	O
		F 026 40 S 0044	L

Towner

Towner 0.8 i

0,8 29 CD 800 <SOHC>	05.97-10.02	0 986 45 P 2061	O
--------------------------	-------------	-----------------	---

Venga

Venga 1.4

1,4 66 G4FA <1400 GAMMA>	12.09→	0 451 10 P 3316	O
		F 026 40 S 0137	L

Venga 1.4 CRDi

1,4 55-57/66 D4FC <1400 - U2>; D4FC <1400 U2>	12.09→	F 026 40 S 0137	L
---	--------	-----------------	---

Venga 1.6

1,6 92 G4FC <1600 GAMMA>	12.09→	0 451 10 P 3316	O
		F 026 40 S 0137	L

Venga 1.6 CRDi

1,6 85/94 D4FB <1600 U2>	12.09→	F 026 40 S 0137	L
------------------------------	--------	-----------------	---

LADA *

Forma

Forma 1.3

1,3 45	09.91-12.00	0 451 10 P 3093	O
		1 457 43 S 2108	L
		EU2 1 457 42 S 9061	L
		0 450 90 F 4058 ¹	K

1,3 48	05.93-12.00	1 457 43 S 2108	L
----------	-------------	-----------------	---



**Forma 1.5**

1,5|53|BA3/21083

09.91-12.00	WW	0 451 10 P 3093	O
		1 457 43 S 2108	L
	EU2	1 457 42 S 9061	L
		0 450 90 F 4058 ¹	K

Kalina**Kalina 1.4**

1,4|65,5|11194;11194 <Euro 3>

07.07→		0 451 10 P 3060	O
		0 451 20 P 3154	O
		1 457 42 S 9061	L
		0 450 90 F 5273 ¹	K
	WW	0 450 90 F 5316 ¹	K

Kalina 1.6

1,6|59,5|11183-0... <Euro 3>

07.07→		0 451 10 P 3060	O
		0 451 20 P 3154	O
		1 457 42 S 9061	L
		0 450 90 F 5273 ¹	K
		0 450 90 F 5911 ¹	K
		0 986 45 F 0124 ¹	K
	WW	0 450 90 F 5316 ¹	K

1,6|59,5/65,5|21114;21114 <Euro 3>;21114-90 <Euro 2>;21124 <Euro 3>

11.04→		0 451 20 P 3154	O
		1 457 42 S 9061	L
		0 450 90 F 5273 ¹	K
	WW	0 450 90 F 5316 ¹	K

1,6|62|11183-5... <Euro 3>

01.10→		0 451 10 P 3060	O
		1 457 42 S 9061	L
		0 450 90 F 5911 ¹	K
		0 986 45 F 0124 ¹	K

Laika**Laika 1.5**

1,5|53

02.93-10.98		1 457 43 S 2108	L
-------------	--	-----------------	---

Laika 1.6

1,6|54

02.93-10.98		1 457 43 S 2108	L
-------------	--	-----------------	---

Niva**Niva 1.6**

1,6|56-58|2121

12.76-12.96		0 451 20 P 3154	O
		1 457 43 S 2108	L

Niva 1.6 4x4

1,6|54

02.93-12.99		1 457 43 S 2108	L
-------------	--	-----------------	---

Niva 1.7

1,7|56|2121.3

01.93-12.99		0 451 20 P 3154	O
		1 457 43 S 2108	L
	CSA,FKR	0 450 90 F 4149 ¹	K

Niva 1.7 i

1,7|59|2123

07.99-12.00		0 451 10 P 3274	O
		1 457 42 S 9061	L

1,7|59-62|21214 <Euro 3>;21214-10 <Euro 2>

07.96→		0 451 20 P 3154	O
		1 457 42 S 9061	L
		0 450 90 F 4058 ¹	K

1,7|59-62|21214-10 <Euro 3>

06.07→		0 451 20 P 3154	O
		1 457 42 S 9061	L

Oka**Oka 640**

0,6|22|1111

01.88-12.96		0 451 10 P 3093	O
		1 457 43 S 2108	L

Oka 750

0,7|24|11113

01.95→		0 451 10 P 3093	O
		1 457 43 S 2108	L

Priora**Priora 1.6 , 16V**

1,6|72|21126

11.06→		0 451 20 P 3154	O
01.08→		0 451 10 P 3060	O
11.06→		1 457 42 S 9061	L
	TW	1 987 43 R 2435 ⁸	I

Priora 1.6 8V

1,6|59,5|21114

09.08→		0 451 20 P 3154	O
		1 457 42 S 9061	L
	TW	1 987 43 R 2435 ⁸	I

Priora 1.8

1,8|72|21128

03.08→		0 451 20 P 3154	O
		1 457 42 S 9061	L
		1 987 43 R 2435 ⁸	I





Samara

Samara 1.1

1,1 39/43 21081; 21081-10	01.84→	0451 10 P 3093	O
		WW 0451 10 P 3274	O
		1457 43 S 2108	L
		WW 1457 43 S 2108	L
		CSA 0450 90 F 4149 ¹	K

Samara 1.1 i

1,1 39/43 21081; 21081-10	09.91-12.00	WW 1457 43 S 2108	L
-------------------------------	-------------	-------------------	---

Samara 1.3

1,3 45-48 2108	01.84→	0451 10 P 3093	O
		WW 0451 10 P 3274	O
		1457 43 S 2108	L
		WW 1457 43 S 2108	L
	09.88→	NOR 1457 43 S 2108	L
	01.84→	CSA 0450 90 F 4149 ¹	K

Samara 1.3 i

1,3 45-48 2108	01.86→	0451 10 P 3093	O
		WW 0451 10 P 3274	O
		1457 43 S 2108	L
		NOR 1457 43 S 2108	L
		WW 1457 43 S 2108	L

1,3 50 2108	02.96→	0451 10 P 3093	O
		WW 0451 10 P 3274	O
		NOR 1457 43 S 2108	L
		WW 1457 43 S 2108	L
		0986 45 F 0124 ¹	K

Samara 1.5

1,5 50-53 2108	09.88→	0451 10 P 3093	O
		WW 0451 10 P 3274	O
		1457 43 S 2108	L
		NOR 1457 43 S 2108	L
		WW 1457 43 S 2108	L

1,5 52 21083	09.91→	0451 10 P 3093	O
		WW 0451 10 P 3274	O
		1457 43 S 2108	L
		WW 1457 43 S 2108	L
		CSA 0450 90 F 4149 ¹	K

1,5 55	01.86→	0451 10 P 3093	O
		WW 0451 10 P 3274	O
		1457 43 S 2108	L
		WW 1457 43 S 2108	L

Samara 1.5 D

1,5 40-42 TUD5	01.95→	0451 10 P 3093	O
		WW 0451 10 P 3274	O



Samara 1.5 i

1,5 50 2111	03.93-12.00	0451 10 P 3093	O
		WW 0451 10 P 3274	O
		1457 42 S 9061	L
		1457 43 S 2108	L

1,5 57 2111	01.84→	0451 10 P 3093	O
		WW 0451 10 P 3274	O
		1457 42 S 9061	L
		0450 90 F 4058 ¹	K
		WW 0450 90 F 4058 ¹	K

1,5 57 21083	01.84→	0451 10 P 3093	O
		WW 0451 10 P 3274	O
		1457 43 S 2108	L
		NOR 1457 43 S 2108	L
		WW 1457 43 S 2108	L
		0450 90 F 4058 ¹	K
		WW 0450 90 F 4058 ¹	K

1,5 60 2111	01.95→	0451 10 P 3093	O
		WW 0451 10 P 3274	O
		1457 42 S 9061	L
		0450 90 F 4058 ¹	K

Samara 1.6 i

1,6 59,5 21114-12	01.07→	0451 20 P 3154	O
		1457 42 S 9061	L

Samara 2.6

2,6 88-92 411	07.97→	0451 10 P 3093	O
		WW 0451 10 P 3274	O

Serie 110

Serie 110 1.5

1,5 54 2110	01.96-12.00	0451 10 P 3093	O
		WW 1457 43 S 2108	L
		CSA 0450 90 F 4149 ¹	K
		CSA,WW 0450 90 F 4149 ¹	K
		1987 43 R 2435 ⁸	I

1,5 56 2110 <R-83>	01.96-12.04	0451 10 P 3093	O
		1457 43 S 2108	L
		CSA 0450 90 F 4149 ¹	K

Serie 110 1.5 i

1,5 56,4 2111-77 <Euro 3>	01.96-12.04	0451 10 P 3093	O
		1457 42 S 9061	L
		0450 90 F 4058 ¹	K



**Serie 110 1.5 i 8V**

1,5 56 2111-14/16 <Euro 2>	01.96-12.04	0 451 10 P 3093	O
		1 457 42 S 9061	L
		0 450 90 F 4058 ¹	K
		1 987 43 R 2435 ⁸	I
1,5 58 2111	01.96-12.04	0 451 10 P 3093	O
		1 457 42 S 9061	L
		0 450 90 F 4058 ¹	K

Serie 110 1.5 i 8V, i 16V

1,5 57/68/69 2111/2111-12 <R-83>; 2112; 2112/-10 <Euro 2>; 2112-70/76	01.96-12.04	0 451 10 P 3093	O
		1 457 42 S 9061	L
		0 450 90 F 4058 ¹	K
		1 987 43 R 2435 ⁸	I

Serie 110 1.5 16V Premier

1,5 57/68/69 2111/2111-12 <R-83>; 2112; 2112/-10 <Euro 2>; 2112-70/76	06.99-12.00	0 451 10 P 3093	O
		0 450 90 F 4058 ¹	K
		1 987 43 R 2435 ⁸	I

Serie 110 1.6 i

1,6 59 21114 <Euro 3>	01.05→	1 987 43 R 2435 ⁸	I
1,6 65,5 21124 <Euro 3>	01.05→	1 987 43 R 2435 ⁸	I

Serie 110 1.6 i 8V

1,6 59 21114	01.05→	0 451 20 P 3154	O
		WW 0 451 10 P 3093	O
		1 457 42 S 9061	L
		0 450 90 F 5911 ¹	K

Serie 110 1.6 i 16V

1,6 65,5 21124	01.05→	0 451 10 P 3093	O
		1 457 42 S 9061	L
		0 450 90 F 5911 ¹	K

Serie 110 2.0 GTI, 16V

2,0 110 C20XE	01.96-12.00	1 987 43 R 2435 ⁸	I
---------------	-------------	------------------------------	---

Serie 110 2.6 Wankel

2,6 88 411	01.96-12.00	1 987 43 R 2435 ⁸	I
------------	-------------	------------------------------	---

Serie 111**Serie 111 1.5**

1,5 56 2110 <R-83>	01.96-12.04	0 451 10 P 3093	O
		1 457 43 S 2108	L
		CSA 0 450 90 F 4149 ¹	K

Serie 111 1.5 i, i 8V

1,5 56,4/57-58 2111; 2111-14 <Euro 2>; 2111-77 <Euro 3>	01.96-12.04	0 451 10 P 3093	O
		1 457 42 S 9061	L
		0 450 90 F 4058 ¹	K
		1 987 43 R 2435 ⁸	I

Serie 111 1.5 i 8V

1,5 58 2111; 2111-14 <Euro 2>; 2111-77 <Euro 3>	01.96-12.04	0 451 10 P 3093	O
		1 457 42 S 9061	L
		0 450 90 F 4058 ¹	K

Serie 111 1.5 i 16V

1,5 68 2112	01.96-12.04	0 451 10 P 3093	O
		1 457 42 S 9061	L
		0 450 90 F 4058 ¹	K

1,5|69/70|2112-10 <Euro 2>; 2112-10/16

1,5 69/70 2112-10 <Euro 2>; 2112-10/16	01.96-12.04	0 451 10 P 3093	O
		1 457 42 S 9061	L
		0 450 90 F 4058 ¹	K
		1 987 43 R 2435 ⁸	I

Serie 111 1.6 i

1,6 59 21114 <Euro 2>	01.05→	0 451 20 P 3154	O
		1 457 42 S 9061	L
		0 450 90 F 5911 ¹	K
		1 987 43 R 2435 ⁸	I

1,6|59/65,5/65,9|21114 <Euro 3>; 21124 <Euro 2>; 21124 <Euro 3>

1,6 59/65,5/65,9 21114 <Euro 3>; 21124 <Euro 2>; 21124 <Euro 3>	01.05→	1 987 43 R 2435 ⁸	I
---	--------	------------------------------	---

Serie 112**Serie 112 1.5 i**

1,5 54	01.96→	0 451 10 P 3093	O
		1 457 42 S 9061	L
		0 450 90 F 4058 ¹	K
		WW 0 450 90 F 4058 ¹	K
		1 987 43 R 2435 ⁸	I

1,5|56,4|2111-15 <Euro 2>

1,5 56,4 2111-15 <Euro 2>	01.05→	1 987 43 R 2435 ⁸	I
---------------------------	--------	------------------------------	---





Serie 112 1.5 i, i 8V, i 16V

1,5 56/56,4/66/67 2111-77 <Euro 3>; 2111/2111-12; 2112	01.96-12.04	0 451 10 P 3093	O
		1 457 42 S 9061	L
		0 450 90 F 4058 ¹	K
		1 987 43 R 2435 ⁸	I

Serie 112 1.5 i 8V

1,5 58 2111	01.96-12.04	0 451 10 P 3093	O
		1 457 42 S 9061	L
		0 450 90 F 4058 ¹	K

Serie 112 1.5 i 16V

1,5 69 2111-77 <Euro 3>; 2111/2111-12; 2112	01.96-12.04	0 451 10 P 3093	O
		1 457 42 S 9061	L
		0 450 90 F 4058 ¹	K

Serie 112 1.6 i

1,6 59 21114 <Euro 2>	01.05→	0 451 20 P 3154	O
		1 457 42 S 9061	L
		0 450 90 F 5911 ¹	K
		1 987 43 R 2435 ⁸	I

1,6 59/65,5 21114 <Euro 3>; 21124 <Euro 2>; 21124 <Euro 3>	01.05→	1 987 43 R 2435 ⁸	I
--	--------	------------------------------	---

Serie 114

Serie 114 1.6 i

1,6 65,5 21124 <Euro 3>	12.08→	0 451 10 P 3093	O
		1 987 43 R 2435 ⁸	I

Serie 115

Serie 115 1.3

1,3 47 2114	01.98→	0 451 10 P 3093	O
		1 457 43 S 2108	L
		CSA 0 450 90 F 4149 ¹	K
		CSA,WW 0 450 90 F 4149 ¹	K

Serie 115 1.3 i

1,3 47 2114	01.00→	0 451 10 P 3093	O
		1 457 42 S 9061	L
		0 450 90 F 4058 ¹	K

Serie 115 1.5

1,5 52 2114	01.98→	0 451 10 P 3093	O
		1 457 43 S 2108	L
		CSA 0 450 90 F 4149 ¹	K
		CSA,WW 0 450 90 F 4149 ¹	K



Serie 115 1.5 i

1,5 56,4 2111-80 <Euro 2>	01.00→	0 451 10 P 3093	O
		1 457 42 S 9061	L
		1 987 43 R 2435 ⁸	I

1,5 57 2114	01.00→	0 451 10 P 3093	O
		1 457 42 S 9061	L
		0 450 90 F 4058 ¹	K

Serie 2100

Serie 2100 2104 1.5

1,5 49 ECE	08.94-12.00	1 457 43 S 2108	L
----------------	-------------	-----------------	---

1,5 55 2103	01.88-12.93	1 457 43 S 2108	L
-----------------	-------------	-----------------	---

Serie 2100 2104 1.7

1,7 59-62 ECE	08.94-12.00	1 457 43 S 2108	L
-------------------	-------------	-----------------	---

Serie 2100 2105 1.2

1,2 44 2102	09.81-12.93	0 451 10 P 3093	O
		1 457 43 S 2108	L

Serie 2100 2105 1.3

1,3 48 2105	05.81-12.93	0 451 10 P 3093	O
		1 457 43 S 2108	L

Serie 2100 2105 1.5

1,4 55-56 2103	09.86-12.93	0 451 10 P 3093	O
		1 457 43 S 2108	L

1,5 55 2103	01.88-12.93	0 451 10 P 3093	O
		1 457 43 S 2108	L

Serie 2100 2106 1.6

1,6 55 2106 <Euro 2>	09.75→	0 451 20 P 3154	O
		1 457 43 S 2108	L
		CSA 0 450 90 F 4149 ¹	K

Serie 2100 2107 1.6

1,6 56 2106	05.81-12.93	TW 1 457 43 S 2108	L
		0 450 90 F 4058 ¹	K

Serie 2100 2107-02 1.5

1,5 52 2103	01.86→	0 451 20 P 3154	O
		TW 1 457 43 S 2108	L
		0 450 90 F 4058 ¹	K
		CSA 0 450 90 F 4149 ¹	K





Serie 2113

Serie 2113 1.6 i

1,6 59,5 11183 <Euro 3>	01.07→	0 451 20 P 3154	0
-----------------------------	--------	-----------------	---

Serie 2114

Serie 2114 1.5 i

1,5 56,4-57,2 2111-74	10.01→	0 451 10 P 3093	0
		1 457 42 S 9061	L
		1 987 43 R 2435 ⁸	I

Serie 2114 1.6 i

1,6 59,5 11183 <Euro 3>	01.07→	0 451 20 P 3154	0
-----------------------------	--------	-----------------	---

1,6 | 59,5 | 21114-12

01.07→	0 451 20 P 3154	0
	1 457 42 S 9061	L

Serie 2115

Serie 2115 1.6 i

1,6 59,5 11183	01.07→	0 451 20 P 3154	0
--------------------	--------	-----------------	---

1,6 | 59,5 | 21114-12

01.07→	0 451 20 P 3154	0
	1 457 42 S 9061	L

Serie 21000

Serie 21000 21041-30 1.6i

1,6 54,5 21067 <Euro 3>	11.07→	0 451 10 P 3093	0
-----------------------------	--------	-----------------	---

Serie 21000 21061 1.5

1,5 48	01.82→	0 451 20 P 3154	0
		1 457 43 S 2108	L
		CSA 0 450 90 F 4149 ¹	K

Serie 21000 21063 1.3

1,3 48 21011	01.86→	0 451 20 P 3154	0
		1 457 43 S 2108	L
		CSA 0 450 90 F 4149 ¹	K

Serie 21000 21072 1.3

1,3 48	02.86→	0 451 20 P 3154	0
		TW 1 457 43 S 2108	L
		0 450 90 F 4058 ¹	K
		CSA 0 450 90 F 4149 ¹	K

Serie 21000 21073-40 1.7

1,7	01.86→	0 451 20 P 3154	0
		1 457 43 S 2108	L
		0 450 90 F 4058 ¹	K

Serie 21000 21074 1.6

1,6 55 2106 <Euro 2>	05.82→	TW 1 457 43 S 2108	L
		0 450 90 F 4058 ¹	K
		CSA 0 450 90 F 4149 ¹	K

Serie 21000 21077 1.3

1,3 48 2105	01.86-12.00	TW 1 457 43 S 2108	L
		0 450 90 F 4058 ¹	K

Serie 21000 21093 1500

1,5 52	06.89-12.93	1 457 43 S 2108	L
----------	-------------	-----------------	---

Serie 21000 21099 1.5i

1,5 56,4 2111-74	01.90-01.04	0 451 10 P 3093	0
		WW 0 451 10 P 3274	0
		1 457 42 S 9061	L

Serie 21000 210540 1.6i

1,6 53,5 21067 <Euro 3>	12.05→	0 451 10 P 3093	0
-----------------------------	--------	-----------------	---

Serie 21000 210740 1.6i

1,6 53,5 21067 <Euro 3>	12.05→	0 451 10 P 3093	0
-----------------------------	--------	-----------------	---

Toscana

Toscana 1.4

1,4 55 2103	01.86-12.00	TW 1 457 43 S 2108	L
		0 450 90 F 4058 ¹	K

Toscana 1.5

1,5 55 2103	01.86-12.00	TW 1 457 43 S 2108	L
		0 450 90 F 4058 ¹	K

4x4

4x4 1.7 i

1,7 59,5 21214	06.07→	0 451 20 P 3154	0
		1 457 42 S 9061	L





LANCIA *

Dedra

Dedra 1.6 i

1,6 55 835C1.000 Kat <M7>	04.93-10.94	0 451 10 P 3351	O
		1 457 43 S 3541	L
		0 450 90 F 2151 ¹	K
	KL	1 987 43 M 2014	I

1,6 57 835A1.046 Kat <M2>	08.89-03.93	0 451 10 P 3351	O
		1 457 43 S 2180	L
		0 450 90 F 2151 ¹	K

1,6 65 835A1.000 SPI-Weber <M1 / M5>	01.89-10.94	0 451 10 P 3351	O
		1 457 43 S 2180	L
		0 450 90 F 5002 ¹	K

1,6 66 159B9.000 MPI-GM <M1>	10.94-04.98	0 451 10 P 3111	O
		1 457 43 S 2183	L
		0 450 90 F 5273 ¹	K
	KL	1 987 43 M 2014	I

Dedra 1.6 i 16V

1,6 76 182A4.000 MPI-Weber <M6>	04.98-10.99	0 451 10 P 3111	O
		1 457 43 S 3253	L
	KL	1 987 43 M 2014	I

Dedra 1.8 i

1,8 74 836A5.000 MPI-Weber <M2>	10.94-12.95	0 451 10 P 3350	O
		1 457 43 S 3253	L
		0 450 90 F 5021 ¹	K
	KL	1 987 43 M 2014	I

1,8 77 835A2.046 Kat <M4>	09.89-10.94	0 451 10 P 3350	O
		1 457 43 S 2183	L
		0 450 90 F 5021 ¹	K
	01.93-10.94 KL	1 987 43 M 2014	I

1,8 80 835A2.000 MPI-Weber <M3>	01.89-07.92	0 451 10 P 3350	O
		1 457 43 S 2183	L
		0 450 90 F 5021 ¹	K

Dedra 1.8 i 16V

1,8 83 182A2.000 MPI-Hit. <M4>	01.96-10.99	0 451 10 P 3300	O
		1 457 43 S 3253	L
		0 450 90 F 5021 ¹	K
	KL	1 987 43 M 2014	I

1,8 97 183A1.000 MPI-Hit. <M2>	01.96-10.99	0 451 10 P 3300	O
		1 457 43 S 3253	L
		0 450 90 F 5273 ¹	K
	KL	1 987 43 M 2014	I



Dedra 1.9 TD

1,9 66 835A4.000 <M1>	01.89-10.94	0 451 10 P 3170	O
		1 457 43 N 4105 ²	K
	01.93-10.94 KL	1 987 43 M 2014	I

1,9 66 835A4.000/160D1.000 <M1/M2>	10.94-10.99	0 451 10 P 3352	O
		1 457 43 S 2183	L
		1 457 43 N 4105 ²	K
	KL	1 987 43 M 2014	I

Dedra 2.0 i

2,0 86 835A5.000 MPI-Weber <M5>	01.89-07.92	0 451 10 P 3350	O
		1 457 43 S 2183	L
		0 450 90 F 5021 ¹	K

2,0 119 835A8.046 Kat <M2>	11.90-10.94	0 451 10 P 3350	O
		1 457 43 S 2183	L
		0 450 90 F 5021 ¹	K
	01.93-10.94 KL	1 987 43 M 2014	I

2,0 132 835A8.000 MPI-Weber <M1>	06.90-07.92	0 451 10 P 3350	O
		1 457 43 S 2183	L
		0 450 90 F 5021 ¹	K

Dedra 2.0 i, i Automatic

2,0 83 835A5.046 Kat <M3>; 835A5.046 Kat <M6>	09.89-10.99	0 451 10 P 3350	O
		1 457 43 S 2183	L
		0 450 90 F 5021 ¹	K
	01.93-10.99 KL	1 987 43 M 2014	I

Dedra 2.0 i 4x4 Integrale

2,0 121 835A7.046 Kat <M4>	04.91-10.94	0 451 10 P 3350	O
		1 457 43 S 2183	L
		0 450 90 F 5021 ¹	K
	01.93-10.94 KL	1 987 43 M 2014	I

2,0 124 835A7.000 <M3>	06.90-07.92	0 451 10 P 3350	O
		1 457 43 S 2183	L
		0 450 90 F 5021 ¹	K

Dedra 2.0 i 16V, i 16V 4x4

2,0 102 836A3.000 MPI-Weber <M1>	10.94-10.99	0 451 10 P 3350	O
		1 457 43 S 3253	L
		0 450 90 F 5021 ¹	K
	KL	1 987 43 M 2014	I

Delta

Delta 1.3

1,3 55-58 831B.000 <M2>	05.86-08.92	XXX	0 451 10 P 3096	O
			1 457 43 S 2174	L

**Delta 1.4 i**

1,4 51 160A1.046 SPI-Bosch <SF M1>			
01.93-04.94	0 451 10 P 3351	O	
	1 457 43 S 2180	L	
	0 450 90 F 2151 ¹	K	
10.93-04.94 KL	1 987 43 M 2014	I	

1,4 | 51 | 836A4.000 SPI-Bosch <SF M7>

04.94-09.94	0 451 10 P 3351	O	
10.94-12.99	0 451 10 P 3111	O	
04.94-12.99	1 457 43 S 2180	L	
	0 450 90 F 2151 ¹	K	
KL	1 987 43 M 2014	I	

Delta 1.4 i LPG, i 16V**1,4 | 88/110 | 198 A 1.000 <M21>; 198 A 4.000 <M20>; 198A4.000 <M20>**

07.08 →	1 457 42 P 9256	O	
	1 987 43 R 2377 ⁸	I	

Delta 1.4 i 16V**1,4 | 103**

08.10 →	1 457 42 P 9256	O	
	1 987 43 R 2377 ⁸	I	

Delta 1.6 i**1,6 | 55 | 835C1.000 SPI-Bosch <SF M2>**

01.93-09.94	0 451 10 P 3351	O	
10.94-12.99	0 451 10 P 3111	O	
01.93-12.99	1 457 43 S 3541	L	
	0 450 90 F 2151 ¹	K	
10.93-12.99 KL	1 987 43 M 2014	I	

1,6 | 66 | 149C2.000 Kat <M2>

05.87-08.92	0 451 10 P 3350	O	
	1 457 43 S 2174	L	
	0 450 90 F 2151 ¹	K	

Delta 1.6 i HF Turbo**1,6 | 97 | 831B7.046 Kat <M4>**

04.87-08.92	0 451 10 P 3350	O	
	1 457 43 S 2174	L	
	0 450 90 F 2151 ¹	K	

Delta 1.6 i, i HF Turbo**1,6 | 80/103 | 831B3.000 MPI-Weber <M3>; 831B7.000 MPI-Weber <M1>**

05.86-08.92	0 451 10 P 3350	O	
	1 457 43 S 2174	L	
	0 450 90 F 5021 ¹	K	

Delta 1.6 i 16V HPE**1,6 | 66/76 | 182A4.000 MPI-Weber <SF M9>; 182A6.000 MPI-Weber <SF M10>**

01.96-12.99	0 451 10 P 3111	O	
	1 457 43 S 3253	L	
	0 450 90 F 5273 ¹	K	
KL	1 987 43 M 2014	I	

Delta 1.6 JTD**1,6 | 88 | 198 A 2.000 <M78>**

07.08 →	1 987 43 R 2377 ⁸	I	
---------	------------------------------	----------	--

**Delta 1.8 i****1,8 | 66/74/76 | 835C2.000 MPI-Weber <SF M3>; 835/836C4.000 MPI-W. <SF M4>; 836A5.000 MPI-Weber <SF M5>; 836A6.000 MPI-Weber <SF M6>**

01.93-12.99	0 451 10 P 3350	O	
	1 457 43 S 3253	L	
	0 450 90 F 5021 ¹	K	
10.93-12.99 KL	1 987 43 M 2014	I	

Delta 1.8 i GT 16V, i 16V**1,8 | 83/97 | 182A2.000 MPI-Hit. <SF M8>; 183A1.000 MPI-Hit. <SG M3>**

01.96-12.99	0 451 10 P 3300	O	
	1 457 43 S 3253	L	
	0 450 90 F 5273 ¹	K	
KL	1 987 43 M 2014	I	

Delta 1.8 TBi**1,8 | 147 | 939B1000 <M66>**

05.09 →	1 987 43 R 2377 ⁸	I	
---------	------------------------------	----------	--

Delta 1.9 JTD**1,9 | 140 | 844 A 1.000 <M94>**

08.08 →	1 987 43 R 2377 ⁸	I	
---------	------------------------------	----------	--

Delta 1.9 TD**1,9 | 59 | 831D1.000 <M8>**

06.86-06.91	0 451 10 P 3028	O	
XXX	1 457 43 D 701 ²	K	

1,9 | 66 | 160D1.000 <SQ M2>

10.95-12.99	0 451 10 P 3352	O	
	1 457 43 S 2183	L	
KL	1 987 43 M 2014	I	

1,9 | 66 | 835A4.000 <SQ M1>

07.94-10.95	0 451 10 P 3352	O	
	1 457 43 S 2183	L	
KL	1 987 43 M 2014	I	

Delta 2.0 i Turbo 8V Int. 4x4, i Turbo 16V Int. 4x4**2,0 | 126/147 | 831C5.046 Kat <M2>; 831D5.000 MPI-Weber <M4>**

03.89-12.94	0 451 10 P 3349	O	
03.89-12.92	1 457 43 S 2174	L	
03.89-12.94	0 450 90 F 5021 ¹	K	

Delta 2.0 i Turbo 16V Int. 4x4**2,0 | 136 | 831E5.046 Kat <M3>**

06.91-12.94	0 451 10 P 3349	O	
	0 450 90 F 5021 ¹	K	

2,0 | 144-147 | 831E5.000 MPI-Weber <M1>

06.91-12.94	0 451 10 P 3349	O	
	1 457 43 S 2174	L	
	0 450 90 F 5021 ¹	K	



Delta 2.0 i 16V, i 16V Turbo HPE

2,0 102 137 836A2.000 MPI-Weber <SG M2>; 836A3.000 MPI-Weber <SG M1>			
01.93-09.96	0 451 10 P 3350	O	
	1 457 43 S 3253	L	
	0 450 90 F 5021 ¹	K	
10.93-09.96 KL	1 987 43 M 2014	I	

Delta 2.0 i 16V Turbo HPE

2,0 137 175A4.000 MPI-Weber <SG M4>			
09.96-12.99	0 451 10 P 3350	O	
	1 457 43 S 3253	L	
	0 450 90 F 5021 ¹	K	
KL	1 987 43 M 2014	I	

Delta 2.0 MJTD

2,0 121 198 A 5.000 <M120>			
08.08→	1 987 43 R 2377 ⁸	I	

Kappa

Kappa 2.0 i Turbo 16V

2,0 151 834A4.000 MPI-Bosch <M3>			
04.97-06.98	0 451 10 P 3350	O	
	1 457 43 S 2172	L	
	0 450 90 F 5087 ¹	K	
KL	1 987 43 R 2360 ⁸	I	

2,0 151 838A4.000 <M3>			
11.94-06.98	0 451 10 P 3350	O	
	1 457 43 S 2172	L	
	0 450 90 F 5087 ¹	K	
07.96-06.98 KL	1 987 43 R 2360 ⁸	I	

Kappa 2.0 i Turbo 20V

2,0 162 175A3.000 MPI-Bosch <M4>; 175A3.000 <M6>			
06.98-12.00	0 451 10 P 3354	O	
	1 457 43 S 3791	L	
	0 450 90 F 5087 ¹	K	
KL	1 987 43 R 2360 ⁸	I	

Kappa 2.0 i 20V

2,0 110 838A1.000 <M1>			
11.94-06.96	0 451 10 P 3354	O	
	1 457 43 S 3791	L	
	0 450 90 F 5087 ¹	K	

2,0 114 838A6.000 <M4>			
06.96-12.00	0 451 10 P 3354	O	
	1 457 43 S 3791	L	
	0 450 90 F 5087 ¹	K	
07.96-12.00 KL	1 987 43 R 2360 ⁸	I	

Kappa 2.4 D Turbo

2,4 91 838A7.000 <M2>			
06.96-03.98	0 451 10 P 3354	O	
	1 457 43 S 3791	L	
	1 457 43 N 4192 ²	K	
	MES 1 457 43 N 4192 ²	K	
	MWA 1 457 43 N 4194 ²	K	
07.96-03.98 KL	1 987 43 R 2360 ⁸	I	



Kappa 2.4 i 20V

2,4 129 838A2.000 MPI-RB <M1>; 838A2.000 <M2>			
11.94-06.98	0 451 10 P 3354	O	
	1 457 43 S 3791	L	
	0 450 90 F 5087 ¹	K	
07.96-06.98 KL	1 987 43 R 2360 ⁸	I	

2,4 | 129 | 838B2.000 MPI-RB <M5>; 838B2.000 <M8>

06.98-12.00	0 451 10 P 3354	O	
	1 457 43 S 3791	L	
	0 450 90 F 5087 ¹	K	
KL	1 987 43 R 2360 ⁸	I	

Kappa 2.4 JTD

2,4 100 838A8.000 <M3>			
03.98-12.00	0 451 10 P 3354	O	
	1 457 43 S 3791	L	
Mot.Nr. →1930904	03.98-03.00 MW8	1 457 43 N 4198 ²	K
Mot.Nr. 1930905→	03.00-12.00 MW1	1 457 43 N 4293 ²	K

Kappa 2.4 TD

2,4 91 838A3.000 <M1>			
11.94-06.96	0 451 10 P 3354	O	
	1 457 43 S 3791	L	
Mot.Nr. →0446112	11.94-06.96 MES	1 457 43 N 4192 ²	K
Mot.Nr. 0121220→0446112	11.94-06.96 MES	1 457 43 N 4192 ²	K
Mot.Nr. 0446113→	11.94-06.96 MWA	1 457 43 N 4194 ²	K

2,4 | 91 | 838A7.000 <M2>

06.96-03.98	0 451 10 P 3354	O	
	1 457 43 S 3791	L	
Mot.Nr. →0446112	06.96-03.98 MES	1 457 43 N 4192 ²	K
Mot.Nr. 0121220→0446112	06.96-03.98 MES	1 457 43 N 4192 ²	K
Mot.Nr. 0446113→	06.96-03.98 MWA	1 457 43 N 4194 ²	K
07.96-03.98 KL	1 987 43 R 2360 ⁸	I	

Kappa 3.0 i 24V, i 24V V6

3,0 150 838B.000; 838B.000 MPI-RB <M2>; 838.000			
11.94-12.00	0 451 10 P 3351	O	
	1 457 43 S 3791	L	
	0 450 90 F 5087 ¹	K	
07.96-12.00 KL	1 987 43 R 2360 ⁸	I	

Lybra

Lybra 1.6 i 16V

1,6 76 182A4.000 <M1 CF2>			
10.99-09.00	0 451 10 P 3111	O	
	1 457 43 S 3791	L	
KL	1 987 43 R 2303 ⁸	I	

1,6 | 76 | 182B6.000 <M2 CF3>

10.00-09.05	0 451 10 P 3111	O	
10.00-07.03	1 457 43 S 3791	L	
08.03-09.05	1 457 43 S 3329	L	
10.00-09.05 KL	1 987 43 R 2303 ⁸	I	

Lybra 1.8 i 16V

1,8 96 839A4.000 <M5 CF2>; 839A7.000 <M6 CF3>			
10.99-02.02	0 451 10 P 3300	O	
	1 457 43 S 3791	L	
KL	1 987 43 R 2303 ⁸	I	

**1,8 | 96 | 839A9.000 <M7 CF4>**

03.02-06.04	0 451 10 P 3300	O
03.02-07.03	1 457 43 S 3791	L
08.03-09.05	1 457 43 S 3329	L
03.02-09.05 KL	1 987 43 R 2303 ⁸	I

Lybra 1.9 JTD**1,9 | 77 | AR32302 <M1 CF2>**

10.99-09.00	0 451 10 P 3354	O
	1 457 43 S 3791	L
Fg.Nr. →0031402	10.99-03.00 MW8	1 457 43 N 4198 ² K
Fg.Nr. 0031403→	03.00-09.00 MW1	1 457 43 N 4293 ² K
	10.99-09.00 KL	1 987 43 R 2303 ⁸ I

1,9 | 80 | AR37101 <M2 CF3>

09.00-06.01	0 451 10 P 3354	O
	1 457 43 S 3791	L
	1 457 43 N 4314 ²	K
	KL	1 987 43 R 2303 ⁸ I

1,9 | 85 | 937A2.000 <M3 CF3>

06.01-11.06	0 451 10 P 3300	O
06.01-07.03	1 457 43 S 3791	L
08.03-11.06	1 457 43 S 3329	L
06.01-12.02	1 457 43 N 4314 ²	K
06.01-11.06 KL	1 987 43 R 2303 ⁸	I

Lybra 2.0 i 20V**2,0 | 110 | 185A8.000 <M11 CF3>**

10.00-09.05	0 451 10 P 3300	O
10.00-07.03	1 457 43 S 3791	L
08.03-09.05	1 457 43 S 3329	L
10.00-09.05 KL	1 987 43 R 2303 ⁸	I

2,0 | 113 | 182B7.000 <M10 CF2>

10.99-09.00	0 451 10 P 3300	O
	1 457 43 S 3791	L
	KL	1 987 43 R 2303 ⁸ I

2,0 | 113 | 185A8.000 <M11 CF3>

10.00-09.05	0 451 10 P 3300	O
10.00-06.03	1 457 43 S 3791	L
10.00-09.05 KL	1 987 43 R 2303 ⁸	I

Lybra 2.4 i 20V**2,4 | 129 | 192A2.000 <M15>**

10.99-05.02	0 451 10 P 3300	O
	1 457 43 S 3791	L
	KL	1 987 43 R 2303 ⁸ I

Lybra 2.4 JTD**2,4 | 98 | 839A5.000/AR32501 <M6/M5 CF2>**

10.99-09.00	0 451 10 P 3354	O
	1 457 43 S 3791	L
Mot.Nr. →1930904	10.99-03.00 MW8	1 457 43 N 4198 ² K
Mot.Nr. 1930905→2138653	03.00-09.00 MW1	1 457 43 N 4293 ² K
Mot.Nr. 2138654→	10.99-09.00 MW1,XXX	1 457 43 N 4306 ² K
	10.99-09.00 KL	1 987 43 R 2303 ⁸ I

2,4 | 103 | 839A6.000 <M7 CF3>

09.00-05.02	0 451 10 P 3354	O
	1 457 43 S 3791	L
	1 457 43 N 4314 ²	K
	KL	1 987 43 R 2303 ⁸ I

2,4 | 110 | 841C000 <M8 CF3>

06.02-09.05	0 451 10 P 3300	O
06.02-07.03	1 457 43 S 3791	L
08.03-09.05	1 457 43 S 3329	L
06.02-12.02	1 457 43 N 4314 ²	K
06.02-09.05 KL	1 987 43 R 2303 ⁸	I

Musa**Musa 1.3 MJTD****1,3 | 51 | 188A9000 <M30>**

10.04→	1 457 42 P 9256	O
	EU4 F 026 40 S 0002	L
	1 457 07 N 0001 ²	K
	1 987 43 M 2072	I

Musa 1.3 MJTD 16V**1,3 | 66 | 199A3000 <M72>**

01.06→	1 457 42 P 9256	O
	F 026 40 S 0002	L
	1 457 07 N 0001 ²	K
	1 987 43 M 2072	I

1,3 | 70 | 199B1000

02.10→	1 987 43 M 2072	I
--------	-----------------	---

Musa 1.4**1,4 | 55 | 350A1000 <M11>**

03.05-05.10	0 986 45 P 2041	O
06.10→	0 451 10 P 3364	O
03.05→	F 026 40 S 0036	L
	1 987 43 M 2072	I

Musa 1.4 LPG**1,4 | 57 | 350A1000 <M7>**

03.09-05.10	0 986 45 P 2041	O
06.10→	0 451 10 P 3364	O
03.09→	F 026 40 S 0036	L

Musa 1.4 16V**1,4 | 66 | 192B2000 <M15>**

03.05-05.10	0 986 45 P 2041	O
06.10→	0 451 10 P 3364	O
03.05→	1 457 43 S 3317	L
	1 987 43 M 2072	I

1,4 | 70 | 843A1000 <M10>

10.04-05.10	0 986 45 P 2041	O
06.10→	0 451 10 P 3364	O
10.04→	1 457 43 S 3317	L
	1 987 43 M 2072	I





Musa 1.6 JTD

1,6 85/88 350A2000 <M78>; 350A3000 <M77>			
10.07→	1 457 43	S 3553	L
	1 987 43	M 2072	I

Musa 1.9 JTD

1,9 74 188B2000 <M40>			
10.04→	0 451 10	P 3300	O
	1 457 43	S 3553	L
	1 457 07	N 0001 ²	K
	1 987 43	M 2072	I

Phedra

Phedra 2.0 JTD 16V

2,0 80 RHM <M7>			
09.02-02.06	0 451 10	P 3355	O
	1 457 07	N 0000	K
	1 987 43	M 2091	I

2,0 80 RHW <M5>			
09.02-03.06	0 451 10	P 3355	O
	1 457 43	S 2200	L
	1 457 07	N 0000	K
	1 987 43	M 2091	I

2,0 88 RHK <M8>			
03.06-12.10	1 457 42	P 9249	O
	F 026 40	S 0058	L
	1 457 43	N 1723	K
	1 987 43	M 2091	I

2,0 100 RHR <M9>			
10.06-12.10	1 457 42	P 9249	O
	F 026 40	S 0058	L
	1 457 43	N 1723	K
	1 987 43	M 2091	I

Phedra 2.0 16V

2,0 100 RFN <M1>			
09.02-09.05	0 451 10	P 3355	O
	1 457 43	S 2200	L
	1 987 43	M 2091	I

Phedra 2.2 JTD 16V

2,2 95 4HW <M10>			
09.02-09.07	0 451 10	P 3355	O
	1 457 43	S 2200	L
	1 457 07	N 0000	K
	1 987 43	M 2091	I

2,2 125 4HT <M11>			
10.07-12.10	1 457 42	P 9249	O
	F 026 40	S 0058	L
	1 987 43	M 2091	I

2,2 125 4H01 <M12/M13>			
03.08-12.10	1 457 42	P 9249	O
	F 026 40	S 0058	L
	1 987 43	M 2091	I



Phedra 3.0 24V

3,0 150 XFW <M15>			
09.02-09.05	0 451 10	P 3355	O
	1 457 43	S 2200	L
	1 987 43	M 2091	I

Thema

Thema 2.0 i.e.

2,0 84 834 B 146 <M1>			
05.92-11.94	0 451 10	P 3350	O
	1 457 43	S 2172	L
	0 450 90	F 5401 ¹	K

Thema 2.0 i.e., i.e. 16V

2,0 86/108 834 B 1.000 <M1>; 834 B 2.000 <M4>			
06.88-05.92	0 451 10	P 3350	O
	1 457 43	S 2172	L
	0 450 90	F 5005 ¹	K
	KL	1 987 43	M 2005

Thema 2.0 i.e. Turbo 16V

2,0 132/136 834 C 1.000 <M6>; 834 C 1.246 Kat <M7>			
06.88-05.92	0 451 10	P 3350	O
	1 457 43	S 2172	L
	0 450 90	F 5005 ¹	K
	KL	1 987 43	M 2005

Thema 2.0 i.e. 16V

2,0 107 834 B 2.246 Kat <M5>			
02.89-05.92	0 451 10	P 3350	O
	1 457 43	S 2172	L
	0 450 90	F 5401 ¹	K
	KL	1 987 43	M 2005

Thema 2.0 i.e. 16V, i.e. 16V Turbo

2,0 112/148 834 F 1.000 <M1>; 834 F 2.000 <M2>			
05.92-11.94	0 451 10	P 3350	O
	1 457 43	S 2172	L
	0 450 90	F 5401 ¹	K

Thema 2.5 TD

2,5 85 8144.97S.2200 <M9>			
06.88-05.92	0 451 20	P 3201	O
05.92-05.92	1 457 43	S 2172	L
06.88-05.92	1 457 43	N 4106 ²	K
	KL	1 987 43	M 2005

2,5 | 85 | 8144.97Y; 8144.97Y EDC-Bosch

05.92-11.94	0 451 20	P 3201	O
	1 457 43	S 2172	L
	1 457 43	N 4105 ²	K
	1 457 43	N 4106 ²	K

2,5 | 85 | 8144.97.2200 <M8>; 8144.97.2200 <SZ M8>

06.88-05.92	0 451 20	P 3201	O
05.92-05.92	1 457 43	S 2172	L
06.88-05.92	1 457 43	N 4106 ²	K
	KL	1 987 43	M 2005



**Thema 2.9 6 V PRV****2,9 | 108 | 834 E 146 <M10>**

06.88-09.91	0 451 10 P 3189	O
	1 457 43 S 2172	L
	0 450 90 F 5401 ¹	K
KL	1 987 43 M 2005	I

Thema 3.0 i.e.**3,0 | 126 | 834 F.000 <M1>**

05.92-11.94	0 451 10 P 3349	O
	1 457 43 S 3258	L
	0 450 90 F 5401 ¹	K

Thesis**Thesis 2.0 Turbo 20V****2,0 | 136 | 841 E.000 <M1>**

04.02-12.09	0 451 10 P 3300	O
04.02-06.03	1 457 43 S 3791	L
07.03-12.09	1 457 43 S 3329	L

Thesis 2.4 JTD 10V**2,4 | 110 | 841 C.000 <M20>**

Mot.Nr. →3684835	04.02-02.05	0 451 10 P 3354	O
Mot.Nr. 3684836→	04.02-02.05	0 451 10 P 3300	O
	04.02-06.03	1 457 43 S 3791	L
	07.03-02.05	1 457 43 S 3329	L
	04.02-12.02	1 457 43 N 4314 ²	K

Thesis 2.4 JTD 20V**2,4 | 120/129/136 | 841 G.000 <M24>; 841 H.000 <M25>; 841 M.000 <M22>; 841 N.000 <M23>; 841 P.000 <M99 CF4>**

06.03-12.09	0 451 10 P 3300	O
07.03-12.09	1 457 43 S 3329	L
06.03-12.09	F 026 40 N 2048 ²	K

Thesis 2.4 20V**2,4 | 125 | 841 D.000 <M5>**

04.02-06.03	1 457 43 S 3791	L
07.03-12.09	1 457 43 S 3329	L

Thesis 3.0 V6 24V**3,0 | 158 | 841 A.000 <M10>**

04.02-06.03	1 457 43 S 3791	L
07.03-07.03	1 457 43 S 3329	L

Thesis 3.2 V6 24V**3,2 | 169 | 841 A.000 <M11>**

08.03-12.09	1 457 43 S 3329	L
-------------	-----------------	---

Y**Y 1.1 i.e.****1,1 | 40 | 176 B2.000 SPI-Weber <M5 CF2>**

04.97-06.00	0 451 10 P 3111	O
	1 457 43 S 3255	L
	0 450 90 F 5273 ¹	K
KL	1 987 43 M 2019	I

Y 1.2 i 8V**1,2 | 44 | 188 A4.000 <M1 CF3>**

06.00-06.03	0 451 10 P 3300	O
	1 457 43 S 3521	L
KL	1 987 43 M 2019	I

Y 1.2 i 16V**1,2 | 63 | 188 A5.000 <M2 CF3>**

06.00-06.03	0 986 45 P 2041	O
	1 457 43 S 3520	L
KL	1 987 43 M 2019	I

Y 1.2 i.e. 8V**1,2 | 44 | 840 A3.000 SPI-Weber <M1 CF2>**

01.96-06.00	0 451 10 P 3111	O
	1 457 43 S 3255	L
01.96-05.96	0 450 90 F 2151 ¹	K
06.96-06.00	0 450 90 F 5273 ¹	K
01.96-06.00 KL	1 987 43 M 2019	I

Y 1.2 i.e. 16V**1,2 | 63 | 176 B9.000 MPI-Weber <M4 CF2>**

04.97-06.00	0 451 10 P 3111	O
	1 457 43 S 3257	L
	0 450 90 F 5273 ¹	K
KL	1 987 43 M 2019	I

Y 1.4 i.e. 12V**1,4 | 55/59 | 840 A2.000 SPI-Bosch <M2>; 840 A4.000 SPI-Bosch <M3>**

01.96-06.00	0 451 10 P 3111	O
	1 457 43 S 3256	L
01.96-05.96	0 450 90 F 2151 ¹	K
06.96-06.00	0 450 90 F 5273 ¹	K
01.96-06.00 KL	1 987 43 M 2019	I

Y 10**Y 10 1.0 fire****1,0 | 32 | 156 A2.100 Ecotronic <M2>**

03.89-06.91	0 451 10 P 3111	O
	1 457 43 S 2173	L
	0 450 90 F 4058 ¹	K

Y 10 1.0 i fire**1,0 | 33 | 156 A2.246 SPI-Bosch <M3>**

10.87-02.92	0 451 10 P 3111	O
	1 457 43 S 2173	L
	0 450 90 F 2151 ¹	K





Y 10 1.1 i, i fire LX, i fire 4x4, i Selectronic, i 4x4

1,1 37/40/41 156C.000 SPI-Bosch <M4>; 156C.046 Kat <M5>; 156C.046 SPI-Bosch <M1>; 176B2.000 <M3>			
01.89-12.95	0451 10	P 3111	O
	1457 43	S 2173	L
	0450 90	F 2151	K

Y 10 1.3 i, i GT

1,3 53/56/57 146A5.046 Kat <M7>; 146A5.046 MPI-Bosch <M2>; 146A5.046 MPI-Bosch <M7>; 156B.000 <M6>			
01.89-12.95	XXX	0451 10	P 3096 O
		1457 43	S 2205 L
		0450 90	F 5005 K

Ypsilon

Ypsilon 1.2 8V

1,2 44 188A4.000 <M1>			
Mot.Nr. 1898442→2935743	10.03→	0451 10	P 3364 O
Mot.Nr. 2935744→	06.03-05.10	0986 45	P 2041 O
	06.10→	0451 10	P 3364 O
	06.03→	1457 43	S 3316 L
		1987 43	M 2072 I

1,2 51 169A4000			
	06.11→	0451 10	P 3364 O
		F 026 40	S 0036 L

Ypsilon 1.2 16V

1,2 59 188A5.000 <M5>			
	06.03-09.06	0986 45	P 2041 O
		1457 43	S 3317 L
		1987 43	M 2072 I

Ypsilon 1.3 JTD 16V

1,3 51 188A9000 <M15>			
	06.03-09.06	PRF	1457 42 P 9256 O
		EU4	F 026 40 S 0002 L
			1457 07 N 0001 K
			1987 43 M 2072 I

Ypsilon 1.3 Multijet 16V

1,3 55 199A2000 <M73>			
	10.06→	PRF	1457 42 P 9256 O
		UFI	F 026 40 P 7067 O
		EU4	F 026 40 S 0002 L
		EU5	1457 07 N 0001 K
			1987 43 M 2072 I

1,3 55 199A2000 <M75>			
	10.09→	EU5	1457 07 N 0001 K
			1987 43 M 2072 I

1,3 66/77 199A3000 <M72>; 199A3000 <M105>			
	10.06→	PRF	1457 42 P 9256 O
		UFI	F 026 40 P 7067 O
		EU4	F 026 40 S 0002 L
		EU5	1457 07 N 0001 K
			1987 43 M 2072 I



Ypsilon 1.4 LPG, 8V

1,4 55 350A1000 <M7>; 350A1000 <M11>			
Mot.Nr. 2935744→	10.06-05.10	0986 45	P 2041 O
	06.10→	0451 10	P 3364 O
	10.06→	F 026 40	S 0036 L
		1987 43	M 2072 I

Ypsilon 1.4 16V

1,4 70 843A1.000 <M10>			
Mot.Nr. 2935744→	06.03-05.10	0986 45	P 2041 O
	06.10→	0451 10	P 3364 O
	06.03→	1457 43	S 3317 L
		1987 43	M 2072 I

ZETA

ZETA 2.0 i.e. Turbo

2,0 110 RGX <M1>			
	04.96-06.99	0451 10	P 3261 O
	09.94-06.99	1457 43	S 2200 L
Ricam.Nr →2409	09.94-06.96	0450 90	F 5002 K
Ricam.Nr 2410→	06.96-06.99	0450 90	F 5287 K
	09.94-06.99	3FE,KL	1987 43 M 2060 I

ZETA 2.0 JTD

2,0 80 RHW <M11>			
	10.00-06.02	0451 10	P 3355 O
		1457 43	S 2200 L
Ricam.Nr →8910	10.00-04.01	1457 03	N 0013 K
Ricam.Nr 8911→	04.01-06.02	1457 07	N 0000 K
	10.00-06.02	3FE,KL	1987 43 M 2060 I

2,0 | 80 | RHZ <M4>

06.99-06.02	0451 10	P 3355 O
	STZ	1457 43 S 2200 L
		1457 03 N 0013 K
	3FE,KL	1987 43 M 2060 I

ZETA 2.0 16V

2,0 97 RFN <M10>			
	10.00-06.02	0451 10	P 3355 O
		1457 43	S 2200 L
		0450 90	F 5287 K
		3FE,KL	1987 43 M 2060 I

2,0 | 97 | RFV <M3>

06.99-10.00	0451 10	P 3261 O
	1457 43	S 2200 L
	0450 90	F 5287 K
	3FE,KL	1987 43 M 2060 I

ZETA 2.1 TD

2,1 80 P8C <M2>			
	05.96-06.99	0451 10	P 3261 O
		1457 43	S 2200 L
Ricam.Nr →7302	05.96-11.96	1457 42	N 9291 K
Ricam.Nr 7303→	12.96-06.99	1457 43	N 1702 K
	05.96-06.99	3FE,KL	1987 43 M 2060 I





LAND ROVER GROUP

Defender

Defender 2.5

2,5 62	08.90-09.01	0 451 10 P 4014	O
--------	-------------	-----------------	---

Defender 2.5 D

2,5 50-51	08.90-09.01	0 451 10 P 4014	O
		1 457 43 D 701 ²	K
		1 457 43 N 4201 ²	K

Defender 2.5 D Turbo

2,5 80-83 Gemini TCI D.I. 23L <200/300 Tdi>	08.90-12.01	0 451 10 P 4014	O
Mot.Nr. 16 L...→	09.94-12.01 XXX	1 987 42 S 9155	L
	08.90-12.01	1 457 43 D 701 ²	K

Defender 2.5 Td5

2,5 90 Td5	06.98-07.07	0 451 10 P 3342	O
		1 457 43 S 3549	L

Defender 2.8

2,8 140-142 M52	09.00-09.04	0 986 45 F 0119 ¹	K
-----------------	-------------	------------------------------	---

Defender 3.5

3,5 100 V8	08.90-12.98	0 451 10 P 4014	O
------------	-------------	-----------------	---

Defender 4.0

4,0	09.93-08.97	0 451 10 P 4014	O
-----	-------------	-----------------	---

Defender 4.0 i

3,9 134 V8	09.95-12.01	0 451 10 P 4014	O
		0 986 45 F 0119 ¹	K

Discovery I

Discovery I 2.0 i 16V

2,0 100 20 T4 <MPi>			
Fg.Nr. MA 081991→	10.93-06.98	1 457 43 S 3547	L
	10.93-06.98	0 986 45 F 0119 ¹	K

Discovery I 2.5 TDi

2,5 82-83 200 Tdi	09.89-09.94	0 451 10 P 4014	O
Fg.Nr. →JA 018272	09.89-09.94	1 457 43 S 3652	L
	09.89-09.94	KZO,MHE 1 457 43 D 701 ²	K



2,5 82-90 19L 21L 22L 300 Gemi	10.93-12.98	0 451 10 P 4014	O
		1 457 43 S 3547	L
		KZO,MHE 1 457 43 D 701 ²	K

Discovery I 3.5

3,5 107 V8 3.5	09.89-12.98	0 451 10 P 4014	O
		0 986 45 F 0119 ¹	K

Discovery I 3.5 i

3,5 110-113 22D <Kat.>	09.89-12.98	0 451 10 P 4014	O
Fg.Nr. MA 081991→	09.89-12.98	1 457 43 S 3547	L
	09.89-12.98	0 986 45 F 0119 ¹	K

Discovery I 3.9 i V8

3,9 134 V8 3.9 <EFi>	10.93-12.98	0 451 10 P 4014	O
Fg.Nr. MA 081991→	10.93-12.98	1 457 43 S 3547	L
	10.93-12.98	0 986 45 F 0119 ¹	K

Discovery II

Discovery II 2.5 Td5

2,5 100-102 15P 10P	10.98-08.04	0 451 10 P 3342	O
		1 457 43 S 3549	L

Discovery II 4.0 i

4,0 134-139 36D 94D 56D <OHV>	10.98-08.04	0 451 10 P 4014	O
		1 457 43 S 3549	L

Discovery II 4.6 i

4,6 140 V8 - EFi	01.03-12.04	0 451 10 P 4014	O
		1 457 43 S 3549	L

Discovery III

Discovery III 2.7 TDV6

2,7 140-147 276DT <Lion 2.7V6-14>	09.04-08.09	1 457 42 P 9307	O
		F 026 40 S 0099	L
		1 987 43 M 2235	I

Discovery III 4.0

4,0 156-161 406PN	09.04-08.09	F 026 40 S 0099	L
		1 987 43 M 2235	I

Discovery III 4.4

4,4 220 448PN	09.04-08.09	0 451 10 P 3367	O
		F 026 40 S 0099	L
		1 987 43 M 2235	I





Discovery IV

Discovery IV 2.7 TDV6

2,7 140 276DT	09.09→	1 457 42 P9307	O
		F 026 40 S 0099	L
		1 987 43 M 2235	I

Discovery IV 3.0 TDV6

3,0 155-188 306DT	09.09→	F 026 40 S 0099	L
		1 987 43 M 2235	I

Discovery IV 4.0 V6

4,0 161 406PN	09.09→	F 026 40 S 0099	L
		1 987 43 M 2235	I

Discovery IV 5.0 V8

5,0 276-280 508PN <AJ133>	09.09→	1 987 43 M 2235	I
-------------------------------	--------	------------------------	----------

Freelander

Freelander 1.8 i 16V

1,8 84-88 K18 / 18K16 <K-Serie>	09.97-03.07	0 451 10 P 4026	O
		1 457 43 S 3781	L
		0 986 45 F 0119 ¹	K
		1 987 43 M 2116	I

Freelander 2.0 D

2,0 70-72 20T <L-Serie>	09.97-09.03	0 451 10 P 3341	O
Fg.Nr. →YA 999999	09.97-09.03	1 457 43 S 3781	L
		0 450 90 N 6172 ¹	K
Fg.Nr. 1A 000001→	09.97-09.03	F 026 40 N 2002 ¹	K
	09.97-09.03	1 987 43 M 2116	I

Freelander 2.0 Td4

2,0 80-82 204D3/TD4	09.01-03.07	1 457 42 P 9119	O
		1 457 43 S 3588	L
Fg.Nr. →2A218129	09.01-03.07	F 026 40 N 2002	K
	09.01-03.07	1 987 43 M 2116	I

Freelander 2.5 V6

2,5 130 KV6	09.01-03.07	0 451 10 P 4026	O
		1 457 43 S 3549	L
		1 987 43 M 2116	I

Freelander II

Freelander II 2.2 Td4

2,2 110-118 224DT	10.06→	1 457 42 P 9249	O
		F 026 40 S 0104	L
		1 987 43 M 2205	I
		1 987 43 R 2405 ⁸	I



Freelander II 3.2 i6

3,2 170-171 DW12BTED4	10.06→	F 026 40 P 7075	O
		F 026 40 S 0104	L
		1 987 43 M 2205	I
		1 987 43 R 2405 ⁸	I

Range Rover Evoque

Range Rover Evoque 2.0 Si4

2,0 177	09.11→	1 987 43 M 2205	I
		1 987 43 R 2405 ⁸	I

Range Rover Evoque 2.2 SD4

2,2 140	09.11→	1 457 42 P 9249	O
		1 987 43 M 2205	I
		1 987 43 R 2405 ⁸	I

Range Rover I

Range Rover I 2.5 D Turbo

2,5 89 VM-HR-492.4	09.90-09.94	1 457 43 S 3652	L
Fg.Nr. CA→HA 610293	09.90-09.94	1 457 43 N 4106 ²	K
		VQW 1 457 43 D 701 ²	K

Range Rover I 2.5 TDi Classic

2,5 83 14L <200 TDi>	10.92-09.95	0 451 10 P 4014	O
		1 457 43 N 4106 ²	K
		VQW 1 457 43 D 701 ²	K

Range Rover I 3.9 i, i Classic

3,9 127/134 35D,36D <V8-EFI-KAT>; 37D,38D <V8-EFI-KAT>			
Fg.Nr. JA 610294→	11.88-04.96	0 451 10 P 4014	O
Fg.Nr. →HA 610293	11.88-04.96	0 986 45 P 2001	O
Fg.Nr. MA 647645→	11.88-04.96	1 457 43 S 3547	L
Fg.Nr. HA 464554→	11.88-04.96	0 986 45 F 0119 ¹	K

Range Rover I 4.3 Vogue LSE

4,3 149 40D <V8-EFI-KAT>			
Fg.Nr. JA 610294→	09.92-04.96	0 451 10 P 4014	O
Fg.Nr. →HA 610293	09.92-04.96	0 986 45 P 2001	O
Fg.Nr. MA 647645→	09.92-04.96	1 457 43 S 3547	L
Fg.Nr. HA 464554→	09.92-04.96	0 986 45 F 0119 ¹	K

Range Rover II

Range Rover II 2.5 D

2,5 100-102 25 6T			
Mot.Nr. →33978348	09.94-08.02	1 457 42 P 9123	O
Mot.Nr. 33988348→	09.94-08.02	1 457 42 P 9139	O
Fg.Nr. WA 376580→	09.94-08.02	1 457 43 S 3549	L
	09.94-08.02	1 457 43 N 4187	K
		ZE 1 987 43 M 2169	I





Range Rover II 2.5 TDi

2,5 81-83 14L <300 TDi>				
	10.94-04.96	0 451 10 P 4014	O	
		1 457 43 N 4106 ²	K	
		WOW 1 457 43 D 701 ²	K	

Range Rover II 4.0 i V8

4,0 136-140 42D				
	09.94-08.02	0 451 10 P 4014	O	
Fg.Nr. VA 346794→VA 376579	09.94-08.02	1 457 43 S 3549	L	
WA 385949→				
Fg.Nr. →WA 410481	09.94-08.02	0 986 45 F 0119 ¹	K	
	09.94-08.02 ZE	1 987 43 M 2169	I	

Range Rover II 4.6 i V8

4,6 158-166 46D				
	09.94-08.02	0 451 10 P 4014	O	
Fg.Nr. VA 346794→VA 376579	09.94-08.02	1 457 43 S 3549	L	
WA 385949→				
Fg.Nr. →WA 410481	09.94-08.02	0 986 45 F 0119 ¹	K	
	09.94-08.02 ZE	1 987 43 M 2169	I	

Range Rover III

Range Rover III 3.0 Td6

2,9 130 M57 D30				
	03.02-09.06	1 457 42 P 9118	O	
		1 457 43 S 3589	L	
		0 450 90 N 6451 ¹	K	
		1 987 43 R 2425 ⁸	I	

Range Rover III 3.6 TDV8

3,6 200 3.6 32V Lion				
	09.06-08.09	1 987 42 S 9190	L	
		1 987 43 R 2425 ⁸	I	

Range Rover III 4.2

4,2 291 AJ-V8				
	03.05-08.09	0 451 10 P 3367	O	
		1 987 42 S 9190	L	
		1 987 43 R 2425 ⁸	I	

Range Rover III 4.4 V8

4,4 210 M62B44 V8				
	03.02-07.05	1 457 42 P 9141	O	
		1 987 43 R 2425 ⁸	I	

4,4 225 AJ 4.4				
	05.05-08.09	0 451 10 P 3367	O	
		1 987 42 S 9190	L	
		1 987 43 R 2425 ⁸	I	

Range Rover IV

Range Rover IV 3.6 TDV8

3,6 200 368DT				
	09.09→	1 987 42 S 9190	L	
		1 987 43 R 2425 ⁸	I	

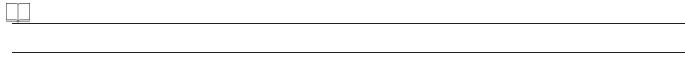

Range Rover IV 4.4 TDV8

4,4 230 4,4				
	09.10→	1 987 43 R 2425 ⁸	I	

Range Rover IV 5.0 V8, V8 SC

5,0 276-280/375				
	09.09→	1 987 43 R 2425 ⁸	I	

Range Rover Sport I

Range Rover Sport I 2.7 TDV6

2,7 140 276DT				
	03.05-08.09	1 457 42 P 9307	O	
		F 026 40 S 0099	L	
		1 987 43 M 2235	I	

Range Rover Sport I 3.6 TDV8

3,6 200				
	01.07-08.09	F 026 40 S 0099	L	
		1 987 43 M 2235	I	

Range Rover Sport I 4.2 Supercharged V8

4,2 286-287 428 PS				
	03.05-08.09	0 451 10 P 3367	O	
		F 026 40 S 0099	L	
		1 987 43 M 2235	I	

Range Rover Sport I 4.4 V8

4,4 220 448 PN				
	03.05-08.09	0 451 10 P 3367	O	
		F 026 40 S 0099	L	
		1 987 43 M 2235	I	

Range Rover Sport II

Range Rover Sport II 3.0 TDV6

3,0 155-188 306DT				
	09.09→	F 026 40 S 0099	L	
		1 987 43 M 2235	I	

Range Rover Sport II 3.6 TDV8

3,6 200				
	09.09→	F 026 40 S 0099	L	
		1 987 43 M 2235	I	

Range Rover Sport II 5.0 V8, V8 SC

5,0 276-280/372-375 ; 5.0 SGM <AJ133>				
	09.09→	1 987 43 M 2235	I	





LDV GROUP LIMITED

Maxus

Maxus 2.5

2,5 70-88 VM39C; VM40C	01.05→	XXX	0 451 10 P 3360	O
		TW	1 457 43 N 4050 ²	K
			1 457 43 N 4432 ²	K

LEXUS

CT

CT 200h 1.8i

1,8 73-100 2ZRFXE	12.10→		F 026 40 S0153	L
			1 987 43 M 2190	I

ES

ES 300 i

3,0 136 3VZFE	03.92-08.96		0 986 45 P 2044	O
			1 987 42 S 9151	L
			0 986 45 F 0604 ¹	K

3,0 158 1MZFE	08.96-07.03		0 986 45 P 2044	O
	08.96-07.01		1 987 42 S 9151	L
	07.01-07.03		1 987 42 S 9187	L
			1 987 43 R 2320 ⁸	I

ES 330 i

3,3 168 3MZFE	07.01→		0 986 45 P 2044	O
			1 987 42 S 9187	L

ES 350 i

3,5 200 2GRFE	03.06→		F 026 40 S 0188	L
			1 987 43 M 2190	I

GS

GS 300

3,0 183 3GRFSE	01.05-06.06		F 026 40 S0162	L
	01.05→		1 987 43 M 2190	I

GS 300 i

3,0 156 2JZGE	03.93-08.97		0 986 45 P 2044	O
			0 450 90 F 5912 ¹	K

3,0 161 2JZGE	03.93-08.97		0 986 45 P 2044	O
-------------------	-------------	--	-----------------	---



3,0 163-168 2JZGE	08.97-01.05		0 986 45 P 2044	O
	07.00-01.05		1 987 43 R 2319 ⁸	I

GS 350

3,5 232 2GRFSE	08.05-06.06		F 026 40 S0162	L
	08.05→		1 987 43 M 2190	I

GS 350 4x4

3,5 232 2GRFSE	08.05→		F 026 40 P 7090	O
	08.05-06.06		F 026 40 S0162	L
	08.05→		1 987 43 M 2190	I

GS 430

4,3 206 3UZFE	08.05-10.07		0 986 45 P 2044	O
-------------------	-------------	--	-----------------	---

4,3 221 3UZFE	01.05→		0 986 45 P 2044	O
			1 987 43 M 2190	I

GS 430 i

4,3 208 3UZFE	07.00-01.07		0 986 45 P 2044	O
			F 026 40 S0162	L
			1 987 43 R 2319 ⁸	I

GS 450h 3.5

3,5 218-250 2GRFSE	02.06→		F 026 40 S0162	L
			1 987 43 M 2190	I

GS 460

4,6 255 1URFSE	09.07→		F 026 40 P 7090	O
			1 987 43 M 2190	I

GX

GX 470 4x4

4,7 172 2UZFE	11.02→		0 986 45 P 2044	O
-------------------	--------	--	-----------------	---

IS

IS 5.0

5,0 311 2URGSE	12.07→		1 987 43 M 2190	I
--------------------	--------	--	-----------------	---

IS 200 i

2,0 114 1GFE	01.99-07.05		0 986 45 P 2044	O
			F 026 40 S0158	L

IS 220 d

2,2 110/130 2ADFHV; 2ADFTV	11.05→		F 026 40 S 0176	L
			1 987 43 M 2190	I





IS 250 C i			
2,5 153 4GRFSE	04.09→	1 987 43 M 2190	I
IS 250 i			
2,5 158 4GRFSE	08.05→	1 987 43 M 2190	I
IS 250 4x4			
2,5 158 4GRFSE	08.05→	F 026 40 P 7090 1 987 43 M 2190	O I
IS 300 i			
3,0 157 2JZGE	07.01-07.05	0 986 45 P 2044	O
IS 350 C i, i			
3,5 180/233 2GRFSE	04.09→	1 987 43 M 2190	I
LFA			
LFA 4.8 i			
4,8 412 1LRGUE	12.10→	1 987 43 M 2190	I
LS			
LS 400 i			
4,0 185/186/194/209 1UZFE	10.94-08.00	0 986 45 P 2044 1 987 43 R 2468 ⁸	O I
LS 430 i			
4,3 208 3UZFE	08.00-08.06	0 986 45 P 2044 1 987 43 R 2319 ⁸	O I
LS 460 i			
4,6 280/283 1URF; 1URFSE	08.06→	F 026 40 P 7090	O
LS 600h 5.0 4x4			
5,0 283-328 2URFSE	04.07→	F 026 40 P 7090	O
LX			
LX 450 4x4			
4,5 158 1FZFE	04.96-01.98 11.95-01.98 XXX	0 986 45 P 2044 0 986 45 F 0120 ¹	O K



LX 470 4x4			
4,7 172 2UZFE	01.98-08.07	0 986 45 P 2044	O
LX 570 4x4			
5,7 282 3URFE	11.07→	1 987 43 M 2190	I
RX			
RX 270 i			
2,7 138 1ARFE	08.10→	1 987 43 M 2190	I
RX 300 i 4x4			
3,0 148 1MZFE	02.03→	0 986 45 P 2044 1 987 42 S 9187 1 987 43 R 2320 ⁸	O L I
RX 300 4x4			
3,0 164 1MZFE	01.98-02.03	0 986 45 P 2044 1 987 42 S 9151	O L
RX 330 4x4			
3,3 172 3MZFE	03.02→	0 986 45 P 2044 1 987 42 S 9151	O L
RX 350 i 4x4			
3,5 204 2GRFE	12.08→	1 987 43 M 2190	I
RX 350 4x4			
3,5 203 2GRFE	01.06→	1 987 42 S 9187 1 987 43 R 2320 ⁸	L I
RX 400h 3.3			
3,3 155-200 3MZFE	03.05→	0 986 45 P 2044	O
RX 400h 3.3 4x4			
3,3 155-200 3MZFE	03.05→	0 986 45 P 2044 1 987 43 R 2320	O I
RX 450h 3.5i, 3.5i 4x4			
3,5 183-220 2GRFXE	03.09→	1 987 43 M 2190	I





SC

SC 400 i

4,0 186 1UZFE	09.91-08.95	0 986 45 P 2044	0
		0 450 90 F 5912 ¹	K

SC 430

4,3 210 3UZFE	05.01→	0 986 45 P 2044	0
		F 026 40 S 0162	L
		1 987 43 R 2319 ⁸	I

SC 430 i

4,3 206 3UZFE	12.07→	0 986 45 P 2044	0
		F 026 40 S 0162	L

LUFENG

Landwind

Landwind 2.5 D

2,5 156 VM_EU3	10.06-02.07	1 457 43 N 4310	K
--------------------	-------------	-----------------	---

MAHINDRA

Scorpio

Scorpio 2.6 CRDe

2,6 85 SZ CRDe	02.05→	1 457 43 N 4314 ²	K
--------------------	--------	------------------------------	---

MAYBACH

Serie 240

Serie 240 57

5,5 405 M 285.950 <E 55>	09.02→	1 987 42 S 9402	L
------------------------------	--------	-----------------	---

Serie 240 57 S

6,0 450 M 285.980 <E 60>	09.05→	1 987 42 S 9402	L
------------------------------	--------	-----------------	---

Serie 240 62

5,5 405 M 285.950 <E 55>	09.02→	1 987 42 S 9402	L
------------------------------	--------	-----------------	---

Serie 240 62 S

6,0 450 M 285.980 <E 60>	09.05→	1 987 42 S 9402	L
------------------------------	--------	-----------------	---



MAZDA

Atenza

Atenza 2.0 i

2,0 106 LFDE			
Fg.Nr. 100001→103815	05.02-05.05	1 457 42 P 9257	0
Fg.Nr. 103816→	05.02-05.05	0 986 45 P 2068	0
	05.02-05.05	1 987 42 S 9188	L

2,0 | 110 | LFDE

Fg.Nr. 100001→101452	05.02-06.05	1 457 42 P 9257	0
Fg.Nr. 101453→	05.02-06.05	0 986 45 P 2068	0
	05.02-06.05	1 987 42 S 9188	L

Atenza 2.3 i

2,3 131 L3VE	05.02-12.07	1 457 42 P 9257	0
		1 987 42 S 9188	L

Axela

Axela 1.5 i

1,5 84 ZYVE	10.03-06.09	0 986 45 P 2061	0
		1 987 42 S 9184	L

Axela 2.0 i

2,0 110 LFDE	10.03-06.09	0 986 45 P 2068	0
		F 026 40 S 0129	L

Axela 2.3 i

2,3 126 L3VE	10.03-06.09	1 457 42 P 9257	0
		F 026 40 S 0129	L

AZ-3

AZ-3 1.5 i

1,5 85-88 B5 (DOHC)	06.91-01.98	0 986 45 P 2061	0
-------------------------	-------------	-----------------	---

AZ-3 1.8 i

1,8 107 K8ZE	09.93-01.98	0 986 45 P 2041	0
------------------	-------------	-----------------	---

Bongo

Bongo 1.8 i

1,8 66-70 F8E	05.99-08.10	0 986 45 P 2061	0
-------------------	-------------	-----------------	---





Bongo 2.0

2,0 60 FE (SOHC)	08.93-09.95	WW	0 986 45 P 2061	0
Org.Nr. 100001→507449	11.86-09.95		0 986 45 P 2041	0
	11.86-09.95		0 986 45 F 0117 ¹	K

Bongo 2.0 D Turbo, D Turbo 4WD

2,0 63 RF	12.03-08.10		1 457 43 N 4440	K
------------------	-------------	--	-----------------	---

Bongo 2.2 D

2,2 45 R2	08.93-05.99		0 986 45 P 2064	0
2,2 45-56 R2	10.96-05.99		1 457 43 N 4440 ²	K
Fg.Nr. →101362	09.93-09.96		1 457 43 N 4453 ²	K
2,2 58 R2	05.99-12.03		0 986 45 P 2042	0
			1 457 43 N 4440 ²	K

Bongo 2.2 D 4WD

2,2 45-56 R2	09.87-05.99		0 451 10 P 3316	0
---------------------	-------------	--	-----------------	---

Bongo Brawny

Bongo Brawny 2.0

2,0 63 FE (SOHC)	07.85-05.97		0 986 45 P 2061	0
Fg.Nr. 20001→				
Org.Nr. Z-SRE9V				
Org.Nr. M-SRE9V	07.85-05.97		0 986 45 P 2041	0
Fg.Nr. →20000				
Org.Nr. Z-SRE9V				

2,0 63-69 FE (SOHC)	09.87-06.99		0 986 45 P 2041	0
Org.Nr. M-SDEAT, Org.Nr. T-SDEAT				
Fg.Nr. 500001→600000				
Org.Nr. Z-SDEAT				

Bongo Brawny 2.0 D Turbo

2,0 63 RF	11.04-08.10		1 457 43 N 4440	K
------------------	-------------	--	-----------------	---

Bongo Brawny 2.2 D

2,2 45 R2	09.87-05.97		0 986 45 P 2064	0
	09.87-08.93		1 457 43 N 4453 ²	K
Fg.Nr. →501080	09.87-09.95		1 457 43 N 4453 ²	K

2,2 45-56 R2	09.87-06.99		0 986 45 P 2064	0
---------------------	-------------	--	-----------------	---

Bongo Brawny 2.2 D 4WD

2,2 45-56 R2	09.87-06.99		0 451 10 P 3316	0
---------------------	-------------	--	-----------------	---



Bongo Brawny 2.5 D, D 4WD

2,5 65 WL	04.97-11.04		0 986 45 P 2042	0
			1 457 43 N 4440 ²	K
			1 457 43 N 4440	K

BT-50

BT-50 3.0 D Turbo

3,0 115 WEC <DuraTORQ TDCi>	03.06→		0 986 45 P 2068	0
--	--------	--	-----------------	---

Capella

Capella 1.8

1,8 60 F8	07.87-01.92		0 986 45 P 2041	0
Org.Nr. E-GD8P	07.87-01.92		0 986 45 F 0117 ¹	K

Capella 2.0 i

2,0 92/125 FSDE; FSZE	07.94-03.02		0 986 45 P 2061	0
			1 457 43 S 3072	L

2,0 110 FE (DOHC)	07.87-10.91		1 457 43 S 3605	L
--------------------------	-------------	--	-----------------	---

CX-7

CX-7 2.2 MZR CD 4x4

2,2 120/127 R2	06.09→		0 451 10 P 3316	0
			1 457 43 N 4438 ²	K
			1 987 43 M 2092	I

CX-7 2.3 MZR DISI Turbo 4x4

2,3 191 L3	07.09→		0 986 45 P 2068	0
Fg.Nr. ER*9**200001→	05.07-06.09		1 457 42 P 9257	0
Fg.Nr. →ER*9**200000	05.07→		1 987 43 M 2092	I

Demio

Demio 1.3 i

1,3 46/53 B3	05.98-02.03		0 986 45 P 2061	0
			1 457 43 S 3961	L
		XXX	0 986 45 F 0510 ¹	K

1,3 61 B3ME/B3E	07.96-07.02		0 986 45 P 2061	0
			1 457 43 S 3961	L

Demio 1.3 i, i 4WD

1,3 67 ZJVE	06.02-05.07		0 986 45 P 2061	0
			1 987 42 S 9184	L
			0 450 90 F 5926 ¹	K





Demio 1.5 i

1,5 55 B5	01.00-02.03	0 986 45 P 2061	O
		1 457 43 S 3961	L
	XXX	0 986 45 F 0510 ¹	K
1,5 74 B5ME/B5E	07.96-07.02	0 986 45 P 2061	O
		1 457 43 S 3961	L

Demio 1.5 i, i 4WD

1,5 83 ZYVE	06.02-05.07	0 986 45 P 2061	O
		1 987 42 S 9184	L
		0 450 90 F 5926 ¹	K

Eunos

Eunos 1.5 i

1,5 85-88 B5 (DOHC)	09.93-01.98	0 986 45 P 2061	O
-------------------------	-------------	-----------------	---

Eunos 1.6 i

1,6 88 B6ZE	06.89-08.93	0 986 45 P 2061	O
		1 987 42 S 9146	L
		0 450 90 F 5956 ¹	K

Eunos 1.8 i

1,8 96 BPZE	08.93-11.97	0 986 45 P 2061	O
		1 987 42 S 9146	L
		0 450 90 F 5956 ¹	K

1,8 99/107 K8; K8ZE	09.93-01.98	0 986 45 P 2041	O
-------------------------	-------------	-----------------	---

Familia

Familia 1.3

1,3 47 E3	11.85-08.94	0 986 45 P 2061	O
---------------	-------------	-----------------	---

Familia 1.3 i

1,3 58 B3	11.90-01.96	0 986 45 P 2061	O
		1 987 42 S 9172	L
1,3 63 B3ME	08.96-09.02	0 986 45 P 2061	O
	08.96-05.99	1 457 43 S 3959	L

Familia 1.5 i

1,5 71-81/96 ZLDE; ZLVE; Z5DE	03.94-10.03	0 986 45 P 2061	O
		1 457 43 S 3959	L
1,5 77 GA15	05.96-04.99	0 986 45 P 2023	O
1,5 85-92 B5ZE	05.94-10.96	0 986 45 P 2061	O
		1 457 43 S 3959	L



Familia 1.7 D

1,7 43 PN	11.85-08.94	0 451 10 P 3316	O
---------------	-------------	-----------------	---

Familia 1.8 i

1,8 99 BPZE	05.94-05.99	1 457 43 S 3959	L
-----------------	-------------	-----------------	---

Familia 2.0 D

2,0 51 RF	04.98-10.00	1 457 43 S 3066	L
		1 457 43 N 4440 ²	K

Familia 2.0 i

2,0 121-125 FSZE	06.99-10.03	0 986 45 P 2061	O
		1 457 43 S 3959	L

Lantis

Lantis 2.0 i

2,0 125 KFZE	08.93-06.97	0 986 45 P 2041	O
		1 457 43 S 3605	L

Millenia

Millenia 2.0 i

2,0 118 KFZE	06.98-10.02	0 986 45 P 2041	O
		1 457 43 S 3968	L

Millenia 2.3 i, i 24V Kompressor 4WS

2,3 149/162 KJ <Miller-Cycle>; KJZEM	07.97→	0 986 45 P 2041	O
		1 457 43 S 3958	L

Millenia 2.5 i

2,5 140-147 KLZE	07.97-10.03	0 986 45 P 2041	O
		1 457 43 S 3968	L

MPV

MPV 2.0 D Turbo

2,0 100 RF	03.02-06.04	0 451 10 P 3316	O
		1 987 42 S 9188	L
		1 457 43 N 4440 ²	K

MPV 2.0 i, i 16V

2,0 90/99 FS	05.99-04.02	0 986 45 P 2061	O
		1 987 42 S 9188	L

MPV 2.3 i

2,3 104 L3	03.02-06.04	1 457 42 P 9257	O
Fg.Nr. →306353	03.02-06.04	1 987 42 S 9188	L





2,3 120 L3/L3DE			
Fg.Nr. 300001→407213	03.02-12.05	1 457 42 P 9257	O
Fg.Nr. 407214→	03.02-12.05	0 986 45 P 2068	O
	03.02-12.05	1 987 42 S 9188	L

MPV 2.3 i 4WD

2,3 117 L3/L3DE			
	03.02-12.05	1 457 42 P 9257	O
		1 987 42 S 9188	L

MPV 2.5 D Turbo, D Turbo 4WD

2,5 92 WLT			
	10.95-05.99	1 457 43 N 4453 ²	K

MPV 2.5 i

2,5 88 G5/G5E			
	12.94-05.99	0 986 45 P 2041	O

MPV 2.5 i, i 4WD, i 24V

2,5 125/129 G; GY			
	05.99→	1 987 42 S 9188	L

MPV 2.5 12V D Turbo

2,5 85 WLT			
	03.96-05.99	0 986 45 P 2042	O
		1 457 43 N 4453 ²	K

MPV 3.0 i

3,0 109-113 JE; JE <Kat.>			
	11.95-05.99	0 986 45 P 2041	O
		0 986 45 F 0143 ¹	K

3,0 110-116 JE; JE <Kat.>			
	09.88-07.99	0 986 45 P 2041	O

3,0 113 JE; JE <Kat.>			
	07.94-10.95	0 986 45 P 2041	O
		0 986 45 F 0143 ¹	K

3,0 114 JE/JEE			
	11.89-05.99	0 986 45 P 2041	O

3,0 115 E			
	08.93→	0 986 45 P 2041	O

3,0 145 AJ/AJDE			
	03.02-12.05	1 987 42 S 9188	L

3,0 147 E			
Fg.Nr. 306354→	05.02-08.04	0 986 45 P 2068	O
	05.02-08.04	1 987 42 S 9188	L

MS-8

MS-8 2.0 i

2,0 118 KFZE			
	01.92-02.98	0 986 45 P 2041	O

MX-3

MX-3 1.6 i

1,6 65-66 B69			
	05.91-10.93	0 986 45 P 2061	O
		0 986 45 F 0108 ¹	K

1,6 79-81 B6; B6D			
	11.93-02.98	0 986 45 P 2061	O
		0 450 90 F 5989 ¹	K

MX-3 1.8 i

1,8 95-100 K8; K819; K838			
	05.91-02.98	0 986 45 P 2041	O

MX-5

MX-5 1.6 i

1,6 81 B6D			
	01.98-07.05	0 986 45 P 2061	O
	01.98-08.02	1 457 43 S 3072	L
	01.98-07.05	0 450 90 F 5967 ¹	K

1,6 85 B64F			
	09.89-08.93	0 986 45 P 2061	O
	08.89-08.93	1 987 42 S 9146	L
		0 450 90 F 5956 ¹	K

MX-5 1.6 i 16V

1,6 66 B6			
	12.94-11.97	0 986 45 P 2061	O
		1 987 42 S 9146	L
		0 450 90 F 5956 ¹	K

MX-5 1.8

1,8 93			
	07.05→	0 986 45 P 2068	O

MX-5 1.8 i

1,8 96-98 BPF1			
	09.93-11.94	0 986 45 P 2061	O
		1 987 42 S 9146	L
		0 450 90 F 5956 ¹	K

1,8 96-98 BPZE			
	12.94-11.97	0 986 45 P 2061	O
		1 987 42 S 9146	L
		0 450 90 F 5956 ¹	K

1,8 98 BP			
	09.93-11.97	0 986 45 P 2061	O
		1 987 42 S 9146	L
		0 450 90 F 5956 ¹	K

1,8 103-106 BPD			
	01.98-07.05	0 986 45 P 2061	O
	01.98-08.02	1 457 43 S 3072	L
	01.98-07.05	0 450 90 F 5967 ¹	K





◀ MX-5 1.8 i

1,8 107-113 BPZE	09.00-07.05	0 986 45 P 2061	O
		1 457 43 S 3072	L
		0 450 90 F 5967 ¹	K

MX-5 2.0

2,0 118 LF	07.05→	0 986 45 P 2068	O
----------------	--------	-----------------	---

MX-6

MX-6 2.0 i

2,0 85 FS	07.91-06.94	0 986 45 P 2061	O
Fg.Nr. →GE***431480	06.93-06.97	0 986 45 P 2041	O
Fg.Nr. 431480→	06.93-06.97	0 986 45 P 2061	O
	07.91-06.97	1 457 43 S 3072	L
		0 986 45 F 0106 ¹	K

MX-6 2.2 i Turbo 2WS, 4WS

2,2 100 F2	09.89-06.91	0 986 45 P 2041	O
		1 457 43 S 3605	L
		ABS 0 986 45 F 0102 ¹	K
		ABS 0 986 45 F 0105 ¹	K

MX-6 2.5 i, i 4WS

2,5 121-123 KL	07.91-06.97	0 986 45 P 2041	O
		1 457 43 S 3072	L
	07.91-12.98	0 986 45 F 0106 ¹	K

Premacy

Premacy 1.8 i

1,8 74/84 FP	03.99-05.05	0 986 45 P 2061	O
		1 457 43 S 3959	L
		2FE, KL 1 987 43 M 2117	I

1,8 | 92 | FP

02.00→	0 986 45 P 2061	O
	1 457 43 S 3959	L

1,8 | 96-99 | FPDE

02.99-02.05	0 986 45 P 2061	O
	1 457 43 S 3959	L

Premacy 2.0 D Turbo

2,0 66/74 RF; RF <DIRECO-D>	06.99-05.05	0 986 45 P 2036	O
		1 457 43 S 3066	L
		1 457 43 N 4440 ²	K
		2FE, KL 1 987 43 M 2117	I

Premacy 2.0 i

2,0 96 FS	11.01-05.05	0 986 45 P 2061	O
		1 457 43 S 3959	L
		2FE, KL 1 987 43 M 2117	I



2,0 107 LFDE	02.05-08.07	0 986 45 P 2068	O
		F 026 40 S 0129	L

2,0 111 LF-VD	01.07→	1 457 42 P 9257	O
-------------------	--------	-----------------	---

2,0 121 FSZE	06.01-02.05	0 986 45 P 2061	O
		1 457 43 S 3959	L

Premacy 2.3 i

2,3 121 L3VE	02.05→	F 026 40 S 0129	L
------------------	--------	-----------------	---

Proceed

Proceed 2.6 i 4WD

2,6 88 G6	11.89-02.99	0 986 45 P 2041	O
---------------	-------------	-----------------	---

Roadster

Roadster 1.6 i

1,6 92 B6ZE	12.97-08.05	0 986 45 P 2061	O
	12.97-08.02	1 457 43 S 3072	L
	12.97-08.05	0 450 90 F 5967 ¹	K

Roadster 1.8 i

1,8 107 BPZE	12.97-06.00	0 986 45 P 2061	O
		1 457 43 S 3072	L
		0 450 90 F 5967 ¹	K

1,8 | 118 | BPVE

06.00-08.05	0 986 45 P 2061	O	
Org.Nr. GF-NB8C	06.00-06.00	1 457 43 S 3072	L
	06.00-08.05	0 450 90 F 5967 ¹	K
	10.03-08.05	0 986 45 F 0117 ¹	K

Roadster 1.8 i Turbo

1,8 126 BPZET	02.04-08.05	0 986 45 P 2061	O
		0 450 90 F 5967 ¹	K

RX-7

RX-7

1,3 120 13B	03.89-11.91	0 986 45 P 2061	O
-----------------	-------------	-----------------	---

RX-7 Biturbo

1,3 176-177/204 RE13B; 13B	01.92→	0 986 45 P 2061	O
--------------------------------	--------	-----------------	---

RX-7 Turbo

1,3 147/151 13B; 13B <Kat.>	09.85-12.92	0 986 45 P 2061	O
		0 986 45 F 0108 ¹	K



Typ					Type
1,3 188-195/206 13BREW	10.91-08.02	0 986 45 P 2061			O
RX-8					
RX-8					
1,3 141/158/170/173-184 13B; 13BMSP	04.03→	0 986 45 P 2061			O
Serie B					
Serie B 2000					
2,0 65	11.89-02.95	0 986 45 F 0117 ¹			K
Serie B 2200					
2,2 60	02.99-03.06	0 986 45 P 2061			O
2,2 68	08.91-03.96	0 451 10 P 3316			O
Serie B 2200 , 4x4					
2,2 68 F2; JL22	03.96-03.06	0 986 45 P 2061			O
Serie B 2200 D					
2,2 43-47 R2	01.90-04.95	NEB 0 451 10 P 3270			O
		1 457 43 N 4456 ²			K
Serie B 2500 D, D 4x4					
2,5 57 ; MD25NA					
Fg.Nr. →355919	02.99-03.06	0 986 45 P 2062			O
	02.99-03.06	F 026 40 S 0165			L
Fg.Nr. →178376	02.99-03.06	1 457 43 N 4438 ²			K
Fg.Nr. 2178377→	02.99-03.06	1 457 43 N 4438 ²			K
Serie B 2500 D Turbo, D Turbo 4x4					
2,5 62 WLE7					
Fg.Nr. →355919	09.01-03.06	0 986 45 P 2062			O
	09.01-03.06	F 026 40 S 0165			L
Fg.Nr. →178376	09.01-03.06	1 457 43 N 4438 ²			K
Fg.Nr. 2178377→	09.01-03.06	1 457 43 N 4438 ²			K
Serie B 2500 D Turbo 4x4					
2,5 80 WLT					
	02.99-03.06	F 026 40 S 0165			L
Fg.Nr. →178376	02.99-03.06	1 457 43 N 4438 ²			K
Fg.Nr. 2178377→	02.99-03.06	1 457 43 N 4438 ²			K
Serie B 2500 12V D, 12V D 4x4					
2,5 57-63 WL					
	03.96-05.99	0 986 45 P 2042			O
		1 457 43 N 4456 ²			K

Typ					Type
Serie B 2600 i, i 12V 4x4, 4x4					
2,6 73-90/92 G6	11.89-03.06	0 986 45 P 2041			O
Serie E					
Serie E 2.0					
2,0 60-63 FEEN; FEET	07.89-03.95	0 986 45 P 2041			O
		0 986 45 F 0117 ¹			K
Serie E 2.0 i					
2,0 70 FEJL	08.91-04.97	0 986 45 P 2041			O
		0 986 45 F 0108 ¹			K
Serie E 2.2 D					
2,2 44-47 R296	07.89-04.97	0 451 10 P 3316			O
Fg.Nr. SD132702434→	07.89-04.97	1 457 43 N 4456 ²			K
2,2 52	03.97-08.98	0 451 10 P 3316			O
	09.98-08.99	0 986 45 P 2042			O
	03.97-08.99	1 457 43 N 4438			K
Serie E 2.2 D, D 4WD					
2,2 44-47 R293; R294	07.89-04.97	0 451 10 P 3316			O
Fg.Nr. SR1H32710925→	07.89-04.97	1 457 43 N 4456 ²			K
Serie E 2.2 D 4WD					
2,2 52	03.97-12.01	0 451 10 P 3316			O
		1 457 43 N 4438 ²			K
Tribute					
Tribute 2.0 i, i 4x4, 4x4					
2,0 91/95/97 YF	09.00→	0 451 10 P 3371			O
Tribute 2.3 i, i 4WD					
2,3 115 L3	12.03-12.05	1 987 42 S 9188			L
Tribute 2.3 i, i 4x4					
2,3 110 GZ	12.03-05.04	0 986 45 P 2068			O
Verisa					
Verisa 1.5 i 4WD					
1,5 83 ZYVE	06.04→	0 986 45 P 2061			O
		1 987 42 S 9184			L
		0 450 90 F 5926 ¹			K





Xedos-6

Xedos-6 1.6 i

1,6 79/83-85 B6E; B69	01.92-02.99	0 986 45 P 2061	0
		0 986 45 F 0106 ¹	K

Xedos-6 2.0 i

2,0 103 KF1	04.96-02.99	0 986 45 P 2041	0
		0 986 45 F 0106 ¹	K

2,0 105-108 KF1	01.92-03.94	0 986 45 P 2041	0
		0 986 45 F 0106 ¹	K

Xedos-9

Xedos-9 2.0 i

2,0 105-107 KF	09.93-07.00	0 986 45 P 2041	0
		1 457 43 S 3968	L

Xedos-9 2.3 i Kompressor

2,3 155-162 KJ	12.94-07.00	0 986 45 P 2041	0
		1 457 43 S 3958	L

Xedos-9 2.5 i, i 4WS

2,5 120/123-125 KL	07.93-11.02	0 986 45 P 2041	0
		1 457 43 S 3968	L

2

2 1.25

1,2 55 FUJA	02.03-06.07	F 026 40 P 7078	0
		1 457 43 S 3593	L
		0 450 90 F 5926 ¹	K
		1 987 43 M 2092	I

2 1.3

1,3 55/62-63 ZJ	06.07→	0 986 45 P 2061	0
		1 987 42 S 9184	L

2 1.4

1,4 59 FXJA	02.03-06.07	F 026 40 P 7078	0
		1 457 43 S 3593	L
		0 450 90 F 5926 ¹	K
		1 987 43 M 2092	I

2 1.4 CD

1,4 50 F6JB	08.07→	1 457 42 P 9238	0
		1 457 43 S 3076	L



2 1.4 D Turbo

1,4 50 F6JA	02.03-06.07	1 457 42 P 9238	0
		1 457 43 S 3076	L
		0 450 90 N 6460 ¹	K
		1 987 43 M 2092	I

2 1.5

1,5 75-76 ZY	06.07→	0 986 45 P 2061	0
		1 987 42 S 9184	L

2 1.6

1,6 74 FYJA	02.03-06.07	1 457 43 S 3593	L
		0 450 90 F 5926 ¹	K
		1 987 43 M 2092	I

2 1.6 CD

1,6 66 Y6	11.08→	1 457 42 P 9238	0
		F 026 40 S 0135	L
Fg.Nr. →DEA4**400000→DEA3**300000	11.08-07.10	F 026 40 N 2046 ¹	K

1,6 70	08.10→	1 457 42 P 9238	0
		F 026 40 S 0135	L

3

3 1.4

1,4 59 ZJ	08.03-12.08	0 986 45 P 2061	0
		1 987 42 S 9184	L
		1 987 43 M 2163	I

3 1.6

1,6 76 Z6V	01.04→	0 986 45 P 2061	0
----------------	--------	-----------------	---

1,6 77 Z6	07.03-12.08	0 986 45 P 2061	0
		1 987 42 S 9184	L
		1 987 43 M 2163	I

3 1.6 MZ-CD

1,6 66/80 Y6	12.03-12.08	1 457 42 P 9238	0
		1 457 43 S 3099	L
Fg.Nr. →185433	12.03-12.08	0 450 90 N 6471 ¹	K
Fg.Nr. 185434→502447	12.03-12.08	0 450 90 N 6471 ¹	K
Fg.Nr. 502448→	12.03-12.08	F 026 40 N 2046 ¹	K
	12.03-12.08	1 987 43 M 2163	I

3 1.6 MZR

1,6 77 Z6	12.08→	0 986 45 P 2061	0
		1 987 42 S 9184	L





3 1.6 MZR-CD

1,6 80-81 Y6	12.08→	1 457 42 P 9238	O
		F 026 40 S0136	L
		F 026 40 N 2046 ¹	K

1,6 85	10.10→	1 457 42 P 9238	O
		F 026 40 S0136	L

3 2.0

2,0 110 LF	07.03-12.08	0 986 45 P 2068	O
		F 026 40 S0129	L
		1 987 43 M 2163	I

3 2.0 MZR

2,0 110 LF...	12.08→	0 986 45 P 2068	O
		F 026 40 S0129	L

3 2.0 MZR DISI

2,0 111 LF...	12.08→	0 986 45 P 2068	O
---------------	--------	------------------------	----------

3 2.0 MZR-CD

2,0 105 RF7J	12.06-12.08	0 451 10 P 3316	O
		F 026 40 S0129	L
		1 457 43 N 4438 ²	K
		1 987 43 M 2163	I

3 2.2 MZR-CD

2,2 110/136 HP (R2); LP (R2)	01.09→	0 451 10 P 3316	O
		F 026 40 S0129	L
		1 457 43 N 4438 ²	K

3 2.3 MPS

2,3 184-191 L3	07.06-12.08	1 457 42 P 9257	O
		F 026 40 S0129	L
		1 987 43 M 2163	I

2,3 191 L3 DISI	09.09→	0 986 45 P 2068	O
		F 026 40 S0129	L

5

5 1.6 CD

1,6 85	06.10→	1 457 42 P 9238	O
--------	--------	------------------------	----------



5 1.8

1,8 85 L8	02.05→	0 986 45 P 2068	O
		F 026 40 S0129	L
		02.05-04.05 KL	1 987 43 M 2163

5 2.0

2,0 106 LF	09.10→	0 986 45 P 2068	O
		F 026 40 S0129	L

2,0 107 LF	02.05→	0 986 45 P 2068	O
		F 026 40 S0129	L
		02.05-04.05 KL	1 987 43 M 2163

5 2.0 CD

2,0 81/105 RF	03.05→	0 451 10 P 3316	O
		F 026 40 S0129	L
	03.05-09.07	1 457 43 N 4438 ²	K
	03.05-04.05 KL	1 987 43 M 2163	I

5 2.0 DISI

2,0 110 LF	06.10→	0 986 45 P 2068	O
------------	--------	------------------------	----------

6

6 1.8

1,8 88 L8	04.05-12.07	0 986 45 P 2068	O		
		Fg.Nr. →176450	02.02-03.05	1 457 42 P 9257	O
		Fg.Nr. 176451→	02.02-08.07	0 986 45 P 2068	O
			02.02-12.07	1 987 42 S 9188	L
		Fg.Nr. →400099	06.02-12.07	1 987 43 M 2092	I
		Fg.Nr. 118245→601662	02.02-08.07	1 987 43 M 2092	I

6 1.8 MZR

1,8 88 L8	08.07→	0 986 45 P 2068	O
		1 987 42 S 9188	L
		1 987 43 M 2092	I

1,8 88 L813	12.07→	0 986 45 P 2068	O
		1 987 42 S 9188	L
		1 987 43 M 2092	I

6 2.0

2,0 104-108 LF	04.05-12.07	0 986 45 P 2068	O		
		Fg.Nr. →176450	02.02-03.05	1 457 42 P 9257	O
		Fg.Nr. 176451→	02.02-08.07	0 986 45 P 2068	O
			02.02-12.07	1 987 42 S 9188	L
		Fg.Nr. →400099	06.02-12.07	1 987 43 M 2092	I
		Fg.Nr. 118245→601662	02.02-08.07	1 987 43 M 2092	I





6 2.0 D Turbo

2,0 89 RF				
	06.02-12.07	0 451 10 P 3316	O	
		1 987 42 S 9188	L	
	06.02-02.05	1 457 43 N 4440 ²	K	
	03.05-12.07	1 457 43 N 4438 ²	K	
Fg.Nr. →400099	06.02-12.07	1 987 43 M 2092	I	
Fg.Nr. 118245→601662	06.02-08.07	1 987 43 M 2092	I	

2,0|100-105|RF

	06.02-12.07	0 451 10 P 3316	O	
		1 987 42 S 9188	L	
	06.02-02.05	1 457 43 N 4440 ²	K	
	03.05-12.07	1 457 43 N 4438 ²	K	
Fg.Nr. →400099	06.02-12.07	1 987 43 M 2092	I	
Fg.Nr. 118245→601662	06.02-08.07	1 987 43 M 2092	I	

6 2.0 i

2,0 108 LF				
	06.04-02.07	1 987 42 S 9188	L	
		1 987 43 M 2092	I	

6 2.0 MZR

2,0 108 LF				
	08.07→	0 986 45 P 2068	O	
		1 987 42 S 9188	L	
		1 987 43 M 2092	I	

6 2.0 MZR DISI

2,0 114 LF				
	04.10→	0 986 45 P 2068	O	
		1 987 42 S 9188	L	
		1 987 43 M 2092	I	

6 2.0 MZR-CD

2,0 103				
	11.07-01.10	0 451 10 P 3316	O	
		1 987 42 S 9188	L	
		1 457 43 N 4438 ²	K	
		1 987 43 M 2092	I	

6 2.2 MZR-CD

2,2 92/95/120/132/136 ;R2				
	10.08→	0 451 10 P 3316	O	
		1 987 42 S 9188	L	
		1 457 43 N 4438 ²	K	
		1 987 43 M 2092	I	

6 2.3

2,3 122 L3				
	02.02-08.08	1 457 42 P 9257	O	
		1 987 42 S 9188	L	
Fg.Nr. →400099	06.02-12.07	1 987 43 M 2092	I	
Fg.Nr. 118245→601662	02.02-08.08	1 987 43 M 2092	I	

6 2.3 i

2,3 119 L3				
	04.04-02.07	1 987 42 S 9188	L	
		1 987 43 M 2092	I	



2,3 122 L3				
	04.02→	1 457 42 P 9257	O	
		1 987 42 S 9188	L	

6 2.3 MPS 4x4

2,3 191				
	07.05-08.07	1 457 42 P 9257	O	
		1 987 43 M 2092	I	

6 2.3 4x4

2,3 119 L3				
	08.02-12.07	1 457 42 P 9257	O	
		1 987 42 S 9188	L	
Fg.Nr. →400099	08.02-12.07	1 987 43 M 2092	I	

6 2.5 MZR

2,5 125 L5				
Fg.Nr. →246851	08.07-06.09	1 457 42 P 9257	O	
Fg.Nr. 246852→	07.09→	0 986 45 P 2068	O	
	08.07→	1 987 42 S 9188	L	
		1 987 43 M 2092	I	

121

121 1.1

1,1 40 B1				
	11.90-12.95	0 986 45 P 2061	O	
		1 987 42 S 9172	L	
		0 986 45 F 0117 ¹	K	

121 1.25 i 16V

1,3 55 DHF				
	01.96-10.99	F 026 40 P 7078	O	
		1 457 43 S 3605	L	
		1 987 43 M 2006	I	
		1 987 43 R 2306 ⁸	I	

1,3|55|DHG

	11.99-01.02	F 026 40 P 7078	O	
		1 457 43 S 3605	L	
	WW	0 450 90 F 5966 ¹	K	
		1 987 43 M 2006	I	

121 1.3 i

1,3 37/44				
	11.99-01.02	0 451 10 P 3298	O	
		1 457 43 S 3605	L	
	WW	0 450 90 F 5966 ¹	K	
		1 987 43 M 2006	I	

1,3|37/44|JJM;J4R

	01.96-10.99	0 451 10 P 3298	O	
		1 457 43 S 3605	L	
		1 987 43 M 2006	I	

1,3|39-40/44|B3

	11.93-12.95	0 986 45 P 2061	O	
		1 987 42 S 9172	L	

1,3|44|HCS

	05.97-12.98	0 451 10 P 3298	O	
		1 457 43 S 3605	L	





1,3 53 B3	08.96-12.02	0 986 45 P 2061	O
		1 457 43 S 3961	L

1,3 53-56 B3	11.90-12.95	0 986 45 P 2061	O
		1 987 42 S 9172	L

1,3 54 B3	10.90-12.95	0 986 45 P 2061	O
		1 987 42 S 9172	L
	10.90-11.93	0 986 45 F 0108 ¹	K

1,3 55 B3	11.95-11.97	0 986 45 P 2061	O
		1 987 42 S 9172	L

121 1.4 i

1,4 55 CHV,PTE	10.98-12.00	1 457 43 S 3605	L
-----------------------	-------------	------------------------	----------

121 1.8 D

1,8 44	01.96-10.99	0 451 10 P 3227	O
	01.96-01.02	1 457 43 S 3605	L
		0 450 90 N 6261 ¹	K
		1 987 43 M 2006	I

323

323 P 1.3 i

1,3 54 B3	09.98-10.00	0 986 45 P 2061	O
------------------	-------------	------------------------	----------

1,3 54-55 B3	10.96-09.00	0 986 45 P 2061	O
		1 457 43 S 3959	L
		0 986 45 F 0108 ¹	K
		1 987 43 M 2162	I

323 P 1.5 i

1,5 65 ZL	09.98-10.00	0 986 45 P 2061	O
		1 457 43 S 3959	L

1,5 65 Z5	10.96-09.00	0 986 45 P 2061	O
		1 457 43 S 3959	L
		0 986 45 F 0108 ¹	K
		1 987 43 M 2162	I

323 P 2.0 D

2,0 52 RF	03.97-09.00	TW	0 451 10 P 3270	O
			0 451 10 P 3316	O
			1 457 43 S 3066	L
			1 457 43 N 4453 ²	K
			1 987 43 M 2162	I



323 1.3 i

1,3 50 B383	06.89-03.91	0 986 45 P 2061	O
		1 987 42 S 9146	L
		0 986 45 F 0108 ¹	K

1,3 54 B3	05.98-09.03	0 986 45 P 2061	O	
	05.98-01.01	2FE	1 987 43 M 2117	I

1,3 54-55 B3	06.94-06.98	0 986 45 P 2061	O
		1 457 43 S 3959	L
	06.94-07.95	0 450 90 F 5989 ¹	K
	08.95-06.98	0 986 45 F 0108 ¹	K

1,3 63 8A	01.00→	0 986 45 P 2041	O
------------------	--------	------------------------	----------

323 1.3 i 16V

1,3 54-55 B3F5	04.91-05.96	0 986 45 P 2061	O
		1 987 42 S 9146	L
		0 986 45 F 0108 ¹	K

323 1.3 16V

1,3 55/58 B3F; B3F <Kat.>	03.91-05.96	0 986 45 P 2061	O
		0 450 90 N 4161 ¹	K

1,3 55/58 B38; B38 <Kat.>	06.89-03.91	0 986 45 P 2061	O
		0 450 90 N 4161 ¹	K

323 1.5

1,5 54/56 B56 <Kat.>; B564	09.89-06.95	0 986 45 P 2061	O
		0 986 45 F 0117 ¹	K

323 1.5 i

1,5 65 ZL	05.98-01.01	0 986 45 P 2061	O	
		1 457 43 S 3959	L	
		2FE	1 987 43 M 2117	I

1,5 65 Z5	10.96-07.98	0 986 45 P 2061	O
		1 457 43 S 3959	L
		0 986 45 F 0108 ¹	K

1,5 65-71 Z5	06.94-11.96	0 986 45 P 2061	O
		1 457 43 S 3959	L
	06.94-07.95	0 450 90 F 5989 ¹	K
	08.95-11.96	0 986 45 F 0108 ¹	K

323 1.6 , 16V

1,6 64 B6	07.89-12.95	0 986 45 P 2061	O
		0 450 90 N 4161 ¹	K





323 1.6 i

1,6 62 B61T <Kat.>	06.89-03.91	0 986 45 P 2061	O
		1 987 42 S 9146	L
		0 986 45 F 0108 ¹	K
1,6 70-72/78 ZM	07.98→	0 986 45 P 2061	O
		1 457 43 S 3959	L
1,6 78 B6	08.95-09.96	0 986 45 P 2061	O
		1 457 43 S 3959	L
		0 986 45 F 0108 ¹	K
1,6 78 M	07.98-11.00	0 986 45 P 2061	O
	01.01→	0 986 45 P 2061	O
	07.98-11.00	1 457 43 S 3959	L
	01.01→	1 457 43 S 3959	L
1,6 79 ZM	07.98-10.00	0 986 45 P 2061	O
		1 457 43 S 3959	L
	2FE	1 987 43 M 2117	I

323 1.6 i, i Turbo, i Turbo 4x4

1,6 61/97 B6B1/2; B6E8; B6E9	05.87-12.97	0 986 45 P 2061	O
	XXX	1 987 42 S 9120	L
Fg.Nr. 205905→	05.87-12.97 XXX	0 986 45 F 0121 ¹	K

323 1.6 i, i 4x4

1,6 63-66 B65 <Kat.>; B65L <Kat.>; B65M <Kat.>	09.89-10.95	0 986 45 P 2061	O
	XXX	1 987 42 S 9120	L
		0 986 45 F 0121 ¹	K

323 1.6 i 16V

1,6 65-66 B6 <Kat.>	03.91-07.94	0 986 45 P 2061	O
		1 987 42 S 9146	L
		0 986 45 F 0108 ¹	K
1,6 65-66 B67	03.91-02.97	0 986 45 P 2061	O
		1 987 42 S 9146	L
		0 986 45 F 0108 ¹	K

323 1.6 16V

1,6 64 B61	06.89-03.91	0 986 45 P 2061	O
		0 450 90 N 4161 ¹	K
1,6 64 B62	06.89-03.91	0 986 45 P 2061	O
		0 450 90 N 4161 ¹	K
1,6 64 B67	03.91-07.94	0 986 45 P 2061	O
		0 450 90 N 4161 ¹	K
1,6 64 B67 <Kat.>	03.91-07.94	0 986 45 P 2061	O
		0 450 90 N 4161 ¹	K



323 1.7 D

1,7 41 PN46	06.89-03.91	1 987 42 S 9128	L
		1 457 43 N 4302 ²	K
1,7 41 PN54	09.89-06.95	1 987 42 S 9128	L
		1 457 43 N 4453 ²	K
1,7 43 PN62	03.91-02.96	1 987 42 S 9128	L
		1 457 43 N 4302 ²	K

323 1.7 D Turbo

1,7 60-62 Y7	08.95-12.96	0 986 45 P 2041	O
		1 457 43 S 3066	L
		1 457 43 N 4453 ²	K

323 1.8

1,8 92 BP	05.94-09.95	0 986 45 P 2061	O
		1 457 43 S 3959	L

323 1.8 i

1,8 76 BP	07.89-05.94	0 986 45 P 2061	O
		1 987 42 S 9146	L
		0 986 45 F 0108 ¹	K

1,8 84	12.00-09.03	0 986 45 P 2061	O
		1 457 43 S 3959	L

1,8 84 FP	05.98-09.03	0 986 45 P 2061	O
		1 457 43 S 3959	L
	2FE	1 987 43 M 2117	I

1,8 84-85 BP	08.94-11.96	0 986 45 P 2061	O
		1 457 43 S 3959	L
	08.94-07.95	0 450 90 F 5989 ¹	K
	08.95-11.96	0 986 45 F 0108 ¹	K

1,8 92 BP	05.94-06.98	0 986 45 P 2061	O
		1 457 43 S 3959	L
	05.94-09.96	0 986 45 F 0108 ¹	K
Fg.Nr. →BA11*3-200850	10.96-06.98	0 986 45 F 0108 ¹	K

1,8 92 FP	07.98→	0 986 45 P 2061	O
		1 457 43 S 3959	L

1,8 99 BP	10.96-06.98	0 986 45 P 2061	O
		1 457 43 S 3959	L
		0 986 45 F 0108 ¹	K





323 1.8 i Astina

1,8 92 P	08.95-06.98	0 986 45 P 2061	O
		1 457 43 S 3959	L
	08.95-09.96	0 986 45 F 0108 ¹	K
Fg.Nr. →BA11*3-200850	10.96-06.98	0 986 45 F 0108 ¹	K

323 1.8 i 4x4

1,8 76 BP	11.89-04.92	0 986 45 P 2061	O
		1 987 42 S 9146	L

323 1.8 i 16V

1,8 76 BP	07.89-03.91	0 986 45 P 2061	O
		1 987 42 S 9146	L
		0 986 45 F 0108 ¹	K

1,8|76-78|BP <DOHC>; BP <DOHC Kat.>; BP <Kat.>; BP <SOHC Kat.>

03.91-07.94	0 986 45 P 2061	O
	1 987 42 S 9146	L
	0 986 45 F 0108 ¹	K

1,8|76-78|BPC2 <Kat.>

03.91-05.94	0 986 45 P 2061	O
	1 987 42 S 9146	L
	0 986 45 F 0108 ¹	K

1,8|92|BP

04.91-05.94	0 986 45 P 2061	O
	1 987 42 S 9146	L
	0 986 45 F 0108 ¹	K

1,8|94-96/103|BP <DOHC>; BP <DOHC Kat.>; BP <Kat.>; BP <SOHC Kat.>

06.89-07.94	0 986 45 P 2061	O
	1 987 42 S 9146	L
	0 986 45 F 0108 ¹	K

323 1.8 i 16V GT

1,8 94 BP <DOHC>; BP <DOHC Kat.>; BP <Kat.>; BP <SOHC Kat.>	06.89-07.94	1 987 42 S 9146	L
---	-------------	-----------------	---

323 1.8 i 16V Turbo 4x4

1,8 120 BP	11.89-04.92	0 986 45 P 2061	O
		1 987 42 S 9146	L

323 1.8 i 16V 4x4

1,8 76-78 BPC <Kat.>	06.91-05.94	0 986 45 P 2061	O
		1 987 42 S 9146	L

1,8|76-78|BPC7 <Kat.>

06.91-05.94	0 986 45 P 2061	O
	1 987 42 S 9146	L

1,8|94-96/103|BP <DOHC>; BP <DOHC Kat.>; BP <Kat.>; BP <SOHC Kat.>

06.91-05.94	1 987 42 S 9146	L
-------------	-----------------	---



323 1.8 i 16V 4x4, i 16V 4x4 Turbo

1,8 69/132 BP52;BP55 <Kat.>	11.89-03.91	0 986 45 P 2061	O
		1 987 42 S 9146	L

323 1.8 i 16V 4x4 Turbo

1,8 136-139 BP <DOHC>; BP <DOHC Kat.>; BP <Kat.>; BP <SOHC Kat.>	01.92-05.94	0 986 45 P 2061	O
		1 987 42 S 9146	L

323 2.0 D

2,0 52 RF	03.97-06.98	TW	0 451 10 P 3270	O
			0 451 10 P 3316	O
	05.98-10.00	HAU	0 451 10 P 3316	O
Fg.Nr. →126855	05.98-10.00	NEB	0 451 10 P 3270	O
	03.97-10.00		1 457 43 S 3066	L
	03.97-06.98		1 457 43 N 4453 ²	K
	05.98-10.00		1 457 43 N 4440 ²	K
		2FE	1 987 43 M 2117	I

323 2.0 D Turbo

2,0 66 RF	07.98-01.01	0 986 45 P 2036	O	
		1 457 43 S 3066	L	
			1 457 43 N 4440 ²	K
		2FE	1 987 43 M 2117	I

2,0|74

11.00-09.03	0 986 45 P 2036	O
	1 457 43 S 3066	L
	1 457 43 N 4440 ²	K

2,0|74|RF

10.00-09.03	0 986 45 P 2036	O
	1 457 43 S 3066	L
	1 457 43 N 4440 ²	K

323 2.0 i

2,0 96/98 FS	09.00→	0 986 45 P 2061	O
		1 457 43 S 3959	L

2,0|104|KF/F

05.94-09.95	0 986 45 P 2041	O
	1 457 43 S 3605	L

323 2.0 i Astina

2,0 104 F	08.95-09.96	0 986 45 P 2041	O
		1 457 43 S 3605	L





323 F

323 F 1.5 i

1,5 65-66 Z5			
	05.94-07.98	0 986 45 P 2061	O
		1 457 43 S 3959	L
	05.94-07.95	0 450 90 F 5989 ¹	K
	08.95-07.98	0 986 45 F 0108 ¹	K
	05.94-07.95 KL	1 987 43 M 2162	I

1,5 81 Z5			
	10.96-05.98	0 986 45 P 2061	O
		1 457 43 S 3959	L
		0 986 45 F 0108 ¹	K

323 F 1.8 i

1,8 84-85 BP			
	08.94-11.96	0 986 45 P 2061	O
		1 457 43 S 3959	L
	08.94-07.95	0 450 90 F 5989 ¹	K
	08.95-11.96	0 986 45 F 0108 ¹	K

1,8 99 BP			
	11.96-07.98	0 986 45 P 2061	O
		1 457 43 S 3959	L
		0 986 45 F 0108 ¹	K

323 F 2.0 i

2,0 106-108 KF			
	05.94-07.98	0 986 45 P 2041	O
		1 457 43 S 3605	L

626

626 1.6			
1,6 54-60 F68			
	03.88-07.91	0 986 45 P 2041	O
		1 457 42 S 9806	L
		0 986 45 F 0117 ¹	K

626 1.8 , 12V

1,8 60-66 F8			
	07.87-03.92	0 986 45 P 2041	O
		1 457 42 S 9806	L
		0 986 45 F 0117 ¹	K

626 1.8 i 16V

1,8 66 FP			
	06.94-03.97	0 986 45 P 2061	O
	10.97-06.00	0 986 45 P 2061	O
	06.94-03.97	1 457 43 S 3072	L
	10.97-10.99	1 457 43 S 3072	L
	08.99-06.00 TW	1 457 43 S 3072	L
	06.94-03.97	0 986 45 F 0106 ¹	K
	10.97-10.99	0 450 90 F 5983 ¹	K
	08.99-06.00	0 986 45 F 0108 ¹	K
	2FE, KL	1 987 43 M 2117	I



1,8 | 66-67 | FPY3

	04.97-09.99	0 986 45 P 2061	O
		1 457 43 S 3072	L
		0 450 90 F 5983 ¹	K
	2FE	1 987 43 M 2117	I
	05.97-09.99 2FE, KL	1 987 43 M 2117	I

1,8 | 74 | FP

	08.99-04.02	0 986 45 P 2061	O
	08.99-03.02 TW	1 457 43 S 3072	L
	10.99-04.02	1 457 43 S 3072	L
	08.99-03.02	0 986 45 F 0108 ¹	K
	10.99-04.02	0 450 90 F 5983 ¹	K
	08.99-04.02 2FE, KL	1 987 43 M 2117	I

1,8 | 77 | FP

	08.91-03.97	0 986 45 P 2061	O
		1 457 43 S 3072	L
		0 986 45 F 0106 ¹	K

626 1.8 16V

1,8FP			
	11.97-09.99	0 986 45 P 2061	O
		1 457 43 S 3072	L
		0 450 90 F 5983 ¹	K

1,8 | 66 | FP

	11.97-08.99	0 986 45 P 2061	O
		1 457 43 S 3072	L
		0 450 90 F 5983 ¹	K
	2FE	1 987 43 M 2117	I

626 2.0 , 12V

2,0 75/79-80 FE			
	06.87-03.92	0 986 45 P 2041	O
		1 457 42 S 9806	L
		0 986 45 F 0117 ¹	K

626 2.0 D

2,0 44 RF			
	07.87-07.91	0 986 45 P 2064	O
	07.87-03.92	1 457 43 N 4302 ²	K

2,0 | 55 | RFH7

	03.92-10.97	0 451 10 P 3316	O
		1 457 43 N 4302 ²	K

626 2.0 D Complex

2,0 55 RF			
	03.92-03.97	0 986 45 P 2064	O
		1 457 43 N 4302 ²	K

2,0 | 60 | RFH5

	03.92-10.97	1 457 43 N 4302 ²	K
--	-------------	-------------------------------------	----------

626 2.0 D Turbo

2,0 66 RF3F			
	09.99-04.02	0 986 45 P 2036	O
		1 987 42 S 9188	L
		1 457 43 N 4440 ²	K
	2FE, KL	1 987 43 M 2117	I





2,0 74 RF	10.99-04.02	0 986 45 P 2036	O
		1 987 42 S 9188	L
		1 457 43 N 4440 ²	K
		2FE, KL 1 987 43 M 2117	I

2,0 81 RF	10.00-04.02	0 986 45 P 2036	O
		1 987 42 S 9188	L
		1 457 43 N 4440 ²	K
		2FE, KL 1 987 43 M 2117	I

626 2.0 i

2,0 66 FE <Kat.>	06.87-07.91	0 986 45 P 2061	O	
		03.88-03.92	0 986 45 P 2041	O
		06.87-03.92	1 457 43 S 3605	L
		06.87-07.91 ABS	0 986 45 F 0105 ¹	K
		06.87-03.92	0 986 45 F 0102 ¹	K

2,0 66 FEKF <Kat.>	03.92-04.96	0 986 45 P 2041	O
		1 457 43 S 3605	L
		0 986 45 F 0102 ¹	K
		ABS 0 986 45 F 0105 ¹	K

2,0 93 FS	11.97→	0 986 45 P 2061	O
		1 457 43 S 3072	L
		0 450 90 F 5983 ¹	K

626 2.0 i 12V

2,0 80-81 FE	03.88-03.92	0 986 45 P 2041	O
		1 457 43 S 3605	L
		0 986 45 F 0102 ¹	K

626 2.0 i 16V

2,0FS	09.99-06.00	0 986 45 P 2061	O
		TW 1 457 43 S 3072	L
		0 986 45 F 0108 ¹	K
		2FE, KL 1 987 43 M 2117	I

2,0 85 FS	05.93-02.96	0 451 10 P 3316	O
		10.97-04.02	0 986 45 P 2061
	08.99-04.02 TW	1 457 43 S 3072	L
		0 450 90 F 5983 ¹	K
	08.99-06.00	0 986 45 F 0108 ¹	K
	08.99-04.02 GS	0 986 45 F 0108 ¹	K
		2FE, KL 1 987 43 M 2117	I

2,0 85 FSY9	04.97-09.99	0 986 45 P 2061	O
		1 457 43 S 3072	L
		0 450 90 F 5983 ¹	K
		04.97-08.99 2FE	1 987 43 M 2117

2,0 85-86 FS	08.91-06.97	0 986 45 P 2061	O
		1 457 43 S 3072	L
		0 986 45 F 0106 ¹	K
		07.94-03.97	0 450 90 F 5982 ¹

2,0 93 FSD	06.97→	0 986 45 P 2061	O
		1 457 43 S 3072	L
		0 450 90 F 5983 ¹	K

2,0 93 FSD DOHC	05.97-10.99	0 986 45 P 2061	O
		1 457 43 S 3072	L
		0 450 90 F 5983 ¹	K
		2FE 1 987 43 M 2117	I

2,0 100 FS	09.97-04.02	0 986 45 P 2061	O	
		09.97-09.99	1 457 43 S 3072	L
		08.99-04.02 TW	1 457 43 S 3072	L
		11.99-04.02	1 457 43 S 3072	L
		09.97-09.99	0 450 90 F 5983 ¹	K
		08.99-04.02 GS	0 986 45 F 0108 ¹	K
		11.99-04.02	0 450 90 F 5983 ¹	K
		09.97-09.99 2FE	1 987 43 M 2117	I
		08.99-04.02 2FE, KL	1 987 43 M 2117	I

2,0 100 FSY8	04.97-09.99	0 986 45 P 2061	O	
		04.97-08.99	1 457 43 S 3072	L
		11.98-09.99 TW	1 457 43 S 3072	L
		04.97-08.99	0 450 90 F 5983 ¹	K
		11.98-09.99 GS	0 986 45 F 0108 ¹	K
		04.97-08.99 2FE	1 987 43 M 2117	I

2,0 100-100 FS	10.97-11.99	0 986 45 P 2061	O
		1 457 43 S 3072	L
		0 450 90 F 5983 ¹	K

2,0 103 FE <Kat.>	06.87-07.91	0 986 45 P 2061	O	
		03.88-03.92	0 986 45 P 2036	O
		06.87-07.91 ABS	0 986 45 F 0105 ¹	K
		06.87-03.92	0 986 45 F 0102 ¹	K

2,0 103 FEKG <Kat.>	03.92-02.95	0 986 45 P 2036	O
		0 986 45 F 0102 ¹	K
		ABS 0 986 45 F 0105 ¹	K

2,0 109 FE	03.88-03.92	0 986 45 P 2036	O
		0 986 45 F 0102 ¹	K

626 2.0 i 16V 4x4

2,0 85-86 FS	09.91-03.97	0 986 45 P 2061	O	
		09.91-05.94	1 457 43 S 3072	L





626 2.0 16V

2,0 85 FS	11.97-09.99	0 986 45 P 2061	O
		1 457 43 S 3072	L
		0 450 90 F 5983 ¹	K
	11.97-08.99 2FE	1 987 43 M 2117	I

626 2.0 16V D Turbo

2,0 66 RF	04.98-08.99	0 986 45 P 2036	O
		1 987 42 S 9188	L
		1 457 43 N 4440 ²	K
	2FE	1 987 43 M 2117	I

2,0 74 RF	04.98-10.99	0 986 45 P 2036	O
		1 987 42 S 9188	L
	05.98-10.99	1 457 43 N 4440 ²	K

2,0 74 RF <DIRECO-D>	08.99-07.02	0 986 45 P 2036	O
		1 987 42 S 9188	L
		1 457 43 N 4440 ²	K
	2FE, KL	1 987 43 M 2117	I

2,0 81 RF	10.00-07.02	0 986 45 P 2036	O
		1 987 42 S 9188	L
		1 457 43 N 4440 ²	K
	2FE	1 987 43 M 2117	I

2,0 81 RF <DIRECO-D>	10.00-07.02	0 986 45 P 2036	O
		1 987 42 S 9188	L
		1 457 43 N 4440 ²	K

626 2.2 i

2,2 84 F2 SOHC	04.92-01.95	0 986 45 P 2061	O
		1 457 43 S 3605	L
	ABS	0 986 45 F 0102 ¹	K
	ABS	0 986 45 F 0105 ¹	K

626 2.2 i, i Turbo 2/4WS

2,2 84/100 F2	08.88-09.91	0 986 45 P 2041	O
		1 457 43 S 3605	L
	ABS	0 986 45 F 0102 ¹	K
	ABS	0 986 45 F 0105 ¹	K

626 2.2 i, i 4WD

2,2 85 F2G <Kat.>; F2L1 <Kat.>	03.92-10.97	0 986 45 P 2041	O
		1 457 43 S 3605	L
		0 986 45 F 0102 ¹	K
	ABS	0 986 45 F 0105 ¹	K

626 2.2 i 12V, i 12V 4x4

2,2 85 F2 <Kat.>; F2 <Kat.>	11.87-03.92	0 986 45 P 2041	O
		1 457 43 S 3605	L
	11.87-07.91 ABS	0 986 45 F 0105 ¹	K
	11.87-03.92	0 986 45 F 0102 ¹	K



626 2.5 i, i 24V, i 24V 4WS

2,5 121-123 KL	09.91-06.97	0 986 45 P 2041	O
		1 457 43 S 3072	L
		0 986 45 F 0106 ¹	K

929

929 2.0 i

2,0 85 FEFA	06.89-09.92	0 986 45 P 2041	O
-------------	-------------	------------------------	----------

929 2.2 i 12V

2,2 93-94/100 F2E; F2E <Kat.>	06.89-09.92	0 986 45 P 2041	O
-------------------------------	-------------	------------------------	----------

929 3.0 i 18V

3,0 118 JE	08.89-06.91	0 986 45 P 2041	O
	Fg.Nr. →HC10E1-112570	02.87-06.91	0 986 45 P 2061

3,0 123-125 JE3 <Kat.>	06.89-09.92	0 986 45 P 2041	O
------------------------	-------------	------------------------	----------

929 3.0 i 24V

3,0 140 JE	08.89-06.91	0 986 45 P 2041	O
------------	-------------	------------------------	----------

929 3.0 i 24V 4WS

3,0 140 JE	12.93-12.95	0 986 45 P 2041	O
	Fg.Nr. →HD10*-108884	05.91-11.93	0 986 45 P 2041
	05.91-12.95	1 457 43 S 3952	L

MERCEDES-BENZ

Classe A

Classe A 160

1,6 75 M 166.960 <E16>	05.99-08.05	1 457 43 S 3715	L
		0 450 91 F 5001 ¹	K

Classe A 190

1,9 92 M 166.990 <E19>	09.00-08.05	1 457 43 S 3715	L
		0 450 91 F 5001 ¹	K

MB

MB 100

2,3 58 OM 661.911	01.96→	1 457 42 P 9278	O
		0 450 90 N 4077 ¹	K
		1 457 43 N 4123 ²	K

2,3 110 M 161.971	11.96→	1 457 42 P 9122	O
-------------------	--------	------------------------	----------



2,9 69,8 OM 662.911	01.96→	1 457 42 P 9278	O
		0 450 90 N 4077 ¹	K
		1 457 43 N 4123 ²	K

MB 100 D

2,4 53-56 OM 616.963	09.87-08.91	1 457 42 P 9267	O
Fg.Nr. →146978	09.87-08.91	1 457 43 S 3627	L
	09.87-08.91	1 457 43 N 4153 ²	K
Mot.Nr. ...126322→	06.90-08.91	0 450 90 F 4060 ¹	K

2,4 55 OM 616.963	09.91-01.96	1 457 42 P 9267	O
	XXX	1 457 43 S 3702	L
		0 450 90 F 4060 ¹	K
		1 457 43 N 4153 ²	K

MB 180

2,4 56 OM 616.963	01.87-01.96	1 457 42 P 9267	O
Fg.Nr. →146978	01.87-01.96	1 457 43 S 3627	L
Mot.Nr. ...146979→	01.87-01.96	XXX 1 457 43 S 3702	L

Medio

Medio 4.2

4,2 110 OM 904 LA <Euro 3>	01.01→	1 457 43 S 3626	L
--------------------------------	--------	-----------------	---

Serie A (168)

Serie A (168) 140

1,4 60 M 166.940 <E 14>	10.97-08.04	1 457 42 P 9147	O
		1 457 43 S 3715	L
		0 450 91 F 5001 ¹	K
		KL 1 987 43 R 2337 ⁸	I
		KL 1 987 43 M 2037	I

1,6 60 M 166.960 <E 16>	10.97-08.04	1 457 42 P 9147	O
		1 457 43 S 3715	L
		0 450 91 F 5001 ¹	K
		KL 1 987 43 R 2337 ⁸	I
		KL 1 987 43 M 2037	I

Serie A (168) 160

1,6 75 M 166.960 <E 16>	10.97-08.04	1 457 42 P 9147	O
		1 457 43 S 3715	L
		0 450 91 F 5001 ¹	K
		KL 1 987 43 R 2337 ⁸	I
		KL 1 987 43 M 2037	I

□□

Serie A (168) 160 CDI

1,7 44/55 OM 668.940 <DE 17 LA>; OM 668.941 <DE 17 A>	09.98-08.04	1 457 42 P 9272	O
		1 457 43 S 3069	L
		0 450 90 N 5930 ¹	K
		KL 1 987 43 R 2337 ⁸	I
		KL 1 987 43 M 2037	I

Serie A (168) 170 CDI

1,7 66/70 OM 668.940 <DE 17 LA>; OM 668.942 <DE 17 LA>	07.98-08.04	1 457 42 P 9272	O
		1 457 43 S 3069	L
		0 450 90 N 5930 ¹	K
		KL 1 987 43 R 2337 ⁸	I
		KL 1 987 43 M 2037	I

Serie A (168) 190

1,9 92 M 166.990 <E 19>	03.99-08.04	1 457 42 P 9147	O
		1 457 43 S 3715	L
		0 450 91 F 5001 ¹	K
		KL 1 987 43 R 2337 ⁸	I
		KL 1 987 43 M 2037	I

Serie A (168) 210 Evolution

2,1 103 M 166.995 <E 21>	03.02-08.04	1 457 42 P 9147	O
		1 457 43 S 3715	L
		0 450 91 F 5001 ¹	K
		KL 1 987 43 R 2337 ⁸	I
		KL 1 987 43 M 2037	I

Serie A (169)

Serie A (169) E-Cell

50 EM 780.992	01.11→	1 987 43 R 2410 ⁸	I
-----------------	--------	------------------------------	---

Serie A (169) 150

1,5 70 M 266.920 <E 15>	09.04-04.09	1 457 42 P 9306	O
		1 457 43 S 3585	L
		1 987 43 R 2410 ⁸	I

Serie A (169) 160

1,5 70 M 266.920 <E 15>	04.09→	1 457 42 P 9306	O
		1 457 43 S 3585	L
		1 987 43 R 2410 ⁸	I

Serie A (169) 160 CDI

2,0 60 OM 640.942 <DE 20 LA>	09.04→	1 457 42 P 9272	O
		1 457 43 S 3594	L
Mot.Nr. →...30553857	09.04-11.08	WAS 1 457 43 N 4437 ¹	K
Mot.Nr. ...30553858→	12.08→	WAS F 026 40 N 2065 ¹	K
	09.04→	1 987 43 R 2410 ⁸	I





Serie A (169) 170

1,7 85 M 266.940 <E 17>			
09.04-04.09	1 457 42	P 9306	O
	1 457 43	S 3585	L
	1 987 43	R 2410⁸	I

Serie A (169) 180

1,7 85 M 266.940 <E 17>			
04.09→	1 457 42	P 9306	O
	1 457 43	S 3585	L
	1 987 43	R 2410⁸	I

Serie A (169) 180 CDI

2,0 80 OM 640.940 <DE 20 LA>			
09.04→	1 457 42	P 9272	O
	1 457 43	S 3594	L
Mot.Nr. →...30553857	09.04-11.08	WAS	1 457 43 N 4437¹ K
Mot.Nr. ...30553858→	12.08→	WAS	F 026 40 N 2065¹ K
	09.04→		1 987 43 R 2410⁸ I

Serie A (169) 200 , Turbo

2,0 100/142 M 266.960 <E 20>; M 266.980 <E 20 LA>			
04.04→	1 457 42	P 9306	O
	1 457 43	S 3585	L
	1 987 43	R 2410⁸	I

Serie A (169) 200 CDI

2,0 103 OM 640.941 <DE 20 LA>			
09.04→	1 457 42	P 9272	O
	1 457 43	S 3594	L
Mot.Nr. →...30553857	09.04-11.08	WAS	1 457 43 N 4437¹ K
Mot.Nr. ...30553858→	12.08→	WAS	F 026 40 N 2065¹ K
	09.04→		1 987 43 R 2410⁸ I

Serie B (245)

Serie B (245) 150

1,5 70 M 266.920 <E 15>			
04.05-04.09	1 457 42	P 9306	O
	1 457 43	S 3585	L
	1 987 43	R 2410⁸	I

Serie B (245) 160

1,5 70 M 266.920 <E 15>			
04.09→	1 457 42	P 9306	O
	1 457 43	S 3585	L
	1 987 43	R 2410⁸	I

Serie B (245) 170

1,7 85 M 266.940 <E 17>			
04.05-04.09	1 457 42	P 9306	O
	1 457 43	S 3585	L
	1 987 43	R 2410⁸	I

Serie B (245) 170 NGT

2,0 85 M 266.960 <E 20>			
05.08-04.09	1 457 42	P 9306	O
	1 457 43	S 3585	L
	1 987 43	R 2410⁸	I



Serie B (245) 180

1,7 85 M 266.940 <E 17>			
04.09→	1 457 42	P 9306	O
	1 457 43	S 3585	L
	1 987 43	R 2410⁸	I

Serie B (245) 180 CDI

2,0 80 OM 640.940 <DE 20 LA>			
04.05→	1 457 42	P 9272	O
	1 457 43	S 3594	L
Mot.Nr. →...30553857	04.05-11.08	WAS	1 457 43 N 4437¹ K
Mot.Nr. ...30553858→	12.08→	WAS	F 026 40 N 2065¹ K
	04.05→		1 987 43 R 2410⁸ I

Serie B (245) 180 NGT

2,0 85 M 266.960 <E 20>			
05.09→	1 457 42	P 9306	O
	1 457 43	S 3585	L
	1 987 43	R 2410⁸	I

Serie B (245) 200 , Turbo

2,0 100/142 M 266.960 <E 20>; M 266.980 <E 20 LA>			
04.05→	1 457 42	P 9306	O
	1 457 43	S 3585	L
	1 987 43	R 2410⁸	I

Serie B (245) 200 CDI

2,0 103 OM 640.941 <DE 20 LA>			
04.05→	1 457 42	P 9272	O
	1 457 43	S 3594	L
Mot.Nr. →...30553857	04.05-11.08	WAS	1 457 43 N 4437¹ K
Mot.Nr. ...30553858→	12.08→	WAS	F 026 40 N 2065¹ K
	04.05→		1 987 43 R 2410⁸ I

Serie C (202)

Serie C (202) 36 AMG

3,6 206 M 104.941			
09.94-05.97	1 457 42	P 9122	O
	1 457 43	S 3752	L
	ATP	0 450 90 F 5275¹	K
Fg.Nr. A205024→F175421→	09.94-05.97	ATP	0 450 90 F 5275¹ K
Fg.Nr. →A205023→F175420	09.94-05.97	ATP	0 450 90 F 5203¹ K
	09.94-05.97	KL	1 987 43 R 2301⁸ I
		KL	1 987 43 M 2001 I
			1 457 42 P 9416³ P

3,6 | 206 | M 104.941 <AMG>

01.94-05.97	1 457 42	P 9122	O
	1 457 43	S 3752	L
	0 450 90	F 5275¹	K
	KL	1 987 43 R 2301⁸	I
	KL	1 987 43 M 2001	I
		1 457 42 P 9416³	P





Serie C (202) 43 AMG

4,3 225 M 113.944			
	10.97-02.01	1 457 42 P 9263	O
		1 457 43 S 3752	L
		0 450 91 F 5003 ¹	K
	KL	1 987 43 R 2301 ⁸	I
	KL	1 987 43 M 2001	I

Serie C (202) 180

1,8 90 M 111.920 <E 18>; M 111.921 <E 18>			
	03.93-02.01	1 457 42 P 9122	O
		1 457 43 S 3752	L
	03.93-04.00 ATP	0 450 90 F 5275 ¹	K
	05.96-02.01	0 450 90 F 5275 ¹	K
Fg.Nr. A205024→F175421→	03.93-04.00 ATP	0 450 90 F 5275 ¹	K
Fg.Nr. →A205023→F175420	03.93-04.00 ATP	0 450 90 F 5203 ¹	K
	03.93-02.01 KL	1 987 43 R 2301 ⁸	I
	KL	1 987 43 M 2001	I

2,0|95|M 111.952 <E 20 EVO>

	09.00-02.01	1 457 42 P 9122	O
		1 457 43 S 3752	L
		0 450 91 F 5003 ¹	K
	KL	1 987 43 R 2301 ⁸	I
	KL	1 987 43 M 2001	I

Serie C (202) 200

2,0 100 M 111.941 <E 20>; M 111.944 <E 20 ML>; M 111.945			
	01.94-02.01	1 457 42 P 9122	O
		1 457 43 S 3752	L
	01.94-04.00 ATP	0 450 90 F 5275 ¹	K
	05.96-02.01	0 450 90 F 5275 ¹	K
Fg.Nr. A205024→F175421→	01.94-04.00 ATP	0 450 90 F 5275 ¹	K
Fg.Nr. →A205023→F175420	01.94-04.00 ATP	0 450 90 F 5203 ¹	K
	01.94-02.01 KL	1 987 43 R 2301 ⁸	I
	KL	1 987 43 M 2001	I

Serie C (202) 200 CDI

2,2 75 OM 611.960 <DE LA>			
	03.98-02.01	1 457 42 P 9116	O
		1 457 43 S 3752	L
		1 457 43 N 1704	K
	KL	1 987 43 R 2301 ⁸	I
	KL	1 987 43 M 2001	I

Serie C (202) 200 D

2,0 55 OM 601.913			
	03.93-08.95	1 457 42 P 9274	O
		1 457 43 S 3752	L
		1 457 43 N 4123 ²	K
	KL	1 987 43 R 2301 ⁸	I
	KL	1 987 43 M 2001	I

2,0|55-65|OM 604.915 <D 20>

	09.96-06.99	1 457 42 P 9278	O
		1 457 43 S 3752	L
		WAS 1 457 43 N 4123 ²	K
		WAS,WW 1 457 43 N 4331 ²	K
	KL	1 987 43 R 2301 ⁸	I
	KL	1 987 43 M 2001	I

Serie C (202) 200 KOMPRESSOR

2,0 120 M 111.956 <E 20 EVO ML>			
	04.00-02.01	1 457 42 P 9122	O
		1 457 43 S 3752	L
		0 450 91 F 5003 ¹	K
	KL	1 987 43 R 2301 ⁸	I
	KL	1 987 43 M 2001	I

2,0|132|M 111.941 <E 20>; M 111.944 <E 20 ML>; M 111.945

	05.96-08.97	1 457 42 P 9122	O
		1 457 43 S 3752	L
		0 450 90 F 5275 ¹	K
	KL	1 987 43 R 2301 ⁸	I
	KL	1 987 43 M 2001	I

2,0|132-141|M 111.941 <E 20>; M 111.944 <E 20 ML>; M 111.945

	09.95-04.00	1 457 42 P 9122	O
		1 457 43 S 3752	L
		ATP 0 450 90 F 5275 ¹	K
Fg.Nr. A205024→F175421→	09.95-04.00 ATP	0 450 90 F 5275 ¹	K
Fg.Nr. →A205023→F175420	09.95-04.00 ATP	0 450 90 F 5203 ¹	K
	09.95-04.00 KL	1 987 43 R 2301 ⁸	I
	KL	1 987 43 M 2001	I

2,0|141|M 111.941 <E 20>; M 111.944 <E 20 ML>; M 111.945

	09.97-03.00	1 457 42 P 9122	O
		1 457 43 S 3752	L
		0 450 90 F 5275 ¹	K
	KL	1 987 43 R 2301 ⁸	I
	KL	1 987 43 M 2001	I

Serie C (202) 220

2,2 110 M 111.961 <E 22>			
	03.93-09.96	1 457 42 P 9122	O
		1 457 43 S 3752	L
		ATP 0 450 90 F 5275 ¹	K
Fg.Nr. A205024→F175421→	03.93-09.96 ATP	0 450 90 F 5275 ¹	K
Fg.Nr. →A205023→F175420	03.93-09.96 ATP	0 450 90 F 5203 ¹	K
	03.93-09.96 KL	1 987 43 R 2301 ⁸	I
	KL	1 987 43 M 2001	I

Serie C (202) 220 CDI

2,2 92 OM 611.960 <DE LA>			
	12.97-02.01	1 457 42 P 9116	O
		1 457 43 S 3752	L
		1 457 43 N 1704	K
	KL	1 987 43 R 2301 ⁸	I
	KL	1 987 43 M 2001	I





Serie C (202) 220 D

2,2 55-70 OM 604.910 <D 22>				
Mot.Nr. →..004360	08.93-06.99	AG	1 457 42	P 9274 O
Mot.Nr. →..021055	08.93-06.99	GS	1 457 42	P 9274 O
Mot.Nr. ..004361→	08.93-06.99	AG	1 457 42	P 9278 O
Mot.Nr. ..021056→	08.93-06.99	GS	1 457 42	P 9278 O
	08.93-06.99		1 457 43	S 3752 L
		WAS	1 457 43	N 4123² K
		WAS,WW	1 457 43	N 4331² K
		KL	1 987 43	R 2301⁸ I
		KL	1 987 43	M 2001 I

Serie C (202) 230

2,3 110 M 111.974				
	05.96-05.97		1 457 42	P 9122 O
			1 457 43	S 3752 L
			0 450 90	F 5275¹ K
		KL	1 987 43	R 2301⁸ I
		KL	1 987 43	M 2001 I

2,3 110 M 111.974 <E 23>				
	09.96-08.98		1 457 42	P 9122 O
			1 457 43	S 3752 L
		ATP	0 450 90	F 5275¹ K
Fg.Nr. A205024→F175421→	09.96-08.98	ATP	0 450 90	F 5275¹ K
Fg.Nr. →A205023→F175420	09.96-08.98	ATP	0 450 90	F 5203¹ K
	09.96-08.97	KL	1 987 43	M 2001 I
	09.96-08.98	KL	1 987 43	R 2301⁸ I

Serie C (202) 230 KOMPRESSOR

2,3 142 M 111.975 <E 23 ML>				
	09.95-02.01		1 457 42	P 9122 O
			1 457 43	S 3752 L
	09.95-04.00	ATP	0 450 90	F 5275¹ K
	06.97-02.01		0 450 90	F 5275¹ K
Fg.Nr. A205024→F175421→	09.95-04.00	ATP	0 450 90	F 5275¹ K
Fg.Nr. →A205023→F175420	09.95-04.00	ATP	0 450 90	F 5203¹ K
	09.95-02.01	KL	1 987 43	R 2301⁸ I
		KL	1 987 43	M 2001 I

Serie C (202) 240

2,4 125 M 112.910 <E 24>				
	06.97-02.01		1 457 42	P 9263 O
			1 457 43	S 3752 L
			0 450 91	F 5003¹ K
		KL	1 987 43	R 2301⁸ I
		KL	1 987 43	M 2001 I

2,6 125 M 112.915 <E 26>				
	08.00-02.01		1 457 42	P 9263 O
			1 457 43	S 3752 L
			0 450 91	F 5003¹ K
		KL	1 987 43	R 2301⁸ I
		KL	1 987 43	M 2001 I



Serie C (202) 250 D

2,5 83 OM 605.910				
Mot.Nr. →..006578	05.93-08.95	AG	1 457 42	P 9274 O
Mot.Nr. →..014796	05.93-08.95	GS	1 457 42	P 9274 O
Mot.Nr. ..006579→	05.93-08.95	AG	1 457 42	P 9278 O
Mot.Nr. ..014797→	05.93-08.95	GS	1 457 42	P 9278 O
	05.93-08.95		1 457 43	S 3752 L
			1 457 43	N 4123² K
		KL	1 987 43	R 2301⁸ I
		KL	1 987 43	M 2001 I

Serie C (202) 250 D Turbo

2,5 110 OM 605.960 <AD 25 LA>				
	09.95-02.01		1 457 42	P 9278 O
			1 457 43	S 3752 L
			1 457 43	N 4123² K
		KL	1 987 43	R 2301⁸ I
		KL	1 987 43	M 2001 I

Serie C (202) 280

2,8 142 M 104.941				
	05.93-05.97		1 457 42	P 9122 O
			1 457 43	S 3752 L
		ATP	0 450 90	F 5275¹ K
Fg.Nr. A205024→F175421→	05.93-05.97	ATP	0 450 90	F 5275¹ K
Fg.Nr. →A205023→F175420	05.93-05.97	ATP	0 450 90	F 5203¹ K
	05.93-05.97	KL	1 987 43	R 2301⁸ I
		KL	1 987 43	M 2001 I
			1 457 42	P 9416³ P

2,8 | 145 | M 112.920; M 112.920 <E 28>

	06.97-02.01		1 457 42	P 9263 O
			1 457 43	S 3752 L
			0 450 91	F 5003¹ K
		KL	1 987 43	R 2301⁸ I
		KL	1 987 43	M 2001 I

Serie C (203)

Serie C (203) 30 AMG CDI

3,0 170 OM 612.990 <DE 30 LA AMG>				
	09.02-08.04		1 457 42	P 9126 O
		MKL	1 987 43	M 2070 I
		MKL	1 987 43	R 2370⁸ I

Serie C (203) 32 AMG KOMPRESSOR

3,2 260 M 112.961 <E 32 AMG>				
	01.01-01.04		1 457 42	P 9263 O
			1 457 43	S 3581 L
			0 450 91	F 5003¹ K
			1 987 43	M 2070 I
		KBF	1 987 43	R 2370⁸ I

Serie C (203) 55 AMG

5,4 270 M 113.988 <E 55>				
	02.04-08.07		1 457 42	P 9263 O
			1 457 43	S 3071 L
			0 450 91	F 5003¹ K
			1 987 43	M 2070 I
		KBF	1 987 43	R 2370⁸ I



Serie C (203) 160 KOMPRESSOR

1,8 90 M 271.921 <KE 16 ML RED2>			
06.05-02.08	1 457 42	P 9261	O
	1 987 42	S 9401	L
	0 450 91	F 5003 ¹	K
	1 987 43	M 2070	I
KBF	1 987 43	R 2370 ⁸	I

Serie C (203) 180

2,0 95 M 111.951 <E 20 EVO>			
10.00-08.02	1 457 42	P 9122	O
	1 457 43	S 3043	L
	0 450 91	F 5003 ¹	K
	1 987 43	M 2070	I
KBF	1 987 43	R 2370 ⁸	I

Serie C (203) 180 KOMPRESSOR

1,8 105 M 271.946 <KE 18 ML>			
09.02-02.08	1 457 42	P 9261	O
	1 987 42	S 9401	L
	0 450 91	F 5003 ¹	K
	1 987 43	M 2070	I
KBF	1 987 43	R 2370 ⁸	I

Serie C (203) 200 CDI

2,2 75/90 OM 646.962 <DE 22 LA>			
03.03-02.08	1 457 42	P 9116	O
	F 026 40	S 0024	L
	1 457 43	N 4437 ¹	K
MKL	1 987 43	M 2070	I
MKL	1 987 43	R 2370 ⁸	I

2,2 | 85 | OM 611.962 <DE LA>

10.00-02.03	1 457 42	P 9116	O
	1 457 43	S 3065	L
RAP	1 457 43	N 4416 ¹	K
MKL	1 987 43	M 2070	I
MKL	1 987 43	R 2370 ⁸	I

Serie C (203) 200 CGI KOMPRESSOR, KOMPRESSOR

1,8 120/125 M 271.940 <KE 18 ML>; M 271.942 <DE 18 ML>			
09.02-02.08	1 457 42	P 9261	O
	1 987 42	S 9401	L
	0 450 91	F 5003 ¹	K
	1 987 43	M 2070	I
KBF	1 987 43	R 2370 ⁸	I

Serie C (203) 200 KOMPRESSOR

2,0 120 M 111.955 <E 20 EVO ML>			
05.00-08.02	1 457 42	P 9122	O
	1 457 43	S 3522	L
	0 450 91	F 5003 ¹	K
	1 987 43	M 2070	I
KBF	1 987 43	R 2370 ⁸	I

Serie C (203) 220 CDI

2,2 100-105 OM 611.962 <DE LA>			
05.00-02.03	1 457 42	P 9116	O
	1 457 43	S 3065	L
RAP	1 457 43	N 4416 ¹	K
MKL	1 987 43	M 2070	I
MKL	1 987 43	R 2370 ⁸	I

2,2 | 110 | OM 646.963 <DE 22 LA>

03.03-02.08	1 457 42	P 9116	O
	F 026 40	S 0024	L
	1 457 43	N 4437 ¹	K
MKL	1 987 43	M 2070	I
MKL	1 987 43	R 2370 ⁸	I

Serie C (203) 230

2,5 150 M 272.920 <E 25>			
06.05-02.08	1 457 42	P 9263	O
	1 457 43	S 3071	L
	0 450 91	F 5003 ¹	K
	1 987 43	M 2070	I
KBF	1 987 43	R 2370 ⁸	I

Serie C (203) 230 KOMPRESSOR

1,8 141 M 271.948 <KE 18 ML>			
08.03-05.05	1 457 42	P 9261	O
	1 987 42	S 9401	L
	0 450 91	F 5003 ¹	K
	1 987 43	M 2070	I
KBF	1 987 43	R 2370 ⁸	I

2,3 | 145 | M 111.981 <E 23 EVO ML>

01.01-01.04	1 457 42	P 9122	O
	1 457 43	S 3522	L
	0 450 91	F 5003 ¹	K
	1 987 43	M 2070	I
KBF	1 987 43	R 2370 ⁸	I

Serie C (203) 240 , 4MATIC

2,6 125 M 112.912 <E 26>; M 112.916 <E 26>			
05.00-06.05	1 457 42	P 9263	O
	1 457 43	S 3071	L
	0 450 91	F 5003 ¹	K
	1 987 43	M 2070	I
KBF	1 987 43	R 2370 ⁸	I

Serie C (203) 270 CDI

2,7 125 OM 612.962 <DE LA>			
12.00-08.04	1 457 42	P 9116	O
	1 457 43	S 3065	L
Mot.Nr. →30 044707	12.00-08.04	1 457 43	N 1704
Mot.Nr. 30 044708 →	12.00-08.04	1 457 43	N 4416 ¹
	12.00-08.04	MKL	1 987 43 M 2070
		MKL	1 987 43 R 2370 ⁸





Serie C (203) 280 , 4MATIC

3,0 170 M 272.940 <E 30>; M 272.941 <E 30>			
06.05-08.07	1 457 42	P 9263	O
	1 457 43	S 3071	L
	0 450 91	F 5003 ¹	K
	1 987 43	M 2070	I
KBF	1 987 43	R 2370 ⁸	I

Serie C (203) 320 , 4MATIC

3,2 160 M 112.946 <DE LA>; M 112.946 <E 32>; M 112.953 <E 32>			
05.00-06.05	1 457 42	P 9263	O
	1 457 43	S 3071	L
	0 450 91	F 5003 ¹	K
	1 987 43	M 2070	I
KBF	1 987 43	R 2370 ⁸	I

Serie C (203) 320 CDI

3,0 165 OM 642.910 <D 30>			
09.04-08.07	F 026 40	P 7008	O
	LAB	F 026 40 S 0215	L
	RAB	F 026 40 S 0216	L
09.04-05.07	MWA	F 026 40 N 2056 ¹	K
09.04-08.07	WAS	1 457 43 N 4437 ¹	K
	WAS	F 026 40 N 2056 ¹	K
	MKL	1 987 43 M 2070	I
	MKL	1 987 43 R 2370 ⁸	I

Serie C (203) 350 , 4MATIC

3,5 200 M 272.960 <E 35>; M 272.970 <E 35>			
06.05-02.08	1 457 42	P 9263	O
	1 457 43	S 3071	L
	0 450 91	F 5003 ¹	K
	1 987 43	M 2070	I
KBF	1 987 43	R 2370 ⁸	I

Serie C (204)

Serie C (204) 63 AMG

6,2 336/380 M 156.985 <E 63>			
02.08→	F 026 40	S 0152	L
	1 987 43	R 2326 ⁸	I

Serie C (204) 180 CDI

2,1 88 OM 651.913 <D 22 LHD RED>			
01.11→	F 026 40	S 0133	L
	HEI,SWA	F 026 40 N 2065 ¹	K
	1 987 43	R 2326 ⁸	I

Serie C (204) 180 CGI

1,8 115 M 271.820 <DE 18 EVO RED>			
01.09→	F 026 40	S 0134	L
	1 987 43	R 2326 ⁸	I

Serie C (204) 180 KOMPRESSOR

1,6 115 M 271.910 <KE 16 ML>			
04.08-04.10	1 457 42	P 9261	O
	1 987 42	S 9401	L
	1 987 43	R 2326 ⁸	I



1,8 115 M 271.952 <KE 18 ML>			
01.07-10.08	1 457 42	P 9261	O
	1 987 42	S 9401	L
	1 987 43	R 2326 ⁸	I

Serie C (204) 200 CDI

2,1 100 OM 651.913 <D 22 LHD RED>; OM 651.913 <DE 22 LHD RED>			
04.08→	F 026 40	S 0133	L
	HEI,SWA	F 026 40 N 2065 ¹	K
	1 987 43	R 2326 ⁸	I

2,2 | 100 | OM 646.81... <DE 22 LA LL EVO>

01.07-12.10	1 457 42	P 9116	O
	WAS	1 457 43 N 4437 ¹	K
	WAS	F 026 40 N 2056 ¹	K
	1 987 43	R 2326 ⁸	I

2,2 | 100 | OM 646.811 <DE 22 LA LL>

09.07-10.09	1 457 42	P 9116	O
	MWA	F 026 40 N 2056 ¹	K
	WAS	1 457 43 N 4437 ¹	K
	1 987 43	R 2326 ⁸	I

Serie C (204) 200 CGI

1,8 135 M 271.8... <DE 18 EVO>; M 271.820 <DE 18 EVO RED>			
04.09→	F 026 40	S 0134	L
	1 987 43	R 2326 ⁸	I

Serie C (204) 200 KOMPRESSOR

1,8 135 M 271.950 <KE 18 ML>			
03.07-04.10	1 457 42	P 9261	O
	1 987 42	S 9401	L
	1 987 43	R 2326 ⁸	I

Serie C (204) 220 CDI

2,1 125 OM 646.811 <DE 22>			
09.07-03.09	1 457 42	P 9116	O
	MWA	F 026 40 N 2056 ¹	K
	WAS	1 457 43 N 4437 ¹	K
	1 987 43	R 2326 ⁸	I

2,1 | 125 | OM 651.911 <D 22 G>

04.09→	F 026 40	S 0133	L
	TW	F 026 40 N 2065 ¹	K
	1 987 43	R 2326 ⁸	I

2,1 | 125 | OM 651.911 <D 22 LHD>

12.08→	F 026 40	S 0133	L
	TW	F 026 40 N 2065 ¹	K
03.11→	HEI,SWA	F 026 40 N 2065 ¹	K
12.08→	1 987 43	R 2326 ⁸	I

2,2 | 125 | OM 646.811 <DE 22 LA LL EVO>

03.07-04.09	1 457 42	P 9116	O
	MWA	F 026 40 N 2056 ¹	K
	WAS	1 457 43 N 4437 ¹	K
	1 987 43	R 2326 ⁸	I

Serie C (204) 230 , 4MATIC

2,5 150 M 272.911 <E 25>; M 272.921 <KE 25>			
08.07-04.09	1 457 42	P 9263	O
	1 457 43	S 3071	L
	1 987 43	R 2326 ⁸	I





Serie C (204) 250 CDI

2,1 150 OM 651.911 <D 22 LHD>			
04.09→		F 026 40 S0133	L
	WAS	F 026 40 N 2065 ¹	K
03.11→	HEI,SWA	F 026 40 N 2065 ¹	K
04.09→		1 987 43 R 2326 ⁸	I

2,2 150 OM 651.911 <D 22 LHD>			
09.08→		F 026 40 S0133	L
Komp.Nr. 801/802/803	09.08→	WAS	F 026 40 N 2065 ¹ K
	09.08→		1 987 43 R 2326 ⁸ I

Serie C (204) 250 CDI 4MATIC

2,1 150 OM 651.912 <D 22 G>			
Komp.Nr. 801/802/803	04.10→	SWA	F 026 40 N 2065 ¹ K
	04.10→		1 987 43 R 2326 ⁸ I

Serie C (204) 250 CGI

1,8 150 M 271.860 <DE 18 EVO>			
04.09→		F 026 40 S0134	L
		1 987 43 R 2326 ⁸	I

Serie C (204) 280 , 4MATIC

3,0 170 M 272.947 <KE 30>; M 272.948 <KE 30>			
03.07-04.09		1 457 42 P 9263	O
		1 457 43 S 3071	L
		1 987 43 R 2326 ⁸	I

Serie C (204) 300 , 4MATIC

3,0 170 M 272.947 <KE 30>; M 272.948 <KE 30>			
04.09-01.11		1 457 42 P 9263	O
		1 457 43 S 3071	L
		1 987 43 R 2326 ⁸	I

Serie C (204) 320 CDI, CDI 4MATIC

3,0 165 OM 642.960 <D 30>; OM 642.961 <D 30>			
06.07-04.09		F 026 40 P 7008	O
	LAB	F 026 40 S 0215	L
	RAB	F 026 40 S 0216	L
	MWA	F 026 40 N 2056 ¹	K
	WAS	1 457 43 N 4437 ¹	K
		1 987 43 R 2326 ⁸	I

Serie C (204) 350 , CGI, 4MATIC

3,5 200/215/225 M 272.961 <KE 35>; M 272.971 <E 35>; M 272.982 <DE 35>			
03.07→		1 457 42 P 9263	O
		1 457 43 S 3071	L
		1 987 43 R 2326 ⁸	I

Serie C (204) 350 CDI

3,0 170 OM 642.830 <D 30 LHD>; OM 642.830 <D 30 LHD REPO>			
10.09-01.11		F 026 40 P 7008	O
	WAS	F 026 40 N 2065 ¹	K
		1 987 43 R 2326 ⁸	I

3,0 195 OM 642.834			
02.11→		F 026 40 P 7008	O
		1 987 43 R 2326 ⁸	I



Serie C (204) 350 CDI 4MATIC

3,0 170 OM 642.832 <D 30 LHD>; OM 642.832 <D 30 LHD REPO>			
10.09→		F 026 40 P 7008	O
	HEI,SWA	F 026 40 N 2065 ¹	K
		1 987 43 R 2326 ⁸	I

Serie C (204) 350 CGI, CGI 4MATIC

3,5 225 M 276.957 <DE 35>			
01.11→		1 987 43 R 2326 ⁸	I

Serie CL

Serie CL 420

4,2 205 M 119.971,981			
06.96-08.99		1 457 42 P 9616	O
	KNE	1 457 43 S 3700	L
Fg.Nr. A220201→	06.96-08.99	0 450 90 F 5275 ¹	K
Fg.Nr. →A220200	06.96-08.99	0 450 90 F 5203 ¹	K

Serie CL 500

5,0 235 M 119.970,980			
06.96-08.99		1 457 42 P 9616	O
	KNE	1 457 43 S 3700	L
Fg.Nr. A220201→	06.96-08.99	0 450 90 F 5275 ¹	K
Fg.Nr. →A220200	06.96-08.99	0 450 90 F 5203 ¹	K

Serie CL 600

6,0 290 M 120.982			
06.96-08.99		1 457 42 P 9153	O
		1 457 43 S 3524	L
Fg.Nr. A220201→	06.96-08.99	0 450 90 F 5275 ¹	K
Fg.Nr. →A220200	06.96-08.99	0 450 90 F 5203 ¹	K

Serie CL (215,216)

Serie CL (215,216) 55 AMG

5,4 265 M 113.986 <E 55>			
09.99-08.02		1 457 42 P 9263	O
		1 457 43 S 3071	L
		0 450 91 F 5003 ¹	K
	2FE	1 987 43 M 2020	I

Serie CL (215,216) 55 AMG KOMPRESSOR

5,4 368 M 113.991 <E 55 ML AMG>			
09.02-08.06		1 457 42 P 9263	O
		1 457 43 S 3071	L
		0 450 90 F 5275 ¹	K
	2FE	1 987 43 M 2020	I

Serie CL (215,216) 63 AMG

5,5 400 M 157.980 <DE 55 LA>			
08.10→		1 987 43 R 2438 ⁸	I

6,2 386 M 156.984 <E 63>			
01.07-07.10		F 026 40 S0152	L
		1 987 43 R 2438 ⁸	I





Serie CL (215,216) 65 AMG

6,0 450 M 275.980 <E 60>	09.03-08.06	1 987 42 S 9402	L
	2FE	1 987 43 M 2020	I

6,0 450/463 M 275.982 <E 60>	09.07→	1 987 42 S 9402	L
		1 987 43 R 2438 ⁸	I

Serie CL (215,216) 500

5,0 225 M 113.960 <E 50>	09.99-05.06	1 457 42 P 9263	O
		1 457 43 S 3071	L
		0 450 91 F 5003 ¹	K
	2FE	1 987 43 M 2020	I

Serie CL (215,216) 500 , 4MATIC

5,5 285 M 273.961 <E 55>; M 273.968 <E 55>	06.06-07.10	1 457 42 P 9263	O
		1 457 43 S 3071	L
		1 987 43 R 2438 ⁸	I

Serie CL (215,216) 500 CGI, CGI 4MATIC

4,7 320 M 278.920 <DE 46 LA>	07.10→	1 987 43 R 2438 ⁸	I
----------------------------------	--------	-------------------------------------	---

Serie CL (215,216) 600

5,5 368 M 275.950 <E 55>	09.02-08.06	1 987 42 S 9402	L
		0 450 90 F 5968 ¹	K
	2FE	1 987 43 M 2020	I

5,5 380 M 275.953 <E 55>	09.06→	1 987 42 S 9402	L
		1 987 43 R 2438 ⁸	I

5,8 270 M 137.970 <E 58>	09.99-08.02	1 457 42 P 9263	O
		1 457 43 S 3788	L
		0 450 91 F 5003 ¹	K
	2FE	1 987 43 M 2020	I

Serie CLC (203)

Serie CLC (203) 160

1,6 95 M 271.911 <KE 16 ML>; M 271.921 <KE 16 ML>	02.09-10.10	1 457 42 P 9261	O
		1 987 42 S 9401	L
		0 450 91 F 5003 ¹	K
	MKL	1 987 43 R 2370 ⁸	I

Serie CLC (203) 180 KOMPRESSOR

1,8 105 M 271.946 <KE 18 ML>	03.08-05.10	1 457 42 P 9261	O
		1 987 42 S 9401	L
		0 450 91 F 5003 ¹	K
	MKL	1 987 43 R 2370 ⁸	I



Serie CLC (203) 200 CDI

2,2 90 OM 646.962 <DE 22 LA>	03.08-05.10	1 457 42 P 9116	O
		F 026 40 S 0024	L
		1 457 43 N 4437 ¹	K
	MKL	1 987 43 R 2370 ⁸	I

Serie CLC (203) 200 KOMPRESSOR

1,8 135 M 271.955 <KE 18 ML>	03.08-05.10	1 457 42 P 9261	O
		1 987 42 S 9401	L
		0 450 91 F 5003 ¹	K
	MKL	1 987 43 R 2370 ⁸	I

Serie CLC (203) 220 CDI

2,2 110 OM 646.963 <DE 22 LA>	03.08-05.10	1 457 42 P 9116	O
		F 026 40 S 0024	L
		1 457 43 N 4437 ¹	K
	MKL	1 987 43 R 2370 ⁸	I

Serie CLC (203) 230

2,5 150 M 272.920 <E 25>	03.08-05.10	1 457 42 P 9263	O
		1 457 43 S 3071	L
		0 450 91 F 5003 ¹	K
	KBF	1 987 43 R 2370 ⁸	I

Serie CLC (203) 350

3,5 200 M 272.960 <E 35>	03.08-05.10	1 457 42 P 9263	O
		1 457 43 S 3071	L
		0 450 91 F 5003 ¹	K
	KBF	1 987 43 R 2370 ⁸	I

Serie CLK (208,209)

Serie CLK (208,209) 55 AMG

5,4 255 M 113.984 <E55>	05.99-04.02	1 457 42 P 9263	O
		0 450 91 F 5003 ¹	K
	KL	1 987 43 R 2301 ⁸	I
	MKL	1 987 43 M 2001	I

5,4 270 M 113.987 <E 55>	08.01-08.06	1 457 42 P 9263	O
		1 457 43 S 3071	L
		0 450 91 F 5003 ¹	K
		1 987 43 M 2070	I

Serie CLK (208,209) 63 AMG

6,2 354/373 M 156.982 <E 63>	09.06-12.09	F 026 40 S0152	L
		MKL	1 987 43 R 2370 ⁸
		I	





Serie CLK (208,209) 200 , KOMPRESSOR			
2,0 100/142 M 111.944 <E20 ML>; M 111.945 <E20>			
	09.96-06.00	1 457 42 P 9122	O
		1 457 43 S 3752	L
	BO	0 450 90 F 5275 ¹	K
	KL	1 987 43 R 2301 ⁸	I
	KL	1 987 43 M 2001	I

Serie CLK (208,209) 270 CDI			
2,7 125 OM 612.962; 967 <DE LA>			
	09.02-03.05	1 457 42 P 9116	O
		1 457 43 S 3065	L
Mot.Nr. →30 044707	09.02-03.05	1 457 43 N 1704	K
Mot.Nr. 30 044708→	09.02-03.05	1 457 43 N 4416 ¹	K
	09.02-03.05	1 987 43 M 2070	I

Serie CLK (208,209) 200 CGI KOMPRESSOR, KOMPRESSOR			
1,8 120/125 M 271.940 <KE 18 ML>; M 271.942 <DE 18 ML>			
	05.02-09.06	1 457 42 P 9261	O
		1 987 42 S 9401	L
		0 450 91 F 5003 ¹	K
		1 987 43 M 2070	I

Serie CLK (208,209) 280			
3,0 170 M 272.940 <E 30>			
	04.05-12.09	1 457 42 P 9263	O
		1 457 43 S 3071	L
		0 450 91 F 5003 ¹	K
	04.05-04.09	1 987 43 R 2370 ⁸	I
	04.05-12.09	1 987 43 M 2070	I

Serie CLK (208,209) 200 KOMPRESSOR			
1,8 135 M 271.955 <KE 18 ML>			
	10.06-12.09	1 457 42 P 9261	O
		1 987 42 S 9401	L
		0 450 91 F 5003 ¹	K
	MKL	1 987 43 R 2370 ⁸	I

Serie CLK (208,209) 320			
3,2 160 M 112.940 <E32>			
	01.97-01.03	1 457 42 P 9263	O
		1 457 43 S 3752	L
		0 450 91 F 5003 ¹	K
		KL 1 987 43 R 2301 ⁸	I
		KL 1 987 43 M 2001	I

2,0 120 M 111.956 <E 20 EVO ML>			
	06.00-01.03	1 457 42 P 9122	O
		1 457 43 S 3752	L
		0 450 91 F 5003 ¹	K
	KL	1 987 43 R 2301 ⁸	I
	KL	1 987 43 M 2001	I

3,2 160 M 112.955 <E 32>			
	05.02-03.05	1 457 42 P 9263	O
		1 457 43 S 3071	L
		0 450 91 F 5003 ¹	K
		1 987 43 M 2070	I

Serie CLK (208,209) 220 CDI			
2,1 110 OM 646.966 <DE 22 LA>			
	04.05-04.09	1 457 42 P 9116	O
		F 026 40 S 0024	L
		1 457 43 N 4437 ¹	K
	MKL	1 987 43 R 2370 ⁸	I

Serie CLK (208,209) 320 CDI			
3,0 165 OM 642.910 <D 30>			
	04.05-12.09	F 026 40 P 7008	O
		LAB F 026 40 S 0215	L
		RAB F 026 40 S 0216	L
		WAS 1 457 43 N 4437 ¹	K
		WAS F 026 40 N 2056 ¹	K
	04.05-04.09	1 987 43 M 2070	I
	04.05-12.09	1 987 43 R 2370 ⁸	I

Serie CLK (208,209) 230 KOMPRESSOR			
2,3 142 M 111.975 <E23 ML>			
	06.97-06.00	1 457 42 P 9122	O
		1 457 43 S 3752	L
	BO	0 450 90 F 5275 ¹	K
	KL	1 987 43 R 2301 ⁸	I
	KL	1 987 43 M 2001	I

Serie CLK (208,209) 350			
3,5 200 M 272.960 <E 35>			
	04.05-12.09	1 457 42 P 9263	O
		1 457 43 S 3071	L
		0 450 91 F 5003 ¹	K
		MKL 1 987 43 R 2370 ⁸	I

2,3 145 M 111.982 <EVO ML>			
	06.00-01.03	1 457 42 P 9122	O
		1 457 43 S 3752	L
		0 450 91 F 5003 ¹	K
	KL	1 987 43 R 2301 ⁸	I
	KL	1 987 43 M 2001	I

Serie CLK (208,209) 430			
4,3 205 M 113.943 <E43>			
	09.98-01.03	1 457 42 P 9263	O
		0 450 91 F 5003 ¹	K
		KL 1 987 43 R 2301 ⁸	I
		KL 1 987 43 M 2001	I

Serie CLK (208,209) 240			
2,6 125 M 112.912 <E 26>			
	05.02-03.05	1 457 42 P 9263	O
		1 457 43 S 3071	L
		0 450 91 F 5003 ¹	K
		1 987 43 M 2070	I





Serie CLK (208,209) 500

5,0 225 M 113.968 <E 50>	05.02-07.06	1 457 42 P 9263	O
		1 457 43 S 3071	L
		0 450 91 F 5003 ¹	K
		1 987 43 M 2070	I

5,0 285 M 273.967 <E 55>	09.06-12.09	1 457 42 P 9263	O
		1 457 43 S 3071	L
	09.06-04.09 MKL	1 987 43 M 2070	I
		09.06-12.09 MKL	1 987 43 R 2370 ⁸

Serie CLS (218,219)

Serie CLS (218,219) 55 AMG

5,4 350 M 113.990 <E 55>	06.04-08.06	1 457 42 P 9263	O
		1 987 43 R 2381	I

Serie CLS (218,219) 63 AMG

5,5 386 M 157.98... <DE 55 LA / E 60>	10.10→	1 987 43 R 2326 ⁸	I
6,2 378 M 156.983 <E 63>	04.06→	F 026 40 S 0152	L
		1 987 43 R 2381	I

Serie CLS (218,219) 250 CDI

2,1 150 OM 651.924 <D 22 LHD>	10.10→	F 026 40 S 0133	L
		1 987 43 R 2326 ⁸	I

Serie CLS (218,219) 280

3,0 170 M 272.943 <E 30>	01.08-04.09	1 457 42 P 9263	O
		1 457 43 S 3071	L
		1 987 43 R 2381	I

Serie CLS (218,219) 300

3,0 170 M 272.943 <E 30>	05.09-09.09	1 457 42 P 9263	O
		1 457 43 S 3071	L
		1 987 43 R 2381	I

Serie CLS (218,219) 320 CDI

3,0 165 OM 642.920 <D 30>	05.05-04.09	F 026 40 P 7008	O
		LAB F 026 40 S 0215	L
		RAB F 026 40 S 0216	L
		SCJ F 026 40 N 2056 ¹	K
		SCJ 1 457 43 N 4437 ¹	K
		1 987 43 R 2381	I

Serie CLS (218,219) 350 , CGI

3,5 200/215 M 272.964 <E 35>; M 272.985 <DE 35>	06.04→	1 457 42 P 9263	O
		1 457 43 S 3071	L
		1 987 43 R 2381	I



Serie CLS (218,219) 350 CDI

3,0 165 OM 642.920 <D 30>	05.09-09.09	F 026 40 P 7008	O
		LAB F 026 40 S 0215	L
		RAB F 026 40 S 0216	L
		SCJ F 026 40 N 2056 ¹	K
		SCJ 1 457 43 N 4437 ¹	K
		1 987 43 R 2381	I

Serie CLS (218,219) 350 CDI, CDI 4MATIC

3,0 195 OM 642.853 <D 30 LHD>; OM 642.854 <D 30 LHD REPO GEST>	10.10→	F 026 40 P 7008	O
		1 987 43 R 2326 ⁸	I

Serie CLS (218,219) 350 CGI

3,5 225 M 276.952 <DE 35>	10.10→	1 987 43 R 2326 ⁸	I
-------------------------------	--------	-------------------------------------	----------

Serie CLS (218,219) 500

5,0 225 M 113.967 <E 50>	06.04-04.06	1 457 42 P 9263	O
		1 457 43 S 3071	L
		1 987 43 R 2381	I

5,5 285 M 273.960 <E 55>	04.06→	1 457 42 P 9263	O
		1 457 43 S 3071	L
		1 987 43 R 2381	I

Serie CLS (218,219) 500 , 4MATIC

4,7 300 M 278.922 <DE 46 LA>; M 278.922 <DELA 46>	02.11→	1 987 43 R 2326 ⁸	I
---	--------	-------------------------------------	----------

Serie E

Serie E 300 AMG E 3.4

3,4 200 M 104.980	02.92-06.93	1 457 42 P 9122	O
		1 457 42 S 9786	L
Fg.Nr. A368937→	02.92-06.93	0 450 90 F 5177 ¹	K
Fg.Nr. →A368936	02.92-06.93	0 450 90 F 5203 ¹	K
	02.92-06.93	1 457 42 P 9416 ³	P

Serie E (124)

Serie E (124) 36 AMG

3,6 195 M 104.992	07.93-02.94	1 457 42 P 9122	O
		LUM 1 457 43 S 3701	L
Fg.Nr. C226336→	07.93-02.94	0 450 90 F 5275 ¹	K
Fg.Nr. →C226335	07.93-02.94	0 450 90 F 5203 ¹	K
	07.93-02.94	2FE 1 987 43 M 2051	I
		1 457 42 P 9416 ³	P

3,6 195-200 M 104.992	03.94-05.96	1 457 42 P 9122	O
		LUM 1 457 43 S 3701	L
		0 450 90 F 5203 ¹	K
		2FE 1 987 43 M 2051	I
		1 457 42 P 9416 ³	P





3,6 200 M 104.992			
	03.94-06.98	1 457 42	P 9122 O
		LUM	1 457 43 S 3701 L
Fg.Nr. C226336→	03.94-06.98	0 450 90	F 5275¹ K
Fg.Nr. →C226335	03.94-06.98	0 450 90	F 5203¹ K
	03.94-06.98	2FE	1 987 43 M 2051 I
			1 457 42 P 9416³ P

Serie E (124) 60 AMG

6,0 280 M 119.974			
	07.93-06.95	1 457 42	P 9616 O
		KNE	1 457 43 S 3700 L
			0 450 90 F 5203¹ K

Serie E (124) 200

2,0 100 M 111.940			
	07.93-06.98	1 457 42	P 9122 O
			1 457 43 S 3607 L
			0 450 90 F 5203¹ K
Fg.Nr. C226336→	07.93-06.98	0 450 90	F 5275¹ K
Fg.Nr. →C226335	07.93-06.98	0 450 90	F 5203¹ K
	07.93-06.98	2FE	1 987 43 M 2051 I

Serie E (124) 200 D

2,0 55 OM 601.912			
	07.93-06.95	1 457 42	P 9274 O
			1 457 42 S 9875 L
			1 457 43 N 4123² K
		2FE	1 987 43 M 2051 I

Serie E (124) 220

2,2 110 M 111.960			
	07.93-06.98	1 457 42	P 9122 O
			1 457 43 S 3607 L
			0 450 90 F 5203¹ K
Fg.Nr. C226336→	07.93-06.98	0 450 90	F 5275¹ K
Fg.Nr. →C226335	07.93-06.98	0 450 90	F 5203¹ K
	07.93-06.98	2FE	1 987 43 M 2051 I

Serie E (124) 250 D

2,5 83 OM 605.911			
Mot.Nr. →..010704	07.93-05.96	AG	1 457 42 P 9274 O
Mot.Nr. →..028586	07.93-05.96	GS	1 457 42 P 9274 O
Mot.Nr. →..010705→	07.93-05.96	AG	1 457 42 P 9278 O
Mot.Nr. →..028587→	07.93-05.96	GS	1 457 42 P 9278 O
	07.93-05.96		1 457 43 S 3002 L
			1 457 43 N 4123² K
		2FE	1 987 43 M 2051 I

Serie E (124) 250 D Turbo

2,5 93 OM 602.962			
	07.93-06.95	1 457 42	P 9274 O
			1 457 43 S 3002 L
			0 450 90 N 4077¹ K
			1 457 43 N 4123² K
		2FE	1 987 43 M 2051 I

Serie E (124) 280

2,8 142 M 104.942			
	07.93-06.95	1 457 42	P 9122 O
		LUM	1 457 43 S 3701 L
			0 450 90 F 5203¹ K
			1 457 42 P 9416³ P

2,8 | 142-145 | M 104.942

	07.93-05.96	1 457 42	P 9122 O
		LUM	1 457 43 S 3701 L
			0 450 90 F 5203¹ K
		2FE	1 987 43 M 2051 I
			1 457 42 P 9416³ P

Serie E (124) 300 D

3,0 100 OM 606.910			
	07.93-05.96	1 457 42	P 9274 O
			1 457 43 S 3002 L
			1 457 43 N 4123² K
		2FE	1 987 43 M 2051 I

Serie E (124) 300 D Turbo, D Turbo 4MATIC

3,0 105-108 OM 603.960; OM 603.963			
	07.93-05.96	1 457 42	P 9274 O
			1 457 42 S 9949 L
			0 450 90 N 4077¹ K
			1 457 43 N 4123² K
		2FE	1 987 43 M 2051 I
			1 457 42 P 9416³ P

Serie E (124) 300 4MATIC

3,0 132 M 103.985			
	07.93-06.95	0 451 10	P 3105 O
		LUM	1 457 42 S 9970 L
			0 450 90 F 5203¹ K
Fg.Nr. A368937→	07.93-06.95	0 450 90	F 5177¹ K
Fg.Nr. →A368936	07.93-06.95	0 450 90	F 5203¹ K
	07.93-06.95	2FE	1 987 43 M 2051 I
			1 457 42 P 9416³ P

Serie E (124) 320

3,2 162 M 104.992			
	07.93-06.98	1 457 42	P 9122 O
		LUM	1 457 43 S 3701 L
			0 450 90 F 5203¹ K
Fg.Nr. C226336→	07.93-06.98	0 450 90	F 5275¹ K
Fg.Nr. →C226335	07.93-06.98	0 450 90	F 5203¹ K
	07.93-06.95	2FE	1 987 43 M 2051 I
	07.93-06.98		1 457 42 P 9416³ P

3,2 | 162-170 | M 104.992

	05.93-06.98	1 457 42	P 9122 O
		LUM	1 457 43 S 3701 L
Fg.Nr. C226336→	05.93-06.98	0 450 90	F 5275¹ K
Fg.Nr. →C226335	05.93-06.98	0 450 90	F 5203¹ K
	05.93-06.98		1 457 42 P 9416³ P





Serie E (124) 420

4,2 205/210 M 119.975	07.93-06.95	1 457 42 P 9616	O
		KNE 1 457 43 S 3700	L
		0 450 90 F 5203 ¹	K
	2FE	1 987 43 M 2051	I

Serie E (124) 500

5,0 235-240 M 119.974	07.93-06.95	1 457 42 P 9616	O
		KNE 1 457 43 S 3700	L
		0 450 90 F 5203 ¹	K
	2FE	1 987 43 M 2051	I

Serie E (207,212)

Serie E (207,212) 63 AMG

5,5 386/410 M 157.98... <DE 55 LA>	02.11→	1 987 43 R 2326 ⁸	I
6,2 386 M 156.985 <E 63>; M 156.985 <M 156 E63>	04.09→	F 026 40 S 0152	L
		1 987 43 R 2326 ⁸	I

Serie E (207,212) 200 CDI

2,1 100 OM 651.925 <D 22 LHD RED>; OM 651.925 <D 22 R>	04.09→	F 026 40 S 0133	L
		WAS F 026 40 N 2065 ¹	K
		1 987 43 R 2326 ⁸	I

Serie E (207,212) 200 CGI

1,8 135 M 271.8... <DE 18 EVO>; M 271.860 <DE 18 EVO>	04.09→	F 026 40 S 0134	L
		1 987 43 R 2326 ⁸	I

Serie E (207,212) 200 NGT

1,8 120 M 271.958 <KE 18 ML>	01.11→	1 457 42 P 9261	O
		1 987 42 S 9401	L
		1 987 43 R 2326 ⁸	I

Serie E (207,212) 220 CDI

2,1 125 OM 651.911 <D 22 G>	07.09→	F 026 40 S 0133	L
	07.09-03.10 WAS	F 026 40 N 2065 ¹	K
	07.09→	1 987 43 R 2326 ⁸	I

2,1 125 OM 651.924 <D 22 LHD>; OM 651.924 <D 22 LL>	12.08→	F 026 40 S 0133	L
		WAS F 026 40 N 2065 ¹	K
		1 987 43 R 2326 ⁸	I

Serie E (207,212) 250 CDI

2,1 150 OM 651.911 <D 22 G>	02.09→	F 026 40 S 0133	L
	02.09-03.10 FIU	F 026 40 N 2065 ¹	K
	02.09→	1 987 43 R 2326 ⁸	I

2,1 150 OM 651.924 <D 22 LHD>; OM 651.924 <D 22 LL>	12.08→	F 026 40 S 0133	L
		WAS F 026 40 N 2065 ¹	K
		1 987 43 R 2326 ⁸	I



Serie E (207,212) 250 CDI 4MATIC

2,1 150 OM 651.924 <D 22 LHD>; OM 651.924 <D 22 LL>	01.11→	F 026 40 S 0133	L
		1 987 43 R 2326 ⁸	I

Serie E (207,212) 250 CGI

1,8 150 M 271.860 <DE 18>; M 271.860 <DE 18 EVO>; M 271.860 <DE 35>	02.09→	F 026 40 S 0134	L
		1 987 43 R 2326 ⁸	I

Serie E (207,212) 280

3,0 170 M 272.952 <E 30>	02.10→	1 457 42 P 9263	O
		1 457 43 S 3071	L
		1 987 43 R 2326 ⁸	I

Serie E (207,212) 300

3,0 170 M 272.952 <E 30>	04.09→	1 457 42 P 9263	O
		1 457 43 S 3071	L
		1 987 43 R 2326 ⁸	I

Serie E (207,212) 300 , CGI, 4MATIC

3,5 185 M 276.952 <DE 35>; M 276.957 <DE 35>	01.11→	1 987 43 R 2326 ⁸	I
--	--------	------------------------------	---

Serie E (207,212) 300 CDI

3,0 150 OM 642.850 <D 30 LHD REPO>	12.09-12.10	F 026 40 P 7008	O
		WAS F 026 40 N 2065 ¹	K
		1 987 43 R 2326 ⁸	I

3,0 | 170 | OM 642.850 <D 30 LHD REPO>

	01.11→	F 026 40 P 7008	O
		LAB,SCJ F 026 40 S 0215	L
		RAB,SCJ F 026 40 S 0216	L
		HEI,SWA F 026 40 N 2065 ¹	K
		1 987 43 R 2326 ⁸	I

Serie E (207,212) 350

3,5 200 M 272.988 <E 35>	01.10→	1 457 42 P 9263	O
Komp.Nr. 2U3	01.10→	1 457 43 S 3071	L
	01.10→	1 987 43 R 2326 ⁸	I

Serie E (207,212) 350 , CGI

3,5 200/215 M 272.980 <M272 E35>; M 272.983 <DE 35>	04.09→	1 457 42 P 9263	O
		1 457 43 S 3071	L
		1 987 43 R 2326 ⁸	I

Serie E (207,212) 350 , CGI, 4MATIC

3,5 225 M 276.952 <DE 35>; M 276.952 <E 35>; M 276.952 <M272 E35>; M 276.957 <DE 35>	02.11→	1 987 43 R 2326 ⁸	I
--	--------	------------------------------	---

Serie E (207,212) 350 , 4MATIC

3,5 200 M 272.961 <E 35>; M 272.977 <E 35>	01.09→	1 457 42 P 9263	O
		1 457 43 S 3071	L
		1 987 43 R 2326 ⁸	I





Serie E (207,212) 350 BlueTec

3,0 155 OM 642.850 <D 30>; OM 642.850 <D 30 LHD REPO>			
04.09→	F 026 40	P 7008	O
	LAB,SCJ	F 026 40	S 0215 L
	RAB,SCJ	F 026 40	S 0216 L
	WAS	F 026 40	N 2065 ¹ K
		1987 43	R 2326 ⁸ I

Serie E (207,212) 350 CDI

3,0 170 OM 642.836 <D 30>			
02.09-03.11	F 026 40	P 7008	O
	WAS	1457 43	N 4437 ¹ K
		1987 43	R 2326 ⁸ I

3,0 170 OM 642.836 <D 30 LHD REPO>			
01.10-01.11	F 026 40	P 7008	O
	WAS	F 026 40	N 2065 ¹ K
		1987 43	R 2326 ⁸ I

3,0 170 OM 642.850 <D 30 LL>			
08.08-11.10	F 026 40	P 7008	O
	WAS	F 026 40	N 2065 ¹ K
		1987 43	R 2326 ⁸ I

3,0 170 OM 642.850 <D 30>; OM 642.850 <D 30 LHD REPO>			
08.09-11.10	F 026 40	P 7008	O
	WAS	F 026 40	N 2065 ¹ K
		1987 43	R 2326 ⁸ I

3,0 195 OM 642.852 <D 30 LHD REPO GEST>; OM 642.852 <D 30 LL>			
12.10→	F 026 40	P 7008	O
	LAB,SCJ	F 026 40	S 0215 L
	RAB,SCJ	F 026 40	S 0216 L
		1987 43	R 2326 ⁸ I

Serie E (207,212) 350 CDI 4MATIC

3,0 170 OM 642.856 <D 30>; OM 642.856 <D 30 LHD REPO>			
04.09-11.10	F 026 40	P 7008	O
	WAS	F 026 40	N 2065 ¹ K
		1987 43	R 2326 ⁸ I

3,0 195 OM 642.858 <D 30 LHD REP GEST>; OM 642.858 <D 30 LHD REPO>			
12.10→	F 026 40	P 7008	O
	LAB,SCJ	F 026 40	S 0215 L
	RAB,SCJ	F 026 40	S 0216 L
		1987 43	R 2326 ⁸ I

Serie E (207,212) 350 CGI

3,5 215 M 272.98... <DES 35>			
02.09-01.11	1457 42	P 9263	O
	1987 43	R 2326 ⁸	I

Serie E (207,212) 500

5,5 285 M 273.966 <E 55>			
02.09-01.11	1457 42	P 9263	O
	1987 43	R 2326 ⁸	I

Serie E (207,212) 500 , CGI, 4MATIC

4,7 300 M 278.922 <DE 46 LA>; M 278.922 <DELA 46>			
02.11→	1987 43	R 2326 ⁸	I



Serie E (207,212) 500 , 4MATIC

5,5 285 M 273.970 <E 55>; M 273.971 <E 55>; M 273.971 <E 55 KE>			
01.09→	1457 42	P 9263	O
	1457 43	S 3071	L
	1987 43	R 2326 ⁸	I

Serie E (210)

Serie E (210) 50 AMG

5,0 205-235 M 119.980,985			
01.96-08.97	1457 42	P 9616	O
Mot.Typ M 119.980	01.96-08.97	KNE	1457 43 S 3700 L
Mot.Typ M 119.985	01.96-08.97	LUM	1457 43 S 3699 L
	01.96-08.97		0450 90 F 5275 ¹ K
		KL	1987 43 R 2301 ⁸ I
		KL	1987 43 M 2001 I
		2FE,MKL	1987 43 M 2020 I

Serie E (210) 55 AMG

5,5 260 M 113.980 <E55>			
09.97-03.03	1457 42	P 9263	O
	0450 91	F 5003 ¹	K
	KL	1987 43	R 2301 ⁸ I
	KL	1987 43	M 2001 I
	2FE,MKL	1987 43	M 2020 I

Serie E (210) 200

2,0 100 M 111.942 <E20>			
06.95-01.03	1457 42	P 9122	O
06.95-08.99	KNE	1457 43	S 3699 L
09.99-01.03	LUM	1457 43	S 3523 L
06.95-01.03		0450 90	F 5275 ¹ K
	KL	1987 43	R 2301 ⁸ I
	KL	1987 43	M 2001 I
	2FE,MKL	1987 43	M 2020 I

Serie E (210) 200 CDI

2,1 85 OM 611.961 <DE LA>			
07.99-03.02	1457 42	P 9116	O
07.99-08.99		1457 43	S 3699 L
09.99-03.02		1457 43	S 3065 L
07.99-03.02		1457 43	N 1704 K
	KL	1987 43	R 2301 ⁸ I
	KL	1987 43	M 2001 I
	2FE,MKL	1987 43	M 2020 I

2,2 | 75 | OM 611.961 <DE LA>

07.98-03.02	1457 42	P 9116	O
07.98-08.99		1457 43	S 3699 L
07.98-03.02		1457 43	N 1704 K
	KL	1987 43	R 2301 ⁸ I
	KL	1987 43	M 2001 I
	2FE,MKL	1987 43	M 2020 I





Serie E (210) 200 D

2,0 65 OM 604.917 <D20>			
03.97-05.99	1 457 42	P 9278	O
	1 457 43	S 3699	L
	WAS	1 457 43 N 4123 ²	K
	WAS, WW	1 457 43 N 4331 ²	K
	KL	1 987 43 R 2301 ⁸	I
	KL	1 987 43 M 2001	I
	2FE, MKL	1 987 43 M 2020	I

Serie E (210) 200 KOMPRESSOR

2,0 120 M 111.957 <E20 EVO ML>			
09.00-01.03	1 457 42	P 9122	O
	LUM	1 457 43 S 3523	L
		0 450 91 F 5003 ¹	K
	KL	1 987 43 R 2301 ⁸	I
	KL	1 987 43 M 2001	I
	2FE, MKL	1 987 43 M 2020	I

2,0 137 M 111.947 <E20>			
09.97-01.03	1 457 42	P 9122	O
	1 457 43	S 3699	L
09.97-05.99	0 450 91	F 5003 ¹	K
09.97-08.00	0 450 90	F 5275 ¹	K
07.99-01.03	0 450 91	F 5003 ¹	K
09.97-01.03	KL	1 987 43 R 2301 ⁸	I
	KL	1 987 43 M 2001	I
	2FE, MKL	1 987 43 M 2020	I

Serie E (210) 220 CDI

2,1 100-105 OM 611.961 <DELA>			
07.99-01.03	1 457 42	P 9116	O
07.99-08.99	1 457 43	S 3699	L
09.99-01.03	1 457 43	S 3065	L
07.99-01.03	1 457 43	N 1704	K
	KL	1 987 43 R 2301 ⁸	I
	KL	1 987 43 M 2001	I
	2FE, MKL	1 987 43 M 2020	I

2,2 92 OM 611.961 <DELA>			
07.98-05.99	1 457 42	P 9116	O
	1 457 43	S 3699	L
	1 457 43	N 1704	K
	KL	1 987 43 R 2301 ⁸	I
	KL	1 987 43 M 2001	I
	2FE, MKL	1 987 43 M 2020	I

Serie E (210) 220 D

2,2 55-70 OM 604.912 <D22>			
06.95-05.99	1 457 42	P 9278	O
	1 457 43	S 3699	L
	WAS	1 457 43 N 4123 ²	K
	WAS, WW	1 457 43 N 4331 ²	K
	KL	1 987 43 R 2301 ⁸	I
	KL	1 987 43 M 2001	I
	2FE, MKL	1 987 43 M 2020	I



Serie E (210) 230

2,3 110 M 111.970 <E23>			
06.95-08.97	1 457 42	P 9122	O
	1 457 43	S 3699	L
	0 450 90	F 5275 ¹	K
	KL	1 987 43 R 2301 ⁸	I
	KL	1 987 43 M 2001	I
	2FE, MKL	1 987 43 M 2020	I

Serie E (210) 240

2,4 125 M 112.911 <E24>			
09.97-01.03	1 457 42	P 9263	O
09.97-08.99	LUM	1 457 43 S 3699	L
09.99-01.03	LUM	1 457 43 S 3523	L
09.97-01.03	0 450 91	F 5003 ¹	K
	KL	1 987 43 R 2301 ⁸	I
	KL	1 987 43 M 2001	I
	2FE, MKL	1 987 43 M 2020	I

2,6 | 125 | M 112.914 <E26>

06.99-01.03	1 457 42	P 9263	O
09.99-01.03	LUM	1 457 43 S 3523	L
06.99-01.03	0 450 91	F 5003 ¹	K
	KL	1 987 43 R 2301 ⁸	I
	KL	1 987 43 M 2001	I
	2FE, MKL	1 987 43 M 2020	I

Serie E (210) 250 D, D Turbo

2,5 83/110 OM 605.912 <D25>; OM 605.962 <A D25 LA>			
06.95-08.99	1 457 42	P 9278	O
	1 457 43	S 3699	L
	1 457 43	N 4123 ²	K
	KL	1 987 43 R 2301 ⁸	I
	KL	1 987 43 M 2001	I
	2FE, MKL	1 987 43 M 2020	I

Serie E (210) 270 CDI

2,7 125 OM 612.961 <DE LA>			
06.99-01.03	1 457 42	P 9116	O
	1 457 43	S 3065	L
	1 457 43	N 1704	K
	KL	1 987 43 R 2301 ⁸	I
	KL	1 987 43 M 2001	I
	2FE, MKL	1 987 43 M 2020	I

Serie E (210) 280

2,8 142 M 104.945			
01.96-02.97	1 457 42	P 9122	O
	1 457 43	S 3699	L
	0 450 90	F 5275 ¹	K
	KL	1 987 43 R 2301 ⁸	I
	KL	1 987 43 M 2001	I
	2FE, MKL	1 987 43 M 2020	I
		1 457 42 P 9416 ³	P





Serie E (210) 280 , 4MATIC

2,8|150|M 112.921 <E28>

06.95-01.03		1 457 42	P 9263	O
06.95-08.99	LUM	1 457 43	S 3699	L
09.99-01.03	LUM	1 457 43	S 3523	L
06.95-01.03		0 450 91	F 5003 ¹	K
	KL	1 987 43	R 2301 ⁸	I
	KL	1 987 43	M 2001	I
	2FE,MKL	1 987 43	M 2020	I

Serie E (210) 290 D Turbo

2,9|95|OM 602.982 <DE LA>

01.96-05.99		1 457 42	P 9278	O
		1 457 43	S 3699	L
		1 457 43	N 4123 ²	K
	KL	1 987 43	R 2301 ⁸	I
	KL	1 987 43	M 2001	I
	2FE,MKL	1 987 43	M 2020	I

Serie E (210) 300 D

3,0|100|OM 606.912

06.95-08.95		1 457 42	P 9274	O
06.95-08.97		1 457 42	P 9278	O
		1 457 43	S 3699	L
		1 457 43	N 4123 ²	K
	KL	1 987 43	R 2301 ⁸	I
	KL	1 987 43	M 2001	I
	2FE,MKL	1 987 43	M 2020	I

Serie E (210) 300 D Turbo

3,0|130|OM 606.962 <D30 LA>

03.97-05.99		1 457 42	P 9278	O
		1 457 43	S 3699	L
		1 457 43	N 4123 ²	K
	KL	1 987 43	R 2301 ⁸	I
	KL	1 987 43	M 2001	I
	2FE,MKL	1 987 43	M 2020	I

Serie E (210) 320

3,2|162|M 104.995

06.95-02.97		1 457 42	P 9122	O
		1 457 43	S 3699	L
		0 450 90	F 5275 ¹	K
	KL	1 987 43	R 2301 ⁸	I
	KL	1 987 43	M 2001	I
	2FE,MKL	1 987 43	M 2020	I
		1 457 42	P 9416 ³	P

3,2|165|M 112.941 <E32>

03.97-05.99		1 457 42	P 9263	O
07.99-08.03		1 457 42	P 9263	O
03.97-05.99	LUM	1 457 43	S 3699	L
07.99-07.99	LUM	1 457 43	S 3699	L
08.99-08.03	LUM	1 457 43	S 3523	L
03.97-05.99		0 450 91	F 5003 ¹	K
07.99-08.03		0 450 91	F 5003 ¹	K
03.97-05.99	KL	1 987 43	R 2301 ⁸	I
	KL	1 987 43	M 2001	I
	2FE,MKL	1 987 43	M 2020	I
07.99-08.03	KL	1 987 43	R 2301 ⁸	I
	KL	1 987 43	M 2001	I
	2FE,MKL	1 987 43	M 2020	I

Serie E (210) 320 CDI

3,2|145|OM 613.961 <DE LA>

06.99-01.03		1 457 42	P 9126	O
		1 457 43	S 3065	L
		1 457 43	N 1704	K
	KL	1 987 43	R 2301 ⁸	I
	KL	1 987 43	M 2001	I
	2FE,MKL	1 987 43	M 2020	I

Serie E (210) 320 4MATIC

3,2|165|M 112.941 <E32>

06.97-05.99		1 457 42	P 9263	O
07.99-02.03		1 457 42	P 9263	O
06.97-05.99	LUM	1 457 43	S 3699	L
07.99-07.99	LUM	1 457 43	S 3699	L
08.99-02.03	LUM	1 457 43	S 3523	L
06.97-05.99		0 450 91	F 5003 ¹	K
07.99-02.03		0 450 91	F 5003 ¹	K
06.97-05.99	KL	1 987 43	R 2301 ⁸	I
	KL	1 987 43	M 2001	I
	2FE,MKL	1 987 43	M 2020	I
07.99-02.03	KL	1 987 43	R 2301 ⁸	I
	KL	1 987 43	M 2001	I
	2FE,MKL	1 987 43	M 2020	I

Serie E (210) 420

4,2|205|M 119.985

01.96-08.97		1 457 42	P 9616	O
	LUM	1 457 43	S 3699	L
		0 450 90	F 5275 ¹	K
	KL	1 987 43	R 2301 ⁸	I
	KL	1 987 43	M 2001	I
	2FE,MKL	1 987 43	M 2020	I

Serie E (210) 430 , 4MATIC

4,3|205|M 113.940 <E43>

06.97-01.03		1 457 42	P 9263	O
06.97-07.99	LUM	1 457 43	S 3699	L
08.99-01.03	LUM	1 457 43	S 3523	L
06.97-01.03		0 450 91	F 5003 ¹	K
	KL	1 987 43	R 2301 ⁸	I
	KL	1 987 43	M 2001	I
	2FE,MKL	1 987 43	M 2020	I





Serie E (211)

Serie E (211) 55 AMG KOMPRESSOR

5,4 350 M 113.990 <E 55 ML AMG>	10.02-05.06	1457 42 P 9263	O
		1987 43 R 2512⁸	I
		KL 1987 43 R 2381	I
		MKL 1987 43 M 2081	I
		MKL,RLE 1987 43 M 2281	I

Serie E (211) 63 AMG

6,2 378 M 156.983 <E 63 AMG>	06.06-08.09	F 026 40 S 0152	L
		1987 43 R 2381	I
		1987 43 R 2512⁸	I

Serie E (211) 200 CDI

2,1 75/90 OM 646.951 <DE 22 LA>	07.02-09.08	1457 42 P 9116	O
		1457 43 S 3333	L
		1457 43 N 4437¹	K
		1987 43 R 2512⁸	I
		KL 1987 43 R 2381	I
		MKL 1987 43 M 2081	I
		MKL,RLE 1987 43 M 2281	I

2,1 | 100 | OM 646.82... <DE 22 LA LL>; OM 646.821 <DE 22 LA LL>

	04.06-08.09	1457 42 P 9116	O
		F 026 40 S 0205	L
		1457 43 N 4437¹	K
		1987 43 R 2381	I
		1987 43 R 2512⁸	I

Serie E (211) 200 KOMPRESSOR

1,8 135 M 271.956 <KE 18 ML>	04.06-08.09	1457 42 P 9261	O
		1987 42 S 9401	L
		1987 43 R 2381	I
		1987 43 R 2512⁸	I

Serie E (211) 200 KOMPRESSOR, KOMPRESSOR NGT

1,8 120 M 271.941 <KE 18 ML>	03.02-09.08	1457 42 P 9261	O
		1987 42 S 9401	L
		1987 43 R 2512⁸	I
		KL 1987 43 R 2381	I
		MKL 1987 43 M 2081	I
		MKL,RLE 1987 43 M 2281	I

Serie E (211) 220 CDI

2,1 100/110 OM 646.961 <DE 22 LA>	03.02-08.09	1457 42 P 9116	O
		1457 43 S 3333	L
		1457 43 N 4437¹	K
		1987 43 R 2512⁸	I
		KL 1987 43 R 2381	I
		MKL 1987 43 M 2081	I
		MKL,RLE 1987 43 M 2281	I



2,1 | 125 | OM 646.821 <DE 22 LA LL>

	04.06-08.09	1457 42 P 9116	O
		F 026 40 S 0205	L
		1457 43 N 4437¹	K
		1987 43 R 2381	I
		1987 43 R 2512⁸	I

Serie E (211) 230

2,5 150 M 272.922 <E 25>	09.07-08.09	1457 42 P 9263	O
		1457 43 S 3071	L
		1987 43 R 2381	I
		1987 43 R 2512⁸	I

Serie E (211) 240 , 4MATIC

2,6 130 M 112.913 <E 26>; M 112.917 <E 26>	03.02-08.09	1457 42 P 9263	O
		1457 43 S 3071	L
		1987 43 R 2512⁸	I
		KL 1987 43 R 2381	I
		MKL 1987 43 M 2081	I
		MKL,RLE 1987 43 M 2281	I

Serie E (211) 270 CDI

2,7 130 OM 647.961 <DE 27 LA>	03.02-03.05	1457 42 P 9116	O
Fg.Nr. A 196440→	03.02-03.05	1457 43 S 3334	L
Fg.Nr. →A 196439	03.02-03.05	1457 43 S 3333	L
	03.02-03.05	1457 43 N 4437¹	K
		1987 43 R 2512⁸	I
		KL 1987 43 R 2381	I
		MKL 1987 43 M 2081	I
		MKL,RLE 1987 43 M 2281	I

Serie E (211) 280 , 4MATIC

3,0 170 M 272.943 <E 30>; M 272.944 <E 30>	04.05-08.09	1457 42 P 9263	O
		1457 43 S 3071	L
		1987 43 R 2381	I
		1987 43 R 2512⁸	I

Serie E (211) 280 CDI

3,2 130 OM 648.961 <DE 32 LA>	04.04-03.05	1457 42 P 9126	O
		1457 43 S 3334	L
		1457 43 N 4437¹	K
		1987 43 R 2512⁸	I
		KL 1987 43 R 2381	I
		MKL 1987 43 M 2081	I
		MKL,RLE 1987 43 M 2281	I

Serie E (211) 280 CDI, CDI 4MATIC

3,0 140 OM 642.920 <D 30>; OM 642.921 <D 30>	04.05-08.09	F 026 40 P 7008	O
		LAB F 026 40 S 0215	L
		RAB F 026 40 S 0216	L
		1457 43 N 4437¹	K
		1987 43 R 2381	I
		1987 43 R 2512⁸	I





Serie E (211) 300 BlueTec

3,0 155 OM 642.920 <D 30>			
12.07-01.09	F 026 40	P 7008	O
	LAB	F 026 40	S 0215 L
	RAB	F 026 40	S 0216 L
		1 457 43	N 4437 ¹ K
		1 987 43	R 2381 I
		1 987 43	R 2512 ⁸ I

Serie E (211) 320 , 4MATIC

3,2 165 M 112.949 <E 32>;M 112.954 <E 32>			
03.02-03.05	1 457 42	P 9263	O
	1 457 43	S 3071	L
	1 987 43	R 2512 ⁸	I
	KL	1 987 43	R 2381 I
	MKL	1 987 43	M 2081 I
	MKL,RLE	1 987 43	M 2281 I

Serie E (211) 320 CDI

3,2 150 OM 648.961 <DE 32 LA>			
11.02-03.05	1 457 42	P 9126	O
Fg.Nr. A 196440→	11.02-03.05	1 457 43	S 3334 L
Fg.Nr. →A 196439	11.02-03.05	1 457 43	S 3333 L
	11.02-03.05	1 457 43	N 4437 ¹ K
		1 987 43	R 2512 ⁸ I
	KL	1 987 43	R 2381 I
	MKL	1 987 43	M 2081 I
	MKL,RLE	1 987 43	M 2281 I

Serie E (211) 320 CDI, CDI 4MATIC

3,0 165 OM 642.920 <D 30>;OM 642.921 <D 30>			
04.05-08.09	F 026 40	P 7008	O
	LAB	F 026 40	S 0215 L
	RAB	F 026 40	S 0216 L
		1 457 43	N 4437 ¹ K
		1 987 43	R 2381 I
		1 987 43	R 2512 ⁸ I

Serie E (211) 350 , CGI, 4MATIC

3,5 200/215 M 272.964 <E 35>;M 272.972 <E 35>;M 272.985 <DE 35>			
04.05-08.09	1 457 42	P 9263	O
	1 457 43	S 3071	L
	1 987 43	R 2381	I
	1 987 43	R 2512 ⁸	I

Serie E (211) 400 CDI

4,0 191 OM 628.961 <DE 40 LA>			
02.03-04.05	F 026 40	P 7003	O
	LUM,XXX	1 457 43	S 3053 L
		0 450 90	N 6464 ¹ K
		1 987 43	R 2512 ⁸ I
	KL	1 987 43	R 2381 I
	MKL	1 987 43	M 2081 I
	MKL,RLE	1 987 43	M 2281 I



Serie E (211) 420 CDI

4,0 231 OM 629.910 <DE 40 LL>			
09.05-01.09	F 026 40	P 7076	O
	1 457 43	N 4437 ¹	K
	1 987 43	R 2381	I
	1 987 43	R 2512 ⁸	I

Serie E (211) 500

5,0 225 M 113.967 <E 50>			
03.02-03.06	1 457 42	P 9263	O
	1 457 43	S 3071	L
	0 450 91	F 5003 ¹	K
	1 987 43	R 2512 ⁸	I
	KL	1 987 43	R 2381 I
	MKL	1 987 43	M 2081 I
	MKL,RLE	1 987 43	M 2281 I

Serie E (211) 500 , 4MATIC

5,5 285 M 273.960 <E 55>;M 273.962 <E 55>			
04.06-08.09	1 457 42	P 9263	O
	1 457 43	S 3071	L
	1 987 43	R 2381	I
	1 987 43	R 2512 ⁸	I

Serie E (211) 500 4MATIC

5,0 225 M 113.969 <E 50>			
09.03-08.06	1 457 42	P 9263	O
	1 457 43	S 3071	L
	1 987 43	R 2512 ⁸	I
	KL	1 987 43	R 2381 I
	MKL	1 987 43	M 2081 I
	MKL,RLE	1 987 43	M 2281 I

Serie G (460,461,463)

Serie G (460,461,463) 55 AMG

5,4 260 M 113.982			
04.99-03.04	1 457 42	P 9263	O
	1 457 43	S 3071	L
	0 450 91	F 5003 ¹	K
	1 987 43	R 2357 ⁸	I

Serie G (460,461,463) 55 AMG KOMPRESSOR

5,4 350-373 M 113.993 <E 55>			
04.04→	1 457 42	P 9263	O
	TW	1 457 43	S 3071 L
		0 450 90	F 5275 ¹ K
		1 987 43	R 2357 ⁸ I

Serie G (460,461,463) 200 E

2,0 80 M 102.965			
01.90-07.93	1 457 42	P 9605	O
	1 457 42	S 9787	L
	0 450 90	F 5177 ¹	K
	1 987 43	R 2357 ⁸	I





Serie G (460,461,463) 230

2,3 66 M 115.974	04.92-09.93	0 450 90 F 5177 ¹	K
2,3 79 M 102.958	04.92-09.95	1 457 42 P 9605	O
		0 450 90 F 4163 ¹	K
		1 457 42 P 9416 ³	P

Serie G (460,461,463) 230 , E

2,3 92-95 M 102.989	09.89-10.94	1 457 42 P 9605	O
		1 457 42 S 9787	L
		0 450 90 F 5177 ¹	K
		1 987 43 R 2357 ⁸	I

Serie G (460,461,463) 230 E

2,3 90 M 102.979;996	04.93-09.95	1 457 42 P 9605	O
2,3 90-92 M 102.987 <KAT>	03.86-08.92	1 457 42 P 9605	O
		0 450 90 F 5203 ¹	K
		1 457 42 P 9416 ³	P

2,3 92 M 102.979	04.92-09.95	1 457 42 P 9605	O
------------------	-------------	-----------------	---

2,3 92 M 102.979;996	04.92-09.95	1 457 42 P 9605	O
		1 457 42 P 9820	O
		0 450 90 F 5177 ¹	K

2,3 92 M 102.981	04.92-09.95	1 457 42 P 9605	O
		1 457 42 P 9416 ³	P

2,3 92 M 102.981;998	04.92-09.95	1 457 42 P 9605	O
----------------------	-------------	-----------------	---

2,3 92 M 102.996; M 102.997	04.92-09.95	1 457 42 P 9605	O
-----------------------------	-------------	-----------------	---

2,3 92 M 102.998	04.92-09.95	1 457 42 P 9605	O
		1 457 42 P 9416 ³	P

Serie G (460,461,463) 250 D

2,5 62-69 OM 602.930	09.87-08.92	1 457 42 P 9274	O
		1 457 43 N 4123 ²	K

2,5 69 OM 602.930	04.92-09.97	1 457 42 P 9274	O
-------------------	-------------	-----------------	---

2,5 69 OM 602.931	09.89-07.93	1 457 42 P 9274	O
		1 457 42 S 9783	L
		0 450 90 N 4077 ¹	K
		1 457 43 N 4123 ²	K
		1 987 43 R 2357 ⁸	I

2,5 69/70 OM 602.938; OM 602.939; OM 602.946	04.90-09.97	1 457 42 P 9274	O
--	-------------	-----------------	---

2,9 70 OM 602.946	04.92-09.97	1 457 42 P 9274	O
-------------------	-------------	-----------------	---



Serie G (460,461,463) 270 CDI

2,7 115 OM 612.965 <DE LA>	10.01-08.06	1 457 42 P 9116	O
		1 457 43 S 3065	L
Mot.Nr. →30 044707	10.01-08.06	1 457 43 N 1704	K
Mot.Nr. 30 044708→	10.01-08.06	1 457 43 N 4416 ¹	K
	10.01-08.06	1 987 43 R 2357 ⁸	I

Serie G (460,461,463) 290 D

2,9 69/70/72 OM 602.942; OM 602.946; OM 602.947	04.92-09.97	1 457 42 P 9274	O
---	-------------	-----------------	---

Serie G (460,461,463) 290 DT

2,9 90 OM 602.983	04.97-09.01	1 457 42 P 9278	O
-------------------	-------------	-----------------	---

Serie G (460,461,463) 300 , E

3,0 125/126 M 103.987	09.89-10.94	1 457 42 P 9122	O
	LUM	1 457 42 S 9970	L
		0 450 90 F 5177 ¹	K
		1 987 43 R 2357 ⁸	I

Serie G (460,461,463) 300 D

3,0 64/65 OM 617.932; OM 617.933	04.92-07.97	1 457 42 P 9265	O
----------------------------------	-------------	-----------------	---

3,0 65 OM 616.932	04.92-07.97	1 457 42 P 9175	O
-------------------	-------------	-----------------	---

3,0 65 OM 617.931	12.79-08.91	1 457 42 P 9265	O
		0 450 90 N 4077 ¹	K
		1 457 43 N 4153 ²	K

3,0 83 OM 603.931	09.89-07.97	1 457 42 P 9274	O
		1 457 42 S 9988	L
		0 450 90 N 4077 ¹	K
		1 457 43 N 4123 ²	K
		1 987 43 R 2357 ⁸	I

Serie G (460,461,463) 300 D Turbo

3,0 130 OM 606.964	09.96-11.00	1 457 42 P 9278	O
		0 450 90 N 4077 ¹	K
		1 457 43 N 4123 ²	K
	WW	1 457 43 N 4331 ²	K
		1 987 43 R 2357 ⁸	I

Serie G (460,461,463) 320

3,2 154/158 M 112.945 <E 32>	06.97-08.06	1 457 42 P 9263	O
		1 457 43 S 3071	L
		0 450 91 F 5003 ¹	K
		1 987 43 R 2357 ⁸	I

3,2 155 M 104.996	08.93-11.97	1 457 42 P 9122	O
		0 450 90 F 5203 ¹	K
		1 987 43 R 2357 ⁸	I
		1 457 42 P 9416 ³	P





Serie G (460,461,463) 320 CDI

3,0 165 OM 642.970	09.06→	F 026 40 P 7008	O
		LAB F 026 40 S 0215	L
		RAB F 026 40 S 0216	L
		F 026 40 N 2056 ¹	K
		1987 43 R 2357 ⁸	I

Serie G (460,461,463) 350 D Turbo

3,5 100 OM 603.972	09.91-06.96	1 457 42 P 9274	O
		1 457 42 S 9988	L
		0 450 90 N 4077 ¹	K
		1 457 43 N 4123 ²	K
		1987 43 R 2357 ⁸	I

Serie G (460,461,463) 400 CDI

4,0 184 OM 628.962 <DE40LARI>	12.00-08.06	F 026 40 P 7003	O
		LUM,XXX 1 457 43 S 3053	L
		0 450 90 N 6464 ¹	K
		1987 43 R 2357 ⁸	I

Serie G (460,461,463) 500

5,0 218 M 113.962	04.98-08.08	1 457 42 P 9263	O
		1 457 43 S 3071	L
		0 450 91 F 5003 ¹	K
		1987 43 R 2357 ⁸	I

5,5|285|M 273.963 <M273 E55>

	06.08→	1 457 42 P 9263	O
		1 457 43 S 3071	L
		0 450 91 F 5003 ¹	K
		1987 43 R 2357 ⁸	I

Serie G (460,461,463) 500 AMG E

5,0 195 M 117.965	03.93-09.01	1 457 42 P 9610	O
		1 457 42 S 9993	L
		0 450 90 F 5177 ¹	K
		1987 43 R 2357 ⁸	I

Serie GL

Serie GL 320 CDI 4MATIC

3,0 165 OM 642.820 <D 30 LHD REPO>	09.08→	F 026 40 P 7008	O
		LAB,SCJ F 026 40 S 0215	L
		RAB,SCJ F 026 40 S 0216	L
		TW,WAS F 026 40 N 2065 ¹	K
		1987 43 R 2309 ⁸	I

3,0|165|OM 642.940 <D 30>

	02.06-04.09	F 026 40 P 7008	O
		LAB F 026 40 S 0215	L
		RAB F 026 40 S 0216	L
		1 457 43 N 4437 ¹	K
		1987 43 R 2309 ⁸	I



Serie GL 350 BlueTec 4MATIC

3,0 155 OM 642.820 <D 30 LHD REPO>	04.09→	F 026 40 P 7008	O
		LAB,SCJ F 026 40 S 0215	L
		RAB,SCJ F 026 40 S 0216	L
		TW,WAS F 026 40 N 2065 ¹	K
		1987 43 R 2309 ⁸	I

Serie GL 350 CDI 4MATIC

3,0 165 OM 642.940 <D 30>	05.09-08.10	F 026 40 P 7008	O
		LAB F 026 40 S 0215	L
		RAB F 026 40 S 0216	L
		1 457 43 N 4437 ¹	K
		1987 43 R 2309 ⁸	I

3,0|195|OM 642.822 <D 30 LHD REPO>

	09.10→	F 026 40 P 7008	O
		LAB,SCJ F 026 40 S 0215	L
		RAB,SCJ F 026 40 S 0216	L
		F 026 40 N 2065 ¹	K
		1987 43 R 2309 ⁸	I

Serie GL 420 CDI 4MATIC

4,0 225 OM 629.912 <DE 30 LA>	02.06-04.09	F 026 40 P 7076	O
		1 457 43 N 4437 ¹	K
		1987 43 R 2309 ⁸	I

Serie GL 450 CDI 4MATIC

4,0 225 OM 629.912 <DE 30 LA>	05.09→	F 026 40 P 7076	O
		1 457 43 N 4437 ¹	K
		1987 43 R 2309 ⁸	I

Serie GL 450 4MATIC

4,7 250 M 273.923 <E 46>	02.06→	1 457 42 P 9263	O
		1 457 43 S 3071	L
		1987 43 R 2309 ⁸	I

Serie GL 500 4MATIC

5,5 285 M 273.963 <E 55>	02.06→	1 457 42 P 9263	O
		1 457 43 S 3071	L
		1987 43 R 2309 ⁸	I

Serie GLK

Serie GLK 200 CDI

2,1 105 OM 651.913 <D 22 LHD>	07.10→	F 026 40 S0133	L
		F 026 40 N 2065 ¹	K
		1987 43 R 2326 ⁸	I





Serie GLK 220 CDI

2,1 125 OM 651.916 <D 22 LHD>	04.09→	F 026 40 S0133	L
		WAS F 026 40 N 2065 ¹	K
		1 987 43 R 2326 ⁸	I

Serie GLK 220 CDI 4MATIC

2,1 125 OM 651.912 <D 22 LL>	06.08→	F 026 40 S0133	L
		F 026 40 N 2065 ¹	K
		1 987 43 R 2326 ⁸	I

Serie GLK 250 CDI 4MATIC

2,1 150 OM 651.912 <D 22 LHD>	04.09→	F 026 40 S0133	L
		F 026 40 N 2065 ¹	K
		1 987 43 R 2326 ⁸	I

Serie GLK 280 4MATIC

3,0 170 M 272.948 <E 30>	09.08-04.09	1 457 42 P 9263	O
		1 457 43 S 3071	L
		1 987 43 R 2326 ⁸	I

Serie GLK 300 4MATIC

3,0 170 M 272.948 <E 30>	05.09→	1 457 42 P 9263	O
		1 457 43 S 3071	L
		1 987 43 R 2326 ⁸	I

Serie GLK 320 CDI 4MATIC

3,0 165 OM 642.961 <D 30>	09.08→	F 026 40 P 7008	O
		LAB F 026 40 S 0215	L
		RAB F 026 40 S 0216	L
		TW,WAS F 026 40 N 2065 ¹	K
		1 457 43 N 4437 ¹	K
		1 987 43 R 2326 ⁸	I

Serie GLK 350 , 4MATIC

3,5 200 M 272.971 <E 35>; M 272.991 <E 35>	09.08→	1 457 42 P 9263	O
		1 457 43 S 3071	L
		1 987 43 R 2326 ⁸	I

Serie GLK 350 CDI 4MATIC

3,0 165-170 OM 642.832 <D 30 LHD REPO>	04.10→	F 026 40 P 7008	O
		TW,WAS F 026 40 N 2065 ¹	K
		1 987 43 R 2326 ⁸	I

Serie GLK 350 CGI 4MATIC

3,5 225 M 276.957 <DE 35>	06.11→	1 987 43 R 2326 ⁸	I
-------------------------------	--------	-------------------------------------	---



Serie ML (163,164)

Serie ML (163,164) 55 AMG

5,4 255 M 113.981 <E 55>	03.00-06.05	1 457 42 P 9263	O
		1 457 43 S 3752	L
		1 987 43 R 2364 ⁸	I

Serie ML (163,164) 63 AMG

6,2 375 M 156.980 <E 63>	02.06→	F 026 40 S0152	L
		1 987 43 R 2309 ⁸	I

Serie ML (163,164) 230

2,3 110 M 111.977 <E 23>	03.98-06.00	1 457 42 P 9122	O
		1 457 43 S 3752	L
		1 987 43 R 2364 ⁸	I

Serie ML (163,164) 270 CDI

2,7 120 OM 612.963 <DE LA>	11.99-06.05	1 457 42 P 9116	O
		1 457 43 S 3065	L
Mot.Nr. →30 044707	11.99-06.05	1 457 43 N 1704	K
Mot.Nr. 30 044708→	11.99-06.05	1 457 43 N 4416 ¹	K
	11.99-06.05	1 987 43 R 2364 ⁸	I

Serie ML (163,164) 280 CDI 4MATIC

3,0 140 OM 642.940 <D 30>	07.05-04.09	F 026 40 P 7008	O
		LAB F 026 40 S 0215	L
		RAB F 026 40 S 0216	L
		WAS 1 457 43 N 4437 ¹	K
		WAS F 026 40 N 2056 ¹	K
		1 987 43 R 2309 ⁸	I

Serie ML (163,164) 300 CDI 4MATIC

3,0 140 OM 642.940 <D 30>	05.09-12.10	F 026 40 P 7008	O
		LAB F 026 40 S 0215	L
		RAB F 026 40 S 0216	L
		SWA, F 026 40 N 2065 ¹	K
		WAS	
		WAS 1 457 43 N 4437 ¹	K
		1 987 43 R 2309 ⁸	I

3,0 | 150 | OM 642.820 <D 30 LHD REPO>

	05.09→	F 026 40 P 7008	O
		LAB,SCJ F 026 40 S 0215	L
		RAB,SCJ F 026 40 S 0216	L
		F 026 40 N 2065 ¹	K
		1 987 43 R 2309 ⁸	I

Serie ML (163,164) 320

3,2 160 M 112.942 <E 32>	03.98-09.02	1 457 42 P 9263	O
		1 457 43 S 3752	L
		1 987 43 R 2364 ⁸	I





Serie ML (163,164) 320 CDI 4MATIC

3,0 165 OM 642.940 <D 30>	03.05-04.09	F 026 40 P 7008	O
		LAB F 026 40 S 0215	L
		RAB F 026 40 S 0216	L
		1 457 43 N 4437 ¹	K
		1 987 43 R 2309 ⁸	I

Serie ML (163,164) 350

3,7 173/180 M 112.970 <E 37>	08.02-06.05	1 457 42 P 9263	O
		1 457 43 S 3752	L
		1 987 43 R 2364 ⁸	I

Serie ML (163,164) 350 BlueTec 4MATIC, CDI 4MATIC

3,0 155/170 OM 642.820 <D 30>; OM 642.820 <D 30 LHD REPO>	05.09→	F 026 40 P 7008	O
		LAB,SCJ F 026 40 S 0215	L
		RAB,SCJ F 026 40 S 0216	L
		F 026 40 N 2065 ¹	K
		1 987 43 R 2309 ⁸	I

Serie ML (163,164) 350 CDI 4MATIC

3,0 165 OM 642.940 <D 30>	05.09→	F 026 40 P 7008	O
		LAB,SCJ F 026 40 S 0215	L
		RAB,SCJ F 026 40 S 0216	L
		1 457 43 N 4437 ¹	K
		1 987 43 R 2309 ⁸	I

Serie ML (163,164) 350 4MATIC

3,5 200 M 272.967 <E 35>	09.05→	1 457 42 P 9263	O
		1 457 43 S 3071	L
		1 987 43 R 2309 ⁸	I

Serie ML (163,164) 400 CDI

4,0 184 OM 628.963 <DE 40 LALL>	09.01-06.05	F 026 40 P 7003	O
		1 457 43 S 3752	L
		0 450 90 N 6464 ¹	K
		1 987 43 R 2364 ⁸	I

Serie ML (163,164) 420 CDI 4MATIC

4,0 225 OM 629.912 <DE 40 LA>	02.06-04.09	F 026 40 P 7076	O
		1 457 43 N 4437 ¹	K
		1 987 43 R 2309 ⁸	I

Serie ML (163,164) 430

4,3 200 M 113.942 <E 43>	09.98-07.02	1 457 42 P 9263	O
		1 457 43 S 3752	L
		1 987 43 R 2364 ⁸	I

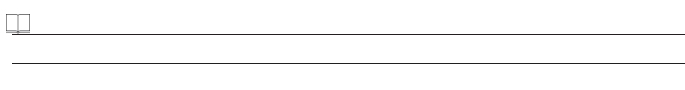

Serie ML (163,164) 450 CDI 4MATIC

4,0 225 OM 629.912 <DE 40 LA>	05.09→	F 026 40 P 7076	O
		1 457 43 N 4437 ¹	K
		1 987 43 R 2309 ⁸	I

Serie ML (163,164) 500

5,0 215 M 113.965 <E 50>	09.01-06.05	1 457 42 P 9263	O
		1 457 43 S 3752	L
		1 987 43 R 2364 ⁸	I

Serie ML (163,164) 500 4MATIC

5,0 225 M 113.964 <E 50>	09.05-08.07	1 457 42 P 9263	O
		1 457 43 S 3071	L
		1 987 43 R 2309 ⁸	I

5,5 285 M 273.963 <E 55>	09.07→	1 457 42 P 9263	O
		1 457 43 S 3071	L
		1 987 43 R 2309 ⁸	I

Serie ML (166)

Serie ML (166) 350 BlueTec 4MATIC

3,0 190 OM 642.826 <D 30 LHD REPO GEST>	06.11→	F 026 40 P 7008	O
---	--------	-----------------	---

Serie R

Serie R 63 AMG 4MATIC

6,2 375 M 156.980 <E 63>	04.06-08.07	F 026 40 S 0152	L
		1 987 43 R 2309 ⁸	I

Serie R 280

3,0 170 M 272.945 <E 30>	05.07-04.09	1 457 42 P 9263	O
		1 457 43 S 3071	L
		1 987 43 R 2309 ⁸	I

Serie R 280 CDI, CDI 4MATIC

3,0 140 OM 642.950 <D 30>	04.06-04.09	F 026 40 P 7008	O
		LAB F 026 40 S 0215	L
		RAB F 026 40 S 0216	L
		FIH,WAS F 026 40 N 2065 ¹	K
		FIU,WAS 1 457 43 N 4437 ¹	K
		1 987 43 R 2309 ⁸	I

Serie R 280 4MATIC

3,0 170 M 272.945 <E 30>	07.09→	1 457 42 P 9263	O
		1 457 43 S 3071	L
		1 987 43 R 2309 ⁸	I

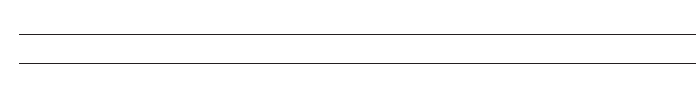



Serie R 300

3,0 170 M 272.945 <E 30>	05.09→	1 457 42 P 9263	O
		1 457 43 S 3071	L
		1 987 43 R 2309 ⁸	I

Serie R 300 CDI

3,0 140 OM 642.87... <D 30>	05.10→	F 026 40 P 7008	O
		LAB,SCJ F 026 40 S 0215	L
		RAB,SCJ F 026 40 S 0216	L
		1 987 43 R 2309 ⁸	I

Serie R 300 CDI, CDI 4MATIC

3,0 140 OM 642.950 <D 30>	05.09-05.10	F 026 40 P 7008	O
		LAB F 026 40 S 0215	L
		RAB F 026 40 S 0216	L
		FIH,WAS F 026 40 N 2065 ¹	K
		FIU,WAS 1 457 43 N 4437 ¹	K
		1 987 43 R 2309 ⁸	I

Serie R 320 CDI 4MATIC

3,0 165 OM 642.950 <D 30>	09.05-05.09	F 026 40 P 7008	O
	09.05-04.09	LAB F 026 40 S 0215	L
		RAB F 026 40 S 0216	L
	06.07-05.09	LAB,SCJ F 026 40 S 0215	L
		RAB,SCJ F 026 40 S 0216	L
	09.05-04.09	1 457 43 N 4437 ¹	K
	06.07-05.09	FIH,WAS F 026 40 N 2065 ¹	K
		FIU,WAS 1 457 43 N 4437 ¹	K
	09.05-05.09	1 987 43 R 2309 ⁸	I

Serie R 350 , 4MATIC

3,5 200 M 272.967 <E 35>	09.05→	1 457 42 P 9263	O
		1 457 43 S 3071	L
		1 987 43 R 2309 ⁸	I

Serie R 350 BlueTec 4MATIC

3,0 155 OM 642.870 <D 30 LHD REPO>	05.09→	F 026 40 P 7008	O
		LAB,SCJ F 026 40 S 0215	L
		RAB,SCJ F 026 40 S 0216	L
		F 026 40 N 2065 ¹	K
		1 987 43 R 2309 ⁸	I

Serie R 350 CDI 4MATIC

3,0 195 OM 642.872 <D 30>	05.10→	F 026 40 P 7008	O
		LAB,SCJ F 026 40 S 0215	L
		RAB,SCJ F 026 40 S 0216	L
		1 987 43 R 2309 ⁸	I

Serie R 500 4MATIC

5,0 225/285 M 113.971 <E 50>; M 273.963 <E 55>	02.06→	1 457 42 P 9263	O
		1 457 43 S 3071	L
		1 987 43 R 2309 ⁸	I



Serie S (140)

Serie S (140) 280

2,8 142-145 M 104.944	06.93-09.98	1 457 42 P 9122	O
		1 457 43 S 3052	L
Fg.Nr. A220201→	06.93-09.98	0 450 90 F 5275 ¹	K
Fg.Nr. →A220200	06.93-09.98	0 450 90 F 5203 ¹	K
	06.93-09.98	1 457 42 P 9416 ³	P

Serie S (140) 300 D Turbo

3,0 130 OM 606.961	06.96-09.98	1 457 42 P 9278	O
		1 457 43 N 4123 ²	K

Serie S (140) 300 SD Turbo

3,5 100-110 OM 603.971	09.91-08.93	1 457 42 P 9274	O
		0 450 90 F 4060 ¹	K
		1 457 43 N 4123 ²	K

Serie S (140) 300 SE

3,2 170 M 104.99...	03.91-05.93	1 457 42 P 9122	O
		1 457 43 S 3052	L
Fg.Nr. A220201→	03.91-05.93	0 450 90 F 5275 ¹	K
Fg.Nr. →A220200	03.91-05.93	0 450 90 F 5203 ¹	K
	03.91-05.93	1 457 42 P 9416 ³	P

Serie S (140) 300 SE 2.8

2,8 142-145 M 104.944	09.92-05.93	1 457 42 P 9122	O
		1 457 43 S 3052	L
Fg.Nr. A220201→	09.92-05.93	0 450 90 F 5275 ¹	K
Fg.Nr. →A220200	09.92-05.93	0 450 90 F 5203 ¹	K
	09.92-05.93	1 457 42 P 9416 ³	P

Serie S (140) 300 SEL 3.2

3,2 170 M 104.99...	03.91-05.93	1 457 42 P 9122	O
		0 450 90 F 5275 ¹	K
Fg.Nr. A220201→	03.91-05.93	0 450 90 F 5203 ¹	K
Fg.Nr. →A220200	03.91-05.93	1 457 42 P 9416 ³	P

Serie S (140) 320

3,2 170 M 104.990	03.93-09.98	1 457 42 P 9122	O
		0 450 90 F 5275 ¹	K
Fg.Nr. A220201→	03.93-09.98	0 450 90 F 5203 ¹	K
Fg.Nr. →A220200	03.93-09.98	1 457 42 P 9416 ³	P

3,2 | 170 | M 104.994

05.93-09.98	1 457 42 P 9122	O	
	1 457 43 S 3052	L	
Fg.Nr. A220201→	05.93-09.98	0 450 90 F 5275 ¹	K
Fg.Nr. →A220200	05.93-09.98	0 450 90 F 5203 ¹	K
	05.93-09.98	1 457 42 P 9416 ³	P





Serie S (140) 350 D Turbo

3,5 100-110 OM 603.971			
	09.93-06.96	1 457 42 P 9274	O
		0 450 90 F 4060 ¹	K
		1 457 43 N 4123 ²	K

Serie S (140) 400 SE, SEL

4,2 205-210 M 119.971;981			
	02.91-05.93	1 457 42 P 9616	O
		KNE 1 457 43 S 3700	L
Fg.Nr. A220201→	02.91-05.93	0 450 90 F 5275 ¹	K
Fg.Nr. →A220200	02.91-05.93	0 450 90 F 5203 ¹	K

Serie S (140) 420

4,2 205-210 M 119.971;981			
	06.93-09.98	1 457 42 P 9616	O
		KNE 1 457 43 S 3700	L
Fg.Nr. A220201→	06.93-09.98	0 450 90 F 5275 ¹	K
Fg.Nr. →A220200	06.93-09.98	0 450 90 F 5203 ¹	K

Serie S (140) 500 , SE, SEL

5,0 235-240 M 119.970;980			
	02.91-09.98	1 457 42 P 9616	O
		KNE 1 457 43 S 3700	L
Fg.Nr. A220201→	02.91-09.98	0 450 90 F 5275 ¹	K
Fg.Nr. →A220200	02.91-09.98	0 450 90 F 5203 ¹	K

Serie S (140) 600 , SE, SEL

6,0 290-300 M 120.980;982			
	04.91-09.98	1 457 42 P 9153	O
		1 457 43 S 3524	L
Fg.Nr. A220201→	04.91-09.98	0 450 90 F 5275 ¹	K
Fg.Nr. →A220200	04.91-09.98	0 450 90 F 5203 ¹	K

Serie S (220)

Serie S (220) 55 AMG

5,4 265 113.986 <E55 AMG>			
	09.00-09.02	1 457 42 P 9263	O
		1 457 43 S 3071	L
		0 450 91 F 5003 ¹	K
	2FE	1 987 43 M 2020	I

Serie S (220) 55 AMG KOMPRESSOR

5,4 368 113.991 <E55 AMG>			
	09.02-08.06	1 457 42 P 9263	O
		1 457 43 S 3071	L
		0 450 90 F 5275 ¹	K
	2FE	1 987 43 M 2020	I

Serie S (220) 65 AMG

6,0 450 M 275.980 <E60>			
	02.04-09.05	1 987 42 S 9402	L
	2FE	1 987 43 M 2020	I



Serie S (220) 280

2,8 150 M 112.922 <E28>			
	01.99-08.05	1 457 42 P 9263	O
		1 457 43 S 3071	L
		0 450 91 F 5003 ¹	K
	2FE	1 987 43 M 2020	I

Serie S (220) 320

3,2 165 M 112.944 <E32>			
	10.98-08.02	1 457 42 P 9263	O
		1 457 43 S 3071	L
		0 450 91 F 5003 ¹	K
	2FE	1 987 43 M 2020	I

Serie S (220) 320 CDI

3,2 145 OM 613.960 <DE 32 LA>			
	06.99-08.02	1 457 42 P 9126	O
		1 457 43 S 3065	L
		1 457 43 N 1704	K
	2FE	1 987 43 M 2020	I

3,2 | 150 | OM 648.960 <DE 32 LA>

	09.02-08.05	1 457 42 P 9126	O
Fg.Nr. A 345453→	09.02-08.05	1 457 43 S 3334	L
Fg.Nr. →A 345452	09.02-08.05	1 457 43 S 3333	L
	09.02-08.05	1 457 43 N 4437 ¹	K
	2FE	1 987 43 M 2020	I

Serie S (220) 350 , 4MATIC

3,7 180 M 112.972 <E37>; M 112.975 <E37>			
	09.02-08.05	1 457 42 P 9263	O
		1 457 43 S 3071	L
		0 450 91 F 5003 ¹	K
	2FE	1 987 43 M 2020	I

Serie S (220) 400 CDI

4,0 184/191 OM 628.960 <DE 40 LA>			
	06.99-08.05	F 026 40 P 7003	O
		XXX 1 457 43 S 3053	L
		0 450 90 N 6464 ¹	K
	2FE	1 987 43 M 2020	I

Serie S (220) 430 , 4MATIC

4,3 205 M 113.941 <E43>; M 113.948 <E43>			
	10.98-09.05	1 457 42 P 9263	O
		1 457 43 S 3071	L
		0 450 91 F 5003 ¹	K
	2FE	1 987 43 M 2020	I

Serie S (220) 500 , 4MATIC

5,0 225 M 113.960 <E50>; M 113.966 <E50>			
	10.98-09.05	1 457 42 P 9263	O
		1 457 43 S 3071	L
		0 450 91 F 5003 ¹	K
	2FE	1 987 43 M 2020	I





Serie S (220) 600

5,5 368 M 275.950 <E55>	09.02-09.05	1 987 42 S 9402	L
		0 450 90 F 5968 ¹	K
	2FE	1 987 43 M 2020	I

5,8 270 M 137.970 <E58>	08.99-08.05	1 457 42 P 9263	O
		1 457 43 S 3788	L
		0 450 91 F 5003 ¹	K
		2FE	1 987 43 M 2020

Serie S (221)

Serie S (221) 63 AMG

5,5 400 M 157.980 <DE 55 LA>	08.10→	1 987 43 R 2438 ⁸	I
6,2 386 M 156.984 <E 63>	12.06-07.10	F 026 40 S0152	L
		1 987 43 R 2438 ⁸	I

Serie S (221) 65 AMG

6,0 450/463 M 275.982 <E 60>	07.06→	1 987 42 S 9402	L
		1 987 43 R 2438 ⁸	I

Serie S (221) 250 CDI

2,1 150 OM 651.961 <D 22 LHD GST>	09.10→	1 987 43 R 2438 ⁸	I

Serie S (221) 280

3,0 170 M 272.946 <E 30>	09.05→	1 457 42 P 9263	O

Serie S (221) 320 CDI

3,0 173 OM 642.930 <D 30>	12.05-04.09	F 026 40 P 7008	O	
		LAB	F 026 40 S 0215	L
		RAB	F 026 40 S 0216	L
		WAS	1 457 43 N 4437 ¹	K
			1 987 43 R 2438 ⁸	I

Serie S (221) 320 CDI 4MATIC

3,0 173 OM 642.930 <D 30>	12.06-04.09	F 026 40 P 7008	O	
		LAB	F 026 40 S 0215	L
		RAB	F 026 40 S 0216	L
			1 457 43 N 4437 ¹	K
			1 987 43 R 2438 ⁸	I

Serie S (221) 350 , 4MATIC

3,5 200 M 272.965 <E 35>; M 272.975 <E 35>	09.05→	1 457 42 P 9263	O
		1 457 43 S 3071	L
		1 987 43 R 2438 ⁸	I

Serie S (221) 350 BlueTEC, BlueTEC 4MATIC

3,0 190 OM 642.862 <D 30 LHD>; OM 642.868 <D 30 LHD>	07.10→	F 026 40 P 7008	O
		1 987 43 R 2438 ⁸	I



Serie S (221) 350 CDI

3,0 173 OM 642.930 <D 30>	05.09-06.10	F 026 40 P 7008	O	
		LAB	F 026 40 S 0215	L
		RAB	F 026 40 S 0216	L
		FIU,WAS	F 026 40 N 2065 ¹	K
		WAS	1 457 43 N 4437 ¹	K

Serie S (221) 350 CDI 4MATIC

3,0 173 OM 642.932 <D 30>	05.09-06.10	F 026 40 P 7008	O	
		LAB	F 026 40 S 0215	L
		RAB	F 026 40 S 0216	L
		FIU	F 026 40 N 2065 ¹	K

Serie S (221) 350 CGI, CGI 4MATIC

3,5 225 M 276.950 <DE 35>	09.10→	1 987 43 R 2438 ⁸	I

Serie S (221) 400 Hybrid

3,5 205 M 272.974 <E 35>	04.09→	1 457 42 P 9263	O
		1 457 43 S 3071	L
		1 987 43 R 2438 ⁸	I

Serie S (221) 420 CDI

4,0 235 OM 629.911 <DE 40 LA>	12.06-04.09	F 026 40 P 7076	O
		1 457 43 N 4437 ¹	K
		1 987 43 R 2438 ⁸	I

Serie S (221) 450 , 4MATIC

4,7 250 M 273.922 <E 46>	06.06→	1 457 42 P 9263	O
		1 457 43 S 3071	L
		1 987 43 R 2438 ⁸	I

Serie S (221) 450 CDI

4,0 235 OM 629.911 <DE 40 LA>	05.09-06.10	F 026 40 P 7076	O
		1 457 43 N 4437 ¹	K
		1 987 43 R 2438 ⁸	I

Serie S (221) 500 , 4MATIC

5,5 285 M 273.961 <E 55>; M 273.968 <E 55>	09.05→	1 457 42 P 9263	O
		1 457 43 S 3071	L
		1 987 43 R 2438 ⁸	I

Serie S (221) 500 CGI, CGI 4MATIC

4,7 320 M 278.932 <DELA 46>	09.10→	1 987 43 R 2438 ⁸	I

Serie S (221) 600

5,5 380 M 275.953 <E 55>	12.05→	1 987 42 S 9402	L
		1 987 43 R 2438 ⁸	I





Serie SL (129)

Serie SL (129) 60 AMG

6,0 280 M 119.982				
	07.93-06.98	1 457 42 P 9153	O	
		1 457 43 S 3524	L	
	BO	0 450 90 F 5275 ¹	K	

Serie SL (129) 280

2,8 142 M 104.943				
	07.93-05.98	1 457 42 P 9122	O	
		0 450 90 F 5203 ¹	K	
		1 457 42 P 9416 ³	P	

2,8 150 M 112.923				
	06.98-08.01	1 457 42 P 9263	O	
		1 457 43 S 3071	L	
		0 450 91 F 5003 ¹	K	

Serie SL (129) 300

3,0 140 M 103.984				
	03.89-06.93	0 451 10 P 3105	O	
		LUM 1 457 42 S 9970	L	
		0 450 90 F 5203 ¹	K	

Serie SL (129) 300 24V

3,0 170 M 104.981				
	03.89-06.93	1 457 42 P 9122	O	
		1 457 42 S 9786	L	
		0 450 90 F 5203 ¹	K	
		1 457 42 P 9416 ³	P	

Serie SL (129) 320

3,2 165 M 112.943				
	06.98-08.01	1 457 42 P 9263	O	
		1 457 43 S 3071	L	
		0 450 91 F 5003 ¹	K	

3,2 170 M 104.991				
	07.93-05.98	1 457 42 P 9122	O	
		0 450 90 F 5203 ¹	K	
		1 457 42 P 9416 ³	P	

Serie SL (129) 500

5,0 225 M 113.961				
	06.98-09.01	1 457 42 P 9263	O	
		1 457 43 S 3071	L	
		0 450 91 F 5003 ¹	K	

5,0 235-240 M 119.960				
	03.89-09.92	1 457 42 P 9616	O	
		XXX 1 457 42 S 9782	L	
		0 450 90 F 5203 ¹	K	

5,0 235-240 M 119.972; M 119.982				
	09.92-09.04	1 457 42 P 9616	O	
		KNE 1 457 43 S 3700	L	
	09.92-05.98	0 450 90 F 5203 ¹	K	



Serie SL (129) 600

6,0 290 M 120.981; M 120.981;983; M 120.983				
	07.92-09.01	1 457 42 P 9153	O	
		1 457 43 S 3524	L	
	BO	0 450 90 F 5275 ¹	K	

Serie SL (230)

Serie SL (230) 55 AMG

5,4 368/380 M 113.992 <E 55>; M 113.995 <E 55>				
	10.01-03.08	1 457 42 P 9263	O	
		0 450 90 F 5275 ¹	K	

Serie SL (230) 63 AMG

6,2 386 M 156.981 <E 63>				
	01.08→	F 026 40 S 0152	L	

Serie SL (230) 65 AMG

6,0 450 M 275.981 <E 60>				
	09.04→	1 987 42 S 9402	L	

Serie SL (230) 280

3,0 170 M 272.949 <E 30>				
	01.08-04.09	1 457 42 P 9263	O	
		1 457 43 S 3071	L	
		0 450 91 F 5003 ¹	K	

Serie SL (230) 300

3,0 170 M 272.949 <E 30>				
	05.09→	1 457 42 P 9263	O	
		1 457 43 S 3071	L	
		0 450 91 F 5003 ¹	K	

Serie SL (230) 350

3,5 200/232 M 272.966 <E 35>; M 272.968 <E 35>				
	01.06→	1 457 42 P 9263	O	
		1 457 43 S 3071	L	
		0 450 91 F 5003 ¹	K	

3,7 180 M 112.973 <E 37>				
	03.03-12.05	1 457 42 P 9263	O	
		1 457 43 S 3071	L	
		0 450 91 F 5003 ¹	K	

Serie SL (230) 500

5,0 225 M 113.963 <E 50>				
	10.01-12.05	1 457 42 P 9263	O	
		1 457 43 S 3071	L	
		0 450 91 F 5003 ¹	K	

5,5 285 M 273.965 <E 55>				
	01.06→	1 457 42 P 9263	O	
		1 457 43 S 3071	L	
		0 450 91 F 5003 ¹	K	





Serie SL (230) 600

5,5 368 M 275.951 <E 55>	03.03-12.05	1 987 42 S 9402	L
		0 450 90 F 5968 ¹	K
5,5 380 M 275.954 <E 55>	01.06→	1 987 42 S 9402	L

Serie SLK (170,171,172)

Serie SLK (170,171,172) 32 AMG KOMPRESSOR

3,2 260 M 112.960 <E32 ML>	06.99-03.04	1 457 42 P 9263	O
		1 457 43 S 3581	L
		0 450 91 F 5003 ¹	K
		KL 1 987 43 R 2301 ⁸	I
		KL 1 987 43 M 2001	I

Serie SLK (170,171,172) 55 AMG

5,4 265 M 113.989 <E 55>	04.04-11.10	1 457 43 S 3071	L
------------------------------	-------------	------------------------	---

Serie SLK (170,171,172) 200

1,8 135 M 271.861 <DE 18 EVO>	01.11→	F 026 40 S 0134	L
-----------------------------------	--------	------------------------	---

Serie SLK (170,171,172) 200 , KOMPRESSOR

2,0 100/135 M 111.943 <E20 ML>; M 111.946 <E20>	09.96-01.00	1 457 42 P 9122	O
		1 457 43 S 3751	L
		BO 0 450 90 F 5275 ¹	K
		KL 1 987 43 R 2301 ⁸	I
		KL 1 987 43 M 2001	I

Serie SLK (170,171,172) 200 KOMPRESSOR

1,8 120/135 M 271.944 <KE 18 ML>; M 271.954 <KE 18 ML>	04.04-11.10	1 457 42 P 9261	O
		1 987 42 S 9401	L

Serie SLK (170,171,172) 200 KOMPRESSOR

2,0 120 M 111.958 <E20 EVO ML>	02.00-03.04	1 457 42 P 9122	O
		1 457 43 S 3751	L
		0 450 91 F 5003 ¹	K
		KL 1 987 43 R 2301 ⁸	I
		KL 1 987 43 M 2001	I

Serie SLK (170,171,172) 230 KOMPRESSOR

2,3 142 M 111.973 <E23 ML>	09.96-01.00	1 457 42 P 9122	O
		1 457 43 S 3751	L
		BO 0 450 90 F 5275 ¹	K
		KL 1 987 43 R 2301 ⁸	I
		KL 1 987 43 M 2001	I

Serie SLK (170,171,172) 230 KOMPRESSOR

2,3 145 M 111.983 <E23 EVO ML>	02.00-03.04	1 457 42 P 9122	O
		1 457 43 S 3751	L
		0 450 91 F 5003 ¹	K
		KL 1 987 43 R 2301 ⁸	I
		KL 1 987 43 M 2001	I



Serie SLK (170,171,172) 250

1,8 150 M 271.861 <DE 18 EVO>	01.11→	F 026 40 S 0134	L
-----------------------------------	--------	------------------------	---

Serie SLK (170,171,172) 280

3,0 170 M 272.942 <E 30>	05.05-02.09	1 457 42 P 9263	O
		1 457 43 S 3071	L

Serie SLK (170,171,172) 300

3,0 170 M 272.942 <E 30>	03.09-11.10	1 457 42 P 9263	O
		1 457 43 S 3071	L

Serie SLK (170,171,172) 320

3,2 160 M 112.947 <E32>	06.99-03.04	1 457 42 P 9263	O
		XXX 1 457 43 S 3049	L
		0 450 91 F 5003 ¹	K
		KL 1 987 43 R 2301 ⁸	I
		KL 1 987 43 M 2001	I

Serie SLK (170,171,172) 350

3,5 200/224 M 272.963 <E 35>; M 272.969 <E 35>	04.04-11.10	1 457 42 P 9263	O
		1 457 43 S 3071	L

Serie SLR (199)

Serie SLR (199) 5.4 , 722 Edition

5,4 460/478 M 155.980 <M 155 E 55>	04.04-12.09	1 457 43 S 3752	L
--	-------------	------------------------	---

Serie SLS (197)

Serie SLS (197) 6.2 AMG

6,2 420 159.980 <M159 E63>	03.10→	1 987 43 R 2326 ⁸	I
--------------------------------	--------	-------------------------------------	---

Serie S/SE/SEL (126)

Serie S/SE/SEL (126) 260 SE

2,6 118-122 M 103.941	09.85-06.91	0 451 10 P 3105	O
		LUM 1 457 42 S 9970	L
		0 450 90 F 5177 ¹	K
		1 457 42 P 9416 ³	P

Serie S/SE/SEL (126) 300 SE, SEL

3,0 132-138 M 103.981	09.85-08.91	0 451 10 P 3105	O
		LUM 1 457 42 S 9970	L
		0 450 90 F 5177 ¹	K

Serie S/SE/SEL (126) 350 SDL Turbo

3,5 100 OM 603.970	03.90-06.91	1 457 42 P 9274	O
		1 457 42 S 9949	L
		1 457 43 N 4123 ²	K





Serie S/SE/SEL (126) 420 SE, SEL

4,2 150-170 M 116.965	09.85-06.91	1 457 42 P 9610	O
		1 457 42 S 9993	L
		0 450 90 F 5177 ¹	K

Serie S/SE/SEL (126) 500 SE

5,0 164-195 M 117.965	09.85-06.91	1 457 42 P 9610	O
		1 457 42 S 9993	L
		0 450 90 F 5177 ¹	K

Serie S/SE/SEL (126) 560 SE, SEL

5,6 178 M 117.968; M 117.968 <KAT>	10.85-06.91	1 457 42 P 9610	O
		1 457 42 S 9993	L
		0 450 90 F 5177 ¹	K

Serie V

Serie V 200

2,0 95/100 M 111.948 <E20>; M 111.950 <E20>	04.96-09.03	1 457 42 P 9122	O
		1 457 43 S 3753	L
		0 450 90 F 5275 ¹	K
		1 987 43 M 2044	I

Serie V 200 CDI

2,2 75 OM 611.980	06.99-09.03	1 457 42 P 9116	O
		1 457 43 S 3748	L
		WAS 0 450 90 N 5930 ¹	K
		SWA F 026 40 N 2044 ¹	K
		1 987 43 M 2044	I

Serie V 220 CDI

2,2 90 OM 611.980	06.99-09.03	1 457 42 P 9116	O
		1 457 43 S 3748	L
		WAS 0 450 90 N 5930 ¹	K
		SWA F 026 40 N 2044 ¹	K
		1 987 43 M 2044	I

Serie V 230

2,3 105 M 111.978 <E23>; M 111.980 <E23>	04.96-09.03	1 457 42 P 9122	O
		1 457 43 S 3753	L
		0 450 90 F 5275 ¹	K
		1 987 43 M 2044	I

Serie V 230 TD

2,3 72 OM 601.970	04.96-09.03	1 457 42 P 9278	O
		1 457 43 S 3753	L
		1 457 43 N 4123 ²	K
		1 987 43 M 2044	I



Serie V 280

2,8 128 M 104.900	04.96-09.03	1 457 42 P 9142	O
		1 457 43 S 3753	L
		0 450 90 F 5275 ¹	K
		1 987 43 M 2044	I

Serie 124

Serie 124 200 D

2,0 53-55 OM 601.912	12.84-06.93	1 457 42 P 9274	O
		1 457 42 S 9875	L
		0 450 90 N 4077 ¹	K
	09.85-08.91	1 457 43 N 4123 ²	K
		1 457 42 P 9416 ³	P

Serie 124 200 E

2,0 87-90 M 102.963	06.86-10.92	0 451 10 P 3105	O	
		1 457 42 S 9787	L	
		0 450 90 F 5203 ¹	K	
	06.86-10.92	Fg.Nr. A368937→	0 450 90 F 5177 ¹	K
		Fg.Nr. →A368936	0 450 90 F 5203 ¹	K

2,0|90|M 102.963

2,0 90 M 102.963	09.89-06.93	0 451 10 P 3105	O	
		1 457 42 S 9787	L	
		0 450 90 F 5275 ¹	K	
	09.89-06.93	Fg.Nr. C226336→	0 450 90 F 5275 ¹	K
		Fg.Nr. →C226335	0 450 90 F 5203 ¹	K

2,0|100|M 111.940

2,0 100 M 111.940	06.91-06.93	1 457 42 P 9122	O	
		1 457 43 S 3607	L	
		0 450 90 F 5203 ¹	K	
	09.92-06.93	Fg.Nr. C226336→	0 450 90 F 5275 ¹	K
		Fg.Nr. →C226335	0 450 90 F 5203 ¹	K

Serie 124 220 E

2,2 110 M 111.960	07.91-06.93	1 457 42 P 9122	O	
		1 457 43 S 3607	L	
		0 450 90 F 5203 ¹	K	
	07.91-06.93	Fg.Nr. C226336→	0 450 90 F 5275 ¹	K
		Fg.Nr. →C226335	0 450 90 F 5203 ¹	K





Serie 124 230 E

2,3 97-100 M 102.982				
	12.84-08.93		0 451 10 P 3105	O
Mot.Nr. →..103066	12.84-08.93	AG	1 457 42 S 9992	L
Mot.Nr. →..106103	12.84-08.93	GS	1 457 42 S 9992	L
Mot.Nr. ...103067→	12.84-08.93	AG	1 457 42 S 9787	L
Mot.Nr. ...106104→	12.84-08.93	GS	1 457 42 S 9787	L
Fg.Nr. A368937→	12.84-08.93		0 450 90 F 5177 ¹	K
Fg.Nr. C226336→	03.87-08.92		0 450 90 F 5275 ¹	K
Fg.Nr. →A368936	12.84-08.93		0 450 90 F 5203 ¹	K
Fg.Nr. →C226335	03.87-08.92		0 450 90 F 5203 ¹	K
	12.84-08.93		1 457 42 P 9416 ³	P

Serie 124 250 D

2,5 66-69 OM 602.912				
	01.85-06.93		1 457 42 P 9274	O
			1 457 42 S 9783	L
			0 450 90 N 4077 ¹	K
			1 457 43 N 4123 ²	K
			1 457 42 P 9416 ³	P

Serie 124 250 D Turbo

2,5 93 OM 602.962				
	09.88-06.93		1 457 42 P 9274	O
			1 457 43 S 3002	L
			0 450 90 N 4077 ¹	K
			1 457 43 N 4123 ²	K

Serie 124 260 E

2,6 118-122 M 103.940				
	09.85-10.92		0 451 10 P 3105	O
		LUM	1 457 42 S 9970	L
	09.85-08.92		0 450 90 F 5203 ¹	K
Fg.Nr. A368937→	09.85-10.92		0 450 90 F 5177 ¹	K
Fg.Nr. →A368936	09.85-10.92		0 450 90 F 5203 ¹	K
	09.85-10.92		1 457 42 P 9416 ³	P

2,6 | 125 | M 103.940

	09.89-08.92		0 451 10 P 3105	O
		LUM	1 457 42 S 9970	L
			0 450 90 F 5177 ¹	K
			1 457 42 P 9416 ³	P

Serie 124 260 E 4MATIC

2,6 118-122 M 103.943				
	09.86-08.92		0 451 10 P 3105	O
		LUM	1 457 42 S 9970	L
Fg.Nr. A368937→	09.86-08.92		0 450 90 F 5177 ¹	K
Fg.Nr. →A368936	09.86-08.92		0 450 90 F 5203 ¹	K
	09.86-08.92		1 457 42 P 9416 ³	P

Serie 124 280 E

2,8 142-145 M 104.942				
	09.89-06.93		1 457 42 P 9122	O
		LUM	1 457 43 S 3701	L
			0 450 90 F 5203 ¹	K
			1 457 42 P 9416 ³	P

Serie 124 300 D, D 4MATIC

3,0 80-83 OM 603.912; OM 603.913				
	01.85-06.93		1 457 42 P 9274	O
			1 457 42 S 9988	L
			0 450 90 N 4077 ¹	K
			1 457 43 N 4123 ²	K
			1 457 42 P 9416 ³	P

Serie 124 300 D Turbo, D Turbo 4MATIC

3,0 105-108 OM 603.960; OM 603.963				
	09.86-06.93		1 457 42 P 9274	O
			1 457 42 S 9949	L
			0 450 90 N 4077 ¹	K
			1 457 43 N 4123 ²	K
			1 457 42 P 9416 ³	P

Serie 124 300 E

3,0 132 M 103.983				
	09.87-08.92		0 451 10 P 3105	O
		LUM	1 457 42 S 9970	L
			0 450 90 F 5203 ¹	K
			1 457 42 P 9416 ³	P

3,0 | 132-138 | M 103.980;983

	01.85-08.93		0 451 10 P 3105	O
		LUM	1 457 42 S 9970	L
Fg.Nr. A368937→	01.85-08.93		0 450 90 F 5177 ¹	K
Fg.Nr. →A368936	01.85-08.93		0 450 90 F 5203 ¹	K
	01.85-08.93		1 457 42 P 9416 ³	P

3,0 | 132-138 | M 103.983

	01.86-06.93		0 451 10 P 3105	O
	09.89-06.93		1 457 42 P 9122	O
	01.86-06.93	LUM	1 457 42 S 9970	L
	01.86-08.92		0 450 90 F 5203 ¹	K
Fg.Nr. C226336→	03.87-06.93		0 450 90 F 5275 ¹	K
Fg.Nr. →C226335	03.87-06.93		0 450 90 F 5203 ¹	K
	01.86-06.93		1 457 42 P 9416 ³	P

3,2 | 162 | M 104.992

	04.92-04.93		1 457 42 P 9122	O
		LUM	1 457 43 S 3701	L
Fg.Nr. C226336→	04.92-04.93		0 450 90 F 5275 ¹	K
Fg.Nr. →C226335	04.92-04.93		0 450 90 F 5203 ¹	K
	04.92-04.93		1 457 42 P 9416 ³	P

Serie 124 300 E 2.8

2,8 145 M 104.942				
	09.92-06.93		1 457 42 P 9122	O
		LUM	1 457 43 S 3701	L
			0 450 90 F 5177 ¹	K
			1 457 42 P 9416 ³	P

Serie 124 300 E 4MATIC

3,0 132 M 103.985				
	09.89-06.93		0 451 10 P 3105	O
		LUM	1 457 42 S 9970	L
			0 450 90 F 5203 ¹	K
			1 457 42 P 9416 ³	P





3,0 132-138 M 103.985	09.86-06.93	0 451 10 P 3105	O
	LUM	1 457 42 S 9970	L
Fg.Nr. A368937→	09.86-06.93	0 450 90 F 5177 ¹	K
Fg.Nr. →A368936	09.86-06.93	0 450 90 F 5203 ¹	K
	09.86-06.93	1 457 42 P 9416 ³	P

Serie 124 300 E-24V

3,0 162 M 104.980	09.89-06.93	1 457 42 P 9122	O
		1 457 42 S 9786	L
	09.89-08.92	0 450 90 F 5203 ¹	K
Fg.Nr. C226336→	09.89-06.93	0 450 90 F 5275 ¹	K
Fg.Nr. →C226335	09.89-06.93	0 450 90 F 5203 ¹	K
	09.89-06.93	1 457 42 P 9416 ³	P

3,0 | 162-170 | M 104.980

	09.88-10.92	1 457 42 P 9122	O
		1 457 42 S 9786	L
Fg.Nr. A368937→	09.88-10.92	0 450 90 F 5177 ¹	K
Fg.Nr. →A368936	09.88-10.92	0 450 90 F 5203 ¹	K
	09.88-10.92	1 457 42 P 9416 ³	P

3,0 | 170 | M 104.980

	09.89-06.93	1 457 42 P 9122	O
		1 457 42 S 9786	L
Fg.Nr. C226336→	09.89-06.93	0 450 90 F 5275 ¹	K
Fg.Nr. →C226335	09.89-06.93	0 450 90 F 5203 ¹	K
	09.89-06.93	1 457 42 P 9416 ³	P

Serie 124 300 AMG E 3.4

3,4 190 M 104.980	09.89-08.92	1 457 42 P 9122	O
		1 457 42 S 9786	L
		0 450 90 F 5203 ¹	K
		1 457 42 P 9416 ³	P

3,4 | 200 | M 104.980

	09.89-08.92	1 457 42 P 9122	O
		1 457 42 S 9786	L
Fg.Nr. C226336→	09.89-08.92	0 450 90 F 5275 ¹	K
Fg.Nr. →C226335	09.89-08.92	0 450 90 F 5203 ¹	K
	09.89-08.92	1 457 42 P 9416 ³	P

Serie 124 320 E

3,2 162 M 104.992	09.92-06.93	1 457 42 P 9122	O
	LUM	1 457 43 S 3701	L
		0 450 90 F 5203 ¹	K
Fg.Nr. C226336→	09.92-06.93	0 450 90 F 5275 ¹	K
Fg.Nr. →C226335	09.92-06.93	0 450 90 F 5203 ¹	K
	09.92-06.93	2FE 1 987 43 M 2051	I
		1 457 42 P 9416 ³	P

Serie 124 400 E

4,2 205 M 119.975	09.91-06.93	1 457 42 P 9616	O
	KNE	1 457 43 S 3700	L
		0 450 90 F 5203 ¹	K
	2FE	1 987 43 M 2051	I



4,2 210 M 119.975	09.91-06.93	1 457 42 P 9616	O
	KNE	1 457 43 S 3700	L
		0 450 90 F 5203 ¹	K

Serie 124 500 E

5,0 240 M 119.974	01.91-06.93	1 457 42 P 9616	O
	KNE	1 457 43 S 3700	L
		0 450 90 F 5203 ¹	K
	2FE	1 987 43 M 2051	I

Serie 124 500 AMG E 6.0

6,0 276 M 119.974	01.91-06.93	1 457 42 P 9616	O
	KNE	1 457 43 S 3700	L
		0 450 90 F 5203 ¹	K

Serie 190

Serie 190 190 2.0

2,0 75-77 M 102.924	09.88-08.93	0 451 10 P 3105	O
		KAT,VFA 1 457 42 S 9871	L
		KAT,XXX 1 457 42 S 9934	L
		0 450 90 F 4163 ¹	K
		1 457 42 P 9416 ³	P

Serie 190 190 D 2.0

2,0 55 OM 601.911	09.89-08.93	1 457 42 P 9274	O
		1 457 42 S 9875	L
		0 450 90 F 4060 ¹	K
		1 457 43 N 4123 ²	K
		1 457 42 P 9416 ³	P

Serie 190 190 D 2.5

2,5 66/69 OM 602.911	09.85-08.93	1 457 42 P 9274	O
		1 457 42 S 9783	L
		0 450 90 F 4060 ¹	K
		1 457 43 N 4123 ²	K
		1 457 42 P 9416 ³	P

Serie 190 190 D 2.5 Turbo

2,5 93 OM 602.961	09.86-08.93	1 457 42 P 9274	O
		1 457 43 S 3002	L
		0 450 90 N 4077 ¹	K
		1 457 43 N 4123 ²	K
		1 457 42 P 9416 ³	P

Serie 190 190 E 1.8

1,8 77/80 M 102.910; M 102.919	03.90-04.94	0 451 10 P 3105	O
		1 457 42 S 9787	L
		0 450 90 F 5177 ¹	K
		1 457 42 P 9416 ³	P





Serie 190 190 E 2.0

2,0 87 M 102.962	09.86-09.93	0 451 10 P 3105	O
Mot.Nr. →..092904	09.86-09.93 AG,KNE	1 457 42 S 9992	L
Mot.Nr. →..180173	09.86-09.93 GS,KNE	1 457 42 S 9992	L
Mot.Nr. ..092905→	09.86-09.93 AG,KNE	1 457 42 S 9787	L
Mot.Nr. ...180174→	09.86-09.93 GS,KNE	1 457 42 S 9787	L
	09.86-09.93	0 450 90 F 5177 ¹	K
		1 457 42 P 9416 ³	P

Serie 190 190 E 2.3

2,3 97/100 M 102.985	08.84-08.93	0 451 10 P 3105	O
		1 457 42 S 9787	L
		0 450 90 F 5177 ¹	K
		1 457 42 P 9416 ³	P

Serie 190 190 E 2.5-16, 2.5-16 Evolution II

2,5 143/150/173 M 102.990; M 102.992	09.88-08.93	1 457 42 P 9605	O
		0 450 90 F 5177 ¹	K
		1 457 42 P 9416 ³	P

Serie 190 190 E 2.6

2,6 118 M 103.942	09.86-08.93	0 451 10 P 3105	O
		1 457 42 S 9948	L
		0 450 90 F 5177 ¹	K
		1 457 42 P 9416 ³	P

Serie 190 190 E 3.2 AMG

3,2 172 M 103.983	09.88-08.93	0 451 10 P 3105	O
		1 457 42 S 9948	L
		0 450 90 F 5177 ¹	K
		1 457 42 P 9416 ³	P

Sprinter

Sprinter 208 CDI

2,2 60 OM 611.987 DE LA	04.00-05.06	1 457 42 P 9116	O
		FVA 1 457 43 S 3703	L
		FVA 1 457 43 S 3748	L
		WAS 0 450 90 N 5930 ¹	K
		SWA F 026 40 N 2044 ¹	K
		KL 1 987 43 M 2043	I

Sprinter 208 D

2,3 58-60 OM 601.943	02.95-03.00	1 457 42 P 9278	O
		FVA 1 457 43 S 3703	L
		FVA 1 457 43 S 3748	L
		1 457 43 N 4123 ²	K
		1 987 43 M 2043	I



Sprinter 209 CDI

2,1 65 OM 646.984 DE 22 LA <Euro 4>	04.06-03.09	1 457 42 P 9116	O
		F 026 40 S 0055	L
		SWA 1 457 43 N 4437 ¹	K
		SWA F 026 40 N 2056 ¹	K
		1 987 43 M 2213	I
		1 987 43 M 2213 ⁸	I

Sprinter 210 CDI

2,1 70 OM 651.955 DE 22 LA <Euro 5>	03.09→	F 026 40 S 0055	L
		WAS,XHI F 026 40 N 2065 ¹	K
		1 987 43 M 2213	I
		1 987 43 M 2213 ⁸	I

Sprinter 210 D

2,9 75 OM 602.980 DE LA	01.97-03.00	1 457 42 P 9278	O
		FVA 1 457 43 S 3703	L
		FVA 1 457 43 S 3748	L
		WAS 1 457 43 N 4123 ²	K
		KL 1 987 43 M 2043	I

Sprinter 211 CDI

2,1 80 OM 646.985 DE 22 LA <Euro 4>	04.06→	1 457 42 P 9116	O
		F 026 40 S 0055	L
		SWA 1 457 43 N 4437 ¹	K
		SWA F 026 40 N 2056 ¹	K
		1 987 43 M 2213 ⁸	I
		1 987 43 M 2213	I

Sprinter 212 D

2,2 80 OM 611.981 DE LA	04.00-05.06	1 457 42 P 9116	O
		FVA 1 457 43 S 3703	L
		FVA 1 457 43 S 3748	L
		WAS 0 450 90 N 5930 ¹	K
		SWA F 026 40 N 2044 ¹	K
		KL 1 987 43 M 2043	I

Sprinter 212 D

2,9 90 OM 602.980 DE LA	02.95-03.00	1 457 42 P 9278	O
		FVA 1 457 43 S 3703	L
		FVA 1 457 43 S 3748	L
		WAS 1 457 43 N 4123 ²	K
		KL 1 987 43 M 2043	I

Sprinter 213 CDI

2,1 95 OM 646.986 DE 22 LA <Euro 4>	04.06-03.09	1 457 42 P 9116	O
		F 026 40 S 0055	L
		SWA 1 457 43 N 4437 ¹	K
		SWA F 026 40 N 2056 ¹	K
		1 987 43 M 2213	I
		1 987 43 M 2213 ⁸	I



2,1 95 OM 651.956 DE 22 LA <Euro 5>			
03.09→	F 026 40 S 0055	L	
	WAS,XHI F 026 40 N 2065 ¹	K	
	1 987 43 M 2213 ⁸	I	
	1 987 43 M 2213	I	

2,2 95 OM 611.981 DE LA			
04.00-05.06	1 457 42 P 9116	O	
	FVA 1 457 43 S 3703	L	
	FVA 1 457 43 S 3748	L	
	WAS 0 450 90 N 5930 ¹	K	
	SWA F 026 40 N 2044 ¹	K	
	KL 1 987 43 M 2043	I	

Sprinter 214 , NGT

2,3 95/105-108 M 111 <E 23>; M 111.979 <E23>; M 111.984 <E23>			
02.95-05.06	1 457 42 P 9122	O	
	1 457 43 S 3748	L	
	FVA 1 457 43 S 3703	L	
	0 450 90 F 5275 ¹	K	
	KL 1 987 43 M 2043	I	

Sprinter 215 CDI

2,1 110 OM 646.9... DE 22 LA <Euro 4>			
04.06→	1 457 42 P 9116	O	
	F 026 40 S 0055	L	
	WAS 1 457 43 N 4437 ¹	K	
	WAS F 026 40 N 2056 ¹	K	
	1 987 43 M 2213	I	
	1 987 43 M 2213 ⁸	I	

Sprinter 216

1,8 115 M 271.951 <M 271 E 18 ML>			
09.08→	1 457 42 P 9261	O	
	1 987 42 S 9401	L	
	1 987 43 M 2213 ⁸	I	
	1 987 43 M 2213	I	

Sprinter 216 CDI

2,1 120 OM 651.957 DE 22 LA <Euro 5>			
03.09→	F 026 40 S 0055	L	
	WAS,XHI F 026 40 N 2065 ¹	K	
	1 987 43 M 2213 ⁸	I	
	1 987 43 M 2213	I	

2,7 | 115 | OM 612.981 DE LA

04.00-05.06	1 457 42 P 9116	O	
	FVA 1 457 43 S 3703	L	
	FVA 1 457 43 S 3748	L	
	MWA F 026 40 N 2003 ¹	K	
	WAS 0 450 90 N 5930 ¹	K	
	KL 1 987 43 M 2043	I	

Sprinter 218 CDI

3,0 135 OM 642... <Euro 4>			
04.06-03.09	F 026 40 P 7008	O	
	F 026 40 S 0055	L	
	WAS 1 457 43 N 4437 ¹	K	
	WAS F 026 40 N 2056 ¹	K	
	1 987 43 M 2213	I	
	1 987 43 M 2213 ⁸	I	

Sprinter 219 CDI

3,0 140 OM 642.992 DE 30 LA <Euro 5>			
03.09→	F 026 40 P 7008	O	
	F 026 40 S 0055	L	
	WAS 1 457 43 N 4437 ¹	K	
	1 987 43 M 2213	I	
	1 987 43 M 2213 ⁸	I	

Sprinter 224

3,5 190 M 272.979 <Euro 4>			
04.06→	1 457 42 P 9263	O	
	F 026 40 S 0055	L	
	1 987 43 M 2213 ⁸	I	
	1 987 43 M 2213	I	

Sprinter 308 CDI

2,2 60 OM 611.987 DE LA			
04.00-05.06	1 457 42 P 9116	O	
	FVA 1 457 43 S 3703	L	
	FVA 1 457 43 S 3748	L	
	WAS 0 450 90 N 5930 ¹	K	
	SWA F 026 40 N 2044 ¹	K	
	KL 1 987 43 M 2043	I	

Sprinter 308 D, D James Cook

2,3 58 OM 601.943			
02.95-03.00	1 457 42 P 9278	O	
	FVA 1 457 43 S 3703	L	
	FVA 1 457 43 S 3748	L	
	1 457 43 N 4123 ²	K	
	1 987 43 M 2043	I	

Sprinter 309 CDI

2,1 65 OM 646.984 DE 22 LA <Euro 4>			
04.06-03.09	1 457 42 P 9116	O	
	F 026 40 S 0055	L	
	SWA 1 457 43 N 4437 ¹	K	
	SWA F 026 40 N 2056 ¹	K	
	1 987 43 M 2213 ⁸	I	
	1 987 43 M 2213	I	

Sprinter 310 CDI

2,1 70 OM 651.955 DE 22 LA <Euro 5>			
03.09→	F 026 40 S 0055	L	
	WAS,XHI F 026 40 N 2065 ¹	K	
	1 987 43 M 2213 ⁸	I	
	1 987 43 M 2213	I	





Sprinter 310 D

2,5 70 OM 014 A <(632.999)>	09.96-05.01	FVA	1 457 43	S 3703	L
---------------------------------	-------------	-----	----------	---------------	---

Sprinter 310 D, D James Cook

2,9 75 OM 602.980 DE LA	01.97-03.00		1 457 42	P 9278	O
		FVA	1 457 43	S 3703	L
		FVA	1 457 43	S 3748	L
		WAS	1 457 43	N 4123 ²	K
		KL	1 987 43	M 2043	I

Sprinter 311 CDI

2,1 80 OM 611.981 DE LA	08.02-05.06		1 457 42	P 9116	O
		FVA	1 457 43	S 3703	L
		FVA	1 457 43	S 3748	L
		WAS	0 450 90	N 5930 ¹	K
		SWA	F 026 40	N 2044 ¹	K
		KL	1 987 43	M 2043	I

2,1 | 80 | OM 646.985 DE 22 LA <Euro 4>

	04.06→		1 457 42	P 9116	O
			F 026 40	S 0055	L
		SWA	1 457 43	N 4437 ¹	K
		SWA	F 026 40	N 2056 ¹	K
			1 987 43	M 2213	I
			1 987 43	M 2213 ⁸	I

2,2 | 80 | OM 611 LA

	06.01-12.04	FVA	1 457 43	S 3703	L
		WAS	0 450 90	N 5930 ¹	K

2,2 | 80 | OM 611.981 DE LA

	04.00-05.06		1 457 42	P 9116	O
		FVA	1 457 43	S 3703	L
		FVA	1 457 43	S 3748	L
		WAS	0 450 90	N 5930 ¹	K
		SWA	F 026 40	N 2044 ¹	K
		KL	1 987 43	M 2043	I

Sprinter 312 D

2,5 77/85 OM 014 LA <Euro 2 (632.997)>; OM 014 LA <Euro 2 (632.998)>	08.99-05.01	FVA	1 457 43	S 3703	L
--	-------------	-----	----------	---------------	---

Sprinter 312 D, D James Cook

2,9 90 OM 602.980 DE LA	02.95-03.00		1 457 42	P 9278	O
		FVA	1 457 43	S 3703	L
		FVA	1 457 43	S 3748	L
		WAS	1 457 43	N 4123 ²	K
		KL	1 987 43	M 2043	I

Sprinter 313 CDI

2,1 95 OM 646.986 DE 22 LA <Euro 4>	04.06-03.09		1 457 42	P 9116	O
			F 026 40	S 0055	L
		SWA	1 457 43	N 4437 ¹	K
		SWA	F 026 40	N 2056 ¹	K
			1 987 43	M 2213	I
			1 987 43	M 2213 ⁸	I



2,1 | 95 | OM 651.956 DE 22 LA <Euro 5>

	03.09→		F 026 40	S 0055	L
		WAS, XHI	F 026 40	N 2065 ¹	K
			1 987 43	M 2213 ⁸	I
			1 987 43	M 2213	I

2,2 | 95 | OM 611 LA

	06.01→	FVA	1 457 43	S 3703	L
		FVA	1 457 43	S 3748	L
		WAS	0 450 90	N 5930 ¹	K

2,2 | 95 | OM 611.981 DE LA

	04.00-05.06		1 457 42	P 9116	O
		FVA	1 457 43	S 3703	L
		FVA	1 457 43	S 3748	L
		WAS	0 450 90	N 5930 ¹	K
		SWA	F 026 40	N 2044 ¹	K
		KL	1 987 43	M 2043	I

Sprinter 314 , James Cook, NGT

2,3 | 95/105-108 | M 111 <E23>; M 111.979 <E23>; M 111.984 <E23>

	02.95-05.06		1 457 42	P 9122	O
		FVA	1 457 43	S 3703	L
		FVA	1 457 43	S 3748	L
			0 450 90	F 5275 ¹	K
		KL	1 987 43	M 2043	I

Sprinter 315 CDI

2,1 | 110 | OM 646.9... DE 22 LA <Euro 4>

	04.06→		1 457 42	P 9116	O
			F 026 40	S 0055	L
		WAS	1 457 43	N 4437 ¹	K
		WAS	F 026 40	N 2056 ¹	K
			1 987 43	M 2213 ⁸	I
			1 987 43	M 2213	I

Sprinter 316

1,8 | 115 | M 271.951 <M 271 E 18 ML>

	09.08→		1 457 42	P 9261	O
			1 987 42	S 9401	L
			1 987 43	M 2213	I
			1 987 43	M 2213 ⁸	I

Sprinter 316 CDI

2,1 | 120 | OM 651.957 DE 22 LA <Euro 5>

	03.09→		F 026 40	S 0055	L
		WAS, XHI	F 026 40	N 2065 ¹	K
			1 987 43	M 2213 ⁸	I
			1 987 43	M 2213	I

2,7 | 115 | OM 647.981 DE 27 LA

	10.04-05.06		1 457 42	P 9116	O
			1 457 43	S 3748	L
			F 026 40	N 2056 ¹	K
		KL	1 987 43	M 2043	I





Sprinter 316 CDI, CDI James Cook

2,7 115 OM 612.981 DE LA			
04.00-05.06	1 457 42	P 9116	O
	FVA	1 457 43	S 3703 L
	FVA	1 457 43	S 3748 L
	MWA	F 026 40	N 2003 ¹ K
	WAS	0 450 90	N 5930 ¹ K
	KL	1 987 43	M 2043 I

Sprinter 316 NGT

1,8 115 M 271.951 <M 271 E 18 ML>			
09.08→	1 457 42	P 9261	O
	1 987 42	S 9401	L
	0 450 90	F 5975 ¹	K
	1 987 43	M 2213	I
	1 987 43	M 2213 ⁸	I

Sprinter 318 CDI

3,0 135 OM 642... <Euro 4>			
04.06-03.09	F 026 40	P 7008	O
	F 026 40	S 0055	L
	WAS	1 457 43	N 4437 ¹ K
	WAS	F 026 40	N 2056 ¹ K
		1 987 43	M 2213 ⁸ I
		1 987 43	M 2213 I

Sprinter 319 CDI

3,0 140 OM 642.992 DE 30 LA <Euro 5>			
03.09→	F 026 40	P 7008	O
	F 026 40	S 0055	L
	WAS	1 457 43	N 4437 ¹ K
		1 987 43	M 2213 ⁸ I
		1 987 43	M 2213 I

Sprinter 324

3,5 190 M 272.979 <Euro 4>			
04.06→	1 457 42	P 9263	O
	F 026 40	S 0055	L
	1 987 43	M 2213	I
	1 987 43	M 2213 ⁸	I

Sprinter 408 CDI

2,2 60 OM 611.987 DE LA			
04.00-05.06	1 457 42	P 9116	O
	FVA	1 457 43	S 3703 L
	FVA	1 457 43	S 3748 L
	WAS	0 450 90	N 5930 ¹ K
	SWA	F 026 40	N 2044 ¹ K
	KL	1 987 43	M 2043 I

Sprinter 408 D

2,3 58 OM 601.943			
02.95-03.00	1 457 42	P 9278	O
	FVA	1 457 43	S 3703 L
	FVA	1 457 43	S 3748 L
		1 457 43	N 4123 ² K
		1 987 43	M 2043 I



Sprinter 410 D

2,9 75 OM 602.980 DE LA			
01.97-03.00	1 457 42	P 9278	O
	FVA	1 457 43	S 3703 L
	FVA	1 457 43	S 3748 L
	WAS	1 457 43	N 4123 ² K
	KL	1 987 43	M 2043 I

Sprinter 411 CDI

2,1 80 OM 646.985 DE 22 LA <Euro 4>			
04.06-03.09	1 457 42	P 9116	O
	F 026 40	S 0055	L
	SWA	1 457 43	N 4437 ¹ K
	SWA	F 026 40	N 2056 ¹ K
		1 987 43	M 2213 I
		1 987 43	M 2213 ⁸ I

Sprinter 412 D

2,2 80 OM 611.981 DE LA			
04.00-05.06	1 457 42	P 9116	O
	FVA	1 457 43	S 3703 L
	FVA	1 457 43	S 3748 L
	WAS	0 450 90	N 5930 ¹ K
	SWA	F 026 40	N 2044 ¹ K
	KL	1 987 43	M 2043 I

Sprinter 412 D

2,5 85 OM 014 LA <Euro 2>			
10.99-05.01	FVA	1 457 43	S 3703 L

Sprinter 413 CDI

2,9 90 OM 602.980 DE LA			
02.95-03.00	1 457 42	P 9278	O
	FVA	1 457 43	S 3703 L
	FVA	1 457 43	S 3748 L
	WAS	1 457 43	N 4123 ² K
	KL	1 987 43	M 2043 I

2,1 95 OM 651.956 DE 22 LA <Euro 5>			
03.09→	F 026 40	S 0055	L
	WAS,XHI	F 026 40	N 2065 ¹ K
		1 987 43	M 2213 I
		1 987 43	M 2213 ⁸ I

Sprinter 413 CDI

2,2 95 OM 611 LA			
06.01→	FVA	1 457 43	S 3703 L
	FVA	1 457 43	S 3748 L
	WAS	0 450 90	N 5930 ¹ K

Sprinter 413 CDI

2,2 95 OM 611.981 DE LA			
04.00-05.06	1 457 42	P 9116	O
	FVA	1 457 43	S 3703 L
	FVA	1 457 43	S 3748 L
	WAS	0 450 90	N 5930 ¹ K
	SWA	F 026 40	N 2044 ¹ K
	KL	1 987 43	M 2043 I





Sprinter 414

2,3 105-108 M 111.979 <E23>; M 111.984 <E23>			
02.95-05.06	1 457 42	P 9122	O
	1 457 43	S 3748	L
FVA	1 457 43	S 3703	L
	0 450 90	F 5275 ¹	K
KL	1 987 43	M 2043	I

Sprinter 415 CDI

2,1 110 OM 646.9... DE 22 LA <Euro 4>			
04.06-03.09	1 457 42	P 9116	O
	F 026 40	S 0055	L
WAS	1 457 43	N 4437 ¹	K
WAS	F 026 40	N 2056 ¹	K
	1 987 43	M 2213	I
	1 987 43	M 2213 ⁸	I

Sprinter 416 CDI

2,1 120 OM 651.957 DE 22 LA <Euro 5>			
03.09→	F 026 40	S 0055	L
	WAS,XHI	F 026 40	N 2065 ¹
		1 987 43	M 2213 ⁸
		1 987 43	M 2213

2,7 115 OM 612.981 DE LA			
04.00-05.06	1 457 42	P 9116	O
FVA	1 457 43	S 3703	L
FVA	1 457 43	S 3748	L
MWA	F 026 40	N 2003 ¹	K
WAS	0 450 90	N 5930 ¹	K
KL	1 987 43	M 2043	I

2,7 115 OM 647.981 DE 27 LA			
10.04-05.06	1 457 42	P 9116	O
	1 457 43	S 3748	L
	F 026 40	N 2056 ¹	K
KL	1 987 43	M 2043	I

Sprinter 418 CDI

3,0 135 OM 642... <Euro 4>			
04.06-03.09	F 026 40	P 7008	O
	F 026 40	S 0055	L
WAS	1 457 43	N 4437 ¹	K
WAS	F 026 40	N 2056 ¹	K
	1 987 43	M 2213	I
	1 987 43	M 2213 ⁸	I

Sprinter 419 CDI

3,0 140 OM 642.992 DE 30 LA <Euro 5>			
03.09→	F 026 40	P 7008	O
	F 026 40	S 0055	L
WAS	1 457 43	N 4437 ¹	K
	1 987 43	M 2213	I
	1 987 43	M 2213 ⁸	I

Sprinter 424

3,5 190 M 272.979 <Euro 4>			
04.06→	1 457 42	P 9263	O
	F 026 40	S 0055	L
	1 987 43	M 2213 ⁸	I
	1 987 43	M 2213	I



Sprinter 509 CDI

2,1 65 OM 646.984 DE 22 LA <Euro 4>			
04.06-03.09	1 457 42	P 9116	O
	F 026 40	S 0055	L
SWA	1 457 43	N 4437 ¹	K
SWA	F 026 40	N 2056 ¹	K
	1 987 43	M 2213	I
	1 987 43	M 2213 ⁸	I

Sprinter 510 CDI

2,1 70 OM 651.955 DE 22 LA <Euro 5>			
03.09→	F 026 40	S 0055	L
	WAS,XHI	F 026 40	N 2065 ¹
		1 987 43	M 2213
		1 987 43	M 2213 ⁸

Sprinter 511 CDI

2,1 80 OM 646.985 DE 22 LA <Euro 4>			
04.06-03.09	1 457 42	P 9116	O
	F 026 40	S 0055	L
SWA	1 457 43	N 4437 ¹	K
SWA	F 026 40	N 2056 ¹	K
	1 987 43	M 2213	I
	1 987 43	M 2213 ⁸	I

Sprinter 513 CDI

2,1 95 OM 651.956 DE 22 LA <Euro 5>			
03.09→	F 026 40	S 0055	L
	WAS,XHI	F 026 40	N 2065 ¹
		1 987 43	M 2213
		1 987 43	M 2213 ⁸

Sprinter 515 CDI

2,1 110 OM 646.9... DE 22 LA <Euro 4>			
04.06-03.09	1 457 42	P 9116	O
	F 026 40	S 0055	L
WAS	1 457 43	N 4437 ¹	K
WAS	F 026 40	N 2056 ¹	K
	1 987 43	M 2213	I
	1 987 43	M 2213 ⁸	I

Sprinter 516

1,8 115 M 271.951 <M 271 E 18 ML>			
09.08→	1 457 42	P 9261	O
	1 987 42	S 9401	L
	1 987 43	M 2213 ⁸	I
	1 987 43	M 2213	I

Sprinter 516 CDI

2,1 120 OM 651.957 DE 22 LA <Euro 5>			
03.09→	F 026 40	S 0055	L
	WAS,XHI	F 026 40	N 2065 ¹
		1 987 43	M 2213
		1 987 43	M 2213 ⁸



Sprinter 516 NGT

1,8 115 M 271.951 <M 271 E 18 ML>			
09.08→	1 457 42	P 9261	O
	1 987 42	S 9401	L
	0 450 90	F 5975 ¹	K
	1 987 43	M 2213	I
	1 987 43	M 2213 ⁸	I

Sprinter 518 CDI

3,0 135 OM 642... <Euro 4>			
04.06-03.09	F 026 40	P 7008	O
	F 026 40	S 0055	L
	WAS	1 457 43 N 4437 ¹	K
	WAS	F 026 40 N 2056 ¹	K
		1 987 43 M 2213	I
		1 987 43 M 2213 ⁸	I

Sprinter 519 CDI

3,0 140 OM 642.992 DE 30 LA <Euro 5>			
03.09→	F 026 40	P 7008	O
	F 026 40	S 0055	L
	WAS	1 457 43 N 4437 ¹	K
		1 987 43 M 2213 ⁸	I
		1 987 43 M 2213	I

Sprinter 524

3,5 190 M 272.979 <Euro 4>			
04.06→	1 457 42	P 9263	O
	F 026 40	S 0055	L
		1 987 43 M 2213	I
		1 987 43 M 2213 ⁸	I

Sprinter 616 CDI

2,7 115 OM 612.981 DE LA			
02.01-05.06	1 457 42	P 9116	O
	FVA	1 457 43 S 3703	L
	FVA	1 457 43 S 3748	L
	MWA	F 026 40 N 2003 ¹	K
	WAS	0 450 90 N 5930 ¹	K
	KL	1 987 43 M 2043	I

Vaneo

Vaneo 1.6

1,6 60/75 M 166.961 <E 16>			
02.02-08.05	1 457 42	P 9147	O
	1 457 43	S 3715	L
	0 450 91	F 5001 ¹	K
	KL	1 987 43 R 2337 ⁸	I
	KL	1 987 43 M 2037	I

Vaneo 1.7 CDI

1,7 55/67 OM 668.914 <DE 17 LA>			
02.02-08.05	1 457 42	P 9272	O
	1 457 43	S 3069	L
	0 450 90	N 5930 ¹	K
	KL	1 987 43 R 2337 ⁸	I
	KL	1 987 43 M 2037	I



Vaneo 1.9

1,9 92 M 166.991 <E 19>			
02.02-08.05	1 457 42	P 9147	O
	1 457 43	S 3715	L
	0 450 91	F 5001 ¹	K
	KL	1 987 43 R 2337 ⁸	I
	KL	1 987 43 M 2037	I

Vario

Vario O 810, 814, 815

4,2 75/100/112 OM 904.904 LA <Euro 2>; OM 904.908 LA <Euro 2>; OM 904.923 LA <Euro 2>			
09.96-01.01	F 026 40	P 7040	O
	1 457 43	S 3626	L
	WAS	1 457 43 N 1707	K

Vario O 812

2,9 90 OM 602.98... LA <Euro 2>			
09.96-01.01	1 457 42	P 9278	O
	1 457 43	S 3626	L
	1 457 43	N 4123 ²	K

Vario 512 D

2,9 90 OM 602.984 LA <Euro 2>			
09.96-01.01	1 457 42	P 9278	O
	1 457 43	S 3626	L
	1 457 43	N 4123 ²	K

Vario 612 D

2,9 90 OM 602.984,985 LA <Euro 2>			
09.96-01.01	1 457 42	P 9278	O
	1 457 43	S 3626	L
	1 457 43	N 4123 ²	K

Vario 613 D

4,2 95 OM 900.917 (904 LA) <Euro 4 (BlueTec)>			
09.06→	F 026 40	P 7040	O
	1 457 43	S 3626	L
	1 457 43	N 1707	K

Vario 614 D

4,2 100 OM 904.908 LA <Euro 2>; OM 904.914 LA <Euro 3>			
09.96-09.06	F 026 40	P 7040	O
	1 457 43	S 3626	L
	WAS	1 457 43 N 1707	K

Vario 615 D

4,2 110/112 OM 904.923 LA <Euro 2>; OM 904.936 LA <Euro 3>			
10.98-09.06	F 026 40	P 7040	O
	1 457 43	S 3626	L
	WAS	1 457 43 N 1707	K





Vario 616 D

4,2 115 OM 900.918 (904 LA) <Euro 4 (BlueTec)>	09.06→	F 026 40 P 7040	O
		1 457 43 S 3626	L
		1 457 43 N 1707	K

Vario 618 D

4,2 130 OM 900.919 (904 LA) <Euro 4 (BlueTec)>	09.06→	F 026 40 P 7040	O
		1 457 43 S 3626	L
		1 457 43 N 1707	K

4,2 130 OM 904.964 LA <Euro 3>	06.03-09.06	F 026 40 P 7040	O
		1 457 43 S 3626	L
	WAS	1 457 43 N 1707	K

4,2 130 OM 904.964 (904 LA)	09.06-03.09	F 026 40 P 7040	O
		1 457 43 S 3626	L
		1 457 43 N 1707	K

Vario 810 DT

4,2 75 OM 904.904 LA <Euro 2>	09.96-09.06	F 026 40 P 7040	O
		1 457 43 S 3626	L
	WAS	1 457 43 N 1707	K

Vario 812 D

2,9 90 OM 602.984,985 LA <Euro 2>	09.96-09.06	1 457 42 P 9278	O
		1 457 43 S 3626	L
		1 457 43 N 4123 ²	K

Vario 813 D/DA

4,2 95 OM 900.917 (904 LA) <Euro 4 (BlueTec)>	09.06→	F 026 40 P 7040	O
		1 457 43 S 3626	L
		1 457 43 N 1707	K

Vario 814 D

4,2 100 OM 904.908 LA <Euro 2>; OM 904.914 LA <Euro 3>	09.96-09.06	F 026 40 P 7040	O
		1 457 43 S 3626	L
	WAS	1 457 43 N 1707	K

Vario 814 DA

4,3 100 OM 904.908,923 LA <Euro 2>	09.96-01.01	F 026 40 P 7040	O
		1 457 43 S 3626	L
	WAS	1 457 43 N 1707	K

Vario 815 D, DA

4,2 110-112 OM 904.908,923 LA <Euro 2>; OM 904.923,936 LA <Euro 2>; OM 904.936 LA <Euro 3>	01.96-09.06	F 026 40 P 7040	O
		1 457 43 S 3626	L
	WAS	1 457 43 N 1707	K



Vario 816 D/DA

4,2 115 OM 900.918 (904 LA) <Euro 4 (BlueTec)>	09.06→	F 026 40 P 7040	O
		1 457 43 S 3626	L
		1 457 43 N 1707	K

Vario 818 D

4,2 130 OM 904.964 LA <Euro 3>	06.03-09.06	F 026 40 P 7040	O
		1 457 43 S 3626	L
	WAS	1 457 43 N 1707	K

Vario 818 D/DA

4,2 130 OM 900.919 (904 LA) <Euro 4 (BlueTec)>	09.06→	F 026 40 P 7040	O
		1 457 43 S 3626	L
		1 457 43 N 1707	K

4,2 130 OM 904.964 (904 LA)	09.06-03.09	F 026 40 P 7040	O
		1 457 43 S 3626	L
		1 457 43 N 1707	K

Viano

Viano 2.0 CDI

2,1 80 OM 646.982 <OM 646 DE22LA (MOC2)>	09.03-10.06	1 457 42 P 9116	O
		F 026 40 S 0122	L
	MWA	F 026 40 N 2056 ¹	K
	WAS	1 457 43 N 4437 ¹	K
	TER	1 987 43 M 2195	I
	TMT	1 987 43 R 2495	I

2,1 85 OM 646.981 <OM 646 DE22LA>	11.06-08.10	1 457 42 P 9116	O
		F 026 40 S 0122	L
	WAS	1 457 43 N 4437 ¹	K
	WAS	F 026 40 N 2056 ¹	K
	TER	1 987 43 M 2195	I
	TMT	1 987 43 R 2495	I

2,1 100 OM 651.940 <OM 651 DE22LA>	07.10→	F 026 40 S 0122	L
		TW	F 026 40 N 2065 ¹
		TER	1 987 43 M 2195
		TMT	1 987 43 R 2495

Viano 2.2 CDI

2,1 110 OM 646.982 <OM 646 DE22LA>	09.03-08.10	1 457 42 P 9116	O
		F 026 40 S 0122	L
	WAS	1 457 43 N 4437 ¹	K
	WAS	F 026 40 N 2056 ¹	K
	TER	1 987 43 M 2195	I
	TMT	1 987 43 R 2495	I

2,1 120 OM 651.940 <OM 651 DE22LA>	07.10→	F 026 40 S 0122	L
		TW	F 026 40 N 2065 ¹
		TER	1 987 43 M 2195
		TMT	1 987 43 R 2495





Viano 3.0 CDI

3,0 150 OM 642.990 <OM 642 DE 30LA>			
04.06-08.10	F 026 40	P 7008	O
	WAS	1 457 43 N 4437 ¹	K
	TER	1 987 43 M 2195	I
	TMT	1 987 43 R 2495	I

3,0 165 OM 642... <OM 642 DE 30LA>			
07.10→	F 026 40	P 7008	O
	TER	1 987 43 M 2195	I
	TMT	1 987 43 R 2495	I

Viano 3.2

3,2 140/160 M 112.951 <M 112.E32 (MC7)>; M 112.951 <M 112.E32 (MC8)>			
09.03-12.07	1 457 42	P 9263	O
	F 026 40	S0122	L
	0 450 90	F 5975 ¹	K
	TER	1 987 43 M 2195	I
	TMT	1 987 43 R 2495	I

Viano 3.5

3,5 190 M 272.978 <M272 E35>			
09.07→	1 457 42	P 9263	O
	F 026 40	S0122	L
	0 450 90	F 5975 ¹	K
	TER	1 987 43 M 2195	I
	TMT	1 987 43 R 2495	I

3,7 170 M 112.976 <M 112.E37 (MGO)>			
06.04-08.07	1 457 42	P 9263	O
	F 026 40	S0122	L
	0 450 90	F 5975 ¹	K
	TER	1 987 43 M 2195	I
	TMT	1 987 43 R 2495	I

Vito

Vito 108 CDI

2,2 60 OM 611.980			
04.99-09.03	1 457 42	P 9116	O
	1 457 43	S 3748	L
	WAS	0 450 90 N 5930 ¹	K
	SWA	F 026 40 N 2044 ¹	K
		1 987 43 M 2044	I

Vito 108 D

2,3 60 OM 601.942			
11.95-09.03	1 457 42	P 9278	O
	1 457 43	S 3753	L
	1 457 43	N 4123 ²	K
	1 987 43	M 2044	I



Vito 109 CDI

2,1 65 OM 646.983 <OM 646 DE22LA>			
10.03-10.06	1 457 42	P 9116	O
	F 026 40	S0122	L
	MWA	F 026 40 N 2056 ¹	K
	WAS	1 457 43 N 4437 ¹	K
	TER	1 987 43 M 2195	I
	TMT	1 987 43 R 2495	I

2,1 70 OM 646.980 <OM 646 DE22LA>			
11.06→	1 457 42	P 9116	O
	F 026 40	S0122	L
	WAS	1 457 43 N 4437 ¹	K
	WAS	F 026 40 N 2056 ¹	K
	TER	1 987 43 M 2195	I
	TMT	1 987 43 R 2495	I

Vito 110 CDI

2,1 70 OM 651.940 <OM 651 DE22LA>			
07.10→	F 026 40	S0122	L
	TW	F 026 40 N 2065 ¹	K
	TER	1 987 43 M 2195	I
	TMT	1 987 43 R 2495	I

2,2 75 OM 611.980			
04.99-09.03	1 457 42	P 9116	O
	1 457 43	S 3748	L
	WAS	0 450 90 N 5930 ¹	K
	SWA	F 026 40 N 2044 ¹	K
		1 987 43 M 2044	I

Vito 110 D

2,3 72 OM 601.970			
11.95-09.03	1 457 42	P 9278	O
	1 457 43	S 3753	L
	1 457 43	N 4123 ²	K
	1 987 43	M 2044	I

Vito 111 CDI

2,1 80 OM 646.982 <OM 646 DE22LA>			
10.03-10.06	1 457 42	P 9116	O
	F 026 40	S0122	L
	MWA	F 026 40 N 2056 ¹	K
	WAS	1 457 43 N 4437 ¹	K
	TER	1 987 43 M 2195	I
	TMT	1 987 43 R 2495	I

2,1 85 OM 646.981 <OM 646 DE22LA>			
11.06→	1 457 42	P 9116	O
	F 026 40	S0122	L
	WAS	1 457 43 N 4437 ¹	K
	WAS	F 026 40 N 2056 ¹	K
	TER	1 987 43 M 2195	I
	TMT	1 987 43 R 2495	I





Vito 112 CDI

2,2 90 OM 611.980			
04.99-09.03	1 457 42	P 9116	O
	1 457 43	S 3748	L
WAS	0 450 90	N 5930 ¹	K
SWA	F 026 40	N 2044 ¹	K
	1 987 43	M 2044	I

Vito 113

2,0 95/100 M 111.948 <E20>; M 111.950 <E20>			
11.95-09.03	1 457 42	P 9122	O
	1 457 43	S 3753	L
	0 450 90	F 5275 ¹	K
	1 987 43	M 2044	I

Vito 113 CDI

2,1 100 OM 651.940 <OM 651 DE22LA>			
07.10→	F 026 40	S0122	L
	TW	F 026 40	N 2065 ¹ K
	TER	1 987 43	M 2195 I
	TMT	1 987 43	R 2495 I

Vito 114

2,3 105 M 111.978 <E23>; M 111.980 <E23>			
11.95-09.03	1 457 42	P 9122	O
	1 457 43	S 3753	L
	0 450 90	F 5275 ¹	K
	1 987 43	M 2044	I

Vito 115 CDI

2,1 110 OM 646.982 <OM 646 DE22LA>			
10.03→	1 457 42	P 9116	O
	F 026 40	S0122	L
WAS	1 457 43	N 4437 ¹	K
WAS	F 026 40	N 2056 ¹	K
TER	1 987 43	M 2195	I
TMT	1 987 43	R 2495	I

Vito 116 CDI

2,1 120 OM 651.940 <OM 651 DE22LA>			
07.10→	F 026 40	S0122	L
	TW	F 026 40	N 2065 ¹ K
	TER	1 987 43	M 2195 I
	TMT	1 987 43	R 2495 I

Vito 119

3,2 140 M 112.951 <M 112.E32>			
10.03→	1 457 42	P 9263	O
	F 026 40	S0122	L
	0 450 90	F 5975 ¹	K
TER	1 987 43	M 2195	I
TMT	1 987 43	R 2495	I

Vito 120 CDI

3,0 150 642.990 <OM 642 DE30LA>			
04.06→	F 026 40	P 7008	O
WAS	1 457 43	N 4437 ¹	K
TER	1 987 43	M 2195	I
TMT	1 987 43	R 2495	I



Vito 122

3,2 160 M 112.951 <M 112.E32>			
10.03→	1 457 42	P 9263	O
	F 026 40	S0122	L
	0 450 90	F 5975 ¹	K
TER	1 987 43	M 2195	I
TMT	1 987 43	R 2495	I

Vito 122 CDI

3,0 165 OM 642.9.. DE 30 LA <Euro 5>			
07.10→	F 026 40	P 7008	O
	1 457 43	N 4437 ¹	K
TER	1 987 43	M 2195	I
TMT	1 987 43	R 2495	I

Vito 123

3,7 170 M 112.976 <M 112.E37>			
06.04-08.07	1 457 42	P 9263	O
	F 026 40	S0122	L
	0 450 90	F 5975 ¹	K
TER	1 987 43	M 2195	I
TMT	1 987 43	R 2495	I

Vito 126

3,5 190 M 272.978 <M272 E35>			
09.07→	1 457 42	P 9263	O
	F 026 40	S0122	L
	0 450 90	F 5975 ¹	K
TER	1 987 43	M 2195	I
TMT	1 987 43	R 2495	I

2t

2t 208 D

2,3 58-60 OM 601.940			
10.88-06.95	1 457 42	P 9274	O
	1 457 43	S 3005	L
	0 450 90	N 4077 ¹	K
	1 457 43	N 4123 ²	K

2t 210

2,3 70-77 M 102.942 <V23>			
08.82-06.95	1 457 42	P 9605	O
	1 457 42	S 9080	L
	1 457 42	P 9416 ³	P

2,3 | 70-77 | M 102.945 <V23>

10.87-06.95	1 457 42	P 9605	O
	1 457 42	S 9080	L

2t 210 D

2,9 70-72 OM 602.940			
10.88-06.95	1 457 42	P 9274	O
	1 457 43	S 3005	L
	0 450 90	N 4077 ¹	K
	1 457 43	N 4123 ²	K





3t

3t 308 D

2,3 58-60 OM 601.940	10.88-06.95	1 457 42 P 9274	O
		1 457 43 S 3005	L
		1 457 43 N 4123 ²	K
Fg.Nr. →941505	10.88-06.95	0 450 90 N 4077 ¹	K

3t 310

2,3 70-77 M 102.942 <V23>; M 102.945 <V23>	08.82-06.95	1 457 42 P 9605	O
		1 457 42 S 9080	L

3t 310 D

2,9 70-72 OM 602.940	10.88-06.95	1 457 42 P 9274	O
		1 457 43 S 3005	L
		1 457 43 N 4123 ²	K
Fg.Nr. →941505	10.88-06.95	0 450 90 N 4077 ¹	K

4t

4t 408 D

2,3 58-60 OM 601.940	11.88-06.95	1 457 42 P 9274	O
Fg.Nr. 899081→941503	11.88-06.95	1 457 43 S 3005	L
Fg.Nr. 941506→	11.88-06.95	1 457 43 S 3005	L
	11.88-06.95	1 457 43 N 4123 ²	K

4t 410

2,3 70-77 M 102 <V23>	08.82-06.95	1 457 42 P 9605	O
		1 457 42 S 9080	L

4t 410 D

2,9 70-72 OM 602.940	11.88-06.95	1 457 42 P 9274	O
Fg.Nr. 899081→941503	11.88-06.95	1 457 43 S 3005	L
Fg.Nr. 941506→	11.88-06.95	1 457 43 S 3005	L
	11.88-06.95	1 457 43 N 4123 ²	K
Fg.Nr. →556499	11.88-06.95	TW 0 450 90 F 4060 ¹	K
Fg.Nr. →941505	11.88-06.95	TW 0 450 90 N 4077 ¹	K
Fg.Nr. 556500→	11.88-06.95	TW 0 450 90 N 4077 ¹	K

MERCURY

Mystique

Mystique 2.0

2,0 93	09.94-08.97	W50 0 451 10 P 3219	O
----------	-------------	---------------------	---



Topaz

Topaz 2.3 i

2,3 67 4L HSC <SFI X>	09.91-08.94	W50 0 451 10 P 3219	O
---------------------------	-------------	---------------------	---

MG

MG TF

MG TF 115 1.6i 16V

1,6 85 16 K4F K-Serie <DOHC>	03.02-05.05	0 451 10 P 4026	O
		0 450 90 F 5911 ¹	K

MG TF 120 1.8i 16V Stepspeed

1,8 88 18 K4F K-Serie <DOHC>	03.02-05.05	0 451 10 P 4026	O
		0 450 90 F 5911 ¹	K

MG TF 135 1.8i 16V

1,8 100 18 K4F K-Serie <DOHC>	03.02→	0 451 10 P 4026	O
		0 450 90 F 5911 ¹	K

MG TF 160 1.8i 16V

1,8 118 18 K4F K-Serie- VVC- <DOHC>	03.02-05.05	0 451 10 P 4026	O
		0 450 90 F 5911 ¹	K

MGF

MGF 1.6 i 16V

1,6 82 16 K4F <K-Serie>	10.01-03.02	0 451 10 P 4026	O
		0 450 90 F 5911 ¹	K

MGF 1.8 i 16V, 16V Trophy

1,8 88/107/118 18 K4F <K-Serie>; 18 K4K K-Serie <MPI VVC>; 18 K4K <MPI VVC K-Serie>	10.95-03.02	0 451 10 P 4026	O
		0 450 90 F 5911 ¹	K

RV8

RV8 3.9

3,9 140 V8	09.92-12.95	0 450 90 F 5030 ¹	K
----------------	-------------	------------------------------	---

ZR

ZR 2.0 D Turbo

2,0 74/82 20 T2N <L-Serie>	10.01-05.05	0 451 10 P 3341	O
		1 457 43 S 3781	L
		1 987 43 M 2121	I





ZR 105 1.4i 16V

1,4 76 14 K4F <K-Serie>			
10.01-05.05	0 451 10	P 4026	O
	1 457 43	S 3736	L
	0 450 90	F 5911 ¹	K
	1 987 43	M 2121	I

ZR 120 1.8i 16V

1,8 86 18 K4F <K-Serie>			
10.01-05.05	0 451 10	P 4026	O
	1 457 43	S 3736	L
	0 450 90	F 5911 ¹	K
	1 987 43	M 2121	I

ZR 160 1.8i 16V

1,8 118 18 K4K <K-Serie>			
10.01-05.05	0 451 10	P 4026	O
	1 457 43	S 3736	L
	0 450 90	F 5911 ¹	K
	1 987 43	M 2121	I

ZS

ZS 2.0 TD

2,0 74 20 T2N <L-Serie>			
10.01-05.05	0 451 10	P 3341	O
	1 457 43	S 3781	L
	0 450 90	N 6172 ¹	K
Fg.Nr. →WD 354434	10.01-05.05	KZ	1 987 43 M 2026 I

ZS 110 1.6i 16V

1,6 80 16 K4F <K-Serie>			
03.05-05.05	0 451 10	P 4026	O
	1 457 43	S 3781	L
	0 450 90	F 5911 ¹	K
Fg.Nr. →WD 354434	03.05-05.05	KZ	1 987 43 M 2026 I

ZS 120 1.8i 16V

1,8 86 18 K4F <K-Serie>			
10.01-05.05	0 451 10	P 4026	O
	1 457 43	S 3781	L
	0 450 90	F 5911 ¹	K
Fg.Nr. →WD 354434	10.01-05.05	KZ	1 987 43 M 2026 I

ZS 180 2.5i 24V

2,5 130 25 K4F <K-Serie 2.5KV6>			
10.01-05.05	0 451 10	P 3340	O
	0 450 90	F 5911 ¹	K
Fg.Nr. →WD 354434	10.01-05.05	KZ	1 987 43 M 2026 I

ZT

ZT 1.8 i 16V, T 16V

1,8 88/118 K1.8T <K-Serie>; 18 K4F <K-Serie K 1.8>			
03.02-05.05	0 451 10	P 4026	O
	1 457 43	S 3550	L
	1 987 43	M 2182	I
	1 987 43	R 2482 ⁸	I



ZT 135 2.0 CDTi

2,0 96 20 4D 2 <M47R>			
10.02-05.05	1 457 42	P 9119	O
	1 457 43	S 3588	L
	F 026 40	N 2002 ²	K
	1 987 43	M 2182	I
	1 987 43	R 2482 ⁸	I

ZT 160 2.5i 24V

2,5 118 25 K4F <K-Serie>			
10.01-05.05	0 451 10	P 3340	O
	1 457 43	S 3550	L
	1 987 43	M 2182	I
	1 987 43	R 2482 ⁸	I

ZT 190 1.8 T 16V, 1.8i 16V

1,8 88/118 K1.8T <K-Serie>; 18 K4F <K-Serie K 1.8>			
03.02-05.05	0 451 10	P 4026	O
	1 457 43	S 3550	L
	1 987 43	M 2182	I
	1 987 43	R 2482 ⁸	I

ZT 190 2.0 CDT

2,0 85 20 4D 2 <M47R>			
10.01-05.05	1 457 42	P 9119	O
	1 457 43	S 3588	L
	F 026 40	N 2002 ²	K
	1 987 43	M 2182	I
	1 987 43	R 2482 ⁸	I

ZT 190 2.5i 24V

2,5 140 25 K4F <K-Serie>			
10.01-05.05	0 451 10	P 3340	O
	1 457 43	S 3550	L
	1 987 43	M 2182	I
	1 987 43	R 2482 ⁸	I

ZT 260 4.6i Power Supercharged

4,6 191 46F2F <260>			
03.02-05.05	1 987 43	M 2182	I
	1 987 43	R 2482 ⁸	I

MINI (BMW)

Mini

Mini Cooper

1,6 85 W10 B16A...			
06.01-02.09	1 457 42	P 9197	O
06.01-06.04	KZ	1 457 43 S 3306	L
07.04-02.09	AG, KZ	1 457 43 S 3306	L
	GS, KZ	1 457 43 S 3100	L
06.01-02.09	1 987 43	M 2082	I
	1 987 43	R 2382 ⁸	I
1,6 88 N12 B16...			
11.06-08.10	1 457 42	P 9249	O
	FML	F 026 40 S 0050	L
	1 987 43	M 2296	I





1,6 90 N16 B16A	03.10→	1 457 42 P 9249 O
		<u>FML</u> F 026 40 S 0050 L
		1 987 43 M 2296 I

Mini Cooper D

1,6 80 9HZ	03.07-07.10	1 457 42 P 9238 O
		1 457 43 S 3327 L
		0 450 90 N 6471 ¹ K
		1 987 43 M 2296 I

1,6 82 N47 C16A	09.10→	0 450 90 N 6457 ¹ K
		1 987 43 M 2296 I

2,0 82/105 N47 C20A	03.11→	0 450 90 N 6457 ¹ K
		1 987 43 M 2296 I

Mini Cooper D ALL4

1,6 82 N47 C16A	09.10→	1 987 43 M 2296 I
-----------------	--------	-------------------

2,0 82/105 N47 C20A	03.11→	1 987 43 M 2296 I
---------------------	--------	-------------------

Mini Cooper S

1,6 120/125 W11 B16A	03.02-02.09	1 457 42 P 9197 O
		<u>FIR</u> 1 987 42 S 9181 L
		1 987 43 M 2082 I
		1 987 43 R 2382 ⁸ I

1,6 120-128 N14 B16A...	11.06-07.10	1 457 42 P 9249 O
		F 026 40 S 0151 L
		1 987 43 M 2296 I

Mini Cooper S, S ALL4

1,6 135 N18 B16A	03.10→	1 457 42 P 9249 O
		1 987 43 M 2296 I

Mini Cooper SD

2,0 82/105 N47 C20A	03.11→	0 450 90 N 6457 ¹ K
		1 987 43 M 2296 I

Mini Cooper SD ALL4

2,0 82/105 N47 C20A	03.11→	1 987 43 M 2296 I
---------------------	--------	-------------------

Mini John Cooper Works

1,6 147/154-160 W11 B16A	10.03-02.09	1 457 42 P 9197 O
		1 987 43 M 2082 I
		1 987 43 R 2382 ⁸ I



1,6 155 N14 B16C	07.08→	1 457 42 P 9249 O
		1 987 43 M 2296 I

Mini One

1,4 55/70 N12 B14A	03.07-02.10	1 457 42 P 9249 O
		F 026 40 S 0050 L
		1 987 43 M 2296 I

1,6 55 N16 B16A	03.10→	1 457 42 P 9249 O
		F 026 40 S 0050 L
		1 987 43 M 2296 I

1,6 66 W10 B16A...	07.04-02.09	1 457 42 P 9197 O
		<u>KZO</u> 1 457 43 S 3100 L
		1 987 43 M 2082 I
		1 987 43 R 2382 ⁸ I

1,6 72 N16 B16A	03.10→	1 457 42 P 9249 O
		F 026 40 S 0050 L
		<u>FML</u> F 026 40 S 0050 L
		1 987 43 M 2296 I

Mini One D

1,6 66 N47 C16A	09.10→	0 450 90 N 6457 ¹ K
		1 987 43 M 2296 I

1,6 66 9HZ	09.09-07.10	1 457 42 P 9238 O
		1 457 43 S 3327 L
		0 450 90 N 6471 ¹ K
		1 987 43 M 2296 I

Mini One 1.4 D

1,4 55/65 1 ND <W17 D14A>	03.03-11.06	0 986 45 P 2044 O
		0 450 90 N 6462 ¹ K
		1 987 43 M 2082 I
		1 987 43 R 2382 ⁸ I

Mini One 1.4i

1,4 55 W10 B14A	09.02-12.04	1 457 42 P 9197 O
	09.02-06.04	1 457 43 S 3306 L
	07.04-12.04	1 457 43 S 3100 L
	09.02-12.04	1 987 43 M 2082 I
		1 987 43 R 2382 ⁸ I



Mini One 1.6i			
1,6 66 W10 B16A...			
06.01-11.06		1 457 42 P 9197	O
06.01-06.04	KZØ	1 457 43 S 3306	L
07.04-11.06	AG, KZØ	1 457 43 S 3306	L
	GS, KZØ	1 457 43 S 3100	L
06.01-11.06		1 987 43 M 2082	I
		1 987 43 R 2382 ⁸	I

MITSUBISHI

Airtrek

Airtrek 2.0 i Turbo 4WD, i 4WD			
2,0 93/177 4G63 (DOHC); 4G63 (SOHC)			
06.01-09.05		0 451 10 P 3316	O
		1 457 43 S 3969	L

ASX

ASX 1.6			
1,6 86 4A92			
04.10 →		0 986 45 P 2041	O
		1 987 43 M 2216	I

ASX 1.8 DI-D, DI-D 4x4

1,8 85/110 4N13			
04.10 →		0 986 45 P 2041	O
		1 457 43 S 3952	L
		1 987 43 M 2216	I

Canter

Canter 2.0			
2,0 74-79 4G63 (SOHC)			
06.97-04.99		0 986 45 P 2041	O

Canter 2.5 D

2,5 51 4D56			
01.86-09.96	HAU	0 986 45 P 2020	O
		0 986 45 N 0508 ²	K

Canter 2.8 D

2,8 69 4M40			
10.96-06.97		0 986 45 P 2063	O
10.96-04.98		0 986 45 N 0508 ²	K

Canter 2.8 D Turbo Interc.

2,8 85 4M40			
05.98-10.00		0 986 45 N 0508 ²	K

Carisma

Carisma 1.3 i 16V			
1,3 60 4G13			
07.01-12.03		0 986 45 P 2041	O
		1 457 43 S 3276	L



Carisma 1.6 i 16V			
1,6 66/73-76 4G92 Kat.			
05.95-12.03	TW	0 451 10 P 3316	O
		0 986 45 P 2041	O
		1 457 43 S 3276	L
		0 450 90 F 5983 ¹	K

Carisma 1.8 GDI

1,8 92 4G93			
05.97-12.03	TW	0 451 10 P 3316	O
		0 986 45 P 2041	O
		1 457 43 S 3276	L
		0 450 90 F 5983 ¹	K

Carisma 1.8 GDI, i 16V

1,8 92/103 4G93 DOHC Kat.; 4G93 Kat.			
05.95-02.99	TW	0 451 10 P 3316	O
		0 986 45 P 2041	O
		1 457 43 S 3276	L
		0 450 90 F 5983 ¹	K

Carisma 1.8 i

1,8 92 4G93 (SOHC)			
10.96-09.97		0 986 45 P 2041	O
1,8 103 4G93 (DOHC)			
10.97-10.99		0 986 45 P 2041	O

Carisma 1.8 i 16V

1,8 85 4G93 SOHC Kat.			
05.95-02.99	TW	0 451 10 P 3316	O
		0 986 45 P 2041	O
		1 457 43 S 3276	L
		0 450 90 F 5983 ¹	K

Carisma 1.9 D Turbo

1,9 66 F8Q			
05.96-06.00		0 451 10 P 3336	O
		1 457 43 S 3535	L
		1 457 43 N 4291 ²	K

Carisma 1.9 DI-D

1,9 75/85 F9Q-200; F9Q-204			
07.00-12.03		0 451 10 P 3336	O
		1 457 43 S 3535	L
		1 457 43 N 1705	K

Challenger

Challenger 2.5 D Turbo 4WD

2,5 77 4D56			
05.96-07.97		0 986 45 P 2042	O
		1 987 42 S 9169	L
		0 986 45 N 0508	K

Challenger 2.8 D Turbo 4WD

2,8 92 4M40			
05.96-05.99		0 986 45 P 2063	O
		1 987 42 S 9169	L
		0 986 45 N 0508	K



Challenger 3.0 i 4WD, i 4x4

3,0 136 6G72;6G72 (SOHC)			
05.96→	0 451 10	P 3316	O
	1 457 43	S 3965	L

Challenger 3.5 i 4WD

3,5 180 6G74 (DOHC)			
08.97-08.01	0 451 10	P 3316	O

Chariot

Chariot 2.0 D Turbo

2,0 65-69 4D68			
06.92-10.97	0 986 45	P 2042	O
	1 457 43	N 4435²	K

Chariot 2.0 i

2,0 99 4G63 (SOHC)			
06.92-10.97	TW	0 451 10	P 3316 O
		0 986 45	P 2041 O
		1 457 43	S 3968 L
		0 450 90	F 5914¹ K

Chariot 2.0 i Turbo 4WD

2,0 169 4G63 (DOHC)			
05.95-10.97	0 986 45	P 2041	O
	1 457 43	S 3968	L
	0 450 90	F 5914¹	K

Chariot 2.4 i

2,4 107 4G64 (SOHC)			
05.93-10.97	TW	0 451 10	P 3316 O
		0 986 45	P 2041 O
		1 457 43	S 3968 L
		0 450 90	F 5914¹ K

Chariot 2.4 i, i 4WD

2,4 121 4G64 (DOHC)			
08.97-05.03	0 451 10	P 3316	O

Colt

Colt 1.1

1,1 55 3A91			
08.04-06.10	0 451 10	P 3372	O
07.10→	0 986 45	P 2041	O
08.04→	1 457 43	S 3599	L
08.04-01.07	1 987 43	R 2434⁸	I
02.07→	1 987 43	M 2034	I

Colt 1.3

1,3 44-51 4G13			
04.88-05.92	TW	0 986 45	P 2016 O
		0 986 45	P 2041 O
06.90-05.92		1 987 42	S 9159 L

1,3 70 4A90			
04.04-06.10	0 451 10	P 3372	O
07.10→	0 986 45	P 2041	O
04.04→	1 457 43	S 3599	L
04.04-01.07	1 987 43	R 2434⁸	I
02.07→	1 987 43	M 2034	I

Colt 1.3 i, i 4WD

1,3 67/68 4A90			
10.04→	0 451 10	P 3372	O

Colt 1.3 i 12V

1,3 55 4G13 Kat.			
12.91-11.95	0 986 45	P 2041	O
11.95-05.00	TW	0 451 10	P 3316 O
		0 986 45	P 2041 O
12.91-11.95	1 457 43	S 3954	L
11.95-05.00	1 457 43	S 3969	L
12.91-11.95	0 986 45	F 0604¹	K
11.95-05.00	1 987 43	M 2086	I

Colt 1.3 i 16V

1,3 60 4G13 Kat.			
06.00-06.03	TW	0 451 10	P 3316 O
		0 986 45	P 2041 O
		1 457 43	S 3969 L
		1 987 43	M 2086 I

Colt 1.3 12V

1,3 55 4G13 Kat.			
04.88-05.92	TW	0 986 45	P 2016 O
		0 986 45	P 2041 O
06.90-05.92		1 987 42	S 9159 L

Colt 1.5

1,5 62 4G15			
04.88-05.92	TW	0 986 45	P 2016 O
		0 986 45	P 2041 O
06.90-05.92		1 987 42	S 9159 L

1,5|69|4G15

11.95-05.00	TW	0 451 10	P 3316 O
		0 986 45	P 2041 O
		1 987 42	S 9159 L

1,5|80|4A91

04.04-06.10	0 451 10	P 3372	O
	1 457 43	S 3599	L
04.04-07.08	1 987 43	R 2434⁸	I
02.07-06.10	1 987 43	M 2034	I

Colt 1.5 DI-D

1,5 50/70 OM 639.393			
08.04-09.08	F 026 40	S 0006	L
	1 457 43	N 4437¹	K
08.04-01.07	1 987 43	R 2434⁸	I
02.07-09.08	1 987 43	M 2034	I





Colt 1.5 i

1,5 62-66 4G15 Kat.				
04.88-05.92	TW	0 986 45 P 2016	0	
		0 986 45 P 2041	0	
		1 987 42 S 9127	L	
06.90-05.92		0 986 45 F 0113 ¹	K	

1,5 72 4G15 (DOHC)				
10.02-10.04	TW	0 986 45 P 2041	0	

Colt 1.5 i, i 4WD

1,5 75/77 4A91				
10.04→		0 451 10 P 3372	0	

Colt 1.5 i Turbo

1,5 108/113-120 4G15 (DOHC)				
10.04→		0 451 10 P 3316	0	

Colt 1.5 Turbo

1,5 110 4G15				
01.05→		0 451 10 P 3316	0	
		F 026 40 S 0006	L	
01.05-01.07		1 987 43 R 2434 ⁸	I	
02.07→		1 987 43 M 2034	I	

1,5 110 4G15T				
05.06-07.08		0 451 10 P 3316	0	
		F 026 40 S 0006	L	

Colt 1.6 i

1,6 66 4G92				
12.91-12.96		0 986 45 P 2041	0	
		1 457 43 S 3954	L	
		0 986 45 F 0604 ¹	K	

Colt 1.6 i 16V

1,6 66/76 4G92 Kat.				
11.95-06.03	TW	0 451 10 P 3316	0	
		0 986 45 P 2041	0	
		1 457 43 S 3969	L	
		1 987 43 M 2086	I	

Colt 1.6 i 16V 2WD, i 16V 4WD

1,6 83 4G92 Kat.				
12.91-11.95		0 986 45 P 2041	0	
		1 457 43 S 3954	L	
		0 986 45 F 0604 ¹	K	

Colt 1.8 D

1,8 44 4D65				
04.88-05.92		0 986 45 P 2042	0	
		1 457 43 N 4435 ²	K	

Colt 1.8 i

1,8 100 4G67				
11.89-05.92		0 986 45 P 2016	0	
		1 987 42 S 9127	L	

1,8 100 4G67 Kat.				
11.89-05.92		0 986 45 P 2016	0	
		1 987 42 S 9127	L	
06.90-05.92		0 986 45 F 0113 ¹	K	



1,8 103 4G93 Kat.				
12.91-11.95		0 986 45 P 2041	0	
		1 457 43 S 3954	L	
		0 986 45 F 0604 ¹	K	

Colt L300

Colt L300 2.5 D

2,5 53 4D56				
01.90→		0 986 45 P 2042	0	
		1 457 42 S 9933	L	
		0 986 45 N 0508 ²	K	

Colt Plus

Colt Plus 1.5 i, i 4WD

1,5 75/77 4A91				
10.04→		0 451 10 P 3372	0	

Delica

Delica 2.4 i

2,4 107 4G64 (SOHC)				
03.94-07.02	TW	0 451 10 P 3316	0	
		0 986 45 P 2041	0	
		1 457 43 S 3965	L	

Delica 2.4 i 4WD

2,4 107 4G64 (SOHC)				
03.94-05.97	TW	0 451 10 P 3316	0	
		0 986 45 P 2041	0	
		1 457 43 S 3965	L	
		0 450 90 F 5963 ¹	K	

Delica 2.5 D, D Turbo

2,5 51/63 4D56				
04.86-08.99		0 986 45 P 2042	0	
		1 457 42 S 9933	L	
		0 986 45 N 0508	K	

Delica 2.5 D Turbo

2,5 77 4D56				
03.94-04.99		0 986 45 P 2042	0	
		0 986 45 N 0508	K	

Delica 2.8 D Turbo 4WD

2,8 92/103 4M40				
03.94-10.04		0 986 45 N 0508	K	
		0 986 45 N 0508 ²	K	

Delica 3.0 i 4WD

3,0 136 6G72 (SOHC)				
03.94-12.06		0 451 10 P 3316	0	
		1 457 43 S 3965	L	
03.94-04.99		0 450 90 F 5914 ¹	K	





Diamante

Diamante 2.0 i

2,0 107 6A12 (SOHC)	09.92-01.95	1 457 43 S 3965	L
		0 986 45 F 0107 ¹	K

Diamante 2.5 i

2,5 129 6G73 (SOHC)	05.90-01.95	0 451 10 P 3316	O
		1 457 43 S 3965	L
		0 986 45 F 0107 ¹	K

Diamante 3.0 i 24V

3,0 151 6G72 DOHC Kat.	01.90-12.94	0 451 10 P 3316	O
		1 457 43 S 3965	L
		0 986 45 F 0107 ¹	K

Dion

Dion 1.8 i Turbo 4WD

1,8 121 4G93 (DOHC)	04.02-12.05	1 457 43 S 3969	L
-------------------------	-------------	------------------------	----------

Dion 2.0 i

2,0 99 4G63 (DOHC)	01.00-03.02	0 451 10 P 3316	O
		1 457 43 S 3969	L
2,0 99 4G94 (DOHC)	07.00-12.05	1 457 43 S 3969	L

Eclipse

Eclipse 1.8 i

1,8 68 4G37 Kat.	01.90-03.94	0 451 10 P 3316	O
		0 986 45 P 2041	O
		1 987 42 S 9127	L
		0 986 45 F 0103 ¹	K

Eclipse 2.0 i Turbo

2,0 162 4G63 (DOHC)	06.95-09.00	0 986 45 P 2041	O
-------------------------	-------------	------------------------	----------

Eclipse 2.0 i 16V, i 16V Turbo, i 16V 4WD

2,0 110/147 4G63 Kat.	01.90-03.94	0 451 10 P 3316	O
		0 986 45 P 2041	O
		1 987 42 S 9127	L
		0 986 45 F 0103 ¹	K



Eclipse 2.0 i 16V Turbo

2,0 157 4G63 Kat.	08.95-04.99	TW	0 451 10 P 3316	O
			0 986 45 P 2041	O
			1 457 43 S 3968	L

Express

Express 2.4

2,4 97 4G64	09.94→		0 986 45 P 2041	O
			1 457 43 S 3965	L

Express 2.5 D 4x4

2,5 55 4D56	09.94→		0 986 45 P 2042	O
-----------------	--------	--	------------------------	----------

Express L300

Express L300 1.6

1,6 52 4G32	01.86→		0 451 10 P 3316	O
-----------------	--------	--	------------------------	----------

FTO

FTO 1.8 i

1,8 92 4G93 (SOHC)	09.94-07.00		0 986 45 P 2041	O
			1 457 43 S 3968	L

FTO 2.0 i

2,0 125-132 6A12 (DOHC)	09.94-07.00		0 986 45 P 2041	O
			1 457 43 S 3968	L

2,0 147 6A12 (DOHC)	09.94-07.00		1 457 43 S 3968	L
-------------------------	-------------	--	------------------------	----------

Galant

Galant 1.6

1,6 55 4G32	11.87-10.92		0 986 45 P 2016	O
			1 457 43 S 3682	L

1,6 58 4G32	08.87-05.92		0 451 10 P 3316	O
			1 457 43 S 3682	L

Galant 1.8

1,8 63 4G37	08.87-05.92		0 451 10 P 3316	O
Org.Nr. E-E32A	08.87-05.92		1 457 43 S 3682	L

1,8 81 4G93 (SOHC)	03.92-08.96		0 986 45 P 2041	O
------------------------	-------------	--	------------------------	----------





Galant 1.8 D Turbo

1,8 55/56 4D65	12.87-10.92	0 986 45 P 2042	O
		1 987 42 S 9127	L
		1 457 43 N 4435 ²	K

Galant 1.8 i

1,8 66 4G37	11.87-10.92	0 986 45 P 2016	O
		1 987 42 S 9127	L
		0 986 45 F 0103 ¹	K

1,8 66 4G37 Kat.	10.89-10.92	0 986 45 P 2016	O
		1 987 42 S 9127	L
		0 986 45 F 0103 ¹	K

1,8 85 4G93 (SOHC)	08.94-08.96	1 457 43 S 3968	L
------------------------	-------------	-----------------	---

1,8 99 4G67	04.89-05.92	0 451 10 P 3316	O
		0 986 45 P 2041	O
		1 987 42 S 9127	L
		0 986 45 F 0103 ¹	K

1,8 99 6A11	03.92-08.96	1 457 43 S 3968	L
		0 986 45 F 0107 ¹	K

1,8 103 4G93 (DOHC)	08.94-08.96	1 457 43 S 3968	L
-------------------------	-------------	-----------------	---

Galant 1.8 i 4WD

1,8 69 4G37	09.88-05.92	0 451 10 P 3316	O
		1 987 42 S 9127	L
		0 986 45 F 0103 ¹	K

Galant 1.8 i 16V

1,8 85-93 4G93 Kat.	11.92-05.96	0 986 45 P 2041	O
		1 457 43 S 3968	L
		0 986 45 F 0107 ¹	K

Galant 2.0 D Turbo

2,0 66 4D68	10.96-02.00	1 987 42 S 9127	L
		1 457 43 N 4435 ²	K
		1 987 43 M 2207	I

2,0 66-69 4D68	11.92-10.96	0 986 45 P 2042	O
		1 987 42 S 9127	L
		1 457 43 N 4435 ²	K

Galant 2.0 D Turbo, D Turbo 4WD

2,0 69 4D68	06.92-08.96	0 986 45 P 2042	O
		1 457 43 N 4435 ²	K

Galant 2.0 i

2,0 77 4G63 SOHC	01.90-12.93	0 986 45 F 0103 ¹	K
----------------------	-------------	------------------------------	---



2,0 80 4G63 Kat.	11.87-10.92	TW	0 451 10 P 3316	O
			0 986 45 P 2016	O
			1 987 42 S 9127	L
			0 986 45 F 0103 ¹	K

2,0 82 4G63	11.87-10.92	TW	0 451 10 P 3316	O
			0 986 45 P 2016	O
			1 987 42 S 9127	L
	07.90-10.92		1 457 43 S 3968	L
	11.87-10.92		0 986 45 F 0103 ¹	K

2,0 84 4G63	11.91-12.98		1 457 43 S 3968	L
-----------------	-------------	--	-----------------	---

2,0 100 4G63	01.97-12.03	ND,WW	0 451 10 P 3316	O
		TOR	0 986 45 P 2041	O
			0 450 90 F 5953 ¹	K

2,0 107 6A12 (SOHC)	03.92-08.96	TW	0 986 45 P 2041	O
			1 457 43 S 3968	L

2,0 125 6A12 (DOHC)	03.92-08.96		0 986 45 P 2041	O
			1 457 43 S 3968	L
	03.92-10.93		0 986 45 F 0107 ¹	K

2,0 147 6A12 (DOHC)	10.94-08.96		0 986 45 P 2041	O
			1 457 43 S 3968	L

Galant 2.0 i 4WD, i 4WD 4WS, i 4WD, i 4WD 4WS

2,0 80 4G63 Kat.	06.88-10.92		0 986 45 P 2016	O
			1 987 42 S 9127	L
			0 986 45 F 0103 ¹	K

Galant 2.0 i, i Turbo, i Turbo 4WD, i 4WD

2,0 102/107/125/148/162/177 4G63 (DOHC); 4G63 DOHC	08.87-12.93		0 451 10 P 3316	O
			1 987 42 S 9127	L
			0 986 45 F 0103 ¹	K

Galant 2.0 i Turbo 4WD

2,0 158-177 6A12 (DOHC)	03.92-08.96		0 451 10 P 3316	O
			1 457 43 S 3968	L

Galant 2.0 i V6-24

2,0 110 6A12 Kat.	11.92-05.96	TW	0 451 10 P 3316	O
			0 986 45 P 2041	O
			1 457 43 S 3968	L
			0 986 45 F 0107 ¹	K

Galant 2.0 i V6-24 4WS

2,0 110 6A12 Kat.	11.92-04.95		0 451 10 P 3316	O
			1 457 43 S 3968	L
			0 986 45 F 0107 ¹	K





Galant 2.0 i 4WD

2,0 125 6A12 (DOHC)			
10.94-08.96		0 451 10 P 3316	O
		1 457 43 S 3968	L
		0 986 45 F 0107 ¹	K

Galant 2.0 i 16V

2,0 100 4G63			
10.96-05.03	TW	0 451 10 P 3316	O
		0 986 45 P 2041	O
		0 450 90 F 5953 ¹	K
	VKL	1 987 43 M 2207	I

2,0|106|4G63 Kat.

11.87-10.92	TW	0 451 10 P 3316	O
		0 986 45 P 2016	O
		1 987 42 S 9127	L
		0 986 45 F 0103 ¹	K

2,0|107|4G63

11.87-10.92	TW	0 451 10 P 3316	O
		0 986 45 P 2016	O
		1 987 42 S 9127	L
		0 986 45 F 0103 ¹	K

Galant 2.0 i 16V, i 16V 4WD

2,0 101 4G63 Kat.			
11.92-05.96	TW	0 451 10 P 3316	O
		0 986 45 P 2041	O
		1 457 43 S 3968	L
		0 986 45 F 0107 ¹	K

Galant 2.0 i 16V 4WD 4WS

2,0 106 4G63 Kat.			
06.88-10.92		0 986 45 P 2016	O
		1 987 42 S 9127	L
		0 986 45 F 0103 ¹	K

Galant 2.4 GDI

2,4 110 4G64			
12.98-05.03		0 451 10 P 3316	O
	VKL	1 987 43 M 2207	I

Galant 2.4 i, i 4WD

2,4 121 4G64 (DOHC)			
08.98-09.02		0 451 10 P 3316	O

Galant 2.5 i Turbo 4WD

2,5 191-206 6A13 (DOHC)			
07.96-09.02		0 451 10 P 3316	O
		0 450 90 F 5953 ¹	K

Galant 2.5 i V6-24

2,5 118 6A13			
10.96-05.03		0 451 10 P 3316	O
		0 450 90 F 5953 ¹	K
	VKL	1 987 43 M 2207	I



2,5 125 6G73			
11.92-05.96		0 451 10 P 3316	O
		1 457 43 S 3968	L
		0 986 45 F 0107 ¹	K

Galant Sports

Galant Sports 2.0 i

2,0 107 6A12 (SOHC)			
08.94-09.95		1 457 43 S 3968	L
		0 986 45 F 0107 ¹	K

Galant Sports 2.0 i Turbo 4WD

2,0 158-177 6A12 (DOHC)			
08.94-08.96		0 451 10 P 3316	O
		1 457 43 S 3968	L

Galloper

Galloper 2.5 TD

2,5 65 D4BF <4D56TC>			
02.99-12.01		0 451 10 P 3366	O
		1 457 43 N 4453 ²	K

Galloper 2.5 TD Interc.

2,5 73 D4BH <4D56TCI>			
05.98-12.01		0 451 10 P 3366	O

Galloper 3.0 V6

3,0 104 G6AT			
09.98-12.01		0 451 10 P 3316	O
		1 987 42 S 9127	L

Grandis

Grandis 2.0 DI-D

2,0 100-103 BSY			
06.05→		1 457 42 P 9192	O
		F 026 40 N 2086 ¹	K
		1 987 43 R 2426 ⁸	I

Grandis 2.4

2,4 121 4G69			
01.04→		0 451 10 P 3316	O
		1 987 43 R 2426 ⁸	I

Grandis 2.4 i, i 4WD

2,4 121 4G69			
05.03-03.09		0 451 10 P 3316	O

GTO

GTO 3.0 i Turbo 4WD, i 4WD

3,0 165/206 6G72 (DOHC)			
10.90-07.00		0 451 10 P 3316	O
		1 457 43 S 3965	L





i

i 0.7 i Turbo

0,7 47 3B20	12.05→	F 026 40 P 7089	O
-----------------	--------	-----------------	---

L 200

L 200 1.6

1,6 48 4G32	11.86-03.95	0 986 45 P 2016	O
		0 451 10 P 3364	L

L 200 2.0 i 16V

2,0 90 4G63 Kat.	01.96-06.01	TW	0 451 10 P 3316	O
			0 986 45 P 2041	O
			1 457 43 S 3965	L

L 200 2.0 2WD

2,0 65 4G63	11.86-05.95	TW	0 986 45 P 2016	O
			0 986 45 P 2041	O
			1 457 43 S 2108	L

L 200 2.0 4WD

2,0 65 4G63	11.86-05.94	TW	0 451 10 P 3316	O
			0 986 45 P 2041	O
			1 457 43 S 2108	L

L 200 2.4 i 2WD, i 4WD

2,4 82 4G64 Kat.	06.90-11.97	TW	0 451 10 P 3316	O
			0 986 45 P 2041	O
			1 457 43 S 3965	L

L 200 2.4 i 4WD

2,4 97 4G64 Kat.	01.96-12.07		0 986 45 P 2041	O
		WW	0 451 10 P 3316	O
			1 457 43 S 3965	L

L 200 2.5 D, D 2WD, D 4WD

2,5 55-64 4D56	06.95-06.01		0 986 45 P 2042	O
			1 987 42 S 9186	L
			0 986 45 N 0508 ²	K

L 200 2.5 D Turbo Interc., D Turbo Interc. 2WD, D Turbo Interc. 4WD

2,5 73-85 4D56	01.96→		0 986 45 P 2042	O
			1 987 42 S 9186	L
			0 986 45 N 0508 ²	K



L 200 2.5 D Turbo 4WD

2,5 73 4D56	11.92-03.01		0 986 45 P 2042	O
			1 987 42 S 9169	L
			0 986 45 N 0508 ²	K

L 200 2.5 D 2WD

2,5 54 4D56	10.84-05.96		0 986 45 P 2042	O
	11.93-05.96		1 987 42 S 9169	L
	10.84-05.96		0 986 45 N 0508 ²	K

L 200 2.5 D 4WD

2,5 54 4D56	12.87-10.92		0 986 45 P 2042	O
			0 986 45 N 0508 ²	K

L 200 2.5 DI-D, DI-D 4x4

2,5 94/100/123/131 4D56	12.05→		0 986 45 P 2042	O
		HEI	1 457 43 N 4438 ²	K

L 200 2.6

2,6 76 G54B	11.89-05.95	TW	0 451 10 P 3316	O
			0 986 45 P 2016	O
			0 986 45 P 2041	O
			1 457 43 S 2108	L

L 200 2.8 D

2,8 92 4M40	06.95→		0 986 45 N 0508 ²	K
-----------------	--------	--	------------------------------	---

L 200 3.0 i V6

3,0 110 6G72	06.90-05.91	TW	0 451 10 P 3316	O
			0 986 45 P 2016	O
			1 457 43 S 3965	L

L 300

L 300 1.6

1,6 48-51 4G32	11.86-05.94		0 986 45 P 2016	O
		TW	0 451 10 P 3316	O
			0 986 45 P 2041	O
			1 987 42 S 9107	L

L 300 1.6 2WD

1,6 48-51 4G32	11.86-05.94	TW	0 451 10 P 3316	O
			0 986 45 P 2041	O

L 300 2.0 i 2WD

2,0 65 4G63 Kat.	06.94-12.01	TW	0 451 10 P 3316	O
			0 986 45 P 2041	O
			0 450 90 F 5972 ¹	K





2,0 83 4G63 Kat.	06.96-08.97	TW	0 451 10 P 3316	0
			0 986 45 P 2041	0
			0 450 90 F 5972 ¹	K

L 300 2.0 i 16V

2,0 85 4G63 Kat.	06.94-04.00	TW	0 451 10 P 3316	0
			0 986 45 P 2041	0

L 300 2.0 2WD

2,0 66 4G63 Kat.	11.86-06.95	TW	0 451 10 P 3316	0
			0 986 45 P 2041	0

L 300 2.0 4WD

2,0 65 4G63	11.86-06.93	TW	0 451 10 P 3316	0
			0 986 45 P 2041	0

L 300 2.0 16V

2,0 65 4G63 Kat.	06.94-05.96	TW	0 451 10 P 3316	0
			0 986 45 P 2041	0

L 300 2.4 i 2WD

2,4 82 4G64 Kat.	11.90-05.96	TW	0 451 10 P 3316	0
			0 986 45 P 2041	0
			0 450 90 F 5972 ¹	K

L 300 2.4 i 4WD

2,4 82 4G64 Kat.	11.88-06.95	TW	0 451 10 P 3316	0
			0 986 45 P 2041	0

L 300 2.5 D, D Turbo, D Turbo 4WD, D Turbo 4WD Wagon, D 2WD, D 2WD long, D 2WD short

2,5 51/52/62-64 4D56	11.86-12.01		0 986 45 P 2042	0
			1 457 42 S 9933	L
			0 986 45 N 0508 ²	K

L 400

L 400 2.0 i

2,0 83-85 4G63 Kat.	12.94-03.01	TW	0 451 10 P 3316	0
			0 986 45 P 2041	0
			1 457 43 S 3965	L

L 400 2.4 i

2,4 97 4G64 Kat.	12.94-03.01	TW	0 451 10 P 3316	0
			0 986 45 P 2041	0
			1 457 43 S 3965	L
	12.94-08.99		0 450 90 F 5963 ¹	K



L 400 2.5 D Turbo 2WD, D Turbo 4WD

2,5 64 4D56	12.94-03.01		0 986 45 P 2042	0
			0 986 45 N 0508 ²	K

Lancer

Lancer 1.2

1,2 40 4G16	04.88-05.92		0 986 45 P 2016	0
			1 987 42 S 9121	L

Lancer 1.3

1,3 44 4G13	04.88-07.95		0 986 45 P 2016	0
	06.90-07.95		1 987 42 S 9159	L

1,3 49 4G13	05.88-10.91		0 986 45 P 2041	0
-----------------	-------------	--	-----------------	---

1,3 49-58 G13B (SOHC)	01.85-09.92		0 986 45 P 2041	0
---------------------------	-------------	--	-----------------	---

1,3 55 4G13 Kat.	04.88-05.92		0 986 45 P 2016	0
	12.91-06.93		0 986 45 P 2041	0
	06.90-06.93		1 987 42 S 9159	L

1,3 58 4G13	10.91-10.95		1 987 42 S 9159	L
-----------------	-------------	--	-----------------	---

Lancer 1.3 i

1,3 55 4G13 Kat.	06.92-07.95		0 986 45 P 2016	0
			1 457 43 S 3954	L
			0 986 45 F 0113 ¹	K

1,3 58 4G13 Kat.	07.93-12.96		0 986 45 P 2041	0
			1 457 43 S 3954	L
			0 986 45 F 0604 ¹	K

1,3 60 4G13	06.03-04.10		0 986 45 P 2041	0
			1 457 43 S 3969	L
			1 987 43 R 2426 ⁸	I

1,3 65 4G13	08.95-05.00	TW	0 986 45 P 2041	0
			1 457 43 S 3969	L

Lancer 1.3 I

1,3 55 4G13	01.89-12.94		0 986 45 P 2041	0
			1 987 42 S 9159	L
			0 986 45 F 0604 ¹	K





Lancer 1.3 i 12V

1,3 55 4G13 Kat.	11.95-05.01	TW	0 451 10 P 3316	O
			0 986 45 P 2041	O
			1 457 43 S 3969	L
			1 987 43 M 2086	I

Lancer 1.5

1,5 51-55 4G15 <MPI>	07.93-12.94		0 986 45 P 2041	O
			1 987 42 S 9127	L

1,5 54 4G15 (SOHC)	05.88-10.91		0 986 45 P 2016	O
-------------------------------	-------------	--	------------------------	----------

1,5 60 4G15	06.85-05.92	TW	0 986 45 P 2016	O
			0 986 45 P 2041	O
	06.90-05.92		1 987 42 S 9159	L

1,5 65 4G15	10.92-06.96		0 986 45 P 2041	O
			1 987 42 S 9159	L

1,5 66 4G15	01.89-12.94		0 986 45 P 2041	O
	06.91-06.93		1 987 42 S 9159	L

1,5 67 4G15	12.91-10.96		0 986 45 P 2041	O
			1 987 42 S 9159	L

1,5 67-69 4G15	11.95-09.00	TW	0 451 10 P 3316	O
			0 986 45 P 2041	O
			1 987 42 S 9159	L

1,5 80 4A91	03.07-06.10		0 451 10 P 3372	O
	07.10→		0 986 45 P 2041	O
	03.07→		1 987 43 M 2216	I

Lancer 1.5 , 4WD

1,5 54-63 G15B	01.85-09.92		0 986 45 P 2041	O
---------------------------	-------------	--	------------------------	----------

Lancer 1.5 i

1,5 60 4G15 (SOHC)	06.88-10.91		0 986 45 P 2041	O
			1 987 42 S 9127	L

1,5 62 4G15	05.89-05.92		0 986 45 P 2016	O
			1 987 42 S 9127	L

1,5 62-66 4G15 Kat.	04.88-05.92		0 986 45 P 2016	O
			1 987 42 S 9127	L
	06.90-05.92		0 986 45 F 0113 ¹	K

1,5 64 4G15	01.98→		0 986 45 P 2041	O
			1 457 43 S 3969	L

1,5 66 4G15 Kat.	06.88-05.92		0 986 45 P 2016	O
			1 987 42 S 9127	L



1,5 66 4G15 (SOHC)	02.03-05.10		1 457 43 S 3969	L
			1 987 43 R 2426	I

1,5 67 4G15 (SOHC)	10.91-10.95		1 457 43 S 3954	L
			0 986 45 F 0604 ¹	K

1,5 68 4G15 <MPI>	07.93-12.97		0 986 45 P 2041	O
			1 457 43 S 3954	L
			0 986 45 F 0604 ¹	K

1,5 69 4G15 (SOHC)	08.95-06.99	TW	0 451 10 P 3316	O
			0 986 45 P 2041	O
			1 457 43 S 3969	L

1,5 70 4G15	08.95-02.00		0 986 45 P 2041	O
			1 457 43 S 3969	L

1,5 85 4G91	10.91-10.95		1 457 43 S 3954	L
------------------------	-------------	--	------------------------	----------

1,5 94 4G15	01.96-12.04		1 987 42 S 9121	L
------------------------	-------------	--	------------------------	----------

Lancer 1.5 i, i 4WD

1,5 81 4G15 (DOHC)	08.95-05.00	TW	0 451 10 P 3316	O
			0 986 45 P 2041	O
			1 457 43 S 3969	L

Lancer 1.5 i 12V

1,5 65 4G15 SOHC	01.90-11.91		0 451 10 P 3316	O
	12.91-12.92		0 986 45 P 2041	O

Lancer 1.5 8V

1,5 62 4G15	04.88-05.92		0 986 45 P 2016	O
	06.90-05.92		1 987 42 S 9159	L

Lancer 1.5 12V

1,5 67 4G15	06.92-07.95		0 986 45 P 2016	O
			1 987 42 S 9159	L

Lancer 1.6

1,6 77 4G92 Kat.	10.92-06.96		0 986 45 F 0604 ¹	K
-----------------------------	-------------	--	-------------------------------------	----------

1,6 86 4A92	07.10→		0 986 45 P 2041	O
			1 987 43 M 2216	I

Lancer 1.6 i

1,6 72 4G18	06.03-04.10		0 986 45 P 2041	O
			1 457 43 S 3969	L
			1 987 43 R 2426 ⁸	I





1,6 77-81 4G18	05.00-02.03	0 986 45 P 2041	O
		1 457 43 S 3969	L

1,6 81 4G18	11.93-12.96	1 457 43 S 3969	L
------------------------	-------------	------------------------	----------

1,6 81 4G92	11.03→	0 986 45 P 2041	O
	07.99-02.01	1 457 43 S 3969	L
	11.03→	1 457 43 S 3969	L

1,6 90 4G61 DOHC	10.90-09.92	0 451 10 P 3316	O
		1 987 42 S 9159	L

1,6 91 4G92	01.96-12.03	1 457 43 S 3969	L
------------------------	-------------	------------------------	----------

1,6 92-96 4G61	05.88-10.91	0 986 45 P 2041	O
		1 987 42 S 9127	L

1,6 103 6A10	10.91-10.95	1 457 43 S 3954	L
		0 986 45 F 0604 ¹	K

1,6 129 4G92 (DOHC)	10.92-05.00	1 457 43 S 3954	L
Org.Nr. E-CB4A	10.92-05.00	1 457 43 S 3969	L
Org.Nr. E-CK4A,	10.92-05.00	1 457 43 S 3969	L
Org.Nr. GF-CK4A	10.92-05.00	0 986 45 F 0604 ¹	K

Lancer 1.6 i 16V

1,6 66 4G92 Kat.	11.95-09.00	TW	0 451 10 P 3316	O
			0 986 45 P 2041	O
			1 457 43 S 3969	L

1,6 66 4G92 MVV	12.93-12.96	0 986 45 P 2041	O
		1 457 43 S 3954	L
		0 986 45 F 0604 ¹	K

1,6 83 4G92 Kat.	05.92-12.96	0 986 45 P 2041	O	
	06.92-07.95	TW	0 986 45 P 2016	O
	06.92-09.00	TW	0 451 10 P 3316	O
			0 986 45 P 2041	O
	05.92-09.00		1 457 43 S 3954	L
	05.92-12.96		0 986 45 F 0604 ¹	K
	06.92-07.95		0 986 45 F 0113 ¹	K

Lancer 1.6 i 16V 4WD

1,6 83 4G92 Kat.	05.92-11.93	0 986 45 P 2041	O	
	06.92-07.95	0 986 45 P 2016	O	
	06.92-09.00	TW	0 451 10 P 3316	O
			0 986 45 P 2041	O
	05.92-09.00		1 457 43 S 3954	L
	05.92-11.93		0 986 45 F 0604 ¹	K

Lancer 1.8			
1,8 103-105 4B10	02.08→	0 986 45 P 2041	O
		1 987 43 M 2216	I

Lancer 1.8 , i 16V

1,8 86/100-103 4G93 Kat.	05.92-12.96	0 986 45 P 2041	O
		1 457 43 S 3954	L
		0 986 45 F 0604 ¹	K

Lancer 1.8 D, D Turbo 4WD, D 4WD

1,8 44-45/56 4D65	06.86-09.92	0 986 45 P 2042	O
		1 457 43 N 4435 ²	K

Lancer 1.8 DI-D

1,8 85/110 4N13	07.10→	0 986 45 P 2041	O
		1 457 43 S 3952	L
		1 987 43 M 2216	I

Lancer 1.8 i

1,8 85 4G93 Kat.	05.96-05.01	1 457 43 S 3969	L
-----------------------------	-------------	------------------------	----------

1,8 88 4G93 (SOHC)	10.92-10.96	1 457 43 S 3954	L
-------------------------------	-------------	------------------------	----------

1,8 91 4G93	06.00→	1 457 43 S 3969	L
------------------------	--------	------------------------	----------

1,8 92 4G93 (SOHC)	07.96-05.00	0 986 45 P 2041	O
		1 457 43 S 3969	L

1,8 99 6A11	08.95-06.99	1 457 43 S 3969	L
------------------------	-------------	------------------------	----------

Lancer 1.8 i, i Turbo

1,8 84/121 4G93 (DOHC)	02.03-07.07	1 457 43 S 3969	L
-----------------------------------	-------------	------------------------	----------

Lancer 1.8 i Turbo 4WD

1,8 151 4G93 (DOHC)	08.95-05.00	0 986 45 P 2041	O
		1 457 43 S 3969	L

Lancer 1.8 i 4WD

1,8 69 4G37	10.90-09.92	0 986 45 P 2041	O
		1 987 42 S 9127	L

1,8 69 4G37 Kat.	06.90-05.92	TW	0 451 10 P 3316	O
			0 986 45 P 2016	O
			1 987 42 S 9127	L

1,8 71 4G37 Kat.	05.89-05.92	0 986 45 P 2016	O
		1 987 42 S 9127	L





Lancer 1.8 i 16V

1,8 100 4G67; 4G67 Kat.	11.89-05.92	0 451 10 P 3316	O
		1 987 42 S 9127	L
	06.90-05.92	0 986 45 F 0113 ¹	K

1,8 103 4G93 Kat.	06.92-07.95	TW	0 986 45 P 2016	O
			0 986 45 P 2041	O
			1 457 43 S 3954	L
			0 986 45 F 0113 ¹	K

Lancer 1.8 4WD

1,8 66 4G37	11.86-05.92	TW	0 451 10 P 3316	O
			0 986 45 P 2016	O
			1 457 43 S 3682	L

Lancer 2.0 D

2,0 50 4D68	05.92-12.96	0 986 45 P 2042	O
		1 987 42 S 9127	L
	03.98→	1 987 42 S 9127	L
	05.92-12.96	1 457 43 N 4435 ²	K
	03.98→	1 457 43 N 4435 ²	K

2,0 54 4D68	05.92-12.96	0 986 45 P 2042	O
		1 987 42 S 9127	L
		1 457 43 N 4435 ²	K

Lancer 2.0 D Turbo

2,0 65 4D68	10.92-10.96	0 986 45 P 2042	O	
		10.92-06.99	1 457 43 N 4435 ²	K

Lancer 2.0 D Turbo 4WD

2,0 65 4D68	08.95-06.99	1 457 43 N 4435 ²	K
-----------------	-------------	------------------------------	---

Lancer 2.0 DI-D

2,0 103	02.08→	1 457 42 P 9192	O
		F 026 40 N 2086 ¹	K
		1 987 43 M 2216	I

Lancer 2.0 EvoX FQ-330 4x4, EvoX FQ-360 4x4, EvoX FQ-400 4x4

2,0 242/264/300 4B11	06.08→	1 987 43 M 2216	I
--------------------------	--------	-----------------	---

Lancer 2.0 i

2,0 84 4G94 (SOHC)	01.05-06.07	1 457 43 S 3969	L
------------------------	-------------	-----------------	---

2,0 114 4B11 <DOHC MIVEC 16v>	07.07→	0 451 10 P 3364	O
-----------------------------------	--------	-----------------	---

Lancer 2.0 i, i Turbo Evo7 4x4, i Turbo Evo8 4x4

2,0 99/195/206 4G63	12.00-04.10	0 451 10 P 3316	O
		1 457 43 S 3969	L
		1 987 43 R 2426 ⁸	I



Lancer 2.0 i Turbo EvoX 4WD

2,0 217 4B11 <T/C MIVEC 14>	08.07→	0 451 10 P 3316	O
		1 987 43 M 2216	I

Lancer 2.0 i Turbo Evo4

2,0 199 4G63 Kat.	08.96-06.97	0 451 10 P 3316	O
		1 457 43 S 3969	L

Lancer 2.0 i Turbo Evo5/6

2,0 206 4G63 Kat.	01.98-09.00	0 451 10 P 3316	O
		1 457 43 S 3969	L

Lancer 2.0 i Turbo Evo9 4x4

2,0 206 4G63 MIVEC	08.05-06.07	0 451 10 P 3316	O
		1 457 43 S 3969	L
		1 987 43 R 2426 ⁸	I

Lancer 2.0 i Turbo 4WD

2,0 184/191-199 4G63 (DOHC)	10.92-10.96	TW	0 451 10 P 3316	O
			0 986 45 P 2041	O
			1 457 43 S 3954	L
			0 986 45 F 0604 ¹	K

2,0 200 4G63 (DOHC)	02.02-01.03	0 451 10 P 3316	O
		1 457 43 S 3969	L

2,0 206 4G63 (DOHC)	08.96-05.00	0 451 10 P 3316	O	
		01.01-01.07	0 451 10 P 3316	O
		08.96-05.00	1 457 43 S 3969	L
		01.01-01.07	1 457 43 S 3969	L

Lancer 2.0 Ralliart 4x4

2,0 177 4B11	03.07→	0 451 10 P 3316	O
		1 987 43 M 2216	I

Legnum

Legnum 2.0 i

2,0 107 6A12 (SOHC)	06.96-08.98	0 450 90 F 5953 ¹	K
-------------------------	-------------	------------------------------	---

Legnum 2.4 i, i 4WD

2,4 121 4G64 (DOHC)	08.98-08.02	0 451 10 P 3316	O
-------------------------	-------------	-----------------	---

Legnum 2.5 i

2,5 129 6A13 (SOHC)	06.96-08.98	0 450 90 F 5953 ¹	K
-------------------------	-------------	------------------------------	---

Legnum 2.5 i Turbo 4WD

2,5 191-206 6A13 (DOHC)	06.96-08.02	0 451 10 P 3316	O
		0 450 90 F 5953 ¹	K





Mega Cab

Mega Cab 2.5 D

2,5 67 4D56	02.96-02.03	1 987 42 S 9186	L
		0 986 45 N 0508 ²	K

Minica

Minica 0.7

0,7 29 3G83 (SOHC)	01.90-10.95	F 026 40 P 7089	O
		0 986 45 F 0138 ¹	K

Minica 0.7 4WD

0,7 29 3G83 (SOHC)	09.93-10.98	0 986 45 F 0138 ¹	K
------------------------	-------------	-------------------------------------	----------

Mirage

Mirage 1.3

1,3 58 4G13	09.87-10.91	0 986 45 P 2041	O
	10.91-10.95	1 987 42 S 9159	L

Mirage 1.3 i

1,3 65 4G13	08.95-08.00	TW	0 451 10 P 3316	O
			0 986 45 P 2041	O
			1 457 43 S 3969	L

Mirage 1.5

1,5 63 4G15 (SOHC)	09.87-10.91	0 986 45 P 2041	O
------------------------	-------------	------------------------	----------

Mirage 1.5 i

1,5 67 4G15 (SOHC)	10.91-10.95	1 457 43 S 3954	L
		0 986 45 F 0604 ¹	K

1,5 69 4G15 (SOHC)	08.95-06.99	0 451 10 P 3316	O
		1 457 43 S 3969	L

1,5 74 4G15 (SOHC)	12.87-10.91	0 986 45 P 2016	O
		1 987 42 S 9127	L

1,5 81 4G15 (DOHC)	08.95-08.00	TW	0 451 10 P 3316	O
			0 986 45 P 2041	O
			1 457 43 S 3969	L

Mirage 1.5 i, i 12V

1,5 68/69 4G15 <SOHC Kat.>; 4G15 S3	01.93→	0 986 45 P 2041	O
		1 457 43 S 3969	L



Mirage 1.6 i

1,6 96 4G61	09.87-10.91	0 986 45 P 2041	O
		1 987 42 S 9127	L

1,6 103 6A10	10.91-10.95	1 457 43 S 3954	L
		0 986 45 F 0604 ¹	K

1,6 129 4G92 (DOHC)	08.95-08.00	1 457 43 S 3969	L
-------------------------	-------------	------------------------	----------

Mirage 1.8 i

1,8 99 4G93 (DOHC)	02.00-08.02	1 457 43 S 3969	L
------------------------	-------------	------------------------	----------

1,8 99 6A11	08.95-06.99	1 457 43 S 3969	L
-----------------	-------------	------------------------	----------

Outlander

Outlander 2.0

2,0 108 4B11	09.07→	0 451 10 P 3364	O
		1 987 43 M 2216	I

Outlander 2.0 DI-D 4x4

2,0 103 BSY	02.07→	1 457 42 P 9192	O
		F 026 40 N 2086 ¹	K
		1 987 43 M 2216	I

Outlander 2.0 i Turbo 4WD, i 2WD, i 4WD

2,0 100/148 4G63	02.03-09.07	0 451 10 P 3316	O
		1 457 43 S 3969	L
		1 987 43 R 2426 ⁸	I

Outlander 2.2 DI-D

2,3 130 4N14	07.10→	0 986 45 P 2041	O
		1 457 43 S 3952	L

Outlander 2.2 DI-D 4x4

2,2 115 4HN <DW12METED4 /FAP>	09.07→	1 457 42 P 9249	O
		1 987 43 M 2216	I

2,3 103 4N14	07.10→	0 986 45 P 2041	O
		1 457 43 S 3952	L

2,3 130 4N14	07.10→	0 986 45 P 2041	O
		1 457 43 S 3952	L
		1 987 43 M 2216	I





Outlander 2.4 , 4x4

2,4 125 4B12	09.07→	0 451 10 P 3364	O
		1 987 43 M 2216	I

Outlander 2.4 i 4WD, i 4x4

2,4 92/118 4G64S4M; 4G69 MIVEC	05.03-09.07	0 451 10 P 3316	O
		1 457 43 S 3969	L
		1 987 43 R 2426 ⁸	I

Outlander 3.0 4x4

3,0 162 6B31	09.07→	0 986 45 P 2041	O
	WW	0 451 10 P 3364	O
		1 987 43 M 2216	I

Pajero

Pajero 1.8 GDI

1,8 96 4G93 Kat.	06.98-09.01	0 986 45 P 2041	O
		1 457 43 S 3969	L

Pajero 2.4 i

2,4 82-100 4G64 Kat.	12.90-05.94	TW	0 451 10 P 3316	O
			0 986 45 P 2041	O
			1 457 43 S 3965	L
			0 450 90 F 5914 ¹	K

Pajero 2.4 i 4WD

2,4 107 4G64 (SOHC)	04.96-09.99	TW	0 451 10 P 3316	O
			0 986 45 P 2041	O
			0 450 90 F 5914 ¹	K

Pajero 2.5 D

2,5 62 4D56	04.91-05.99	0 986 45 P 2042	O
		1 987 42 S 9169	L
		0 986 45 N 0508 ²	K

Pajero 2.5 D Turbo 4WD

2,5 63 4D56	01.91-07.93	0 986 45 P 2042	O
	04.86-07.93	0 986 45 N 0508	K
2,5 69 4D56	09.88-04.91	0 986 45 P 2042	O
		1 987 42 S 9109	L
		0 986 45 N 0508 ²	K
		0 986 45 N 0508	K
2,5 77 4D56	10.90-05.97	0 986 45 P 2042	O
		1 987 42 S 9109	L
		MCY 1 987 42 S 9109	L
	07.95-02.96	MCY 1 987 42 S 9169	L
	10.90-05.97	0 986 45 N 0508 ²	K
		0 986 45 N 0508	K



Pajero 2.5 DI-D

2,5 131 4D56	10.09→	0 986 45 P 2042	O
		HEI 1 457 43 N 4438 ²	K
		1 987 43 R 2426 ⁸	I

Pajero 2.5 TD

2,5 62 4D56	05.86-05.99	0 986 45 P 2042	O
	05.86-06.91	AZY 1 457 42 S 9933	L
		NOR 1 987 42 S 9109	L
	04.91-05.99	1 987 42 S 9169	L
	05.86-05.99	0 986 45 N 0508 ²	K

2,5 | 73-85 | 4D56

08.98-02.09	0 986 45 P 2042	O
	1 987 42 S 9169	L
	0 986 45 N 0508 ²	K
WW	1 457 43 N 4453 ²	K

Pajero 2.5 TD+

2,5 98 4D56	07.01-02.09	0 986 45 P 2042	O
		1 987 42 S 9169	L
		0 986 45 N 0508 ²	K
	WW	1 457 43 N 4453 ²	K

Pajero 2.5 TD Interc.

2,5 70 4D56	11.89-06.91	0 986 45 P 2042	O
		AZY 1 457 42 S 9933	L
		NOR 1 987 42 S 9109	L
		0 986 45 N 0508 ²	K

2,5 | 73-77 | 4D56

12.90-05.01	0 986 45 P 2042	O
	AZY 1 987 42 S 9169	L
	MCY 1 987 42 S 9109	L
	0 986 45 N 0508 ²	K

2,5 | 85 | 4D56

02.00-08.06	0 986 45 P 2042	O
	1 457 43 S 3339	L
	1 457 43 N 4459 ²	K
	1 987 43 R 2498 ⁸	I

Pajero 2.6

2,6 76 4G54	12.82-06.91	TW	0 451 10 P 3316	O
			0 986 45 P 2016	O

2,6 | 79 | G54B

05.86-06.91	TW	0 451 10 P 3316	O
		0 986 45 P 2016	O

2,6 | 88 | 4G54

04.91-05.95	TW	0 451 10 P 3316	O
		0 986 45 P 2041	O
		1 987 42 S 9127	L





Pajero 2.8 D

2,8 92 4M40	06.94-05.99	0 986 45 P 2063	O
		1 987 42 S 9169	L
		0 986 45 N 0508 ²	K

Pajero 2.8 D Turbo

2,8 92 4M40	09.03→	1 987 42 S 9109	L
--------------------	--------	------------------------	----------

Pajero 2.8 D Turbo 4WD

2,8 92 4M40	07.93-09.99	0 986 45 P 2063	O
	07.93-02.96	1 987 42 S 9109	L
Org.Nr. KD-V26WG	03.96-09.99	1 987 42 S 9169	L
Org.Nr. KD-V46W			
Org.Nr. KD-V46WG			
Org.Nr. Y-V46WG	07.93-09.99	0 986 45 N 0508 ²	K
		0 986 45 N 0508	K

2,8 103 4M40	05.97-09.99	0 986 45 P 2063	O
		1 987 42 S 9169	L
		0 986 45 N 0508	K

Pajero 2.8 TD

2,8 92 4M40	07.95-12.98	1 987 42 S 9109	L
--------------------	-------------	------------------------	----------

Pajero 2.8 TD Interc.

2,8 103 4M40	11.93-04.00	0 986 45 P 2063	O
		AZY 1 987 42 S 9169	L
		MCY 1 987 42 S 9109	L
		0 986 45 N 0508 ²	K

Pajero 3.0

3,0 162 6B31	07.08→	0 451 10 P 3364	O
		1 987 43 R 2426 ⁸	I

Pajero 3.0 i

3,0 105 6G72	09.88-04.91	0 451 10 P 3316	O
		1 987 42 S 9127	L
3,0 109 6G72	05.91-08.97	0 451 10 P 3316	O
	12.90-08.97	1 457 43 S 3965	L
	01.97→	1 987 42 S 9109	L
	12.93-08.97	0 450 90 F 5914 ¹	K

3,0 110 6G72 Kat.	06.92-12.98	1 457 43 S 3965	L
--------------------------	-------------	------------------------	----------



Pajero 3.0 i V6

3,0 104 6G72	11.88-06.91	TW	0 451 10 P 3316	O
			0 986 45 P 2016	O
			1 987 42 S 9127	L

3,0 130 6G72	07.96-02.09		0 451 10 P 3316	O
		TW	1 457 43 S 3965	L
			0 450 90 F 5914 ¹	K

Pajero 3.0 i 4WD

3,0 110 6G72 (SOHC)	09.88-04.91	1 987 42 S 9127	L
----------------------------	-------------	------------------------	----------

3,0 114 6G72 (SOHC)	10.90-09.99	0 451 10 P 3316	O
		1 457 43 S 3965	L

3,0 131/132 6G72 (SOHC)	07.00→	0 451 10 P 3316	O
--------------------------------	--------	------------------------	----------

Pajero 3.0 i 4WD Sport

3,0 133 6G72	02.03→	0 451 10 P 3316	O
---------------------	--------	------------------------	----------

Pajero 3.2 D Turbo 4WD

3,2 123 4M41	01.03→	0 451 10 P 3316	O
		1 987 43 R 2498	I

3,2 129 4M41	06.99-11.04	0 986 45 P 2063	O
		1 457 43 S 3339	L

Pajero 3.2 DI-D

3,2 118-125 4M41	09.06→	1 457 43 S 3339	L
		HEI 1 457 43 N 4438 ²	K
		1 987 43 R 2498 ⁸	I

3,2 120 4M41	07.08→	HEI 1 457 43 N 4438 ²	K
---------------------	--------	---	----------

3,2 121	01.00→	0 986 45 P 2063	O
		1 457 43 S 3339	L
		1 457 43 N 4459 ²	K

3,2 140/147 4M41	09.06→	1 457 43 S 3339	L
		HEI 1 457 43 N 4438 ²	K
		1 987 43 R 2498 ⁸	I

Pajero 3.2 DI-D 4WD

3,2 118-121 4M41	02.00-08.06	0 986 45 P 2063	O
		1 457 43 S 3339	L
		1 457 43 N 4459 ²	K
		1 987 43 R 2498 ⁸	I





Pajero 3.5 GDI

3,5 149 6G74-B	02.00-08.06	0 451 10 P 3316	0
		1 987 43 R 2498 ⁸	I

Pajero 3.5 i, V6-24

3,5 140/153-154 6G74 DOHC 24V; 6G74 Kat.	11.93→	0 451 10 P 3316	0
		0 450 90 F 5914 ¹	K

Pajero 3.5 i 4WD

3,5 162 6G74 (DOHC)	06.99-10.05	0 451 10 P 3316	0
-------------------------	-------------	-----------------	---

3,5 169 6G74 (DOHC)	07.93-05.97	0 451 10 P 3316	0
		0 450 90 F 5914 ¹	K

3,5 180 6G74 (DOHC)	05.97-09.99	0 451 10 P 3316	0
-------------------------	-------------	-----------------	---

3,5 206 6G74 (DOHC)	08.97-09.99	0 451 10 P 3316	0
		0 450 90 F 5914 ¹	K

Pajero 3.5 i 24V

3,5 153 6G74	01.95→	0 450 90 F 5914 ¹	K
------------------	--------	------------------------------	---

3,5 180 6G74 DOHC Kat. <GDI>	09.97→	1 987 43 R 2498	I
----------------------------------	--------	-----------------	---

Pajero 3.8

3,8 184 6G75	09.06→	0 451 10 P 3316	0
		WW 0 451 10 P 3316	0
		1 987 43 R 2498 ⁸	I

Pajero 3.8 i 4WD

3,8 161/183-185 6G75	10.05→	0 451 10 P 3316	0
--------------------------	--------	-----------------	---

3,8 204 6G75	01.03→	0 451 10 P 3316	0
------------------	--------	-----------------	---

Pajero 3000 V6

3,0 110 6G721 Kat.	12.90-05.94	0 451 10 P 3316	0
		1 457 43 S 3965	L
		0 450 90 F 5914 ¹	K

Pajero 3000 V6 24V

3,0 130/133 6G728 Kat.	06.94-05.01	0 451 10 P 3316	0
		0 450 90 F 5914 ¹	K

Pajero Mini

Pajero Mini 0.7 i, i Turbo 4WD, i 4WD

0,7 38/47 4A30 (SOHC)	05.06→	F 026 40 P 7089	0
---------------------------	--------	-----------------	---



Pajero Pinin

Pajero Pinin 1.8 , GDI

1,8 84/88 4G93 DOHC; 4G93 SOHC	06.98-02.05	TW	0 451 10 P 3316	0
			0 986 45 P 2041	0
			1 457 43 S 3968	L

Pajero Pinin 1.8 i 4WD

1,8 96 4G93 (DOHC)	03.98-06.00	TW	0 986 45 P 2041	0
			1 457 43 S 3969	L

Pajero Pinin 2.0 GDI

2,0 95 4G94	07.00-01.04		0 986 45 P 2041	0
		WW	0 451 10 P 3316	0
			1 457 43 S 3968	L

Pajero Pinin 2.0 i 4WD

2,0 100 4G94 (DOHC)	06.00-05.07	TW	0 451 10 P 3316	0
			0 986 45 P 2041	0
			1 457 43 S 3969	L

RVR

RVR 2.0 D Turbo 4WD

2,0 65-69 4D68	09.92-11.97		0 986 45 P 2042	0
			1 457 43 N 4435 ²	K

Santamo

Santamo 2.0 , 4x4

2,0 102	05.99-12.02		0 451 10 P 3316	0
			1 987 42 S 9127	L

Sigma

Sigma 2.0 i

2,0 92 6G71	10.90-09.92		0 451 10 P 3316	0
			1 457 43 S 3965	L
			0 986 45 F 0107 ¹	K

2,0 | 107 | 6A12 (SOHC)

	10.92-08.95		1 457 43 S 3965	L
			0 986 45 F 0107 ¹	K

Sigma 2.5 i

2,5 129 6G73 (SOHC)	10.90-08.95		0 451 10 P 3316	0
			1 457 43 S 3965	L
			0 986 45 F 0107 ¹	K





Sigma 3.0

3,0 125-130 6G72	01.93-07.96	0 451 10 P 3316	O
		1 457 43 S 3965	L

Sigma 3.0 i

3,0 154 6G72 (DOHC)	10.90-08.95	0 451 10 P 3316	O
		1 457 43 S 3965	L
		0 986 45 F 0107 ¹	K

Sigma 3.0 i, i 24V, i 24V 4WS

3,0 130/151 6G72 Kat.	12.90-03.96	0 451 10 P 3316	O
		1 457 43 S 3965	L
	RLE	0 986 45 F 0107 ¹	K

Space Gear

Space Gear 2.0 i

2,0 83-85 4G63 Kat.	12.94-03.01	TW	0 451 10 P 3316	O
			0 986 45 P 2041	O
			1 457 43 S 3965	L
	12.94-08.99		0 450 90 F 5963 ¹	K

Space Gear 2.4 i 2WD, i 4WD

2,4 94-97 4G64 Kat.	12.94-03.01	TW	0 451 10 P 3316	O
			0 986 45 P 2041	O
			1 457 43 S 3965	L
	12.94-08.99		0 450 90 F 5963 ¹	K

Space Gear 2.5 D Turbo Interc. 2WD

2,5 73 4D56	12.94-03.01		0 986 45 P 2042	O
		STZ	1 987 42 S 9169	L
			0 986 45 N 0508 ²	K

Space Gear 2.5 D Turbo Interc. 4WD

2,5 73 4D56	12.94-03.01		0 986 45 P 2042	O
			0 986 45 N 0508 ²	K

Space Gear 2.5 D Turbo 2WD long

2,5 64 4D56	06.94-05.95		0 986 45 P 2042	O
			1 987 42 S 9169	L
			0 986 45 N 0508 ²	K

Space Gear 2.5 D Turbo 2WD short

2,5 64 4D56	12.94-03.01		0 986 45 P 2042	O
		STZ	1 987 42 S 9169	L
			0 986 45 N 0508 ²	K



Space Runner

Space Runner 1.8 i, i 16V 4WD

1,8 85-90/92 4G93; 4G93 Kat.	06.91-05.99		0 986 45 P 2041	O
			1 457 43 S 3968	L
			0 450 90 F 5914 ¹	K

Space Runner 2.0 D Turbo

2,0 60 4D68	06.92-05.99		0 986 45 P 2042	O
			1 457 43 N 4435 ²	K

Space Runner 2.0 i 16V

2,0 98 4G63	05.99-08.02		0 451 10 P 3316	O
-------------	-------------	--	-----------------	----------

Space Runner 2.4 GDI

2,4 110 4G64	05.99-08.02		0 451 10 P 3316	O
--------------	-------------	--	-----------------	----------

Space Wagon

Space Wagon 1.8

1,8 66 4G37	10.83-04.91	TW	0 451 10 P 3316	O
			0 986 45 P 2016	O
			1 457 43 S 3682	L

Space Wagon 1.8 D Turbo

1,8 55 4D65	06.85-04.91		0 986 45 P 2020	O
	05.91-05.92		0 986 45 P 2042	O
			1 987 42 S 9127	L
	06.85-05.92		1 457 43 N 4435 ²	K

Space Wagon 1.8 i 16V, i 16V 4WD

1,8 85-88/90 4G93; 4G93 Kat.	05.91-05.92		0 986 45 P 2041	O
			1 457 43 S 3968	L
			0 450 90 F 5914 ¹	K

Space Wagon 2.0 D Turbo

2,0 60 4D68	06.92-11.00		0 986 45 P 2042	O
			1 987 42 S 9127	L
			1 457 43 N 4435 ²	K

Space Wagon 2.0 i 2WD

2,0 74 4G63 Kat.	06.88-04.91	TW	0 451 10 P 3316	O
			0 986 45 P 2016	O
			1 987 42 S 9127	L
			0 986 45 F 0103 ¹	K





Space Wagon 2.0 i 4WD

2,0 74 4G63 Kat.	06.88-04.91	TW	0 451 10 P 3316	O
			0 986 45 P 2016	O
			1 987 42 S 9127	L

Space Wagon 2.0 i 16V

2,0 98 4G63	06.00-01.04		0 451 10 P 3316	O
-------------	-------------	--	------------------------	----------

2,0 98 4G63 Kat.	06.92-11.00	TW	0 451 10 P 3316	O
			0 986 45 P 2041	O
			1 457 43 S 3968	L
			0 450 90 F 5914 ¹	K

Space Wagon 2.0 i 16V 4WD

2,0 98 4G63 Kat.	06.92-11.00		0 986 45 P 2041	O
			1 457 43 S 3968	L
			0 450 90 F 5914 ¹	K

Space Wagon 2.0 4WD

2,0 75 4G63	02.85-04.91	TW	0 451 10 P 3316	O
			0 986 45 P 2016	O
			1 457 43 S 3682	L

Space Wagon 2.4 GDI, GDI 4WD

2,4 110 4G64	07.98-01.04		0 451 10 P 3316	O
--------------	-------------	--	------------------------	----------

Space Wagon 2.4 i 16V

2,4 97 4G64	05.91-05.96	TW	0 451 10 P 3316	O
			0 986 45 P 2041	O
			1 457 43 S 3968	L
			0 450 90 F 5914 ¹	K

Spacestar

Spacestar 1.3 i

1,3 60 4G13	06.98-03.03		0 986 45 P 2041	O
	06.98-12.04		1 457 43 S 3276	L
		KL	1 987 43 M 2086	I
		KL	1 987 43 M 2157	I

Spacestar 1.6 i

1,6 72 4G18	04.01-03.03		0 986 45 P 2041	O
	04.01-12.04		1 457 43 S 3276	L
		KL	1 987 43 M 2086	I
		KL	1 987 43 M 2157	I

Spacestar 1.8 GDI, i

1,8 82/87-90 4G93-G; 4G93-3	08.98-12.04		0 986 45 P 2041	O
			1 457 43 S 3276	L
		KL	1 987 43 M 2086	I
		KL	1 987 43 M 2157	I



Spacestar 1.9 DI-D

1,9 75/85 F9Q	06.00-12.04		0 451 10 P 3336	O
			1 457 43 S 3535	L
			1 457 43 N 1705	K
		KL	1 987 43 M 2086	I
		KL	1 987 43 M 2157	I

Triton

Triton 2.4

2,4 97 4G64	10.96-12.03		0 986 45 P 2041	O
			1 457 43 S 3965	L

Triton 2.8 D 4x4

2,8 71 4M40	10.96-12.02		0 986 45 P 2063	O
			1 987 42 S 9169	L
			0 986 45 N 0508 ²	K

Triton 3.0 4x4

3,0 133 6G72	10.96-04.07		0 451 10 P 3316	O
			1 457 43 S 3965	L

Triton 3.5 i 4WD

3,5 131-137 6G74 (SOHC)	09.06→		0 451 10 P 3316	O
-------------------------	--------	--	------------------------	----------

3000 GT

3000 GT 3.0 i 24V, i 24V Bi-Turbo 4WD 4WS

3,0 165/206-210 6G72	04.90-12.00		0 451 10 P 3316	O
			1 457 43 S 3965	L

MOSKWITSCH

Aleko

Aleko 1.5

1,5 48/52-54	12.86-12.00		0 450 90 F 4058 ¹	K
--------------	-------------	--	-------------------------------------	----------

Aleko 1.6

1,6 52/56-59	12.86-12.00		0 450 90 F 4058 ¹	K
--------------	-------------	--	-------------------------------------	----------

Aleko 1.6

1,6 56 VAZ-2106	01.86-12.00		0 451 10 P 3274	O
			0 450 90 F 4058 ¹	K

Aleko 1.7

1,7 63 UZAM-3317	01.86-12.00		0 450 90 F 4058 ¹	K
------------------	-------------	--	-------------------------------------	----------





Aleko 1.8

1,8 59/70 ;UZAM-3313	01.86-12.00	0 450 90 F 4058 ¹	K
----------------------	-------------	------------------------------	---

Aleko 2.0

2,0 83 REN-F3R	01.86-12.00	0 451 10 P 3336	O
		0 450 90 F 5287 ¹	K

MULTICAR

M25

M25 1.9 4x4

1,9 40 1Y <028.B>	01.91→	0 450 90 N 6174 ¹	K
-------------------	--------	------------------------------	---

M26

M26 1.9 4x4

1,9 40 1Y <028.B>	07.92-12.96	0 450 90 N 6174 ¹	K
		1 457 43 N 4106 ²	K

M26 2.5 4x4

2,5 62 8140 SC 27.02	09.94→	1 457 43 N 4106 ²	K
----------------------	--------	------------------------------	---

M26 2.8 4x4

2,8 78 8140.23.2585 <Euro II>	01.96-12.02	0 451 20 P 3201	O
		1 457 43 N 4106 ²	K

NISSAN

Almera

Almera 1.4 i

1,4 55-64 GA14DE	07.95-04.00	0 986 45 P 2023	O
		1 457 43 S 3274	L
		0 450 90 F 5326 ¹	K
	01.98-04.00	KL,SA 1 987 43 M 2179	I
		2FE, 1 987 43 M 2118	I
		MOO,NOR	

Almera 1.5 D Turbo

1,5 60 K9K	10.02-11.06	0 451 10 P 3336	O
		1 457 43 S 3163	L
		0 450 90 N 6468 ¹	K
		1 987 43 M 2075	I



Almera 1.5 i

1,5 66 QG15DE	01.00-07.02	0 986 45 P 2061	O
	04.00-03.01	F 026 40 P 7001	O
	01.00-07.02	1 987 42 S 9051	L
	04.00-03.01	0 450 90 F 5326 ¹	K
	01.00-07.02	1 987 43 M 2075	I

1,5|72|QG15DE

	08.02-11.06	0 986 45 P 2061	O
		1 987 42 S 9051	L
		1 987 43 M 2075	I

Almera 1.6

1,6|79|QG16

	01.06→	0 986 45 P 2041	O
--	--------	-----------------	---

Almera 1.6 i

1,6|66-73|GA16DE

	07.95-04.00	0 986 45 P 2023	O
		1 457 43 S 3274	L
		0 450 90 F 5326 ¹	K
	01.98-04.00	KL,SA 1 987 43 M 2179	I
		2FE, 1 987 43 M 2118	I
		MOO,NOR	

1,6|81|QG16DE

	01.00→	F 026 40 P 7001	O
		1 987 42 S 9051	L
		0 450 90 F 5326 ¹	K
		1 987 43 M 2075	I

Almera 1.8 i

1,8|84|QG18DE

	01.00-07.02	0 986 45 P 2061	O
	04.00-03.01	F 026 40 P 7001	O
	01.00-07.02	1 987 42 S 9051	L
	04.00-03.01	0 450 90 F 5326 ¹	K
	01.00-07.02	1 987 43 M 2075	I

1,8|84-85|QG18DE

	05.00-12.05	0 986 45 P 2061	O
		1 987 42 S 9051	L
	05.00-11.04	1 987 43 M 2075	I
	12.04-12.05	MKL 1 987 43 M 2075	I

1,8|85|QG18DE

	08.02-11.06	0 986 45 P 2061	O
		1 987 42 S 9051	L
		1 987 43 M 2075	I

1,8|88|GA18DE

	12.00→	F 026 40 P 7001	O
		1 987 42 S 9051	L
		0 450 90 F 5326 ¹	K

1,8|95|QG18DE

	07.01-02.04	1 987 42 S 9051	L
--	-------------	-----------------	---





Almera 2.0 D

2,0 55 CD20			
07.95-04.96		0 986 45 P 2024	O
05.96-04.00		0 986 45 P 2046	O
07.95-04.00		1 987 42 S 9051	L
		1 457 43 N 4281 ²	K
01.98-04.00	KL,SA	1 987 43 M 2179	I
	2FE, MOO,NOR	1 987 43 M 2118	I

Almera 2.0 i

2,0 99-100 SR20DE			
05.00-01.03		0 986 45 P 2061	O
		1 987 42 S 9051	L
		1 987 43 M 2075	I

2,0 105 SR20DE			
04.96-04.00		F 026 40 P 7001	O
		1 987 42 S 9051	L
		0 450 90 F 5326 ¹	K
01.98-04.00	KL,SA	1 987 43 M 2179	I
	2FE, MOO,NOR	1 987 43 M 2118	I

Almera 2.2 D Turbo

2,2 81 YD22DDT			
01.00-02.03		1 457 42 P 9284	O
		1 987 42 S 9051	L
	TW	1 457 43 N 4281 ²	K
		1 457 43 N 4451 ²	K
04.00-03.01		1 457 43 N 4281 ²	K
01.00-02.03		1 987 43 M 2075	I

2,2 | 81-84 | YD22DDTI

05.00-01.03		1 457 42 P 9284	O
		1 987 42 S 9051	L
SKA 05.00-01.02		1 457 43 N 4281 ²	K
02.02-01.03		1 457 43 N 4451 ²	K
SKA 05.00-01.03		1 457 43 N 4281 ²	K
05.00-01.03		1 987 43 M 2075	I

2,2 | 82/100 | YD22DDT

02.03-03.03		1 457 42 P 9284	O
04.03-11.06		0 986 45 P 2003	O
02.03-11.06		1 987 42 S 9051	L
	KZO	1 457 43 N 4451 ²	K
		1 987 43 M 2075	I

2,2 | 82/100 | YD22DDTI

02.03-03.03		1 457 42 P 9284	O
04.03-12.05		0 986 45 P 2003	O
02.03-12.05		1 987 42 S 9051	L
SKA 02.03-12.05		1 457 43 N 4451 ²	K
SKA 02.03-12.05		1 457 43 N 4281 ²	K
02.03-11.04		1 987 43 M 2075	I
12.04-12.05	MKL	1 987 43 M 2075	I

Altima

Altima 2.4 i

2,4 110-112 KA24DE			
06.92-05.97		0 986 45 P 2023	O
		1 987 42 S 9051	L



2,4 112-116 KA24DE			
06.97-08.01		0 986 45 P 2036	O
		1 987 42 S 9051	L

Altima 2.5

2,5 | 127-131 | QR25DE

11.06→		F 026 40 P 7001	O
--------	--	------------------------	----------

2,5 | 131 | QR25DE

09.01-12.06		0 986 45 P 2036	O
		1 987 42 S 9051	L

Altima 3.5

3,5 | 183 | VQ35DE

09.01-10.06		F 026 40 P 7001	O
		1 987 42 S 9051	L

Atlas

Atlas 1.6

1,6 | 56 | NA16S

01.92-06.95		0 986 45 P 2023	O
-------------	--	------------------------	----------

Atlas 2.0

2,0 | 67 | NA20S

01.92-06.99		0 986 45 P 2023	O
-------------	--	------------------------	----------

Atlas 3.5 D

3,5 | 77 | FD35

11.86-10.91		1 457 43 N 4281 ²	K
-------------	--	-------------------------------------	----------

Avenir

Avenir 2.0 i

2,0 | 110 | QR20DE

08.02-09.05		F 026 40 P 7001	O
		1 987 42 S 9051	L

Bluebird

Bluebird 1.6

1,6 | 58 | CA16S

09.87-08.91		0 986 45 P 2023	O
	XXX	1 987 42 S 9046	L

1,6 | 71 | GA16DS

09.91-11.95		0 986 45 P 2023	O
		1 987 42 S 9148	L

Bluebird 1.8 i

1,8 | 65 | CA18I

09.87-08.91		0 986 45 P 2023	O
	XXX	1 987 42 S 9046	L

1,8 | 92 | SR18DE

09.91-11.95		0 986 45 P 2060	O
01.96-09.98		F 026 40 P 7001	O
09.91-11.95		1 987 42 S 9051	L
01.96-09.98		1 987 42 S 9051	L





1,8 92/96 QG18DD; QG18DE	09.98-08.01	F 026 40 P 7001 1 987 42 S 9051	O L
------------------------------	-------------	------------------------------------	--------

Bluebird 1.8 i, i 4WD

1,8 81 SR18DI	10.89-08.91	0 986 45 P 2060 1 987 42 S 9170	O L
-------------------	-------------	------------------------------------	--------

Bluebird 1.8 i 4WD

1,8 92 SR18DE	09.91-11.95 01.96-08.01 09.91-11.95 01.96-08.01	0 986 45 P 2060 F 026 40 P 7001 1 987 42 S 9051 1 987 42 S 9051	O O L L
-------------------	--	--	------------------

Bluebird 2.0 D

2,0 49 LD20	09.87-08.91	0 986 45 P 2046 1 987 42 S 9051 1 457 43 N 4281 ²	O L K
-----------------	-------------	--	-------------

2,0 56 CD20	09.91-11.95 01.96-09.98	0 986 45 P 2046 1 987 42 S 9051 1 987 42 S 9051	O L L
-----------------	----------------------------	---	-------------

2,0 56 CD20E	09.98-08.01	1 987 42 S 9051	L
------------------	-------------	-----------------	---

Bluebird 2.0 D 4WD

2,0 56 CD20	09.91-11.95	0 986 45 P 2046 1 987 42 S 9051 1 457 43 N 4281 ²	O L K
-----------------	-------------	--	-------------

Bluebird 2.0 i

2,0 103 SR20DE	10.89-04.92	0 986 45 P 2060 1 987 42 S 9051 0 450 90 F 5326 ¹	O L K
--------------------	-------------	--	-------------

2,0 107 SR20DE	09.91-11.95 01.96-08.01 09.91-11.95 01.96-08.01	0 986 45 P 2060 F 026 40 P 7001 1 987 42 S 9051 1 987 42 S 9051	O O L L
--------------------	--	--	------------------

2,0 140 SR20VE	09.97-08.01	F 026 40 P 7001 1 987 42 S 9051	O L
--------------------	-------------	------------------------------------	--------

Bluebird 2.0 i Turbo 4WD

2,0 151/154 SR20DET	10.89-11.95	0 986 45 P 2060 1 987 42 S 9051	O L
-------------------------	-------------	------------------------------------	--------



Bluebird 2.0 i 4WD

2,0 103 SR20DE	10.89-08.91	0 986 45 P 2060 1 987 42 S 9051	O L
--------------------	-------------	------------------------------------	--------

2,0 107 SR20DE	09.91-11.95 01.96-08.01 09.91-11.95 01.96-08.01	0 986 45 P 2060 F 026 40 P 7001 1 987 42 S 9051 1 987 42 S 9051	O O L L
--------------------	--	--	------------------

Bluebird 2.4 i

2,4 110/112 KA24DE	07.93-09.97	0 986 45 P 2023 1 987 42 S 9051	O L
------------------------	-------------	------------------------------------	--------

Bluebird Sylphy

Bluebird Sylphy 1.5 i

1,5 77-80 QG15DE	08.00-12.05	F 026 40 P 7001 1 987 42 S 9051	O L
----------------------	-------------	------------------------------------	--------

Bluebird Sylphy 1.8 i

1,8 88 QG18DE	08.00-12.05	F 026 40 P 7001 1 987 42 S 9051	O L
-------------------	-------------	------------------------------------	--------

Bluebird Sylphy 2.0 i

2,0 98 MR20DE	12.05→	F 026 40 P 7001	O
-------------------	--------	-----------------	---

Cabstar

Cabstar 2.0

2,0 66 NA20S	07.92-05.94 XXX	0 986 45 P 2023 1 987 42 S 9046	O L
------------------	--------------------	------------------------------------	--------

2,0 66 Z20	03.85-06.92	0 986 45 P 2023	O
----------------	-------------	-----------------	---

Cabstar 2.0 D Turbo

2,0 60 LD20T	01.83-06.92	0 986 45 P 2023	O
------------------	-------------	-----------------	---

Cabstar 2.3 D

2,3 54/56 SD23; TD23	01.83-06.92	0 986 45 P 2023	O
--------------------------	-------------	-----------------	---

Cabstar 2.5 D

2,5 57 SD25	01.83-06.92	0 986 45 P 2023	O
2,5 59 TD25	07.92-05.96	0 451 10 P 3357 1 457 43 N 4281 ²	O K





Cabstar 2.5 D Turbo

2,5 81/96 YD25DDTI	09.06→	0 986 45 P 2003	0
		F 026 40 N 2059 ¹	K

Cabstar 2.7 D

2,7 66 TD27	10.86-06.92	0 986 45 P 2005	0
-----------------	-------------	-----------------	---

Cabstar 3.0 D Turbo

3,0 81 BD30Ti	10.98-08.06	0 451 10 P 3357	0
		1 457 43 N 4439 ²	K

3,0 88 BD30Ti	10.98-08.06	0 451 10 P 3357	0
-------------------	-------------	-----------------	---

3,0 110 ZD30DDTI	09.06→	1 457 42 P 9271	0
	09.06-06.08	F 026 40 N 2059 ¹	K
	07.08→	3T5 F 026 40 N 2059 ¹	K
		4T5, MG6 F 026 40 N 2059 ¹	K

Cabstar 3.2

3,2 70 QD32	10.99→	0 451 10 P 3357	0
-----------------	--------	-----------------	---

Cabstar 3.3 D

3,3 71 ED33	01.85-06.92	0 986 45 P 2023	0
-----------------	-------------	-----------------	---

Cabstar 3.5 D

3,5FD35	11.86-06.92	1 457 43 N 4281 ²	K
---------	-------------	------------------------------	---

Caravan

Caravan 2.7 D

2,7 63 TD27	10.90-05.93	1 457 42 S 9933	L
-----------------	-------------	-----------------	---

Cedric

Cedric 2.0

2,0CA20S	10.83-07.95	0 986 45 P 2023	0
		TW,XXX 1 987 42 S 9046	L

Cedric 2.0 i

2,0 85/92 VG20E	06.83-08.02	0 986 45 P 2023	0
		1 987 42 S 9051	L

Cedric 3.0

3,0VG30S	10.83-07.95	0 986 45 P 2023	0
----------	-------------	-----------------	---

Cedric 3.2 D

3,2 48 QD32	01.90→	0 451 10 P 3357	0
-----------------	--------	-----------------	---



Cefiro

Cefiro 2.0 i

2,0 114 VQ20DE	08.94-12.98	0 986 45 P 2041	0
		1 987 42 S 9051	L
		0 450 90 F 5326 ¹	K

Cefiro 2.0 V6 24V

2,0 110 VQ20DE	07.01→	1 987 42 S 9051	L
--------------------	--------	-----------------	---

Cube

Cube 1.3 i

1,3 63 CGA3DE	11.99-10.02	0 986 45 P 2060	0
		TW 1 457 42 S 9944	L
	05.01-10.02	TW 1 457 43 S 3274	L

Cube 1.4 i, i 4WD

1,4 71/72 CR14DE	10.02-11.08	0 986 45 P 2060	0
		1 457 42 S 9944	L

Cube 1.5 dCi

1,5 81 K9K	10.09→	F 026 40 P 7022	0
		1 457 43 S 3595	L
		0 450 90 N 6468 ¹	K

Cube 1.5 i

1,5 80 HR15DE	05.05-11.08	F 026 40 P 7001	0
-------------------	-------------	-----------------	---

Cube 1.6

1,6 81 HR16DE	08.09→	F 026 40 P 7001	0
		F 026 40 S 0101	L

Datsun Truck

Datsun Truck 1.6

1,6 54 NA16S	09.89-08.95	0 986 45 P 2023	0
		1 457 42 S 9800	L

Datsun Truck 2.0

2,0 67 NA20S	09.89-06.99	0 986 45 P 2023	0
	09.89-01.97	1 457 42 S 9800	L

Datsun Truck 2.0 i

2,0 92 KA20DE	06.99-08.02	1 987 42 S 9051	L
-------------------	-------------	-----------------	---





Datsun Truck 2.3 D

2,3 56 TD23	08.87-08.92	1 457 42 S 9800	L
		1 457 43 N 4281 ²	K

Datsun Truck 2.7 D

2,7 63 TD27	08.92-01.97	1 457 42 S 9800	L
-------------	-------------	------------------------	---

Elgrand

Elgrand 2.5 i, i 4WD

2,5 137 VQ25DE	12.04-08.10	F 026 40 P 7001	O
		1 987 42 S 9051	L

Elgrand 3.5 i, i 4WD

3,5 177 VQ35DE	05.02-08.10	F 026 40 P 7001	O
	08.00-08.10	1 987 42 S 9051	L

E20

E20 2.0

2,0H20	05.81-12.96	1 987 42 S 9161	L
--------	-------------	------------------------	---

Fairlady Z

Fairlady Z 3.0 i

3,0 169 VG30DE	07.89-08.00	0 986 45 P 2023	O
	08.92-10.98	0 450 90 F 5326 ¹	K

Fairlady Z 3.0 i Turbo

3,0 206 VG30DETT	07.89-08.00	0 986 45 P 2023	O
------------------	-------------	------------------------	---

Fairlady Z 3.5 i

3,5 206 VQ35DE	07.02-11.08	F 026 40 P 7001	O
		1 987 42 S 9051	L

3,5 230 VQ35HR	01.07-11.08	F 026 40 P 7001	O
----------------	-------------	------------------------	---

Frontier

Frontier 2.5

2,5 98 TD25	05.00→	0 986 45 P 2005	O
-------------	--------	------------------------	---

Frontier 2.7 D

2,7 65-66 TD27	05.00→	1 457 43 N 4281 ²	K
----------------	--------	-------------------------------------	---



Fuga

Fuga 2.5 i

2,5 154 VQ25DE	10.04-12.07	F 026 40 P 7001	O
----------------	-------------	------------------------	---

Fuga 3.5 i

3,5 206 VQ35DE	10.04-12.07	F 026 40 P 7001	O
----------------	-------------	------------------------	---

Gloria

Gloria 3.0 i

3,0 177 VQ30DD	06.99-12.04	1 987 42 S 9051	L
----------------	-------------	------------------------	---

GT-R

GT-R 3.8 Turbo

3,8 357 VR38DETT	12.08→	0 986 45 P 2041	O
------------------	--------	------------------------	---

Hardbody

Hardbody 2.5 D Turbo

2,5 98 YD25DDTI	01.06-06.08	1 457 42 P 9284	O
	TW	F 026 40 S 0199	L
		1 457 43 N 4281 ²	K

Hardbody 2.5 D Turbo 4x4

2,5 98 YD25DDTI	05.08→	1 457 42 P 9284	O
		F 026 40 S 0199	L
	TW	1 457 43 N 4281 ²	K

Hardbody 2.7 TD

2,7 76 TD27	05.02-06.06	0 451 10 P 3357	O
-------------	-------------	------------------------	---

Hardbody 3.2 D 4x4

3,2 76 QD32	05.02-12.08	0 451 10 P 3357	O
-------------	-------------	------------------------	---

Homy

Homy 3.0 i

3,0 114 VG30E	10.88-06.99	0 986 45 P 2023	O
	10.88-05.93	1 457 43 S 3275	L





Interstar

Interstar 1.9 D Turbo dCi 80

1,9 59-60 F9Q...	07.02→		F 026 40 P 7022	O
		TW	F 026 40 S 0014	L
			F 026 40 S 0166	L
		DHI, TW	1 457 43 N 1720	K
		PRF, TW	F 026 40 N 2047	K
			1 457 43 N 1724	K

Interstar 2.2 D Turbo dCi 90

2,2 66 G9T...	07.02→	TW	1 457 42 P 9198	O
			F 026 40 S 0014	L
			F 026 40 S 0166	L
		DHI, TW	1 457 43 N 1720	K
		PRF, TW	F 026 40 N 2047	K
			1 457 43 N 1724	K

Interstar 2.5 D Turbo dCi 100

2,5 73-74 G9U...	11.03→		F 026 40 P 7014	O
Mot.Nr. G9U 650	11.03→	TW	1 457 42 P 9198	O
Mot.Nr. G9U 754	11.03-08.05	TW	F 026 40 S 0014	L
	11.03→	TW	F 026 40 S 0166	L
		DHI, TW	1 457 43 N 1720	K
		PRF, TW	F 026 40 N 2047	K
			1 457 43 N 1724	K

Interstar 2.5 D Turbo dCi 120

2,5 84-88 G9U...	07.02→		F 026 40 P 7014	O
Mot.Nr. G9U 632, 650	07.02→	TW	1 457 42 P 9198	O
Mot.Nr. G9U 720, 724	07.02-08.05	TW	F 026 40 S 0014	L
Mot.Nr. G9U 750, 754	11.03→	TW	F 026 40 S 0166	L
		DHI, TW	1 457 43 N 1720	K
		PRF, TW	F 026 40 N 2047	K
			1 457 43 N 1724	K

Interstar 3.0 D Turbo dCi 140

3,0 99-100 ZD3	11.03→		1 457 42 P 9271	O
		TW	F 026 40 N 2047	K
			1 457 43 N 1724	K

Juke

Juke 1.5 dCi

1,5 81 K9K <Euro 5>	07.10→		F 026 40 P 7022	O
			1 457 43 S 3595	L
		TW	0 450 90 N 6468 ¹	K

Juke 1.6 , DIG-T, DIG-T 4x4

1,6 86/140 HR16DE <Euro 5>; MR16DDT <Euro 5>	07.10→		F 026 40 P 7001	O
			1 457 43 S 3274	L



Kubistar

Kubistar 1.1 i 8V

1,1 44 D7F	07.03→		0 451 10 P 4025	O
			F 026 40 S 0011	L
		KL	1 987 43 M 2039	I
		KL	1 987 43 M 2193	I

Kubistar 1.1 i 16V

1,1 55-56 D4F	07.03→		0 451 10 P 4025	O
		TW	1 457 43 S 3078	L
		KL	1 987 43 M 2039	I
		KL	1 987 43 M 2193	I

Kubistar 1.4 i

1,4 55 K7J	07.03→	KL	1 987 43 M 2039	I
		KL	1 987 43 M 2193	I

Kubistar 1.5 D Turbo 60

1,5 40-45 K9K 710, 714	07.03→		0 451 10 P 3336	O
Mot.Nr. K9K 710	07.03-09.07		0 451 10 P 3336	O
Mot.Nr. K9K 714	10.07→		F 026 40 P 7022	O
	07.03-10.05		1 457 43 S 3163	L
	07.03-01.05	TW	0 450 90 N 6468 ¹	K
	07.03→	KL	1 987 43 M 2039	I
		KL	1 987 43 M 2193	I

Kubistar 1.5 D Turbo 70

1,5 48-50 K9K 700, 704, 716	07.03→		0 451 10 P 3336	O
Mot.Nr. K9K 700	07.03-09.07		0 451 10 P 3336	O
Mot.Nr. K9K 704	10.07→		F 026 40 P 7022	O
Mot.Nr. K9K 716	07.03-10.05		1 457 43 S 3163	L
	07.03-01.05	TW	0 450 90 N 6468 ¹	K
	07.03→	KL	1 987 43 M 2039	I
		KL	1 987 43 M 2193	I

Kubistar 1.5 D Turbo 80

1,5 60-62 K9K 702, 718	07.03→		0 451 10 P 3336	O
Mot.Nr. K9K 702	07.03-09.07		0 451 10 P 3336	O
Mot.Nr. K9K 718	10.07→		F 026 40 P 7022	O
	07.03-10.05		1 457 43 S 3163	L
	07.03-01.05	TW	0 450 90 N 6468 ¹	K
	07.03→	KL	1 987 43 M 2039	I
		KL	1 987 43 M 2193	I

Kubistar 1.6 i

1,6 70-71 K4M	07.03→		1 457 43 S 3529	L
		KL	1 987 43 M 2039	I
		KL	1 987 43 M 2193	I





Lafesta

Lafesta 2.0 i

2,0 101 MR20DE	12.04→	F 026 40 P 7001	O
		1 457 43 S 3772	L

Largo

Largo 2.4 i 4WD

2,4 107 KA24DE	05.93-06.99	0 986 45 P 2060	O
		1 987 42 S 9051	L

Laurel

Laurel 2.0 i

2,0 92 RB20E	12.88-01.93	0 986 45 P 2023	O
		1 987 42 S 9051	L

2,0 110 RB20E	01.93-06.97	0 986 45 P 2023	O
		1 987 42 S 9051	L
		0 450 90 F 5326 ¹	K

Laurel 2.0 i, i Turbo

2,0 110/114/151 RB20DE; RB20DET	12.88-09.94	0 986 45 P 2023	O
		1 987 42 S 9051	L

Laurel 2.8 D

2,8 69 RD28	12.88-01.93	0 986 45 P 2046	O
		1 457 43 N 4281 ²	K

Leopard

Leopard 2.0 i

2,0 92 VG20E	01.97-06.99	0 986 45 P 2023	O
		1 987 42 S 9051	L
		0 450 90 F 5326 ¹	K

March

March 1.0

1,0 38 MA10S	12.82-01.92	1 987 42 S 9115	L
--------------	-------------	-----------------	---

March 1.0 i

1,0 43/44 CG10DE	01.92-01.02	0 986 45 P 2060	O
		1 457 42 S 9944	L
		0 450 90 F 5326 ¹	K



1,0 50 CR10DE	02.02-07.03	0 986 45 P 2060	O
		1 457 42 S 9944	L

March 1.2 i

1,2 66 CR12DE	02.02-07.10	0 986 45 P 2060	O
		1 457 42 S 9944	L

March 1.3 i

1,3 55 CGA3DE <DOHC>	11.99→	1 457 42 S 9944	L
----------------------	--------	-----------------	---

1,3 58 CG13DE	01.92-11.99	0 986 45 P 2060	O
		1 457 42 S 9944	L
	05.97-11.99	1 457 43 S 3273	L
	01.92-11.99	0 450 90 F 5326 ¹	K

1,3 63 CGA3DE	11.99-01.02	0 986 45 P 2060	O
		1 457 42 S 9944	L
		0 450 90 F 5326 ¹	K

March 1.4 i, i 4WD

1,4 71/72 CR14DE	02.02-07.10	0 986 45 P 2060	O
		1 457 42 S 9944	L

Maxima

Maxima 3.0 i

3,0 118 VG30E	10.88-08.91	0 986 45 P 2023	O
		0 450 90 F 5326 ¹	K

3,0 122/125/128 VG30E	10.88-06.94	0 986 45 P 2023	O
	09.88-06.94	1 987 42 S 9051	L
		0 450 90 F 5326 ¹	K

3,0 142 VQ30DE	02.95-09.99	0 986 45 P 2041	O
		1 987 42 S 9051	L
		0 450 90 F 5326 ¹	K

3,0 143 VE30DE	08.91-02.94	0 986 45 P 2023	O
		0 450 90 F 5326 ¹	K

Maxima 3.5

3,5 195 VQ35DE	02.03-05.08	F 026 40 P 7001	O
		1 987 42 S 9051	L





Maxima QX

Maxima QX 2.0 i

2,0 103 VQ20DE				
	10.94-08.00	0 986 45 P 2041	O	
	09.00-01.06	F 026 40 P 7001	O	
	10.94-10.99	1 987 42 S 9051	L	
	01.00-01.06	1 987 42 S 9051	L	
	10.94-01.06	0 450 90 F 5326 ¹	K	

Maxima QX 3.0 i

3,0 142 VQ30DE				
	10.94-01.00	0 986 45 P 2041	O	
		1 987 42 S 9051	L	
		0 450 90 F 5326 ¹	K	

3,0 147 VQ30DE				
	01.96→	0 986 45 P 2041	O	
	09.00-01.06	F 026 40 P 7001	O	
	01.96→	1 987 42 S 9051	L	
		0 450 90 F 5326 ¹	K	

Micra

Micra 1.0

1,0 37-40 MA10S				
	12.82-07.92	0 986 45 P 2035	O	
		1 987 42 S 9115	L	
		0 450 90 F 4058 ¹	K	

Micra 1.0 i

1,0 40-44 CG10DE				
	08.92-10.02	0 986 45 P 2060	O	
		1 457 43 S 3273	L	
		0 450 90 F 5326 ¹	K	
		1 987 43 M 2119	I	

1,0 48 CG10DE				
	11.02-05.05	0 986 45 P 2060	O	
		1 457 43 S 3273	L	
		1 987 43 M 2120	I	

Micra 1.2

1,2 40-42/44 MA12S				
	07.86-07.92	0 986 45 P 2035	O	
		1 987 42 S 9115	L	
		0 450 90 F 4058 ¹	K	

Micra 1.2 DIG-S

1,2 72 HR12DDR				
	03.11→	F 026 40 P 7001	O	

Micra 1.2 i

1,2 48/59 CG12DE; CR12DE				
	11.02→	0 986 45 P 2060	O	
		1 457 43 S 3273	L	
		1 987 43 M 2120	I	



Micra 1.3 i

1,3 55 CG13DE				
	08.92-10.00	0 986 45 P 2060	O	
		1 457 43 S 3273	L	
	08.92-07.00	0 450 90 F 5326 ¹	K	
		1 987 43 M 2119	I	

Micra 1.4 i

1,4 60 CGA3DE				
	07.00-10.02	0 986 45 P 2060	O	
		1 457 43 S 3273	L	
		1 987 43 M 2119	I	

1,4 65 CGA3DE				
	11.02-05.05	0 986 45 P 2060	O	
		1 457 43 S 3273	L	
		1 987 43 M 2120	I	

1,4 65 CR14DE				
	06.05→	0 986 45 P 2060	O	
		1 457 43 S 3273	L	
		1 987 43 M 2120	I	

Micra 1.5 D

1,5 42 TD15				
	02.98-10.02	0 451 10 P 3261	O	
		1 457 43 S 3234	L	
		1 457 43 N 4321 ²	K	
		1 987 43 M 2119	I	

Micra 1.5 D Turbo

1,5 48-50 K9K				
	02.03-08.07	0 451 10 P 3336	O	
	02.03-05.05	1 457 43 S 3595	L	
	10.05-09.07 TW	1 457 43 S 3595	L	
	02.03-09.05	0 450 90 N 6468 ¹	K	
	10.05-10.05 TW	0 450 90 N 6468 ¹	K	
Komp.Nr. R635121	06.05-09.07 WAS	0 450 90 N 6468 ¹	K	
Komp.Nr. R6351010	06.05-09.07 WAS	0 450 90 N 6468 ¹	K	
	02.03-09.07	1 987 43 M 2120	I	

1,5 60-63 K9K				
	08.03-08.07	0 451 10 P 3336	O	
	09.07→ TW	F 026 40 P 7022	O	
		0 451 10 P 3336	O	
	08.03→	1 457 43 S 3595	L	
		0 450 90 N 6468 ¹	K	
		1 987 43 M 2120	I	

Micra 1.6 i

1,6 81 HR16DE				
	06.05→	F 026 40 P 7001	O	
		F 026 40 S 0101	L	
		1 987 43 M 2120	I	

Murano

Murano 2.5 dCi 4x4

2,5 140 YD25DDTI				
	05.10→	0 986 45 P 2003	O	





Murano 2.5 i

2,5 120 QR25DE	09.04-09.08	F 026 40 P 7001	O
		1 987 42 S 9051	L

Murano 3.5 i, i 4WD, i 4x4, 4x4

3,5 170/172/188-195 VQ35DE	09.04→	F 026 40 P 7001	O
		1 987 42 S 9051	L

Navara

Navara 2.5 dCi

2,5 106 YD25DDTI	05.05-12.09	0 986 45 P 2003	O
		F 026 40 S 0033	L
	05.05-06.06	KZO 1 457 43 N 4451 ²	K
		KZO 1 457 43 N 4281 ²	K
	05.05-12.09	1 987 43 M 2194	I

2,5 120 YD25DDTI	01.10→	0 986 45 P 2003	O
		F 026 40 S 0033	L
		1 987 43 M 2194	I

Navara 2.5 dCi 4x4

2,5 126-128 YD25DDTI	05.05-12.09	0 986 45 P 2003	O
		F 026 40 S 0033	L
	05.05-06.06	KZO 1 457 43 N 4451 ²	K
		KZO 1 457 43 N 4281 ²	K
	05.05-12.09	1 987 43 M 2194	I

2,5 140 YD25DDTI	01.10→	0 986 45 P 2003	O
		F 026 40 S 0033	L
		1 987 43 M 2194	I

Navara 3.0 D Turbo 4x4

3,0 110 ZD30	11.01→	1 457 42 P 9271	O
		1 457 43 N 4439 ²	K

Navara 3.0 dCi 4x4

3,0 170 V9X	05.10→	F 026 40 S 0033	L
		1 987 43 M 2194	I

Navara 3.0 i

3,0 113 VG30E	06.92-03.97	0 450 90 F 5326 ¹	K
3,0 120 VG30E	06.00-11.05	0 986 45 P 2060	O
		1 987 42 S 9051	L

Navara 3.2 D 4x4

3,2 76 QD32	06.00-11.01	1 457 43 N 4281 ²	K
-------------	-------------	------------------------------	---



Note

Note 1.4

1,4 65 CR14DE	01.06→	0 986 45 P 2060	O
		1 457 43 S 3273	L
		1 987 43 M 2120	I

Note 1.5 dCi 70

1,5 50 K9K	01.06-12.08	0 451 10 P 3336	O
		1 457 43 S 3595	L
		0 450 90 N 6468 ¹	K
		1 987 43 M 2120	I

Note 1.5 dCi 86

1,5 63 K9K	01.06-09.07	0 451 10 P 3336	O
	10.07→	F 026 40 P 7022	O
	01.06→	1 457 43 S 3595	L
		TW 0 450 90 N 6468 ¹	K
		1 987 43 M 2120	I

Note 1.5 dCi 90

1,5 66 K9K <Euro 5>	11.10→	F 026 40 P 7022	O
		1 457 43 S 3595	L
		TW 0 450 90 N 6468 ¹	K
		1 987 43 M 2120	I

Note 1.5 dCi 105

1,5 76 K9K	01.08→	F 026 40 P 7022	O
		1 457 43 S 3595	L
		TW 0 450 90 N 6468 ¹	K
		1 987 43 M 2120	I

Note 1.5 i, i 4WD

1,5 80-85 HR15DE	01.05→	F 026 40 P 7001	O
------------------	--------	-----------------	---

Note 1.6

1,6 81 HR16DE	01.06→	F 026 40 P 7001	O
		F 026 40 S 0101	L
		1 987 43 M 2120	I

NP300

NP300 2.5 dCi, dCi 4x4

2,5 98 YD25	08.10→	0 986 45 P 2003	O
		1 457 43 N 4281 ²	K





NV200

NV200 1.5 dCi

1,5 63/66/81 K9K	08.09→	F 026 40 P 7022 O
		1 457 43 S 3595 L
	TW	0 450 90 N 6468 ¹ K

NV200 1.6

1,6 81 HR16DE	08.09→	F 026 40 P 7001 O
		F 026 40 S 0101 L

Pathfinder

Pathfinder 2.4 4WD

2,4 74-80 Z24S	08.86-07.92	0 986 45 P 2024 O
		1 457 42 S 9800 L

Pathfinder 2.5 dCi 4x4

2,5 128 YD25DDTI	01.05-12.09	0 986 45 P 2003 O
		F 026 40 S 0033 L
	01.05-06.06 KZO	1 457 43 N 4451 ² K
	KZO	1 457 43 N 4281 ² K
	01.05-12.09	1 987 43 M 2194 I

2,5 140 YD25DDTI	01.10→	0 986 45 P 2003 O
		F 026 40 S 0033 L
		1 987 43 M 2194 I

Pathfinder 3.0 dCi 4x4

3,0 170 V9X	05.10→	F 026 40 S 0033 L
		1 987 43 M 2194 I

Pathfinder 3.0 i 4WD

3,0 113 VG30E	07.92-07.95	0 986 45 P 2023 O
		1 987 42 S 9051 L
		0 450 90 F 5326 ¹ K

Pathfinder 3.3 i

3,3 125 VG33E	09.95→	F 026 40 P 7001 O
		0 450 90 F 5002 ¹ K

Pathfinder 3.3 i, i 4x4

3,3 110-125 VG33E	09.95→	0 986 45 P 2041 O
		1 987 42 S 9051 L
		0 450 90 F 5326 ¹ K

Pathfinder 3.5 i

3,5 162 VQ35DE	07.00-08.03	F 026 40 P 7001 O
		1 987 42 S 9051 L
		0 450 90 F 5326 ¹ K



Pathfinder 4.0 4x4

4,0 198 VQ40DE	06.05→	0 986 45 P 2041 O
		F 026 40 S 0004 L
		1 987 43 M 2194 I

Patrol

Patrol 2.7 D Turbo

2,7TD27T	05.98-12.05	0 451 10 P 3357 O
		1 457 43 S 3786 L
	XXX	1 457 43 N 4439 ² K

Patrol 2.8 D

2,8 57 A428II	04.89-05.98	0 451 10 P 4067 O
		1 457 42 S 9932 L

Patrol 2.8 D, D Turbo

2,8 80/85 RD28; RD28T	10.96-05.98	0 451 10 P 3357 O
	04.89-05.98	1 457 43 S 3677 L
	04.89-12.91	1 457 43 N 4281 ² K
	01.92-05.98	1 457 43 N 4439 ² K

Patrol 2.8 D Turbo

2,8 70 A428T	04.89-05.98	0 451 10 P 4067 O
		1 457 42 S 9941 L

Patrol 3.0

3,0RB30S	04.89-05.98	0 986 45 P 2023 O
----------	-------------	---------------------------------

Patrol 3.0 D Turbo

3,0 118 ZD30DDTI	03.00→	1 457 43 N 4281 ² K
----------------------	--------	--

Patrol 3.0 D Turbo 4WD

3,0 118 ZD30DDTI	03.03→	1 457 42 P 9271 O
		1 457 43 N 4281 ² K

Patrol 4.2 D Turbo 4WD

4,2 86 TD42T	09.93-06.00	1 457 43 N 4281 ² K
------------------	-------------	--

Patrol 5.6 4x4

5,6 298 VK56VD <Euro 4>	03.10→	0 986 45 P 2041 O
-----------------------------	--------	---------------------------------





Patrol GR

Patrol GR 2.8 D Turbo

2,8 85 RD28T	09.88-08.95	NOR	0 986 45 P 2005	O
		SA	0 986 45 P 2046	O
	10.94-09.97		0 986 45 P 2046	O
	09.88-09.97		1 457 43 S 3677	L
			1 457 43 N 4281 ²	K

Patrol GR 2.8 D Turbo, D Turbo 4x4

2,8 95-96 RD28TI	10.97→		0 986 45 P 2046	O
			1 457 43 N 4281 ²	K

Patrol GR 3.0 dCi 4x4

3,0 118 ZD30DDTI	01.07-03.10		1 457 42 P 9271	O
			F 026 40 N 2059 ¹	K

Patrol GR 3.0 Di Hardtop 4x4, Di 4x4

3,0 116 ZD30DDTI	02.00-03.10		1 457 42 P 9271	O
			1 457 43 N 4281 ²	K

Patrol GR 4.2

4,2 125 TB42S	08.87-09.97		0 986 45 P 2024	O
-------------------	-------------	--	-----------------	---

Patrol GR 4.2 D

4,2 92 TD42	08.87-09.97		0 986 45 P 2005	O
	08.92-09.97		0 451 10 P 3357	O
	08.87-09.97		1 457 43 N 4281 ²	K

Patrol GR 4.2 i

4,2 118-121 TB42E	10.91-09.97		0 986 45 P 2024	O
			1 987 42 S 9051	L

Patrol GR 4.5 i

4,5 147 TB45E	08.97→		0 986 45 P 2041	O
			0 450 90 F 5326 ¹	K

Patrol GR 4.8

4,8 180-185 TB48DE	10.02-03.10		0 986 45 P 2041	O
	04.07-03.10		0 450 90 F 5326 ¹	K

Pickup

Pickup 1.6

1,6Z16	09.85-07.92		0 986 45 P 2024	O

□□

Pickup 2.0

2,0 64/65/66 Z20; Z20S	09.85-09.95		0 986 45 P 2024	O
			1 457 42 S 9800	L

Pickup 2.4 , 4WD

2,4 74 Z24	09.85-04.92		0 986 45 P 2024	O
			1 457 42 S 9800	L

Pickup 2.4 i

2,4 91-93 KA24E	04.92-02.98		0 986 45 P 2023	O
			1 987 42 S 9051	L

Pickup 2.4 i, i 4WD

2,4 88 KA24E	02.98-11.01		0 986 45 P 2023	O
			1 987 42 S 9051	L
			0 450 90 F 5326 ¹	K

Pickup 2.4 | 98 | KA24DE

2,4 98 KA24DE	11.01-01.08		F 026 40 P 7001	O
			0 450 90 F 5326 ¹	K

Pickup 2.4 i 2WD, i 4WD

2,4 93 KA24E	03.92→		0 986 45 P 2023	O
			1 987 42 S 9051	L
	09.93→		0 450 90 F 5326 ¹	K

Pickup 2.4 i 4WD

2,4 74 Z24i	08.88-04.92		0 986 45 P 2024	O
-----------------	-------------	--	-----------------	---

Pickup 2.4 i 4x4

2,4 91-93 KA24E <s>	04.92-02.98		0 986 45 P 2023	O
			1 987 42 S 9051	L

Pickup 2.5 D

2,5 59-63 TD25	08.87-04.92		0 986 45 P 2005	O
	05.92-02.98		0 451 10 P 3357	O
	08.87-02.98		1 457 42 S 9800	L
			1 457 43 N 4281 ²	K

Pickup 2.5 D, D 4WD

2,5 61 TD25	02.98-11.01		0 451 10 P 3357	O
			1 457 43 N 4281 ²	K

Pickup 2.5 D Turbo, D Turbo 4WD

2,5 98 YD25	11.01-01.08		1 457 42 P 9284	O
			F 026 40 S 0199	L
			FMV,NOR 1 457 43 N 4281 ²	K





Pickup 2.5 D Turbo 4WD

2,5 76 TD25TI	05.98-11.01	0 451 10 P 3357	O
		1 457 43 S 3154	L
		1 457 43 N 4281 ²	K

Pickup 2.5 D 4WD

2,5 55 TD25	08.87-02.92	0 986 45 P 2005	O
		1 457 42 S 9800	L
		1 457 43 N 4281 ²	K

2,5 59-63 TD25	08.87-02.98	0 986 45 P 2046	O
		1 457 42 S 9800	L
		1 457 43 N 4281 ²	K

Pickup 2.5 dCi, dCi 4x4

2,5 98 YD25DDTI	02.08→	0 986 45 P 2003	O
		1 457 43 N 4281 ²	K

Pickup 2.7 D, D 4WD

2,7 73 TD27	08.87-01.97	0 986 45 P 2005	O
-----------------	-------------	------------------------	----------

Pickup 2.7 D 2WD

2,7 64 TD27	02.97→	0 451 10 P 3357	O
-----------------	--------	------------------------	----------

Pickup 2.7 D 2WD, D 4WD

2,7 62 TD27	08.87-03.92	0 986 45 P 2005	O
	04.92-03.97	0 451 10 P 3357	O
	08.87-03.97	1 457 42 S 9800	L
		1 457 43 N 4281 ²	K

Pickup 2.7 TD

2,7 62 TD273	01.96-12.02	1 457 43 S 3588	L
------------------	-------------	------------------------	----------

Pickup 3.2 D 4WD

3,2QD32	02.97→	0 451 10 P 3357	O
---------	--------	------------------------	----------

3,2 76 QD32	02.97-12.07	0 986 45 P 2005	O
		1 457 43 N 4439 ²	K

Pintara

Pintara 2.0 i

2,0 83 CA20E	08.89-10.92	0 986 45 P 2023	O
		1 987 42 S 9051	L
		0 450 90 F 5030 ¹	K



Pixo

Pixo 1.0

1,0 50 K10B	03.09→	0 986 45 P 2058	O
-----------------	--------	------------------------	----------

Prairie

Prairie 2.0 , 4WD

2,0 67 CA20S	09.88-08.95	0 986 45 P 2023	O
		1 987 42 S 9051	L

Prairie 2.0 i

2,0 107 SR20DE	08.95-11.98	F 026 40 P 7001	O
		1 987 42 S 9051	L

Prairie 2.4 i, i 4WD

2,4 103 KA24E	09.90-08.95	0 986 45 P 2023	O
		1 987 42 S 9051	L
		0 450 90 F 5326 ¹	K

Prairie Liberty

Prairie Liberty 2.0 i, i 4WD

2,0 103 SR20DE	11.98-05.01	F 026 40 P 7001	O
		1 987 42 S 9051	L

Prairie Pro

Prairie Pro 2.0 , i, i 4WD, 4WD

2,0 67/72/73 CA20E; CA20S	10.88-04.92	0 986 45 P 2023	O
		1 987 42 S 9051	L

Prairie Pro 2.4 i, i 4WD

2,4 98 KA24E	04.92-07.94	0 986 45 P 2023	O
		1 987 42 S 9051	L
		0 450 90 F 5326 ¹	K

Presage

Presage 2.5 i

2,5 120 QR25DE	06.03-07.09	F 026 40 P 7001	O
		1 987 42 S 9051	L

Presage 3.5 i

3,5 170 VQ35DE	06.03-07.09	F 026 40 P 7001	O
		1 987 42 S 9051	L





Presea

Presea 1.5 i

1,5 77 GA15DE	01.95-08.00	0 986 45 P 2023	O
	ABS	0 450 90 F 5326 ¹	K

Presea 2.0 i

2,0 107 SR20DE	01.95-08.00	F 026 40 P 7001	O
		1 987 42 S 9051	L

President JS

President JS 4.5 i

4,5 199 VH45DE	02.92-08.02	0 986 45 P 2023	O
----------------	-------------	------------------------	----------

Primastar

Primastar 1.9 dCi 80, dCi 100

1,9 59-60/74 F9Q 760; F9Q 762	07.02→	F 026 40 P 7022	O
		1 457 43 S 3531	L
	07.02-04.03 DHI	1 457 43 N 1720	K
	07.02→ PRF,TW	F 026 40 N 2047	K
		1 457 43 N 1724	K
		1 987 43 M 2208	I

Primastar 2.0 dCi 90, dCi 115

2,0 66/84-85 M9R 780, 782	10.06→	F 026 40 P 7014	O
		F 026 40 S 0103	L
	TW	F 026 40 N 2047	K
		1 457 43 N 1724	K
		1 987 43 M 2208	I

Primastar 2.0 i

2,0 88 F4R	02.03→	0 451 10 P 3336	O
		1 457 43 S 3529	L
		1 987 43 M 2208	I

Primastar 2.5 dCi 140

2,5 99 G9U 730	09.03→	TW 1 457 42 P 9198	O
		F 026 40 S 0103	L
		TW F 026 40 N 2047	K
		1 457 43 N 1724	K
		1 987 43 M 2208	I



Primastar 2.5 dCi 150

2,5 107-110 G9U 630	10.06→	F 026 40 P 7014	O
		F 026 40 S 0103	L
	TW	F 026 40 N 2047	K
		1 457 43 N 1724	K
		1 987 43 M 2208	I

Primera

Primera 1.6

1,6 66/70 GA16DS	06.90-05.93	0 986 45 P 2023	O
		1 987 42 S 9148	L

1,6 78-80 QG16DE	12.01-06.10	0 986 45 P 2061	O
		1 987 42 S 9051	L
		1 987 43 M 2075	I

Primera 1.6 i

1,6 66 GA16DE	01.98-06.99	0 986 45 P 2023	O
		1 987 43 M 2058	I

1,6 66-73 GA16DE	06.96-05.99	0 986 45 P 2023	O
		0 450 90 F 5326 ¹	K
		1 987 43 M 2058	I

1,6 66-75 GA16DE	04.93-12.97	0 986 45 P 2023	O
		1 457 43 S 3274	L
		0 450 90 F 5326 ¹	K

1,6 71-75 GA16DE	05.93-06.96	0 986 45 P 2023	O
		1 457 43 S 3274	L
		0 450 90 F 5264 ¹	K

1,6 73 GA16DE	01.98-12.01	0 986 45 P 2023	O
	06.99-12.01	1 457 43 S 3274	L
	01.98-12.01	1 987 43 M 2058	I

1,6 78 QG16DE	09.00-12.01	0 986 45 P 2061	O
		1 987 42 S 9051	L
		1 987 43 M 2058	I

1,6 81 GA16DE	09.98-12.00	0 986 45 P 2023	O
---------------	-------------	------------------------	----------

Primera 1.8

1,8 85 QG18DE	12.01-07.10	0 986 45 P 2061	O
		1 987 42 S 9051	L
		1 987 43 M 2075	I





Primera 1.8 i

1,8 81 SR18DI	02.90-09.92	0 986 45 P 2060	O
		1 987 42 S 9170	L
1,8 84 QG18DE	06.99-12.01	0 986 45 P 2061	O
		1 987 42 S 9051	L
		1 987 43 M 2058	I
1,8 92 QG18DE	09.98-01.01	F 026 40 P 7001	O
	02.02-12.05	F 026 40 P 7001	O
	09.98-01.01	1 987 42 S 9051	L
	02.02-12.05	1 987 42 S 9051	L
	09.98-01.01	0 450 90 F 5326 ¹	K
	02.02-12.05	1 987 43 M 2075	I
1,8 92 SR18DE	09.92-09.94	0 986 45 P 2060	O
	10.94-09.98	F 026 40 P 7001	O
	09.92-09.98	1 987 42 S 9051	L
	09.95-09.98	0 450 90 F 5326 ¹	K
1,8 96 QG18DD	09.98-01.01	F 026 40 P 7001	O
		1 987 42 S 9051	L

Primera 1.9 D Turbo

1,9 85-88 F9Q	01.03-10.03	0 451 10 P 3336	O
	11.03-07.10	F 026 40 P 7022	O
	01.03-01.05	1 457 43 N 1724	K
	02.05-07.10	1 457 43 N 1705	K
	01.03-07.10	1 987 43 M 2075	I

Primera 2.0

2,0 103 QR20DE	12.01-07.10	F 026 40 P 7001	O
		1 987 42 S 9051	L
		1 987 43 M 2075	I

Primera 2.0 D

2,0 55 CD20	07.90-04.96	KZO	0 986 45 P 2046	O
	07.90-06.96		0 986 45 P 2024	O
	01.91-06.96	AGF	0 986 45 P 2046	O
	07.90-06.96		1 987 42 S 9051	L
			1 457 43 N 4281 ²	K

Primera 2.0 D Turbo

2,0 66 CD20T	06.96-12.01	0 986 45 P 2046	O
		1 987 42 S 9051	L
		1 457 43 N 4281 ²	K
		1 987 43 M 2058	I



Primera 2.0 i

2,0 85 SR20DE	06.96-10.97	F 026 40 P 7001	O
	01.98-06.99	F 026 40 P 7001	O
	06.96-10.97	1 987 42 S 9051	L
	01.98-06.99	1 987 42 S 9051	L
	01.97-10.97	0 450 90 F 5326 ¹	K
	01.98-06.99	0 450 90 F 5326 ¹	K
	06.96-10.97	1 987 43 M 2058	I
	01.98-06.99	1 987 43 M 2058	I
2,0 85/89 SR20Di	06.90-07.94	0 986 45 P 2060	O
		1 987 42 S 9170	L
	06.90-05.93	0 450 90 F 5264 ¹	K
	07.90-07.94	0 450 90 F 5326 ¹	K
2,0 85-92 SR20De	07.94-12.97	0 986 45 P 2060	O
		1 987 42 S 9051	L
		0 450 90 F 5326 ¹	K
2,0 85-92 SR20DE	09.94-06.96	0 986 45 P 2060	O
		1 987 42 S 9051	L
		0 450 90 F 5264 ¹	K
2,0 96 SR20DE	06.96-10.97	F 026 40 P 7001	O
	01.98-06.99	F 026 40 P 7001	O
	06.96-10.97	1 987 42 S 9051	L
	01.98-06.99	1 987 42 S 9051	L
	01.97-10.97	0 450 90 F 5326 ¹	K
	01.98-06.99	0 450 90 F 5326 ¹	K
	06.96-10.97	1 987 43 M 2058	I
	01.98-06.99	1 987 43 M 2058	I
2,0 103 SR20DE	06.99-12.01	F 026 40 P 7001	O
	06.99→	1 987 42 S 9051	L
	06.99-12.01	1 987 43 M 2058	I
2,0 110 SR20DE	02.90-11.96	0 986 45 P 2060	O
	10.94-01.01	F 026 40 P 7001	O
	11.96-09.98	0 986 45 P 2061	O
	02.90-01.01	1 987 42 S 9051	L
	06.90-06.96	0 450 90 F 5264 ¹	K
	09.95-01.01	0 450 90 F 5326 ¹	K
2,0 112 SR20DE	06.90-05.93	0 986 45 P 2060	O
		1 987 42 S 9051	L
		0 450 90 F 5264 ¹	K
2,0 140 SR20VE	09.97-01.01	F 026 40 P 7001	O
		1 987 42 S 9051	L
2,0 150 SR20VE	08.01-07.03	F 026 40 P 7001	O
		1 987 42 S 9051	L



**Primera 2.0 i GT**

2,0 110 SR20DE	06.96-10.97	F 026 40 P 7001	O
		1 987 42 S 9051	L
	01.97-10.97	0 450 90 F 5326 ¹	K
	06.96-10.97	1 987 43 M 2058	I

Primera 2.0 i, i GT

2,0 96/110 SR20DEH;SR20DEL	10.97-06.99	F 026 40 P 7001	O
		1 987 42 S 9051	L
		0 450 90 F 5326 ¹	K
		1 987 43 M 2058	I

Primera 2.0 i, i 4WD

2,0 110 QR20DE	01.01-12.05	F 026 40 P 7001	O
		1 987 42 S 9051	L

Primera 2.0 i 4WD

2,0 85/89 SR20Di	04.91-05.93	0 986 45 P 2060	O
		1 987 42 S 9170	L
		0 450 90 F 5326 ¹	K

2,0|110|SR20DE

10.90-06.96	0 986 45 P 2060	O
10.94-01.01	F 026 40 P 7001	O
10.90-01.01	1 987 42 S 9051	L
04.91-09.94	0 450 90 F 5326 ¹	K
10.94-06.96	0 450 90 F 5264 ¹	K
09.95-01.01	0 450 90 F 5326 ¹	K

2,0|112|SR20DE

04.91-05.93	0 986 45 P 2060	O
	1 987 42 S 9051	L
	0 450 90 F 5326 ¹	K

Primera 2.2 D Turbo

2,2 93/100-102 YD22DDT	12.01-03.03	1 457 42 P 9284	O
	04.03-09.10	0 986 45 P 2003	O
	12.01-09.10	1 987 42 S 9051	L
	KZO	1 457 43 N 4451 ²	K
	KZO	1 457 43 N 4281 ²	K
	RLE	1 457 43 N 4451 ²	K
		1 987 43 M 2075	I

Primera 2.5 i

2,5 125 QR25DD	01.01-12.05	F 026 40 P 7001	O
		1 987 42 S 9051	L

Pulsar**Pulsar 1.5 i**

1,5 77 GA15DE	01.95-08.00	0 986 45 P 2023	O
		1 457 43 S 3972	L
		ABS 0 450 90 F 5326 ¹	K
		1 987 43 M 2084	I

Pulsar 1.6

1,6 86 GA16DE	08.91-05.95	0 986 45 P 2023	O
	08.95-06.00	0 986 45 P 2023	O
	08.91-05.95	1 987 42 S 9051	L
	08.95-06.00	1 987 42 S 9051	L
	08.91-05.95	0 450 90 F 5326 ¹	K

Pulsar 1.6 i

1,6 86 GA16DE	08.91-05.95	0 986 45 P 2023	O
	10.95-10.99	0 986 45 P 2023	O
	08.91-05.95	1 987 42 S 9051	L
	10.95-10.99	1 987 42 S 9051	L
	08.91-05.95	0 450 90 F 5326 ¹	K

1,6|88|GA16DE

01.95-08.00	0 986 45 P 2023	O
	1 987 42 S 9051	L

1,6|129|SR16VE

09.97-08.00	F 026 40 P 7001	O
	1 987 42 S 9051	L

Pulsar 1.8 i

1,8 103 SR18DE	01.95-08.00	F 026 40 P 7001	O
		1 987 42 S 9051	L

Pulsar 2.0 D

2,0 56 CD20	01.95-08.00	1 987 42 S 9051	L
		1 457 43 N 4281 ²	K

Pulsar 2.0 i

2,0 105 SR20DE	08.95-06.00	F 026 40 P 7001	O
		1 987 42 S 9051	L
		ABS 0 450 90 F 5326 ¹	K

Qashqai**Qashqai 1.5 dCi**

1,5 76-78 K9K	12.06-09.07	0 451 10 P 3336	O
	10.07→	F 026 40 P 7022	O
	12.06→	F 026 40 S 0101	L
	12.06-03.09	1 987 43 M 2238	I
	04.09-01.10 TW	1 987 43 M 2238	I
	02.10→	1 987 43 M 2238	I





◀ Qashqai 1.5 dCi

1,5 78 K9K	08.08→	F 026 40 P 7022	O
		F 026 40 S 0101	L
	08.08-12.08	1 987 43 M 2238	I
	01.10→	1 987 43 M 2238	I

1,5 81 K9K	01.10→	F 026 40 P 7022	O
		F 026 40 S 0101	L
		1 987 43 M 2238	I

Qashqai 1.6

1,6 84 HR16DE	12.06→	F 026 40 P 7001	O
		F 026 40 S 0126	L
		1 987 43 M 2238	I
		TW	

1,6 86 HR16DE	11.10→	F 026 40 P 7001	O
		F 026 40 S 0126	L
		1 987 43 M 2238	I

Qashqai 2.0 , 4x4

2,0 103-104 MR20DE	12.06→	F 026 40 P 7001	O
		F 026 40 S 0126	L
		1 987 43 M 2238	I
		TW	

Qashqai 2.0 dCi

2,0 110 M9R	04.07→	F 026 40 P 7014	O
		F 026 40 S 0126	L
	04.07-03.09	1 987 43 M 2238	I
	04.09-01.10	TW 1 987 43 M 2238	I
	01.10→	1 987 43 M 2238	I

Qashqai 2.0 dCi 4x4

2,0 110 M9R	04.07→	F 026 40 P 7014	O
		F 026 40 S 0126	L
	04.07-03.09	1 987 43 M 2238	I
	04.09-01.10	TW 1 987 43 M 2238	I
	01.10→	1 987 43 M 2238	I

Quest

Quest 3.0

3,0 113 VG30E	04.92-09.98	0 986 45 P 2023	O
	04.92-04.93	0 450 90 F 5326 ¹	K

Quest 3.3

3,3 125 VG33E	10.98-04.03	0 451 10 P 3364	O
-------------------	-------------	-----------------	---

Safari

Safari 4.2 i 4WD

4,2 129 TB42E	10.91-10.97	1 987 42 S 9051	L
-------------------	-------------	-----------------	---



Sentra

Sentra 1.4 i

1,4 66 GA14DNE	06.97-12.01	1 457 43 S 3274	L
--------------------	-------------	-----------------	---

Sentra 1.6 i

1,6 79 GA16DE	05.92-12.97	1 987 42 S 9051	L
-------------------	-------------	-----------------	---

1,6 81 GA16DE	10.94-12.01	0 986 45 P 2023	O
		1 457 43 S 3274	L
		0 450 90 F 5326 ¹	K

Sentra 1.6 i 16V

1,6 77 GA16	01.94→	1 987 42 S 9148	L
		0 450 90 F 5326 ¹	K

Sentra 1.8 , i

1,8 94/96 QG18DE	01.00→	1 987 42 S 9051	L
----------------------	--------	-----------------	---

Sentra 1.8 i

1,8 103 CA18DE	10.89-12.92	1 987 42 S 9051	L
--------------------	-------------	-----------------	---

Serena

Serena 1.6 i

1,6 71 GA16DE	07.92-11.01	0 986 45 P 2023	O
		1 987 42 S 9051	L
		0 450 90 F 5264 ¹	K

1,6 74 GA16DE	06.91-01.97	0 986 45 P 2023	O
		05.94-06.99	0 986 45 P 2060
	06.91-06.99	1 987 42 S 9051	L
	05.94-06.99	0 450 90 F 5326 ¹	K

Serena 2.0 D

2,0 49 LD20	07.92-09.94	TW	0 986 45 P 2024	O
			0 986 45 P 2046	O
			1 987 42 S 9051	L
	07.92-11.93	KZO	1 457 43 N 4281 ²	K
	07.92-09.94	KZO	1 457 43 N 4281 ²	K
	12.93-09.94	KZO	1 457 43 N 4439 ²	K

2,0 56 CD20	06.91-06.99	1 987 42 S 9051	L
		1 457 43 N 4281 ²	K

Serena 2.0 D Turbo, D Turbo 4WD

2,0 67/71 CD20ET; CD20T	06.91-06.99	1 457 43 N 4281 ²	K
-----------------------------	-------------	------------------------------	---





Serena 2.0 i

2,0 93 SR20DE	07.92-11.01	0 986 45 P 2060 O 1 987 42 S 9051 L 0 450 90 F 5264 ¹ K
2,0 96 SR20DE	01.94-06.99	0 986 45 P 2060 O 1 987 42 S 9051 L 0 450 90 F 5326 ¹ K
2,0 101 MR20DE	05.05-11.10	F 026 40 P 7001 O
2,0 107 SR20DE	06.99-12.01	F 026 40 P 7001 O 1 987 42 S 9051 L

Serena 2.0 i, i 4WD

2,0 108 QR20DE	12.01-05.05	F 026 40 P 7001 O 1 987 42 S 9051 L
-----------------------	-------------	--

Serena 2.0 i 4WD

2,0 96 SR20DE	06.91-06.99	0 986 45 P 2060 O 1 987 42 S 9051 L
----------------------	-------------	--

Serena 2.3 D

2,3 55 LD23	09.94-06.96 TW	0 986 45 P 2024 O 0 986 45 P 2046 O 07.96-11.01 0 986 45 P 2024 O 09.94-11.01 1 987 42 S 9051 L KZO 1 457 43 N 4439 ² K KZO 1 457 43 N 4281 ² K
--------------------	----------------	--

Serena 2.5 D Turbo, D Turbo 4WD

2,5 110 YD25DDTi	06.99-12.01	1 987 42 S 9051 L
-------------------------	-------------	---------------------------------

Serena 2.5 i

2,5 118 QR25DE	12.01-05.05	F 026 40 P 7001 O 1 987 42 S 9051 L
-----------------------	-------------	--

Silvia

Silvia 1.8 i, i Turbo

1,8 99/129 CA18DE; CA18DET	05.88-01.91	0 986 45 P 2023 O 1 987 42 S 9051 L 0 450 90 F 5326 ¹ K
-----------------------------------	-------------	--

Silvia 2.0 i

2,0 103 SR20DE; SR20DET	01.91-10.93	0 986 45 P 2060 O 1 987 42 S 9051 L 0 450 90 F 5326 ¹ K
--------------------------------	-------------	--



2,0 118 SR20DE; SR20DET	10.93-01.99	F 026 40 P 7001 O 1 987 42 S 9051 L
--------------------------------	-------------	--

Silvia 2.0 i, i Turbo

2,0 162/165/184 SR20DE; SR20DET	10.93-08.02	F 026 40 P 7001 O 1 987 42 S 9051 L
--	-------------	--

Silvia 2.0 i Turbo

2,0 151 SR20DE; SR20DET	01.91-10.93	0 986 45 P 2060 O 1 987 42 S 9051 L 0 450 90 F 5326 ¹ K
--------------------------------	-------------	--

Skyline

Skyline 1.8 i

1,8 67 CA18I	05.89-08.93	0 986 45 P 2023 O XXX 1 987 42 S 9046 L
---------------------	-------------	--

Skyline 2.0 i

2,0 85 RB20E	05.87-12.92	1 987 42 S 9051 L
---------------------	-------------	---------------------------------

2,0|92/96|RB20E

	05.89-01.99	0 986 45 P 2023 O 1 987 42 S 9051 L
--	-------------	--

2,0|114|RB20DE

	05.98-10.98	0 986 45 P 2023 O
	11.98-06.01	0 986 45 P 2060 O
	05.98-06.01	1 987 42 S 9051 L

Skyline 2.5 i

2,5 140-147 RB25DE; RB25DET	08.93-05.98	0 986 45 P 2023 O 1 987 42 S 9051 L
------------------------------------	-------------	--

2,5|147|RB25DE; RB25DET

	05.98-10.98	0 986 45 P 2023 O
	11.98-06.01	0 986 45 P 2060 O
	05.98-06.01	1 987 42 S 9051 L

Skyline 2.5 i, i 4WD

2,5 158 VQ25DD	06.01-10.06	F 026 40 P 7001 O 1 987 42 S 9051 L
-----------------------	-------------	--

Skyline 2.5 i Turbo

2,5 184 RB25DE; RB25DET	08.93-05.98	0 986 45 P 2023 O 1 987 42 S 9051 L
--------------------------------	-------------	--

2,5|206|RB25DE; RB25DET

	05.98-10.98	0 986 45 P 2023 O
	11.98-06.01	0 986 45 P 2060 O
	05.98-06.01	1 987 42 S 9051 L





Skyline 3.0 i

3,0 126 RB30E	05.87-12.92	1 987 42 S 9051	L
3,0 191 VQ30DD	06.01-11.04	F 026 40 P 7001 1 987 42 S 9051	O L

Skyline 3.5 i

3,5 200 VQ35DE	01.02-09.07	F 026 40 P 7001 1 987 42 S 9051	O L
--------------------	-------------	------------------------------------	--------

Skyline GT-R

Skyline GT-R 2.6 i Turbo 4WD

2,6 206 RB26DETT	08.89-11.94	0 986 45 P 2023	O
	01.95-01.99	0 986 45 P 2023	O
	01.99-08.02	0 986 45 P 2060	O
	08.89-11.94	1 987 42 S 9051	L
	01.95-08.02	1 987 42 S 9051	L

Stagea

Stagea 2.5 i

2,5 140-147 RB25DE	09.96-10.98	0 986 45 P 2023	O
	11.98-10.01	0 986 45 P 2060	O
	09.96-10.01	1 987 42 S 9051	L

Stagea 2.5 i, i 4WD

2,5 158 VQ25DD	10.01-06.07	F 026 40 P 7001 1 987 42 S 9051	O L
--------------------	-------------	------------------------------------	--------

Stagea 2.5 i Turbo

2,5 206 RB25DET	08.98-10.98	0 986 45 P 2023	O
	08.98-10.01	1 987 42 S 9051	L

Stagea 3.5 i

3,5 200 VQ35DE	08.04-06.07	F 026 40 P 7001 1 987 42 S 9051	O L
--------------------	-------------	------------------------------------	--------

Sunny

Sunny 1.3

1,3 58 GA13DS	01.90-12.93	0 986 45 P 2023 1 987 42 S 9148	O L
-------------------	-------------	------------------------------------	--------

Sunny 1.3 i

1,3 63 GA13DE	01.94-10.98	0 986 45 P 2023 1 457 43 S 3274	O L
-------------------	-------------	------------------------------------	--------

1,3 64-66 QG13DE	10.98-10.04	F 026 40 P 7001 1 987 42 S 9051	O L
----------------------	-------------	------------------------------------	--------



Sunny 1.4 , 12V

1,4 55/58-63 GA14DS; GA14S	10.88-05.95	0 986 45 P 2023 1 987 42 S 9148	O L
--------------------------------	-------------	------------------------------------	--------

Sunny 1.4 i

1,4 60-64 GA14DE	10.92-05.95	0 986 45 P 2023 1 457 43 S 3274 0 450 90 F 5326 ¹	O L K
----------------------	-------------	--	-------------

Sunny 1.5

1,5 69 GA15DS	01.90-06.95	0 986 45 P 2023	O
	01.90-12.93	1 987 42 S 9148	L
		0 986 45 F 0624 ¹	K

Sunny 1.5 i

1,5 77 GA15DE	01.94-10.98	0 986 45 P 2023 1 457 43 S 3274 0 986 45 F 0222 ¹	O L K
-------------------	-------------	--	-------------

Sunny 1.5 i, i 4WD

1,5 77-80 QG15DE	10.98-10.04	F 026 40 P 7001 1 987 42 S 9051	O L
----------------------	-------------	------------------------------------	--------

Sunny 1.5 i 4WD

1,5 77 GA15DE	01.94-10.98	0 986 45 P 2023 1 457 43 S 3274	O L
-------------------	-------------	------------------------------------	--------

Sunny 1.5 4WD

1,5 69 GA15DS	01.90-06.95	0 986 45 P 2023 1 987 42 S 9148	O L
-------------------	-------------	------------------------------------	--------

Sunny 1.6 , 4WD

1,6 66/70 GA16DS; GA16DS <AY>	10.90-07.95	0 986 45 P 2023 1 987 42 S 9148	O L
-----------------------------------	-------------	------------------------------------	--------

Sunny 1.6 i

1,6 81 QG16DE <DOHC CVTC>	10.00→	1 987 42 S 9051	L
-------------------------------	--------	-----------------	---

1,6 81/88 GA16DE	01.90-10.98	0 986 45 P 2023 1 987 42 S 9051	O L
----------------------	-------------	------------------------------------	--------

1,6 82 GA16DNE	06.98-10.02	0 986 45 P 2023	O
--------------------	-------------	-----------------	---

1,6 129 SR16VE	10.98-09.00	F 026 40 P 7001 1 987 42 S 9051	O L
--------------------	-------------	------------------------------------	--------



**Sunny 1.6 i, i 4WD****1,6|75-81|GA16DE**

10.92-05.95	0 986 45 P 2023	O
	1 457 43 S 3274	L
	0 450 90 F 5326 ¹	K

1,6|75-81|GA16DE <AY>

10.92-03.00	0 986 45 P 2023	O
	1 457 43 S 3274	L
	0 450 90 F 5326 ¹	K

Sunny 1.7 D**1,7|40|CD17**

Org.Nr. Q-SB13	01.90-01.92	AG	0 986 45 P 2046	O
Org.Nr. X-SB13	01.90-12.93		1 987 42 S 9051	L
			1 457 43 N 4281 ²	K

1,7|40|CD17 <VA>

05.92-04.98	0 986 45 P 2046	O
BG,PL, 05.92-04.98	0 986 45 P 2024	O
RO		
BG,PL, 05.92-04.98	0 986 45 P 2046	O
RO		
05.92-04.98	1 987 42 S 9051	L
	1 457 43 N 4281 ²	K

Sunny 1.7 D 4WD**1,7|40|CD17**

Org.Nr. X-SNB13	02.92-12.93	0 986 45 P 2046	O
	01.90-12.93	1 987 42 S 9051	L
		1 457 43 N 4281 ²	K

Sunny 1.8 i**1,8|96|QG18DD**

10.98-05.02	F 026 40 P 7001	O
	1 987 42 S 9051	L

1,8|103|SR18DE

01.90-12.93	0 986 45 P 2060	O
01.94-05.97	F 026 40 P 7001	O
01.90-05.97	1 987 42 S 9051	L

Sunny 2.0 D**2,0|55|CD20**

10.90-05.95	0 986 45 P 2024	O
	0 986 45 P 2024	O
	0 986 45 P 2046	O
	1 987 42 S 9051	L
	1 457 43 N 4281 ²	K

2,0|55|CD20 <VC>

11.90-07.95	0 986 45 P 2046	O
11.90-06.96	0 986 45 P 2024	O
07.96-03.00	0 986 45 P 2046	O
A,CH 11.93-04.98 SA	0 986 45 P 2046	O
11.90-03.00	1 987 42 S 9051	L
	1 457 43 N 4281 ²	K

Sunny 2.0 D, D 4WD**2,0|56|CD20**

01.94-09.99	0 986 45 P 2046	O
	1 987 42 S 9051	L
	1 457 43 N 4281 ²	K

Sunny 2.0 i**2,0|105|SR20DE**

10.90-09.94	0 986 45 P 2060	O
	1 987 42 S 9051	L
	0 450 90 F 5326 ¹	K

Sunny 2.0 i Turbo 4x4**2,0|162/169|SR20DET**

10.90-10.92	0 986 45 P 2060	O
	1 987 42 S 9051	L

Sunny 2.2 D**2,2|58|YD22DD**

09.99-05.02	1 987 42 S 9051	L
-------------	-----------------	---

Teana**Teana 2.0****2,0|100|QR20DE**

04.06-02.08	F 026 40 P 7001	O
	1 987 42 S 9051	L

Teana 2.3 , i**2,3|127|VQ23DE**

02.03-06.08	F 026 40 P 7001	O
	1 987 42 S 9051	L

Teana 2.5 , i 4WD**2,5|118/132-136|QR25DE; VQ25DE**

02.03→	F 026 40 P 7001	O
	1 987 42 S 9051	L

Teana 3.5 , i**3,5|170/180-185|VQ35DE**

02.03→	F 026 40 P 7001	O
	1 987 42 S 9051	L

Terrano**Terrano 2.4 , i****2,4|74/76|Z24; Z24i**

08.86-11.95	0 986 45 P 2024	O
-------------	-----------------	---

Terrano 2.4 i 4x4**2,4|85-87|KA24E**

05.96-06.00	0 986 45 P 2023	O
03.02-12.06	0 986 45 P 2023	O
05.96-12.06	1 987 42 S 9051	L
	0 450 90 F 5326 ¹	K
	1 987 43 M 2058	I
11.96-12.99 KL	1 987 43 M 2058	I





◀ Terrano 2.4 i 4x4

2,4 91 KA24E	02.93-05.96	0 986 45 P 2023	O
		1 987 42 S 9051	L
		0 450 90 F 5326 ¹	K

Terrano 2.7 D

2,7 62 TD27	08.87-11.95	0 986 45 P 2005	O
-----------------	-------------	-----------------	---

Terrano 2.7 D Turbo

2,7 73 TD27T	02.89-10.93	0 986 45 P 2046	O
		1 457 43 S 3275	L
		1 457 43 N 4281 ²	K

Terrano 2.7 D Turbo 4WD

2,7 74 TD27T	11.88-08.95	1 457 43 S 3275	L
		1 457 43 N 4281 ²	K

Terrano 2.7 D Turbo 4x4

2,7 74 TD27T	02.93-02.02	0 986 45 P 2046	O	
		1 457 43 S 3275	L	
	02.93-03.01	1 457 43 N 4281 ²	K	
	03.01-02.02	1 457 43 N 4451 ²	K	
	10.99-02.02 KL	1 987 43 M 2058	I	
	E 04.99-10.99 KL	1 987 43 M 2058	I	
	2,7 92 TD27TI	01.96-05.96	0 986 45 P 2046	O
		06.96→	0 451 10 P 3357	O
		01.96→	1 457 43 S 3154	L
		01.96-03.01	1 457 43 N 4281 ²	K
11.96→		1 457 43 N 4439 ²	K	
	04.01-12.06	1 457 43 N 4451 ²	K	
	01.96-12.06	1 987 43 M 2058	I	
	11.96→ KL	1 987 43 M 2058	I	

Terrano 2.7 D 4WD

2,7 63 TD27	08.86-01.93	1 457 42 S 9800	L
		1 457 43 N 4281 ²	K

Terrano 3.0 D Turbo 4x4

3,0 113 ZD30	02.02-12.06	1 457 42 P 9271	O
		1 457 43 S 3154	L
		SWA 1 457 43 N 4451 ²	K
		SWA 1 457 43 N 4439 ²	K
		KL 1 987 43 M 2058	I

Terrano 3.0 i, i 4WD

3,0 109 VG30E	01.90-10.95	0 986 45 P 2023	O
		1 987 42 S 9051	L



Terrano 3.0 i 4WD

3,0 114 VG30E	10.89-08.95	0 986 45 P 2023	O
		1 987 42 S 9051	L
		0 450 90 F 5326 ¹	K

Terrano 3.3 i, i 4WD

3,3 125 VG33E	09.95-08.02	1 987 42 S 9051	L
-------------------	-------------	-----------------	---

Tiida

Tiida 1.5 dCi

1,5 77 K9K	02.07-09.07	0 451 10 P 3336	O
	10.07→	F 026 40 P 7022	O
	02.07→	1 457 43 S 3595	L
		TW 0 450 90 N 6468 ¹	K

Tiida 1.5 i

1,5 80 HR15DE	09.04→	F 026 40 P 7001	O
-------------------	--------	-----------------	---

Tiida 1.6

1,6 81 HR16DE	02.07→	F 026 40 P 7001	O
		F 026 40 S 0101	L

Tiida 1.8

1,8 93 MR18DE	02.07→	F 026 40 P 7001	O
		F 026 40 S 0101	L

Tiida 1.8 i

1,8 94 MR18DE	01.05→	F 026 40 P 7001	O
-------------------	--------	-----------------	---

Tino

Tino 1.8 i

1,8 88-90 QG18DE	12.98-02.03	F 026 40 P 7001	O
		1 987 42 S 9051	L

Tino 2.0 i

2,0 99 SR20DE	12.98-10.02	F 026 40 P 7001	O
		1 987 42 S 9051	L

Trade

Trade 2.8 D

2,8 57-60 A428II	03.87-12.98	0 451 10 P 4067	O
		1 457 43 N 4439 ²	K





Trade 3.0 D

3,0 63 BD30	04.93-12.98	0 986 45 P 2005	O
		1 457 42 S 9932	L
		1 457 43 N 4281 ²	K

Urvan

Urvan 2.0

2,0 64-66 Z20; Z20S	11.86-01.95	0 986 45 P 2023	O
		1 457 43 S 3275	L

Urvan 2.4 , i

2,4 74-76 Z24i; Z24S	11.86-06.97	0 986 45 P 2023	O
		1 457 43 S 3275	L

Urvan 2.5 D

2,5 59 TD25	12.88-07.92	0 986 45 P 2005	O
	08.92-05.97	0 451 10 P 3357	O
	12.88-05.97	1 457 42 S 9933	L
		1 457 43 N 4281 ²	K

2,5 63 TD25	03.89-06.97	0 986 45 P 2005	O
		1 457 43 N 4281 ²	K

Urvan 2.7 D

2,7 62 TD27	11.86-08.92	0 986 45 P 2005	O
	09.92-06.97	0 451 10 P 3357	O
	11.86-06.97	1 457 42 S 9933	L
		1 457 43 N 4281 ²	K

UTE

UTE 4.1

4,1 97,5 V	01.88-12.91	0 451 10 P 4063	O
------------	-------------	-----------------	---

Vanette

Vanette 1.2

1,2 38 A12	09.85-03.94	0 986 45 P 2023	O
		1 987 42 S 9117	L

1,2 38 A12S	11.88-03.94	1 987 42 S 9117	L
-------------	-------------	-----------------	---

Vanette 1.5

1,5 49 A15	09.85-06.91	0 986 45 P 2023	O
	09.85-03.94	1 987 42 S 9117	L



1,5 49/51 A15S	05.86-12.96	0 986 45 P 2023	O
		1 987 42 S 9117	L

1,5 51 A15	09.85-06.94	1 987 42 S 9117	L
		0 450 90 F 4058 ¹	K

1,5 60	10.96→	1 987 42 S 9117	L
--------	--------	-----------------	---

Vanette 1.6 i

1,6 71-72 GA16DE	07.92-11.01	0 986 45 P 2023	O
		1 987 42 S 9051	L
		0 450 90 F 5264 ¹	K

Vanette 1.8 i Turbo

1,8 88 CA18ET	05.86-04.93	0 986 45 P 2023	O
---------------	-------------	-----------------	---

Vanette 2.0

2,0SR20DE	05.92-09.94	0 986 45 P 2060	O
		1 987 42 S 9051	L
		0 450 90 F 5326 ¹	K

2,0 64/66 Z20S	05.86-04.93	0 986 45 P 2023	O
		1 987 42 S 9117	L

2,0 65 CA20S	09.85-04.93	0 986 45 P 2023	O
--------------	-------------	-----------------	---

2,0 67 NA20S	08.90-03.94	1 987 42 S 9117	L
--------------	-------------	-----------------	---

Vanette 2.0 D

2,0 44/47-49 LD20II; LD20IIL	04.87-11.94	0 986 45 P 2024	O
		1 987 42 S 9117	L
		1 457 43 N 4281 ²	K

2,0 47-49 LD20	09.86-04.93	0 986 45 P 2024	O
		1 457 43 N 4281 ²	K

2,0 49 LD20	09.85-03.94	0 986 45 P 2024	O
	07.92-09.94 TW	0 986 45 P 2024	O
		0 986 45 P 2046	O
		1 987 42 S 9051	L
	07.92-11.93 KZO	1 457 43 N 4281 ²	K
	07.92-09.94 KZO	1 457 43 N 4281 ²	K
	12.93-09.94 KZO	1 457 43 N 4439 ²	K

Vanette 2.0 D 4WD

2,0 49 LD20	11.88-03.94	0 986 45 P 2024	O
-------------	-------------	-----------------	---





Vanette 2.3 D

2,3 55 LD23	09.94-06.96	TW	0 986 45 P 2024	0
			0 986 45 P 2046	0
	07.96-11.01		0 986 45 P 2024	0
	09.94-11.01		1 987 42 S 9051	L
		KZO	1 457 43 N 4439 ²	K
		KZO	1 457 43 N 4281 ²	K

Vanette 2.4

2,4 74 Z24S	06.86-10.91		0 986 45 P 2023	0
			1 987 42 S 9117	L

Vanette 2.4 i

2,4 74-77 Z24I	09.86-03.93		0 986 45 P 2023	0
			0 450 90 F 5326 ¹	K

Wingroad

Wingroad 1.5 i

1,5 77 GA15DE	05.96-06.99		0 986 45 P 2023	0
			1 457 43 S 3274	L
		ABS	0 450 90 F 5326 ¹	K

1,5 77-78 QG15DE	05.99-11.05		F 026 40 P 7001	0
			1 987 42 S 9051	L

1,5 80 HR15DE	11.05→		F 026 40 P 7001	0
---------------	--------	--	-----------------	---

Wingroad 1.8 i, i 4WD

1,8 85-90 QG18DE	05.99-11.05		F 026 40 P 7001	0
			1 987 42 S 9051	L

X-Trail

X-Trail 2.0

2,0 101 MR20DE	08.07→		F 026 40 P 7001	0
----------------	--------	--	-----------------	---

X-Trail 2.0 , 4x4

2,0 104 MR20DE	04.07→		F 026 40 P 7001	0
			F 026 40 S 0126	L
			1 987 43 M 2238	I

X-Trail 2.0 dCi, dCi 4x4

2,0 110/127 M9R	04.07→		F 026 40 P 7014	0
			F 026 40 S 0126	L
			1 987 43 M 2238	I

X-Trail 2.0 i, i Turbo 4WD, i 4WD, 4x2, 4x4

2,0 103/110/206 QR20DE; SR20VT	10.00→		F 026 40 P 7001	0
			1 987 42 S 9051	L



X-Trail 2.2 D Turbo

2,2 84 YD22ETI	11.01→		1 987 42 S 9051	L
			1 457 43 N 4281 ²	K

X-Trail 2.2 D Turbo 4x2, D Turbo 4x4

2,2 100 YD22DDTi	09.03-03.07		0 986 45 P 2003	0
			1 987 42 S 9051	L
	09.03-10.05		1 457 43 N 4281 ²	K
	11.05-03.07		F 026 40 N 2059 ¹	K

X-Trail 2.2 D Turbo 4x4

2,2 84 YD22ETI	06.01-08.03		1 457 42 P 9284	0
			1 987 42 S 9051	L
			1 457 43 N 4281 ²	K

X-Trail 2.5 i 4WD

2,5 132 QR25DE	09.01→		F 026 40 P 7001	0
			1 987 42 S 9051	L

X-Trail 2.5 4x4

2,5 121 QR25DE	09.02-03.07		F 026 40 P 7001	0
			1 987 42 S 9051	L

2,5 124 QR25DE	04.07→		F 026 40 P 7001	0
			1 457 43 S 3274	L
			1 987 43 M 2238	I

100 NX

100 NX 1.6

1,6 66/70 GA16DS	10.90-10.92		0 986 45 P 2023	0
			1 987 42 S 9148	L

100 NX 1.6 i

1,6 75-81 GA16DE	10.92-10.94		0 986 45 P 2023	0
			1 457 43 S 3274	L
			0 450 90 F 5326 ¹	K

100 NX 2.0 i

2,0 104/105 SR20DE	08.90-10.93		0 986 45 P 2060	0
			1 987 42 S 9051	L
		ABS	0 450 90 F 5326 ¹	K

180 SX

180 SX 1.8 i Turbo

1,8 129 CA18DET	03.89-01.91		0 986 45 P 2023	0
			1 987 42 S 9051	L





180 SX 2.0 i, i Turbo

2,0 103/151 SR20DE; SR20DET	01.91-01.99	0 986 45 P 2060	O
		1 987 42 S 9051	L

200 SX

200 SX 1.8 i Turbo

1,8 124/129 CA18DT <CA18ET>	09.88-12.93	0 986 45 P 2023	O
		1 987 42 S 9051	L
		0 450 90 F 5326 ¹	K

200 SX 2.0 i Turbo

2,0 147 SR20DET	04.94-12.99	F 026 40 P 7001	O
		1 987 42 S 9051	L
		0 450 90 F 5326 ¹	K

300 ZX

300 ZX 3.0 i, i Biturbo

3,0 168/197-208 VG30DE; VG30DETT	01.90-03.96	0 986 45 P 2023	O
		1 457 43 S 3274	L

350 Z

350 Z 3.5

3,5 206-222 VQ35DE	09.02→	F 026 40 P 7001	O
		1 987 42 S 9051	L

3,5 230 VQ35HR	09.06→	F 026 40 P 7001	O
		F 026 40 S 0130	L

370 Z

370 Z 3.7

3,7 241/243 VQ37VHR	01.09→	F 026 40 P 7001	O
		F 026 40 S 0130	L

OPEL *

Agila

Agila 1.0 i, Twinport

1,0 43/44 Z 10 XE; Z 10 XEP <Twinport ECO>			
Mot.Nr. →19MA9234	06.00-02.08	F 026 40 P 7015	O
Mot.Nr. 19MA9235→	06.00-02.08	F 026 40 P 7006	O
	06.00-02.08	1 457 43 S 3153	L
		1 987 43 M 2066	I

Agila 1.0 Twinport

1,0 48 K 10 B <Twinport ECO>	03.08→	0 986 45 P 2058	O
		1 987 43 M 2214	I

Agila 1.2 i, Twinport

1,2 | 55/59 | Z 12 XE; Z 12 XEP <Ecotec>

Mot.Nr. →19MA9234	06.00-02.08	F 026 40 P 7015	O
Mot.Nr. 19MA9235→	06.00-02.08	F 026 40 P 7006	O
	06.00-02.08	1 457 43 S 3153	L
		1 987 43 M 2066	I

Agila 1.2 Twinport

1,2 63-69 K 12 B <Ecotec>	03.08→	0 986 45 P 2058	O
		1 987 43 M 2214	I

Agila 1.3 CDTI

1,2 55 D 13 A; Z 13 DTJ	03.08→	F 026 40 P 7067	O
		1 987 43 M 2214	I

1,3 | 51 | Z 13 DT <Turbo>

	08.03-02.08	1 457 42 P 9256	O
		1 987 42 S 9173	L
		1 457 07 N 0001	K
		1 987 43 M 2066	I

Antara

Antara 2.4 , 4x4

2,4 104 Z 24 XE <Ecotec>	05.06→	0 451 10 P 3079	O
------------------------------	--------	-----------------	----------

2,4 123 A 24 XE <Ecotec>	11.10→	F 026 40 P 7016	O
------------------------------	--------	-----------------	----------

Arena

Arena 1.9 D

1,9 44 F 8Q 600 <TF1J/L>	03.98-08.01	1 457 43 N 1705	K
------------------------------	-------------	-----------------	----------

1,9 44 F 8Q 606 <TF1J/L>	03.98-08.01	1 457 43 N 1705	K
------------------------------	-------------	-----------------	----------

Arena 2.5 D

2,5 55 S8U-758 <TF1G/M,THBJ/L,THBG/M>	03.98-08.01	0 451 20 P 3201	O
---	-------------	-----------------	----------

2,5 55 S8U-780 <TF1G/M,THBJ/L,THBG/M>	03.98-08.01	0 451 20 P 3201	O
		1 457 43 N 1705	K

2,5 55 S8U-782 <TF1G/M,THBJ/L,THBG/M>	03.98-08.01	0 451 20 P 3201	O
---	-------------	-----------------	----------

Fg.Nr. Y257500→	03.98-08.01	1 457 43 N 1705	K
-----------------	-------------	-----------------	----------





Astra F

Astra F 1.4

1,4 55 14 NV <OHC>	09.91-09.93	0 451 10 P 3079	O
		1 457 43 S 3007	L
		0 450 90 F 5280 ¹	K
		1 987 43 M 2010	I
		1 987 43 R 2310 ⁸	I

Astra F 1.4 i

1,4 44 C 14 NZ <OHC>	09.91-02.98	0 451 10 P 3079	O
		1 457 43 S 3007	L
		0 450 90 F 5280 ¹	K
		1 987 43 M 2010	I
		1 987 43 R 2310 ⁸	I

1,4 44 X 14 NZ <Ecotec OHC>	09.97-08.02	0 451 10 P 3079	O
		1 457 43 S 3007	L
		0 450 90 F 5280 ¹	K
		1 987 43 M 2010	I
		1 987 43 R 2310 ⁸	I

1,4 44/66 X 14 NZ <OHC>; X 14 XE <Ecotec DOHC>	04.96-02.98	0 451 10 P 3079	O
		1 457 43 S 3007	L
		0 450 90 F 5280 ¹	K
		1 987 43 M 2010	I
		1 987 43 R 2310 ⁸	I

1,4 60 14 SE / C 14 SE <OHC>	03.92-02.98	0 451 10 P 3079	O
		1 457 43 S 3007	L
		0 450 90 F 5280 ¹	K
		1 987 43 M 2010	I
		1 987 43 R 2310 ⁸	I

1,4 65 14 SE	05.96-12.98	1 457 43 S 3007	L
------------------	-------------	------------------------	----------

Astra F 1.6

1,6 60 16 SV	09.91-02.92	0 451 10 P 3079	O
		1 457 42 S 9053	L
		1 987 43 M 2010	I
		1 987 43 R 2310 ⁸	I

Astra F 1.6 i

1,6 52/55/74 C 16 SE <OHC>; C/E 16 NZ <OHC>; X 16 SZ	09.91-02.98	0 451 10 P 3079	O
		1 457 43 S 3007	L
		0 450 90 F 5280 ¹	K
		1 987 43 M 2010	I
		1 987 43 R 2310 ⁸	I

1,6 55 X 16 SZR <Ecotec OHC>	09.97-08.02	0 451 10 P 3079	O
		1 457 43 S 3007	L
		0 450 90 F 5280 ¹	K
		1 987 43 M 2010	I



1,6 55 16 LZ2, NZ2 <OHC>; 16 NZR; 16 NZR <OHC>	09.94-02.98	0 451 10 P 3079	O
		1 457 43 S 3007	L
		0 450 90 F 5280 ¹	K
		1 987 43 M 2010	I
		1 987 43 R 2310 ⁸	I

1,6 55/74 X 16 SZR <OHC Ecotec>; X 16 XEL <DOHC Ecotec>	09.94-02.98	0 451 10 P 3079	O
		1 457 43 S 3007	L
		0 450 90 F 5280 ¹	K
		1 987 43 M 2010	I
		1 987 43 R 2310 ⁸	I

1,6 74 X 16 XEL <Ecotec DOHC>	09.97-08.02	0 451 10 P 3079	O
		1 457 43 S 3007	L
		0 450 90 F 5280 ¹	K
		1 987 43 M 2010	I

Astra F 1.7 D

1,7 42-44 17 D/DR <OHC>	12.91-08.94	0 451 10 P 3232	O
		1 457 43 S 3007	L
		1 457 43 N 4106 ²	K
		1 987 43 M 2010	I
		1 987 43 R 2310 ⁸	I

Astra F 1.7 TD

1,7 50 X 17 DTL <OHC>	09.94-02.98	0 451 10 P 3297	O
		1 457 43 S 3007	L
		1 457 43 N 4106 ²	K
		1 987 43 M 2010	I
		1 987 43 R 2310 ⁸	I

1,7 60 17 TD/TC4 <OHC EE1>	12.91-12.95	0 986 45 P 2036	O	
	01.96-02.98	0 986 45 P 2041	O	
	Fg.Nr. T8000001→TP000001→	12.91-02.98	1 457 43 S 3007	L
	Fg.Nr. →S8999999→SP999999	12.91-02.98	1 457 42 S 9894	L
	12.91-02.98	1 457 43 N 4106 ²	K	
		1 987 43 M 2010	I	
		1 987 43 R 2310 ⁸	I	

Astra F 1.8 i

1,8 66/82/85/92 C 18 NZ <OHC>; C 18 SEL <DOHC>; C 18 XE <DOHC>; C 18 XEL <DOHC>; X 18 XE <DOHC>; 18 SE <OHC>	09.91-08.98	0 451 10 P 3079	O
		1 457 43 S 3007	L
		0 450 90 F 5280 ¹	K
		1 987 43 M 2010	I
		1 987 43 R 2310 ⁸	I

Astra F 2.0 i

2,0 85/100/110 C 20 NE / 20 NE <OHC>; C 20 XE / XE-LN <DOHC>; C 20 XE <DOHC>; X 20 XEV <DOHC Ecotec>	09.91-02.98	0 451 10 P 3079	O
		1 457 43 S 3007	L
		0 450 90 F 5280 ¹	K
		1 987 43 M 2010	I
		1 987 43 R 2310 ⁸	I





Astra G

Astra G 1.2 i

1,2 48/55 X 12 XE <Ecotec>; X 12 XE <Ecotec OHC>; Z 12 XE <Ecotec>; Z 12 XE <Ecotec OHC>			
09.97-09.03	F 026 40	P 7015	O
	1 457 43	S 3281	L
	0 450 90	F 5273 ¹	K
BHR	1 987 43	M 2038	I
DHI,ELH	1 987 43	M 2040	I

Astra G 1.4 i

1,4 66 X 14 XE <Ecotec>; X 14 XE <Ecotec OHC>; Z 14 XE <Ecotec>; Z 14 XE <Ecotec OHC>			
09.97-08.05	0 451 10	P 3079	O
	1 457 43	S 3281	L
	0 450 90	F 5273 ¹	K
BHR	1 987 43	M 2038	I
DHI,ELH	1 987 43	M 2040	I

Astra G 1.4 Twinport

1,4 66 Z 14 XEP <Twinport Ecotec>			
09.03-03.04	F 026 40	P 7015	O
	1 457 43	S 3281	L
	0 450 90	F 5273 ¹	K
BHR	1 987 43	M 2038	I
DHI,ELH	1 987 43	M 2040	I

Astra G 1.6 i

1,6 55/62/74 X 16 SZR <Ecotec DOHC>; X 16 SZR <Ecotec OHC>; X 16 XEL <Ecotec DOHC>; Z 16 SE <Ecotec>; Z 16 SE <Ecotec OHC>			
09.97-06.04	0 451 10	P 3079	O
	1 457 43	S 3281	L
	0 450 90	F 5273 ¹	K
BHR	1 987 43	M 2038	I
DHI,ELH	1 987 43	M 2040	I

1,6 | 74 | C 16 SEL <DOHC>

09.98-06.04	0 451 10	P 3079	O
	1 457 43	S 3281	L
	0 450 90	F 5273 ¹	K
BHR	1 987 43	M 2038	I
DHI,ELH	1 987 43	M 2040	I

1,6 | 74 | C 16 SEL <Ecotec>

10.99-12.05	1 457 43	S 3281	L
	0 450 90	F 5273 ¹	K
	1 987 43	M 2038	I

1,6 | 74 | Z 16 XE <Ecotec>

09.00-08.05	0 451 10	P 3370	O
	1 457 43	S 3281	L
	0 450 90	F 5273 ¹	K
BHR	1 987 43	M 2038	I
DHI,ELH	1 987 43	M 2040	I

1,6 | 77 | Z 16 XE <Ecotec>

05.05-05.06	0 451 10	P 3370	O
	0 450 90	F 5273 ¹	K
	1 987 43	M 2040	I



Astra G 1.6 i CNG

1,6 69-73 Z 16 YNG <Ecotec Gasmotor>			
09.02-06.04	0 451 10	P 3079	O
	1 457 43	S 3281	L
	0 450 90	F 5273 ¹	K
BHR	1 987 43	M 2038	I
DHI,ELH	1 987 43	M 2040	I

Astra G 1.6 i, i Twinport

1,6 74/76 Z 16 XE <Ecotec DOHC>; Z 16 XEP <DOHC>; Z 16 XEP <Twinport DOHC>			
09.00-06.04	0 451 10	P 3370	O
	1 457 43	S 3281	L
	0 450 90	F 5273 ¹	K
BHR	1 987 43	M 2038	I
DHI,ELH	1 987 43	M 2040	I

Astra G 1.6 Twinport

1,6 76 Z 16 XEP <Twinport Ecotec>			
03.03-08.05	0 451 10	P 3370	O
	1 457 43	S 3281	L
	0 450 90	F 5273 ¹	K
03.03-02.05	DHI,RLE	1 987 43	M 2040
03.03-08.05	BHR	1 987 43	M 2038
	DHI,ELH	1 987 43	M 2040

Astra G 1.7 CDTI

1,7 59 Z 17 DTL <Turbo>			
03.03-08.05	1 457 42	P 9199	O
	1 457 43	S 3281	L
	1 457 42	N 9656	K
03.03-02.05	DHI,RLE	1 987 43	M 2040
03.03-08.05	BHR	1 987 43	M 2038
	DHI,ELH	1 987 43	M 2040

Astra G 1.7 DT

1,7 50 X 17 DTL <Turbo>			
03.98-08.00	0 451 10	P 3297	O
	1 457 43	S 3281	L
	1 457 42	N 9656	K
BHR	1 987 43	M 2038	I
DHI,ELH	1 987 43	M 2040	I

Astra G 1.7 DTI

1,7 55 Y 17 DT <Ecotec Turbo>; Y 17 DT <Turbo>			
09.00-06.04	1 457 42	P 9199	O
	1 457 43	S 3281	L
	1 457 42	N 9656	K
BHR	1 987 43	M 2038	I
DHI,ELH	1 987 43	M 2040	I

Astra G 1.8 i

1,8 85 X 18 XE1 <Ecotec>			
Mot.Nr. →20V00604	09.97-08.00	1 457 42	P 9178
Mot.Nr. 20V00605→	09.97-08.00	0 451 10	P 3079
	09.97-12.02	1 457 43	S 3281
		0 450 90	F 5273 ¹
	09.97-08.00	BHR	1 987 43
		DHI,ELH	1 987 43





◀ Astra G 1.8 i

1,8 | 85/92 | X 18 XE1 <Ecotec DOHC>; Z 18 XE <Ecotec>; Z 18 XE <Ecotec DOHC>; Z 18 XEL <Ecotec>; Z 18 XEL <Ecotec DOHC>

Mot.Nr. →20V00604	09.97-08.05	1 457 42 P 9178	O
Mot.Nr. 20V00605→	09.97-08.05	0 451 10 P 3079	O
	09.97-08.05	1 457 43 S 3281	L
		0 450 90 F 5273 ¹	K
	BHR	1 987 43 M 2038	I
	DHI,ELH	1 987 43 M 2040	I

1,8 | 92 | X 18 XE1 <Ecotec>

01.03-12.05	1 457 43 S 3281	L
	0 450 90 F 5273 ¹	K
	1 987 43 M 2040	I

1,8 | 95 | X 18 XE1 <Ecotec DOHC>; Z 18 XE <Ecotec>; Z 18 XE <Ecotec DOHC>; Z 18 XEL <Ecotec>; Z 18 XEL <Ecotec DOHC>

01.03-12.05	1 457 43 S 3281	L
	0 450 90 F 5273 ¹	K

Astra G 2.0 DT

2,0 | 60 | X 20 DTL <Turbo>

03.98-08.00	1 457 42 P 9157	O	
	1 457 43 S 3281	L	
	1 457 42 N 9656	K	
	BHR	1 987 43 M 2038	I
	DHI,ELH	1 987 43 M 2040	I

Astra G 2.0 DTI, DTL

2,0 | 60/74 | Y 20 DTH <Turbo>; Y 20 DTL <Turbo>

09.99-01.05	1 457 42 P 9157	O	
Fg.Nr. →12999999→15999999	09.99-01.05	1 457 43 S 3281	L
→18999999			
Fg.Nr. 22000001→25000001→	09.99-01.05	F 026 40 S 0013	L
28000001→			
09.99-01.05	1 457 42 N 9656	K	
	BHR	1 987 43 M 2038	I
	DHI,ELH	1 987 43 M 2040	I

Astra G 2.0 i

2,0 | 100 | X 20 XEV <Ecotec>; X 20 XEV <Ecotec DOHC>

09.97-06.04	0 451 10 P 3079	O	
	1 457 43 S 3281	L	
	0 450 90 F 5273 ¹	K	
	BHR	1 987 43 M 2038	I
	DHI,ELH	1 987 43 M 2040	I

2,0 | 100 | 20 SEL <Ecotec>

10.99-12.01	0 450 90 F 5273 ¹	K
-------------	------------------------------	---

2,0 | 118 | X 20 XER <Ecotec>

10.99-09.02	0 451 10 P 3297	O	
	1 457 43 S 3281	L	
	0 450 90 F 5273 ¹	K	
	BHR	1 987 43 M 2038	I
	DHI,ELH	1 987 43 M 2040	I

Astra G 2.0 Turbo

2,0 | 141-147 | Z 20 LET <Turbo Ecotec>

09.00-08.05	0 451 10 P 3079	O	
	1 457 43 S 3281	L	
	0 450 90 F 5273 ¹	K	
	BHR	1 987 43 M 2038	I
	DHI,ELH	1 987 43 M 2040	I



Astra G 2.2 DTI

2,2 | 92 | Y 22 DTR <Turbo>

09.01-08.05	1 457 42 P 9157	O	
	1 457 43 S 3281	L	
	1 457 42 N 9656	K	
	BHR	1 987 43 M 2038	I
	DHI,ELH	1 987 43 M 2040	I
03.02-02.05	DHI,RLE	1 987 43 M 2040	I

Astra G 2.2 i

2,2 | 108 | Z 22 SE <Ecotec>; Z 22 SE <Ecotec DOHC>

09.00-08.05	F 026 40 P 7016	O	
	1 457 43 S 3079	L	
09.00-12.05	0 450 90 F 5273 ¹	K	
09.00-08.05	BHR	1 987 43 M 2038	I
	DHI,ELH	1 987 43 M 2040	I

Astra H

Astra H 1.2 i Twinport, Twinport

1,2 | 59 | Z 12 XEP

Mot.Nr. →19MA9234	03.07-03.09	F 026 40 P 7015	O
Mot.Nr. 19MA9235→	03.07-03.09	F 026 40 P 7006	O
	03.07-03.09	1 457 43 S 3281	L
		1 987 43 M 2040	I

Astra H 1.3 CDTI

1,3 | 66 | Z 13 DTH <Ecotec>

06.05-03.10	PRF	1 457 42 P 9256	O
	UFI	F 026 40 P 7067	O
08.05-03.10		1 457 42 P 9256	O
06.05-03.10		F 026 40 S 0013	L
		1 457 07 N 0001	K
		1 987 43 M 2040	I

Astra H 1.4 , i, Twinport

1,4 | 55/66 | Z 14 XEL <Ecotec>; Z 14 XEL <Twinport Ecotec>; Z 14 XEP <Twinport Ecotec>

Mot.Nr. →19MA9234	03.04-03.10	F 026 40 P 7015	O
Mot.Nr. 19MA9235→	03.04-03.10	F 026 40 P 7006	O
	03.04-03.10	1 457 43 S 3281	L
		1 987 43 M 2040	I

Astra H 1.6 , i

1,6 | 85 | A 16 XER <Ecotec>

01.11→	F 026 40 P 7006	O
	1 457 43 S 3281	L
	1 987 43 M 2040	I

1,6 | 85 | Z 16 XER <Ecotec>

12.06→	F 026 40 P 7006	O
	1 457 43 S 3281	L
	1 987 43 M 2040	I

Astra H 1.6 i Turbo, Turbo

1,6 | 132 | Z 16 LET <Ecotec>

02.07→	F 026 40 P 7006	O
	F 026 40 S 0012	L
	1 987 43 M 2040	I





Astra H 1.6 i, Twinport

1,6 76-77 Z 16 XE... <Ecotec>; Z 16 XEP <Twinport Ecotec>			
03.04-03.08	0 451 10	P 3370	O
	1 457 43	S 3281	L
	1 987 43	M 2040	I

Astra H 1.6 Turbo

1,6 132 A 16 LET <Ecotec>			
01.11→	F 026 40	P 7006	O
	F 026 40	S 0012	L
	1 987 43	M 2040	I

Astra H 1.6 Twinport

1,6 77 Z 16 XE1 <Twinport Ecotec>			
03.07-03.09	0 451 10	P 3370	O
	1 457 43	S 3281	L
	1 987 43	M 2040	I

Astra H 1.7 CDTI

1,7 59 Z 17 DTL <Turbo Ecotec>			
03.04-03.07	1 457 42	P 9199	O
	F 026 40	S 0013	L
Fg.Nr. →62005916→65020044→68	03.04-03.07	1 457 42	N 9656 K
	03.04-03.07	1 987 43	M 2040 I

1,7 74 Z 17 DTH <Turbo Ecotec>			
03.04-03.07	1 457 42	P 9199	O
	F 026 40	S 0013	L
Fg.Nr. →62005916→65020044→68	03.04-03.07	1 457 42	N 9656 K
	03.04-03.07	1 987 43	M 2040 I

1,7 81 Z 17 DTJ <Turbo Ecotec>			
02.07-03.10	F 026 40	P 7073	O
	F 026 40	S 0012	L
	1 987 43	M 2040	I

1,7 81/92 ... 17 DTR <Turbo Ecotec>; A 17 DTJ <Turbo Ecotec>; A 17 DTR <Turbo Ecotec>			
02.07→	F 026 40	P 7073	O
	F 026 40	S 0012	L
	1 987 43	M 2040	I

1,7 92 Z 17 DTR <Turbo Ecotec>			
02.07-03.10	F 026 40	P 7073	O
	F 026 40	S 0012	L
	1 987 43	M 2040	I

Astra H 1.8 , i

1,8 103 A 18 XER <Ecotec>			
01.11→	F 026 40	P 7006	O
	1 457 43	S 3281	L
	1 987 43	M 2040	I

Astra H 1.8 i

1,8 92 Z 18 XE <Ecotec>			
03.04-02.09	0 451 10	P 3370	O
	1 457 43	S 3281	L
	1 987 43	M 2040	I



1,8 103 Z 18 XER <Ecotec>			
08.05→	F 026 40	P 7006	O
	1 457 43	S 3281	L
	1 987 43	M 2040	I

Astra H 1.9 , CDTi, CDTI

1,9 74/88/110 Z 19 DT <Turbo Ecotec>; Z 19 DTH <Ecotec>; Z 19 DTH <Turbo Ecotec>; Z 19 DTJ <Turbo Ecotec>; Z 19 DTL <Turbo Ecotec>			
04.04→	1 457 42	P 9248	O
	F 026 40	S 0012	L
	1 457 07	N 0001	K
	1 987 43	M 2040	I

Astra H 2.0 i Turbo, Turbo

2,0 125/147/177 Z 20 LEH <Turbo Ecotec>; Z 20 LEL <Ecotec>; Z 20 LEL <Turbo Ecotec>; Z 20 LER <Ecotec>; Z 20 LER <Turbo Ecotec>			
03.04→	0 451 10	P 3370	O
	1 457 43	S 3281	L
	1 987 43	M 2040	I

Astra J

Astra J 1.3 CDTI

1,2 66-70 A 13 DTE <ecoFlex>; A 13 DTE <ecoFLEX>			
09.09→	F 026 40	N 2062	K
	1 987 43	R 2304 ⁸	I

Astra J 1.4

1,4 74 A 14 XER <ecoFlex>			
09.11→	F 026 40	P 7006	O
	1 987 43	M 2004	I
	1 987 43	R 2304 ⁸	I

Astra J 1.4 i

1,4 64 A 14 XEL <ecoFlex>			
09.09→	F 026 40	P 7006	O
	1 987 43	R 2304 ⁸	I

1,4 74 A 14 XER <ecoFlex>			
09.09→	F 026 40	P 7006	O
	1 987 43	R 2304 ⁸	I

Astra J 1.4 i Turbo

1,4 103 A 14 NET <Ecotec>			
09.09→	F 026 40	P 7006	O
	1 987 43	R 2304 ⁸	I

Astra J 1.4 i Turbo, Turbo

1,4 88 A 14 NEL <Ecotec>; A 14 NEL <Turbo ecoFLEX>			
09.09→	F 026 40	P 7006	O
	1 987 43	M 2004	I
	1 987 43	R 2304 ⁸	I

Astra J 1.4 Turbo

1,4 103 A 14 NET <Turbo ecoFLEX>			
09.11→	F 026 40	P 7006	O
	1 987 43	M 2004	I
	1 987 43	R 2304 ⁸	I





Astra J 1.6 i, Turbo

1,6 85/132 A 16 LET <Turbo ecoFLEX>; A 16 XER <Ecotec>			
09.09→	F 026 40	P 7006	O
	1 987 43	R 2304⁸	I
09.10→	1 987 43	M 2004	I

Astra J 1.6 i Turbo

1,6 132 A 16 LET <Ecotec>			
09.09→	F 026 40	P 7006	O
	1 987 43	R 2304⁸	I

Astra J 1.7 CDTI

1,7 81/92 A 17 DTJ <Ecotec>; A 17 DTR <Ecotec>			
09.09→	F 026 40	P 7073	O
	F 026 40	N 2062	K
	1 987 43	R 2304⁸	I
09.10→	1 987 43	M 2004	I

Astra J 2.0

2,0 121 A 20 DTH <ecoFlex>			
09.11→	1 987 43	R 2304⁸	I

Astra J 2.0 CDTI

2,0 118 A 20 DTH <Ecotec>			
09.09→	F 026 40	P 7087	O
	F 026 40	N 2062	K
	1 987 43	R 2304⁸	I
09.10→	1 987 43	M 2004	I

2,0 121 A 20 DTH <Ecotec>			
09.11→	1 987 43	R 2304⁸	I

Calibra

Calibra 2.0 i

2,0 85 C 20 NE <OHC II>			
06.90-03.97	0 451 10	P 3079	O
	1 457 42	S 9896	L
	0 450 90	F 5280¹	K
08.93-03.97	1 987 43	M 2010	I
	1 987 43	R 2310⁸	I

2,0 100 X 20 XEV <Ecotec DOHC II>			
09.93-08.96	0 451 10	P 3079	O
	1 457 42	S 9898	L
	0 450 90	F 5280¹	K
	1 987 43	M 2010	I
	1 987 43	R 2310⁸	I

2,0 110 C 20 XE, XE-LN <DOHC>			
06.90-03.97	0 451 10	P 3079	O
05.94-03.97	1 457 42	S 9898	L
06.90-03.97	0 450 90	F 5280¹	K
08.93-03.97	1 987 43	M 2010	I
	1 987 43	R 2310⁸	I



Calibra 2.0 i Turbo

2,0 150 C 20 LET <DOHC>			
03.92-03.97	0 451 10	P 3079	O
05.94-03.97	1 457 42	S 9898	L
03.92-03.97	0 450 90	F 5280¹	K
08.93-03.97	1 987 43	M 2010	I
	1 987 43	R 2310⁸	I

Calibra 2.5 i V6

2,5 125 C 25 XE; X 25 XE			
04.93-03.97	0 451 10	P 3079	O
05.94-03.97	1 457 42	S 9898	L
04.93-03.97	0 450 90	F 5280¹	K
08.93-03.97	1 987 43	M 2010	I
	1 987 43	R 2310⁸	I

Campo

Campo 2.2 D

2,2 39-45 4 FD1			
08.87-09.96	1 457 43	N 4453²	K

Campo 2.3 , i

2,3 65-72 4 ZD1; 4 ZD1-23P			
09.91-09.96	0 451 10	P 3316	O

Campo 2.5 D

2,5 56 4 JA1			
06.90-08.97	FOE	0 986 45	P 2064
02.89-08.97	XXX	1 987 42	S 9154
		1 457 43	N 4453²

Campo 2.5 DI

2,5 56 4 JA1 T			
Mot.Nr. →7/01(AH/AB)	03.97-07.01	0 986 45	P 2064
Fg.Nr. →7/01(AH/AB)	03.97-07.01	XXX	1 987 42
		1 457 43	N 4453²

Campo 2.5 TD

2,5 56 4 JA1 T			
10.89-08.97	0 986 45	P 2064	O
	XXX	1 987 42	S 9154
		1 457 43	N 4453²

Campo 3.1 TD

3,1 80 4 JG2 T			
03.95-08.97	0 986 45	P 2064	O
	1 457 43	N 4453²	K

Campo 3.1 TDS

3,1 80 4 JG 2 T <Turbo>			
03.97-08.02	0 986 45	P 2064	O
Fg.Nr. →7/01(AH/AB)	03.97-07.01	1 457 43	N 4453²





Combo

Combo 1.2 i

1,2 | 33 | C 12 NZ; X 12 SZ <Ecotec>; 12 NZ

09.94-10.01		0 451 10 P 3079	O
	TRQ	1 457 43 S 3603	L
		0 450 90 F 5273 ¹	K
	KL	1 987 43 M 2010	I
		1 987 43 R 2310 ⁸	I
	KL	1 987 43 M 2015	I

Combo 1.3 CDTI

1,3 | 51 | Y 13 DT <Ecotec>; Z 13 DT <Ecotec>

09.04-09.07	PRF	1 457 42 P 9256	O
	UFI	F 026 40 P 7067	O
	TW	F 026 40 S 0020	L
		1 457 43 S 3055	L
		1 457 07 N 0001	K
	MOO	1 987 43 M 2076	I
		1 987 43 R 2376 ⁸	I

1,3 | 55 | Z 13 DTJ <Ecotec>

10.05→	PRF	1 457 42 P 9256	O
	UFI	F 026 40 P 7067	O
		1 457 43 S 3055	L
	TW	F 026 40 S 0020	L
		1 457 07 N 0001	K
	MOO	1 987 43 M 2076	I
		1 987 43 R 2376 ⁸	I

Combo 1.4 i

1,4 | 44 | X 14 SZ <Ecotec>

04.96-10.01		0 451 10 P 3079	O
	TRQ	1 457 43 S 3603	L
		0 450 90 F 5273 ¹	K
	KL	1 987 43 M 2010	I
		1 987 43 R 2310 ⁸	I
	KL	1 987 43 M 2015	I

1,4 | 44/60 | C 14 NZ; C 14 SE

09.94-10.01		0 451 10 P 3079	O
	TRQ	1 457 43 S 3603	L
		0 450 90 F 5273 ¹	K
	KL	1 987 43 M 2010	I
		1 987 43 R 2310 ⁸	I
	KL	1 987 43 M 2015	I

1,4 | 66 | C 14 SEL

08.99-10.01		0 451 10 P 3079	O
08.08→		0 451 10 P 3079	O
08.99-10.01	TRQ	1 457 43 S 3603	L
08.08→	TRQ	1 457 43 S 3603	L
08.99-10.01		0 450 90 F 5273 ¹	K
08.08→		0 450 90 F 5273 ¹	K
08.99-10.01	KL	1 987 43 M 2010	I
		1 987 43 R 2310 ⁸	I
	KL	1 987 43 M 2015	I
08.08→	KL	1 987 43 M 2010	I
		1 987 43 R 2310 ⁸	I
	KL	1 987 43 M 2015	I

Combo 1.4 i Twinport

1,4 | 66 | Z 14 XEP <Twinport Ecotec>

Mot.Nr. →19MA9234	09.04→	F 026 40 P 7015	O
Mot.Nr. 19MA9235→	09.04→	F 026 40 P 7006	O
	09.04→	1 457 43 S 3055	L
		0 450 90 F 5273 ¹	K
	MOO	1 987 43 M 2076	I
		1 987 43 R 2376 ⁸	I

Combo 1.6 CNG

1,6 | 69 | Z 16 YNG <Ecotec-Gas CNG>

06.06→		0 451 10 P 3370	O
		1 457 43 S 3055	L
		0 450 90 F 5273 ¹	K
	MOO	1 987 43 M 2076	I
		1 987 43 R 2376 ⁸	I

1,6 | 71 | Y 16 YNG <Ecotec-Gas CNG>

04.05-05.06		0 451 10 P 3370	O
		1 457 43 S 3055	L
		0 450 90 F 5273 ¹	K
	MOO	1 987 43 M 2076	I
		1 987 43 R 2376 ⁸	I

Combo 1.6 i

1,6 | 64 | Z 16 SE

10.01-08.04		0 451 10 P 3079	O
		1 457 43 S 3055	L
		0 450 90 F 5273 ¹	K
	MOO	1 987 43 M 2076	I
		1 987 43 R 2376 ⁸	I

Combo 1.7 CDTI

1,7 | 74 | Z 17 DTH <Turbo>

09.04→		1 457 42 P 9199	O
	TW	F 026 40 S 0020	L
		1 457 43 S 3055	L

Fg.Nr. →53999999→54999999

09.04-08.05		1 457 42 N 9656	K
→56999999			
09.04→	MOO	1 987 43 M 2076	I
		1 987 43 R 2376 ⁸	I

Combo 1.7 D

1,7 | 44 | X 17 D 4EE1

04.96-10.01		0 986 45 P 2041	O
		1 457 43 S 3713	L
		1 457 43 N 4106 ²	K
	KL	1 987 43 M 2010	I
		1 987 43 R 2310 ⁸	I
	KL	1 987 43 M 2015	I

1,7 | 44 | 17 D <4EE1>

09.94-10.01		0 986 45 P 2041	O
		1 457 43 S 3713	L
		1 457 43 N 4106 ²	K
	KL	1 987 43 M 2010	I
		1 987 43 R 2310 ⁸	I
	KL	1 987 43 M 2015	I





Combo 1.7 DI, DTI

1,7 48/55 Y 17 DT <Turbo>; Y 17 DTL <Turbo>			
10.01-08.04	1 457 42 P 9199	O	
	1 457 43 S 3055	L	
	1 457 42 N 9656	K	
MOO	1 987 43 M 2076	I	
	1 987 43 R 2376 ⁸	I	

Corsa

Corsa 1.4 i, i Sail

1,4 65 e-tec X14NE			
01.00→	1 457 43 S 3054	L	

Corsa 1.4 i Swing

1,4 65 e-tec X14NE			
01.00-10.04	0 451 10 P 3079	O	
	1 457 43 S 3054	L	

Corsa 1.6 i, i Sail, i Swing

1,6 68 e-tec X16NE			
01.00→	1 457 43 S 3054	L	

Corsa A

Corsa A 1.0 S

1,0 33 10 S OHV			
09.82-08.94	0 451 10 P 2056	O	
	1 457 42 S 9050	L	

Corsa A 1.2

1,2 33 E 12 GV <OHC>			
01.87-08.94	0 451 10 P 2056	O	
	1 457 42 S 9050	L	

Corsa A 1.2 , S

1,2 38/40 12 NV <OHC>; 12 S <OHC>			
Mot.Nr. →19382906	09.86-08.94	0 451 10 P 2056	O
Mot.Nr. 19382907→	09.86-08.94	0 451 10 P 3079	O
	09.86-08.94	1 457 42 S 9050	L

Corsa A 1.2 i

1,2 33 C 12 NZ <OHC>			
09.90-08.94	0 451 10 P 3079	O	
	1 457 42 S 9053	L	
09.90-03.93	0 450 90 F 5280 ¹	K	

Corsa A 1.2 S

1,2 37-40 A 12 ST <OHC>			
Mot.Nr. →19382906	09.86-08.94	0 451 10 P 2056	O
Mot.Nr. 19382907→	09.86-08.94	0 451 10 P 3079	O
Fg.Nr. G4000001→	09.86-08.94	1 457 42 S 9053	L
Fg.Nr. →F4999999	09.86-08.94	1 457 42 S 9050	L

1,2 | 40 | S 12 ST <OHC>

Mot.Nr. →19382906	09.84-08.94	0 451 10 P 2056	O
Mot.Nr. 19382907→	09.84-08.94	0 451 10 P 3079	O
Fg.Nr. G4000001→	09.84-08.94	1 457 42 S 9053	L
Fg.Nr. →F4999999	09.84-08.94	1 457 42 S 9050	L



1,2 | 40-44 | 12 ST <OHC>

Mot.Nr. →19382906	09.82-08.94	0 451 10 P 2056	O
Mot.Nr. 19382907→	09.82-08.94	0 451 10 P 3079	O
Fg.Nr. G4000001→	09.82-08.94	1 457 42 S 9053	L
Fg.Nr. →F4999999	09.82-08.94	1 457 42 S 9050	L

Corsa A 1.3 i

1,3 | 44 | C 13 N <OHC>

Mot.Nr. →1486846→19389114	09.85-12.92	0 451 10 P 2056	O
Mot.Nr. 1486847→19389115→	09.85-12.92	0 451 10 P 3079	O
	09.85-12.92	1 457 42 S 9053	L
		0 450 90 F 5280 ¹	K

Corsa A 1.3 S

1,3 | 51 | 13 S <OHC>; 13 SB <OHC>

Mot.Nr. →1486846→19389114	09.82-08.94	0 451 10 P 2056	O
Mot.Nr. 1486847→19389115→	09.82-08.94	0 451 10 P 3079	O
	09.82-08.94	1 457 42 S 9053	L

Corsa A 1.3 Sprint R

1,3 | 61 | 13 E <Irmischer>

	04.85-03.93	0 451 10 P 3079	O
		0 450 90 F 5280 ¹	K

Corsa A 1.4

1,4 | 53 | 14 NV <OHC>

	01.90-08.94	0 451 10 P 3079	O
		1 457 42 S 9053	L

Corsa A 1.4 i

1,4 | 40-44 | C 14 NZ <OHC>

	01.90-08.94	0 451 10 P 3079	O
		1 457 42 S 9053	L
	01.90-03.93	0 450 90 F 5280 ¹	K

1,4 | 60 | C 14 SE <OHC>

	09.91-08.94	0 451 10 P 3079	O
		0 450 90 F 5280 ¹	K

Corsa A 1.5 D, TD

1,5 | 37/49 | 15 D <4EC1-AAD OHC>; 15 DT/T4EC1-AADT

	09.87-08.94	0 986 45 P 2041	O
		1 457 42 S 9894	L
		1 457 43 N 4106 ²	K
	FIH	1 457 43 N 4105 ²	K

Corsa A 1.6 i

1,6 | 55 | C 16 NZ <OHC>

	04.89-08.94	0 451 10 P 3079	O
		1 457 42 S 9053	L
		0 450 90 F 5280 ¹	K

1,6 | 72 | C16 SEI <OHC Irmischer>

	09.89-03.93	0 451 10 P 3079	O
		0 450 90 F 5280 ¹	K

1,6 | 74 | C 16 SE <OHC>

	05.88-08.94	0 451 10 P 3079	O
		0 450 90 F 5280 ¹	K



1,6 74 E 16 SE <OHC>	05.88-08.94	0 451 10 P 3079	O
		1 457 43 S 3309	L
		0 450 90 F 5280 ¹	K

Corsa B

Corsa B 1.0 i

1,0 40 X 10 XE <Ecotec>	09.96-09.00	F 026 40 P 7015	O
		TRQ 1 457 43 S 3603	L
		0 450 90 F 5273 ¹	K
		KL 1 987 43 M 2010	I
		1 987 43 R 2310 ⁸	I
		KL 1 987 43 M 2015	I

Corsa B 1.2 i

1,2 33 C 12 NZ; X 12 SZ <Ecotec>	03.93-08.00	0 451 10 P 3079	O
		TRQ 1 457 43 S 3603	L
		0 450 90 F 5273 ¹	K
		KL 1 987 43 M 2010	I
		1 987 43 R 2310 ⁸	I
		KL 1 987 43 M 2015	I

1,2 | 33 | 12 NZ

03.93-08.00	0 451 10 P 3079	O
	TRQ 1 457 43 S 3603	L
	0 450 90 F 5273 ¹	K
	KL 1 987 43 M 2010	I
	1 987 43 R 2310 ⁸	I
	KL 1 987 43 M 2015	I

1,2 | 48 | X 12 XE <Ecotec>

09.97-08.00	F 026 40 P 7015	O	
Fg.Nr. X3000001→	09.97-08.00	1 457 43 S 3054	L
Fg.Nr. →W6999999	09.97-08.00	1 457 43 S 3603	L
	09.97-08.00	0 450 90 F 5273 ¹	K
		KL 1 987 43 M 2010	I
		1 987 43 R 2310 ⁸	I
		KL 1 987 43 M 2015	I

Corsa B 1.3 i Utility

1,3 58 13 NE	01.96-12.00	1 457 43 S 3603	L
-------------------------	-------------	------------------------	----------

Corsa B 1.4 i

1,4 44/60/63/66 C 14 NZ; C 14 SE; C 14 SEL; X 14 SZ <Ecotec>; X 14 XE <Ecotec>	03.93-09.00	0 451 10 P 3079	O
		TRQ 1 457 43 S 3603	L
		0 450 90 F 5273 ¹	K
		KL 1 987 43 M 2010	I
		1 987 43 R 2310 ⁸	I
		KL 1 987 43 M 2015	I

1,4 | 65 | 14 NE

03.00-12.03	1 457 43 S 3603	L
-------------	------------------------	----------

Corsa B 1.5 D, TD, XD, XTD

1,5 37/49 X 15 D <4EC1>; X 15 TD <4EE1 Turbo>; 15 D <4EC1>; 15 TD <T4EC1 Turbo>	03.94-08.00	0 986 45 P 2041	O
	03.93-08.00	1 457 43 S 3713	L
		1 457 43 N 4106 ²	K
	KL	1 987 43 M 2010	I
		1 987 43 R 2310 ⁸	I
	KL	1 987 43 M 2015	I

Corsa B 1.6 GSI, i, i GSI

1,6 74/78/80 C 16 SEL; C 16 XE; X 16 XE <Ecotec>	03.93-08.00	0 451 10 P 3079	O
		TRQ 1 457 43 S 3603	L
		0 450 90 F 5273 ¹	K
		KL 1 987 43 M 2010	I
		1 987 43 R 2310 ⁸	I
		KL 1 987 43 M 2015	I

Corsa B 1.6 i, i Utility

1,6 55/75 16 NE; 16 SE	09.98-12.00	1 457 43 S 3603	L
-----------------------------------	-------------	------------------------	----------

Corsa B 1.7 D

1,7 44 X 17 D <4EE1>	04.96-08.00	0 986 45 P 2041	O
		1 457 43 S 3713	L
		1 457 43 N 4106 ²	K
	KL	1 987 43 M 2010	I
		1 987 43 R 2310 ⁸	I
	KL	1 987 43 M 2015	I

1,7 | 44 | 17 D <4EE1>

03.94-08.00	0 986 45 P 2041	O
03.93-08.00	1 457 43 S 3713	L
	1 457 43 N 4106 ²	K
	KL 1 987 43 M 2010	I
	1 987 43 R 2310 ⁸	I
	KL 1 987 43 M 2015	I

Corsa B 1.7 D Utility

1,7 42 X 17 D4EE1	09.98-10.05	1 457 43 S 3713	L
------------------------------	-------------	------------------------	----------

Corsa B 170 D Utility

1,7 42 X 17 D	09.00-12.02	1 457 43 S 3713	L
--------------------------	-------------	------------------------	----------

Corsa C

Corsa C 1.0 i 12V, Twinport

1,0 43/44 Z 10 XE <Ecotec>; Z 10 XEP <Twinport ECO>	Mot.Nr. →19MA9234	09.00-09.06	F 026 40 P 7015	O
	Mot.Nr. 19MA9235→	09.00-09.06	F 026 40 P 7006	O
		09.00-09.06	1 457 43 S 3055	L
			0 450 90 F 5273 ¹	K
		MOO	1 987 43 M 2076	I
			1 987 43 R 2376 ⁸	I





Corsa C 1.2 i Twinport, i 16V

1,2 55/59 Z 12 XE <Ecotec>; Z 12 XEP <Ecotec>			
Mot.Nr. →19MA9234	09.00-09.06	F 026 40 P 7015	O
Mot.Nr. 19MA9235→	09.00-09.06	F 026 40 P 7006	O
	09.00-09.06	1 457 43 S 3055	L
		0 450 90 F 5273 ¹	K
	MOO	1 987 43 M 2076	I
		1 987 43 R 2376 ⁸	I

Corsa C 1.3 CDTI

1,3 51/55 Y 13 DT <Ecotec>; Z 13 DT <Ecotec>; Z 13 DTJ <Ecotec>			
	09.03-09.06	PRF 1 457 42 P 9256	O
		UFI F 026 40 P 7067	O
		PRF 1 457 43 S 3055	L
		UFI F 026 40 S 0020	L
		1 457 07 N 0001	K
	MOO	1 987 43 M 2076	I
		1 987 43 R 2376 ⁸	I

Corsa C 1.4 i

1,4 66 C 14 SE			
	03.00-12.06	1 457 43 S 3603	L

Corsa C 1.4 i 16V

1,4 66 Z 14 XE <Ecotec>			
	09.00-08.03	0 451 10 P 3370	O
		1 457 43 S 3055	L
		0 450 90 F 5273 ¹	K
	MOO	1 987 43 M 2076	I
		1 987 43 R 2376 ⁸	I

Corsa C 1.4 Twinport

1,4 66 Z 14 XEP <Twinport ECO>			
Mot.Nr. →19MA9234	09.03-09.06	F 026 40 P 7015	O
Mot.Nr. 19MA9235→	09.03-09.06	F 026 40 P 7006	O
	09.03-09.06	1 457 43 S 3055	L
		0 450 90 F 5273 ¹	K
	MOO	1 987 43 M 2076	I
		1 987 43 R 2376 ⁸	I

Corsa C 1.6 i

1,6 62 Z 16 SE <Ecotec>			
	09.01-08.05	0 451 10 P 3370	O
		1 457 43 S 3055	L
		0 450 90 F 5273 ¹	K
	MOO	1 987 43 M 2076	I
		1 987 43 R 2376 ⁸	I

Corsa C 1.7 CDTi, CDTI, DI

1,7 48/55/74-75 Y 17 DT; Y 17 DTL; Z 17 DTH			
	09.00-12.06	1 457 42 P 9199	O
		1 457 43 S 3055	L
		1 457 42 N 9656	K
	MOO	1 987 43 M 2076	I
		1 987 43 R 2376 ⁸	I

Corsa C 1.7 DTi

1,7 48/55/74-75 Y 17 DT; Y 17 DTL; Z 17 DTH			
	10.02-12.05	1 457 43 S 3055	L
		1 457 42 N 9656	K



Corsa C 1.7 DTi

1,7 48/55/74-75 Y 17 DT; Y 17 DTL; Z 17 DTH			
	09.00-08.03	1 457 42 P 9199	O
		1 457 43 S 3055	L
		1 457 42 N 9656	K
	MOO	1 987 43 M 2076	I
		1 987 43 R 2376 ⁸	I

Corsa C 1.7 DTi Utility

1,7 48/55/74-75 Y 17 DT; Y 17 DTL; Z 17 DTH			
	10.02-06.10	1 457 42 P 9199	O
		1 457 43 S 3055	L

Corsa C 1.8 i 16V

1,8 92 Z 18 XE <GSI/Ecotec>			
Mot.Nr. →20V00604	09.01-08.05	1 457 42 P 9178	O
Mot.Nr. 20V00605→	09.01-08.05	0 451 10 P 3370	O
	09.01-08.05	1 457 43 S 3055	L
		0 450 90 F 5273 ¹	K
	MOO	1 987 43 M 2076	I
		1 987 43 R 2376 ⁸	I

Corsa D

Corsa D 1.0 Twinport

1,0 44/48 A 10 XEP <Twinport ECO>; Z 10 XEP <Twinport ECO>			
Mot.Nr. →19MA9234	07.06→	F 026 40 P 7015	O
Mot.Nr. 19MA9235→	07.06→	F 026 40 P 7006	O
	07.06→	F 026 40 S 0097	L
		1 987 43 M 2188	I
		1 987 43 R 2488 ⁸	I

Corsa D 1.2 i Twinport, LPG

1,2 51/57/59/63 A 12 XEL <Ecotec>; A 12 XER <Ecotec>; Z 12 XEP; Z 12 XEP <Ecotec>			
Mot.Nr. →19MA9234	07.06→	F 026 40 P 7015	O
Mot.Nr. 19MA9235→	07.06→	F 026 40 P 7006	O
	07.06→	F 026 40 S 0097	L
		1 987 43 M 2188	I
		1 987 43 R 2488 ⁸	I

Corsa D 1.3 CDTI

1,2 55 A 13 DTC <Ecotec>			
	01.11→	F 026 40 S 0049	L
		0 450 90 N 6503 ¹	K
		1 987 43 M 2188	I
		1 987 43 R 2488 ⁸	I

1,2 | 55 | Z 13 DTJ <Ecotec>

	07.06→	PRF 1 457 42 P 9256	O
		UFI F 026 40 P 7067	O
		F 026 40 S 0049	L
		F 026 40 N 2051 ¹	K
		1 987 43 M 2188	I
		1 987 43 R 2488 ⁸	I

1,2 | 66 | A 13 DTH <Ecotec>

	10.06-02.09	PRF 1 457 42 P 9256	O
		UFI F 026 40 P 7067	O
		F 026 40 S 0049	L
		F 026 40 N 2051 ¹	K
		1 987 43 M 2188	I
		1 987 43 R 2488 ⁸	I



1,2 | 66 | Z 13 DTH <Ecotec>

	07.06→	PRF	1 457 42	P 9256	O
		UFI	F 026 40	P 7067	O
			F 026 40	S 0049	L
Fg.Nr. →96129269	07.06→		F 026 40	N 2051 ¹	K
Fg.Nr. 96129270→	07.06→		0 450 90	N 6503 ¹	K
	07.06→		1 987 43	M 2188	I
			1 987 43	R 2488 ⁸	I

1,2 | 70 | A 13 DTR; Z 13 DTE

	12.09→		F 026 40	S 0049	L
			0 450 90	N 6503 ¹	K
			1 987 43	M 2188	I
			1 987 43	R 2488 ⁸	I

Corsa D 1.4 LPG, Twinport

1,4 | 64/66/74 | A 14 XEL <Twinport ECO>; A 14 XER <Twinport ECO>; Z 14 XEP; Z 14 XEP <Twinport ECO>

Mot.Nr. →19MA9234	07.06→		F 026 40	P 7015	O
Mot.Nr. 19MA9235→	07.06→		F 026 40	P 7006	O
	07.06→		F 026 40	S 0097	L
			1 987 43	M 2188	I
			1 987 43	R 2488 ⁸	I

Corsa D 1.6 i OPC Turbo, i Turbo

1,6 | 110/141 | A 16 LEL <Turbo ECOTEC>; A 16 LER <OPC Turbo ECOTEC>; Z 16 LEL <Turbo ECOTEC>; Z 16 LER <OPC Turbo ECOTEC>

	02.07→		F 026 40	P 7006	O
			F 026 40	S 0049	L
			1 987 43	M 2188	I
			1 987 43	R 2488 ⁸	I

Corsa D 1.7 CDTI

1,7 | 92 | A 17 DTR

	07.06-02.09		F 026 40	P 7073	O
Fg.Nr. →86059280→84	07.06-02.09		F 026 40	S 0049	L
	07.06-02.09		1 987 43	M 2188	I
			1 987 43	R 2488 ⁸	I

1,7 | 92 | Z 17 DTR

	07.06→		F 026 40	P 7073	O
Fg.Nr. →86059280→84	07.06→		F 026 40	S 0049	L
	07.06→		1 987 43	M 2188	I
			1 987 43	R 2488 ⁸	I

1,7 | 96 | A 17 DTS

	12.09→		F 026 40	P 7073	O
			0 450 90	N 6503 ¹	K
			1 987 43	M 2188	I
			1 987 43	R 2488 ⁸	I

Euromidi

Euromidi 2.0

2,0 74 20 S (NEF)	09.88-08.96		0 986 45	P 2041	O
------------------------------	-------------	--	----------	---------------	----------

Euromidi 2.0 DT

2,0 51 4 FC1T	09.88-08.96	MC1	0 986 45	P 2041	O
--------------------------	-------------	-----	----------	---------------	----------

Euromidi 2.2 D

2,2 45 4 FD1	09.88-08.96	MC1	0 986 45	P 2041	O
-------------------------	-------------	-----	----------	---------------	----------

Euromidi 2.4 DT

2,4 56 4 FG1T	09.88-08.96	MC1	0 986 45	P 2041	O
--------------------------	-------------	-----	----------	---------------	----------

Frontera

Frontera 2.0 i

2,0 85 C 20 NE; X 20 SE <Ecotec>	09.91-08.98		0 451 10	P 3079	O
			1 457 43	S 3310	L
			0 450 90	F 5280 ¹	K

Frontera 2.2 DTI

2,2 85 X 22 DTH <Turbo>	09.98-10.02		1 457 42	P 9157	O
			1 987 42	S 9162	L
			1 457 42	N 9656	K

2,2 | 88 | Y 22 DTH <Turbo>

	09.02-09.04		1 457 42	P 9157	O
			1 987 42	S 9162	L
			1 457 42	N 9656	K

Frontera 2.2 i

2,2 100 X 22 SE <Ecotec>	09.98-12.00		0 451 10	P 3079	O
			1 987 42	S 9162	L
			0 450 90	F 5280 ¹	K

2,2 | 100 | X 22 XE <Ecotec>

	02.95-08.98		0 451 10	P 3079	O
			1 457 43	S 3310	L
			0 450 90	F 5280 ¹	K





◀ Frontera 2.2 i

2,2 100 Y 22 SE <Ecotec>	09.00-09.04	0 451 10 P 3079	O
		1 987 42 S 9162	L
		0 450 90 F 5280 ¹	K

Frontera 2.3 TD

2,3 74 23 DT <Turbo>	09.91-08.95	0 451 10 P 3217	O
		1 457 43 S 3310	L
		1 457 43 N 4106 ²	K

Frontera 2.4 i

2,4 92 C 24 NE CIH	09.91-08.95	0 451 10 P 2056	O
		1 457 43 S 3310	L
		0 450 90 F 5280 ¹	K

Frontera 2.5 TDS Turbo

2,5 85 VM 41 B <Venturi-25TD>	06.96-08.98	XXX 0 451 10 P 3360	O
		1 457 43 S 3310	L
		1 457 43 N 4106 ²	K

Frontera 2.8 TDI

2,8 83 4JB1T <(28TD)>	02.95-08.98	0 986 45 P 2064	O
		1 457 43 S 3310	L
		1 457 43 N 4106 ²	K

Frontera 3.2 i

3,2 151 3.2	09.98-09.04	0 986 45 P 2041	O
		1 987 42 S 9162	L
		0 450 90 F 5280 ¹	K

GT

GT 2.0 Turbo

2,0 191-194 Z 20 NHH <Turbo Ecotec>	06.07-12.09	F 026 40 P 7016	O
--	-------------	------------------------	----------

Insignia

Insignia 1.4 , Turbo

1,4 103 A 14 NET <Turbo ecoFLEX>	09.11→	F 026 40 P 7006	O
		1 987 43 M 2004	I
		1 987 43 R 2304 ⁸	I

Insignia 1.6

1,6 85 A 16 XER <Ecotec>	09.08→	F 026 40 P 7006	O
		F 026 40 S 0111	L
		1 987 43 M 2004	I
		1 987 43 R 2304 ⁸	I

1,6 | 132 | A 16 LET <Ecotec>

09.08→	F 026 40 P 7006	O
	1 987 43 M 2004	I
	1 987 43 R 2304 ⁸	I



Insignia 1.8

1,8 103 A 18 XER <Ecotec>	09.08→	F 026 40 P 7006	O
		F 026 40 S 0111	L
		1 987 43 M 2004	I
		1 987 43 R 2304 ⁸	I

Insignia 2.0 CDTI

2,0 81/96/118 A 20 DT... <ecoFlex>; A 20 DT... <Ecotec>; A 20 DTH <ecoFlex>	Fg.Nr. →91999999	09.08→	F 026 40 P 7087	O
		09.08→	F 026 40 N 2062	K
			1 987 43 M 2004	I
			1 987 43 R 2304 ⁸	I

Insignia 2.0 CDTI, CDTI 4x4

2,0 140 A 20 DTR <Ecotec>	Fg.Nr. →91999999	07.09→	F 026 40 P 7087	O
		07.09→	F 026 40 N 2062	K
			1 987 43 M 2004	I
			1 987 43 R 2304 ⁸	I

Insignia 2.0 CDTI 4x4

2,0 118 A 20 DTH <Ecotec>	06.10→	F 026 40 N 2062	K
		1 987 43 R 2304 ⁸	I

Insignia 2.0 Turbo

2,0 162 A 20 NFT <Ecotec>	01.11→	F 026 40 P 7016	O
		F 026 40 S 0111	L
		1 987 43 M 2004	I
		1 987 43 R 2304 ⁸	I

Insignia 2.0 Turbo, Turbo 4x4

2,0 162 A 20 NHT <Ecotec>	09.08→	F 026 40 P 7016	O
Fg.Nr. B1000001→	09.08→	F 026 40 S 0111	L
	09.08→	1 987 43 M 2004	I
		1 987 43 R 2304 ⁸	I

Insignia 2.8 Turbo 4x4

2,8 191/239 A 28 NER <OPC Ecotec>; A 28 NET <Ecotec>	09.08→	1 987 43 M 2004	I
		1 987 43 R 2304 ⁸	I

Kadett

Kadett 1.3

1,3 44 13 N, NB <OHC>	Mot.Nr. →19389114	09.84-08.91	0 451 10 P 2056	O
	Mot.Nr. 19389115→	09.84-08.91	0 451 10 P 3079	O
		09.84-08.91	1 457 42 S 9053	L

Kadett 1.3 i

1,3 44 C 13 N <OHC>	Mot.Nr. →19389114	09.85-08.91	0 451 10 P 2056	O
	Mot.Nr. 19389115→	09.85-08.91	0 451 10 P 3079	O
		09.85-08.91	1 457 42 S 9053	L
			0 450 90 F 5280 ¹	K



Kadett 1.4

1,4 44 E 14 LV <OHC>	01.90-08.91	0 451 10 P 3079	O
----------------------	-------------	-----------------	---

1,4 55 14 NV <OHC>	01.90-08.91	0 451 10 P 3079	O
		1 457 42 S 9053	L

Kadett 1.4 i

1,4 44 C 14 NZ <OHC>	01.90-08.91	0 451 10 P 3079	O
		1 457 42 S 9053	L
		0 450 90 F 5280 ¹	K

Kadett 1.5 TD

1,5 53 15 DT <T4EC1>	09.88-08.91	0 986 45 P 2036	O
		1 457 42 S 9894	L
Fg.Nr. J2661242→J5148466→	09.88-08.91	1 457 43 N 4106 ²	K

Kadett 1.6

1,6 60 16 SV <OHC>	09.86-08.91	0 451 10 P 3079	O
		1 457 42 S 9053	L

Kadett 1.6 i

1,6 55 C 16 LZ; C 16 NZ <OHC>; E 16 NZ <OHC>	09.86-08.93	0 451 10 P 3079	O
		1 457 42 S 9053	L
		0 450 90 F 5280 ¹	K

1,6 74 E 16 SE <OHC>	04.89-08.91	0 451 10 P 3079	O
----------------------	-------------	-----------------	---

Kadett 1.7 D/DR

1,7 42 17 D/DR <OHC>	02.89-08.91	0 451 10 P 3232	O
		1 457 42 S 9844	L
Fg.Nr. J2661242→J5148466→	02.89-08.91	1 457 43 N 4106 ²	K

Kadett 1.8 , S

1,8 62 E 18 NV <OHC>; S 18 NV <OHC>	09.86-08.91	0 451 10 P 3079	O
	XXX	1 457 42 S 9876	L

Kadett 1.8 i

1,8 66 C 18 NZ <OHC>	09.90-08.91	0 451 10 P 3079	O
		1 457 43 S 3003	L
		0 450 90 F 5280 ¹	K

1,8 82-85 18 E <OHC>	09.86-08.91	0 451 10 P 3079	O
		0 450 90 F 5280 ¹	K

Kadett 2.0 i

2,0 85/91/95 C 20 NE <OHC>; 20 NE <OHC>; 20 SEH <OHC>; 20 SER <OHC>	09.86-08.91	0 451 10 P 3079	O
		0 450 90 F 5280 ¹	K



2,0 110-115 20 XE <DOHC>	03.88-08.91	0 451 10 P 3079	O
		1 457 43 S 3003	L
		0 450 90 F 5280 ¹	K

Meriva

Meriva 1.3 CDTI

1,2 55/70 A 13 DTC <Ecotec>; A 13 DTE <ecoFLEX>	04.10→	F 026 40 N 2062	K
		1 987 43 M 2004	I
		1 987 43 R 2304 ⁸	I

1,3|55|Y 13 DT <Ecotec>; Z 13 DT <Ecotec>

	04.05-03.10	PRF	1 457 42 P 9256	O
		UFI	F 026 40 P 7067	O
			F 026 40 S 0020	L
Fg.Nr. →64138771	04.05-03.10		1 457 07 N 0001	K
Fg.Nr. 64138772→	04.05-03.10		F 026 40 N 2054 ¹	K
	04.05-03.10		1 987 43 M 2111	I
			1 987 43 R 2411 ⁸	I

1,3|55|Z 13 DTJ <Ecotec>

	09.03-03.10	PRF	1 457 42 P 9256	O
		UFI	F 026 40 P 7067	O
			F 026 40 S 0020	L
Fg.Nr. →64088960	09.03-03.10		1 457 07 N 0001	K
Fg.Nr. 64088961→	09.03-03.10		F 026 40 N 2054 ¹	K
	09.03-03.10		1 987 43 M 2111	I
			1 987 43 R 2411 ⁸	I

Meriva 1.4 ecoFLEX, Ecotec

1,4 74/88/103 A 14 NEL <ecoFLEX>; A 14 NET <Ecotec>; A 14 XER <Ecotec>	04.10→	F 026 40 P 7006	O
		1 987 43 M 2004	I
		1 987 43 R 2304 ⁸	I

Meriva 1.4 i Twinport

1,4 66 Z 14 XEP <Twinport Ecotec>				
Mot.Nr. →19MA9234	07.04-03.10		F 026 40 P 7015	O
Mot.Nr. 19MA9235→	07.04-03.10		F 026 40 P 7006	O
	07.04-03.10		1 457 43 S 3055	L
			0 450 90 F 5273 ¹	K
			1 987 43 M 2111	I
			1 987 43 R 2411 ⁸	I

Meriva 1.6 i, i 16V Twinport

1,6 64/74/77 Z 16 SE; Z 16 XE; Z 16 XEP	03.03-03.10	0 451 10 P 3370	O
		1 457 43 S 3055	L
		0 450 90 F 5273 ¹	K
		1 987 43 M 2111	I
		1 987 43 R 2411 ⁸	I





Meriva 1.6 i OPC Turbo

1,6 132 Z 16 LET <Ecotec>			
09.05-03.10	F 026 40 P 7006	O	
	F 026 40 S 0020	L	
	0 450 90 F 5273 ¹	K	
	1 987 43 M 2111	I	
	1 987 43 R 2411 ⁸	I	

Meriva 1.7 CDTI

1,7 74 A 17 DT <Ecotec>			
06.10→	F 026 40 P 7073	O	
	F 026 40 N 2062	K	
	1 987 43 M 2004	I	
	1 987 43 R 2304 ⁸	I	

1,7 | 74 | Z 17 DTH <Turbo Ecotec (EE4)>

09.03-09.09	1 457 42 P 9199	O	
	1 457 43 S 3055	L	
	1 457 42 N 9656	K	
	1 987 43 M 2111	I	
	1 987 43 R 2411 ⁸	I	

1,7 | 81/96 | A 17 DTC <Ecotec>; A 17 DTS <Ecotec>

06.10→	F 026 40 P 7073	O	
	1 987 43 R 2304 ⁸	I	

1,7 | 92 | A 17 ... <MT-6>

09.06-03.10	F 026 40 P 7073	O	
Fg.Nr. →84094750	F 026 40 S 0020	L	
09.06-03.10	1 987 43 M 2111	I	
	1 987 43 R 2411 ⁸	I	

1,7 | 92 | Z 17 DT... <MT-6>

09.06-03.10	F 026 40 P 7073	O	
Fg.Nr. →84094750	F 026 40 S 0020	L	
09.06-03.10	1 987 43 M 2111	I	
	1 987 43 R 2411 ⁸	I	

Meriva 1.7 DTI

1,7 55 Y 17 DT <Turbo (EE4)>			
03.03-09.05	1 457 42 P 9199	O	
	1 457 43 S 3055	L	
	1 457 42 N 9656	K	
	1 987 43 M 2111	I	
	1 987 43 R 2411 ⁸	I	

Meriva 1.8 i 16V

1,8 92 Z 18 XE <Ecotec>			
03.03-03.10	0 451 10 P 3370	O	
	1 457 43 S 3055	L	
	0 450 90 F 5273 ¹	K	
	1 987 43 M 2111	I	
	1 987 43 R 2411 ⁸	I	

Monterey

Monterey 3.1 TD

3,1 84 4 JG2 TC <OHV>			
09.91-12.97	0 986 45 P 2064	O	
	1 457 43 N 4453 ²	K	



Monterey 3.2 i

3,2 130 6VDI			
04.92-12.97	0 451 10 P 3316	O	
	0 450 90 F 5280 ¹	K	

Monterey 3.5 i V6

3,5 158 6 VE 1			
02.98-12.99	0 986 45 P 2041	O	
	0 450 90 F 5280 ¹	K	

Movano

Movano 1.9 D

1,9 59 F9Q-770 <EEC96/69>			
01.99-10.01	F 026 40 P 7022	O	
	1 457 43 S 3531	L	
	1 457 43 N 1705	K	

Movano 1.9 DTI

1,9 60 F9Q... <EEC99/102A>			
10.01-10.05	F 026 40 P 7022	O	
	F 026 40 S 0014	L	
	1 457 43 N 1720	K	

Movano 2.2 DTI

2,2 66 G9T... <ECC99/102A>			
03.01-10.05	1 457 42 P 9198	O	
	F 026 40 S 0014	L	
	1 457 43 N 1720	K	

2,2 | 66 | G9T-720 <EEC96/69>

09.00-10.05	1 457 42 P 9198	O	
	F 026 40 S 0014	L	
	TW 1 457 43 N 1720	K	
Org.Nr. (KZ C491)→	09.00-10.05	L11	1 457 43 N 1724
Org.Nr. (KZ C492)→	09.00-10.05	TW	F 026 40 N 2047

Movano 2.5 D

2,5 59 S8U-772 <EEC96/69>			
10.98-09.01	0 451 20 P 3201	O	
	F 026 40 S 0014	L	
	1 457 43 N 1705	K	

Movano 2.5 DTI

2,5 73-74 G9U-754 <ECC99/102A>			
10.01-03.10	1 457 42 P 9198	O	
	F 026 40 S 0014	L	
	DHI 1 457 43 N 1720	K	
	H12,PRF 1 457 43 N 1724	K	
	H90,PRF F 026 40 N 2047	K	

2,5 | 84 | G9U... <ECC99/102A>

10.01-10.07	1 457 42 P 9198	O	
	KOB F 026 40 S 0014	L	
	KW F 026 40 S 0166	L	
	DHI 1 457 43 N 1720	K	
	H12,PRF 1 457 43 N 1724	K	
	H90,PRF F 026 40 N 2047	K	



2,5 88 G9U-632	08.06-03.10	F 026 40 P 7014	O
		TW F 026 40 S0166	L
		1 457 43 N 1705	K

2,5 88 G9U-650	08.06-03.10	F 026 40 P 7014	O
		TW F 026 40 S0166	L
		1 457 43 N 1705	K

2,5 107 G9U-632	08.06-03.10	F 026 40 P 7014	O
		F 026 40 S0166	L
		1 457 43 N 1705	K

Movano 2.8 DTI

2,8 84 S9W-700 <EEC96/69>; S9W-702 <EEC88/77>	06.98-09.02	0 451 20 P 3201	O
		F 026 40 S 0014	L
		1 457 43 N 1705	K

Movano 3.0 CDTI

3,0 100 ZD3... <Turbo>	03.03-10.05	H12 1 457 43 N 1724	K
		H90 F 026 40 N 2047	K

Omega A

Omega A 1.8

1,8 60/65 E 18 NVR; S 18 NV	09.86-03.94	0 451 10 P 3079	O
		XXX 1 457 42 S 9876	L

Omega A 1.8 i

1,8 85 18 SEH	09.86-03.94	0 451 10 P 3079	O
		1 457 42 S 9873	L
		0 450 90 F 5280 ¹	K

Omega A 1.8 S

1,8 66 18 SV	09.86-03.94	0 451 10 P 3079	O
		XXX 1 457 42 S 9876	L

Omega A 2.0 i

2,0 74/85/90 C 20 NE; C 20 NEJ /NEF; 20 SE	09.86-03.94	0 451 10 P 3079	O
		1 457 42 S 9873	L
		0 450 90 F 5280 ¹	K

Omega A 2.3 D

2,3 54 23 YD	09.86-03.94	0 451 20 P 3005	O
		1 457 43 S 3310	L
		1 457 43 N 4106 ²	K

Omega A 2.3 TD

2,3 74 23 DTR	09.88-03.94	0 451 10 P 3217	O
		1 457 43 S 3310	L
		1 457 43 N 4106 ²	K

Omega A 2.4 i

2,4 92 C 24 NE CIH	09.88-03.94	0 451 10 P 2056	O
		1 457 43 S 3310	L
		0 450 90 F 5280 ¹	K

Omega A 2.6 i

2,6 110 C 26 NE CIH	09.90-03.94	0 451 10 P 3093	O
		1 457 43 S 3310	L
		0 450 90 F 5280 ¹	K

Omega A 3.0 i

3,0 130 C 30 NE CIH	01.88-03.94	0 451 10 P 3093	O
		1 457 43 S 3310	L
		0 450 90 F 5280 ¹	K

3,0 | 147-150 | C 30 SE, SEJ

09.89-03.94	0 451 10 P 3093	O
	DEL 1 457 42 S 9877	L
	0 450 90 F 5280 ¹	K

Omega A 3.0 i Evol. 500

3,0 169 X 30 XEI	12.90-03.94	0 451 10 P 3093	O
		1 457 42 S 9877	L

Omega A 3.6 i

3,6 277-281 C 36 GET	01.90-03.94	1 457 42 S 9877	L
--------------------------	-------------	-----------------	---

Omega B

Omega B 2.0 DTI Turbo

2,0 74 X 20 DTH	09.97-08.00	1 457 42 P 9157	O
		1 457 43 S 3571	L
		1 457 42 N 9656	K

Fg.Nr. Y1000001→	09.97-08.00	1 987 43 R 2366 ⁸	I
Fg.Nr. →X1999999	09.97-08.00	1 987 43 M 2016	I

Omega B 2.0 i

2,0 85/100 X 20 SE <Ecotec>; X 20 XEV <Ecotec>; 20 SE <Ecotec>	09.93-08.99	0 451 10 P 3079	O
		TRØ 1 457 43 S 3571	L
		0 450 90 F 5273 ¹	K

Fg.Nr. Y1000001→	09.93-08.99	1 987 43 R 2366 ⁸	I
Fg.Nr. →X1999999	09.93-08.99	1 987 43 M 2016	I





Omega B 2.2 DTI

2,2 88 Y 22 DTH <Turbo>			
	06.00-07.03	1 457 42 P 9157	O
		1 457 43 S 3571	L
		1 457 42 N 9656	K
Fg.Nr. Y1000001→	06.00-07.03	1 987 43 R 2366 ⁸	I
Fg.Nr. →X1999999	06.00-07.03	1 987 43 M 2016	I

Omega B 2.2 i

2,2 103-106 Y 22 XE; Z 22 XE			
	09.99-09.03	0 451 10 P 3079	O
		1 457 43 S 3571	L
		0 450 90 F 5273 ¹	K
Fg.Nr. Y1000001→	09.99-09.03	1 987 43 R 2366 ⁸	I
Fg.Nr. →X1999999	09.99-09.03	1 987 43 M 2016	I

Omega B 2.5 DTI Turbo

2,5 110 Y 25 TD			
	06.01-09.03	1 457 42 P 9118	O
		1 457 43 S 3571	L
		0 450 90 N 6451 ¹	K
Fg.Nr. Y1000001→	06.01-09.03	1 987 43 R 2366 ⁸	I
Fg.Nr. →X1999999	06.01-09.03	1 987 43 M 2016	I

Omega B 2.5 i

2,5 125 X 25 XE <Ecotec>			
Mot.Nr. →08300418	04.94-11.00	0 451 10 P 3079	O
Mot.Nr. 08300419→	04.94-11.00	1 457 42 P 9178	O
	04.94-11.00	1 457 43 S 3571	L
		0 450 90 F 5273 ¹	K
Fg.Nr. Y1000001→	04.94-11.00	1 987 43 R 2366 ⁸	I
Fg.Nr. →X1999999	04.94-11.00	1 987 43 M 2016	I

Omega B 2.5 TD

2,5 96 U 25 TD; X 25 TD			
Mot.Nr. →34398417	04.94-02.01	1 457 42 P 9123	O
Mot.Nr. 34408417→	04.94-02.01	1 457 42 P 9139	O
	04.94-02.01	1 457 43 S 3571	L
		1 457 43 N 4106 ²	K
		XXX 1 457 43 N 4105 ²	K
Fg.Nr. Y1000001→	04.94-02.01	1 987 43 R 2366 ⁸	I
Fg.Nr. →X1999999	04.94-02.01	1 987 43 M 2016	I

Omega B 2.6 i

2,6 132 Y 26 SE <Ecotec>			
Mot.Nr. →08300418	09.00-09.03	0 451 10 P 3079	O
Mot.Nr. 08300419→	09.00-09.03	1 457 42 P 9178	O
	09.00-09.03	1 457 43 S 3571	L
		0 450 90 F 5273 ¹	K
Fg.Nr. Y1000001→	09.00-09.03	1 987 43 R 2366 ⁸	I
Fg.Nr. →X1999999	09.00-09.03	1 987 43 M 2016	I

Omega B 3.0 i

3,0 155 X 30 XE <Ecotec>			
Mot.Nr. →08300418	04.94-02.01	0 451 10 P 3079	O
Mot.Nr. 08300419→	04.94-02.01	1 457 42 P 9178	O
	04.94-02.01	1 457 43 S 3571	L
		0 450 90 F 5273 ¹	K
Fg.Nr. Y1000001→	04.94-02.01	1 987 43 R 2366 ⁸	I
Fg.Nr. →X1999999	04.94-02.01	1 987 43 M 2016	I



Omega B 3.2 i

3,2 160 Y 32 SE <Ecotec>			
	09.00-09.03	1 457 42 P 9178	O
		1 457 43 S 3571	L
		0 450 90 F 5273 ¹	K
Fg.Nr. Y1000001→	09.00-09.03	1 987 43 R 2366 ⁸	I
Fg.Nr. →X1999999	09.00-09.03	1 987 43 M 2016	I

Senator

Senator 2.6 i

2,6 110 C 26 NE CIH			
	09.90-09.93	0 451 10 P 3093	O
		1 457 43 S 3310	L
		0 450 90 F 5280 ¹	K

Senator 3.0 i

3,0 115/130 C 30 LE CIH; C 30 NE CIH			
	09.87-09.93	0 451 10 P 3093	O
		1 457 43 S 3310	L
		0 450 90 F 5280 ¹	K

Senator 3.0 i 24V

3,0 150 C 30 SE <DOHC>			
	09.89-09.93	0 451 10 P 3093	O
		DEL 1 457 42 S 9877	L
		0 450 90 F 5280 ¹	K

Senator 3.6 i

3,6 145 C 3.6 NE <Irmischer>			
	08.89-09.93	0 451 10 P 3093	O

Signum

Signum 1.8 i

1,8 90 Z 18 XE <Ecotec>			
	05.03-02.05	0 451 10 P 3370	O
		1 457 43 S 3578	L
		0 450 90 F 5273 ¹	K
		1 987 43 M 2076	I
		1 987 43 R 2376 ⁸	I

1,8 | 103 | Z 18 XER <Ecotec>

	09.05-09.08	F 026 40 P 7006	O
		1 457 43 S 3578	L
		0 450 90 F 5273 ¹	K
		1 987 43 M 2076	I
		1 987 43 R 2376 ⁸	I

Signum 1.9 CDTI

1,9 74/88/110 Z 19 DT <Ecotec>; Z 19 DTH <Ecotec>; Z 19 DTL <Ecotec>			
	04.04-09.08	1 457 42 P 9248	O
		1 457 43 S 3579	L
		1 457 07 N 0001	K
		1 987 43 M 2076	I
		1 987 43 R 2376 ⁸	I





Signum 2.0 DTI

2,0 74 Y 20 DTH <Ecotec>			
05.03-09.05	1 457 42	P 9157	O
	1 457 43	S 3579	L
	1 457 42	N 9656	K
	1 987 43	M 2076	I
	1 987 43	R 2376⁸	I

Signum 2.0 Turbo

2,0 129 Z 20 NET <Ecotec>			
05.03-09.08	F 026 40	P 7016	O
	1 457 43	S 3579	L
	0 450 90	F 5273¹	K
	1 987 43	M 2076	I
	1 987 43	R 2376⁸	I

Signum 2.2 Direct

2,2 114 Z 22 YH <Ecotec>			
05.03-09.08	F 026 40	P 7016	O
	1 457 43	S 3579	L
	0 450 90	F 5273¹	K
	1 987 43	M 2076	I
	1 987 43	R 2376⁸	I

Signum 2.2 DTI

2,2 86-92 Y 22 DTR <Ecotec>			
05.03-09.05	1 457 42	P 9157	O
	1 457 43	S 3579	L
	1 457 42	N 9656	K
	1 987 43	M 2076	I
	1 987 43	R 2376⁸	I

Signum 2.8 V6 Turbo

2,8 169/184 Z 28 NEL <Ecotec>; Z 28 NET <Ecotec>			
09.05-09.08	1 987 42	S 9193	L
	0 450 90	F 5273¹	K
	1 987 43	M 2076	I
	1 987 43	R 2376⁸	I

Signum 3.0 CDTI

3,0 130-135 Y 30 DT <Ecotec>			
05.03-09.05	1 457 42	P 9302	O
	1 457 43	S 3579	L
	1 457 42	N 9656	K
	1 987 43	M 2076	I
	1 987 43	R 2376⁸	I

3,0 130-135 Z 30 DT <Ecotec>			
09.05-09.08	1 457 43	S 3579	L
	1 987 43	M 2076	I
	1 987 43	R 2376⁸	I



Signum 3.2 V6

3,2 155 Z 32 SE <Ecotec>			
05.03-09.05	1 457 42	P 9178	O
	1 457 43	S 3579	L
	0 450 90	F 5273¹	K
	1 987 43	M 2076	I
	1 987 43	R 2376⁸	I

Sintra

Sintra 2.2 i 16V

2,2 104 X 22 XE <Ecotec>			
09.96-09.99	0 451 10	P 3079	O
	1 457 43	S 3056	L
	0 450 90	F 5979¹	K
	2FE	1 987 43	M 2052
			I

Sintra 2.2 TD

2,2 85 X 22 DTH <Turbo>			
09.97-09.99	TW	1 457 42	P 9154
		1 457 42	P 9157
		1 457 42	N 9656
	2FE	1 987 43	M 2052
			I

Sintra 3.0 i 24V

3,0 148 X 30 XE <Ecotec>			
Mot.Nr. →08300418	09.96-09.99	0 451 10	P 3079
Mot.Nr. 08300419→	09.96-09.99	1 457 42	P 9178
	09.96-09.99	1 457 43	S 3056
		0 450 90	F 5979¹
	2FE	1 987 43	M 2052
			I

Speedster

Speedster 2.0 Turbo

2,0 147 Z 20 LET <Turbo Ecotec>			
04.03-09.06	0 451 10	P 3370	O
	1 457 43	S 3281	L

Speedster 2.2 i

2,2 108 Z 22 SE			
09.00-09.06	F 026 40	P 7016	O
	1 457 43	S 3740	L

Tigra

Tigra 1.3 CDTI

1,3 51 Z 13 DT <Turbo Ecotec>			
06.04-03.09	1 457 42	P 9256	O
	F 026 40	S 0020	L
	1 457 07	N 0001	K
	1 987 43	M 2076	I
	1 987 43	R 2376⁸	I





Tigra 1.4 i

1,4 63-66 X 14 XE <Ecotec>	09.94-08.99	0 451 10 P 3079	O
		FRQ 1 457 43 S 3603	L
		0 450 90 F 5273 ¹	K
	KL	1 987 43 M 2010	I
		1 987 43 R 2310 ⁸	I
	KL	1 987 43 M 2015	I

1,4 | 66 | Z 14 XEP <Twinport Ecotec>

Mot.Nr. →19MA9234	06.04-12.09	F 026 40 P 7015	O
Mot.Nr. 19MA9235→	06.04-12.09	F 026 40 P 7006	O
	06.04-12.09	1 457 43 S 3055	L
		0 450 90 F 5273 ¹	K
		1 987 43 M 2076	I
		1 987 43 R 2376 ⁸	I

Tigra 1.6 i, i 16V

1,6 74/78 C 16 SEL <Ecotec>; X 16 XE <Ecotec>	09.94-08.99	0 451 10 P 3079	O
		FRQ 1 457 43 S 3603	L
		0 450 90 F 5273 ¹	K
	KL	1 987 43 M 2010	I
		1 987 43 R 2310 ⁸	I
	KL	1 987 43 M 2015	I

Tigra 1.8 i

1,8 92 Z 18 XE <Ecotec>	06.04-12.09	0 451 10 P 3370	O
		1 457 43 S 3055	L
		0 450 90 F 5273 ¹	K
		1 987 43 M 2076	I
		1 987 43 R 2376 ⁸	I

Vectra

Vectra 1.6 i

1,6 55 X 16 SZR <Ecotec>	09.96-07.03	0 451 10 P 3079	O
		1 457 43 S 3799	L
		0 450 90 F 5273 ¹	K
		1 987 43 M 2030	I
		1 987 43 R 2330 ⁸	I

1,6 | 55 | 16 LZ2

	09.95-07.03	0 451 10 P 3079	O
		1 457 43 S 3087	L
		0 450 90 F 5273 ¹	K
		1 987 43 M 2030	I
		1 987 43 R 2330 ⁸	I

Vectra 1.6 i 16V

1,6 74 X 16 XEL <Ecotec>; Y 16 XE; Z 16 XE	09.95-09.02	0 451 10 P 3079	O
		FRQ 1 457 43 S 3740	L
		0 450 90 F 5273 ¹	K
		1 987 43 M 2030	I
		1 987 43 R 2330 ⁸	I



Vectra 1.7 TD

1,7 60 X 17 TD <TC4 EE1>; X 17 TD <TC4 EE1 Turbo>	09.95-09.98	0 986 45 P 2041	O
		1 457 43 S 3741	L
		1 457 43 N 4106 ²	K
		1 987 43 M 2030	I
		1 987 43 R 2330 ⁸	I

Vectra A

Vectra A 1.4

1,4 55 14 NV	09.88-09.92	0 451 10 P 3079	O
		1 457 42 S 9053	L

Vectra A 1.6 i, i KAT

1,6 52/55-60 C 16 LZ2; C 16 NZ2; E 16 NZ, C 16 NZ; X 16 SZ <Ecotec>	09.88-08.95	0 451 10 P 3079	O
		1 457 42 S 9896	L
		0 450 90 F 5280 ¹	K

Vectra A 1.6 S

1,6 60 16 SV	09.88-08.95	0 451 10 P 3079	O
Fg.Nr. LV100001→L1000001→L5000001→	09.88-08.95	1 457 42 S 9896	L
Fg.Nr. →KV999999→K1999999→K5999999	09.88-08.95	1 457 42 S 9053	L

Vectra A 1.7 D

1,7 42 17 D/DR	10.88-08.95	0 451 10 P 3232	O
		1 457 42 S 9895	L
		1 457 43 N 4106 ²	K

Vectra A 1.7 TD

1,7 60 X 17 DT <TC4 EE1>	03.90-08.95	0 986 45 P 2041	O
		1 457 42 S 9894	L
		1 457 43 N 4106 ²	K

Vectra A 1.8 , 4x4

1,8 66 18 SV	09.89-08.95	0 451 10 P 3079	O
Fg.Nr. LV100001→L1000001→L5000001→	09.89-08.95	1 457 42 S 9896	L

Vectra A 1.8 i

1,8 66 C 18 NZ	03.90-08.95	0 451 10 P 3079	O
Fg.Nr. LV100001→L1000001→L5000001→	03.90-08.95	1 457 42 S 9896	L
	03.90-08.95	0 450 90 F 5280 ¹	K





Vectra A 1.8 S, S 4x4

1,8 65 E 18 NVR			
	09.88-08.95	0 451 10	P 3079 O
Fg.Nr. LV100001→L1000001→	09.88-08.95	1 457 42	S 9896 L
L5000001→			
Fg.Nr. →KV999999→K1999999	09.88-08.95 XXX	1 457 42	S 9876 L
→K5999999			
	09.88-08.95	0 450 90	F 5280¹ K

Vectra A 2.0 i, i 4x4

2,0 74-85/95 20 NE, C 20 NE; 20 NE, C 20 NE/NEF; 20 SEH			
	09.88-08.95	0 451 10	P 3079 O
		1 457 42	S 9896 L
		0 450 90	F 5280¹ K

Vectra A 2.0 i 4x4 Turbo, i 16V

2,0 100/110/150 C 20 LET; C 20 XE/XEJ; X 20 XEV <Ecotec>			
	09.92-08.95	0 451 10	P 3079 O
		1 457 42	S 9898 L
		0 450 90	F 5280¹ K

Vectra A 2.0 i 16V

2,0 110 20 XE/XEJ			
	09.92-08.95	0 451 10	P 3079 O
		1 457 42	S 9898 L
		0 450 90	F 5280¹ K

Vectra A 2.5 i

2,5 125 C 25 XE			
	02.93-08.95	0 451 10	P 3079 O
		1 457 42	S 9898 L
		0 450 90	F 5280¹ K

Vectra A 2000 i 16V, i 16V 4x4

2,0 110-115 C 20 XE/XEJ; 20 XE/XEJ			
	09.89-08.92	0 451 10	P 3079 O
		1 457 42	S 9898 L
		0 450 90	F 5280¹ K

Vectra B

Vectra B 1.6 i

1,6 55 X 16 SZR <Ecotec>			
	09.96-09.00	0 451 10	P 3079 O
		1 457 43	S 3799 L
		0 450 90	F 5273¹ K
		1 987 43	M 2030 I
		1 987 43	R 2330⁸ I
1,6 55 16 LZ2			
	09.95-07.00	0 451 10	P 3079 O
		1 457 43	S 3087 L
		0 450 90	F 5273¹ K
		1 987 43	M 2030 I
		1 987 43	R 2330⁸ I



Vectra B 1.6 i 16V

1,6 74 X 16 XEL <Ecotec>; Y 16 XE; Z 16 XE			
	09.96-09.02	0 451 10	P 3079 O
		1 457 43	S 3740 L
		0 450 90	F 5273¹ K
		1 987 43	M 2030 I
		1 987 43	R 2330⁸ I

Vectra B 1.7 TD

1,7 60 X 17 TD <TC4 EE1 Turbo>			
	09.95-09.98	0 986 45	P 2041 O
		1 457 43	S 3741 L
		1 457 43	N 4106² K
		1 987 43	M 2030 I
		1 987 43	R 2330⁸ I

Vectra B 1.8 i 16V

1,8 85 X 18 XE <Ecotec>			
	09.95-09.00	0 451 10	P 3079 O
		1 457 43	S 3740 L
		0 450 90	F 5273¹ K
		1 987 43	M 2030 I
		1 987 43	R 2330⁸ I

1,8|85/92|X 18 XE1 <Ecotec>; Z 18 XE <Ecotec>; Z 18 XEL <Ecotec>

Mot.Nr. →20V00604	09.98-09.03	1 457 42	P 9178 O
Mot.Nr. 20V00605→	09.98-09.03	0 451 10	P 3079 O
	09.98-09.03	1 457 43	S 3740 L
		0 450 90	F 5273¹ K
		1 987 43	M 2030 I
		1 987 43	R 2330⁸ I

Vectra B 2.0 DI

2,0 60 X 20 DTL <Ecotec 16V Turbo>; X 20 DTL <16V Turbo Ecotec>; X 20 DTL 16V Turbo <Ecotec>			
Mot.Nr. →17028712	09.96-08.02	1 457 42	P 9154 O
Mot.Nr. 17028713→	09.96-08.02	1 457 42	P 9157 O
	09.96-08.02	1 457 43	S 3045 L
		1 457 42	N 9656 K
		1 987 43	M 2030 I
		1 987 43	R 2330⁸ I

Vectra B 2.0 DTI

2,0 74 X 20 DTH			
	09.97-08.03	1 457 42	P 9157 O
		1 457 43	S 3045 L
		1 457 42	N 9656 K
		1 987 43	M 2030 I
		1 987 43	R 2330⁸ I
2,0 74 Y 20 DTH			
	09.00-09.03	1 457 42	P 9157 O
		1 457 43	S 3045 L
		1 457 42	N 9656 K
		1 987 43	M 2030 I
		1 987 43	R 2330⁸ I





Vectra B 2.0 i

2,0 82 20 NEJ	09.95-02.02	0 451 10 P 3079	O
		1 457 43 S 3087	L
		0 450 90 F 5273 ¹	K
		1 987 43 M 2030	I
		1 987 43 R 2330 ⁸	I

2,0 100 C 20 SEL	05.97-09.02	0 451 10 P 3079	O
		TRQ 1 457 43 S 3740	L
		0 450 90 F 5273 ¹	K
		1 987 43 M 2030	I
		1 987 43 R 2330 ⁸	I

Vectra B 2.0 i 16V

2,0 100 X 20 XEV <Ecotec>	09.95-09.02	0 451 10 P 3079	O
		TRQ 1 457 43 S 3740	L
		0 450 90 F 5273 ¹	K
		1 987 43 M 2030	I
		1 987 43 R 2330 ⁸	I

Vectra B 2.2 DTI

2,2 92 Y 22 DTR <Ecotec>	09.00-09.03	1 457 42 P 9157	O
		1 457 43 S 3045	L
		1 457 42 N 9656	K
		1 987 43 M 2030	I
		1 987 43 R 2330 ⁸	I

Vectra B 2.2 i

2,2 106 C 22 SEL	06.00-09.02	0 451 10 P 3079	O
		TRQ 1 457 43 S 3740	L
		0 450 90 F 5273 ¹	K
		1 987 43 M 2030	I
		1 987 43 R 2330 ⁸	I

Vectra B 2.2 i 16V

2,2 108 Z 22 SE <Ecotec>	09.00-09.03	F 026 40 P 7016	O
		1 457 43 S 3771	L
		0 450 90 F 5273 ¹	K
		1 987 43 M 2030	I
		1 987 43 R 2330 ⁸	I

Vectra B 2.5 i V6

2,5 125-143 X 25 XE <Ecotec>			
Fg.Nr. W1285447→W7154529→	09.95-09.00	1 457 42 P 9178	O
Fg.Nr. →W1285446→W5276825	09.95-09.00	0 451 10 P 3079	O
→W7154528	09.95-09.00	TRQ 1 457 43 S 3740	L
		0 450 90 F 5273 ¹	K
		1 987 43 M 2030	I
		1 987 43 R 2330 ⁸	I



Vectra B 2.6 V6

2,6 130 Y 26 SE <Ecotec>	09.00-09.02	1 457 42 P 9178	O
		TRQ 1 457 43 S 3740	L
		0 450 90 F 5273 ¹	K
		1 987 43 M 2030	I
		1 987 43 R 2330 ⁸	I

Vectra C

Vectra C 1.6 i, i GTS

1,6 74 Z 16 XE <Ecotec>	09.01-07.05	0 451 10 P 3370	O
		1 457 43 S 3578	L
		0 450 90 F 5273 ¹	K
		1 987 43 M 2076	I
		1 987 43 R 2376 ⁸	I

1,6 74-77 Z 16 XEP <Ecotec>	06.04-10.08	0 451 10 P 3370	O
		1 457 43 S 3578	L
		1 987 43 M 2076	I
		1 987 43 R 2376 ⁸	I

Vectra C 1.8 i, i GTS

1,8 81/90 Z 18 XE <Ecotec>; Z 18 XEL <Ecotec>	09.01-12.05	0 451 10 P 3370	O
		1 457 43 S 3578	L
		0 450 90 F 5273 ¹	K
		1 987 43 M 2076	I
		1 987 43 R 2376 ⁸	I

1,8 103 Z 18 XER <Ecotec>	01.06-10.08	F 026 40 P 7006	O
		1 457 43 S 3578	L
		0 450 90 F 5273 ¹	K
		1 987 43 M 2076	I
		1 987 43 R 2376 ⁸	I

Vectra C 1.9 CDTI, CDTI GTS

1,9 74/88/110 Z 19 DT <Ecotec>; Z 19 DTH <Ecotec>; Z 19 DTL <Ecotec>	04.04-10.08	1 457 42 P 9248	O
		1 457 43 S 3579	L
		1 457 07 N 0001	K
		1 987 43 M 2076	I
		1 987 43 R 2376 ⁸	I

Vectra C 2.0 DTI, DTI GTS

2,0 74 Y 20 DTH <Ecotec>; Y 20 DTH <Turbo Ecotec>	04.02-09.05	1 457 42 P 9157	O
		1 457 43 S 3579	L
		1 457 42 N 9656	K
		1 987 43 M 2076	I
		1 987 43 R 2376 ⁸	I

Vectra C 2.0 Turbo, Turbo GTS

2,0 129 Z 20 NET <Turbo Ecotec>	03.03-10.08	F 026 40 P 7016	O
		1 457 43 S 3579	L
		0 450 90 F 5273 ¹	K
		1 987 43 M 2076	I
		1 987 43 R 2376 ⁸	I





Vectra C 2.2 Direct, Direct GTS, i, i GTS

2,2 108/110-114 Z 22 SE <Ecotec>; Z 22 YH <Ecotec>			
09.01-10.08	F 026 40	P 7016	O
	1 457 43	S 3579	L
	0 450 90	F 5273 ¹	K
	1 987 43	M 2076	I
	1 987 43	R 2376 ⁸	I

Vectra C 2.2 DTI, DTI GTS

2,2 86-92 Y 22 DTR <Turbo Ecotec>			
04.02-09.05	1 457 42	P 9157	O
	1 457 43	S 3579	L
	1 457 42	N 9656	K
	1 987 43	M 2076	I
	1 987 43	R 2376 ⁸	I

Vectra C 2.8 GTS Turbo, Turbo

2,8 169/184-188/206 Z 28 NEL <Turbo Ecotec>; Z 28 NET <Turbo Ecotec>			
08.05-10.08	1 987 42	S 9193	L
	0 450 90	F 5273 ¹	K
	1 987 43	M 2076	I
	1 987 43	R 2376 ⁸	I

Vectra C 3.0 CDTI, CDTI GTS

3,0 130 Y 30 DT <Ecotec>; Y 30 DT <Turbo Ecotec>			
03.03-08.05	1 457 42	P 9302	O
	1 457 43	S 3579	L
	1 457 42	N 9656	K
	1 987 43	M 2076	I
	1 987 43	R 2376 ⁸	I

3,0 135 Z 30 DT <Ecotec>; Z 30 DT <Turbo Ecotec>			
08.05-10.08	1 457 43	S 3579	L
	1 457 42	N 9656	K
	1 987 43	M 2076	I
	1 987 43	R 2376 ⁸	I

Vectra C 3.2 i, i GTS

3,2 155 Z 32 SE <Ecotec>			
08.02-09.05	1 457 42	P 9178	O
	1 457 43	S 3579	L
	0 450 90	F 5273 ¹	K
	1 987 43	M 2076	I
	1 987 43	R 2376 ⁸	I

Vivaro

Vivaro 1.9 CDTI, DTI

1,9 60/74 F9Q-760; F9Q-762			
03.01-08.06	F 026 40	P 7022	O
	1 457 43	S 3531	L
	H12,PRF	1 457 43 N 1724	K
	H90,PRF	F 026 40 N 2047	K
	1 987 43	M 2208	I



Vivaro 2.0 CDTI

2,0 66/84 M9R...			
08.06→	F 026 40	P 7014	O
	F 026 40	S 0103	L
	H12,PRF	1 457 43 N 1724	K
	H90,PRF	F 026 40 N 2047	K
	1 987 43	M 2208	I

Vivaro 2.0 16V

2,0 86-88 F4R...			
03.01→	0 451 10	P 3336	O
	1 457 43	S 3529	L
	0 450 90	F 5287 ¹	K
	1 987 43	M 2208	I

Vivaro 2.5 CDTI

2,5 84/107 G9U-630 <Turbo-Ecotec>; G9U-630,G9MB6 <Turbo>			
08.06→	F 026 40	P 7014	O
	F 026 40	S 0103	L
	H12,PRF	1 457 43 N 1724	K
	H90,PRF	F 026 40 N 2047	K
	1 987 43	M 2208	I

2,5 99 G9U-730 <Turbo>			
09.02-08.06	1 457 42	P 9198	O
	F 026 40	S 0103	L
	H12,PRF	1 457 43 N 1724	K
	H90,PRF	F 026 40 N 2047	K
	1 987 43	M 2208	I

Zafira

Zafira 1.6 CNG

1,6 69-71 Z 16 YNG <Ecotec-Gas CNG>			
09.05-03.10	0 451 10	P 3370	O
	1 457 43	S 3281	L
	1 987 43	M 2038	I

Zafira 1.6 CNG Turbo

1,6 110 A 16 XNT <CNG-eco Flex>			
01.11→	F 026 40	P 7006	O
	F 026 40	S 0012	L
	1 987 43	M 2038	I

1,6 110 Z 16 XNT <CNG-eco Flex>			
03.09→	F 026 40	P 7006	O
	F 026 40	S 0012	L
	1 987 43	M 2038	I

Zafira 1.6 i

1,6 74 X 16 XEL <Ecotec>			
03.99-08.99	0 451 10	P 3079	O
	1 457 43	S 3281	L
	0 450 90	F 5273 ¹	K
	BHR	1 987 43 M 2038	I





◀ Zafira 1.6 i

1,6 74 Z 16 XE <Ecotec>			
09.99-07.05	0 451 10 P 3370	O	
	1 457 43 S 3281	L	
	0 450 90 F 5273 ¹	K	
BHR	1 987 43 M 2038	I	

1,6 77 Z 16 XE... <Ecotec>			
07.05-09.07	0 451 10 P 3370	O	
	1 457 43 S 3281	L	
	1 987 43 M 2038	I	

1,6 77 Z 16 XE1 <Ecotec>			
03.06-02.09	0 451 10 P 3370	O	
	1 457 43 S 3281	L	
	1 987 43 M 2038	I	

1,6 85 A 16 XER <Ecotec>			
Fg.Nr. →72999999→7G999999	01.11→	F 026 40 P 7006	O
	01.11→	1 457 43 S 3281	L
		1 987 43 M 2038	I

1,6 85 Z 16 XER <Ecotec>			
Fg.Nr. →72999999→7G999999	03.07→	F 026 40 P 7006	O
	03.07→	1 457 43 S 3281	L
		1 987 43 M 2038	I

Zafira 1.6 i CNG

1,6 69-73 Z 16 YNG <Ecotec-Gas CNG>			
09.01-07.05	0 451 10 P 3079	O	
	1 457 43 S 3281	L	
	0 450 90 F 5273 ¹	K	
BHR	1 987 43 M 2038	I	

Zafira 1.7 CDTI

1,7 81/92 A 17 DTJ <Ecotec>; A 17 DTR <Ecotec>; Z 17 DTJ <Ecotec>; Z 17 DTR <Ecotec>			
03.08→	F 026 40 P 7073	O	
	F 026 40 S 0012	L	
	1 987 43 M 2038	I	

Zafira 1.8 i

1,8 85/92 X 18 XE1 <Ecotec>; Z 18 XE <Ecotec>			
Mot.Nr. →20V00604	03.99-07.05	1 457 42 P 9178	O
Mot.Nr. 20V00605→	03.99-07.05	0 451 10 P 3370	O
	03.99-07.05	1 457 43 S 3281	L
		0 450 90 F 5273 ¹	K
BHR	1 987 43 M 2038	I	

1,8 103 A 18 XER <Ecotec>			
01.11→	F 026 40 P 7006	O	
	1 457 43 S 3281	L	
	1 987 43 M 2038	I	

1,8 103 Z 18 XER <Ecotec>			
07.05-02.10	F 026 40 P 7006	O	
	1 457 43 S 3281	L	
	0 450 90 F 5273 ¹	K	
	1 987 43 M 2038	I	

Zafira 1.8 LPG

1,8 101-103 Z 18 XER <eco Flex>			
03.10→	F 026 40 P 7006	O	
	1 457 43 S 3281	L	
	1 987 43 M 2038	I	



Zafira 1.9 CDTI

1,9 74/88/110 Z 19 DT <Ecotec>; Z 19 DTH <Ecotec>; Z 19 DTL <Ecotec>			
07.05→	1 457 42 P 9248	O	
	F 026 40 S 0012	L	
	1 457 07 N 0001	K	
	1 987 43 M 2038	I	

Zafira 2.0 DI

2,0 60 X 20 DTL <Turbo>			
03.99-08.00	1 457 42 P 9157	O	
	1 457 43 S 3281	L	
	1 457 42 N 9656	K	
BHR	1 987 43 M 2038	I	

Zafira 2.0 DTI

2,0 74 Y 20 DTH <Turbo>			
04.99-07.05	1 457 42 P 9157	O	
Fg.Nr. →12999999→15999999	04.99-07.05	1 457 43 S 3281	L
→18999999			
Fg.Nr. 22000001→25000001→	04.99-07.05	F 026 40 S 0013	L
28000001→			
04.99-07.05	1 457 42 N 9656	K	
BHR	1 987 43 M 2038	I	

Zafira 2.0 i Turbo

2,0 147/177 Z 20 LEH <Ecotec>; Z 20 LER <Ecotec>			
07.05→	0 451 10 P 3370	O	
	1 457 43 S 3281	L	
	1 987 43 M 2038	I	

Zafira 2.0 Turbo

2,0 141-147 Z 20 LET <Turbo Ecotec>			
09.01-07.05	0 451 10 P 3079	O	
	1 457 43 S 3281	L	
	0 450 90 F 5273 ¹	K	
BHR	1 987 43 M 2038	I	

Zafira 2.2

2,2 108 Z 22 SE <Ecotec>			
09.00-07.05	F 026 40 P 7016	O	
	1 457 43 S 3079	L	
	0 450 90 F 5273 ¹	K	
BHR	1 987 43 M 2038	I	

Zafira 2.2 DTI

2,2 92 Y 22 DTR <Turbo>			
03.02-07.05	1 457 42 P 9157	O	
	1 457 43 S 3281	L	
	1 457 42 N 9656	K	
BHR	1 987 43 M 2038	I	

Zafira 2.2 i Direct

2,2 110 Z 22 YH <Ecotec>			
07.05→	F 026 40 P 7016	O	
	1 457 43 S 3079	L	
	1 987 43 M 2038	I	



PEUGEOT *

Bipper

Bipper 1.4 HDi

1,4 50 8HS <DV4TED>	02.08→	1 457 42 P 9238	O
		1 457 43 S 3076	L
		0 450 90 N 6460 ¹	K

Bipper 1.4 i

1,4 54 KFT <TU3AE5>; KfV <TU3A>	02.08→	1 457 42 P 9249	O
--	--------	------------------------	----------

Boxer

Boxer 1.9 D

1,9 50 DJY <XUD9A>	07.98-02.02	0 451 10 P 3261	O
		1 457 43 S 2138	L
Fg.Nr. →15707154	07.98-02.02	LUC 1 457 43 N 4201 ²	K
Fg.Nr. 15707155→	07.98-02.02	BO,MW1 1 457 43 N 4106 ²	K
		BO,MW8 1 457 43 N 4105 ²	K
	07.98-02.02	KL 1 987 43 M 2042	I

1,9 | 51 | D9B <XUD9A>

	02.94-02.02	0 451 10 P 3261	O
		1 457 43 S 2138	L
Fg.Nr. →15707154	02.94-02.02	LUC 1 457 43 N 4201 ²	K
Fg.Nr. 15707155→	02.94-02.02	BO,MW1 1 457 43 N 4106 ²	K
		BO,MW8 1 457 43 N 4105 ²	K
	02.94-02.02	KL 1 987 43 M 2042	I

Boxer 1.9 D Turbo

1,9 66 DHX <XUD9TE>	02.94-02.02	0 451 10 P 3261	O
		1 457 43 S 3790	L
Fg.Nr. →15707154	02.94-02.02	LUC 1 457 43 N 4201 ²	K
Fg.Nr. 15707155→	02.94-02.02	BO,MW1 1 457 43 N 4106 ²	K
		BO,MW8 1 457 43 N 4105 ²	K
	02.94-02.02	KL 1 987 43 M 2042	I

1,9 | 68 | D8C <XUD9TE>

	02.94-02.02	0 451 10 P 3261	O
		1 457 43 S 3790	L
Fg.Nr. →15707154	02.94-02.02	LUC 1 457 43 N 4201 ²	K
Fg.Nr. 15707155→	02.94-02.02	BO,MW1 1 457 43 N 4106 ²	K
		BO,MW8 1 457 43 N 4105 ²	K
	02.94-02.02	KL 1 987 43 M 2042	I

Boxer 2.0

2,0 79 R5B <XU102C>	02.94-05.98	0 451 10 P 3261	O
	06.98-02.02	0 451 10 P 3355	O
	02.94-02.02	1 457 43 S 3790	L
		0 450 90 F 4058 ¹	K
	KL	1 987 43 M 2042	I



Boxer 2.0 HDi

2,0 62 RHV <DW10TD>	09.01-05.06	0 451 10 P 3355	O
		1 457 43 S 3790	L
	09.01-09.02	1 457 43 N 4314 ²	K
	10.02-05.06	F 026 40 N 2013 ²	K
	09.01-05.06	KL 1 987 43 M 2042	I

Boxer 2.0 i

2,0 80-81 RFL <XU10J2>	02.02-05.06	0 451 10 P 3355	O
		1 457 43 S 3790	L
Fg.Nr. →15408415	02.02-05.06	0 450 90 F 5016 ¹	K
	02.02-05.06	KL 1 987 43 M 2042	I

2,0 | 80-81 | RFW <XU10J2>

	02.94-05.98	0 451 10 P 3261	O
	06.98-02.02	0 451 10 P 3355	O
	02.94-02.02	1 457 43 S 3790	L
Fg.Nr. →15408415	02.94-02.02	0 450 90 F 5016 ¹	K
	02.94-02.02	KL 1 987 43 M 2042	I

Boxer 2.2 HDi

2,2 74 4HY <DW12TED>	02.02-05.06	0 451 10 P 3355	O
		1 457 43 S 3790	L
	02.02-09.02	1 457 43 N 4314 ²	K
	10.02-05.06	F 026 40 N 2013 ²	K
	02.02-05.06	KL 1 987 43 M 2042	I

2,2 | 74/88 | 4HU <22DT>; 4HV <22DT>

	06.06→	1 457 42 P 9249	O
	Y45	F 026 40 S 0059	L
		1 457 07 N 0001	K
		1 987 43 M 2065	I

Boxer 2.5 D

2,5 62 8140 67 <SOFIM 2500>	01.99-02.02	0 451 20 P 3201	O
		1 457 43 S 3790	L
		MW1 1 457 43 N 4106 ²	K
		MW8 1 457 43 N 4105 ²	K
	KL	1 987 43 M 2042	I

2,5 | 63 | T9A <DJ5>

	02.94-02.02	0 451 10 P 3238	O
		LBE 1 457 43 S 2138	L
		SBE 1 457 43 S 3790	L
Fg.Nr. →15707204	02.94-02.02	LUC 1 457 43 N 4201 ²	K
Fg.Nr. 15707205→	02.94-02.02	BO,MW1 1 457 43 N 4106 ²	K
		BO,MW8 1 457 43 N 4105 ²	K
	02.94-02.02	KL 1 987 43 M 2042	I

Boxer 2.5 D Turbo

2,5 76-77 THZ <DJ5T>; T8A <DJ5T>	02.94-02.02	0 451 10 P 3238	O
		1 457 43 S 3790	L
		1 457 43 N 4201 ²	K
	KL	1 987 43 M 2042	I





Boxer 2.5 TDi

2,5 79-81 THX <DJ5TED>				
	10.96-02.02		0 451 10 P 3238	O
			1 457 43 S 3790	L
Fg.Nr. →15707704	10.96-02.02	LUC	1 457 43 N 4201 ²	K
Fg.Nr. 15707705→	10.96-02.02	BO,MW1	1 457 43 N 4106 ²	K
		BO,MW8	1 457 43 N 4105 ²	K
	10.96-02.02	KL	1 987 43 M 2042	I

Boxer 2.8 D

2,8 64 8140 63 <SOFIM 2800>				
	01.99-02.02		0 451 20 P 3201	O
			1 457 43 S 3790	L
			1 457 43 N 4194 ²	K
		KL	1 987 43 M 2042	I

Boxer 2.8 D, D Turbo

2,8 66/77				
	01.02-08.05		0 451 20 P 3201	O
			1 457 43 S 3790	L
			1 457 43 N 4194 ²	K

Boxer 2.8 D Turbo

2,8 90 8140 43 <SOFIM 2800 TD>				
	10.99-02.02		0 451 20 P 3201	O
Mot.Nr. →4006625	02.02-05.06		0 451 20 P 3201	O
Mot.Nr. 4006626→	02.02-05.06	F 026 40 P 7053	O	
	10.99-05.06		1 457 43 S 3790	L
			1 457 43 N 4194 ²	K
		KL	1 987 43 M 2042	I

Boxer 2.8 HDi

2,8 94 8140 43s <SOFIM 2800 HDi>				
	09.00-02.02		0 451 20 P 3201	O
Mot.Nr. →4006625	02.02-05.06		0 451 20 P 3201	O
Mot.Nr. 4006626→	02.02-05.06	F 026 40 P 7053	O	
	09.00-05.06		1 457 43 S 3790	L
	09.00-09.02		1 457 43 N 4314 ²	K
	10.02-05.06	F 026 40 N 2013 ²	K	
	09.00-05.06	KL	1 987 43 M 2042	I

2,8 | 107 | 8140 43N <SOFIM 2800 HDi>

Mot.Nr. →4006625	08.04-05.06		0 451 20 P 3201	O
Mot.Nr. 4006626→	08.04-05.06	F 026 40 P 7053	O	
	08.04-05.06		1 457 43 S 3790	L
			1 457 43 N 4314 ²	K
		KL	1 987 43 M 2042	I

Boxer 2.8 HDi

2,8 93 8140 43s				
	09.05-09.09		0 451 20 P 3201	O
			1 457 43 S 3790	L
			1 457 43 N 4314 ²	K

Boxer 3.0 HDi

3,0 107/115/116 F1C... <SOFIM F 30DT/PEF>; F1CE348ID <30DT PEF EURO5 155>; F1CE348IN <30DT PEF EURO5 145>				
	06.06→		F 026 40 P 7083	O
		Y45	F 026 40 S 0059	L
			1 457 07 N 0001	K
			1 987 43 M 2065	I



Expert (G9,U64)

Expert (G9,U64) 1.6 HDi

1,6 66 9HU <DV6UTED4>				
	02.07→		1 457 42 P 9238	O
			1 457 43 S 3327	L
			0 450 90 N 6471 ¹	K
			1 987 43 M 2206	I
			1 987 43 R 2406 ⁸	I

Expert (G9,U64) 1.6 i

1,6 58 220 A2.000 <1580 SPI>				
	09.95-05.00		0 451 10 P 3111	O
			1 457 43 S 2200	L
Org.Nr. →7160	09.95-06.96		0 450 90 F 5030 ¹	K
Org.Nr. 7161→	07.96-05.00		0 450 90 F 2161 ¹	K
	09.95-05.00	3FE	1 987 43 M 2060	I

Expert (G9,U64) 1.8 i

1,8 70 L6B <XU7JP>				
	09.96-06.98		0 451 10 P 3261	O
Org.Nr. →7874	09.96-06.98		0 451 10 P 3261	O
Org.Nr. 7875→	07.98-01.07		0 451 10 P 3355	O
	09.96-01.07		1 457 43 S 2200	L
			0 450 90 F 2161 ¹	K
		3FE	1 987 43 M 2060	I

Expert (G9,U64) 1.9 D

1,9 51-52 D9B <XUD9>				
	09.95-05.00		0 451 10 P 3261	O
			1 457 43 S 2200	L
			1 457 42 N 9291	K
		3FE	1 987 43 M 2060	I

1,9 | 51/52 | WJY <DW8B>; WJZ <DW8>

	06.98-01.07		0 451 10 P 3355	O
			1 457 43 S 2200	L
			1 457 43 N 1703	K
		3FE	1 987 43 M 2060	I

Expert (G9,U64) 1.9 D Turbo

1,9 66-68 DHX <XUD9TE>				
	09.95-06.98		0 451 10 P 3261	O
Org.Nr. →7874	09.95-06.98		0 451 10 P 3261	O
Org.Nr. 7875→	07.98-05.00		0 451 10 P 3355	O
	09.95-05.00		1 457 43 S 2200	L
			1 457 42 N 9291	K
		3FE	1 987 43 M 2060	I





1,9 68 D8B <XUD9TE>			
Org.Nr. →7874	09.95-06.98	0 451 10 P 3261	O
	09.95-07.98	1 457 43 S 2200	L
		1 457 42 N 9291	K
	3FE	1 987 43 M 2060	I

Expert (G9,U64) 2.0 HDi

2,0 70 RHX <DW10BTD>			
	10.99-01.07	0 451 10 P 3355	O
		1 457 43 S 2200	L
Org.Nr. →9155	10.99-12.01	1 457 03 N 0013	K
Org.Nr. 9156→	01.02-01.07	1 457 07 N 0000	K
	10.99-01.07	3FE 1 987 43 M 2060	I

2,0 80 RHZ <DW10ATED>			
	10.99-01.07	0 451 10 P 3355	O
		1 457 43 S 2200	L
		1 457 03 N 0013	K
	3FE	1 987 43 M 2060	I

2,0 81 RHW <DW10ATED4/L4>			
	06.00-01.07	0 451 10 P 3355	O
		1 457 43 S 2200	L
Org.Nr. →8910	06.00-04.01	1 457 03 N 0013	K
Org.Nr. 8911→	05.01-01.07	1 457 07 N 0000	K
	06.00-01.07	3FE 1 987 43 M 2060	I

2,0 88 RH... <DW10UTED4>			
	02.07→	1 457 42 P 9249	O
		F 026 40 S 0058	L
		1 457 43 N 1723	K
		1 987 43 M 2206	I
		1 987 43 R 2406 ⁸	I

2,0 100 RHR <DW10BTD4>			
	02.07→	1 457 42 P 9249	O
		F 026 40 S 0058	L
		1 457 43 N 1723	K
		1 987 43 M 2206	I
		1 987 43 R 2406 ⁸	I

2,0 120 RHH <DW10CTED4>			
	04.10→	1 457 42 P 9249	O
		F 026 40 S 0058	L
		1 987 43 M 2206	I
		1 987 43 R 2406 ⁸	I

Expert (G9,U64) 2.0 i 16V

2,0 100 RFN <EW10J4>			
	03.00-01.07	0 451 10 P 3355	O
		1 457 43 S 2200	L
		0 450 90 F 2161 ¹	K
	3FE	1 987 43 M 2060	I

2,0 103 RF... <EW10A>			
	02.07→	1 457 42 P 9249	O
		1 457 43 S 2200	L
		0 450 90 F 2161 ¹	K
		1 987 43 M 2206	I
		1 987 43 R 2406 ⁸	I

J 5

J 5 1.8			
1,8 49-51 169A,169B <XM7T>			
	01.84-12.93	0 451 10 P 3261	O
	09.81-12.93	XXX 1 457 43 S 2149	L
		0 450 90 F 4058 ¹	K

J 5 1.9 D

1,9 51 D9B <XUD9A>			
	11.87-12.93	0 451 10 P 3261	O
		1 457 43 S 2138	L
		BO 1 457 42 N 9289	K
		CAV 1 457 43 N 4200 ²	K

J 5 1.9 D Turbo

1,9 60 <M705(XT)>			
	08.92-12.93	1 457 43 S 2138	L

J 5 2.0

2,0 55-63/72 170B <XN1T>; 170C <XN1TA>; 170D <XN1TACP KAT.>			
	01.84-12.93	0 451 10 P 3261	O
	09.81-12.93	XXX 1 457 43 S 2149	L
		0 450 90 F 4058 ¹	K

J 5 2.5 D, D Turbo

2,5 54-55/70 661 <CRD93>; 673 <CRD93S>			
	08.83-12.93	0 451 10 P 3238	O
		XXX 1 457 43 S 3800	L
		CAV 1 457 43 N 4200 ²	K
	11.87-12.93	BO 1 457 42 N 9289	K

P 4

P 4 1.2

1,2 36 177A <XN8 A>			
	10.86-12.96	0 451 10 P 3261	O

P 4 2.5 D

2,5 56 155 PB <XD3>			
	10.86-12.96	0 451 10 P 3261	O
		1 457 42 N 9289	K

Partner

Partner 1.6 i 16V

1,6 81 <TU5JP4>			
	02.04→	1 457 42 P 9193	O
		1 457 43 S 3090	L
		FMV F 026 40 S 0023	L
		1 987 43 M 2083	I
		1 987 43 R 2379 ⁸	I





Partner 1.8 i

1,8 66 <XU7JB>			
Org.Nr. 7875→	10.99-12.03	0 451 10 P 3355	O
	10.99-12.03	1 457 43 S 3606	L
		1 987 43 M 2083	I
		1 987 43 R 2379 ⁸	I

Partner 1.9 D

1,9 51 DW8			
	10.99→	1 457 43 S 3544	L
		1 457 43 N 1703	K

Partner 2.0 HDI

2,0 66 DW10TD			
	10.00→	1 457 43 S 3061	L
		1 457 03 N 0013	K

Partner (M4,M5,B9)

Partner (M4,M5,B9) Electrique

24 SA18			
	01.98-08.02	KL	1 987 43 M 2021
			I

Partner (M4,M5,B9) 1.1 i

1,1 44 HDY <TU1M+>; HDZ <TU1M+>			
Org.Nr. →7874	07.96-05.98	0 451 10 P 3261	O
Org.Nr. 7875→	06.98-08.02	0 451 10 P 3355	O
	07.96-08.02	1 457 43 S 3227	L
		0 450 90 F 2161 ¹	K
		KL	1 987 43 M 2021
			I

1,1 44 HFX <TU1JP>			
	09.00-08.02	1 457 42 P 9193	O
Mot.Nr. →4413114	09.02-10.05	1 457 42 P 9193	O
Mot.Nr. 4413115→	09.02-10.05	1 457 42 P 9249	O
	09.00-08.02	1 457 43 S 3769	L
	09.02-10.05	LBE	1 457 43 S 3158
		SBE	1 457 43 S 3159
	09.00-10.05	0 450 90 F 2161 ¹	K
	09.00-08.02	KL	1 987 43 M 2021
	09.02-10.05	1 987 43 M 2083	I
		RLE	1 987 43 M 2021
			I

Partner (M4,M5,B9) 1.4

1,4 51-52 K5A <TU3.2>			
Org.Nr. →7874	11.96-05.98	0 451 10 P 3261	O
Org.Nr. 7875→	06.98-08.02	0 451 10 P 3355	O
	11.96-08.02	1 457 43 S 3227	L
		0 450 90 F 2161 ¹	K
		KL	1 987 43 M 2021
			I

Partner (M4,M5,B9) 1.4 i

1,4 55 KFW <TU3JP/L4>			
	09.00-08.02	1 457 42 P 9193	O
		1 457 43 S 3769	L
		0 450 90 F 2161 ¹	K
		KL	1 987 43 M 2021
			I



1,4 | 55 | KFW <TU3JP/TU3A>

Mot.Nr. →4717577	09.02-04.08	1 457 42 P 9193	O
Mot.Nr. 4717578→	09.02-04.08	1 457 42 P 9249	O
	09.02-04.08	LBE	1 457 43 S 3158
		SBE	1 457 43 S 3159
		0 450 90 F 2161 ¹	K
		1 987 43 M 2083	I
		RLE	1 987 43 M 2021
			I

1,4 | 55 | KFX <TU3JP>

Org.Nr. →7874	07.96-05.98	0 451 10 P 3261	O
Org.Nr. 7875→	06.98-08.02	0 451 10 P 3355	O
	07.96-08.02	1 457 43 S 3769	L
		0 450 90 F 2161 ¹	K
		KL	1 987 43 M 2021
			I

1,4 | 55 | K6C <TU3JP>

	06.98-08.02	0 451 10 P 3355	O
		1 457 43 S 3769	L
		0 450 90 F 2161 ¹	K
		KL	1 987 43 M 2021
			I

Partner (M4,M5,B9) 1.6 HDi

1,6 | 55/66 | 9HS <DV6TED4BU/FAP>; 9HT <DV6B/DV6BUTED4>; 9HV <DV6TED4/FAP>

	05.08→	1 457 42 P 9238	O
		1 457 43 S 3160	L
		0 450 90 N 6471 ¹	K
		1 987 43 M 2137	I
		1 987 43 R 2437 ⁸	I

1,6 | 55/66 | 9HW <DV6BTED4>; 9HX <DV6ATED4>

	09.05-04.08	1 457 42 P 9238	O
		1 457 43 S 3160	L
		0 450 90 N 6471 ¹	K
		1 987 43 M 2083	I
		RLE	1 987 43 M 2021
			I

1,6 | 55/66/68 | 9HF <DV6DTE4>; 9HJ <DV6DTE4 M>; 9HK <DV6ETED M>

	07.10→	1 457 42 P 9238	O
		1 987 43 M 2137	I
		1 987 43 R 2437 ⁸	I

1,6 | 55/68 | 9HN <DV6ETED4>; 9HP <DV6DTE4>

	08.10→	1 457 42 P 9238	O
		1 987 43 M 2137	I
		1 987 43 R 2437 ⁸	I

1,6 | 66/80 | 9HX <DV6ATED4/DV6AUTED4>; 9HZ <DV6TED4 FAP>

	05.08→	1 457 42 P 9238	O
		1 457 43 S 3160	L
		0 450 90 N 6471 ¹	K
		1 987 43 M 2137	I
		1 987 43 R 2437 ⁸	I

1,6 | 82 | 9HL <DV6C>

	03.10→	1 987 43 M 2137	I
		1 987 43 R 2437 ⁸	I

Partner (M4,M5,B9) 1.6 i

1,6 | 72/88 | 5FK <EP6C DTR>; 5FS <EP6C>

	09.09→	1 457 42 P 9249	O
		F 026 40 S 0050	L
		0 450 90 F 2161 ¹	K
		1 987 43 M 2137	I
		1 987 43 R 2437 ⁸	I



Partner (M4,M5,B9) 1.6 i 16V

1,6 66 NFR <TU5JP4>			
	05.08→	1 457 42 P 9249	O
		0 450 90 F 2161 ¹	K
		1 987 43 M 2137	I
		1 987 43 R 2437 ⁸	I
1,6 80 NFU <TU5JP4>			
	09.00-08.02	1 457 42 P 9193	O
	05.08→	1 457 42 P 9249	O
Org.Nr. →10072	09.02-06.04	1 457 42 P 9193	O
Org.Nr. 10073→	07.04-04.08	1 457 42 P 9249	O
	09.00-08.02	FMV F 026 40 S 0023	L
	09.02-04.08	LBE 1 457 43 S 3325	L
		SBE 1 457 43 S 3159	L
	09.00→	0 450 90 F 2161 ¹	K
	09.00-08.02	KL 1 987 43 M 2021	I
	09.02-04.08	1 987 43 M 2083	I
		RLE 1 987 43 M 2021	I
	05.08→	1 987 43 M 2137	I
		1 987 43 R 2437 ⁸	I

Partner (M4,M5,B9) 1.8 D

1,8 43-44 A9A <XUD7>			
	07.96-08.02	0 451 10 P 3261	O
Org.Nr. →7300	07.96-11.96	1 457 43 S 2154	L
Org.Nr. 7301→	12.96-08.02	1 457 43 S 3544	L
	07.96-08.02	1 457 42 N 9291	K
		KL 1 987 43 M 2021	I

Partner (M4,M5,B9) 1.8 i

1,8 66 LFX <XU7JB>			
Org.Nr. →7874	03.97-05.98	0 451 10 P 3261	O
Org.Nr. 7875→	06.98-08.02	0 451 10 P 3355	O
	03.97-08.02	1 457 43 S 3606	L
		0 450 90 F 2161 ¹	K
		KL 1 987 43 M 2021	I

Partner (M4,M5,B9) 1.9 D

1,9 50/51 DJY <XUD9Y>; D9B <XUD9A>			
	07.96-08.02	0 451 10 P 3261	O
Org.Nr. →7300	07.96-11.96	1 457 43 S 2154	L
Org.Nr. 7301→	12.96-08.02	1 457 43 S 3544	L
	07.96-08.02	1 457 42 N 9291	K
		KL 1 987 43 M 2021	I

1,9|51|WJZ <DW8>

	11.98-08.02	0 451 10 P 3355	O
		1 457 43 S 3544	L
		1 457 43 N 1703	K
		KL 1 987 43 M 2021	I

1,9|52|WJY <DW8B>

	09.00-03.07	0 451 10 P 3355	O
	09.00-08.02	1 457 43 S 3077	L
	09.02-03.07	1 987 42 S 9182	L
	09.00-03.07	1 457 43 N 1703	K
	09.00-08.02	KL 1 987 43 M 2021	I
	09.02-03.07	1 987 43 M 2083	I
		RLE 1 987 43 M 2021	I



Partner (M4,M5,B9) 2.0 HDi

2,0 66 RHY <DW10TD>			
	12.99-07.06	0 451 10 P 3355	O
	12.99-08.02	LBE 1 457 43 S 3555	L
		SBE 1 457 43 S 3061	L
	09.02-07.06	1 987 42 S 9182	L
	12.99-08.02	BO 1 457 03 N 0013	K
		SIE 1 457 07 N 0000	K
	09.02-07.06	1 457 07 N 0000	K
	12.99-08.02	KL 1 987 43 M 2021	I
	09.02-07.06	1 987 43 M 2083	I
		RLE 1 987 43 M 2021	I

Ranch

Ranch 1.4 i

1,4 55 KFX <TU3JP>			
Org.Nr. →7874	07.97-05.98	0 451 10 P 3261	O
Org.Nr. 7875→	06.98-08.02	0 451 10 P 3355	O
	07.97-08.02	1 457 43 S 3769	L
		0 450 90 F 2161 ¹	K
		KL 1 987 43 M 2021	I

Ranch 1.9 D

1,9 51 D9B <XUD9A>			
	07.97-10.98	0 451 10 P 3261	O
Org.Nr. 7301→	07.97-10.98	1 457 43 S 3544	L
	07.97-10.98	1 457 42 N 9291	K
		KL 1 987 43 M 2021	I

1,9|51|WJZ <DW8>

	11.98-08.02	0 451 10 P 3355	O
Org.Nr. 7301→	11.98-08.02	1 457 43 S 3544	L
	11.98-08.02	1 457 43 N 1703	K
		KL 1 987 43 M 2021	I

RCZ

RCZ 1.6 i THP

1,6 115/147 5FU <EP6CDTX>; 5FV <EP6CDT>			
	01.10→	1 457 42 P 9249	O
		0 450 90 F 2161 ¹	K
		1 987 43 R 2379 ⁸	I

RCZ 2.0 HDi

2,0 120 RHH <DW10CTED4/FAP>			
	01.10→	1 457 42 P 9249	O
		F026 40 S0150	L
		1 987 43 R 2379 ⁸	I

106 (S1,S2)

106 (S1,S2) Electric

11-20 ZAA <SA13>			
	07.95-05.05	1 987 43 M 2154	I





106 (S1,S2) 1.0

1,0 33 C1A,C1B <TU9>			
09.91-04.96	0451 10	P 3261	O
	1457 42	S 9908	L
09.91-10.95	0450 90	F 4058 ¹	K
11.95-04.96	0450 90	F 2161 ¹	K
09.91-04.96	1987 43	M 2154	I

106 (S1,S2) 1.0 i

1,0 33 CDY <TU9M>			
07.92-05.05	0451 10	P 3261	O
	1457 42	S 9908	L
07.92-10.95	0450 90	F 5002 ¹	K
11.95-05.05	0450 90	F 2161 ¹	K
07.92-05.05	1987 43	M 2154	I

1,0 | 37 | CDZ <TU9M>

07.92-04.96	0451 10	P 3261	O
Org.Nr. →8239	05.96-06.99	0451 10	P 3261
Org.Nr. 8240→	07.99-05.05	0451 10	P 3355
	07.92-05.05	1457 42	S 9908
	07.92-10.95	0450 90	F 5002 ¹
	11.95-05.05	0450 90	F 2161 ¹
	07.92-05.05	1987 43	M 2154

106 (S1,S2) 1.1

1,1 40/44 H1A,H1B <TU1>; H3A <TU1>			
09.91-04.96	0451 10	P 3261	O
	1457 42	S 9908	L
09.91-10.95	0450 90	F 4058 ¹	K
11.95-04.96	0450 90	F 2161 ¹	K
09.91-04.96	1987 43	M 2154	I

106 (S1,S2) 1.1 i

1,1 40-44 HDY <TU1M+>			
05.96-05.05	0451 10	P 3261	O
	1457 43	S 3227	L
	0450 90	F 2161 ¹	K
	1987 43	M 2154	I

1,1 | 40-44 | HDY <TU1M>

08.92-04.96	0451 10	P 3261	O
	1457 43	S 3227	L
08.92-10.95	0450 90	F 5002 ¹	K
11.95-04.96	0450 90	F 2161 ¹	K
08.92-04.96	1987 43	M 2154	I

1,1 | 40/44 | H1A,H1B <TU1>; H3A <TU1>

05.96-05.05	0451 10	P 3261	O
	1457 42	S 9908	L
	0450 90	F 2161 ¹	K
	1987 43	M 2154	I

1,1 | 44 | HDZ <TU1M+>

05.96-06.99	0451 10	P 3261	O
Org.Nr. 8240→	07.99-05.05	0451 10	P 3355
	05.96-05.05	1457 43	S 3227
		0450 90	F 2161 ¹
		1987 43	M 2154



1,1 | 44 | HDZ <TU1M>

09.91-12.93	0451 10	P 3261	O
	1457 43	S 3227	L
	0450 90	F 5002 ¹	K
	1987 43	M 2154	I

1,1 | 44 | HFX <TU1JP>

03.00-05.05	1457 42	P 9193	O
	1457 43	S 3769	L
	0450 90	F 2161 ¹	K
	1987 43	M 2154	I

106 (S1,S2) 1.3 i

1,3 72-74 MFZ <TU2J2>			
10.93-04.96	0451 10	P 3261	O
	1457 43	S 3620	L
	0450 90	F 5002 ¹	K
	0450 90	F 2161 ¹	K
10.93-04.96	1987 43	M 2154	I

106 (S1,S2) 1.4

1,4 44/55 K2D <TU3.2>; K3A <TU3>			
09.91-04.96	0451 10	P 3261	O
	1457 43	S 3227	L
09.91-10.95	0450 90	F 4058 ¹	K
11.95-04.96	0450 90	F 2161 ¹	K
09.91-04.96	1987 43	M 2154	I

1,4 | 55 | K5A <TU3.2>

05.96-05.05	0451 10	P 3261	O
	1457 43	S 3227	L
	0450 90	F 2161 ¹	K
	1987 43	M 2154	I

106 (S1,S2) 1.4 D

1,4 37 K9A, K9B <TUD3>; K9Y <TUD3 KAT.>			
09.92-04.96	0451 10	P 3261	O
	1457 43	S 2200	L
	1457 43	N 4321 ²	K
	1987 43	M 2154	I

106 (S1,S2) 1.4 i

1,4 55 KDY <TU3M KAT.>			
09.91-02.94	0451 10	P 3261	O
	1457 43	S 3227	L
	0450 90	F 5002 ¹	K
	1987 43	M 2154	I

1,4 | 55 | KFW <TU3JP/L4>

03.00-05.05	1457 42	P 9193	O
	1457 43	S 3769	L
	0450 90	F 2161 ¹	K
	1987 43	M 2154	I

1,4 | 55 | KFX <TU3JP>

05.96-05.98	0451 10	P 3261	O
Org.Nr. →7874	06.98-05.05	0451 10	P 3355
Org.Nr. 7875→	05.96-05.05	1457 43	S 3769
		0450 90	F 2161 ¹
		1987 43	M 2154





1,4 55-56 KDX <TU3FMC KAT.>; KDX <TU3MC KAT.>			
12.92-04.96	0 451 10 P 3261	O	
	1 457 43 S 3227	L	
12.92-10.95	0 450 90 F 5002 ¹	K	
11.95-04.96	0 450 90 F 2161 ¹	K	
12.92-04.96	1 987 43 M 2154	I	

1,4 69 KFZ <TU3FJ KAT.>			
09.91-04.96	0 451 10 P 3261	O	
	1 457 43 S 3227	L	
09.91-10.95	0 450 90 F 5002 ¹	K	
11.95-04.96	0 450 90 F 2161 ¹	K	
09.91-04.96	1 987 43 M 2154	I	

1,4 72 K6B <TU3FJ>			
09.91-04.96	0 451 10 P 3261	O	
	1 457 43 S 3227	L	
09.91-10.95	0 450 90 F 5002 ¹	K	
11.95-04.96	0 450 90 F 2161 ¹	K	
09.91-04.96	1 987 43 M 2154	I	

106 (S1,S2) 1.5 D

1,5 40 VJY <TUD5>; VJZ <TUD5>			
Org.Nr. →7874	05.96-05.98	0 451 10 P 3261	O
Org.Nr. 7875→	06.98-05.05	0 451 10 P 3355	O
	05.96-05.05	1 457 43 S 3234	L
		1 457 43 N 4321 ²	K
		1 987 43 M 2154	I

1,5 40-42 VJY <TUD5>; VJZ <TUD5>			
	04.95-04.96	0 451 10 P 3261	O
Org.Nr. →7874	05.96-05.98	0 451 10 P 3261	O
Org.Nr. 7875→	06.98-05.05	0 451 10 P 3355	O
	04.95-05.05	1 457 43 S 3234	L
		1 457 43 N 4321 ²	K
		1 987 43 M 2154	I

1,5 42 VJX <TUD5B>			
	07.00-05.05	0 451 10 P 3355	O
		1 457 43 S 3234	L
		1 457 43 N 4321 ²	K
		1 987 43 M 2154	I

1,5 42 VJY <TUD5>; VJZ <TUD5>			
	07.94-04.96	0 451 10 P 3261	O
		1 457 43 S 3234	L
		1 457 43 N 4321 ²	K
		1 987 43 M 2154	I

106 (S1,S2) 1.6 i

1,6 65-66 NFY <TU5J2>; NFZ <TU5JP>			
	06.93-05.05	0 451 10 P 3261	O
		1 457 43 S 3227	L
	06.93-10.95	0 450 90 F 5002 ¹	K
	11.95-05.05	0 450 90 F 2161 ¹	K
	06.93-05.05	1 987 43 M 2154	I

1,6 74-77 NFW <TU5J2>			
	05.96-05.05	0 451 10 P 3261	O
		1 457 43 S 3227	L
		0 450 90 F 2161 ¹	K
		1 987 43 M 2154	I

1,6 74-77 NFY <TU5J2>; NFZ <TU5JP>			
	05.96-05.05	0 451 10 P 3261	O
		1 457 43 S 3227	L
		0 450 90 F 2161 ¹	K
		1 987 43 M 2154	I

1,6 76-77 NFY <TU5J2>; NFZ <TU5JP>			
	06.93-04.96	0 451 10 P 3261	O
		1 457 43 S 3227	L
	06.93-10.95	0 450 90 F 5002 ¹	K
	11.95-04.96	0 450 90 F 2161 ¹	K
	06.93-04.96	1 987 43 M 2154	I

106 (S1,S2) 1.6 i 16S

1,6 87-88 NFX <TU5J4>			
Org.Nr. →7874	05.96-05.98	0 451 10 P 3261	O
Org.Nr. 7875→	06.98-05.05	0 451 10 P 3355	O
	05.96-05.05	0 450 90 F 2161 ¹	K
		1 987 43 M 2154	I

107

107 1.0 i

1,0 50 CFA <384F Euro 4>; <384F Euro 5>			
	06.05→	0 986 45 P 2028	O
		1 457 43 S 3971	L
		1 987 43 M 2189	I

107 1.4 HDi

1,4 40 8HT <DV4TD>			
	06.05→	1 457 42 P 9238	O
		1 457 43 S 3076	L
		0 450 90 N 6460 ¹	K
		1 987 43 M 2189	I

205

205 1.0

1,0 33 C1A,C1B <TU9>			
	10.87-09.98	0 451 10 P 3261	O
		1 457 42 S 9908	L
		0 450 90 F 4058 ¹	K

205 1.0 i

1,0 33-37 CDZ,CDY <TU9M>			
	07.92-09.98	0 451 10 P 3261	O
		1 457 42 S 9908	L
		0 450 90 F 5095 ¹	K

205 1.1 i

1,1 44 HDZ, HDY <TU1M>			
	07.89-09.98	0 451 10 P 3261	O
Fg.Nr. →24902800	07.89-09.98	1 457 42 S 9908	L
Fg.Nr. 24902801→	07.89-09.98	1 457 43 S 3227	L
	07.89-09.98	0 450 90 F 5095 ¹	K





205 1.4

1,4 43 K3A <TU3>	10.87-12.94	0 451 10 P 3261 O
		1 457 42 S 9908 L
		0 450 90 F 4058 ¹ K

1,4 44-50 K1D,K1F <TU3A>	10.87-12.94	0 451 10 P 3261 O
		1 457 42 S 9908 L
		0 450 90 F 4058 ¹ K

1,4 55 K2D <TU3.2>	09.91-12.94	0 451 10 P 3261 O
		1 457 43 S 3227 L
		0 450 90 F 4058 ¹ K

205 1.4 i

1,4 55-56 KDX <TU3MC Kat.(Gußmot.)>	09.92-09.98	0 451 10 P 3261 O
		1 457 43 S 3227 L
		0 450 90 F 5095 ¹ K

1,4 55-58 KDY <TU3FM Kat.(Gußmot.)>; KDY <TU3M Kat.>	07.88-09.98	0 451 10 P 3261 O
		1 457 42 S 9908 L
		0 450 90 F 5095 ¹ K

205 1.6

1,6 53-58 B1E,B2A, B2B,B2C <XU51C>	11.90-09.98	0 451 10 P 3261 O
		1 457 42 S 9908 L
		0 450 90 F 4058 ¹ K

205 1.6 i

1,6 65 BDY <XU5M Kat.>	11.90-09.98	0 451 10 P 3261 O
		1 457 42 S 9908 L
		0 450 90 F 5002 ¹ K

1,6 83 B6E <XU5JA>	11.90-09.98	0 451 10 P 3261 O
		0 450 90 F 5104 ¹ K

205 1.8 D

1,8 44 A9A,161A <XUD7>	07.87-12.98	0 451 10 P 3261 O
		1 457 43 S 2154 L
	BO	1 457 42 N 9289 K
	CAV	1 457 43 N 4200 ² K

1,8 44 <XUD7>	05.85-09.98	0 451 10 P 3261 O
		1 457 43 S 2154 L
	BO	1 457 42 N 9289 K
	CAV	1 457 43 N 4200 ² K
	LUC	1 457 42 N 9291 K

205 1.8 D Turbo

1,8 58 A8A,A8B <XUD7T>	01.90-09.98	0 451 10 P 3261 O
		1 457 43 S 2154 L
	BO	1 457 42 N 9289 K
	CAV	1 457 43 N 4200 ² K
	LUC	1 457 42 N 9291 K



205 1.9 D

1,9 47 DJZ,162 <XUD9>	10.87-09.98	0 451 10 P 3261 O
		1 457 43 S 2154 L
	BO	1 457 42 N 9289 K
	CAV	1 457 43 N 4200 ² K
	LUC	1 457 42 N 9291 K

205 1.9 i

1,9 75 DFZ <XU9J1 Kat.>	10.87-10.94	GS	0 451 10 P 3261 O
			0 450 90 F 5104 ¹ K

1,9 88 DFY,DKZ <XU9JAZ Kat.>	10.87-10.94	GS	0 451 10 P 3261 O
	11.90-10.94	AG	0 451 10 P 3336 O
	10.87-10.94		0 450 90 F 5104 ¹ K

1,9 90-94 D6B <XU9JA>	10.87-09.98	0 451 10 P 3261 O
		0 450 90 F 5104 ¹ K

206

206 1.4 i

1,4 55 KFW <TU3JP>	02.04-12.05	1 457 42 P 9193 O
		F 026 40 S 0010 L
	03.05-12.05	1 987 43 M 2048 I
		MKL 1 987 43 R 2348 I

206 1.6 i

1,6 65 NFZ <TU5JP>	10.99-10.03	0 451 10 P 3355 O
	10.99-10.03	MKL 1 987 43 R 2348 I

206 1.6 i 16V

1,6 79 N6A <TU5JP4>	Org.Nr. →10072	06.01-02.07	1 457 42 P 9193 O
	Org.Nr. 10073→	06.01-02.07	1 457 42 P 9249 O
	Org.Nr. →10219	06.01-02.07	1 457 43 S 3526 L
		06.01-02.07	MKL 1 987 43 R 2348 I

206 (T1)

206 (T1) 1.1 i

1,1 40/44 HFY <TU1JP/L3>; HFZ <TU1JP/D3>	Org.Nr. →8239	06.98-06.99	0 451 10 P 3261 O
	Org.Nr. 8240→	07.99-10.05	0 451 10 P 3355 O
		06.98-10.05	1 457 43 S 3526 L
			0 450 90 F 2161 ¹ K
			1 987 43 M 2048 I
			1 987 43 R 2348 ⁸ I

1,1 44 HFZ <TU1JP/L4/FL5>	Mot.Nr. →4413114	03.00-10.05	1 457 42 P 9193 O
	Mot.Nr. 4413115→	03.00-10.05	1 457 42 P 9249 O
		03.00-10.05	1 457 43 S 3526 L
			0 450 90 F 2161 ¹ K
			1 987 43 M 2048 I
			1 987 43 R 2348 ⁸ I





206 (T1) 1.4 HDi, HDi 16V

1,4 | 50 | 8H... <DV4TD>; 8HX <DV4TD>

09.01→	1 457 42	P 9238	O
	1 457 43	S 3076	L
	0 450 90	N 6460 ¹	K
	1 987 43	M 2048	I
	1 987 43	R 2348 ⁸	I

206 (T1) 1.4 i

1,4 | 55 | KFW <TU3JP/L4/FL5>

Mot.Nr. →4717577	03.02-12.06	1 457 42	P 9193	O
Mot.Nr. 4717578→	03.02-12.06	1 457 42	P 9249	O
Org.Nr. →10254	03.02-12.04	1 457 43	S 3526	L
Org.Nr. 10255→	01.05-12.06	F 026 40	S 0010	L
	03.02-12.06	0 450 90	F 2161 ¹	K
		1 987 43	M 2048	I
		1 987 43	R 2348 ⁸	I

1,4 | 55 | KFW <TU3JP/L4/FL5/TU3AF>

Mot.Nr. →4717577	03.00-02.09	1 457 42	P 9193	O
Mot.Nr. 4717578→	03.00-02.09	1 457 42	P 9249	O
	03.00-02.09	FMV,IF5	1 457 43	S 3592
		LBE,NL4	1 457 43	S 3526
		NL4,SBE	F 026 40	S 0010
		0 450 90	F 2161 ¹	K
		1 987 43	M 2048	I
		1 987 43	R 2348 ⁸	I

1,4 | 55 | KFX <TU3JP>; K6C/ K6D <TU3JP>

Org.Nr. →8239	06.98-06.99	0 451 10	P 3261	O
Org.Nr. 8240→	07.99-02.09	0 451 10	P 3355	O
	06.98-02.09	1 457 43	S 3526	L
		0 450 90	F 2161 ¹	K
		1 987 43	M 2048	I
		1 987 43	R 2348 ⁸	I

206 (T1) 1.4 i 16V

1,4 | 65 | KFU <ET3J4>

10.03-05.06	1 457 42	P 9249	O
	FMV	1 457 43	S 3592
	0 450 90	F 2161 ¹	K
	1 987 43	M 2048	I
	1 987 43	R 2348 ⁸	I

206 (T1) 1.6 HDi

1,6 | 80 | 9H... <DV6TED4>

05.04-03.07	1 457 42	P 9238	O
	1 457 43	S 3160	L
	0 450 90	N 6471 ¹	K
	1 987 43	M 2048	I
	1 987 43	R 2348 ⁸	I

206 (T1) 1.6 i

1,6 | 66 | NFZ <TU5JP>

Org.Nr. →8239	06.98-06.99	0 451 10	P 3261	O
Org.Nr. 8240→	07.99-08.07	0 451 10	P 3355	O
	06.98-08.07	1 457 43	S 3526	L
		0 450 90	F 2161 ¹	K
		1 987 43	M 2048	I
		1 987 43	R 2348 ⁸	I

206 (T1) 1.6 i 16V

1,6 | 80 | NFU <TU5JP4>

	03.07→	1 457 42	P 9249	O
Org.Nr. →10072	03.00-06.04	1 457 42	P 9193	O
Org.Nr. 10073→	07.04-08.07	1 457 42	P 9249	O
	03.07→	TW	F 026 40	S 0010
		0 450 90	F 2161 ¹	K
Org.Nr. →10254	03.00-12.04	FL5	1 457 43	S 3526
Org.Nr. 10255→	01.05-08.07	FL5	F 026 40	S 0010
	03.00→	0 450 90	F 2161 ¹	K
		1 987 43	M 2048	I
		1 987 43	R 2348 ⁸	I

206 (T1) 1.9 D

1,9 | 51/52 | WJY <DW8B>; WJZ <DW8>

Org.Nr. →8239	06.98-06.99	0 451 10	P 3261	O
Org.Nr. 8240→	07.99-03.06	0 451 10	P 3355	O
	06.98-03.06	FMV	1 457 43	S 3526
		FMV	1 457 43	S 3280
		1 457 43	N 1703	K
		1 987 43	M 2048	I
		1 987 43	R 2348 ⁸	I

206 (T1) 2.0 HDi

2,0 | 66 | RHY <DW10TD>

	04.99-10.05	0 451 10	P 3355	O
Org.Nr. →10247	04.99-12.04	LBE	F 026 40	S 0010
		SBE	1 457 43	S 3526
Org.Nr. 10248→	01.05-10.05	F 026 40	S 0010	L
	03.02-10.05	1 457 07	N 0000	K
Org.Nr. →9153	04.99-12.01	1 457 03	N 0013	K
Org.Nr. 9154→	01.02-10.05	1 457 07	N 0000	K
	04.99-10.05	1 987 43	M 2048	I
		1 987 43	R 2348 ⁸	I

206 (T1) 2.0 i RC

2,0 | 130 | RFK <EW10J4S>

	03.03-08.06	0 451 10	P 3355	O
		1 457 43	S 3150	L
		0 450 90	F 2161 ¹	K
		1 987 43	M 2048	I
		1 987 43	R 2348 ⁸	I





206 (T1) 2.0 i S16

2,0 99 RFR <EW10J4>			
Org.Nr. →8239	01.99-06.99	0 451 10 P 3261	O
Org.Nr. 8240→	07.99-09.00	0 451 10 P 3355	O
	01.99-09.00	FMV 1 457 43 S 3526	L
		FMV 1 457 43 S 3280	L
		0 450 90 F 2161 ¹	K
		1 987 43 M 2048	I
		1 987 43 R 2348 ⁸	I

2,0 | 100 | RFN <EW10J4>

	09.00-03.07	0 451 10 P 3355	O
		FMV 1 457 43 S 3526	L
		FMV 1 457 43 S 3280	L
		0 450 90 F 2161 ¹	K
		1 987 43 M 2048	I
		1 987 43 R 2348 ⁸	I

206+ (T3E)

206+ (T3E) 1.1 i

1,1 44 HFV <TU1AE5>			
	03.10→	1 457 42 P 9249	O
		1 457 43 S 3592	L
		0 450 90 F 2161 ¹	K
		1 987 43 M 2048	I

1,1 | 44 | HFX <TU1A>

	03.09→	1 457 42 P 9249	O
		FMV 1 457 43 S 3592	L
		0 450 90 F 2161 ¹	K
		1 987 43 M 2048	I

206+ (T3E) 1.4 HDi

1,4 50 8HR <DV4C>			
	06.10→	1 457 42 P 9238	O
		1 987 43 M 2048	I

1,4 | 50 | 8HZ <DV4TD>

	03.09→	1 457 42 P 9238	O
		1 457 43 S 3076	L
		0 450 90 N 6460 ¹	K
		1 987 43 M 2048	I

206+ (T3E) 1.4 i

1,4 54 KFT <TU3AE5>			
	04.10→	1 457 42 P 9249	O
		1 457 43 S 3592	L
		0 450 90 F 2161 ¹	K
		1 987 43 M 2048	I

1,4 | 55 | KF... <TU3A>

	03.09→	1 457 42 P 9249	O
		FMV 1 457 43 S 3592	L
		0 450 90 F 2161 ¹	K
		1 987 43 M 2048	I

207 (A7,T3)

207 (A7,T3) 1.4 HDi

1,4 50 8HR <DV4C>			
	05.10→	1 457 42 P 9238	O
		2FE 1 987 43 M 2136	I



1,4 | 50 | 8HZ <DV4TD>

	05.06-04.10	1 457 42 P 9238	O
		1 457 43 S 3076	L
		0 450 90 N 6460 ¹	K
		2FE 1 987 43 M 2136	I

207 (A7,T3) 1.4 i

1,4 | 54 | KFT <TU3AE5>

	07.09→	1 457 42 P 9249	O
Org.Nr. →12410	07.09-11.10	1 457 43 S 3158	L
	07.09→	2FE 1 987 43 M 2136	I

1,4 | 54 | KFV <TU3A>

	05.06-06.09	1 457 42 P 9249	O
		LBE 1 457 43 S 3158	L
Org.Nr. →11829	05.06-04.09	SBE 1 457 43 S 3159	L
Org.Nr. 11830→	05.09-06.09	SBE 1 457 43 S 3158	L
	05.06-06.09	0 450 90 F 2161 ¹	K
		2FE 1 987 43 M 2136	I

1,4 | 70 | 8FS <EP3>

	06.07-06.09	1 457 42 P 9249	O
		LAB F 026 40 S 0050	L
		0 450 90 F 2161 ¹	K
		2FE 1 987 43 M 2136	I

207 (A7,T3) 1.4 i 16V

1,4 | 65 | KFU <ET3J4>

	05.06-06.08	1 457 42 P 9249	O
		LBE 1 457 43 S 3158	L
		SBE 1 457 43 S 3159	L
		0 450 90 F 2161 ¹	K
		2FE 1 987 43 M 2136	I

207 (A7,T3) 1.4 VTi

1,4 | 70-72 | 8F... <EP3C>

	07.09→	1 457 42 P 9249	O
		F 026 40 S 0050	L
		0 450 90 F 2161 ¹	K
		2FE 1 987 43 M 2136	I

207 (A7,T3) 1.6 HDi

1,6 | 66/80 | 9HV <DV6TED4/FAP>; 9HX <DV6ATED4>; 9HZ <DV6TED4>

	05.06-04.11	1 457 42 P 9238	O
		1 457 43 S 3160	L
		0 450 90 N 6471 ¹	K
		2FE 1 987 43 M 2136	I

1,6 | 68/82 | 9HP <DV6DTE4>; 9HR <DV6C>

	02.10→	1 457 42 P 9238	O
		2FE 1 987 43 M 2136	I

1,6 | 80 | 9H... <DV6TED4>

	05.06-04.10	1 457 42 P 9238	O
		1 457 43 S 3160	L
		0 450 90 N 6471 ¹	K
		2FE 1 987 43 M 2136	I



207 (A7,T3) 1.6 i

1,6 80 NFU <TU5JP4>			
	05.06-08.07	1 457 42	P 9249 O
		LBE 1 457 43	S 3325 L
		SBE 1 457 43	S 3159 L
		0 450 90	F 2161¹ K
	2FE	1 987 43	M 2136 I

1,6 88 5FS <EP6C>; 5FW <EP6>			
	03.07→	1 457 42	P 9249 O
		LBE F 026 40	S 0050 L
		0 450 90	F 2161¹ K
	2FE	1 987 43	M 2136 I

207 (A7,T3) 1.6 i, i RC

1,6 110/128 5FX <EP6DT>; 5FY <EP6DTS>			
	07.06-02.11	1 457 42	P 9249 O
		LBE F 026 40	S 0151 L
		0 450 90	F 2161¹ K
	2FE	1 987 43	M 2136 I

207 (A7,T3) 1.6 i THP

1,6 115 5FR <EP6DT/EURO 5>			
	04.10→	1 457 42	P 9249 O
Org.Nr. →12410	04.10-11.10	LBE F 026 40	S 0151 L
	04.10→	0 450 90	F 2161¹ K
	2FE	1 987 43	M 2136 I

306

306 1.8 i

1,8 74 <XU7JP>			
	07.00-03.07	1 457 42	P 9193 O
Org.Nr. →7874	03.97-05.98	0 451 10	P 3261 O
Org.Nr. 7875→	06.98-03.07	0 451 10	P 3355 O
	03.97-03.07	1 457 43	S 3606 L

306 1.9 D

1,9 50 <XUD9>			
Org.Nr. →7972	10.97-09.98	1 457 43	S 2154 L
Org.Nr. 7973→	10.98→	1 457 43	S 3544 L
	10.97→	1 457 42	N 9291 K

306 2.0 HDI

2,0 66 <DW10TD>			
	12.00→	1 457 43	S 3061 L
		1 457 03	N 0013 K

306 (N3,N5)

306 (N3,N5) 1.1 i

1,1 40/44 HDY <TU1M+>; HDY <TU1M>; HDZ <TU1M+>; HDZ <TU1M>			
	01.93-04.97	0 451 10	P 3261 O
		1 457 43	S 3227 L
		0 450 90	F 5002¹ K



306 (N3,N5) 1.4

1,4 44 K3A <TU3>			
	01.93-04.97	0 451 10	P 3261 O
		1 457 43	S 3227 L
Org.Nr. →7265	01.93-10.96	0 450 90	F 4058¹ K
Org.Nr. 7266→	11.96-04.97	0 450 90	F 2161¹ K

1,4 55 K2D <TU3.2>			
	01.93-05.96	0 451 10	P 3261 O
		1 457 43	S 3227 L
		0 450 90	F 4058¹ K

1,4 55 K5A <TU3.2>			
	06.96-04.97	0 451 10	P 3261 O
Org.Nr. →7874	05.97-05.98	0 451 10	P 3261 O
Org.Nr. 7875→	06.98-10.03	0 451 10	P 3355 O
	06.96-10.03	1 457 43	S 3227 L
	05.97-10.03	0 450 90	F 2161¹ K
Org.Nr. →7265	06.96-10.96	0 450 90	F 4058¹ K
Org.Nr. 7266→	11.96-04.97	0 450 90	F 2161¹ K

306 (N3,N5) 1.4 i

1,4 55 KDX <TU3MC>			
	01.93-04.97	0 451 10	P 3261 O
		1 457 43	S 3227 L
		0 450 90	F 5002¹ K

1,4 55 KFW <TU3JP/L4>			
	10.00-10.03	1 457 42	P 9193 O
		1 457 43	S 3769 L
		0 450 90	F 2161¹ K

1,4 55 KFX <TU3JP>			
	09.96-04.97	0 451 10	P 3261 O
Org.Nr. →7874	05.97-05.98	0 451 10	P 3261 O
Org.Nr. 7875→	06.98-10.03	0 451 10	P 3355 O
	09.96-10.03	1 457 43	S 3769 L
	05.97-10.03	0 450 90	F 2161¹ K
Org.Nr. →7265	09.96-10.96	0 450 90	F 5002¹ K
Org.Nr. 7266→	11.96-04.97	0 450 90	F 2161¹ K

1,4 55 K6C <TU3JP>			
Org.Nr. →7874	05.97-05.98	0 451 10	P 3261 O
Org.Nr. 7875→	06.98-10.03	0 451 10	P 3355 O
	05.97-10.03	1 457 43	S 3769 L
		0 450 90	F 2161¹ K

1,4 55 K6D <TU3JP>			
	05.97-10.03	1 457 42	P 9193 O
		1 457 43	S 3769 L
		0 450 90	F 2161¹ K

306 (N3,N5) 1.6 i

1,6 65-66 NFZ <TU5JP>			
	01.93-04.97	0 451 10	P 3261 O
Org.Nr. →7874	05.97-05.98	0 451 10	P 3261 O
Org.Nr. 7875→	06.98-10.03	0 451 10	P 3355 O
	01.93-10.03	1 457 43	S 3227 L
	05.97-10.03	0 450 90	F 2161¹ K
Org.Nr. →7265	01.93-10.96	0 450 90	F 5002¹ K
Org.Nr. 7266→	11.96-04.97	0 450 90	F 2161¹ K





◀ 306 (N3,N5) 1.6 i

1,6 74 NFT <TU5JP/L4>	10.00-10.03	1 457 42 P 9193	O
		F 026 40 S 0025	L
		0 450 90 F 2161 ¹	K

306 (N3,N5) 1.8 D

1,8 44 A9A <XUD7>; A9A,161A <XUD7>	05.93-10.03	0 451 10 P 3261	O
		1 457 43 S 2154	L
		1 457 42 N 9291	K

1,8 44 161A <XUD7>	05.93-04.97	0 451 10 P 3261	O
		1 457 43 S 2154	L
		1 457 42 N 9291	K

306 (N3,N5) 1.8 i

1,8 74-76 LFZ <XU7JP KAT.>	01.93-04.97	0 451 10 P 3261	O
Org.Nr. →7874	05.97-05.98	0 451 10 P 3261	O
Org.Nr. 7875→	06.98-10.03	0 451 10 P 3355	O
	01.93-10.03	1 457 43 S 3606	L
	05.97-10.03	0 450 90 F 2161 ¹	K
Org.Nr. →7265	01.93-10.96	0 450 90 F 5002 ¹	K
Org.Nr. 7266→	11.96-04.97	0 450 90 F 2161 ¹	K

1,8 74-76 LFZ <XU7JP KAT.>	05.97-05.98	0 451 10 P 3261	O
Org.Nr. →7874	05.97-05.98	0 451 10 P 3261	O
Org.Nr. 7875→	06.98-10.03	0 451 10 P 3355	O
	05.97-10.03	1 457 43 S 3606	L
		0 450 90 F 2161 ¹	K

1,8 74-76 L6A <XU7JP>	01.93-04.97	0 451 10 P 3261	O
Org.Nr. →7874	05.97-05.98	0 451 10 P 3261	O
Org.Nr. 7875→	06.98-10.03	0 451 10 P 3355	O
	01.93-10.03	1 457 43 S 3606	L
	05.97-10.03	0 450 90 F 2161 ¹	K
Org.Nr. →7265	01.93-10.96	0 450 90 F 5002 ¹	K
Org.Nr. 7266→	11.96-04.97	0 450 90 F 2161 ¹	K

306 (N3,N5) 1.8 i 16V

1,8 81 LFY <XU7JP4>	05.97-05.98	0 451 10 P 3261	O
Org.Nr. →7874	05.97-05.98	0 451 10 P 3261	O
Org.Nr. 7875→	06.98-10.03	0 451 10 P 3355	O
	05.97-10.03	LBE 1 457 43 S 3543	L
		SBE 1 457 43 S 3527	L
		0 450 90 F 2161 ¹	K

306 (N3,N5) 1.9 D

1,9 47-48/50 DJY <XUD9Y>; DJZ <XUD9Y>	05.93-04.97	0 451 10 P 3261	O
		1 457 43 S 2154	L
		1 457 42 N 9291	K

1,9 50 DJY <XUD9>	05.97-10.03	0 451 10 P 3261	O
Org.Nr. →7972	05.97-09.98	1 457 43 S 2154	L
Org.Nr. 7973→	10.98-10.03	1 457 43 S 3544	L
	05.97-10.03	1 457 42 N 9291	K



1,9 51 D9B <XUD9>	05.97-10.03	0 451 10 P 3261	O
Org.Nr. →7972	05.97-09.98	1 457 43 S 2154	L
Org.Nr. 7973→	10.98-10.03	1 457 43 S 3544	L
	05.97-10.03	1 457 42 N 9291	K

1,9 51 D9B <XUD9A>	05.93-04.97	0 451 10 P 3261	O
		1 457 43 S 2154	L
		1 457 42 N 9291	K

1,9 51 WJZ <DW8>	09.98-10.03	0 451 10 P 3355	O
		1 457 43 S 3544	L
		1 457 43 N 1703	K

1,9 52 WJY <DW8B>	09.99-10.03	0 451 10 P 3261	O
		1 457 43 S 3544	L
		1 457 43 N 1703	K

306 (N3,N5) 1.9 D Turbo

1,9 55 DHV <XUD9BSD>; DHW <XUD9BSD>	06.98-10.03	0 451 10 P 3261	O
		1 457 43 S 2154	L
		1 457 42 N 9291	K

1,9 66 DHY <XUD9TE>	05.97-05.98	0 451 10 P 3261	O
Org.Nr. →7874	05.97-05.98	0 451 10 P 3261	O
Org.Nr. 7875→	06.98-10.03	0 451 10 P 3355	O
Org.Nr. →7685	05.97-11.97	1 457 43 S 3229	L
Org.Nr. 7686→8512	12.97-03.00	1 457 43 S 3077	L
Org.Nr. 8513→	04.00-10.03	1 457 43 S 3544	L
	05.97-10.03	1 457 42 N 9291	K

1,9 66-67 DHY <XUD9TE>	05.93-04.97	0 451 10 P 3261	O
		1 457 43 S 3229	L
		1 457 42 N 9291	K

1,9 68 D8A <XUD9TE>	05.93-04.97	0 451 10 P 3261	O
		1 457 43 S 3229	L
		1 457 42 N 9291	K

306 (N3,N5) 2.0 HDi

2,0 66 RHY <DW10TD>	06.99-10.03	0 451 10 P 3355	O
		LBE 1 457 43 S 3555	L
		SBE 1 457 43 S 3061	L
		1 457 03 N 0013	K

306 (N3,N5) 2.0 i

2,0 89-90 RFX <XU10J2 KAT.>	08.93-04.97	0 451 10 P 3261	O
		1 457 43 S 3606	L
Org.Nr. →7265	08.93-10.96	0 450 90 F 5002 ¹	K
Org.Nr. 7266→	11.96-04.97	0 450 90 F 2161 ¹	K

2,0 89-90 R6D <XU10J2>	08.93-04.97	0 451 10 P 3261	O
		1 457 43 S 3606	L
Org.Nr. →7265	08.93-10.96	0 450 90 F 5002 ¹	K
Org.Nr. 7266→	11.96-04.97	0 450 90 F 2161 ¹	K





306 (N3,N5) 2.0 i 16V

2,0 97-99 RFV <XU10J4R>			
Org.Nr. →7874	05.97-05.98	0 451 10 P 3261	O
Org.Nr. 7875→	06.98-10.03	0 451 10 P 3355	O
	05.97-10.03	LBE 1 457 43 S 3543	L
		SBE 1 457 43 S 3527	L
		0 450 90 F 2161 ¹	K

2,0 97-99 R6E <XU10J4R>			
Org.Nr. →7874	05.97-05.98	0 451 10 P 3261	O
Org.Nr. 7875→	06.98-10.03	0 451 10 P 3355	O
	05.97-10.03	LBE 1 457 43 S 3543	L
		SBE 1 457 43 S 3527	L
		0 450 90 F 2161 ¹	K

2,0 110-114 RFT <XU10J4>			
	08.94-04.97	0 451 10 P 3261	O
		1 457 43 S 3229	L
		0 450 90 F 5002 ¹	K

2,0 110-114 RFY <XU10J4>			
	08.93-04.97	0 451 10 P 3261	O
		1 457 43 S 3229	L
		0 450 90 F 5002 ¹	K

2,0 120 RFS <XU10J4RS>			
	07.96-04.97	0 451 10 P 3261	O
Org.Nr. →7874	05.97-05.98	0 451 10 P 3261	O
Org.Nr. 7875→	06.98-10.03	0 451 10 P 3355	O
	05.97-10.03	0 450 90 F 2161 ¹	K
Org.Nr. →7265	07.96-10.96	0 450 90 F 5002 ¹	K
Org.Nr. 7266→	11.96-04.97	0 450 90 F 2161 ¹	K

307 (T5,T6)

307 (T5,T6) 1.4 HDi

1,4 50 8HZ <DV4TD>			
	10.01-05.05	1 457 42 P 9238	O
		1 457 43 S 3076	L
		0 450 90 N 6460 ¹	K
		MKL 1 987 43 R 2379 ⁸	I
		MKL 1 987 43 M 2079	I

307 (T5,T6) 1.4 i

1,4 55 KFW <TU3JP>			
	03.02→	1 457 42 P 9193	O
Mot.Nr. →4717577	08.00-05.05	1 457 42 P 9193	O
Mot.Nr. 4717578→	08.00-05.05	1 457 42 P 9249	O
	08.00→	1 457 43 S 3090	L
		0 450 90 F 2161 ¹	K
		MKL 1 987 43 R 2379 ⁸	I
		MKL 1 987 43 M 2079	I

307 (T5,T6) 1.4 i, i 16V

1,4 65 KFU <ET3J4>			
	11.03-05.08	1 457 42 P 9249	O
		LBE 1 457 43 S 3592	L
		0 450 90 F 2161 ¹	K
		MKL 1 987 43 R 2379 ⁸	I
		MKL 1 987 43 M 2079	I



307 (T5,T6) 1.6 HDi

1,6 66/80 9H... <DV6TED4>; 9HV <DV6TED4/FAP>; 9HX <DV6ATED4>			
	02.04-05.08	1 457 42 P 9238	O
		1 457 43 S 3160	L
		0 450 90 N 6471 ¹	K
		MKL 1 987 43 R 2379 ⁸	I
		MKL 1 987 43 M 2079	I

307 (T5,T6) 1.6 i

1,6 80 NFU <TU5JP4>			
	06.05-03.09	1 457 42 P 9249	O
Org.Nr. →10072	08.00-06.04	1 457 42 P 9193	O
Org.Nr. 10073→	07.04-05.05	1 457 42 P 9249	O
	08.00-05.05	1 457 43 S 3090	L
	08.00-03.09	0 450 90 F 2161 ¹	K
	08.00-08.07	MKL 1 987 43 R 2379 ⁸	I
	08.00-03.09	MKL 1 987 43 M 2079	I
	06.05-03.09	1 987 43 R 2379 ⁸	I

307 (T5,T6) 1.6 i 16V

1,6 80 NFU <TU5JP4>			
	06.05-05.08	1 457 42 P 9249	O
		0 450 90 F 2161 ¹	K
		MKL 1 987 43 R 2379 ⁸	I
		MKL 1 987 43 M 2079	I

1,6 80 <TU5JP4>			
	06.04-04.06	1 457 42 P 9249	O
		1 457 43 S 3090	L
		MKL 1 987 43 R 2379 ⁸	I
		MKL 1 987 43 M 2079	I

1,6 81 TU5JP4			
	08.06→	1 987 43 R 2379 ⁸	I

307 (T5,T6) 1.6 i 16V BioFlex

1,6 80 N6A <TU5JP4>			
	09.07→	1 457 42 P 9249	O
		MKL 1 987 43 R 2379 ⁸	I
		MKL 1 987 43 M 2079	I

307 (T5,T6) 2.0 HDi

2,0 66 RHY <DW10TD>			
	08.00-05.05	0 451 10 P 3355	O
	08.00→	1 457 43 S 3150	L
	08.00-05.05	SIE 1 457 07 N 0000	K
	03.02→	1 457 07 N 0000	K
Org.Nr. →9170	08.00-12.01	BO 1 457 03 N 0013	K
Org.Nr. 9171→	01.02-05.05	BO 1 457 07 N 0000	K
	08.00-05.05	MKL 1 987 43 R 2379 ⁸	I
		MKL 1 987 43 M 2079	I
	11.04→	1 987 43 M 2079	I

2,0 79 RHS <DW10ATED/FAP>			
	03.02-05.05	0 451 10 P 3355	O
		1 457 43 S 3150	L
		1 457 07 N 0000	K
		MKL 1 987 43 R 2379 ⁸	I
		MKL 1 987 43 M 2079	I





◀ 307 (T5,T6) 2.0 HDi

2,0 | 100 | RHR <DW10BTE4/FAP>

10.03-03.09	1 457 42	P 9249	O	
10.03-05.08	1 457 43	S 3098	L	
06.05-03.09	AG	F 026 40	S 0150	L
	GS	1 457 43	S 3098	L
10.03-03.09	1 457 43	N 1723	K	
10.03-05.08	MKL	1 987 43	R 2379 ⁸	I
10.03-03.09	MKL	1 987 43	M 2079	I
06.05-03.09	1 987 43	R 2379 ⁸	I	

307 (T5,T6) 2.0 i

2,0 | 100 | RFN <EW10J4>

08.00-05.05	0 451 10	P 3355	O	
	1 457 43	S 3090	L	
	0 450 90	F 2161 ¹	K	
	MKL	1 987 43	R 2379 ⁸	I
	MKL	1 987 43	M 2079	I

2,0 | 103 | RFJ <EW10A>

06.05-03.09	1 457 42	P 9249	O	
	F 026 40	S 0120	L	
	0 450 90	F 2161 ¹	K	
06.05-05.08	MKL	1 987 43	R 2379 ⁸	I
06.05-03.09	1 987 43	R 2379 ⁸	I	
	MKL	1 987 43	M 2079	I

2,0 | 130 | RFK <EW10J4S>

06.05-12.06	0 451 10	P 3355	O	
	1 457 43	S 3150	L	
	0 450 90	F 2161 ¹	K	
	MKL	1 987 43	R 2379 ⁸	I
	MKL	1 987 43	M 2079	I

307 (T5,T6) 2.0 i Sport

2,0 | 130 | RFK <EW10J4S>

10.03-03.09	0 451 10	P 3355	O	
	1 457 43	S 3150	L	
	0 450 90	F 2161 ¹	K	
10.03-05.05	MKL	1 987 43	R 2379 ⁸	I
10.03-03.09	MKL	1 987 43	M 2079	I
06.05-03.09	1 987 43	R 2379 ⁸	I	

307 (T5,T6) 2.0 i 16V

2,0 | 100 | <EW10A>

06.04-04.06	1 457 42	P 9249	O	
	F 026 40	S 0120	L	
	0 450 90	F 2161 ¹	K	
	MKL	1 987 43	R 2379 ⁸	I
	MKL	1 987 43	M 2079	I

2,0 | 105 | <EW10A>

05.06→	1 457 42	P 9249	O	
	F 026 40	S 0120	L	
	1 987 43	M 2079	I	
	MKL	1 987 43	R 2379 ⁸	I



308

308 1.4 i, VTi

1,4 | 70/72 | 8FR <EP3C>; 8FS <EP3>

09.07→	1 457 42	P 9249	O
	F 026 40	S 0050	L
	0 450 90	F 2161 ¹	K
	1 987 43	M 2079	I
	1 987 43	R 2379 ⁸	I

308 1.6 GTi THP

1,6 | 147 | 5FU <EP6CDTX>

05.10→	1 457 42	P 9249	O
	1 987 43	M 2079	I
	1 987 43	R 2379 ⁸	I

308 1.6 HDi

1,6 | 66/80 | 9HV <DV6TED4/FAP>; 9HX <DV6ATED4>; 9HZ <DV6TED4/FAP>

09.07→	1 457 42	P 9238	O
	1 457 43	S 3160	L
	0 450 90	N 6471 ¹	K
	1 987 43	M 2079	I
	1 987 43	R 2379 ⁸	I

1,6 | 68 | 9HP <DV6DTE4>

04.10→	1 457 42	P 9238	O
	1 987 43	M 2079	I
	1 987 43	R 2379 ⁸	I

1,6 | 80 | 9H... <DV6TED4>

05.08→	1 457 42	P 9238	O
	1 457 43	S 3160	L
	0 450 90	N 6471 ¹	K
	1 987 43	M 2079	I
	1 987 43	R 2379 ⁸	I

1,6 | 82 | 9H... <DV6C>

03.09→	1 457 42	P 9238	O
	1 987 43	M 2079	I
	1 987 43	R 2379 ⁸	I

308 1.6 i

1,6 | 88 | 5FS <EP6C>

03.09→	1 457 42	P 9249	O
	F 026 40	S 0050	L
	0 450 90	F 2161 ¹	K
	1 987 43	M 2079	I
	1 987 43	R 2379 ⁸	I

1,6 | 88 | 5FW <EP6>

09.07→	1 457 42	P 9249	O
	F 026 40	S 0050	L
	MXF 0 450 90	F 2161 ¹	K
	1 987 43	M 2079	I
	1 987 43	R 2379 ⁸	I

1,6 | 103 | 5FT <EP6DT>

11.07→	1 457 42	P 9249	O
	F 026 40	S 0151	L
	0 450 90	F 2161 ¹	K
	1 987 43	M 2079	I
	1 987 43	R 2379 ⁸	I





1,6 110 5FX <EP6DT>			
09.07→	1 457 42	P 9249	O
	F 026 40	S0151	L
	0 450 90	F 2161 ¹	K
	1 987 43	M 2079	I
	1 987 43	R 2379 ⁸	I

1,6 128 5FY <EP6DTS>			
03.08→	1 457 42	P 9249	O
Org.Nr. →11920	03.08-07.09	F 026 40	S0151 L
03.08→	MXF	0 450 90	F 2161 ¹ K
		1 987 43	M 2079 I
		1 987 43	R 2379 ⁸ I

308 1.6 i BioFlex			
1,6 82 NFU <TU5JP4>			
03.09→	1 457 42	P 9249	O
	1 987 43	M 2079	I
	1 987 43	R 2379 ⁸	I

308 1.6 i, i THP			
1,6 80/110 N6A <TU5JP4>; 5FE <EP6CDT M>			
07.08→	1 457 42	P 9249	O
	0 450 90	F 2161 ¹	K
	1 987 43	M 2079	I
	1 987 43	R 2379 ⁸	I

308 1.6 i THP			
1,6 115 5FV <EP6CDT>			
09.09→	1 457 42	P 9249	O
	0 450 90	F 2161 ¹	K
	1 987 43	M 2079	I
	1 987 43	R 2379 ⁸	I

308 2.0 HDi			
2,0 100 RHR <DW10BTED4>			
03.09→	1 457 42	P 9249	O
	LBE	F 026 40	S0150 L
	SBE	F 026 40	S0150 L
		1 457 43	N 1723 K
		1 987 43	M 2079 I
		1 987 43	R 2379 ⁸ I

2,0 100-103 RH... <DW10BTED4/FAP>; RHF <DW10BTED4>			
09.07→	1 457 42	P 9249	O
	LBE	F 026 40	S0150 L
	SBE	F 026 40	S0150 L
		1 457 43	N 1723 K
		1 987 43	M 2079 I
		1 987 43	R 2379 ⁸ I

2,0 120 RHH <DW10CTED4/DTR>			
09.09→	1 457 42	P 9249	O
	F 026 40	S0150	L
	1 987 43	M 2079	I
	1 987 43	R 2379 ⁸	I

308 2.0 i			
2,0 103 RFJ <EW10A>			
05.08→	1 457 42	P 9249	O
	F 026 40	S0120	L
	MXF	0 450 90	F 2161 ¹ K
		1 987 43	M 2079 I
		1 987 43	R 2379 ⁸ I

309			
309 1.1			
1,1 40 E1A <E1>			
10.85-12.91	0 451 10	P 3139	O
	1 457 42	S 9908	L
	0 450 90	F 4058 ¹	K

1,1 40 H1A,H1B <TU1>			
07.89-12.93	0 451 10	P 3261	O
	1 457 42	S 9908	L
	0 450 90	F 4058 ¹	K

309 1.1 i			
1,1 40-44 HDZ,HDY <TU1MZ Kat.>			
10.90-12.93	0 451 10	P 3261	O
	1 457 42	S 9908	L
	0 450 90	F 5095 ¹	K
	RLE	0 450 90	F 5002 ¹ K

309 1.3			
1,3 47 1G1A <G1>			
10.85-12.91	0 451 10	P 3139	O
	1 457 42	S 9908	L
	0 450 90	F 4058 ¹	K

309 1.4			
1,4 42-44 K3A <TU3>			
07.89-12.93	0 451 10	P 3261	O
	1 457 42	S 9908	L
	0 450 90	F 4058 ¹	K

1,4 51/62 K1D,K1F, K1G <TU3A>; K2B <TU3S>			
01.89-12.93	0 451 10	P 3261	O
	1 457 42	S 9908	L
	0 450 90	F 4058 ¹	K

1,4 55 K2D <TU3F2>			
07.91-12.93	0 451 10	P 3261	O
	1 457 43	S 3227	L
	0 450 90	F 4058 ¹	K

1,4 61 Y2A <Y2>			
10.86-12.91	0 451 10	P 3139	O
	0 450 90	F 4058 ¹	K

309 1.4 i			
1,4 55-58 KDY <TU3FM Kat.(Gußmot.)>; KDY <TU3M Kat.>			
06.90-12.93	0 451 10	P 3261	O
	1 457 42	S 9908	L
	0 450 90	F 5095 ¹	K
	RLE	0 450 90	F 5002 ¹ K





309 1.6

1,6 65/68 B2A,B2B, B2C <XU52C>; B5A <XU52C>			
	07.88-12.93	0 451 10 P 3261	O
		1 457 42 S 9908	L
		0 450 90 F 4058 ¹	K
1,6 69 J2A <J2>			
	10.86-12.91	0 451 10 P 3139	O
		0 450 90 F 4058 ¹	K

309 1.6 i

1,6 65 BDY <XU5M Kat.>; BDZ <XU5M Kat.>			
	07.89-12.93	0 451 10 P 3261	O
		1 457 42 S 9908	L
		0 450 90 F 5002 ¹	K
1,6 90 B6E <XU5JA>			
	10.90-12.93	0 451 10 P 3261	O
		0 450 90 F 5104 ¹	K

309 1.8 D

1,8 44 161A,A9A <XUD7>			
	06.86-12.93	0 451 10 P 3261	O
		1 457 43 S 2154	L
	06.86-05.92 CAV	1 457 43 N 4200 ²	K
	06.86-12.93 BO	1 457 42 N 9289	K
	05.92-12.93 CAV	1 457 42 N 9291	K

309 1.8 D Turbo

1,8 58 A8A,A8B <XUD7T>			
	11.89-12.93	0 451 10 P 3261	O
		1 457 43 S 2154	L
		BO 1 457 42 N 9289	K
		CAV 1 457 43 N 4200 ²	K

309 1.9

1,9 80 D2H,D2F <XU92C>			
	10.90-12.93	0 451 10 P 3261	O
		1 457 42 S 9908	L
		0 450 90 F 4058 ¹	K

309 1.9 D

1,9 47 DJZ <XUD9Y>			
	06.86-12.93	0 451 10 P 3261	O
		1 457 43 S 2154	L
	06.86-05.92 CAV	1 457 43 N 4200 ²	K
	06.86-12.93 BO	1 457 42 N 9289	K
	05.92-12.93 CAV	1 457 42 N 9291	K

1,9 | 47 | 162,D9A <XUD9>

	06.86-12.93	0 451 10 P 3261	O
		1 457 43 S 2154	L
	06.86-05.92 CAV	1 457 43 N 4200 ²	K
	06.86-12.93 BO	1 457 42 N 9289	K
	05.92-12.93 CAV	1 457 42 N 9291	K

309 1.9 GTI

1,9 94 D6B <XU9JA>			
	10.86-12.93	0 451 10 P 3261	O
		0 450 90 F 5104 ¹	K



309 1.9 i

1,9 72 DFZ <XU9J1 Kat.>			
	03.86-12.93	0 451 10 P 3261	O
		0 450 90 F 5104 ¹	K
1,9 80 DDZ <XU9M Kat.>			
	07.88-12.93	0 451 10 P 3261	O
		1 457 42 S 9908	L
		0 450 90 F 5002 ¹	K
1,9 88-90 DKZ,DFY <XU9JAZ Kat.>			
	07.88-12.93	0 451 10 P 3261	O
		0 450 90 F 5104 ¹	K

309 1.9 i 16V

1,9 108 DFW <XU9J4/Z Kat.>			
	08.90-12.93	0 451 10 P 3261	O
		1 457 43 S 3229	L
	08.90-09.91	0 450 90 F 5104 ¹	K
	10.91-12.93	0 450 90 F 5002 ¹	K

1,9 | 116 | D6C <XU9J4/K>

	02.90-12.93	0 451 10 P 3261	O
		1 457 43 S 3229	L
	02.90-09.91	0 450 90 F 5104 ¹	K
	10.91-12.93	0 450 90 F 5002 ¹	K

405

405 1.8 i

1,8 74 <XU7UP>			
	04.96-04.06	0 451 10 P 3261	O
		1 457 43 S 3606	L
		0 986 BF CB 0572	I
		1 987 43 M 2022	I

405 1.9 D

1,9 50/66/68 D8A <XUD9TE>; XUD9; XUD9T			
	03.95→	1 457 43 S 2200	L
		1 457 42 N 9291	K
		1 987 43 M 2022	I

405 2.0 i

2,0 91 <XU10J2C>			
	10.99-10.04	0 451 10 P 3261	O
		1 457 43 S 3606	L
		0 986 BF CB 0572	I
		1 987 43 M 2022	I

405 (4,15)

405 (4,15) 1.4

1,4 44 K3A <TU3TR>			
	11.87-12.92	0 451 10 P 3261	O
		1 457 42 S 9908	L
		0 450 90 F 4058 ¹	K
		1 987 43 M 2022	I





1,4 51 K1G <TU3A>	07.88-12.92	0 451 10 P 3261	O
		1 457 42 S 9908	L
		0 450 90 F 4058 ¹	K
		1 987 43 M 2022	I

1,4 55 K2D <TU3F2>; K2D <TU3.2>	06.91-04.97	0 451 10 P 3261	O
		1 457 43 S 3227	L
		0 450 90 F 4058 ¹	K
		1 987 43 M 2022	I

405 (4,15) 1.4 i

1,4 55 KDX <TU3MC Kat.>	06.92-04.97	0 451 10 P 3261	O
		1 457 43 S 3227	L
		0 450 90 F 5095 ¹	K
		1 987 43 M 2022	I

405 (4,15) 1.6

1,6 53 B1D,B1E <XU51C>	07.87-12.92	0 451 10 P 3261	O
		1 457 43 S 2200	L
		1 987 43 M 2022	I

1,6 65-66/68 B2A, B2B, B2C <XU52C>; B2A <XU52C>; B5A <XU52C>	07.87-04.97	0 451 10 P 3261	O
		1 457 43 S 2200	L
		0 450 90 F 4058 ¹	K
		1 987 43 M 2022	I

405 (4,15) 1.6 i

1,6 65 BFZ <XU5JP>	09.94-04.97	0 451 10 P 3261	O
		1 457 43 S 3606	L
	09.94-02.95	0 450 90 F 5095 ¹	K
	03.95-04.97	0 450 90 F 2161 ¹	K
	09.94-04.97	1 987 43 M 2022	I

1,6 65-66 BDY <XU5M Kat.>	09.90-04.97	0 451 10 P 3261	O
		1 457 43 S 2200	L
		0 450 90 F 5095 ¹	K
		1 987 43 M 2022	I

405 (4,15) 1.8 D

1,8 44 161A <XUD7>	10.90-12.92	0 451 10 P 3261	O
		1 457 43 S 2200	L
		BO 1 457 42 N 9289	K
		CAV 1 457 43 N 4200 ²	K
		1 987 43 M 2022	I

405 (4,15) 1.8 D, D Turbo

1,8 44/64-66 AJZ <XUD7TEY>; A8A,A8B <XUD7TE>; A9A <XUD7>	03.88-12.92	0 451 10 P 3261	O
		1 457 43 S 2200	L
		BO 1 457 42 N 9289	K
		CAV 1 457 43 N 4200 ²	K
		1 987 43 M 2022	I

405 (4,15) 1.8 i

1,8 74-76 LFZ <XU7JP Kat.>; L6A <XU7JP>	08.94-04.97	0 451 10 P 3261	O
	06.92-04.97	1 457 43 S 3606	L
	06.92-02.95	0 450 90 F 5095 ¹	K
	03.95-04.97	0 450 90 F 2161 ¹	K
	06.92-04.97	1 987 43 M 2022	I

405 (4,15) 1.9

1,9 70/71/80/81 D2C <XU92C>; D2D <XU92C>; D2H <XU92C>; D5A <XU92C>; D5A <XU92CTR>	07.87-04.97	0 451 10 P 3261	O
		1 457 43 S 2200	L
		0 450 90 F 4058 ¹	K
		1 987 43 M 2022	I

405 (4,15) 1.9 D

1,9 47 DJZ <XUD9Y>	07.88-09.92	0 451 10 P 3261	O
Org.Nr. →6778	06.92-06.94	0 451 10 P 3261	O
	07.88-06.94	1 457 43 S 2200	L
	07.88-09.92	BO 1 457 42 N 9289	K
		CAV 1 457 43 N 4200 ²	K
	06.92-06.94	1 457 42 N 9291	K
	07.88-06.94	1 987 43 M 2022	I

1,9 51 D9B <XUD9A>	03.88-12.92	0 451 10 P 3261	O
		1 457 43 S 2200	L
		BO 1 457 42 N 9289	K
		CAV 1 457 43 N 4200 ²	K
		1 987 43 M 2022	I

1,9 51-52 D9B <XUD9A>	06.92-04.97	0 451 10 P 3261	O
		1 457 43 S 2200	L
		1 457 42 N 9291	K
		1 987 43 M 2022	I

405 (4,15) 1.9 D, D Turbo

1,9 50/66-68 DHY <XUD9TE Kat.>; DJY <XUD9Y>	06.92-04.97	0 451 10 P 3261	O
		1 457 43 S 2200	L
		1 457 42 N 9291	K
		1 987 43 M 2022	I

405 (4,15) 1.9 D Turbo

1,9 68 D8A <XUD9TE>	06.92-04.97	0 451 10 P 3261	O
		1 457 43 S 2200	L
		1 457 42 N 9291	K
		1 987 43 M 2022	I

405 (4,15) 1.9 i

1,9 77 DFZ <XU9J1 Kat.>	07.87-12.92	0 451 10 P 3261	O
		1 457 43 S 2200	L
		0 450 90 F 5095 ¹	K
		1 987 43 M 2022	I





◀ 405 (4,15) 1.9 i

1,9 80 DDZ <XU9M Kat.>			
	07.88-12.92	0 451 10 P 3261	O
		1 457 43 S 2200	L
Fg.Nr. S 8870628→	07.88-12.92 AA	0 450 90 F 5104 ¹	K
Fg.Nr. →S 8870627	07.88-12.92	0 450 90 F 5095 ¹	K
	07.88-12.92	1 987 43 M 2022	I

1,9 82 DFV <XU9J2 Kat.>			
	07.87-12.92	0 451 10 P 3261	O
		1 457 43 S 2200	L
		0 450 90 F 5095 ¹	K
		1 987 43 M 2022	I

1,9 88 DKZ,DFY <XU9JAZ Kat.>			
	07.88-12.92	0 451 10 P 3261	O
		1 457 43 S 2200	L
		0 450 90 F 5095 ¹	K
		1 987 43 M 2022	I

1,9 89/90-92 D6D <XU9J2>			
	07.87-04.97	0 451 10 P 3261	O
		1 457 43 S 2200	L
		0 450 90 F 5095 ¹	K
		1 987 43 M 2022	I

1,9 90-92 D6A <XU9J2>			
	07.87-12.92	0 451 10 P 3261	O
		1 457 43 S 2200	L
		0 450 90 F 5095 ¹	K
		1 987 43 M 2022	I

405 (4,15) 1.9 i 16V

1,9 108-111 DFW <XU9J4Z Kat.>			
	04.88-12.92	0 451 10 P 3261	O
		1 457 43 S 2200	L
Fg.Nr. S 8870628→	04.88-12.92 AA	0 450 90 F 5104 ¹	K
Fg.Nr. →S 8870627	04.88-12.92	0 450 90 F 5095 ¹	K
	04.88-12.92	1 987 43 M 2022	I

1,9 116 D6C <XU9J4/K>			
	07.87-12.92	0 451 10 P 3261	O
		1 457 43 S 2200	L
Fg.Nr. S 8870628→	07.87-12.92 AA	0 450 90 F 5104 ¹	K
Fg.Nr. →S 8870627	07.87-12.92	0 450 90 F 5095 ¹	K
	07.87-12.92	1 987 43 M 2022	I

405 (4,15) 2.0 i

2,0 89-91 RFX <XU10J2 Kat.>			
	08.94-04.97	0 451 10 P 3261	O
	06.92-04.97	1 457 43 S 3606	L
	06.92-02.95	0 450 90 F 5095 ¹	K
	03.95-04.97	0 450 90 F 2161 ¹	K
	06.92-04.97	1 987 43 M 2022	I

2,0 89-91 R6D <XU10J2>			
	08.94-04.97	0 451 10 P 3261	O
	06.92-04.97	1 457 43 S 3606	L
	06.92-02.95	0 450 90 F 5095 ¹	K
	03.95-04.97	0 450 90 F 2161 ¹	K
	06.92-04.97	1 987 43 M 2022	I



405 (4,15) 2.0 i Mi16

2,0 110-118 RFT <XU10J4>			
	08.94-04.97	0 451 10 P 3261	O
	01.93-04.97	1 457 43 S 3229	L
	01.93-02.95	0 450 90 F 5095 ¹	K
	03.95-04.97	0 450 90 F 2161 ¹	K
	01.93-04.97	1 987 43 M 2022	I

2,0 110-118 RFY <XU10J4>			
	08.94-04.97	0 451 10 P 3261	O
	01.93-04.97	1 457 43 S 3229	L
	01.93-02.95	0 450 90 F 5095 ¹	K
	03.95-04.97	0 450 90 F 2161 ¹	K
	01.93-04.97	1 987 43 M 2022	I

405 (4,15) 2.0 i T16 4x4

2,0 144-159 RGZ <XU10J4TE>			
	08.94-04.97	0 451 10 P 3261	O
	09.92-04.97	1 457 43 S 3229	L
		0 450 90 F 5104 ¹	K
		1 987 43 M 2022	I

405 (4,15) 2.0 i 4x4, i 4x4

2,0 89-91 RFX <XU10J2 Kat.>			
	08.94-04.97	0 451 10 P 3261	O
	06.92-04.97	1 457 43 S 3606	L
		0 450 90 F 5104 ¹	K
		1 987 43 M 2022	I

406 (D8,D9)

406 (D8,D9) 1.6 i

1,6 65 BFZ <XU5JP>			
	10.95-03.99	0 451 10 P 3261	O
	04.99-06.04	0 451 10 P 3355	O
	10.95-06.04	1 457 43 S 3606	L
		0 450 90 F 2161 ¹	K
	KL	1 987 43 M 2007	I
		1 987 43 R 2307 ⁸	I

406 (D8,D9) 1.8 i

1,8 66 LFX <XU7JB>			
	09.97-03.99	0 451 10 P 3261	O
	04.99-06.04	0 451 10 P 3355	O
	09.97-06.04	1 457 43 S 3606	L
		0 450 90 F 2161 ¹	K
	KL	1 987 43 M 2007	I
		1 987 43 R 2307 ⁸	I

1,8 | 74-76 | L6A <XU7JP>

	12.95-03.99	0 451 10 P 3261	O
	04.99-06.04	0 451 10 P 3355	O
	12.95-06.04	1 457 43 S 3606	L
		0 450 90 F 2161 ¹	K
	KL	1 987 43 M 2007	I
		1 987 43 R 2307 ⁸	I





406 (D8,D9) 1.8 i 16V

1,8 81 LFY <XU7JP4>			
	04.99-06.04	0 451 10 P 3355	O
		1 457 43 S 2200	L
		0 450 90 F 2161 ¹	K
	KL	1 987 43 M 2007	I
		1 987 43 R 2307 ⁸	I

1,8 81-82 LFY <XU7JP4>			
	10.95-03.99	0 451 10 P 3261	O
	04.99-06.04	0 451 10 P 3355	O
	10.95-06.04	1 457 43 S 2200	L
		0 450 90 F 2161 ¹	K
	KL	1 987 43 M 2007	I
		1 987 43 R 2307 ⁸	I

1,8 81-82 LFY <XU7JP4/L3>			
	10.96-03.99	0 451 10 P 3261	O
		1 457 43 S 2200	L
		0 450 90 F 2161 ¹	K
	KL	1 987 43 M 2007	I
		1 987 43 R 2307 ⁸	I

1,8 85 6FZ <EW7J4>			
	10.00-06.04	0 451 10 P 3355	O
		1 457 43 S 2200	L
		0 450 90 F 2161 ¹	K
	KL	1 987 43 M 2007	I
		1 987 43 R 2307 ⁸	I

406 (D8,D9) 1.9 D Turbo

1,9 55/66-68 DHW <XUD9SD>; DHX <XUD9TE>; D8B <XUD9TE>			
	12.95-03.99	0 451 10 P 3261	O
		1 457 43 S 2200	L
		1 457 42 N 9291	K
	KL	1 987 43 M 2007	I
		1 987 43 R 2307 ⁸	I

406 (D8,D9) 2.0 HDi

2,0 66/79 RHS <DW10ATED/FAP>; RHY <DW10TD>			
	04.99-06.04	0 451 10 P 3355	O
		1 457 43 S 2200	L
		1 457 03 N 0013	K
	KL	1 987 43 M 2007	I
		1 987 43 R 2307 ⁸	I

2,0 80 RHZ <DW10ATED>			
	10.98-03.99	0 451 10 P 3261	O
	04.99-06.04	0 451 10 P 3355	O
	10.98-06.04	1 457 43 S 2200	L
		1 457 03 N 0013	K
Org.Nr. 8975→	06.01-06.04	1 457 07 N 0000	K
	10.98-06.04	KL 1 987 43 M 2007	I
		1 987 43 R 2307 ⁸	I



406 (D8,D9) 2.0 HPi

2,0 103 RLZ <EW10D>			
	10.00-06.04	0 451 10 P 3355	O
		1 457 43 S 2200	L
		0 450 90 F 2161 ¹	K
	KL	1 987 43 M 2007	I
		1 987 43 R 2307 ⁸	I

406 (D8,D9) 2.0 i Turbo

2,0 108-110 RGX <XU10J2TE>			
	04.96-03.99	0 451 10 P 3261	O
		1 457 43 S 2200	L
		0 450 90 F 2161 ¹	K
	KL	1 987 43 M 2007	I
		1 987 43 R 2307 ⁸	I

406 (D8,D9) 2.0 i 16V

2,0 97 RFV <XU10J4R>			
	04.99-06.04	0 451 10 P 3355	O
		1 457 43 S 2200	L
		0 450 90 F 2161 ¹	K
	KL	1 987 43 M 2007	I
		1 987 43 R 2307 ⁸	I

2,0 97-99 RFV <XU10J4R>			
	10.95-03.99	0 451 10 P 3261	O
	04.99-02.05	0 451 10 P 3355	O
	10.95-02.05	1 457 43 S 2200	L
		0 450 90 F 2161 ¹	K
	KL	1 987 43 M 2007	I
		1 987 43 R 2307 ⁸	I

2,0 97-99 R6E <XU10J4R>			
	12.95-03.99	0 451 10 P 3261	O
		1 457 43 S 2200	L
		0 450 90 F 2161 ¹	K
	KL	1 987 43 M 2007	I
		1 987 43 R 2307 ⁸	I

2,0 99/100 RFN <EW10J4>; RFR <EW10J4>			
	04.99-02.05	0 451 10 P 3355	O
		1 457 43 S 2200	L
		0 450 90 F 2161 ¹	K
	KL	1 987 43 M 2007	I
		1 987 43 R 2307 ⁸	I

406 (D8,D9) 2.1 D Turbo

2,1 80-81 P8C <XUD11BTE>			
	12.95-03.99	0 451 10 P 3261	O
		1 457 43 S 2200	L
		1 457 42 N 9291	K
	KL	1 987 43 M 2007	I
		1 987 43 R 2307 ⁸	I





406 (D8,D9) 2.2 HDi

2,2 98 4HX <DW12TED4>				
	03.00-02.05	0 451 10 P 3355	O	
		1 457 43 S 2200	L	
Org.Nr. →9001	03.00-07.01	1 457 03 N 0013	K	
	XXX	1 457 03 N 0013	K	
Org.Nr. 9002→	08.01-02.05	1 457 07 N 0000	K	
	03.00-02.05	1 987 43 M 2007	I	
		1 987 43 R 2307 ⁸	I	

406 (D8,D9) 2.2 i 16V

2,2 116 3FZ <EW12J4>				
	04.99-02.05	0 451 10 P 3355	O	
		1 457 43 S 2200	L	
		0 450 90 F 2161 ¹	K	
	KL	1 987 43 M 2007	I	
		1 987 43 R 2307 ⁸	I	

406 (D8,D9) 3.0 i

3,0 140-143/150 XFZ <ES9J4S>; XFZ <ES9J4>				
	08.96-02.05	0 451 10 P 3261	O	
		1 457 43 S 2200	L	
		0 450 90 F 2161 ¹	K	
	KL	1 987 43 M 2007	I	
		1 987 43 R 2307 ⁸	I	

407

407 1.6 HDi

1,6 80 9H... <DV6TED4>				
	05.04→	1 457 42 P 9238	O	
		1 457 43 S 3327	L	
		MPR 0 450 90 N 6471 ¹	K	
		MPR 0 450 90 N 6471 ¹	K	
Org.Nr. →11437	05.04-03.08	1 987 43 R 2412 ⁸	I	
Org.Nr. 11438→	04.08→	1 987 43 R 2311 ⁸	I	

407 1.8 i

1,8 85 6FZ <EW7J4>				
	05.04-10.05	0 451 10 P 3355	O	
		1 457 43 S 3591	L	
		0 450 90 F 2161 ¹	K	
		1 987 43 R 2412 ⁸	I	

1,8 | 92 | 6FY <EW7A>

	10.05→	1 457 42 P 9249	O	
		1 457 43 S 3591	L	
		0 450 90 F 2161 ¹	K	
Org.Nr. →11437	10.05-03.08	1 987 43 R 2412 ⁸	I	
Org.Nr. 11438→	04.08→	1 987 43 R 2311 ⁸	I	

407 2.0 HDi

2,0 100 RHR <DW10BTED4>				
	07.07-06.09	1 457 42 P 9249	O	
		LBE 1 457 43 S 3596	L	
		SBE F 026 40 S 0108	L	
		1 457 43 N 1723	K	
Org.Nr. →11437	07.07-03.08	1 987 43 R 2412 ⁸	I	
Org.Nr. 11438→	04.08-06.09	1 987 43 R 2311 ⁸	I	



2,0 | 100-103 | RH... <DW10BTED4>

	05.04→	1 457 42 P 9249	O	
		LBE 1 457 43 S 3596	L	
		SBE F 026 40 S 0108	L	
		1 457 43 N 1723	K	
Org.Nr. →11437	05.04-03.08	1 987 43 R 2412 ⁸	I	
Org.Nr. 11438→	04.08→	1 987 43 R 2311 ⁸	I	

407 2.0 HDi, HDi 16V

2,0 110/120 RHE <DW10CTED4/FAP>; RHH <DW10CTED4/FAP>				
	07.09→	1 457 42 P 9249	O	
		1 987 43 R 2311 ⁸	I	

407 2.0 i

2,0 100 RFN <EW10J4>				
	05.04-11.05	0 451 10 P 3355	O	
		LBE 1 457 43 S 3591	L	
		0 450 90 F 2161 ¹	K	
		1 987 43 R 2412 ⁸	I	

2,0 | 103 | RFJ <EW10A>

	10.05→	1 457 42 P 9249	O	
		1 457 43 S 3591	L	
		0 450 90 F 2161 ¹	K	
Org.Nr. →11437	10.05-03.08	1 987 43 R 2412 ⁸	I	
Org.Nr. 11438→	04.08→	1 987 43 R 2311 ⁸	I	

407 2.2 HDi

2,2 125 4H... <DW12BTED4>				
	05.06→	1 457 42 P 9249	O	
Org.Nr. →11437	05.06-03.08	1 987 43 R 2412 ⁸	I	
Org.Nr. 11438→	04.08→	1 987 43 R 2311 ⁸	I	

407 2.2 i

2,2 116 3FZ <EW12J4>				
	05.04-10.05	0 451 10 P 3355	O	
		LBE 1 457 43 S 3591	L	
		0 450 90 F 2161 ¹	K	
		1 987 43 R 2412 ⁸	I	

2,2 | 120 | 3FY <EW12J4 / L5>

	10.05-06.09	0 451 10 P 3355	O	
		LBE 1 457 43 S 3591	L	
		0 450 90 F 2161 ¹	K	
Org.Nr. →11437	10.05-03.08	1 987 43 R 2412 ⁸	I	
Org.Nr. 11438→	04.08-06.09	1 987 43 R 2311 ⁸	I	

407 2.7 HDi

2,7 150 UHZ <DT17TED4>				
	10.05-06.09	1 457 42 P 9307	O	
		F 026 40 N 2004	K	
Org.Nr. →11437	10.05-03.08	1 987 43 R 2412 ⁸	I	
Org.Nr. 11438→	04.08-06.09	1 987 43 R 2311 ⁸	I	

407 3.0 HDi 24V

3,0 177 X8Z <DT20C>				
	07.09→	1 987 43 R 2311 ⁸	I	





407 3.0 i

3,0 155 XFV<ES9A>			
	05.04-06.09	0 451 10 P 3355	O
		LBE 1 457 43 S 3591	L
		0 450 90 F 2161 ¹	K
	05.04-12.06	1 987 43 R 2412 ⁸	I
Org.Nr. →11437	10.05-03.08	1 987 43 R 2412 ⁸	I
Org.Nr. 11438→	04.08-06.09	1 987 43 R 2311 ⁸	I

504

504 2.0 GR

2,0 73 XN2			
	02.85-11.96	0 451 10 P 3261	O

505

505 1.8

1,8 62 150C<XM7A>			
	10.85-12.93	0 451 10 P 3261	O
		LAT,XXX 1 457 43 S 2149	L
		0 450 90 F 4058 ¹	K

505 2.0

2,0 60-71/72-74 106E<XN1>;106ER<XN1A>			
	10.83-12.93	0 451 10 P 3261	O
	05.79-12.93	LAT,XXX 1 457 43 S 2149	L
		0 450 90 F 4058 ¹	K

505 2.0 SR, SW8

2,0 72-74/79 <XN1A>;XN1A			
	02.83-12.96	0 451 10 P 3261	O
		0 450 90 F 4058 ¹	K

505 2.2 i

2,2 84/90-96 851B,851Y<ZDJL>;851X<ZDJL Kat.>			
Fg.Nr. 1578001→	10.83-12.93	0 451 10 P 3261	O
	08.83-12.93	0 450 90 F 5030 ¹	K

505 2.5 D

2,5 51-56 155<XD3>			
	11.81-12.93	0 451 10 P 3261	O
	06.81-12.93	CAV 1 457 43 N 4201 ²	K
		PRF 1 457 43 N 1028	K

505 2.5 D Turbo

2,5 66-70/77 152A,152Y<XD3T>;152B<XD3TE>			
	10.83-12.93	0 451 10 P 3238	O
		CAV 1 457 43 N 4201 ²	K
		PRF 1 457 43 N 1028	K

505 2.8 i V6

2,8 105/122 154F<ZN3J>;154X<ZN3J Kat.>			
	06.86-12.93	0 451 10 P 3238	O
		0 450 90 F 5104 ¹	K



508

508 1.6 HDi

1,6 82 9H...<DV6C>			
	10.10→	1 457 42 P 9238	O

508 1.6 i THP

1,6 110 5FN<EP6CDT>			
	11.10→	1 457 42 P 9249	O
		0 450 90 F 2161 ¹	K

1,6|115|5FV<EP6CDT>

	11.10→	1 457 42 P 9249	O
		0 450 90 F 2161 ¹	K

508 1.6 VTi

1,6 85 5FH<EP6C>			
	11.10→	1 457 42 P 9249	O
		F026 40 S 0050	L
		0 450 90 F 2161 ¹	K

1,6|88|5FS<EP6C>

	10.10→	1 457 42 P 9249	O
		F026 40 S 0050	L
		0 450 90 F 2161 ¹	K

508 2.0 HDi

2,0 100-103 RH...<DW10BTED4>			
	10.10→	1 457 42 P 9249	O
		1 457 43 N 1723	K

2,0|100/120|RHD<DW10CTED4>;RHH<DW10CTED4>

	10.10→	1 457 42 P 9249	O
--	--------	-----------------	----------

508 2.2 HDi

2,2 150 4HL<DW12C>			
	10.10→	1 457 42 P 9249	O

605

605 2.0

2,0 79/84 R2A<XU102C>;R5A<XU102C>			
	10.89-05.99	0 451 10 P 3261	O
		1 457 43 S 3250	L
		0 450 90 F 4058 ¹	K

605 2.0 i

2,0 79 RDZ<XU10M KAT.>			
	06.89-06.94	0 451 10 P 3261	O
		1 457 43 S 3250	L
		0 450 90 F 5095 ¹	K

2,0|89-90|RFZ<XU10J2 KAT.>

	06.89-06.94	0 451 10 P 3261	O
		1 457 43 S 3250	L
		0 450 90 F 5095 ¹	K





◀ 605 2.0 i

2,0 94 R6A <XU10J2>	10.89-05.99	0 451 10 P 3261	O
		1 457 43 S 3250	L
		0 450 90 F 5095 ¹	K

605 2.0 i Turbo

2,0 104 RGY <XU10J2TE KAT.>	07.92-06.94	0 451 10 P 3261	O
		1 457 43 S 3250	L
		0 450 90 F 5095 ¹	K

2,0 104-110 RGX <XU10J2TE KAT.>	07.94-05.99	0 451 10 P 3261	O
		1 457 43 S 3250	L
Org.Nr. →7237	07.94-09.96	0 450 90 F 5095 ¹	K
Org.Nr. 7238→	10.96-05.99	0 450 90 F 2161 ¹	K

605 2.0 i 16V

2,0 97-99 RFV <XU10J4R KAT.>	07.94-05.99	0 451 10 P 3261	O
		1 457 43 S 3250	L
Org.Nr. →7237	07.94-09.96	0 450 90 F 5095 ¹	K
Org.Nr. 7238→	10.96-05.99	0 450 90 F 2161 ¹	K

2,0 97-99 R6E <XU10J4R KAT.>	07.94-05.99	0 451 10 P 3261	O
		1 457 43 S 3250	L
Org.Nr. →7237	07.94-09.96	0 450 90 F 5095 ¹	K
Org.Nr. 7238→	10.96-05.99	0 450 90 F 2161 ¹	K

605 2.1 D

2,1 60-61 P9A <XUD11A>	06.89-06.94	0 451 10 P 3261	O
		1 457 43 S 3250	L
		BO 1 457 42 N 9289	K
		CAV 1 457 43 N 4200 ²	K

605 2.1 D, D Turbo

2,1 60-61/80-81 PHZ <XUD11ATE>; PJZ <XUD11A>; P8A <XUD11ATE>; P8B <XUD11ATE>	06.89-10.96	0 451 10 P 3261	O
		1 457 43 S 3250	L
		BO 1 457 42 N 9289	K
		CAV 1 457 43 N 4200 ²	K

605 2.1 D Turbo

2,1 80-81 P8C <XUD11BTE>	07.94-05.99	0 451 10 P 3261	O
		1 457 43 S 3250	L
		1 457 42 N 9291	K

605 2.5 D Turbo

2,5 94-96 THY <DK5ATE>	07.94-05.99	0 451 10 P 3238	O
		1 457 43 S 3250	L
		BO 1 457 42 N 9289	K



605 3.0 i

3,0 123-125 UFZ <ZPJ KAT.>	07.93-05.99	0 451 10 P 3238	O
		1 457 43 S 3250	L
Org.Nr. →7237	07.93-09.96	0 450 90 F 5095 ¹	K
Org.Nr. 7238→	10.96-05.99	0 450 90 F 2161 ¹	K

3,0 140-143 XFZ <ES9J4>	03.97-05.99	0 451 10 P 3261	O
		1 457 43 S 3250	L
		0 450 90 F 5095 ¹	K

605 3.0 i, i 24V

3,0 123/125/147 SFZ <ZPJ KAT.>; SKZ <ZPJ4 KAT.>; S6A <ZPJ>	10.89-10.93	0 451 10 P 3238	O
		1 457 43 S 3250	L
		0 450 90 F 5095 ¹	K

605 3.0 i 24V

3,0 147 UKZ <ZPJ4 KAT.>	07.93-05.99	0 451 10 P 3238	O
		1 457 43 S 3250	L
		0 450 90 F 5095 ¹	K

607 (Z8,Z9)

607 (Z8,Z9) 2.0 HDi

2,0 79 RHS <DW10ATED>	12.04-12.07	0 451 10 P 3355	O
		1 457 07 N 0000	K
		1 987 43 R 2399 ⁸	I

2,0 79/80 RHS <DW10ATED/FAP>; RHZ <DW10ATED>	03.00-11.04	0 451 10 P 3355	O
		1 457 43 S 2200	L
		1 457 07 N 0000	K
		1 987 43 R 2399 ⁸	I

2,0 100 RHR / RHL <DW10BTED4>	03.06→	1 457 42 P 9249	O
		1 457 43 N 1723	K
		1 987 43 R 2399 ⁸	I

607 (Z8,Z9) 2.0 i 16V

2,0 100 RFN <EW10J4>	03.00-11.04	0 451 10 P 3355	O
		LBE 1 457 43 S 2200	L
		0 450 90 F 2161 ¹	K
		1 987 43 R 2399 ⁸	I

607 (Z8,Z9) 2.2 HDi

2,2 98 4HX <DW12TED4>	03.00-12.07	0 451 10 P 3355	O
		1 457 43 S 2200	L
	12.04-12.07	1 457 07 N 0000	K
Org.Nr. →8938	03.00-05.01	1 457 03 N 0013	K
Org.Nr. 8939→	06.01-11.04	1 457 07 N 0000	K
	03.00-12.07	1 987 43 R 2399 ⁸	I

2,2 125 4H ... <DW12BTED4>	05.06→	1 457 42 P 9249	O
		1 987 43 R 2399 ⁸	I





607 (Z8,Z9) 2.2 i, i 16V

2,2 | 116/120 | 3FY <EW12J4>; 3FZ <EW12J4>

03.00-12.07	0 451 10 P 3355	O
LBE	1 457 43 S 2200	L
	0 450 90 F 2161 ¹	K
	1 987 43 R 2399 ⁸	I

607 (Z8,Z9) 2.7 HDi

2,7 | 150 | UHZ <DT17TED4>

12.04->	1 457 42 P9307	O
	F 026 40 N 2004	K
	1 987 43 R 2399 ⁸	I

607 (Z8,Z9) 3.0 i

2,9 | 152 | XFX <ES9J4S>

03.00-11.04	0 451 10 P 3261	O
	1 457 43 S 2200	L
	0 450 90 F 2161 ¹	K
	1 987 43 R 2399 ⁸	I

3,0 | 155 | XFX <ES9A>

12.04->	0 451 10 P 3355	O
	0 450 90 F 2161 ¹	K
	1 987 43 R 2399 ⁸	I

806

806 1.8 i

1,8 | 73 | LFW <XU7JP>

Org.Nr. ->8239	07.95-06.99	0 451 10 P 3261	O
Org.Nr. 8240->	07.99-08.02	0 451 10 P 3355	O
	07.95-08.02	1 457 43 S 2200	L
		0 450 90 F 2161 ¹	K
	3FE	1 987 43 M 2060	I

806 1.9 D Turbo

1,9 | 66-68 | DHX <XUD9TE>; D8B <XUD9TE>

12.94-08.02	0 451 10 P 3261	O
	1 457 43 S 2200	L
	1 457 42 N 9291	K
3FE	1 987 43 M 2060	I

806 2.0 HDi

2,0 | 80 | RHZ <DW10ATED>

08.99-08.02	0 451 10 P 3355	O
	1 457 43 S 2200	L
	1 457 03 N 0013	K
3FE	1 987 43 M 2060	I

2,0 | 81 | RHW <DW10ATED4/L4>

06.00-08.02	0 451 10 P 3355	O	
	1 457 43 S 2200	L	
Org.Nr. ->8910	06.00-04.01	1 457 03 N 0013	K
Org.Nr. 8911->	05.01-08.02	1 457 07 N 0000	K
	06.00-08.02	3FE 1 987 43 M 2060	I



806 2.0 i

2,0 | 89-90 | RFU <XU10J2>

Org.Nr. ->8239	06.94-06.99	0 451 10 P 3261	O
Org.Nr. 8240->	07.99-08.02	0 451 10 P 3355	O
	06.94-08.02	1 457 43 S 2200	L
Org.Nr. ->7160	06.94-06.96	0 450 90 F 5030 ¹	K
Org.Nr. 7161->	07.96-08.02	0 450 90 F 2161 ¹	K
	06.94-08.02	3FE 1 987 43 M 2060	I

806 2.0 i Turbo

2,0 | 108-110 | RGX <XU10J2TE>

Org.Nr. ->8239	06.94-06.99	0 451 10 P 3261	O
Org.Nr. 8240->	07.99-08.02	0 451 10 P 3355	O
	06.94-08.02	1 457 43 S 2200	L
Org.Nr. ->7160	06.94-06.96	0 450 90 F 5030 ¹	K
Org.Nr. 7161->	07.96-08.02	0 450 90 F 2161 ¹	K
	06.94-08.02	3FE 1 987 43 M 2060	I

806 2.0 i 16V

2,0 | 97-99 | RFV <XU10J4R>

Org.Nr. ->8239	05.98-06.99	0 451 10 P 3261	O
Org.Nr. 8240->	07.99-09.00	0 451 10 P 3355	O
	05.98-09.00	1 457 43 S 2200	L
		0 450 90 F 2161 ¹	K
	3FE	1 987 43 M 2060	I

2,0 | 100 | RFN <EW10J4>

09.00-08.02	0 451 10 P 3355	O
	1 457 43 S 2200	L
	0 450 90 F 2161 ¹	K
3FE	1 987 43 M 2060	I

806 2.1 D Turbo

2,1 | 80-81 | P8C <XUD11BTE>

04.96-08.00	KL	0 451 10 P 3261	O
Org.Nr. ->8239	04.96-06.99	KL 0 451 10 P 3261	O
Org.Nr. 8240->	07.99-08.00	KL 0 451 10 P 3355	O
	04.96-08.00	1 457 43 S 2200	L
Org.Nr. ->7302	04.96-11.96	1 457 42 N 9291	K
Org.Nr. 7303->	12.96-08.00	1 457 43 N 1702	K
	04.96-08.00	3FE 1 987 43 M 2060	I

807

807 2.0 HDi

2,0 | 81 | RH... <DW10ATED4/FAP>

06.02-12.06	0 451 10 P 3355	O	
Org.Nr. ->10121	06.02-08.04	1 457 43 S 2200	L
	06.02-12.06	1 457 07 N 0000	K
		1 987 43 M 2091	I

2,0 | 81 | RHW <DW10ATED4>

06.02-12.06	0 451 10 P 3355	O
	1 457 43 S 2200	L
	1 457 07 N 0000	K
	1 987 43 M 2091	I





◀ 807 2.0 HDi

2,0 88/100 RHK <DW10UTED4>; RHR <DW10BTED4>			
03.06-05.10	1 457 42	P 9249	O
	F 026 40	S 0058	L
	1 457 43	N 1723	K
	1 987 43	M 2091	I

2,0 100/120 RHD <DW10CBDTR>; RHH <DW10CTED4>			
06.10→	1 457 42	P 9249	O
	F 026 40	S 0058	L
	1 987 43	M 2091	I

807 2.0 i 16V

2,0 100 RFN <EW10J4>			
06.02-05.06	0 451 10	P 3355	O
	1 457 43	S 2200	L
	0 450 90	F 2161 ¹	K
	1 987 43	M 2091	I

2,0 103 RFJ <EW10A>			
10.05-05.10	1 457 42	P 9249	O
	1 457 43	S 2200	L
	1 987 43	M 2091	I

807 2.2 HDi

2,2 94 4HW <DW12TED4/FAP>			
06.02-07.06	0 451 10	P 3355	O
	1 457 43	S 2200	L
	1 457 07	N 0000	K
	1 987 43	M 2091	I

2,2 125 4H ... <DW12BTED4>			
09.07-05.10	1 457 42	P 9249	O
	F 026 40	S 0058	L
	1 987 43	M 2091	I

807 2.2 i 16V

2,2 116 3FZ <EW12J4>			
06.02-05.06	0 451 10	P 3355	O
	1 457 43	S 2200	L
	0 450 90	F 2161 ¹	K
	1 987 43	M 2091	I

807 3.0 i

2,9 152 XFW <ES9J4S>			
06.02-05.06	0 451 10	P 3261	O
	1 457 43	S 2200	L
	0 450 90	F 2161 ¹	K
	1 987 43	M 2091	I

1007

1007 1.4 HDi

1,4 50 8HX <DV4TD/L5>; 8HZ <DV4TD/CEE2000>			
04.05-01.09	1 457 42	P 9238	O
	1 457 43	S 3076	L
	0 450 90	N 6460 ¹	K
	1 987 43	M 2079	I
	1 987 43	R 2379 ⁸	I



1007 1.4 i

1,4 54/65 KFV <ET3J4>; KFV <TU3A/L5>; KFV <TU3JP>			
04.05→	1 457 42	P 9249	O
LBE	1 457 43	S 3158	L
SBE	1 457 43	S 3159	L
	0 450 90	F 2161 ¹	K
	1 987 43	M 2079	I
	1 987 43	R 2379 ⁸	I

1007 1.6 HDi

1,6 80 9HZ <DV6TED4>			
03.07→	1 457 42	P 9238	O
	1 457 43	S 3160	L
	0 450 90	N 6471 ¹	K
	1 987 43	M 2079	I
	1 987 43	R 2379 ⁸	I

1007 1.6 i

1,6 80 NFU <TU5JP4>			
04.05-01.09	1 457 42	P 9249	O
LBE	1 457 43	S 3325	L
SBE	1 457 43	S 3159	L
	0 450 90	F 2161 ¹	K
	1 987 43	M 2079	I
	1 987 43	R 2379 ⁸	I

3008

3008 1.6 HDi

1,6 80 9HZ <DV6TED4/FAP>			
05.09→	1 457 42	P 9238	O
	1 457 43	S 3160	L
	0 450 90	N 6471 ¹	K
	1 987 43	M 2137	I

1,6 82 9H... <DV6C>			
11.09→	1 457 42	P 9238	O
	1 987 43	M 2137	I

3008 1.6 i

1,6 88 5FS <EP6C>			
09.09→	1 457 42	P 9249	O
	F 026 40	S 0050	L
	1 987 43	M 2137	I

1,6 88 5FW <EP6>			
05.09→	1 457 42	P 9249	O
	F 026 40	S 0050	L
	0 450 90	F 2161 ¹	K
	1 987 43	M 2137	I

1,6 110 5FX <EP6DT>			
05.09→	1 457 42	P 9249	O
Org.Nr. →11920	05.09-07.09	F 026 40	S 0151
	05.09→	0 450 90	F 2161 ¹
		1 987 43	M 2137

1,6 115 5FV <EP6CDT>			
05.09→	1 457 42	P 9249	O
	1 987 43	M 2137	I

**3008 1.6 i THP**

1,6 110/120 5FE <EP6CDT M>; 5FM <EP6CDT M>			
01.11→	1 457 42	P 9249	O
	0 450 90	F 2161 ¹	K
	1 987 43	M 2137	I

3008 2.0 HDi

2,0 110/120 RHE <DW10CTED4/FAP>; RHH <DW10CTED4/FAP>			
05.09→	1 457 42	P 9249	O
	F 026 40	S 0150	L
	1 987 43	M 2137	I

3008 2.0 HDi HYbrid4 4x4

2,0 120 RHH <DW10CTED4/HYbrid>			
09.10→	0 451 10	P 3355	O
	F 026 40	S 0150	L
	1 987 43	M 2137	I

4007**4007 2.0 i, i 4x4**

2,0 108 AFZ <4B11 MMC>			
11.10→	0 451 10	P 3364	O
	1 987 43	R 2416 ⁸	I

4007 2.2 HDi 4x4

2,2 115 4HK <DW12ME5>; 4HN <DW12METED4/FAP>			
09.07→	1 457 42	P 9249	O
	1 987 43	R 2416 ⁸	I

4007 2.4 i 4x4

2,4 125 SF... <4B12 MMC>			
11.07→	0 451 10	P 3364	O
	1 987 43	R 2416 ⁸	I

5008**5008 1.6 HDi**

1,6 80 9H... <DV6TED4/FAP>			
09.09→	1 457 42	P 9238	O
	1 457 43	S 3160	L
	0 450 90	N 6471 ¹	K
	1 987 43	M 2137	I

1,6 | 82 | 9H... <DV6C>

11.09→	1 457 42	P 9238	O
	1 987 43	M 2137	I

5008 1.6 i

1,6 88 5FS <EP6C>			
09.09→	1 457 42	P 9249	O
	F 026 40	S 0050	L
	0 450 90	F 2161 ¹	K
	1 987 43	M 2137	I

**1,6 | 88 | 5FW <EP6>**

09.09→	1 457 42	P 9249	O
	F 026 40	S 0050	L
	1 987 43	M 2137	I

5008 1.6 i THP**1,6 | 115 | 5FV <EP6CDT>**

09.09→	1 457 42	P 9249	O
	0 450 90	F 2161 ¹	K
	1 987 43	M 2137	I

5008 2.0 HDi**2,0 | 110/120 | RHE <DW10CTED4/FAP>; RHH <DW10CTED4/FAP>**

09.09→	1 457 42	P 9249	O
	F 026 40	S 0150	L
	1 987 43	M 2137	I

PLYMOUTH**Acclaim****Acclaim 2.5 i**

2,5 74 TBI			
01.89-08.95	0 451 10	P 3219	O

Acclaim 3.0 LX

3,0 104 EFA			
08.90-08.95	0 451 10	P 3251	O
09.90-08.95	0 451 10	P 3219	O
01.89-08.95	1 457 42	S 9957	L

Grand Voyager**Grand Voyager 3.0 , 4x4**

3,0 105/112 ; EFA			
09.91-08.00	0 451 10	P 3219	O

Grand Voyager 3.3 , 4x4

3,3 118 EGA			
09.95-08.00	0 451 10	P 3219	O

Grand Voyager 3.8 , 4x4

3,8 134 EGA			
09.95-08.99	0 451 10	P 3219	O

Prowler**Prowler 3.5 i 24V**

3,5 157/186 EGE; EGG			
01.96-12.01	0 451 10	P 3219	O
	0 451 10	P 3251	O
	1 457 42	S 9957	L





Sundance

Sundance 2.2

2,2 71 EDF	09.90-12.97	0 451 10 P 3219	0
----------------	-------------	-----------------	---

Voyager

Voyager 2.5

2,5 74 EDM	09.90-08.95	0 451 10 P 3219	0
----------------	-------------	-----------------	---

Voyager 3.0

3,0 112 EFA	09.95-08.00	0 451 10 P 3219	0
-----------------	-------------	-----------------	---

Voyager 3.8 V6

3,8 122-134 EGH	01.95-09.00	0 451 10 P 3219	0
---------------------	-------------	-----------------	---

POLSKI FIAT

Polonez

Polonez 1.5 Turbo

1,5 70	01.78-12.91	0 451 20 P 3154	0
----------	-------------	-----------------	---

PONTIAC

Aztek

Aztek 3.4 , 4x4

3,4 138 LA1	09.00-08.05	0 451 10 P 3079	0
-----------------	-------------	-----------------	---

Bonneville

Bonneville 3.8

3,8 123/126 LN3; L27	09.87-08.94	0 451 10 P 3079	0
--------------------------	-------------	-----------------	---

3,8 153 L36	09.98-05.05	0 451 10 P 3079	0
-----------------	-------------	-----------------	---

3,8 153/167 L67	09.91-08.95	0 451 10 P 3079	0
---------------------	-------------	-----------------	---

3,8 179 L67	09.99-08.03	0 451 10 P 3079	0
-----------------	-------------	-----------------	---

Firebird

Firebird 3.4

3,4 109 L32	09.92-08.95	0 451 10 P 3079	0
-----------------	-------------	-----------------	---



Firebird 3.8

3,8 143 L36	09.94-09.02	0 451 10 P 3079	0
-----------------	-------------	-----------------	---

Grand Am

Grand Am 2.2

2,2 104 L61	09.01-08.05	F 026 40 P 7016	0
-----------------	-------------	-----------------	---

Grand Am 2.3 8V, 16V

2,3 86-90/112-119/130-134 LD2; LG0; LG0; L40	09.87-08.95	0 451 10 P 3079	0
--	-------------	-----------------	---

Grand Am 3.1

3,1 114 L82	09.93-08.98	0 451 10 P 3079	0
-----------------	-------------	-----------------	---

Grand Am 3.3

3,3 119 LG7	09.91-08.93	0 451 10 P 3079	0
-----------------	-------------	-----------------	---

Grand Am 3.4 , V6

3,4 127-131 LA1	09.98-08.05	0 451 10 P 3079	0
---------------------	-------------	-----------------	---

Grand Prix

Grand Prix 3.1

3,1 120/131 LG8; L82	09.93-08.03	0 451 10 P 3079	0
--------------------------	-------------	-----------------	---

Grand Prix 3.8 , Turbo

3,8 145-149/179/194 L26; L32; L36; L67	09.96-08.08	0 451 10 P 3079	0
--	-------------	-----------------	---

G5

G5 2.2

2,2 110 L61	09.06-08.08	F 026 40 P 7016	0
-----------------	-------------	-----------------	---

LeMans

LeMans 1.6

1,6 55	09.87-08.93	0 451 10 P 3079	0
----------	-------------	-----------------	---

Montana

Montana 3.4 , 4x4

3,4 138 LA1	09.98-08.05	0 451 10 P 3079	0
-----------------	-------------	-----------------	---

Montana 3.5 4x4

3,5 149 LX9	09.04-08.06	0 451 10 P 3079	0
-----------------	-------------	-----------------	---





Solstice

Solstice 2.0

2,0 194 5LNF	09.06-09.08	F 026 40 P 7016	0
------------------	-------------	-----------------	---

Solstice 2.4

2,4 132 LE5	09.05→	F 026 40 P 7016	0
-----------------	--------	-----------------	---

Sunbird

Sunbird 2.0 , Turbo

2,0 72-83/123 LT2; LT3	09.86-08.91	0 451 10 P 3079	0
----------------------------	-------------	-----------------	---

Sunfire

Sunfire 2.2 i

2,2 86/90 LN2	09.94-08.02	0 451 10 P 3079	0
-------------------	-------------	-----------------	---

2,2 104 L61	09.01-06.05	F 026 40 P 7016	0
-----------------	-------------	-----------------	---

Trans Sport

Trans Sport 3.1

3,1 90-104 LG6	09.94-08.95	0 451 10 P 3079	0
--------------------	-------------	-----------------	---

Trans Sport 3.4

3,4 134-137 LA1	09.95-08.98	0 451 10 P 3079	0
---------------------	-------------	-----------------	---

Trans Sport 3.8

3,8 112-127 L27	09.91-08.95	0 451 10 P 3079	0
---------------------	-------------	-----------------	---

PORSCHE

Boxster (986,987)

Boxster (986,987) 2.5

2,5 150 M96.20	10.96-08.99	1 457 42 P 9144	0
	XXX	0 450 90 F 5940 ¹	K
		1 987 43 M 2200	I
		1 987 43 R 2407 ⁸	I

Boxster (986,987) 2.7

2,7 162 M96.22	09.99-08.02	1 457 42 P 9144	0
	09.99-08.01 XXX	0 450 90 F 5940 ¹	K
	09.99-08.02	1 987 43 M 2200	I
		1 987 43 R 2407 ⁸	I

☐☐

2,7 168 M96.23	09.02-08.04	1 457 42 P 9144	0
		1 987 43 M 2200	I
		1 987 43 R 2407 ⁸	I

2,7 176/180 M96.25; M97.20	09.04-01.09	1 457 42 P 9144	0
		F 026 40 S0131	L
		1 987 43 R 2407 ⁸	I

Boxster (986,987) 2.9

2,9 188-193 MA1.20	02.09→	F 026 40 S0131	L
		1 987 43 R 2407 ⁸	I

Boxster (986,987) 3.2 S

3,2 185 M96.21	09.99-08.02	1 457 42 P 9144	0
	09.99-08.01 XXX	0 450 90 F 5940 ¹	K
	09.99-08.02	1 987 43 M 2200	I
		1 987 43 R 2407 ⁸	I

3,2 191-196 M96.24	09.02-08.04	1 457 42 P 9144	0
		1 987 43 M 2200	I
		1 987 43 R 2407 ⁸	I

3,2 206 M96.26	09.04-08.06	1 457 42 P 9144	0
		F 026 40 S0131	L
		1 987 43 R 2407 ⁸	I

Boxster (986,987) 3.4 S

3,4 217 M97.21	09.06-01.09	1 457 42 P 9144	0
		F 026 40 S0131	L
		1 987 43 R 2407 ⁸	I

Boxster (986,987) 3.4 S, S Cabriolet, Spyder

3,4 228-231/235 MA1.21; MA1.21C	08.08→	F 026 40 S0131	L
		1 987 43 R 2407 ⁸	I

Carrera GT

Carrera GT 5.7

5,7 450 M80.01	10.04-04.06	1 457 42 P 9144	0
--------------------	-------------	-----------------	---

Cayenne (92A,9PA)

Cayenne (92A,9PA) 3.0

3,0 176 M05.9D	09.08-08.10	F 026 40 P 7102	0
		1 987 42 S 9190	L
		F 026 40 N 2015	K
		1 987 43 R 2431	I

3,0 176 M05.9E	09.10→	F 026 40 P 7066	0
--------------------	--------	-----------------	---





Cayenne (92A,9PA) 3.2

3,2 184 M02.2Y	09.02-01.07	1 457 42 P 9142	0
		1 987 42 S 9190	L
		1 987 43 R 2431	I

Cayenne (92A,9PA) 3.6

3,6 213 M55.01	02.07-08.10	1 457 42 P 9142	0
		1 987 42 S 9190	L
		1 987 43 R 2431	I

3,6 220 M55.02	09.10→	1 457 42 P 9142	0
--------------------	--------	-----------------	---

Cayenne (92A,9PA) 4.5 S, Turbo, Turbo S

4,5 250/331/368/383 M48.00; M48.50	09.02-01.07	1 457 42 P 9144	0
		ZE 1 987 42 S 9190	L
		1 987 43 R 2431	I

Cayenne (92A,9PA) 4.8 GTS, S

4,8 283/298 M48.01; M48.01G	02.07-08.10	F 026 40 P 7102	0
		ZE 1 987 42 S 9190	L
		1 987 43 R 2431	I

Cayenne (92A,9PA) 4.8 S

4,8 294 M48.02	09.10→	F 026 40 P 7102	0
--------------------	--------	-----------------	---

Cayenne (92A,9PA) 4.8 Turbo

4,8 368 M48.52	09.10→	F 026 40 P 7102	0
--------------------	--------	-----------------	---

Cayenne (92A,9PA) 4.8 Turbo, Turbo S

4,8 368-411 M48.51; M48.51T	02.07-08.10	F 026 40 P 7102	0
		ZE 1 987 42 S 9190	L
		1 987 43 R 2431	I

Cayman

Cayman 2.7

2,7 180 M97.20	09.06-01.09	1 457 42 P 9144	0
		F 026 40 S 0131	L
		1 987 43 R 2407 ⁸	I

Cayman 2.9

2,9 195 MA1.20C	02.09→	F 026 40 S 0131	L
		1 987 43 R 2407 ⁸	I

Cayman 3.4 R, S

3,4 235/243 MA1.21C	02.09→	F 026 40 S 0131	L
		1 987 43 R 2407 ⁸	I



Cayman 3.4 S, S Sport

3,4 217/223 M97.21; M97.22	11.05-01.09	1 457 42 P 9144	0
		F 026 40 S 0131	L
		1 987 43 R 2407 ⁸	I

Panamera

Panamera 3.6 , 4

3,6 220 M46.20; M46.40	05.10→	F 026 40 P 7102	0
----------------------------	--------	-----------------	---

Panamera 4.8 S, Turbo, Turbo S, 4S

4,8 294/368/404 M48.20; M48.40; M48.70	03.09→	F 026 40 P 7102	0
--	--------	-----------------	---

911 (964)

911 (964) 3.3 Turbo

3,3 235 M30.69	12.90-08.92	0 451 10 P 3213	0
--------------------	-------------	-----------------	---

911 (964) 3.6 Carrera 2, Carrera 2RS, Carrera 4

3,6 184/191 M64.01; M64.01/.02; M64.03	09.89-08.93	0 451 20 P 3218	0
--	-------------	-----------------	---

911 (964) 3.6 Turbo

3,6 265 M64.50	02.93-09.93	0 451 10 P 3213	0
--------------------	-------------	-----------------	---

911 (996)

911 (996) 3.4 24V Carrera

3,4 220 M96.04	09.99-08.01	1 457 42 P 9144	0
		NAA,XXX 0 450 90 F 5940 ¹	K
		1 987 43 M 2200	I
		1 987 43 R 2407 ⁸	I

911 (996) 3.4 24V Carrera 4, 24V Carrera 4 Cabriolet

3,4 220 M96.02	09.98-08.99	1 457 42 P 9144	0
		1 987 43 M 2200	I
		1 987 43 R 2407 ⁸	I

911 (996) 3.4 24V Carrera, 24V Carrera Cabriolet

3,4 220 M96.01	09.97-08.99	1 457 42 P 9144	0
		XXX 0 450 90 F 5940 ¹	K
		1 987 43 M 2200	I
		1 987 43 R 2407 ⁸	I

911 (996) 3.6 Carrera, Carrera Cabriolet, Carrera Targa, Carrera 4, Carrera 4 Cabriolet, Carrera 4 S, Carrera 4 S Cabriolet

3,6 235/254 M96.03	09.01-07.04	1 457 42 P 9144	0
		1 987 43 M 2200	I
		1 987 43 R 2407 ⁸	I





911 (1996) 3.6 GT2, Turbo Cabriolet 4x4, Turbo Coupé 4x4, Turbo S Cabriolet 4x4, Turbo S Coupé 4x4

3,6 309/331/340-360 M96.70; M96.70E; M96.70S	06.00-09.05	1 457 42 P 9144	0
		1 987 43 M 2007	I
		1 987 43 R 2307 ⁸	I

911 (1996) 3.6 GT3

3,6 265 M96.76	03.99-08.01	1 457 42 P 9144	0
		1 987 43 M 2200	I
		1 987 43 R 2407 ⁸	I

3,6 280 M96.79	10.03-09.05	1 457 42 P 9144	0
		1 987 43 M 2200	I
		1 987 43 R 2407 ⁸	I

911 (1997)

911 (1997) 3.6 Carrera, Carrera Cabriolet, Carrera 4, Carrera 4 Cabriolet, Targa 4

3,6 235-239 M96.05	08.04-05.08	1 457 42 P 9144	0
		1 987 43 R 2407 ⁸	I

3,6 254 MA1.02	06.08→	F 026 40 P 7102	0
		F 026 40 S 0213	L
		1 987 43 R 2407 ⁸	I

911 (1997) 3.6 GT2, GT3

3,6 305/390 M97.70S; M97.76	03.06-08.09	1 457 42 P 9144	0
		1 987 43 R 2407 ⁸	I

911 (1997) 3.6 GT2 RS

3,6 456 M97.70	09.10→	1 457 42 P 9144	0
		1 987 43 R 2407 ⁸	I

911 (1997) 3.6 Turbo Carrera Cabriolet 4x4, Turbo Carrera 4x4

3,6 353 M97.70	03.06-08.09	1 457 42 P 9144	0
		1 987 43 R 2407 ⁸	I

911 (1997) 3.8 Carrera Cabriolet

3,8 283/300 MA1.01; MA1.01S	06.08→	F 026 40 P 7102	0
		F 026 40 S 0213	L
		1 987 43 R 2407 ⁸	I

911 (1997) 3.8 Carrera GTS, Carrera GTS Cabriolet

3,8 283/300 MA1.01; MA1.01S	10.10→	F 026 40 P 7102	0
		1 987 43 R 2407 ⁸	I



911 (1997) 3.8 Carrera S, Carrera S Cabriolet, Carrera 4S, Carrera 4S Cabriolet, Speedster

3,8 283/300 MA1.01; MA1.01S	06.08→	F 026 40 P 7102	0
		F 026 40 S 0213	L
		1 987 43 R 2407 ⁸	I

911 (1997) 3.8 Carrera S, Carrera S Cabriolet, Carrera 4S, Carrera 4S Cabriolet, Targa 4S

3,8 261 M97.01	08.04-05.08	1 457 42 P 9144	0
		1 987 43 R 2407 ⁸	I

911 (1997) 3.8 GT3, GT3 RS

3,8 320/331 M97.77; M97.79R	08.09→	1 457 42 P 9144	0
		1 987 43 R 2407 ⁸	I

911 (1997) 3.8 Sport Classic

3,8 283/300 MA1.01; MA1.01S	10.09→	F 026 40 P 7102	0
		F 026 40 S 0213	L

911 (1997) 3.8 Targa 4S

3,8 283/300 MA1.01; MA1.01S	06.08→	F 026 40 P 7102	0
		F 026 40 S 0213	L
		1 987 43 R 2407 ⁸	I

911 (1997) 3.8 Turbo Cabriolet 4x4, Turbo S Cabriolet 4x4, Turbo S 4x4, Turbo 4x4

3,8 368/390 MA1.70	10.09→	F 026 40 P 7102	0
		1 987 43 R 2407 ⁸	I

928

928 5.0 GT, S4

5,0 235/243 M28.41; M28.47	08.86-07.91	0 451 10 P 3215	0
--------------------------------	-------------	-----------------	---

928 5.4 GTS

5,4 257 M28.49/.50	08.91-11.95	0 451 10 P 3215	0
------------------------	-------------	-----------------	---

944

944 2.5 Turbo

2,5 184 M44.52	09.87-07.91	0 451 10 P 3213	0
--------------------	-------------	-----------------	---

944 3.0 S2

3,0 155 M44.41	12.88-07.91	0 451 10 P 3213	0
	WW	0 451 10 P 3215	0





968

968 3.0 , Turbo S

3,0 | 176/224 | M44.43/.44; M44.44
08.91-11.95 0 451 10 P 3213 0

PROTON

GEN2

GEN2 1.6 i

1,6 | 82 | S4PH <Campro>
02.04→ 0 986 45 P 2041 0

Persona

Persona 1.3 i

1,3 | 55 | 4G13 Euro II
12.95→ 0 986 45 P 2016 0
0 986 45 P 2041 0
0 986 45 F 0604¹ K

1,3 | 55 | 4G13B Euro I
11.94-12.97 0 986 45 P 2016 0
0 986 45 F 0604¹ K

Persona 1.5 i

1,5 | 66 | 4G15 <Euro II>
12.95→ 0 986 45 P 2016 0
0 986 45 F 0604¹ K

1,5 | 66 | 4G15 Euro II
12.95→ 0 986 45 P 2016 0
1 457 43 S 3954 L
0 986 45 F 0604¹ K

Persona 1.5 i 12V

1,5 | 66 | 4G15 Euro I
11.94-12.97 0 986 45 P 2016 0
01.93-12.97 1 457 43 S 3954 L
11.94-12.97 0 986 45 F 0604¹ K

Persona 1.6 i 16V

1,6 | 70 | 4G92 Euro II <SOHC>
12.95→ 0 986 45 P 2041 0
0 986 45 F 0604¹ K

1,6 | 83 | 4G92 Euro I
11.94-12.97 0 986 45 F 0604¹ K

Persona 1.8 i, i 16V

1,8 | 85 | 4G93; 4G93 SOHC
12.95→ 0 986 45 P 2041 0
0 986 45 F 0604¹ K

Persona 2.0 D, D Turbo

2,0 | 50/60 | 4D68
12.95→ 1 457 43 N 4435² K



Satria

Satria 1.3

1,3 | 55 | 4G13
03.96→ 0 986 45 P 2016 0

Savvy

Savvy 1.2 i

1,2 | 55 | D4F <MPI SOHC>
06.05→ 1 457 43 S 3660 L

Waja

Waja 1.6 i

1,6 | 76 | 4G18 S4
09.00→ 0 986 45 P 2041 0

Wira

Wira 1.5

1,5 | 63-66 | 4G15
11.94-06.01 0 986 45 P 2016 0

RENAULT *

Alpine

Alpine A 610 3.0i Turbo

3,0 | 184 | Z7X 744 Kat. <D503>
03.91-12.95 0 451 10 P 3299 0
0 450 90 F 5030¹ K

Alpine 2.5 i Turbo

2,5 | 136 | Z7U 734 Kat.
06.87-12.92 0 451 10 P 3299 0
0 450 90 F 5030¹ K

2,5 | 147 | Z7U 730
03.85-12.92 0 451 10 P 3299 0
1 457 43 S 3230 L
0 450 90 F 5030¹ K

Alpine 2.9

2,9 | 116 | Z6W 700; Z6W 702
03.85-12.92 0 451 10 P 3299 0
1 457 43 S 3232 L

Avantime

Avantime 2.0 16V Turbo

2,0 | 120 | F4R 760; F4R 761; F4R 769
09.01-12.03 0 451 10 P 3336 0
1 457 43 S 3282 L
0 450 90 F 5287¹ K
2FE 1 987 43 M 2049 I





Avantime 2.2 DCI

2,2 110 G9T 712			
12.01-12.03	1 457 42	P 9198	O
	1 457 43	S 3577	L
	1 457 43	N 1705	K
2FE	1 987 43	M 2049	I

Avantime 3.0 V6 24V

3,0 152 L7X 720; L7X 721; L7X 722			
09.01-12.03	0 451 10	P 3299	O
XXX	1 457 43	S 3080	L
	0 450 90	F 5287 ¹	K
2FE	1 987 43	M 2049	I

Clio I

Clio I 1.1

1,1 35-36 C1E 700			
06.90-03.96	0 451 10	P 3336	O
	1 457 43	S 2134	L
	0 450 90	F 4159 ¹	K

Clio I 1.2

1,2 40-44 E5F 710; E5F 716			
06.90-02.98	0 451 10	P 3336	O
	1 457 42	S 9923	L
	0 450 90	F 4159 ¹	K

Clio I 1.2 i

1,2 40 C3G 700,720			
09.95-03.96	0 451 10	P 3336	O
	1 457 43	S 3623	L
09.95-01.96	0 450 90	F 5030 ¹	K
02.96-03.96	0 450 90	F 5287 ¹	K

1,2 | 40-41 | E7F 706 Kat.

06.90-02.98	0 451 10	P 3336	O
	1 457 42	S 9923	L
06.90-01.96	0 450 90	F 5030 ¹	K
02.96-02.98	0 450 90	F 5287 ¹	K

1,2 | 40-44 | D7F 730

04.96-02.98	0 451 10	P 3292	O
	F 026 40	S 0011	L
	0 450 90	F 5287 ¹	K

1,2 | 40/44 | E7F 708 Kat.; E7F 750 Kat.

01.94-02.98	0 451 10	P 3336	O
	1 457 42	S 9923	L
01.94-01.96	0 450 90	F 5030 ¹	K
02.96-02.98	0 450 90	F 5287 ¹	K

1,2 | 44 | E7F 700 Kat.

06.90-03.96	0 451 10	P 3336	O
	1 457 42	S 9923	L
06.90-01.96	0 450 90	F 5030 ¹	K
02.96-03.96	0 450 90	F 5287 ¹	K



1,2 | 44 | E7F 704 Kat.

07.92-03.94	0 451 10	P 3336	O
	1 457 42	S 9923	L
	0 450 90	F 5030 ¹	K

1,2 | 44 | E7F 708

04.96-02.98	0 451 10	P 3336	O
	1 457 42	S 9923	L
	0 450 90	F 5287 ¹	K

Clio I 1.4

1,4 | 55-57 | E6J 712,713; E6J 718; E6J 760

06.90-02.98	0 451 10	P 3336	O
	1 457 42	S 9923	L
	0 450 90	F 4159 ¹	K

Clio I 1.4 i

1,4 | 55-58 | E7J 756,757 Kat.

04.90-02.98	0 451 10	P 3336	O
	1 457 42	S 9923	L
02.96-02.98	0 450 90	F 5287 ¹	K

1,4 | 55-59 | E7J 601 Kat.; E7J 710,711 Kat.; E7J 716 Kat.; E7J 718,719 Kat.; E7J 754 Kat.

06.90-02.98	0 451 10	P 3336	O
	1 457 42	S 9923	L
06.90-01.96	0 450 90	F 5030 ¹	K
02.96-02.98	0 450 90	F 5287 ¹	K

Clio I 1.6 i

1,6 | 54 | C2L

02.96→	1 457 43	S 3233	L
	0 450 90	F 5030 ¹	K

1,6 | 66 | K7M

01.96-08.99	0 451 10	P 3336	O
	1 457 43	S 3233	L
	0 450 90	F 5287 ¹	K
	0 986 BF	CB 0550	I

Clio I 1.7

1,7 | 66-68 | F2N 770

06.90-03.96	0 451 10	P 3336	O
	1 457 43	S 3233	L
	0 450 90	F 4159 ¹	K

Clio I 1.8 i

1,8 | 65-70/80-81 | F3P 710 Kat.; F3P 712 Kat.; F3P 714 Kat.

06.90-02.98	0 451 10	P 3336	O
	1 457 43	S 3233	L
06.90-01.96	0 450 90	F 5030 ¹	K
02.96-02.98	0 450 90	F 5287 ¹	K

1,8 | 66 | F3P 744,745 Kat.

09.96-02.98	0 451 10	P 3336	O
GS	1 457 43	S 3233	L
	0 450 90	F 5287 ¹	K

1,8 | 66 | F3P 745 Kat.

09.96-02.98	0 451 10	P 3336	O
	0 450 90	F 5287 ¹	K





◀ Clio I 1.8 i

1,8 66 F3P 754,755 Kat.	01.94-02.98	0 451 10 P 3336	O
	GS	1 457 43 S 3233	L
	01.94-01.96	0 450 90 F 5030 ¹	K
	02.96-02.98	0 450 90 F 5287 ¹	K

1,8 66 F3P 755 Kat.	01.94-02.98	0 451 10 P 3336	O
	01.94-01.96	0 450 90 F 5030 ¹	K
	02.96-02.98	0 450 90 F 5287 ¹	K

1,8 79-81 F3P 748	09.96-02.98	0 451 10 P 3336	O
		1 457 43 S 3233	L
		0 450 90 F 5287 ¹	K

1,8 79-81 F3P 758	09.96-12.97	0 451 10 P 3336	O
		1 457 43 S 3233	L
		0 450 90 F 5287 ¹	K

1,8 80-81 F3P 758 Kat.	01.94-02.98	0 451 10 P 3336	O
		1 457 43 S 3233	L
	01.94-01.96	0 450 90 F 5030 ¹	K
	02.96-02.98	0 450 90 F 5287 ¹	K

Clio I 1.8 i 16V

1,8 99-103 F7P 720; F7P 722 Kat.	03.91-03.96	0 451 10 P 3336	O
	XXX	1 457 43 S 3032	L
	03.91-01.96	0 450 90 F 5030 ¹	K
	02.96-03.96	0 450 90 F 5287 ¹	K

Clio I 1.9 D

1,9 47 F8Q 672; F8Q 676	04.96-02.98	0 451 10 P 3353	O
		1 457 43 S 3233	L
	LUC	1 457 42 N 9621	K

1,9 47 F8Q 678	10.94-02.96	0 451 10 P 3240	O
	03.96-02.98	0 451 10 P 3353	O
	10.94-02.98	1 457 43 S 3233	L
	BO	1 457 43 N 1028	K

1,9 47 F8Q 692; F8Q 696	09.96-02.98	0 451 10 P 3353	O
		1 457 43 S 3233	L
	LUC	1 457 42 N 9621	K

1,9 47 F8Q 732	06.90-02.96	0 451 10 P 3240	O
	03.96-02.98	0 451 10 P 3353	O
	06.90-02.98	1 457 43 S 3233	L
	BO	1 457 43 N 1028	K
	LUC	1 457 42 N 9621	K
	03.96→	0 986 BF CB 0550	I

1,9 47-48 F8Q 714; F8Q 730	06.90-02.96	0 451 10 P 3240	O
	03.96-02.98	0 451 10 P 3353	O
	06.90-02.98	1 457 43 S 3233	L
	BO	1 457 43 N 1028	K
	LUC	1 457 42 N 9621	K



1,9 48 F8Q-676	04.95-10.00	0 451 10 P 3336	O
	BO	1 457 42 N 9657	K
	LUC	1 457 42 N 9621	K

Clio I 2.0 i Williams

2,0 108-110 F7R 700	07.92-03.96	0 451 10 P 3336	O
	XXX	1 457 43 S 3032	L
	07.92-01.96	0 450 90 F 5030 ¹	K
	02.96-03.96	0 450 90 F 5287 ¹	K

Clio II

Clio II 1.0 i

1,0 43 D7D 760	03.99-03.00	0 451 10 P 3292	O
	04.00-03.03	1 457 42 P 9184	O
	04.03-11.04	0 451 10 P 4025	O
	03.99-11.04	F 026 40 S 0011	L
		0 450 90 F 5287 ¹	K
		1 987 43 M 2039	I
		1 987 43 R 2197 ⁸	I

Clio II 1.0 i 8V

1,0 43 D7D	09.99-03.00	0 451 10 P 3292	O
	09.99-12.06	F 026 40 S 0011	L
		0 450 90 F 5287 ¹	K
		0 986 BF CB 0550	I

Clio II 1.0 i 16V

1,0 50 D4D 700	06.01-02.03	1 457 42 P 9184	O
	03.03-11.04	0 451 10 P 4025	O
	06.01-11.04	1 457 43 S 3078	L
		0 450 90 F 5287 ¹	K
		1 987 43 M 2039	I
		1 987 43 R 2197 ⁸	I

1,0 50 D4D 706	12.04-10.07	0 451 10 P 4025	O
		1 457 43 S 3660	L
		1 987 43 M 2039	I
		1 987 43 R 2197 ⁸	I

1,0 52 D4D	01.01-12.02	0 986 45 P 2061	O
	01.01-01.05	1 457 43 S 3078	L
	06.00-01.05	0 450 90 F 5287 ¹	K
		0 986 BF CB 0550	I

Clio II 1.2

1,2 43 D7F726	10.99-03.00	0 451 10 P 3292	O
	04.00-03.03	1 457 42 P 9184	O
	04.03→	0 451 10 P 4025	O
	10.99→	F 026 40 S 0011	L
		0 450 90 F 5287 ¹	K
		1 987 43 M 2039	I
		1 987 43 R 2197 ⁸	I





1,2 43 D7F766	01.01→	0 451 10 P 4025	O
		F 026 40 S 0011	L
		1 987 43 M 2039	I
		1 987 43 R 2197 ⁸	I

Clio II 1.2 i

1,2 43 D7F 720; D7F 722	03.98-03.00	0 451 10 P 3292	O
	04.00-03.03	1 457 42 P 9184	O
	04.03-10.07	0 451 10 P 4025	O
	03.98-10.07	F 026 40 S 0011	L
		0 450 90 F 5287 ¹	K
		1 987 43 M 2039	I
		1 987 43 R 2197 ⁸	I

1,2 43 D7F 744; D7F 746; D7F 764	03.98-02.03	1 457 42 P 9184	O
	03.03-10.07	0 451 10 P 4025	O
	03.98-10.07	F 026 40 S 0011	L
		0 450 90 F 5287 ¹	K
		1 987 43 M 2039	I
		1 987 43 R 2197 ⁸	I

Clio II 1.2 i 16V

1,2 55 D4F	03.03→	0 451 10 P 4025	O
	01.02→	1 457 43 S 3163	L
		0 450 90 F 5287 ¹	K

1,2 55 D4F 706; D4F 712	03.00-02.03	1 457 42 P 9184	O
	03.03-03.04	0 451 10 P 4025	O
	03.00-03.04	1 457 43 S 3078	L
		0 450 90 F 5287 ¹	K
		1 987 43 M 2039	I
		1 987 43 R 2197 ⁸	I

1,2 55 D4F 728	04.04-10.07	0 451 10 P 4025	O
		1 457 43 S 3660	L
		1 987 43 M 2039	I
		1 987 43 R 2197 ⁸	I

Clio II 1.2 16V

1,2 55 D4F722	10.03→	0 451 10 P 4025	O
		1 457 43 S 3660	L
		0 450 90 F 5287 ¹	K
		1 987 43 M 2039	I
		1 987 43 R 2197 ⁸	I

Clio II 1.4 i

1,4 55 E7J 634; E7J 635	03.99-10.07	0 451 10 P 3336	O
		1 457 43 S 3311	L
		0 450 90 F 5287 ¹	K
		1 987 43 M 2039	I
		1 987 43 R 2197 ⁸	I

1,4 55 E7J 780	03.98-10.07	0 451 10 P 3336	O
		1 457 43 S 3606	L
		0 450 90 F 5287 ¹	K
		1 987 43 M 2039	I
		1 987 43 R 2197 ⁸	I

1,4 | 55 | K7J 700

	10.00-10.07	0 451 10 P 3336	O
		1 457 43 S 3311	L
		0 450 90 F 5287 ¹	K
		1 987 43 M 2039	I
		1 987 43 R 2197 ⁸	I

Clio II 1.4 i 16V

1,4 70-72 K4J 710; K4J 711; K4J 712; K4J 713; K4J 715	10.99-10.07	0 451 10 P 3336	O
		1 457 43 S 3529	L
		0 450 90 F 5287 ¹	K
		1 987 43 M 2039	I
		1 987 43 R 2197 ⁸	I

Clio II 1.5 dCi

1,5 47 K9K740	04.07-08.07	0 451 10 P 3336	O
	09.07→	F 026 40 P 7022	O
	04.07→	F 026 40 S 0051	L
		1 987 43 R 2197 ⁸	I

1,5 | 48 | K9K-700

	06.03→	1 457 43 S 3163	L
		0 986 BF CB 0550	I

1,5 | 48/60 | K9K 700; K9K 702; K9K 704; K9K 710

	06.01-10.07	0 451 10 P 3336	O
		1 457 43 S 3163	L
	06.01-01.05 WAS	0 450 90 N 6468 ¹	K
	06.01-10.07	1 987 43 M 2039	I
		1 987 43 R 2197 ⁸	I

1,5 | 50 | K9K 714

	10.05-10.07	0 451 10 P 3336	O
		F 026 40 S 0051	L
		1 987 43 M 2039	I
		1 987 43 R 2197 ⁸	I

1,5 | 62 | K9K718

	02.07→	0 451 10 P 3336	O
		F 026 40 S 0051	L
		1 987 43 M 2039	I
		1 987 43 R 2197 ⁸	I

1,5 | 74 | K9K 712

	03.03-10.07	0 451 10 P 3336	O
		F 026 40 S 0051	L
	03.03-01.05 WAS	0 450 90 N 6468 ¹	K
	03.03-10.07	1 987 43 M 2039	I
		1 987 43 R 2197 ⁸	I





Clio II 1.6 i

1,6 66 K4M 736	11.04-10.07	0 451 10 P 3336	O
		1 457 43 S 3529	L
		1 987 43 M 2039	I
		1 987 43 R 2197 ⁸	I

1,6 66 K4M 746	10.99-10.07	0 451 10 P 3336	O
		1 457 43 S 3311	L
		0 450 90 F 5287 ¹	K
		1 987 43 M 2039	I
		1 987 43 R 2197 ⁸	I

1,6 66 K7M 744; K7M 745	03.98-10.07	0 451 10 P 3336	O
		1 457 43 S 3606	L
		0 450 90 F 5287 ¹	K
		1 987 43 M 2039	I
		1 987 43 R 2197 ⁸	I

1,6 66/81 K4M 740; K4M 742; K4M 743; K4M 744; K4M 745	10.99-10.07	0 451 10 P 3336	O
		1 457 43 S 3529	L
		0 450 90 F 5287 ¹	K
		1 987 43 M 2039	I
		1 987 43 R 2197 ⁸	I

Clio II 1.6 i 8V

1,6 66 K7M	09.99-12.02	0 451 10 P 3336	O
		1 457 43 S 3311	L
		0 450 90 F 5287 ¹	K
		0 986 BF CB 0550	I

Clio II 1.6 i 16V

1,6 66/81 K4M 740; K4M 742; K4M 743; K4M 744; K4M 745	06.99→	0 451 10 P 3336	O
		0 450 90 F 5287 ¹	K

1,6 79 K4M 708	08.00-10.07	0 451 10 P 3336	O
		1 457 43 S 3529	L
		0 450 90 F 5287 ¹	K
		1 987 43 M 2039	I
		1 987 43 R 2197 ⁸	I

1,6 79 K4M 748	06.98-10.07	0 451 10 P 3336	O
		1 457 43 S 3529	L
		0 450 90 F 5287 ¹	K
		1 987 43 M 2039	I
		1 987 43 R 2197 ⁸	I

1,6 81 K4M	05.00-12.06	0 450 90 F 5287 ¹	K
		0 986 BF CB 0550	I



Clio II 1.9 D

1,9 47-48 F8Q 630	03.98-10.07	0 451 10 P 3336	O
		1 457 43 S 3773	L
		LUC 1 457 43 N 1712	K
		PRF 1 457 42 N 9657	K
		1 987 43 M 2039	I
		1 987 43 R 2197 ⁸	I

1,9 47-48 F8Q 632	03.99-10.07	0 451 10 P 3336	O
		F 026 40 S 0015	L
		BO,PRF 1 457 42 N 9657	K
		LUC 1 457 43 N 1712	K
		1 987 43 M 2039	I
		1 987 43 R 2197 ⁸	I

1,9 47-48 F8Q 662	03.98-10.07	0 451 10 P 3336	O
		1 457 43 S 3773	L
		BO,PRF 1 457 42 N 9657	K
		LUC 1 457 43 N 1712	K
		1 987 43 M 2039	I
		1 987 43 R 2197 ⁸	I

Clio II 1.9 D DTI

1,9 59 F9Q 780; F9Q 782	03.99-10.07	0 451 10 P 3336	O
		1 457 43 S 3531	L
		1 457 43 N 1712	K
		1 987 43 M 2039	I
		1 987 43 R 2197 ⁸	I

Clio II 2.0 16V

2,0 124 F4R 730; F4R 732	03.99-10.07	0 451 10 P 3336	O
		1 457 43 S 3230	L
		0 450 90 F 5287 ¹	K
		1 987 43 M 2039	I
		1 987 43 R 2197 ⁸	I

2,0 124 F4R 736; F4R 738	06.01-10.07	0 451 10 P 3336	O
		1 457 43 S 3320	L
		0 450 90 F 5287 ¹	K
		1 987 43 M 2039	I
		1 987 43 R 2197 ⁸	I

Clio II 3.0 24V Sport

3,0 170 L7X 760	09.00-11.02	0 451 10 P 3299	O
		1 457 43 S 3075	L
		0 450 90 F 5287 ¹	K
		1 987 43 M 2039	I
		1 987 43 R 2197 ⁸	I

3,0 170/188 L7X 762	09.00-06.05	0 451 10 P 3299	O
		0 450 90 F 5287 ¹	K
		1 987 43 M 2039	I





Clio III (BR/CR/KR)

Clio III (BR/CR/KR) 1.2

1,1 57,5 D4F 764	08.07→	0 451 10 P 4025	O
		1 457 43 S 3660	L
		0 450 90 F 5287 ¹	K
		1 987 43 M 2120	I

1,2 | 48/55/57,5 | D4F 740; D4F 742; D4F 764

1,2 48/55/57,5 D4F 740; D4F 742; D4F 764	06.05→	0 451 10 P 4025	O
		1 457 43 S 3660	L
		0 450 90 F 5287 ¹	K
		1 987 43 M 2120	I

Clio III (BR/CR/KR) 1.2 TCe

1,1 | 74 | D4F 78...

1,1 74 D4F 78...	08.07→	0 451 10 P 4025	O
		1 457 43 S 3595	L
		0 450 90 F 5287 ¹	K
		1 987 43 M 2120	I

Clio III (BR/CR/KR) 1.4

1,4 | 72 | K4J 780

1,4 72 K4J 780	06.05→	0 451 10 P 3336	O
		F 026 40 S 0047	L
		0 450 90 F 5287 ¹	K
		1 987 43 M 2120	I

Clio III (BR/CR/KR) 1.5 dCi

1,5 | 50 | K9K 768

1,5 50 K9K 768	06.05-09.07	0 451 10 P 3336	O
	09.07→	F 026 40 P 7022	O
	06.05-06.07	1 457 43 S 3595	L
	07.07→	F 026 40 S 0047	L
	06.05→	WAS 0 450 90 N 6473 ¹	K
		1 987 43 M 2120	I

1,5 | 50/63 | K9K 760; K9K 762

1,5 50/63 K9K 760; K9K 762	06.05-08.07	0 451 10 P 3336	O
	09.07-10.09	F 026 40 P 7022	O
	06.05-10.09	F 026 40 S 0047	L
		WAS 0 450 90 N 6473 ¹	K
		1 987 43 M 2120	I

1,5 | 50/65 | K9K 750; K9K 752

1,5 50/65 K9K 750; K9K 752	11.05→	0 451 10 P 3336	O
		1 457 43 S 3595	L
		WAS 0 450 90 N 6473 ¹	K
		1 987 43 M 2120	I

1,5 | 63/78 | K9K 764; K9K 766

1,5 63/78 K9K 764; K9K 766	06.05-09.07	0 451 10 P 3336	O
	10.07→	F 026 40 P 7022	O
	06.05→	F 026 40 S 0047	L
		WAS 0 450 90 N 6473 ¹	K
	1 987 43 M 2120	I	



1,5 | 78 | K9K 772

1,5 78 K9K 772	03.06-09.07	0 451 10 P 3336	O
	09.07→	F 026 40 P 7022	O
	03.06→	F 026 40 S 0047	L
		WAS 0 450 90 N 6473 ¹	K
		1 987 43 M 2120	I

Clio III (BR/CR/KR) 1.6 , 16V

1,6 | 65/82/94 | K4M 800; K4M 801; K4M 804; K4M 862

1,6 65/82/94 K4M 800; K4M 801; K4M 804; K4M 862	06.05→	0 451 10 P 3336	O
		F 026 40 S 0047	L
		0 450 90 F 5287 ¹	K
		1 987 43 M 2120	I

Clio III (BR/CR/KR) 2.0

2,0 | 102 | M4R 700; M4R 701

2,0 102 M4R 700; M4R 701	06.05-09.05	0 986 45 P 2061	O
	10.05→	F 026 40 P 7001	O
	06.05→	F 026 40 S 0047	L
		0 450 90 F 5287 ¹	K
		1 987 43 M 2120	I

Clio III (BR/CR/KR) 2.0 R.S., Sport

2,0 | 145/147,5 | F4R 830; F4R 832

2,0 145/147,5 F4R 830; F4R 832	12.05→	0 451 10 P 3336	O
		F 026 40 S 0047	L
		0 450 90 F 5287 ¹	K
		1 987 43 M 2120	I

Espace II

Espace II 2.0 i

2,0 | 77 | J7R 768

2,0 77 J7R 768	01.91-09.96	0 451 10 P 3299	O
		1 457 43 S 2124	L
		0 450 90 F 5030 ¹	K

Espace II 2.1 D Turbo

2,1 | 65 | J8S 610

2,1 65 J8S 610	06.92-09.96	0 451 10 P 3353	O
		1 457 43 S 3231	L
		BO 1 457 43 N 4150 ²	K
		BO,XXX 1 457 43 N 4150 ²	K
		CAV 1 457 43 N 4200 ²	K

2,1 | 66 | J8S 612

2,1 66 J8S 612	12.94-09.96	0 451 10 P 3353	O
		1 457 43 S 3231	L
		BO 1 457 43 N 4150 ²	K
		BO,XXX 1 457 43 N 4150 ²	K

Espace II 2.1 D Turbo, D Turbo 4x4

2,1 | 65 | J8S 772; J8S 776; J8S 778

2,1 65 J8S 772; J8S 776; J8S 778	01.91-09.96	0 451 10 P 3353	O
		1 457 43 S 3231	L
		BO 1 457 43 N 4150 ²	K
		BO,XXX 1 457 43 N 4150 ²	K
		CAV 1 457 43 N 4200 ²	K





Espace II 2.2 i, i 4x4

2,2 79-81 J7T 772; J7T 772,773; J7T 776			
01.91-09.96	0 451 10 P 3299	O	
	1 457 43 S 2124	L	
	0 450 90 F 5030 ¹	K	

Espace II 2.9 i

2,9 110-113 Z7W 712,713; Z7W 717			
01.91-09.96	0 451 10 P 3299	O	
	1 457 43 S 3230	L	
	0 450 90 F 5030 ¹	K	

Espace III

Espace III 1.9 dTi

1,9 72 F9Q 720; F9Q 722			
02.99-10.02	0 451 10 P 3336	O	
	1 457 43 S 3161	L	
	PRF 1 457 43 N 1705	K	
	2FE 1 987 43 M 2049	I	

Espace III 2.0 i

2,0 83,5 F3R 728			
10.96-06.97	0 451 10 P 3336	O	
	1 457 43 S 3260	L	
10.96-10.96	0 450 90 F 5287 ¹	K	
11.96-06.97	0 450 90 F 5030 ¹	K	
10.96-06.97	2FE 1 987 43 M 2049	I	

2,0 | 83,5 | F3R 729

10.96-10.97	0 451 10 P 3336	O	
	1 457 43 S 3260	L	
10.96-10.96	0 450 90 F 5287 ¹	K	
11.96-07.97	0 450 90 F 5030 ¹	K	
08.97-10.97	0 450 90 F 5287 ¹	K	
10.96-10.97	2FE 1 987 43 M 2049	I	

2,0 | 83,5 | F3R 768

10.96-10.02	0 451 10 P 3336	O	
	1 457 43 S 3260	L	
10.96-10.96	0 450 90 F 5287 ¹	K	
11.96-07.97	0 450 90 F 5030 ¹	K	
08.97-10.02	0 450 90 F 5287 ¹	K	
10.96-10.02	2FE 1 987 43 M 2049	I	

2,0 | 83,5 | F3R 769

10.96-10.02	0 451 10 P 3336	O	
	1 457 43 S 3260	L	
10.96-10.96	0 450 90 F 5287 ¹	K	
11.96-07.97	0 450 90 F 5030 ¹	K	
08.97-10.02	0 450 90 F 5287 ¹	K	
10.96-10.02	2FE 1 987 43 M 2049	I	

Espace III 2.0 i GPL

2,0 83,5 F3R 742			
02.98-10.02	0 451 10 P 3336	O	
	1 457 43 S 3260	L	
	0 450 90 F 5287 ¹	K	
	2FE 1 987 43 M 2049	I	



Espace III 2.0 i 16V

2,0 102-103 F4R 700; F4R 701			
10.98-10.02	0 451 10 P 3336	O	
	0 450 90 F 5287 ¹	K	
	2FE 1 987 43 M 2049	I	

Espace III 2.2 D Turbo

2,2 83 G8T 714			
10.96-01.99	F 026 40 P 7106	O	
02.99-10.02	0 451 10 P 3353	O	
10.96-10.02	1 457 43 S 3282	L	
10.96-12.97	BO 1 457 43 N 4291 ²	K	
11.97-10.02	PRF 1 457 43 N 1705	K	
10.96-10.02	2FE 1 987 43 M 2049	I	

2,2 | 83 | G8T 716

10.96-01.99	F 026 40 P 7106	O	
02.99-10.02	0 451 10 P 3353	O	
10.96-10.02	1 457 43 S 3282	L	
10.96-10.97	1 457 43 N 4291 ²	K	
11.97-10.02	1 457 43 N 1705	K	
10.96-10.02	2FE 1 987 43 M 2049	I	

Espace III 2.2 dCi

2,2 85-95 G9T...			
07.00-10.02	1 457 42 P 9198	O	
	1 457 43 S 3577	L	
	0 450 90 N 6461 ¹	K	
	2FE 1 987 43 M 2049	I	

Espace III 3.0 i V6

3,0 123 Z7X 775			
10.96-10.02	0 451 10 P 3299	O	
	1 457 43 S 3261	L	
10.96-10.96	0 450 90 F 5287 ¹	K	
11.96-07.97	0 450 90 F 5030 ¹	K	
08.97-10.02	0 450 90 F 5287 ¹	K	
10.96-10.02	2FE 1 987 43 M 2049	I	

Espace III 3.0 i V6 24V

3,0 140 L7X 727			
10.98-10.02	0 451 10 P 3299	O	
	XXX 1 457 43 S 3080	L	
	0 450 90 F 5287 ¹	K	
	2FE 1 987 43 M 2049	I	

Espace IV

Espace IV 1.9 dCi

1,9 88 F9Q 680; F9Q 820; F9Q 826			
11.02-12.06	F 026 40 P 7022	O	
	1 457 43 S 3075	L	
	1 457 43 N 1705	K	
	1 987 43 R 2400 ⁸	I	

Espace IV 2.0 , 16V

2,0 100 F4R 790; F4R 791; F4R 792			
11.02→	0 451 10 P 3336	O	
	1 457 43 S 3529	L	
	0 450 90 F 5287 ¹	K	
	1 987 43 R 2400 ⁸	I	





Espace IV 2.0 dCi

2,0 96 110 127 M9R 740; M9R 760; M9R 761			
05.05→	F 026 40	P 7014	O
	1 457 43	S 3075	L
	1 457 43	N 1705	K
	1 987 43	R 2400 ⁸	I

Espace IV 2.0 TCe

2,0 125 F4R 796			
06.04→	0 451 10	P 3336	O
	1 457 43	S 3075	L
	0 450 90	F 5287 ¹	K
	1 987 43	R 2400 ⁸	I

2,0 125 F4R 797			
06.04→	0 451 10	P 3336	O
	1 457 43	S 3075	L
	0 450 90	F 5287 ¹	K
	1 987 43	R 2400 ⁸	I

2,0 125 F4R 896; F4R 897			
06.05→	0 451 10	P 3336	O
	1 457 43	S 3075	L
	0 450 90	F 5287 ¹	K
	1 987 43	R 2400 ⁸	I

Espace IV 2.0 Turbo

2,0 120 F4R 794			
11.02-12.06	0 451 10	P 3336	O
	1 457 43	S 3075	L
	0 450 90	F 5287 ¹	K
	1 987 43	R 2400 ⁸	I

2,0 120 F4R 795			
11.02-12.06	0 451 10	P 3336	O
	1 457 43	S 3075	L
	0 450 90	F 5287 ¹	K
	1 987 43	R 2400 ⁸	I

Espace IV 2.2 dCi

2,2 102 G9T 645			
07.05→	F 026 40	P 7014	O
	1 457 43	S 3075	L
	1 457 43	N 1705	K
	1 987 43	R 2400 ⁸	I

2,2 110 G9T 642			
11.02-12.06	1 457 42	P 9198	O
	1 457 43	S 3075	L
	1 457 43	N 1705	K
	1 987 43	R 2400 ⁸	I

2,2 110 G9T 742; G9T 743			
11.02-12.06	1 457 42	P 9198	O
	1 457 43	S 3075	L
	1 457 43	N 1705	K
	1 987 43	R 2400 ⁸	I



Espace IV 3.0 dCi

3,0 130 P9X 701			
11.02-12.06	1 457 42	P 9302	O
	1 457 43	S 3075	L
	1 457 43	N 1705	K
	1 987 43	R 2400 ⁸	I

3,0 133 P9X 715			
07.05-05.08	1 457 43	N 1705	K
07.05→	1 987 43	R 2400 ⁸	I

Espace IV 3.5

3,5 177 V4Y 711			
11.02→	0 986 45	P 2061	O
	1 457 43	S 3075	L
	0 450 90	F 5287 ¹	K
	1 987 43	R 2400 ⁸	I

3,5 177 V4Y 715			
10.05→	0 986 45	P 2061	O
	0 450 90	F 5287 ¹	K
	1 987 43	R 2400 ⁸	I

Express

Express 1.9 D

1,9 40 F8Q-682			
07.95-09.02	0 451 10	P 3240	O
	BO	1 457 43	N 1028
	LUC	1 457 42	N 9621
			K

Express, Extra, Rapid

Express, Extra, Rapid 1.0

1,0 27-30 C1C 706,700			
03.86-08.91	0 451 10	P 3336	O

Express, Extra, Rapid 1.1

1,1 33 C1E 756			
06.87-08.91	0 451 10	P 3336	O
	TW	1 457 43	S 2204
			L

1,1 34 C1E 754			
03.86-08.91	0 451 10	P 3336	O
	TW	1 457 43	S 2134
			L

1,1 34/36 C1E 760; C1E 762; C1E 764; C1E 792			
03.86-10.97	0 451 10	P 3336	O
		1 457 43	S 2134
			L

Express, Extra, Rapid 1.2

1,2 40 C1G 726,730			
09.91-09.96	0 451 10	P 3336	O
		1 457 43	S 2134
			L





Express, Extra, Rapid 1.2 i

1,2 40 C3G 700,710	09.91-10.97	0 451 10 P 3336	O
		1 457 43 S 3623	L
	09.91-01.96	0 450 90 F 5030 ¹	K
	02.96-10.97	0 450 90 F 5287 ¹	K

1,2 40 C3G 712	10.96-10.97	0 451 10 P 3336	O
		1 457 43 S 3623	L
		0 450 90 F 5287 ¹	K

Express, Extra, Rapid 1.4

1,4 43 E6J 734,712; E6J 738,712	09.91-09.97	0 451 10 P 3336	O
		1 457 42 S 9923	L

1,4 43/44 C1J 768,715; C1J 780; C2J 782,784	03.86-09.97	0 451 10 P 3336	O
		1 457 43 S 2134	L

Express, Extra, Rapid 1.4 i

1,4 44 C3J 702 Kat.	06.87-08.91	0 451 10 P 3336	O
		1 457 43 S 2134	L
	09.90-08.91	0 450 90 F 5030 ¹	K

1,4 44 C3J 760 Kat.	06.87-08.91	0 451 10 P 3336	O
	09.90-08.91	0 450 90 F 5030 ¹	K

1,4 44 C3J 762 Kat.	09.91-03.97	0 451 10 P 3336	O
	09.91-01.96	0 450 90 F 5030 ¹	K
	02.96-03.97	0 450 90 F 5287 ¹	K

1,4 55-59 E7J 720 Kat.; E7J 724,710 Kat.; E7J 726,710 Kat.; E7J 728,754 Kat.	09.91-10.97	0 451 10 P 3336	O
		1 457 42 S 9923	L
	09.91-01.96	0 450 90 F 5030 ¹	K
	02.96-10.97	0 450 90 F 5287 ¹	K

1,4 55-59 E7J 770,771	03.96-09.97	0 451 10 P 3336	O
		1 457 42 S 9923	L
		0 450 90 F 5287 ¹	K

1,4 55-59 E7J 773,710 Kat.	03.94-10.97	0 451 10 P 3336	O
		1 457 42 S 9923	L
	03.94-01.96	0 450 90 F 5030 ¹	K
	02.96-10.97	0 450 90 F 5287 ¹	K

Express, Extra, Rapid 1.6 D

1,6 40 F8M 720; F8M 730	03.86-03.97	0 451 10 P 3336	O
		1 457 42 S 9079	L
		BO 1 457 43 N 1028	K
		CAV 1 457 43 N 4201 ²	K



1,6 40 F8M 736	09.91-03.97	0 451 10 P 3336	O
Mot.Nr. C099635→	04.93-03.97	ERH 0 451 10 P 3240	O
	09.91-03.97	1 457 42 S 9079	L
		BO 1 457 43 N 1028	K
		CAV 1 457 43 N 4201 ²	K

1,6 40 F8M 760	09.91-03.97	0 451 10 P 3336	O
		1 457 42 S 9079	L
		BO 1 457 43 N 1028	K
		1 457 43 N 4106 ²	K
		CAV 1 457 43 N 4201 ²	K

Express, Extra, Rapid 1.9 D

1,9 40 F8Q 640	09.94-02.96	0 451 10 P 3240	O
	03.96-03.97	0 451 10 P 3353	O
	09.94-03.97	1 457 43 S 3233	L
	09.94-03.96	BO 1 457 43 N 1028	K
	04.96-03.97	LUC 1 457 42 N 9621	K

1,9 40/47-48 F8Q 644; F8Q 646; F8Q 648; F8Q 680; F8Q 682; F8Q 684	06.96-09.97	0 451 10 P 3353	O
		1 457 43 S 3233	L
		LUC 1 457 42 N 9621	K

1,9 47-48 F8Q 722,730	09.91-09.92	0 451 10 P 3240	O
		1 457 43 S 3233	L
		BO 1 457 43 N 1028	K

1,9 47-48 F8Q 724,732	09.91-02.96	0 451 10 P 3240	O
	03.96-10.97	0 451 10 P 3353	O
	09.91-10.97	1 457 43 S 3233	L
		BO 1 457 43 N 1028	K

1,9 47-48 F8Q 774	10.92-02.96	0 451 10 P 3240	O
	10.92-09.96	1 457 43 S 3233	L
		BO 1 457 43 N 1028	K

1,9 47-48 F8Q 776,730	09.91-02.96	0 451 10 P 3240	O
	03.96-03.97	0 451 10 P 3353	O
	09.91-03.97	1 457 43 S 3233	L
	09.91-03.96	BO 1 457 43 N 1028	K
	04.96-03.97	LUC 1 457 42 N 9621	K

Fluence

Fluence 1.5 dCi

1,5 63/66/78/81 K9K 830; K9K 832; K9K 834; K9K 836	11.09→	F 026 40 P 7022	O
		F 026 40 S 0138	L
		F 026 40 N 2067 ¹	K

Fluence 1.6

1,6 81 K4M 838; K4M 839	11.09→	0 451 10 P 3336	O
		F 026 40 S 0138	L
		0 450 90 F 5287 ¹	K





Fluence 2.0

2,0 103 M4R 714	02.10→	F 026 40 S0138 L 0 450 90 F 5287 ¹ K
2,0 103 M4R 751	02.10→	F 026 40 S 0139 L 0 450 90 F 5287 ¹ K

Kangoo

Kangoo 1.2 i 16V

1,2 44 D4F	03.03→	0 451 10 P 4025 O
	01.02→	0 450 90 F 5287 ¹ K

Kangoo 1.6 i 8V

1,6 66 K7M-746	06.99-12.03	1 457 43 S 3311 L 0 986 BF CB 0550 I
----------------	-------------	---

Kangoo 1.6 i 16V

1,6 70 K4M-706	02.03→	0 451 10 P 3336 O 1 457 43 S 3311 L 0 450 90 F 5287 ¹ K
----------------	--------	---

1,6 81 K4M	01.02→	0 450 90 F 5287 ¹ K
------------	--------	---------------------------------------

Kangoo 1.9 D

1,9 47 F8Q	01.99→	1 457 43 S 3773 L PRF 1 457 42 N 9657 K 0 986 BF CB 0550 I
------------	--------	---

Kangoo I

Kangoo I 1.0 i

1,0 43 D7D 700; D7D 760	09.98-03.00	0 451 10 P 3292 O
	04.00-03.03	1 457 42 P 9184 O
	04.03-12.07	0 451 10 P 4025 O
	09.98-12.07	F 026 40 S 0011 L 0 450 90 F 5287 ¹ K KL 1 987 43 M 2039 I KL 1 987 43 M 2193 I

Kangoo I 1.0 i 16V

1,0 50 D4D 700; D4D 720	02.01-02.03	1 457 42 P 9184 O
	03.03-12.07	0 451 10 P 4025 O
	02.01-12.07	1 457 43 S 3078 L 0 450 90 F 5287 ¹ K KL 1 987 43 M 2039 I KL 1 987 43 M 2193 I

Kangoo I 1.2 GPL, i

1,2 44 D7F 710	10.97-12.07	0 451 10 P 3292 O F 026 40 S 0011 L 0 450 90 F 5287 ¹ K KL 1 987 43 M 2039 I 1 987 43 R 2197 ⁸ I KL 1 987 43 M 2193 I
----------------	-------------	--

1,2|44|D7F 720; D7F 722; D7F 726

	10.97-03.00	0 451 10 P 3292 O
	04.00-02.03	1 457 42 P 9184 O
	03.03-12.07	0 451 10 P 4025 O
	10.97-12.07	F 026 40 S 0011 L 0 450 90 F 5287 ¹ K KL 1 987 43 M 2039 I 1 987 43 R 2197 ⁸ I KL 1 987 43 M 2193 I

Kangoo I 1.2 i

1,2|44|D7F 744; D7F 746

	05.00-02.03	1 457 42 P 9184 O
	03.03-12.07	0 451 10 P 4025 O
	05.00-12.07	F 026 40 S 0011 L 0 450 90 F 5287 ¹ K KL 1 987 43 M 2039 I 1 987 43 R 2197 ⁸ I KL 1 987 43 M 2193 I

1,2|44|D7F 764

	03.02-02.03	1 457 42 P 9184 O
	03.03-12.07	0 451 10 P 4025 O
	03.02-12.07	F 026 40 S 0011 L 0 450 90 F 5287 ¹ K KL 1 987 43 M 2039 I KL 1 987 43 M 2193 I

1,2|44|D7F 766

	03.02-12.07	0 451 10 P 4025 O F 026 40 S 0011 L 0 450 90 F 5287 ¹ K KL 1 987 43 M 2039 I KL 1 987 43 M 2193 I
--	-------------	---

Kangoo I 1.2 i 16V

1,2|55|D4F 712; D4F 714; D4F 716

	05.00-02.03	1 457 42 P 9184 O
	03.03-12.07	0 451 10 P 4025 O
	05.00-12.07	1 457 43 S 3078 L 0 450 90 F 5287 ¹ K KL 1 987 43 M 2039 I 1 987 43 R 2197 ⁸ I KL 1 987 43 M 2193 I

1,2|55|D4F 730

	04.04-12.07	0 451 10 P 4025 O 1 457 43 S 3660 L 0 450 90 F 5287 ¹ K KL 1 987 43 M 2039 I KL 1 987 43 M 2193 I
--	-------------	---





Kangoo I 1.4 i

1,4 55 E7J 634; E7J 635			
09.98-12.07	0 451 10 P 3336	O	
	1 457 43 S 3311	L	
	0 450 90 F 5287 ¹	K	
KL	1 987 43 M 2039	I	
	1 987 43 R 2197 ⁸	I	
KL	1 987 43 M 2193	I	

1,4 55 E7J 780			
10.97-12.07	0 451 10 P 3336	O	
	1 457 43 S 3606	L	
	0 450 90 F 5287 ¹	K	
KL	1 987 43 M 2039	I	
KL	1 987 43 M 2193	I	

1,4 55 K7J 700			
06.00-12.07	0 451 10 P 3336	O	
	1 457 43 S 3311	L	
	0 450 90 F 5287 ¹	K	
KL	1 987 43 M 2039	I	
	1 987 43 R 2197 ⁸	I	
KL	1 987 43 M 2193	I	

1,4 55 K7J 701			
06.00-12.07	0 451 10 P 3336	O	
	1 457 43 S 3311	L	
	0 450 90 F 5287 ¹	K	
KL	1 987 43 M 2039	I	
KL	1 987 43 M 2193	I	

Kangoo I 1.5 DCI

1,5 45/50/62 K9K 714; K9K 716; K9K 718			
04.05-08.07	0 451 10 P 3336	O	
09.07-12.07	F 026 40 P 7022	O	
04.05-12.07	F 026 40 S 0051	L	
KL	1 987 43 M 2039	I	
	1 987 43 R 2197 ⁸	I	
KL	1 987 43 M 2193	I	

1,5 48 K9K 700			
05.00-12.07	0 451 10 P 3336	O	
	1 457 43 S 3163	L	
05.00-01.05	WAS 0 450 90 N 6468 ¹	K	
05.00-12.07	KL 1 987 43 M 2039	I	
	1 987 43 R 2197 ⁸	I	
KL	1 987 43 M 2193	I	

1,5 48 K9K 704			
05.00-12.07	0 451 10 P 3336	O	
	1 457 43 S 3163	L	
05.00-01.05	WAS 0 450 90 N 6468 ¹	K	
05.00-12.07	KL 1 987 43 M 2039	I	
	1 987 43 R 2197 ⁸	I	
KL	1 987 43 M 2193	I	

1,5 60 K9K 702			
02.01-12.07	0 451 10 P 3336	O	
	1 457 43 S 3163	L	
02.01-01.05	WAS 0 450 90 N 6468 ¹	K	
02.01-12.07	KL 1 987 43 M 2039	I	
	1 987 43 R 2197 ⁸	I	
KL	1 987 43 M 2193	I	

1,5 60 K9K 710			
02.01-12.07	0 451 10 P 3336	O	
	1 457 43 S 3163	L	
02.01-01.05	WAS 0 450 90 N 6468 ¹	K	
02.01-12.07	KL 1 987 43 M 2039	I	
	1 987 43 R 2197 ⁸	I	
KL	1 987 43 M 2193	I	

Kangoo I 1.6 i

1,6 66 K7M 746			
09.99-12.07	0 451 10 P 3336	O	
	1 457 43 S 3311	L	
	0 450 90 F 5287 ¹	K	
KL	1 987 43 M 2039	I	
KL	1 987 43 M 2193	I	

1,6 70 K4M 730; K4M 732			
09.01-12.07	0 451 10 P 3336	O	
	1 457 43 S 3529	L	
	0 450 90 F 5287 ¹	K	
KL	1 987 43 M 2039	I	
KL	1 987 43 M 2193	I	

Kangoo I 1.6 i, i 4x4

1,6 70 K4M 708			
06.00-12.07	0 451 10 P 3336	O	
	1 457 43 S 3529	L	
	0 450 90 F 5287 ¹	K	
KL	1 987 43 M 2039	I	
	1 987 43 R 2197 ⁸	I	
KL	1 987 43 M 2193	I	

1,6 70 K4M 750; K4M 752; K4M 753; K4M 754			
06.00-12.07	0 451 10 P 3336	O	
	1 457 43 S 3529	L	
	0 450 90 F 5287 ¹	K	
KL	1 987 43 M 2039	I	
	1 987 43 R 2197 ⁸	I	
KL	1 987 43 M 2193	I	

Kangoo I 1.9 D

1,9 40 F8Q 662			
10.97-12.07	F 026 40 P 7022	O	
	1 457 43 S 3773	L	
	BO,PRF 1 457 42 N 9657	K	
	LUC 1 457 43 N 1712	K	
KL	1 987 43 M 2039	I	
KL	1 987 43 M 2193	I	

1,9 47-48 F8Q 630			
10.97-12.07	F 026 40 P 7022	O	
	1 457 43 S 3773	L	
	BO,PRF 1 457 42 N 9657	K	
	LUC 1 457 43 N 1712	K	
KL	1 987 43 M 2039	I	
	1 987 43 R 2197 ⁸	I	
KL	1 987 43 M 2193	I	





1,9 47-48 F8Q 632			
	01.98-12.07	F 026 40 P 7022	O
		F 026 40 S 0015	L
	BO,PRF	1 457 42 N 9657	K
	LUC	1 457 43 N 1712	K
	KL	1 987 43 M 2039	I
		1 987 43 R 2197⁸	I
	KL	1 987 43 M 2193	I

Kangoo I 1.9 DCI, DCI 4x4

1,9 59 F9Q 790			
	05.00-12.07	F 026 40 P 7022	O
		1 457 43 S 3531	L
		0 450 90 N 6461¹	K
	KL	1 987 43 M 2039	I
		1 987 43 R 2197⁸	I
	KL	1 987 43 M 2193	I

Kangoo I 1.9 DTI

1,9 47 F8Q 632			
	01.98-12.07	0 451 10 P 3336	O
		F 026 40 S 0015	L
	BO,PRF	1 457 42 N 9657	K
	LUC	1 457 43 N 1712	K
	KL	1 987 43 M 2039	I
		1 987 43 R 2197⁸	I
	KL	1 987 43 M 2193	I

Kangoo I 1.9 DTI, DTI 4x4

1,9 59 F9Q 780; F9Q 782			
	09.98-12.07	F 026 40 P 7022	O
		1 457 43 S 3531	L
	LUC	1 457 43 N 1712	K
	PRF	1 457 42 N 9657	K
	KL	1 987 43 M 2039	I
		1 987 43 R 2197⁸	I
	KL	1 987 43 M 2193	I

Kangoo II

Kangoo II 1.5 DCI

1,5 50/63/76/78/80 K9K 800; K9K 802; K9K 804; K9K 806; K9K 812			
	01.08→	F 026 40 P 7022	O
		SWA F 026 40 N 2081¹	K
		1 987 43 M 2078	I

1,5 80 K9K 816			
	03.11→	F 026 40 P 7022	O
		1 987 43 M 2078	I

Kangoo II 1.6

1,6 64 K7M 750			
	01.08→	0 451 10 P 3336	O
		0 450 90 F 5287¹	K
		1 987 43 M 2078	I



Kangoo II 1.6 16V

1,6 78 K4M 830; K4M 834			
	01.08→	0 451 10 P 3336	O
		1 457 43 S 3529	L
		0 450 90 F 5287¹	K
		1 987 43 M 2078	I

Koleos

Koleos 2.0 dCi, dCi 4x4

2,0 110/127 M9R 830; M9R 832; M9R 833			
	09.08→	F 026 40 P 7014	O
		F 026 40 S 0126	L

Koleos 2.5 , 4x4

2,5 126 2TR 700			
	09.08→	F 026 40 P 7001	O
		1 457 43 S 3274	L

Laguna I

Laguna I 1.6 i 16V

1,6 79 K4M 720			
	05.98-02.01	0 451 10 P 3336	O
		1 457 43 S 3529	L
		0 450 90 F 5287¹	K
		1 987 43 M 2027	I
	RLE	1 987 43 M 2050	I

Laguna I 1.8 GPL

1,8 66-70 F3P 676			
	05.98-02.01	0 451 10 P 3336	O
		1 457 43 S 3260	L
		0 450 90 F 5287¹	K
		1 987 43 M 2027	I
	RLE	1 987 43 M 2050	I

Laguna I 1.8 GPL, i

1,8 66-70 F3P 670; F3P 674			
	09.95-03.01	0 451 10 P 3336	O
		1 457 43 S 3260	L
	09.95-12.95	0 450 90 F 5903¹	K
	01.96-03.01	0 450 90 F 5287¹	K
	09.95-03.01	1 987 43 M 2027	I
	RLE	1 987 43 M 2050	I

Laguna I 1.8 i

1,8 66-70 F3P 678; F3P 720; F3P 724			
	01.94-03.01	0 451 10 P 3336	O
		1 457 43 S 3260	L
	01.94-12.95	0 450 90 F 5903¹	K
	01.96-03.01	0 450 90 F 5287¹	K
	01.94-03.01	1 987 43 M 2027	I
	RLE	1 987 43 M 2050	I





Laguna I 1.8 i 16V

1,8 88 F4P 760			
05.98-02.01	0 451 10 P 3336	O	
	1 457 43 S 3529	L	
	0 450 90 F 5287 ¹	K	
	1 987 43 M 2027	I	
RLE	1 987 43 M 2050	I	

Laguna I 1.9 DCI

1,9 80 F9Q 718			
09.99-02.01	0 451 10 P 3336	O	
	1 457 43 S 3161	L	
PRF	0 450 90 N 6461 ¹	K	
	1 987 43 M 2027	I	
RLE	1 987 43 M 2050	I	

Laguna I 1.9 DTI

1,9 72 F9Q 710			
09.99-02.01	0 451 10 P 3336	O	
	1 457 43 S 3161	L	
LUC	1 457 43 N 1712	K	
PRF	1 457 42 N 9657	K	
	1 987 43 M 2027	I	
RLE	1 987 43 M 2050	I	

1,9 72 F9Q 716			
10.97-02.01	0 451 10 P 3336	O	
	1 457 43 S 3161	L	
BO	1 457 42 N 9657	K	
	1 987 43 M 2027	I	
RLE	1 987 43 M 2050	I	

1,9 72 F9Q 717			
04.99-02.01	0 451 10 P 3336	O	
	1 457 43 S 3161	L	
LUC	1 457 43 N 1712	K	
PRF	1 457 42 N 9657	K	
	1 987 43 M 2027	I	
RLE	1 987 43 M 2050	I	

Laguna I 2.0 i

2,0 83-85 F3R 611			
05.98-02.01	0 451 10 P 3336	O	
	1 457 43 S 3260	L	
	0 450 90 F 5287 ¹	K	
	1 987 43 M 2027	I	
RLE	1 987 43 M 2050	I	

2,0 83-85 F3R 722; F3R 723; F3R 728; F3R 729; F3R 768; F3R 769			
01.94-02.01	0 451 10 P 3336	O	
	1 457 43 S 3260	L	
01.94-12.95	0 450 90 F 5903 ¹	K	
01.96-02.01	0 450 90 F 5287 ¹	K	
01.94-02.01	1 987 43 M 2027	I	
RLE	1 987 43 M 2050	I	

Laguna I 2.0 i 16V

2,0 100 F4R 780			
09.99-02.01	0 451 10 P 3336	O	
	1 457 43 S 3529	L	
	0 450 90 F 5287 ¹	K	
	1 987 43 M 2027	I	
RLE	1 987 43 M 2050	I	



2,0|102|N7Q 700; N7Q 704

09.95-02.01	0 451 10 P 3299	O	
	1 457 43 S 3743	L	
09.95-12.95	0 450 90 F 5903 ¹	K	
01.96-02.01	0 450 90 F 5287 ¹	K	
09.95-02.01	1 987 43 M 2027	I	
RLE	1 987 43 M 2050	I	

Laguna I 2.2 D

2,2 61-63 G8T 706; G8T 752			
01.94-02.01	F 026 40 P 7106	O	
	1 457 43 S 3266	L	
	1 457 43 N 4291 ²	K	
	1 987 43 M 2027	I	
RLE	1 987 43 M 2050	I	

2,2 61-63 G8T 790			
01.94-10.95	F 026 40 P 7106	O	
	1 457 43 S 3266	L	
	1 457 43 N 4291 ²	K	
	1 987 43 M 2027	I	
RLE	1 987 43 M 2050	I	

2,2 61-63 G8T 792			
09.95-02.01	F 026 40 P 7106	O	
	1 457 43 S 3266	L	
09.95-12.97	1 457 43 N 4291 ²	K	
BO	1 457 43 N 4291 ²	K	
01.98-02.01	PRF 1 457 43 N 1705	K	
09.95-02.01	1 987 43 M 2027	I	
RLE	1 987 43 M 2050	I	

2,2 61-63 G8T 794			
10.95-02.01	F 026 40 P 7106	O	
	1 457 43 S 3266	L	
	1 457 43 N 4291 ²	K	
	1 987 43 M 2027	I	
RLE	1 987 43 M 2050	I	

Laguna I 2.2 D Turbo

2,2 83-85 G8T 760			
02.96-01.99	F 026 40 P 7106	O	
02.99-02.01	0 451 10 P 3353	O	
02.96-02.01	1 457 43 S 3282	L	
02.96-12.97	1 457 43 N 4291 ²	K	
BO	1 457 43 N 4291 ²	K	
01.98-02.01	PRF 1 457 43 N 1705	K	
02.96-02.01	1 987 43 M 2027	I	
RLE	1 987 43 M 2050	I	

Laguna I 3.0 i

3,0 123-125 Z7X 760; Z7X 765			
01.94-02.01	0 451 10 P 3299	O	
	1 457 43 S 3261	L	
01.94-12.95	0 450 90 F 5903 ¹	K	
01.96-02.01	0 450 90 F 5287 ¹	K	
01.94-02.01	1 987 43 M 2027	I	
RLE	1 987 43 M 2050	I	



3,0 123-125 Z7X 767			
09.96-02.01	0 451 10 P 3299	O	
	1 457 43 S 3261	L	
	0 450 90 F 5287 ¹	K	
	1 987 43 M 2027	I	
RLE	1 987 43 M 2050	I	

Laguna I 3.0 i 24V

3,0 143 L7X 700; L7X 701			
03.97-02.01	0 451 10 P 3299	O	
	0 450 90 F 5287 ¹	K	
	1 987 43 M 2027	I	
RLE	1 987 43 M 2050	I	

Laguna II

Laguna II 1.6 16V

1,6 79 K4M 710; K4M 711; K4M 714			
03.01-09.07	0 451 10 P 3336	O	
	1 457 43 S 3529	L	
	0 450 90 F 5287 ¹	K	
	1 987 43 R 2380 ⁸	I	

1,6 82 K4M 716			
01.05-09.07	0 451 10 P 3336	O	
	1 457 43 S 3075	L	
	0 450 90 F 5287 ¹	K	
	1 987 43 R 2380 ⁸	I	

Laguna II 1.8 16V

1,8 85/88/89 F4P 770; F4P 771; F4P 772; F4P 773; F4P 774; F4P 775			
03.01-09.07	0 451 10 P 3336	O	
	1 457 43 S 3529	L	
	0 450 90 F 5287 ¹	K	
	1 987 43 R 2380 ⁸	I	

Laguna II 1.9 DCI

1,9 68/81/88 F9Q 650; F9Q 664; F9Q 670; F9Q 674; F9Q 750			
03.01-09.07	F 026 40 P 7022	O	
	1 457 43 S 3075	L	
	1 457 43 N 1705	K	
	1 987 43 R 2380 ⁸	I	

1,9 74-79 F9Q 751; F9Q 752; F9Q 754			
03.01-09.07	F 026 40 P 7022	O	
	1 457 43 S 3075	L	
	0 450 90 N 6461 ¹	K	
	1 987 43 R 2380 ⁸	I	

1,9 96 F9Q 758; F9Q 759			
04.04-09.07	F 026 40 P 7022	O	
	1 457 43 S 3075	L	
	1 457 43 N 1705	K	
	1 987 43 R 2380 ⁸	I	

Laguna II 2.0 DCI			
2,0 110/127 M9R 740; M9R 760			
09.04-09.07	F 026 40 P 7014	O	
	1 457 43 S 3075	L	
	1 457 43 N 1705	K	
	1 987 43 R 2380 ⁸	I	

Laguna II 2.0 T, 16V IDE

2,0 103/120-125/150 F4R 764; F4R 765; F4R 784; F4R 786; F4R 787; F4R 886; F4R 887; F5R 700; F5R 701			
03.01-09.07	0 451 10 P 3336	O	
	1 457 43 S 3075	L	
	0 450 90 F 5287 ¹	K	
	1 987 43 R 2380 ⁸	I	

Laguna II 2.0 16V

2,0 99/103 F4R 712; F4R 713; F4R 714; F4R 715			
03.01-09.07	0 451 10 P 3336	O	
	1 457 43 S 3529	L	
	0 450 90 F 5287 ¹	K	
	1 987 43 R 2380 ⁸	I	

Laguna II 2.2 DCI

2,2 102/110 G9T 605; G9T 700; G9T 702; G9T 703			
03.01-09.07	1 457 42 P 9198	O	
	1 457 43 S 3075	L	
	1 457 43 N 1705	K	
	1 987 43 R 2380 ⁸	I	

2,2 110 G9T 600			
07.02-09.07	1 457 42 P 9198	O	
	1 457 43 S 3075	L	
	1 457 43 N 1705	K	
	1 987 43 R 2380 ⁸	I	

2,2 110 G9T 706			
03.01-09.07	1 457 42 P 9198	O	
	1 457 43 S 3075	L	
	1 457 43 N 1705	K	
	1 987 43 R 2380 ⁸	I	

2,2 110 G9T 707			
03.01-09.07	1 457 42 P 9198	O	
	1 457 43 S 3075	L	
	1 457 43 N 1705	K	
	1 987 43 R 2380 ⁸	I	

Laguna II 3.0 V6 24V

3,0 152 L7X 731; L7X 733			
03.01-09.07	0 451 10 P 3299	O	
	1 457 43 S 3075	L	
	0 450 90 F 5287 ¹	K	
	1 987 43 R 2380 ⁸	I	





Laguna III

Laguna III 1.5 DCI

1,5 81 K9K 780	07.07→	F 026 40 P 7022	O
		F 026 40 S 0052	L
		SWA F 026 40 N2081 ¹	K
		1 987 43 R 2500	I

Laguna III 1.6

1,6 83 K4M 824	10.07→	0 451 10 P 3336	O
		0 450 90 F 5287 ¹	K
		1 987 43 R 2500	I

Laguna III 2.0

2,0 103 M4R 704	10.07→	F 026 40 P 7001	O
		1 987 43 R 2500	I

Laguna III 2.0 DCI

2,0 96 M9R 802	10.07→	F 026 40 P 7014	O
		F 026 40 S 0052	L
		SWA F 026 40 N2081 ¹	K
		1 987 43 R 2500	I

2,0 110 M9R 742	10.07→	F 026 40 P 7014	O
		F 026 40 S 0052	L
		SWA F 026 40 N2081 ¹	K
		1 987 43 R 2500	I

2,0 110 M9R 802	10.07→	F 026 40 P 7014	O
		F 026 40 S 0052	L
	10.07-05.09	SWA F 026 40 N2081 ¹	K
	10.07→	1 987 43 R 2500	I

2,0 110 M9R 805	10.07→	F 026 40 P 7014	O
		F 026 40 S 0052	L
	10.07-05.09	SWA F 026 40 N2081 ¹	K
	10.07→	1 987 43 R 2500	I

2,0 127 M9R 800	10.07→	F 026 40 P 7014	O
		SWA F 026 40 N2081 ¹	K
		1 987 43 R 2500	I

2,0 131 M9R 816	02.08→	F 026 40 P 7014	O
		SWA F 026 40 N2081 ¹	K
		1 987 43 R 2500	I

Laguna III 2.0 TCe

2,0 125/150 F4R 800; F4R 811; F4R 813	10.07→	0 451 10 P 3336	O
		F 026 40 S 0052	L
		1 987 43 R 2500	I



Laguna III 3.0 DCI

3,0 173 V9X 791	02.08→	SWA F 026 40 N2081 ¹	K
		1 987 43 R 2500	I

3,0 173 V9X 891	02.08-05.09	SWA F 026 40 N2081 ¹	K
	02.08→	1 987 43 R 2500	I

Laguna III 3.5

3,5 175 V4Y 713	02.08→	F 026 40 P 7001	O
		1 987 43 R 2500	I

Latitude

Latitude 1.5 dCi

1,5 81 K9K 782	09.10→	F 026 40 P 7022	O
		F 026 40 S 0052	L

Latitude 2.0

2,0 103 M4R 730; M4R 731; M4R 735; M4R 746	09.10→	0 450 90 F 5287 ¹	K
--	--------	------------------------------	---

Latitude 2.0 dCi

2,0 110/127 M9R 804; M9R 817; M9R 824	09.10→	F 026 40 P 7014	O
---	--------	-----------------	---

Latitude 2.5

2,5 130 2ZV 604	09.10→	F 026 40 P 7001	O
		0 450 90 F 5287 ¹	K

Latitude 3.5

3,5 171 5ZV 604	09.10→	F 026 40 P 7001	O
		0 450 90 F 5287 ¹	K

Logan

Logan 1.4

1,4 55 K7J 710	07.04→	0 451 10 P 3336	O
		1 457 43 S 3311	L
		0 450 90 F 2161 ¹	K
		1 987 43 M 2120	I

Logan 1.5 dCi

1,5 48 K9K 790	06.05→	0 451 10 P 3336	O
	06.05-04.07	1 457 43 S 3163	L
	05.07→	F 026 40 S 0051	L
	06.05→	SWA F 026 40 N2072 ¹	K
		SWA F 026 40 N2019 ¹	K
		1 987 43 M 2120	I





1,5 50 K9K 792			
10.05-09.07	0 451 10 P 3336	O	
10.07→	F 026 40 P 7022	O	
10.05→	F 026 40 S 0051	L	
	SWA F 026 40 N2072 ¹	K	
	SWA F 026 40 N2019 ¹	K	

1,5 63 K9K 796			
10.05→	F 026 40 P 7022	O	
	F 026 40 S 0051	L	
	SWA F 026 40 N2072 ¹	K	
	SWA F 026 40 N2019 ¹	K	

Logan 1.6

1,6 64 K7M 710			
07.04→	0 451 10 P 3336	O	
	1 457 43 S 3311	L	
	0 450 90 F 2161 ¹	K	
	1 987 43 M 2120	I	

Logan 1.6 16V

1,6 77 K4M 690			
12.05→	0 451 10 P 3336	O	
	1 457 43 S 3529	L	
	0 450 90 F 2161 ¹	K	
	1 987 43 M 2120	I	

Master

Master P28 -35

2,0 63 J5R 718,728			
10.86-09.97	0 451 10 P 3299	O	
	1 457 43 S 3231	L	
	0 450 90 F 4159 ¹	K	

Master T28 -35

2,0 57-59 J5R 718			
10.86-09.97	0 451 10 P 3299	O	
	1 457 43 S 3231	L	

2,2 67 J7T 782 Kat.			
09.80-09.97	0 451 10 P 3299	O	
	1 457 43 S 3231	L	
	0 450 90 F 5030 ¹	K	

2,2 67 J7T 788 Kat.			
01.94-09.97	0 451 10 P 3299	O	
	0 450 90 F 5030 ¹	K	

2,4 55 8140.67.2560 <S8U 748>			
01.94-09.97	0 451 20 P 3201	O	
	ROD 1 457 43 N 4200 ²	K	

2,5 69 8140.27.2590 <S9U 740>			
01.94-09.97	0 451 20 P 3201	O	
	1 457 43 N 4291 ²	K	

Master T28 -35D

2,1 44 J8S 330			
09.80-09.97	0 451 10 P 3353	O	
	1 457 43 S 3231	L	
	ROD 1 457 43 N 4200 ²	K	

2,4 52-55 8140.61.2300 <S8U 731>			
04.86-09.97	0 451 20 P 3201	O	
09.80-09.97	1 457 43 S 3231	L	
	ROD 1 457 43 N 4200 ²	K	

2,4 55 8140.67.2510 <S8U 742>			
09.80-09.97	0 451 20 P 3201	O	
	1 457 43 S 3231	L	
	ROD 1 457 43 N 4200 ²	K	

2,5 69 8140.27.2500,2510 <S9U 700>; 8140.27.2510 <S9U 704>; 8140.27.2512 <S9U 704>			
09.80-09.97	0 451 20 P 3201	O	
	1 457 43 S 3231	L	
	ROD 1 457 43 N 4200 ²	K	

2,5 69 8140.27.2560 <S9U 714>			
01.94-09.97	0 451 20 P 3201	O	
	ROD 1 457 43 N 4200 ²	K	

2,5 72 8140.27.2580 <S9U 702>			
09.80-09.97	0 451 20 P 3201	O	
	1 457 43 S 3231	L	
	ROD 1 457 43 N 4200 ²	K	
01.90-09.97	XXX 1 457 43 D 701 ²	K	

Master 1.9 dCi 80

1,9 60 F9Q 772			
05.00-09.03	0 451 10 P 3336	O	
	F 026 40 S 0014	L	
	DHI,H96 1 457 43 N 1720	K	
	PRF 1 457 43 N 1724	K	

1,9 60 F9Q 774			
10.03-10.06	F 026 40 P 7022	O	
	F 026 40 S0166	L	
	DHI,H96 1 457 43 N 1720	K	
	PRF 1 457 43 N 1724	K	

Master 1.9 dTi 80

1,9 58 F9Q 770			
01.00-09.03	0 451 10 P 3336	O	
	1 457 43 S 3531	L	
	1 457 43 N 1705	K	

Master 2.2 dCi 90

2,2 66 G9T 720			
01.00-09.03	1 457 42 P 9198	O	
	F 026 40 S 0014	L	
	DHI,H96 1 457 43 N 1720	K	

2,2 66 G9T 722			
05.00-09.03	1 457 42 P 9198	O	
	F 026 40 S 0014	L	
	DHI,H96 1 457 43 N 1720	K	
	H90 F 026 40 N 2047	K	





◀ Master 2.2 dCi 90

2,2 66 G9T 750	10.03-10.06	1 457 42 P 9198	O
		F 026 40 S 0166	L
	DHI,H96	1 457 43 N 1720	K
	H90	F 026 40 N 2047	K

Master 2.3 dCi

2,3 74-92/107 M9T 670 <120BU/BV>; M9T 672 <120CA/CB>; M9T 676 <120BX/BY>; M9T 678 <120BZ>; M9T 680 <120BW/FY>; M9T 690 <120CD/CE>; M9T 692 <120CG/CH>; M9T 694 <120CJ>; M9T 698 <120CF/CY>	02.10→	1 987 43 M 2078	I
--	--------	-----------------	---

Master 2.5 D

2,5 60 S8U 770 <8140,67.2620/29>; S8U 772	10.97-09.03	0 451 20 P 3201	O
		F 026 40 S 0014	L
		1 457 43 N 1705	K

Master 2.5 dCi 16V

2,5 85 G9U-724	10.04→	1 457 42 P 9198	O
--------------------	--------	-----------------	---

Master 2.5 dCi 90, dCi 120

2,5 84 G9U 720; G9U 724	05.00-09.03	1 457 42 P 9198	O
		F 026 40 S 0014	L
	DHI,H96	1 457 43 N 1720	K
	H90	F 026 40 N 2047	K

Master 2.5 dCi 100

2,5 73 G9U 750; G9U 754	10.03-10.06	1 457 42 P 9198	O
		F 026 40 S 0166	L
	DHI,H96	1 457 43 N 1720	K

Master 2.5 dCi 100, dCi 120, dCi 120 FAP, dCi 150 FAP

2,5 74/88/107 G9U 632 (MY) <Euro 4>; G9U 632 (M1) <120BQ, Euro 4>; G9U 650 (M1) <120BO, Euro 4>; G9U 650 (M2) <120BN, Euro 4>	11.06-04.10	F 026 40 P 7014	O
		F 026 40 S 0166	L
	H12	1 457 43 N 1724	K
	H90	F 026 40 N 2047	K

Master 2.5 dCi 110, dCi 120

2,5 81/84 G9U 750; G9U 754	10.03-10.06	1 457 42 P 9198	O
		F 026 40 S 0166	L
	DHI,H96	1 457 43 N 1720	K
	H90	F 026 40 N 2047	K

Master 2.8 D

2,8 86 S8W 700	05.01-10.04	0 451 20 P 3201	O
		F 026 40 S 0014	L

Master 2.8 DTI

2,8 84 8140 TCA	01.02-09.04	0 451 20 P 3201	O
---------------------	-------------	-----------------	---



Master 2.8 dTi 110, dTi 120

2,8 81/84 S9W 700 <Sofim8140.43,2609/39>; S9W 702 <Sofim8140.43,2620/29>	10.97-09.03	0 451 20 P 3201	O
		F 026 40 S 0014	L
		1 457 43 N 1705	K

Master 3.0 dCi 140

3,0 100 ZD3 200 <Euro 3>; ZD3 202 <Euro 3>	10.03-10.06	1 457 42 P 9271	O
		PRF 1 457 43 N 1724	K
		TW F 026 40 N 2047	K

Megane

Megane 1.6 i

1,6 54 K7M	09.97→	0 451 10 P 3336	O
		1 457 42 S 9923	L
		0 450 90 F 5287 ¹	K
		0 986 BF CB 0565	I

Megane 1.6 i 16V

1,6 54 K4M	09.97-02.06	0 450 90 F 5287 ¹	K
		0 986 BF CB 0550	I

Megane 1.6 i 16V GNC

1,6 69 K4M-706	06.03→	1 987 42 S 9406	L
		0 450 90 F 5287 ¹	K

Megane 1.9 D

1,9 68 F9QT	06.99→	1 457 43 S 3531	L
		1 457 42 N 9657	K
		0 986 BF CB 0550	I

Megane 2.0 i

2,0 85 F3R	05.98-05.01	1 457 42 S 9841	L
		0 450 90 F 5287 ¹	K
		0 986 BF CB 0565	I

Megane 2.0 i 16V

2,0 103 F4R	07.01→	0 450 90 F 5287 ¹	K
		0 986 BF CB 0550	I

Megane I

Megane I 1.4 i

1,4 51 E7J 626	02.99-09.03	0 451 10 P 3336	O
		1 457 43 S 3311	L
		0 450 90 F 5287 ¹	K
		KL 1 987 43 M 2061	I
		KL 1 987 43 M 2039	I
		1 987 43 R 2197 ⁸	I





1,4 | 51-52 | E7J 624

01.96-02.99	0 451 10	P 3336	O
	1 457 42	S 9923	L
01.96-03.96	0 450 90	F 5904 ¹	K
04.96-02.99	0 450 90	F 5287 ¹	K
01.96-04.98	1 987 43	M 2009	I
05.98-02.99	KL	1 987 43	M 2061
	KL	1 987 43	M 2039

1,4 | 51-55 | E7J 626

03.99-10.02	0 451 10	P 3336	O
	1 457 43	S 3311	L
	0 450 90	F 5287 ¹	K
	KL	1 987 43	M 2061
	KL	1 987 43	M 2039

1,4 | 55 | E7J 764

01.96-09.03	0 451 10	P 3336	O
	1 457 42	S 9923	L
01.96-03.96	0 450 90	F 5904 ¹	K
04.96-09.03	0 450 90	F 5287 ¹	K
01.96-04.98	1 987 43	M 2009	I
04.98-09.03	KL	1 987 43	M 2061
	KL	1 987 43	M 2039
		1 987 43	R 2197 ⁸

Megane I 1.4 i, i 16V

1,4 | 70 | K4J 714; K4J 750

06.98-09.03	0 451 10	P 3336	O
	1 457 43	S 3529	L
	0 450 90	F 5287 ¹	K
	KL	1 987 43	M 2061
	KL	1 987 43	M 2039
03.99-09.03	KL	1 987 43	R 2197 ⁸

Megane I 1.4 i 16V

1,4 | 70 | K4J 700

05.00-10.02	0 451 10	P 3336	O
	1 457 43	S 3529	L
	0 450 90	F 5287 ¹	K
	KL	1 987 43	M 2061
	KL	1 987 43	M 2039

Megane I 1.6 i

1,6 | 55 | K7M 720

01.96-09.03	0 451 10	P 3336	O
	1 457 43	S 2124	L
01.96-03.96	0 450 90	F 5904 ¹	K
04.96-09.03	0 450 90	F 5287 ¹	K
01.96-04.98	1 987 43	M 2009	I
04.98-09.03	KL	1 987 43	M 2061
	KL	1 987 43	M 2039
		1 987 43	R 2197 ⁸

1,6 | 66 | K7M 702

01.96-09.03	0 451 10	P 3336	O
	1 457 43	S 2124	L
01.97-09.03	1 457 43	S 3062	L
01.96-03.96	0 450 90	F 5904 ¹	K
04.96-09.03	0 450 90	F 5287 ¹	K
01.96-04.98	1 987 43	M 2009	I
04.98-09.03	KL	1 987 43	M 2061
	KL	1 987 43	M 2039
		1 987 43	R 2197 ⁸

1,6 | 66 | K7M 703

01.96-09.03	0 451 10	P 3336	O
	1 457 43	S 2124	L
01.96-03.96	0 450 90	F 5904 ¹	K
04.96-09.03	0 450 90	F 5287 ¹	K
01.96-04.98	1 987 43	M 2009	I
04.98-09.03	KL	1 987 43	M 2061
	KL	1 987 43	M 2039
		1 987 43	R 2197 ⁸

1,6 | 66 | K7M 704

01.01-10.02	0 451 10	P 3336	O
	1 457 43	S 3311	L
	0 450 90	F 5287 ¹	K
	KL	1 987 43	M 2061
	KL	1 987 43	M 2039

1,6 | 66 | K7M 790

01.96-02.99	0 451 10	P 3336	O
01.96-12.96	1 457 43	S 2124	L
01.97-02.99	1 457 43	S 3062	L
01.96-03.96	0 450 90	F 5904 ¹	K
04.96-02.99	0 450 90	F 5287 ¹	K
01.96-04.98	1 987 43	M 2009	I
05.98-02.99	KL	1 987 43	M 2061
	KL	1 987 43	M 2039

1,6 | 79 | K7M 704

10.99-09.03	0 451 10	P 3336	O
	1 457 43	S 3311	L
	0 450 90	F 5287 ¹	K
	KL	1 987 43	M 2061
	KL	1 987 43	M 2039
		1 987 43	R 2197 ⁸

Megane I 1.6 i, i 16V

1,6 | 79 | K4M 700; K4M 701

06.98-09.03	0 451 10	P 3336	O
	1 457 43	S 3529	L
	0 450 90	F 5287 ¹	K
	KL	1 987 43	M 2061
	KL	1 987 43	M 2039
08.98-09.03	KL	1 987 43	R 2197 ⁸

1,6 | 79 | K4M 706; K4M 708; K4M 709

03.99-09.03	0 451 10	P 3336	O
	1 457 43	S 3529	L
	0 450 90	F 5287 ¹	K
	KL	1 987 43	M 2061
	KL	1 987 43	M 2039
10.99-09.03	KL	1 987 43	R 2197 ⁸





Megane I 1.6 i 16V

1,6 79 K4M 704			
03.99-09.03	0451 10	P 3336	O
	1457 43	S 3529	L
	0450 90	F 5287¹	K
KL	1987 43	M 2061	I
KL	1987 43	M 2039	I

1,6 79 K4M 712			
03.99-09.03	0451 10	P 3336	O
	1457 43	S 3529	L
	0450 90	F 5287¹	K
KL	1987 43	M 2061	I
KL	1987 43	M 2039	I

Megane I 1.8 i

1,8 85/88 F4P 720; F4P 722			
05.00-09.03	0451 10	P 3336	O
	1457 43	S 3529	L
	0450 90	F 5287¹	K
KL	1987 43	M 2061	I
KL	1987 43	M 2039	I
	1987 43	R 2197⁸	I

Megane I 1.8 i 16V

1,8 85/88 F4P 720; F4P 722			
03.99-09.03	0451 10	P 3336	O
	1457 43	S 3529	L
	0450 90	F 5287¹	K
KL	1987 43	M 2061	I
KL	1987 43	M 2039	I

Megane I 1.9 D

1,9 47 F8Q 620			
01.96-02.99	0451 10	P 3336	O
	1457 42	S 9841	L
LUC	1457 42	N 9621	K
01.96-04.98	1987 43	M 2009	I
05.98-02.99	KL	1987 43	M 2061
	KL	1987 43	M 2039

1,9 47 F8Q 622			
01.01-09.03	0451 10	P 3336	O
	F 026 40	S 0015	L
LUC	1457 43	N 1712	K
KL	1987 43	M 2061	I
KL	1987 43	M 2039	I

1,9 47 F8Q 624			
09.96-09.03	0451 10	P 3336	O
	1457 42	S 9841	L
Mot.Nr. C103898 →	11.98-09.03	LUC	1457 43 N 1712
		PRF	1457 42 N 9657
Mot.Nr. →C103897	09.96-10.98	LUC	1457 42 N 9621
	09.96-04.98		1987 43 M 2009
	04.98-09.03	KL	1987 43 M 2061
		KL	1987 43 M 2039
			1987 43 R 2197⁸



1,9 47 F8Q 790			
03.99-09.03	0451 10	P 3336	O
	F 026 40	S 0015	L
	1457 43	N 1712	K
KL	1987 43	M 2061	I
KL	1987 43	M 2039	I

1,9 47-48 F8Q 620			
01.96-04.97	0451 10	P 3336	O
	1457 42	S 9841	L
LUC	1457 42	N 9621	K
	1987 43	M 2009	I

1,9 47-48 F8Q 622			
06.98-09.03	0451 10	P 3336	O
	F 026 40	S 0015	L
LUC	1457 43	N 1712	K
PRF	1457 42	N 9657	K
KL	1987 43	M 2061	I
KL	1987 43	M 2039	I
	1987 43	R 2197⁸	I

1,9 47-48 F8Q 624			
09.96-09.03	0451 10	P 3336	O
	1457 42	S 9841	L
Mot.Nr. C103898 →	11.98-09.03	LUC	1457 43 N 1712
		PRF	1457 42 N 9657
Mot.Nr. →C103897	09.96-10.98	LUC	1457 42 N 9621
	09.96-04.98		1987 43 M 2009
	04.98-09.03	KL	1987 43 M 2061
		KL	1987 43 M 2039
			1987 43 R 2197⁸

1,9 59 F9Q 744			
01.01-09.03	0451 10	P 3336	O
	1457 43	S 3531	L
LUC	1457 43	N 1712	K
PRF	1457 42	N 9657	K
KL	1987 43	M 2061	I
KL	1987 43	M 2039	I

Megane I 1.9 D Turbo

1,9 66-69 F8Q 784			
09.96-03.97	0451 10	P 3336	O
	1457 43	S 3624	L
LUC	1457 42	N 9621	K
	1987 43	M 2009	I

1,9 66-69 F8Q 786			
09.96-09.03	0451 10	P 3336	O
	1457 43	S 3624	L
LUC	1457 42	N 9621	K
09.96-03.98	1987 43	M 2009	I
04.98-09.03	KL	1987 43	M 2061
	KL	1987 43	M 2039
			1987 43 R 2197⁸

1,9 66-70 F8Q 784			
01.96-02.99	0451 10	P 3336	O
	1457 43	S 3624	L
	1457 42	N 9621	K
01.96-04.98	1987 43	M 2009	I
05.98-02.99	KL	1987 43	M 2061
	KL	1987 43	M 2039





1,9 66-70 F8Q 786			
01.96-02.99	0 451 10	P 3336	O
	1 457 43	S 3624	L
	1 457 42	N 9621	K
01.96-04.98	1 987 43	M 2009	I
05.98-02.99	KL	1 987 43	M 2061
	KL	1 987 43	M 2039

Megane I 1.9 DCI

1,9 72-75 F9Q 732			
03.99-09.03	F 026 40	P 7022	O
	1 457 43	S 3531	L
	0 450 90	N 6461 ¹	K
	KL	1 987 43	M 2061
	KL	1 987 43	M 2039
04.99-09.03	KL	1 987 43	R 2197 ⁸

1,9 72-75 F9Q 733			
03.99-09.03	0 451 10	P 3336	O
	1 457 43	S 3531	L
	0 450 90	N 6461 ¹	K
	KL	1 987 43	M 2061
	KL	1 987 43	M 2039
04.99-09.03	KL	1 987 43	R 2197 ⁸

1,9 75 F9Q 732			
05.00-09.03	F 026 40	P 7022	O
	1 457 43	S 3529	L
	1 457 43	S 3531	L
	0 450 90	N 6461 ¹	K
	KL	1 987 43	M 2061
	KL	1 987 43	M 2039
	KL	1 987 43	R 2197 ⁸

1,9 75 F9Q 733			
05.00-10.02	0 451 10	P 3336	O
	1 457 43	S 3531	L
	0 450 90	N 6461 ¹	K
	KL	1 987 43	M 2061
	KL	1 987 43	M 2039

1,9 75 F9Q 738			
03.99-09.03	0 451 10	P 3336	O
01.01-10.02	F 026 40	P 7022	O
03.99-09.03	1 457 43	S 3531	L
	0 450 90	N 6461 ¹	K
	KL	1 987 43	M 2061
	KL	1 987 43	M 2039
05.00-09.03	KL	1 987 43	R 2197 ⁸

Megane I 1.9 DTI

1,9 59 F9Q 744			
11.00-09.03	F 026 40	P 7022	O
01.01-10.02	0 451 10	P 3336	O
11.00-09.03	1 457 43	S 3531	L
	LUC	1 457 43	N 1712
	PRF	1 457 42	N 9657
	KL	1 987 43	M 2061
	KL	1 987 43	M 2039
	KL	1 987 43	R 2197 ⁸



1,9 69 F9Q 730			
06.97-02.99	0 451 10	P 3336	O
	1 457 43	S 3624	L
	1 457 42	N 9657	K
06.97-04.98	1 987 43	M 2009	I
05.98-02.99	KL	1 987 43	M 2061
	KL	1 987 43	M 2039

1,9 72 F9Q 730			
08.97-09.03	0 451 10	P 3336	O
	1 457 43	S 3624	L
	1 457 42	N 9657	K
08.97-03.98	1 987 43	M 2009	I
04.98-09.03	KL	1 987 43	M 2061
	KL	1 987 43	M 2039
	KL	1 987 43	R 2197 ⁸

1,9 72 F9Q 731			
03.99-09.03	0 451 10	P 3336	O
	1 457 43	S 3531	L
	LUC	1 457 43	N 1712
	PRF	1 457 42	N 9657
	KL	1 987 43	M 2061
	KL	1 987 43	M 2039
04.99-09.03	KL	1 987 43	R 2197 ⁸

1,9 72 F9Q 734			
06.97-02.99	0 451 10	P 3336	O
	1 457 43	S 3624	L
	1 457 42	N 9657	K
06.97-04.98	1 987 43	M 2009	I
04.98-02.99	KL	1 987 43	M 2061
	KL	1 987 43	M 2039
	KL	1 987 43	R 2197 ⁸

1,9 72 F9Q 736			
07.98-09.03	0 451 10	P 3336	O
	1 457 43	S 3531	L
	LUC	1 457 43	N 1712
	PRF	1 457 42	N 9657
	KL	1 987 43	M 2061
	KL	1 987 43	M 2039
04.99-09.03	KL	1 987 43	R 2197 ⁸

Megane I 2.0 i

2,0 83 F3R 750; F3R 751			
01.96-02.99	0 451 10	P 3336	O
	FMV	1 457 42	S 9841
01.96-03.96	0 450 90	F 5904 ¹	K
04.96-02.99	0 450 90	F 5287 ¹	K
01.96-04.98	1 987 43	M 2009	I
05.98-02.99	KL	1 987 43	M 2061
	KL	1 987 43	M 2039

2,0 83 F3R 791			
09.96-09.03	0 451 10	P 3336	O
	FMV	1 457 42	S 9841
	0 450 90	F 5287 ¹	K
09.96-03.98	1 987 43	M 2009	I
04.98-09.03	KL	1 987 43	M 2061
	KL	1 987 43	M 2039
	KL	1 987 43	R 2197 ⁸





◀ Megane | 2.0 i

2,0 83 F3R 796			
09.96-09.03		0 451 10 P 3336	O
	<u>FMV</u>	1 457 42 S 9841	L
		0 450 90 F 5287 ¹	K
09.96-03.98		1 987 43 M 2009	I
04.98-09.03	KL	1 987 43 M 2061	I
	KL	1 987 43 M 2039	I
		1 987 43 R 2197 ⁸	I

2,0 83 F3R 797			
04.97-10.02		0 451 10 P 3336	O
	<u>FMV</u>	1 457 42 S 9841	L
		0 450 90 F 5287 ¹	K
04.97-03.98		1 987 43 M 2009	I
04.98-10.02	KL	1 987 43 M 2061	I
	KL	1 987 43 M 2039	I

2,0 83-84 F3R 750; F3R 751			
09.96-04.97		0 451 10 P 3336	O
	<u>FMV</u>	1 457 42 S 9841	L
		0 450 90 F 5287 ¹	K
		1 987 43 M 2009	I

2,0 84 F3R 750; F3R 751			
09.96-02.99		0 451 10 P 3336	O
	<u>FMV</u>	1 457 42 S 9841	L
		0 450 90 F 5287 ¹	K
09.96-04.98		1 987 43 M 2009	I
05.98-02.99	KL	1 987 43 M 2061	I
	KL	1 987 43 M 2039	I

2,0 84 F3R 752			
09.96-04.97		0 451 10 P 3336	O
	<u>FMV</u>	1 457 42 S 9841	L
		0 450 90 F 5287 ¹	K
		1 987 43 M 2009	I

2,0 84 F3R 791			
03.97-09.03		0 451 10 P 3336	O
	<u>FMV</u>	1 457 42 S 9841	L
		0 450 90 F 5287 ¹	K
03.97-04.98		1 987 43 M 2009	I
04.98-09.03	KL	1 987 43 M 2061	I
	KL	1 987 43 M 2039	I
		1 987 43 R 2197 ⁸	I

2,0 84 F3R 796			
09.96-09.03		0 451 10 P 3336	O
	<u>FMV</u>	1 457 42 S 9841	L
		0 450 90 F 5287 ¹	K
09.96-04.98		1 987 43 M 2009	I
04.98-09.03	KL	1 987 43 M 2061	I
	KL	1 987 43 M 2039	I
		1 987 43 R 2197 ⁸	I

2,0 84 F3R 797			
09.96-09.03		0 451 10 P 3336	O
	<u>FMV</u>	1 457 42 S 9841	L
		0 450 90 F 5287 ¹	K
09.96-04.98		1 987 43 M 2009	I
04.98-09.03	KL	1 987 43 M 2061	I
	KL	1 987 43 M 2039	I
		1 987 43 R 2197 ⁸	I



2,0 84 F3R 798			
09.96-09.03		0 451 10 P 3336	O
	<u>FMV</u>	1 457 42 S 9841	L
		0 450 90 F 5287 ¹	K
09.96-04.98		1 987 43 M 2009	I
04.98-09.03	KL	1 987 43 M 2061	I
	KL	1 987 43 M 2039	I
		1 987 43 R 2197 ⁸	I

2,0 102 F4R 746			
03.01-09.03		F 026 40 P 7022	O
		1 457 43 S 3529	L
		0 450 90 F 5287 ¹	K
	KL	1 987 43 M 2061	I
	KL	1 987 43 M 2039	I
		1 987 43 R 2197 ⁸	I

Megane | 2.0 i, i 16V

2,0 101,5 F4R 740; F4R 741			
05.00-09.03		0 451 10 P 3336	O
		1 457 43 S 3529	L
		0 450 90 F 5287 ¹	K
	KL	1 987 43 M 2061	I
	KL	1 987 43 M 2039	I
		1 987 43 R 2197 ⁸	I

Megane | 2.0 i 16V

2,0 102 F4R 746			
01.01-09.03		F 026 40 P 7022	O
09.01-10.02		0 451 10 P 3336	O
01.01-09.03		1 457 43 S 3529	L
		0 450 90 F 5287 ¹	K
	KL	1 987 43 M 2061	I
	KL	1 987 43 M 2039	I
		1 987 43 R 2197 ⁸	I

2,0 103 F4R 746			
05.00-10.02		F 026 40 P 7022	O
		1 457 43 S 3529	L
		0 450 90 F 5287 ¹	K
	KL	1 987 43 M 2061	I
	KL	1 987 43 M 2039	I
		1 987 43 R 2197 ⁸	I

2,0 108 F7R 714			
05.97-09.03		0 451 10 P 3336	O
	XXX	1 457 43 S 3032	L
		0 450 90 F 5287 ¹	K
05.97-03.98		1 987 43 M 2009	I
04.98-09.03	KL	1 987 43 M 2061	I
	KL	1 987 43 M 2039	I
		1 987 43 R 2197 ⁸	I

2,0 108-110 F7R 710			
01.96-04.97		0 451 10 P 3336	O
	XXX	1 457 43 S 3032	L
01.96-03.96		0 450 90 F 5904 ¹	K
04.96-04.97		0 450 90 F 5287 ¹	K
01.96-04.97		1 987 43 M 2009	I





2,0 | 108-110 | F7R 714

05.97-10.02	0 451 10 P 3336	O
	XXX 1 457 43 S 3032	L
	0 450 90 F 5287 ¹	K
05.97-04.98	1 987 43 M 2009	I
05.98-10.02	KL 1 987 43 M 2061	I
	KL 1 987 43 M 2039	I

Megane I 2.0 i 16V IDE

2,0 | 103 | F5R 740

03.99-09.03	0 451 10 P 3336	O
	1 457 42 S 9841	L
	0 450 90 F 5287 ¹	K
	KL 1 987 43 M 2061	I
KL	1 987 43 M 2039	I
	1 987 43 R 2197 ⁸	I

Megane II

Megane II 1.4

1,4 | 72 | K4J 730

05.05-10.09	0 451 10 P 3336	O
	1 457 43 S 3529	L
	0 450 90 F 5287 ¹	K
	1 987 43 M 2093	I
	1 987 43 R 2393 ⁸	I

1,4 | 72 | K4J 732

10.03-10.09	0 451 10 P 3336	O
	1 457 43 S 3529	L
	0 450 90 F 5287 ¹	K
	1 987 43 M 2093	I
	1 987 43 R 2393 ⁸	I

1,4 | 72 | K4J 740

10.03-10.09	0 451 10 P 3336	O
	1 457 43 S 3529	L
	0 450 90 F 5287 ¹	K
	1 987 43 M 2093	I
	1 987 43 R 2393 ⁸	I

Megane II 1.4 16V

1,4 | 72 | K4J 730

11.02-05.09	0 451 10 P 3336	O
	1 457 43 S 3529	L
	0 450 90 F 5287 ¹	K
11.02-01.06	1 987 43 M 2093	I
02.06-05.09	1 987 43 R 2393 ⁸	I

1,4 | 72 | K4J 732

11.02-10.08	0 451 10 P 3336	O
	1 457 43 S 3529	L
	0 450 90 F 5287 ¹	K
11.02-01.06	1 987 43 M 2093	I
02.06-10.08	1 987 43 R 2393 ⁸	I

1,4 | 72 | K4J 740

05.05-05.09	0 451 10 P 3336	O
	1 457 43 S 3529	L
	0 450 90 F 5287 ¹	K
05.05-01.06	1 987 43 M 2093	I
02.06-05.09	1 987 43 R 2393 ⁸	I

Megane II 1.5 DCI

1,5 | 60 | K9K 722

11.02-10.09	0 451 10 P 3336	O	
	1 987 42 S 9406	L	
11.02-12.04 SWA	0 450 90 N 6469 ¹	K	
Komp.Nr. R6351060	11.02-12.04 SWA	0 450 90 N 6469 ¹	K
11.02-10.09	1 987 43 M 2093	I	
	1 987 43 R 2393 ⁸	I	

1,5 | 60 | K9K 728

11.02-09.07	0 451 10 P 3336	O	
	F 026 40 P 7022	O	
11.02-10.09	1 987 42 S 9406	L	
11.02-12.04 SWA	0 450 90 N 6469 ¹	K	
Komp.Nr. R6351060	11.02-12.04 SWA	0 450 90 N 6469 ¹	K
11.02-10.09	1 987 43 M 2093	I	
	1 987 43 R 2393 ⁸	I	

1,5 | 60 | K9K 729

11.02-09.07	0 451 10 P 3336	O	
	F 026 40 P 7022	O	
11.02-10.09	1 987 42 S 9406	L	
10.03-12.04 SWA	0 450 90 N 6469 ¹	K	
Komp.Nr. R6351060	11.02-05.09 SWA	0 450 90 N 6469 ¹	K
11.02-10.09	1 987 43 M 2093	I	
	1 987 43 R 2393 ⁸	I	

1,5 | 63 | K9K 724

10.04-09.07	0 451 10 P 3336	O
	F 026 40 P 7022	O
10.04-05.09	1 987 42 S 9406	L
07.07-10.09	1 457 43 S 3573	L
10.04-05.09	F 026 40 N 2016 ¹	K
	WW F 026 40 N 2061 ¹	K
10.04-10.09	SWA F 026 40 N 2016 ¹	K
	SWA F 026 40 N 2061 ¹	K
	1 987 43 M 2093	I
	1 987 43 R 2393 ⁸	I

1,5 | 76 | K9K 734

11.02-09.07	0 451 10 P 3336	O
	F 026 40 P 7022	O
11.02-03.10	1 457 43 S 3573	L
11.02-05.09	F 026 40 N 2016 ¹	K
	WW F 026 40 N 2061 ¹	K
11.02-03.10	SWA F 026 40 N 2016 ¹	K
	SWA F 026 40 N 2061 ¹	K
	1 987 43 M 2093	I
	1 987 43 R 2393 ⁸	I





◀ Megane II 1.5 DCI

1,5 78 K9K 732	09.04-09.07	0 451 10 P 3336	O
	10.07-03.10	F 026 40 P 7022	O
09.04-03.10		1 457 43 S 3573	L
	SWA	F 026 40 N 2016 ¹	K
	SWA	F 026 40 N 2061 ¹	K
10.04-05.09		F 026 40 N 2016 ¹	K
	WW	F 026 40 N 2061 ¹	K
09.04-03.10		1 987 43 M 2093	I
		1 987 43 R 2393 ⁸	I

Megane II 1.6 16V

1,6 83 K4M 760	11.02-03.10	0 451 10 P 3336	O
		1 987 42 S 9406	L
		0 450 90 F 5287 ¹	K
		1 987 43 M 2093	I
10.03-03.10		1 987 43 R 2393 ⁸	I

1,6 83 K4M 761	11.02-03.10	0 451 10 P 3336	O
		1 987 42 S 9406	L
		0 450 90 F 5287 ¹	K
		1 987 43 M 2093	I
10.03-03.10		1 987 43 R 2393 ⁸	I

1,6 83 K4M 762	10.05-10.09	0 451 10 P 3336	O
		1 987 42 S 9406	L
		1 457 43 S 3529	L
		0 450 90 F 5287 ¹	K
		1 987 43 M 2093	I
		1 987 43 R 2393 ⁸	I

1,6 83 K4M 764	11.02-10.09	0 451 10 P 3336	O
		1 457 43 S 3529	L
		0 450 90 F 5287 ¹	K
		1 987 43 M 2093	I
10.03-10.09		1 987 43 R 2393 ⁸	I

1,6 83 K4M 768	10.05-10.09	0 451 10 P 3336	O
		1 987 42 S 9406	L
		1 457 43 S 3529	L
		0 450 90 F 5287 ¹	K
		1 987 43 M 2093	I
		1 987 43 R 2393 ⁸	I

1,6 83 K4M 788	10.05-10.08	0 451 10 P 3336	O
		1 457 43 S 3529	L
		0 450 90 F 5287 ¹	K
		1 987 43 M 2093	I
02.06-10.08		1 987 43 R 2393 ⁸	I

1,6 83 K4M 812	05.05-03.10	0 451 10 P 3336	O
		1 987 42 S 9406	L
		0 450 90 F 5287 ¹	K
		1 987 43 M 2093	I
		1 987 43 R 2393 ⁸	I



1,6 83 K4M 813	05.05-03.10	0 451 10 P 3336	O
		1 987 42 S 9406	L
		0 450 90 F 5287 ¹	K
		1 987 43 M 2093	I
		1 987 43 R 2393 ⁸	I

Megane II 1.6 16V Flex-Fuel

1,6 77 K4M 856	01.07-10.08	0 451 10 P 3336	O
		1 457 43 S 3529	L
		1 987 43 R 2393 ⁸	I

Megane II 1.9 DCI

1,9 68 F9Q 808	11.02-10.09	F 026 40 P 7022	O
		1 457 43 S 3573	L
		1 457 43 N 1705	K
		1 987 43 M 2093	I
10.03-10.09		1 987 43 R 2393 ⁸	I

1,9 88 F9Q 800	11.02-03.10	F 026 40 P 7022	O
		1 457 43 S 3573	L
		1 457 43 N 1705	K
		1 987 43 M 2093	I
10.03-03.10		1 987 43 R 2393 ⁸	I

1,9 96 F9Q 803	05.05-03.10	F 026 40 P 7022	O
		1 457 43 S 3573	L
		1 457 43 N 1705	K
		1 987 43 M 2093	I
		1 987 43 R 2393 ⁸	I

1,9 96 F9Q 804	09.04-03.10	F 026 40 P 7022	O
		1 457 43 S 3573	L
		1 457 43 N 1705	K
		1 987 43 M 2093	I
		1 987 43 R 2393 ⁸	I

1,9 96 F9Q 814	05.04-03.10	F 026 40 P 7022	O
		1 457 43 S 3573	L
		1 457 43 N 1705	K
		1 987 43 M 2093	I
		1 987 43 R 2393 ⁸	I

Megane II 2.0 DCI

2,0 110 M9R 700	09.04-03.10	F 026 40 P 7014	O	
		1 457 43 S 3573	L	
	09.04-05.09	F 026 40 N 2016 ¹	K	
		WW	F 026 40 N 2061 ¹	K
	09.04-03.10	SWA	F 026 40 N 2016 ¹	K
		SWA	F 026 40 N 2061 ¹	K
			1 987 43 M 2093	I
			1 987 43 R 2393 ⁸	I



2,0 110 M9R 722	09.04-03.10	F 026 40 P 7014	O
		1 457 43 S 3573	L
	09.04-05.09	F 026 40 N 2016 ¹	K
		WW F 026 40 N 2061 ¹	K
	09.04-03.10	SWA F 026 40 N 2016 ¹	K
	SWA F 026 40 N 2061 ¹	K	
	1 987 43 M 2093	I	
	1 987 43 R 2393 ⁸	I	

Megane II 2.0 T

2,0 120 F4R 776	10.03-03.10	0 451 10 P 3336	O
		1 457 43 S 3573	L
		0 450 90 F 5287 ¹	K
		1 987 43 M 2093	I
		1 987 43 R 2393 ⁸	I

Megane II 2.0 16V

2,0 99 F4R 770	09.02-03.10	0 451 10 P 3336	O
		1 987 42 S 9406	L
		0 450 90 F 5287 ¹	K
		1 987 43 M 2093	I
		1 987 43 R 2393 ⁸	I

2,0 99 F4R 771	11.02-03.10	0 451 10 P 3336	O
		1 987 42 S 9406	L
		0 450 90 F 5287 ¹	K
		1 987 43 M 2093	I
		1 987 43 R 2393 ⁸	I
2,0 102 F4R	07.03-03.10	1 987 43 R 2393 ⁸	I

2,0 102 F4R	06.06-01.11	0 450 90 F 5287 ¹	K
------------------------	-------------	-------------------------------------	----------

Megane II 2.0 16V Sport

2,0 165 F4R 774	03.03-10.08	0 451 10 P 3336	O
		1 457 43 S 3573	L
		0 450 90 F 5287 ¹	K
	03.03-01.06	1 987 43 M 2093	I
	02.06-10.08	1 987 43 R 2393 ⁸	I

Megane III

Megane III 1.4

1,4 96 H4J 700	11.08→	F 026 40 P 7022	O
		F 026 40 S0138	L
		0 450 90 F 5287 ¹	K
		1 987 43 R 2327 ⁸	I

Megane III 1.5 dCi

1,5 66/78/81 K9K 830; K9K 832; K9K 834; K9K 836	11.08→	F 026 40 P 7022	O
		F 026 40 S0138	L
		F 026 40 N 2067 ¹	K
		1 987 43 R 2327 ⁸	I



1,5 81 K9K 837	10.10→	F 026 40 P 7022	O
		F 026 40 S0138	L
		1 987 43 R 2327 ⁸	I

Megane III 1.6

1,6 74/81 K4M 848; K4M 858	11.08→	0 451 10 P 3336	O
		F 026 40 S0138	L
		1 987 43 R 2327 ⁸	I

1,6 | 81 | K4M 866

	11.08→	0 451 10 P 3336	O
		F 026 40 S0138	L
	10.10→	0 450 90 F 5287 ¹	K
	11.08→	1 987 43 R 2327 ⁸	I

Megane III 1.9 dCi

1,9 96 F9Q 870; F9Q 872	11.08→	F 026 40 P 7022	O
		F 026 40 S0138	L
		F 026 40 N 2067 ¹	K
		1 987 43 R 2327 ⁸	I

Megane III 2.0

2,0 102-103 M4R 713	10.10→	F 026 40 S0139	L
		0 450 90 F 5287 ¹	K
		1 987 43 R 2327 ⁸	I

2,0 | 103 | M4R 711

	11.08→	F 026 40 P 7001	O
		F 026 40 S0139	L
		1 987 43 R 2327 ⁸	I

Megane III 2.0 dCi

2,0 110/118 M9R 610; M9R 615	11.08→	F 026 40 P 7014	O
		F 026 40 N 2067 ¹	K
		1 987 43 R 2327 ⁸	I

Megane III 2.0 R.S.

2,0 184 F4R 874	11.09→	F 026 40 P 7022	O
----------------------------	--------	------------------------	----------

Megane III 2.0 TCe

2,0 132 F4R 870	11.08→	F 026 40 P 7022	O
		1 987 43 R 2327 ⁸	I

2,0 132 F4R 872	10.10→	F 026 40 P 7022	O
		0 450 90 F 5287 ¹	K
		1 987 43 R 2327 ⁸	I





Modus

Modus 1.2

1,2 55/57,5 D4F 740; D4F 764				
	09.04→	0451 10 P 4025	O	
		1457 43 S 3660	L	
		0450 90 F 5287 ¹	K	
		1987 43 M 2120	I	

Modus 1.2 TCe

1,1 74 D4F 78...				
	10.07→	0451 10 P 4025	O	
		1457 43 S 3595	L	
		0450 90 F 5287 ¹	K	
		1987 43 M 2120	I	

Modus 1.4

1,4 72 K4J 770; K4J 780				
	06.04-12.06	0451 10 P 3336	O	
		1457 43 S 3595	L	
		0450 90 F 5287 ¹	K	
		1987 43 M 2120	I	

Modus 1.5 dCi

1,5 50 K9K 762				
	09.04→	0451 10 P 3336	O	
	09.04-06.07	1457 43 S 3595	L	
	07.07→	F 026 40 S 0047	L	
	09.04→	WAS 0450 90 N 6473 ¹	K	
		1987 43 M 2120	I	

1,5 50 K9K 768				
	06.05→	0451 10 P 3336	O	
		1457 43 S 3595	L	
		WAS 0450 90 N 6473 ¹	K	
		1987 43 M 2120	I	

1,5 50/65 K9K 750; K9K 752				
	09.04→	0451 10 P 3336	O	
		1457 43 S 3595	L	
		WAS 0450 90 N 6473 ¹	K	
		1987 43 M 2120	I	

1,5 63 K9K 760				
	09.04→	0451 10 P 3336	O	
		F 026 40 S 0047	L	
		WAS 0450 90 N 6473 ¹	K	
		1987 43 M 2120	I	

1,5 63/78 K9K 764; K9K 766				
	09.04→	0451 10 P 3336	O	
		F 026 40 S 0047	L	
		WAS 0450 90 N 6473 ¹	K	
		1987 43 M 2120	I	

1,5 78 K9K 772				
	02.06→	0451 10 P 3336	O	
		F 026 40 S 0047	L	
		WAS 0450 90 N 6473 ¹	K	
		1987 43 M 2120	I	



Modus 1.6

1,6 65 K4M 792; K4M 794				
	09.04-12.06	0451 10 P 3336	O	
		1457 43 S 3595	L	
		0450 90 F 5287 ¹	K	
		1987 43 M 2120	I	

1,6 82 K4M 800; K4M 801				
	02.05→	0451 10 P 3336	O	
		F 026 40 S 0047	L	
		0450 90 F 5287 ¹	K	
		1987 43 M 2120	I	

1,6 83 K4M 790; K4M 791				
	09.04→	0451 10 P 3336	O	
		F 026 40 S 0047	L	
		0450 90 F 5287 ¹	K	
		1987 43 M 2120	I	

R 4

R 4 0.8

0,8 21,5 B1B 707; 800 705				
	10.82-12.93	0451 10 P 3141	O	
		0450 90 F 4058 ¹	K	

R 4 1.0

1,0 25 C1C 708				
	10.86-12.93	0451 10 P 3336	O	
		1457 43 S 2134	L	
		1457 43 S 2204	L	
		0450 90 F 4058 ¹	K	

R 4 1.1

1,1 25 C1E 714				
	11.84-12.93	0451 10 P 3336	O	
	10.82-12.93	0450 90 F 4058 ¹	K	

1,1 25 C1E 719				
	10.84-12.93	0451 10 P 3336	O	
		1457 43 S 2128	L	
		0450 90 F 4058 ¹	K	

1,1 25 688 712				
	11.84-12.93	0451 10 P 3336	O	
	10.82-12.93	0450 90 F 4058 ¹	K	

R 4 (F4/F6)

R 4 (F4/F6) 0.8

0,8 21,5/25 B1B 707; 800 705				
	10.76-12.93	0451 10 P 3141	O	

R 4 (F4/F6) 1.1

1,1 25 C1E 714; C1E 718				
	11.84-12.93	0451 10 P 3336	O	
	10.82-12.93	XXX 1457 43 S 2100	L	





1,1 25 C1E 719			
11.84-12.93	0 451 10 P 3336	O	
10.83-12.93	1 457 43 S 2134	L	
ABM	1 457 43 S 2128	L	
	1 457 43 S 2134	L	
XXX	1 457 43 S 2100	L	

1,1 25 688 711			
11.84-12.93	0 451 10 P 3336	O	
10.82-12.93	XXX 1 457 43 S 2100	L	

R 5

R 5 1.0

1,0 30 C1C 700			
10.84-12.96	0 451 10 P 3336	O	
	1 457 43 S 2204	L	
	0 450 90 F 4159 ¹	K	

R 5 1.1

1,1 33 C1E 750; C1E 760			
10.84-12.96	0 451 10 P 3336	O	
	1 457 43 S 2204	L	
	0 450 90 F 4159 ¹	K	

R 5 1.2

1,2 40 C1G 702,730; C1G 720; C1G 722			
10.84-12.96	0 451 10 P 3336	O	
	1 457 43 S 2204	L	
	0 450 90 F 4159 ¹	K	

R 5 1.4

1,4 43 C1J 768,715			
10.84-12.96	0 451 10 P 3336	O	
	1 457 43 S 2204	L	
	0 450 90 F 4159 ¹	K	

1,4 44/49/50 C2J 700; C2J 718,781; C2J 766; C2J 767,789; C2J 782; C2J 784; C2J 788			
10.84-12.96	0 451 10 P 3336	O	
	1 457 43 S 2134	L	
	0 450 90 F 4159 ¹	K	

R 5 1.4 i

1,4 44 C3J 760 Kat.			
10.85-12.96	0 451 10 P 3336	O	
	1 457 43 S 2134	L	
	0 450 90 F 5030 ¹	K	

R 5 1.4 Turbo

1,4 77 C1J 784			
10.84-12.96	0 451 10 P 3235	O	
	0 450 90 F 4159 ¹	K	

1,4 88 C1J 788			
06.87-12.96	0 451 10 P 3235	O	
	0 450 90 F 5030 ¹	K	

R 5 1.6 D

1,6 40 F8M 730			
10.87-12.96	0 451 10 P 3353	O	
	1 457 42 S 9079	L	
	1 457 43 N 4201 ²	K	
BO	1 457 43 N 1028	K	
TW	1 457 43 N 4106 ²	K	

R 5 1.7

1,7 66 F2N 710,740; F2N 742			
06.87-12.96	0 451 10 P 3336	O	
	1 457 42 S 9923	L	
	0 450 90 F 4159 ¹	K	

R 5 1.7 i

1,7 55 F3N 716,718 Kat.; F3N 717 Kat.			
10.86-12.96	0 451 10 P 3299	O	
	1 457 42 S 9818	L	
	0 450 90 F 5030 ¹	K	

1,7 69 F3N 702,722 Kat.			
10.86-12.96	0 451 10 P 3336	O	
	1 457 43 S 3230	L	
	0 450 90 F 5030 ¹	K	

R 9

R 9 1.2

1,2 40 C1G 710			
09.86-03.91	0 451 10 P 3336	O	
	1 457 43 S 2134	L	

R 9 1.4

1,4 44/49/50-53 C1J 798; C2J 717; C2J 717,718; C2J 730; C2J 766,767; C2J 768; C2J 792; C2J 794; C2J 796; C2J 796,797; C2J 797			
09.84-12.95	0 451 10 P 3336	O	
09.81-12.95	1 457 43 S 2134	L	

1,4 49-50 C2L 720			
03.94-12.95	0 451 10 P 3336	O	
	1 457 43 S 2134	L	

1,4 52 C2J-794			
11.87-09.93	0 450 90 F 5030 ¹	K	

R 9 1.4 i

1,4 44 C3J 756,700			
06.87-03.91	0 451 10 P 3336	O	
	1 457 43 S 2134	L	
	0 450 90 F 5030 ¹	K	

R 9 1.4 Turbo

1,4 77/85 C1J 760; C1J 764; C1J 770,782			
10.84-03.91	0 451 10 P 3336	O	
09.84-03.91	1 457 43 S 2106	L	
	0 450 90 F 5030 ¹	K	





R 9 1.6 D

1,6 40 F8M 700			
	01.86-12.92	0 451 10 P 3336	O
		1 457 42 S 9079	L
	BO	1 457 43 N 4150 ²	K
1,6 40 F8M 700,720			
	09.82-03.91	0 451 10 P 3336	O
		1 457 42 S 9079	L
	BO	1 457 43 N 4121 ²	K
	CAV	1 457 43 N 4201 ²	K
1,6 40 F8M 730			
	01.86-12.92	0 451 10 P 3336	O
		1 457 42 S 9079	L
	BO	1 457 43 N 4150 ²	K
	10.87-03.91	BO	1 457 43 N 4121 ²
		CAV	1 457 43 N 4201 ²

R 9 1.7

1,7 54/64/65 F2N 708,710; F2N 730,712; F2N 732,742			
	10.86-03.91	0 451 10 P 3299	O
		1 457 42 S 9923	L

R 9 1.7 i

1,7 54 F3N 718 Kat.			
	09.84-03.91	0 451 10 P 3299	O
		1 457 42 S 9818	L
		0 450 90 F 5030 ¹	K
1,7 69 F3N 708,722 Kat.			
	10.86-03.91	0 451 10 P 3299	O
		1 457 43 S 3230	L
		0 450 90 F 5030 ¹	K

R 11

R 11 1.1

1,1 35 C1E 715; C1E 720			
	11.84-03.91	0 451 10 P 3336	O
	03.83-03.91	1 457 43 S 2134	L

R 11 1.2

1,2 40 C1G 710			
	06.86-03.91	0 451 10 P 3336	O
		1 457 43 S 2134	L

R 11 1.4

1,4 44/46/49-53 C2J 717; C2J 717,718; C2J 720; C2J 730; C2J 766; C2J 767; C2J 768; C2J 794; C2L 720			
	11.84-03.95	0 451 10 P 3336	O
	03.83-03.95	1 457 43 S 2134	L

R 11 1.4 i

1,4 43 C3J 700 Kat.			
	06.87-03.91	0 451 10 P 3336	O
Komp.Nr. 53mm X 257mm	06.87-03.91	1 457 42 S 9818	L
Komp.Nr. 63mm X 248mm	06.87-03.91	1 457 43 S 2134	L
Komp.Nr. 63mm X 264mm	06.87-03.91	1 457 42 S 9923	L
	06.87-03.91	0 450 90 F 5030 ¹	K



1,4 43 C3J 756 Kat.			
	06.87-03.91	0 451 10 P 3336	O
		1 457 43 S 2134	L
		0 450 90 F 5030 ¹	K

R 11 1.4 Turbo

1,4 77 C1J 764			
	11.84-03.91	0 451 10 P 3235	O
	09.83-03.91	1 457 43 S 2106	L
		0 450 90 F 5030 ¹	K

1,4 85 C1J 770,782			
	06.85-03.91	0 451 10 P 3336	O
		1 457 43 S 2106	L
		0 450 90 F 5030 ¹	K

R 11 1.6 D

1,6 40 F8M 700; F8M 730			
	03.83-03.91	0 451 10 P 3336	O
	10.83-03.91	1 457 42 S 9079	L
	03.83-03.91	BO	1 457 43 N 4121 ²
		CAV	1 457 43 N 4201 ²

R 11 1.7

1,7 54/64/65 F2N 708,710; F2N 730,712; F2N 732,742			
	10.86-03.91	0 451 10 P 3299	O
		1 457 42 S 9923	L

1,7 65 F2N 798			
	01.85-03.95	0 451 10 P 3336	O
		1 457 42 S 9923	L

R 11 1.7 i

1,7 55 F3N 718 Kat.			
	10.84-03.91	0 451 10 P 3299	O
		1 457 42 S 9818	L
		0 450 90 F 5030 ¹	K

1,7 69 F3N 708,722 Kat.			
	06.87-03.91	0 451 10 P 3299	O
		1 457 43 S 3230	L
		0 450 90 F 5030 ¹	K

1,7 69 F3N 722 Kat.			
	10.83-03.91	0 451 10 P 3299	O
	06.87-03.91	1 457 43 S 3230	L
	10.83-03.91	0 450 90 F 5030 ¹	K

R 19

R 19 1.2

1,2 40 C1G 730			
	09.88-12.01	0 451 10 P 3336	O
		1 457 43 S 2134	L
		0 450 90 F 4159 ¹	K

R 19 1.2 i

1,2 46 E7F 730 Kat.			
	05.92-12.01	0 451 10 P 3336	O
		1 457 42 S 9923	L
		SHL	0 450 90 F 5030 ¹
		SVL	0 450 90 F 5903 ¹





R 19 1.4

1,4 43/50 C1J 742; C2J 772; C2J 776	09.88-12.01	0 451 10 P 3336	O
		1 457 43 S 2134	L
		0 450 90 F 4159 ¹	K

1,4 58-59 E6J 700	09.88-12.01	0 451 10 P 3336	O
		1 457 43 S 2124	L
		0 450 90 F 4159 ¹	K

1,4 58-59 E6J 701; E6J 706	09.88-12.01	0 451 10 P 3336	O
		1 457 43 S 2124	L
		0 450 90 F 4159 ¹	K
		SHL 0 450 90 F 5030 ¹	K

R 19 1.4 i

1,4 40-44 C3J 710 Kat.	09.88-12.01	0 451 10 P 3336	O
		0 450 90 F 5030 ¹	K

1,4 55-59 E7J 700 Kat.; E7J 706 Kat.; E7J 742 Kat.; E7J 745 Kat.	05.90-12.01	0 451 10 P 3336	O
		1 457 42 S 9923	L
		SHL 0 450 90 F 5030 ¹	K
		SVL 0 450 90 F 5903 ¹	K

R 19 1.6

1,6 61 F3P	07.93-03.98	0 451 10 P 3336	O
		0 450 90 F 4058 ¹	K

R 19 1.6 i

1,6 61 C3L	01.93-05.00	0 451 10 P 3336	O
		1 457 43 S 2134	L
		0 450 90 F 5030 ¹	K

R 19 1.7

1,7 55-56 F2N 724	09.88-12.95	0 451 10 P 3336	O
		1 457 42 S 9923	L
		0 450 90 F 4159 ¹	K

1,7 68 F2N 720; F2N 721	09.88-12.95	0 451 10 P 3336	O
		1 457 42 S 9841	L
		0 450 90 F 4159 ¹	K

1,7 68 F2N 726; F2N 727	09.90-12.95	0 451 10 P 3336	O
		1 457 42 S 9841	L
		0 450 90 F 4159 ¹	K



R 19 1.7 i

1,7 54 F3N 740 Kat.; F3N 741 Kat.	09.88-12.95	0 451 10 P 3336	O
		1 457 42 S 9818	L
		SHL 0 450 90 F 5030 ¹	K
		SVL 0 450 90 F 5903 ¹	K

1,7 66-70 F3N 742 Kat.; F3N 743 Kat.; F3N 746	09.88-12.95	0 451 10 P 3336	O
		1 457 43 S 3230	L
		0 450 90 F 5030 ¹	K

R 19 1.8 i

1,8 65 F3P 704 Kat.	05.92-12.95	0 451 10 P 3336	O
		10.94-12.95	1 457 42 S 9841
		GS 1 457 42 S 9841	L
	05.92-12.95	SHL 0 450 90 F 5030 ¹	K
		SVL 0 450 90 F 5903 ¹	K

1,8 65 F3P 705 Kat.	05.92-12.95	0 451 10 P 3336	O
		10.94-12.95	GS 1 457 42 S 9841
	05.92-12.95	SHL 0 450 90 F 5030 ¹	K
		SVL 0 450 90 F 5903 ¹	K

1,8 65 F3P 706 Kat.	05.92-12.95	0 451 10 P 3336	O
		10.94-12.95	1 457 42 S 9841
		GS 1 457 42 S 9841	L
	05.92-12.95	SHL 0 450 90 F 5030 ¹	K
	SVL 0 450 90 F 5903 ¹	K	

1,8 65 F3P 707 Kat.	05.92-12.95	0 451 10 P 3336	O
		10.94-12.95	GS 1 457 42 S 9841
	05.92-12.95	SHL 0 450 90 F 5030 ¹	K
		SVL 0 450 90 F 5903 ¹	K

1,8 65 F3P 708 Kat.; F3P 760 Kat.	02.93-12.95	0 451 10 P 3336	O
		1 457 42 S 9841	L
		GS 1 457 42 S 9841	L
		SHL 0 450 90 F 5030 ¹	K
		SVL 0 450 90 F 5903 ¹	K

1,8 65-66 F3P 706 Kat.	09.94-12.95	0 451 10 P 3336	O
		1 457 42 S 9841	L
	10.94-12.95	GS 1 457 42 S 9841	L
	09.94-12.95	SHL 0 450 90 F 5030 ¹	K
		SVL 0 450 90 F 5903 ¹	K

1,8 79 F3P 682 Kat.	09.94-12.95	0 451 10 P 3336	O
		1 457 42 S 9841	L
		SHL 0 450 90 F 5030 ¹	K
		SVL 0 450 90 F 5903 ¹	K





◀ R 19 1.8 i

1,8 | 79 | F3P 764 Kat.; F3P 765 Kat.

09.94-12.95	0 451 10 P 3336	O
	1 457 42 S 9841	L
SHL	0 450 90 F 5030 ¹	K
SVL	0 450 90 F 5903 ¹	K

1,8 | 79-83 | F3P 682 Kat.

05.92-12.95	0 451 10 P 3336	O
	1 457 42 S 9841	L
SHL	0 450 90 F 5030 ¹	K
SVL	0 450 90 F 5903 ¹	K
09.94-12.95	0 450 90 F 5030 ¹	K

1,8 | 79-83 | F3P 700 Kat.

05.92-12.95	0 451 10 P 3336	O
	1 457 42 S 9841	L
SHL	0 450 90 F 5030 ¹	K
SVL	0 450 90 F 5903 ¹	K

R 19 1.8 i 16V

1,8 | 99-101 | F7P 704 Kat.

06.89-12.95	0 451 10 P 3336	O
	KL 1 457 43 S 3624	L
	KL 1 457 42 S 9841	L
	0 450 90 F 5030 ¹	K

1,8 | 103 | F7P 700

06.89-09.92	0 451 10 P 3336	O
	1 457 42 S 9841	L
	0 450 90 F 5030 ¹	K

R 19 1.9 D

1,9 | 47 | F8Q 706

09.88-12.01	0 451 10 P 3336	O
	1 457 42 S 9841	L
Komp.Nr. R6260B640	09.88-12.01	1 457 43 N 4201 ² K
Komp.Nr. R6260B640	09.88-12.01	1 457 43 N 4200 ² K

1,9 | 47 | F8Q 742

06.90-12.01	0 451 10 P 3336	O
	1 457 42 S 9841	L
	1 457 43 N 4201 ²	K

1,9 | 47 | F8Q 764

05.92-12.01	0 451 10 P 3336	O
	1 457 42 S 9841	L
B,GB, P	05.92-12.01	1 457 43 N 4200 ² K
P	05.92-12.01	1 457 43 N 4201 ² K

1,9 | 48 | F8Q-756

01.94-11.01	0 451 10 P 3336	O
	1 457 42 S 9923	L
BO	1 457 43 N 1028	K
LUC	1 457 42 N 9621	K

R 19 1.9 D Turbo

1,9 | 66 | F8Q 744

05.92-12.01	0 451 10 P 3336	O
	1 457 43 S 3624	L
	1 457 43 N 4201 ²	K



1,9 | 66-68 | F8Q 610

08.95-12.01	0 451 10 P 3336	O
	1 457 43 S 3624	L
	1 457 43 N 4291 ²	K

1,9 | 66-68 | F8Q 768

09.94-12.01	0 451 10 P 3336	O
	1 457 43 S 3624	L
	1 457 43 N 4291 ²	K

1,9 | 68 | F8Q 740

09.90-07.95	0 451 10 P 3336	O
	1 457 43 S 3624	L
	1 457 43 N 4201 ²	K

R 21 (B48,K48,L48)

R 21 (B48,K48,L48) 1.4

1,4 | 49-50/51 | C2J 760,717; C2J 770,717; C2L 714; C2L 714,717; C2L 717

06.88-12.95	0 451 10 P 3336	O
	1 457 43 S 2134	L
	0 450 90 F 4159 ¹	K

R 21 (B48,K48,L48) 1.7

1,7 | 53-56 | F2N 712; F2N 716

06.86-12.95	0 451 10 P 3299	O
	1 457 42 S 9923	L
	0 450 90 F 4159 ¹	K

1,7 | 54/55-56/64 | F2N 716,712; F2N 750,712; F2N 752,742

03.86-12.94	0 451 10 P 3299	O
	TW 1 457 42 S 9818	L
	1 457 42 S 9923	L
	0 450 90 F 4159 ¹	K

1,7 | 54-60 | F2N 758,720

06.90-12.95	0 451 10 P 3299	O
	1 457 42 S 9841	L
	0 450 90 F 4159 ¹	K

1,7 | 54-60 | F2N 786

06.90-12.95	0 451 10 P 3299	O
	1 457 42 S 9841	L

1,7 | 55 | F2N 711,720

09.89-03.93	0 451 10 P 3299	O
	1 457 42 S 9841	L
	0 450 90 F 4159 ¹	K

1,7 | 55/65 | F2N 754,711,720; F2N 754,720

02.88-12.95	0 451 10 P 3299	O
	1 457 42 S 9841	L
	0 450 90 F 4159 ¹	K

1,7 | 65 | F2N 754,720,711

01.89-03.93	0 451 10 P 3299	O
	1 457 42 S 9923	L
	0 450 90 F 4159 ¹	K

1,7 | 65 | F2N 758,720

06.90-12.94	KL 0 451 10 P 3299	O
	KL 0 451 10 P 3235	O
	1 457 42 S 9841	L
	0 450 90 F 4159 ¹	K





1,7 65 F2N 783	03.86-03.92	0 451 10 P 3299	O
		1 457 42 S 9923	L
		0 450 90 F 4159 ¹	K

1,7 65 F2N 786	06.90-12.94	KL 0 451 10 P 3299	O
		KL 0 451 10 P 3235	O
		1 457 42 S 9841	L
		0 450 90 F 4159 ¹	K

1,7 68-70 F2N 710	06.86-12.95	0 451 10 P 3299	O
		1 457 42 S 9923	L
		0 450 90 F 4159 ¹	K

R 21 (B48,K48,L48) 1.7 i

1,7 54 F3N 726,718,740 Kat.; F3N 726,740,718 Kat.	03.86-12.95	0 451 10 P 3299	O
		1 457 42 S 9818	L
		0 450 90 F 5030 ¹	K

1,7 66-70 F3N 722,723 Kat.	03.86-12.95	0 451 10 P 3299	O
		1 457 43 S 3230	L
		0 450 90 F 5030 ¹	K

R 21 (B48,K48,L48) 1.9 D

1,9 48 F8Q 710	05.89-12.95	0 451 10 P 3336	O
		1 457 42 S 9841	L
		BO 1 457 43 N 4106 ²	K
		CAV 1 457 43 N 4201 ²	K
	09.89-12.93	1 457 43 N 4201 ²	K

R 21 (B48,K48,L48) 2.0

2,0 66 F2R 702	03.86-03.92	0 451 10 P 3299	O
		1 457 43 S 2106	L
		0 450 90 F 4159 ¹	K

2,0 75/76 J6R 758; J6R 759; J6R 792; J6R 792,793; J6R 793	03.86-12.95	0 451 10 P 3299	O
		1 457 43 S 2124	L
		0 450 90 F 4159 ¹	K

R 21 (B48,K48,L48) 2.0 i

2,0 85-88/99-100 J7R 740 Kat.; J7R 746,747 Kat.; J7R 750,751	10.86-12.95	0 451 10 P 3299	O
		1 457 43 S 2124	L
		0 450 90 F 5030 ¹	K

2,0 98-102 J7R 754	05.89-03.92	0 451 10 P 3299	O
		1 457 43 S 2124	L
		0 450 90 F 5030 ¹	K

R 21 (B48,K48,L48) 2.0 i Turbo

2,0 119-121 J7R 756 Kat.	05.89-03.93	0 451 10 P 3299	O
		1 457 43 S 3230	L
		0 450 90 F 5030 ¹	K

2,0 119-129 J7R 752	04.87-03.92	0 451 10 P 3299	O
		1 457 43 S 3230	L
		0 450 90 F 5030 ¹	K

R 21 (B48,K48,L48) 2.1 D

2,1 46-54 J8S 704	03.86-03.92	0 451 10 P 3353	O
		1 457 42 S 9079	L
	E 03.86-03.92	BO 1 457 43 N 4150 ²	K
		BO,XXX 1 457 43 N 4150 ²	K
	E 03.86-03.92	ROD 1 457 43 N 4200 ²	K

2,1 46-56 J8S 600	04.92-12.94	0 451 10 P 3353	O
		1 457 42 S 9079	L
		ROD 1 457 43 N 4200 ²	K

2,1 49 J8S 704	10.86-12.95	0 451 10 P 3353	O
		1 457 42 S 9079	L
		BO 1 457 43 N 4150 ²	K
		BO,XXX 1 457 43 N 4150 ²	K
		CAV 1 457 43 N 4200 ²	K

2,1 49-54 J8S 784; J8S 786; J8S 788	04.92-12.94	0 451 10 P 3353	O
		1 457 43 S 3231	L
		ROD 1 457 43 N 4200 ²	K

2,1 51-53 J8S 784; J8S 786; J8S 788	04.92-12.93	0 451 10 P 3353	O
		1 457 43 S 3231	L
		CAV 1 457 43 N 4200 ²	K

2,1 51-54 J8S 600	04.92-12.95	0 451 10 P 3353	O
		1 457 43 S 3231	L
		BO 1 457 43 N 4150 ²	K
		BO,XXX 1 457 43 N 4150 ²	K
		CAV 1 457 43 N 4200 ²	K

2,1 51-54 J8S 784; J8S 786; J8S 788	04.92-12.95	0 451 10 P 3353	O
		1 457 43 S 3231	L
		BO 1 457 43 N 4150 ²	K
		BO,XXX 1 457 43 N 4150 ²	K
		CAV 1 457 43 N 4200 ²	K





◀ R 21 (B48,K48,L48) 2.1 D

2,1 | 53 | J8S 740; J8S 742

	05.89-12.93		0 451 10 P 3353	O
			1 457 43 S 3231	L
	09.89-12.93	CAV	1 457 43 N 4200 ²	K
E	05.89-03.93	BO	1 457 43 N 4150 ²	K
		BO,XXX	1 457 43 N 4150 ²	K
E	05.89-03.93	ROD	1 457 43 N 4200 ²	K
Fg.Nr. F795884→	E	09.89-12.93	1 457 43 N 4200 ²	K
Fg.Nr. →F795883	E	09.89-12.93	BO	1 457 43 N 4150 ²
		BO,XXX	1 457 43 N 4150 ²	K

2,1 | 53-54 | J8S 740; J8S 742

	05.89-12.95		0 451 10 P 3353	O
			1 457 43 S 3231	L
		BO	1 457 43 N 4150 ²	K
		BO,XXX	1 457 43 N 4150 ²	K
		CAV	1 457 43 N 4200 ²	K

2,1 | 54 | J8S 704

	09.89-03.92		0 451 10 P 3353	O
			1 457 42 S 9079	L
		CAV	1 457 43 N 4200 ²	K

R 21 (B48,K48,L48) 2.1 D Turbo

2,1 | 65 | J8S 604

	04.92-12.95		0 451 10 P 3353	O
			1 457 43 S 3231	L
		BO	1 457 43 N 4150 ²	K
		BO,XXX	1 457 43 N 4150 ²	K
		CAV	1 457 43 N 4200 ²	K

2,1 | 65 | J8S 714

	03.86-03.93		0 451 10 P 3353	O
			1 457 43 S 3231	L
E	03.86-03.93	BO	1 457 43 N 4150 ²	K
		BO,XXX	1 457 43 N 4150 ²	K
E	03.86-03.93	ROD	1 457 43 N 4200 ²	K

2,1 | 65 | J8S 740; J8S 742

	03.86-12.95		0 451 10 P 3353	O
			1 457 43 S 3231	L
	07.89-12.95	BO	1 457 43 N 4150 ²	K
		BO,XXX	1 457 43 N 4150 ²	K
		CAV	1 457 43 N 4200 ²	K
E	03.86-03.93	BO	1 457 43 N 4150 ²	K
		BO,XXX	1 457 43 N 4150 ²	K
E	03.86-03.93	ROD	1 457 43 N 4200 ²	K
Fg.Nr. F795884→	E	09.89-03.92	1 457 43 N 4200 ²	K
Fg.Nr. →F795883	E	09.89-03.92	BO	1 457 43 N 4150 ²
		BO,XXX	1 457 43 N 4150 ²	K

2,1 | 65 | J8S 746

	05.89-12.95		0 451 10 P 3353	O
			1 457 43 S 3231	L
	05.89-05.91	ROD	1 457 43 N 4200 ²	K
	05.89-12.95	BO	1 457 43 N 4150 ²	K
		BO,XXX	1 457 43 N 4150 ²	K
		CAV	1 457 43 N 4200 ²	K

2,1 | 65 | J8S 746,714

	09.89-03.92		0 451 10 P 3353	O
			1 457 43 S 3231	L
		CAV	1 457 43 N 4200 ²	K



2,1 | 65 | J8S 784; J8S 786; J8S 788

	06.90-12.95		0 451 10 P 3353	O
			1 457 43 S 3231	L
	06.90-12.94	ROD	1 457 43 N 4200 ²	K
	06.90-12.95	BO	1 457 43 N 4150 ²	K
		BO,XXX	1 457 43 N 4150 ²	K
		CAV	1 457 43 N 4200 ²	K

2,1 | 65 | J8S 788,714

	06.90-03.92		0 451 10 P 3353	O
			1 457 43 S 3231	L
		CAV	1 457 43 N 4200 ²	K

2,1 | 65-68 | J8S 604

	04.92-12.94		0 451 10 P 3353	O
			1 457 43 S 3231	L
		ROD	1 457 43 N 4200 ²	K

R 21 (B48,K48,L48) 2.2

2,2 | 85 | J6T 790,791

	03.86-12.95		0 451 10 P 3299	O
			1 457 43 S 2124	L
			0 450 90 F 4159 ¹	K

R 21 (B48,K48,L48) 2.2 i

2,2 | 79-81 | J7T 754,755 Kat.; J7T 756 Kat.

	07.86-12.95		0 451 10 P 3299	O
			1 457 43 S 2124	L
			0 450 90 F 5030 ¹	K

R 25

R 25 2.0

2,0 | 74 | J6R 706,707; J6R 760,762,763

	11.84-12.92		0 451 10 P 3299	O
	01.84-12.92		1 457 43 S 2124	L
			0 450 90 F 4058 ¹	K

R 25 2.0 i

2,0 | 88/99-100/103 | J7R 720,721; J7R 722,723; J7R 726 Kat.

	06.87-12.92		0 451 10 P 3299	O
			1 457 43 S 2124	L
			0 450 90 F 5030 ¹	K

R 25 2.1 D, D Turbo

2,1 | 50-51/63 | J8S 708; J8S 736

	01.84-12.92		0 451 10 P 3353	O
			1 457 43 S 3231	L
	10.89-12.92		1 457 43 N 4200 ²	K

R 25 2.1 D Turbo

2,1 | 63 | J8S 738

	06.89-12.92		0 451 10 P 3353	O
			1 457 43 S 3231	L
		ROD	1 457 43 N 4200 ²	K

R 25 2.2 i

2,2 | 79-81 | J7T 732,733 Kat.

	10.86-12.92		0 451 10 P 3299	O
			1 457 43 S 2124	L
			0 450 90 F 5030 ¹	K





R 25 2.5 i Turbo

2,5 147-151 Z7U 700	05.89-12.92	0 451 10 P 3299	O
		1 457 43 S 3230	L
		0 450 90 F 5030 ¹	K

R 25 2.9 i

2,9 110-112/115 Z7W 700; Z7W 701; Z7W 706,707 Kat.; Z7W 709	06.87-12.92	0 451 10 P 3299	O
		1 457 43 S 3230	L
		0 450 90 F 5030 ¹	K

Safrane

Safrane 2.0 i

2,0 77/97-99 J7R 732,733; J7R 734,735; J7R 738,739	04.92-09.96	0 451 10 P 3299	O
		1 457 42 S 9079	L
	04.92-02.96	0 450 90 F 5030 ¹	K
	03.96-09.96	0 450 90 F 5903 ¹	K

Safrane 2.0 i 16V

2,0 100 N7Q 710; N7Q 711	10.96-12.00	0 451 10 P 3299	O
		1 457 43 S 3743	L
		0 450 90 F 5903 ¹	K

Safrane 2.1 D Turbo

2,1 65-66 J8S 760	04.92-09.96	0 451 10 P 3353	O
		1 457 42 S 9079	L
		BO 1 457 43 N 4150 ²	K
		CAV 1 457 43 N 4200 ²	K

Safrane 2.2 i

2,2 79-81/101-104 J7T 760,761; J7T 762,763; J7T 766,767	04.92-09.96	0 451 10 P 3299	O
		1 457 42 S 9079	L
	04.92-02.96	0 450 90 F 5030 ¹	K
	03.96-09.96	0 450 90 F 5903 ¹	K

Safrane 2.2 12V D Turbo

2,2 83 G8T 740	10.96-01.99	F 026 40 P 7106	O
	02.99-12.00	0 451 10 P 3353	O
	10.96-12.00	1 457 43 S 3282	L
		CAV 1 457 42 N 9621	K
		PRF 1 457 43 N 1705	K

Safrane 2.5 D Turbo

2,5 83-85 S8U 762,763 <8144 97 ..>	04.92-09.96	0 451 20 P 3201	O
		BO 1 457 43 N 4150 ²	K
Fg.Nr. S 028216→	06.95-09.96	CAV 1 457 42 N 9621	K



Safrane 2.5 i 20V

2,5 121 N7U 700; N7U 701	10.96-12.00	0 451 10 P 3299	O
		0 450 90 F 5903 ¹	K

Safrane 3.0 i

3,0 123-125 Z7X 755	10.96-12.00	0 451 10 P 3299	O
		0 450 90 F 5903 ¹	K

Safrane 3.0 i, i Biturbo

3,0 123-125/190-197 Z7X 721; Z7X 722,723; Z7X 726; Z7X 753	04.92-09.96	0 451 10 P 3299	O
	04.92-02.96	0 450 90 F 5030 ¹	K
	03.96-09.96	0 450 90 F 5903 ¹	K

Safrane 3.0 i 24V

3,0 140 L7X 713	03.99-12.00	0 451 10 P 3299	O
		0 450 90 F 5903 ¹	K

Scenic

Scenic 1.6 i 16V

1,6 79/81 K4M	08.99-07.10	0 450 90 F 5287 ¹	K
		0 986 BF CB 0565	I

Scenic 2.0 i

2,0 85 F3R	01.99-12.01	1 457 42 S 9841	L
		0 450 90 F 5287 ¹	K
		0 986 BF CB 0565	I

Scenic 2.0 i 16V

2,0 102 F4R 741	05.99-10.03	1 987 43 M 2069	I
2,0 103 F4R	01.02-07.10	0 450 90 F 5287 ¹	K
		1 987 43 M 2069	I

Scenic I / Megane Scenic (JA)

Scenic I / Megane Scenic (JA) 1.4 i

1,4 55 E7J 764	11.96-04.03	0 451 10 P 3336	O
		1 457 42 S 9923	L
		0 450 90 F 5287 ¹	K
	11.96-12.97	KL 1 987 43 M 2089	I
	01.98-09.99	KL 1 987 43 M 2090	I
	10.99-04.03	KL 1 987 43 M 2069	I
1,4 70 K4J 714	02.00-04.03	0 451 10 P 3336	O
		1 457 43 S 3529	L
		0 450 90 F 5287 ¹	K
		KL 1 987 43 M 2069	I





◀ Scenic I / Megane Scenic (JA) 1.4 i

1,4 70 K4J 750			
	08.98-04.03	0 451 10 P 3336	O
		1 457 43 S 3529	L
		0 450 90 F 5287 ¹	K
	08.98-09.99 KL	1 987 43 M 2090	I
	10.99-04.03 KL	1 987 43 M 2069	I

Scenic I / Megane Scenic (JA) 1.6 i

1,6 55/66 K7M 702; K7M 703; K7M 720			
	01.96-04.03	0 451 10 P 3336	O
		1 457 43 S 2124	L
		0 450 90 F 5287 ¹	K
	01.96-12.97 KL	1 987 43 M 2089	I
	01.98-09.99 KL	1 987 43 M 2090	I
	10.99-04.03 KL	1 987 43 M 2069	I

1,6 | 79 | K4M 700; K4M 701; K4M 704

	08.98-04.03	0 451 10 P 3336	O
		1 457 43 S 3529	L
		0 450 90 F 5287 ¹	K
	08.98-09.99 KL	1 987 43 M 2090	I
	10.99-04.03 KL	1 987 43 M 2069	I

1,6 | 79 | K4M 706; K4M 707; K4M 708

	10.99-04.03	0 451 10 P 3336	O
		1 457 43 S 3529	L
		0 450 90 F 5287 ¹	K
	KL	1 987 43 M 2069	I

1,6 | 79 | K4M 709

	03.99-04.03	0 451 10 P 3336	O
		1 457 43 S 3529	L
		0 450 90 F 5287 ¹	K
	03.99-09.99 KL	1 987 43 M 2090	I
	10.99-04.03 KL	1 987 43 M 2069	I

1,6 | 79 | K4M 712; K4M 776

	09.00-04.03	0 451 10 P 3336	O
		1 457 43 S 3529	L
		0 450 90 F 5287 ¹	K
	KL	1 987 43 M 2069	I

Scenic I / Megane Scenic (JA) 1.8 i

1,8 | 85/88 | F4P 720; F4P 722

	09.00-04.03	0 451 10 P 3336	O
		1 457 43 S 3529	L
		0 450 90 F 5287 ¹	K
	KL	1 987 43 M 2069	I

Scenic I / Megane Scenic (JA) 1.9 D

1,9 | 47 | F8Q 790

	03.99-04.03	F 026 40 P 7022	O
		F 026 40 S 0015	L
		LUC 1 457 43 N 1712	K
		PRF 1 457 42 N 9657	K
	03.99-09.99 KL	1 987 43 M 2090	I
	10.99-04.03 KL	1 987 43 M 2069	I



1,9 | 47-48 | F8Q 788

	11.96-04.03	F 026 40 P 7022	O
	11.96-02.99	1 457 42 S 9841	L
	03.99-04.03	F 026 40 S 0015	L
	11.96-11.98	1 457 42 N 9657	K
	12.98-04.03	1 457 43 N 1712	K
	11.96-12.97 KL	1 987 43 M 2089	I
	01.98-09.99 KL	1 987 43 M 2090	I
	10.99-04.03 KL	1 987 43 M 2069	I

1,9 | 74 | F9Q 740

	04.99→	1 987 43 M 2069	I
--	--------	-----------------	----------

Scenic I / Megane Scenic (JA) 1.9 D Turbo

1,9 | 66 | F8Q 786

	11.96-04.03	0 451 10 P 3336	O
		1 457 43 S 3624	L
		BO 1 457 42 N 9657	K
		LUC 1 457 42 N 9621	K
	11.96-12.97 KL	1 987 43 M 2089	I
	01.98-09.99 KL	1 987 43 M 2090	I
	10.99-04.03 KL	1 987 43 M 2069	I

1,9 | 66-69 | F8Q 784

	11.96-03.97	0 451 10 P 3336	O
		1 457 43 S 3624	L
		BO 1 457 42 N 9657	K
		LUC 1 457 42 N 9621	K
	KL	1 987 43 M 2089	I

Scenic I / Megane Scenic (JA) 1.9 DCI

1,9 | 75 | F9Q 738

	09.00-04.03	F 026 40 P 7022	O
		1 457 43 S 3531	L
		0 450 90 N 6461 ¹	K
	KL	1 987 43 M 2069	I

Scenic I / Megane Scenic (JA) 1.9 DCI, DCI RX4

1,9 | 75 | F9Q 732

	03.99-04.03	F 026 40 P 7022	O
		1 457 43 S 3531	L
		0 450 90 N 6461 ¹	K
	03.99-09.99 KL	1 987 43 M 2090	I
	10.99-04.03 KL	1 987 43 M 2069	I

1,9 | 75 | F9Q 733

	10.99-04.03	F 026 40 P 7022	O
		1 457 43 S 3531	L
		0 450 90 N 6461 ¹	K
	KL	1 987 43 M 2069	I

1,9 | 75 | F9Q 740

	06.00-04.03	F 026 40 P 7022	O
		1 457 43 S 3531	L
		0 450 90 N 6461 ¹	K
	KL	1 987 43 M 2069	I

1,9 | 75 | F9Q 746; F9Q 748

	02.01-04.03	F 026 40 P 7022	O
		1 457 43 S 3531	L
		0 450 90 N 6461 ¹	K
	KL	1 987 43 M 2069	I





1,9 75 F9Q 796	06.97-04.03	F 026 40 P 7022	O
		1 457 43 S 3531	L
		0 450 90 N 6461 ¹	K
	06.97-12.97 KL	1 987 43 M 2089	I
	01.98-09.99 KL	1 987 43 M 2090	I
	10.99-04.03 KL	1 987 43 M 2069	I

Scenic I / Megane Scenic (JA) 1.9 DTI

1,9 59 F9Q 744	11.00-04.03	F 026 40 P 7022	O
		1 457 43 S 3531	L
		1 457 42 N 9657	K
	KL	1 987 43 M 2069	I

1,9 72 F9Q 731	03.99-04.03	F 026 40 P 7022	O
		1 457 43 S 3531	L
		LUC 1 457 43 N 1712	K
		PRF 1 457 42 N 9657	K
	03.99-09.99 KL	1 987 43 M 2090	I
	10.99-04.03 KL	1 987 43 M 2069	I

1,9 72 F9Q 734	06.97-02.99	F 026 40 P 7022	O
		1 457 43 S 3624	L
		1 457 42 N 9657	K
	06.97-12.97 KL	1 987 43 M 2089	I
	01.98-02.99 KL	1 987 43 M 2090	I

1,9 72 F9Q 736	03.99-04.03	F 026 40 P 7022	O
		1 457 43 S 3531	L
		LUC 1 457 43 N 1712	K
		PRF 1 457 42 N 9657	K
	03.99-09.99 KL	1 987 43 M 2090	I
	10.99-04.03 KL	1 987 43 M 2069	I

Scenic I / Megane Scenic (JA) 2.0 i

2,0 83-84 F3R 750; F3R 751	11.96-03.97	0 451 10 P 3336	O
		1 457 42 S 9841	L
		0 450 90 F 5287 ¹	K
	KL	1 987 43 M 2089	I

2,0 84 F3R 791; F3R 796; F3R 797; F3R 798	11.96-04.03	0 451 10 P 3336	O
		1 457 42 S 9841	L
		0 450 90 F 5287 ¹	K
	11.96-12.97 KL	1 987 43 M 2089	I
	01.98-09.99 KL	1 987 43 M 2090	I
	10.99-04.03 KL	1 987 43 M 2069	I

2,0 101,5 F4R 740; F4R 741	03.99-04.03	F 026 40 P 7022	O
		1 457 43 S 3529	L
		0 450 90 F 5287 ¹	K
	03.99-09.99 KL	1 987 43 M 2090	I
	10.99-04.03 KL	1 987 43 M 2069	I

2,0 101,5 F4R 744	11.00-04.03	0 451 10 P 3336	O
		1 457 43 S 3529	L
		0 450 90 F 5287 ¹	K
	KL	1 987 43 M 2069	I

Scenic I / Megane Scenic (JA) 2.0 i, i RX4

2,0 101,5/102 F4R 746; F4R 747	06.00-04.03	F 026 40 P 7022	O
		1 457 43 S 3529	L
		0 450 90 F 5287 ¹	K
	KL	1 987 43 M 2069	I

Scenic I / Megane Scenic (JA) 2.0 i RX4

2,0 101,5 F4R 744	06.99-04.03	0 451 10 P 3336	O
		1 457 43 S 3529	L
		0 450 90 F 5287 ¹	K
	06.99-09.99 KL	1 987 43 M 2090	I
	10.99-04.03 KL	1 987 43 M 2069	I

Scenic II (JM)

Scenic II (JM) 1.4 16V

1,4 72 K4J 730; K4J 740	05.03-04.09	0 451 10 P 3336	O
		1 457 43 S 3529	L
		0 450 90 F 5287 ¹	K
		1 987 43 M 2094	I

Scenic II (JM) 1.5 DCI

1,5 60-63 K9K 722	05.03-12.06	0 451 10 P 3336	O
		1 987 42 S 9406	L
		0 450 90 N 6469 ¹	K
	05.03-12.06	1 987 43 M 2094	I

1,5 63 K9K 724	09.05-12.06	0 451 10 P 3336	O
		1 987 42 S 9406	L
		F 026 40 N 2016 ¹	K
	WW	F 026 40 N 2061 ¹	K
		1 987 43 M 2094	I

1,5 74 K9K 729	05.03-08.07	0 451 10 P 3336	O
	09.07-04.09	F 026 40 P 7022	O
	05.03-04.09	1 987 42 S 9406	L
	Komp.Nr. R6351060	05.03-04.09 SWA	0 450 90 N 6469 ¹
		1 987 43 M 2094	I

1,5 74-78 K9K 728	05.03-08.07	0 451 10 P 3336	O
	09.07-04.09	F 026 40 P 7022	O
	05.03-04.09	1 987 42 S 9406	L
	Komp.Nr. R6351060	05.03-12.04 SWA	0 450 90 N 6469 ¹
		1 987 43 M 2094	I





◀ Scenic II (JM) 1.5 DCI

1,5 | 78 | K9K 732

09.04-08.07	0 451 10 P 3336	O
09.07-04.09	F 026 40 P 7022	O
09.04-04.09	1 457 43 S 3573	L
	F 026 40 N 2016 ¹	K
WW	F 026 40 N 2061 ¹	K
	1 987 43 M 2094	I

Scenic II (JM) 1.6 16V

1,6 | 83 | K4M 760; K4M 761; K4M 762

05.03-04.09	0 451 10 P 3336	O
	1 987 42 S 9406	L
	0 450 90 F 5287 ¹	K
	1 987 43 M 2094	I

1,6 | 83 | K4M 764

05.03-04.09	0 451 10 P 3336	O
	1 457 43 S 3529	L
	0 450 90 F 5287 ¹	K
	1 987 43 M 2094	I

1,6 | 83 | K4M 766; K4M 782

05.03-04.09	0 451 10 P 3336	O
	1 987 42 S 9406	L
	0 450 90 F 5287 ¹	K
	1 987 43 M 2094	I

1,6 | 83 | K4M 788

07.05-04.09	0 451 10 P 3336	O
	1 457 43 S 3529	L
	0 450 90 F 5287 ¹	K
	1 987 43 M 2094	I

1,6 | 83 | K4M 812; K4M 813

05.05-04.09	0 451 10 P 3336	O
	1 987 42 S 9406	L
	0 450 90 F 5287 ¹	K
	1 987 43 M 2094	I

Scenic II (JM) 1.9 DCI

1,9 | 81/88/96 | F9Q 803; F9Q 804; F9Q 812; F9Q 814

05.03-04.09	F 026 40 P 7022	O
	1 457 43 S 3573	L
	1 457 43 N 1705	K
	1 987 43 M 2094	I

Scenic II (JM) 2.0 DCI

2,0 | 110 | M9R 700

09.04-04.09	F 026 40 P 7014	O
	1 457 43 S 3573	L
	F 026 40 N 2016 ¹	K
WW	F 026 40 N 2061 ¹	K
	1 987 43 M 2094	I

2,0 | 110 | M9R 720

09.04-04.09	1 457 43 S 3573	L
	1 987 43 M 2094	I

2,0 | 110 | M9R 721

09.04-04.09	F 026 40 P 7014	O
	1 457 43 S 3573	L
	F 026 40 N 2016 ¹	K
WW	F 026 40 N 2061 ¹	K
	1 987 43 M 2094	I



Scenic II (JM) 2.0 16V

2,0 | 99 | F4R 770; F4R 771

05.03-04.09	0 451 10 P 3336	O
	1 987 42 S 9406	L
	0 450 90 F 5287 ¹	K
	1 987 43 M 2094	I

Scenic II (JM) 2.0 16V Turbo

2,0 | 120 | F4R 776

06.03-04.09	0 451 10 P 3336	O
	1 457 43 S 3573	L
	0 450 90 F 5287 ¹	K
	1 987 43 M 2094	I

Scenic II (J95)

Scenic II (J95) 1.4

1,4 | 96 | H4J 700

05.09→	F 026 40 P 7022	O
	F 026 40 S 0138	L
	0 450 90 F 5287 ¹	K

Scenic II (J95) 1.5 dCi

1,5 | 63/77/81 | K9K 83...; K9K 830; K9K 832

05.09→	F 026 40 P 7022	O
	F 026 40 S 0138	L
	F 026 40 N 2067 ¹	K

Scenic II (J95) 1.6

1,6 | 81 | K4M 858; K4M 866

05.09→	0 451 10 P 3336	O
	F 026 40 S 0138	L

Scenic II (J95) 1.9 dCi

1,9 | 96 | F9Q 870; F9Q 872

05.09→	F 026 40 P 7022	O
	F 026 40 S 0138	L
	F 026 40 N 2067 ¹	K

Scenic II (J95) 2.0

2,0 | 103 | M4R 711

05.09→	F 026 40 P 7001	O
	F 026 40 S 0139	L

Scenic II (J95) 2.0 dCi

2,0 | 110/118 | M9R 610; M9R 615

05.09→	F 026 40 P 7014	O
	F 026 40 N 2067 ¹	K

SG

SG 2

3,6 | 61 | 712-18

09.86-01.94	1 457 42 P 9546	O
-------------	-----------------	---





Sport Spider

Sport Spider 2.0

2,0 108-110 F7R 710; F7R 712; F7R 714; F7R 720			
05.96-10.99	0 451 10 P 3336	O	
XXX	1 457 43 S 3032	L	
	0 450 90 F 5030 ¹	K	

Symbol

Symbol 1.4 i 8V

1,4 55 E7J 635			
01.01→	1 457 43 S 3311	L	

Thalia

Thalia 1.0 i 16V

1,0 50 D4D 700			
06.01-02.03	1 457 42 P 9184	O	
03.03-11.04	0 451 10 P 4025	O	
06.01-11.04	1 457 43 S 3078	L	
	0 450 90 F 5287 ¹	K	
	1 987 43 M 2039	I	
	1 987 43 R 2197 ⁸	I	

1,0 50 D4D 706			
12.04-10.07	0 451 10 P 4025	O	
	1 457 43 S 3660	L	
	1 987 43 M 2039	I	
	1 987 43 R 2197 ⁸	I	

Thalia 1.2

1,1 55 D4F 728			
10.08→	0 451 10 P 4025	O	
	1 457 43 S 3660	L	
	0 450 90 F 5287 ¹	K	
	1 987 43 M 2039	I	

Thalia 1.2 i

1,2 43 D7F 726			
06.01-03.03	1 457 42 P 9184	O	
04.03-10.07	0 451 10 P 4025	O	
06.01-10.07	F 026 40 S 0011	L	
	0 450 90 F 5287 ¹	K	
	1 987 43 M 2039	I	
	1 987 43 R 2197 ⁸	I	

Thalia 1.2 i 16V

1,2 55 D4F 706; D4F 712			
09.01-02.03	1 457 42 P 9184	O	
03.03-10.07	0 451 10 P 4025	O	
09.01-10.07	1 457 43 S 3078	L	
	0 450 90 F 5287 ¹	K	
	1 987 43 M 2039	I	
	1 987 43 R 2197 ⁸	I	



1,2 55 D4F 728			
04.04-10.07	0 451 10 P 4025	O	
	1 457 43 S 3660	L	
	0 450 90 F 5287 ¹	K	
	1 987 43 M 2039	I	
	1 987 43 R 2197 ⁸	I	

Thalia 1.4

1,4 72 K4J 712			
10.08→	0 451 10 P 3336	O	
	1 457 43 S 3529	L	
	0 450 90 F 5287 ¹	K	

1,4 72 K4J 713			
10.08→	0 451 10 P 3336	O	
	1 457 43 S 3529	L	
	0 450 90 F 5287 ¹	K	

Thalia 1.4 i

1,4 55 K7J 700			
10.99-10.07	0 451 10 P 3336	O	
	1 457 43 S 3311	L	
	0 450 90 F 5287 ¹	K	
	1 987 43 M 2039	I	
	1 987 43 R 2197 ⁸	I	

Thalia 1.4 i 16V

1,4 70 K4J 713			
11.01-10.07	0 451 10 P 3336	O	
	1 457 43 S 3529	L	
	0 450 90 F 5287 ¹	K	
	1 987 43 M 2039	I	
	1 987 43 R 2197 ⁸	I	

1,4 70-72 K4J 712			
06.01-10.07	0 451 10 P 3336	O	
	1 457 43 S 3529	L	
	0 450 90 F 5287 ¹	K	
	1 987 43 M 2039	I	
	1 987 43 R 2197 ⁸	I	

Thalia 1.5 dCi

1,5 47/62 K9K 718; K9K 740			
10.08→	F 026 40 P 7022	O	
	F 026 40 S 0051	L	

1,5 48 K9K 700			
09.01-10.07	0 451 10 P 3336	O	
	1 457 43 S 3163	L	
09.01-01.05	WAS	0 450 90 N 6468 ¹	K
09.01-10.07	1 987 43 M 2039	I	
	1 987 43 R 2197 ⁸	I	

1,5 50 K9K 714			
10.05-10.07	0 451 10 P 3336	O	
	F 026 40 S 0051	L	
	1 987 43 M 2039	I	
	1 987 43 R 2197 ⁸	I	





◀ Thalia 1.5 dCi

1,5 59 K9K 702	06.01-10.07	0 451 10 P 3336	O
	06.01-04.07	1 457 43 S 3163	L
	05.07-10.07	F 026 40 S 0051	L
	06.01-01.05 WAS	0 450 90 N 6468 ¹	K
	06.01-10.07	1 987 43 R 2197 ⁸	I

1,5 60 K9K 706	05.04-10.07	0 451 10 P 3336	O
		1 457 43 S 3163	L
	05.04-01.05 WAS	0 450 90 N 6468 ¹	K
	05.04-10.07	1 987 43 M 2039	I
		1 987 43 R 2197 ⁸	I

Thalia 1.6

1,6 77 K4M 744; K4M 745	10.08→	0 451 10 P 3336	O
		1 457 43 S 3529	L
		0 450 90 F 5287 ¹	K

Thalia 1.6 i

1,6 66 K4M 732; K4M 734	11.01-10.07	0 451 10 P 3336	O
		1 457 43 S 3529	L
		0 450 90 F 5287 ¹	K
		1 987 43 M 2039	I
		1 987 43 R 2197 ⁸	I

1,6 66 K4M 736	11.04-10.07	0 451 10 P 3336	O
		1 457 43 S 3529	L
		1 987 43 M 2039	I
		1 987 43 R 2197 ⁸	I

1,6 66 K4M 746	10.99-10.07	0 451 10 P 3336	O
		1 457 43 S 3311	L
		0 450 90 F 5287 ¹	K
		1 987 43 M 2039	I
		1 987 43 R 2197 ⁸	I

1,6 66/81 K4M 740; K4M 742; K4M 743	06.01-10.07	0 451 10 P 3336	O
		1 457 43 S 3529	L
		0 450 90 F 5287 ¹	K
		1 987 43 M 2039	I
		1 987 43 R 2197 ⁸	I

Thalia 1.9 D

1,9 47-48 F8Q 630	10.99-10.07	0 451 10 P 3336	O
		1 457 43 S 3773	L
		BO,PRF 1 457 42 N 9657	K
		LUC 1 457 43 N 1712	K
		1 987 43 M 2039	I
		1 987 43 R 2197 ⁸	I

Trafic

Trafic 1.4

1,4 36 847 700 <C1J 700>	10.84-10.97	0 451 10 P 3336	O
	09.80-10.97	1 457 43 S 2106	L



Trafic 1.7

1,7 50/58 F1N 722,720; F1N 724; F1N 724,720	10.84-10.97	0 451 10 P 3336	O
		1 457 43 S 2106	L

Trafic 1.9 D

1,9 45 F8Q 606	02.88-11.03	0 986 B0 OB 0006	O
		1 457 42 N 9657	K

1,9 47-48 F8Q 600	11.97-05.01	0 451 10 P 3336	O
		1 457 43 S 3231	L
		1 457 43 N 1705	K

1,9 47-48 F8Q 606	11.97-05.01	0 451 10 P 3336	O
		1 457 43 S 3231	L
	11.97-06.98 BO	1 457 42 N 9657	K
	07.98-05.01	1 457 43 N 1705	K

Trafic 1.9 DCI

1,9 60/74 F9Q 760; F9Q 762	05.01-12.06	F 026 40 P 7022	O
		1 457 43 S 3531	L
		DHL,H96 1 457 43 N 1720	K
		PRF 1 457 43 N 1724	K
		1 987 43 M 2208	I

Trafic 2.0

2,0 59 J5R 716; J5R 726	09.80-10.97	0 451 10 P 3299	O
		1 457 43 S 2124	L

2,0 81 F3R	06.99-12.02	1 457 43 S 3231	L
		0 450 90 F 5030 ¹	K

Trafic 2.0 , 16V

2,0 86/88 F4R 720; F4R 820	06.01→	0 451 10 P 3336	O
		1 457 43 S 3529	L
		0 450 90 F 5287 ¹	K
		1 987 43 M 2208	I

Trafic 2.0 DCI

2,0 66/84 M9R630	05.10→	F 026 40 S 0103	L
		WAS 1 457 43 N 1724	K
		WAS F 026 40 N 2047	K
		1 987 43 M 2208	I

2,0 66/85 M9R 780; M9R 782	01.06→	F 026 40 P 7014	O
		F 026 40 S 0103	L
		H12 1 457 43 N 1724	K
		H90 F 026 40 N 2047	K
		1 987 43 M 2208	I

**Trafic 2.1 D**

2,1 43-44 852 720; 852 750			
09.80-10.97	0 451 10 P 3353	O	
	1 457 43 S 3299	L	
	BO 1 457 43 N 4150 ²	K	
	BO,XXX 1 457 43 N 4150 ²	K	
	CAV 1 457 43 N 4200 ²	K	

2,1 44 J8S			
07.86-10.99	1 457 43 N 4291 ²	K	
	ROD 1 457 43 N 4200 ²	K	

2,1 47 J8S 620			
09.94-10.97	1 457 43 N 4291 ²	K	

2,1 47 J8S 622			
09.94-10.97	0 451 10 P 3353	O	
	1 457 43 N 4291 ²	K	

2,1 47 J8S 758			
09.94-10.97	0 451 10 P 3353	O	
	1 457 43 S 3230	L	
	1 457 43 N 4291 ²	K	

Trafic 2.2

2,2 59 J5T			
01.95-05.99	0 986 B0 OB 0006	O	
	1 457 43 S 2124	L	

Trafic 2.2 i

2,2 69-71 J7T 780 Kat.			
03.89-10.97	0 451 10 P 3299	O	
	1 457 43 S 2124	L	
	0 450 90 F 5030 ¹	K	

2,2 74 J7T 600 Kat.			
09.94-10.97	0 451 10 P 3299	O	

Trafic 2.5 D

2,5 55 S8U 758 <Sofim8140.67,2550/52>			
09.94-10.97	0 451 20 P 3201	O	

2,5 55 8140.67.2500 <S8U 750>; 8140.67.2580 <S8U 752>			
03.89-10.97	0 451 20 P 3201	O	
	1 457 43 S 3231	L	
	CAV 1 457 43 N 4200 ²	K	

Trafic 2.5 D, D 4x4

2,5 55 S8U 782			
11.97-05.01	0 451 20 P 3201	O	
	1 457 43 S 3231	L	
11.97-06.98	BO 1 457 42 N 9657	K	
07.98-05.01	1 457 43 N 1705	K	

Trafic 2.5 D 4x4

2,5 55 S8U 758			
11.97-05.01	0 451 20 P 3201	O	
	1 457 43 S 3231	L	
11.97-06.98	BO 1 457 42 N 9657	K	
07.98-05.01	1 457 43 N 1705	K	



2,5 55 S8U 780			
11.97-05.01	1 457 43 S 3231	L	
	1 457 43 N 1705	K	

Trafic 2.5 DCI

2,5 98 G9U 730			
06.02-12.06	1 457 42 P 9198	O	
	F 026 40 S 0103	L	
	1 457 43 N 1724	K	
	WW F 026 40 N 2047	K	
	1 987 43 M 2208	I	

2,5 107 G9U 630			
01.06→	F 026 40 P 7014	O	
	F 026 40 S 0103	L	
	H12 1 457 43 N 1724	K	
	H90 F 026 40 N 2047	K	
	1 987 43 M 2208	I	

Twingo**Twingo 1.2 i**

1,2 55 D7F 702			
01.02→	F 026 40 S 0011	L	

Twingo I**Twingo I 1.0 i**

1,0 43 D7D 740			
01.00-03.00	0 451 10 P 3292	O	
04.00-03.03	1 457 42 P 9184	O	
04.03-05.07	0 451 10 P 4025	O	
01.00-05.07	F 026 40 S 0011	L	
	0 450 90 F 5287 ¹	K	
	1 987 43 M 2095	I	

Twingo I 1.0 i 16V

1,0 50 D4D 712			
03.01-02.03	1 457 42 P 9184	O	
03.03-05.07	0 451 10 P 4025	O	
03.01-05.07	1 457 43 S 3078	L	
	0 450 90 F 5287 ¹	K	
	1 987 43 M 2095	I	

Twingo I 1.2 i

1,2 40 C3G 700; C3G 702			
03.93-08.97	0 451 10 P 3336	O	
	1 457 43 S 3623	L	
03.93-02.96	0 450 90 F 5904 ¹	K	
03.96-08.97	0 450 90 F 5287 ¹	K	
03.93-08.97	1 987 43 M 2095	I	

1,2 | 40-44 | D7F 700; D7F 701; D7F 702

09.96-03.00	0 451 10 P 3292	O	
04.00-02.03	1 457 42 P 9184	O	
03.03-05.07	0 451 10 P 4025	O	
09.96-05.07	F 026 40 S 0011	L	
	0 450 90 F 5287 ¹	K	
	1 987 43 M 2095	I	



Type

◀ Twingo I 1.2 i

1,2 | 43 | D7F 703; D7F 703 E0BD; D7F 704

01.96-02.03	1 457 42 P 9184	O
03.03-05.07	0 451 10 P 4025	O
01.96-05.07	F 026 40 S 0011	L
	0 450 90 F 5287 ¹	K
	1 987 43 M 2095	I

1,2 | 43 | D7F 706

09.98-03.00	0 451 10 P 3292	O
04.00-02.03	1 457 42 P 9184	O
03.03-05.07	0 451 10 P 4025	O
09.98-05.07	F 026 40 S 0011	L
	0 450 90 F 5287 ¹	K
	1 987 43 M 2095	I

1,2 | 43 | D7F 708

02.01-05.07	0 451 10 P 4025	O
	F 026 40 S 0011	L
	0 450 90 F 5287 ¹	K
	1 987 43 M 2095	I

Twingo I 1.2 i 16V

1,2 | 55 | D4F 702

09.00-02.03	1 457 42 P 9184	O	
03.03-05.07	0 451 10 P 4025	O	
Fg.Nr. C06C	09.00-05.07	1 457 43 S 3078	L
Fg.Nr. C06D			
Fg.Nr. C06K			
Fg.Nr. S06C			
Fg.Nr. S06D			
Fg.Nr. S06K			
Fg.Nr. C06G	09.00-05.07	F 026 40 S 0011	L
	09.00-05.07	0 450 90 F 5287 ¹	K
		1 987 43 M 2095	I

1,2 | 55 | D4F 704

09.00-02.03	1 457 42 P 9184	O
03.03-05.07	0 451 10 P 4025	O
09.00-05.07	1 457 43 S 3078	L
	0 450 90 F 5287 ¹	K
	1 987 43 M 2095	I

1,2 | 55 | D4F 708

10.03-05.07	0 451 10 P 4025	O	
Fg.Nr. C06G	10.03-05.07	F 026 40 S 0011	L
Fg.Nr. C06W	10.03-05.07	1 457 43 S 3660	L
Fg.Nr. C060			
Fg.Nr. C061			
Fg.Nr. C062			
Fg.Nr. C06V			
	10.03-05.07	0 450 90 F 5287 ¹	K
		1 987 43 M 2095	I

Twingo II

Twingo II 1.2

1,2 | 43 | D7F 800

04.07→	0 451 10 P 4025	O
	F 026 40 S 0011	L
	0 450 90 F 5287 ¹	K
	1 987 43 M 2120	I

Type

Twingo II 1.2 TCe

1,2 | 74-75 | D4F 78...

04.07→	0 451 10 P 4025	O
	0 450 90 F 5287 ¹	K
	1 987 43 M 2120	I

Twingo II 1.2 16V

1,2 | 56 | D4F 77...

04.07→	0 451 10 P 4025	O
	1 457 43 S 3660	L
	0 450 90 F 5287 ¹	K
	1 987 43 M 2120	I

Twingo II 1.5 dCi

1,5 | 47 | K9K 740

04.07-08.07	0 451 10 P 3336	O
09.07→	F 026 40 P 7022	O
04.07→	F 026 40 S 0051	L
	SWA F 026 40 N 2081 ¹	K
	1 987 43 M 2120	I

1,5 | 62 | K9K 718

04.10→	F 026 40 P 7022	O
	F 026 40 S 0051	L
	SWA F 026 40 N 2081 ¹	K
	1 987 43 M 2120	I

Twingo II 1.6 R.S.

1,6 | 98 | K4M 854

07.07→	0 451 10 P 3336	O
	0 450 90 F 5287 ¹	K
	1 987 43 M 2120	I

Vel Satis

Vel Satis 2.0

2,0 | 120 | F4R 762; F4R 763; F4R 764; F4R 765; F4R 766; F4R 767

04.02-12.06	0 451 10 P 3336	O
	1 457 43 S 3075	L
	1 987 43 R 2380 ⁸	I

Vel Satis 2.0 DCI

2,0 | 110/127 | M9R 760

08.05-12.09	F 026 40 P 7014	O
	1 457 43 S 3075	L
	1 457 43 N 1705	K
	1 987 43 R 2380 ⁸	I

Vel Satis 2.0 T

2,0 | 125 | F4R 867

07.05-12.09	0 451 10 P 3336	O
	1 457 43 S 3075	L
	0 450 90 F 5287 ¹	K
	1 987 43 R 2380 ⁸	I

Vel Satis 2.2 DCI

2,2 | 102 | G9T 607

07.05-12.09	F 026 40 P 7014	O
	1 457 43 S 3075	L
	1 457 43 N 1705	K
	1 987 43 R 2380 ⁸	I





2,2 102/110 G9T 600; G9T 606	09.02-12.09	1 457 42 P 9198	O
		1 457 43 S 3075	L
		1 457 43 N 1705	K
		1 987 43 R 2380 ⁸	I

2,2 110 G9T 700	01.05-12.09	1 457 43 S 3075	L
	04.02-12.09	1 457 43 N 1705	K
		1 987 43 R 2380 ⁸	I

2,2 110 G9T 702; G9T 703	04.02-12.09	1 457 42 P 9198	O
		1 457 43 S 3075	L
		1 457 43 N 1705	K
		1 987 43 R 2380 ⁸	I

Vel Satis 3.0 DCI V6

3,0 130 P9X 701	04.02-12.09	1 457 42 P 9302	O
		1 457 43 S 3075	L
	04.02-05.08	1 457 43 N 1705	K
	04.02-12.09	1 987 43 R 2380 ⁸	I

3,0 133 P9X 715	07.05-05.08	1 457 43 N 1705	K
	07.05-12.09	1 987 43 R 2380 ⁸	I

Vel Satis 3.5 V6

3,5 177 V4Y 701	04.02-12.09	0 986 45 P 2061	O
		1 457 43 S 3075	L
		1 987 43 R 2380 ⁸	I

3,5 177 V4Y 711	04.02-12.09	0 986 45 P 2061	O
	04.02-06.05	1 457 43 S 3075	L
	04.02-12.09	1 987 43 R 2380 ⁸	I

3,5 177 V4Y 715	06.05-12.09	0 986 45 P 2061	O
		1 987 43 R 2380 ⁸	I

Wind

Wind 1.2

1,1 74-75 D4F 78...	04.10→	0 451 10 P 4025	O
		1 987 43 M 2120	I

Wind 1.6

1,6 98 K4M 854	04.10→	0 451 10 P 3336	O
		1 987 43 M 2120	I

Winnebago

Winnebago 2.2 i

2,2 79 J7T 736	03.88-12.00	0 450 90 F 5030 ¹	K
--------------------	-------------	-------------------------------------	----------



ROLLS-ROYCE

Corniche

Corniche 6.8

6,8 184 L 410 M	04.93-08.94	0 450 90 F 5200 ¹	K
---------------------	-------------	-------------------------------------	----------

Flying Spur

Flying Spur 6.8 V8

6,8 182 OHV V8	08.94-07.95	0 450 90 F 5200 ¹	K
--------------------	-------------	-------------------------------------	----------

Ghost

Ghost 6.6

6,6 420 N74 B66A	12.09→	2FE	1 987 43 R 2315 ⁸	I
----------------------	--------	-----	-------------------------------------	----------

Phantom

Phantom 6.8

6,8 338 N73 B68	03.03-09.06	1 457 43 S 3091	L
---------------------	-------------	------------------------	----------

Silver Spirit

Silver Spirit 6.8

6,8 184 L 410 MN 1T	03.94-05.98	0 450 90 F 5200 ¹	K
-------------------------	-------------	-------------------------------------	----------

Silver Spur

Silver Spur 6.8

6,8 182 OHV V8	04.93-12.98	0 450 90 F 5200 ¹	K
--------------------	-------------	-------------------------------------	----------

ROVER

Maestro

Maestro 1.3

1,3 49-51 A-Plus	09.88-12.93	0 451 10 P 4026	O
----------------------	-------------	------------------------	----------

Maestro 1.6

1,6 61-63/72 <S-Series>; 16 H <S-Series>	09.88-12.93	0 451 10 P 3298	O
Fg.Nr. 367395→	09.88-12.93	1 457 43 S 3652	L





Maestro 2.0 D

2,0 46 Prima 65				
	09.88-12.93		0 451 10 P 3311	O
			1 457 43 S 3652	L
		LIM	1 457 43 N 4106 ²	K
		LWG	1 457 43 N 4106 ²	K
	04.92-12.93	BO	1 457 43 N 4106 ²	K

Maestro 2.0 D Turbo

2,0 60 Prima-80T				
	07.89-12.93		0 451 10 P 3311	O
		LIM	1 457 43 N 4106 ²	K
		LWG	1 457 43 N 4106 ²	K
	04.92-12.93		1 457 43 D 701 ²	K

Maestro 2.0 i

2,0 83 20 H-EFI <O-Series>				
	09.88-12.93		0 451 10 P 4026	O
Fg.Nr. 367395→	09.88-12.93		1 457 43 S 3652	L
	09.88-12.93		0 450 90 F 5030 ¹	K

Mini

Mini 1.0

1,0 29-33 A-Plus				
	09.88-12.92		0 451 10 P 2056	O

Mini 1.3

1,3 39-45				
	02.90-10.96	AG	1 457 42 P 9493	O
Fg.Nr. BD 134455→	02.90-10.96	GS	0 451 10 P 4026	O
Fg.Nr. →BD 134454	02.90-10.96	GS	0 451 10 P 2056	O

Mini 1.3 i

1,3 39-46 <MPi>				
	10.96-09.00	AG	1 457 42 P 9493	O
Fg.Nr. BD 134455→	10.96-09.00	GS	0 451 10 P 4026	O
Fg.Nr. →BD 134454	10.96-09.00	GS	0 451 10 P 2056	O
Fg.Nr. BD 134455→WD 169573	10.96-09.00		0 986 45 F 0119 ¹	K
Fg.Nr. WD 169574→	10.96-09.00		0 450 90 F 5911 ¹	K

1,3 | 39-46 | <SPi>

	02.91-09.00	AG	1 457 42 P 9493	O
Fg.Nr. BD 134455→	02.91-09.00	GS	0 451 10 P 4026	O
Fg.Nr. →BD 134454	02.91-09.00	GS	0 451 10 P 2056	O
Fg.Nr. WD 169574→	02.91-09.00		0 450 90 F 5911 ¹	K
Fg.Nr. →WD 169573	02.91-09.00		0 986 45 F 0119 ¹	K

Mini Cooper

Mini Cooper 1.3

1,3 39-45 <MPi>				
	02.90-10.96	AG	1 457 42 P 9493	O
Fg.Nr. BD 134455→	02.90-10.96	GS	0 451 10 P 4026	O
Fg.Nr. →BD 134454	02.90-10.96	GS	0 451 10 P 2056	O

1,3 | 39-46 | <SPi>

	02.91-09.00	AG	1 457 42 P 9493	O
Fg.Nr. BD 134455→	02.91-09.00	GS	0 451 10 P 4026	O
Fg.Nr. →BD 134454	02.91-09.00	GS	0 451 10 P 2056	O
Fg.Nr. WD 169574→	02.91-09.00		0 450 90 F 5911 ¹	K



Fg.Nr. →WD 169573	02.91-09.00		0 986 45 F 0119 ¹	K
-------------------	-------------	--	-------------------------------------	----------

1,3 | 39-46 | 12 HL <MPi>

	10.96-09.00	AG	1 457 42 P 9493	O
Fg.Nr. BD 134455→	10.96-09.00	GS	0 451 10 P 4026	O
Fg.Nr. →BD 134454	10.96-09.00	GS	0 451 10 P 2056	O
Fg.Nr. BD 134455→WD 169573	10.96-09.00		0 986 45 F 0119 ¹	K
Fg.Nr. WD 169574→	10.96-09.00		0 450 90 F 5911 ¹	K

Mini Cooper 1.3 , i

1,3 | 39-46/59 | <MPi>

	09.94-09.00	AG	1 457 42 P 9493	O
Fg.Nr. BD 134455→	09.94-09.00	GS	0 451 10 P 4026	O
Fg.Nr. →BD 134454	09.94-09.00	GS	0 451 10 P 2056	O
Fg.Nr. BD 134455→WD 169573	09.94-09.00		0 986 45 F 0119 ¹	K
Fg.Nr. WD 169574→	09.94-09.00		0 450 90 F 5911 ¹	K

Mini De Ville

Mini De Ville 1.3 i

1,3 59				
	09.94-09.96	AG	1 457 42 P 9493	O
Fg.Nr. BD 134455→	09.94-09.96	GS	0 451 10 P 4026	O
Fg.Nr. →BD 134454	09.94-09.96	GS	0 451 10 P 2056	O
Fg.Nr. BD 134455→WD 169573	09.94-09.96		0 986 45 F 0119 ¹	K
Fg.Nr. WD 169574→	09.94-09.96		0 450 90 F 5911 ¹	K

Mini Margrave

Mini Margrave 1.4 i

1,4 77				
Fg.Nr. BD 134455→WD 169573	09.95-09.00		0 986 45 F 0119 ¹	K
Fg.Nr. WD 169574→	09.95-09.00		0 450 90 F 5911 ¹	K

Mini Retro Rally

Mini Retro Rally 1.3 i

1,3 60				
	09.94-09.96	AG	1 457 42 P 9493	O
Fg.Nr. BD 134455→	09.94-09.96	GS	0 451 10 P 4026	O
Fg.Nr. →BD 134454	09.94-09.96	GS	0 451 10 P 2056	O
Fg.Nr. BD 134455→WD 169573	09.94-09.96		0 986 45 F 0119 ¹	K
Fg.Nr. WD 169574→	09.94-09.96		0 450 90 F 5911 ¹	K

Montego

Montego 1.6 , Estate

1,6 61-63 16HL <S-Serie>				
	09.88-12.93		0 451 10 P 3298	O
	A,CH, 09.88-12.93		0 451 10 P 3298	O
	D,E,F, H,I			
Fg.Nr. 464731→	09.88-12.93	KZO	1 457 43 S 3652	L

Montego 2.0

2,0 77 <O-Serie>				
	09.88-12.93		0 451 10 P 4026	O
		KL	1 457 43 S 3652	L



**Montego 2.0 D Turbo**

2,0 60 Prima-80T	09.88-12.93	0 451 10 P 3311	O
		1 457 43 S 3652	L
		1 457 43 D 701 ²	K
		1 457 43 N 4106 ²	K

Montego 2.0 D Turbo Estate

2,0 60 Prima-80T	09.88-12.93	0 451 10 P 3311	O
		1 457 43 S 3652	L
		1 457 43 D 701 ²	K
		1 457 43 N 4106 ²	K

Montego 2.0 i, i Estate

2,0 83 20H	09.88-12.93	0 451 10 P 4026	O
Fg.Nr. 464731→	09.88-12.93	KZO 1 457 43 S 3652	L
Fg.Nr. →659916	09.88-12.93	0 450 90 F 5030 ¹	K

Montego 2.0 i Turbo

2,0 110 20HT	09.88-12.93	0 451 10 P 4026	O
		1 457 43 S 3652	L

RV8**RV8 3.9 i**

3,9 140 V8	09.92-12.95	0 450 90 F 5030 ¹	K
------------	-------------	------------------------------	---

Serie 200**Serie 200 211 i**

1,1 44-45 11K2D <K-Serie>	11.95-03.00	0 451 10 P 4026	O
		1 457 43 S 3736	L
		0 450 90 F 5911 ¹	K

Serie 200 214 Cabrio

1,4 66 14K4C <8V-DOHC>	10.92-02.96	0 451 10 P 4026	O
------------------------	-------------	-----------------	---

Serie 200 214 i

1,4 55 14K2A <K8-SOHC>	01.93-02.96	0 451 10 P 4026	O
		1 457 43 S 3294	L
		0 986 45 F 0119 ¹	K

1,4|55|14K2F <K-Serie>

	10.95-03.00	0 451 10 P 4026	O
		1 457 43 S 3736	L
		0 450 90 F 5911 ¹	K

**Serie 200 214 i 16V**

1,4 66-70 14K4C	10.89-09.93	0 451 10 P 4026	O
		1 457 43 S 3294	L
		0 986 45 F 0119 ¹	K

Serie 200 214 S

1,4 55-56 <K8-SOHC>	10.89-12.92	0 451 10 P 4026	O
---------------------	-------------	-----------------	---

Serie 200 214 Si 16V, Si 16V Cabrio

1,4 76 K16	10.92-03.96	0 451 10 P 4026	O
		1 457 43 S 3736	L
		0 986 45 F 0119 ¹	K

Serie 200 214 16V Coupé

1,4 76 14K4F <K-Serie>	10.95-03.00	0 451 10 P 4026	O
		1 457 43 S 3736	L
		0 450 90 F 5911 ¹	K

Serie 200 216 GTi 16V

1,6 90-96 D16A...	09.90-02.96	0 986 45 P 2036	O
		1 457 43 S 3279	L
		0 450 90 F 5909 ¹	K

Serie 200 216 GTi 16V Cabrio

1,6 90 D16A8 <ZC-DOHC Twin Cam>	01.92-02.96	0 986 45 P 2036	O
		1 457 43 S 3279	L
Fg.Nr. 605482→	10.92-02.96	0 450 90 F 5909 ¹	K

Serie 200 216 i 16V

1,6 82-85 D16...	10.89-02.96	0 986 45 P 2036	O
		1 457 43 S 3279	L
Fg.Nr. →370499	10.89-02.96	0 450 90 F 5030 ¹	K
Fg.Nr. 605482→	10.92-02.96	0 450 90 F 5909 ¹	K

Serie 200 216 i 16V Cabrio, i 16V Coupé, 16V

1,6 82 16K4F <K-Serie>	10.95-03.00	0 451 10 P 4026	O
		1 457 43 S 3736	L
		0 450 90 F 5911 ¹	K

Serie 200 216 i 16V Coupé

1,6 90 D16Z2 <D 16 Honda, PGM 16V>	10.89-02.96	0 986 45 P 2036	O
		1 457 43 S 3279	L
Fg.Nr. →370499	10.89-02.96	0 450 90 F 5030 ¹	K
Fg.Nr. 605482→	10.92-02.96	0 450 90 F 5909 ¹	K





Serie 200 218 D Turbo

1,8 65 XUD7TE <PSA>			
10.92-02.96	0 451 10	P 3261	O
XXX	1 457 43	S 3548	L
	1 457 43	N 4200²	K

Serie 200 218 i 16V

1,8 107 18K4K -VVC- <K-Serie>			
09.95-03.00	0 451 10	P 4026	O
	1 457 43	S 3736	L
	0 450 90	F 5911¹	K

Serie 200 218 i 16V, i 16V Coupé

1,8 88/107 <K-Serie-VVC>; S <K-Serie>			
09.95-03.00	0 451 10	P 4026	O
	1 457 43	S 3736	L
	0 450 90	F 5911¹	K

Serie 200 218 1.9 D

1,9 52 PSA			
10.92-12.94	0 451 10	P 3261	O
XXX	1 457 43	S 3548	L
	1 457 43	N 4200²	K

Serie 200 220 GTi 16V

2,0 103 T16			
09.91-06.96	0 451 10	P 4026	O
	1 457 43	S 3736	L
	0 986 45	F 0119¹	K

Serie 200 220 GTi/GSi

2,0 100 T16			
10.92-06.96	0 451 10	P 4026	O
	1 457 43	S 3736	L

Serie 200 220 i Turbo, i Turbo Coupé

2,0 147 20T4G			
Fg.Nr. 605482->	01.93-06.96	DOH	0 451 10 P 4026 O
	01.93-06.96		1 457 43 S 3736 L

Serie 200 220 SD, SDI

2,0 63/77 20 T2N <TCie>; 20 T2R <TCie-M>			
09.95-03.00	0 451 10	P 3341	O
	1 457 43	S 3781	L
	0 450 90	N 6172¹	K

Serie 400

Serie 400 414 Si 16V

1,4 76 14 K4F <K-Serie>			
05.95-03.00	0 451 10	P 4026	O
	1 457 43	S 3781	L
	0 450 90	F 5911¹	K

Serie 400 414 16V

1,4 66-70 14K4C			
04.90-10.92	0 451 10	P 4026	O
	1 457 43	S 3294	L
	0 986 45	F 0119¹	K



1,4 | 76 | K14K4F

01.93-02.96	0 451 10	P 4026	O
	1 457 43	S 3736	L
	0 986 45	F 0119¹	K
05.95-02.96	KL	1 987 43	M 2121 I
Fg.Nr. ->WD 354434	05.95-02.96	KL	1 987 43 M 2026 I

Serie 400 416 GSi 16V

1,6 82-85 D16.. <Honda-PGM-FI D/6A>			
04.90-02.96	0 986 45	P 2036	O
	1 457 43	S 3279	L
	0 450 90	F 5909¹	K
05.95-02.96	AG, KL	1 987 43	M 2053 I
	GS, KL	1 987 43	M 2121 I
Fg.Nr. ->WD 354434	05.95-02.96	KL	1 987 43 M 2026 I

1,6 | 82-85 | D16Z2 <Honda-PGM-FI D/6A>

04.90-02.96	0 986 45	P 2036	O
	1 457 43	S 3279	L
	0 450 90	F 5909¹	K
05.95-02.96	AG, KL	1 987 43	M 2053 I
	GS, KL	1 987 43	M 2121 I
Fg.Nr. ->WD 354434	05.95-02.96	KL	1 987 43 M 2026 I

Serie 400 416 GTi 16V

1,6 90-96 16V ZC			
04.90-02.96	0 986 45	P 2036	O
	1 457 43	S 3279	L
	0 450 90	F 5909¹	K
05.95-02.96	AG, KL	1 987 43	M 2053 I
	GS, KL	1 987 43	M 2121 I
Fg.Nr. ->WD 354434	05.95-02.96	KL	1 987 43 M 2026 I

Serie 400 416 i 16V

1,6 82 D16B2/D16Y3			
02.96-03.00	0 451 10	P 4026	O
	1 457 43	S 3736	L
	0 450 90	F 5911¹	K
03.96-03.00		1 987 43	M 2121 I

1,6 | 82 | K16 <K-Serie>

05.95-03.00	0 451 10	P 4026	O
	1 457 43	S 3781	L
	0 450 90	F 5911¹	K
03.96-03.00		1 987 43	M 2121 I

1,6 | 83 | <D16Y3-SOHC>

05.95-10.99	SOH	0 986 45	P 2036 O
	AG	1 457 43	S 3951 L
		0 450 90	F 5916¹ K

Serie 400 418 D 1.9

1,9 49 XUD9			
09.91-04.95	0 451 10	P 3261	O
	XXX	1 457 43	S 3548 L
		1 457 43	N 4200² K



**Serie 400 418 GSi 16V**

1,8 107 <DOHC-VVC>			
	01.97-12.98	0 451 10 P 4026	O
		1 457 43 S 3736	L
		0 450 90 F 5911 ¹	K
		GS, KL 1 987 43 M 2121	I
Fg.Nr. →WD 354434	01.97-12.98	KL 1 987 43 M 2026	I

Serie 400 418 i 16V

1,8 107 <DOHC-VVC>			
	03.96-12.98	0 451 10 P 4026	O
		1 457 43 S 3736	L
		0 450 90 F 5911 ¹	K

Serie 400 418 TD

1,8 65 XUD7TE			
	09.91-03.00	0 451 10 P 3261	O
		XXX 1 457 43 S 3548	L
		1 457 43 N 4200 ²	K
	05.95-03.00	KL 1 987 43 M 2121	I
	02.96-03.00	KL 1 987 43 M 2026	I
Fg.Nr. →WD 354434	05.95-02.96	KL 1 987 43 M 2026	I

Serie 400 420 i Turbo 16V

2,0 147 20 T4G			
	01.93-02.96	0 451 10 P 4026	O
		1 457 43 S 3736	L
		0 986 45 F 0119 ¹	K
	05.95-02.96	GS, KL 1 987 43 M 2121	I
Fg.Nr. →WD 354434	05.95-02.96	KL 1 987 43 M 2026	I

Serie 400 420 SD, SDI

2,0 63/77 20 T2N <Serie-L>; 20 T2R <Serie-L>			
	10.95-03.00	0 451 10 P 3341	O
		1 457 43 S 3781	L
		0 450 90 N 6172 ¹	K
		GS, KL 1 987 43 M 2121	I
Fg.Nr. →WD 354434	10.95-03.00	KL 1 987 43 M 2026	I

Serie 400 420 16V

2,0 100 20T 4H <T-Serie>			
	10.95-03.00	0 451 10 P 4026	O
		1 457 43 S 3736	L
		0 450 90 F 5911 ¹	K
		GS, KL 1 987 43 M 2121	I
Fg.Nr. →WD 354434	10.95-03.00	KL 1 987 43 M 2026	I
2,0 103 T16 <DOHC-16V>			
	02.92-02.96	0 451 10 P 4026	O
		1 457 43 S 3736	L
		0 986 45 F 0119 ¹	K
	05.95-02.96	GS, KL 1 987 43 M 2121	I
Fg.Nr. →WD 354434	05.95-02.96	KL 1 987 43 M 2026	I

Serie 600**Serie 600 618 i 16V**

1,8 85 F18 A3 <SOHC>			
	03.96-06.99	0 986 45 P 2036	O
		1 457 43 S 3950	L
Fg.Nr. →AM 246796	03.96-06.99	0 986 45 F 0104 ¹	K

Serie 600 620 i 16V

2,0 85/96/100 F-20-Z1; F-20-Z2 H; <T-Serie>			
	04.93-09.00	0 986 45 P 2036	O
		1 457 43 S 3950	L
Fg.Nr. →AM 246796	04.93-09.00	0 986 45 F 0104 ¹	K

Serie 600 620 i 16V Turbo

2,0 147 T16-Turbo			
	04.93-12.98	0 451 10 P 4026	O
		1 457 43 S 3781	L
		0 986 45 F 0119 ¹	K

Serie 600 620 SDi

2,0 77 20 T2N <SERIE-L>			
	03.95-12.98	0 451 10 P 3341	O
		1 457 43 S 3781	L
		0 450 90 N 6172 ¹	K

Serie 600 623 i 16V

2,3 116 H23A2			
	04.93-06.99	0 986 45 P 2036	O
		1 457 43 S 3950	L
Fg.Nr. →AM 246796	04.93-06.99	0 986 45 F 0104 ¹	K

Serie 800**Serie 800 820**

2,0 74			
	10.86-10.91	0 451 10 P 4026	O
Fg.Nr. →297485	10.86-10.91	1 457 43 S 3652	L

Serie 800 820 i

2,0 98 20H <M16i KAT.>			
	10.88-10.91	0 451 10 P 4026	O
Fg.Nr. →297485	10.88-10.91	1 457 43 S 3652	L
	10.88-10.91	0 450 90 F 5215 ¹	K

Serie 800 820 i 16V

2,0 100			
	01.96-09.99	0 451 10 P 4026	O
2,0 100-103 20T4H			
	01.92-01.96	0 451 10 P 4026	O
		0 450 90 F 5215 ¹	K

Serie 800 820 i 16V Turbo

2,0 132-147 20 T4G			
	01.92-01.99	0 451 10 P 4026	O
		1 457 43 S 3736	L
	01.92-01.96	0 450 90 F 5215 ¹	K





Serie 800 825 i, i Coupé

2,5 129 25K4F <KV 6 KAT>	01.96-12.98	1 457 43 S 3781	L
------------------------------	-------------	-----------------	---

Serie 800 825 TD

2,5 87/88/92 VM; VM-425-CLIER; VM-425-SLIER; VM-425-SLIRR	10.88-12.98	0 451 20 P 3194	O
		1 457 43 N 4106 ²	K

Serie 800 827 i Si

2,7 124 C27A V6	02.88-10.91	0 451 10 P 3266	O
		0 450 90 F 5215 ¹	K

Serie 800 827 i Si, i Sterling

2,7 130 C27A V6	02.88-10.91	0 451 10 P 3266	O
		0 450 90 F 5215 ¹	K

Serie 800 827 i Sterling

2,7 124 C27A V6 <KAT.>	02.88-10.91	0 451 10 P 3266	O
----------------------------	-------------	-----------------	---

Serie 800 827 i 24V

2,7 124-130 C27A1 V6	01.92-01.96	0 451 10 P 3266	O
--------------------------	-------------	-----------------	---

Serie 800 827 i 24V Coupé

2,7 124 C27A V6	01.92-01.96	0 451 10 P 3266	O
---------------------	-------------	-----------------	---

Streetwise

Streetwise 1.4

1,4 62/76 14K2; 14K4	09.03-05.05	0 451 10 P 4026	O
		1 457 43 S 3736	L
		0 450 90 F 5911 ¹	K
		1 987 43 M 2121	I

Streetwise 2.0 TD

2,0 74 20 T2N	09.03-05.05	0 451 10 P 3341	O
		1 457 43 S 3781	L
		0 450 90 N 6172 ¹	K
		1 987 43 M 2121	I

25

25 1.1 i 16V

1,1 55 11 K4F <K-Serie>	02.03-05.05	0 451 10 P 4026	O
		1 457 43 S 3736	L
		0 450 90 F 5911 ¹	K
		1 987 43 M 2121	I



25 1.4 i 16V

1,4 62/76 14 K4F <K-Serie K 1.4>; 14 K4M <K-Serie K 1.4>	02.00-05.05	0 451 10 P 4026	O
		1 457 43 S 3736	L
		0 450 90 F 5911 ¹	K
		1 987 43 M 2121	I

25 1.6 i 16V

1,6 80 16 K4F <K-Serie K 1.6>	02.00-05.05	0 451 10 P 4026	O
		1 457 43 S 3736	L
		0 450 90 F 5911 ¹	K
		1 987 43 M 2121	I

25 1.8 i 16V

1,8 86/107 18 K4F <K-Serie>; 18 K4K-VVC <K-Serie>	02.00-10.04	0 451 10 P 4026	O
		1 457 43 S 3736	L
		0 450 90 F 5911 ¹	K
		1 987 43 M 2121	I

25 2.0 iDT

2,0 74/83 20 T2N <L-Serie>	02.00-05.05	0 451 10 P 3341	O
		1 457 43 S 3781	L
		0 450 90 N 6172 ¹	K
		1 987 43 M 2121	I

45

45 1.4 16V

1,4 76 14 K4F <K-Serie K 1.4>	02.00-05.05	0 451 10 P 4026	O
		1 457 43 S 3781	L
		0 450 90 F 5911 ¹	K
Fg.Nr. ->WD 354434	02.00-05.05	1 987 43 M 2026	I

45 1.6 16V

1,6 80 16 K4F <K-Serie K 1.6>	02.00-05.05	0 451 10 P 4026	O
		1 457 43 S 3781	L
		0 450 90 F 5911 ¹	K
Fg.Nr. ->WD 354434	02.00-05.05	1 987 43 M 2026	I

45 1.8 16V

1,8 86 18 K4F <K-Serie K 1.8>	02.00-05.05	0 451 10 P 4026	O
		1 457 43 S 3781	L
		0 450 90 F 5911 ¹	K
Fg.Nr. ->WD 354434	02.00-05.05	1 987 43 M 2026	I

45 2.0 iDT

2,0 74/83 20 T2N <L-Serie>	02.00-05.05	0 451 10 P 3341	O
		1 457 43 S 3781	L
		0 450 90 N 6172 ¹	K
Fg.Nr. ->WD 354434	02.00-05.05	1 987 43 M 2026	I





45 2.0 V6

2,0 110 20 K4F <K-Serie>	02.00-05.05	0 451 10 P 3340	O
		0 450 90 F 5911 ¹	K
Fg.Nr. →WD 354434	02.00-05.05	1 987 43 M 2026	I

75

75 1.8 i T 16V, i 16V

1,8 88/110 K 1.8T; K 1.8/18K4F	01.99-05.05	0 451 10 P 4026	O
		1 457 43 S 3550	L
		1 987 43 M 2182	I
		1 987 43 R 2482 ⁸	I

75 2.0 CDT, CDTi

2,0 85/96 20 4D 2 <M 47 D 20>	01.99-05.05	1 457 42 P 9119	O
		1 457 43 S 3588	L
		F 026 40 N 2002 ²	K
		1 987 43 M 2182	I
		1 987 43 R 2482 ⁸	I

75 2.0 i 24V

2,0 110 20 K4F <KV 6>	01.99-05.05	0 451 10 P 3340	O
		1 457 43 S 3550	L
		1 987 43 M 2182	I
		1 987 43 R 2482 ⁸	I

75 2.5 i 24V

2,5 130 25 K4F <KV 6>	01.99-05.05	0 451 10 P 3340	O
		1 457 43 S 3550	L
		1 987 43 M 2182	I
		1 987 43 R 2482 ⁸	I

75 4.6 i Power Supercharged

4,6 191 46F2F	10.03-05.05	1 987 43 M 2182	I
		1 987 43 R 2482 ⁸	I

100 Metro

100 Metro 1.1

1,1 44 11K2D <K-Serie>	05.90-02.95	0 451 10 P 4026	O
---	-------------	------------------------	----------

100 Metro 1.1 i

1,1 44 11K2D <K-Serie>	09.90-12.98	0 451 10 P 4026	O
Fg.Nr. XP 100001→	09.90-12.98	0 986 45 F 0119 ¹	K

100 Metro 1.4

1,4 55-56 14K2A <K-Serie>	05.90-10.92	0 451 10 P 4026	O
--	-------------	------------------------	----------



100 Metro 1.4 D

1,4 38 PSA TUD3	01.93-12.94	0 451 10 P 3261	O
		1 457 43 N 4321 ²	K

100 Metro 1.4 GTi 16V

1,4 76 14K4F <K-Serie>	09.90-10.95	0 451 10 P 4026	O
		1 457 43 S 3736	L
Fg.Nr. XP 100001→	09.90-10.95	0 986 45 F 0119 ¹	K

100 Metro 1.4 i, i 16V

1,4 55/75 <K-Serie>	09.90-10.98	0 451 10 P 4026	O
		1 457 43 S 3736	L
Fg.Nr. XP 100001→	09.90-10.98	0 986 45 F 0119 ¹	K

100 Metro 1.4 i 16V

1,4 66-70 14K 4D/14K4C <K-Serie>	05.90-12.92	0 451 10 P 4026	O
		1 457 43 S 3294	L
Fg.Nr. XP 100001→	05.90-12.92	0 986 45 F 0119 ¹	K

1,4 | 75 | 14 K4F <K-Serie>

	04.97-10.98	0 451 10 P 4026	O
		1 457 43 S 3736	L
Fg.Nr. XP 100001→	04.97-10.98	0 986 45 F 0119 ¹	K

100 Metro 1.5 D

1,5 42 PSA-TUD5	12.94-12.98	0 451 10 P 3261	O
		1 457 43 S 3234	L

SAAB (SAAB AUTOMOBILE AB) *

9-3

9-3 1.8 i

1,8 90 Z18XE	09.04→	0 451 10 P 3370	O
		0 450 90 F 5273 ¹	K
		1 987 43 M 2076	I
		1 987 43 R 2376 ⁸	I

9-3 1.8 T, T BioPower

2,0 110/129 B207E; B207L	09.02→	F 026 40 P 7016	O
		1 987 42 S 9193	L
		0 450 90 F 5273 ¹	K
		1 987 43 M 2076	I
		1 987 43 R 2376 ⁸	I





9-3 1.9 TiD

1,9 88/110 Z19DT; Z19DTH			
09.04→	1 457 42	P 9248	O
	1 457 43	S 3655	L
	F 026 40	N 2043	K
	1 987 43	M 2076	I
	1 987 43	R 2376⁸	I

9-3 1.9 TTiD

1,9 96/118 A19DTR (130); A19DTR (160)			
09.10→	1 457 43	S 3655	L
	F 026 40	N 2062	K
	1 987 43	M 2076	I
	1 987 43	R 2376⁸	I

1,9 132 Z19DTR			
02.08→	1 457 43	S 3655	L
	F 026 40	N 2043	K
SKA 02.08→	1 457 07	N 0001	K
02.08→	1 987 43	M 2076	I
	1 987 43	R 2376⁸	I

9-3 2.0 i 16V, i 16V Turbo

2,0 96/113/136/147 B204E; B204I; B204L; B204R			
03.98-08.00	F 026 40	P 7005	O
	1 457 43	S 3263	L
	0 450 90	F 5200¹	K
	1 987 43	M 2096	I

9-3 2.0 i 16V Turbo

2,0 136/151 B205L; B205R <Ecopower DOHC>; B205R <Turbo>			
09.99-08.03	F 026 40	P 7005	O
	1 457 43	S 3263	L
	0 450 90	F 5200¹	K
	1 987 43	M 2096	I

9-3 2.0 i 16V Turbo, T

2,0 110 B205E; B205E <(Ecopower)>			
10.98-07.03	F 026 40	P 7005	O
	0 450 90	F 5200¹	K
	1 987 43	M 2096	I

9-3 2.0 T

2,0 136/151 B205L; B205R <Ecopower DOHC>; B205R <Turbo>			
10.99-07.03	F 026 40	P 7005	O
	0 450 90	F 5200¹	K
	1 987 43	M 2096	I

2,0 145-147 B207E; B207L; B207R			
07.07→	F 026 40	P 7016	O
	1 987 42	S 9193	L

2,0 147 B207E; B207L; B207R			
03.09→	F 026 40	P 7016	O
	1 987 42	S 9193	L
	0 450 90	F 5273¹	K

2,0 154 B207E; B207L; B207R			
02.03→	F 026 40	P 7016	O
	1 987 42	S 9193	L
	0 450 90	F 5273¹	K
	1 987 43	M 2076	I
	1 987 43	R 2376⁸	I



2,0 177 B207E; B207L; B207R			
05.09→	F 026 40	P 7016	O
	1 987 42	S 9193	L
	0 450 90	F 5273¹	K

9-3 2.0 T BioPower

2,0 145-147 B207R <BioPower>			
07.07→	F 026 40	P 7016	O
	1 987 42	S 9193	L

2,0 154 B207E; B207L; B207R			
09.02→	F 026 40	P 7016	O
	1 987 42	S 9193	L
	1 987 43	M 2076	I
	1 987 43	R 2376⁸	I

9-3 2.0 T BioPower, T BioPower XWD

2,0 147 B207E; B207L; B207R			
07.07→	F 026 40	P 7016	O
	1 987 42	S 9193	L

9-3 2.0 T BioPower XWD, T XWD, T 4x4

2,0 154 B207E; B207L; B207R			
06.08→	F 026 40	P 7016	O
	1 987 42	S 9193	L
	0 450 90	F 5273¹	K
	1 987 43	M 2076	I
	1 987 43	R 2376⁸	I

9-3 2.0 T, T Sport

2,0 110/129 B207E; B207L; B207R			
09.02→	F 026 40	P 7016	O
	1 987 42	S 9193	L
	0 450 90	F 5273¹	K
	1 987 43	M 2076	I
	1 987 43	R 2376⁸	I

9-3 2.2 TiD

2,2 95 D223L			
10.02-08.04	1 457 42	P 9157	O
	1 457 43	S 3655	L
	1 987 43	M 2076	I
	1 987 43	R 2376⁸	I

9-3 2.2 16V D Turbo

2,2 85/92 D223L <X 22 DTH>; D223L <Y 22 DTH>			
03.98-09.02	1 457 42	P 9157	O
	1 457 43	S 3797	L
	1 457 42	N 9656	K
	1 987 43	M 2096	I

9-3 2.3 i 16V

2,3 110 B234I; B235R			
03.98-08.00	F 026 40	P 7005	O
	1 457 43	S 3263	L
	0 450 90	F 5200¹	K
	1 987 43	M 2096	I



**9-3 2.3 i 16V Turbo**

2,3 125 B234I; B235R	01.99-08.00	F 026 40 P 7005	O
		0 450 90 F 5200 ¹	K
		1 987 43 M 2096	I

2,3 | 165 | B234I; B235R

09.99-08.00	F 026 40 P 7005	O
	1 457 43 S 3263	L
	0 450 90 F 5200 ¹	K
	1 987 43 M 2096	I

2,3 | 169 | B234I; B235R

09.99-08.00	F 026 40 P 7005	O
	1 457 43 S 3263	L
	0 450 90 F 5200 ¹	K
	1 987 43 M 2096	I

9-3 2.3 T**2,3 | 165-169 | B234I; B235R**

10.99-08.03	F 026 40 P 7005	O
	0 450 90 F 5200 ¹	K

9-3 2.8 T**2,8 | 184-188 | B284 <Turbo>**

09.05→	1 987 42 S 9193	L
	0 450 90 F 5273 ¹	K
	1 987 43 M 2076	I
	1 987 43 R 2376 ⁸	I

2,8 | 184-188/203 | B284L <Turbo>

03.05→	1 987 42 S 9193	L
	0 450 90 F 5273 ¹	K
	1 987 43 M 2076	I
	1 987 43 R 2376 ⁸	I

9-3 2.8 T XWD**2,8 | 206 | B284L**

05.08→	1 987 42 S 9193	L
	1 987 43 M 2076	I
	1 987 43 R 2376 ⁸	I

2,8 | 206 | B284R

01.08→	1 987 42 S 9193	L
--------	-----------------	---

9-3X**9-3X 2.0 T BioPower XWD, T XWD****2,0 | 154 | B207R**

03.10→	F 026 40 P 7016	O
	1 987 42 S 9193	L

9-5**9-5 1.9 TiD****1,9 | 110/129 | Z19DTH**

09.05→	1 457 42 P 9248	O
	F 026 40 N 2043	K

9-5 2.0 , T**2,0 | 136 | B205L**

07.00-02.10	F 026 40 P 7005	O	
	1 457 43 S 3590	L	
Fg.Nr. →53510415	07.00-02.10	0 450 90 F 5200 ¹	K
	Fg.Nr. 53510416→	07.00-02.10	0 450 90 F 5273 ¹

9-5 2.0 Biopower, Biopower XWD, T, T XWD**2,0 | 162 | A 20 NHT; A 20 NHT**

03.10→	F 026 40 P 7016	O
	1 987 43 R 2304 ⁸	I

9-5 2.0 t**2,0 | 110 | B205E <Ecopower>**

06.97-08.09	F 026 40 P 7005	O	
	1 457 43 S 3590	L	
Fg.Nr. Y3003736→	06.97-08.09	0 450 90 F 5200 ¹	K
	06.97-08.09	KL 1 987 43 R 2401 ⁸	I
	KL	1 987 43 R 2401	I

2,0 | 140 | B205E <Ecopower>

09.99-08.00	F 026 40 P 7005	O	
	1 457 43 S 3590	L	
Fg.Nr. Y3003736→	09.99-08.00	0 450 90 F 5200 ¹	K
	09.99-08.00	KL 1 987 43 R 2401 ⁸	I
	KL	1 987 43 R 2401	I

9-5 2.0 T BioPower**2,0 | 110 | B205E <Ecopower>**

01.05→	F 026 40 P 7005	O
	1 457 43 S 3590	L

2,0 | 110/132 | B205E

09.05→	F 026 40 P 7005	O
	1 457 43 S 3590	L

9-5 2.0 TiD4, TTiD4, TTiD4 XWD**2,0 | 118/140 | A 20 DTH; A 20 DTR**

03.10→	F 026 40 N 2062	K
	1 987 43 R 2304 ⁸	I

9-5 2.2 TiD**2,2 | 88 | D223L**

03.02-08.05	1 457 42 P 9157	O	
	1 457 43 S 3590	L	
Fg.Nr. Y3003736→	03.02-08.05	1 457 42 N 9656	K
	03.02-08.05	KL 1 987 43 R 2401 ⁸	I
	KL	1 987 43 R 2401	I

9-5 2.3**2,3 | 172-187 | B235R**

09.99-08.05	F 026 40 P 7005	O	
	1 457 43 S 3590	L	
Fg.Nr. →53510415	09.99-08.05	0 450 90 F 5200 ¹	K
	Fg.Nr. 53510416→	09.99-08.05	0 450 90 F 5273 ¹





9-5 2.3 t

2,3 125 B235E <Ecopower>			
	06.97-08.00	F 026 40 P 7005	O
Fg.Nr. Y3003736 →	06.97-08.00	1 457 43 S 3590	L
	06.97-08.00	0 450 90 F 5200 ¹	K
		KL 1 987 43 R 2401 ⁸	I
		KL 1 987 43 R 2401	I

2,3 136 B235E <Ecopower>			
	09.00-02.10	F 026 40 P 7005	O
		1 457 43 S 3590	L
		0 450 90 F 5200 ¹	K
		KL 1 987 43 R 2401 ⁸	I
		KL 1 987 43 R 2401	I

9-5 2.3 T

2,3 162 B235L			
	09.03-02.10	F 026 40 P 7005	O
		1 457 43 S 3590	L
		0 450 90 F 5200 ¹	K
		KL 1 987 43 R 2401 ⁸	I
		KL 1 987 43 R 2401	I

9-5 2.3 T BioPower

2,3 136 B235E			
	01.07 →	F 026 40 P 7005	O
		1 457 43 S 3590	L

9-5 2.3 Turbo

2,3 169 B235R <Ecopower>			
	05.99-09.01	F 026 40 P 7005	O
Fg.Nr. Y3003736 →	05.99-09.01	1 457 43 S 3590	L
	05.99-09.01	0 450 90 F 5200 ¹	K
		KL 1 987 43 R 2401 ⁸	I
		KL 1 987 43 R 2401	I

2,3 184 B235R			
	09.01-02.10	F 026 40 P 7005	O
Fg.Nr. Y3003736 →	09.01-02.10	1 457 43 S 3590	L
	09.01-02.10	0 450 90 F 5200 ¹	K
		KL 1 987 43 R 2401 ⁸	I
		KL 1 987 43 R 2401	I

2,3 224			
	06.03-08.05	F 026 40 P 7005	O
		1 457 43 S 3590	L
		0 450 90 F 5200 ¹	K

9-5 2.8 T XWD

2,8 221 A 28 NER			
	03.10 →	1 987 43 R 2304 ⁸	I

9-5 3.0 t

3,0 147 B308E <Ecopower>			
	06.97-08.03	F 026 40 P 7005	O
Fg.Nr. Y3003736 →	06.97-08.03	1 457 43 S 3590	L
	06.97-08.03	0 450 90 F 5200 ¹	K
		KL 1 987 43 R 2401 ⁸	I
		KL 1 987 43 R 2401	I



9-5 3.0 TiD

3,0 130 D308L			
	09.01-08.05	1 457 42 P 9302	O
Fg.Nr. →33029139	09.01-08.05	1 457 43 S 3590	L
	09.01-08.05	1 457 42 N 9656	K
		KL 1 987 43 R 2401 ⁸	I
		KL 1 987 43 R 2401	I

900

900 2.0 , i

2,0 92-99 B 202 Kat.			
	09.85-08.93	F 026 40 P 7005	O
		BO 1 457 43 S 3796	L
	01.90-08.93	LUC 1 457 42 S 9900	L
	09.85-08.93	0 450 90 F 5601 ¹	K

900 2.0 i

2,0 81 B 201 Kat.			
	09.85-08.91	F 026 40 P 7005	O
		1 457 42 S 9900	L
Fg.Nr. G3021452 → H2017192	09.85-08.91	0 450 90 F 5401 ¹	K
Fg.Nr. H2017193 → J3007496	09.85-08.91	0 450 90 F 5601 ¹	K
Fg.Nr. H7002161 → H7023610	09.85-08.91	0 450 90 F 5401 ¹	K
Fg.Nr. H7023611 → J3007496	09.85-08.91	0 450 90 F 5601 ¹	K
Fg.Nr. J3007497 →	09.85-08.91	0 450 90 F 5145 ¹	K
Fg.Nr. → H7002160	09.85-08.91	0 450 90 F 5021 ¹	K

2,0 | 92-98 | B 202 |

	09.88-08.93	F 026 40 P 7005	O
		BO 1 457 43 S 3796	L
	01.90-08.93	LUC 1 457 42 S 9900	L
Fg.Nr. H7002161 → H7023610	09.88-08.93	0 450 90 F 5401 ¹	K
Fg.Nr. H7023611 → J3007496	09.88-08.93	0 450 90 F 5601 ¹	K
Fg.Nr. J3007497 →	09.88-08.93	0 450 90 F 5145 ¹	K
Fg.Nr. → H7002160	09.88-08.93	0 450 90 F 5021 ¹	K

900 2.0 i, i Turbo

2,0 96/98/136 B 204 Kat.; B 204 L Kat.; B 206 Kat.			
	09.93-08.98	F 026 40 P 7005	O
		1 457 43 S 3263	L
		0 450 90 F 5200 ¹	K
		1 987 43 M 2096	I

900 2.0 i Turbo

2,0 104-107 B 202 S Kat.			
	09.91-08.93	F 026 40 P 7005	O
		LUC 1 457 42 S 9900	L

900 2.0 i Turbo, Turbo

2,0 118/129-132 B 202 L; B 202 L Kat.			
	02.84-08.93	F 026 40 P 7005	O
	09.90-09.93	1 457 42 S 9900	L

900 2.0 Turbo

2,0B 202 R			
	09.92-08.93	F 026 40 P 7005	O
		1 457 42 S 9900	L
		0 450 90 F 5200 ¹	K



**900 2.1 i****2,1 | 100-103 | B 212 | Kat.**

09.90-08.93	F 026 40 P 7005	O
	1 457 42 S 9890	L
	0 450 90 F 5601 ¹	K

2,1 | 103 | B 212 | Kat.

09.90-08.94	F 026 40 P 7005	O
09.90-08.93	1 457 42 S 9890	L
09.90-08.94	1 457 42 S 9900	L
09.90-08.93	0 450 90 F 5601 ¹	K
09.90-08.94	0 450 90 F 5200 ¹	K

900 2.3 i**2,3 | 110 | B 234 | Kat.**

09.93-08.98	F 026 40 P 7005	O
	1 457 43 S 3263	L
	0 450 90 F 5200 ¹	K
	1 987 43 M 2096	I

2,3 | 112 | B 234 |

09.93-08.98	F 026 40 P 7005	O
	1 457 43 S 3263	L
	0 450 90 F 5200 ¹	K

900 2.5 i**2,5 | 125 | B 258 |**

09.93-10.98	0 451 10 P 3079	O
	1 457 42 S 9898	L
	0 450 90 F 5200 ¹	K
	1 987 43 M 2096	I

2,5 | 125 | B 258 | <KAT>; B 258 | Kat.

09.93-10.98	0 451 10 P 3079	O
	1 457 42 S 9898	L
	0 450 90 F 5200 ¹	K
	1 987 43 M 2096	I

2,5 | 127 | B 258 |

09.93-08.97	F 026 40 P 7005	O
	1 457 43 S 3263	L
	0 450 90 F 5200 ¹	K

9000**9000 2.0 CD Turbo****2,0 | 118-120 | B 202 L <Turbo- Katalysator>**

05.88-08.93	F 026 40 P 7005	O
	1 457 42 S 9839	L
	0 450 90 F 5200 ¹	K

2,0 | 129-136 | B 202 L <Turbo>

05.88-08.92	F 026 40 P 7005	O
	1 457 42 S 9839	L
	0 450 90 F 5200 ¹	K

9000 2.0 CD Turbo 16V, CS, CS Turbo**2,0 | 96/108/110 | B 202 S <Turbo- Katalysator>; B 204 E <Turbo- Katalysator>; B 204 L <Kat>**

09.92-12.98	F 026 40 P 7005	O
	1 457 42 S 9839	L
	0 450 90 F 5200 ¹	K

9000 2.0 CD 16V**2,0 | 92-96 | B 202 | <Kat>**

09.89-08.93	F 026 40 P 7005	O	
	1 457 42 S 9839	L	
	0 450 90 F 5200 ¹	K	
09.89-08.91	KL	1 987 43 M 2005	I

9000 2.0 i 16V**2,0 | 90-92 | B 202 | <Kat>**

08.86-08.93	F 026 40 P 7005	O
09.88-08.93	1 457 42 S 9839	L
08.86-08.93	0 450 90 F 5200 ¹	K

2,0 | 94-96 | B 202 |

12.85-08.93	F 026 40 P 7005	O
09.88-08.93	1 457 42 S 9839	L
12.85-08.93	0 450 90 F 5200 ¹	K

9000 2.0 Turbo 16V**2,0 | 118-121 | B 202 L <Turbo- Katalysator>**

01.90-08.93	F 026 40 P 7005	O	
	1 457 42 S 9839	L	
	0 450 90 F 5200 ¹	K	
01.90-08.91	KL	1 987 43 M 2005	I

9000 2.3 CD Turbo, CD Turbo S**2,3 | 143 | B 234 L <Turbo- Katalysator>**

09.90-08.93	F 026 40 P 7005	O	
	1 457 42 S 9839	L	
	0 450 90 F 5200 ¹	K	
09.90-08.91	KL	1 987 43 M 2005	I

9000 2.3 CD Turbo Ecopow., CDE Turbo Ecopower, CS Turbo Ecopower**2,3 | 125 | B 234 E <Turbo- Katalysator>**

09.93-12.98	F 026 40 P 7005	O
	1 457 42 S 9839	L
	0 450 90 F 5200 ¹	K

9000 2.3 CD 16V**2,3 | 107-114 | B 234 I; B 234 I <Kat>**

09.89-08.93	F 026 40 P 7005	O	
	1 457 42 S 9839	L	
	0 450 90 F 5200 ¹	K	
09.89-08.91	KL	1 987 43 M 2005	I

9000 2.3 CD 16V, CS 16V**2,3 | 108 | B 234 I; B 234 I <Kat>**

09.93-12.98	F 026 40 P 7005	O
	1 457 42 S 9839	L
	0 450 90 F 5200 ¹	K





9000 2.3 CD 16V, i 16V

2,3 110 B 234 I; B 234 I <Kat>	09.90-08.93	F 026 40 P 7005	O
		1 457 42 S 9839	L
		0 450 90 F 5200 ¹	K
	09.90-08.91 KL	1 987 43 M 2005	I

9000 2.3 CDE Turbo

2,3 147 B 234 L <Kat>	09.93-12.98	F 026 40 P 7005	O
		1 457 42 S 9839	L
		0 450 90 F 5200 ¹	K

9000 2.3 CS Aero Turbo

2,3 165 B 234 R <Turbo- Katalysator>	09.92-12.98	F 026 40 P 7005	O
		1 457 42 S 9839	L
		0 450 90 F 5200 ¹	K

9000 2.3 CS Turbo, CS Turbo S

2,3 143 B 234 L <Turbo- Katalysator>	09.91-08.93	F 026 40 P 7005	O
		1 457 42 S 9839	L
		0 450 90 F 5200 ¹	K

9000 2.3 CS 16V

2,3 107-114 B 234 I; B 234 I <Kat>	09.91-08.93	F 026 40 P 7005	O
		1 457 42 S 9839	L
		0 450 90 F 5200 ¹	K

9000 2.3 CSE Turbo

2,3 147 B 234 L <Turbo- Katalysator>	09.93-12.98	F 026 40 P 7005	O
		1 457 42 S 9839	L
		0 450 90 F 5200 ¹	K

9000 2.3 i 16V

2,3 107-114 B 234 I; B 234 I <Kat>	09.89-08.93	F 026 40 P 7005	O
		1 457 42 S 9839	L
		0 450 90 F 5200 ¹	K
	09.89-08.91 KL	1 987 43 M 2005	I

9000 2.3 Turbo 16V

2,3 143 B 234 L <Turbo- Katalysator>	09.90-08.93	F 026 40 P 7005	O
		1 457 42 S 9839	L
		0 450 90 F 5200 ¹	K
	09.90-08.91 KL	1 987 43 M 2005	I

9000 3.0 CD, CS, Griffin

3,0 155 B 308 I <Kat>	09.94-12.98	0 451 10 P 3079	O
		1 457 42 S 9839	L
		0 450 90 F 5200 ¹	K



SATURN

Ion

Ion 2.2

2,2 104 L61	09.02→	W50	F 026 40 P 7016	O
-----------------	--------	-----	-----------------	---

Relay

Relay 3.5

3,5 149 LX9	09.04-08.06	W50	0 451 10 P 3079	O
-----------------	-------------	-----	-----------------	---

Serie L

Serie L LS1 2.2

2,2 101 L61	09.99-08.03	W50	F 026 40 P 7016	O
-----------------	-------------	-----	-----------------	---

Serie L LS2 3.0

3,0 136 L81	09.99-12.05	W50	1 457 42 P 9178	O
-----------------	-------------	-----	-----------------	---

Serie L LW1 2.2

2,2 101 L61	09.99-09.03	W50	F 026 40 P 7016	O
-----------------	-------------	-----	-----------------	---

Serie L LW2 3.0

3,0 136 L81	09.99-09.03	W50	1 457 42 P 9178	O
-----------------	-------------	-----	-----------------	---

Vue

Vue 2.2 , 4x4

2,2 107 L61	09.01→	W50	F 026 40 P 7016	O
-----------------	--------	-----	-----------------	---

Vue 3.0 , 4x4

3,0 135 L81	09.01-08.03	W50	1 457 42 P 9178	O
-----------------	-------------	-----	-----------------	---

SEAT

Alhambra

Alhambra 1.4 TSI

1,4 110 CAVA	05.10-05.11	KZO	1 987 42 S 9404	L
			1 987 43 M 2097	I
			1 987 43 R 2397 ⁸	I
		RLE	1 987 43 R 2597 ⁸	I



**Alhambra 1.8 T**

1,8 110 AJH	05.98-02.00	0 451 10 P 3314	O
		1 457 43 S 3742	L
		0 450 90 F 5264 ¹	K
		1 987 43 M 2028	I
		1 987 43 R 2328 ⁸	I

1,8|110|AWC

06.00-03.10	0 451 10 P 3314	O
	1 457 43 S 3089	L
	0 450 90 F 5264 ¹	K
	1 987 43 M 2028	I
	1 987 43 R 2328 ⁸	I

Alhambra 1.9 TDI**1,9|66|AHU**

07.96-02.00	0 451 10 P 3347	O
	1 457 43 S 3742	L
	0 450 90 N 6267 ¹	K
	1 987 43 M 2028	I
	1 987 43 R 2328 ⁸	I

1,9|66|ANU

06.00-03.10	1 457 42 P 9619	O
	1 457 43 S 3089	L
	0 450 90 N 6334 ¹	K
	1 987 43 M 2028	I
	1 987 43 R 2328 ⁸	I

1,9|66|1Z

03.96-07.96	0 451 10 P 3347	O
	1 457 43 S 3742	L
	0 450 90 N 6267 ¹	K
	1 987 43 M 2028	I
	1 987 43 R 2328 ⁸	I

1,9|81|AFN

05.97-02.00	0 451 10 P 3290	O
	1 457 43 S 3742	L
	0 450 90 N 6267 ¹	K
	1 987 43 M 2028	I
	1 987 43 R 2328 ⁸	I

1,9|81|AVG

09.97-02.00	0 451 10 P 3290	O
	1 457 43 S 3742	L
	0 450 90 N 6267 ¹	K
	1 987 43 M 2028	I
	1 987 43 R 2328 ⁸	I

1,9|110|BTB

06.05-05.07	1 457 42 P 9192	O
	1 457 43 S 3089	L
	0 450 90 N 6334 ¹	K
	1 987 43 M 2028	I
	1 987 43 R 2328 ⁸	I

Alhambra 1.9 TDI, TDI 4Motion**1,9|85|AUY**

06.00-03.10	1 457 42 P 9619	O
	1 457 43 S 3089	L
	0 450 90 N 6334 ¹	K
	1 987 43 M 2028	I
	1 987 43 R 2328 ⁸	I

1,9|85|BVK

11.05-03.10	1 457 42 P 9619	O
	1 457 43 S 3089	L
	0 450 90 N 6334 ¹	K
	1 987 43 M 2028	I
	1 987 43 R 2328 ⁸	I

1,9|96|ASZ

11.02-11.08	1 457 42 P 9192	O
	1 457 43 S 3089	L
	0 450 90 N 6334 ¹	K
	1 987 43 M 2028	I
	1 987 43 R 2328 ⁸	I

Alhambra 2.0**2,0|85|ADY**

03.96-02.00	0 451 10 P 3314	O
	1 457 43 S 3742	L
	1 987 43 M 2028	I
	1 987 43 R 2328 ⁸	I

2,0|85|ATM

06.00-03.10	0 451 10 P 3314	O
	1 457 43 S 3089	L
	0 450 90 F 5264 ¹	K
	1 987 43 M 2028	I
	1 987 43 R 2328 ⁸	I

Alhambra 2.0 TDI**2,0|103|BRT**

11.05-03.10	1 457 42 P 9192	O
	1 457 43 S 3089	L
	0 450 90 N 6334 ¹	K
	1 987 43 M 2028	I
	1 987 43 R 2328 ⁸	I

Alhambra 2.0 TDI, TDI 4WD**2,0|85/100/103/125|CFFA; CFFB; CFFB <D91>; CFFE <DE4>; CFGB**

05.10→	F 026 40 P 7023	O
	KZO 1 987 42 S 9404	L
	1 987 43 M 2097	I
	1 987 43 R 2397 ⁸	I
	RLE 1 987 43 R 2597 ⁸	I

Alhambra 2.0 TSI**2,0|147|CCZA <D2L>**

12.10→	F 026 40 P 7080	O
	1 987 42 S 9404	L
	1 987 43 M 2097	I
	1 987 43 R 2397 ⁸	I
	RLE 1 987 43 R 2597 ⁸	I





Alhambra 2.8 , 4Motion

2,8 150 AUE	06.00-04.02	1 987 43 M 2028	I
		1 987 43 R 2328 ⁸	I
2,8 150 AYL	06.00-03.10	1 457 42 P 9192	O
		1 457 43 S 3089	L
		0 450 90 F 5264 ¹	K
		1 987 43 M 2028	I
		1 987 43 R 2328 ⁸	I

Altea

Altea 1.2 TSI

1,2 77 CBZB <DB0>	05.10→	1 987 42 S 9405	L
		0 450 90 F 5959 ¹	K
		1 987 43 M 2097	I
		1 987 43 R 2397 ⁸	I
	RLE	1 987 43 R 2597 ⁸	I

Altea 1.4

1,4 63 BXW <D22>	05.06-05.10	0 451 10 P 3318	O
		F 026 40 S 0035	L
		F 026 40 F 3006 ¹	K
		1 987 43 M 2097	I
		1 987 43 R 2397 ⁸	I
	RLE	1 987 43 R 2597 ⁸	I

1,4 | 63 | CGGB <D22>

	05.10→	0 451 10 P 3318	O
		F 026 40 S 0035	L
		1 987 43 M 2097	I
		1 987 43 R 2397 ⁸	I
	RLE	1 987 43 R 2597 ⁸	I

Altea 1.4 TSI

1,4 92 CAXC <D33>			
Fg.Nr. →5P..8..090000	11.07-04.08	1 457 42 P 9301	O
Fg.Nr. 1P..8..090001→	05.08-05.10	F 026 40 P 7079	O
	11.07→	1 987 42 S 9405	L
		0 450 90 F 5959 ¹	K
		1 987 43 M 2097	I
		1 987 43 R 2397 ⁸	I
	RLE	1 987 43 R 2597 ⁸	I

Altea 1.6

1,6 72-75 CHGA <T53>	09.09→	0 451 10 P 3314	O
		KZO 1 987 42 S 9405	L
		KZO 1 457 43 S 3576	L
		1 987 43 M 2097	I
		1 987 43 R 2397 ⁸	I
	RLE	1 987 43 R 2597 ⁸	I



1,6 | 75 | BGU

	03.04-05.05	0 451 10 P 3314	O
		KZO 1 987 42 S 9405	L
		KZO 1 457 43 S 3576	L
		0 450 90 F 5959 ¹	K
		1 987 43 M 2097	I
		1 987 43 R 2397 ⁸	I
	RLE	1 987 43 R 2597 ⁸	I

1,6 | 75 | BSE <T53>; BSF <T53>

	05.05→	0 451 10 P 3314	O
		KZO 1 987 42 S 9405	L
		KZO 1 457 43 S 3576	L
	05.05-05.10	F 026 40 F 3006 ¹	K
	05.05→	1 987 43 M 2097	I
		1 987 43 R 2397 ⁸	I
	RLE	1 987 43 R 2597 ⁸	I

1,6 | 75 | CCSA <T53>

	12.07-11.10	0 451 10 P 3314	O
		KZO 1 987 42 S 9405	L
		KZO 1 457 43 S 3576	L
	12.07-05.10	F 026 40 F 3006 ¹	K
	12.07-11.10	1 987 43 M 2097	I
		1 987 43 R 2397 ⁸	I
	RLE	1 987 43 R 2597 ⁸	I

Altea 1.6 TDI

1,6 | 66/77 | CAYB <D36>; CAYC <D38>

	10.09→	F 026 40 P 7023	O
		KZO 1 987 42 S 9404	L
		F 026 40 N 2006	K
		1 987 43 M 2097	I
		1 987 43 R 2397 ⁸	I
	RLE	1 987 43 R 2597 ⁸	I

Altea 1.8 TSI

1,8 | 118 | BYT

	01.07-06.07	F 026 40 P 7080	O
		1 987 42 S 9404	L
		0 450 90 F 5959 ¹	K
		1 987 43 M 2097	I
		1 987 43 R 2397 ⁸	I
	RLE	1 987 43 R 2597 ⁸	I

1,8 | 118 | BZB

	06.07-03.09	F 026 40 P 7080	O
		1 987 42 S 9404	L
		0 450 90 F 5959 ¹	K
		1 987 43 M 2097	I

1,8 | 118 | CDAA <D67>

	03.09→	F 026 40 P 7080	O
		1 987 42 S 9404	L
		0 450 90 F 5959 ¹	K
		1 987 43 M 2097	I
		1 987 43 R 2397 ⁸	I
	RLE	1 987 43 R 2597 ⁸	I



**Altea 1.9 TDI**

1,9 | 66/77 | BKC; BLS <D3W>; BXE <D3W>; BXF <MF7>

04.04-12.10		1 457 42	P 9192	O
	KZO	1 987 42	S 9404	L
	H42,TW	1 457 07	N0007	K
	TW,UFI	F 026 40	N 2006	K
04.06-12.10	H16,TW	F 026 40	N 2008	K
04.04-12.10		1 987 43	M 2097	I
		1 987 43	R 2397⁸	I
	RLE	1 987 43	R 2597⁸	I

1,9 | 77 | BJB

04.04-09.05		1 457 42	P 9192	O
	KZO	1 987 42	S 9404	L
	H42,TW	1 457 07	N0007	K
	TW,UFI	F 026 40	N 2006	K
		1 987 43	M 2097	I
		1 987 43	R 2397⁸	I
	RLE	1 987 43	R 2597⁸	I

Altea 2.0 FSI

2,0 | 110 | BLR; BLY

05.04-11.05		1 457 42	P 9243	O
	KZO	1 987 42	S 9405	L
	KZO	1 457 43	S 3576	L
		0 450 90	F 5959¹	K
		1 987 43	M 2097	I
		1 987 43	R 2397⁸	I
	RLE	1 987 43	R 2597⁸	I

2,0 | 110 | BVY; BVZ

11.05-03.09		1 457 42	P 9243	O
	KZO	1 987 42	S 9405	L
	KZO	1 457 43	S 3576	L
		0 450 90	F 5959¹	K
		1 987 43	M 2097	I
		1 987 43	R 2397⁸	I
	RLE	1 987 43	R 2597⁸	I

Altea 2.0 TDI

2,0 | 100/103 | AZV; BKD <D3X>

03.04-07.11		1 457 42	P 9192	O
	KZO	1 987 42	S 9404	L
	H42,TW	1 457 07	N0007	K
	TW,UFI	F 026 40	N 2006	K
04.06-07.11	H16,TW	F 026 40	N 2008	K
03.04-07.11		1 987 43	M 2097	I
		1 987 43	R 2397⁸	I
	RLE	1 987 43	R 2597⁸	I

Altea 2.0 TDI, TDI 4WD

2,0 | 103/125 | BMM <D7N>; BMN

11.05-11.10		1 457 42	P 9192	O
	KZO	1 987 42	S 9404	L
	H42,TW	1 457 07	N0007	K
	TW,UFI	F 026 40	N 2006	K
04.06-11.10	H16,TW	F 026 40	N 2008	K
11.05-11.10		1 987 43	M 2097	I
		1 987 43	R 2397⁸	I
	RLE	1 987 43	R 2597⁸	I

2,0 | 103/125 | CFHC <D91>; CFJA <D93>

09.10→		F 026 40	P 7023	O
	KZO	1 987 42	S 9404	L
		F 026 40	N 2006	K
		1 987 43	M 2097	I
		1 987 43	R 2397⁸	I
	RLE	1 987 43	R 2597⁸	I

2,0 | 125 | CEGA <D93>

03.09-10.10		1 457 42	P 9192	O
	KZO	1 987 42	S 9404	L
	H16,TW	F 026 40	N 2008	K
	H42,TW	1 457 07	N0007	K
	TW,UFI	F 026 40	N 2006	K
		1 987 43	M 2097	I
		1 987 43	R 2397⁸	I
	RLE	1 987 43	R 2597⁸	I

Altea 2.0 TFSI

2,0 | 155 | CCZB <D2D>

07.09→		F 026 40	P 7080	O
		1 987 42	S 9404	L
		0 450 90	F 5959¹	K
		1 987 43	M 2097	I
		1 987 43	R 2397⁸	I
	RLE	1 987 43	R 2597⁸	I

Altea 2.0 TFSI, TFSI 4WD

2,0 | 147 | BWA

05.06-06.09		1 457 42	P 9243	O
		1 457 43	S 3102	L
		0 450 90	F 5959¹	K
		1 987 43	M 2097	I
		1 987 43	R 2397⁸	I
	RLE	1 987 43	R 2597⁸	I

Altea 2.0 TFSI 4WD

2,0 | 155 | CCZB <D2D>

07.09→		F 026 40	P 7080	O
		1 987 42	S 9404	L
		0 450 90	F 5959¹	K
		1 987 43	M 2097	I
		1 987 43	R 2397⁸	I
	RLE	1 987 43	R 2597⁸	I





Altea XL

Altea XL 1.2 TSI

1,2 77 CBZB <DB0>				
	04.10→	1987 42 S 9405	L	
		0450 90 F 5959 ¹	K	
		1987 43 M 2097	I	
		1987 43 R 2397 ⁸	I	
	RLE	1987 43 R 2597 ⁸	I	

Altea XL 1.4

1,4 63 BXW <D22>				
	10.06-05.10	0451 10 P 3318	O	
		F 026 40 S 0035	L	
		F 026 40 F 3006 ¹	K	
		1987 43 M 2097	I	
		1987 43 R 2397 ⁸	I	
	RLE	1987 43 R 2597 ⁸	I	

1,4 63 CGGB <D22>				
	05.10→	0451 10 P 3318	O	
		F 026 40 S 0035	L	
		1987 43 M 2097	I	
		1987 43 R 2397 ⁸	I	
	RLE	1987 43 R 2597 ⁸	I	

Altea XL 1.4 TSI

1,4 92 CAXC <D33>				
Fg.Nr. →5P..8..090000	11.07-04.08	1457 42 P 9301	O	
Fg.Nr. 1P..8..090001→	05.08-05.10	F 026 40 P 7079	O	
	11.07→	1987 42 S 9405	L	
		0450 90 F 5959 ¹	K	
		1987 43 M 2097	I	
		1987 43 R 2397 ⁸	I	
	RLE	1987 43 R 2597 ⁸	I	

Altea XL 1.6

1,6 72-75 CHGA <T53>				
	09.09→	0451 10 P 3314	O	
		KZO 1987 42 S 9405	L	
		KZO 1457 43 S 3576	L	
		1987 43 M 2097	I	
		1987 43 R 2397 ⁸	I	
	RLE	1987 43 R 2597 ⁸	I	

1,6 75 BSE <T53>; BSF <T53>				
	10.06→	0451 10 P 3314	O	
		KZO 1987 42 S 9405	L	
		KZO 1457 43 S 3576	L	
		1987 43 M 2097	I	
		1987 43 R 2397 ⁸	I	
	RLE	1987 43 R 2597 ⁸	I	
	10.06-05.10	F 026 40 F 3006 ¹	K	
	10.06→	1987 43 M 2097	I	
		1987 43 R 2397 ⁸	I	
	RLE	1987 43 R 2597 ⁸	I	

1,6 75 CCSA <T53>				
	12.07-11.10	0451 10 P 3314	O	
		KZO 1987 42 S 9405	L	
		KZO 1457 43 S 3576	L	
	12.07-05.10	F 026 40 F 3006 ¹	K	
	12.07-11.10	1987 43 M 2097	I	
		1987 43 R 2397 ⁸	I	
	RLE	1987 43 R 2597 ⁸	I	



Altea XL 1.6 TDI

1,6 66/77 CAYB <D36>; CAYC <D38>				
	10.09→	F 026 40 P 7023	O	
		KZO 1987 42 S 9404	L	
		F 026 40 N 2006	K	
		1987 43 M 2097	I	
		1987 43 R 2397 ⁸	I	
	RLE	1987 43 R 2597 ⁸	I	

Altea XL 1.8 TSI

1,8 118 BYT				
	01.07-06.07	F 026 40 P 7080	O	
		1987 42 S 9404	L	
		0450 90 F 5959 ¹	K	
		1987 43 M 2097	I	
		1987 43 R 2397 ⁸	I	
	RLE	1987 43 R 2597 ⁸	I	

1,8 118 BZB				
	06.07-03.09	F 026 40 P 7080	O	
		1987 42 S 9404	L	
		0450 90 F 5959 ¹	K	
		1987 43 M 2097	I	
		1987 43 R 2397 ⁸	I	
	RLE	1987 43 R 2597 ⁸	I	

1,8 118 CDAA <D67>				
	03.09→	F 026 40 P 7080	O	
		1987 42 S 9404	L	
		0450 90 F 5959 ¹	K	
		1987 43 M 2097	I	
		1987 43 R 2397 ⁸	I	
	RLE	1987 43 R 2597 ⁸	I	

Altea XL 1.9 TDI

1,9 66/77 BLS <D3W>; BXE <D3W>; BXF <MF7>				
	10.06-12.10	1457 42 P 9192	O	
		KZO 1987 42 S 9404	L	
		H16,TW F 026 40 N 2008	K	
		H42,TW 1457 07 N0007	K	
		TW,UFI F 026 40 N 2006	K	
		1987 43 M 2097	I	
		1987 43 R 2397 ⁸	I	
	RLE	1987 43 R 2597 ⁸	I	

Altea XL 2.0 FSI

2,0 110 BVY; BVZ				
	10.06-03.09	1457 42 P 9243	O	
		KZO 1987 42 S 9405	L	
		KZO 1457 43 S 3576	L	
		0450 90 F 5959 ¹	K	
		1987 43 M 2097	I	
		1987 43 R 2397 ⁸	I	
	RLE	1987 43 R 2597 ⁸	I	



**Altea XL 2.0 TDI****2,0|100|AZV**

10.06-03.09	1 457 42	P 9192	O
	KZ0	1 987 42	S 9404 L
	H16,TW	F 026 40	N 2008 K
	H42,TW	1 457 07	N0007 K
	TW,UFI	F 026 40	N 2006 K
		1 987 43	M 2097 I
		1 987 43	R 2397 ⁸ I
	RLE	1 987 43	R 2597 ⁸ I

2,0|103|BKD <D3X>

05.06-09.11	1 457 42	P 9192	O
	KZ0	1 987 42	S 9404 L
	H42,TW	1 457 07	N0007 K
	TW,UFI	F 026 40	N 2006 K
		1 987 43	M 2097 I
		1 987 43	R 2397 ⁸ I
	RLE	1 987 43	R 2597 ⁸ I

2,0|103|CFHC <D91>

10.10→	F 026 40	P 7023	O
	KZ0	1 987 42	S 9404 L
		F 026 40	N 2006 K
		1 987 43	M 2097 I
		1 987 43	R 2397 ⁸ I
	RLE	1 987 43	R 2597 ⁸ I

2,0|103/125|BMM <D7N>; BMN

10.06-11.10	1 457 42	P 9192	O
	KZ0	1 987 42	S 9404 L
	H16,TW	F 026 40	N 2008 K
	H42,TW	1 457 07	N0007 K
	TW,UFI	F 026 40	N 2006 K
		1 987 43	M 2097 I
		1 987 43	R 2397 ⁸ I
	RLE	1 987 43	R 2597 ⁸ I

2,0|125|CEGA <D93>

03.09-05.10	1 457 42	P 9192	O
	KZ0	1 987 42	S 9404 L
	H16,TW	F 026 40	N 2008 K
	H42,TW	1 457 07	N0007 K
	TW,UFI	F 026 40	N 2006 K
		1 987 43	M 2097 I
		1 987 43	R 2397 ⁸ I
	RLE	1 987 43	R 2597 ⁸ I

Altea XL 2.0 TFSI**2,0|147|BWA**

10.06-03.09	1 457 42	P 9243	O
		1 457 43	S 3102 L
		0 450 90	F 5959 ¹ K
		1 987 43	M 2097 I
		1 987 43	R 2397 ⁸ I
	RLE	1 987 43	R 2597 ⁸ I

Arosa**Arosa 1.0****1,0|37|AER**

02.97-09.99	0 451 10	P 3318	O
		1 457 43	S 3540 L
		0 450 90	F 5316 ¹ K
		1 987 43	M 2012 I
		1 987 43	R 2312 ⁸ I

1,0|37|AHT

10.97-02.00	0 451 10	P 3337	O
		1 457 43	S 3540 L
		0 450 90	F 5316 ¹ K
		1 987 43	M 2012 I
		1 987 43	R 2312 ⁸ I

1,0|37|ALD

01.99-07.00	0 451 10	P 3318	O
		1 457 43	S 3539 L
		0 450 90	F 5316 ¹ K
		1 987 43	M 2012 I
		1 987 43	R 2312 ⁸ I

1,0|37|ALL

10.97-05.99	0 451 10	P 3318	O
		1 457 43	S 3540 L
		0 450 90	F 5316 ¹ K
		1 987 43	M 2012 I
		1 987 43	R 2312 ⁸ I

1,0|37|ANV;AUC

01.99-06.04	0 451 10	P 3318	O
		1 457 43	S 3539 L
		0 450 90	F 5316 ¹ K
		1 987 43	M 2012 I
		1 987 43	R 2312 ⁸ I

Arosa 1.4**1,4|44|AEX**

02.97-11.97	0 451 10	P 3318	O
		1 457 43	S 3540 L
		0 450 90	F 5316 ¹ K
		1 987 43	M 2012 I
		1 987 43	R 2312 ⁸ I

1,4|44|AKK

01.99-10.00	0 451 10	P 3318	O
		1 457 43	S 3539 L
		0 450 90	F 5316 ¹ K
		1 987 43	M 2012 I
		1 987 43	R 2312 ⁸ I

1,4|44|AKV

05.97-09.99	0 451 10	P 3318	O
		1 457 43	S 3540 L
		0 450 90	F 5316 ¹ K
		1 987 43	M 2012 I
		1 987 43	R 2312 ⁸ I





◀ Arosa 1.4

1,4 44 ANW	01.99-10.00	0 451 10 P 3318 O
		1 457 43 S 3539 L
		0 450 90 F 5316 ¹ K
		1 987 43 M 2012 I
		1 987 43 R 2312 ⁸ I

1,4 44 APQ	12.97-08.98	0 451 10 P 3318 O
		1 457 43 S 3540 L
		0 450 90 F 5316 ¹ K
		1 987 43 M 2012 I
		1 987 43 R 2312 ⁸ I

1,4 44 AUD	01.99-06.04	0 451 10 P 3318 O
		1 457 43 S 3539 L
		0 450 90 F 5316 ¹ K
		1 987 43 M 2012 I
		1 987 43 R 2312 ⁸ I

Arosa 1.4 TDI

1,4 55 AMF	01.98-06.04	1 457 42 P 9192 O
		1 457 43 S 3538 L
		0 450 90 N 6373 ¹ K
		1 987 43 M 2012 I
		1 987 43 R 2312 ⁸ I

Arosa 1.4 16V

1,4 74 AFK	01.99-09.00	0 451 10 P 3318 O
		1 457 43 S 3716 L
		0 450 90 F 5316 ¹ K
		1 987 43 M 2012 I
		1 987 43 R 2312 ⁸ I

1,4 74 AQQ; AUB	05.99-06.04	0 451 10 P 3318 O
		1 457 43 S 3716 L
		0 450 90 F 5316 ¹ K
		1 987 43 M 2012 I
		1 987 43 R 2312 ⁸ I

Arosa 1.7 SDI

1,7 44 AKU	08.97-10.03	0 451 10 P 3289 O
Fg.Nr. →6H..Y..028 000	08.97-09.00	1 457 43 S 3712 L
Fg.Nr. 6H..Y..028 001→	10.00-10.03	1 457 43 S 3538 L
Fg.Nr. →6H..Y..020 000	08.97-04.00	0 450 90 N 6274 ¹ K
Fg.Nr. 6H..Y..020 001→	05.00-10.03	0 450 90 N 6373 ¹ K
	08.97-10.03	1 987 43 M 2012 I
		1 987 43 R 2312 ⁸ I



Cordoba

Cordoba 1.0

1,0 37 AER	09.96-06.99	0 451 10 P 3318 O
		1 457 43 S 3540 L
Fg.Nr. →6K..V..250 000	09.96-08.97	0 450 90 F 5002 ¹ K
Fg.Nr. 6K..W..000 001→	09.97-06.99	0 450 90 F 5316 ¹ K
	09.96-06.99	1 987 43 M 2012 I
		1 987 43 R 2312 ⁸ I

1,0|37|ALD; ANV; AUC

	05.99-12.02	0 451 10 P 3318 O
		1 457 43 S 3539 L
		0 450 90 F 5316 ¹ K
		1 987 43 M 2012 I
		1 987 43 R 2312 ⁸ I

1,0|51|AVZ

	05.00-12.02	0 451 10 P 3318 O
		F 026 40 S 0019 L
		0 450 90 F 5316 ¹ K
		1 987 43 M 2012 I
		1 987 43 R 2312 ⁸ I

Cordoba 1.2

1,2|47|AZQ

	10.02-04.04	1 457 42 P 9194 O
		1 457 43 S 3319 L
PR-Nr. OF2	10.02-04.04	MRK 0 450 90 F 5316 ¹ K
PR-Nr. 1A1	10.02-04.04	DRR F 026 40 F 3008 ¹ K
		DTV,ORR 0 450 90 F 5925 ¹ K
PR-Nr. 1A3	10.02-04.04	DRR F 026 40 F 3006 ¹ K
	10.02-04.04	1 987 43 M 2057 I
		1 987 43 R 2357 ⁸ I

1,2|47|BME

	11.04-06.06	1 457 42 P 9194 O
		1 457 43 S 3319 L
Fg.Nr. →6L..6..069 000	11.04-09.05	DTV,ORR 0 450 90 F 5925 ¹ K
PR-Nr. 1A1		
PR-Nr. OF2	11.04-06.06	MRK 0 450 90 F 5316 ¹ K
PR-Nr. 1A1	11.04-06.06	DRR F 026 40 F 3008 ¹ K
PR-Nr. 1A3	11.04-06.06	DRR F 026 40 F 3006 ¹ K
	11.04-06.06	1 987 43 M 2057 I
		1 987 43 R 2357 ⁸ I

1,2|51|BXV

	05.06-11.09	1 457 42 P 9194 O
		1 457 43 S 3319 L
PR-Nr. OF2	05.06-11.09	MRK 0 450 90 F 5316 ¹ K
PR-Nr. 1A1	05.06-11.09	DRR F 026 40 F 3008 ¹ K
PR-Nr. 1A3	05.06-11.09	DRR F 026 40 F 3006 ¹ K
	05.06-11.09	1 987 43 M 2057 I
		1 987 43 R 2357 ⁸ I

Cordoba 1.4

1,4|44|ABD

	09.93-12.95	0 451 10 P 3314 O
		1 457 43 S 3540 L
		0 450 90 F 5002 ¹ K
		1 987 43 M 2012 I
		1 987 43 R 2312 ⁸ I



**1,4 | 44 | AEX**

	01.96-12.97	0 451 10 P 3318	O
		1 457 43 S 3540	L
	05.97-08.97	0 450 90 F 5002	¹ K
Fg.Nr. →6K..V..250 000	01.96-08.97	0 450 90 F 5002	¹ K
Fg.Nr. 6K..W..000 001→	09.97-12.97	0 450 90 F 5316	¹ K
	01.96-12.97	1 987 43 M 2012	I
		1 987 43 R 2312	⁸ I

1,4 | 44 | AKK

	05.99-12.02	0 451 10 P 3318	O
		STZ 1 457 43 S 3539	L
		0 450 90 F 5316	¹ K
		1 987 43 M 2012	I
		1 987 43 R 2312	⁸ I

1,4 | 44 | AKV

	09.97-12.02	0 451 10 P 3318	O
		1 457 43 S 3540	L
		0 450 90 F 5316	¹ K
		1 987 43 M 2012	I
		1 987 43 R 2312	⁸ I

1,4 | 44 | ANW

	05.99-08.00	0 451 10 P 3318	O
		STZ 1 457 43 S 3539	L
		0 450 90 F 5316	¹ K
		1 987 43 M 2012	I
		1 987 43 R 2312	⁸ I

1,4 | 44 | ANX

	01.98-05.98	0 451 10 P 3318	O
		1 457 43 S 3540	L
		0 450 90 F 5316	¹ K
		1 987 43 M 2012	I
		1 987 43 R 2312	⁸ I

1,4 | 44 | APQ

	12.97-12.02	0 451 10 P 3318	O
		1 457 43 S 3540	L
		0 450 90 F 5316	¹ K
		1 987 43 M 2012	I
		1 987 43 R 2312	⁸ I

1,4 | 44 | AUD

	06.00-12.02	0 451 10 P 3318	O
		STZ 1 457 43 S 3539	L
		0 450 90 F 5316	¹ K
		1 987 43 M 2012	I
		1 987 43 R 2312	⁸ I

1,4 | 55 | APE

	05.99-06.00	0 451 10 P 3318	O
		F 026 40 S 0019	L
		0 450 90 F 5316	¹ K
		1 987 43 M 2012	I
		1 987 43 R 2312	⁸ I

1,4 | 55 | AUA

	05.00-08.03	0 451 10 P 3318	O
		F 026 40 S 0019	L
		0 450 90 F 5316	¹ K
		1 987 43 M 2012	I
		1 987 43 R 2312	⁸ I

1,4 | 55 | BBY

	09.02-04.04	0 451 10 P 3318	O
		1 457 43 S 3059	L
Fg.Nr. →6L..6..069 000	09.02-04.04	DTV,ØRK 0 450 90 F 5925	¹ K
PR-Nr. 1A1			
PR-Nr. 0F2	09.02-04.04	MRK 0 450 90 F 5316	¹ K
PR-Nr. 1A1	09.02-04.04	DRR F 026 40 F 3008	¹ K
PR-Nr. 1A3	09.02-04.04	DRR F 026 40 F 3006	¹ K
	09.02-04.04	1 987 43 M 2057	I
		1 987 43 R 2357	⁸ I

1,4 | 55 | BKY

	05.04-12.07	0 451 10 P 3318	O
		1 457 43 S 3059	L
Fg.Nr. →6L..6..069 000	05.04-09.05	DTV,ØRK 0 450 90 F 5925	¹ K
PR-Nr. 1A1			
PR-Nr. 0F2	05.04-12.07	MRK 0 450 90 F 5316	¹ K
PR-Nr. 1A1	05.04-12.07	DRR F 026 40 F 3008	¹ K
PR-Nr. 1A3	05.04-12.07	DRR F 026 40 F 3006	¹ K
	05.04-12.07	1 987 43 M 2057	I
		1 987 43 R 2357	⁸ I

1,4 | 63 | BXW

	05.06-11.09	0 451 10 P 3318	O
		F 026 40 S 0035	L
PR-Nr. 0F2	05.06-11.09	MRK 0 450 90 F 5316	¹ K
PR-Nr. 1A1	05.06-11.09	DRR F 026 40 F 3008	¹ K
		DTV,ØRK 0 450 90 F 5925	¹ K
PR-Nr. 1A3	05.06-11.09	DRR F 026 40 F 3006	¹ K
	05.06-11.09	1 987 43 M 2057	I
		1 987 43 R 2357	⁸ I

1,4 | 74 | AFH

	07.96-12.02	0 451 10 P 3318	O
	03.97-12.02	1 457 43 S 3716	L
Fg.Nr. →6K..V..250 000	07.96-08.97	0 450 90 F 5002	¹ K
Fg.Nr. 6K..W..000 001→	09.97-12.02	0 450 90 F 5316	¹ K
	07.96-12.02	1 987 43 M 2012	I
		1 987 43 R 2312	⁸ I

1,4 | 74 | AQQ

	09.99-07.00	0 451 10 P 3318	O
		F 026 40 S 0019	L
		1 457 43 S 3716	L
		0 450 90 F 5316	¹ K
		1 987 43 M 2012	I
		1 987 43 R 2312	⁸ I

1,4 | 74 | AUB

	05.00-12.02	0 451 10 P 3318	O
		1 457 43 S 3716	L
		0 450 90 F 5316	¹ K
		1 987 43 M 2012	I
		1 987 43 R 2312	⁸ I





◀ Cordoba 1.4

1,4 74 BBZ	10.02-11.06	0 451 10 P 3318	O
		1 457 43 S 3059	L
PR-Nr. OF2	10.02-11.06	MRK 0 450 90 F 5316 ¹	K
PR-Nr. 1A1	10.02-11.06	DRR F 026 40 F 3008 ¹	K
		DTV,ORR 0 450 90 F 5925 ¹	K
PR-Nr. 1A3	10.02-11.06	DRR F 026 40 F 3006 ¹	K
	10.02-11.06	1 987 43 M 2057	I
		1 987 43 R 2357 ⁸	I

Cordoba 1.4 TDI

1,4 51/58 BNM; BNW	05.05-11.09	1 457 42 P 9192	O
		1 457 43 S 3575	L
	05.05-05.05	0 450 90 N 6322 ¹	K
	06.05-11.09	0 450 90 N 6500 ¹	K
	05.05-11.09	1 987 43 M 2057	I
		1 987 43 R 2357 ⁸	I

1,4 | 55 | AMF

10.02-12.05	1 457 42 P 9192	O
	1 457 43 S 3575	L
10.02-05.05	0 450 90 N 6322 ¹	K
06.05-12.05	0 450 90 N 6500 ¹	K
10.02-12.05	1 987 43 M 2057	I
	1 987 43 R 2357 ⁸	I

1,4 | 59 | BMS

06.06-11.09	1 457 42 P 9192	O
	1 457 43 S 3575	L
	0 450 90 N 6500 ¹	K
	1 987 43 M 2057	I
	1 987 43 R 2357 ⁸	I

Cordoba 1.6

1,6 55 ABU	09.93-07.94	0 451 10 P 3314	O
		1 457 43 S 3540	L
		0 450 90 F 5002 ¹	K
		1 987 43 M 2012	I
		1 987 43 R 2312 ⁸	I

1,6 | 55 | AEE

03.97-12.98	0 451 10 P 3318	O	
	1 457 43 S 3540	L	
Fg.Nr. →6K..V..250 000	03.97-08.97	0 450 90 F 5002 ¹	K
Fg.Nr. 6K..W..000 001→	09.97-12.98	0 450 90 F 5316 ¹	K
	03.97-12.98	1 987 43 M 2012	I
		1 987 43 R 2312 ⁸	I

1,6 | 55 | ALM

09.97-12.02	0 451 10 P 3318	O
	1 457 43 S 3540	L
	0 450 90 F 5316 ¹	K
	1 987 43 M 2012	I
	1 987 43 R 2312 ⁸	I

1,6 | 55 | 1F

05.94-06.99	0 451 10 P 3314	O	
	1 457 43 S 3264	L	
Fg.Nr. →6K..V..250 000	05.94-08.97	0 450 90 F 5002 ¹	K
Fg.Nr. 6K..W..000 001→	09.97-06.99	0 450 90 F 5316 ¹	K
	05.94-06.99	1 987 43 M 2012	I
		1 987 43 R 2312 ⁸	I



1,6 74 AEH	05.99-12.02	0 451 10 P 3314	O
		1 457 43 S 3058	L
		0 450 90 F 5316 ¹	K
		1 987 43 M 2012	I
		1 987 43 R 2312 ⁸	I

1,6 | 74 | AFT

12.95-11.02	0 451 10 P 3314	O	
	1 457 43 S 3264	L	
Fg.Nr. →6K..V..250 000	12.95-08.97	0 450 90 F 5002 ¹	K
Fg.Nr. 6K..W..000 001→	09.97-11.02	0 450 90 F 5316 ¹	K
	12.95-11.02	1 987 43 M 2012	I
		1 987 43 R 2312 ⁸	I

1,6 | 74 | AKL

05.99-10.04	0 451 10 P 3314	O
	1 457 43 S 3058	L
	0 450 90 F 5316 ¹	K
05.99-12.02	1 987 43 M 2012	I
	1 987 43 R 2312 ⁸	I

1,6 | 74 | APF; AUR

09.99-12.02	0 451 10 P 3314	O
	1 457 43 S 3058	L
	0 450 90 F 5316 ¹	K
	1 987 43 M 2012	I
	1 987 43 R 2312 ⁸	I

1,6 | 74 | BAH

04.03-11.09	0 451 10 P 3318	O	
	1 457 43 S 3059	L	
Fg.Nr. →6L..6..069 000	04.03-09.05	DTV,ORR 0 450 90 F 5925 ¹	K
PR-Nr. 1A1			
PR-Nr. OF2	04.03-11.09	MRK 0 450 90 F 5316 ¹	K
PR-Nr. 1A1	04.03-11.09	DRR F 026 40 F 3008 ¹	K
PR-Nr. 1A3	04.03-11.09	DRR F 026 40 F 3006 ¹	K
	04.03-11.09	1 987 43 M 2057	I
		1 987 43 R 2357 ⁸	I

1,6 | 76 | AKL

10.99-10.04	0 451 10 P 3314	O
	1 457 43 S 3058	L
	0 450 90 F 5316 ¹	K

1,6 | 77 | BTS

11.06-11.09	1 457 42 P 9301	O	
PR-Nr. OF2	11.06-11.09	MRK 0 450 90 F 5316 ¹	K
PR-Nr. 1A1	11.06-11.09	DRR F 026 40 F 3008 ¹	K
		DTV,ORR 0 450 90 F 5925 ¹	K
PR-Nr. 1A3	11.06-11.09	DRR F 026 40 F 3006 ¹	K
	11.06-11.09	1 987 43 M 2057	I
		1 987 43 R 2357 ⁸	I

Cordoba 1.8

1,8 66 ABS	09.93-07.94	0 451 10 P 3314	O
		1 457 43 S 3264	L
		0 450 90 F 5002 ¹	K
		1 987 43 M 2012	I
		1 987 43 R 2312 ⁸	I



1,8 66 ACC	03.95-12.02	0 451 10 P 3314	O
		1 457 43 S 3264	L
Fg.Nr. →6K..V..250 000	03.95-08.97	0 450 90 F 5002 ¹	K
Fg.Nr. 6K..W..000 001→	09.97-12.02	0 450 90 F 5316 ¹	K
	03.95-12.02	1 987 43 M 2012	I
		1 987 43 R 2312 ⁸	I

1,8 66 ADZ	07.94-12.02	0 451 10 P 3314	O
		1 457 43 S 3264	L
Fg.Nr. →6K..V..250 000	07.94-08.97	0 450 90 F 5002 ¹	K
Fg.Nr. 6K..W..000 001→	09.97-12.02	0 450 90 F 5316 ¹	K
	07.94-12.02	1 987 43 M 2012	I
		1 987 43 R 2312 ⁸	I

1,8 95 ADL	09.93-06.96	0 451 10 P 3314	O
		1 457 43 S 3264	L
		0 450 90 F 5002 ¹	K
		1 987 43 M 2012	I
		1 987 43 R 2312 ⁸	I

Cordoba 1.8 T Cupra

1,8 115 AQX; AYP	05.99-12.02	0 451 10 P 3314	O
		1 457 43 S 3058	L
		0 450 90 F 5316 ¹	K
		1 987 43 M 2012	I
		1 987 43 R 2312 ⁸	I

Cordoba 1.9 D

1,9 47-50 1Y	09.93-12.02	0 451 20 P 3012	O
		1 457 43 S 3264	L
		0 450 90 N 6274 ¹	K
		1 987 43 M 2012	I
		1 987 43 R 2312 ⁸	I

Cordoba 1.9 SDI

1,9 47 AEY	12.95-12.02	0 451 20 P 3012	O
		1 457 43 S 3264	L
		0 450 90 N 6274 ¹	K
		1 987 43 M 2012	I
		1 987 43 R 2312 ⁸	I

1,9 47 ASY	09.02-12.05	1 457 42 P 9192	O
		1 457 43 S 3575	L
		0 450 90 N 6322 ¹	K
		1 987 43 M 2057	I
		1 987 43 R 2357 ⁸	I



Cordoba 1.9 SDI, TDI			
1,9 50/66 AGP; AGR	05.99-12.02	1 457 42 P 9619	O
		1 457 43 S 3058	L
		0 450 90 N 6409 ¹	K
		1 987 43 M 2012	I
		1 987 43 R 2312 ⁸	I

1,9 50/66/81 ALH; AQM; ASV	05.99-12.02	1 457 42 P 9619	O
		1 457 43 S 3058	L
		0 450 90 N 6409 ¹	K
		1 987 43 M 2012	I
		1 987 43 R 2312 ⁸	I

Cordoba 1.9 TD

1,9 55 AAZ	09.93-08.97	0 451 20 P 3012	O
		1 457 43 S 3264	L
		0 450 90 N 6267 ¹	K
		1 987 43 M 2012	I
		1 987 43 R 2312 ⁸	I

Cordoba 1.9 TDI

1,9 66 AHU	07.96-12.02	0 451 10 P 3347	O
		1 457 43 S 3264	L
		0 450 90 N 6274 ¹	K
		1 987 43 M 2012	I
		1 987 43 R 2312 ⁸	I

1,9 66 1Z	07.96-12.96	0 451 10 P 3347	O
		1 457 43 S 3264	L
		0 450 90 N 6274 ¹	K
		1 987 43 M 2012	I
		1 987 43 R 2312 ⁸	I

1,9 74/96 ATD; AXR; BLT; BMT	09.02→	1 457 42 P 9192	O
		1 457 43 S 3575	L
		0 450 90 N 6426 ¹	K
		1 987 43 M 2057	I
		1 987 43 R 2357 ⁸	I

1,9 81 AFN	03.97-12.02	0 451 10 P 3290	O
		1 457 43 S 3264	L
		0 450 90 N 6274 ¹	K
		1 987 43 M 2012	I
		1 987 43 R 2312 ⁸	I

1,9 96 ASZ	10.02-09.05	1 457 42 P 9192	O
		1 457 43 S 3575	L
	10.02-05.05	0 450 90 N 6322 ¹	K
	06.05-09.05	0 450 90 N 6426 ¹	K
	10.02-09.05	1 987 43 M 2057	I
		1 987 43 R 2357 ⁸	I





Cordoba 2.0

2,0 85 AZL; BBX			
	09.02-11.09	0 451 10 P 3314	O
		1 457 43 S 3575	L
Fg.Nr. →6K..6..069 000	09.02-09.05	DTV, ORR 0 450 90 F 5925 ¹	K
PR-Nr. 1A1			
PR-Nr. OF2	09.02-11.09	MRK 0 450 90 F 5316 ¹	K
PR-Nr. 1A1	09.02-11.09	DRR F 026 40 F 3008 ¹	K
PR-Nr. 1A3	09.02-11.09	DRR F 026 40 F 3006 ¹	K
	09.02-11.09	1 987 43 M 2057	I
		1 987 43 R 2357 ⁸	I

2,0 85 2E			
	09.93-04.96	0 451 10 P 3314	O
		1 457 43 S 3264	L
		0 450 90 F 5002 ¹	K
		1 987 43 M 2012	I
		1 987 43 R 2312 ⁸	I

2,0 85/110 ABF; AGG			
	04.96-12.02	0 451 10 P 3314	O
		1 457 43 S 3264	L
Fg.Nr. →6K..V..250 000	04.96-08.97	0 450 90 F 5002 ¹	K
Fg.Nr. 6K..W..000 001→	09.97-12.02	0 450 90 F 5316 ¹	K
	04.96-12.02	1 987 43 M 2012	I
		1 987 43 R 2312 ⁸	I

Exeo

Exeo 1.6

1,6 75 ALZ <MW6>			
	03.09-09.10	0 451 10 P 3314	O
		1 457 43 S 3046	L
		0 450 90 F 5318 ¹	K
		1 987 43 M 2071	I
		1 987 43 R 2371 ⁸	I

Exeo 1.8

1,8 110 CFMA <MW8>			
	12.08-05.10	F 026 40 P 7004	O
		1 457 43 S 3046	L
		1 987 43 M 2071	I
		1 987 43 R 2371 ⁸	I

Exeo 1.8 TSI

1,8 88/118 CDHA <D2S>; CDHB <D67>			
	05.10-08.11	F 026 40 P 7080	O
	05.10→	1 457 43 S 3046	L
		F 026 40 F 3012 ¹	K
		1 987 43 M 2071	I
		1 987 43 R 2371 ⁸	I

Exeo 2.0 TDI

2,0 88/105/125 CAGA <D92>; CAGC <D90>; CAHA <D93>			
	12.08→	1 457 42 P 9192	O
		1 457 43 S 3046	L
		F 026 40 N 2066 ¹	K
		1 987 43 M 2071	I
		1 987 43 R 2371 ⁸	I



Exeo 2.0 TFSI, TSI

2,0 147 BWE <D2L>			
	03.09→	1 457 42 P 9243	O
		1 457 43 S 3046	L
		F 026 40 F 3012 ¹	K
		1 987 43 M 2071	I
		1 987 43 R 2371 ⁸	I

Exeo 2.0 TSI

2,0 155 CDND <D2D>			
	05.10-08.11	F 026 40 P 7080	O
	05.10→	1 457 43 S 3046	L
		F 026 40 F 3012 ¹	K
		1 987 43 M 2071	I
		1 987 43 R 2371 ⁸	I

Ibiza

Ibiza 0.9

0,9 29-32 1000 GL 7000			
	06.84-05.93	0 451 10 P 3349	O
		1 457 43 S 2111	L

Ibiza 1.0

1,0 33 AAU			
	03.93-06.96	0 451 10 P 3314	O
		1 457 42 S 9915	L
		0 450 90 F 5002 ¹	K
		1 987 43 M 2012	I
		1 987 43 R 2312 ⁸	I

1,0 | 37 | AER

	09.96-10.99	0 451 10 P 3318	O
		1 457 43 S 3540	L
Fg.Nr. →6K..V..250 000	09.96-08.97	0 450 90 F 5002 ¹	K
Fg.Nr. 6K..W..000 001→	09.97-10.99	0 450 90 F 5316 ¹	K
	09.96-10.99	1 987 43 M 2012	I
		1 987 43 R 2312 ⁸	I

1,0 | 37 | ALD; ANV

	05.99-05.02	0 451 10 P 3318	O
		STZ 1 457 43 S 3539	L
		0 450 90 F 5316 ¹	K
		1 987 43 M 2012	I
		1 987 43 R 2312 ⁸	I

1,0 | 37 | AUC

	07.00-05.02	0 451 10 P 3318	O
		STZ 1 457 43 S 3539	L
		0 450 90 F 5316 ¹	K
		1 987 43 M 2012	I
		1 987 43 R 2312 ⁸	I

1,0 | 51 | AST

	10.99-05.02	0 451 10 P 3318	O
		F 026 40 S 0019	L
		0 450 90 F 5316 ¹	K
		1 987 43 M 2012	I
		1 987 43 R 2312 ⁸	I





1,0 51 AVZ	05.00-05.02	0 451 10 P 3318	O
		F 026 40 S 0019	L
		0 450 90 F 5316 ¹	K
		1 987 43 M 2012	I
		1 987 43 R 2312 ⁸	I

Ibiza 1.0 16V

1,0 52 AST	10.99-10.04	F 026 40 S 0019	L
		0 450 90 F 5316 ¹	K

Ibiza 1.2

1,2 44 BBM	06.07-05.08	1 457 42 P 9194	O
		1 457 43 S 3532	L
PR-Nr. OF2	06.07-05.08	MRK 0 450 90 F 5316 ¹	K
PR-Nr. 1A1	06.07-05.08	3BA,DRR, F 026 40 F 3008 ¹	K
		ORK	
PR-Nr. 1A3	06.07-05.08	4BA,DRR, F 026 40 F 3006 ¹	K
		ORK	
	06.07-05.08	1 987 43 M 2057	I
		1 987 43 R 2357 ⁸	I

1,2 | 44-47 | 021 A 1000

	06.84-05.93	0 451 10 P 3033	O
		1 457 42 S 9050	L
		0 450 90 F 4058 ¹	K

1,2 | 44/51 | CGPA; CGPB

	06.09→	1 457 42 P 9194	O
		1 457 43 S 3532	L
		F 026 40 F 3006 ¹	K
	06.09-09.10	1 987 43 M 2057	I
		1 987 43 R 2357 ⁸	I

1,2 | 47 | AZQ

	11.01-04.04	1 457 42 P 9194	O
		1 457 43 S 3319	L
Fg.Nr. →6L..6..069 000	11.01-04.04	DTV, ORK 0 450 90 F 5925 ¹	K
PR-Nr. 1A1			
PR-Nr. OF2	11.01-04.04	MRK 0 450 90 F 5316 ¹	K
PR-Nr. 1A1	11.01-04.04	3BA,DRR, F 026 40 F 3008 ¹	K
		ORK	
PR-Nr. 1A3	11.01-04.04	4BA,DRR, F 026 40 F 3006 ¹	K
		ORK	
	11.01-04.04	1 987 43 M 2057	I
		1 987 43 R 2357 ⁸	I

1,2 | 47 | BME

	11.04-06.06	1 457 42 P 9194	O
		1 457 43 S 3319	L
Fg.Nr. →6L..6..069 000	11.04-09.05	DTV, ORK 0 450 90 F 5925 ¹	K
PR-Nr. 1A1			
PR-Nr. OF2	11.04-06.06	MRK 0 450 90 F 5316 ¹	K
PR-Nr. 1A1	11.04-06.06	3BA,DRR, F 026 40 F 3008 ¹	K
		ORK	
PR-Nr. 1A3	11.04-06.06	4BA,DRR, F 026 40 F 3006 ¹	K
		ORK	
	11.04-06.06	1 987 43 M 2057	I
		1 987 43 R 2357 ⁸	I



1,2 51 BXV	05.06-11.09	1 457 42 P 9194	O
		1 457 43 S 3319	L
PR-Nr. OF2	05.06-11.09	MRK 0 450 90 F 5316 ¹	K
PR-Nr. 1A1	05.06-11.09	3BA,DRR, F 026 40 F 3008 ¹	K
		ORK	
PR-Nr. 1A3	05.06-11.09	4BA,DRR, F 026 40 F 3006 ¹	K
		ORK	
	05.06-11.09	1 987 43 M 2057	I
		1 987 43 R 2357 ⁸	I

1,2 | 51 | BZG

	03.08-05.11	1 457 42 P 9194	O
		1 457 43 S 3532	L
		F 026 40 F 3006 ¹	K
		1 987 43 M 2057	I
		1 987 43 R 2357 ⁸	I

Ibiza 1.2 i

1,2 51 021 C.1000	12.89-05.93	0 451 10 P 3314	O
		1 457 42 S 9846	L
		0 450 90 F 5030 ¹	K

Ibiza 1.2 TDI, TSI

1,2 55/77 CBZB <DB0>; CFWA <D28>	04.10→	F 026 40 S 0156	L
	04.10-09.10	1 987 43 M 2057	I
		1 987 43 R 2357 ⁸	I

Ibiza 1.3

1,3 40 AAV	03.93-07.94	0 451 10 P 3314	O
		1 457 43 S 3540	L
		0 450 90 F 5002 ¹	K
		1 987 43 M 2012	I
		1 987 43 R 2312 ⁸	I

1,3 | 40 | 2G

	03.93-07.94	0 451 10 P 3314	O
		1 457 42 S 9915	L
		CSA 0 450 90 F 4149 ¹	K
		1 987 43 M 2012	I
		1 987 43 R 2312 ⁸	I

Ibiza 1.4

1,4 44 ABD	09.93-12.95	0 451 10 P 3314	O
		1 457 43 S 3540	L
		0 450 90 F 5002 ¹	K
		1 987 43 M 2012	I
		1 987 43 R 2312 ⁸	I

1,4 | 44 | AEX

	12.95-12.97	0 451 10 P 3318	O
		1 457 43 S 3540	L
Fg.Nr. →6K..V..250 000	12.95-08.97	0 450 90 F 5002 ¹	K
Fg.Nr. 6K..W..000 001→	09.97-12.97	0 450 90 F 5316 ¹	K
	12.95-12.97	1 987 43 M 2012	I
		1 987 43 R 2312 ⁸	I





◀ Ibiza 1.4

1,4 44 AKK	05.99-05.02	0 451 10 P 3318 O
		STZ 1 457 43 S 3539 L
		0 450 90 F 5316 ¹ K
		1 987 43 M 2012 I
		1 987 43 R 2312 ⁸ I

1,4 44 AKV	12.97-10.99	0 451 10 P 3318 O
		1 457 43 S 3540 L
		0 450 90 F 5316 ¹ K
		1 987 43 M 2012 I
		1 987 43 R 2312 ⁸ I

1,4 44 ANW	05.99-08.00	0 451 10 P 3318 O
		STZ 1 457 43 S 3539 L
		0 450 90 F 5316 ¹ K
		1 987 43 M 2012 I
		1 987 43 R 2312 ⁸ I

1,4 44 ANX	01.98-05.98	0 451 10 P 3318 O
		1 457 43 S 3540 L
		0 450 90 F 5316 ¹ K
		1 987 43 M 2012 I
		1 987 43 R 2312 ⁸ I

1,4 44 APQ	12.97-10.99	0 451 10 P 3318 O
		1 457 43 S 3540 L
		0 450 90 F 5316 ¹ K
		1 987 43 M 2012 I
		1 987 43 R 2312 ⁸ I

1,4 44 AUD	06.00-05.02	0 451 10 P 3318 O
		STZ 1 457 43 S 3539 L
		0 450 90 F 5316 ¹ K
		1 987 43 M 2012 I
		1 987 43 R 2312 ⁸ I

1,4 55 APE	05.99-06.00	0 451 10 P 3318 O
		1 457 43 S 3716 L
		0 450 90 F 5316 ¹ K
		1 987 43 M 2012 I
		1 987 43 R 2312 ⁸ I

1,4 55/74 AQQ; AUA	09.99-05.02	0 451 10 P 3318 O
		1 457 43 S 3716 L
		0 450 90 F 5316 ¹ K
		1 987 43 M 2012 I
		1 987 43 R 2312 ⁸ I



1,4 55/74 BBY; BBZ; BKY	01.02-11.09	0 451 10 P 3318 O				
		1 457 43 S 3059 L				
		Fg.Nr. →6L..6..069 000				
		DTV,ORK 0 450 90 F 5925 ¹ K				
		PR-Nr. 1A1				
PR-Nr. OF2	01.02-11.09	MRK 0 450 90 F 5316 ¹ K				
		PR-Nr. 1A1	01.02-11.09	3BA,DRR, F 026 40 F 3008 ¹ K		
				ORK		
				PR-Nr. 1A3	01.02-11.09	4BA,DRR, F 026 40 F 3006 ¹ K
						ORK
01.02-11.09	1 987 43 M 2057 I					
	1 987 43 R 2357 ⁸ I					

1,4 63 BXW	05.06-11.09	0 451 10 P 3318 O	
		F 026 40 S 0035 L	
		PR-Nr. OF2	
		05.06-11.09	MRK 0 450 90 F 5316 ¹ K
		PR-Nr. 1A1	05.06-11.09
PR-Nr. 1A3	05.06-11.09	ORK	
		05.06-11.09	4BA,DRR, F 026 40 F 3006 ¹ K
		05.06-11.09	1 987 43 M 2057 I
			1 987 43 R 2357 ⁸ I

1,4 63 BXW <D22>	03.08-06.11	0 451 10 P 3318 O
		F 026 40 S 0035 L
		F 026 40 F 3006 ¹ K
		1 987 43 M 2057 I
		1 987 43 R 2357 ⁸ I

1,4 63 CGGB <D22>	04.10→	0 451 10 P 3318 O	
		F 026 40 S 0035 L	
		F 026 40 F 3006 ¹ K	
		04.10-09.10	1 987 43 M 2057 I
		1 987 43 R 2357 ⁸ I	

1,4 74 AFH	11.96-10.99	0 451 10 P 3318 O		
		03.97-10.99	1 457 43 S 3716 L	
		Fg.Nr. →6K..V..250 000	11.96-08.97	0 450 90 F 5002 ¹ K
		Fg.Nr. 6K..W..000 001→	09.97-10.99	0 450 90 F 5316 ¹ K
		11.96-10.99	1 987 43 M 2012 I	
1 987 43 R 2312 ⁸ I				

1,4 74 AUB	07.00-05.02	0 451 10 P 3318 O		
		1 457 43 S 3716 L		
		Fg.Nr. →6K..2..199 999	09.01-12.01	1 457 43 S 3716 L
		Fg.Nr. 6L..2..000 001→	01.02-05.02	1 457 43 S 3059 L
		07.00-05.02	0 450 90 F 5316 ¹ K	
Fg.Nr. →6L..6..069 000	09.01-05.02	DTV,ORK 0 450 90 F 5925 ¹ K		
		PR-Nr. 1A1		
		09.01-05.02	MRK 0 450 90 F 5316 ¹ K	
		PR-Nr. 1A1	09.01-05.02	3BA,DRR, F 026 40 F 3008 ¹ K
				ORK
PR-Nr. 1A3	09.01-05.02	4BA,DRR, F 026 40 F 3006 ¹ K		
		ORK		
07.00-05.02	1 987 43 M 2012 I			
	1 987 43 R 2312 ⁸ I			
09.01-05.02	1 987 43 M 2057 I			
1 987 43 R 2357 ⁸ I				



**Ibiza 1.4 TDI****1,4 | 51/59 | BMS; BMS <D4T>; BNM; BNV**

05.05-06.10	1 457 42	P 9192	O
	1 457 43	S 3575	L
	0 450 90	N 6500 ¹	K
	1 987 43	M 2057	I
	1 987 43	R 2357 ⁸	I

1,4 | 55 | AMF

05.02-12.05	1 457 42	P 9192	O
	1 457 43	S 3575	L
05.02-05.05	0 450 90	N 6322 ¹	K
06.05-12.05	0 450 90	N 6500 ¹	K
05.02-12.05	1 987 43	M 2057	I
	1 987 43	R 2357 ⁸	I

Ibiza 1.4 TSI, TSI Cupra**1,4 | 110/132 | CAVE <D32>; CAVF <D31>**

03.09-05.10	F 026 40	P 7079	O
03.09→	F 026 40	S 0156	L
	OR K	0 450 90	F 5959 ¹
	MR K	F 026 40	F 3006 ¹
03.09-09.10	1 987 43	M 2057	I
	1 987 43	R 2357 ⁸	I

Ibiza 1.5**1,5 | 63 | 021 A 2000**

06.84-05.93	0 451 10	P 3033	O
	1 457 42	S 9050	L

Ibiza 1.5 i**1,5 | 65-70 | 021 A 2000 <Kat.>; 021 D.2000**

10.86-05.93	0 451 10	P 3033	O
	1 457 42	S 9846	L
	0 450 90	F 5030 ¹	K

1,5 | 74 | 021 A 2000

10.86-05.93	0 451 10	P 3033	O
	1 457 42	S 9846	L
	0 450 90	F 5030 ¹	K

Ibiza 1.6**1,6 | 55 | ABU**

03.93-07.94	0 451 10	P 3314	O
	1 457 43	S 3540	L
	0 450 90	F 5002 ¹	K
	1 987 43	M 2012	I
	1 987 43	R 2312 ⁸	I

1,6 | 55 | AEE

03.97-12.98	0 451 10	P 3318	O
	1 457 43	S 3540	L
Fg.Nr. →6K..V..250 000	03.97-08.97	0 450 90	F 5002 ¹
Fg.Nr. 6K..W..000 001→	09.97-12.98	0 450 90	F 5316 ¹
	03.97-12.98	1 987 43	M 2012
		1 987 43	R 2312 ⁸

1,6 | 55 | ALM

09.97-05.02	0 451 10	P 3318	O
	1 457 43	S 3540	L
	0 450 90	F 5316 ¹	K
	1 987 43	M 2012	I
	1 987 43	R 2312 ⁸	I

1,6 | 55 | 1F

05.94-08.99	0 451 10	P 3314	O
	1 457 43	S 3264	L
Fg.Nr. →6K..V..250 000	05.94-08.97	0 450 90	F 5002 ¹
Fg.Nr. 6K..W..000 001→	09.97-08.99	0 450 90	F 5316 ¹
	05.94-08.99	1 987 43	M 2012
		1 987 43	R 2312 ⁸

1,6 | 74 | AEH

05.99-05.02	0 451 10	P 3314	O
	1 457 43	S 3058	L
	0 450 90	F 5316 ¹	K
	1 987 43	M 2012	I
	1 987 43	R 2312 ⁸	I

1,6 | 74 | AFT

12.95-10.99	0 451 10	P 3314	O
	1 457 43	S 3264	L
Fg.Nr. →6K..V..250 000	12.95-08.97	0 450 90	F 5002 ¹
Fg.Nr. 6K..W..000 001→	09.97-10.99	0 450 90	F 5316 ¹
	12.95-10.99	1 987 43	M 2012
		1 987 43	R 2312 ⁸

1,6 | 74 | AKL

05.99-05.02	0 451 10	P 3314	O
	1 457 43	S 3058	L
	0 450 90	F 5316 ¹	K
	1 987 43	M 2012	I
	1 987 43	R 2312 ⁸	I

1,6 | 74 | APF; AUR

09.99-05.02	0 451 10	P 3314	O
	1 457 43	S 3058	L
	0 450 90	F 5316 ¹	K
	1 987 43	M 2012	I
	1 987 43	R 2312 ⁸	I

1,6 | 74 | BAH

04.03-11.09	0 451 10	P 3318	O
	1 457 43	S 3059	L
Fg.Nr. →6L..6..069 000	04.03-09.05	DTV, OR K	0 450 90
PR-Nr. 1A1			F 5925 ¹
PR-Nr. 0F2	04.03-11.09	MR K	0 450 90
PR-Nr. 1A1	04.03-11.09	3BA,DRR, F 026 40	F 3008 ¹
		OR K	
PR-Nr. 1A3	04.03-11.09	4BA,DRR, F 026 40	F 3006 ¹
		OR K	
	04.03-11.09		1 987 43
			M 2057
			1 987 43
			R 2357 ⁸

1,6 | 76 | AKL

05.95-10.04	0 451 10	P 3314	O
	05.95-09.99	1 457 43	S 3264
	10.99-10.04	1 457 43	S 3058
	05.95-09.97	0 450 90	F 5002 ¹
	10.97-10.04	0 450 90	F 5316 ¹





◀ Ibiza 1.6

1,6 77 BTS	11.06-11.09	1 457 42 P 9301 O	
		F 026 40 S 0035 L	
PR-Nr. OF2	11.06-11.09 MRK	0 450 90 F 5316 ¹ K	
PR-Nr. 1A1	11.06-11.09 3BA,DRR, F 026 40 F 3008 ¹ K		
	ORR		
PR-Nr. 1A3	11.06-11.09 4BA,DRR, F 026 40 F 3006 ¹ K		
	ORR		
	11.06-11.09	1 987 43 M 2057 I	
		1 987 43 R 2357 ⁸ I	

1,6 77 BTS <D3H>	05.08→	1 457 42 P 9301 O	
		F 026 40 S 0035 L	
		F 026 40 F 3006 ¹ K	
	05.08-09.10	1 987 43 M 2057 I	
		1 987 43 R 2357 ⁸ I	

Ibiza 1.6 GLP

1,6 60 CNKA <DP1>	05.11→	F 026 40 S 0035 L	
		F 026 40 F 3006 ¹ K	

Ibiza 1.6 TDI

1,6 66/77 CAYB <D36>; CAYC <D38>	05.09→	F 026 40 P 7023 O	
		F 026 40 S 0156 L	
		0 450 90 N 6500 ¹ K	
	05.09-09.10	1 987 43 M 2057 I	
		1 987 43 R 2357 ⁸ I	

Ibiza 1.7 D

1,7 40 138 A 5..	06.84-05.93	0 451 10 P 3170 O	
		1 457 43 N 4201 ² K	

Ibiza 1.7 i

1,7 72-76 021...	01.91-05.93	0 451 10 P 3314 O	
		1 457 42 S 9846 L	
		0 450 90 F 5030 ¹ K	

Ibiza 1.8

1,8 66 ABS	03.93-07.94	0 451 10 P 3314 O	
		1 457 43 S 3264 L	
		0 450 90 F 5002 ¹ K	
		1 987 43 M 2012 I	
		1 987 43 R 2312 ⁸ I	

1,8 | 66 | ACC

	03.95-10.99	0 451 10 P 3314 O	
		1 457 43 S 3264 L	
Fg.Nr. →6K..V..250 000	03.95-08.97	0 450 90 F 5002 ¹ K	
Fg.Nr. 6K..W..000 001→	09.97-10.99	0 450 90 F 5316 ¹ K	
	03.95-10.99	1 987 43 M 2012 I	
		1 987 43 R 2312 ⁸ I	



1,8 66 ADZ	07.94-10.99	0 451 10 P 3314 O	
		1 457 43 S 3264 L	
Fg.Nr. →6K..V..250 000	07.94-08.97	0 450 90 F 5002 ¹ K	
Fg.Nr. 6K..W..000 001→	09.97-10.99	0 450 90 F 5316 ¹ K	
	07.94-10.99	1 987 43 M 2012 I	
		1 987 43 R 2312 ⁸ I	

1,8 | 95 | ADL

	09.93-06.96	0 451 10 P 3314 O	
		1 457 43 S 3264 L	
		0 450 90 F 5002 ¹ K	
		1 987 43 M 2012 I	
		1 987 43 R 2312 ⁸ I	

Ibiza 1.8 T Cupra

1,8 115 AQX; AYP	10.99-05.02	0 451 10 P 3314 O	
		1 457 43 S 3058 L	
		0 450 90 F 5316 ¹ K	
		1 987 43 M 2012 I	
		1 987 43 R 2312 ⁸ I	

Ibiza 1.8 T, T Cupra R

1,8 110/132 BBU; BJX; BKV; BLZ	12.03-11.09	0 451 10 P 3314 O	
		1 457 43 S 3575 L	
Fg.Nr. →6L..6..069 000	12.03-09.05	DTV, ORR 0 450 90 F 5925 ¹ K	
PR-Nr. 1A1			
PR-Nr. OF2	12.03-11.09 MRK	0 450 90 F 5316 ¹ K	
PR-Nr. 1A1	12.03-11.09 3BA,DRR, F 026 40 F 3008 ¹ K		
	ORR		
PR-Nr. 1A3	12.03-11.09 4BA,DRR, F 026 40 F 3006 ¹ K		
	ORR		
	12.03-11.09	1 987 43 M 2057 I	
		1 987 43 R 2357 ⁸ I	

Ibiza 1.9 D

1,9 47-50 1Y	03.93-10.99	0 451 20 P 3012 O	
		1 457 43 S 3264 L	
		0 450 90 N 6274 ¹ K	
		1 987 43 M 2012 I	
		1 987 43 R 2312 ⁸ I	

Ibiza 1.9 SDI

1,9 47 AEW	12.95-10.99	0 451 20 P 3012 O	
		1 457 43 S 3264 L	
		0 450 90 N 6274 ¹ K	
		1 987 43 M 2012 I	
		1 987 43 R 2312 ⁸ I	

1,9 | 47 | ASY

	01.02-12.05	1 457 42 P 9192 O	
		1 457 43 S 3575 L	
		0 450 90 N 6322 ¹ K	
		1 987 43 M 2057 I	
		1 987 43 R 2357 ⁸ I	



**Ibiza 1.9 SDI, TDI**

1,9 50/66 AGP;AGR	05.99-05.02	1 457 42 P 9619	O
		1 457 43 S 3058	L
		0 450 90 N 6409 ¹	K
		1 987 43 M 2012	I
		1 987 43 R 2312 ⁸	I

1,9 50/66/81 ALH;AQM;ASV	05.99-05.02	1 457 42 P 9619	O
		1 457 43 S 3058	L
		0 450 90 N 6409 ¹	K
		1 987 43 M 2012	I
		1 987 43 R 2312 ⁸	I

Ibiza 1.9 TD

1,9 55 AAZ	03.93-08.97	0 451 20 P 3012	O
		1 457 43 S 3264	L
		0 450 90 N 6267 ¹	K
		1 987 43 M 2012	I
		1 987 43 R 2312 ⁸	I

Ibiza 1.9 TDI

1,9 66 AHU	12.96-06.99	0 451 10 P 3347	O
		1 457 43 S 3264	L
		0 450 90 N 6274 ¹	K
		1 987 43 M 2012	I
		1 987 43 R 2312 ⁸	I

1,9 66 BXJ	06.08-06.10	1 457 42 P 9192	O
		1 457 43 S 3575	L
		0 450 90 N 6500 ¹	K
		1 987 43 M 2057	I
		1 987 43 R 2357 ⁸	I

1,9 66 1Z	07.96-12.96	0 451 10 P 3347	O
		1 457 43 S 3264	L
		0 450 90 N 6274 ¹	K
		1 987 43 M 2012	I
		1 987 43 R 2312 ⁸	I

1,9 74 ATD;AXR	09.01-11.09	1 457 42 P 9192	O
		1 457 43 S 3575	L
		0 450 90 N 6426 ¹	K
		1 987 43 M 2057	I
		1 987 43 R 2357 ⁸	I

1,9 74/96 BLT;BMT	05.05-11.09	1 457 42 P 9192	O
		1 457 43 S 3575	L
		0 450 90 N 6426 ¹	K
		1 987 43 M 2057	I
		1 987 43 R 2357 ⁸	I

1,9 77 BLS<D3W>	02.08-06.10	1 457 42 P 9192	O
		1 457 43 S 3575	L
		0 450 90 N 6500 ¹	K
		1 987 43 M 2057	I
		1 987 43 R 2357 ⁸	I

1,9 81 AFN	03.97-06.99	0 451 10 P 3290	O
		1 457 43 S 3264	L
		0 450 90 N 6274 ¹	K
		1 987 43 M 2012	I
		1 987 43 R 2312 ⁸	I

1,9 96 ASZ	11.01-09.05	1 457 42 P 9192	O
		1 457 43 S 3575	L
	11.01-05.05	0 450 90 N 6322 ¹	K
	06.05-09.05	0 450 90 N 6426 ¹	K
	11.01-09.05	1 987 43 M 2057	I
		1 987 43 R 2357 ⁸	I

Ibiza 1.9 TDI Cupra R

1,9 118 BPX;BUK	03.04-02.08	1 457 42 P 9619	O
		1 457 43 S 3575	L
		0 450 90 N 6426 ¹	K
		1 987 43 M 2057	I
		1 987 43 R 2357 ⁸	I

Ibiza 2.0

2,0 85 AZL;BBX	07.02-11.09	0 451 10 P 3314	O
		1 457 43 S 3575	L

Fg.Nr. →6L..6..069 000	07.02-09.05	DTV,ØRK	0 450 90 F 5925 ¹	K
PR-Nr. 1A1				
PR-Nr. 0F2	07.02-11.09	MRK	0 450 90 F 5316 ¹	K
PR-Nr. 1A1	07.02-11.09	3BA,DRR, F 026 40 F	3008 ¹	K
		ØRK		
PR-Nr. 1A3	07.02-11.09	4BA,DRR, F 026 40 F	3006 ¹	K
		ØRK		
	07.02-11.09		1 987 43 M 2057	I
			1 987 43 R 2357 ⁸	I

2,0 85 2E	03.93-04.96	0 451 10 P 3314	O
		1 457 43 S 3264	L
		0 450 90 F 5002 ¹	K
		1 987 43 M 2012	I
		1 987 43 R 2312 ⁸	I

2,0 85/110 ABF;AGG	04.96-10.99	0 451 10 P 3314	O	
		1 457 43 S 3264	L	
Fg.Nr. →6K..V..250 000	04.96-08.97		0 450 90 F 5002 ¹	K
Fg.Nr. 6K..W..000 001→	09.97-10.99		0 450 90 F 5316 ¹	K
	04.96-10.99		1 987 43 M 2012	I
			1 987 43 R 2312 ⁸	I





Ibiza 2.0 TDI

2,0 105 CFHD <D92>			
	01.10→	F 026 40	P 7023 O
	01.10-09.10	1987 43	M 2057 I
		1987 43	R 2357⁸ I

Inca

Inca 1.4

1,4 44 AEX; AKV; APQ			
	11.95-06.03	0 451 10	P 3318 O
		1 457 43	S 3540 L
		0 450 90	F 5002¹ K
		1 987 43	M 2012 I
		1 987 43	R 2312⁸ I

1,4 | 44 | AUD

	09.00-06.03	0 451 10	P 3318 O
		1 457 43	S 3539 L
		0 450 90	F 5002¹ K
		1 987 43	M 2012 I
		1 987 43	R 2312⁸ I

1,4 | 55 | AUA

	09.00-06.03	0 451 10	P 3318 O
		F 026 40	S 0019 L
		0 450 90	F 5002¹ K
		1 987 43	M 2012 I
		1 987 43	R 2312⁸ I

Inca 1.6

1,6 55 AEE			
	06.97-09.00	0 451 10	P 3318 O
		1 457 43	S 3540 L
		0 450 90	F 5002¹ K
		1 987 43	M 2012 I
		1 987 43	R 2312⁸ I

1,6 | 55 | 1F

	11.95-05.97	0 451 10	P 3314 O
		1 457 43	S 3008 L
		0 450 90	F 5002¹ K
		1 987 43	M 2012 I
		1 987 43	R 2312⁸ I

Inca 1.7 D

1,7 42 AHB			
	09.96-09.00	0 451 20	P 3012 O
		1 457 43	S 3264 L
		0 450 90	N 6274¹ K
		1 987 43	M 2012 I
		1 987 43	R 2312⁸ I

Inca 1.9 D

1,9 47 1Y			
	11.95-06.03	0 451 20	P 3012 O
		1 457 43	S 3264 L
		0 450 90	N 6274¹ K
		1 987 43	M 2012 I
		1 987 43	R 2312⁸ I



Inca 1.9 SDI

1,9 47 AEY			
	12.95-09.00	0 451 20	P 3012 O
		1 457 43	S 3264 L
		0 450 90	N 6274¹ K
		1 987 43	M 2012 I
		1 987 43	R 2312⁸ I

1,9 | 47 | AYQ

	09.00-06.03	1 457 42	P 9619 O
		1 457 43	S 3058 L
		0 450 90	N 6409¹ K
		1 987 43	M 2012 I
		1 987 43	R 2312⁸ I

Leon

Leon 1.2 TSI

1,2 77 CBZB <DB0>			
	05.10→	1 987 42	S 9405 L
		0 450 90	F 5959¹ K
		1 987 43	M 2097 I
		1 987 43	R 2397⁸ I
		RLE	1 987 43 R 2597⁸ I

Leon 1.4

1,4 55 AHW; APE; AXP; BCA			
	12.99-04.04	0 451 10	P 3318 O
		1 457 43	S 3716 L
		0 450 90	F 5318¹ K
		1 987 43	M 2012 I
		1 987 43	R 2312⁸ I

1,4 | 63 | BXW <D22>

	06.06-05.10	0 451 10	P 3318 O
		F 026 40	S 0035 L
		DRR	F 026 40 F 3006¹ K
		DRR	0 450 90 F 5925¹ K
			1 987 43 M 2097 I
			1 987 43 R 2397⁸ I
		RLE	1 987 43 R 2597⁸ I

1,4 | 63 | CGGB <D22>

	05.10→	0 451 10	P 3318 O
		F 026 40	S 0035 L
		F 026 40	F 3006¹ K
		1 987 43	M 2097 I
		1 987 43	R 2397⁸ I
		RLE	1 987 43 R 2597⁸ I

Leon 1.4 TSI

1,4 92 CAXC <D33>			
	Fg.Nr. 1P..8..119 001→	05.08-05.10	F 026 40 P 7079 O
		11.07→	1 987 42 S 9405 L
			0 450 90 F 5959¹ K
			1 987 43 M 2097 I
			1 987 43 R 2397⁸ I
		RLE	1 987 43 R 2597⁸ I



**Leon 1.6****1,6 | 74 | AEH; AKL**

10.98-07.04	0 451 10 P 3314	O
	KZO 1 457 43 S 3714	L
	KZO 1 457 43 S 3081	L
	0 450 90 F 5318 ¹	K
	1 987 43 M 2012	I
	1 987 43 R 2312 ⁸	I

1,6 | 75 | BFQ

10.05-06.06	0 451 10 P 3314	O
	KZO 1 457 43 S 3714	L
	KZO 1 457 43 S 3081	L
	0 450 90 F 5318 ¹	K
	1 987 43 M 2012	I
	1 987 43 R 2312 ⁸	I

1,6 | 75 | BSE <MW6>; BSF <MW6>

07.05→	0 451 10 P 3314	O
	KZO 1 987 42 S 9405	L
	KZO 1 457 43 S 3576	L
	F 026 40 F 3006 ¹	K
	1 987 43 M 2097	I
	1 987 43 R 2397 ⁸	I
	RLE 1 987 43 R 2597 ⁸	I

1,6 | 75 | CCSA <MW6>

12.07-11.10	0 451 10 P 3314	O
	KZO 1 987 42 S 9405	L
	KZO 1 457 43 S 3576	L
	F 026 40 F 3006 ¹	K
	1 987 43 M 2097	I
	1 987 43 R 2397 ⁸	I
	RLE 1 987 43 R 2597 ⁸	I

1,6 | 75 | CHGA <DF2>

12.09→	0 451 10 P 3314	O
	KZO 1 987 42 S 9405	L
	KZO 1 457 43 S 3576	L
12.09-05.10	TW F 026 40 F 3013 ¹	K
12.09→	TW F 026 40 F 3006 ¹	K
	1 987 43 M 2097	I
	1 987 43 R 2397 ⁸	I
	RLE 1 987 43 R 2597 ⁸	I

1,6 | 75 | CMXA <MW6>

11.10→	0 451 10 P 3314	O
	KZO 1 987 42 S 9405	L
	KZO 1 457 43 S 3576	L
	F 026 40 F 3006 ¹	K
	1 987 43 M 2097	I
	1 987 43 R 2397 ⁸	I
	RLE 1 987 43 R 2597 ⁸	I

1,6 | 77 | AUS

06.00-04.01	0 451 10 P 3318	O
	1 457 43 S 3716	L
	0 450 90 F 5318 ¹	K
	1 987 43 M 2012	I
	1 987 43 R 2312 ⁸	I

1,6 | 77 | AZD; BCB

09.00-06.06	0 451 10 P 3318	O
	1 457 43 S 3059	L
	0 450 90 F 5318 ¹	K
	1 987 43 M 2012	I
	1 987 43 R 2312 ⁸	I

Leon 1.6 TDI**1,6 | 66/77 | CAYB <D36>; CAYC <D38>**

02.10→	F 026 40 P 7023	O
	KZO 1 987 42 S 9404	L
	F 026 40 N 2006	K
	1 987 43 M 2097	I
	1 987 43 R 2397 ⁸	I
	RLE 1 987 43 R 2597 ⁸	I

Leon 1.8**1,8 | 92 | AGN**

10.98-12.03	0 451 10 P 3314	O
	KZO 1 457 43 S 3714	L
	KZO 1 457 43 S 3081	L
	0 450 90 F 5318 ¹	K
	1 987 43 M 2012	I
	1 987 43 R 2312 ⁸	I

1,8 | 92 | APG

12.99-07.04	0 451 10 P 3314	O
	KZO 1 457 43 S 3714	L
	KZO 1 457 43 S 3081	L
	0 450 90 F 5318 ¹	K
	1 987 43 M 2012	I
	1 987 43 R 2312 ⁸	I

Leon 1.8 T**1,8 | 132 | APP**

12.99-12.00	0 451 10 P 3314	O
	1 457 43 S 3714	L
	0 450 90 F 5318 ¹	K
	1 987 43 M 2012	I
	1 987 43 R 2312 ⁸	I

1,8 | 132 | ARY

09.00-04.04	0 451 10 P 3314	O
	KZO 1 457 43 S 3714	L
	KZO 1 457 43 S 3081	L
	0 450 90 F 5318 ¹	K
	1 987 43 M 2012	I
	1 987 43 R 2312 ⁸	I

1,8 | 132 | AUQ

09.00-04.04	0 451 10 P 3314	O
	KZO 1 457 43 S 3714	L
	KZO 1 457 43 S 3081	L
	0 450 90 F 5318 ¹	K
	1 987 43 M 2012	I
	1 987 43 R 2312 ⁸	I





Leon 1.8 T Cupra R

1,8 154 AMK	05.02-05.03	0 451 10 P 3314 O
		1 457 43 S 3714 L
		0 450 90 F 5318 ¹ K
		1 987 43 M 2012 I
		1 987 43 R 2312 ⁸ I

1,8 165 BAM	05.03-06.06	0 451 10 P 3314 O
		1 457 43 S 3714 L
		0 450 90 F 5318 ¹ K
		1 987 43 M 2012 I
		1 987 43 R 2312 ⁸ I

Leon 1.8 T Syncro

1,8 132 AJQ	03.00-01.01	0 451 10 P 3314 O
		1 457 43 S 3714 L
		0 450 90 F 5318 ¹ K
		1 987 43 M 2012 I
		1 987 43 R 2312 ⁸ I

1,8 132 ARY	09.00-04.04	0 451 10 P 3314 O
		1 457 43 S 3714 L
		0 450 90 F 5318 ¹ K
		1 987 43 M 2012 I
		1 987 43 R 2312 ⁸ I

Leon 1.8 TSI

1,8 118 BZB	06.07-03.09	F 026 40 P 7080 O
		1 987 42 S 9404 L
		DRR F 026 40 F 3006 ¹ K
		DRR 0 450 90 F 5925 ¹ K
		1 987 43 M 2097 I
		1 987 43 R 2397 ⁸ I
		RLE 1 987 43 R 2597 ⁸ I

1,8 118 CDA <D67>	03.09->	F 026 40 P 7080 O
		1 987 42 S 9404 L
		0 450 90 F 5959 ¹ K
		1 987 43 M 2097 I
		1 987 43 R 2397 ⁸ I
		RLE 1 987 43 R 2597 ⁸ I

Leon 1.9 SDI

1,9 50 AQM	12.99-10.03	1 457 42 P 9619 O
		1 457 43 S 3714 L
		0 450 90 N 6437 ¹ K
		1 987 43 M 2012 I
		1 987 43 R 2312 ⁸ I



Leon 1.9 TDI

1,9 66 AGR	12.99-09.02	1 457 42 P 9619 O
		KZO 1 457 43 S 3714 L
		KZO 1 457 43 S 3081 L
		0 450 90 N 6437 ¹ K
		1 987 43 M 2012 I
		1 987 43 R 2312 ⁸ I

1,9 66 ALH	03.99-07.04	1 457 42 P 9619 O
		KZO 1 457 43 S 3714 L
		KZO 1 457 43 S 3081 L
		0 450 90 N 6437 ¹ K
		1 987 43 M 2012 I
		1 987 43 R 2312 ⁸ I

1,9 66/77 BLS <D3W>; BXE <D3W>; BXF <MF7>	11.05-12.10	1 457 42 P 9192 O
		KZO 1 987 42 S 9404 L
		F 026 40 N 2006 K
		1 987 43 M 2097 I
		1 987 43 R 2397 ⁸ I
		RLE 1 987 43 R 2597 ⁸ I

1,9 74/96 ASZ; AXR	05.03-06.06	1 457 42 P 9619 O
		KZO 1 457 43 S 3714 L
		KZO 1 457 43 S 3081 L
		0 450 90 N 6374 ¹ K
		1 987 43 M 2012 I
		1 987 43 R 2312 ⁸ I

1,9 77 BKC	07.05-02.06	1 457 42 P 9192 O
		KZO 1 987 42 S 9404 L
		H42,TW 1 457 07 N0007 K
		TW,UFI F 026 40 N 2006 K
		1 987 43 M 2097 I
		1 987 43 R 2397 ⁸ I
		RLE 1 987 43 R 2597 ⁸ I

1,9 81 AHF	10.98-09.02	1 457 42 P 9619 O
		KZO 1 457 43 S 3714 L
		KZO 1 457 43 S 3081 L
		VOW 0 450 90 N 6437 ¹ K
		VOW 0 450 90 N 6374 ¹ K
		1 987 43 M 2012 I
1 987 43 R 2312 ⁸ I		

1,9 81 ASV	10.99-07.04	1 457 42 P 9619 O
		KZO 1 457 43 S 3714 L
		KZO 1 457 43 S 3081 L
		0 450 90 N 6437 ¹ K
		1 987 43 M 2012 I
		1 987 43 R 2312 ⁸ I



**Leon 1.9 TDI, TDI Syncro****1,9|110|ARL**

09.00-12.05	1 457 42	P 9619	O
	KZO	1 457 43 S 3714	L
	KZO	1 457 43 S 3081	L
		0 450 90 N 6374 ¹	K
		1 987 43 M 2012	I
		1 987 43 R 2312 ⁸	I

Leon 2.0 FSI**2,0|110|BLR;BLY**

07.05-11.05	1 457 42	P 9243	O
	KZO	1 987 42 S 9405	L
	KZO	1 457 43 S 3576	L
	DRR	0 450 90 F 5925 ¹	K
Fg.Nr. →1P..7..105 000	07.05-11.05	DRR	0 450 90 F 5959 ¹ K
	07.05-11.05		1 987 43 M 2097 I
			1 987 43 R 2397 ⁸ I
	RLE	1 987 43 R 2597 ⁸	I

2,0|110|BVY;BVZ

11.05-03.09	1 457 42	P 9243	O
	KZO	1 987 42 S 9405	L
	KZO	1 457 43 S 3576	L
	DRR	0 450 90 F 5925 ¹	K
Fg.Nr. →1P..7..105 000	11.05-04.07	DRR	0 450 90 F 5959 ¹ K
Fg.Nr. 1P..7..105 001→	05.07-03.09	DRR	0 450 90 F 5959 ¹ K
	11.05-03.09		1 987 43 M 2097 I
			1 987 43 R 2397 ⁸ I
	RLE	1 987 43 R 2597 ⁸	I

Leon 2.0 FSI, TFSI Cupra**2,0|177/195|CDLA <D3Q>; CDLD <D63>**

05.09→	1 457 42	P 9243	O
		F 026 40 S 0178	L
		0 450 90 F 5959 ¹	K
		1 987 43 M 2097	I
		1 987 43 R 2397 ⁸	I
	RLE	1 987 43 R 2597 ⁸	I

Leon 2.0 TDI**2,0|100|AZV**

07.05-03.09	1 457 42	P 9192	O
	KZO	1 987 42 S 9404	L
	H42,TW	1 457 07 N 0007	K
	TW,UFI	F 026 40 N 2006	K
04.06-03.09	H16,TW	F 026 40 N 2008	K
07.05-03.09		1 987 43 M 2097	I
		1 987 43 R 2397 ⁸	I
	RLE	1 987 43 R 2597 ⁸	I

2,0|103|BKD <D3X>

07.05→	1 457 42	P 9192	O
	KZO	1 987 42 S 9404	L
		F 026 40 N 2006	K
		1 987 43 M 2097	I
		1 987 43 R 2397 ⁸	I
	RLE	1 987 43 R 2597 ⁸	I

2,0|103|BMM <D7N>

10.05-10.10	1 457 42	P 9192	O
	KZO	1 987 42 S 9404	L
		F 026 40 N 2006	K
		1 987 43 M 2097	I
		1 987 43 R 2397 ⁸	I
	RLE	1 987 43 R 2597 ⁸	I

2,0|103/125|CFHC <D91>; CFJA <D93>

05.10→	F 026 40	P 7023	O
	KZO	1 987 42 S 9404	L
		F 026 40 N 2006	K
		1 987 43 M 2097	I
		1 987 43 R 2397 ⁸	I
	RLE	1 987 43 R 2597 ⁸	I

2,0|125|BMN

05.06-03.09	1 457 42	P 9192	O
	KZO	1 987 42 S 9404	L
	H16,TW	F 026 40 N 2008	K
	H42,TW	1 457 07 N 0007	K
	TW,UFI	F 026 40 N 2006	K
		1 987 43 M 2097	I
		1 987 43 R 2397 ⁸	I
	RLE	1 987 43 R 2597 ⁸	I

2,0|125|CEGA <D93>

03.09→	1 457 42	P 9192	O
	KZO	1 987 42 S 9404	L
		F 026 40 N 2006	K
		1 987 43 M 2097	I
		1 987 43 R 2397 ⁸	I
	RLE	1 987 43 R 2597 ⁸	I

Leon 2.0 TFSI**2,0|136-147|BWA**

05.05-03.09	1 457 42	P 9243	O
		1 457 43 S 3102	L
	DRR	0 450 90 F 5925 ¹	K
Fg.Nr. →1P..7..105 000	05.05-04.07	DRR	0 450 90 F 5959 ¹ K
Fg.Nr. 1P..7..105 001→	05.07-03.09	DRR	0 450 90 F 5959 ¹ K
	05.05-03.09		1 987 43 M 2097 I
			1 987 43 R 2397 ⁸ I
	RLE	1 987 43 R 2597 ⁸	I

2,0|155|CCZB <D2D>

06.09→	F 026 40	P 7080	O
		1 987 42 S 9404	L
		0 450 90 F 5959 ¹	K
		1 987 43 M 2097	I
		1 987 43 R 2397 ⁸	I
	RLE	1 987 43 R 2597 ⁸	I

2,0|177|BWJ

11.06-05.09	1 457 42	P 9243	O
		F 026 40 S 0178	L
	DRR	0 450 90 F 5925 ¹	K
Fg.Nr. →1P..7..105 000	11.06-04.07	DRR	0 450 90 F 5959 ¹ K
Fg.Nr. 1P..7..105 001→	05.07-05.09	DRR	0 450 90 F 5959 ¹ K
	11.06-05.09		1 987 43 M 2097 I
			1 987 43 R 2397 ⁸ I
	RLE	1 987 43 R 2597 ⁸	I





Leon 2.8 , Cupra Syncro

2,8 150 AUE; BDE	10.00-04.04	1 457 42 P 9192	O
		KZO 1 457 43 S 3714	L
		KZO 1 457 43 S 3081	L
		0 450 90 F 5318 ¹	K
		1 987 43 M 2012	I
		1 987 43 R 2312 ⁸	I

Malaga

Malaga 1.2

1,2 44-47 021 A 1000	05.85-12.93	0 451 10 P 3033	O
		1 457 42 S 9050	L

Malaga 1.2 i

1,2 51 021 C.1000	12.89-12.93	1 457 42 S 9846	L
		0 450 90 F 5030 ¹	K

Malaga 1.5

1,5 63-66 021 A 2000	05.85-12.93	0 451 10 P 3033	O
		1 457 42 S 9050	L

Malaga 1.5 i

1,5 66 021 A 2000 <Kat.>	10.86-12.93	0 451 10 P 3033	O
		1 457 42 S 9846	L
		0 450 90 F 5030 ¹	K

Malaga 1.5 i

1,5 70-74 021 B.2000	11.89-12.93	1 457 42 S 9846	L
		0 450 90 F 5030 ¹	K

Malaga 1.7 D

1,7 40 138 A 5..	05.85-12.93	0 451 10 P 3170	O
		BO 1 457 43 N 4106 ²	K
		CAV 1 457 43 N 4201 ²	K

Malaga 1.7 i

1,7 77	01.91-12.93	1 457 42 S 9846	L
		0 450 90 F 5030 ¹	K

Marbella

Marbella 0.8

0,8 25 08 NCA	01.87-10.93	0 451 10 P 3349	O
		1 457 43 S 2111	L
		0 450 90 F 4058 ¹	K

Marbella 0.9

0,9 29-30 09 NCA	01.87-02.97	0 451 10 P 3349	O
		1 457 43 S 2111	L
		0 450 90 F 4058 ¹	K



Terra

Terra 0.9

0,9 29 09 NCA	01.87-12.94	0 451 10 P 3349	O
		1 457 43 S 2111	L

Terra 1.3 D

1,3 33	03.90-12.94	0 450 90 N 6172 ¹	K
----------	-------------	-------------------------------------	----------

Terra 1.4 D

1,4 35	10.90-12.94	0 451 20 P 3012	O
		0 450 90 N 6172 ¹	K

Toledo

Toledo 1.4

1,4 55 AHW; AXP	07.99-05.02	0 451 10 P 3318	O
		1 457 43 S 3716	L
		0 450 90 F 5318 ¹	K
		1 987 43 M 2012	I
		1 987 43 R 2312 ⁸	I

Toledo 1.4

1,4 63 BXW	05.06-05.09	0 451 10 P 3318	O
		F 026 40 S 0035	L
		DRR F 026 40 F 3006 ¹	K
		1 987 43 M 2097	I
		1 987 43 R 2397 ⁸	I
		RLE 1 987 43 R 2597 ⁸	I

Toledo 1.4 TSI

1,4 92 CAXC	11.07-05.09	1 457 42 P 9301	O
		1 987 42 S 9405	L
		1 987 43 M 2097	I

Toledo 1.6

1,6 55 ABN	01.92-07.94	0 451 10 P 3314	O
		1 457 43 S 3008	L
		CSA 0 450 90 F 4149 ¹	K
		1 987 43 M 2011	I

Toledo 1.6

1,6 55 EZ	05.91-09.91	0 451 10 P 3314	O
		1 457 43 S 3008	L
		CSA 0 450 90 F 4149 ¹	K
		1 987 43 M 2011	I

Toledo 1.6

1,6 55 1F	05.91-03.99	0 451 10 P 3314	O
		1 457 43 S 3008	L
		0 450 90 F 5264 ¹	K
		1 987 43 M 2011	I



**1,6 | 74 | AEH**

04.99-05.02		0 451 10 P 3314	O
	KZO	1 457 43 S 3714	L
	KZO	1 457 43 S 3081	L
		0 450 90 F 5318 ¹	K
		1 987 43 M 2012	I
		1 987 43 R 2312 ⁸	I

1,6 | 74 | AFT

11.96-03.99		0 451 10 P 3314	O
		1 457 43 S 3264	L
		0 450 90 F 5264 ¹	K
		1 987 43 M 2011	I

1,6 | 74 | AKL

04.99-05.02		0 451 10 P 3314	O
	KZO	1 457 43 S 3714	L
	KZO	1 457 43 S 3081	L
		0 450 90 F 5318 ¹	K
		1 987 43 M 2012	I
		1 987 43 R 2312 ⁸	I

1,6 | 75 | BGU

09.04-05.05		0 451 10 P 3314	O
	KZO	1 987 42 S 9405	L
	KZO	1 457 43 S 3576	L
	DRR	0 450 90 F 5925 ¹	K
		1 987 43 M 2097	I
		1 987 43 R 2397 ⁸	I
	RLE	1 987 43 R 2597 ⁸	I

1,6 | 75 | BSE; BSF

05.05→		0 451 10 P 3314	O
	KZO	1 987 42 S 9405	L
	KZO	1 457 43 S 3576	L
Fg.Nr. →5P..6..045 000	05.05-11.05	DRR	0 450 90 F 5925 ¹ K
Fg.Nr. 5P..6..045 001→	12.05→	DRR	F 026 40 F 3006 ¹ K
	05.05→		1 987 43 M 2097 I
			1 987 43 R 2397 ⁸ I
	RLE		1 987 43 R 2597 ⁸ I

1,6 | 75 | CCSA

12.07→		0 451 10 P 3314	O
		1 987 43 M 2097	I

1,6 | 77 | AUS

06.00-04.01		0 451 10 P 3318	O
		1 457 43 S 3716	L
		0 450 90 F 5318 ¹	K
		1 987 43 M 2012	I
		1 987 43 R 2312 ⁸	I

1,6 | 77 | AZD; BCB

09.00-07.04		0 451 10 P 3318	O
		1 457 43 S 3059	L
		0 450 90 F 5318 ¹	K
		1 987 43 M 2012	I
		1 987 43 R 2312 ⁸	I

Toledo 1.8**1,8 | 66 | ABS**

11.93-07.94		0 451 10 P 3314	O
		1 457 43 S 3008	L
		0 450 90 F 5264 ¹	K
		1 987 43 M 2011	I

1,8 | 66 | ACC

09.95-09.96		0 451 10 P 3314	O
-------------	--	-----------------	---

1,8 | 66 | ADZ

07.94-03.99		0 451 10 P 3314	O
		1 457 43 S 3008	L
		0 450 90 F 5264 ¹	K
		1 987 43 M 2011	I

1,8 | 66 | RP

05.91-11.93		0 451 10 P 3314	O
		1 457 43 S 3008	L
		0 450 90 F 5264 ¹	K
		1 987 43 M 2011	I

1,8 | 95/98-102 | KR; PL

05.91-03.94		0 451 10 P 3314	O
		0 450 90 F 5145 ¹	K
		1 987 43 M 2011	I

Toledo 1.8 , T**1,8 | 92/132 | AGN; APG; AUQ**

04.99-12.03		0 451 10 P 3314	O
	KZO	1 457 43 S 3714	L
	KZO	1 457 43 S 3081	L
		0 450 90 F 5318 ¹	K
		1 987 43 M 2012	I
		1 987 43 R 2312 ⁸	I

Toledo 1.8 TSI**1,8 | 118 | BYT**

01.07-06.07		F 026 40 P 7080	O
		1 987 42 S 9404	L
		0 450 90 F 5959 ¹	K
		1 987 43 M 2097	I
		1 987 43 R 2397 ⁸	I
	RLE	1 987 43 R 2597 ⁸	I

1,8 | 118 | BZB

06.07-03.09		F 026 40 P 7080	O
		1 987 42 S 9404	L
		0 450 90 F 5959 ¹	K
		1 987 43 M 2097	I

1,8 | 118 | CDA

03.09-05.09		F 026 40 P 7080	O
-------------	--	-----------------	---

Toledo 1.9 D**1,9 | 47 | 1Y**

05.91-03.99		0 451 20 P 3012	O
		1 457 43 S 3264	L
		0 450 90 N 6267 ¹	K
		1 987 43 M 2011	I





Toledo 1.9 TD

1,9 55 AAZ	05.91-04.97	0 451 20 P 3012	O
		1 457 43 S 3264	L
		0 450 90 N 6267 ¹	K
		1 987 43 M 2011	I

Toledo 1.9 TDI

1,9 66 AGR	04.99-09.02	1 457 42 P 9619	O
		1 457 43 S 3714	L
		0 450 90 N 6437 ¹	K
		1 987 43 M 2012	I
		1 987 43 R 2312 ⁸	I

1,9 66 AHU	06.96-03.99	0 451 10 P 3347	O
		1 457 43 S 3264	L
		0 450 90 N 6267 ¹	K
		1 987 43 M 2011	I

1,9 66 ALH	04.99-07.04	1 457 42 P 9619	O
		1 457 43 S 3714	L
		0 450 90 N 6437 ¹	K
		1 987 43 M 2012	I
		1 987 43 R 2312 ⁸	I

1,9 66 1Z	04.95-12.96	0 451 10 P 3347	O
		1 457 43 S 3008	L
		0 450 90 N 6267 ¹	K
		1 987 43 M 2011	I

1,9 77 BJB; BKC	09.04-02.06	1 457 42 P 9192	O
		KZO 1 987 42 S 9404	L
		H42,TW 1 457 07 N0007	K
		TW,UFI F 026 40 N 2006	K
		1 987 43 M 2097	I
		1 987 43 R 2397 ⁸	I
		RLE 1 987 43 R 2597 ⁸	I

1,9 77 BLS; BXE	10.05→	1 457 42 P 9192	O
		KZO 1 987 42 S 9404	L
		H42,TW 1 457 07 N0007	K
		TW,UFI F 026 40 N 2006	K
	04.06→	H16,TW F 026 40 N 2008	K
	10.05→	1 987 43 M 2097	I
		1 987 43 R 2397 ⁸	I
		RLE 1 987 43 R 2597 ⁸	I

1,9 81 AFN	11.96-03.99	0 451 10 P 3290	O
		1 457 43 S 3264	L
		0 450 90 N 6267 ¹	K
		1 987 43 M 2011	I



1,9 81 AHF	04.99-09.02	1 457 42 P 9619	O
		1 457 43 S 3714	L
		VOW 0 450 90 N 6437 ¹	K
		VOW 0 450 90 N 6374 ¹	K
		1 987 43 M 2012	I
		1 987 43 R 2312 ⁸	I

1,9 81 ASV	05.99-12.03	1 457 42 P 9619	O
		1 457 43 S 3714	L
		0 450 90 N 6437 ¹	K
		1 987 43 M 2012	I
		1 987 43 R 2312 ⁸	I

1,9 96 ASZ	05.03-07.04	1 457 42 P 9619	O
		KZO 1 457 43 S 3714	L
		KZO 1 457 43 S 3081	L
		0 450 90 N 6374 ¹	K
		1 987 43 M 2012	I
		1 987 43 R 2312 ⁸	I

1,9 110 ARL	09.00-05.02	1 457 42 P 9619	O
		KZO 1 457 43 S 3714	L
		KZO 1 457 43 S 3081	L
		0 450 90 N 6374 ¹	K
		1 987 43 M 2012	I
		1 987 43 R 2312 ⁸	I

Toledo 2.0

2,0 85 2E	05.91-06.96	0 451 10 P 3314	O
		1 457 43 S 3008	L
		0 450 90 F 5264 ¹	K
		1 987 43 M 2011	I

2,0 85/110 ABF; AGG	03.94-03.99	0 451 10 P 3314	O
		1 457 43 S 3008	L
		0 450 90 F 5264 ¹	K
		1 987 43 M 2011	I

Toledo 2.0 FSI

2,0 110 BLR; BLY	09.04-11.05	1 457 42 P 9243	O
		KZO 1 987 42 S 9405	L
		KZO 1 457 43 S 3576	L
		0 450 90 F 5959 ¹	K
		1 987 43 M 2097	I
		1 987 43 R 2397 ⁸	I
		RLE 1 987 43 R 2597 ⁸	I

2,0 110 BVY; BVZ	11.05-03.09	1 457 42 P 9243	O
		KZO 1 987 42 S 9405	L
		KZO 1 457 43 S 3576	L
		0 450 90 F 5959 ¹	K
		1 987 43 M 2097	I
		1 987 43 R 2397 ⁸	I
		RLE 1 987 43 R 2597 ⁸	I



**Toledo 2.0 TDI****2,0|100|AZV**

09.04-05.09		1 457 42	P 9192	O
	KZO	1 987 42	S 9404	L
	H42,TW	1 457 07	N0007	K
	TW,UFI	F 026 40	N 2006	K
04.06-05.09	H16,TW	F 026 40	N 2008	K
09.04-05.09		1 987 43	M 2097	I
		1 987 43	R 2397 ⁸	I
	RLE	1 987 43	R 2597 ⁸	I

2,0|103|BKD

09.04-05.09		1 457 42	P 9192	O
	KZO	1 987 42	S 9404	L
	UFI	F 026 40	N 2006	K

Fg.Nr. →5P..6..023 451	09.04-07.05	MHF,TW	1 457 07	N0007	K
			1 457 43	N 1715	K

Fg.Nr. 5P..6..023 452→	08.05-05.09	H16,MHF	F 026 40	N 2008	K
	09.04-05.09		1 987 43	M 2097	I
			1 987 43	R 2397 ⁸	I
	RLE	1 987 43	R 2597 ⁸	I	

2,0|103/125|BMM; BMN

01.06-05.09		1 457 42	P 9192	O
	KZO	1 987 42	S 9404	L
	H42,TW	1 457 07	N0007	K
	TW,UFI	F 026 40	N 2006	K
04.06-05.09	H16,TW	F 026 40	N 2008	K
01.06-05.09		1 987 43	M 2097	I
		1 987 43	R 2397 ⁸	I
	RLE	1 987 43	R 2597 ⁸	I

2,0|125|CEGA

03.09-05.09		1 457 42	P 9192	O
	KZO	1 987 42	S 9404	L
	H16,TW	F 026 40	N 2008	K
	H42,TW	1 457 07	N0007	K
	TW,UFI	F 026 40	N 2006	K

Toledo 2.0 TFSI**2,0|147|BWA**

11.05-05.09		1 457 42	P 9243	O
		1 457 43	S 3102	L
		0 450 90	F 5959 ¹	K
		1 987 43	M 2097	I
		1 987 43	R 2397 ⁸	I
	RLE	1 987 43	R 2597 ⁸	I

Toledo 2.3**2,3|110/125|AGZ; AQN**

04.99-11.03		1 457 42	P 9192	O
	KZO	1 457 43	S 3714	L
	KZO	1 457 43	S 3081	L
		0 450 90	F 5318 ¹	K
		1 987 43	M 2012	I
		1 987 43	R 2312 ⁸	I

SKODA**Fabia****Fabia 1.0****1,0|37|AQV; ARV**

09.99-08.02		0 451 10	P 3337	O
		1 457 43	S 3532	L
	ORK	0 450 90	F 5925 ¹	K
	MRK	0 450 90	F 5316 ¹	K
		1 987 43	M 2057	I
		1 987 43	R 2357 ⁸	I

Fabia 1.2**1,2|40|AWY**

07.01-05.04		1 457 42	P 9194	O
		1 457 43	S 3574	L
	ORK	0 450 90	F 5925 ¹	K
	MRK	0 450 90	F 5316 ¹	K
		1 987 43	M 2057	I
		1 987 43	R 2357 ⁸	I

1,2|40|BMD

05.04-12.07		1 457 42	P 9194	O
		1 457 43	S 3532	L
	ORK	0 450 90	F 5925 ¹	K
	MRK	0 450 90	F 5316 ¹	K
		1 987 43	M 2057	I
		1 987 43	R 2357 ⁸	I

1,2|44|BBM <MM4>

12.06-05.09		1 457 42	P 9194	O
		1 457 43	S 3532	L
		F 026 40	F 3006 ¹	K
		1 987 43	M 2057	I
		1 987 43	R 2357 ⁸	I

1,2|44|CGPB <DG3>

11.11→		1 457 42	P 9194	O
		1 457 43	S 3532	L
		1 987 43	M 2057	I
		1 987 43	R 2357 ⁸	I

1,2|44/51|CHFA <MM4>; CHFA <T73>; CHTA

03.09→		1 457 42	P 9194	O
		1 457 43	S 3532	L
		F 026 40	F 3006 ¹	K
		1 987 43	M 2057	I
		1 987 43	R 2357 ⁸	I

1,2|47|AZQ

02.03-11.04		1 457 42	P 9194	O
		1 457 43	S 3319	L
	ORK	0 450 90	F 5925 ¹	K
	MRK	0 450 90	F 5316 ¹	K
		1 987 43	M 2057	I
		1 987 43	R 2357 ⁸	I





◀ Fabia 1.2

1,2 47 BME	11.04-12.07	1457 42 P 9194	O
		1457 43 S 3319	L
	ØRK	0450 90 F 5925 ¹	K
	MRK	0450 90 F 5316 ¹	K
		1987 43 M 2057	I
		1987 43 R 2357 ⁸	I

1,2 51 BBM	05.08→	1457 42 P 9194	O	
		1457 43 S 3532	L	
			1987 43 M 2057	I
			1987 43 R 2357 ⁸	I

1,2 51 BZG <D21>	01.07-05.09	1457 42 P 9194	O	
		1457 43 S 3532	L	
		F 026 40 F 3006 ¹	K	
			1987 43 M 2057	I
			1987 43 R 2357 ⁸	I

1,2 51 CEVA <D21>	01.08-03.09	1457 42 P 9194	O	
		1457 43 S 3532	L	
			1987 43 M 2057	I
			1987 43 R 2357 ⁸	I

1,2 51 CGPA <D21>	03.09→	1457 42 P 9194	O
		1457 43 S 3532	L
	03.09-05.10	F 026 40 F 3006 ¹	K
	03.09→	1987 43 M 2057	I
		1987 43 R 2357 ⁸	I

1,2 55 CFWA; CFWA <D28>	03.10→	F 026 40 S 0156	L
	03.10-06.10	1987 43 M 2057	I
		1987 43 R 2357 ⁸	I

1,2 63/77 CBZA; CBZA <DB1>; CBZB <DB0>; CBZB <TW0>	03.10→	F 026 40 P 7079	O	
		F 026 40 S 0156	L	
		F 026 40 F 3006 ¹	K	
			1987 43 M 2057	I
			1987 43 R 2357 ⁸	I

Fabia 1.4

1,4 44 AZE; AZF	04.00-03.03	0451 10 P 3337	O	
		1457 43 S 3532	L	
		ØRK	0450 90 F 5925 ¹	K
		MRK	0450 90 F 5316 ¹	K
			1987 43 M 2057	I
			1987 43 R 2357 ⁸	I

1,4 50 AME	09.99-05.03	0451 10 P 3337	O	
		1457 43 S 3532	L	
		ØRK	0450 90 F 5925 ¹	K
		MRK	0450 90 F 5316 ¹	K
			1987 43 M 2057	I
			1987 43 R 2357 ⁸	I



1,4 50 AQW; ATZ	09.99-05.03	0451 10 P 3337	O	
		1457 43 S 3532	L	
		ØRK	0450 90 F 5925 ¹	K
		MRK	0450 90 F 5316 ¹	K
			1987 43 M 2057	I
		1987 43 R 2357 ⁸	I	

1,4 55/74 AUA; AUB	09.99-08.03	0451 10 P 3318	O	
		1457 43 S 3059	L	
		ØRK	0450 90 F 5925 ¹	K
		MRK	0450 90 F 5316 ¹	K
			1987 43 M 2057	I
		1987 43 R 2357 ⁸	I	

1,4 55/74 BBY; BBZ; BKY	09.00-12.07	0451 10 P 3318	O	
		1457 43 S 3059	L	
		ØRK	0450 90 F 5925 ¹	K
		MRK	0450 90 F 5316 ¹	K
			1987 43 M 2057	I
		1987 43 R 2357 ⁸	I	

1,4 59 BUD	05.06-12.07	0451 10 P 3318	O	
		F 026 40 S 0035	L	
		ØRK	0450 90 F 5925 ¹	K
		MRK	0450 90 F 5316 ¹	K
			1987 43 M 2057	I
		1987 43 R 2357 ⁸	I	

1,4 63 BXW <TT1>	01.07-03.10	0451 10 P 3318	O	
		F 026 40 S 0035	L	
		F 026 40 F 3006 ¹	K	
			1987 43 M 2057	I
			1987 43 R 2357 ⁸	I

1,4 63 CGGB <D22>; CGGB <TT1>	03.10→	0451 10 P 3318	O	
		F 026 40 S 0035	L	
		F 026 40 F 3006 ¹	K	
			1987 43 M 2057	I
			1987 43 R 2357 ⁸	I

PR-Nr. 7JQ	RUS	03.10→	0451 10 P 3318	O
		03.10→	F 026 40 S 0035	L
		03.10-05.10	F 026 40 F 3006 ¹	K
		03.10→	1987 43 M 2057	I
			1987 43 R 2357 ⁸	I

Fabia 1.4 TDI

1,4 51/59 BMS <D4T>; BNM; BNM <D4S>; BNV; BNV <D4T>	10.05-03.10	1457 42 P 9192	O	
		1457 43 S 3575	L	
			0450 90 N 6500 ¹	K
			1987 43 M 2057	I
			1987 43 R 2357 ⁸	I

1,4 55 AMF	05.03-04.07	1457 42 P 9192	O	
		1457 43 S 3575	L	
			0450 90 N 6322 ¹	K
			1987 43 M 2057	I
			1987 43 R 2357 ⁸	I



**Fabia 1.4 TSI RS**

1,4 | 132 | CAVE; CAVE <D32>

05.10→	F 026 40 P 7079	O
	F 026 40 S 0156	L
	1 987 43 M 2057	I
	1 987 43 R 2357 ⁸	I

Fabia 1.6

1,6 | 77 | BTS <TTO>

04.07-07.10	1 457 42 P 9301	O
	F 026 40 S 0035	L
	F 026 40 F 3006 ¹	K
	1 987 43 M 2057	I
	1 987 43 R 2357 ⁸	I

1,6 | 77 | CFNA <D3H>; CFNA <TTO>

06.10→	1 457 42 P 9301	O	
PR-Nr. 7JQ	RUS 06.10→	F 026 40 S 0035	L
	06.10→	1 987 43 M 2057	I
		1 987 43 R 2357 ⁸	I

Fabia 1.6 TDI

1,6 | 55/66/77 | CAYA; CAYA <D37>; CAYB; CAYB <D36>; CAYC; CAYC <D38>

03.10→	F 026 40 P 7023	O
	F 026 40 S 0156	L
	0 450 90 N 6500 ¹	K
	1 987 43 M 2057	I
	1 987 43 R 2357 ⁸	I

Fabia 1.9 SDI

1,9 | 47 | ASY

09.99-03.08	1 457 42 P 9192	O
	1 457 43 S 3575	L
	0 450 90 N 6322 ¹	K
	1 987 43 M 2057	I
	1 987 43 R 2357 ⁸	I

Fabia 1.9 TDI, TDI RS

1,9 | 74/77/96 | AXR; BLS <D3W>; BLT; BSW <D3W>

10.05-03.10	1 457 42 P 9192	O
	1 457 43 S 3575	L
	0 450 90 N 6426 ¹	K
	1 987 43 M 2057	I
	1 987 43 R 2357 ⁸	I

1,9 | 74/96 | ASZ; ATD

09.99-04.07	1 457 42 P 9192	O
	1 457 43 S 3575	L

Fg.Nr. →6Y..5..391 600

09.99-04.05 0 450 90 N 6322¹ K

Fg.Nr. 6Y..5..391 601→

05.05-04.07 0 450 90 N 6426¹ K

09.99-04.07 1 987 43 M 2057 I

1 987 43 R 2357⁸ I**Fabia 2.0**

2,0 | 85 | AZL

07.00-12.07	0 451 10 P 3314	O
	1 457 43 S 3575	L
	ORR 0 450 90 F 5925 ¹	K
	MRK 0 450 90 F 5316 ¹	K
	1 987 43 M 2057	I
	1 987 43 R 2357 ⁸	I

Favorit**Favorit 135**

1,3 | 40 | 781.135E <OHV Kat.>

05.89-09.94	0 451 20 P 3154	O
	1 457 42 S 9064	L
	0 450 90 F 5280 ¹	K

1,3 | 43 | <OHV>

09.88-09.94	0 451 10 P 3298	O
	1 457 42 S 9064	L

Favorit 136

1,3 | 46 | <OHV>

09.88-09.94	0 451 20 P 3154	O
	1 457 42 S 9064	L

Favorit 136 i.e.

1,3 | 40 | A01 <OHV Kat.>

08.92-07.93	0 451 20 P 3154	O
	1 457 42 S 9064	L
08.92-09.94	0 450 90 F 5280 ¹	K

1,3 | 40 | A02

07.93-12.98	0 451 10 P 3298	O
	1 457 42 S 9054	L
	0 450 90 F 5280 ¹	K

1,3 | 50 | A01

07.93-09.94 0 450 90 F 5280¹ K

1,3 | 50 | A02

07.93-12.98	0 451 10 P 3298	O
09.94-12.98	1 457 42 S 9054	L
07.93-12.98	0 450 90 F 5280 ¹	K

Felicia**Felicia 1.3**

1,3 | 42/43 | 135...

10.94-07.96	0 451 10 P 3298	O
	1 457 42 S 9064	L
	0 450 90 F 4159 ¹	K

Felicia 1.3 , i

1,3 | 40/43/50 | AMG; AMH; AMJ

08.96-08.01	0 451 10 P 3298	O
	1 457 43 S 3008	L
	0 450 90 F 5280 ¹	K





Felicia 1.3 i

1,3 40 135B	10.94-07.96	0 451 10 P 3298 O
		1 457 43 S 3540 L
		0 450 90 F 5280 ¹ K
1,3 40 135M	08.96-08.01	0 451 10 P 3298 O
		1 457 43 S 3008 L
		0 450 90 F 5280 ¹ K
1,3 50 136B	10.94-07.96	0 451 10 P 3298 O
		1 457 43 S 3540 L
		0 450 90 F 5280 ¹ K
1,3 50 136M	08.96-08.01	0 451 10 P 3298 O
		1 457 43 S 3008 L
		0 450 90 F 5280 ¹ K

Felicia 1.6 , i

1,6 55 AEE	05.95-08.01	0 451 10 P 3318 O
		1 457 43 S 3008 L
		0 450 90 F 5280 ¹ K

Felicia 1.9 D

1,9 47 AEF	10.95-08.01	0 451 10 P 3289 O
		1 457 43 S 3008 L
		0 450 90 N 6274 ¹ K

Forman

Forman 1.3

1,3 45 <OHC>	10.90-12.95	0 451 20 P 3154 O
		1 457 42 S 9064 L
		0 450 90 F 5280 ¹ K

Forman 1.3 i.e.

1,3 40 781.135E <OHC Kat.>	08.92-07.93	0 451 20 P 3154 O
	07.93-12.95	0 451 10 P 3298 O
	08.92-07.93	1 457 42 S 9064 L
	07.93-12.95	EVG 1 457 42 S 9064 L
		TW 1 457 43 S 3540 L
	08.92-12.95	0 450 90 F 5280 ¹ K
1,3 50 136B <OHC Kat.>	09.93-12.95	0 451 10 P 3298 O
		1 457 42 S 9054 L
		0 450 90 F 5280 ¹ K



Octavia

Octavia 1.2 TSI

1,2 77 CBZB	02.10→	F 026 40 P 7079 O
		1 987 42 S 9405 L
		1 987 43 M 2097 I
		1 987 43 R 2397 ⁸ I
	RLE	1 987 43 R 2597 ⁸ I

Octavia 1.4

1,4 44 AMD	06.99-03.01	0 451 10 P 3337 O
		1 457 43 S 3714 L
		0 450 90 F 5318 ¹ K
		1 987 43 M 2012 I
		1 987 43 R 2300 ⁸ I
1,4 55 AXP	08.00-01.02	0 451 10 P 3318 O
		1 457 43 S 3716 L
		0 450 90 F 5318 ¹ K
		1 987 43 M 2012 I
		1 987 43 R 2300 ⁸ I

1,4 55 BCA	01.02→	0 451 10 P 3318 O
	01.02-12.10	1 457 43 S 3716 L
	05.04→	1 457 43 S 3059 L
	01.02-12.10	0 450 90 F 5318 ¹ K
	05.04→	0 450 90 F 5925 ¹ K
	01.02-12.10	1 987 43 M 2012 I
		1 987 43 R 2300 ⁸ I
	05.04→	1 987 43 M 2097 I
		1 987 43 R 2397 ⁸ I
	RLE	1 987 43 R 2597 ⁸ I

1,4 59 BUD	05.06→	0 451 10 P 3318 O
		F 026 40 S 0035 L
		0 450 90 F 5925 ¹ K
		1 987 43 M 2097 I
		1 987 43 R 2397 ⁸ I
	RLE	1 987 43 R 2597 ⁸ I

1,4 59 CGGA <D4W>	11.10→	0 451 10 P 3318 O
	RUS 11.10→	F 026 40 S 0035 L
	PR-Nr. 1A1 11.10→	NFV F 026 40 F 3006 ¹ K
	PR-Nr. 1A4 11.10→	NFV F 026 40 F 3013 ¹ K
	11.10→	1 987 43 M 2097 I
		1 987 43 R 2397 ⁸ I
	RLE	1 987 43 R 2597 ⁸ I

Octavia 1.4 TSI

1,4 90 CAXA	11.08→	TW F 026 40 P 7079 O
		1 457 42 P 9301 O
		1 987 42 S 9405 L
		0 450 90 F 5959 ¹ K
		1 987 43 M 2097 I
		1 987 43 R 2397 ⁸ I
	RLE	1 987 43 R 2597 ⁸ I



**Octavia 1.6****1,6|55|AEE**

09.96-09.04	0 451 10 P 3318	O
	1 457 42 S 9054	L
	0 450 90 F 5318 ¹	K
	1 987 43 M 2012	I
	1 987 43 R 2300 ⁸	I

1,6|74/75|AEH; AKL; AVU; BFQ

11.96-12.10	0 451 10 P 3314	O
	1 457 43 S 3714	L
	0 450 90 F 5318 ¹	K
	1 987 43 M 2012	I
	1 987 43 R 2300 ⁸	I

1,6|75|BGU

05.04-05.05	0 451 10 P 3314	O
KZO	1 987 42 S 9405	L
KZO	1 457 43 S 3576	L
	0 450 90 F 5925 ¹	K
	1 987 43 M 2097	I
	1 987 43 R 2397 ⁸	I
RLE	1 987 43 R 2597 ⁸	I

1,6|75|BSE; BSF

05.05→	0 451 10 P 3314	O
KZO	1 987 42 S 9405	L
KZO	1 457 43 S 3576	L
	0 450 90 F 5925 ¹	K
	1 987 43 M 2097	I
	1 987 43 R 2397 ⁸	I
RLE	1 987 43 R 2597 ⁸	I

1,6|75|CCSA

11.07→	0 451 10 P 3314	O
KZO	1 987 42 S 9405	L
KZO	1 457 43 S 3576	L
	0 450 90 F 5925 ¹	K
	1 987 43 M 2097	I
	1 987 43 R 2397 ⁸	I
RLE	1 987 43 R 2597 ⁸	I

1,6|75|CHGA <DF2>

08.09→	0 451 10 P 3314	O
	1 987 42 S 9405	L

PR-Nr. 1A1 08.09→ F 026 40 F 3006¹ KPR-Nr. 1A4 08.09→ F 026 40 F 3013¹ K

08.09→	1 987 43 M 2097	I
	1 987 43 R 2397 ⁸	I
RLE	1 987 43 R 2597 ⁸	I

1,6|75|CMXA <MW6>

05.10→	0 451 10 P 3314	O
	1 987 42 S 9405	L

PR-Nr. 1A1 05.10→ NFV F 026 40 F 3006¹ KPR-Nr. 1A4 05.10→ ~~NFV~~ F 026 40 F 3013¹ K

05.10→	1 987 43 M 2097	I
	1 987 43 R 2397 ⁸	I
RLE	1 987 43 R 2597 ⁸	I

Octavia 1.6 FSI**1,6|85|BLF**

05.04→	1 457 42 P 9301	O
	1 457 43 S 3315	L
	0 450 90 F 5959 ¹	K
	1 987 43 M 2097	I
	1 987 43 R 2397 ⁸	I
RLE	1 987 43 R 2597 ⁸	I

Octavia 1.6 TDI, TDI 4x4**1,6|77|CAYC**

06.09→	F 026 40 P 7023	O
	F 026 40 S 0035	L
	F 026 40 N 2006	K
	1 987 43 M 2097	I
	1 987 43 R 2397 ⁸	I
RLE	1 987 43 R 2597 ⁸	I

Octavia 1.8 , RS, T, T 4x4**1,8|92/110/132|AGN; AGU; ARX; ARZ; AUM; AUQ**

09.96-12.10	0 451 10 P 3314	O
	1 457 43 S 3714	L
	0 450 90 F 5318 ¹	K
	1 987 43 M 2012	I
	1 987 43 R 2300 ⁸	I

Octavia 1.8 TSI, TSI 4x4**1,8|112/118|BZB; CDAA; CDAB <M92>**

06.07→	F 026 40 P 7080	O
	1 987 42 S 9404	L
	0 450 90 F 5959 ¹	K
	1 987 43 M 2097	I
	1 987 43 R 2397 ⁸	I
RLE	1 987 43 R 2597 ⁸	I

Octavia 1.9 SDI, TDI, TDI 4x4**1,9|50/66/81|AGP; AGR; AHF; ALH; AQM; ASV**

09.96-03.10	1 457 42 P 9619	O
	1 457 43 S 3714	L
	0 450 90 N 6374 ¹	K
	1 987 43 M 2012	I
	1 987 43 R 2300 ⁸	I

Octavia 1.9 TDI**1,9|74|AXR**

10.05-12.10	1 457 42 P 9619	O
	1 457 43 S 3714	L
	0 450 90 N 6374 ¹	K
	1 987 43 M 2012	I
	1 987 43 R 2300 ⁸	I





Octavia 1.9 TDI, TDI 4x4

1,9 74/96 ASZ; ATD			
08.00-01.06		1 457 42 P 9619	O
	KZO	1 457 43 S 3714	L
	KZO	1 457 43 S 3081	L
		0 450 90 N 6374 ¹	K
		1 987 43 M 2012	I
		1 987 43 R 2300 ⁸	I

1,9 77 BJB; BKC; BLS; BXE			
05.04→		1 457 42 P 9192	O
	KZO	1 987 42 S 9404	L
05.04-11.06	H42,	1 457 07 N0007	K
	MHF,TW	1 457 43 N 1715	K
09.05→	UFI	F 026 40 N 2006	K
04.06→	H16,MHF	F 026 40 N 2008	K
05.04→		1 987 43 M 2097	I
		1 987 43 R 2397 ⁸	I
	RLE	1 987 43 R 2597 ⁸	I

Octavia 2.0 , i, 4x4

2,0 85 AEG; APK; AQY			
06.99-05.07		0 451 10 P 3314	O
		1 457 43 S 3714	L
		0 450 90 F 5318 ¹	K
		1 987 43 M 2012	I
		1 987 43 R 2300 ⁸	I

Octavia 2.0 , 4x4

2,0 85 AZH; AZJ			
08.00-01.06		0 451 10 P 3314	O
		1 457 43 S 3714	L
		0 450 90 F 5318 ¹	K
		1 987 43 M 2012	I
		1 987 43 R 2300 ⁸	I

Octavia 2.0 FSI, FSI 4x4

2,0 110 BLR; BLX; BLY			
11.04-11.05		1 457 42 P 9243	O
	KZO	1 987 42 S 9405	L
	KZO	1 457 43 S 3576	L
		0 450 90 F 5959 ¹	K
		1 987 43 M 2097	I
		1 987 43 R 2397 ⁸	I
	RLE	1 987 43 R 2597 ⁸	I

2,0 | 110 | BVX; BVY; BVZ

11.05→		1 457 42 P 9243	O
	KZO	1 987 42 S 9405	L
	KZO	1 457 43 S 3576	L
		0 450 90 F 5959 ¹	K
		1 987 43 M 2097	I
		1 987 43 R 2397 ⁸	I
	RLE	1 987 43 R 2597 ⁸	I



Octavia 2.0 FSI RS

2,0 147 CCZA <DL2>			
11.08→		F 026 40 P 7080	O
		1 987 42 S 9404	L
		0 450 90 F 5959 ¹	K
		1 987 43 M 2097	I
		1 987 43 R 2397 ⁸	I
	RLE	1 987 43 R 2597 ⁸	I

Octavia 2.0 RS

2,0 147 BWA			
10.05-10.08		1 457 42 P 9243	O
		1 457 43 S 3102	L
		0 450 90 F 5959 ¹	K
		1 987 43 M 2097	I
		1 987 43 R 2397 ⁸	I
	RLE	1 987 43 R 2597 ⁸	I

Octavia 2.0 TDI

2,0 100/103 AZV; BKD			
05.04→		1 457 42 P 9192	O
	KZO	1 987 42 S 9404	L
05.04-11.06	H42,	1 457 07 N0007	K
	MHF,TW	1 457 43 N 1715	K
09.05→	UFI	F 026 40 N 2006	K
04.06→	H16,MHF	F 026 40 N 2008	K
05.04→		1 987 43 M 2097	I
		1 987 43 R 2397 ⁸	I
	RLE	1 987 43 R 2597 ⁸	I

2,0 | 103 | CLCB <D91>

02.10→		F 026 40 P 7023	O
		1 987 42 S 9404	L
		F 026 40 N 2006	K
		1 987 43 M 2097	I
		1 987 43 R 2397 ⁸	I
	RLE	1 987 43 R 2597 ⁸	I

Octavia 2.0 TDI RS

2,0 125 CEGA			
05.08→		1 457 42 P 9192	O
	KZO	1 987 42 S 9404	L
		F 026 40 N 2006	K
		1 987 43 M 2097	I
		1 987 43 R 2397 ⁸	I
	RLE	1 987 43 R 2597 ⁸	I

Octavia 2.0 TDI, TDI RS, TDI 4x4

2,0 103/125 BMM; BMN			
11.05→		1 457 42 P 9192	O
	KZO	1 987 42 S 9404	L
11.05-11.06	H42,	1 457 07 N0007	K
	MHF,TW	1 457 43 N 1715	K
11.05→	UFI	F 026 40 N 2006	K
04.06→	H16,MHF	F 026 40 N 2008	K
11.05→		1 987 43 M 2097	I
		1 987 43 R 2397 ⁸	I
	RLE	1 987 43 R 2597 ⁸	I



**Octavia 2.0 TDI, TDI 4x4****2,0|81|CFHF <D96>; CLCA**

03.10→	F 026 40 P 7023	O
	KZ0 1987 42 S 9404	L
	F 026 40 N 2006	K
	1987 43 M 2097	I
	1987 43 R 2397 ⁸	I
RLE	1987 43 R 2597 ⁸	I

2,0|103|CFHC

05.10→	F 026 40 P 7023	O
	1987 42 S 9404	L
	F 026 40 N 2006	K
	1987 43 M 2097	I
	1987 43 R 2397 ⁸	I
RLE	1987 43 R 2597 ⁸	I

Octavia 2.0 4x4**2,0|88|ATF**

Fg.Nr. 1U..Y...000 001→	11.99-12.00	0 451 10 P 3314	O
	11.99-12.00	1 457 43 S 3714	L

Pick-Up**Pick-Up 1.6 MPI****1,6|55|AEE**

10.95-03.01	0 451 10 P 3318	O
	1 457 43 S 3008	L
	0 450 90 F 5280 ¹	K

Pick-Up 1.9 D**1,9|47|AEF**

01.96-03.01	0 451 10 P 3289	O
	1 457 43 S 3008	L
	0 450 90 N 6274 ¹	K

Pick-Up 135**1,3|40**

09.91-12.97	0 451 10 P 3298	O
	1 457 42 S 9064	L
	0 450 90 F 4159 ¹	K

1,3|42/43

09.91-12.97	1 457 42 S 9064	L
	0 450 90 F 4159 ¹	K

Pick-Up 135 i.e.**1,3|40|136B**

07.93-12.97	1 457 43 S 3540	L
	0 450 90 F 5280 ¹	K

Pick-Up 135 MPI**1,3|40|AMG <MPI>**

08.96-03.01	0 451 10 P 3298	O
	1 457 43 S 3008	L
	0 450 90 F 5280 ¹	K

Pick-Up 136 i.e.**1,3|50|A01**

07.93-12.97	0 451 10 P 3298	O
	1 457 43 S 3540	L
	0 450 90 F 5280 ¹	K

Pick-Up 136 MPI**1,3|50|AMH <MPI>**

08.96-03.01	0 451 10 P 3298	O
	1 457 43 S 3008	L
	0 450 90 F 5280 ¹	K

Praktik**Praktik 1.2****1,2|51|BZG**

03.07-03.09	1 457 42 P 9194	O
	1 457 43 S 3532	L
	F 026 40 F 3006 ¹	K
	1 987 43 M 2057	I
	1 987 43 R 2357 ⁸	I

1,2|51|CGPA

03.09→	1 457 42 P 9194	O
	1 457 43 S 3532	L
	F 026 40 F 3006 ¹	K
	1 987 43 M 2057	I
	1 987 43 R 2357 ⁸	I

1,2|63|CBZA <TWO>

03.10→	F 026 40 P 7079	O
	F 026 40 S 0156	L
	0 450 90 F 5959 ¹	K
	1 987 43 M 2057	I
	1 987 43 R 2357 ⁸	I

Praktik 1.2 TDI**1,2|55|CFWA <D28>**

03.10→	F 026 40 S 0156	L
	1 987 43 M 2057	I
	1 987 43 R 2357 ⁸	I

Praktik 1.4**1,4|63|BXW**

03.07→	0 451 10 P 3318	O
	F 026 40 S 0035	L
	F 026 40 F 3006 ¹	K
	1 987 43 M 2057	I
	1 987 43 R 2357 ⁸	I

1,4|63|CGGB <TT1>

03.10→	0 451 10 P 3318	O
	F 026 40 S 0035	L
03.10-06.10	F 026 40 F 3006 ¹	K
03.10→	1 987 43 M 2057	I
	1 987 43 R 2357 ⁸	I





Praktik 1.4 TDI

1,4 51/59 BMS; BNM; BNV			
03.07→	1 457 42	P 9192	O
	1 457 43	S 3575	L
	0 450 90	N 6500 ¹	K
	1 987 43	M 2057	I
	1 987 43	R 2357 ⁸	I

Praktik 1.6 TDI

1,6 66 CAYB <D36>			
03.10→	F 026 40	P 7023	O
	F 026 40	S 0156	L
	0 450 90	N 6500 ¹	K
	1 987 43	M 2057	I
	1 987 43	R 2357 ⁸	I

Rapid

Rapid 1.6

1,6 77 CLSA <D3H>			
09.11→	1 987 43	M 2057	I
	1 987 43	R 2357 ⁸	I

Rapid 1.6 TDI

1,6 77 CLNA <D38>			
09.11→	F 026 40	P 7023	O
	F 026 40	S 0156	L
	1 987 43	M 2057	I
	1 987 43	R 2357 ⁸	I

Roomster

Roomster 1.2

1,2 47 BME			
05.06-01.07	1 457 42	P 9194	O
	1 457 43	S 3319	L
	F 026 40	F 3006 ¹	K
	1 987 43	M 2057	I
	1 987 43	R 2357 ⁸	I

1,2 51 BZG <T70>			
01.07-03.09	1 457 42	P 9194	O
	1 457 43	S 3532	L
	F 026 40	F 3006 ¹	K
	1 987 43	M 2057	I
	1 987 43	R 2357 ⁸	I

1,2 51 CGPA			
03.09→	1 457 42	P 9194	O
	1 457 43	S 3532	L
	F 026 40	F 3006 ¹	K
	1 987 43	M 2057	I
	1 987 43	R 2357 ⁸	I

1,2 63/77 CBZA; CBZB			
03.10→	F 026 40	P 7079	O
	F 026 40	S 0156	L
	0 450 90	F 5959 ¹	K
	1 987 43	M 2057	I
	1 987 43	R 2357 ⁸	I



Roomster 1.2 TDI

1,2 55 CFWA <D28>			
03.10→	F 026 40	S 0156	L
	1 987 43	M 2057	I
	1 987 43	R 2357 ⁸	I

Roomster 1.4

1,4 63 BXW <TT1>; CGGB <TT1>			
05.06→	0 451 10	P 3318	O
	F 026 40	S 0035	L
05.06-06.10	F 026 40	F 3006 ¹	K
05.06→	1 987 43	M 2057	I
	1 987 43	R 2357 ⁸	I

Roomster 1.4 TDI

1,4 51/59 BMS <D4T>; BNM <D4S>; BNV <D4T>			
05.06-03.10	1 457 42	P 9192	O
	1 457 43	S 3575	L
	0 450 90	N 6500 ¹	K
	1 987 43	M 2057	I
	1 987 43	R 2357 ⁸	I

Roomster 1.6

1,6 66/77 CAYB <D36>; CAYC			
03.10→	F 026 40	P 7023	O
	F 026 40	S 0156	L
	0 450 90	N 6500 ¹	K
	1 987 43	M 2057	I
	1 987 43	R 2357 ⁸	I

1,6 77 BTS <TT0>			
05.06-07.10	1 457 42	P 9301	O
	F 026 40	S 0035	L
	F 026 40	F 3006 ¹	K
	1 987 43	M 2057	I
	1 987 43	R 2357 ⁸	I

1,6 77 CFNA <TT0>			
06.10→	1 457 42	P 9301	O
	F 026 40	S 0035	L
06.10-06.10	F 026 40	F 3006 ¹	K
06.10→	1 987 43	M 2057	I
	1 987 43	R 2357 ⁸	I

Roomster 1.9 TDI

1,9 74/77 AXR; BLS <D3W>; BSW <D3W>			
03.06-03.10	1 457 42	P 9192	O
	1 457 43	S 3575	L
	0 450 90	N 6426 ¹	K
	1 987 43	M 2057	I
	1 987 43	R 2357 ⁸	I

Superb

Superb 1.4 TSI

1,4 92 CAXC			
04.08→	TW	F 026 40	P 7079
		1 987 42	S 9405
		0 450 90	F 5959 ¹
		1 987 43	M 2097
		1 987 43	R 2397 ⁸
	RLE	1 987 43	R 2597 ⁸



**Superb 1.6 TDI****1,6|77|CAYC<D38>**

09.10→	F 026 40 P 7023	O
	1987 42 S 9404	L
	F 026 40 N 2006	K
	1987 43 M 2097	I
	1987 43 R 2397 ⁸	I
RLE	1987 43 R 2597 ⁸	I

Superb 1.8 T**1,8|110|AWT**

12.01-03.08	F 026 40 P 7004	O
KZO	1457 43 S 3698	L
	0450 90 F 5264 ¹	K
	1987 43 M 2012	I

Superb 1.8 TSI, TSI 4x4**1,8|112/118|BZB; CDAA; CDAA<D67>; CDAB<M92>**

03.08→	F 026 40 P 7080	O
	1987 42 S 9404	L
	0450 90 F 5959 ¹	K
	1987 43 M 2097	I
	1987 43 R 2397 ⁸	I
RLE	1987 43 R 2597 ⁸	I

Superb 1.9 TDI**1,9|74|AVB**

02.02-10.05	1457 42 P 9619	O
	1457 43 S 3698	L
Fg.Nr. →3U..39018 401	02.02-05.02	1457 43 N 4329 ¹
Fg.Nr. 3U..39018 402→	06.02-10.05	0450 90 N 6374 ¹
	02.02-10.05	1987 43 M 2012

1,9|77|BLS; BLS<D3W>

03.08→	1457 42 P 9192	O
	1987 42 S 9404	L
	F 026 40 N 2006	K
	1987 43 M 2097	I
	1987 43 R 2397 ⁸	I
RLE	1987 43 R 2597 ⁸	I

1,9|77|BXE

03.08→	1457 42 P 9192	O
	1987 42 S 9404	L
	F 026 40 N 2006	K
	1987 43 M 2097	I
	1987 43 R 2397 ⁸	I
RLE	1987 43 R 2597 ⁸	I

1,9|77/85|BPZ; BSV

10.05-03.08	1457 42 P 9619	O
	1457 43 S 3698	L
	0450 90 N 6374 ¹	K
	1987 43 M 2012	I

1,9|96|AVF

01.04-03.08	1457 42 P 9619	O
	1457 43 S 3698	L
	0450 90 N 6374 ¹	K
	1987 43 M 2012	I

1,9|96|AWX

12.01-03.08	1457 42 P 9619	O
	1457 43 S 3698	L
Fg.Nr. →3U..39018 401	12.01-05.02	1457 43 N 4329 ¹
Fg.Nr. 3U..39018 402→	06.02-03.08	0450 90 N 6374 ¹
	12.01-03.08	1987 43 M 2012

Superb 2.0**2,0|85|AZM**

12.01-03.08	0451 10 P 3314	O
KZO	1457 43 S 3698	L
	0450 90 F 5264 ¹	K
	1987 43 M 2012	I

Superb 2.0 TDI**2,0|91/103|BSS; BWW**

10.05-03.08	1457 42 P 9619	O
	1457 43 S 3698	L
	0450 90 N 6374 ¹	K
	1987 43 M 2012	I

2,0|103|BKD; BMP; BMP<D7N>

03.08→	1457 42 P 9192	O
	1987 42 S 9404	L
	F 026 40 N 2006	K
	1987 43 M 2097	I
	1987 43 R 2397 ⁸	I
RLE	1987 43 R 2597 ⁸	I

Superb 2.0 TDI, TDI 4x4**2,0|103/125|CFFB<D91>; CFGB; CLJA; CLJA<D91>**

02.10→	F 026 40 P 7023	O
	1987 42 S 9404	L
	F 026 40 N 2006	K
	1987 43 M 2097	I
	1987 43 R 2397 ⁸	I
RLE	1987 43 R 2597 ⁸	I

2,0|125|CBBB

06.08→	1457 42 P 9192	O
	1987 42 S 9404	L
	F 026 40 N 2006	K
	1987 43 M 2097	I
	1987 43 R 2397 ⁸	I
RLE	1987 43 R 2597 ⁸	I

Superb 2.0 TSI**2,0|147|CCZA<D2L>**

05.10→	F 026 40 P 7080	O
	1987 42 S 9404	L
	0450 90 F 5959 ¹	K
	1987 43 M 2097	I
	1987 43 R 2397 ⁸	I
RLE	1987 43 R 2597 ⁸	I





Superb 2.5 TDI

2,5 114/120 AYM; BDG			
12.01-03.08	1 457 42	P 9152	O
	KZO 1 457 43	S 3772	L
	KZO 1 457 43	S 3698	L
	0 986 45	N 0509¹	K
	1 987 43	M 2012	I

Superb 2.8

2,8 140/142 AMX; BBG			
12.01-03.08	0 451 10	P 3313	O
	1 457 43	S 3698	L
	0 450 90	F 5264¹	K
	1 987 43	M 2012	I

Superb 3.6 V6 4x4

3,6 191 CDVA			
11.08→	1 457 42	P 9192	O
	0 450 90	F 5959¹	K
	1 987 43	M 2097	I
	1 987 43	R 2397⁸	I
RLE	1 987 43	R 2597⁸	I

Yeti

Yeti 1.2 TSI

1,2 77 CBZB			
09.09-02.10	F 026 40	P 7079	O
09.09→	1 987 42	S 9405	L
	F 026 40	F 3006¹	K
	1 987 43	M 2097	I
	1 987 43	R 2397⁸	I
RLE	1 987 43	R 2597⁸	I

Yeti 1.4 TSI

1,4 90 CAXA			
06.10→	TW	F 026 40	P 7079
		1 457 42	P 9301
		1 987 42	S 9405
		0 450 90	F 5959¹
		1 987 43	M 2097
		1 987 43	R 2397⁸
RLE		1 987 43	R 2597⁸

Yeti 1.6 TDI

1,6 77 CAYC <D38>			
11.10→		F 026 40	P 7023
	KZO	1 987 42	S 9404
		F 026 40	N 2006
		1 987 43	M 2097
		1 987 43	R 2397⁸
RLE		1 987 43	R 2597⁸

Yeti 1.8 TSI 4x4

1,8 112/118 CDAA; CDAB			
05.09→		F 026 40	P 7080
		1 987 42	S 9404
		0 450 90	F 5959¹
		1 987 43	M 2097
		1 987 43	R 2397⁸
RLE		1 987 43	R 2597⁸



Yeti 2.0 TDI, TDI 4x4

2,0 81/103 CFHA; CFHC			
11.09→		F 026 40	P 7023
	KZO	1 987 42	S 9404
		F 026 40	N 2006
		1 987 43	M 2097
		1 987 43	R 2397⁸
RLE		1 987 43	R 2597⁸

2,0 | 81/103/125 | CFJA <D93>; CLCA <D96>; CLCB <D91>

05.10→		F 026 40	P 7023
	KZO	1 987 42	S 9404
		F 026 40	N 2006
		1 987 43	M 2097
		1 987 43	R 2397⁸
RLE		1 987 43	R 2597⁸

Yeti 2.0 TDI 4x4

2,0 | 81 | CFHF

11.09→		F 026 40	P 7023
		1 987 42	S 9404
	KZO	1 987 42	S 9404
		F 026 40	N 2006
		1 987 43	M 2097
		1 987 43	R 2397⁸
RLE		1 987 43	R 2597⁸

2,0 | 103/125 | CBDB; CEGA

05.09-05.10		1 457 42	P 9192
	KZO	1 987 42	S 9404
		F 026 40	N 2006
		1 987 43	M 2097
		1 987 43	R 2397⁸
RLE		1 987 43	R 2597⁸

SMART (MCC)

Forfour

Forfour 1.1

1,1 47/55 134.910; 134.911			
01.04-06.07		0 451 10	P 3372
		1 457 43	S 3599
		1 987 43	R 2434⁸

Forfour 1.3

1,3 70 135.930			
01.04-06.07		0 451 10	P 3372
		1 457 43	S 3599
		1 987 43	R 2434⁸

Forfour 1.5

1,5 80 135.950			
01.04-06.07		0 451 10	P 3372
		1 457 43	S 3599
		1 987 43	R 2434⁸

Forfour 1.5 Brabus

1,5 130 122.950			
04.05-06.07		F 026 40	S 0006
		1 987 43	R 2434⁸





Forfour 1.5 cdi

1,5 50/70 639.939	09.04-06.07	F 026 40 P 7027	O
		F 026 40 S 0006	L
		1987 43 R 2434 ⁸	I

Forfour 1.5 Sportstyle

1,5 90	04.04-06.07	0 451 10 P 3372	O
		1457 43 S 3599	L
		1987 43 R 2434 ⁸	I

Fortwo

Fortwo 0.7 , Brabus

0,7 37/45/55 160.910;160.920	02.04-03.07	1457 42 P 9127	O
		1457 43 S 3739	L
		0450 90 F 2161 ¹	K
	KL	1987 43 R 2378 ⁸	I

Fortwo 0.8

0,8 33 660.950	04.07-07.09	1457 42 P 9127	O
		F 026 40 S 0144	L
		1987 43 M 2299	I
		1987 43 R 2499 ⁸	I

0,8 40 660.951 <OM 660>	08.09->	1457 42 P 9127	O
		F 026 40 S 0144	L

Fortwo 0.8 cdi

0,8 30 OM 660.940	02.04-03.07	1457 42 P 9127	O
		1457 43 S 3044	L
		F 026 40 N 2001 ¹	K
	KL	1987 43 R 2378 ⁸	I

Fortwo 1.0 , Brabus, mhd

1,0 45/52/62/72/75 132.910 <RA1>;132.930 <RA1>	04.07->	F 026 40 P 7089	O
		F 026 40 S 0144	L
		1987 43 M 2299	I
		1987 43 R 2499 ⁸	I

Roadster

Roadster 0.7 , Brabus

0,7 45/60/74 160.921;160.922;160.923	04.03-11.05	1457 42 P 9127	O
		1457 43 S 3084	L
		0450 90 F 2161 ¹	K



Smart

Smart 0.6

0,6 33/40/45/52 160.910	07.98-01.04	1457 42 P 9127	O
		1457 43 S 3739	L
		0450 90 F 2161 ¹	K
	KL	1987 43 R 2378 ⁸	I

Smart 0.7 , Brabus

0,7 37/45/55 160.920	01.03-01.04	1457 42 P 9127	O
		1457 43 S 3739	L
		0450 90 F 2161 ¹	K
	KL	1987 43 R 2378 ⁸	I

Smart 0.8 cdi

0,8 30 OM 660.940;660.940	11.99-01.04	1457 42 P 9127	O
		1457 43 S 3044	L
		F 026 40 N 2001 ¹	K
	KL	1987 43 R 2378 ⁸	I

SSANGYONG

Chairman

Chairman 2.3 i

2,3 110 <DOHC M111>	10.97-09.03	1457 42 P 9122	O
---------------------	-------------	-----------------------	----------

Chairman 2.8 i

2,8 145 <DOHC M104>	09.03-01.08	1457 42 P 9122	O
---------------------	-------------	-----------------------	----------

Chairman 3.2 i

3,2 162 162-994-000 <DOHC M104>	09.03-01.08	1457 42 P 9122	O
---------------------------------	-------------	-----------------------	----------

Istana

Istana 2.3 i 16V

2,3 110 M161 E23 <M 111.970>	11.96->	1457 42 P 9122	O
------------------------------	---------	-----------------------	----------

Istana 2.9 D Bus

2,9 70 OM662	01.92-06.03	1457 43 N 4331 ²	K
--------------	-------------	------------------------------------	----------

Istana 2.9 D Van

2,9 70 OM662	01.92-06.03	1457 42 P 9274	O
		1457 43 N 4331 ²	K
	04.95-06.03	0450 90 N 4077 ¹	K





Korando

Korando 2.0 i

2,0 94 M161 E20	07.96-12.05	1 457 42 P 9122	O
	07.96-09.99	0 450 90 F 5281 ¹	K

Korando 2.3 D

2,3 58-59 OM661 D23 <OM 601.990>	10.86-12.05	1 457 42 P 9274	O
		1 457 43 N 4331 ²	K
	07.96-12.05	0 450 90 N 4077 ¹	K

Korando 2.3 i 16V

2,3 103-105 M161 E23 <M 111>	07.96-12.05	1 457 42 P 9122	O
	07.96-09.99	0 450 90 F 5281 ¹	K

Korando 2.3 TCI

2,3 53 OM661	03.83-12.95	1 457 42 P 9274	O
		1 457 43 N 4331 ²	K

Korando 2.9 D

2,9 70-73 OM662 D29 <OM 602.910>	07.96-12.05	1 457 42 P 9274	O
		1 457 42 S 9783	L
		0 450 90 N 4077 ¹	K
		1 457 43 N 4331 ²	K

2,9 88-97 OM 662 LA	07.96-10.05	1 457 42 P 9274	O
		1 457 43 N 4331 ²	K

Korando 2.9 TCI Van

2,9 88	07.96-02.04	1 457 43 N 4331 ²	K
----------	-------------	------------------------------	---

Korando 2.9 TD Intercooler

2,9 88-97 OM 662 LA <OM 602>	07.96-12.05	1 457 42 P 9274	O
		0 450 90 N 4077 ¹	K
		1 457 43 N 4331 ²	K

Korando 3.2 i

3,2 154-162 M162.995 E32	07.96-12.05	1 457 42 P 9122	O
	07.96-09.99	0 450 90 F 5281 ¹	K

Musso

Musso 2.0 i

2,0 100 M161 E20 <M 111.940>	05.96-12.05	1 457 42 P 9122	O
		0 450 90 F 5281 ¹	K



Musso 2.3 D

2,3 57-58 OM661 D23 <OM 601.910>	07.93-12.05	1 457 42 P 9274	O
		0 450 90 N 4077 ¹	K
		1 457 43 N 4331 ²	K

2,3 74 E23	08.93-04.05	1 457 42 P 9274	O
		1 457 43 N 4331 ²	K

Musso 2.3 i

2,3 103-110 M161 E23 <M 111.970>	05.96-12.05	1 457 42 P 9122	O
		0 450 90 F 5281 ¹	K

Musso 2.9 D

2,9 70-73 OM 662 D29 <OM 602.910>	07.93-12.05	1 457 42 P 9274	O
		1 457 42 S 9783	L
		0 450 90 N 4077 ¹	K
		1 457 43 N 4331 ²	K

2,9 88 OM 662	07.93-04.05	1 457 42 P 9274	O
		1 457 42 S 9783	L
		1 457 43 N 4331 ²	K

Musso 2.9 TCI Sports

2,9 88 662-902	10.02-12.05	1 457 43 N 4331 ²	K
--------------------	-------------	------------------------------	---

Musso 2.9 TD Intercooler

2,9 88 OM 662 D29 LA <OM 602.910>	05.97-12.05	1 457 42 P 9274	O
		0 450 90 N 4077 ¹	K
		1 457 43 N 4331 ²	K

Musso 3.2 i

3,2 162 M162 E32 <M 104.>	01.96-12.05	1 457 42 P 9122	O
		0 450 90 F 5281 ¹	K

Rexton

Rexton 2.3 i

2,3 103 M 111 E23	09.02→	1 457 42 P 9122	O
-----------------------	--------	-----------------	---

Rexton 2.7 CRDi

2,7 130 D27DT	12.03→	1 457 42 P 9122	O
-------------------	--------	-----------------	---

Rexton 2.7 Xdi

2,7 120 D27DT (OM665.925)	08.04→	1 457 42 P 9122	O
		0 450 90 N 6508 ¹	K

Rexton 2.9 TCI

2,9 97 OM 662 LA	09.01→	1 457 42 P 9274	O
		1 457 43 N 4331 ²	K



**Rexton 2.9 TD**

2,9 | 88 | 662 LA <(OM 662.925 LA)>

09.02→	1 457 42 P 9122	O
	1 457 43 N 4331 ²	K

Rexton 3.2 i

3,2 | 162 | E32 <M104>; E32(M162.995.)

09.01→	1 457 42 P 9122	O
--------	-----------------	---

Rodius**Rodius 2.7 CRDI**

2,7 | 121 | 665-926-00 <2.7DI>

08.04→	1 457 42 P 9122	O
--------	-----------------	---

Rodius 2.7 Xdi 2WD, Xdi 4WD

2,7 | 121

05.05→	1 457 42 P 9122	O
	TW 0 450 90 N 6508 ¹	K

STEYR (STEYR-DAIMLER-PUCH AG)**G****G 300 DT**

3,0 | 130 | OM 606.964

01.98→	1 457 42 P 9278	O
	1 457 43 N 4123 ²	K

G 320

3,2 | 158 | M 112.945

01.98→	XXX 1 457 42 P 9196	O
	1 457 43 S 3071	L
	0 450 91 F 5003 ¹	K

G 500 V8

5,0 | 218 | M 113.962

01.98→	XXX 1 457 42 P 9196	O
	1 457 43 S 3071	L
	0 450 91 F 5003 ¹	K

Pinzgauer**Pinzgauer 2.4 D Turbo**

2,4 | 77 | NY

10.86-12.96	0 451 20 P 3087	O
	1 457 42 S 9946	L
	1 457 43 D 701 ²	K

SUBARU**Alcyone****Alcyone 1.8 i Turbo, i Turbo 4WD**

1,8 | 88 | EA82

06.85-08.91	1 987 42 S 9132	L
-------------	-----------------	---

Alcyone 3.3 i 4WD

3,3 | 177 | EG33

09.91-11.96	0 451 10 P 3316	O
	1 987 42 S 9051	L
	0 986 45 F 0114 ¹	K

Domingo**Domingo 1.0**

1,0 | 35 | EF10

10.83-06.94	0 986 45 P 2061	O
-------------	-----------------	---

Domingo 1.2 i 4WD, 4WD

1,2 | 38/45 | EF12

06.86-11.98	0 986 45 P 2061	O
-------------	-----------------	---

Forester**Forester 2.0**

2,0 | 110 | EJ204

12.07→	F 026 40 P 7001	O
--------	-----------------	---

Forester 2.0 i S Turbo 4x4

2,0 | 125-130 | EJ205

03.98-05.02	0 451 10 P 3275	O
	1 987 42 S 9051	L
	0 986 45 F 0114 ¹	K
	1 987 43 M 2218	I

2,0 | 130 | EJ205

06.02-05.05	1 987 42 S 9051	L
	0 986 45 F 0114 ¹	K

Forester 2.0 i Turbo 4WD

2,0 | 177-184 | EJ20 (DOHC); EJ20 (SOHC)

02.97-01.02	0 451 10 P 3275	O
	1 987 42 S 9051	L

Forester 2.0 i Turbo 4WD, i 4WD

2,0 | 101-103/162 | EJ20 (DOHC); EJ20 (SOHC)

02.02-11.07	F 026 40 P 7001	O
	1 987 42 S 9051	L
	0 986 45 F 0114 ¹	K

Forester 2.0 i Turbo 4x4

2,0 | 184 | EJ20

03.97-02.02	1 987 43 M 2218	I
-------------	-----------------	---





Forester 2.0 i 4WD

2,0 99-101 EJ20 (DOHC); EJ20 (SOHC)	06.97-01.02	0 451 10 P 3275	O
		1 987 42 S 9051	L

Forester 2.0 i 4x4

2,0 90 EJ20J	01.97-07.98	0 451 10 P 3275	O
		1 987 42 S 9051	L
		0 986 45 F 0114 ¹	K
		1 987 43 M 2218	I

2,0 92 EJ201	06.02-05.05	0 986 45 F 0114 ¹	K
------------------	-------------	------------------------------	---

2,0 92 EJ202	03.98-05.02	0 451 10 P 3275	O
		0 986 45 F 0114 ¹	K
		1 987 43 M 2218	I

2,0 116 EJ204	06.05-11.07	F 026 40 P 7001	O
		1 987 42 S 9051	L
		0 986 45 F 0114 ¹	K

Forester 2.5

2,5 126 EJ253; EJ255	12.07→	F 026 40 P 7001	O
--------------------------	--------	-----------------	---

Forester 2.5 i Turbo 4WD

2,5 195 EJ25 (DOHC)	02.04-11.07	F 026 40 P 7001	O
		1 987 42 S 9051	L
		0 986 45 F 0114 ¹	K

Forester 2.5 i Turbo 4x4

2,5 155 EJ253; EJ255	04.03-11.07	1 987 42 S 9051	L
		0 986 45 F 0114 ¹	K

2,5 169 EJ253; EJ255	06.05-11.07	F 026 40 P 7001	O
		1 987 42 S 9051	L
		0 986 45 F 0114 ¹	K

Forester 2.5 i 4WD

2,5 123 EJ25 (DOHC)	08.98-01.02	0 451 10 P 3275	O
		1 987 42 S 9051	L

Forester 2.5 i 4x4

2,5 110 EJ25	07.98-05.02	0 451 10 P 3275	O
		0 986 45 F 0114 ¹	K
		1 987 43 M 2218	I

2,5 115 EJ251	06.02-05.05	0 986 45 P 2061	O
		0 986 45 F 0114 ¹	K

2,5 129 EJ253; EJ255	06.05-11.07	F 026 40 P 7001	O
		1 987 42 S 9051	L
		0 986 45 F 0114 ¹	K



Forester 2.5 Turbo

2,5 169 EJ253; EJ255	12.07→	F 026 40 P 7001	O
--------------------------	--------	-----------------	---

Impreza

Impreza 1.5 i, i 4WD

1,5 70-75 EJ15 (SOHC)	11.92-07.00	0 451 10 P 3275	O
		1 987 42 S 9051	L

1,5 74 EJ15 (SOHC)	08.00-06.07	F 026 40 P 7001	O
		1 987 42 S 9051	L
	08.00-09.02	0 986 45 F 0114 ¹	K

1,5 81 EJ15 (DOHC)	06.06-06.07	F 026 40 P 7001	O
------------------------	-------------	-----------------	---

Impreza 1.5 i 4WD

1,5 77	05.06-06.07	F 026 40 P 7001	O
		1 987 42 S 9051	L
		0 986 45 F 0114 ¹	K

Impreza 1.5 R, R 4x4

1,5 79 EJ154	06.07→	F 026 40 P 7001	O
------------------	--------	-----------------	---

Impreza 1.6 i

1,6 66 EJ16	01.93-12.95	0 986 45 F 0114 ¹	K
-----------------	-------------	------------------------------	---

Impreza 1.6 i, i 4WD

1,6 66 EJ16E; EJ16J	01.93-07.98	0 451 10 P 3275	O
		1 987 42 S 9051	L
		0 986 45 F 0114 ¹	K
	01.93-09.00	1 987 43 M 2218	I

1,6 70 EJ161	08.98-09.00	0 451 10 P 3275	O
	10.00-06.07	F 026 40 P 7001	O
	08.98-06.07	0 986 45 F 0114 ¹	K
	08.98-09.00	1 987 43 M 2218	I

1,6 74 EJ16	11.92-08.96	0 451 10 P 3275	O
		1 987 42 S 9051	L

Impreza 1.8 i

1,8 76 EJ18S	01.93-12.95	0 451 10 P 3275	O
		1 987 42 S 9051	L
		0 986 45 F 0114 ¹	K

Impreza 1.8 i, i 4WD

1,8 76 EJ18E	01.93-06.97	0 451 10 P 3275	O
		1 987 42 S 9051	L
		0 986 45 F 0114 ¹	K
		1 987 43 M 2218	I





1,8 85-88 EJ18	11.92-07.00	0 451 10 P 3275	O
		1 987 42 S 9051	L

Impreza 2.0 i

2,0 92 EJ201	08.98-09.00	0 451 10 P 3275	O
		0 986 45 F 0114 ¹	K

Impreza 2.0 i, i 4WD, i 4WD Turbo

2,0 85/155 EJ20E; EJ20G	12.93-07.98	0 451 10 P 3275	O
		1 987 42 S 9051	L
		0 986 45 F 0114 ¹	K

Impreza 2.0 i Turbo 4WD

2,0 162-184 EJ20 (DOHC)	11.92-07.00	0 451 10 P 3275	O
		1 987 42 S 9051	L

2,0 | 184 | EJ20 (DOHC)

08.00-06.07	F 026 40 P 7001	O
	1 987 42 S 9051	L
	0 986 45 F 0114 ¹	K

2,0 | 191-206 | EJ20 (DOHC)

10.94-07.00	0 451 10 P 3275	O
	1 987 42 S 9051	L

2,0 | 206 | EJ20 (DOHC)

09.96-07.00	0 451 10 P 3275	O
08.00-08.01 TW	0 451 10 P 3275	O
08.00-06.07	F 026 40 P 7001	O
09.96-06.07	1 987 42 S 9051	L
08.00-10.02	0 986 45 F 0114 ¹	K

Impreza 2.0 i 4WD

2,0 92 EJ201	08.98-09.00	0 451 10 P 3275	O
	10.00-06.07	F 026 40 P 7001	O
	08.98-06.07	0 986 45 F 0114 ¹	K

2,0 | 99 | EJ20 (SOHC)

10.95-09.98	0 451 10 P 3275	O
	1 987 42 S 9051	L

2,0 | 114 | EJ20 (DOHC)

09.98-08.03	0 451 10 P 3275	O
08.00-05.04	F 026 40 P 7001	O
09.98-05.04	1 987 42 S 9051	L
08.00-08.03	0 986 45 F 0114 ¹	K

2,0 | 118 | EJ204

06.05-06.07	F 026 40 P 7001	O
	1 987 42 S 9051	L
	0 986 45 F 0114 ¹	K

Impreza 2.0 i 4WD Turbo

2,0 160 EJ205	08.98-09.00	0 451 10 P 3275	O
	10.00-10.02	F 026 40 P 7001	O
	08.98-10.02	1 987 42 S 9051	L
		0 986 45 F 0114 ¹	K

2,0 | 165 | EJ205

11.02-05.05 WW	F 026 40 P 7001	O
	0 986 45 P 2061	O
	1 987 42 S 9051	L
	0 986 45 F 0114 ¹	K

Impreza 2.0 i 4WD Turbo STI

2,0 195 EJ207	10.01-05.05	F 026 40 P 7001	O
		1 987 42 S 9051	L
		0 986 45 F 0114 ¹	K

Impreza 2.0 R XV Crossover 4x4, R 4x4

2,0 110 EJ204	06.07→	F 026 40 P 7001	O
-------------------	--------	-----------------	---

Impreza 2.5

2,5 169 EJ255; EJ257	09.10→	F 026 40 P 7001	O
--------------------------	--------	-----------------	---

2,5 169-195 EJ255; EJ257	06.07-08.10	F 026 40 P 7001	O
------------------------------	-------------	-----------------	---

2,5 221-243 EJ255; EJ257	06.07→	F 026 40 P 7001	O
------------------------------	--------	-----------------	---

Impreza 2.5 i 4WD

2,5 112 EJ251	07.01-05.05	F 026 40 P 7001	O
		0 986 45 F 0114 ¹	K

Impreza 2.5 i 4WD Turbo

2,5 169 EJ255; EJ257	06.05-06.07	F 026 40 P 7001	O
		1 987 42 S 9051	L

Impreza 2.5 i 4WD Turbo STI

2,5 206 EJ255; EJ257	09.03-06.07	F 026 40 P 7001	O
		1 987 42 S 9051	L

Justy

Justy 1.0 , 4WD

1,0 37 EF10 <Kat.>	05.87-10.95	0 986 45 P 2061	O
		1 457 42 S 9801	L

Justy 1.2 , 4WD

1,2 49 EF12 <Kat.>	05.87-10.95	0 986 45 P 2061	O
		1 457 42 S 9801	L





◀ Justy 1.2 , 4WD

1,2 54 EF12	01.87-03.94	1 457 42	S 9801	L
-----------------	-------------	----------	--------	---

Justy 1.2 i 4WD

1,2 55 EF12 <Kat.>	05.91-12.94	0 986 45	P 2061	O
		0 450 90	F 5971 ¹	K

Justy 1.3 4x4

1,3 50 G13B	10.95-08.03	0 986 45	P 2058	O
		1 457 43	S 3785	L
	XXX	0 986 45	F 0226 ¹	K

1,3 | 69

	09.03-08.07	0 451 10	P 3276	O
		F 026 40	S 0045	L
		1 987 43	M 2066	I

Justy 1.5 4x4

1,5 73 M15A	09.03-08.07	0 451 10	P 3276	O
		F 026 40	S 0045	L
		1 987 43	M 2066	I

Legacy

Legacy 1.6

1,6EJ16	05.90-12.93	0 451 10	P 3275	O
---------	-------------	----------	--------	---

Legacy 1.8 , 4WD

1,8 76 EJ18A	07.89-12.93	0 451 10	P 3275	O
	01.89-12.93	1 457 43	S 3274	L

Legacy 1.8 i

1,8EJ18E	07.95-11.98	0 451 10	P 3275	O
		1 987 42	S 9051	L

1,8 | 85 | EJ18

	06.94-11.98	0 451 10	P 3275	O
		1 987 42	S 9051	L

Legacy 1.8 i, i 4WD

1,8 76 EJ18S	07.89-12.93	0 451 10	P 3275	O
	01.89-12.93	1 457 43	S 3274	L
	08.89-12.93	0 986 45	F 0114 ¹	K

1,8 | 85-88 | EJ18

	06.94-11.98	0 451 10	P 3275	O
--	-------------	----------	--------	---

Legacy 1.8 i 4WD

1,8 81 EJ18	02.89-09.93	0 451 10	P 3275	O
	08.89-09.93	0 986 45	F 0114 ¹	K



Legacy 2.0

2,0 110 EJ204	06.09→	F 026 40	P 7001	O
		1 987 43	M 2190	I

Legacy 2.0 D

2,0 110 EE20Z	06.09→	1 987 43	M 2190	I
-------------------	--------	----------	--------	---

Legacy 2.0 i

2,0 92 EJ20 (DOHC); EJ20 (SOHC)	06.91-11.98	0 451 10	P 3275	O
		1 987 42	S 9051	L

2,0 | 92-99 | EJ20 (DOHC); EJ20 (SOHC)

	10.93-11.98	0 451 10	P 3275	O
--	-------------	----------	--------	---

2,0 | 110 | EJ20 (DOHC); EJ20 (SOHC)

	10.93-11.98	0 451 10	P 3275	O
		1 987 42	S 9051	L

Legacy 2.0 i CNG 4WD

2,0 110 EJ20 (DOHC); EJ20 (SOHC)	05.04-04.07	F 026 40	P 7001	O
--------------------------------------	-------------	----------	--------	---

Legacy 2.0 i, i 4WD

2,0 103-110 EJ20 (DOHC); EJ20 (SOHC)	02.89-09.93	0 451 10	P 3275	O
		1 987 42	S 9051	L

Legacy 2.0 i, i 4WD, i 4WD Turbo

2,0 85/147 EJ20E; EJ20G	05.92-11.98	0 451 10	P 3275	O
		1 987 42	S 9051	L
	05.92-12.93	0 986 45	F 0114 ¹	K

Legacy 2.0 i Turbo 4WD

2,0 147 EJ20 (DOHC); EJ20 (SOHC)	10.89-09.93	F 026 40	P 7001	O
		0 451 10	P 3275	O
		1 987 42	S 9051	L

2,0 | 162/184 | EJ20 (DOHC); EJ20 (SOHC)

	02.89-11.98	0 451 10	P 3275	O
		1 987 42	S 9051	L

2,0 | 184-206 | EJ20 (DOHC); EJ20 (SOHC)

	10.93-04.03	0 451 10	P 3275	O
	10.93-05.09	F 026 40	P 7001	O
	10.93-04.03	1 987 42	S 9051	L

2,0 | 206 | EJ208

	05.01-03.03	0 451 10	P 3275	O
	04.03-06.03	F 026 40	P 7001	O
	05.01-06.03	1 987 42	S 9051	L
	TW	0 986 45	F 0114 ¹	K

2,0 | 216 | EJ20 (DOHC); EJ20 (SOHC)

	11.02-04.03	0 451 10	P 3275	O
--	-------------	----------	--------	---



**Legacy 2.0 i 4WD**

2,0 92 EJ20 (DOHC); EJ20 (SOHC)			
	02.89-09.93	F 026 40 P 7001	O
	06.91-11.98	0 451 10 P 3275	O
	06.96-11.98	F 026 40 P 7001	O
	06.91-11.98	1 987 42 S 9051	L

2,0 | 92 | EJ201

	10.98-03.03	0 451 10 P 3275	O
	04.03-06.03	F 026 40 P 7001	O
	10.98-06.03 TW	0 986 45 F 0114 ¹	K

2,0 | 92-99 | EJ20 (DOHC); EJ20 (SOHC)

	10.93-11.98	F 026 40 P 7001	O
--	-------------	-----------------	----------

2,0 | 101/103 | EJ20 (DOHC); EJ20 (SOHC)

	06.98-05.09	F 026 40 P 7001	O
--	-------------	-----------------	----------

2,0 | 110 | EJ20 (DOHC); EJ20 (SOHC)

	02.89-09.93	F 026 40 P 7001	O
	10.93-11.98	0 451 10 P 3275	O
		1 987 42 S 9051	L

2,0 | 110-114 | EJ20 (DOHC); EJ20 (SOHC)

	10.93-11.98	F 026 40 P 7001	O
--	-------------	-----------------	----------

2,0 | 114 | EJ20 (DOHC); EJ20 (SOHC)

	06.98-04.03	F 026 40 P 7001	O
	11.98-04.03	0 451 10 P 3275	O
		1 987 42 S 9051	L

2,0 | 132-140 | EJ20 (DOHC); EJ20 (SOHC)

	05.03-05.09	F 026 40 P 7001	O
--	-------------	-----------------	----------

Legacy 2.0 R 4WD**2,0 | 110-121 | EJ204**

	03.05-05.09	F 026 40 P 7001	O
--	-------------	-----------------	----------

Legacy 2.0 4WD**2,0 | 101 | EJ202**

	07.03-06.04	F 026 40 P 7001	O
--	-------------	-----------------	----------

Legacy 2.2 i**2,2 | 94-96 | EJ22E**

	01.94-05.97	0 451 10 P 3275	O
		1 987 42 S 9051	L
		0 986 45 F 0114 ¹	K

2,2 | 100 | EJ22

	12.90-12.93	0 451 10 P 3275	O
--	-------------	-----------------	----------

Legacy 2.2 i, i 4WD**2,2 | 97/99 | EJ22**

	01.90-05.96	0 451 10 P 3275	O
--	-------------	-----------------	----------

Legacy 2.2 i Turbo 4x4**2,2 | 119**

	09.88-12.93	0 451 10 P 3275	O
--	-------------	-----------------	----------

**Legacy 2.2 i 4WD****2,2 | 94-96 | EJ22E**

	01.94-05.97	0 451 10 P 3275	O
		1 987 42 S 9051	L

2,2 | 100 | EJ22

	07.89-12.93	0 451 10 P 3275	O
	01.89-08.95	1 987 42 S 9051	L
	08.89-08.95	0 986 45 F 0114 ¹	K

Legacy 2.5 , Turbo**2,5 | 123/195 | EJ253; EJ255**

	06.09→	F 026 40 P 7001	O
		1 987 43 M 2190	I

Legacy 2.5 i 4WD**2,5 | 110 | EJ25D <4CAM>**

	06.96-12.99	0 451 10 P 3275	O
		1 987 42 S 9051	L

2,5 | 115 | EJ251

	10.98-03.03	0 451 10 P 3275	O
	04.03-06.03	F 026 40 P 7001	O
	10.98-06.03 WW	1 987 42 S 9151	L
		TW 0 986 45 F 0114 ¹	K

2,5 | 115 | EJ252

	10.98-06.03	0 451 10 P 3275	O
--	-------------	-----------------	----------

2,5 | 118 | EJ25 (DOHC)

	10.94-11.98	0 451 10 P 3275	O
		1 987 42 S 9051	L

2,5 | 118-129 | EJ25 (DOHC)

	10.94-11.98	0 451 10 P 3275	O
--	-------------	-----------------	----------

2,5 | 121 | EJ25 (SOHC)

	10.03-04.06	F 026 40 P 7001	O
		TW 0 986 45 P 2061	O
		0 986 45 F 0114 ¹	K

2,5 | 123-125/129 | EJ25 (DOHC)

	08.97-04.03	0 451 10 P 3275	O
		1 987 42 S 9051	L

2,5 | 130 | EJ25 (SOHC)

	05.06-05.09	F 026 40 P 7001	O
--	-------------	-----------------	----------

Legacy 2.5 4WD**2,5 | 121 | EJ25**

	07.03-06.06	F 026 40 P 7001	O
		0 451 10 P 3275	O
		1 987 42 S 9051	L

2,5 | 127 | EJ25

	07.06-05.09	F 026 40 P 7001	O
--	-------------	-----------------	----------

Legacy 3.0 i 4WD**3,0 | 154 | EZ30D**

	07.00-06.03	0 451 10 P 3316	O
		1 987 42 S 9051	L
		TW 0 986 45 F 0114 ¹	K



◀ Legacy 3.0 i 4WD

3,0 162 EZ30	05.00-04.03	0 451 10 P 3316	0
		1 987 42 S 9051	L

3,0 184 EZ30	09.03-05.09	0 451 10 P 3316	0
--------------	-------------	-----------------	---

Legacy 3.0 4WD

3,0 180 EZ30D	07.03-05.09	0 451 10 P 3316	0
---------------	-------------	-----------------	---

Legacy 3.6

3,6 191 EZ36D	06.09→	0 451 10 P 3316	0
		1 987 43 M 2190	I

Leone

Leone 1.6 , 4WD

1,6 56 EA71	07.84-03.94	1 987 42 S 9036	L
		0 986 45 F 0117 ¹	K

Libero

Libero 1.0 , 4WD

1,0 37 EF10	10.83-04.93	0 986 45 P 2061	0
-------------	-------------	-----------------	---

Libero 1.2 i, i 4WD, i 4WD Transporter

1,2 40 EF12E	05.93-11.98	0 986 45 P 2061	0
--------------	-------------	-----------------	---

Liberty

Liberty 2.2 i

2,2 100 EJ22	01.89-12.95	0 451 10 P 3275	0
	01.89-12.94	1 987 42 S 9051	L
		0 986 45 F 0114 ¹	K

Outback

Outback 2.0 D

2,0 110 EE20Z	06.09→	1 987 43 M 2190	I
---------------	--------	-----------------	---

Outback 2.5

2,5 123 EJ253	06.09→	F 026 40 P 7001	0
		1 987 43 M 2190	I

Outback 3.6

3,6 191 EZ36D	06.09→	0 451 10 P 3316	0
		1 987 43 M 2190	I



Rex

Rex 0.7 i Supercharger 4WD, i 4WD

0,7 34-35/47 EN07 (SOHC)	03.90-03.92	0 986 45 P 2061	0
--------------------------	-------------	-----------------	---

SVX

SVX 3.3 i 4WD

3,3 169-176 EG33	09.92-12.96	1 987 42 S 9051	L
		0 986 45 F 0114 ¹	K

Tribeca

Tribeca 3.0 4x4

3,0 180 EZ30D	04.06-11.07	0 451 10 P 3316	0
---------------	-------------	-----------------	---

Tribeca 3.6 R

3,6 190 EZ36D	11.07→	0 451 10 P 3316	0
---------------	--------	-----------------	---

Vivio

Vivio 660 , i, i 4WD

0,7 32 EN07C; EN07E	08.93-04.00	0 986 45 P 2061	0
---------------------	-------------	-----------------	---

SUZUKI

Aerio

Aerio 1.5 i

1,5 81 M15A	11.01-07.07	0 451 10 P 3276	0
Fg.Nr. 100001→200000	11.01-07.07	1 987 42 S 9175	L
Fg.Nr. 100001→250000	11.01-07.07 TW	F 026 40 S 0090	L

Aerio 1.8 i

1,8 92 M18A	11.03-07.07	0 451 10 P 3276	0
		F 026 40 S 0090	L

Alto

Alto 0.7 , i, i Turbo, i 4WD

0,7 26-29/31/34/40/45/47 F6A (SOHC); K6A	03.90-12.09	0 986 45 P 2058	0
--	-------------	-----------------	---

Alto 1.0 , i

1,0 39/40 G10B	10.94-02.02	0 986 45 P 2058	0
Fg.Nr. →00180000	10.94-02.02 XXX	1 457 43 S 2109	L
	10.94-02.02	0 450 90 F 5954 ¹	K



**Alto 1.1 i 16V**

1,1 46 F10DN	02.02-12.06	0 986 45 P 2058	O
--------------	-------------	-----------------	---

Alto 800

0,8 29 F8B	01.86-11.93	0 986 45 P 2019	O
	XXX	1 457 43 S 2109	L

Baleno**Baleno 1.3 i 16V**

1,3 62-63 G13B	04.95-09.07	0 986 45 P 2058	O
		1 457 43 S 3953	L
		0 450 90 F 5920 ¹	K

Baleno 1.5 i 16V

1,5 71 G15A	04.95-04.05	0 986 45 P 2058	O
		1 457 43 S 3953	L
		0 450 90 F 5920 ¹	K

Baleno 1.6 i 16V

1,6 72 G16B	04.95-04.05	0 986 45 P 2044	O
		1 457 43 S 3953	L
		0 450 90 F 5920 ¹	K

1,6|72-74|G16B

04.95-04.05	0 986 45 P 2058	O
08.96-05.02	0 986 45 P 2044	O
04.95-04.05	1 457 43 S 3953	L
	0 450 90 F 5920 ¹	K

Baleno 1.6 i 16V 4WD

1,6 72-74 G16B	04.95-04.05	0 986 45 P 2058	O
		1 457 43 S 3953	L
		0 450 90 F 5920 ¹	K

Baleno 1.8 i 16V

1,8 89 G18A	09.95-08.06	0 451 10 P 3276	O
		1 457 43 S 3953	L
		0 450 90 F 5920 ¹	K

Baleno 1.9 D Turbo

1,9 55 XUD9	04.98-05.02	0 451 10 P 3261	O
		1 457 43 S 3953	L

Cappuccino**Cappuccino 0.7 i Turbo**

0,7 47 F6A (DOHC); K6A	10.91-10.98	0 986 45 P 2058	O
------------------------	-------------	-----------------	---

**Cappuccino 660 Turbo**

0,7 47 F6A	08.93-08.03	0 986 45 P 2058	O
------------	-------------	-----------------	---

Carry**Carry 0.7 , i, i Turbo, i 4WD**

0,7 28-31/35-36/37/44-47 F6A (SOHC); K6A	10.90→	0 986 45 P 2058	O
--	--------	-----------------	---

Carry 1.0

1,0 31	07.90-11.93	0 986 45 P 2019	O
	12.93-09.94	0 986 45 P 2058	O
	07.90-09.94	0 986 45 F 0030 ¹	K

1,0|32-33|F10A

07.90-11.93	0 986 45 P 2019	O
12.93-09.94	0 986 45 P 2058	O
07.90-09.94	0 986 45 F 0030 ¹	K

1,0|33

04.88-09.94	0 986 45 F 0030 ¹	K
-------------	------------------------------	---

1,0|33|F10A

10.94-03.99	0 986 45 P 2058	O
10.85-03.99	1 987 42 S 9042/1	L
	0 986 45 F 0030 ¹	K

1,0|33|F10AK

10.94-03.99	0 986 45 P 2058	O
10.85-03.99	1 987 42 S 9042/1	L
	0 986 45 F 0030 ¹	K

Carry 1.3 16V

1,3 58 G13B	03.99-03.09	0 986 45 P 2058	O
-------------	-------------	-----------------	---

Escudo**Escudo 1.6 i**

1,6 79 G16A	01.94→	0 451 10 P 3276	O
		1 457 43 S 3956	L

Escudo 1.6 i 4WD

1,6 74 G16A	08.90-11.97	0 451 10 P 3276	O
		0 986 45 F 0109 ¹	K

1,6|79|G16A

11.97-11.02	0 451 10 P 3276	O
	1 457 43 S 3956	L
	0 450 90 F 5986 ¹	K

Escudo 2.0 i

2,0 94 J20A	01.01→	1 457 43 S 3956	L
-------------	--------	-----------------	---





Escudo 2.0 i 4WD

2,0 103 J20A	10.96-04.05	0 451 10 P 3276	O
		1 457 43 S 3956	L
2,0 107 J20A	05.05→	0 451 10 P 3276	O
		F 026 40 S 0125	L

Escudo 2.5 i 4WD

2,5 118 H25A	10.96-06.05	0 451 10 P 3276	O
		1 457 43 S 3956	L
		0 986 45 F 0109 ¹	K

Escudo 2.7 i 4WD

2,7 135 H27A	06.05→	0 451 10 P 3276	O
		F 026 40 S 0125	L

Every

Every 0.7

0,7 28-31 F6A (SOHC)	03.90-01.99	0 986 45 P 2058	O
		0 986 45 F 0030 ¹	K

Every 0.7 i, i Turbo

0,7 37/43-47 F6A (SOHC)	03.90-09.01	0 986 45 P 2058	O
-----------------------------	-------------	-----------------	---

Grand Escudo

Grand Escudo 2.7 i 4WD

2,7 130-135 H27A	12.00-06.05	0 451 10 P 3276	O
		1 457 43 S 3956	L
		1 987 43 M 2156	I
		1 987 43 M 2221	I

Grand Vitara

Grand Vitara 1.6 i 16V

1,6 69 G16B	03.98-03.08	0 451 10 P 3276	O	
		1 457 43 S 3956	L	
	B,D, GB	03.98-12.05	0 450 90 F 5986 ¹	K
		03.98-12.05	1 987 43 M 2156	I
	Fg.Nr. →00470000	03.98-03.08	1 987 43 M 2156	I

Grand Vitara 1.6 4WD

1,6 78 M16A	10.05→	0 451 10 P 3276	O
		F 026 40 S 0125	L
		1 987 43 M 2236	I



Grand Vitara 1.9 DDiS

1,9 95 F9Q	10.05→	F 026 40 P 7022	O
		F 026 40 S 0125	L
		1 457 43 N 1705	K
		1 987 43 M 2236	I

Grand Vitara 2.0

2,0 94 J20A	05.98→	1 457 43 S 3956	L
-----------------	--------	-----------------	---

Grand Vitara 2.0 D Turbo

2,0 68 RF	03.98-03.08	1 457 43 S 3956	L
		0 986 45 N 0508 ²	K
		1 987 43 M 2156	I

2,0 80 RHW	11.00-12.05	0 451 10 P 3355	O
		1 457 43 S 3956	L
		1 457 03 N 0013	K
		1 987 43 M 2221	I

2,0 80 RHZ	11.00-12.05	0 451 10 P 3355	O
		1 457 43 S 3956	L
		1 457 03 N 0013	K
		1 987 43 M 2156	I

Grand Vitara 2.0 i 4WD

2,0 103 J20A	10.00→	0 451 10 P 3276	O
		1 457 43 S 3956	L
		1 987 43 M 2221	I

Grand Vitara 2.0 i 16V

2,0 94 J20A	03.98-03.08	0 451 10 P 3276	O	
		1 457 43 S 3956	L	
		0 450 90 F 5986 ¹	K	
	B,D, GB	03.98-12.05	0 450 90 F 5986 ¹	K
		03.98-12.05	1 987 43 M 2221	I
Fg.Nr. →00470000	03.98-03.08	1 987 43 M 2156	I	

Grand Vitara 2.0 4WD

2,0 103 J20A	10.05→	0 451 10 P 3276	O
		F 026 40 S 0125	L
		1 987 43 M 2236	I

Grand Vitara 2.4 4x4

2,4 122-124 J24B	09.08→	0 451 10 P 3276	O
		1 987 43 M 2236	I

Grand Vitara 2.5 i 4WD

2,5 87 H25A	03.01-12.04	0 451 10 P 3276	O
		1 457 43 S 3956	L
		1 987 43 M 2221	I

**Grand Vitara 2.5 i 24V**

2,5 106 H25A				
	04.98-12.05	0 451 10 P 3276	O	
		1 457 43 S 3956	L	
	B,D, GB	04.98-12.05	0 450 90 F 5986	1 K
	04.98-12.05	1 987 43 M 2221	I	

Grand Vitara 2.7 i XL-7 4WD

2,7 128 H27A				
	10.02→	0 451 10 P 3276	O	
		1 987 43 M 2221	I	

Grand Vitara 2.7 XL-7

2,7 127-135 H27A				
	06.01→	0 451 10 P 3276	O	
Fg.Nr. →00200000	06.01→	1 457 43 S 3956	L	
Fg.Nr. →00170000	06.01→	1 987 43 M 2156	I	
Fg.Nr. 00170001→	06.01→	1 987 43 M 2221	I	

Grand Vitara 3.2 4x4

3,2 171 N32A				
	01.09→	1 987 43 M 2236	I	

Ignis**Ignis 1.3 DDiS Turbo**

1,2 51 Z13DT				
	10.03-12.07	F 026 40 P 7067	O	
		1 987 42 S 9173	L	
		1 457 07 N 0001	K	
		1 987 43 M 2066	I	

Ignis 1.3 i 16V

1,3 61 M13A				
	10.00-09.03	0 451 10 P 3276	O	
Fg.Nr. S00170001→	10.00-09.03	0 451 10 P 3276	O	
Fg.Nr. →S00170000	10.00-09.03	0 451 10 P 3276	O	
	10.00-09.03	F 026 40 S 0001	L	

Ignis 1.3 i 16V, i 16V 4WD

1,3 69 M13A				
	10.03-12.07	0 451 10 P 3276	O	
		F 026 40 S 0045	L	
		1 987 43 M 2066	I	

Ignis 1.3 i 16V 4WD

1,3 61 M13A				
	10.00-09.03	0 451 10 P 3276	O	
		F 026 40 S 0001	L	

Ignis 1.5 i 16V, i 16V 4WD

1,5 73 M15A				
	10.03-12.07	0 451 10 P 3276	O	
		F 026 40 S 0045	L	
		1 987 43 M 2066	I	

**Ignis 1.5 i 16V Sport**

1,5 80 M15A				
	12.03-12.07	0 451 10 P 3276	O	
		F 026 40 S 0045	L	

Jimny**Jimny 0.7 i Turbo 4WD**

0,7 47 F6A(SOHC)				
	11.95-10.98	0 986 45 P 2058	O	
		1 987 42 S 9042/1	L	

0,7|47|K6A

	10.98→	0 986 45 P 2058	O	
--	--------	------------------------	----------	--

Jimny 1.3 i 4WD

1,3 63 G13B(SOHC)				
	11.95-12.97	0 451 10 P 3276	O	
		1 987 42 S 9125	L	

Jimny 1.3 i 4WD, i 16V, i 16V 4WD

1,3 59/60-63/65 G13BB;M13A				
	10.98→	0 451 10 P 3276	O	

Jimny 1.5 DDiS 4WD

1,5 48/63 ;K9K				
	12.03→	F 026 40 P 7022	O	

Kizashi**Kizashi 2.4 i, i 4WD**

2,4 131 J24B				
	06.10→	0 451 10 P 3276	O	

Liana**Liana 1.3 i 16V**

1,3 66 M13A				
	03.01-12.04	0 451 10 P 3276	O	
		F 026 40 S 0090	L	
Fg.Nr. →00150000	04.02-12.04	1 987 42 S 9175	L	
Fg.Nr. 00150001→	04.02-12.04	F 026 40 S 0090	L	
	03.01-12.04	1 987 43 M 2172	I	

Liana 1.4 D

1,4 66 8HY				
	03.05-12.07	1 457 42 P 9238	O	
		1 457 43 S 3160	L	





Liana 1.6 i 16V

1,6 76 M16A			
	03.01-04.08	0 451 10 P 3276	O
Fg.Nr. →00150000	04.02-12.07	1 987 42 S 9175	L
Fg.Nr. →00200000	03.01-04.08	1 987 42 S 9175	L
Fg.Nr. 00150001→00300000	04.02-12.07	F 026 40 S 0090	L
Fg.Nr. 00200001→00350000	03.01-04.08	F 026 40 S 0090	L
	03.01-04.08	0 450 90 F 2162 ¹	K
		1 987 43 M 2172	I

Liana 1.6 i 16V 4WD

1,6 76 M16A			
	03.01-04.08	0 451 10 P 3276	O
Fg.Nr. →00150000	04.02-12.07	1 987 42 S 9175	L
Fg.Nr. →00200000	03.01-04.08	1 987 42 S 9175	L
Fg.Nr. 00150001→00300000	04.02-12.07	F 026 40 S 0090	L
Fg.Nr. 00200001→00350000	03.01-04.08	F 026 40 S 0090	L
	03.01-04.08	1 987 43 M 2172	I

Liana 1.8 i 16V

1,8 92 M18A			
	04.05-12.07	0 451 10 P 3276	O
		F 026 40 S 0090	L
		1 987 43 M 2172	I

MR

MR 0.7 i, i Turbo

0,7 40/44 K6A			
	01.06-01.11	0 986 45 P 2058	O

Samurai

Samurai 1.3

1,3G13B			
	09.91-12.01	0 451 10 P 3276	O
		1 987 42 S 9125	L
		0 986 45 F 0030 ¹	K

1,3 | 44/47/50 | G13A

	11.88-12.04	0 451 10 P 3276	O
	11.88-03.95	1 987 42 S 9125	L
		0 986 45 F 0030 ¹	K

1,3 | 51 | G13B

	03.87-12.97	0 451 10 P 3276	O
		1 987 42 S 9125	L
		0 986 45 F 0030 ¹	K

Samurai 1.3 i

1,3 47 G13B			
	04.95-12.04	0 451 10 P 3276	O

1,3 | 51 | G13B

	08.93-12.04	0 451 10 P 3276	O
--	-------------	------------------------	----------

Samurai 1.9 D Turbo 4x4

1,9 | 46 | XUD9

	08.93-12.04	0 451 10 P 3261	O
Fg.Nr. *03CNT*	08.93-12.04	0 451 10 P 3261	O
Fg.Nr. *04CNA*	08.93-12.04	0 451 10 P 3336	O
	08.93-12.04	F 026 40 S 0015	L



Sidekick

Sidekick 1.5

1,5 103 G15A			
	06.95-12.01	1 457 43 S 3542	L

Solio

Solio 1.3 i 4WD

1,3 65 M13A			
	04.04-12.10	0 451 10 P 3276	O
		F 026 40 S 0001	L

Splash

Splash 1.0

1,0 48 K10B			
	01.08→	0 986 45 P 2058	O
		1 987 43 M 2214	I

Splash 1.2

1,2 63 K12B			
	01.08→	0 986 45 P 2058	O
		1 987 43 M 2214	I

Splash 1.3 DDiS

1,2 55 D13A <DPF>; Z13DTJ			
	01.08→	F 026 40 P 7067	O
		1 457 07 N 0001	K
		1 987 43 M 2214	I

Swift

Swift 1.0

1,0 40 G10			
	10.89-04.95	0 986 45 P 2058	O
		XXX 1 987 42 S 9149	L

Swift 1.0 i

1,0 39 G10			
	10.89-09.95	0 986 45 P 2058	O
		1 457 43 S 3785	L
		0 450 90 F 2162 ¹	K

1,0 | 39 | G10A

Fg.Nr. 00100001→00800000	03.96-12.04	0 986 45 P 2058	O
Fg.Nr. *00800001→	03.96-12.04	0 451 10 P 3276	O
	03.96-12.04	1 457 43 S 3785	L
		0 450 90 F 2162 ¹	K

Swift 1.2

1,2 69 K12B			
	09.10→	0 986 45 P 2058	O
		1 987 43 M 2173	I

Swift 1.2 4WD

1,2 69 K12B			
	01.11→	0 986 45 P 2058	O

**Swift 1.3****1,3|49|G13B**

10.89-12.91	0 986 45 P 2019	O
09.91-12.95	0 986 45 P 2058	O
10.89-12.91 EFV	1 457 43 S 3785	L
10.89-12.95 XXX	1 987 42 S 9149	L
01.90-12.91	0 450 90 F 2162 ¹	K

1,3|67|M13A

11.04→	0 451 10 P 3276	O
	F 026 40 S 0037	L
	1 987 43 M 2173	I

Swift 1.3 DDiS D Turbo**1,2|51-55|Z13DT**

Fg.Nr. →00500000	08.05→	F 026 40 P 7067	O
Fg.Nr. 00500001→	08.05→	F 026 40 P 7067	O
	08.05→	1 457 07 N 0001	K
		1 987 43 M 2173	I

1,2|55|D13A <DPF>

02.08→	F 026 40 P 7067	O
	1 457 07 N 0001	K
	1 987 43 M 2173	I

Swift 1.3 i**1,3|50|G13B**

08.91-09.95	0 986 45 P 2019	O
09.91-12.95	0 986 45 P 2058	O
08.91-12.95	1 457 43 S 3785	L
	0 450 90 F 2162 ¹	K

1,3|50|G13BA

06.96-03.01	0 986 45 P 2058	O
	1 457 43 S 3785	L
	0 450 90 F 2162 ¹	K

Swift 1.3 i, i 4WD**1,3|65|M13A**

02.00-03.06	0 451 10 P 3276	O
	F 026 40 S 0001	L

1,3|67|M13A

11.04-09.10	0 451 10 P 3276	O
-------------	-----------------	---

Swift 1.3 i 4WD**1,3|50|G13B**

03.91-04.95	0 986 45 P 2019	O
	1 457 43 S 3785	L
XXX	0 986 45 F 0226 ¹	K

Swift 1.3 i 16V**1,3|63|G13BB**

04.01-12.04	0 451 10 P 3276	O
XXX	1 987 42 S 9156	L
	0 450 90 F 2162 ¹	K

Swift 1.3 4WD**1,3|49|G13B**

01.90-12.91	0 986 45 P 2019	O
	EFV 1 457 43 S 3785	L
	XXX 1 987 42 S 9149	L
	0 986 45 F 0226 ¹	K

1,3|67|M13A

11.04→	0 451 10 P 3276	O
	1 987 43 M 2173	I

Swift 1.3 16V GTi**1,3|74|G13B**

03.89-09.95	0 986 45 P 2019	O
	XXX 1 987 42 S 9156	L
01.89-09.95	0 450 90 F 2162 ¹	K

Swift 1.4**1,4|70|K14B**

01.11→	0 986 45 P 2058	O
--------	-----------------	---

Swift 1.5**1,5|81|M15A**

11.04→	0 451 10 P 3276	O
	F 026 40 S 0037	L
	1 987 43 M 2173	I

Swift 1.5 i**1,5|85|M15A**

06.03-03.05	0 451 10 P 3276	O
-------------	-----------------	---

Swift 1.5 i, i 4WD**1,5|81|M15A**

11.04-09.10	0 451 10 P 3276	O
-------------	-----------------	---

Swift 1.6**1,6|92|M16A**

01.07→	0 451 10 P 3276	O
	F 026 40 S 0037	L
	1 987 43 M 2173	I

Swift 1.6 i**1,6|92|M16A**

09.05→	0 451 10 P 3276	O
--------	-----------------	---

Swift 1.6 i 16V**1,6|68|G16B**

09.91-09.95	0 986 45 P 2019	O
	0 450 90 F 2162 ¹	K

Swift 1.6 i 16V 4WD**1,6|68|G16B**

09.91-09.95	0 986 45 P 2019	O
XXX	0 986 45 F 0226 ¹	K





Swift 1.6 16V

1,6 70 G16A	11.89-12.91	0 986 45 P 2058	O
	11.89-09.95	0 986 45 P 2019	O
	11.89-12.91 XXX	1 987 42 S 9149	L
	09.91-09.95	0 450 90 F 2162 ¹	K

1,6 70 G16B	11.89-12.91	0 986 45 P 2019	O
	XXX	1 987 42 S 9149	L

Swift 1.6 16V 4WD

1,6 68 G16B	01.90-12.91	0 986 45 P 2019	O
	XXX	1 987 42 S 9149	L

1,6 70 G16A	01.90-09.95	0 986 45 P 2019	O
	01.90-12.91 XXX	1 987 42 S 9149	L
	09.91-09.95 XXX	0 986 45 F 0226 ¹	K

SX4

SX4 1.5

1,5 73 M15A	05.06→	0 451 10 P 3276	O	
	Fg.Nr. →00450000	05.06→	F 026 40 S 0201	L
	05.06→	1 987 43 M 2173	I	

SX4 1.6 DDiS

1,6 66 9HX	04.07→	1 457 42 P 9238	O
		1 457 43 S 3160	L
		1 987 43 M 2173	I

SX4 1.6 VVT, VVT 4WD

1,6 79 M16A	05.06→	0 451 10 P 3276	O
		F 026 40 S 0201	L
		1 987 43 M 2173	I

1,6 88 M16A	09.09→	0 451 10 P 3276	O
		1 987 43 M 2173	I

SX4 1.9 DDiS, DDiS 4WD

1,9 88 D19AA	05.06→	1 457 42 P 9248	O
		F 026 40 S 0056	L
		1 987 43 M 2173	I

SX4 2.0 DDiS, DDiS 4WD

2,0 99 D20AA <DPF>	09.09→	1 987 43 M 2173	I
--------------------	--------	-----------------	---

Twin

Twin 0.7 i

0,7 32 K6A	01.03-08.05	0 986 45 P 2058	O
------------	-------------	-----------------	---



Vitara

Vitara 1.6

1,6 60 G16A	03.88-03.98	0 451 10 P 3276	O
	09.88-03.98	1 457 43 S 3542	L
	XXX	0 986 45 F 0137 ¹	K

Vitara 1.6 i

1,6 55 G16A	03.88-03.98	0 451 10 P 3276	O
	03.95-03.98	1 457 43 S 3037	L
		0 986 45 F 0109 ¹	K

1,6 59 G16A	09.91-03.98	0 451 10 P 3276	O
		1 457 43 S 3037	L
		0 986 45 F 0109 ¹	K

Vitara 1.6 i 16V

1,6 70 G16B		0 451 10 P 3276	O
		0 986 45 F 0109 ¹	K

1,6 71 G16B	07.90-03.98	0 451 10 P 3276	O
		0 986 45 F 0109 ¹	K

Vitara 1.9 D 4x4

1,9 50 XUD9A	01.95-03.98	0 451 10 P 3261	O
		1 457 43 S 3956	L
		1 457 43 N 4201 ²	K

Vitara 2.0 D Turbo, D Turbo Interc.

2,0 52/64 RF	03.95-03.98	0 986 45 P 2064	O
		1 457 43 S 3956	L
		D 12.94-03.98	0 986 45 N 0508 ²

Vitara 2.0 i 16V, i 24V

2,0 97/100 H20A; J20A	03.95-03.98	0 451 10 P 3276	O
		1 457 43 S 3956	L
		0 986 45 F 0109 ¹	K

Vitara 2.5 i 24V

2,5 118 H25A	03.95-03.98	0 451 10 P 3276	O
		1 457 43 S 3956	L
		0 986 45 F 0109 ¹	K

Wagon R

Wagon R 0.7 i

0,7 38 F6A (SOHC)	10.98-12.00	0 986 45 P 2058	O
-------------------	-------------	-----------------	---

Wagon R 0.7 i, i Turbo, i 4WD

0,7 40/44/47 K6A	04.97-09.08	0 986 45 P 2058	O
------------------	-------------	-----------------	---



**Wagon R 0.7 i Turbo**

0,7 41-45 F6A(SOHC)	02.95-10.98	0 986 45 P 2058	O
		0 450 90 F 5954 ¹	K

Wagon R 0.7 i Turbo, i Turbo 4WD

0,7 44 F6A(SOHC)	10.98-11.01	0 986 45 P 2058	O
------------------	-------------	-----------------	---

Wagon R 1.0 i

1,0 51 K10A	05.99-12.00	0 986 45 P 2058	O
-------------	-------------	-----------------	---

Wagon R 1.0 i Turbo

1,0 74 K10A	05.99-12.00	0 986 45 P 2058	O
-------------	-------------	-----------------	---

Wagon R 1.0 i 16V

1,0 48-52 K10A	09.97-05.00	0 986 45 P 2058	O
----------------	-------------	-----------------	---

1,0 51 K10A	05.00-08.03	0 451 10 P 3276	O
		1 457 43 S 3153	L

Wagon R 1.2 i 16V, i 16V 4WD

1,2 51 K12A	07.98-05.00	0 986 45 P 2058	O
-------------	-------------	-----------------	---

Wagon R 1.3 DDiS D Turbo

1,3 51 Z13DT	09.03-03.06	F 026 40 P 7067	O
		1 987 42 S 9173	L
		1 457 07 N 0001	K

Wagon R 1.3 i

1,3 65 M13A	12.00-08.05	0 451 10 P 3276	O
		F 026 40 S 0001	L

Wagon R 1.3 i 16V, i 16V 4WD

1,3 56 G13BB	05.00-08.03	0 451 10 P 3276	O
		1 457 43 S 3153	L

1,3 69	09.03-03.06	0 451 10 P 3276	O
		F 026 40 S 0045	L

X-90**X-90 1.6 i, i 4WD, i 4x4**

1,6 71/74 G16A; G16B	09.95→	0 451 10 P 3276	O
		0 986 45 F 0109 ¹	K

TALBOT ***Express****Express 1.8**

1,8 50 XM7T	01.84-12.93	0 451 10 P 3261	O
	09.81-12.93 XXX	1 457 43 S 2149	L

Express 1.9 D

1,9 51 XUD9A	11.87-12.93	0 451 10 P 3261	O
		1 457 43 S 2138	L
		1 457 42 N 9289	K

Express 2.0

2,0 57/72 XN1TA; XN1TACP Kat.	01.84-12.93	0 451 10 P 3261	O
	09.81-12.93 XXX	1 457 43 S 2149	L

Express 2.5 D

2,5 55 CRD93	09.81-12.93	0 451 10 P 3144	O
	XXX	1 457 43 S 3800	L
	06.86-12.93 CAV	1 457 43 N 4200 ²	K

Express 2.5 D Turbo

2,5 70 CRD93LS	07.87-12.93	0 451 10 P 3238	O
	XXX	1 457 43 S 3800	L
	CAV	1 457 43 N 4200 ²	K

TATA (TELCO)**Estate****Estate 2.0 i 16V**

2,0 103 4PL	10.95→	0 450 90 F 5201 ¹	K
-------------	--------	------------------------------	---

Sierra**Sierra 2.0 i 16V**

2,0 103 4PL	10.95→	0 450 90 F 5201 ¹	K
-------------	--------	------------------------------	---

Tatamobile**Tatamobile 2.0 i 16V**

2,0 103	10.95→	0 450 90 F 5201 ¹	K
---------	--------	------------------------------	---





Telcoline

Telcoline 2.0 TDi

2,0 64	10.03→	1 457 43 N 4459 ²	K
--------	--------	------------------------------	---

THINK NORDIC

Think City

Think City

30 958617	08.10→	1 987 43 M 2048	I
-----------	--------	-----------------	---

TOYOTA

Allex

Allex 1.5 i, i 4WD

1,5 77/80-81 1NZFE	01.01-10.06	0 986 45 P 2028	O
		F 026 40 S 0017	L

Allex 1.8 i

1,8 140 2ZZGE	01.01-10.06	0 451 10 P 3276	O
		F 026 40 S 0017	L

Allion

Allion 1.5 i

1,5 80 1NZFE	12.01-05.07	0 986 45 P 2028	O
		F 026 40 S 0017	L

Allion 1.8 i, i 4WD

1,8 92/97 1ZZFE	12.01-05.07	0 986 45 P 2028	O
		F 026 40 S 0017	L

Alphard

Alphard 2.4 i, i 4WD

2,4 96/117 2AZFE; 2AZFXE	05.02-05.08	0 451 10 P 3276	O
		1 987 42 S 9163	L

Alphard 3.0 i

3,0 162 1MZFE	05.02-05.08	0 986 45 P 2044	O
		1 987 42 S 9187	L



Altezza

Altezza 2.0 i

2,0 118 1GFE	10.98-07.05	0 986 45 P 2044	O
		F 026 40 S 0158	L

2,0 147 3SGE	10.98-07.05	0 986 45 P 2028	O
--------------	-------------	-----------------	---

Altezza 3.0 i

3,0 162 2JZGE	06.01-07.05	0 986 45 P 2044	O
---------------	-------------	-----------------	---

Aristo

Aristo 3.0 i, i Turbo

3,0 169/206 2JZGE; 2JZGTE	08.97-01.05	0 986 45 P 2044	O
---------------------------	-------------	-----------------	---

Auris

Auris 1.3 VVT-i

1,3 74 1NRFE	11.08→	F 026 40 S 0114	L
		1 987 43 M 2190	I

Auris 1.4

1,4 71 4ZZFE	10.06-03.09	0 986 45 P 2028	O
	02.07-03.09	F 026 40 S 0114	L
		1 987 43 M 2190	I

Auris 1.4 D-4D

1,4 66 1NDTV	10.06-01.09	0 986 45 P 2044	O
	02.07→	1 987 43 M 2190	I

Auris 1.4 i

1,4 71 4ZZFE	07.07→	0 986 45 P 2028	O
		F 026 40 S 0114	L

Auris 1.6

1,6 91 1ZRFE	10.06-02.09	0 986 45 P 2028	O
	12.08→	F 026 40 P 7091	O
	10.06→	F 026 40 S 0114	L
		1 987 43 M 2190	I

1,6|97|1ZRFAE

	12.08→	F 026 40 P 7091	O
	02.09→	F 026 40 S 0114	L
		1 987 43 M 2190	I

Auris 1.8 i

1,8 100 2ZRFE	10.06-10.09	F 026 40 P 7091	O
---------------	-------------	-----------------	---





1,8 108 2ZRFAE	12.08→	F 026 40 P 7091	O
	02.09→	F 026 40 S 0114	L
		1 987 43 M 2190	I

Auris 1.8 VVT-i HSD

1,8 73 2ZRFXE	06.10→	F 026 40 P 7091	O
		F 026 40 S 0153	L
		1 987 43 M 2190	I

Auris 2.0 D-4D

2,0 93 1ADFTV	09.06→	F 026 40 P 7090	O
		1 987 43 M 2190	I

Auris 2.2 D-CAT

2,2 130 2AD-FHV	02.07→	F 026 40 P 7090	O
		1 987 43 M 2190	I

Avalon

Avalon 3.0

3,0 141 1MZFE	09.98-08.04	0 986 45 P 2044	O
		1 987 42 S 9151	L

Avalon 3.0 i 24V

3,0 141 1MZFE	09.94-08.99	0 986 45 P 2044	O
		1 987 42 S 9151	L
		0 986 45 F 0221 ¹	K

3,0 145 1MZFE	01.03-06.05	0 986 45 P 2044	O
		1 987 42 S 9151	L

3,0 147-157 1MZFE	03.95-02.00	0 986 45 P 2044	O
		1 987 42 S 9151	L

Avensis

Avensis 1.6

1,6 97 1ZRFAE	11.08-11.11	F 026 40 P 7091	O
		F 026 40 S 0114	L
		1 987 43 M 2190	I

Avensis 1.6 i 16V

1,6 74/81 4AFE	10.97-07.00	0 986 45 P 2028	O
		1 987 42 S 9152	L
		F 026 40 F 3001 ¹	K
		0 986 45 F 0221 ¹	K
		RLE 0 986 45 F 0221 ¹	K
		1 987 43 M 2159	I



1,6 81 3ZZFE	07.00-11.08	0 986 45 P 2028	O
		0 986 45 S 9152	L
		0 986 45 F 5978 ¹	K
		RLE 0 450 90 F 5987 ¹	K
		1 987 43 M 2159	I
		1 987 43 M 2088	I

Avensis 1.8

1,8 108 2ZRFAE	11.08-11.11	F 026 40 P 7091	O
		F 026 40 S 0114	L
		1 987 43 M 2190	I

Avensis 1.8 i 16V

1,8 81 7AFE	10.97-07.00	0 986 45 P 2028	O
		1 987 42 S 9152	L
		F 026 40 F 3001 ¹	K
		0 986 45 F 0221 ¹	K
		RLE 0 986 45 F 0221 ¹	K

1,8 | 95 | 1ZZFE

	07.00-11.08	0 986 45 P 2028	O
		1 987 42 S 9152	L
		0 986 45 F 5978 ¹	K
		RLE 0 450 90 F 5987 ¹	K
		1 987 43 M 2159	I
		1 987 43 M 2088	I

Avensis 2.0

2,0 102/112 3ZRFAE; 3ZRFE	11.08→	F 026 40 P 7091	O
		F 026 40 S 0114	L
		1 987 43 M 2190	I

2,0 112 1AZFE	11.08-11.11	0 451 10 P 3276	O
		F 026 40 S 0188	L
		1 987 43 M 2190	I

Avensis 2.0 D Turbo

2,0 66 2CT; 2CTE	10.97-07.00	0 451 10 P 3365	O
		1 457 43 S 3060	L
		1 457 43 N 4440 ²	K
		1 987 43 M 2159	I

2,0 85 1CDFTV	08.99-01.03	0 986 45 P 2062	O
		0 451 10 P 3365	O
		1 987 42 S 9135	L
		1 987 42 S 9183	L
		1 457 43 N 4440 ²	K
		1 457 43 N 4438 ²	K
		1 987 43 M 2159	I
		1 987 43 M 2088	I





Avensis 2.0 D-4D

2,0 93 1ADFTV	04.06-11.11	F 026 40 P 7090	O
	04.06-11.08	F 026 40 S0121	L
	04.06-04.10	1 457 43 N 4440 ²	K
	04.06-11.08	1 987 43 M 2088	I
	11.08-11.11	1 987 43 M 2190	I

Avensis 2.0 i 16V

2,0 94 3SFE	10.97-01.03	0 986 45 P 2028	O
		1 987 42 S 9152	L
		F 026 40 F 3001 ¹	K
	RLE	0 986 45 F 0221 ¹	K
		1 987 43 M 2159	I

2,0 108 1AZFE	01.03-11.08	0 451 10 P 3276	O
		WW F 026 40 S 0017	L
		1 987 43 M 2088	I

2,0 110 1AZFSE	07.00-01.03	0 451 10 P 3276	O	
		1 987 42 S 9152	L	
		0 450 90 F 5951 ¹	K	
		RLE	0 450 90 F 5987 ¹	K
			1 987 43 M 2159	I

2,0 114 1AZFSE	01.03-11.08	0 451 10 P 3276	O
		WW F 026 40 S 0017	L
		1 987 43 M 2088	I

Avensis 2.0 i 16V 4WD

2,0 114 1AZFSE	09.03-11.08	0 451 10 P 3276	O
		F 026 40 S 0017	L
		1 987 43 M 2088	I

Avensis 2.2 D-CAT

2,2 110-130 2ADFHV	11.08-11.11	F 026 40 P 7090	O
	11.08-04.10	1 457 43 N 4440 ²	K
	11.08-11.11	1 987 43 M 2190	I

2,2 130 2AD-FHV	04.05-11.08	F 026 40 P 7090	O
		F 026 40 S0121	L
		1 457 43 N 4440 ²	K
		1 987 43 M 2088	I

Avensis 2.2 D-4D

2,2 110 2AD-FTV	04.05-11.08	F 026 40 P 7090	O
		F 026 40 S0121	L
		1 457 43 N 4440 ²	K
		1 987 43 M 2088	I

2,2 110 2ADFTV	11.08-11.11	F 026 40 P 7090	O
	11.08-04.10	1 457 43 N 4440 ²	K
	11.08-11.11	1 987 43 M 2190	I



Avensis 2.4 i

2,4 120 2AZFSE	09.03-11.08	0 451 10 P 3276	O
		WW F 026 40 S 0017	L
		1 987 43 M 2088	I

Avensis Verso

Avensis Verso 2.0 D Turbo

2,0 85 1CDFTV	05.01-07.05	0 451 10 P 3365	O
		1 987 42 S 9135	L
		1 457 43 N 4440 ²	K
		1 987 43 M 2085	I

Avensis Verso 2.0 i 16V

2,0 110 1AZFE	05.01-07.05	0 451 10 P 3276	O
		F 026 40 S 0017	L
		1 987 43 M 2085	I

Avensis Verso 2.4 i 16V

2,4 115 2AZFE	10.03→	0 451 10 P 3276	O
		F 026 40 S 0017	L
		1 987 43 M 2085	I

Aygo

Aygo 1.0

1,0 50 1KRFE	02.05→	0 986 45 P 2028	O
		1 457 43 S 3971	L
		1 987 43 M 2189	I

Aygo 1.4

1,4 40 2WZTV	05.05→	1 457 43 S 3076	L
		0 450 90 N 6460 ¹	K
		1 987 43 M 2189	I

Belta

Belta 1.3 i

1,3 64 2SZFE	11.05→	0 986 45 P 2028	O
--------------	--------	-----------------	---

Caldina

Caldina 1.8 i

1,8 85 7AFE	01.96-09.02	0 986 45 P 2028	O
		1 987 42 S 9135	L
		0 986 45 F 0221 ¹	K

1,8 97 1ZZFE	09.02-06.07	0 986 45 P 2028	O
		F 026 40 S 0017	L



Caldina 2.0 D			
2,0 54 2C	11.92-01.96	0 986 45 P 2030	O
		1 987 42 S 9135	L

Caldina 2.0 i, i 4WD			
2,0 99 103 3SFE	08.97-09.02	0 986 45 P 2028	O
		1 987 42 S 9135	L
		0 986 45 F 0221 ¹	K

2,0 110-114 1AZFSE	09.02-06.07	0 451 10 P 3276	O
		F 026 40 S 0017	L

Caldina 2.0 i Turbo 4WD			
2,0 191 3SGTE	08.97-06.07	0 451 10 P 3276	O
		1 987 42 S 9151	L
	08.97-09.02	0 986 45 F 0221 ¹	K

Caldina 2.2 D Turbo 4WD			
2,2 69 3CTE	08.97-09.02	0 451 10 P 3365	O
		F 026 40 S 0038	L
		1 457 43 N 4440 ²	K

Camry

Camry 1.8 i			
1,8 85 92 4SFE	07.90-06.98	0 986 45 P 2028	O
		1 987 42 S 9135	L

Camry 2.0			
2,0 82 3SFC	07.89-06.91	0 986 45 P 2028	O
		0 986 45 F 0039 ¹	K

Camry 2.0 D Turbo			
2,0 62-63 67 2CT	10.86-06.94	0 986 45 P 2030	O
		F 026 40 S 0038	L
	01.86-06.94	1 457 43 N 4438 ²	K
		1 457 43 N 4438	K
		1 457 43 N 4438 ²	K

Camry 2.0 i			
2,0 88 3SFE	01.87-11.92	0 986 45 P 2028	O
		1 987 42 S 9123	L

2,0 92 3SFE	11.92-07.01	0 986 45 P 2028	O
		1 987 42 S 9151	L
		0 986 45 F 0604 ¹	K



2,0 107 1AZFE	05.02-11.04	0 451 10 P 3276	O
		FPJ 1 987 42 S 9187	L

Camry 2.0 i, i 4WD			
2,0 99 103 3SFE	07.90-06.98	0 986 45 P 2028	O
		1 987 42 S 9135	L

Camry 2.0 i, i 4x4			
2,0 89-94 3SFE	10.86-05.91	0 986 45 P 2028	O
		1 987 42 S 9123	L
		0 450 90 F 5955 ¹	K

Camry 2.0 i 16V			
2,0 118 1AZFE	08.01-01.06	0 451 10 P 3276	O
		1 987 42 S 9187	L

Camry 2.2 D Turbo, D Turbo 4WD			
2,2 65 67 3CT	06.94-06.98	0 451 10 P 3365	O
		F 026 40 S 0038	L
		1 457 43 N 4438	K

Camry 2.2 i			
2,2 93 5SFE	02.93-04.98	0 986 45 P 2028	O
	02.93-06.95	1 987 42 S 9151	L
	02.93-04.98	0 986 45 F 0604 ¹	K

2,2 94 5SFE	05.98-02.02	0 986 45 P 2028	O
		1 987 42 S 9151	L
		0 450 90 F 5914 ¹	K

2,2 95 5SFE	10.96-12.02	0 986 45 P 2028	O
		1 987 42 S 9151	L
		0 986 45 F 0221 ¹	K

2,2 97 5SFE	11.97-02.03	0 986 45 P 2028	O
	06.92-02.03	1 987 42 S 9151	L
	11.92-10.97	0 986 45 F 0604 ¹	K
	09.00-02.03 TW	0 986 45 F 0221 ¹	K

Camry 2.2 i, i 4WD			
2,2 103 5SFE	12.96-09.01	0 986 45 P 2028	O
		1 987 42 S 9151	L

Camry 2.2 i 16V			
2,2 96 5SFE	08.96-09.01	0 986 45 P 2028	O
		1 987 42 S 9151	L



◀ Camry 2.2 i 16V

2,2 100 5SFE	08.96-09.01	0 986 45 P 2028	O
		1 987 42 S 9151	L
2,2 100-103 5SFE	03.92-08.96	0 986 45 P 2028	O
		1 987 42 S 9151	L
		0 986 45 F 0604 ¹	K
		0 986 45 F 0221 ¹	K

Camry 2.4

2,4 123 2AZFE	08.02-08.09	0 451 10 P 3276	O
		1 987 42 S 9187	L
		1 987 43 M 2085	I

Camry 2.4 i

2,4 112 2AZFE	09.02-05.06	0 451 10 P 3276	O
		1 987 42 S 9187	L
		1 987 43 M 2085	I

2,4 113 2AZFE	08.01-01.06	0 451 10 P 3276	O
		1 987 42 S 9187	L
		1 987 43 R 2320	I

2,4 123 2AZFE	01.06→	0 451 10 P 3276	O
		1 987 43 M 2190	I

Camry 2.4 i, i 4WD

2,4 117 2AZFE	09.01-01.06	0 451 10 P 3276	O
		1 987 42 S 9187	L

Camry 2.4 i 4WD

2,4 123 2AZFE	01.06→	0 451 10 P 3276	O
---------------	--------	-----------------	---

Camry 2.4 i 16V

2,4 112 2AZFE	08.01-01.06	0 451 10 P 3276	O
		1 987 42 S 9187	L
		1 987 43 R 2320 ⁸	I

Camry 2.5 , i Hybrid

2,5 133/151 2ARFXE; 2AZFE	08.11→	1 987 43 M 2190	I
---------------------------	--------	-----------------	---

Camry 2.5 i

2,5 117 2VZFE	06.88-02.93	0 986 45 P 2044	O
		1 987 42 S 9135	L

2,5 118 2VZFE	02.88-05.91	0 986 45 P 2044	O
		1 987 42 S 9135	L
		0 450 90 F 5955 ¹	K

2,5 147 2MZFE	12.96-09.01	0 986 45 P 2044	O
		1 987 42 S 9151	L



Camry 3.0 i

3,0 136 3VZFE	02.93-06.97	0 986 45 P 2044	O
		1 987 42 S 9151	L
		0 986 45 F 0604 ¹	K

3,0 138 3VZFE	11.92-08.97	0 986 45 P 2044	O	
		0 896 08.97	1 987 42 S 9151	L
		11.92-08.97	0 986 45 F 0604 ¹	K

3,0 141 1MZFE	07.97-06.06	0 986 45 P 2044	O	
		0 797 08.02	1 987 42 S 9151	L
		0 902 06.06	1 987 42 S 9187	L
		0 797 08.02	0 986 45 F 0604 ¹	K
		0 902 06.06	1 987 43 M 2085	I

Camry 3.0 i, i 24V

3,0 138/140 1MZFE	08.96-02.03	0 986 45 P 2044	O
		1 987 42 S 9151	L

Camry 3.0 i 24V

3,0 137 1MZFE	08.99-01.06	0 986 45 P 2044	O	
		0 998 08.06	1 987 42 S 9187	L
		0 899 01.06	1 987 43 R 2320	I

3,0 138 3VZFE	06.91-08.96	0 986 45 P 2044	O
		1 987 42 S 9151	L
		0 691 08.94	0 986 45 F 0604 ¹
	0 994 08.96	0 986 45 F 0221 ¹	K

3,0 141 1MZFE	08.96-09.01	0 986 45 P 2044	O
		1 987 42 S 9151	L

Camry 3.0 Si

3,0 138 3VZFE	08.92-08.97	0 986 45 P 2044	O
		11.92-08.97	0 986 45 F 0604 ¹

Camry 3.5

3,5 204 2GRFE	01.06→	F 026 40 S 0188	L
		1 987 43 M 2190	I

Carina

Carina 1.5 i

1,5 69 5AFE	05.90-11.92	0 986 45 P 2028	O
		1 987 42 S 9135	L

1,5 74 5AFE	08.96-12.01	0 986 45 P 2028	O
		1 987 42 S 9135	L
		0 986 45 F 0221 ¹	K

1,5 77 5AFE	08.92-08.96	0 986 45 P 2028	O
		1 987 42 S 9135	L

**Carina 1.6 i**

1,6 77 4AFE	08.92-08.96	0 986 45 P 2028	O
		1 987 42 S 9135	L

1,6 81 4AFHE	05.90-08.92	0 451 10 P 3276	O
		1 987 42 S 9135	L
		0 986 45 F 0111 ¹	K

1,6 88 4AGE	05.88-08.92	0 451 10 P 3276	O
		1 987 42 S 9135	L
		0 986 45 F 0111 ¹	K

1,6 121 4AGE	08.96-12.01	0 986 45 P 2028	O
		1 987 42 S 9135	L
		0 986 45 F 0221 ¹	K

Carina 1.6 i 4WD

1,6 74 4AFE	08.88-08.92	0 986 45 P 2028	O
		1 987 42 S 9137	L
		0 986 45 F 0110 ¹	K

Carina 1.6 i 16V

1,6 72-75 4AFE	12.87-01.92	0 986 45 P 2028	O
		1 987 42 S 9137	L
		11.89-01.92 AG	1 987 42 S 9135
	12.87-01.92	0 986 45 F 0111 ¹	K

1,6 75 4AFE	02.94-01.96	0 986 45 P 2028	O
		1 987 42 S 9152	L
		0 986 45 F 0123 ¹	K

1,6 79 4AFE	02.92-10.97	0 986 45 P 2028	O
		1 987 42 S 9135	L
		1 987 42 S 9152	L
		0 986 45 F 0123 ¹	K
		1 987 43 M 2159	I
		1 987 43 M 2159	I

1,6 79 4AFE <Lean Burn>	12.92-10.97	0 986 45 P 2028	O
		1 987 42 S 9135	L
		1 987 42 S 9152	L
		0 986 45 F 0123 ¹	K
		1 987 43 M 2159	I

1,6 85 4AFE	02.92-10.97	0 986 45 P 2028	O
		1 987 42 S 9135	L
		1 987 42 S 9152	L
		0 986 45 F 0123 ¹	K
		1 987 43 M 2159	I

**Carina 1.6 i 16V, 16V**

1,6 67 4AF	12.87-01.92	0 986 45 P 2028	O
		1 987 42 S 9133	L

Carina 1.8 i

1,8 85 4SFE	05.90-11.92	0 986 45 P 2028	O
		1 987 42 S 9123	L
		0 986 45 F 0111 ¹	K

1,8 85 7AFE	08.94-12.01	0 986 45 P 2028	O
		1 987 42 S 9135	L
	08.96-12.01	0 986 45 F 0221 ¹	K

1,8 92 4SFE	08.92-04.98	0 986 45 P 2028	O
		1 987 42 S 9135	L
		1 987 42 S 9151	L
		0 986 45 F 0107 ¹	K

Carina 1.8 i 16V

1,8 79 7AFE	11.94-10.97	0 986 45 P 2028	O
		1 987 42 S 9135	L
		1 987 42 S 9152	L
		0 986 45 F 0123 ¹	K
		1 987 43 M 2159	I
		1 987 43 M 2159	I

Carina 2.0 D

2,0 53-54 2C	02.92-01.96	0 986 45 P 2030	O
		1 987 42 S 9135	L
		1 457 43 N 4438 ²	K
		1 987 43 M 2159	I

Carina 2.0 D, D 4WD

2,0 54 2C	12.87-08.96	0 986 45 P 2030	O
		1 987 42 S 9135	L
		1 457 43 N 4438	K
		1 457 43 N 4438 ²	K
		1 457 43 N 4438	K
		1 457 43 N 4438 ²	K

Carina 2.0 D Turbo

2,0 61 2CT	01.96-10.97	0 451 10 P 3365	O
		1 457 43 S 3060	L
		1 457 43 N 4440 ²	K

Carina 2.0 D Turbo, D Turbo 4WD

2,0 65 2CT	08.96-08.98	0 451 10 P 3365	O
		1 457 43 S 3060	L
		1 457 43 N 4440 ²	K





Carina 2.0 i

2,0 92 3SFE	09.89-09.93	0 986 45 P 2028	O
	09.90-09.93	1 987 42 S 9135	L
	09.89-09.93	0 986 45 F 0103 ¹	K
2,0 103 3SFE	09.93-04.98	0 986 45 P 2028	O
		1 987 42 S 9151	L
2,0 121 3SGE	09.89-09.93	0 986 45 P 2028	O
	09.90-09.93	1 987 42 S 9135	L
	09.89-09.93	0 986 45 F 0103 ¹	K
2,0 125 3SGE	09.93-04.98	0 986 45 P 2028	O
		1 987 42 S 9151	L

Carina 2.0 i 4WD

2,0 99 3SFE	08.92-12.01	0 986 45 P 2028	O
		1 987 42 S 9135	L
	08.92-08.96	0 986 45 F 0107 ¹	K
	08.96-12.01	0 986 45 F 0221 ¹	K
2,0 129 3SGE	05.94-04.98	0 986 45 P 2028	O
		1 987 42 S 9151	L

Carina 2.0 i 16V

2,0 89 3SFE	12.87-01.92	0 986 45 P 2028	O
		1 987 42 S 9135	L
		0 986 45 F 0111 ¹	K
2,0 94 3SFE	12.87-01.92	0 986 45 P 2028	O
		1 987 42 S 9123	L
		0 986 45 F 0111 ¹	K
2,0 98 3SFE	02.92-10.97	0 986 45 P 2028	O
	02.92-01.96	1 987 42 S 9135	L
	09.93-10.97	1 987 42 S 9152	L
	02.92-10.97	0 986 45 F 0107 ¹	K
		1 987 43 M 2159	I

2,0 115-116 3SGE	02.92-01.96	0 986 45 P 2028	O
		1 987 42 S 9135	L
		0 986 45 F 0107 ¹	K

2,0 129 3SGE	02.92-01.96	0 986 45 P 2028	O
		1 987 42 S 9135	L
		0 986 45 F 0107 ¹	K

Carina 2.2 D Turbo, D Turbo 4WD

2,2 69 3CTE	08.98-12.01	0 451 10 P 3365	O
		F 026 40 S 0038	L
		1 457 43 N 4440 ²	K



Celica

Celica 1.6 i 16V

1,6 77 4AFE	10.89-11.93	0 986 45 P 2028	O
	10.89-10.93	1 987 42 S 9137	L
		0 986 45 F 0123 ¹	K

Celica 1.8 i

1,8 107 1ZZFE	09.99-04.06	0 986 45 P 2028	O
		1 987 42 S 9137	L

1,8 140 2ZZGE	08.99-04.06	0 451 10 P 3276	O
		1 987 42 S 9137	L

Celica 1.8 i 16V

1,8 85 7AFE	11.93-08.99	0 986 45 P 2028	O
		1 987 42 S 9151	L
		0 986 45 F 0123 ¹	K

1,8 105 1ZZFE	08.99-09.05	0 986 45 P 2028	O
		1 987 42 S 9137	L
		1 987 43 M 2085	I

1,8 140 2ZZGE	08.00-08.05	0 451 10 P 3276	O
		1 987 42 S 9137	L
		1 987 43 M 2085	I

Celica 2.0 i

2,0 103 3SFE	09.89-08.99	0 986 45 P 2028	O
	09.89-09.93	0 986 45 F 0103 ¹	K

2,0 121 3SGE	09.89-09.93	0 986 45 P 2028	O
		0 986 45 F 0103 ¹	K

Celica 2.0 i, i 16V

2,0 125-132/147 3SGE	09.93-08.99	0 986 45 P 2028	O
		1 987 42 S 9151	L

Celica 2.0 i Turbo 4WD

2,0 165 3SGTE	10.89-09.93	0 986 45 F 0103 ¹	K

2,0 188 3SGTE	02.94-08.99	0 986 45 P 2028	O
		1 987 42 S 9151	L

Celica 2.0 i 16V

2,0 118 3SGE	10.89-11.93	0 986 45 P 2028	O
		1 987 42 S 9135	L
	10.89-10.93	0 986 45 F 0103 ¹	K



**Celica 2.0 i 16V Turbo**

2,0 178 3SGTE	02.94-08.99	0 986 45 F 0103 ¹	K
---------------	-------------	------------------------------	---

Celica 2.0 i 16V Turbo 4WD

2,0 150-153 3SGTE	10.89-08.93	0 451 10 P 3276	O
	10.87-08.93	1 987 42 S 9135	L
	10.89-08.93	0 986 45 F 0103 ¹	K

2,0 178 3SGTE	02.94-06.96	0 451 10 P 3276	O
		1 987 42 S 9151	L

Celica 2.2 i 16V

2,2 98 5SFE	10.89-09.94	0 986 45 P 2028	O
	10.89-08.91	1 987 42 S 9137	L
	09.91-09.94	1 987 42 S 9135	L
	10.89-09.94	0 986 45 F 0103 ¹	K

2,2 100 5SFE	10.89-08.99	0 986 45 P 2028	O
	10.89-08.91	1 987 42 S 9137	L
	09.91-09.97	1 987 42 S 9135	L
	11.93-08.99	1 987 42 S 9151	L
	10.89-08.99	0 986 45 F 0103 ¹	K

Celsior

4,0 195/206 1UZFE	10.94-08.00	0 986 45 P 2044	O
-------------------	-------------	-----------------	---

4,3 206 3UZFE	08.00-06.06	0 986 45 P 2044	O
---------------	-------------	-----------------	---

Century

4,0 121 5VEU	09.87-01.92	0 451 10 P 4063	O
	02.92-01.97	0 986 45 P 2044	O
	09.87-01.97	1 457 43 S 3734	L

5,0 206/220 1GZFE	04.97→	1 457 43 S 3952	L
		1 987 43 R 2468 ⁸	I

Chaser

2,0 110 1GGE	08.88-10.92	0 986 45 P 2044	O
--------------	-------------	-----------------	---

Coaster

3,4 72 3B	02.83-07.99	0 986 45 P 2001	O
-----------	-------------	-----------------	---

4,2 103 1HZ	01.90-07.99	0 986 45 P 2062	O
-------------	-------------	-----------------	---

Comfort

2,0 96 3SFE	08.01→	0 986 45 P 2028	O
-------------	--------	-----------------	---

Condor

1,8 65 2Y	06.00-06.03	0 986 45 P 2000	O
-----------	-------------	-----------------	---

2,4 85 2RZE	06.00-02.05	0 986 45 P 2044	O
-------------	-------------	-----------------	---

Conquest

1,3 53 2E	10.88-08.93	0 986 45 F 0039 ¹	K
-----------	-------------	------------------------------	---

1,3 55 2E	06.93-09.96	0 986 45 F 0039 ¹	K
	11.98→	0 986 45 F 0039 ¹	K

1,6 79 4AFE	09.93-07.06	0 986 45 P 2028	O
		0 450 90 F 5963 ¹	K

Corolla

1,3 53 2E	04.97-07.01	0 986 45 P 2028	O
	04.97-10.99	1 987 42 S 9122	L
	04.97-07.01	0 986 45 F 0039 ¹	K

1,3 54 2E	05.87-01.94	0 986 45 P 2028	O
	11.97-11.04	0 986 45 P 2028	O
	05.87-01.94	1 987 42 S 9122	L
	11.97-11.04	1 987 42 S 9122	L
	08.87-09.91	0 986 45 F 0039 ¹	K
	11.97-11.04	0 986 45 F 0039 ¹	K





Corolla 1.3 , 12V

1,3 55 2E	05.87-08.99	0 986 45 P 2028	O
		1 987 42 S 9122	L
	05.92-08.99	0 986 45 F 0039 ¹	K

Corolla 1.3 i

1,3 64-65 2NZFE	08.00-10.06	0 986 45 P 2028	O
		F 026 40 S 0017	L

Corolla 1.3 i, i 16V

1,3 55-69 4EFE	05.92-06.02	0 986 45 P 2028	O
		1 457 43 S 3784	L
		0 986 45 F 0115 ¹	K

1,3 63-65/74 4EFE	09.90-08.00	0 986 45 P 2028	O
		1 457 43 S 3784	L
		0 986 45 F 0115 ¹	K

Corolla 1.3 i 12V

1,3 55/60 2EE	08.89-04.92	0 986 45 P 2028	O
		1 987 42 S 9137	L
		0 986 45 F 0110 ¹	K

Corolla 1.3 i 16V

1,3 63 4EFE	04.97-10.99	0 986 45 P 2028	O
		1 457 43 S 3784	L
		0 986 45 F 0115 ¹	K
		1 987 43 M 2155	I

Corolla 1.3 VVT-i

1,3 74 1NRFE	12.08→	F 026 40 S 0114	L
		1 987 43 M 2190	I

Corolla 1.3 12V

1,3 53-60 2E	05.87-04.92	0 986 45 P 2028	O
		1 987 42 S 9122	L

1,3 55-58 2E	08.87-04.92	0 986 45 P 2028	O
		1 987 42 S 9122	L

Corolla 1.4 , 16V

1,4 60 6AF	01.89-05.92	0 986 45 P 2028	O
		1 987 42 S 9133	L
		0 986 45 F 0138 ¹	K

Corolla 1.4 D Turbo

1,4 66 1NDTV	09.02-12.07	0 986 45 P 2044	O
		1 987 42 S 9183	L
		1 457 43 N 4440 ²	K
		1 987 43 M 2088	I



Corolla 1.4 D-4D

1,4 66 1NDTV <NDE150>	12.08→	1 987 43 M 2190	I
-----------------------	--------	------------------------	----------

Corolla 1.4 i

1,4 71 4ZZFE	01.02-07.07	0 986 45 P 2028	O
		F 026 40 S 0017	L
		0 986 45 F 0115 ¹	K

Corolla 1.4 i 16V

1,4 71 4ZZFE	10.99-12.07	0 986 45 P 2028	O
	10.99-09.01	1 457 43 S 3958	L
	10.01-12.07	F 026 40 S 0017	L
	10.99-09.01	0 450 90 F 5980 ¹	K
		1 987 43 M 2155	I
	06.04-12.07	1 987 43 M 2088	I

Corolla 1.4 VVT-i

1,4 71 4ZZFE	11.06-12.08	0 986 45 P 2028	O
		1 987 43 M 2190	I

Corolla 1.4 16V

1,4 60 6AFC	01.89-04.92	0 986 45 F 0138 ¹	K
-------------	-------------	-------------------------------------	----------

Corolla 1.5

1,5 58 3E	08.87-01.94	0 986 45 P 2028	O	
		09.91-01.94	1 987 42 S 9122	L
			0 986 45 F 0039 ¹	K

Corolla 1.5 D Turbo

1,5 49 1NT	10.94-07.99	0 451 10 P 3365	O	
		05.86-09.94	0 986 45 P 2030	O
		05.86-07.99	1 457 43 N 4438	K

Corolla 1.5 i

1,5 65-71 5EFE	01.94-06.02	0 986 45 P 2028	O
		1 457 43 S 3784	L
		0 986 45 F 0115 ¹	K

1,5 69 5AFE	05.89-09.91	0 986 45 P 2028	O
	06.89-09.91	1 987 42 S 9135	L
	05.89-09.91	0 986 45 F 0110 ¹	K

1,5 74-77 5AFE	06.91-08.00	0 986 45 P 2028	O
		1 457 43 S 3958	L
		0 986 45 F 0115 ¹	K

1,5 77 5AFHE	05.89-06.91	0 451 10 P 3276	O
		1 987 42 S 9135	L
		0 986 45 F 0110 ¹	K



Typ					Type
1,5 85 5EFHE	09.90-09.94	0 986 45 P 2028 1 457 43 S 3784	O L		
Corolla 1.5 i, i 4WD					
1,5 67/69/74/77 5EFE	09.90-07.99	0 986 45 P 2028 1 457 43 S 3784	O L		
1,5 77/80-81 1NZFE; 1NZFE <DOHC>	08.00-06.07	0 986 45 P 2028 F 026 40 S 0017	O L		
Corolla 1.5 i 16V					
1,5 77 5AFHE	01.89-12.92	0 986 45 P 2028 1 987 42 S 9135	O L		
Corolla 1.6					
1,6 67 4AF	02.89-06.94	0 986 45 P 2028 1 987 42 S 9133 0 986 45 F 0138 ¹	O L K		
1,6 84-88 4AFE	01.87-11.92	0 986 45 P 2028 0 986 45 F 0115 ¹	O K		
1,6 88 4AFE	01.92-05.01	0 986 45 P 2028 0 986 45 F 0115 ¹	O K		
1,6 97 1ZRFAE	12.08→	F 026 40 P 7091 F 026 40 S 0114 1 987 43 M 2190	O L I		
Corolla 1.6 i					
1,6 78 4AFE	07.94-08.98	0 986 45 P 2028 1 457 43 S 3958 0 986 45 F 0115 ¹	O L K		
1,6 79 4AFE	09.93-09.02	0 986 45 P 2028 1 457 43 S 3958 0 986 45 F 0115 ¹	O L K		
1,6 81 3ZZFE	01.02-07.07 01.02-02.07 09.02-07.07	0 986 45 P 2028 F 026 40 S 0017 1 987 43 M 2088 1 987 43 M 2084	O L I I		
1,6 82 3ZZFE	05.01-10.06 03.99-01.08	0 986 45 P 2028 F 026 40 S 0017	O L		
1,6 85 4AFE	08.90-08.98 06.91-08.98	0 986 45 P 2028 1 457 43 S 3958 0 986 45 F 0115 ¹	O L K		

Typ					Type
1,6 103 4AGE	06.89-06.91 05.87-06.91	1 987 42 S 9135 0 986 45 F 0110 ¹	L K		
1,6 118-121 4AGE	06.91-08.00	0 986 45 P 2028 1 457 43 S 3958 0 986 45 F 0115 ¹	O L K		
Corolla 1.6 i, i 4x4, i 16V					
1,6 76 4AFE	01.88-07.95	0 986 45 P 2028 1 987 42 S 9137	O L		
Corolla 1.6 i 4WD					
1,6 85 4AFE	09.91-05.95	0 986 45 P 2028 1 457 43 S 3958 0 986 45 F 0115 ¹	O L K		
Corolla 1.6 i 4WD, i 16V					
1,6 81-85 4AFE	05.92-06.02	0 986 45 P 2028 1 457 43 S 3958 0 986 45 F 0115 ¹	O L K		
Corolla 1.6 i 16V					
1,6 70 4AFE	05.87-04.92 08.89-04.92 05.87-04.92 09.89-04.92 05.87-04.92	0 451 10 P 3276 0 986 45 P 2028 1 987 42 S 9137 1 987 42 S 9135 0 986 45 F 0110 ¹	O O L L K		
1,6 77 4AFE	08.89-04.92 09.89-04.92 08.89-04.92	0 986 45 P 2028 1 987 42 S 9135 0 986 45 F 0110 ¹	O L K		
1,6 78 4AFE	09.94-04.97	0 986 45 P 2028 0 986 45 P 2044 1 457 43 S 3958 0 986 45 F 0115 ¹	O O L K		
1,6 79-81 4AFE	04.97-10.99	0 986 45 P 2028 1 457 43 S 3958 0 986 45 F 0115 ¹ 1 987 43 M 2155	O L K I		
1,6 81 3ZZFE	10.99-11.06 10.99-09.01 ABM,TW 10.01-11.06 10.99-09.01 10.01-11.06	0 986 45 P 2028 1 457 43 S 3958 1 457 43 S 3533 1 457 43 S 3958 F 026 40 S 0017 0 450 90 F 5980 ¹ 1 987 43 M 2155 1 987 43 M 2088	O L L L L K I I		





◀ Corolla 1.6 i 16V

1,6 81 3ZZ-FE <VVT-i DOHC>	05.02-03.08	F 026 40 S 0017	L
		0 986 45 F 0115 ¹	K
1,6 85-92 4AGE	08.87-04.92	0 451 10 P 3276	O
		1 987 42 S 9137	L
		0 986 45 F 0110 ¹	K
1,6 88-92 4AGE	05.87-04.92	0 451 10 P 3276	O
		0 986 45 F 0110 ¹	K
		1 987 42 S 9135	L

Corolla 1.6 i 16V 4WD

1,6 66-70 4AFE	09.90-04.92	0 986 45 P 2028	O
		1 987 42 S 9137	L
		0 986 45 F 0110 ¹	K
1,6 77 4AFE	09.90-08.93	0 986 45 P 2028	O
		1 987 42 S 9137	L
		0 986 45 F 0110 ¹	K

Corolla 1.6 VVT-i

1,6 91 1ZRFE	11.06→	0 986 45 P 2028	O
		F 026 40 S 0114	L
		1 987 43 M 2190	I

Corolla 1.6 16V

1,6 66 4AF	05.87-04.92	0 986 45 P 2028	O
		1 987 42 S 9133	L
1,6 67 4AFC	01.89-04.92	0 986 45 P 2028	O
		1 987 42 S 9133	L
		0 986 45 F 0138 ¹	K

Corolla 1.6 16V 4WD

1,6 67 4AFE	09.90-08.92	0 986 45 P 2028	O
		1 987 42 S 9133	L
		0 986 45 F 0039 ¹	K

Corolla 1.6 16V, 16V 4WD

1,6 67 4AF	05.87-04.92	0 986 45 P 2028	O
		1 987 42 S 9133	L

Corolla 1.8 D

1,8 47 1C	08.87-09.91	1 457 43 N 4438	K
1,8 47-49 1C	05.87-04.92	0 986 45 P 2030	O
		1 987 42 S 9135	L
1,8 49 1C	05.87-09.91	0 986 45 P 2030	O
		1 987 42 S 9135	L
		1 457 43 N 4438	K



Corolla 1.8 i

1,8 75 4AFE	01.91-12.92	0 986 45 P 2028	O
		1 987 42 S 9137	L
1,8 85 7AFE	10.92-08.02	0 986 45 P 2028	O
		1 987 42 S 9137	L
		1 457 43 S 3958	L
		0 986 45 F 0115 ¹	K
1,8 88 7AFE	01.92-06.01	0 986 45 P 2028	O
		0 986 45 F 0115 ¹	K
1,8 100 2ZRFE	10.06-04.10	F 026 40 P 7091	O
		0 986 45 P 2028	O
		1 987 43 M 2190	I
1,8 101 1ZZFE	03.99-01.08	0 986 45 P 2028	O
		F 026 40 S 0017	L
1,8 140 2ZZGE	01.01-10.06	0 451 10 P 3276	O
		F 026 40 S 0017	L

Corolla 1.8 i, i 16V

1,8 97-100 1ZZFE	08.00-08.08	0 986 45 P 2028	O
		F 026 40 S 0017	L
		1 987 43 M 2084	I

Corolla 1.8 i RXi

1,8 141 2ZZGE	09.02-07.07	0 451 10 P 3276	O
		F 026 40 S 0017	L

Corolla 1.8 i 4WD

1,8 92 1ZZFE	08.00-06.07	0 986 45 P 2028	O
		F 026 40 S 0017	L

Corolla 1.8 i 16V

1,8 77-85 7AFE	09.92-08.97	0 986 45 P 2028	O
		1 457 43 S 3958	L
		0 986 45 F 0115 ¹	K
1,8 85 7A-FE	08.98-06.02	1 457 43 S 3958	L
		0 986 45 F 0115 ¹	K
		1 987 43 M 2155	I
1,8 85 7AFE	10.92-04.97	0 986 45 P 2028	O
		1 457 43 S 3958	L
1,8 86 7AFE	11.92-05.95	0 986 45 P 2028	O
		1 457 43 S 3958	L
		0 986 45 F 0115 ¹	K



1,8 92 1ZZFE	09.97→	0 986 45 P 2028	O
	09.97-08.02	1 457 43 S 3958	L

1,8 100 1ZZ-FE <VVT-i DOHC>	05.02-03.08	F 026 40 S 0017	L
		0 986 45 F 0115 ¹	K

1,8 140-165 2ZZGE	11.01-12.07	0 451 10 P 3276	O
		F 026 40 S 0017	L
		1 987 43 M 2084	I
		1 987 43 M 2088	I

Corolla 1.8 i 16V Fielder

1,8 100 1ZZ-FE <VVT-i DOHC>	05.04-12.07	F 026 40 S 0017	L
--	-------------	------------------------	----------

Corolla 1.8 i 16V 4x4

1,8 77-85 7AFE	04.97-07.01	0 986 45 P 2028	O
		1 457 43 S 3958	L

Corolla 1.9 D, D 4x4

1,9 51 1WZ	12.99-11.01	1 987 42 S 9135	L
		1 457 43 N 1703 ²	K

Corolla 2.0 D

2,0 53 2CE	04.97-10.99	0 451 10 P 3365	O
		1 987 42 S 9135	L
		1 457 43 N 4438 ²	K

2,0 53-54 2C	05.92-05.95	0 986 45 P 2030	O	
		05.95-04.97	0 451 10 P 3365	O
		05.92-04.97	1 987 42 S 9135	L
			1 457 43 N 4438 ²	K

2,0 54 2C	06.91-05.95	0 986 45 P 2030	O	
	05.95-04.98	0 451 10 P 3365	O	
	Org.Nr. KD-CE108G	09.95-04.98	0 451 10 P 3365	O
		09.91-08.95	0 986 45 P 2030	O
	Org.Nr. X-CE108G	06.91-04.98	1 987 42 S 9135	L
			1 457 43 N 4438	K
		1 457 43 N 4438 ²	K	

Corolla 2.0 D Turbo

2,0 66 1CDFTV	08.00-09.01	0 986 45 P 2062	O
	10.01-05.04	0 986 45 P 2044	O
	11.01-02.07	0 451 10 P 3365	O
	08.00-09.01	F 026 40 S 0038	L
	10.01-02.07	1 987 42 S 9183	L
	08.00-05.04	1 457 43 N 4440 ²	K
	06.04-02.07	1 457 43 N 4438 ²	K
	01.02-02.07	1 987 43 M 2088	I

2,0 81-85 1CDFTV	11.01-05.04	0 451 10 P 3365	O
		1 987 42 S 9183	L
		1 457 43 N 4440 ²	K

2,0 82 1CDFTV	08.00-09.01	0 986 45 P 2062	O
	10.01-05.04	0 451 10 P 3365	O
	08.00-09.01	F 026 40 S 0038	L
	10.01-05.04	1 987 42 S 9183	L
	08.00-05.04	1 457 43 N 4440 ²	K

Corolla 2.0 D 4WD

2,0 54 2C	10.89-06.91	0 986 45 P 2030	O
	09.91-05.95	0 986 45 P 2030	O
	05.95-04.98	0 451 10 P 3365	O
	10.89-06.91	F 026 40 S 0038	L
	09.91-04.98	1 987 42 S 9135	L
	10.89-06.91	1 457 43 N 4438	K
	09.91-04.98	1 457 43 N 4438	K

Corolla 2.0 D 4x4

2,0 53 2CE	04.97-10.99	0 451 10 P 3365	O
		1 987 42 S 9135	L
		1 457 43 N 4438 ²	K
		1 987 43 M 2155	I

Corolla 2.0 D-4D

2,0 93 1ADFTV	11.06→	F 026 40 P 7090	O
		1 987 43 M 2190	I

Corolla 2.2 D

2,2 58 3CE	04.98-06.04	0 451 10 P 3365	O	
		1 987 42 S 9135	L	
		04.98-08.00	1 457 43 N 4438	K
		08.00-06.04	1 457 43 N 4440 ²	K

Corolla 2.2 D 4WD

2,2 58 3CE	04.98-06.02	0 451 10 P 3365	O
		1 987 42 S 9135	L





Corolla 2.2 D 4x4

2,2 58 3CE	04.98-08.00	0 451 10 P 3365	O
		1 987 42 S 9135	L
		1 457 43 N 4438	K

Corolla Verso

Corolla Verso 1.6 i

1,6 97 1ZRFAE	02.09→	F 026 40 P 7091	O
		F 026 40 S 0114	L
		1 987 43 M 2190	I

Corolla Verso 1.6 i 16V

1,6 81 3ZZFE	09.01→	0 986 45 P 2028	O
		F 026 40 S 0017	L
	09.01-01.04 TW	1 987 43 M 2088	I
	02.04→	1 987 43 M 2088	I

Corolla Verso 1.8 i 16V

1,8 95 1ZZFE	02.04→	0 986 45 P 2028	O
		F 026 40 S 0017	L
		1 987 43 M 2088	I

1,8 97 1ZZFE	02.04→	0 986 45 P 2028	O
		1 987 43 M 2088	I

1,8 99 1ZZFE	09.01-01.04	0 986 45 P 2028	O
		F 026 40 S 0017	L
		1 987 43 M 2084	I
	TW	1 987 43 M 2088	I

Corolla Verso 1.8 VVT-i

1,8 108 2ZRFAE	02.09→	F 026 40 P 7091	O
		F 026 40 S 0114	L
		1 987 43 M 2190	I

Corolla Verso 2.0 D Turbo

2,0 66 1CDFTV	09.01-01.04	0 451 10 P 3365	O
		1 987 42 S 9183	L
		VOW 1 457 43 N 4440 ²	K
		VOW 1 457 43 N 4438 ²	K
		TW 1 987 43 M 2088	I

2,0 85 1CDFTV	02.04-08.05	0 451 10 P 3365	O
		1 987 42 S 9183	L
		1 457 43 N 4438 ²	K
		1 987 43 M 2088	I

Corolla Verso 2.0 D-4D

2,0 93 1ADFTV	02.09→	F 026 40 P 7090	O
	02.09-02.10	1 457 43 N 4440 ²	K
	02.09→	1 987 43 M 2190	I



Corolla Verso 2.2 D-CAT

2,2 110-130 2ADFHV	02.09→	F 026 40 P 7090	O
	02.09-02.10	1 457 43 N 4440 ²	K
	02.09→	1 987 43 M 2190	I

2,2 130 2ADFHV	08.05→	F 026 40 P 7090	O
		F 026 40 S 0121	L
		1 457 43 N 4440 ²	K
		1 987 43 M 2088	I

Corolla Verso 2.2 D-4D

2,2 110 2ADFTV	08.05→	F 026 40 P 7090	O
		F 026 40 S 0121	L
		1 457 43 N 4440 ²	K
		1 987 43 M 2088	I

Corona

Corona 1.6 i

1,6 85 4AFE	02.92-01.96	0 986 45 P 2028	O
		1 987 42 S 9135	L

1,6 86 4AFE	04.93-02.98	0 986 45 P 2028	O
		1 987 42 S 9135	L
		0 986 45 F 0123 ¹	K

Corona 1.6 i 4WD

1,6 74 4AFE	08.88-02.92	0 986 45 P 2028	O
		1 987 42 S 9137	L
		0 986 45 F 0110 ¹	K

Corona 1.8

1,8 57 2Y	12.86-07.99	0 986 45 P 2000	O
		0 986 45 F 0018 ¹	K

Corona 1.8 i

1,8 85 4SFE	11.89-02.92	0 986 45 P 2028	O
		1 987 42 S 9123	L
		0 986 45 F 0111 ¹	K

1,8 85 7AFE	01.96-12.01	0 986 45 P 2028	O
		1 987 42 S 9135	L
		0 986 45 F 0221 ¹	K

1,8 92 4SFE	02.92-01.96	0 986 45 P 2028	O
		1 987 42 S 9135	L
		0 986 45 F 0107 ¹	K

Corona 2.0 D

2,0 54 2C	02.92-01.96	0 986 45 P 2030	O
		1 987 42 S 9135	L



**Corona 2.0 D 4x4**

2,0 54 2C	08.92-01.96	0 986 45 P 2030	O
		1 987 42 S 9135	L
		1 457 43 N 4438	K

Corona 2.0 i

2,0 92 3SFE	11.89-02.92	0 986 45 P 2028	O
		1 987 42 S 9123	L
		0 986 45 F 0111 ¹	K

2,0 96 3SFE	04.93-12.99	0 986 45 P 2028	O
		1 987 42 S 9135	L
		0 986 45 F 0107 ¹	K

2,0 103 3SFE	02.92-01.96	0 986 45 P 2028	O
		1 987 42 S 9135	L
		0 986 45 F 0103 ¹	K
		0 986 45 F 0107 ¹	K

2,0 121 3SGE	11.89-02.92	0 986 45 P 2028	O
		1 987 42 S 9135	L
		0 986 45 F 0111 ¹	K

Corona 2.0 i 4WD

2,0 99 3SFE	02.92-01.96	0 986 45 P 2028	O
		1 987 42 S 9135	L
		0 986 45 F 0107 ¹	K

Corona 2.0 i 4x4

2,0 99 3SFE	01.96-12.01	0 986 45 P 2028	O
		1 987 42 S 9135	L
		0 986 45 F 0221 ¹	K

Corona 2.0 16V

2,03SF	12.87-08.92	0 986 45 P 2028	O
		1 987 42 S 9137	L
		12.87-08.92	0 986 45 F 0039 ¹

Cressida**Cressida 2.0**

2,0 75 22R	08.88-08.96	0 451 10 P 4014	O
		0 986 45 F 0018 ¹	K

Cressida 2.0 i 24V

2,0 99 1GFE	08.88-08.96	0 986 45 P 2044	O
-------------	-------------	------------------------	----------

**Cressida 2.4 D**

2,4 62 2L	08.88-08.96	0 986 45 P 2001	O
		1 457 43 N 4438 ²	K

Cressida 2.8 i

2,8 95 5ME	08.88-08.96	0 986 45 P 2044	O
------------	-------------	------------------------	----------

Cressida 3.0 i 24V

3,0 142 7MGE	09.88-08.92	0 986 45 P 2044	O
--------------	-------------	------------------------	----------

Crown**Crown 2.0**

2,0 81 5M	09.87-10.91	0 986 45 P 2044	O
-----------	-------------	------------------------	----------

Crown 2.0 i

2,0 99 1GFE	10.91-04.99	0 986 45 P 2044	O
-------------	-------------	------------------------	----------

2,0 99-118 1GFE	08.95-08.01	0 986 45 P 2044	O
		09.98-08.01	F 026 40 S 0158

2,0 118 1GFE	12.88-10.91	0 986 45 P 2044	O	
		08.01→	0 986 45 P 2044	O
			F 026 40 S 0158	L

Crown 2.4 D Turbo

2,4 71 2LTE	08.93-09.99	0 986 45 P 2062	O
-------------	-------------	------------------------	----------

Crown 2.5 i

2,5 132 1JZGE	10.91-12.95	0 986 45 P 2044	O
		1 457 43 S 2180	L

2,5 132-147 1JZGE	10.91-08.01	0 986 45 P 2044	O
		10.91-04.99	1 457 43 S 2180

2,5 147 1JZFSE	08.01-06.07	0 986 45 P 2044	O
----------------	-------------	------------------------	----------

2,5 158 4GRFSE	12.03-02.08	F 026 40 S 0162	L
----------------	-------------	------------------------	----------

Crown 2.5 i, i 4x4

2,5 144-147 1JZGE	09.99-06.07	0 986 45 P 2044	O
-------------------	-------------	------------------------	----------

Crown 2.5 i Turbo

2,5 206 1JZGTE	09.99-12.03	0 986 45 P 2044	O
----------------	-------------	------------------------	----------





Crown 3.0 i

3,0 140 7MGE	09.87-10.95	0 986 45 P 2044	O
3,0 162 2JZFSE	09.99-06.07	0 986 45 P 2044	O
3,0 162 2JZGE	08.95-08.01	0 986 45 P 2044	O
	08.95-09.99	0 450 90 F 5912 ¹	K
3,0 169 2JZGE	10.91-12.95	0 986 45 P 2044	O
		1 457 43 S 2180	L
3,0 188 3GRFSE	12.03-02.08	F 026 40 S0162	L

Crown 4.0 i

4,0 191 1UZFE	08.89-08.95	0 986 45 P 2044	O
	10.91-08.95	0 450 90 F 5912 ¹	K

Crown 4.3 i

4,3 206 3UZFE	07.04-03.09	0 986 45 P 2044	O
		F 026 40 S0162	L

Curren

Curren 2.0 i

2,0 103/132 3SFE; 3SGE	02.94-07.98	0 986 45 P 2028	O
		1 987 42 S 9151	L

Cynos

Cynos 1.3 i

1,3 65 4EFE	08.95-07.99	0 986 45 P 2028	O
		1 457 43 S 3784	L

Cynos 1.5 i

1,5 77/81 5EFE; 5EFHE	01.91-07.99	0 986 45 P 2028	O
		1 457 43 S 3784	L

Duet

Duet 1.0 i

1,0 47 EJVE	05.00-06.04	1 987 42 S 9164	L
-----------------	-------------	-----------------	---

Duet 1.3 i

1,3 66 K3VE	12.01-06.04	1 987 42 S 9164	L
-----------------	-------------	-----------------	---



Dyna

Dyna Rino 3.4 D

3,4 66 13B	01.84-12.92	1 457 43 N 4438 ²	K
	12.93-08.02	1 457 43 N 4438 ²	K

Dyna 1.8

1,8 57 2Y	08.87-05.95	0 986 45 P 2000	O
		1 457 43 S 3971	L
	XXX	0 450 90 F 5923 ¹	K

1,8 58 2Y	08.87-09.93	0 986 45 P 2000	O
---------------	-------------	-----------------	---

Dyna 2.4 D

2,4 63 2L	08.85-05.95	1 457 43 N 4438	K
---------------	-------------	-----------------	---

Dyna 2.5 D

2,5 53 2L	08.87-05.95	0 986 45 P 2062	O
		1 457 43 N 4438 ²	K

2,5 55 2L	08.87-05.95	0 986 45 P 2062	O
	RLE	0 986 45 P 2001	O
	05.95-08.01	0 986 45 P 2044	O
	08.87-08.01	1 457 43 N 4438 ²	K

2,5 80 2KDFTV	08.04-09.07	0 986 45 P 2044	O
		1 457 43 N 4438	K

Dyna 2.8 D

2,8 58 3L	08.88-07.92	0 986 45 P 2001	O
	08.92-05.95	0 986 45 P 2062	O
	05.95-07.01	0 986 45 P 2044	O
	08.88-07.92	XXX	1 987 42 S 9158
	08.88-07.01	1 457 43 N 4438 ²	K

2,8 67 3L	08.88-05.99	1 457 43 N 4438	K
---------------	-------------	-----------------	---

Dyna 3.0 D

3,0 59 B	08.88-05.95	0 986 45 P 2001	O
	XXX	1 987 42 S 9158	L
		1 457 43 N 4438 ²	K

3,0 59 11B	08.88-10.92	0 986 45 P 2001	O
	XXX	1 987 42 S 9158	L

3,0 63 B	09.84-05.95	1 457 43 N 4438	K
--------------	-------------	-----------------	---

3,0 65 5L	05.98-08.01	0 986 45 P 2044	O
	05.99-08.01	0 986 45 P 2062	O
	05.98-08.01	1 457 43 N 4438 ²	K



Typ					Type
3,0 67 5L	05.99-07.01	0 986 45 P 2062	O		
	05.99-08.04	1 457 43 N 4438 ²	K		
		1 457 43 N 4438	K		
Dyna 3.0 D Turbo 4WD					
3,0 100-106 1KDFTV	08.07→	1 457 43 N 4438	K		
Dyna 3.0 D-4D					
3,0 80 1KDFTV	09.06→	0 986 45 P 2044	O		
		1 457 43 S 3534	L		
		1 457 43 N 4438 ²	K		
Dyna 3.4 D					
3,4 72 3B	05.95-06.99	1 457 43 N 4438	K		
Dyna 3.7 D					
3,7 74 4B	05.99-06.04	0 986 45 P 2062	O		
		1 457 43 N 4438 ²	K		
Dyna 3.7 D, D 4WD					
3,7 85 14B	08.88-05.95	0 986 45 P 2062	O		
		1 457 43 N 4438	K		
Dyna 4-093 3.0 D					
3,0 67 5L	11.99→	0 986 45 P 2062	O		
		XXX 1 987 42 S 9158	L		
		1 457 43 N 4438 ²	K		
Dyna 4.1 D					
4,1 92 15BF	05.95-06.99	0 986 45 P 2062	O		
		1 457 43 S 3534	L		
		1 457 43 N 4438	K		
Dyna 4.6 D					
4,6 96 S05C	10.00-06.02	1 987 42 S 9157	L		
		1 457 43 N 4438 ²	K		
Dyna 5-103					
3,7 72 14B	12.95-04.03	0 986 45 P 2001	O		
	12.95-10.98	XXX 1 987 42 S 9158	L		
Dyna 6-094 3.0					
3,011B	10.86-12.95	0 986 45 P 2001	O		

Typ					Type
Dyna 6-104/5 4.0					
4,0 77 W04D	05.03→	1 987 42 S 9157	L		
Dyna 7-145 4.1					
4,1 100 15BFT	05.99-04.03	0 986 45 P 2062	O		
Echo					
Echo 1.5 i 16V					
1,5 78/80 1NZFE	09.99→	0 986 45 P 2028	O		
		1 457 43 S 3972	L		
		1 987 43 M 2084	I		
Estima					
Estima 2.2 D Turbo					
2,2 74 3CTE	02.95-12.99	0 451 10 P 3365	O		
Org.Nr. KD-CXR10G					
Org.Nr. KD-CXR11G					
Org.Nr. Y-CXR10G	08.93-01.95	0 986 45 P 2030	O		
Org.Nr. Y-CXR11G	08.93-12.99	F 026 40 S 0038	L		
Estima 2.2 D Turbo 4WD					
2,2 74 3CTE	02.95-12.99	0 451 10 P 3365	O		
Org.Nr. KD-CXR20G					
Org.Nr. KD-CXR21G					
Org.Nr. Y-CXR20G	08.93-01.95	0 986 45 P 2030	O		
Org.Nr. Y-CXR21G	08.93-12.99	F 026 40 S 0038	L		
Estima 2.4 i					
2,4 118 2AZFE	02.00-01.06	0 451 10 P 3276	O		
		1 987 42 S 9163	L		
		1 987 43 M 2085	I		
2,4 125 2AZFE	01.06→	0 451 10 P 3276	O		
Estima 2.4 i, i Supercharged, i Supercharged 4WD, i 4WD					
2,4 99/118 2TZFE; 2TZFZE	05.90-12.99	0 986 45 P 2044	O		
		1 457 43 S 3952	L		
		0 450 90 F 5984 ¹	K		
Estima 2.4 i 4WD					
2,4 96 2AZFXE	05.01-11.05	0 451 10 P 3276	O		
		1 987 42 S 9163	L		
2,4 118 2AZFE	02.00-01.06	0 451 10 P 3276	O		
		1 987 42 S 9163	L		



Estima 3.0 i, i 4WD

3,0 162 1MZFE	12.99-01.06	0 986 45 P 2044	0
		1 987 42 S 9187	L

Fortuner

Fortuner 2.7 i 4WD

2,7 118 2TRFE <VTi>	02.06→	0 986 45 P 2044	0
		1 987 43 M 2190	I

Fortuner 4.0 i 4WD

4,0 175 1GRFE	05.06→	1 987 43 M 2190	I
-------------------	--------	-----------------	---

Funcargo

Funcargo 1.3 i

1,3 64-65 2NZFE	08.99-09.05	0 986 45 P 2028	0
		1 457 43 S 3972	L

Funcargo 1.5 i

1,5 80-81 1NZFE	08.99-09.05	0 986 45 P 2028	0
		1 457 43 S 3972	L

Gaia

Gaia 2.0 i

2,0 112 1AZFSE	04.01-09.04	0 451 10 P 3276	0
		1 987 42 S 9135	L
		0 450 90 F 5988 ¹	K

Gaia 2.2 D Turbo

2,2 69 3CTE	05.98-09.04	0 451 10 P 3365	0
		F 026 40 S 0038	L
		1 457 43 N 4440 ²	K

Grand Hiace

Grand Hiace 3.0 D Turbo, D Turbo 4WD

3,0 103 1KZTE	07.99-05.02	0 986 45 P 2062	0
		1 457 43 N 4440 ²	K

Granvia

Granvia 3.0 D Turbo

3,0 96-103 1KZTE	09.95-05.02	0 986 45 P 2062	0
----------------------	-------------	-----------------	---



Harrier

Harrier 2.2 i, i 4WD

2,2 103 5SFE	12.97-11.00	0 986 45 P 2028	0
		1 987 42 S 9151	L

Harrier 2.4 i

2,4 118 2AZFE	02.03→	0 451 10 P 3276	0
		1 987 42 S 9187	L

Harrier 2.4 i 4WD

2,4 118 2AZFE	11.00→	0 451 10 P 3276	0
	11.00-02.03	1 987 42 S 9151	L
	02.03→	1 987 42 S 9187	L

Harrier 3.0 i, i 4WD

3,0 162 1MZFE	12.97-01.06	0 986 45 P 2044	0
	12.97-02.03	1 987 42 S 9151	L
	02.03-01.06	1 987 42 S 9187	L

Harrier 3.3 i 4WD

3,3 155 3MZFE	03.05→	0 986 45 P 2044	0
-------------------	--------	-----------------	---

Hiace

Hiace 2.0

2,0 74 1RZ	08.89-09.02	0 986 45 P 2044	0
	08.89-07.95	1 457 43 S 3795	L

Hiace 2.0 i

2,0 81 1RZE	08.89-07.03	0 986 45 P 2044	0
		1 457 43 S 3795	L

Hiace 2.0 i 4WD

2,0 98 1TRFE	07.03-01.05	0 986 45 P 2044	0
	08.04→	F 026 40 P 7090	0
	07.03-01.05	1 457 43 S 3795	L

Hiace 2.4

2,4 84 2RZ	01.93-08.98	0 986 45 P 2044	0
	08.89-07.95	1 457 43 S 3795	L

Hiace 2.4 , i, i 4WD

2,4 85 2RZE	08.95-11.09	0 986 45 P 2044	0
		F 026 40 S 0092	L



**Hiace 2.4 D**

2,4 62 2L			
	08.95-08.01	0 986 45 P 2062	O
	08.89-02.06	1 457 43 S 3795	L
	08.95-08.01	F 026 40 S 0092	L
	08.89-02.06	1 457 43 N 4438 ²	K
2,4 63 2L			
	08.89-08.93	0 986 45 P 2062	O
		1 457 43 S 3795	L
	08.88-05.95	1 457 43 N 4438	K

Hiace 2.4 D Turbo

2,4 71 2LTE			
	10.90-08.93	0 986 45 P 2062	O
		1 457 43 S 3795	L
		1 457 43 N 4438	K

Hiace 2.4 D Turbo, D Turbo 4WD

2,4 66 2LT			
	08.95-08.01	0 986 45 P 2062	O
		F 026 40 S 0092	L
		1 457 43 N 4438 ²	K

Hiace 2.4 D 4WD

2,4 63 2L			
	10.89-05.95	1 457 43 N 4438	K

Hiace 2.4 D 4x4

2,4 62 2L			
	08.89-08.95	0 986 45 P 2062	O
		1 457 43 S 3795	L
		1 457 43 N 4438 ²	K

Hiace 2.4 i

2,4 88 2RZE			
	08.89-02.05	0 986 45 P 2044	O
		1 457 43 S 3795	L

Hiace 2.4 i 4WD

2,4 88 2RZE			
	08.89-07.95	0 986 45 P 2044	O
		1 457 43 S 3795	L

Hiace 2.5 D Turbo

2,5 75 2KDFTV			
	08.01→	0 986 45 P 2044	O
2,5 80 2KDFTV			
	08.04-09.07	0 986 45 P 2044	O
	01.05-09.07	1 457 43 N 4438 ²	K

Hiace 2.5 D Turbo 4WD

2,5 80 2KDFTV			
	08.04-09.07	0 986 45 P 2044	O

**Hiace 2.5 D Turbo 4x4**

2,5 65 2KDFTV			
	08.01→	0 986 45 P 2044	O
		F 026 40 S 0092	L
	08.01-04.04	1 457 43 N 4438 ²	K
	05.04→	VOW	1 457 43 N 4438 ²
		VOW	1 457 43 N 4438 ²

Hiace 2.5 D-4D, D-4D 4x4

2,5 70-86 2KDFTV			
	08.01→	0 986 45 P 2044	O
		F 026 40 S 0092	L
	08.01-04.04	1 457 43 N 4438 ²	K
	05.04→	VOW	1 457 43 N 4438 ²
		VOW	1 457 43 N 4438 ²

Hiace 2.7

2,7 111 2TRFE			
	03.05→	0 986 45 P 2044	O
		1 457 43 S 3795	L

Hiace 2.7 , 4x4

2,7 105 3RZFE			
	04.98-05.09	0 986 45 P 2044	O
		F 026 40 S 0092	L

Hiace 2.7 i

2,7 111 2TRFE			
	08.04→	F 026 40 P 7090	O
		1 457 43 S 3795	L

Hiace 2.8 D

2,8 58 3L			
	08.89-08.00	0 986 45 P 2062	O
		1 457 43 S 3795	L
	08.99-08.00	1 457 43 N 4438 ²	K
2,8 67 3L			
	08.89-08.98	1 457 43 S 3795	L
	05.95-10.96	1 457 43 N 4438	K

Hiace 2.8 D 4WD

2,8 67 3L			
	08.89-08.93	0 986 45 P 2062	O
	08.89-08.98	1 457 43 S 3795	L
	08.89-08.93	1 457 43 N 4438	K

Hiace 3.0 D

3,0 65 5L			
	08.98-02.06	1 457 43 S 3795	L
		1 457 43 N 4438 ²	K
3,0 67 5L			
	08.98-10.04	0 986 45 P 2062	O
		1 457 43 S 3795	L
3,0 75 5LE			
	08.01-02.06	1 457 43 S 3795	L
		1 457 43 N 4438 ²	K





Hiace 3.0 D Turbo, D Turbo 4WD

3,0 96 1KZTE	08.93-10.04	0 986 45 P 2062	O
	08.95-10.04	1 457 43 N 4438	K

Hiace 3.0 D 4WD

3,0 67 5L	08.98-10.04	0 986 45 P 2062	O
		1 457 43 S 3795	L
		1 457 43 N 4438 ²	K

Hilux

Hilux D4D 2.5 D Turbo 4x4

2,5 76 2KDFTV	11.01-09.04	1 457 43 N 4438 ²	K
---------------	-------------	------------------------------	---

Hilux 1.6

1,6 50 1Y	08.86-07.98	0 986 45 P 2000	O
		0 986 45 F 0018 ¹	K

Hilux 1.8

1,8 57 2Y	08.88-10.94	0 986 45 P 2000	O
		0 986 45 F 0018 ¹	K

1,8 58 2Y	09.88-08.93	0 986 45 P 2000	O
		0 986 45 P 3276	O
		0 986 45 F 0018 ¹	K

1,8 59 2Y	11.86-08.98	0 986 45 F 0018 ¹	K
-----------	-------------	------------------------------	---

Hilux 1.8 LWB

1,8 59 2Y	10.98-10.00	0 986 45 P 2000	O
		0 986 45 F 0018 ¹	K

Hilux 2.0 , i, i 4x4

2,0 68/81 1RZ;1RZE	08.97-07.04	0 986 45 P 2044	O
--------------------	-------------	-----------------	---

Hilux 2.0 i VVTi

2,0 100 1TR-FE <VVTi>	05.05→	0 986 45 P 2044	O
	08.08→	1 987 43 M 2190	I

Hilux 2.0 4WD

2,0 65 3Y	09.88-08.93	0 986 45 P 2000	O
	09.93-08.94	0 451 10 P 3276	O

Hilux 2.2

2,2 75 4Y	08.86-07.98	0 986 45 P 2000	O
		0 986 45 F 0018 ¹	K



Hilux 2.2 , 4x4

2,2 70 4Y	02.86-08.98	0 986 45 P 2003	O
		0 986 45 F 0018 ¹	K

Hilux 2.2 4WD

2,2 69 4Y	02.90-08.94	0 986 45 P 2003	O
	08.88-08.94	0 986 45 F 0018 ¹	K

Hilux 2.4

2,4 80 22R	01.86-07.98	0 451 10 P 4014	O
		0 986 45 F 0039 ¹	K

Hilux 2.4 D

2,4 55 2L	10.84-03.98	0 986 45 P 2001	O
-----------	-------------	-----------------	---

2,4 62 2L	08.84-07.98	0 986 45 P 2000	O
	08.88-08.01	0 986 45 P 2062	O
	08.88-08.97	1 457 43 S 3734	L
	08.97-08.01	F 026 40 S 0040	L
	09.85-08.01	1 457 43 N 4438 ²	K

2,4 63 2L	09.88-08.94	0 451 10 P 4063	O
		1 457 43 S 3734	L

Hilux 2.4 D Turbo

2,4 64 2L	05.95-12.00	0 986 45 P 2001	O
-----------	-------------	-----------------	---

2,4 66 2LT	08.97-08.01	0 986 45 P 2062	O
		F 026 40 S 0040	L
		1 457 43 N 4440 ²	K

2,4 69 2LT	01.90-11.95	0 986 45 P 2062	O
		1 457 43 S 3734	L
		1 457 43 N 4438 ²	K

Hilux 2.4 D Turbo 4x4

2,4 71 2LTE	08.90-08.93	0 986 45 P 2062	O
	08.95-08.99	0 986 45 P 2062	O
	08.90-08.93	1 457 43 S 3734	L
	08.95-08.97	1 457 43 N 4438	K
	08.97-08.99	1 457 43 N 4440	K

Hilux 2.4 D 4x4

2,4 62 2L	09.88-08.97	0 986 45 P 2062	O
		1 457 43 S 3734	L
		1 457 43 N 4438 ²	K

Hilux 2.4 i

2,4 104 2RZFE EFi	08.97-08.99	0 986 45 P 2044	O
-------------------	-------------	-----------------	---



**Hilux 2.4 i Pickup 4x4**

2,4 103 2RZFE	01.00→	0 451 20 P 3154	O
---------------	--------	-----------------	---

Hilux 2.4 i 4WD

2,4 79 2RZFE	11.97-08.01	0 986 45 P 2044	O
--------------	-------------	-----------------	---

Hilux 2.4 i 4WD, i 4x4

2,4 84 22RE	09.88-08.97	0 986 45 P 2044	O
		1 457 43 S 3952	L
		0 450 90 F 5912 ¹	K

Hilux 2.4 TD

2,4 61 2L	10.98-12.04	0 986 45 P 2062	O
-----------	-------------	-----------------	---

Hilux 2.4 4x4

2,4 75 22R	08.88-08.97	0 986 45 P 2044	O
		0 986 45 F 0018 ¹	K

Hilux 2.5 D Turbo, D Turbo 4x4

2,5 76 2KDFTV	10.04→	0 986 45 P 2044	O
---------------	--------	-----------------	---

Hilux 2.5 D Turbo 4x4

2,5 65 2KDFTV	08.01-08.05	0 986 45 P 2003	O
		1 457 43 N 4438 ²	K

2,5 75 2KDFTV	08.01-08.05	0 986 45 P 2003	O
		1 457 43 N 4438 ²	K

Hilux 2.5 D-4D, D-4D 4x4

2,5 75 2KDFTV	07.11→	0 986 45 P 2044	O
		1 987 43 M 2190	I

2,5 106 2KDFTV	07.05→	0 986 45 P 2044	O
		1 987 43 M 2190	I

Hilux 2.5 D-4D 4x4

2,5 75-106 2KDFTV	07.05→	0 986 45 P 2044	O
		1 987 43 M 2190	I

Hilux 2.5 TDi 4x4

2,5 75 2KD-FTV	07.05→	0 986 45 P 2044	O
	08.08→	1 987 43 M 2190	I

**Hilux 2.5 16V D Turbo**

2,5 75 2KD-FTV	03.05→	0 986 45 P 2044	O
		1 457 43 N 4438 ²	K

Hilux 2.7 i, i 4WD

2,7 107/108 3RZFE	10.97-02.05	0 986 45 P 2044	O
-------------------	-------------	-----------------	---

Hilux 2.7 i, i 4x4

2,7 120 2TRFE	08.04-07.09	F 026 40 P 7090	O
---------------	-------------	-----------------	---

Hilux 2.7 i VVTi 4x4

2,7 118 2TR-FE <VVTi>	06.05→	0 986 45 P 2044	O
	08.08→	1 987 43 M 2190	I

Hilux 2.7 i 4WD

2,7 110 3RZFE	11.02-08.04	0 986 45 P 2044	O
---------------	-------------	-----------------	---

Hilux 2.7 i 4x4

2,7 110 3RZFE	11.95-11.02	0 986 45 P 2044	O
		1 457 43 S 3952	L

Hilux 2.8 D

2,8 58 3L	08.95-07.98	0 986 45 P 2000	O
		1 457 43 N 4438 ²	K

2,8 67 3L	08.94-08.97	0 986 45 P 2001	O
		1 457 43 S 3734	L
		1 457 43 N 4438	K

Hilux 2.8 D, D 4x4

2,8 60 3L	10.88-12.97	0 451 10 P 4063	O
-----------	-------------	-----------------	---

Hilux 2.8 D 4WD

2,8 67 3L	09.88-08.97	AGR	0 451 10 P 4063	O
	04.89-08.93		0 451 10 P 4063	O
	08.94-08.97	AGR	0 986 45 P 2062	O
	09.88-08.97		1 457 43 S 3734	L

Hilux 3.0 D

3,0 92 1KZT	08.93-11.95	0 986 45 P 2062	O
		1 457 43 N 4438 ²	K

Hilux 3.0 D, D 4x4

3,0 65 5L	10.97-02.05	0 451 10 P 4063	O
-----------	-------------	-----------------	---





◀ Hilux 3.0 D, D 4x4

3,0 67 5L	08.97-06.04	0 986 45 P 2062	0
		1 457 43 N 4440 ²	K
Hilux 3.0 D Turbo 4x4			
3,0 85 1KZTE	12.99→	0 986 45 P 2062	0
3,0 96/103-107 1KZTE	08.93-08.00	0 986 45 P 2062	0
	11.95-08.00	1 987 42 S 9157	L
3,0 120 1KDFTV	03.05→	0 986 45 P 2044	0
3,0 125 1KDFTV	06.00-08.05	0 986 45 P 2062	0
	06.00-11.02	1 987 42 S 9157	L
		1 457 43 N 4438 ²	K
Hilux 3.0 D 4x4			
3,0 67 5LE	01.98→	0 986 45 P 2062	0
		1 457 43 N 4438 ²	K
Hilux 3.0 D-4D, D-4D 4x4			
3,0 120 1KDFTV	05.05→	0 986 45 P 2044	0
	08.08→	1 987 43 M 2190	I
Hilux 3.0 D-4D 4x4			
3,0 120-126 1KDFTV	10.06→	0 986 45 P 2044	0
		1 987 43 M 2190	I
3,0 126 1KDFTV	07.11→	0 986 45 P 2044	0
		1 987 43 M 2190	I
Hilux 3.0 i, i 4WD			
3,0 105/110 3VZE	08.89-11.95	0 986 45 P 2044	0
		0 450 90 F 5912 ¹	K
Hilux 3.0 TD			
3,0 85 5LE	01.02-02.05	0 986 45 P 2001	0
Hilux 3.0 TD 4x4			
3,0 85 1KZTE	03.02-05.05	0 986 45 P 2062	0
		1 457 43 N 4438 ²	K
		1 987 43 M 2085	I
Hilux 3.0 16V D Turbo Interc., 16V D Turbo Interc. 4x4			
3,0 120 1KD-FTV <D4D>	03.05→	0 986 45 P 2044	0
		1 457 43 N 4438 ²	K
Hilux 3.4 i			
3,4 124 5VZFE	10.02→	0 986 45 P 2044	0



3,4 136 5VZFE	11.02-08.05	0 986 45 P 2044	0
Hilux 3.4 i 4WD			
3,4 136 5VZFE	11.95-11.02	0 986 45 P 2044	0
		0 450 90 F 5912 ¹	K
Hilux 3.4 i 4x4			
3,4 136 5VZFE	11.02-08.05	0 986 45 P 2044	0
Innova			
Innova 2.0 i			
2,0 100 1TRFE	02.05→	0 986 45 P 2044	0
Innova 2.5 CRDi			
2,5 75 D4D	02.05→	0 986 45 P 2044	0
Ipsium			
Ipsium 2.4 i, i 4WD			
2,4 118 2AZFE	05.01→	0 451 10 P 3276	0
		F 026 40 S 0017	L
iQ			
iQ 1.0			
1,0 50 1KRFE	11.08→	0 986 45 P 2028	0
		F 026 40 S 0154	L
iQ 1.3 VVT-i			
1,3 72 1NRFE	05.09→	F 026 40 S 0154	L
iQ 1.4			
1,4 66 1NDTV	11.08→	F 026 40 S 0140	L
		1 457 43 N 4440 ²	K
Isis			
Isis 1.8 i			
1,8 97 1ZZFE	09.04-09.09	0 986 45 P 2028	0
		F 026 40 S 0017	L
Isis 2.0 i			
2,0 114 1AZFSE	09.04-09.09	F 026 40 S 0017	L



**Ist****Ist 1.3 i**

1,3 64 2NZFE	04.02-07.07	0 986 45 P 2028	0
		1 457 43 S 3972	L

Ist 1.5 i, i 4WD

1,5 77/80 1NZFE	04.02-07.07	0 986 45 P 2028	0
		1 457 43 S 3972	L

Kluger**Kluger 2.4 i, i 4WD**

2,4 118 2AZFE	11.00-05.07	0 451 10 P 3276	0
		1 987 42 S 9187	L

Kluger 3.3 i

3,3 172 3MZFE	10.03→	0 986 45 P 2044	0
		1 987 42 S 9187	L

Kluger 3.3 i 4WD

3,3 155 3MZFE	03.05-05.07	0 986 45 P 2044	0
---------------	-------------	-----------------	---

Land Cruiser**Land Cruiser 2.4**

2,4 81 22R	01.90-04.92	0 986 45 P 2062	0
	05.92-05.93	0 986 45 P 2044	0

Land Cruiser 2.4 D Turbo

2,4 63 2LT	02.90-01.95	0 986 45 P 2062	0
	10.85-01.95	1 457 43 N 4438 ²	K

2,4|69|2LT

01.90-01.95	0 986 45 P 2062	0
	1 457 43 N 4438 ²	K

Land Cruiser 2.4 D Turbo 4x4

2,4 71 2LTE	04.90-05.93	0 986 45 P 2062	0
-------------	-------------	-----------------	---

Land Cruiser 2.4 i

2,4 81 22RE	01.90-04.92	0 986 45 P 2062	0
	05.92-04.96	0 986 45 P 2044	0

2,4|84|22RE

01.90-04.92	0 986 45 P 2062	0
05.92-04.96	0 986 45 P 2044	0
01.90-04.96	0 450 90 F 5912 ¹	K

**Land Cruiser 2.7 i 4x4**

2,7 110 3RZFE	04.96-09.02	0 986 45 P 2044	0
		1 457 43 S 3952	L
	GS	0 986 45 F 0109 ¹	K

2,7|120|2TRFE

08.04-09.09	F 026 40 P 7090	0
-------------	-----------------	---

2,7|150|3RZFE

09.02-08.04	0 986 45 P 2044	0
-------------	-----------------	---

Land Cruiser 2.7 i 16V

2,7 97 3RZFE	10.96-12.06	0 986 45 P 2044	0
--------------	-------------	-----------------	---

2,7|112|3RZFE

10.96-09.04	0 986 45 P 2044	0	
	XXX	1 987 42 S 9158	L
	GS	0 986 45 F 0109 ¹	K

Land Cruiser 2.8 D

2,8 58 3L	04.96-09.02	0 986 45 P 2001	0
		1 987 42 S 9157	L
		1 457 43 N 4438 ²	K

Land Cruiser 3.0 D Turbo

3,0 88 1KZT	04.96-08.00	0 986 45 P 2062	0
		1 987 42 S 9157	L
		1 457 43 N 4438 ²	K

3,0|92|1KZT

05.93-04.96	0 986 45 P 2062	0
	1 457 43 S 3534	L
	1 457 43 N 4438 ²	K

3,0|120|1KDFTV

08.00-09.02	0 986 45 P 2062	0
	1 457 43 N 4438 ²	K

Land Cruiser 3.0 D Turbo Interc.**3,0|92|1KZTE**

04.96-09.02	0 986 45 P 2062	0
	1 987 42 S 9157	L
	1 457 43 N 4438 ²	K

Land Cruiser 3.0 D Turbo 4x4

3,0 96 1KZTE	05.93-04.96	0 986 45 P 2062	0
	03.00-09.02	0 986 45 P 2062	0
	05.93-04.96	1 457 43 S 3534	L

3,0|98|1KZTE

01.05→	1 987 43 M 2085	I
--------	-----------------	---

3,0|103-107|1KZTE

04.96-08.00	0 986 45 P 2062	0
	1 987 42 S 9157	L





◀ Land Cruiser 3.0 D Turbo 4x4

3,0 125 1KDFTV	08.00-07.07	0 986 45 P 2062	O
	08.00-11.02	1 987 42 S 9157	L
		1 457 43 N 4438 ²	K

Land Cruiser 3.0 D-4D

3,0 120 1KDFTV	09.02-07.06	0 986 45 P 2062	O
	08.06→	0 986 45 P 2044	O
	03.04-12.09	1 457 43 N 4438 ²	K
	09.02-08.09	1 987 43 M 2085	I
	08.09→	1 987 43 M 2190	I

Land Cruiser 3.4 D

3,4 66 3B	11.84-02.94	0 986 45 P 2001	O
		1 457 43 S 3534	L
		1 457 43 N 4438 ²	K

Land Cruiser 3.4 i 4x4, i 24V

3,4 131-136 5VZFE	04.96-12.06	0 986 45 P 2044	O
		0 450 90 F 5912 ¹	K

Land Cruiser 3.5 D

3,5 85 1PZ	01.90-08.92	0 986 45 P 2062	O
		1 457 43 S 3534	L
		1 457 43 N 4438 ²	K

Land Cruiser 3.5 D 4x4

3,5 85 1PZ	01.90-01.94	0 986 45 P 2062	O
		1 457 43 N 4438	K

Land Cruiser 4.0 i

4,0 114-115 3FE	01.90-08.92	0 986 45 P 2001	O
		1 457 43 S 3534	L

Land Cruiser 4.0 i, i 24V

4,0 179/183 1GRFE	01.03→	0 986 45 P 2044	O
		1 987 43 M 2085	I

Land Cruiser 4.0 i 24V

4,0 202 1GRFE	08.09→	F 026 40 P 7090	O
		1 987 43 M 2190	I

Land Cruiser 4.0 4x4

4,0 110 3F	09.87-12.92	0 451 10 P 4063	O
		1 457 43 S 3534	L

Land Cruiser 4.2 D

4,2 96 1HZ	12.91→	0 986 45 P 2062	O
		1 457 43 S 3534	L



4,2 96-99 1HZ	01.90-08.01	0 986 45 P 2062	O
		1 457 43 S 3534	L
		1 457 43 N 4438 ²	K

Land Cruiser 4.2 D Turbo

4,2 118-125 1HDT	01.90-01.95	0 986 45 P 2062	O
		1 457 43 S 3534	L
		1 457 43 N 4438 ²	K

Land Cruiser 4.2 D Turbo 4x4

4,2 118/150 1HDFTE	05.95-07.08	0 986 45 P 2062	O
		1 457 43 N 4438 ²	K

4,2 | 151 | 1HDFTE

4,2 151 1HDFTE	06.01→	0 986 45 P 2062	O
		1 457 43 S 3534	L

Land Cruiser 4.2 D 4x4

4,2 96 1HZ	01.98→	0 986 45 P 2062	O	
		1 457 43 S 3534	L	
		03.98-10.07	1 987 42 S 9157	L
		03.99-02.07	1 457 43 N 4438 ²	K
			1 457 43 N 4438 ²	K

4,2 | 96-99 | 1HZ

4,2 96-99 1HZ	08.91-08.99	0 986 45 P 2062	O
-------------------	-------------	-----------------	---

Land Cruiser 4.2 24V D Turbo

4,2 125 1HDFT	01.95-01.98	0 986 45 P 2062	O
		1 457 43 S 3534	L
		1 457 43 N 4438 ²	K

Land Cruiser 4.5 D-4D 4x4

4,5 210 1VDFTV	09.07→	1 987 43 M 2190	I
--------------------	--------	-----------------	---

Land Cruiser 4.5 i 4x4

4,5 158 1FZFE	08.92-11.96	0 451 10 P 4063	O	
		12.96-01.98	0 986 45 P 2044	O
		08.92-01.98	1 457 43 S 3534	L

Land Cruiser 4.5 i 24V

4,5 151-158 1FZFE	08.92-01.98	0 986 45 P 2001	O
		1 457 43 S 3534	L
		XXX	0 986 45 F 0120 ¹

4,5 | 165 | 1FZFE

4,5 165 1FZFE	01.98→	1 987 42 S 9157	L
-------------------	--------	-----------------	---

Land Cruiser 4.5 4x4

4,5 158 1FZFE	03.98-04.05	0 986 45 P 2044	O
		11.92-04.05	1 457 43 S 3534





4,5 165 1FZFE	03.98-09.02	1 987 42	S 9157	L
	10.99-02.07	1 457 43	S 3534	L
		1 987 43	M 2190	I

Land Cruiser 4.5 24V

4,51FZF	04.92-01.98	1 457 43	S 3534	L
---------	-------------	----------	---------------	----------

Land Cruiser 4.7 i 4WD, i 4x4, i 32V 4x4

4,7 173/175 2UZFE	01.98-07.08	0 986 45	P 2044	O
-----------------------	-------------	----------	---------------	----------

Land Cruiser 4.7 i 4x4

4,7 212 2UZFE	09.07→	0 986 45	P 2044	O
		1 987 43	M 2190	I

Limo**Limo 1.5 i**

1,5 80 1NZFE	05.04→	0 986 45	P 2028	O
		1 457 43	S 3972	L

Liteace**Liteace 1.5**

1,5 49 5K	08.88-01.92	0 986 45	P 2000	O
	XXX	0 450 90	F 5923 ¹	K

1,5 51 5K	10.86-06.99	0 986 45	P 2028	O
---------------	-------------	----------	---------------	----------

1,5 51 5KJ; 5KU	09.85-10.96	0 986 45	P 2028	O
---------------------	-------------	----------	---------------	----------

Liteace 1.8 i

1,8 60 7KE	12.98-08.07	1 457 43	S 3952	L
	06.96-08.07	0 450 90	F 5955 ¹	K

Liteace 2.0 D

2,0 53 2C	08.88-01.92	0 986 45	P 2030	O
	06.89-01.92 XXX	1 987 42	S 9156	L
	08.88-01.92	1 457 43	N 4438 ²	K

Liteace 2.0 D, D 4WD

2,0 54 2C	08.87-10.96	0 986 45	P 2030	O
	11.96-12.98	0 451 10	P 3365	O
	08.87-09.93	1 457 42	S 9840	L
	08.87-06.99	1 457 43	N 4438	K
	11.96-12.98	1 457 43	N 4440 ²	K

**Liteace 2.0 D Turbo**

2,0 63 2CT	08.87-01.92	0 986 45	P 2030	O
		1 457 42	S 9840	L
		1 457 43	N 4438	K

Liteace 2.0 i

2,0 96 3SFE	10.96-11.01	0 986 45	P 2028	O
		1 457 43	S 3952	L

Liteace 2.0 i 4WD

2,0 71 3YEU	01.92-09.93	0 986 45	P 2000	O
	10.93-10.96	0 451 10	P 3276	O

Liteace 2.2 D

2,2 43 3CE	12.98-06.04	0 451 10	P 3365	O
		1 457 43	S 3952	L
		1 457 43	N 4440 ²	K

Liteace 2.2 D, D 4x4

2,2 58 3CE	06.99-06.04	0 451 10	P 3365	O
		1 457 43	N 4440 ²	K

Liteace 2.2 D Turbo

2,2 65-67 3CT	09.94-10.96	0 451 10	P 3365	O
Org.Nr. KD-CR22G				
Org.Nr. KD-CR29G				
Org.Nr. Y-CR22G	09.93-08.94	0 986 45	P 2030	O
Org.Nr. Y-CR29G	09.93-10.96	1 457 43	N 4438	K

2,2 67 3CT	10.96-12.98	0 451 10	P 3365	O
		1 457 43	S 3952	L
		1 457 43	N 4440 ²	K

2,2 69 3CTE	12.98-11.01	0 451 10	P 3365	O
		1 457 43	S 3952	L
		1 457 43	N 4440 ²	K

Liteace 2.2 D Turbo 4x4

2,2 65-67 3CT	09.94-10.96	0 451 10	P 3365	O
Org.Nr. KD-CR31G				
Org.Nr. KD-CR38G				
Org.Nr. Y-CR31G	09.93-08.94	0 986 45	P 2030	O
Org.Nr. Y-CR38G	09.93-10.96	1 457 43	N 4438	K

Liteace 2.2 D 4x4

2,2 43 3CE	12.98-06.04	0 451 10	P 3365	O
		1 457 43	N 4440 ²	K





Mark

Mark 1.8 i

1,8 88 4SFE	10.92-09.96	0 986 45 P 2028	0
-----------------	-------------	-----------------	---

Mark 2.0 i

2,0 71 3YE	02.93-04.97	0 986 45 P 2000	0
----------------	-------------	-----------------	---

2,0 118 1GFE	10.00-06.07	0 986 45 P 2044 F 026 40 S 0158	0 L
------------------	-------------	------------------------------------	--------

Mark 2.2 i

2,2 103 5SFE	04.97-12.01	0 986 45 P 2028 1 987 42 S 9151	0 L
------------------	-------------	------------------------------------	--------

Mark 2.5 i

2,5 132 1JZGE	10.92-09.96	0 986 45 P 2044	0
-------------------	-------------	-----------------	---

2,5 147 1JZFSE	10.00-06.07	0 986 45 P 2044	0
--------------------	-------------	-----------------	---

2,5 147 2MZFE	04.97-12.01	0 986 45 P 2044 1 987 42 S 9151	0 L
-------------------	-------------	------------------------------------	--------

Mark 2.5 i Turbo

2,5 206 1JZGTE	10.00-06.07	0 986 45 P 2044	0
--------------------	-------------	-----------------	---

Mark 2.5 i 4WD

2,5 144 1JZGE	01.02-06.07	0 986 45 P 2044	0
-------------------	-------------	-----------------	---

MR-S

MR-S 1.8 i

1,8 103 1ZZFE	10.99-07.07	0 986 45 P 2028 1 987 42 S 9137	0 L
-------------------	-------------	------------------------------------	--------

MR2

MR2 1.8 16V

1,8 103 1ZZFE	12.99-05.06	0 986 45 P 2028 1 987 42 S 9137	0 L
-------------------	-------------	------------------------------------	--------

MR2 2.0 i

2,0 121-147 3SGE	12.89-08.99	0 986 45 P 2028 1 987 42 S 9135 1 987 42 S 9151	0 L L
----------------------	-------------	---	-------------

2,0 125 3SGE	12.89-08.99	0 986 45 P 2028 1 987 42 S 9135	0 L
------------------	-------------	------------------------------------	--------



MR2 2.0 i Turbo

2,0 165-180 3SGTE	12.89-08.99	0 451 10 P 3276 1 987 42 S 9135	0 L
-----------------------	-------------	------------------------------------	--------

MR2 2.0 i 16V

2,0 89 3SFE	12.89-08.92	0 986 45 P 2028 1 987 42 S 9135	0 L
-----------------	-------------	------------------------------------	--------

2,0 115/118 3SGE	12.89-01.95	0 986 45 P 2028 1 987 42 S 9135	0 L
----------------------	-------------	------------------------------------	--------

Noah

Noah 2.0 i

2,0 112-114 1AZFSE	11.01-06.07	0 451 10 P 3276 F 026 40 S 0017	0 L
------------------------	-------------	------------------------------------	--------

Opa

Opa 1.8 i, i 4WD

1,8 92/97-100 1ZZFE	04.00-02.05	0 986 45 P 2028 F 026 40 S 0017	0 L
-------------------------	-------------	------------------------------------	--------

Paseo

Paseo 1.5 i 16V

1,5 69 5EFE	08.95-07.99	0 986 45 P 2028 1 457 43 S 3957 RLE 1 457 43 S 3784 0 450 90 F 5924 ¹	0 L L K
-----------------	-------------	---	------------------

1,5 74 5EFE	09.91-08.95	0 986 45 P 2028 1 457 43 S 3784	0 L
-----------------	-------------	------------------------------------	--------

1,5 81-85 5EFE	09.95-08.99	0 986 45 P 2028 1 457 43 S 3957	0 L
--------------------	-------------	------------------------------------	--------

Passo

Passo 1.0 i

1,0 52 1KRFE	06.04-02.10	1 457 43 S 3971	L
------------------	-------------	-----------------	---

Picnic

Picnic 2.0 i 16V

2,0 98 3SFE	09.96-05.01	0 986 45 P 2028 1 987 42 S 9135 0 450 90 F 5988 ¹	0 L K
-----------------	-------------	--	-------------

**Picnic 2.2 D Turbo**

2,2 66 3CTE	09.97-05.01	0 451 10 P 3365	O
		F 026 40 S 0038	L
		1 457 43 N 4440 ²	K
		1 987 43 M 2159	I

Platz**Platz 1.0 i**

1,0 51 1SZFE	08.99-11.05	0 986 45 P 2028	O
		1 457 43 S 3971	L

Platz 1.3 i 4WD

1,3 64-65 2NZFE	08.99-11.05	0 986 45 P 2028	O
		1 457 43 S 3972	L

Platz 1.5 i

1,5 80-81 1NZFE	08.99-11.05	0 986 45 P 2028	O
		1 457 43 S 3972	L

Porte**Porte 1.3 i**

1,3 64 2NZFE	07.04→	0 986 45 P 2028	O
		1 457 43 S 3972	L

Porte 1.5 i

1,5 80 1NZFE	07.04→	0 986 45 P 2028	O
		1 457 43 S 3972	L

Premio**Premio 1.5 i**

1,5 80 1NZFE	12.01-05.07	0 986 45 P 2028	O
		F 026 40 S 0017	L

Premio 1.8 i, i 4WD

1,8 92/97 1ZZFE	12.01-05.07	0 986 45 P 2028	O
		F 026 40 S 0017	L

Premio 2.0 i

2,0 112-114 1AZFSE	12.01-05.07	0 451 10 P 3276	O
		F 026 40 S 0017	L

**Previa****Previa 2.0 D Turbo**

2,0 85 1CDFTV	02.01-01.06	0 451 10 P 3365	O
		1 987 42 S 9135	L
		1 457 43 N 4440 ²	K
		1 987 43 M 2085	I

Previa 2.4 i 16V, i 16V 4x4

2,4 97/99-103 2TZFE	05.90-12.00	0 986 45 P 2044	O
		1 457 43 S 3952	L
		0 450 90 F 5984 ¹	K

2,4|118|2AZFE

	02.00→	0 451 10 P 3276	O
		1 987 42 S 9163	L
		1 987 43 M 2085	I

Prius**Prius 1.5 i**

1,5 43-53 1NZFXE	12.97-09.03	0 986 45 P 2028	O
1,5 53/57 1NZFXE	09.00→	0 986 45 P 2028	O
	09.00-03.09	1 987 43 M 2085	I

Prius 1.8 i, Plug-in

1,8 73-100 2ZRFXE	04.09→	F 026 40 P 7091	O
		F 026 40 S 0153	L
		1 987 43 M 2190	I

Probox**Probox 1.3 i**

1,3 64 2NZFE	06.02→	0 986 45 P 2028	O
		1 457 43 S 3972	L

Probox 1.5 i

1,5 80 1NZFE	06.02→	0 986 45 P 2028	O
		1 457 43 S 3972	L

Quantum**Quantum 2.5 D-4D**

2,5 75 2KDFTV	03.05→	0 986 45 P 2044	O
---------------	--------	-----------------	----------





Ractis

Ractis 1.3 i

1,3 64 2SZFE	09.05-11.10	0 986 45 P 2028	O
--------------	-------------	-----------------	---

Ractis 1.5 i

1,5 81 1NZFE	09.05-11.10	0 986 45 P 2028	O
--------------	-------------	-----------------	---

Raum

Raum 1.5 i, i 4WD

1,5 77/80 1NZFE	04.03→	0 986 45 P 2028	O
		1 457 43 S 3972	L

RAV4

RAV4 1.8 i

1,8 92 1ZZFE	05.00-11.05	0 986 45 P 2028	O
		F 026 40 S 0158	L

RAV4 1.8 i 16V

1,8 103 1ZZFE	05.00-11.05	0 986 45 P 2028	O
		F 026 40 S 0158	L
		1 987 43 M 2084	I

RAV4 2.0 , 4x4

2,0 116 3ZRFAE	12.08→	F 026 40 P 7091	O
		F 026 40 S 0114	L
		1 987 43 M 2190	I

RAV4 2.0 D Turbo

2,0 85 1CDFTV	05.01-11.05	0 451 10 P 3365	O
	05.01-04.05	1 987 42 S 9135	L
	05.01-11.05	1 457 43 N 4440 ²	K
		1 987 43 M 2084	I

RAV4 2.0 i, i 4WD

2,0 99 3SFE	09.97-05.00	0 986 45 P 2028	O
		1 987 42 S 9135	L
		0 450 90 F 5990 ¹	K

RAV4 2.0 i 4WD

2,0 112-114 1AZFSE	05.00-11.05	0 451 10 P 3276	O
		1 987 42 S 9163	L

2,0 121-132 3SGE	08.96-05.00	0 986 45 P 2028	O
		1 987 42 S 9135	L



RAV4 2.0 i 4x4

2,0 99 3SFE	04.94-05.00	0 986 45 P 2028	O
		1 987 42 S 9135	L

RAV4 2.0 i 16V 4x4

2,0 94/96 3SFE	04.94-08.00	0 986 45 P 2028	O
		1 987 42 S 9135	L
	11.95-08.00 TW	0 986 45 F 0221 ¹	K
	10.97-08.00	0 986 45 F 0221 ¹	K
	RLE	0 450 90 F 5990 ¹	K

2,0 99 3SFE	04.94-08.00	0 986 45 P 2028	O
		1 987 42 S 9135	L
	11.95-08.00 TW	0 986 45 F 0221 ¹	K
	10.97-08.00	0 986 45 F 0221 ¹	K
	RLE	0 450 90 F 5990 ¹	K

RAV4 2.0 VVT-i 4x4

2,0 110 1AZFE	05.00-11.05	0 451 10 P 3276	O
		1 987 42 S 9163	L
		1 987 43 M 2084	I

RAV4 2.0 4x4

2,0 112 1AZFE	11.05→	0 451 10 P 3276	O
		F 026 40 S 0188	L
		1 987 43 M 2190	I

RAV4 2.2 D-CAT 4x4

2,2 130 2AD-FHV	11.05-11.08	F 026 40 P 7090	O
	09.09→	F 026 40 P 7090	O
	11.05→	F 026 40 S 0176	L
		1 457 43 N 4440 ²	K
		1 987 43 M 2190	I

RAV4 2.2 D-4D

2,2 100 2ADFTV	11.05-11.08	F 026 40 P 7090	O
	09.09→	F 026 40 P 7090	O
	11.05→	F 026 40 S 0176	L
		1 457 43 N 4440 ²	K

RAV4 2.2 D-4D 4x4

2,2 100 2AD-FTV	11.05-11.08	F 026 40 P 7090	O
	09.09→	F 026 40 P 7090	O
	11.05→	F 026 40 S 0176	L
		1 457 43 N 4440 ²	K
		1 987 43 M 2190	I

RAV4 2.4 i 4x4

2,4 120 2AZFE	07.03-01.06	0 451 10 P 3276	O
		1 987 42 S 9163	L
		1 987 43 M 2084	I



**RAV4 2.4 4x4**

2,4 125 2AZFE	11.05→	0 451 10 P 3276 O	
		F 026 40 S 0188 L	
		1 987 43 M 2084 I	
		1 987 43 M 2190 I	

RAV4 3.5 4x4

3,5 201 2GRFE	11.05→	F 026 40 S 0188 L	
		1 987 43 M 2190 I	

Regiusace**Regiusace 2.0 i**

2,0 98 1TRFE	08.04→	F 026 40 P 7090 O	
--------------	--------	---------------------------------	--

Sequoia**Sequoia 4.7 , 4x4**

4,7 179-204 2UZFE	09.00-08.07	0 986 45 P 2044 O	
-------------------	-------------	---------------------------------	--

Sequoia 5.7 , 4x4

5,7 280 3URFE	09.07→	1 987 43 M 2190 I	
---------------	--------	---------------------------------	--

Sera**Sera 1.5 i**

1,5 81 5EFHE	03.90-12.95	0 986 45 P 2028 O	
--------------	-------------	---------------------------------	--

Soarer**Soarer 2.0 i, i Turbo**

2,0 99/110/154 1GFE; 1GGEU; 1GGTEU	01.86-04.91	0 986 45 P 2044 O	
------------------------------------	-------------	---------------------------------	--

Soarer 2.5 i Turbo

2,5 206 1JZGTE	05.91-12.00	0 986 45 P 2044 O	
		0 450 90 F 5912 1 K	

Soarer 3.0 i

3,0 165-169 2JZGE	01.94-12.00	0 986 45 P 2044 O	
-------------------	-------------	---------------------------------	--

Soarer 3.0 i Turbo

3,0 177 7MGTEU	01.86-04.91	0 986 45 P 2044 O	
----------------	-------------	---------------------------------	--

**Soarer 4.0 i**

4,0 191 1UZFE	05.91-09.97	0 986 45 P 2044 O	
		0 450 90 F 5912 1 K	

Soarer 4.3 i

4,3 206 3UZFE	04.01-07.05	0 986 45 P 2044 O	
		F 026 40 S 0162 L	

Spacia**Spacia 2.2 i 16V**

2,2 75 4YEC	01.93-01.98	0 451 10 P 3276 O	
-------------	-------------	---------------------------------	--

Sprinter**Sprinter 1.3**

1,3 54 2E	08.87-09.91	0 986 45 P 2028 O	
		1 987 42 S 9122 L	

Sprinter 1.3 i

1,3 59-69 4EFE	01.94-06.02	0 986 45 P 2028 O	
		1 457 43 S 3784 L	
		0 986 45 F 0115 1 K	

Sprinter 1.5 i

1,5 69 5AFE	05.89-06.91	0 986 45 P 2028 O	
	06.89-06.91	1 987 42 S 9135 L	
	05.89-06.91	0 986 45 F 0110 1 K	

1,5|74|5AFE

	05.95-08.00	0 986 45 P 2028 O	
		1 457 43 S 3958 L	
		0 986 45 F 0115 1 K	

Sprinter 1.6 i, i 4WD

1,6 81-85/118-121 4AFE; 4AGE	06.91-07.02	0 986 45 P 2028 O	
		1 457 43 S 3958 L	
		0 986 45 F 0115 1 K	

Sprinter 2.2 D

2,2 58 3CE	04.98-08.00	0 451 10 P 3365 O	
		1 987 42 S 9135 L	
		1 457 43 N 4438 K	





Starlet

Starlet 1.0

1,0 40 1E	12.89-01.96	0 986 45 P 2028	O
		1 987 42 S 9122	L
		0 986 45 F 0018 ¹	K
1,0 40 2A	08.85-02.97	0 986 45 P 2028	O
		0 986 45 F 0018 ¹	K

Starlet 1.3

1,3 53 2A	09.88-09.97	0 986 45 P 2028	O
		0 986 45 F 0018 ¹	K

Starlet 1.3 i

1,3 60 4EF	12.89-01.92	0 986 45 P 2028	O
------------	-------------	-----------------	---

Starlet 1.3 i, i 4WD

1,3 63/71/74 4EFE	12.89-07.99	0 986 45 P 2028	O
		1 457 43 S 3784	L

Starlet 1.3 i Turbo

1,3 99 4EFTE	12.89-07.99	0 986 45 P 2028	O
		1 457 43 S 3784	L

Starlet 1.3 i 4WD

1,3 60 4EFE	01.96-07.99	0 986 45 P 2028	O
		1 457 43 S 3784	L

Starlet 1.3 i 12V

1,3 55-60 2EE	12.89-01.96	0 986 45 P 2028	O
		1 987 42 S 9171	L
		0 986 45 F 0107 ¹	K

Starlet 1.3 i 16V

1,3 55 4EFE	01.96-07.99	0 986 45 P 2028	O
		1 457 43 S 3957	L
	RLE	1 457 43 S 3784	L
		0 986 45 F 0115 ¹	K
1,3 60-62 4EFE	01.96-07.99	0 986 45 P 2028	O
		1 457 43 S 3957	L
	RLE	1 457 43 S 3784	L
		0 986 45 F 0115 ¹	K

Starlet 1.3 12V

1,3 53 2E	12.89-07.99	0 986 45 P 2028	O
		1 987 42 S 9122	L
		0 986 45 F 0018 ¹	K



Starlet 1.5 D

1,5 40 1N	12.89-01.96	0 986 45 P 2030	O
	01.96-07.99	0 451 10 P 3365	O
Org.Nr. Q-NP80	12.89-01.92	0 986 45 P 2044	O
Org.Nr. X-NP80	02.92-09.95	AG 0 986 45 P 2044	O
		GS 0 986 45 P 2030	O
	12.89-07.99	1 987 42 S 9123	L
	12.89-01.96	1 457 43 N 4438 ²	K
		1 457 43 N 4438	K

Succeed

Succeed 1.5 i, i 4WD

1,5 77/80 1NZFE	06.02→	0 986 45 P 2028	O
		1 457 43 S 3972	L

Supra

Supra 2.5 i Turbo

2,5 206 1JZGTE	08.90-05.93	0 986 45 P 2044	O
----------------	-------------	-----------------	---

Supra 3.0 i, i Turbo, i 24V, i 24V Bi-Turbo

3,0 165/175/206/243 2JZGE; 2JZGTE; 7MGTE	08.88-08.02	0 986 45 P 2044	O
--	-------------	-----------------	---

Tercel

Tercel 1.3 i

1,3 65 4EFE	09.94-07.99	0 986 45 P 2028	O
		1 457 43 S 3784	L

Tercel 1.5 D Turbo

1,5 49 1NT	10.94-07.99	0 451 10 P 3365	O
Org.Nr. KD-NL50	09.90-09.94	0 986 45 P 2030	O
Org.Nr. X-NL40	09.90-07.99	1 457 43 S 3952	L
		1 457 43 N 4438	K

Tercel 1.5 i 4WD

1,5 67/74 5EFE	09.90-07.99	0 986 45 P 2028	O
		1 457 43 S 3784	L

Touring Hiace

Touring Hiace 2.7 i, i 4WD

2,7 107 3RZFE	07.99-05.02	0 986 45 P 2044	O
		F 026 40 S 0092	L

Townace

Townace 1.5

1,5 51 5K	10.86-06.99	0 986 45 P 2028	O
-----------	-------------	-----------------	---



**Townace 1.8 i**

1,8 60 7KE	12.98-08.07	0 451 10 P 3276	O
		1 457 43 S 3952	L
	06.99-08.07	0 450 90 F 5955 ¹	K

Townace 2.0

2,0 65 3YC	04.92-12.96	0 451 10 P 3276	O
------------	-------------	-----------------	---

Townace 2.0 D

2,0 54 2C	11.96-12.98	0 451 10 P 3365	O
	08.87-10.96	1 987 42 S 9135	L
	08.87-06.99	1 457 43 N 4438	K
	11.96-12.98	1 457 43 N 4440 ²	K

Townace 2.0 i

2,0 96 3SFE	10.96-11.01	0 986 45 P 2028	O
		1 457 43 S 3952	L

Townace 2.2 D, D 4WD

2,2 43/58 3CE	12.98-06.04	0 451 10 P 3365	O
		1 457 43 N 4440 ²	K

Townace 2.2 D Turbo

2,2 67/69 3CT; 3CTE	10.96-11.01	0 451 10 P 3365	O
		1 457 43 S 3952	L
		1 457 43 N 4440 ²	K

Toyoace**Toyoace 2.5 D**

2,5 80 2KDFTV	08.04-09.07	0 986 45 P 2044	O
		1 457 43 S 3534	L
		1 457 43 N 4438	K

Toyoace 3.0 D

3,0 67 5L	07.01-08.04	1 457 43 N 4438 ²	K
-----------	-------------	------------------------------	---

Toyoace 3.0 D Turbo

3,0 100-106 1KDFTV	08.07→	1 457 43 N 4438	K
--------------------	--------	-----------------	---

Toyoace 3.7 D

3,7 74 4B	05.99-06.04	0 986 45 P 2062	O
		1 457 43 N 4438 ²	K

**Urban Cruiser****Urban Cruiser 1.3 VVT-i**

1,3 74 1NRFE	01.09→	1 457 43 S 3972	L
		1 987 43 M 2190	I

Urban Cruiser 1.4 D-4D 4x4

1,4 66 1NDTV	01.09→	F 026 40 S 0140	L
		1 457 43 N 4440 ²	K
		1 987 43 M 2190	I

Venture**Venture 1.8**

1,8 65 2Y	11.91-05.00	0 986 45 P 2000	O
-----------	-------------	-----------------	---

Venture 2.2

2,2 75 4Y	10.94-05.00	0 986 45 P 2000	O
-----------	-------------	-----------------	---

Verossa**Verossa 2.0 i**

2,0 118 1GFE	06.01-04.04	0 986 45 P 2044	O
		F 026 40 S 0158	L

Verso-S**Verso-S 1.3 VVT-i**

1,3 73 1NRFE	11.10→	1 457 43 S 3972	L
		1 987 43 M 2190	I

Verso-S 1.4 D-4D

1,4 66 1ND-TV	11.10→	F 026 40 S 0140	L
		1 457 43 N 4440 ²	K
		1 987 43 M 2190	I

Vista**Vista 1.8 i**

1,8 92/96-100 1ZZFE; 4SFE	06.94-10.03	0 986 45 P 2028	O
		1 987 42 S 9135	L

Vista 2.0 i 4WD

2,0 99 3SFE	07.90-06.94	0 986 45 P 2028	O
	06.98-04.02	0 986 45 P 2028	O
	07.90-06.94	1 987 42 S 9135	L
	06.98-04.02	1 987 42 S 9135	L



◀ Vista 2.0 i 4WD

2,0 110 1AZFSE	04.02-10.03	0 451 10 P 3276	0
		1 987 42 S 9135	L

Vitz

Vitz 1.0 i

1,0 51 1SZFE	01.99-02.05	0 986 45 P 2028	0
		1 457 43 S 3971	L

Vitz 1.3 i

1,3 64 2SZFE	12.02-12.10	0 986 45 P 2028	0
	12.02-02.05	1 457 43 S 3971	L

1,3 | 64-65 | 2NZFE

09.99-02.05	0 986 45 P 2028	0
	1 457 43 S 3972	L
	1 987 43 M 2084	I

Vitz 1.3 i 4WD

1,3 64 2NZFE	01.05-12.10	0 986 45 P 2028	0
------------------	-------------	-----------------	---

1,3 | 64-65 | 2NZFE

08.99-02.05	0 986 45 P 2028	0
	1 457 43 S 3972	L

Vitz 1.5 i

1,5 80-81 1NZFE	10.00-02.05	0 986 45 P 2028	0
		1 457 43 S 3972	L

1,5 | 81 | 1NZFE

01.05-12.10	0 986 45 P 2028	0
-------------	-----------------	---

Voltz

Voltz 1.8 i

1,8 140 2ZZGE	05.02-02.04	0 451 10 P 3276	0
-------------------	-------------	-----------------	---

Voltz 1.8 i, i 4WD

1,8 92/97 1ZZFE	05.02-02.04	0 986 45 P 2028	0
---------------------	-------------	-----------------	---

Voxy

Voxy 2.0 i

2,0 112-114 1AZFSE	11.01-06.07	0 451 10 P 3276	0
		F 026 40 S 0017	L

WiLL

WiLL 1.3 i

1,3 64 2NZFE	09.02-07.05	0 986 45 P 2028	0
		1 457 43 S 3972	L



1,3 65 2NZFE	01.00-12.01	0 986 45 P 2028	0
		1 457 43 S 3972	L

WiLL 1.5 i 4WD

1,5 | 77 | 1NZFE

09.02-07.05	0 986 45 P 2028	0
	1 457 43 S 3972	L

Windom

Windom 2.5 i

2,5 147 2MZFE	08.96-07.01	0 986 45 P 2044	0
		1 987 42 S 9151	L

Windom 3.0 i

3,0 158 1MZFE	08.98-02.06	0 986 45 P 2044	0
	08.98-07.01	1 987 42 S 9151	L
	07.01-02.06	1 987 42 S 9187	L

Wish

Wish 1.8 i, i 4WD

1,8 92/97 1ZZFE	01.03-04.09	0 986 45 P 2028	0
		F 026 40 S 0017	L

Wish 2.0 i

2,0 114 1AZFSE	04.03-04.09	0 451 10 P 3276	0
		F 026 40 S 0017	L

Yaris

Yaris 1.0 , VVT-i

1,0 51 1KRFE	08.05→	0 986 45 P 2028	0
		1 457 43 S 3971	L
		1 987 43 M 2190	I

Yaris 1.0 i 16V

1,0 50 1SZFE	01.99-08.05	0 986 45 P 2028	0
		1 457 43 S 3971	L
	01.99-12.02	1 987 43 M 2084	I
	01.01-08.05	1 987 43 M 2085	I

Yaris 1.3 , VVT-i

1,3 73/74 1NRFE	11.08→	1 457 43 S 3972	L
		1 987 43 M 2190	I

Yaris 1.3 i 16V

1,3 63 2SZFE	05.02-08.05	0 986 45 P 2028	0
		1 457 43 S 3971	L
		1 987 43 M 2085	I





1,3 66 2NZFE	08.99-12.02	0 986 45 P 2028	O
		1 457 43 S 3972	L
		1 987 43 M 2084	I

Yaris 1.3 VVT-i

1,3 64 2NZFE	01.06→	0 986 45 P 2028	O
		F 026 40 S 0114	L
		1 987 43 M 2084	I
		1 987 43 M 2190	I
	TW	1 987 43 M 2190	I

1,3 64 2SZFE	11.05-10.08	0 986 45 P 2028	O
		1 457 43 S 3971	L
		1 987 43 M 2190	I

Yaris 1.4 D Turbo

1,4 55 1ND-TV	10.01-08.05	0 986 45 P 2044	O
		1 987 42 S 9177	L
		1 457 43 N 4440 ²	K
		1 987 43 M 2084	I

1,4 55 1NDTV	02.03-08.06	0 986 45 P 2044	O
	WW	1 987 42 S 9177	L
		1 457 43 N 4440 ²	K
		1 987 43 M 2085	I

Yaris 1.4 D-4D

1,4 66 1NDTV	11.05-10.08	0 986 45 P 2044	O
		F 026 40 S 0143	L
	11.08→	F 026 40 S 0140	L
	11.05→	1 457 43 N 4440 ²	K
		1 987 43 M 2190	I

Yaris 1.5 i 16V

1,5 78 1NZ-FE	01.01-08.05	0 986 45 P 2028	O
		1 457 43 S 3972	L
		1 987 43 M 2084	I

Yaris 1.5 VVT-i

1,5 81 1NZFE	01.06→	0 986 45 P 2028	O
		F 026 40 S 0114	L
		1 987 43 M 2084	I
		1 987 43 M 2190	I

Yaris 1.8 VVT-i

1,8 97 2ZRFE	11.06→	F 026 40 P 7091	O
		F 026 40 S 0114	L
		1 987 43 M 2190	I

Yaris Verso

Yaris Verso 1.3 i 16V

1,3 63 2NZFE	08.99-09.05	0 986 45 P 2028	O
		1 457 43 S 3972	L
		1 987 43 M 2084	I

Yaris Verso 1.4 D Turbo

1,4 55 1NDTV	08.01-09.05	0 986 45 P 2044	O
		1 987 42 S 9177	L
		1 457 43 N 4440 ²	K
		1 987 43 M 2084	I

Yaris Verso 1.5 i 16V

1,5 81 1NZFE	08.99-09.05	0 986 45 P 2028	O
		1 457 43 S 3972	L
		1 987 43 M 2084	I

4-Runner

4-Runner 2.4

2,4 75 22R	08.89-11.95	0 986 45 P 2001	O
		0 986 45 F 0039 ¹	K
2,4 82 22RE	08.90-08.95	0 986 45 P 2044	O
		0 986 45 F 0039 ¹	K

4-Runner 2.4 D Turbo

2,4 69 2LT	01.90-11.95	0 986 45 P 2062	O
		1 457 43 S 3734	L
		1 457 43 N 4438 ²	K

4-Runner 3.0 D Turbo

3,0 92 1KZT	11.95-08.00	0 986 45 P 2062	O
		1 987 42 S 9157	L
	11.95-05.99	1 457 43 N 4438 ²	K

4-Runner 3.0 D Turbo AWD

3,0 92 1KZTE	08.00→	0 986 45 P 2062	O
		1 987 42 S 9157	L
		1 457 43 N 4438	K

4-Runner 3.0 i

3,0 105 3VZE	09.89-11.95	0 986 45 P 2044	O
	01.90-11.95	1 457 43 S 2111	L
	09.89-11.95	0 450 90 F 5912 ¹	K





4-Runner 3.4 i

3,4 136 5VZFE	08.00→	0 986 45 P 2044	0
		0 450 90 F 5912 ¹	K

4-Runner 4.0 i

4,0 236 1GRFE	09.02→	0 986 45 P 2044	0
		1 987 43 M 2085	I

4-Runner 4.7 i 4x4

4,7 260 2UZFE	09.02→	0 986 45 P 2044	0
		1 987 43 M 2085	I

TRABANT

601

601 1.1

1,1 29-30	05.90-12.91	0 451 10 P 3033	0
		1 457 42 S 9061	L

UAZ

Hunter

Hunter 2.7 i 4x4

2,7 94,1 40904 <Euro 3>	01.08→	0 451 20 P 3154	0
		0 450 90 F 5200 ¹	K

2,7 105 409.10 <Euro 2>	01.06→	0 451 20 P 3154	0
		TW 0 450 90 F 5030 ¹	K
		0 450 90 F 5200 ¹	K

Patriot

Patriot 2.7 4x4

2,7 105 409.10 <Euro 2>	09.05→	0 451 20 P 3154	0
		0 450 90 F 5200 ¹	K
		TW 0 450 90 F 5030 ¹	K
		0 450 90 F 5200 ¹	K

2,7 105 40904 <Euro 3>	01.08→	0 451 20 P 3154	0
		0 450 90 F 5200 ¹	K

220...

220... 220695 2.7i

2,7 82,5 409.10 <Euro 3>	01.08→	0 451 20 P 3154	0
		TW 0 450 90 F 5030 ¹	K
		0 450 90 F 5200 ¹	K



VAUXHALL

Agila

Agila 1.0 i, Twinport

1,0 43/44 Z 10 XE <Ecotec>; Z 10 XEP <Twinport Ecotec>			
Mot.Nr. →19MA9234	09.99-02.08	F 026 40 P 7015	0
Mot.Nr. 19MA9235→	09.99-02.08	F 026 40 P 7006	0
	09.99-02.08	1 457 43 S 3153	L
		1 987 43 M 2066	I

Agila 1.0 Twinport

1,0 48 K 10 B <Twinport Ecotec>			
	03.08→	0 986 45 P 2058	0
		1 987 43 M 2214	I

Agila 1.2 i, Twinport

1,2 55/59 Z 12 XE <Ecotec>; Z 12 XEP <Twinport Ecotec>			
Mot.Nr. →19MA9234	09.00-02.08	F 026 40 P 7015	0
Mot.Nr. 19MA9235→	09.00-02.08	F 026 40 P 7006	0
	09.00-02.08	1 457 43 S 3153	L
		1 987 43 M 2066	I

Agila 1.2 Twinport, VVT

1,2 63/69 K 12 B; K 12 B <Twinport Ecotec>			
	03.08→	0 986 45 P 2058	0
		1 987 43 M 2214	I

Agila 1.3 CDTI

1,3 55 D 13 A <Turbo>; Z 13 DTJ			
	03.08→	F 026 40 P 7067	0
		1 987 43 M 2214	I

Antara

Antara 2.4 4x4

2,4 104 Z 24 XE <Ecotec>			
	11.06→	0 451 10 P 3079	0

Arena

Arena 1.9 D

1,9 44 F 8Q 600 <TF1J/L>			
	03.98-08.01	1 457 43 N 1705	K
1,9 44 F 8Q 606 <TF1J/L>			
Fg.Nr. C057917→	03.98-08.01	1 457 43 N 1705	K

Arena 2.5

2,5 55 S8U-758 <TF1G/M,THBJ/L,THBG/M>			
	03.98-08.01	0 451 20 P 3201	0

Arena 2.5 D

2,5 55 S8U-780 <TF1G/M,THBJ/L,THBG/M>			
	03.98-08.01	0 451 20 P 3201	0
		1 457 43 N 1705	K
2,5 55 S8U-782 <TF1G/M,THBJ/L,THBG/M>			
	03.98-08.01	0 451 20 P 3201	0
Fg.Nr. Y257500→	03.98-08.01	1 457 43 N 1705	K



Astra E

Astra E 1.3

1,3 44 13N,NB <OHC>	09.84-08.91	0 451 10 P 3079	O
Mot.Nr. →19389114	09.84-08.91	0 451 10 P 2056	O
	09.84-08.91	1 457 42 S 9053	L

Astra E 1.3 i

1,3 44 C 13 N <OHC>	09.85-08.91	0 451 10 P 3079	O
Mot.Nr. →19389114	09.85-08.91	0 451 10 P 2056	O
	09.85-08.91	1 457 42 S 9053	L
		0 450 90 F 5280 ¹	K

Astra E 1.6

1,6 60/66 16 S/SH <OHC>; 16 SV <OHC>	09.84-08.91	0 451 10 P 3079	O
		1 457 42 S 9053	L

Astra E 1.8 i

1,8 82 18 E <OHC>	09.84-08.91	0 450 90 F 5002 ¹	K
1,8 82-85 18 SE <OHC>	09.86-08.91	0 451 10 P 3079	O
		0 450 90 F 5002 ¹	K

Astra E 2.0 i

2,0 95/110-115 C20 XE (XEJ) <DOHC>; 20 SEH <OHC>; 20 XE <DOHC>	09.86-08.91	0 451 10 P 3079	O
		0 450 90 F 5002 ¹	K

Astra F

Astra F 1.4 , i

1,4 55/60/66 X 14 XE <Ecotec DOHC>; 14 NV <OHC>; 14 SE/ C 14 SE <OHC>	09.91-02.98	0 451 10 P 3079	O
		1 457 43 S 3007	L
		0 450 90 F 5002 ¹	K
		1 987 43 M 2010	I

Astra F 1.4 i

1,4 44 C 14 NZ <OHC>	09.90-02.98	0 451 10 P 3079	O
		1 457 43 S 3007	L
		0 450 90 F 5002 ¹	K
		1 987 43 M 2010	I

1,4|44|X 14 NZ <OHC>

09.97-02.98	0 451 10 P 3079	O
	1 457 43 S 3007	L
	0 450 90 F 5280 ¹	K
	1 987 43 M 2010	I

Astra F 1.6 i

1,6 52/55/74 C 16 SE <OHC>; X 16 SZ <OHC>; X 16 SZR <OHC>	03.92-02.98	0 451 10 P 3079	O
		1 457 43 S 3007	L
		0 450 90 F 5002 ¹	K
		1 987 43 M 2010	I

1,6|55|C 16 NZ / E 16 NZ <OHC>

09.91-02.98	0 451 10 P 3079	O
	1 457 43 S 3007	L
	0 450 90 F 5280 ¹	K
	1 987 43 M 2010	I

1,6|55/74|X 16 XEL <Ecotec DOHC>; 16 LZ2,16NZ2 <OHC>

09.91-02.98	0 451 10 P 3079	O
	1 457 43 S 3007	L
	0 450 90 F 5280 ¹	K
	1 987 43 M 2010	I

Astra F 1.7 D/DR

1,7|42-44|17 D/DR <OHC>

12.91-02.98	0 451 10 P 3232	O
	1 457 43 S 3007	L
	1 457 43 N 4106 ²	K
	1 987 43 M 2010	I

Astra F 1.7 DTL

1,7|50|X 17 DTL <OHC>

07.95-02.98	0 451 10 P 3297	O
	1 457 43 S 3007	L
	1 457 43 N 4106 ²	K
	1 987 43 M 2010	I

Astra F 1.7 TD

1,7|60|17 DT <TC4EE1>; 17 DT/TC4 <EE1 OHC>

12.91-12.95	0 986 45 P 2036	O	
01.96-02.98	0 986 45 P 2041	O	
Fg.Nr. T8000001→TP000001→	12.91-02.98	1 457 43 S 3007	L
Fg.Nr. →S89999999→SP9999999	12.91-02.98	1 457 42 S 9894	L
	12.91-02.98	1 457 43 N 4106 ²	K
		1 987 43 M 2010	I

Astra F 1.8 i

1,8|66/82/85/92|C 18 NZ <OHC>; C 18 XE <DOHC>; C 18 XEL <DOHC>; X 18 XE <DOHC>; 18 SE <OHC>

09.91-02.98	0 451 10 P 3079	O
	1 457 43 S 3007	L
	0 450 90 F 5280 ¹	K
	1 987 43 M 2010	I

Astra F 2.0 i

2,0|85/110|C 20 NE , 20 NE <OHC>; C 20 XE,XE-LN <DOHC>

09.91-02.98	0 451 10 P 3079	O
	1 457 43 S 3007	L
	0 450 90 F 5002 ¹	K
	1 987 43 M 2010	I





◀ Astra F 2.0 i

2,0 100 X 20 XEV <Ecotec DOHC>			
01.95-02.98	0 451 10	P 3079	O
	1 457 43	S 3007	L
	0 450 90	F 5280 ¹	K
	1 987 43	M 2010	I

Astra G

Astra G 1.2 i

1,2 48/55 X 12 XE <Ecotec>; Z 12 XE <Ecotec>			
09.97-08.05	F 026 40	P 7015	O
	1 457 43	S 3281	L
BHR	1 987 43	M 2038	I
DHI,ELH	1 987 43	M 2040	I

Astra G 1.4 i

1,4 66 X 14 XE <Ecotec>; Z 14 XE <Ecotec>			
09.97-08.05	0 451 10	P 3079	O
	1 457 43	S 3281	L
BHR	1 987 43	M 2038	I
DHI,ELH	1 987 43	M 2040	I

Astra G 1.6 i

1,6 55/62/74 C 16 SEL; X 16 SZR <Ecotec>; X 16 XEL <Ecotec>; Z 16 SE <Ecotec>			
09.97-08.05	0 451 10	P 3079	O
	1 457 43	S 3281	L
BHR	1 987 43	M 2038	I
DHI,ELH	1 987 43	M 2040	I

1,6 74 Z 16 XE <Ecotec>			
09.00-08.05	0 451 10	P 3079	O
	0 451 10	P 3370	O
	1 457 43	S 3281	L
BHR	1 987 43	M 2038	I
DHI,ELH	1 987 43	M 2040	I

1,6 74 Z 16 XEP <Ecotec>			
09.02-08.05	0 451 10	P 3079	O
	1 457 43	S 3281	L
BHR	1 987 43	M 2038	I
DHI,ELH	1 987 43	M 2040	I

Astra G 1.6 i Dualfuel

1,6 63-73 Z 16 YNG <Gasmotor Ecotec LPG>			
09.02-08.05	0 451 10	P 3079	O
	1 457 43	S 3281	L
	0 450 90	F 5273 ¹	K
BHR	1 987 43	M 2038	I
DHI,ELH	1 987 43	M 2040	I

Astra G 1.6 i Twinport

1,6 76 Z 16 XEP <Twinport Ecotec>			
03.03-08.05	0 451 10	P 3079	O
	0 451 10	P 3370	O
	1 457 43	S 3281	L
BHR	1 987 43	M 2038	I
DHI,ELH	1 987 43	M 2040	I
DHI,RLE	1 987 43	M 2040	I



Astra G 1.7 CDTI, CDTI 16V

1,7 59 Z 17 DTL <Turbo>			
03.03-08.05	1 457 42	P 9199	O
	1 457 43	S 3281	L
	1 457 42	N 9656	K
BHR	1 987 43	M 2038	I
DHI,ELH	1 987 43	M 2040	I

Astra G 1.7 DT

1,7 50 X 17 DTL <Turbo>			
03.98-08.00	0 451 10	P 3297	O
	1 457 43	S 3281	L
	1 457 42	N 9656	K
BHR	1 987 43	M 2038	I
DHI,ELH	1 987 43	M 2040	I

Astra G 1.7 DTI

1,7 55 Y 17 DT <Turbo (EE 4)>			
09.00-08.05	1 457 42	P 9199	O
Fg.Nr. →Y8999999	09.00-08.05	1 457 43	S 3281
	09.00-08.05	1 457 42	N 9656
		BHR	1 987 43 M 2038
		DHI,ELH	1 987 43 M 2040

Astra G 1.8 i

1,8 85 Z 18 XEL <Ecotec>			
Fg.Nr. 20V00605→	03.01-08.05	0 451 10	P 3079
Mot.Nr. →20V00604	03.01-08.05	1 457 42	P 9178
	03.01-08.05	1 457 43	S 3281
		BHR	1 987 43 M 2038
		DHI,ELH	1 987 43 M 2040

1,8 85/92 X 18 XE1 <Ecotec>; Z 18 XE <Ecotec>			
Fg.Nr. 20V00605→	09.97-08.05	0 451 10	P 3079
Mot.Nr. →20V00604	09.97-08.05	1 457 42	P 9178
	09.97-08.05	1 457 43	S 3281
		BHR	1 987 43 M 2038
		DHI,ELH	1 987 43 M 2040

Astra G 1.8 i Dualfuel

1,8 87-93 Z 18 XE <Gasmotor Ecotec LPG>			
Fg.Nr. 20V00605→	09.02-08.05	0 451 10	P 3079
Mot.Nr. →20V00604	09.02-08.05	1 457 42	P 9178
	09.02-08.05	1 457 43	S 3281
		NGB	0 450 90 F 5273 ¹
		BHR	1 987 43 M 2038
		DHI,ELH	1 987 43 M 2040

Astra G 2.0 DTI, DTL

2,0 60/74 Y 20 DTH <Turbo>; Y 20 DTL <Turbo>			
09.00-08.05	1 457 42	P 9157	O
Fg.Nr. →Y8999999	09.00-08.05	1 457 43	S 3281
	09.00-08.05	1 457 42	N 9656
		BHR	1 987 43 M 2038
		DHI,ELH	1 987 43 M 2040

**Astra G 2.0 DTL****2,0|60|X 20 DTL <Turbo>**

	03.98-08.00	1 457 42	P 9157	O
Fg.Nr. →Y8999999	03.98-08.00	1 457 43	S 3281	L
	03.98-08.00	1 457 42	N 9656	K
		BHR	1 987 43	M 2038
		DHI,ELH	1 987 43	M 2040

Astra G 2.0 i**2,0|100|X 20 XEV <Ecotec>**

	09.97-08.05	0 451 10	P 3079	O
			1 457 43 S 3281	L
		BHR	1 987 43	M 2038
		DHI,ELH	1 987 43	M 2040

2,0|118|X 20 XER <Ecotec>

	09.00-08.05	0 451 10	P 3297	O
			1 457 43 S 3281	L
		BHR	1 987 43	M 2038
		DHI,ELH	1 987 43	M 2040

Astra G 2.0 i Turbo, Turbo**2,0|141|Z 20 LET <Turbo Ecotec>**

	09.00-08.05	0 451 10	P 3079	O
			1 457 43 S 3281	L
		BHR	1 987 43	M 2038
		DHI,ELH	1 987 43	M 2040

Astra G 2.2 DTI**2,2|92|Y 22 DTR <Turbo>**

	09.01-08.05	1 457 42	P 9157	O
			1 457 42 N 9656	K
		BHR	1 987 43	M 2038
		DHI,ELH	1 987 43	M 2040

Astra G 2.2 i**2,2|108|Z 22 SE <Ecotec>**

	09.00-08.05	F 026 40	P 7016	O
		BHR	1 987 43	M 2038
		DHI,ELH	1 987 43	M 2040

Astra H**Astra H 1.2 Twinport****1,2|59|Z 12 XEP <Twinport Ecotec>**

Mot.Nr. →19MA9234	03.07-03.09	F 026 40	P 7015	O
Mot.Nr. 19MA9235→	03.07-03.09	F 026 40	P 7006	O
	03.07-03.09		1 457 43 S 3281	L
			1 987 43 M 2040	I

Astra H 1.3 CDTI**1,3|66|Z 13 DTH <Ecotec>**

	06.05-03.10	1 457 42	P 9256	O
			F 026 40 S 0013	L
			1 457 07 N 0001	K
			1 987 43 M 2040	I

**Astra H 1.4 , i****1,4|55|Z 14 XEL <Ecotec>**

Mot.Nr. →19MA9234	09.04-12.05	F 026 40	P 7015	O
Mot.Nr. 19MA9235→	09.04-12.05	F 026 40	P 7006	O
	09.04-12.05		1 457 43 S 3281	L
			1 987 43 M 2040	I

Astra H 1.4 Twinport**1,4|55|Z 14 XEL <Twinport Ecotec>**

Mot.Nr. →19MA9234	09.05-02.09	F 026 40	P 7015	O
Mot.Nr. 19MA9235→	09.05-02.09	F 026 40	P 7006	O
	09.05-02.09		1 457 43 S 3281	L

Astra H 1.4 Twinport, Twinport Dualfuel**1,4|66|Z 14 XEP <Ecotec / Twinport>; Z 14 XEP <Gasmotor Ecotec LPG>; Z 14 XEP <Twinport Ecotec>**

Mot.Nr. →19MA9234	03.04-03.10	F 026 40	P 7015	O
Mot.Nr. 19MA9235→	03.04-03.10	F 026 40	P 7006	O
	03.04-03.10		1 457 43 S 3281	L
			1 987 43 M 2040	I

Astra H 1.6**1,6|85|A 16 XER; A 16 XER <Ecotec>**

	01.11→	F 026 40	P 7006	O
			1 457 43 S 3281	L
			1 987 43 M 2040	I

Astra H 1.6 , i**1,6|85|Z 16 XER <Ecotec>**

	03.07-03.10	F 026 40	P 7006	O
			1 457 43 S 3281	L
			1 987 43 M 2040	I

Astra H 1.6 i**1,6|76-77|Z 16 XEP <Ecotec>**

	09.05-03.08	0 451 10	P 3370	O
			1 457 43 S 3281	L

Astra H 1.6 i Turbo, Turbo**1,6|132|Z 16 LET <Ecotec>**

	03.07-03.10	F 026 40	P 7006	O
			F 026 40 S 0012	L
			1 987 43 M 2040	I

Astra H 1.6 Turbo**1,6|132|A 16 LET <Ecotec>**

	01.11→	F 026 40	P 7006	O
			F 026 40 S 0012	L
			1 987 43 M 2040	I

Astra H 1.6 Twinport**1,6|77|Z 16 XEP <Twinport Ecotec>**

	03.04-03.08	0 451 10	P 3370	O
			1 457 43 S 3281	L
	03.04-03.07		1 987 43 M 2040	I



◀ Astra H 1.6 Twinport

1,6 77 Z 16 XE1 <Twinport Ecotec>	03.07-03.09	0 451 10 P 3370	O
		1 457 43 S 3281	L
		1 987 43 M 2040	I

Astra H 1.6 VVT

1,6 85 Z 16 XER	12.06→	F 026 40 P 7006	O
		1 457 43 S 3281	L

Astra H 1.7 CDTI

1,7 59 Z 17 DTL <Turbo Ecotec>	03.04-03.07	1 457 42 P 9199	O
		F 026 40 S 0013	L

Fg.Nr. →62005916→65020044→68	03.04-03.07	1 457 42 N 9656	K
	03.04-03.07	1 987 43 M 2040	I

1,7 74 Z 17 DTH <Turbo Ecotec>	03.04-03.07	1 457 42 P 9199	O
		F 026 40 S 0013	L

Fg.Nr. →62005916→65020044→68	03.04-03.07	1 457 42 N 9656	K
	03.04-03.07	1 987 43 M 2040	I

1,7 81 A 17 DTJ <ecoFLEX>	04.09-09.09	F 026 40 S 0012	L
		1 987 43 M 2040	I

1,7 81 Z 17 DTJ <ecoFLEX>; Z 17 DTJ <Turbo Ecotec>	03.07-03.10	F 026 40 S 0012	L
		1 987 43 M 2040	I

1,7 81/92 A 17 DTJ <Turbo Ecotec>; A 17 DTR <Turbo Ecotec>	03.10→	F 026 40 S 0012	L
		1 987 43 M 2040	I

1,7 92 Z 17 DTR <Turbo Ecotec>	05.07-03.10	F 026 40 S 0012	L
		1 987 43 M 2040	I

Astra H 1.8 i

1,8 92 Z 18 XE <Ecotec>	03.04-02.09	0 451 10 P 3370	O
		1 457 43 S 3281	L
		1 987 43 M 2040	I

1,8 103 Z 18 XER <Ecotec>	08.05-03.10	F 026 40 P 7006	O
		1 457 43 S 3281	L
		1 987 43 M 2040	I

Astra H 1.8 i VVT

1,8 103 A 18 XER	01.11→	F 026 40 P 7006	O
		1 457 43 S 3281	L
		1 987 43 M 2040	I

Astra H 1.9 CDTi

1,9 110 Z 19 DTH <Ecotec>	09.05-12.09	1 457 42 P 9248	O
		F 026 40 S 0012	L
		1 457 07 N 0001	K



Astra H 1.9 CDTI

1,9 74/88/110 Z 19 DTH <Turbo Ecotec>; Z 19 DTJ <Turbo Ecotec>; Z 19 DTL <Turbo Ecotec>	03.04-03.10	1 457 42 P 9248	O
		F 026 40 S 0012	L
		1 457 07 N 0001	K
		1 987 43 M 2040	I

1,9 88 Z 19 DT <Turbo Ecotec>	09.05-03.10	1 457 42 P 9248	O
		F 026 40 S 0012	L
		1 457 07 N 0001	K
		1 987 43 M 2040	I

Astra H 2.0 i Turbo

2,0 125 Z 20 LEL <Ecotec>	09.05-02.09	0 451 10 P 3370	O
		1 457 43 S 3281	L

2,0 147 Z 20 LER <Ecotec>	09.05-12.09	0 451 10 P 3370	O
		1 457 43 S 3281	L

Astra H 2.0 Turbo

2,0 125 Z 20 LEL <Turbo Ecotec>	03.04-02.09	0 451 10 P 3370	O
		1 457 43 S 3281	L
		1 987 43 M 2040	I

2,0 177 Z 20 LEH <Turbo Ecotec>	03.05-03.10	0 451 10 P 3370	O
		1 457 43 S 3281	L
		1 987 43 M 2040	I

Astra H 2.0 Turbo 16V

2,0 147 Z 20 LER <Turbo Ecotec>	03.04-03.10	0 451 10 P 3370	O
		1 457 43 S 3281	L
		1 987 43 M 2040	I

2,0 177 Z 20 LEH <Turbo Ecotec>	06.05-03.09	0 451 10 P 3370	O
		1 457 43 S 3281	L

Astra J

Astra J 1.3 CDTI

1,2 70 A 13 DTE	09.10→	F 026 40 N 2062	K
		1 987 43 R 2304 ⁸	I

1,3 70 A 13 DTE <eco Flex>	09.09→	F 026 40 N 2062	K
		1 987 43 R 2304 ⁸	I

Astra J 1.4 i

1,4 64/74 A 14 XEL <eco Flex>; A 14 XER <eco Flex>; A 14 XER <ecoFlex>	09.09→	F 026 40 P 7006	O
		1 987 43 R 2304 ⁸	I



**Astra J 1.4 i Turbo, Turbo**

1,4 | 103 | A 14 NET; A 14 NET <Ecotec>

09.09→	F 026 40 P 7006	O
	1 987 43 R 2304 ⁸	I

Astra J 1.4 Turbo

1,4 | 88 | A 14 NEL <Ecotec>; A 14 NEL <Turbo ecoFLEX>

09.11→	F 026 40 P 7006	O
	1 987 43 M 2004	I
	1 987 43 R 2304 ⁸	I

1,4 | 103 | A 14 NET <Turbo ecoFLEX>

09.11→	F 026 40 P 7006	O
	1 987 43 M 2004	I
	1 987 43 R 2304 ⁸	I

Astra J 1.6 i

1,6 | 85 | A 16 XER <Ecotec>

09.09→	F 026 40 P 7006	O
	1 987 43 R 2304 ⁸	I

Astra J 1.6 i, Turbo

1,6 | 85/132 | A 16 LET <Turbo ecoFLEX>; A 16 XER

09.10→	F 026 40 P 7006	O
	1 987 43 M 2004	I
	1 987 43 R 2304 ⁸	I

Astra J 1.6 i Turbo

1,6 | 132 | A 16 LET <Ecotec>

09.09→	F 026 40 P 7006	O
	1 987 43 R 2304 ⁸	I

Astra J 1.7 CDTI

1,7 | 81 | A 17 DTJ

09.10→	F 026 40 N 2062	K
	1 987 43 M 2004	I
	1 987 43 R 2304 ⁸	I

1,7 | 81 | A 17 DTJ <Ecotec>

09.09→	F 026 40 S 0012	L
	F 026 40 N 2062	K
	1 987 43 R 2304 ⁸	I

1,7 | 92 | A 17 DTR

09.10→	F 026 40 N 2062	K
	1 987 43 M 2004	I
	1 987 43 R 2304 ⁸	I

1,7 | 92 | A 17 DTR <Ecotec>

09.09→	F 026 40 N 2062	K
	1 987 43 R 2304 ⁸	I

Astra J 2.0

2,0 | 121 | A 20 DTH <Turbo ecoFLEX>

09.11→	1 987 43 R 2304 ⁸	I
--------	------------------------------	---

Astra J 2.0 CDTI

2,0 | 118 | A 20 DTH

09.10→	F 026 40 P 7087	O
	F 026 40 N 2062	K
	1 987 43 M 2004	I
	1 987 43 R 2304 ⁸	I

2,0 | 118 | A 20 DTH <Ecotec>

09.09→	F 026 40 P 7087	O
	F 026 40 N 2062	K
	1 987 43 R 2304 ⁸	I

2,0 | 121 | A 20 DTH

09.10→	1 987 43 R 2304 ⁸	I
--------	------------------------------	---

2,0 | 121 | A 20 DTH <Ecotec>

09.11→	1 987 43 R 2304 ⁸	I
--------	------------------------------	---

Belmont**Belmont 1.3**

1,3 | 55 | 13 S <OHC>

09.85-09.93	0 451 10 P 2056	O
	1 457 42 S 9053	L

Belmont 1.6 D

1,6 | 40 | 16 D/DA <OHC>

09.85-09.93	0 451 10 P 3232	O
	1 457 42 S 9079	L
	1 457 43 N 4103 ²	K

Belmont 1.6 S

1,6 | 60/66 | 16 S -SH <OHC>; 16 SV <OHC>

09.85-09.93	0 451 10 P 3079	O
	1 457 42 S 9053	L

Belmont 1.8 i

1,8 | 82-85 | 18 SE <OHC II>

09.86-09.93	0 451 10 P 3079	O
	0 450 90 F 5002 ¹	K

Brava**Brava 2.2 D**

2,2 | 39 | 4 FD1

06.89-09.96	1 457 43 N 4453 ²	K
-------------	------------------------------	---

Brava 2.3 , i

2,3 | 69/72 | 4 ZD1; 4 ZD1-23P

09.91-09.96	0 451 10 P 3316	O
09.91-06.94	1 457 42 S 9800	L

Brava 2.5 D

2,5 | 56-74 | 4 JA1

06.90-09.96	FOE	0 986 45 P 2064	O
	XXX	1 987 42 S 9154	L
02.89-09.96		1 457 43 N 4453 ²	K





Brava 2.5 TD

2,5 56 4 JA1 T			
06.90-12.96	0 986 45	P 2064	O
03.97-08.02	0 986 45	P 2064	O
06.90-12.96	XXX	1 987 42	S 9154 L
03.97-08.02	XXX	1 987 42	S 9154 L
10.89-12.96	1 457 43	N 4453 ²	K
03.97-08.02	1 457 43	N 4453 ²	K

Brava 3.1 TD

3,1 80 4 JG 2T <Turbo>			
03.97-08.02	0 986 45	P 2064	O
	1 457 43	N 4453 ²	K
3,1 80 4 JG2 T			
03.95-12.96	0 986 45	P 2064	O

Calibra

Calibra 2.0 i

2,0 85 C 20 NE <OHC II>			
03.90-03.98	0 451 10	P 3079	O
	1 457 42	S 9896	L
	0 450 90	F 5002 ¹	K
2,0 100 X 20 XEV <DOHC II>			
09.93-07.97	0 450 90	F 5002 ¹	K
	1 987 43	M 2010	I
2,0 110 C 20 XE, XE-LN <DOHC>			
03.90-03.97	0 451 10	P 3079	O
	0 450 90	F 5002 ¹	K

Calibra 2.0 i turbo

2,0 150 C 20 LET <DOHC>			
03.92-07.97	0 450 90	F 5002 ¹	K
	1 987 43	M 2010	I

Calibra 2.5 i V6

2,5 125 C 25 XE, X 25 XE			
04.93-03.97	0 450 90	F 5002 ¹	K
	1 987 43	M 2010	I

Carlton

Carlton 1.8

1,8 65-66 18 SV / 18NVR			
09.86-10.94	0 451 10	P 3079	O
	XXX	1 457 42	S 9876 L

Carlton 1.8 i

1,8 85 18 SEH			
09.86-10.94	0 451 10	P 3079	O
	0 450 90	F 5002 ¹	K

Carlton 2.0 i

2,0 73-74/85/90 C 20 NE; C 20 NEJ/NEF; 20 SE			
09.86-10.94	0 451 10	P 3079	O
	0 450 90	F 5002 ¹	K



Carlton 2.3 D

2,3 54 23 YD			
09.86-10.94	0 451 20	P 3005	O
	1 457 43	S 3310	L
	1 457 43	N 4106 ²	K

Carlton 2.3 TD Interc.

2,3 74 23 DTR			
09.88-10.94	0 451 10	P 3217	O
	1 457 43	S 3310	L
	1 457 43	N 4106 ²	K

Carlton 2.4 i

2,4 92 C 24 NE CIH			
09.86-10.94	0 451 10	P 2056	O
	1 457 43	S 3310	L
	0 450 90	F 5002 ¹	K

Carlton 2.6 i

2,6 110 C 26 NE CIH			
09.90-10.94	0 451 10	P 3093	O
	1 457 43	S 3310	L
	0 450 90	F 5002 ¹	K

Carlton 3.0 i

3,0 130 C 30 NE CIH			
03.87-10.94	0 451 10	P 3093	O
	1 457 43	S 3310	L

3,0 | 130 | 30 NE CIH

03.87-10.94	0 451 10	P 3093	O
	1 457 43	S 3310	L
	0 450 90	F 5002 ¹	K

3,0 | 147-150 | C 30 SE/SEJ

01.89-10.94	0 451 10	P 3093	O
	DEL	1 457 42	S 9877 L
	0 450 90	F 5002 ¹	K

Carlton 3.6 i

3,6 277-281 C 36 GET			
01.90-03.94	1 457 42	S 9877	L

Cavalier

Cavalier 1.4

1,4 55 14 NV			
09.94-08.95	0 451 10	P 3079	O
09.88-11.95	1 457 42	S 9053	L

Cavalier 1.6 i, i KAT

1,6 52/55-60 C 16 LZ2; E16 NZ, C16 NZ; X 16 SZ <Ecotec>			
09.94-08.95	0 451 10	P 3079	O
09.88-11.95	1 457 42	S 9896	L
	0 450 90	F 5002 ¹	K





Cavalier 1.6 S

1,6 60 16SV			
	09.94-08.95	0 451 10 P 3079	O
Fg.Nr. LV100001→L1000001→	09.88-08.95	1 457 42 S 9896	L
L5000001→			
Fg.Nr. →KV999999→K1999999	09.88-08.95	1 457 42 S 9053	L
→K5999999			

Cavalier 1.7 D

1,7 42 17D/DR			
	09.88-11.95	0 451 10 P 3232	O
		1 457 42 S 9895	L
		1 457 43 N 4106 ²	K

Cavalier 1.7 TD

1,7 60 17DT/TC4EE1			
	09.88-11.95	0 986 45 P 2041	O
		1 457 42 S 9894	L
		1 457 43 N 4106 ²	K

Cavalier 1.8

1,8 66 18SV			
	09.94-08.95	0 451 10 P 3079	O
Fg.Nr. LV100001→L1000001→	09.88-08.95	1 457 42 S 9896	L
L5000001→			

Cavalier 1.8 i

1,8 66 C18NZ			
	09.94-08.95	0 451 10 P 3079	O
Fg.Nr. LV100001→L1000001→	09.88-11.95	1 457 42 S 9896	L
L5000001→			
	09.88-11.95	0 450 90 F 5002 ¹	K

Cavalier 1.8 S

1,8 65 E18NVR			
	09.94-08.95	0 451 10 P 3079	O
Fg.Nr. LV100001→L1000001→	09.88-08.95	1 457 42 S 9896	L
L5000001→			
Fg.Nr. →KV999999→K1999999	09.88-08.95	XXX 1 457 42 S 9876	L
→K5999999			
	09.88-08.95	0 450 90 F 5002 ¹	K

Cavalier 2.0 i, i 4x4, i 16V, i 16V 4x4

2,0 85/86/95/100/110/150 C 20 LET <Turbo>; C 20 NE; C 20 XE (XEJ-LN); X 20 XEV; 20 NE; 20 SEH; 20 XE/XEJ			
	09.94-08.95	0 451 10 P 3079	O
	09.88-11.95	1 457 42 S 9896	L
		0 450 90 F 5002 ¹	K

Cavalier 2.5 i V6

2,5 125 C25XE			
	09.94-08.95	0 451 10 P 3079	O
	02.93-11.95	1 457 42 S 9896	L
		0 450 90 F 5002 ¹	K



Combo

Combo 1.2 i

1,2 33 C12NZ; X12SZ <Ecotec>; 12NZ			
	09.94-10.01	0 451 10 P 3079	O
		1 457 43 S 3603	L
		0 450 90 F 5273 ¹	K
		1 987 43 M 2015	I

Combo 1.3 CDTi

1,2 51 Z13DT <Turbo>			
	09.04→	1 457 42 P 9256	O
	TW	F 026 40 S 0020	L
		1 457 43 S 3055	L
		1 457 07 N 0001	K
	MOO	1 987 43 M 2076	I
		1 987 43 R 2376 ⁸	I

1,3|51/55|Y13DT <Turbo>; Z13DTJ <Turbo>

	09.04→	1 457 42 P 9256	O
	TW	F 026 40 S 0020	L
		1 457 43 S 3055	L
		1 457 07 N 0001	K
	MOO	1 987 43 M 2076	I
		1 987 43 R 2376 ⁸	I

Combo 1.4 i

1,4|44/60/66|C14NZ; C14SE; C14SEL; X14SZ <Ecotec>

	09.94-10.01	0 451 10 P 3079	O
		1 457 43 S 3603	L
		0 450 90 F 5273 ¹	K
		1 987 43 M 2015	I

Combo 1.4 i Twinport, i Twinport Dualfuel

1,4|65/66|Z14XEP <Gasmotor Ecotec LPG>; Z14XEP <Twinport>

Mot.Nr. →19MA9234	01.04→	F 026 40 P 7015	O
Mot.Nr. 19MA9235→	01.04→	F 026 40 P 7006	O
	01.04→	1 457 43 S 3055	L
		MOO 1 987 43 M 2076	I
		1 987 43 R 2376 ⁸	I

Combo 1.6 CNG

1,6|69|Z16YNG <Ecotec-Gas CNG>

	06.06→	0 451 10 P 3370	O
		1 457 43 S 3055	L
		MOO 1 987 43 M 2076	I
		1 987 43 R 2376 ⁸	I

1,6|71|Y16YNG <Ecotec-Gas CNG>

	04.05-05.06	0 451 10 P 3370	O
		1 457 43 S 3055	L
		MOO 1 987 43 M 2076	I
		1 987 43 R 2376 ⁸	I





Combo 1.6 i

1,6 64 Z 16 SE			
	10.01-08.04	0 451 10 P 3079	O
		1 457 43 S 3055	L
	MOO	1 987 43 M 2076	I
		1 987 43 R 2376⁸	I

Combo 1.7 CDTi

1,7 74 Z 17 DTH <Turbo>			
	09.04->	1 457 42 P 9199	O
		1 457 43 S 3529	L
	MOO	1 987 43 M 2076	I
		1 987 43 R 2376⁸	I

Combo 1.7 D

1,7 44 X 17 D 4EE1			
	04.96-10.01	0 986 45 P 2041	O
		1 457 43 S 3713	L
		1 457 43 N 4106²	K
	KL	1 987 43 M 2015	I

1,7 44 17 D <4EE1>			
	09.94-10.01	0 986 45 P 2041	O
		1 457 43 S 3713	L
		1 457 43 N 4106²	K
	KL	1 987 43 M 2015	I

Combo 1.7 DI, DTI

1,7 48/55 Y 17 DT Turbo; Y 17 DTL Turbo			
	09.01-08.04	1 457 42 P 9199	O
		1 457 43 S 3055	L
		1 457 42 N 9656	K
	MOO	1 987 43 M 2076	I
		1 987 43 R 2376⁸	I

Corsa

Corsa 1.0 i

1,0 40 X 10 XE <Ecotec>			
	09.96-09.00	F 026 40 P 7015	O
		1 457 43 S 3603	L
	KL	1 987 43 M 2015	I

Corsa 1.0 i 12V

1,0 43 Z 10 XE <Ecotec>			
Fg.Nr. ->19MA9234	09.00-08.03	F 026 40 P 7015	O
Mot.Nr. 19MA9235->	09.00-08.03	F 026 40 P 7006	O
	09.00-08.03	1 457 43 S 3055	L
	KL	1 987 43 M 2076	I
		1 987 43 R 2376⁸	I



Corsa 1.0 Twinport

1,0 44 Z 10 XEP <Twinport Eco>			
Fg.Nr. ->19MA9234	09.03-08.05	F 026 40 P 7015	O
	07.06->	F 026 40 P 7015	O
Mot.Nr. 19MA9235->	09.03-08.05	F 026 40 P 7006	O
	07.06->	F 026 40 P 7006	O
	09.03-08.05	1 457 43 S 3055	L
	07.06->	F 026 40 S 0097	L
	09.03-08.05	MOO 1 987 43 M 2076	I
		1 987 43 R 2376⁸	I
	07.06->	1 987 43 M 2188	I
		1 987 43 R 2488⁸	I

1,0|48|A 10 XEP <Twinport Eco>

Fg.Nr. ->19MA9234	12.09->	F 026 40 P 7015	O
Mot.Nr. 19MA9235->	12.09->	F 026 40 P 7006	O
	12.09->	F 026 40 S 0097	L
		1 987 43 M 2188	I
		1 987 43 R 2488⁸	I

Corsa 1.2 i

1,2 33 C 12 NZ			
	09.94-08.00	0 451 10 P 3079	O
		1 457 43 S 3603	L
		0 450 90 F 5273¹	K
	KL	1 987 43 M 2015	I

1,2|33|X 12 SZ <Ecotec>

	09.94-08.00	0 451 10 P 3079	O
		1 457 43 S 3603	L
		0 450 90 F 5273¹	K
	KL	1 987 43 M 2015	I

1,2|33|12 NZ

	09.94-08.00	0 451 10 P 3079	O
		1 457 43 S 3603	L
		0 450 90 F 5273¹	K
	KL	1 987 43 M 2015	I

1,2|48|X 12 XE <Ecotec>

	09.97-08.00	F 026 40 P 7015	O
Fg.Nr. X3000001->	09.97-08.00	1 457 43 S 3054	L
Fg.Nr. ->W69999999	09.97-08.00	1 457 43 S 3603	L
	09.97-08.00	KL 1 987 43 M 2015	I

Corsa 1.2 i LPG

1,2|55-59|<eco FLEX>

Fg.Nr. ->19MA9234	12.09->	F 026 40 P 7015	O
Mot.Nr. 19MA9235->	12.09->	F 026 40 P 7006	O
	12.09->	F 026 40 S 0097	L
		1 987 43 M 2188	I
		1 987 43 R 2488⁸	I

Corsa 1.2 i Twinport, Twinport

1,2|51/63|A 12 XEL <Twinport Eco>; A 12 XER <Twinport Eco>

Fg.Nr. ->19MA9234	12.09->	F 026 40 P 7015	O
Mot.Nr. 19MA9235->	12.09->	F 026 40 P 7006	O
	12.09->	F 026 40 S 0097	L
		1 987 43 M 2188	I
		1 987 43 R 2488⁸	I





Corsa 1.2 i 16V

1,2 | 55 | Z 12 XE <Ecotec>

Fg.Nr. →19MA9234	09.00-08.04	F 026 40 P 7015	O
Mot.Nr. 19MA9235→	09.00-08.04	F 026 40 P 7006	O
	09.00-08.04	1 457 43 S 3055	L
	KL	1 987 43 M 2076	I
		1 987 43 R 2376 ⁸	I

Corsa 1.2 Twinport

1,2 | 59 | Z 12 XEP <Twinport Eco>

Fg.Nr. →19MA9234	09.04→	F 026 40 P 7015	O
Mot.Nr. 19MA9235→	09.04→	F 026 40 P 7006	O
	09.04-09.06	1 457 43 S 3055	L
	07.06→	F 026 40 S 0097	L
	09.04-09.06 MOO	1 987 43 M 2076	I
		1 987 43 R 2376 ⁸	I
	07.06→	1 987 43 M 2188	I
		1 987 43 R 2488 ⁸	I

Corsa 1.2 Twinport Dualfuel

1,2 | 59 | Z 12 XEP <Gasmotor Ecotec LPG>

Fg.Nr. →19MA9234	09.04-09.06	F 026 40 P 7015	O
Mot.Nr. 19MA9235→	09.04-09.06	F 026 40 P 7006	O
	09.04-09.06	1 457 43 S 3055	L
	MOO	1 987 43 M 2076	I
		1 987 43 R 2376 ⁸	I

Corsa 1.2 16V Dualfuel

1,2 | 55 | Z 12 XE <Gasmotor Ecotec LPG>

Fg.Nr. →19MA9234	08.01-08.04	F 026 40 P 7015	O
Mot.Nr. 19MA9235→	08.01-08.04	F 026 40 P 7006	O
	08.01-08.04	1 457 43 S 3055	L
		0 450 90 F 5273 ¹	K
	KL	1 987 43 M 2076	I
		1 987 43 R 2376 ⁸	I

Corsa 1.3 CDTI

1,2 | 55/70 | A 13 DTC <Turbo Ecotec>; A 13 DTR <eco Flex>

	01.11→	F 026 40 S 0049	L
		0 450 90 N 6503 ¹	K
		1 987 43 M 2188	I
		1 987 43 R 2488 ⁸	I

1,3 | 51 | ... 13 DT <Turbo Ecotec>

	09.03-09.06	1 457 42 P 9256	O
		1 457 43 S 3055	L
		1 457 07 N 0001	K
	MOO	1 987 43 M 2076	I
		1 987 43 R 2376 ⁸	I

1,3 | 55 | Z 13 DTJ <Turbo Ecotec>

	09.05-09.06	1 457 42 P 9256	O
	TW	F 026 40 P 7067	O
	07.06→	F 026 40 P 7067	O
	09.05-09.06	F 026 40 S 0020	L
	07.06→	F 026 40 S 0049	L
	09.05-09.06	1 457 07 N 0001	K
Fg.Nr. →96129269	09.05→	F 026 40 N 2051 ¹	K
Fg.Nr. 96129270→	09.05→	0 450 90 N 6503 ¹	K
	09.05-09.06 MOO	1 987 43 M 2076	I
		1 987 43 R 2376 ⁸	I
	07.06→	1 987 43 M 2188	I
		1 987 43 R 2488 ⁸	I

1,3 | 55/66 | A 13 DTH <Turbo Ecotec>; A 13 DTJ <Turbo Ecotec>

	10.06-02.09	F 026 40 S 0049	L
Fg.Nr. →96129269	10.06-02.09	F 026 40 N 2051 ¹	K
Fg.Nr. 96129270→	10.06-02.09	0 450 90 N 6503 ¹	K
	10.06-02.09	1 987 43 M 2188	I
		1 987 43 R 2488 ⁸	I

1,3 | 66 | Z 13 DTH <Turbo Ecotec>

	07.06→	TW	1 457 42 P 9256	O
			F 026 40 S 0049	L
Fg.Nr. →96129269	07.06→		F 026 40 N 2051 ¹	K
Fg.Nr. 96129270→	07.06→		0 450 90 N 6503 ¹	K
	07.06→		1 987 43 M 2188	I
			1 987 43 R 2488 ⁸	I

1,3 | 70 | Z 13 DTE <eco Flex>

	12.09→	F 026 40 S 0049	L
		0 450 90 N 6503 ¹	K
		1 987 43 M 2188	I
		1 987 43 R 2488 ⁸	I

Corsa 1.4 i

1,4 | 44/60/63 | C 14 NZ; C 14 SE; C 14 SEL

	09.94-08.00	0 451 10 P 3079	O
		1 457 43 S 3603	L
		0 450 90 F 5273 ¹	K
	KL	1 987 43 M 2015	I

1,4 | 44/66 | X 14 SZ <Ecotec>; X 14 XE <Ecotec>

	09.94-08.99	0 451 10 P 3079	O
		1 457 43 S 3603	L
		0 450 90 F 5273 ¹	K
	KL	1 987 43 M 2015	I

Corsa 1.4 i 16V

1,4 | 66 | Z 14 XE <Ecotec>

Fg.Nr. →33999999→34999999	09.00-08.03	0 451 10 P 3079	O
→36999999			
Fg.Nr. 43000001→44000001→	09.00-08.03	0 451 10 P 3370	O
46000001→			
	09.00-08.03	1 457 43 S 3055	L
	KL	1 987 43 M 2076	I
		1 987 43 R 2376 ⁸	I





Corsa 1.4 LPG

1,4 | 65-66 | <eco Flex>

Fg.Nr. →19MA9234	12.09→	F 026 40 P 7015	O
Mot.Nr. 19MA9235→	12.09→	F 026 40 P 7006	O
	12.09→	F 026 40 S 0097	L
		1 987 43 M 2188	I
		1 987 43 R 2488 ⁸	I

Corsa 1.4 Twinport

1,4 | 64/74 | A 14 XEL <Twinport Eco>; A 14 XER <Twinport Eco>

Fg.Nr. →19MA9234	12.09→	F 026 40 P 7015	O
Mot.Nr. 19MA9235→	12.09→	F 026 40 P 7006	O
	12.09→	F 026 40 S 0097	L
		1 987 43 M 2188	I
		1 987 43 R 2488 ⁸	I

1,4 | 66 | Z 14 XEP <Twinport Eco>

Fg.Nr. →19MA9234	07.06→	F 026 40 P 7015	O
Mot.Nr. →19MA9234	09.03-08.05	F 026 40 P 7015	O
Mot.Nr. 19MA9235→	09.03-08.05	F 026 40 P 7006	O
	07.06→	F 026 40 P 7006	O
	09.03-08.05	1 457 43 S 3055	L
	07.06→	F 026 40 S 0097	L
	09.03-08.05 MOO	1 987 43 M 2076	I
		1 987 43 R 2376 ⁸	I
	07.06→	1 987 43 M 2188	I
		1 987 43 R 2488 ⁸	I

Corsa 1.5 D, TD, XTD

1,5 | 37/49 | X 15 D <4EC1 OHC>; X 15 TD <4EE1 Turbo>; 15 D <4EC1>; 15 TD <T4EC1 Turbo>

	09.94-08.00	0 986 45 P 2041	O
		1 457 43 S 3713	L
		1 457 43 N 4106 ²	K
	KL	1 987 43 M 2015	I

Corsa 1.6 GSI, i

1,6 | 74/78/80 | C 16 SEL; C 16 XE; X 16 XE <Ecotec>

	09.94-08.00	0 451 10 P 3079	O
		1 457 43 S 3603	L
		0 450 90 F 5273 ¹	K
	KL	1 987 43 M 2015	I

Corsa 1.6 i

1,6 | 62 | Z 16 SE <Ecotec>

Fg.Nr. →33999999→34999999	09.01-08.03	0 451 10 P 3079	O
→36999999			
Fg.Nr. 43000001→44000001→	09.01-08.03	0 451 10 P 3370	O
46000001→			
	09.01-08.03	1 457 43 S 3055	L
	KL	1 987 43 M 2076	I
		1 987 43 R 2376 ⁸	I

Corsa 1.6 i OPC Turbo, i Turbo

1,6 | 110/141 | A 16 LEL <Turbo ECOTEC>; A 16 LER <Turbo ECOTEC>

	11.09→	F 026 40 P 7006	O
		F 026 40 S 0049	L
		1 987 43 M 2188	I
		1 987 43 R 2488 ⁸	I



1,6 | 110/141 | Z 16 LEL <Turbo ECOTEC>; Z 16 LER <Turbo ECOTEC>

	02.07→	F 026 40 P 7006	O
		F 026 40 S 0049	L
		1 987 43 M 2188	I
		1 987 43 R 2488 ⁸	I

Corsa 1.7 CDTI

1,7 | 74 | Z 17 DTH <Turbo Ecotec>

	09.03-08.05	1 457 42 P 9199	O
		1 457 43 S 3055	L
		1 457 42 N 9656	K
	MOO	1 987 43 M 2076	I
		1 987 43 R 2376 ⁸	I

1,7 | 92 | A 17 DTR

Fg.Nr. →86059280	07.06-02.09	F 026 40 S 0049	L
	07.06-02.09	1 987 43 M 2188	I
		1 987 43 R 2488 ⁸	I

1,7 | 92 | Z 17 DTR

Fg.Nr. →86059280	07.06→	F 026 40 S 0049	L
	07.06→	1 987 43 M 2188	I
		1 987 43 R 2488 ⁸	I

1,7 | 96 | A 17 DTS

	12.09→	0 450 90 N 6503 ¹	K
		1 987 43 M 2188	I
		1 987 43 R 2488 ⁸	I

Corsa 1.7 D

1,7 | 44 | X 17 D 4EE1

	04.96-08.00	0 986 45 P 2041	O
		1 457 43 S 3713	L
		1 457 43 N 4106 ²	K
	KL	1 987 43 M 2015	I

1,7 | 44 | 17 D <4EE1>

	09.94-08.00	0 986 45 P 2041	O
		1 457 43 S 3713	L
		1 457 43 N 4106 ²	K
	KL	1 987 43 M 2015	I

Corsa 1.7 DI, DTI

1,7 | 48/55 | Y 17 DT; Y 17 DTL

	09.00-08.03	1 457 42 P 9199	O
		1 457 43 S 3055	L
		1 457 42 N 9656	K
	KL	1 987 43 M 2076	I
		1 987 43 R 2376 ⁸	I

Corsa 1.8 i 16V

1,8 | 92 | Z 18 XE <GSI/Ecotec>

Mot.Nr. →20V00604	09.01-08.05	1 457 42 P 9178	O
Mot.Nr. 20V00605→	09.01-08.05	0 451 10 P 3370	O
	09.01-08.05	1 457 43 S 3055	L
	KL	1 987 43 M 2076	I
		1 987 43 R 2376 ⁸	I

Euromidi

Euromidi 2.0

2,0 | 74 | 20 S <OHC (NEF)>

	09.88-08.96	0 986 45 P 2041	O
--	-------------	-----------------	---



**Euromidi 2.0 DT**

2,0 51 4FC1T	09.88-08.96	MC1	0 986 45 P 2041	O
--------------	-------------	-----	-----------------	---

Euromidi 2.2 D

2,2 45 4FD1	09.88-08.96	MC1	0 986 45 P 2041	O
-------------	-------------	-----	-----------------	---

Euromidi 2.4 DT

2,4 56 4FG1T	09.88-08.96	MC1	0 986 45 P 2041	O
--------------	-------------	-----	-----------------	---

Frontera**Frontera 2.0 i**

2,0 85 C 20 NE; X 20 SE <Ecotec>	01.92-08.98		0 451 10 P 3079	O
			1 457 42 S 9877	L
			0 450 90 F 5002 ¹	K

Frontera 2.2 DTI

2,2 85 X 22 DTH <Turbo>	09.98-09.04		1 457 42 P 9157	O
			1 987 42 S 9162	L
			1 457 42 N 9656	K

2,2 88 Y 22 DTH <Turbo>	09.98-09.04		1 457 42 P 9157	O
			1 987 42 S 9162	L
			1 457 42 N 9656	K

Frontera 2.2 i

2,2 100 X 22 SE <Ecotec>	09.98-12.00		0 451 10 P 3079	O
			1 987 42 S 9162	L

2,2 100 X 22 XE <Ecotec>	02.95-08.98		0 451 10 P 3079	O
			1 457 42 S 9877	L
			0 450 90 F 5002 ¹	K

2,2 100 Y 22 SE <Ecotec>	09.00-09.04		0 451 10 P 3079	O
			1 987 42 S 9162	L

Frontera 2.3 TD

2,3 74 23 DT <Turbo>	01.92-08.95		0 451 10 P 3217	O
			1 457 42 S 9877	L

Frontera 2.4 i

2,4 92 C 24 NE CIH	01.92-08.95		0 451 10 P 2056	O
			1 457 42 S 9877	L
			0 450 90 F 5002 ¹	K

**Frontera 2.5 TDS Turbo**

2,5 85 VM41B <Venturi-25TD>	06.96-08.98	XXX	0 451 10 P 3360	O
			1 457 42 S 9877	L

Frontera 2.8 TDI Turbo

2,8 83 4JB1T	02.95-08.98		0 986 45 P 2064	O
			1 457 42 S 9877	L

Frontera 3.2 i

3,2 151 6VD1	09.98-09.04		0 986 45 P 2041	O
			1 987 42 S 9162	L

Insignia**Insignia 1.4 , Turbo**

1,4 103 A 14 NET <Turbo ecoFLEX>	09.11→		F 026 40 P 7006	O
			1 987 43 M 2004	I
			1 987 43 R 2304 ⁸	I

Insignia 1.6

1,6 85 A 16 XER <Ecotec>	11.08→		F 026 40 P 7006	O
			F 026 40 S 0111	L
			1 987 43 M 2004	I
			1 987 43 R 2304 ⁸	I

Insignia 1.6

1,6 132 A 16 LET <Ecotec>	11.08→		F 026 40 P 7006	O
			1 987 43 M 2004	I
			1 987 43 R 2304 ⁸	I

Insignia 1.8

1,8 103 A 18 XER <Ecotec>	11.08→		F 026 40 P 7006	O
			F 026 40 S 0111	L
			1 987 43 M 2004	I
			1 987 43 R 2304 ⁸	I

Insignia 2.0 CDTI

2,0 81 A 20 DTC <Ecotec>	11.08→		F 026 40 P 7087	O
			F 026 40 N 2062	K
			1 987 43 M 2004	I
			1 987 43 R 2304 ⁸	I

2,0|96|A 20 DT... <eco Flex>

Fg.Nr. →91999999	11.08→		F 026 40 P 7087	O
	11.08→		F 026 40 N 2062	K
			1 987 43 M 2004	I
			1 987 43 R 2304 ⁸	I





◀ Insignia 2.0 CDTI

2,0 118 A 20 DTH <ecoFlex>				
Fg.Nr. →91999999	11.08→	F 026 40 P 7087	O	
	11.08→	F 026 40 N 2062	K	
		1 987 43 M 2004	I	
		1 987 43 R 2304 ⁸	I	

Insignia 2.0 CDTI 4x4

2,0 118 A 20 DTH <ecoFlex>				
	06.10→	F 026 40 N 2062	K	
		1 987 43 R 2304 ⁸	I	

2,0 140 A 20 DTR <Ecotec>				
	07.09→	F 026 40 P 7087	O	
		F 026 40 N 2062	K	
		1 987 43 M 2004	I	
		1 987 43 R 2304 ⁸	I	

Insignia 2.0 Turbo

2,0 162 A 20 NHT <Ecotec>				
	11.08→	F 026 40 P 7016	O	
Fg.Nr. B1000001→	11.08→	F 026 40 S 0111	L	
	11.08→	1 987 43 M 2004	I	
		1 987 43 R 2304 ⁸	I	

Insignia 2.0 Turbo 4x4, 4x4

2,0 162 A 20 NHT <Ecotec>				
	11.08→	F 026 40 P 7016	O	
Fg.Nr. B1000001→B1999999	11.08→	F 026 40 S 0111	L	
	11.08→	1 987 43 M 2004	I	
		1 987 43 R 2304 ⁸	I	

Insignia 2.8 Turbo 4x4, 4x4

2,8 191/239 A 28 NER <Ecotec>; A 28 NET <Ecotec>				
	11.08→	1 987 43 M 2004	I	
		1 987 43 R 2304 ⁸	I	

Meriva

Meriva 1.3 CDTI

1,2 55 ... 13 DT <Ecotec>				
	09.05-03.10	1 457 42 P 9256	O	
		TW F 026 40 P 7067	O	
		F 026 40 S 0020	L	
Fg.Nr. →64138771	09.05-03.10	1 457 07 N 0001	K	
Fg.Nr. 64138772→	09.05-03.10	F 026 40 N 2054 ¹	K	

1,2 55/70 A 13 DTC <Ecotec>; A 13 DTE <ecoFlex>				
	06.10→	F 026 40 N 2062	K	
		1 987 43 M 2004	I	
		1 987 43 R 2304 ⁸	I	

1,3 55 Z 13 DTJ <Ecotec>				
	09.03-03.10	1 457 42 P 9256	O	
		TW F 026 40 P 7067	O	
		F 026 40 S 0020	L	
Fg.Nr. →64088960	09.03-03.10	1 457 07 N 0001	K	
Fg.Nr. 64088961→	09.03-03.10	F 026 40 N 2054 ¹	K	
	09.03-03.10	1 987 43 M 2111	I	
		1 987 43 R 2411 ⁸	I	



Meriva 1.4 ecoFLEX, Ecotec

1,4 74/88/103 A 14 NEL <ecoFLEX>; A 14 NET <Ecotec>; A 14 XER <Ecotec>				
	04.10→	F 026 40 P 7006	O	
		1 987 43 M 2004	I	
		1 987 43 R 2304 ⁸	I	

Meriva 1.4 16V Twinport

1,4 66 Z 14 XEP <Twinport Ecotec>				
Mot.Nr. →19MA9234	07.04-03.10	F 026 40 P 7015	O	
Mot.Nr. 19MA9235→	07.04-03.10	F 026 40 P 7006	O	
	07.04-03.10	1 457 43 S 3055	L	
		0 450 90 F 5273 ¹	K	
		1 987 43 M 2111	I	
		1 987 43 R 2411 ⁸	I	

Meriva 1.6 i, i 16V

1,6 64/74 Z 16 SE <Ecotec>; Z 16 XE <Ecotec>				
Fg.Nr. →34999999	03.03-02.06	0 451 10 P 3079	O	
Fg.Nr. 44000001→	03.03-02.06	0 451 10 P 3370	O	
	03.03-02.06	1 457 43 S 3055	L	
		0 450 90 F 5273 ¹	K	
		1 987 43 M 2111	I	

Meriva 1.6 i OPC Turbo

1,6 132 Z 16 LET <Ecotec>				
	09.05-03.10	F 026 40 P 7006	O	
		F 026 40 S 0020	L	
		0 450 90 F 5273 ¹	K	
		1 987 43 M 2111	I	
		1 987 43 R 2411 ⁸	I	

Meriva 1.6 i 16V

1,6 77 Z 16 XEP <Ecotec>				
	01.06-03.10	0 451 10 P 3370	O	
		1 457 43 S 3055	L	
		1 987 43 M 2111	I	
		1 987 43 R 2411 ⁸	I	

Meriva 1.7 CDTI

1,7 74 A 17 DT <Ecotec>				
	04.10→	F 026 40 N 2062	K	
		1 987 43 M 2004	I	
		1 987 43 R 2304 ⁸	I	

1,7 74 Z 17 DTH <Turbo Ecotec (EE4)>				
	09.03-09.09	1 457 42 P 9199	O	
		1 457 43 S 3055	L	
		1 987 43 M 2111	I	

1,7 92 A 17 ... <MT-6>				
Fg.Nr. →84094750	09.06-03.10	F 026 40 S 0020	L	
	09.06-03.10	1 987 43 M 2111	I	
		1 987 43 R 2411 ⁸	I	

1,7 92 Z 17 ... <MT-6>				
Fg.Nr. →84094750	09.06-03.10	F 026 40 S 0020	L	
	09.06-03.10	1 987 43 M 2111	I	
		1 987 43 R 2411 ⁸	I	

1,7 96 A 17 DTS <Ecotec>				
	04.10→	1 987 43 R 2304 ⁸	I	

**Meriva 1.7 DTI****1,7|55|Y 17 DT <Turbo (EE4)>**

03.03-09.05	1 457 42 P 9199	O
	1 457 43 S 3055	L
	1 987 43 M 2111	I

Meriva 1.8 i 16V**1,8|92|Z 18 XE <Ecotec>**

Fg.Nr. →34999999	03.03-03.10	0 451 10 P 3079	O
Fg.Nr. 44000001→	03.03-03.10	0 451 10 P 3370	O
	03.03-03.10	1 457 43 S 3055	L
		0 450 90 F 5273 ¹	K
		1 987 43 M 2111	I

Monterey**Monterey 3.1 TD****3,1|84|4 JG2 TCOHV**

09.91-08.98	0 986 45 P 2064	O
	1 457 43 N 4453 ²	K

Monterey 3.2 i**3,2|130|6VDI**

06.92-08.98	0 451 10 P 3316	O
	0 450 90 F 5280 ¹	K

Monterey 3.5 i V6**3,5|158|6VE 1**

02.98-12.99	0 986 45 P 2041	O
	0 450 90 F 5280 ¹	K

Movano**Movano 1.9 D****1,9|59|F9Q-770**

01.99-10.01	1 457 43 S 3531	L
	1 457 43 N 1705	K

Movano 1.9 DTI**1,9|60|F9Q-772; F9Q-774**

10.01-10.05	F 026 40 S 0014	L
	1 457 43 N 1720	K

Movano 2.2 DTI**2,2|66|G9T-720; G9T-722; G9T-750**

01.01-10.05	1 457 42 P 9198	O
	F 026 40 S 0014	L
	1 457 43 N 1720	K

Movano 2.5 D**2,5|59|S8U-772**

10.98-10.05	0 451 20 P 3201	O
	F 026 40 S 0014	L
	1 457 43 N 1705	K

Movano 2.5 DTI**2,5|74-84|G9U... <Turbo>**

04.04-03.10	1 457 42 P 9198	O
	1 457 43 N 1705	K

2,5|74-88|G9U... <Turbo>

08.06-03.10	F 026 40 P 7014	O
	1 457 43 N 1705	K

2,5|84|G9U... <Turbo>

10.01-03.07	1 457 42 P 9198	O
	F 026 40 S 0014	L
	1 457 43 N 1720	K

2,5|84|G9U-724

10.03-03.07	1 457 42 P 9198	O
	F 026 40 S 0014	L
	1 457 43 N 1720	K

2,5|107|G9U-632 <Turbo>

08.06-03.10	F 026 40 P 7014	O
	1 457 43 N 1705	K

Movano 2.8 DTI**2,8|84|S9W-700; S9W-702**

06.98-10.05	0 451 20 P 3201	O
	F 026 40 S 0014	L
	1 457 43 N 1705	K

Movano 3.0 DTI**3,0|100|ZD3-...**

10.03-10.05	L11	1 457 43 N 1724	K
	L90	F 026 40 N 2047	K

Nova**Nova 1.0****1,0|33|10 S OHV**

05.83-08.94	0 451 10 P 2056	O
	1 457 42 S 9050	L

Nova 1.2**1,2|33-39|E 12 GV <OHC>; 12 NC OHV**

05.83-08.94	0 451 10 P 2056	O
	1 457 42 S 9050	L

Nova 1.2 , i, S**1,2|33/40-43|12 NV <OHC I>; 12 S <OHC>; 12 ST**

Mot.Nr. →19382906	05.83-08.94	0 451 10 P 2056	O
Mot.Nr. 19382907→	05.83-08.94	0 451 10 P 3079	O
	05.83-08.94	1 457 42 S 9050	L

Nova 1.2 i**1,2|33|C 12 NZ <OHC>**

09.90-08.94	0 451 10 P 3079	O
	1 457 42 S 9053	L
	0 450 90 F 5002 ¹	K





Nova 1.3

1,3 | 44 | C 13 N <OHC>

Mot.Nr. →1486846→19389114	05.89-08.94	0 451 10 P 2056	O
Mot.Nr. 1486847→19389115→	05.89-08.94	0 451 10 P 3079	O
	05.89-08.94	1 457 42 S 9053	L
		0 450 90 F 5002 ¹	K

1,3 | 51 | 13 S <OHC>; 13 SB <OHC>

Mot.Nr. →1486846→19389114	05.83-08.94	0 451 10 P 2056	O
Mot.Nr. 1486847→19389115→	05.83-08.94	0 451 10 P 3079	O
	05.83-08.94	1 457 42 S 9053	L

Nova 1.4

1,4 | 55 | 14 NV <OHC>

01.90-08.94	0 451 10 P 3079	O
	1 457 42 S 9053	L

Nova 1.4 i

1,4 | 44 | C 14 NZ <OHC I>

01.90-08.94	0 451 10 P 3079	O
	1 457 42 S 9053	L
	0 450 90 F 5002 ¹	K

1,4 | 60 | C 14 SE <OHC I>

09.91-08.94	0 451 10 P 3079	O
-------------	-----------------	---

Nova 1.5 D

1,5 | 37 | 15 D/4EC1-AAD <OHC>

09.87-08.94	0 986 45 P 2041	O
	1 457 42 S 9894	L

Fg.Nr. J4094465→	09.87-08.94	1 457 43 N 4106 ²	K
Fg.Nr. →J4094464	09.87-08.94	1 457 43 N 4106 ²	K

Nova 1.5 TD

1,5 | 49 | 15 DT/T4EC1-AADT <OHC>

01.90-08.94	0 986 45 P 2041	O
	1 457 42 S 9894	L

Fg.Nr. J4157454→	01.90-08.94	1 457 43 N 4106 ²	K
Fg.Nr. →J4157453	01.90-08.94	1 457 43 N 4106 ²	K

Nova 1.6 i

1,6 | 55 | C 16 NZ <OHC>

05.89-08.94	0 451 10 P 3079	O
	1 457 42 S 9053	L
	0 450 90 F 5280 ¹	K

1,6 | 74 | C 16 SE <OHC>

05.88-08.94	0 451 10 P 3079	O
-------------	-----------------	---

1,6 | 74 | E 16 SE <OHC>

05.88-03.93	0 451 10 P 3079	O
	0 450 90 F 5002 ¹	K

Omega

Omega 2.0 DTI

2,0 | 74 | X 20 DTH Turbo

09.97-08.00	1 457 42 P 9157	O	
	1 457 43 S 3571	L	
	1 457 42 N 9656	K	
Fg.Nr. →X1999999	09.97-08.00	1 987 43 M 2016	I



Omega 2.0 i

2,0 | 85/100 | X 20 SE <Ecotec>; X 20 XEV <Ecotec>; 20 SE

09.93-12.00	0 451 10 P 3079	O	
	1 457 43 S 3571	L	
Fg.Nr. →X1999999	09.93-12.00	1 987 43 M 2016	I

Omega 2.2 DTI

2,2 | 88 | Y 22 DTH <Turbo>

06.00-09.03	1 457 42 P 9157	O	
	1 457 43 S 3571	L	
	1 457 42 N 9656	K	
Fg.Nr. →X1999999	06.00-09.03	1 987 43 M 2016	I

Omega 2.2 i

2,2 | 103-106 | Y 22 XE; Z 22 XE

09.99-09.04	0 451 10 P 3079	O	
	1 457 43 S 3571	L	
Fg.Nr. →X1999999	09.99-09.04	1 987 43 M 2016	I

Omega 2.5 i

2,5 | 125 | X 25 XE <Ecotec>

Mot.Nr. →08300418	04.94-09.04	0 451 10 P 3079	O
Mot.Nr. 08300419→	04.94-09.04	1 457 42 P 9178	O
	04.94-09.04	1 457 43 S 3571	L
Fg.Nr. →X1999999	04.94-09.04	1 987 43 M 2016	I

Omega 2.5 TD

2,5 | 96 | U 25 TD <R6 Turbo>

Mot.Nr. →34408417	04.94-02.01	1 457 42 P 9123	O
Mot.Nr. 34408417→	04.94-02.01	1 457 42 P 9139	O
	04.94-02.01	1 457 43 N 4106 ²	K
		XXX 1 457 43 N 4105 ²	K
Fg.Nr. →X1999999	04.94-02.01	1 987 43 M 2016	I

Omega 2.5 TDI

2,5 | 96 | X 25 TD <Turbo>

Mot.Nr. →34408417	04.96-09.04	1 457 42 P 9123	O
Mot.Nr. 34408417→	04.96-09.04	1 457 42 P 9139	O
	04.96-09.04	1 457 43 S 3571	L
		1 457 43 N 4106 ²	K
		XXX 1 457 43 N 4105 ²	K
Fg.Nr. →X1999999	04.96-09.04	1 987 43 M 2016	I

2,5 | 110 | Y 25 TD <Turbo>

09.01-09.04	1 457 42 P 9118	O	
	1 457 43 S 3571	L	
	0 450 90 N 6451 ¹	K	
Fg.Nr. →X1999999	09.01-09.04	1 987 43 M 2016	I

Omega 2.6 i

2,6 | 132 | Y 26 SE <Ecotec>

Mot.Nr. →08300418	09.00-09.04	0 451 10 P 3079	O
Mot.Nr. 08300419→	09.00-09.04	1 457 42 P 9178	O
	09.00-09.04	1 457 43 S 3571	L
Fg.Nr. →X1999999	09.00-09.04	1 987 43 M 2016	I





Omega 3.0 i

3,0 155 X 30 XE <Ecotec>			
Mot.Nr. →08300418	04.94-02.01	0 451 10 P 3079	O
Mot.Nr. 08300419→	04.94-02.01	1 457 42 P 9178	O
	04.94-02.01	1 457 43 S 3571	L
Fg.Nr. →X1999999	04.94-02.01	1 987 43 M 2016	I

Omega 3.2 i

3,2 160 Y 32 SE <Ecotec>			
	09.00-09.04	1 457 42 P 9178	O
		1 457 43 S 3571	L
Fg.Nr. →X1999999	09.00-09.04	1 987 43 M 2016	I

Senator

Senator 2.6 i

2,6 110 C 26 NE CIH			
	09.90-08.93	0 451 10 P 3093	O
		1 457 43 S 3310	L

Senator 3.0 i

3,0 115/130 C 30 LE CIH; C 30 NE CIH			
	09.87-08.93	0 451 10 P 3093	O
		1 457 43 S 3310	L

Senator 3.0 i 24V

3,0 150 C 30 SE <DOHC>			
	09.89-08.93	0 451 10 P 3093	O
	DEL	1 457 42 S 9877	L

Signum

Signum 1.8 i

1,8 90 Z 18 XE <Ecotec>			
Mot.Nr. →20BW7583	05.03-02.05	0 451 10 P 3079	O
Mot.Nr. 20BW7584→	05.03-02.05	0 451 10 P 3370	O
	05.03-02.05	1 457 43 S 3578	L
		0 450 90 F 5273 ¹	K
		1 987 43 M 2076	I
		1 987 43 R 2376 ⁸	I

1,8 103 Z 18 XER <Ecotec>			
	03.06-09.08	F 026 40 P 7006	O
		1 457 43 S 3578	L
		0 450 90 F 5273 ¹	K
		1 987 43 M 2076	I
		1 987 43 R 2376 ⁸	I

Signum 1.9 CDTI

1,9 74/88/110 Z 19 DT <Ecotec>; Z 19 DTH <Ecotec>; Z 19 DTL <Ecotec>			
	04.04-09.08	1 457 42 P 9248	O
		1 457 43 S 3579	L
		1 457 07 N 0001	K
		1 987 43 M 2076	I
		1 987 43 R 2376 ⁸	I



Signum 2.0 DTI

2,0 74 Y 20 DTH <Ecotec>			
	05.03-09.05	1 457 42 P 9157	O
		1 457 43 S 3579	L
		1 457 42 N 9656	K
		1 987 43 M 2076	I
		1 987 43 R 2376 ⁸	I

Signum 2.0 Turbo

2,0 129 Z 20 NET <Ecotec>			
	05.03-09.08	F 026 40 P 7016	O
		1 457 43 S 3579	L
		0 450 90 F 5273 ¹	K
		1 987 43 M 2076	I
		1 987 43 R 2376 ⁸	I

Signum 2.2 Direct

2,2 114 Z 22 YH <Ecotec>			
	05.03-09.08	F 026 40 P 7016	O
		1 457 43 S 3579	L
		0 450 90 F 5273 ¹	K
		1 987 43 M 2076	I
		1 987 43 R 2376 ⁸	I

Signum 2.2 DTI

2,2 86-92 Y 22 DTR <Ecotec>			
	05.03-09.08	1 457 42 P 9157	O
		1 457 43 S 3579	L
		1 457 42 N 9656	K
		1 987 43 M 2076	I
		1 987 43 R 2376 ⁸	I

Signum 2.8 V6 Turbo

2,8 169/184 Z 28 NEL <Ecotec>; Z 28 NET <Ecotec>			
	08.05-09.08	1 987 42 S 9193	L
		0 450 90 F 5273 ¹	K
		1 987 43 M 2076	I
		1 987 43 R 2376 ⁸	I

Signum 3.0 CDTI

3,0 130-135 Y 30 DT <Ecotec>			
	05.03-09.05	1 457 42 P 9302	O
		1 457 43 S 3579	L
		1 457 42 N 9656	K
		1 987 43 M 2076	I
		1 987 43 R 2376 ⁸	I

3,0|130-135|Z 30 DT <Ecotec>

	09.05-09.08	1 457 43 S 3579	L
		1 987 43 M 2076	I
		1 987 43 R 2376 ⁸	I





Signum 3.2 i

3,2 155 Z 32 SE <Ecotec>	05.03-09.05	1 457 42 P 9178	O
		1 457 43 S 3579	L
		0 450 90 F 5273 ¹	K
		1 987 43 M 2076	I
		1 987 43 R 2376 ⁸	I

Sintra

Sintra 2.2 i 16V

2,2 104 X 22 XE <Ecotec>	09.96-09.99	0 451 10 P 3079	O
		1 457 43 S 3056	L
		0 450 90 F 5979 ¹	K
	2FE,WW	1 987 43 M 2052	I

Sintra 2.2 TD

2,2 85 X 22 DTH <Turbo>	09.97-09.99	TW	1 457 42 P 9154	O
			1 457 42 P 9157	O
			1 457 42 N 9656	K
	2FE,WW		1 987 43 M 2052	I

Sintra 3.0 i V6 24V

3,0 148 X 30 XE <Ecotec>				
Mot.Nr. →08300418	09.96-09.99	0 451 10 P 3079	O	
Mot.Nr. 08300419→	09.96-09.99	1 457 42 P 9178	O	
	09.96-09.99	1 457 43 S 3056	L	
		0 450 90 F 5979 ¹	K	
	2FE,WW	1 987 43 M 2052	I	

Tigra

Tigra 1.3 CDTI

1,3 51 Z 13 DT <Turbo Ecotec>	06.04-03.09	1 457 42 P 9256	O
		F 026 40 S 0020	L
		1 457 07 N 0001	K
		1 987 43 M 2076	I
		1 987 43 R 2376 ⁸	I

Tigra 1.4 i

1,4 66 X 14 XE <Ecotec>	09.94-08.99	0 451 10 P 3079	O
		1 457 43 S 3603	L
		0 450 90 F 5273 ¹	K
	⌘	1 987 43 M 2015	I

1,4 | 66 | Z 14 XEP <Twinport Ecotec>

Mot.Nr. →19MA9234	06.04-12.09	F 026 40 P 7015	O
Mot.Nr. 19MA9235→	06.04-12.09	F 026 40 P 7006	O
	06.04-12.09	1 457 43 S 3055	L
		0 450 90 F 5273 ¹	K
		1 987 43 M 2076	I
		1 987 43 R 2376 ⁸	I



Tigra 1.6 i

1,6 78 X 16 XE <Ecotec>	09.94-08.99	0 451 10 P 3079	O
		1 457 43 S 3603	L
		0 450 90 F 5273 ¹	K
	⌘	1 987 43 M 2015	I

Tigra 1.8 i

1,8 92 Z 18 XE <Ecotec>	06.04-12.09	0 451 10 P 3370	O
		1 457 43 S 3055	L
		0 450 90 F 5273 ¹	K
		1 987 43 M 2076	I
		1 987 43 R 2376 ⁸	I

Vectra

Vectra 1.6 i

1,6 74 Z 16 XE <Ecotec>				
Mot.Nr. →20BW7609	09.01-07.05	0 451 10 P 3079	O	
Mot.Nr. 20BW7610→	09.01-07.05	0 451 10 P 3370	O	
	09.01-07.05	1 457 43 S 3578	L	
		0 450 90 F 5273 ¹	K	
		1 987 43 M 2076	I	
		1 987 43 R 2376 ⁸	I	

Vectra 1.6 i, i GTS

1,6 74-77 Z 16 XEP <Ecotec>	07.04-10.08	0 451 10 P 3370	O
		1 457 43 S 3578	L
		1 987 43 M 2076	I
		1 987 43 R 2376 ⁸	I

Vectra 1.6 i, i 16V

1,6 55 X 16 SZR <Ecotec>	09.96-08.00	0 451 10 P 3079	O
		1 457 43 S 3799	L
		1 987 43 M 2030	I
		1 987 43 R 2330 ⁸	I

1,6 | 55 | 16 LZ2

	09.95-08.00	0 451 10 P 3079	O
		1 457 43 S 3799	L
		1 987 43 M 2030	I
		1 987 43 R 2330 ⁸	I

Vectra 1.6 i 16V

1,6 74 X 16 XEL <Ecotec>; Y 16 XE; Z 16 XE	09.95-08.01	0 451 10 P 3079	O
		1 457 43 S 3740	L
		1 987 43 M 2030	I
		1 987 43 R 2330 ⁸	I

Vectra 1.7 TD

1,7 60 X 17 TD <TC4 EE1 Turbo>	09.95-08.01	0 986 45 P 2041	O
		1 457 43 S 3741	L
		1 457 43 N 4106 ²	K
		1 987 43 M 2030	I
		1 987 43 R 2330 ⁸	I



**Vectra 1.8 Dualfuel****1,8 | 87-93 | Z 18 XE <Gasmotor Ecotec LPG>**

Mot.Nr. →20BW7583	04.02-08.06	0 451 10 P 3079	O
Mot.Nr. 20BW7584→	04.02-08.06	0 451 10 P 3370	O
	04.02-08.06	1 457 43 S 3578	L
		1 987 43 M 2076	I
		1 987 43 R 2376 ⁸	I

Vectra 1.8 i**1,8 | 81 | Z 18 XEL <Ecotec>**

Mot.Nr. →20BW7583	09.03-08.05	0 451 10 P 3079	O
Mot.Nr. 20BW7584→	09.03-08.05	0 451 10 P 3370	O
	09.03-08.05	1 457 43 S 3578	L
		1 987 43 M 2076	I
		1 987 43 R 2376 ⁸	I

1,8 | 81-85 | Z 18 XEL <Ecotec>

Mot.Nr. →20BW7583	09.01-08.05	0 451 10 P 3079	O
Mot.Nr. 20BW7584→	09.01-08.05	0 451 10 P 3370	O
	09.01-08.05	1 457 43 S 3578	L
		0 450 90 F 5273 ¹	K
		1 987 43 M 2076	I
		1 987 43 R 2376 ⁸	I

1,8 | 90 | Z 18 XE <Ecotec>

Mot.Nr. →20BW7583	09.01-08.05	0 451 10 P 3079	O
Mot.Nr. 20BW7584→	09.01-08.05	0 451 10 P 3370	O
	09.01-08.05	1 457 43 S 3578	L
		0 450 90 F 5273 ¹	K
		1 987 43 M 2076	I
		1 987 43 R 2376 ⁸	I

1,8 | 103 | Z 18 XER <Ecotec>

01.06-10.08	F 026 40 P 7006	O
	1 457 43 S 3578	L
	0 450 90 F 5273 ¹	K
	1 987 43 M 2076	I
	1 987 43 R 2376 ⁸	I

Vectra 1.8 i 16V**1,8 | 81 | Z 18 XEL <Ecotec>**

Fg.Nr. 20V00605→	03.01-08.01	0 451 10 P 3079	O
Mot.Nr. →20V00604	03.01-08.01	1 457 42 P 9178	O
	03.01-08.01	1 457 43 S 3740	L
		1 987 43 M 2030	I
		1 987 43 R 2330 ⁸	I

1,8 | 85 | X 18 XE <Ecotec>

09.95-08.99	0 451 10 P 3079	O
	1 457 43 S 3740	L
	1 987 43 M 2030	I
	1 987 43 R 2330 ⁸	I

1,8 | 85 | X 18 XE1 <Ecotec>

Fg.Nr. 20V00605→	09.98-08.99	0 451 10 P 3079	O
Mot.Nr. →20V00604	09.98-08.99	1 457 42 P 9178	O
	09.98-08.99	1 457 43 S 3740	L
		1 987 43 M 2030	I
		1 987 43 R 2330 ⁸	I

1,8 | 92 | Z 18 XE <Ecotec>

Fg.Nr. 20V00605→	09.00-08.01	0 451 10 P 3079	O
Mot.Nr. →20V00604	09.00-08.01	1 457 42 P 9178	O
	09.00-08.01	1 457 43 S 3740	L
		1 987 43 M 2030	I
		1 987 43 R 2330 ⁸	I

Vectra 1.9 CDTI**1,9 | 74/88/110 | Z 19 DT <Ecotec>; Z 19 DTH <Ecotec>; Z 19 DTL <Ecotec>**

04.04-10.08	1 457 42 P 9248	O
	1 457 43 S 3579	L
	1 457 07 N 0001	K
	1 987 43 M 2076	I
	1 987 43 R 2376 ⁸	I

Vectra 2.0 DI**2,0 | 60 | X 20 DTL <Ecotec 16V Turbo>**

Mot.Nr. →17028712	09.96-08.00	1 457 42 P 9154	O
Mot.Nr. 17028713→	09.96-08.00	1 457 42 P 9157	O
	09.96-08.00	1 457 43 S 3045	L
		1 457 42 N 9656	K
		1 987 43 M 2030	I
		1 987 43 R 2330 ⁸	I

Vectra 2.0 DTI**2,0 | 74 | X 20 DTH <16V Turbo>**

09.97-08.00	1 457 42 P 9157	O
	1 457 43 S 3045	L
	1 457 42 N 9656	K
	1 987 43 M 2030	I
	1 987 43 R 2330 ⁸	I

2,0 | 74 | Y 20 DTH <Turbo Ecotec>

04.02-09.05	1 457 42 P 9157	O
	1 457 43 S 3579	L
	1 457 42 N 9656	K
	1 987 43 M 2076	I
	1 987 43 R 2376 ⁸	I

2,0 | 74 | Y 20 DTH <16V Turbo>

09.00-08.01	1 457 42 P 9157	O
	1 457 43 S 3045	L
	1 457 42 N 9656	K
	1 987 43 M 2030	I
	1 987 43 R 2330 ⁸	I

Vectra 2.0 i**2,0 | 82 | 20 NEJ**

09.95-08.01	0 451 10 P 3079	O
	1 457 43 S 3087	L
	1 987 43 M 2030	I
	1 987 43 R 2330 ⁸	I

2,0 | 100 | C 20 SEL

05.97-09.02	0 451 10 P 3079	O
	1 457 43 S 3740	L
	1 987 43 M 2030	I
	1 987 43 R 2330 ⁸	I





Vectra 2.0 i 16V

2,0 100 X 20 XEV <Ecotec>	09.95-08.01	0 451 10 P 3079	O
		1 457 43 S 3740	L
		1 987 43 M 2030	I
		1 987 43 R 2330 ⁸	I

Vectra 2.0 Turbo

2,0 129 Z 20 NET <Turbo Ecotec>	03.03-10.08	F 026 40 P 7016	O
		1 457 43 S 3579	L
		1 987 43 M 2076	I
		1 987 43 R 2376 ⁸	I

Vectra 2.2 Direct

2,2 100-114 Z 22 YH <Ecotec>	09.03-10.08	F 026 40 P 7016	O
		1 457 43 S 3579	L
		1 987 43 M 2076	I
		1 987 43 R 2376 ⁸	I

Vectra 2.2 DTI

2,2 86-92 Y 22 DTR <Ecotec>	09.03-09.05	1 457 42 P 9157	O
		1 457 43 S 3579	L
		1 457 42 N 9656	K
		1 987 43 M 2076	I
		1 987 43 R 2376 ⁸	I

2,2 86-92 Y 22 DTR <Turbo Ecotec>	04.02-09.05	1 457 42 P 9157	O
		1 457 43 S 3579	L
		1 457 42 N 9656	K
		1 987 43 M 2076	I
		1 987 43 R 2376 ⁸	I

2,2 92 Y 22 DTR <Turbo>	09.00-08.01	1 457 42 P 9157	O
		1 457 43 S 3045	L
		1 457 42 N 9656	K
		1 987 43 M 2030	I
		1 987 43 R 2330 ⁸	I

Vectra 2.2 i

2,2 106 C 22 SEL	10.99-08.01	0 451 10 P 3079	O
		1 457 43 S 3740	L
		1 987 43 M 2030	I
		1 987 43 R 2330 ⁸	I

2,2 108 Z 22 SE <Ecotec>	09.01-09.05	F 026 40 P 7016	O
		1 457 43 S 3579	L
		0 450 90 F 5273 ¹	K
		1 987 43 M 2076	I
		1 987 43 R 2376 ⁸	I

Vectra 2.2 i 16V

2,2 108 Z 22 SE <Ecotec>	09.00-08.01	F 026 40 P 7016	O
		1 987 43 M 2030	I
		1 987 43 R 2330 ⁸	I



Vectra 2.5 i V6

2,5 125-143 X 25 XE <Ecotec>	Fg.Nr. W1285447→W7154529→	09.95-08.01	1 457 42 P 9178	O
	Fg.Nr. →W1285446→W5276825	09.95-08.01	0 451 10 P 3079	O
	→W7154528			
		09.95-08.01	1 457 43 S 3740	L
			1 987 43 M 2030	I
			1 987 43 R 2330 ⁸	I

Vectra 2.6 V6

2,6 130 Y 26 SE <Ecotec>	09.00-08.01	1 457 42 P 9178	O
		1 457 43 S 3740	L
		1 987 43 M 2030	I
		1 987 43 R 2330 ⁸	I

Vectra 2.8 GTS Turbo, Turbo

2,8 169/184-188/206 Z 28 NEL <Turbo Ecotec>; Z 28 NET <Turbo Ecotec>	09.05-10.08	1 987 42 S 9193	L
		0 450 90 F 5273 ¹	K
		1 987 43 M 2076	I
		1 987 43 R 2376 ⁸	I

Vectra 3.0 CDTI

3,0 130-135 Y 30 DT <Ecotec>; Z 30 DT <Ecotec>	03.03-10.08	1 457 43 S 3579	L
		1 457 42 N 9656	K
		1 987 43 M 2076	I
		1 987 43 R 2376 ⁸	I

Vectra 3.2 i

3,2 155 Z 32 SE <Ecotec>	08.02-09.05	1 457 42 P 9178	O
		1 457 43 S 3579	L
		0 450 90 F 5273 ¹	K
		1 987 43 M 2076	I
		1 987 43 R 2376 ⁸	I

Vivaro

Vivaro 1.9 DI, DTI

1,9 59-60/74 F9Q-760; F9Q-762	03.01-08.06	F 026 40 P 7022	O
		1 457 43 S 3531	L
		H12,PRF 1 457 43 N 1724	K
		H90,PRF F 026 40 N 2047	K
		1 987 43 M 2208	I

Vivaro 2.0 CDTI

2,0 66/84 M9R-...; M9R-780	08.06→	F 026 40 P 7014	O
		F 026 40 S 0103	L
		H12,PRF 1 457 43 N 1724	K
		H90,PRF F 026 40 N 2047	K
		1 987 43 M 2208	I





Vivaro 2.0 16V

2,0 86-88 F4R... <DOHC>			
03.01→	0 451 10 P 3336	O	
	1 457 43 S 3529	L	
	0 450 90 F 5287 ¹	K	
	1 987 43 M 2208	I	

Vivaro 2.5 CDTI

2,5 84 G9U-630 <Turbo-Ecotec>			
09.06-06.08	F 026 40 S 0103	L	
	H12,PRF 1 457 43 N 1724	K	
	H90,PRF F 026 40 N 2047	K	
	1 987 43 M 2208	I	

2,5 | 107 | G9U-630 <Turbo>

08.06→	F 026 40 P 7014	O	
	F 026 40 S 0103	L	
	H12,PRF 1 457 43 N 1724	K	
	H90,PRF F 026 40 N 2047	K	
	1 987 43 M 2208	I	

Vivaro 2.5 DTI

2,5 99 G9U-730 <Turbo>			
04.04-08.06	1 457 42 P 9198	O	
	F 026 40 S 0103	L	
	H12,PRF 1 457 43 N 1724	K	
	H90,PRF F 026 40 N 2047	K	
	1 987 43 M 2208	I	

VX

VX 2.0 i 16V Turbo

2,0 147 Z 20 LET			
04.03-09.05	0 451 10 P 3079	O	
	1 457 43 S 3281	L	

VX 2.2 i 16V

2,2 108 Z 22 SE			
09.00-09.05	F 026 40 P 7016	O	
	1 457 43 S 3740	L	

Zafira

Zafira 1.6 CNG

1,6 69-71 Z 16 YNG <Ecotec-Gas CNG>			
09.05-03.10	0 451 10 P 3370	O	
	1 457 43 S 3281	L	

Zafira 1.6 CNG Turbo

1,6 110 A 16 XNT <CNG-eco Flex>			
01.11→	F 026 40 P 7006	O	
	F 026 40 S 0012	L	
	1 987 43 M 2038	I	

1,6 | 110 | Z 16 XNT <CNG-eco Flex>

03.09→	F 026 40 P 7006	O	
	F 026 40 S 0012	L	
	1 987 43 M 2038	I	



Zafira 1.6 i

1,6 74 X 16 XEL <Ecotec>			
09.98-08.99	0 451 10 P 3079	O	
	1 457 43 S 3281	L	
	BHR 1 987 43 M 2038	I	

1,6 | 77 | Z 16 XEP <Ecotec>

07.05-09.07	0 451 10 P 3370	O	
	1 457 43 S 3281	L	

1,6 | 77 | Z 16 XE1 <Ecotec>

03.06-02.09	0 451 10 P 3370	O	
	1 457 43 S 3281	L	

1,6 | 83 | Z 16 XER <Ecotec>

Fg.Nr. →72999999→7G999999	03.07→	F 026 40 P 7006	O
	03.07→	1 457 43 S 3281	L

1,6 | 85 | A 16 XER <Ecotec>

Fg.Nr. →72999999→7G999999	01.11→	F 026 40 P 7006	O
	01.11→	1 457 43 S 3281	L

Zafira 1.6 i CNG

1,6 | 69-73 | Z 16 YNG <Ecotec-Gas CNG>

09.01-06.05	0 451 10 P 3079	O	
	1 457 43 S 3281	L	
	0 450 90 F 5273 ¹	K	
	BHR 1 987 43 M 2038	I	

Zafira 1.6 i, i Dualfuel

1,6 | 74 | Z 16 XE <Ecotec>; Z 16 XE <Gasmotor Ecotec LPG>

Mot.Nr. →20BW7609	09.99-06.05	0 451 10 P 3079	O
Mot.Nr. 20BW7610→	09.99-06.05	0 451 10 P 3370	O
	09.99-06.05	1 457 43 S 3281	L
	BHR 1 987 43 M 2038	I	

Zafira 1.7 CDTI

1,7 | 81/92 | A 17 DTJ <Ecotec>; A 17 DTR <Ecotec>; Z 17 DTJ <Ecotec>; Z 17 DTR <Ecotec>

03.08→	F 026 40 S 0012	L	
	1 987 43 M 2038	I	

Zafira 1.8 i

1,8 | 103 | A 18 XER <Ecotec>

01.11→	F 026 40 P 7006	O	
	1 457 43 S 3281	L	

1,8 | 103 | Z 18 XER <Ecotec>

07.05-02.10	F 026 40 P 7006	O	
	1 457 43 S 3281	L	

Zafira 1.8 i, i Dualfuel

1,8 | 85/92 | X 18 XE1 <Ecotec>; Z 18 XE <Ecotec>; Z 18 XE <Gasmotor Ecotec LPG>

Mot.Nr. →20V00604	03.99-06.05	1 457 42 P 9178	O
Mot.Nr. 20V00605→	03.99-06.05	0 451 10 P 3370	O
	03.99-06.05	1 457 43 S 3281	L
	BHR 1 987 43 M 2038	I	





Zafira 1.8 LPG

1,8 101-103 <eco Flex>	03.10→	F 026 40 P 7006	O
		1 457 43 S 3281	L
		1 987 43 M 2038	I

Zafira 1.9 CDTI

1,9 74 Z 19 DTL <Ecotec>	07.05-03.08	F 026 40 S 0012	L
1,9 88 Z 19 DT <Ecotec>	07.05→	F 026 40 S 0012	L
1,9 110 Z 19 DTH <Ecotec>	07.05→	1 457 42 P 9248	O
		F 026 40 S 0012	L

Zafira 2.0 DI, DTI

2,0 60/74 X 20 DTL <Turbo Ecotec>; Y 20 DTH <Turbo Ecotec>	03.99-06.05	1 457 42 P 9157	O
Fg.Nr. →Y8999999	03.99-06.05	1 457 43 S 3281	L
	03.99-06.05	1 457 42 N 9656	K
	BHR	1 987 43 M 2038	I

Zafira 2.0 i Turbo

2,0 147/177 Z 20 LEH <Ecotec>; Z 20 LER <Ecotec>	07.05→	0 451 10 P 3370	O
		1 457 43 S 3281	L

Zafira 2.0 Turbo

2,0 141 Z 20 LET <Ecotec>	09.01-06.05	0 451 10 P 3079	O
		1 457 43 S 3281	L
	BHR	1 987 43 M 2038	I

Zafira 2.2

2,2 108 Z 22 SE <Ecotec>	09.00-06.05	F 026 40 P 7016	O
	BHR	1 987 43 M 2038	I

Zafira 2.2 DTI

2,2 92 Y 22 DTR <Turbo Ecotec>	03.02-06.05	1 457 42 P 9157	O
		1 457 42 N 9656	K
	BHR	1 987 43 M 2038	I

Zafira 2.2 i Direkt

2,2 110 Z 22 YH <Ecotec>	07.05→	F 026 40 P 7016	O
		1 457 43 S 3079	L

VOLGA

3102/3105/3110

3102/3105/3110 2.0 16V

2,0 100 20T4	01.86→	0 451 10 P 4026	O
------------------	--------	------------------------	----------



3102/3105/3110 2.3 16V

2,3 110 ZMZ 406	01.95→	0 451 20 P 3154	O
		0 450 90 F 5200 ¹	K

3102/3105/3110 3.4 24V

3,4 143 5VZ-FE	01.86→	0 986 45 P 2044	O
--------------------	--------	------------------------	----------

VOLVO

C30

C30 Electric

82 E400V1	08.11→	1 987 43 M 2113	I
		1 987 43 R 2413 ⁸	I

C30 1.6

1,6 74 B4164S3	10.06→	F 026 40 P 7078	O
	10.06-07.07	1 457 43 S 3323	L
Fg.Nr. →239214	08.07→	F 026 40 S0136	L
	10.06→	MXF F 026 40 F 3009 ¹	K
		1 987 43 M 2113	I
		1 987 43 R 2413 ⁸	I

C30 1.6 D DRIVE

1,6 80 D4164T	10.06-07.11	1 457 42 P 9238	O
	10.06-07.07	F 026 40 S0141	L
	08.07-07.11	F 026 40 S0136	L
	10.06-07.11	F 026 40 N 2046 ¹	K
		1 987 43 M 2113	I
		1 987 43 R 2413 ⁸	I

C30 1.6 D2 DRIVE

1,6 84 D4162T	08.10→	1 457 42 P 9238	O
		1 987 43 M 2113	I
		1 987 43 R 2413 ⁸	I

C30 1.8 , Flexifuel

1,8 92 B4184S8; B4184S11	10.06-07.10	0 451 10 P 3363	O
	10.06-07.07	1 457 43 S 3323	L
	08.07-07.10	F 026 40 S0136	L
	10.06-07.10	MXF F 026 40 F 3009 ¹	K
		1 987 43 M 2113	I
		1 987 43 R 2413 ⁸	I

C30 2.0

2,0 107 B4204S3	10.06→	0 451 10 P 3363	O
	10.06-07.07	1 457 43 S 3323	L
Fg.Nr. →239214	08.07→	F 026 40 S0136	L
	10.06→	MXF F 026 40 F 3009 ¹	K
		1 987 43 M 2113	I
		1 987 43 R 2413 ⁸	I

**C30 2.0 D**

2,0 96 D4204T2	10.06-07.07	1 457 42 P 9249	O
		1 457 43 S 3096	L
		1 457 43 N 1723	K
		1 987 43 M 2113	I
		1 987 43 R 2413 ⁸	I

2,0|100|D4204T

10.06-09.10	1 457 42 P 9249	O
10.06-07.07	1 457 43 S 3096	L
08.07-09.10	F 026 40 S0136	L
10.06-09.10	1 457 43 N 1723	K
	1 987 43 M 2113	I
	1 987 43 R 2413 ⁸	I

C30 2.0 D3, D4**2,0|110/130|D5204T; D5204T5**

08.10→	F 026 40 P 7097	O
	F 026 40 N2078	K
	1 987 43 M 2113	I
	1 987 43 R 2413 ⁸	I

C30 2.0 F Flexifuel**2,0|107|B4204S4**

08.09→	0 451 10 P 3363	O	
Fg.Nr. →239214	08.09→	F 026 40 S0136	L
	08.09→	MXF F 026 40 F 3009 ¹	K
		1 987 43 M 2113	I
		1 987 43 R 2413 ⁸	I

C30 2.4 D5**2,4|120/132|D5244T8; D5244T9**

10.06-07.10	1 457 42 P 9244	O
	F 026 40 N2078	K
	1 987 43 M 2113	I
	1 987 43 R 2413 ⁸	I

C30 2.4 i**2,4|125|B5244S4**

10.06-07.11	1 457 42 P 9244	O
	1 457 43 S 3583	L
	MXF 0 450 90 F 5939 ¹	K
	1 987 43 M 2113	I
	1 987 43 R 2413 ⁸	I

C30 2.5 T5**2,5|162/169|B5254T3; B5254T7**

10.06→	1 457 42 P 9244	O
	1 457 43 S 3583	L
	MXF F 026 40 F 3009 ¹	K
	1 987 43 M 2113	I
	1 987 43 R 2413 ⁸	I

C70**C70 2.0 D**

2,0 100 D4204T	01.08-07.10	1 457 42 P 9249	O
		F 026 40 S0136	L
		1 457 43 N 1723	K
		1 987 43 M 2113	I
		1 987 43 R 2413 ⁸	I

C70 2.0 D3, D4**2,0|110/130|D5204T; D5204T5**

10.10→	F 026 40 P 7097	O
	F 026 40 N2078	K
	1 987 43 M 2113	I
	1 987 43 R 2413 ⁸	I

C70 2.0 T**2,0|120|B5204 T4**

08.99-07.02	1 457 42 P 9762	O
	1 457 43 S 3642	L
XXX	0 450 90 F 5216 ¹	K
	1 987 43 M 2062	I

2,0|120|B5204T4

08.99-03.06	1 457 42 P 9762	O
	1 457 43 S 3642	L
08.99-07.02	XXX 0 450 90 F 5216 ¹	K
08.02-03.06	0 450 90 F 5921 ¹	K
08.99-03.06	1 987 43 M 2062	I

2,0|132|B5204T2

01.97-07.98	0 451 10 P 3219	O
	1 457 43 S 3642	L
XXX	0 450 90 F 5216 ¹	K
	1 987 43 M 2062	I

2,0|166|B5204 T3

01.97-07.99	0 451 10 P 3219	O
08.99-07.00	1 457 42 P 9762	O
01.97-07.00	1 457 43 S 3642	L
XXX	0 450 90 F 5216 ¹	K
	1 987 43 M 2062	I

2,0|166|B5204T3

08.98-07.99	0 451 10 P 3219	O
08.99-07.00	1 457 42 P 9762	O
08.98-07.00	1 457 43 S 3642	L
XXX	0 450 90 F 5216 ¹	K
	1 987 43 M 2062	I

C70 2.3 T5**2,3|176|B5234T3**

09.97-07.99	0 451 10 P 3219	O
08.99-07.02	1 457 42 P 9762	O
09.97-07.02	1 457 43 S 3642	L
XXX	0 450 90 F 5216 ¹	K
	1 987 43 M 2062	I





◀ C70 2.3 T5

2,3 180 B5234T9	08.02-03.06	1 457 42 P 9762	O
		1 457 43 S 3642	L
		0 450 90 F 5921 ¹	K
		1 987 43 M 2062	I

C70 2.4 , i

2,4 103/125 B5244S4; B5244S5	03.06-07.10	1 457 42 P 9244	O
		1 457 43 S 3583	L
		MXF F 026 40 F 3009 ¹	K
		1 987 43 M 2113	I
		1 987 43 R 2413 ⁸	I

C70 2.4 , 20V

2,4 103/121 B5244S	03.99-07.99	0 451 10 P 3219	O	
		08.99-07.00	1 457 42 P 9762	O
		03.99-07.00	1 457 43 S 3642	L
		XXX	0 450 90 F 5216 ¹	K
			1 987 43 M 2062	I

C70 2.4 D, D5

2,4 120/132 D5244T8; D5244T9	08.06-07.10	1 457 42 P 9244	O
		F 026 40 N 2078	K
		1 987 43 M 2113	I
		1 987 43 R 2413 ⁸	I

C70 2.4 T

2,4 142 B5244T	08.99-07.02	1 457 42 P 9762	O	
		1 457 43 S 3642	L	
		XXX	0 450 90 F 5216 ¹	K
			1 987 43 M 2062	I

2,4 | 142 | B5254T

08.98-07.99	0 451 10 P 3219	O	
	1 457 43 S 3642	L	
	XXX	0 450 90 F 5216 ¹	K
		1 987 43 M 2062	I

C70 2.4 T5

2,4 147 B5244T7	08.02-03.06	1 457 42 P 9762	O
		1 457 43 S 3642	L
		1 987 43 M 2062	I

C70 2.5 LPT

2,4 142 B5254T	01.98-07.99	0 451 10 P 3219	O	
		1 457 43 S 3642	L	
		XXX	0 450 90 F 5216 ¹	K
			1 987 43 M 2062	I

C70 2.5 T5

2,5 162/169 B5254T3; B5254T7	03.06→	1 457 42 P 9244	O	
		1 457 43 S 3583	L	
		MXF	0 450 90 F 5939 ¹	K
			1 987 43 M 2113	I
			1 987 43 R 2413 ⁸	I



C70 2.5 20V

2,4 125 B5254S	08.99-07.00	1 457 42 P 9762	O	
		03.99-07.00	1 457 43 S 3642	L
		XXX	0 450 90 F 5216 ¹	K
			1 987 43 M 2062	I

S40 I

S40 I 1.6 16V

1,6 77 B4164S	01.97-08.97	0 451 10 P 3219	O		
		08.97-07.99	1 457 42 P 9762	O	
		Fg.Nr. →190624	01.97-07.99	1 457 43 S 3272	L
		Fg.Nr. 190625→	01.97-07.99	1 457 43 S 3276	L
			01.97-07.99	0 450 90 F 5908 ¹	K
	KL	1 987 43 M 2063	I		

1,6 | 80 | B4164S2

08.99-01.04	1 457 42 P 9762	O	
	1 457 43 S 3276	L	
	08.99-07.00	0 450 90 F 5908 ¹	K
	08.00-01.04	0 450 90 F 5921 ¹	K
08.99-01.04	KL	1 987 43 M 2063	I

S40 I 1.8 16V

1,8 85 B4184S	09.95-08.97	0 451 10 P 3219	O		
		08.97-07.99	1 457 42 P 9762	O	
		Fg.Nr. →190624	09.95-07.99	1 457 43 S 3272	L
		Fg.Nr. 190625→	09.95-07.99	1 457 43 S 3276	L
			09.95-07.99	0 450 90 F 5908 ¹	K
	KL	1 987 43 M 2063	I		

1,8 | 90 | B4184SJ

08.00-01.04	0 986 45 P 2041	O
	1 457 43 S 3276	L
	0 450 90 F 5921 ¹	K
KL	1 987 43 M 2063	I

1,8 | 90 | B4184S2; B4184S3

08.99-01.04	1 457 42 P 9762	O	
	1 457 43 S 3276	L	
	08.99-07.00	0 450 90 F 5908 ¹	K
	08.00-01.04	0 450 90 F 5921 ¹	K
	08.99-01.04	KL	1 987 43 M 2063

1,8 | 90 | B4184S9; B4184S10

08.99-01.04	1 457 42 P 9762	O	
	1 457 43 S 3276	L	
	08.00-01.04	0 450 90 F 5921 ¹	K
08.99-01.04	KL	1 987 43 M 2063	I

1,8 | 92 | B4184SM

09.97-07.00	0 986 45 P 2041	O
	1 457 43 S 3276	L
	0 450 90 F 5908 ¹	K
	KL	1 987 43 M 2063



**S40 I 1.9 D****1,9|66/70|D4192T; D4192T2**

05.96-07.00	0 451 10 P 3260	O
	1 457 43 S 3535	L
	1 457 43 N 4291 ²	K
KL	1 987 43 M 2063	I

1,9|75/85|D4192T3/DI; D4192T4/DI

08.00-01.04	0 451 10 P 3260	O
	1 457 43 S 3535	L
	1 457 43 N 1705	K
KL	1 987 43 M 2063	I

S40 I 1.9 T4**1,9|147|B4194T**

05.97-08.97	0 451 10 P 3219	O
08.97-07.99	1 457 42 P 9762	O
05.97-07.99	F 026 40 S 0112	L
	0 450 90 F 5908 ¹	K
KL	1 987 43 M 2063	I

1,9|147|B4194T2

08.99-07.00	1 457 42 P 9762	O
	F 026 40 S 0112	L
	0 450 90 F 5908 ¹	K
KL	1 987 43 M 2063	I

S40 I 2.0 T, T4**1,9|120/121/147|B4204T3; B4204T5**

08.00-01.04	1 457 42 P 9762	O
	F 026 40 S 0112	L
	0 450 90 F 5921 ¹	K
KL	1 987 43 M 2063	I

S40 I 2.0 T 16V**1,9|118|B4204T2**

08.99-07.00	1 457 42 P 9762	O
	F 026 40 S 0112	L
	0 450 90 F 5908 ¹	K
KL	1 987 43 M 2063	I

2,0|118|B4204T

04.98-07.99	1 457 42 P 9762	O
	F 026 40 S 0112	L
	0 450 90 F 5908 ¹	K
KL	1 987 43 M 2063	I

S40 I 2.0 16V**2,0|100|B4204S2**

08.99-01.04	1 457 42 P 9762	O
	1 457 43 S 3276	L
08.99-07.00	0 450 90 F 5908 ¹	K
08.00-01.04	0 450 90 F 5921 ¹	K
08.99-01.04	KL 1 987 43 M 2063	I

2,0|103|B4204S

09.95-08.97	0 451 10 P 3219	O	
08.97-07.99	1 457 42 P 9762	O	
Fg.Nr. →190624	09.95-07.99	1 457 43 S 3272	L
Fg.Nr. 190625→	09.95-07.99	1 457 43 S 3276	L
	09.95-07.99	0 450 90 F 5908 ¹	K
	KL 1 987 43 M 2063	I	

S40 II**S40 II 1.6****1,6|74|B4164S3**

11.04→	F 026 40 P 7078	O
11.04-07.07	1 457 43 S 3323	L
08.07→	F 026 40 S 0136	L
11.04→	MXF F 026 40 F 3009 ¹	K
	1 987 43 M 2113	I
	1 987 43 R 2413 ⁸	I

S40 II 1.6 D DRIVE**1,6|80-81|D4164T**

11.04→	1 457 42 P 9238	O	
11.04-07.07	F 026 40 S 0141	L	
08.07→	F 026 40 S 0136	L	
Fg.Nr. →177503	11.04→	FIU 0 450 90 N 6471 ¹	K
Fg.Nr. 177504→	11.04→	FIH F 026 40 N 2046 ¹	K
	11.04→	1 987 43 M 2113	I
		1 987 43 R 2413 ⁸	I

S40 II 1.6 D2**1,6|84|D4162T**

08.11→	1 457 42 P 9238	O
	F 026 40 S 0136	L
	1 987 43 M 2113	I
	1 987 43 R 2413 ⁸	I

S40 II 1.8 , Flexifuel**1,8|92|B4184S8; B4184S11**

04.04-07.10	0 451 10 P 3363	O
04.04-07.07	1 457 43 S 3323	L
08.07-07.10	F 026 40 S 0136	L
04.04-07.10	MXF F 026 40 F 3009 ¹	K
	1 987 43 M 2113	I
	1 987 43 R 2413 ⁸	I

S40 II 2.0**2,0|107|B4204S3**

10.06→	0 451 10 P 3363	O
10.06-07.07	1 457 43 S 3323	L
08.07→	F 026 40 S 0136	L
10.06→	MXF F 026 40 F 3009 ¹	K
	1 987 43 M 2113	I
	1 987 43 R 2413 ⁸	I





S40 II 2.0 D

2,0 96 D4204T2	04.04-07.07	1 457 42 P 9249	O
		1 457 43 S 3096	L
		1 457 43 N 1723	K
		1 987 43 M 2113	I
		1 987 43 R 2413 ⁸	I

2,0 100 D4204T	01.04-07.10	1 457 42 P 9249	O
	01.04-07.07	1 457 43 S 3096	L
	08.07-07.10	F 026 40 S0136	L
	01.04-07.10	1 457 43 N 1723	K
		1 987 43 M 2113	I
		1 987 43 R 2413 ⁸	I

S40 II 2.0 D3, D4

2,0 110/130 D5204T; D5204T5	08.10→	F 026 40 P 7097	O
		F 026 40 N2078	K
		1 987 43 M 2113	I
		1 987 43 R 2413 ⁸	I

S40 II 2.0 F Flexifuel

2,0 107 B4204S4	08.09→	0 451 10 P 3363	O
		F 026 40 S0136	L
		MXF F 026 40 F 3009 ¹	K
		1 987 43 M 2113	I
		1 987 43 R 2413 ⁸	I

S40 II 2.4

2,4 103/125 B5244S4; B5244S5	12.03-07.10	1 457 42 P 9244	O
		1 457 43 S 3583	L
		MXF F 026 40 F 3009 ¹	K
		1 987 43 M 2113	I
		1 987 43 R 2413 ⁸	I

2,4 125 B 5244 S4	12.03→	1 457 42 P 9244	O
		F 026 40 S0141	L
		0 450 90 F 5939 ¹	K

S40 II 2.4 D5

2,4 120/132 D5244T8; D5244T9	03.06-07.10	1 457 42 P 9244	O
		F 026 40 N2078	K
		1 987 43 M 2113	I
		1 987 43 R 2413 ⁸	I

S40 II 2.4 i

2,4 125 B5244S7	08.05-07.10	1 457 42 P 9244	O
		1 457 43 S 3583	L
		1 987 43 M 2113	I
		1 987 43 R 2413 ⁸	I



S40 II 2.5 T5

2,5 162 B 5254 T3	12.03→	1 457 42 P 9244	O
		F 026 40 S0141	L
		0 450 90 F 5939 ¹	K

S40 II 2.5 T5, T5 AWD

2,5 162/169 B5254T3; B5254T7	12.03→	1 457 42 P 9244	O
		1 457 43 S 3583	L
		MXF F 026 40 F 3009 ¹	K
		1 987 43 M 2113	I
		1 987 43 R 2413 ⁸	I

S60

S60 1.6 DRIVe

1,6 85 D 4162T	08.11→	1 457 42 P 9238	O
		F 026 40 S 0181	L
		1 987 43 M 2205	I
		1 987 43 R 2405 ⁸	I

S60 1.6 T3, T4, T4F

1,6 110/132 B4164T; B4164T2; B4164T3	11.10→	F 026 40 P 7078	O
		F 026 40 S 0181	L
		MXF F 026 40 F 3014 ¹	K
		1 987 43 M 2205	I
		1 987 43 R 2405 ⁸	I

S60 2.0 D3

2,0 120 D5204T2; D5204T3	08.10→	F 026 40 P 7097	O
		F 026 40 S 0181	L
Fg.Nr. 26821→	08.10→	F 026 40 N2078	K
	08.10→	1 987 43 M 2205	I
		1 987 43 R 2405 ⁸	I

S60 2.0 T

2,0 132 B5204T5	11.00-07.09	1 457 42 P 9762	O
	DK , 11.00-07.09 327	1 457 43 S 3300	L
	FIN, N, S		
Fg.Nr. →18763	11.00-07.09	MXF 0 450 90 F 5908 ¹	K
Fg.Nr. 18764→	11.00-07.09	MXF 0 450 90 F 5921 ¹	K
	11.00-07.09	1 987 43 M 2064	I

S60 2.0 T, T5

2,0 149/177 B4204T6; B4204T7	08.10→	F 026 40 S 0181	L
		MXF F 026 40 F 3014 ¹	K
		1 987 43 M 2205	I
		1 987 43 R 2405 ⁸	I



**S60 2.3 T5****2,3 | 184-195 | B5234T3**

	11.00-03.04		1 457 42	P 9762	O
	DK, 11.00-03.04	327	1 457 43	S 3300	L
	FIN,N,S				
Fg.Nr. →18763	11.00-03.04	MXF	0 450 90	F 5908 ¹	K
Fg.Nr. 18764→	11.00-03.04	MXF	0 450 90	F 5921 ¹	K
	11.00-03.04		1 987 43	M 2064	I

S60 2.4**2,4 | 103/123 | B5244S2; B5244S6**

	11.00-07.09		1 457 42	P 9762	O
			1 457 43	S 3300	L
Fg.Nr. →18763	11.00-07.09	MXF	0 450 90	F 5908 ¹	K
Fg.Nr. 18764→	11.00-07.09	MXF	0 450 90	F 5921 ¹	K
	11.00-07.09		1 987 43	M 2064	I

2,4 | 125 | B5244S

	11.00-07.09		1 457 42	P 9762	O
			1 457 43	S 3300	L
Fg.Nr. →18763	11.00-07.09	MXF	0 450 90	F 5908 ¹	K
Fg.Nr. 18764→	11.00-07.09	MXF	0 450 90	F 5921 ¹	K
	11.00-07.09		1 987 43	M 2064	I

S60 2.4 Bi-Fuel CNG, Bi-Fuel LPG**2,4 | 103 | B5244SG; B5244SG2**

	06.02-07.08		1 457 42	P 9762	O
			1 457 43	S 3300	L
			0 450 90	F 5921 ¹	K
			1 987 43	M 2064	I

S60 2.4 D**2,4 | 96/120 | D5244T; D5244T2**

	08.01-07.06		1 457 42	P 9244	O
	DK, 08.01-07.06		1 457 43	S 3300	L
	FIN,N,S				
Fg.Nr. →367586	08.01-07.06		1 457 43	N 4436 ²	K
Fg.Nr. 367587→	08.01-07.06		F 026 40	N 2005	K
	08.01-07.06		1 987 43	M 2064	I

S60 2.4 D, D5**2,4 | 93/120/136 | D5244T4; D5244T5; D5244T7**

	08.05-07.09		1 457 42	P 9244	O
			F 026 40	S 0026	L
Fg.Nr. →367586	08.05-07.09		1 457 43	N 4436 ²	K
Fg.Nr. 367587→	08.05-07.09		F 026 40	N 2005	K
	08.05-07.09		1 987 43	M 2064	I

S60 2.4 D5, D5 AWD**2,4 | 151/158 | D5244T10; D5244T11; D5244T15**

	08.10→		F 026 40	P 7097	O
			F 026 40	S 0181	L
Fg.Nr. 26821→	08.10→		F 026 40	N2078	K
	08.10→		1 987 43	M 2205	I
			1 987 43	R 2405 ⁸	I

S60 2.4 T, T AWD**2,4 | 147 | B5244T3**

	11.00-07.03		1 457 42	P 9762	O
	DK, 11.00-07.03	327	1 457 43	S 3300	L
	FIN,N,S				
Fg.Nr. →18763	11.00-07.03	MXF	0 450 90	F 5908 ¹	K
Fg.Nr. 18764→	11.00-07.03	MXF	0 450 90	F 5921 ¹	K
	11.00-07.03		1 987 43	M 2064	I

S60 2.4 T, T AWD, T5**2,4 | 162/191 | B5244T4; B5244T5**

	08.03-07.09		1 457 42	P 9762	O
Fg.Nr. →18763	08.03-07.09	MXF	0 450 90	F 5908 ¹	K
Fg.Nr. 18764→	08.03-07.09	MXF	0 450 90	F 5921 ¹	K
	08.03-07.09		1 987 43	M 2064	I

S60 2.5 R**2,5 | 220 | B5254T4**

	03.03-07.07		1 457 42	P 9762	O
Fg.Nr. →18763	03.03-07.07	MXF	0 450 90	F 5908 ¹	K
Fg.Nr. 18764→	03.03-07.07	MXF	0 450 90	F 5921 ¹	K
	03.03-07.07		1 987 43	M 2064	I

S60 2.5 T, T AWD**2,5 | 154 | B5254T2**

	04.04-07.09		1 457 42	P 9762	O
	DK, 04.04-07.09	327	1 457 43	S 3300	L
	FIN,N,S				
Fg.Nr. →18763	04.04-07.09	MXF	0 450 90	F 5908 ¹	K
Fg.Nr. 18764→	04.04-07.09	MXF	0 450 90	F 5921 ¹	K
	04.04-07.09		1 987 43	M 2064	I

S60 2.5 T5**2,5 | 187 | B5254T5**

	08.11→		1 457 42	P 9244	O
			1 457 43	S 3583	L
			1 987 43	M 2205	I
			1 987 43	R 2405 ⁸	I

S60 3.0 T6 AWD**3,0 | 224 | B6304T4**

	08.10→		F 026 40	P 7075	O
			F 026 40	S0146	L
		MXF	F 026 40	F 3014 ¹	K
			1 987 43	M 2205	I
			1 987 43	R 2405 ⁸	I

S70**S70 R 2.3 T, T AWD****2,3 | 184 | B5234T4**

	01.97-07.98		0 451 10	P 3219	O
			1 457 43	S 3642	L
		XXX	0 450 90	F 5216 ¹	K
			1 987 43	M 2062	I





S70 2.0

2,0 105 B 5204 S	01.97-07.98	0 451 10 P 3219	O
		1 457 43 S 3642	L
	XXX	0 450 90 F 5216 ¹	K
		1 987 43 M 2062	I

S70 2.0 , T

2,0 93/132/155 B5202 S; B5204T; B5204T2	01.97-07.99	0 451 10 P 3219	O
		1 457 43 S 3642	L
	XXX	0 450 90 F 5216 ¹	K
		1 987 43 M 2062	I

S70 2.0 T

2,0 166 B 5204 T3	08.98-07.99	0 451 10 P 3219	O
	08.99-07.00	1 457 42 P 9762	O
	08.98-07.00	1 457 43 S 3642	L
	XXX	0 450 90 F 5216 ¹	K
		1 987 43 M 2062	I

S70 2.0 T AWD, T 20V

2,0 120/166 B5204T3; B5204T4	08.98-07.99	0 451 10 P 3219	O
	08.99-07.00	1 457 42 P 9762	O
	08.98-07.00	1 457 43 S 3642	L
	XXX	0 450 90 F 5216 ¹	K
		1 987 43 M 2062	I

S70 2.3

2,3 160 B5234T2	01.97-07.98	0 451 10 P 3219	O
		1 457 43 S 3642	L
	XXX	0 450 90 F 5216 ¹	K
		1 987 43 M 2062	I

S70 2.3 T-5

2,3 176 B5234T3	01.97-07.99	0 451 10 P 3219	O
	08.99-07.00	1 457 42 P 9762	O
	01.97-07.00	1 457 43 S 3642	L
	XXX	0 450 90 F 5216 ¹	K
		1 987 43 M 2062	I

S70 2.4

2,4 142 B5244T	01.99-07.99	0 451 10 P 3219	O
	08.99-07.00	1 457 42 P 9762	O
	01.99-07.00	1 457 43 S 3642	L
	XXX	0 450 90 F 5216 ¹	K
		1 987 43 M 2062	I

S70 2.4 , AWD

2,4 103/125 B5244S; B5244S2	08.99-07.00	1 457 42 P 9762	O
		1 457 43 S 3642	L
	XXX	0 450 90 F 5216 ¹	K
		1 987 43 M 2062	I



S70 2.5 , Bifuel, T, T AWD, 20V

2,4 106/121/142 B5252S; B5254S; B5254T	01.97-07.99	0 451 10 P 3219	O
		1 457 43 S 3642	L
	XXX	0 450 90 F 5216 ¹	K
		1 987 43 M 2062	I

S70 2.5 Bifuel

2,4 103 B5244SG; B5244SG2	08.99-07.00	1 457 42 P 9762	O
		1 457 43 S 3642	L
	XXX	0 450 90 F 5216 ¹	K
		1 987 43 M 2062	I

S70 2.5 TDI

2,5 103 D5252 T	01.97-07.00	0 451 20 P 3223	O
		1 457 43 S 3642	L
		1 457 43 N 4184 ²	K
		1 987 43 M 2062	I

S80 I

S80 I 2.0 T, T5

2,0 120/132/165/166 B5204T3; B5204T4; B5204T5	08.98-07.06	1 457 42 P 9762	O	
	35N	1 457 43 S 3536	L	
	DK, 08.98-07.06	327	1 457 43 S 3300	L
	FIN, N, S			
	Fg.Nr. →184992	08.98-07.06	0 450 90 F 5908 ¹	K

S80 I 2.3 R

2,3 195 B5234T7	04.00-07.05	1 457 42 P 9762	O	
	327	1 457 43 S 3300	L	
	35N	1 457 43 S 3536	L	
	Fg.Nr. →184992	04.00-07.05	0 450 90 F 5908 ¹	K
	Fg.Nr. 184993→	04.00-07.05	0 450 90 F 5921 ¹	K

S80 I 2.4

2,4 103 B5244S2	08.98-07.06	1 457 42 P 9762	O	
	35N	1 457 43 S 3536	L	
	DK, 08.98-07.06	327	1 457 43 S 3300	L
	FIN, N, S			
	Fg.Nr. →184992	08.98-07.06	0 450 90 F 5908 ¹	K

2,4 | 125 | B5244S

2,4 125 B5244S	08.98-07.06	1 457 42 P 9762	O	
	35N	1 457 43 S 3536	L	
	DK, 08.98-07.06	327	1 457 43 S 3300	L
	FIN, N, S			
	Fg.Nr. →184992	08.98-07.06	0 450 90 F 5908 ¹	K



**S80 I 2.4 Bi-Fuel LPG**

2,4|103|B5244SG2

08.01-07.06	1 457 42	P 9762	O
327	1 457 43	S 3300	L
	0 450 90	F 5921 ¹	K
	1 987 43	M 2064	I

S80 I 2.4 D, D5

2,4|96/120|D5244T;D5244T2

08.01-07.06	1 457 42	P 9244	O
DK, 08.01-07.06	1 457 43	S 3300	L
FIN,N,S			
Fg.Nr. →359376	08.01-07.06	1 457 43	N 4436 ² K
Fg.Nr. 359377→	08.01-07.06	F 026 40	N 2005 K
	08.01-07.06	1 987 43	M 2064 I

S80 I 2.4 T

2,4|132-147|B5244T4

08.03-07.06	1 457 42	P 9762	O
Fg.Nr. →184992	08.03-07.06	0 450 90	F 5908 ¹ K
Fg.Nr. 184993→	08.03-07.06	0 450 90	F 5921 ¹ K
	08.03-07.06	1 987 43	M 2064 I

S80 I 2.4 T, T AWD

2,4|147|B5244T3

08.00-07.03	1 457 42	P 9762	O
327	1 457 43	S 3300	L
35N	1 457 43	S 3536	L
Fg.Nr. →184992	08.00-07.03	0 450 90	F 5908 ¹ K
Fg.Nr. 184993→	08.00-07.03	0 450 90	F 5921 ¹ K
	08.00-07.03	1 987 43	M 2064 I

S80 I 2.4 T4 Bi-Fuel CNG

2,4|103|B5244SG

08.01-07.06	1 457 42	P 9762	O
327	1 457 43	S 3300	L
35N	1 457 43	S 3536	L
	0 450 90	F 5921 ¹	K
	1 987 43	M 2064	I

S80 I 2.5 , AWD

2,5|154|B5254T2

08.03-07.06	1 457 42	P 9762	O
35N	1 457 43	S 3536	L
DK, 08.03-07.06	327	1 457 43	S 3300 L
FIN,N,S			
08.03-07.06	0 450 90	F 5921 ¹	K
	1 987 43	M 2064	I

S80 I 2.5 TDI

2,5|103|D5252T

08.98-07.01	0 451 20	P 3223	O
327	1 457 43	S 3300	L
35N	1 457 43	S 3536	L
	1 457 43	N 4184 ²	K
	1 987 43	M 2064	I

S80 I 2.8 T6

2,8|200|B6284 T;B6284T

05.98-07.01	1 457 42	P 9762	O
327	1 457 43	S 3300	L
35N	1 457 43	S 3536	L
Fg.Nr. →184992	05.98-07.01	0 450 90	F 5908 ¹ K
Fg.Nr. 184993→	05.98-07.01	0 450 90	F 5921 ¹ K
	05.98-07.01	1 987 43	M 2064 I

S80 I 2.9

2,9|147/150|B6294S; B6304 S3; B6304S3

06.98-07.01	1 457 42	P 9762	O
327	1 457 43	S 3300	L
35N	1 457 43	S 3536	L
Fg.Nr. →184992	06.98-07.01	0 450 90	F 5908 ¹ K
Fg.Nr. 184993→	06.98-07.01	0 450 90	F 5921 ¹ K
	06.98-07.01	1 987 43	M 2064 I

S80 I 3.0 , T6

2,9|144/200|B6294S2; B6294T

08.01-07.06	1 457 42	P 9762	O
327	1 457 43	S 3300	L
35N	1 457 43	S 3536	L
Fg.Nr. →184992	08.01-07.06	0 450 90	F 5908 ¹ K
Fg.Nr. 184993→	08.01-07.06	0 450 90	F 5921 ¹ K
	08.01-07.06	1 987 43	M 2064 I

S80 II**S80 II 1.6 D DRIVE**

1,6|80|D4164T

08.09→	1 457 42	P 9238	O
	F 026 40	S 0181	L
	F 026 40	N 2046 ¹	K
	1 987 43	M 2205	I
	1 987 43	R 2405 ⁸	I

S80 II 1.6 T4

1,6|132|B4164T

10.10→	F 026 40	P 7078	O
	F 026 40	S 0181	L
MXF	F 026 40	F 3014 ¹	K
	1 987 43	M 2205	I
	1 987 43	R 2405 ⁸	I

S80 II 2.0 B, F Flexifuel

2,0|107|B4204S3; B4204S4

01.08→	0 451 10	P 3363	O
	F 026 40	S 0109	L
MXF	F 026 40	F 3014 ¹	K
	1 987 43	M 2205	I
	1 987 43	R 2405 ⁸	I





S80 II 2.0 D

2,0 100 D4204T	08.07-07.10	1 457 42 P 9249	O
		F 026 40 S 0109	L
Fg.Nr. →19258	08.07-07.10	F 026 40 N2078	K
	08.07-07.10	1 987 43 M 2205	I
		1 987 43 R 2405⁸	I

S80 II 2.0 D3

2,0 120 D5204T2; D5204T3	08.10→	F 026 40 P 7097	O
		F 026 40 S 0181	L
Fg.Nr. →19258	08.10→	F 026 40 N2078	K
	08.10→	1 987 43 M 2205	I
		1 987 43 R 2405⁸	I

S80 II 2.0 T, T5

2,0 149/177 B4204T6; B4204T7	08.10→	F 026 40 S 0181	L
		MXF F 026 40 F 3014¹	K
		1 987 43 M 2205	I
		1 987 43 R 2405⁸	I

S80 II 2.4 D, D5, D5 AWD

2,4 120/129/151/158 D5244T10; D5244T11; D5244T14; D5244T15; D5244T19	11.08→	F 026 40 P 7097	O
		F 026 40 S 0181	L
		1 987 43 M 2205	I
		1 987 43 R 2405⁸	I

2,4 | 120/136 | D5244T4; D5244T5

	03.06-07.09	1 457 42 P 9244	O
		F 026 40 S 0181	L
Fg.Nr. →19258	03.06-07.09	F 026 40 N2078	K
	03.06-07.09	1 987 43 M 2205	I
		1 987 43 R 2405⁸	I

S80 II 2.5 FT Flexifuel, T

2,5 147/170 B5254T6; B5254T8; B5254T10; B5254T11	03.06→	1 457 42 P 9244	O
		1 457 43 S 3583	L
		MXF F 026 40 F 3014¹	K
		1 987 43 M 2205	I
		1 987 43 R 2405⁸	I

S80 II 3.0 T6 AWD

3,0 210 B6304T2	01.07-07.10	F 026 40 P 7075	O
		F 026 40 S 0146	L
		MXF F 026 40 F 3014¹	K
		1 987 43 M 2205	I
		1 987 43 R 2405⁸	I

3,0 | 224 | B6304T4

	10.10→	F 026 40 P 7075	O
		F 026 40 S 0146	L
		MXF F 026 40 F 3014¹	K
		1 987 43 M 2205	I
		1 987 43 R 2405⁸	I



S80 II 3.2 , AWD

3,2 175/179 B6324S; B6324S4; B6324S5	08.06→	F 026 40 P 7075	O
		F 026 40 S 0146	L
		MXF F 026 40 F 3014¹	K
		1 987 43 M 2205	I
		1 987 43 R 2405⁸	I

S80 II 4.4 V8 AWD

4,4 232 B8444S	03.06-12.10	1 457 42 P 9762	O
		F 026 40 S 0181	L
		MXF F 026 40 F 3014¹	K
		1 987 43 M 2205	I
		1 987 43 R 2405⁸	I

S90

S90 2.5

2,5 120-132 B6244S	11.96-12.99	0 451 10 P 3219	O
		1 457 42 S 9987	L
		0 450 90 F 5200¹	K
		1 987 43 M 2062	I

S90 2.9 , Exekutive, Exekutive Plus

2,9 132/150 B6304S; B6304S2	01.97-05.98	0 451 10 P 3219	O
		1 457 42 S 9987	L
		0 450 90 F 5200¹	K
		1 987 43 M 2062	I

V40

V40 1.6 16V

1,6 77 B4164S	01.97-07.97	0 451 10 P 3219	O
	08.97-07.99	1 457 42 P 9762	O
Fg.Nr. →190624	01.97-07.99	1 457 43 S 3272	L
Fg.Nr. 190625→	01.97-07.99	1 457 43 S 3276	L
	01.97-07.99	0 450 90 F 5908¹	K
		KL 1 987 43 M 2063	I

1,6 | 80 | B4164S2

	08.99-04.04	1 457 42 P 9762	O
		1 457 43 S 3276	L
	08.99-07.00	0 450 90 F 5908¹	K
	08.00-04.04	0 450 90 F 5921¹	K
	08.99-04.04	KL 1 987 43 M 2063	I

V40 1.8 16V

1,8 85 B4184S	01.95-08.97	0 451 10 P 3219	O
	08.97-07.99	1 457 42 P 9762	O
Fg.Nr. →190624	01.95-07.99	1 457 43 S 3272	L
Fg.Nr. 190625→	01.95-07.99	1 457 43 S 3276	L
	01.95-07.99	0 450 90 F 5908¹	K
		KL 1 987 43 M 2063	I





1,8 90 B4184SJ	08.00-04.04	0 986 45 P 2041	O
		1 457 43 S 3276	L
		0 450 90 F 5921 ¹	K
	KL	1 987 43 M 2063	I

1,8 90 B4184S2; B4184S3; B4184S9; B4184S10	04.99-06.04	1 457 42 P 9762	O
		1 457 43 S 3276	L
	04.99-07.00	0 450 90 F 5908 ¹	K
	08.00-06.04	0 450 90 F 5921 ¹	K
	04.99-06.04 KL	1 987 43 M 2063	I

1,8 92 B4184SM	08.97-07.00	0 986 45 P 2041	O
		1 457 43 S 3276	L
		0 450 90 F 5908 ¹	K
	KL	1 987 43 M 2063	I

V40 1.9 D

1,9 66/70 D4192T; D4192T2	01.96-07.00	0 451 10 P 3260	O
		1 457 43 S 3535	L
		1 457 43 N 4291 ²	K
	KL	1 987 43 M 2063	I

1,9 75/85 D4192T3/DI; D4192T4/DI	03.00-04.04	0 451 10 P 3260	O
		1 457 43 S 3535	L
		1 457 43 N 1705	K
	KL	1 987 43 M 2063	I

V40 1.9 T4

1,9 147 B4194T	05.97-07.97	0 451 10 P 3219	O
	08.97-07.99	1 457 42 P 9762	O
	05.97-07.99	F 026 40 S 0112	L
		0 450 90 F 5908 ¹	K
	KL	1 987 43 M 2063	I

1,9 147 B4194T2	08.99-07.00	1 457 42 P 9762	O
		F 026 40 S 0112	L
		0 450 90 F 5908 ¹	K
	KL	1 987 43 M 2063	I

V40 2.0

2,0 103 B4204S	01.96-07.97	0 451 10 P 3219	O
	08.97-07.99	1 457 42 P 9762	O
Fg.Nr. →190624	01.96-07.99	1 457 43 S 3272	L
Fg.Nr. 190625→	01.96-07.99	1 457 43 S 3276	L
	01.96-07.99	0 450 90 F 5908 ¹	K
	KL	1 987 43 M 2063	I

V40 2.0 T

1,9 120 B4204T3	08.01-04.04	1 457 42 P 9762	O
		F 026 40 S 0112	L
		0 450 90 F 5921 ¹	K
	KL	1 987 43 M 2063	I

V40 2.0 T, T4 T

2,0 121/147 B4204T3; B4204T5	08.00-04.04	1 457 42 P 9762	O
		F 026 40 S 0112	L
		0 450 90 F 5921 ¹	K
	KL	1 987 43 M 2063	I

V40 2.0 16V

2,0 100 B4204S2	08.99-04.04	1 457 42 P 9762	O
		1 457 43 S 3276	L
	08.99-07.00	0 450 90 F 5908 ¹	K
	08.00-04.04	0 450 90 F 5921 ¹	K
	08.99-04.04 KL	1 987 43 M 2063	I

V40 2.0 16V T

1,9 118 B4204T2	08.99-07.00	1 457 42 P 9762	O
		F 026 40 S 0112	L
		0 450 90 F 5908 ¹	K
	KL	1 987 43 M 2063	I

2,0 118 B4204T	04.98-07.99	1 457 42 P 9762	O
		F 026 40 S 0112	L
		0 450 90 F 5908 ¹	K
	KL	1 987 43 M 2063	I

V50**V50 1.6**

1,6 74 B4164S3	01.05→	F 026 40 P 7078	O
	01.05-07.07	1 457 43 S 3323	L
	08.07→	F 026 40 S 0136	L
	01.05→	MXF F 026 40 F 3009 ¹	K
		1 987 43 M 2113	I
		1 987 43 R 2413 ⁸	I

V50 1.6 D DRIVe

1,6 80-81 D4164T	11.04→	1 457 42 P 9238	O
	11.04-07.07	F 026 40 S 0141	L
	08.07→	F 026 40 S 0136	L
Fg.Nr. →179691	11.04→	FIU	0 450 90 N 6471 ¹
Fg.Nr. 179692→	11.04→	FIH	F 026 40 N 2046 ¹
	11.04→		1 987 43 M 2113
			1 987 43 R 2413 ⁸

V50 1.6 D2

1,6 84 D4162T	08.11→	1 457 42 P 9238	O
		F 026 40 S 0136	L
		1 987 43 M 2113	I
		1 987 43 R 2413 ⁸	I





V50 1.8 , Flexifuel

1,8 92 B4184S8; B4184S11			
04.04-07.10	0 451 10	P 3363	O
04.04-07.07	1 457 43	S 3323	L
08.07-07.10	F 026 40	S0136	L
04.04-07.10	MXF	F 026 40 F 3009 ¹	K
		1 987 43 M 2113	I
		1 987 43 R 2413 ⁸	I

V50 2.0

2,0 107 B4204S3			
10.06→	0 451 10	P 3363	O
10.06-07.07	1 457 43	S 3323	L
08.07→	F 026 40	S0136	L
10.06→	MXF	F 026 40 F 3009 ¹	K
		1 987 43 M 2113	I
		1 987 43 R 2413 ⁸	I

V50 2.0 D

2,0 96 D4204T2			
04.04-07.07	1 457 42	P 9249	O
	1 457 43	S 3096	L
	1 457 43	N 1723	K
	1 987 43	M 2113	I
	1 987 43	R 2413 ⁸	I

2,0 | 100 | D4204T

04.04-07.10	1 457 42	P 9249	O
04.04-07.07	1 457 43	S 3096	L
08.07-07.10	F 026 40	S0136	L
04.04-07.10	1 457 43	N 1723	K
	1 987 43	M 2113	I
	1 987 43	R 2413 ⁸	I

V50 2.0 D3, D4

2,0 110/130 D5204T; D5204T5			
08.10→	F 026 40	P 7097	O
	F 026 40	N2078	K
	1 987 43	M 2113	I
	1 987 43	R 2413 ⁸	I

V50 2.0 F Flexifuel

2,0 107 B4204S4			
08.09→	0 451 10	P 3363	O
	F 026 40	S0136	L
	MXF	F 026 40 F 3009 ¹	K
		1 987 43 M 2113	I
		1 987 43 R 2413 ⁸	I

V50 2.4 , i

2,4 103/125-125 B5244S4; B5244S5			
04.04-07.10	1 457 42	P 9244	O
	1 457 43	S 3583	L
	MXF	F 026 40 F 3009 ¹	K
		1 987 43 M 2113	I
		1 987 43 R 2413 ⁸	I



V50 2.4 D5

2,4 120/132 D5244T8; D5244T9			
04.06-07.10	1 457 42	P 9244	O
	F 026 40	N2078	K
	1 987 43	M 2113	I
	1 987 43	R 2413 ⁸	I

V50 2.4 i

2,4 125 B5244S7			
04.04-07.10	1 457 42	P 9244	O
	1 457 43	S 3583	L
	1 987 43	M 2113	I
	1 987 43	R 2413 ⁸	I

V50 2.5 T5, T5 AWD

2,5 162/169 B5254T3; B5254T7			
04.04→	1 457 42	P 9244	O
	1 457 43	S 3583	L
	MXF	F 026 40 F 3009 ¹	K
		1 987 43 M 2113	I
		1 987 43 R 2413 ⁸	I

V60

V60 1.6 DRIVE

1,6 85 D 4162T			
08.11→	1 457 42	P 9238	O
	F 026 40	S 0181	L
	1 987 43	M 2205	I
	1 987 43	R 2405 ⁸	I

V60 1.6 T3, T4, T4F

1,6 110/132 B4164T; B4164T2; B4164T3			
09.10→	F 026 40	P 7078	O
	F 026 40	S 0181	L
	1 987 43	M 2205	I
	1 987 43	R 2405 ⁸	I

V60 2.0 D3

2,0 120 D5204T2			
09.10→	F 026 40	P 7097	O
	F 026 40	S 0181	L
	1 987 43	M 2205	I
	1 987 43	R 2405 ⁸	I

V60 2.0 T, T5

2,0 149/177 B4204T6; B4204T7			
09.10→	F 026 40	S 0181	L
	1 987 43	M 2205	I
	1 987 43	R 2405 ⁸	I

V60 2.4 D5, D5 AWD

2,4 151 D5244T10			
09.10-07.11	F 026 40	P 7097	O
	F 026 40	S 0181	L
	1 987 43	M 2205	I
	1 987 43	R 2405 ⁸	I



**V60 3.0 T6 AWD**

3,0|224|B6304T4

09.10→	F 026 40 P 7075	O
	F 026 40 S0146	L
	1 987 43 M 2205	I
	1 987 43 R 2405 ⁸	I

V70 I**V70 I 2.0**

2,0|93|B5202FS

01.97-07.99	0 451 10 P 3219	O
	1 457 43 S 3642	L
XXX	0 450 90 F 5216 ¹	K
	1 987 43 M 2062	I

V70 I 2.0 , Turbo

2,0|105/155|B5204S; B5204T

01.97-07.99	0 451 10 P 3219	O
08.99-03.00	1 457 42 P 9762	O
01.97-03.00	1 457 43 S 3642	L
XXX	0 450 90 F 5216 ¹	K
	1 987 43 M 2062	I

V70 I 2.0 AWD Turbo, T 20V, Turbo

2,0|120/132/166|B5204T2; B5204T3; B5204T4

01.97-07.99	0 451 10 P 3219	O
01.97-03.00	1 457 43 S 3642	L
XXX	0 450 90 F 5216 ¹	K
	1 987 43 M 2062	I

V70 I 2.3

2,3|160|B5234T2

01.97-07.98	0 451 10 P 3219	O
	1 457 43 S 3642	L
XXX	0 450 90 F 5216 ¹	K
	1 987 43 M 2062	I

V70 I 2.3 AWD, T-5 AWD

2,3|176/195|B5234T6; B5234T8

01.97-07.99	0 451 10 P 3219	O
08.99-03.00	1 457 42 P 9762	O
01.97-03.00	1 457 43 S 3642	L
XXX	0 450 90 F 5216 ¹	K
	1 987 43 M 2062	I

V70 I 2.3 R, R AWD

2,3|184|B5234T4

01.97-07.98	0 451 10 P 3219	O
	1 457 43 S 3642	L
XXX	0 450 90 F 5216 ¹	K
	1 987 43 M 2062	I

V70 I 2.3 T-5

2,3|176|B5234T3

01.97-07.99	0 451 10 P 3219	O
08.99-03.00	1 457 42 P 9762	O
01.97-03.00	1 457 43 S 3642	L
XXX	0 450 90 F 5216 ¹	K
	1 987 43 M 2062	I

V70 I 2.4

2,4|103|B5244S2

05.99-07.99	0 451 10 P 3219	O
05.99-03.00	1 457 42 P 9762	O
	1 457 43 S 3642	L
XXX	0 450 90 F 5216 ¹	K
	1 987 43 M 2062	I

2,4|125|B5244S

05.99-07.99	0 451 10 P 3219	O
08.99-03.00	1 457 42 P 9762	O
05.99-03.00	1 457 43 S 3642	L
XXX	0 450 90 F 5216 ¹	K
	1 987 43 M 2062	I

V70 I 2.4 XC AWD

2,4|142|B5244T

03.99-07.99	0 451 10 P 3219	O
08.99-03.00	1 457 42 P 9762	O
03.99-03.00	1 457 43 S 3642	L
XXX	0 450 90 F 5216 ¹	K
	1 987 43 M 2062	I

V70 I 2.5 , AWD, T, T AWD, T XC, T XC AWD, 20V

2,4|106/121/142/195|B5244T2; B5252S; B5254S; B5254T

01.97-07.99	0 451 10 P 3219	O
08.99-03.00	1 457 42 P 9762	O
01.97-03.00	1 457 43 S 3642	L
XXX	0 450 90 F 5216 ¹	K
	1 987 43 M 2062	I

V70 I 2.5 BI-FUEL

2,4|103|GB5244SG

08.99-03.00	1 457 42 P 9762	O
	1 457 43 S 3642	L
XXX	0 450 90 F 5216 ¹	K
	1 987 43 M 2062	I

2,4|103|GB5252S

08.97-07.99	0 451 10 P 3219	O
	1 457 43 S 3642	L
XXX	0 450 90 F 5216 ¹	K
	1 987 43 M 2062	I

V70 I 2.5 TDI

2,5|103|D5252T

01.97-03.00	0 451 20 P 3223	O
	1 457 43 S 3642	L
	1 457 43 N 4184 ²	K
	1 987 43 M 2062	I





V70 II

V70 II 2.0 T

2,0 | 132 | B5204T5

	03.00-07.07		1 457 42	P 9762	O
DK, FIN, N, S	03.00-07.07	327	1 457 43	S 3300	L
	03.00-07.07		0 450 90	F 5908 ¹	K
		KL	1 987 43	M 2064	I

V70 II 2.3 , T5

2,3 | 184/195 | B5234T3; B5234T7

	03.00-07.04		1 457 42	P 9762	O
DK, FIN, N, S	03.00-07.04	327	1 457 43	S 3300	L
	03.00-07.04		0 450 90	F 5908 ¹	K
		KL	1 987 43	M 2064	I

V70 II 2.4

2,4 | 103/125 | B5244S; B5244S2; B5244S6

	03.00-07.07		1 457 42	P 9762	O
			1 457 43	S 3300	L
Fg.Nr. FC1/83268→FC2/77342→	03.00-07.07		0 450 90	F 5921 ¹	K
Fg.Nr. →FC1/83267→FC2/77341	03.00-07.07		0 450 90	F 5908 ¹	K
	03.00-07.07	KL	1 987 43	M 2064	I

V70 II 2.4 D, D AWD

2,4 | 96/120 | D5244T; D5244T2

	08.01-07.06		1 457 42	P 9244	O
	08.05-07.06	GS	F 026 40	S 0026	L
DK, FIN, N, S	08.01-07.05		1 457 43	S 3300	L
	08.05-07.06	AG	1 457 43	S 3300	L
Fg.Nr. →1400539→2397951	08.01-07.06		1 457 43	N 4436 ²	K
Fg.Nr. 1400540→2397952→	08.01-07.06		F 026 40	N 2005	K
	08.01-07.06	KL	1 987 43	M 2064	I

V70 II 2.4 D, D5, D5 AWD

2,4 | 90/93/120/136 | D5244T4; D5244T5; D5244T6; D5244T7

	08.06-07.07		1 457 42	P 9244	O
		GS	F 026 40	S 0026	L
DK, FIN, N, S	08.06-07.07	AG	1 457 43	S 3300	L
	08.06-07.07		F 026 40	N 2005	K
		KL	1 987 43	M 2064	I

V70 II 2.4 D5

2,4 | 136 | D5244T3

	12.05-07.06		1 457 42	P 9244	O
		GS	F 026 40	S 0026	L
DK, FIN, N, S	12.05-07.06	AG	1 457 43	S 3300	L
Fg.Nr. →1400539→2397951	12.05-07.06		1 457 43	N 4436 ²	K
Fg.Nr. 1400540→2397952→	12.05-07.06		F 026 40	N 2005	K
	12.05-07.06		1 987 43	M 2064	I



V70 II 2.4 D5 AWD

2,4 | 136 | D5244T3

	12.05-07.06		1 457 42	P 9244	O
		GS	F 026 40	S 0026	L
DK, FIN, N, S	12.05-07.06	AG	1 457 43	S 3300	L
Fg.Nr. →1400539→2397951	12.05-07.06		1 457 43	N 4436 ²	K
Fg.Nr. 1400540→2397952→	12.05-07.06		F 026 40	N 2005	K
	12.05-07.06	KL	1 987 43	M 2064	I

V70 II 2.4 T

2,4 | 147 | B5244T3

	03.00-07.03		1 457 42	P 9762	O
DK, FIN, N, S	03.00-07.03	327	1 457 43	S 3300	L
	03.00-07.03		0 450 90	F 5908 ¹	K
		KL	1 987 43	M 2064	I

V70 II 2.4 T5

2,4 | 191 | B5244T5

	04.04-07.07		1 457 42	P 9762	O
DK, FIN, N, S	04.04-07.07	327	1 457 43	S 3300	L
	04.04-07.07		0 450 90	F 5908 ¹	K
		KL	1 987 43	M 2064	I

V70 II 2.4 XC

2,4 | 147 | B5244T3

	09.00-07.02		1 457 42	P 9762	O
			1 457 43	S 3300	L
DK, FIN, N, S	09.00-07.02	327	1 457 43	S 3300	L
	09.00-07.02		0 450 90	F 5908 ¹	K
		KL	1 987 43	M 2064	I

V70 II 2.4 XC AWD

2,4 | 147 | B5244T3

	09.00-07.02		1 457 42	P 9762	O
DK, FIN, N, S	09.00-07.02	327	1 457 43	S 3300	L
	09.00-07.02		0 450 90	F 5908 ¹	K
		KL	1 987 43	M 2064	I

V70 II 2.5 BI-FUEL CNG, BI-FUEL LPG

2,5 | 103 | B5244SG; B5244SG2

	09.01-07.07		1 457 42	P 9762	O
			1 457 43	S 3300	L
			0 450 90	F 5921 ¹	K
		KL	1 987 43	M 2064	I

V70 II 2.5 D

2,5 | 103 | D5252T

	03.00-07.01		0 451 20	P 3223	O
DK, FIN, N, S	03.00-07.01		1 457 43	S 3300	L
	03.00-07.01		1 457 43	N 4184 ²	K
		KL	1 987 43	M 2064	I

V70 II 2.5 T AWD R

2,5 | 220 | B5254T4

	03.03-07.07		1 457 42	P 9762	O
		KL	1 987 43	M 2064	I



**V70 II 2.5 T, T AWD**

2,5|154|B5254T2

	08.02-07.07	1 457 42	P 9762	O	
DK,	08.02-07.07	327	1 457 43	S 3300	L
FIN,N,S					
	08.02-07.07		0 450 90	F 5908 ¹	K
		KL	1 987 43	M 2064	I

V70 III**V70 III 1.6 D DRIVE**

1,6|80|D4164T

	01.10-07.11	1 457 42	P 9238	O	
			F 026 40	S 0181	L
			F 026 40	N 2046 ¹	K
			1 987 43	M 2205	I
			1 987 43	R 2405 ⁸	I

1,6|84|D4162T

	08.11→	1 457 42	P 9238	O	
			F 026 40	S 0181	L
			1 987 43	M 2205	I
			1 987 43	R 2405 ⁸	I

V70 III 1.6 T4, T4F

1,6|132|B4164T;B4164T2

	08.10→		F 026 40	P 7078	O
			F 026 40	S 0181	L
		MXF	F 026 40	F 3014 ¹	K
			1 987 43	M 2205	I
			1 987 43	R 2405 ⁸	I

V70 III 2.0 B

2,0|107|B4204S3

	10.07-07.11	0 451 10	P 3363	O	
			F 026 40	S 0109	L
		MXF	F 026 40	F 3014 ¹	K
			1 987 43	M 2205	I
			1 987 43	R 2405 ⁸	I

V70 III 2.0 D

2,0|100|D4204T

	10.07-07.10	1 457 42	P 9249	O	
			F 026 40	S 0109	L
			1 987 43	M 2205	I
			1 987 43	R 2405 ⁸	I

V70 III 2.0 D3

2,0|120|D5204T2;D5204T3

	08.10→		F 026 40	P 7097	O
			F 026 40	S 0181	L
Fg.Nr. 197287→	08.10→		F 026 40	N 2078	K
	08.10→		1 987 43	M 2205	I
			1 987 43	R 2405 ⁸	I

V70 III 2.0 Flexifuel

2,0|107|B4204S4

	10.07-07.11	0 451 10	P 3363	O	
			F 026 40	S 0109	L
			1 987 43	M 2205	I
			1 987 43	R 2405 ⁸	I

V70 III 2.0 T, T5

2,0|149/177|B4204T6;B4204T7

	08.10→		F 026 40	S 0181	L	
			MXF	F 026 40	F 3014 ¹	K
			1 987 43	M 2205	I	
			1 987 43	R 2405 ⁸	I	

V70 III 2.4 D

2,4|129|D5244T14

	08.09-07.10		F 026 40	P 7097	O
			F 026 40	S 0181	L
			1 987 43	M 2205	I
			1 987 43	R 2405 ⁸	I

V70 III 2.4 D, D5, D5 AWD

2,4|120/136|D5244T4;D5244T5

	08.07-07.09	1 457 42	P 9244	O	
			F 026 40	S 0181	L
			1 987 43	M 2205	I
			1 987 43	R 2405 ⁸	I

V70 III 2.4 D5

2,4|158|D5244T11

	08.11→		F 026 40	P 7097	O
Fg.Nr. 197287→	08.11→		F 026 40	N 2078	K
	08.11→		1 987 43	M 2205	I
			1 987 43	R 2405 ⁸	I

2,4|158|D5244T15

	08.11→		F 026 40	P 7097	O
			F 026 40	S 0181	L
Fg.Nr. 197287→	08.11→		F 026 40	N 2078	K
	08.11→		1 987 43	M 2205	I
			1 987 43	R 2405 ⁸	I

V70 III 2.4 D5 AWD

2,4|158|D5244T15

	08.11→		F 026 40	P 7097	O
			F 026 40	N 2078	K
Fg.Nr. 197287→	08.11→		1 987 43	M 2205	I
			1 987 43	R 2405 ⁸	I

V70 III 2.4 D5, D5 AWD

2,4|151|D5244T10

	08.09-07.11		F 026 40	P 7097	O
			F 026 40	S 0181	L
Fg.Nr. 197287→	08.09-07.11		F 026 40	N 2078	K
	08.09-07.11		1 987 43	M 2205	I
			1 987 43	R 2405 ⁸	I





V70 III 2.5 FT Flexifuel, T

2,5 147/170 B5254T6; B5254T8; B5254T10; B5254T11			
08.07→	1 457 42	P 9244	O
	1 457 43	S 3583	L
MXF	F 026 40	F 3014 ¹	K
	1 987 43	M 2205	I
	1 987 43	R 2405 ⁸	I

V70 III 3.0 T6 AWD

3,0 210/224 B6304T2; B6304T4			
08.07→	F 026 40	P 7075	O
	F 026 40	S 0146	L
MXF	F 026 40	F 3014 ¹	K
	1 987 43	M 2205	I
	1 987 43	R 2405 ⁸	I

V70 III 3.2 , AWD

3,2 175-175/179 B6324S; B6324S5			
08.07→	F 026 40	P 7075	O
	F 026 40	S 0146	L
MXF	F 026 40	F 3014 ¹	K
	1 987 43	M 2205	I
	1 987 43	R 2405 ⁸	I

V90

V90 2.9

2,9 132			
01.97-07.98	0 451 10	P 3219	O
	1 457 42	S 9987	L
	1 987 43	M 2062	I
2,9 150 B6304S; B6304S2			
01.97-07.98	0 451 10	P 3219	O
	1 457 42	S 9987	L
	0 450 90	F 5200 ¹	K
	1 987 43	M 2062	I

XC60

XC60 2.0 D3 DRIVE

2,0 120 D5204T2; D5204T3			
08.10→	F 026 40	P 7097	O
	F 026 40	S 0181	L
Fg.Nr. 185775→	08.10→	F 026 40	N2078 K
	08.10→	1 987 43	M 2205 I
		1 987 43	R 2405 ⁸ I

XC60 2.0 T, T5

2,0 149/177 B4204T6; B4204T7			
08.10→	F 026 40	S 0181	L
MXF	F 026 40	F 3014 ¹	K
	1 987 43	M 2205	I
	1 987 43	R 2405 ⁸	I



XC60 2.4 D AWD, D3 AWD

2,4 120 D5244T16; D5244T17			
08.09→	F 026 40	P 7097	O
	F 026 40	S 0181	L
Fg.Nr. 185775→	08.09→	F 026 40	N2078 K
	08.09→	1 987 43	M 2205 I
		1 987 43	R 2405 ⁸ I

XC60 2.4 D AWD, D5 AWD

2,4 120/136 D5244T4; D5244T5			
03.09-07.09	1 457 42	P 9244	O
	F 026 40	S 0181	L
	1 987 43	M 2205	I
	1 987 43	R 2405 ⁸	I

XC60 2.4 D DRIVE

2,4 129 D5244T14			
08.09-07.10	F 026 40	P 7097	O
	F 026 40	S 0181	L
	1 987 43	M 2205	I
	1 987 43	R 2405 ⁸	I

XC60 2.4 D5 AWD

2,4 151/158 D5244T10; D5244T11			
08.09→	F 026 40	P 7097	O
	F 026 40	S 0181	L
Fg.Nr. 185775→	08.09→	F 026 40	N2078 K
	08.09→	1 987 43	M 2205 I
		1 987 43	R 2405 ⁸ I

XC60 3.0 T6 AWD

3,0 210/224 B6304T2; B6304T4			
03.09→	F 026 40	P 7075	O
	F 026 40	S 0146	L
MXF	F 026 40	F 3014 ¹	K
	1 987 43	M 2205	I
	1 987 43	R 2405 ⁸	I

XC60 3.2

3,2 179 B6324S5			
08.10→	F 026 40	P 7075	O
	F 026 40	S 0146	L
	1 987 43	M 2205	I
	1 987 43	R 2405 ⁸	I

XC60 3.2 , AWD

3,2 175 B6324S			
08.09-07.10	F 026 40	P 7075	O
	F 026 40	S 0146	L
MXF	F 026 40	F 3014 ¹	K
	1 987 43	M 2205	I
	1 987 43	R 2405 ⁸	I

3,2 175 B6324S4			
08.10→	F 026 40	P 7075	O
	F 026 40	S 0146	L
	1 987 43	M 2205	I
	1 987 43	R 2405 ⁸	I

**XC60 3.2 AWD**

3,2|179|B6324S5

03.10→	F 026 40 P 7075	O
	F 026 40 S 0146	L
	<u>MXF</u> F 026 40 F 3014 ¹	K
	1 987 43 M 2205	I
	1 987 43 R 2405 ⁸	I

XC70 I**XC70 I 2.3 T**

2,3|140|B5234T7

	08.02-07.04	1 457 42 P 9762	O
Fg.Nr. →220844	08.02-07.04	1 457 43 S 3300	L
Fg.Nr. 220845→	08.02-07.04	F 026 40 S 0026	L
Fg.Nr. →16633	08.02-07.04	0 450 90 F 5908 ¹	K
Fg.Nr. 16634→	08.02-07.04	0 450 90 F 5921 ¹	K
Fg.Nr. →282000	08.02-07.04	1 987 43 M 2064	I

XC70 I 2.4 D

2,4|120|D5244T

	08.02-07.06	1 457 42 P 9244	O
	08.05-07.06	F 026 40 S 0026	L
	<u>DK</u> , 08.02-07.05	1 457 43 S 3300	L
	<u>FIN,N,S</u>		
Fg.Nr. →145267	08.02-07.06	1 457 43 N 4436 ²	K
Fg.Nr. 145268→	08.02-07.06	F 026 40 N 2005	K
Fg.Nr. →282000	08.02-07.06	1 987 43 M 2064	I

XC70 I 2.4 D5

2,4|136|D5244T4

	12.05-07.07	1 457 42 P 9244	O
		F 026 40 S 0026	L
		F 026 40 N 2005	K
Fg.Nr. →282000	12.05-07.07	1 987 43 M 2064	I

XC70 I 2.4 T

2,4|147-147|B5244T4

	08.04-07.07	1 457 42 P 9762	O
Fg.Nr. →16633	08.04-07.07	0 450 90 F 5908 ¹	K
Fg.Nr. 16634→	08.04-07.07	0 450 90 F 5921 ¹	K
Fg.Nr. →282000	08.04-07.07	1 987 43 M 2064	I

XC70 I 2.5 T

2,5|154|B5254T2

	08.02-07.07	1 457 42 P 9762	O
Fg.Nr. →220844	08.02-07.07	1 457 43 S 3300	L
Fg.Nr. 220845→	08.02-07.07	F 026 40 S 0026	L
Fg.Nr. →16633	08.02-07.07	0 450 90 F 5908 ¹	K
Fg.Nr. 16634→	08.02-07.07	0 450 90 F 5921 ¹	K
Fg.Nr. →282000	08.02-07.07	1 987 43 M 2064	I

XC70 II**XC70 II 2.0 D3 DRIVE**

2,0|120|D5204T2;D5204T3

08.10→	F 026 40 P 7097	O
	F 026 40 S 0181	L
	1 987 43 M 2205	I
	1 987 43 R 2405 ⁸	I

XC70 II 2.4 D AWD, D DRIVE, D3 AWD, D5 AWD

2,4|120/129/151/158|D5244T10;D5244T11;D5244T14;D5244T15;D5244T16;D5244T17

08.09→	F 026 40 P 7097	O
	F 026 40 S 0181	L
	1 987 43 M 2205	I
	1 987 43 R 2405 ⁸	I

XC70 II 2.4 D AWD, D5 AWD

2,4|120/136|D5244T4;D5244T5

08.07-07.09	1 457 42 P 9244	O
	F 026 40 S 0181	L
	1 987 43 M 2205	I
	1 987 43 R 2405 ⁸	I

XC70 II 3.0 T6 AWD

3,0|210/224|B6304T2;B6304T4

08.08→	F 026 40 P 7075	O
	F 026 40 S 0146	L
	<u>MXF</u> F 026 40 F 3014 ¹	K
	1 987 43 M 2205	I
	1 987 43 R 2405 ⁸	I

XC70 II 3.2 AWD, 2WD

3,2|175/179|B6324S;B6324S4;B6324S5

08.07→	F 026 40 P 7075	O
	F 026 40 S 0146	L
	<u>MXF</u> F 026 40 F 3014 ¹	K
	1 987 43 M 2205	I
	1 987 43 R 2405 ⁸	I

XC90**XC90 2.4 D3 FWD**

2,4|120|D5244T5

08.10→	1 457 42 P 9244	O
	F 026 40 S 0026	L
	F 026 40 N 2005	K
	1 987 43 M 2064	I





XC90 2.4 D5 AWD

2,4 | 120 | D5244T

	01.03-07.06		1 457 42 P 9244	O
Fg.Nr. →224082	01.03-07.06	GS	1 457 43 S 3587	L
Fg.Nr. →256550	01.03-07.06	327,AG	1 457 43 S 3587	L
Fg.Nr. 224083→	01.03-07.06	GS	F 026 40 S 0026	L
Fg.Nr. 256551→	01.03-07.06	AG	F 026 40 S 0026	L
Fg.Nr. →71956	01.03-07.06		1 457 43 N 4436 ²	K
Fg.Nr. 71957→	01.03-07.06		F 026 40 N 2005	K
	01.03-07.06		1 987 43 M 2064	I

2,4 | 120 | D5244T5

	10.07→		1 457 42 P 9244	O
		GS	F 026 40 S 0026	L
Fg.Nr. →256550	10.07→	327,AG	1 457 43 S 3587	L
Fg.Nr. 256551→	10.07→	AG	F 026 40 S 0026	L
	10.07→		F 026 40 N 2005	K
			1 987 43 M 2064	I

2,4 | 136 | D5244T4

	05.05→		1 457 42 P 9244	O
Fg.Nr. →224082	05.05→	GS	1 457 43 S 3587	L
Fg.Nr. →256550	05.05→	327,AG	1 457 43 S 3587	L
Fg.Nr. 224083→	05.05→	GS	F 026 40 S 0026	L
Fg.Nr. 256551→	05.05→	AG	F 026 40 S 0026	L
	05.05→		F 026 40 N 2005	K
			1 987 43 M 2064	I

2,4 | 147 | D5244T18

	08.10→		1 457 42 P 9244	O
			F 026 40 S 0026	L
			F 026 40 N 2005	K
			1 987 43 M 2064	I

XC90 2.5 T AWD, T FWD

2,5 | 154 | B5254T2

	10.02→		1 457 42 P 9762	O
			1 457 43 S 3587	L
	10.02-07.04		0 450 90 F 5921 ¹	K
	10.02→		1 987 43 M 2064	I

XC90 2.9 T6 AWD

2,9 | 200 | B6294T

	01.03-07.06		1 457 42 P 9762	O
			1 457 43 S 3587	L
	01.03-07.04		0 450 90 F 5921 ¹	K
	01.03-07.06		1 987 43 M 2064	I

XC90 3.2 AWD, FWD

3,2 | 175/179 | B6324S; B6324S5

	08.06→		F 026 40 P 7075	O
			1 987 43 M 2064	I

XC90 4.4 V8 AWD

4,4 | 232 | B8444S

	03.05-12.10		1 457 42 P 9762	O
			1 987 43 M 2064	I



240

240 2.0 i

2,0 | 82-86 | B200E; B200F Kat.

	08.84-07.92		0 451 10 P 3219	O
			1 457 42 S 9085	L
			0 450 90 F 5601 ¹	K

240 2.3 i

2,3 | 84/100 | B230F; B230F Kat.

	08.88-07.93		0 451 10 P 3219	O
			1 457 42 S 9085	L
			0 450 90 F 5601 ¹	K

2,3 | 95-96 | B230E

	08.84-07.92		0 451 10 P 3219	O
			1 457 42 S 9085	L
	04.86-07.91		0 450 90 F 5601 ¹	K

240 2.4 D

2,4 | 58-60 | D24

	04.79-07.93		0 451 20 P 3012	O
			1 457 42 S 9061	L
		BO	1 457 43 D 701 ²	K
			1 457 43 N 4106 ²	K

340

340 1.3

1,3 | 49 | B13

	08.84-07.91		0 451 10 P 3224	O
	08.80-07.91		1 457 42 S 9955	L

340 1.4

1,4 | 47-53 | B14

	08.84-07.91		0 451 10 P 3224	O
	08.80-07.91		1 457 42 S 9955	L

340 1.6 D

1,6 | 40 | D16

	09.84-07.91		0 451 10 P 3224	O
			1 457 42 S 9079	L
		BO	1 457 43 D 701 ²	K
			1 457 43 N 4106 ²	K
		CAV	1 457 43 N 4200 ²	K

340 1.7

1,7 | 61 | B172K

	07.85-10.91		0 451 10 P 3224	O
			1 457 42 S 9955	L

440

440 1.6 i

1,6 | 61 | B16F Kat.

	09.88-07.97		0 451 10 P 3224	O
			1 457 42 S 9778	L
			0 450 90 F 5087 ¹	K



**440 1.7**

1,7 | 58-64 | B18K; B18KP

09.88-07.93	0 451 10 P 3224	O
	1 457 42 S 9923	L

440 1.7 i

1,7 | 70-75/78-80 | B18EP; B18F Kat.; B18FP Kat.

09.88-07.94	0 451 10 P 3224	O
	1 457 42 S 9778	L
	0 450 90 F 5087 ¹	K

440 1.8 i

1,8 | 66 | B18U Kat.

09.91-07.97	0 451 10 P 3224	O
	1 457 42 S 9778	L
	0 450 90 F 5087 ¹	K

440 1.8 T

1,7 | 88 | B18FT Kat.

09.88-07.96	0 451 10 P 3224	O
	1 457 42 S 9778	L
	0 450 90 F 5087 ¹	K

440 1.9 D T

1,9 | 66 | D19T

09.93-07.97	0 451 10 P 3260	O
	1 457 43 S 3750	L
	1 457 43 N 4201 ²	K

440 2.0 i

2,0 | 80 | B20F Kat.

09.92-12.96	0 451 10 P 3224	O
	1 457 42 S 9778	L
	0 450 90 F 5087 ¹	K

460**460 1.6 i**

1,6 | 61 | B16F Kat.

03.90-07.97	0 451 10 P 3224	O
	1 457 42 S 9778	L
	0 450 90 F 5087 ¹	K

460 1.7

1,7 | 66 | B18KP

03.90-07.97	0 451 10 P 3224	O
	1 457 42 S 9923	L

460 1.7 i, i T

1,7 | 75/78/88 | B18EP; B18FP Kat.; B18FT Kat.

03.90-07.97	0 451 10 P 3224	O
	1 457 42 S 9778	L
	0 450 90 F 5087 ¹	K

460 1.8 i

1,8 | 66 | B18U Kat.

09.91-07.97	0 451 10 P 3224	O
	1 457 42 S 9778	L
	0 450 90 F 5087 ¹	K

460 1.9 D

1,9 | 66 | D19T

09.93-07.97	0 451 10 P 3260	O
	1 457 43 S 3750	L
	1 457 43 N 4201 ²	K

460 2.0 i

2,0 | 80 | B20F Kat.

09.92-12.96	0 451 10 P 3224	O
	1 457 42 S 9778	L
	0 450 90 F 5087 ¹	K

480**480 1.7 i, i T**

1,7 | 75/88-90 | B18FP Kat.; B18FT Kat.

08.88-07.95	0 451 10 P 3224	O
	1 457 42 S 9778	L
	0 450 90 F 5087 ¹	K

480 2.0 i

2,0 | 81 | B20F Kat.

09.92-12.96	0 451 10 P 3224	O
	1 457 42 S 9778	L
	0 450 90 F 5087 ¹	K

740**740 2.0 i**

2,0 | 80 | B200G

08.91-07.94	0 451 10 P 3219	O
	1 457 42 S 9987	L
	0 450 90 F 5601 ¹	K

2,0 | 82 | B200F Kat.

08.89-07.93	0 451 10 P 3219	O
	1 457 42 S 9987	L
08.89-07.91	0 450 90 F 5601 ¹	K
08.91-07.93	0 450 90 F 5200 ¹	K

2,0 | 88 | B200E

08.84-07.91	0 451 10 P 3219	O
	1 457 42 S 9987	L
	0 450 90 F 5601 ¹	K

740 2.0 i T

2,0 | 114 | B200FT Kat.

08.90-07.92	0 451 10 P 3219	O
	1 457 43 S 2203	L
	0 450 90 F 5601 ¹	K





740 2.3 i

2,3 85/96 B230E; B230F Kat.			
08.84-07.95	0 451 10 P 3219	O	
	1 457 42 S 9987	L	
	0 450 90 F 5601 ¹	K	
2,3 96 B 230 FB Kat.			
08.90-08.91	0 450 90 F 5601 ¹	K	
09.91-08.94	0 450 90 F 5200 ¹	K	
09.94-07.95	0 450 90 F 5601 ¹	K	

740 2.3 i, i 16V

2,3 94/114 B230G; B234G			
08.90-07.95	0 451 10 P 3219	O	
	1 457 42 S 9987	L	
	0 450 90 F 5601 ¹	K	

740 2.3 i T

2,3 114-119 B230FT Kat.			
08.84-10.91	0 451 10 P 3219	O	
	1 457 43 S 2203	L	
	0 450 90 F 5601 ¹	K	

740 2.4 D, TD

2,4 60/80/85 D24; D24T; D24TIC			
04.84-07.92	0 451 20 P 3087	O	
	1 457 43 S 2203	L	
BO	1 457 43 D 701 ²	K	
	1 457 43 N 4106 ²	K	

760

760 2.3 i T

2,3 114-119 B230FT Kat.			
08.84-07.92	0 451 10 P 3219	O	
	1 457 43 S 2203	L	
	0 450 90 F 5601 ¹	K	

760 2.4 TD

2,4 85 D24TIC			
08.87-07.92	0 451 20 P 3087	O	
	1 457 43 S 2203	L	
BO	1 457 43 D 701 ²	K	
	1 457 43 N 4106 ²	K	

760 2.8 i

2,8 105 B280F Kat.			
05.86-07.91	0 451 10 P 3219	O	
	1 457 42 S 9987	L	
	0 450 90 F 5601 ¹	K	

2,8 | 108-125 | B280E

08.86-07.91	0 451 10 P 3219	O	
	1 457 42 S 9987	L	



780

780 2.3 i 16V T

2,3 165-190 B230FT			
08.88-07.91	0 451 10 P 3219	O	
	1 457 43 S 2203	L	
	0 450 90 F 5601 ¹	K	

780 2.4 TD

2,4 85 D24TIC			
08.85-07.91	0 451 20 P 3087	O	
	1 457 43 S 2203	L	
BO	1 457 43 D 701 ²	K	
	1 457 43 N 4106 ²	K	

780 2.8 i

2,8 108-125 B280E; B280F Kat.			
05.86-07.91	0 451 10 P 3219	O	
	1 457 42 S 9987	L	
	0 450 90 F 5601 ¹	K	

850

850 R

2,3 184 B5234T4 Kat.; B5234T5 Kat.			
08.95-07.97	0 451 10 P 3219	O	
	1 457 43 S 3642	L	
XXX	0 450 90 F 5216 ¹	K	
253	1 987 43 M 2062	I	

850 TDI

2,5 103 D5252T			
05.96-07.97	0 451 20 P 3223	O	
	1 457 43 S 3642	L	
	1 457 43 N 4184 ²	K	
253	1 987 43 M 2062	I	

850 T-5

2,0 155 B5204FT Kat.			
01.94-07.96	0 451 10 P 3219	O	
	1 457 43 S 3642	L	
XXX	0 450 90 F 5216 ¹	K	
253	1 987 43 M 2062	I	

2,3 | 160/166 | B5234FT Kat.; B5234T Kat.

09.93-07.97	0 451 10 P 3219	O	
	1 457 43 S 3642	L	
XXX	0 450 90 F 5216 ¹	K	
253	1 987 43 M 2062	I	

850 T-5R

2,3 177 B5234T Kat.			
09.94-07.97	0 451 10 P 3219	O	
	1 457 43 S 3642	L	
XXX	0 450 90 F 5216 ¹	K	
253	1 987 43 M 2062	I	



**850 2.0 , GLT, Turbo**

2,0|93/105/129-132/155 | B5202S Kat.; B5204S Kat.; B5204T Kat.; B5204T2 Kat.

09.91-07.97	0 451 10 P 3219	O
	1 457 43 S 3642	L
XXX	0 450 90 F 5216 ¹	K
253	1 987 43 M 2062	I

850 2.3

2,3|120|B5234S Kat.

09.93-07.96	0 451 10 P 3219	O
09.97-07.98	0 451 10 P 3219	O
09.93-07.96	1 457 43 S 3642	L
09.97-07.98	1 457 43 S 3642	L
09.93-07.96 XXX	0 450 90 F 5216 ¹	K
09.97-07.98 XXX	0 450 90 F 5216 ¹	K
09.93-07.96 253	1 987 43 M 2062	I
09.97-07.98 253	1 987 43 M 2062	I

850 2.3 Turbo

2,3|177|B5234T Kat.

09.94-07.95	0 451 10 P 3219	O
	1 457 43 S 3642	L
XXX	0 450 90 F 5216 ¹	K
253	1 987 43 M 2062	I

850 2.5 AWD, GLE, GLT, Turbo

2,4|103-106/125/140-142|B5252S Kat.; B5254S Kat.; B5254T Kat.

09.91-07.97	0 451 10 P 3219	O
	1 457 43 S 3642	L
XXX	0 450 90 F 5216 ¹	K
253	1 987 43 M 2062	I

940**940 2.0**

2,0|80-89|B200G

09.91-07.95	0 451 10 P 3219	O
	1 457 42 S 9987	L
	0 450 90 F 5200 ¹	K

2,0|82|B200F Kat.

01.92-07.95	0 451 10 P 3219	O
	1 457 42 S 9987	L
	0 450 90 F 5200 ¹	K

2,0|88-90|B200E

09.90-07.91	0 451 10 P 3219	O
	1 457 42 S 9987	L
	0 450 90 F 5601 ¹	K

940 2.0 Turbo

2,0|114|B200GT.

04.96-09.98	0 451 10 P 3219	O
	1 457 43 S 2203	L
	0 450 90 F 5601 ¹	K

940 2.0 Turbo Interc.

2,0|114|B200FT Kat.

09.91-07.97	0 451 10 P 3219	O
	1 457 43 S 2203	L
	0 450 90 F 5601 ¹	K

940 2.0 16V

2,0|100-103|B204E

09.90-07.91	0 451 10 P 3219	O
	1 457 42 S 9987	L
	0 450 90 F 5601 ¹	K

940 2.3

2,3|84|B230F Kat.

09.94-07.95	0 451 10 P 3219	O
	1 457 42 S 9987	L
	0 450 90 F 5200 ¹	K

2,3|84|B230FD Kat.

09.92-07.95	0 451 10 P 3219	O
	1 457 42 S 9987	L
	0 450 90 F 5200 ¹	K

2,3|96|B230FB Kat.

09.92-07.95	1 457 42 S 9987	L
09.92-08.94	0 450 90 F 5200 ¹	K
09.94-07.95	0 450 90 F 5601 ¹	K

2,3|96|B230G

09.91-07.95	0 451 10 P 3219	O
	1 457 42 S 9987	L
	0 450 90 F 5200 ¹	K

2,3|96-99|B230F Kat.

06.91-07.95	0 451 10 P 3219	O
	1 457 42 S 9987	L
	0 450 90 F 5601 ¹	K

940 2.3 Turbo Interc.

2,3|104|B230GK

09.91-07.97	0 451 10 P 3219	O
	1 457 43 S 2203	L
	0 450 90 F 5200 ¹	K

2,3|113-121|B230FT4

05.95-07.97	0 451 10 P 3219	O
	1 457 43 S 2203	L

940 2.3 Turbo, Turbo Interc.

2,3|99/121-151|B230FK Kat.; B230FT Kat.

09.90-10.98	0 451 10 P 3219	O
	1 457 43 S 2203	L
	0 450 90 F 5601 ¹	K

940 2.3 16V

2,3|114|B234F Kat.; B234G

09.90-07.92	0 451 10 P 3219	O
	1 457 42 S 9987	L
	0 450 90 F 5601 ¹	K





940 2.4 D

2,4 60 D24	09.90-07.93	0 451 20 P 3012	O
		1 457 43 S 2203	L
	BO	1 457 43 D 701 ²	K
		1 457 43 N 4106 ²	K

940 2.4 TD

2,4 80/90 D24T; D24TIC	09.90-07.97	0 451 20 P 3087	O
		1 457 43 S 2203	L
	BO	1 457 43 D 701 ²	K
		1 457 43 N 4106 ²	K

960

960 2.0 T, T 16V

2,0 103/140 B204E; B204FT Kat.	09.91-07.94	0 451 10 P 3219	O
		1 457 43 S 2203	L
		0 450 90 F 5200 ¹	K

960 2.3 T

2,3 121/125 B230FT Kat.; B230GK	09.91-07.97	0 451 10 P 3219	O
		1 457 43 S 2203	L
		0 450 90 F 5200 ¹	K

960 2.4

2,4 120 B6244S Kat.	09.94-07.97	0 451 10 P 3219	O
-------------------------	-------------	------------------------	----------

960 2.4 TD

2,4 85 D24TIC	08.90-07.97	0 451 20 P 3087	O
		1 457 43 S 2203	L
	BO	1 457 43 D 701 ²	K
		1 457 43 N 4106 ²	K

960 2.5

2,5 125 B6254S; B6254S Kat.	09.94-07.97	0 451 10 P 3219	O
		1 457 42 S 9987	L
		0 450 90 F 5601 ¹	K

960 2.8

2,8 110/125 B280E; B280F Kat.	09.90-07.91	0 451 10 P 3219	O
		1 457 42 S 9987	L
		0 450 90 F 5601 ¹	K

960 3.0

3,0 150 B6304FS Kat.; B6304FS2	09.90-07.98	0 451 10 P 3219	O
	09.90-07.97	1 457 42 S 9987	L
	09.90-08.91	0 450 90 F 5601 ¹	K
	09.91-07.97	0 450 90 F 5200 ¹	K



3,0 150 B6304GS	09.91-07.97	0 451 10 P 3219	O
		1 457 42 S 9987	L
		0 450 90 F 5200 ¹	K

3,0 150 B6304S Kat.	09.94-07.95	0 451 10 P 3219	O
		0 450 90 F 5200 ¹	K

VW (VOLKSWAGEN) **

Amarok

Amarok 2.0 BiTDI, BiTDI 4Motion, TDI, TDI 4Motion

2,0 90/120 CDBA <D45>; CDCA <D46>	09.10->	F 026 40 P 7023	O
		1 987 43 M 2114	I
		1 987 43 R 2431 ⁸	I

Amarok 2.0 TSI

2,0 118 CFPA <DF0>	12.10->	F 026 40 P 7080	O
		0 450 90 F 5959 ¹	K
		1 987 43 M 2114	I
		1 987 43 R 2431 ⁸	I

Bora

Bora 1.4

1,4 55 AHW; AKQ; APE; AXP; BCA	09.98-05.05	0 451 10 P 3318	O
		1 457 43 S 3716	L
		0 450 90 F 5318 ¹	K
		1 987 43 R 2300 ⁸	I

Bora 1.6

1,6 74 AEH; AKL; APF	09.98-05.05	0 451 10 P 3314	O
		KZO 1 457 43 S 3714	L
		KZO 1 457 43 S 3081	L
		0 450 90 F 5318 ¹	K
		1 987 43 R 2300 ⁸	I

1,6 | 75 | AVU

	09.00-05.05	0 451 10 P 3314	O
		KZO 1 457 43 S 3714	L
		KZO 1 457 43 S 3081	L
		0 450 90 F 5318 ¹	K
		1 987 43 R 2300 ⁸	I

1,6 | 75 | BFQ

	05.02-05.03	0 451 10 P 3314	O
		KZO 1 457 43 S 3714	L
		KZO 1 457 43 S 3081	L
		0 450 90 F 5318 ¹	K
		1 987 43 R 2300 ⁸	I

1,6 | 77 | ATN; AUS

	08.99-10.00	0 451 10 P 3318	O
		1 457 43 S 3716	L
		0 450 90 F 5318 ¹	K
		1 987 43 R 2300 ⁸	I





1,6 77 AZD	09.00-11.01	0 451 10 P 3318	O
		1 457 43 S 3059	L
		0 450 90 F 5318 ¹	K
		1 987 43 R 2300 ⁸	I

1,6 77 BCB	11.01-05.05	0 451 10 P 3318	O
		1 457 43 S 3059	L
		0 450 90 F 5318 ¹	K
		1 987 43 R 2300 ⁸	I

Bora 1.6 FSI

1,6 81 BAD	08.01-05.05	0 451 10 P 3318	O
		KZO 1 457 43 S 3714	L
		KZO 1 457 43 S 3081	L
		0 450 90 F 5318 ¹	K
		1 987 43 R 2300 ⁸	I

Bora 1.8 , T, 4 Motion

1,8 92/110 AGN;AGU	09.98-05.05	0 451 10 P 3314	O
		KZO 1 457 43 S 3714	L
		KZO 1 457 43 S 3081	L
		0 450 90 F 5318 ¹	K
		1 987 43 R 2300 ⁸	I

Bora 1.8 i, i Turbo

1,8 92/110 BAE;BAF	08.01-11.06	0 451 10 P 3314	O
		1 457 43 S 3081	L
		0 450 90 F 5318 ¹	K
		1 987 43 M 2012	I
		1 987 43 R 2300 ⁸	I

Bora 1.8 T

1,8 110 ARX	09.00-04.01	0 451 10 P 3314	O
		1 457 43 S 3714	L
		0 450 90 F 5318 ¹	K
		1 987 43 R 2300 ⁸	I

1,8 110/132 AUM;AUG	09.00-05.05	0 451 10 P 3314	O
		KZO 1 457 43 S 3714	L
		KZO 1 457 43 S 3081	L
		0 450 90 F 5318 ¹	K
		1 987 43 R 2300 ⁸	I

Bora 1.9 SDI, TDI, TDI 4 Motion

1,9 50/66/74/81/85/96/110 AGP;AGR;AHF;AJM;ALH;AQM;ARL;ASV;ASZ;ATD;AUY;AXR	09.98-05.05	1 457 42 P 9619	O
		KZO 1 457 43 S 3714	L
		KZO 1 457 43 S 3081	L
		0 450 90 N 6374 ¹	K
		1 987 43 R 2300 ⁸	I

Bora 2.0

2,0 85 BER	09.02→	0 451 10 P 3314	O
-------------------	--------	------------------------	----------

Bora 2.0 , 4 Motion

2,0 85 APK;AQY;AZG;AZH;AZJ	09.98-05.05	0 451 10 P 3314	O
		KZO 1 457 43 S 3714	L
		KZO 1 457 43 S 3081	L
		0 450 90 F 5318 ¹	K
		1 987 43 R 2300 ⁸	I

Bora 2.3 , 4 Motion

2,3 110/125 AGZ;AQN	09.98-05.05	1 457 42 P 9192	O
		KZO 1 457 43 S 3714	L
		KZO 1 457 43 S 3081	L
		0 450 90 F 5318 ¹	K
		1 987 43 R 2300 ⁸	I

Bora 2.8 4 Motion

2,8 150 AQP;AUE;BDE	05.99-05.05	1 457 42 P 9192	O
		KZO 1 457 43 S 3714	L
		KZO 1 457 43 S 3081	L
		0 450 90 F 5318 ¹	K
		1 987 43 R 2300 ⁸	I

Caddy

Caddy 1.2 TSI

1,2 63/77 CBZA <DB1>;CBZB <DB0>	09.10→	1 987 42 S 9405	L
		1 987 43 M 2097	I
		1 987 43 R 2397 ⁸	I
	RLE	1 987 43 R 2597 ⁸	I

Caddy 1.4

1,4 44 AEX;AKV;APQ	11.95-06.03	0 451 10 P 3318	O
		1 457 43 S 3540	L
		0 450 90 F 5002 ¹	K
		1 987 43 M 2012	I
		1 987 43 R 2312 ⁸	I

1,4 44 AUD	09.00-06.03	0 451 10 P 3318	O
		1 457 43 S 3539	L
		0 450 90 F 5002 ¹	K
		1 987 43 M 2012	I
		1 987 43 R 2312 ⁸	I

1,4 55 AUA	09.00-06.03	0 451 10 P 3318	O
		F 026 40 S 0019	L
		0 450 90 F 5002 ¹	K
		1 987 43 M 2012	I
		1 987 43 R 2312 ⁸	I





◀ Caddy 1.4

1,4 55 BCA	02.04-05.06	0 451 10 P 3318	O
		1 457 43 S 3059	L
	DRR	0 450 90 F 5925 ¹	K
	4BA,DRR	F 026 40 F 3006 ¹	K
		1 987 43 M 2097	I
		1 987 43 R 2397 ⁸	I
	RLE	1 987 43 R 2597 ⁸	I

1,4 59 BUD <D4W>	05.06-08.10	0 451 10 P 3318	O
		F 026 40 S 0035	L
	DRR	F 026 40 F 3006 ¹	K
	DRR	0 450 90 F 5925 ¹	K
		1 987 43 M 2097	I
		1 987 43 R 2397 ⁸	I
	RLE	1 987 43 R 2597 ⁸	I

Caddy 1.6

1,6 55 AEE	06.96-12.00	0 451 10 P 3318	O
		1 457 43 S 3264	L
	06.97-09.00	1 457 43 S 3540	L
	06.96-12.00	0 450 90 F 5280 ¹	K
	06.97-09.00	0 450 90 F 5002 ¹	K
	06.96-12.00	1 987 43 M 2012	I
		1 987 43 R 2312 ⁸	I

1,6 55 EW	08.83-07.92	0 451 10 P 3033	O
		1 457 42 S 9030	L
	CSA	0 450 90 F 4149 ¹	K

1,6 55 1F	11.95-05.97	0 451 10 P 3314	O
		1 457 43 S 3008	L
		0 450 90 F 5002 ¹	K
		1 987 43 M 2012	I
		1 987 43 R 2312 ⁸	I

1,6 75 BGU	04.04→	0 451 10 P 3314	O	
		KZO	1 987 42 S 9405	L
		KZO	1 457 43 S 3576	L
	04.04-05.05	DRR	0 450 90 F 5925 ¹	K
		4BA,DRR	F 026 40 F 3006 ¹	K
	06.04→		0 450 90 F 5925 ¹	K
	04.04→		1 987 43 M 2097	I
			1 987 43 R 2397 ⁸	I
		RLE	1 987 43 R 2597 ⁸	I

1,6 75 BSE <MW6>	06.05-08.10	0 451 10 P 3314	O	
		KZO	1 987 42 S 9405	L
		KZO	1 457 43 S 3576	L
		DRR	F 026 40 F 3006 ¹	K
		DRR	0 450 90 F 5925 ¹	K
			1 987 43 M 2097	I
			1 987 43 R 2397 ⁸	I
		RLE	1 987 43 R 2597 ⁸	I



1,6 75 BSF <MW6>	06.05-08.10	0 451 10 P 3314	O	
	10.10→		0 451 10 P 3314	O
	06.05-08.10	KZO	1 987 42 S 9405	L
		KZO	1 457 43 S 3576	L
	10.10→		1 987 42 S 9405	L
	06.05-08.10	DRR	F 026 40 F 3006 ¹	K
		DRR	0 450 90 F 5925 ¹	K
	10.10→		F 026 40 F 3006 ¹	K
	06.05-08.10		1 987 43 M 2097	I
			1 987 43 R 2397 ⁸	I
		RLE	1 987 43 R 2597 ⁸	I

Caddy 1.6 BiFuel

1,6 72-75 CHGA <DF2>	05.11→	0 451 10 P 3314	O
		1 987 42 S 9405	L
		1 987 43 M 2097	I
		1 987 43 R 2397 ⁸	I
		RLE	1 987 43 R 2597 ⁸

Caddy 1.6 D

1,6 40 ME	08.90-07.92	0 451 20 P 3012	O
		1 457 42 S 9994	L
	VOW	0 450 90 N 6172 ¹	K
	VOW	0 450 90 N 6267 ¹	K

Caddy 1.6 i

1,6 76 BRY	04.05-01.06	1 987 43 M 2097	I
-----------------------	-------------	------------------------	----------

Caddy 1.6 TDI

1,6 55/75 CAYD <D27>; CAYE	08.10→	F 026 40 P 7023	O	
		KZO	1 987 42 S 9404	L
		EU5,MHF	F 026 40 N 2008	K
		EU5,UFI	F 026 40 N 2006	K
			1 987 43 M 2097	I
			1 987 43 R 2397 ⁸	I
		RLE	1 987 43 R 2597 ⁸	I

Caddy 1.7 SDI

1,7 42 AHB	07.96-09.00	0 451 20 P 3012	O
		1 457 43 S 3264	L
		0 450 90 N 6274 ¹	K
		1 987 43 M 2012	I
			1 987 43 R 2312 ⁸

Caddy 1.8

1,8 70 JH	08.85-07.92	0 451 10 P 3033	O
		1 457 42 S 9957	L
	Fg.Nr. 14..J..007 383→	04.88-07.92	0 450 90 F 5145 ¹



Caddy 1.9 D

1,9 47 AEF	06.96-12.00	0 451 10 P 3289	O
		1 457 43 S 3008	L
		0 450 90 N 6274 ¹	K
		1 987 43 M 2012	I
		1 987 43 R 2312 ⁸	I

1,9 47 1Y	11.95-06.03	0 451 20 P 3012	O
		1 457 43 S 3264	L
		0 450 90 N 6274 ¹	K
		1 987 43 M 2012	I
		1 987 43 R 2312 ⁸	I

Caddy 1.9 SDI

1,9 47 AEY	11.95-09.00	0 451 20 P 3012	O
		1 457 43 S 3264	L
		0 450 90 N 6274 ¹	K
		1 987 43 M 2012	I
		1 987 43 R 2312 ⁸	I

Caddy 1.9 SDI, TDI

1,9 47 66 ALH;AYQ	09.00-06.03	1 457 42 P 9619	O
		1 457 43 S 3058	L
		0 450 90 N 6409 ¹	K
		1 987 43 M 2012	I
		1 987 43 R 2312 ⁸	I

Caddy 1.9 TDI

1,9 55 BSU<D4U>	09.05-08.10	1 457 42 P 9192	O
		KZO 1 987 42 S 9404	L
Fg.Nr. →2K..6..090 000	09.05-02.06	1 457 07 N0007	K
Fg.Nr. 2K..6..090 001→	03.06-08.10	F 026 40 N 2006	K
	09.05-08.10	1 987 43 M 2097	I
		1 987 43 R 2397 ⁸	I
		RLE 1 987 43 R 2597 ⁸	I

1,9|66|AHU;ALE

12.96-09.00	0 451 20 P 3012	O
	1 457 43 S 3008	L
	0 450 90 N 6274 ¹	K
	1 987 43 M 2012	I
	1 987 43 R 2312 ⁸	I

1,9|66|1Z

10.96-03.97	0 451 20 P 3012	O
	1 457 43 S 3008	L
	0 450 90 N 6274 ¹	K
	1 987 43 M 2012	I
	1 987 43 R 2312 ⁸	I



1,9|77|BJB<D3W>

02.04-08.10	1 457 42 P 9192	O	
	KZO 1 987 42 S 9404	L	
Fg.Nr. →2K..6..090 000	02.04-02.06	1 457 07 N0007	K
Fg.Nr. 2K..6..090 001→	03.06-08.10	F 026 40 N 2006	K
	02.04-08.10	1 987 43 M 2097	I
		1 987 43 R 2397 ⁸	I
	RLE 1 987 43 R 2597 ⁸	I	

1,9|77|BLS<D3W>

06.05-08.10	1 457 42 P 9192	O	
	KZO 1 987 42 S 9404	L	
Fg.Nr. →2K..6..090 000	06.05-02.06	1 457 07 N0007	K
Fg.Nr. 2K..6..090 001→	03.06-08.10	F 026 40 N 2006	K
	06.05-08.10	1 987 43 M 2097	I
		1 987 43 R 2397 ⁸	I
	RLE 1 987 43 R 2597 ⁸	I	

Caddy 1.9 TDI 4 Motion

1,9 77 BLS<D3W>	11.08-08.10	1 457 42 P 9192	O
		KZO 1 987 42 S 9404	L
		F 026 40 N 2006	K
		1 987 43 M 2097	I
		1 987 43 R 2397 ⁸	I
	RLE 1 987 43 R 2597 ⁸	I	

Caddy 2.0 EcoFuel

2,0 80 BSX<D7R>	04.06-08.10	0 451 10 P 3314	O
	10.10→	0 451 10 P 3314	O
	04.06-08.10	1 987 42 S 9405	L
	10.10→	1 987 42 S 9405	L
	04.06-08.10	F 026 40 F 3006 ¹	K
	10.10→	F 026 40 F 3006 ¹	K
	04.06-08.10	1 987 43 M 2097	I
		1 987 43 R 2397 ⁸	I
		RLE 1 987 43 R 2597 ⁸	I
	10.10→	1 987 43 M 2097	I
		1 987 43 R 2397 ⁸	I
		RLE 1 987 43 R 2597 ⁸	I

Caddy 2.0 SDI

2,0 51 BDJ<DOK>	02.04-08.10	1 457 42 P 9192	O
		KZO 1 987 42 S 9405	L
		KZO 1 457 43 S 3576	L
Fg.Nr. →2K..6..090 000	02.04-02.06	1 457 07 N0007	K
Fg.Nr. 2K..6..090 001→	03.06-08.10	F 026 40 N 2006	K
	02.04-08.10	1 987 43 M 2097	I
		1 987 43 R 2397 ⁸	I
		RLE 1 987 43 R 2597 ⁸	I





◀ Caddy 2.0 SDI

2,0 51 BST <D0K>			
	06.05-08.10	1 457 42 P 9192	O
		KZO 1 987 42 S 9405	L
		KZO 1 457 43 S 3576	L
Fg.Nr. →2K..6..090 000	06.05-02.06	1 457 07 N0007	K
Fg.Nr. 2K..6..090 001→	03.06-08.10	F 026 40 N 2006	K
	06.05-08.10	1 987 43 M 2097	I
		1 987 43 R 2397 ⁸	I
	RLE	1 987 43 R 2597 ⁸	I

Caddy 2.0 TDI

2,0 103 BMM <D7N>			
	09.07-08.10	1 457 42 P 9192	O
		KZO 1 987 42 S 9404	L
		F 026 40 N 2006	K
		1 987 43 M 2097	I
		1 987 43 R 2397 ⁸	I
	RLE	1 987 43 R 2597 ⁸	I

Caddy 2.0 TDI, TDI 4 Motion

2,0 81/103 CFHC <D91>; CFHE; CFHF; CLCA <D96>			
	08.10→	F 026 40 P 7023	O
		KZO 1 987 42 S 9404	L
		F 026 40 N 2006	K
		1 987 43 M 2097	I
		1 987 43 R 2397 ⁸	I
	RLE	1 987 43 R 2597 ⁸	I

Caravelle

Caravelle 2.1 i

2,1 82 DJ			
	06.87-12.91	0 451 10 P 3074	O
		1 457 42 S 9890	L
		0 450 90 F 5264 ¹	K

Corrado

Corrado 1.8 G60

1,8 118 PG			
	09.88-09.93	0 451 10 P 3280	O
		1 457 42 S 9777	L
		0 450 90 F 5264 ¹	K

Corrado 1.8 16V

1,8 98-102 KR			
	09.88-07.92	0 451 10 P 3314	O
		0 450 90 F 5143 ¹	K

Corrado 2.0

2,0 85 ADY; 2E			
	04.93-07.95	0 451 10 P 3314	O
		1 457 42 S 9777	L
		0 450 90 F 5145 ¹	K

Corrado 2.0 16V

2,0 100 9A			
	08.91-07.95	0 451 10 P 3314	O
		0 450 90 F 5145 ¹	K



Corrado 2.8

2,8 128 AAA			
	08.91-07.95	ABM,TW 1 457 42 P 9103	O
		1 457 42 S 9777	L
		0 450 90 F 5264 ¹	K

Corrado 2.9

2,9 140 ABV			
	08.91-07.95	ABM,TW 1 457 42 P 9103	O
		1 457 42 S 9777	L
		0 450 90 F 5264 ¹	K

Crafter

Crafter 2.5 TDI

2,5 65/80/100/120 BJJ <D5K>; BJK <D5L>; BJL <D5M>; BJM <D5N>; CEBA <D5K>; CEBB <D5L>; CECA <D5M>; CECB <D5N>			
	04.06→	1 457 42 P 9619	O
		F 026 40 S 0055	L
		F 026 40 N 2101	K
		1 987 43 M 2213	I
		1 987 43 R 2513 ⁸	I

Eos

Eos 1.4 TSI

1,4 90 CAXA <D4X>			
	11.10→	F 026 40 P 7079	O
Fg.Nr. →1F..8..060000	11.07-04.08	1 457 42 P 9301	O
Fg.Nr. 1F..9..000001→	05.08-11.10	F 026 40 P 7079	O
	11.07→	1 987 42 S 9405	L
	11.07-11.10	4BA F 026 40 F 3006 ¹	K
		6BA 0 450 90 F 5959 ¹	K
	11.10→	0 450 90 F 5959 ¹	K
	11.07→	1 987 43 M 2097	I
		1 987 43 R 2397 ⁸	I
	RLE	1 987 43 R 2597 ⁸	I

1,4 | 118 | CAVD <D4L>

	05.08→	F 026 40 P 7079	O
		KZO 1 987 42 S 9404	L
	05.08-11.10	4BA F 026 40 F 3006 ¹	K
		6BA 0 450 90 F 5959 ¹	K
	11.10→	0 450 90 F 5959 ¹	K
	05.08→	1 987 43 M 2097	I
		1 987 43 R 2397 ⁸	I
	RLE	1 987 43 R 2597 ⁸	I

Eos 1.6 FSI

1,6 85 BLF			
	05.06-05.08	1 457 42 P 9301	O
		1 457 43 S 3315	L
		0 450 90 F 5959 ¹	K
		1 987 43 R 2397 ⁸	I
	RLE	1 987 43 R 2597 ⁸	I





Eos 2.0 FSI

2,0 110 BVY; BVZ			
05.06-05.08	1 457 42	P 9243	O
	KZO	1 987 42	S 9405 L
	KZO	1 457 43	S 3576 L
		0 450 90	F 5959 ¹ K
		1 987 43	R 2397 ⁸ I
	RLE	1 987 43	R 2597 ⁸ I

2,0 147 BPY			
09.06-11.09	1 457 42	P 9243	O
		1 457 43	S 3102 L
	4BA	F 026 40	F 3006 ¹ K
	6BA	0 450 90	F 5959 ¹ K
		1 987 43	R 2397 ⁸ I
	RLE	1 987 43	R 2597 ⁸ I

Eos 2.0 TDI

2,0 100/103 CFFA <D94>; CFFB <D91>			
11.10→	F 026 40	P 7023	O
	KZO	1 987 42	S 9404 L
		F 026 40	N 2006 K
		1 987 43	M 2097 I
		1 987 43	R 2397 ⁸ I
	RLE	1 987 43	R 2597 ⁸ I

2,0 103 BMM			
05.06-05.08	1 457 42	P 9192	O
	KZO	1 987 42	S 9404 L
		F 026 40	N 2006 K
		1 987 43	R 2397 ⁸ I
	RLE	1 987 43	R 2597 ⁸ I

2,0 103 CBAB <D91>			
05.08-11.10	1 457 42	P 9192	O
	KZO	1 987 42	S 9404 L
		F 026 40	N 2006 K
		1 987 43	M 2097 I
		1 987 43	R 2397 ⁸ I
	RLE	1 987 43	R 2597 ⁸ I

Eos 2.0 TSI

2,0 147 BWA <D2L>			
05.06-11.10	1 457 42	P 9243	O
		1 457 43	S 3102 L
	4BA	F 026 40	F 3006 ¹ K
	6BA	0 450 90	F 5959 ¹ K
		1 987 43	M 2097 I
		1 987 43	R 2397 ⁸ I
	RLE	1 987 43	R 2597 ⁸ I

2,0 147 CAWB <D2L>			
05.08-11.09	F 026 40	P 7080	O
		1 987 42	S 9404 L
	4BA	F 026 40	F 3006 ¹ K
	6BA	0 450 90	F 5959 ¹ K
		1 987 43	R 2397 ⁸ I
	RLE	1 987 43	R 2597 ⁸ I



2,0 | 147/155 | CCZA <D2L>; CCZB <D2D>

05.09→	F 026 40	P 7080	O
		1 987 42	S 9404 L
05.09-11.10	4BA	F 026 40	F 3006 ¹ K
	6BA	0 450 90	F 5959 ¹ K
11.10→		0 450 90	F 5959 ¹ K
05.09→		1 987 43	M 2097 I
		1 987 43	R 2397 ⁸ I
	RLE	1 987 43	R 2597 ⁸ I

Eos 3.2

3,2 184 BUB <D6D>			
05.06-11.10	1 457 42	P 9192	O
	4BA	F 026 40	F 3006 ¹ K
	6BA	0 450 90	F 5959 ¹ K
		1 987 43	M 2097 I
		1 987 43	R 2397 ⁸ I
	RLE	1 987 43	R 2597 ⁸ I

Eos 3.2 FSI

3,2 184 CBRA			
05.07-05.08	1 457 42	P 9192	O
		0 450 90	F 5959 ¹ K
		1 987 43	R 2397 ⁸ I
	RLE	1 987 43	R 2597 ⁸ I

Eos 3.6

3,6 191 CDVA <D04>			
05.09-11.10	1 457 42	P 9192	O
	4BA	F 026 40	F 3006 ¹ K
	6BA	0 450 90	F 5959 ¹ K
		1 987 43	M 2097 I
		1 987 43	R 2397 ⁸ I
	RLE	1 987 43	R 2597 ⁸ I

Fox

Fox 1.2

1,2 40 BMD <MM2>			
04.05→	1 457 42	P 9194	O
		1 457 43	S 3532 L
		0 450 90	F 5316 ¹ K
		1 987 43	M 2057 I
		1 987 43	R 2357 ⁸ I

1,2 40 CHFB <MM2>			
06.09→	1 457 42	P 9194	O
		1 457 43	S 3532 L
		0 450 90	F 5316 ¹ K
		1 987 43	M 2057 I
		1 987 43	R 2357 ⁸ I

1,2 44 CHFA <MM4>			
09.10→	1 457 42	P 9194	O
		1 457 43	S 3532 L
		1 987 43	M 2057 I
		1 987 43	R 2357 ⁸ I





Fox 1.4

1,4 55 BKR <D4H>	04.05→	0 451 10 P 3318	O
		0 450 90 F 5316 ¹	K
		1 987 43 M 2057	I
		1 987 43 R 2357 ⁸	I

Fox 1.4 TDI

1,4 51 BNM <D4S>	04.05→	1 457 42 P 9192	O
		1 457 43 S 3575	L
		0 450 90 N 6500 ¹	K
		1 987 43 M 2057	I
		1 987 43 R 2357 ⁸	I

Fox 1.8

1,8 60 UM	02.87-12.97	0 450 90 F 5601 ¹	K
---------------	-------------	------------------------------	---

Golf

Golf 1.6 D

1,6 40 ME	12.88-12.91	0 451 20 P 3012	O
		1 457 42 S 9994	L
		VOW 0 450 90 N 6172 ¹	K
		VOW 0 450 90 N 6267 ¹	K

Golf 1.8

1,8 79 PF	12.88-12.91	0 451 10 P 3033	O
		1 457 42 S 9777	L
		0 450 90 F 5264 ¹	K

Golf 2.0

2,0 85 ABA	01.96-06.02	0 451 10 P 3314	O
		1 457 43 S 3023	L
	TW	0 450 90 F 5030 ¹	K
		0 450 90 F 5264 ¹	K
		1 987 43 R 2300 ⁸	I

2,0 | 85 | ADC

08.96-09.98	0 451 10 P 3314	O
TW	0 450 90 F 5030 ¹	K
	0 450 90 F 5264 ¹	K
	1 987 43 R 2300 ⁸	I

Golf 2.0 16V

2,0 100 9A	09.89-08.92	0 451 10 P 3033	O
		1 457 42 S 9777	L
		0 450 90 F 5133 ¹	K



Golf City

Golf City 1.6

1,6 55 1F	12.97-04.08	0 451 10 P 3314	O
		1 457 43 S 3264	L
		0 450 90 F 5264 ¹	K
		1 987 43 M 2012	I
		1 987 43 R 2312 ⁸	I

Golf I

Golf I 1.3

1,3 44 GF	11.79-12.95	0 451 10 P 3033	O
		1 457 42 S 9959	L
	CSA	0 450 90 F 4149 ¹	K

1,3 | 48 | GY

06.96-06.99	0 451 10 P 3033	O
CSA	0 450 90 F 4149 ¹	K

1,3 | 52 | AJD

06.96-06.00	0 451 10 P 3033	O
-------------	-----------------	---

Golf I 1.4

1,4 | 54 | BBV

05.98→	0 451 10 P 3033	O
	1 457 42 S 9030	L
CSA	0 450 90 F 4149 ¹	K

Golf I 1.6

1,6 | 51-55 | EW, EWA

08.83-12.92	0 451 10 P 3033	O
	1 457 42 S 9030	L
CSA	0 450 90 F 4149 ¹	K

1,6 | 60 | HM

06.81→	0 451 10 P 3033	O
	1 457 42 S 9030	L
CSA	0 450 90 F 4149 ¹	K

1,6 | 63 | FR

06.81-12.96	1 457 42 S 9030	L
CSA	0 450 90 F 4149 ¹	K

Golf I 1.6 i

1,6 | 74 | AFX

09.98→	0 450 90 F 5316 ¹	K
--------	------------------------------	---

Golf I 1.8

1,8 | 66/70 | EX; HV

08.83-12.97	0 451 10 P 3033	O
08.83-12.95	1 457 42 S 9030	L
08.83-12.97 CSA	0 450 90 F 4149 ¹	K

1,8 | 70 | JH

08.83-08.93	0 451 10 P 3033	O
	1 457 42 S 9957	L
	0 450 90 F 5401 ¹	K





1,8 72 2H	08.89-08.93	0 451 10 P 3033	O
		1 457 42 S 9957	L
		0 450 90 F 5030 ¹	K

Golf I 1.8 , i

1,8 82 DX	08.82-12.95	0 451 10 P 3033	O
		1 457 42 S 9957	L
		0 450 90 F 5021 ¹	K

Golf II**Golf II 1.0**

1,0 37 HZ	10.85-10.91	0 451 10 P 3033	O
	CSA	1 457 42 S 9789	L
		0 450 90 F 4149 ¹	K
	TW	1 987 43 M 2011	I

Golf II 1.3

1,3 40 NZ	08.85-07.92	0 451 10 P 3033	O
		1 457 42 S 9076	L
		0 450 90 F 5264 ¹	K
	TW	1 987 43 M 2011	I

1,3|40|2G

01.89-07.92	0 451 10 P 3033	O
	1 457 42 S 9915	L
CSA	0 450 90 F 4149 ¹	K
TW	1 987 43 M 2011	I

Golf II 1.6

1,6 51-53 EZ, EZA	08.83-07.91	0 451 10 P 3033	O
		1 457 42 S 9030	L
	CSA	0 450 90 F 4149 ¹	K
	TW	1 987 43 M 2011	I

1,6|51/53|PN; RF

02.86-07.92	0 451 10 P 3033	O
	1 457 42 S 9030	L
CSA	0 450 90 F 4149 ¹	K
TW	1 987 43 M 2011	I

Golf II 1.6 D, TD

1,6 40/51 JP; JR; ME; MF	08.83-08.92	0 451 20 P 3012	O
		1 457 42 S 9994	L
	VOW	0 450 90 N 6172 ¹	K
	VOW	0 450 90 N 6267 ¹	K
	TW	1 987 43 M 2011	I

Golf II 1.6 TD

1,6 44/59 SB; 1V	08.89-07.92	0 451 20 P 3012	O
		1 457 42 S 9777	L
	VOW	0 450 90 N 6172 ¹	K
	VOW	0 450 90 N 6267 ¹	K
	TW	1 987 43 M 2011	I

Golf II 1.8

1,8 66 GU	11.83-10.91	0 451 10 P 3033	O
		1 457 42 S 9030	L
	CSA	0 450 90 F 4149 ¹	K
	TW	1 987 43 M 2011	I

1,8|66/77|RP; RV

08.87-11.92	0 451 10 P 3033	O
	1 457 42 S 9777	L
	0 450 90 F 5264 ¹	K
TW	1 987 43 M 2011	I

1,8|79/82|PB; PF

01.87-08.92	0 451 10 P 3033	O
	1 457 42 S 9777	L
	0 450 90 F 5264 ¹	K
TW	1 987 43 M 2011	I

1,8|95|PL

02.86-10.91	0 451 10 P 3033	O
	ED1 1 457 42 S 9777	L
	NOR 1 457 42 S 9076	L
08.88-10.91	0 450 90 F 5145 ¹	K
02.86-10.91 TW	1 987 43 M 2011	I

1,8|102|KR

02.86-10.91	0 451 10 P 3033	O
	ED1 1 457 42 S 9777	L
	NOR 1 457 42 S 9076	L
08.88-10.91	0 450 90 F 5145 ¹	K
02.86-10.91 TW	1 987 43 M 2011	I

Golf II 1.8 G60

1,8 118 PG	04.90-07.91	0 451 10 P 3280	O
		1 457 42 S 9777	L
		0 450 90 F 5264 ¹	K
	TW	1 987 43 M 2011	I

Golf II 1.8 G60 syncro

1,8 118 PG	01.90-07.91	0 451 10 P 3033	O
		1 457 42 S 9777	L
		0 450 90 F 5264 ¹	K
		1 987 43 M 2011	I

Golf II 1.8 i

1,8 82 EV	11.84-12.92	1 457 42 S 9030	L
		0 450 90 F 5143 ¹	K



**1,8|66|ACC**

	12.94-12.97	0 451 10 P 3314	O
Fg.Nr. →1H..R..990 000	10.92-06.94	0 451 10 P 3033	O
Fg.Nr. 1H..R..990 001→	07.94-07.99	0 451 10 P 3314	O
	08.92-07.99	1 457 43 S 3023	L
		0 450 90 F 5264 ¹	K
	12.94-12.97	1 987 43 M 2012	I
		1 987 43 R 2300 ⁸	I
	WW	1 987 43 R 2312 ⁸	I

1,8|66|ADZ

	10.94-02.99	0 451 10 P 3314	O
		1 457 43 S 3023	L
		0 450 90 F 5264 ¹	K
	10.94-12.97	1 987 43 R 2300 ⁸	I
	WW	1 987 43 R 2312 ⁸	I
	10.94-02.99	1 987 43 M 2012	I

1,8|70|ACH

	11.92-12.99	1 457 43 S 3023	L
	CSA	0 450 90 F 4149 ¹	K

Golf III 1.8 syncro**1,8|66|ABS**

	01.93-07.94	0 451 10 P 3033	O
	01.93-09.94	1 457 43 S 3023	L
		0 450 90 F 5030 ¹	K
	04.93-09.94	1 987 43 M 2012	I
		1 987 43 R 2312 ⁸	I

1,8|66|ADZ

	10.94-12.97	0 451 10 P 3314	O
		1 457 43 S 3023	L
		0 450 90 F 5030 ¹	K
Fg.Nr. →1H-T 400 000	10.94-05.96	0 450 90 F 5030 ¹	K
Fg.Nr. 1H-V 000 001→	06.96-12.97	0 450 90 F 5264 ¹	K
	10.94-12.97	1 987 43 M 2012	I
		1 987 43 R 2312 ⁸	I

Golf III 1.9 D**1,9|47|1Y**

	11.91-02.99	0 451 20 P 3012	O
		1 457 43 S 3023	L
		0 450 90 N 6267 ¹	K
	11.91-12.97	1 987 43 R 2300 ⁸	I
	WW	1 987 43 R 2312 ⁸	I
	11.91-02.99	1 987 43 M 2012	I

Golf III 1.9 SDI**1,9|47|AEY**

	01.95-02.99	0 451 20 P 3012	O
		1 457 43 S 3023	L
		0 450 90 N 6267 ¹	K
	01.95-12.97	1 987 43 R 2300 ⁸	I
	WW	1 987 43 R 2312 ⁸	I
	01.95-02.99	1 987 43 M 2012	I

Golf III 1.9 TD**1,9|55|AAZ**

	11.91-02.99	0 451 20 P 3012	O
	08.92-07.98	0 451 10 P 3314	O
	11.91-02.99	1 457 43 S 3023	L
		0 450 90 N 6267 ¹	K
	08.92-07.98	0 450 90 N 6281 ¹	K
	11.91-12.97	1 987 43 R 2300 ⁸	I
	WW	1 987 43 R 2312 ⁸	I
	11.91-02.99	1 987 43 M 2012	I

Golf III 1.9 TDI**1,9|66|AHU**

	08.96-02.99	0 451 10 P 3347	O
		1 457 43 S 3023	L
		0 450 90 N 6267 ¹	K
	08.96-12.97	1 987 43 R 2300 ⁸	I
	WW	1 987 43 R 2312 ⁸	I
	08.96-02.99	1 987 43 M 2012	I

1,9|66|ALE

	04.97-02.99	0 451 10 P 3347	O
		1 457 43 S 3023	L
		0 450 90 N 6267 ¹	K
	05.97-12.97	1 987 43 R 2300 ⁸	I
	WW	1 987 43 R 2312 ⁸	I
	05.97-02.99	1 987 43 M 2012	I

1,9|66|1Z

	07.93-07.96	0 451 10 P 3347	O
	08.95→	0 451 20 P 3012	O
	07.93→	1 457 43 S 3023	L
	07.93-07.96	0 450 90 N 6267 ¹	K
	08.95→	0 450 90 N 6281 ¹	K
	07.93-07.96	1 987 43 M 2012	I
	09.93-07.96	1 987 43 R 2300 ⁸	I
	WW	1 987 43 R 2312 ⁸	I

1,9|81|AFN

	02.96-02.99	0 451 10 P 3290	O
		1 457 43 S 3023	L
		0 450 90 N 6267 ¹	K
		1 987 43 M 2012	I
	03.96-12.97	1 987 43 R 2300 ⁸	I
	WW	1 987 43 R 2312 ⁸	I

Golf III 1.9 TDI syncro**1,9|66|AHU**

	08.96-12.97	0 451 10 P 3347	O
		1 457 43 S 3023	L
		0 450 90 N 6267 ¹	K
		1 987 43 M 2012	I
		1 987 43 R 2312 ⁸	I

1,9|66|ALE

	05.96-12.97	0 451 10 P 3347	O
		1 457 43 S 3023	L
		0 450 90 N 6267 ¹	K
		1 987 43 M 2012	I





◀ Golf III 1.9 TDI syncro

1,9 66 1Z			
	03.95-07.96	0 451 10 P 3347	O
Fg.Nr. →1H-T 400 000	10.94-05.96	0 451 20 P 3012	O
Fg.Nr. 1H-V 000 001→	06.96-07.96	0 451 10 P 3347	O
	10.94-07.96	1 457 43 S 3023	L
		VOW 0 450 90 N 6172 ¹	K
		VOW 0 450 90 N 6267 ¹	K
	07.95-07.96	0 450 90 N 6267 ¹	K
	10.94-07.96	1 987 43 M 2012	I
	03.95-07.96	1 987 43 R 2312 ⁸	I

Golf III 2.0

2,0 79/85/110 ABF;ADY;AEP			
	08.92-12.97	0 451 10 P 3314	O
		1 457 43 S 3023	L
		0 450 90 F 5264 ¹	K
		1 987 43 M 2012	I
		1 987 43 R 2300 ⁸	I
	WW	1 987 43 R 2312 ⁸	I

2,0|85|ABA

Fg.Nr. →1H..R..990 000	10.92-06.94	0 451 10 P 3033	O
Fg.Nr. 1H..R..990 001→	07.94-07.99	0 451 10 P 3314	O
	08.92-07.99	1 457 43 S 3023	L
		0 450 90 F 5264 ¹	K

2,0|85|AGG

	07.95-02.99	0 451 10 P 3314	O
		1 457 43 S 3023	L
		0 450 90 F 5264 ¹	K
	07.95-12.97	1 987 43 R 2300 ⁸	I
	WW	1 987 43 R 2312 ⁸	I
	07.95-02.99	1 987 43 M 2012	I

2,0|85|AKR

	04.97-02.99	0 451 10 P 3314	O
		1 457 43 S 3023	L
		0 450 90 F 5264 ¹	K
	05.97-12.97	1 987 43 R 2300 ⁸	I
	05.97-02.99	1 987 43 M 2012	I

2,0|85|2E

	11.91-09.94	0 451 10 P 3314	O
	07.93-07.94	0 451 10 P 3033	O
Fg.Nr. →1E..R..030 000	09.93-07.94	0 451 10 P 3033	O
Fg.Nr. 1E..R..030 001→	07.94-09.94	0 451 10 P 3314	O
	11.91-09.94	1 457 43 S 3023	L
		0 450 90 F 5264 ¹	K
		1 987 43 M 2012	I
		1 987 43 R 2300 ⁸	I
	WW	1 987 43 R 2312 ⁸	I

Golf III 2.0 i

2,0 85 2E			
	11.92-12.96	0 451 10 P 3033	O
		1 457 43 S 3023	L
		0 450 90 F 5264 ¹	K

Golf III 2.0 Mi

2,0 85	01.94-07.98	0 451 10 P 3314	O
---------------	-------------	-----------------	---



Golf III 2.0 syncro

2,0 85 AGG			
	07.95-12.97	0 451 10 P 3314	O
		1 457 43 S 3023	L
		0 450 90 F 5264 ¹	K
Fg.Nr. →1H-T 400 000	07.95-05.96	0 450 90 F 5030 ¹	K
Fg.Nr. 1H-V 000 001→	06.96-12.97	0 450 90 F 5264 ¹	K
	07.95-12.97	1 987 43 M 2012	I
		1 987 43 R 2312 ⁸	I

Golf III 2.8

2,8|128|AAA

Mot.Nr. AAA 176 890→	11.95-12.97	1 457 42 P 9142	O
Mot.Nr. AAA-176 890→	01.96-12.99	1 457 42 P 9142	O
Mot.Nr. →AAA 176 889	01.92-10.95 ABM,TW	1 457 42 P 9103	O
	08.94-12.95	1 457 42 P 9103	O
	01.92-12.99	1 457 43 S 3023	L
		0 450 90 F 5264 ¹	K
	01.92-12.97	1 987 43 M 2012	I
		1 987 43 R 2300 ⁸	I

Golf III 2.8 , i VR6

2,8|120|AAA

Mot.Nr. AAA 176 890→	11.95-12.97	1 457 42 P 9142	O
Mot.Nr. →AAA 176 889	07.94-10.95	1 457 42 P 9103	O
	07.94-12.97	1 457 43 S 3023	L
		0 450 90 F 5264 ¹	K
		1 987 43 M 2012	I
		1 987 43 R 2300 ⁸	I

Golf III 2.8 i VR6

2,8|128|AAA

Mot.Nr. →AAA 176 889	10.93-09.95	1 457 42 P 9103	O
	10.93-12.99	1 457 43 S 3023	L
		0 450 90 F 5264 ¹	K

Golf III 2.9 syncro

2,9|140|ABV

Mot.Nr. ABV 019 554→	11.95-12.97	1 457 42 P 9142	O
Mot.Nr. →ABV 019 553	01.94-10.95	1 457 42 P 9103	O
	01.94-12.97	1 457 43 S 3023	L
		0 450 90 F 5264 ¹	K
Fg.Nr. →1H-T 400 000	07.95-05.96	0 450 90 F 5030 ¹	K
Fg.Nr. 1H-V 000 001→	06.96-12.97	0 450 90 F 5264 ¹	K
	01.94-12.97	1 987 43 M 2012	I
		1 987 43 R 2312 ⁸	I

Golf IV

Golf IV 1.4

1,4 55 AHW;AKQ;APE;AXP;BCA			
	10.97-06.06	0 451 10 P 3318	O
		1 457 43 S 3716	L
		0 450 90 F 5318 ¹	K
		1 987 43 R 2300 ⁸	I





Golf IV 1.6

1,6 74 AFT	04.98-10.00	0 451 10 P 3314 O
		1 457 43 S 3023 L
		0 450 90 F 5264 ¹ K
		1 987 43 M 2012 I
		1 987 43 R 2300 ⁸ I

1,6 74 AKL <EA113>	08.99-06.01	0 451 10 P 3314 O
---------------------------------	-------------	---------------------------------

1,6 74 AKS	04.98-10.00	0 451 10 P 3314 O
		1 457 43 S 3023 L
		0 450 90 F 5264 ¹ K
		1 987 43 M 2012 I
		1 987 43 R 2300 ⁸ I

1,6 74 APF	05.99-04.01	0 451 10 P 3314 O
		KZO 1 457 43 S 3714 L
		KZO 1 457 43 S 3081 L
		0 450 90 F 5318 ¹ K
		1 987 43 R 2300 ⁸ I

1,6 75 AVU	09.00-06.06	0 451 10 P 3314 O
		KZO 1 457 43 S 3714 L
		KZO 1 457 43 S 3081 L
		0 450 90 F 5318 ¹ K
		1 987 43 R 2300 ⁸ I

1,6 75 BFQ	05.02-06.06	0 451 10 P 3314 O
		KZO 1 457 43 S 3714 L
		KZO 1 457 43 S 3081 L
		0 450 90 F 5318 ¹ K
		1 987 43 R 2300 ⁸ I

1,6 77 ATN; AUS	05.99-10.00	0 451 10 P 3318 O
		1 457 43 S 3716 L
		0 450 90 F 5318 ¹ K
		1 987 43 R 2300 ⁸ I

1,6 77 AZD	09.00-11.01	0 451 10 P 3318 O
		1 457 43 S 3059 L
		0 450 90 F 5318 ¹ K
		1 987 43 R 2300 ⁸ I

1,6 77 BCB	11.01-06.06	0 451 10 P 3318 O
		1 457 43 S 3059 L
		0 450 90 F 5318 ¹ K
		1 987 43 R 2300 ⁸ I



Golf IV 1.6 , i

1,6 74 AEH	10.97-06.06	0 451 10 P 3314 O
		KZO 1 457 43 S 3714 L
		KZO 1 457 43 S 3081 L
		0 450 90 F 5318 ¹ K
		1 987 43 R 2300 ⁸ I

1,6 74 AKL	10.97-06.06	0 451 10 P 3314 O
		KZO 1 457 43 S 3714 L
		KZO 1 457 43 S 3081 L
		0 450 90 F 5318 ¹ K
		1 987 43 R 2300 ⁸ I

Golf IV 1.6 FSI

1,6 81 BAD	08.01-06.06	0 451 10 P 3318 O
		KZO 1 457 43 S 3714 L
		KZO 1 457 43 S 3081 L
		0 450 90 F 5318 ¹ K
		1 987 43 R 2300 ⁸ I

Golf IV 1.6 Total Flex

1,6 74-77 CCRA <EA111 VHT>	05.08→	1 987 43 M 2012 I
		1 987 43 R 2300 ⁸ I

Golf IV 1.8

1,8 55/66 AAM; ADZ	04.98-10.00	0 451 10 P 3314 O
		1 457 43 S 3023 L
		0 450 90 F 5264 ¹ K
		1 987 43 M 2012 I
		1 987 43 R 2300 ⁸ I

1,8 55/66 ANN; ANP	04.98-10.00	0 451 10 P 3314 O
		1 457 43 S 3023 L
		0 450 90 F 5264 ¹ K
		1 987 43 M 2012 I
		1 987 43 R 2300 ⁸ I

1,8 92/110 AGN; AGU	10.97-10.00	0 451 10 P 3314 O
		KZO 1 457 43 S 3714 L
		KZO 1 457 43 S 3081 L
		0 450 90 F 5318 ¹ K
		1 987 43 R 2300 ⁸ I

Golf IV 1.8 , GTI Turbo

1,8 110/132 AWP; AWW	08.00-03.07	0 451 10 P 3314 O
-----------------------------	-------------	---------------------------------

Golf IV 1.8 GTI Turbo

1,8 92/110 AGN; AGU	08.99-06.02	0 451 10 P 3314 O
1,8 132 AUQ	07.02-03.07	0 451 10 P 3314 O





◀ Golf IV 1.8 GTI Turbo

1,8 142 AUQ	04.07-05.08	0 451 10 P 3314	O
		1 987 43 M 2012	I
		1 987 43 R 2300 ⁸	I

Golf IV 1.8 i

1,8 92 BAF	12.03→	0 451 10 P 3314	O
		1 457 43 S 3714	L
		0 450 90 F 5318 ¹	K
		1 987 43 R 2300 ⁸	I

Golf IV 1.8 i, T, 4 Motion

1,8 92/110 AGN; AGU	10.97-12.05	0 451 10 P 3314	O
		KZO 1 457 43 S 3714	L
		KZO 1 457 43 S 3081	L
		0 450 90 F 5318 ¹	K
		1 987 43 R 2300 ⁸	I

Golf IV 1.8 T

1,8 110 ARZ; AUM	05.99-05.03	0 451 10 P 3314	O
		KZO 1 457 43 S 3714	L
		KZO 1 457 43 S 3081	L
		0 450 90 F 5318 ¹	K
		1 987 43 R 2300 ⁸	I

1,8 | 132 | AUQ

06.01-12.05	0 451 10 P 3314	O
	06.01-05.04 KZO 1 457 43 S 3714	L
	KZO 1 457 43 S 3081	L
	05.03-12.05 1 457 43 S 3714	L
	06.01-05.04 0 450 90 F 5318 ¹	K
	06.01-12.05 1 987 43 R 2300 ⁸	I

Golf IV 1.9 SDI

1,9 50 AGP	10.97-04.01	1 457 42 P 9619	O
		KZO 1 457 43 S 3714	L
		KZO 1 457 43 S 3081	L
		0 450 90 N 6374 ¹	K
		1 987 43 R 2300 ⁸	I

Golf IV 1.9 SDI, TDI, TDI 4 Motion

1,9 50/66/74/81/85/96/110 ALH; AQM; ARL; ASV; ASZ; ATD; AUY	10.97-06.06	1 457 42 P 9619	O
		KZO 1 457 43 S 3714	L
		KZO 1 457 43 S 3081	L
		0 450 90 N 6374 ¹	K
		1 987 43 R 2300 ⁸	I



Golf IV 1.9 TDI

1,9 66 AGR	10.97-09.02	1 457 42 P 9619	O
		04.07→ 1 457 42 P 9619	O
	10.97-09.02	KZO 1 457 43 S 3714	L
		KZO 1 457 43 S 3081	L
		0 450 90 N 6374 ¹	K
	04.07→	0 450 90 N 6374 ¹	K
	10.97-09.02	1 987 43 R 2300 ⁸	I
	04.07→	1 987 43 M 2012	I
		1 987 43 R 2300 ⁸	I

1,9 | 66 | AHU

04.98-06.00	0 451 10 P 3347	O
	1 457 43 S 3023	L
	0 450 90 N 6267 ¹	K
	1 987 43 M 2012	I
	1 987 43 R 2300 ⁸	I

1,9 | 66 | ALE

04.98-12.01	0 451 10 P 3347	O
	1 457 43 S 3023	L
	0 450 90 N 6267 ¹	K
	1 987 43 M 2012	I
	1 987 43 R 2300 ⁸	I

1,9 | 74 | AXR

05.01-06.06	1 457 42 P 9619	O
	KZO 1 457 43 S 3714	L
	KZO 1 457 43 S 3081	L
	0 450 90 N 6374 ¹	K
	1 987 43 R 2300 ⁸	I

1,9 | 81 | AFN

04.98-08.99	0 451 10 P 3290	O
	1 457 43 S 3023	L
	0 450 90 N 6267 ¹	K
	1 987 43 M 2012	I
	1 987 43 R 2300 ⁸	I

1,9 | 81 | AHF

10.97-06.06	1 457 42 P 9619	O
	KZO 1 457 43 S 3714	L
	KZO 1 457 43 S 3081	L
	0 450 90 N 6374 ¹	K
	05.00-12.05 VOW 0 450 90 N 6374 ¹	K
	10.97-06.06 1 987 43 R 2300 ⁸	I

1,9 | 81 | AVG

08.99-10.00	0 451 10 P 3290	O
	1 457 43 S 3023	L
	0 450 90 N 6267 ¹	K
	1 987 43 M 2012	I
	1 987 43 R 2300 ⁸	I

Golf IV 1.9 TDI, TDI 4 Motion

1,9 85 AJM	05.99-07.01	1 457 42 P 9619	O
		KZO 1 457 43 S 3714	L
		KZO 1 457 43 S 3081	L
		0 450 90 N 6374 ¹	K
		1 987 43 R 2300 ⁸	I



**Golf IV 1.9 TDI 4 Motion**

1,9|66|AGR

07.98-04.02	1 457 42	P 9619	O
	KZO	1 457 43	S 3714 L
	KZO	1 457 43	S 3081 L
		0 450 90	N 6374 ¹ K
		1 987 43	R 2300 ⁸ I

Golf IV 2.0

2,0|85|AEG

12.98-10.02	0 451 10	P 3314	O
		1 457 43	S 3714 L

2,0|85|AGG; AKR

04.98-12.01	0 451 10	P 3314	O
		1 457 43	S 3023 L
		0 450 90	F 5264 ¹ K
		1 987 43	M 2012 I
		1 987 43	R 2300 ⁸ I

2,0|85|ATU

06.99-06.00	0 451 10	P 3314	O
		1 457 43	S 3023 L
		0 450 90	F 5264 ¹ K
		1 987 43	M 2012 I
		1 987 43	R 2300 ⁸ I

2,0|85|AVH

08.00-07.03	0 451 10	P 3314	O
-------------	----------	---------------	----------

2,0|85|AWF; AWG

06.00-06.02	0 451 10	P 3314	O
		1 457 43	S 3023 L
		0 450 90	F 5264 ¹ K
		1 987 43	M 2012 I
		1 987 43	R 2300 ⁸ I

2,0|85|BER

03.02-05.08	0 451 10	P 3314	O
04.07-05.08		1 987 43	M 2012 I
		1 987 43	R 2300 ⁸ I

2,0|85|BEV

07.03-05.08	0 451 10	P 3314	O
-------------	----------	---------------	----------

2,0|85|BHP

04.07-05.08	1 987 43	M 2012	I
		1 987 43	R 2300 ⁸ I

2,0|85|CBPA

10.07-05.08	0 451 10	P 3314	O
		F 026 40	F 3008 ¹ K
		1 987 43	M 2012 I
		1 987 43	R 2300 ⁸ I

Golf IV 2.0 , BiFuel, 4 Motion

2,0|85|AZG; AZH; AZJ; BEH

04.00-06.06	0 451 10	P 3314	O
		KZO	1 457 43
		KZO	1 457 43
		0 450 90	F 5318 ¹ K
		1 987 43	R 2300 ⁸ I

Golf IV 2.0 , i

2,0|85|APK; AQY

08.98-06.06	0 451 10	P 3314	O
		KZO	1 457 43
		KZO	1 457 43
		0 450 90	F 5318 ¹ K
		1 987 43	R 2300 ⁸ I

Golf IV 2.3 , 4 Motion

2,3|110/125|AGZ; AQN

10.97-06.06	1 457 42	P 9192	O
		KZO	1 457 43
		KZO	1 457 43
		0 450 90	F 5318 ¹ K
		1 987 43	R 2300 ⁸ I

Golf IV 2.8 4 Motion

2,8|150|AQP; AUE; BDE

05.99-06.06	1 457 42	P 9192	O
		KZO	1 457 43
		KZO	1 457 43
		0 450 90	F 5318 ¹ K
		1 987 43	R 2300 ⁸ I

Golf IV 3.2 4 Motion R32

3,2|177|BFH; BML

06.02-05.04	1 457 42	P 9192	O
		KZO	1 457 43
		KZO	1 457 43
		0 450 90	F 5318 ¹ K
		1 987 43	R 2300 ⁸ I

Golf Plus**Golf Plus 1.2 TSI**

1,2|63|CBZA <DB1>

05.10→	1 987 42	S 9405	L
		0 450 90	F 5959 ¹ K
		1 987 43	M 2097 I
		1 987 43	R 2397 ⁸ I
	RLE	1 987 43	R 2597 ⁸ I

1,2|77|CBZB <DB0>

08.09-03.10	F 026 40	P 7079	O
08.09→		1 987 42	S 9405 L
		0 450 90	F 5959 ¹ K
		1 987 43	M 2097 I
		1 987 43	R 2397 ⁸ I
	RLE	1 987 43	R 2597 ⁸ I





Golf Plus 1.4

1,4 55 BCA			
	01.05-05.06	0 451 10 P 3318	O
		1 457 43 S 3059	L
		DTV 0 450 90 F 5316 ¹	K
		4BA,DRR F 026 40 F 3006 ¹	K
		6BA,DRR 0 450 90 F 5959 ¹	K
Fg.Nr. ->1K..6..550 000	01.05-04.05	0 450 90 F 5925 ¹	K
	01.05-05.06	1 987 43 M 2097	I
		1 987 43 R 2397 ⁸	I
	RLE	1 987 43 R 2597 ⁸	I

1,4 59 BUD			
	05.06-12.08	0 451 10 P 3318	O
		F 026 40 S 0035	L
		DTV 0 450 90 F 5316 ¹	K
		4BA,DRR F 026 40 F 3006 ¹	K
		6BA,DRR 0 450 90 F 5959 ¹	K
		1 987 43 M 2097	I
		1 987 43 R 2397 ⁸	I
	RLE	1 987 43 R 2597 ⁸	I

1,4 59 BUD <D4W>			
	05.09->	0 451 10 P 3318	O
		F 026 40 S 0035	L
		F 026 40 F 3006 ¹	K
		1 987 43 M 2097	I
		1 987 43 R 2397 ⁸	I
	RLE	1 987 43 R 2597 ⁸	I

1,4 59 CGGA <D4W>			
	01.09->	0 451 10 P 3318	O
		F 026 40 S 0035	L
		F 026 40 F 3006 ¹	K
		1 987 43 M 2097	I
		1 987 43 R 2397 ⁸	I
	RLE	1 987 43 R 2597 ⁸	I

Golf Plus 1.4 FSI

1,4 66 BLN			
	07.05-05.06	1 457 42 P 9301	O
		1 987 42 S 9403	L
		DTV 0 450 90 F 5316 ¹	K
		4BA,DRR F 026 40 F 3006 ¹	K
		6BA,DRR 0 450 90 F 5959 ¹	K
		1 987 43 M 2097	I
		1 987 43 R 2397 ⁸	I
	RLE	1 987 43 R 2597 ⁸	I

1,4 66 BLN <D4M>			
	05.09->	0 450 90 F 5959 ¹	K
		1 987 43 M 2097	I
		1 987 43 R 2397 ⁸	I
	RLE	1 987 43 R 2597 ⁸	I



Golf Plus 1.4 TSI

1,4 90 CAXA <D4X>			
	07.07-05.08	1 457 42 P 9301	O
	06.08-05.10	F 026 40 P 7079	O
	07.07->	1 987 42 S 9405	L
	07.07-12.08	DTV 0 450 90 F 5316 ¹	K
		4BA,DRR F 026 40 F 3006 ¹	K
		6BA,DRR 0 450 90 F 5959 ¹	K
	01.09->	0 450 90 F 5959 ¹	K
	07.07->	1 987 43 M 2097	I
		1 987 43 R 2397 ⁸	I
	RLE	1 987 43 R 2597 ⁸	I

1,4 103 BMY			
	05.06-06.08	1 457 42 P 9301	O
		KZO 1 987 42 S 9404	L
		DTV 0 450 90 F 5316 ¹	K
		4BA,DRR F 026 40 F 3006 ¹	K
		6BA,DRR 0 450 90 F 5959 ¹	K
		1 987 43 M 2097	I
		1 987 43 R 2397 ⁸	I
	RLE	1 987 43 R 2597 ⁸	I

1,4 118 CAVD <D4L>			
	05.08-05.10	F 026 40 P 7079	O
	05.08->	KZO 1 987 42 S 9404	L
	05.08-12.08	DTV 0 450 90 F 5316 ¹	K
		4BA,DRR F 026 40 F 3006 ¹	K
		6BA,DRR 0 450 90 F 5959 ¹	K
	01.09->	0 450 90 F 5959 ¹	K
	05.08->	1 987 43 M 2097	I
		1 987 43 R 2397 ⁸	I
	RLE	1 987 43 R 2597 ⁸	I

1,4 125 BLG			
	05.06-06.08	1 457 42 P 9301	O
		KZO 1 987 42 S 9404	L
		DTV 0 450 90 F 5316 ¹	K
		4BA,DRR F 026 40 F 3006 ¹	K
		6BA,DRR 0 450 90 F 5959 ¹	K
		1 987 43 M 2097	I
		1 987 43 R 2397 ⁸	I
	RLE	1 987 43 R 2597 ⁸	I

Golf Plus 1.6

1,6 75 BSE			
	05.05-12.08	0 451 10 P 3314	O
		KZO 1 987 42 S 9405	L
		KZO 1 457 43 S 3576	L
		DTV 0 450 90 F 5316 ¹	K
		4BA,DRR F 026 40 F 3006 ¹	K
		6BA,DRR 0 450 90 F 5959 ¹	K
		1 987 43 M 2097	I
		1 987 43 R 2397 ⁸	I
	RLE	1 987 43 R 2597 ⁸	I

1,6 75 BSE <MW6>			
	05.09->	0 451 10 P 3314	O
		1 987 42 S 9405	L
		F 026 40 F 3006 ¹	K
		1 987 43 M 2097	I
		1 987 43 R 2397 ⁸	I
	RLE	1 987 43 R 2597 ⁸	I





1,6|75|BSF

05.05-12.08	0 451 10	P 3314	O
	KZO	1 987 42	S 9405
	KZO	1 457 43	S 3576
	DFV	0 450 90	F 5316 ¹
	4BA,DRR	F 026 40	F 3006 ¹
	6BA,DRR	0 450 90	F 5959 ¹
		1 987 43	M 2097
		1 987 43	R 2397 ⁸
	RLE	1 987 43	R 2597 ⁸

1,6|75|BSF <MW6>

01.09→	0 451 10	P 3314	O
		1 987 42	S 9405
		F 026 40	F 3006 ¹
		1 987 43	M 2097
		1 987 43	R 2397 ⁸
	RLE	1 987 43	R 2597 ⁸

1,6|75|CCSA

11.07-12.08	0 451 10	P 3314	O
		1 987 42	S 9405
	DFV	0 450 90	F 5316 ¹
	4BA,DRR	F 026 40	F 3006 ¹
	6BA,DRR	0 450 90	F 5959 ¹
		1 987 43	M 2097
		1 987 43	R 2397 ⁸
	RLE	1 987 43	R 2597 ⁸

1,6|75|CCSA <MW6>

01.09→	0 451 10	P 3314	O
		1 987 42	S 9405
		F 026 40	F 3006 ¹
		1 987 43	M 2097
		1 987 43	R 2397 ⁸
	RLE	1 987 43	R 2597 ⁸

1,6|75|CMXA <MW6>

05.10→	0 451 10	P 3314	O
		1 987 42	S 9405
		F 026 40	F 3006 ¹
		1 987 43	M 2097
		1 987 43	R 2397 ⁸
	RLE	1 987 43	R 2597 ⁸

Golf Plus 1.6 BiFuel

1,6|72-75|CHGA <DF2>

05.09→	0 451 10	P 3314	O
		1 987 42	S 9405
05.09-04.11	F 026 40	F 3013 ¹	K
05.09→		1 987 43	M 2097
		1 987 43	R 2397 ⁸
	RLE	1 987 43	R 2597 ⁸

Golf Plus 1.6 FSI

1,6|85|BLF

01.05-05.08	1 457 42	P 9301	O
06.08-01.09	F 026 40	F 7079	O
01.05-01.09		1 457 43	S 3315
	DFV	0 450 90	F 5316 ¹
	4BA,DRR	F 026 40	F 3006 ¹
	6BA,DRR	0 450 90	F 5959 ¹
Fg.Nr. →1K..6..550 000	01.05-04.05	0 450 90	F 5925 ¹
	01.05-01.09		1 987 43 M 2097
			1 987 43 R 2397 ⁸
	RLE	1 987 43	R 2597 ⁸

Golf Plus 1.6 TDI

1,6|66/77|CAYB <D36>; CAYC <D38>

05.09→	F 026 40	P 7023	O
	KZO	1 987 42	S 9404
		F 026 40	N 2008
		1 987 43	M 2097
		1 987 43	R 2397 ⁸
	RLE	1 987 43	R 2597 ⁸

Golf Plus 1.9 TDI

1,9|66|BRU

05.05-02.06	1 457 42	P 9192	O
	KZO	1 987 42	S 9404
		1 457 07	N0007
		1 987 43	M 2097
		1 987 43	R 2397 ⁸
	RLE	1 987 43	R 2597 ⁸

1,9|66|BXF

02.06-01.09	1 457 42	P 9192	O
	KZO	1 987 42	S 9404
Fg.Nr. →1K..6..600 000	02.06-02.06	1 457 07	N0007
Fg.Nr. 1K..6..600 001→	03.06-01.09	F 026 40	N 2008
	02.06-01.09		1 987 43 M 2097
			1 987 43 R 2397 ⁸
	RLE	1 987 43	R 2597 ⁸

1,9|66|BXJ

11.07-01.09	1 457 42	P 9192	O
	KZO	1 987 42	S 9404
		F 026 40	N 2008
		1 987 43	M 2097
		1 987 43	R 2397 ⁸
	RLE	1 987 43	R 2597 ⁸

1,9|77|BKC;BLS

01.05-01.09	1 457 42	P 9192	O
	KZO	1 987 42	S 9404
Fg.Nr. →1K..6..600 000	01.05-02.06	1 457 07	N0007
Fg.Nr. 1K..6..600 001→	03.06-01.09	F 026 40	N 2008
	01.05-01.09		1 987 43 M 2097
			1 987 43 R 2397 ⁸
	RLE	1 987 43	R 2597 ⁸





◀ Golf Plus 1.9 TDI

1,9 | 77 | BXE

05.06-01.09	1 457 42 P 9192	O
KZO	1 987 42 S 9404	L
	F 026 40 N 2008	K
	1 987 43 M 2097	I
	1 987 43 R 2397 ⁸	I
RLE	1 987 43 R 2597 ⁸	I

Golf Plus 2.0 FSI

2,0 | 110 | BLR; BLV

05.05-11.05	1 457 42 P 9243	O
KZO	1 987 42 S 9405	L
KZO	1 457 43 S 3576	L
DTV	0 450 90 F 5316 ¹	K
4BA,DRR	F 026 40 F 3006 ¹	K
6BA,DRR	0 450 90 F 5959 ¹	K
	1 987 43 M 2097	I
	1 987 43 R 2397 ⁸	I
RLE	1 987 43 R 2597 ⁸	I

2,0 | 110 | BVY; BVZ

11.05-06.08	1 457 42 P 9243	O
KZO	1 987 42 S 9405	L
KZO	1 457 43 S 3576	L
DTV	0 450 90 F 5316 ¹	K
4BA,DRR	F 026 40 F 3006 ¹	K
6BA,DRR	0 450 90 F 5959 ¹	K
	1 987 43 M 2097	I
	1 987 43 R 2397 ⁸	I
RLE	1 987 43 R 2597 ⁸	I

Golf Plus 2.0 TDI

2,0 | 81/100/103 | CBDA <D94>; CBDB <D91>; CBDC <D96>

01.09-05.10	1 457 42 P 9192	O
KZO	1 987 42 S 9404	L
	F 026 40 N 2008	K
	1 987 43 M 2097	I
	1 987 43 R 2397 ⁸	I
RLE	1 987 43 R 2597 ⁸	I

2,0 | 81/100/103 | CFHB <D94>; CFHC <D91>; CLCA <D96>

11.09-→	F 026 40 P 7023	O
KZO	1 987 42 S 9404	L
	F 026 40 N 2008	K
	1 987 43 M 2097	I
	1 987 43 R 2397 ⁸	I
RLE	1 987 43 R 2597 ⁸	I

2,0 | 96/100/103 | AZV; BEE; BKD

01.05-05.09	1 457 42 P 9192	O	
KZO	1 987 42 S 9404	L	
Fg.Nr. →1K..6..600 000	01.05-02.06	1 457 07 N0007	K
Fg.Nr. 1K..6..600 001→	03.06-05.09	F 026 40 N 2008	K
	01.05-05.09	1 987 43 M 2097	I
		1 987 43 R 2397 ⁸	I
RLE		1 987 43 R 2597 ⁸	I



2,0 | 103 | BMM

12.05-01.09	1 457 42 P 9192	O	
KZO	1 987 42 S 9404	L	
Fg.Nr. →1K..6..600 000	12.05-02.06	1 457 07 N0007	K
Fg.Nr. 1K..6..600 001→	03.06-01.09	F 026 40 N 2008	K
	12.05-01.09	1 987 43 M 2097	I
		1 987 43 R 2397 ⁸	I
RLE		1 987 43 R 2597 ⁸	I

Golf V

Golf V 1.4

1,4 | 55 | BCA

10.03-05.06	0 451 10 P 3318	O
	1 457 43 S 3059	L
DTV	0 450 90 F 5316 ¹	K
DTV	0 450 90 F 5925 ¹	K
	1 987 43 M 2097	I
	1 987 43 R 2397 ⁸	I
RLE	1 987 43 R 2597 ⁸	I

1,4 | 59 | BUD

05.06-11.08	0 451 10 P 3318	O
	F 026 40 S 0035	L
	F 026 40 F 3006 ¹	K
08.07-11.08	0 450 90 F 5959 ¹	K
05.06-11.08	1 987 43 M 2097	I
	1 987 43 R 2397 ⁸	I
RLE	1 987 43 R 2597 ⁸	I

Golf V 1.4 FSI

1,4 | 66 | BKG

10.03-12.04	1 457 42 P 9301	O
	1 987 42 S 9403	L
	0 450 90 F 5959 ¹	K
	1 987 43 M 2097	I
	1 987 43 R 2397 ⁸	I
RLE	1 987 43 R 2597 ⁸	I

1,4 | 66 | BLN

11.04-05.06	1 457 42 P 9301	O
	1 987 42 S 9403	L
07.05-05.06	0 450 90 F 5959 ¹	K
11.04-05.06	1 987 43 M 2097	I
	1 987 43 R 2397 ⁸	I
RLE	1 987 43 R 2597 ⁸	I

Golf V 1.4 TSI

1,4 | 90 | CAXA; CAXA <D4X>

07.07-05.08	1 457 42 P 9301	O
06.08-11.08	F 026 40 P 7079	O
07.07-11.08	1 987 42 S 9405	L
	0 450 90 F 5959 ¹	K
	1 987 43 M 2097	I
	1 987 43 R 2397 ⁸	I
RLE	1 987 43 R 2597 ⁸	I





1,4 | 103 | BMY

05.06-11.08	1 457 42 P 9301	O
	KZO 1 987 42 S 9404	L
	0 450 90 F 5959 ¹	K
	1 987 43 M 2097	I
	1 987 43 R 2397 ⁸	I
RLE	1 987 43 R 2597 ⁸	I

1,4 | 118 | CAVD <D4L>

07.08-07.09	F 026 40 P 7079	O
	KZO 1 987 42 S 9404	L
	0 450 90 F 5959 ¹	K
	1 987 43 M 2097	I
	1 987 43 R 2397 ⁸	I
RLE	1 987 43 R 2597 ⁸	I

1,4 | 125 | BLG

11.05-11.08	1 457 42 P 9301	O
	KZO 1 987 42 S 9404	L
	0 450 90 F 5959 ¹	K
	1 987 43 M 2097	I
	1 987 43 R 2397 ⁸	I
RLE	1 987 43 R 2597 ⁸	I

Golf V 1.6

1,6 | 75 | BGU

01.04-07.07	0 451 10 P 3314	O
01.04-05.05	KZO 1 457 43 S 3576	L
01.04-07.07	KZO 1 987 42 S 9405	L
	F 026 40 F 3006 ¹	K
01.04-05.05	1 987 43 R 2397 ⁸	I
	RLE 1 987 43 R 2597 ⁸	I
01.04-07.07	1 987 43 M 2097	I

1,6 | 75 | BSE; BSF

06.05-11.08	0 451 10 P 3314	O
	KZO 1 987 42 S 9405	L
	KZO 1 457 43 S 3576	L
	F 026 40 F 3006 ¹	K
	1 987 43 M 2097	I
	1 987 43 R 2397 ⁸	I
RLE	1 987 43 R 2597 ⁸	I

1,6 | 75 | CCSA

11.07-11.08	0 451 10 P 3314	O
	1 987 42 S 9405	L
	F 026 40 F 3006 ¹	K
	1 987 43 M 2097	I
	1 987 43 R 2397 ⁸	I
RLE	1 987 43 R 2597 ⁸	I

Golf V 1.6 FSI

1,6 | 85 | BAG

10.03-07.04	1 457 42 P 9301	O
	1 457 43 S 3315	L
	0 450 90 F 5316 ¹	K
	1 987 43 M 2097	I
	1 987 43 R 2397 ⁸	I
RLE	1 987 43 R 2597 ⁸	I

1,6 | 85 | BLF

01.05-05.08	1 457 42 P 9301	O
06.08-07.08	F 026 40 P 7079	O
01.05-07.08	1 457 43 S 3315	L
01.05-06.05	0 450 90 F 5316 ¹	K
07.05-07.08	0 450 90 F 5959 ¹	K
01.05-07.08	1 987 43 M 2097	I
	1 987 43 R 2397 ⁸	I
RLE	1 987 43 R 2597 ⁸	I

1,6 | 85 | BLP

05.04-02.05	1 457 42 P 9301	O
	1 457 43 S 3315	L
	1 987 43 M 2097	I
	1 987 43 R 2397 ⁸	I
RLE	1 987 43 R 2597 ⁸	I

Golf V 1.9 TDI

1,9 | 66 | BRU

05.04-02.06	1 457 42 P 9192	O
	KZO 1 987 42 S 9404	L
	1 457 07 N 0007	K
	1 987 43 M 2097	I
	1 987 43 R 2397 ⁸	I
RLE	1 987 43 R 2597 ⁸	I

1,9 | 66 | BXF

02.06-11.08	1 457 42 P 9192	O	
	KZO 1 987 42 S 9404	L	
Fg.Nr. →1K..6..160 000	02.06-03.06	1 457 07 N 0007	K
Fg.Nr. 1K..6..160 001→	04.06-11.08	F 026 40 N 2008	K
	02.06-11.08	1 987 43 M 2097	I
		1 987 43 R 2397 ⁸	I
	RLE	1 987 43 R 2597 ⁸	I

1,9 | 66 | BXJ

05.07-11.08	1 457 42 P 9192	O
	KZO 1 987 42 S 9404	L
	F 026 40 N 2008	K
	1 987 43 M 2097	I
	1 987 43 R 2397 ⁸	I
RLE	1 987 43 R 2597 ⁸	I

1,9 | 77 | BXE

02.06-11.08	1 457 42 P 9192	O	
	KZO 1 987 42 S 9404	L	
	05.07-11.08	F 026 40 N 2008	K
Fg.Nr. →1K..6..160 000	02.06-03.06	1 457 07 N 0007	K
Fg.Nr. 1K..6..160 001→	04.06-11.08	F 026 40 N 2008	K
	02.06-11.08	1 987 43 M 2097	I
		1 987 43 R 2397 ⁸	I
	RLE	1 987 43 R 2597 ⁸	I

Golf V 1.9 TDI, TDI 4 Motion

1,9 | 77 | BKC

10.03-02.06	1 457 42 P 9192	O
	KZO 1 987 42 S 9404	L
	1 457 07 N 0007	K
	1 987 43 M 2097	I
	1 987 43 R 2397 ⁸	I
RLE	1 987 43 R 2597 ⁸	I





◀ Golf V 1.9 TDI, TDI 4 Motion

1,9 77 BLS				
	08.05-06.09	1 457 42	P 9192	O
		KZO	1 987 42	S 9404
	05.07-06.09	F 026 40	N 2008	K
Fg.Nr. →1K..6..160 000	08.05-03.06	1 457 07	N0007	K
Fg.Nr. 1K..6..160 001→	04.06-11.08	F 026 40	N 2008	K
	08.05-06.09	1 987 43	M 2097	I
			1 987 43	R 2397⁸
		RLE	1 987 43	R 2597⁸

Golf V 1.9 TDI 4 Motion

1,9 77 BXE				
	02.06-10.08	1 457 42	P 9192	O
		KZO	1 987 42	S 9404
Fg.Nr. →1K..6..160 000	02.06-03.06	1 457 07	N0007	K
Fg.Nr. 1K..6..160 001→	04.06-10.08	F 026 40	N 2008	K
	02.06-10.08	1 987 43	M 2097	I
			1 987 43	R 2397⁸
		RLE	1 987 43	R 2597⁸

Golf V 2.0 FSI

2,0 85 BHY				
	03.06-11.08	0 451 10	P 3314	O
			1 987 42	S 9405
			0 450 90	F 5959¹
			1 987 43	M 2097
				I

2,0 | 110 | AXW

	01.04-07.04	1 457 42	P 9243	O
		KZO	1 987 42	S 9405
		KZO	1 457 43	S 3576
			0 450 90	F 5316¹
			1 987 43	M 2097
				I
			1 987 43	R 2397⁸
		RLE	1 987 43	R 2597⁸

Golf V 2.0 FSI, FSI 4 Motion

2,0 110 BLR; BLX; BLY				
	05.04-11.05	1 457 42	P 9243	O
		KZO	1 987 42	S 9405
		KZO	1 457 43	S 3576
	05.04-06.05	0 450 90	F 5316¹	K
	07.05-11.05	0 450 90	F 5959¹	K
	05.04-11.05	1 987 43	M 2097	I
			1 987 43	R 2397⁸
		RLE	1 987 43	R 2597⁸

2,0 | 110 | BVX; BVY; BVZ

	11.05-11.08	1 457 42	P 9243	O
		KZO	1 987 42	S 9405
		KZO	1 457 43	S 3576
			0 450 90	F 5959¹
			1 987 43	M 2097
				I
			1 987 43	R 2397⁸
		RLE	1 987 43	R 2597⁸



Golf V 2.0 GTI

2,0 147 AXS <TFSI>				
	09.04-11.05	1 457 42	P 9243	O
			1 457 43	S 3102
	09.04-06.05	0 450 90	F 5316¹	K
	07.05-11.05	0 450 90	F 5959¹	K
	09.04-11.05	1 987 43	M 2097	I
			1 987 43	R 2397⁸
		RLE	1 987 43	R 2597⁸

2,0 | 147 | BPY <TFSI>

	11.05-08.08	1 457 42	P 9243	O
			1 457 43	S 3102
			0 450 90	F 5959¹
			1 987 43	M 2097
				I
			1 987 43	R 2397⁸
		RLE	1 987 43	R 2597⁸

2,0 | 147 | BWA <TFSI>

	11.05-03.09	1 457 42	P 9243	O
			1 457 43	S 3102
			0 450 90	F 5959¹
			1 987 43	M 2097
				I
			1 987 43	R 2397⁸
		RLE	1 987 43	R 2597⁸

2,0 | 147 | CAWB <D2L>

	03.08-06.09	F 026 40	P 7080	O
			1 987 42	S 9404
	04.08-06.09	0 450 90	F 5959¹	K
	03.08-06.09	1 987 43	M 2097	I
				I
			1 987 43	R 2397⁸
		RLE	1 987 43	R 2597⁸

2,0 | 147 | CBFA <D2L>; CCTA; CCTA <D2L>

	11.07-11.08	F 026 40	P 7080	O
			1 987 42	S 9404
			0 450 90	F 5959¹
			1 987 43	M 2097
				I
			1 987 43	R 2397⁸
		RLE	1 987 43	R 2597⁸

2,0 | 169 | BYD <TFSI>

	09.06-11.08	1 457 42	P 9243	O
			0 450 90	F 5959¹
			1 987 43	M 2097
				I
			1 987 43	R 2397⁸
		RLE	1 987 43	R 2597⁸

Golf V 2.0 SDI

2,0 55 BDK				
	01.04-11.08	1 457 42	P 9192	O
		KZO	1 987 42	S 9405
		KZO	1 457 43	S 3576
Fg.Nr. →1K..6..160 000	01.04-03.06	1 457 07	N0007	K
Fg.Nr. 1K..6..160 001→	04.06-11.08	F 026 40	N 2008	K
	01.04-11.08	1 987 43	M 2097	I
				I
			1 987 43	R 2397⁸
		RLE	1 987 43	R 2597⁸



Golf V 2.0 TDI

2,0 96 BVB				
	06.07-11.08	KZO	1 987 42 S 9404	L
			1 987 43 M 2097	I
			1 987 43 R 2397⁸	I
		RLE	1 987 43 R 2597⁸	I

2,0 100 AZV				
	10.03-11.08		1 457 42 P 9192	O
		KZO	1 987 42 S 9404	L
	05.07-05.08		F 026 40 N 2008	K
Fg.Nr. →1K..6..160 000	10.03-03.06		1 457 07 N0007	K
Fg.Nr. 1K..6..160 001→	04.06-11.08		F 026 40 N 2008	K
	10.03-11.08		1 987 43 M 2097	I
			1 987 43 R 2397⁸	I
		RLE	1 987 43 R 2597⁸	I

2,0 100/103 CBDA; CBDB				
	07.08-07.09		1 457 42 P 9192	O
		KZO	1 987 42 S 9404	L
			1 987 43 M 2097	I
			1 987 43 R 2397⁸	I
		RLE	1 987 43 R 2597⁸	I

2,0 103 BKD				
	10.03-11.08		1 457 42 P 9192	O
		KZO	1 987 42 S 9404	L
	05.07-05.08		F 026 40 N 2008	K
Fg.Nr. →1K..6..160 000	10.03-03.06		1 457 07 N0007	K
Fg.Nr. 1K..6..160 001→	04.06-11.08		F 026 40 N 2008	K
	10.03-11.08		1 987 43 M 2097	I
			1 987 43 R 2397⁸	I
		RLE	1 987 43 R 2597⁸	I

2,0 103 BMM				
	12.04-11.08		1 457 42 P 9192	O
		KZO	1 987 42 S 9404	L
	05.07-05.08		F 026 40 N 2008	K
Fg.Nr. →1K..6..160 000	12.04-03.06		1 457 07 N0007	K
Fg.Nr. 1K..6..160 001→	04.06-11.08		F 026 40 N 2008	K
	12.04-11.08		1 987 43 M 2097	I
			1 987 43 R 2397⁸	I
		RLE	1 987 43 R 2597⁸	I

2,0 125 BMN				
	11.05-11.08		1 457 42 P 9192	O
		KZO	1 987 42 S 9404	L
	11.05-03.06		1 457 07 N0007	K
Fg.Nr. →1K..6..160 000	11.05-03.06		1 457 07 N0007	K
Fg.Nr. 1K..6..160 001→	04.06-11.08		F 026 40 N 2008	K
	11.05-11.08		1 987 43 M 2097	I
			1 987 43 R 2397⁸	I
		RLE	1 987 43 R 2597⁸	I

Golf V 2.0 TDI 4 Motion

2,0 100 AZV				
	05.07-06.09		1 457 42 P 9192	O
		KZO	1 987 42 S 9404	L
			F 026 40 N 2008	K
			1 987 43 M 2097	I
			1 987 43 R 2397⁸	I
		RLE	1 987 43 R 2597⁸	I



2,0 103 BKD				
	10.03-10.08		1 457 42 P 9192	O
		KZO	1 987 42 S 9404	L
Fg.Nr. →1K..6..160 000	10.03-03.06		1 457 07 N0007	K
Fg.Nr. 1K..6..160 001→	04.06-10.08		F 026 40 N 2008	K
	10.03-10.08		1 987 43 M 2097	I
			1 987 43 R 2397⁸	I
		RLE	1 987 43 R 2597⁸	I

2,0 103 BMM				
	12.04-10.08		1 457 42 P 9192	O
		KZO	1 987 42 S 9404	L
Fg.Nr. →1K..6..160 000	12.04-03.06		1 457 07 N0007	K
Fg.Nr. 1K..6..160 001→	04.06-10.08		F 026 40 N 2008	K
	12.04-10.08		1 987 43 M 2097	I
			1 987 43 R 2397⁸	I
		RLE	1 987 43 R 2597⁸	I

Golf V 2.5

2,5 125 CBTA				
	05.07-11.08		1 457 42 P 9243	O
			0 450 90 F 5959¹	K
			1 987 43 M 2097	I
			1 987 43 R 2397⁸	I
		RLE	1 987 43 R 2597⁸	I

Golf V 3.2 R32, R32 4 Motion

3,2 184 BUB; CBRA				
	05.05-11.08		1 457 42 P 9192	O
			0 450 90 F 5925¹	K
			1 987 43 M 2097	I
			1 987 43 R 2397⁸	I
		RLE	1 987 43 R 2597⁸	I

Golf VI

Golf VI 1.2 TSI

1,2 63 CBZA <DB1>				
	07.10→		F 026 40 P 7079	O
	05.10→		1 987 42 S 9405	L
	07.10→		0 450 90 F 5959¹	K
PR-Nr. 1A1	05.10→		F 026 40 F 3006¹	K
PR-Nr. 0F2				
PR-Nr. 1A4	05.10→		F 026 40 F 3013¹	K
PR-Nr. 1A5	05.10→		0 450 90 F 5959¹	K
PR-Nr. 1A7				
	05.10→		1 987 43 M 2097	I
			1 987 43 R 2397⁸	I
		RLE	1 987 43 R 2597⁸	I

1,2 77 CBZB <DB0>				
	05.09→		F 026 40 P 7079	O
			1 987 42 S 9405	L
			0 450 90 F 5959¹	K
			1 987 43 M 2097	I
			1 987 43 R 2397⁸	I
		RLE	1 987 43 R 2597⁸	I





Golf VI 1.4

1,4 59 BUD <D4W>			
	07.09→	0 451 10 P 3318	O
		F 026 40 S 0035	L
PR-Nr. 1A1	07.09→	F 026 40 F 3006 ¹	K
PR-Nr. 1A4	07.09-07.10	F 026 40 F 3013 ¹	K
	07.09→	1 987 43 M 2097	I
		1 987 43 R 2397 ⁸	I
	RLE	1 987 43 R 2597 ⁸	I

1,4 59 CGGA			
	10.08→	0 451 10 P 3318	O
		F 026 40 S 0035	L
		F 026 40 F 3006 ¹	K
		1 987 43 M 2097	I
		1 987 43 R 2397 ⁸	I
	RLE	1 987 43 R 2597 ⁸	I

1,4 59 CGGA <D4W>			
	07.09→	0 451 10 P 3318	O
		F 026 40 S 0035	L
PR-Nr. 1A1	07.09→	F 026 40 F 3006 ¹	K
PR-Nr. 1A4	07.09-07.10	F 026 40 F 3013 ¹	K
	07.09→	1 987 43 M 2097	I
		1 987 43 R 2397 ⁸	I
	RLE	1 987 43 R 2597 ⁸	I

Golf VI 1.4 TSI

1,4 90 CAXA <D4X>			
	10.08→	F 026 40 P 7079	O
		1 987 42 S 9405	L
		0 450 90 F 5959 ¹	K
		1 987 43 M 2097	I
		1 987 43 R 2397 ⁸	I
	RLE	1 987 43 R 2597 ⁸	I

1,4 118 CAVD <D4L>			
	10.08-05.10	F 026 40 P 7079	O
	06.10→	1 457 42 P 9301	O
	10.08→	KZO 1 987 42 S 9404	L
		0 450 90 F 5959 ¹	K
		1 987 43 M 2097	I
		1 987 43 R 2397 ⁸	I
	RLE	1 987 43 R 2597 ⁸	I

Golf VI 1.6

1,6 75 BSE			
	10.08→	0 451 10 P 3314	O
		1 987 42 S 9405	L
		F 026 40 F 3006 ¹	K
		1 987 43 M 2097	I
		1 987 43 R 2397 ⁸	I
	RLE	1 987 43 R 2597 ⁸	I

1,6 75 BSE <MW6>			
	07.09→	0 451 10 P 3314	O
		KZO 1 987 42 S 9405	L
		KZO 1 457 43 S 3576	L
PR-Nr. 1A1	07.09→	F 026 40 F 3006 ¹	K
PR-Nr. 1A4	07.09-07.10	F 026 40 F 3013 ¹	K
	07.09→	1 987 43 M 2097	I
		1 987 43 R 2397 ⁸	I
	RLE	1 987 43 R 2597 ⁸	I



1,6 75 BSF			
	10.08→	0 451 10 P 3314	O
		1 987 42 S 9405	L
		F 026 40 F 3006 ¹	K
		1 987 43 M 2097	I
		1 987 43 R 2397 ⁸	I
	RLE	1 987 43 R 2597 ⁸	I

1,6 75 BSF <MW6>			
	07.09→	0 451 10 P 3314	O
		KZO 1 987 42 S 9405	L
		KZO 1 457 43 S 3576	L
PR-Nr. 1A1	07.09→	F 026 40 F 3006 ¹	K
PR-Nr. 1A4	07.09-07.10	F 026 40 F 3013 ¹	K
	07.09→	1 987 43 M 2097	I
		1 987 43 R 2397 ⁸	I
	RLE	1 987 43 R 2597 ⁸	I

1,6 75 CCSA			
	10.08→	0 451 10 P 3314	O
		1 987 42 S 9405	L
		F 026 40 F 3006 ¹	K
		1 987 43 M 2097	I
		1 987 43 R 2397 ⁸	I
	RLE	1 987 43 R 2597 ⁸	I

1,6 75 CCSA <MW6>			
	07.09→	0 451 10 P 3314	O
		KZO 1 987 42 S 9405	L
		KZO 1 457 43 S 3576	L
PR-Nr. 1A1	07.09→	F 026 40 F 3006 ¹	K
PR-Nr. 1A4	07.09-07.10	F 026 40 F 3013 ¹	K
	07.09→	1 987 43 M 2097	I
		1 987 43 R 2397 ⁸	I
	RLE	1 987 43 R 2597 ⁸	I

1,6 75 CMXA <MW6>			
	05.10→	0 451 10 P 3314	O
		1 987 42 S 9405	L
	07.10→	KZO 1 987 42 S 9405	L
		KZO 1 457 43 S 3576	L
PR-Nr. 1A1	07.10→	F 026 40 F 3006 ¹	K
PR-Nr. 1A1	05.10→	F 026 40 F 3006 ¹	K
PR-Nr. OF2			
PR-Nr. 1A4	05.10→	F 026 40 F 3013 ¹	K
PR-Nr. 1A5	05.10→	0 450 90 F 5959 ¹	K
PR-Nr. 1A7			
	05.10→	1 987 43 M 2097	I
		1 987 43 R 2397 ⁸	I
	RLE	1 987 43 R 2597 ⁸	I

Golf VI 1.6 BiFuel

1,6 72-75 CHGA <DF2>			
	11.08→	0 451 10 P 3314	O
		1 987 42 S 9405	L
		BGB F 026 40 F 3013 ¹	K
		1 987 43 M 2097	I
		1 987 43 R 2397 ⁸	I
	RLE	1 987 43 R 2597 ⁸	I





Golf VI 1.6 TDI

1,6 66 CAYB <D36>			
02.09→	F 026 40 P 7023	O	
	KZO 1987 42 S 9404	L	
	F 026 40 N 2008	K	
	1987 43 M 2097	I	
	1987 43 R 2397 ⁸	I	
	RLE 1987 43 R 2597 ⁸	I	

1,6 77 CAYC <D38>			
12.08→	F 026 40 P 7023	O	
	KZO 1987 42 S 9404	L	
	F 026 40 N 2008	K	
03.11→	F 026 40 N 2006	K	
12.08→	1987 43 M 2097	I	
	1987 43 R 2397 ⁸	I	
	RLE 1987 43 R 2597 ⁸	I	

Golf VI 1.6 TDI 4 Motion

1,6 77 CAYC <D38>			
12.08→	F 026 40 P 7023	O	
	KZO 1987 42 S 9404	L	
	F 026 40 N 2008	K	
	1987 43 M 2097	I	
	1987 43 R 2397 ⁸	I	
	RLE 1987 43 R 2597 ⁸	I	

Golf VI 1.8 TSI

1,8 118 CDA A			
06.09→	F 026 40 P 7080	O	
	1987 42 S 9404	L	
	0 450 90 F 5959 ¹	K	
	1987 43 M 2097	I	
	1987 43 R 2397 ⁸	I	
	RLE 1987 43 R 2597 ⁸	I	

Golf VI 2.0 GTI

2,0 155 CCZB			
04.09→	F 026 40 P 7080	O	
	1987 42 S 9404	L	
	0 450 90 F 5959 ¹	K	
	1987 43 M 2097	I	
	1987 43 R 2397 ⁸	I	
	RLE 1987 43 R 2597 ⁸	I	

Golf VI 2.0 TDI

2,0 81 CLCA <D96>			
01.10→	F 026 40 P 7023	O	
	KZO 1987 42 S 9404	L	
	F 026 40 N 2008	K	
	1987 43 M 2097	I	
	1987 43 R 2397 ⁸	I	
	RLE 1987 43 R 2597 ⁸	I	



2,0|103|BMM <D7N>

07.09→	1 457 42 P 9192	O	
	KZO 1987 42 S 9404	L	
	1987 43 M 2097	I	
	1987 43 R 2397 ⁸	I	
	RLE 1987 43 R 2597 ⁸	I	

2,0|103|CFHC <D91>

07.09→	F 026 40 P 7023	O	
	KZO 1987 42 S 9404	L	
	F 026 40 N 2008	K	
11.11→	F 026 40 N 2006	K	
07.09→	1987 43 M 2097	I	
	1987 43 R 2397 ⁸	I	
	RLE 1987 43 R 2597 ⁸	I	

2,0|103|CJAA

09.09→	1 457 42 P 9192	O	
	KZO 1987 42 S 9404	L	
	F 026 40 N 2008	K	
	1987 43 M 2097	I	
	1987 43 R 2397 ⁸	I	
	RLE 1987 43 R 2597 ⁸	I	

Golf VI 2.0 TDI, TDI 4 Motion

2,0|81/100/103/125|CBAA <D94>; CBAB <D91>; CBBB <D93>; CBDA <D91>; CBDB <D94>; CBDC

10.08→	1 457 42 P 9192	O	
	KZO 1987 42 S 9404	L	
	F 026 40 N 2008	K	
	1987 43 M 2097	I	
	1987 43 R 2397 ⁸	I	
	RLE 1987 43 R 2597 ⁸	I	

2,0|100/103/125|CFFA <D94>; CFFB <D91>; CFGB <D93>; CFHB <D94>

11.09→	F 026 40 P 7023	O	
	KZO 1987 42 S 9404	L	
	F 026 40 N 2008	K	
	1987 43 M 2097	I	
	1987 43 R 2397 ⁸	I	
	RLE 1987 43 R 2597 ⁸	I	

Golf VI 2.0 TSI

2,0|147|CCZA <D2L>

07.09-07.11	F 026 40 P 7080	O	
07.09→	1987 42 S 9404	L	
	0 450 90 F 5959 ¹	K	
	1987 43 M 2097	I	
	1987 43 R 2397 ⁸	I	
	RLE 1987 43 R 2597 ⁸	I	

Golf VI 2.0 TSI 4 Motion

2,0|188/195/199|CDLA; CDLC; CDLF

11.09→	1 457 42 P 9243	O	
	F 026 40 S 0178	L	
	0 450 90 F 5959 ¹	K	
	1987 43 M 2097	I	
	1987 43 R 2397 ⁸	I	
	RLE 1987 43 R 2597 ⁸	I	





Jetta

Jetta 1.0

1,0 37 HZ	08.86-10.91	0451 10 P 3033	O
	CSA	1457 42 S 9789	L
		0450 90 F 4149 ¹	K
		1987 43 M 2011	I

Jetta 1.2 TSI

1,2 77 CBZB <DB0>	10.10->	F 026 40 P 7079	O
		1987 42 S 9405	L
		0450 90 F 5959 ¹	K
		1987 43 M 2097	I

Jetta 1.3

1,3 40 NZ	02.87-07.92	0451 10 P 3033	O
		1457 42 S 9076	L
		0450 90 F 5264 ¹	K
		1987 43 M 2011	I

1,3 40 2G	01.89-07.92	0451 10 P 3033	O
		1457 42 S 9915	L
	CSA	0450 90 F 4149 ¹	K
		1987 43 M 2011	I

1,3 48 GY	01.82-12.93	0451 10 P 3033	O
		1457 42 S 9030	L

Jetta 1.4 TSI

1,4 90 CAXA <D4X>			
Fg.Nr. ->1K..8..195923	07.07-05.08	1457 42 P 9301	O
Fg.Nr. 1K..8..195924->	06.08-10.10	F 026 40 P 7079	O
	07.07-10.10	1987 42 S 9405	L
	07.11->	1987 42 S 9405	L
	07.07-10.10	0450 90 F 5959 ¹	K
	07.11->	4BA F 026 40 F 3006 ¹	K
		6BA 0450 90 F 5959 ¹	K
	07.07-10.10	1987 43 R 2397 ⁸	I
		RLE 1987 43 R 2597 ⁸	I
	07.11->	1987 43 M 2097	I
		1987 43 R 2397 ⁸	I
		RLE 1987 43 R 2597 ⁸	I

1,4 103/125 BLG; BMY	07.06-06.08	1457 42 P 9301	O
		KZO 1987 42 S 9404	L
		0450 90 F 5959 ¹	K
		1987 43 R 2397 ⁸	I
		RLE 1987 43 R 2597 ⁸	I

1,4 110 CAVA <D31>	04.11->	KZO 1987 42 S 9404	L
		4BA F 026 40 F 3006 ¹	K
		6BA 0450 90 F 5959 ¹	K
		1987 43 M 2097	I
		1987 43 R 2397 ⁸	I
		RLE 1987 43 R 2597 ⁸	I



1,4|118|CAVD <D4L>

	07.08-10.10	F 026 40 P 7079	O
		KZO 1987 42 S 9404	L
	04.11->	KZO 1987 42 S 9404	L
	07.08-10.10	0450 90 F 5959 ¹	K
	04.11->	4BA F 026 40 F 3006 ¹	K
		6BA 0450 90 F 5959 ¹	K
	07.08-10.10	1987 43 R 2397 ⁸	I
		RLE 1987 43 R 2597 ⁸	I
	04.11->	1987 43 M 2097	I
		1987 43 R 2397 ⁸	I
		RLE 1987 43 R 2597 ⁸	I

Jetta 1.6

1,6 51 PN	10.86-07.92	0451 10 P 3033	O
		1457 42 S 9030	L
		0450 90 F 5264 ¹	K
		1987 43 M 2011	I

1,6 51-55 EZ, EZA	01.84-07.91	0451 10 P 3033	O
		1457 42 S 9030	L
		CSA 0450 90 F 4149 ¹	K
		1987 43 M 2011	I

1,6 53 RF	03.86-10.91	0451 10 P 3033	O
		1457 42 S 9030	L
		CSA 0450 90 F 4149 ¹	K
		1987 43 M 2011	I

1,6 55 ABN	08.91-07.92	0451 10 P 3033	O
		1457 42 S 9030	L
		0450 90 F 5264 ¹	K
		1987 43 M 2011	I

1,6 60 HM	05.85-11.93	0451 10 P 3033	O
		1457 42 S 9030	L

1,6 75 BGU	03.06->	0451 10 P 3314	O
		KZO 1987 42 S 9405	L
		0450 90 F 5925 ¹	K
		0450 90 F 5959 ¹	K
		TW 0450 90 F 5925 ¹	K

1,6 75 BSE <MW6>; BSF <MW6>	10.05-10.10	0451 10 P 3314	O
		KZO 1987 42 S 9405	L
		KZO 1457 43 S 3576	L
	10.05-05.06	0450 90 F 5925 ¹	K
	06.06-10.10	F 026 40 F 3006 ¹	K
	10.05-10.10	1987 43 R 2397 ⁸	I
		RLE 1987 43 R 2597 ⁸	I

1,6 75 CCSA <MW6>	01.08-10.10	0451 10 P 3314	O
		KZO 1987 42 S 9405	L
		KZO 1457 43 S 3576	L
		F 026 40 F 3006 ¹	K
		1987 43 R 2397 ⁸	I
		RLE 1987 43 R 2597 ⁸	I





Jetta 1.6 , i

1,6 60/74 ACG; AFX	11.92-12.99	0 451 10 P 3033	O
--------------------	-------------	-----------------	---

Jetta 1.6 CEX, GEX

1,6 53 ANL	10.98-01.04	0 451 10 P 3314	O
		1 457 42 S 9777	L
	CSA	0 450 90 F 4149 ¹	K
		1 987 43 M 2011	I

Jetta 1.6 D, D Turbo

1,6 40/51 JP; JR; ME; MF	01.84-09.92	0 451 20 P 3012	O
		1 457 42 S 9994	L
	VOW	0 450 90 N 6172 ¹	K
	VOW	0 450 90 N 6267 ¹	K
		1 987 43 M 2011	I

Jetta 1.6 D Turbo

1,6 44/59 SB; 1V	08.89-07.92	0 451 20 P 3012	O
		1 457 42 S 9777	L
	VOW	0 450 90 N 6172 ¹	K
	VOW	0 450 90 N 6267 ¹	K
		1 987 43 M 2011	I

Jetta 1.6 FSI

1,6 85 BLF	09.05-06.08	1 457 42 P 9301	O
		1 457 43 S 3315	L
		0 450 90 F 5959 ¹	K
		1 987 43 R 2397 ⁸	I
	RLE	1 987 43 R 2597 ⁸	I

Jetta 1.6 i

1,6 74 AKL	09.99-12.05	0 451 10 P 3314	O
		1 457 43 S 3714	L
		1 987 43 R 2300	I

Jetta 1.6 i CI, GI, CIX, GIX

1,6 64 ATK	01.98-02.07	0 451 10 P 3314	O
		1 457 42 S 9777	L
		0 450 90 F 5264 ¹	K
		1 987 43 M 2011	I

Jetta 1.6 TDI

1,6 66 CAYB <D36>	12.09-10.10	F 026 40 P 7023	O
		KZO 1 987 42 S 9404	L
		1 987 43 R 2397 ⁸	I
	RLE	1 987 43 R 2597 ⁸	I



1,6|77|CAYC <D38>

07.09→	F 026 40 P 7023	O
	KZO 1 987 42 S 9404	L
10.10→	F 026 40 N 2008	K
07.09-10.10	1 987 43 R 2397 ⁸	I
	RLE 1 987 43 R 2597 ⁸	I
10.10→	1 987 43 M 2097	I

Jetta 1.8

1,8|66|ACC

Fg.Nr. →1H..R..999 000	10.92-06.94	0 451 10 P 3033	O
Fg.Nr. 1H..R..990 001→	07.94-07.98	0 451 10 P 3314	O
	10.92-07.98	1 457 43 S 3023	L
		0 450 90 F 5030 ¹	K
		0 450 90 F 5264 ¹	K

1,8|66|GU

	01.84-10.91	0 451 10 P 3033	O
		1 457 42 S 9030	L
	CSA	0 450 90 F 4149 ¹	K
		1 987 43 M 2011	I

1,8|66/77|RP; RV

	08.87-07.92	0 451 10 P 3033	O
		1 457 42 S 9777	L
		0 450 90 F 5264 ¹	K
		1 987 43 M 2011	I

1,8|70|HV

	05.85-11.92	0 451 10 P 3033	O
		1 457 42 S 9030	L

1,8|79/82|PB; PF

	02.87-09.92	0 451 10 P 3033	O
		1 457 42 S 9777	L
		0 450 90 F 5264 ¹	K
		1 987 43 M 2011	I

1,8|110/132|AWD; AWP; AWW

	05.99→	KTA F 026 40 F 3006 ¹	K
		1 987 43 R 2300 ⁸	I

Jetta 1.8 i

1,8|82|AFV

	11.96-12.99	0 451 10 P 3033	O
--	-------------	-----------------	---

1,8|82|DX

	05.83-12.95	0 451 10 P 3033	O
		1 457 42 S 9957	L
		0 450 90 F 5021 ¹	K

Jetta 1.8 syncro

1,8|66|GU

	08.87-10.91	0 451 10 P 3033	O
		1 457 42 S 9030	L
		CSA 0 450 90 F 4149 ¹	K
	09.89-10.91	1 987 43 M 2011	I





◀ Jetta 1.8 syncro

1,8 72 1P	08.88-07.92	0 451 10 P 3033	O
		1 457 42 S 9777	L
		0 450 90 F 5264 ¹	K
09.89-07.92	1 987 43 M 2011	I	

Jetta 1.8 T

1,8 110/132 AGU; AUQ	09.03-12.05	0 451 10 P 3314	O
		1 457 43 S 3081	L

Jetta 1.8 16V

1,8 95 PL	08.86-10.91	0 451 10 P 3033	O
		0 450 90 F 5145 ¹	K
		1 987 43 M 2011	I

1,8 102-103 KR	08.86-10.91	0 451 10 P 3033	O
		0 450 90 F 5145 ¹	K
		1 987 43 M 2011	I

Jetta 1.9 TD

1,9 55 AAZ	08.92-07.98	0 451 20 P 3012	O
		1 457 43 S 3023	L
		0 450 90 N 6281 ¹	K

Jetta 1.9 TDI

1,9 66 1Z	08.95→	0 451 20 P 3012	O
		1 457 43 S 3023	L
		0 450 90 N 6281 ¹	K

1,9 74 ATD	03.04-02.07	1 457 42 P 9619	O
------------	-------------	-----------------	---

1,9 74 BEW	07.03→	1 457 42 P 9619	O
		KZO 1 457 43 S 3714	L
		KZO 1 457 43 S 3081	L
		0 450 90 N 6374 ¹	K
		1 987 43 R 2300 ⁸	I

1,9 74 BRM	01.05→	1 457 42 P 9192	O
		KZO 1 987 42 S 9404	L
Fg.Nr. →1K..6..899 000	01.05-06.06	1 457 07 N0007	K
Fg.Nr. 1K..7..000 001→	07.06→	F 026 40 N 2008	K
	01.05→	1 987 43 R 2397 ⁸	I

1,9 77 BKC	09.05→	1 457 42 P 9192	O	
		KZO 1 987 42 S 9404	L	
		1 457 07 N0007	K	
		09.05-02.06	1 987 43 R 2397 ⁸	I
		RLE	1 987 43 R 2597 ⁸	I

1,9 77 BLS<D3W>	09.05-10.10	1 457 42 P 9192	O
		KZO 1 987 42 S 9404	L
Fg.Nr. →1K..6..814 062	09.05-03.06	1 457 07 N0007	K
Fg.Nr. 1K..6..814 063→	04.06-10.10	F 026 40 N 2008	K
	09.05-10.10	1 987 43 R 2397 ⁸	I
		RLE	1 987 43 R 2597 ⁸



1,9 77 BXE<D3W>	03.06-10.10	1 457 42 P 9192	O
		KZO 1 987 42 S 9404	L
		F 026 40 N 2008	K
		1 987 43 R 2397 ⁸	I
		RLE	1 987 43 R 2597 ⁸

1,9 81 AHF	09.99-12.05	1 457 42 P 9619	O
		1 457 43 S 3714	L
		1 987 43 R 2300	I

Jetta 2.0

2,0 85 ABA	Fg.Nr. →1H..R..999 000	10.92-06.94	0 451 10 P 3033	O
		Fg.Nr. 1H..R..990 001→	07.94-09.98	0 451 10 P 3314
		08.92-09.98	1 457 43 S 3023	L
			0 450 90 F 5264 ¹	K

2,0 85 AEG	12.98-10.00	0 451 10 P 3314	O	
		1 457 43 S 3714	L	
		KTA	F 026 40 F 3006 ¹	K
			1 987 43 R 2300 ⁸	I

2,0 85 AVH	06.00-06.04	1 457 43 S 3714	L	
		KTA	F 026 40 F 3006 ¹	K
			1 987 43 R 2300 ⁸	I

2,0 85 AZG	10.00-06.04	1 457 43 S 3714	L	
		KTA	F 026 40 F 3006 ¹	K
			1 987 43 R 2300 ⁸	I

2,0 85 BBW; BEV	07.02-08.05	1 457 43 S 3714	L	
		KTA	F 026 40 F 3006 ¹	K
			1 987 43 R 2300 ⁸	I

2,0 100 9A	08.89-07.92	0 451 10 P 3033	O
		0 450 90 F 5145 ¹	K
		09.89-07.92	1 987 43 M 2011

Jetta 2.0 FSI

2,0 110 BLR; BLY	08.05-11.05	1 457 42 P 9243	O
		KZO 1 987 42 S 9405	L
		KZO 1 457 43 S 3576	L
		0 450 90 F 5959 ¹	K
		1 987 43 R 2397 ⁸	I
	RLE	1 987 43 R 2597 ⁸	I

2,0 110 BVY; BVZ	12.05-06.08	1 457 42 P 9243	O
		KZO 1 987 42 S 9405	L
		KZO 1 457 43 S 3576	L
		0 450 90 F 5959 ¹	K
		1 987 43 R 2397 ⁸	I
	RLE	1 987 43 R 2597 ⁸	I

Jetta 2.0 i

2,0 85 AFW	11.96-12.99	0 451 10 P 3033	O
------------	-------------	-----------------	---



2,0 85 APK	09.99-12.05	0 451 10 P 3314	O
		1 457 43 S 3714	L
		1 987 43 R 2300	I

2,0 85 BHY	03.06→	0 451 10 P 3314	O
		0 450 90 F 5959 ¹	K
	TW	0 450 90 F 5925 ¹	K

2,0 85 2E	08.89-12.96	0 451 10 P 3033	O
	11.92-12.96 EFV	0 450 90 F 5264 ¹	K

Jetta 2.0 T FSI

2,0 147 AXX	03.06→	1 457 43 S 3102	L
		0 450 90 F 5959 ¹	K

2,0 147 BWA	03.06→	1 457 42 P 9243	O
		0 450 90 F 5959 ¹	K

Jetta 2.0 TDI

2,0 81 CLCA <D96>	01.10-10.10	F 026 40 P 7023	O
		KZ0 1 987 42 S 9404	L
		F 026 40 N 2008	K
		1 987 43 R 2397 ⁸	I
		RLE 1 987 43 R 2597 ⁸	I

2,0 100 AZV	09.05-06.08	1 457 42 P 9192	O
		KZ0 1 987 42 S 9404	L
Fg.Nr. →1K..6..814 062	09.05-03.06	1 457 07 N0007	K
Fg.Nr. 1K..6..814 063→	04.06-06.08	F 026 40 N 2008	K
	09.05-06.08	1 987 43 R 2397 ⁸	I
		RLE 1 987 43 R 2597 ⁸	I

2,0 100/103 CBDA <D94>; CBDB <D91>	07.08-10.10	1 457 42 P 9192	O
		KZ0 1 987 42 S 9404	L
		F 026 40 N 2008	K
		1 987 43 R 2397 ⁸	I
		RLE 1 987 43 R 2597 ⁸	I

2,0 103 BKD	08.05→	1 457 42 P 9192	O	
		KZ0 1 987 42 S 9404	L	
	03.06→	1 457 07 N0007	K	
	Fg.Nr. →1K..6..814 062	08.05-03.06	1 457 07 N0007	K
	Fg.Nr. 1K..6..814 063→	04.06-06.08	F 026 40 N 2008	K
	08.05-06.08	1 987 43 R 2397 ⁸	I	
		RLE 1 987 43 R 2597 ⁸	I	

2,0 103 BMM	10.05-06.08	1 457 42 P 9192	O	
		KZ0 1 987 42 S 9404	L	
	Fg.Nr. →1K..6..814 062	10.05-03.06	1 457 07 N0007	K
	Fg.Nr. 1K..6..814 063→	04.06-06.08	F 026 40 N 2008	K
		10.05-06.08	1 987 43 R 2397 ⁸	I
		RLE 1 987 43 R 2597 ⁸	I	

2,0 103 CBEA	04.08→	1 457 42 P 9192	O
		KZ0 1 987 42 S 9404	L
		1 987 43 R 2397 ⁸	I

2,0 103 CFFB <D91>	10.10→	F 026 40 P 7023	O
		KZ0 1 987 42 S 9404	L
		1 987 43 M 2097	I

2,0 103 CLCB <D91>	10.10→	F 026 40 P 7023	O
		KZ0 1 987 42 S 9404	L
		1 457 43 N 1715	K
		1 987 43 M 2097	I

2,0 125 BMN	07.06-06.08	1 457 42 P 9192	O
		KZ0 1 987 42 S 9404	L
		F 026 40 N 2008	K
		1 987 43 R 2397 ⁸	I
		RLE 1 987 43 R 2597 ⁸	I

2,0 125 CEGA <D93>	07.08-10.10	1 457 42 P 9192	O
		KZ0 1 987 42 S 9404	L
		F 026 40 N 2008	K
		1 987 43 R 2397 ⁸	I
		RLE 1 987 43 R 2597 ⁸	I

Jetta 2.0 TSI

2,0 147 BPY	06.05-03.08	1 457 42 P 9243	O
		1 457 43 S 3102	L
		0 450 90 F 5959 ¹	K
		1 987 43 R 2397 ⁸	I
		RLE 1 987 43 R 2597 ⁸	I

2,0 147 BWA <D2L>	09.05-10.10	1 457 42 P 9243	O
		1 457 43 S 3102	L
		0 450 90 F 5959 ¹	K
		1 987 43 R 2397 ⁸	I
		RLE 1 987 43 R 2597 ⁸	I

2,0 147 CAWB <D2L>	07.08-10.10	F 026 40 P 7080	O
		1 987 42 S 9404	L
		0 450 90 F 5959 ¹	K
		1 987 43 R 2397 ⁸	I
		RLE 1 987 43 R 2597 ⁸	I

2,0 147 CBFA <D2L>	02.11→	F 026 40 P 7080	O
		1 987 42 S 9404	L
		0 450 90 F 5959 ¹	K
		1 987 43 M 2097	I





◀ Jetta 2.0 TSI

2,0 | 147 | CCTA <D2L>

04.08-10.10	F 026 40 P 7080	O
02.11→	F 026 40 P 7080	O
04.08-10.10	1 987 42 S 9404	L
02.11→	1 987 42 S 9404	L
04.08-10.10	0 450 90 F 5959 ¹	K
02.11→	0 450 90 F 5959 ¹	K
04.08-10.10	1 987 43 R 2397 ⁸	I
	RLE 1 987 43 R 2597 ⁸	I
02.11→	1 987 43 M 2097	I

Jetta 2.3 i

2,3 | 110 | AGZ

09.99-08.01	1 457 42 P 9192	O
	1 457 43 S 3714	L

2,3 | 125 | AQN

07.01-12.05	1 457 42 P 9192	O
	KZO 1 457 43 S 3714	L
	KZO 1 457 43 S 3081	L
	0 450 90 N 6267 ¹	K
	1 987 43 R 2300 ⁸	I

Jetta 2.5

2,5 | 110 | BGP; BTK

01.05-06.08	1 457 42 P 9243	O
	0 450 90 F 5925 ¹	K
	1 987 43 R 2397 ⁸	I
	RLE 1 987 43 R 2597 ⁸	I

2,5 | 125 | CBTA; CCCA

07.07-10.10	1 457 42 P 9243	O
	F 026 40 F 3006 ¹	K
	1 987 43 R 2397 ⁸	I
	RLE 1 987 43 R 2597 ⁸	I

Jetta 2.8

2,8 | 128 | AAA

Mot.Nr. AAA 176 890→	12.95→	1 457 42 P 9142	O
Mot.Nr. →AAA 176 889	01.94-12.95	1 457 42 P 9103	O
	01.94→	1 457 43 S 3023	L
		0 450 90 F 5030 ¹	K
		0 450 90 F 5264 ¹	K

2,8 | 130 | AFP

10.98-12.04	1 457 42 P 9142	O
	KZO 1 457 43 S 3714	L
	KZO 1 457 43 S 3081	L
	KTA F 026 40 F 3006 ¹	K
	1 987 43 R 2300 ⁸	I

2,8 | 147 | BDF

10.01-06.04	1 457 42 P 9192	O
	KZO 1 457 43 S 3714	L
	KZO 1 457 43 S 3081	L
	KTA F 026 40 F 3006 ¹	K
	1 987 43 R 2300 ⁸	I

Käfer

Käfer 1600

1,6 34 AF	10.73-09.92	1 457 42 S 9076	L
---------------	-------------	------------------------	----------



Käfer 1600 i

1,6 | 34 | ACD

10.92-07.03	0 451 10 P 3033	O
	1 457 42 S 9076	L
	0 450 90 F 5030 ¹	K

Kombi

Kombi 2.5 i

2,5 | 82 | AET

07.93-05.05	0 451 20 P 3087	O
-------------	------------------------	----------

LT

LT 28 2.3

2,3 | 105 | AGL

05.96-11.01	1 457 42 P 9122	O
	1 457 43 S 3748	L
	0 450 90 F 5275 ¹	K
	1 987 43 M 2043	I

LT 28 2.4

2,4 | 66 | DL

12.82-07.92	0 451 20 P 3012	O
	1 457 42 S 9946	L
	CSA 0 450 90 F 4149 ¹	K

2,4 | 70 | 1E

10.88-04.96	0 451 20 P 3012	O
	1 457 42 S 9946	L
	CSA 0 450 90 F 4149 ¹	K

LT 28 2.4 D

2,4 | 55 | DW

12.82-07.92	0 451 20 P 3087	O	
	1 457 42 S 9946	L	
	VOW 0 450 90 N 6267 ¹	K	
Mot.Nr. DW 047 675→	02.86-07.92	VOW 0 450 90 N 6172 ¹	K

LT 28 2.4 D Turbo

2,4 | 75 | DV

12.82-08.92	0 451 20 P 3087	O	
	1 457 42 S 9946	L	
	VOW 0 450 90 N 6267 ¹	K	
Mot.Nr. DV 004 291→	01.86-08.92	VOW 0 450 90 N 6172 ¹	K

LT 28 2.4 D, 2.4 D Turbo

2,4 | 51/68 | 1G; 1S

08.88-08.92	0 451 20 P 3087	O
	1 457 42 S 9946	L
	CSA, 0 450 90 F 4149 ¹	K
	VOW	
	VOW 0 450 90 N 6267 ¹	K

2,4 | 51/70 | ACL; ACT

08.92-04.96	0 451 20 P 3087	O
	1 457 42 S 9946	L
	CSA, 0 450 90 F 4149 ¹	K
	VOW	
	VOW 0 450 90 N 6267 ¹	K



LT 28 2.5 SDI, 2.5 TDI

2,5 | 55/61/66/70/75/80 | AGX; AHD; ANJ; APA; AVR; BBE; BBF

05.96-04.06	1 457 42	P 3087	O
	1 457 43	S 3748	L
	0 450 90	N 6374	K
	1 987 43	M 2043	I

LT 28 2.8 D Turbo

2,8 | 92/96 | AGK; ATA

07.97-01.02	0 451 10	P 3368	O
	1 457 43	S 3748	L
	0 450 90	N 6374	K
	1 987 43	M 2043	I

LT 28 2.8 TDI

2,8 | 116 | AUH; BCQ

02.02-04.06	0 451 10	P 3368	O
	1 457 43	S 3748	L
	F 026 40	N 2005	K
	1 987 43	M 2043	I

LT 31 2.4

2,4 | 66 | DL

12.82-07.92	0 451 20	P 3012	O
	1 457 42	S 9946	L
	CSA	0 450 90	F 4149
			K

2,4 | 70 | 1E

10.88-04.96	0 451 20	P 3012	O
	1 457 42	S 9946	L
	CSA	0 450 90	F 4149
			K

LT 31 2.4 D

2,4 | 55 | DW

12.82-07.92	0 451 20	P 3087	O
	1 457 42	S 9946	L
	VOW	0 450 90	N 6267
			K
Mot.Nr. DW 047 675→	02.86-07.92	VOW	0 450 90 N 6172
			K

LT 31 2.4 D Turbo

2,4 | 75 | DV

12.82-08.92	0 451 20	P 3087	O
	1 457 42	S 9946	L
	VOW	0 450 90	N 6267
			K
Mot.Nr. DV 004 291→	01.86-08.92	VOW	0 450 90 N 6172
			K

LT 31 2.4 D, 2.4 D Turbo

2,4 | 51/68 | 1G; 1S

08.88-08.92	0 451 20	P 3087	O
	1 457 42	S 9946	L
	CSA,	0 450 90	F 4149
	VOW		K
	VOW	0 450 90	N 6267
			K

2,4 | 51/70 | ACL; ACT

08.92-04.96	0 451 20	P 3087	O
	1 457 42	S 9946	L
	CSA,	0 450 90	F 4149
	VOW		K
	VOW	0 450 90	N 6267
			K

LT 35 2.3

2,3 | 105 | AGL

05.96-11.01	1 457 42	P 9122	O
	1 457 43	S 3748	L
	0 450 90	F 5275	K
	1 987 43	M 2043	I

LT 35 2.4

2,4 | 66 | DL

12.82-07.92	0 451 20	P 3012	O
	1 457 42	S 9946	L
	CSA	0 450 90	F 4149
			K

2,4 | 70 | 1E

10.88-04.96	0 451 20	P 3012	O
	1 457 42	S 9946	L
	CSA	0 450 90	F 4149
			K

LT 35 2.4 D

2,4 | 55 | DW

12.82-07.92	0 451 20	P 3087	O
	1 457 42	S 9946	L
	VOW	0 450 90	N 6267
			K
Mot.Nr. DW 047 675→	02.86-07.92	VOW	0 450 90 N 6172
			K

LT 35 2.4 D Turbo

2,4 | 75 | DV

12.82-08.92	0 451 20	P 3087	O
	1 457 42	S 9946	L
	VOW	0 450 90	N 6267
			K
Mot.Nr. DV 004 291→	01.86-08.92	VOW	0 450 90 N 6172
			K

LT 35 2.4 D, 2.4 D Turbo

2,4 | 51/68 | 1G; 1S

08.88-08.92	0 451 20	P 3087	O
	1 457 42	S 9946	L
	CSA,	0 450 90	F 4149
	VOW		K
	VOW	0 450 90	N 6267
			K

2,4 | 51/70 | ACL; ACT

08.92-04.96	0 451 20	P 3087	O
	1 457 42	S 9946	L
	CSA,	0 450 90	F 4149
	VOW		K
	VOW	0 450 90	N 6267
			K





LT 35 2.5 SDI, 2.5 TDI

2,5 | 55/61/66/70/75/80 | AGX; AHD; ANJ; APA; AVR; BBE; BBF

05.96-04.06	1 457 42 P 3619	O
	1 457 43 S 3748	L
	0 450 90 N 6374 ¹	K
	1 987 43 M 2043	I

LT 35 2.8 D Turbo

2,8 | 92/96 | AGK; ATA

07.97-01.02	0 451 10 P 3368	O
	1 457 43 S 3748	L
	0 450 90 N 6374 ¹	K
	1 987 43 M 2043	I

LT 35 2.8 TDI

2,8 | 116 | AUH; BCO

02.02-04.06	0 451 10 P 3368	O
	1 457 43 S 3748	L
	F 026 40 N 2005	K
	1 987 43 M 2043	I

LT 40 2.4

2,4 | 70 | 1E

10.88-04.96	0 451 20 P 3012	O
	1 457 42 S 9946	L
CSA	0 450 90 F 4149 ¹	K

LT 40 2.4 D Turbo, 2.4 D Turbo 4x4

2,4 | 75 | DV

12.82-08.92	0 451 20 P 3087	O
	1 457 42 S 9946	L
	VOW 0 450 90 N 6267 ¹	K
Mot.Nr. DV 004 291→	01.86-08.92	VOW 0 450 90 N 6172 ¹ K

LT 40 2.4 D, 2.4 D Turbo

2,4 | 51/68 | 1G; 1S

08.88-08.92	0 451 20 P 3087	O
	1 457 42 S 9946	L
CSA,	0 450 90 F 4149 ¹	K
VOW		
VOW	0 450 90 N 6267 ¹	K

2,4 | 51/70 | ACL; ACT

08.92-04.96	0 451 20 P 3087	O
	1 457 42 S 9946	L
CSA,	0 450 90 F 4149 ¹	K
VOW		
VOW	0 450 90 N 6267 ¹	K

LT 40 2.4 D, 2.4 D 4x4

2,4 | 55 | DW

12.82-07.92	0 451 20 P 3087	O
	1 457 42 S 9946	L
	VOW 0 450 90 N 6267 ¹	K
Mot.Nr. DW 047 675→	02.86-07.92	VOW 0 450 90 N 6172 ¹ K

LT 40 2.4, 2.4 4x4

2,4 | 66 | DL

12.82-07.92	0 451 20 P 3012	O
	1 457 42 S 9946	L
CSA	0 450 90 F 4149 ¹	K



LT 45 2.4 D Turbo, 2.4 D Turbo 4x4

2,4 | 75 | DV

12.82-08.92	0 451 20 P 3087	O
	1 457 42 S 9946	L
	VOW 0 450 90 N 6267 ¹	K
Mot.Nr. DV 004 291→	01.86-08.92	VOW 0 450 90 N 6172 ¹ K

LT 45 2.4 D, 2.4 D Turbo

2,4 | 51/70 | ACL; ACT

08.92-04.96	0 451 20 P 3087	O
	1 457 42 S 9946	L
CSA, VOW	0 450 90 F 4149 ¹	K
VOW	0 450 90 N 6267 ¹	K

LT 45 2.4 D, 2.4 D 4x4

2,4 | 55 | DW

12.82-07.92	0 451 20 P 3087	O
	1 457 42 S 9946	L
	VOW 0 450 90 N 6267 ¹	K
Mot.Nr. DW 047 675→	02.86-07.92	VOW 0 450 90 N 6172 ¹ K

LT 45 2.4, 2.4 4x4

2,4 | 66 | DL

12.82-07.92	0 451 20 P 3012	O
	1 457 42 S 9946	L
CSA	0 450 90 F 4149 ¹	K

LT 46 2.3

2,3 | 105 | AGL

05.96-11.01	1 457 42 P 9122	O
	1 457 43 S 3748	L
	0 450 90 F 5275 ¹	K
	1 987 43 M 2043	I

LT 46 2.5 SDI, 2.5 TDI

2,5 | 55/61/66/70/75/80 | AGX; AHD; ANJ; APA; AVR; BBE; BBF

05.96-04.06	1 457 42 P 9619	O
	1 457 43 S 3748	L
	0 450 90 N 6374 ¹	K
	1 987 43 M 2043	I

LT 46 2.8 D Turbo

2,8 | 92/96 | AGK; ATA

07.97-01.02	0 451 10 P 3368	O
	1 457 43 S 3748	L
	0 450 90 N 6374 ¹	K
	1 987 43 M 2043	I

LT 46 2.8 TDI

2,8 | 116 | AUH

02.02-04.06	0 451 10 P 3368	O
	1 457 43 S 3748	L
	F 026 40 N 2005	K
	1 987 43 M 2043	I

LT 50 2.4

2,4 | 66 | DL

12.82-07.92	0 451 20 P 3012	O
	1 457 42 S 9946	L
CSA	0 450 90 F 4149 ¹	K





LT 50 2.4 D

2,4 55 DW	12.82-07.92	0 451 20 P 3087	O
		1 457 42 S 9946	L
		VOW 0 450 90 N 6267 ¹	K
Mot.Nr. DW 047 675→	02.86-07.92	VOW 0 450 90 N 6172 ¹	K

LT 50 2.4 D Turbo

2,4 75 DV	12.82-08.92	0 451 20 P 3087	O
		1 457 42 S 9946	L
		VOW 0 450 90 N 6267 ¹	K
Mot.Nr. DV 004 291→	01.86-08.92	VOW 0 450 90 N 6172 ¹	K

LT 50 2.4 D, 2.4 D Turbo

2,4 51/70 ACL; ACT	08.92-04.96	0 451 20 P 3087	O
		1 457 42 S 9946	L
		CSA, 0 450 90 F 4149 ¹	K
		VOW	
		VOW 0 450 90 N 6267 ¹	K

LT 55 2.4

2,4 66 DL	08.85-07.92	0 451 20 P 3012	O
		1 457 42 S 9946	L
		CSA 0 450 90 F 4149 ¹	K

LT 55 2.4 D

2,4 55 DW	08.85-07.92	0 451 20 P 3087	O
		1 457 42 S 9946	L
		VOW 0 450 90 N 6267 ¹	K
Mot.Nr. DW 047 675→	02.86-07.92	VOW 0 450 90 N 6172 ¹	K

LT 55 2.4 D Turbo

2,4 75 DV	08.85-08.92	0 451 20 P 3087	O
		1 457 42 S 9946	L
		VOW 0 450 90 N 6267 ¹	K
Mot.Nr. DV 004 291→	01.86-08.92	VOW 0 450 90 N 6172 ¹	K

LT 55 2.4 D, 2.4 D Turbo

2,4 51/70 ACL; ACT	08.92-04.96	0 451 20 P 3087	O
		1 457 42 S 9946	L
		CSA, 0 450 90 F 4149 ¹	K
		VOW	
		VOW 0 450 90 N 6267 ¹	K



Lupo

Lupo 1.0

1,0 37 AER	10.98-05.00	0 451 10 P 3318	O
		1 457 43 S 3540	L
		0 450 90 F 5316 ¹	K
		1 987 43 M 2012	I
		1 987 43 R 2300 ⁸	I

1,0 37 AHT	10.98-05.00	0 451 10 P 3337	O
		1 457 43 S 3540	L
		0 450 90 F 5316 ¹	K
		1 987 43 M 2012	I
		1 987 43 R 2300 ⁸	I

1,0 37 ALD	10.98-07.05	0 451 10 P 3318	O
		1 457 43 S 3539	L
		0 450 90 F 5316 ¹	K
		1 987 43 M 2012	I
		1 987 43 R 2300 ⁸	I

1,0 37 ALL	10.98-05.00	0 451 10 P 3318	O
		1 457 43 S 3540	L
		0 450 90 F 5316 ¹	K
		1 987 43 M 2012	I
		1 987 43 R 2300 ⁸	I

1,0 37 ANV; AUC	10.98-07.05	0 451 10 P 3318	O
		1 457 43 S 3539	L
		0 450 90 F 5316 ¹	K
		1 987 43 M 2012	I
		1 987 43 R 2300 ⁸	I

Lupo 1.2 TDI 3L

1,2 45 ANY; AYZ	10.98-07.05	1 457 42 P 9192	O
		1 457 43 S 3538	L
		0 450 90 N 6373 ¹	K
		1 987 43 M 2012	I
		1 987 43 R 2300 ⁸	I

Lupo 1.4

1,4 44 AUD	09.00-07.05	0 451 10 P 3318	O
		1 457 43 S 3539	L
		0 450 90 F 5316 ¹	K
		1 987 43 M 2012	I
		1 987 43 R 2300 ⁸	I

1,4 55 BBY	11.01-07.05	0 451 10 P 3318	O
		1 457 43 S 3716	L
		0 450 90 F 5316 ¹	K
		1 987 43 M 2012	I
		1 987 43 R 2300 ⁸	I





◀ Lupo 1.4

1,4 55/74 AFK; AHW; AKQ	10.98-05.04	0 451 10 P 3318	O
		1 457 43 S 3716	L
		0 450 90 F 5316 ¹	K
		1 987 43 M 2012	I
		1 987 43 R 2300 ⁸	I

1,4 55/74 APE; AQQ	05.99-09.00	0 451 10 P 3318	O
		1 457 43 S 3716	L
		0 450 90 F 5316 ¹	K
		1 987 43 M 2012	I
		1 987 43 R 2300 ⁸	I

1,4 55/74 AUA; AUB	05.00-07.05	0 451 10 P 3318	O
		1 457 43 S 3716	L
		0 450 90 F 5316 ¹	K
		1 987 43 M 2012	I
		1 987 43 R 2300 ⁸	I

Lupo 1.4 FSI

1,4 77 ARR	09.00-11.03	0 451 10 P 3318	O
		1 457 43 S 3538	L
		0 450 90 F 5316 ¹	K
		1 987 43 M 2012	I
		1 987 43 R 2300 ⁸	I

Lupo 1.4 TDI

1,4 55 AMF	06.98-07.05	1 457 42 P 9192	O
		1 457 43 S 3538	L
		0 450 90 N 6373 ¹	K
		1 987 43 M 2012	I
		1 987 43 R 2300 ⁸	I

Lupo 1.6 GTI

1,6 92 AVY	05.00-07.05	0 451 10 P 3318	O
		1 457 43 S 3716	L
		0 450 90 F 5316 ¹	K
		1 987 43 M 2012	I
		1 987 43 R 2300 ⁸	I

Lupo 1.7 SDI

1,7 42 AKU	10.98-07.05	0 451 10 P 3289	O
Fg.Nr. →6E..Y..007 000→6X..Y..060 000	10.98-03.00	1 457 43 S 3712	L
Fg.Nr. 6E..Y..007 001→6X..Y..060 001→	04.00-07.05	1 457 43 S 3538	L
Fg.Nr. →6X..Y..060 000	10.98-03.00	0 450 90 N 6274 ¹	K
Fg.Nr. 6X..Y..060 001→	04.00-07.05	0 450 90 N 6373 ¹	K
	10.98-07.05	1 987 43 M 2012	I
		1 987 43 R 2300 ⁸	I



New Beetle

New Beetle 1.4

1,4 55 BCA <MN7>	11.01-09.10	0 451 10 P 3318	O
		1 457 43 S 3716	L
	DRR	F 026 40 F 3006 ¹	K
	01.03-09.10	DTV ,KTA, 0 450 90 F 5925 ¹	K
		ORK	
		DTV,KTA, F 026 40 F 3006 ¹	K
		ORK	
		KTA, MRK 0 450 90 F 5318 ¹	K
PR-Nr. OF2	11.01-09.10	0 450 90 F 5318 ¹	K
PR-Nr. 2LC			
PR-Nr. 1A3	11.01-09.10	0 450 90 F 5925 ¹	K
PR-Nr. 2LF			
	11.01-09.10	1 987 43 R 2300 ⁸	I

New Beetle 1.6

1,6 74 AWH	10.99-10.00	0 451 10 P 3314	O
		1 457 43 S 3714	L
		0 450 90 F 5318 ¹	K
		1 987 43 R 2300 ⁸	I

1,6 | 75 | AYD

	06.00-06.05	0 451 10 P 3314	O
		1 457 43 S 3714	L
	DRR	F 026 40 F 3006 ¹	K
PR-Nr. OF2	06.00-06.05	0 450 90 F 5318 ¹	K
PR-Nr. 2LC			
PR-Nr. 1A3	06.00-06.05	0 450 90 F 5925 ¹	K
PR-Nr. 2LF			
	06.00-06.05	1 987 43 R 2300 ⁸	I

1,6 | 75 | BFS <MW6>

	06.02-12.10	0 451 10 P 3314	O
		1 457 43 S 3714	L
	DRR	F 026 40 F 3006 ¹	K
	01.03-09.10	DTV ,KTA, 0 450 90 F 5925 ¹	K
		ORK	
		DTV,KTA, F 026 40 F 3006 ¹	K
		ORK	
		KTA, MRK 0 450 90 F 5318 ¹	K
PR-Nr. OF2	06.02-12.10	0 450 90 F 5318 ¹	K
PR-Nr. 2LC			
PR-Nr. 1A3	06.02-12.10	0 450 90 F 5925 ¹	K
PR-Nr. 2LF			
	06.02-12.10	1 987 43 R 2300 ⁸	I

New Beetle 1.8 T

1,8 110 AGU; APH; AVC	01.98-05.01	0 451 10 P 3314	O
		1 457 43 S 3714	L
		0 450 90 F 5318 ¹	K
		1 987 43 R 2300 ⁸	I





1,8 | 110 | AWU <MG8>; AWV; BKF

	06.00→	0 451 10 P 3314	O
		1 457 43 S 3714	L
		DRR F 026 40 F 3006 ¹	K
PR-Nr. 0F2	01.03-09.10	DTV ,KTA, 0 450 90 F 5925 ¹	K
PR-Nr. 2LC		ORK	
PR-Nr. 1A3		DTV,KTA, F 026 40 F 3006 ¹	K
PR-Nr. 2LF		ORK	
		KTA,MRK 0 450 90 F 5318 ¹	K
PR-Nr. 0F2	06.00→	0 450 90 F 5318 ¹	K
PR-Nr. 2LC			
PR-Nr. 1A3	06.00→	0 450 90 F 5925 ¹	K
PR-Nr. 2LF			
	06.00→	1 987 43 R 2300 ⁸	I

1,8 | 132 | AWP

	06.01-07.05	0 451 10 P 3314	O
		1 457 43 S 3714	L
		DRR F 026 40 F 3006 ¹	K
PR-Nr. 0F2	06.01-07.05	0 450 90 F 5318 ¹	K
PR-Nr. 2LC			
PR-Nr. 1A3	06.01-07.05	0 450 90 F 5925 ¹	K
PR-Nr. 2LF			
	06.01-07.05	1 987 43 R 2300 ⁸	I

1,8 | 132 | BNU

	07.04-06.05	0 451 10 P 3314	O
		1 457 43 S 3714	L
		DRR F 026 40 F 3006 ¹	K
PR-Nr. 0F2	07.04-06.05	0 450 90 F 5318 ¹	K
PR-Nr. 2LC			
PR-Nr. 1A3	07.04-06.05	0 450 90 F 5925 ¹	K
PR-Nr. 2LF			
	07.04-06.05	1 987 43 R 2300 ⁸	I

New Beetle 1.9 TDI

1,9 | 66/74 | ALH; ATD; AXR; BEW

	01.98→	1 457 42 P 9619	O
		1 457 43 S 3714	L
	01.98-12.06	0 450 90 N 6374 ¹	K
	01.98→	1 987 43 R 2300 ⁸	I

1,9 | 77 | BSW <D3W>

	07.05→	1 457 42 P 9619	O
		1 457 43 S 3714	L
	07.05-09.10	VOW 0 450 90 N 6295 ¹	K
		VOW 0 450 90 N 6374 ¹	K
	07.05→	0 450 90 N 6374 ¹	K
		1 987 43 R 2300 ⁸	I

New Beetle 2.0

2,0 | 85 | AEG

	01.98-10.01	0 451 10 P 3314	O
		1 457 43 S 3714	L
		0 450 90 F 5318 ¹	K
		1 987 43 R 2300 ⁸	I

2,0 | 85 | APK; AQY; AVH; AZG

	11.98-06.05	0 451 10 P 3314	O
		1 457 43 S 3714	L
		DRR F 026 40 F 3006 ¹	K
PR-Nr. 0F2	11.98-06.05	0 450 90 F 5318 ¹	K
PR-Nr. 2LC			
PR-Nr. 1A3	11.98-06.05	0 450 90 F 5925 ¹	K
PR-Nr. 2LF			
	11.98-06.05	1 987 43 R 2300 ⁸	I

2,0 | 85 | AZJ <MR4>

	06.01-09.10	0 451 10 P 3314	O
		1 457 43 S 3714	L
		DRR F 026 40 F 3006 ¹	K
	01.03-09.10	DTV ,KTA, 0 450 90 F 5925 ¹	K
		ORK	
		DTV,KTA, F 026 40 F 3006 ¹	K
		ORK	
		KTA,MRK 0 450 90 F 5318 ¹	K
PR-Nr. 0F2	06.01-09.10	0 450 90 F 5318 ¹	K
PR-Nr. 2LC			
PR-Nr. 1A3	06.01-09.10	0 450 90 F 5925 ¹	K
PR-Nr. 2LF			
	06.01-09.10	1 987 43 R 2300 ⁸	I

2,0 | 85 | BBW

	06.02-06.04	0 451 10 P 3314	O
		1 457 43 S 3714	L
		DRR F 026 40 F 3006 ¹	K
PR-Nr. 0F2	06.02-06.04	0 450 90 F 5318 ¹	K
PR-Nr. 2LC			
PR-Nr. 1A3	06.02-06.04	0 450 90 F 5925 ¹	K
PR-Nr. 2LF			
	06.02-06.04	1 987 43 R 2300 ⁸	I

2,0 | 85 | BDC

	01.03-07.05	0 451 10 P 3314	O
		1 457 43 S 3714	L
		DTV ,KTA, 0 450 90 F 5925 ¹	K
		ORK	
		DTV,KTA, F 026 40 F 3006 ¹	K
		ORK	
		KTA,MRK 0 450 90 F 5318 ¹	K
		1 987 43 R 2300 ⁸	I

2,0 | 85 | BEJ; BER

	11.01-06.07	0 451 10 P 3314	O
		1 457 43 S 3714	L
		DRR F 026 40 F 3006 ¹	K
PR-Nr. 0F2	11.01-06.07	0 450 90 F 5318 ¹	K
PR-Nr. 2LC			
PR-Nr. 1A3	11.01-06.07	0 450 90 F 5925 ¹	K
PR-Nr. 2LF			
	11.01-06.07	1 987 43 R 2300 ⁸	I





◀ New Beetle 2.0

2,0 85 BEV <ML5>			
	07.04-10.10	0 451 10 P 3314	O
		1 457 43 S 3714	L
	07.04-09.10	DRR F 026 40 F 3006 ¹	K
	07.04-10.10	DTV ,KTA, 0 450 90 F 5925 ¹	K
		ORK	
		DTV,KTA, F 026 40 F 3006 ¹	K
		ORK	
		KTA, MRK 0 450 90 F 5318 ¹	K
PR-Nr. OF2	07.04-09.10	0 450 90 F 5318 ¹	K
PR-Nr. 2LC			
PR-Nr. 1A3	07.04-09.10	0 450 90 F 5925 ¹	K
PR-Nr. 2LF			
	07.04-10.10	1 987 43 R 2300 ⁸	I

2,0 85 BGD			
	01.03-06.06	0 451 10 P 3314	O
		1 457 43 S 3714	L
		DTV ,KTA, 0 450 90 F 5925 ¹	K
		ORK	
		DTV,KTA, F 026 40 F 3006 ¹	K
		ORK	
		KTA, MRK 0 450 90 F 5318 ¹	K
		1 987 43 R 2300 ⁸	I

2,0 85 BHP; CBPA <ML5>			
	07.03-09.10	0 451 10 P 3314	O
		1 457 43 S 3714	L
		DRR F 026 40 F 3006 ¹	K
PR-Nr. OF2	07.03-09.10	0 450 90 F 5318 ¹	K
PR-Nr. 2LC			
PR-Nr. 1A3	07.03-09.10	0 450 90 F 5925 ¹	K
PR-Nr. 2LF			
	07.03-09.10	1 987 43 R 2300 ⁸	I

New Beetle 2.3			
2,3 125 AQN			
	10.00-06.05	1 457 42 P 9192	O
		KZO 1 457 43 S 3714	L
		KZO 1 457 43 S 3081	L
		DRR F 026 40 F 3006 ¹	K
PR-Nr. OF2	10.00-06.05	0 450 90 F 5318 ¹	K
PR-Nr. 2LC			
PR-Nr. 1A3	10.00-06.05	0 450 90 F 5925 ¹	K
PR-Nr. 2LF			
	10.00-06.05	1 987 43 R 2300 ⁸	I

New Beetle 2.5			
2,5 110 BPR <D4F>; BPS <D4F>			
	07.05-09.10	1 457 42 P 9243	O
		1 457 43 S 3081	L
		DTV ,KTA, 0 450 90 F 5925 ¹	K
		ORK	
		DRR F 026 40 F 3006 ¹	K
		DTV,KTA, F 026 40 F 3006 ¹	K
		ORK	
		KTA, MRK 0 450 90 F 5318 ¹	K
PR-Nr. OF2	07.05-09.10	0 450 90 F 5318 ¹	K
PR-Nr. 2LC			
PR-Nr. 1A3	07.05-09.10	0 450 90 F 5925 ¹	K
PR-Nr. 2LF			
	07.05-09.10	1 987 43 R 2300 ⁸	I



New Beetle 3.2 RSI 4x4			
3,2 165 AXJ			
	10.00-05.01	1 457 42 P 9192	O
		1 457 43 S 3714	L
		0 450 90 F 5318 ¹	K
		1 987 43 R 2300 ⁸	I

Passat			
Passat 1.4 TSI			
1,4 90 CAXA <D4X>			
	05.07-04.08	1 457 42 P 9301	O
	05.08-05.10	F 026 40 P 7079	O
	05.07→	1 987 42 S 9405	L
		1 987 43 M 2097	I
		1 987 43 R 2397 ⁸	I
		RLE 1 987 43 R 2597 ⁸	I
1,4 118 CKMA <D4L>			
	11.10→	KZO 1 987 42 S 9404	L
		1 987 43 M 2097	I
		1 987 43 R 2397 ⁸	I
		RLE 1 987 43 R 2597 ⁸	I

Passat 1.4 TSI EcoFuel			
1,4 110 CDGA <D42>			
	11.08-05.10	F 026 40 P 7079	O
	11.08→	KZO 1 987 42 S 9404	L
		0 450 90 F 5959 ¹	K
		1 987 43 M 2097	I
		1 987 43 R 2397 ⁸	I
		RLE 1 987 43 R 2597 ⁸	I

Passat 1.6			
1,6 55 ABN			
	09.91-07.92	0 451 10 P 3033	O
		1 457 42 S 9777	L
		CSA 0 450 90 F 4149 ¹	K
		1 987 43 M 2013	I
		1 987 43 R 2313 ⁸	I
1,6 55 EZ			
	04.88-09.91	0 451 10 P 3033	O
		1 457 42 S 9777	L
		CSA 0 450 90 F 4149 ¹	K
		1 987 43 M 2013	I
		1 987 43 R 2313 ⁸	I

1,6 74 ADP			
	10.96-11.00	0 451 10 P 3314	O
		1 457 42 S 9870	L
		0 450 90 F 5264 ¹	K
		1 987 43 M 2017	I
		1 987 43 R 2317 ⁸	I

1,6 74 AEK; AFT			
	10.94-03.97	0 451 10 P 3314	O
		1 457 42 S 9777	L
		0 450 90 F 5264 ¹	K
		1 987 43 M 2013	I
		1 987 43 R 2313 ⁸	I





1,6 74 AHL	10.96-11.00	0 451 10 P 3314	O
		1 457 42 S 9870	L
		0 450 90 F 5264 ¹	K
		1 987 43 M 2017	I
		1 987 43 R 2317 ⁸	I

1,6 74 ANA; ARM	01.99-11.00	0 451 10 P 3314	O
		1 457 42 S 9870	L
		0 450 90 F 5264 ¹	K
		1 987 43 M 2017	I
		1 987 43 R 2317 ⁸	I

1,6 75 ALZ	10.00-05.05	0 451 10 P 3314	O
		1 457 42 S 9870	L
		0 450 90 F 5264 ¹	K
		1 987 43 M 2012	I
		1 987 43 R 2312 ⁸	I

1,6 75 BSE <MW6>; BSF <MW6>	03.05-11.10	0 451 10 P 3314	O
		KZO 1 987 42 S 9405	L
		KZO 1 457 43 S 3576	L
		1 987 43 M 2097	I
		1 987 43 R 2397 ⁸	I
		RLE 1 987 43 R 2597 ⁸	I

Passat 1.6 FSI

1,6 85 BLF	03.05-06.08	1 457 42 P 9301	O
		1 457 43 S 3315	L
		1 987 43 M 2097	I
		1 987 43 R 2397 ⁸	I
		RLE 1 987 43 R 2597 ⁸	I

Passat 1.6 TD

1,6 59 SB	08.89-09.93	0 451 20 P 3012	O
		1 457 42 S 9777	L
		VOW 0 450 90 N 6172 ¹	K
		VOW 0 450 90 N 6267 ¹	K
		1 987 43 M 2013	I
		1 987 43 R 2313 ⁸	I

Passat 1.6 TDI

1,6 77 CAYC <D38>	08.09→	F 026 40 P 7023	O
		KZO 1 987 42 S 9404	L
	08.09-11.10	F 026 40 N 2006	K
	08.09→	1 987 43 M 2097	I
		1 987 43 R 2397 ⁸	I
		RLE 1 987 43 R 2597 ⁸	I



Passat 1.8

1,8 55/66 AAM; ABS			
Fg.Nr. →3A..R..250 000	08.90-07.94	0 451 10 P 3033	O
Fg.Nr. 3A..R..250 001→	07.94-03.97	0 451 10 P 3314	O
	08.90-03.97	1 457 42 S 9777	L
		0 450 90 F 5264 ¹	K
		1 987 43 M 2013	I
		1 987 43 R 2313 ⁸	I

1,8 66 ADZ	10.94-03.97	0 451 10 P 3314	O
		1 457 42 S 9777	L
		0 450 90 F 5264 ¹	K
		1 987 43 M 2013	I
		1 987 43 R 2313 ⁸	I

1,8 66 RP	04.88-07.91	0 451 10 P 3033	O
		1 457 42 S 9777	L
		0 450 90 F 5264 ¹	K
		1 987 43 M 2013	I
		1 987 43 R 2313 ⁸	I

1,8 85 AFY	01.97-11.00	0 451 10 P 3314	O
		1 457 42 S 9870	L
		0 450 90 F 5264 ¹	K
		1 987 43 M 2017	I
		1 987 43 R 2317 ⁸	I

1,8 92 ADR	12.96-11.00	0 451 10 P 3314	O
		1 457 42 S 9870	L
		0 450 90 F 5264 ¹	K
		1 987 43 M 2017	I
		1 987 43 R 2317 ⁸	I

1,8 92 APT	01.99-11.00	0 451 10 P 3314	O
		1 457 42 S 9870	L
		0 450 90 F 5264 ¹	K
		1 987 43 M 2017	I
		1 987 43 R 2317 ⁸	I

1,8 92 ARG	02.99-11.00	0 451 10 P 3314	O
		1 457 42 S 9870	L
		0 450 90 F 5264 ¹	K
		1 987 43 M 2017	I
		1 987 43 R 2317 ⁸	I

1,8 100 KR	04.88-07.92	0 451 10 P 3033	O
		1 457 42 S 9777	L
		0 450 90 F 5143 ¹	K
		1 987 43 M 2013	I
		1 987 43 R 2313 ⁸	I





◀ Passat 1.8

1,8 110/125 AWM; AWT	10.00-05.05	F 026 40 P 7004 O
		1 457 42 S 9870 L
		0 450 90 F 5264 ¹ K
		1 987 43 M 2012 I
		1 987 43 R 2312 ⁸ I

Passat 1.8 FSI, TFSI, TSI

1,8 112/118 BZB <D67>; CDAA <D67>; CDAB <M92>; CGYA <M92>	05.07→	F 026 40 P 7080 O
		1 987 42 S 9404 L
		1 987 43 M 2097 I
		1 987 43 R 2397 ⁸ I
	RLE	1 987 43 R 2597 ⁸ I

Passat 1.8 G60

1,8 118 PG	09.91-08.94	0 451 10 P 3280 O
		1 457 42 S 9777 L
		0 450 90 F 5264 ¹ K
		1 987 43 M 2013 I
		1 987 43 R 2313 ⁸ I

Passat 1.8 G60 syncro

1,8 118 PG	09.89-07.93	0 451 10 P 3033 O
		0 451 10 P 3280 O
		1 457 42 S 9777 L
		0 450 90 F 5264 ¹ K
		1 987 43 M 2013 I
		1 987 43 R 2313 ⁸ I

Passat 1.8 i

1,8 92 ANQ	01.98-04.04	0 451 10 P 3314 O
		1 457 42 S 9870 L
		0 450 90 F 5264 ¹ K
		1 987 43 M 2017 I

Passat 1.8 i Turbo

1,8 110 AWL	01.98-05.05	0 451 10 P 3314 O
		1 457 42 S 9870 L
		0 450 90 F 5264 ¹ K
		1 987 43 M 2017 I

Passat 1.8 syncro

1,8 92 ADR	06.97-11.00	0 451 10 P 3314 O
		1 457 42 S 9870 L
	05.98-11.00	0 450 90 F 5906 ¹ K
	06.97-11.00	1 987 43 M 2017 I
		1 987 43 R 2317 ⁸ I

1,8 | 92 | APT

01.99-11.00	0 451 10 P 3314 O
	1 457 42 S 9870 L
	0 450 90 F 5906 ¹ K
	1 987 43 M 2017 I
	1 987 43 R 2317 ⁸ I



1,8 92 ARG	02.99-11.00	0 451 10 P 3314 O
		1 457 42 S 9870 L
		0 450 90 F 5906 ¹ K
		1 987 43 M 2017 I
		1 987 43 R 2317 ⁸ I

Passat 1.8 Turbo

1,8 110 AEB	10.96-11.00	F 026 40 P 7004 O
		1 457 42 S 9870 L
		0 450 90 F 5264 ¹ K
		1 987 43 M 2017 I
		1 987 43 R 2317 ⁸ I

1,8 | 110 | ANB

08.98-11.00	F 026 40 P 7004 O
	1 457 42 S 9870 L
	0 450 90 F 5264 ¹ K
	1 987 43 M 2017 I
	1 987 43 R 2317 ⁸ I

1,8 | 110 | APU

01.99-11.00	F 026 40 P 7004 O
	1 457 42 S 9870 L
	0 450 90 F 5264 ¹ K
	1 987 43 M 2017 I
	1 987 43 R 2317 ⁸ I

Passat 1.9 D

1,9 47 1Y	05.89-09.93	0 451 20 P 3012 O
		1 457 42 S 9777 L
		VOW 0 450 90 N 6172 ¹ K
		VOW 0 450 90 N 6267 ¹ K
		1 987 43 M 2013 I
		1 987 43 R 2313 ⁸ I

Passat 1.9 TD

1,9 55 AAZ	03.91-03.97	0 451 20 P 3012 O
		1 457 42 S 9777 L
		VOW 0 450 90 N 6172 ¹ K
		VOW 0 450 90 N 6267 ¹ K
		1 987 43 M 2013 I
		1 987 43 R 2313 ⁸ I

Passat 1.9 TDI

1,9 66 AHH		
Fg.Nr. →3B..X..600 000	08.97-04.99	0 451 10 P 3346 O
Fg.Nr. 3B..Y..000 001→	05.99-11.00	0 986 45 P 2400 O
	08.97-11.00	1 457 42 S 9870 L
Fg.Nr. →3B..Y..350 000	08.97-03.00	1 457 43 N 4184 ² K
Fg.Nr. 3B..Y..350 001→	04.00-11.00	0 450 90 N 6374 ¹ K
	08.97-11.00	1 987 43 M 2017 I
		1 987 43 R 2317 ⁸ I





1,9 66 AHU			
	08.96-03.97	0 451 10 P 3347	O
Fg.Nr. →3B..X..600 000	10.96-04.99	0 451 10 P 3346	O
Fg.Nr. 3B..Y..000 001→	05.99-11.00	0 986 45 P 2400	O
	08.96-03.97	1 457 42 S 9777	L
	10.96-11.00	1 457 42 S 9870	L
	08.96-03.97	0 450 90 N 6267 ¹	K
Fg.Nr. →3B..Y..350 000	10.96-03.00	1 457 43 N 4184 ²	K
Fg.Nr. 3B..Y..350 001→	04.00-11.00	0 450 90 N 6374 ¹	K
	08.96-03.97	1 987 43 M 2013	I
		1 987 43 R 2313 ⁸	I
	10.96-11.00	1 987 43 M 2017	I
		1 987 43 R 2317 ⁸	I

1,9 66 1Z			
	10.93-07.96	0 451 10 P 3347	O
		1 457 42 S 9777	L
	VOW	0 450 90 N 6172 ¹	K
	VOW	0 450 90 N 6267 ¹	K
		1 987 43 M 2013	I
		1 987 43 R 2313 ⁸	I

1,9 74 AVB			
	02.00-05.05	1 457 42 P 9619	O
		1 457 42 S 9870	L
	02.00-11.00	0 450 90 N 6374 ¹	K
Fg.Nr. →3B..2..400 000	10.00-02.02	1 457 43 N 4329 ²	K
Fg.Nr. 3B..2..400 001→	03.02-05.05	0 450 90 N 6374 ¹	K
	02.00-11.00	1 987 43 M 2017	I
		1 987 43 R 2317 ⁸	I
	10.00-05.05	1 987 43 M 2012	I
		1 987 43 R 2312 ⁸	I

1,9 77 BKC; BLS; BXE			
	03.05-11.08	1 457 42 P 9192	O
	KZO	1 987 42 S 9404	L
		F 026 40 N 2006	K
		1 987 43 M 2097	I
		1 987 43 R 2397 ⁸	I
		RLE	1 987 43 R 2597 ⁸

1,9 81 AFN			
	03.96-03.97	0 451 10 P 3290	O
Fg.Nr. →3B..X..600 000	10.96-04.99	0 451 10 P 3346	O
Fg.Nr. 3B..Y..000 001→	05.99-11.00	0 986 45 P 2400	O
	03.96-03.97	1 457 42 S 9777	L
	10.96-11.00	1 457 42 S 9870	L
	03.96-03.97	0 450 90 N 6267 ¹	K
Fg.Nr. →3B..Y..350 000	10.96-03.00	1 457 43 N 4184 ²	K
Fg.Nr. 3B..Y..350 001→	04.00-11.00	0 450 90 N 6374 ¹	K
	03.96-03.97	1 987 43 M 2013	I
		1 987 43 R 2313 ⁸	I
	10.96-11.00	1 987 43 M 2017	I
		1 987 43 R 2317 ⁸	I

1,9 81 AVG			
	08.99-11.00	0 986 45 P 2400	O
		1 457 42 S 9870	L
Fg.Nr. →3B..Y..350 000	08.99-03.00	1 457 43 N 4184 ²	K
Fg.Nr. 3B..Y..350 001→	04.00-11.00	0 450 90 N 6374 ¹	K
	08.99-11.00	1 987 43 M 2017	I
		1 987 43 R 2317 ⁸	I



1,9 85 AJM; ATJ			
	01.98-11.00	1 457 42 P 9619	O
		1 457 42 S 9870	L
		1 457 43 N 4329 ²	K
		1 987 43 M 2017	I
		1 987 43 R 2317 ⁸	I

1,9 96 AVF			
	10.00-05.05	1 457 42 P 9619	O
		1 457 42 S 9870	L
Fg.Nr. →3B..2..400 000	10.00-02.02	1 457 43 N 4329 ²	K
Fg.Nr. 3B..2..400 001→	03.02-05.05	0 450 90 N 6374 ¹	K
	10.00-05.05	1 987 43 M 2012	I
		1 987 43 R 2312 ⁸	I

1,9 96 AWX			
	10.00-05.05	1 457 42 P 9619	O
		1 457 42 S 9870	L
Fg.Nr. →3B..2..400 000	10.00-02.02	1 457 43 N 4329 ²	K
Fg.Nr. 3B..2..400 001→	03.02-05.05	0 450 90 N 6374 ¹	K
	10.00-05.05	1 987 43 M 2012	I
		1 987 43 R 2312 ⁸	I

Passat 1.9 TDI syncro

1,9 81 AFN			
Fg.Nr. →3B..X..600 000	06.97-04.99	0 451 10 P 3346	O
Fg.Nr. 3B..Y..000 001→	05.99-11.00	0 986 45 P 2400	O
	06.97-11.00	1 457 42 S 9870	L
Fg.Nr. →3B..Y..400 000	06.97-04.00	1 457 43 N 4184 ²	K
Fg.Nr. 3B..Y..400 001→	05.00-11.00	0 450 90 N 6374 ¹	K
	06.97-11.00	1 987 43 M 2017	I
		1 987 43 R 2317 ⁸	I

1,9 81 AVG			
	08.99-08.00	0 986 45 P 2400	O
		1 457 42 S 9870	L
Fg.Nr. →3B..Y..400 000	08.99-04.00	1 457 43 N 4184 ²	K
Fg.Nr. 3B..Y..400 001→	05.00-08.00	0 450 90 N 6374 ¹	K
	08.99-08.00	1 987 43 M 2017	I
		1 987 43 R 2317 ⁸	I

1,9 85 AJM; ATJ			
	01.00-11.00	1 457 42 P 9619	O
		1 457 42 S 9870	L
		1 987 43 M 2017	I
		1 987 43 R 2317 ⁸	I

Passat 1.9 TDI 4 Motion

1,9 96 AVF			
	10.00-05.05	1 457 42 P 9619	O
		1 457 42 S 9870	L
Fg.Nr. 3B..2..400 001→	03.02-05.05	0 450 90 N 6374 ¹	K
	10.00-05.05	1 987 43 M 2012	I
		1 987 43 R 2312 ⁸	I

Passat 2.0

2,0 85 ABA			
	03.95-10.96	1 987 43 R 2313 ⁸	I
	03.95-03.97	1 987 43 M 2013	I





◀ Passat 2.0

2,0 85 ADY	10.94-07.95	0 451 10 P 3314	O
		1 457 42 S 9777	L
		0 450 90 F 5264 ¹	K
		1 987 43 M 2013	I
		1 987 43 R 2313 ⁸	I

2,0 85 AZM	10.00-05.05	0 451 10 P 3314	O
		1 457 42 S 9870	L
		0 450 90 F 5264 ¹	K
		1 987 43 M 2012	I
		1 987 43 R 2312 ⁸	I

2,0 88 ASU; AUZ	01.00-08.00	0 451 10 P 3314	O
		1 457 42 S 9870	L
		0 450 90 F 5264 ¹	K

2,0 96 ALT	11.01-05.05	0 451 10 P 3314	O
		1 457 42 S 9870	L
		0 450 90 F 5264 ¹	K
		1 987 43 M 2012	I
		1 987 43 R 2312 ⁸	I

2,0 100 9A	08.88-09.93	0 451 10 P 3033	O
		1 457 42 S 9777	L
		0 450 90 F 5143 ¹	K
		1 987 43 M 2013	I
		1 987 43 R 2313 ⁸	I

2,0 110 ABF	01.94-03.97	0 451 10 P 3314	O
		1 457 42 S 9777	L
		EFV 0 450 90 F 5264 ¹	K
		1 987 43 M 2013	I
		1 987 43 R 2313 ⁸	I

Passat 2.0 , syncro

2,0 79/85 AEP; AGG	10.94-03.97	0 451 10 P 3314	O
		1 457 42 S 9777	L
		0 450 90 F 5264 ¹	K
		1 987 43 M 2013	I
		1 987 43 R 2313 ⁸	I

2,0 85 2E	03.90-09.94	0 451 10 P 3033	O
		1 457 42 S 9777	L
		0 450 90 F 5264 ¹	K
		1 987 43 M 2013	I
		1 987 43 R 2313 ⁸	I

Passat 2.0 FSI, FSI 4 Motion

2,0 110 BLR; BLX; BLY	03.05-11.05	1 457 42 P 9243	O
		KZO 1 987 42 S 9405	L
		KZO 1 457 43 S 3576	L
		1 987 43 M 2097	I
		1 987 43 R 2397 ⁸	I
		RLE 1 987 43 R 2597 ⁸	I



2,0 110 BVX <D2Z>; BVY <D2Z>; BVZ <D2Z>	11.05-11.10	1 457 42 P 9243	O
		KZO 1 987 42 S 9405	L
		KZO 1 457 43 S 3576	L
		1 987 43 M 2097	I
		1 987 43 R 2397 ⁸	I
		RLE 1 987 43 R 2597 ⁸	I

Passat 2.0 syncro

2,0 85 ADY	10.94-12.95	0 451 10 P 3033	O
		1 457 42 S 9777	L
		0 450 90 F 5264 ¹	K
		1 987 43 M 2013	I
		1 987 43 R 2313 ⁸	I

Passat 2.0 TDI

2,0 88 BWW	03.06-05.06	1 457 42 P 9192	O
		KZO 1 987 42 S 9404	L
		F 026 40 N 2006	K
		1 987 43 M 2097	I
		1 987 43 R 2397 ⁸	I
RLE 1 987 43 R 2597 ⁸	I		

2,0 90/120 BUZ; BVE	06.05-06.08	1 457 42 P 9192	O
		KZO 1 987 42 S 9404	L
		F 026 40 N 2006	K
		1 987 43 M 2097	I
		1 987 43 R 2397 ⁸	I
RLE 1 987 43 R 2597 ⁸	I		

2,0 100 BGW	11.03-05.05	1 457 42 P 9619	O
		1 457 42 S 9870	L
		0 450 90 N 6374 ¹	K
		1 987 43 M 2012	I
		1 987 43 R 2312 ⁸	I

Passat 2.0 TDI, TDI 4 Motion

2,0 81/100/103/105/125 CBAA <D94>; CBAB <D91>; CBAC; CBAC <D92>; CBBB <D93>; CBDC <D96>	01.08-11.10	1 457 42 P 9192	O
		KZO 1 987 42 S 9404	L
		F 026 40 N 2006	K
		1 987 43 M 2097	I
		1 987 43 R 2397 ⁸	I
RLE 1 987 43 R 2597 ⁸	I		

2,0 100/103/125 BMA; BMP; BMR	03.05-06.08	1 457 42 P 9192	O
		KZO 1 987 42 S 9404	L
		F 026 40 N 2006	K
		1 987 43 M 2097	I
		1 987 43 R 2397 ⁸	I
RLE 1 987 43 R 2597 ⁸	I		

2,0 100/103/125 CFFA <D94>; CFFB <D91>; CFFB <D93>; CLLA	08.10-→	F 026 40 P 7023	O
		KZO 1 987 42 S 9404	L
		1 987 43 M 2097	I
		1 987 43 R 2397 ⁸	I
		RLE 1 987 43 R 2597 ⁸	I



2,0 103 BKP	03.05-06.08	1 457 42 P 9192	O
	KZO	1 987 42 S 9404	L
		F 026 40 N 2006	K
		1 987 43 M 2097	I
		1 987 43 R 2397 ⁸	I
	RLE	1 987 43 R 2597 ⁸	I

Passat 2.0 TSI

2,0 125/147/155 CBFA <D2L>; CCTA <D2L>; CCTB <D6G>; CCZA <D2L>; CCZB <D2D>	12.07→	F 026 40 P 7080	O
		1 987 42 S 9404	L
		1 987 43 M 2097	I
		1 987 43 R 2397 ⁸	I
	RLE	1 987 43 R 2597 ⁸	I

2,0 147 AXX	03.05-11.05	1 457 42 P 9243	O
		1 457 43 S 3102	L
		1 987 43 M 2097	I
		1 987 43 R 2397 ⁸	I
	RLE	1 987 43 R 2597 ⁸	I

2,0 147 BPY	08.05-12.07	1 457 42 P 9243	O
		1 457 43 S 3102	L
		1 987 43 M 2097	I
		1 987 43 R 2397 ⁸	I
	RLE	1 987 43 R 2597 ⁸	I

2,0 147 BWA	11.05-02.08	1 457 42 P 9243	O
		1 457 43 S 3102	L
		1 987 43 M 2097	I
		1 987 43 R 2397 ⁸	I
	RLE	1 987 43 R 2597 ⁸	I

2,0 147 CAWB <D2L>	11.07-12.10	F 026 40 P 7080	O
		1 987 42 S 9404	L
		1 987 43 M 2097	I
		1 987 43 R 2397 ⁸	I
	RLE	1 987 43 R 2597 ⁸	I

Passat 2.0 4 Motion

2,0 85 AZM	10.00-05.05	0 451 10 P 3314	O
		1 457 42 S 9870	L
		0 450 90 F 5906 ¹	K
		1 987 43 M 2012	I
		1 987 43 R 2312 ⁸	I

Passat 2.3

2,3 110 AGZ	10.96-11.00	1 457 42 P 9142	O
		1 457 42 S 9870	L
		0 450 90 F 5264 ¹	K
		1 987 43 M 2017	I
		1 987 43 R 2317 ⁸	I

2,3 125 AZX	10.00-05.05	1 457 42 P 9142	O
		1 457 42 S 9870	L
		0 450 90 F 5264 ¹	K
		1 987 43 M 2012	I
		1 987 43 R 2312 ⁸	I

Passat 2.3 syncro

2,3 110 AGZ	06.97-11.00	1 457 42 P 9142	O
		1 457 42 S 9870	L
	05.98-11.00	0 450 90 F 5906 ¹	K
	06.97-11.00	1 987 43 M 2017	I
		1 987 43 R 2317 ⁸	I

Passat 2.3 4 Motion

2,3 125 AZX	01.01-05.05	1 457 42 P 9142	O
		1 457 42 S 9870	L
		0 450 90 F 5906 ¹	K
		1 987 43 M 2012	I
		1 987 43 R 2312 ⁸	I

Passat 2.5 TDI

2,5 110 AFB	08.98-11.00	1 457 42 P 9152	O
		1 457 42 S 9870	L
		0 986 45 N 0509 ¹	K
		1 987 43 M 2017	I
		1 987 43 R 2317 ⁸	I

2,5 110 AKN	08.98-05.03	1 457 42 P 9152	O
	08.98-11.00	1 457 42 S 9870	L
	10.00-05.03	KZO 1 457 43 S 3772	L
		KZO 1 457 42 S 9870	L
	08.98-05.03	0 986 45 N 0509 ¹	K
	08.98-11.00	1 987 43 M 2017	I
		1 987 43 R 2317 ⁸	I
	10.00-05.03	1 987 43 M 2012	I
		1 987 43 R 2312 ⁸	I

2,5 120 BDG	05.03-05.05	1 457 42 P 9152	O
		KZO 1 457 43 S 3772	L
		KZO 1 457 42 S 9870	L
		0 986 45 N 0509 ¹	K
		1 987 43 M 2012	I
		1 987 43 R 2312 ⁸	I

Passat 2.5 TDI syncro

2,5 110 AFB	08.98-11.00	1 457 42 P 9152	O
		1 457 43 S 3772	L
		0 986 45 N 0509 ¹	K
		1 987 43 M 2017	I
		1 987 43 R 2317 ⁸	I





◀ Passat 2.5 TDI syncro

2,5 110 AKN	08.98-11.00	1 457 42 P 9152 O
		1 457 43 S 3772 L
		0 986 45 N 0509 ¹ K
		1 987 43 M 2017 I
		1 987 43 R 2317 ⁸ I

Passat 2.5 TDI 4 Motion

2,5 110 AKN	10.00-01.03	1 457 42 P 9152 O
		1 457 43 S 3772 L
		0 986 45 N 0509 ¹ K
		1 987 43 M 2012 I
		1 987 43 R 2312 ⁸ I

2,5 132 BAU	01.03-05.05	1 457 42 P 9152 O
		1 457 43 S 3772 L
		0 986 45 N 0509 ¹ K
		1 987 43 M 2012 I
		1 987 43 R 2312 ⁸ I

2,5 132 BDH	01.03-05.05	1 457 42 P 9152 O
		1 457 43 S 3772 L
		0 986 45 N 0509 ¹ K
		1 987 43 M 2012 I
		1 987 43 R 2312 ⁸ I

Passat 2.8

2,8 128 AAA		
Mot.Nr. AAA 176 890→	10.93-03.97	1 457 42 P 9142 O
Mot.Nr. →AAA 176 889	06.91-09.93 ABM,TW	1 457 42 P 9103 O
	06.91-03.97	1 457 42 S 9777 L
		0 450 90 F 5264 ¹ K
		1 987 43 M 2013 I
		1 987 43 R 2313 ⁸ I

2,8 132 AGE		
Fg.Nr. →3B..X..600 000	01.97-04.99	0 451 10 P 3313 O
Fg.Nr. 3B..Y..000 001→	05.99-11.00	0 451 10 P 3313 O
	01.97-11.00	1 457 42 S 9870 L
		0 450 90 F 5264 ¹ K
		1 987 43 M 2017 I
		1 987 43 R 2317 ⁸ I

2,8 140 ATX	10.99-11.00	0 451 10 P 3313 O
		1 457 42 S 9870 L
		0 450 90 F 5264 ¹ K
		1 987 43 M 2017 I
		1 987 43 R 2317 ⁸ I

2,8 140 BBG	10.00-05.05	0 451 10 P 3313 O
		1 457 42 S 9870 L
		0 450 90 F 5264 ¹ K
		1 987 43 M 2012 I
		1 987 43 R 2312 ⁸ I



2,8 142 ACK		
Fg.Nr. →3B..X..600 000	01.97-04.99	0 451 10 P 3313 O
Fg.Nr. 3B..Y..000 001→	05.99-11.00	0 451 10 P 3313 O
	01.97-11.00	1 457 42 S 9870 L
		0 450 90 F 5264 ¹ K
		1 987 43 M 2017 I
		1 987 43 R 2317 ⁸ I

2,8 142 AMX	10.00-05.05	0 451 10 P 3313 O
		1 457 42 S 9870 L
		0 450 90 F 5264 ¹ K
		1 987 43 M 2012 I
		1 987 43 R 2312 ⁸ I

2,8 142 APR		
Fg.Nr. →3B..X..600 000	01.99-04.99	0 451 10 P 3313 O
Fg.Nr. 3B..Y..000 001→	05.99-11.00	0 451 10 P 3313 O
	01.99-11.00	1 457 42 S 9870 L
		0 450 90 F 5264 ¹ K
		1 987 43 M 2017 I
		1 987 43 R 2317 ⁸ I

2,8 142 AQD	01.99-11.00	0 451 10 P 3313 O
		1 457 42 S 9870 L
		0 450 90 F 5264 ¹ K
		1 987 43 M 2017 I
		1 987 43 R 2317 ⁸ I

2,8 142 ATQ	10.00-05.05	0 451 10 P 3313 O
		1 457 42 S 9870 L
		0 450 90 F 5264 ¹ K
		1 987 43 M 2012 I
		1 987 43 R 2312 ⁸ I

Passat 2.8 syncro

2,8 142 ACK	01.97-11.00	0 451 10 P 3313 O
		1 457 42 S 9870 L
	05.98-11.00	0 450 90 F 5906 ¹ K
	01.97-11.00	1 987 43 M 2017 I
		1 987 43 R 2317 ⁸ I

2,8 142 AHA	10.94-12.95	0 451 10 P 3313 O
	10.97-08.00	0 451 10 P 3313 O
	10.94-12.95	1 457 42 S 9870 L
	10.97-08.00	1 457 42 S 9870 L
	10.94-12.95	0 450 90 F 5264 ¹ K
	10.97-08.00	0 450 90 F 5264 ¹ K
	10.94-12.95	1 987 43 M 2017 I
		1 987 43 R 2317 ⁸ I
	10.97-08.00	1 987 43 M 2017 I
		1 987 43 R 2317 ⁸ I

2,8 142 ALG	06.97-11.00	0 451 10 P 3313 O
		1 457 42 S 9870 L
	05.98-11.00	0 450 90 F 5906 ¹ K
	06.97-11.00	1 987 43 M 2017 I
		1 987 43 R 2317 ⁸ I



2,8 142 APR	01.99-11.00	0 451 10 P 3313	O
		1 457 42 S 9870	L
		0 450 90 F 5906 ¹	K
		1 987 43 M 2017	I
		1 987 43 R 2317 ⁸	I

2,8 142 AQD	01.99-11.00	0 451 10 P 3313	O
		1 457 42 S 9870	L
		0 450 90 F 5906 ¹	K
		1 987 43 M 2017	I
		1 987 43 R 2317 ⁸	I

2,8 142 ATX	10.99-11.00	0 451 10 P 3313	O
		1 457 42 S 9870	L
		0 450 90 F 5906 ¹	K
		1 987 43 M 2017	I
		1 987 43 R 2317 ⁸	I

Passat 2.8 4 Motion

2,8 140 BBG	10.00-05.05	0 451 10 P 3313	O
		1 457 42 S 9870	L
		0 450 90 F 5906 ¹	K
		1 987 43 M 2012	I
		1 987 43 R 2312 ⁸	I

2,8 142 AMX	10.00-05.05	0 451 10 P 3313	O
		1 457 42 S 9870	L
		0 450 90 F 5906 ¹	K
		1 987 43 M 2012	I
		1 987 43 R 2312 ⁸	I

2,8 142 ATQ	10.00-05.05	0 451 10 P 3313	O
		1 457 42 S 9870	L
		0 450 90 F 5906 ¹	K
		1 987 43 M 2012	I
		1 987 43 R 2312 ⁸	I

Passat 2.9 syncro

2,9 135 ABV			
Mot.Nr. ABV 019 554→	12.95-03.97	1 457 42 P 9142	O
Mot.Nr. →ABV 019 553	01.94-11.95	1 457 42 P 9103	O
	01.94-03.97	1 457 42 S 9777	L
		0 450 90 F 5264 ¹	K
		1 987 43 M 2013	I
		1 987 43 R 2313 ⁸	I

Passat 3.2 FSI 4 Motion

3,2 184 AXZ <D6F>	09.05-11.10	1 457 42 P 9192	O
		F 026 40 N 2006	K
		1 987 43 M 2097	I
		1 987 43 R 2397 ⁸	I
	RLE	1 987 43 R 2597 ⁸	I



Passat 3.6 FSI, FSI R36 4 Motion, FSI 4 Motion

3,6 206/220 BLV <D3B>; BWS <D34>			
	09.05-01.11	1 457 42 P 9192	O
	09.05-11.10	F 026 40 N 2006	K
	09.05→	1 987 43 M 2097	I
		1 987 43 R 2397 ⁸	I
	RLE	1 987 43 R 2597 ⁸	I

Passat 3.6 V6 4 Motion

3,6 206/220 BLV <D3B>; BWS <D34>			
	01.11→	1 987 43 M 2097	I
		1 987 43 R 2397 ⁸	I
	RLE	1 987 43 R 2597 ⁸	I

Passat 4.0

4,0 202 BDN; BDP	05.02-09.04	1 457 42 P 9142	O
		1 457 42 S 9870	L
		0 450 90 F 5264 ¹	K
		1 987 43 M 2012	I
		1 987 43 R 2312 ⁸	I

Passat 4.0 4 Motion

4,0 202 BDN; BDP	09.01-09.04	1 457 42 P 9142	O
		1 457 42 S 9870	L
		0 450 90 F 5906 ¹	K
		1 987 43 M 2012	I
		1 987 43 R 2312 ⁸	I

Phaeton

Phaeton 3.0 TDI 4 Motion

3,0 165 BMK	09.04-05.07	F 026 40 P 7002	O
		1 457 43 N 1715	K
3,0 171 CARA			
Fg.Nr. →3D..8..005 000	06.07-04.08	F 026 40 P 7002	O
Fg.Nr. 3D..8..005 001→	05.08-10.08	F 026 40 P 7066	O
	06.07-10.08	1 457 43 N 1715	K

3,0 176 CEXA	06.08→	F 026 40 P 7066	O
		1 457 43 N 1715	K

Phaeton 3.2 , 4 Motion

3,2 177 AYT; BKL; BRK	05.02-10.08	1 457 42 P 9142	O
---------------------------	-------------	-----------------	---

Phaeton 3.6 4 Motion

3,6 206 CHNA; CMVA <D3B>	11.08→	1 457 42 P 9142	O
------------------------------	--------	-----------------	---

Phaeton 4.2 4 Motion

4,2 246 BGH; BGJ	05.03→	F 026 40 P 7007	O
----------------------	--------	-----------------	---





Phaeton 5.0 TDI 4 Motion

5,0 230 AJS	11.02-10.06	2FE	1 457 43 N 1718	K
-----------------	-------------	-----	-----------------	---

Phaeton 6.0 4 Motion

6,0 309 BAN; BAP	05.02-05.05		1 457 42 P 9142	O
----------------------	-------------	--	-----------------	---

Polo

Polo 1.0

1,0 33 AAU	10.90-09.94		0 451 10 P 3318	O
			1 457 42 S 9915	L
			0 450 90 F 5264 ¹	K

1,0 33 ACM	02.92-12.92		0 451 10 P 3318	O
		CSA	1 457 42 S 9789	L
			0 450 90 F 4149 ¹	K

1,0 33 HZ	08.85-01.92		0 451 10 P 3033	O
	10.90-01.92		0 451 10 P 3318	O
	08.85-01.92		1 457 42 S 9959	L
	10.90-01.92	CSA	1 457 42 S 9789	L
	08.85-01.92	CSA	0 450 90 F 4149 ¹	K

1,0 33/37 AER; AEV	10.94-12.99		0 451 10 P 3318	O
			1 457 43 S 3540	L
Fg.Nr. →6N-V 300 000	10.94-04.97		0 450 90 F 5002 ¹	K
Fg.Nr. 6N..W..000 001→	05.97-12.99		0 450 90 F 5316 ¹	K
	10.94-12.99		1 987 43 M 2012	I
			1 987 43 R 2312 ⁸	I

1,0 37 ALD	07.98-09.01		0 451 10 P 3318	O
			1 457 43 S 3539	L
			0 450 90 F 5316 ¹	K
		H25	1 987 43 M 2012	I
			1 987 43 R 2312 ⁸	I
		H30	1 987 43 R 2300 ⁸	I

1,0 37 ALL	05.97-12.99		0 451 10 P 3318	O
			1 457 43 S 3540	L
Fg.Nr. 6N..W..000 001→	05.97-12.99		0 450 90 F 5316 ¹	K
	05.97-12.99		1 987 43 M 2012	I
			1 987 43 R 2312 ⁸	I

1,0 37 AUC	10.99-09.01		0 451 10 P 3318	O
			1 457 43 S 3539	L
			0 450 90 F 5316 ¹	K
		H25	1 987 43 M 2012	I
			1 987 43 R 2312 ⁸	I
		H30	1 987 43 R 2300 ⁸	I

Polo 1.0 16V

1,0 43 ARA	07.02-05.05		0 450 90 F 5925 ¹	K
----------------	-------------	--	------------------------------	---



Polo 1.2

1,2 40 AWY	11.01-05.04		1 457 42 P 9194	O
			1 457 43 S 3574	L
		ORK	0 450 90 F 5925 ¹	K
		MRK	0 450 90 F 5316 ¹	K
			1 987 43 M 2057	I
			1 987 43 R 2357 ⁸	I

1,2 40 BMD	05.04-05.07		1 457 42 P 9194	O
			1 457 43 S 3532	L
	05.04-05.05	ORK	0 450 90 F 5925 ¹	K
		MRK	0 450 90 F 5316 ¹	K
	04.05-05.07	3BA,DRR	F 026 40 F 3008 ¹	K
		4BA,DRR	F 026 40 F 3006 ¹	K
	05.04-05.07		1 987 43 M 2057	I
			1 987 43 R 2357 ⁸	I

1,2 44 BBM	05.07-12.09		1 457 42 P 9194	O
			1 457 43 S 3532	L
		3BA,DRR	F 026 40 F 3008 ¹	K
		4BA,DRR	F 026 40 F 3006 ¹	K
			1 987 43 M 2057	I
			1 987 43 R 2357 ⁸	I

1,2 44/51 CGPA <D21>; CGPB <DG3>; CHFA <MM4>	06.09→		1 457 42 P 9194	O
			1 457 43 S 3532	L
			F 026 40 F 3008 ¹	K
	06.09-05.10		1 987 43 M 2057	I
			1 987 43 R 2357 ⁸	I

1,2 47 AZQ	11.01-05.04		1 457 42 P 9194	O
			1 457 43 S 3319	L
			0 450 90 F 5925 ¹	K
			1 987 43 M 2057	I
			1 987 43 R 2357 ⁸	I

1,2 47 BME	04.05-07.07		1 457 42 P 9194	O
			1 457 43 S 3319	L
		3BA,DRR	F 026 40 F 3008 ¹	K
		4BA,DRR	F 026 40 F 3006 ¹	K
			1 987 43 M 2057	I
			1 987 43 R 2357 ⁸	I

1,2 47 BME <MA5>	11.04-05.05		1 457 42 P 9194	O
			1 457 43 S 3319	L
			0 450 90 F 5925 ¹	K
			1 987 43 M 2057	I
			1 987 43 R 2357 ⁸	I

1,2 51 BZG	05.07-12.09		1 457 42 P 9194	O
			1 457 43 S 3532	L
		3BA,DRR	F 026 40 F 3008 ¹	K
		4BA,DRR	F 026 40 F 3006 ¹	K
			1 987 43 M 2057	I
			1 987 43 R 2357 ⁸	I

**Polo 1.2 TDI****1,2 | 55 | CFWA <D28>**

10.09→	F 026 40 S0156	L
10.09-05.10	1987 43 M 2057	I
	1987 43 R 2357 ⁸	I

Polo 1.2 TSI**1,2 | 63 | CBZA <DB1>**

01.10→	F 026 40 P 7079	O
	1987 42 S 9405	L
01.10-05.10	1987 43 M 2057	I
	1987 43 R 2357 ⁸	I

1,2 | 77 | CBZB <DB0>

06.09→	F 026 40 P 7079	O
	F 026 40 S0156	L
06.09-05.10	1987 43 M 2057	I
	1987 43 R 2357 ⁸	I

Polo 1.3**1,3 | 40 | AAV**

01.91-09.94	0 451 10 P 3318	O
	1 457 42 S 9915	L
	0 450 90 F 5264 ¹	K

1,3 | 40 | ADX

10.94-07.95	0 451 10 P 3318	O	
07.96-12.99	0 451 10 P 3318	O	
10.94-07.95	1 457 43 S 3540	L	
07.96-12.99	1 457 43 S 3540	L	
Fg.Nr. →6N-V 300 000	10.94-07.95	0 450 90 F 5002 ¹	K
	07.96-04.97	0 450 90 F 5002 ¹	K
Fg.Nr. 6N..W..000 001→	05.97-12.99	0 450 90 F 5316 ¹	K
	10.94-07.95	1 987 43 M 2012	I
		1 987 43 R 2312 ⁸	I
	07.96-12.99	1 987 43 M 2012	I
		1 987 43 R 2312 ⁸	I

1,3 | 40 | 2G

10.90-09.94	0 451 10 P 3318	O
	1 457 42 S 9915	L
	CSA 0 450 90 F 4149 ¹	K

1,3 | 56-59 | 3F

10.90-09.94	0 451 10 P 3318	O
	1 457 42 S 9061	L
	0 450 90 F 5264 ¹	K

Polo 1.3 , G40**1,3 | 40/85 | NZ; PY**

10.90-09.94	0 451 10 P 3318	O
	1 457 42 S 9061	L
	0 450 90 F 5264 ¹	K

Polo 1.4**1,4 | 40 | AKP**

09.98-09.01	0 451 10 P 3318	O
	1 457 43 S 3539	L
	0 450 90 F 5316 ¹	K
H25	1 987 43 M 2012	I
	1 987 43 R 2312 ⁸	I
H30	1 987 43 R 2300 ⁸	I

1,4 | 40-44 | AEX

07.95-12.99	0 451 10 P 3318	O	
	1 457 43 S 3540	L	
Fg.Nr. →6N-V 300 000	07.95-04.97	0 450 90 F 5002 ¹	K
Fg.Nr. 6N..W..000 001→	05.97-12.99	0 450 90 F 5316 ¹	K
	07.95-12.99	1 987 43 M 2012	I
		1 987 43 R 2312 ⁸	I

1,4 | 44 | AEX

05.96-12.97	0 451 10 P 3318	O	
	1 457 43 S 3540	L	
Fg.Nr. →6K..W..516 000	05.96-06.97	0 450 90 F 5002 ¹	K
Fg.Nr. 6K..W..516 001→	07.97-12.97	0 450 90 F 5316 ¹	K
	05.96-12.97	H25 1 987 43 M 2012	I
		1 987 43 R 2312 ⁸	I

1,4 | 44 | AKK

09.98-09.01	0 451 10 P 3318	O
	1 457 43 S 3539	L
10.99-09.01	STZ 1 457 43 S 3539	L
09.98-09.01	0 450 90 F 5316 ¹	K
	H25 1 987 43 M 2012	I
	1 987 43 R 2312 ⁸	I
	H30 1 987 43 R 2300 ⁸	I

1,4 | 44 | AKV

05.97-12.99	0 451 10 P 3318	O	
	1 457 43 S 3540	L	
12.97-08.99	0 450 90 F 5316 ¹	K	
Fg.Nr. 6N..W..000 001→	05.97-12.99	0 450 90 F 5316 ¹	K
	05.97-12.99	1 987 43 M 2012	I
		1 987 43 R 2312 ⁸	I
	12.97-08.99	H25 1 987 43 M 2012	I
		1 987 43 R 2312 ⁸	I

1,4 | 44 | ANW

10.99-08.00	0 451 10 P 3318	O
	STZ 1 457 43 S 3539	L
	0 450 90 F 5316 ¹	K
	H25 1 987 43 M 2012	I
	1 987 43 R 2312 ⁸	I

1,4 | 44 | ANX

01.98-12.99	0 451 10 P 3318	O	
	1 457 43 S 3540	L	
01.98-08.99	0 450 90 F 5316 ¹	K	
Fg.Nr. 6N..W..000 001→	01.98-12.99	0 450 90 F 5316 ¹	K
	01.98-08.99	H25 1 987 43 M 2012	I
		1 987 43 R 2312 ⁸	I
	01.98-12.99	1 987 43 M 2012	I
		1 987 43 R 2312 ⁸	I





◀ Polo 1.4

1,4 44 APQ			
	11.97-12.99	0 451 10 P 3318	O
		1 457 43 S 3540	L
	12.97-08.99	0 450 90 F 5316 ¹	K
Fg.Nr. 6N..W..000 001→	11.97-12.99	0 450 90 F 5316 ¹	K
	11.97-12.99	1 987 43 M 2012	I
		1 987 43 R 2312 ⁸	I
	12.97-08.99 H25	1 987 43 M 2012	I
		1 987 43 R 2312 ⁸	I
1,4 44 AUD			
	10.99-09.01	0 451 10 P 3318	O
		1 457 43 S 3539	L
	06.00-09.01 STZ	1 457 43 S 3539	L
	10.99-09.01	0 450 90 F 5316 ¹	K
	H25	1 987 43 M 2012	I
		1 987 43 R 2312 ⁸	I
	H30	1 987 43 R 2300 ⁸	I
1,4 55 APE			
	10.99-06.00	0 451 10 P 3318	O
		F 026 40 S 0019	L
		0 450 90 F 5316 ¹	K
	H25	1 987 43 M 2012	I
		1 987 43 R 2312 ⁸	I
1,4 55 AUA			
	06.00-01.02	0 451 10 P 3318	O
	06.00-09.01	F 026 40 S 0019	L
	09.01-01.02	1 457 43 S 3059	L
	06.00-09.01	0 450 90 F 5316 ¹	K
	09.01-01.02	0 450 90 F 5925 ¹	K
	06.00-09.01 H25	1 987 43 M 2012	I
		1 987 43 R 2312 ⁸	I
	09.01-01.02	1 987 43 M 2057	I
		1 987 43 R 2357 ⁸	I
1,4 55 BBY			
	09.01-05.07	0 451 10 P 3318	O
		1 457 43 S 3059	L
	09.01-05.04	0 450 90 F 5925 ¹	K
PR-Nr. OF2	07.03-05.07	0 450 90 F 5316 ¹	K
PR-Nr. 1A1	07.03-05.07	0 450 90 F 5925 ¹	K
	09.01-05.07	1 987 43 M 2057	I
		1 987 43 R 2357 ⁸	I
1,4 55 BKY			
	05.04-07.07	0 451 10 P 3318	O
		1 457 43 S 3059	L
	05.04-05.05	0 450 90 F 5925 ¹	K
	04.05-07.07 3BA,DRR	F 026 40 F 3008 ¹	K
		4BA,DRR F 026 40 F 3006 ¹	K
PR-Nr. OF2	05.04-05.07	0 450 90 F 5316 ¹	K
PR-Nr. 1A1	05.04-05.07	0 450 90 F 5925 ¹	K
	05.04-07.07	1 987 43 M 2057	I
		1 987 43 R 2357 ⁸	I
1,4 59 BUD			
	05.06-12.09	0 451 10 P 3318	O
		F 026 40 S 0035	L
		3BA,DRR F 026 40 F 3008 ¹	K
		4BA,DRR F 026 40 F 3006 ¹	K
		1 987 43 M 2057	I
		1 987 43 R 2357 ⁸	I



1,4 63 BLM			
	12.03-05.05	0 451 10 P 3318	O
PR-Nr. OF2	12.03-05.05	0 450 90 F 5316 ¹	K
PR-Nr. 1A1	12.03-05.05	0 450 90 F 5925 ¹	K
	12.03-05.05	1 987 43 M 2057	I
		1 987 43 R 2357 ⁸	I
1,4 63 CDDA			
	10.09-05.10	1 987 43 M 2057	I
		1 987 43 R 2357 ⁸	I
1,4 63 CGGB <D22>			
	06.09→	0 451 10 P 3318	O
		F 026 40 S 0035	L
		F 026 40 F 3006 ¹	K
	06.09-05.10	1 987 43 M 2057	I
		1 987 43 R 2357 ⁸	I
1,4 74 AFH			
	04.96-12.99	0 451 10 P 3318	O
		1 457 43 S 3716	L
Fg.Nr. →6N-V 300 000	04.96-04.97	0 450 90 F 5002 ¹	K
Fg.Nr. 6N..W..000 001→	05.97-12.99	0 450 90 F 5316 ¹	K
	04.96-12.99	1 987 43 M 2012	I
		1 987 43 R 2312 ⁸	I
1,4 74 AUB			
	11.01-04.02	0 451 10 P 3318	O
		1 457 43 S 3059	L
		0 450 90 F 5925 ¹	K
		1 987 43 M 2057	I
		1 987 43 R 2357 ⁸	I
1,4 74 BBZ			
	09.01-05.07	0 451 10 P 3318	O
		1 457 43 S 3059	L
	09.01-04.05	0 450 90 F 5925 ¹	K
	04.05-05.07 3BA,DRR	F 026 40 F 3008 ¹	K
		4BA,DRR F 026 40 F 3006 ¹	K
PR-Nr. OF2	11.03-05.07	0 450 90 F 5316 ¹	K
PR-Nr. 1A1	11.03-05.07	0 450 90 F 5925 ¹	K
	09.01-05.07	1 987 43 M 2057	I
		1 987 43 R 2357 ⁸	I
Polo 1.4 BiFuel			
1,4 60 CMAA <DF8>			
	03.10-01.11	0 451 10 P 3318	O
		F 026 40 S 0035	L
	03.10-05.10	1 987 43 M 2057	I
		1 987 43 R 2357 ⁸	I
Polo 1.4 D			
1,4 35 1W			
	10.90-09.94	0 451 20 P 3012	O
		1 457 42 S 9061	L
		VOW 0 450 90 N 6172 ¹	K
		VOW 0 450 90 N 6267 ¹	K





Polo 1.4 FSI

1,4 63 AXU			
	09.01-07.06	1 457 42 P 9301	O
		1 987 42 S 9403	L
		0 450 90 F 5316 ¹	K
		1 987 43 M 2057	I
		1 987 43 R 2357 ⁸	I

Polo 1.4 GTI

1,4 132 CAVE <D32>			
	05.10→	F 026 40 P 7079	O
		F 026 40 S0156	L
	05.10-05.10	1 987 43 M 2057	I
		1 987 43 R 2357 ⁸	I

Polo 1.4 i

1,4 55 BCC <EA111>			
	04.02→	0 451 10 P 3318	O
		1 457 43 S 3059	L
		0 450 90 F 5925 ¹	K
		1 987 43 M 2057	I
		1 987 43 R 2357 ⁸	I

1,4 62 AGY			
	12.94-10.03	0 450 90 F 5002 ¹	K
		1 987 43 M 2012	I

Polo 1.4 TDI

1,4 51 BWB			
	10.05-12.09	1 457 42 P 9192	O
		1 457 43 S 3575	L
		0 450 90 N 6500 ¹	K
		1 987 43 M 2057	I
		1 987 43 R 2357 ⁸	I

1,4 51/58/59 BMS; BNM; BNV			
	04.05→	1 457 42 P 9192	O
		1 457 43 S 3575	L
		0 450 90 N 6500 ¹	K
	04.05-12.09	1 987 43 M 2057	I
		1 987 43 R 2357 ⁸	I

1,4 55 AMF			
	10.99-05.05	1 457 42 P 9192	O
	10.99-09.01	1 457 43 S 3538	L
	09.01-05.05	1 457 43 S 3575	L
	10.99-09.01	0 450 90 N 6373 ¹	K
	09.01-05.05	0 450 90 N 6322 ¹	K
	10.99-09.01	H25 1 987 43 M 2012	I
		1 987 43 R 2312 ⁸	I
		H30 1 987 43 R 2300 ⁸	I
	09.01-05.05	1 987 43 M 2057	I
		1 987 43 R 2357 ⁸	I



1,4 55 BAY			
	09.01-05.07	1 457 42 P 9192	O
	09.01-05.05	1 457 43 S 3575	L
	07.03-05.07	STZ 1 457 43 S 3575	L
		STZ 1 457 43 S 3575	L
	09.01-05.07	0 450 90 N 6322 ¹	K
		1 987 43 M 2057	I
		1 987 43 R 2357 ⁸	I

1,4 66 ATL			
	01.00-04.00	1 457 42 P 9192	O
		1 457 43 S 3538	L
		0 450 90 N 6373 ¹	K
		H25 1 987 43 M 2012	I
		1 987 43 R 2312 ⁸	I
		H30 1 987 43 R 2300 ⁸	I

Polo 1.4 8V

1,4 61 BLM			
	05.02-07.06	0 450 90 F 5925 ¹	K

Polo 1.4 16V

1,4 55 AHW			
	01.99-09.01	0 451 10 P 3318	O
		1 457 43 S 3716	L
		0 450 90 F 5316 ¹	K
		H25 1 987 43 M 2012	I
		1 987 43 R 2312 ⁸	I
		H30 1 987 43 R 2300 ⁸	I

1,4 55 APE			
	05.00-12.00	0 451 10 P 3318	O
		1 457 43 S 3716	L
		0 450 90 F 5316 ¹	K
		1 987 43 M 2012	I
		1 987 43 R 2300 ⁸	I

1,4 55 AUA			
	10.99-09.01	0 451 10 P 3318	O
		1 457 43 S 3716	L
		0 450 90 F 5316 ¹	K
		H25 1 987 43 M 2012	I
		1 987 43 R 2312 ⁸	I
		H30 1 987 43 R 2300 ⁸	I

1,4 55 BBY			
	09.02-02.05	0 451 10 P 3318	O
		0 450 90 F 5925 ¹	K

1,4 55 BKY			
	08.06→	0 451 10 P 3318	O

1,4 74 AFK			
	09.98-09.01	0 451 10 P 3318	O
		1 457 43 S 3716	L
		0 450 90 F 5316 ¹	K
		H25 1 987 43 M 2012	I
		1 987 43 R 2312 ⁸	I
		H30 1 987 43 R 2300 ⁸	I





◀ Polo 1.4 16V

1,4 74 AUB	10.99-09.01	0 451 10 P 3318 O
		1 457 43 S 3716 L
		0 450 90 F 5316 ¹ K
	H25	1 987 43 M 2012 I
		1 987 43 R 2312 ⁸ I
	H30	1 987 43 R 2300 ⁸ I

Polo 1.6

1,6 55 AEA	10.94-07.95	0 451 10 P 3318 O
		1 457 43 S 3540 L
Fg.Nr. →6N-V 300 000	10.94-07.95	0 450 90 F 5002 ¹ K
	10.94-07.95	1 987 43 M 2012 I
		1 987 43 R 2312 ⁸ I

1,6 55 AEE	07.95-12.99	0 451 10 P 3318 O
		1 457 43 S 3540 L
		0 450 90 F 5316 ¹ K
Fg.Nr. →6K..W..516 000	09.97-12.98	0 450 90 F 5316 ¹ K
Fg.Nr. →6N-V 300 000	04.97-06.97	0 450 90 F 5002 ¹ K
Fg.Nr. 6K..W..516 001→	07.95-04.97	0 450 90 F 5002 ¹ K
Fg.Nr. 6N..W..000 001→	07.97-12.98	0 450 90 F 5316 ¹ K
	05.97-12.99	0 450 90 F 5316 ¹ K
	07.95-12.99	1 987 43 M 2012 I
		1 987 43 R 2312 ⁸ I
	04.97-12.98 H25	1 987 43 M 2012 I
		1 987 43 R 2312 ⁸ I

1,6 55 AHS	03.96-12.99	0 451 10 P 3318 O
		1 457 43 S 3540 L
Fg.Nr. →6N-V 300 000	03.96-04.97	0 450 90 F 5002 ¹ K
Fg.Nr. 6N..W..000 001→	05.97-12.99	0 450 90 F 5316 ¹ K
	03.96-12.99	1 987 43 M 2012 I
		1 987 43 R 2312 ⁸ I

1,6 55 ALM	07.98-09.01	0 451 10 P 3318 O
		1 457 43 S 3540 L
		0 450 90 F 5316 ¹ K
	H25	1 987 43 M 2012 I
		1 987 43 R 2312 ⁸ I

1,6 55 1F	11.95-09.97	0 451 10 P 3314 O
	05.96-09.97	1 457 43 S 3264 L
Fg.Nr. →6K..W..516 000	11.95-06.97	0 450 90 F 5002 ¹ K
Fg.Nr. 6K..W..516 001→	07.97-09.97	0 450 90 F 5316 ¹ K
	11.95-09.97 H25	1 987 43 M 2012 I
		1 987 43 R 2312 ⁸ I

1,6 63/77 CFNA <D3H>; CFNB <DP9>	09.10→	F 026 40 P 7079 O
		F 026 40 F 3006 ¹ K
		1 987 43 M 2057 I

1,6 74 AEH	10.99-09.01	0 451 10 P 3314 O
		1 457 43 S 3058 L
		0 450 90 F 5316 ¹ K
	H25	1 987 43 M 2012 I
		1 987 43 R 2312 ⁸ I



1,6 74 AFT	12.95-08.99	0 451 10 P 3314 O
		1 457 43 S 3264 L
Fg.Nr. →6K..W..516 000	12.95-06.97	0 450 90 F 5002 ¹ K
Fg.Nr. 6K..W..516 001→	07.97-08.99	0 450 90 F 5316 ¹ K
	12.95-08.99 H25	1 987 43 M 2012 I
		1 987 43 R 2312 ⁸ I

1,6 74 AKL	10.99-09.01	0 451 10 P 3314 O
		1 457 43 S 3058 L
		0 450 90 F 5316 ¹ K
	H25	1 987 43 M 2012 I
		1 987 43 R 2312 ⁸ I

1,6 74 APF	03.00-10.00	0 451 10 P 3314 O
		1 457 43 S 3058 L
		0 450 90 F 5316 ¹ K
	H25	1 987 43 M 2012 I
		1 987 43 R 2312 ⁸ I

1,6 74 AUR	07.00-09.01	0 451 10 P 3314 O
		1 457 43 S 3058 L
		0 450 90 F 5316 ¹ K
	H25	1 987 43 M 2012 I
		1 987 43 R 2312 ⁸ I

1,6 74 BAH	07.03-05.07	0 451 10 P 3318 O
		1 457 43 S 3059 L
PR-Nr. 0F2	07.03-05.07	0 450 90 F 5316 ¹ K
PR-Nr. 1A1	07.03-05.07	0 450 90 F 5925 ¹ K
	07.03-05.07	1 987 43 M 2057 I
		1 987 43 R 2357 ⁸ I

1,6 74 BAH <EA111>	05.02-07.06	0 450 90 F 5925 ¹ K
-------------------------------------	-------------	--

1,6 77 BTS	05.06-12.09	1 457 42 P 9301 O
		F 026 40 S 0035 L
		3BA,DRR F 026 40 F 3008 ¹ K
		4BA,DRR F 026 40 F 3006 ¹ K
		1 987 43 M 2057 I
		1 987 43 R 2357 ⁸ I

1,6 88 AJV	04.98-12.99	0 451 10 P 3318 O
		1 457 43 S 3716 L
		0 450 90 F 5316 ¹ K
		1 987 43 M 2012 I
		1 987 43 R 2312 ⁸ I

1,6 92 ARC	11.99-09.01	0 451 10 P 3318 O
		1 457 43 S 3716 L
		0 450 90 F 5316 ¹ K
	H25	1 987 43 M 2012 I
		1 987 43 R 2312 ⁸ I
	H30	1 987 43 R 2300 ⁸ I





Polo 1.6 BiFuel

1,6 60 CNKA <DP1>	01.11→	F 026 40 P 7079 O
		F 026 40 S 0035 L

Polo 1.6 i

1,6 74 AFX	12.94-10.03	0 450 90 F 5002 ¹ K
	10.98-10.02	1 987 43 M 2012 I

1,6|74|BAH

06.05→	3BA,DRR	F 026 40 F 3008 ¹ K
	4BA,DRR	F 026 40 F 3006 ¹ K
		1 987 43 M 2057 I
		1 987 43 R 2357 ⁸ I

Polo 1.6 TDI

1,6 55/66/77 CAYA <D37>; CAYB <D36>; CAYC <D38>	06.09→	F 026 40 P 7023 O
		F 026 40 S 0156 L
		0 450 90 N 6500 ¹ K
	06.09-05.10	1 987 43 M 2057 I
		1 987 43 R 2357 ⁸ I

Polo 1.6 16V

1,6 92 AVY	05.00-09.01	0 451 10 P 3318 O
		1 457 43 S 3716 L
		0 450 90 F 5316 ¹ K
	H25	1 987 43 M 2012 I
		1 987 43 R 2312 ⁸ I
	H30	1 987 43 R 2300 ⁸ I

Polo 1.7 SDI

1,7 42/44 AHG; AKU	04.97-09.01	0 451 10 P 3289 O
	04.97-12.99	1 457 43 S 3712 L
	10.99-09.01	1 457 43 S 3538 L
	04.97-12.99	0 450 90 N 6274 ¹ K
Fg.Nr. →6N-Y 050 000	10.99-10.99	0 450 90 N 6274 ¹ K
Fg.Nr. 6N-Y 500 001→	10.99-09.01	0 450 90 N 6373 ¹ K
	04.97-12.99	1 987 43 M 2012 I
		1 987 43 R 2312 ⁸ I
	10.99-09.01	H25 1 987 43 M 2012 I
		1 987 43 R 2312 ⁸ I
	H30	1 987 43 R 2300 ⁸ I

1,7|44|AKW

11.97-08.99	0 451 20 P 3012 O
	1 457 43 S 3264 L
	0 450 90 N 6274 ¹ K
H25	1 987 43 M 2012 I
	1 987 43 R 2312 ⁸ I



Polo 1.8

1,8 66 ADD	03.98-09.01	0 451 10 P 3314 O
		1 457 43 S 3264 L
		0 450 90 F 5316 ¹ K
	H25	1 987 43 M 2012 I
		1 987 43 R 2312 ⁸ I

Polo 1.8 GTI

1,8 110/132 BBU; BJX	09.05-11.09	0 451 10 P 3314 O
		1 457 43 S 3575 L
		3BA,DRR F 026 40 F 3008 ¹ K
		4BA,DRR F 026 40 F 3006 ¹ K
		1 987 43 M 2057 I
		1 987 43 R 2357 ⁸ I

Polo 1.8 i

1,8 82 AFV	10.98-10.02	1 987 43 M 2012 I
-------------------	-------------	---------------------------------

Polo 1.8 Mi

1,8 66 ADD <AP827 M31>	01.01-12.03	0 451 10 P 3314 O
-------------------------------------	-------------	---------------------------------

Polo 1.9 D

1,9 47 AEF	10.94-09.01	0 451 10 P 3289 O
	10.94-12.99	1 457 43 S 3712 L
	10.99-09.01	1 457 43 S 3538 L
	10.94-12.99	0 450 90 N 6274 ¹ K
Fg.Nr. →6N-Y 050 000	10.99-10.99	0 450 90 N 6274 ¹ K
Fg.Nr. 6N-Y 500 001→	10.99-09.01	0 450 90 N 6373 ¹ K
	10.94-12.99	1 987 43 M 2012 I
		1 987 43 R 2312 ⁸ I
	10.99-09.01	H25 1 987 43 M 2012 I
		1 987 43 R 2312 ⁸ I
	H30	1 987 43 R 2300 ⁸ I

1,9|47|AGD

07.96-12.99	0 451 10 P 3289 O
	1 457 43 S 3712 L
	0 450 90 N 6274 ¹ K
	1 987 43 M 2012 I
	1 987 43 R 2312 ⁸ I

1,9|47|1Y

01.96-04.96	0 451 20 P 3012 O
	1 457 43 S 3264 L
	0 450 90 N 6267 ¹ K
H25	1 987 43 M 2012 I
	1 987 43 R 2312 ⁸ I

Polo 1.9 SD

1,9 47 1Y <M9N>	05.96→	1 457 43 S 3008 L
		0 450 90 N 6274 ¹ K





Polo 1.9 SDI

1,9 47 AEY			
12.95-08.99		0 451 20 P 3012	O
		1 457 43 S 3264	L
		0 450 90 N 6274 ¹	K
	H25	1 987 43 M 2012	I
		1 987 43 R 2312 ⁸	I

1,9 47 AGD			
10.99-09.01		0 451 10 P 3289	O
		1 457 43 S 3538	L

Fg.Nr. →6N-Y050 000	10.99-10.99	0 450 90 N 6274 ¹	K
Fg.Nr. 6N-Y500 001→	10.99-09.01	0 450 90 N 6373 ¹	K
	10.99-09.01	H25 1 987 43 M 2012	I
		1 987 43 R 2312 ⁸	I
	H30	1 987 43 R 2300 ⁸	I

1,9 47 ASX			
10.99-09.01		0 451 10 P 3289	O
		1 457 43 S 3538	L
Fg.Nr. →6N-Y050 000	10.99-10.99	0 450 90 N 6274 ¹	K
Fg.Nr. 6N-Y500 001→	10.99-09.01	0 450 90 N 6373 ¹	K
	10.99-09.01	H25 1 987 43 M 2012	I
		1 987 43 R 2312 ⁸	I
	H30	1 987 43 R 2300 ⁸	I

1,9 47 ASY			
09.01→		1 457 42 P 9192	O
09.01-12.09		1 457 43 S 3575	L
11.03-05.07	STZ	1 457 43 S 3575	L
	STZ	1 457 43 S 3575	L
09.01→		0 450 90 N 6322 ¹	K
09.01-12.09		1 987 43 M 2057	I
		1 987 43 R 2357 ⁸	I

1,9 50 AGP			
10.99-09.01		1 457 42 P 9619	O
		1 457 43 S 3058	L
		0 450 90 N 6409 ¹	K
	H25	1 987 43 M 2012	I
		1 987 43 R 2312 ⁸	I

Polo 1.9 SDI, TDI

1,9 50/66/81 ALH; AQM; ASV			
10.99-09.01		1 457 42 P 9619	O
		1 457 43 S 3058	L
		0 450 90 N 6409 ¹	K
	H25	1 987 43 M 2012	I
		1 987 43 R 2312 ⁸	I

Polo 1.9 TDI

1,9 66 AGR			
10.99-09.01		1 457 42 P 9619	O
		1 457 43 S 3058	L
09.00→		1 457 43 S 3008	L
10.99-09.01		0 450 90 N 6409 ¹	K
09.00→		0 450 90 N 6274 ¹	K
		0 450 90 N 6373 ¹	K
10.99-09.01	H25	1 987 43 M 2012	I
		1 987 43 R 2312 ⁸	I



1,9 66 AHU			
07.96-08.99		0 451 10 P 3347	O
		1 457 43 S 3264	L
		0 450 90 N 6274 ¹	K
	H25	1 987 43 M 2012	I
		1 987 43 R 2312 ⁸	I

1,9 66 AHU <M2K>			
03.99-08.00		1 457 43 S 3008	L
		0 450 90 N 6274 ¹	K

1,9 66 ALE			
11.97-08.99		0 451 10 P 3347	O
		1 457 43 S 3264	L
		0 450 90 N 6274 ¹	K
	H25	1 987 43 M 2012	I
		1 987 43 R 2312 ⁸	I

1,9 74 ATD			
09.01-12.09		1 457 42 P 9192	O
		1 457 43 S 3575	L
07.03-05.07	STZ	1 457 43 S 3575	L
	STZ	1 457 43 S 3575	L
		0 450 90 N 6322 ¹	K
Fg.Nr. →9N..6..080 000	04.05-07.05	0 450 90 N 6322 ¹	K
Fg.Nr. 9N..6..080 001→	08.05-12.09	0 450 90 N 6426 ¹	K
	09.01-12.09	1 987 43 M 2057	I
		1 987 43 R 2357 ⁸	I

1,9 74 BMT			
05.06-12.09		1 457 42 P 9192	O
		1 457 43 S 3575	L
		0 450 90 N 6426 ¹	K
		1 987 43 M 2057	I
		1 987 43 R 2357 ⁸	I

1,9 74/96 AXR; BLT			
09.01-12.09		1 457 42 P 9192	O
		1 457 43 S 3575	L
		0 450 90 N 6322 ¹	K
Fg.Nr. →9N..6..080 000	04.05-07.05	0 450 90 N 6322 ¹	K
Fg.Nr. 9N..6..080 001→	08.05-12.09	0 450 90 N 6426 ¹	K
	09.01-12.09	1 987 43 M 2057	I
		1 987 43 R 2357 ⁸	I

1,9 81 AFN			
06.98-08.99		0 451 10 P 3290	O
		1 457 43 S 3264	L
		0 450 90 N 6274 ¹	K
	H25	1 987 43 M 2012	I
		1 987 43 R 2312 ⁸	I

1,9 96 ASZ			
11.03-12.09		1 457 42 P 9192	O
		1 457 43 S 3575	L
		0 450 90 N 6322 ¹	K
Fg.Nr. →9N..6..080 000	04.05-07.05	0 450 90 N 6322 ¹	K
Fg.Nr. 9N..6..080 001→	08.05-12.09	0 450 90 N 6426 ¹	K
	11.03-12.09	1 987 43 M 2057	I
		1 987 43 R 2357 ⁸	I



**Polo 2.0****2,0|85|ADC**

08.99-09.01	0 451 10 P 3314	O
	1 457 43 S 3264	L
	0 450 90 F 5316 ¹	K
H25	1 987 43 M 2012	I
	1 987 43 R 2312 ⁸	I

2,0|85|BBX

05.02-05.07	0 451 10 P 3314	O
07.03-05.07	1 457 43 S 3575	L
PR-Nr. OF2	0 450 90 F 5316 ¹	K
PR-Nr. 1A1	0 450 90 F 5925 ¹	K
07.03-05.07	1 987 43 M 2057	I
	1 987 43 R 2357 ⁸	I

Polo 2.0 Mi**2,0|85|ADC <AP827 M30>**

02.01-04.02	0 451 10 P 3314	O
-------------	-----------------	---

Scirocco**Scirocco 1.4 TSI****1,4|90|CAXA <D4X>**

11.08→	F 026 40 P 7079	O
	1 987 42 S 9405	L
	0 450 90 F 5959 ¹	K
	1 987 43 M 2097	I
	1 987 43 R 2397 ⁸	I
RLE	1 987 43 R 2597 ⁸	I

1,4|118|CAVD <D4L>

08.08→	F 026 40 P 7079	O
	KZ0 1 987 42 S 9404	L
	0 450 90 F 5959 ¹	K
	1 987 43 M 2097	I
	1 987 43 R 2397 ⁸	I
RLE	1 987 43 R 2597 ⁸	I

Scirocco 1.6**1,6|55|EW**

01.83-07.92	0 451 10 P 3033	O
	1 457 42 S 9030	L
CSA	0 450 90 F 4149 ¹	K

Scirocco 1.8**1,8|66|EX**

08.83-07.92	0 451 10 P 3033	O
	1 457 42 S 9030	L
CSA	0 450 90 F 4149 ¹	K

1,8|68-70|JH

05.83-07.92	0 451 10 P 3033	O
	1 457 42 S 9957	L
XXX	0 450 90 F 5066 ¹	K

1,8|82|DX

08.82-07.92	0 451 10 P 3033	O
	1 457 42 S 9957	L
01.86-07.92	0 450 90 F 5145 ¹	K

Scirocco 1.8 16V**1,8|95|PL**

02.86-07.92	0 451 10 P 3033	O
	1 457 42 S 9957	L
	0 450 90 F 5145 ¹	K

Scirocco 2.0 TDI**2,0|100/103/125|CFGB <D93>; CFHB <D94>; CFHC <D91>**

02.11→	F 026 40 P 7023	O
	KZ0 1 987 42 S 9404	L
	F 026 40 N 2006	K
	1 987 43 M 2097	I
	1 987 43 R 2397 ⁸	I
RLE	1 987 43 R 2597 ⁸	I

2,0|103/125|CBBB; CBDB

10.08→	1 457 42 P 9192	O
	KZ0 1 987 42 S 9404	L
	F 026 40 N 2006	K
	1 987 43 M 2097	I
	1 987 43 R 2397 ⁸	I
RLE	1 987 43 R 2597 ⁸	I

Scirocco 2.0 TSI**2,0|147|CAWB <D2L>**

08.08-11.09	F 026 40 P 7080	O
	1 987 42 S 9404	L
	0 450 90 F 5959 ¹	K
	1 987 43 M 2097	I
	1 987 43 R 2397 ⁸	I
RLE	1 987 43 R 2597 ⁸	I

2,0|155|CCZB

11.09→	F 026 40 P 7080	O
	1 987 42 S 9404	L
	0 450 90 F 5959 ¹	K
	1 987 43 M 2097	I
	1 987 43 R 2397 ⁸	I
RLE	1 987 43 R 2597 ⁸	I

2,0|188/195|CDLA; CDLC

11.09→	1 457 42 P 9243	O
	F 026 40 S 0178	L
	0 450 90 F 5959 ¹	K
	1 987 43 M 2097	I
	1 987 43 R 2397 ⁸	I
RLE	1 987 43 R 2597 ⁸	I

Sharan**Sharan 1.4 TSI****1,4|110|CAVA <D31>**

05.10→	F 026 40 P 7079	O
	KZ0 1 987 42 S 9404	L
	1 987 43 M 2097	I
	1 987 43 R 2397 ⁸	I
RLE	1 987 43 R 2597 ⁸	I





Sharan 1.8 T

1,8 110 AJH	11.97-02.00	0 451 10 P 3314 O
		1 457 43 S 3742 L
		0 450 90 F 5264 ¹ K
		1 987 43 M 2028 I
		1 987 43 R 2328 ⁸ I

1,8 110 AWC	05.00-03.10	0 451 10 P 3314 O
		1 457 43 S 3089 L
		0 450 90 F 5264 ¹ K
		1 987 43 M 2028 I
		1 987 43 R 2328 ⁸ I

Sharan 1.9 TDI

1,9 66 AHU	07.96-02.00	0 451 10 P 3347 O
		1 457 43 S 3742 L
		0 450 90 N 6267 ¹ K
		1 987 43 M 2028 I
		1 987 43 R 2328 ⁸ I

1,9 66 ANU	03.99-02.00	1 457 42 P 9619 O
	04.00-03.10	1 457 42 P 9619 O
	03.99-02.00	1 457 43 S 3742 L
	04.00-03.10	1 457 43 S 3089 L
	03.99-02.00	0 450 90 N 6334 ¹ K
	04.00-03.10	0 450 90 N 6334 ¹ K
	03.99-02.00	1 987 43 M 2028 I
		1 987 43 R 2328 ⁸ I
	04.00-03.10	1 987 43 M 2028 I
		1 987 43 R 2328 ⁸ I

1,9 66 IZ	09.95-07.96	0 451 10 P 3347 O
		1 457 43 S 3742 L
		0 450 90 N 6267 ¹ K
		1 987 43 M 2028 I
		1 987 43 R 2328 ⁸ I

1,9 81 AFN	09.96-02.00	0 451 10 P 3290 O
		1 457 43 S 3742 L
		0 450 90 N 6267 ¹ K
		1 987 43 M 2028 I
		1 987 43 R 2328 ⁸ I

1,9 81 AVG	08.99-02.00	0 451 10 P 3290 O
		1 457 43 S 3742 L
		0 450 90 N 6267 ¹ K
		1 987 43 M 2028 I
		1 987 43 R 2328 ⁸ I

1,9 96 ASZ	11.02-03.10	1 457 42 P 9192 O
		1 457 43 S 3089 L
		0 450 90 N 6334 ¹ K
		1 987 43 M 2028 I
		1 987 43 R 2328 ⁸ I



1,9 110 BTB	01.05-06.06	1 457 42 P 9192 O
		1 457 43 S 3089 L
		0 450 90 N 6334 ¹ K
		1 987 43 M 2028 I
		1 987 43 R 2328 ⁸ I

Sharan 1.9 TDI, TDI 4 Motion

1,9 85 AUU	05.00-03.10	1 457 42 P 9619 O
		1 457 43 S 3089 L
		0 450 90 N 6334 ¹ K
		1 987 43 M 2028 I
		1 987 43 R 2328 ⁸ I

1,9 85 BVK	11.05-03.10	1 457 42 P 9619 O
		1 457 43 S 3089 L
		0 450 90 N 6334 ¹ K
		1 987 43 M 2028 I
		1 987 43 R 2328 ⁸ I

Sharan 2.0

2,0 85 ADY	09.95-02.00	0 451 10 P 3314 O
		1 457 43 S 3742 L
		0 450 90 F 5264 ¹ K
		1 987 43 M 2028 I
		1 987 43 R 2328 ⁸ I

2,0 85 ATM	05.00-03.10	0 451 10 P 3314 O
		1 457 43 S 3089 L
		0 450 90 F 5264 ¹ K
		1 987 43 M 2028 I
		1 987 43 R 2328 ⁸ I

Sharan 2.0 TDI

2,0 100/103 BRT; BVH	11.05-03.10	1 457 42 P 9192 O
		1 457 43 S 3089 L
		0 450 90 N 6334 ¹ K
		1 987 43 M 2028 I
		1 987 43 R 2328 ⁸ I

Sharan 2.0 TDI, TDI 4 Motion

2,0 100/103/125 CFFA <D94>; CFFB <D91>; CFGB <D93>	05.10→	F 026 40 P 7023 O
		KZQ 1 987 42 S 9404 L
		1 987 43 M 2097 I
		1 987 43 R 2397 ⁸ I
		RLE 1 987 43 R 2597 ⁸ I

Sharan 2.0 TSI

2,0 147 CCZA <D2L>	11.10→	F 026 40 P 7080 O
		1 987 42 S 9404 L
		1 987 43 M 2097 I
		1 987 43 R 2397 ⁸ I
		RLE 1 987 43 R 2597 ⁸ I





Sharan 2.8

2,8 128 AAA			
Mot.Nr. AAA 176 890→	12.95-02.00	1 457 42 P 9142	O
Mot.Nr. →AAA 176 889	09.95-10.95	1 457 42 P 9103	O
	09.95-02.00	1 457 43 S 3742	L
		0 450 90 F 5264 ¹	K
		1 987 43 M 2028	I
		1 987 43 R 2328 ⁸	I

Sharan 2.8 , syncro

2,8 128 AMY			
	04.98-02.00	1 457 42 P 9142	O
		1 457 43 S 3742	L
		0 450 90 F 5264 ¹	K
		1 987 43 M 2028	I
		1 987 43 R 2328 ⁸	I

Sharan 2.8 , 4 Motion

2,8 150 AYL			
	05.00-03.10	1 457 42 P 9192	O
		1 457 43 S 3089	L
		0 450 90 F 5264 ¹	K
		1 987 43 M 2028	I
		1 987 43 R 2328 ⁸	I

Sharan 2.8 syncro

2,8 128 AAA			
	07.96-02.00	1 457 42 P 9142	O
		1 457 43 S 3742	L
		0 450 90 F 5264 ¹	K
		1 987 43 M 2028	I
		1 987 43 R 2328 ⁸	I

Taro

Taro 1.8

1,8 61 2Y			
Fg.Nr. 7A-L9503 251→	01.90-09.94	0 986 45 P 2003	O

Taro 2.2

2,2 69 4Y			
Fg.Nr. 7A-L9503 251→	01.90-07.94	0 986 45 P 2003	O

Taro 2.4

2,4 84,4 22R			
	06.89-03.97	1 457 43 S 3952	L

Taro 2.4 D, D 4x4

2,4 58-61 2L			
	04.89-03.97	0 986 45 P 2062	O
		1 457 43 S 3734	L



Tiguan

Tiguan 1.4 TSI

1,4 90 CAXA <D4X>			
	08.10-05.11	1 987 42 S 9405	L
		1 987 43 M 2097	I
		1 987 43 R 2397 ⁸	I
		RLE 1 987 43 R 2597 ⁸	I

1,4|110|CAVA <D31>

	05.08→	F 026 40 P 7079	O
		KZØ 1 987 42 S 9404	L
		1 987 43 M 2097	I
		1 987 43 R 2397 ⁸	I
		RLE 1 987 43 R 2597 ⁸	I

Tiguan 1.4 TSI 4 Motion

1,4|110|BWK <D31>

	11.07-11.08	1 457 42 P 9301	O
		KZØ 1 987 42 S 9404	L
		1 987 43 M 2097	I
		1 987 43 R 2397 ⁸	I
		RLE 1 987 43 R 2597 ⁸	I

1,4|110|CAVA <D31>

	03.08-10.08	1 457 42 P 9301	O
	11.08→	F 026 40 P 7079	O
	03.08→	KZØ 1 987 42 S 9404	L
		1 987 43 M 2097	I
		1 987 43 R 2397 ⁸	I
		RLE 1 987 43 R 2597 ⁸	I

Tiguan 2.0 FSI 4 Motion, TSI

2,0|125/147|CCTA <D2L>; CCTB <D6G>

	11.07→	F 026 40 P 7080	O
		1 987 42 S 9404	L
		1 987 43 M 2097	I

Tiguan 2.0 TDI, TDI 4 Motion

2,0|81/103/125|CFFD <D96>; CFGB <D93>; CLJA <D91>

	05.10-05.11	F 026 40 P 7023	O
		KZØ 1 987 42 S 9404	L
		1 987 43 M 2097	I
		1 987 43 R 2397 ⁸	I
		RLE 1 987 43 R 2597 ⁸	I

2,0|100/103/120/125|CBAA <D94>; CBAB <D91>; CBBA <D95>; CBBB <D93>

	11.07→	1 457 42 P 9192	O
		KZØ 1 987 42 S 9404	L
		F 026 40 N 2006	K
		1 987 43 M 2097	I
		1 987 43 R 2397 ⁸	I
		RLE 1 987 43 R 2597 ⁸	I





◀ Tiguan 2.0 TDI, TDI 4 Motion

2,0 103 CFFB <D91>			
11.09→	F 026 40 P 7023	O	
	KZQ 1987 42 S 9404	L	
	F 026 40 N 2006	K	
	1987 43 M 2097	I	
	1987 43 R 2397 ⁸	I	
	RLE 1987 43 R 2597 ⁸	I	

Tiguan 2.0 TDI 4 Motion

2,0 100 CFFA <D94>			
05.10-05.11	F 026 40 P 7023	O	
	KZQ 1987 42 S 9404	L	
	1987 43 M 2097	I	
	1987 43 R 2397 ⁸	I	
	RLE 1987 43 R 2597 ⁸	I	

Tiguan 2.0 TSI 4 Motion

2,0 125/147 CAWA <D6G>; CAWB <D2L>			
11.07-11.09	F 026 40 P 7080	O	
	1987 42 S 9404	L	
	1987 43 M 2097	I	
	1987 43 R 2397 ⁸	I	
	RLE 1987 43 R 2597 ⁸	I	

2,0 125/147 CCZA <D2L>; CCZC <D6G>			
11.09→	F 026 40 P 7080	O	
	1987 42 S 9404	L	
	1987 43 M 2097	I	
	1987 43 R 2397 ⁸	I	
	RLE 1987 43 R 2597 ⁸	I	

Touareg

Touareg 2.5 TDI

2,5 120/128 BAC; BLK; BPD; BPE			
01.03-05.10	1457 42 P 9192	O	
	STZ 1987 42 S 9190	L	
	0450 90 N 6467 ¹	K	
	1987 43 R 2431 ⁸	I	

Touareg 3.0 FSI Hybrid

3,0 245 CGEA			
03.10→	1457 42 P 9268	O	

Touareg 3.0 TDI

3,0 150 CASD <D1Q>			
11.10→	F 026 40 P 7066	O	

3,0 155 BUN			
04.06-11.07	F 026 40 P 7002	O	
	STZ 1987 42 S 9190	L	
	F 026 40 N 2015	K	
	1987 43 R 2431 ⁸	I	

3,0 155/176 CASB; CASC			
Fg.Nr. →7L..8..070 000	11.07-03.08	F 026 40 P 7002	O
Fg.Nr. 7L..8..070 001→	04.08-05.10	F 026 40 P 7066	O
	11.07-05.10	STZ 1987 42 S 9190	L
		F 026 40 N 2015	K
		1987 43 R 2431 ⁸	I



3,0 165 BKS			
	11.04-11.06	F 026 40 P 7002	O
Fg.Nr. →7L..8..059 000	12.06-01.08	F 026 40 P 7002	O
Fg.Nr. 7L..8..059 001→	02.08-05.08	F 026 40 P 7066	O
	11.04-05.08	STZ 1987 42 S 9190	L
		F 026 40 N 2015	K
		1987 43 R 2431 ⁸	I

3,0 165 CATA			
	05.09-05.10	F 026 40 P 7066	O
		STZ 1987 42 S 9190	L
		F 026 40 N 2015	K
		1987 43 R 2431 ⁸	I

3,0 176 CASA			
Fg.Nr. →7L..8..070 000	11.07-03.08	F 026 40 P 7002	O
Fg.Nr. 7L..8..070 001→	04.08-05.10	F 026 40 P 7066	O
	11.07-05.10	STZ 1987 42 S 9190	L
		F 026 40 N 2015	K
		1987 43 R 2431 ⁸	I

3,0 176 CASA <D50>			
	01.10→	F 026 40 P 7066	O

Touareg 3.2

3,2 162 AZZ; BAA; BKJ; BMV; BMX; BRJ			
	11.02-11.06	1457 42 P 9142	O
		STZ 1987 42 S 9190	L
		1987 43 R 2431 ⁸	I

Touareg 3.6 FSI

3,6 183/206 CGRA; CMTA			
	04.10→	1457 42 P 9142	O

3,6 206 BHK; BHL			
	08.05-05.10	1457 42 P 9142	O
		STZ 1987 42 S 9190	L
		1987 43 R 2431 ⁸	I

Touareg 4.2

4,2 228 AXQ			
	12.02-11.06	STZ 1987 42 S 9190	L
		1987 43 R 2431 ⁸	I

4,2 228 BHX			
	04.03-11.06	STZ 1987 42 S 9190	L
		1987 43 R 2431 ⁸	I

Touareg 4.2 FSI

4,2 257 BAR			
	06.06-05.10	F 026 40 P 7011	O
		STZ 1987 42 S 9190	L
		1987 43 R 2431 ⁸	I

4,2 265 CGNA <DH3>			
	01.11→	F 026 40 P 7011	O

Touareg 4.2 TDI

4,2 250 CKDA			
	01.10→	F 026 40 P 7066	O





Touareg 5.0 TDI

5,0 230 BLE	12.06-05.10	STZ	1987 42 S 9190	L
			1457 43 N 1729	K
			1987 43 R 2431 ⁸	I

5,0 230 BWF	12.06-02.09	STZ,ZE	1987 42 S 9190	L
			1987 43 R 2431 ⁸	I

5,0 258 CBWA	08.07-05.10	STZ	1987 42 S 9190	L
			1457 43 N 1729	K
			1987 43 R 2431 ⁸	I

Touareg 6.0

6,0 316/331 BJN;CFRA	08.04-05.10	STZ	1987 42 S 9190	L
			1987 43 R 2431 ⁸	I

Touareg 50 TDI

5,0 230 AYH	11.02-11.06	STZ,ZE	1987 42 S 9190	L	
			2FE	1457 43 N 1718	K
				1987 43 R 2431 ⁸	I

5,0 230 BKW	11.03-11.04		1987 43 R 2431 ⁸	I
-------------	-------------	--	------------------------------------	---

5,0 230 BLE	11.04-11.06	STZ,ZE	1987 42 S 9190	L
			1457 43 N 1729	K
			1987 43 R 2431 ⁸	I

5,0 230 BWF	02.06-11.06	STZ	1987 42 S 9190	L	
			2FE	1457 43 N 1718	K
				1987 43 R 2431 ⁸	I

Touran

Touran 1.2 TSI

1,2 77 CBZB <DB0>	05.10→		1987 42 S 9405	L
			0450 90 F 5959 ¹	K
			1987 43 R 2397 ⁸	I
		RLE	1987 43 R 2597 ⁸	I

Touran 1.4 TSI

1,4 103 BMY	02.06-12.08		1457 42 P 9301	O
		KZO	1987 42 S 9404	L
	02.06-11.06		0450 90 F 5959 ¹	K
		4BA	F 026 40 F 3006 ¹	K
	11.06-12.08	6BA	0450 90 F 5959 ¹	K
			1987 43 M 2097	I
	02.06-12.08		1987 43 R 2397 ⁸	I
		RLE	1987 43 R 2597 ⁸	I

1,4|103/125|CAVB <D4P>;CAVC <D4R>

11.08-05.10	TW	F 026 40 P 7079	O
		1457 42 P 9301	O
11.08→	KZO	1987 42 S 9404	L
11.08-05.10	4BA	F 026 40 F 3006 ¹	K
	6BA	0450 90 F 5959 ¹	K
05.10→		0450 90 F 5959 ¹	K
11.08-05.10		1987 43 M 2097	I
11.08→		1987 43 R 2397 ⁸	I
	RLE	1987 43 R 2597 ⁸	I

1,4|125|BLG

11.06-11.08		1457 42 P 9301	O
	KZO	1987 42 S 9404	L
	4BA	F 026 40 F 3006 ¹	K
	6BA	0450 90 F 5959 ¹	K
		1987 43 M 2097	I
		1987 43 R 2397 ⁸	I
	RLE	1987 43 R 2597 ⁸	I

Touran 1.4 TSI EcoFuel

1,4|110|CDGA <D42>

05.09-05.10		F 026 40 P 7079	O
05.09→	KZO	1987 42 S 9404	L
05.09-05.10	4BA	F 026 40 F 3006 ¹	K
	6BA	0450 90 F 5959 ¹	K
05.10→		0450 90 F 5959 ¹	K
05.09-05.10		1987 43 M 2097	I
05.09→		1987 43 R 2397 ⁸	I
	RLE	1987 43 R 2597 ⁸	I

Touran 1.6

1,6|75|BGU

07.03-05.05		0451 10 P 3314	O
	KZO	1987 42 S 9405	L
	KZO	1457 43 S 3576	L
	DTV	0450 90 F 5316 ¹	K
	DTV	0450 90 F 5925 ¹	K
		1987 43 M 2097	I
		1987 43 R 2397 ⁸	I
	RLE	1987 43 R 2597 ⁸	I

1,6|75|BSE;BSF

06.05-05.10		0451 10 P 3314	O
06.05-11.06	KZO	1987 42 S 9405	L
	KZO	1457 43 S 3576	L
11.06-05.10		1987 42 S 9405	L
06.05-11.06	DTV	0450 90 F 5316 ¹	K
	DTV	0450 90 F 5925 ¹	K
11.06-05.10	4BA	F 026 40 F 3006 ¹	K
	6BA	0450 90 F 5959 ¹	K
06.05-05.10		1987 43 M 2097	I
		1987 43 R 2397 ⁸	I
	RLE	1987 43 R 2597 ⁸	I





Touran 1.6 FSI

1,6 85 BAG			
	02.03-05.04	1 457 42 P 9301	O
Fg.Nr. →1T..4..020 000	02.03-07.03	1 987 42 S 9403	L
Fg.Nr. 1T..4..020 001→	08.03-05.04	1 457 43 S 3315	L
	02.03-05.04	0 450 90 F 5959 ¹	K
		1 987 43 M 2097	I
		1 987 43 R 2397 ⁸	I
	RLE	1 987 43 R 2597 ⁸	I

1,6 85 BLF			
	02.05-01.07	1 457 42 P 9301	O
		1 457 43 S 3315	L
	02.05-11.06	0 450 90 F 5959 ¹	K
	11.06-01.07	4BA F 026 40 F 3006 ¹	K
		6BA 0 450 90 F 5959 ¹	K
	02.05-01.07	1 987 43 M 2097	I
		1 987 43 R 2397 ⁸	I
	RLE	1 987 43 R 2597 ⁸	I

1,6 85 BLP			
	05.04-05.05	1 457 42 P 9301	O
		1 457 43 S 3315	L
		0 450 90 F 5959 ¹	K
		1 987 43 M 2097	I
		1 987 43 R 2397 ⁸	I
	RLE	1 987 43 R 2597 ⁸	I

Touran 1.6 TDI

1,6 66/77 CAYB <D36>; CAYC <D38>			
	05.10→	F 026 40 P 7023	O
		KZO 1 987 42 S 9404	L
		F 026 40 N 2006	K
		1 987 43 R 2397 ⁸	I
	RLE	1 987 43 R 2597 ⁸	I

Touran 1.9 TDI

1,9 66 BRU			
	06.05-02.06	1 457 42 P 9192	O
		KZO 1 987 42 S 9404	L
Fg.Nr. →1T..6..047 274	06.05-08.05	1 457 07 N0007	K
Fg.Nr. 1T..6..047 275→	09.05-02.06	F 026 40 N 2006	K
	06.05-02.06	1 987 43 M 2097	I
		1 987 43 R 2397 ⁸	I
	RLE	1 987 43 R 2597 ⁸	I

1,9 66/77 BXE; BXF; BXJ			
	02.06-05.10	1 457 42 P 9192	O
		KZO 1 987 42 S 9404	L
		F 026 40 N 2006	K
		1 987 43 M 2097	I
		1 987 43 R 2397 ⁸	I
	RLE	1 987 43 R 2597 ⁸	I

1,9 74 AVQ			
	02.03-05.04	1 457 42 P 9192	O
		KZO 1 987 42 S 9404	L
		1 457 07 N0007	K
		1 987 43 M 2097	I
		1 987 43 R 2397 ⁸	I
	RLE	1 987 43 R 2597 ⁸	I



1,9 77 BKC			
	08.03-02.06	1 457 42 P 9192	O
		KZO 1 987 42 S 9404	L
Fg.Nr. →1T..6..047 274	08.03-08.05	1 457 07 N0007	K
Fg.Nr. 1T..6..047 275→	09.05-02.06	F 026 40 N 2006	K
	08.03-02.06	1 987 43 M 2097	I
		1 987 43 R 2397 ⁸	I
	RLE	1 987 43 R 2597 ⁸	I

1,9 77 BLS			
	11.05-05.10	1 457 42 P 9192	O
		KZO 1 987 42 S 9404	L
		F 026 40 N 2006	K
		1 987 43 M 2097	I
		1 987 43 R 2397 ⁸	I
	RLE	1 987 43 R 2597 ⁸	I

Touran 2.0 EcoFuel

2,0 80 BSX			
	02.06-05.10	0 451 10 P 3314	O
		1 987 42 S 9405	L
	02.06-11.06	DTV 0 450 90 F 5316 ¹	K
		DTV 0 450 90 F 5925 ¹	K
	11.06-05.10	4BA F 026 40 F 3006 ¹	K
		6BA 0 450 90 F 5959 ¹	K
	02.06-05.10	1 987 43 M 2097	I
		1 987 43 R 2397 ⁸	I
	RLE	1 987 43 R 2597 ⁸	I

Touran 2.0 FSI

2,0 110 AXW			
	10.03-05.04	1 457 42 P 9243	O
		KZO 1 987 42 S 9405	L
		KZO 1 457 43 S 3576	L
		0 450 90 F 5959 ¹	K
		1 987 43 M 2097	I
		1 987 43 R 2397 ⁸	I
	RLE	1 987 43 R 2597 ⁸	I

2,0 110 BLR; BLX; BLY			
	05.04-11.05	1 457 42 P 9243	O
		KZO 1 987 42 S 9405	L
		KZO 1 457 43 S 3576	L
		0 450 90 F 5959 ¹	K
		1 987 43 M 2097	I
		1 987 43 R 2397 ⁸	I
	RLE	1 987 43 R 2597 ⁸	I

2,0 110 BVY; BVZ			
	11.05-01.07	1 457 42 P 9243	O
		KZO 1 987 42 S 9405	L
		KZO 1 457 43 S 3576	L
	11.05-11.06	0 450 90 F 5959 ¹	K
	11.06-01.07	4BA F 026 40 F 3006 ¹	K
		6BA 0 450 90 F 5959 ¹	K
	11.05-01.07	1 987 43 M 2097	I
		1 987 43 R 2397 ⁸	I
	RLE	1 987 43 R 2597 ⁸	I



**Touran 2.0 TDI****2,0|81/103/125|CFHC <D91>; CFJA; CLCA <D96>**

05.10→	F 026 40 P 7023	O
	KZO 1 987 42 S 9404	L
	F 026 40 N 2006	K
	1 987 43 R 2397 ⁸	I
RLE	1 987 43 R 2597 ⁸	I

2,0|100/103|AZV;BKD

02.03-05.10	1 457 42 P 9192	O	
	KZO 1 987 42 S 9404	L	
11.06-05.10	F 026 40 N 2006	K	
Fg.Nr. →1T..6..047 274	02.03-08.05	1 457 07 N0007	K
Fg.Nr. 1T..6..047 275→	09.05-11.06	F 026 40 N 2006	K
	02.03-05.10	1 987 43 M 2097	I
		1 987 43 R 2397 ⁸	I
RLE	1 987 43 R 2597 ⁸	I	

2,0|103|BMM

06.05-05.10	1 457 42 P 9192	O	
	KZO 1 987 42 S 9404	L	
11.06-05.10	F 026 40 N 2006	K	
Fg.Nr. →1T..6..047 274	06.05-08.05	1 457 07 N0007	K
Fg.Nr. 1T..6..047 275→	09.05-11.06	F 026 40 N 2006	K
	06.05-05.10	1 987 43 M 2097	I
		1 987 43 R 2397 ⁸	I
RLE	1 987 43 R 2597 ⁸	I	

2,0|125|BMN

11.05-05.10	1 457 42 P 9192	O
	KZO 1 987 42 S 9404	L
	F 026 40 N 2006	K
	1 987 43 M 2097	I
	1 987 43 R 2397 ⁸	I
RLE	1 987 43 R 2597 ⁸	I

T3 (Bus,Transporter)**T3 (Bus,Transporter) 1.6 D Turbo, D Turbo Syncro****1,6|51|JX**

08.84-07.92	0 451 20 P 3012	O	
	1 457 42 S 9932	L	
Fg.Nr. 24..H..165 000→	07.87-07.92	VOW 0 450 90 N 6172 ¹	K
		VOW 0 450 90 N 6267 ¹	K

T3 (Bus,Transporter) 1.7 D**1,7|42|KY**

10.86-07.92	0 451 20 P 3012	O
	1 457 42 S 9994	L
	VOW 0 450 90 N 6172 ¹	K
	VOW 0 450 90 N 6267 ¹	K

T3 (Bus,Transporter) 1.9**1,9|44|DF**

08.82-07.92	0 451 10 P 3074	O
	SBE 1 457 42 S 9932	L

1,9|57|DG

09.82-07.92	0 451 10 P 3074	O
08.85-07.92	SBE,XXX 1 457 43 S 3749	L

**T3 (Bus,Transporter) 1.9 Syncro****1,9|57|DG**

02.85-07.92	0 451 10 P 3074	O
	CSA 0 450 90 F 4149 ¹	K

T3 (Bus,Transporter) 2.1**2,1|64|SR**

08.86-07.92	0 451 10 P 3074	O
	1 457 42 S 9890	L
	SBE,XXX 1 457 43 S 3749	L
	0 450 90 F 5264 ¹	K

2,1|68|SS

08.89-07.92	0 451 10 P 3074	O
	1 457 42 S 9890	L
	SBE,XXX 1 457 43 S 3749	L
	0 450 90 F 5264 ¹	K

2,1|70|MV

08.85-07.92	0 451 10 P 3074	O
	1 457 42 S 9890	L
	GRF 1 457 42 S 9890	L
	SBE,XXX 1 457 43 S 3749	L
	0 450 90 F 1005 ¹	K
	0 450 90 F 5264 ¹	K

2,1|82|DJ

07.85-07.92	0 451 10 P 3074	O
08.85-07.92	1 457 42 S 9890	L
	SBE,XXX 1 457 43 S 3749	L
07.85-07.92	0 450 90 F 5264 ¹	K

T3 (Bus,Transporter) 2.1 Syncro**2,1|64|SR**

10.86-07.92	0 451 10 P 3074	O
	XXX 1 457 43 S 3749	L
	0 450 90 F 5264 ¹	K

2,1|70|MV

08.85-07.92	0 451 10 P 3074	O
	GRF 1 457 42 S 9890	L
	SBE,XXX 1 457 43 S 3749	L
	XXX 1 457 43 S 3749	L
	0 450 90 F 5264 ¹	K

2,1|82|DJ

01.86-07.92	0 451 10 P 3074	O
	XXX 1 457 43 S 3749	L
	0 450 90 F 5264 ¹	K

T4 (Bus,Transporter)**T4 (Bus,Transporter) 1.8****1,8|49|PD**

12.90-07.92	0 451 10 P 3033	O
	STZ 1 457 42 S 9795	L
	STZ 1 457 42 S 9944	L
	CSA 0 450 90 F 4149 ¹	K





T4 (Bus,Transporter) 1.9 D, D Turbo

1,9 45/50 ABL; 1X			
	09.90-12.95	0 451 20 P 3223	O
	01.96-06.03	0 451 10 P 3290	O
Fg.Nr. →70..T..199 000	09.90-12.95	STZ 1 457 42 S 9795	L
		STZ 1 457 42 S 9944	L
Fg.Nr. 70..T..200 001→	01.96-06.03	1 457 43 S 3747	L
	09.90-06.03	0 450 90 N 6267 ¹	K
	07.94-06.03	1 987 43 M 2056	I

T4 (Bus,Transporter) 2.0

2,0 62 AAC			
	09.90-06.03	0 451 10 P 3033	O
Fg.Nr. →70..T..199 000	09.90-12.95	STZ 1 457 42 S 9795	L
		STZ 1 457 42 S 9944	L
Fg.Nr. 70..T..200 001→	01.96-06.03	1 457 43 S 3747	L
	09.90-06.03	0 450 90 F 5264 ¹	K
	07.94-06.03	1 987 43 M 2056	I

T4 (Bus,Transporter) 2.4 D

2,4 55 AJA			
	05.97-06.03	0 451 20 P 3087	O
		1 457 43 S 3747	L
		0 450 90 N 6267 ¹	K
		1 987 43 M 2056	I

2,4 57 AAB			
	09.90-05.98	0 451 20 P 3087	O
	10.92-12.95	1 457 42 S 9795	L
		SBE 1 457 42 S 9944	L
Fg.Nr. →70..T..199 000	09.90-12.95	STZ 1 457 42 S 9795	L
		STZ 1 457 42 S 9944	L
Fg.Nr. 70..T..200 001→	01.96-05.98	1 457 43 S 3747	L
	09.90-05.98	0 450 90 N 6267 ¹	K
	10.92-04.97	VOW 0 450 90 N 6172 ¹	K
		VOW 0 450 90 N 6267 ¹	K
	07.94-05.98	1 987 43 M 2056	I

T4 (Bus,Transporter) 2.4 D Syncro

2,4 57 AAB			
	11.92-09.98	0 451 20 P 3087	O
Fg.Nr. →70..T..199 000	11.92-12.95	STZ 1 457 42 S 9795	L
		STZ 1 457 42 S 9944	L
Fg.Nr. 70..T..200 001→	01.96-09.98	1 457 43 S 3747	L
	11.92-09.98	0 450 90 N 6267 ¹	K
		1 987 43 M 2056	I

T4 (Bus,Transporter) 2.5

2,5 81 AAF			
	11.90-08.94	0 451 20 P 3087	O
		STZ 1 457 42 S 9795	L
		STZ 1 457 42 S 9944	L
		0 450 90 F 5264 ¹	K

2,5 81 ACU			
	01.94-10.96	0 451 20 P 3087	O
Fg.Nr. →70..T..199 000	01.94-12.95	STZ 1 457 42 S 9795	L
		STZ 1 457 42 S 9944	L
Fg.Nr. 70..T..200 001→	01.96-10.96	1 457 43 S 3747	L
	01.94-10.96	0 450 90 F 5264 ¹	K
	07.94-10.96	1 987 43 M 2056	I



2,5 81 AEN			
	09.95-12.95	0 451 20 P 3087	O
		STZ 1 457 42 S 9795	L
		STZ 1 457 42 S 9944	L
		0 450 90 F 5264 ¹	K
		1 987 43 M 2056	I

T4 (Bus,Transporter) 2.5 , Syncro

2,5 81/85 AET; AEU			
	05.96-06.03	0 451 20 P 3087	O
		1 457 43 S 3747	L
		0 450 90 F 5264 ¹	K
		1 987 43 M 2056	I

2,5 85 APL			
	05.99-12.99	0 451 20 P 3087	O
		1 457 43 S 3747	L
		0 450 90 F 5264 ¹	K
		1 987 43 M 2056	I

2,5 85 AVT			
	12.99-06.03	0 451 20 P 3087	O
		1 457 43 S 3747	L
		0 450 90 F 5264 ¹	K
		1 987 43 M 2056	I

T4 (Bus,Transporter) 2.5 Syncro

2,5 81 AAF			
	11.92-12.93	0 451 20 P 3087	O
		STZ 1 457 42 S 9795	L
		STZ 1 457 42 S 9944	L
		0 450 90 F 5264 ¹	K
		1 987 43 M 2056	I

2,5 81 ACU			
	01.94-10.96	0 451 20 P 3087	O
Fg.Nr. →70..T..199 000	01.94-12.95	STZ 1 457 42 S 9795	L
		STZ 1 457 42 S 9944	L
Fg.Nr. 70..T..200 001→	01.96-10.96	1 457 43 S 3747	L
	01.94-10.96	0 450 90 F 5264 ¹	K
		1 987 43 M 2056	I

T4 (Bus,Transporter) 2.5 TDI

2,5 65/111 AHY; AJT			
	05.98-06.03	0 451 20 P 3087	O
		1 457 43 S 3747	L
		0 450 90 N 6267 ¹	K
		1 987 43 M 2056	I

2,5 75 ACV			
	01.95-06.03	0 451 20 P 3087	O
Fg.Nr. →70..T..199 000	01.95-12.95	STZ 1 457 42 S 9795	L
		STZ 1 457 42 S 9944	L
Fg.Nr. 70..T..200 001→	01.96-06.03	1 457 43 S 3747	L
	01.95-06.03	0 450 90 N 6267 ¹	K
		1 987 43 M 2056	I

2,5 75 AUF			
	05.99-06.03	0 451 20 P 3087	O
		1 457 43 S 3747	L
		0 450 90 N 6267 ¹	K
		1 987 43 M 2056	I



T4 (Bus,Transporter) 2.5 TDI Syncro

2,5 75 ACV	03.98-06.03	0 451 20 P 3087	O
		1 457 43 S 3747	L
		0 450 90 N 6267 ¹	K
		1 987 43 M 2056	I

T4 (Bus,Transporter) 2.5 TDI, TDI Syncro

2,5 65/75/111 AXG;AXL;AYC;AYY	09.00-06.03	0 451 20 P 3087	O
		1 457 43 S 3747	L
		0 450 90 N 6267 ¹	K
		1 987 43 M 2056	I

T4 (Bus,Transporter) 2.8

2,8 103 AES	01.96-05.00	1 457 42 P 9142	O
		1 457 43 S 3747	L
Fg.Nr. 70-T-200 001→	05.96-05.00	STZ 1 457 43 S 3747	L
	01.96-05.00	0 450 90 F 5264 ¹	K
		1 987 43 M 2056	I

2,8 150 AMV	05.00-06.03	1 457 42 P 9192	O
		1 457 43 S 3747	L
		0 450 90 F 5264 ¹	K
		1 987 43 M 2056	I

2,8 150 AXK	05.00-06.03	1 457 43 S 3747	L
		0 450 90 F 5264 ¹	K

T4 (Bus,Transporter) 2.8 i

2,8 116 AES	01.96-05.00	1 457 43 S 3747	L
-------------	-------------	------------------------	----------

T5 (Bus,Transporter)

T5 (Bus,Transporter) 1.9 TDI

1,9 62/75 BRR;BRS	01.06-11.09	1 457 42 P 9192	O
		STZ 1 457 43 S 3331	L
		STZ F 026 40 S 0007	L
		VOW 0 450 90 N 6467 ¹	K
	06.06-11.09	0 450 90 N 6467 ¹	K
	01.06-11.09	1 987 43 M 2114	I
		1 987 43 R 2431 ⁸	I

1,9 63/77 AXB;AXC	04.03-11.09	1 457 42 P 9192	O
		STZ 1 457 43 S 3331	L
		STZ F 026 40 S 0007	L
		0 450 90 N 6467 ¹	K
		1 987 43 M 2114	I
		1 987 43 R 2431 ⁸	I



T5 (Bus,Transporter) 2.0

2,0 85 AXA	06.03→	0 451 10 P 3314	O
		STZ 1 457 43 S 3331	L
		STZ F 026 40 S 0007	L
		0 450 90 F 5318 ¹	K
		1 987 43 M 2114	I
		1 987 43 R 2431 ⁸	I

T5 (Bus,Transporter) 2.0 TDI, TDI 4 Motion

2,0 62/75/103 CAAA;CAAB;CAAC	09.09→	F 026 40 P 7023	O
		STZ 1 457 43 S 3331	L
		STZ F 026 40 S 0007	L
		0 450 90 N 6467 ¹	K
		1 987 43 M 2114	I
		1 987 43 R 2431 ⁸	I

2,0 100 CAAE <D94>	06.10→	F 026 40 P 7023	O
		STZ 1 457 43 S 3331	L
		0 450 90 N 6467 ¹	K
		1 987 43 M 2114	I
		1 987 43 R 2431 ⁸	I

2,0 100/103 CCHB <D94>	06.10→	F 026 40 P 7023	O
		STZ 1 457 43 S 3331	L
		0 450 90 N 6467 ¹	K
		1 987 43 M 2114	I
		1 987 43 R 2431 ⁸	I

2,0 103 CCHA	09.09→	F 026 40 P 7023	O
		STZ 1 457 43 S 3331	L
		STZ F 026 40 S 0007	L
		0 450 90 N 6467 ¹	K
		1 987 43 M 2114	I
		1 987 43 R 2431 ⁸	I

2,0 103/132 CFCA	09.09→	STZ 1 457 43 S 3331	L
		STZ F 026 40 S 0007	L
		0 450 90 N 6467 ¹	K
		1 987 43 M 2114	I
		1 987 43 R 2431 ⁸	I

T5 (Bus,Transporter) 2.5 TDI

2,5 96/128 AXD;AXE	02.03-11.09	1 457 42 P 9192	O
		STZ 1 457 43 S 3331	L
		STZ F 026 40 S 0007	L
		0 450 90 N 6467 ¹	K
		1 987 43 M 2114	I
		1 987 43 R 2431 ⁸	I





◀ T5 (Bus,Transporter) 2.5 TDI

2,5 96/128 BNZ; BPC			
	01.06-11.09	1 457 42 P 9192	O
	STZ	1 457 43 S 3331	L
	STZ	F 026 40 S 0007	L
	VOW	0 450 90 N 6467 ¹	K
Fg.Nr. →7J..8..019 000	06.06-03.08	0 450 90 N 6467 ¹	K
	01.06-11.09	1 987 43 M 2114	I
		1 987 43 R 2431 ⁸	I

2,5 120 BLJ			
	11.03-11.09	1 457 42 P 9192	O
	STZ	1 457 43 S 3331	L
	STZ	F 026 40 S 0007	L
		0 450 90 N 6467 ¹	K
		1 987 43 M 2114	I
		1 987 43 R 2431 ⁸	I

T5 (Bus,Transporter) 2.5 TDI 4 Motion

2,5 96/128 AXD; AXE			
	07.04-11.09	1 457 42 P 9192	O
	STZ	1 457 43 S 3331	L
	STZ	F 026 40 S 0007	L
		0 450 90 N 6467 ¹	K
	VOW	0 450 90 N 6467 ¹	K
		1 987 43 M 2114	I
		1 987 43 R 2431 ⁸	I

2,5 96/128 BNZ; BPC			
	01.06-11.09	1 457 42 P 9192	O
	STZ	1 457 43 S 3331	L
	STZ	F 026 40 S 0007	L
	VOW	0 450 90 N 6467 ¹	K
		1 987 43 M 2114	I
		1 987 43 R 2431 ⁸	I

T5 (Bus,Transporter) 3.2 , 4 Motion

3,2 170/173 BDL; BKK			
	02.03-11.09	1 457 42 P 9142	O
	STZ	1 457 43 S 3331	L
	STZ	F 026 40 S 0007	L
		0 450 90 F 5318 ¹	K
		1 987 43 M 2114	I
		1 987 43 R 2431 ⁸	I

3,2 173 CFLA			
	05.08-11.09	0 450 90 F 5318 ¹	K
		1 987 43 M 2114	I
		1 987 43 R 2431 ⁸	I

Vento

Vento 1.4

1,4 44 ABD			
	11.91-07.95	0 451 10 P 3318	O
Mot.Nr. ABD..083 207→	07.92-07.95	1 457 43 S 3023	L
Mot.Nr. →ABD..083 206	11.91-06.92	1 457 42 S 9915	L
	11.91-07.95	0 450 90 F 5264 ¹	K
		1 987 43 M 2012	I
		1 987 43 R 2312 ⁸	I



1,4 44 AEX			
	07.95-12.97	0 451 10 P 3318	O
		1 457 43 S 3540	L
		0 450 90 F 5264 ¹	K
		1 987 43 M 2012	I
		1 987 43 R 2312 ⁸	I

Vento 1.6

1,6 55 ABU; AEA			
	09.92-07.95	0 451 10 P 3318	O
		1 457 43 S 3023	L
		0 450 90 F 5264 ¹	K
		1 987 43 M 2012	I
		1 987 43 R 2312 ⁸	I

1,6 55 AEE			
	07.95-12.97	0 451 10 P 3318	O
		1 457 43 S 3540	L
		0 450 90 F 5264 ¹	K
		1 987 43 M 2012	I
		1 987 43 R 2312 ⁸	I

1,6 74 AEK			
	10.94-06.95	0 451 10 P 3033	O
	07.95-12.95	0 451 10 P 3314	O
	10.94-12.95	1 457 43 S 3023	L
		0 450 90 F 5264 ¹	K
		1 987 43 M 2012	I
		1 987 43 R 2312 ⁸	I

1,6 74 AFT; AKS			
	12.95-12.97	0 451 10 P 3314	O
		1 457 43 S 3023	L
		0 450 90 F 5264 ¹	K
		1 987 43 M 2012	I
		1 987 43 R 2312 ⁸	I

Vento 1.8

1,8 55 AAM			
	11.91-06.95	0 451 10 P 3033	O
	07.95-12.97	0 451 10 P 3314	O
	11.91-12.97	1 457 43 S 3023	L
		0 450 90 F 5264 ¹	K
		1 987 43 M 2012	I
		1 987 43 R 2312 ⁸	I

1,8 66 ABS			
	11.91-09.94	0 451 10 P 3033	O
		1 457 43 S 3023	L
		0 450 90 F 5264 ¹	K
		1 987 43 M 2012	I
		1 987 43 R 2312 ⁸	I

1,8 66 ADZ			
	10.94-12.97	0 451 10 P 3314	O
		1 457 43 S 3023	L
		0 450 90 F 5264 ¹	K
		1 987 43 M 2012	I
		1 987 43 R 2312 ⁸	I



Vento 1.9 D, TDI

1,9 47/66 ALE; 1Y; 1Z			
11.91-12.97	0 451 20	P 3012	O
	1 457 43	S 3023	L
	VOW 0 450 90	N 6172 ¹	K
	VOW 0 450 90	N 6267 ¹	K
	1 987 43	M 2012	I
	1 987 43	R 2312 ⁸	I

Vento 1.9 SDI, TD

1,9 47/55 AAZ; AEY			
11.91-12.97	0 451 20	P 3012	O
	1 457 43	S 3023	L
	VOW 0 450 90	N 6172 ¹	K
	VOW 0 450 90	N 6267 ¹	K
	1 987 43	M 2012	I
	1 987 43	R 2312 ⁸	I

Vento 1.9 TDI

1,9 66 AHU			
08.96-12.97	0 451 10	P 3347	O
	1 457 43	S 3023	L
	VOW 0 450 90	N 6172 ¹	K
	VOW 0 450 90	N 6267 ¹	K
	1 987 43	M 2012	I
	1 987 43	R 2312 ⁸	I

1,9|81|AFN

02.96-12.97	0 451 10	P 3290	O
	1 457 43	S 3023	L
	VOW 0 450 90	N 6172 ¹	K
	VOW 0 450 90	N 6267 ¹	K
	1 987 43	M 2012	I
	1 987 43	R 2312 ⁸	I

Vento 2.0

2,0 79/85 ADY; AEP; AGG; AKR			
10.94-12.97	0 451 10	P 3314	O
	1 457 43	S 3023	L
	0 450 90	F 5264 ¹	K
	1 987 43	M 2012	I
	1 987 43	R 2312 ⁸	I

2,0|85|2E

11.91-09.94	0 451 10	P 3033	O
	1 457 43	S 3023	L
	0 450 90	F 5264 ¹	K
	1 987 43	M 2012	I
	1 987 43	R 2312 ⁸	I

Vento 2.8

2,8 120/128 AAA			
Mot.Nr. AAA 176 890→	10.95-12.97	1 457 42	P 9142 O
Mot.Nr. →AAA 176 889	01.92-09.95	1 457 42	P 9103 O
	01.92-12.97	1 457 43	S 3023 L
		0 450 90	F 5264 ¹ K
		1 987 43	M 2012 I
		1 987 43	R 2312 ⁸ I



WARTBURG

1.3

1.3 1.3

1,3 43 VW-Motor			
09.88-05.91	0 451 10	P 3033	O
	1 457 42	S 9061	L

ZAZ

Sens

Sens 1.3 Si

1,3 51 307			
01.02→	1 457 43	S 3963	L

1102/1103

1102/1103 1.1 i

1,1 37-39			
06.90→	0 451 10	P 3274	O
	1 457 43	S 2108	L
	0 450 90	F 4058 ¹	K

1102/1103 1.3 i

1,3 44			
06.90→	0 450 90	F 4058 ¹	K





AMUR (AUTOM.AND MOTOR OF URAL)

10t

10t 531320

4,8 | 100 | D 245.9 E3 <Euro 3>
01.08→ 0 451 20 P 3152 0

11t

11t 341240/ 541340

4,8 | 111,4 | D 245.30 E3 <Euro 3>
04.09→ 0 451 20 P 3152 0

ASKAM

Serie HI-EX

Serie HI-EX 19/ 26/ 32

6,9 | 292 | D0836 LFL01
09.03→ 0 451 30 P 1207 0
1 457 43 N 4447² K

ASTRA

BM

BM 44

8,1 | 118 | OM-8360.05.200
04.91→ 0 451 30 P 1156 0

BM 201

8,0 | 118 | OM-8360.05.200; OM-8360.05.300
06.79→ 0 451 30 P 1156 0

AVIA

A

A 21/ 31/ 60/ 75

3,6 | 76/85 | D421.76.00 <Euro 2>; D421.76.01 <Euro 2>; D421.85.00 <Euro 2>
10.96-07.00 WW 1 457 43 N 4106² K

BAZ (BORISPOL AUTOMOBILE PLA.)

Dolphin

Dolphin 2.5

2,5 | 111,8 | 40522 <Euro 2>
01.07→ 0 451 20 P 3154 0
0 450 90 F 5030¹ K



DAF

CF

CF 65

5,9 | 136/162/184 | CE 136 <Euro3>; CE 162 <Euro3>; CE 184 C <Euro3>
01.01-01.07 F 026 40 P 7057 0
WAS F 026 40 N 2030² K
WAS F 026 40 N 2025² K
1 987 43 M 1169 I
1 987 43 R 1452⁸ I

6,2 | 133 | NS 133 M <EURO 2>
03.98-05.00 TW 1 457 43 S 3564 L
TW,WAS 1 457 43 N 4419² K
WAS F 026 40 N 2025² K
1 987 43 M 1164 I

6,2 | 156/177 | NS 156 M <EURO 2>; NS 177 M <EURO 2>
02.98-04.02 TW 0 451 20 P 3220 0
1 457 43 S 3564 L
1 457 43 N 4419² K
1 987 43 M 1164 I

6,7 | 165/184/210 | GR 165 <Euro 4/5/EEV>; GR 184 <Euro 4/5>; GR 210 <Euro 4>
04.06→ F 026 40 P 7057 0
TW F 026 40 N 2030² K
1 987 43 M 1169 I
1 987 43 R 1452⁸ I

6,7 | 220 | GR 220 <Euro 5/EEV>
07.09→ F 026 40 P 7057 0
1 987 43 M 1169 I
1 987 43 R 1452⁸ I

CF 75

9,2 | 183 | PE 183 <Euro3>
12.99-06.02 OMZ F 026 40 P 7058 0
02.01-02.07 F 026 40 P 7058 0
NOR F 026 40 P 7046 0
WVI F 026 40 P 7047 0
TW F 026 40 S 0072 L
12.99-06.02 F 026 40 N 2037² K
02.01-02.07 TW F 026 40 N 2032 K
F 026 40 N 2033 K
F 026 40 N 2038² K
12.99-06.02 1 987 43 M 1164 I
02.01-02.07 1 987 43 M 1169 I
1 987 43 R 1452⁸ I

9,2 | 183 | PF 183 <Euro 2>
01.98-04.02 TW 1 457 43 S 3564 L
TW,WAS 1 457 43 N 4419² K
WAS F 026 40 N 2025² K
TW 1 987 43 M 1164 I





9,2 | 183/228 | PR 183 <Euro 4/5/EEV>; PR 228 <Euro 3/4/5/EEV>

04.06→	TW	F 00B H4	D0149	
	NOR	F 026 40	P 7046	O
	OMZ	F 026 40	P 7058	O
	VWI	F 026 40	P 7047	O
		F 026 40	S 0072	L
		F 026 40	N 2032	K
		F 026 40	N 2038 ²	K
		1 987 43	M 1169	I
		1 987 43	R 1452 ⁸	I

9,2 | 212 | PE 212 <Euro3>

11.99-02.02	OMZ	F 026 40	P 7058	O
		F 026 40	N 2037 ²	K
		1 987 43	M 1164	I

9,2 | 212 | PF 212 <Euro 2>

01.98-04.02	TW	1 457 42	S 9966	L
		1 457 43	S 3564	L
		1 457 43	N 4419 ²	K
		1 987 43	M 1164	I

9,2 | 228 | PE 228 <Euro3>

02.01-07.07		F 026 40	P 7058	O
	NOR	F 026 40	P 7046	O
	VWI	F 026 40	P 7047	O
	TW	F 026 40	S 0072	L
		F 026 40	N 2038 ²	K
	TW	F 026 40	N 2032	K
		F 026 40	N 2033	K
		1 987 43	M 1169	I
		1 987 43	R 1452 ⁸	I

9,2 | 235 | PE 235 <Euro3>

01.99-01.02	OMZ	F 026 40	P 7058	O
		F 026 40	N 2037 ²	K
		1 987 43	M 1164	I

9,2 | 235 | PF 235 <Euro 2>

12.97-04.02	TW	1 457 43	S 3564	L
	TW,WAS	1 457 43	N 4419 ²	K
	WAS	F 026 40	N 2025 ²	K
		1 987 43	M 1164	I

9,2 | 265 | PE 265 <Euro3>

02.01-05.07		F 026 40	P 7058	O
	NOR	F 026 40	P 7046	O
	VWI	F 026 40	P 7047	O
	TW	F 026 40	S 0072	L
		F 026 40	N 2033	K
	TW	F 026 40	N 2038 ²	K
		1 987 43	M 1169	I
		1 987 43	R 1452 ⁸	I

9,2 | 265 | PR 265 <Euro 4/5/EEV>

05.06→	TW	F 00B H4	D0149	
		F 026 40	P 7058	O
	NOR	F 026 40	P 7046	O
	VWI	F 026 40	P 7047	O
		F 026 40	S 0072	L
		F 026 40	N 2032	K
		F 026 40	N 2038 ²	K
		1 987 43	M 1169	I
		1 987 43	R 1452 ⁸	I

CF 85

12,6 | 250 | XE 250 <Euro 3>

07.99-01.02	OMZ	F 026 40	P 7058	O
	OMZ,XXX	0 451 10	P 4013	O
09.06-01.08	NOR	F 026 40	P 7046	O
	OMZ	F 026 40	P 7058	O
	VWI	F 026 40	P 7047	O
07.99-01.02		F 026 40	S 0087	L
09.06-01.08		F 026 40	S 0071	L
07.99-01.02		F 026 40	N 2037 ²	K
09.06-01.08	NOR	F 026 40	N 2033	K
	VWI	F 026 40	N 2031	K
07.99-01.02		1 987 43	M 1164	I
09.06-01.08		1 987 43	M 1169	I
		1 987 43	R 1452 ⁸	I

12,6 | 250 | XF 250 <Euro 2>

10.97-07.02	OMZ	F 026 40	P 7058	O
	OMZ,TW,XXX	0 451 10	P 4013	O
	TW	F 026 40	S 0087	L
	NOR	1 457 43	N 4419 ²	K
	VWI,XXX	1 457 43	N 4429 ²	K
	WAS	F 026 40	N 2025 ²	K
		1 987 43	M 1164	I

12,6 | 280 | XE 280 <Euro 3>

08.99-02.02	OMZ,XXX	0 451 10	P 4013	O
08.99-12.07	OMZ	F 026 40	P 7058	O
06.01-12.07	NOR	F 026 40	P 7046	O
	VWI	F 026 40	P 7047	O
08.99-02.02		F 026 40	S 0087	L
06.01-12.07		F 026 40	S 0071	L
08.99-02.02		F 026 40	N 2037 ²	K
06.01-12.07	NOR	F 026 40	N 2033	K
	TW	F 026 40	N 2038 ²	K
	VWI	F 026 40	N 2031	K
08.99-02.02		1 987 43	M 1164	I
06.01-12.07		1 987 43	M 1169	I
		1 987 43	R 1452 ⁸	I

12,6 | 280 | XF 280 <Euro 2>

03.98-09.02	NOR,	0 451 10	P 4013	O
	OMZ,XXX			
	OMZ	F 026 40	P 7058	O
		F 026 40	S 0087	L
	NOR	1 457 43	N 4419 ²	K
	VWI,XXX	1 457 43	N 4429 ²	K
	WAS	F 026 40	N 2025 ²	K
		1 987 43	M 1164	I





◀ CF 85

12,6 | 315 | XE 315 <Euro 3>

09.99-01.02	OMZ	F 026 40	P 7058	O
	OMZ,XXX	0 451 10	P 4013	O
01.01-10.07		F 026 40	P 7058	O
	NOR	F 026 40	P 7046	O
	VWI	F 026 40	P 7047	O
09.99-01.02		F 026 40	S 0087	L
01.01-10.07		F 026 40	S 0071	L
09.99-01.02		F 026 40	N 2037 ²	K
01.01-10.07	NOR	F 026 40	N 2033	K
	TW	F 026 40	N 2038 ²	K
	VWI	F 026 40	N 2031	K
09.99-01.02		1 987 43	M 1164	I
01.01-10.07		1 987 43	M 1169	I
		1 987 43	R 1452 ⁸	I

12,6 | 315 | XF 315 <Euro 2>

10.97-04.02	NOR,	0 451 10	P 4013	O
	OMZ,XXX			
	OMZ	F 026 40	P 7058	O
		F 026 40	S 0087	L
	NOR	1 457 43	N 4419 ²	K
	VWI,XXX	1 457 43	N 4429 ²	K
		1 987 43	M 1164	I

12,6 | 355 | XE 355 <Euro 3>

10.01-10.07		F 026 40	P 7058	O
	NOR	F 026 40	P 7046	O
	VWI	F 026 40	P 7047	O
		F 026 40	S 0071	L
		F 026 40	N 2038 ²	K
	NOR	F 026 40	N 2033	K
	VWI	F 026 40	N 2031	K
		1 987 43	M 1169	I
		1 987 43	R 1452 ⁸	I

12,9 | 265/300/340/375 | MX 265 <Euro 3/4/5/EEV>; MX 300 <Euro 3/4/5/EEV>; MX 340 <Euro 4/5/EEV>; MX 375 <Euro 4/5/EEV>

04.06 →	TW	F 00B H4	D0149	
		F 026 40	P 7045	O
		F 026 40	N 2032	K
		F 026 40	N 2038 ²	K
		1 987 43	M 1169	I
		1 987 43	R 1452 ⁸	I

F..

F.. 1500

6,2 85 DF 615	07.78-08.91	1 457 42	N 9675 ²	K
6,2 113 DT 615	07.78-08.91	1 457 42	N 9675 ²	K

F.. 1600

6,2 93 DF 615	01.70-08.91	1 457 42	P 9413	O
		1 457 42	N 9675 ²	K

F.. 1600/ 1800

6,2 113 DT 615	01.70-08.91	1 457 42	P 9413	O
		1 457 42	N 9676 ²	K



F.. 1700

6,2 156 DNS 620	01.88-02.95	TW	0 451 10	P 4015	O
			0 451 10	P 5067	O
			1 457 42	S 9950	L
			1 457 42	N 9675 ²	K

F.. 1700/ 1900

6,2 132/133 DNT 620	12.86-02.95	TW	0 451 10	P 4015	O
			0 451 10	P 5067	O
			1 457 42	S 9946	L
			1 457 42	S 9950	L
			1 457 42	N 9675 ²	K
			1 457 42	N 9676 ²	K

F.. 1900

6,2 156 DNS 620	12.86-09.93	TW	0 451 10	P 4015	O
			0 451 10	P 5067	O
			1 457 42	S 9950	L
		TW	1 457 42	N 9675 ²	K
			1 457 42	N 9676 ²	K

F.. 2100

8,3 151 DHTD 825	07.81-08.91		0 451 20	P 3220	O
		TW	1 457 42	S 9966	L
			1 457 42	S 9975	L
			1 457 42	N 9676 ²	K
			1 457 43	N 4419 ²	K

8,3 | 162-167 | DHT 825

11.81-08.91		0 451 20	P 3220	O
	TW	1 457 42	S 9966	L
		1 457 42	S 9975	L
		1 457 42	N 9675 ²	K
		1 457 42	N 9676 ²	K

F.. 2103/ 2105

8,3 115 DH 825	07.78-08.91		0 451 20	P 3220	O
			1 457 42	S 9975	L
		TW	1 457 42	S 9966	L
			1 457 42	N 9676 ²	K

8,3 | 150 | DHR 825

07.78-08.91		0 451 20	P 3220	O
		1 457 42	S 9975	L
	TW	1 457 42	S 9966	L

F.. 2105

6,2 85 DF 615	07.78-08.91	1 457 42	P 9413	O
		1 457 42	N 9676 ²	K

8,3 | 151 | DHTD 825

07.81-08.91		0 451 20	P 3220	O
		1 457 42	S 9975	L
	TW	1 457 42	S 9966	L
		1 457 42	N 9676 ²	K



8,3 167 DHT 825	01.87-08.91	0 451 20 P 3220	O
		1 457 42 S 9975	L
		1 457 42 N 9676 ²	K

F.. 2300

8,3 162 DHT 825	11.81-08.91	0 451 20 P 3220	O
	TW	1 457 42 S 9966	L
		1 457 42 S 9975	L
		1 457 42 N 9676 ²	K
		1 457 43 N 4419 ²	K

F.. 2303/ 2305

8,3 169 DHU 825	07.78-08.91	0 451 20 P 3220	O
		1 457 42 S 9950	L
	TW	1 457 42 S 9966	L
		1 457 42 S 9975	L
		1 457 42 N 9676 ²	K

F.. 2305

8,3 150 DHR 825	07.78-08.91	0 451 20 P 3220	O
----------------------------	-------------	------------------------	----------

F.. 2500

8,3 184-195 DHS 825	02.82-08.91	0 451 20 P 3220	O
	TW	1 457 42 S 9966	L
		1 457 42 S 9975	L
		1 457 42 N 9676 ²	K
		1 457 43 N 4419 ²	K

F.. 2505

8,3 217 DHS 825SM	01.90-08.91	0 451 20 P 3220	O
		1 457 42 S 9975	L
	TW	1 457 42 N 9676 ²	K
		1 457 43 N 4419 ²	K

F.. 2505/ 2525/ 2535

8,3 184-195 DHS 825	02.82-08.91	0 451 20 P 3220	O
		1 457 42 S 9966	L
	TW	1 457 42 S 9975	L
		1 457 42 N 9676 ²	K

F.. 2525

8,3 217 DHS 825SM	01.90-08.91	0 451 20 P 3220	O
------------------------------	-------------	------------------------	----------

F.. 2700

8,3 200 HS 200 <HS825>	01.90-12.93	0 451 20 P 3220	O
		1 457 42 S 9975	L
	TW	1 457 42 N 9676 ²	K
		1 457 43 N 4419 ²	K



F.. 2800

11,6 206 DKV 1160	05.83-09.91	TW	0 451 10 P 4015	O
			0 451 10 P 5067	O
			1 457 42 S 9950	L
	TW		1 457 42 N 9676 ²	K
			1 457 43 N 4419 ²	K

11,6 | 206-212 | DKX-E 1160 ATI

	06.85-09.91	TW	0 451 10 P 4015	O
			0 451 10 P 5067	O
			1 457 42 S 9950	L
	TW		1 457 42 N 9676 ²	K
			1 457 43 N 4419 ²	K

F.. 2800/ 2803/ 2805

11,6 188 DKTD 1160	01.74-09.91		0 451 10 P 5067	O
		TW	1 457 42 S 9950	L
			1 457 42 N 9676 ²	K

11,6 | 228-236 | DKS 1160

	01.74-09.91		0 451 10 P 5067	O
		TW	1 457 42 S 9950	L
			1 457 42 N 9676 ²	K

F.. 2900

11,6 212 KV 212	01.90-12.93	TW	0 451 10 P 4015	O
			0 451 40 P 3208	O
			1 457 42 S 9950	L
			1 457 43 S 2188	L
			1 457 42 N 9676 ²	K
			1 457 43 N 4419 ²	K

F.. 3200

11,6 238 KS 238	01.90-10.92		0 451 10 P 4015	O
			1 457 42 S 9950	L
		TW	1 457 42 N 9676 ²	K
			1 457 43 N 4419 ²	K

F.. 3300

11,6 206 DKV 1160	05.83-09.91		0 451 10 P 5067	O
			1 457 42 N 9676 ²	K

11,6 | 260 | DKX 1160 ATI

	06.85-09.91	TW	0 451 10 P 4015	O
			0 451 10 P 5067	O
			1 457 42 S 9950	L
	TW		1 457 42 N 9676 ²	K
			1 457 43 N 4419 ²	K

F.. 3300/ 3305/ 3325

11,6 243 DKX 1160	06.81-09.91		0 451 10 P 5067	O
			1 457 42 S 9950	L
			1 457 42 N 9676 ²	K





F.. 3325

11,6 260 DKX 1160 ATI	01.89-09.91	0 451 10 P 5067	O
		1 457 42 S 9950	L
		1 457 42 N 9676 ²	K

F.. 3600

11,6 274 DKZ 1160 ATI	06.85-09.91	TW	0 451 10 P 4015	O
			0 451 10 P 5067	O
			1 457 42 S 9950	L
		TW	1 457 42 N 9676 ²	K
			1 457 43 N 4419 ²	K

LF

LF 45

3,9 110 BE 110 C <Euro 3>	04.01-10.07	F 026 40 P 7057	O
		F 026 40 S 0070	L
		F 026 40 N 2030 ²	K

3,9 123 BE 123 C <Euro 3>	04.01-12.07	F 026 40 P 7057	O
		F 026 40 S 0069	L
		F 026 40 N 2030 ²	K

4,5 103/118 FR 103 <Euro 4/5>; FR 118 <Euro 4/5>	05.06→	F 026 40 P 7057	O
		TW	F 026 40 N 2030 ²

4,5 152 FR 152 <Euro 5/EEV>	09.09→	F 026 40 P 7057	O
---------------------------------	--------	------------------------	----------

5,9 99 BE 99 <Euro 3>	11.01-09.06	F 026 40 P 7057	O
		F 026 40 S 0069	L
		F 026 40 N 2030 ²	K

5,9 136 CE 136 C <Euro 3>	07.01-12.08	F 026 40 P 7057	O
		TW	F 026 40 S 0069
			F 026 40 S 0070
			F 026 40 N 2030 ²

5,9 162 CE 162 C <Euro 3>	11.01-01.09	F 026 40 P 7057	O
		F 026 40 S 0070	L
		F 026 40 N 2030 ²	K

LF 45/ 55

4,5 136 FR 136 <Euro 4/5>	04.06→	F 026 40 P 7057	O
		TW	F 026 40 N 2030 ²

6,7 165 GR 165 <Euro 4/5>	04.06→	F 026 40 P 7057	O
		TW	F 026 40 N 2030 ²

6,7 184 GR 184 <Euro 4/5>	04.06→	F 026 40 P 7057	O
		TW	F 026 40 N 2030 ²



LF 55

5,9 136 CE 136 C	04.01-08.08	F 026 40 P 7057	O
		TW	F 026 40 S 0069
			F 026 40 N 2030 ²

5,9 162/184 CE 162 C; CE 184 C	04.01-08.08	F 026 40 P 7057	O
		TW	F 026 40 S 0070
			F 026 40 N 2030 ²

6,7 210 GR 210 <Euro 4/5>	04.06→	F 026 40 P 7057	O
		TW	F 026 40 N 2030 ²

N..

N.. 2826

11,6 169 DKA 1160	01.82-09.91	0 451 10 P 5067	O
		1 457 42 S 9950	L
	10.80-09.91	1 457 42 N 9676 ²	K

11,6 188/228 DKS 1160; DKTD 1160	01.82-09.91	0 451 10 P 5067	O
	01.81-09.91	TW	1 457 42 S 9950
			1 457 42 N 9676 ²

XF

XF 95

12,6 280 XE 280 C <Euro 3>	04.98-04.03	OMZ	F 026 40 P 7058	O
		OMZ,TW, XXX	0 451 10 P 4013	O
			F 026 40 S 0084	L
Fg.Nr. 0E490601→	04.98-04.03		F 026 40 S 0084	L
	04.98-04.03	WAS	F 026 40 N 2037 ²	K
		WAS	F 026 40 N 2025 ²	K
			1 987 43 M 2152	I

12,6 280 XE 280 <Euro 3>	02.02-01.07	F 026 40 P 7058	O
		TW	F 026 40 P 7046
			F 026 40 P 7047
			F 026 40 S 0084
			F 026 40 N 2038 ²
		NOR	F 026 40 N 2033
		VWI	F 026 40 N 2031
			1 987 43 M 2152

12,6 280/315 XF280M <Euro 2>; XF315M <Euro 2>	01.97-12.02	OMZ	F 026 40 P 7058	O
		OMZ,TW, XXX	0 451 10 P 4013	O
			F 026 40 S 0084	L
Fg.Nr. 0E490601→	01.97-12.02		F 026 40 S 0084	L
	01.97-12.02	NOR	1 457 43 N 4419 ²	K
		VWI,XXX	1 457 43 N 4429 ²	K
		WAS	F 026 40 N 2025 ²	K
			1 987 43 M 2152	I





12,6 | 315 | XE 315 C <Euro 3>

01.99-08.03	NOR,	0 451 10 P 4013	O
	OMZ,TW,		
	XXX		
	OMZ	F 026 40 P 7058	O
		F 026 40 S 0084	L
	WAS	F 026 40 N 2037 ²	K
	WAS	F 026 40 N 2025 ²	K
		1 987 43 M 2152	I

12,6 | 315 | XE 315 <Euro 3>

01.02-12.07	TW	F 026 40 P 7046	O
		F 026 40 P 7047	O
		F 026 40 P 7058	O
		F 026 40 S 0084	L
	NOR	F 026 40 N 2033	K
	TW	F 026 40 N 2025 ²	K
		F 026 40 N 2038 ²	K
	VWI	F 026 40 N 2031	K
		1 987 43 M 2152	I

12,6 | 335 | XE 335 <Euro 3>

02.04-02.07		F 026 40 P 7047	O
		F 026 40 P 7058	O
		F 026 40 S 0084	L
		F 026 40 N 2031	K
		1 987 43 M 2152	I

12,6 | 355 | XE 355 C <Euro 3>

05.98-09.03		F 026 40 P 7046	O
	NOR,	0 451 10 P 4013	O
	OMZ,TW,		
	XXX		
	OMZ	F 026 40 P 7058	O
Fg.Nr. 0E490601→	05.98-09.03	F 026 40 S 0084	L
	05.98-09.03	F 026 40 N 2033	K
	WAS	F 026 40 N 2037 ²	K
	WAS	F 026 40 N 2025 ²	K
		1 987 43 M 2152	I

12,6 | 355 | XE 355 <Euro 3>

02.02-12.07	TW	F 026 40 P 7046	O
		F 026 40 P 7047	O
		F 026 40 P 7058	O
		F 026 40 S 0084	L
		F 026 40 N 2038 ²	K
	NOR	F 026 40 N 2033	K
	VWI	F 026 40 N 2031	K
		1 987 43 M 2152	I

12,6 | 355 | XF355M <Euro 2>

01.97-04.02	NOR,	0 451 10 P 4013	O
	OMZ,XXX		
	OMZ	F 026 40 P 7058	O
Fg.Nr. 0E490601→	01.97-04.02	F 026 40 S 0084	L
	01.97-04.02	NOR,TW	1 457 42 N 9676 ²
			1 457 43 N 4419 ²
	VWI,XXX		1 457 43 N 4429 ²
	WAS	F 026 40 N 2025 ²	K
		1 987 43 M 2152	I

12,6 | 390 | XE 390 C <Euro 3>

11.99-09.03	NOR,	0 451 10 P 4013	O
	OMZ,XXX		
	OMZ	F 026 40 P 7058	O
11.01-01.07		F 026 40 P 7058	O
	TW	F 026 40 P 7046	O
		F 026 40 P 7047	O
11.99-01.07		F 026 40 S 0084	L
11.99-09.03	WAS	F 026 40 N 2037 ²	K
	WAS	F 026 40 N 2025 ²	K
11.01-01.07		F 026 40 N 2038 ²	K
	NOR	F 026 40 N 2033	K
	VWI	F 026 40 N 2031	K
11.99-01.07		1 987 43 M 2152	I

12,9 | 340 | MX 340 <Euro 4>

11.03-10.05		F 026 40 P 7045	O
	TW	F 026 40 S 0084	L
		F 026 40 N 2032	K
		1 987 43 M 2152	I

12,9 | 410 | MX 410 <Euro 3/4>

11.03-12.04		F 026 40 P 7045	O
		F 026 40 S 0084	L
		F 026 40 N 2032	K
		1 987 43 M 2152	I

14,0 | 390 | VF390M <Euro 2>

Fg.Nr. 0E490601→	01.97-11.99	F 026 40 S 0084	L
	01.97-11.99	1 987 43 M 2152	I

XF 105

12,9 | 300/340/375 | MX 300 <Euro 3/4/5>; MX 340 <Euro 3/4/5>; MX 375 <Euro 4/5>

01.06→	TW	F 00B H4 D0149	
		F 026 40 P 7045	O
	TW	F 026 40 S 0084	L
		F 026 40 N 2032	K
		F 026 40 N 2038 ²	K
		1 987 43 M 2152	I

12,9 | 410 | MX 410 <Euro 3/4>

02.04-12.05		F 026 40 P 7045	O
	TW	F 026 40 S 0084	L
		F 026 40 N 2032	K
		F 026 40 N 2038 ²	K
		1 987 43 M 2152	I

65

65 .180

6,2 | 133 | NS 133 L <EURO 1>

01.93-12.97		0 451 10 P 4015	O
		1 457 43 S 3564	L
	TW,WAS	1 457 42 N 9675 ²	K
		1 457 43 N 4419 ²	K
	WAS	F 026 40 N 2025 ²	K





◀ 65 .180

6,2 133 NS 133 M <EURO 2>			
01.93-08.98	0 451 10	P 4015	O
	1 457 43	S 3564	L
TW	1 457 42	N 9676²	K
	1 457 43	N 4419²	K

65 .210

6,2 156 NS 156 L <EURO 1>			
01.93-12.96	0 451 10	P 4015	O
	1 457 43	S 3564	L
TW	1 457 42	N 9676²	K
	1 457 43	N 4419²	K

6,2 156 NS 156 M <EURO 2>			
01.93-04.02	0 451 10	P 4015	O
TW	F 026 40	S 0087	L
	1 457 43	S 3564	L
	1 457 42	N 9676²	K
	1 457 43	N 4419²	K

65 .240

6,2 177 NS 177 L			
03.96-08.98	0 451 10	P 4015	O
	1 457 43	S 3564	L
TW	1 457 42	N 9676²	K
	1 457 43	N 4419²	K

75

75 .240

8,7 180 RS 180 L <Euro 1>; RS 180 M <Euro 2>			
01.92-12.99	1 457 43	S 3564	L
TW	1 457 42	N 9676²	K
	1 457 43	N 4419²	K

75 .270

8,7 200 RS 200 L <Euro 1>			
02.92-12.97	TW	1 457 42	S 9950 L
		1 457 43	S 3564 L
		1 457 42	N 9676² K
		1 457 43	N 4419² K

75 .270/ .300

8,7 200/222 RS 200 M <Euro 2>; RS 222 L <Euro 1>; RS 222 M <Euro 2>			
01.92-04.02		1 457 43	S 3564 L
	TW	1 457 42	N 9676² K
		1 457 43	N 4419² K

85

85 .300

11,6 222 WS 222 <Euro 1>			
01.93-09.96		0 451 40	P 3208 O
		1 457 43	S 3564 L
	TW	1 457 42	N 9676² K
		1 457 43	N 4419² K



85 .330

11,6 242 WS 242 <Euro 1/2>			
02.90-12.98		0 451 40	P 3208 O
	TW	F 026 40	S 0087 L
		1 457 43	S 3564 L
	TW,WAS	1 457 42	N 9676² K
		1 457 43	N 4419² K
	WAS	F 026 40	N 2025² K

85 .360/ .400

11,6 268/295 WS 268 <Euro 1/2>; WS 295 <Euro 1/2>			
12.91-12.99		0 451 40	P 3208 O
	TW	F 026 40	S 0087 L
		1 457 43	S 3564 L
	TW,WAS	1 457 42	N 9676² K
		1 457 43	N 4419² K
	WAS	F 026 40	N 2025² K
	TW	1 987 43	M 1164 I

95

95 .310

11,6 225 WS 225			
01.87-12.95		0 451 40	P 3208 O
	TW	1 457 42	S 9950 L
		1 457 43	S 2188 L
		1 457 42	N 9676² K

95 .330

11,6 242 WS 242 <Euro 0/1>			
06.90-11.95		0 451 40	P 3208 O
		1 457 43	S 2188 L
	TW	1 457 42	N 9676² K
		1 457 43	N 4419² K

95 .350

11,6 259 WS 259			
02.87-01.96		0 451 40	P 3208 O
	TW	1 457 42	S 9950 L
		1 457 43	S 2188 L
		1 457 42	N 9676² K
		1 457 43	N 4419² K

95 .360

11,6 268 WS 268 <Euro 0/1/2>			
10.89-12.97		0 451 40	P 3208 O
	TW	1 457 42	S 9950 L
		1 457 43	S 2188 L
	TW,WAS	1 457 42	N 9676² K
		1 457 43	N 4419² K
	WAS	F 026 40	N 2025² K

95 .380

11,6 282 WS 282 L <Euro 1>			
01.87-12.95		0 451 40	P 3208 O
	TW	1 457 42	S 9950 L
		1 457 43	S 2188 L
		1 457 42	N 9676² K
		1 457 43	N 4419² K





95 .400

11,6 295 WS 295 <Euro 0/1/2>			
10.89-09.98	0 451 40	P 3208	O
TW	1 457 42	S 9950	L
	1 457 43	S 2188	L
TW,WAS	1 457 42	N 9676²	K
	1 457 43	N 4419²	K
WAS	F 026 40	N 2025²	K

95 .430

11,6 315 WS 315 <Euro 0/1/2>			
04.91-12.98	0 451 40	P 3208	O
	1 457 43	S 2188	L
TW,WAS	1 457 42	N 9676²	K
	1 457 43	N 4419²	K
WAS	F 026 40	N 2025²	K

FORD *

Cargo

Cargo 0609/ 0709/ 0809

4,2 63 90/5 AA-Dover			
01.82-01.96	1 457 43	N 4201²	K

Cargo 0711/ 0811/ 0911/ 1011/ 1111

6,0 81 110/6 AA-Dover			
01.82-01.96	TW	1 457 43	S 3650 L
		1 457 43	N 4201² K

Cargo 0813

6,2 94 130/7 AA-Dover <7HA>			
01.82-01.96		1 457 43	N 4201² K

Cargo 0913/ 1013/ 1113/ 1213/ 1313/ 1413/ 1513/ 1713/ 1913

6,2 94 130/7 AA-Dover			
01.82-01.96		1 457 43	N 4201² K

Cargo 0915/ 1015/ 1115/ 1215/ 1315/ 1415/ 1515/ 2015/ 2115

6,0 110 150/6 CA-Dover			
01.82-01.96		1 457 43	N 4201² K

Cargo 1211

6,0 81 110/6 AA-Dover			
01.82-06.94		1 457 43	N 4201² K

Cargo 1311

6,0 81 110/6 AA-Dover			
01.82-06.94	TW	1 457 43	S 3650 L
		1 457 43	N 4201² K

Cargo 1317/ 1517/ 2817

9,6 125 F6L 413 F			
04.82-12.99	0 451 10	P 5067	O
	1 457 42	N 9675²	K



Cargo 1320/ 2420/ 3020

9,6 150 F6L 413 FZ			
04.82-12.99	0 451 10	P 5067	O
	1 457 42	N 9675²	K

Cargo 1928/ 4028

10,0 208 LTA 10-290			
02.86-12.99	XXX	1 457 43	N 4423² K

Cargo 3824

10,0 179 L 10-243			
02.86-12.99	XXX	1 457 43	N 4423² K

GALICH CRANE PLANT

50t

50t KS-64713

11,1 303 650.10 <Euro 3>			
01.10→		0 451 10	P 4010 O
		1 457 43	N 4421² K

GAZ

Sadko

Sadko 4.8

4,8 90 D 245.7 E3 <Euro 3>			
01.08→		0 451 20	P 3152 O

Valday

Valday 4.8

4,8 90 D 245.7 E2 <Euro 2>			
02.04→		0 451 20	P 3152 O
		TW	1 457 43 N 4310² K
		TW,XXX	1 457 43 N 4306² K
E,F	02.04→	TW	1 457 43 G 17² K

4,8 90 D 245.7 E3 <Euro 3>			
01.08→		0 451 20	P 3152 O

3309

3309 4.8

4,8 90 D 245.7 <Euro 1>			
06.03→		0 451 20	P 3152 O
		TW	1 457 43 N 4310² K
		TW,XXX	1 457 43 N 4306² K
E,F	06.03→	TW	1 457 43 G 17² K

4,8 90 D 245.7 E3 <Euro 3>			
01.08→		0 451 20	P 3152 O





IKARUS

Serie 200

Serie 200 255

10,4 141 Raba/D 2156 HM6U		1 457 43 N 1159 ⁶	K
		1 457 43 N 1326 ⁷	K
		1 457 42 P 9165 ³	P

Serie 200 260

10,4 141 Raba/D 2156 HM6U	06.78→	1 457 43 N 1159 ⁶	K
		1 457 43 N 1326 ⁷	K

Serie 200 260/ 280

10,7 162 Raba/D 2356 HM6U	01.78→	1 457 43 N 1159 ⁶	K
		1 457 43 N 1326 ⁷	K

ISUZU

Elf

Elf 3.1

3,1 65-71 4JG2	06.93→	0 986 45 P 2064	O
--------------------	--------	-----------------	---

IVECO

A

A 55/ 70/ 90

5,9 101 8060.05.246	05.88-12.91	0 451 20 P 3152	O
		1 457 43 N 4105 ²	K

A 60

3,9 65 8040.05.200	09.88-12.92	1 457 43 N 4105 ²	K
------------------------	-------------	------------------------------	---

A 79

5,9 102 8060.05.285	07.88-12.92	0 451 20 P 3152	O
		1 457 43 N 4105 ²	K

EuroCargo

EuroCargo 60 E

4,0 75 8040.25B.42...	01.91-05.96	0 451 20 P 3201	O
		1 457 43 N 4105 ²	K

4,0 85/100 8040.25X.4... TC; 8040.45X.4180	01.91-05.96	0 451 20 P 3201	O
		1 457 43 N 4105 ²	K



EuroCargo 60 E/ 65 E

4,0 100 8040.45.40...	01.91-06.96	0 451 20 P 3201	O
		1 457 43 N 4105 ²	K

4,0 100 8040.45.4303	01.91-06.96	0 451 20 P 3201	O
		1 457 43 N 4105 ²	K

EuroCargo 65 E

3,9 103/118 F4AE3481C*P...; F4AE3481D*P...	09.04-08.06	F 026 40 N 2030 ²	K
--	-------------	------------------------------	---

4,0 75 8040.25B.42...	01.91-05.96	0 451 20 P 3201	O
	05.91-12.92	1 457 43 S 3735	L
	01.91-05.96	1 457 43 N 4105 ²	K

4,0 85 8040.25X.40...	01.91-05.96	0 451 20 P 3201	O
	05.91-12.92	1 457 43 S 3735	L
	01.91-05.96	1 457 43 N 4105 ²	K

4,0 85 8040.25X.49...	01.91-05.96	0 451 20 P 3201	O
---------------------------	-------------	-----------------	---

4,0 85 8040.45D...	06.96-07.00	0 451 20 P 3201	O
		1 457 43 N 4105 ²	K

4,0 100 8040.45.5...	01.91-06.96	0 451 20 P 3201	O
		1 457 43 N 4105 ²	K

EuroCargo 65 E/ 75 E

3,9 95 F4AE0481D*C...	08.00-08.05	F 026 40 N 2030 ²	K
		F 026 40 Z 4008	S

EuroCargo 65 E/ 75 E/ 80 E

3,9 110 F4AE0481C*C...	08.00-08.05	F 026 40 N 2030 ²	K
		F 026 40 Z 4008	S

EuroCargo 75 E

3,9 103 F4AE3481C...	09.05→	1 457 43 D 6006	
		F 026 40 N 2030 ²	K
		1 457 43 D 6002	D

3,9 118 F4AE3481D...	09.05→	1 457 43 D 6006	
		F 026 40 N 2030 ²	K
		1 457 43 D 6002	D

3,9 130 F4AE3481B*...	09.05→	1 457 43 D 6006	
		WAS F 026 40 N 2030 ²	K
		WAS F 026 40 N 2036 ²	K
		1 457 43 D 6002	D

4,0 85 8040.25X.40... TC	01.91-05.96	0 451 20 P 3201	O
	05.91-12.92	1 457 43 S 3735	L
	01.91-05.96	1 457 43 N 4105 ²	K



4,0 85 8040.45D.51...	01.94-08.00	0 451 20 P 3201	O
		1 457 43 N 4105 ²	K

4,0 100 8040.45X.4180 TCA; 8040.45.40... TCA; 8040.45.4303 TCA	01.91-05.96	0 451 20 P 3201	O
	05.91-12.92	1 457 43 S 3735	L
	01.91-05.96	1 457 43 N 4105 ²	K

4,0 100 8040.45.5...	01.93-08.00	0 451 20 P 3201	O
		1 457 43 S 3735	L
		1 457 43 N 4105 ²	K

6,0 105 8060.25R.4... LTC	01.91-12.92	0 451 20 P 3201	O
		1 457 43 N 4105 ²	K

EuroCargo 75 E/ 80 E/ 90 E/ 100 E/ 120 E

3,9 125 F4AE0481A*C...	09.00-09.05	F 026 40 N 2030 ²	K
		F 026 40 Z 4008	S

EuroCargo 75 E/ 80 E/ 90 E/ 100 E/ 120 E/ 130 E/ 140 E

5,9 134 F4AE0681E*C...	09.00-09.05	F 026 40 N 2030 ²	K
		F 026 40 Z 4008	S

EuroCargo 75 E/ 80 E/ 90 E/ 100 E/ 120 E/ 130 E/ 150 E

6,0 105 8060.45R.50...	01.91-08.00	0 451 20 P 3201	O
		1 457 43 N 4105 ²	K

EuroCargo 80 E

3,9 118 F4AE3481D...	09.05→	F 026 40 N 2030 ²	K
--------------------------	--------	------------------------------	---

3,9 130 F4AE3481B...	09.05→	1 457 43 D 6006	
		F 026 40 N 2030 ²	K

5,9 160 F4AE3681B...	09.05→	F 026 40 N 2030 ²	K
		1 457 43 D 6002	D

6,0 105 8060.25R.42...	01.91-08.00	0 451 20 P 3201	O
		1 457 43 N 4105 ²	K

6,0 105 8060.45R.4245	01.93-08.00	0 451 20 P 3201	O
		1 457 43 N 4105 ²	K

6,0 130 8060.25V.40...	01.91-08.00	0 451 20 P 3201	O
		1 457 43 N 4105 ²	K

6,0 152 8060.45X.4180	01.92-06.00	0 451 20 P 3201	O
		1 457 43 N 4105 ²	K

EuroCargo 80 E/ 85 E/ 90 E/ 100 E/ 120 E/ 130 E/ 150 E/ 170 E

6,0 130 8060.45B.51...	09.91-07.00	0 451 20 P 3201	O
		1 457 43 N 4105 ²	K

EuroCargo 80 E/ 90 E/ 100 E/ 120 E/ 130 E

5,9 154 F4AE0681D*C...	09.00-08.05	F 026 40 N 2030 ²	K
		F 026 40 Z 4008	S

EuroCargo 80 E/ 90 E/ 100 E/ 120 E/ 150 E/ 180 E

6,0 152 8060.45.52...	01.91-08.00	0 451 20 P 3201	O
		1 457 43 S 3735	L
		1 457 43 N 4105 ²	K

EuroCargo 80 E/ 100 E/ 180 E

6,0 152 8060.45.41...	01.91-11.00	0 451 20 P 3201	O
		1 457 43 N 4105 ²	K

EuroCargo 80 E/ 100 E/ 120 E/ 130 E/ 140 E/ 150 E/ 170 E/ 180 E

6,0 152 8060.45.4403	01.91-08.00	0 451 20 P 3201	O
		1 457 43 N 4105 ²	K

EuroCargo 85 E

6,0 105/130 8060.25R.49...; 8060.25V.49...	01.91-08.00	0 451 20 P 3201	O
		1 457 43 N 4105 ²	K

EuroCargo 85 E/ 90 E

6,0 130 8060.45B.43...	09.91-07.00	0 451 20 P 3201	O
		1 457 43 N 4105 ²	K

EuroCargo 90 E

3,9 130 F4AE3481B...	09.05→	F 026 40 N 2030 ²	K
--------------------------	--------	------------------------------	---

6,0 105 8060.25R.47...	01.83-12.94	0 451 20 P 3201	O
		1 457 43 N 4105 ²	K

6,0 152 8060.45.47...	01.91-12.00	0 451 20 P 3201	O
		1 457 43 N 4105 ²	K

EuroCargo 90 E/ 150 E

5,9 160 F4AE3681B*...	09.05→	F 026 40 N 2030 ²	K
		1 457 43 D 6002	D

EuroCargo 100 E

3,9 130 F4AE3481B...	09.06→	1 457 43 D 6006	
		F 026 40 N 2030 ²	K





◀ EuroCargo 100 E

5,9 135 F4AE3681C*...	09.05→	1 457 43 D 6006 F 026 40 N 2030 ² K 1 457 43 D 6002 D
6,0 105 8060.25R.42...	01.91-08.00	0 451 20 P 3201 O 1 457 43 S 3735 L 1 457 43 N 4105 ² K
6,0 130 8060.25V.40...	01.91-11.00	0 451 20 P 3201 O 1 457 43 S 3735 L 1 457 43 N 4105 ² K
6,0 152 8060.45X.4180 TCA	01.92-11.00	0 451 20 P 3201 O 1 457 43 N 4105 ² K

EuroCargo 100 E/ 110 E

5,9 160 F4AE3681B...	09.05→	1 457 43 D 6006 WAS F 026 40 N 2030 ² K WAS F 026 40 N 2036 ² K 1 457 43 D 6002 D
--------------------------	--------	--

EuroCargo 110 E/ 130 E

5,9 185 F4AE3681D*...	09.05→	F 026 40 N 2030 ² K 1 457 43 D 6002 D
---------------------------	--------	---

EuroCargo 120 E

3,9 134 F4AE3481A...	09.05→	1 457 43 D 6006 F 026 40 N 2030 ² K 1 457 43 D 6002 D
5,9 185 F4AE3681D...	09.05→	F 026 40 N 2030 ² K 1 457 43 D 6002 D
5,9 205 F4AE3681E...	09.05→	F 026 40 N 2030 ² K 1 457 43 D 6002 D
6,0 105 8060.25R.4...	12.91-07.00	0 451 20 P 3201 O 1 457 43 S 3735 L 1 457 43 N 4105 ² K

EuroCargo 120 E/ 130 E

6,0 167 8060.45S.60...	10.91-08.00	F 026 40 P 7049 O 1 457 43 S 3651 L 1 457 43 N 4432 ² K
6,0 167 8060.45S.72...	10.91-08.00	F 026 40 P 7049 O 1 457 43 N 4432 ² K

EuroCargo 120 E/ 130 E/ 140 E

5,9 202 F4AE0681A*C...	09.00-08.05	F 026 40 N 2030 ² K F 026 40 Z 4008 S
----------------------------	-------------	---



EuroCargo 120 E/ 130 E/ 140 E/ 150 E

5,9 176 F4AE0681B*C...	09.00-08.05	F 026 40 N 2030 ² K F 026 40 Z 4008 S
----------------------------	-------------	---

EuroCargo 120 E/ 130 E/ 150 E

6,0 130 8060.25V.4...	09.91-07.00	0 451 20 P 3201 O 1 457 43 S 3735 L 1 457 43 N 4105 ² K
6,0 167 8060.45K.6090	11.91-07.00	F 026 40 P 7049 O 1 457 43 S 3651 L 1 457 43 N 4432 ² K

EuroCargo 120 E/ 140 E

5,9 160 F4AE3681B...	09.05→	1 457 43 D 6006 F 026 40 N 2030 ² K 1 457 43 D 6002 D
--------------------------	--------	--

EuroCargo 120 E/ 160 E

5,9 148 F4BE0641...	01.11→	F 026 40 S 0074 L
-------------------------	--------	-------------------

EuroCargo 120 EL

3,9 130 F4AE3481B*P...	09.05→	F 026 40 N 2030 ² K
----------------------------	--------	--------------------------------

EuroCargo 130 E

3,9 134 F4AE3481A*P...	09.05→	F 026 40 N 2030 ² K 1 457 43 D 6002 D
----------------------------	--------	---

EuroCargo 130 E/ 150 E

6,0 105 8060.25R.4...	12.91-07.00	0 451 20 P 3201 O 1 457 43 N 4105 ² K
---------------------------	-------------	---

EuroCargo 135 E

5,8 130 8060.25V.47...; 8060.45B.51...	01.94-07.00	0 451 20 P 3201 O 1 457 43 N 4105 ² K
5,8 167 8060.45S.67...; 8060.45S.725...	01.94-07.00	F 026 40 P 7049 O 1 457 43 N 4432 ² K

EuroCargo 140 E

3,9 134 F4AE3481A...	09.05→	1 457 43 D 6006 WAS F 026 40 N 2030 ² K WAS F 026 40 N 2036 ² K 1 457 43 D 6002 D
--------------------------	--------	--

5,9 | 154 | F4AE0681D*C...

09.03-08.05	F 026 40 S 0074 L F 026 40 N 2030 ² K F 026 40 Z 4008 S
-------------	--



5,9 | 185 | F4AE3681D...

09.05→	1 457 43 D 6006
	F 026 40 N 2030 ² K
	1 457 43 D 6002 D

5,9 | 205 | F4AE3681E...

09.05→	1 457 43 D 6006
WAS	F 026 40 N 2030 ² K
WAS	F 026 40 N 2036 ² K
	1 457 43 D 6002 D

EuroCargo 150 E

5,9 | 134 | F4AE0681E*C...

09.03-08.05	F 026 40 S 0074 L
09.00-08.05	F 026 40 N 2030 ² K
	F 026 40 Z 4008 S

5,9 | 154 | F4AE0681D*C...

09.01-08.05	F 026 40 N 2030 ² K
	F 026 40 Z 4008 S

5,9 | 185 | F4AE3681D*...

09.05→	1 457 43 D 6006
WAS	F 026 40 N 2030 ² K
WAS	F 026 40 N 2036 ² K
	1 457 43 D 6002 D

5,9 | 202 | F4AE0681A*C...

09.00-08.03	F 026 40 N 2030 ² K
09.03-08.05	WAS F 026 40 N 2030 ² K
	WAS F 026 40 N 2036 ² K
09.00-08.05	F 026 40 Z 4008 S

6,0 | 167 | 8060.45S.6...

10.91-07.00	F 026 40 P 7049 O
	1 457 43 S 3651 L
	1 457 43 N 4432 ² K

6,0 | 167 | 8060.45S.720...

10.91-07.00	F 026 40 P 7049 O
	1 457 43 N 4432 ² K

7,7 | 196 | 8360.46...-Euro2

09.91-07.00	F 026 40 P 7049 O
	1 457 43 S 3651 L
	1 457 43 N 4432 ² K
	F 026 40 Z 4009 C

EuroCargo 150 E/ 160 E

3,9 | 134 | F4AE3481A*...

09.05→	1 457 43 D 6006
WAS	F 026 40 N 2030 ² K
WAS	F 026 40 N 2036 ² K
	1 457 43 D 6002 D

5,9 | 205 | F4AE3681E*...

09.05→	1 457 43 D 6006
	F 026 40 N 2030 ² K
	1 457 43 D 6002 D

5,9 | 220 | F4AE3681A*...

09.05→	1 457 43 D 6006
	F 026 40 N 2030 ² K
	1 457 43 D 6002 D

**EuroCargo 150 E/ 260 E**

7,7 | 196 | 8360.46...-Euro1

09.91-07.00	F 026 40 P 7049 O
	1 457 43 N 4432 ² K
	F 026 40 Z 4009 C

EuroCargo 160 E

5,9 | 154 | F4AE0681D*C...

09.03-08.05	F 026 40 S 0074 L
	F 026 40 N 2030 ² K
	F 026 40 Z 4008 S

5,9 | 160 | F4AE3681B*...

09.05→	1 457 43 D 6006
	F 026 40 N 2030 ² K
	1 457 43 D 6002 D

5,9 | 176 | F4AE0681B*C...

09.03-08.05	F 026 40 S 0075 L
	F 026 40 N 2030 ² K
	F 026 40 Z 4008 S

5,9 | 202 | F4AE0681A*C...

09.03-08.05	F 026 40 S 0075 L
	F 026 40 N 2030 ² K
	1 457 43 D 6002 D
	F 026 40 Z 4008 S

EuroCargo 160 E/ 180 E

5,9 | 185 | F4AE3681D*...

09.05→	1 457 43 D 6006
	F 026 40 N 2030 ² K
	1 457 43 D 6002 D

EuroCargo 170 E

5,8 | 130 | 8060.25V.41...

01.94-07.00	0 451 20 P 3201 O
	1 457 43 N 4105 ² K

5,8 | 167 | 8060.45S.6...; 8060.45S.72...

01.94-07.00	F 026 40 P 7049 O
	1 457 43 N 4432 ² K

6,0 | 105 | 8060.25R.436...

12.91-07.00	0 451 20 P 3201 O
	1 457 43 N 4105 ² K

EuroCargo 170 E/ 260 E/ 320 E

7,7 | 196 | 8360.46...-Euro2

09.91-08.00	F 026 40 P 7049 O
	1 457 43 N 4432 ² K
	F 026 40 Z 4009 C

EuroCargo 180 E

5,9 | 154 | F4AE0681D*C...

09.00-08.05	F 026 40 N 2030 ² K
	F 026 40 Z 4008 S

5,9 | 176 | F4AE0681B*C...

09.00-08.05	F 026 40 N 2030 ² K
	F 026 40 Z 4008 S





◀ EuroCargo 180 E

5,9 202 F4AE0681A*C...	09.00-08.05	F 026 40 N 2030 ² K
		F 026 40 Z 4008 S

5,9 205 F4AE3681E*...	09.05 →	1 457 43 D 6006
		WAS F 026 40 N 2030 ² K
		WAS F 026 40 N 2036 ² K
		1 457 43 D 6002 D

5,9 220 F4AE3681A*...	09.05 →	F 026 40 N 2030 ² K
		1 457 43 D 6002 D

EuroCargo 260 E

5,9 202 F4AE0681A*C...	09.03-08.05	F 026 40 S 0075 L
		F 026 40 N 2030 ² K
		F 026 40 Z 4008 S

6,0 167 8060.45S.6...	12.91-07.00	F 026 40 P 7049 O
		1 457 43 N 4432 ² K

6,0 167 8060.45S.7...	12.91-07.00	F 026 40 P 7049 O
		1 457 43 N 4432 ² K

EuroCargo 280

6,0 167 8060.45S.6...-Euro1	12.91-11.00	F 026 40 P 7049 O
		1 457 43 S 3651 L
		1 457 43 N 4432 ² K

6,0 167 8060.45S.7...-Euro2	12.91-11.00	F 026 40 P 7049 O
		1 457 43 N 4432 ² K

EuroCargo 320 E

5,9 202 F4AE0681A*C...	09.00-08.03	F 026 40 N 2030 ² K
		F 026 40 Z 4008 S

7,7 196 8360.46...-Euro1	10.91-08.00	F 026 40 P 7049 O
		1 457 43 S 3651 L
		1 457 43 N 4432 ² K
		F 026 40 Z 4009 C

EuroMover

EuroMover 190 E/ 260 E

7,8 180 F2BE0681D...; F2BE0681D*A... <Euro 2>	08.00-03.06	F 026 40 P 7048 O
		F 026 40 N 2035 ² K

EuroStar

EuroStar 180 E

9,5 276 8460.41N.6...	09.92-07.00	F 026 40 P 7049 O
		1 457 43 N 4432 ² K
		F 026 40 Z 4009 C



14,0 309 8210.42L.4620 -Euro2	04.92-07.00	F 026 40 P 7049 O
		1 457 43 N 4432 ² K
		F 026 40 Z 4009 C

EuroStar 190 E

9,5 276 8460.41L.5...-Euro1	06.92-07.00	F 026 40 P 7049 O
		TW 1 457 43 N 4154 ² K
		1 457 43 N 4432 ² K
		FRE F 026 40 Z 4006 H
		F 026 40 Z 4009 C

10,5 287 F3AE0681E*A...	08.00-08.03	F 026 40 P 7048 O
		F 026 40 N 2034 ² K

17,2 378 8280.42S.3...	04.92-11.00	F 026 40 P 7105 O
		1 457 43 S 3292 L
		1 457 43 N 4432 ² K
		FRE F 026 40 Z 4006 H

EuroStar 190 E/ 240 E/ 260 E/ 400 E

14,0 309/345 8210.42L.4...-Euro2	04.92-12.00	F 026 40 P 7049 O
		1 457 43 N 4432 ² K
		FRE F 026 40 Z 4006 H

EuroStar 190 E/ 240 E/ 400 E/ 440 E

14,0 309 8210.42L.4...-Euro1	04.92-12.00	F 026 40 P 7049 O
		1 457 43 N 4432 ² K
		FRE F 026 40 Z 4006 H

EuroStar 190 E/ 260 E

10,3 316 F3AE0681D*A...	08.00-08.03	F 026 40 P 7048 O
		1 457 43 S 3292 L
		F 026 40 N 2034 ² K

14,0 345 8210.42M.5... <Euro 2>	04.92-12.00	F 026 40 P 7049 O
		1 457 43 S 3292 L
		1 457 43 N 4432 ² K
		FRE F 026 40 Z 4006 H

EuroStar 190 E/ 260 E/ 440 E

10,3 316 F3AE0681D*B...	08.00-08.03	F 026 40 P 7048 O
		1 457 43 S 3292 L
		F 026 40 N 2034 ² K

EuroStar 190 E/ 400 E/ 440 E

9,5 276 8460.41N.6...-Euro2	09.92-11.00	F 026 40 P 7049 O
		1 457 43 N 4432 ² K
		FRE F 026 40 Z 4006 H
		F 026 40 Z 4009 C

**EuroStar 240 E**

9,5 276 8460.41L.5...	09.92-11.00	F 026 40 P 7049	O
		TW 1 457 43 N 4154 ²	K
		1 457 43 N 4432 ²	K
		FRE F 026 40 Z 4006	H
		F 026 40 Z 4009	C

9,5|276|8460.41N.6...

09.92-11.00	F 026 40 P 7049	O
	1 457 43 N 4432 ²	K
	FRE F 026 40 Z 4006	H
	F 026 40 Z 4009	C

14,0|345|8210.42M... <Euro 2>

11.95-12.02	F 026 40 P 7049	O
	1 457 43 S 3292	L
	1 457 43 N 4432 ²	K
	FRE F 026 40 Z 4006	H

17,2|378|8280.42S.3... <Euro 2>

04.92-12.00	F 026 40 P 7105	O
	1 457 43 S 3292	L
	1 457 43 N 4432 ²	K
	FRE F 026 40 Z 4006	H

EuroStar 260 E**9,5|276|8460.41L.5...-Euro1**

06.92-09.95	F 026 40 P 7049	O
	TW 1 457 43 N 4154 ²	K
	1 457 43 N 4432 ²	K

10,5|287|F3AE0681E*...

08.00-08.03	F 026 40 P 7048	O
	F 026 40 N 2034 ²	K

12,9|353|F3BE0681E*...

08.97-08.03	F 026 40 P 7048	O
	F 026 40 S 0077	L

Fg.Nr. →4262536

08.97-08.03	1 457 43 N 4402 ²	K
-------------	------------------------------	---

Fg.Nr. 4262537→

08.97-08.03	F 026 40 N 2036 ²	K
-------------	------------------------------	---

08.97-08.03	1 987 43 M 1165	I
-------------	-----------------	---

EuroStar 260 E/ 440 E**10,3|294|F3AE0681B*B...**

08.01-09.04	F 026 40 P 7048	O
	F 026 40 N 2034 ²	K

EuroStar 400 E**14,0|345|8210.42M.5...-Euro2**

04.92-11.00	F 026 40 P 7049	O
	1 457 43 S 3292	L
	1 457 43 N 4432 ²	K
	FRE F 026 40 Z 4006	H

17,2|378|8280.42S.3...

04.92-12.00	F 026 40 P 7105	O
	1 457 43 N 4432 ²	K
	FRE F 026 40 Z 4006	H

EuroStar 400 E/ 440 E**9,5|276|8460.41L.5...-Euro1**

09.92-11.00	F 026 40 P 7049	O
	TW 1 457 43 N 4154 ²	K
	1 457 43 N 4432 ²	K
	FRE F 026 40 Z 4006	H
	F 026 40 Z 4009	C

EuroStar 440 E**10,3|287|F3AE0681E*...**

08.99-08.04	F 026 40 P 7048	O
	F 026 40 S 0077	L

Fg.Nr. →4262536

08.99-08.04	1 457 43 N 4402 ²	K
-------------	------------------------------	---

Fg.Nr. 4262537→

08.99-08.04	F 026 40 N 2036 ²	K
-------------	------------------------------	---

08.99-08.04	1 987 43 M 1165	I
-------------	-----------------	---

13,0|339/353|F3BE0681E*...; F3BE0681F*...

08.00-08.03	F 026 40 P 7048	O
	F 026 40 N 2034 ²	K

13,8|345|8210.42M.5...-Euro2

04.92-12.00	F 026 40 P 7049	O
	1 457 43 N 4432 ²	K
	FRE F 026 40 Z 4006	H

17,2|378|8280.42S.3... <Euro I>

04.92-12.00	F 026 40 P 7105	O
	1 457 43 N 4432 ²	K
	FRE F 026 40 Z 4006	H

EuroTech**EuroTech 175 E/ 179 E****7,7|196|OM-8360.46.417 TCA; 8360.46.417 TCA**

04.92-07.00	F 026 40 P 7049	O
	1 457 43 N 4432 ²	K

EuroTech 180 E**9,5|221|8460.41C.3...-Euro1**

07.92-07.00	F 026 40 P 7049	O
	TW 1 457 43 N 4154 ²	K
	1 457 43 N 4432 ²	K
	F 026 40 Z 4009	C

9,5|276|8460.41L.5...-Euro1

09.92-07.00	F 026 40 P 7049	O
	1 457 43 N 4402 ^{2,6}	K
	TW 1 457 43 N 4154 ²	K
	1 457 43 N 4432 ²	K
	FRE F 026 40 Z 4006	H
	F 026 40 Z 4009	C

17,2|378|8280.42S.350

04.92-07.00	F 026 40 P 7105	O
	1 457 43 S 3292	L
	1 457 43 N 4402 ^{2,6}	K
	1 457 43 N 4432 ²	K





EuroTech 180 E/ 190 E

7,7 176 8360.46R...-Euro1	07.92-07.00	F 026 40 P 7049 O
		1 457 43 N 4432 ² K
		F 026 40 Z 4009 C

7,7 176 8360.46R...-Euro2	07.92-07.00	F 026 40 P 7049 O
		1 457 43 N 4432 ² K
		F 026 40 Z 4009 C

EuroTech 180 E/ 190 E/ 240 E/ 260 E/ 400 E/ 440 E

14,0 309 8210.42L.4...-Euro1	04.92-12.00	F 026 40 P 7049 O
		1 457 43 N 4432 ² K
	FRE	F 026 40 Z 4006 H

EuroTech 180 E/ 190 E/ 240 E/ 400 E/ 440 E

9,5 254 8460.41K.4...-Euro1	04.92-12.02	F 026 40 P 7049 O
	TW	1 457 43 N 4154 ² K
		1 457 43 N 4432 ² K
	FRE	F 026 40 Z 4006 H
		F 026 40 Z 4009 C

9,5 254 8460.41K.4...-Euro2	04.92-12.02	F 026 40 P 7049 O
		1 457 43 N 4432 ² K
	FRE	F 026 40 Z 4006 H
		F 026 40 Z 4009 C

EuroTech 180 E/ 190 E/ 325 E

7,7 196 8360.46...-Euro1	07.92-07.00	F 026 40 P 7049 O
		1 457 43 N 4432 ² K
		F 026 40 Z 4009 C

7,7 196 8360.46...-Euro2	07.92-07.00	F 026 40 P 7049 O
		1 457 43 N 4432 ² K
		F 026 40 Z 4009 C

EuroTech 180 E/ 190 E/ 400 E

9,5 221 8460.41C.30...-Euro2	04.92-12.00	F 026 40 P 7049 O
		1 457 43 N 4432 ² K
		F 026 40 Z 4009 C

EuroTech 180 E/ 240 E

9,5 276 8460.41N.6...	09.92-11.00	F 026 40 P 7049 O
		1 457 43 N 4432 ² K
	FRE	F 026 40 Z 4006 H
		F 026 40 Z 4009 C

EuroTech 190 E

7,8 180 F2BE0681D*A... <Euro 2>; F2BE0681D*B... <Euro 3>	08.00-08.03	F 026 40 P 7048 O
		F 026 40 N 2035 ² K



9,5 | 276 | 8460.41L.5...-Euro1

06.92-07.00	F 026 40 P 7049 O
TW	1 457 43 N 4154 ² K
	1 457 43 N 4432 ² K
FRE	F 026 40 Z 4006 H
	F 026 40 Z 4009 C

9,5 | 276 | 8460.41L.6...-Euro2

09.92-07.00	F 026 40 P 7049 O
	1 457 43 N 4432 ² K
FRE	F 026 40 Z 4006 H
	F 026 40 Z 4009 C

9,5 | 276 | 8460.41N.6...-Euro2

09.92-07.00	F 026 40 P 7049 O
	1 457 43 N 4432 ² K
	F 026 40 Z 4009 C

10,3 | 294 | F3AE0681B*...

08.01-09.04	F 026 40 P 7048 O
	F 026 40 N 2034 ² K

10,3 | 316 | F3AE0681D*A...

08.00-08.03	F 026 40 P 7048 O
	F 026 40 N 2034 ² K

10,3 | 316 | F3AE0681D*B...

08.00-08.03	F 026 40 P 7048 O
	F 026 40 N 2034 ² K

10,5 | 287 | F3AE0681E*...

08.00-08.03	F 026 40 P 7048 O
	F 026 40 N 2034 ² K

EuroTech 190 E/ 240 E/ 260 E/ 400 E/ 440 E

14,0 309/345 8210.42L.4...-Euro2	04.92-12.00	F 026 40 P 7049 O
		1 457 43 N 4432 ² K
	FRE	F 026 40 Z 4006 H

EuroTech 190 E/ 240 E/ 400 E

9,5 221 8460.41C.3...-Euro1	04.92-12.02	F 026 40 P 7049 O
	TW	1 457 43 N 4154 ² K
		1 457 43 N 4432 ² K
		F 026 40 Z 4009 C

EuroTech 190 E/ 260 E

7,8 200 F2BE0681C...	08.00-08.03	F 026 40 P 7048 O
		F 026 40 N 2035 ² K

7,8 | 200 | F2BE0681F...

08.00-08.03	F 026 40 P 7048 O
	F 026 40 N 2035 ² K

EuroTech 190 E/ 440 E

7,8 228 F2BE0681B*A...-Euro2	08.00-08.03	F 026 40 P 7048 O
		F 026 40 N 2035 ² K

7,8 | 228 | F2BE0681B*B...-Euro3

08.00-08.03	F 026 40 P 7048 O
	F 026 40 N 2035 ² K



7,8 259 F2BE0681A*A...-Euro2	08.00-08.03	F 026 40 P 7048 O F 026 40 N 2035 ² K
----------------------------------	-------------	---

7,8 259 F2BE0681A*B...-Euro3	08.00-08.03	F 026 40 P 7048 O F 026 40 N 2035 ² K
----------------------------------	-------------	---

EuroTech 240 E

9,5 185 8460.41T.2036	04.97-11.00	F 026 40 P 7049 O 1 457 43 N 4432 ² K F 026 40 Z 4009 C
---------------------------	-------------	--

9,5 221 8460.41C.3032-Euro2	09.96-12.02	F 026 40 P 7049 O 1 457 43 N 4432 ² K F 026 40 Z 4009 C
---------------------------------	-------------	--

9,5 276 8460.41L.5...	09.92-11.00	F 026 40 P 7049 O 1 457 42 N 9681 ² K TW 1 457 43 N 4154 ² K 1 457 43 N 4432 ² K FRE F 026 40 Z 4006 H F 026 40 Z 4009 C
---------------------------	-------------	--

EuroTech 260 E

7,8 180 F2BE0681D...	08.00-08.03	F 026 40 P 7048 O F 026 40 N 2035 ² K
--------------------------	-------------	---

7,8 228/259 F2BE0681A*A... <Euro2>; F2BE0681A*B... <Euro3>; F2BE0681B*A... <Euro2>; F2BE0681B*B... <Euro3>	08.00-08.03	F 026 40 P 7048 O F 026 40 N 2035 ² K
--	-------------	---

9,5 276 8460.41L.5...-Euro1	06.92-09.95	F 026 40 P 7049 O TW 1 457 43 N 4154 ² K 1 457 43 N 4432 ² K F 026 40 Z 4009 C
---------------------------------	-------------	---

9,5 276 8460.41N.6...-Euro2 <Euro 2>	06.92-07.00	F 026 40 P 7049 O 1 457 43 N 4432 ² K F 026 40 Z 4009 C
--	-------------	--

10,3 316 F3AE0681D*B...	08.00-08.03	F 026 40 P 7048 O 1 457 43 S 3292 L F 026 40 N 2034 ² K
-----------------------------	-------------	--

10,5 287 F3AE0681E*A...	08.00-08.03	F 026 40 P 7048 O F 026 40 N 2034 ² K
-----------------------------	-------------	---

EuroTech 260 E/ 400 E

17,2 378 8280.42S.3...	04.92-12.00	F 026 40 P 7105 O 1 457 43 S 3292 L 1 457 43 N 4432 ² K
----------------------------	-------------	--



EuroTech 260 E/ 440 E

10,3 294 F3AE0681B*B...	08.01-09.04	F 026 40 P 7048 O F 026 40 N 2034 ² K
-----------------------------	-------------	---

10,3 316 F3AE0681D*A...	08.00-08.03	F 026 40 P 7048 O 1 457 43 S 3292 L F 026 40 N 2034 ² K
-----------------------------	-------------	--

EuroTech 400 E/ 440 E

9,5 276 8460.41L.5...-Euro1	09.92-11.00	F 026 40 P 7049 O TW 1 457 43 N 4154 ² K 1 457 43 N 4432 ² K FRE F 026 40 Z 4006 H F 026 40 Z 4009 C
---------------------------------	-------------	--

9,5 276 8460.41N.6...-Euro2	09.92-11.00	F 026 40 P 7049 O 1 457 43 N 4432 ² K FRE F 026 40 Z 4006 H F 026 40 Z 4009 C
---------------------------------	-------------	---

EuroTrakker

EuroTrakker 180 E

7,8 180/200 F2BE0681D*A...; F2BE0681D*B...; F2BE0681F*...	08.00-08.04	F 026 40 P 7048 O F 026 40 N 2035 ² K
---	-------------	---

9,5 185 8460.41T...	04.97-11.00	F 026 40 P 7049 O 1 457 43 N 4432 ² K F 026 40 Z 4009 C
-------------------------	-------------	--

EuroTrakker 190 E

7,8 180/200/228/259 F2BE0681A*A...-Euro2; F2BE0681A*B...-Euro3; F2BE0681B*A...-Euro2; F2BE0681B*B...-Euro3; F2BE0681D*A... <Euro 2>; F2BE0681D*B... <Euro 3>; F2BE0681F...	08.00-08.04	F 026 40 P 7048 O F 026 40 N 2035 ² K
--	-------------	---

13,0 280 F3BE0681G...	08.00-08.04	F 026 40 P 7048 O F 026 40 N 2034 ² K
---------------------------	-------------	---

13,0 324 F3BE0681C*...	08.00-08.04	F 026 40 P 7048 O 1 457 43 S 3292 L F 026 40 N 2034 ² K
----------------------------	-------------	--

13,8 272 8210.42K...-Euro1	04.93-11.00	F 026 40 P 7049 O 1 457 43 N 4402 ^{2,6} K 1 457 43 N 4432 ² K FRE F 026 40 Z 4006 H
--------------------------------	-------------	--

13,8 272 8210.42K...-Euro2	04.93-11.00	F 026 40 P 7049 O 1 457 43 N 4432 ² K FRE F 026 40 Z 4006 H
--------------------------------	-------------	--





EuroTrakker 190 E/ 260 E

9,5 221 8460.41C.3...-Euro1	07.92-07.00	F 026 40 P 7049	O
		TW 1 457 43 N 4154 ²	K
		1 457 43 N 4432 ²	K
		F 026 40 Z 4009	C

9,5 221 8460.41C.30...-Euro2	07.92-07.00	F 026 40 P 7049	O
		1 457 43 N 4432 ²	K
		F 026 40 Z 4009	C

9,5 254 8460.41K.4...-Euro1	04.92-07.00	F 026 40 P 7049	O
		TW 1 457 43 N 4154 ²	K
		1 457 43 N 4432 ²	K
		FRE F 026 40 Z 4006	H
		F 026 40 Z 4009	C

9,5 254 8460.41K.4...-Euro2	04.92-07.00	F 026 40 P 7049	O
		1 457 43 N 4432 ²	K
		FRE F 026 40 Z 4006	H
		F 026 40 Z 4009	C

14,0 309 8210.42L.4...-Euro1	04.92-12.00	F 026 40 P 7049	O
		1 457 43 N 4432 ²	K
		FRE F 026 40 Z 4006	H

14,0 309/345 8210.42L.4...-Euro2	04.92-12.00	F 026 40 P 7049	O
		1 457 43 N 4432 ²	K
		FRE F 026 40 Z 4006	H

EuroTrakker 260 E

7,8 228 F2BE0681B*A... <Euro2>; F2BE0681B*B... <Euro3>	08.00-08.04	F 026 40 P 7048	O
		F 026 40 N 2035 ²	K

9,5 272 8210.42K.3...-Euro1; 8210.42K.3...-Euro2	12.94-12.01	F 026 40 P 7049	O
		1 457 43 N 4432 ²	K
		FRE F 026 40 Z 4006	H

13,0 324 F3BE0681C*B...	08.00-08.04	F 026 40 P 7048	O
		F 026 40 N 2034 ²	K

EuroTrakker 260 E/ 340 E/ 380 E

13,0 280 F3BE0681G*B...	08.00-08.04	F 026 40 P 7048	O
		1 457 43 S 3292	L
		F 026 40 N 2034 ²	K

EuroTrakker 260 E/ 340 E/ 380 E/ 400 E/ 410 E

7,8 259 F2BE0681A*A... <Euro2>	08.00-08.04	F 026 40 P 7048	O
		F 026 40 N 2035 ²	K

7,8 259 F2BE0681A*B... <Euro3>	08.00-08.04	F 026 40 P 7048	O
		F 026 40 N 2035 ²	K



EuroTrakker 260 E/ 380 E

14,0 345 8210.42M.5... <Euro 2>	06.92-12.00	F 026 40 P 7049	O
		1 457 43 N 4432 ²	K
		FRE F 026 40 Z 4006	H

EuroTrakker 260 E/ 380 E/ 410 E

13,0 353 F3BE0681E*B...	08.00-08.04	F 026 40 P 7048	O
		F 026 40 N 2034 ²	K

EuroTrakker 330 E/ 340 E

9,5 254 8460.41K.4...-Euro1	04.92-07.00	F 026 40 P 7049	O
		TW 1 457 43 N 4154 ²	K
		1 457 43 N 4432 ²	K
		F 026 40 Z 4009	C

13,8 272 8210.42K.3...-Euro1	04.93-12.02	F 026 40 P 7049	O
		1 457 43 N 4432 ²	K

EuroTrakker 340 E

9,5 254 8460.41K.4...-Euro2	04.92-07.00	F 026 40 P 7049	O
		1 457 43 N 4432 ²	K
		F 026 40 Z 4009	C

13,8 272 8210.42K.3...-Euro2	03.95-12.02	F 026 40 P 7049	O
		1 457 43 N 4432 ²	K

14,0 309/345 8210.42L.4...-Euro2	06.92-12.00	F 026 40 P 7049	O
		1 457 43 N 4432 ²	K

EuroTrakker 340 E/ 380 E

13,0 324 F3BE0681C*B...	08.00-08.04	F 026 40 P 7048	O
		1 457 43 S 3292	L
		F 026 40 N 2034 ²	K

EuroTrakker 340 E/ 400 E/ 410 E/ 440 E

14,0 309 8210.42L.4...-Euro1	04.92-12.00	F 026 40 P 7049	O
		1 457 43 N 4432 ²	K

EuroTrakker 380 E

13,8 272 8210.42K...-Euro1	03.95-12.02	F 026 40 P 7049	O
		1 457 43 N 4432 ²	K
		FRE F 026 40 Z 4006	H

13,8 272 8210.42K.3...-Euro2	03.95-12.02	F 026 40 P 7049	O
		1 457 43 N 4432 ²	K
		FRE F 026 40 Z 4006	H

14,0 309 8210.42L...-Euro1	06.92-12.00	F 026 40 P 7049	O
		1 457 43 N 4432 ²	K
		FRE F 026 40 Z 4006	H

**14,0 | 309/345 | 8210.42L.4...-Euro2**

06.92-12.00	F 026 40 P 7049	O
	1 457 43 N 4432 ²	K
FRE	F 026 40 Z 4006	H

EuroTrakker 380 E/ 400 E**9,5 | 254 | 8460.41K.4...-Euro1**

04.92-12.00	F 026 40 P 7049	O
TW	1 457 43 N 4154 ²	K
	1 457 43 N 4432 ²	K
FRE	F 026 40 Z 4006	H
	F 026 40 Z 4009	C

9,5 | 254 | 8460.41K.4...-Euro2

04.92-12.00	F 026 40 P 7049	O
	1 457 43 N 4432 ²	K
FRE	F 026 40 Z 4006	H
	F 026 40 Z 4009	C

EuroTrakker 400 E**13,0 | 280 | F3BE0681G*B...**

08.00-08.04	F 026 40 P 7048	O
	F 026 40 N 2034 ²	K

13,0 | 324 | F3BE0681C*B...

08.00-08.04	F 026 40 P 7048	O
	F 026 40 N 2034 ²	K

13,8 | 272 | 8210.42K.3...-Euro2

07.94-12.00	F 026 40 P 7049	O
	1 457 43 N 4432 ²	K

EuroTrakker 400 E/ 410 E/ 440 E**14,0 | 309/345 | 8210.42L.4...-Euro2**

04.92-12.00	F 026 40 P 7049	O
	1 457 43 N 4432 ²	K

EuroTrakker 400 E/ 720 E**13,8 | 272 | 8210.42K...-Euro1**

09.93-12.00	F 026 40 P 7049	O
	1 457 43 N 4432 ²	K

EuroTrakker 410 E**13,0 | 280 | F3BE0681G*B...**

08.00-08.04	F 026 40 P 7048	O
	1 457 43 S 3292	L
	F 026 40 N 2034 ²	K

13,0 | 324 | F3BE0681C*B...

08.00-08.04	F 026 40 P 7048	O
	1 457 43 S 3292	L
	F 026 40 N 2034 ²	K

EuroTrakker 410 E/ 440 E**14,0 | 272 | 8210.42K.3...-Euro1**

04.92-11.00	F 026 40 P 7049	O
	1 457 43 N 4432 ²	K

14,0 | 272 | 8210.42K.3...-Euro2

04.92-11.00	F 026 40 P 7049	O
	1 457 43 N 4432 ²	K

**EuroTrakker 440 E****9,5 | 254 | 8460.41K.4...-Euro1**

04.92-07.00	F 026 40 P 7049	O
TW	1 457 43 N 4154 ²	K
	1 457 43 N 4432 ²	K
	F 026 40 Z 4009	C

9,5 | 254 | 8460.41K.4...-Euro2

04.92-07.00	F 026 40 P 7049	O
	1 457 43 N 4432 ²	K
	F 026 40 Z 4009	C

10,5 | 287 | F3AE0681E*A...

08.00-08.04	F 026 40 P 7048	O
	F 026 40 N 2034 ²	K

13,0 | 280 | F3BE0681G*...

08.00-08.04	F 026 40 P 7048	O
	F 026 40 N 2034 ²	K

EuroTrakker 440 E/ 720 E**13,0 | 324 | F3BE0681C*B...**

08.00-08.04	F 026 40 P 7048	O
	F 026 40 N 2034 ²	K

EuroTrakker 720 E**13,0 | 353 | F3BE0681E*B...**

08.00-08.04	F 026 40 P 7048	O
	1 457 43 S 3292	L
	F 026 40 N 2034 ²	K

13,8 | 272 | 8210.42K...-Euro2

09.93-12.95	F 026 40 P 7049	O
	1 457 43 N 4432 ²	K

13,8 | 309/345 | 8210.42L...-Euro1; 8210.42L.4...-Euro2; 8210.42M.5...-Euro2

04.92-12.00	F 026 40 P 7049	O
	1 457 43 N 4432 ²	K
FRE	F 026 40 Z 4006	H

Scudato**Scudato 49/ 59****2,8 | 76 | 8140.43**

11.99-09.05	0 451 20 P 3201	O
Fg.Nr. →8310155	1 457 43 S 3270	L
11.99-09.05	1 457 43 N 4105 ²	K

Scudato 60**2,8 | 92 | 8140.43S**

10.05→	0 451 20 P 3201	O
	1 457 43 S 3270	L
	1 457 43 N 4310 ²	K



Stralis

Stralis L 190 S

10,3 309 F3AE3681D*...	04.07→	1 457 43 D 6006	
		F 026 40 P 7048	O
		F 026 40 S 0080	L
	WAS	F 026 40 N 2036²	K
		1 457 43 D 6002	D
		1 987 43 M 1166	I

Stralis L 190 S/ L 260 S/ L 440 S

12,9 368 F3BE3681B*...	04.07→	1 457 43 D 6006	
		F 026 40 P 7048	O
		F 026 40 S 0080	L
		1 457 43 D 6002	D

Stralis L 190 S/ L 440 S/ 190 S

10,3 331 F3AE3681A*...	04.06→	1 457 43 D 6006	
		F 026 40 P 7048	O
		F 026 40 S 0080	L
		1 457 43 D 6002	D
		1 987 43 M 1166	I

Stralis L 260 S

12,9 412 F3BE3681A*...	04.07→	1 457 43 D 6006	
	TW	F 026 40 P 7048	O
		F 026 40 S 0080	L

Stralis L 440 S

12,9 412 F3BE3681A*...	04.07→	1 457 43 D 6006	
		F 026 40 P 7048	O
		F 026 40 S 0080	L
		1 457 43 D 6002	D

Stralis L 440 S/ 190 S

10,3 309 F3AE3681D*...	04.06→	1 457 43 D 6006	
		F 026 40 P 7048	O
		F 026 40 S 0080	L
		1 457 43 D 6002	D
		1 987 43 M 1166	I

Stralis N 190 S/ N 260 S

7,8 228 F2BE3681C*...	04.07→	1 457 43 D 6006	
		F 026 40 P 7048	O
		F 026 40 S 0080	L
	WAS	F 026 40 N 2035²	K
	WAS	F 026 40 N 2036²	K
		1 457 43 D 6002	D

7,8|243|F2BE3681B*...

04.07→	1 457 43 D 6006	
	F 026 40 P 7048	O
	F 026 40 S 0080	L
WAS	F 026 40 N 2035²	K
WAS	F 026 40 N 2036²	K
	1 457 43 D 6002	D

7,8|265|F2BE3681A*...

04.07→	1 457 43 D 6006	
	F 026 40 P 7048	O
	F 026 40 S 0080	L
	F 026 40 N 2035²	K
	1 457 43 D 6002	D

Stralis N 440 S

7,8|265|F2BE3681A*...

04.07→	1 457 43 D 6006	
	F 026 40 P 7048	O
	F 026 40 S 0080	L
WAS	F 026 40 N 2035²	K
WAS	F 026 40 N 2036²	K
	1 457 43 D 6002	D

Stralis N 440 S/ 190 S/ 260 S

7,8|243|F2BE3681B*...

04.06→	1 457 43 D 6006	
	F 026 40 P 7048	O
	F 026 40 S 0080	L
	F 026 40 N 2035²	K
	1 457 43 D 6002	D

Stralis 190 S

7,8|200|F2BE0641A*...

04.07→	F 026 40 S 0080	L
--------	------------------------	----------

7,8|228|F2BE3681C*...

04.06→	1 457 43 D 6006	
	F 026 40 P 7048	O
	F 026 40 S 0080	L
	F 026 40 N 2035²	K
	1 457 43 D 6002	D
	1 987 43 M 1166	I

7,8|259|F2BE0681A*... <Euro2/3>

08.03-03.06	F 026 40 P 7048	O
	F 026 40 S 0080	L
	F 026 40 N 2035²	K

10,3|294|F3AE0681*...

08.02-03.06	F 026 40 P 7048	O
	F 026 40 S 0080	L
	F 026 40 N 2034²	K

10,5|316|F3AE0681D*...

08.02→	TW	F 026 40 P 7048	O
		F 026 40 S 0080	L
		1 457 43 S 3292	L
	WAS	F 026 40 N 2034²	K
	WAS	F 026 40 N 2036²	K

13,0|353|F3BE0681E*...

08.02-03.06	F 026 40 P 7048	O
	F 026 40 S 0080	L
	F 026 40 N 2034²	K



**Stralis 190 S/ 260 S**

7,8 200 F2BE0681F...	08.03-03.06	F 026 40 P 7048 O F 026 40 S 0080 L F 026 40 N 2035 ² K
7,8 218 F2BE0681E...	08.03-03.06	F 026 40 P 7048 O F 026 40 S 0080 L F 026 40 N 2035 ² K
7,8 228 F2BE0681B*B...-Euro3	08.03-03.06	F 026 40 P 7048 O F 026 40 S 0080 L F 026 40 N 2035 ² K 1 457 43 D 6002 D
7,8 265 F2BE3681A*...	04.06→	1 457 43 D 6006 F 026 40 P 7048 O F 026 40 S 0080 L F 026 40 N 2035 ² K 1 457 43 D 6002 D

Stralis 190 S/ 260 S/ 440 S

12,9 368 F3BE3681B*...	04.06→	1 457 43 D 6006 F 026 40 P 7048 O F 026 40 S 0080 L 1 457 43 D 6002 D 1 987 43 M 1166 I
-----------------------------------	--------	--

Stralis 260 S

7,8 200 F2BE0641A*...	04.07→	TW	F 026 40 S 0078 L F 026 40 S 0080 L
7,8 228 F2BE3681C*...	04.06→		1 457 43 D 6006 F 026 40 P 7048 O F 026 40 S 0080 L F 026 40 N 2035 ² K 1 457 43 D 6002 D
7,8 259 F2BE0681A*...	08.03-03.06		F 026 40 P 7048 O F 026 40 S 0080 L F 026 40 N 2035 ² K
10,3 294 F3AE0681*...	08.02-03.06	TW	F 026 40 P 7048 O F 026 40 S 0077 L F 026 40 S 0080 L F 026 40 N 2034 ² K 1 987 43 M 1166 I

10,3 | 309 | F3AE3681D*...

	04.06→		1 457 43 D 6006 F 026 40 P 7048 O F 026 40 S 0080 L
	04.07→	WAS	F 026 40 N 2036 ² K
	04.06→		1 457 43 D 6002 D 1 987 43 M 1166 I

10,3 | 331 | F3AE3681A*...

	04.06→		1 457 43 D 6006 F 026 40 P 7048 O
	04.07→	TW	F 026 40 P 7048 O
	04.06→		F 026 40 S 0080 L WAS F 026 40 N 2036 ² K 1 457 43 D 6002 D 1 987 43 M 1166 I

10,3 | 338 | F3A

	11.10→		F 026 40 S 0080 L
--	--------	--	---------------------------------

12,9 | 412 | F3BE3681A*...

	04.06-05.09		1 457 43 D 6006 F 026 40 P 7048 O F 026 40 S 0080 L 1 457 43 D 6002 D 1 987 43 M 1166 I
--	-------------	--	--

13,0 | 324 | F3BE0681C*B...

	08.03-03.06		F 026 40 P 7048 O F 026 40 S 0080 L F 026 40 N 2034 ² K
--	-------------	--	--

13,0 | 353 | F3BE0681E*...

	08.02-03.06	TW	F 026 40 P 7048 O F 026 40 S 0077 L F 026 40 S 0080 L F 026 40 N 2034 ² K 1 987 43 M 1166 I
--	-------------	----	--

Stralis 260 S/ 440 S

10,5 316 F3AE0681D*...	08.02→		F 026 40 P 7048 O F 026 40 S 0080 L F 026 40 N 2034 ² K
-----------------------------------	--------	--	--

13,0 | 397 | F3BE0681A*...

	08.03-03.06		F 026 40 P 7048 O F 026 40 S 0080 L F 026 40 N 2034 ² K
--	-------------	--	--

Stralis 320 S

7,8 265 F2BE3681A*...	04.06→		1 457 43 D 6006 F 026 40 S 0080 L
----------------------------------	--------	--	---

Stralis 400 S

12,9 412 F3BE3681A*...	04.06→	TW	F 026 40 P 7048 O F 026 40 S 0080 L
-----------------------------------	--------	----	--





Stralis 440 S

7,8 228/259 F2BE0681A*... <Euro 3>; F2BE0681B*...			
08.03→	F 026 40 P 7048	O	
	F 026 40 S 0080	L	
	F 026 40 N 2035 ²	K	
7,8 243 F2BE3681B*M...			
04.06→	1 457 43 D 6006		
	F 026 40 P 7048	O	
	F 026 40 S 0080	L	
	F 026 40 N 2035 ²	K	
	1 457 43 D 6002	D	
7,8 265 F2BE3681A*...			
04.06→	1 457 43 D 6006		
	F 026 40 P 7048	O	
	F 026 40 S 0080	L	
	F 026 40 N 2035 ²	K	
	1 457 43 D 6002	D	
10,3 294 F3AE0681.*...			
08.02-03.06	F 026 40 P 7048	O	
	F 026 40 S 0080	L	
	F 026 40 N 2034 ²	K	
10,3 309 F3AE3681D*...			
04.06→	1 457 43 D 6006		
	F 026 40 P 7048	O	
	F 026 40 S 0080	L	
	1 457 43 D 6002	D	
	1 987 43 M 1166	I	
10,3 331 F3AE3681A*...			
04.06→	1 457 43 D 6006		
	F 026 40 P 7048	O	
	F 026 40 S 0080	L	
	1 457 43 D 6002	D	
	1 987 43 M 1166	I	
12,9 412 F3BE3681A*...			
04.06→	1 457 43 D 6006		
	F 026 40 P 7048	O	
	F 026 40 S 0080	L	
	1 457 43 D 6002	D	
	1 987 43 M 1166	I	
13,0 324 F3BE0681C*...			
08.03-03.06	F 026 40 P 7048	O	
	F 026 40 S 0080	L	
	F 026 40 N 2034 ²	K	
13,0 353 F3BE0681E*...			
08.02→	1 457 43 D 6006		
	F 026 40 P 7048	O	
TW	F 026 40 S 0077	L	
	F 026 40 S 0080	L	
	F 026 40 N 2034 ²	K	
	1 987 43 M 1166	I	



Trakker

Trakker N 190 T

7,8 228 F2BE3681C*...			
07.07→	1 457 43 D 6006		
	F 026 40 P 7048	O	
	F 026 40 S 0080	L	
	F 026 40 N 2035 ²	K	
	1 457 43 D 6002	D	
	1 987 43 M 1166	I	
7,8 243 F2BE3681B*...			
07.07→	1 457 43 D 6006		
	F 026 40 P 7048	O	
TW	F 026 40 S 0078	L	
	F 026 40 S 0080	L	
	F 026 40 N 2035 ²	K	
	1 457 43 D 6002	D	
	1 987 43 M 1166	I	
13,0 302 F3BE3681D*...			
07.07→	1 457 43 D 6006		
	F 026 40 P 7048	O	
TW	F 026 40 S 0078	L	
	F 026 40 S 0080	L	
	1 457 43 D 6002	D	
	1 987 43 M 1166	I	
13,0 331 F3BE3681C*...			
07.07→	1 457 43 D 6006		
	F 026 40 P 7048	O	
TW	F 026 40 S 0078	L	
	F 026 40 S 0080	L	
	1 457 43 D 6002	D	
	1 987 43 M 1166	I	

Trakker N 190 T/ N 260 T

7,8 265 F2BE3681A*...			
07.07→	1 457 43 D 6006		
	F 026 40 P 7048	O	
	F 026 40 S 0080	L	
	F 026 40 N 2035 ²	K	
	1 457 43 D 6002	D	
	1 987 43 M 1166	I	

Trakker N 260 T

7,8 243 F2BE3681B*...			
07.07→	1 457 43 D 6006		
	F 026 40 P 7048	O	
	F 026 40 S 0080	L	
	F 026 40 N 2035 ²	K	
	1 457 43 D 6002	D	
	1 987 43 M 1166	I	

Trakker N 260 T/ N 340 T/ N 380 T/ N 400 T/ N 410 T/ N 440 T/ N 720 T

13,0 331 F3BE3681C*...			
07.07→	1 457 43 D 6006		
	F 026 40 P 7048	O	
	F 026 40 S 0080	L	
	1 457 43 D 6002	D	
	1 987 43 M 1166	I	

Trakker N 260 T/ N 340 T/ N 380 T/ N 400 T/ N 410 T/ N 440 T/ N 720 T/ 190 T/ 260 T/ 340 T/ 380 T/ 400 T/ 410 T/ 440 T/ 720 T

13,0 302 F3BE3681D*...	04.06→	1 457 43 D 6006	
		F 026 40 P 7048	O
		F 026 40 S 0080	L
		1 457 43 D 6002	D
		1 987 43 M 1166	I

Trakker N 260 T/ N 380 T/ N 400 T

13,0 368 F3BE3681B*...	07.07→	1 457 43 D 6006	
		F 026 40 P 7048	O
		F 026 40 S 0080	L
		1 457 43 D 6002	D
		1 987 43 M 1166	I

Trakker N 340 T

7,8 265 F2BE3681A*...	07.07→	1 457 43 D 6006	
		F 026 40 P 7048	O
		F 026 40 S 0022⁴	L
		F 026 40 S 0079	L
		F 026 40 S 0080	L
		F 026 40 N 2035²	K
		1 457 43 D 6002	D
		1 987 43 M 1166	I

Trakker N 400 T

7,8 265 F2BE3681A*...	07.07→	1 457 43 D 6006	
		F 026 40 P 7048	O
		F 026 40 S 0080	L
		F 026 40 N 2035²	K
		1 457 43 D 6002	D
		1 987 43 M 1166	I

Trakker N 410 T

13,0 368 F3BE3681B*...	07.07→	1 457 43 D 6006	
		F 026 40 P 7048	O
		F 026 40 P 7048	O
		F 026 40 S 0022⁴	L
		F 026 40 S 0079	L
		F 026 40 S 0080	L
		1 457 43 D 6002	D
		1 987 43 M 1166	I

Trakker N 440 T/ N 720 T

13,0 368 F3BE3681B*...	07.07→	1 457 43 D 6006	
		F 026 40 P 7048	O
		F 026 40 S 0080	L
		1 457 43 D 6002	D
		1 987 43 M 1166	I

Trakker 180 T

7,8 180 F2BE0681D*...	09.04-03.06	F 026 40 P 7048	O
		F 026 40 S 0080	L
		F 026 40 N 2035²	K

7,8|228|F2BE0681B*B*...

09.04-03.06	F 026 40 P 7048	O
	F 026 40 S 0080	L
	F 026 40 N 2035²	K

Trakker 180 T/ 190 T

7,8 200 F2BE0681F*B*...	09.04-03.06	F 026 40 P 7048	O
		F 026 40 S 0080	L
		F 026 40 N 2035²	K

Trakker 190 T

7,8 228 F2BE0681B*B*...	09.04-09.06	F 026 40 P 7048	O
		F 026 40 S 0080	L
		F 026 40 N 2035²	K
		1 457 43 D 6002	D

7,8|228|F2BE3681C*...

04.06→	1 457 43 D 6006	
	F 026 40 P 7048	O
	F 026 40 S 0080	L
	F 026 40 N 2035²	K
	1 457 43 D 6002	D

13,0|280|F3BE0681G*...

09.04→	F 026 40 P 7048	O
	F 026 40 S 0080	L
	F 026 40 N 2034²	K
	1 457 43 D 6002	D

13,0|280|F3BE3681C*...

04.05→	F 026 40 P 7048	O
	F 026 40 S 0080	L
	1 457 43 D 6002	D

13,0|324|F3BE0681C*...

09.04→	F 026 40 P 7048	O
	F 026 40 S 0080	L
	F 026 40 N 2034²	K

Trakker 190 T/ 260 T

7,8 243 F2BE3681B*...	04.06→	1 457 43 D 6006	
		F 026 40 P 7048	O
		F 026 40 S 0080	L
		F 026 40 N 2035²	K
		1 457 43 D 6002	D

Trakker 190 T/ 260 T/ 340 T/ 380 T/ 400 T/ 410 T

7,8 259 F2BE0681A*B*...	09.04-03.06	F 026 40 P 7048	O
		F 026 40 S 0080	L
		F 026 40 N 2035²	K





◀ Trakker 190 T/ 260 T/ 340 T/ 380 T/ 400 T/ 410 T

7,8 | 265 | F2BE3681A*...

04.06→	1 457 43 D 6006
	F 026 40 P 7048 O
	F 026 40 S 0080 L
	F 026 40 N 2035 ² K
	1 457 43 D 6002 D

Trakker 190 T/ 260 T/ 340 T/ 380 T/ 410 T/ 440 T/ 720 T

13,0 | 331 | F3BE3681C*...

04.06→	1 457 43 D 6006
	F 026 40 P 7048 O
	F 026 40 S 0080 L
	1 457 43 D 6002 D

Trakker 260 T

7,8 | 228 | F2BE0681B*B...

09.04-03.06	F 026 40 P 7048 O
	F 026 40 S 0080 L
	F 026 40 N 2035 ² K

13,0 | 324 | F3BE0681C*B...

09.04-03.06	F 026 40 P 7048 O
	F 026 40 S 0080 L
	F 026 40 N 2034 ² K

Trakker 260 T/ 340 T

13,0 | 280 | F3BE0681G*B...

09.04→	F 026 40 P 7048 O
	F 026 40 S 0080 L
	F 026 40 N 2034 ² K

Trakker 260 T/ 380 T/ 400 T/ 410 T/ 440 T/ 720 T

13,0 | 368 | F3BE3681B*...

04.06→	1 457 43 D 6006
	F 026 40 P 7048 O
	F 026 40 S 0080 L
	1 457 43 D 6002 D

Trakker 260 T/ 380 T/ 410 T/ 720 T

13,0 | 353 | F3BE0681E*B...

09.04-03.06	F 026 40 P 7048 O
	F 026 40 S 0080 L
	F 026 40 N 2034 ² K

Trakker 340 T

13,0 | 324 | F3BE0681C*B...

09.04-03.06	F 026 40 P 7048 O
TW	F 026 40 S 0022 ⁴ L
	F 026 40 S 0079 L
	F 026 40 S 0080 L
	F 026 40 N 2034 ² K

Trakker 380 T

13,0 | 280 | F3BE0681G*...

09.04→	F 026 40 P 7048 O
	F 026 40 S 0080 L
	F 026 40 N 2034 ² K



13,0 | 309 | F3BE0681V*...

04.06→	TW	F 026 40 P 7048 O
		F 026 40 S 0078 L
		F 026 40 S 0080 L
		F 026 40 N 2034 ² K
		1 987 43 M 1166 I

13,0 | 324 | F3BE0681C*B...

09.04→	TW	F 026 40 P 7048 O
		F 026 40 S 0078 L
		F 026 40 S 0080 L
		F 026 40 N 2034 ² K

Trakker 400 T

13,0 | 280 | F3BE0681G*...

09.04→	TW	F 026 40 P 7048 O
		F 026 40 S 0078 L
		F 026 40 S 0080 L
		F 026 40 N 2034 ² K

13,0 | 324 | F3BE0681C*B...

09.04-03.06	F 026 40 P 7048 O
	F 026 40 S 0080 L
	F 026 40 N 2034 ² K

Trakker 400 T/ 410 T

13,0 | 309 | F3BE0681V*...

04.06→	F 026 40 P 7048 O
	F 026 40 S 0080 L
	F 026 40 N 2034 ² K

Trakker 410 T

13,0 | 280 | F3BE0681G*B...

09.04→	TW	F 026 40 P 7048 O
		F 026 40 S 0078 L
		F 026 40 S 0080 L
		F 026 40 N 2034 ² K

13,0 | 324 | F3BE0681C*B...

09.04→	TW	F 026 40 P 7048 O
		F 026 40 S 0080 L
	TW	F 026 40 N 2034 ² K

Trakker 440 T

13,0 | 280 | F3BE0681G*B...

09.04→	F 026 40 P 7048 O
	F 026 40 S 0080 L
	F 026 40 N 2034 ² K

Trakker 440 T/ 720 T

13,0 | 324 | F3BE0681C*B...

09.04→	F 026 40 P 7048 O
	F 026 40 S 0080 L
	F 026 40 N 2034 ² K

Trakker 720 T

13,0 | 280 | F3BE0681G*...

09.04→	F 026 40 P 7048 O
	F 026 40 S 0080 L
	F 026 40 N 2034 ² K





13,0 309 F3BE0681V*...	04.06→	TW	F 026 40 P 7048	O
			F 026 40 S 0078	L
			F 026 40 S 0080	L
			F 026 40 N 2034 ²	K

TurboStar

TurboStar 190

13,8 277 8210.42...	07.91-11.00		F 026 40 P 7049	O
			1 457 43 S 2188	L

13,8 277 8210.42.074	07.90-12.93		F 026 40 P 7049	O
			1 457 42 N 9681 ²	K

13,8 277 8210.42.201	07.90-12.93		F 026 40 P 7049	O
			1 457 42 N 9681 ²	K

17,2 350/353 8280.42...; 8280.42.050	03.89-11.00		F 026 40 P 7105	O
			1 457 43 N 4154 ²	K
			F 026 40 Z 4009	C

TurboStar 190/ 260

13,8 277 8210.42.1...	07.90-12.00		F 026 40 P 7049	O
			1 457 42 N 9681 ²	K

TurboStar 240

13,8 265-277 8210.42.07...; 8210.42.154	07.87-12.95		F 026 40 P 7049	O
			1 457 42 N 9681 ²	K

17,2 350 8280.42.050 <Euro1>	03.89-11.99		F 026 40 P 7105	O
			1 457 43 N 4154 ²	K
			F 026 40 Z 4009	C

TurboStar 240/ 260

17,2 350 8280.42....	03.89-11.99		F 026 40 P 7105	O
			1 457 43 N 4154 ²	K
			F 026 40 Z 4009	C

TurboTech

TurboTech 190

9,5 177 8460.21.2...	10.88-01.98		F 026 40 P 7049	O
			1 457 42 N 9681 ²	K
			F 026 40 Z 4009	C

9,5 236 8460.41.16...	10.91-01.01		F 026 40 P 7049	O
			1 457 42 N 9681 ²	K
			F 026 40 Z 4009	C



13,8 224 8210.22.17...	03.80-08.95		F 026 40 P 7049	O
			1 457 42 S 9975	L
			1 457 42 N 9681 ²	K

13,8 277 8210.42.07...	09.91-12.94		F 026 40 P 7049	O
			1 457 42 N 9681 ²	K

13,8 277 8210.42.1...	07.90-12.93		F 026 40 P 7049	O
			1 457 43 S 2188	L
			1 457 42 N 9681 ²	K

TurboTech 190/ 220/ 240/ 260

9,5 234 8460.41.1...	10.88-12.00		F 026 40 P 7049	O
			1 457 42 N 9681 ²	K
			F 026 40 Z 4009	C

TurboTech 190/ 240

9,5 192 8460.21.10...	09.86-11.00		F 026 40 P 7049	O
			1 457 42 N 9681 ²	K
			F 026 40 Z 4009	C

TurboTech 190/ 260

13,8 277 8210.42.201	07.90-12.98		F 026 40 P 7049	O
			1 457 42 N 9681 ²	K

TurboTech 220/ 260

13,8 277 8210.42.151	07.90-11.00		F 026 40 P 7049	O
			1 457 42 N 9681 ²	K

TurboTech 240

13,8 277 8210.42.15...- 19...	07.90-12.95		F 026 40 P 7049	O
	01.93-12.95		1 457 43 S 2188	L
	07.90-12.95		1 457 42 N 9681 ²	K

TurboTech 260

13,8 277 8210.42.073	07.90-12.98		F 026 40 P 7049	O
			1 457 42 N 9681 ²	K

13,8 277 8210.42.155,175	07.90-12.99		F 026 40 P 7049	O
			1 457 42 N 9681 ²	K

50

50 50

4,0 65 8040.05.230	01.87-06.91		1 457 43 N 4105 ²	K
------------------------	-------------	--	------------------------------	---





60

60 60

3,9 74 8040.25.230 R	01.87-05.91	0451 30 P 0007	O
		1457 43 N 4105 ²	K

60 65

3,9 65 8040.05.23...	01.87-12.92	1457 43 N 4105 ²	K
--------------------------	-------------	-----------------------------	---

3,9 85 8040.25.2...	01.87-12.92	0451 30 P 0007	O
		1457 43 N 4105 ²	K

70

70 75

5,9 102 8060.05.270	07.87-12.92	0451 20 P 3152	O
		1457 43 N 4105 ²	K

70 79

3,9 85 8040.25.220	01.87-12.92	0451 30 P 0007	O
		1457 43 N 4105 ²	K

5,9 102 8060.05.28...	12.85-12.92	0451 20 P 3152	O
		1457 43 N 4105 ²	K

80

80 80

5,9 102 8060.05.270	06.86-06.94	0451 20 P 3152	O
		1457 43 N 4105 ²	K

5,9 125 8060.25.670	01.86-06.94	CAV	1457 43 N 4201 ²	K
-------------------------	-------------	-----	-----------------------------	---

6,1 96-99 BF6L 913 T; BF6L 913 T Vollkaps.	01.83-12.91	0451 10 P 5067	O
		1457 43 N 4154 ²	K

6,1 118-124 BF6L 913	01.83-12.91	0451 10 P 5067	O
		1457 42 S 9950	L
		1457 43 N 4154 ²	K

90

90 90

5,5 125 8060.25.669,670	01.87-11.95	0451 20 P 3152	O	
		CAV	1457 43 N 4201 ²	K

6,1 96-99 BF6L 913 T	01.83-12.91	0451 40 P 3001	O
		1457 43 N 4154 ²	K



90 95

5,9 102 8060.05.2...	11.85-05.91	0451 20 P 3152	O
		1457 42 S 9946	L
		1457 43 N 4105 ²	K

100

100 109

5,9 102 8060.05.286,288,289	11.85-06.91	0451 20 P 3152	O
		1457 42 S 9946	L
		1457 43 N 4105 ²	K

110

110 110

5,9 130 8060.25.678,679	07.87-12.99	CAV	1457 43 N 4201 ²	K
-----------------------------	-------------	-----	-----------------------------	---

6,1 96-99 BF6L 913 T	01.83-12.91	0451 40 P 3001	O
		1457 43 N 4154 ²	K

6,1 118-124 BF6L 913	01.83-12.91	0451 40 P 3001	O
		1457 42 S 9950	L
		1457 43 N 4154 ²	K

110 115

5,9 99-102 8060.05.20...	11.85-12.91	0451 20 P 3152	O
		1457 43 N 4105 ²	K

5,9 130 8060.25.6...	01.86-12.99	0451 20 P 3201	O
		1457 42 S 9950	L
		1457 43 N 4154 ²	K

130

130 130

5,9 102 8060.05.2...	11.85-12.91	0451 20 P 3152	O
		1457 43 N 4105 ²	K

5,9 130 8060.25.6...	01.86-08.92	0451 20 P 3201	O
		1457 42 S 9950	L
		1457 43 N 4154 ²	K

6,1 118-124 BF6L 913	01.83-10.91	0451 40 P 3001	O
		1457 42 S 9950	L
		1457 43 N 4154 ²	K

140

140 145

5,9 130 8060.25.60...	02.86-07.92	0451 20 P 3201	O
		1457 43 N 4154 ²	K

**150****150 150**

6,1 118 BF6L 913	01.83-12.91	0 451 40 P 3001	O
		1 457 42 S 9950	L
		1 457 43 N 4154 ²	K

170**170 175**

5,9 130 8060.25.6...	09.86-07.92	0 451 20 P 3201	O
		1 457 43 N 4154 ²	K

9,5 177 8460.21.0...	09.86-07.92	F 026 40 P 7049	O
		1 457 42 S 9966	L
		1 457 42 N 9681 ²	K
		1 457 43 N 4106 ²	K
		F 026 40 Z 4009	C

190**190 190**

13,8 224 8210.22.5...	09.87-09.97	0 451 30 P 1156	O
		1 457 42 N 9681 ²	K

13,8 277 8210.42.182/192	07.90-11.98	F 026 40 P 7049	O
		1 457 42 N 9681 ²	K

260**260 260**

12,8 250 BF8L 513	04.89-12.99	0 451 10 P 5067	O
		1 457 42 S 9975	L
		1 457 43 N 4154 ²	K

13,4 168-174/194 F8L 513	04.89-12.99	0 451 10 P 5067	O
		1 457 42 S 9975	L
		1 457 43 N 4154 ²	K

13,8 224 8210.22.269	06.84-10.91	F 026 40 P 7049	O
		1 457 42 S 9975	L
		1 457 42 N 9681 ²	K

300**300 300**

12,8 225-232/243-250 BF8L 513	04.89-12.99	0 451 10 P 5067	O
		1 457 42 S 9975	L
		1 457 43 N 4154 ²	K

**300 315**

5,5 123 8060.24.652	01.83-06.91	0 451 20 P 3201	O
---------------------	-------------	------------------------	----------

300 315/ 316/ 316.8.18

5,5 130 8060.25V.4600; 8060.45B.5160	06.91-11.00	0 451 20 P 3201	O
		1 457 43 N 4105 ²	K

320**320 320**

13,8 224 8210.22.235	01.84-07.96	F 026 40 P 7049	O
		1 457 42 S 9975	L
		1 457 42 N 9681 ²	K

330**330 330**

12,8 225 BF8L 513	05.86-10.91	0 451 10 P 5067	O
		1 457 43 N 4154 ²	K

13,8 224 8210.22....	06.84-12.92	F 026 40 P 7049	O
	10.87-12.95	0 451 30 P 1156	O
	06.84-12.92	1 457 42 S 9975	L
	06.84-12.95	1 457 42 N 9681 ²	K

13,8 265 8210.42.2...	10.91-12.99	F 026 40 P 7049	O
		1 457 42 N 9681 ²	K

17,2 259 8280.02.2...	06.83-01.92	0 451 30 P 1156	O
		1 457 42 N 9681 ²	K
		F 026 40 Z 4009	C

340**340 -34**

12,8 250 BF8L 513	03.89-12.98	0 451 10 P 5067	O
		1 457 42 S 9975	L
		1 457 43 N 4154 ²	K

370**370 370 S**

9,6 177 8460.21.7...	01.87-11.98	F 026 40 P 7049	O
		F 026 40 Z 4009	C

13,8 191 8210.02.426	01.87-12.91	0 451 30 P 1156	O
		1 457 43 S 2188	L



◀ 370 370 S

13,8 220.224 8210.22.406	01.87-11.98	0 451 30 P 1156	O
		1 457 43 S 2188	L
		TW 1 457 42 S 9975	L

17,2 259 8280.02.405	01.87-06.91	F 026 40 Z 4009	C
--------------------------	-------------	------------------------	----------

370 370 SE

7,7 196 8360.46.4370; 8360.46.4637	07.92-07.00	F 026 40 P 7049	O
		1 457 43 N 4432 ²	K
		F 026 40 Z 4009	C

9,5 214 8460.41.721	01.92-11.00	F 026 40 P 7049	O
		F 026 40 Z 4009	C

380

380 380

9,5 214 8460.41.721,723; 8460.41.731,733	01.92-11.00	F 026 40 P 7049	O
--	-------------	------------------------	----------

KÄSSBOHRER

Setra

Setra S 210

11,0 159 OM 421.900	10.83-06.96	1 457 42 P 9735	O
		1 457 42 S 9966	L
		1 457 42 N 9354	K

11,0 184 OM 421 A	09.85-06.96	1 457 42 P 9740	O
		1 457 42 S 9966	L

11,0 191 OM 441 A	03.89-06.96	TW 1 457 42 P 9740	O
		1 457 42 S 9975	L

Setra S 211

11,0 184 OM 421 A	09.85-06.96	1 457 42 P 9735	O
		1 457 42 S 9966	L
		TW 1 457 42 S 9975	L

Setra S 211/ S 213/ S 214/ S 215

14,6 206 OM 422.900	01.80-06.96	1 457 42 P 9740	O
		1 457 42 S 9969	L
	TW	1 457 42 S 9975	L
		01.81-06.96	1 457 42 N 9354

Setra S 213

11,4D 2566 MH	06.79-01.94	1 457 42 P 9740	O
		1 457 42 S 9966	L



Setra S 213/ S 214/ S 215/ S 216/ S 228

14,6 243 OM 422.901 A	07.80-06.96	1 457 42 P 9740	O
		1 457 42 S 9969	L
		01.81-06.96	1 457 42 N 9354

Setra S 214/ S 215

12,0 243 D 2866 LOH	09.86-01.95	1 457 42 P 9740	O
		1 457 42 S 9969	L

Setra S 214/ S 215/ S 216

12,0 265 D 2866 KOH	09.86-01.95	1 457 42 P 9740	O
		1 457 42 S 9969	L

Setra S 215

12,0 177 D 2866 UH	09.85-01.95	1 457 42 P 9740	O
		1 457 42 S 9966	L
		1 457 42 P 9820 ³	P

12,0 184 OM 447 hA	07.92-06.96	1 457 42 P 9740	O
------------------------	-------------	------------------------	----------

12,0 213 D 2866 TUH	09.85-01.95	1 457 42 P 9740	O
		1 457 42 S 9969	L
		1 457 42 P 9820 ³	P

14,6 260 OM 442 A	07.88-06.96	1 457 42 P 9740	O
		1 457 42 S 9969	L
		1 457 42 N 9354	K

14,6 320 OM 442 LA	06.96-06.01	1 457 42 P 9740	O
------------------------	-------------	------------------------	----------

Setra S 216/ S 228

14,6 276 OM 422.901-500 LA	03.82-06.96	1 457 42 P 9740	O
		1 457 42 S 9969	L
		1 457 42 N 9354	K

Setra S 217

14,6 280/320 OM 442 LA <Euro 2>	01.89-06.96	1 457 42 P 9732	O
-------------------------------------	-------------	------------------------	----------

Setra S 228

14,60M 442 A	01.89-06.96	1 457 42 P 9740	O
--------------	-------------	------------------------	----------

14,6 280 OM 442 LA	01.89-06.96	1 457 42 P 9740	O
------------------------	-------------	------------------------	----------

Setra S 300

12,0 177 D 2866 OH	03.92-07.01	1 457 42 P 9740	O
------------------------	-------------	------------------------	----------

12,0 180 D 2866 OH	03.92-07.01	1 457 42 P 9740	O
		1 457 42 S 9966	L
		1 457 42 P 9820 ³	P



Setra S 309

11,0 213 OM 441 LA <Euro 2>			
09.92-07.01	1 457 42	P 9740	O
	1 457 42	P 9820³	P

Setra S 312

14,6 280 OM 442 LA			
09.91-07.01	1 457 42	P 9740	O
	1 457 42	S 9969	L

Setra SG 219/ SG 221

12,0 177 D 2866 UH			
09.85-06.01	1 457 42	P 9740	O

KAVZ KURGAN

Serie 320000

Serie 320000 324410

4,8 80 D 245.12 C <Euro 1>			
01.00→	0 451 20	P 3152	O
	TW	1 457 43 N 4310²	K
	TW,XXX	1 457 43 N 4306²	K

4,8 115 D 245.30 E3 <Euro 3>			
01.08→	0 451 20	P 3152	O

LAZ

A191N

A191N 6.9

6,9 206 D 0836 LOH02 <Euro 3>			
01.08→	0 451 30	P 1207	O

LEYLAND

Constructor

Constructor

12,2 195 Eagle 800			
01.89-10.99	XXX	1 457 43 N 4423²	K

LIAZ LIKINSKI (RUS)

Serie 6000

Serie 6000 6212

11,1 303 650 DCi 11 <Euro 3>			
06.08→	0 451 10	P 4010	O
	1 457 43	N 4421²	K



MAN

Ale

Ale

4,6 125 D 0824 LOH05 <V1901, Euro 3>; D 0834 LOH01 <V5101, Euro 3>			
01.99-12.01	0 451 30	P 1207	O
	ROB	1 457 43 N 4447²	K

Bus 8t

Bus 8t 8.150

4,6 114-118 D 0824 LFO01 <V1700, Euro 2>			
02.95-07.98	0 451 30	P 1207	O
11.95-06.97	TMV	1 457 42 S 9950	L
02.95-07.98	ROB	1 457 43 N 4447²	K
		1 987 43 M 1162	I
		1 457 42 P 9820³	P

6,9 110 D 0826 GF03 <Z8300, Euro 1>			
10.92-05.95	0 451 10	P 5067	O
10.92-10.93		1 457 42 S 9966	L
10.92-05.95	ROB	1 457 43 N 4447²	K

6,9 110-114 D 0826 GF01 <Z8300>			
07.88-11.91	0 451 30	P 1207	O
12.91-10.93		0 451 10 P 5067	O
07.88-10.93		1 457 42 S 9966	L
	ROB	1 457 43 N 4447²	K

Bus 8t 8.160

4,6 114-118 D 0824 LFL09 <V1700, Euro 2>			
07.98-02.01	0 451 30	P 1207	O
	ROB	1 457 43 N 4447²	K
		1 987 43 M 1162	I
		1 457 42 P 9820³	P

Bus 8t 8.170

5,7 125-131 D 0226 MCFO; D 0226 MCFO/170			
02.89-10.93	1 457 42	S 9966	L

Bus 8t 8.220

6,9 162 D 0826 LFL03 <V2300, Euro 2>			
04.95-02.01	MCK	0 451 30 P 1207	O
04.95-06.97		1 457 42 S 9966	L
	SA	1 457 43 S 3611⁴	L
07.97-02.01		F 026 40 S 0067	L
04.95-04.00		1 457 43 N 4447²	K
05.00-02.01	ROB	1 457 43 N 4447²	K
04.95-02.01		1 987 43 M 1162	I
		1 457 42 P 9820³	P





◀ Bus 8t 8.220

6,9 | 162 | D 0826 LFL10 <V2300, Euro 2>

07.98-09.01	MGK	0 451 30	P 1207	O
		F 026 40	S 0067	L
		1 457 43	S 3611 ⁴	L
07.98-04.00		1 457 43	N 4447 ²	K
05.00-09.01	ROB	1 457 43	N 4447 ²	K
07.98-09.01		1 987 43	M 1162	I
		1 457 42	P 9820 ³	P

Bus 9t

Bus 9t 9.150

6,9 | 110 | D 0826 GF03 <Z8300, Euro 1>

10.92-05.95		0 451 10	P 5067	O
10.92-10.93		1 457 42	S 9966	L
10.92-05.95	ROB	1 457 43	N 4447 ²	K

6,9 | 110-114 | D 0826 GF01 <Z8300>

07.88-11.91		0 451 30	P 1207	O
12.91-10.93		0 451 10	P 5067	O
07.88-10.93		1 457 42	S 9966	L
	ROB	1 457 43	N 4447 ²	K

Bus 9t 9.170

5,7 | 125-131 | D 0226 MCF0; D 0226 MCF0/170

02.89-10.93		1 457 42	S 9966	L
-------------	--	----------	---------------	----------

Bus 10t

Bus 10t 10.150

4,6 | 114-118 | D 0824 LFO-01 <V1700, Euro 2>

02.95-01.96		0 451 30	P 1207	O
	ROB	1 457 43	N 4447 ²	K
		1 987 43	M 1162	I
		1 457 42	P 9820 ³	P

6,9 | 110-114 | D 0826 OH02 <Z9300>

01.88-05.92		0 451 30	P 1207	O
		1 457 42	S 9950	L
	ROB	1 457 43	N 4447 ²	K

Bus 10t 10.180

6,9 | 130-137 | D 0826 TOH01 <Z8600>

01.88-05.92		0 451 30	P 1207	O
		1 457 42	S 9966	L
	SA	1 457 43	S 3611 ⁴	L
		1 457 43	N 4154 ²	K
	ROB	1 457 43	N 4447 ²	K

Bus 10t 10.220

6,9 | 162 | D 0826 LFL03 <V2300, Euro 2>

02.95-02.01	MGK	0 451 30	P 1207	O
02.95-06.97		1 457 42	S 9966	L
	SA	1 457 43	S 3611 ⁴	L
07.97-02.01		F 026 40	S 0067	L
02.95-04.00		1 457 43	N 4447 ²	K
05.00-02.01	ROB	1 457 43	N 4447 ²	K
02.95-02.01		1 987 43	M 1162	I
		1 457 42	P 9820 ³	P



6,9 | 162 | D 0826 LFL10 <V2300, Euro 2>

07.98-09.01	MGK	0 451 30	P 1207	O
		F 026 40	S 0067	L
		1 457 43	S 3611 ⁴	L
07.98-04.00		1 457 43	N 4447 ²	K
05.00-09.01	ROB	1 457 43	N 4447 ²	K
07.98-09.01		1 987 43	M 1162	I
		1 457 42	P 9820 ³	P

Bus 11t

Bus 11t 11.150

6,9 | 110-114 | D 0826 OH02 <Z9300>

05.92-02.93		0 451 30	P 1207	O
		1 457 42	S 9950	L
	ROB	1 457 43	N 4447 ²	K

Bus 11t 11.190

6,9 | 140 | D 0826 LOH02 <V0900, Euro 2>

04.92-02.93		0 451 30	P 1207	O
		1 457 42	S 9966	L
	KNE	F 026 40	S 0184	L
		1 457 43	S 3651	L
	ROB, ZE	1 457 43	N 4447 ²	K

6,9 | 140 | D 0826 LOH06 <V0900, Euro 1>

03.93-09.96		0 451 30	P 1207	O
		1 457 42	S 9966	L
	SA	1 457 43	S 3611 ⁴	L
	ROB, ZE	1 457 43	N 4447 ²	K

Bus 11t 11.220

6,9 | 162 | D 0826 LOH15 <V2900,>; D 0826 LOH19 <V2900, Euro 2>

11.95-09.01		0 451 30	P 1207	O
	KNE	1 457 43	S 3651	L
	ROB, ZE	1 457 43	N 4447 ²	K

6,9 | 162 | D 0826 LUH12 <V0300, Euro 2>

07.98-12.00		0 451 30	P 1207	O
	KNE	F 026 40	S 0184	L
		1 457 43	S 3651	L
	FIU, ZE	1 457 43	N 1326 ⁷	K
	ROB, ZE	1 457 43	N 4447 ²	K

6,9 | 162 | D 0836 LOH03 <V4900, Euro 3>

01.01-12.04		0 451 30	P 1207	O
	KNE	F 026 40	S 0184	L
	TMM	1 457 43	S 3651	L
	ROB, ZE	1 457 43	N 4447 ²	K

Bus 11t 11.230

6,9 | 169 | D 0826 LOH03 <V0900, Euro 1>

04.93-02.96		0 451 30	P 1207	O
	KNE	F 026 40	S 0184	L
		1 457 43	S 3651	L
	ROB, ZE	1 457 43	N 4447 ²	K

**Bus 12t****Bus 12t 12.220/ 12.280**

6,9 | 162/206 | D 0826 LOH19 <V2900, Euro 2>; D 0836 LOH02 <V4900, Euro 3>;
D 0836 LOH03 <V4900, Euro 3>

07.98-09.06	0 451 30 P 1207	O
KNE	F 026 40 S 0184	L
	1 457 43 S 3651	L
ROB,ZE	1 457 43 N 4447 ²	K

Bus 13t**Bus 13t 13.220**

6,9 | 162 | D 0826 LOH <Euro 2>

11.95-07.98	0 451 30 P 1207	O
	1 457 43 S 3651	L
KNE	F 026 40 S 0184	L
TW	1 457 43 N 4154 ²	K

6,9 | 162 | D 0826 LOH15 <V2900,>

07.98-09.01	0 451 30 P 1207	O
	1 457 43 S 3651	L
KNE	F 026 40 S 0184	L
ROB,ZE	1 457 43 N 4447 ²	K

6,9 | 162 | D 0826 LUH12 <V0300, Euro 2>

07.98-09.01	0 451 30 P 1207	O
	1 457 43 S 3651	L
KNE	F 026 40 S 0184	L
FIU,ZE	1 457 43 N 1326 ⁷	K
ROB,ZE	1 457 43 N 4447 ²	K

6,9 | 162 | D 0836 LOH03 <V4900, Euro 3>

09.01-05.04	0 451 30 P 1207	O
	1 457 43 S 3651	L
KNE	F 026 40 S 0184	L
ROB,ZE	1 457 43 N 4447 ²	K

Bus 13t 13.230

6,9 | 169 | D 0826 LOH

11.95-09.01	0 451 30 P 1207	O
	1 457 43 S 3651	L
KNE	F 026 40 S 0184	L
TW	1 457 43 N 4154 ²	K

Bus 14t**Bus 14t 14.220**

6,9 | 162 | D 0826 LOH19 <V2900, Euro 2>

07.98-09.01	0 451 30 P 1207	O
KNE	1 457 43 S 3651	L
ROB,ZE	1 457 43 N 4447 ²	K

6,9 | 162 | D 0826 LUH12 <V0300, Euro 2>

07.98-09.01	0 451 30 P 1207	O
KNE	1 457 43 S 3651	L
FIU,ZE	1 457 43 N 1326 ⁷	K
ROB,ZE	1 457 43 N 4447 ²	K

6,9 | 162 | D 0836 LOH03 <V4900, Euro 3>

01.01-09.06	0 451 30 P 1207	O
KNE	1 457 43 S 3651	L
ROB,ZE	1 457 43 N 4447 ²	K

6,9 | 206 | D 0836 LOH02 <V4900, Euro 3>

01.02-09.02	0 451 30 P 1207	O
KNE	1 457 43 S 3651	L
ROB,ZE	1 457 43 N 4447 ²	K

Bus 14t 14.280

6,9 | 206 | D 0836 LOH02 <V4900, Euro 3>

06.03-10.06	0 451 30 P 1207	O
KNE	F 026 40 S 0184	L
MMV	1 457 43 S 3651	L
ROB,ZE	1 457 43 N 4447 ²	K

Bus 16t**Bus 16t 16.290**

12,0 | 213-229 | D 2866 TOH <Z7900>; D 2866 TOH/290 <Z7900>; D 2866 TOH/310
<Z7900>

04.87-03.93	1 457 42 P 9740	O
	1 457 42 S 9969	L
FIH,ROB, ZE	1 457 43 N 4447 ²	K
FIU,ZE	1 457 43 N 1326 ⁷	K

Bus 16t 16.360/ 16.370

12,0 | 274 | D 2866 LOH07 <Z7700>

02.93-11.95	1 457 42 P 9740	O
	1 457 43 N 1270	K

Bus 16t 16.370

12,0 | 272 | D 2866 LOH22 <V1500, Euro 1>

11.95-06.97	LBF	1 457 42 P 9137	O
	LBF	1 457 42 P 9740	O
		1 457 42 S 9969	L
	FIU,ZE	1 457 43 N 1270	K
	ROB,ZE	1 457 43 N 4447 ²	K

Bus 17t**Bus 17t 17.192/ 17.232**

6,9 | 140/169 | D 0826 LF02 <Z9500>; D 0826 LF05 <Z9500, Euro 1>; D 0826 LF06
<Z9500, Euro 1>

03.91-05.94	0 451 30 P 1207	O	
	1 457 42 S 9966	L	
	1 457 43 S 3611 ⁴	L	
	ROB	1 457 43 N 4447 ²	K
		1 457 42 P 9820 ³	P





Bus 18t

Bus 18t LE 232

6,9 | 162 | D 0826 LFL10 <V2300, Euro 2>

08.00→	MGK	0 451 30	P 1207	O
	AHF,ANV	F 026 40	S 0067	L
	AZY	1 457 43	S 3651	L
	ROB,TW,	1 457 43	N 4447²	K
	ZE			
		1 987 43	M 1162	I
		1 457 42	P 9820³	P

Bus 18t LE 282/ 18.282/ 18.292

6,9 | 206 | D 0836 LFO1 <V4000, Euro 2>

09.00→		1 457 42	P 9278	O
	MGK	0 451 30	P 1207	O
	AHF,ANV	F 026 40	S 0067	L
	AZY	1 457 43	S 3651	L
	ROB,ZE	1 457 43	N 4447²	K
		1 987 43	M 1162	I
		1 457 42	P 9820³	P

Bus 18t 18.220

6,9 | 162 | D 0826 LOH19 <V2900, Euro 2>; D 0836 LOH03 <V4900, Euro 3>

07.98-09.06		0 451 30	P 1207	O
	ROB,ZE	1 457 43	N 4447²	K

Bus 18t 18.232

6,9 | 162 | D 0826 LFL10 <V2300, Euro 2>

03.97→	MGK	0 451 30	P 1207	O
	TMV	1 457 43	S 3651	L
	TMV	F 026 40	S 0067	L
	ROB,TW,	1 457 43	N 4447²	K
	ZE			
		1 987 43	M 2151	I
		1 457 42	P 9820³	P

Bus 18t 18.260

12,0 | 191 | D 2866 LOH31 <V1500, Euro 2>

09.96-09.01	LBF	1 457 42	P 9137	O
	LBF	1 457 42	P 9740	O
		1 457 42	S 9969	L
09.96-05.00	FIU,ZE	1 457 43	N 1270	K
09.96-09.01	ROB,ZE	1 457 43	N 4447²	K

12,0 | 191 | D 2866 LOH35 <V4800, Euro 3>

06.01-09.06	LBF	1 457 42	P 9137	O
	LBF	1 457 42	P 9740	O
		1 457 42	S 9969	L
		1 457 43	N 1710	K
	ROB,ZE	1 457 43	N 4447²	K

12,0 | 191 | D 2866 LUH22 <V3200, Euro 2>

07.98-09.01		1 457 42	P 9740	O
	LUM	1 457 43	S 2188	L
		1 457 43	N 1159⁶	K
		1 457 43	N 1326⁷	K
	FIU,ZE	1 457 43	N 1270	K

12,0 | 191 | D 2866 LUH23 <V5000, Euro 3>

06.01-09.06		1 457 42	P 9740	O
	LUM	1 457 43	S 2188	L
		1 457 43	N 1710	K
	ROB,ZE	1 457 43	N 4447²	K

Bus 18t 18.280

6,9 | 206 | D 0836 LOH02 <V4900, Euro 3>

01.01-09.06		0 451 30	P 1207	O
	ROB,ZE	1 457 43	N 4447²	K

Bus 18t 18.282

7,0 | 206 | D 0836 LFL01

09.96→		1 457 42	P 9278	O
	MGK	0 451 30	P 1207	O
	AHF,ANV	F 026 40	S 0067	L
	AZY	1 457 43	S 3651	L
	ROB,ZE	1 457 43	N 4447²	K
		1 987 43	M 1162	I
		1 457 42	P 9820³	P

Bus 18t 18.310

12,0 | 228 | D 2866 LOH27 <V4800, Euro 3>

01.01-09.06	LBF	1 457 42	P 9137	O
	LBF	1 457 42	P 9740	O
		1 457 42	S 9969	L
		1 457 43	N 1710	K
	ROB,ZE	1 457 43	N 4447²	K

12,0 | 228 | D 2866 LUH24 <V5000, Euro 3>

01.01-09.06		1 457 42	P 9740	O
	LUM	1 457 43	S 2188	L
		1 457 43	N 1710	K
	ROB,ZE	1 457 43	N 4447²	K

12,0 | 228 | D 2866 LUH26 <V3200, Euro 2>

07.98-09.06		1 457 42	P 9740	O
	LUM	1 457 43	S 2188	L
	FIH,ROB,	1 457 43	N 4447²	K
	ZE			

12,0 | 230 | D 2866 LOH24 <V1500, Euro 1>

03.95-09.96	LBF	1 457 42	P 9137	O
	LBF	1 457 42	P 9740	O
		1 457 42	S 9969	L
	ROB,ZE	1 457 43	N 4447²	K

12,0 | 230 | D 2866 LOH25 <V1500, Euro 2>

09.96-09.01	LBF	1 457 42	P 9137	O
	LBF	1 457 42	P 9740	O
		1 457 42	S 9969	L
09.96-05.00	FIU,ZE	1 457 43	N 1270	K
09.96-09.01	ROB,ZE	1 457 43	N 4447²	K

Bus 18t 18.320

10,0 | 235 | D 2865 LOH02 <V2200, Euro 1>

02.94-02.95	LBF	1 457 42	P 9740	O
		1 457 42	S 9969	L
	FIH,ROB,	1 457 43	N 4447²	K
	ZE			
	FIU,ZE	1 457 43	N 1270	K



**10,5 | 235 | D2066 LOH01 <V6500 Euro 4>**

10.06→		F 026 40 P 7051	O
	FIH,RME	1 457 43 N 1710	K
	RAP	F 026 40 N 2028	K

Bus 18t 18.350**12,0 | 257 | D 2866 LOH26 <V1500, Euro 2>**

09.96-09.01	LBF	1 457 42 P 9137	O
	LBF	1 457 42 P 9740	O
		1 457 42 S 9969	L
09.96-05.00	FIU,ZE	1 457 43 N 1270	K
09.96-09.01	ROB,ZE	1 457 43 N 4447 ²	K

Bus 18t 18.360**10,5 | 265 | D2066 LOH02 <V6500 Euro 4>**

10.06→		F 026 40 P 7051	O
	FIH,RME	1 457 43 N 1710	K
	RAP	F 026 40 N 2028	K

12,0 | 265 | D 2866 LOH28 <V4800, Euro 3>

01.01-09.06	LBF	1 457 42 P 9137	O
	LBF	1 457 42 P 9740	O
		1 457 42 S 9969	L
		1 457 43 N 1710	K
	ROB,ZE	1 457 43 N 4447 ²	K

Bus 18t 18.370**12,0 | 274 | D 2866 LOH07 <Z7700, Euro 1>**

04.93-09.96		1 457 42 P 9740	O
		1 457 42 S 9969	L
		1 457 43 N 1270	K

Bus 18t 18.400**10,5 | 294 | D2066 LOH03 <V6500 Euro 4>**

10.06→		F 026 40 P 7051	O
	FIH,RME	1 457 43 N 1710	K
	RAP	F 026 40 N 2028	K

12,0 | 294 | D 2866 LOH23 <V1500, Euro 2>; D 2866 LOH24 <V1500, Euro 2>

09.96-09.01	LBF	1 457 42 P 9137	O
	LBF	1 457 42 P 9740	O
		1 457 42 S 9969	L
	ROB,ZE	1 457 43 N 4447 ²	K

Bus 18t 18.410**12,0 | 301 | D 2866 LOH29 <V4800, Euro 3>**

09.02-09.06	LBF	1 457 42 P 9137	O
	LBF	1 457 42 P 9740	O
		1 457 42 S 9969	L
		1 457 43 N 1710	K
	ROB,ZE	1 457 43 N 4447 ²	K

12,8 | 302 | D 2876 LOH05 <V4500, Euro 2>

01.99-09.01	LBF	1 457 42 P 9137	O
	LBF	1 457 42 P 9740	O
		1 457 42 S 9969	L
	ROB,ZE	1 457 43 N 4447 ²	K
08.01-09.01		1 457 43 N 1710	K

Bus 18t 18.420**12,0 | 309 | D 2866 LOH06 <Z7700, Euro 1>**

04.93-09.96		1 457 42 P 9740	O
		1 457 42 S 9969	L
		1 457 43 N 1270	K

Bus 18t 18.440**10,5 | 324 | D2066 LOH04 <V6500 Euro 4>**

10.06→		F 026 40 P 7051	O
	FIH,RME	1 457 43 N 1710	K
	RAP	F 026 40 N 2028	K

Bus 18t 18.460**11,8 | 338 | D 2876 LOH02 <V4500, Euro 3>**

01.01-09.06	LBF	1 457 42 P 9137	O
	LBF	1 457 42 P 9740	O
		1 457 42 S 9969	L
	ROB,ZE	1 457 43 N 4447 ²	K
08.01-09.06		1 457 43 N 1710	K

Bus 22t**Bus 22t 22.360****12,0 | 274 | D 2866 LOH07 <Z7700>**

02.93-04.93		1 457 42 P 9740	O
		1 457 42 S 9969	L
		1 457 43 N 1270	K

Bus 22t 22.361**12,0 | 265-274 | D 2866 LX04**

09.89-04.92	LBF	1 457 42 P 9740	O
		1 457 42 S 9969	L
		1 457 43 N 1159 ⁶	K
		1 457 43 N 1326 ⁷	K
	TW	1 457 43 N 1270	K

Bus 22t 22.370/ 22.400/ 22.420**12,0 | 274/294/309 | D 2866 LOH03 <Z7700, Euro 2>; D 2866 LOH06 <Z7700, Euro 1>; D 2866 LOH07 <Z7700, Euro 1>**

04.93-12.00		1 457 42 P 9740	O
		1 457 42 S 9969	L
		1 457 43 N 1270	K

Bus 24t**Bus 24t 24.310****12,0 | 228 | D 2866 LOH25 <V1500, Euro 2>**

07.98-09.01	LBF	1 457 42 P 9137	O
	LBF	1 457 42 P 9740	O
		1 457 42 S 9969	L
07.98-05.00	FIU,ZE	1 457 43 N 1270	K
07.98-09.01	ROB,ZE	1 457 43 N 4447 ²	K





◀ Bus 24t 24.310

12,0 | 228 | D 2866 LOH27 <V4800, Euro 3>

01.01-09.02	LBF	1 457 42 P 9137	O
	LBF	1 457 42 P 9740	O
		1 457 42 S 9969	L
		1 457 43 N 1710	K
	ROB,ZE	1 457 43 N 4447 ²	K

Bus 24t 24.320

10,5 | 235 | D2066 LOH01 <V6500 Euro 4>

10.06→		F 026 40 P 7051	O
	FIH,RME	1 457 43 N 1710	K
	RAP	F 026 40 N 2028	K

Bus 24t 24.350

12,0 | 258 | D 2866 LOH26 <V1500, Euro 2>

07.98-09.01	LBF	1 457 42 P 9137	O
	LBF	1 457 42 P 9740	O
		1 457 42 S 9969	L
07.98-05.00	FIU,ZE	1 457 43 N 1270	K
07.98-09.01	ROB,ZE	1 457 43 N 4447 ²	K

Bus 24t 24.360

10,5 | 265 | D2066 LOH02 <V6500 Euro 4>

10.06→		F 026 40 P 7051	O
	FIH,RME	1 457 43 N 1710	K
	RAP	F 026 40 N 2028	K

12,0 | 265 | D 2866 LOH28 <V4800, Euro 3>

09.02-09.06	LBF	1 457 42 P 9137	O
	LBF	1 457 42 P 9740	O
		1 457 42 S 9969	L
		1 457 43 N 1710	K
	ROB,ZE	1 457 43 N 4447 ²	K

Bus 24t 24.400

10,5 | 294 | D2066 LOH03 <V6500 Euro 4>

10.06→		F 026 40 P 7051	O
	FIH,RME	1 457 43 N 1710	K
	RAP	F 026 40 N 2028	K

12,0 | 294 | D 2866 LOH23 <V1500, Euro 2>

07.98-09.01	LBF	1 457 42 P 9137	O
	LBF	1 457 42 P 9740	O
		1 457 42 S 9969	L
07.98-05.00	FIU,ZE	1 457 43 N 1270	K
07.98-09.01	ROB,ZE	1 457 43 N 4447 ²	K

12,0 | 294 | D 2866 LOH24 <V1500, Euro 2>

07.96-12.00	LBF	1 457 42 P 9137	O
	LBF	1 457 42 P 9740	O
		1 457 42 S 9969	L
	ROB,ZE	1 457 43 N 4447 ²	K
	TW	1 457 43 N 1270	K

Bus 24t 24.410

12,0 | 301 | D 2866 LOH29 <V4800, Euro 3>

09.02-09.06	LBF	1 457 42 P 9137	O
	LBF	1 457 42 P 9740	O
		1 457 42 S 9969	L
		1 457 43 N 1710	K
	ROB,ZE	1 457 43 N 4447 ²	K



12,8 | 301/302 | D 2876 LOH05 <V4500, Euro 2>

07.98-09.01	LBF	1 457 42 P 9137	O
	LBF	1 457 42 P 9740	O
		1 457 42 S 9969	L
	ROB,ZE	1 457 43 N 4447 ²	K
08.01-09.01		1 457 43 N 1710	K

Bus 24t 24.440

10,5 | 324 | D2066 LOH04 <V6500 Euro 4>

10.06→		F 026 40 P 7051	O
	FIH,RME	1 457 43 N 1710	K
	RAP	F 026 40 N 2028	K

Bus 24t 24.460

12,8 | 338 | D 2876 LOH01 <V3300, Euro 2>

11.99-09.01		1 457 42 P 9740	O
		1 457 42 S 9969	L
		1 457 43 N 1270	K
	ROB,ZE	1 457 43 N 4447 ²	K

12,8 | 339 | D 2876 LOH02 <V4500, Euro 3>

01.01-09.06	LBF	1 457 42 P 9137	O
	LBF	1 457 42 P 9740	O
		1 457 42 S 9969	L
	ROB,ZE	1 457 43 N 4447 ²	K
08.01-09.06		1 457 43 N 1710	K

EL / EM

EL / EM EL 202

6,9 | 157 | D 0826 LUH03 <V0300, Euro 1>

01.93-06.97		0 451 30 P 1207	O
07.95-05.96	KNE	1 457 43 S 3651	L
01.93-06.97	FIU,ZE	1 457 43 N 1326 ⁷	K
	ROB,ZE	1 457 43 N 4447 ²	K

6,9 | 184/198 | D 0826 LUH <V0300, Euro 1>

04.94-06.97		0 451 30 P 1207	O
07.95-05.96	KNE	1 457 43 S 3651	L
02.96-06.97		1 457 43 S 3651	L
04.94-06.97	FIU,ZE	1 457 43 N 1326 ⁷	K
	ROB,ZE	1 457 43 N 4447 ²	K

EL / EM EL 222

6,9 | 162 | D 0826 LUH12 <V0300, Euro 2>

11.95-09.01		0 451 30 P 1207	O
	NEB	F 026 40 P 7054	O
11.95-05.96	KNE	1 457 43 S 3651	L
06.97-05.99		1 457 43 S 3651	L
11.95-09.01	FIU,ZE	1 457 43 N 1326 ⁷	K
	ROB,ZE	1 457 43 N 4447 ²	K

EL / EM EL 262

6,9 | 191 | D 0826 LUH13 <V0300, Euro 2>

02.96-09.01		0 451 30 P 1207	O
02.96-05.96	KNE	1 457 43 S 3651	L
06.97-05.99		1 457 43 S 3651	L
02.96-09.01	FIU,ZE	1 457 43 N 1326 ⁷	K
	ROB,ZE	1 457 43 N 4447 ²	K



**12,0 | 191 | D 2866 LUH22 <V3200, Euro 2>**

07.98-09.01	1 457 42 P 9740	O
	1 457 43 N 1159 ⁶	K
	1 457 43 N 1326 ⁷	K
FIU,ZE	1 457 43 N 1270	K
ROB,ZE	1 457 43 N 4447 ²	K

EL / EM EM 11.222**6,9 | 162 | D 0826 LOH15 <V2900,>**

02.96-09.01	0 451 30 P 1207	O
KNE	1 457 43 S 3651	L
ROB,ZE	1 457 43 N 4447 ²	K

EL / EM EM 13.222**6,9 | 162 | D 0826 LUH12 <V0300, Euro 2>**

06.97-09.01	0 451 30 P 1207	O
	1 457 43 S 3651	L
KNE	F 026 40 S 0184	L
	1 457 43 S 3651	L
FIU,ZE	1 457 43 N 1326 ⁷	K
ROB,ZE	1 457 43 N 4447 ²	K

EL / EM EM 192**6,9 | 140 | D 0826 LOH06 <V0900, Euro 1>**

10.93-06.97	0 451 30 P 1207	O
	1 457 42 S 9966	L
SA	1 457 43 S 3611 ⁴	L
ROB,ZE	1 457 43 N 4447 ²	K

EL / EM EM 220**6,9 | 162 | D 0836 LOH03 <V4900, Euro 3>**

11.99-12.04	0 451 30 P 1207	O
KNE	F 026 40 S 0184	L
TW	1 457 43 S 3651	L
ROB,ZE	1 457 43 N 4447 ²	K

E2000**E2000 19.293****10,0 | 213 | D 2865 LF24 <V2500, Euro 2>**

06.96-01.97	1 457 42 P 9107	O
06.96-09.01	ZE 1 457 42 P 9107	O
02.97-09.01	1 457 42 P 9137	O
06.96-09.01	1 457 43 S 3900	L
	1 457 43 N 4154 ²	K
ROB,ZE	1 457 43 N 4447 ²	K
	1 987 43 M 2151	I

E2000 19.314**12,0 | 228 | D 2866 LF34 <V2600, Euro 2>**

06.98-09.01	1 457 42 P 9137	O
	1 457 43 S 3900	L
	1 457 43 N 1710	K
ROB,ZE	1 457 43 N 4447 ²	K
	1 987 43 M 2151	I
	1 457 42 P 9820 ³	P
TW	1 457 42 P 9165 ³	P
	1 457 42 P 9820 ³	P

E2000 19.343**10,0 | 250 | D 2865 LF21 <V2500, Euro 2>**

06.96-01.97	1 457 42 P 9107	O
02.97-09.01	1 457 42 P 9137	O
06.96-09.01	1 457 43 S 3900	L
ROB,ZE	1 457 43 N 4447 ²	K
	1 987 43 M 2151	I

E2000 19.364**12,0 | 265 | D 2866 LF35 <V2600, Euro 2>**

06.98-09.01	1 457 42 P 9137	O
	1 457 43 S 3900	L
	1 457 43 N 1710	K
ROB,ZE	1 457 43 N 4447 ²	K
	1 987 43 M 2151	I
	1 457 42 P 9820 ³	P
TW	1 457 42 P 9165 ³	P
	1 457 42 P 9820 ³	P

E2000 19.403/ 26.403**12,0 | 294 | D 2866 LF20 <V2600, Euro 2>**

06.96-01.97	1 457 42 P 9107	O
02.97-09.01	1 457 42 P 9137	O
06.96-09.01	1 457 43 S 3900	L
	1 457 43 N 1710	K
ROB,ZE	1 457 43 N 4447 ²	K
	1 987 43 M 2151	I
	1 457 42 P 9820 ³	P
TW	1 457 42 P 9165 ³	P
	1 457 42 P 9820 ³	P

E2000 19.414**12,0 | 301 | D 2866 LF31 <V2600, Euro 2>**

06.98-12.01	1 457 42 P 9137	O
	1 457 43 S 3900	L
	1 457 43 N 1710	K
ROB,ZE	1 457 43 N 4447 ²	K
	1 987 43 M 2151	I
	1 457 42 P 9820 ³	P
TW	1 457 42 P 9165 ³	P
	1 457 42 P 9820 ³	P

E2000 19.463**12,8 | 338 | D 2876 LF02 <V2400, Euro 2>**

06.96-06.96	ZE 1 457 42 P 9107	O
07.96-09.01	1 457 42 P 9137	O
06.96-09.01	1 457 43 S 3900	L
	1 457 43 N 1710	K
ROB,ZE	1 457 43 N 4447 ²	K
	1 987 43 M 2151	I
	1 457 42 P 9820 ³	P
TW	1 457 42 P 9165 ³	P
	1 457 42 P 9820 ³	P





E2000 19.464

12,8 338 D 2876 LF06 <V2400, Euro 2>			
06.98-09.01	1 457 42 P 9137	O	
	1 457 43 S 3900	L	
	1 457 43 N 1710	K	
ROB,ZE	1 457 43 N 4447 ²	K	
	1 987 43 M 2151	I	
	1 457 42 P 9820 ³	P	
TW	1 457 42 P 9165 ³	P	
	1 457 42 P 9820 ³	P	

E2000 26.233/ 28.233

12,0 170 E 2866 DF01 <V2800/CNG>			
10.97-09.02	1 457 42 P 9740	O	
	1 457 43 S 3900	L	
	1 987 43 M 2151	I	
TW	1 457 42 P 9165 ³	P	
	1 457 42 P 9820 ³	P	

E2000 26.293

10,0 213 D 2865 LF24 <V2500, Euro 2>			
09.96-01.97	1 457 42 P 9107	O	
02.97-09.01	1 457 42 P 9137	O	
09.96-09.01	1 457 43 S 3900	L	
ROB,ZE	1 457 43 N 4447 ²	K	
TW	1 987 43 M 2151	I	

E2000 26.314

12,0 228 D 2866 LF34 <V2600, Euro 2>			
07.99-09.01	1 457 42 P 9137	O	
	1 457 43 S 3900	L	
	1 457 43 N 1710	K	
ROB,ZE	1 457 43 N 4447 ²	K	
	1 987 43 M 2151	I	
	1 457 42 P 9820 ³	P	

E2000 26.343

10,0 250 D 2865 LF21 <V2500, Euro 2>			
09.96-01.97	1 457 42 P 9107	O	
02.97-09.01	1 457 42 P 9137	O	
09.96-09.01	1 457 43 S 3900	L	
ROB,ZE	1 457 43 N 4447 ²	K	
TW	1 987 43 M 2151	I	

E2000 26.364

12,0 265 D 2866 LF35 <V2600, Euro 2>			
07.99-09.01	1 457 42 P 9137	O	
	1 457 43 S 3900	L	
	1 457 43 N 1710	K	
ROB,ZE	1 457 43 N 4447 ²	K	
	1 987 43 M 2151	I	
	1 457 42 P 9820 ³	P	

E2000 26.414

12,0 301 D 2866 LF31 <V2600, Euro 2>			
07.99-12.01	1 457 42 P 9137	O	
	1 457 43 S 3900	L	
	1 457 43 N 1710	K	
ROB,ZE	1 457 43 N 4447 ²	K	
	1 987 43 M 2151	I	
	1 457 42 P 9820 ³	P	

E2000 26.463

12,8 338 D 2876 LF02 <V2400, Euro 2>			
09.96-09.01	1 457 42 P 9137	O	
	1 457 43 S 3900	L	
	1 457 43 N 1710	K	
ROB,ZE	1 457 43 N 4447 ²	K	
	1 987 43 M 2151	I	
	1 457 42 P 9820 ³	P	
TW	1 457 42 P 9165 ³	P	
	1 457 42 P 9820 ³	P	

E2000 26.464

12,8 338 D 2876 LF06 <V2400, Euro 2>			
07.99-09.01	1 457 42 P 9137	O	
	1 457 43 S 3900	L	
	1 457 43 N 1710	K	
ROB,ZE	1 457 43 N 4447 ²	K	
	1 987 43 M 2151	I	
	1 457 42 P 9820 ³	P	

E2000 27.604

18,3 441 D 2840 LF21 <V3400, Euro 2>			
07.99-01.02	1 457 42 P 9740	O	
OES,ZE	1 457 42 P 9107	O	
	1 457 43 S 3900	L	
ROB,ZE	1 457 43 N 4447 ²	K	
	1 987 43 M 2151	I	

E2000 28.293

10,0 213 D 2865 LF24 <V2500, Euro 2>			
09.96-01.97	1 457 42 P 9107	O	
02.97-09.01	1 457 42 P 9137	O	
09.96-09.01	1 457 43 S 3900	L	
ROB,ZE	1 457 43 N 4447 ²	K	
	1 987 43 M 2151	I	

E2000 28.314

12,0 228 D 2866 LF34 <V2600, Euro 2>			
07.99-03.01	1 457 42 P 9137	O	
	1 457 43 S 3900	L	
	1 457 43 N 1710	K	
ROB,ZE	1 457 43 N 4447 ²	K	
	1 987 43 M 2151	I	
TW	1 457 42 P 9165 ³	P	
	1 457 42 P 9820 ³	P	

E2000 28.343/ 30.343

10,0 250 D 2865 LF21 <V2500, Euro 2>			
02.97-09.01	1 457 42 P 9137	O	
09.96-09.01	1 457 43 S 3900	L	
ROB,ZE	1 457 43 N 4447 ²	K	
	1 987 43 M 2151	I	



E2000 28.364/ 30.364

12,0 265 D 2866 LF35 <V2600, Euro 2>			
06.98-09.01	1 457 42	P 9137	O
	1 457 43	S 3900	L
	1 457 43	N 1710	K
ROB,ZE	1 457 43	N 4447²	K
	1 987 43	M 2151	I
	1 457 42	P 9820³	P
TW	1 457 42	P 9165³	P
	1 457 42	P 9820³	P

E2000 28.403

12,0 294 D 2866 LF20 <V2600, Euro 2>			
09.96-01.97	1 457 42	P 9107	O
02.97-09.01	1 457 42	P 9137	O
09.96-09.01	1 457 43	S 3900	L
	1 457 43	N 1710	K
ROB,ZE	1 457 43	N 4447²	K
	1 987 43	M 2151	I
	1 457 42	P 9820³	P

E2000 28.414/ 30.414

12,0 301 D 2866 LF31 <V2600, Euro 2>			
06.98-12.01	1 457 42	P 9137	O
	1 457 43	S 3900	L
	1 457 43	N 1710	K
ROB,ZE	1 457 43	N 4447²	K
	1 987 43	M 2151	I
	1 457 42	P 9820³	P
07.99-12.01	TW	1 457 42	P 9165³
	1 457 42	P 9820³	P

E2000 28.463

12,8 338 D 2876 LF02 <V2400, Euro 2>			
09.96-09.01	1 457 42	P 9137	O
	1 457 43	S 3900	L
	1 457 43	N 1710	K
ROB,ZE	1 457 43	N 4447²	K
	1 987 43	M 2151	I
	1 457 42	P 9820³	P

E2000 28.464/ 30.464

12,8 338 D 2876 LF06 <V2400, Euro 2>			
06.98-09.01	1 457 42	P 9137	O
	1 457 43	S 3900	L
	1 457 43	N 1710	K
ROB,ZE	1 457 43	N 4447²	K
	1 987 43	M 2151	I
	1 457 42	P 9820³	P
07.99-09.01	TW	1 457 42	P 9165³
	1 457 42	P 9820³	P

E2000 30.293

10,0 213 D 2865 LF24 <V2500, Euro 2>			
03.97-09.01	1 457 42	P 9137	O
	1 457 43	S 3900	L
ROB,ZE	1 457 43	N 4447²	K
	1 987 43	M 2151	I



E2000 30.314

12,0 228 D 2866 LF34 <V2600, Euro 2>			
06.98-09.01	1 457 42	P 9137	O
	1 457 43	S 3900	L
	1 457 43	N 1710	K
ROB,ZE	1 457 43	N 4447²	K
	1 987 43	M 2151	I
	1 457 42	P 9820³	P

E2000 30.364

12,0 265 D 2866 LF24 <V2600, Euro 2>			
01.00-09.02	1 457 42	P 9137	O
	1 457 43	S 3900	L
	1 457 43	N 1710	K
ROB,ZE	1 457 43	N 4447²	K
	1 987 43	M 2151	I
	1 457 42	P 9820³	P

E2000 30.403

12,0 294 D 2866 LF20 <V2600, Euro 2>			
03.97-09.01	1 457 42	P 9137	O
	1 457 43	S 3900	L
	1 457 43	N 1710	K
ROB,ZE	1 457 43	N 4447²	K
	1 987 43	M 2151	I
	1 457 42	P 9820³	P
TW	1 457 42	P 9165³	P
	1 457 42	P 9820³	P

E2000 30.463

12,8 338 D 2876 LF02 <V2400, Euro 2>			
03.97-09.01	1 457 42	P 9137	O
	1 457 43	S 3900	L
	1 457 43	N 1710	K
ROB,ZE	1 457 43	N 4447²	K
	1 987 43	M 2151	I
	1 457 42	P 9820³	P
TW	1 457 42	P 9165³	P
	1 457 42	P 9820³	P

E2000 32.293

10,0 213 D 2865 LF24 <V2500, Euro 2>			
03.97-09.01	1 457 42	P 9137	O
	1 457 43	S 3900	L
ROB,ZE	1 457 43	N 4447²	K

E2000 32.314

12,0 228 D 2866 LF34 <V2600, Euro 2>			
07.99-09.01	1 457 42	P 9137	O
	1 457 43	S 3900	L
	1 457 43	N 1710	K
ROB,ZE	1 457 43	N 4447²	K
	1 987 43	M 2151	I
TW	1 457 42	P 9165³	P
	1 457 42	P 9820³	P





E2000 32.343

10,0 250 D 2865 LF21 <V2500, Euro 2>			
03.97-09.01	1 457 42	P 9137	O
	1 457 43	S 3900	L
ROB,ZE	1 457 43	N 4447²	K

E2000 32.364

12,0 265 D 2866 LF35 <V2600, Euro 2>			
07.99-09.01	1 457 42	P 9137	O
	1 457 43	S 3900	L
	1 457 43	N 1710	K
ROB,ZE	1 457 43	N 4447²	K
	1 987 43	M 2151	I
TW	1 457 42	P 9165³	P
	1 457 42	P 9820³	P

E2000 32.403

12,0 294 D 2866 LF20 <V2600, Euro 2>			
03.97-09.01	1 457 42	P 9137	O
	1 457 43	S 3900	L
	1 457 43	N 1710	K
ROB,ZE	1 457 43	N 4447²	K
	1 987 43	M 2151	I
TW	1 457 42	P 9165³	P
	1 457 42	P 9820³	P

E2000 32.414

12,0 301 D 2866 LF31 <V2600, Euro 2>			
07.99-12.01	1 457 42	P 9137	O
	1 457 43	S 3900	L
	1 457 43	N 1710	K
ROB,ZE	1 457 43	N 4447²	K
	1 987 43	M 2151	I
TW	1 457 42	P 9165³	P
	1 457 42	P 9820³	P

E2000 32.463

12,8 338 D 2876 LF02 <V2400, Euro 2>			
03.97-09.01	1 457 42	P 9137	O
	1 457 43	S 3900	L
	1 457 43	N 1710	K
ROB,ZE	1 457 43	N 4447²	K
	1 987 43	M 2151	I
TW	1 457 42	P 9165³	P
	1 457 42	P 9820³	P

E2000 32.464

12,8 338 D 2876 LF06 <V2400, Euro 2>			
07.99-09.01	1 457 42	P 9137	O
	1 457 43	S 3900	L
	1 457 43	N 1710	K
ROB,ZE	1 457 43	N 4447²	K
	1 987 43	M 2151	I
TW	1 457 42	P 9165³	P
	1 457 42	P 9820³	P



E2000 33.293

10,0 213 D 2865 LF24 <V2500, Euro 2>			
09.96-01.97	1 457 42	P 9107	O
02.97-09.01	1 457 42	P 9137	O
09.96-09.01	1 457 43	S 3900	L
ROB,ZE	1 457 43	N 4447²	K
	1 987 43	M 2151	I

E2000 33.343

10,0 250 D 2865 LF21 <V2500, Euro 2>			
02.97-09.01	1 457 42	P 9137	O
09.96-09.01	1 457 43	S 3900	L
ROB,ZE	1 457 43	N 4447²	K
	1 987 43	M 2151	I

E2000 33.364

12,0 265 D 2866 LF35 <V2600, Euro 2>			
10.97-09.01	1 457 42	P 9137	O
	1 457 43	S 3900	L
	1 457 43	N 1710	K
ROB,ZE	1 457 43	N 4447²	K
	1 987 43	M 2151	I
TW	1 457 42	P 9165³	P
	1 457 42	P 9820³	P
06.98-09.01	1 457 42	P 9820³	P

E2000 33.403/ 35.403

12,0 294 D 2866 LF20 <V2600, Euro 2>			
06.96-01.97	1 457 42	P 9107	O
02.97-09.01	1 457 42	P 9137	O
06.96-09.01	1 457 43	S 3900	L
	1 457 43	N 1710	K
ROB,ZE	1 457 43	N 4447²	K
	1 987 43	M 2151	I
TW	1 457 42	P 9165³	P
	1 457 42	P 9820³	P
09.96-09.01	1 457 42	P 9820³	P

E2000 33.414/ 35.414

12,0 301 D 2866 LF31 <V2600, Euro 2>			
10.97-12.01	1 457 42	P 9137	O
	1 457 43	S 3900	L
	1 457 43	N 1710	K
ROB,ZE	1 457 43	N 4447²	K
	1 987 43	M 2151	I
TW	1 457 42	P 9165³	P
	1 457 42	P 9820³	P
06.98-12.01	1 457 42	P 9820³	P

E2000 33.463

12,8 338 D 2876 LF02 <V2400, Euro 2>			
09.96-09.01	1 457 42	P 9137	O
	1 457 43	S 3900	L
	1 457 43	N 1710	K
ROB,ZE	1 457 43	N 4447²	K
	1 987 43	M 2151	I
	1 457 42	P 9820³	P
03.97-09.01	TW	1 457 42	P 9165³
		1 457 42	P 9820³

**E2000 33.464****12,8 | 301 | D 2876 LF06 <V2400, Euro 2>**

07.99-09.01	1 457 42 P 9137	O
	1 457 43 S 3900	L
	1 457 43 N 1710	K
ROB,ZE	1 457 43 N 4447 ²	K
	1 987 43 M 2151	I
TW	1 457 42 P 9165 ³	P
	1 457 42 P 9820 ³	P

12,8 | 338 | D 2876 LF02 <V2400, Euro 2>

10.97-09.01	1 457 42 P 9137	O
	1 457 43 S 3900	L
	1 457 43 N 1710	K
ROB,ZE	1 457 43 N 4447 ²	K
	1 987 43 M 2151	I
TW	1 457 42 P 9165 ³	P
	1 457 42 P 9820 ³	P

12,8 | 338 | D 2876 LF06 <V2400, Euro 2>

06.98-09.01	1 457 42 P 9137	O
	1 457 43 S 3900	L
	1 457 43 N 1710	K
ROB,ZE	1 457 43 N 4447 ²	K
	1 987 43 M 2151	I
	1 457 42 P 9820 ³	P

E2000 33.604**18,3 | 441 | D 2840 LF21 <V3400, Euro 2>**

08.97-01.02	1 457 42 P 9740	O	
OES,ZE	1 457 42 P 9107	O	
	1 457 43 S 3900	L	
ROB,ZE	1 457 43 N 4447 ²	K	
07.99-09.01	TW	1 987 43 M 2151	I
07.99-01.02		1 987 43 M 2151	I

E2000 35.343/ 41.343**10,0 | 250 | D 2865 LF21 <V2500, Euro 2>**

06.96-01.97	1 457 42 P 9107	O
02.97-09.01	1 457 42 P 9137	O
06.96-09.01	1 457 43 S 3900	L
ROB,ZE	1 457 43 N 4447 ²	K
	1 987 43 M 2151	I
	1 457 42 P 9820 ³	P

E2000 35.364/ 41.364**12,0 | 265 | D 2866 LF35 <V2600, Euro 2>**

06.98-09.01	1 457 42 P 9137	O
	1 457 43 S 3900	L
	1 457 43 N 1710	K
ROB,ZE	1 457 43 N 4447 ²	K
	1 987 43 M 2151	I
TW	1 457 42 P 9165 ³	P
	1 457 42 P 9820 ³	P

E2000 35.463**12,8 | 338 | D 2876 LF02 <V2400, Euro 2>**

07.96-09.01	1 457 42 P 9137	O	
10.97-09.01	ZE	1 457 42 P 9107	O
06.96-09.01	1 457 43 S 3900	L	
	1 457 43 N 1710	K	
ROB,ZE	1 457 43 N 4447 ²	K	
	1 987 43 M 2151	I	
TW	1 457 42 P 9165 ³	P	
	1 457 42 P 9820 ³	P	
10.97-09.01	1 457 42 P 9820 ³	P	

E2000 35.464**12,8 | 338 | D 2876 LF06 <V2400, Euro 2>**

06.98-09.01	1 457 42 P 9137	O	
07.99-09.01	ZE	1 457 42 P 9107	O
06.98-09.01	1 457 43 S 3900	L	
	1 457 43 N 1710	K	
ROB,ZE	1 457 43 N 4447 ²	K	
	1 987 43 M 2151	I	
TW	1 457 42 P 9165 ³	P	
	1 457 42 P 9820 ³	P	
07.99-09.01	1 457 42 P 9820 ³	P	

E2000 40.604**18,3 | 441 | D 2840 LF21 <V3400, Euro 2>**

09.98-09.01	1 457 42 P 9740	O	
	OES,ZE	1 457 42 P 9107	O
	1 457 43 S 3900	L	
	ROB,ZE	1 457 43 N 4447 ²	K
	TW	1 987 43 M 2151	I

E2000 41.403**12,0 | 294 | D 2866 LF20 <V2600, Euro 2>**

06.96-01.97	1 457 42 P 9107	O
02.97-09.01	1 457 42 P 9137	O
06.96-09.01	1 457 43 S 3900	L
	1 457 43 N 1710	K
ROB,ZE	1 457 43 N 4447 ²	K
	1 987 43 M 2151	I
TW	1 457 42 P 9165 ³	P
	1 457 42 P 9820 ³	P

E2000 41.414**12,0 | 301 | D 2866 LF31 <V2600, Euro 2>**

06.98-12.01	1 457 42 P 9137	O
	1 457 43 S 3900	L
	1 457 43 N 1710	K
ROB,ZE	1 457 43 N 4447 ²	K
	1 987 43 M 2151	I
TW	1 457 42 P 9165 ³	P
	1 457 42 P 9820 ³	P





E2000 41.463

12,8 | 338 | D 2876 LF02 <V2400, Euro 2>

07.96-09.01	1 457 42 P 9137	O
06.96-09.01	1 457 43 S 3900	L
	1 457 43 N 1710	K
ROB,ZE	1 457 43 N 4447 ²	K
	1 987 43 M 2151	I
TW	1 457 42 P 9165 ³	P
	1 457 42 P 9820 ³	P
09.96-09.01	1 457 42 P 9820 ³	P

E2000 41.464

12,8 | 338 | D 2876 LF06 <V2400, Euro 2>

06.98-09.01	1 457 42 P 9137	O
	1 457 43 S 3900	L
	1 457 43 N 1710	K
ROB,ZE	1 457 43 N 4447 ²	K
	1 987 43 M 2151	I
TW	1 457 42 P 9165 ³	P
	1 457 42 P 9820 ³	P
07.99-09.01	1 457 42 P 9820 ³	P

E2000 41.604/ 50.604

18,3 | 441 | D 2840 LF21 <V3400, Euro 2>

02.97-09.01	1 457 42 P 9740	O
OES,ZE	1 457 42 P 9107	O
	1 457 43 S 3900	L
ROB,ZE	1 457 43 N 4447 ²	K
	1 987 43 M 2151	I

E2000 42.414

12,0 | 301 | D 2866 LF25 <V2600, Euro 3>

01.00-08.01	1 457 42 P 9137	O
	1 457 43 S 3900	L
	1 457 43 N 1710	K
ROB,ZE	1 457 43 N 4447 ²	K
	1 987 43 M 2151	I

12,0 | 301 | D 2866 LF31 <V2600, Euro 2>

06.98-08.01	1 457 42 P 9137	O
	1 457 43 S 3900	L
	1 457 43 N 1710	K
ROB,ZE	1 457 43 N 4447 ²	K
	1 987 43 M 2151	I
TW	1 457 42 P 9165 ³	P

E2000 42.464

12,8 | 338 | D 2876 LF03 <V2400, Euro 3>

01.00-08.01	1 457 42 P 9137	O
	1 457 43 S 3900	L
	1 457 43 N 1710	K
ROB,ZE	1 457 43 N 4447 ²	K
	1 987 43 M 2151	I
	1 457 42 P 9820 ³	P

12,8 | 338 | D 2876 LF06 <V2400, Euro 2>

06.98-08.01	1 457 42 P 9137	O
TW	1 457 42 P 9107	O
	1 457 43 S 3900	L
	1 457 43 N 1710	K
ROB,ZE	1 457 43 N 4447 ²	K
	1 987 43 M 2151	I
TW	1 457 42 P 9165 ³	P
	1 457 42 P 9820 ³	P

E2000 50.414

12,0 | 301 | D 2866 LF31 <V2600, Euro 2>

06.98-09.01	1 457 42 P 9137	O
	1 457 43 S 3900	L
	1 457 43 N 1710	K
ROB,ZE	1 457 43 N 4447 ²	K
	1 987 43 M 2151	I
TW	1 457 42 P 9165 ³	P
	1 457 42 P 9820 ³	P

12,8 | 338 | D 2876 LF06 <V2400, Euro 2>

06.98-09.01	1 457 42 P 9137	O
	1 457 43 S 3900	L
	1 457 43 N 1710	K
ROB,ZE	1 457 43 N 4447 ²	K
	1 987 43 M 2151	I
	1 457 42 P 9820 ³	P

E2000 50.464

12,8 | 338 | D 2876 LF06 <V2400, Euro 2>

06.98-09.01	1 457 42 P 9137	O
	1 457 43 S 3900	L
	1 457 43 N 1710	K
ROB,ZE	1 457 43 N 4447 ²	K
	1 987 43 M 2151	I
TW	1 457 42 P 9165 ³	P
	1 457 42 P 9820 ³	P
07.99-09.01	1 457 42 P 9820 ³	P

E2000 Evol. (FE)

E2000 Evol. (FE) 19.310

12,0 | 228 | D 2866 LF23 <V2600, Euro 3>

09.02-06.03	1 457 42 P 9137	O
	1 457 43 S 3900	L
	1 457 43 N 1710	K
ROB,ZE	1 457 43 N 4447 ²	K
	1 987 43 M 2151	I
	1 457 42 P 9820 ³	P

E2000 Evol. (FE) 19.360/ 26.360

12,0 | 265 | D 2866 LF24 <V2600, Euro 3>

09.02-10.03	1 457 42 P 9137	O
	1 457 43 S 3900	L
	1 457 43 N 1710	K
ROB,ZE	1 457 43 N 4447 ²	K
	1 987 43 M 2151	I
	1 457 42 P 9820 ³	P





E2000 Evol. (FE) 19.410/ 26.410

12,0 301 D 2866 LF25 <V2600, Euro 3>			
09.02-10.03	1 457 42	P 9137	O
	1 457 43	S 3900	L
	1 457 43	N 1710	K
ROB,ZE	1 457 43	N 4447²	K
	1 987 43	M 2151	I
	1 457 42	P 9820³	P

E2000 Evol. (FE) 19.460/ 26.460

12,8 338 D 2876 LF03 <V2400, Euro 3>			
09.01-10.03	1 457 42	P 9137	O
	1 457 43	S 3900	L
	1 457 43	N 1710	K
ROB,ZE	1 457 43	N 4447²	K
	1 987 43	M 2151	I
	1 457 42	P 9820³	P

E2000 Evol. (FE) 28.310

12,0 228 D 2866 LF23 <V2600, Euro 3>			
09.02-12.03	1 457 42	P 9137	O
	1 457 43	S 3900	L
	1 457 43	N 1710	K
ROB,ZE	1 457 43	N 4447²	K
	1 987 43	M 2151	I
TW	1 457 42	P 9165³	P

E2000 Evol. (FE) 28.360

12,0 265 D 2866 LF24 <V2600, Euro 3>			
09.02-11.03	1 457 42	P 9137	O
	1 457 43	S 3900	L
	1 457 43	N 1710	K
ROB,ZE	1 457 43	N 4447²	K
	1 987 43	M 2151	I
09.02-10.03	1 457 42	P 9820³	P
09.02-11.03	TW	1 457 42	P 9165³

E2000 Evol. (FE) 28.410

12,0 301 D 2866 LF25 <V2600, Euro 3>			
08.02-11.03	1 457 42	P 9137	O
	1 457 43	S 3900	L
	1 457 43	N 1710	K
ROB,ZE	1 457 43	N 4447²	K
	1 987 43	M 2151	I
08.02-10.03	1 457 42	P 9820³	P
09.02-11.03	TW	1 457 42	P 9165³

E2000 Evol. (FE) 28.460

12,8 338 D 2876 LF03 <V2400, Euro 3>			
09.02-11.03	1 457 42	P 9137	O
	1 457 43	S 3900	L
	1 457 43	N 1710	K
ROB,ZE	1 457 43	N 4447²	K
	1 987 43	M 2151	I
09.02-10.03	1 457 42	P 9820³	P
09.02-11.03	TW	1 457 42	P 9165³



E2000 Evol. (FE) 30.360/ 32.360

12,0 265 D 2866 LF24 <V2600, Euro 3>			
09.02-10.03	1 457 42	P 9137	O
	1 457 43	S 3900	L
	1 457 43	N 1710	K
ROB,ZE	1 457 43	N 4447²	K
	1 987 43	M 2151	I
TW	1 457 42	P 9165³	P
	1 457 42	P 9820³	P

E2000 Evol. (FE) 30.410/ 32.410

12,0 301 D 2866 LF25 <V2600, Euro 3>			
09.02-10.03	1 457 42	P 9137	O
	1 457 43	S 3900	L
	1 457 43	N 1710	K
ROB,ZE	1 457 43	N 4447²	K
	1 987 43	M 2151	I
TW	1 457 42	P 9165³	P
	1 457 42	P 9820³	P

E2000 Evol. (FE) 30.460/ 32.460

12,8 338 D 2876 LF03 <V2400, Euro 3>			
08.02-10.03	1 457 42	P 9137	O
	1 457 43	S 3900	L
	1 457 43	N 1710	K
ROB,ZE	1 457 43	N 4447²	K
	1 987 43	M 2151	I
TW	1 457 42	P 9165³	P
	1 457 42	P 9820³	P

E2000 Evol. (FE) 33.360/ 35.360/ 360A

12,0 265 D 2866 LF24 <V2600, Euro 3>			
01.00-09.03	1 457 42	P 9137	O
	1 457 43	S 3900	L
	1 457 43	N 1710	K
ROB,ZE	1 457 43	N 4447²	K
	1 987 43	M 2151	I
	1 457 42	P 9820³	P
TW	1 457 42	P 9165³	P
	1 457 42	P 9820³	P

E2000 Evol. (FE) 33.410

12,0 301 D 2866 LF25 <V2600, Euro 3>			
09.02-06.03	1 457 42	P 9137	O
	1 457 43	S 3900	L
	1 457 43	N 1710	K
ROB,ZE	1 457 43	N 4447²	K
	1 987 43	M 2151	I
	1 457 42	P 9820³	P
TW	1 457 42	P 9165³	P
	1 457 42	P 9820³	P





E2000 Evol. (FE) 33.460/ 35.460/ 41.460/ 50.460/ 460A

12,8 338 D 2876 LF03 <V2400, Euro 3>			
01.00-10.03	1 457 42	P 9137	O
	1 457 43	S 3900	L
	1 457 43	N 1710	K
	ROB,ZE	1 457 43	N 4447² K
		1 987 43	M 2151 I
01.00-09.03	TW	1 457 42	P 9165³ P
		1 457 42	P 9820³ P
01.00-10.03		1 457 42	P 9820³ P

E2000 Evol. (FE) 35.410/ 41.410/ 50.410

12,0 301 D 2866 LF25 <V2600, Euro 3>			
09.02-10.03	1 457 42	P 9137	O
	1 457 43	S 3900	L
	1 457 43	N 1710	K
	ROB,ZE	1 457 43	N 4447² K
		1 987 43	M 2151 I
09.02-09.03	TW	1 457 42	P 9165³ P
		1 457 42	P 9820³ P

E2000 Evol. (FE) 310A

12,0 228 D 2866 LF23 <V2600, Euro 3>			
01.00-08.02	1 457 42	P 9137	O
	1 457 43	S 3900	L
	1 457 43	N 1710	K
	ROB,ZE	1 457 43	N 4447² K
		1 987 43	M 2151 I
		1 457 42	P 9820³ P
	TW	1 457 42	P 9165³ P
		1 457 42	P 9820³ P

12,0 228 D 2866 LF23 <V2600, Euro 3>			
01.02-08.02	1 457 42	P 9137	O
	1 457 43	S 3900	L
	1 457 43	N 1710	K
	ROB,ZE	1 457 43	N 4447² K
		1 987 43	M 2151 I
	TW	1 457 42	P 9165³ P
		1 457 42	P 9820³ P

E2000 Evol. (FE) 410A

12,0 301 D 2866 LF25 <V2600, Euro 3>			
01.00-09.02	1 457 42	P 9137	O
	1 457 43	S 3900	L
	1 457 43	N 1710	K
	ROB,ZE	1 457 43	N 4447² K
		1 987 43	M 2151 I
		1 457 42	P 9820³ P
	TW	1 457 42	P 9165³ P
		1 457 42	P 9820³ P

F / HF

F / HF 292

12,0 213-229 D 2866 TUH/290 <V0100>			
03.86-04.94	1 457 42	P 9740	O
	ROB	1 457 43	N 4447² K



F / HF 332

12,0 243 D 2866 LUH/330			
09.85-04.94	1 457 42	P 9740	O
		1 457 43	N 1270 K

F / HF 362

12,0 265 D 2866 KUH/360 <Z6400, Euro 1>			
09.85-04.94	1 457 42	P 9740	O
	TW,ZE	1 457 43	N 1270 K

F/M/U 90

F/M/U 90 19.272

10,0 198 D 2865 LF02 <V0700>			
02.90-10.92	1 457 42	P 9740	O
		1 457 43	S 3900 L
	LUM	1 457 42	S 9969 L
	ROB	1 457 43	N 4447² K

10,0 | 198 | D 2865 LF05 <V0700, Euro 1>

10.92-05.95	1 457 42	P 9740	O
		1 457 43	S 3900 L
	LUM	1 457 42	S 9969 L
	ROB	1 457 43	N 4447² K

F/M/U 90 19.302

12,0 220 D 2866 LF04 <Z7601>			
05.90-09.91	1 457 42	P 9740	O
		1 457 42	S 9969 L
		1 457 43	S 3900 L
	LUM	1 457 42	S 9969 L
	ROB,ZE	1 457 43	N 4447² K

F/M/U 90 19.322

10,0 235 D 2865 LF03 <V0700>			
02.90-10.92	1 457 42	P 9740	O
		1 457 43	S 3900 L
	LUM	1 457 42	S 9969 L
	ROB	1 457 43	N 4447² K

10,0 | 235 | D 2865 LF06 <V0700, Euro 1>

10.92-06.96	1 457 42	P 9740	O
10.92-05.95	1 457 43	S 3900	L
	LUM	1 457 42	S 9969 L
10.92-06.96	ROB	1 457 43	N 4447² K

F/M/U 90 19.342

10,0 250 D 2865 LF09 <V0700, Euro 2>			
05.94-06.96	1 457 42	P 9740	O
05.94-05.95	1 457 43	S 3900	L
	LUM	1 457 42	S 9969 L
05.94-06.96	ROB	1 457 43	N 4447² K

F/M/U 90 19.362

12,0 265 D 2866 KUL/360 <Z5100, Euro 1>			
07.86-01.91	1 457 42	P 9740	O
		1 457 42	S 9969 L





F/M/U 90 19.372

12,0 | 249 | D 2866 LXF/Silent

05.90-04.95	LBF	1 457 42 P 9740	O
	KNE	1 457 43 S 3900	L
	LUM	1 457 42 S 9969	L
		1 457 43 N 1326 ⁷	K
	FIH	1 457 43 N 4150 ²	K

12,0 | 272 | D 2866 LF03 <Z7601>

02.90-10.92		1 457 42 P 9740	O
		1 457 43 S 3900	L
	LUM	1 457 42 S 9969	L
	ROB,ZE	1 457 43 N 4447 ²	K

12,0 | 272 | D 2866 LF05 <Z7601, Euro 1>

10.92-05.94		1 457 42 P 9740	O
		1 457 43 S 3900	L
	LUM	1 457 42 S 9969	L
	ROB,ZE	1 457 43 N 4447 ²	K

12,0 | 272 | D 2866 LF15 <Z7601, Euro 1>

05.94-06.96		1 457 42 P 9740	O
05.94-05.95		1 457 43 S 3900	L
	LUM	1 457 42 S 9969	L
05.94-06.96	ROB,ZE	1 457 43 N 4447 ²	K

F/M/U 90 19.402

12,0 | 294 | D 2866 LF16 <Z7601, Euro 2>

05.94-06.96		1 457 42 P 9740	O
05.94-05.95		1 457 43 S 3900	L
	LUM	1 457 42 S 9969	L
05.94-06.96	ROB,ZE	1 457 43 N 4447 ²	K

F/M/U 90 19.422

12,0 | 309 | D 2866 LF06 <Z7601>

02.90-10.92		1 457 42 P 9740	O
		1 457 43 S 3900	L
	LUM	1 457 42 S 9969	L
	ROB,ZE	1 457 43 N 4447 ²	K

12,0 | 309 | D 2866 LF09 <Z7601, Euro 1>

10.92-06.96		1 457 42 P 9740	O
10.92-05.95		1 457 43 S 3900	L
	LUM	1 457 42 S 9969	L
10.92-06.96		1 457 42 S 9969	L
	ROB,ZE	1 457 43 N 4447 ²	K

12,0 | 309 | D 2866 LF10 <Euro 1>

01.91-06.96	LBF	1 457 42 P 9740	O
		1 457 43 S 3900	L
	LUM	1 457 42 S 9969	L
		1 457 43 N 4154 ²	K

12,0 | 309 | D 2866 LF10 <Z7601, Euro 1>

01.91-06.96		1 457 42 P 9740	O
	ROB,ZE	1 457 43 N 4447 ²	K



F/M/U 90 19.502

18,3 | 368 | D 2840 LF01 <V0600,>

02.90-10.92	XXX	1 457 42 P 9631	O
		1 457 42 S 9975	L
		1 457 43 N 1159 ⁶	K
		1 457 43 N 1326 ⁷	K
	ROB	1 457 43 N 4447 ²	K

F/M/U 90 19.502/ 25.502/ 26.502/ 33.502

18,3 | 368 | D 2840 LF04 <V0600, Euro 1>

10.92-06.96	XXX	1 457 42 P 9631	O
	ROB	1 457 43 N 4447 ²	K

F/M/U 90 19.502/ 26.502/ 33.502

18,3 | 368 | D 2840 LF06 <V0600, Euro 1>

05.94-06.96	XXX	1 457 42 P 9631	O
	ROB	1 457 43 N 4447 ²	K

F/M/U 90 23.272/ 25.272/ 26.272/ 32.272/ 33.272

10,0 | 198 | D 2865 LF05 <V0700, Euro 1>

03.91-06.96		1 457 42 P 9740	O
	ROB	1 457 43 N 4447 ²	K

F/M/U 90 23.322/ 25.322/ 26.322/ 32.322/ 33.322/ 35.322

10,0 | 235 | D 2865 LF06 <V0700, Euro 1>

10.92-06.96		1 457 42 P 9740	O
	ROB	1 457 43 N 4447 ²	K

F/M/U 90 23.342/ 26.342/ 32.342/ 33.342/ 35.342

10,0 | 250 | D 2865 LF09 <V0700, Euro 2>

05.94-06.96		1 457 42 P 9740	O
	ROB	1 457 43 N 4447 ²	K

F/M/U 90 23.372/ 25.372

12,0 | 272 | D 2866 LF05 <Z7601, Euro 1>

10.92-05.94		1 457 42 P 9740	O
	ROB,ZE	1 457 43 N 4447 ²	K

F/M/U 90 23.372/ 26.372/ 32.372/ 33.372/ 35.372

12,0 | 272 | D 2866 LF15 <Z7601, Euro 1>

05.94-06.96		1 457 42 P 9740	O
	ROB,ZE	1 457 43 N 4447 ²	K

F/M/U 90 23.402/ 26.402/ 32.402/ 33.402/ 35.402

12,0 | 294 | D 2866 LF16 <Z7601, Euro 2>

05.94-06.96		1 457 42 P 9740	O
	ROB,ZE	1 457 43 N 4447 ²	K

F/M/U 90 23.422/ 25.422/ 26.422/ 32.422/ 33.422/ 35.422

12,0 | 309 | D 2866 LF09 <Z7601, Euro 1>

10.92-06.96		1 457 42 P 9740	O
	ROB,ZE	1 457 43 N 4447 ²	K





F/M/U 90 24.192/ 24.222

6,9 | 140/162 | D 0826 LF01 <Z9500>; D 0826 LF05 <Z9500, Euro 1>; D 0826 LF07 <Z9500, Euro 1>; D 0826 LF11 <Z9500, Euro 2>

07.89-06.96		0 451 30 P 1207	O
	FW,SA,	1 457 43 S 3611 ⁴	L
	TAF		
	FW,TAF	1 457 42 S 9966	L
	MHE	1 457 42 N 9230	K
	ROB	1 457 43 N 4447 ²	K
		1 987 43 M 2151	I

F/M/U 90 24.232

6,9 | 160 | D 0826 LF/217/Silent <Z9500>

05.90-04.95		0 451 30 P 1207	O
	FW,SA,	1 457 43 S 3611 ⁴	L
	TAF		
	FW,TAF	1 457 42 S 9966	L
	MHE	1 457 42 N 9230	K
	ROB	1 457 43 N 4447 ²	K
		1 987 43 M 2151	I

6,9 | 169 | D 0826 LF02 <Z9500>; D 0826 LF06 <Z9500, Euro 1>; D 0826 LF08 <Z9500, Euro 1>

07.89-06.96		0 451 30 P 1207	O
02.90-06.96	GA	0 451 30 P 1207	O
07.89-06.96	FW,SA,	1 457 43 S 3611 ⁴	L
	TAF		
	FW,TAF	1 457 42 S 9966	L
	MHE	1 457 42 N 9230	K
	ROB	1 457 43 N 4447 ²	K
		1 987 43 M 2151	I

F/M/U 90 24.262

6,9 | 191 | D 0826 LF13 <Z9500, Euro 2>

08.95-06.96		0 451 30 P 1207	O
	FW,SA,	1 457 43 S 3611 ⁴	L
	TAF		
	FW,TAF	1 457 42 S 9966	L
	MHE	1 457 42 N 9230	K
	ROB	1 457 43 N 4447 ²	K
		1 987 43 M 2151	I

F/M/U 90 24.272

6,9 | 198 | D 0826 LF04 <Z9500, Euro 1>

10.92-06.96		0 451 30 P 1207	O
	FW,TAF	1 457 42 S 9966	L
03.93-06.96		1 457 43 S 3651	L
10.92-06.96	MHE	1 457 42 N 9230	K
	ROB	1 457 43 N 4447 ²	K
		1 987 43 M 2151	I

10,0 | 198 | D 2865 LF02 <V0700>

02.90-04.95		1 457 42 P 9740	O
09.91-05.94	FW,SA,	1 457 43 S 3611 ⁴	L
	TAF		
	FW,TAF	1 457 42 S 9966	L
02.90-04.95	ROB	1 457 43 N 4447 ²	K
09.91-05.94	MHE	1 457 42 N 9230	K
		1 987 43 M 2151	I



F/M/U 90 25.272/ 26.272

10,0 | 198 | D 2865 LF02 <V0700>

02.90-12.92		1 457 42 P 9740	O
	ROB	1 457 43 N 4447 ²	K

F/M/U 90 25.302/ 26.302

12,0 | 220 | D 2866 LF04 <Z7601>

05.90-12.91		1 457 42 P 9740	O
	ROB,ZE	1 457 43 N 4447 ²	K

F/M/U 90 25.322/ 26.322/ 33.322

10,0 | 235 | D 2865 LF03 <V0700>

02.90-12.92		1 457 42 P 9740	O
	ROB	1 457 43 N 4447 ²	K

F/M/U 90 25.372

12,0 | 272 | D 2866 LF03 <Z7601>

09.90-12.92		1 457 42 P 9740	O
	ROB,ZE	1 457 43 N 4447 ²	K

F/M/U 90 25.372/ 26.372

12,0 | 249 | D 2866 LXF/Silent

05.90-10.93	LBF	1 457 42 P 9740	O
		1 457 43 N 1326 ⁷	K
	FIH	1 457 43 N 4150 ²	K

F/M/U 90 25.422/ 26.422/ 33.422

12,0 | 309 | D 2866 LF06 <Z7601>

02.90-05.94		1 457 42 P 9740	O
	ROB,ZE	1 457 43 N 4447 ²	K

F/M/U 90 25.502/ 26.502/ 33.502

18,3 | 368 | D 2840 LF01 <V0600,>

02.90-11.92	XXX	1 457 42 P 9631	O
	ROB	1 457 43 N 4447 ²	K

F/M/U 90 26.322

10,0 | 235 | D 2865 LF06 <V0700, Euro 1> Euro 1>

10.92-12.92		1 457 42 P 9740	O
	ROB	1 457 43 N 4447 ²	K

F/M/U 90 26.372

12,0 | 272 | D 2866 LF03 <Z7601>

02.90-10.92		1 457 42 P 9740	O
	LUM	1 457 42 S 9969	L
	ROB,ZE	1 457 43 N 4447 ²	K

12,0 | 272 | D 2866 LF05 <Z7601, Euro 1>

10.92-05.94		1 457 42 P 9740	O
	LBF	1 457 42 P 9740	O
	ROB,ZE	1 457 43 N 4447 ²	K

F/M/U 90 32.372/ 33.372/ 35.372

12,0 | 272 | D 2866 LF05 <Z7601, Euro 1>

10.92-05.94		1 457 42 P 9740	O
	ROB,ZE	1 457 43 N 4447 ²	K

F/M/U 90 33.372

12,0 | 272 | D 2866 LF03 <Z7601>

09.91-10.92		1 457 42 P 9740	O
	ROB,ZE	1 457 43 N 4447 ²	K



F/M/U 90 35.292

12,0 213 D 2866 LFZ/290 <Z6700>				
10.88-04.95	LBF,SA,XXX	1 457 42	P 9631	O
	LBF	1 457 42	P 9740	O
		1 457 42	S 9969	L
	FIH,ROB,ZE	1 457 43	N 4447²	K
	FIU,ZE	1 457 43	N 1326⁷	K

F/M/U 90 35.322

10,0 235 D 2865 LF03 <V0700>				
02.90-05.94		1 457 42	P 9740	O
		1 457 42	S 9969	L
	ROB	1 457 43	N 4447²	K

F/M/U 90 35.332

12,0 243 D 2866 LFZ/330 <Z6700>				
10.88-04.95	LBF,SA,XXX	1 457 42	P 9631	O
	LBF	1 457 42	P 9740	O
		1 457 42	S 9969	L
	FIH,ROB,ZE	1 457 43	N 4447²	K
	FIU,ZE	1 457 43	N 1326⁷	K

F/M/U 90 35.372

12,0 272 D 2866 LF03 <Z7601>				
02.90-05.94		1 457 42	P 9740	O
		1 457 42	S 9969	L
	ROB,ZE	1 457 43	N 4447²	K

F/M/U 90 35.422

12,0 309 D 2866 LF06 <Z7601>				
02.90-05.94		1 457 42	P 9740	O
		1 457 42	S 9969	L
	ROB,ZE	1 457 43	N 4447²	K

FR / FRH

FR / FRH 352

12,0 257 D 2866 LOH26 <V1500, Euro 2>				
07.98-09.01	LBF	1 457 42	P 9137	O
	LBF	1 457 42	P 9740	O
		1 457 42	S 9969	L
07.98-05.00	FIU,ZE	1 457 43	N 1270	K
07.98-09.01	ROB,ZE	1 457 43	N 4447²	K

12,0 257 D 2866 LUH21 <V3200, Euro 2>				
07.98-09.01		1 457 42	P 9740	O
		1 457 42	S 9969	L
	ROB,ZE	1 457 43	N 4447²	K



FR / FRH 402

12,0 294 D 2866 LOH23 <V1500, Euro 2>				
07.98-09.01	LBF	1 457 42	P 9137	O
	LBF	1 457 42	P 9740	O
		1 457 42	S 9969	L
07.98-05.00	FIU,ZE	1 457 43	N 1270	K
07.98-09.01	ROB,ZE	1 457 43	N 4447²	K

FR-FRH

FR-FRH 292

12,0 213-224 D 2866 TUH/290 <V0100>				
05.85-04.92		1 457 42	P 9740	O
	ROB	1 457 43	N 4447²	K

12,0 | 229 | D 2866 TOH/310 <Z7900>

03.91-12.92		1 457 42	P 9740	O
	FIH,ROB,ZE	1 457 43	N 4447²	K
	FIU,ZE	1 457 43	N 1326⁷	K

FR-FRH 352

12,0 257 D 2866 LOH26 <V1500, Euro 2>				
09.95-11.99	LBF	1 457 42	P 9137	O
	LBF	1 457 42	P 9740	O
		1 457 42	S 9969	L
	FIU,ZE	1 457 43	N 1270	K
	ROB,ZE	1 457 43	N 4447²	K

FR-FRH 362

12,0 265 D 2866 KUH/360 <Z6400, Euro 1>				
05.85-12.92		1 457 42	P 9740	O
	TW,ZE	1 457 43	N 1270	K

FR-FRH 402

12,0 294 D 2866 LOH23 <V1500, Euro 2>				
09.95-11.99	LBF	1 457 42	P 9137	O
	LBF	1 457 42	P 9740	O
		1 457 42	S 9969	L
	FIU,ZE	1 457 43	N 1270	K
	ROB,ZE	1 457 43	N 4447²	K

F90

F90 32.272

10,0 198 D 2865 LF02 <V0700>				
02.90-05.94		1 457 42	P 9740	O
	ROB	1 457 43	N 4447²	K

F90 32.302

12,0 220 D 2866 LF04 <Z7601>				
05.90-09.91		1 457 42	P 9740	O
	ROB,ZE	1 457 43	N 4447²	K

F90 32.322

10,0 235 D 2865 LF03 <V0700>				
02.90-05.94		1 457 42	P 9740	O
	ROB	1 457 43	N 4447²	K





F90 32.372

12,0 249 D 2866 LXF/Silent				
05.90-04.95	LBF	1 457 42	P 9740	O
			1 457 43 N 1326⁷	K
	FIH	1 457 43	N 4150²	K

12,0 272 D 2866 LF03 <Z7601>				
02.90-05.94		1 457 42	P 9740	O
	ROB,ZE	1 457 43	N 4447²	K

F90 32.422

12,0 309 D 2866 LF06 <Z7601>				
02.90-05.94		1 457 42	P 9740	O
	ROB,ZE	1 457 43	N 4447²	K

F90 35.272

10,0 198 D 2865 LF02 <V0700>				
02.90-12.91		1 457 42	P 9740	O
			1 457 42 S 9969	L
	ROB	1 457 43	N 4447²	K

F90 35.302

12,0 220 D 2866 LF04 <Z7601>				
05.90-09.91		1 457 42	P 9740	O
			1 457 42 S 9969	L
	ROB,ZE	1 457 43	N 4447²	K

F90 35.322

10,0 235 D 2865 LF03 <V0700>				
02.90-05.94		1 457 42	P 9740	O
			1 457 42 S 9969	L
	ROB	1 457 43	N 4447²	K

F90 35.372

12,0 249 D 2866 LXF/Silent				
02.90-04.95	LBF	1 457 42	P 9740	O
			1 457 42 S 9969	L
			1 457 43 N 1326⁷	K
	FIH	1 457 43	N 4150²	K

12,0 272 D 2866 LF03 <Z7601>				
02.90-05.94		1 457 42	P 9740	O
			1 457 42 S 9969	L
	ROB,ZE	1 457 43	N 4447²	K

F90 35.422

12,0 309 D 2866 LF06 <Z7601>				
02.90-05.94		1 457 42	P 9740	O
			1 457 42 S 9969	L
	ROB,ZE	1 457 43	N 4447²	K



F2000

F2000 17.373/ 19.373

12,0 272 D 2866 LF21 <V2600, Euro 1>				
01.94-01.95		1 457 42	P 9277	O
02.95-01.97		1 457 42	P 9107	O
01.94-12.00		1 457 43	S 3900	L
			1 457 43 N 1710	K
	ROB,ZE	1 457 43	N 4447²	K
			1 987 43 M 2151	I
			1 457 42 P 9820³	P

F2000 19.233/ 26.233

12,0 170 E 2866 DF21 <V2800/CNG>				
01.94-08.02		1 457 42	P 9740	O
			1 457 43 S 3900	L
09.96-08.02		1 987 43	M 2151	I
01.94-08.02		1 457 42	P 9820³	P

F2000 19.273

10,0 198 D 2865 LF22 <V2500, Euro 1>				
01.94-01.95		1 457 42	P 9277	O
02.95-01.97		1 457 42	P 9107	O
01.94-03.97		1 457 43	S 3900	L
	ROB,ZE	1 457 43	N 4447²	K
			1 987 43 M 2151	I

F2000 19.293

10,0 213 D 2865 LF24 <V2500, Euro 2>				
04.95-01.97		1 457 42	P 9107	O
02.97-01.00		1 457 42	P 9137	O
04.95-01.00		1 457 43	S 3900	L
	ROB,ZE	1 457 43	N 4447²	K
			1 987 43 M 2151	I

F2000 19.314

12,0 228 D 2866 LF34 <V2600, Euro 2>				
06.98-12.01		1 457 42	P 9137	O
			1 457 43 S 3900	L
			1 457 43 N 1710	K
	ROB,ZE	1 457 43	N 4447²	K
			1 987 43 M 2151	I
			1 457 42 P 9820³	P

F2000 19.320/ 19.323/ 24.323/ 26.323/ 27.323/ 33.323

10,0 235 D 2865 LF23 <V2500, Euro 1>				
01.94-01.95		1 457 42	P 9277	O
02.95-12.95		1 457 42	P 9107	O
01.94-12.95		1 457 43	S 3900	L
	ROB,ZE	1 457 43	N 4447²	K
	TW	1 987 43	M 2151	I

F2000 19.343/ 23.343/ 24.343/ 26.343/ 27.343

10,0 250 D 2865 LF21 <V2500, Euro 2>				
01.94-01.95		1 457 42	P 9277	O
02.95-01.97		1 457 42	P 9107	O
02.97-01.00		1 457 42	P 9137	O
01.94-01.00		1 457 43	S 3900	L
	ROB,ZE	1 457 43	N 4447²	K
	TW	1 987 43	M 2151	I





F2000 19.364

12,0 265 D 2866 LF35 <V2600, Euro 2>			
06.98-12.01	1 457 42	P 9137	O
	1 457 43	S 3900	L
	1 457 43	N 1710	K
ROB,ZE	1 457 43	N 4447²	K
	1 987 43	M 2151	I
	1 457 42	P 9820³	P

F2000 19.403

12,0 294 D 2866 LF20 <V2600, Euro 2>			
01.94-01.95	1 457 42	P 9277	O
02.95-01.97	1 457 42	P 9107	O
02.97-12.01	1 457 42	P 9137	O
01.94-12.01	1 457 43	S 3900	L
	1 457 43	N 1710	K
ROB,ZE	1 457 43	N 4447²	K
	1 987 43	M 2151	I
	1 457 42	P 9820³	P

F2000 19.414

12,0 301 D 2866 LF31 <V2600, Euro 2>			
06.98-12.01	1 457 42	P 9137	O
	1 457 43	S 3900	L
	1 457 43	N 1710	K
ROB,ZE	1 457 43	N 4447²	K
	1 987 43	M 2151	I
	1 457 42	P 9820³	P

F2000 19.414/ 23.414

12,0 301 D 2866 LF25 <V2600, Euro 3>			
01.00-12.02	1 457 42	P 9137	O
	1 457 43	S 3900	L
	1 457 43	N 1710	K
ROB,ZE	1 457 43	N 4447²	K
	1 987 43	M 2151	I

F2000 19.423

12,0 309 D 2866 LF22 <V2600, Euro 1>			
01.94-01.95	1 457 42	P 9277	O
02.95-12.95	1 457 42	P 9107	O
01.94-12.95	1 457 43	S 3900	L
	1 457 43	N 1710	K
ROB,ZE	1 457 43	N 4447²	K
	1 987 43	M 2151	I
	1 457 42	P 9820³	P

F2000 19.463

12,8 338 D 2876 LF02 <V2400, Euro 2>			
01.94-01.95	1 457 42	P 9277	O
02.95-06.96	ZE	1 457 42	P 9107
07.96-12.01	1 457 42	P 9137	O
01.94-12.01	1 457 43	S 3900	L
	1 457 43	N 1710	K
ROB,ZE	1 457 43	N 4447²	K
	1 987 43	M 2151	I
	1 457 42	P 9820³	P



F2000 19.464

12,8 338 D 2876 LF03 <V2400, Euro 3>			
01.00-12.02	1 457 42	P 9137	O
	1 457 43	S 3900	L
	1 457 43	N 1710	K
ROB,ZE	1 457 43	N 4447²	K
01.00-12.01	1 987 43	M 2151	I
01.00-12.02	1 457 42	P 9820³	P

12,8 | 338 | D 2876 LF06 <V2400, Euro 2>

06.98-07.01	1 457 42	P 9137	O
	1 457 43	S 3900	L
	1 457 43	N 1710	K
ROB,ZE	1 457 43	N 4447²	K
	1 987 43	M 2151	I
	1 457 42	P 9820³	P

F2000 19.603

18,3 441 D 2840 LF20 <V3400, Euro 2>			
04.96-08.01	1 457 42	P 9740	O
	OES,ZE	1 457 42	P 9107
	1 457 43	S 3900	L
ROB,ZE	1 457 43	N 4447²	K
TW	1 987 43	M 2151	I

F2000 19.604

18,3 441 D 2840 LF21 <V3400, Euro 2>			
07.99-08.01	1 457 42	P 9740	O
	OES,ZE	1 457 42	P 9107
	1 457 43	S 3900	L
ROB,ZE	1 457 43	N 4447²	K
TW	1 987 43	M 2151	I

F2000 23.293

10,0 213 D 2865 LF24 <V2500, Euro 2>			
04.95-01.97	1 457 42	P 9107	O
02.97-01.00	1 457 42	P 9137	O
04.95-01.00	1 457 43	S 3900	L
ROB,ZE	1 457 43	N 4447²	K
TW	1 987 43	M 2151	I

F2000 23.314

12,0 228 D 2866 LF23 <V2600, Euro 3>			
01.00-12.02	1 457 42	P 9137	O
	1 457 43	S 3900	L
	1 457 43	N 1710	K
ROB,ZE	1 457 43	N 4447²	K
	1 987 43	M 2151	I

12,0 | 228 | D 2866 LF34 <V2600, Euro 2>

07.99-09.01	1 457 42	P 9137	O
	1 457 43	S 3900	L
	1 457 43	N 1710	K
ROB,ZE	1 457 43	N 4447²	K
	1 987 43	M 2151	I





F2000 23.364

12,0 265 D 2866 LF24 <V2600, Euro 3>			
01.00-12.02	1 457 42	P 9137	O
	1 457 43	S 3900	L
	1 457 43	N 1710	K
ROB,ZE	1 457 43	N 4447²	K
	1 987 43	M 2151	I

12,0 | 265 | D 2866 LF35 <V2600, Euro 2>

07.99-09.01	1 457 42	P 9137	O
	1 457 43	S 3900	L
	1 457 43	N 1710	K
ROB,ZE	1 457 43	N 4447²	K
	1 987 43	M 2151	I

F2000 23.403

12,0 | 294 | D 2866 LF20 <V2600, Euro 2>

01.94-01.95	1 457 42	P 9277	O
02.95-01.97	1 457 42	P 9107	O
02.97-09.01	1 457 42	P 9137	O
01.94-09.01	1 457 43	S 3900	L
	1 457 43	N 1710	K
ROB,ZE	1 457 43	N 4447²	K
	1 987 43	M 2151	I

F2000 23.414

12,0 | 301 | D 2866 LF31 <V2600, Euro 2>

07.99-12.01	1 457 42	P 9137	O
	1 457 43	S 3900	L
	1 457 43	N 1710	K
ROB,ZE	1 457 43	N 4447²	K
	1 987 43	M 2151	I

F2000 23.463

12,8 | 338 | D 2876 LF02 <V2400, Euro 2>

01.94-01.95	1 457 42	P 9277	O
02.95-06.96	ZE	1 457 42	P 9107
07.96-09.01	1 457 42	P 9137	O
01.94-09.01	1 457 43	S 3900	L
	1 457 43	N 1710	K
ROB,ZE	1 457 43	N 4447²	K
	1 987 43	M 2151	I

F2000 23.464

12,8 | 338 | D 2876 LF03 <V2400, Euro 3>

01.00-12.02	1 457 42	P 9137	O
	1 457 43	S 3900	L
	1 457 43	N 1710	K
ROB,ZE	1 457 43	N 4447²	K
	1 987 43	M 2151	I

12,8 | 338 | D 2876 LF06 <V2400, Euro 2>

07.99-09.01	1 457 42	P 9137	O
	1 457 43	S 3900	L
	1 457 43	N 1710	K
ROB,ZE	1 457 43	N 4447²	K
	1 987 43	M 2151	I



F2000 24.273/ 26.273/ 27.273

10,0 | 198 | D 2865 LF22 <V2500, Euro 1>

01.94-01.95	1 457 42	P 9277	O
02.95-12.95	1 457 42	P 9107	O
01.94-12.95	1 457 43	S 3900	L
ROB,ZE	1 457 43	N 4447²	K
TW	1 987 43	M 2151	I

F2000 24.293

10,0 | 213 | D 2865 LF24 <V2500, Euro 2>

01.94-01.95	1 457 42	P 9277	O
02.95-01.97	1 457 42	P 9107	O
02.97-01.00	1 457 42	P 9137	O
01.94-01.00	1 457 43	S 3900	L
ROB,ZE	1 457 43	N 4447²	K
TW	1 987 43	M 2151	I

F2000 24.314

12,0 | 228 | D 2866 LF34 <V2600, Euro 2>

07.99-09.01	1 457 42	P 9137	O
	1 457 43	S 3900	L
	1 457 43	N 1710	K
ROB,ZE	1 457 43	N 4447²	K
	1 987 43	M 2151	I
TW	1 457 42	P 9165³	P
	1 457 42	P 9820³	P

F2000 24.314/ 26.314

12,0 | 228 | D 2866 LF23 <V2600, Euro 3>

01.00-08.02	1 457 42	P 9137	O
	1 457 43	S 3900	L
	1 457 43	N 1710	K
ROB,ZE	1 457 43	N 4447²	K
	1 987 43	M 2151	I
TW	1 457 42	P 9165³	P
	1 457 42	P 9820³	P

F2000 24.364

12,0 | 265 | D 2866 LF35 <V2600, Euro 2>

07.99-09.01	1 457 42	P 9137	O
	1 457 43	S 3900	L
	1 457 43	N 1710	K
ROB,ZE	1 457 43	N 4447²	K
	1 987 43	M 2151	I
TW	1 457 42	P 9165³	P
	1 457 42	P 9820³	P

F2000 24.373

12,0 | 272 | D 2866 LF21 <V2600, Euro 1>

01.94-01.95	1 457 42	P 9277	O
02.95-12.95	1 457 42	P 9107	O
01.94-12.95	1 457 43	S 3900	L
	1 457 43	N 1710	K
ROB,ZE	1 457 43	N 4447²	K
	1 987 43	M 2151	I
TW	1 457 42	P 9165³	P
	1 457 42	P 9820³	P



**F2000 24.403**

12,0 | 294 | D 2866 LF20 <V2600, Euro 2>

01.94-01.95	1 457 42 P 9277	O
02.95-01.97	1 457 42 P 9107	O
02.97-09.01	1 457 42 P 9137	O
01.94-09.01	1 457 43 S 3900	L
	1 457 43 N 1710	K
ROB,ZE	1 457 43 N 4447 ²	K
	1 987 43 M 2151	I
TW	1 457 42 P 9165 ³	P
	1 457 42 P 9820 ³	P

F2000 24.414

12,0 | 301 | D 2866 LF31 <V2600, Euro 2>

07.99-12.01	1 457 42 P 9137	O
	1 457 43 S 3900	L
	1 457 43 N 1710	K
ROB,ZE	1 457 43 N 4447 ²	K
	1 987 43 M 2151	I
TW	1 457 42 P 9165 ³	P
	1 457 42 P 9820 ³	P

F2000 24.423

12,0 | 309 | D 2866 LF22 <V2600, Euro 1>

01.94-01.95	1 457 42 P 9277	O
02.95-12.95	1 457 42 P 9107	O
01.94-12.95	1 457 43 S 3900	L
	1 457 43 N 1710	K
ROB,ZE	1 457 43 N 4447 ²	K
	1 987 43 M 2151	I
TW	1 457 42 P 9165 ³	P
	1 457 42 P 9820 ³	P

F2000 24.463

12,8 | 338 | D 2876 LF02 <V2400, Euro 2>

01.94-01.95	1 457 42 P 9277	O
02.95-06.96	ZE 1 457 42 P 9107	O
07.96-09.01	1 457 42 P 9137	O
01.94-09.01	1 457 43 S 3900	L
	1 457 43 N 1710	K
ROB,ZE	1 457 43 N 4447 ²	K
	1 987 43 M 2151	I
TW	1 457 42 P 9165 ³	P
	1 457 42 P 9820 ³	P

F2000 24.464

12,8 | 338 | D 2876 LF06 <V2400, Euro 2>

07.99-09.01	1 457 42 P 9137	O
	1 457 43 S 3900	L
	1 457 43 N 1710	K
ROB,ZE	1 457 43 N 4447 ²	K
	1 987 43 M 2151	I
TW	1 457 42 P 9165 ³	P
	1 457 42 P 9820 ³	P

F2000 26.293/ 27.293/ 32.293

10,0 | 213 | D 2865 LF24 <V2500, Euro 2>

04.95-01.97	1 457 42 P 9107	O
02.97-01.00	1 457 42 P 9137	O
04.95-01.00	1 457 43 S 3900	L
	ROB,ZE 1 457 43 N 4447 ²	K
	TW 1 987 43 M 2151	I

F2000 26.314

12,0 | 228 | D 2866 LF34 <V2600, Euro 2>

07.99-06.02	1 457 42 P 9137	O
	1 457 43 S 3900	L
	1 457 43 N 1710	K
ROB,ZE	1 457 43 N 4447 ²	K
	1 987 43 M 2151	I
07.99-08.01	1 457 42 P 9820 ³	P
07.99-06.02	TW 1 457 42 P 9165 ³	P
	1 457 42 P 9820 ³	P

F2000 26.364

12,0 | 265 | D 2866 LF35 <V2600, Euro 2>

07.99-06.02	1 457 42 P 9137	O
	1 457 43 S 3900	L
	1 457 43 N 1710	K
ROB,ZE	1 457 43 N 4447 ²	K
	1 987 43 M 2151	I
07.99-09.01	1 457 42 P 9820 ³	P
07.99-06.02	TW 1 457 42 P 9165 ³	P
	1 457 42 P 9820 ³	P

F2000 26.373/ 27.373/ 33.373

12,0 | 272 | D 2866 LF21 <V2600, Euro 1>

01.94-01.95	1 457 42 P 9277	O
02.95-01.97	1 457 42 P 9107	O
01.94-12.00	1 457 43 S 3900	L
	1 457 43 N 1710	K
ROB,ZE	1 457 43 N 4447 ²	K
	1 987 43 M 2151	I
01.94-12.95	1 457 42 P 9820 ³	P
01.94-12.00	TW 1 457 42 P 9165 ³	P
	1 457 42 P 9820 ³	P

F2000 26.403

12,0 | 294 | D 2866 LF20 <V2600, Euro 2>

01.94-01.95	1 457 42 P 9277	O
02.95-01.97	1 457 42 P 9107	O
02.97-09.01	1 457 42 P 9137	O
01.94-09.01	1 457 43 S 3900	L
	1 457 43 N 1710	K
ROB,ZE	1 457 43 N 4447 ²	K
	1 987 43 M 2151	I
	1 457 42 P 9820 ³	P
TW	1 457 42 P 9165 ³	P
	1 457 42 P 9820 ³	P





F2000 26.414

12,0 301 D 2866 LF31 <V2600, Euro 2>			
07.99-06.02	1 457 42	P 9137	O
	1 457 43	S 3900	L
	1 457 43	N 1710	K
ROB,ZE	1 457 43	N 4447²	K
	1 987 43	M 2151	I
07.99-12.01	1 457 42	P 9820³	P
07.99-06.02 TW	1 457 42	P 9165³	P
	1 457 42	P 9820³	P

F2000 26.423

12,0 309 D 2866 LF22 <V2600, Euro 1>			
01.94-01.95	1 457 42	P 9277	O
02.95-12.95	1 457 42	P 9107	O
01.94-12.95	1 457 43	S 3900	L
	1 457 43	N 1710	K
ROB,ZE	1 457 43	N 4447²	K
	1 987 43	M 2151	I
	1 457 42	P 9820³	P
TW	1 457 42	P 9165³	P
	1 457 42	P 9820³	P

F2000 26.463/ 27.463

12,8 338 D 2876 LF02 <V2400, Euro 2>			
01.94-01.95	1 457 42	P 9277	O
02.95-06.96 ZE	1 457 42	P 9107	O
07.96-09.01	1 457 42	P 9137	O
01.94-09.01	1 457 43	S 3900	L
	1 457 43	N 1710	K
ROB,ZE	1 457 43	N 4447²	K
	1 987 43	M 2151	I
	1 457 42	P 9820³	P
TW	1 457 42	P 9165³	P
	1 457 42	P 9820³	P

F2000 26.464/ 27.464

12,8 338 D 2876 LF06 <V2400, Euro 2>			
07.99-06.02	1 457 42	P 9137	O
	1 457 43	S 3900	L
	1 457 43	N 1710	K
ROB,ZE	1 457 43	N 4447²	K
	1 987 43	M 2151	I
07.99-09.01	1 457 42	P 9820³	P
07.99-06.02 TW	1 457 42	P 9165³	P
	1 457 42	P 9820³	P

F2000 26.603/ 27.603/ 33.603

18,3 441 D 2840 LF20 <V3400, Euro 2>			
06.96-01.02	1 457 42	P 9740	O
OES,ZE	1 457 42	P 9107	O
	1 457 43	S 3900	L
ROB,ZE	1 457 43	N 4447²	K
	1 987 43	M 2151	I



F2000 26.604/ 27.604/ 33.604

18,3 441 D 2840 LF21 <V3400, Euro 2>			
07.99-08.01	1 457 42	P 9740	O
OES,ZE	1 457 42	P 9107	O
	1 457 43	S 3900	L
ROB,ZE	1 457 43	N 4447²	K
	1 987 43	M 2151	I

F2000 27.314

12,0 228 D 2866 LF34 <V2600, Euro 2>			
07.99-09.01	1 457 42	P 9137	O
	1 457 43	S 3900	L
	1 457 43	N 1710	K
ROB,ZE	1 457 43	N 4447²	K
	1 987 43	M 2151	I
TW	1 457 42	P 9165³	P
	1 457 42	P 9820³	P

F2000 27.364

12,0 265 D 2866 LF35 <V2600, Euro 2>			
07.99-09.01	1 457 42	P 9137	O
	1 457 43	S 3900	L
	1 457 43	N 1710	K
ROB,ZE	1 457 43	N 4447²	K
	1 987 43	M 2151	I
TW	1 457 42	P 9165³	P
	1 457 42	P 9820³	P

F2000 27.403

12,0 294 D 2866 LF20 <V2600, Euro 2>			
01.94-01.95	1 457 42	P 9277	O
02.95-01.97	1 457 42	P 9107	O
02.97-09.01	1 457 42	P 9137	O
01.94-09.01	1 457 43	S 3900	L
	1 457 43	N 1710	K
ROB,ZE	1 457 43	N 4447²	K
	1 987 43	M 2151	I
TW	1 457 42	P 9165³	P
	1 457 42	P 9820³	P

F2000 27.414

12,0 301 D 2866 LF31 <V2600, Euro 2>			
07.99-12.01	1 457 42	P 9137	O
	1 457 43	S 3900	L
	1 457 43	N 1710	K
ROB,ZE	1 457 43	N 4447²	K
	1 987 43	M 2151	I
TW	1 457 42	P 9165³	P
	1 457 42	P 9820³	P

F2000 27.423/ 33.423

12,0 309 D 2866 LF22 <V2600, Euro 1>			
01.94-01.95	1 457 42	P 9277	O
02.95-12.95	1 457 42	P 9107	O
01.94-12.95	1 457 43	S 3900	L
	1 457 43	N 1710	K
ROB,ZE	1 457 43	N 4447²	K
	1 987 43	M 2151	I
TW	1 457 42	P 9165³	P
	1 457 42	P 9820³	P



F2000 32.314

12,0 228 D 2866 LF34 <V2600, Euro 2>			
07.99-09.01	1 457 42	P 9137	O
	1 457 43	S 3900	L
	1 457 43	N 1710	K
ROB,ZE	1 457 43	N 4447²	K
	1 987 43	M 2151	I

F2000 32.343

10,0 250 D 2865 LF21 <V2500, Euro 2>			
08.95-01.97	1 457 42	P 9107	O
02.97-01.00	1 457 42	P 9137	O
08.95-01.00	1 457 43	S 3900	L
ROB,ZE	1 457 43	N 4447²	K
TW	1 987 43	M 2151	I

F2000 32.364

12,0 265 D 2866 LF35 <V2600, Euro 2>			
07.99-09.01	1 457 42	P 9137	O
	1 457 43	S 3900	L
	1 457 43	N 1710	K
ROB,ZE	1 457 43	N 4447²	K
	1 987 43	M 2151	I

F2000 32.403

12,0 294 D 2866 LF20 <V2600, Euro 2>			
08.95-01.97	1 457 42	P 9107	O
02.97-09.01	1 457 42	P 9137	O
08.95-09.01	1 457 43	S 3900	L
	1 457 43	N 1710	K
ROB,ZE	1 457 43	N 4447²	K
	1 987 43	M 2151	I

F2000 32.414

12,0 301 D 2866 LF31 <V2600, Euro 2>			
07.99-12.01	1 457 42	P 9137	O
	1 457 43	S 3900	L
	1 457 43	N 1710	K
ROB,ZE	1 457 43	N 4447²	K
	1 987 43	M 2151	I

F2000 32.463

12,8 338 D 2876 LF02 <V2400, Euro 2>			
08.95-06.96	ZE	1 457 42	P 9107 O
07.96-09.01		1 457 42	P 9137 O
08.95-09.01		1 457 43	S 3900 L
		1 457 43	N 1710 K
ROB,ZE		1 457 43	N 4447² K
		1 987 43	M 2151 I
		1 457 42	P 9820³ P

F2000 32.464

12,8 338 D 2876 LF06 <V2400, Euro 2>			
07.99-09.01		1 457 42	P 9137 O
		1 457 43	S 3900 L
		1 457 43	N 1710 K
ROB,ZE		1 457 43	N 4447² K
		1 987 43	M 2151 I
		1 457 42	P 9820³ P

F2000 33.343

10,0 250 D 2865 LF21 <V2500, Euro 2>			
01.94-01.95		1 457 42	P 9277 O
02.95-01.97		1 457 42	P 9107 O
02.97-01.00		1 457 42	P 9137 O
01.94-01.00		1 457 43	S 3900 L
ROB,ZE		1 457 43	N 4447² K
TW		1 987 43	M 2151 I

F2000 33.364

12,0 265 D 2866 LF35 <V2600, Euro 2>			
07.99-09.01		1 457 42	P 9137 O
		1 457 43	S 3900 L
		1 457 43	N 1710 K
ROB,ZE		1 457 43	N 4447² K
		1 987 43	M 2151 I
TW		1 457 42	P 9165³ P
		1 457 42	P 9820³ P

F2000 33.374

12,0 272 D 2866 LF21 <V2600, Euro 1>			
01.01→		1 457 43	S 3900 L
		1 457 43	N 1710 K
ROB,ZE		1 457 43	N 4447² K
		1 987 43	M 2151 I
TW		1 457 42	P 9165³ P
		1 457 42	P 9820³ P

F2000 33.403

12,0 294 D 2866 LF20 <V2600, Euro 2>			
01.94-01.95		1 457 42	P 9277 O
02.95-01.97		1 457 42	P 9107 O
02.97-09.01		1 457 42	P 9137 O
01.94-09.01		1 457 43	S 3900 L
		1 457 43	N 1710 K
ROB,ZE		1 457 43	N 4447² K
		1 987 43	M 2151 I
TW		1 457 42	P 9165³ P
		1 457 42	P 9820³ P

F2000 33.414

12,0 301 D 2866 LF31 <V2600, Euro 2>			
07.99-12.01		1 457 42	P 9137 O
		1 457 43	S 3900 L
		1 457 43	N 1710 K
ROB,ZE		1 457 43	N 4447² K
		1 987 43	M 2151 I
TW		1 457 42	P 9165³ P
		1 457 42	P 9820³ P





F2000 33.463

12,8 338 D 2876 LF02 <V2400, Euro 2>			
01.94-01.95	1 457 42	P 9277	O
02.95-06.96	ZE 1 457 42	P 9107	O
07.96-09.01	1 457 42	P 9137	O
01.94-09.01	1 457 43	S 3900	L
	1 457 43	N 1710	K
ROB,ZE	1 457 43	N 4447²	K
	1 987 43	M 2151	I
	1 457 42	P 9820³	P
TW	1 457 42	P 9165³	P
	1 457 42	P 9820³	P

F2000 33.464

12,8 338 D 2876 LF06 <V2400, Euro 2>			
07.99-09.01	1 457 42	P 9137	O
	1 457 43	S 3900	L
	1 457 43	N 1710	K
ROB,ZE	1 457 43	N 4447²	K
	1 987 43	M 2151	I
	1 457 42	P 9820³	P
TW	1 457 42	P 9165³	P
	1 457 42	P 9820³	P

F2000 35.343/ 41.343

10,0 250 D 2865 LF21 <V2500, Euro 2>			
08.95-01.97	1 457 42	P 9107	O
02.97-01.00	1 457 42	P 9137	O
08.95-01.00	1 457 43	S 3900	L
ROB,ZE	1 457 43	N 4447²	K
TW	1 987 43	M 2151	I

F2000 35.364/ 41.364

12,0 265 D 2866 LF35 <V2600, Euro 2>			
07.99-09.01	1 457 42	P 9137	O
	1 457 43	S 3900	L
	1 457 43	N 1710	K
ROB,ZE	1 457 43	N 4447²	K
	1 987 43	M 2151	I
	1 457 42	P 9820³	P

F2000 35.403/ 41.403

12,0 294 D 2866 LF20 <V2600, Euro 2>			
08.95-01.97	1 457 42	P 9107	O
02.97-09.01	1 457 42	P 9137	O
08.95-09.01	1 457 43	S 3900	L
	1 457 43	N 1710	K
ROB,ZE	1 457 43	N 4447²	K
	1 987 43	M 2151	I
	1 457 42	P 9820³	P

F2000 35.414/ 40.414/ 41.414

12,0 301 D 2866 LF31 <V2600, Euro 2>			
12.97-12.01	1 457 42	P 9137	O
	1 457 43	S 3900	L
	1 457 43	N 1710	K
ROB,ZE	1 457 43	N 4447²	K
	1 987 43	M 2151	I
	1 457 42	P 9820³	P

F2000 35.463/ 41.463

12,8 338 D 2876 LF02 <V2400, Euro 2>			
02.97-09.01	1 457 42	P 9137	O
08.95-09.01	1 457 43	S 3900	L
	1 457 43	N 1710	K
ROB,ZE	1 457 43	N 4447²	K
	1 987 43	M 2151	I
	1 457 42	P 9820³	P

F2000 35.464/ 40.464/ 41.464

12,8 338 D 2876 LF06 <V2400, Euro 2>			
12.97-09.01	1 457 42	P 9137	O
	1 457 43	S 3900	L
	1 457 43	N 1710	K
ROB,ZE	1 457 43	N 4447²	K
	1 987 43	M 2151	I
	1 457 42	P 9820³	P

F2000 Evol. (FE)

F2000 Evol. (FE) 26.310

12,0 228 D 2866 LF23 <V2600, Euro 3>			
09.02-06.03	1 457 42	P 9137	O
	1 457 43	S 3900	L
	1 457 43	N 1710	K
ROB,ZE	1 457 43	N 4447²	K
	1 987 43	M 2151	I
TW	1 457 42	P 9165³	P

F2000 Evol. (FE) 26.360/ 360A

12,0 265 D 2866 LF24 <V2600, Euro 3>			
07.99-06.03	1 457 42	P 9137	O
	1 457 43	S 3900	L
	1 457 43	N 1710	K
ROB,ZE	1 457 43	N 4447²	K
	1 987 43	M 2151	I
TW	1 457 42	P 9165³	P
	1 457 42	P 9820³	P
01.00-06.03	1 457 42	P 9820³	P

F2000 Evol. (FE) 35.310

12,0 228 D 2866 LF23 <V2600, Euro 3>			
09.02-09.03	1 457 42	P 9137	O
	1 457 43	S 3900	L
	1 457 43	N 1710	K
	1 987 43	M 2151	I
	1 457 42	P 9820³	P

F2000 Evol. (FE) 35.410

12,0 301 D 2866 LF25 <V2600, Euro 3>			
09.02-06.03	1 457 42	P 9137	O
	1 457 43	S 3900	L
	1 457 43	N 1710	K
ROB,ZE	1 457 43	N 4447²	K
	1 987 43	M 2151	I
	1 457 42	P 9820³	P





F2000 Evol. (FE) 310A

12,0 228 D 2866 LF23 <V2600, Euro 3>			
07.99-08.02		1 457 42 P 9137	O
		1 457 43 S 3900	L
		1 457 43 N 1710	K
01.00-08.02	ROB,ZE	1 457 43 N 4447 ²	K
07.99-08.02		1 987 43 M 2151	I
		1 457 42 P 9820 ³	P
01.00-08.02	TW	1 457 42 P 9165 ³	P
		1 457 42 P 9820 ³	P

F2000 Evol. (FE) 410A

12,0 301 D 2866 LF25 <V2600, Euro 3>			
07.99-09.02		1 457 42 P 9137	O
		1 457 43 S 3900	L
		1 457 43 N 1710	K
	ROB,ZE	1 457 43 N 4447 ²	K
		1 987 43 M 2151	I
07.99-08.02		1 457 42 P 9820 ³	P
01.00-09.02	TW	1 457 42 P 9165 ³	P
		1 457 42 P 9820 ³	P

F2000 Evol. (FE) 460A

12,8 338 D 2876 LF03 <V2400, Euro 3>			
01.00-09.02		1 457 42 P 9137	O
		1 457 43 S 3900	L
		1 457 43 N 1710	K
	ROB,ZE	1 457 43 N 4447 ²	K
		1 987 43 M 2151	I
01.00-08.02		1 457 42 P 9820 ³	P
01.00-09.02	TW	1 457 42 P 9165 ³	P
		1 457 42 P 9820 ³	P

Lion's City

Lion's City G, GL

10,5 228/257 D 2066 LUH02 <Euro4>; D 2066 LUH12 <Euro4>			
10.06→		F 026 40 P 7051	O
	KNE	F 026 40 S 0184	L
		F 026 40 N 2028	K

12,8 228 E 2876 LUH02 <V6200, CNG>			
10.06→	LBF	1 457 42 P 9740	O
	KNE	F 026 40 S 0184	L

Lion's City NG

12,0 177 G 2866 DUH05 <V0400>			
06.02-09.06	LBF	1 457 42 P 9740	O
	FKO,XXX	1 457 42 S 9882	L
	KNE	F 026 40 S 0184	L

12,0 | 191 | D 2866 LUH22 <V3200, Euro 2>

07.98-09.01		1 457 42 P 9740	O
	KNE	F 026 40 S 0184	L
		1 457 43 N 1159 ⁶	K
		1 457 43 N 1326 ⁷	K
	FIU,ZE	1 457 43 N 1270	K
	ROB,ZE	1 457 43 N 4447 ²	K



12,0 | 191/228 | D 2866 LUH23 <V5000, Euro 3>; D 2866 LUH24 <V5000, Euro 3>

01.01-09.06		1 457 42 P 9740	O
	KNE	F 026 40 S 0184	L
		1 457 43 N 1710	K
	ROB,ZE	1 457 43 N 4447 ²	K

12,0 | 228 | D 2866 LUH26 <V3200, Euro 2>

07.98-12.01		1 457 42 P 9740	O
	KNE	F 026 40 S 0184	L
	ROB,ZE	1 457 43 N 4447 ²	K

12,0 | 228 | E 2866 LUH01 <V3600, CNG>

07.98-12.01	LBF	1 457 42 P 9740	O
	KNE	F 026 40 S 0184	L

12,0 | 228 | E 2866 LUH02 <V3600, Euro 3, CNG>

09.02-09.06	LBF	1 457 42 P 9740	O
	KNE	F 026 40 S 0184	L

12,0 | 258 | D 2866 LUH21 <V3200, Euro 2>

01.01-12.01		1 457 42 P 9740	O
	KNE	F 026 40 S 0184	L
	ROB,ZE	1 457 43 N 4447 ²	K

12,0 | 265 | D 2866 LUH25 <V5000, Euro 3>

01.01-09.06		1 457 42 P 9740	O
	FKO,XXX	1 457 42 S 9882	L
	KNE	F 026 40 S 0184	L
		1 457 43 N 1710	K
	ROB,ZE	1 457 43 N 4447 ²	K

Lion's City / NL

Lion's City / NL

6,9 | 176 | D 0836 LUH41 <V5700, Euro 3>

06.04-09.06		1 457 42 P 9107	O
		F 026 40 S 0184	L
	FIH	1 457 43 N 1710	K
	FIU	1 457 43 N 4447 ²	K
	TW	F 026 40 N 2028	K

10,5 | 199/206/228/235/257/264/265 | D 2066 LUH16 <Euro 4/OBD1>; D 2066 LUH17 <Euro 4/OBD1>; D 2066 LUH21 <Euro 4/OBD1>; D 2066 LUH22 <Euro 4/OBD1>; D 2066 LUH23 <Euro 4/OBD1>; D 2066 LUH26 <Euro 4/OBD1>; D 2066 LUH27 <Euro 4/OBD1>; D 2066 LUH41 <Euro 5/EEV/OBD2>; D 2066 LUH42 <Euro 5/EEV>; D 2066 LUH43 <Euro 5/EEV>; D 2066 LUH46 <Euro 5/EEV/OBD2>; D 2066 LUH47 <Euro 5/EEV/OBD2>; D 2066 LUH48 <Euro 5/EEV/OBD2>

08.06→		F 026 40 S 0184	L
--------	--	------------------------	----------

12,0 | 180/228 | D 2866 LUH28 <Euro 3>; E 2866 DUH04 <EEV>

04.06→		F 026 40 S 0184	L
--------	--	------------------------	----------

12,8 | 200 | G 2876 DUH01 <Euro 5/EEV/LPG>

08.06→		F 026 40 S 0184	L
--------	--	------------------------	----------

Lion's City / NL NL 202

6,9 | 157 | D 0826 LUH03 <V0300, Euro 1>; D 0826 LUH/213 <V0300,>

09.89-03.97		0 451 30 P 1207	O
	KNE	1 457 43 S 3651	L
	FIU,ZE	1 457 43 N 1326 ⁷	K
	ROB,ZE	1 457 43 N 4447 ²	K





◀ Lion's City / NL NL 202

6,9 | 184/198 | D 0826 LUH <Euro 1>

04.94-03.97		0 451 30	P 1207	O
	KNE	1 457 43	S 3651	L
	ROB,ZE	1 457 43	N 4447²	K

Lion's City / NL NL 222

6,9 | 162 | D 0826 LUH12 <V0300, Euro 2>

11.95-11.99	NEB	F 026 40	P 7054	O
11.95-09.01		0 451 30	P 1207	O
11.95-11.99	KNE	1 457 43	S 3651	L
02.96-09.01	KNE,TW	1 457 43	S 3651	L
11.95-09.01	FIU,ZE	1 457 43	N 1326⁷	K
	ROB,ZE	1 457 43	N 4447²	K

Lion's City / NL NL 223

6,9 | 162 | D 0826 LUH12 <V0300, Euro 2>

02.96-09.01		0 451 30	P 1207	O
		F 026 40	S 0184	L
	FIU,ZE	1 457 43	N 1326⁷	K
	ROB,ZE	1 457 43	N 4447²	K

6,9 | 162 | D 0836 LUH02 <V4600, Euro 3>

01.01-09.01		1 457 42	P 9278	O
01.01-09.06		0 451 30	P 1207	O
10.01-09.06		1 457 42	P 9107	O
01.01-09.06		F 026 40	S 0184	L
		1 457 43	N 1710	K
	ROB,ZE	1 457 43	N 4447²	K

Lion's City / NL NL 232

12,0 | 170 | E 2866 DUH01 <V1601, CNG>

04.94-06.00	LBF	1 457 42	P 9740	O
		1 457 43	S 3651	L

Lion's City / NL NL 233

12,0 | 170 | E 2866 DUH02 <V1601, CNG>

07.98→	LBF	1 457 42	P 9740	O
		F 026 40	S 0184	L
01.01→	FKO,XXX	1 457 42	S 9882	L

Lion's City / NL NL 243

6,9 | 176 | D 0836 LOH41 <V5600, Euro 3>

01.02-09.06		0 451 30	P 1207	O
		F 026 40	S 0184	L
		F 026 40	N 2028	K

12,0 | 177 | G 2866 DUH05 <V0400>

06.02-01.06	LBF	1 457 42	P 9740	O
	FKO,XXX	1 457 42	S 9882	L
	KNE	F 026 40	S 0184	L

12,0 | 180 | E 2866 DUH03 <V1601, EEV (Euro 5)>; E 2866 DUH03 <V1601, EEV Euro 5>

01.02→	LBF	1 457 42	P 9740	O
		F 026 40	S 0184	L

Lion's City / NL NL 243/ NL 263

12,0 | 191 | D 2866 LUH23 <V5000, Euro 3>

07.98-09.06		1 457 42	P 9740	O
		F 026 40	S 0184	L
		1 457 43	N 1710	K
	ROB,ZE	1 457 43	N 4447²	K



Lion's City / NL NL 262

6,9 | 191 | D 0826 LUH13 <V0300, Euro 2>

02.96-09.01		0 451 30	P 1207	O
02.96-11.99	KNE	1 457 43	S 3651	L
02.96-09.01	KNE,TW	1 457 43	S 3651	L
02.96-11.99	ROB,ZE	1 457 43	N 4447²	K
02.96-09.01	FIU,ZE	1 457 43	N 1326⁷	K

10,0 | 191 | D 2865 LUH09 <V1400, Euro 2>

06.97-07.98		1 457 42	P 9740	O
	KNE	1 457 43	S 3651	L
	LUM	1 457 43	S 2188	L
	ROB,ZE	1 457 43	N 4447²	K

12,0 | 191 | D 2866 LUH22 <V3200, Euro 2>

07.98-11.99		1 457 42	P 9740	O
	KNE	1 457 43	S 3651	L
		1 457 43	N 1159⁶	K
		1 457 43	N 1326⁷	K
	FIU,ZE	1 457 43	N 1270	K
	ROB,ZE	1 457 43	N 4447²	K

Lion's City / NL NL 263

6,9 | 191 | D 0826 LUH13 <V0300, Euro 2>

07.98-09.01		0 451 30	P 1207	O
		F 026 40	S 0184	L
	FIU,ZE	1 457 43	N 1326⁷	K
	ROB,ZE	1 457 43	N 4447²	K

12,0 | 191 | D 2866 LUH22 <V3200, Euro 2>

07.98-09.01		1 457 42	P 9740	O
		F 026 40	S 0184	L
		1 457 43	N 1159⁶	K
		1 457 43	N 1326⁷	K
	FIU,ZE	1 457 43	N 1270	K
	ROB,ZE	1 457 43	N 4447²	K

Lion's City / NL NL 283

6,9 | 206 | D 0836 LOH40 <V5600, Euro 3>

01.02-09.06		0 451 30	P 1207	O
		F 026 40	S 0184	L
		F 026 40	N 2028	K

6,9 | 206 | D 0836 LUH01 <V4600, Euro 3>

01.01-09.01		1 457 42	P 9278	O
01.01-09.06		0 451 30	P 1207	O
10.01-09.06		1 457 42	P 9107	O
01.01-09.06		F 026 40	S 0184	L
		1 457 43	N 1710	K
	ROB,ZE	1 457 43	N 4447²	K

Lion's City / NL NL 312

10,0 | 228 | D 2865 LUH07 <V1400, Euro 2>

11.95-09.01		1 457 42	P 9740	O
	NEB	F 026 40	P 7054	O
11.95-07.98	KNE	1 457 43	S 3651	L
	LUM	1 457 43	S 2188	L
02.96-09.01		1 457 43	S 2188	L
	KNE,TW	1 457 43	S 3651	L
11.95-09.01	ROB,ZE	1 457 43	N 4447²	K

**Lion's City / NL NL 313**

12,0 | 228 | D 2866 LUH24 <V5000, Euro 3>

01.01-09.06	1 457 42 P 9740	O
	F 026 40 S 0184	L
	1 457 43 N 1710	K
ROB,ZE	1 457 43 N 4447 ²	K

12,0 | 228 | D 2866 LUH26 <V3200, Euro 2>

07.98-09.02	1 457 42 P 9740	O
	F 026 40 S 0184	L
07.98-12.01	1 457 43 N 1159 ⁶	K
07.98-09.02 ROB,ZE	1 457 43 N 4447 ²	K

12,0 | 228 | E 2866 LUH01 <V3600, CNG>

07.98-12.01	LBF	1 457 42 P 9740	O
		F 026 40 S 0184	L

12,0 | 228 | E 2866 LUH02 <V3600, Euro 3, CNG>

09.02-09.06	LBF	1 457 42 P 9740	O
		F 026 40 S 0184	L

12,8 | 228 | E 2876 LUH01 <V6200, CNG>

05.04-09.06	LBF	1 457 42 P 9740	O
		F 026 40 S 0184	L

Lion's City / NL NL 353

12,0 | 258 | D 2866 LUH21 <V3200, Euro 2>

11.99-09.01	1 457 42 P 9740	O
	F 026 40 S 0184	L
ROB,ZE	1 457 43 N 4447 ²	K

Lion's City / NL NL 363

12,0 | 265 | D 2866 LUH25 <V5000, Euro 3>

01.01-03.06	1 457 42 P 9740	O
	F 026 40 S 0184	L
	1 457 43 N 1710	K
ROB,ZE	1 457 43 N 4447 ²	K

Lion's City DD / ND**Lion's City DD / ND ND 222**

6,9 | 162 | D 0826 LUH12 <V0300, Euro 2>

06.97-09.01	0 451 30 P 1207	O
	FIU,ZE 1 457 43 N 1326 ⁷	K
	ROB,ZE 1 457 43 N 4447 ²	K

Lion's City DD / ND ND 313

10,5 | 228/235/257 | D 2066 LUH12 <Euro4>; D 2066 LUH13 <Euro4>; D 2066 LUH17 <Euro 4/OBD1>; D 2066 LUH27 <Euro 4/OBD1>; D 2066 LUH47 <Euro 5/EEV/OBD2>

04.06→	F 026 40 S 0184	L
--------	-----------------	---

12,0 | 228 | D 2866 LUH51 <Euro4>

08.03→	1 457 42 P 9740	O
	F 026 40 S 0184	L
	1 457 43 N 1710	K
	1 457 43 N 4447 ²	K

Lion's City G, GL / NG**Lion's City G, GL / NG**

12,0 | 228 | D 2866 LOH27 <Euro 3>

06.06→	F 026 40 S 0184	L
--------	-----------------	---

Lion's City LL / NL**Lion's City LL / NL**

10,5 | 228/235/257/265 | D 2066 LUH12 <Euro 4>; D 2066 LUH17 <Euro 4/OBD1>; D 2066 LUH22 <Euro 4/OBD1>; D 2066 LUH23 <Euro 4/OBD1>; D 2066 LUH28 <Euro 4/OBD1>; D 2066 LUH42 <Euro 5/EEV>; D 2066 LUH43 <Euro 5/EEV>; D 2066 LUH47 <Euro 5/EEV/OBD2>; D 2066 LUH48 <Euro 5/EEV/OBD2>

02.06→	F 026 40 S 0184	L
--------	-----------------	---

Lion's City LL / NL NL 263

12,0 | 191 | D 2866 LUH22 <V3200, Euro 2>

08.98-09.01	1 457 42 P 9740	O
	F 026 40 S 0184	L
	1 457 43 N 1159 ⁶	K
	1 457 43 N 1326 ⁷	K
FIU,ZE	1 457 43 N 1270	K
ROB,ZE	1 457 43 N 4447 ²	K

Lion's City LL / NL NL 263/ NL 313

12,0 | 191/228 | D 2866 LUH23 <V5000, Euro 3>; D 2866 LUH24 <V5000, Euro 3>

01.01-09.06	1 457 42 P 9740	O
	F 026 40 S 0184	L
	1 457 43 N 1710	K
ROB,ZE	1 457 43 N 4447 ²	K

Lion's City LL / NL NL 313

12,0 | 228 | D 2866 LUH26 <V3200, Euro 2>

08.98-12.01	1 457 42 P 9740	O
	F 026 40 S 0184	L
ROB,ZE	1 457 43 N 4447 ²	K

12,8 | 228 | E 2876 LUH01 <V6200, CNG EEV>

05.04-09.06	LBF	1 457 42 P 9740	O
		F 026 40 S 0184	L

Lion's City LL / NL NL 353

12,0 | 257 | D 2866 LUH21 <V3200, Euro 2>

08.98-12.01	1 457 42 P 9740	O
	F 026 40 S 0184	L
ROB,ZE	1 457 43 N 4447 ²	K

Lion's City LL / NL NL 363

12,0 | 265 | D 2866 LUH25 <V5000, Euro 3>

01.01-09.06	1 457 42 P 9740	O
	F 026 40 S 0184	L
	1 457 43 N 1710	K
ROB,ZE	1 457 43 N 4447 ²	K





Lion's City M / NM

Lion's City M / NM

6,9 162 D 0836 LOH03 <V4900, Euro 3>	04.04-09.06	0 451 30 P 1207	O
	ROB,ZE	1 457 43 N 4447 ²	K

6,9 176/206 D 0836 LOH51 <Euro 4>; D 0836 LOH52 <V7200, Euro4>	01.06-08.09	0 451 30 P 1207	O
		1 457 42 P 9278	O
		F 026 40 S 0184	L
		F 026 40 N 2028	K

Lion's City M / NM NM 11.222/ NM 11.223

6,9 162 D 0826 LOH15 <V2900,>	02.96-09.01	0 451 30 P 1207	O
	KNE	1 457 43 S 3651	L
	ROB,ZE	1 457 43 N 4447 ²	K

Lion's City M / NM NM 152

4,6 114 D 0824 LOH01 <V1900, Euro 1>	08.91-05.96	0 451 30 P 1207	O
		1 457 42 S 9950	L
		1 457 43 N 4154 ²	K
	ROB	1 457 43 N 4447 ²	K
		1 457 42 P 9820 ³	P

Lion's City M / NM NM 222

6,9 162 D 0826 LUH12 <V0300, Euro 2>	06.97-09.01	0 451 30 P 1207	O
	KNE	F 026 40 S 0184	L
	FIU,ZE	1 457 43 N 1326 ⁷	K
	ROB,ZE	1 457 43 N 4447 ²	K

Lion's City M / NM NM 223

6,9 162 D 0836 LOH03 <V4900, Euro 3>	01.00-09.06	0 451 30 P 1207	O
	KNE	F 026 40 S 0184	L
	ROB,ZE	1 457 43 N 4447 ²	K

Lion's City M / NM NM 283

6,9 206 D 0836 LOH02 <V4900, Euro 3>	10.01-09.06	0 451 30 P 1207	O
	KNE	F 026 40 S 0184	L
	ROB,ZE	1 457 43 N 4447 ²	K

Lion's City T,TÜ / EL

Lion's City T,TÜ / EL

6,9 162/206 D 0836 LOH02 <V4900, Euro 3>; D 0836 LOH03 <V4900, Euro 3>	06.04-09.06	0 451 30 P 1207	O
	ROB,ZE	1 457 43 N 4447 ²	K
		1 987 43 R 1458 ⁸	I

Lion's City Ü

Lion's City Ü

10,5 199/228 D 2066 LUH11 <V6400, Euro 4>; D 2066 LUH12 <V6400, Euro 4>	10.06→	F 026 40 P 7051	O
		F 026 40 S 0184	L
		F 026 40 N 2028	K



12,0 180 E 2866 DUH03 <V1601, CNG>	10.06→	F 026 40 S 0184	L
--	--------	-----------------	---

12,8 228 E 2876 LUH02 <V6200, CNG>	10.06→	LBF	1 457 42 P 9740	O
			F 026 40 S 0184	L

Lion's City Ü / NÜ

Lion's City Ü / NÜ

6,9 176/206 D 0836 LUH40 <Euro 3>; D 0836 LUH41 <V5700, Euro 3>	06.04-09.06	1 457 42 P 9107	O
		F 026 40 S 0184	L
	FIH	1 457 43 N 1710	K
	FIU	1 457 43 N 4447 ²	K
	TW	F 026 40 N 2028	K

10,5 199/206/228/235/257/265 D 2066 LUH 46 <Euro 5/EEV/OBD2>; D 2066 LUH13 <Euro4>; D 2066 LUH16 <Euro 4/OBD1>; D 2066 LUH17 <Euro 4/OBD1>; D 2066 LUH21 <Euro 4/OBD1>; D 2066 LUH22 <Euro 4/OBD1>; D 2066 LUH23 <Euro 4/OBD1>; D 2066 LUH26 <Euro 4/OBD1>; D 2066 LUH27 <Euro 4/OBD1>; D 2066 LUH28 <Euro 4/OBD1>; D 2066 LUH41 <Euro 5/EEV/OBD2>; D 2066 LUH42 <Euro 5/EEV>; D 2066 LUH47 <Euro 5/EEV/OBD2>; D 2066 LUH48 <Euro 5/EEV/OBD2>	05.06→	F 026 40 P 7051	O
		F 026 40 S 0184	L

12,0 191 D 2866 LUH34 <Euro 3>	03.06→	F 026 40 S 0184	L
------------------------------------	--------	-----------------	---

12,8 200 G 2876 DUH01 <Euro 5/EEV/LPG>	07.06→	F 026 40 S 0184	L
--	--------	-----------------	---

Lion's City Ü / NÜ NÜ 233

12,0 170 E 2866 DUH02 <V1601, CNG>	07.98→	LBF	1 457 42 P 9740	O
			F 026 40 S 0184	L
			1 457 43 N 1710	K

Lion's City Ü / NÜ NÜ 243

12,0 180 E 2866 DUH03 <V1601, EEV Euro 5>	01.02→	LBF	1 457 42 P 9740	O
			F 026 40 S 0184	L

Lion's City Ü / NÜ NÜ 263

6,9 191 D 0826 LUH13 <V0300, Euro 2>	07.98-09.01	0 451 30 P 1207	O	
		F 026 40 S 0184	L	
		1 457 43 N 1710	K	
		FIU,ZE	1 457 43 N 1326 ⁷	K
		ROB,ZE	1 457 43 N 4447 ²	K

10,0 191 D 2865 LUH09 <V1400, Euro 2>	09.96-07.98	1 457 42 P 9740	O	
		F 026 40 S 0184	L	
		1 457 43 N 1710	K	
		ROB,ZE	1 457 43 N 4447 ²	K



12,0 191 D 2866 LUH22 <V3200, Euro 2>			
07.98-09.01	1 457 42	P 9740	O
	F 026 40	S 0184	L
	1 457 43	N 1159⁶	K
	1 457 43	N 1326⁷	K
	1 457 43	N 1710	K
FIU,ZE	1 457 43	N 1270	K
ROB,ZE	1 457 43	N 4447²	K

12,0 191 D 2866 LUH23 <V5000, Euro 3>			
01.01-09.06	1 457 42	P 9740	O
	F 026 40	S 0184	L
	1 457 43	N 1710	K
ROB,ZE	1 457 43	N 4447²	K

Lion's City Ü / NÜ NÜ 283			
6,9 206 D 0836 LUH01 <V4600, Euro 3>			
01.01-09.01	1 457 42	P 9278	O
01.01-09.06	0 451 30	P 1207	O
10.01-09.06	1 457 42	P 9107	O
01.01-09.06	F 026 40	S 0184	L
	1 457 43	N 1710	K
ROB,ZE	1 457 43	N 4447²	K

Lion's City Ü / NÜ NÜ 313			
12,0 228 D 2866 LUH24 <V5000, Euro 3>; D 2866 LUH26 <V3200, Euro 2>			
07.98-09.06	1 457 42	P 9740	O
	F 026 40	S 0184	L
	1 457 43	N 1710	K
ROB,ZE	1 457 43	N 4447²	K

12,0 228 E 2866 LUH01 <V3600, CNG>; E 2866 LUH02 <V3600, Euro 3, CNG>			
07.98-09.06	LBF	1 457 42	P 9740
	F 026 40	S 0184	L

12,8 228 E 2876 DUH01 <V6200, CNG EEV>			
05.04-09.06	LBF	1 457 42	P 9740
	F 026 40	S 0184	L

Lion's City ÜLL / NÜ

Lion's City ÜLL / NÜ NÜ 313			
12,0 228 D 2866 LUH24 <V5000, Euro 3>			
02.98-09.06	1 457 42	P 9740	O
	F 026 40	S 0184	L
	1 457 43	N 1710	K
ROB,ZE	1 457 43	N 4447²	K

12,0 228 D 2866 LUH26 <V3200, Euro 2>			
02.98-12.01	1 457 42	P 9740	O
	F 026 40	S 0184	L
ROB,ZE	1 457 43	N 4447²	K

12,0 228 E 2866 LUH01 <V3600, CNG>; E 2866 LUH02 <V3600, Euro 3, CNG>			
02.98-09.06	LBF	1 457 42	P 9740
	F 026 40	S 0184	L

Lion's City ÜLL / NÜ NÜ 353			
12,0 257 D 2866 LUH21 <V3200, Euro 2>			
02.98-12.01	1 457 42	P 9740	O
	F 026 40	S 0184	L
ROB,ZE	1 457 43	N 4447²	K

Lion's City ÜLL / NÜ NÜ 363			
12,0 265 D 2866 LUH25 <V5000, Euro 3>			
01.01-09.06	1 457 42	P 9740	O
	F 026 40	S 0184	L
	1 457 43	N 1710	K
ROB,ZE	1 457 43	N 4447²	K

Lion's Classic

Lion's Classic SG			
12,0 191/228 D 2866 LUH23 <V5000, Euro 3>; D 2866 LUH24 <V5000, Euro 3>			
06.03-09.06	1 457 42	P 9740	O
LUM	1 457 43	S 2188	L
	1 457 43	N 1710	K
ROB,ZE	1 457 43	N 4447²	K

Lion's Classic / SL

Lion's Classic / SL SL 223/ SL 283			
6,9 162/206 D 0836 LOH02 <V4900, Euro 3>; D 0836 LOH03 <V4900, Euro 3>			
06.03-10.06	0 451 30	P 1207	O
ROB,ZE	1 457 43	N 4447²	K

Lion's Coach

Lion's Coach			
10,5 294/324 D 2066 LOH03 <Euro 4>; D 2066 LOH04 <Euro 4>			
09.05→	F 026 40	P 7051	O
FIH,RME	1 457 43	N 1710	K
RAP	F 026 40	N 2028	K
	1 987 43	R 1458⁸	I

Lion's Coach C, L

10,5 294/324 D 2066 LOH07 <Euro 4/OBD1>; D 2066 LOH08 <Euro 4/OBD1>			
04.07→	F 026 40	P 7051	O
FIH,RME	1 457 43	N 1710	K
RAP	F 026 40	N 2028	K

12,0 301 D 2866 LOH34 <V4800, Euro 3>			
09.02-09.06	LBF	1 457 42	P 9137
	LBF	1 457 42	P 9740
09.02-06.03	1 457 42	S 9969	L
09.02-09.06	TW	F 026 40	S 0210⁴
07.03-09.06	F 026 40	S 0068	L
09.02-09.06	1 457 43	N 1710	K
ROB,ZE	1 457 43	N 4447²	K

12,4 338 D 2676 LOH01 <V6700, Euro 4>			
09.05-09.06	F 026 40	P 7051	O
	F 026 40	N 2028	K





◀ Lion's Coach C, L

12,8 | 338 | D 2876 LOH03 <V4500, Euro 3>

09.02-09.06	LBF	1 457 42	P 9137	O
	LBF	1 457 42	P 9740	O
09.02-06.03		1 457 42	S 9969	L
09.02-09.06	TW	F 026 40	S 0210 ⁴	L
07.03-09.06		F 026 40	S 0068	L
09.02-09.06		1 457 43	N 1710	K
	ROB,ZE	1 457 43	N 4447 ²	K

Lion's Coach RHC

12,0 | 301 | D 2866 LOH34 <V4800, Euro 3>

09.02-09.06	LBF	1 457 42	P 9137	O
	LBF	1 457 42	P 9740	O
09.02-06.03		1 457 42	S 9969	L
09.02-09.06	TW	F 026 40	S 0210 ⁴	L
07.03-09.06		F 026 40	S 0068	L
09.02-09.06		1 457 43	N 1710	K
	ROB,ZE	1 457 43	N 4447 ²	K
		1 987 43	R 1458 ⁸	I

12,8 | 338 | D 2876 LOH03 <V4500, Euro 3>

09.02-09.06	LBF	1 457 42	P 9137	O
	LBF	1 457 42	P 9740	O
09.02-06.03		1 457 42	S 9969	L
09.02-09.06	TW	F 026 40	S 0210 ⁴	L
07.03-09.06		F 026 40	S 0068	L
09.02-09.06		1 457 43	N 1710	K
	ROB,ZE	1 457 43	N 4447 ²	K
		1 987 43	R 1458 ⁸	I

Lion's Comfort

Lion's Comfort R 313/ ÜL 313/ ÜL 353

12,0 | 228/257 | D 2866 LUH21 <V3200, Euro 2>; D 2866 LUH26 <V3200, Euro 2>

01.98-12.01		1 457 42	P 9740	O
		1 457 43	S 2188	L
	ROB,ZE	1 457 43	N 4447 ²	K
		1 987 43	M 2151	I
		1 457 42	P 9820 ³	P

Lion's Regio C

Lion's Regio C

10,5 | 228/257/287 | D 2066 LUH01 <V6400, Euro4>; D 2066 LUH02 <V6400, Euro4>; D 2066 LUH03 <V6400, Euro4>

10.06-05.07		F 026 40	P 7051	O
		F 026 40	N 2028	K

Lion's Regio L

Lion's Regio L

10,5 | 228/257/287 | D 2066 LUH01 <V6400, Euro4>; D 2066 LUH02 <V6400, Euro4>; D 2066 LUH03 <V6400, Euro4>

10.06-05.07		F 026 40	P 7051	O
		F 026 40	N 2028	K
		1 987 43	M 1163	I
		1 987 43	R 1458 ⁸	I



Lion's Regio ÜL

Lion's Regio ÜL ÜL 314/ ÜL 364

12,0 | 228/265 | D 2866 LUH24 <V5000, Euro3>; D 2866 LUH25 <V5000, Euro3>

06.04-09.06		1 457 42	P 9740	O
		1 457 43	N 1710	K
	ROB,ZE	1 457 43	N 4447 ²	K
		1 987 43	M 1163	I
		1 987 43	R 1458 ⁸	I

Lion's Star

Lion's Star FRH

12,0 | 309 | D 2866 LOH20 <V1500, Euro 1>

01.93-09.96	LBF	1 457 42	P 9137	O
	LBF	1 457 42	P 9740	O
		1 457 42	S 9969	L
01.93-01.96	FIU,ZE	1 457 43	N 1270	K

12,0 | 309 | D 2866 LOH21 <V1500, Euro 1>

01.93-09.96	LBF	1 457 42	P 9137	O
	LBF	1 457 42	P 9740	O
		1 457 42	S 9969	L
	FIU,ZE	1 457 43	N 1270	K
	ROB,ZE	1 457 43	N 4447 ²	K

Lion's Star RH

12,0 | 257/294 | D 2866 LOH23 <V1500, Euro 2>; D 2866 LOH26 <V1500, Euro 2>

07.98-09.01	LBF	1 457 42	P 9137	O
	LBF	1 457 42	P 9740	O
		1 457 42	S 9969	L
07.98-05.00	FIU,ZE	1 457 43	N 1270	K
07.98-09.01	ROB,ZE	1 457 43	N 4447 ²	K

12,8 | 338 | D 2876 LOH01 <V3300, Euro 2>

06.99-09.01		1 457 42	P 9740	O
		1 457 42	S 9969	L
		1 457 43	N 1270	K
	ROB,ZE	1 457 43	N 4447 ²	K

Lion's Star RHS

12,0 | 301/338 | D 2866 LOH34 <V4800, Euro 3>; D 2876 LOH03 <V4500, Euro 3>

10.01-09.06	LBF	1 457 42	P 9137	O
	LBF	1 457 42	P 9740	O
10.01-06.03		1 457 42	S 9969	L
10.01-09.06		1 457 43	N 1710	K
	ROB,ZE	1 457 43	N 4447 ²	K
		1 987 43	M 1163	I
		1 987 43	R 1458 ⁸	I

Lion's Star L

Lion's Star L RHS

12,0 | 301 | D 2866 LOH34 <V4800, Euro 3>

10.01-09.06	LBF	1 457 42	P 9137	O
	LBF	1 457 42	P 9740	O
10.01-06.03		1 457 42	S 9969	L
10.01-09.06		1 987 43	M 1163	I
		1 987 43	R 1458 ⁸	I



12,0 | 338 | D 2876 LOH03 <V4500, Euro 3>

10.01-09.06	LBF	1 457 42 P 9137	O
	LBF	1 457 42 P 9740	O
		1 457 42 S 9969	L
		1 457 43 N 1710	K
	ROB, ZE	1 457 43 N 4447 ²	K
		1 987 43 M 1163	I
		1 987 43 R 1458 ⁸	I

Lion's Top Coach

Lion's Top Coach RH

12,0 | 294 | D 2866 LOH23 <V1500, Euro 2>

06.99-01.04	LBF	1 457 42 P 9137	O
	LBF	1 457 42 P 9740	O
		1 457 42 S 9969	L
06.99-05.00	FIU, ZE	1 457 43 N 1270	K
06.99-01.04		1 457 43 N 4295 ²	K
	ROB, ZE	1 457 43 N 4447 ²	K

12,8 | 339 | D 2876 LOH01 <V3300, Euro 2>

06.99-01.04		1 457 42 P 9740	O
		1 457 42 S 9969	L
		1 457 43 N 1270	K
	ROB, ZE	1 457 43 N 4447 ²	K

Lion's Top Coach RHC

12,8 | 339 | D 2876 LOH03

01.09→		1 457 42 S 9969	L
--------	--	-----------------	---

Lion's Top Star

Lion's Top Star RHS

12,0 | 301 | D 2866 LOH34 <V4800, Euro 3>

01.02-09.06	LBF	1 457 42 P 9137	O
	LBF	1 457 42 P 9740	O
01.02-06.03		1 457 42 S 9969	L
01.02-09.06		1 457 43 N 1710	K
	ROB, ZE	1 457 43 N 4447 ²	K
		1 987 43 M 1163	I
		1 987 43 R 1458 ⁸	I

12,8 | 338 | D 2876 LOH03 <V4500, Euro 3>

01.02-09.06	LBF	1 457 42 P 9137	O
	LBF	1 457 42 P 9740	O
		1 457 42 S 9969	L
		1 457 43 N 1710	K
	ROB, ZE	1 457 43 N 4447 ²	K
		1 987 43 M 1163	I
		1 987 43 R 1458 ⁸	I

L2000

L2000 8.103/ 8.113

4,6 | 75/81 | D 0824 FL01 <V1800, Euro 1>; D 0824 LFL04 <V1700, Euro 2>

10.93-03.97		0 451 30 P 1207	O
		1 457 42 S 9950	L
	ROB	1 457 43 N 4447 ²	K
		1 987 43 M 1162	I
		1 457 42 P 9820 ³	P

L2000 8.113

4,6 | 83 | D 0824 LFL08 <V1700, Euro 2>

03.97-09.01		0 451 30 P 1207	O
		1 457 42 S 9950	L
03.98-03.01		F 026 40 S 0067	L
03.97-09.01	ROB	1 457 43 N 4447 ²	K
		1 987 43 M 1162	I
		1 457 42 P 9820 ³	P

L2000 8.153

4,6 | 114 | D 0824 LFL01 <V1700, Euro 1>

10.93-12.95		0 451 30 P 1207	O
		1 457 42 S 9950	L
01.95-12.95	TMV	1 457 42 S 9966	L
	TMV	F 026 40 S 0067	L
10.93-12.95	ROB	1 457 43 N 4447 ²	K
		1 987 43 M 1162	I
		1 457 42 P 9820 ³	P

4,6 | 114 | D 0824 LFL05 <V1700, Euro 1>

08.95-07.97		0 451 30 P 1207	O
08.95-06.96	TMV	1 457 42 S 9966	L
	TMV	F 026 40 S 0067	L
08.95-07.97		1 457 42 S 9950	L
	ROB	1 457 43 N 4447 ²	K
		1 987 43 M 1162	I
		1 457 42 P 9820 ³	P

L2000 8.163

4,6 | 104 | D 0824 LFL07 <V1700, Euro 2>

08.95-03.01		0 451 30 P 1207	O
08.95-03.97	TMV	1 457 42 S 9966	L
	TMV	F 026 40 S 0067	L
08.95-02.98		1 457 42 S 9950	L
03.98-03.01		F 026 40 S 0067	L
08.95-03.01	ROB	1 457 43 N 4447 ²	K
		1 987 43 M 1162	I
		1 457 42 P 9820 ³	P

4,6 | 114 | D 0824 LFL06 <V1700, Euro 2>

08.95-03.97		0 451 30 P 1207	O
		1 457 42 S 9950	L
	TMV	1 457 42 S 9966	L
	TMV	F 026 40 S 0067	L
	ROB	1 457 43 N 4447 ²	K
		1 987 43 M 1162	I
		1 457 42 P 9820 ³	P





◀ L2000 8.163

4,6 | 114 | D 0824 LFL09 <V1700, Euro 2>

03.97-02.02		0 451 30	P 1207	O
03.97-09.01		1 457 42	S 9950	L
03.97-02.02	TMV	1 457 42	S 9966	L
03.98-02.02		F 026 40	S 0067	L
03.97-02.02	ROB	1 457 43	N 4447²	K
		1 987 43	M 1162	I
		1 457 42	P 9820³	P

4,6 | 118 | D 0824 LFL02 <V1700, Euro 2>

05.94-12.95		0 451 30	P 1207	O
		1 457 42	S 9950	L
01.95-12.95	TMV	1 457 42	S 9966	L
	TMV	F 026 40	S 0067	L
05.94-12.95	ROB	1 457 43	N 4447²	K
		1 987 43	M 1162	I
		1 457 42	P 9820³	P

L2000 8.185/ 9.185

4,6 | 132 | D 0834 LFL03 <V4400, Euro 3>

09.00-08.02		0 451 30	P 1207	O
		1 457 42	P 9278	O
		F 026 40	S 0067	L
	ROB	1 457 43	N 4447²	K
		1 987 43	M 1162	I
		1 457 42	P 9820³	P

L2000 8.223/ 9.223

6,9 | 162 | D 0826 LFL06 <V2300, Euro 1>

05.94-06.96	MGK	0 451 30	P 1207	O
		1 457 42	S 9966	L
	SA	1 457 43	S 3611⁴	L
	SA, TMV	1 457 43	S 3611⁴	L
	TMV	1 457 42	S 9966	L
	TMV	F 026 40	S 0067	L
		1 457 43	N 4447²	K
		1 987 43	M 1162	I
		1 457 42	P 9820³	P

L2000 8.224

6,9 | 162 | D 0826 LFL03 <V2300, Euro 2>

05.94-09.01	MGK	0 451 30	P 1207	O
05.94-06.97	SA	1 457 43	S 3611⁴	L
05.94-02.98		1 457 42	S 9966	L
05.94-09.01	SA, TMV	1 457 43	S 3611⁴	L
	TMV	1 457 42	S 9966	L
	TMV	F 026 40	S 0067	L
07.97-08.01		F 026 40	S 0067	L
05.94-04.00		1 457 43	N 4447²	K
05.00-09.01	ROB	1 457 43	N 4447²	K
05.94-09.01		1 987 43	M 1162	I
		1 457 42	P 9820³	P



6,9 | 162 | D 0826 LFL10 <V2300, Euro 2>

07.94-09.01	MGK	0 451 30	P 1207	O
	SA, TMV	1 457 43	S 3611⁴	L
	TMV	1 457 42	S 9966	L
	TMV	F 026 40	S 0067	L
08.94-06.97	SA	1 457 43	S 3611⁴	L
08.94-02.98		1 457 42	S 9966	L
07.97-08.01		F 026 40	S 0067	L
07.94-04.00		1 457 43	N 4447²	K
05.00-09.01	ROB	1 457 43	N 4447²	K
07.94-09.01		1 987 43	M 1162	I
		1 457 42	P 9820³	P

L2000 9.153

4,6 | 114 | D 0824 LFL01 <V1700, Euro 1>

10.93-12.95		0 451 30	P 1207	O
		1 457 42	S 9950	L
	ROB	1 457 43	N 4447²	K
		1 987 43	M 1162	I
		1 457 42	P 9820³	P

4,6 | 114 | D 0824 LFL05 <V1700, Euro 1>

08.95-06.96		0 451 30	P 1207	O
		1 457 42	S 9950	L
	ROB	1 457 43	N 4447²	K
		1 987 43	M 1162	I
		1 457 42	P 9820³	P

L2000 9.163

4,6 | 104 | D 0824 LFL07 <V1700, Euro 2>

08.95-03.97		0 451 30	P 1207	O
		1 457 42	S 9950	L
	ROB	1 457 43	N 4447²	K
		1 987 43	M 1162	I
		1 457 42	P 9820³	P

4,6 | 114 | D 0824 LFL06 <V1700, Euro 2>

08.95-03.97		0 451 30	P 1207	O
		1 457 42	S 9950	L
	ROB	1 457 43	N 4447²	K
		1 987 43	M 1162	I
		1 457 42	P 9820³	P

4,6 | 114 | D 0824 LFL09 <V1700, Euro 2>

03.97-09.01		0 451 30	P 1207	O
		1 457 42	S 9950	L
03.98-03.01		F 026 40	S 0067	L
03.97-09.01	ROB	1 457 43	N 4447²	K
		1 987 43	M 1162	I
		1 457 42	P 9820³	P

4,6 | 118 | D 0824 LFL02 <V1700, Euro 2>

05.94-12.95		0 451 30	P 1207	O
		1 457 42	S 9950	L
	ROB	1 457 43	N 4447²	K
		1 987 43	M 1162	I
		1 457 42	P 9820³	P





L2000 9.224

162 D 0826 LFL10 <V2300, Euro2>				
07.94-09.01	MGK	0 451 30	P 1207	O
	SA, TMV	1 457 43	S 3611 ⁴	L
	TMV	1 457 42	S 9966	L
	TMV	F 026 40	S 0067	L
07.94-04.00		1 457 43	N 4447 ²	K
05.00-09.01	ROB	1 457 43	N 4447 ²	K
07.94-09.01		1 987 43	M 1162	I
		1 457 42	P 9820 ³	P

6,9 162 D 0826 LFL03 <V2300, Euro 2>				
05.94-09.01	MGK	0 451 30	P 1207	O
05.94-06.97	SA	1 457 43	S 3611 ⁴	L
05.94-02.98		1 457 42	S 9966	L
05.94-09.01	SA, TMV	1 457 43	S 3611 ⁴	L
	TMV	1 457 42	S 9966	L
	TMV	F 026 40	S 0067	L
03.98-03.01		F 026 40	S 0067	L
05.94-04.00		1 457 43	N 4447 ²	K
05.00-09.01	ROB	1 457 43	N 4447 ²	K
05.94-09.01		1 987 43	M 1162	I
		1 457 42	P 9820 ³	P

6,9 162 D 0826 LFL10 <V2300, Euro2>				
07.94-09.01	MGK	0 451 30	P 1207	O
07.94-06.97	SA	1 457 43	S 3611 ⁴	L
07.94-02.98		1 457 42	S 9966	L
07.94-09.01	SA, TMV	1 457 43	S 3611 ⁴	L
	TMV	1 457 42	S 9966	L
	TMV	F 026 40	S 0067	L
03.98-03.01		F 026 40	S 0067	L
07.94-04.00		1 457 43	N 4447 ²	K
05.00-09.01	ROB	1 457 43	N 4447 ²	K
07.94-09.01		1 987 43	M 1162	I
		1 457 42	P 9820 ³	P

L2000 10.145

4,6 103 D 0834 LFL02 <V4400, Euro 3>				
07.01-06.02		0 451 30	P 1207	O
		1 457 42	P 9278	O
		F 026 40	S 0067	L
		1 457 42	S 9950	L
	ROB	1 457 43	N 4447 ²	K
		1 987 43	M 1162	I
		1 457 42	P 9820 ³	P

L2000 10.153

4,6 114 D 0824 LFL01 <V1700, Euro 1>				
10.93-12.95		0 451 30	P 1207	O
		1 457 42	S 9950	L
01.95-12.95	AHF, TMV	1 457 42	S 9966	L
	SA, TMV	1 457 43	S 3611 ⁴	L
10.93-12.95	ROB	1 457 43	N 4447 ²	K
		1 987 43	M 1162	I
		1 457 42	P 9820 ³	P

4,6 | 114 | D 0824 LFL05 <V1700, Euro 1>

08.95-06.96		0 451 30	P 1207	O
		1 457 42	S 9950	L
	AHF, TMV	1 457 42	S 9966	L
	SA, TMV	1 457 43	S 3611 ⁴	L
	ROB	1 457 43	N 4447 ²	K
		1 987 43	M 1162	I
		1 457 42	P 9820 ³	P

L2000 10.160

4,6 114 D 0824 LFL09 <V1700, Euro 2>				
03.97-09.06		0 451 30	P 1207	O
		1 457 42	S 9950	L
	AHF, TMV	1 457 42	S 9966	L
	SA, TMV	1 457 43	S 3611 ⁴	L
	TMV	F 026 40	S 0067	L
	ROB	1 457 43	N 4447 ²	K
		1 987 43	M 1162	I
		1 457 42	P 9820 ³	P

L2000 10.163

4,6 114 D 0824 LFL06 <V1700, Euro 2>				
08.95-03.97		0 451 30	P 1207	O
		1 457 42	S 9950	L
	AHF, TMV	1 457 42	S 9966	L
	SA, TMV	1 457 43	S 3611 ⁴	L
	ROB	1 457 43	N 4447 ²	K
		1 987 43	M 1162	I
		1 457 42	P 9820 ³	P

4,6 | 114 | D 0824 LFL09 <V1700, Euro 2>

03.97→		0 451 30	P 1207	O
		1 457 42	S 9950	L
03.98-01.01		F 026 40	S 0067	L
03.00→	AHF, TMV	1 457 42	S 9966	L
	SA, TMV	1 457 43	S 3611 ⁴	L
03.97→	ROB	1 457 43	N 4447 ²	K
		1 987 43	M 1162	I
		1 457 42	P 9820 ³	P

4,6 | 118 | D 0824 LFL02 <V1700, Euro 2>

05.94-12.95		0 451 30	P 1207	O
		1 457 42	S 9950	L
01.95-12.95	AHF, TMV	1 457 42	S 9966	L
	SA, TMV	1 457 43	S 3611 ⁴	L
05.94-12.95	ROB	1 457 43	N 4447 ²	K
		1 987 43	M 1162	I
		1 457 42	P 9820 ³	P





L2000 10.223

6,9 | 162 | D 0826 LFL06 <V2300, Euro 1>

05.94-06.96	MGK	0 451 30	P 1207	O
05.94-01.95		1 457 42	S 9950	L
05.94-06.96	AHF, TMV	1 457 42	S 9966	L
	SA, TMV	1 457 43	S 3611⁴	L
	TMV	F 026 40	S 0067	L
01.95-06.96		1 457 42	S 9966	L
		1 457 43	S 3611⁴	L
05.95-06.96	TMV	1 457 42	S 9950	L
05.94-06.96		1 457 43	N 4447²	K
		1 987 43	M 1162	I
		1 457 42	P 9820³	P

L2000 10.224

6,9 | 162 | D 0826 LFL03 <V2300, Euro 2>

05.94-09.01	MGK	0 451 30	P 1207	O
05.94-01.95		1 457 42	S 9950	L
05.94-09.01	AHF, TMV	1 457 42	S 9966	L
	SA, TMV	1 457 43	S 3611⁴	L
	TMV	F 026 40	S 0067	L
01.95-02.98		1 457 42	S 9966	L
		1 457 43	S 3611⁴	L
05.95-06.97	TMV	1 457 42	S 9950	L
07.97-09.01		F 026 40	S 0067	L
05.94-04.00		1 457 43	N 4447²	K
05.00-09.01	ROB	1 457 43	N 4447²	K
05.94-09.01		1 987 43	M 1162	I
		1 457 42	P 9820³	P

6,9 | 162 | D 0826 LFL10 <V2300, Euro 2>

07.98-09.01	MGK	0 451 30	P 1207	O
		F 026 40	S 0067	L
	AHF, TMV	1 457 42	S 9966	L
07.98-04.00		1 457 43	N 4447²	K
05.00-09.01	ROB	1 457 43	N 4447²	K
07.98-09.01		1 987 43	M 1162	I
		1 457 42	P 9820³	P

6,9 | 162 | D 0826 LFL10 <V2300, Euro2>

07.98-12.06	MGK	0 451 30	P 1207	O
07.98-09.01	AHF, TMV	1 457 42	S 9966	L
	SA, TMV	1 457 43	S 3611⁴	L
	TMV	F 026 40	S 0067	L
07.98-12.06		F 026 40	S 0067	L
07.98-04.00		1 457 43	N 4447²	K
05.00-12.06	ROB	1 457 43	N 4447²	K
07.98-12.06		1 987 43	M 1162	I
		1 457 42	P 9820³	P

L2000 12.163

4,6 | 114 | D 0824 LFL06 <V1700, Euro 2>

08.95-03.97		0 451 30	P 1207	O
		1 457 42	S 9950	L
	ROB	1 457 43	N 4447²	K
		1 987 43	M 1162	I
		1 457 42	P 9820³	P



4,6 | 114 | D 0824 LFL09 <V1700, Euro 2>

03.97-08.01		0 451 30	P 1207	O
03.97-02.98		1 457 42	S 9950	L
03.98-08.01		F 026 40	S 0067	L
03.97-08.01	ROB	1 457 43	N 4447²	K
		1 987 43	M 1162	I
		1 457 42	P 9820³	P

L2000 12.224

6,9 | 162 | D 0826 LFL03 <V2300, Euro 2>

08.95-03.97	MGK	0 451 30	P 1207	O
	AHF, TMV	1 457 42	S 9966	L
	SA	1 457 43	S 3611⁴	L
		1 457 43	N 4447²	K
		1 987 43	M 1162	I
		1 457 42	P 9820³	P

6,9 | 162 | D 0826 LFL10 <V2300, Euro 2>

03.97-09.01	MGK	0 451 30	P 1207	O
	AHF, TMV	1 457 42	S 9966	L
	SA	1 457 43	S 3611⁴	L
07.97-08.01		F 026 40	S 0067	L
03.97-04.00		1 457 43	N 4447²	K
05.00-09.01	ROB	1 457 43	N 4447²	K
03.97-09.01		1 987 43	M 1162	I
		1 457 42	P 9820³	P

L2000 14.163

4,6 | 114 | D 0824 LFL06 <V1700, Euro 2>

08.95-03.97		0 451 30	P 1207	O
		F 026 40	S 0067	L
	AZY	1 457 43	S 3651	L
	ROB	1 457 43	N 4447²	K
		1 987 43	M 1162	I
		1 457 42	P 9820³	P

4,6 | 114 | D 0824 LFL09 <V1700, Euro 2>

03.97-08.01		0 451 30	P 1207	O
		F 026 40	S 0067	L
	AZY	1 457 43	S 3651	L
	ROB	1 457 43	N 4447²	K
		1 987 43	M 1162	I
		1 457 42	P 9820³	P

L2000 14.224

6,9 | 162 | D 0826 LFL03 <V2300, Euro 2>

08.95-03.97	MGK	0 451 30	P 1207	O
		F 026 40	S 0067	L
	AHF, ANV	F 026 40	S 0067	L
	AZY	1 457 43	S 3651	L
	MCY	F 026 40	S 0067	L
		1 457 43	N 4447²	K
		1 987 43	M 1162	I
		1 457 42	P 9820³	P





6,9 | 162 | D 0826 LFL10 <V2300, Euro 2>

03.97-09.01		0 451 30 P 1207	O
	MGK	0 451 30 P 1207	O
		F 026 40 S 0067	L
	AHF,ANV	F 026 40 S 0067	L
	AZY	1 457 43 S 3651	L
	MCY	F 026 40 S 0067	L
03.97-04.00		1 457 43 N 4447 ²	K
05.00-09.01	ROB	1 457 43 N 4447 ²	K
03.97-09.01		1 987 43 M 1162	I
		1 457 42 P 9820 ³	P

L2000 14.264

6,9 | 191 | D 0826 LFL09 <V2300, Euro 2>

08.95-09.01	MGK	0 451 30 P 1207	O
		F 026 40 S 0067	L
	AHF,ANV	F 026 40 S 0067	L
	AZY	1 457 43 S 3651	L
	MCY	F 026 40 S 0067	L
08.95-04.00		1 457 43 N 4447 ²	K
05.00-09.01	ROB	1 457 43 N 4447 ²	K
08.95-09.01		1 987 43 M 1162	I
		1 457 42 P 9820 ³	P

L2000 15.163

4,6 | 114 | D 0824 LFL06 <V1700, Euro 2>

08.95-03.97		0 451 30 P 1207	O
	AHF,ANV	F 026 40 S 0067	L
	AZY	1 457 43 S 3651	L
	ROB	1 457 43 N 4447 ²	K
		1 987 43 M 1162	I
		1 457 42 P 9820 ³	P

4,6 | 114 | D 0824 LFL09 <V1700, Euro 2>

03.97-09.01		0 451 30 P 1207	O
	AHF,ANV	F 026 40 S 0067	L
	AZY	1 457 43 S 3651	L
	ROB	1 457 43 N 4447 ²	K
		1 987 43 M 1162	I
		1 457 42 P 9820 ³	P

L2000 15.224

6,9 | 162 | D 0826 LFL10 <V2300, Euro 2>

03.97→	MGK	0 451 30 P 1207	O
	AHF,ANV	F 026 40 S 0067	L
	AZY	1 457 43 S 3651	L
	ROB,TW,	1 457 43 N 4447 ²	K
	ZE		
		1 987 43 M 1162	I
		1 457 42 P 9820 ³	P

L2000 15.224/ 18.224

6,9 | 162 | D 0826 LFL03 <V2300, Euro 2>

08.95-03.97	MGK	0 451 30 P 1207	O
	AHF,ANV	F 026 40 S 0067	L
	AZY	1 457 43 S 3651	L
		1 457 43 N 4447 ²	K
		1 987 43 M 1162	I
		1 457 42 P 9820 ³	P

L2000 15.224/ 18.224/ 20.224

6,9 | 162 | D 0826 LFL10 <V2300, Euro 2>

03.97-09.01	MGK	0 451 30 P 1207	O
	AHF,ANV	F 026 40 S 0067	L
	AZY	1 457 43 S 3651	L
03.97-04.00		1 457 43 N 4447 ²	K
05.00-09.01	ROB	1 457 43 N 4447 ²	K
03.97-09.01		1 987 43 M 1162	I
		1 457 42 P 9820 ³	P

L2000 15.264/ 18.264/ 20.264

6,9 | 191 | D 0826 LFL09 <V2300, Euro 2>

08.95-09.01	MGK	0 451 30 P 1207	O
	AHF,ANV	F 026 40 S 0067	L
	AZY	1 457 43 S 3651	L
08.95-04.00		1 457 43 N 4447 ²	K
05.00-09.01	ROB	1 457 43 N 4447 ²	K
08.95-09.01		1 987 43 M 1162	I
		1 457 42 P 9820 ³	P

L2000 Evol. (LE)

L2000 Evol. (LE) 8.140/ 9.140/ 140C

4,6 | 103 | D 0834 LFL02 <V4400, Euro 3>

07.01-08.04		0 451 30 P 1207	O
		1 457 42 P 9278	O
		F 026 40 S 0067	L
	ROB	1 457 43 N 4447 ²	K
		1 987 43 M 1162	I
		1 457 42 P 9820 ³	P

L2000 Evol. (LE) 8.150/ 9.150

4,6 | 110 | D 0834 LFL04 <V4400, Euro 3>

06.04-12.05		0 451 30 P 1207	O
		1 457 42 P 9278	O
		F 026 40 S 0067	L
	ROB	1 457 43 N 4447 ²	K
		1 987 43 M 1162	I

L2000 Evol. (LE) 8.180/ 9.180

4,6 | 132 | D 0834 LFL03 <V4400, Euro 3>

09.02-12.05		0 451 30 P 1207	O
		1 457 42 P 9278	O
		F 026 40 S 0067	L
	ROB	1 457 43 N 4447 ²	K
		1 987 43 M 1162	I
		1 457 42 P 9820 ³	P

L2000 Evol. (LE) 8.220/ 9.220

6,9 | 162 | D 0836 LFL02 <V3900, Euro 3>

09.02-12.05		1 457 42 P 9278	O
	MGK	0 451 30 P 1207	O
	SA,TMV	1 457 43 S 3611 ⁴	L
	TMV	1 457 42 S 9966	L
	TMV	F 026 40 S 0067	L
	ROB	1 457 43 N 4447 ²	K
		1 987 43 M 1162	I
		1 457 42 P 9820 ³	P





L2000 Evol. (LE) 10.150

4,6 110 D 0834 LFL04 <V4400, Euro 3>			
06.04-06.05	0 451 30	P 1207	O
	1 457 42	P 9278	O
	1 457 42	S 9950	L
ROB	1 457 43	N 4447²	K
	1 987 43	M 1162	I

L2000 Evol. (LE) 10.180

4,6 132 D 0834 LFL03 <V4400, Euro 3>			
09.02-10.06	0 451 30	P 1207	O
	1 457 42	P 9278	O
09.02-06.05	F 026 40	S 0067	L
09.02-10.06	1 457 42	S 9950	L
AHF, TMV	1 457 42	S 9966	L
SA, TMV	1 457 43	S 3611⁴	L
TW	F 026 40	S 0067	L
ROB	1 457 43	N 4447²	K
	1 987 43	M 1162	I
	1 457 42	P 9820³	P

L2000 Evol. (LE) 10.220

6,9 162 D 0836 LFL02 <V3900, Euro 3>			
09.02-12.06	1 457 42	P 9278	O
MGK	0 451 30	P 1207	O
09.02-06.05	AHF, TMV	1 457 42	S 9966 L
09.02-12.06	F 026 40	S 0067	L
ROB	1 457 43	N 4447²	K
	1 987 43	M 1162	I
	1 457 42	P 9820³	P

L2000 Evol. (LE) 160B

4,6 114 D 0824 LFL06 <V1700, Euro 2>			
09.00-09.01	0 451 30	P 1207	O
	1 457 42	S 9950	L
ROB	1 457 43	N 4447²	K
	1 987 43	M 1162	I
	1 457 42	P 9820³	P

L2000 Evol. (LE) 160C

4,6 114 D 0824 LFL06 <V1700, Euro 2>			
09.00-09.01	0 451 30	P 1207	O
	F 026 40	S 0067	L
	1 457 42	S 9950	L
ROB	1 457 43	N 4447²	K
	1 987 43	M 1162	I
	1 457 42	P 9820³	P

L2000 Evol. (LE) 180C

4,6 132 D 0834 LFL03 <V4400, Euro 3>			
09.00-08.02	0 451 30	P 1207	O
	1 457 42	P 9278	O
	F 026 40	S 0067	L
07.01-08.02	1 457 42	S 9950	L
AHF, TMV	1 457 42	S 9966	L
SA, TMV	1 457 43	S 3611⁴	L
09.00-08.02	ROB	1 457 43	N 4447² K
	1 987 43	M 1162	I
	1 457 42	P 9820³	P



L2000 Evol. (LE) 220C

6,9 162 D 0826 LFL10 <V2300, Euro 2>			
09.00-01.02	MGK	0 451 30	P 1207 O
09.00-09.01	F 026 40	S 0067	L
	AHF, TMV	1 457 42	S 9966 L
	SA	1 457 43	S 3611⁴ L
	TW	F 026 40	S 0067 L
09.00-01.02	SA, TMV	1 457 43	S 3611⁴ L
	TMV	1 457 42	S 9966 L
	TMV	F 026 40	S 0067 L
ROB	1 457 43	N 4447²	K
	1 987 43	M 1162	I
	1 457 42	P 9820³	P

6,9 | 162 | D 0836 LFL02 <V3900, Euro 3>

07.01-08.02	1 457 42	P 9278	O
MGK	0 451 30	P 1207	O
	F 026 40	S 0067	L
AHF, TMV	1 457 42	S 9966	L
SA, TMV	1 457 43	S 3611⁴	L
TMV	1 457 42	S 9966	L
TMV	F 026 40	S 0067	L
ROB	1 457 43	N 4447²	K
	1 987 43	M 1162	I
	1 457 42	P 9820³	P

Midi Beta

Midi Beta 11.190

6,9 | 140 | D 0826 LOH06 <V0900, Euro 1>

03.93-09.95	0 451 30	P 1207	O
TW	1 457 43	N 4106²	K
	1 457 43	N 4154²	K
	1 457 42	P 9820³	P

M2000

M2000 12.163

4,6 | 114 | D 0824 LFL09 <V1700, Euro 2>

03.00-12.01	0 451 30	P 1207	O
	F 026 40	S 0067	L
ROB	1 457 43	N 4447²	K
	1 987 43	M 1162	I
	1 457 42	P 9820³	P

M2000 12.224

6,9 | 162 | D 0826 LF18 <V3000, Euro 2>

03.97-09.01	GA	0 451 30	P 1207 O
	TMV	1 457 43	S 3651 L
	TMV	F 026 40	S 0067 L
ROB, ZE	1 457 43	N 4447²	K
	1 987 43	M 2151	I



**M2000 12.255**

6,9 | 180 | D 0836 LF05 <V4000, Euro 3>

01.01-08.02		1 457 42 P 9278	O
	MGK	0 451 30 P 1207	O
	TMV	1 457 43 S 3651	L
	TMV	F 026 40 S 0067	L
	ROB,ZE	1 457 43 N 4447 ²	K
		1 987 43 M 2151	I
		1 457 42 P 9820 ³	P

M2000 12.264

6,9 | 191 | D 0826 LF17 <V3000, Euro 2>

03.97-09.01	GA	0 451 30 P 1207	O
	TMV	1 457 43 S 3651	L
	TMV	F 026 40 S 0067	L
	ROB,ZE	1 457 43 N 4447 ²	K
		1 987 43 M 2151	I

M2000 12.284/ 14.284

6,9 | 206 | D 0836 LF01 <V4000, Euro 2>

06.98-09.01		1 457 42 P 9278	O
	MGK	0 451 30 P 1207	O
	TMV	1 457 43 S 3651	L
	TMV	F 026 40 S 0067	L
	ROB,ZE	1 457 43 N 4447 ²	K
		1 987 43 M 2151	I
		1 457 42 P 9820 ³	P

M2000 12.285

6,9 | 206 | D 0836 LF03 <V4000, Euro 3>

01.01-09.01		1 457 42 P 9278	O
	MGK	0 451 30 P 1207	O
	TMV	1 457 43 S 3651	L
	TMV	F 026 40 S 0067	L
	ROB,ZE	1 457 43 N 4447 ²	K
		1 987 43 M 2151	I
		1 457 42 P 9820 ³	P

M2000 14.224/ 18.224

6,9 | 162 | D 0826 LF15 <V3000, Euro 2>

08.95-03.97	GA	0 451 30 P 1207	O
	TMV	1 457 43 S 3651	L
	TMV	F 026 40 S 0067	L
	ROB,ZE	1 457 43 N 4447 ²	K
		1 987 43 M 2151	I
		1 457 42 P 9820 ³	P

6,9 | 162 | D 0826 LF18 <V3000, Euro 2>

03.97-09.01	GA	0 451 30 P 1207	O
	TMV	1 457 43 S 3651	L
	TMV	F 026 40 S 0067	L
	ROB,ZE	1 457 43 N 4447 ²	K
		1 987 43 M 2151	I
		1 457 42 P 9820 ³	P

M2000 14.264/ 18.264

6,9 | 191 | D 0826 LF17 <V3000, Euro 2>

08.95-09.01	GA	0 451 30 P 1207	O
	TMV	1 457 43 S 3651	L
	TMV	F 026 40 S 0067	L
	ROB,ZE	1 457 43 N 4447 ²	K
		1 987 43 M 2151	I
		1 457 42 P 9820 ³	P

M2000 14.284

6,9 | 206 | D 0836 LFL01 <V3900, Euro 2>

06.98-09.01		1 457 42 P 9278	O
	MGK	0 451 30 P 1207	O
	AHF,ANV	F 026 40 S 0067	L
	AZY	1 457 43 S 3651	L
10.98-09.01		F 026 40 S 0067	L
	MGK	F 026 40 S 0067	L
06.98-09.01	ROB,ZE	1 457 43 N 4447 ²	K
		1 987 43 M 1162	I
		1 457 42 P 9820 ³	P

M2000 15.284/ 18.284/ 20.284/ 26.284

6,9 | 206 | D 0836 LFL01 <V3900, Euro 2>

06.98-09.01		1 457 42 P 9278	O
	MGK	0 451 30 P 1207	O
	AHF,ANV	F 026 40 S 0067	L
	AZY	1 457 43 S 3651	L
	ROB,ZE	1 457 43 N 4447 ²	K
		1 987 43 M 1162	I
		1 457 42 P 9820 ³	P

M2000 18.224

6,9 | 162 | D 0826 LFL10 <V2300, Euro 2>

07.99-09.01	MGK	0 451 30 P 1207	O
	TMV	1 457 43 S 3651	L
	TMV	F 026 40 S 0067	L
07.99-04.00		1 457 43 N 4447 ²	K
05.00-09.01	ROB	1 457 43 N 4447 ²	K
07.99-09.01		1 987 43 M 2151	I
		1 457 42 P 9820 ³	P

M2000 18.284/ 25.284

6,9 | 206 | D 0836 LF01 <V4000, Euro 2>

06.98→		1 457 42 P 9278	O
	MGK	0 451 30 P 1207	O
06.98-09.01	TMV	1 457 43 S 3651	L
	TMV	F 026 40 S 0067	L
09.00→	AHF,ANV	F 026 40 S 0067	L
	AZY	1 457 43 S 3651	L
06.98→	ROB,ZE	1 457 43 N 4447 ²	K
06.98-09.01		1 987 43 M 2151	I
09.00→		1 987 43 M 1162	I
06.98→		1 457 42 P 9820 ³	P





M2000 25.224

6,9 | 162 | D 0826 LF15 <V3000, Euro 2>

08.95-03.97	GA	0 451 30	P 1207	O
	TMV	1 457 43	S 3651	L
	TMV	F 026 40	S 0067	L
	ROB,ZE	1 457 43	N 4447²	K
		1 987 43	M 2151	I

6,9 | 162 | D 0826 LF18 <V3000, Euro 2>

03.97-09.01	GA	0 451 30	P 1207	O
	TMV	1 457 43	S 3651	L
	TMV	F 026 40	S 0067	L
	ROB,ZE	1 457 43	N 4447²	K
		1 987 43	M 2151	I

M2000 25.264

6,9 | 191 | D 0826 LF17 <V3000, Euro 2>

08.95-09.01	GA	0 451 30	P 1207	O
	TMV	1 457 43	S 3651	L
	TMV	F 026 40	S 0067	L
	ROB,ZE	1 457 43	N 4447²	K
		1 987 43	M 2151	I

M2000 26.225/ 26.255

6,9 | 119/180 | D 0836 LFL02 <V3900, Euro 3>; D 0836 LFL05 <V3900, Euro 3>

01.99-06.02		1 457 42	P 9278	O
	MCK	0 451 30	P 1207	O
	AHF,ANV	F 026 40	S 0067	L
	AZY	1 457 43	S 3651	L
	ROB,ZE	1 457 43	N 4447²	K
		1 987 43	M 1162	I
		1 457 42	P 9820³	P

M2000 26.284

6,9 | 206 | D 0836 LF01 <V4000, Euro 2>

09.00→		1 457 42	P 9278	O
	MCK	0 451 30	P 1207	O
	AHF,ANV	F 026 40	S 0067	L
	AZY	1 457 43	S 3651	L
	ROB,ZE	1 457 43	N 4447²	K
		1 987 43	M 1162	I
		1 457 42	P 9820³	P

M2000 26.285

6,9 | 206 | D 0836 LFL03 <V3900, Euro 3>

01.99-12.02		1 457 42	P 9278	O
	MCK	0 451 30	P 1207	O
	AHF,ANV	F 026 40	S 0067	L
	AZY	1 457 43	S 3651	L
	ROB,ZE	1 457 43	N 4447²	K
		1 987 43	M 1162	I
		1 457 42	P 9820³	P



M2000 Evol. (LE)

M2000 Evol. (LE) 12.180

4,6 | 132 | D 0834 LFL03 <V4400, Euro 3>

09.02-12.05		0 451 30	P 1207	O
		1 457 42	P 9278	O
		F 026 40	S 0067	L
	ROB	1 457 43	N 4447²	K
		1 987 43	M 1162	I
		1 457 42	P 9820³	P

M2000 Evol. (LE) 12.220

6,9 | 162 | D 0836 LFL02 <V3900, Euro 3>

09.02-06.06		1 457 42	P 9278	O
	MCK	0 451 30	P 1207	O
	AHF,TMV	1 457 42	S 9966	L
	AZY	1 457 43	S 3651	L
	MCY	F 026 40	S 0067	L
	SA	1 457 43	S 3611⁴	L
	ROB	1 457 43	N 4447²	K
		1 987 43	M 1162	I
		1 457 42	P 9820³	P

M2000 Evol. (LE) 12.250/ 14.250/ 14.255

6,9 | 180 | D 0836 LFL05 <V3900, Euro 3>

09.02-09.06		1 457 42	P 9278	O
	MCK	0 451 30	P 1207	O
	AZY	1 457 43	S 3651	L
	MCY	F 026 40	S 0067	L
	ROB	1 457 43	N 4447²	K
		1 987 43	M 1162	I
		1 457 42	P 9820³	P

M2000 Evol. (LE) 12.280/ 14.280/ 14.285

6,9 | 206 | D 0836 LFL03 <V3900, Euro 3>

09.02-09.06		1 457 42	P 9278	O
	MCK	0 451 30	P 1207	O
	AZY	1 457 43	S 3651	L
	MCY	F 026 40	S 0067	L
	ROB	1 457 43	N 4447²	K
		1 987 43	M 1162	I
		1 457 42	P 9820³	P

M2000 Evol. (LE) 14.220/ 14.225

6,9 | 162 | D 0836 LFL03 <V3900, Euro 3>

09.02-09.06		1 457 42	P 9278	O
	MCK	0 451 30	P 1207	O
	AZY	1 457 43	S 3651	L
	MCY	F 026 40	S 0067	L
	ROB	1 457 43	N 4447²	K
		1 987 43	M 1162	I
		1 457 42	P 9820³	P



**M2000 Evol. (LE) 15.180/ 180B**

4,6 | 132 | D 0834 LFL03 <V4400, Euro 3>

07.01-03.05	0 451 30 P 1207	O
	1 457 42 P 9278	O
AHF,ANV	F 026 40 S 0067	L
AZY	1 457 43 S 3651	L
ROB	1 457 43 N 4447 ²	K
	1 987 43 M 1162	I
	1 457 42 P 9820 ³	P

M2000 Evol. (LE) 15.220

6,9 | 162 | D 0836 LFL02 <V3900, Euro 3>

09.02-09.06	1 457 42 P 9278	O
MGK	0 451 30 P 1207	O
AHF,ANV	F 026 40 S 0067	L
AZY	1 457 43 S 3651	L
ROB	1 457 43 N 4447 ²	K
	1 987 43 M 1162	I
	1 457 42 P 9820 ³	P

M2000 Evol. (LE) 15.250/ 18.250B/ 20.250

6,9 | 180 | D 0836 LFL05 <V3900, Euro 3>

09.02-09.06	1 457 42 P 9278	O
MGK	0 451 30 P 1207	O
AHF,ANV	F 026 40 S 0067	L
AZY	1 457 43 S 3651	L
ROB	1 457 43 N 4447 ²	K
	1 987 43 M 1162	I
	1 457 42 P 9820 ³	P

M2000 Evol. (LE) 15.280

6,9 | 206 | D 0836 LFL03 <V3900, Euro 3>

09.02-09.06	1 457 42 P 9278	O
MGK	0 451 30 P 1207	O
AHF,ANV	F 026 40 S 0067	L
AZY	1 457 43 S 3651	L
ROB	1 457 43 N 4447 ²	K
	1 987 43 M 1162	I
	1 457 42 P 9820 ³	P

M2000 Evol. (LE) 18.220

6,9 | 162 | D 0836 LFL02 <V3900, Euro 3>

09.02-09.06	1 457 42 P 9278	O
MGK	0 451 30 P 1207	O
AHF,ANV	F 026 40 S 0067	L
AZY	1 457 43 S 3651	L
MGK	F 026 40 S 0067	L
ROB	1 457 43 N 4447 ²	K
	1 987 43 M 1162	I
	1 457 42 P 9820 ³	P

M2000 Evol. (LE) 18.250B/ 250B

6,9 | 180 | D 0836 LFL05 <V4000, Euro 3>

07.01-09.06	1 457 42 P 9278	O
MGK	0 451 30 P 1207	O
AZY	1 457 43 S 3651	L
MGK	F 026 40 S 0067	L
ROB,ZE	1 457 43 N 4447 ²	K
	1 987 43 M 1162	I
	1 457 42 P 9820 ³	P

M2000 Evol. (LE) 18.280

6,9 | 206 | D 0836 LFL03 <V3900, Euro 3>

09.02-09.06	1 457 42 P 9278	O
MGK	0 451 30 P 1207	O
AHF,ANV	F 026 40 S 0067	L
AZY	1 457 43 S 3651	L
MGK	F 026 40 S 0067	L
ROB	1 457 43 N 4447 ²	K
	1 987 43 M 1162	I
	1 457 42 P 9820 ³	P

M2000 Evol. (LE) 20.220

6,9 | 162 | D 0836 LFL02 <V3900, Euro 3>

09.02-09.06	1 457 42 P 9278	O
MGK	0 451 30 P 1207	O
AHF,ANV	F 026 40 S 0067	L
AZY	1 457 43 S 3651	L
ROB	1 457 43 N 4447 ²	K
	1 987 43 M 1162	I
	1 457 42 P 9820 ³	P

M2000 Evol. (LE) 20.280

6,9 | 206 | D 0836 LFL03 <V3900, Euro 3>

09.02-09.06	1 457 42 P 9278	O
MGK	0 451 30 P 1207	O
AHF,ANV	F 026 40 S 0067	L
AZY	1 457 43 S 3651	L
ROB	1 457 43 N 4447 ²	K
	1 987 43 M 1162	I
	1 457 42 P 9820 ³	P

M2000 Evol. (LE) 160B

4,6 | 114 | D 0824 LFL06 <V1700, Euro 2>

09.00-09.01	0 451 30 P 1207	O
	F 026 40 S 0067	L
AHF,ANV	F 026 40 S 0067	L
AZY	1 457 43 S 3651	L
ROB	1 457 43 N 4447 ²	K
	1 987 43 M 1162	I
	1 457 42 P 9820 ³	P





M2000 Evol. (LE) 180C

4,6 | 132 | D 0834 LFL03 <V4400, Euro 3>

07.01-09.02		0 451 30 P 1207	O
		1 457 42 P 9278	O
		F 026 40 S 0067	L
	ROB	1 457 43 N 4447 ²	K
		1 987 43 M 1162	I
		1 457 42 P 9820 ³	P

M2000 Evol. (LE) 220B

6,9 | 162 | D 0826 LFL10 <V2300, Euro 2>

08.00-09.01	MGK	0 451 30 P 1207	O
	AHF,ANV	F 026 40 S 0067	L
	AZY	1 457 43 S 3651	L
09.00-09.01	MCY	F 026 40 S 0067	L
08.00-09.01	ROB	1 457 43 N 4447 ²	K
		1 987 43 M 1162	I
		1 457 42 P 9820 ³	P

6,9 | 162 | D 0836 LFL02 <V3900, Euro 3>

07.01-09.02		1 457 42 P 9278	O
	MGK	0 451 30 P 1207	O
07.01-08.02	MCY	F 026 40 S 0067	L
07.01-09.02	AHF,ANV	F 026 40 S 0067	L
	AZY	1 457 43 S 3651	L
	ROB	1 457 43 N 4447 ²	K
		1 987 43 M 1162	I
		1 457 42 P 9820 ³	P

M2000 Evol. (LE) 220C

6,9 | 162 | D 0836 LFL02 <V3900, Euro 3>

07.01-08.02		1 457 42 P 9278	O
	MGK	0 451 30 P 1207	O
	AHF,TMV	1 457 42 S 9966	L
	SA	1 457 43 S 3611 ⁴	L
	TW	F 026 40 S 0067	L
	ROB	1 457 43 N 4447 ²	K
		1 987 43 M 1162	I
		1 457 42 P 9820 ³	P

M2000 Evol. (LE) 250B

6,9 | 180 | D 0836 LFL05 <V3900, Euro 3>

07.01-09.02		1 457 42 P 9278	O
	MGK	0 451 30 P 1207	O
07.01-08.02	MCY	F 026 40 S 0067	L
07.01-09.02	AHF,ANV	F 026 40 S 0067	L
	AZY	1 457 43 S 3651	L
	ROB	1 457 43 N 4447 ²	K
		1 987 43 M 1162	I
		1 457 42 P 9820 ³	P

M2000 Evol. (LE) 280B

6,9 | 206 | D 0836 LFL03 <V3900, Euro 3>

07.01-09.02		1 457 42 P 9278	O
	MGK	0 451 30 P 1207	O
07.01-08.02	MCY	F 026 40 S 0067	L
07.01-09.02	AHF,ANV	F 026 40 S 0067	L
	AZY	1 457 43 S 3651	L
	ROB	1 457 43 N 4447 ²	K
		1 987 43 M 1162	I
		1 457 42 P 9820 ³	P

6,9 | 206 | D 0836 LFL01 <V4000, Euro 2>

09.00-09.01		1 457 42 P 9278	O
	MGK	0 451 30 P 1207	O
	AHF,ANV	F 026 40 S 0067	L
	AZY	1 457 43 S 3651	L
	MCY	F 026 40 S 0067	L
	ROB,ZE	1 457 43 N 4447 ²	K
		1 987 43 M 1162	I
		1 457 42 P 9820 ³	P

M2000 Evol. (ME)

M2000 Evol. (ME) 12.220/ 14.220/ 18.220/ 220B

6,9 | 162 | D 0836 LFL04 <V4000, Euro 3>

09.00-07.05		1 457 42 P 9278	O
	MGK	0 451 30 P 1207	O
	TMV	1 457 43 S 3651	L
	TMV	F 026 40 S 0067	L
	ROB,ZE	1 457 43 N 4447 ²	K
		1 987 43 M 2151	I
		1 457 42 P 9820 ³	P

M2000 Evol. (ME) 12.250/ 14.250/ 25.250/ 250B

6,9 | 180 | D 0836 LFL05 <V4000, Euro 3>

07.01-07.05		1 457 42 P 9278	O
	MGK	0 451 30 P 1207	O
	TMV	1 457 43 S 3651	L
	TMV	F 026 40 S 0067	L
	ROB,ZE	1 457 43 N 4447 ²	K
		1 987 43 M 2151	I
		1 457 42 P 9820 ³	P

M2000 Evol. (ME) 12.280/ 25.280/ 280B

6,9 | 206 | D 0836 LFL03 <V4000, Euro 3>

07.01-07.05		1 457 42 P 9278	O
	MGK	0 451 30 P 1207	O
	TMV	1 457 43 S 3651	L
	TMV	F 026 40 S 0067	L
	ROB,ZE	1 457 43 N 4447 ²	K
		1 987 43 M 2151	I
		1 457 42 P 9820 ³	P

M2000 Evol. (ME) 14.250/ 18.250/ 250B

6,9 | 180 | D 0836 LFL05 <V3900, Euro 3>

06.01-07.05		1 457 42 P 9278	O
	MGK	0 451 30 P 1207	O
	TMV	1 457 43 S 3651	L
	TMV	F 026 40 S 0067	L
	ROB	1 457 43 N 4447 ²	K
		1 987 43 M 2151	I
		1 457 42 P 9820 ³	P

M2000 Evol. (ME) 14.280/ 18.280/ 280B

6,9 | 206 | D 0836 LFL03 <V3900, Euro 3>

07.01-07.05		1 457 42 P 9278	O
	MGK	0 451 30 P 1207	O
	TMV	1 457 43 S 3651	L
	TMV	F 026 40 S 0067	L
	ROB	1 457 43 N 4447 ²	K
		1 987 43 M 2151	I
		1 457 42 P 9820 ³	P



**M2000 Evol. (ME) 220B**

6,9 | 162 | D 0826 LF18 <V3000, Euro 2>

09.00-09.01	GA	0 451 30	P 1207	O
	TMV	1 457 43	S 3651	L
	TMV	F 026 40	S 0067	L
	ROB,ZE	1 457 43	N 4447²	K
		1 987 43	M 2151	I

M2000 Evol. (ME) 280B

6,9 | 206 | D 0836 LF01 <V4000, Euro 2>

08.00-09.01		1 457 42	P 9278	O
	MGK	0 451 30	P 1207	O
	TMV	1 457 43	S 3651	L
	TMV	F 026 40	S 0067	L
	ROB,ZE	1 457 43	N 4447²	K
		1 987 43	M 2151	I
		1 457 42	P 9820³	P

NG**NG 232**

12,0 | 170 | E 2866 DUH01 <V1601, CNG>

04.94-11.99	LBF	1 457 42	P 9740	O
		1 457 43	S 3651	L

NG 262

6,9 | 191 | D 0826 LUH13 <V0300, Euro 2>

06.97-07.98		0 451 30	P 1207	O
	LUM	1 457 43	S 2188	L
	FIU,ZE	1 457 43	N 1326⁷	K
	ROB,ZE	1 457 43	N 4447²	K

10,0 | 191 | D 2865 LUH09 <V1400, Euro 2>

06.97-07.98		1 457 42	P 9740	O
	NEB	F 026 40	P 7054	O
	LUM	1 457 43	S 2188	L
	ROB,ZE	1 457 43	N 4447²	K

12,0 | 191 | D 2866 LUH22 <V3200, Euro 2>

07.98-11.99		1 457 42	P 9740	O
	LUM	1 457 43	S 2188	L
		1 457 43	N 1159⁶	K
		1 457 43	N 1326⁷	K
	FIU,ZE	1 457 43	N 1270	K
	ROB,ZE	1 457 43	N 4447²	K

NG 263

12,0 | 191 | D 2866 LUH22 <V3200, Euro 2>

07.98-12.01		1 457 42	P 9740	O
		F 026 40	S 0184	L
		1 457 43	N 1159⁶	K
		1 457 43	N 1326⁷	K
	FIU,ZE	1 457 43	N 1270	K
	ROB,ZE	1 457 43	N 4447²	K

12,0 | 191 | D 2866 LUH23 <V5000, Euro 3>

01.01-09.06		1 457 42	P 9740	O
		F 026 40	S 0184	L
		1 457 43	N 1710	K
	ROB,ZE	1 457 43	N 4447²	K

NG 272

6,9 | 180-198 | D 0826 LUH <V2300,>

06.90-09.95		0 451 30	P 1207	O
	KNE	1 457 43	S 3651	L
		1 457 43	N 4447²	K

6,9 | 198 | D 0826 LUH01 <V0300, Euro 1>

08.92-09.95		0 451 30	P 1207	O
	LUM	1 457 43	S 2188	L
	FIU,ZE	1 457 43	N 1326⁷	K
	ROB,ZE	1 457 43	N 4447²	K

NG 312

10,0 | 228 | D 2865 LUH07 <V1400, Euro 2>

09.95-07.98		1 457 42	P 9740	O
	NEB	F 026 40	P 7054	O
	LUM	1 457 43	S 2188	L
	ROB,ZE	1 457 43	N 4447²	K

12,0 | 228 | D 2866 LUH26 <V3200, Euro 2>

07.98-11.99		1 457 42	P 9740	O
	LUM	1 457 43	S 2188	L
	ROB,ZE	1 457 43	N 4447²	K

NG 313

12,0 | 228 | D 2866 LUH24 <V5000, Euro 3>

01.01-09.06		1 457 42	P 9740	O
		F 026 40	S 0184	L
		1 457 43	N 1710	K
	ROB,ZE	1 457 43	N 4447²	K

12,0 | 228 | D 2866 LUH26 <V3200, Euro 2>

07.98-12.01		1 457 42	P 9740	O
		F 026 40	S 0184	L
	ROB,ZE	1 457 43	N 4447²	K

12,0 | 228 | E 2866 LUH01 <V3600, CNG>; E 2866 LUH02 <V3600, Euro 3, CNG>

07.98-09.06	LBF	1 457 42	P 9740	O
		F 026 40	S 0184	L

NG 363

12,0 | 265 | D 2866 LUH25 <V5000, Euro 3>

01.01-09.06		1 457 42	P 9740	O
		F 026 40	S 0184	L
		1 457 43	N 1710	K
	ROB,ZE	1 457 43	N 4447²	K

R**R 292**

12,0 | 213-224 | D 2866 TUH/290 <V0100>

03.86-04.92		1 457 42	P 9740	O
		1 457 42	S 9969	L
	ROB	1 457 43	N 4447²	K





◀ R 292

12,0 229 D 2866 TOH/310 <Z7900>				
04.92-01.93		1 457 42	P 9740	O
	FIH,ROB,	1 457 43	N 4447²	K
	ZE			
	FIU,ZE	1 457 43	N 1326⁷	K

RH

RH 352/ 402/ 403

12,0 257/294 D 2866 LOH23 <V1500, Euro 2>; D 2866 LOH26 <V1500, Euro 2>				
07.98-09.01	LBF	1 457 42	P 9137	O
	LBF	1 457 42	P 9740	O
		1 457 42	S 9969	L
07.98-05.00	FIU,ZE	1 457 43	N 1270	K
07.98-09.01	ROB,ZE	1 457 43	N 4447²	K

RN

RN 313/ 353

12,0 228/257 D 2866 LUH20 <V3200, Euro 2>; D 2866 LUH21 <V3200, Euro 2>				
09.98-03.98		1 457 42	P 9740	O
	ROB,ZE	1 457 43	N 4447²	K

SD

SD 202

11,4 150-157 D 2566 UH/205 <Z5500,>				
01.87-04.91		1 457 42	P 9740	O

11,4 155 D 2566 UH <Z5500,>				
10.85-04.94		1 457 42	P 9740	O
		1 457 43	N 1158⁶	K
		1 457 43	N 1261⁷	K
		1 457 43	N 1325⁷	K
		1 457 42	P 9165³	P

SG

SG 242

12,0 177-180/213-224 D 2866 TUH/290 <V0100>; D 2866 UH/240 <Z6500, Euro 1>				
09.85-04.94		1 457 42	P 9740	O
	ROB	1 457 43	N 4447²	K

SG 263

12,0 191 D 2866 LUH23 <V5000, Euro 3>				
06.04-09.06		1 457 42	P 9740	O
		1 457 43	S 2188	L
		1 457 43	N 1710	K
	ROB,ZE	1 457 43	N 4447²	K

SG 292

12,0 229 D 2866 TOH/310 <Z7900>				
04.92-04.93		1 457 42	P 9740	O
	FIH,ROB,	1 457 43	N 4447²	K
	ZE			
	FIU,ZE	1 457 43	N 1326⁷	K



SG 312

10,0 228 D 2865 LUH07 <V1400, Euro 2>				
02.96-06.97		1 457 42	P 9740	O
	ROB,ZE	1 457 43	N 4447²	K
		1 457 42	P 9165³	P

SG 313

12,0 228 D 2866 LUH24 <V5000, Euro 3>				
06.04-09.06		1 457 42	P 9740	O
		1 457 43	S 2188	L
		1 457 43	N 1710	K
	ROB,ZE	1 457 43	N 4447²	K

SG 322

10,0 235 D 2865 LUH08 <V1400, Euro 1>				
04.94-06.97		1 457 42	P 9740	O
	ROB,ZE	1 457 43	N 4447²	K
		1 457 42	P 9165³	P

SL

SL 202

12,0 170 E 2866 DUH02 <V1601, CNG>				
04.96-01.98	LBF	1 457 42	P 9740	O

SL 223/ 283

6,9 162/206 D 0836 LOH02 <V4900, Euro 3>; D 0836 LOH03 <V4900, Euro 3>				
06.04-09.06		0 451 30	P 1207	O
	ROB,ZE	1 457 43	N 4447²	K

SL II

SL II 202

150 <Euro 1>				
04.93-04.94		1 457 42	P 9740	O
		1 457 43	N 1159⁶	K
		1 457 43	N 1326⁷	K
		1 457 42	P 9165³	P

11,4 150-157 D 2566 UH <Z5500,>				
09.89-04.91		1 457 42	P 9740	O
		1 457 42	S 9966	L
		1 457 43	N 1159⁶	K
		1 457 43	N 1326⁷	K
		1 457 42	P 9165³	P

11,4 155 D 2566 UH <Z5500,>				
08.89-04.93		1 457 42	P 9740	O
		1 457 43	N 1158⁶	K
		1 457 43	N 1159⁶	K
		1 457 43	N 1261⁷	K
		1 457 43	N 1325⁷	K
		1 457 43	N 1326⁷	K
		1 457 42	P 9165³	P

12,0 170 E 2866 DUH01 <V1600, CNG>				
06.92-03.94		1 457 42	P 9740	O
		1 457 42	P 9165³	P

12,0 177-180 D 2866 UH/240 <Z6500, Euro 1>				
06.84-04.94		1 457 42	P 9740	O
	ROB	1 457 43	N 4447²	K

**SM****SM 152**

6,9 | 110-114 | D 0826 OH02 <Z9300>

11.87-04.94	0 451 30 P 1207	O
11.87-01.94	1 457 42 S 9950	L
11.87-04.94 ROB	1 457 43 N 4447 ²	K

SM 182

6,9 | 130-137 | D 0826 TOH01 <Z8600>

11.87-04.92	0 451 30 P 1207	O
	1 457 42 S 9966	L
SA	1 457 43 S 3611 ⁴	L
ROB	1 457 43 N 4447 ²	K

SM 192

6,9 | 140 | D 0826 LOH01 <V0900, Euro 1>

04.92-02.95	0 451 30 P 1207	O
KNE	F 026 40 S 0184	L
	1 457 43 S 3651	L
ROB, ZE	1 457 43 N 4447 ²	K

SÜ**SÜ 223**

6,9 | 162 | D 0826 LOH19 <V2900, Euro 2>

11.99-09.01	0 451 30 P 1207	O
LUM	1 457 43 S 2188	L
ROB, ZE	1 457 43 N 4447 ²	K

6,9 | 162 | D 0836 LOH03 <V4900, Euro 3>

06.04-09.06	0 451 30 P 1207	O
ROB, ZE	1 457 43 N 4447 ²	K

SÜ 242

12,0 | 177-180 | D 2866 UH/240 <Z6500, Euro 1>

01.87-04.93	1 457 42 P 9740	O
	1 457 42 S 9966	L
ROB	1 457 43 N 4447 ²	K

SÜ 263

6,9 | 191 | D 0826 LOH18 <V2900, Euro 2>

11.99-09.01	0 451 30 P 1207	O
ROB, ZE	1 457 43 N 4447 ²	K

SÜ 272

10,0 | 198 | D 2865 LUH02 <V1400, Euro 1>

04.93-05.95	1 457 42 P 9740	O
ROB, ZE	1 457 43 N 4447 ²	K

SÜ 283

6,9 | 206 | D 0836 LOH02 <V4900, Euro 3>

06.04-09.06	0 451 30 P 1207	O
ROB, ZE	1 457 43 N 4447 ²	K

SÜ 292

12,0 | 229 | D 2866 TOH/310 <Z7900>

04.92-04.93	1 457 42 P 9740	O
FIH, ROB, ZE	1 457 43 N 4447 ²	K
FIU, ZE	1 457 43 N 1326 ⁷	K

SÜ 313

12,0 | 228 | D 2866 LUH24 <V5000, Euro 3>

06.04-09.06	1 457 42 P 9740	O
LUM	1 457 43 S 2188	L
	1 457 43 N 1710	K
ROB, ZE	1 457 43 N 4447 ²	K

12,0 | 228 | D 2866 LUH26 <V3200, Euro 2>

11.99-06.01	1 457 42 P 9740	O
LUM	1 457 43 S 2188	L
ROB, ZE	1 457 43 N 4447 ²	K

SÜ 322

10,0 | 235 | D 2865 LUH08 <V1400, Euro 1>

05.95-06.97	1 457 42 P 9740	O
ROB, ZE	1 457 43 N 4447 ²	K

SÜ 363/ 383

12,0 | 265 | D 2866 LUH25 <V5000, Euro 3>

06.04-09.06	1 457 42 P 9740	O
LUM	1 457 43 S 2188	L
	1 457 43 N 1710	K
ROB, ZE	1 457 43 N 4447 ²	K

TAG**TAG 24.430**

10,5 | 316 | D 2066 LF01 <V5500, Euro 3>

09.04-09.06	F 026 40 P 7051	O
	F 026 40 S 0068	L
SA	F 026 40 S 0210 ⁴	L
	F 026 40 N 2028	K
	1 987 43 M 1163	I
	1 987 43 R 1458 ⁸	I

TG**TG 310A/ 360A/ 410A**

12,0 | 228/265/301 | D 2866 LF26 <V4200, Euro 3>; D 2866 LF27 <V4200, Euro 3>; D 2866 LF28 <V4200, Euro 3>; D 2866 LF32 <V4200, Euro 2>; D 2866 LF36 <V4200, Euro 2>; D 2866 LF37 <V4200, Euro 2>

03.99-08.02	1 457 42 P 9137	O
	F 026 40 S 0068	L
SA	F 026 40 S 0210 ⁴	L
	1 457 43 N 1710	K
	1 987 43 M 1163	I
01.01-08.02	1 987 43 R 1458 ⁸	I
03.99-08.02	1 457 42 P 9820 ³	P





TG 460A/ 510A

12,8 | 338/375 | D 2876 LF04 <V4300, Euro 3>; D 2876 LF05 <V4300, Euro 3>; D 2876 LF07 <V4300, Euro 2>

03.99-04.07	1 457 42 P 9137	O
	F 026 40 S 0068	L
SA	F 026 40 S 0210 ⁴	L
	1 457 43 N 1710	K
	1 987 43 M 1163	I
01.01-04.07	1 987 43 R 1458 ⁸	I
03.99-04.07	1 457 42 P 9820 ³	P

TGA

TGA 18.310/ 26.310/ 28.310

10,5 | 228 | D 2066 LF14 <V5500, Euro 4>

10.04-09.07	F 026 40 P 7051	O
	F 026 40 S 0068	L
SA	F 026 40 S 0210 ⁴	L
	F 026 40 N 2028	K
	1 987 43 M 1163	I
	1 987 43 R 1458 ⁸	I

TGA 18.310/ 26.310/ 28.310/ 32.310/ 35.310

12,0 | 228 | D 2866 LF26 <V4200, Euro 3>

06.02-12.05	1 457 42 P 9137	O
	F 026 40 S 0068	L
SA	F 026 40 S 0210 ⁴	L
	1 457 43 N 1710	K
	1 987 43 M 1163	I
	1 987 43 R 1458 ⁸	I
	1 457 42 P 9820 ³	P

TGA 18.310/ 26.310/ 28.310/ 33.310

10,5 | 228 | D 2066 LF04 <V5500, Euro 3>

03.04-09.06	F 026 40 P 7051	O
	F 026 40 S 0068	L
SA	F 026 40 S 0210 ⁴	L
	F 026 40 N 2028	K
	1 987 43 M 1163	I
	1 987 43 R 1458 ⁸	I

TGA 18.320

10,5 | 235 | D 2066 LF30 <Euro 5/OBD1>

04.07-09.07	F 026 40 P 7051	O
	F 026 40 S 0068	L
SA	F 026 40 S 0210 ⁴	L
	F 026 40 N 2028	K
	1 987 43 M 1163	I
	1 987 43 R 1458 ⁸	I

TGA 18.320/ 26.320/ 28.320

10,5 | 235 | D 2066 LF35 <V5500, Euro 4>

04.06-03.09	F 026 40 P 7051	O
	F 026 40 S 0068	L
SA	F 026 40 S 0210 ⁴	L
	F 026 40 N 2028	K
07.06-03.09	1 987 43 M 1163	I
	1 987 43 R 1458 ⁸	I



10,5 | 235 | D 2066 LF39 <V5500, Euro 4>

10.07-03.09	F 026 40 P 7051	O
	F 026 40 S 0068	L
SA	F 026 40 S 0210 ⁴	L
	F 026 40 N 2028	K
	1 987 43 M 1163	I
	1 987 43 R 1458 ⁸	I

10,5 | 235/236 | D 2066 LF20 <V5500, Euro 5>

04.08-08.08	F 026 40 P 7051	O
	F 026 40 S 0068	L
SA	F 026 40 S 0210 ⁴	L
	F 026 40 N 2028	K
	1 987 43 M 1163	I
	1 987 43 R 1458 ⁸	I

10,5 | 235/236 | D 2066 LF28 <Euro 5/OBD1>

10.07-08.08	F 026 40 P 7051	O
	F 026 40 S 0068	L
SA	F 026 40 S 0210 ⁴	L
	F 026 40 N 2028	K
	1 987 43 M 1163	I
	1 987 43 R 1458 ⁸	I

TGA 18.350/ 24.350/ 26.350/ 28.350/ 32.350/ 33.350

10,5 | 257 | D 2066 LF03 <V5500, Euro 3>

03.04-08.08	F 026 40 P 7051	O
	F 026 40 S 0068	L
SA	F 026 40 S 0210 ⁴	L
	F 026 40 N 2028	K
	1 987 43 M 1163	I
	1 987 43 R 1458 ⁸	I

10,5 | 257 | D 2066 LF13 <V5500, Euro 4>

10.04-09.06	F 026 40 P 7051	O
	F 026 40 S 0068	L
SA	F 026 40 S 0210 ⁴	L
	F 026 40 N 2028	K
	1 987 43 M 1163	I
	1 987 43 R 1458 ⁸	I

TGA 18.360/ 24.360/ 26.360/ 28.360

10,5 | 265 | D 2066 LF19 <V5500, Euro 5>

04.08-08.08	F 026 40 P 7051	O
	F 026 40 S 0068	L
SA	F 026 40 S 0210 ⁴	L
	F 026 40 N 2028	K
	1 987 43 M 1163	I
	1 987 43 R 1458 ⁸	I

10,5 | 265 | D 2066 LF27 <Euro 5/OBD1>

10.07-08.08	F 026 40 P 7051	O
	F 026 40 S 0068	L
SA	F 026 40 S 0210 ⁴	L
	F 026 40 N 2028	K
	1 987 43 M 1163	I
	1 987 43 R 1458 ⁸	I

10,5 | 265 | D 2066 LF29 <V5500, Euro 5>

04.07-09.07	F 026 40 P 7051	O
	F 026 40 S 0068	L
SA	F 026 40 S 0210 ⁴	L
	F 026 40 N 2028	K
	1 987 43 M 1163	I
	1 987 43 R 1458 ⁸	I





TGA 18.360/ 24.360/ 26.360/ 28.360/ 32.360/ 33.360/ 35.360

12,0 265 D 2866 LF27 <V4200, Euro 3>			
09.02-02.08	1 457 42	P 9137	O
	F 026 40	S 0068	L
SA	F 026 40	S 0210⁴	L
	1 457 43	N 1710	K
	1 987 43	M 1163	I
	1 987 43	R 1458⁸	I
	1 457 42	P 9820³	P

TGA 18.360/ 24.360/ 26.360/ 28.360/ 32.360/ 33.360/ 35.360/ 37.360

10,5 265 D 2066 LF38 <V5500, Euro 4>			
10.07-03.09	F 026 40	P 7051	O
	F 026 40	S 0068	L
SA	F 026 40	S 0210⁴	L
	F 026 40	N 2028	K
	1 987 43	M 1163	I
	1 987 43	R 1458⁸	I

TGA 18.360/ 24.360/ 26.360/ 28.360/ 32.360/ 33.360/ 35.360/ 37.360/ 41.360

10,5 265 D 2066 LF33 <V5500, Euro 4>			
07.06-03.09	F 026 40	P 7051	O
	F 026 40	S 0068	L
SA	F 026 40	S 0210⁴	L
	F 026 40	N 2028	K
	1 987 43	M 1163	I
	1 987 43	R 1458⁸	I

TGA 18.390/ 24.390/ 26.390/ 28.390/ 32.390/ 33.390

10,5 287 D 2066 LF02 <V5500, Euro 3>			
03.04-08.08	F 026 40	P 7051	O
	F 026 40	S 0068	L
SA	F 026 40	S 0210⁴	L
	F 026 40	N 2028	K
	1 987 43	M 1163	I
	1 987 43	R 1458⁸	I

TGA 18.390/ 24.390/ 26.390/ 28.390/ 33.390/ 35.390/ 37.390/ 39.390/ 41.390

10,5 287 D 2066 LF12 <Euro 4>			
10.04-09.06	F 026 40	P 7051	O
	F 026 40	S 0068	L
	F 026 40	S 0210⁴	L
	F 026 40	N 2028	K
	1 987 43	M 1163	I
	1 987 43	R 1458⁸	I

TGA 18.400/ 24.400/ 26.400/ 28.400

10,5 294 D 2066 LF18 <Euro 5/OBD1>			
04.08-08.08	F 026 40	P 7051	O
	F 026 40	S 0068	L
SA	F 026 40	S 0210⁴	L
	F 026 40	N 2028	K
	1 987 43	M 1163	I
	1 987 43	R 1458⁸	I



10,5 | 294 | D 2066 LF22 <V5500, Euro 5>

01.06-11.06	TW	F 00B H4	D 0012
		F 026 40	P 7051
		F 026 40	S 0068
	SA	F 026 40	S 0210⁴
		F 026 40	N 2028
		1 987 43	M 1163
		1 987 43	R 1458⁸

10,5 | 294 | D 2066 LF24 <Euro 5/OBD1>

01.06-09.07		F 026 40	P 7051
		F 026 40	S 0068
	SA	F 026 40	S 0210⁴
		F 026 40	N 2028
		1 987 43	M 1163
		1 987 43	R 1458⁸

10,5 | 294 | D 2066 LF26 <Euro 5/OBD1>

10.07-08.08		F 026 40	P 7051
		F 026 40	S 0068
	SA	F 026 40	S 0210⁴
		F 026 40	N 2028
		1 987 43	M 1163
		1 987 43	R 1458⁸

TGA 18.400/ 24.400/ 26.400/ 28.400/ 32.400/ 33.400/ 35.400/ 37.400/ 39.400

10,5 294 D 2066 LF37 <V5500, Euro 4>			
10.07-03.09		F 026 40	P 7051
		F 026 40	S 0068
	SA	F 026 40	S 0210⁴
		F 026 40	N 2028
		1 987 43	M 1163
		1 987 43	R 1458⁸

TGA 18.400/ 24.400/ 26.400/ 28.400/ 32.400/ 33.400/ 35.400/ 37.400/ 39.400/ 41.400

10,5 292 D 2066 LF32 <V5500, Euro 4>			
07.06-03.09		F 026 40	P 7051
		F 026 40	S 0068
	SA	F 026 40	S 0210⁴
		F 026 40	N 2028
		1 987 43	M 1163
		1 987 43	R 1458⁸

TGA 18.410/ 24.410/ 26.410/ 28.410/ 32.410/ 33.410/ 35.410

12,0 301 D 2866 LF28 <V4200, Euro 3>			
09.02-01.06		1 457 42	P 9137
		F 026 40	S 0068
	SA	F 026 40	S 0210⁴
		1 457 43	N 1710
		1 987 43	M 1163
		1 987 43	R 1458⁸
09.02-12.05		1 457 42	P 9820³





TGA 18.430/ 24.430/ 26.430/ 28.430/ 32.430/ 33.430

10,5 316 D 2066 LF11 <V5500, Euro 4>			
09.04-09.06	F 026 40 P 7051	O	
	F 026 40 S 0068	L	
SA	F 026 40 S 0210 ⁴	L	
	F 026 40 N 2028	K	
	1 987 43 M 1163	I	
	1 987 43 R 1458 ⁸	I	

TGA 18.430/ 26.430/ 28.430/ 32.430/ 33.430

10,5 316 D 2066 LF01 <V5500, Euro 3>			
03.04-08.08	F 026 40 P 7051	O	
	F 026 40 S 0068	L	
SA	F 026 40 S 0210 ⁴	L	
	F 026 40 N 2028	K	
	1 987 43 M 1163	I	
	1 987 43 R 1458 ⁸	I	

TGA 18.440/ 24.440

10,5 321 D 2066 LF23 <Euro 5/OBD1>			
02.07-09.07	F 026 40 P 7051	O	
	F 026 40 S 0068	L	
SA	F 026 40 S 0210 ⁴	L	
	F 026 40 N 2028	K	
	1 987 43 M 1163	I	
	1 987 43 R 1458 ⁸	I	

TGA 18.440/ 24.440/ 26.440/ 28.440

10,5 321 D 2066 LF21 <V5500, Euro 5>			
01.06-11.06	TW	F 00B H4 D 0012	
		F 026 40 P 7051	O
		F 026 40 S 0068	L
SA		F 026 40 S 0210 ⁴	L
		F 026 40 N 2028	K
		1 987 43 M 1163	I
		1 987 43 R 1458 ⁸	I

10,5 | 321/324 | D 2066 LF17 <Euro 5/OBD1>

04.08-08.08		F 026 40 P 7051	O
		F 026 40 S 0068	L
SA		F 026 40 S 0210 ⁴	L
		F 026 40 N 2028	K
		1 987 43 M 1163	I
		1 987 43 R 1458 ⁸	I

10,5 | 324 | D 2066 LF25 <Euro 5/OBD1>

10.07-08.08		F 026 40 P 7051	O
		F 026 40 S 0068	L
SA		F 026 40 S 0210 ⁴	L
		F 026 40 N 2028	K
		1 987 43 M 1163	I
		1 987 43 R 1458 ⁸	I

TGA 18.440/ 24.440/ 26.440/ 28.440/ 32.440/ 33.440/ 35.440

10,5 324 D 2066 LF36 <V5500, Euro 4>			
10.07-03.09		F 026 40 P 7051	O
		F 026 40 S 0068	L
SA		F 026 40 S 0210 ⁴	L
		F 026 40 N 2028	K
		1 987 43 M 1163	I
		1 987 43 R 1458 ⁸	I



TGA 18.440/ 24.440/ 26.440/ 28.440/ 32.440/ 33.440/ 35.440/ 37.440/ 39.440/ 41.440

10,5 324 D 2066 LF31 <V5500, Euro 4>			
07.06-03.09		F 026 40 P 7051	O
		F 026 40 S 0068	L
SA		F 026 40 S 0210 ⁴	L
		F 026 40 N 2028	K
		1 987 43 M 1163	I
		1 987 43 R 1458 ⁸	I

TGA 18.460/ 24.460/ 26.460/ 28.460/ 32.460/ 33.460/ 35.460

12,8 338 D 2876 LF04 <V4300, Euro 3>			
09.02-01.06		1 457 42 P 9137	O
		F 026 40 S 0068	L
SA		F 026 40 S 0210 ⁴	L
		1 457 43 N 1710	K
		1 987 43 M 1163	I
		1 987 43 R 1458 ⁸	I
09.02-12.05		1 457 42 P 9820 ³	P

TGA 18.480

12,8 353 D 2876 LF12 <V5300, Euro 3>			
10.02-09.06		1 457 42 P 9137	O
07.03-09.06		F 026 40 P 7051	O
10.02-09.06		F 026 40 S 0068	L
	SA	F 026 40 S 0210 ⁴	L
		F 026 40 N 2029	K
		1 987 43 M 1163	I
		1 987 43 R 1458 ⁸	I
		1 457 42 P 9820 ³	P

TGA 18.480/ 24.480/ 26.480/ 28.480

12,4 353 D 2676 LF14 <V7300, Euro 5>			
10.07-08.08		F 026 40 P 7051	O
		F 026 40 S 0068	L
SA		F 026 40 S 0210 ⁴	L
		F 026 40 N 2028	K
		1 987 43 M 1163	I
		1 987 43 R 1458 ⁸	I

12,4 | 353 | D 2676 LF16 <V7300, Euro 5>

04.08-08.08		F 026 40 P 7051	O
		F 026 40 S 0068	L
SA		F 026 40 S 0210 ⁴	L
		F 026 40 N 2028	K
		1 987 43 M 1163	I
		1 987 43 R 1458 ⁸	I

TGA 18.480/ 24.480/ 26.480/ 28.480/ 32.480/ 33.480/ 35.480/ 37.480/ 39.480/ 41.480

12,4 353 D 2676 LF01 <V7300, Euro 4>			
04.06-03.09		F 026 40 P 7051	O
		F 026 40 S 0068	L
SA		F 026 40 S 0210 ⁴	L
		F 026 40 N 2028	K
		1 987 43 M 1163	I
		1 987 43 R 1458 ⁸	I



**12,4 | 353 | D 2676 LF05 <V7300, Euro 4>**

10.07-03.09	F 026 40 P 7051	O
	F 026 40 S 0068	L
SA	F 026 40 S 0210 ⁴	L
	F 026 40 N 2028	K
	1987 43 M 1163	I
	1987 43 R 1458 ⁸	I

TGA 18.480/ 24.480/ 28.480**12,4 | 353 | D 2676 LF12 <V7300, Euro 5 OBD>**

07.06-09.07	F 026 40 P 7051	O
	F 026 40 S 0068	L
SA	F 026 40 S 0210 ⁴	L
	F 026 40 N 2028	K
	1987 43 M 1163	I
	1987 43 R 1458 ⁸	I

TGA 18.510/ 24.510/ 26.510/ 28.510/ 33.510**12,8 | 375 | D 2876 LF05 <V4300, Euro 3>**

09.02-06.03	1 457 42 P 9137	O
	F 026 40 S 0068	L
SA	F 026 40 S 0210 ⁴	L
	1 457 43 N 1710	K
	1987 43 M 1163	I
	1987 43 R 1458 ⁸	I
	1 457 42 P 9820 ³	P

TGA 18.530/ 24.530/ 26.530/ 28.530/ 32.530/ 33.530**12,8 | 390 | D 2876 LF13 <V5300, Euro 3>**

09.02-09.06	1 457 42 P 9137	O
	F 026 40 S 0068	L
SA	F 026 40 S 0210 ⁴	L
	F 026 40 N 2029	K
	1987 43 M 1163	I
	1987 43 R 1458 ⁸	I
	1 457 42 P 9820 ³	P

TGA 18.540/ 24.540/ 26.540/ 28.540**12,4 | 397 | D 2676 LF15 <V7300, Euro 5>**

04.08-08.08	F 026 40 P 7051	O
	F 026 40 S 0068	L
SA	F 026 40 S 0210 ⁴	L
	F 026 40 N 2028	K
	1987 43 M 1163	I
	1987 43 R 1458 ⁸	I

TGA 18.540/ 24.540/ 26.540/ 28.540/ 41.540**12,4 | 397 | D 2676 LF11 <Euro 5/OBD1>**

02.07-09.07	F 026 40 P 7051	O
	F 026 40 S 0068	L
SA	F 026 40 S 0210 ⁴	L
	F 026 40 N 2028	K
	1987 43 M 1163	I
	1987 43 R 1458 ⁸	I

12,4 | 397 | D 2676 LF13 <V7300, Euro 5>

10.07-08.08	F 026 40 P 7051	O
	F 026 40 S 0068	L
SA	F 026 40 S 0210 ⁴	L
	F 026 40 N 2028	K
	1987 43 M 1163	I
	1987 43 R 1458 ⁸	I

TGA 19.350/ 33.350/ 41.350**10,5 | 257/258 | D 2066 LF03 <Euro 3>**

03.04-05.10	F 026 40 P 7051	O
	F 026 40 S 0068	L
	F 026 40 S 0210 ⁴	L
	F 026 40 N 2028	K
	1987 43 M 1163	I
	1987 43 R 1458 ⁸	I

TGA 19.360/ 33.360/ 41.360**10,5 | 265 | D 2066 LF07 <Euro 2>**

07.06-05.10	F 026 40 P 7051	O
	F 026 40 S 0068	L
	F 026 40 S 0210 ⁴	L
	F 026 40 N 2028	K
	1987 43 M 1163	I
	1987 43 R 1458 ⁸	I

TGA 19.390/ 33.390/ 40.390/ 41.390**10,5 | 287 | D 2066 LF02 <Euro 3>**

03.04-05.10	F 026 40 P 7051	O
	F 026 40 S 0068	L
	F 026 40 S 0210 ⁴	L
	F 026 40 N 2028	K
	1987 43 M 1163	I
	1987 43 R 1458 ⁸	I

TGA 19.400/ 33.400/ 40.400/ 41.400**10,5 | 294 | D 2066 LF06 <Euro 2>**

07.06-05.10	F 026 40 P 7051	O
	F 026 40 S 0068	L
	F 026 40 S 0210 ⁴	L
	F 026 40 N 2028	K
	1987 43 M 1163	I
	1987 43 R 1458 ⁸	I

TGA 19.430/ 33.430/ 40.430/ 41.430**10,5 | 316 | D 2066 LF01 <Euro 3>**

03.04-05.10	F 026 40 P 7051	O
	F 026 40 S 0068	L
	F 026 40 S 0210 ⁴	L
	F 026 40 N 2028	K
	1987 43 M 1163	I
	1987 43 R 1458 ⁸	I





TGA 19.440/ 33.440/ 40.440/ 41.440

12,4 324 D 2676 LF04 <Euro 2>	07.06-05.10	F 026 40 P 7051	O
		F 026 40 S 0068	L
		F 026 40 S 0210 ⁴	L
		F 026 40 N 2028	K
		1 987 43 M 1163	I
		1 987 43 R 1458 ⁸	I

TGA 19.480/ 33.480/ 40.480/ 41.480

12,4 353 D 2676 LF02 <Euro 3>	07.06-05.10	F 026 40 P 7051	O
		F 026 40 S 0068	L
		F 026 40 S 0210 ⁴	L
		F 026 40 N 2028	K
		1 987 43 M 1163	I
		1 987 43 R 1458 ⁸	I

12,4 353 D 2676 LF03 <Euro 2>	07.06-05.10	F 026 40 P 7051	O
		F 026 40 S 0068	L
		F 026 40 S 0210 ⁴	L
		F 026 40 N 2028	K
		1 987 43 M 1163	I
		1 987 43 R 1458 ⁸	I

TGA 24.480/ 26.480/ 28.480/ 33.480/ 35.480

12,8 353 D 2876 LF12 <V5300, Euro 3>	09.02-09.06	1 457 42 P 9137	O
		F 026 40 S 0068	L
	SA	F 026 40 S 0210 ⁴	L
		F 026 40 N 2029	K
		1 987 43 M 1163	I
		1 987 43 R 1458 ⁸	I
		1 457 42 P 9820 ³	P

TGA 26.280

12,0 206 D 0836 LF41 <V5200, Euro 3>	03.03-02.05	1 457 42 P 9278	O
		F 026 40 S 0068	L
	SA	F 026 40 S 0210 ⁴	L
		F 026 40 N 2028	K
	ROB,ZE	1 457 43 N 4447 ²	K
		1 987 43 M 1163	I
		1 987 43 R 1458 ⁸	I
		1 457 42 P 9820 ³	P

TGA 26.320

10,5 235 D 2066 LF30 <Euro 5/OBD1>	04.07-09.07	F 026 40 P 7051	O
		F 026 40 S 0068	L
	SA	F 026 40 S 0210 ⁴	L
		F 026 40 N 2028	K



TGA 26.330

6,9 240 D 0836 LF44 <V5200, Euro 3>	03.03-02.05	1 457 42 P 9278	O
		F 026 40 S 0068	L
	SA	F 026 40 S 0210 ⁴	L
		F 026 40 N 2028	K
	ROB,ZE	1 457 43 N 4447 ²	K
		1 987 43 M 1163	I
		1 987 43 R 1458 ⁸	I
		1 457 42 P 9820 ³	P

TGA 26.440

10,5 321 D 2066 LF23 <Euro 5/OBD1>	02.07-09.07	F 026 40 P 7051	O
		F 026 40 S 0068	L
	SA	F 026 40 S 0210 ⁴	L
		F 026 40 N 2028	K

TGA 26.480

12,4 353 D 2676 LF12 <V7300, Euro 5>	07.06-09.07	F 026 40 P 7051	O
		F 026 40 S 0068	L
	SA	F 026 40 S 0210 ⁴	L
		F 026 40 N 2028	K
		1 987 43 M 1163	I
		1 987 43 R 1458 ⁸	I

TGA 28.320

10,5 235 D 2066 LF30 <Euro 5/OBD1>	04.07-09.07	F 026 40 P 7051	O
		F 026 40 S 0068	L
	SA	F 026 40 S 0210 ⁴	L
		F 026 40 N 2028	K
		1 987 43 M 1163	I
		1 987 43 R 1458 ⁸	I

TGA 28.430

10,5 257 D 2066 LF01 <V5500, Euro 3>	10.04-09.06	F 026 40 P 7051	O
		F 026 40 S 0068	L
	SA	F 026 40 S 0210 ⁴	L
		F 026 40 N 2028	K
		1 987 43 M 1163	I
		1 987 43 R 1458 ⁸	I

TGA 28.440

10,5 321 D 2066 LF23 <Euro 5/OBD1>	02.07-09.07	F 026 40 P 7051	O
		F 026 40 S 0068	L
	SA	F 026 40 S 0210 ⁴	L
		F 026 40 N 2028	K
		1 987 43 M 1163	I
		1 987 43 R 1458 ⁸	I



**TGA 32.480**

12,8 | 352 | D 2876 LF12 <V5300, Euro 3>

05.04-01.06	1 457 42 P 9137	O
	F 026 40 S 0068	L
SA	F 026 40 S 0210 ⁴	L
	F 026 40 N 2029	K
	1 987 43 M 1163	I
	1 987 43 R 1458 ⁸	I
	1 457 42 P 9820 ³	P

TGA 33.460/ 41.460

12,8 | 338 | D 2876 LF07 <Euro 2>

09.03-05.10	1 457 42 P 9137	O
	F 026 40 S 0068	L
	F 026 40 S 0210 ⁴	L
	1 457 43 N 1710	K
	1 987 43 M 1163	I
	1 987 43 R 1458 ⁸	I

TGA 33.480

12,4 | 353 | D 2876 LF25 <Euro 2>

07.06-03.09	1 457 42 P 9137	O
	F 026 40 S 0068	L
SA	F 026 40 S 0210 ⁴	L
	1 987 43 M 1163	I
	1 987 43 R 1458 ⁸	I

12,8 | 352/353 | D 2876 LF12 <Euro 3>

06.03-03.09	1 457 42 P 9137	O
	F 026 40 S 0068	L
	F 026 40 S 0210 ⁴	L
	F 026 40 N 2029	K
	1 987 43 M 1163	I
	1 987 43 R 1458 ⁸	I
	1 457 42 P 9820 ³	P

TGA 35.350

10,5 | 257 | D 2066 LF03 <V5500, Euro 3>

03.04-09.06	F 026 40 P 7051	O
	F 026 40 S 0068	L
SA	F 026 40 S 0210 ⁴	L
08.04-09.06	F 026 40 S 0210 ⁴	L
03.04-09.06	F 026 40 N 2028	K
	1 987 43 M 1163	I
	1 987 43 R 1458 ⁸	I

10,5 | 257 | D 2066 LF13 <V5500, Euro 4>

10.04-09.06	F 026 40 P 7051	O
	F 026 40 S 0068	L
	F 026 40 S 0210 ⁴	L
SA	F 026 40 S 0210 ⁴	L
	F 026 40 N 2028	K
	1 987 43 M 1163	I
	1 987 43 R 1458 ⁸	I

TGA 35.390

10,5 | 287 | D 2066 LF02 <V5500, Euro 3>

03.04-09.06	F 026 40 P 7051	O
	F 026 40 S 0068	L
SA	F 026 40 S 0210 ⁴	L
08.04-09.06	F 026 40 S 0210 ⁴	L
03.04-09.06	F 026 40 N 2028	K
	1 987 43 M 1163	I
	1 987 43 R 1458 ⁸	I

TGA 35.430

10,5 | 316 | D 2066 LF01 <V5500, Euro 3>

03.04-09.06	F 026 40 P 7051	O
	F 026 40 S 0068	L
SA	F 026 40 S 0210 ⁴	L
08.04-09.06	F 026 40 S 0210 ⁴	L
03.04-09.06	F 026 40 N 2028	K
	1 987 43 M 1163	I
	1 987 43 R 1458 ⁸	I

10,5 | 316 | D 2066 LF11 <V5500, Euro 4>

10.04-09.06	F 026 40 P 7051	O
	F 026 40 S 0068	L
	F 026 40 S 0210 ⁴	L
SA	F 026 40 S 0210 ⁴	L
	F 026 40 N 2028	K
	1 987 43 M 1163	I
	1 987 43 R 1458 ⁸	I

TGA 35.480

12,8 | 352 | D 2876 LF12 <V5300, Euro 3>

06.03-03.06	1 457 42 P 9137	O
	F 026 40 S 0068	L
SA	F 026 40 S 0210 ⁴	L
	F 026 40 N 2029	K
07.03-03.06	1 457 43 N 1710	K
06.03-03.06	1 987 43 M 1163	I
	1 987 43 R 1458 ⁸	I
	1 457 42 P 9820 ³	P

TGA 35.530/ 37.530

12,8 | 390 | D 2876 LF13 <V5300, Euro 3>

06.03-09.06	1 457 42 P 9137	O
	F 026 40 S 0068	L
SA	F 026 40 S 0210 ⁴	L
	F 026 40 N 2029	K
	1 987 43 M 1163	I
	1 987 43 R 1458 ⁸	I

TGA 37.350

10,5 | 257 | D 2066 LF03 <V5500, Euro 3>

03.04-09.06	F 026 40 P 7051	O
	F 026 40 S 0068	L
SA	F 026 40 S 0210 ⁴	L
	F 026 40 N 2028	K
	1 987 43 M 1163	I
	1 987 43 R 1458 ⁸	I





TGA 37.350/ 41.350

10,5 257 D 2066 LF13 <V5500, Euro 4>			
10.04-09.06	F 026 40	P 7051	O
	F 026 40	S 0068	L
SA	F 026 40	S 0210⁴	L
	F 026 40	N 2028	K
	1 987 43	M 1163	I
	1 987 43	R 1458⁸	I

TGA 37.360

12,0 265 D 2866 LF27 <V4200, Euro 3>			
05.04-12.05	1 457 42	P 9137	O
	F 026 40	S 0068	L
SA	F 026 40	S 0210⁴	L
	1 457 43	N 1710	K
	1 987 43	M 1163	I
	1 987 43	R 1458⁸	I

TGA 37.390/ 39.390

10,5 287 D 2066 LF02 <V5500, Euro 3>			
03.04-09.06	F 026 40	P 7051	O
	F 026 40	S 0068	L
SA	F 026 40	S 0210⁴	L
	F 026 40	N 2028	K
	1 987 43	M 1163	I
	1 987 43	R 1458⁸	I

TGA 37.410

12,0 301 D 2866 LF28 <V4200, Euro 3>			
05.04-12.05	1 457 42	P 9137	O
	F 026 40	S 0068	L
SA	F 026 40	S 0210⁴	L
	1 457 43	N 1710	K
	1 987 43	M 1163	I
	1 987 43	R 1458⁸	I

TGA 37.430/ 39.430/ 41.430

10,5 316 D 2066 LF01 <V5500, Euro 3>			
03.04-09.06	F 026 40	P 7051	O
	F 026 40	S 0068	L
SA	F 026 40	S 0210⁴	L
	F 026 40	N 2028	K
	1 987 43	M 1163	I
	1 987 43	R 1458⁸	I

10,5 316 D 2066 LF11 <V5500, Euro 4>			
10.04-09.06	F 026 40	P 7051	O
	F 026 40	S 0068	L
SA	F 026 40	S 0210⁴	L
	F 026 40	N 2028	K
	1 987 43	M 1163	I
	1 987 43	R 1458⁸	I

TGA 37.440

10,5 324 D 2066 LF36 <V5500, Euro 4>			
09.07-08.08	F 026 40	P 7051	O
	F 026 40	S 0068	L
SA	F 026 40	S 0210⁴	L
	F 026 40	N 2028	K
	1 987 43	M 1163	I



TGA 37.460

12,8 338 D 2876 LF04 <V4300, Euro 3>			
05.04-06.05	1 457 42	P 9137	O
	F 026 40	S 0068	L
SA	F 026 40	S 0210⁴	L
	1 457 43	N 1710	K
	1 987 43	M 1163	I
	1 987 43	R 1458⁸	I

TGA 37.480

12,8 353 D 2876 LF12 <V5300, Euro 3>			
08.04-09.06	1 457 42	P 9137	O
	F 026 40	S 0068	L
	F 026 40	N 2029	K
	1 987 43	M 1163	I
	1 987 43	R 1458⁸	I

TGA 39.440/ 41.440

10,5 324 D 2066 LF36 <V5500, Euro 4>			
10.07-08.08	F 026 40	P 7051	O
	F 026 40	S 0068	L
SA	F 026 40	S 0210⁴	L
	F 026 40	N 2028	K
	1 987 43	M 1163	I
	1 987 43	R 1458⁸	I

TGA 40.400

10,5 294 D 2066 LF32 <Euro 4/OBD1>; D 2066 LF37 <Euro 4/OBD1>			
09.08-05.10	F 026 40	P 7051	O
	F 026 40	S 0068	L
	F 026 40	S 0210⁴	L
	F 026 40	N 2028	K
	1 987 43	M 1163	I
	1 987 43	R 1458⁸	I

TGA 40.410

12,0 301 D 2866 LF28 <V4200, Euro 3>			
06.04-12.05	1 457 42	P 9137	O
	F 026 40	S 0068	L
	F 026 40	S 0210⁴	L
	1 457 43	N 1710	K
	1 987 43	M 1163	I
	1 987 43	R 1458⁸	I

TGA 40.440

10,5 324 D 2066 LF31 <Euro 4/OBD1>; D 2066 LF36 <Euro 4/OBD1>			
09.08-05.10	F 026 40	P 7051	O
	F 026 40	S 0068	L
	F 026 40	S 0210⁴	L
	F 026 40	N 2028	K
	1 987 43	M 1163	I
	1 987 43	R 1458⁸	I

TGA 40.480

12,8 352/353 D 2876 LF12 <Euro 3>			
11.04-03.09	1 457 42	P 9137	O
	F 026 40	S 0068	L
	F 026 40	S 0210⁴	L
	F 026 40	N 2029	K
	1 987 43	M 1163	I
	1 987 43	R 1458⁸	I





12,8 353 D 2876 LF12 <V5300, Euro 3>			
10.04-03.06	1 457 42	P 9137	O
	F 026 40	S 0068	L
	F 026 40	S 0210 ⁴	L
	F 026 40	N 2029	K
	1 987 43	M 1163	I
	1 987 43	R 1458 ⁸	I

12,8 353 D 2876 LF25 <Euro 2>			
07.06-03.09	1 457 42	P 9137	O
	F 026 40	S 0068	L
	F 026 40	S 0210 ⁴	L
	F 026 40	N 2029	K
	1 987 43	M 1163	I
	1 987 43	R 1458 ⁸	I

TGA 41.360			
10,5 265 D 2066 LF38 <V5500, Euro 4>			
09.07-08.08	F 026 40	P 7051	O
	F 026 40	S 0068	L
SA	F 026 40	S 0210 ⁴	L
	F 026 40	N 2028	K
	1 987 43	M 1163	I

12,0 265 D 2866 LF27 <V4200, Euro 3>			
09.02-12.05	1 457 42	P 9137	O
	F 026 40	S 0068	L
SA	F 026 40	S 0210 ⁴	L
	1 457 43	N 1710	K
	1 987 43	M 1163	I
	1 987 43	R 1458 ⁸	I
	1 457 42	P 9820 ³	P

TGA 41.400			
10,5 294 D 2066 LF37 <V5500, Euro 4>			
09.07-08.08	F 026 40	P 7051	O
	F 026 40	S 0068	L
SA	F 026 40	S 0210 ⁴	L
	F 026 40	N 2028	K
	1 987 43	M 1163	I

TGA 41.410			
12,0 301 D 2866 LF28 <V4200, Euro 3>			
09.02-12.05	1 457 42	P 9137	O
	F 026 40	S 0068	L
SA	F 026 40	S 0210 ⁴	L
	1 457 43	N 1710	K
	1 987 43	M 1163	I
	1 987 43	R 1458 ⁸	I
	1 457 42	P 9820 ³	P

TGA 41.460			
12,8 338 D 2876 LF04 <V4300, Euro 3>			
09.02-06.05	1 457 42	P 9137	O
	F 026 40	S 0068	L
SA	F 026 40	S 0210 ⁴	L
	1 457 43	N 1710	K
	1 987 43	M 1163	I
	1 987 43	R 1458 ⁸	I
	1 457 42	P 9820 ³	P

TGA 41.480			
12,4 353 D 2876 LF25 <Euro 2>			
07.06-03.09	1 457 42	P 9137	O
	F 026 40	S 0068	L
SA	F 026 40	S 0210 ⁴	L

12,8 352/353 D 2876 LF12 <Euro 3>			
06.03-03.09	1 457 42	P 9137	O
	F 026 40	S 0068	L
	F 026 40	S 0210 ⁴	L
	F 026 40	N 2029	K
	1 987 43	M 1163	I
	1 987 43	R 1458 ⁸	I
	1 457 42	P 9820 ³	P

12,8 353 D 2876 LF12 <V5300, Euro 3>			
05.03-09.06	1 457 42	P 9137	O
	F 026 40	S 0068	L
SA	F 026 40	S 0210 ⁴	L
	F 026 40	N 2029	K
	1 987 43	M 1163	I
	1 987 43	R 1458 ⁸	I
	1 457 42	P 9820 ³	P

TGA 41.530			
12,8 390 D 2876 LF13 <V5300, Euro 3>			
06.03-09.06	1 457 42	P 9137	O
	F 026 40	S 0068	L
SA	F 026 40	S 0210 ⁴	L
	F 026 40	N 2029	K
	1 987 43	M 1163	I
	1 987 43	R 1458 ⁸	I
	1 457 42	P 9820 ³	P

TGA 41.660			
18,3 485 D 2840 LF25 <V5800, Euro 3>			
04.03-09.06	ZE	1 457 42	P 9107
		F 026 40	S 0068
	SA	F 026 40	S 0210 ⁴
		F 026 40	N 2029
		1 987 43	M 1163
		1 987 43	R 1458 ⁸
		1 457 42	P 9820 ³

TGL			
TGL 7.150			
4,6 110 D 0834 LFL40 <V6300, Euro 3>			
05.05-09.06		1 457 42	P 9278
	TW	F 026 40	S 0209
		F 026 40	S 0211
		F 026 40	N 2028
		1 987 43	M 1163
		1 987 43	R 1458 ⁸





TGL 7.150/ 8.150

4,6 110 D 0834 LFL50 <Euro 4/OBD1>			
04.06→	1 457 42	P 9278	O
TW	F 026 40	S 0211	L
	F 026 40	N 2028	K
	1 987 43	M 1163	I
	1 987 43	R 1458⁸	I

4,6 110 D 0834 LFL53 <Euro 4/OBD1>			
09.07→	1 457 42	P 9278	O
TW	F 026 40	S 0211	L
	F 026 40	N 2028	K
	1 987 43	M 1163	I
	1 987 43	R 1458⁸	I

4,6 110 D 0834 LFL60 <Euro 5/EEV/OBD2>			
04.09→	1 457 42	P 9278	O
TW	F 026 40	S 0211	L
	F 026 40	N 2028	K
	1 987 43	M 1163	I
	1 987 43	R 1458⁸	I

4,6 110 D 0834 LFL63 <Euro 5/OBD2>			
04.09→	1 457 42	P 9278	O
TW	F 026 40	S 0211	L
	F 026 40	N 2028	K
	1 987 43	M 1163	I
	1 987 43	R 1458⁸	I

TGL 7.180/ 8.180

4,6 132 D 0834 LFL41 <V6300, Euro 3>			
05.05-09.06	1 457 42	P 9278	O
TW	F 026 40	S 0209	L
	F 026 40	S 0211	L
	F 026 40	N 2028	K
	1 987 43	M 1163	I
	1 987 43	R 1458⁸	I

4,6 132 D 0834 LFL51 <Euro 4/OBD1>			
04.06→	1 457 42	P 9278	O
TW	F 026 40	S 0211	L
	F 026 40	N 2028	K
	1 987 43	M 1163	I
	1 987 43	R 1458⁸	I

TGL 7.180/ 8.180/ 10.180/ 12.180

4,6 132 D 0834 LFL54 <Euro 4/OBD1>			
09.07→	1 457 42	P 9278	O
TW	F 026 40	S 0211	L
	F 026 40	N 2028	K
	1 987 43	M 1163	I
	1 987 43	R 1458⁸	I

4,6 132 D 0834 LFL61 <Euro 5/EEV/OBD2>			
04.09→	1 457 42	P 9278	O
TW	F 026 40	S 0211	L
	F 026 40	N 2028	K
	1 987 43	M 1163	I
	1 987 43	R 1458⁸	I



4,6 | 132 | D 0834 LFL64 <Euro 5/OBD2>

04.09→	1 457 42	P 9278	O
TW	F 026 40	S 0211	L
	F 026 40	N 2028	K
	1 987 43	M 1163	I
	1 987 43	R 1458⁸	I

TGL 8.210

4,6 151 D 0834 LFL42 <V6300, Euro 3>			
05.05-09.06	1 457 42	P 9278	O
TW	F 026 40	S 0209	L
	F 026 40	S 0211	L
	F 026 40	N 2028	K
	1 987 43	M 1163	I
	1 987 43	R 1458⁸	I

4,6 151 D 0834 LFL52 <Euro 4/OBD1>			
04.06→	1 457 42	P 9278	O
TW	F 026 40	S 0211	L
	F 026 40	N 2028	K
	1 987 43	M 1163	I
	1 987 43	R 1458⁸	I

TGL 8.210/ 10.210/ 12.210

4,6 151 D 0834 LFL55 <Euro 4/OBD1>			
09.07→	1 457 42	P 9278	O
TW	F 026 40	S 0211	L
	F 026 40	N 2028	K
	1 987 43	M 1163	I
	1 987 43	R 1458⁸	I

TGL 8.220/ 10.220/ 12.220

4,6 162 D 0834 LFL62 <Euro 5/EEV/OBD2>			
04.09→	1 457 42	P 9278	O
TW	F 026 40	S 0211	L
	F 026 40	N 2028	K
	1 987 43	M 1163	I
	1 987 43	R 1458⁸	I

4,6 162 D 0834 LFL65 <Euro 5/OBD2>			
04.09→	1 457 42	P 9278	O
TW	F 026 40	S 0211	L
	F 026 40	N 2028	K
	1 987 43	M 1163	I
	1 987 43	R 1458⁸	I

TGL 8.240/ 10.240/ 12.240

6,9 176 D 0836 LFL40 <V6000, Euro 3>			
05.05-09.06	0 451 30	P 1207	O
	1 457 42	P 9278	O
TW	F 026 40	S 0211	L
	F 026 40	N 2028	K
	1 987 43	M 1163	I
	1 987 43	R 1458⁸	I

6,9 177 D 0836 LFL50 <Euro 4/OBD1>			
04.06→	1 457 42	P 9278	O
TW	F 026 40	S 0211	L
	F 026 40	N 2028	K
	1 987 43	M 1163	I
	1 987 43	R 1458⁸	I





6,9 177 D 0836 LFL53 <Euro 4/OBD1>			
09.07→		1 457 42 P 9278	O
	TW	F 026 40 S 0211	L
		F 026 40 N 2028	K
		1 987 43 M 1163	I
		1 987 43 R 1458⁸	I

TGL 8.250/ 10.250/ 12.250

6,9 184 D 0836 LFL60 <Euro 5/EEV/OBD2>			
04.09→	TW	1 457 42 P 9107	O
		1 457 42 P 9278	O
		F 026 40 S 0211	L
		F 026 40 N 2028	K
		1 987 43 M 1163	I
		1 987 43 R 1458⁸	I

6,9 184 D 0836 LFL63 <Euro 5/OBD2>			
04.09→	TW	1 457 42 P 9107	O
		1 457 42 P 9278	O
		F 026 40 S 0211	L
		F 026 40 N 2028	K
		1 987 43 M 1163	I
		1 987 43 R 1458⁸	I

TGL 10.180

4,6 132 D 0834 LFL41 <V6300, Euro 3>			
05.05-09.06		1 457 42 P 9278	O
	TW	F 026 40 S 0211	L
		F 026 40 N 2028	K
		1 987 43 M 1163	I
		1 987 43 R 1458⁸	I

4,6 132 D 0834 LFL51 <Euro 4>			
04.06-09.07		1 457 42 P 9278	O
	TW	F 026 40 S 0211	L
		F 026 40 N 2028	K
		1 987 43 M 1163	I
		1 987 43 R 1458⁸	I

TGL 10.210

4,6 151 D 0834 LFL42 <V6300, Euro 3>			
05.05-09.06		1 457 42 P 9278	O
	TW	F 026 40 S 0211	L
		F 026 40 N 2028	K
		1 987 43 M 1163	I
		1 987 43 R 1458⁸	I

4,6 151 D 0834 LFL52 <Euro 4>			
04.06-09.07		1 457 42 P 9278	O
	TW	F 026 40 S 0211	L
		F 026 40 N 2028	K
		1 987 43 M 1163	I
		1 987 43 R 1458⁸	I

TGL 12.180

4,6 132 D 0834 LFL41 <V6300, Euro 3>			
05.05-09.06		1 457 42 P 9278	O
	TW	F 026 40 S 0209	L
		F 026 40 S 0211	L
		F 026 40 N 2028	K
		1 987 43 M 1163	I
		1 987 43 R 1458⁸	I

4,6 132 D 0834 LFL51 <Euro 4>			
04.06-09.07		1 457 42 P 9278	O
	TW	F 026 40 S 0209	L
		F 026 40 S 0211	L
		F 026 40 N 2028	K
		1 987 43 M 1163	I
		1 987 43 R 1458⁸	I

TGL 12.210

4,6 151 D 0834 LFL42 <V6300, Euro 3>			
05.05-09.06		1 457 42 P 9278	O
	TW	F 026 40 S 0209	L
		F 026 40 S 0211	L
		F 026 40 N 2028	K
		1 987 43 M 1163	I
		1 987 43 R 1458⁸	I

4,6 151 D 0834 LFL52 <Euro 4>			
04.06-09.07		1 457 42 P 9278	O
	TW	F 026 40 S 0209	L
		F 026 40 S 0211	L
		F 026 40 N 2028	K
		1 987 43 M 1163	I
		1 987 43 R 1458⁸	I

TGM

TGM 12.240/ 13.240/ 15.240/ 18.240

6,9 176/177 D 0836 LFL50 <Euro 4/OBD1>			
04.06→		1 457 42 P 9278	O
	TW	F 026 40 S 0211	L
		F 026 40 N 2028	K
		1 987 43 M 1163	I
		1 987 43 R 1458⁸	I

TGM 12.240/ 13.240/ 15.240/ 18.240/ 22.240

6,9 176/177 D 0836 LFL53 <Euro 4/OBD1>			
09.07→		1 457 42 P 9278	O
	TW	F 026 40 S 0211	L
		F 026 40 N 2028	K
		1 987 43 M 1163	I
		1 987 43 R 1458⁸	I





TGM 12.250/ 13.250/ 15.250/ 18.250/ 22.250

6,9 184 D 0836 LFL60 <Euro 5/EEV/OBD2>				
04.09→	TW	1 457 42 P 9107	O	
		1 457 42 P 9278	O	
		F 026 40 S 0211	L	
		F 026 40 N 2028	K	
		1 987 43 M 1163	I	
		1 987 43 R 1458 ⁸	I	

6,9 | 184 | D 0836 LFL63 <Euro 5/OBD2>

04.09→	TW	1 457 42 P 9107	O	
		1 457 42 P 9278	O	
		F 026 40 S 0211	L	
		F 026 40 N 2028	K	
		1 987 43 M 1163	I	
		1 987 43 R 1458 ⁸	I	

TGM 12.280/ 13.280/ 15.280

6,9 | 206 | D 0836 LFL51 <V7100, Euro 4>

04.06-09.07		1 457 42 P 9278	O	
	TW	F 026 40 S 0211	L	
		F 026 40 N 2028	K	
		1 987 43 M 1163	I	
		1 987 43 R 1458 ⁸	I	

TGM 12.280/ 13.280/ 15.280/ 18.280/ 22.280/ 26.280

6,9 | 206 | D 0836 LFL54 <Euro 4/OBD1>

09.07→		1 457 42 P 9278	O	
	TW	F 026 40 S 0211	L	
		F 026 40 N 2028	K	
		1 987 43 M 1163	I	
		1 987 43 R 1458 ⁸	I	

TGM 12.290/ 13.290/ 15.290/ 18.290/ 22.290/ 26.290

6,9 | 213 | D 0836 LFL61 <Euro 5/EEV/OBD2>

04.09→	TW	1 457 42 P 9107	O	
		1 457 42 P 9278	O	
		F 026 40 S 0211	L	
		F 026 40 N 2028	K	
		1 987 43 M 1163	I	
		1 987 43 R 1458 ⁸	I	

6,9 | 213 | D 0836 LFL64 <Euro 5/OBD2>

04.09→	TW	1 457 42 P 9107	O	
		1 457 42 P 9278	O	
		F 026 40 S 0211	L	
		F 026 40 N 2028	K	
		1 987 43 M 1163	I	
		1 987 43 R 1458 ⁸	I	

TGM 13.240/ 18.240

6,9 | 176 | D 0836 LFL40 <V6000, Euro 3>

10.05-10.07		0 451 30 P 1207	O	
		1 457 42 P 9278	O	
	TW	F 026 40 S 0211	L	
		F 026 40 N 2028	K	
		1 987 43 M 1163	I	
		1 987 43 R 1458 ⁸	I	

TGM 13.280/ 18.280

6,9 | 206 | D 0836 LFL41 <V6000, Euro 3>

10.05-09.06		0 451 30 P 1207	O	
		1 457 42 P 9278	O	
	TW	F 026 40 S 0211	L	
		F 026 40 N 2028	K	
		1 987 43 M 1163	I	
		1 987 43 R 1458 ⁸	I	

TGM 15.330/ 18.280/ 26.280

6,9 | 206/240 | D 0836 LFL51 <Euro 4/OBD1>

04.06→		1 457 42 P 9278	O	
	TW	F 026 40 S 0211	L	
		F 026 40 N 2028	K	
		1 987 43 M 1163	I	
		1 987 43 R 1458 ⁸	I	

TGM 15.330/ 18.330/ 26.330

6,9 | 240 | D 0836 LFL55 <Euro 4/OBD1>

09.07→		1 457 42 P 9278	O	
	TW	F 026 40 S 0211	L	
		F 026 40 N 2028	K	
		1 987 43 M 1163	I	
		1 987 43 R 1458 ⁸	I	

TGM 15.340/ 18.340/ 26.340

6,9 | 250 | D 0836 LFL62 <Euro 5/EEV/OBD2>

04.09→	TW	1 457 42 P 9107	O	
		1 457 42 P 9278	O	
		F 026 40 S 0211	L	
		F 026 40 N 2028	K	
		1 987 43 M 1163	I	
		1 987 43 R 1458 ⁸	I	

6,9 | 250 | D 0836 LFL65 <Euro 5/OBD2>

04.09→	TW	1 457 42 P 9107	O	
		1 457 42 P 9278	O	
		F 026 40 S 0211	L	
		F 026 40 N 2028	K	
		1 987 43 M 1163	I	
		1 987 43 R 1458 ⁸	I	

TGM 18.330

6,9 | 240 | D 0836 LFL44 <V6000, Euro 3>

10.05-09.06		0 451 30 P 1207	O	
		1 457 42 P 9278	O	
	TW	F 026 40 S 0211	L	
		F 026 40 N 2028	K	
		1 987 43 M 1163	I	
		1 987 43 R 1458 ⁸	I	

TGM 18.330/ 26.330

6,9 | 240 | D 0836 LFL52 <Euro 4/OBD1>

07.06→		1 457 42 P 9278	O	
	TW	F 026 40 S 0211	L	
		F 026 40 N 2028	K	
		1 987 43 M 1163	I	
		1 987 43 R 1458 ⁸	I	



**TGS****TGS 18.320/ 24.320/ 26.320/ 28.320/ 32.320/ 33.320/ 35.320/ 37.320/ 41.320****10,5 | 235 | D 2066 LF39 <Euro 4/OBD1>**

09.07→	F 026 40 P 7051	O
	F 026 40 S 0068	L
	F 026 40 S 0210 ⁴	L
	F 026 40 N 2028	K
	1 987 43 M 1163	I
	1 987 43 R 1458 ⁸	I

10,5 | 235 | D 2066 LF43 <Euro 5/OBD2>

09.09→	F 026 40 P 7051	O
	F 026 40 S 0068	L
	F 026 40 S 0210 ⁴	L
	F 026 40 N 2028	K
	1 987 43 M 1163	I
	1 987 43 R 1458 ⁸	I

10,5 | 235 | D 2066 LF60 <Euro 5/EEV/OBD2>

09.09→	F 026 40 P 7051	O
	F 026 40 S 0068	L
	F 026 40 S 0210 ⁴	L
	F 026 40 N 2028	K
	1 987 43 M 1163	I
	1 987 43 R 1458 ⁸	I

10,5 | 235/236 | D 2066 LF20 <Euro 5/OBD1>

04.08→	F 026 40 P 7051	O
	F 026 40 S 0068	L
	F 026 40 S 0210 ⁴	L
	F 026 40 N 2028	K
	1 987 43 M 1163	I
	1 987 43 R 1458 ⁸	I

10,5 | 235/236 | D 2066 LF28 <Euro 5/OBD1>

09.07→	F 026 40 P 7051	O
	F 026 40 S 0068	L
	F 026 40 S 0210 ⁴	L
	F 026 40 N 2028	K
	1 987 43 M 1163	I
	1 987 43 R 1458 ⁸	I

TGS 18.320/ 24.320/ 26.320/ 32.320/ 35.320**10,5 | 235 | D 2066 LF53 <Euro 5/OBD2>**

10.09→	F 026 40 P 7051	O
	F 026 40 S 0068	L
	F 026 40 S 0210 ⁴	L
	F 026 40 N 2028	K
	1 987 43 M 1163	I
	1 987 43 R 1458 ⁸	I

TGS 18.360/ 24.360/ 26.360/ 28.360/ 32.360/ 33.360/ 35.360/ 37.360/ 41.360**10,5 | 265 | D 2066 LF19 <Euro 5/OBD1>**

04.08→	F 026 40 P 7051	O
	F 026 40 S 0068	L
	F 026 40 S 0210 ⁴	L
	F 026 40 N 2028	K
	1 987 43 M 1163	I
	1 987 43 R 1458 ⁸	I

10,5 | 265 | D 2066 LF27 <Euro 5/OBD1>

09.07→	F 026 40 P 7051	O
	F 026 40 S 0068	L
	F 026 40 S 0210 ⁴	L
	F 026 40 N 2028	K
	1 987 43 M 1163	I
	1 987 43 R 1458 ⁸	I

10,5 | 265 | D 2066 LF38 <Euro 4/OBD1>

09.07→	F 026 40 P 7051	O
	F 026 40 S 0068	L
	F 026 40 S 0210 ⁴	L
	F 026 40 N 2028	K
	1 987 43 M 1163	I
	1 987 43 R 1458 ⁸	I

10,5 | 265 | D 2066 LF42 <Euro 5/OBD2>

09.09→	F 026 40 P 7051	O
	F 026 40 S 0068	L
	F 026 40 S 0210 ⁴	L
	F 026 40 N 2028	K
	1 987 43 M 1163	I
	1 987 43 R 1458 ⁸	I

10,5 | 265 | D 2066 LF59 <Euro 5/EEV/OBD2>

09.09→	F 026 40 P 7051	O
	F 026 40 S 0068	L
	F 026 40 S 0210 ⁴	L
	F 026 40 N 2028	K
	1 987 43 M 1163	I
	1 987 43 R 1458 ⁸	I

TGS 18.360/ 24.360/ 26.360/ 32.360/ 35.360**10,5 | 265 | D 2066 LF52 <Euro 5/OBD2>**

10.09→	F 026 40 P 7051	O
	F 026 40 S 0068	L
	F 026 40 S 0210 ⁴	L
	F 026 40 N 2028	K
	1 987 43 M 1163	I
	1 987 43 R 1458 ⁸	I

TGS 18.400/ 24.400/ 26.400/ 28.400/ 32.400/ 33.400/ 35.400/ 37.400/ 41.400**10,5 | 294 | D 2066 LF26 <Euro 5/OBD1>**

09.07→	F 026 40 P 7051	O
	F 026 40 S 0068	L
	F 026 40 S 0210 ⁴	L
	F 026 40 N 2028	K
	1 987 43 M 1163	I
	1 987 43 R 1458 ⁸	I





◀ TGS 18.400/ 24.400/ 26.400/ 28.400/ 32.400/ 33.400/ 35.400/37.400/ 41.400

10,5 294 D 2066 LF37 <Euro 4/OBD1>			
09.07→	F 026 40 P 7051	O	
	F 026 40 S 0068	L	
	F 026 40 S 0210 ⁴	L	
	F 026 40 N 2028	K	
	1 987 43 M 1163	I	
	1 987 43 R 1458 ⁸	I	

10,5 294 D 2066 LF41 <Euro 5/OBD2>			
09.09→	F 026 40 P 7051	O	
	F 026 40 S 0068	L	
	F 026 40 S 0210 ⁴	L	
	F 026 40 N 2028	K	
	1 987 43 M 1163	I	
	1 987 43 R 1458 ⁸	I	

10,5 294 D 2066 LF58 <Euro 5/EEV/OBD2>			
09.09→	F 026 40 P 7051	O	
	F 026 40 S 0068	L	
	F 026 40 S 0210 ⁴	L	
	F 026 40 N 2028	K	
	1 987 43 M 1163	I	
	1 987 43 R 1458 ⁸	I	

TGS 18.400/ 24.400/ 26.400/ 28.400/ 32.400/ 33.400/ 35.400/ 41.400

10,5 294 D 2066 LF18 <Euro 5/OBD1>			
04.08→	F 026 40 P 7051	O	
	F 026 40 S 0068	L	
	F 026 40 S 0210 ⁴	L	
	F 026 40 N 2028	K	
	1 987 43 M 1163	I	
	1 987 43 R 1458 ⁸	I	

TGS 18.400/ 24.400/ 26.400/ 32.400/ 35.400

10,5 294 D 2066 LF51 <Euro 5/OBD2>			
10.09→	F 026 40 P 7051	O	
	F 026 40 S 0068	L	
	F 026 40 S 0210 ⁴	L	
	F 026 40 N 2028	K	
	1 987 43 M 1163	I	
	1 987 43 R 1458 ⁸	I	

TGS 18.440/ 24.440/ 26.440/ 28.440/ 32.440/ 33.440/ 35.440/ 37.440/ 41.440

10,5 324 D 2066 LF17 <Euro 5/OBD1>			
04.08→	F 026 40 P 7051	O	
	F 026 40 S 0068	L	
	F 026 40 S 0210 ⁴	L	
	F 026 40 N 2028	K	
	1 987 43 M 1163	I	
	1 987 43 R 1458 ⁸	I	

10,5 324 D 2066 LF25 <Euro 5/OBD1>			
09.07→	F 026 40 P 7051	O	
	F 026 40 S 0068	L	
	F 026 40 S 0210 ⁴	L	
	F 026 40 N 2028	K	
	1 987 43 M 1163	I	
	1 987 43 R 1458 ⁸	I	

10,5 324 D 2066 LF36 <Euro 4/OBD1>			
09.07→	F 026 40 P 7051	O	
	F 026 40 S 0068	L	
	F 026 40 S 0210 ⁴	L	
	F 026 40 N 2028	K	
	1 987 43 M 1163	I	
	1 987 43 R 1458 ⁸	I	

10,5 324 D 2066 LF40 <Euro 5/OBD2>			
09.09→	F 026 40 P 7051	O	
	F 026 40 S 0068	L	
	F 026 40 S 0210 ⁴	L	
	F 026 40 N 2028	K	
	1 987 43 M 1163	I	
	1 987 43 R 1458 ⁸	I	

10,5 324 D 2066 LF57 <Euro 5/EEV/OBD2>			
09.09→	F 026 40 P 7051	O	
	F 026 40 S 0068	L	
	F 026 40 S 0210 ⁴	L	
	F 026 40 N 2028	K	
	1 987 43 M 1163	I	
	1 987 43 R 1458 ⁸	I	

TGS 18.440/ 24.440/ 26.440/ 32.440/ 35.440

12,4 324 D 2676 LF22 <Euro 5/OBD2>			
10.09→	F 026 40 P 7051	O	
	F 026 40 S 0068	L	
	F 026 40 S 0210 ⁴	L	
	F 026 40 N 2028	K	
	1 987 43 M 1163	I	
	1 987 43 R 1458 ⁸	I	

TGS 18.480/ 24.480/ 26.480/ 28.480/ 32.480/ 33.480/ 35.480/ 37.480/ 41.480

12,4 353 D 2676 LF05 <Euro 4/OBD1>			
09.07→	F 026 40 P 7051	O	
	F 026 40 S 0068	L	
	F 026 40 S 0210 ⁴	L	
	F 026 40 N 2028	K	
	1 987 43 M 1163	I	
	1 987 43 R 1458 ⁸	I	

12,4 353 D 2676 LF07 <Euro 5/OBD2>			
09.09→	F 026 40 P 7051	O	
	F 026 40 S 0068	L	
	F 026 40 S 0210 ⁴	L	
	F 026 40 N 2028	K	
	1 987 43 M 1163	I	
	1 987 43 R 1458 ⁸	I	

12,4 353 D 2676 LF14 <Euro 5/OBD1>			
09.07→	F 026 40 P 7051	O	
	F 026 40 S 0068	L	
	F 026 40 S 0210 ⁴	L	
	F 026 40 N 2028	K	
	1 987 43 M 1163	I	
	1 987 43 R 1458 ⁸	I	





12,4 353 D 2676 LF16 <Euro 5/OBD1>			
04.08→	F 026 40 P 7051	O	
	F 026 40 S 0068	L	
	F 026 40 S 0210 ⁴	L	
	F 026 40 N 2028	K	
	1987 43 M 1163	I	
	1987 43 R 1458 ⁸	I	

12,4 353 D 2676 LF18 <Euro 5/EEV/OBD2>			
09.09→	F 026 40 P 7051	O	
	F 026 40 S 0068	L	
	F 026 40 S 0210 ⁴	L	
	F 026 40 N 2028	K	
	1987 43 M 1163	I	
	1987 43 R 1458 ⁸	I	

TGS 18.540/ 24.540/ 26.540/ 28.540/ 33.540/ 35.540/ 37.540/ 41.540

12,4 397 D 2676 LF06 <Euro 5/OBD2>			
09.09→	F 026 40 P 7051	O	
	F 026 40 S 0068	L	
	F 026 40 S 0210 ⁴	L	
	F 026 40 N 2028	K	
	1987 43 M 1163	I	
	1987 43 R 1458 ⁸	I	

TGS 18.540/ 26.540/ 28.540/ 33.540/ 35.540/ 37.540/ 41.540

12,4 397 D 2676 LF13 <Euro 5/OBD1>			
09.07→	F 026 40 P 7051	O	
	F 026 40 S 0068	L	
	F 026 40 S 0210 ⁴	L	
	F 026 40 N 2028	K	
	1987 43 M 1163	I	
	1987 43 R 1458 ⁸	I	

12,4 397 D 2676 LF15 <Euro 5/OBD1>			
04.08→	F 026 40 P 7051	O	
	F 026 40 S 0068	L	
	F 026 40 S 0210 ⁴	L	
	F 026 40 N 2028	K	
	1987 43 M 1163	I	
	1987 43 R 1458 ⁸	I	

TGS 19.350/ 26.350/ 28.350/ 41.350

10,5 257 D 2066 LF03 <Euro 3>			
01.10→	F 026 40 P 7051	O	
	F 026 40 S 0068	L	
	F 026 40 S 0210 ⁴	L	
	F 026 40 N 2028	K	
	1987 43 M 1163	I	
	1987 43 R 1458 ⁸	I	

TGS 19.360/ 26.360/ 33.360/ 35.360/ 41.360

10,5 265 D 2066 LF64 <Euro 4/OBD2>			
02.11→	F 026 40 P 7051	O	
	F 026 40 S 0068	L	
	F 026 40 S 0210 ⁴	L	
	F 026 40 N 2028	K	
	1987 43 M 1163	I	
	1987 43 R 1458 ⁸	I	

TGS 19.360/ 33.360/ 41.360

10,5 265 D 2066 LF07 <Euro 2>			
01.10→	F 026 40 P 7051	O	
	F 026 40 S 0068	L	
	F 026 40 S 0210 ⁴	L	
	F 026 40 N 2028	K	
	1987 43 M 1163	I	
	1987 43 R 1458 ⁸	I	

TGS 19.390/ 26.390/ 33.390/ 35.390/ 40.390/ 41.390

10,5 287 D 2066 LF02 <Euro 3>			
01.10→	F 026 40 P 7051	O	
	F 026 40 S 0068	L	
	F 026 40 S 0210 ⁴	L	
	F 026 40 N 2028	K	
	1987 43 M 1163	I	
	1987 43 R 1458 ⁸	I	

TGS 19.400/ 26.400/ 33.400/ 35.400/ 41.400

10,5 294 D 2066 LF63 <Euro 4/OBD2>			
02.11→	F 026 40 P 7051	O	
	F 026 40 S 0068	L	
	F 026 40 S 0210 ⁴	L	
	F 026 40 N 2028	K	
	1987 43 M 1163	I	
	1987 43 R 1458 ⁸	I	

TGS 19.400/ 26.430/ 28.430/ 33.430/ 35.430/ 40.430

10,5 316 D 2066 LF01 <Euro 3>			
01.10→	F 026 40 P 7051	O	
	F 026 40 S 0068	L	
	F 026 40 S 0210 ⁴	L	
	F 026 40 N 2028	K	
	1987 43 M 1163	I	
	1987 43 R 1458 ⁸	I	

TGS 19.400/ 33.400/ 40.400/ 41.400

10,5 294 D 2066 LF06 <Euro 2>			
01.10→	F 026 40 P 7051	O	
	F 026 40 S 0068	L	
	F 026 40 S 0210 ⁴	L	
	F 026 40 N 2028	K	
	1987 43 M 1163	I	
	1987 43 R 1458 ⁸	I	





TGS 19.400/ 35.400

10,5 294 D 2066 LF49 <Euro 3>	02.11→	F 026 40 P 7051	O
		F 026 40 S 0068	L
		F 026 40 S 0210 ⁴	L
		F 026 40 N 2028	K
		1 987 43 M 1163	I
		1 987 43 R 1458 ⁸	I

TGS 19.440/ 26.440

10,5 324 D 2066 LF62 <Euro 4/OBD2>	02.11→	F 026 40 P 7051	O
		F 026 40 S 0068	L
		F 026 40 S 0210 ⁴	L
		F 026 40 N 2028	K
		1 987 43 M 1163	I
		1 987 43 R 1458 ⁸	I

TGS 19.440/ 26.480/ 33.480/ 40.480/ 41.480

12,4 353 D 2676 LF02 <Euro 3>	01.10→	F 026 40 P 7051	O
		F 026 40 S 0068	L
		F 026 40 S 0210 ⁴	L
		F 026 40 N 2028	K
		1 987 43 M 1163	I
		1 987 43 R 1458 ⁸	I

TGS 19.440/ 33.440/ 40.440/ 41.440

12,4 324 D 2676 LF04 <Euro 2>	01.10→	F 026 40 P 7051	O
		F 026 40 S 0068	L
		F 026 40 S 0210 ⁴	L
		F 026 40 N 2028	K
		1 987 43 M 1163	I
		1 987 43 R 1458 ⁸	I

TGS 19.440/ 33.480/ 40.480/ 41.480

12,4 353 D 2676 LF03 <Euro 2>	01.10→	F 026 40 P 7051	O
		F 026 40 S 0068	L
		F 026 40 S 0210 ⁴	L
		F 026 40 N 2028	K
		1 987 43 M 1163	I
		1 987 43 R 1458 ⁸	I

TGS 26.440/ 33.440/ 35.440

10,5 324 D 2066 LF50 <Euro 3>	02.11→	F 026 40 P 7051	O
		F 026 40 S 0068	L
		F 026 40 S 0210 ⁴	L
		F 026 40 N 2028	K
		1 987 43 M 1163	I
		1 987 43 R 1458 ⁸	I



TGS 33.360

10,5 265 D 2066 LF48 <Euro 3>	02.11→	F 026 40 P 7051	O
		F 026 40 S 0068	L
		F 026 40 S 0210 ⁴	L
		F 026 40 N 2028	K
		1 987 43 M 1163	I
		1 987 43 R 1458 ⁸	I

TGS 33.480/ 35.480/ 41.480

12,4 353 D 2676 LF20 <Euro 4/OBD2>	02.11→	F 026 40 P 7051	O
		F 026 40 S 0068	L
		F 026 40 S 0210 ⁴	L
		F 026 40 N 2028	K
		1 987 43 M 1163	I
		1 987 43 R 1458 ⁸	I

TGX

TGX 18.360/ 24.360/ 26.360/ 28.360/ 33.360/ 35.360

10,5 265 D 2066 LF19 <Euro 5/OBD1>	04.08→	F 026 40 P 7051	O
		F 026 40 S 0068	L
		F 026 40 S 0210 ⁴	L
		F 026 40 N 2028	K
		1 987 43 M 1163	I
		1 987 43 R 1458 ⁸	I

10,5 | 265 | D 2066 LF27 <Euro 5/OBD1>

	09.07→	F 026 40 P 7051	O
		F 026 40 S 0068	L
		F 026 40 S 0210 ⁴	L
		F 026 40 N 2028	K
		1 987 43 M 1163	I
		1 987 43 R 1458 ⁸	I

10,5 | 265 | D 2066 LF38 <Euro 4/OBD1>

	09.07→	F 026 40 P 7051	O
		F 026 40 S 0068	L
		F 026 40 S 0210 ⁴	L
		F 026 40 N 2028	K
		1 987 43 M 1163	I
		1 987 43 R 1458 ⁸	I

10,5 | 265 | D 2066 LF42 <Euro 5/OBD2>

	09.09→	F 026 40 P 7051	O
		F 026 40 S 0068	L
		F 026 40 S 0210 ⁴	L
		F 026 40 N 2028	K
		1 987 43 M 1163	I
		1 987 43 R 1458 ⁸	I

10,5 | 265 | D 2066 LF59 <Euro 5/EEV/OBD2>

	09.09→	F 026 40 P 7051	O
		F 026 40 S 0068	L
		F 026 40 S 0210 ⁴	L
		F 026 40 N 2028	K
		1 987 43 M 1163	I
		1 987 43 R 1458 ⁸	I





TGX 18.400/ 24.400/ 26.400

10,5 294 D 2066 LF51 <Euro 5/OBD2>			
10.09→	F 026 40 P 7051	O	
	F 026 40 S 0068	L	
	F 026 40 S 0210 ⁴	L	
	F 026 40 N 2028	K	
	1987 43 M 1163	I	
	1987 43 R 1458 ⁸	I	

TGX 18.400/ 24.400/ 26.400/ 28.400/ 33.400/ 35.400

10,5 294 D 2066 LF18 <Euro 5/OBD1>			
04.08→	F 026 40 P 7051	O	
	F 026 40 S 0068	L	
	F 026 40 S 0210 ⁴	L	
	F 026 40 N 2028	K	
	1987 43 M 1163	I	
	1987 43 R 1458 ⁸	I	

10,5 294 D 2066 LF26 <Euro 5/OBD1>			
09.07→	F 026 40 P 7051	O	
	F 026 40 S 0068	L	
	F 026 40 S 0210 ⁴	L	
	F 026 40 N 2028	K	
	1987 43 M 1163	I	
	1987 43 R 1458 ⁸	I	

10,5 294 D 2066 LF37 <Euro 4/OBD1>			
09.07→	F 026 40 P 7051	O	
	F 026 40 S 0068	L	
	F 026 40 S 0210 ⁴	L	
	F 026 40 N 2028	K	
	1987 43 M 1163	I	
	1987 43 R 1458 ⁸	I	

10,5 294 D 2066 LF41 <Euro 5/OBD2>			
09.09→	F 026 40 P 7051	O	
	F 026 40 S 0068	L	
	F 026 40 S 0210 ⁴	L	
	F 026 40 N 2028	K	
	1987 43 M 1163	I	
	1987 43 R 1458 ⁸	I	

10,5 294 D 2066 LF58 <Euro 5/EEV/OBD2>			
09.09→	F 026 40 P 7051	O	
	F 026 40 S 0068	L	
	F 026 40 S 0210 ⁴	L	
	F 026 40 N 2028	K	
	1987 43 M 1163	I	
	1987 43 R 1458 ⁸	I	

TGX 18.440/ 24.440/ 26.440

12,4 324 D 2676 LF22 <Euro 5/OBD2>			
10.09→	F 026 40 P 7051	O	
	F 026 40 S 0068	L	
	F 026 40 S 0210 ⁴	L	
	F 026 40 N 2028	K	
	1987 43 M 1163	I	
	1987 43 R 1458 ⁸	I	



TGX 18.440/ 24.440/ 26.440/ 28.440/ 33.440/ 35.440

10,5 324 D 2066 LF17 <Euro 5/OBD1>			
04.08→	F 026 40 P 7051	O	
	F 026 40 S 0068	L	
	F 026 40 S 0210 ⁴	L	
	F 026 40 N 2028	K	
	1987 43 M 1163	I	
	1987 43 R 1458 ⁸	I	

10,5 324 D 2066 LF25 <Euro 5/OBD1>			
09.07→	F 026 40 P 7051	O	
	F 026 40 S 0068	L	
	F 026 40 S 0210 ⁴	L	
	F 026 40 N 2028	K	
	1987 43 M 1163	I	
	1987 43 R 1458 ⁸	I	

10,5 324 D 2066 LF36 <Euro 4/OBD1>			
09.07→	F 026 40 P 7051	O	
	F 026 40 S 0068	L	
	F 026 40 S 0210 ⁴	L	
	F 026 40 N 2028	K	
	1987 43 M 1163	I	
	1987 43 R 1458 ⁸	I	

10,5 324 D 2066 LF40 <Euro 5/OBD2>			
09.09→	F 026 40 P 7051	O	
	F 026 40 S 0068	L	
	F 026 40 S 0210 ⁴	L	
	F 026 40 N 2028	K	
	1987 43 M 1163	I	
	1987 43 R 1458 ⁸	I	

10,5 324 D 2066 LF57 <Euro 5/EEV/OBD2>			
09.09→	F 026 40 P 7051	O	
	F 026 40 S 0068	L	
	F 026 40 S 0210 ⁴	L	
	F 026 40 N 2028	K	
	1987 43 M 1163	I	
	1987 43 R 1458 ⁸	I	

TGX 18.480/ 24.480/ 26.480/ 28.480/ 33.480/ 35.480

12,4 353 D 2676 LF05 <Euro 4/OBD1>			
09.07→	F 026 40 P 7051	O	
	F 026 40 S 0068	L	
	F 026 40 S 0210 ⁴	L	
	F 026 40 N 2028	K	
	1987 43 M 1163	I	
	1987 43 R 1458 ⁸	I	

12,4 353 D 2676 LF07 <Euro 5/OBD2>			
09.09→	F 026 40 P 7051	O	
	F 026 40 S 0068	L	
	F 026 40 S 0210 ⁴	L	
	F 026 40 N 2028	K	
	1987 43 M 1163	I	
	1987 43 R 1458 ⁸	I	





◀ TGX 18.480/ 24.480/ 26.480/ 28.480/ 33.480/ 35.480

12,4 353 D 2676 LF14 <Euro 5/OBD1>			
09.07→	F 026 40 P 7051	O	
	F 026 40 S 0068	L	
	F 026 40 S 0210 ⁴	L	
	F 026 40 N 2028	K	
	1 987 43 M 1163	I	
	1 987 43 R 1458 ⁸	I	

12,4 353 D 2676 LF18 <Euro 5/EEV/OBD2>			
09.09→	F 026 40 P 7051	O	
	F 026 40 S 0068	L	
	F 026 40 S 0210 ⁴	L	
	F 026 40 N 2028	K	
	1 987 43 M 1163	I	
	1 987 43 R 1458 ⁸	I	

TGX 18.480/ 24.480/ 26.480/ 33.480/ 35.480

12,4 353 D 2676 LF16 <Euro 5/OBD1>			
10.07→	F 026 40 P 7051	O	
	F 026 40 S 0068	L	
	F 026 40 S 0210 ⁴	L	
	F 026 40 N 2028	K	
	1 987 43 M 1163	I	
	1 987 43 R 1458 ⁸	I	

TGX 18.540/ 24.540/ 26.540/ 28.540/ 33.540/ 35.540/ 41.540

12,4 397 D 2676 LF06 <Euro 5/OBD2>			
09.09→	F 026 40 P 7051	O	
	F 026 40 S 0068	L	
	F 026 40 S 0210 ⁴	L	
	F 026 40 N 2028	K	
	1 987 43 M 1163	I	
	1 987 43 R 1458 ⁸	I	

TGX 18.540/ 26.540/ 28.540/ 33.540/ 35.540/ 41.540

12,4 397 D 2676 LF13 <Euro 5/OBD1>			
09.07→	F 026 40 P 7051	O	
	F 026 40 S 0068	L	
	F 026 40 S 0210 ⁴	L	
	F 026 40 N 2028	K	
	1 987 43 M 1163	I	
	1 987 43 R 1458 ⁸	I	

12,4 397 D 2676 LF15 <Euro 5/OBD1>			
04.08→	F 026 40 P 7051	O	
	F 026 40 S 0068	L	
	F 026 40 S 0210 ⁴	L	
	F 026 40 N 2028	K	
	1 987 43 M 1163	I	
	1 987 43 R 1458 ⁸	I	

TGX 18.680/ 33.680

16,2 500 D 2868 LF02 <Euro 5/OBD1>			
01.08→	F 026 40 P 7051	O	
	F 026 40 S 0068	L	
	F 026 40 S 0210 ⁴	L	
	F 026 40 N 2028	K	
	1 987 43 M 1163	I	
	1 987 43 R 1458 ⁸	I	



16,2 500 D 2868 LF05 <Euro 5/EEV/OBD2>			
09.09→	F 026 40 P 7051	O	
	F 026 40 S 0068	L	
	F 026 40 S 0210 ⁴	L	
	F 026 40 N 2028	K	
	1 987 43 M 1163	I	
	1 987 43 R 1458 ⁸	I	

TGX 41.680

16,2 500 D 2868 LF03 <Euro 5/OBD1>; D 2868 LF06 <Euro 5/OBD2>			
01.08→	F 026 40 P 7051	O	
	F 026 40 S 0068	L	
	F 026 40 S 0210 ⁴	L	
	F 026 40 N 2028	K	
	1 987 43 M 1163	I	
	1 987 43 R 1458 ⁸	I	

ÜL

ÜL 242

12,0 177 D 2866 UH/240 <Z6500, Euro 1>			
09.89-03.93	1 457 42 P 9740	O	
	1 457 42 P 9820 ³	P	

ÜL 272

10,0 198 D 2865 LUH02 <V1400, Euro 1>			
03.93-07.94	1 457 42 P 9740	O	
	ROB,ZE 1 457 43 N 4447 ²	K	
	1 457 42 P 9820 ³	P	

10,0 198 D 2865 LUH05 <Euro 1>			
07.94-09.95	1 457 42 P 9740	O	
	1 457 43 N 4154 ²	K	
	1 457 42 P 9820 ³	P	

ÜL 292

12,0 213 D 2866 TUH01 <V0100>			
09.89-03.93	1 457 42 P 9740	O	
	ROB 1 457 43 N 4447 ²	K	
	1 457 42 P 9820 ³	P	

ÜL 312

10,0 228 D 2865 LUH07 <V1400, Euro 2>			
09.95-09.96	1 457 42 P 9740	O	
	ROB,ZE 1 457 43 N 4447 ²	K	
	1 457 42 P 9820 ³	P	

ÜL 313

12,0 228 D 2866 LUH20 <V3200, Euro 2>			
09.96-09.01	1 457 42 P 9740	O	
	1 457 43 S 2188	L	
	ROB,ZE 1 457 43 N 4447 ²	K	
	1 987 43 M 2151	I	
	1 457 42 P 9820 ³	P	

12,0 228 D 2866 LUH24 <V5000, Euro 3>			
05.99-09.06	1 457 42 P 9740	O	
	1 457 43 S 2188	L	
	1 457 43 N 1710	K	
	ROB,ZE 1 457 43 N 4447 ²	K	
	1 987 43 M 2151	I	
	1 457 42 P 9820 ³	P	



ÜL 322

10,0 235 D 2865 LUH08 <V1400, Euro 1>			
04.92-09.95	1 457 42	P 9740	O
	ROB,ZE	1 457 43 N 4447 ²	K
		1 457 42 P 9820 ³	P

ÜL 353

12,0 257 D 2866 LUH21 <V3200, Euro 2>			
06.97-12.01	1 457 42	P 9740	O
		1 457 43 S 2188	L
	ROB,ZE	1 457 43 N 4447 ²	K
		1 987 43 M 2151	I
		1 457 42 P 9820 ³	P

ÜL 363

12,0 265 D 2866 LUH25 <V5000, Euro 3>			
01.01-09.06	1 457 42	P 9740	O
		1 457 43 S 2188	L
		1 457 43 N 1710	K
	ROB,ZE	1 457 43 N 4447 ²	K
		1 987 43 M 2151	I
		1 457 42 P 9820 ³	P

6t

6t 6.100

4,6 75 D 0824 GF, GF01 <Z8200>			
09.87-12.92	0 451 30	P 1207	O
		1 457 42 S 9950	L
	ROB	1 457 43 N 4447 ²	K

4,6 75 D 0824 GF02 <Z8200, Euro 1>			
10.92-10.93	0 451 30	P 1207	O
	ROB	1 457 43 N 4447 ²	K

8t

8t 8.100

4,6 75 D 0824 GF, GF01 <Z8200>			
09.87-12.92	0 451 30	P 1207	O
		1 457 42 S 9950	L

4,6 75 D 0824 GF02 <Z8200, Euro 1>			
10.92-10.93	0 451 30	P 1207	O

8t 8.150

6,9 110 D 0826 GF03 <Z8300, Euro 1>			
10.92-05.95	0 451 10	P 5067	O
	ROB	1 457 43 N 4447 ²	K

6,9 110-114 D 0826 GF <Z8300>			
09.87-11.91	0 451 30	P 1207	O
12.91-12.92	0 451 10	P 5067	O
09.87-12.92	1 457 42	S 9950	L
	ROB	1 457 43 N 4447 ²	K



9t

9t 9.150

6,9 110 D 0826 GF03 <Z8300, Euro 1>			
10.92-05.95	0 451 10	P 5067	O
	ROB	1 457 43 N 4447 ²	K

6,9 | 110-114 | D 0826 GF <Z8300>

09.87-11.91	0 451 30	P 1207	O
12.91-12.92	0 451 10	P 5067	O
09.87-12.92	1 457 42	S 9950	L
	ROB	1 457 43 N 4447 ²	K

10t

10t 10.150

6,9 110 D 0826 GF03 <Z8300, Euro 1>			
10.92-10.93	0 451 10	P 5067	O
	ROB	1 457 43 N 4447 ²	K

6,9 | 110-114 | D 0826 GF01 <Z8300>

09.87-11.91	0 451 30	P 1207	O
12.91-12.92	0 451 10	P 5067	O
09.87-12.92	1 457 42	S 9950	L
	ROB	1 457 43 N 4447 ²	K

12t

12t 12.152

4,6 114 D 0824 LF01 <V2700, Euro 1>			
05.94-06.97	0 451 30	P 1207	O
		1 457 42 S 9950	L
	FW,SA,	1 457 43 S 3611 ⁴	L
	TAF		
	FW,TAF	1 457 42 S 9966	L
	MHE	1 457 42 N 9230	K
	ROB	1 457 43 N 4447 ²	K
		1 987 43 M 2151	I
		1 457 42 P 9820 ³	P

6,9 | 110-114 | D 0826 F01 <V0200>; D 0826 F02 <V0200, Euro 1>

12.88-05.94	0 451 30	P 1207	O
		1 457 42 S 9950	L
	FW,SA,	1 457 43 S 3611 ⁴	L
	TAF		
	FW,TAF	1 457 42 S 9966	L
	NOR	1 457 43 N 4159 ²	K
	ROB	1 457 43 N 4447 ²	K
		1 987 43 M 2151	I
		1 457 42 P 9820 ³	P





12t 12.162

4,6 118 D 0824 LF02 <V2700, Euro 2>			
08.95-06.97	0 451 30	P 1207	O
	1 457 42	S 9950	L
FW,SA,	1 457 43	S 3611⁴	L
TAF			
FW,TAF	1 457 42	S 9966	L
	1 457 43	N 4295²	K
MHE	1 457 42	N 9230	K
	1 987 43	M 2151	I
	1 457 42	P 9820³	P

12t 12.192/ 12.222/ 12.232/ 12.262

6,9 140/162/169/191 D 0826 LF01 <Z9500>; D 0826 LF02 <Z9500>; D 0826 LF05 <Z9500, Euro 1>; D 0826 LF06 <Z9500, Euro 1>; D 0826 LF07 <Z9500, Euro 1>; D 0826 LF08 <Z9500, Euro 1>; D 0826 LF11 <Z9500, Euro 2>; D 0826 LF13 <Z9500, Euro 2>			
08.88-06.96	0 451 30	P 1207	O
	1 457 42	S 9950	L
FW,SA,	1 457 43	S 3611⁴	L
TAF			
FW,TAF	1 457 42	S 9966	L
MHE	1 457 42	N 9230	K
ROB	1 457 43	N 4447²	K
	1 987 43	M 2151	I
	1 457 42	P 9820³	P

12t 12.272

6,9 198 D 0826 LF04 <Z9500, Euro 1>			
10.92-06.96	0 451 30	P 1207	O
03.93-06.96	1 457 43	S 3651	L
10.92-06.96	MHE	1 457 42	N 9230
	ROB	1 457 43	N 4447²
		1 987 43	M 2151
		1 457 42	P 9820³

10,0 | 198 | D 2865 LF02 <V0700>

09.91-10.92	1 457 42	P 9740	O
	1 457 42	S 9950	L
FW,SA,	1 457 43	S 3611⁴	L
TAF			
FW,TAF	1 457 42	S 9966	L
MHE	1 457 42	N 9230	K
ROB	1 457 43	N 4447²	K
	1 987 43	M 2151	I

14t

14t 14.152

4,6 114 D 0824 LF01 <V2700, Euro 1>			
05.94-06.97	0 451 30	P 1207	O
	1 457 42	S 9950	L
FW,SA,	1 457 43	S 3611⁴	L
TAF			
FW,TAF	1 457 42	S 9966	L
MHE	1 457 42	N 9230	K
ROB	1 457 43	N 4447²	K
	1 987 43	M 2151	I



6,9 | 110-114 | D 0826 F01 <V0200>; D 0826 F02 <V0200, Euro 1>

12.88-05.94	0 451 30	P 1207	O
	1 457 42	S 9950	L
FW,SA,	1 457 43	S 3611⁴	L
TAF			
FW,TAF	1 457 42	S 9966	L
NOR	1 457 43	N 4159²	K
ROB	1 457 43	N 4447²	K
	1 987 43	M 2151	I

14t 14.162

4,6 | 118 | D 0824 LF02 <V2700, Euro 2>

08.95-06.97	0 451 30	P 1207	O
	1 457 42	S 9950	L
FW,SA,	1 457 43	S 3611⁴	L
TAF			
FW,TAF	1 457 42	S 9966	L
	1 457 43	N 4295²	K
MHE	1 457 42	N 9230	K
	1 987 43	M 2151	I

14t 14.192/ 14.222/ 14.232/ 14.262

6,9 140/160/162/169/191 D 0826 LF01 <Z9500>; D 0826 LF02 <Z9500>; D 0826 LF05 <Z9500, Euro 1>; D 0826 LF06 <Z9500, Euro 1>; D 0826 LF07 <Z9500, Euro 1>; D 0826 LF08 <Z9500, Euro 1>; D 0826 LF11 <Z9500, Euro 2>; D 0826 LF13 <Z9500, Euro 2>; D 0826 LF/217/Silent <Z9500>			
08.88-06.96	0 451 30	P 1207	O
	1 457 42	S 9950	L
FW,SA,	1 457 43	S 3611⁴	L
TAF			
FW,TAF	1 457 42	S 9966	L
MHE	1 457 42	N 9230	K
ROB	1 457 43	N 4447²	K
	1 987 43	M 2151	I

10,0 | 198 | D 2865 LF04 <Z9500, Euro 1>

08.88-06.96	0 451 30	P 1207	O
	1 457 42	S 9950	L
FW,SA,	1 457 43	S 3611⁴	L
TAF			
FW,TAF	1 457 42	S 9966	L
MHE	1 457 42	N 9230	K
ROB	1 457 43	N 4447²	K
	1 987 43	M 2151	I

14t 14.272

6,9 | 198 | D 0826 LF04 <Z9500, Euro 1>

10.92-06.96	0 451 30	P 1207	O
03.93-06.96	1 457 43	S 3651	L
10.92-06.96	MHE	1 457 42	N 9230
	ROB	1 457 43	N 4447²
		1 987 43	M 2151

10,0 | 198 | D 2865 LF02 <V0700>

09.91-10.92	1 457 42	P 9740	O
	1 457 42	S 9950	L
FW,SA,	1 457 43	S 3611⁴	L
TAF			
FW,TAF	1 457 42	S 9966	L
MHE	1 457 42	N 9230	K
ROB	1 457 43	N 4447²	K
	1 987 43	M 2151	I
	1 457 42	P 9165³	P

10,0 | 198 | D 2865 LU01/Silent <V0500>

05.90-10.93	1 457 42	P 9740	O
	1 457 43	N 1270	K
FIH	1 457 43	N 4150²	K
	1 457 42	P 9165³	P



17t

17t 17.192

6,9 | 140 | D 0826 LF01 <Z9500>

07.90-04.95	0 451 30 P 1207	O
FW,SA	1 457 43 S 3611 ⁴	L
TAF		
FW,TAF	1 457 42 S 9966	L
MHE	1 457 42 N 9230	K
ROB	1 457 43 N 4447 ²	K
07.90-01.91	TW	1 987 43 M 2151
07.90-04.95		1 987 43 M 2151

17t 17.192/ 17.222

6,9 | 140/162 | D 0826 LF05 <Z9500, Euro 1>; D 0826 LF07 <Z9500, Euro 1>; D 0826 LF11 <Z9500, Euro 2>

10.92-06.96	0 451 30 P 1207	O
FW,SA	1 457 43 S 3611 ⁴	L
TAF		
FW,TAF	1 457 42 S 9966	L
MHE	1 457 42 N 9230	K
ROB	1 457 43 N 4447 ²	K
		1 987 43 M 2151

17t 17.232

6,9 | 160 | D 0826 LF/217/Silent <Z9500>

05.90-04.95	0 451 30 P 1207	O
FW,SA	1 457 43 S 3611 ⁴	L
TAF		
FW,TAF	1 457 42 S 9966	L
MHE	1 457 42 N 9230	K
ROB	1 457 43 N 4447 ²	K
05.90-01.91	TW	1 987 43 M 2151
05.90-04.95		1 987 43 M 2151

6,9 | 169 | D 0826 LF02 <Z9500>

08.88-05.95	0 451 30 P 1207	O
FW,SA	1 457 43 S 3611 ⁴	L
TAF		
FW,TAF	1 457 42 S 9966	L
MHE	1 457 42 N 9230	K
ROB	1 457 43 N 4447 ²	K
08.88-01.91	TW	1 987 43 M 2151
08.88-05.95		1 987 43 M 2151

6,9 | 169 | D 0826 LF06 <Z9500, Euro 1>; D 0826 LF08 <Z9500, Euro 1>

10.92-06.96	0 451 30 P 1207	O
FW,SA	1 457 43 S 3611 ⁴	L
TAF		
FW,TAF	1 457 42 S 9966	L
MHE	1 457 42 N 9230	K
ROB	1 457 43 N 4447 ²	K
		1 987 43 M 2151

17t 17.272

6,9 | 198 | D 0826 LF04 <Z9500, Euro 1>

10.92-05.95	0 451 30 P 1207	O
03.93-05.95	1 457 43 S 3651	L
10.92-05.95	MHE	1 457 42 N 9230
	ROB	1 457 43 N 4447 ²
		1 987 43 M 2151

10,0 | 198 | D 2865 LF02 <V0700>

09.91-05.95	1 457 42 P 9740	O
FW,SA	1 457 43 S 3611 ⁴	L
TAF		
FW,TAF	1 457 42 S 9966	L
MHE	1 457 42 N 9230	K
ROB	1 457 43 N 4447 ²	K
		1 987 43 M 2151

18t

18t 18.192

6,9 | 140 | D 0826 LF01 <Z9500>; D 0826 LF05 <Z9500, Euro 1>

09.90-05.94	0 451 30 P 1207	O
FW,SA	1 457 43 S 3611 ⁴	L
TAF		
FW,TAF	1 457 42 S 9966	L
MHE	1 457 42 N 9230	K
ROB	1 457 43 N 4447 ²	K
		1 987 43 M 2151
		TW
		1 987 43 M 2151

18t 18.192/ 18.222

6,9 | 140/162 | D 0826 LF07 <Z9500, Euro 1>; D 0826 LF11 <Z9500, Euro 2>

05.94-06.96	0 451 30 P 1207	O
FW,SA	1 457 43 S 3611 ⁴	L
TAF		
FW,TAF	1 457 42 S 9966	L
MHE	1 457 42 N 9230	K
ROB	1 457 43 N 4447 ²	K
		1 987 43 M 2151
		TW
		1 987 43 M 2151

18t 18.232

6,9 | 169 | D 0826 LF02 <Z9500>; D 0826 LF06 <Z9500, Euro 1>

09.90-05.94	0 451 30 P 1207	O
FW,SA	1 457 43 S 3611 ⁴	L
TAF		
FW,TAF	1 457 42 S 9966	L
MHE	1 457 42 N 9230	K
ROB	1 457 43 N 4447 ²	K
		1 987 43 M 2151
		TW
		1 987 43 M 2151

6,9 | 169 | D 0826 LF08 <Z9500, Euro 1>

05.94-06.96	0 451 30 P 1207	O
FW,SA	1 457 43 S 3611 ⁴	L
TAF		
FW,TAF	1 457 42 S 9966	L
MHE	1 457 42 N 9230	K
ROB	1 457 43 N 4447 ²	K
		1 987 43 M 2151
		TW
		1 987 43 M 2151





18t 18.241

11,4 | 177 | D 2566 M
09.90-10.93 1 457 42 P 9740 O

18t 18.262

6,9 | 191 | D 0826 LF13 <Z9500, Euro 2>
08.95-06.96 0 451 30 P 1207 O
FW,SA, 1 457 43 S 3611⁴ L
TAF
FW,TAF 1 457 42 S 9966 L
MHE 1 457 42 N 9230 K
ROB 1 457 43 N 4447² K
TW 1 987 43 M 2151 I

18t 18.272

6,9 | 198 | D 0826 LF04 <Z9500, Euro 1>
10.92-06.96 0 451 30 P 1207 O
03.93-06.96 1 457 43 S 3651 L
10.92-06.96 MHE 1 457 42 N 9230 K
ROB 1 457 43 N 4447² K
1 987 43 M 2151 I
TW 1 987 43 M 2151 I

10,0 | 198 | D 2865 LF02 <V0700>

09.91-05.94 1 457 42 P 9740 O
FW,SA, 1 457 43 S 3611⁴ L
TAF
FW,TAF 1 457 42 S 9966 L
MHE 1 457 42 N 9230 K
ROB 1 457 43 N 4447² K
1 987 43 M 2151 I
TW 1 987 43 M 2151 I

40t

40t 40.422

12,0 | 309 | D 2866 LF06 <Z7601>
12.91-10.92 1 457 42 P 9740 O
ROB,ZE 1 457 43 N 4447² K

41t

41t 41.272/ 41.322

10,0 | 198/235 | D 2865 LF02 <V0700>; D 2865 LF03 <V0700>
02.90-05.94 1 457 42 P 9740 O
ROB 1 457 43 N 4447² K

41t 41.372

12,0 | 272 | D 2866 LF03 <Z7601>
02.90-05.94 1 457 42 P 9740 O
ROB,ZE 1 457 43 N 4447² K

12,0 | 272 | D 2866 LF05 <Euro 1>

10.92-05.94 LBF 1 457 42 P 9740 O
1 457 43 N 4154² K

41t 41.422

12,0 | 309 | D 2866 LF06 <Z7601>; D 2866 LF09 <Z7601, Euro 1>
02.90-06.96 1 457 42 P 9740 O
ROB,ZE 1 457 43 N 4447² K



MAZ MINSK

Serie 100

Serie 100 105/ 107

6,4 | 205 | OM 906 LA <Euro 3>
01.02→ F 026 40 P 7026 O

Serie 200

Serie 200 203

6,4 | 170/205 | OM 906 LA <Euro 3>
01.02→ F 026 40 P 7026 O

Serie 200 206/ 256

4,8 | 115 | D 245.30 E2 <Euro 2>
01.02→ 0 451 20 P 3152 O
TW 1 457 43 N 4310² K
TW,XXX 1 457 43 N 4306² K
E,F 01.02→ TW 1 457 43 G 17² K

10t

10t 437041/ 437141/ 457041

4,8 | 115 | D 245.30 E2 <Euro 2>
01.02→ 0 451 20 P 3152 O
TW 1 457 43 N 4310² K
TW,XXX 1 457 43 N 4306² K
E,F 01.02→ TW 1 457 43 G 17² K

10t 437041/ 457043

4,8 | 115 | D 245.30 E3 <Euro 3>
01.08→ 0 451 20 P 3152 O

18t

18t 5440A9

11,1 | 303 | 650.10 <Euro 3>
01.02→ 0 451 10 P 4010 O
1 457 43 N 4421² K

25t

25t 643069

12,0 | 301 | D 2866 LF25 <Euro 3>
01.02→ 1 457 42 P 9137 O
1 457 43 S 3900 L
1 457 43 N 1710 K
ROB,ZE 1 457 43 N 4447² K
1 457 42 P 9165³ P





33t

33t 551669

12,0 301 D 2866 LF25 <Euro 3>			
01.02→	1 457 42	P 9137	O
	1 457 43	S 3900	L
	1 457 43	N 1710	K
ROB, ZE	1 457 43	N 4447²	K
	1 457 42	P 9165³	P

MERCEDES-BENZ

Actros

Actros 1831/ 2031

11,9 230 OM 541.941 <(501)LA Euro3>			
Komp.Nr. 508046/05	09.96-09.03	TNK	1 457 43 S 3730 L
Komp.Nr. 508046/01/07	09.96-09.03	TNK	F 026 40 S 0094 L
Komp.Nr. 508046/15			
Komp.Nr. 508046/03	09.96-09.03	TNK	1 457 43 S 3728 L
Komp.Nr. 508046/04	09.96-09.03	TNK	1 457 43 S 3729 L
Komp.Nr. 508046/08/09	09.96-09.03	TNK	1 457 42 S 9975 L

Actros 1831/ 2031/ 2531/ 2631

11,9 230 OM 541.940 <(501)LA Euro3>			
Komp.Nr. 508046/05	09.96-09.03	TNK	1 457 43 S 3730 L
Komp.Nr. 508046/01/07	09.96-09.03	TNK	F 026 40 S 0094 L
Komp.Nr. 508046/15			
Komp.Nr. 508046/03	09.96-09.03	TNK	1 457 43 S 3728 L
Komp.Nr. 508046/04	09.96-09.03	TNK	1 457 43 S 3729 L
Komp.Nr. 508046/08/09	09.96-09.03	TNK	1 457 42 S 9975 L

Actros 1831/ 2031/ 2531/ 2631/ 3231/ 3331

12,0 230 OM 541.920 <(501)LA Euro2>			
	09.96-09.03		1 457 42 P 9128 O
Komp.Nr. 508046/05	09.96-09.03	TNK	1 457 43 S 3730 L
Komp.Nr. 508046/07/15	09.96-09.03	TNK	F 026 40 S 0094 L
Komp.Nr. 508046/22			
Komp.Nr. 508046/03	09.96-09.03	TNK	1 457 43 S 3728 L
Komp.Nr. 508046/04	09.96-09.03	TNK	1 457 43 S 3729 L
Komp.Nr. 508046/08	09.96-09.03	TNK	1 457 42 S 9975 L
	09.96-09.03		1 457 42 N 9655 K
		FBF	1 987 43 M 2150 I
Komp.Nr. 507615/01	09.96-09.03	TNK	1 987 43 R 1455⁸ I
Komp.Nr. 507627/02/03/04			
Komp.Nr. 507677/02	09.96-09.03	FBF, TNK	1 987 43 M 1154 I
	09.96-09.03		1 457 42 P 9820³ P

Actros 1831/ 2031/ 3331

12,0 230 OM 541.926 <(501)LA Euro2>			
	09.96-09.03		1 457 42 P 9128 O
Komp.Nr. 508046/05	09.96-09.03	TNK	1 457 43 S 3730 L
Komp.Nr. 508046/07/15	09.96-09.03	TNK	F 026 40 S 0094 L
Komp.Nr. 508046/22			
Komp.Nr. 508046/03	09.96-09.03	TNK	1 457 43 S 3728 L
Komp.Nr. 508046/04	09.96-09.03	TNK	1 457 43 S 3729 L
Komp.Nr. 508046/08	09.96-09.03	TNK	1 457 42 S 9975 L



	09.96-09.03		1 457 42 N 9655 K
		FBF	1 987 43 M 2150 I
Komp.Nr. 507615/01	09.96-09.03	TNK	1 987 43 R 1455⁸ I
Komp.Nr. 507627/02/03/04			
Komp.Nr. 507677/02	09.96-09.03	FBF, TNK	1 987 43 M 1154 I
	09.96-09.03		1 457 42 P 9820³ P

Actros 1835

11,9 260 OM 541.943 <(501)LA Euro3>			
Komp.Nr. 508046/05	09.96-09.03	TNK	1 457 43 S 3730 L
Komp.Nr. 508046/01/07	09.96-09.03	TNK	F 026 40 S 0094 L
Komp.Nr. 508046/15			
Komp.Nr. 508046/03	09.96-09.03	TNK	1 457 43 S 3728 L
Komp.Nr. 508046/04	09.96-09.03	TNK	1 457 43 S 3729 L
Komp.Nr. 508046/08/09	09.96-09.03	TNK	1 457 42 S 9975 L

Actros 1835/ 2035

12,0 260 OM 541.927 <(501)LA Euro2>			
	04.97-09.03		1 457 42 P 9128 O
Komp.Nr. 508046/05	04.97-09.03	TNK	1 457 43 S 3730 L
Komp.Nr. 508046/07/15	04.97-09.03	TNK	F 026 40 S 0094 L
Komp.Nr. 508046/22			
Komp.Nr. 508046/03	04.97-09.03	TNK	1 457 43 S 3728 L
Komp.Nr. 508046/04	04.97-09.03	TNK	1 457 43 S 3729 L
Komp.Nr. 508046/08	04.97-09.03	TNK	1 457 42 S 9975 L
	04.97-09.03		1 457 42 N 9655 K
		FBF	1 987 43 M 2150 I
Komp.Nr. 507615/01	04.97-09.03	TNK	1 987 43 R 1455⁸ I
Komp.Nr. 507627/02/03/04			
Komp.Nr. 507677/02	04.97-09.03	FBF, TNK	1 987 43 M 1154 I

Actros 1835/ 2035/ 2535/ 2635

11,9 260 OM 541.942 <(501)LA Euro3>			
Komp.Nr. 508046/05	09.96-09.03	TNK	1 457 43 S 3730 L
Komp.Nr. 508046/01/07	09.96-09.03	TNK	F 026 40 S 0094 L
Komp.Nr. 508046/15			
Komp.Nr. 508046/03	09.96-09.03	TNK	1 457 43 S 3728 L
Komp.Nr. 508046/04	09.96-09.03	TNK	1 457 43 S 3729 L
Komp.Nr. 508046/08/09	09.96-09.03	TNK	1 457 42 S 9975 L

Actros 1835/ 2535/ 2635/ 3235/ 3335

12,0 260 OM 541.922 <(501)LA Euro2>			
	09.96-09.03		1 457 42 P 9128 O
Komp.Nr. 508046/05	09.96-09.03	TNK	1 457 43 S 3730 L
Komp.Nr. 508046/07/15	09.96-09.03	TNK	F 026 40 S 0094 L
Komp.Nr. 508046/22			
Komp.Nr. 508046/03	09.96-09.03	TNK	1 457 43 S 3728 L
Komp.Nr. 508046/04	09.96-09.03	TNK	1 457 43 S 3729 L
Komp.Nr. 508046/08	09.96-09.03	TNK	1 457 42 S 9975 L
	09.96-09.03		1 457 42 N 9655 K
		FBF	1 987 43 M 2150 I
Komp.Nr. 507615/01	09.96-09.03	TNK	1 987 43 R 1455⁸ I
Komp.Nr. 507627/02/03/04			
Komp.Nr. 507677/02	09.96-09.03	FBF, TNK	1 987 43 M 1154 I
	09.96-09.03		1 457 42 P 9820³ P

Actros 1840/ 2040

11,9 290 OM 541.945 <(501)LA Euro3>			
Komp.Nr. 508046/05	09.96-09.03	TNK	1 457 43 S 3730 L





◀ Actros 1840/ 2040

Komp.Nr. 508046/01/07	09.96-09.03	TNK	F 026 40	S 0094	L
Komp.Nr. 508046/15					
Komp.Nr. 508046/03	09.96-09.03	TNK	1 457 43	S 3728	L
Komp.Nr. 508046/04	09.96-09.03	TNK	1 457 43	S 3729	L
Komp.Nr. 508046/08/09	09.96-09.03	TNK	1 457 42	S 9975	L

Actros 1840/ 2040/ 2540

11,9 | 290 | OM 541.944 <(501)LA Euro3>

Komp.Nr. 508046/05	09.96-09.03	TNK	1 457 43	S 3730	L
Komp.Nr. 508046/01/07	09.96-09.03	TNK	F 026 40	S 0094	L
Komp.Nr. 508046/15					
Komp.Nr. 508046/03	09.96-09.03	TNK	1 457 43	S 3728	L
Komp.Nr. 508046/04	09.96-09.03	TNK	1 457 43	S 3729	L
Komp.Nr. 508046/08/09	09.96-09.03	TNK	1 457 42	S 9975	L

Actros 1840/ 2040/ 2540/ 2640/ 3240/ 3340/ 4140

12,0 | 290 | OM 541.923 <(501)LA Euro2>

	09.96-09.03		1 457 42	P 9128	O
Komp.Nr. 508046/05	09.96-09.03	TNK	1 457 43	S 3730	L
Komp.Nr. 508046/07/15	09.96-09.03	TNK	F 026 40	S 0094	L
Komp.Nr. 508046/22					
Komp.Nr. 508046/03	09.96-09.03	TNK	1 457 43	S 3728	L
Komp.Nr. 508046/04	09.96-09.03	TNK	1 457 43	S 3729	L
Komp.Nr. 508046/08	09.96-09.03	TNK	1 457 42	S 9975	L
	09.96-09.03		1 457 42	N 9655	K
		FBF	1 987 43	M 2150	I
Komp.Nr. 507615/01	09.96-09.03	TNK	1 987 43	R 1455⁸	I
Komp.Nr. 507627/02/03/04					
Komp.Nr. 507677/02	09.96-09.03	FBF,TNK	1 987 43	M 1154	I
	09.96-09.03		1 457 42	P 9820³	P

Actros 1840/ 2040/ 4140

12,0 | 290 | OM 541.924 <(501)LA Euro2>

	09.96-09.03		1 457 42	P 9128	O
Komp.Nr. 508046/05	09.96-09.03	TNK	1 457 43	S 3730	L
Komp.Nr. 508046/07/15	09.96-09.03	TNK	F 026 40	S 0094	L
Komp.Nr. 508046/22					
Komp.Nr. 508046/03	09.96-09.03	TNK	1 457 43	S 3728	L
Komp.Nr. 508046/04	09.96-09.03	TNK	1 457 43	S 3729	L
Komp.Nr. 508046/08	09.96-09.03	TNK	1 457 42	S 9975	L
	09.96-09.03		1 457 42	N 9655	K
		FBF	1 987 43	M 2150	I
Komp.Nr. 507615/01	09.96-09.03	TNK	1 987 43	R 1455⁸	I
Komp.Nr. 507627/02/03/04					
Komp.Nr. 507677/02	09.96-09.03	FBF,TNK	1 987 43	M 1154	I
	09.96-09.03		1 457 42	P 9820³	P

Actros 1843/ 2543/ 2643

11,9 | 315 | OM 541.946 <(501)LA Euro3>

Komp.Nr. 508046/05	09.96-09.03	TNK	1 457 43	S 3730	L
Komp.Nr. 508046/01/07	09.96-09.03	TNK	F 026 40	S 0094	L
Komp.Nr. 508046/15					
Komp.Nr. 508046/03	09.96-09.03	TNK	1 457 43	S 3728	L
Komp.Nr. 508046/04	09.96-09.03	TNK	1 457 43	S 3729	L
Komp.Nr. 508046/08/09	09.96-09.03	TNK	1 457 42	S 9975	L

Actros 1843/ 2543/ 2643/ 3243/ 3343/ 4143

12,0 | 315 | OM 541.925 <(501)LA Euro2>

	09.96-09.03		1 457 42	P 9128	O
Komp.Nr. 508046/05	09.96-09.03	TNK	1 457 43	S 3730	L
Komp.Nr. 508046/07/15	09.96-09.03	TNK	F 026 40	S 0094	L
Komp.Nr. 508046/22					



Komp.Nr. 508046/03	09.96-09.03	TNK	1 457 43	S 3728	L
Komp.Nr. 508046/04	09.96-09.03	TNK	1 457 43	S 3729	L
Komp.Nr. 508046/08	09.96-09.03	TNK	1 457 42	S 9975	L
	09.96-09.03		1 457 42	N 9655	K
		FBF	1 987 43	M 2150	I
Komp.Nr. 507615/01	09.96-09.03	TNK	1 987 43	R 1455⁸	I
Komp.Nr. 507627/02/03/04					
Komp.Nr. 507677/02	09.96-09.03	FBF,TNK	1 987 43	M 1154	I
	09.96-09.03		1 457 42	P 9820³	P

Actros 1843/ 3343/ 4143

12,0 | 315 | OM 541.921 <(501)LA Euro2>

	04.97-09.03		1 457 42	P 9128	O
Komp.Nr. 508046/05	04.97-09.03	TNK	1 457 43	S 3730	L
Komp.Nr. 508046/07/15	04.97-09.03	TNK	F 026 40	S 0094	L
Komp.Nr. 508046/22					
Komp.Nr. 508046/03	04.97-09.03	TNK	1 457 43	S 3728	L
Komp.Nr. 508046/03/04/23	04.97-09.03	TNK	F 026 40	S 0088	L
Komp.Nr. 508046/04	04.97-09.03	TNK	1 457 43	S 3729	L
Komp.Nr. 508046/08	04.97-09.03	TNK	1 457 42	S 9975	L
	04.97-09.03		1 457 42	N 9655	K
			1 987 43	R 1455⁸	I
		FBF	1 987 43	M 1154	I
		FBF	1 987 43	M 2150	I
			1 457 42	P 9820³	P

Actros 1848

16,0 | 350 | OM 542.921 <(502)LA Euro2>

	09.96-09.03		1 457 42	P 9128	O
Komp.Nr. 508046/05	09.96-09.03	TNK	1 457 43	S 3730	L
Komp.Nr. 508046/07/15	09.96-09.03	TNK	F 026 40	S 0094	L
Komp.Nr. 508046/22					
Komp.Nr. 508046/03	09.96-09.03	TNK	1 457 43	S 3728	L
Komp.Nr. 508046/04	09.96-09.03	TNK	1 457 43	S 3729	L
Komp.Nr. 508046/08	09.96-09.03	TNK	1 457 42	S 9975	L
	09.96-09.03		1 457 42	N 9655	K
			1 987 43	R 1455⁸	I
		FBF	1 987 43	M 1154	I
		FBF	1 987 43	M 2150	I
Komp.Nr. 507615/01	09.96-09.03	TNK	1 987 43	R 1455⁸	I
Komp.Nr. 507627/02/03/04					
Komp.Nr. 507677/02	09.96-09.03	FBF,TNK	1 987 43	M 1154	I
	09.96-09.03		1 457 42	P 9820³	P

Actros 1848/ 2048

15,9 | 350 | OM 542.941 <(502)LA Euro3>

Komp.Nr. 508046/05	09.96-09.03	TNK	1 457 43	S 3730	L
Komp.Nr. 508046/01/07	09.96-09.03	TNK	F 026 40	S 0094	L
Komp.Nr. 508046/15					
Komp.Nr. 508046/03	09.96-09.03	TNK	1 457 43	S 3728	L
Komp.Nr. 508046/04	09.96-09.03	TNK	1 457 43	S 3729	L
Komp.Nr. 508046/08/09	09.96-09.03	TNK	1 457 42	S 9975	L

Actros 1848/ 2548/ 2648

15,9 | 350 | OM 542.940 <(502)LA Euro3>

Komp.Nr. 508046/05	09.96-09.03	TNK	1 457 43	S 3730	L
Komp.Nr. 508046/01/07	09.96-09.03	TNK	F 026 40	S 0094	L
Komp.Nr. 508046/15					
Komp.Nr. 508046/03	09.96-09.03	TNK	1 457 43	S 3728	L
Komp.Nr. 508046/04	09.96-09.03	TNK	1 457 43	S 3729	L
Komp.Nr. 508046/08/09	09.96-09.03	TNK	1 457 42	S 9975	L



Actros 1848/ 3348

16,0 350 OM 542.925 <(502)LA Euro2>				
	04.97-09.03		1 457 42	P 9128 O
Komp.Nr. 508046 /05	04.97-09.03	TNK	1 457 43	S 3730 L
Komp.Nr. 508046 /07/15	04.97-09.03	TNK	F 026 40	S 0094 L
Komp.Nr. 508046 /22				
Komp.Nr. 508046/03	04.97-09.03	TNK	1 457 43	S 3728 L
Komp.Nr. 508046/04	04.97-09.03	TNK	1 457 43	S 3729 L
Komp.Nr. 508046/08	04.97-09.03	TNK	1 457 42	S 9975 L
	04.97-09.03		1 457 42	N 9655 K
			1 987 43	R 1455⁸ I
		FBF	1 987 43	M 1154 I
		FBF	1 987 43	M 2150 I
			1 457 42	P 9820³ P

Actros 1853

15,9 390 OM 542.943 <(502)LA Euro2>				
Komp.Nr. 508046 /05	09.96-09.03	TNK	1 457 43	S 3730 L
Komp.Nr. 508046/01/07	09.96-09.03	TNK	F 026 40	S 0094 L
Komp.Nr. 508046/15				
Komp.Nr. 508046/03	09.96-09.03	TNK	1 457 43	S 3728 L
Komp.Nr. 508046/04	09.96-09.03	TNK	1 457 43	S 3729 L
Komp.Nr. 508046/08/09	09.96-09.03	TNK	1 457 42	S 9975 L

Actros 1853/ 2553/ 2653

15,9 390 OM 542.942 <(502)LA Euro3>				
Komp.Nr. 508046 /05	09.96-09.03	TNK	1 457 43	S 3730 L
Komp.Nr. 508046/01/07	09.96-09.03	TNK	F 026 40	S 0094 L
Komp.Nr. 508046/15				
Komp.Nr. 508046/03	09.96-09.03	TNK	1 457 43	S 3728 L
Komp.Nr. 508046/04	09.96-09.03	TNK	1 457 43	S 3729 L
Komp.Nr. 508046/08/09	09.96-09.03	TNK	1 457 42	S 9975 L

Actros 1853/ 2553/ 2653/ 3353

16,0 390 OM 542.920 <(502)LA Euro2>				
	09.96-09.03		1 457 42	P 9128 O
Komp.Nr. 508046 /05	09.96-09.03	TNK	1 457 43	S 3730 L
Komp.Nr. 508046 /07/15	09.96-09.03	TNK	F 026 40	S 0094 L
Komp.Nr. 508046 /22				
Komp.Nr. 508046/03	09.96-09.03	TNK	1 457 43	S 3728 L
Komp.Nr. 508046/04	09.96-09.03	TNK	1 457 43	S 3729 L
Komp.Nr. 508046/08	09.96-09.03	TNK	1 457 42	S 9975 L
	09.96-09.03		1 457 42	N 9655 K
			1 987 43	R 1455⁸ I
		FBF	1 987 43	M 1154 I
		FBF	1 987 43	M 2150 I
			1 457 42	P 9820³ P

Actros 1857/ 2557/ 2657

15,9 420 OM 542.944 <(502)LA Euro3>				
Komp.Nr. 508046 /05	09.96-09.03	TNK	1 457 43	S 3730 L
Komp.Nr. 508046/01/07	09.96-09.03	TNK	F 026 40	S 0094 L
Komp.Nr. 508046/15				
Komp.Nr. 508046/03	09.96-09.03	TNK	1 457 43	S 3728 L
Komp.Nr. 508046/04	09.96-09.03	TNK	1 457 43	S 3729 L
Komp.Nr. 508046/08/09	09.96-09.03	TNK	1 457 42	S 9975 L

Actros 1857/ 2557/ 2657/ 3357

16,0 420 OM 542.922 <(502)LA Euro2>				
	04.97-09.03		1 457 42	P 9128 O
Komp.Nr. 508046 /05	04.97-09.03	TNK	1 457 43	S 3730 L
Komp.Nr. 508046 /07/15	04.97-09.03	TNK	F 026 40	S 0094 L
Komp.Nr. 508046 /22				
Komp.Nr. 508046/03	04.97-09.03	TNK	1 457 43	S 3728 L
Komp.Nr. 508046/04	04.97-09.03	TNK	1 457 43	S 3729 L
Komp.Nr. 508046/08	04.97-09.03	TNK	1 457 42	S 9975 L
	04.97-09.03		1 457 42	N 9655 K
			1 987 43	R 1455⁸ I
		FBF	1 987 43	M 1154 I
		FBF	1 987 43	M 2150 I
			1 457 42	P 9820³ P

Actros 2043

11,9 315 OM 541.947 <(501)LA Euro3>				
Komp.Nr. 508046 /05	09.98-09.03	TNK	1 457 43	S 3730 L
Komp.Nr. 508046/01/07	09.98-09.03	TNK	F 026 40	S 0094 L
Komp.Nr. 508046/15				
Komp.Nr. 508046/03	09.98-09.03	TNK	1 457 43	S 3728 L
Komp.Nr. 508046/04	09.98-09.03	TNK	1 457 43	S 3729 L
Komp.Nr. 508046/08/09	09.98-09.03	TNK	1 457 42	S 9975 L

12,0 | 315 | OM 541.921 <(501)LA>

	09.96-09.03		1 457 42	P 9128 O
Komp.Nr. 508046 /05	09.96-09.03	TNK	1 457 43	S 3730 L
Komp.Nr. 508046 /07/15	09.96-09.03	TNK	F 026 40	S 0094 L
Komp.Nr. 508046 /22				
Komp.Nr. 508046/03	09.96-09.03	TNK	1 457 43	S 3728 L
Komp.Nr. 508046/03/04/23	09.96-09.03	TNK	F 026 40	S 0088 L
Komp.Nr. 508046/04	09.96-09.03	TNK	1 457 43	S 3729 L
Komp.Nr. 508046/08	09.96-09.03	TNK	1 457 42	S 9975 L
	09.96-09.03		1 457 42	N 9655 K
			1 987 43	R 1455⁸ I
		FBF	1 987 43	M 1154 I
		FBF	1 987 43	M 2150 I
			1 457 42	P 9820³ P

Actros 2048

15,9 350 OM 542.925 <(502)LA>				
	09.96-09.03		1 457 42	P 9128 O
Komp.Nr. 508046 /05	09.96-09.03	TNK	1 457 43	S 3730 L
Komp.Nr. 508046 /07/15	09.96-09.03	TNK	F 026 40	S 0094 L
Komp.Nr. 508046 /22				
Komp.Nr. 508046/03	09.96-09.03	TNK	1 457 43	S 3728 L
Komp.Nr. 508046/04	09.96-09.03	TNK	1 457 43	S 3729 L
Komp.Nr. 508046/08	09.96-09.03	TNK	1 457 42	S 9975 L
	09.96-09.03		1 457 42	N 9655 K
			1 987 43	R 1455⁸ I
		FBF	1 987 43	M 1154 I
		FBF	1 987 43	M 2150 I

Actros 2053

12,0 390 OM 542.920 <(501)LA Euro2>				
	09.96-09.03		1 457 42	P 9128 O
Komp.Nr. 508046 /05	09.96-09.03	TNK	1 457 43	S 3730 L
Komp.Nr. 508046 /07/15	09.96-09.03	TNK	F 026 40	S 0094 L
Komp.Nr. 508046 /22				

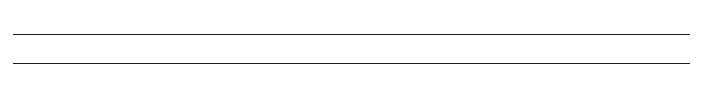
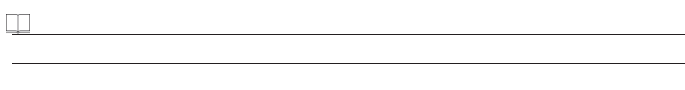



◀ Actros 2053

Komp.Nr. 508046/03	09.96-09.03	TNK	1 457 43	S 3728	L
Komp.Nr. 508046/04	09.96-09.03	TNK	1 457 43	S 3729	L
Komp.Nr. 508046/08	09.96-09.03	TNK	1 457 42	S 9975	L
	09.96-09.03		1 457 42	N 9655	K
			1 987 43	R 1455⁸	I
		FBF	1 987 43	M 1154	I
		FBF	1 987 43	M 2150	I
			1 457 42	P 9820³	P

Actros 2548/ 2648/ 3348/ 4148

16,0 | 350 | OM 542.921 <(502)LA Euro2>

	09.96-09.03		1 457 42	P 9128	O
Komp.Nr. 508046/05	09.96-09.03	TNK	1 457 43	S 3730	L
Komp.Nr. 508046/07/15	09.96-09.03	TNK	F 026 40	S 0094	L
Komp.Nr. 508046/22					
Komp.Nr. 508046/03	09.96-09.03	TNK	1 457 43	S 3728	L
Komp.Nr. 508046/04	09.96-09.03	TNK	1 457 43	S 3729	L
Komp.Nr. 508046/08	09.96-09.03	TNK	1 457 42	S 9975	L
	09.96-09.03		1 457 42	N 9655	K
			1 987 43	R 1455⁸	I
		FBF	1 987 43	M 1154	I
		FBF	1 987 43	M 2150	I
			1 457 42	P 9820³	P

Actros 2640

11,9 | 290 | OM 541.944 <(501)LA Euro2>

Komp.Nr. 508046/05	09.96-09.03	TNK	1 457 43	S 3730	L
Komp.Nr. 508046/01/07	09.96-09.03	TNK	F 026 40	S 0094	L
Komp.Nr. 508046/15					
Komp.Nr. 508046/03	09.96-09.03	TNK	1 457 43	S 3728	L
Komp.Nr. 508046/04	09.96-09.03	TNK	1 457 43	S 3729	L
Komp.Nr. 508046/08/09	09.96-09.03	TNK	1 457 42	S 9975	L

Actros 3340

12,0 | 290 | OM 541.924 <(501)LA Euro 2>

	04.97-09.03		1 457 42	P 9128	O
Komp.Nr. 508046/05	04.97-09.03	TNK	1 457 43	S 3730	L
Komp.Nr. 508046/07/15	04.97-09.03	TNK	F 026 40	S 0094	L
Komp.Nr. 508046/22					
Komp.Nr. 508046/03	04.97-09.03	TNK	1 457 43	S 3728	L
Komp.Nr. 508046/04	04.97-09.03	TNK	1 457 43	S 3729	L
Komp.Nr. 508046/08	04.97-09.03	TNK	1 457 42	S 9975	L
	04.97-09.03		1 457 42	N 9655	K
		FBF	1 987 43	M 2150	I
Komp.Nr. 507615/01	04.97-09.03	TNK	1 987 43	R 1455⁸	I
Komp.Nr. 507627/02/03/04					
Komp.Nr. 507677/02	04.97-09.03	FBF,TNK	1 987 43	M 1154	I
	04.97-09.03		1 457 42	P 9820³	P

Actros 4148

15,9 | 350 | OM 542.925 <(502)LA Euro2>

	04.97-09.03		1 457 42	P 9128	O
Komp.Nr. 508046/05	04.97-09.03	TNK	1 457 43	S 3730	L
Komp.Nr. 508046/07/15	04.97-09.03	TNK	F 026 40	S 0094	L
Komp.Nr. 508046/22					
Komp.Nr. 508046/03	04.97-09.03	TNK	1 457 43	S 3728	L
Komp.Nr. 508046/04	04.97-09.03	TNK	1 457 43	S 3729	L
Komp.Nr. 508046/08	04.97-09.03	TNK	1 457 42	S 9975	L



	04.97-09.03		1 457 42	N 9655	K
			1 987 43	R 1455⁸	I
		FBF	1 987 43	M 1154	I
		FBF	1 987 43	M 2150	I
			1 457 42	P 9820³	P

Actros II

Actros II 1832

12,0 | 235 | OM 541.940 <501 LA Euro3>

	04.03-12.08	OMZ	1 457 42	P 9128	O
Fg.Nr. →..K 871496	04.03-12.08	TNK	1 457 42	S 9975	L
Komp.Nr. 508046/08/09					
Komp.Nr. 508046/03	04.03-12.08	TNK	1 457 43	S 3728	L
Fg.Nr. →..K 823576					
Komp.Nr. 508046/04	04.03-12.08	TNK	1 457 43	S 3729	L
Fg.Nr. →..K 823576					
Komp.Nr. 508046/05	04.03-12.08	TNK	1 457 43	S 3730	L
Komp.Nr. 508046/07/15	04.03-12.08	TNK	F 026 40	S 0094	L
Komp.Nr. 508046/22					
Komp.Nr. 508046/08/09	04.03-12.08	TNK	F 026 40	S 0064	L
Fg.Nr. K 871497→					
Komp.Nr. 508046/17/18	04.03-12.08	TNK	F 026 40	S 0064	L
Komp.Nr. 508046/20/21					
Komp.Nr. 508046/03/04	04.03-12.08	TNK	F 026 40	S 0088	L
Fg.Nr. ...K 823577→					
Komp.Nr. 508046/04	04.03-12.08	TNK	F 026 40	S 0088	L
	04.03-12.08	WAS	1 457 42	N 9655	K
			1 987 43	R 1454⁸	I
		FBF	1 987 43	M 1154	I
		FBF	1 987 43	M 2150	I

12,0 | 235 | OM 541.970 <501 LA Euro4/5>

	02.05-12.08	OMZ	1 457 42	P 9128	O
Komp.Nr. 508046/03	02.05-12.08	TNK	1 457 43	S 3728	L
Fg.Nr. →..K 823576					
Komp.Nr. 508046/03/04	02.05-12.08	TNK	F 026 40	S 0088	L
Fg.Nr. ...K 823577→					
Komp.Nr. 508046/04	02.05-12.08	TNK	1 457 43	S 3729	L
Fg.Nr. →..K 823576					
Komp.Nr. 508046/05	02.05-12.08	TNK	1 457 43	S 3730	L
Komp.Nr. 508046/08/09	02.05-12.08	TNK	F 026 40	S 0064	L
Fg.Nr. K 871497→					
Komp.Nr. 508046/08/09	02.05-12.08	TNK	1 457 42	S 9975	L
Fg.Nr. →K 871496					
Komp.Nr. 508046/20	02.05-12.08	TNK	F 026 40	S 0064	L
Komp.Nr. 508046/07/15	02.05-12.08	TNK	F 026 40	S 0094	L
Komp.Nr. 508046/22					
Komp.Nr. 508046/14	02.05-12.08	TNK	1 457 43	S 3901	L
	02.05-12.08	WAS	1 457 42	N 9655	K
			1 987 43	R 1454⁸	I
		FBF	1 987 43	M 1154	I
		FBF	1 987 43	M 2150	I

Actros II 1836

12,0 | 265 | OM 541.972 <501 LA Euro4/5>

	02.05-12.08	OMZ	1 457 42	P 9128	O
Komp.Nr. 508046/03	02.05-12.08	TNK	1 457 43	S 3728	L
Fg.Nr. →..K 823576					
Komp.Nr. 508046/03/04	02.05-12.08	TNK	F 026 40	S 0088	L
Fg.Nr. ...K 823577→					



Komp.Nr. 508046/04	02.05-12.08	TNK	1 457 43	S 3729	L
Fg.Nr. →..K 823576					
Komp.Nr. 508046/05	02.05-12.08	TNK	1 457 43	S 3730	L
Komp.Nr. 508046/07/15	02.05-12.08	TNK	F 026 40	S 0094	L
Komp.Nr. 508046/22					
Komp.Nr. 508046/08/09	02.05-12.08	TNK	F 026 40	S 0064	L
Fg.Nr. K 871497→					
Komp.Nr. 508046/08/09	02.05-12.08	TNK	1 457 42	S 9975	L
Fg.Nr. →K 871496					
Komp.Nr. 508046/17/18	02.05-12.08	TNK	F 026 40	S 0064	L
Komp.Nr. 508046/20/21					
	02.05-12.08	WAS	1 457 42	N 9655	K
				1 987 43	R 1454⁸
		FBF	1 987 43	M 1154	I
		FBF	1 987 43	M 2150	I

Actros II 1836/ 2536/ 2636

12,0 265 OM 541.942 <501 LA Euro3>					
	04.03-12.08	OMZ	1 457 42	P 9128	O
Komp.Nr. 508046/03	04.03-12.08	TNK	1 457 43	S 3728	L
Fg.Nr. →..K 823576					
Komp.Nr. 508046/04	04.03-12.08	TNK	1 457 43	S 3729	L
Fg.Nr. →..K 823576					
Komp.Nr. 508046/05	04.03-12.08	TNK	1 457 43	S 3730	L
Komp.Nr. 508046/07/15	04.03-12.08	TNK	F 026 40	S 0094	L
Komp.Nr. 508046/22					
Komp.Nr. 508046/08/09	04.03-12.08	TNK	F 026 40	S 0064	L
Fg.Nr. K 871497→					
Komp.Nr. 508046/08/09	04.03-12.08	TNK	1 457 42	S 9975	L
Fg.Nr. →K 871496					
Komp.Nr. 508046/17/18	04.03-12.08	TNK	F 026 40	S 0064	L
Komp.Nr. 508046/20/21					
Komp.Nr. 508046/03/04	04.03-12.08	TNK	F 026 40	S 0088	L
Fg.Nr. ...K 823577→					
Komp.Nr. 508046/04	04.03-12.08	TNK	F 026 40	S 0088	L
	04.03-12.08	WAS	1 457 42	N 9655	K
				1 987 43	R 1454⁸
		FBF	1 987 43	M 1154	I
		FBF	1 987 43	M 2150	I

Actros II 1841

12,0 300 OM 541.974 <501 LA Euro4/5>					
	02.05-12.08	OMZ	1 457 42	P 9128	O
Komp.Nr. 508046/03	02.05-12.08	TNK	1 457 43	S 3728	L
Fg.Nr. →..K 823576					
Komp.Nr. 508046/03/04	02.05-12.08	TNK	F 026 40	S 0088	L
Fg.Nr. ...K 823577→					
Komp.Nr. 508046/04	02.05-12.08	TNK	1 457 43	S 3729	L
Fg.Nr. →..K 823576					
Komp.Nr. 508046/05	02.05-12.08	TNK	1 457 43	S 3730	L
Komp.Nr. 508046/08/09	02.05-12.08	TNK	F 026 40	S 0064	L
Fg.Nr. K 871497→					
Komp.Nr. 508046/08/09	02.05-12.08	TNK	1 457 42	S 9975	L
Fg.Nr. →K 871496					
Komp.Nr. 508046/17/18	02.05-12.08	TNK	F 026 40	S 0064	L
Komp.Nr. 508046/20/21					
Komp.Nr. 508046/07/15	02.05-12.08	TNK	F 026 40	S 0094	L
Komp.Nr. 508046/22					
Komp.Nr. 508046/14	02.05-12.08	TNK	1 457 43	S 3901	L

	02.05-12.08	WAS	1 457 42	N 9655	K
				1 987 43	R 1454⁸
		FBF	1 987 43	M 1154	I
		FBF	1 987 43	M 2150	I

Actros II 1841/ 2041/ 2541/ 2641

12,0 300 OM 541.944 <501 LA Euro3>					
	04.03-12.08	OMZ	1 457 42	P 9128	O
Komp.Nr. 508046/03	04.03-12.08	TNK	1 457 43	S 3728	L
Fg.Nr. →..K 823576					
Komp.Nr. 508046/05	04.03-12.08	TNK	1 457 43	S 3730	L
Komp.Nr. 508046/07/15	04.03-12.08	TNK	F 026 40	S 0094	L
Komp.Nr. 508046/22					
Komp.Nr. 508046/08/09	04.03-12.08	TNK	F 026 40	S 0064	L
Fg.Nr. K 871497→					
Komp.Nr. 508046/08/09	04.03-12.08	TNK	1 457 42	S 9975	L
Fg.Nr. →K 871496					
Komp.Nr. 508046/17/18	04.03-12.08	TNK	F 026 40	S 0064	L
Komp.Nr. 508046/20/21					
Komp.Nr. 508046/03/04	04.03-12.08	TNK	F 026 40	S 0088	L
Fg.Nr. ...K 823577→					
	04.03-12.08	WAS	1 457 42	N 9655	K
				1 987 43	R 1454⁸
		FBF	1 987 43	M 1154	I
		FBF	1 987 43	M 2150	I

Actros II 1844

12,0 320 OM 541.976 <501 LA Euro4/5>					
	02.05-12.08	OMZ	1 457 42	P 9128	O
Komp.Nr. 508046/03	02.05-12.08	TNK	1 457 43	S 3728	L
Fg.Nr. →..K 823576					
Komp.Nr. 508046/03/04	02.05-12.08	TNK	F 026 40	S 0088	L
Fg.Nr. ...K 823577→					
Komp.Nr. 508046/04	02.05-12.08	TNK	1 457 43	S 3729	L
Fg.Nr. →..K 823576					
Komp.Nr. 508046/05	02.05-12.08	TNK	1 457 43	S 3730	L
Komp.Nr. 508046/08/09	02.05-12.08	TNK	F 026 40	S 0064	L
Fg.Nr. K 871497→					
Komp.Nr. 508046/08/09	02.05-12.08	TNK	1 457 42	S 9975	L
Fg.Nr. →K 871496					
Komp.Nr. 508046/17/18	02.05-12.08	TNK	F 026 40	S 0064	L
Komp.Nr. 508046/20/21					
Komp.Nr. 508046/07/15	02.05-12.08	TNK	F 026 40	S 0094	L
Komp.Nr. 508046/22					
	02.05-12.08	WAS	1 457 42	N 9655	K
				1 987 43	R 1454⁸
		FBF	1 987 43	M 1154	I
		FBF	1 987 43	M 2150	I

Actros II 1844/ 2544/ 2644/ 3344/ 4144

12,0 320 OM 541.946 <501 LA Euro3>					
	04.03-12.08	OMZ	1 457 42	P 9128	O
Komp.Nr. 508046/03/04	04.03-12.08	TNK	F 026 40	S 0088	L
Fg.Nr. ...K 823577→					
Komp.Nr. 508046/05	04.03-12.08	TNK	1 457 43	S 3730	L
Komp.Nr. 508046/07/15	04.03-12.08	TNK	F 026 40	S 0094	L
Komp.Nr. 508046/22					
Komp.Nr. 508046/08/09	04.03-12.08	TNK	F 026 40	S 0064	L
Fg.Nr. K 871497→					





◀ Actros II 1844/ 2544/ 2644/ 3344/ 4144

Komp.Nr. 508046/08/09	04.03-12.08	TNK	1 457 42	S 9975	L
Fg.Nr. →K 871496					
Komp.Nr. 508046/17/18	04.03-12.08	TNK	F 026 40	S 0064	L
Komp.Nr. 508046/20/21					
Komp.Nr. 508046/03	04.03-12.08	TNK	1 457 43	S 3728	L
Komp.Nr. 508046/04	04.03-12.08	TNK	F 026 40	S 0088	L
			1 457 43	S 3729	L
	04.03-12.08	WAS	1 457 42	N 9655	K
			1 987 43	R 1454⁸	I
		FBF	1 987 43	M 1154	I
		FBF	1 987 43	M 2150	I

Actros II 1846

12,0 | 335 | OM 541.980 <501 LA Euro4/5>

	02.05-12.08	OMZ	1 457 42	P 9128	O
Komp.Nr. 508046/03	02.05-12.08	TNK	1 457 43	S 3728	L
Fg.Nr. →.K 823576					
Komp.Nr. 508046/04	02.05-12.08	TNK	1 457 43	S 3729	L
Fg.Nr. →.K 823576					
Komp.Nr. 508046/05	02.05-12.08	TNK	1 457 43	S 3730	L
Komp.Nr. 508046/08/09	02.05-12.08	TNK	F 026 40	S 0064	L
Fg.Nr. K 871497→					
Komp.Nr. 508046/08/09	02.05-12.08	TNK	1 457 42	S 9975	L
Fg.Nr. →K 871496					
Komp.Nr. 508046/17/18	02.05-12.08	TNK	F 026 40	S 0064	L
Komp.Nr. 508046/20/21					
Komp.Nr. 508046/03/04	02.05-12.08	TNK	F 026 40	S 0088	L
Fg.Nr. →.K 823577→					
Komp.Nr. 508046/07/15	02.05-12.08	TNK	F 026 40	S 0094	L
Komp.Nr. 508046/22					
	02.05-12.08	WAS	1 457 42	N 9655	K
			1 987 43	R 1454⁸	I
		FBF	1 987 43	M 1154	I
		FBF	1 987 43	M 2150	I

Actros II 1846/ 2046/ 2546/ 2646/ 3246

12,0 | 335 | OM 541.948 <501 LA Euro3>

	04.03-12.08	OMZ	1 457 42	P 9128	O
Komp.Nr. 508046/03	04.03-12.08	TNK	1 457 43	S 3728	L
Fg.Nr. →.K 823576					
Komp.Nr. 508046/04	04.03-12.08	TNK	1 457 43	S 3729	L
Fg.Nr. →.K 823576					
Komp.Nr. 508046/05	04.03-12.08	TNK	1 457 43	S 3730	L
Komp.Nr. 508046/07/15	04.03-12.08	TNK	F 026 40	S 0094	L
Komp.Nr. 508046/22					
Komp.Nr. 508046/08/09	04.03-12.08	TNK	F 026 40	S 0064	L
Fg.Nr. K 871497→					
Komp.Nr. 508046/08/09	04.03-12.08	TNK	1 457 42	S 9975	L
Fg.Nr. →K 871496					
Komp.Nr. 508046/17/18	04.03-12.08	TNK	F 026 40	S 0064	L
Komp.Nr. 508046/20/21					
Komp.Nr. 508046/03/04	04.03-12.08	TNK	F 026 40	S 0088	L
Fg.Nr. →.K 823577→					
	04.03-12.08	WAS	1 457 42	N 9655	K
			1 987 43	R 1454⁸	I
		FBF	1 987 43	M 1154	I
		FBF	1 987 43	M 2150	I

Actros II 1848/ 2048/ 2548/ 2648

12,0 | 350 | OM 541.978 <501 LA Euro4/5>

	02.05-12.08	OMZ	1 457 42	P 9128	O
--	-------------	-----	----------	---------------	----------



Komp.Nr. 508046/03	02.05-12.08	TNK	1 457 43	S 3728	L
Fg.Nr. →.K 823576					
Komp.Nr. 508046/03/04	02.05-12.08	TNK	F 026 40	S 0088	L
Fg.Nr. →.K 823577→					
Komp.Nr. 508046/04	02.05-12.08	TNK	1 457 43	S 3729	L
Fg.Nr. →.K 823576					
Komp.Nr. 508046/05	02.05-12.08	TNK	1 457 43	S 3730	L
Komp.Nr. 508046/08/09	02.05-12.08	TNK	F 026 40	S 0064	L
Fg.Nr. K 871497→					
Komp.Nr. 508046/08/09	02.05-12.08	TNK	1 457 42	S 9975	L
Fg.Nr. →K 871496					
Komp.Nr. 508046/17/18	02.05-12.08	TNK	F 026 40	S 0064	L
Komp.Nr. 508046/20/21					
Komp.Nr. 508046/07/15	02.05-12.08	TNK	F 026 40	S 0094	L
Komp.Nr. 508046/22					
	02.05-12.08	WAS	1 457 42	N 9655	K
			1 987 43	R 1454⁸	I
		FBF	1 987 43	M 1154	I
		FBF	1 987 43	M 2150	I

Actros II 1850

15,9 | 370 | OM 542.940 <502 LA Euro3>

	04.03-12.08	OMZ	1 457 42	P 9128	O
Komp.Nr. 508046/03	04.03-12.08	TNK	1 457 43	S 3728	L
Fg.Nr. →.K 823576					
Komp.Nr. 508046/03/04	04.03-12.08	TNK	F 026 40	S 0088	L
Fg.Nr. →.K 823577→					
Komp.Nr. 508046/04	04.03-12.08	TNK	1 457 43	S 3729	L
Fg.Nr. →.K 823576					
Komp.Nr. 508046/05	04.03-12.08	TNK	1 457 43	S 3730	L
Komp.Nr. 508046/07/15	04.03-12.08	TNK	F 026 40	S 0094	L
Komp.Nr. 508046/22					
Komp.Nr. 508046/08/09	04.03-12.08	TNK	F 026 40	S 0064	L
Fg.Nr. K 871497→					
Komp.Nr. 508046/08/09	04.03-12.08	TNK	1 457 42	S 9975	L
Fg.Nr. →K 871496					
Komp.Nr. 508046/17/18	04.03-12.08	TNK	F 026 40	S 0064	L
Komp.Nr. 508046/20/21					
Komp.Nr. 508046/14	04.03-12.08	TNK	1 457 43	S 3901	L
	04.03-12.08	WAS	1 457 42	N 9655	K
			1 987 43	R 1454⁸	I
		FBF	1 987 43	M 1154	I
		FBF	1 987 43	M 2150	I

Actros II 1851/ 2051/ 2551/ 2651/ 3351

15,9 | 375 | OM 542.960 <502 LA Euro4/5>

	02.05-12.08	OMZ	1 457 42	P 9128	O
Komp.Nr. 508046/03	02.05-12.08	TNK	1 457 43	S 3728	L
Fg.Nr. →.K 823576					
Komp.Nr. 508046/04	02.05-12.08	TNK	1 457 43	S 3729	L
Fg.Nr. →.K 823576					
Komp.Nr. 508046/05	02.05-12.08	TNK	1 457 43	S 3730	L
Komp.Nr. 508046/08/09	02.05-12.08	TNK	F 026 40	S 0064	L
Fg.Nr. K 871497→					
Komp.Nr. 508046/08/09	02.05-12.08	TNK	1 457 42	S 9975	L
Fg.Nr. →K 871496					
Komp.Nr. 508046/17/18	02.05-12.08	TNK	F 026 40	S 0064	L
Komp.Nr. 508046/20/21					
Komp.Nr. 508046/03/04	02.05-12.08	TNK	F 026 40	S 0088	L
Fg.Nr. →.K 823577→					
Komp.Nr. 508046/07/15	02.05-12.08	TNK	F 026 40	S 0094	L
Komp.Nr. 508046/22					



	02.05-12.08	<u>WAS</u>	1 457 42 N 9655	K
			1 987 43 R 1454 ⁸	I
		FBF	1 987 43 M 1154	I
		<u>FBF</u>	1 987 43 M 2150	I

Actros II 1854/ 2054/ 2554/ 2654

15,9 | 395 | OM 542.942 <502 LA Euro3>

	04.03-12.08	<u>OMZ</u>	1 457 42 P 9128	O
Fg.Nr. →.K 871496	04.03-12.08	TNK	1 457 42 S 9975	L
Komp.Nr. 508046/08/09				
Komp.Nr. 508046/03	04.03-12.08	TNK	1 457 43 S 3728	L
Fg.Nr. →.K 823576				
Komp.Nr. 508046/03/04	04.03-12.08	TNK	F 026 40 S 0088	L
Fg.Nr. →.K 823577→				
Komp.Nr. 508046/04	04.03-12.08	TNK	1 457 43 S 3729	L
Fg.Nr. →.K 823576				
Komp.Nr. 508046/05	04.03-12.08	TNK	1 457 43 S 3730	L
Komp.Nr. 508046/07/15	04.03-12.08	TNK	F 026 40 S 0094	L
Komp.Nr. 508046/22				
Komp.Nr. 508046/08/09	04.03-12.08	TNK	F 026 40 S 0064	L
Fg.Nr. K 871497→				
Komp.Nr. 508046/17/18	04.03-12.08	TNK	F 026 40 S 0064	L
Komp.Nr. 508046/20/21				
	04.03-12.08	<u>WAS</u>	1 457 42 N 9655	K
			1 987 43 R 1454 ⁸	I
		FBF	1 987 43 M 1154	I
		<u>FBF</u>	1 987 43 M 2150	I

Actros II 1855

15,9 | 405 | OM 542.962 <502 LA Euro4/5>

	07.05-12.08	<u>OMZ</u>	1 457 42 P 9128	O
Komp.Nr. 508046/03	07.05-12.08	TNK	1 457 43 S 3728	L
Fg.Nr. →.K 823576				
Komp.Nr. 508046/03/04	07.05-12.08	TNK	F 026 40 S 0088	L
Fg.Nr. →.K 823577→				
Komp.Nr. 508046/04	07.05-12.08	TNK	1 457 43 S 3729	L
Fg.Nr. →.K 823576				
Komp.Nr. 508046/05	07.05-12.08	TNK	1 457 43 S 3730	L
Komp.Nr. 508046/08/09	07.05-12.08	TNK	F 026 40 S 0064	L
Fg.Nr. K 871497→				
Komp.Nr. 508046/08/09	07.05-12.08	TNK	1 457 42 S 9975	L
Fg.Nr. →K 871496				
Komp.Nr. 508046/17/18	07.05-12.08	TNK	F 026 40 S 0064	L
Komp.Nr. 508046/20/21				
Komp.Nr. 508046/07/15	07.05-12.08	TNK	F 026 40 S 0094	L
Komp.Nr. 508046/22				
Komp.Nr. 508046/14	07.05-12.08	TNK	1 457 43 S 3901	L
	07.05-12.08	<u>WAS</u>	1 457 42 N 9655	K
			1 987 43 R 1454 ⁸	I
		FBF	1 987 43 M 1154	I
		<u>FBF</u>	1 987 43 M 2150	I

Actros II 1858

15,9 | 425 | OM 542.944 <502 LA Euro3>

	04.03-12.08	<u>OMZ</u>	1 457 42 P 9128	O
Komp.Nr. 508046/03	04.03-12.08	TNK	1 457 43 S 3728	L
Fg.Nr. →.K 823576				
Komp.Nr. 508046/03/04	04.03-12.08	TNK	F 026 40 S 0088	L
Fg.Nr. →.K 823577→				



Komp.Nr. 508046/04	04.03-12.08	TNK	1 457 43 S 3729	L
Fg.Nr. →.K 823576				
Komp.Nr. 508046/05	04.03-12.08	TNK	1 457 43 S 3730	L
Komp.Nr. 508046/07/15	04.03-12.08	TNK	F 026 40 S 0094	L
Komp.Nr. 508046/22				
Komp.Nr. 508046/08/09	04.03-12.08	TNK	F 026 40 S 0064	L
Fg.Nr. K 871497→				
Komp.Nr. 508046/08/09	04.03-12.08	TNK	1 457 42 S 9975	L
Fg.Nr. →K 871496				
Komp.Nr. 508046/17/18	04.03-12.08	TNK	F 026 40 S 0064	L
Komp.Nr. 508046/20/21				
Komp.Nr. 508046/14	04.03-12.08	TNK	1 457 43 S 3901	L
	04.03-12.08	<u>WAS</u>	1 457 42 N 9655	K
			1 987 43 R 1454 ⁸	I
		FBF	1 987 43 M 1154	I
		<u>FBF</u>	1 987 43 M 2150	I

Actros II 1860

15,9 | 440 | OM 542.964 <502 LA Euro4/5>

	07.05-12.08	<u>OMZ</u>	1 457 42 P 9128	O
Fg.Nr. →.K 871496	07.05-12.08	TNK	1 457 42 S 9975	L
Komp.Nr. 508046/08/09				
Komp.Nr. 508046/03	07.05-12.08	TNK	1 457 43 S 3728	L
Fg.Nr. →.K 823576				
Komp.Nr. 508046/03/04	07.05-12.08	TNK	F 026 40 S 0088	L
Fg.Nr. →.K 823577→				
Komp.Nr. 508046/04	07.05-12.08	TNK	1 457 43 S 3729	L
Fg.Nr. →.K 823576				
Komp.Nr. 508046/05	07.05-12.08	TNK	1 457 43 S 3730	L
Komp.Nr. 508046/08/09	07.05-12.08	TNK	F 026 40 S 0064	L
Fg.Nr. K 871497→				
Komp.Nr. 508046/17/18	07.05-12.08	TNK	F 026 40 S 0064	L
Komp.Nr. 508046/20/21				
Komp.Nr. 508046/07/15	07.05-12.08	TNK	F 026 40 S 0094	L
Komp.Nr. 508046/22				
Komp.Nr. 508046/14	07.05-12.08	TNK	1 457 43 S 3901	L
	07.05-12.08	<u>WAS</u>	1 457 42 N 9655	K
			1 987 43 R 1454 ⁸	I
		FBF	1 987 43 M 1154	I
		<u>FBF</u>	1 987 43 M 2150	I

Actros II 1861

15,9 | 450 | OM 542.958 <502 LA Euro3>

	09.04-12.08	<u>OMZ</u>	1 457 42 P 9128	O
			F 026 40 S 0088	L
		<u>WAS</u>	1 457 42 N 9655	K
			1 987 43 R 1454 ⁸	I
		FBF	1 987 43 M 1154	I
		<u>FBF</u>	1 987 43 M 2150	I

Actros II 2032

12,0 | 235 | OM 541.940,941 <501 LA Euro3>

	04.03-12.08	<u>OMZ</u>	1 457 42 P 9128	O
Fg.Nr. →.K 871496	04.03-12.08	TNK	1 457 42 S 9975	L
Komp.Nr. 508046/08/09				
Komp.Nr. 508046/03	04.03-12.08	TNK	1 457 43 S 3728	L
Fg.Nr. →.K 823576				
Komp.Nr. 508046/04	04.03-12.08	TNK	1 457 43 S 3729	L
Fg.Nr. →.K 823576				





◀ Actros II 2032

Komp.Nr. 508046/05	04.03-12.08	TNK	1 457 43 S 3730	L
Komp.Nr. 508046/07/15	04.03-12.08	TNK	F 026 40 S 0094	L
Komp.Nr. 508046/22				
Komp.Nr. 508046/08/09	04.03-12.08	TNK	F 026 40 S 0064	L
Fg.Nr. K 871497→				
Komp.Nr. 508046/17/18	04.03-12.08	TNK	F 026 40 S 0064	L
Komp.Nr. 508046/20/21				
Komp.Nr. 508046/03/04	04.03-12.08	TNK	F 026 40 S 0088	L
Fg.Nr. ...K 823577→				
Komp.Nr. 508046/04	04.03-12.08	TNK	F 026 40 S 0088	L
	04.03-12.08	WAS	1 457 42 N 9655	K
			1 987 43 R 1454 ⁸	I
		FBF	1 987 43 M 1154	I
		FBF	1 987 43 M 2150	I

12,0 | 235 | OM 541.970 <501 LA Euro4/5>

	02.05-12.08	OMZ	1 457 42 P 9128	O
Komp.Nr. 508046/03	02.05-12.08	TNK	1 457 43 S 3728	L
Fg.Nr. →...K 823576				
Komp.Nr. 508046/04	02.05-12.08	TNK	1 457 43 S 3729	L
Fg.Nr. →...K 823576				
Komp.Nr. 508046/05	02.05-12.08	TNK	1 457 43 S 3730	L
Komp.Nr. 508046/07/15	02.05-12.08	TNK	F 026 40 S 0094	L
Komp.Nr. 508046/22				
Komp.Nr. 508046/08/09	02.05-12.08	TNK	F 026 40 S 0064	L
Fg.Nr. K 871497→				
Komp.Nr. 508046/08/09	02.05-12.08	TNK	1 457 42 S 9975	L
Fg.Nr. →K 871496				
Komp.Nr. 508046/17/18	02.05-12.08	TNK	F 026 40 S 0064	L
Komp.Nr. 508046/20/21				
Komp.Nr. 508046/03/04	02.05-12.08	TNK	F 026 40 S 0088	L
Fg.Nr. ...K 823577→				
	02.05-12.08	WAS	1 457 42 N 9655	K
			1 987 43 R 1454 ⁸	I
		FBF	1 987 43 M 1154	I
		FBF	1 987 43 M 2150	I

Actros II 2036

12,0 | 265 | OM 541.9... <501 LA Euro3>

	04.03-12.08	OMZ	1 457 42 P 9128	O
Komp.Nr. 508046/03	04.03-12.08	TNK	1 457 43 S 3728	L
Fg.Nr. →...K 823576				
Komp.Nr. 508046/04	04.03-12.08	TNK	1 457 43 S 3729	L
Fg.Nr. →...K 823576				
Komp.Nr. 508046/05	04.03-12.08	TNK	1 457 43 S 3730	L
Komp.Nr. 508046/07/15	04.03-12.08	TNK	F 026 40 S 0094	L
Komp.Nr. 508046/22				
Komp.Nr. 508046/08/09	04.03-12.08	TNK	F 026 40 S 0064	L
Fg.Nr. K 871497→				
Komp.Nr. 508046/08/09	04.03-12.08	TNK	1 457 42 S 9975	L
Fg.Nr. →K 871496				
Komp.Nr. 508046/17/18	04.03-12.08	TNK	F 026 40 S 0064	L
Komp.Nr. 508046/20/21				
Komp.Nr. 508046/03/04	04.03-12.08	TNK	F 026 40 S 0088	L
Fg.Nr. ...K 823577→				
Komp.Nr. 508046/04	04.03-12.08	TNK	F 026 40 S 0088	L
	04.03-12.08	WAS	1 457 42 N 9655	K
			1 987 43 R 1454 ⁸	I
		FBF	1 987 43 M 1154	I
		FBF	1 987 43 M 2150	I

12,0 | 265 | OM 541.972 <501 LA Euro4/5>

	02.05-12.08	OMZ	1 457 42 P 9128	O
--	-------------	-----	-----------------	---



Komp.Nr. 508046/03	02.05-12.08	TNK	1 457 43 S 3728	L
Fg.Nr. →...K 823576				
Komp.Nr. 508046/04	02.05-12.08	TNK	1 457 43 S 3729	L
Fg.Nr. →...K 823576				
Komp.Nr. 508046/05	02.05-12.08	TNK	1 457 43 S 3730	L
Komp.Nr. 508046/07/15	02.05-12.08	TNK	F 026 40 S 0094	L
Komp.Nr. 508046/22				
Komp.Nr. 508046/08/09	02.05-12.08	TNK	F 026 40 S 0064	L
Fg.Nr. K 871497→				
Komp.Nr. 508046/08/09	02.05-12.08	TNK	1 457 42 S 9975	L
Fg.Nr. →K 871496				
Komp.Nr. 508046/17/18	02.05-12.08	TNK	F 026 40 S 0064	L
Komp.Nr. 508046/20/21				
Komp.Nr. 508046/03/04	02.05-12.08	TNK	F 026 40 S 0088	L
Fg.Nr. ...K 823577→				
	02.05-12.08	WAS	1 457 42 N 9655	K
			1 987 43 R 1454 ⁸	I
		FBF	1 987 43 M 1154	I
		FBF	1 987 43 M 2150	I

Actros II 2041

12,0 | 300 | OM 541.974 <501 LA Euro4/5>

	02.05-12.08	OMZ	1 457 42 P 9128	O
Komp.Nr. 508046/03	02.05-12.08	TNK	1 457 43 S 3728	L
Fg.Nr. →...K 823576				
Komp.Nr. 508046/04	02.05-12.08	TNK	1 457 43 S 3729	L
Fg.Nr. →...K 823576				
Komp.Nr. 508046/05	02.05-12.08	TNK	1 457 43 S 3730	L
Komp.Nr. 508046/07/15	02.05-12.08	TNK	F 026 40 S 0094	L
Komp.Nr. 508046/22				
Komp.Nr. 508046/08/09	02.05-12.08	TNK	F 026 40 S 0064	L
Fg.Nr. K 871497→				
Komp.Nr. 508046/08/09	02.05-12.08	TNK	1 457 42 S 9975	L
Fg.Nr. →K 871496				
Komp.Nr. 508046/17/18	02.05-12.08	TNK	F 026 40 S 0064	L
Komp.Nr. 508046/20/21				
Komp.Nr. 508046/03/04	02.05-12.08	TNK	F 026 40 S 0088	L
Fg.Nr. ...K 823577→				
	02.05-12.08	WAS	1 457 42 N 9655	K
			1 987 43 R 1454 ⁸	I
		FBF	1 987 43 M 1154	I
		FBF	1 987 43 M 2150	I

Actros II 2044

12,0 | 320 | OM 541.9... <501 LA Euro3>

	04.03-12.08	OMZ	1 457 42 P 9128	O
Komp.Nr. 508046/03/04	04.03-12.08	TNK	F 026 40 S 0088	L
Fg.Nr. ...K 823577→				
Komp.Nr. 508046/05	04.03-12.08	TNK	1 457 43 S 3730	L
Komp.Nr. 508046/07/15	04.03-12.08	TNK	F 026 40 S 0094	L
Komp.Nr. 508046/22				
Komp.Nr. 508046/08/09	04.03-12.08	TNK	F 026 40 S 0064	L
Fg.Nr. K 871497→				
Komp.Nr. 508046/08/09	04.03-12.08	TNK	1 457 42 S 9975	L
Fg.Nr. →K 871496				
Komp.Nr. 508046/17/18	04.03-12.08	TNK	F 026 40 S 0064	L
Komp.Nr. 508046/20/21				
Komp.Nr. 508046/03	04.03-12.08	TNK	1 457 43 S 3728	L
Komp.Nr. 508046/04	04.03-12.08	TNK	F 026 40 S 0088	L
			1 457 43 S 3729	L



	04.03-12.08	<u>WAS</u>	1 457 42	N 9655	K
			1 987 43	R 1454⁸	I
		FBF	1 987 43	M 1154	I
		<u>FBF</u>	1 987 43	M 2150	I

12,0 | 320 | OM 541.976 <501 LA Euro4/5>

	02.05-12.08	<u>OMZ</u>	1 457 42	P 9128	O
Komp.Nr. 508046/03	02.05-12.08	TNK	1 457 43	S 3728	L
Fg.Nr. →..K 823576					
Komp.Nr. 508046/04	02.05-12.08	TNK	1 457 43	S 3729	L
Fg.Nr. →..K 823576					
Komp.Nr. 508046/05	02.05-12.08	TNK	1 457 43	S 3730	L
Komp.Nr. 508046/07/15	02.05-12.08	TNK	F 026 40	S 0094	L
Komp.Nr. 508046/22					
Komp.Nr. 508046/08/09	02.05-12.08	TNK	F 026 40	S 0064	L
Fg.Nr. K 871497→					
Komp.Nr. 508046/08/09	02.05-12.08	TNK	1 457 42	S 9975	L
Fg.Nr. →K 871496					
Komp.Nr. 508046/17/18	02.05-12.08	TNK	F 026 40	S 0064	L
Komp.Nr. 508046/20/21					
Komp.Nr. 508046/03/04	02.05-12.08	TNK	F 026 40	S 0088	L
Fg.Nr. →..K 823577→					
	02.05-12.08	<u>WAS</u>	1 457 42	N 9655	K
			1 987 43	R 1454⁸	I
		FBF	1 987 43	M 1154	I
		<u>FBF</u>	1 987 43	M 2150	I

Actros II 2046

12,0 | 335 | OM 541.980 <501 LA Euro4/5>

	02.05-12.08	<u>OMZ</u>	1 457 42	P 9128	O
Komp.Nr. 508046/03	02.05-12.08	TNK	1 457 43	S 3728	L
Fg.Nr. →..K 823576					
Komp.Nr. 508046/04	02.05-12.08	TNK	1 457 43	S 3729	L
Fg.Nr. →..K 823576					
Komp.Nr. 508046/05	02.05-12.08	TNK	1 457 43	S 3730	L
Komp.Nr. 508046/07/15	02.05-12.08	TNK	F 026 40	S 0094	L
Komp.Nr. 508046/22					
Komp.Nr. 508046/08/09	02.05-12.08	TNK	F 026 40	S 0064	L
Fg.Nr. K 871497→					
Komp.Nr. 508046/08/09	02.05-12.08	TNK	1 457 42	S 9975	L
Fg.Nr. →K 871496					
Komp.Nr. 508046/17/18	02.05-12.08	TNK	F 026 40	S 0064	L
Komp.Nr. 508046/20/21					
Komp.Nr. 508046/03/04	02.05-12.08	TNK	F 026 40	S 0088	L
Fg.Nr. →..K 823577→					
	02.05-12.08	<u>WAS</u>	1 457 42	N 9655	K
			1 987 43	R 1454⁸	I
		FBF	1 987 43	M 1154	I
		<u>FBF</u>	1 987 43	M 2150	I

Actros II 2050

15,9 | 370 | OM 542.940 <502 LA Euro3>

	04.03-12.08	<u>OMZ</u>	1 457 42	P 9128	O
Komp.Nr. 508046/03	04.03-12.08	TNK	1 457 43	S 3728	L
Fg.Nr. →..K 823576					
Komp.Nr. 508046/03/04	04.03-12.08	TNK	F 026 40	S 0088	L
Fg.Nr. →..K 823577→					
Komp.Nr. 508046/04	04.03-12.08	TNK	1 457 43	S 3729	L
Fg.Nr. →..K 823576					
Komp.Nr. 508046/05	04.03-12.08	TNK	1 457 43	S 3730	L



Komp.Nr. 508046/07/15	04.03-12.08	TNK	F 026 40	S 0094	L
Komp.Nr. 508046/22					
Komp.Nr. 508046/08/09	04.03-12.08	TNK	F 026 40	S 0064	L
Fg.Nr. K 871497→					
Komp.Nr. 508046/08/09	04.03-12.08	TNK	1 457 42	S 9975	L
Fg.Nr. →K 871496					
Komp.Nr. 508046/17/18	04.03-12.08	TNK	F 026 40	S 0064	L
Komp.Nr. 508046/20/21					
	04.03-12.08	<u>WAS</u>	1 457 42	N 9655	K
			1 987 43	R 1454⁸	I
		FBF	1 987 43	M 1154	I
		<u>FBF</u>	1 987 43	M 2150	I

Actros II 2055

15,9 | 405 | OM 542.962 <502 LA Euro4/5>

	07.05-12.08	<u>OMZ</u>	1 457 42	P 9128	O
Komp.Nr. 508046/03	07.05-12.08	TNK	1 457 43	S 3728	L
Fg.Nr. →..K 823576					
Komp.Nr. 508046/03/04	07.05-12.08	TNK	F 026 40	S 0088	L
Fg.Nr. →..K 823577→					
Komp.Nr. 508046/04	07.05-12.08	TNK	1 457 43	S 3729	L
Fg.Nr. →..K 823576					
Komp.Nr. 508046/05	07.05-12.08	TNK	1 457 43	S 3730	L
Komp.Nr. 508046/08/09	07.05-12.08	TNK	F 026 40	S 0064	L
Fg.Nr. K 871497→					
Komp.Nr. 508046/08/09	07.05-12.08	TNK	1 457 42	S 9975	L
Fg.Nr. →K 871496					
Komp.Nr. 508046/17/18	07.05-12.08	TNK	F 026 40	S 0064	L
Komp.Nr. 508046/20/21					
Komp.Nr. 508046/07/15	07.05-12.08	TNK	F 026 40	S 0094	L
Komp.Nr. 508046/22					
	07.05-12.08	<u>WAS</u>	1 457 42	N 9655	K
			1 987 43	R 1454⁸	I
		FBF	1 987 43	M 1154	I
		<u>FBF</u>	1 987 43	M 2150	I

Actros II 2532

12,0 | 235 | OM 541.970 <501 LA Euro4/5>

	02.05-12.08	<u>OMZ</u>	1 457 42	P 9128	O
Komp.Nr. 508046/03	02.05-12.08	TNK	1 457 43	S 3728	L
Fg.Nr. →..K 823576					
Komp.Nr. 508046/03/04	02.05-12.08	TNK	F 026 40	S 0088	L
Fg.Nr. →..K 823577→					
Komp.Nr. 508046/04	02.05-12.08	TNK	1 457 43	S 3729	L
Fg.Nr. →..K 823576					
Komp.Nr. 508046/05	02.05-12.08	TNK	1 457 43	S 3730	L
Komp.Nr. 508046/08/09	02.05-12.08	TNK	F 026 40	S 0064	L
Fg.Nr. K 871497→					
Komp.Nr. 508046/08/09	02.05-12.08	TNK	1 457 42	S 9975	L
Fg.Nr. →K 871496					
Komp.Nr. 508046/17/18	02.05-12.08	TNK	F 026 40	S 0064	L
Komp.Nr. 508046/20/21					
Komp.Nr. 508046/07/15	02.05-12.08	TNK	F 026 40	S 0094	L
Komp.Nr. 508046/22					
	02.05-12.08	<u>WAS</u>	1 457 42	N 9655	K
			1 987 43	R 1454⁸	I
		FBF	1 987 43	M 1154	I
		<u>FBF</u>	1 987 43	M 2150	I





Actros II 2532/ 2632

12,0 | 235 | OM 541.940 <501 LA Euro3>

	04.03-12.08	OMZ	1 457 42	P 9128	O
Komp.Nr. 508046 /03	04.03-12.08	TNK	1 457 43	S 3728	L
Fg.Nr. →..K 823576					
Komp.Nr. 508046 /04	04.03-12.08	TNK	1 457 43	S 3729	L
Fg.Nr. →..K 823576					
Komp.Nr. 508046 /05	04.03-12.08	TNK	1 457 43	S 3730	L
Komp.Nr. 508046 /07/15	04.03-12.08	TNK	F 026 40	S 0094	L
Komp.Nr. 508046 /22					
Komp.Nr. 508046/03/04	04.03-12.08	TNK	F 026 40	S 0088	L
Fg.Nr. ..K 823577→					
Komp.Nr. 508046/04	04.03-12.08	TNK	F 026 40	S 0088	L
	04.03-12.08	WAS	1 457 42	N 9655	K
				1 987 43	R 1454⁸
		FBF	1 987 43	M 1154	I
		FBF	1 987 43	M 2150	I

Actros II 2536

12,0 | 265 | OM 541.972 <501 LA Euro4/5>

	02.05-12.08	OMZ	1 457 42	P 9128	O
Komp.Nr. 508046 /03	02.05-12.08	TNK	1 457 43	S 3728	L
Fg.Nr. →..K 823576					
Komp.Nr. 508046 /03/04	02.05-12.08	TNK	F 026 40	S 0088	L
Fg.Nr. ..K 823577→					
Komp.Nr. 508046 /04	02.05-12.08	TNK	1 457 43	S 3729	L
Fg.Nr. →..K 823576					
Komp.Nr. 508046 /05	02.05-12.08	TNK	1 457 43	S 3730	L
Komp.Nr. 508046 /07/15	02.05-12.08	TNK	F 026 40	S 0094	L
Komp.Nr. 508046 /22					
Komp.Nr. 508046 /08/09	02.05-12.08	TNK	F 026 40	S 0064	L
Fg.Nr. K 871497→					
Komp.Nr. 508046 /08/09	02.05-12.08	TNK	1 457 42	S 9975	L
Fg.Nr. →K 871496					
Komp.Nr. 508046 /17/18	02.05-12.08	TNK	F 026 40	S 0064	L
Komp.Nr. 508046 /20/21					
	02.05-12.08	WAS	1 457 42	N 9655	K
				1 987 43	R 1454⁸
		FBF	1 987 43	M 1154	I
		FBF	1 987 43	M 2150	I

Actros II 2541

12,0 | 300 | OM 541.974 <501 LA Euro4/5>

	02.05-12.08	OMZ	1 457 42	P 9128	O
Komp.Nr. 508046 /03	02.05-12.08	TNK	1 457 43	S 3728	L
Fg.Nr. →..K 823576					
Komp.Nr. 508046 /04	02.05-12.08	TNK	1 457 43	S 3729	L
Fg.Nr. →..K 823576					
Komp.Nr. 508046 /05	02.05-12.08	TNK	1 457 43	S 3730	L
Komp.Nr. 508046 /08/09	02.05-12.08	TNK	F 026 40	S 0064	L
Fg.Nr. K 871497→					
Komp.Nr. 508046 /08/09	02.05-12.08	TNK	1 457 42	S 9975	L
Fg.Nr. →K 871496					
Komp.Nr. 508046 /17/18	02.05-12.08	TNK	F 026 40	S 0064	L
Komp.Nr. 508046 /20/21					
Komp.Nr. 508046/03/04	02.05-12.08	TNK	F 026 40	S 0088	L
Fg.Nr. ..K 823577→					
Komp.Nr. 508046/07/15	02.05-12.08	TNK	F 026 40	S 0094	L
Komp.Nr. 508046/22					
Komp.Nr. 508046/14	02.05-12.08	TNK	1 457 43	S 3901	L

	02.05-12.08	WAS	1 457 42	N 9655	K
				1 987 43	R 1454⁸
		FBF	1 987 43	M 1154	I
		FBF	1 987 43	M 2150	I

Actros II 2544

12,0 | 320 | OM 541.976 <501 LA Euro4/5>

	02.05-12.08	OMZ	1 457 42	P 9128	O
Komp.Nr. 508046 /03	02.05-12.08	TNK	1 457 43	S 3728	L
Fg.Nr. →..K 823576					
Komp.Nr. 508046 /04	02.05-12.08	TNK	1 457 43	S 3729	L
Fg.Nr. →..K 823576					
Komp.Nr. 508046 /05	02.05-12.08	TNK	1 457 43	S 3730	L
Komp.Nr. 508046 /08/09	02.05-12.08	TNK	F 026 40	S 0064	L
Fg.Nr. K 871497→					
Komp.Nr. 508046 /08/09	02.05-12.08	TNK	1 457 42	S 9975	L
Fg.Nr. →K 871496					
Komp.Nr. 508046 /17/18	02.05-12.08	TNK	F 026 40	S 0064	L
Komp.Nr. 508046 /20/21					
Komp.Nr. 508046/03/04	02.05-12.08	TNK	F 026 40	S 0088	L
Fg.Nr. ..K 823577→					
Komp.Nr. 508046/07/15	02.05-12.08	TNK	F 026 40	S 0094	L
Komp.Nr. 508046/22					

	02.05-12.08	WAS	1 457 42	N 9655	K
				1 987 43	R 1454⁸
		FBF	1 987 43	M 1154	I
		FBF	1 987 43	M 2150	I

Actros II 2546

12,0 | 335 | OM 541.980 <501 LA Euro4/5>

	02.05-12.08	OMZ	1 457 42	P 9128	O
Komp.Nr. 508046 /03	02.05-12.08	TNK	1 457 43	S 3728	L
Fg.Nr. →..K 823576					
Komp.Nr. 508046 /04	02.05-12.08	TNK	1 457 43	S 3729	L
Fg.Nr. →..K 823576					
Komp.Nr. 508046 /05	02.05-12.08	TNK	1 457 43	S 3730	L
Komp.Nr. 508046 /08/09	02.05-12.08	TNK	F 026 40	S 0064	L
Fg.Nr. K 871497→					
Komp.Nr. 508046 /08/09	02.05-12.08	TNK	1 457 42	S 9975	L
Fg.Nr. →K 871496					
Komp.Nr. 508046 /17/18	02.05-12.08	TNK	F 026 40	S 0064	L
Komp.Nr. 508046 /20/21					
Komp.Nr. 508046/03/04	02.05-12.08	TNK	F 026 40	S 0088	L
Fg.Nr. ..K 823577→					
Komp.Nr. 508046/07/15	02.05-12.08	TNK	F 026 40	S 0094	L
Komp.Nr. 508046/22					

	02.05-12.08	WAS	1 457 42	N 9655	K
				1 987 43	R 1454⁸
		FBF	1 987 43	M 1154	I
		FBF	1 987 43	M 2150	I

Actros II 2550

15,9 | 370 | OM 542.940 <502 LA Euro3>

	04.03-12.08	OMZ	1 457 42	P 9128	O
Komp.Nr. 508046 /03	04.03-12.08	TNK	1 457 43	S 3728	L
Fg.Nr. →..K 823576					
Komp.Nr. 508046 /03/04	04.03-12.08	TNK	F 026 40	S 0088	L
Fg.Nr. ..K 823577→					
Komp.Nr. 508046 /04	04.03-12.08	TNK	1 457 43	S 3729	L
Fg.Nr. →..K 823576					
Komp.Nr. 508046 /05	04.03-12.08	TNK	1 457 43	S 3730	L



Komp.Nr. 508046/07/15	04.03-12.08	TNK	F 026 40 S 0094	L
Komp.Nr. 508046/22				
Komp.Nr. 508046/08/09	04.03-12.08	TNK	F 026 40 S 0064	L
Fg.Nr. K 871497→				
Komp.Nr. 508046/08/09	04.03-12.08	TNK	1 457 42 S 9975	L
Fg.Nr. →K 871496				
Komp.Nr. 508046/17/18	04.03-12.08	TNK	F 026 40 S 0064	L
Komp.Nr. 508046/20/21				
Komp.Nr. 508046/14	04.03-12.08	TNK	1 457 43 S 3901	L
	04.03-12.08	WAS	1 457 42 N 9655	K
			1 987 43 R 1454 ⁸	I
		FBF	1 987 43 M 1154	I
		FBF	1 987 43 M 2150	I

Actros II 2555/ 2655/ 3355

15,9 | 405 | OM 542.962 <502 LA Euro4/5>

Komp.Nr. 508046/03	07.05-12.08	OMZ	1 457 42 P 9128	O
Fg.Nr. →..K 823576	07.05-12.08	TNK	1 457 43 S 3728	L
Komp.Nr. 508046/03/04	07.05-12.08	TNK	F 026 40 S 0088	L
Fg.Nr. →..K 823577→				
Komp.Nr. 508046/04	07.05-12.08	TNK	1 457 43 S 3729	L
Fg.Nr. →..K 823576				
Komp.Nr. 508046/05	07.05-12.08	TNK	1 457 43 S 3730	L
Komp.Nr. 508046/08/09	07.05-12.08	TNK	F 026 40 S 0064	L
Fg.Nr. K 871497→				
Komp.Nr. 508046/08/09	07.05-12.08	TNK	1 457 42 S 9975	L
Fg.Nr. →K 871496				
Komp.Nr. 508046/17/18	07.05-12.08	TNK	F 026 40 S 0064	L
Komp.Nr. 508046/20/21				
Komp.Nr. 508046/07/15	07.05-12.08	TNK	F 026 40 S 0094	L
Komp.Nr. 508046/22				
Komp.Nr. 508046/14	07.05-12.08	TNK	1 457 43 S 3901	L
	07.05-12.08	WAS	1 457 42 N 9655	K
			1 987 43 R 1454 ⁸	I
		FBF	1 987 43 M 1154	I
		FBF	1 987 43 M 2150	I

Actros II 2558

15,9 | 425 | OM 542.944 <502 LA Euro3>

Komp.Nr. 508046/03	04.03-12.08	OMZ	1 457 42 P 9128	O
Fg.Nr. →..K 823576	04.03-12.08	TNK	1 457 43 S 3728	L
Komp.Nr. 508046/03/04	04.03-12.08	TNK	F 026 40 S 0088	L
Fg.Nr. →..K 823577→				
Komp.Nr. 508046/04	04.03-12.08	TNK	1 457 43 S 3729	L
Fg.Nr. →..K 823576				
Komp.Nr. 508046/05	04.03-12.08	TNK	1 457 43 S 3730	L
Komp.Nr. 508046/07/15	04.03-12.08	TNK	F 026 40 S 0094	L
Komp.Nr. 508046/22				
Komp.Nr. 508046/08/09	04.03-12.08	TNK	F 026 40 S 0064	L
Fg.Nr. K 871497→				
Komp.Nr. 508046/08/09	04.03-12.08	TNK	1 457 42 S 9975	L
Fg.Nr. →K 871496				
Komp.Nr. 508046/17/18	04.03-12.08	TNK	F 026 40 S 0064	L
Komp.Nr. 508046/20/21				

	04.03-12.08	WAS	1 457 42 N 9655	K
			1 987 43 R 1454 ⁸	I
		FBF	1 987 43 M 1154	I
		FBF	1 987 43 M 2150	I

Actros II 2560/ 3360

15,9 | 440 | OM 542.964 <502 LA Euro4/5>

	07.05-12.08	OMZ	1 457 42 P 9128	O
Fg.Nr. →..K 871496	07.05-12.08	TNK	1 457 42 S 9975	L
Komp.Nr. 508046/08/09				
Komp.Nr. 508046/03	07.05-12.08	TNK	1 457 43 S 3728	L
Fg.Nr. →..K 823576				
Komp.Nr. 508046/03/04	07.05-12.08	TNK	F 026 40 S 0088	L
Fg.Nr. →..K 823577→				
Komp.Nr. 508046/04	07.05-12.08	TNK	1 457 43 S 3729	L
Fg.Nr. →..K 823576				
Komp.Nr. 508046/05	07.05-12.08	TNK	1 457 43 S 3730	L
Komp.Nr. 508046/08/09	07.05-12.08	TNK	F 026 40 S 0064	L
Fg.Nr. K 871497→				
Komp.Nr. 508046/17/18	07.05-12.08	TNK	F 026 40 S 0064	L
Komp.Nr. 508046/20/21				
Komp.Nr. 508046/07/15	07.05-12.08	TNK	F 026 40 S 0094	L
Komp.Nr. 508046/22				

	07.05-12.08	WAS	1 457 42 N 9655	K
			1 987 43 R 1454 ⁸	I
		FBF	1 987 43 M 1154	I
		FBF	1 987 43 M 2150	I

Actros II 2632

12,0 | 235 | OM 541.970 <501 LA Euro4/5>

	09.05-12.08	OMZ	1 457 42 P 9128	O
Komp.Nr. 508046/03	09.05-12.08	TNK	1 457 43 S 3728	L
Fg.Nr. →..K 823576				
Komp.Nr. 508046/04	09.05-12.08	TNK	1 457 43 S 3729	L
Fg.Nr. →..K 823576				
Komp.Nr. 508046/05	09.05-12.08	TNK	1 457 43 S 3730	L
Komp.Nr. 508046/07/15	09.05-12.08	TNK	F 026 40 S 0094	L
Komp.Nr. 508046/22				
Komp.Nr. 508046/08/09	09.05-12.08	TNK	F 026 40 S 0064	L
Fg.Nr. K 871497→				
Komp.Nr. 508046/08/09	09.05-12.08	TNK	1 457 42 S 9975	L
Fg.Nr. →K 871496				
Komp.Nr. 508046/17/18	09.05-12.08	TNK	F 026 40 S 0064	L
Komp.Nr. 508046/20/21				
Komp.Nr. 508046/03/04	09.05-12.08	TNK	F 026 40 S 0088	L
Fg.Nr. →..K 823577→				

	09.05-12.08	WAS	1 457 42 N 9655	K
			1 987 43 R 1454 ⁸	I
		FBF	1 987 43 M 1154	I
		FBF	1 987 43 M 2150	I

Actros II 2636

12,0 | 265 | OM 541.972 <501 LA Euro4/5>

	09.05-12.08	OMZ	1 457 42 P 9128	O
Komp.Nr. 508046/03	09.05-12.08	TNK	1 457 43 S 3728	L
Fg.Nr. →..K 823576				
Komp.Nr. 508046/04	09.05-12.08	TNK	1 457 43 S 3729	L
Fg.Nr. →..K 823576				
Komp.Nr. 508046/05	09.05-12.08	TNK	1 457 43 S 3730	L





◀ Actros II 2636

Komp.Nr. 508046/07/15	09.05-12.08	TNK	F 026 40	S 0094	L
Komp.Nr. 508046 /22					
Komp.Nr. 508046/08/09	09.05-12.08	TNK	F 026 40	S 0064	L
Fg.Nr. K 871497→					
Komp.Nr. 508046/08/09	09.05-12.08	TNK	1 457 42	S 9975	L
Fg.Nr. →K 871496					
Komp.Nr. 508046/17/18	09.05-12.08	TNK	F 026 40	S 0064	L
Komp.Nr. 508046 /20/21					
Komp.Nr. 508046/03/04	09.05-12.08	TNK	F 026 40	S 0088	L
Fg.Nr. ...K 823577→					
	09.05-12.08	WAS	1 457 42	N 9655	K
			1 987 43	R 1454⁸	I
		FBF	1 987 43	M 1154	I
		FBF	1 987 43	M 2150	I

Actros II 2641

11,9 | 300 | OM 541.974 <501 LA Euro4/5>

Komp.Nr. 508046/03	09.05-12.08	OMZ	1 457 42	P 9128	O
Fg.Nr. →...K 823576					
Komp.Nr. 508046/04	09.05-12.08	TNK	1 457 43	S 3729	L
Fg.Nr. →...K 823576					
Komp.Nr. 508046/05	09.05-12.08	TNK	1 457 43	S 3730	L
Komp.Nr. 508046/07/15	09.05-12.08	TNK	F 026 40	S 0094	L
Komp.Nr. 508046 /22					
Komp.Nr. 508046/08/09	09.05-12.08	TNK	F 026 40	S 0064	L
Fg.Nr. K 871497→					
Komp.Nr. 508046/08/09	09.05-12.08	TNK	1 457 42	S 9975	L
Fg.Nr. →K 871496					
Komp.Nr. 508046/17/18	09.05-12.08	TNK	F 026 40	S 0064	L
Komp.Nr. 508046 /20/21					
Komp.Nr. 508046/03/04	09.05-12.08	TNK	F 026 40	S 0088	L
Fg.Nr. ...K 823577→					
	09.05-12.08	WAS	1 457 42	N 9655	K
			1 987 43	R 1454⁸	I
		FBF	1 987 43	M 1154	I
		FBF	1 987 43	M 2150	I

Actros II 2644/ 3244/ 3344

12,0 | 320 | OM 541.976 <501 LA Euro4/5>

Komp.Nr. 508046/03	02.05-12.08	OMZ	1 457 42	P 9128	O
Fg.Nr. →...K 823576					
Komp.Nr. 508046/04	02.05-12.08	TNK	1 457 43	S 3729	L
Fg.Nr. →...K 823576					
Komp.Nr. 508046/05	02.05-12.08	TNK	1 457 43	S 3730	L
Komp.Nr. 508046/07/15	02.05-12.08	TNK	F 026 40	S 0094	L
Komp.Nr. 508046 /22					
Komp.Nr. 508046/08/09	02.05-12.08	TNK	F 026 40	S 0064	L
Fg.Nr. K 871497→					
Komp.Nr. 508046/08/09	02.05-12.08	TNK	1 457 42	S 9975	L
Fg.Nr. →K 871496					
Komp.Nr. 508046/17/18	02.05-12.08	TNK	F 026 40	S 0064	L
Komp.Nr. 508046 /20/21					
Komp.Nr. 508046/03/04	02.05-12.08	TNK	F 026 40	S 0088	L
Fg.Nr. ...K 823577→					
	02.05-12.08	WAS	1 457 42	N 9655	K
			1 987 43	R 1454⁸	I
		FBF	1 987 43	M 1154	I
		FBF	1 987 43	M 2150	I



Actros II 2646

12,0 | 335 | OM 541.980 <501 LA Euro4/5>

	09.05-12.08	OMZ	1 457 42	P 9128	O
Komp.Nr. 508046/03	09.05-12.08	TNK	1 457 43	S 3728	L
Fg.Nr. →...K 823576					
Komp.Nr. 508046/04	09.05-12.08	TNK	1 457 43	S 3729	L
Fg.Nr. →...K 823576					
Komp.Nr. 508046/05	09.05-12.08	TNK	1 457 43	S 3730	L
Komp.Nr. 508046/07/15	09.05-12.08	TNK	F 026 40	S 0094	L
Komp.Nr. 508046 /22					
Komp.Nr. 508046/08/09	09.05-12.08	TNK	F 026 40	S 0064	L
Fg.Nr. K 871497→					
Komp.Nr. 508046/08/09	09.05-12.08	TNK	1 457 42	S 9975	L
Fg.Nr. →K 871496					
Komp.Nr. 508046/17/18	09.05-12.08	TNK	F 026 40	S 0064	L
Komp.Nr. 508046 /20/21					
Komp.Nr. 508046/03/04	09.05-12.08	TNK	F 026 40	S 0088	L
Fg.Nr. ...K 823577→					
	09.05-12.08	WAS	1 457 42	N 9655	K
			1 987 43	R 1454⁸	I
		FBF	1 987 43	M 1154	I
		FBF	1 987 43	M 2150	I

Actros II 2650/ 3350

15,9 | 370 | OM 542.940 <502 LA Euro3>

	04.03-12.08	OMZ	1 457 42	P 9128	O
Komp.Nr. 508046/03	04.03-12.08	TNK	1 457 43	S 3728	L
Fg.Nr. →...K 823576					
Komp.Nr. 508046/03/04	04.03-12.08	TNK	F 026 40	S 0088	L
Fg.Nr. ...K 823577→					
Komp.Nr. 508046/04	04.03-12.08	TNK	1 457 43	S 3729	L
Fg.Nr. →...K 823576					
Komp.Nr. 508046/05	04.03-12.08	TNK	1 457 43	S 3730	L
Komp.Nr. 508046/07/15	04.03-12.08	TNK	F 026 40	S 0094	L
Komp.Nr. 508046 /22					
Komp.Nr. 508046/08/09	04.03-12.08	TNK	F 026 40	S 0064	L
Fg.Nr. K 871497→					
Komp.Nr. 508046/08/09	04.03-12.08	TNK	1 457 42	S 9975	L
Fg.Nr. →K 871496					
Komp.Nr. 508046/17/18	04.03-12.08	TNK	F 026 40	S 0064	L
Komp.Nr. 508046 /20/21					
	04.03-12.08	WAS	1 457 42	N 9655	K
			1 987 43	R 1454⁸	I
		FBF	1 987 43	M 1154	I
		FBF	1 987 43	M 2150	I

Actros II 2658

15,9 | 425 | OM 542.944 <502 LA Euro3>

	04.03-12.08	OMZ	1 457 42	P 9128	O
Komp.Nr. 508046/03	04.03-12.08	TNK	1 457 43	S 3728	L
Fg.Nr. →...K 823576					
Komp.Nr. 508046/03/04	04.03-12.08	TNK	F 026 40	S 0088	L
Fg.Nr. ...K 823577→					
Komp.Nr. 508046/04	04.03-12.08	TNK	1 457 43	S 3729	L
Fg.Nr. →...K 823576					
Komp.Nr. 508046/05	04.03-12.08	TNK	1 457 43	S 3730	L
Komp.Nr. 508046/07/15	04.03-12.08	TNK	F 026 40	S 0094	L
Komp.Nr. 508046 /22					
Komp.Nr. 508046/08/09	04.03-12.08	TNK	F 026 40	S 0064	L
Fg.Nr. K 871497→					
Komp.Nr. 508046/08/09	04.03-12.08	TNK	1 457 42	S 9975	L
Fg.Nr. →K 871496					



Komp.Nr. 508046/17/18	04.03-12.08	TNK	F 026 40	S 0064	L
Komp.Nr. 508046/20/21					
Komp.Nr. 508046/14	04.03-12.08	TNK	1 457 43	S 3901	L
	04.03-12.08	WAS	1 457 42	N 9655	K
			1 987 43	R 1454 ⁸	I
		FBF	1 987 43	M 1154	I
		FBF	1 987 43	M 2150	I

Actros II 3232

12,0 235 OM 541.940 <501 LA Euro3>					
	04.03-12.08	OMZ	1 457 42	P 9128	O
Komp.Nr. 508046/05	04.03-12.08	TNK	1 457 43	S 3730	L
Komp.Nr. 508046/07/15	04.03-12.08	TNK	F 026 40	S 0094	L
Komp.Nr. 508046/22					
Komp.Nr. 508046/04	04.03-12.08	TNK	F 026 40	S 0088	L
	04.03-12.08	WAS	1 457 42	N 9655	K
			1 987 43	R 1454 ⁸	I
		FBF	1 987 43	M 1154	I
		FBF	1 987 43	M 2150	I

12,0 | 235 | OM 541.970 <501 LA Euro4/5>

Komp.Nr. 508046/03	02.05-12.08	OMZ	1 457 42	P 9128	O
Fg.Nr. →..K 823576	02.05-12.08	TNK	1 457 43	S 3728	L
Komp.Nr. 508046/04	02.05-12.08	TNK	1 457 43	S 3729	L
Fg.Nr. →..K 823576					
Komp.Nr. 508046/05	02.05-12.08	TNK	1 457 43	S 3730	L
Komp.Nr. 508046/07/15	02.05-12.08	TNK	F 026 40	S 0094	L
Komp.Nr. 508046/22					
Komp.Nr. 508046/08/09	02.05-12.08	TNK	F 026 40	S 0064	L
Fg.Nr. K 871497→					
Komp.Nr. 508046/08/09	02.05-12.08	TNK	1 457 42	S 9975	L
Fg.Nr. →K 871496					
Komp.Nr. 508046/20/21	02.05-12.08	TNK	F 026 40	S 0064	L
Komp.Nr. 508046/03/04	02.05-12.08	TNK	F 026 40	S 0088	L
Fg.Nr. →..K 823577→					
	02.05-12.08	WAS	1 457 42	N 9655	K
			1 987 43	R 1454 ⁸	I
		FBF	1 987 43	M 1154	I
		FBF	1 987 43	M 2150	I

Actros II 3236

12,0 265 OM 541.942 <501 LA Euro3>					
Komp.Nr. 508046/03	04.03-12.08	OMZ	1 457 42	P 9128	O
Fg.Nr. →..K 823576	04.03-12.08	TNK	1 457 43	S 3728	L
Komp.Nr. 508046/04	04.03-12.08	TNK	1 457 43	S 3729	L
Fg.Nr. →..K 823576					
Komp.Nr. 508046/07/15	04.03-12.08	TNK	F 026 40	S 0094	L
Komp.Nr. 508046/22					
Komp.Nr. 508046/08/09	04.03-12.08	TNK	F 026 40	S 0064	L
Fg.Nr. K 871497→					
Komp.Nr. 508046/08/09	04.03-12.08	TNK	1 457 42	S 9975	L
Fg.Nr. →K 871496					
Komp.Nr. 508046/17/18	04.03-12.08	TNK	F 026 40	S 0064	L
Komp.Nr. 508046/20/21					
Komp.Nr. 508046/03/04	04.03-12.08	TNK	F 026 40	S 0088	L
Fg.Nr. →..K 823577→					
Komp.Nr. 508046/04	04.03-12.08	TNK	F 026 40	S 0088	L



	04.03-12.08	WAS	1 457 42	N 9655	K
			1 987 43	R 1454 ⁸	I
		FBF	1 987 43	M 1154	I
		FBF	1 987 43	M 2150	I

12,0 | 265 | OM 541.972 <501 LA Euro4/5>

	02.05-12.08	OMZ	1 457 42	P 9128	O
Komp.Nr. 508046/07/15	02.05-12.08	TNK	F 026 40	S 0094	L
Komp.Nr. 508046/22					
Komp.Nr. 508046/08/09	02.05-12.08	TNK	F 026 40	S 0064	L
Fg.Nr. K 871497→					
Komp.Nr. 508046/08/09	02.05-12.08	TNK	1 457 42	S 9975	L
Fg.Nr. →K 871496					
Komp.Nr. 508046/17/18	02.05-12.08	TNK	F 026 40	S 0064	L
Komp.Nr. 508046/20/21					

	02.05-12.08	WAS	1 457 42	N 9655	K
			1 987 43	R 1454 ⁸	I
		FBF	1 987 43	M 1154	I
		FBF	1 987 43	M 2150	I

Actros II 3241

12,0 | 300 | OM 541.944 <501 LA Euro3>

Komp.Nr. 508046/07/15	04.03-12.08	OMZ	1 457 42	P 9128	O
Komp.Nr. 508046/22	04.03-12.08	TNK	F 026 40	S 0094	L
Komp.Nr. 508046/08/09	04.03-12.08	TNK	F 026 40	S 0064	L
Fg.Nr. K 871497→					
Komp.Nr. 508046/08/09	04.03-12.08	TNK	1 457 42	S 9975	L
Fg.Nr. →K 871496					
Komp.Nr. 508046/17/18	04.03-12.08	TNK	F 026 40	S 0064	L
Komp.Nr. 508046/20/21					

	04.03-12.08	WAS	1 457 42	N 9655	K
			1 987 43	R 1454 ⁸	I
		FBF	1 987 43	M 1154	I
		FBF	1 987 43	M 2150	I

12,0 | 300 | OM 541.974 <501 LA Euro4/5>

Komp.Nr. 508046/07/15	02.05-12.08	OMZ	1 457 42	P 9128	O
Komp.Nr. 508046/22	02.05-12.08	TNK	F 026 40	S 0094	L
Komp.Nr. 508046/08/09	02.05-12.08	TNK	F 026 40	S 0064	L
Fg.Nr. K 871497→					
Komp.Nr. 508046/08/09	02.05-12.08	TNK	1 457 42	S 9975	L
Fg.Nr. →K 871496					
Komp.Nr. 508046/17/18	02.05-12.08	TNK	F 026 40	S 0064	L
Komp.Nr. 508046/20/21					

	02.05-12.08	WAS	1 457 42	N 9655	K
			1 987 43	R 1454 ⁸	I
		FBF	1 987 43	M 1154	I
		FBF	1 987 43	M 2150	I

Actros II 3246

12,0 | 335 | OM 541.980 <501 LA Euro4/5>

	02.05-12.08	OMZ	1 457 42	P 9128	O
Komp.Nr. 508046/07/15	02.05-12.08	TNK	F 026 40	S 0094	L
Komp.Nr. 508046/22					
Komp.Nr. 508046/08/09	02.05-12.08	TNK	F 026 40	S 0064	L
Fg.Nr. K 871497→					
Komp.Nr. 508046/08/09	02.05-12.08	TNK	1 457 42	S 9975	L
Fg.Nr. →K 871496					





◀ Actros II 3246

Komp.Nr. 508046/17/18	02.05-12.08	TNK	F 026 40	S 0064	L
Komp.Nr. 508046/20/21					
	02.05-12.08	WAS	1 457 42	N 9655	K
				1 987 43	R 1454^B
		FBF	1 987 43	M 1154	I
		FBF	1 987 43	M 2150	I

Actros II 3248

12,0 | 350 | OM 541.978 <501 LA Euro4/5>

	02.05-12.08	OMZ	1 457 42	P 9128	O
Komp.Nr. 508046/08/09	02.05-12.08	TNK	F 026 40	S 0064	L
Fg.Nr. K 871497→					
Komp.Nr. 508046/08/09	02.05-12.08	TNK	1 457 42	S 9975	L
Fg.Nr. →K 871496					
Komp.Nr. 508046/17/18	02.05-12.08	TNK	F 026 40	S 0064	L
Komp.Nr. 508046/20/21					
Komp.Nr. 508046/07/15	02.05-12.08	TNK	F 026 40	S 0094	L
Komp.Nr. 508046/22					
	02.05-12.08	WAS	1 457 42	N 9655	K
				1 987 43	R 1454^B
		FBF	1 987 43	M 1154	I
		FBF	1 987 43	M 2150	I

Actros II 3332

12,0 | 235 | OM 541.940 <501 LA Euro3>

	04.03-12.08	OMZ	1 457 42	P 9128	O
Komp.Nr. 508046/03	04.03-12.08	TNK	1 457 43	S 3728	L
Fg.Nr. →..K 823576					
Komp.Nr. 508046/04	04.03-12.08	TNK	1 457 43	S 3729	L
Fg.Nr. →..K 823576					
Komp.Nr. 508046/05	04.03-12.08	TNK	1 457 43	S 3730	L
Komp.Nr. 508046/07/15	04.03-12.08	TNK	F 026 40	S 0094	L
Komp.Nr. 508046/22					
Komp.Nr. 508046/03/04	04.03-12.08	TNK	F 026 40	S 0088	L
Fg.Nr. →..K 823577→					
Komp.Nr. 508046/04	04.03-12.08	TNK	F 026 40	S 0088	L
	04.03-12.08	WAS	1 457 42	N 9655	K
				1 987 43	R 1454^B
		FBF	1 987 43	M 1154	I
		FBF	1 987 43	M 2150	I

12,0 | 235 | OM 541.970 <501 LA Euro4/5>

	02.05-12.08	OMZ	1 457 42	P 9128	O
Komp.Nr. 508046/03	02.05-12.08	TNK	1 457 43	S 3728	L
Fg.Nr. →..K 823576					
Komp.Nr. 508046/03/04	02.05-12.08	TNK	F 026 40	S 0088	L
Fg.Nr. →..K 823577→					
Komp.Nr. 508046/04	02.05-12.08	TNK	1 457 43	S 3729	L
Fg.Nr. →..K 823576					
Komp.Nr. 508046/05	02.05-12.08	TNK	1 457 43	S 3730	L
Komp.Nr. 508046/08/09	02.05-12.08	TNK	F 026 40	S 0064	L
Fg.Nr. K 871497→					
Komp.Nr. 508046/08/09	02.05-12.08	TNK	1 457 42	S 9975	L
Fg.Nr. →K 871496					
Komp.Nr. 508046/17/18	02.05-12.08	TNK	F 026 40	S 0064	L
Komp.Nr. 508046/20/21					
Komp.Nr. 508046/07/15	02.05-12.08	TNK	F 026 40	S 0094	L
Komp.Nr. 508046/22					
	02.05-12.08	WAS	1 457 42	N 9655	K
				1 987 43	R 1454^B
		FBF	1 987 43	M 1154	I
		FBF	1 987 43	M 2150	I



Actros II 3336

12,0 | 265 | OM 541.942 <501 LA Euro3>

	04.03-12.08	OMZ	1 457 42	P 9128	O
Komp.Nr. 508046/03	04.03-12.08	TNK	1 457 43	S 3728	L
Fg.Nr. →..K 823576					
Komp.Nr. 508046/04	04.03-12.08	TNK	1 457 43	S 3729	L
Fg.Nr. →..K 823576					
Komp.Nr. 508046/05	04.03-12.08	TNK	1 457 43	S 3730	L
Komp.Nr. 508046/07/15	04.03-12.08	TNK	F 026 40	S 0094	L
Komp.Nr. 508046/22					
Komp.Nr. 508046/08/09	04.03-12.08	TNK	F 026 40	S 0064	L
Fg.Nr. K 871497→					
Komp.Nr. 508046/08/09	04.03-12.08	TNK	1 457 42	S 9975	L
Fg.Nr. →K 871496					
Komp.Nr. 508046/17/18	04.03-12.08	TNK	F 026 40	S 0064	L
Komp.Nr. 508046/20/21					
Komp.Nr. 508046/03/04	04.03-12.08	TNK	F 026 40	S 0088	L
Fg.Nr. →..K 823577→					
Komp.Nr. 508046/04	04.03-12.08	TNK	F 026 40	S 0088	L
	04.03-12.08	WAS	1 457 42	N 9655	K
				1 987 43	R 1454^B
		FBF	1 987 43	M 1154	I
		FBF	1 987 43	M 2150	I

12,0 | 265 | OM 541.972 <501 LA Euro4/5>

	02.05-12.08	OMZ	1 457 42	P 9128	O
Komp.Nr. 508046/04	02.05-12.08	TNK	1 457 43	S 3729	L
Fg.Nr. →..K 823576					
Komp.Nr. 508046/05	02.05-12.08	TNK	1 457 43	S 3730	L
Komp.Nr. 508046/07/15	02.05-12.08	TNK	F 026 40	S 0094	L
Komp.Nr. 508046/22					
Komp.Nr. 508046/08/09	02.05-12.08	TNK	F 026 40	S 0064	L
Fg.Nr. K 871497→					
Komp.Nr. 508046/08/09	02.05-12.08	TNK	1 457 42	S 9975	L
Fg.Nr. →K 871496					
Komp.Nr. 508046/17/18	02.05-12.08	TNK	F 026 40	S 0064	L
Komp.Nr. 508046/20/21					
Komp.Nr. 508046/03/04	02.05-12.08	TNK	F 026 40	S 0088	L
Fg.Nr. →..K 823577→					
	02.05-12.08	WAS	1 457 42	N 9655	K
				1 987 43	R 1454^B
		FBF	1 987 43	M 1154	I
		FBF	1 987 43	M 2150	I

Actros II 3341

12,0 | 300 | OM 541.944 <501 LA Euro3>

	04.03-12.08	OMZ	1 457 42	P 9128	O
Komp.Nr. 508046/03	04.03-12.08	TNK	1 457 43	S 3728	L
Fg.Nr. →..K 823576					
Komp.Nr. 508046/05	04.03-12.08	TNK	1 457 43	S 3730	L
Komp.Nr. 508046/07/15	04.03-12.08	TNK	F 026 40	S 0094	L
Komp.Nr. 508046/22					
Komp.Nr. 508046/08/09	04.03-12.08	TNK	F 026 40	S 0064	L
Fg.Nr. K 871497→					
Komp.Nr. 508046/08/09	04.03-12.08	TNK	1 457 42	S 9975	L
Fg.Nr. →K 871496					
Komp.Nr. 508046/17/18	04.03-12.08	TNK	F 026 40	S 0064	L
Komp.Nr. 508046/20/21					
Komp.Nr. 508046/03/04	04.03-12.08	TNK	F 026 40	S 0088	L
Fg.Nr. →..K 823577→					



	04.03-12.08	WAS	1 457 42	N 9655	K
			1 987 43	R 1454⁸	I
		FBF	1 987 43	M 1154	I
		FBF	1 987 43	M 2150	I

12,0 | 300 | OM 541.974 <501 LA Euro4/5>

	02.05-12.08	OMZ	1 457 42	P 9128	O
Komp.Nr. 508046 /03	02.05-12.08	TNK	1 457 43	S 3728	L
Fg.Nr. →..K 823576					
Komp.Nr. 508046 /04	02.05-12.08	TNK	1 457 43	S 3729	L
Fg.Nr. →..K 823576					
Komp.Nr. 508046 /05	02.05-12.08	TNK	1 457 43	S 3730	L
Komp.Nr. 508046 /07/15	02.05-12.08	TNK	F 026 40	S 0094	L
Komp.Nr. 508046 /22					
Komp.Nr. 508046 /08/09	02.05-12.08	TNK	F 026 40	S 0064	L
Fg.Nr. K 871497→					
Komp.Nr. 508046 /08/09	02.05-12.08	TNK	1 457 42	S 9975	L
Fg.Nr. →K 871496					
Komp.Nr. 508046 /17/18	02.05-12.08	TNK	F 026 40	S 0064	L
Komp.Nr. 508046 /20/21					
Komp.Nr. 508046 /03/04	02.05-12.08	TNK	F 026 40	S 0088	L
Fg.Nr. →..K 823577→					

	02.05-12.08	WAS	1 457 42	N 9655	K
			1 987 43	R 1454⁸	I
		FBF	1 987 43	M 1154	I
		FBF	1 987 43	M 2150	I

Actros II 3346

12,0 | 335 | OM 541.948 <501 LA Euro3>

	06.03-12.08	OMZ	1 457 42	P 9128	O
Komp.Nr. 508046 /03	06.03-12.08	TNK	1 457 43	S 3728	L
Fg.Nr. →..K 823576					
Komp.Nr. 508046 /04	06.03-12.08	TNK	1 457 43	S 3729	L
Fg.Nr. →..K 823576					
Komp.Nr. 508046 /05	06.03-12.08	TNK	1 457 43	S 3730	L
Komp.Nr. 508046 /07/15	06.03-12.08	TNK	F 026 40	S 0094	L
Komp.Nr. 508046 /22					
Komp.Nr. 508046 /08/09	06.03-12.08	TNK	F 026 40	S 0064	L
Fg.Nr. K 871497→					
Komp.Nr. 508046 /08/09	06.03-12.08	TNK	1 457 42	S 9975	L
Fg.Nr. →K 871496					
Komp.Nr. 508046 /17/18	06.03-12.08	TNK	F 026 40	S 0064	L
Komp.Nr. 508046 /20/21					
Komp.Nr. 508046 /03/04	06.03-12.08	TNK	F 026 40	S 0088	L
Fg.Nr. →..K 823577→					
Komp.Nr. 508046 /14	06.03-12.08	TNK	1 457 43	S 3901	L

	06.03-12.08	WAS	1 457 42	N 9655	K
			1 987 43	R 1454⁸	I
		FBF	1 987 43	M 1154	I
		FBF	1 987 43	M 2150	I

12,0 | 335 | OM 541.980 <501 LA Euro4/5>

	02.05-12.08	OMZ	1 457 42	P 9128	O
Komp.Nr. 508046 /03	02.05-12.08	TNK	1 457 43	S 3728	L
Fg.Nr. →..K 823576					
Komp.Nr. 508046 /04	02.05-12.08	TNK	1 457 43	S 3729	L
Fg.Nr. →..K 823576					
Komp.Nr. 508046 /05	02.05-12.08	TNK	1 457 43	S 3730	L
Komp.Nr. 508046 /07/15	02.05-12.08	TNK	F 026 40	S 0094	L
Komp.Nr. 508046 /22					

Komp.Nr. 508046 /08/09	02.05-12.08	TNK	F 026 40	S 0064	L
Fg.Nr. K 871497→					
Komp.Nr. 508046 /08/09	02.05-12.08	TNK	1 457 42	S 9975	L
Fg.Nr. →K 871496					
Komp.Nr. 508046 /17/18	02.05-12.08	TNK	F 026 40	S 0064	L
Komp.Nr. 508046 /20/21					
Komp.Nr. 508046 /03/04	02.05-12.08	TNK	F 026 40	S 0088	L
Fg.Nr. →..K 823577→					
Komp.Nr. 508046 /14	02.05-12.08	TNK	1 457 43	S 3901	L
	02.05-12.08	WAS	1 457 42	N 9655	K
			1 987 43	R 1454⁸	I
		FBF	1 987 43	M 1154	I
		FBF	1 987 43	M 2150	I

Actros II 3348/ 4148

12,0 | 350 | OM 541.978 <501 LA Euro4/5>

	02.05-12.08	OMZ	1 457 42	P 9128	O
Komp.Nr. 508046 /03	02.05-12.08	TNK	1 457 43	S 3728	L
Fg.Nr. →..K 823576					
Komp.Nr. 508046 /03/04	02.05-12.08	TNK	F 026 40	S 0088	L
Fg.Nr. →..K 823577→					
Komp.Nr. 508046 /04	02.05-12.08	TNK	1 457 43	S 3729	L
Fg.Nr. →..K 823576					
Komp.Nr. 508046 /05	02.05-12.08	TNK	1 457 43	S 3730	L
Komp.Nr. 508046 /08/09	02.05-12.08	TNK	F 026 40	S 0064	L
Fg.Nr. K 871497→					
Komp.Nr. 508046 /08/09	02.05-12.08	TNK	1 457 42	S 9975	L
Fg.Nr. →K 871496					
Komp.Nr. 508046 /17/18	02.05-12.08	TNK	F 026 40	S 0064	L
Komp.Nr. 508046 /20/21					
Komp.Nr. 508046 /07/15	02.05-12.08	TNK	F 026 40	S 0094	L
Komp.Nr. 508046 /22					

	02.05-12.08	WAS	1 457 42	N 9655	K
			1 987 43	R 1454⁸	I
		FBF	1 987 43	M 1154	I
		FBF	1 987 43	M 2150	I

Actros II 3350

15,9 | 370 | OM 542.941 <502 LA Euro3>

	04.03-12.08	OMZ	1 457 42	P 9128	O
Komp.Nr. 508046 /03	04.03-12.08	TNK	1 457 43	S 3728	L
Fg.Nr. →..K 823576					
Komp.Nr. 508046 /03/04	04.03-12.08	TNK	F 026 40	S 0088	L
Fg.Nr. →..K 823577→					
Komp.Nr. 508046 /04	04.03-12.08	TNK	1 457 43	S 3729	L
Fg.Nr. →..K 823576					
Komp.Nr. 508046 /05	04.03-12.08	TNK	1 457 43	S 3730	L
Komp.Nr. 508046 /07/15	04.03-12.08	TNK	F 026 40	S 0094	L
Komp.Nr. 508046 /22					
Komp.Nr. 508046 /08/09	04.03-12.08	TNK	F 026 40	S 0064	L
Fg.Nr. K 871497→					
Komp.Nr. 508046 /08/09	04.03-12.08	TNK	1 457 42	S 9975	L
Fg.Nr. →K 871496					
Komp.Nr. 508046 /17/18	04.03-12.08	TNK	F 026 40	S 0064	L
Komp.Nr. 508046 /20/21					

	04.03-12.08	WAS	1 457 42	N 9655	K
			1 987 43	R 1454⁸	I
		FBF	1 987 43	M 1154	I
		FBF	1 987 43	M 2150	I





Actros II 3354

15,9 395 OM 542.942 <502 LA Euro3>				
	04.03-12.08	OMZ	1 457 42 P 9128	O
Fg.Nr. →..K 871496	04.03-12.08	TNK	1 457 42 S 9975	L
Komp.Nr. 508046/08/09				
Komp.Nr. 508046/03	04.03-12.08	TNK	1 457 43 S 3728	L
Fg.Nr. →..K 823576				
Komp.Nr. 508046/03/04	04.03-12.08	TNK	F 026 40 S 0088	L
Fg.Nr. →..K 823577→				
Komp.Nr. 508046/04	04.03-12.08	TNK	1 457 43 S 3729	L
Fg.Nr. →..K 823576				
Komp.Nr. 508046/05	04.03-12.08	TNK	1 457 43 S 3730	L
Komp.Nr. 508046/07/15	04.03-12.08	TNK	F 026 40 S 0094	L
Komp.Nr. 508046/22				
Komp.Nr. 508046/08/09	04.03-12.08	TNK	F 026 40 S 0064	L
Fg.Nr. K 871497→				
Komp.Nr. 508046/17/18	04.03-12.08	TNK	F 026 40 S 0064	L
Komp.Nr. 508046/20/21				
Komp.Nr. 508046/14	04.03-12.08	TNK	1 457 43 S 3901	L
	04.03-12.08	WAS	1 457 42 N 9655	K
			1 987 43 R 1454 ⁸	I
		FBF	1 987 43 M 1154	I
		FBF	1 987 43 M 2150	I

Actros II 3358

15,9 425 OM 542.944 <502 LA Euro3>				
	04.03-12.08	OMZ	1 457 42 P 9128	O
Komp.Nr. 508046/03	04.03-12.08	TNK	1 457 43 S 3728	L
Fg.Nr. →..K 823576				
Komp.Nr. 508046/03/04	04.03-12.08	TNK	F 026 40 S 0088	L
Fg.Nr. →..K 823577→				
Komp.Nr. 508046/04	04.03-12.08	TNK	1 457 43 S 3729	L
Fg.Nr. →..K 823576				
Komp.Nr. 508046/05	04.03-12.08	TNK	1 457 43 S 3730	L
Komp.Nr. 508046/07/15	04.03-12.08	TNK	F 026 40 S 0094	L
Komp.Nr. 508046/22				
Komp.Nr. 508046/08/09	04.03-12.08	TNK	F 026 40 S 0064	L
Fg.Nr. K 871497→				
Komp.Nr. 508046/08/09	04.03-12.08	TNK	1 457 42 S 9975	L
Fg.Nr. →K 871496				
Komp.Nr. 508046/17/18	04.03-12.08	TNK	F 026 40 S 0064	L
Komp.Nr. 508046/20/21				
	04.03-12.08	WAS	1 457 42 N 9655	K
			1 987 43 R 1454 ⁸	I
		FBF	1 987 43 M 1154	I
		FBF	1 987 43 M 2150	I

Actros II 4141

12,0 300 OM 541.944 <501 LA Euro3>				
	04.03-12.08	OMZ	1 457 42 P 9128	O
Komp.Nr. 508046/07/15	04.03-12.08	TNK	F 026 40 S 0094	L
Komp.Nr. 508046/22				
Komp.Nr. 508046/08/09	04.03-12.08	TNK	F 026 40 S 0064	L
Fg.Nr. K 871497→				
Komp.Nr. 508046/08/09	04.03-12.08	TNK	1 457 42 S 9975	L
Fg.Nr. →K 871496				
Komp.Nr. 508046/20/21	04.03-12.08	TNK	F 026 40 S 0064	L
	04.03-12.08	WAS	1 457 42 N 9655	K
			1 987 43 R 1454 ⁸	I
		FBF	1 987 43 M 1154	I
		FBF	1 987 43 M 2150	I



12,0 | 300 | OM 541.974 <501 LA Euro4/5>

	09.06-12.08	OMZ	1 457 42 P 9128	O
Komp.Nr. 508046/08/09	09.06-12.08	TNK	F 026 40 S 0064	L
Fg.Nr. K 871497→				
Komp.Nr. 508046/08/09	09.06-12.08	TNK	1 457 42 S 9975	L
Fg.Nr. →K 871496				
Komp.Nr. 508046/17/18	09.06-12.08	TNK	F 026 40 S 0064	L
Komp.Nr. 508046/20/21				
Komp.Nr. 508046/07/15	09.06-12.08	TNK	F 026 40 S 0094	L
Komp.Nr. 508046/22				
	09.06-12.08	WAS	1 457 42 N 9655	K
			1 987 43 R 1454 ⁸	I
		FBF	1 987 43 M 1154	I
		FBF	1 987 43 M 2150	I

Actros II 4144

12,0 | 320 | OM 541.976 <501 LA Euro4/5>

	09.06-12.08	OMZ	1 457 42 P 9128	O
Komp.Nr. 508046/03	09.06-12.08	TNK	1 457 43 S 3728	L
Fg.Nr. →..K 823576				
Komp.Nr. 508046/04	09.06-12.08	TNK	1 457 43 S 3729	L
Fg.Nr. →..K 823576				
Komp.Nr. 508046/05	09.06-12.08	TNK	1 457 43 S 3730	L
Komp.Nr. 508046/08/09	09.06-12.08	TNK	F 026 40 S 0064	L
Fg.Nr. K 871497→				
Komp.Nr. 508046/17/18	09.06-12.08	TNK	F 026 40 S 0064	L
Komp.Nr. 508046/20/21				
Komp.Nr. 508046/03/04	09.06-12.08	TNK	F 026 40 S 0088	L
Fg.Nr. →..K 823577→				
Komp.Nr. 508046/07/15	09.06-12.08	TNK	F 026 40 S 0094	L
Komp.Nr. 508046/22				
	09.06-12.08	WAS	1 457 42 N 9655	K
			1 987 43 R 1454 ⁸	I
		FBF	1 987 43 M 1154	I
		FBF	1 987 43 M 2150	I

Actros II 4146

12,0 | 335 | OM 541.948 <501 LA Euro3>

	04.03-12.08	OMZ	1 457 42 P 9128	O
Komp.Nr. 508046/07/15	04.03-12.08	TNK	F 026 40 S 0094	L
Komp.Nr. 508046/22				
Komp.Nr. 508046/08/09	04.03-12.08	TNK	F 026 40 S 0064	L
Fg.Nr. K 871497→				
Komp.Nr. 508046/08/09	04.03-12.08	TNK	1 457 42 S 9975	L
Fg.Nr. →K 871496				
Komp.Nr. 508046/20/21	04.03-12.08	TNK	F 026 40 S 0064	L
	04.03-12.08	WAS	1 457 42 N 9655	K
			1 987 43 R 1454 ⁸	I
		FBF	1 987 43 M 1154	I
		FBF	1 987 43 M 2150	I

12,0 | 335 | OM 541.980 <501 LA Euro4/5>

	09.06-12.08	OMZ	1 457 42 P 9128	O
Komp.Nr. 508046/08/09	09.06-12.08	TNK	F 026 40 S 0064	L
Fg.Nr. K 871497→				
Komp.Nr. 508046/08/09	09.06-12.08	TNK	1 457 42 S 9975	L
Fg.Nr. →K 871496				
Komp.Nr. 508046/17/18	09.06-12.08	TNK	F 026 40 S 0064	L
Komp.Nr. 508046/20/21				
Komp.Nr. 508046/07/15	09.06-12.08	TNK	F 026 40 S 0094	L
Komp.Nr. 508046/22				



	09.06-12.08	WAS	1 457 42 N 9655	K
			1 987 43 R 1454 ⁸	I
		FBF	1 987 43 M 1154	I
		FBF	1 987 43 M 2150	I

Actros II 4150

15,9 | 370 | OM 542.940 <502 LA Euro3>

	04.03-12.08	OMZ	1 457 42 P 9128	O
Komp.Nr. 508046/07/15	04.03-12.08	TNK	F 026 40 S 0094	L
Komp.Nr. 508046/22				
Komp.Nr. 508046/08/09	04.03-12.08	TNK	F 026 40 S 0064	L
Fg.Nr. K 871497→				
Komp.Nr. 508046/08/09	04.03-12.08	TNK	1 457 42 S 9975	L
Fg.Nr. →K 871496				
Komp.Nr. 508046/17/18	04.03-12.08	TNK	F 026 40 S 0064	L
Komp.Nr. 508046/20/21				
	04.03-12.08	WAS	1 457 42 N 9655	K
			1 987 43 R 1454 ⁸	I
		FBF	1 987 43 M 1154	I
		FBF	1 987 43 M 2150	I

Actros II 4151

15,9 | 375 | OM 542.960 <502 LA Euro4/5>

	09.06-12.08	OMZ	1 457 42 P 9128	O
Komp.Nr. 508046/08/09	09.06-12.08	TNK	F 026 40 S 0064	L
Fg.Nr. K 871497→				
Komp.Nr. 508046/08/09	09.06-12.08	TNK	1 457 42 S 9975	L
Fg.Nr. →K 871496				
Komp.Nr. 508046/17/18	09.06-12.08	TNK	F 026 40 S 0064	L
Komp.Nr. 508046/20/21				
Komp.Nr. 508046/07/15	09.06-12.08	TNK	F 026 40 S 0094	L
Komp.Nr. 508046/22				
	09.06-12.08	WAS	1 457 42 N 9655	K
			1 987 43 R 1454 ⁸	I
		FBF	1 987 43 M 1154	I
		FBF	1 987 43 M 2150	I

Actros III

Actros III 1832

11,9 | 235 | OM 541.970 <501 LA Euro 4/5>

	06.08→	OMZ	1 457 42 P 9128	O
Komp.Nr. 508046/03	06.08→	TNK	1 457 43 S 3728	L
Fg.Nr. →.K 823576				
Komp.Nr. 508046/03/04	06.08→	TNK	F 026 40 S 0088	L
Fg.Nr. →.K 823577→				
Komp.Nr. 508046/04	06.08→	TNK	1 457 43 S 3729	L
Fg.Nr. →.K 823576				
Komp.Nr. 508046/05	06.08→	TNK	1 457 43 S 3730	L
Komp.Nr. 508046/08/09	06.08→	TNK	F 026 40 S 0064	L
Fg.Nr. K 871497→				
Komp.Nr. 508046/08/09	06.08→	TNK	1 457 42 S 9975	L
Fg.Nr. →K 871496				
Komp.Nr. 508046/17/18	06.08→	TNK	F 026 40 S 0064	L
Komp.Nr. 508046/20/21				
Komp.Nr. 508046/07/15	06.08→	TNK	F 026 40 S 0094	L
Komp.Nr. 508046/22				
Komp.Nr. 508046/14	06.08→	TNK	1 457 43 S 3901	L



	06.08→	WAS	1 457 42 N 9655	K
			1 987 43 R 1454 ⁸	I
		FBF	1 987 43 M 1154	I
		FBF	1 987 43 M 2150	I

11,9 | 235 | OM 541.996 <501 LA EEV>

	07.10→	OMZ	1 457 42 P 9128	O
Komp.Nr. 508046/03	07.10→	TNK	1 457 43 S 3728	L
Fg.Nr. →.K 823576				
Komp.Nr. 508046/03/04	07.10→	TNK	F 026 40 S 0088	L
Fg.Nr. →.K 823577→				
Komp.Nr. 508046/04	07.10→	TNK	1 457 43 S 3729	L
Fg.Nr. →.K 823576				
Komp.Nr. 508046/05	07.10→	TNK	1 457 43 S 3730	L
Komp.Nr. 508046/08/09	07.10→	TNK	F 026 40 S 0064	L
Fg.Nr. K 871497→				
Komp.Nr. 508046/08/09	07.10→	TNK	1 457 42 S 9975	L
Fg.Nr. →K 871496				
Komp.Nr. 508046/20	07.10→	TNK	F 026 40 S 0064	L
Komp.Nr. 508046/07/15	07.10→	TNK	F 026 40 S 0094	L
Komp.Nr. 508046/22				
Komp.Nr. 508046/14	07.10→	TNK	1 457 43 S 3901	L
	07.10→	WAS	1 457 42 N 9655	K
			1 987 43 R 1454 ⁸	I
		FBF	1 987 43 M 1154	I
		FBF	1 987 43 M 2150	I

Actros III 1832/ 2032/ 3332

11,9 | 235 | OM 541.997 <501 LA EEV>

	07.10→	OMZ	1 457 42 P 9128	O
Komp.Nr. 508046/03	07.10→	TNK	1 457 43 S 3728	L
Fg.Nr. →.K 823576				
Komp.Nr. 508046/03/04	07.10→	TNK	F 026 40 S 0088	L
Fg.Nr. →.K 823577→				
Komp.Nr. 508046/04	07.10→	TNK	1 457 43 S 3729	L
Fg.Nr. →.K 823576				
Komp.Nr. 508046/05	07.10→	TNK	1 457 43 S 3730	L
Komp.Nr. 508046/08/09	07.10→	TNK	F 026 40 S 0064	L
Fg.Nr. K 871497→				
Komp.Nr. 508046/08/09	07.10→	TNK	1 457 42 S 9975	L
Fg.Nr. →K 871496				
Komp.Nr. 508046/20	07.10→	TNK	F 026 40 S 0064	L
Komp.Nr. 508046/07/15	07.10→	TNK	F 026 40 S 0094	L
Komp.Nr. 508046/22				
Komp.Nr. 508046/14	07.10→	TNK	1 457 43 S 3901	L
	07.10→	WAS	1 457 42 N 9655	K
			1 987 43 R 1454 ⁸	I
		FBF	1 987 43 M 1154	I
		FBF	1 987 43 M 2150	I

Actros III 1836

11,9 | 265 | OM 541.972 <501 LA Euro4/5>

	06.08→	OMZ	1 457 42 P 9128	O
Komp.Nr. 508046/03	06.08→	TNK	1 457 43 S 3728	L
Fg.Nr. →.K 823576				
Komp.Nr. 508046/03/04	06.08→	TNK	F 026 40 S 0088	L
Fg.Nr. →.K 823577→				
Komp.Nr. 508046/04	06.08→	TNK	1 457 43 S 3729	L
Fg.Nr. →.K 823576				
Komp.Nr. 508046/05	06.08→	TNK	1 457 43 S 3730	L





◀ Actros III 1836

Komp.Nr. 508046/07/15	06.08→	TNK	F 026 40	S 0094	L
Komp.Nr. 508046/22					
Komp.Nr. 508046/08/09	06.08→	TNK	F 026 40	S 0064	L
Fg.Nr. K 871497→					
Komp.Nr. 508046/08/09	06.08→	TNK	1 457 42	S 9975	L
Fg.Nr. →K 871496					
Komp.Nr. 508046/17/18	06.08→	TNK	F 026 40	S 0064	L
Komp.Nr. 508046/20/21					
	06.08→	WAS	1 457 42	N 9655	K
			1 987 43	R 1454⁸	I
		FBF	1 987 43	M 1154	I
		FBF	1 987 43	M 2150	I

Actros III 1836/ 2036

11,9 | 265 | OM 541.998 <501 LA EEV>

Komp.Nr. 508046/03	07.10→	OMZ	1 457 42	P 9128	O
Fg.Nr. →..K 823576	07.10→	TNK	1 457 43	S 3728	L
Komp.Nr. 508046/03/04	07.10→	TNK	F 026 40	S 0088	L
Fg.Nr. ..K 823577→					
Komp.Nr. 508046/04	07.10→	TNK	1 457 43	S 3729	L
Fg.Nr. →..K 823576					
Komp.Nr. 508046/05	07.10→	TNK	1 457 43	S 3730	L
Komp.Nr. 508046/07/15	07.10→	TNK	F 026 40	S 0094	L
Komp.Nr. 508046/22					
Komp.Nr. 508046/08/09	07.10→	TNK	F 026 40	S 0064	L
Fg.Nr. K 871497→					
Komp.Nr. 508046/08/09	07.10→	TNK	1 457 42	S 9975	L
Fg.Nr. →K 871496					
Komp.Nr. 508046/17/18	07.10→	TNK	F 026 40	S 0064	L
Komp.Nr. 508046/20/21					
	07.10→	WAS	1 457 42	N 9655	K
			1 987 43	R 1454⁸	I
		FBF	1 987 43	M 1154	I
		FBF	1 987 43	M 2150	I

Actros III 1836/ 2036/ 3336

11,9 | 265 | OM 541.999 <501 LA EEV>

Komp.Nr. 508046/03	07.10→	OMZ	1 457 42	P 9128	O
Fg.Nr. →..K 823576	07.10→	TNK	1 457 43	S 3728	L
Komp.Nr. 508046/03/04	07.10→	TNK	F 026 40	S 0088	L
Fg.Nr. ..K 823577→					
Komp.Nr. 508046/04	07.10→	TNK	1 457 43	S 3729	L
Fg.Nr. →..K 823576					
Komp.Nr. 508046/05	07.10→	TNK	1 457 43	S 3730	L
Komp.Nr. 508046/08/09	07.10→	TNK	F 026 40	S 0064	L
Fg.Nr. K 871497→					
Komp.Nr. 508046/08/09	07.10→	TNK	1 457 42	S 9975	L
Fg.Nr. →K 871496					
Komp.Nr. 508046/20	07.10→	TNK	F 026 40	S 0064	L
Komp.Nr. 508046/07/15	07.10→	TNK	F 026 40	S 0094	L
Komp.Nr. 508046/22					
Komp.Nr. 508046/14	07.10→	TNK	1 457 43	S 3901	L
	07.10→	WAS	1 457 42	N 9655	K
			1 987 43	R 1454⁸	I
		FBF	1 987 43	M 1154	I
		FBF	1 987 43	M 2150	I

Actros III 1841

11,9 | 300 | OM 541.974 <501 LA Euro4/5>

	06.08→	OMZ	1 457 42	P 9128	O
--	--------	-----	----------	---------------	----------



Komp.Nr. 508046/03	06.08→	TNK	1 457 43	S 3728	L
Fg.Nr. →..K 823576					
Komp.Nr. 508046/03/04	06.08→	TNK	F 026 40	S 0088	L
Fg.Nr. ..K 823577→					
Komp.Nr. 508046/04	06.08→	TNK	1 457 43	S 3729	L
Fg.Nr. →..K 823576					
Komp.Nr. 508046/05	06.08→	TNK	1 457 43	S 3730	L
Komp.Nr. 508046/08/09	06.08→	TNK	F 026 40	S 0064	L
Fg.Nr. K 871497→					
Komp.Nr. 508046/08/09	06.08→	TNK	1 457 42	S 9975	L
Fg.Nr. →K 871496					
Komp.Nr. 508046/17/18	06.08→	TNK	F 026 40	S 0064	L
Komp.Nr. 508046/20/21					
Komp.Nr. 508046/07/15	06.08→	TNK	F 026 40	S 0094	L
Komp.Nr. 508046/22					
Komp.Nr. 508046/14	06.08→	TNK	1 457 43	S 3901	L
	06.08→	WAS	1 457 42	N 9655	K
			1 987 43	R 1454⁸	I
		FBF	1 987 43	M 1154	I
		FBF	1 987 43	M 2150	I

11,9 | 300 | OM 541.990 <501 LA EEV>

	12.09→	OMZ	1 457 42	P 9128	O
Fg.Nr. →..K 871496	12.09→	TNK	1 457 42	S 9975	L
Komp.Nr. 508046/08/09					
Komp.Nr. 508046/03	12.09→	TNK	1 457 43	S 3728	L
Fg.Nr. →..K 823576					
Komp.Nr. 508046/04	12.09→	TNK	1 457 43	S 3729	L
Fg.Nr. →..K 823576					
Komp.Nr. 508046/05	12.09→	TNK	1 457 43	S 3730	L
Komp.Nr. 508046/07/15	12.09→	TNK	F 026 40	S 0094	L
Komp.Nr. 508046/22					
Komp.Nr. 508046/08/09	12.09→	TNK	F 026 40	S 0064	L
Fg.Nr. K 871497→					
Komp.Nr. 508046/17/18	12.09→	TNK	F 026 40	S 0064	L
Komp.Nr. 508046/20/21					
Komp.Nr. 508046/03/04	12.09→	TNK	F 026 40	S 0088	L
Fg.Nr. →..K 823577→					
Komp.Nr. 508046/14	12.09→	TNK	1 457 43	S 3901	L
	12.09→	WAS	1 457 42	N 9655	K
			1 987 43	R 1454⁸	I
		FBF	1 987 43	M 1154	I
		FBF	1 987 43	M 2150	I

Actros III 1841/ 2041/ 2741

11,9 | 300 | OM 541.991 <501 LA EEV>

	12.09→	OMZ	1 457 42	P 9128	O
Komp.Nr. 508046/03	12.09→	TNK	1 457 43	S 3728	L
Fg.Nr. →..K 823576					
Komp.Nr. 508046/04	12.09→	TNK	1 457 43	S 3729	L
Fg.Nr. →..K 823576					
Komp.Nr. 508046/05	12.09→	TNK	1 457 43	S 3730	L
Komp.Nr. 508046/07/15	12.09→	TNK	F 026 40	S 0094	L
Komp.Nr. 508046/22					
Komp.Nr. 508046/08/09	12.09→	TNK	1 457 42	S 9975	L
Fg.Nr. →K 871496					
Komp.Nr. 508046/20/21	12.09→	TNK	F 026 40	S 0064	L
Komp.Nr. 508046/03/04	12.09→	TNK	F 026 40	S 0088	L
Fg.Nr. →..K 823577→					
	12.09→	WAS	1 457 42	N 9655	K
			1 987 43	R 1454⁸	I
		FBF	1 987 43	M 1154	I
		FBF	1 987 43	M 2150	I



Actros III 1844

11,9 | 320 | OM 541.976 <501 LA Euro4/5>

	06.08→	OMZ	1 457 42 P 9128	O
Komp.Nr. 508046 /03	06.08→	TNK	1 457 43 S 3728	L
Fg.Nr. →..K 823576				
Komp.Nr. 508046 /03/04	06.08→	TNK	F 026 40 S 0088	L
Fg.Nr. ...K 823577→				
Komp.Nr. 508046 /04	06.08→	TNK	1 457 43 S 3729	L
Fg.Nr. →..K 823576				
Komp.Nr. 508046 /05	06.08→	TNK	1 457 43 S 3730	L
Komp.Nr. 508046 /08/09	06.08→	TNK	F 026 40 S 0064	L
Fg.Nr. K 871497→				
Komp.Nr. 508046 /08/09	06.08→	TNK	1 457 42 S 9975	L
Fg.Nr. →K 871496				
Komp.Nr. 508046 /17/18	06.08→	TNK	F 026 40 S 0064	L
Komp.Nr. 508046 /20/21				
Komp.Nr. 508046 /07/15	06.08→	TNK	F 026 40 S 0094	L
Komp.Nr. 508046 /22				
	06.08→	WAS	1 457 42 N 9655	K
			1 987 43 R 1454 ⁸	I
		FBF	1 987 43 M 1154	I
		FBF	1 987 43 M 2150	I

11,9 | 320 | OM 541.992 <501 LA EEV>

	12.09→	OMZ	1 457 42 P 9128	O
Fg.Nr. →..K 871496	12.09→	TNK	1 457 42 S 9975	L
Komp.Nr. 508046 /08/09				
Komp.Nr. 508046 /04	12.09→	TNK	1 457 43 S 3729	L
Fg.Nr. →..K 823576				
Komp.Nr. 508046 /05	12.09→	TNK	1 457 43 S 3730	L
Komp.Nr. 508046 /07/15	12.09→	TNK	F 026 40 S 0094	L
Komp.Nr. 508046 /22				
Komp.Nr. 508046 /08/09	12.09→	TNK	F 026 40 S 0064	L
Fg.Nr. K 871497→				
Komp.Nr. 508046 /17/18	12.09→	TNK	F 026 40 S 0064	L
Komp.Nr. 508046 /20/21				
Komp.Nr. 508046 /03	12.09→	TNK	1 457 43 S 3728	L
Komp.Nr. 508046 /03/04	12.09→	TNK	F 026 40 S 0088	L
Fg.Nr. ...K 823577→				
Komp.Nr. 508046 /14	12.09→	TNK	1 457 43 S 3901	L
	12.09→	WAS	1 457 42 N 9655	K
			1 987 43 R 1454 ⁸	I
		FBF	1 987 43 M 1154	I
		FBF	1 987 43 M 2150	I

Actros III 1844/ 2044/ 2744/ 3344

11,9 | 320 | OM 541.993 <501 LA EEV>

	12.09→	OMZ	1 457 42 P 9128	O
Fg.Nr. →..K 871496	12.09→	TNK	1 457 42 S 9975	L
Komp.Nr. 508046 /08/09				
Komp.Nr. 508046 /03	12.09→	TNK	1 457 43 S 3728	L
Fg.Nr. →..K 823576				
Komp.Nr. 508046 /04	12.09→	TNK	1 457 43 S 3729	L
Fg.Nr. →..K 823576				
Komp.Nr. 508046 /05	12.09→	TNK	1 457 43 S 3730	L
Komp.Nr. 508046 /07/15	12.09→	TNK	F 026 40 S 0094	L
Komp.Nr. 508046 /22				
Komp.Nr. 508046 /08/09	12.09→	TNK	F 026 40 S 0064	L
Fg.Nr. K 871497→				



Komp.Nr. 508046 /20/21	12.09→	TNK	F 026 40 S 0064	L
Komp.Nr. 508046 /03/04	12.09→	TNK	F 026 40 S 0088	L
Fg.Nr. ...K 823577→				

	12.09→	WAS	1 457 42 N 9655	K
			1 987 43 R 1454 ⁸	I
		FBF	1 987 43 M 1154	I
		FBF	1 987 43 M 2150	I

Actros III 1846

11,9 | 335 | OM 541.980 <501 LA Euro4/5>

	06.08→	OMZ	1 457 42 P 9128	O
Komp.Nr. 508046 /03	06.08→	TNK	1 457 43 S 3728	L
Fg.Nr. →..K 823576				
Komp.Nr. 508046 /04	06.08→	TNK	1 457 43 S 3729	L
Fg.Nr. →..K 823576				
Komp.Nr. 508046 /05	06.08→	TNK	1 457 43 S 3730	L
Komp.Nr. 508046 /08/09	06.08→	TNK	F 026 40 S 0064	L
Fg.Nr. K 871497→				
Komp.Nr. 508046 /08/09	06.08→	TNK	1 457 42 S 9975	L
Fg.Nr. →K 871496				
Komp.Nr. 508046 /17/18	06.08→	TNK	F 026 40 S 0064	L
Komp.Nr. 508046 /20/21				
Komp.Nr. 508046 /03/04	06.08→	TNK	F 026 40 S 0088	L
Fg.Nr. ...K 823577→				
Komp.Nr. 508046 /07/15	06.08→	TNK	F 026 40 S 0094	L
Komp.Nr. 508046 /22				
	06.08→	WAS	1 457 42 N 9655	K
			1 987 43 R 1454 ⁸	I
		FBF	1 987 43 M 1154	I
		FBF	1 987 43 M 2150	I

11,9 | 335 | OM 541.994 <501 LA EEV>

	12.09→	OMZ	1 457 42 P 9128	O
Komp.Nr. 508046 /03	12.09→	TNK	1 457 43 S 3728	L
Fg.Nr. →..K 823576				
Komp.Nr. 508046 /04	12.09→	TNK	1 457 43 S 3729	L
Fg.Nr. →..K 823576				
Komp.Nr. 508046 /05	12.09→	TNK	1 457 43 S 3730	L
Komp.Nr. 508046 /07/15	12.09→	TNK	F 026 40 S 0094	L
Komp.Nr. 508046 /22				
Komp.Nr. 508046 /08/09	12.09→	TNK	F 026 40 S 0064	L
Fg.Nr. K 871497→				
Komp.Nr. 508046 /08/09	12.09→	TNK	1 457 42 S 9975	L
Fg.Nr. →K 871496				
Komp.Nr. 508046 /17/18	12.09→	TNK	F 026 40 S 0064	L
Komp.Nr. 508046 /20/21				
Komp.Nr. 508046 /03/04	12.09→	TNK	F 026 40 S 0088	L
Fg.Nr. ...K 823577→				
Komp.Nr. 508046 /14	12.09→	TNK	1 457 43 S 3901	L
	12.09→	WAS	1 457 42 N 9655	K
			1 987 43 R 1454 ⁸	I
		FBF	1 987 43 M 1154	I
		FBF	1 987 43 M 2150	I

Actros III 1846/ 2046/ 2746/ 3346

11,9 | 335 | OM 541.995 <501 LA EEV>

	12.09→	OMZ	1 457 42 P 9128	O
Fg.Nr. →..K 871496	12.09→	TNK	1 457 42 S 9975	L
Komp.Nr. 508046 /08/09				





◀ Actros III 1846/ 2046/ 2746/ 3346

Komp.Nr. 508046/03 Fg.Nr. →..K 823576	12.09→	TNK	1 457 43 S 3728	L
Komp.Nr. 508046/04 Fg.Nr. →..K 823576	12.09→	TNK	1 457 43 S 3729	L
Komp.Nr. 508046/05	12.09→	TNK	1 457 43 S 3730	L
Komp.Nr. 508046/07/15 Komp.Nr. 508046/22	12.09→	TNK	F 026 40 S 0094	L
Komp.Nr. 508046/08/09 Fg.Nr. K 871497→	12.09→	TNK	F 026 40 S 0064	L
Komp.Nr. 508046/17/18	12.09→	TNK	F 026 40 S 0064	L
Komp.Nr. 508046/20/21	12.09→	TNK	F 026 40 S 0088	L
Komp.Nr. 508046/03/04 Fg.Nr. ..K 823577→	12.09→	TNK	F 026 40 S 0088	L
	12.09→	WAS	1 457 42 N 9655	K
			1 987 43 R 1454 ⁸	I
		FBF	1 987 43 M 1154	I
		FBF	1 987 43 M 2150	I

Actros III 1848/ 2048

11,9 | 350 | OM 541.978 <502 LA Euro4/5>

	06.08→	OMZ	1 457 42 P 9128	O
Komp.Nr. 508046/03 Fg.Nr. →..K 823576	06.08→	TNK	1 457 43 S 3728	L
Komp.Nr. 508046/03/04 Fg.Nr. ..K 823577→	06.08→	TNK	F 026 40 S 0088	L
Komp.Nr. 508046/04 Fg.Nr. →..K 823576	06.08→	TNK	1 457 43 S 3729	L
Komp.Nr. 508046/05	06.08→	TNK	1 457 43 S 3730	L
Komp.Nr. 508046/08/09 Fg.Nr. K 871497→	06.08→	TNK	F 026 40 S 0064	L
Komp.Nr. 508046/08/09 Fg.Nr. →K 871496	06.08→	TNK	1 457 42 S 9975	L
Komp.Nr. 508046/17/18	06.08→	TNK	F 026 40 S 0064	L
Komp.Nr. 508046/20/21	06.08→	TNK	F 026 40 S 0094	L
Komp.Nr. 508046/22	06.08→	WAS	1 457 42 N 9655	K
			1 987 43 R 1454 ⁸	I
		FBF	1 987 43 M 1154	I
		FBF	1 987 43 M 2150	I

Actros III 1851/ 2051

15,9 | 375 | OM 542.960 <502 LA Euro4/5>

	06.08→	OMZ	1 457 42 P 9128	O
Komp.Nr. 508046/03 Fg.Nr. →..K 823576	06.08→	TNK	1 457 43 S 3728	L
Komp.Nr. 508046/04 Fg.Nr. →..K 823576	06.08→	TNK	1 457 43 S 3729	L
Komp.Nr. 508046/05	06.08→	TNK	1 457 43 S 3730	L
Komp.Nr. 508046/08/09 Fg.Nr. K 871497→	06.08→	TNK	F 026 40 S 0064	L
Komp.Nr. 508046/08/09 Fg.Nr. →K 871496	06.08→	TNK	1 457 42 S 9975	L
Komp.Nr. 508046/17/18	06.08→	TNK	F 026 40 S 0064	L
Komp.Nr. 508046/20/21	06.08→	TNK	F 026 40 S 0088	L
Komp.Nr. 508046/03/04 Fg.Nr. ..K 823577→	06.08→	TNK	F 026 40 S 0094	L
Komp.Nr. 508046/22	06.08→	TNK	F 026 40 S 0094	L



	06.08→	WAS	1 457 42 N 9655	K
			1 987 43 R 1454 ⁸	I
		FBF	1 987 43 M 1154	I
		FBF	1 987 43 M 2150	I

Actros III 1855

15,9 | 405 | OM 542.962 <502 LA Euro4/5>

	06.08→	OMZ	1 457 42 P 9128	O
Komp.Nr. 508046/03 Fg.Nr. →..K 823576	06.08→	TNK	1 457 43 S 3728	L
Komp.Nr. 508046/03/04 Fg.Nr. ..K 823577→	06.08→	TNK	F 026 40 S 0088	L
Komp.Nr. 508046/04 Fg.Nr. →..K 823576	06.08→	TNK	1 457 43 S 3729	L
Komp.Nr. 508046/05	06.08→	TNK	1 457 43 S 3730	L
Komp.Nr. 508046/08/09 Fg.Nr. K 871497→	06.08→	TNK	F 026 40 S 0064	L
Komp.Nr. 508046/08/09 Fg.Nr. →K 871496	06.08→	TNK	1 457 42 S 9975	L
Komp.Nr. 508046/17/18	06.08→	TNK	F 026 40 S 0064	L
Komp.Nr. 508046/20/21	06.08→	TNK	F 026 40 S 0094	L
Komp.Nr. 508046/22	06.08→	TNK	F 026 40 S 0094	L
Komp.Nr. 508046/14	06.08→	TNK	1 457 43 S 3901	L
	06.08→	WAS	1 457 42 N 9655	K
			1 987 43 R 1454 ⁸	I
		FBF	1 987 43 M 1154	I
		FBF	1 987 43 M 2150	I

Actros III 1860

15,9 | 440 | OM 542.964 <502 LA Euro4/5>

	06.08→	OMZ	1 457 42 P 9128	O
Fg.Nr. →..K 871496	06.08→	TNK	1 457 42 S 9975	L
Komp.Nr. 508046/08/09	06.08→	TNK	1 457 43 S 3728	L
Komp.Nr. 508046/03 Fg.Nr. →..K 823576	06.08→	TNK	F 026 40 S 0088	L
Komp.Nr. 508046/03/04 Fg.Nr. ..K 823577→	06.08→	TNK	F 026 40 S 0088	L
Komp.Nr. 508046/04 Fg.Nr. →..K 823576	06.08→	TNK	1 457 43 S 3729	L
Komp.Nr. 508046/05	06.08→	TNK	1 457 43 S 3730	L
Komp.Nr. 508046/08/09 Fg.Nr. K 871497→	06.08→	TNK	F 026 40 S 0064	L
Komp.Nr. 508046/17/18	06.08→	TNK	F 026 40 S 0064	L
Komp.Nr. 508046/20/21	06.08→	TNK	F 026 40 S 0094	L
Komp.Nr. 508046/22	06.08→	TNK	F 026 40 S 0094	L
Komp.Nr. 508046/14	06.08→	TNK	1 457 43 S 3901	L
	06.08→	WAS	1 457 42 N 9655	K
			1 987 43 R 1454 ⁸	I
		FBF	1 987 43 M 1154	I
		FBF	1 987 43 M 2150	I

Actros III 2032

11,9 | 235 | OM 541.970 <501 LA Euro4/5>

	06.08→	OMZ	1 457 42 P 9128	O
Komp.Nr. 508046/03 Fg.Nr. →..K 823576	06.08→	TNK	1 457 43 S 3728	L
Komp.Nr. 508046/04 Fg.Nr. →..K 823576	06.08→	TNK	1 457 43 S 3729	L
Komp.Nr. 508046/05	06.08→	TNK	1 457 43 S 3730	L



Komp.Nr. 508046/07/15	06.08→	TNK	F 026 40 S 0094	L
Komp.Nr. 508046/22				
Komp.Nr. 508046/08/09	06.08→	TNK	F 026 40 S 0064	L
Fg.Nr. K 871497→				
Komp.Nr. 508046/08/09	06.08→	TNK	1 457 42 S 9975	L
Fg.Nr. →K 871496				
Komp.Nr. 508046/17/18	06.08→	TNK	F 026 40 S 0064	L
Komp.Nr. 508046/20/21				
Komp.Nr. 508046/03/04	06.08→	TNK	F 026 40 S 0088	L
Fg.Nr. ...K 823577→				
	06.08→	WAS	1 457 42 N 9655	K
			1 987 43 R 1454 ⁸	I
		FBF	1 987 43 M 1154	I
		FBF	1 987 43 M 2150	I

11,9 | 235 | OM 541.996 <501 LA EEV>

	07.10→	OMZ	1 457 42 P 9128	O
Komp.Nr. 508046/03	07.10→	TNK	1 457 43 S 3728	L
Fg.Nr. →..K 823576				
Komp.Nr. 508046/04	07.10→	TNK	1 457 43 S 3729	L
Fg.Nr. →..K 823576				
Komp.Nr. 508046/05	07.10→	TNK	1 457 43 S 3730	L
Komp.Nr. 508046/07/15	07.10→	TNK	F 026 40 S 0094	L
Komp.Nr. 508046/22				
Komp.Nr. 508046/08/09	07.10→	TNK	F 026 40 S 0064	L
Fg.Nr. K 871497→				
Komp.Nr. 508046/08/09x	07.10→	TNK	1 457 42 S 9975	L
Fg.Nr. K 871497→				
Komp.Nr. 508046/17/18	07.10→	TNK	F 026 40 S 0064	L
Komp.Nr. 508046/20/21				
Komp.Nr. 508046/03/04	07.10→	TNK	F 026 40 S 0088	L
Fg.Nr. ...K 823577→				
	07.10→	WAS	1 457 42 N 9655	K
			1 987 43 R 1454 ⁸	I
		FBF	1 987 43 M 1154	I
		FBF	1 987 43 M 2150	I

Actros III 2036

11,9 | 265 | OM 541.972 <501 LA Euro4/5>

	06.08→	OMZ	1 457 42 P 9128	O
Komp.Nr. 508046/03	06.08→	TNK	1 457 43 S 3728	L
Fg.Nr. →..K 823576				
Komp.Nr. 508046/04	06.08→	TNK	1 457 43 S 3729	L
Fg.Nr. →..K 823576				
Komp.Nr. 508046/05	06.08→	TNK	1 457 43 S 3730	L
Komp.Nr. 508046/07/15	06.08→	TNK	F 026 40 S 0094	L
Komp.Nr. 508046/22				
Komp.Nr. 508046/08/09	06.08→	TNK	F 026 40 S 0064	L
Fg.Nr. K 871497→				
Komp.Nr. 508046/08/09	06.08→	TNK	1 457 42 S 9975	L
Fg.Nr. →K 871496				
Komp.Nr. 508046/17/18	06.08→	TNK	F 026 40 S 0064	L
Komp.Nr. 508046/20/21				
Komp.Nr. 508046/03/04	06.08→	TNK	F 026 40 S 0088	L
Fg.Nr. ...K 823577→				
	06.08→	WAS	1 457 42 N 9655	K
			1 987 43 R 1454 ⁸	I
		FBF	1 987 43 M 1154	I
		FBF	1 987 43 M 2150	I

Actros III 2041

11,9 | 300 | OM 541.974 <501 LA Euro4/5>

	06.08→	OMZ	1 457 42 P 9128	O
Komp.Nr. 508046/03	06.08→	TNK	1 457 43 S 3728	L
Fg.Nr. →..K 823576				
Komp.Nr. 508046/04	06.08→	TNK	1 457 43 S 3729	L
Fg.Nr. →..K 823576				
Komp.Nr. 508046/05	06.08→	TNK	1 457 43 S 3730	L
Komp.Nr. 508046/07/15	06.08→	TNK	F 026 40 S 0094	L
Komp.Nr. 508046/22				
Komp.Nr. 508046/08/09	06.08→	TNK	F 026 40 S 0064	L
Fg.Nr. K 871497→				
Komp.Nr. 508046/08/09	06.08→	TNK	1 457 42 S 9975	L
Fg.Nr. →K 871496				
Komp.Nr. 508046/17/18	06.08→	TNK	F 026 40 S 0064	L
Komp.Nr. 508046/20/21				
Komp.Nr. 508046/03/04	06.08→	TNK	F 026 40 S 0088	L
Fg.Nr. ...K 823577→				
	06.08→	WAS	1 457 42 N 9655	K
			1 987 43 R 1454 ⁸	I
		FBF	1 987 43 M 1154	I
		FBF	1 987 43 M 2150	I

11,9 | 300 | OM 541.990 <501 LA EEV>

	12.09→	OMZ	1 457 42 P 9128	O
Fg.Nr. →..K 871496	12.09→	TNK	1 457 42 S 9975	L
Komp.Nr. 508046/08/09				
Komp.Nr. 508046/03	12.09→	TNK	1 457 43 S 3728	L
Fg.Nr. →..K 823576				
Komp.Nr. 508046/04	12.09→	TNK	1 457 43 S 3729	L
Fg.Nr. →..K 823576				
Komp.Nr. 508046/05	12.09→	TNK	1 457 43 S 3730	L
Komp.Nr. 508046/07/15	12.09→	TNK	F 026 40 S 0094	L
Komp.Nr. 508046/22				
Komp.Nr. 508046/08/09	12.09→	TNK	F 026 40 S 0064	L
Fg.Nr. K 871497→				
Komp.Nr. 508046/17/18	12.09→	TNK	F 026 40 S 0064	L
Komp.Nr. 508046/20/21				
Komp.Nr. 508046/03/04	12.09→	TNK	F 026 40 S 0088	L
Fg.Nr. ...K 823577→				
	12.09→	WAS	1 457 42 N 9655	K
			1 987 43 R 1454 ⁸	I
		FBF	1 987 43 M 1154	I
		FBF	1 987 43 M 2150	I

Actros III 2044

11,9 | 320 | OM 541.976 <501 LA Euro4/5>

	06.08→	OMZ	1 457 42 P 9128	O
Komp.Nr. 508046/03	06.08→	TNK	1 457 43 S 3728	L
Fg.Nr. →..K 823576				
Komp.Nr. 508046/04	06.08→	TNK	1 457 43 S 3729	L
Fg.Nr. →..K 823576				
Komp.Nr. 508046/05	06.08→	TNK	1 457 43 S 3730	L
Komp.Nr. 508046/08/09	06.08→	TNK	F 026 40 S 0064	L
Fg.Nr. K 871497→				
Komp.Nr. 508046/08/09	06.08→	TNK	1 457 42 S 9975	L
Fg.Nr. →K 871496				
Komp.Nr. 508046/17/18	06.08→	TNK	F 026 40 S 0064	L
Komp.Nr. 508046/20/21				





◀ Actros III 2044

Komp.Nr. 508046/03/04	06.08→	TNK	F 026 40 S 0088	L
Fg.Nr. ..K 823577→				
Komp.Nr. 508046/07/15	06.08→	TNK	F 026 40 S 0094	L
Komp.Nr. 508046/22				
	06.08→	WAS	1 457 42 N 9655	K
			1 987 43 R 1454 ⁸	I
		FBF	1 987 43 M 1154	I
		FBF	1 987 43 M 2150	I

11,9 | 320 | OM 541.992 <501 LA EEV>

	12.09→	OMZ	1 457 42 P 9128	O
Fg.Nr. →..K 871496	12.09→	TNK	1 457 42 S 9975	L
Komp.Nr. 508046/08/09				
Komp.Nr. 508046/04	12.09→	TNK	1 457 43 S 3729	L
Fg.Nr. →..K 823576				
Komp.Nr. 508046/05	12.09→	TNK	1 457 43 S 3730	L
Komp.Nr. 508046/07/15	12.09→	TNK	F 026 40 S 0094	L
Komp.Nr. 508046/22				
Komp.Nr. 508046/08/09	12.09→	TNK	F 026 40 S 0064	L
Fg.Nr. K 871497→				
Komp.Nr. 508046/17/18	12.09→	TNK	F 026 40 S 0064	L
Komp.Nr. 508046/20/21				
Komp.Nr. 508046/03	12.09→	TNK	1 457 43 S 3728	L
Komp.Nr. 508046/03/04	12.09→	TNK	F 026 40 S 0088	L
Fg.Nr. ..K 823577→				
	12.09→	WAS	1 457 42 N 9655	K
			1 987 43 R 1454 ⁸	I
		FBF	1 987 43 M 1154	I
		FBF	1 987 43 M 2150	I

Actros III 2046

11,9 | 335 | OM 541.980 <501 LA Euro4/5>

	06.08→	OMZ	1 457 42 P 9128	O
Komp.Nr. 508046/03	06.08→	TNK	1 457 43 S 3728	L
Fg.Nr. →..K 823576				
Komp.Nr. 508046/04	06.08→	TNK	1 457 43 S 3729	L
Fg.Nr. →..K 823576				
Komp.Nr. 508046/05	06.08→	TNK	1 457 43 S 3730	L
Komp.Nr. 508046/07/15	06.08→	TNK	F 026 40 S 0094	L
Komp.Nr. 508046/22				
Komp.Nr. 508046/08/09	06.08→	TNK	F 026 40 S 0064	L
Fg.Nr. K 871497→				
Komp.Nr. 508046/08/09	06.08→	TNK	1 457 42 S 9975	L
Fg.Nr. →K 871496				
Komp.Nr. 508046/17/18	06.08→	TNK	F 026 40 S 0064	L
Komp.Nr. 508046/20/21				
Komp.Nr. 508046/03/04	06.08→	TNK	F 026 40 S 0088	L
Fg.Nr. ..K 823577→				
	06.08→	WAS	1 457 42 N 9655	K
			1 987 43 R 1454 ⁸	I
		FBF	1 987 43 M 1154	I
		FBF	1 987 43 M 2150	I

11,9 | 335 | OM 541.994 <501 LA EEV>

	12.09→	OMZ	1 457 42 P 9128	O
Komp.Nr. 508046/03	12.09→	TNK	1 457 43 S 3728	L
Fg.Nr. →..K 823576				
Komp.Nr. 508046/04	12.09→	TNK	1 457 43 S 3729	L
Fg.Nr. →..K 823576				
Komp.Nr. 508046/05	12.09→	TNK	1 457 43 S 3730	L
Komp.Nr. 508046/07/15	12.09→	TNK	F 026 40 S 0094	L
Komp.Nr. 508046/22				



Komp.Nr. 508046/08/09	12.09→	TNK	F 026 40 S 0064	L
Fg.Nr. K 871497→				
Komp.Nr. 508046/08/09	12.09→	TNK	1 457 42 S 9975	L
Fg.Nr. →K 871496				
Komp.Nr. 508046/17/18	12.09→	TNK	F 026 40 S 0064	L
Komp.Nr. 508046/20/21				
Komp.Nr. 508046/03/04	12.09→	TNK	F 026 40 S 0088	L
Fg.Nr. ..K 823577→				
	12.09→	WAS	1 457 42 N 9655	K
			1 987 43 R 1454 ⁸	I
		FBF	1 987 43 M 1154	I
		FBF	1 987 43 M 2150	I

Actros III 2055

15,9 | 405 | OM 542.962 <502 LA Euro4/5>

	06.08→	OMZ	1 457 42 P 9128	O
Komp.Nr. 508046/03	06.08→	TNK	1 457 43 S 3728	L
Fg.Nr. →..K 823576				
Komp.Nr. 508046/03/04	06.08→	TNK	F 026 40 S 0088	L
Fg.Nr. ..K 823577→				
Komp.Nr. 508046/04	06.08→	TNK	1 457 43 S 3729	L
Fg.Nr. →..K 823576				
Komp.Nr. 508046/05	06.08→	TNK	1 457 43 S 3730	L
Komp.Nr. 508046/08/09	06.08→	TNK	F 026 40 S 0064	L
Fg.Nr. K 871497→				
Komp.Nr. 508046/08/09	06.08→	TNK	1 457 42 S 9975	L
Fg.Nr. →K 871496				
Komp.Nr. 508046/17/18	06.08→	TNK	F 026 40 S 0064	L
Komp.Nr. 508046/20/21				
Komp.Nr. 508046/07/15	06.08→	TNK	F 026 40 S 0094	L
Komp.Nr. 508046/22				
	06.08→	WAS	1 457 42 N 9655	K
			1 987 43 R 1454 ⁸	I
		FBF	1 987 43 M 1154	I
		FBF	1 987 43 M 2150	I

Actros III 2432

11,9 | 235 | OM 541.970 <501 LA Euro4/5>

	06.08→	OMZ	1 457 42 P 9128	O
Komp.Nr. 508046/08/09	06.08→	TNK	F 026 40 S 0064	L
Fg.Nr. K 871497→				
Komp.Nr. 508046/08/09	06.08→	TNK	1 457 42 S 9975	L
Fg.Nr. →K 871496				
Komp.Nr. 508046/17/18	06.08→	TNK	F 026 40 S 0064	L
Komp.Nr. 508046/20/21				
Komp.Nr. 508046/14	06.08→	TNK	1 457 43 S 3901	L
	06.08→	WAS	1 457 42 N 9655	K
			1 987 43 R 1454 ⁸	I
		FBF	1 987 43 M 1154	I
		FBF	1 987 43 M 2150	I

11,9 | 235 | OM 541.996 <501 LA EEV>

	07.10→	OMZ	1 457 42 P 9128	O
Komp.Nr. 508046/08/09	07.10→	TNK	F 026 40 S 0064	L
Fg.Nr. K 871497→				
Komp.Nr. 508046/08/09	07.10→	TNK	1 457 42 S 9975	L
Fg.Nr. →K 871496				
Komp.Nr. 508046/17/18	07.10→	TNK	F 026 40 S 0064	L
Komp.Nr. 508046/20/21				
Komp.Nr. 508046/14	07.10→	TNK	1 457 43 S 3901	L



07.10→	WAS	1 457 42 N 9655	K
		1 987 43 R 1454 ⁸	I
	FBF	1 987 43 M 1154	I
	FBF	1 987 43 M 2150	I

Actros III 2436

11,9 | 265 | OM 541.972 <501 LA Euro4/5>

06.08→	OMZ	1 457 42 P 9128	O
Komp.Nr. 508046/08/09	06.08→	TNK	F 026 40 S 0064 L
Fg.Nr. K 871497→			
Komp.Nr. 508046/08/09	06.08→	TNK	1 457 42 S 9975 L
Fg.Nr. →K 871496			
Komp.Nr. 508046/17/18	06.08→	TNK	F 026 40 S 0064 L
Komp.Nr. 508046/20/21			
Komp.Nr. 508046/14	06.08→	TNK	1 457 43 S 3901 L
	06.08→	WAS	1 457 42 N 9655 K
		1 987 43 R 1454 ⁸	I
		FBF	1 987 43 M 1154 I
		FBF	1 987 43 M 2150 I

11,9 | 265 | OM 541.998 <501 LA EEV>

07.10→	OMZ	1 457 42 P 9128	O
Komp.Nr. 508046/08/09	07.10→	TNK	F 026 40 S 0064 L
Fg.Nr. K 871497→			
Komp.Nr. 508046/08/09	07.10→	TNK	1 457 42 S 9975 L
Fg.Nr. →K 871496			
Komp.Nr. 508046/17/18	07.10→	TNK	F 026 40 S 0064 L
Komp.Nr. 508046/20/21			
Komp.Nr. 508046/14	07.10→	TNK	1 457 43 S 3901 L
	07.10→	WAS	1 457 42 N 9655 K
		1 987 43 R 1454 ⁸	I
		FBF	1 987 43 M 1154 I
		FBF	1 987 43 M 2150 I

Actros III 2441

11,9 | 300 | OM 541.974 <501 LA Euro4/5>

06.08→	OMZ	1 457 42 P 9128	O
Komp.Nr. 508046/08/09	06.08→	TNK	F 026 40 S 0064 L
Fg.Nr. K 871497→			
Komp.Nr. 508046/08/09	06.08→	TNK	1 457 42 S 9975 L
Fg.Nr. →K 871496			
Komp.Nr. 508046/17/18	06.08→	TNK	F 026 40 S 0064 L
Komp.Nr. 508046/20/21			
Komp.Nr. 508046/14	06.08→	TNK	1 457 43 S 3901 L
	06.08→	WAS	1 457 42 N 9655 K
		1 987 43 R 1454 ⁸	I
		FBF	1 987 43 M 1154 I
		FBF	1 987 43 M 2150 I

11,9 | 300 | OM 541.990 <501 LA EEV>

12.09→	OMZ	1 457 42 P 9128	O
Fg.Nr. →.K 871496	12.09→	TNK	1 457 42 S 9975 L
Komp.Nr. 508046/08/09			
Komp.Nr. 508046/08/09	12.09→	TNK	F 026 40 S 0064 L
Fg.Nr. K 871497→			
Komp.Nr. 508046/17/18	12.09→	TNK	F 026 40 S 0064 L
Komp.Nr. 508046/20/21			
Komp.Nr. 508046/14	12.09→	TNK	1 457 43 S 3901 L



12.09→	WAS	1 457 42 N 9655	K
		1 987 43 R 1454 ⁸	I
	FBF	1 987 43 M 1154	I
	FBF	1 987 43 M 2150	I

Actros III 2444

11,9 | 320 | OM 541.976 <501 LA Euro4/5>

06.08→	OMZ	1 457 42 P 9128	O
Komp.Nr. 508046/08/09	06.08→	TNK	F 026 40 S 0064 L
Fg.Nr. K 871497→			
Komp.Nr. 508046/08/09	06.08→	TNK	1 457 42 S 9975 L
Fg.Nr. →K 871496			
Komp.Nr. 508046/17/18	06.08→	TNK	F 026 40 S 0064 L
Komp.Nr. 508046/20/21			
Komp.Nr. 508046/14	06.08→	TNK	1 457 43 S 3901 L
	06.08→	WAS	1 457 42 N 9655 K
		1 987 43 R 1454 ⁸	I
		FBF	1 987 43 M 1154 I
		FBF	1 987 43 M 2150 I

11,9 | 320 | OM 541.992 <501 LA EEV>

12.09→	OMZ	1 457 42 P 9128	O
Fg.Nr. →.K 871496	12.09→	TNK	1 457 42 S 9975 L
Komp.Nr. 508046/08/09			
Komp.Nr. 508046/08/09	12.09→	TNK	F 026 40 S 0064 L
Fg.Nr. K 871497→			
Komp.Nr. 508046/17/18	12.09→	TNK	F 026 40 S 0064 L
Komp.Nr. 508046/20/21			
Komp.Nr. 508046/14	12.09→	TNK	1 457 43 S 3901 L
	12.09→	WAS	1 457 42 N 9655 K
		1 987 43 R 1454 ⁸	I
		FBF	1 987 43 M 1154 I
		FBF	1 987 43 M 2150 I

Actros III 2446

11,9 | 335 | OM 541.980 <501 LA Euro4/5>

06.08→	OMZ	1 457 42 P 9128	O
Komp.Nr. 508046/08/09	06.08→	TNK	F 026 40 S 0064 L
Fg.Nr. K 871497→			
Komp.Nr. 508046/08/09	06.08→	TNK	1 457 42 S 9975 L
Fg.Nr. →K 871496			
Komp.Nr. 508046/17/18	06.08→	TNK	F 026 40 S 0064 L
Komp.Nr. 508046/20/21			
Komp.Nr. 508046/14	06.08→	TNK	1 457 43 S 3901 L
	06.08→	WAS	1 457 42 N 9655 K
		1 987 43 R 1454 ⁸	I
		FBF	1 987 43 M 1154 I
		FBF	1 987 43 M 2150 I

Actros III 2448

11,9 | 350 | OM 541.978 <501 LA Euro4/5>

06.08→	OMZ	1 457 42 P 9128	O
Komp.Nr. 508046/08/09	06.08→	TNK	F 026 40 S 0064 L
Fg.Nr. K 871497→			
Komp.Nr. 508046/08/09	06.08→	TNK	1 457 42 S 9975 L
Fg.Nr. →K 871496			
Komp.Nr. 508046/17/18	06.08→	TNK	F 026 40 S 0064 L
Komp.Nr. 508046/20/21			
Komp.Nr. 508046/14	06.08→	TNK	1 457 43 S 3901 L





◀ Actros III 2448

06.08→	WAS	1 457 42 N 9655	K
		1 987 43 R 1454 ⁸	I
	FBF	1 987 43 M 1154	I
	FBF	1 987 43 M 2150	I

Actros III 2451

15,9 | 375 | OM 542.960 <502 LA Euro4/5>

06.08→	OMZ	1 457 42 P 9128	O
Komp.Nr. 508046 /08/09	06.08→	TNK	F 026 40 S 0064 L
Fg.Nr. K 871497→			
Komp.Nr. 508046 /08/09	06.08→	TNK	1 457 42 S 9975 L
Fg.Nr. →K 871496			
Komp.Nr. 508046 /17/18	06.08→	TNK	F 026 40 S 0064 L
Komp.Nr. 508046 /20/21			
Komp.Nr. 508046 /14	06.08→	TNK	1 457 43 S 3901 L
	06.08→	WAS	1 457 42 N 9655 K
		1 987 43 R 1454 ⁸	I
		FBF	1 987 43 M 1154 I
		FBF	1 987 43 M 2150 I

Actros III 2455

15,9 | 405 | OM 542.962 <502 LA Euro4/5>

06.08→	OMZ	1 457 42 P 9128	O
Komp.Nr. 508046 /08/09	06.08→	TNK	F 026 40 S 0064 L
Fg.Nr. K 871497→			
Komp.Nr. 508046 /08/09	06.08→	TNK	1 457 42 S 9975 L
Fg.Nr. →K 871496			
Komp.Nr. 508046 /17/18	06.08→	TNK	F 026 40 S 0064 L
Komp.Nr. 508046 /20/21			
Komp.Nr. 508046 /14	06.08→	TNK	1 457 43 S 3901 L
	06.08→	WAS	1 457 42 N 9655 K
		1 987 43 R 1454 ⁸	I
		FBF	1 987 43 M 1154 I
		FBF	1 987 43 M 2150 I

Actros III 2460

15,9 | 440 | OM 542.964 <502 LA Euro4/5>

06.08→	OMZ	1 457 42 P 9128	O
Komp.Nr. 508046 /08/09	06.08→	TNK	F 026 40 S 0064 L
Fg.Nr. K 871497→			
Komp.Nr. 508046 /08/09	06.08→	TNK	1 457 42 S 9975 L
Fg.Nr. →K 871496			
Komp.Nr. 508046 /17/18	06.08→	TNK	F 026 40 S 0064 L
Komp.Nr. 508046 /20/21			
Komp.Nr. 508046 /14	06.08→	TNK	1 457 43 S 3901 L
	06.08→	WAS	1 457 42 N 9655 K
		1 987 43 R 1454 ⁸	I
		FBF	1 987 43 M 1154 I
		FBF	1 987 43 M 2150 I

Actros III 2532

11,9 | 235 | OM 541.970 <501 LA Euro4/5>

06.08→	OMZ	1 457 42 P 9128	O
Komp.Nr. 508046 /03	06.08→	TNK	1 457 43 S 3728 L
Fg.Nr. →..K 823576			
Komp.Nr. 508046 /03/04	06.08→	TNK	F 026 40 S 0088 L
Fg.Nr. ..K 823577→			
Komp.Nr. 508046 /04	06.08→	TNK	1 457 43 S 3729 L
Fg.Nr. →..K 823576			
Komp.Nr. 508046 /05	06.08→	TNK	1 457 43 S 3730 L
Komp.Nr. 508046 /08/09	06.08→	TNK	F 026 40 S 0064 L
Fg.Nr. K 871497→			



Komp.Nr. 508046 /08/09	06.08→	TNK	1 457 42 S 9975	L
Fg.Nr. →K 871496				
Komp.Nr. 508046 /17/18	06.08→	TNK	F 026 40 S 0064	L
Komp.Nr. 508046 /20/21				
Komp.Nr. 508046 /07/15	06.08→	TNK	F 026 40 S 0094	L
Komp.Nr. 508046 /22				

06.08→	WAS	1 457 42 N 9655	K
		1 987 43 R 1454 ⁸	I
	FBF	1 987 43 M 1154	I
	FBF	1 987 43 M 2150	I

11,9 | 235 | OM 541.996 <501 LA EEV>

07.10→	OMZ	1 457 42 P 9128	O
Komp.Nr. 508046 /03	07.10→	TNK	1 457 43 S 3728 L
Fg.Nr. →..K 823576			
Komp.Nr. 508046 /03/04	07.10→	TNK	F 026 40 S 0088 L
Fg.Nr. ...K 823577→			
Komp.Nr. 508046 /04	07.10→	TNK	1 457 43 S 3729 L
Fg.Nr. →..K 823576			
Komp.Nr. 508046 /05	07.10→	TNK	1 457 43 S 3730 L
Komp.Nr. 508046 /08/09	07.10→	TNK	F 026 40 S 0064 L
Fg.Nr. K 871497→			
Komp.Nr. 508046 /08/09	07.10→	TNK	1 457 42 S 9975 L
Fg.Nr. →K 871496			
Komp.Nr. 508046 /17/18	07.10→	TNK	F 026 40 S 0064 L
Komp.Nr. 508046 /20/21			
Komp.Nr. 508046 /07/15	07.10→	TNK	F 026 40 S 0094 L
Komp.Nr. 508046 /22			

07.10→	WAS	1 457 42 N 9655	K
		1 987 43 R 1454 ⁸	I
	FBF	1 987 43 M 1154	I
	FBF	1 987 43 M 2150	I

Actros III 2536

11,9 | 265 | OM 541.972 <501 LA Euro4/5>

06.08→	OMZ	1 457 42 P 9128	O
Komp.Nr. 508046 /03	06.08→	TNK	1 457 43 S 3728 L
Fg.Nr. →..K 823576			
Komp.Nr. 508046 /03/04	06.08→	TNK	F 026 40 S 0088 L
Fg.Nr. ...K 823577→			
Komp.Nr. 508046 /04	06.08→	TNK	1 457 43 S 3729 L
Fg.Nr. →..K 823576			
Komp.Nr. 508046 /05	06.08→	TNK	1 457 43 S 3730 L
Komp.Nr. 508046 /07/15	06.08→	TNK	F 026 40 S 0094 L
Komp.Nr. 508046 /22			
Komp.Nr. 508046 /08/09	06.08→	TNK	F 026 40 S 0064 L
Fg.Nr. K 871497→			
Komp.Nr. 508046 /08/09	06.08→	TNK	1 457 42 S 9975 L
Fg.Nr. →K 871496			
Komp.Nr. 508046 /17/18	06.08→	TNK	F 026 40 S 0064 L
Komp.Nr. 508046 /20/21			

06.08→	WAS	1 457 42 N 9655	K
		1 987 43 R 1454 ⁸	I
	FBF	1 987 43 M 1154	I
	FBF	1 987 43 M 2150	I

11,9 | 265 | OM 541.998 <501 LA EEV>

07.10→	OMZ	1 457 42 P 9128	O
Komp.Nr. 508046 /03	07.10→	TNK	1 457 43 S 3728 L
Fg.Nr. →..K 823576			
Komp.Nr. 508046 /03/04	07.10→	TNK	F 026 40 S 0088 L
Fg.Nr. ...K 823577→			



Komp.Nr. 508046/04	07.10→	TNK	1 457 43 S 3729	L
Fg.Nr. →.K 823576				
Komp.Nr. 508046/05	07.10→	TNK	1 457 43 S 3730	L
Komp.Nr. 508046/07/15	07.10→	TNK	F 026 40 S 0094	L
Komp.Nr. 508046/22				
Komp.Nr. 508046/08/09	07.10→	TNK	F 026 40 S 0064	L
Fg.Nr. K 871497→				
Komp.Nr. 508046/08/09	07.10→	TNK	1 457 42 S 9975	L
Fg.Nr. →K 871496				
Komp.Nr. 508046/17/18	07.10→	TNK	F 026 40 S 0064	L
Komp.Nr. 508046/20/21				
	07.10→	WAS	1 457 42 N 9655	K
			1 987 43 R 1454 ⁸	I
		FBF	1 987 43 M 1154	I
		FBF	1 987 43 M 2150	I

Actros III 2541

11,9 | 300 | OM 541.974 <501 LA Euro4/5>

	06.08→	OMZ	1 457 42 P 9128	O
Komp.Nr. 508046/03	06.08→	TNK	1 457 43 S 3728	L
Fg.Nr. →.K 823576				
Komp.Nr. 508046/04	06.08→	TNK	1 457 43 S 3729	L
Fg.Nr. →.K 823576				
Komp.Nr. 508046/05	06.08→	TNK	1 457 43 S 3730	L
Komp.Nr. 508046/08/09	06.08→	TNK	F 026 40 S 0064	L
Fg.Nr. K 871497→				
Komp.Nr. 508046/08/09	06.08→	TNK	1 457 42 S 9975	L
Fg.Nr. →K 871496				
Komp.Nr. 508046/17/18	06.08→	TNK	F 026 40 S 0064	L
Komp.Nr. 508046/20/21				
Komp.Nr. 508046/03/04	06.08→	TNK	F 026 40 S 0088	L
Fg.Nr. →.K 823577→				
Komp.Nr. 508046/07/15	06.08→	TNK	F 026 40 S 0094	L
Komp.Nr. 508046/22				
Komp.Nr. 508046/14	06.08→	TNK	1 457 43 S 3901	L
	06.08→	WAS	1 457 42 N 9655	K
			1 987 43 R 1454 ⁸	I
		FBF	1 987 43 M 1154	I
		FBF	1 987 43 M 2150	I

Actros III 2541/ 2641

11,9 | 300 | OM 541.990 <501 LA EEV>

	12.09→	OMZ	1 457 42 P 9128	O
Fg.Nr. →.K 871496	12.09→	TNK	1 457 42 S 9975	L
Komp.Nr. 508046/08/09				
Komp.Nr. 508046/03	12.09→	TNK	1 457 43 S 3728	L
Fg.Nr. →.K 823576				
Komp.Nr. 508046/04	12.09→	TNK	1 457 43 S 3729	L
Fg.Nr. →.K 823576				
Komp.Nr. 508046/05	12.09→	TNK	1 457 43 S 3730	L
Komp.Nr. 508046/07/15	12.09→	TNK	F 026 40 S 0094	L
Komp.Nr. 508046/22				
Komp.Nr. 508046/08/09	12.09→	TNK	F 026 40 S 0064	L
Fg.Nr. K 871497→				
Komp.Nr. 508046/17/18	12.09→	TNK	F 026 40 S 0064	L
Komp.Nr. 508046/20/21				
Komp.Nr. 508046/03/04	12.09→	TNK	F 026 40 S 0088	L
Fg.Nr. →.K 823577→				
Komp.Nr. 508046/14	12.09→	TNK	1 457 43 S 3901	L



	12.09→	WAS	1 457 42 N 9655	K
			1 987 43 R 1454 ⁸	I
		FBF	1 987 43 M 1154	I
		FBF	1 987 43 M 2150	I

Actros III 2544/ 2644

11,9 | 320 | OM 541.976 <501 LA Euro4/5>

	06.08→	OMZ	1 457 42 P 9128	O
Komp.Nr. 508046/03	06.08→	TNK	1 457 43 S 3728	L
Fg.Nr. →.K 823576				
Komp.Nr. 508046/04	06.08→	TNK	1 457 43 S 3729	L
Fg.Nr. →.K 823576				
Komp.Nr. 508046/05	06.08→	TNK	1 457 43 S 3730	L
Komp.Nr. 508046/08/09	06.08→	TNK	F 026 40 S 0064	L
Fg.Nr. K 871497→				
Komp.Nr. 508046/08/09	06.08→	TNK	1 457 42 S 9975	L
Fg.Nr. →K 871496				
Komp.Nr. 508046/17/18	06.08→	TNK	F 026 40 S 0064	L
Komp.Nr. 508046/20/21				
Komp.Nr. 508046/03/04	06.08→	TNK	F 026 40 S 0088	L
Fg.Nr. →.K 823577→				
Komp.Nr. 508046/07/15	06.08→	TNK	F 026 40 S 0094	L
Komp.Nr. 508046/22				
	06.08→	WAS	1 457 42 N 9655	K
			1 987 43 R 1454 ⁸	I
		FBF	1 987 43 M 1154	I
		FBF	1 987 43 M 2150	I

11,9 | 320 | OM 541.992 <501 LA EEV>

	12.09→	OMZ	1 457 42 P 9128	O
Fg.Nr. →.K 871496	12.09→	TNK	1 457 42 S 9975	L
Komp.Nr. 508046/08/09				
Komp.Nr. 508046/04	12.09→	TNK	1 457 43 S 3729	L
Fg.Nr. →.K 823576				
Komp.Nr. 508046/05	12.09→	TNK	1 457 43 S 3730	L
Komp.Nr. 508046/07/15	12.09→	TNK	F 026 40 S 0094	L
Komp.Nr. 508046/22				
Komp.Nr. 508046/08/09	12.09→	TNK	F 026 40 S 0064	L
Fg.Nr. K 871497→				
Komp.Nr. 508046/17/18	12.09→	TNK	F 026 40 S 0064	L
Komp.Nr. 508046/20/21				
Komp.Nr. 508046/03	12.09→	TNK	1 457 43 S 3728	L
Komp.Nr. 508046/03/04	12.09→	TNK	F 026 40 S 0088	L
Fg.Nr. →.K 823577→				
Komp.Nr. 508046/14	12.09→	TNK	1 457 43 S 3901	L
	12.09→	WAS	1 457 42 N 9655	K
			1 987 43 R 1454 ⁸	I
		FBF	1 987 43 M 1154	I
		FBF	1 987 43 M 2150	I

Actros III 2546

11,9 | 335 | OM 541.980 <501 LA Euro4/5>

	06.08→	OMZ	1 457 42 P 9128	O
Komp.Nr. 508046/03	06.08→	TNK	1 457 43 S 3728	L
Fg.Nr. →.K 823576				
Komp.Nr. 508046/04	06.08→	TNK	1 457 43 S 3729	L
Fg.Nr. →.K 823576				
Komp.Nr. 508046/05	06.08→	TNK	1 457 43 S 3730	L
Komp.Nr. 508046/08/09	06.08→	TNK	F 026 40 S 0064	L
Fg.Nr. K 871497→				





◀ Actros III 2546

Komp.Nr. 508046/08/09 Fg.Nr. →K 871496	06.08→	TNK	1 457 42 S 9975	L
Komp.Nr. 508046/17/18 Komp.Nr. 508046/20/21	06.08→	TNK	F 026 40 S 0064	L
Komp.Nr. 508046/03/04 Fg.Nr. ...K 823577→	06.08→	TNK	F 026 40 S 0088	L
Komp.Nr. 508046/07/15 Komp.Nr. 508046/22	06.08→	TNK	F 026 40 S 0094	L
	06.08→	WAS	1 457 42 N 9655	K
			1 987 43 R 1454 ⁸	I
		FBF	1 987 43 M 1154	I
		FBF	1 987 43 M 2150	I

Actros III 2546/ 2646

11,9 | 335 | OM 541.994 <501 LA EEV>

Komp.Nr. 508046/03 Fg.Nr. →...K 823576	12.09→	OMZ	1 457 42 P 9128	O
Komp.Nr. 508046/04 Fg.Nr. →...K 823576	12.09→	TNK	1 457 43 S 3728	L
Komp.Nr. 508046/05 Komp.Nr. 508046/07/15 Komp.Nr. 508046/22	12.09→	TNK	1 457 43 S 3730	L
Komp.Nr. 508046/08/09 Fg.Nr. K 871497→	12.09→	TNK	F 026 40 S 0094	L
Komp.Nr. 508046/08/09 Fg.Nr. →K 871496	12.09→	TNK	F 026 40 S 0064	L
Komp.Nr. 508046/17/18 Komp.Nr. 508046/20/21	12.09→	TNK	1 457 42 S 9975	L
Komp.Nr. 508046/03/04 Fg.Nr. ...K 823577→	12.09→	TNK	F 026 40 S 0088	L
Komp.Nr. 508046/14	12.09→	TNK	1 457 43 S 3901	L
	12.09→	WAS	1 457 42 N 9655	K
			1 987 43 R 1454 ⁸	I
		FBF	1 987 43 M 1154	I
		FBF	1 987 43 M 2150	I

Actros III 2548/ 2648

11,9 | 350 | OM 541.978 <501 LA Euro4/5>

Komp.Nr. 508046/03 Fg.Nr. →...K 823576	06.08→	OMZ	1 457 42 P 9128	O
Komp.Nr. 508046/03/04 Fg.Nr. ...K 823577→	06.08→	TNK	1 457 43 S 3728	L
Komp.Nr. 508046/04 Fg.Nr. →...K 823576	06.08→	TNK	F 026 40 S 0088	L
Komp.Nr. 508046/05 Komp.Nr. 508046/08/09 Fg.Nr. K 871497→	06.08→	TNK	1 457 43 S 3730	L
Komp.Nr. 508046/08/09 Fg.Nr. →K 871496	06.08→	TNK	F 026 40 S 0064	L
Komp.Nr. 508046/17/18 Komp.Nr. 508046/20/21	06.08→	TNK	1 457 42 S 9975	L
Komp.Nr. 508046/07/15 Komp.Nr. 508046/22	06.08→	TNK	F 026 40 S 0094	L
	06.08→	WAS	1 457 42 N 9655	K
			1 987 43 R 1454 ⁸	I
		FBF	1 987 43 M 1154	I
		FBF	1 987 43 M 2150	I



Actros III 2551/ 2651/ 3351

15,9 | 375 | OM 542.960 <502 LA Euro4/5>

	06.08→	OMZ	1 457 42 P 9128	O
Komp.Nr. 508046/03 Fg.Nr. →...K 823576	06.08→	TNK	1 457 43 S 3728	L
Komp.Nr. 508046/04 Fg.Nr. →...K 823576	06.08→	TNK	1 457 43 S 3729	L
Komp.Nr. 508046/05 Komp.Nr. 508046/08/09 Fg.Nr. K 871497→	06.08→	TNK	1 457 43 S 3730	L
Komp.Nr. 508046/08/09 Fg.Nr. →K 871496	06.08→	TNK	F 026 40 S 0064	L
Komp.Nr. 508046/17/18 Komp.Nr. 508046/20/21	06.08→	TNK	1 457 42 S 9975	L
Komp.Nr. 508046/03/04 Fg.Nr. ...K 823577→	06.08→	TNK	F 026 40 S 0088	L
Komp.Nr. 508046/07/15 Komp.Nr. 508046/22	06.08→	TNK	F 026 40 S 0094	L
	06.08→	WAS	1 457 42 N 9655	K
			1 987 43 R 1454 ⁸	I
		FBF	1 987 43 M 1154	I
		FBF	1 987 43 M 2150	I

Actros III 2555/ 2655/ 3355

15,9 | 405 | OM 542.962 <502 LA Euro4/5>

	06.08→	OMZ	1 457 42 P 9128	O
Komp.Nr. 508046/03 Fg.Nr. →...K 823576	06.08→	TNK	1 457 43 S 3728	L
Komp.Nr. 508046/03/04 Fg.Nr. ...K 823577→	06.08→	TNK	F 026 40 S 0088	L
Komp.Nr. 508046/04 Fg.Nr. →...K 823576	06.08→	TNK	1 457 43 S 3729	L
Komp.Nr. 508046/05 Komp.Nr. 508046/08/09 Fg.Nr. K 871497→	06.08→	TNK	1 457 43 S 3730	L
Komp.Nr. 508046/08/09 Fg.Nr. →K 871496	06.08→	TNK	F 026 40 S 0064	L
Komp.Nr. 508046/17/18 Komp.Nr. 508046/20/21	06.08→	TNK	1 457 42 S 9975	L
Komp.Nr. 508046/07/15 Komp.Nr. 508046/22	06.08→	TNK	F 026 40 S 0094	L
Komp.Nr. 508046/14	06.08→	TNK	1 457 43 S 3901	L
	06.08→	WAS	1 457 42 N 9655	K
			1 987 43 R 1454 ⁸	I
		FBF	1 987 43 M 1154	I
		FBF	1 987 43 M 2150	I

Actros III 2560/ 2660/ 3360

15,9 | 440 | OM 542.964 <502 LA Euro4/5>

	06.08→	OMZ	1 457 42 P 9128	O
Fg.Nr. →...K 871496	06.08→	TNK	1 457 42 S 9975	L
Komp.Nr. 508046/08/09 Komp.Nr. 508046/03 Fg.Nr. →...K 823576	06.08→	TNK	1 457 43 S 3728	L
Komp.Nr. 508046/03/04 Fg.Nr. ...K 823577→	06.08→	TNK	F 026 40 S 0088	L
Komp.Nr. 508046/04 Fg.Nr. →...K 823576	06.08→	TNK	1 457 43 S 3729	L
Komp.Nr. 508046/05 Komp.Nr. 508046/08/09 Fg.Nr. K 871497→	06.08→	TNK	1 457 43 S 3730	L
	06.08→	TNK	F 026 40 S 0064	L



Komp.Nr. 508046/17/18	06.08→	TNK	F 026 40 S 0064	L
Komp.Nr. 508046/20/21				
Komp.Nr. 508046/07/15	06.08→	TNK	F 026 40 S 0094	L
Komp.Nr. 508046/22				
	06.08→	WAS	1 457 42 N 9655	K
			1 987 43 R 1454 ⁸	I
		FBF	1 987 43 M 1154	I
		FBF	1 987 43 M 2150	I

Actros III 2632

11,9 | 235 | OM 541.970 <501 LA Euro4/5>

	06.08→	OMZ	1 457 42 P 9128	O
Komp.Nr. 508046/03	06.08→	TNK	1 457 43 S 3728	L
Fg.Nr. →..K 823576				
Komp.Nr. 508046/04	06.08→	TNK	1 457 43 S 3729	L
Fg.Nr. →..K 823576				
Komp.Nr. 508046/05	06.08→	TNK	1 457 43 S 3730	L
Komp.Nr. 508046/07/15	06.08→	TNK	F 026 40 S 0094	L
Komp.Nr. 508046/22				
Komp.Nr. 508046/08/09	06.08→	TNK	F 026 40 S 0064	L
Fg.Nr. K 871497→				
Komp.Nr. 508046/08/09	06.08→	TNK	1 457 42 S 9975	L
Fg.Nr. →K 871496				
Komp.Nr. 508046/17/18	06.08→	TNK	F 026 40 S 0064	L
Komp.Nr. 508046/20/21				
Komp.Nr. 508046/03/04	06.08→	TNK	F 026 40 S 0088	L
Fg.Nr. →K 823577→				
	06.08→	WAS	1 457 42 N 9655	K
			1 987 43 R 1454 ⁸	I
		FBF	1 987 43 M 1154	I
		FBF	1 987 43 M 2150	I

11,9 | 235 | OM 541.996 <501 LA EEV>

	07.10→	OMZ	1 457 42 P 9128	O
Komp.Nr. 508046/03	07.10→	TNK	1 457 43 S 3728	L
Fg.Nr. →..K 823576				
Komp.Nr. 508046/04	07.10→	TNK	1 457 43 S 3729	L
Fg.Nr. →..K 823576				
Komp.Nr. 508046/05	07.10→	TNK	1 457 43 S 3730	L
Komp.Nr. 508046/07/15	07.10→	TNK	F 026 40 S 0094	L
Komp.Nr. 508046/22				
Komp.Nr. 508046/08/09	07.10→	TNK	F 026 40 S 0064	L
Fg.Nr. K 871497→				
Komp.Nr. 508046/08/09	07.10→	TNK	1 457 42 S 9975	L
Fg.Nr. →K 871496				
Komp.Nr. 508046/17/18	07.10→	TNK	F 026 40 S 0064	L
Komp.Nr. 508046/20/21				
Komp.Nr. 508046/03/04	07.10→	TNK	F 026 40 S 0088	L
Fg.Nr. →K 823577→				
	07.10→	WAS	1 457 42 N 9655	K
			1 987 43 R 1454 ⁸	I
		FBF	1 987 43 M 1154	I
		FBF	1 987 43 M 2150	I

Actros III 2636

11,9 | 265 | OM 541.972 <501 LA Euro4/5>

	06.08→	OMZ	1 457 42 P 9128	O
Komp.Nr. 508046/03	06.08→	TNK	1 457 43 S 3728	L
Fg.Nr. →..K 823576				



Komp.Nr. 508046/04	06.08→	TNK	1 457 43 S 3729	L
Fg.Nr. →..K 823576				
Komp.Nr. 508046/05	06.08→	TNK	1 457 43 S 3730	L
Komp.Nr. 508046/07/15	06.08→	TNK	F 026 40 S 0094	L
Komp.Nr. 508046/22				
Komp.Nr. 508046/08/09	06.08→	TNK	F 026 40 S 0064	L
Fg.Nr. K 871497→				
Komp.Nr. 508046/08/09	06.08→	TNK	1 457 42 S 9975	L
Fg.Nr. →K 871496				
Komp.Nr. 508046/17/18	06.08→	TNK	F 026 40 S 0064	L
Komp.Nr. 508046/20/21				
Komp.Nr. 508046/03/04	06.08→	TNK	F 026 40 S 0088	L
Fg.Nr. →K 823577→				
	06.08→	WAS	1 457 42 N 9655	K
			1 987 43 R 1454 ⁸	I
		FBF	1 987 43 M 1154	I
		FBF	1 987 43 M 2150	I

11,9 | 265 | OM 541.998 <501 LA EEV>

	07.10→	OMZ	1 457 42 P 9128	O
Komp.Nr. 508046/03	07.10→	TNK	1 457 43 S 3728	L
Fg.Nr. →..K 823576				
Komp.Nr. 508046/04	07.10→	TNK	1 457 43 S 3729	L
Fg.Nr. →..K 823576				
Komp.Nr. 508046/05	07.10→	TNK	1 457 43 S 3730	L
Komp.Nr. 508046/07/15	07.10→	TNK	F 026 40 S 0094	L
Komp.Nr. 508046/22				
Komp.Nr. 508046/08/09	07.10→	TNK	F 026 40 S 0064	L
Fg.Nr. K 871497→				
Komp.Nr. 508046/08/09	07.10→	TNK	1 457 42 S 9975	L
Fg.Nr. →K 871496				
Komp.Nr. 508046/17/18	07.10→	TNK	F 026 40 S 0064	L
Komp.Nr. 508046/20/21				
Komp.Nr. 508046/03/04	07.10→	TNK	F 026 40 S 0088	L
Fg.Nr. →K 823577→				
	07.10→	WAS	1 457 42 N 9655	K
			1 987 43 R 1454 ⁸	I
		FBF	1 987 43 M 1154	I
		FBF	1 987 43 M 2150	I

Actros III 2641

11,9 | 300 | OM 541.974 <501 LA Euro4/5>

	06.08→	OMZ	1 457 42 P 9128	O
Komp.Nr. 508046/03	06.08→	TNK	1 457 43 S 3728	L
Fg.Nr. →..K 823576				
Komp.Nr. 508046/04	06.08→	TNK	1 457 43 S 3729	L
Fg.Nr. →..K 823576				
Komp.Nr. 508046/05	06.08→	TNK	1 457 43 S 3730	L
Komp.Nr. 508046/07/15	06.08→	TNK	F 026 40 S 0094	L
Komp.Nr. 508046/22				
Komp.Nr. 508046/08/09	06.08→	TNK	F 026 40 S 0064	L
Fg.Nr. K 871497→				
Komp.Nr. 508046/08/09	06.08→	TNK	1 457 42 S 9975	L
Fg.Nr. →K 871496				
Komp.Nr. 508046/17/18	06.08→	TNK	F 026 40 S 0064	L
Komp.Nr. 508046/20/21				
Komp.Nr. 508046/03/04	06.08→	TNK	F 026 40 S 0088	L
Fg.Nr. →K 823577→				





◀ Actros III 2641

06.08→	WAS	1 457 42 N 9655	K
		1 987 43 R 1454 ⁸	I
	FBF	1 987 43 M 1154	I
	FBF	1 987 43 M 2150	I

Actros III 2646

11,9 | 335 | OM 541.980 <501 LA Euro4/5>

06.08→	OMZ	1 457 42 P 9128	O
Komp.Nr. 508046/03	06.08→	TNK	1 457 43 S 3728 L
Fg.Nr. →..K 823576			
Komp.Nr. 508046/04	06.08→	TNK	1 457 43 S 3729 L
Fg.Nr. →..K 823576			
Komp.Nr. 508046/05	06.08→	TNK	1 457 43 S 3730 L
Komp.Nr. 508046/07/15	06.08→	TNK	F 026 40 S 0094 L
Komp.Nr. 508046/22			
Komp.Nr. 508046/08/09	06.08→	TNK	F 026 40 S 0064 L
Fg.Nr. K 871497→			
Komp.Nr. 508046/08/09	06.08→	TNK	1 457 42 S 9975 L
Fg.Nr. →K 871496			
Komp.Nr. 508046/17/18	06.08→	TNK	F 026 40 S 0064 L
Komp.Nr. 508046/20/21			
Komp.Nr. 508046/03/04	06.08→	TNK	F 026 40 S 0088 L
Fg.Nr. →K 823577→			
06.08→	WAS	1 457 42 N 9655	K
		1 987 43 R 1454 ⁸	I
	FBF	1 987 43 M 1154	I
	FBF	1 987 43 M 2150	I

Actros III 2732

11,9 | 235 | OM 541.971 <501 LA Euro 4/5>

06.08→	OMZ	1 457 42 P 9128	O
Komp.Nr. 508046/03	06.08→	TNK	1 457 43 S 3728 L
Fg.Nr. →..K 823576			
Komp.Nr. 508046/03/04	06.08→	TNK	F 026 40 S 0088 L
Fg.Nr. →K 823577→			
Komp.Nr. 508046/04	06.08→	TNK	1 457 43 S 3729 L
Fg.Nr. →..K 823576			
Komp.Nr. 508046/05	06.08→	TNK	1 457 43 S 3730 L
Komp.Nr. 508046/08/09	06.08→	TNK	F 026 40 S 0064 L
Fg.Nr. K 871497→			
Komp.Nr. 508046/08/09	06.08→	TNK	1 457 42 S 9975 L
Fg.Nr. →K 871496			
Komp.Nr. 508046/17/18	06.08→	TNK	F 026 40 S 0064 L
Komp.Nr. 508046/20/21			
Komp.Nr. 508046/07/15	06.08→	TNK	F 026 40 S 0094 L
Komp.Nr. 508046/22			
Komp.Nr. 508046/14	06.08→	TNK	1 457 43 S 3901 L
06.08→	WAS	1 457 42 N 9655	K
		1 987 43 R 1454 ⁸	I
	FBF	1 987 43 M 1154	I
	FBF	1 987 43 M 2150	I

Actros III 2736

11,9 | 265 | OM 541.973 <501 LA Euro 4/5>

06.08→	OMZ	1 457 42 P 9128	O
Komp.Nr. 508046/03	06.08→	TNK	1 457 43 S 3728 L
Fg.Nr. →..K 823576			
Komp.Nr. 508046/03/04	06.08→	TNK	F 026 40 S 0088 L
Fg.Nr. →K 823577→			
Komp.Nr. 508046/04	06.08→	TNK	1 457 43 S 3729 L
Fg.Nr. →..K 823576			
Komp.Nr. 508046/05	06.08→	TNK	1 457 43 S 3730 L



Komp.Nr. 508046/07/15	06.08→	TNK	F 026 40 S 0094	L
Komp.Nr. 508046/22				
Komp.Nr. 508046/08/09	06.08→	TNK	F 026 40 S 0064	L
Fg.Nr. K 871497→				
Komp.Nr. 508046/08/09	06.08→	TNK	1 457 42 S 9975	L
Fg.Nr. →K 871496				
Komp.Nr. 508046/17/18	06.08→	TNK	F 026 40 S 0064	L
Komp.Nr. 508046/20/21				
06.08→	WAS	1 457 42 N 9655	K	
		1 987 43 R 1454 ⁸	I	
	FBF	1 987 43 M 1154	I	
	FBF	1 987 43 M 2150	I	

Actros III 2741

11,9 | 300 | OM 541.975 <501 LA Euro 4/5>

06.08→	OMZ	1 457 42 P 9128	O
Komp.Nr. 508046/03	06.08→	TNK	1 457 43 S 3728 L
Fg.Nr. →..K 823576			
Komp.Nr. 508046/03/04	06.08→	TNK	F 026 40 S 0088 L
Fg.Nr. →K 823577→			
Komp.Nr. 508046/04	06.08→	TNK	1 457 43 S 3729 L
Fg.Nr. →..K 823576			
Komp.Nr. 508046/05	06.08→	TNK	1 457 43 S 3730 L
Komp.Nr. 508046/08/09	06.08→	TNK	F 026 40 S 0064 L
Fg.Nr. K 871497→			
Komp.Nr. 508046/08/09	06.08→	TNK	1 457 42 S 9975 L
Fg.Nr. →K 871496			
Komp.Nr. 508046/17/18	06.08→	TNK	F 026 40 S 0064 L
Komp.Nr. 508046/20/21			
Komp.Nr. 508046/07/15	06.08→	TNK	F 026 40 S 0094 L
Komp.Nr. 508046/22			
Komp.Nr. 508046/14	06.08→	TNK	1 457 43 S 3901 L
06.08→	WAS	1 457 42 N 9655	K
		1 987 43 R 1454 ⁸	I
	FBF	1 987 43 M 1154	I
	FBF	1 987 43 M 2150	I

Actros III 2744

11,9 | 320 | OM 541.977 <501 LA Euro 4/5>

06.08→	OMZ	1 457 42 P 9128	O
Komp.Nr. 508046/03	06.08→	TNK	1 457 43 S 3728 L
Fg.Nr. →..K 823576			
Komp.Nr. 508046/04	06.08→	TNK	1 457 43 S 3729 L
Fg.Nr. →..K 823576			
Komp.Nr. 508046/05	06.08→	TNK	1 457 43 S 3730 L
Komp.Nr. 508046/07/15	06.08→	TNK	F 026 40 S 0094 L
Komp.Nr. 508046/22			
Komp.Nr. 508046/08/09	06.08→	TNK	1 457 42 S 9975 L
Fg.Nr. →K 871496			
Komp.Nr. 508046/20/21	06.08→	TNK	F 026 40 S 0064 L
Komp.Nr. 508046/03/04	06.08→	TNK	F 026 40 S 0088 L
Fg.Nr. →K 823577→			
06.08→	WAS	1 457 42 N 9655	K
		1 987 43 R 1454 ⁸	I
	FBF	1 987 43 M 1154	I
	FBF	1 987 43 M 2150	I

Actros III 2746

11,9 | 335 | OM 541.981 <501 LA Euro 4/5>

06.08→	OMZ	1 457 42 P 9128	O
Komp.Nr. 508046/03	06.08→	TNK	1 457 43 S 3728 L
Fg.Nr. →..K 823576			



Komp.Nr. 508046/03/04	06.08→	TNK	F 026 40 S 0088	L
Fg.Nr. →..K 823577→				
Komp.Nr. 508046/04	06.08→	TNK	1 457 43 S 3729	L
Fg.Nr. →..K 823576				
Komp.Nr. 508046/05	06.08→	TNK	1 457 43 S 3730	L
Komp.Nr. 508046/08/09	06.08→	TNK	F 026 40 S 0064	L
Fg.Nr. K 871497→				
Komp.Nr. 508046/08/09	06.08→	TNK	1 457 42 S 9975	L
Fg.Nr. →K 871496				
Komp.Nr. 508046/17/18	06.08→	TNK	F 026 40 S 0064	L
Komp.Nr. 508046/20/21				
Komp.Nr. 508046/07/15	06.08→	TNK	F 026 40 S 0094	L
Komp.Nr. 508046/22				
Komp.Nr. 508046/14	06.08→	TNK	1 457 43 S 3901	L
	06.08→	WAS	1 457 42 N 9655	K
			1 987 43 R 1454 ⁸	I
		FBF	1 987 43 M 1154	I
		FBF	1 987 43 M 2150	I

Actros III 2748

11,9 | 350 | OM 541.979 <501 LA Euro 4/5>

	06.08→	OMZ	1 457 42 P 9128	O
Komp.Nr. 508046/03	06.08→	TNK	1 457 43 S 3728	L
Fg.Nr. →..K 823576				
Komp.Nr. 508046/03/04	06.08→	TNK	F 026 40 S 0088	L
Fg.Nr. →..K 823577→				
Komp.Nr. 508046/04	06.08→	TNK	1 457 43 S 3729	L
Fg.Nr. →..K 823576				
Komp.Nr. 508046/05	06.08→	TNK	1 457 43 S 3730	L
Komp.Nr. 508046/08/09	06.08→	TNK	F 026 40 S 0064	L
Fg.Nr. K 871497→				
Komp.Nr. 508046/08/09	06.08→	TNK	1 457 42 S 9975	L
Fg.Nr. →K 871496				
Komp.Nr. 508046/17/18	06.08→	TNK	F 026 40 S 0064	L
Komp.Nr. 508046/20/21				
Komp.Nr. 508046/07/15	06.08→	TNK	F 026 40 S 0094	L
Komp.Nr. 508046/22				
Komp.Nr. 508046/14	06.08→	TNK	1 457 43 S 3901	L
	06.08→	WAS	1 457 42 N 9655	K
			1 987 43 R 1454 ⁸	I
		FBF	1 987 43 M 1154	I
		FBF	1 987 43 M 2150	I

Actros III 3232

11,9 | 235 | OM 541.970 <501 LA Euro4/5>

	06.08→	OMZ	1 457 42 P 9128	O
Komp.Nr. 508046/03	06.08→	TNK	1 457 43 S 3728	L
Fg.Nr. →..K 823576				
Komp.Nr. 508046/04	06.08→	TNK	1 457 43 S 3729	L
Fg.Nr. →..K 823576				
Komp.Nr. 508046/05	06.08→	TNK	1 457 43 S 3730	L
Komp.Nr. 508046/07/15	06.08→	TNK	F 026 40 S 0094	L
Komp.Nr. 508046/22				
Komp.Nr. 508046/08/09	06.08→	TNK	F 026 40 S 0064	L
Fg.Nr. K 871497→				
Komp.Nr. 508046/08/09	06.08→	TNK	1 457 42 S 9975	L
Fg.Nr. →K 871496				
Komp.Nr. 508046/20/21	06.08→	TNK	F 026 40 S 0064	L

Komp.Nr. 508046/03/04	06.08→	TNK	F 026 40 S 0088	L
Fg.Nr. →..K 823577→				
	06.08→	WAS	1 457 42 N 9655	K
			1 987 43 R 1454 ⁸	I
		FBF	1 987 43 M 1154	I
		FBF	1 987 43 M 2150	I
11,9 235 OM 541.996 <501 LA EEV>				
	07.10→	OMZ	1 457 42 P 9128	O
Komp.Nr. 508046/03	07.10→	TNK	1 457 43 S 3728	L
Fg.Nr. →..K 823576				
Komp.Nr. 508046/04	07.10→	TNK	1 457 43 S 3729	L
Fg.Nr. →..K 823576				
Komp.Nr. 508046/05	07.10→	TNK	1 457 43 S 3730	L
Komp.Nr. 508046/07/15	07.10→	TNK	F 026 40 S 0094	L
Komp.Nr. 508046/22				
Komp.Nr. 508046/08/09	07.10→	TNK	F 026 40 S 0064	L
Fg.Nr. K 871497→				
Komp.Nr. 508046/08/09	07.10→	TNK	1 457 42 S 9975	L
Fg.Nr. →K 871496				
Komp.Nr. 508046/20/21	07.10→	TNK	F 026 40 S 0064	L
Komp.Nr. 508046/03/04	07.10→	TNK	F 026 40 S 0088	L
Fg.Nr. →..K 823577→				
	07.10→	WAS	1 457 42 N 9655	K
			1 987 43 R 1454 ⁸	I
		FBF	1 987 43 M 1154	I
		FBF	1 987 43 M 2150	I

Actros III 3236

11,9 | 265 | OM 541.972 <501 LA Euro4/5>

	06.08→	OMZ	1 457 42 P 9128	O
Komp.Nr. 508046/07/15	06.08→	TNK	F 026 40 S 0094	L
Komp.Nr. 508046/22				
Komp.Nr. 508046/08/09	06.08→	TNK	F 026 40 S 0064	L
Fg.Nr. K 871497→				
Komp.Nr. 508046/08/09	06.08→	TNK	1 457 42 S 9975	L
Fg.Nr. →K 871496				
Komp.Nr. 508046/17/18	06.08→	TNK	F 026 40 S 0064	L
Komp.Nr. 508046/20/21				
	06.08→	WAS	1 457 42 N 9655	K
			1 987 43 R 1454 ⁸	I
		FBF	1 987 43 M 1154	I
		FBF	1 987 43 M 2150	I

11,9 | 265 | OM 541.998 <501 LA EEV>

	07.10→	OMZ	1 457 42 P 9128	O
Komp.Nr. 508046/07/15	07.10→	TNK	F 026 40 S 0094	L
Komp.Nr. 508046/22				
Komp.Nr. 508046/08/09	07.10→	TNK	F 026 40 S 0064	L
Fg.Nr. K 871497→				
Komp.Nr. 508046/08/09	07.10→	TNK	1 457 42 S 9975	L
Fg.Nr. →K 871496				
Komp.Nr. 508046/17/18	07.10→	TNK	F 026 40 S 0064	L
Komp.Nr. 508046/20/21				
	07.10→	WAS	1 457 42 N 9655	K
			1 987 43 R 1454 ⁸	I
		FBF	1 987 43 M 1154	I
		FBF	1 987 43 M 2150	I





Actros III 3241

11,9 300 OM 541.974 <501 LA Euro4/5>				
	06.08→	OMZ	1 457 42 P 9128	O
Komp.Nr. 508046/07/15	06.08→	TNK	F 026 40 S 0094	L
Komp.Nr. 508046/22				
Komp.Nr. 508046/08/09	06.08→	TNK	F 026 40 S 0064	L
Fg.Nr. K 871497→				
Komp.Nr. 508046/08/09	06.08→	TNK	1 457 42 S 9975	L
Fg.Nr. →K 871496				
Komp.Nr. 508046/17/18	06.08→	TNK	F 026 40 S 0064	L
Komp.Nr. 508046/20/21				
	06.08→	WAS	1 457 42 N 9655	K
			1 987 43 R 1454 ⁸	I
		FBF	1 987 43 M 1154	I
		FBF	1 987 43 M 2150	I

11,9 | 300 | OM 541.990 <501 LA EEV>

	12.09→	OMZ	1 457 42 P 9128	O
Fg.Nr. →.K 871496	12.09→	TNK	1 457 42 S 9975	L
Komp.Nr. 508046/08/09				
Komp.Nr. 508046/03	12.09→	TNK	1 457 43 S 3728	L
Fg.Nr. →.K 823576				
Komp.Nr. 508046/04	12.09→	TNK	1 457 43 S 3729	L
Fg.Nr. →.K 823576				
Komp.Nr. 508046/05	12.09→	TNK	1 457 43 S 3730	L
Komp.Nr. 508046/07/15	12.09→	TNK	F 026 40 S 0094	L
Komp.Nr. 508046/22				
Komp.Nr. 508046/08/09	12.09→	TNK	F 026 40 S 0064	L
Fg.Nr. K 871497→				
Komp.Nr. 508046/17/18	12.09→	TNK	F 026 40 S 0064	L
Komp.Nr. 508046/20/21				
Komp.Nr. 508046/03/04	12.09→	TNK	F 026 40 S 0088	L
Fg.Nr. →.K 823577→				
	12.09→	WAS	1 457 42 N 9655	K
			1 987 43 R 1454 ⁸	I
		FBF	1 987 43 M 1154	I
		FBF	1 987 43 M 2150	I

Actros III 3244

11,9 320 OM 541.976 <501 LA Euro4/5>				
	06.08→	OMZ	1 457 42 P 9128	O
Komp.Nr. 508046/08/09	06.08→	TNK	F 026 40 S 0064	L
Fg.Nr. K 871497→				
Komp.Nr. 508046/08/09	06.08→	TNK	1 457 42 S 9975	L
Fg.Nr. →K 871496				
Komp.Nr. 508046/17/18	06.08→	TNK	F 026 40 S 0064	L
Komp.Nr. 508046/20/21				
Komp.Nr. 508046/07/15	06.08→	TNK	F 026 40 S 0094	L
Komp.Nr. 508046/22				
	06.08→	WAS	1 457 42 N 9655	K
			1 987 43 R 1454 ⁸	I
		FBF	1 987 43 M 1154	I
		FBF	1 987 43 M 2150	I

11,9 | 320 | OM 541.992 <501 LA EEV>

	12.09→	OMZ	1 457 42 P 9128	O
Fg.Nr. →.K 871496	12.09→	TNK	1 457 42 S 9975	L
Komp.Nr. 508046/08/09				
Komp.Nr. 508046/04	12.09→	TNK	1 457 43 S 3729	L
Fg.Nr. →.K 823576				
Komp.Nr. 508046/05	12.09→	TNK	1 457 43 S 3730	L
Komp.Nr. 508046/07/15	12.09→	TNK	F 026 40 S 0094	L
Komp.Nr. 508046/22				



Komp.Nr. 508046/08/09	12.09→	TNK	F 026 40 S 0064	L
Fg.Nr. K 871497→				
Komp.Nr. 508046/17/18	12.09→	TNK	F 026 40 S 0064	L
Komp.Nr. 508046/20/21				
Komp.Nr. 508046/03	12.09→	TNK	1 457 43 S 3728	L
Komp.Nr. 508046/03/04	12.09→	TNK	F 026 40 S 0088	L
Fg.Nr. →.K 823577→				
	12.09→	WAS	1 457 42 N 9655	K
			1 987 43 R 1454 ⁸	I
		FBF	1 987 43 M 1154	I
		FBF	1 987 43 M 2150	I

Actros III 3246

11,9 335 OM 541.980 <501 LA Euro4/5>				
	06.08→	OMZ	1 457 42 P 9128	O
Komp.Nr. 508046/07/15	06.08→	TNK	F 026 40 S 0094	L
Komp.Nr. 508046/22				
Komp.Nr. 508046/08/09	06.08→	TNK	F 026 40 S 0064	L
Fg.Nr. K 871497→				
Komp.Nr. 508046/08/09	06.08→	TNK	1 457 42 S 9975	L
Fg.Nr. →K 871496				
Komp.Nr. 508046/17/18	06.08→	TNK	F 026 40 S 0064	L
Komp.Nr. 508046/20/21				
	06.08→	WAS	1 457 42 N 9655	K
			1 987 43 R 1454 ⁸	I
		FBF	1 987 43 M 1154	I
		FBF	1 987 43 M 2150	I

11,9 | 335 | OM 541.994 <501 LA EEV>

	12.09→	OMZ	1 457 42 P 9128	O
Komp.Nr. 508046/07/15	12.09→	TNK	F 026 40 S 0094	L
Komp.Nr. 508046/22				
Komp.Nr. 508046/08/09	12.09→	TNK	F 026 40 S 0064	L
Fg.Nr. K 871497→				
Komp.Nr. 508046/08/09	12.09→	TNK	1 457 42 S 9975	L
Fg.Nr. →K 871496				
Komp.Nr. 508046/17/18	12.09→	TNK	F 026 40 S 0064	L
Komp.Nr. 508046/20/21				
	12.09→	WAS	1 457 42 N 9655	K
			1 987 43 R 1454 ⁸	I
		FBF	1 987 43 M 1154	I
		FBF	1 987 43 M 2150	I

Actros III 3248

11,9 350 OM 541.978 <501 LA Euro4/5>				
	06.08→	OMZ	1 457 42 P 9128	O
Komp.Nr. 508046/08/09	06.08→	TNK	F 026 40 S 0064	L
Fg.Nr. K 871497→				
Komp.Nr. 508046/08/09	06.08→	TNK	1 457 42 S 9975	L
Fg.Nr. →K 871496				
Komp.Nr. 508046/17/18	06.08→	TNK	F 026 40 S 0064	L
Komp.Nr. 508046/20/21				
Komp.Nr. 508046/07/15	06.08→	TNK	F 026 40 S 0094	L
Komp.Nr. 508046/22				
	06.08→	WAS	1 457 42 N 9655	K
			1 987 43 R 1454 ⁸	I
		FBF	1 987 43 M 1154	I
		FBF	1 987 43 M 2150	I



Actros III 3332

11,9 | 235 | OM 541.970 <501 LA Euro4/5>

	06.08→	OMZ	1 457 42 P 9128	O
Komp.Nr. 508046 /03	06.08→	TNK	1 457 43 S 3728	L
Fg.Nr. →..K 823576				
Komp.Nr. 508046 /03/04	06.08→	TNK	F 026 40 S 0088	L
Fg.Nr. ...K 823577→				
Komp.Nr. 508046 /04	06.08→	TNK	1 457 43 S 3729	L
Fg.Nr. →..K 823576				
Komp.Nr. 508046 /05	06.08→	TNK	1 457 43 S 3730	L
Komp.Nr. 508046 /08/09	06.08→	TNK	F 026 40 S 0064	L
Fg.Nr. K 871497→				
Komp.Nr. 508046 /08/09	06.08→	TNK	1 457 42 S 9975	L
Fg.Nr. →K 871496				
Komp.Nr. 508046 /17/18	06.08→	TNK	F 026 40 S 0064	L
Komp.Nr. 508046 /20/21				
Komp.Nr. 508046 /07/15	06.08→	TNK	F 026 40 S 0094	L
Komp.Nr. 508046 /22				
	06.08→	WAS	1 457 42 N 9655	K
			1 987 43 R 1454 ⁸	I
		FBF	1 987 43 M 1154	I
		FBF	1 987 43 M 2150	I

11,9 | 235 | OM 541.996 <501 LA EEV>

	07.10→	OMZ	1 457 42 P 9128	O
Komp.Nr. 508046 /03	07.10→	TNK	1 457 43 S 3728	L
Fg.Nr. →..K 823576				
Komp.Nr. 508046 /03/04	07.10→	TNK	F 026 40 S 0088	L
Fg.Nr. ...K 823577→				
Komp.Nr. 508046 /04	07.10→	TNK	1 457 43 S 3729	L
Fg.Nr. →..K 823576				
Komp.Nr. 508046 /05	07.10→	TNK	1 457 43 S 3730	L
Komp.Nr. 508046 /08/09	07.10→	TNK	F 026 40 S 0064	L
Fg.Nr. K 871497→				
Komp.Nr. 508046 /08/09	07.10→	TNK	1 457 42 S 9975	L
Fg.Nr. →K 871496				
Komp.Nr. 508046 /17/18	07.10→	TNK	F 026 40 S 0064	L
Komp.Nr. 508046 /20/21				
Komp.Nr. 508046 /07/15	07.10→	TNK	F 026 40 S 0094	L
Komp.Nr. 508046 /22				
	07.10→	WAS	1 457 42 N 9655	K
			1 987 43 R 1454 ⁸	I
		FBF	1 987 43 M 1154	I
		FBF	1 987 43 M 2150	I

Actros III 3336

11,9 | 265 | OM 541.972 <501 LA Euro4/5>

	06.08→	OMZ	1 457 42 P 9128	O
Komp.Nr. 508046 /04	06.08→	TNK	1 457 43 S 3729	L
Fg.Nr. →..K 823576				
Komp.Nr. 508046 /05	06.08→	TNK	1 457 43 S 3730	L
Komp.Nr. 508046 /07/15	06.08→	TNK	F 026 40 S 0094	L
Komp.Nr. 508046 /22				
Komp.Nr. 508046 /08/09	06.08→	TNK	F 026 40 S 0064	L
Fg.Nr. K 871497→				
Komp.Nr. 508046 /08/09	06.08→	TNK	1 457 42 S 9975	L
Fg.Nr. →K 871496				
Komp.Nr. 508046 /17/18	06.08→	TNK	F 026 40 S 0064	L
Komp.Nr. 508046 /20/21				



Komp.Nr. 508046/03/04 06.08→ TNK F 026 40 **S 0088** **L**

Fg.Nr. ...K 823577→

	06.08→	WAS	1 457 42 N 9655	K
			1 987 43 R 1454 ⁸	I
		FBF	1 987 43 M 1154	I
		FBF	1 987 43 M 2150	I

11,9 | 265 | OM 541.998 <501 LA EEV>

	07.10→	OMZ	1 457 42 P 9128	O
Komp.Nr. 508046 /04	07.10→	TNK	1 457 43 S 3729	L
Fg.Nr. →..K 823576				
Komp.Nr. 508046 /05	07.10→	TNK	1 457 43 S 3730	L
Komp.Nr. 508046 /07/15	07.10→	TNK	F 026 40 S 0094	L
Komp.Nr. 508046 /22				
Komp.Nr. 508046 /08/09	07.10→	TNK	F 026 40 S 0064	L
Fg.Nr. K 871497→				
Komp.Nr. 508046 /08/09	07.10→	TNK	1 457 42 S 9975	L
Fg.Nr. →K 871496				
Komp.Nr. 508046 /17/18	07.10→	TNK	F 026 40 S 0064	L
Komp.Nr. 508046 /20/21				
Komp.Nr. 508046 /03/04	07.10→	TNK	F 026 40 S 0088	L
Fg.Nr. ...K 823577→				
	07.10→	WAS	1 457 42 N 9655	K
			1 987 43 R 1454 ⁸	I
		FBF	1 987 43 M 1154	I
		FBF	1 987 43 M 2150	I

Actros III 3341

11,9 | 300 | OM 541.974 <501 LA Euro4/5>

	06.08→	OMZ	1 457 42 P 9128	O
Komp.Nr. 508046 /03	06.08→	TNK	1 457 43 S 3728	L
Fg.Nr. →..K 823576				
Komp.Nr. 508046 /04	06.08→	TNK	1 457 43 S 3729	L
Fg.Nr. →..K 823576				
Komp.Nr. 508046 /05	06.08→	TNK	1 457 43 S 3730	L
Komp.Nr. 508046 /07/15	06.08→	TNK	F 026 40 S 0094	L
Komp.Nr. 508046 /22				
Komp.Nr. 508046 /08/09	06.08→	TNK	F 026 40 S 0064	L
Fg.Nr. K 871497→				
Komp.Nr. 508046 /08/09	06.08→	TNK	1 457 42 S 9975	L
Fg.Nr. →K 871496				
Komp.Nr. 508046 /17/18	06.08→	TNK	F 026 40 S 0064	L
Komp.Nr. 508046 /20/21				
Komp.Nr. 508046 /03/04	06.08→	TNK	F 026 40 S 0088	L
Fg.Nr. ...K 823577→				
	06.08→	WAS	1 457 42 N 9655	K
			1 987 43 R 1454 ⁸	I
		FBF	1 987 43 M 1154	I
		FBF	1 987 43 M 2150	I

11,9 | 300 | OM 541.990 <501 LA EEV>

	12.09→	OMZ	1 457 42 P 9128	O
Fg.Nr. →..K 871496	12.09→	TNK	1 457 42 S 9975	L
Komp.Nr. 508046 /08/09				
Komp.Nr. 508046 /03	12.09→	TNK	1 457 43 S 3728	L
Fg.Nr. →..K 823576				
Komp.Nr. 508046 /04	12.09→	TNK	1 457 43 S 3729	L
Fg.Nr. →..K 823576				
Komp.Nr. 508046 /05	12.09→	TNK	1 457 43 S 3730	L





◀ Actros III 3341

Komp.Nr. 508046/07/15	12.09→	TNK	F 026 40 S 0094	L
Komp.Nr. 508046/22				
Komp.Nr. 508046/08/09	12.09→	TNK	F 026 40 S 0064	L
Fg.Nr. K 871497→				
Komp.Nr. 508046/17/18	12.09→	TNK	F 026 40 S 0064	L
Komp.Nr. 508046/20/21				
Komp.Nr. 508046/03/04	12.09→	TNK	F 026 40 S 0088	L
Fg.Nr. ...K 823577→				
Komp.Nr. 508046/14	12.09→	TNK	1 457 43 S 3901	L
	12.09→	WAS	1 457 42 N 9655	K
			1 987 43 R 1454 ⁸	I
		FBF	1 987 43 M 1154	I
		FBF	1 987 43 M 2150	I
11,9 300 OM 541.991 <501 LA EEV>				
	12.09→	OMZ	1 457 42 P 9128	O
Komp.Nr. 508046/03	12.09→	TNK	1 457 43 S 3728	L
Fg.Nr. →...K 823576				
Komp.Nr. 508046/04	12.09→	TNK	1 457 43 S 3729	L
Fg.Nr. →...K 823576				
Komp.Nr. 508046/05	12.09→	TNK	1 457 43 S 3730	L
Komp.Nr. 508046/07/15	12.09→	TNK	F 026 40 S 0094	L
Komp.Nr. 508046/22				
Komp.Nr. 508046/08/09	12.09→	TNK	1 457 42 S 9975	L
Fg.Nr. →K 871496				
Komp.Nr. 508046/20/21	12.09→	TNK	F 026 40 S 0064	L
Komp.Nr. 508046/03/04	12.09→	TNK	F 026 40 S 0088	L
Fg.Nr. ...K 823577→				
Komp.Nr. 508046/14	12.09→	TNK	1 457 43 S 3901	L
	12.09→	WAS	1 457 42 N 9655	K
			1 987 43 R 1454 ⁸	I
		FBF	1 987 43 M 1154	I
		FBF	1 987 43 M 2150	I

Actros III 3344

11,9 | 320 | OM 541.976 <501 LA Euro4/5>

	06.08→	OMZ	1 457 42 P 9128	O
Komp.Nr. 508046/03	06.08→	TNK	1 457 43 S 3728	L
Fg.Nr. →...K 823576				
Komp.Nr. 508046/04	06.08→	TNK	1 457 43 S 3729	L
Fg.Nr. →...K 823576				
Komp.Nr. 508046/05	06.08→	TNK	1 457 43 S 3730	L
Komp.Nr. 508046/08/09	06.08→	TNK	F 026 40 S 0064	L
Fg.Nr. K 871497→				
Komp.Nr. 508046/08/09	06.08→	TNK	1 457 42 S 9975	L
Fg.Nr. →K 871496				
Komp.Nr. 508046/17/18	06.08→	TNK	F 026 40 S 0064	L
Komp.Nr. 508046/20/21				
Komp.Nr. 508046/03/04	06.08→	TNK	F 026 40 S 0088	L
Fg.Nr. ...K 823577→				
Komp.Nr. 508046/07/15	06.08→	TNK	F 026 40 S 0094	L
Komp.Nr. 508046/22				
	06.08→	WAS	1 457 42 N 9655	K
			1 987 43 R 1454 ⁸	I
		FBF	1 987 43 M 1154	I
		FBF	1 987 43 M 2150	I

Actros III 3344/ 4144

11,9 | 320 | OM 541.992 <501 LA EEV>

	12.09→	OMZ	1 457 42 P 9128	O
Fg.Nr. →...K 871496	12.09→	TNK	1 457 42 S 9975	L
Komp.Nr. 508046/08/09				



Komp.Nr. 508046/04	12.09→	TNK	1 457 43 S 3729	L
Fg.Nr. →...K 823576				
Komp.Nr. 508046/05	12.09→	TNK	1 457 43 S 3730	L
Komp.Nr. 508046/07/15	12.09→	TNK	F 026 40 S 0094	L
Komp.Nr. 508046/22				
Komp.Nr. 508046/08/09	12.09→	TNK	F 026 40 S 0064	L
Fg.Nr. K 871497→				
Komp.Nr. 508046/17/18	12.09→	TNK	F 026 40 S 0064	L
Komp.Nr. 508046/20/21				
Komp.Nr. 508046/03	12.09→	TNK	1 457 43 S 3728	L
Komp.Nr. 508046/03/04	12.09→	TNK	F 026 40 S 0088	L
Fg.Nr. ...K 823577→				
Komp.Nr. 508046/14	12.09→	TNK	1 457 43 S 3901	L
	12.09→	WAS	1 457 42 N 9655	K
			1 987 43 R 1454 ⁸	I
		FBF	1 987 43 M 1154	I
		FBF	1 987 43 M 2150	I

Actros III 3346

11,9 | 335 | OM 541.980 <501 LA Euro4/5>

	06.08→	OMZ	1 457 42 P 9128	O
Komp.Nr. 508046/03	06.08→	TNK	1 457 43 S 3728	L
Fg.Nr. →...K 823576				
Komp.Nr. 508046/04	06.08→	TNK	1 457 43 S 3729	L
Fg.Nr. →...K 823576				
Komp.Nr. 508046/05	06.08→	TNK	1 457 43 S 3730	L
Komp.Nr. 508046/07/15	06.08→	TNK	F 026 40 S 0094	L
Komp.Nr. 508046/22				
Komp.Nr. 508046/08/09	06.08→	TNK	F 026 40 S 0064	L
Fg.Nr. K 871497→				
Komp.Nr. 508046/08/09	06.08→	TNK	1 457 42 S 9975	L
Fg.Nr. →K 871496				
Komp.Nr. 508046/17/18	06.08→	TNK	F 026 40 S 0064	L
Komp.Nr. 508046/20/21				
Komp.Nr. 508046/03/04	06.08→	TNK	F 026 40 S 0088	L
Fg.Nr. ...K 823577→				
Komp.Nr. 508046/14	06.08→	TNK	1 457 43 S 3901	L
	06.08→	WAS	1 457 42 N 9655	K
			1 987 43 R 1454 ⁸	I
		FBF	1 987 43 M 1154	I
		FBF	1 987 43 M 2150	I

11,9 | 335 | OM 541.994 <501 LA EEV>

	12.09→	OMZ	1 457 42 P 9128	O
Komp.Nr. 508046/03	12.09→	TNK	1 457 43 S 3728	L
Fg.Nr. →...K 823576				
Komp.Nr. 508046/04	12.09→	TNK	1 457 43 S 3729	L
Fg.Nr. →...K 823576				
Komp.Nr. 508046/05	12.09→	TNK	1 457 43 S 3730	L
Komp.Nr. 508046/07/15	12.09→	TNK	F 026 40 S 0094	L
Komp.Nr. 508046/22				
Komp.Nr. 508046/08/09	12.09→	TNK	F 026 40 S 0064	L
Fg.Nr. K 871497→				
Komp.Nr. 508046/08/09	12.09→	TNK	1 457 42 S 9975	L
Fg.Nr. →K 871496				
Komp.Nr. 508046/17/18	12.09→	TNK	F 026 40 S 0064	L
Komp.Nr. 508046/20/21				
Komp.Nr. 508046/03/04	12.09→	TNK	F 026 40 S 0088	L
Fg.Nr. ...K 823577→				
Komp.Nr. 508046/14	12.09→	TNK	1 457 43 S 3901	L



12.09→	WAS	1 457 42	N 9655	K
		1 987 43	R 1454⁸	I
	FBF	1 987 43	M 1154	I
	FBF	1 987 43	M 2150	I

Actros III 3348/ 4148

11,9 350 OM 541.978 <501 LA Euro4/5>				
06.08→	OMZ	1 457 42	P 9128	O
Komp.Nr. 508046 /03	06.08→	TNK	1 457 43	S 3728 L
Fg.Nr. →.K 823576				
Komp.Nr. 508046 /03/04	06.08→	TNK	F 026 40	S 0088 L
Fg.Nr. →.K 823577→				
Komp.Nr. 508046 /04	06.08→	TNK	1 457 43	S 3729 L
Fg.Nr. →.K 823576				
Komp.Nr. 508046 /05	06.08→	TNK	1 457 43	S 3730 L
Komp.Nr. 508046 /08/09	06.08→	TNK	F 026 40	S 0064 L
Fg.Nr. K 871497→				
Komp.Nr. 508046 /08/09	06.08→	TNK	1 457 42	S 9975 L
Fg.Nr. →K 871496				
Komp.Nr. 508046 /17/18	06.08→	TNK	F 026 40	S 0064 L
Komp.Nr. 508046 /20/21				
Komp.Nr. 508046 /07/15	06.08→	TNK	F 026 40	S 0094 L
Komp.Nr. 508046 /22				
06.08→	WAS	1 457 42	N 9655	K
		1 987 43	R 1454⁸	I
	FBF	1 987 43	M 1154	I
	FBF	1 987 43	M 2150	I

Actros III 3641/ 4141

11,9 300 OM 541.991 <501 LA EEV>				
12.09→	OMZ	1 457 42	P 9128	O
Komp.Nr. 508046 /03	12.09→	TNK	1 457 43	S 3728 L
Fg.Nr. →.K 823576				
Komp.Nr. 508046 /04	12.09→	TNK	1 457 43	S 3729 L
Fg.Nr. →.K 823576				
Komp.Nr. 508046 /05	12.09→	TNK	1 457 43	S 3730 L
Komp.Nr. 508046 /07/15	12.09→	TNK	F 026 40	S 0094 L
Komp.Nr. 508046 /22				
Komp.Nr. 508046 /08/09	12.09→	TNK	1 457 42	S 9975 L
Fg.Nr. →K 871496				
Komp.Nr. 508046 /20/21	12.09→	TNK	F 026 40	S 0064 L
Komp.Nr. 508046 /03/04	12.09→	TNK	F 026 40	S 0088 L
Fg.Nr. →.K 823577→				
12.09→	WAS	1 457 42	N 9655	K
		1 987 43	R 1454⁸	I
	FBF	1 987 43	M 1154	I
	FBF	1 987 43	M 2150	I

Actros III 3644/ 4144

11,9 320 OM 541.993 <501 LA EEV>				
12.09→	OMZ	1 457 42	P 9128	O
Fg.Nr. →.K 871496	12.09→	TNK	1 457 42	S 9975 L
Komp.Nr. 508046 /08/09				
Komp.Nr. 508046 /07/15	12.09→	TNK	F 026 40	S 0094 L
Komp.Nr. 508046 /22				
Komp.Nr. 508046 /08/09	12.09→	TNK	F 026 40	S 0064 L
Fg.Nr. K 871497→				
Komp.Nr. 508046 /20/21	12.09→	TNK	F 026 40	S 0064 L

12.09→	WAS	1 457 42	N 9655	K
		1 987 43	R 1454⁸	I
	FBF	1 987 43	M 1154	I
	FBF	1 987 43	M 2150	I

Actros III 4141

11,9 300 OM 541.974 <501 LA Euro4/5>				
06.08→	OMZ	1 457 42	P 9128	O
Komp.Nr. 508046 /08/09	06.08→	TNK	F 026 40	S 0064 L
Fg.Nr. K 871497→				
Komp.Nr. 508046 /08/09	06.08→	TNK	1 457 42	S 9975 L
Fg.Nr. →K 871496				
Komp.Nr. 508046 /17/18	06.08→	TNK	F 026 40	S 0064 L
Komp.Nr. 508046 /20/21				
Komp.Nr. 508046 /07/15	06.08→	TNK	F 026 40	S 0094 L
Komp.Nr. 508046 /22				
06.08→	WAS	1 457 42	N 9655	K
		1 987 43	R 1454⁸	I
	FBF	1 987 43	M 1154	I
	FBF	1 987 43	M 2150	I

11,9 | 300 | OM 541.990 <501 LA EEV>

12.09→	OMZ	1 457 42	P 9128	O
Fg.Nr. →.K 871496	12.09→	TNK	1 457 42	S 9975 L
Komp.Nr. 508046 /08/09				
Komp.Nr. 508046 /03	12.09→	TNK	1 457 43	S 3728 L
Fg.Nr. →.K 823576				
Komp.Nr. 508046 /04	12.09→	TNK	1 457 43	S 3729 L
Fg.Nr. →.K 823576				
Komp.Nr. 508046 /05	12.09→	TNK	1 457 43	S 3730 L
Komp.Nr. 508046 /07/15	12.09→	TNK	F 026 40	S 0094 L
Komp.Nr. 508046 /22				
Komp.Nr. 508046 /08/09	12.09→	TNK	F 026 40	S 0064 L
Fg.Nr. K 871497→				
Komp.Nr. 508046 /17/18	12.09→	TNK	F 026 40	S 0064 L
Komp.Nr. 508046 /20/21				
Komp.Nr. 508046 /03/04	12.09→	TNK	F 026 40	S 0088 L
Fg.Nr. →.K 823577→				
12.09→	WAS	1 457 42	N 9655	K
		1 987 43	R 1454⁸	I
	FBF	1 987 43	M 1154	I
	FBF	1 987 43	M 2150	I

Actros III 4144

11,9 320 OM 541.976 <501 LA Euro4/5>				
06.08→	OMZ	1 457 42	P 9128	O
Komp.Nr. 508046 /03	06.08→	TNK	1 457 43	S 3728 L
Fg.Nr. →.K 823576				
Komp.Nr. 508046 /04	06.08→	TNK	1 457 43	S 3729 L
Fg.Nr. →.K 823576				
Komp.Nr. 508046 /05	06.08→	TNK	1 457 43	S 3730 L
Komp.Nr. 508046 /08/09	06.08→	TNK	F 026 40	S 0064 L
Fg.Nr. K 871497→				
Komp.Nr. 508046 /17/18	06.08→	TNK	F 026 40	S 0064 L
Komp.Nr. 508046 /20/21				
Komp.Nr. 508046 /03/04	06.08→	TNK	F 026 40	S 0088 L
Fg.Nr. →.K 823577→				
Komp.Nr. 508046 /07/15	06.08→	TNK	F 026 40	S 0094 L
Komp.Nr. 508046 /22				





◀ Actros III 4144

06.08→	WAS	1 457 42 N 9655	K
		1 987 43 R 1454 ⁸	I
	FBF	1 987 43 M 1154	I
	FBF	1 987 43 M 2150	I

Actros III 4146

11,9 | 335 | OM 541.980 <501 LA Euro4/5>

06.08→	OMZ	1 457 42 P 9128	O
Komp.Nr. 508046 /08/09	06.08→	TNK	F 026 40 S 0064 L
Fg.Nr. K 871497→			
Komp.Nr. 508046 /08/09	06.08→	TNK	1 457 42 S 9975 L
Fg.Nr. →K 871496			
Komp.Nr. 508046 /17/18	06.08→	TNK	F 026 40 S 0064 L
Komp.Nr. 508046 /20/21			
Komp.Nr. 508046 /07/15	06.08→	TNK	F 026 40 S 0094 L
Komp.Nr. 508046 /22			

06.08→	WAS	1 457 42 N 9655	K
		1 987 43 R 1454 ⁸	I
	FBF	1 987 43 M 1154	I
	FBF	1 987 43 M 2150	I

11,9 | 335 | OM 541.994 <501 LA EEV>

12.09→	OMZ	1 457 42 P 9128	O
Komp.Nr. 508046 /03	12.09→	TNK	1 457 43 S 3728 L
Fg.Nr. →.K 823576			
Komp.Nr. 508046 /04	12.09→	TNK	1 457 43 S 3729 L
Fg.Nr. →.K 823576			
Komp.Nr. 508046 /05	12.09→	TNK	1 457 43 S 3730 L
Komp.Nr. 508046 /07/15	12.09→	TNK	F 026 40 S 0094 L
Komp.Nr. 508046 /22			
Komp.Nr. 508046 /08/09	12.09→	TNK	F 026 40 S 0064 L
Fg.Nr. K 871497→			
Komp.Nr. 508046 /08/09	12.09→	TNK	1 457 42 S 9975 L
Fg.Nr. →K 871496			
Komp.Nr. 508046 /17/18	12.09→	TNK	F 026 40 S 0064 L
Komp.Nr. 508046 /20/21			
Komp.Nr. 508046 /03/04	12.09→	TNK	F 026 40 S 0088 L
Fg.Nr. →.K 823577→			

12.09→	WAS	1 457 42 N 9655	K
		1 987 43 R 1454 ⁸	I
	FBF	1 987 43 M 1154	I
	FBF	1 987 43 M 2150	I

Actros III 4151

15,9 | 375 | OM 542.960 <502 LA Euro4/5>

06.08→	OMZ	1 457 42 P 9128	O
Komp.Nr. 508046 /08/09	06.08→	TNK	F 026 40 S 0064 L
Fg.Nr. K 871497→			
Komp.Nr. 508046 /08/09	06.08→	TNK	1 457 42 S 9975 L
Fg.Nr. →K 871496			
Komp.Nr. 508046 /17/18	06.08→	TNK	F 026 40 S 0064 L
Komp.Nr. 508046 /20/21			
Komp.Nr. 508046 /07/15	06.08→	TNK	F 026 40 S 0094 L
Komp.Nr. 508046 /22			

06.08→	WAS	1 457 42 N 9655	K
		1 987 43 R 1454 ⁸	I
	FBF	1 987 43 M 1154	I
	FBF	1 987 43 M 2150	I



Actros III 4155

15,9 | 405 | OM 542.962 <502 LA Euro4/5>

06.08→	OMZ	1 457 42 P 9128	O
Komp.Nr. 508046 /08/09	06.08→	TNK	F 026 40 S 0064 L
Fg.Nr. K 871497→			
Komp.Nr. 508046 /08/09	06.08→	TNK	1 457 42 S 9975 L
Fg.Nr. →K 871496			
Komp.Nr. 508046 /17/18	06.08→	TNK	F 026 40 S 0064 L
Komp.Nr. 508046 /20/21			
Komp.Nr. 508046 /07/15	06.08→	TNK	F 026 40 S 0094 L
Komp.Nr. 508046 /22			

06.08→	WAS	1 457 42 N 9655	K
		1 987 43 R 1454 ⁸	I
	FBF	1 987 43 M 1154	I
	FBF	1 987 43 M 2150	I

Actros III 4160

15,9 | 440 | OM 542.964 <502 LA Euro4/5>

06.08→	OMZ	1 457 42 P 9128	O
Fg.Nr. →.K 871496	06.08→	TNK	1 457 42 S 9975 L
Komp.Nr. 508046 /08/09			
Komp.Nr. 508046 /08/09	06.08→	TNK	F 026 40 S 0064 L
Fg.Nr. K 871497→			
Komp.Nr. 508046 /17/18	06.08→	TNK	F 026 40 S 0064 L
Komp.Nr. 508046 /20/21			
Komp.Nr. 508046 /07/15	06.08→	TNK	F 026 40 S 0094 L
Komp.Nr. 508046 /22			

06.08→	WAS	1 457 42 N 9655	K
		1 987 43 R 1454 ⁸	I
	FBF	1 987 43 M 1154	I
	FBF	1 987 43 M 2150	I

Atego

Atego 712

4,3 | 90 | OM 904.909 LA <Euro2>

01.98-09.04	F 026 40 P 7040	O
	1 457 43 S 3560	L
	WAS	1 457 43 N 1707 K
		1 987 43 R 1456 ⁸ I
	FBF	1 987 43 M 1156 I
	NOR	1 987 43 M 1157 I
		1 457 42 P 9820 ³ P

4,3 | 90 | OM 904.915 LA <Euro 3>

09.00-09.04	F 026 40 P 7026	O
	WAS	F 026 40 P 7040 O
		1 457 43 S 3560 L
	WAS	1 457 43 N 1707 K
		1 987 43 R 1456 ⁸ I
	FBF	1 987 43 M 1156 I
	NOR	1 987 43 M 1157 I
		1 457 42 P 9820 ³ P





Atego 714

4,3 100 OM 904.916 LA <Euro 3>			
09.00-09.04	F 026 40 P 7040	O	
	1 457 43 S 3560	L	
	WAS 1 457 43 N 1707	K	
	1 987 43 R 1456 ⁸	I	
	FBF 1 987 43 M 1156	I	
	NOR 1 987 43 M 1157	I	
	1 457 42 P 9820 ³	P	

Atego 714/ 814/ 1214

4,3 100 OM 904.910 LA <Euro 2>			
01.98-09.04	F 026 40 P 7040	O	
	1 457 43 S 3560	L	
	WAS 1 457 43 N 1707	K	
	1 987 43 R 1456 ⁸	I	
	FBF 1 987 43 M 1156	I	
	NOR 1 987 43 M 1157	I	
	1 457 42 P 9820 ³	P	

Atego 715/ 815/ 817/ 1215

4,3 112 OM 904.922 LA <Euro 2>			
01.98-09.04	F 026 40 P 7040	O	
	1 457 43 S 3560	L	
	WAS 1 457 43 N 1707	K	
	1 987 43 R 1456 ⁸	I	
	FBF 1 987 43 M 1156	I	
	NOR 1 987 43 M 1157	I	
	1 457 42 P 9820 ³	P	

Atego 715/ 815/ 915/ 1015/ 1215

4,3 110 OM 904.950 LA <Euro 3>			
09.00-09.04	F 026 40 P 7026	O	
	F 026 40 P 7040	O	
	1 457 43 S 3560	L	
	WAS 1 457 43 N 1707	K	
	1 987 43 R 1456 ⁸	I	
	FBF 1 987 43 M 1156	I	
	NOR 1 987 43 M 1157	I	
	1 457 42 P 9820 ³	P	

Atego 717

4,3 125 OM 904.917 LA <Euro 3>			
09.00-09.04	F 026 40 P 7026	O	
	1 457 43 S 3560	L	
	WAS 1 457 43 N 1707	K	
	1 987 43 R 1456 ⁸	I	
	FBF 1 987 43 M 1156	I	
	NOR 1 987 43 M 1157	I	
	1 457 42 P 9820 ³	P	



Atego 717/ 817/ 915/ 917/ 1017/ 1217/ 1317/ 1517

4,3 125 OM 904.911 LA <Euro 2>			
01.98-09.04	F 026 40 P 7040	O	
	1 457 43 S 3560	L	
	WAS 1 457 43 N 1707	K	
	1 987 43 R 1456 ⁸	I	
	FBF 1 987 43 M 1156	I	
	NOR 1 987 43 M 1157	I	
	1 457 42 P 9820 ³	P	

Atego 812

4,3 90 OM 904.909 LA <Euro 3>			
01.98-10.04	F 026 40 P 7040	O	
	1 457 43 S 3560	L	
	WAS 1 457 43 N 1707	K	
	1 987 43 R 1456 ⁸	I	
	FBF 1 987 43 M 1156	I	
	NOR 1 987 43 M 1157	I	
	1 457 42 P 9820 ³	P	

Atego 814

4,3 100 OM 904.916 LA <Euro 3>			
09.00-09.04	F 026 40 P 7040	O	
	1 457 43 S 3560	L	
	WAS 1 457 43 N 1707	K	
	1 987 43 R 1456 ⁸	I	
	FBF 1 987 43 M 1156	I	
	NOR 1 987 43 M 1157	I	
	1 457 42 P 9820 ³	P	

Atego 817/ 1017/ 1217/ 1317/ 1517

4,3 125 OM 904.917 LA <Euro 3>			
01.98-09.04	1 457 43 S 3560	L	

Atego 818/ 1018/ 1218/ 1318/ 1518

4,3 130 OM 904.951 LA <Euro 3>			
09.00-09.04	F 026 40 P 7026	O	
	F 026 40 P 7040	O	
	1 457 43 S 3560	L	
	WAS 1 457 43 N 1707	K	
	1 987 43 R 1456 ⁸	I	
	FBF 1 987 43 M 1156	I	
	NOR 1 987 43 M 1157	I	
	1 457 42 P 9820 ³	P	

Atego 823/ 923

6,4 170 OM 906.925 LA <Euro 3>			
09.00-09.04	F 026 40 P 7026	O	
Komp.Nr. 508046/10/11	09.00-09.04	TNK	1 457 43 S 3560 L
Komp.Nr. 508046/12/13			
Komp.Nr. 531715/04			
Komp.Nr. 508046/03	09.00-09.04	TNK	1 457 43 S 3728 L
Komp.Nr. 508046/04	09.00-09.04	TNK	1 457 43 S 3729 L
	09.00-09.04		1 457 43 N 1707 K
			1 987 43 R 1456 ⁸ I
		FBF	1 987 43 M 1156 I
		NOR	1 987 43 M 1157 I
			1 457 42 P 9820 ³ P





Atego 823/ 923/ 1023/ 1223/ 1323/ 1523

6,4 170 OM 906.910 LA <Euro2>			
01.98-09.04	F 026 40	P 7026	O
	1 457 43	S 3560	L
	WAS	1 457 43	N 1707 K
		1 987 43	R 1456⁸ I
	FBF	1 987 43	M 1156 I
	NOR	1 987 43	M 1157 I
		1 457 42	P 9820³ P

Atego 917

4,3 125 OM 904.911LA <Euro2>			
01.98-09.04	F 026 40	P 7040	O
	1 457 43	S 3560	L
	WAS	1 457 43	N 1707 K
		1 987 43	R 1456⁸ I
	FBF	1 987 43	M 1156 I
	NOR	1 987 43	M 1157 I
		1 457 42	P 9820³ P

4,3 125 OM 904.917LA <Euro3>			
01.98-09.04	1 457 43	S 3560	L

Atego 918

4,3 130 OM 904.951 LA <Euro3>			
09.00-09.04	F 026 40	P 7026	O
	F 026 40	P 7040	O
	1 457 43	S 3560	L
	WAS	1 457 43	N 1707 K
		1 987 43	R 1456⁸ I
	FBF	1 987 43	M 1156 I
	NOR	1 987 43	M 1157 I
		1 457 42	P 9820³ P

Atego 925/ 1228/ 1328/ 1528

6,4 205 OM 906.911 LA <Euro2>			
01.98-09.04	F 026 40	P 7026	O
	1 457 43	S 3560	L
	WAS	1 457 43	N 1707 K
		1 987 43	R 1456⁸ I
	FBF	1 987 43	M 1156 I
	NOR	1 987 43	M 1157 I
		1 457 42	P 9820³ P

Atego 1023/ 1223/ 1523/ 1823

6,4 170 OM 906.925 LA <Euro3>			
09.00-10.04	F 026 40	P 7026	O
Komp.Nr. 508046/10/11	09.00-10.04	TNK	1 457 43 S 3560 L
Komp.Nr. 508046/12/13			
Komp.Nr. 531715/04			
Komp.Nr. 508046/03	09.00-10.04	TNK	1 457 43 S 3728 L
Komp.Nr. 508046/04	09.00-10.04	TNK	1 457 43 S 3729 L
	09.00-10.04		1 457 43 N 1707 K
			1 987 43 R 1456⁸ I
	FBF	1 987 43	M 1156 I
	NOR	1 987 43	M 1157 I



Atego 1225/ 1325/ 1525

6,4 180 OM 906.919 LA <Euro2>			
01.98-09.04	F 026 40	P 7026	O
	1 457 43	S 3560	L
	WAS	1 457 43	N 1707 K
		1 987 43	R 1456⁸ I
	FBF	1 987 43	M 1156 I
	NOR	1 987 43	M 1157 I
		1 457 42	P 9820³ P

Atego 1228/ 1328/ 1528/ 1828/ 2528/ 2628

6,4 205 OM 906.926 LA <Euro3>			
09.00-10.04	F 026 40	P 7026	O
	1 457 43	S 3560	L
	1 457 43	N 1707	K
	1 987 43	R 1456⁸	I
	FBF	1 987 43	M 1156 I
	NOR	1 987 43	M 1157 I

Atego 1823

6,4 170 OM 906.922 LA <Euro2>			
05.98-09.04	F 026 40	P 7026	O
Komp.Nr. 508046/07/15	05.98-09.04	TNK	F 026 40 S 0094 L
Komp.Nr. 508046/22			
Komp.Nr. 508046/03	05.98-09.04	TNK	1 457 43 S 3728 L
Komp.Nr. 508046/03/04/23	05.98-09.04	TNK	F 026 40 S 0088 L
Komp.Nr. 508046/04	05.98-09.04	TNK	1 457 43 S 3729 L
Komp.Nr. 509088/02	05.98-09.04	TNK	1 457 43 S 3560 L
Komp.Nr. 509088/06			
Komp.Nr. 509088/07			
Komp.Nr. 509088/08			
Komp.Nr. 509088/11			
	05.98-09.04	WAS	1 457 43 N 1707 K
			1 987 43 R 1457⁸ I
		FBF	1 987 43 M 1155 I
		NOR	1 987 43 M 1168 I
			1 457 42 P 9820³ P

Atego 1823/ 2523

6,4 170 OM 906.920 LA <Euro2>			
05.98-09.04	F 026 40	P 7026	O
Komp.Nr. 508046/07/15	05.98-09.04	TNK	F 026 40 S 0094 L
Komp.Nr. 508046/22			
Komp.Nr. 508046/03	05.98-09.04	TNK	1 457 43 S 3728 L
Komp.Nr. 508046/03/04/23	05.98-09.04	TNK	F 026 40 S 0088 L
Komp.Nr. 508046/04	05.98-09.04	TNK	1 457 43 S 3729 L
Komp.Nr. 508046/08/09	05.98-09.04	TNK	F 026 40 S 0064 L
Komp.Nr. 508046/17/18			
Komp.Nr. 508046/20			
Komp.Nr. 509088/02	05.98-09.04	TNK	1 457 43 S 3560 L
Komp.Nr. 509088/06			
Komp.Nr. 509088/07			
Komp.Nr. 509088/08			
Komp.Nr. 509088/11			
	05.98-09.04	WAS	1 457 43 N 1707 K
			1 987 43 R 1457⁸ I
		FBF	1 987 43 M 1155 I
		NOR	1 987 43 M 1168 I
			1 457 42 P 9820³ P





Atego 1828

6,4 205 OM 906.923 LA <Euro2>				
	05.98-09.04		F 026 40 P 7026	O
Komp.Nr. 508046 /07/15	05.98-09.04	TNK	F 026 40 S 0094	L
Komp.Nr. 508046 /22				
Komp.Nr. 508046/03	05.98-09.04	TNK	1 457 43 S 3728	L
Komp.Nr. 508046/03/04/23	05.98-09.04	TNK	F 026 40 S 0088	L
Komp.Nr. 508046/04	05.98-09.04	TNK	1 457 43 S 3729	L
Komp.Nr. 508046/08/09	05.98-09.04	TNK	F 026 40 S 0064	L
Komp.Nr. 508046/17/18				
Komp.Nr. 508046/20				
Komp.Nr. 509088/02	05.98-09.04	TNK	1 457 43 S 3560	L
Komp.Nr. 509088/06				
Komp.Nr. 509088/07				
Komp.Nr. 509088/08				
Komp.Nr. 509088/11				
	05.98-09.04	WAS	1 457 43 N 1707	K
			1 987 43 R 1456 ⁸	I
		FBF	1 987 43 M 1155	I
		NOR	1 987 43 M 1168	I
			1 457 42 P 9820 ³	P

Atego 1828/ 2528/ 2628

6,4 205 OM 906.921 LA <Euro2>				
	05.98-09.04		F 026 40 P 7026	O
Komp.Nr. 508046 /07/15	05.98-09.04	TNK	F 026 40 S 0094	L
Komp.Nr. 508046 /22				
Komp.Nr. 508046/03	05.98-09.04	TNK	1 457 43 S 3728	L
Komp.Nr. 508046/03/04/23	05.98-09.04	TNK	F 026 40 S 0088	L
Komp.Nr. 508046/04	05.98-09.04	TNK	1 457 43 S 3729	L
Komp.Nr. 509088/02	05.98-09.04	TNK	1 457 43 S 3560	L
Komp.Nr. 509088/06				
Komp.Nr. 509088/07				
Komp.Nr. 509088/08				
Komp.Nr. 509088/11				
	05.98-09.04	WAS	1 457 43 N 1707	K
			1 987 43 R 1456 ⁸	I
		FBF	1 987 43 M 1155	I
		NOR	1 987 43 M 1168	I
			1 457 42 P 9820 ³	P

Atego 1833/ 2533/ 2633

7,2 240 OM 926.913 LA <Euro3>				
	09.00-09.04		F 026 40 P 7026	O
Komp.Nr. 508046 /10/11	09.00-09.04	TNK	1 457 43 S 3560	L
Komp.Nr. 508046 /12/13				
Komp.Nr. 531715 /04				
Komp.Nr. 508046/03	09.00-09.04	TNK	1 457 43 S 3728	L
Komp.Nr. 508046/03/04/23	09.00-09.04	TNK	F 026 40 S 0088	L
Komp.Nr. 508046/04	09.00-09.04	TNK	1 457 43 S 3729	L
Komp.Nr. 508046/07	09.00-09.04	TNK	F 026 40 S 0094	L
Komp.Nr. 508046/15				
	09.00-09.04		1 457 43 N 1707	K
			1 987 43 R 1456 ⁸	I
		FBF	1 987 43 M 1156	I
		NOR	1 987 43 M 1157	I



Atego II

Atego II 713/ 813

4,3 95 OM 900.911 <(904 LA) Euro 4>				
	02.06→		F 026 40 P 7040	O
			1 457 43 S 3560	L
		WAS	1 457 43 N 1707	K
			1 987 43 R 1456 ⁸	I
		FBF	1 987 43 M 1156	I
		NOR	1 987 43 M 1157	I

Atego II 716/ 816/ 916/ 1016/ 1216

4,3 115 OM 900... <Euro 4/5>				
	02.06→		F 026 40 P 7040	O
			1 457 43 S 3560	L
		WAS	1 457 43 N 1707	K
			1 987 43 R 1456 ⁸	I
		FBF	1 987 43 M 1156	I
		NOR	1 987 43 M 1157	I

Atego II 818/ 918/ 1018/ 1218/ 1318/ 1518

4,3 130 OM 900.913 <(904) Euro 4>				
	02.06→		F 026 40 P 7040	O
			1 457 43 S 3560	L
		WAS	1 457 43 N 1707	K
			1 987 43 R 1456 ⁸	I
		FBF	1 987 43 M 1156	I
		NOR	1 987 43 M 1157	I

Atego II 822/ 922

4,8 160 OM 924.920 <Euro 3>				
	09.04→		F 026 40 P 7040	O
			1 457 43 S 3560	L
		WAS	1 457 43 N 1707	K
			1 987 43 R 1456 ⁸	I
		FBF	1 987 43 M 1156	I
		NOR	1 987 43 M 1157	I
			1 457 42 P 9820 ³	P

Atego II 822/ 922/ 1022/ 1222/ 1322/ 1522

4,8 160 OM 924.922 LA <Euro 4>				
	06.06→		F 026 40 P 7040	O
			1 457 43 S 3560	L
		WAS	1 457 43 N 1707	K
			1 987 43 R 1456 ⁸	I
		FBF	1 987 43 M 1156	I
		NOR	1 987 43 M 1157	I

4,8 | 160 | OM 924.930 LA <Euro 5/EEV>

	06.06→		F 026 40 P 7040	O
			1 457 43 S 3560	L
		WAS	1 457 43 N 1707	K
			1 987 43 R 1456 ⁸	I
		FBF	1 987 43 M 1156	I
		NOR	1 987 43 M 1157	I





Atego II 823/ 923/ 1023/ 1223/ 1323/ 1523

6,4 170 OM 906.915 <Euro 3>	09.04→	F 026 40 P 7026	O
		1 457 43 S 3560	L
	WAS	1 457 43 N 1707	K
		1 987 43 R 1456⁸	I
	FBF	1 987 43 M 1156	I
	NOR	1 987 43 M 1157	I

Atego II 824/ 924/ 1024/ 1224/ 1324/ 1524

6,4 175 OM 902.916 <(906) Euro 4>	02.06→	F 026 40 P 7026	O
		1 457 43 S 3560	L
	WAS	1 457 43 N 1707	K
		1 987 43 R 1456⁸	I
	FBF	1 987 43 M 1156	I
	NOR	1 987 43 M 1157	I

Atego II 824/ 1224/ 1226/ 1229/ 1324/ 1326/ 1329/ 1524/ 1526/ 1529

7,2 175/188/210 OM 925.920 <(926 LA) EEV>	03.10→	F 026 40 P 7026	O
		1 457 43 S 3560	L
	WAS	1 457 43 N 1707	K
		1 987 43 R 1456⁸	I
	FBF	1 987 43 M 1156	I
	NOR	1 987 43 M 1157	I

Atego II 926

6,4 188 OM 902.917 <(906 LA) Euro 4>	02.06→	F 026 40 P 7026	O
		1 457 43 S 3560	L
	WAS	1 457 43 N 1707	K
		1 987 43 R 1456⁸	I
	FBF	1 987 43 M 1156	I
	NOR	1 987 43 M 1157	I

Atego II 1022/ 1222/ 1322/ 1522

4,8 160 OM 924.920 <Euro 3>	09.04→	F 026 40 P 7040	O
		1 457 43 S 3560	L
	WAS	1 457 43 N 1707	K
		1 987 43 R 1456⁸	I
	FBF	1 987 43 M 1156	I
	NOR	1 987 43 M 1157	I

Atego II 1226/ 1326/ 1526

6,4 188 OM 902.917 <(906) Euro 4>	02.06→	F 026 40 P 7026	O
		1 457 43 S 3560	L
	WAS	1 457 43 N 1707	K
		1 987 43 R 1456⁸	I
	FBF	1 987 43 M 1156	I
	NOR	1 987 43 M 1157	I



Atego II 1228/ 1328/ 1528

6,4 205 OM 906.916 <(906) Euro 3>	09.04→	F 026 40 P 7026	O
		1 457 43 S 3560	L
	WAS	1 457 43 N 1707	K
		1 987 43 R 1456⁸	I
	FBF	1 987 43 M 1156	I
	NOR	1 987 43 M 1157	I

Atego II 1229/ 1329/ 1529

6,4 210 OM 902.918 <(906) Euro 4>	02.06→	F 026 40 P 7026	O
		1 457 43 S 3560	L
	WAS	1 457 43 N 1707	K
		1 987 43 R 1456⁸	I
	FBF	1 987 43 M 1156	I
	NOR	1 987 43 M 1157	I

Axor

Axor 1823/ 2523

6,4 170 OM 906.920 LA	01.02-08.06	F 026 40 P 7026	O
Komp.Nr. 508046/10/11	01.02-08.06	TNK	1 457 43 S 3560 L
Komp.Nr. 508046/12/13			
Komp.Nr. 531715/04			
Komp.Nr. 508046/03	01.02-08.06	TNK	1 457 43 S 3728 L
Komp.Nr. 508046/03/04/23	01.02-08.06	TNK	F 026 40 S 0088 L
Komp.Nr. 508046/04	01.02-08.06	TNK	1 457 43 S 3729 L
Komp.Nr. 508046/07	01.02-08.06	TNK	F 026 40 S 0094 L
	01.02-08.06	WAS	1 457 43 N 1707 K
			1 987 43 R 1457⁸ I
		FBF	1 987 43 M 1155 I
		NOR	1 987 43 M 1168 I

Axor 1828/ 2528/ 2628

6,4 205 OM 906.921 LA	01.02-08.06	F 026 40 P 7026	O
Komp.Nr. 508046/10/11	01.02-08.06	TNK	1 457 43 S 3560 L
Komp.Nr. 508046/12/13			
Komp.Nr. 531715/04			
Komp.Nr. 508046/03	01.02-08.06	TNK	1 457 43 S 3728 L
Komp.Nr. 508046/03/04/23	01.02-08.06	TNK	F 026 40 S 0088 L
Komp.Nr. 508046/04	01.02-08.06	TNK	1 457 43 S 3729 L
Komp.Nr. 508046/07	01.02-08.06	TNK	F 026 40 S 0094 L
	01.02-08.06	WAS	1 457 43 N 1707 K
			1 987 43 R 1457⁸ I
		FBF	1 987 43 M 1155 I
		NOR	1 987 43 M 1168 I

Axor 1835/ 1843/ 2535/ 2540/ 2543

11,7 260/295/315 OM 457.937 LA	01.02-08.06	F 026 40 P 7042	O
Komp.Nr. 508046/03	01.02-08.06	TNK	1 457 43 S 3728 L
Komp.Nr. 508046/24	01.02-08.06	TNK	F 026 40 S 0064 L
Komp.Nr. 531715/01	01.02-08.06	TNK	F 026 40 S 0088 L
Komp.Nr. 531715/07			1 457 43 S 3729 L
	01.02-08.06		1 457 42 N 9655 K
			1 987 43 R 1457⁸ I
		FBF	1 987 43 M 1155 I
		NOR	1 987 43 M 1168 I





Axor 1840				
12,0 295 OM 457.937 LA				
	01.02-08.06		F 026 40 P 7042	O
Komp.Nr. 508046/03	01.02-08.06	TNK	1 457 43 S 3728	L
Komp.Nr. 508046/24	01.02-08.06	TNK	F 026 40 S 0064	L
Komp.Nr. 531715/01	01.02-08.06	TNK	F 026 40 S 0088	L
Komp.Nr. 531715/07			1 457 43 S 3729	L
	01.02-08.06		1 457 42 N 9655	K
			1 987 43 R 1457 ⁸	I
		FBF	1 987 43 M 1155	I
		NOR	1 987 43 M 1168	I

Axor 3028				
6,4 205 OM 906.921 <OM 906 LA>				
	03.03->		F 026 40 P 7026	O
Komp.Nr. 531715 /01/07	03.03->	TNK	F 026 40 S 0088	L
Komp.Nr. 531715 /03/05	03.03->	TNK	1 457 43 S 3560	L
	03.03->	WAS	1 457 43 N 1707	K
		FBF	1 987 43 M 1155	I
		NOR	1 987 43 M 1168	I

Axor II				
Axor II 1824/ 1826				
6,4 175/188 OM 902.913 (OM 906) <Euro 4 (BlueTec)>; OM 902.914 (OM 906) <Euro 4 (BlueTec)>				
	09.06->		F 026 40 P 7026	O
Komp.Nr. 508046 /03	09.06->	TNK	1 457 43 S 3728	L
Fg.Nr. ->..K 823576				
Komp.Nr. 508046 /04	09.06->	TNK	1 457 43 S 3729	L
Fg.Nr. ->..K 823576				
Komp.Nr. 508046 /08/09	09.06->	TNK	F 026 40 S 0064	L
Komp.Nr. 508046 /20/26				
Komp.Nr. 508046 /27				
Komp.Nr. 508046 /10/11	09.06->	TNK	1 457 43 S 3560	L
Komp.Nr. 508046 /12/13				
Komp.Nr. 531715 /04				
Komp.Nr. 508046/03/04	09.06->	TNK	F 026 40 S 0088	L
Fg.Nr. ->..K 823577->				
Komp.Nr. 508046/07	09.06->	TNK	F 026 40 S 0094	L
	09.06->	WAS	1 457 43 N 1707	K
			1 987 43 R 1457 ⁸	I
		FBF	1 987 43 M 1155	I
		NOR	1 987 43 M 1168	I

Axor II 1829/ 2529/ 2629				
6,4 210 OM 902.915 (OM 906) <Euro 4 (BlueTec)>				
	09.06->		F 026 40 P 7026	O
Komp.Nr. 508046 /03	09.06->	TNK	1 457 43 S 3728	L
Fg.Nr. ->..K 823576				
Komp.Nr. 508046 /04	09.06->	TNK	1 457 43 S 3729	L
Fg.Nr. ->..K 823576				
Komp.Nr. 508046 /08/09	09.06->	TNK	F 026 40 S 0064	L
Komp.Nr. 508046 /20/26				
Komp.Nr. 508046 /27				
Komp.Nr. 508046 /10/11	09.06->	TNK	1 457 43 S 3560	L
Komp.Nr. 508046 /12/13				
Komp.Nr. 531715 /04				



Komp.Nr. 508046/03/04	09.06->	TNK	F 026 40 S 0088	L
Fg.Nr. ->..K 823577->				
Komp.Nr. 508046/07	09.06->	TNK	F 026 40 S 0094	L
	09.06->	WAS	1 457 43 N 1707	K
			1 987 43 R 1457 ⁸	I
		FBF	1 987 43 M 1155	I
		NOR	1 987 43 M 1168	I

Axor II 1833/ 2533/ 2633				
7,2 240 OM 926.913 LA				
	09.04-08.06		F 026 40 P 7026	O
Komp.Nr. 508046 /04	09.04-08.06	TNK	1 457 43 S 3729	L
Fg.Nr. ->..K 823576				
Komp.Nr. 508046 /08/09	09.04-08.06	TNK	F 026 40 S 0064	L
Komp.Nr. 508046 /20/26				
Komp.Nr. 508046 /27				
Komp.Nr. 508046 /10/11	09.04-08.06	TNK	1 457 43 S 3560	L
Komp.Nr. 508046 /12/13				
Komp.Nr. 531715 /04				
Komp.Nr. 508046/03	09.04-08.06	TNK	1 457 43 S 3728	L
Komp.Nr. 508046/03/04				
Fg.Nr. ->..K 823577->	09.04-08.06	TNK	F 026 40 S 0088	L
Komp.Nr. 508046/07	09.04-08.06	TNK	F 026 40 S 0094	L
	09.04-08.06	WAS	1 457 43 N 1707	K
			1 987 43 R 1457 ⁸	I
		FBF	1 987 43 M 1155	I
		NOR	1 987 43 M 1168	I

7,2 240 OM 926.919 LA <Euro 4 (BlueTec)>				
	09.06->		F 026 40 P 7026	O
Komp.Nr. 508046 /03	09.06->	TNK	1 457 43 S 3728	L
Fg.Nr. ->..K 823576				
Komp.Nr. 508046 /04	09.06->	TNK	1 457 43 S 3729	L
Fg.Nr. ->..K 823576				
Komp.Nr. 508046 /08/09	09.06->	TNK	F 026 40 S 0064	L
Komp.Nr. 508046 /20/26				
Komp.Nr. 508046 /27				
Komp.Nr. 508046 /10/11	09.06->	TNK	1 457 43 S 3560	L
Komp.Nr. 508046 /12/13				
Komp.Nr. 531715 /04				
Komp.Nr. 508046/03/04	09.06->	TNK	F 026 40 S 0088	L
Fg.Nr. ->..K 823577->				
Komp.Nr. 508046/07	09.06->	TNK	F 026 40 S 0094	L
	09.06->	WAS	1 457 43 N 1707	K
			1 987 43 R 1457 ⁸	I
		FBF	1 987 43 M 1155	I
		NOR	1 987 43 M 1168	I

7,2 240 OM 926.945 LA <Euro 5/EEV (BlueTec)>				
	12.09->		F 026 40 P 7026	O
Komp.Nr. 508046 /03	12.09->	TNK	1 457 43 S 3728	L
Fg.Nr. ->..K 823576				
Komp.Nr. 508046 /04	12.09->	TNK	1 457 43 S 3729	L
Fg.Nr. ->..K 823576				
Komp.Nr. 508046 /08/09	12.09->	TNK	F 026 40 S 0064	L
Komp.Nr. 508046 /20/26				
Komp.Nr. 508046 /27				
Komp.Nr. 508046 /10/11	12.09->	TNK	1 457 43 S 3560	L
Komp.Nr. 508046 /12/13				
Komp.Nr. 531715 /04				





Komp.Nr. 508046/03/04	12.09→	TNK	F 026 40 S 0088	L
Fg.Nr. ..K823577→				
Komp.Nr. 508046/07	12.09→	TNK	F 026 40 S 0094	L
	12.09→	WAS	1 457 43 N 1707	K
			1 987 43 R 1457 ⁸	I
		FBF	1 987 43 M 1155	I
		NOR	1 987 43 M 1168	I

Axor II 1836

12,0 265 OM 457.948 LA <Euro 4/5 (BlueTec)>				
	09.06→		F 026 40 P 7042	O
Fg.Nr. 531715/01/07	09.06→	TNK	1 457 43 S 3729	L
→..K823576→..B823576				
Komp.Nr. 508046/24	09.06→	TNK	F 026 40 S 0064	L
Komp.Nr. 531715/01/07	09.06→	TNK	F 026 40 S 0088	L
Komp.Nr. 508046/03				
Fg.Nr. ..K823577→..B823577→				
	09.06→	WAS	1 457 42 N 9655	K
			1 987 43 R 1457 ⁸	I
		FBF	1 987 43 M 1155	I
		NOR	1 987 43 M 1168	I

Axor II 1840

12,0 295 OM 457.948 LA <Euro 4/5 (BlueTec)>				
	09.06→		F 026 40 P 7042	O
Fg.Nr. 531715/01/07	09.06→	TNK	1 457 43 S 3729	L
→..K823576→..B823576				
Komp.Nr. 508046/24	09.06→	TNK	F 026 40 S 0064	L
Komp.Nr. 531715/01/07	09.06→	TNK	F 026 40 S 0088	L
Komp.Nr. 508046/03				
Fg.Nr. ..K823577→..B823577→				
	09.06→	WAS	1 457 42 N 9655	K
			1 987 43 R 1457 ⁸	I
		FBF	1 987 43 M 1155	I
		NOR	1 987 43 M 1168	I

Axor II 1843

12,0 315 OM 457.948 LA <Euro 4/5 (BlueTec)>				
	09.06→		F 026 40 P 7042	O
Fg.Nr. 531715/01/07	09.06→	TNK	1 457 43 S 3729	L
→..K823576→..B823576				
Komp.Nr. 508046/24	09.06→	TNK	F 026 40 S 0064	L
Komp.Nr. 531715/01/07	09.06→	TNK	F 026 40 S 0088	L
Komp.Nr. 508046/03				
Fg.Nr. ..K823577→..B823577→				
	09.06→	WAS	1 457 42 N 9655	K
			1 987 43 R 1457 ⁸	I
		FBF	1 987 43 M 1155	I
		NOR	1 987 43 M 1168	I

Axor II 2536

12,0 265 OM 457.948 LA <Euro 4/5 (BlueTec)>				
	09.06→		F 026 40 P 7042	O
Fg.Nr. 531715/01/07	09.06→	TNK	1 457 43 S 3729	L
→..K823576→..B823576				
Komp.Nr. 508046/03	09.06→	TNK	1 457 43 S 3728	L
Fg.Nr. →..K823576→..B823576				
Komp.Nr. 508046/10/11	09.06→	TNK	1 457 43 S 3560	L
Komp.Nr. 508046/12/13				
Komp.Nr. 531715/04				
Komp.Nr. 508046/24	09.06→	TNK	F 026 40 S 0064	L



Komp.Nr. 531715/09	09.06→	TNK	F 026 40 S 0064	L
Fg.Nr. ..L067314→				
Komp.Nr. 531715/09	09.06→	TNK	F 026 40 S 0064	L
Fg.Nr. →..L067313				
Komp.Nr. 531715/01/07	09.06→	TNK	F 026 40 S 0088	L
Komp.Nr. 508046/03				
Fg.Nr. ..K823577→..B823577→				
	09.06→	WAS	1 457 42 N 9655	K
			1 987 43 R 1457 ⁸	I
		FBF	1 987 43 M 1155	I
		NOR	1 987 43 M 1168	I

Axor II 2540

12,0 295 OM 457.948 LA <Euro 4/5 (BlueTec)>				
	09.06→		F 026 40 P 7042	O
Fg.Nr. 531715/01/07	09.06→	TNK	1 457 43 S 3729	L
→..K823576→..B823576				
Komp.Nr. 508046/03	09.06→	TNK	1 457 43 S 3728	L
Fg.Nr. →..K823576→..B823576				
Komp.Nr. 508046/24	09.06→	TNK	F 026 40 S 0064	L
Komp.Nr. 531715/09	09.06→	TNK	F 026 40 S 0064	L
Fg.Nr. ..L067314→				
Komp.Nr. 531715/09	09.06→	TNK	F 026 40 S 0064	L
Fg.Nr. →..L067313				
Komp.Nr. 531715/01/07	09.06→	TNK	F 026 40 S 0088	L
Komp.Nr. 508046/03				
Fg.Nr. ..K823577→..B823577→				
	09.06→	WAS	1 457 42 N 9655	K
			1 987 43 R 1457 ⁸	I
		FBF	1 987 43 M 1155	I
		NOR	1 987 43 M 1168	I

Axor II 2543

12,0 315 OM 457.948 LA <Euro 4/5 (BlueTec)>				
	09.06→		F 026 40 P 7042	O
Fg.Nr. 531715/01/07	09.06→	TNK	1 457 43 S 3729	L
→..K823576→..B823576				
Komp.Nr. 508046/03	09.06→	TNK	1 457 43 S 3728	L
Fg.Nr. →..K823576→..B823576				
Komp.Nr. 508046/24	09.06→	TNK	F 026 40 S 0064	L
Komp.Nr. 531715/02/08	09.06→	TNK	1 457 43 S 3901	L
Komp.Nr. 531715/09	09.06→	TNK	F 026 40 S 0064	L
Fg.Nr. ..L067314→				
Komp.Nr. 531715/09	09.06→	TNK	F 026 40 S 0064	L
Fg.Nr. →..L067313				
Komp.Nr. 531715/01/07	09.06→	TNK	F 026 40 S 0088	L
Komp.Nr. 508046/03				
Fg.Nr. ..K823577→..B823577→				
	09.06→	WAS	1 457 42 N 9655	K
			1 987 43 R 1457 ⁸	I
		FBF	1 987 43 M 1155	I
		NOR	1 987 43 M 1168	I

Axor II 2635

12,0 260 OM 457.956 <(457 LA) Euro 3>				
	09.04→		F 026 40 P 7042	O
Fg.Nr. ..K823577→..B823577→	09.04→		F 026 40 S 0088	L
Fg.Nr. 531715/01/07	09.04→	TNK	1 457 43 S 3729	L
→..K823576→..B823576				
Komp.Nr. 508046/03	09.04→	TNK	1 457 43 S 3728	L
Fg.Nr. →..K823576→..B823576				



Komp.Nr. 508046/08/20	09.04→	TNK	F 026 40 S 0064	L
Komp.Nr. 508046/24/26				
Komp.Nr. 508046/27				
Komp.Nr. 531715/02/08	09.04→	TNK	1 457 43 S 3901	L
Komp.Nr. 531715/09	09.04→	TNK	F 026 40 S 0064	L
Fg.Nr. →..L 067314→				
Komp.Nr. 531715/09	09.04→	TNK	F 026 40 S 0064	L
Fg.Nr. →..L 067313				
	09.04→	WAS	1 457 42 N 9655	K
			1 987 43 R 1457 ⁸	I
		FBF	1 987 43 M 1155	I
		NOR	1 987 43 M 1168	I

Axor II 2636/ 2640/ 2643/ 3236/ 3240/ 3243

12,0 | 265/295/315 | OM 457... LA <Euro 4/5 (BlueTec)>; OM 457.957 LA <Euro 4/5 (BlueTec)>

	09.06→		F 026 40 P 7042	O
Fg.Nr. →..K 823577→..B 823577→	09.06→		F 026 40 S 0088	L
Fg.Nr. 531715/01/07	09.06→	TNK	1 457 43 S 3729	L
→..K 823576→..B 823576				
Komp.Nr. 508046/03	09.06→	TNK	1 457 43 S 3728	L
Fg.Nr. →..K 823576→..B 823576				
Komp.Nr. 508046/10/11	09.06→	TNK	1 457 43 S 3560	L
Komp.Nr. 508046/12/13				
Komp.Nr. 531715/04				
Komp.Nr. 508046/08/20	09.06→	TNK	F 026 40 S 0064	L
Komp.Nr. 508046/24/26				
Komp.Nr. 508046/27				
	09.06→	WAS	1 457 42 N 9655	K
			1 987 43 R 1457 ⁸	I
		FBF	1 987 43 M 1155	I
		NOR	1 987 43 M 1168	I

Axor II 3335/ 3340/ 3343

12,0 | 260/295/315 | OM 457.956 LA <Euro 3>

	09.04→		F 026 40 P 7042	O
Fg.Nr. →..K 823577→..B 823577→	09.04→		F 026 40 S 0088	L
Fg.Nr. 531715/01/07	09.04→	TNK	1 457 43 S 3729	L
→..K 823576→..B 823576				
Komp.Nr. 508046/03	09.04→	TNK	1 457 43 S 3728	L
Fg.Nr. →..K 823576→..B 823576				
Komp.Nr. 508046/08/20	09.04→	TNK	F 026 40 S 0064	L
Komp.Nr. 508046/24/26				
Komp.Nr. 508046/27				
Komp.Nr. 531715/02/08	09.04→	TNK	1 457 43 S 3901	L
	09.04→	WAS	1 457 42 N 9655	K
			1 987 43 R 1457 ⁸	I
		FBF	1 987 43 M 1155	I
		NOR	1 987 43 M 1168	I

Axor II 4135

12,0 | 260 | OM 457.956 <(457 LA) Euro 3>

	09.04→		F 026 40 P 7042	O
Fg.Nr. →..K 823577→..B 823577→	09.04→		F 026 40 S 0088	L
Fg.Nr. 531715/01/07	09.04→	TNK	1 457 43 S 3729	L
→..K 823576→..B 823576				
Komp.Nr. 508046/03	09.04→	TNK	1 457 43 S 3728	L
Fg.Nr. →..K 823576→..B 823576				



Komp.Nr. 508046/08/20	09.04→	TNK	F 026 40 S 0064	L
Komp.Nr. 508046/24/26				
Komp.Nr. 508046/27				
Komp.Nr. 531715/02/08	09.04→	TNK	1 457 43 S 3901	L
	09.04→	WAS	1 457 42 N 9655	K
			1 987 43 R 1457 ⁸	I
		FBF	1 987 43 M 1155	I
		NOR	1 987 43 M 1168	I

Axor II 4140/ 4143

12,0 | 295/315 | OM 457.956 <(457 LA) Euro 3>

	09.04→		F 026 40 P 7042	O
Fg.Nr. →..K 823577→..B 823577→	09.04→		F 026 40 S 0088	L
Fg.Nr. 531715/01/07	09.04→	TNK	1 457 43 S 3729	L
→..K 823576→..B 823576				
Komp.Nr. 508046/03	09.04→	TNK	1 457 43 S 3728	L
Fg.Nr. →..K 823576→..B 823576				
Komp.Nr. 508046/08/20	09.04→	TNK	F 026 40 S 0064	L
Komp.Nr. 508046/24/26				
Komp.Nr. 508046/27				
Komp.Nr. 531715/02/08	09.04→	TNK	1 457 43 S 3901	L
	09.04→	WAS	1 457 42 N 9655	K
			1 987 43 R 1457 ⁸	I
		FBF	1 987 43 M 1155	I
		NOR	1 987 43 M 1168	I

12,0 | 295/315 | OM 457.957 <Euro 4/5 (BlueTec)>

	09.06→		F 026 40 P 7042	O
Fg.Nr. →..K 823577→..B 823577→	09.06→		F 026 40 S 0088	L
Fg.Nr. 531715/01/07	09.06→	TNK	1 457 43 S 3729	L
→..K 823576→..B 823576				
Komp.Nr. 508046/03	09.06→	TNK	1 457 43 S 3728	L
Fg.Nr. →..K 823576→..B 823576				
Komp.Nr. 508046/08/20	09.06→	TNK	F 026 40 S 0064	L
Komp.Nr. 508046/24/26				
Komp.Nr. 508046/27				
	09.06→	WAS	1 457 42 N 9655	K
			1 987 43 R 1457 ⁸	I
		FBF	1 987 43 M 1155	I
		NOR	1 987 43 M 1168	I



Citaro

Citaro O 530

170 | OM 906.931 HLA <Euro 2>

	01.98-09.04		F 026 40 P 7026	O
Komp.Nr. 505013/04	01.98-09.04	TNK, WAS	1 457 42 N 9655	K
Komp.Nr. 505079/03				
Komp.Nr. 505079/03	01.98-09.04	TNK	1 457 43 N 1707	K

185-240 | M 476 HLAG <M 447 HLAG Euro 2>; M 476.930 HLAG <M 447 HLAG Euro 2>; M 476.932 HLAG <M 447 HLAG Euro 2>

	04.00→		F 026 40 P 7026	O
--	--------	--	-----------------	---

205 | OM 909.921 LA <Euro 2>

Komp.Nr. 505025/03	01.99-09.04	TNK	F 026 40 P 7040	O
Komp.Nr. 505025/06				
Komp.Nr. 505025/09				
Komp.Nr. 505025/07	01.99-09.04	TNK	F 026 40 P 7026	O
Komp.Nr. 505025/08				



◀ Citaro O 530

Komp.Nr. 505013/08	01.99-09.04	TNK	1 457 43 N 1707	K
Komp.Nr. 505013/11				
Komp.Nr. 505013/14	01.99-09.04	TNK	1 457 42 N 9655	K
6,4 170/205 OM 909.900,911 LA <Euro 2>; OM 909.901 LA <Euro 2>				
	01.99-09.04		F 026 40 P 7026	O
		WAS	1 457 42 N 9655	K
6,4 180 OM 906.963 HLA <Euro 3>				
	04.99-09.06		F 026 40 P 7026	O
Komp.Nr. 505013/14	04.99-09.06	TNK	1 457 42 N 9655	K
Komp.Nr. 505079/03	04.99-09.06	TNK	1 457 43 N 1707	K
6,4 180/205 OM 906.961 <Euro 3>; OM 906.962 <Euro 3>				
	04.00-09.06		F 026 40 P 7026	O
Komp.Nr. 505013/04	04.00-09.06	TNK	1 457 43 N 1707	K
Komp.Nr. 505013/07				
Komp.Nr. 505013/08				
Komp.Nr. 505013/11				
Komp.Nr. 505013/19				
Komp.Nr. 505013/14	04.00-09.06	TNK	1 457 42 N 9655	K
6,4 205 OM 906.930 HLA <Euro 2>				
	01.98-09.04		F 026 40 P 7026	O
		WAS	1 457 42 N 9655	K
Komp.Nr. 505013/04	01.99-09.04	TNK, WAS	1 457 42 N 9655	K
Komp.Nr. 505079/03				
Komp.Nr. 505079/03	01.99-09.04	TNK	1 457 43 N 1707	K
6,4 205 OM 906.960 LA <Euro 3>				
	04.99-09.06		F 026 40 P 7026	O
Komp.Nr. 505013/14	04.99-09.06	TNK	1 457 42 N 9655	K
Komp.Nr. 505079/03	04.99-09.06	TNK	1 457 43 N 1707	K
6,4 210 OM 902.9... HLA(906) <Euro 4 (BlueTec)>; OM 902.925 LA(906) <Euro 4 (BlueTec)>				
	10.06→		F 026 40 P 7026	O
		TW, WAS	1 457 42 N 9655	K
			1 457 43 N 1707	K
7,2 210 OM 926... LA <Euro 4 (BlueTec)>				
	10.06→		F 026 40 P 7026	O
		TW, WAS	1 457 42 N 9655	K
			1 457 43 N 1707	K
12,0 185/220/260 OM 457.933 HLA <Euro 2>; OM 457.934 HLA <Euro 2>; OM 457.935 HLA <Euro 2>				
	01.98-09.04		F 026 40 P 7026	O
		WAS	1 457 42 N 9655	K
12,0 185-240 M 476... HLAG <Euro 4>				
	10.06→		F 026 40 P 7026	O
12,0 185-260 OM 457.941 HLA <Euro 3>; OM 457.942 HLA <Euro 3>				
	04.99-10.06		F 026 40 P 7026	O
			1 457 42 N 9655	K
12,0 195 OM 457.943 LA <Euro 3>				
	04.00-09.06	WAS	1 457 42 N 9655	K
12,0 220-260 OM 457.95... HLA <Euro 4/5 (BlueTec)>				
	10.06→		F 026 40 P 7026	O
		WAS	1 457 42 N 9655	K
12,0 260 OM 457... <Euro 4/5 (BlueTec)>				
	10.06→	WAS	1 457 42 N 9655	K



Citaro L

Citaro L O 530

205 | OM 906.960 LA <Euro 3>

	01.01-09.06		F 026 40 P 7026	O
Komp.Nr. 505013/14	01.01-09.06	TNK	1 457 42 N 9655	K
Komp.Nr. 505079/03	01.01-09.06	TNK	1 457 43 N 1707	K

205 | OM 909.921 LA <Euro 2>

Komp.Nr. 505025/03	01.99-09.04	TNK	F 026 40 P 7040	O
Komp.Nr. 505025/06				
Komp.Nr. 505025/09				
Komp.Nr. 505025/07	01.99-09.04	TNK	F 026 40 P 7026	O
Komp.Nr. 505025/08				
Komp.Nr. 505013/08	01.99-09.04	TNK	1 457 43 N 1707	K
Komp.Nr. 505013/11				
Komp.Nr. 505013/14	01.99-09.04	TNK	1 457 42 N 9655	K

6,4 | 205 | OM 906.930 HLA <Euro 2>; OM 909.901 LA <Euro 2>

	01.99-09.04		F 026 40 P 7026	O
		WAS	1 457 42 N 9655	K

12,0 | 185/220 | OM 457.934 HLA <Euro 2>; OM 457.935 HLA <Euro 2>

	01.99-09.04		F 026 40 P 7026	O
		WAS	1 457 42 N 9655	K

Cito

Cito O 520

4,3 | 125 | OM 904 LA <Euro 2>

	01.99-09.03		F 026 40 P 7040	O
		WAS	1 457 43 N 1707	K

Conecto

Conecto

6,4 | 210 | OM 902.925 (906 LA) <Euro 4>

	09.07→		F 026 40 P 7026	O
		TW, WAS	1 457 42 N 9655	K
			1 457 43 N 1707	K

7,2 | 210 | OM 926.939 (926 LA) <Euro 4>

	09.07→		F 026 40 P 7026	O
		TW, WAS	1 457 42 N 9655	K
			1 457 43 N 1707	K

Conecto G

12,0 | 260 | OM 457... <Euro 4/5>

	09.07→	WAS	1 457 42 N 9655	K
--	--------	-----	-----------------	---

Conecto O 345

6,4 | 205 | OM 906.960 (906 LA) <Euro 2>

	05.01-08.07		F 026 40 P 7026	O
		TW, WAS	1 457 42 N 9655	K
			1 457 43 N 1707	K

12,0 | 185-260 | OM 457.942 (457 HLA) <Euro 3>

	10.01-08.07		F 026 40 P 7026	O
		WAS	1 457 42 N 9655	K



Econic

Econic 1823/ 1824

6,4 170/175 OM 902.933 (OM 906) <Euro 4 (BlueTec)>; OM 906.940 LA <Euro 2>; OM 906.951 LA <Euro 3>			
03.98→	F 026 40 P 7026	O	
	WAS 1 457 43 N 1707	K	
	1 987 43 M 2150	I	

Econic 1828/ 2628

6,4 205 OM 906.941 LA <Euro 2>			
03.98-03.01	F 026 40 P 7026	O	
	WAS 1 457 43 N 1707	K	
	1 987 43 M 2150	I	

6,4 205 OM 906.952 LA <Euro 3>			
03.00-09.06	F 026 40 P 7026	O	
	WAS 1 457 43 N 1707	K	
	1 987 43 M 2150	I	

6,9 205 M 902.90... LAG <Euro 4/5>			
09.06→	F 026 40 P 7026	O	
	1 987 43 M 2150	I	

6,9 205 M 906.900 LAG <Euro 3>			
03.00-08.06	F 026 40 P 7026	O	
	1 987 43 M 2150	I	

Econic 1829/ 2629

6,4 210 OM 902.927 (OM 906) <Euro 4 (BlueTec)>			
09.06→	F 026 40 P 7026	O	
	WAS 1 457 43 N 1707	K	
	1 987 43 M 2150	I	

Econic 1833/ 2633

7,2 240 OM 926.924 LA <Euro 3>			
03.00-09.06	F 026 40 P 7026	O	
	WAS 1 457 43 N 1707	K	
	1 987 43 M 2150	I	

Econic 1833/ 2633/ 3233

7,2 240 OM 926.934 LA <Euro 4 (BlueTec)>			
09.06→	F 026 40 P 7026	O	
	WAS 1 457 43 N 1707	K	
	1 987 43 M 2150	I	

Integro I

Integro I O 550

12,0 184-260 OM 447 HLA Euro 2 <447.903>			
09.99-09.06	1 457 42 P 9740	O	

12,0 185-260 OM 457 HLA Euro 3 <457>			
11.01-09.06	F 026 40 P 7026	O	
	1 457 42 N 9655	K	



Integro II

Integro II / L/ M

7,2 210 OM 926.939 LA <Euro 4 (BlueTec)>			
09.06→	F 026 40 P 7026	O	
	TW, WAS 1 457 42 N 9655	K	
	1 457 43 N 1707	K	

12,0 220-300 OM 457... <Euro 4/5 (BlueTec)>			
09.06→	F 026 40 P 7026	O	
	WAS 1 457 42 N 9655	K	

Intouro

Intouro O 560

11,0 250 OM 441 LA Euro 2			
01.00-03.07	1 457 42 P 9732	O	

O 100

O 100 CITY

2,9 70 OM 602.940			
01.94→	1 457 42 P 9274	O	
	1 457 43 S 3005	L	
	1 457 43 N 4123 ²	K	
Fg.Nr. →941505	01.94→	0 450 90 N 4077 ¹	K

O 301

O 301 F

6,0 100/125 OM 366.917; OM 366.965 A			
06.86-02.01	1 457 42 P 9735	O	
	1 457 42 S 9950	L	
	1 457 42 N 9359	K	

O 303

O 303

11,0 160-165 OM 441.908,909,911			
09.87-09.92	1 457 42 P 9735	O	
	1 457 42 N 9359	K	

11,0 191-200 OM 441.950,953 A			
12.87-09.92	1 457 42 P 9735	O	
	1 457 42 S 9975	L	
	1 457 42 N 9359	K	

15,0 213-218/260-269 OM 442.9...; OM 442.960,961 A			
09.87-09.92	1 457 42 P 9740	O	
	1 457 42 N 9359	K	

O 345

O 345

6,4 205 OM 906.960 (906 LA) <Euro 3>			
10.01→	TNK F 026 40 P 7026	O	
	WAS 1 457 42 N 9655	K	





◀ O 345

10,0 155 OM 489.960 (449 HLA) <Euro 2>			
10.95→	1 457 42 P 9740	O	
	1 457 42 S 9975	L	
	FHE 1 457 42 N 9359	K	
	WAS 1 457 42 N 9354	K	
	TNK 1 457 42 P 9820 ³	P	

12,0 157/184 OM 447.949 (447 HLA) <Euro 2>; OM 447.960 (447 HLA) <Euro 1>			
12.96→	1 457 42 P 9740	O	
	1 457 42 S 9975	L	
	FHE 1 457 42 N 9359	K	
	WAS 1 457 42 N 9354	K	
	TNK 1 457 42 P 9820 ³	P	

O 345 G

10,0 184 OM 489.961 (449 HLA) <Euro 1>			
10.95→	1 457 42 P 9740	O	
	1 457 42 S 9975	L	
	FHE 1 457 42 N 9359	K	
	WAS 1 457 42 N 9354	K	
	TNK 1 457 42 P 9820 ³	P	

12,0 185-260 OM 457.942 (457 HLA) <Euro 3>			
10.01→	TNK F 026 40 P 7026	O	
	WAS 1 457 42 N 9655	K	

O 345 K

12,0 220 OM 447.947 (447 HLA) <Euro 1>; OM 447.948 (447 HLA) <Euro 2>			
05.97→	1 457 42 P 9740	O	
	1 457 42 S 9975	L	
	FHE 1 457 42 N 9359	K	
	WAS 1 457 42 N 9354	K	
	TNK 1 457 42 P 9820 ³	P	

O 402

O 402 / F

6,0 100/125 OM 366.917; OM 366.965 A			
02.86-02.01	1 457 42 P 9646	O	
	1 457 42 S 9950	L	
	1 457 42 N 9359	K	

O 404

O 404

9,6 200 OM 401.974 LA <Euro 1>			
09.91-10.99	1 457 42 P 9732	O	
	1 457 42 S 9975	L	
	1 457 42 N 9354	K	
	1 457 42 P 9820 ³	P	

9,6 213 OM 401.970 LA <Euro 1>			
09.91-10.99	1 457 42 P 9732	O	
	TW 1 457 42 S 9969	L	
	1 457 42 S 9975	L	
01.93-10.99	1 457 42 S 9975	L	
09.91-10.99	1 457 42 N 9354	K	
	1 457 42 P 9820 ³	P	



11,0 151 OM 441.922 <Euro 1>			
09.91-01.92	1 457 42 P 9732	O	
	1 457 42 S 9975	L	
	1 457 42 N 9354	K	
	1 457 42 P 9820 ³	P	

11,0 213/250 OM 445.934 (441) LA <Euro 2>; OM 445.935 (441) LA <Euro 2>			
01.95-10.99	1 457 42 P 9732	O	
	WW 1 457 42 S 9899	L	
	1 457 42 S 9969	L	
	1 457 42 N 9354	K	

11,0 250 OM 441.980 LA <Euro 1>			
09.91-10.99	1 457 42 P 9732	O	
	TW 1 457 42 S 9899	L	
	1 457 42 S 9969	L	
	1 457 42 N 9354	K	
	1 457 42 P 9820 ³	P	

12,8 280 OM 402.970 LA <Euro 1>			
09.91-10.99	1 457 42 P 9732	O	
	TW 1 457 42 S 9899	L	
	1 457 42 S 9969	L	
	1 457 42 N 9354	K	
	1 457 42 P 9820 ³	P	

12,8 280-295 OM 402.974 LA <Euro 1>			
09.91-10.99	1 457 42 P 9732	O	
	WW 1 457 42 S 9899	L	
	1 457 42 S 9969	L	
	1 457 42 N 9354	K	

15,0 195/213 OM 442.930; OM 442.931 <Euro 1>			
09.91-01.92	1 457 42 P 9732	O	
	1 457 42 S 9975	L	
	1 457 42 N 9354	K	
	1 457 42 P 9820 ³	P	

15,0 280 OM 446.934 (442) LA <Euro 2>; OM 446.938 (442) LA <Euro 2>			
01.95-10.99	1 457 42 P 9732	O	
	WW 1 457 42 S 9899	L	
	1 457 42 S 9969	L	
	1 457 42 N 9354	K	

O 405

O 405 / E/ G

12,0 150/157/177/184/206/220 OM 447.905 h; OM 447.906,907,908 h; OM 447.907 h; OM 447.913 h <Euro 1>; OM 447.950 hA; OM 447.950,951 hA; OM 447.956 hA <Euro 1>; OM 447.970 hIA <Euro 2>; OM 447.971 hIA <Euro 2>; OM 447.972 hIA <Euro 2>; OM 447.973 hIA <Euro 2>; OM 447.974 hIA <Euro 2>; OM 447.976 hIA <Euro 2>; OM 447.977 hIA <Euro 2>; OM 447.980 <Euro 1>; OM 447.981 hIA <Euro 1>			
11.86-02.01	1 457 42 P 9740	O	
	1 457 42 S 9975	L	
	1 457 42 N 9354	K	

O 405 GAS

177 476.927			
01.85-02.01	1 457 42 P 9740	O	





O 405 GN/ GNDE

12,0 184/220 OM 447.959 hA <Euro 1>; OM 447.978 HLA <Euro 2>; OM 447.979 HLA <Euro 2>; OM 447.984 hLA <Euro 1>; OM 447.999 hIA <Euro 2>			
09.91-12.97	1 457 42 P 9740	O	
	1 457 42 S 9975	L	
	1 457 42 N 9354	K	

O 405 GN-G

177 476.926			
01.85-02.01	1 457 42 P 9740	O	

O 405 GNTD/ GT

12,0 220/235 OM 447.968 hIA <Euro 2>; OM 447.998 hIA <Euro 2>			
09.91-12.97	1 457 42 P 9740	O	
	1 457 42 N 9354	K	

O 405 GTD

184 OM 447.955 ha <Euro 1>			
11.86-02.01	1 457 42 P 9740	O	
	1 457 42 S 9975	L	
	1 457 42 N 9354	K	

O 405 GTZ

72 OM 602.990; OM 602.994			
11.86-02.01	1 457 42 P 9274	O	
	1 457 42 S 9783	L	

O 405 N

12,0 150/157/177/184 OM 447.910 h; OM 447.911 hIA; OM 447.914 h <Euro 1>; OM 447.957 hA <Euro 1>			
10.89-02.01	1 457 42 P 9740	O	
	1 457 42 S 9975	L	
	1 457 42 N 9354	K	
	1 457 42 P 9820 ³	P	

12,0 184/220 OM 447.986 hLA <Euro 1>; OM 447.996 hIA <Euro 2>			
09.91-12.97	1 457 42 P 9740	O	
	1 457 42 S 9975	L	
	1 457 42 N 9354	K	

O 405 N-G

177 476.925			
01.85-02.01	1 457 42 P 9740	O	

O 405 N1

12,0 220 OM 447.975 hIA <Euro 2>			
09.91-12.97	1 457 42 P 9740	O	
	1 457 42 S 9975	L	
	1 457 42 N 9354	K	

O 407

O 407

12,0 177/220 OM 447.906 h; OM 447.908 h; OM 447.985 HIA <Euro 1>			
03.87-02.01	1 457 42 P 9740	O	
	1 457 42 S 9975	L	
	1 457 42 N 9354	K	
	FHE 1 457 42 N 9359	K	



12,0 184/220 OM 447.990 HIA <Euro 2>; OM 447.991 HIA <Euro 2>			
02.91-02.01	1 457 42 P 9740	O	
	1 457 42 S 9975	L	
	1 457 42 N 9354	K	

O 408

O 408

12,0 184-220 OM 447.992,993 HLA <Euro 2>			
08.92-12.01	1 457 42 P 9740	O	
	1 457 42 S 9975	L	
	1 457 42 N 9354	K	

12,0 184/220 OM 447.912 h; OM 447.958 hA <Euro 1>; OM 447.987 hLA <Euro 1>			
01.91-12.01	1 457 42 P 9740	O	
	1 457 42 S 9975	L	
	1 457 42 N 9354	K	
	FHE 1 457 42 N 9359	K	

Tourino

Tourino O 510

6,4 180-205 OM 906.96... LA <Euro 3>			
01.04→	F 026 40 P 7026	O	
	TW,WAS 1 457 42 N 9655	K	
	1 457 43 N 1707	K	
	TW F 026 40 Z 4012	A	

7,2 210 OM 926... <Euro 4/5 (BlueTec)>			
09.06→	F 026 40 P 7026	O	
	TW,WAS 1 457 42 N 9655	K	
	1 457 43 N 1707	K	

Tourismo

Tourismo

12,0 260-300 OM 457... <Euro 4/5 (BlueTec)>			
10.06→	F 026 40 P 7026	O	
	WAS 1 457 42 N 9655	K	

Tourismo M, L

12,0 315 OM 457... <Euro 4/5 (BlueTec)>			
10.06→	F 026 40 P 7042	O	
	F 026 40 S 0189	L	
	WAS 1 457 42 N 9655	K	

Tourismo O 350

11,0 250 OM 441.980 LA <Euro 1>; OM 445.934 LA <Euro 2>			
10.95-09.06	1 457 42 P 9732	O	
	1 457 42 S 9969	L	
	WAS 1 457 42 N 9354	K	

12,8 280 OM 402.970 LA <Euro 1>			
10.95-09.06	1 457 42 P 9732	O	
	1 457 42 S 9969	L	
	WAS 1 457 42 N 9354	K	





◀ Tourismo O 350

14,6 280 OM 446.938 LA <Euro 2>	10.95-09.06		1 457 42 P 9732	O
			1 457 42 S 9969	L
		WAS	1 457 42 N 9354	K

Tourismo RH/ RH-M

12,0 260-300 OM 457... HLA <Euro 4/5 (BlueTec)>	09.09→		F 026 40 P 7026	O
		WAS	1 457 42 N 9655	K

Tourismo 15

12,0 260-310 OM 457.944 HLA <Euro 3>; OM 457.944 LA <Euro 3>				
Komp.Nr. 522037/01	10.99-09.06	TNK	1 457 42 P 9740	O
Komp.Nr. 522037/03	10.99-09.06	TNK	F 026 40 P 7042	O
Komp.Nr. 522037/16	10.99-09.06		1 457 42 S 9969	L
		WAS	1 457 42 N 9655	K

Touro

Touro OC 500

12,0 260-310 OM 457.944 LA <Euro 3>	10.02→	TW	F 026 40 P 7042	O
			1 457 42 P 9740	O
		WAS	1 457 42 N 9655	K

Travego

Travego O 580

12,0 260-310 OM 457.93... LA/HLA <Euro 3>	10.99-02.06		F 026 40 P 7026	O
		WAS	1 457 42 N 9655	K
			1 457 42 P 9820 ³	P

12,0 310 OM 457.938 LA <Euro 3>	10.99-02.06		F 026 40 P 7026	O
		WAS	1 457 42 N 9655	K

12,0 315 OM 457.953 <(OM 457 LA) Euro 4>	02.06→		F 026 40 P 7042	O
			F 026 40 S 0189	L
		WAS	1 457 42 N 9655	K

15,9 320-350 OM 942.900 LA <(OM 502 LA) Euro 3>	02.01-02.06	OMZ	1 457 42 P 9128	O
			1 457 43 S 3901	L
			1 457 42 N 9655	K

15,9 350 OM 542.948 <(OM 502 LA)>; OM 542.966 <(OM 502 LA) Euro 4>	02.06→		1 457 42 P 9128	O
		TW	F 026 40 S 0189	L
		WAS	1 457 42 N 9655	K

Travego 15/ 16/ 17

12,0 315 OM 457.961 <OM 457 LA (Euro 5)>	09.09→		F 026 40 P 7042	O
			F 026 40 S 0189	L
		WAS	1 457 42 N 9655	K



Unimog

Unimog U

2,4 38/44 OM 616.942; OM 616.943	05.88-02.01		1 457 42 P 9265	O
		TW	1 457 42 S 9980	L
			0 450 90 F 4060 ¹	K
			1 457 42 N 9359	K
			1 457 42 P 9401	H

2,9 65 OM 602.941 D29; OM 602.941 D29 <LEV>	11.92-09.97		1 457 42 P 9274	O
			F 026 40 S 0082	L
			1 457 42 S 9946	L
			0 450 90 F 4060 ¹	K
			1 457 43 N 4123 ²	K

2,9 71 OM 602.948 D29	11.92-09.96		1 457 42 P 9274	O
			F 026 40 S 0082	L
			1 457 42 S 9946	L
			1 457 43 N 4123 ²	K

2,9 90 OM 602.981,989 turbo; OM 602.981,989 turbo <LEV>	07.96-09.01		1 457 42 P 9278	O
			F 026 40 S 0082	L
			1 457 42 S 9946	L
			1 457 43 N 4123 ²	K

4,0 75/77/98/100/103 OM 354.926 LA <Euro 2>; OM 364.955 A <Euro 1>; OM 364.956 A <Euro 1>; OM 364.982 LA <Euro 1>; OM 364.985 LA <Euro 1>; OM 364.989 LA <Euro 1>	07.92-09.98		1 457 42 P 9647	O
			1 457 42 S 9950	L
			1 457 42 N 9359	K

4,3 100 OM 904.927 LA <Euro3>	04.00→		F 026 40 P 7040	O
			F 026 40 S 0067	L
		WAS	1 457 43 N 1707	K
		2FE	1 987 43 M 2020	I

4,3 110 OM 900.915 LA <Euro 4 (BlueTec)>	10.07→		F 026 40 P 7040	O
			1 457 43 N 1707	K

4,3 110/130/160 OM 904.952 LA <Euro3>; OM 904.953 LA <Euro3>; OM 924.916 <Euro 3>	09.02→		F 026 40 P 7040	O
			1 457 42 S 9966	L
			1 457 43 S 3611 ⁴	L
		WAS	1 457 43 N 1707	K

4,3 115 OM 900.915 LA <Euro 4 (BlueTec)>	09.06→		F 026 40 P 7040	O
			F 026 40 S 0067	L
		WAS	1 457 43 N 1707	K
		2FE	1 987 43 M 2020	I

4,3 125 OM 904.928 LA <Euro3>	04.00→		F 026 40 P 7040	O
			F 026 40 S 0067	L
		TW	F 026 40 S 0067	L
			1 457 42 S 9975	L
		WAS	1 457 43 N 1707	K
		2FE	1 987 43 M 2020	I



4,3 130 OM 900.921 LA <Euro 4 (BlueTec)>			
09.06→	F 026 40	P 7040	O
	1 457 42	S 9966	L
	1 457 43	S 3611⁴	L
WAS	1 457 43	N 1707	K

4,8 160 OM 924.923 <Euro 4 (BlueTec)>; OM 924.931 <OM 924 LA (Euro 5)>; OM 924.931 <OM 924 LA Euro 5>			
09.06→	F 026 40	P 7040	O
	1 457 42	S 9966	L
	1 457 43	S 3611⁴	L
WAS	1 457 43	N 1707	K

5,7 62 OM 353.902			
05.88-02.01	TW	1 457 42	P 9647 O
Mot.Nr. ...880615→...999999	05.88-02.01	TW	1 457 42 P 9648 O
..100001→..127491			
05.88-02.01	TW	1 457 42	S 9980 L
		1 457 42	N 9359 K
		1 457 42	P 9401 H

5,7 81 OM 353.940			
05.88-02.01	TW	1 457 42	S 9980 L
		1 457 42	N 9359 K
		1 457 42	P 9401 H

6,0 75 OM 356.914 (366) <EURO 1>			
09.91-12.92		1 457 42	P 9647 O
		1 457 43	S 2192 L
		1 457 42	N 9359 K
		1 457 42	P 9401 H
		1 457 42	P 9820³ P

6,0 75 OM 366.915			
Mot.Nr. ...933908→	01.89-12.92	1 457 42	P 9647 O
	01.88-12.92	1 457 43	S 2192 L
		TW	1 457 42 S 9980 L
		1 457 42	N 9359 K
	05.88-12.92	0 450 90	N 4077¹ K
	01.88-12.92	1 457 42	P 9401 H
		1 457 42	P 9820³ P

6,0 81 OM 366.939			
Mot.Nr. →..127491	11.88-02.01	1 457 42	P 9648 O
Mot.Nr. ...127492→	11.88-02.01	1 457 42	P 9647 O
	11.88-02.01	TW	1 457 42 S 9980 L
		1 457 42	N 9359 K
		1 457 42	P 9401 H
		1 457 42	P 9820³ P

6,0 92 OM 356.950 A (366) <Euro 1>			
01.94-09.01		1 457 42	P 9647 O
		1 457 43	S 2192 L
		1 457 42	N 9359 K
		1 457 42	P 9820³ P

6,0 92 OM 356.950 (366) A <Euro 1>			
01.92-01.01		1 457 42	P 9647 O
		1 457 43	S 2192 L
		1 457 42	N 9359 K
		1 457 42	P 9401 H
		1 457 42	P 9820³ P

6,0 92 OM 356.954 A (366) <Euro1>			
01.88-04.00		1 457 42	P 9647 O
		1 457 43	S 2192 L
		1 457 42	N 9359 K
		1 457 42	P 9820³ P

6,0 92 OM 356.954 (366) A <Euro 1>			
09.91-09.01		1 457 42	P 9647 O
		1 457 43	S 2192 L
		1 457 42	N 9359 K
09.91-01.01		1 457 42	P 9401 H
09.91-09.01		1 457 42	P 9820³ P

6,0 92 OM 366.949 A			
Mot.Nr. ...933908→	01.89-02.01	1 457 42	P 9647 O
	01.88-02.01	1 457 43	S 2192 L
		1 457 42	N 9359 K
	05.88-02.01	0 450 90	N 4077¹ K
	01.88-02.01	1 457 42	P 9401 H
		1 457 42	P 9820³ P

6,0 92 OM 366.949 A (366)			
01.88-02.01		1 457 43	S 2192 L
		1 457 42	P 9820³ P

6,0 92-115 OM 366.947,948,949 A; OM 366.948 A			
01.88-04.00		1 457 42	P 9646 O
		1 457 43	S 2192 L
		1 457 42	N 9359 K
05.88-04.00		0 450 90	N 4077¹ K
01.88-04.00		1 457 42	P 9401 H
		1 457 42	P 9820³ P

6,0 100 OM 356.955 (366) A <Euro 1>			
01.88-09.01		1 457 42	P 9647 O
		1 457 43	S 2192 L
		1 457 42	N 9359 K
		1 457 42	P 9820³ P

6,0 100 OM 356.955 (366) A <EURO 1>			
01.92→		1 457 42	P 9647 O
		1 457 43	S 2192 L
		1 457 42	N 9359 K
		1 457 42	P 9401 H

6,0 100 OM 356.955 (366) A <Euro1>			
01.88-09.01		1 457 42	P 9647 O
		1 457 43	S 2192 L
		1 457 42	N 9359 K
09.91-04.00		0 450 90	N 4077¹ K
		1 457 42	P 9401 H
01.88-09.01		1 457 42	P 9820³ P

6,0 100 OM 356.955 <(366)A Euro1>			
09.91-08.02		1 457 42	P 9647 O
		1 457 43	S 2192 L
Fg.Nr. →187553	09.91-08.02	FW	1 457 42 S 9966 L
	09.91-08.02	0 450 90	N 4077¹ K
		1 457 42	N 9359 K
		1 457 42	P 9401 H
		1 457 42	P 9820³ P





◀ Unimog U

6,0 100 OM 357.912 LA			
	05.88-04.00	1 457 42 P 9646	O
		1 457 43 S 2192	L
Fg.Nr. →187553	05.88-04.00 FW	1 457 42 S 9966	L
	05.88-04.00	1 457 42 N 9359	K
6,0 100 OM 357.912 LA (366) <Euro 2>			
	01.88-02.01	1 457 43 S 2192	L
		1 457 42 P 9820 ³	P
6,0 100 OM 357.912 LA (366) <Euro 2>			
	11.92-09.02	1 457 42 P 9646	O
	01.88-04.00	1 457 43 S 2192	L
	11.92-09.02	1 457 42 S 9966	L
		1 457 42 N 9359	K
	01.88-09.02	1 457 42 P 9820 ³	P
6,0 100 OM 357.912 (366) LA <Euro 2>; OM 357.912 (366) LA <Euro 2>			
	09.91-09.01	1 457 42 P 9646	O
		1 457 43 S 2192	L
		1 457 42 N 9359	K
		1 457 42 P 9820 ³	P
6,0 100 OM 366.9...A			
Mot.Nr. ...933908→	01.89-04.00	1 457 42 P 9647	O
	01.88-04.00	1 457 43 S 2192	L
		1 457 42 N 9359	K
	05.88-04.00	0 450 90 N 4077 ¹	K
	01.88-04.00	1 457 42 P 9401	H
		1 457 42 P 9820 ³	P
6,0 100 OM 366.947 A			
Mot.Nr. ...933908→	01.89-04.00	1 457 42 P 9647	O
	01.88-02.01	1 457 43 S 2192	L
	01.88-04.00	1 457 42 N 9359	K
	05.88-04.00	0 450 90 N 4077 ¹	K
	01.88-04.00	1 457 42 P 9401	H
	01.88-02.01	1 457 42 P 9820 ³	P
6,0 100 OM 366.947 A (366)			
Mot.Nr. →...933907	01.94-09.01	1 457 42 P 9646	O
Mot.Nr. ...933908→	01.94-09.01	1 457 42 P 9647	O
	01.94-09.01	1 457 43 S 2192	L
		1 457 42 N 9359	K
		1 457 42 P 9820 ³	P
6,0 100 OM 366.955 A			
Mot.Nr. →...916577	05.88-02.01 TW	1 457 42 P 9646	O
Mot.Nr. 933908/	05.88-02.01	1 457 42 P 9647	O
BJ.1989→999999/			
BJ.1990100001/BJ.1990→			
Mot.Nr. ...933908→	01.89-02.01	1 457 42 P 9647	O
	11.86-02.01	1 457 43 S 2192	L
Fg.Nr. →187553	05.88-02.01 FW	1 457 42 S 9966	L
	11.86-02.01	1 457 42 N 9359	K
	05.88-02.01	0 450 90 N 4077 ¹	K
	11.86-02.01	1 457 42 P 9401	H
	01.88-02.01	1 457 42 P 9820 ³	P
6,0 100 OM 366.955 A (366)			
Mot.Nr. →...933907	01.94-09.01	1 457 42 P 9646	O
Mot.Nr. ...933908→	01.94-09.01	1 457 42 P 9647	O
	01.94-09.01	1 457 43 S 2192	L
		1 457 42 N 9359	K
		1 457 42 P 9820 ³	P



6,0 110-115 OM 366.956 A; OM 366.963 A			
	11.86-02.01	1 457 42 P 9646	O
		1 457 43 S 2192	L
		1 457 42 N 9359	K
		1 457 42 P 9401	H
6,0 114/115 OM 356.956 <Euro 1>; OM 356.956 (366) A <Euro 1>; OM 356.956 (366) A <Euro 1>			
	09.91-04.00	1 457 42 P 9646	O
		1 457 43 S 2192	L
		1 457 42 N 9359	K
		1 457 42 P 9401	H
		1 457 42 P 9820 ³	P
6,0 115 OM 356.956 (366) A <Euro 1>			
	01.88-04.00	1 457 42 P 9646	O
		1 457 43 S 2192	L
		1 457 42 N 9359	K
		1 457 42 P 9820 ³	P
6,0 115/125 OM 366.956 A; OM 366.963 A			
	05.88-02.01	1 457 42 P 9646	O
	01.88-02.01	1 457 43 S 2192	L
Fg.Nr. →187553	05.88-02.01 FW	1 457 42 S 9966	L
	05.88-02.01	0 450 90 N 4077 ¹	K
		1 457 42 N 9359	K
		1 457 42 P 9401	H
	01.88-02.01	1 457 42 P 9820 ³	P
6,0 120 OM 357.913 LA			
	05.88-04.00	1 457 42 P 9646	O
		1 457 43 S 2192	L
Fg.Nr. →187553	05.88-04.00 FW	1 457 42 S 9966	L
	05.88-04.00	1 457 42 N 9359	K
6,0 120 OM 357.913 LA (366) <Euro 2>; OM 357.913 LA (366) <Euro 2>			
	01.88-02.01	1 457 43 S 2192	L
		1 457 42 P 9820 ³	P
6,0 120 OM 357.913 (366) LA <EURO 2>			
	09.91-09.01	1 457 42 P 9646	O
		1 457 43 S 2192	L
		1 457 42 N 9359	K
		1 457 42 P 9820 ³	P
6,0 120 OM 357.913 (366) LA <Euro 2>; OM 357.913 (366) A <Euro 2>			
	01.88-04.00	1 457 43 S 2192	L
		1 457 42 P 9820 ³	P
6,0 122 OM 356.957 (366) A <Euro 1>; OM 356.957 (366) A <LEV>			
	01.92-08.02	1 457 42 P 9646	O
		1 457 43 S 2192	L
		1 457 42 N 9359	K
		1 457 42 P 9401	H
6,0 127 OM 356.981 (366) LA			
	05.91-08.02	1 457 42 P 9646	O
		1 457 43 S 2192	L
Fg.Nr. →187553	05.91-08.02 FW	1 457 42 S 9966	L
	05.91-08.02	1 457 42 N 9359	K
		1 457 42 P 9401	H



6,0 132 OM 356.998 LA (366) <Euro 1>; OM 356.998 LA (366) <Euro1>			
01.88-09.02	1 457 42 P 9646	O	
	1 457 42 S 9966	L	
	1 457 43 S 3611 ⁴	L	
	1 457 42 N 9359	K	
	1 457 42 P 9820 ³	P	

6,0 132 OM 356.998 (366) LA <LEV>			
04.92-08.02	1 457 42 P 9646	O	
	1 457 42 S 9966	L	
	1 457 43 S 3611 ⁴	L	
	1 457 42 N 9359	K	
	1 457 42 P 9401	H	
	1 457 42 P 9820 ³	P	

6,0 150 OM 366.984 LA			
09.88-02.01	1 457 42 P 9646	O	
	1 457 42 S 9966	L	
	1 457 43 S 3611 ⁴	L	
	1 457 42 N 9359	K	
	1 457 42 P 9401	H	
	1 457 42 P 9820 ³	P	

6,0 155 OM 357.924 LA <Euro 2>			
05.88-04.00	1 457 42 P 9646	O	
	1 457 42 S 9966	L	
	1 457 43 S 3611 ⁴	L	
	1 457 42 N 9359	K	

6,0 155 OM 357.924 LA (366) <Euro 2>			
01.88-02.01	1 457 42 S 9966	L	
	1 457 43 S 3611 ⁴	L	
	1 457 42 P 9820 ³	P	

6,0 155 OM 357.924 (366) LA <Euro 2>			
11.92-09.02	1 457 42 P 9646	O	
	1 457 42 S 9966	L	
	1 457 43 S 3611 ⁴	L	
	1 457 42 N 9359	K	
	1 457 42 P 9820 ³	P	

6,0 155 OM 357.924 (366) LA <Euro2>; OM 357.924 <(366)LA Euro2>			
09.89-08.02	1 457 42 P 9646	O	
	1 457 42 S 9966	L	
	1 457 43 S 3611 ⁴	L	
	1 457 42 N 9359	K	

6,0 157 OM 356.99...LA <Euro1>			
01.92-04.00	1 457 42 P 9646	O	
	1 457 42 S 9966	L	
	1 457 43 S 3611 ⁴	L	
	1 457 42 N 9359	K	
	1 457 42 P 9401	H	
	1 457 42 P 9820 ³	P	

6,0 157 OM 356.997 LA (366) <Euro 1>; OM 356.997 LA (366) <Euro1>			
01.88-09.02	1 457 42 P 9646	O	
	1 457 42 S 9966	L	
	1 457 43 S 3611 ⁴	L	
	1 457 42 N 9359	K	
	1 457 42 P 9820 ³	P	

6,0 157 OM 356.997 <(366)LA Euro1>			
01.92-08.02	1 457 42 P 9646	O	
	1 457 42 S 9966	L	
	1 457 43 S 3611 ⁴	L	
	1 457 42 N 9359	K	
	1 457 42 P 9401	H	
	1 457 42 P 9820 ³	P	

6,0 157 OM 366.984 LA			
05.88-02.01	1 457 42 P 9646	O	
	1 457 42 S 9966	L	
	1 457 43 S 3611 ⁴	L	
	0 450 90 N 4077 ¹	K	
	1 457 42 N 9359	K	
	1 457 42 P 9401	H	
	1 457 42 P 9820 ³	P	

6,0 177 OM 356.980 LA (366) <Euro 1>			
01.88-02.01	1 457 42 P 9646	O	
	1 457 42 S 9966	L	
	1 457 43 S 3611 ⁴	L	
	1 457 42 N 9359	K	
	1 457 42 P 9820 ³	P	

6,0 177 OM 356.980 LA (366) <Euro1>			
05.91-09.02	1 457 42 P 9646	O	
	1 457 42 S 9966	L	
	1 457 43 S 3611 ⁴	L	
	0 450 90 N 4077 ¹	K	
	1 457 42 N 9359	K	
	1 457 42 P 9820 ³	P	

6,0 177 OM 356.980 <(366)LA Euro1>			
03.90-08.02	1 457 42 P 9646	O	
	1 457 42 S 9966	L	
	1 457 43 S 3611 ⁴	L	
	0 450 90 N 4077 ¹	K	
	1 457 42 N 9359	K	
	1 457 42 P 9401	H	
	1 457 42 P 9820 ³	P	

6,0 177 OM 357.945 LA (366) <Euro2>			
11.92-09.02	1 457 42 P 9646	O	
01.88-09.02	1 457 42 S 9966	L	
	1 457 43 S 3611 ⁴	L	
11.92-09.02	1 457 42 N 9359	K	
01.88-09.02	1 457 42 P 9820 ³	P	

6,0 177 OM 357.945 <(366)LA Euro1>; OM 357.945 <(366)LA Euro2>			
05.91-08.02	1 457 42 P 9646	O	
	1 457 42 S 9966	L	
	1 457 43 S 3611 ⁴	L	
	1 457 42 N 9359	K	

6,4 170 OM 906.935 LA <Euro 3>			
03.03→	F 026 40 P 7026	O	
	1 457 42 S 9975	L	
	WAS 1 457 43 N 1707	K	





◀ Unimog U

6,4 170 OM 906.935 LA <Euro3>			
04.00→		F 026 40 P 7026	O
	TW	F 026 40 S 0067	L
		1 457 42 S 9975	L
02.01→		1 457 42 S 9975	L
04.00→	WAS	1 457 43 N 1707	K
	2FE	1 987 43 M 2020	I

6,4 205 OM 906.955 LA <Euro3>			
02.01→		F 026 40 P 7026	O
		1 457 42 S 9975	L
	WAS	1 457 43 N 1707	K
	2FE	1 987 43 M 2020	I

6,4 210 OM 902.924 LA (906) <Euro 4 (BlueTec)>			
09.06→		F 026 40 P 7026	O
	WAS	1 457 43 N 1707	K
	2FE	1 987 43 M 2020	I

UX

UX 100

2,9 80 OM 602.989 DE 29 LA <Euro 2>			
08.96→		1 457 42 P 9278	O
		1 457 43 N 4123 ²	K

Zetros

Zetros 1833/ 2733

7,2 240 OM 926.935 <(926 LA) Euro 3>; OM 926.947 <(926 LA) Euro 5>			
09.08→		F 026 40 P 7026	O
		1 457 42 S 9969	L
	WAS	1 457 43 N 1707	K
		1 987 43 M 1154	I
		1 987 43 R 1454 ⁸	I

5t

5t 508

2,3 58 OM 601.941			
03.89-02.01		1 457 42 P 9274	O
		1 457 43 S 3626	L
		0 450 90 N 4077 ¹	K
		1 457 43 N 4123 ²	K

5t 510

2,3 70-77 M 102.946			
04.86-02.01		1 457 42 P 9605	O
		1 457 42 S 9080	L

6t

6t 609

4,0 63 OM 364.919 <Euro 1>			
Mot.Nr. →..286114	02.92-09.01	1 457 42 P 9647	O
Mot.Nr. ...286115→	02.92-09.01	1 457 42 P 9276	O
	02.92-09.01	TW 1 457 43 S 3626	L
		WW 1 457 43 S 3601	L
		1 457 42 N 9359	K

4,0 66 OM 364.906			
Mot.Nr. →..286114	04.86-12.93	1 457 42 P 9647	O



Mot.Nr. ...286115→	04.86-02.01	1 457 42 P 9276	O
	04.86-02.01	TW 1 457 43 S 3626	L
		WW 1 457 43 S 3601	L
		1 457 42 N 9359	K

6t 611

4,0 77 OM 354.902 (364) LA <Euro 2>			
	06.94-09.01	1 457 42 P 9647	O
		TW 1 457 43 S 3626	L
		WW 1 457 43 S 3601	L
		1 457 42 N 9359	K

7t

7t 709

4,0 63 OM 364.918 <Euro 1>			
	02.92-12.99	1 457 42 P 9276	O
		1 457 42 S 9854	L
Fg.Nr. →5 462572	02.92-12.99	RLE 1 457 42 S 9966	L
Fg.Nr. 5 462573→	02.92-12.99	RLE 1 457 42 S 9980	L
	02.92-12.99	1 457 42 N 9359	K
		1 457 42 P 9820 ³	P

4,0 | 63 | OM 364.919,921 <Euro 1>

Mot.Nr. →..286114	02.92-02.01	1 457 42 P 9647	O
Mot.Nr. ...286115→	02.92-02.01	1 457 42 P 9276	O
	02.92-02.01	1 457 43 S 3626	L
		WW 1 457 43 S 3601	L
		1 457 42 N 9359	K

4,0 | 66 | OM 364.906,912

Mot.Nr. →..286114	04.86-02.01	1 457 42 P 9647	O
Mot.Nr. ...286115→	04.86-02.01	1 457 42 P 9276	O
	04.86-02.01	1 457 43 S 3626	L
		WW 1 457 43 S 3601	L
		1 457 42 N 9359	K

4,0 | 66 | OM 364.907

Mot.Nr. →..286114	03.84-02.93	1 457 42 P 9647	O
Mot.Nr. ...286115→	03.84-02.93	1 457 42 P 9276	O
	03.84-02.93	1 457 42 S 9854	L
Fg.Nr. →5 462572	03.84-02.93	RLE 1 457 42 S 9966	L
Fg.Nr. 5 462573→	03.84-02.93	RLE 1 457 42 S 9980	L
	03.84-02.93	1 457 42 N 9359	K
		1 457 42 P 9820 ³	P

7t 711

4,0 77 OM 354.90... A <Euro 2>			
	06.94-02.01	1 457 43 S 3626	L
		WW 1 457 43 S 3601	L
		1 457 42 N 9359	K

4,0 | 77 | OM 354.900 (364) LA <Euro 2>

	03.94-12.99	1 457 42 P 9647	O
		1 457 42 S 9854	L
		RLE 1 457 42 S 9980	L
		1 457 42 N 9359	K
		1 457 42 P 9820 ³	P

4,0 | 77/85 | OM 364.950,952 A; OM 364.957 A <Euro 1>

	04.86-02.01	1 457 42 P 9647	O
		1 457 43 S 3626	L
		WW 1 457 43 S 3601	L
		1 457 42 N 9359	K



4,3 | 90 | OM 904.905 LA <Euro 2>

03.96-12.99	F 026 40 P 7040	O
	1 457 42 S 9966	L
WAS	1 457 43 N 1707	K
	1 457 42 P 9820 ³	P

7t 714

4,0 | 103 | OM 354.923,924 LA <Euro 2>

06.94-02.01	1 457 43 S 3626	L
WW	1 457 43 S 3601	L
	1 457 42 N 9359	K

8t

8t 809

4,0 | 63 | OM 364.918 <Euro 1>

Mot.Nr. →..286114	02.92-12.93	1 457 42 P 9647	O
Mot.Nr. ...286115→	01.93-12.99	1 457 42 P 9276	O
	02.92-12.99	1 457 42 S 9854	L
Fg.Nr. →5 462572	02.92-12.99	RLE 1 457 42 S 9966	L
Fg.Nr. 5 462573→	02.92-12.99	RLE 1 457 42 S 9980	L
	02.92-12.99	1 457 42 N 9359	K
		1 457 42 P 9820 ³	P

4,0 | 63 | OM 364.920 <Euro 1>; OM 364.921 <Euro 1>

Mot.Nr. →..286114	02.92-02.01	1 457 42 P 9647	O
Mot.Nr. ...286115→	02.92-02.01	1 457 42 P 9276	O
	02.92-02.01	TW 1 457 43 S 3601	L
		1 457 43 S 3626	L
		1 457 42 N 9359	K

4,0 | 66 | OM 364.906

Mot.Nr. →..286114	04.86-02.01	1 457 42 P 9647	O
Mot.Nr. ...286115→	04.86-02.01	1 457 42 P 9276	O
	04.86-02.01	TW 1 457 43 S 3601	L
		1 457 43 S 3626	L
		1 457 42 N 9359	K

4,0 | 66 | OM 364.907

Mot.Nr. →..286114	03.84-02.93	1 457 42 P 9647	O
Mot.Nr. ...286115→	03.84-02.93	1 457 42 P 9276	O
	03.84-02.93	1 457 42 S 9854	L
Fg.Nr. →5 462572	03.84-02.93	RLE 1 457 42 S 9966	L
Fg.Nr. 5 462573→	03.84-02.93	RLE 1 457 42 S 9980	L
	03.84-02.93	1 457 42 N 9359	K
		1 457 42 P 9820 ³	P

4,0 | 66 | OM 364.911; OM 364.912

Mot.Nr. →..286114	04.86-02.01	1 457 42 P 9647	O
Mot.Nr. ...286115→	04.86-02.01	1 457 42 P 9276	O
	04.86-02.01	TW 1 457 43 S 3601	L
		1 457 43 S 3626	L
		1 457 42 N 9359	K

8t 810

4,0 | 77 | OM 354.903 (364) LA <Euro 2>

06.94-02.01	1 457 42 P 9647	O
TW	1 457 43 S 3601	L
	1 457 43 S 3626	L
	1 457 42 N 9359	K



8t 811

4,0 | 77 | OM 354.900 (364) LA <Euro 2>

03.94-12.99	1 457 42 P 9647	O
	1 457 42 S 9854	L
RLE	1 457 42 S 9980	L
	1 457 42 N 9359	K
	1 457 42 P 9820 ³	P

4,0 | 77 | OM 354.901 (364) LA <Euro 2>

06.94-02.01	1 457 42 P 9647	O
TW	1 457 43 S 3601	L
	1 457 43 S 3626	L
	1 457 42 N 9359	K

4,0 | 77 | OM 364.958 A <Euro 1>

02.92-02.01	1 457 42 P 9647	O
TW	1 457 43 S 3601	L
	1 457 43 S 3626	L
	1 457 42 N 9359	K

4,0 | 85 | OM 364.950,952 A; OM 364.954 A

04.86-02.01	TW 1 457 43 S 3601	L
	1 457 43 S 3626	L
	1 457 42 N 9359	K

4,3 | 90 | OM 904.905 LA <Euro 2>

03.96-12.99	F 026 40 P 7040	O
	1 457 42 S 9966	L
WAS	1 457 43 N 1707	K
	1 457 42 P 9820 ³	P

8t 814

4,0 | 100/103 | OM 354.924 (364) LA <Euro 2>; OM 354.925 (364) LA <Euro 2>; OM 364.981 LA; OM 364.984 LA; OM 364.986 LA <Euro 1>; OM 364.987 LA <Euro 1>

11.87-02.01	1 457 42 P 9647	O
TW	1 457 43 S 3601	L
	1 457 43 S 3626	L
	1 457 42 N 9359	K

4,0 | 103 | OM 354.920 (364) LA <Euro 2>; OM 354.921 (364) LA <Euro 2>; OM 354.922 (364) LA <Euro 2>

03.94-12.99	1 457 42 P 9647	O
	1 457 42 S 9854	L
RLE	1 457 42 S 9980	L
	1 457 42 N 9359	K
	1 457 42 P 9820 ³	P

4,3 | 100 | OM 904.906 LA <Euro 2>

03.96-12.99	F 026 40 P 7040	O
	1 457 42 S 9966	L
WAS	1 457 43 N 1707	K
	1 457 42 P 9820 ³	P

6,0 | 95 | OM 356.901 (366) <Euro 1>; OM 356.902 (366) <Euro 1>; OM 356.905 <Euro 1>

Mot.Nr. →..286114	02.92-12.93	1 457 42 P 9647	O
Mot.Nr. ...286115→	02.92-12.99	1 457 42 P 9276	O
	02.92-12.99	1 457 42 S 9854	L
Fg.Nr. →5 462572	02.92-12.99	RLE 1 457 42 S 9966	L
Fg.Nr. 5 462573→	02.92-12.99	RLE 1 457 42 S 9980	L
	02.92-12.99	1 457 42 N 9359	K
		1 457 42 P 9820 ³	P





8t 814

6,0 95 OM 356.906 (366) <Euro 1>				
Mot.Nr. →..286114	02.92-12.93	1 457 42	P 9647	O
Mot.Nr. ..286115→	01.93-12.99	1 457 42	P 9276	O
	02.92-12.99	1 457 42	S 9854	L
Fg.Nr. →5 462572	02.92-12.99	RLE	1 457 42	S 9966 L
Fg.Nr. 5 462573→	02.92-12.99	RLE	1 457 42	S 9980 L
	02.92-12.99		1 457 42	N 9359 K
			1 457 42	P 9820 ³ P

6,0 95 OM 356.911 <Euro 1>				
Mot.Nr. →..286114	02.92-12.93	1 457 42	P 9647	O
Mot.Nr. ..286115→	01.93-12.99	1 457 42	P 9276	O
	02.92-12.99	1 457 42	S 9950	L
			1 457 42	N 9359 K
			1 457 42	P 9820 ³ P

6,0 100 OM 366.905				
Mot.Nr. →..916577	05.86-02.93	1 457 42	P 9646	O
Mot.Nr. 364 180 01 09→	05.86-02.93	1 457 42	P 9647	O
	05.86-02.93	1 457 42	S 9854	L
	01.87-02.93	1 457 42	S 9950	L
Fg.Nr. →5 462572	05.86-02.93	RLE	1 457 42	S 9966 L
Fg.Nr. 5 462573→	05.86-02.93	RLE	1 457 42	S 9980 L
	05.86-02.93		1 457 42	N 9359 K
			1 457 42	P 9820 ³ P

6,0 100 OM 366.905,906,907				
Mot.Nr. →..916577	03.84-02.93	1 457 42	P 9646	O
Mot.Nr. 364 180 01 09→	03.84-02.93	1 457 42	P 9647	O
	03.84-02.93	1 457 42	S 9854	L
		KO	1 457 42	S 9950 L
Fg.Nr. →5 462572	03.84-02.93	RLE	1 457 42	S 9966 L
Fg.Nr. 5 462573→	03.84-02.93	RLE	1 457 42	S 9980 L
	03.84-02.93		1 457 42	N 9359 K
			1 457 42	P 9820 ³ P

6,0 100 OM 366.910				
Mot.Nr. 916578 / 100001→999999 / 286114	12.88-02.93	1 457 42	P 9647	O
	06.84-02.93	1 457 42	S 9854	L
Fg.Nr. →5 462572	06.84-02.93	RLE	1 457 42	S 9966 L
Fg.Nr. 5 462573→	06.84-02.93	RLE	1 457 42	S 9980 L
	06.84-02.93		1 457 42	N 9359 K
			1 457 42	P 9820 ³ P

6,0 100 OM 366.932				
Mot.Nr. →..916577	12.86-02.93	1 457 42	P 9646	O
Mot.Nr. ..286115→	12.86-02.93	1 457 42	P 9276	O
Mot.Nr. ..916578→..999999	12.86-02.93	1 457 42	P 9647	O
..100001→..286114	12.86-02.93	1 457 42	S 9854	L
Fg.Nr. →5 462572	12.86-02.93	RLE	1 457 42	S 9966 L
Fg.Nr. 5 462573→	12.86-02.93	RLE	1 457 42	S 9980 L
	12.86-02.93		1 457 42	N 9359 K
			1 457 42	P 9820 ³ P

8t 817

4,3 125 OM 904.907 LA <Euro 2>				
	03.96-12.99	F 026 40	P 7040	O
		KNE	1 457 42	S 9966 L
		LUM	1 457 42	S 9941 L
		WAS	1 457 43	N 1707 K
			1 457 42	P 9820 ³ P



6,0 116 OM 356.948 (366) A <Euro 1>				
Mot.Nr. →..286114	02.92-11.93	1 457 42	P 9646	O
Mot.Nr. ..286115→	01.93-12.99	1 457 42	P 9277	O
	02.92-12.99	KNE	1 457 42	S 9966 L
		LUM	1 457 42	S 9941 L
			1 457 42	N 9359 K
			1 457 42	P 9820 ³ P

6,0 116/121/125 OM 366.942 (366) A <Euro 1>; OM 366.943 (366) A <Euro 1>; OM 366.967 A; OM 366.967,973 A				
Mot.Nr. ..286115→	03.84-12.99	1 457 42	P 9277	O
Mot.Nr. ..923827→..999999	03.84-12.99	1 457 42	P 9646	O
..100001→..286114	03.84-12.99	KNE	1 457 42	S 9966 L
		LUM	1 457 42	S 9941 L
			1 457 42	N 9359 K
			1 457 42	P 9820 ³ P

6,0 116/125 OM 356.951 (366) A <Euro 1>; OM 357.9... LA <Euro 2>; OM 357.900 (366) LA <Euro 2>; OM 357.908 (366) LA <Euro 2>; OM 357.917 (366) LA <Euro 2>				
	12.92-12.99	1 457 42	P 9277	O
		KNE	1 457 42	S 9966 L
		LUM	1 457 42	S 9941 L
			1 457 42	N 9359 K
			1 457 42	P 9820 ³ P

6,0 125 OM 366.968 A; OM 366.969 A				
Mot.Nr. BM:366.967 / 286115→	01.93-02.93	1 457 42	P 9277	O
Mot.Nr. 923827 /	12.88-02.93	1 457 42	P 9646	O
100001→999999 / 286114	01.86-02.93	KNE	1 457 42	S 9966 L
		LUM	1 457 42	S 9941 L
			1 457 42	N 9359 K
			1 457 42	P 9820 ³ P

9t

9t L 911 / LA 911

5,7 81 OM 352.906,990				
	01.79-02.01	1 457 42	P 9646	O
	10.68-02.01	1 457 42	S 9980	L
			1 457 42	N 9359 K
		SA	1 457 42	N 9354 K
			1 457 42	P 9820 ³ P

5,7 96 OM 352.969				
	01.79-02.01	1 457 42	P 9646	O
	10.69-02.01	1 457 42	S 9980	L
			1 457 42	N 9359 K
			1 457 42	P 9820 ³ P

5,7 124 OM 353.911 A				
	01.79-02.01	1 457 42	P 9646	O
	01.72-02.01	1 457 42	S 9980	L
			1 457 42	N 9359 K
			1 457 42	P 9820 ³ P

9t 914

6,0 95 OM 356.901 (366) <Euro 1>				
Mot.Nr. →..286114	02.92-12.93	1 457 42	P 9647	O
Mot.Nr. ..286115→	02.92-12.99	1 457 42	P 9276	O
	02.92-12.99		1 457 42	S 9854 L
Fg.Nr. →5 462572	02.92-12.99	RLE	1 457 42	S 9966 L



Fg.Nr. 5 462573→	02.92-12.99	RLE	1 457 42 S 9980	L
	02.92-12.99		1 457 42 N 9359	K
			1 457 42 P 9820 ³	P

6,0|95|OM 356.901,911 (366) <Euro 1>

Mot.Nr. →.286114	01.94-12.99		1 457 42 P 9647	O
Mot.Nr. ...286115→	01.94-12.99		1 457 42 P 9276	O
	01.94-12.99		1 457 42 S 9950	L
			1 457 42 P 9820 ³	P

6,0|95|OM 356.903 (366) <Euro 1>

	02.92-12.99		1 457 42 P 9647	O
			1 457 42 S 9941	L

Fg.Nr. →5 462572	02.92-12.99	RLE	1 457 42 S 9966	L
Fg.Nr. 5 462573→	02.92-12.99	RLE	1 457 42 S 9980	L
	02.92-12.99		1 457 42 N 9359	K
			1 457 42 P 9820 ³	P

6,0|100|OM 366.905,907

Mot.Nr. →.286114	03.84-02.93		1 457 42 P 9647	O
Mot.Nr. ...286115→	03.84-02.93		1 457 42 P 9276	O
	03.84-02.93		1 457 42 S 9854	L
Fg.Nr. →5 462572	03.84-02.93	RLE	1 457 42 S 9966	L
Fg.Nr. 5 462573→	03.84-02.93	RLE	1 457 42 S 9980	L
	03.84-02.93		1 457 42 N 9359	K
			1 457 42 P 9820 ³	P

6,0|100|OM 366.905,940

Mot.Nr. →286114	01.87-02.93		1 457 42 P 9647	O
Mot.Nr. ...286115→	01.87-02.93		1 457 42 P 9276	O
	01.87-02.93		1 457 42 S 9950	L
			1 457 42 N 9359	K
			1 457 42 P 9820 ³	P

6,0|100|OM 366.918

Mot.Nr. →.933907	02.87-02.93		1 457 42 P 9646	O
Mot.Nr. ...933908→	02.87-02.93		1 457 42 P 9647	O
	02.87-02.93		1 457 42 S 9941	L
Fg.Nr. →5 462572	02.87-02.93	RLE	1 457 42 S 9966	L
Fg.Nr. 5 462573→	02.87-02.93	RLE	1 457 42 S 9980	L
	02.87-02.93		1 457 42 N 9359	K
			1 457 42 P 9820 ³	P

6,0|100|OM 366.930

Mot.Nr. →.916577	07.86-02.93		1 457 42 P 9646	O
Mot.Nr. ...916578→..999999	07.86-02.93		1 457 42 P 9647	O
..100001→..286114	07.86-02.93		1 457 42 S 9854	L
		RLE	1 457 42 S 9966	L
Fg.Nr. 5 463888→	07.86-02.93	RLE	1 457 42 S 9980	L
	07.86-02.93		1 457 42 N 9359	K

6,0|100|OM 366.932

Mot.Nr. →.916577	12.86-02.93		1 457 42 P 9646	O
Mot.Nr. ...286115→	12.86-02.93		1 457 42 P 9276	O
Mot.Nr. ...916578→..999999	12.86-02.93		1 457 42 P 9647	O
..100001→..286114	12.86-02.93		1 457 42 S 9854	L
		RLE	1 457 42 S 9966	L
			1 457 42 N 9359	K
			1 457 42 P 9820 ³	P



6,0 125 OM 366.944,945 A				
Mot.Nr. ...923827→	02.87-02.93	TW	1 457 42 P 9646	O
	02.87-02.93		1 457 42 S 9941	L

Fg.Nr. →5 462572	02.87-02.93	RLE	1 457 42 S 9966	L
Fg.Nr. 5 462573→	02.87-02.93	RLE	1 457 42 S 9980	L
	02.87-02.93		1 457 42 N 9359	K
			1 457 42 P 9820 ³	P

9t 917

4,3|125|OM 904.907 LA <Euro 2>

	03.96-12.99		F 026 40 P 7040	O
			1 457 42 S 9950	L
			1 457 42 S 9966	L
		TW	1 457 42 S 9941	L
		WAS	1 457 43 N 1707	K
			1 457 42 P 9820 ³	P

6,0|116|OM 356.9...A <Euro 1>

	12.92-12.99		1 457 42 P 9646	O
			1 457 42 S 9941	L
		RLE	1 457 42 S 9966	L
			1 457 42 N 9359	K
			1 457 42 P 9820 ³	P

6,0|125|OM 357.9... LA <Euro 2>

	03.94-12.99		1 457 42 P 9277	O
			1 457 42 S 9950	L
			1 457 42 N 9359	K
			1 457 42 P 9820 ³	P

6,0|125|OM 357.900 (366) LA <Euro 2>

	03.94-12.99		1 457 42 P 9277	O
			1 457 42 S 9966	L
			1 457 42 N 9359	K
			1 457 42 P 9820 ³	P

6,0|125|OM 357.906 (366) LA <Euro 2>; OM 357.909,910 LA <Euro 2>

	03.94-12.99		1 457 42 P 9646	O
			1 457 42 S 9941	L
			1 457 42 N 9359	K
			1 457 42 P 9820 ³	P

6,0|125|OM 366.966 A

Mot.Nr. ...923827→	02.87-02.93	TW	1 457 42 P 9646	O
	02.87-02.93		1 457 42 S 9941	L
			1 457 42 N 9359	K

6,0|125|OM 366.974,978 A

Mot.Nr. ...923827→	02.87-02.93	TW	1 457 42 P 9646	O
	02.87-02.93		1 457 42 S 9941	L
		RLE	1 457 42 S 9966	L
			1 457 42 N 9359	K
			1 457 42 P 9820 ³	P

10t

10t 1017

5,7|124|OM 353.9... <352>; OM 353.950,952,953 A

	11.75-02.91		1 457 43 S 2192	L
			1 457 42 N 9359	K
			1 457 42 P 9165 ³	P





11t

11t L 1113/ LA 1113

5,7 124 OM 353.913 A (352)			
01.72-02.01	1457 42	P 9629	O
	1457 43	S 2192	L
	1457 42	N 9359	K
	1457 42	P 9165³	P

11t L 1113/ LA 1113/ LKO 1113

5,7 96 OM 352.908			
01.79-02.01	1457 42	P 9646	O
10.69-02.01	1457 42	S 9950	L
	TW	1457 42	S 9980 L
01.71-02.01	1457 42	N 9359	K
10.69-02.01	1457 42	P 9165³	P

11t O 1114

6,0 95 OM 356.907 (366) <Euro 1>			
02.92-12.99	1457 42	P 9276	O
	1457 42	S 9854	L
Fg.Nr. →5 462572	02.92-12.99	RLE	1457 42 S 9966 L
Fg.Nr. 5 462573→	02.92-12.99		1457 42 S 9980 L
	02.92-12.99		1457 42 N 9359 K
			1457 42 P 9820³ P

11t OF 1113

5,7 96 OM 352.997,998			
07.88-12.92	1457 42	P 9647	O
Mot.Nr. →..493600	01.75-12.92		1457 42 P 9265 O
	01.75-12.92		1457 42 N 9359 K

11t 1114

6,0 95 OM 356.903 (366) <Euro 1>			
02.92-12.99	1457 42	P 9647	O
	1457 42	S 9941	L
Fg.Nr. →5 462572	02.92-12.99	RLE	1457 42 S 9966 L
Fg.Nr. 5 462573→	02.92-12.99	RLE	1457 42 S 9980 L
	02.92-12.99		1457 42 N 9359 K

6,0 95 OM 356.904 (366) <Euro 1>			
Mot.Nr. →..286114	02.92-12.99		1457 42 P 9647 O
Mot.Nr. ..286115→	02.92-12.99		1457 42 P 9276 O
	02.92-12.99		1457 42 S 9854 L
Fg.Nr. →5 462572	02.92-12.99	RLE	1457 42 S 9966 L
Fg.Nr. 5 462573→	02.92-12.99	RLE	1457 42 S 9980 L
	02.92-12.99		1457 42 N 9359 K
			1457 42 P 9820³ P

6,0 95 OM 356.907 (366) <Euro 1>			
Mot.Nr. →..286114	02.92-12.93		1457 42 P 9647 O
Mot.Nr. ..286115→	02.92-12.99		1457 42 P 9276 O
	02.92-12.99		1457 42 S 9854 L
Fg.Nr. →5 462572	02.92-12.99	RLE	1457 42 S 9966 L
Fg.Nr. 5 462573→	02.92-12.99	RLE	1457 42 S 9980 L
	02.92-12.99		1457 42 N 9359 K

6,0 100 OM 366.907,914			
Mot.Nr. →..916577	03.84-02.93		1457 42 P 9646 O
Mot.Nr. ..286115→	03.84-02.93	TW	1457 42 P 9276 O
Mot.Nr. ..916578→..286114	03.84-02.93	TW	1457 42 P 9647 O
	03.84-02.93		1457 42 S 9854 L
Fg.Nr. →5 462572	03.84-02.93	RLE	1457 42 S 9966 L



Fg.Nr. 5 462573→	03.84-02.93	RLE	1457 42 S 9980 L
	03.84-02.93		1457 42 N 9359 K
			1457 42 P 9820³ P

6,0 | 100 | OM 366.914

Mot.Nr. →..916577	10.84-02.93		1457 42 P 9646 O
Mot.Nr. ..286115→	10.84-02.93		1457 42 P 9276 O
Mot.Nr. ..916578→..999999	10.84-02.93		1457 42 P 9647 O
..100001→..286114			

	12.85-02.93		1457 42 S 9854 L
Fg.Nr. →5 462572	10.84-02.93	RLE	1457 42 S 9966 L
Fg.Nr. 5 462573→	10.84-02.93	RLE	1457 42 S 9980 L
	10.84-02.93		1457 42 N 9359 K
			1457 42 P 9820³ P

6,0 | 100 | OM 366.918

Mot.Nr. →..933907	02.87-02.93		1457 42 P 9646 O
Mot.Nr. ..933908→	02.87-02.93		1457 42 P 9647 O
	02.87-02.93		1457 42 S 9941 L

Fg.Nr. →5 462572	02.87-02.93	RLE	1457 42 S 9966 L
Fg.Nr. 5 462573→	02.87-02.93	RLE	1457 42 S 9980 L
	02.87-02.93		1457 42 N 9359 K
			1457 42 P 9820³ P

6,0 | 100 | OM 366.930

Mot.Nr. →..916577	07.86-02.93		1457 42 P 9646 O
Mot.Nr. ..286115→	07.86-02.93	TW	1457 42 P 9276 O
Mot.Nr. ..916578→..286114	07.86-02.93	TW	1457 42 P 9647 O
	07.86-02.93		1457 42 S 9854 L
		RLE	1457 42 S 9966 L

Fg.Nr. 5 463888→	07.86-02.93	RLE	1457 42 S 9980 L
	07.86-02.93		1457 42 N 9359 K

6,0 | 100 | OM 366.931

Mot.Nr. →..933907	07.86-02.93		1457 42 P 9646 O
Mot.Nr. ..933908→	07.86-02.93		1457 42 P 9647 O
	07.86-02.93	TW	1457 42 S 9854 L

			1457 42 S 9941 L
			1457 42 S 9966 L
			1457 42 S 9980 L
			1457 42 N 9359 K
			1457 42 P 9820³ P

6,0 | 100 | OM 366.933

Mot.Nr. →..916577	12.85-02.93		1457 42 P 9646 O
Mot.Nr. ..286115→	12.85-02.93		1457 42 P 9276 O
Mot.Nr. ..916578→..999999	12.85-02.93		1457 42 P 9647 O
..100001→..286114			

	12.85-02.93		1457 42 S 9854 L
Fg.Nr. →5 462572	12.85-02.93	RLE	1457 42 S 9966 L
Fg.Nr. 5 462573→	12.85-02.93	RLE	1457 42 S 9980 L
	12.85-02.93		1457 42 N 9359 K
			1457 42 P 9820³ P

6,0 | 100 | OM 366.935

Mot.Nr. →..933907	07.86-02.93		1457 42 P 9646 O
Mot.Nr. ..933908→	07.86-02.93		1457 42 P 9647 O
	07.86-02.93		1457 42 S 9854 L
		RLE	1457 42 S 9966 L
			1457 42 N 9359 K



11t 1117

4,3 125 OM 904.907 LA <Euro 2>			
03.96-12.99	F 026 40 P 7040	O	
	1457 42 S 9966	L	
	WAS 1457 43 N 1707	K	
	1457 42 P 9820 ³	P	

6,0 116 OM 356.947 (366) A <Euro 1>			
02.92-12.99	1457 42 P 9646	O	
	1457 42 S 9941	L	
	RLE 1457 42 S 9966	L	
	1457 42 N 9359	K	
	1457 42 P 9820 ³	P	

6,0 116 OM 356.949 (366) A <Euro 1>			
Mot.Nr. ...286115→	03.93-12.99	TW	1457 42 P 9277 O
	03.93-12.99		1457 42 S 9941 L
			1457 42 S 9966 L
			1457 42 N 9359 K
			1457 42 P 9820 ³ P

6,0 116 OM 366.941 A <Euro 1>			
Mot.Nr. ...286115→	02.92-12.99	TW	1457 42 P 9277 O
Mot.Nr. ...923827→..286114	02.92-12.99	TW	1457 42 P 9646 O
	02.92-12.99		1457 42 S 9966 L
			1457 42 N 9359 K
			1457 42 P 9820 ³ P

6,0 125 OM 357.901 (366) LA <Euro 2>			
03.94-12.99	1457 42 P 9277	O	
	1457 42 S 9966	L	
	1457 42 N 9359	K	
	1457 42 P 9820 ³	P	

6,0 125 OM 357.902 (366) LA <Euro 2>			
03.94-12.99	1457 42 P 9277	O	
	1457 42 S 9941	L	
	1457 42 S 9966	L	
	1457 42 N 9359	K	
	1457 42 P 9820 ³	P	

6,0 125 OM 357.906 (366) LA <Euro 2>			
03.94-12.99	1457 42 S 9941	L	
	1457 42 S 9966	L	
	1457 42 N 9359	K	
	1457 42 P 9820 ³	P	

6,0 125 OM 357.918 (366) LA <Euro 2>; OM 357.919 (366) LA <Euro 2>			
03.94-12.99	1457 42 P 9277	O	
	1457 42 S 9941	L	
	1457 42 S 9966	L	
	1457 42 N 9359	K	

6,0 125 OM 366.953,962 A			
04.84-12.92	1457 42 P 9735	O	
	1457 42 S 9941	L	
	1457 42 S 9966	L	
	1457 42 N 9359	K	
	1457 42 P 9820 ³	P	

6,0 125 OM 366.962 A			
Mot.Nr. ...286115→	10.84-12.92	TW	1457 42 P 9277 O
Mot.Nr. ...923827→..286114	10.84-12.92	TW	1457 42 P 9646 O



10.84-12.92	1457 42 S 9941	L	
	1457 42 S 9966	L	
	1457 42 N 9359	K	
	1457 42 P 9820 ³	P	

6,0 125 OM 366.966 A			
Mot.Nr. ...923827→	06.87-12.92	TW	1457 42 P 9646 O
	06.87-12.92		1457 42 S 9941 L
		RLE	1457 42 S 9966 L
			1457 42 N 9359 K
			1457 42 P 9820 ³ P

6,0 125 OM 366.970 A			
07.86-02.93	1457 42 S 9966	L	
	1457 42 N 9359	K	

6,0 125 OM 366.971 A			
Mot.Nr. →..923826	03.84-12.99	TW	1457 42 P 9735 O
Mot.Nr. ...286115→	03.84-12.99		1457 42 P 9277 O
Mot.Nr. ...923827→..286114	03.84-12.99	TW	1457 42 P 9646 O
	03.84-12.99		1457 42 S 9966 L
			1457 42 N 9359 K
	03.93-12.99		1457 42 P 9820 ³ P

6,0 125 OM 366.975,976 A			
Mot.Nr. →..923826	09.88-02.93	TW	1457 42 P 9735 O
Mot.Nr. ...923827→	09.88-02.93	TW	1457 42 P 9646 O
	09.88-02.93		1457 42 S 9966 L
			1457 42 N 9359 K
			1457 42 P 9820 ³ P

11t 1120

6,0 125-150 OM 366.962 A			
Mot.Nr. →..923826	08.84-02.93		1457 42 P 9735 O
Mot.Nr. ...286115→	08.84-02.93		1457 42 P 9277 O
Mot.Nr. ...923827→..999999	08.84-02.93		1457 42 P 9646 O
..100001→..286114			
	08.84-02.93		1457 42 S 9941 L
		RLE	1457 42 S 9966 L
			1457 42 N 9359 K

6,0 148-150 OM 366.988 LA			
Mot.Nr. ...286115→	06.84-02.93		1457 42 P 9277 O
Mot.Nr. ...923827→..999999	06.84-02.93		1457 42 P 9646 O
..100001→..286114			
	06.84-02.93		1457 42 S 9966 L
			1457 42 N 9359 K
			1457 42 P 9820 ³ P

6,0 150 OM 366.992 LA			
Mot.Nr. ...923827→..999999	02.90-12.92		1457 42 P 9646 O
..100001→..286114			
	02.90-12.92		1457 42 S 9966 L
			1457 42 N 9359 K

6,0 150 OM 366.992,994 LA			
Mot.Nr. ...923827→..999999	02.87-12.92		1457 42 P 9646 O
..100001→..286114			
	02.87-12.92		1457 42 S 9941 L
		RLE	1457 42 S 9966 L
			1457 42 N 9359 K





◀ 11t 1120

6,0 150 OM 366.993 LA				
Mot.Nr. →..923826	02.92-12.99	1 457 42 P 9735	O	
Mot.Nr. ...286115→	02.92-12.99	1 457 42 P 9277	O	
Mot.Nr. ...923827→..999999	02.92-12.99	1 457 42 P 9646	O	
..100001→..286114				
	02.92-12.99	1 457 42 S 9966	L	
		1 457 42 N 9359	K	

6,0 155 OM 356.9... (366) LA <Euro 1>				
Mot.Nr. →..286114	02.92-12.99	1 457 42 P 9646	O	
Mot.Nr. ...286115→	02.92-12.99	1 457 42 P 9277	O	
	02.92-12.99	1 457 42 S 9966	L	
		1 457 42 N 9359	K	

6,0 155 OM 356.99... LA <Euro 1>				
	10.92-12.99	RLE 1 457 42 S 9966	L	
		1 457 42 N 9359	K	

6,0 155 OM 356.993 (366) LA <Euro 1>				
Mot.Nr. →..286114	02.92-12.99	TW 1 457 42 P 9646	O	
Mot.Nr. ...286115→	02.92-12.99	TW 1 457 42 P 9277	O	
	02.92-12.99	1 457 42 S 9966	L	
		1 457 42 N 9359	K	

6,0 155 OM 356.996 (366) LA <Euro 1>				
Mot.Nr. →..286114	10.92-12.99	1 457 42 P 9646	O	
Mot.Nr. ...286115→	10.92-12.99	1 457 42 P 9277	O	
	10.92-12.99	1 457 42 S 9941	L	
		RLE 1 457 42 S 9966	L	
		1 457 42 N 9359	K	

6,0 155 OM 357.9... LA <Euro 2>; OM 357.92... LA <Euro 2>				
	06.94-12.99	1 457 42 P 9277	O	
		1 457 43 S 3651	L	
		RLE 1 457 42 S 9966	L	
		1 457 42 N 9359	K	
		1 457 42 P 9820 ³	P	

6,0 155 OM 357.929 (366) LA <Euro 2>; OM 357.932 (366) LA <Euro 2>				
	06.94-12.99	1 457 42 P 9277	O	
		1 457 43 S 3651	L	
		RLE 1 457 42 S 9966	L	
		1 457 42 N 9359	K	

11t 1124

6,0 155 OM 357.933 (366) LA <Euro 2>				
	06.94-12.99	1 457 42 P 9277	O	
		1 457 42 S 9941	L	
		RLE 1 457 42 S 9966	L	
		1 457 42 N 9359	K	

6,0 177 OM 356.9...LA <Euro 1>				
Mot.Nr. →..286114	03.92-12.99	1 457 42 P 9646	O	
Mot.Typ 356.983				
Mot.Nr. ...286115→	03.92-12.99	1 457 42 P 9277	O	
Mot.Typ 356.983				
Mot.Typ 356.989	03.92-12.99	1 457 42 P 9646	O	
Mot.Typ 356.991				
	03.92-12.99	1 457 42 S 9941	L	
		1 457 42 S 9966	L	
		RLE 1 457 42 S 9966	L	
		1 457 42 N 9359	K	



6,0 177 OM 357.94... LA <Euro 2>				
	06.94-12.99	1 457 42 P 9646	O	
		1 457 42 S 9941	L	
		RLE 1 457 42 S 9966	L	
		1 457 42 N 9359	K	
		1 457 42 P 9820 ³	P	

6,0 177 OM 357.942 (366) LA <Euro 2>				
	06.94-12.99	1 457 42 P 9277	O	
		1 457 43 S 3651	L	
		RLE 1 457 42 S 9966	L	
		1 457 42 N 9359	K	
		1 457 42 P 9820 ³	P	

12t

12t 1217

6,0 125 OM 357.9... LA <Euro 2>				
	03.94-12.99	1 457 42 P 9277	O	
		1 457 42 N 9359	K	

12t 1222

11,0 159 OM 421.906				
	05.82-12.91	1 457 42 P 9740	O	
		1 457 43 S 2192	L	
		1 457 42 N 9359	K	

11,0 165 OM 441.905,913				
	07.89-08.94	1 457 42 P 9735	O	
	03.90-08.94	ZE 1 457 42 P 9732	O	
	07.89-08.94	1 457 42 N 9354	K	

11,0 165 OM 441.914				
	09.89-07.94	1 457 42 P 9735	O	
		1 457 42 N 9354	K	

12t 1224

6,0 177 OM 356.999 (366) LA <Euro 1>				
	02.93→	1 457 42 P 9646	O	
		1 457 42 N 9359	K	
		1 457 42 P 9820 ³	P	

12t 1226

15,0 195 OM 442.920,933				
	02.90-09.93	1 457 42 P 9735	O	
Mot.Nr. 442.933→	06.90-09.93	RLE 1 457 42 P 9735	O	
		ZE 1 457 42 P 9732	O	
	02.90-09.93	1 457 42 N 9354	K	

13t

13t L 1313/ LA 1313

5,7 96 OM 352.938,963 (352)				
	01.79-02.01	1 457 42 P 9646	O	
	01.67-02.01	1 457 42 S 9950	L	
		TW 1 457 42 S 9980	L	
		1 457 42 N 9359	K	
		SA 1 457 42 N 9354	K	
		1 457 42 P 9165 ³	P	





5,7 124 OM 353.913 A (352)				
	01.72-02.01	1 457 42 P 9629	O	
		1 457 43 S 2192	L	
		1 457 42 N 9359	K	
	SA	1 457 42 N 9354	K	
		1 457 42 P 9165 ³	P	

13t L 1319

6,0 142 OM 366 LA <376.981,88, 98>				
	12.85-12.01	1 457 42 P 9735	O	

13t LF 1313

5,7 115 OM 352.968 (352)				
	01.79-02.01	1 457 42 P 9646	O	
	01.67-02.01	1 457 42 S 9950	L	
	TW	1 457 42 S 9980	L	
		1 457 42 N 9359	K	
	SA	1 457 42 N 9354	K	
		1 457 42 P 9165 ³	P	

13t 1314

6,0 95 OM 356.908 (366) <Euro 1>				
Mot.Nr. →..286114	12.92-12.93	1 457 42 P 9647	O	
Mot.Nr. ...286115→	12.92-09.95	1 457 42 P 9276	O	
	12.92-09.95	1 457 42 S 9950	L	

6,0 95 OM 356.909 (366) <Euro 1>				
	12.92-12.99	1 457 42 P 9647	O	
		1 457 42 S 9854	L	
Fg.Nr. →5 462572	12.92-12.99	RLE 1 457 42 S 9966	L	
Fg.Nr. 5 462573→	12.92-12.99	RLE 1 457 42 S 9980	L	
	12.92-12.99	1 457 42 N 9359	K	

6,0 95 OM 356.910 (366) <Euro 1>				
Mot.Nr. →..286114	12.92-12.93	1 457 42 P 9647	O	
Mot.Nr. ...286115→	01.93-12.99	1 457 42 P 9276	O	
	12.92-12.99	1 457 42 S 9854	L	
Fg.Nr. →5 462572	12.92-12.99	RLE 1 457 42 S 9966	L	
Fg.Nr. 5 462573→	12.92-12.99	RLE 1 457 42 S 9980	L	
	12.92-12.99	1 457 42 N 9359	K	

6,0 100 OM 366.907,914,938				
	07.84-02.93	1 457 42 P 9646	O	
	12.85-02.93	1 457 42 S 9854	L	
Fg.Nr. →5 462572	07.84-02.93	RLE 1 457 42 S 9966	L	
Fg.Nr. 5 462573→	07.84-02.93	RLE 1 457 42 S 9980	L	
	07.84-02.93	1 457 42 N 9359	K	
		1 457 42 P 9820 ³	P	

6,0 100 OM 366.918,937				
Mot.Nr. →..933907	06.87-02.93	1 457 42 P 9646	O	
Mot.Nr. ...933908→	06.87-02.93	1 457 42 P 9647	O	
	06.87-02.93	1 457 42 S 9854	L	
Fg.Nr. →5 462572	06.87-02.93	RLE 1 457 42 S 9966	L	
Fg.Nr. 5 462573→	06.87-02.93	RLE 1 457 42 S 9980	L	
	06.87-02.93	1 457 42 N 9359	K	
		1 457 42 P 9820 ³	P	

6,0 100 OM 366.936				
Mot.Nr. →..916577	07.84-02.93	1 457 42 P 9646	O	
Mot.Nr. ...286115→	07.84-02.93	1 457 42 P 9276	O	



Mot.Nr. →..916578→..999999	07.84-02.93	1 457 42 P 9647	O	
..100001→..286114				
	07.84-02.93	1 457 42 S 9950	L	
		1 457 42 N 9359	K	

13t 1317

4,3 125 OM 904.907 LA <Euro 2>				
	03.96-12.99	F 026 40 P 7040	O	
		1 457 42 S 9950	L	
		1 457 42 S 9966	L	
	KO	1 457 42 S 9950	L	
	WAS	1 457 43 N 1707	K	
		1 457 42 P 9820 ³	P	

6,0 116 OM 356.944 (366) A <Euro 1>				
Mot.Nr. →..286114	12.92-12.99	1 457 42 P 9646	O	
Mot.Nr. ...286115→	12.92-12.99	1 457 42 P 9277	O	
	12.92-12.99	1 457 42 N 9359	K	

6,0 116/155 OM 356.945 (366) A <Euro 1>; OM 356.995 (366) LA <Euro 1>				
	12.92-12.99	1 457 42 P 9646	O	
		1 457 42 N 9359	K	

6,0 125 OM 357.9... LA <Euro 2>				
	03.94-12.99	1 457 42 P 9277	O	
		1 457 42 S 9966	L	
	RLE	1 457 42 S 9966	L	
	ZE	1 457 42 S 9941	L	
		1 457 42 N 9359	K	
		1 457 42 P 9820 ³	P	

6,0 125 OM 357.907 (366) LA <Euro 2>				
	03.94-12.99	1 457 42 P 9646	O	
		1 457 42 N 9359	K	
		1 457 42 P 9820 ³	P	

6,0 125 OM 366.946,953,962 A; OM 366.946,962 A				
	08.84-02.93	1 457 42 P 9735	O	
		1 457 42 S 9966	L	
		1 457 42 N 9359	K	
		1 457 42 P 9820 ³	P	

6,0 125 OM 366.962 A				
Mot.Nr. ...286115→	07.84-02.93	1 457 42 P 9277	O	
Mot.Nr. ...923827→..999999	07.84-02.93	1 457 42 P 9646	O	
..100001→..286114				
	12.85-02.93	1 457 42 S 9854	L	
Fg.Nr. →5 462572	07.84-02.93	RLE 1 457 42 S 9966	L	
Fg.Nr. 5 462573→	07.84-02.93	RLE 1 457 42 S 9980	L	
	07.84-02.93	1 457 42 N 9359	K	

6,0 125 OM 366.966 A				
Mot.Nr. →..923826	06.87-02.93	1 457 42 P 9735	O	
Mot.Nr. ...923827→	06.87-02.93	1 457 42 P 9646	O	
	06.87-02.93	1 457 42 S 9854	L	
Fg.Nr. →5 462572	06.87-02.93	RLE 1 457 42 S 9966	L	
Fg.Nr. 5 462573→	06.87-02.93	RLE 1 457 42 S 9980	L	
	06.87-02.93	1 457 42 N 9359	K	

13t 1320

6,0 125 OM 366.962 A				
Mot.Nr. →..923826	10.84-02.93	1 457 42 P 9735	O	
Mot.Nr. ...286115→	10.84-02.93	1 457 42 P 9277	O	





◀ 13t 1320

Mot.Nr. ..923827→..999999	10.84-02.93		1 457 42 P 9646	O
..100001→..286114				
	10.84-02.93	RLE	1 457 42 S 9966	L
			1 457 42 N 9359	K

6,0 | 125 | OM 366.962,966 A

Mot.Nr. →..923826	03.85-02.93		1 457 42 P 9735	O
Mot.Nr. ...286115→	03.85-02.93		1 457 42 P 9277	O
Mot.Nr. ..923827→..999999	03.85-02.93		1 457 42 P 9646	O
..100001→..286114				
	03.85-02.93	RLE	1 457 42 S 9966	L
			1 457 42 N 9359	K

6,0 | 148 | OM 366.980 LA

	10.84-02.93	RLE	1 457 42 S 9966	L
--	-------------	-----	-----------------	---

6,0 | 148-150 | OM 366...; OM 366.9...LA

Mot.Nr. ...286115→	10.84-02.93		1 457 42 P 9277	O
Mot.Nr. ..923827→..999999	10.84-02.93		1 457 42 P 9646	O
..100001→..286114				
	10.84-02.93		1 457 42 S 9966	L
			1 457 42 N 9359	K
			1 457 42 P 9820 ³	P

6,0 | 155 | OM 356.9... (366) LA <Euro 1>

Mot.Nr. →..286114	12.92-12.98		1 457 42 P 9646	O
Mot.Typ 356.992				
Mot.Nr. ...286115→	12.92-12.98		1 457 42 P 9277	O
Mot.Typ 356.992				
Mot.Typ 359.995	12.92-12.98		1 457 42 P 9646	O
	12.92-12.98	RLE	1 457 42 S 9966	L
			1 457 42 N 9359	K

6,0 | 155 | OM 356.992 (366) LA <Euro 1>

Mot.Nr. →..286114	12.92-12.93		1 457 42 P 9646	O
Mot.Nr. ...286115→	01.93-12.99		1 457 42 P 9277	O
	12.92-12.99	RLE	1 457 42 S 9966	L
			1 457 42 N 9359	K

6,0 | 155 | OM 357.9... LA <Euro 2>

	03.94-12.99		1 457 42 P 9277	O
			1 457 43 S 3651	L
		RLE	1 457 42 S 9966	L
			1 457 42 N 9359	K
			1 457 42 P 9820 ³	P

6,0 | 155 | OM 357.932 (366) LA <Euro 2>

	03.94-12.99		1 457 42 P 9277	O
			1 457 43 S 3651	L
		RLE	1 457 42 S 9966	L
			1 457 42 N 9359	K
			1 457 42 P 9820 ³	P

6,0 | 177 | OM 356.983 (366) LA <Euro 1>

Mot.Nr. →..286114	12.92-12.99		1 457 42 P 9646	O
Mot.Typ 356.983				
Mot.Nr. ...286115→	12.92-12.99		1 457 42 P 9277	O
Mot.Typ 356.983				
	12.92-12.99	RLE	1 457 42 S 9966	L
			1 457 42 N 9359	K

13t 1324

6,0 | 150/170 | OM 366.997 LA <Euro 1>; OM 366.999 LA <Euro 1>

	01.91-02.01		1 457 43 S 3651	L
		RLE	1 457 42 S 9966	L



6,0 | 177 | OM 356.983 (366) LA <Euro 1>

	01.91-02.01	WW	1 457 42 P 9277	O
Mot.Nr. →..286114	01.91-02.01		1 457 42 P 9646	O
	01.91-02.01		1 457 43 S 3651	L
		RLE	1 457 42 S 9966	L
			1 457 42 N 9359	K

6,0 | 177 | OM 357.94... LA <Euro 2>; OM 357.948 (366) LA <Euro 2>

	03.94→		1 457 42 P 9277	O
			1 457 43 S 3651	L
		RLE	1 457 42 S 9966	L
			1 457 42 N 9359	K
			1 457 42 P 9820 ³	P

14t

14t 1414

6,0 | 100 | OM 366.906,909

	04.84-03.91		1 457 42 P 9646	O
			1 457 42 S 9854	L
			1 457 42 N 9359	K
			1 457 42 P 9820 ³	P

14t 1417

6,0 | 121-129 | OM 356... <Euro 1>; OM 356.943 (366) A <Euro 1>

Mot.Nr. →..286114	07.92-12.93		1 457 42 P 9646	O
Mot.Nr. ...286115→	01.93-09.96		1 457 42 P 9277	O
	07.92-09.96		1 457 42 N 9359	K

6,0 | 125 | OM 366.951,952 A

Mot.Nr. →..923826	04.84-03.91		1 457 42 P 9735	O
Mot.Nr. ..923827→	12.88-03.91		1 457 42 P 9646	O
	04.84-03.91		1 457 42 S 9966	L
			1 457 42 N 9359	K
			1 457 42 P 9820 ³	P

6,0 | 125/129 | OM 366.952 A

	07.89-07.92		1 457 42 P 9646	O
			1 457 42 N 9359	K

14t 1420

6,0 | 150 | OM 366.983 LA

Mot.Nr. →..923826	07.85-03.91		1 457 42 P 9735	O
	07.85-03.91		1 457 42 S 9966	L
			1 457 42 N 9359	K
			1 457 42 P 9820 ³	P

6,0 | 155 | OM 356.984 (366) LA

Mot.Nr. →..286114	07.92-06.93		1 457 42 P 9646	O
Mot.Nr. ...286115→	01.93-06.93		1 457 42 P 9277	O
	02.90-06.93		1 457 42 N 9359	K

14t 1422

11,0 | 160/165 | OM 441.905

	06.89-09.93		1 457 42 P 9735	O
	06.89-08.94		1 457 42 N 9354	K

11,0 | 165 | OM 441.913

	03.90-09.93	RLE	1 457 42 P 9735	O
		ZE	1 457 42 P 9732	O
	07.89-09.93		1 457 42 N 9354	K



14t 1424

9,6 180 OM 401.975 LA <Euro 1>; OM 401.975,994 LA <Euro 1>			
02.93→		1 457 42 P 9732	O
	RLE	1 457 42 P 9740	O
		1 457 42 N 9354	K
		1 457 42 P 9820 ³	P

9,6 200 OM 401.973 LA <Euro 1>			
02.93→		1 457 42 P 9732	O
		1 457 42 P 9740	O
		1 457 42 N 9354	K

11,0 180 OM 445.9... LA <Euro 2>			
01.95→	RLE,ZE	1 457 42 P 9740	O
	ZE	1 457 42 P 9732	O
		1 457 42 N 9354	K
		1 457 42 P 9820 ³	P

14t 1425

14,6 184 OM 422.909			
12.82-03.91		1 457 42 P 9740	O
		1 457 43 S 2192	L
		1 457 42 N 9354	K
		1 457 42 P 9820 ³	P

14t 1426

15,0 191-195 OM 442.914,932			
06.89-09.93		1 457 42 P 9735	O
		1 457 42 N 9354	K

15,0 195 OM 442.914,932			
02.90-09.93		1 457 42 P 9735	O
Mot.Typ 442.932	02.90-09.93	RLE	1 457 42 P 9735 O
Mot.Typ 442.932→	06.90-09.93	ZE	1 457 42 P 9732 O
	02.90-09.93		1 457 42 N 9354 K

14t 1427

9,6 200 OM 401.985,991 LA <Euro 1>			
02.93-09.96		1 457 42 P 9732	O
	RLE	1 457 42 P 9740	O
		1 457 42 N 9354	K
		1 457 42 P 9820 ³	P

14t 1431

15,0 218 OM 442.907			
12.87-08.96		1 457 42 P 9735	O
		1 457 42 N 9354	K

15t

15t L 1513

5,7 96 OM 352.936			
01.79-02.01		1 457 42 P 9646	O
10.69-02.01		1 457 42 S 9950	L
		1 457 42 N 9359	K
		1 457 42 P 9165 ³	P



15t L 1513/ LA 1513

5,7 110 OM 352.937			
01.79-02.01		1 457 42 P 9646	O
10.69-02.01		1 457 42 S 9950	L
		1 457 42 N 9359	K
		1 457 42 P 9165 ³	P

5,7 124 OM 353.912 A			
01.72-02.01		1 457 42 P 9629	O
		1 457 43 S 2192	L
		1 457 42 N 9359	K
		1 457 42 P 9165 ³	P

15t LA 1513

5,7 96 OM 352.936			
01.79-02.01		1 457 42 P 9646	O
10.69-02.01		1 457 42 N 9359	K
		1 457 42 P 9165 ³	P

15t LPS 1525

10,0 175/186 OM 429.951 LA; OM 429.953,955 LA			
01.85-12.01		1 457 42 P 9740	O
		1 457 42 N 9354	K

15t 1514

6,0 95 OM 356.908 (366) <Euro 1>			
Mot.Nr. →..286114	12.92-12.93		1 457 42 P 9647 O
Mot.Nr. ...286115→	12.92-12.99		1 457 42 P 9276 O
	12.92-12.99	RLE	1 457 42 S 9980 L
Fg.Nr. →5 451580	12.92-12.99		1 457 42 S 9854 L
Fg.Nr. →5 462572	12.92-12.99	RLE	1 457 42 S 9966 L
Fg.Nr. 5 451581→	12.92-12.99		1 457 42 S 9966 L
Fg.Nr. 5 462573→	12.92-12.99	RLE	1 457 42 S 9980 L
	12.92-12.99		1 457 42 N 9359 K

6,0|100|OM 366.936

Mot.Nr. →..916577	01.89-12.92		1 457 42 P 9646 O
Mot.Nr. ...286115→	01.89-12.92		1 457 42 P 9276 O
Mot.Nr. ...916578→..999999	01.89-12.92		1 457 42 P 9647 O
..100001→..286114	01.89-12.92	RLE	1 457 42 S 9980 L
Fg.Nr. →5 451580	01.89-12.92		1 457 42 S 9854 L
Fg.Nr. →5 462572	01.89-12.92	RLE	1 457 42 S 9966 L
Fg.Nr. 5 451581→	01.89-12.92		1 457 42 S 9966 L
Fg.Nr. 5 462573→	01.89-12.92	RLE	1 457 42 S 9980 L
	01.89-12.92		1 457 42 N 9359 K

15t 1517

4,3 125 OM 904.907 LA <Euro 2>			
03.96-12.99		F 026 40 P 7040	O
		1 457 42 S 9966	L
	WAS	1 457 43 N 1707	K
		1 457 42 P 9820 ³	P

6,0|116|OM 356.9... A <Euro 1>; OM 356.953 (366) A <Euro 1>

Mot.Nr. →..286114	12.92-12.99		1 457 42 P 9646 O
Mot.Nr. ...286115→	12.92-12.99		1 457 42 P 9277 O
	12.92-12.99		1 457 42 N 9359 K





◀ 15t 1517

6,0 125 OM 357.9... LA <Euro 2>; OM 357.962 (366) LA <Euro 2>			
03.94-12.99	1 457 42 P 9277	O	
	1 457 42 S 9966	L	
	1 457 42 N 9359	K	
	1 457 42 P 9820 ³	P	

6,0 125 OM 366.945,979 A; OM 366.979 A			
10.88-12.92	1 457 42 P 9735	O	
	1 457 42 S 9966	L	
	1 457 42 N 9359	K	

15t 1520

6,0 150 OM 366.995 LA			
01.89-12.92	WW	1 457 42 P 9277	O
Mot.Nr. ...923827→...999999	01.89-12.92	1 457 42 P 9646	O
..100001→..286114	01.89-12.92	1 457 42 S 9966	L
		1 457 42 N 9359	K

6,0 155 OM 356.990 (366) LA <Euro 1>			
Mot.Nr. →..286114	12.92-12.99	1 457 42 P 9646	O
Mot.Nr. ...286115→	01.93-12.99	1 457 42 P 9277	O
	12.92-12.99	RLE 1 457 42 S 9966	L
		1 457 42 N 9359	K

6,0 155 OM 357.922 (366) LA <Euro 2>; OM 357.930 (366) LA <Euro 2>			
03.94-12.99	1 457 42 P 9277	O	
	1 457 43 S 3651	L	
	RLE 1 457 42 S 9966	L	
	1 457 42 N 9359	K	
	1 457 42 P 9820 ³	P	

15t 1524

6,0 170 OM 366.999 LA <Euro 1>			
Mot.Nr. →..286114	02.91-12.93	1 457 42 P 9646	O
Mot.Nr. ...286115→	01.93-02.01	1 457 42 P 9277	O
	02.91-02.01	1 457 43 S 3651	L
		RLE 1 457 42 S 9966	L
		1 457 42 N 9359	K

6,0 177 OM 356.999 (366) LA <Euro 1>			
Mot.Nr. →..286114	02.91-02.01	1 457 42 P 9646	O
Mot.Nr. ...286115→	02.91-02.01	1 457 42 P 9277	O
	02.91-02.01	1 457 43 S 3651	L
		RLE 1 457 42 S 9966	L
		1 457 42 N 9359	K

6,0 177 OM 357.941 (366) LA <Euro 2>; OM 357.947 (366) LA <Euro 2>			
03.94→	1 457 42 P 9277	O	
	1 457 43 S 3651	L	
	RLE 1 457 42 S 9966	L	
	1 457 42 N 9359	K	
	1 457 42 P 9820 ³	P	

16t

16t 1614

6,0 100 OM 366.906			
04.84-03.91	1 457 42 P 9646	O	
	1 457 42 S 9854	L	
	1 457 42 N 9359	K	
	1 457 42 P 9820 ³	P	



16t 1617

6,0 125 OM 366.951 A			
04.84-03.91	1 457 42 P 9735	O	
	1 457 42 S 9966	L	
	1 457 42 N 9359	K	
	1 457 42 P 9820 ³	P	

6,0 125 OM 366.951,952 A			
04.84-03.91	1 457 42 P 9735	O	
	1 457 42 N 9359	K	
	1 457 42 P 9820 ³	P	

16t 1617/ 1620

6,0 125/150 OM 366.952 A; OM 366.983 LA			
06.84-03.91	1 457 42 P 9735	O	
	1 457 42 S 9966	L	
	1 457 42 N 9359	K	
	1 457 42 P 9820 ³	P	

16t 1622

11,0 150 OM 441.906			
03.87-03.91	1 457 42 P 9735	O	
	1 457 42 N 9354	K	

11,0 159 OM 421.905			
05.82-03.91	1 457 42 P 9740	O	
	1 457 43 S 2192	L	
	1 457 42 N 9359	K	
	1 457 42 P 9820 ³	P	

16t 1624

9,6 180 OM 401.975 <Euro 1>			
02.93-08.94	1 457 42 P 9732	O	
	RLE 1 457 42 P 9740	O	
	1 457 42 N 9354	K	
	1 457 42 P 9820 ³	P	

16t 1636

18,3 261 OM 423.905,908			
12.83-03.91	1 457 42 P 9740	O	
	1 457 42 S 9991	L	
	1 457 42 N 9359	K	

17t

17t 1717

6,0 129 OM 366.952,356.940 A			
Mot.Nr. →..286114	09.89-12.93	1 457 42 P 9646	O
Mot.Nr. ...286115→	01.93-08.94	1 457 42 P 9277	O
	09.89-08.94	1 457 42 N 9359	K

17t 1720

6,0 150 OM 356.985 (366) LA			
Mot.Nr. →..286114	01.91-12.93	1 457 42 P 9646	O
Mot.Nr. ...286115→	01.93-02.01	1 457 42 P 9277	O
	01.91-02.01	1 457 42 S 9966	L
		1 457 42 N 9359	K

6,0 150 OM 366.995 LA			
01.84-12.98	1 457 42 P 9646	O	
	1 457 42 S 9966	L	
	1 457 42 N 9359	K	



6,0 155 OM 356.984 (366) LA				
	02.90-07.92	1 457 42 P 9646	O	
Mot.Nr. →..286114	02.90-12.93	1 457 42 P 9646	O	
Mot.Nr. ...286115→	01.93-08.94	1 457 42 P 9277	O	
	02.90-08.94	1 457 42 N 9359	K	

17t 1722

6,0 150 OM 366.983 LA <Euro 1>				
Mot.Nr. →..286115→	01.93-08.94	1 457 42 P 9277	O	
Mot.Nr. ...923827→..999999	12.88-12.93	1 457 42 P 9646	O	
..100001→..286114	12.88-08.94	1 457 42 N 9359	K	

6,0 177 OM 356.999 (366) LA <Euro 1>				
Mot.Nr. →..286114	09.89-12.93	1 457 42 P 9646	O	
Mot.Nr. ...286115→	01.93-08.94	1 457 42 P 9277	O	
	12.88-08.94	1 457 42 N 9359	K	

9,6 200/230 OM 401.973,978 LA <Euro 1>; OM 401.979 LA <Euro 1>				
	12.88-08.94	1 457 42 P 9732	O	
		RLE 1 457 42 P 9740	O	
		1 457 42 N 9354	K	

11,0 151/160 OM 441.923; OM 441.926; OM 441.932 <Euro 1>; OM 441.933 <Euro 1>				
	12.88-08.94	1 457 42 P 9732	O	
		RLE 1 457 42 P 9735	O	
		1 457 42 N 9354	K	

11,0 153/165 OM 441.905,913,914; OM 441.905,914; OM 441.914; OM 441.916; OM 441.920				
	12.88-08.94	1 457 42 P 9735	O	
		1 457 42 N 9354	K	

17t 1722/ 1726

15,0 218 OM 442.907				
	12.88-08.94	1 457 42 P 9735	O	
		1 457 42 N 9354	K	

17t 1724

6,0 170 OM 366.999 LA <Euro 1>				
Mot.Nr. →..286114	02.91-12.93	1 457 42 P 9646	O	
Mot.Nr. ...286115→	01.93-02.01	1 457 42 P 9277	O	
	01.91-02.01	1 457 43 S 3651	L	
		RLE 1 457 42 S 9966	L	
		1 457 42 N 9359	K	

17t 1726

11,0 250 OM 441.960 LA				
	12.88-08.94	1 457 42 P 9732	O	
		RLE 1 457 42 P 9740	O	
		1 457 42 N 9354	K	

15,0 195 OM 442.9...				
Mot.Typ 442.914	12.88-08.94	1 457 42 P 9735	O	
Mot.Typ 442.922				
Mot.Typ 442.932				
Mot.Typ 442.935				
Mot.Typ 442.922	06.89-08.94	1 457 42 P 9735	O	
Mot.Typ 442.932	12.88-08.94	1 457 42 P 9732	O	
Mot.Typ 442.935				



Mot.Typ 442.935	06.89-08.94	1 457 42 P 9732	O	
		RLE 1 457 42 P 9735	O	
	12.88-08.94	1 457 42 N 9354	K	

15,0 195 OM 442.914,932				
Mot.Typ 442.914	12.88-08.94	1 457 42 P 9735	O	
Mot.Typ 442.932	12.88-08.94	1 457 42 P 9732	O	
		RLE 1 457 42 P 9735	O	
	12.88-08.94	1 457 42 N 9354	K	

15,0 210 OM 442.909				
	12.88-08.94	1 457 42 P 9735	O	
		1 457 42 N 9354	K	

15,0 210 OM 442.923				
	12.88-08.94	1 457 42 P 9735	O	
		1 457 42 N 9354	K	

15,0 218 OM 442.906,907				
	12.88-08.94	1 457 42 P 9735	O	
		1 457 42 N 9354	K	

15,1 195 OM 440.909 (442)				
	12.88-08.94	1 457 42 P 9735	O	
		1 457 42 N 9354	K	

17t 1727

9,6 200 OM 401.9... LA <Euro 1>				
	12.88-08.94	1 457 42 P 9732	O	
		RLE 1 457 42 P 9740	O	
		1 457 42 N 9359	K	

17t 1729

15,0 210 OM 442.923				
	07.88-08.94	1 457 42 P 9735	O	
		1 457 42 N 9354	K	
		1 987 43 M 1175	I	

15,0 213 OM 442.907,926				
	07.88-09.93	1 457 42 P 9735	O	
		1 457 42 N 9354	K	
		1 987 43 M 1175	I	

15,0 213 OM 442.925				
	07.88-08.94	1 457 42 P 9732	O	
		RLE 1 457 42 P 9735	O	
		1 457 43 S 3729	L	
		1 457 42 N 9354	K	

15,0 218 OM 442.9...				
	12.87-08.94	1 457 42 P 9735	O	
		1 457 42 N 9354	K	

15,0 218 OM 442.906,907				
	07.88-08.94	1 457 42 P 9735	O	
		1 457 42 N 9354	K	
		1 987 43 M 1175	I	

17t 1733

11,0 243-249 OM 441.9... LA				
	01.89-07.92	RLE 1 457 42 P 9740	O	
		1 457 42 N 9354	K	





17t 1734

11,0 250 OM 441.9... LA <Euro 1>			
01.91-09.96	1 457 42 P 9732	O	
	RLE 1 457 42 P 9740	O	
	1 457 42 N 9354	K	
	1 987 43 M 1175	I	

11,0 250 OM 445.9... (441)LA <Euro 2>			
01.94-08.96	1 457 42 P 9732	O	
	RLE 1 457 42 P 9740	O	
	1 457 42 N 9354	K	

17t 1735

14,6 250 OM 440.940 (442) A <Euro 1>			
07.91-08.94	1 457 42 P 9732	O	
	1 457 42 S 9899	L	
	1 457 42 N 9354	K	
	1 987 43 M 1175	I	

15,0 218 OM 442.906			
07.88-08.94	1 457 42 P 9735	O	
	1 457 42 S 9899	L	
	1 457 42 N 9354	K	
	1 987 43 M 1175	I	

15,0 260-269 OM 442.942,966 A; OM 442.944,63,64,76A; OM 442.944,963 A			
07.88-08.94	1 457 42 P 9732	O	
	1 457 42 S 9899	L	
	1 457 42 N 9354	K	
	1 987 43 M 1175	I	

17t 1748

15,0 353-362 OM 442.985,989 LA			
07.88-07.92	1 457 42 P 9740	O	
	LBF 1 457 43 S 3901	L	
	LBF 1 457 42 S 9899	L	
Fg.Nr. 655.592	07.88-07.92	1 457 42 S 9998	L
Fg.Nr. 655.593	07.88-07.92	1 457 42 N 9354	K
		1 987 43 M 1175	I

18t

18t 1820

6,0 155 OM 356.984 (366) LA			
01.91-02.01	1 457 42 P 9646	O	
	1 457 42 N 9359	K	

6,0 155 OM 356.987 (366) LA <Euro 1>			
05.92→	1 457 42 P 9646	O	
	1 457 42 N 9359	K	
	1 457 42 P 9820 ³	P	

18t 1824

9,6 180 OM 401.975 LA <Euro 1>			
08.92→	1 457 42 P 9732	O	
	RLE 1 457 42 P 9740	O	
	1 457 42 N 9354	K	
11.92→	1 457 42 P 9820 ³	P	

9,6 180 OM 401.984 LA <Euro 1>			
08.92→	1 457 42 P 9732	O	
	RLE 1 457 42 P 9740	O	
	1 457 42 N 9354	K	



11,0 180 OM 445.925 (441) LA <Euro 2>				
	01.94-09.96	RLE	1 457 42 S 9899	L
Fg.Nr. →K 022393	01.94-09.96		1 457 42 S 9950	L

11,0 200 OM 445.933 (441) LA <Euro 2>				
	01.94-09.96	RLE	1 457 42 S 9899	L
Fg.Nr. →K 022393	01.94-09.96		1 457 42 S 9950	L

11,0 230 OM 445.930 (441) LA <Euro 2>				
	01.94-09.96	RLE	1 457 42 S 9899	L
Fg.Nr. →K 022393	01.94-09.96		1 457 42 S 9950	L

18t 1827

9,6 200 OM 401.9...LA <Euro 1>				
	12.90→		1 457 42 P 9732	O
		RLE	1 457 42 P 9735	O
			1 457 42 N 9354	K

9,6 200 OM 401.973,77,91 LA <Euro 1>				
	02.91-02.01		1 457 42 P 9732	O
		RLE	1 457 42 P 9735	O
			1 457 42 N 9354	K

11,0 200 OM 445.926,36(441)LA <Euro 2>				
	01.94→		1 457 42 P 9732	O
		RLE	1 457 42 P 9740	O
			1 457 42 N 9354	K
Mot.Nr. 445.936→	01.94→		1 457 42 N 9359	K
	01.94→	STZ,TW	1 987 43 M 1174	I
		STZ	1 987 43 M 1175	I

18t 1831

9,6 230 OM 401.9...LA <Euro 1>				
	12.90-02.01		1 457 42 P 9732	O
		RLE	1 457 42 P 9735	O
Fg.Nr. BM 655...→	01.92-02.01		1 457 42 S 9899	L
	12.90-02.01		1 457 42 N 9354	K

9,6 230 OM 401.972,79,93 LA <Euro 1>				
	02.91-02.01		1 457 42 P 9732	O
		RLE	1 457 42 P 9735	O
	07.92-08.96	RLE	1 457 42 P 9740	O
	02.91-02.01		1 457 42 N 9354	K
	07.92-08.96		1 987 43 M 1175	I
			1 457 42 P 9820 ³	P

9,6 230 OM 401.979,993 LA <Euro 1>				
	06.93-08.96		1 457 42 P 9732	O
		RLE	1 457 42 P 9740	O
			1 457 42 N 9354	K
			1 987 43 M 1175	I
			1 457 42 P 9820 ³	P

9,6 230 OM 401.986 LA <Euro 1>				
	05.91-08.96		1 457 42 P 9732	O
		LBF	1 457 42 S 9899	L
			1 457 42 N 9354	K
			1 987 43 M 1175	I
			1 457 42 P 9820 ³	P

11,0 230 OM 445.9... LA <Euro 2>				
	01.94-08.96		1 457 42 P 9732	O
		RLE	1 457 42 P 9740	O
			1 457 42 N 9354	K



11,0 230 OM 445.929,37(441) LA <Euro 2>			
01.94→	1 457 42	P 9732	O
	RLE	P 9740	O
		N 9354	K
Mot.Nr. →445.937	01.94→	1 457 42	N 9359 K

11,0 230 OM 445.930 (441) LA <Euro 2>			
01.94-08.96	1 457 42	P 9732	O
	LBF	S 9899	L
		N 9359	K

12,8 280 OM 402.987 <Euro 1>			
12.90-02.01	1 457 42	P 9732	O
		N 9354	K

18t 1831/ 1834

11,0 250 OM 441.9... LA <Euro 1>			
01.91-02.01	1 457 42	P 9732	O
	RLE	P 9740	O
		N 9354	K
07.92-08.96	1 987 43	M 1175	I

18t 1834

11,0 250 OM 445.9... (441) LA <Euro 2>			
01.94-02.01	1 457 42	P 9732	O
	RLE	P 9740	O
		N 9354	K
		P 9820³	P

18t 1838

12,8 280 OM 402.9... LA <Euro 1>; OM 402.972,986 LA <Euro 1>			
12.90-02.01	1 457 42	P 9732	O
		S 9899	L
		N 9354	K
	1 987 43	M 1175	I

12,8 280 OM 402.978,996 LA <Euro 1>			
12.92-08.96	1 457 42	P 9732	O
		S 9899	L
		N 9354	K
	1 987 43	M 1175	I
	1 457 42	P 9820³	P

14,6 280/320 OM 446.924,25(442) LA <Euro 2>; OM 446.927 (442) LA <Euro 2>; OM 446.943 (442) LA <Euro 2>			
01.94-08.96	1 457 42	P 9732	O
		S 9899	L
		N 9354	K
	1 987 43	M 1175	I
	1 457 42	P 9820³	P

14,6 320 OM 440.978 LA <Euro 1>; OM 440.978,91(442) LA <Euro 1>			
12.90-02.01	1 457 42	P 9732	O
		S 9899	L
		N 9354	K
	1 987 43	M 1175	I

14,6 320 OM 440.979 (442) LA <Euro 1>			
12.92-08.96	1 457 42	P 9732	O
		S 9899	L
		N 9354	K



14,6 370 OM 440.982 (442) LA <Euro 1>			
12.92-08.96	1 457 42	P 9732	O
		S 9899	L
		N 9354	K
	1 987 43	M 1175	I

18t 1840

12,8 280 OM 402.971 LA <Euro 1>			
07.91-07.92	1 457 42	P 9732	O
		S 9899	L
		N 9354	K
	1 987 43	M 1175	I

18t 1844

14,6 320 OM 440.970 (442) LA <Euro 1>			
11.91-08.96	1 457 42	P 9732	O
		S 9899	L
		N 9354	K

14,6 320 OM 446.922 (442) LA <Euro 2>			
01.94-08.96	1 457 42	P 9732	O
		S 9899	L
		N 9354	K
	1 987 43	M 1175	I
	1 457 42	P 9820³	P

18t 1850

14,6 362/370 OM 440.971,73(442) LA <Euro 1>; OM 440.973 (442) LA <Euro 1>; OM 442.985,992 LA			
12.90-02.01	1 457 42	P 9732	O
		S 9899	L
		N 9354	K
	1 987 43	M 1175	I

15,0 362 OM 442...; OM 442.985,992 LA			
12.90-02.01	1 457 42	P 9732	O
		S 9899	L
		N 9354	K
	1 987 43	M 1175	I

15,0 370 OM 442.997 LA <Euro 1>			
01.91-02.01	1 457 42	P 9732	O
		S 9899	L
		S 3901	L
		N 9354	K

18t 1853

14,6 390 OM 446.920 (442) LA <Euro 2>; OM 446.920,46(422) LA <Euro 2>			
01.96-08.96	1 457 42	P 9732	O
		S 9899	L
		N 9354	K
	1 987 43	M 1175	I
	1 457 42	P 9820³	P





19t

19t L 1924

11,6 177 OM 355.983	05.79-02.01	1 457 42 P 9600	O
		1 457 42 N 9354	K
		1 457 42 P 9165 ³	P

19t L 1928

11,6 206 OM 355.969 A	05.79-02.01	1 457 42 P 9600	O
		1 457 42 S 9975	L
		1 457 42 N 9354	K
		1 457 42 P 9165 ³	P

19t 1922

11,0 159 OM 421.905	10.81-03.91	1 457 42 P 9740	O
		1 457 43 S 2192	L
		1 457 42 N 9359	K
		1 457 42 P 9820 ³	P

11,0 160 OM 441.923	05.89-08.94	1 457 42 P 9732	O
		RLE 1 457 42 P 9735	O
		LBF 1 457 42 S 9899	L
		1 457 42 N 9354	K
		1 987 43 M 1175	I

11,0 160 OM 441.926	10.89-08.94	RLE 1 457 42 P 9735	O
		ZE 1 457 42 P 9732	O
	08.89-08.94	LBF 1 457 42 S 9899	L
		1 457 42 N 9354	K

11,0 165 OM 441.9...; OM 441.905,914; OM 441.914	05.89-08.94	1 457 42 P 9735	O
		LBF 1 457 42 S 9899	L
		1 457 42 N 9354	K

19t 1926

15,0 195 OM 442.9...	12.87-09.96	1 457 42 P 9735	O
Mot.Typ 442.914	12.87-09.96	1 457 42 P 9732	O
Mot.Typ 442.932	12.87-09.96	RLE 1 457 42 P 9735	O
	12.87-09.96	1 457 42 N 9354	K

19t 1928

14,6 206 OM 422.9...	09.86-03.91	1 457 42 P 9735	O
Mot.Nr. ...139200→	04.81-03.91	1 457 42 S 9991	L
	07.82-03.91	1 457 42 N 9354	K
	01.80-03.91	1 457 42 P 9820 ³	P

19t 1929

15,0 210 OM 442.908,923	07.88-08.94	1 457 42 P 9735	O
		1 457 42 N 9354	K

15,0 210 OM 442.909,924	07.88-08.94	1 457 42 P 9735	O
		1 457 42 N 9354	K
		1 987 43 M 1175	I



15,0 213 OM 442.925	07.88-08.94	1 457 42 P 9732	O
		RLE 1 457 42 P 9735	O
		1 457 42 N 9354	K
		1 987 43 M 1175	I

15,0 213 OM 442.926,929	07.88-08.94	1 457 42 P 9732	O
	10.89-08.94	RLE 1 457 42 P 9735	O
	07.88-08.94	1 457 42 N 9354	K
		1 987 43 M 1175	I

15,0 218 OM 442.906; OM 442.906,907	07.88-08.94	1 457 42 P 9735	O
		1 457 42 N 9354	K
		1 987 43 M 1175	I

15,0 269 OM 442.966 A; OM 442.971 A	07.88-08.94	1 457 42 P 9740	O
		1 457 42 N 9354	K
		1 987 43 M 1175	I

18,3 340 OM 443.940 A	07.88-08.94	1 457 42 P 9740	O
		1 457 42 N 9354	K

19t 1933

14,6 243 OM 422.95...A; OM 422.954 A	11.80-03.91	1 457 42 P 9740	O
		1 457 42 S 9998	L
		1 457 42 N 9354	K
		1 457 42 P 9820 ³	P

19t 1935

14,6 250 OM 440.94... A <Euro 1>; OM 440.940 (442) A <Euro 1>	07.91-08.94	1 457 42 P 9732	O
		LBF 1 457 42 S 9899	L
		1 457 42 N 9354	K

14,6 370 OM 440.971 (442) LA <Euro 1>	01.91-10.93	1 457 42 P 9732	O
		LBF 1 457 42 S 9899	L
		1 457 42 N 9354	K
		1 987 43 M 1175	I

15,0 250/269/362/370 OM 442.976 A; OM 442.977 A <Euro 1>; OM 442.978 A <Euro 1>; OM 442.989 LA; OM 442.997 LA <Euro 1>	05.89-08.94	1 457 42 P 9732	O
		1 457 42 S 9899	L
		1 457 42 N 9354	K
		1 987 43 M 1175	I

15,0 260-269 OM 442.962 A	09.87-03.91	1 457 42 P 9740	O
		1 457 42 N 9354	K

15,0 269 OM 442.942,966 A	05.89-08.94	1 457 42 P 9740	O
		1 457 42 S 9899	L
		1 457 42 N 9354	K
		1 987 43 M 1175	I

15,0 269 OM 442.943,944,963 A	05.89-08.94	1 457 42 P 9732	O
		1 457 42 S 9899	L
		1 457 42 N 9354	K
		1 987 43 M 1175	I





15,0 269 OM 442.964 A; OM 442.971,972 A			
05.89-08.94	1 457 42	P 9740	O
	1 457 42	N 9354	K
	1 987 43	M 1175	I

19t 1936

18,3 261 OM 423.905,906,907; OM 423.905,906,908			
10.81-03.91	1 457 42	P 9740	O
	1 457 42	S 9991	L
	1 457 42	N 9354	K

18,3 331 OM 443.940 A			
01.90-03.91	1 457 42	P 9740	O
02.90-03.91	1 457 42	S 9991	L
01.90-03.91	1 457 42	N 9354	K

19t 1948

15,0 353-362 OM 442.98...LA			
09.88-07.92	1 457 42	P 9732	O
	1 457 42	S 9899	L
	1 457 42	N 9354	K
	1 987 43	M 1175	I

20t

20t 2020

6,0 150 OM 366.995 LA			
01.84-12.98	1 457 42	P 9646	O
	1 457 42	S 9966	L
	1 457 42	N 9359	K

20t 2024

6,0 177 OM 357.94...(366) LA <Euro 2>			
03.94-02.01	1 457 42	P 9277	O
	1 457 43	S 3651	L
RLE	1 457 42	S 9966	L
	1 457 42	N 9359	K
	1 457 42	P 9820³	P

9,6 180 OM 401.975 LA <Euro 1>			
02.93-08.96	1 457 42	P 9732	O
RLE	1 457 42	P 9740	O
LBF	1 457 42	S 9899	L
	1 457 42	N 9354	K
	1 987 43	M 1175	I

9,6 180 OM 401.984 LA <Euro 1>			
02.93-08.96	1 457 42	P 9732	O
LBF	1 457 42	S 9899	L
	1 457 42	N 9359	K
	1 987 43	M 1175	I

11,0 180 OM 445.924 (441) LA <Euro 2>			
01.94-08.96	1 457 42	P 9732	O
RLE	1 457 42	P 9740	O
LBF	1 457 42	S 9899	L
	1 457 42	N 9354	K
	1 987 43	M 1175	I



11,0 180 OM 445.925 (441) LA <Euro 2>			
01.94-08.96	1 457 42	P 9732	O
LBF	1 457 42	S 9899	L
	1 457 42	N 9359	K
	1 987 43	M 1175	I

20t 2025

14,6 184 OM 422.909			
08.83-03.91	1 457 42	P 9740	O
	1 457 43	S 2192	L
	1 457 42	N 9354	K
	1 457 42	P 9820³	P

20t 2027

9,6 200 OM 401.989			
02.93-08.96	1 457 42	P 9732	O
LBF	1 457 42	S 9899	L
	1 457 42	N 9359	K
	1 987 43	M 1175	I

20t 2031

9,6 230 OM 401.9...LA <Euro 1>			
03.92-09.96	1 457 42	P 9732	O
RLE	1 457 42	P 9740	O
LBF	1 457 42	S 9899	L
	1 457 42	N 9354	K
	1 987 43	M 1175	I
	1 457 42	P 9820³	P

9,6 230 OM 401.986 LA <Euro 1>			
03.92-08.96	1 457 42	P 9732	O
LBF	1 457 42	S 9899	L
	1 457 42	N 9354	K
	1 987 43	M 1175	I
	1 457 42	P 9820³	P

11,0 230 OM 441.998 LA <Euro 1>			
03.92-08.96	1 457 42	P 9732	O
RLE	1 457 42	P 9740	O
LBF	1 457 42	S 9899	L
	1 457 42	N 9354	K

11,0 230 OM 445.929 (441) LA <Euro 2>			
01.94-09.96	1 457 42	P 9732	O
RLE	1 457 42	P 9740	O
	1 457 42	N 9354	K
	1 987 43	M 1175	I

11,0 230 OM 445.930 (441) LA <Euro 2>			
01.94-08.96	1 457 42	P 9732	O
LBF	1 457 42	S 9899	L
	1 457 42	N 9359	K
	1 987 43	M 1175	I

12,8 280 OM 402.978,996 LA <Euro 1>			
03.92-08.96	1 457 42	P 9732	O
	1 457 42	S 9899	L
	1 457 42	N 9354	K
	1 987 43	M 1175	I
	1 457 42	P 9820³	P





◀ 20t 2031

14,6 280 OM 446.927 (441) LA <Euro 2>			
01.94-08.96	1 457 42 P 9732	O	
	1 457 42 S 9899	L	
	1 457 42 N 9354	K	
	1 987 43 M 1175	I	
	1 457 42 P 9820 ³	P	

14,6 320 OM 440.979 (442) LA <Euro 1>			
03.92-08.96	1 457 42 P 9732	O	
	1 457 42 S 9899	L	
	1 457 42 N 9354	K	
	1 987 43 M 1175	I	

20t 2036

18,3 261 OM 423.905,908			
03.84-03.91	1 457 42 P 9740	O	
	1 457 42 S 9991	L	
	1 457 42 N 9359	K	

20t 2038

12,8 280 OM 402.971,985 LA <Euro 1>; OM 402.972,986 LA <Euro 1>			
11.91-08.96	1 457 42 P 9732	O	
	1 457 42 S 9899	L	
	1 457 42 N 9354	K	
	1 987 43 M 1175	I	

12,8 280 OM 402.978 LA <Euro 1>			
12.92-08.96	1 457 42 P 9732	O	
	1 457 42 S 9899	L	
	1 457 42 N 9354	K	
	1 987 43 M 1175	I	
	1 457 42 P 9820 ³	P	

14,6 280 OM 440.990 (442) LA <Euro 1>			
11.91-08.96	1 457 42 P 9732	O	
	LBF 1 457 42 S 9899	L	
	1 457 42 N 9354	K	

14,6 280 OM 446.92... LA <Euro 2>; OM 446.927 (442) LA <Euro 2>			
01.94-08.96	1 457 42 P 9732	O	
	1 457 42 S 9899	L	
	1 457 42 N 9354	K	
	1 987 43 M 1175	I	
	1 457 42 P 9820 ³	P	

14,6 320 OM 440.97... LA <Euro 1>			
12.92-08.96	1 457 42 P 9732	O	
	1 457 42 S 9899	L	
	1 457 42 N 9354	K	
	1 987 43 M 1175	I	

20t 2044

14,6 320 OM 440.9... (442) LA <Euro 1>			
01.92-08.96	1 457 42 P 9732	O	
	1 457 42 S 9899	L	
	1 457 42 N 9354	K	
	1 987 43 M 1175	I	

14,6 320 OM 446.9... <Euro 2>			
01.94-08.96	1 457 42 P 9732	O	
	1 457 42 S 9899	L	
	1 457 42 N 9354	K	
	1 987 43 M 1175	I	
	1 457 42 P 9820 ³	P	



20t 2050

14,6 370 OM 440.976 (422) LA <Euro 1>			
01.91-02.01	1 457 42 P 9732	O	
	1 457 43 S 3901	L	
	1 457 42 N 9354	K	
	1 987 43 M 1175	I	

20t 2050/ 2055

15,0 362/370 OM 442.9... LA; OM 442.997 LA <Euro 1>			
01.91-02.01	1 457 42 P 9732	O	
	1 457 42 S 9899	L	
	1 457 42 N 9354	K	
	1 987 43 M 1175	I	

22t

22t 2220

6,0 150 OM 366.983 LA			
07.85-03.91	1 457 42 P 9735	O	
	1 457 42 S 9966	L	
	1 457 42 N 9359	K	

22t 2222

11,0 150 OM 441.906			
03.87-03.91	1 457 42 P 9735	O	
	1 457 42 N 9354	K	
	1 457 42 P 9820 ³	P	

11,0 159 OM 421.905; OM 421.905,907			
05.82-03.91	1 457 42 P 9740	O	
	1 457 43 S 2192	L	
	1 457 42 N 9359	K	
	1 457 42 P 9820 ³	P	

22t 2225

14,6 184 OM 422.909; OM 422.912			
08.83-03.91	1 457 42 P 9740	O	
	1 457 43 S 2192	L	
	1 457 42 N 9354	K	
	1 457 42 P 9820 ³	P	

15,0 191 OM 442.905			
03.87-03.91	1 457 42 P 9735	O	
	1 457 42 S 9991	L	
	1 457 42 N 9354	K	
	1 457 42 P 9820 ³	P	

22t 2228

14,6 206 OM 422.905,911			
12.79-03.91	1 457 42 P 9740	O	
04.81-03.91	1 457 42 S 9991	L	
07.82-03.91	1 457 42 N 9354	K	
12.79-03.91	1 457 42 P 9820 ³	P	

22t 2236

18,3 261 OM 423.905,908			
09.82-03.91	1 457 42 P 9740	O	
	1 457 42 S 9991	L	
	1 457 42 N 9359	K	





23t

23t 2327

9,6 200 OM 401.973 <Euro 1>			
02.93-09.96	1 457 42	P 9732	O
	RLE	1 457 42 P 9740	O
		1 457 42 N 9354	K
		1 457 42 P 9820 ³	P

11,0 | 200 | OM 445.926 (441) LA <Euro 2>

01.94-09.96	1 457 42	P 9732	O
	RLE	1 457 42 P 9740	O
		1 457 42 N 9354	K

Mot.Nr. 445.936→ 01.94-09.96 1 457 42 **N 9359** **K**

24t

24t 2420

6,0 155 OM 356.984 (366) LA			
02.90-08.94	1 457 42	P 9646	O
		1 457 42 N 9359	K
03.90-08.94	1 457 42	P 9820 ³	P

24t 2422

11,0 165 OM 441.905			
09.89-08.94	1 457 42	P 9735	O
		1 457 42 N 9354	K
		1 457 42 P 9820 ³	P

11,0 | 165 | OM 441.905,912

09.89-08.94	1 457 42	P 9735	O
		1 457 42 N 9354	K

24t 2426

15,0 195 OM 442.9...			
01.90-08.94	1 457 42	P 9735	O
Mot.Nr. 442.932,934→	03.90-08.94	ZE	1 457 42 P 9732 O
	01.90-08.94		1 457 42 N 9354 K

15,0 | 195 | OM 442.914,932

02.90-08.94	1 457 42	P 9735	O
Mot.Nr. 442.932,934→	03.90-08.94	ZE	1 457 42 P 9732 O
	02.90-08.94		1 457 42 N 9354 K
			1 457 42 P 9820 ³ P

24t 2427

9,6 200 OM 401.973 LA <Euro 1>			
07.92-09.96	1 457 42	P 9732	O
	RLE	1 457 42 P 9740	O
		1 457 42 N 9354	K
		1 457 42 P 9820 ³	P

24t 2429

15,0 210 OM 442.923			
07.88-08.94	1 457 42	P 9735	O
		1 457 42 N 9354	K



15,0 213 OM 442.925			
07.88-08.94	1 457 42	P 9732	O
	RLE	1 457 42 P 9735	O
		1 457 42 N 9354	K

15,0 | 218 | OM 442.906; OM 442.906,907

07.88-08.94	1 457 42	P 9735	O
		1 457 42 N 9354	K
	SA	1 987 43 M 1174	I

24t 2431

9,6 | 230 | OM 401.9...LA <Euro 1>

12.87-09.96	1 457 42	P 9732	O
	RLE	1 457 42 P 9740	O
	LBF	1 457 42 S 9899	L
		1 457 42 N 9354	K
		1 987 43 M 1175	I

24t 2433

11,0 | 243-249 | OM 441.9...; OM 441.960,981 LA

05.89-07.92	RLE	1 457 42 P 9740	O
	ZE	1 457 42 P 9732	O
		1 457 42 N 9354	K
		1 457 42 P 9820 ³	P

14,6 | 243 | OM 422.954,957

12.82-11.91	1 457 42	P 9740	O
		1 457 42 S 9998	L
		1 457 42 N 9354	K

24t 2434

11,0 | 250 | OM 441.9... LA <Euro 1>

01.91-09.96	1 457 42	P 9732	O
	RLE	1 457 42 P 9740	O
		1 457 42 N 9354	K
		1 987 43 M 1175	I

11,0 | 250 | OM 445.9... (441) LA <Euro 2>

01.94-08.96	1 457 42	P 9732	O
	RLE	1 457 42 P 9740	O
		1 457 42 N 9354	K

24t 2435

14,6 | 250 | OM 440.940 (442) A <Euro 1>

07.91-08.94	1 457 42	P 9732	O
		1 457 42 S 9899	L
		1 457 42 N 9354	K
	FBF	1 987 43 M 1175	I
	SA	1 987 43 M 1174	I

15,0 | 260-269 | OM 442.943,944 A

07.88-08.94	1 457 42	P 9732	O
Fg.Nr. BM 657	07.88-08.94	1 457 42 S 9950	L
Fg.Nr. BM 658	07.88-08.94	1 457 42 S 9899	L
	07.88-08.94	1 457 42 N 9354	K
		FBF	1 987 43 M 1175 I
		SA	1 987 43 M 1174 I





◀ 24t 2435

15,0 260-269 OM 442.963,964,965 A			
07.88-08.94	1 457 42 P 9740	O	
	1 457 42 N 9354	K	
FBF	1 987 43 M 1175	I	
SA	1 987 43 M 1174	I	

15,0 260-269 OM 442.963-965,968 A			
07.88-08.94	1 457 42 P 9740	O	
	1 457 42 S 9899	L	
	1 457 42 N 9354	K	
FBF	1 987 43 M 1175	I	
SA	1 987 43 M 1174	I	

15,0 269 OM 442.976 A			
07.88-08.94	1 457 42 P 9732	O	
	1 457 42 S 9899	L	
	1 457 42 N 9354	K	
FBF	1 987 43 M 1175	I	
SA	1 987 43 M 1174	I	

24t 2444

14,6 320 OM 442.9...			
10.85-08.96	1 457 42 P 9740	O	
	1 457 42 S 9899	L	
	1 457 42 N 9354	K	
	1 457 42 P 9820 ³	P	

24t 2448

15,0 353-362 OM 442.9...LA; OM 442.985,989 LA			
07.88-07.92	1 457 42 P 9732	O	
Fg.Nr. →5 708335	1 457 42 S 9998	L	
Fg.Nr. 5 708336→	1 457 43 S 3901	L	
07.88-07.92	1 457 42 N 9354	K	
SA	1 987 43 M 1174	I	

25t

25t 2524

9,6 180 OM 401.975 LA <Euro 1>			
06.92→	1 457 42 P 9732	O	
	RLE 1 457 42 P 9740	O	
	1 457 42 N 9354	K	
	1 457 42 P 9820 ³	P	

25t 2527

9,6 200 OM 401.9...LA <Euro 1>			
03.91→	1 457 42 P 9732	O	
	RLE 1 457 42 P 9740	O	
	1 457 42 N 9354	K	

9,6 200 OM 401.973,977 LA <Euro 1>			
09.92-08.94	1 457 42 P 9732	O	
	RLE 1 457 42 P 9740	O	
	1 457 42 N 9354	K	
	1 457 42 P 9820 ³	P	

25t 2528

14,6 206 OM 422.907,913			
Mot.Nr. ...139200→	09.86-12.92	1 457 42 P 9735	O
	01.86-12.92	1 457 42 S 9991	L
		1 457 42 N 9354	K



25t 2531

9,6 230 OM 401... <Euro 1>			
03.91-09.96	1 457 42 P 9732	O	
	LBF 1 457 42 S 9899	L	
	1 457 42 N 9354	K	
	SA 1 987 43 M 1174	I	
06.92-09.96	1 457 42 P 9820 ³	P	

9,6 230 OM 401.9... LA <Euro 1>			
12.90→	1 457 42 P 9732	O	
	RLE 1 457 42 P 9740	O	
	1 457 42 N 9354	K	
06.92→	1 457 42 P 9820 ³	P	

11,0 230 OM 445.9... (441) LA <Euro 2>			
01.94-09.96	1 457 42 P 9732	O	
	LBF 1 457 42 S 9899	L	
	1 457 42 N 9359	K	
	SA 1 987 43 M 1174	I	

25t 2534

11,0 250 OM 441.98... LA <Euro 1>			
03.91-01.01	1 457 42 P 9732	O	
	RLE 1 457 42 P 9740	O	
	1 457 42 N 9354	K	
06.92-01.01	1 457 42 P 9820 ³	P	

11,0 250 OM 441.986 LA <Euro 1>			
01.91-02.01	1 457 42 P 9732	O	
	RLE 1 457 42 P 9740	O	
	1 457 42 N 9354	K	

25t 2536

18,3 261 OM 423.907			
01.86-12.92	1 457 42 P 9740	O	
	1 457 42 S 9991	L	
	1 457 42 N 9354	K	

25t 2538

12,8 280 OM 402.971,972,975LA <Euro 1>; OM 402.985,986 LA <Euro 1>; OM 402.985,986,989LA <Euro 1>; OM 402.989,990 LA <Euro 1>			
03.91-08.96	1 457 42 P 9732	O	
	LBF 1 457 42 S 9899	L	
	1 457 42 N 9354	K	
	FBF 1 987 43 M 1175	I	
	SA 1 987 43 M 1174	I	

14,6 280/320 OM 446.9... LA <Euro 2>; OM 446.92... LA <Euro 2>; OM 446.928 (442) LA <Euro 2>; OM 446.94... LA <Euro 2>			
01.94-08.96	1 457 42 P 9732	O	
	1 457 42 S 9899	L	
	1 457 42 N 9354	K	
	FBF 1 987 43 M 1175	I	
	SA 1 987 43 M 1174	I	
	1 457 42 P 9820 ³	P	

14,6 320/370 OM 440.9... LA <Euro 1>			
03.91-08.96	1 457 42 P 9732	O	
	LBF 1 457 42 S 9899	L	
	1 457 42 N 9354	K	
	FBF 1 987 43 M 1175	I	
	SA 1 987 43 M 1174	I	



15,0 362/370 OM 442.989 (442) LA <Euro 1>; OM 442.997 (442) LA <Euro 1>			
03.91-08.96	1 457 42	P 9732	O
LBF	1 457 42	S 9899	L
	1 457 42	N 9354	K
FBF	1 987 43	M 1175	I
SA	1 987 43	M 1174	I

25t 2538/ 2550

14,6 320/370 OM 440.97... LA <Euro 1>			
01.91-08.96	1 457 42	P 9732	O
LBF	1 457 42	S 9899	L
	1 457 42	N 9354	K
FBF	1 987 43	M 1175	I
SA	1 987 43	M 1174	I

25t 2544

14,6 320 OM 440.97... (442) LA <Euro 1>			
01.92-08.96	1 457 42	P 9732	O
LBF	1 457 42	S 9899	L
	1 457 42	N 9354	K
FBF	1 987 43	M 1175	I
SA	1 987 43	M 1174	I

14,6 320 OM 446.922 (442) LA <Euro 2>			
01.94-08.96	1 457 42	P 9732	O
	1 457 42	S 9899	L
	1 457 42	N 9354	K
FBF	1 987 43	M 1175	I
SA	1 987 43	M 1174	I
	1 457 42	P 9820³	P

25t 2550

14,6 370 OM 440.973 (442) LA <Euro 1>			
07.91-08.96	1 457 42	P 9732	O
LBF	1 457 42	S 9899	L
	1 457 42	N 9354	K
FBF	1 987 43	M 1175	I
SA	1 987 43	M 1174	I

14,6 390 OM 446.920 (442) LA <Euro 2>			
01.94-08.96	1 457 42	P 9732	O
	1 457 42	S 9899	L
	1 457 42	N 9354	K
FBF	1 987 43	M 1175	I
SA	1 987 43	M 1174	I
	1 457 42	P 9820³	P

15,0 370 OM 442.997 LA <Euro 1>; OM 442.997,998 LA <Euro 1>			
01.91-08.96	1 457 42	P 9732	O
LBF	1 457 42	S 9899	L
	1 457 42	N 9354	K
FBF	1 987 43	M 1175	I
SA	1 987 43	M 1174	I



25t 2553			
14,6 390 OM 446.920 LA <Euro 2>			
01.96-08.96	1 457 42	P 9732	O
	1 457 42	S 9899	L
	1 457 42	N 9354	K
FBF	1 987 43	M 1175	I
SA	1 987 43	M 1174	I
	1 457 42	P 9820³	P

26t

26t L 2624

11,6 177 OM 355.983,984			
01.78-02.01	1 457 42	P 9600	O
	1 457 42	N 9354	K
	1 457 42	P 9165³	P

26t L 2628

11,6 206 OM 355.969 A			
11.78-02.01	1 457 42	P 9600	O
	1 457 42	S 9975	L
	1 457 42	N 9354	K
	1 457 42	P 9165³	P

26t 2628

14,6 206 OM 422.905,911; OM 422.907,913			
02.80-03.91	1 457 42	P 9740	O
04.81-03.91	1 457 42	S 9991	L
07.82-03.91	1 457 42	N 9354	K
02.80-03.91	1 457 42	P 9820³	P

26t 2628/ 2636

18,3 331 OM 443.940 A			
01.90-03.91	1 457 42	P 9740	O
	1 457 42	S 9991	L
	1 457 42	N 9354	K

26t 2629

15,0 213/218 OM 442.906,907,917; OM 442.926			
07.88-08.94	1 457 42	P 9732	O
RLE	1 457 42	P 9735	O
	1 457 42	N 9354	K
	1 457 42	P 9820³	P

26t 2631

9,6 230 OM 401.972,981 LA <Euro 1>; OM 401.986 LA <Euro 1>			
06.92-08.96	1 457 42	P 9732	O
RLE	1 457 42	P 9735	O
	1 457 42	N 9354	K
	1 457 42	P 9820³	P

26t 2635

14,6 250 OM 440.940 (442) A <Euro 1>			
07.91-08.94	1 457 42	P 9732	O
	1 457 42	S 9899	L
	1 457 42	N 9354	K





◀ 26t 2635

15,0 260-269 OM 442.942,966,972 A; OM 442.944,964,966 A; OM 442.950,952 A; OM 442.962 A			
04.86-08.94	1 457 42 P 9740	O	
	1 457 42 S 9899	L	
	1 457 42 N 9354	K	

26t 2636

18,3 261 OM 423.905; OM 423.907			
11.81-03.91	1 457 42 P 9740	O	
	1 457 42 S 9991	L	
	1 457 42 N 9359	K	

26t 2638

12,8 280 OM 402.971,972,975LA <Euro 1>; OM 402.975,978,996LA <Euro 1>			
09.91-09.96	1 457 42 P 9732	O	
	1 457 42 S 9899	L	
	1 457 42 N 9354	K	
	1 457 42 P 9820 ³	P	

14,6 280 OM 446.927 (442) LA <Euro 2>			
01.94-09.96	1 457 42 P 9732	O	
	1 457 42 N 9354	K	
	1 457 42 P 9820 ³	P	

26t 2644

14,6 320 OM 440.97... (442)LA <Euro 1>			
01.92-09.96	1 457 42 P 9732	O	
	1 457 42 S 9899	L	
Fg.Nr. →BM 659.191	01.92-09.96	1 457 43 S 3901	L
	01.92-09.96	1 457 42 N 9354	K
		1 457 42 P 9820 ³	P
14,6 320 OM 446.922 (442) LA <Euro 2>			
01.94-09.96	1 457 42 P 9732	O	
	1 457 42 N 9354	K	

26t 2648

15,0 353-362 OM 442.9...LA			
12.88-07.92	1 457 42 P 9740	O	
03.90-07.92	TW,ZE	1 457 42 P 9732	O
12.88-07.92	1 457 42 S 9998	L	
	1 457 42 N 9354	K	

26t 2650

15,0 370 OM 442.997 LA <Euro 1>			
07.92-09.96	1 457 42 P 9732	O	
	1 457 42 S 9899	L	
	1 457 42 N 9354	K	
	1 457 42 P 9820 ³	P	

26t 2653

14,6 390 OM 446... <Euro 2>			
01.96-09.96	1 457 42 P 9732	O	
	1 457 42 S 9899	L	
	1 457 42 N 9354	K	
	1 457 42 P 9820 ³	P	

14,6 390 OM 446.920 (442) LA <Euro 2>			
01.96-09.96	1 457 42 P 9732	O	
	1 457 43 S 3901	L	
	1 457 42 N 9354	K	
	1 457 42 P 9820 ³	P	



30t

30t 3033

14,6 243 OM 422.954,957			
12.82-11.91	1 457 42 P 9740	O	
	1 457 42 S 9998	L	
	1 457 42 N 9354	K	

30t 3050

14,6 370 OM 440.976 (442) LA <Euro 1>			
12.93-09.96	1 457 42 P 9732	O	
	1 457 42 N 9354	K	

14,6 390 OM 446.933 (442) LA <Euro 2>			
01.94-09.96	1 457 43 S 3901	L	

15,0 370 OM 442.997 LA <Euro 1>			
02.91-02.01	1 457 42 P 9732	O	
	1 457 42 S 9998	L	
	1 457 42 N 9354	K	

32t

32t 3225/ 3228

14,6 184/206 OM 422.919,921; OM 422.920			
Mot.Nr. ...139200→	07.87-03.91	1 457 42 P 9735	O
	07.87-03.91	1 457 42 N 9354	K

32t 3229

15,0 213 OM 442.927,928			
09.89-08.94	1 457 42 P 9735	O	
Mot.Nr. Bm.442.927,928→	09.89-08.94	ZE	1 457 42 P 9732
	09.89-08.94	1 457 42 N 9354	K
		1 457 42 P 9165 ³	P

32t 3233

11,0 250 OM 441.982,985 LA			
10.90-07.92	1 457 42 P 9732	O	
	RLE	1 457 42 P 9740	O
		1 457 42 S 9950	L
		1 457 42 N 9354	K
		1 457 42 P 9165 ³	P

32t 3234

11,0 250 OM 441.988,990,992LA <Euro 1>			
02.92-09.96	1 457 42 P 9732	O	
	RLE	1 457 42 P 9740	O
		1 457 42 N 9354	K
		1 457 42 P 9165 ³	P

32t 3235

15,0 260 OM 442.959 A			
10.88-07.92	1 457 42 P 9740	O	
	1 457 42 S 9950	L	
	1 457 42 N 9354	K	
	1 457 42 P 9165 ³	P	

15,0 260-269 OM 442.944			
07.88-08.94	1 457 42 P 9740	O	
	1 457 42 S 9899	L	
	1 457 42 N 9354	K	



32t 3238

12,8 280 OM 402.9... <Euro 1>			
10.90-02.01	1 457 42 P 9732	O	
	1 457 42 S 9950	L	
	1 457 42 N 9354	K	
	1 457 42 P 9165 ³	P	

32t 3244

14,6 320 OM 440.9... LA <Euro 1>			
10.90-02.01	1 457 42 P 9732	O	
	1 457 43 S 3901	L	
	1 457 42 N 9354	K	
	1 457 42 P 9820 ³	P	

32t 3248

15,0 362 OM 442.985 LA			
07.87-09.96	1 457 42 P 9740	O	
	1 457 42 S 9998	L	
	1 457 42 N 9354	K	

32t 3250

18,3 368 OM 423.950,951 LA			
09.85-08.94	1 457 42 P 9740	O	
	1 457 42 S 9991	L	
	1 457 42 N 9354	K	

18,3 412 OM 443.980 LA			
01.90-09.93	1 457 42 P 9740	O	
	1 457 42 N 9354	K	

33t

33t 3333

14,6 243 OM 422.954 A			
12.82-11.91	1 457 42 P 9740	O	
	1 457 42 S 9998	L	
	1 457 42 N 9354	K	

33t 3336

18,3 261 OM 423.905; OM 423.907			
12.82-11.91	1 457 42 P 9740	O	
	1 457 42 S 9991	L	
	1 457 42 N 9359	K	

35t

35t 3535

15,0 266 OM 442.946,957 A			
02.90-08.94	1 457 42 P 9740	O	
	1 457 42 N 9354	K	

15,0 269 OM 442.945,959 A			
10.88-08.94	1 457 42 P 9740	O	
	1 457 42 S 9950	L	
	1 457 42 N 9354	K	



35t 3538

12,8 280 OM 402.9... <Euro 1>; OM 402.982,983 LA <Euro 1>			
03.91-09.96	1 457 42 P 9732	O	
	1 457 42 N 9354	K	
	1 457 42 P 9165 ³	P	

35t 3544

14,6 320 OM 440.970 (442) LA <LEV>			
07.92-09.96	1 457 42 P 9732	O	
	1 457 43 S 3901	L	
	1 457 42 N 9354	K	
	1 457 42 P 9820 ³	P	

15,0 320 OM 442.951,953,980			
09.87-03.92	1 457 42 P 9740	O	
	1 457 42 N 9354	K	

35t 3548

14,6 370 OM 440.975 (442) LA <LEV>			
Fg.Nr. →6 901842	05.92-07.92	1 457 42 S 9998	L
Fg.Nr. 6 901843→6 902121	05.92-07.92	1 457 42 S 9899	L
Fg.Nr. 6 902122→	05.92-07.92	1 457 43 S 3901	L
	05.92-07.92	1 457 42 N 9354	K
		1 457 42 P 9165 ³	P

15,0 362 OM 442.993 LA			
12.90-07.92	1 457 42 P 9732	O	
Fg.Nr. →6 901842	12.90-07.92	1 457 42 S 9998	L
Fg.Nr. 6 901843→6 902121	12.90-07.92	1 457 42 S 9899	L
Fg.Nr. 6 902122→	12.90-07.92	1 457 43 S 3901	L
	12.90-07.92	1 457 42 N 9354	K
		1 457 42 P 9165 ³	P

35t 3550

14,6 370 OM 440.975 (442) LA <Euro 1>			
Fg.Nr. →6 901842	05.92-09.96	1 457 42 S 9998	L
Fg.Nr. 6 901843→6 902121	05.92-09.96	1 457 42 S 9899	L
Fg.Nr. 6 902122→	05.92-09.96	1 457 43 S 3901	L
	05.92-09.96	1 457 42 N 9354	K
		1 457 42 P 9165 ³	P

35t 3553

14,6 390 OM 446.9... LA <Euro 2>			
01.96-09.96	1 457 42 P 9732	O	
	1 457 43 S 3901	L	
	1 457 42 N 9354	K	
	1 457 42 P 9820 ³	P	

14,6 390 OM 446.932 LA <Euro 2>			
01.96-09.96	1 457 42 P 9732	O	
	RLE 1 457 42 P 9740	O	
	1 457 43 S 3901	L	
	1 457 42 N 9354	K	
	1 457 42 P 9820 ³	P	





38t

38t 3836

18,3 261 OM 423.907	11.81-03.91	1 457 42 P 9740	O
		1 457 42 S 9991	L
		1 457 42 N 9359	K

38t 3850

18,3 368 OM 423.950 LA	09.85-08.94	1 457 42 P 9740	O
		1 457 42 S 9991	L
		1 457 42 N 9354	K

44t

44t 4435

15,0 260 OM 442.959 A	10.89-02.01	1 457 42 P 9740	O
		1 457 42 S 9950	L
		1 457 42 N 9354	K

48t

48t 4844

14,6 320 OM 440.979 <Euro 1>	07.92-09.96	1 457 42 P 9732	O
----------------------------------	-------------	-----------------	---

48t 4850

18,3 368 OM 423.950	07.87-08.96	1 457 42 P 9740	O
		1 457 42 S 9991	L
		1 457 42 N 9354	K

MITSUBISHI

Canter 35

Canter 35 2.8

2,8 66 4M40	09.04-08.06	0 986 45 N 0508 ²	K
2,8 85 4M40	05.96-06.97	0 986 45 P 2063	O
	05.96-10.00	0 986 45 N 0508 ²	K

Canter 35 3C

3,9 104 4D34 <Euro 3>	01.05→	1 457 43 N 4459 ²	K
---------------------------	--------	------------------------------	---

Canter 35 3C/ 3S

3,0 81 4M42 <Euro 3>	01.05-03.06	1 457 43 N 4459 ²	K
--------------------------	-------------	------------------------------	---

Canter 35 3.0

3,0 92 4M42; 4M42-OAT	11.00-02.05	1 457 43 N 4459 ²	K
---------------------------	-------------	------------------------------	---



Canter 55

Canter 55 3.0/ 5S

3,0 92 4M42-OAT; 4M42-3A T1 <Euro 3>	11.00-03.06	1 457 43 N 4459 ²	K
--	-------------	------------------------------	---

Canter 60

Canter 60 3.9

3,9 105 4D34-2AT	05.96-09.96	0 986 45 P 2063	O
	11.00-02.05	1 457 43 N 4459 ²	K

Canter 65

Canter 65 6C

3,9 104 4D34 <Euro 3>	01.05→	1 457 43 N 4459 ²	K
---------------------------	--------	------------------------------	---

Canter 75

Canter 75 3.9

3,9 105 4D34A-2A	11.00-02.05	1 457 43 N 4459 ²	K
----------------------	-------------	------------------------------	---

Canter 75 5.0

5,0 107/115 6D31T; 6D310AT	01.88-03.92 HAU	0 451 20 P 3231	O
	04.92-07.97 HAU	0 986 45 P 2063	O

Canter 75 7C

3,9 104 4D34 <Euro 3>	01.05→	1 457 43 N 4459 ²	K
---------------------------	--------	------------------------------	---

Strada

Strada 2.5

2,5 77 4D56	06.97-03.99	0 986 45 P 2042	O
-----------------	-------------	-----------------	---

MITSUBISHI FUSO TRUCK & BUS CO

Canter

Canter 3.0

3,0 81/92/107 4M42-3AT1 <Euro 4>; 4M42-3AT2 <Euro 4>; 4M42-3AT4 <Euro 4>	04.06→	0 986 45 P 2063	O
--	--------	-----------------	---

Canter 3.9

3,9 105 4D34-2AT6 <Euro 3>	06.05→	0 986 45 P 2063	O
		1 457 43 N 4459 ²	K



**MZKT****42t****42t 700600**

11,1 303 650.10 <Euro 3>	01.10→	0 451 10 P 4010	O
		1 457 43 N 4421 ²	K

NEFAZ NEFTEKAMSK**Serie 50000****Serie 50000 52999**

12,6 315 XE315C <Euro 3>	12.06→	F 026 40 S 0084	L
------------------------------	--------	------------------------	----------

NEOPLAN**Tourline****Tourline 2216**

12,0 301 D2866 LOH34 <V4800, Euro 3>	11.03→	1 457 42 P 9740	O
		1 457 42 S 9969	L
		1 457 43 N 1710	K
	ROB,ZE	1 457 43 N 4447 ²	K
		1 987 43 M 1163	I
		1 987 43 R 1458 ⁸	I

12,8 338 D2876 LOH03 <V4500, Euro 3>	11.03→	1 457 42 P 9740	O
		1 457 42 S 9969	L
		1 457 43 N 1710	K
	ROB,ZE	1 457 43 N 4447 ²	K
		1 987 43 M 1163	I
		1 987 43 R 1458 ⁸	I

Tourline 2216/3

12,0 301 D2866 LOH34 <V4800, Euro 3>	11.03→	1 457 42 P 9740	O
		1 457 43 N 1710	K
	ROB,ZE	1 457 43 N 4447 ²	K
		1 987 43 M 1163	I
		1 987 43 R 1458 ⁸	I

12,8 338 D2876 LOH03 <V4500, Euro 3>	11.03→	1 457 42 P 9740	O
		1 457 43 N 1710	K
	ROB,ZE	1 457 43 N 4447 ²	K
		1 987 43 M 1163	I
		1 987 43 R 1458 ⁸	I

**NISSAN****Atlas****Atlas 3.0**

3,0 74 BD30	05.89-05.95	1 457 43 N 4281 ²	K
-----------------	-------------	-------------------------------------	----------

Atleon**Atleon 140**

4,0 102 B4-40Ti	09.99→	0 451 10 P 4067	O
---------------------	--------	------------------------	----------

Civilian**Civilian 3.3**

3,3ED33	02.84-03.91 TW	1 457 43 N 4189 ²	K
	05.88-03.91 TW	1 457 43 N 4281 ²	K

Civilian 4.2

4,2 99 TD42	03.91-07.92	0 986 45 P 2005	O
	08.92-03.01	0 451 10 P 3357	O
	03.91-03.01	1 457 43 N 4281 ²	K

Vanette Van**Vanette Van 2.0**

2,0 49 LD20	09.88-06.91	0 986 45 P 2024	O
		1 457 43 N 4281 ²	K

PAZ PAVLOVO**Serie 3000****Serie 3000 3204/ 3205**

3,9 103/104 EQB-140-20 <Euro 2>; 4BTAA 3.9-140 <Euro 2>	01.00→	1 457 43 N 4432 ²	K
---	--------	-------------------------------------	----------

Serie 4000**Serie 4000 4230**

4,8 100 245.9 <Euro 1>	01.00→	0 451 20 P 3152	O
		TW 1 457 43 N 4310 ²	K
		TW,XXX 1 457 43 N 4306 ²	K

Serie 4000 4234

4,8 110 D 245.9 E3 <Euro 3>	01.08→	0 451 20 P 3152	O
---------------------------------	--------	------------------------	----------





Serie 32000

Serie 32000 32053

4,8 110 D 245.9 E3 <Euro 3>	01.08→	0 451 20 P 3152	O
---------------------------------	--------	-----------------	---

Serie 32000 32054

4,8 90 D 245.7 <Euro 2>	01.00→	0 451 20 P 3152	O
		TW 1 457 43 N 4310 ²	K
		TW,XXX 1 457 43 N 4306 ²	K

PEGASO (ENASA)

Serie 5000

Serie 5000 5031

10,5 147 9106.7	10.85→	1 457 43 N 4201 ²	K
---------------------	--------	------------------------------	---

Serie 5000 5064

6,6 99 9130.15; 9130.17	01.86→	1 457 43 N 4201 ²	K
-----------------------------	--------	------------------------------	---

Serie 6000

Serie 6000 6100

12,0 228 9156.9	03.84→	0 451 30 P 0004	O
		1 457 42 S 9975	L
		1 457 43 N 4201 ²	K

RENAULT *

Agora

Agora Citybus

9,9 144/191 MIDR 06.20.45 F/3 <Euro 2>; MIDR 06.20.45 I/3 <Euro 2>	06.95-09.96	ZE 0 451 10 P 5188	O
		1 457 43 S 3731	L
		BO 1 457 43 N 4165 ²	K
		1 457 42 P 9820 ³	P

9,9 185 MGDR 06.20.45 A491 <Euro 2, GNV>; MGDR 06.20.45 D491 <Euro 2, GNV>	06.95→	1 457 43 S 3731	L
--	--------	-----------------	---

9,9 188 MIDR 06.20.45 I41 <Euro 2>	06.95-09.96	ZE 0 451 10 P 5188	O
	06.95→	0 451 30 P 0008	O
		1 457 43 S 3731	L
		BO 1 457 43 N 4165 ²	K
		1 457 42 P 9820 ³	P

9,9 220 MIDR 06.20.45 J41	09.94→	0 451 30 P 0008	O
		TW 0 451 40 P 3077	O
		1 457 43 S 3731	L
		XXX 1 457 43 N 4409 ²	K



Agora Line

9,9 152/185 MI7R 06.20.45 B41 <Euro 2>; MI7R 06.20.45 C41 <Euro 2>	05.98→	0 451 40 P 3077	O
		BO 1 457 43 N 4165 ²	K
		WW,XXX 1 457 43 N 4409 ²	K

Ares

Ares 300/ 340

9,8 221/250 MIDR 06.20.45 M41 <Euro2>; MIDR 06.20.45 R41 <Euro2>	04.98→	0 451 40 P 3077	O
		F 026 40 S 0086	L
	F 04.98→	F 026 40 S 0083	L
	04.98→	BO 1 457 43 N 4165 ²	K

Ares 380

11,1 280 MIDR 06.23.56 A/41 <Euro2>	06.00→	0 451 40 P 3077	O
		F 026 40 S 0086	L
	F 06.00→	F 026 40 S 0083	L
	06.00→	BO 1 457 43 N 4165 ²	K

B

B 80

2,5 55 8140.07.2585 <Euro 1>; 8140.67.2585 <Euro 2>	07.94-06.99	0 451 20 P 3201	O
		DON,LSP 1 457 42 S 9946	L
		1 457 42 P 9820 ³	P

2,5 56 8140.07.2530 ID	08.90-06.94	0 451 20 P 3201	O
		1 457 43 S 3231	L
	BO	1 457 43 N 4150 ²	K
		1 457 42 P 9820 ³	P

B 90

2,5 68-71/78 8140.21.235 IDS; 8140.27.2582; 8140.27.2582 IDS	01.86-07.96	0 451 20 P 3201	O
		DON,LSP 1 457 42 S 9946	L
		BO 1 457 43 N 4150 ²	K
		1 457 42 P 9820 ³	P

B 110

2,5 78 8140.27.2530 IDS; 8140.27.2565 IDS	08.90-08.96	0 451 20 P 3201	O
		DON,LSP 1 457 42 S 9946	L
		BO 1 457 43 N 4150 ²	K
		1 457 42 P 9820 ³	P

2,5 78 8140.27.2585 <Euro 1>	07.94-07.96	0 451 20 P 3201	O
		DON,LSP 1 457 42 S 9946	L
		1 457 42 P 9820 ³	P

2,8 78 8140.23.2565; 8140.23.2585 <Euro 2>	06.96-06.99	0 451 20 P 3201	O
		DON,LSP 1 457 42 S 9946	L
		1 457 42 P 9820 ³	P



B 120

2,5 | 85 | 8140.47.2530 IDR

10.91-06.94		0 451 20	P 3201	O
	DON,LSP	1 457 42	S 9946	L
	BO	1 457 43	N 4150 ²	K
		1 457 42	P 9820 ³	P

2,5 | 85 | 8140.47.2585 <Euro 1>; 8140.47.2590 <Euro 1>

07.94-07.96		0 451 20	P 3201	O
	DON,LSP	1 457 42	S 9946	L
		1 457 42	P 9820 ³	P

2,8 | 90 | 8140.43.2585 <Euro 2>

06.96-06.01		0 451 20	P 3201	O
	DON,LSP	1 457 42	S 9946	L
		1 457 42	P 9820 ³	P

C

C 210

8,8 | 153 | MIDS 06.20.30 N

12.83-05.91	ZE	0 451 10	P 5188	O
06.88-05.91	STZ	1 457 43	S 3731	L
12.83-05.91	BO	1 457 43	N 4165 ²	K
12.84-05.91	VOW,WW,XXX	1 457 43	N 4409 ²	K

C 230

6,2 | 166 | MIDR 06.02.26 D; MIDR 06.02.26 X <Euro 1>

05.90-10.98		0 451 40	P 3077	O
	NOR	1 457 43	S 3726	L
	STZ	1 457 43	S 3731	L
	TW	1 457 43	N 4165 ²	K

C 260

9,8 | 192 | MIDS 06.20.45 B

10.82-05.91	ZE	0 451 10	P 5188	O
06.88-05.91	STZ	1 457 43	S 3731	L
10.82-05.91	BO	1 457 43	N 4165 ²	K
	PRF	1 457 43	N 4252 ²	K

C 280

9,8 | 202 | MIDS 06.20.45 B

07.92-03.93		0 451 10	P 5188	O
	NOR	1 457 43	S 3726	L
	STZ	1 457 43	S 3731	L
		1 457 43	N 4165 ²	K

C 290

9,8 | 214 | MIDR 06.20.45 D

05.86-05.91	ZE	0 451 10	P 5188	O
06.88-05.91	STZ	1 457 43	S 3731	L
05.86-05.91	BO,TW	1 457 43	N 4252 ²	K
	WW	1 457 43	N 4165 ²	K
	WW,XXX	1 457 43	N 4409 ²	K



C 300

9,8 | 222 | MIDR 06.20.45 D

09.92-03.93		0 451 10	P 5188	O
	NOR	1 457 43	S 3726	L
	STZ	1 457 43	S 3731	L
		1 457 43	N 4165 ²	K

9,8 | 222 | MIDR 06.20.45 D/3 <Euro 1>

03.93-10.98		0 451 10	P 5188	O
	NOR	1 457 43	S 3726	L
	STZ	1 457 43	S 3731	L
		1 457 43	N 4165 ²	K

C 340

9,8 | 236/249 | MIDR 06.20.45 E; MIDR 06.20.45 E <Euro 1>; MIDR 06.20.45 E2

07.90-10.98		0 451 40	P 3077	O
	NOR	1 457 43	S 3726	L
	STZ	1 457 43	S 3731	L
	ZE	1 457 43	N 4165 ²	K

CBH

CBH 280

12,0 | 208 | MIDS 06.35.40 D

04.86-10.92		0 451 10	P 5188	O
06.88-10.92	SA	1 457 43	S 3731	L
04.86-10.92	BO	1 457 43	N 4165 ²	K
09.87-10.92		1 457 42	P 9820 ³	P

CBH 320

12,0 | 236 | MIDR 06.35.40 M3 <Euro 1>

10.92-10.98		0 451 40	P 3077	O
11.93-10.98	TW	1 457 43	S 3731	L
10.92-10.98	BO	1 457 43	N 4165 ²	K
		1 457 42	P 9820 ³	P

CBH 340/ 350/ 380

12,0 | 243-247/259/275 | MIDR 06.35.40 G; MIDR 06.35.40 H

04.88-01.93		0 451 10	P 5188	O
06.88-01.93	SA	1 457 43	S 3731	L
04.88-01.93	BO	1 457 43	N 4165 ²	K
		1 457 42	P 9820 ³	P

CBH 385

12,0 | 283 | MIDR 06.35.40 N3 <Euro 1>

10.92-10.98		0 451 40	P 3077	O
11.93-10.98	TW	1 457 43	S 3731	L
10.92-10.98	BO	1 457 43	N 4165 ²	K
		1 457 42	P 9820 ³	P

CLM

CLM 280

12,0 | 208 | MIDS 06.35.40 D

04.86-10.92	ZE	0 451 10	P 5188	O
	STZ	1 457 43	S 3731	L
	PRF,ZE	1 457 43	N 4165 ²	K





CLM 320

12,0 236 MIDR 06.35.40 M3 <Euro 1>				
10.92-10.98	ZE	0 451 40	P 3077	O
11.93-10.98		1 457 43	S 3731	L
10.92-10.98	PRF,ZE	1 457 43	N 4165²	K

CLM 340

12,0 247 MIDR 06.35.40 G				
02.88-10.91	ZE	0 451 10	P 5188	O
	STZ	1 457 43	S 3731	L
	PRF,ZE	1 457 43	N 4165²	K

CLM 385

12,0 283 MIDR 06.35.40 N3 <Euro 1>				
10.92-10.98	ZE	0 451 40	P 3077	O
11.93-10.98		1 457 43	S 3731	L
10.92-10.98	PRF,ZE	1 457 43	N 4165²	K

CLR

CLR 220

9,0 162 MIDS 06.20.30 N				
05.86-05.91	ZE	0 451 10	P 5188	O
		1 457 43	S 3726	L
		1 457 43	N 4165²	K
	WW,XXX	1 457 43	N 4409²	K
09.87-05.91		1 457 42	P 9820³	P

CLR 230

6,2 166 MIDR 06.02.26 D				
10.90-10.98		0 451 40	P 3077	O
	STZ	1 457 43	S 3726	L
	STZ	1 457 43	S 3731	L
		1 457 43	N 4165²	K
		1 457 42	P 9820³	P

FR

FR 1

9,8 202 MIDR 06.20.45 A2				
06.91-12.96	ZE	0 451 10	P 5188	O
	BO	1 457 43	N 4165²	K

9,8 222 MIDR 06.20.45 D				
04.87-12.93		0 451 10	P 5188	O
	TW	1 457 43	S 3775	L
	BO	1 457 43	N 4165²	K
	TW	1 457 42	P 9820³	P

9,8 222 MIDR 06.20.45 D/3 <Euro 1>				
12.92-12.96		0 451 10	P 5188	O
	TW	1 457 43	S 3731	L
	BO	1 457 43	N 4165²	K
		1 457 42	P 9820³	P

9,8 250 MIDR 06.20.45 M				
09.85-12.93	ZE	0 451 10	P 5188	O
	TW	1 457 43	S 3775	L
	BO	1 457 43	N 4165²	K
	TW	1 457 42	P 9820³	P



9,8 250 MIDR 06.20.45 M3 <Euro 1>				
12.92-12.96		0 451 40	P 3077	O
	TW	1 457 43	S 3731	L
	BO	1 457 43	N 4165²	K
		1 457 42	P 9820³	P

11,0 250 Mack-EE6-335				
01.84-11.92	TW	1 457 43	S 3775	L

G

G 200

6,2 137 MIDR 06.02.26 Q				
06.91-04.93		0 451 40	P 3077	O

6,2 144 MIDR 06.02.26 H				
05.90-06.93		0 451 40	P 3077	O
11.90-06.93	LUB	1 457 43	S 3726	L
	LUD	1 457 43	S 3731	L
05.90-06.93	BO	1 457 43	N 4165²	K

G 210

6,2 151 MIDR 06.02.26 W <Euro 1>				
01.90-10.96		0 451 40	P 3077	O
11.90-10.96	LUB	1 457 43	S 3726	L
	LUD	1 457 43	S 3731	L
01.90-10.96	BO	1 457 43	N 4165²	K

G 220

10,0 161/168 MIDR 06.20.45 J/3 <Euro 1>; MIDS 06.20.45 J				
03.91-10.96	ZE	0 451 10	P 5188	O
	LUB	1 457 43	S 3726	L
	LUD	1 457 43	S 3731	L
	BO	1 457 43	N 4165²	K

G 230

6,2 166 MIDR 06.02.26 D; MIDR 06.02.26 X <Euro 1>				
01.90-10.96		0 451 40	P 3077	O
11.90-10.96	LUB	1 457 43	S 3726	L
	LUD	1 457 43	S 3731	L
01.90-10.96	BO	1 457 43	N 4165²	K

8,8 169-177 MIDS 06.20.30 P				
03.84-06.93	ZE	0 451 10	P 5188	O
	BO	1 457 43	N 4165²	K

G 235

9,8 168 MIDR 06.20.45 J/3 <Euro 1>				
05.95-10.96	ZE	0 451 40	P 3077	O
		1 457 43	S 3726	L
	STZ	1 457 43	S 3731	L
	BO	1 457 43	N 4165²	K

G 260

9,8 188 MIDR 06.20.45 C/4 <Euro 2>				
02.96-06.97		0 451 40	P 3077	O
	BO	1 457 43	N 4165²	K



G 270

10,0 195 MIDR 06.20.45 B/3 <Euro 1>			
11.92-10.96		0 451 10 P 5188	O
01.95-10.96	ZE	0 451 40 P 3077	O
11.92-10.96	ASO	1 457 43 S 3726	L
	LUD	1 457 43 S 3731	L
01.95-10.96		1 457 43 S 3726	L
11.92-10.96	BO	1 457 43 N 4165 ²	K

G 280

9,8 202 MIDS 06.20.45 B			
01.90-06.93		0 451 10 P 5188	O
	LSP	1 457 43 S 3726	L
	BO	1 457 43 N 4165 ²	K

9,8 | 206 | MIDR 06.20.45 D

06.85-06.93		0 451 10 P 5067	O
	TW	1 457 43 S 3726	L
		1 457 43 S 3731	L
	WW	1 457 43 N 4165 ²	K
	WW,XXX	1 457 43 N 4409 ²	K

G 300

9,8 | 210-222 | MIDR 06.20.45 D

01.90-03.93		0 451 40 P 3077	O
		1 457 43 S 3726	L
Komp.Nr. FO 2420	01.90-03.93	LUD	1 457 43 S 3731
	01.90-03.93	BO	1 457 43 N 4165 ²

9,8 | 219 | MIDR 06.20.45 D/41 <Euro 2>

02.96-06.97		0 451 40 P 3077	O
	STZ	1 457 43 S 3731	L
	BO	1 457 43 N 4165 ²	K

9,8 | 222 | MIDR 06.20.45 D/3 <Euro 1>

09.92-10.96		0 451 40 P 3077	O
		1 457 43 S 3726	L
Komp.Nr. FO 2420	09.92-10.96	LUD	1 457 43 S 3731
	09.92-10.96	BO	1 457 43 N 4165 ²

G 330

9,8 | 240/249 | MIDR 06.20.45 E/2; MIDR 06.20.45 H

02.90-03.93		0 451 40 P 3077	O
		1 457 43 S 3726	L
	STZ	1 457 43 S 3731	L
	BO	1 457 43 N 4165 ²	K

G 340

9,8 | 236-249 | MIDR 06.20.45 E

01.90-03.93		0 451 40 P 3077	O
	TW	1 457 43 S 3726	L
	BO	1 457 43 N 4165 ²	K

9,8 | 249 | MIDR 06.20.45 E

09.91-03.93		0 451 40 P 3077	O
		1 457 43 S 3726	L
	STZ	1 457 43 S 3731	L
	BO	1 457 43 N 4165 ²	K



9,8 | 249 | MIDR 06.20.45 E/3 <Euro 1>

02.92-10.96		0 451 40 P 3077	O
		1 457 43 S 3731	L
	STZ	1 457 43 S 3726	L
	BO	1 457 43 N 4165 ²	K

9,8 | 249 | MIDR 06.20.45 E/41 <Euro 2>

02.96-06.97		0 451 40 P 3077	O
	BO	1 457 43 N 4165 ²	K

GBH

GBH 280

12,0 | 206-208 | MIDS 06.35.40 D

06.80-06.91		0 451 10 P 5188	O
	BO	1 457 43 N 4165 ²	K
	PRF	1 457 43 N 4252 ²	K
	SGP	1 457 43 N 4251 ²	K

GLM

GLM 280

12,0 | 206 | MIDS 06.35.40 D

06.80-06.91		0 451 10 P 5188	O
	BO	1 457 43 N 4165 ²	K
	PRF	1 457 43 N 4252 ²	K
	SGP	1 457 43 N 4251 ²	K

GLR

GLR 190

8,8 | 141 | MID 06.20.30 G

09.78-06.91		1 457 43 S 3611 ⁴	L
-------------	--	------------------------------	---

GLR 230

8,8 | 159 | MIDS 06.20.30 B

06.80-06.91		0 451 10 P 5067	O
		1 457 43 S 3611 ⁴	L
		1 457 43 N 4251 ²	K
	BO	1 457 43 N 4252 ²	K

Iliade

Iliade FRH/ GTX, GTXE, RTX, TEX

11,1 | 280 | MIDR 06.23.56 A/41 <Euro 2>

10.96-09.01	ZE	0 451 40 P 3077	O
	LSP	F 026 40 S 0086	L
F	10.96-09.01	F 026 40 S 0083	L
	10.96-09.01	BO	1 457 43 N 4165 ²
			1 457 42 P 9820 ³

Iliade GT, GTC, GTE/ GTX, GTXE, RTX, TEX/ RT, RTC, TE, TEC

9,9 | 222 | MIDR 06.20.45 R41 <Euro 2>

10.96-09.01	ZE	0 451 40 P 3077	O
	LSP	F 026 40 S 0086	L
F	10.96-09.01	F 026 40 S 0083	L
	10.96-09.01	BO	1 457 43 N 4165 ²
			1 457 42 P 9820 ³





◀ Iliade GT, GTC, GTE/ GTX, GTXE, RTX, TEX/ RT, RTC, TE, TEC

9,9 | 250 | MIDR 06.20.45 M41 <Euro 2>

10.96-09.01	ZE	0 451 40	P 3077	O
	LSP	F 026 40	S 0086	L
F 10.96-09.01		F 026 40	S 0083	L
10.96-09.01	BO	1 457 43	N 4165²	K
		1 457 42	P 9820³	P

JE

JE 13/ 15

5,5 | 117/134 | MIDR 06.02.12 D; MIDS 06.02.12 B

06.90-06.91		0 451 40	P 3077	O
01.83-06.91	PRF	1 457 43	N 4165²	K

Kerax

Kerax 260

9,8 | 188 | MIDR 06.20.45 C/4 <Euro 2>

06.97-12.02	OMZ	F 026 40	P 7059	O
	ZE	0 451 40	P 3077	O
		F 026 40	S 0086	L
		1 457 43	N 4165²	K
	WW,XXX	1 457 43	N 4409²	K
		F 026 40	Z 4006	H
		1 457 42	P 9820³	P

Kerax 270

11,1 | 195 | dCI 11 I <Euro 3>

01.01-04.06	OMZ	F 026 40	P 7060	O
	ZE	0 451 40	P 3077	O
		F 026 40	S 0086	L
	ZE	1 457 43	N 4421²	K

Kerax 300

9,8 | 219 | MIDR 06.20.45 D/41 <Euro 2>

06.97-12.02	OMZ	F 026 40	P 7059	O
	ZE	0 451 40	P 3077	O
		F 026 40	S 0086	L
	ZE	1 457 43	N 4165²	K
		F 026 40	Z 4006	H
		1 457 42	P 9820³	P

Kerax 320

11,1 | 230 | dCI 11 G <Euro 3>

01.01-04.06	OMZ	F 026 40	P 7060	O
	ZE	0 451 40	P 3077	O
		F 026 40	S 0086	L
	ZE	1 457 43	N 4421²	K

Kerax 340

9,8 | 249 | MIDR 06.20.45 E/3 <Euro 1>

06.97-12.99	OMZ	F 026 40	P 7059	O
	ZE	0 451 40	P 3077	O
		F 026 40	S 0086	L
	ZE	1 457 43	N 4165²	K
		F 026 40	Z 4006	H
		1 457 42	P 9820³	P



Kerax 340/ 350

9,9 | 249/250 | MIDR 06.20.45 E/41 <Euro 2>; MIDR 06.23.56 A3 <Euro 2>

06.97-12.03	OMZ	F 026 40	P 7059	O
	ZE	0 451 40	P 3077	O
		F 026 40	S 0086	L
	ZE	1 457 43	N 4165²	K
		F 026 40	Z 4006	H
		1 457 42	P 9820³	P

Kerax 370

10,8 | 272 | DXi 11 370 <Euro 4>; DXi 11 370 <Euro 5>

05.06-03.09	ZE	F 026 40	P 7043	O
	ZUE	0 451 30	P 0003	O
	TW	F 026 40	Z 4001	H
		F 026 40	Z 4006	H

11,1 | 266 | dCI 11 E <Euro 3>

01.01-04.06	OMZ	F 026 40	P 7060	O
	ZE	0 451 40	P 3077	O
		F 026 40	S 0086	L
	ZE	1 457 43	N 4421²	K

Kerax 380

10,8 | 280 | DXi 11 380 <Euro 5>

04.09→	ZE	F 026 40	P 7043	O
	ZUE	0 451 30	P 0003	O
		F 026 40	N 2017²	K
	TW	F 026 40	Z 4001	H
		F 026 40	Z 4006	H

Kerax 385/ 400

11,1 | 280/288 | MIDR 06.23.56 A/41 <Euro 2>; MIDR 06.23.56 B/41 <Euro 2>

02.98-12.02	OMZ	F 026 40	P 7059	O
	ZE	0 451 40	P 3077	O
		F 026 40	S 0086	L
	ZE	1 457 43	N 4165²	K
		F 026 40	Z 4006	H
		1 457 42	P 9820³	P

Kerax 410

10,8 | 302 | DXi 11 410 <Euro 4>; DXi 11 410 <Euro 5>

05.06-03.09	ZE	F 026 40	P 7043	O
	ZUE	0 451 30	P 0003	O
	TW	F 026 40	Z 4001	H
		F 026 40	Z 4006	H

Kerax 420

11,1 | 303 | dCI 11 C <Euro 3>

01.01-04.06	OMZ	F 026 40	P 7060	O
	ZE	0 451 40	P 3077	O
		F 026 40	S 0086	L
	ZE	1 457 43	N 4421²	K

Kerax 430

10,8 | 316 | DXi 11 430 <Euro 5>

04.09→	ZE	F 026 40	P 7043	O
	ZUE	0 451 30	P 0003	O
		F 026 40	N 2017²	K
	TW	F 026 40	Z 4001	H
		F 026 40	Z 4006	H





Kerax 450

10,8 | 331 | DXi 11 450 <Euro 4>; DXi 11 450 <Euro 5>

05.06-03.09	ZE	F 026 40 P 7043	O
	ZUE	0 451 30 P 0003	O
	TW	F 026 40 Z 4001	H
		F 026 40 Z 4006	H

Kerax 460

10,8 | 339 | DXi 11 460 <Euro 5>

04.09→	ZE	F 026 40 P 7043	O
	ZUE	0 451 30 P 0003	O
		F 026 40 N 2017 ²	K
	TW	F 026 40 Z 4001	H
		F 026 40 Z 4006	H

12,8 | 339 | DXi 13 460 <Euro 4>

03.08-03.09	ZE	F 026 40 P 7043	O
	ZUE	0 451 30 P 0003	O
	TW	F 026 40 N 2017 ²	K
		F 026 40 Z 4001	H
		F 026 40 Z 4006	H

Kerax 480

12,8 | 353 | DXi 13 480 <Euro 5>

04.09→	ZE	F 026 40 P 7043	O
	ZUE	0 451 30 P 0003	O
		F 026 40 N 2017 ²	K
	TW	F 026 40 Z 4001	H
		F 026 40 Z 4006	H

Kerax 500

12,8 | 369 | DXi 13 500 <Euro 4>

03.08-03.09	ZE	F 026 40 P 7043	O
	ZUE	0 451 30 P 0003	O
	TW	F 026 40 Z 4001	H
		F 026 40 Z 4006	H

Kerax 520

12,8 | 383 | DXi 13 520 <Euro 5>

04.09→	ZE	F 026 40 P 7043	O
	ZUE	0 451 30 P 0003	O
		F 026 40 N 2017 ²	K
	TW	F 026 40 Z 4001	H
		F 026 40 Z 4006	H

Magnum

Magnum 380/ 385

12,0 | 275/283 | MIDR 06.35.40 H; MIDR 06.35.40 L/1; MIDR 06.35.40 N/3 <Euro 1>

09.90-10.96	ZE	0 451 40 P 3077	O
		1 457 43 N 4165 ²	K
		1 457 42 P 9820 ³	P

Magnum 390

12,0 | 287 | MIDR 06.24.65 A42 <Euro 2, V-Mac>

09.96-05.00	OMZ	F 026 40 P 7059	O
	ZE	0 451 40 P 3077	O
	LSP	F 026 40 S 0083	L
	ZE	1 457 43 N 4165 ²	K
		1 457 42 P 9820 ³	P

Magnum 400

12,0 | 294/295 | MACK E-TECH A <Euro 3>; MIDR 06.24.65 A46 <Euro 2>

11.99-09.04	ZE	0 451 40 P 3077	O
		F 026 40 S 0083	L
	ZE	1 457 43 N 4421 ²	K
		F 026 40 Z 4006	H
		1 457 42 P 9820 ³	P

Magnum 420

12,0 | 305 | MIDR 06.35.40 P41 <Euro 2>

04.96-01.97	FEP	F 026 40 P 7044	O
	OMZ	F 026 40 P 7059	O
	OMZ	0 451 40 P 3077	O
	ASG	F 026 40 S 0083	L
	ZE	1 457 43 N 4165 ²	K
		1 457 42 P 9820 ³	P

12,0 | 305/314 | MIDR 06.35.40 J1 <Euro 1>; MIDR 06.35.40 J3 <Euro 1>

02.92-10.96	ZE	0 451 40 P 3077	O
	ASG	F 026 40 S 0083	L
	ZE	1 457 43 N 4165 ²	K
		1 457 42 P 9820 ³	P

Magnum 430

12,0 | 316 | MIDR 06.24.65 B42 <Euro 2, V-Mac>

09.96-05.00	OMZ	F 026 40 P 7059	O
	ZE	0 451 40 P 3077	O
	LSP	F 026 40 S 0083	L
	ZE	1 457 43 N 4165 ²	K
		1 457 42 P 9820 ³	P

Magnum 440

12,0 | 324 | MACK E-TECH B <Euro 3>; MIDR 06.24.65 B46 <Euro 2>

11.99-09.04	ZE	0 451 40 P 3077	O
		F 026 40 S 0083	L
	ZE	1 457 43 N 4421 ²	K
		F 026 40 Z 4006	H
		1 457 42 P 9820 ³	P

12,1 | 324 | DXi 12 440 <Euro 3>

10.04-04.06	ZE	F 026 40 P 7043	O
	ZUE	0 451 30 P 0003	O
		F 026 40 S 0145	L
	TW	F 026 40 N 2017 ²	K
		F 026 40 Z 4001	H
		F 026 40 Z 4003	H
		F 026 40 Z 4004	H





◀ Magnum 440

12,8 | 323 | DXi 13 440 <Euro 5>

04.09→	ZE	F 026 40 P 7043	O
	ZUE	0 451 30 P 0003	O
		F 026 40 S0145	L
		F 026 40 N 2017 ²	K
		F 026 40 Z 4001	H

Magnum 460

12,8 | 339 | DXi 13 460 <2001/72B1, Euro 4>; DXi 13 460 <2001/72B2, Euro 5>

05.06-03.09	ZE	F 026 40 P 7043	O
	ZUE	0 451 30 P 0003	O
		F 026 40 S0145	L
	TW	F 026 40 N 2017 ²	K
		F 026 40 Z 4001	H
		F 026 40 Z 4006	H

Magnum 470

12,0 | 346 | MIDR 06.24.65 C42 <Euro 2, V-Mac>

11.96-05.00	OMZ	F 026 40 P 7059	O
	ZE	0 451 40 P 3077	O
	LSP	F 026 40 S 0083	L
	ZE	1 457 43 N 4165 ²	K
		1 457 42 P 9820 ³	P

Magnum 480

12,0 | 347/353 | MACK E-TECH C <Euro 3>; MIDR 06.24.65 C46 <Euro 2>

11.99-01.05	ZE	0 451 40 P 3077	O
		F 026 40 S 0083	L
	ZE	1 457 43 N 4421 ²	K
		F 026 40 Z 4006	H
		1 457 42 P 9820 ³	P

12,1 | 353 | DXi 12 480 <Euro 3>

10.04-04.06	ZE	F 026 40 P 7043	O
	ZUE	0 451 30 P 0003	O
		F 026 40 S0145	L
	TW	F 026 40 N 2017 ²	K
		F 026 40 Z 4001	H
		F 026 40 Z 4003	H
		F 026 40 Z 4004	H

12,8 | 353 | DXi 13 480 <Euro 5>

04.09→	ZE	F 026 40 P 7043	O
	ZUE	0 451 30 P 0003	O
		F 026 40 S0145	L
		F 026 40 N 2017 ²	K
		F 026 40 Z 4001	H

Magnum 500

12,8 | 368 | DXi 13 500 <2001/72B1, Euro 4>; DXi 13 500 <2001/72B2, Euro 5>

05.06-03.09	ZE	F 026 40 P 7043	O
	ZUE	0 451 30 P 0003	O
		F 026 40 S0145	L
	TW	F 026 40 N 2017 ²	K
		F 026 40 Z 4001	H
		F 026 40 Z 4006	H

16,4 | 370 | Mack-EE9-502 4VH

09.90-10.92	DE	0 451 40 P 3077	O
	ASG	F 026 40 S 0083	L
	ZE	1 457 43 N 4165 ²	K
		1 457 42 P 9820 ³	P



Magnum 520

12,8 | 382 | DXi 13 520 <Euro 5>

04.09→	ZE	F 026 40 P 7043	O
	ZUE	0 451 30 P 0003	O
		F 026 40 S0145	L
		F 026 40 N 2017 ²	K
		F 026 40 Z 4001	H

16,5 | 390 | Mack-EE9-530 <Euro 1>

10.92-05.96	DE	0 451 40 P 3077	O
	ASG	F 026 40 S 0083	L
	ZE	1 457 43 N 4165 ²	K
		1 457 42 P 9820 ³	P

Magnum 560

16,5 | 412 | V-Mack-EE9-560 <Euro 2>

04.96-05.00	ZE	0 451 40 P 3077	O
	LSP	F 026 40 S 0083	L
	ZE	1 457 43 N 4165 ²	K
		1 457 42 P 9820 ³	P

Mascott

Mascott 90

2,8 | 63 | 8140.63.2585; 8140.63.2586

01.99-06.04		0 451 20 P 3201	O
		1 457 42 P 9820 ³	P

Mascott 110

2,8 | 78 | 8140.43B.3586/3588; 8140.43C.2586; 8140.43C.2586/2588 <Euro2>; 8140.43C.2588

01.99-06.04		0 451 20 P 3201	O
		1 457 42 P 9820 ³	P

Mascott 120

3,0 | 85 | DXi 3-120 ZD3 600

05.04-05.07		1 457 42 P 9271	O
		1 457 42 P 9820 ³	P

Mascott 130

2,8 | 92 | 8140.43S.2585; 8140.43S.3585

01.99-06.04		0 451 20 P 3201	O
		1 457 42 P 9820 ³	P

3,0 | 96 | DXi 3-130

06.07→		1 457 42 P 9271	O
--------	--	-----------------	---

Mascott 140/ 150

2,8 | 103/107 | 8140.43K.2585; 8140.43N.3585

01.01-06.04		0 451 20 P 3201	O
		1 457 42 P 9820 ³	P

Mascott 150

3,0 | 110 | DXi 3-150

06.07→		1 457 42 P 9271	O
--------	--	-----------------	---

Mascott 160

3,0 | 115 | DXi 3-160 ZD3 604

05.04-05.07		1 457 42 P 9271	O
		1 457 42 P 9820 ³	P





Maxity

Maxity 110/ 130

2,5 | 81/96 | DXi 2,5 110 <YD25DDT, Euro 4>; DXi 2,5 130 <YD25DDTI, Euro 4>
03.07→ F 026 40 N 2059¹ K

Maxity 150

3,0 | 110 | DXi 3 150 <ZD30DDTI, Euro 4>
03.07→ 1 457 42 P 9271 O
TW F 026 40 N 2059¹ K

Midliner

Midliner CE 160

5,5 | 117 | MIDS 06.02.12 B
06.90-12.01 0 451 40 P 3077 O
10.86-12.01 1 457 43 N 4165² K
TW 1 457 42 P 9820³ P

Midliner M 140

5,5 | 97-103 | MIDS 06.02.12 C
06.89-03.93 0 451 40 P 3077 O
1 457 42 S 9950 L
1 457 43 N 4165² K
1 457 42 P 9820³ P

Midliner M 150

6,2 | 110 | MIDR 06.02.26 U <Euro 1>; MIDR 06.02.26 U/4 <Euro 2>
11.92-12.00 0 451 40 P 3077 O
ASO 1 457 43 S 3726 L
ASU 1 457 42 S 9966 L
1 457 43 N 4165² K
1 457 42 P 9820³ P

Midliner M 160

5,5 | 117 | MIDS 06.02.12 B
06.89-03.93 0 451 40 P 3077 O
1 457 42 S 9950 L
1 457 43 N 4165² K
1 457 42 P 9820³ P

5,5 | 124 | MIDR 06.02.26 P

06.91-03.93 0 451 40 P 3077 O
ASO 1 457 43 S 3726 L
ASU 1 457 42 S 9966 L
1 457 43 N 4165² K
1 457 42 P 9820³ P

Midliner M 180

5,5 | 134 | MIDR 06.02.12 D
06.91-03.93 0 451 40 P 3077 O
ASO 1 457 43 S 3726 L
ASU 1 457 42 S 9966 L
1 457 43 N 4165² K
1 457 42 P 9820³ P



6,2 | 129/132 | MIDR 06.02.26 V <Euro 1>; MIDR 06.02.26 V4(1) <Euro 2>
11.92-01.00 0 451 40 P 3077 O
ASO 1 457 43 S 3726 L
ASU 1 457 42 S 9966 L
1 457 43 N 4165² K
1 457 42 P 9820³ P

Midliner M 200

6,2 | 137/144 | MIDR 06.02.26 H; MIDR 06.02.26 Q
06.89-06.93 0 451 40 P 3077 O
1 457 42 S 9950 L
1 457 43 N 4165² K

Midliner M 210

6,2 | 151/154 | MIDR 06.02.26 W <Euro 1>; MIDR 06.02.26 W4(1) <Euro 2>
05.92-12.00 0 451 40 P 3077 O
ASO 1 457 43 S 3726 L
ASU 1 457 42 S 9966 L
1 457 43 N 4165² K

Midliner M 220

6,2 | 154 | MIDR 06.02.26 W4 <Euro 2>
12.98-12.00 0 451 40 P 3077 O
ASO 1 457 43 S 3726 L
ASU 1 457 42 S 9966 L
1 457 43 N 4165² K
1 457 42 P 9820³ P

Midliner M 230

6,2 | 166 | MIDR 06.02.26 D, S
06.89-03.93 0 451 40 P 3077 O
1 457 42 S 9950 L
1 457 43 N 4165² K

Midliner M 230/ M 250

6,2 | 166/184 | MIDR 06.02.26 X <Euro 1>; MIDR 06.02.26 Y4(1) <Euro 2>
05.92-01.00 0 451 40 P 3077 O
ASO 1 457 43 S 3726 L
ASU 1 457 42 S 9966 L
1 457 43 N 4165² K

Midliner ME 160

5,5 | 117 | MIDS 06.02.12 B
01.90-12.01 0 451 40 P 3077 O
1 457 43 N 4165² K
1 457 42 P 9820³ P

Midliner ME 180

5,5 | 134 | MIDR 06.02.12 D
01.90-12.01 0 451 40 P 3077 O
1 457 43 N 4165² K
1 457 42 P 9820³ P

Midliner ME 210

6,2 | 154 | MIDR 06.02.26 W4 <Euro 2>
03.99-12.01 0 451 40 P 3077 O
1 457 43 N 4165² K
1 457 42 P 9820³ P





Midliner SE 160

5,5 117 MIDS 06.02.12 B	06.90-12.01	0 451 40 P 3077	O
	01.86-12.01 ZE	1 457 43 N 4165 ²	K

Midliner SE 180

5,5 134 MIDR 06.02.12 D	06.91-11.94	0 451 40 P 3077	O
	ZE	1 457 43 N 4165 ²	K

Midlum

Midlum 135

4,0 100 MIDR 04.02.26 A/4 <Euro 2>	02.00-06.01	0 451 30 P 0008	O
	ASO	F 026 40 S 0083	L
	LHT	1 457 42 S 9966	L
		1 457 43 N 4165 ²	K
		1 457 42 P 9820 ³	P

Midlum 150

4,0 110 MIDR 04.02.26 B/4 <Euro 2>	02.00-06.01	0 451 30 P 0008	O
	ASO	F 026 40 S 0083	L
	LHT	1 457 42 S 9966	L
		1 457 43 N 4165 ²	K
		1 457 42 P 9820 ³	P

4,0 | 112 | dCI 4B <Euro 3>

07.01-04.06	0 451 30 P 0008	O
ASO	F 026 40 S 0083	L
ZE	1 457 43 N 4421 ²	K
	1 457 42 P 9820 ³	P

Midlum 180

4,0 128 dCI 4C <Euro 3>	07.01-04.06	0 451 30 P 0008	O
	ASO	F 026 40 S 0083	L
	ZE	1 457 43 N 4421 ²	K
		1 457 42 P 9820 ³	P

Midlum 180/ 210

6,2 132/154 MIDR 06.02.26 V/4 <Euro 2>; MIDR 06.02.26 W/4 <Euro 2>	02.00-06.01	0 451 40 P 3077	O
	ASO	F 026 40 S 0083	L
	LHT	1 457 42 S 9966	L
		1 457 43 N 4165 ²	K
		1 457 42 P 9820 ³	P

Midlum 220

6,2 158/162 dCI 6W <Euro 3>	07.01-04.06	0 451 40 P 3077	O
	ASO	F 026 40 S 0083	L
	ZE	1 457 43 N 4421 ²	K
		1 457 42 P 9820 ³	P



Midlum 250

6,2 184 MIDR 06.02.26 Y/41 <Euro 2>	02.00-06.01	0 451 40 P 3077	O
	ASO	F 026 40 S 0083	L
	LHT	1 457 42 S 9966	L
		1 457 43 N 4165 ²	K
		1 457 42 P 9820 ³	P

Midlum 270

6,2 195 dCI 6A <Euro 3>	07.01-04.06	0 451 40 P 3077	O
	ASO	F 026 40 S 0083	L
	ZE	1 457 43 N 4421 ²	K
		1 457 42 P 9820 ³	P

Midlum II

Midlum II 160/ 180/ 190/ 220

4,8 118/132/140/158/162 DXi 5 160 <Euro 3/4>; DXi 5 180 <Euro 5>; DXi 5 190 <Euro 3/4>; DXi 5 220 <Euro 3/4>; DXi 5 220 <Euro 5>	05.06→	TW	F 026 40 S0145	L
--	--------	----	----------------	---

Midlum II 240/ 270/ 280/ 300

7,2 177/199/206/221 DXi 7 240 <Euro 3/4>; DXi 7 270 <Euro 5>; DXi 7 280 <Euro 3/4>; DXi 7 280 <Euro 5>; DXi 7 300 <Euro 5>	05.06→	TW	F 026 40 S0145	L
--	--------	----	----------------	---

PR

PR 180

9,8 176 MIPS 06.20.45 B	07.89-06.93	ZE	0 451 10 P 5188	O
Mot.Nr. MIPS 062045 B→	07.89-06.93		1 457 42 S 9966	L
	07.89-06.93		1 457 43 N 4165 ²	K
			1 457 42 P 9820 ³	P

9,8 | 191 | MIPR 06.20.45 B/3

07.93→	ZE	0 451 10 P 5188	O
		1 457 43 S 3731	L
		1 457 43 N 4165 ²	K
		1 457 42 P 9820 ³	P

9,8 | 210 | MIPR 06.20.45 A

07.89→	ZE	0 451 10 P 5188	O	
07.93→		1 457 43 S 3731	L	
Mot.Nr. MIPS 062045 B→	07.89-06.93		1 457 42 S 9966	L
	07.89→		1 457 43 N 4165 ²	K
			1 457 42 P 9820 ³	P

Premium

Premium 210

6,2 154 MIDR 06.02.26 W4 <Euro 2>	04.96-09.01	0 451 40 P 3077	O
	ASG	F 026 40 S 0083	L
	LSP	F 026 40 S 0086	L
		1 457 43 N 4165 ²	K
	WW,XXX	1 457 43 N 4409 ²	K
		F 026 40 Z 4006	H
		1 457 42 P 9820 ³	P





Premium 220

6,2 158 dCl 6 W <Euro 3>			
11.00-04.06		0 451 40 P 3077	O
	ASG	F 026 40 S 0083	L
	LSP	F 026 40 S 0086	L
	ZE	1 457 43 N 4421 ²	K
		F 026 40 Z 4006	H
		1 457 42 P 9820 ³	P

Premium 250

6,2 184 MIDR 06.02.26 Y41 <Euro 2>			
04.96-09.01		0 451 40 P 3077	O
	ASG	F 026 40 S 0083	L
	LSP	F 026 40 S 0086	L
		1 457 43 N 4165 ²	K
	WW,XXX	1 457 43 N 4409 ²	K
		F 026 40 Z 4006	H
		1 457 42 P 9820 ³	P

Premium 260

9,8 188 MIDR 06.20.45 C/4 <Euro 2>			
04.96-12.01	OMZ	F 026 40 P 7059	O
	ZE	0 451 40 P 3077	O
04.96-09.01	ASG	F 026 40 S 0083	L
	LSP	F 026 40 S 0086	L
07.97-12.01		F 026 40 S 0083	L
04.96-12.01		1 457 43 N 4165 ²	K
	WW,XXX	1 457 43 N 4409 ²	K
04.96-09.01		F 026 40 Z 4006	H
04.96-12.01		1 457 42 P 9820 ³	P

Premium 270

6,2 195 dCl 6 A <Euro 3>			
11.00-04.06		0 451 40 P 3077	O
01.04-04.06	ZE	0 451 40 P 3077	O
11.00-04.06	ASG	F 026 40 S 0083	L
	LSP	F 026 40 S 0086	L
	ZE	1 457 43 N 4421 ²	K
		F 026 40 Z 4006	H
		1 457 42 P 9820 ³	P

Premium 300

9,8 219 MIDR 06.20.45 D/41 <Euro 2>			
02.96-09.01	OMZ	F 026 40 P 7059	O
	ZE	0 451 40 P 3077	O
	ASG	F 026 40 S 0083	L
	LSP	F 026 40 S 0086	L
	ZE	1 457 43 N 4165 ²	K
		F 026 40 Z 4006	H
		1 457 42 P 9820 ³	P



Premium 320

11,1 229 dCl 11 G <Euro 3>			
01.00-04.06	ZE	0 451 40 P 3077	O
	ASG	F 026 40 S 0083	L
	LSP	F 026 40 S 0086	L
	ZE	1 457 43 N 4421 ²	K
		F 026 40 Z 4006	H
		1 457 42 P 9820 ³	P

Premium 340

9,8 249 MIDR 06.20.45 E/41 <Euro 2>			
04.96-03.01	OMZ	F 026 40 P 7059	O
	ZE	0 451 40 P 3077	O
	ASG	F 026 40 S 0083	L
	LSP	F 026 40 S 0086	L
	ZE	1 457 43 N 4165 ²	K
		F 026 40 Z 4006	H
		1 457 42 P 9820 ³	P

Premium 370

11,1 266 dCl 11 E <Euro 3>			
01.00-04.06	ZE	0 451 40 P 3077	O
01.04-04.06	ZUE	0 451 30 P 0003	O
01.00-04.06	ASG	F 026 40 S 0083	L
	LSP	F 026 40 S 0086	L
	ZE	1 457 43 N 4421 ²	K
		F 026 40 Z 4006	H
		1 457 42 P 9820 ³	P

Premium 385/ 400

11,1 280/288 MIDR 06.23.56 A/41 <Euro 2>; MIDR 06.23.56 B/41 <Euro 2>			
02.96-03.01	OMZ	F 026 40 P 7059	O
	ZE	0 451 40 P 3077	O
	ASG	F 026 40 S 0083	L
	LSP	F 026 40 S 0086	L
	ZE	1 457 43 N 4165 ²	K
		F 026 40 Z 4006	H
		1 457 42 P 9820 ³	P

Premium 420

11,1 303 dCl 06.23.56 B43 <Euro 3>			
01.00-09.01	OMZ	F 026 40 P 7060	O
	ZE	0 451 40 P 3077	O
	ASG	F 026 40 S 0083	L
	LSP	F 026 40 S 0086	L
	ZE	1 457 43 N 4421 ²	K
		F 026 40 Z 4006	H
		1 457 42 P 9820 ³	P

11,1 303 dCl 11 C <Euro 3>			
11.00-04.06	ZE	0 451 40 P 3077	O
	ASG	F 026 40 S 0083	L
	LSP	F 026 40 S 0086	L
	ZE	1 457 43 N 4421 ²	K
		F 026 40 Z 4006	H
		1 457 42 P 9820 ³	P





Premium II

Premium II 240

7,2 | 177 | DXi 7 240 <122CX, Euro 4>

06.06-03.09	ANV	F 026 40 S0145	L
	TW	F 026 40 Z 4001	H
		F 026 40 Z 4006	H

Premium II 270

7,2 | 199 | DXi 7 270 <Euro 5>

04.09→	TW	F 026 40 S0145	L
		F 026 40 Z 4001	H
		F 026 40 Z 4006	H

Premium II 280

7,2 | 206 | DXi 7 280 <Euro 5>; DXi 7 280 <122CW, Euro 4>

06.06-03.09	ANV	F 026 40 S0145	L
	TW	F 026 40 Z 4001	H
		F 026 40 Z 4006	H

Premium II 310

7,2 | 228 | DXi 7 310 <Euro 5>

04.09→	TW	F 026 40 S0145	L
		F 026 40 Z 4001	H
		F 026 40 Z 4006	H

Premium II 320

7,2 | 235 | DXi 7 320 <Euro 5>; DXi 7 320 <122CY, Euro 4>

05.06-03.09	ANV	F 026 40 S0145	L
	TW	F 026 40 Z 4001	H
		F 026 40 Z 4006	H

Premium II 330

10,8 | 243 | DXi 11 330 <Euro 3>

09.05-04.06	ZE	F 026 40 P 7043	O
	ZUE	0 451 30 P 0003	O
	ANV	F 026 40 S0145	L
	TW	F 026 40 N 2017 ²	K
		F 026 40 Z 4001	H
		F 026 40 Z 4003	H
		F 026 40 Z 4004	H
		F 026 40 Z 4006	H

Premium II 340

7,2 | 250 | DXi 7 340 <Euro 5>

04.09→	TW	F 026 40 S0145	L
		F 026 40 Z 4001	H
		F 026 40 Z 4006	H

Premium II 370

10,8 | 272 | DXi 11 370 <Euro 5>; DXi 11 370 <2001/72B1 Euro 4>; DXi 11 370 <2001/72B2 Euro 5>

05.06-03.09	ZE	F 026 40 P 7043	O
	ZUE	0 451 30 P 0003	O
	ANV	F 026 40 S0145	L
	TW	F 026 40 N 2017 ²	K
		F 026 40 Z 4001	H
		F 026 40 Z 4006	H



Premium II 380

10,8 | 279 | DXi 11 380 <Euro 3>

09.05-04.06	ZE	F 026 40 P 7043	O
	ZUE	0 451 30 P 0003	O
	ANV	F 026 40 S0145	L
	TW	F 026 40 N 2017 ²	K
		F 026 40 Z 4001	H
		F 026 40 Z 4003	H
		F 026 40 Z 4004	H
		F 026 40 Z 4006	H

10,8 | 280 | DXi 11 380 <Euro 5>; DXi 11 380 <Euro 5/EEV>

04.09→	ZE	F 026 40 P 7043	O
	ZUE	0 451 30 P 0003	O
	TW	F 026 40 S0145	L
		F 026 40 N 2017 ²	K
	TW	F 026 40 Z 4001	H
		F 026 40 Z 4006	H

Premium II 410

10,8 | 302 | DXi 11 410 <2001/72B1 Euro 4>; DXi 11 410 <2001/72B2 Euro 5>

05.06-03.09	ZE	F 026 40 P 7043	O
	ZUE	0 451 30 P 0003	O
	ANV	F 026 40 S0145	L
	TW	F 026 40 N 2017 ²	K
		F 026 40 Z 4001	H
		F 026 40 Z 4006	H

Premium II 430

10,8 | 316 | DXi 11 430 <Euro 5>; DXi 11 430 <Euro 5/EEV>

04.09→	ZE	F 026 40 P 7043	O
	ZUE	0 451 30 P 0003	O
	TW	F 026 40 S0145	L
		F 026 40 N 2017 ²	K
	TW	F 026 40 Z 4001	H
		F 026 40 Z 4006	H

Premium II 440

10,8 | 321 | DXi 11 440 <Euro 3>

09.05-04.06	ZE	F 026 40 P 7043	O
	ZUE	0 451 30 P 0003	O
	ANV	F 026 40 S0145	L
	TW	F 026 40 N 2017 ²	K
		F 026 40 Z 4001	H
		F 026 40 Z 4003	H
		F 026 40 Z 4004	H
		F 026 40 Z 4006	H

Premium II 450

10,8 | 331 | DXi 11 450 <Euro 5>; DXi 11 450 <2001/72B1 Euro 4>; DXi 11 450 <2001/72B2 Euro 5>

05.06-03.09	ZE	F 026 40 P 7043	O
	ZUE	0 451 30 P 0003	O
	ANV	F 026 40 S0145	L
	TW	F 026 40 N 2017 ²	K
		F 026 40 Z 4001	H
		F 026 40 Z 4006	H





Premium II 460

10,8 339 DXi 11 460 <Euro 5>; DXi 11 460 <Euro 5/EEV>				
04.09→	ZE	F 026 40	P 7043	O
	ZUE	0 451 30	P 0003	O
	TW	F 026 40	S0145	L
		F 026 40	N 2017²	K
	TW	F 026 40	Z 4001	H
		F 026 40	Z 4006	H

R

R TS/ 420

12,0 305 MIDR 06.35.40 J3 <Euro 1>				
10.92-10.96		0 451 40	P 3077	O
	BO	1 457 43	N 4165²	K

R 312

9,8 129/137/144/152/186 MIDR 06.20.45; MIDR 06.20.45 F3 <Euro 1>; MIDS 06.20.45; MIDS 06.20.45 D; MIDS 06.20.45 F				
11.86-12.03	TW	0 451 10	P 5188	O
11.86-03.93		1 457 43	S 3731	L
11.86-12.03	BO	1 457 43	N 4165²	K

R 330

9,8 236-249 MIDR 06.20.45 E				
05.88-05.91		0 451 40	P 3077	O
	FG	0 451 10	P 3274	O
	PRF	1 457 43	N 4165²	K

R 332

9,8 185 MIHR 06.20.45 A41 <EURO 2>				
07.96-12.03		0 451 40	P 3077	O
	TW	1 457 43	S 3731	L

9,8 | 185 | MIHS 06.20.45 A

06.89-05.93	ZE	0 451 10	P 5188	O
06.89-12.03	TW	1 457 43	S 3731	L
	WW	1 457 43	N 4165²	K
	WW,XXX	1 457 43	N 4409²	K

9,8 | 186-191 | MIHR 06.20.45 A3 <Euro 1>

06.93-06.96	ZE	0 451 40	P 3077	O
09.92-12.03	TW	1 457 43	S 3731	L
	WW	1 457 43	N 4165²	K
	WW,XXX	1 457 43	N 4409²	K

R 340

9,8 236-249 MIDR 06.20.45 E				
01.90-12.92		0 451 40	P 3077	O
	BO	1 457 43	N 4165²	K

9,8 | 249 | MIDR 06.20.45 E/2; MIDR 06.20.45 E/3 <Euro 1>

02.90-01.96		0 451 40	P 3077	O
	BO	1 457 43	N 4165²	K

R 350

12,0 259 MIDR 06.35.40 G				
01.90-01.92		0 451 40	P 3077	O
	BO	1 457 43	N 4165²	K



R 357

12,0 263-264 MIDR 06.35.40 H				
10.89-10.96	ZE	0 451 40	P 3077	O
01.86-10.96	BO	1 457 43	N 4165²	K

R 380

12,0 276 MIDR 06.35.40 H				
01.90-01.92		0 451 40	P 3077	O
	BO	1 457 43	N 4165²	K

R 385

12,0 283 MIDR 06.35.40 L1				
12.91-03.93		0 451 40	P 3077	O
	BO	1 457 43	N 4165²	K

12,0 | 283 | MIDR 06.35.40 N3 <Euro 1>

09.93-10.96		0 451 40	P 3077	O
	BO	1 457 43	N 4165²	K

R 420

12,0 314 MIDR 06.35.40 J1				
09.91-03.93		0 451 40	P 3077	O
	BO	1 457 43	N 4165²	K

15,0 | 299-302/310 | MIVR 08.35.30 G; MIVR 08.35.30 H

10.88-10.91		0 451 10	P 5188	O
	PRF	1 457 43	N 4165²	K

S

S 45

7,3 118 D 0846 HM 42 U				
06.80-12.94		1 457 43	N 1158⁶	K
		1 457 43	N 1325⁷	K

S 90

3,6 67 720.12.01				
05.84-06.91		0 451 10	P 4065	O
	TW	1 457 43	S 3722	L
10.84-06.91		1 457 43	N 4165²	K

S 120

4,0 82 Phaser 110 T <T4.40 A/3, Euro 1>; Phaser 110 T <T4.40 CC>				
09.90-06.96		0 451 20	P 3010	O
		1 457 42	S 9950	L
		1 457 43	N 4150²	K

S 130

5,5 89 797 NFA				
11.89-06.91		0 451 10	P 4065	O
		1 457 43	N 4250²	K

5,5 | 89 | 797.23 Export

09.85-06.91		0 451 10	P 5188	O
	TW	1 457 43	S 3722	L
		1 457 43	N 4165²	K





S 135

4,0 102 Phaser 110T <T4.40 B/3, Euro 1>			
02.94-05.96	0 451 20 P 3010	O	
	1 457 42 S 9950	L	
	1 457 43 N 4150 ²	K	
4,1 100 MIDR 04.02.26 A/4 <Euro 2>			
05.96-01.00	0 451 30 P 0008	O	
	1 457 42 S 9966	L	
	1 457 43 N 4165 ²	K	

S 140

5,5 103 MIDS 06.02.12 C			
02.90-09.93	0 451 40 P 3077	O	
	1 457 42 S 9950	L	
	1 457 43 N 4165 ²	K	

S 150

4,1 110 MIDR 04.02.26 B4 <Euro 2>			
05.96-01.00	0 451 30 P 0008	O	
	1 457 42 S 9966	L	
	1 457 43 N 4165 ²	K	

5,5 110 MIDR 06.02.12 D3 <Euro 1>			
01.94-05.96	0 451 40 P 3077	O	
	ASO 1 457 43 S 3726	L	
	ASU 1 457 42 S 9966	L	
	1 457 43 N 4165 ²	K	

6,2 110 MIDR 06.02.26 U <Euro 1>			
11.92-01.94	0 451 40 P 3077	O	
	ASO 1 457 43 S 3726	L	
	ASU 1 457 42 S 9966	L	
	1 457 43 N 4165 ²	K	

6,2 110 MIDR 06.02.26 U4 <Euro 2>			
05.96-01.00	0 451 40 P 3077	O	
	ASO 1 457 43 S 3726	L	
	ASU 1 457 42 S 9966	L	
	1 457 43 N 4165 ²	K	

S 160

5,5 117 MIDS 06.02.12 B			
02.90-04.93	0 451 40 P 3077	O	
	1 457 42 S 9950	L	
	1 457 43 N 4165 ²	K	

S 170

5,5 127 MIDR 06.02.12 D			
10.82-03.93	TW 0 451 10 P 5188	O	
	0 451 40 P 3077	O	
	1 457 43 S 3722	L	
	1 457 43 N 4165 ²	K	

S 180/ 210

6,2 129/132/154 MIDR 06.02.26 V <Euro 1>; MIDR 06.02.26 V4 <Euro 2>; MIDR 06.02.26 W4 <Euro 2>			
11.92-01.00	0 451 40 P 3077	O	
	ASO 1 457 43 S 3726	L	
	ASU 1 457 42 S 9966	L	
	1 457 43 N 4165 ²	K	



TBH

TBH 280

12,0 178/206-208 MDS 06.35.40 H; MIDS 06.35.40 D			
06.80-06.91	ZE 0 451 10 P 5188	O	
	BO 1 457 43 N 4165 ²	K	
	PRF 1 457 43 N 4252 ²	K	
	SGP 1 457 43 N 4251 ²	K	

Tracer

Tracer

9,8 185 MIHR 06.20.45 A41 <Euro 2>			
07.96→	ZE 0 451 40 P 3077	O	
	TW 1 457 43 S 3731	L	
	BO 1 457 43 N 4165 ²	K	
	1 457 42 P 9820 ³	P	

9,8 185 MIHS 06.20.45 A			
03.92-05.93	ZE 0 451 10 P 5188	O	
	BO 1 457 43 N 4165 ²	K	
	1 457 42 P 9820 ³	P	

9,8 186 MIHS 06.20.45 B			
03.92-05.93	ZE 0 451 40 P 3077	O	
	BO 1 457 43 N 4165 ²	K	
	1 457 42 P 9820 ³	P	

9,8 186-191 MIHR 06.20.45 A3 <Euro 1>			
06.93-09.96	ZE 0 451 40 P 3077	O	
	BO 1 457 43 N 4165 ²	K	
	1 457 42 P 9820 ³	P	

110

110 .150/ .170

5,5 117/127/134 MIDR 06.02.12 D; MIDS 06.02.12 B			
09.85-01.95	0 451 40 P 3077	O	
	LUB 1 457 42 S 9966	L	
	BO 1 457 43 N 4165 ²	K	

SCANIA

G

G 230

8,9 169 DC 9.13 <Euro 3>; DC 9.16 <Euro 4>			
09.07→	0 451 10 P 3343	O	
	DON, 1 457 43 S 3903	L	
	LBF, TW		
	TW F 026 40 N 2025 ⁶	K	
	KL 1 987 43 M 1172	I	
Fg.Nr. →2036225→3621168	09.07→	KL 1 987 43 M 2153	I
→5200027→9130724			
Fg.Nr. 2036226→3617864→	09.07→	KL 1 987 43 M 1172	I
5200028→9130725→			

9,3 169 DC 9.30 <Euro 5/EEV>; DC 9.35 <Euro 5>; DC 9.39 <Euro 5>			
09.07→	F 026 40 P 7100	O	
	DON, 1 457 43 S 3903	L	
	LBF, TW		
	KL 1 987 43 M 1172	I	



Fg.Nr. →2036225→3621168 →5200027→9130724	09.07→	KL	1 987 43 M 2153	I
Fg.Nr. 2036226→3617864→ 5200028→9130725→	09.07→	KL	1 987 43 M 1172	I

G 270

8,9 198 DC 9.12 <Euro 3>; DC 9.17 <Euro 4>				
	09.07→		0 451 10 P 3343	O
		DON,	1 457 43 S 3903	L
		LBF,TW		
		TW	F 026 40 N 2025 ⁶	K
		KL	1 987 43 M 1172	I

Fg.Nr. →2036225→3621168 →5200027→9130724	09.07→	KL	1 987 43 M 2153	I
Fg.Nr. 2036226→3617864→ 5200028→9130725→	09.07→	KL	1 987 43 M 1172	I

G 280

9,3 206 DC 9.29 <Euro 5 / EEV>; DC 9.36 <Euro 5>; DC 9.38 <Euro 5>				
	09.07→		F 026 40 P 7100	O
		DON,	1 457 43 S 3903	L
		LBF,TW		
		KL	1 987 43 M 1172	I

Fg.Nr. →2036225→3621168 →5200027→9130724	09.07→	KL	1 987 43 M 2153	I
Fg.Nr. 2036226→3617864→ 5200028→9130725→	09.07→	KL	1 987 43 M 1172	I

G 310

8,9 228 DC 9.11 <Euro 3>; DC 9.18 <Euro 4>				
	09.07→		0 451 10 P 3343	O
		DON,	1 457 43 S 3903	L
		LBF,TW		
		TW	F 026 40 N 2025 ⁶	K
		KL	1 987 43 M 1172	I

Fg.Nr. →2036225→3621168 →5200027→9130724	09.07→	KL	1 987 43 M 2153	I
Fg.Nr. 2036226→3617864→ 5200028→9130725→	09.07→	KL	1 987 43 M 1172	I

G 320

9,3 235 DC 9.22 <Euro 5>				
	09.07→		F 026 40 P 7100	O
		DON,	1 457 43 S 3903	L
		LBF,TW		
		KL	1 987 43 M 1172	I

Fg.Nr. →2036225→3621168 →5200027→9130724	09.07→	KL	1 987 43 M 2153	I
Fg.Nr. 2036226→3617864→ 5200028→9130725→	09.07→	KL	1 987 43 M 1172	I

9,3 | 235 | DC 9.28 <Euro 5 / EEV>

	09.08→		F 026 40 P 7100	O
		KL	1 987 43 M 1172	I
Fg.Nr. →2036225→3621168 →5200027→9130724	09.08→	KL	1 987 43 M 2153	I
Fg.Nr. 2036226→3617864→ 5200028→9130725→	09.08→	KL	1 987 43 M 1172	I

9,3 235 DC 9.32 <Euro 5 / EEV>; DC 9.37 <Euro 5>				
	09.07→		0 451 10 P 3343	O
		DON,	1 457 43 S 3903	L
		LBF,TW		
		KL	1 987 43 M 1172	I

Fg.Nr. →2036225→3621168 →5200027→9130724	09.07→	KL	1 987 43 M 2153	I
Fg.Nr. 2036226→3617864→ 5200028→9130725→	09.07→	KL	1 987 43 M 1172	I

G 340

10,6 250 DC 11.08 <Euro 3>				
	09.07→		0 451 10 P 3343	O
		DON,	1 457 43 S 3903	L
		LBF,TW		
		TW	F 026 40 N 2025 ⁶	K
		KL	1 987 43 M 1172	I

Fg.Nr. →2036225→3621168 →5200027→9130724	09.07→	KL	1 987 43 M 2153	I
Fg.Nr. 2036226→3617864→ 5200028→9130725→	09.07→	KL	1 987 43 M 1172	I

12,0 | 250 | DC 12.10 <Euro 4>

	09.07→		0 451 10 P 3343	O
Fg.Nr. →2018047→3588939 →5149840→9111174	09.07→	ANV,DON	1 457 43 S 3903	L
Fg.Nr. 2018048→3588940→ 5149841→9111175→	09.07→	ANV,DON	1 457 43 S 3903	L
	09.07→	KL	1 987 43 M 1172	I

Fg.Nr. →2036225→3621168 →5200027→9130724	09.07→	KL	1 987 43 M 2153	I
Fg.Nr. 2036226→3617864→ 5200028→9130725→	09.07→	KL	1 987 43 M 1172	I

G 360

13,0 265 DC 13.06 <Euro 5>				
	09.08→		F 026 40 P 7100	O
		DON,	1 457 43 S 3903	L
		LBF,TW		
		KL	1 987 43 M 1172	I

Fg.Nr. →2036225→3621168 →5200027→9130724	09.08→	KL	1 987 43 M 2153	I
Fg.Nr. 2036226→3617864→ 5200028→9130725→	09.08→	KL	1 987 43 M 1172	I

G 380

11,0 280 DC 11.09 <Euro 3>				
	09.07→		0 451 10 P 3343	O
		DON,	1 457 43 S 3903	L
		LBF,TW		
		TW	F 026 40 N 2025 ⁶	K
		KL	1 987 43 M 1172	I

Fg.Nr. →2036225→3621168 →5200027→9130724	09.07→	KL	1 987 43 M 2153	I
Fg.Nr. 2036226→3617864→ 5200028→9130725→	09.07→	KL	1 987 43 M 1172	I





◀ G 380

11,7 280 DC 12.18 <Euro 5>	09.07→		0 451 10 P 3343	O
		DON,	1 457 43 S 3903	L
		LBF,TW		
		KL	1 987 43 M 1172	I
Fg.Nr. →2036225→3621168 →5200027→9130724	09.07→	KL	1 987 43 M 2153	I
Fg.Nr. 2036226→3617864→ 5200028→9130725→	09.07→	KL	1 987 43 M 1172	I

12,0 280 DC 12.13 <Euro 4>	09.07→		0 451 10 P 3343	O
		DON,	1 457 43 S 3903	L
		LBF,TW		
		KL	1 987 43 M 1172	I
Fg.Nr. →2036225→3621168 →5200027→9130724	09.07→	KL	1 987 43 M 2153	I
Fg.Nr. 2036226→3617864→ 5200028→9130725→	09.07→	KL	1 987 43 M 1172	I

12,0 280 DC 12.17 <Euro 3>	09.08→	DON,	1 457 43 S 3903	L
		LBF,TW		
		TW	F 026 40 N 2025⁶	K
		KL	1 987 43 M 1172	I
Fg.Nr. →2036225→3621168 →5200027→9130724	09.08→	KL	1 987 43 M 2153	I
Fg.Nr. 2036226→3617864→ 5200028→9130725→	09.08→	KL	1 987 43 M 1172	I

G 400

13,0 294 DC 13.05 <Euro 5>	09.08→		F 026 40 P 7100	O
		DON,	1 457 43 S 3903	L
		LBF,TW		
		KL	1 987 43 M 1172	I
Fg.Nr. →2036225→3621168 →5200027→9130724	09.08→	KL	1 987 43 M 2153	I
Fg.Nr. 2036226→3617864→ 5200028→9130725→	09.08→	KL	1 987 43 M 1172	I

G 420

11,7 309 DC 12.22 <Euro 5/EEV>	09.07→		0 451 10 P 3343	O
		DON,	1 457 43 S 3903	L
		LBF,TW		
		KL	1 987 43 M 1172	I
Fg.Nr. →2036225→3621168 →5200027→9130724	09.07→	KL	1 987 43 M 2153	I
Fg.Nr. 2036226→3617864→ 5200028→9130725→	09.07→	KL	1 987 43 M 1172	I

12,0 309 DC 12.06 <Euro 3>	09.07→	DON,	1 457 43 S 3903	L
		LBF,TW		
		TW	F 026 40 N 2025⁶	K
		KL	1 987 43 M 1172	I
Fg.Nr. →2036225→3621168 →5200027→9130724	09.07→	KL	1 987 43 M 2153	I
Fg.Nr. 2036226→3617864→ 5200028→9130725→	09.07→	KL	1 987 43 M 1172	I



12,0 309 DC 12.14 <Euro 3>; DC 12.15 <Euro 5>; DT 12.12 <Euro 4>	09.07→		0 451 10 P 3343	O
		DON,	1 457 43 S 3903	L
		LBF,TW		
		KL	1 987 43 M 1172	I
Fg.Nr. →2036225→3621168 →5200027→9130724	09.07→	KL	1 987 43 M 2153	I
Fg.Nr. 2036226→3617864→ 5200028→9130725→	09.07→	KL	1 987 43 M 1172	I

G 440

12,0 324 DT 12.18 <Euro 3>	09.07→	KL	1 987 43 M 1172	I
Fg.Nr. →2036225→3621168 →5200027→9130724	09.07→	KL	1 987 43 M 2153	I
Fg.Nr. 2036226→3617864→ 5200028→9130725→	09.07→	KL	1 987 43 M 1172	I

12,7 324 DC 13.10 <Euro 5>	09.07→		F 026 40 P 7100	O
		DON,	1 457 43 S 3903	L
		LBF,TW		
		KL	1 987 43 M 1172	I
Fg.Nr. →2036225→3621168 →5200027→9130724	09.07→	KL	1 987 43 M 2153	I
Fg.Nr. 2036226→3617864→ 5200028→9130725→	09.07→	KL	1 987 43 M 1172	I

G 470/ 480

12,0 346/353 DT 12.06 <Euro 3>; DT 12.17 <Euro 4>	09.07→		0 451 10 P 3343	O
		DON,	1 457 43 S 3903	L
		LBF,TW		
		KL	1 987 43 M 1172	I
Fg.Nr. →2036225→3621168 →5200027→9130724	09.07→	KL	1 987 43 M 2153	I
Fg.Nr. 2036226→3617864→ 5200028→9130725→	09.07→	KL	1 987 43 M 1172	I

G 480

13,0 353 DC 13.07 <Euro 5>	09.08→		F 026 40 P 7100	O
		DON,	1 457 43 S 3903	L
		LBF,TW		
		KL	1 987 43 M 1172	I
Fg.Nr. →2036225→3621168 →5200027→9130724	09.08→	KL	1 987 43 M 2153	I
Fg.Nr. 2036226→3617864→ 5200028→9130725→	09.08→	KL	1 987 43 M 1172	I

P

P 230

8,9 169 DC 9.13 <Euro 3>; DC 9.16 <Euro 4>	09.04→		0 451 10 P 3343	O
		DON,	1 457 43 S 3903	L
		LBF,TW		
		TW	F 026 40 N 2025⁶	K
		KL	1 987 43 M 1172	I
Fg.Nr. →2036225→3621168 →5200027→9130724	09.04→	KL	1 987 43 M 2153	I



Fg.Nr. 2036226→3617864→ 09.04→ ~~KL~~ 1 987 43 **M 1172** **I**
5200028→9130725→

9,3 | 169 | DC 9.30 <Euro 5 / EEV>; DC 9.35 <Euro 5>; DC 9.39 <Euro 5>
09.07→ F 026 40 **P 7100** **O**
DON, 1 457 43 **S 3903** **L**
~~LBF,TW~~
KL 1 987 43 **M 1172** **I**

Fg.Nr. →2036225→3621168 09.07→ ~~KL~~ 1 987 43 **M 2153** **I**
→5200027→9130724

Fg.Nr. 2036226→3617864→ 09.07→ ~~KL~~ 1 987 43 **M 1172** **I**
5200028→9130725→

P 270

8,9 | 198 | DC 9.E02 <Euro 5 / EEV>; DC 9.12 <Euro 3>; DC 9.17 <Euro 4>
09.04→ 0 451 10 **P 3343** **O**
DON, 1 457 43 **S 3903** **L**
~~LBF,TW~~
TW F 026 40 **N 2025** ⁶ **K**
KL 1 987 43 **M 1172** **I**

Fg.Nr. →2036225→3621168 09.04→ ~~KL~~ 1 987 43 **M 2153** **I**
→5200027→9130724

Fg.Nr. 2036226→3617864→ 09.04→ ~~KL~~ 1 987 43 **M 1172** **I**
5200028→9130725→

P 280

9,3 | 206 | DC 9.29 <Euro 5 / EEV>; DC 9.36 <Euro 5>; DC 9.38 <Euro 5>
09.07→ F 026 40 **P 7100** **O**
DON, 1 457 43 **S 3903** **L**
~~LBF,TW~~
KL 1 987 43 **M 1172** **I**

Fg.Nr. →2036225→3621168 09.07→ ~~KL~~ 1 987 43 **M 2153** **I**
→5200027→9130724

Fg.Nr. 2036226→3617864→ 09.07→ ~~KL~~ 1 987 43 **M 1172** **I**
5200028→9130725→

P 310

8,9 | 228 | DC 9.11 <Euro 3>; DC 9.18 <Euro 4>
09.04→ 0 451 10 **P 3343** **O**
DON, 1 457 43 **S 3903** **L**
~~LBF,TW~~
TW F 026 40 **N 2025** ⁶ **K**
KL 1 987 43 **M 1172** **I**

Fg.Nr. →2036225→3621168 09.04→ ~~KL~~ 1 987 43 **M 2153** **I**
→5200027→9130724

Fg.Nr. 2036226→3617864→ 09.04→ ~~KL~~ 1 987 43 **M 1172** **I**
5200028→9130725→

P 320

9,3 | 235 | DC 9.22 <Euro 5>
09.07→ F 026 40 **P 7100** **O**
DON, 1 457 43 **S 3903** **L**
~~LBF,TW~~
KL 1 987 43 **M 1172** **I**

Fg.Nr. →2036225→3621168 09.07→ ~~KL~~ 1 987 43 **M 2153** **I**
→5200027→9130724

Fg.Nr. 2036226→3617864→ 09.07→ ~~KL~~ 1 987 43 **M 1172** **I**
5200028→9130725→



9,3 | 235 | DC 9.28 <Euro 5 / EEV>
09.07→ F 026 40 **P 7100** **O**
KL 1 987 43 **M 1172** **I**

Fg.Nr. →2036225→3621168 09.07→ ~~KL~~ 1 987 43 **M 2153** **I**
→5200027→9130724

Fg.Nr. 2036226→3617864→ 09.07→ ~~KL~~ 1 987 43 **M 1172** **I**
5200028→9130725→

9,3 | 235 | DC 9.32 <Euro 5 / EEV>; DC 9.37 <Euro 5>

09.07→ 0 451 10 **P 3343** **O**
DON, 1 457 43 **S 3903** **L**
~~LBF,TW~~
KL 1 987 43 **M 1172** **I**

Fg.Nr. →2036225→3621168 09.07→ ~~KL~~ 1 987 43 **M 2153** **I**
→5200027→9130724

Fg.Nr. 2036226→3617864→ 09.07→ ~~KL~~ 1 987 43 **M 1172** **I**
5200028→9130725→

P 340

10,6 | 250 | DC 11.08 <Euro 3>
09.04→ 0 451 10 **P 3343** **O**
DON, 1 457 43 **S 3903** **L**
~~LBF,TW~~
TW F 026 40 **N 2025** ⁶ **K**
KL 1 987 43 **M 1172** **I**

Fg.Nr. →2036225→3621168 09.04→ ~~KL~~ 1 987 43 **M 2153** **I**
→5200027→9130724

Fg.Nr. 2036226→3617864→ 09.04→ ~~KL~~ 1 987 43 **M 1172** **I**
5200028→9130725→

12,0 | 250 | DC 12.10 <Euro 4>

09.05→ 0 451 10 **P 3343** **O**
DON, 1 457 43 **S 3903** **L**
~~LBF,TW~~
KL 1 987 43 **M 1172** **I**

Fg.Nr. →2036225→3621168 09.05→ ~~KL~~ 1 987 43 **M 2153** **I**
→5200027→9130724

Fg.Nr. 2036226→3617864→ 09.05→ ~~KL~~ 1 987 43 **M 1172** **I**
5200028→9130725→

P 360

13,0 | 265 | DC 13.06 <Euro 5>
09.07→ F 026 40 **P 7100** **O**
DON, 1 457 43 **S 3903** **L**
~~LBF,TW~~
KL 1 987 43 **M 1172** **I**

Fg.Nr. →2036225→3621168 09.07→ ~~KL~~ 1 987 43 **M 2153** **I**
→5200027→9130724

Fg.Nr. 2036226→3617864→ 09.07→ ~~KL~~ 1 987 43 **M 1172** **I**
5200028→9130725→

P 380

11,0 | 280 | DC 11.09 <Euro 3>
09.04→ 0 451 10 **P 3343** **O**
DON, 1 457 43 **S 3903** **L**
~~LBF,TW~~
TW F 026 40 **N 2025** ⁶ **K**
KL 1 987 43 **M 1172** **I**

Fg.Nr. →2036225→3621168 09.04→ ~~KL~~ 1 987 43 **M 2153** **I**
→5200027→9130724





◀ P 380

Fg.Nr. 2036226→3617864→ 09.04→ ~~KL~~ 1 987 43 **M 1172** I
5200028→9130725→

11,7 | 280 | DC 12.18 <Euro 5>

09.06→ 0 451 10 **P 3343** **O**
DON, 1 457 43 **S 3903** L
LBF,TW
KL 1 987 43 **M 1172** I

Fg.Nr. →2036225→3621168 09.06→ ~~KL~~ 1 987 43 **M 2153** I
→5200027→9130724

Fg.Nr. 2036226→3617864→ 09.06→~~KL~~ 1 987 43 **M 1172** I
5200028→9130725→

12,0 | 280 | DC 12.13 <Euro 4>

09.05→ 0 451 10 **P 3343** **O**
DON, 1 457 43 **S 3903** L
LBF,TW
KL 1 987 43 **M 1172** I

Fg.Nr. →2036225→3621168 09.05→ ~~KL~~ 1 987 43 **M 2153** I
→5200027→9130724

Fg.Nr. 2036226→3617864→ 09.05→ ~~KL~~ 1 987 43 **M 1172** I
5200028→9130725→

12,0 | 280 | DC 12.17 <Euro 3>

09.07→ DON, 1 457 43 **S 3903** L
LBF,TW
TW F 026 40 **N 2025⁶** K
KL 1 987 43 **M 1172** I

Fg.Nr. →2036225→3621168→ 09.07→ ~~KL~~ 1 987 43 **M 2153** I
5200027→9130724

Fg.Nr. 2036226→3617864→ 09.07→ ~~KL~~ 1 987 43 **M 1172** I
5200028→9130725→

P 400

13,0 | 294 | DC 13.05 <Euro 5>

09.07→ F 026 40 **P 7100** **O**
DON, 1 457 43 **S 3903** L
LBF,TW
KL 1 987 43 **M 1172** I

Fg.Nr. →2036225→3621168 09.07→ ~~KL~~ 1 987 43 **M 2153** I
→5200027→9130724

Fg.Nr. 2036226→3617864→ 09.07→ ~~KL~~ 1 987 43 **M 1172** I
5200028→9130725→

P 420

11,7 | 309 | DC 12.22 <Euro 5/EEV>

09.07→ 0 451 10 **P 3343** **O**
DON, 1 457 43 **S 3903** L
LBF,TW
KL 1 987 43 **M 1172** I

Fg.Nr. →2036225→3621168 09.07→ ~~KL~~ 1 987 43 **M 2153** I
→5200027→9130724

Fg.Nr. 2036226→3617864→ 09.07→ ~~KL~~ 1 987 43 **M 1172** I
5200028→9130725→

12,0 | 309 | DC 12.06 <Euro 3>

09.07→ DON, 1 457 43 **S 3903** L
LBF,TW
TW F 026 40 **N 2025⁶** K
KL 1 987 43 **M 1172** I

Fg.Nr. →2036225→3621168 09.07→ ~~KL~~ 1 987 43 **M 2153** I
→5200027→9130724

Fg.Nr. 2036226→3617864→ 09.07→ ~~KL~~ 1 987 43 **M 1172** I
5200028→9130725→



P 420/ 470/ 480

12,0 | 309/346/353 | DC 12.14 <Euro 3>; DC 12.15 <Euro 5>; DT 12.06 <Euro 3>; DT 12.12 <Euro 4>; DT 12.17 <Euro 4>

09.04→ 0 451 10 **P 3343** **O**
DON, 1 457 43 **S 3903** L
LBF,TW
KL 1 987 43 **M 1172** I

Fg.Nr. →2036225→3621168 09.04→ ~~KL~~ 1 987 43 **M 2153** I
→5200027→9130724

Fg.Nr. 2036226→3617864→ 09.04→ ~~KL~~ 1 987 43 **M 1172** I
5200028→9130725→

R

R 230/ 270/ 310

8,9 | 169/198/228 | DC 9.11 <Euro 3>; DC 9.12 <Euro 3>; DC 9.13 <Euro 3>; DC 9.16 <Euro 4>; DC 9.17 <Euro 4>; DC 9.18 <Euro 4>

09.04→ 0 451 10 **P 3343** **O**
DON, 1 457 43 **S 3903** L
LBF,TW
TW F 026 40 **N 2025⁶** K
KL 1 987 43 **M 1172** I

Fg.Nr. →2036225→3621168 09.04→ ~~KL~~ 1 987 43 **M 2153** I
→5200027→9130724

Fg.Nr. 2036226→3617864→ 09.04→ ~~KL~~ 1 987 43 **M 1172** I
5200028→9130725→

R 340

10,6 | 250 | DC 11.08 <Euro 3>

03.04→ 0 451 10 **P 3343** **O**
DON, 1 457 43 **S 3903** L
LBF,TW
TW F 026 40 **N 2025⁶** K
KL 1 987 43 **M 1172** I

Fg.Nr. →2036225→3621168 03.04→ ~~KL~~ 1 987 43 **M 2153** I
→5200027→9130724

Fg.Nr. 2036226→3617864→ 03.04→ ~~KL~~ 1 987 43 **M 1172** I
5200028→9130725→

12,0 | 250 | DC 12.10 <Euro 4>

09.05→ 0 451 10 **P 3343** **O**
ANV,DON 1 457 43 **S 3903** L
5149840→9111174
ANV,DON 1 457 43 **S 3903** L
5149841→9111175→

09.05→ ~~KL~~ 1 987 43 **M 1172** I
Fg.Nr. →2036225→3621168 09.05→ ~~KL~~ 1 987 43 **M 2153** I
→5200027→9130724

Fg.Nr. 2036226→3617864→ 09.05→ ~~KL~~ 1 987 43 **M 1172** I
5200028→9130725→

R 360

13,0 | 265 | DC 13.06 <Euro 5>

09.07→ F 026 40 **P 7100** **O**
DON, 1 457 43 **S 3903** L
LBF,TW
KL 1 987 43 **M 1172** I

Fg.Nr. →2036225→3621168 09.07→ ~~KL~~ 1 987 43 **M 2153** I
→5200027→9130724

Fg.Nr. 2036226→3617864→ 09.07→ ~~KL~~ 1 987 43 **M 1172** I
5200028→9130725→





R 380

11,0 | 280 | DC 11.09 <Euro 3>

	03.04→		0 451 10 P 3343	O
		DON,	1 457 43 S 3903	L
		LBF,TW		
		TW	F 026 40 N 2025 ⁶	K
		KL	1 987 43 M 1172	I

Fg.Nr. →2036225→3621168 →5200027→9130724	03.04→	KL	1 987 43 M 2153	I
Fg.Nr. 2036226→3617864→ 5200028→9130725→	03.04→	KL	1 987 43 M 1172	I

11,7 | 280 | DC 12.18 <Euro 5>

	09.06→		0 451 10 P 3343	O
		DON,	1 457 43 S 3903	L
		LBF,TW		
		KL	1 987 43 M 1172	I

Fg.Nr. →2036225→3621168 →5200027→9130724	09.06→	KL	1 987 43 M 2153	I
Fg.Nr. 2036226→3617864→ 5200028→9130725→	09.06→	KL	1 987 43 M 1172	I

12,0 | 280 | DC 12.13 <Euro 4>

	09.05→		0 451 10 P 3343	O
		DON,	1 457 43 S 3903	L
		LBF,TW		
		KL	1 987 43 M 1172	I

Fg.Nr. →2036225→3621168 →5200027→9130724	09.05→	KL	1 987 43 M 2153	I
Fg.Nr. 2036226→3617864→ 5200028→9130725→	09.05→	KL	1 987 43 M 1172	I

R 400

13,0 | 294 | DC 13.05 <Euro 5>

	09.07→		F 026 40 P 7100	O
		DON,	1 457 43 S 3903	L
		LBF,TW		
		KL	1 987 43 M 1172	I

Fg.Nr. →2036225→3621168 →5200027→9130724	09.07→	KL	1 987 43 M 2153	I
Fg.Nr. 2036226→3617864→ 5200028→9130725→	09.07→	KL	1 987 43 M 1172	I

R 420

11,7 | 309 | DC 12.22 <Euro 5/EEV>

	09.07→		0 451 10 P 3343	O
		DON,	1 457 43 S 3903	L
		LBF,TW		
		KL	1 987 43 M 1172	I

Fg.Nr. →2036225→3621168 →5200027→9130724	09.07→	KL	1 987 43 M 2153	I
Fg.Nr. 2036226→3617864→ 5200028→9130725→	09.07→	KL	1 987 43 M 1172	I

12,0 | 309 | DC 12.06 <Euro 3>

	09.07→	DON,	1 457 43 S 3903	L
		LBF,TW		
		TW	F 026 40 N 2025 ⁶	K
		KL	1 987 43 M 1172	I



Fg.Nr. →2036225→3621168 →5200027→9130724	09.07→	KL	1 987 43 M 2153	I
Fg.Nr. 2036226→3617864→ 5200028→9130725→	09.07→	KL	1 987 43 M 1172	I

12,0 | 309 | DC 12.14 <Euro 3>; DC 12.15 <Euro 5>; DT 12.11 <Euro 4>; DT 12.12 <Euro 4>

	02.04→		0 451 10 P 3343	O
		DON,	1 457 43 S 3903	L
		LBF,TW		
		KL	1 987 43 M 1172	I

Fg.Nr. →2036225→3621168 →5200027→9130724	02.04→	KL	1 987 43 M 2153	I
Fg.Nr. 2036226→3617864→ 5200028→9130725→	02.04→	KL	1 987 43 M 1172	I

R 440

12,0 | 324 | DT 12.18 <Euro 3>

	09.07→	KL	1 987 43 M 1172	I
Fg.Nr. →2036225→3621168 →5200027→9130724	09.07→	KL	1 987 43 M 2153	I
Fg.Nr. 2036226→3617864→ 5200028→9130725→	09.07→	KL	1 987 43 M 1172	I

13,0 | 324 | DC 13.10 <Euro 5>

	09.07→		F 026 40 P 7100	O
		DON,	1 457 43 S 3903	L
		LBF,TW		
		KL	1 987 43 M 1172	I

Fg.Nr. →2036225→3621168 →5200027→9130724	09.07→	KL	1 987 43 M 2153	I
Fg.Nr. 2036226→3617864→ 5200028→9130725→	09.07→	KL	1 987 43 M 1172	I

R 470/ 480

12,0 | 346/353 | DT 12.03 <Euro 4>; DT 12.06 <Euro 3>; DT 12.17 <Euro 4>

	04.04→		0 451 10 P 3343	O
		DON,	1 457 43 S 3903	L
		LBF,TW		
		KL	1 987 43 M 1172	I

Fg.Nr. →2036225→3621168 →5200027→9130724	04.04→	KL	1 987 43 M 2153	I
Fg.Nr. 2036226→3617864→ 5200028→9130725→	04.04→	KL	1 987 43 M 1172	I

R 480

13,0 | 353 | DC 13.07 <Euro 5>

	09.07→		F 026 40 P 7100	O
		DON,	1 457 43 S 3903	L
		LBF,TW		
		KL	1 987 43 M 1172	I

Fg.Nr. →2036225→3621168 →5200027→9130724	09.07→	KL	1 987 43 M 2153	I
Fg.Nr. 2036226→3617864→ 5200028→9130725→	09.07→	KL	1 987 43 M 1172	I





R 500/ 560/ 580/ 620

16,0 | 368/412/426/456 | DC 16.03 <Euro 3>; DC 16.04 <Euro 3>; DC 16.05 <Euro 4>;
DC 16.06 <Euro 4>; DC 16.08 <Euro 4>; DC 16.09 <Euro 5>; DC 16.17 <Euro 5>;
DC 16.18 <Euro 5>; DC 16.19 <Euro 5>

	03.04→	TW	F 026 40	N 2025⁶	K
		KL	1 987 43	M 1172	I
Fg.Nr. →2036225→3621168 →5200027→9130724	03.04→	KL	1 987 43	M 2153	I
Fg.Nr. 2036226→3617864→ 5200028→9130725→	03.04→	KL	1 987 43	M 1172	I

Serie 82

Serie 82 F

7,8DS 8.05 B	10.81-01.95	1 457 42	P 9105	O
---------------------	-------------	----------	---------------	----------

Serie 82 K

7,8DSI 8.01 B	03.84-12.95	WAS	1 457 43	N 4154²	K
		WAS	1 457 43	N 4106²	K
			1 457 42	P 9820³	P

Serie 82 S

7,8DS 8.05 B	10.81-10.91	1 457 43	N 4154²	K
		1 457 42	P 9820³	P

Serie 86

Serie 86 B

7,8 155 DS 8.01 B10	06.82-01.95	0 451 10	P 3004	O
		1 457 42	S 9966	L

Serie 86 BF

7,8 114 D 8.01 B09, .02 B09	06.82-01.99	1 457 42	S 9950	L
--	-------------	----------	---------------	----------

7,8 155 DS 8.01 B10	06.82-01.99	1 457 42	S 9966	L
--------------------------------	-------------	----------	---------------	----------

Serie 92

Serie 92 K

DS 9.03 B 01,02	05.82-12.94	WAS	1 457 43	N 4154²	K
		WAS	1 457 43	N 4106²	K
			1 457 42	P 9820³	P

Serie 93

Serie 93 F

8,5 127 DN 9.01	06.90-01.98	FRE	1 457 42	P 9174	O
		MOR	0 451 10	P 3004	O
			1 457 43	S 2188	L
		WAS	1 457 43	N 4154²	K
		WAS	1 457 43	N 4106²	K
			1 457 42	P 9820³	P



8,5 167 DS 9.06	06.90-01.98	FRE	1 457 42	P 9174	O
		MOR	0 451 10	P 3004	O
			1 457 43	S 2188	L
		WAS	1 457 43	N 4154²	K
		WAS	1 457 43	N 4106²	K
			1 457 42	P 9820³	P

Serie 93 G

8,5 167 DS 9.06	03.88-01.93	FRE	1 457 42	P 9174	O
		MOR	0 451 10	P 3004	O
			1 457 43	S 2188	L
		WAS	1 457 43	N 4165²	K
		WAS	1 457 43	N 4106²	K
			1 457 42	P 9820³	P

8,5 | 208 | DSC 9.08 <Euro 1>

12.91-08.97	FRE	1 457 42	P 9174	O
	MOR	0 451 10	P 3004	O
		1 457 43	S 2188	L
	WAS	1 457 43	N 4165²	K
	WAS	1 457 43	N 4106²	K
		1 457 42	P 9820³	P

Serie 93 G/ P/ R/ T

8,5 155 DS 9.08	03.88-01.93	FRE	1 457 42	P 9174	O
		MOR	0 451 10	P 3004	O
			1 457 43	S 2188	L
		WAS	1 457 43	N 4165²	K
		WAS	1 457 43	N 4106²	K
			1 457 42	P 9820³	P

8,5 | 162 | DSC 9.10 <Euro 1>

12.91-08.97	FRE	1 457 42	P 9174	O
	MOR	0 451 10	P 3004	O
		1 457 43	S 2188	L
	WAS	1 457 43	N 4165²	K
	WAS	1 457 43	N 4106²	K
		1 457 42	P 9820³	P

8,5 | 185 | DS 9.05

03.88-01.91	FRE	1 457 42	P 9174	O
	MOR	0 451 10	P 3004	O
		1 457 43	S 2188	L
	WAS	1 457 43	N 4165²	K
	WAS	1 457 43	N 4106²	K
		1 457 42	P 9820³	P

8,5 | 185 | DSC 9.07 <Euro 1>

12.91-08.97	FRE	1 457 42	P 9174	O
	MOR	0 451 10	P 3004	O
		1 457 43	S 2188	L
	WAS	1 457 43	N 4165²	K
	WAS	1 457 43	N 4106²	K
		1 457 42	P 9820³	P

8,5 | 207 | DSC 9.02

03.88-01.95	FRE	1 457 42	P 9174	O
	MOR	0 451 10	P 3004	O
		1 457 43	S 2188	L
	WAS	1 457 43	N 4165²	K
	WAS	1 457 43	N 4106²	K
		1 457 42	P 9820³	P



Serie 93 K

8,5 185 DS 9.05 B 01,02				
11.87-02.97	FRE	1 457 42	P 9174	O
	MOR	0 451 10	P 3004	O
			S 2188	L
	WAS	1 457 43	N 4154 ²	K
	WAS	1 457 43	N 4106 ²	K
		1 457 42	P 9820 ³	P

8,5 | 208 | DSC 9.08 <Euro 1>

11.87-02.97	FRE	1 457 42	P 9174	O
	MOR	0 451 10	P 3004	O
11.87-12.01			S 2188	L
	WAS	1 457 43	N 4154 ²	K
	WAS	1 457 43	N 4106 ²	K
		1 457 42	P 9820 ³	P

Serie 93 P

8,5 167 DS 9.06				
03.88-08.97	FRE	1 457 42	P 9174	O
	MOR	0 451 10	P 3004	O
			S 2188	L
	WAS	1 457 43	N 4165 ²	K
	WAS	1 457 43	N 4105 ²	K
		1 457 43	N 4106 ²	K
		1 457 42	P 9820 ³	P

Serie 93 P/ R

8,5 184 DSC 9.09 <Euro 2>				
12.91-08.97	FRE	1 457 42	P 9174	O
	MOR	0 451 10	P 3004	O
			S 2188	L
	WAS	1 457 43	N 4165 ²	K
	WAS	1 457 43	N 4106 ²	K
		1 457 42	P 9820 ³	P

Serie 93 P/ R/ T

8,5 208 DSC 9.08 <Euro 1>				
12.91-08.97	FRE	1 457 42	P 9174	O
	MOR	0 451 10	P 3004	O
			S 2188	L
	WAS	1 457 43	N 4165 ²	K
	WAS	1 457 43	N 4106 ²	K
		1 457 42	P 9820 ³	P

Serie 93 P/ T

8,5 128 DN 9.01				
03.88-01.91	FRE	1 457 42	P 9174	O
	MOR	0 451 10	P 3004	O
			S 2188	L
	WAS	1 457 43	N 4165 ²	K
	WAS	1 457 43	N 4106 ²	K
		1 457 42	P 9820 ³	P



Serie 93 R/ T

8,5 167 DS 9.06				
03.88-01.93	FRE	1 457 42	P 9174	O
	MOR	0 451 10	P 3004	O
			S 2188	L
	WAS	1 457 43	N 4165 ²	K
	WAS	1 457 43	N 4106 ²	K
		1 457 42	P 9820 ³	P

Serie 94

Serie 94 K/ L

9,0 228 DSC 9.15 <Euro 2>				
03.97-10.00	DIF	0 451 10	P 3330	O
	FRE	1 457 42	P 9174	O
	MOR	0 451 10	P 3343	O
	ASG,DON	1 457 43	S 3903	L
	ASG,KNE	1 457 43	S 3042	L
	LSP	1 457 43	S 2188	L
		1 457 42	P 9820 ³	P

Serie 94 L

9,0 169 DC 9.01 <Euro 3>				
04.99→	DIF	0 451 10	P 3330	O
	FRE	1 457 42	P 9174	O
	MOR	0 451 10	P 3343	O
	ASG,DON	1 457 43	S 3903	L
	ASG,KNE	1 457 43	S 3042	L
	LSP	1 457 43	S 2188	L
		1 457 42	P 9820 ³	P

9,0 | 169 | DC 9.04 <Euro 3>

08.99→	DIF	0 451 10	P 3330	O
	FRE	1 457 42	P 9174	O
	MOR	0 451 10	P 3343	O
	ASG,DON	1 457 43	S 3903	L
	ASG,KNE	1 457 43	S 3042	L
	LSP	1 457 43	S 2188	L
		1 457 42	P 9820 ³	P

9,0 | 191 | DC 9.02 <Euro 3>

02.00→	DIF	0 451 10	P 3330	O
	FRE	1 457 42	P 9174	O
	MOR	0 451 10	P 3343	O
	ASG,DON	1 457 43	S 3903	L
	ASG,KNE	1 457 43	S 3042	L
	LSP	1 457 43	S 2188	L
		1 457 42	P 9820 ³	P

9,0 | 191 | DC 9.05 <Euro 3>

09.01→	DIF	0 451 10	P 3330	O
	FRE	1 457 42	P 9174	O
	MOR	0 451 10	P 3343	O
	ASG,DON	1 457 43	S 3903	L
	ASG,KNE	1 457 43	S 3042	L
	LSP	1 457 43	S 2188	L
		1 457 42	P 9820 ³	P





◀ Serie 94 L

9,0 191 DSC 9.12 <Euro 2>					
03.97-10.01	DIF	0 451 10	P 3330	O	
	FRE	1 457 42	P 9174	O	
	MOR	0 451 10	P 3343	O	
	ASG,DON	1 457 43	S 3903	L	
	ASG,KNE	1 457 43	S 3042	L	
	LSP	1 457 43	S 2188	L	
		1 457 42	P 9820³	P	

9,0 221 DC 9.03 <Euro 3>					
02.00→	DIF	0 451 10	P 3330	O	
	FRE	1 457 42	P 9174	O	
	MOR	0 451 10	P 3343	O	
	ASG,DON	1 457 43	S 3903	L	
	ASG,KNE	1 457 43	S 3042	L	
	LSP	1 457 43	S 2188	L	
		1 457 42	P 9820³	P	

9,0 221 DC 9.06 <Euro 3>					
09.00→	DIF	0 451 10	P 3330	O	
	FRE	1 457 42	P 9174	O	
	MOR	0 451 10	P 3343	O	
	ASG,DON	1 457 43	S 3903	L	
	ASG,KNE	1 457 43	S 3042	L	
	LSP	1 457 43	S 2188	L	
		1 457 42	P 9820³	P	

9,0 228 DSC 9.13 <Euro 2>					
03.97-08.02	DIF	0 451 10	P 3330	O	
	FRE	1 457 42	P 9174	O	
	MOR	0 451 10	P 3343	O	
	ASG,DON	1 457 43	S 3903	L	
	ASG,KNE	1 457 43	S 3042	L	
	LSP	1 457 43	S 2188	L	
		1 457 42	P 9820³	P	

Serie 94 L/ N

9,0 162 DSC 9.11 <Euro 2>					
03.97-08.02	DIF	0 451 10	P 3330	O	
	FRE	1 457 42	P 9174	O	
	MOR	0 451 10	P 3343	O	
	ASG,DON	1 457 43	S 3903	L	
	ASG,KNE	1 457 43	S 3042	L	
	LSP	1 457 43	S 2188	L	
		1 457 42	P 9820³	P	

Serie 94 P,R/ T

9,0 162 DSC 9.11 <Euro 2>					
08.96-08.02	DIF	0 451 10	P 3330	O	
	FRE	1 457 42	P 9174	O	
	MOR	0 451 10	P 3343	O	
	DON	1 457 43	S 3903	L	
	KNE	1 457 43	S 3042	L	
		1 987 43	M 2153	I	
		1 457 42	P 9820³	P	

9,0 169 DC 9.01 <Euro 3>					
04.99-09.04	DIF	0 451 10	P 3330	O	
	FRE	1 457 42	P 9174	O	
	MOR	0 451 10	P 3343	O	
	DON	1 457 43	S 3903	L	
	KNE	1 457 43	S 3042	L	
		1 987 43	M 2153	I	
		1 457 42	P 9820³	P	



9,0 169 DC 9.04 <Euro 3>					
08.99-09.04	DIF	0 451 10	P 3330	O	
	FRE	1 457 42	P 9174	O	
	MOR	0 451 10	P 3343	O	
	DON	1 457 43	S 3903	L	
	KNE	1 457 43	S 3042	L	
		1 987 43	M 2153	I	
		1 457 42	P 9820³	P	

9,0 191 DC 9.02 <Euro 3>					
02.00-09.04	DIF	0 451 10	P 3330	O	
	FRE	1 457 42	P 9174	O	
	MOR	0 451 10	P 3343	O	
	DON	1 457 43	S 3903	L	
	KNE	1 457 43	S 3042	L	
		1 987 43	M 2153	I	
		1 457 42	P 9820³	P	

9,0 191 DC 9.05 <Euro 3>					
09.01-09.04	DIF	0 451 10	P 3330	O	
	FRE	1 457 42	P 9174	O	
	MOR	0 451 10	P 3343	O	
	DON	1 457 43	S 3903	L	
	KNE	1 457 43	S 3042	L	
		1 987 43	M 2153	I	
		1 457 42	P 9820³	P	

9,0 191 DSC 9.12 <Euro 2>					
08.96-10.01	DIF	0 451 10	P 3330	O	
	FRE	1 457 42	P 9174	O	
	MOR	0 451 10	P 3343	O	
	DON	1 457 43	S 3903	L	
	KNE	1 457 43	S 3042	L	
		1 987 43	M 2153	I	
		1 457 42	P 9820³	P	

9,0 221 DC 9.03 <Euro 3>					
02.00-09.04	DIF	0 451 10	P 3330	O	
	FRE	1 457 42	P 9174	O	
	MOR	0 451 10	P 3343	O	
	DON	1 457 43	S 3903	L	
	KNE	1 457 43	S 3042	L	
		1 987 43	M 2153	I	
		1 457 42	P 9820³	P	

9,0 221 DC 9.06 <Euro 3>					
09.00-09.04	DIF	0 451 10	P 3330	O	
	FRE	1 457 42	P 9174	O	
	MOR	0 451 10	P 3343	O	
	DON	1 457 43	S 3903	L	
	KNE	1 457 43	S 3042	L	
		1 987 43	M 2153	I	
		1 457 42	P 9820³	P	

9,0 228 DSC 9.13 <Euro 2>					
08.96-08.02	DIF	0 451 10	P 3330	O	
	FRE	1 457 42	P 9174	O	
	MOR	0 451 10	P 3343	O	
	DON	1 457 43	S 3903	L	
	KNE	1 457 43	S 3042	L	
		1 987 43	M 2153	I	
		1 457 42	P 9820³	P	



9,0 228 DSC 9.15 <Euro 2>				
08.96-10.00	DIF	0 451 10	P 3330	O
	FRE	1 457 42	P 9174	O
	MOR	0 451 10	P 3343	O
	DON	1 457 43	S 3903	L
	KNE	1 457 43	S 3042	L
		1 987 43	M 2153	I
		1 457 42	P 9820³	P

Serie 111

Serie 111 B

11,0DN 11.01 B10, 04 B10				
06.90-01.99		1 457 42	S 9966	L

Serie 111 BF

11,0DS 11.01 B 06				
01.91-01.99		1 457 42	S 9950	L

Serie 112

Serie 112 BK

11,0 143/224 DN 11.06 B; DS 11.15 B				
05.82-11.99	WAS	1 457 43	N 4106²	K

Serie 112 BR/ CR

11,0 232 DS 11.15				
07.81-12.92		1 457 42	S 9874	L

Serie 112 K

11,0 224 DS 11.15				
07.82-12.95	WAS	1 457 43	N 4154²	K
	WAS	1 457 43	N 4106²	K

Serie 112 N

11,0 158 DN 11.01 C 09; DN 11.04 C 01				
01.90-12.00		1 457 43	N 4154²	K
	WAS	1 457 43	N 4106²	K
		1 457 42	P 9165³	P

Serie 113

Serie 113 BN

11,0 228 DSC 11.08 C				
05.90-08.98	FRE	1 457 42	P 9174	O
	MOR	0 451 10	P 3004	O
		1 457 43	S 2188	L
	WAS	1 457 43	N 4154²	K
	WAS	1 457 43	N 4106²	K
		1 457 42	P 9820³	P

Serie 113 BN/ CN/ F/ K/ L/ N

11,0 228 DS 11.34				
01.90-08.98	FRE	1 457 42	P 9174	O
	MOR	0 451 10	P 3004	O
		1 457 43	S 2188	L
	WAS	1 457 43	N 4154²	K
	WAS	1 457 43	N 4106²	K
		1 457 42	P 9820³	P

Serie 113 BN/ CN/ N

11,0 189 DSC 11.04				
01.90-08.98	FRE	1 457 42	P 9174	O
	MOR	0 451 10	P 3004	O
		1 457 43	S 2188	L
	WAS	1 457 43	N 4154²	K
	WAS	1 457 43	N 4106²	K
		1 457 42	P 9820³	P

Serie 113 BN/ N

11,0 134 DN 11.06 C				
05.90-08.98	FRE	1 457 42	P 9174	O
	MOR	0 451 10	P 3004	O
		1 457 43	S 2188	L
	WAS	1 457 43	N 4154²	K
	WAS	1 457 43	N 4106²	K
		1 457 42	P 9820³	P

11,0 | 189 | DS 11.71

05.90-08.98	FRE	1 457 42	P 9174	O
	MOR	0 451 10	P 3004	O
		1 457 43	S 2188	L
	WAS	1 457 43	N 4154²	K
	WAS	1 457 43	N 4106²	K
		1 457 42	P 9820³	P

Serie 113 CN/ K/ L/ N

11,0 189 DS 11.74				
01.90-08.98	FRE	1 457 42	P 9174	O
	MOR	0 451 10	P 3004	O
		1 457 43	S 2188	L
	WAS	1 457 43	N 4154²	K
	WAS	1 457 43	N 4106²	K
		1 457 42	P 9820³	P

11,0 | 228 | DSC 11.08

01.90-08.98	FRE	1 457 42	P 9174	O
	MOR	0 451 10	P 3004	O
		1 457 43	S 2188	L
	WAS	1 457 43	N 4154²	K
	WAS	1 457 43	N 4106²	K
		1 457 42	P 9820³	P





Serie 113 K

11,0DSC 11.35

07.90-08.98	FRE	1 457 42	P 9174	O
	MOR	0 451 10	P 3004	O
			1 457 43 S 2188	L
	WAS	1 457 43	N 4154²	K
	WAS	1 457 43	N 4106²	K
			1 457 42 P 9820³	P

11,0DSC 11.36

07.90-08.98	FRE	1 457 42	P 9174	O
	MOR	0 451 10	P 3004	O
			1 457 43 S 2188	L
	WAS	1 457 43	N 4154²	K
	WAS	1 457 43	N 4106²	K
			1 457 42 P 9820³	P

11,0 | 228/239/267 | DSC 11.08 B; DSC 11.13 B; DSC 11.16 B

07.90-08.98	FRE	1 457 42	P 9174	O
	MOR	0 451 10	P 3004	O
			1 457 43 S 2188	L
	WAS	1 457 43	N 4154²	K
	WAS	1 457 43	N 4106²	K
			1 457 42 P 9820³	P

11,0 | 235 | DSC 11.17

07.90-08.98	FRE	1 457 42	P 9174	O
	MOR	0 451 10	P 3004	O
			1 457 43 S 2188	L
	WAS	1 457 43	N 4154²	K
	WAS	1 457 43	N 4106²	K
			1 457 42 P 9820³	P

11,0 | 265 | DS 11.75

07.90-08.98	FRE	1 457 42	P 9174	O
	MOR	0 451 10	P 3004	O
			1 457 43 S 2188	L
	WAS	1 457 43	N 4154²	K
	WAS	1 457 43	N 4106²	K
			1 457 42 P 9820³	P

11,0 | 266 | DSC 11.23 <Euro 1>

07.90-08.98	FRE	1 457 42	P 9174	O
	MOR	0 451 10	P 3004	O
			1 457 43 S 2188	L
	WAS	1 457 43	N 4154²	K
	WAS	1 457 43	N 4106²	K
			1 457 42 P 9820³	P

11,0 | 267 | DSC 11.18

07.90-08.98	FRE	1 457 42	P 9174	O
	MOR	0 451 10	P 3004	O
			1 457 43 S 2188	L
	WAS	1 457 43	N 4154²	K
	WAS	1 457 43	N 4106²	K
			1 457 42 P 9820³	P

11,0 | 280 | DSC 11.22 <Euro 1>

07.90-08.98	FRE	1 457 42	P 9174	O
	MOR	0 451 10	P 3004	O
			1 457 43 S 2188	L
	WAS	1 457 43	N 4154²	K
	WAS	1 457 43	N 4106²	K
			1 457 42 P 9820³	P

11,0 | 280/305 | DSC 11.70 <Euro 2>; DSC 11.81

05.82-08.98	FRE	1 457 42	P 9174	O
	MOR	0 451 10	P 3004	O
			1 457 43 S 2188	L
	WAS	1 457 43	N 4154²	K
	WAS	1 457 43	N 4106²	K
			1 457 42 P 9820³	P

Serie 113 K/ L/ N

11,0DS 11.78

07.90-08.98	FRE	1 457 42	P 9174	O
	MOR	0 451 10	P 3004	O
			1 457 43 S 2188	L
	WAS	1 457 43	N 4154²	K
	WAS	1 457 43	N 4106²	K
			1 457 42 P 9820³	P

11,0 | 235 | DSC 11.21 <Euro 1>

01.90-08.98	FRE	1 457 42	P 9174	O
	MOR	0 451 10	P 3004	O
			1 457 43 S 2188	L
	WAS	1 457 43	N 4154²	K
	WAS	1 457 43	N 4106²	K
			1 457 42 P 9820³	P

Serie 113 K/ N

11,0 | 230 | DS 11.73

07.90-08.98	FRE	1 457 42	P 9174	O
	MOR	0 451 10	P 3004	O
			1 457 43 S 2188	L
	WAS	1 457 43	N 4154²	K
	WAS	1 457 43	N 4106²	K
			1 457 42 P 9820³	P

Serie 113 L/ N

11,0DSC 11.71

04.95-08.98	FRE	1 457 42	P 9174	O
	MOR	0 451 10	P 3004	O
			1 457 43 S 2188	L
	WAS	1 457 43	N 4154²	K
	WAS	1 457 43	N 4106²	K
			1 457 42 P 9820³	P

11,0 | 180 | DSC 11.27 <EDC>

04.91-08.98	FRE	1 457 42	P 9174	O
	MOR	0 451 10	P 3004	O
			1 457 43 S 2188	L
	WAS	1 457 43	N 4154²	K
	WAS	1 457 43	N 4106²	K
			1 457 42 P 9820³	P

11,0 | 191-193 | DSC 11.24 <EDC>

04.91-08.98	FRE	1 457 42	P 9174	O
	MOR	0 451 10	P 3004	O
			1 457 43 S 2188	L
	WAS	1 457 43	N 4154²	K
	WAS	1 457 43	N 4106²	K
			1 457 42 P 9820³	P





Serie 113 N

11,0 | 189 | DS 11.74 C; DS 11.77

04.91-08.98	FRE	1 457 42	P 9174	O
	MOR	0 451 10	P 3004	O
			1 457 43 S 2188	L
	WAS	1 457 43	N 4154²	K
	WAS	1 457 43	N 4106²	K
		1 457 42	P 9820³	P

11,0 | 189 | DSC 11.04 C

12.88-08.98	FRE	1 457 42	P 9174	O
	MOR	0 451 10	P 3004	O
			1 457 43 S 2188	L
	WAS	1 457 43	N 4154²	K
	WAS	1 457 43	N 4106²	K
		1 457 42	P 9820³	P

11,0 | 191 | DSI 11 E 01; DSI 11 E 01

09.91-08.98	FRE	1 457 42	P 9174	O
	MOR	0 451 10	P 3004	O
			1 457 43 S 2188	L
	WAS	1 457 43	N 4154²	K
	WAS	1 457 43	N 4106²	K
		1 457 42	P 9820³	P

Serie 113 P

11,0 | 230 | DS 11.73

06.88-12.00	DIF	0 451 10	P 3330	O
	FRE	1 457 42	P 9174	O
	MOR	0 451 10	P 3004	O
			1 457 43 S 2188	L
	WAS	1 457 43	N 4154²	K
	WAS	1 457 43	N 4106²	K
		1 457 42	P 9820³	P

Serie 113 P/ R

11,0 | 229 | DSC 11.06

05.88-12.00	DIF	0 451 10	P 3330	O
	FRE	1 457 42	P 9174	O
	MOR	0 451 10	P 3004	O
			1 457 43 S 2188	L
	WAS	1 457 43	N 4154²	K
	WAS	1 457 43	N 4106²	K
		1 457 42	P 9820³	P

11,0 | 254 | DSC 11.03

05.88-12.00	DIF	0 451 10	P 3330	O
	FRE	1 457 42	P 9174	O
	MOR	0 451 10	P 3004	O
			1 457 43 S 2188	L
	WAS	1 457 43	N 4154²	K
	WAS	1 457 43	N 4106²	K
		1 457 42	P 9820³	P

11,0 | 267 | DSC 11.13

06.88-05.97	DIF	0 451 10	P 3330	O
	FRE	1 457 42	P 9174	O
	MOR	0 451 10	P 3004	O
			1 457 43 S 2188	L
	WAS	1 457 43	N 4154²	K
	WAS	1 457 43	N 4106²	K
		1 457 42	P 9820³	P

11,0 | 267 | DSC 11.18

06.88-05.97	DIF	0 451 10	P 3330	O
	FRE	1 457 42	P 9174	O
	MOR	0 451 10	P 3004	O
			1 457 43 S 2188	L
	WAS	1 457 43	N 4154²	K
	WAS	1 457 43	N 4106²	K
		1 457 42	P 9820³	P

Serie 113 P,R

11,0 | 228 | DS 11.34

06.88-05.97	DIF	0 451 10	P 3330	O
	FRE	1 457 42	P 9174	O
	MOR	0 451 10	P 3004	O
			1 457 43 S 2188	L
	WAS	1 457 43	N 4154²	K
	WAS	1 457 43	N 4106²	K
		1 457 42	P 9820³	P

11,0 | 228 | DS 11.75

06.88-05.97	DIF	0 451 10	P 3330	O
	FRE	1 457 42	P 9174	O
	MOR	0 451 10	P 3004	O
			1 457 43 S 2188	L
	WAS	1 457 43	N 4154²	K
	WAS	1 457 43	N 4106²	K
		1 457 42	P 9820³	P

11,0 | 228 | DSC 11.08

11.91-02.95	DIF	0 451 10	P 3330	O
	FRE	1 457 42	P 9174	O
	MOR	0 451 10	P 3004	O
			1 457 43 S 2188	L
	WAS	1 457 43	N 4154²	K
	WAS	1 457 43	N 4106²	K
		1 457 42	P 9820³	P

11,0 | 230 | DS 11.73

05.88-02.95	DIF	0 451 10	P 3330	O
	FRE	1 457 42	P 9174	O
	MOR	0 451 10	P 3004	O
			1 457 43 S 2188	L
	WAS	1 457 43	N 4154²	K
	WAS	1 457 43	N 4106²	K
		1 457 42	P 9820³	P





◀ Serie 113 P,R

11,0 | 236 | DSC 11.17

11.91-02.95	DIF	0 451 10	P 3330	O
	FRE	1 457 42	P 9174	O
	MOR	0 451 10	P 3004	O
	TW	1 457 43	S 2188	L
	WAS	1 457 43	N 4154²	K
	WAS	1 457 43	N 4106²	K
		1 457 42	P 9820³	P

11,0 | 250/252 | DSC 11.10; DSC 11.12

05.88-02.95	DIF	0 451 10	P 3330	O
	FRE	1 457 42	P 9174	O
	MOR	0 451 10	P 3004	O
	TW	1 457 43	S 2188	L
	WAS	1 457 43	N 4154²	K
	WAS	1 457 43	N 4106²	K
		1 457 42	P 9820³	P

11,0 | 258/295 | DSC 11.39 <Euro 1>; DTC 11.01 <Euro I>; DTC 11.02 <Euro 2>

06.88-05.97	DIF	0 451 10	P 3330	O
	FRE	1 457 42	P 9174	O
	MOR	0 451 10	P 3004	O
	TW	1 457 43	S 2188	L
	WAS	1 457 43	N 4154²	K
	WAS	1 457 43	N 4106²	K
		1 457 42	P 9820³	P

11,0 | 265 | DSC 11.30

02.90-02.95	DIF	0 451 10	P 3330	O
	FRE	1 457 42	P 9174	O
	MOR	0 451 10	P 3004	O
	TW	1 457 43	S 2188	L
	WAS	1 457 43	N 4154²	K
	WAS	1 457 43	N 4106²	K
		1 457 42	P 9820³	P

Serie 113 P,R/ T

11,0 | 235 | DSC 11.16

05.88-05.00	DIF	0 451 10	P 3330	O
	FRE	1 457 42	P 9174	O
	MOR	0 451 10	P 3004	O
	TW	1 457 43	S 2188	L
	WAS	1 457 43	N 4154²	K
	WAS	1 457 43	N 4106²	K
		1 457 42	P 9820³	P

11,0 | 235 | DSC 11.21 <Euro 1>

11.91-05.00	DIF	0 451 10	P 3330	O
	FRE	1 457 42	P 9174	O
	MOR	0 451 10	P 3004	O
	TW	1 457 43	S 2188	L
	WAS	1 457 43	N 4154²	K
	WAS	1 457 43	N 4106²	K
		1 457 42	P 9820³	P

11,0 | 236 | DSC 11.35

06.88-05.00	DIF	0 451 10	P 3330	O
	FRE	1 457 42	P 9174	O
	MOR	0 451 10	P 3004	O
	TW	1 457 43	S 2188	L
	WAS	1 457 43	N 4154²	K
	WAS	1 457 43	N 4106²	K
		1 457 42	P 9820³	P



11,0 | 265 | DSC 11.13

05.88-05.97	DIF	0 451 10	P 3330	O
	FRE	1 457 42	P 9174	O
	MOR	0 451 10	P 3004	O
	TW	1 457 43	S 2188	L
	WAS	1 457 43	N 4154²	K
	WAS	1 457 43	N 4106²	K
		1 457 42	P 9820³	P

11,0 | 265 | DSC 11.18

06.88-05.00	DIF	0 451 10	P 3330	O
	FRE	1 457 42	P 9174	O
	MOR	0 451 10	P 3004	O
	TW	1 457 43	S 2188	L
	WAS	1 457 43	N 4154²	K
	WAS	1 457 43	N 4106²	K
		1 457 42	P 9820³	P

11,0 | 265 | DSC 11.23 <Euro 1>

11.91-05.00	DIF	0 451 10	P 3330	O
	FRE	1 457 42	P 9174	O
	MOR	0 451 10	P 3004	O
	TW	1 457 43	S 2188	L
	WAS	1 457 43	N 4154²	K
	WAS	1 457 43	N 4106²	K
		1 457 42	P 9820³	P

11,0 | 265 | DSC 11.36

06.88-05.00	DIF	0 451 10	P 3330	O
	FRE	1 457 42	P 9174	O
	MOR	0 451 10	P 3004	O
	TW	1 457 43	S 2188	L
	WAS	1 457 43	N 4154²	K
	WAS	1 457 43	N 4106²	K
		1 457 42	P 9820³	P

Serie 113 R

11,0 | 149 | DN 11.08

10.91-12.98		0 451 10	P 3004	O
-------------	--	----------	---------------	----------

11,0 | 228 | DS 11.34

06.88-05.97	DIF	0 451 10	P 3330	O
	FRE	1 457 42	P 9174	O
	MOR	0 451 10	P 3004	O
		1 457 43	S 2188	L
	WAS	1 457 43	N 4154²	K
	WAS	1 457 43	N 4106²	K
		1 457 42	P 9820³	P

11,0 | 230 | DS 11.73

06.88-05.97	DIF	0 451 10	P 3330	O
	FRE	1 457 42	P 9174	O
	MOR	0 451 10	P 3004	O
		1 457 43	S 2188	L
	WAS	1 457 43	N 4154²	K
	WAS	1 457 43	N 4106²	K
		1 457 42	P 9820³	P



11,0 | 280 | DSC 11.22 <Euro 1>

01.91-05.97	DIF	0 451 10	P 3330	O
	FRE	1 457 42	P 9174	O
	MOR	0 451 10	P 3004	O
		1 457 43	S 2188	L
10.94-05.97	TW	1 457 43	S 2188	L
01.91-05.97	WAS	1 457 43	N 4154 ²	K
	WAS	1 457 43	N 4106 ²	K
		1 457 42	P 9820 ³	P

Serie 113 R/ T

11,0 | 158/280 | DN 11.01; DSC 11.70

05.88-05.00	DIF	0 451 10	P 3330	O
	FRE	1 457 42	P 9174	O
	MOR	0 451 10	P 3004	O
	TW	1 457 43	S 2188	L
	WAS	1 457 43	N 4154 ²	K
	WAS	1 457 43	N 4106 ²	K
		1 457 42	P 9820 ³	P

Serie 113 T

11,0 | 228 | DS 11.34

06.88-05.97	DIF	0 451 10	P 3330	O
	FRE	1 457 42	P 9174	O
	MOR	0 451 10	P 3004	O
	TW	1 457 43	S 2188	L
	WAS	1 457 43	N 4154 ²	K
	WAS	1 457 43	N 4106 ²	K
		1 457 42	P 9820 ³	P

11,0 | 230 | DS 11.73

05.88-05.97	DIF	0 451 10	P 3330	O
	FRE	1 457 42	P 9174	O
	MOR	0 451 10	P 3004	O
	TW	1 457 43	S 2188	L
	WAS	1 457 43	N 4154 ²	K
	WAS	1 457 43	N 4106 ²	K
		1 457 42	P 9820 ³	P

11,0 | 230-230 | DS 11.73

05.88-05.00	DIF	0 451 10	P 3330	O
	FRE	1 457 42	P 9174	O
	MOR	0 451 10	P 3004	O
	WAS	1 457 43	N 4154 ²	K
	WAS	1 457 43	N 4106 ²	K
		1 457 42	P 9820 ³	P

11,0 | 235 | DSC 11.17

11.91-02.95	DIF	0 451 10	P 3330	O
	FRE	1 457 42	P 9174	O
	MOR	0 451 10	P 3004	O
	TW	1 457 43	S 2188	L
	WAS	1 457 43	N 4154 ²	K
	WAS	1 457 43	N 4106 ²	K
		1 457 42	P 9820 ³	P

11,0 | 265 | DS 11.75

06.88-02.95	DIF	0 451 10	P 3330	O
	FRE	1 457 42	P 9174	O
	MOR	0 451 10	P 3004	O
	TW	1 457 43	S 2188	L
	WAS	1 457 43	N 4154 ²	K
	WAS	1 457 43	N 4106 ²	K
		1 457 42	P 9820 ³	P

11,0 | 267 | DSC 11.13

05.88-05.00	DIF	0 451 10	P 3330	O
	FRE	1 457 42	P 9174	O
	MOR	0 451 10	P 3004	O
	WAS	1 457 43	N 4154 ²	K
	WAS	1 457 43	N 4106 ²	K
		1 457 42	P 9820 ³	P

11,0 | 280 | DSC 11.22 <Euro 1>

01.91-05.00	DIF	0 451 10	P 3330	O
	FRE	1 457 42	P 9174	O
	MOR	0 451 10	P 3004	O
	TW	1 457 43	S 2188	L
	WAS	1 457 43	N 4154 ²	K
	WAS	1 457 43	N 4106 ²	K
		1 457 42	P 9820 ³	P

Serie 114

Serie 114 K

10,6 | 250 | DC 11.03 <Euro 3>

08.97→	DIF	0 451 10	P 3330	O
	FRE	1 457 42	P 9174	O
	MOR	0 451 10	P 3343	O
	DON	1 457 43	S 3903	L
	KNE	1 457 43	S 3042	L
	WAS	1 457 43	N 4428 ²	K

10,6 | 250 | DC 11.06 <Euro 3>

08.97→	DIF	0 451 10	P 3330	O
	FRE	1 457 42	P 9174	O
	MOR	0 451 10	P 3343	O
	DON	1 457 43	S 3903	L
	KNE	1 457 43	S 3042	L
	WAS	1 457 43	N 4428 ²	K

10,6 | 280 | DC 11.04 <Euro 3>

08.97→	DIF	0 451 10	P 3330	O
	FRE	1 457 42	P 9174	O
	MOR	0 451 10	P 3343	O
	DON	1 457 43	S 3903	L
	KNE	1 457 43	S 3042	L
	WAS	1 457 43	N 4428 ²	K

11,6 | 265 | DC 11.07 <Euro 2>

08.97-12.03	DIF	0 451 10	P 3330	O
	FRE	1 457 42	P 9174	O
	MOR	0 451 10	P 3343	O
	DON	1 457 43	S 3903	L
	KNE	1 457 43	S 3042	L
	WAS	1 457 43	N 4428 ²	K





Serie 114 P

11,0|191|OSC 11.G03 <Euro 3>

02.01-09.04	DIF	0 451 10	P 3330	O
	FRE	1 457 42	P 9174	O
	FWG	1 457 42	P 9167	O
	DON	1 457 43	S 3903	L
	KNE	1 457 43	S 3042	L
		1 987 43	M 2153	I
		1 457 42	P 9820³	P

Serie 114 P,R/ T

10,6|250|DC 11.01 <Euro 2>

03.96-02.02	DIF	0 451 10	P 3330	O
	FRE	1 457 42	P 9174	O
	FWG	1 457 42	P 9167	O
	MOR	0 451 10	P 3343	O
	DON	1 457 43	S 3903	L
	KNE	1 457 43	S 3042	L
	WAS	1 457 43	N 4428²	K
		1 987 43	M 2153	I
		1 457 42	P 9820³	P

10,6|250|DC 11.03 <Euro 3>

02.96-09.04	DIF	0 451 10	P 3330	O
	FRE	1 457 42	P 9174	O
	FWG	1 457 42	P 9167	O
	MOR	0 451 10	P 3343	O
	DON	1 457 43	S 3903	L
	KNE	1 457 43	S 3042	L
	WAS	1 457 43	N 4428²	K
		1 987 43	M 2153	I
		1 457 42	P 9820³	P

10,6|250|DC 11.06 <Euro 3>

02.96-09.04	DIF	0 451 10	P 3330	O
	FRE	1 457 42	P 9174	O
	FWG	1 457 42	P 9167	O
	MOR	0 451 10	P 3343	O
	DON	1 457 43	S 3903	L
	KNE	1 457 43	S 3042	L
	WAS	1 457 43	N 4428²	K
		1 987 43	M 2153	I
		1 457 42	P 9820³	P

10,6|280|DC 11.02 <Euro 2>

03.96-02.02	DIF	0 451 10	P 3330	O
	FRE	1 457 42	P 9174	O
	FWG	1 457 42	P 9167	O
	MOR	0 451 10	P 3343	O
	DON	1 457 43	S 3903	L
	KNE	1 457 43	S 3042	L
	WAS	1 457 43	N 4428²	K
		1 987 43	M 2153	I
		1 457 42	P 9820³	P

10,6|280|DC 11.04 <Euro 3>

02.96-09.04	DIF	0 451 10	P 3330	O
	FRE	1 457 42	P 9174	O
	FWG	1 457 42	P 9167	O
	MOR	0 451 10	P 3343	O
	DON	1 457 43	S 3903	L
	KNE	1 457 43	S 3042	L
	WAS	1 457 43	N 4428²	K
		1 987 43	M 2153	I
		1 457 42	P 9820³	P

11,0|235|DSC 11.74 <Euro 1>

05.96-05.99	DIF	0 451 10	P 3330	O
	FRE	1 457 42	P 9174	O
	FWG	1 457 42	P 9167	O
	DON	1 457 43	S 3903	L
	KNE	1 457 43	S 3042	L
		1 987 43	M 2153	I
		1 457 42	P 9820³	P

11,0|250|DSC 11.79 <Euro 2>

05.96-05.99	DIF	0 451 10	P 3330	O
	FRE	1 457 42	P 9174	O
	FWG	1 457 42	P 9167	O
	DON	1 457 43	S 3903	L
	KNE	1 457 43	S 3042	L
		1 987 43	M 2153	I
		1 457 42	P 9820³	P

11,0|265|DSC 11.75 <Euro 1>

05.96-05.99	DIF	0 451 10	P 3330	O
	FRE	1 457 42	P 9174	O
	FWG	1 457 42	P 9167	O
	DON	1 457 43	S 3903	L
	KNE	1 457 43	S 3042	L
		1 987 43	M 2153	I
		1 457 42	P 9820³	P

Serie 124

Serie 124 H

12,0|309|DC 12.03 <Euro 3>

09.02→	FRE	1 457 42	P 9174	O
	MOR	0 451 10	P 3343	O
	DON	1 457 43	S 3903	L
	KNE	1 457 43	S 3042	L
		F 026 40	N 2100	K

Serie 124 K

11,7|309|DC 12.01 <Euro 3>

10.97-08.02	DIF	0 451 10	P 3330	O
	FRE	1 457 42	P 9174	O
	MOR	0 451 10	P 3343	O
		1 457 43	S 2188	L
	WAS	1 457 43	N 4154²	K
	WAS	1 457 43	N 4106²	K

11,7|309|DC 12.03 <Euro 3>

09.02→	FRE	1 457 42	P 9174	O
	MOR	0 451 10	P 3343	O
	DON	1 457 43	S 3903	L
	KNE	1 457 43	S 3042	L
		F 026 40	N 2100	K





12,0 | 265 | DSC 12.02 <Euro 2>

08.97-02.02	DIF	0 451 10	P 3330	O
	FRE	1 457 42	P 9174	O
	MOR	0 451 10	P 3343	O
		1 457 43	S 2188	L
		1 457 42	P 9820 ³	P

12,0 | 294 | DC 12.02 <Euro 3>

08.97→	DIF	0 451 10	P 3330	O
	FRE	1 457 42	P 9174	O
	MOR	0 451 10	P 3343	O
		1 457 43	S 2188	L
	WAS	1 457 43	N 4154 ²	K
	WAS	1 457 43	N 4106 ²	K

12,0 | 309 | DC 12.01 <Euro 3>

08.97-08.02	DIF	0 451 10	P 3330	O
	FRE	1 457 42	P 9174	O
	MOR	0 451 10	P 3343	O
		1 457 43	S 2188	L
	WAS	1 457 43	N 4154 ²	K
	WAS	1 457 43	N 4106 ²	K

12,0 | 309 | DSC 12.05 <Euro 2>

08.97-02.02	DIF	0 451 10	P 3330	O
	FRE	1 457 42	P 9174	O
	MOR	0 451 10	P 3343	O
		1 457 43	S 2188	L
	WAS	1 457 43	N 4428 ²	K
	WAS	1 457 43	N 4106 ²	K
		1 457 42	P 9820 ³	P

Serie 124 P,R

12,0 | 265 | DC 12.02 <Euro 3>

09.95-09.04	DIF	0 451 10	P 3330	O
	FRE	1 457 42	P 9174	O
	MOR	0 451 10	P 3343	O
	DON	1 457 43	S 3903	L
	KNE	1 457 43	S 3042	L
		1 987 43	M 2153	I
		1 457 42	P 9820 ³	P

Serie 124 P,R/ T

12,0 | 265 | DSC 12.02 <Euro 2>

09.95-02.02	DIF	0 451 10	P 3330	O
	FRE	1 457 42	P 9174	O
	MOR	0 451 10	P 3343	O
	DON	1 457 43	S 3903	L
	KNE	1 457 43	S 3042	L
		1 987 43	M 2153	I
		1 457 42	P 9820 ³	P

12,0 | 294 | DSC 12.01 <Euro 2>

03.95-01.00	DIF	0 451 10	P 3330	O
	FRE	1 457 42	P 9174	O
	MOR	0 451 10	P 3343	O
	DON	1 457 43	S 3903	L
	KNE	1 457 43	S 3042	L
		1 987 43	M 2153	I
		1 457 42	P 9820 ³	P

12,0 | 309 | DC 12.01 <Euro 3>

09.95-08.02	DIF	0 451 10	P 3330	O
	FRE	1 457 42	P 9174	O
	MOR	0 451 10	P 3343	O
	DON	1 457 43	S 3903	L
	KNE	1 457 43	S 3042	L
		1 987 43	M 2153	I
		1 457 42	P 9820 ³	P

12,0 | 309 | DC 12.03 <Euro 3>

09.02-09.04	DIF	0 451 10	P 3330	O
	FRE	1 457 42	P 9174	O
	MOR	0 451 10	P 3343	O
	DON	1 457 43	S 3903	L
	KNE	1 457 43	S 3042	L
		F 026 40	N 2100	K
		1 987 43	M 2153	I
		1 457 42	P 9820 ³	P

12,0 | 309 | DSC 12.05 <Euro 2>

09.95-02.02	DIF	0 451 10	P 3330	O
	FRE	1 457 42	P 9174	O
	MOR	0 451 10	P 3343	O
	DON	1 457 43	S 3903	L
	KNE	1 457 43	S 3042	L
	WAS	1 457 43	N 4428 ²	K
		1 987 43	M 2153	I
		1 457 42	P 9820 ³	P

12,0 | 324 | DT 12.08 <Euro 3>

09.00-09.04	DIF	0 451 10	P 3330	O
	FRE	1 457 42	P 9174	O
	MOR	0 451 10	P 3343	O
	DON	1 457 43	S 3903	L
	KNE	1 457 43	S 3042	L
		F 026 40	N 2100	K
		1 987 43	M 2153	I
		1 457 42	P 9820 ³	P

12,0 | 346 | DT 12.02 <Euro 3>

09.00-09.04	DIF	0 451 10	P 3330	O
	FRE	1 457 42	P 9174	O
	MOR	0 451 10	P 3343	O
	DON	1 457 43	S 3903	L
	KNE	1 457 43	S 3042	L
		F 026 40	N 2100	K
		1 987 43	M 2153	I
		1 457 42	P 9820 ³	P

Serie 124 T

12,0 | 294 | DC 12.02 <Euro 3>

09.95-09.04	DIF	0 451 10	P 3330	O
	FRE	1 457 42	P 9174	O
	MOR	0 451 10	P 3343	O
	DON	1 457 43	S 3903	L
	KNE	1 457 43	S 3042	L
		1 987 43	M 2153	I
		1 457 42	P 9820 ³	P





◀ Serie 124 T

12,0 309 DC 12.02 <Euro 3>				
09.95-09.04	DIF	0 451 10	P 3330	O
	FRE	1 457 42	P 9174	O
	MOR	0 451 10	P 3343	O
	DON	1 457 43	S 3903	L
	KNE	1 457 43	S 3042	L
		1 987 43	M 2153	I
		1 457 42	P 9820³	P

12,0 309 DSC 12.03				
06.96-02.02	DIF	0 451 10	P 3330	O
	FRE	1 457 42	P 9174	O
	MOR	0 451 10	P 3343	O
	DON	1 457 43	S 3903	L
	KNE	1 457 43	S 3042	L
	WAS	1 457 43	N 4428²	K
		1 987 43	M 2153	I
		1 457 42	P 9820³	P

Serie 143

Serie 143 R

14,2 297 DSC 14.06				
05.88-12.94	DIF	0 451 10	P 3330	O
	FRE	1 457 42	P 9174	O
	MOR	0 451 10	P 3004	O
		1 457 43	S 2188	L
	WAS	1 457 43	N 4154²	K
	WAS	1 457 43	N 4106²	K
	ABM	1 457 42	P 9820³	P

14,2 309 DSC 14.08 <Euro I>				
01.91-12.96	DIF	0 451 10	P 3330	O
	FRE	1 457 42	P 9174	O
	MOR	0 451 10	P 3004	O
		1 457 43	S 2188	L
	WAS	1 457 43	N 4154²	K
	WAS	1 457 43	N 4106²	K
	ABM	1 457 42	P 9820³	P

14,2 331 DSC 14.03				
05.88-12.94	DIF	0 451 10	P 3330	O
	FRE	1 457 42	P 9174	O
	MOR	0 451 10	P 3004	O
		1 457 43	S 2188	L
	WAS	1 457 43	N 4154²	K
	WAS	1 457 43	N 4106²	K
10.96-06.98	ZE	1 457 43	N 4165²	K
05.88-12.94	ABM	1 457 42	P 9820³	P

14,2 333 DSC 14.10 <Euro I>				
06.92-12.96	DIF	0 451 10	P 3330	O
	FRE	1 457 42	P 9174	O
	MOR	0 451 10	P 3004	O
		1 457 43	S 2188	L
	WAS	1 457 43	N 4154²	K
	WAS	1 457 43	N 4106²	K
	ABM	1 457 42	P 9820³	P



14,2 346 DSC 14.04 <EDC>				
03.88-05.91	DIF	0 451 10	P 3330	O
	FRE	1 457 42	P 9174	O
	MOR	0 451 10	P 3004	O
		1 457 43	S 2188	L
	WAS	1 457 43	N 4154²	K
	WAS	1 457 43	N 4106²	K
	ABM	1 457 42	P 9820³	P

14,2 368 DSC 14.09 <Euro 1>				
01.91-12.96	DIF	0 451 10	P 3330	O
	FRE	1 457 42	P 9174	O
	MOR	0 451 10	P 3004	O
		1 457 43	S 2188	L
	WAS	1 457 43	N 4154²	K
	WAS	1 457 43	N 4106²	K
	ABM	1 457 42	P 9820³	P

14,2 368 DSC 14.16 <Euro 2>				
12.94-12.96	DIF	0 451 10	P 3330	O
	FRE	1 457 42	P 9174	O
	MOR	0 451 10	P 3004	O
		1 457 43	S 2188	L
	WAS	1 457 43	N 4154²	K
	WAS	1 457 43	N 4106²	K
	ABM	1 457 42	P 9820³	P

Serie 143 R/ T

14,2 390 DSC 14.13				
12.94-12.96	DIF	0 451 10	P 3330	O
	FRE	1 457 42	P 9174	O
	MOR	0 451 10	P 3004	O
		1 457 43	S 2188	L
	WAS	1 457 43	N 4154²	K
	WAS	1 457 43	N 4106²	K
	ABM	1 457 42	P 9820³	P

Serie 143 T

14,2 297 DSC 14.06				
05.88-12.96	DIF	0 451 10	P 3330	O
	FRE	1 457 42	P 9174	O
	MOR	0 451 10	P 3004	O
	WAS	1 457 43	N 4154²	K
	WAS	1 457 43	N 4106²	K
	ABM	1 457 42	P 9820³	P

14,2 309 DSC 14.08 <Euro 1>				
06.88-12.96	DIF	0 451 10	P 3330	O
	FRE	1 457 42	P 9174	O
	MOR	0 451 10	P 3004	O
	WAS	1 457 43	N 4154²	K
	WAS	1 457 43	N 4106²	K
	ABM	1 457 42	P 9820³	P

14,2 331 DSC 14.03				
05.88-12.96	DIF	0 451 10	P 3330	O
	FRE	1 457 42	P 9174	O
	MOR	0 451 10	P 3004	O
	WAS	1 457 43	N 4154²	K
	WAS	1 457 43	N 4106²	K
	ABM	1 457 42	P 9820³	P





14,2 333 DSC 14.10 <Euro I>				
06.92-12.96	DIF	0 451 10	P 3330	O
	FRE	1 457 42	P 9174	O
	MOR	0 451 10	P 3004	O
	WAS	1 457 43	N 4154 ²	K
	WAS	1 457 43	N 4106 ²	K
	ABM	1 457 42	P 9820 ³	P

14,2 346 DSC 14.04 <EDC>				
11.89-12.96	DIF	0 451 10	P 3330	O
	FRE	1 457 42	P 9174	O
	MOR	0 451 10	P 3004	O
	WAS	1 457 43	N 4154 ²	K
	WAS	1 457 43	N 4106 ²	K
	ABM	1 457 42	P 9820 ³	P

14,2 368 DSC 14.09 <Euro 1>				
06.88-12.96	DIF	0 451 10	P 3330	O
	FRE	1 457 42	P 9174	O
	MOR	0 451 10	P 3004	O
	WAS	1 457 43	N 4154 ²	K
	WAS	1 457 43	N 4106 ²	K
	ABM	1 457 42	P 9820 ³	P

14,2 368 DSC 14.16 <Euro 2>				
12.94-12.96	DIF	0 451 10	P 3330	O
	FRE	1 457 42	P 9174	O
	MOR	0 451 10	P 3004	O
	WAS	1 457 43	N 4154 ²	K
	WAS	1 457 43	N 4106 ²	K
	ABM	1 457 42	P 9820 ³	P

Serie 144

Serie 144 R/ T

14,2 338/389/390 DSC 14.13 <Euro 2>; DSC 14.15 <Euro 2>				
01.96-08.01	DIF	0 451 10	P 3330	O
	FRE	1 457 42	P 9174	O
	MOR	0 451 10	P 3343	O
	DON	1 457 43	S 3904	L
		1 987 43	M 2153	I
		1 457 42	P 9820 ³	P

Serie 164

Serie 164 R

16,0 353 DC 16.02 <Euro 3>				
04.00-05.04	DIF	0 451 10	P 3330	O
	FRE	1 457 42	P 9174	O
	DON	1 457 43	S 3904	L
		F 026 40	N 2025 ⁶	K
		1 987 43	M 2153	I
		1 457 42	P 9820 ³	P

16,0 427 DC 16.01 <Euro 3>				
04.00-05.04	DIF	0 451 10	P 3330	O
	FRE	1 457 42	P 9174	O
	DON	1 457 43	S 3904	L
		F 026 40	N 2025 ⁶	K
		1 987 43	M 2153	I
		1 457 42	P 9820 ³	P



Serie 164 T

16,0 353 DC 16.02 <Euro 3>				
04.00-09.04	DIF	0 451 10	P 3330	O
	FRE	1 457 42	P 9174	O
		1 457 43	S 3904	L
		F 026 40	N 2025 ⁶	K
		1 987 43	M 2153	I
		1 457 42	P 9820 ³	P

16,0 427 DC 16.01 <Euro 3>				
04.00-09.04	DIF	0 451 10	P 3330	O
	FRE	1 457 42	P 9174	O
		1 457 43	S 3904	L
		F 026 40	N 2025 ⁶	K
		1 987 43	M 2153	I
		1 457 42	P 9820 ³	P

T

T 340

10,6 250 DC 11.08 <Euro 3>				
09.04-10.05		0 451 10	P 3343	O
Fg.Nr. →2018047→3588939	09.04-10.05	ANV,DON	1 457 43	S 3903
→5149840→9111174				L
Fg.Nr. 2018048→3588940→	09.04-10.05	ANV,DON	1 457 43	S 3903
5149841→9111175→				L
	09.04-10.05	TW	F 026 40	N 2025 ⁶
		KL	1 987 43	M 1172
				I
Fg.Nr. →2036225→3621168	09.04-10.05	KL	1 987 43	M 2153
→5200027→9130724				I
Fg.Nr. 2036226→3617864→	09.04-10.05	KL	1 987 43	M 1172
5200028→9130725→				I

T 380

11,0 280 DC 11.09 <Euro 3>				
09.04-10.05		0 451 10	P 3343	O
Fg.Nr. →2018047→3588939	09.04-10.05	ANV,DON	1 457 43	S 3903
→5149840→9111174				L
Fg.Nr. 2018048→3588940→	09.04-10.05	ANV,DON	1 457 43	S 3903
5149841→9111175→				L
	09.04-10.05	TW	F 026 40	N 2025 ⁶
		KL	1 987 43	M 1172
				I
Fg.Nr. →2036225→3621168	09.04-10.05	KL	1 987 43	M 2153
→5200027→9130724				I
Fg.Nr. 2036226→3617864→	09.04-10.05	KL	1 987 43	M 1172
5200028→9130725→				I

T 420/ 470

12,0 309/346 DC 12.14 <Euro 3>; DT 12.06 <Euro 3>; DT 12.11 <Euro 4>				
09.04-10.05		0 451 10	P 3343	O
Fg.Nr. →2018047→3588939	09.04-10.05	ANV,DON	1 457 43	S 3903
→5149840→9111174				L
	09.04-10.05	KL	1 987 43	M 1172
				I
Fg.Nr. →2036225→3621168	09.04-10.05	KL	1 987 43	M 2153
→5200027→9130724				I
Fg.Nr. 2036226→3617864→	09.04-10.05	KL	1 987 43	M 1172
5200028→9130725→				I





T 500/ 580

16,0 368/426 DC 16.03 <Euro 3>; DC 16.04 <Euro 3>				
	09.04-10.05	TW	F 026 40 N 2025⁶	K
		KL	1 987 43 M 1172	I
Fg.Nr. →2036225→3621168	09.04-10.05	KL	1 987 43 M 2153	I
→5200027→9130724				
Fg.Nr. 2036226→3617864→	09.04-10.05	KL	1 987 43 M 1172	I
5200028→9130725→				

SETRA

ComfortClass 400

ComfortClass 400 S 415

12,0 185-300 OM 457.941 hLA <Euro 3>				
	02.03→		F 026 40 P 7026	O
			1 457 42 N 9655	K

ComfortClass 400 S 415/ S 416/ S 417

12,0 260-310 OM 457.944 hLA <Euro 3>				
Komp.Nr. 522037/01	02.03→	TNK	1 457 42 P 9740	O
Komp.Nr. 522037/08				
Komp.Nr. 522037/03	02.03→	TNK	F 026 40 P 7042	O
	02.03→		1 457 42 N 9655	K

MultiClass 300

MultiClass 300 S 313/ S 315/ S 316/ S 317/ S 319/ SG 321

12,0 185/220 OM 457 HLA <Euro 3>				
	07.01-09.05		F 026 40 P 7026	O
			1 457 42 N 9655	K

MultiClass 300 S 317

14,6 280/320 OM 442 LA <Euro 2>				
	10.97-03.05		1 457 42 P 9732	O

MultiClass 300 S 319

12,0 184 OM 457 hLA <Euro 3>				
Komp.Nr. 522037/01	12.97-03.05	TNK	1 457 42 P 9740	O
Komp.Nr. 522037/08				

Setra

Setra S 215

14,6 280/320 OM 442 LA				
	06.96-06.01		1 457 42 P 9740	O

Setra S 309

9,6 213 OM 401 LA <LEV>				
	03.95-09.05		1 457 42 P 9740	O
			1 457 42 P 9820³	P

Setra S 312

11,0 250 OM 441 LA				
	03.95-09.05		1 457 42 P 9740	O
			1 457 42 S 9969	L



Setra S 313/ S 315/ S 319/ SG 321

12,0 184/220 OM 447 hLA <Euro 2>				
Komp.Nr. 522037/01	03.95-09.05	TNK	1 457 42 P 9740	O
Komp.Nr. 522037/08				

Setra S 315

11,0 250 OM 441 LA <Euro 2>				
	03.95-07.01		1 457 42 S 9969	L

12,0 294 D 2866 LOH 23 <Euro 2>				
	03.95-03.05		1 457 42 S 9969	L

14,6 250 OM 442				
	03.95-07.01		1 457 42 P 9740	O

14,6 269 OM 442 A				
	03.95-07.01		1 457 42 P 9740	O
			1 457 42 S 9969	L

Setra S 315/ S 316

14,6 280/320 OM 442 LA <Euro 2>				
	03.95-03.05		1 457 42 P 9732	O
			1 457 42 S 9969	L

Setra S 315/ S 319

11,0 320 OM 442 LA <Euro 2>				
	07.96-03.05		1 457 42 P 9732	O

Setra S 328

14,6 280/320 OM 442 LA <Euro 2>				
	03.95-03.05		1 457 42 P 9732	O

14,6 385 OM 442 LA <Euro 2>				
	03.95-03.05		1 457 42 P 9732	O

STEYR (STEYR-DAIMLER-PUCH AG)

Serie 11-18 HU

Serie 11-18 HU SFL/ SG/ SL/ SS

11,0 147/184/206 9 FUA				
	01.84→		0 451 40 P 3001	O

8 S

8 S 14

6,6 100 WD 612.61				
	05.89→		0 451 10 P 5067	O
			1 457 42 S 9950	L
			1 457 43 N 4105²	K

8 S 18

6,6 130 WD 612.63				
	05.89→		0 451 10 P 5067	O
			1 457 42 S 9950	L
			1 457 43 N 1158⁶	K





9 S

9 S 14

6,6 100 WD 612.61	06.86→	0 451 10 P 5067	O
		1 457 42 S 9950	L
		1 457 43 N 4105 ²	K

9 S 18

6,6 130 WD 612.63,73	04.86→	0 451 10 P 5067	O
		1 457 42 S 9950	L
		1 457 43 N 1158 ⁶	K

10 S

10 S 14

6,6 100 WD 612.61	06.86→	0 451 10 P 5067	O
		1 457 42 S 9950	L
		1 457 43 N 4105 ²	K

10 S 18

6,6 130 WD 612.63,73	04.86→	0 451 10 P 5067	O
		1 457 42 S 9950	L
		1 457 43 N 1158 ⁶	K

11 S

11 S 14

6,6 100 WD 612.61	07.89→	0 451 10 P 5067	O
		1 457 42 S 9950	L
		1 457 43 N 4105 ²	K

11 S 18

6,6 130 WD 612.63	07.89→	0 451 10 P 5067	O
		1 457 42 S 9950	L
		1 457 43 N 1158 ⁶	K

12 M

12 M 18

6,6 130 WD 612.74	09.86→	0 451 10 P 5067	O
		1 457 42 S 9950	L
		1 457 43 N 1158 ⁶	K

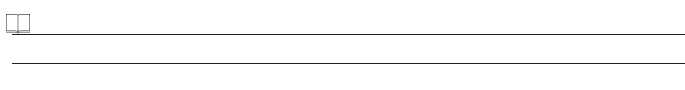

12 S

12 S 14

6,6 100 WD 612.61	06.86→	0 451 10 P 5067	O
		1 457 42 S 9950	L
		1 457 43 N 4105 ²	K

12 S 18/ 21

6,6 130/154 WD 612.63,73; WD 612.65,75	04.86→	0 451 10 P 5067	O
		1 457 42 S 9950	L
		1 457 43 N 1158 ⁶	K

13 S

13 S 14

6,6 100 WD 612.61	09.88→	0 451 10 P 5067	O
		1 457 42 S 9950	L
		1 457 43 N 4105 ²	K

13 S 18/ 21

6,6 130/154 WD 612.63; WD 612.65,75	09.88→	0 451 10 P 5067	O
		1 457 42 S 9950	L
		1 457 43 N 1158 ⁶	K

13 S 23

6,6 171 WD 612.66			
Mot.Nr. 11750→	07.89→	0 451 10 P 5067	O
Mot.Nr. →13286	07.89→	1 457 42 N 9230 ⁷	K
		1 457 43 N 1158 ⁶	K

14 S

14 S 14

6,6 100 WD 612.61	06.86→	0 451 10 P 5067	O
		1 457 42 S 9950	L
		1 457 43 N 4105 ²	K

6,6 | 100 | WD 612.92

	06.86→	0 451 10 P 5067	O
		1 457 42 S 9950	L
Mot.Nr. 13287→	06.86→	1 457 43 N 4105 ²	K

14 S 18/ 21

6,6 130/154 WD 612.63,73; WD 612.65,75	04.86→	0 451 10 P 5067	O
		1 457 42 S 9950	L
		1 457 43 N 1158 ⁶	K
Mot.Nr. →13286	04.86→	1 457 42 N 9230 ⁷	K
		1 457 43 N 1158 ⁶	K
Mot.Nr. 13287→	05.86→	1 457 43 N 4105 ²	K





15 S

15 S 14

6,6 100 WD 612.92			
Mot.Nr. 11750→	04.86→	0 451 10 P 5067	O
Mot.Nr. 13287→	04.86→	1 457 43 N 4105 ²	K

15 S 18

6,6 130 WD 612.63			
	04.86→	1 457 42 S 9950	L

15 S 18/ 21

6,6 130/154 WD 612.63,73; WD 612.65,75			
	04.86→	0 451 10 P 5067	O
		1 457 42 S 9950	L
		1 457 43 N 1158 ⁶	K

15 S 23

6,6 165 WD 612.93			
	01.88→	0 451 10 P 5067	O
		1 457 42 S 9950	L
		1 457 43 N 1158 ⁶	K

6,6 170 WD 612.66			
Mot.Nr. 11750→	04.86→	0 451 10 P 5067	O
Mot.Nr. →13286	04.86→	1 457 43 N 1158 ⁶	K
Mot.Nr. 13287→	04.86→	1 457 43 N 4105 ²	K

16 S

16 S 18/ 21

6,6 130/154/158 WD 612.63; WD 612.63,73; WD 612.65; WD 612.65,75			
	04.86→	0 451 10 P 5067	O
		1 457 42 S 9950	L
		1 457 43 N 1158 ⁶	K

16 S 23

6,6 171 WD 612.93			
	04.86→	0 451 10 P 5067	O
		1 457 42 S 9950	L
Mot.Nr. →13286	04.86→	1 457 42 N 9230 ⁷	K
		1 457 43 N 1158 ⁶	K
Mot.Nr. 13287→	04.86→	1 457 43 N 4105 ²	K

17 S

17 S 18/ 21

6,6 130/154 WD 612.63; WD 612.65			
	09.88→	0 451 10 P 5067	O
		1 457 42 S 9950	L
		1 457 43 N 1158 ⁶	K

17 S 23

6,6 171 WD 612.66			
Mot.Nr. 11750→	09.88→	0 451 10 P 5067	O
	09.88→	1 457 42 S 9950	L



19 S

19 S 24

9,7 175 WD 615.64; WD 615.74			
	01.88→	0 451 10 P 5067	O

19 S 28

9,7 204 WD 615.63; WD 615.73			
	01.88→	0 451 10 P 5067	O
		1 457 42 S 9975	L
		1 457 42 S 9975	L

19 S 31

9,7 225-228 WD 615.68,98; WD 615.78,98			
	10.87→	0 451 10 P 5067	O
		1 457 42 S 9975	L
		1 457 43 N 1159 ⁶	K
		1 457 43 N 1326 ⁷	K

19 S 34

12,0 240/250 WD 815.64,79; WD 815.67,69			
	10.87-06.96	1 457 42 P 9130	O

19 S 37/ 39

12,0 270/284 WD 815.66; WD 815.66,76			
	10.87-06.96	1 457 42 P 9130	O
		1 457 42 S 9969	L
		1 457 42 N 9675 ²	K

22 S

22 S 28/ 31

9,7 204/225-228 WD 615.63; WD 615.68; WD 615.78			
	10.87→	0 451 10 P 5067	O
		1 457 42 S 9975	L
		1 457 43 N 1159 ⁶	K
		1 457 43 N 1326 ⁷	K

22 S 34

12,0 240/250 WD 815.64; WD 815.67,69			
	10.87-06.96	1 457 42 P 9130	O
		1 457 42 S 9975	L

22 S 37

12,0 270 WD 815.66			
	10.87-06.96	1 457 42 P 9130	O
		1 457 42 N 9675 ²	K

26 S

26 S 28/ 31

9,7 204/225 WD 615.63; WD 615.68; WD 615.73; WD 615.78			
	10.87→	0 451 10 P 5067	O
		1 457 42 S 9975	L
		1 457 43 N 1159 ⁶	K
		1 457 43 N 1326 ⁷	K

26 S 34

12,0 240/250 WD 815.64; WD 815.67,69			
	10.87-06.96	1 457 42 P 9130	O



**26 S 37**

12,0 270 WD 815.66,76	10.87-06.96	1 457 42 P 9130	O
		1 457 42 S 9969	L

32 S**32 S 28/ 31**

9,7 204/225-228 WD 615.63; WD 615.68; WD 615.73; WD 615.78	10.87→	0 451 10 P 5067	O
		1 457 42 S 9975	L
		1 457 43 N 1159 ⁶	K
		1 457 43 N 1326 ⁷	K

32 S 34

12,0 240/250 WD 815.64,79; WD 815.67,69	10.87-06.96	1 457 42 P 9130	O
---	-------------	------------------------	----------

32 S 37

12,0 270 WD 815.66,76	10.87-06.96	1 457 42 P 9130	O
		1 457 42 S 9969	L

TEMSA**Opalin****Opalin 8**

4,6 152 D0834 LFL51/52 <Euro 4>	09.05→	1 457 42 P 9278	O
		F 026 40 N 2028	K

Opalin 9

6,9 176 D0836 LOH52 <Euro 4>	09.05→	1 457 42 P 9278	O
		F 026 40 N 2028	K

Safir**Safir**

12,9 302 MX300U3 <Euro 5>	10.09→	F 026 40 P 7045	O
		F 026 40 N 2032	K

Tourmalin**Tourmalin 13**

12,0 228 D2866 LUH24 <Euro 3>	01.05→	1 457 42 P 9740	O
		1 457 42 S 9969	L
		1 457 43 N 4447 ²	K

**TONAR****24t****24t 5422/ 6428/ 6528**

11,1 303 650.10 <Euro 3>	01.10→	0 451 10 P 4010	O
		1 457 43 N 4421 ²	K

TOYOTA**Coaster****Coaster 2.7**

2,73RZF	09.93-07.99	0 986 45 P 2044	O
		1 457 43 S 3534	L

2,73RZFE	07.99→	0 986 45 P 2044	O
		0 986 45 F 0109 ¹	K

Coaster 3.7

3,714B	01.93→	0 986 45 P 2001	O
		XXX 1 987 42 S 9158	L
	07.99→	1 457 43 N 4438 ²	K

Coaster 4.1

4,115BFT	05.97→	0 986 45 P 2044	O
	07.99→	1 457 43 N 4438 ²	K

4,1 114 15BFT	05.96→	0 986 45 P 2044	O
		HEI 1 457 43 N 4438 ²	K

Coaster 4.2

4,2 96 1HZ	01.93→	0 986 45 P 2044	O
		1 457 43 S 3534	L
	08.99→	1 457 43 N 4438 ²	K

Dyna**Dyna 4.1**

4,1 125 15BFTE	08.99-06.04	0 986 45 P 2062	O
--------------------	-------------	------------------------	----------

Dyna 4.6

4,6 96 S05C	05.99-06.04	0 986 45 P 2062	O
-----------------	-------------	------------------------	----------

Dyna 4.9

4,9 99-103 S05D	05.99→	0 986 45 P 2062	O
---------------------	--------	------------------------	----------





Hiace Van

Hiace Van 2.4

2,4 56-63 2L	01.84-05.95	0 986 45 P 2001	0
------------------	-------------	-----------------	---

Land Cruiser

Land Cruiser 3.5

3,5 85 1PZ	04.90-01.94	0 986 45 P 2062	0
----------------	-------------	-----------------	---

Land Cruiser 4.2

4,2 96/99/121-125/144-151 1HDFTE; 1HDT/1HDF; 1HZ	01.90-06.04	0 986 45 P 2062	0
--	-------------	-----------------	---

Quick Delivery

Quick Delivery 3.7

3,7 74 4B	08.99-06.04	0 986 45 P 2062	0
---------------	-------------	-----------------	---

Toyoace

Toyoace 4.1

4,1 125 15BFTE	08.99-06.04	0 986 45 P 2062	0
--------------------	-------------	-----------------	---

Toyoace 4.6

4,6 96 S05C	05.99-06.04	0 986 45 P 2062	0
-----------------	-------------	-----------------	---

Toyoace 4.9

4,9 99-103 S05D	05.99→	0 986 45 P 2062	0
---------------------	--------	-----------------	---

URAL AUTOMOBIL PLANT

18t

18t 6367

11,1 266 6501.10 <Euro 3>	12.09→	0 451 10 P 4010	0
		1 457 43 N 4421 ²	K

29t

29t 6470

11,1 303 650 DCi 11 <Euro 3>	01.08→	0 451 10 P 4010	0
		1 457 43 N 4421 ²	K



33t

33t 6329/ 6529

13,8 272 8210.42K <Euro 2>	01.03→	F 026 40 P 7049	0
		1 457 43 N 4432 ²	K

33t 63621

11,1 303 650.10 <Euro 3>	01.08→	0 451 10 P 4010	0
		1 457 43 N 4421 ²	K

33t 65685

11,1 303 650 DCi 11 <Euro 3>	01.08→	0 451 10 P 4010	0
		1 457 43 N 4421 ²	K

41t

41t 6563

11,1 303 650 DCi 11 <Euro 3>	01.08→	0 451 10 P 4010	0
		1 457 43 N 4421 ²	K

88t

88t 632911

13,8 272 8210.42K <Euro 2>	01.03→	F 026 40 P 7049	0
		1 457 43 N 4432 ²	K

VOLVO

B

B 7

6,7 169/191/210 D7A230; D7A285; D7B230; D7B260	01.99→	0 451 40 P 3077	0
		NEB 0 451 30 P 0003	0
		1 457 43 S 3566 ⁴	L
		1 457 43 N 4294 ²	K
		1 457 42 P 9820 ³	P

7,0 | 158/184/202/213/228 | D7C

	05.99→	KWI,MOR 0 451 40 P 3077	0
		MOR,NEB 0 451 30 P 0003	0
		MOR,VWI 0 451 10 P 3343	0
		F 026 40 S0117	L
		F 026 40 N 2025 ²	K
		1 457 43 N 4294 ²	K
		1 457 42 P 9820 ³	P

B 10

9,6THD 104 KF	01.94→	ZE 0 451 40 P 3077	0
Get.Nr. VXL MT647→	01.94→	FG,TW 0 451 30 P 0003	0
	01.94→	1 457 43 S 3566 ⁴	L
Fg.Nr. 50477→	01.94→	F 026 40 N 2025 ²	K
Mot.Nr. 63645→	01.94→	ZE 1 457 43 N 4154 ²	K





	01.94→		1 457 42 P 9820 ³	P
9,6 160/180 THD 100 EB; THD 100 EC				
Mot.Nr. 23621→	11.83-01.96	EFV,ZE	1 457 43 N 4154 ²	K
9,6 160/180/202/210/228/235 THD 101 GB; THD 101 GC; THD 101 GD; THD 101 KB; THD 101 KC; THD 101 KE				
	06.86-01.96		0 451 40 P 3077	O
			1 457 43 N 4154 ²	K
9,6 180 GH 10 A				
	05.94→	ZE	0 451 40 P 3077	O
			1 457 43 S 3566 ⁴	L
			1 457 42 P 9820 ³	P
9,6 180 THD 104 KF <Euro II>; THG 103 K				
	05.94-01.96	ZE	0 451 40 P 3077	O
			1 457 43 S 3566 ⁴	L
		ZE	1 457 43 N 4154 ²	K
			1 457 42 P 9820 ³	P
9,6 180/184/213 GH 10 B; GH 10 C				
	05.94→	ZE	0 451 40 P 3077	O
9,6 180/210 DH 10 A				
	05.94→	ZE	0 451 40 P 3077	O
			1 457 43 S 3566 ⁴	L
		ZE	1 457 43 N 4154 ²	K
			1 457 42 P 9820 ³	P
9,6 180/210 GH 10A180; GH 10B180; GH 10B210				
	01.95→	ZE	0 451 40 P 3077	O
Get.Nr. VXL MT647→	01.95→	FG,TW	0 451 30 P 0003	O
	01.95→		1 457 43 S 3566 ⁴	L
			1 457 42 P 9820 ³	P
9,6 180/210/250 THD 103 KB; THD 103 KD; THD 103 KF; THD 104 KB				
	05.93→	ZE	0 451 40 P 3077	O
Get.Nr. VXL MT647→	05.93→	FG,TW	0 451 30 P 0003	O
	05.93→		1 457 43 S 3566 ⁴	L
Fg.Nr. 50477→	05.93→		F 026 40 N 2025 ²	K
Mot.Nr. 63645→	05.93→	ZE	1 457 43 N 4154 ²	K
	05.93→		1 457 42 P 9820 ³	P
9,6 180/210/250/257/265 DH 10A245; DH 10A285; DH 10A340; DH 10A350; DH 10A360				
	01.95→	ZE	0 451 40 P 3077	O
Get.Nr. VXL MT647→	01.95→	FG,TW	0 451 30 P 0003	O
	01.95→		1 457 43 S 3566 ⁴	L
Fg.Nr. 50477→	01.95→		F 026 40 N 2025 ²	K
Mot.Nr. 63645→	01.95→	ZE	1 457 43 N 4154 ²	K
	01.95→		1 457 42 P 9820 ³	P
9,6 193 THD 102 KA				
Mot.Nr. 63645→	05.88-01.96	ZE	1 457 43 N 4154 ²	K
9,6 200 THD 102 KF				
	05.88-01.96	ZE	0 451 40 P 3077	O
			1 457 43 S 3566 ⁴	L
		ZE	1 457 43 N 4154 ²	K
Fg.Nr. 50477→	05.88-01.96		F 026 40 N 2025 ²	K
	05.88-01.96		1 457 42 P 9820 ³	P

9,6 210 THD 102 KB				
	05.88-01.96	ZE	0 451 40 P 3077	O
			1 457 43 S 3566 ⁴	L
		ZE	1 457 43 N 4154 ²	K
Fg.Nr. 50477→	05.88-01.96		F 026 40 N 2025 ²	K
	05.88-01.96		1 457 42 P 9820 ³	P
9,6 210 THD 104 KB <Euro II>				
	05.94-01.96	ZE	0 451 40 P 3077	O
			1 457 43 S 3566 ⁴	L
		ZE	1 457 43 N 4154 ²	K
			1 457 42 P 9820 ³	P
9,6 250 THD 102 KD				
	05.88-01.96		1 457 43 N 4154 ²	K
10,0 180/210/265 DH10A; THD101GC; THD101GD; THD102KB; THD102KD; THD102KF; THD103KB; THD103KD; THD103KF; THD104KB; THD104KF				
	01.92-01.96		0 451 40 P 3077	O
		HYP	0 451 10 P 5188	O
		NEB	0 451 30 P 0003	O
Get.Nr. G7-EGS→G8-EGS→	01.92-01.96	FG	0 451 10 P 3221	O
	01.92-01.96		1 457 43 S 3566 ⁴	L
		ZE	1 457 43 N 4154 ²	K
			1 457 42 P 9820 ³	P

B 12

12,0 250/272/279/305/309 D12A340 <Euro 2>; D12A370 <Euro 2>; D12A380 <Euro 2>; D12A415 <Euro 2>; D12A420 <Euro 2>				
	10.95-12.00	FG,TW	F 026 40 Z 4004	O
			0 451 10 P 3221	O
		NEB	0 451 30 P 0003	O
		ZE	0 451 40 P 3077	O
			1 457 43 S 3566 ⁴	L
			1 457 43 N 4294 ²	K
		TW	F 026 40 N 2025 ²	K
			1 457 42 P 9820 ³	P
12,0 250/279/280/309/313/338 DH12D340; DH12D380; DH12D420; DH12D425; DH12E340; DH12E380; DH12E420; DH12E460				
	06.01→	MOR	0 451 10 P 3343	O
		NEB	0 451 30 P 0003	O
			F 026 40 N 2017 ²	K

12,0 250/280/309 D12D340; D12D380; D12D420				
	01.01→	NEB	0 451 30 P 0003	O
		VWI,ZE	0 451 10 P 3343	O
			1 457 43 S 3566 ⁴	L
		WAS	1 457 43 N 4294 ²	K
		WAS	F 026 40 N 2025 ²	K

12,0 262 TD 122 FH <Euro I>				
	09.91-10.95		0 451 40 P 3077	O
		NEB	0 451 30 P 0003	O
			1 457 43 S 3566 ⁴	L
			1 457 43 S 3670	L
			1 457 43 N 4154 ²	K
			1 457 42 P 9820 ³	P





◀ B 12

12,0 262/291/298 TD 122 FL; TD 123 E <Euro I, EDC>; TD 123 ES <Euro I, EDC>			
09.91-10.95	0 451 40	P 3077	O
	NEB	0 451 30	P 0003 O
		1 457 43	S 3566 ⁴ L
		1 457 43	N 4154 ² K
		1 457 42	P 9820 ³ P

12,0 312 D12C425			
01.01→	FG,TW	F 026 40	Z 4004 O
		0 451 10	P 3221 O
	NEB	0 451 30	P 0003 O
	VWI,ZE	0 451 10	P 3343 O
		1 457 43	S 3566 ⁴ L
	WAS	1 457 43	N 4294 ² K
	WAS	F 026 40	N 2025 ² K

BB

BB 57

6,7 143/157 TD 70 H; TD 70 HA			
09.78-01.96	0 451 40	P 3077	O
	1 457 42	S 9979	L

F

F 10

9,6 191/232 TD 102 FDQ; TD 102 FEQ			
12.87-12.94	0 451 40	P 3077	O
	1 457 43	S 3670	L
Fg.Nr. →344407	12.87-12.94	1 457 43	S 3671 ⁴ L
	12.87-12.94	1 457 43	N 4154 ² K

9,6 205/210/230 TD 102 FF; TD 102 FGQ; TD 102 FH			
12.87-12.94	1 457 43	S 3670	L
Fg.Nr. →344407	12.87-12.94	1 457 43	S 3671 ⁴ L

9,6 210-235 TD 102 FM; TD 103 E, ES <EDC>			
12.87-12.94	1 457 43	S 3670	L
Fg.Nr. →344407	12.87-12.94	1 457 43	S 3671 ⁴ L

9,6 220 TD 102 FCQ			
12.87-12.94	1 457 43	S 3670	L
Fg.Nr. →344407	12.87-12.94	1 457 43	S 3671 ⁴ L

9,6 221/228/230-234 TD 102 F; TD 102 FAQ; TD 102 FBQ			
10.87-12.94	0 451 40	P 3077	O
	1 457 43	S 3670	L
Fg.Nr. →344407	10.87-12.94	1 457 43	S 3671 ⁴ L
	10.87-12.94	1 457 43	N 4154 ² K

9,6 234 TD 102 FL			
12.87-12.94	0 451 40	P 3077	O
	1 457 43	S 3670	L
Fg.Nr. →344407	12.87-12.94	1 457 43	S 3671 ⁴ L
	12.87-12.94	1 457 43	N 4154 ² K

F 12

12,0 220 TD 120 FTQ			
Fg.Nr. →344404	08.87-12.94	1 457 43	S 3671 ⁴ L

12,0 221/262 TD 122 FTO; TD 123 E <EDC, Euro I>			
Fg.Nr. →344404	08.87-12.94	1 457 43	S 3671 ⁴ L
	08.87-12.94	TW	1 457 42 P 9165 ³ P
			1 457 42 P 9820 ³ P



12,0 224/246/270/301 TD 123 EA <EDC>; TD 123 EB <EDC>; TD 123 EC <EDC>; TD 123 ED <EDC>			
	10.90-12.94	0 451 40	P 3077 O
Fg.Nr. →344404	10.90-12.94	1 457 43	S 3671 ⁴ L
	10.90-12.94	1 457 43	N 4154 ² K
		TW	1 457 42 P 9165 ³ P
			1 457 42 P 9820 ³ P

12,0 232/243/283 TD 121 FD; TD 121 FH; TD 121 GD			
	10.83-12.94	0 451 40	P 3077 O
Fg.Nr. →344404	10.83-12.94	1 457 43	S 3671 ⁴ L
	10.83-12.94	1 457 43	N 4154 ² K

12,0 254 TD 122 FKQ			
Fg.Nr. →344404	08.87-12.94	1 457 43	S 3671 ⁴ L
	08.87-12.94	TW	1 457 42 P 9165 ³ P
			1 457 42 P 9820 ³ P

12,0 257 TD 122 F			
	11.87-12.94	0 451 40	P 3077 O
Fg.Nr. →344404	11.87-12.94	1 457 43	S 3671 ⁴ L
	11.87-12.94	1 457 43	N 4154 ² K
		TW	1 457 42 P 9165 ³ P
			1 457 42 P 9820 ³ P

12,0 257-262 TD 122 F			
Fg.Nr. →344404	08.87-12.94	1 457 43	S 3671 ⁴ L
	08.87-12.94	TW	1 457 42 P 9165 ³ P
			1 457 42 P 9820 ³ P

12,0 262 TD 122 FH			
	01.90-12.94	0 451 40	P 3077 O
		1 457 43	S 3670 L
Fg.Nr. →344404	01.90-12.94	1 457 43	S 3671 ⁴ L
	01.90-12.94	1 457 43	N 4154 ² K
		TW	1 457 42 P 9165 ³ P
			1 457 42 P 9820 ³ P

12,0 287 TD 122 FK			
	05.88-12.92	0 451 40	P 3077 O
Fg.Nr. →344404	05.88-12.92	1 457 43	S 3671 ⁴ L
	05.88-12.92	TW	1 457 42 P 9165 ³ P
			1 457 42 P 9820 ³ P

12,0 287 TD 122 FR			
	05.88-12.94	0 451 40	P 3077 O
Fg.Nr. →344404	05.88-12.94	1 457 43	S 3671 ⁴ L
	05.88-12.94	TW	1 457 42 P 9165 ³ P
			1 457 42 P 9820 ³ P

12,0 287 TD 122 FS <EDC>			
	11.87-12.94	0 451 40	P 3077 O
Fg.Nr. →344404	11.87-12.94	1 457 43	S 3671 ⁴ L
	11.87-12.94	1 457 43	N 4154 ² K
		TW	1 457 42 P 9165 ³ P
			1 457 42 P 9820 ³ P

12,0 287/396 TD 122 FA; TD 122 FAQ; TD 122 FBQ; TD 122 FCQ			
Fg.Nr. →344404	08.87-12.94	1 457 43	S 3671 ⁴ L
	08.87-12.94	TW	1 457 42 P 9165 ³ P
			1 457 42 P 9820 ³ P

12,0 291 TD 122 FL			
	10.89-12.94	0 451 40	P 3077 O
		1 457 43	S 3670 L
Fg.Nr. →344404	10.89-12.94	1 457 43	S 3671 ⁴ L



	10.89-12.94		1 457 43 N 4154 ²	K
		TW	1 457 42 P 9165 ³	P
			1 457 42 P 9820 ³	P

12,0 | 298 | TD 123 ES <EDC, Euro I>

Fg.Nr. →344404	01.92-12.94		1 457 43 S 3671 ⁴	L
	01.92-12.94	TW	1 457 42 P 9165 ³	P
			1 457 42 P 9820 ³	P

12,0 | 300-310 | TD 122; TD 122 ED

Fg.Nr. →344404	10.91-12.94		1 457 43 S 3671 ⁴	L
	10.91-12.94	TW	1 457 42 P 9165 ³	P
			1 457 42 P 9820 ³	P

F 16**16,0 | 330-357 | TD 162 F,FJ,FL,FS**

	10.87-12.94	HAU	0 451 40 P 3077	O
		NEB	0 451 30 P 0003	O
			1 457 43 N 4154 ²	K
		TW	1 457 42 P 9165 ³	P
			1 457 42 P 9820 ³	P

16,0 | 357 | TD 163 ES <EDC, Euro I>

	08.91-12.94	TW	1 457 42 P 9165 ³	P
			1 457 42 P 9820 ³	P

FE**FE 240/ 260/ 280/ 300/ 320/ 340****7,1 | 177/191/206/221/235/250 | D7E240; D7E280; D7E320; D7F240; D7F260; D7F300; D7F340**

	05.06→	TW	F 026 40 S0145	L
--	--------	----	----------------	---

FH**FH 12****12,0 | 250/279/309 | D 12A340 <Euro 2>; D 12A380 <Euro 2>; D 12A420 <Euro 2>**

	08.93-08.98		0 451 40 P 3077	O
		FG,NEA	0 451 10 P 3219	O
		NEB	0 451 30 P 0003	O
			F 026 40 S 0207	L
		LAF	F 026 40 S 0197 ⁴	L
			1 457 43 N 4294 ²	K
			1 987 43 M 1167	I

12,0 | 250/279/309/338 | D 12C340 <Euro 2>; D 12C380 <Euro 2>; D 12C420 <Euro 2>; D 12C460 <Euro 2>

	08.98-08.02	MOR,ZE	0 451 10 P 3343	O
		NEA	0 451 10 P 3219	O
		NEB	0 451 30 P 0003	O
Get.Nr. VT-2014/OD-2514/OD→	08.98-08.02	FG	F 026 40 Z 4004	O
	08.98-08.02		F 026 40 S 0197 ⁴	L
		KUF	F 026 40 S 0207	L
		LAF	F 026 40 S 0034	L
			1 457 43 N 4294 ²	K
			1 987 43 M 1167	I

12,0 | 279 | D 12D380

	10.03-08.06		F 026 40 N 2017 ²	K
			F 026 40 Z 4011	C

12,1 | 250/280/309/339/368 | D 12D340; D 12D380; D 12D420; D 12D460; D 12D500

	09.01-08.06	FG	F 026 40 Z 4004	O
		KWI,ZE	0 451 40 P 3077	O
		NEB	0 451 30 P 0003	O
		VWI,ZE	0 451 10 P 3343	O
		TW	F 026 40 S 0197 ⁴	L
		303	F 026 40 S0117	L
		352	F 026 40 S 0034	L
		LVH,TW	F 026 40 N 2017 ^{2,7}	K
		TW	F 026 40 N 2017 ²	K
			F 026 40 N 2025 ²	K
			1 457 43 N 4294 ²	K
			1 987 43 R 1451 ⁸	I

FH 16**16,0 | 346/382 | D 16A470; D 16A520 <Euro 2>**

	08.93-12.99		0 451 40 P 3077	O
		FG,TW	0 451 10 P 3219	O
		NEB	0 451 30 P 0003	O
		VWI	0 451 10 P 3343	O
			F 026 40 S 0197 ⁴	L
		E96,ZE	1 457 43 N 4154 ²	K
		STH	1 457 43 N 4106 ²	K
			1 987 43 M 1167	I
		TW	1 987 43 R 1451 ⁸	I

16,0 | 346/382 | D 16B470; D 16B520 <Euro 2>

	08.98-12.02	FG	F 026 40 Z 4004	O
		NEB	0 451 30 P 0003	O
		ZE	0 451 40 P 3077	O
			F 026 40 S 0197 ⁴	L
		E96,ZE	1 457 43 N 4154 ²	K
			1 987 43 M 1167	I
		TW	1 987 43 R 1451 ⁸	I
			1 457 42 P 9820 ³	P

16,0 | 397/404/426/442/449/485/515 | D16C550; D16C610; D16E540; D16E580; D16E660; D16G540; D16G600; D16G700

	01.03→	KWI	0 451 40 P 3077	O
		NEB	0 451 30 P 0003	O
		VWI	0 451 10 P 3343	O
		TW	F 026 40 S 0197 ⁴	L
		356	F 026 40 S 0179	L
		TW	F 026 40 N 2017 ²	K
			1 987 43 M 1167	I
			1 987 43 R 1451 ⁸	I

FH 380**12,8 | 280 | D13C380**

	01.09→	VWI	0 451 10 P 3343	O
		TW	F 026 40 S 0197 ⁴	L
		352	F 026 40 S 0034	L
		PRI	F 026 40 N 2017 ²	K
			1 987 43 M 1167	I
			1 987 43 R 1451 ⁸	I





FH 400

12,8 294 D13A400	09.06→	VWI	0 451 10	P 3343	O
		TW	F 026 40	S 0197⁴	L
		352	F 026 40	S 0034	L
		EU3,TW,	F 026 40	N 2017²	K
		WAS			
		EU4,TW,	F 026 40	N 2017²	K
		WAS			
				1 987 43	M 1167
		1 987 43	R 1451⁸	I	

FH 400/ 420

12,8 294/309 D13B400; D13C420	09.07→	VWI	0 451 10	P 3343	O	
		TW	F 026 40	S 0197⁴	L	
		352	F 026 40	S 0034	L	
		PRI	F 026 40	N 2017²	K	
				1 987 43	M 1167	I
				1 987 43	R 1451⁸	I

FH 440

12,8 324 D13A440	09.06→	VWI	0 451 10	P 3343	O
		TW	F 026 40	S 0197⁴	L
		352	F 026 40	S 0034	L
		EU3,TW,	F 026 40	N 2017²	K
		WAS			
		EU4,TW,	F 026 40	N 2017²	K
		WAS			
				1 987 43	M 1167
		1 987 43	R 1451⁸	I	

FH 440/ 460

12,8 324/339 D13B440; D13C460	09.07→	VWI	0 451 10	P 3343	O	
		TW	F 026 40	S 0197⁴	L	
		352	F 026 40	S 0034	L	
		PRI	F 026 40	N 2017²	K	
				1 987 43	M 1167	I
				1 987 43	R 1451⁸	I

FH 480

12,8 353 D13A480	09.06→	VWI	0 451 10	P 3343	O
		TW	F 026 40	S 0197⁴	L
		352	F 026 40	S 0034	L
		EU3,TW,	F 026 40	N 2017²	K
		WAS			
		EU4,TW,	F 026 40	N 2017²	K
		WAS			
				1 987 43	M 1167
		1 987 43	R 1451⁸	I	



FH 500

12,8 368 D13B500; D13C500	09.07→	VWI	0 451 10	P 3343	O	
		TW	F 026 40	S 0197⁴	L	
		352	F 026 40	S 0034	L	
		PRI	F 026 40	N 2017²	K	
				1 987 43	M 1167	I
				1 987 43	R 1451⁸	I

FH 520

12,8 382 D13A520	09.06→	VWI	0 451 10	P 3343	O
		TW	F 026 40	S 0197⁴	L
		352	F 026 40	S 0034	L
		EU3,TW,	F 026 40	N 2017²	K
		WAS			
		EU4,TW,	F 026 40	N 2017²	K
		WAS			
				1 987 43	M 1167
		1 987 43	R 1451⁸	I	

FH 540

12,8 397 D13C540	01.09→	VWI	0 451 10	P 3343	O	
		TW	F 026 40	S 0197⁴	L	
		352	F 026 40	S 0034	L	
		PRI	F 026 40	N 2017²	K	
				1 987 43	M 1167	I
				1 987 43	R 1451⁸	I

FL

FL 6

5,5 132/162/184 D6B180; D6B220; D6B250	05.00-05.06	FG	0 451 30	P 0003	O	
		MOR	0 451 10	P 3343	O	
		NEB	0 451 30	P 0003	O	
				1 457 43	N 4294²	K
				1 457 42	S 9076	I

FL 7

6,7 169/191/210 D 7 A285 <Euro 2>; D 7 B230 <Euro 2>; D 7 B260 <Euro 2>; TD 73 E <Euro 1>; TD 73 ES <Euro 1>	11.91-01.95	VO	0 451 30	P 0003	O			
		HI	0 451 40	P 3077	O			
		NEA	0 451 10	P 3219	O			
				F 026 40	S 0065⁴	L		
		ZE	1 457 43	N 4154²	K			
				1 987 43	M 1159	I		
				1 457 42	P 9820³	P		
		7,0 160 TD 73 EA	10.90-10.99		0 451 40	P 3077	O	
				NEB	0 451 30	P 0003	O	
						F 026 40	S 0065⁴	L
				ZE	1 457 43	N 4154²	K	
						1 987 43	M 1159	I
				1 457 42	P 9820³	P		

**7,0 | 169-173 | TD 71 F, FQ; TD 71 FD**

09.85-10.94	HI	0 451 40	P 3077	O
	VO	0 451 30	P 0003	O
		F 026 40	S 0065⁴	L
	ZE	1 457 43	N 4154²	K
		1 987 43	M 1159	I

7,0 | 178-184 | TD 71 FS, FSQ

09.85-10.94	HI	0 451 40	P 3077	O
	VO	0 451 30	P 0003	O
		F 026 40	S 0065⁴	L
	ZE	1 457 43	N 4154²	K
		1 987 43	M 1159	I
		1 457 42	P 9820³	P

7,0 | 184 | TD 73 EB

10.90-10.99	NEA	0 451 10	P 3219	O
	NEB	0 451 30	P 0003	O
		F 026 40	S 0065⁴	L
	ZE	1 457 43	N 4154²	K
		1 987 43	M 1159	I
		1 457 42	P 9820³	P

FL 10**9,6TD 103 EA**

11.92-02.96	FG	0 451 10	P 3219	O
	NEA	0 451 10	P 3219	O
	VWI	0 451 10	P 3343	O

Get.Nr. MT654CR→

11.92-02.96	FG	0 451 30	P 0003	O
11.92-02.96		F 026 40	S 0065⁴	L
	SFZ	1 457 43	S 3566⁴	L
	ZE	1 457 43	N 4154²	K
		1 987 43	M 1159	I

9,6 | 202/209/210/220/221/222/230-234 | TD 101 F; TD 101 FA; TD 101 FC; TD 101 FD; TD 101 G; TD 102 F; TD 102 FDQ; TD 102 FF; TD 102 FH; TD 102 FL; TD 102 FM; TD 102 FQ; TD 103 E

09.85-09.94		0 451 40	P 3077	O
	FG	0 451 10	P 3219	O
	NEA	0 451 10	P 3219	O
	VWI	0 451 10	P 3343	O

Get.Nr. MT654CR→

09.85-09.94	FG	0 451 30	P 0003	O
09.85-09.94		F 026 40	S 0065⁴	L
	SFZ	1 457 43	S 3566⁴	L
	ZE	1 457 43	N 4154²	K
		1 987 43	M 1159	I

9,6 | 228/235/258/265 | D 10A 310; D 10A 320; D 10A 350; D 10A 360

02.95-12.01		0 451 40	P 3077	O
	VWI	0 451 10	P 3343	O

Get.Nr. MT654CR→

02.95-12.01	FG	0 451 30	P 0003	O
-------------	----	----------	---------------	----------

Get.Nr. R/SR-1400/1700→

02.95-12.01	FG	F 026 40	Z 4004	O
02.95-12.01		F 026 40	S 0065⁴	L
	SFZ	1 457 43	S 3566⁴	L
	ZE	1 457 43	N 4154²	K
		1 987 43	M 1159	I

9,6 | 236 | TD 103 ES

11.92-02.96		0 451 40	P 3077	O
	FG	0 451 10	P 3219	O
	NEA	0 451 10	P 3219	O
	VWI	0 451 10	P 3343	O



Get.Nr. MT654CR→	11.92-02.96	FG	0 451 30	P 0003	O
	11.92-02.96		F 026 40	S 0065⁴	L
		SFZ	1 457 43	S 3566⁴	L
		ZE	1 457 43	N 4154²	K
			1 987 43	M 1159	I

FL 12**12,0 | 279/309 | D12A380 <Euro 2>; D12A420 <Euro 2>**

09.95-12.01		0 451 40	P 3077	O
	FG	F 026 40	Z 4004	O
	NEB	0 451 30	P 0003	O
	VWI	0 451 10	P 3343	O

Get.Nr. VX-KYL7→

09.95-12.01	FG	0 451 10	P 3219	O
09.95-12.01		1 457 43	N 4294²	K
		1 987 43	M 1159	I
	TW	1 457 42	P 9820³	P

FL 240/ 260/ 280/ 290/ 320**7,1 | 177/191/206/213/236 | D7E240; D7E280; D7E320; D7F240; D7F260; D7F290**

05.06→	TW	F 026 40	S 0145	L
--------	----	----------	---------------	----------

FL 408**3,6 | 82-91 | TD 41 G**

02.86-12.95		0 451 20	P 3002	O
	XXX	1 457 43	N 4105²	K

FL 608**5,5 | 108 | TD 61 G**

03.87-11.94		0 451 40	P 3077	O
	FG	0 451 30	P 0003	O
	NEA	0 451 10	P 3219	O
		F 026 40	S 0085	L
	ZE	1 457 43	N 4154²	K
		1 457 42	S 9076	I
		1 457 42	P 9820³	P

FL 608/ 611**5,5 | 112 | TD 61 GA**

09.86-11.94		0 451 40	P 3077	O
	FG	0 451 30	P 0003	O
	NEA	0 451 10	P 3219	O
		F 026 40	S 0085	L
	ZE	1 457 43	N 4154²	K
		1 457 42	S 9076	I
		1 457 42	P 9820³	P

FL 608/ 611/ 612/ 614/ 615/ 618**5,5 | 132 | D6A180 <Euro 2>**

02.95-08.00		0 451 40	P 3077	O
	FG	0 451 30	P 0003	O
	NEA	0 451 10	P 3219	O
	NEB	0 451 30	P 0003	O
	ZE	1 457 43	N 4154²	K
		1 457 42	S 9076	I
		1 457 42	P 9820³	P





◀ FL 608/ 611/ 612/ 614/ 615/ 618

5,5 132 TD 63 E <Euro 1>			
11.91-12.96	0 451 40	P 3077	O
FG	0 451 30	P 0003	O
NEA	0 451 10	P 3219	O
ZE	1 457 43	N 4154²	K
	1 457 42	S 9076	I
	1 457 42	P 9820³	P

5,5 154 D6A210 <Euro 2>			
02.95-08.00	0 451 40	P 3077	O
FG	0 451 30	P 0003	O
NEA	0 451 10	P 3219	O
NEB	0 451 30	P 0003	O
ZE	1 457 43	N 4154²	K
	1 457 42	S 9076	I
	1 457 42	P 9820³	P

5,5 154 TD 63 ES <Euro 1>			
11.91-12.96	0 451 40	P 3077	O
FG	0 451 30	P 0003	O
NEA	0 451 10	P 3219	O
ZE	1 457 43	N 4154²	K
	1 457 42	S 9076	I
	1 457 42	P 9820³	P

FL 610/ 611

5,5 112-113 TD 61 G <3012>			
09.85-11.94	0 451 40	P 3077	O
FG	0 451 30	P 0003	O
NEA	0 451 10	P 3219	O
	F 026 40	S 0085	L
ZE	1 457 43	N 4154²	K
	1 457 42	S 9076	I
	1 457 42	P 9820³	P

FL 611

5,5 126 TD 61 GB			
01.90-11.94	0 451 40	P 3077	O
FG	0 451 30	P 0003	O
NEA	0 451 10	P 3219	O
	F 026 40	S 0085	L
ZE	1 457 43	N 4154²	K
	1 457 42	S 9076	I
	1 457 42	P 9820³	P

FL 611/ 612/ 613/ 614

5,5 131-132 TD 61 GS <3012>			
09.85-11.94	0 451 40	P 3077	O
FG	0 451 30	P 0003	O
NEA	0 451 10	P 3219	O
	F 026 40	S 0085	L
ZE	1 457 43	N 4154²	K
	1 457 42	S 9076	I
	1 457 42	P 9820³	P



FL 611/ 612/ 613/ 614/ 617

5,5 132 TD 61 GC			
01.90-11.94	0 451 40	P 3077	O
FG	0 451 30	P 0003	O
NEA	0 451 10	P 3219	O
	F 026 40	S 0085	L
ZE	1 457 43	N 4154²	K
	1 457 42	S 9076	I
	1 457 42	P 9820³	P

FL 611/ 614/ 616/ 617/ 619

5,5 150-152 TD 61 F <3012>			
09.85-11.94	0 451 40	P 3077	O
FG	0 451 30	P 0003	O
NEA	0 451 10	P 3219	O
	F 026 40	S 0085	L
ZE	1 457 43	N 4154²	K
	1 457 42	S 9076	I
	1 457 42	P 9820³	P

FL 612/ 614/ 615/ 618

5,5 169 D6A230 <Euro 2>			
02.95-08.00	0 451 40	P 3077	O
FG	0 451 30	P 0003	O
NEA	0 451 10	P 3219	O
NEB	0 451 30	P 0003	O
ZE	1 457 43	N 4154²	K
	1 457 42	S 9076	I
	1 457 42	P 9820³	P

5,5 | 184 | D6A250 <Euro 2>

02.95-08.00	0 451 40	P 3077	O
FG	0 451 30	P 0003	O
NEA	0 451 10	P 3219	O
NEB	0 451 30	P 0003	O
ZE	1 457 43	N 4154²	K
	1 457 42	S 9076	I
	1 457 42	P 9820³	P

FL 616/ 617

5,5 131-132 TD 61 GS/GB <3012>			
09.85-11.94	0 451 40	P 3077	O
FG	0 451 30	P 0003	O
NEA	0 451 10	P 3219	O
	F 026 40	S 0085	L
ZE	1 457 43	N 4154²	K
	1 457 42	S 9076	I
	1 457 42	P 9820³	P

FLC

FLC

4,0 99 D4A135 <Euro 2>			
09.96-09.00	0 451 20	P 3010	O
	1 457 42	S 9076	I
	1 457 42	P 9820³	P



**FM****FM 7**

7,3 | 184/210/228 | D 7C250; D 7C290; D 7C310

09.98-12.01		0 451 40	P 3077	O
	FG	F 026 40	Z 4004	O
	NEA	0 451 10	P 3219	O
	NEB	0 451 30	P 0003	O
	VWI	0 451 10	P 3343	O
		F 026 40	S0117	L
		1 457 43	N 4294 ²	K
	TW	F 026 40	N 2025 ²	K

FM 9

9,0 | 191/221/250/280 | D9A

12.01-08.05	GS	F 026 40	Z 4004	O
	NEB	0 451 30	P 0003	O
	VWI, ZE	0 451 10	P 3343	O
	LAF	F 026 40	S0117	L
		F 026 40	N 2017 ²	K
		1 987 43	M 1167	I
	TW	1 987 43	R 1451 ⁸	I

9,4 | 221/280 | D9B300; D9B340; D9B380

09.05→	NEB	0 451 30	P 0003	O
	VWI	0 451 10	P 3343	O
		F 026 40	S0117	L
		F 026 40	N 2017 ²	K
		1 987 43	M 1167	I
		1 987 43	R 1451 ⁸	I

FM 10

9,6 | 236/265 | D 10B320; D 10B360

04.99-12.01		0 451 40	P 3077	O
	VWI	0 451 10	P 3343	O
Get.Nr. R/SR-1400/1700→	04.99-12.01	FG	F 026 40	Z 4004
	04.99-12.01	LAF	F 026 40	S0117
			F 026 40	N 2025 ²
			1 457 43	N 4294 ²
			1 457 42	P 9820 ³

FM 12

12,1 | 250 | D 12C340

09.98-01.02	FG	F 026 40	Z 4004	O
	KWI, ZE	0 451 40	P 3077	O
	NEB	0 451 30	P 0003	O
	VWI, ZE	0 451 10	P 3343	O
		F 026 40	S0117	L
		F 026 40	N 2025 ²	K
		1 457 43	N 4294 ²	K
		1 457 42	P 9820 ³	P

12,1 | 250/280/309/339 | D 12D340; D 12D380; D 12D420; D 12D460

01.02-09.05	FG	F 026 40	Z 4004	O
	KWI	0 451 40	P 3077	O
	NEB	0 451 30	P 0003	O
	VWI	0 451 10	P 3343	O
	TW	F 026 40	S 0197 ⁴	L
	303	F 026 40	S0117	L
	352	F 026 40	S 0034	L
	TW	F 026 40	N 2017 ^{2,7}	K
		F 026 40	N 2025 ²	K
		1 457 43	N 4294 ²	K
		1 987 43	R 1451 ⁸	I

12,1 | 254 | D 12C345

11.02-09.05	FG	F 026 40	Z 4004	O
	KWI, ZE	0 451 40	P 3077	O
	NEB	0 451 30	P 0003	O
	VWI	0 451 10	P 3343	O
	TW	F 026 40	S 0197 ⁴	L
	303	F 026 40	S0117	L
	352	F 026 40	S 0034	L
	TW	F 026 40	N 2017 ^{2,7}	K
		F 026 40	N 2025 ²	K
		1 457 43	N 4294 ²	K
		1 987 43	R 1451 ⁸	I

12,1 | 279 | D 12C380

09.98-01.02	FG	F 026 40	Z 4004	O
	KWI, ZE	0 451 40	P 3077	O
	NEB	0 451 30	P 0003	O
	VWI, ZE	0 451 10	P 3343	O
		F 026 40	S0117	L
		F 026 40	N 2025 ²	K
		1 457 43	N 4294 ²	K
		1 457 42	P 9820 ³	P

12,1 | 283 | D 12C385

11.02-09.05	FG	F 026 40	Z 4004	O
	KWI, ZE	0 451 40	P 3077	O
	NEB	0 451 30	P 0003	O
	VWI	0 451 10	P 3343	O
	TW	F 026 40	S 0197 ⁴	L
	303	F 026 40	S0117	L
	352	F 026 40	S 0034	L
	TW	F 026 40	N 2017 ^{2,7}	K
		F 026 40	N 2025 ²	K
		1 457 43	N 4294 ²	K
		1 987 43	R 1451 ⁸	I

12,1 | 309 | D 12C420

09.98-01.02	FG	F 026 40	Z 4004	O
	KWI, ZE	0 451 40	P 3077	O
	NEB	0 451 30	P 0003	O
	VWI, ZE	0 451 10	P 3343	O
		F 026 40	S0117	L
		F 026 40	N 2025 ²	K
		1 457 43	N 4294 ²	K
		1 457 42	P 9820 ³	P





◀ FM 12

12,1 | 313 | D12C425

11.02-09.05	FG	F 026 40 Z 4004	O
	KWI,ZE	0 451 40 P 3077	O
	NEB	0 451 30 P 0003	O
	VWI	0 451 10 P 3343	O
	TW	F 026 40 S 0197 ⁴	L
	303	F 026 40 S 0117	L
	352	F 026 40 S 0034	L
	TW	F 026 40 N 2017 ^{2,7}	K
		F 026 40 N 2025 ²	K
		1 457 43 N 4294 ²	K
		1 987 43 R 1451 ⁸	I

12,1 | 339 | D12C460

09.98-01.02	FG	F 026 40 Z 4004	O
	KWI,ZE	0 451 40 P 3077	O
	NEB	0 451 30 P 0003	O
	VWI,ZE	0 451 10 P 3343	O
		F 026 40 S 0117	L
		F 026 40 N 2025 ²	K
		1 457 43 N 4294 ²	K

12,1 | 368 | D12D500

01.02-09.05	FG	F 026 40 Z 4004	O
	KWI,ZE	0 451 40 P 3077	O
	NEB	0 451 30 P 0003	O
	VWI,ZE	0 451 10 P 3343	O
	TW	F 026 40 S 0197 ⁴	L
	303	F 026 40 S 0117	L
	352	F 026 40 S 0034	L
	LVH,TW	F 026 40 N 2017 ^{2,7}	K
	TW	F 026 40 N 2017 ²	K
		F 026 40 N 2025 ²	K
		1 457 43 N 4294 ²	K
		1 987 43 R 1451 ⁸	I

FM 330/ 350

10,8 | 243/258 | D11B350; D11C330

06.08→	NEB	0 451 30 P 0003	O
	VWI	0 451 10 P 3343	O
		F 026 40 S 0117	L
	TW	F 026 40 N 2017 ²	K
		1 987 43 M 1167	I
		1 987 43 R 1451 ⁸	I

FM 360

12,8 | 265 | D13A360; D13B360

09.05→	NEB	0 451 30 P 0003	O
	VWI	0 451 10 P 3343	O
		F 026 40 S 0117	L
	TW	F 026 40 N 2017 ²	K
		1 987 43 M 1167	I
		1 987 43 R 1451 ⁸	I

FM 370

10,8 | 272 | D11A370; D11C370

06.08→	NEB	0 451 30 P 0003	O
	VWI	0 451 10 P 3343	O
		F 026 40 S 0117	L
	TW	F 026 40 N 2017 ²	K
		1 987 43 M 1167	I
		1 987 43 R 1451 ⁸	I



FM 380

12,8 | 280 | D13C380

05.09→	NEB	0 451 30 P 0003	O
	VWI	0 451 10 P 3343	O
		F 026 40 S 0117	L
	TW	F 026 40 N 2017 ²	K
		1 987 43 M 1167	I
		1 987 43 R 1451 ⁸	I

FM 390

10,8 | 287 | D11B390

06.08→	NEB	0 451 30 P 0003	O
	VWI	0 451 10 P 3343	O
		F 026 40 S 0117	L
	TW	F 026 40 N 2017 ²	K
		1 987 43 M 1167	I
		1 987 43 R 1451 ⁸	I

FM 400

12,8 | 294 | D13A400; D13B400

09.05→	NEB	0 451 30 P 0003	O
	VWI	0 451 10 P 3343	O
		F 026 40 S 0117	L
	TW	F 026 40 N 2017 ²	K
		1 987 43 M 1167	I
		1 987 43 R 1451 ⁸	I

FM 410

10,8 | 302 | D11C410

05.09→	NEB	0 451 30 P 0003	O
	VWI	0 451 10 P 3343	O
		F 026 40 S 0117	L
	TW	F 026 40 N 2017 ²	K
		1 987 43 M 1167	I
		1 987 43 R 1451 ⁸	I

FM 420

12,8 | 309 | D13C420

05.09→	NEB	0 451 30 P 0003	O
	VWI	0 451 10 P 3343	O
		F 026 40 S 0117	L
	TW	F 026 40 N 2017 ²	K
		1 987 43 M 1167	I
		1 987 43 R 1451 ⁸	I

FM 430

10,8 | 316 | D11B430

06.08→	NEB	0 451 30 P 0003	O
	VWI	0 451 10 P 3343	O
		F 026 40 S 0117	L
	TW	F 026 40 N 2017 ²	K
		1 987 43 M 1167	I
		1 987 43 R 1451 ⁸	I



FM 440

12,8 | 324 | D13A440; D13B440

09.05→	NEB	0 451 30	P 0003	O
	VWI	0 451 10	P 3343	O
		F 026 40	S0117	L
	TW	F 026 40	N 2017²	K
		1 987 43	M 1167	I
		1 987 43	R 1451⁸	I

FM 450

10,8 | 331 | D11C450

05.09→	NEB	0 451 30	P 0003	O
	VWI	0 451 10	P 3343	O
		F 026 40	S0117	L
	TW	F 026 40	N 2017²	K
		1 987 43	M 1167	I
		1 987 43	R 1451⁸	I

FM 460/ 480/ 500

12,8 | 339/353/368 | D13A480; D13C460; D13C500

09.05→	NEB	0 451 30	P 0003	O
	VWI	0 451 10	P 3343	O
		F 026 40	S0117	L
	TW	F 026 40	N 2017²	K
		1 987 43	M 1167	I
		1 987 43	R 1451⁸	I

FS

FS 10

9,6 | 234 | TD 102 FDQ

09.88-12.95		0 451 40	P 3077	O
		1 457 43	N 4154²	K

FS 718

6,7 | 169/191 | D7B230 <Euro 2>; D7B260 <Euro 2>; TD 73 E <Euro 1>; TD 73 ES <Euro 1>

11.91-03.96		0 451 40	P 3077	O
	FG	0 451 30	P 0003	O
	NEA	0 451 30	P 0003	O
	NEB	0 451 30	P 0003	O
		1 457 43	N 4154²	K
		1 457 42	S 9076	I
		1 457 42	P 9820³	P

N

N 12

12,0 | 206/210/232/235-243/257/272-283 | TD 121 F; TD 121 FA; TD 121 FB; TD 121 FC; TD 121 FD; TD 121 FE; TD 121 FF; TD 121 FG; TD 121 G; TD 121 GD

09.83-01.98		0 451 40	P 3077	O
		1 457 43	N 4154²	K



NL

NL 10

9,6 | 202/210/234/236 | TD 101 G; TD 102 F; TD 102 FH; TD 102 FL; TD 103 ES

05.91-09.01	VWI	0 451 10	P 3343	O
	ZE	0 451 40	P 3077	O
		1 457 43	S 3566⁴	L
	ZE	1 457 43	N 4154²	K

NL 12

12,0 | 235-243/257-262/287-291/298 | TD 121 G; TD 122 F; TD 122 FH; TD 122 FL; TD 122 FS; TD 123 E; TD 123 ES

05.91-09.01	ZE	0 451 40	P 3077	O
		1 457 43	S 3566⁴	L
	ZE	1 457 43	N 4154²	K

VOLZHANIN

Serie 6000

Serie 6000 6270

9,0 | 221 | DC 9 03 <Euro 3>

01.10→		1 457 43	S 2188	L
--------	--	----------	---------------	----------

VW (VOLKSWAGEN) **

L80

L80

4,3 | 103 | AGF

01.95-12.99		0 450 90	N 6267¹	K
		F 026 40	Z 4012	A

ZIL

Serie 7t

Serie 7t 5301BE

4,8 | 100 | D 245.9 E2 <Euro 2>

01.94→		0 451 20	P 3152	O
		TW	1 457 43	N 4310²
		TW,XXX	1 457 43	N 4306²
E,F	01.94→	TW	1 457 43	G 17²

Serie 7t 5301EE

4,8 | 100 | D 245.9 E3 <Euro 3>

01.08→		0 451 20	P 3152	O
--------	--	----------	---------------	----------





Serie 7t Bus

Serie 7t Bus 3250B0

4,8 | 100 | D 245.9 E2 <Euro 2>

	01.98→		0 451 20 P 3152	O
		TW	1 457 43 N 4310 ²	K
		TW,XXX	1 457 43 N 4306 ²	K
E,F	01.98→	TW	1 457 43 G 17 ²	K

Serie 8t

Serie 8t 43272N

4,8 | 100 | D 245.9 E2 <Euro 2>

	01.98→		0 451 20 P 3152	O
		TW	1 457 43 N 4310 ²	K
		TW,XXX	1 457 43 N 4306 ²	K
E,F	01.98→	TW	1 457 43 G 17 ²	K

Serie 9t

Serie 9t 436200

4,8 | 100 | D 245.9 E2 <Euro 2>

	01.06→		0 451 20 P 3152	O
		TW	1 457 43 N 4310 ²	K
		TW,XXX	1 457 43 N 4306 ²	K
E,F	01.06→	TW	1 457 43 G 17 ²	K

Serie 11t

Serie 11t 432960/ 497442

4,8 | 100 | D 245.9 E2 <Euro 2>

	01.93→		0 451 20 P 3152	O
		TW	1 457 43 N 4310 ²	K
		TW,XXX	1 457 43 N 4306 ²	K
E,F	01.93→	TW	1 457 43 G 17 ²	K

Serie 15t

Serie 15t 4334B1

4,8 | 115 | D 245.30 E2 <Euro 2>

	01.95→		0 451 20 P 3152	O
		TW	1 457 43 N 4310 ²	K
		TW,XXX	1 457 43 N 4306 ²	K
E,F	01.95→	TW	1 457 43 G 17 ²	K

4,8 | 115 | D 245.30 E3 <Euro 3>

	05.08→		0 451 20 P 3152	O
--	--------	--	------------------------	----------





AKERMANS VERKSTAD AB

Serie H

Serie H 7

Volvo TD 60 B	→12.91	0 451 20 P 3226	O
		1 457 43 N 4154 ²	K

Serie H 9, 11 B

Volvo D 70 A	→12.91	0 451 20 P 3226	O
		1 457 43 N 4201 ²	K

Serie H 25

Volvo TD 120 B	→12.91	0 451 20 P 3226	O
		1 457 42 S 9056	L
		1 457 43 N 4154 ²	K

ATLAS COPCO

Serie XRH-XRS

Serie XRH-XRS XRH/ XRHS/ XRS

F 6 F 413 F; F 12 L 413 F		0 451 10 P 5067	O
		1 457 42 S 9966	L

CASE IH (CASE INTERNATIONAL)

Serie 1000

Serie 1000 1255

5,9 92 DT-358	01.86-01.01	1 457 42 S 9950	L
		1 457 43 N 4201 ²	K

Serie 1000 1455

6,6 107 DT-402	01.86-01.01	1 457 42 S 9950	L
		1 457 43 N 4201 ²	K

DEMAG

SC-Serie

SC-Serie 3

F 2 L 912	→12.91	1 457 43 N 4051 ²	K
-----------	--------	------------------------------	---

□□

DEUTZ-FAHR

D

D 2807

1,9 21 F 2 L 912	06.86-06.01	1 457 42 S 9942	L
------------------	-------------	-----------------	---

D 3607

1,9 25 F 2 L 912	06.86-06.01	1 457 42 S 9942	L
		1 457 43 N 1326 ⁷	K
	TW	1 457 43 N 4051 ²	K

D 6807/ 7007

3,8 49/51 F 4 L 912	06.86-06.01	0 451 10 P 4005	O
		1 457 43 N 4154 ²	K

DX

DX 3

2,8 34/40 F 3 L 912	06.86-06.01	0 451 10 P 4066	O
		1 457 42 S 9942	L
		1 457 43 N 4105 ²	K

3,1 40/44 F 3 L 913	06.86-06.01	0 451 10 P 4066	O
		1 457 42 S 9942	L
		1 457 43 N 4105 ²	K

3,8 48-51 F 4 L 912	06.86-06.01	0 451 10 P 4066	O
		1 457 43 N 4105 ²	K

4,1 55 F 4 L 913	06.86-06.01	0 451 10 P 4066	O
		1 457 43 N 4105 ²	K

DX 4

3,8 51 F 4 L 912	06.86-06.01	0 451 10 P 4066	O
		1 457 43 N 4105 ²	K

4,1 55-66 BF 4 L 913; BF 4 L 913 T; F 4 L 913	06.86-06.01	0 451 10 P 4066	O
		1 457 43 N 4105 ²	K

DX 6

5,7 72-74 F 6 L 912	06.86-06.01	0 451 10 P 5067	O
		1 457 43 N 4105 ²	K

6,0 110 BF 6 L 913	10.88-10.03	1 457 43 N 4105 ²	K
--------------------	-------------	------------------------------	---

6,1 85 F 6 L 913	06.86-06.01	0 451 10 P 5067	O
		1 457 43 N 4105 ²	K





◀ DX 6

6,1 101 BF 6 L 913	06.86-06.01	0 451 40 P 3001	O
		1 457 42 S 9950	L
		1 457 43 N 4105 ²	K

DX 7

6,1 117 BF 6 L 913	06.86-06.01	0 451 40 P 3001	O
		1 457 42 S 9950	L
		1 457 43 N 4105 ²	K

FENDT

F

F 275

3,8 51 F 4 L 912	02.76-02.91	0 451 10 P 4065	O
		TW 0 451 10 P 4066	O
		1 457 42 S 9932	L
		1 457 43 N 4154 ²	K
		TW 1 457 43 N 4105 ²	K

Farmer 100-Serie

Farmer 100-Serie 105

4,2 44 D 226-4	02.77-02.92	0 451 10 P 3028	O
		1 457 42 S 9944	L

Farmer 200-Serie

Farmer 200-Serie 204

3,8 48 F 4 L 912	02.79-02.94	0 451 10 P 4066	O
		1 457 42 S 9942	L
		WW 1 457 42 S 9817	L
		1 457 43 N 4154 ²	K
		TW 1 457 43 N 4051 ²	K

Farmer 300-Serie

Farmer 300-Serie 305

3,8 46 D 227-4	02.80-02.95	0 451 10 P 4065	O
		1 457 42 S 9941	L
		1 457 43 N 4154 ²	K

Farmer 300-Serie 306/ 308

4,2 50/57 D 226-4	02.80-02.95	0 451 10 P 4065	O
		1 457 42 S 9941	L
		1 457 43 N 4154 ²	K



Favorit

Favorit 610

5,7 70 D 226-6	02.78-02.93	0 451 10 P 4065	O
		1 457 42 S 9950	L
		1 457 43 N 1158 ⁶	K
		1 457 43 N 1325 ⁷	K
		TW 1 457 43 N 4105 ²	K
		1 457 43 N 4154 ²	K
XXX	1 457 42 P 9649 ³	P	

Favorit 611

6,2 77 D 226-6	02.76-02.91	0 451 10 P 4065	O
		1 457 42 S 9950	L
		1 457 43 N 1158 ⁶	K
		1 457 43 N 1325 ⁷	K
		TW 1 457 43 N 4105 ²	K
		1 457 43 N 4154 ²	K
XXX	1 457 42 P 9649 ³	P	

Favorit 612

6,2 88 D 226-6	02.76-02.91	0 451 10 P 4065	O
		1 457 42 S 9950	L
		1 457 43 N 1158 ⁶	K
		1 457 43 N 1325 ⁷	K
		1 457 43 N 4154 ²	K
		TW 1 457 43 N 4105 ²	K
XXX	1 457 42 P 9649 ³	P	

Favorit 614

6,2 99 TD 226-6	02.78-02.93	0 451 10 P 4065	O	
		TW 0 451 10 P 5067	O	
		1 457 42 S 9950	L	
		TW 1 457 42 S 9946	L	
		1 457 43 N 1158 ⁶	K	
		1 457 43 N 1325 ⁷	K	
		1 457 43 N 4154 ²	K	
		1 457 43 N 4154 ²	K	
		XXX	1 457 42 P 9649 ³	P

Favorit 615

6,2 110 TD 228-6	02.78-02.93	0 451 10 P 4065	O	
		TW 0 451 10 P 5067	O	
		1 457 42 S 9950	L	
		TW 1 457 42 S 9946	L	
		1 457 43 N 1158 ⁶	K	
		1 457 43 N 1325 ⁷	K	
		TW 1 457 43 N 4105 ²	K	
		XXX	1 457 42 P 9649 ³	P





FIAT-ALLIS

F

F 4

2,9 42 8035.05.265	04.85-12.92	1 457 43 D 701 ²	K
--------------------	-------------	-----------------------------	---

FORD NEW HOLLAND

Serie 8000

Serie 8000 8030/8040

8061	12.86-12.00	0 451 20 P 3152	O
	CAV	1 457 43 N 4201 ²	K

Serie 8000 8070

Ford-2704 ET	12.86-12.01	1 457 42 P 9559	O
	CAV	1 457 43 N 4201 ²	K

5,7 111 OM 352 A	11.86-11.01	1 457 42 P 9629	O
		1 457 43 N 1158 ⁶	K
		1 457 43 N 1325 ⁷	K

8,1 114 8361-I	11.86-11.01	0 451 30 P 1156	O
	12.86-11.01	1 457 42 N 9681 ²	K

Serie 8000 8080

8,1 125 8361-SI	11.86-11.01	0 451 30 P 1156	O
-----------------	-------------	-----------------	---

GAZ

3409

3409 2.1

2,1 81 5601 <Euro 2>	11.04→	0 451 20 P 3194	O
		1 457 43 N 4105 ²	K

34039

34039 4.8

4,8 100 D 245.9	02.00→	0 451 20 P 3152	O
		TW 1 457 43 N 4310 ²	K
		TW,XXX 1 457 43 N 4306 ²	K
E,F	02.00→	TW 1 457 43 G 17 ²	K

HAMM

GRW

GRW 10

5,7 64 F 6 L 912	05.77-05.92	0 451 10 P 5067	O
		1 457 43 N 4154 ²	K

HANOMAG GMBH

C

C 44

7,2 85 D 943 B	02.80-07.92	0 451 10 P 5067	O
----------------	-------------	-----------------	---

C 55

9,5 108 D 962 B	02.80-03.96	0 451 10 P 5067	O
-----------------	-------------	-----------------	---

C 66

10,8 157 D 963 A 1 Turbo	02.80-03.96	0 451 10 P 5067	O
--------------------------	-------------	-----------------	---

D

D 600

9,5 108 D 962 K	02.80-03.96	0 451 10 P 5067	O
-----------------	-------------	-----------------	---

D 700

10,8 150 D 963 A 1 Turbo	04.80-03.96	0 451 10 P 5067	O
--------------------------	-------------	-----------------	---

L

L 600

9,5 108 D 962 K	02.80-03.96	0 451 10 P 5067	O
-----------------	-------------	-----------------	---

Serie 5-70

Serie 5-70 22

4,1 55 4.248	02.80-02.95	0 451 10 P 4063	O
		1 457 43 S 3201	L
		1 457 43 N 4200 ²	K

Serie 5-70 33

5,8 71 A 6.354.4	07.80-07.95	0 451 10 P 4063	O
		1 457 42 S 9794	L
		1 457 43 N 4200 ²	K



H



Serie 5-70 44

7,2 85/92 D 943 A 1 Turbo; D 943 B	02.80-03.96	0 451 10 P 5067	O
	CAV	1 457 43 N 4201 ²	K

Serie 5-70 55

9,5 108 D 962 B	02.80-03.96	0 451 10 P 5067	O
	CAV	1 457 43 N 4201 ²	K

10,8 118 D 963 B	01.81-03.96	0 451 10 P 5067	O
	CAV	1 457 43 N 4201 ²	K

Serie 5-70 66

10,8 157 D 963 A 1 Turbo	02.80-03.96	0 451 10 P 5067	O
------------------------------	-------------	-----------------	---

Serie 5-70 77

10,8 193 D 963 A 2 Turbo	02.80-03.96	0 451 10 P 5067	O
		1 457 43 N 4154 ²	K

Serie 400-600

Serie 400-600 400

5,8 70 A 6.354	02.80-02.95	0 451 20 P 3010	O
		1 457 42 S 9794	L

JOHN DEERE

JD

JD 310

2,9 39 3.179 DL-03	03.74-03.99	0 451 10 P 4005	O
		1 457 42 S 9933	L
	WW	1 457 43 S 3200	L
		1 457 43 N 4201 ²	K

JD 350

2,5 32 3.152 DL-10	03.71→	0 451 10 P 4005	O
		1 457 42 S 9933	L
	WW	1 457 43 S 3200	L
		1 457 43 N 4201 ²	K

JD 410

3,6 48 4.219 DL-09	03.74→	0 451 10 P 4005	O
		1 457 42 S 9933	L
	WW	1 457 43 S 3200	L
		1 457 43 N 4201 ²	K



Serie MD 1000

Serie MD 1000 1032/ 1042/ 1052

4,0 48/55/63	10.83-10.98	0 451 10 P 4005	O
		1 457 42 S 9941	L

Serie MD 1000 1055

5,9 77	10.83-10.98	0 451 10 P 4005	O
		1 457 43 S 2193	L

Serie MD 1000 1065/ 1072/ 1075

5,9 92/110 ; 6.359 TZ-02; 6.359 TZ-03	10.81-01.97	0 451 10 P 4005	O
	TW	0 451 40 P 3210	O
	11.81-01.97	1 457 42 S 9950	L

Serie MD 1000 1085

7,6 125/143 6.466 AZ-01; 6.466 TZ-01	02.82-03.97	TW	0 451 40 P 3210	O
			1 457 42 S 9966	L

KÄSSBOHRER

FM-Serie

FM-Serie 23.150

6,1 112 BF 6 L 913	01.88-01.03	0 451 40 P 3001	O
		1 457 43 N 4154 ²	K

LINDE

H

H 20/ 25/ 30

3,1 35 F 3 L 913 G	11.84-11.99	1 457 42 S 9932	L
		1 457 43 N 4154 ²	K

H 35/ 40

3,8 49 F 4 L 912	06.81-06.97	0 451 10 P 5067	O
		1 457 42 S 9941	L
	TW,XXX	1 457 42 S 9882	L
		1 457 43 N 4154 ²	K

H 70

5,7 74 F 6 L 912	06.81→	0 451 10 P 5067	O
		1 457 42 S 9946	L
	TW,XXX	1 457 42 S 9882	L
		1 457 43 N 4154 ²	K





MARSHALL (MARSHALL TRACTORS)

D

D 110

5,2 | 81 | Steyr-WD 611.88
01.90-01.05 0 451 10 P 5067 O

D 135

6,6 | 99 | Steyr-WD 612.87
01.90-01.05 0 451 10 P 5067 O

D 642/ 644

3,5 | 47 | Steyr-WD 411.44
01.90-01.05 0 451 10 P 4065 O
1 457 43 N 4105² K

D 742/ 744

3,5 | 53 | Steyr-WD 411.90
01.90-01.05 0 451 10 P 4065 O

D 842/ 844

3,5 | 59 | Steyr-WD 411.88
01.90-01.05 0 451 10 P 4065 O
1 457 42 S 9941 L
1 457 43 N 4105² K

D 944

5,2 | 66 | Steyr-WD 611.43
01.90-01.05 0 451 10 P 5067 O

MASSEY-FERGUSON (MF)

50-Serie

50-Serie 50

3,9 | 52 | A 4.236
01.84-01.99 0 451 10 P 4063 O
1 457 43 N 4201² K

MERCEDES-BENZ

Trac

Trac 700/ 800/ 900

4,0 | 50/57/66 | OM 364.908; OM 364.909; OM 364.951 A
03.87-12.92 1 457 42 P 9647 O
F 026 40 S 0082 L
0 450 90 N 4077¹ K
1 457 42 N 9359 K

Trac 1000/ 1100

6,0 | 74/81 | OM 366.908; OM 366.912
03.87-12.92 1 457 42 P 9647 O
0 450 90 N 4077¹ K
1 457 42 N 9359 K

Trac 1300/ 1400/ 1600

6,0 | 92/100/115 | OM 366.954 A; OM 366.958 A; OM 366.977 A
03.87-12.92 1 457 42 P 9646 O
04.87-12.92 1 457 43 S 3611⁴ L
03.87-12.92 0 450 90 N 4077¹ K
1 457 42 N 9359 K

MTZ (MINSK TRAKTOR WERK)

Belarus

Belarus 1025

4,8 | 105 | D 245 E3 <Euro 3>
01.08→ 0 451 20 P 3152 O

POCLAIN

Serie 60

Serie 60 60

3,8 | 46 | F 4 L 912
03.76-03.91 0 451 10 P 4066 O
1 457 43 S 3201 L
TW 1 457 43 S 2193 L
1 457 43 N 4154² K

Serie 90

Serie 90 90

5,7 | 78 | F 6 L 912
01.76-01.01 0 451 10 P 5067 O
1 457 43 N 4154² K

SAME (S+L+H)

Explorer

Explorer 70/ 80

4,0 | 51/59 | 1000.4 A
07.86-10.01 0 451 10 P 3028 O
1 457 43 N 4201² K



S



Laser

Laser 100

5,2 72 105.5 P	03.84-03.99	0451 20 P 3152	0
		1457 43 N 4200 ²	K

Laser 110

5,7 81 100.6 P	03.83-03.98	0451 20 P 3152	0
		1457 43 N 4200 ²	K

Laser 130

6,2 92 105.6 P	04.83-04.98	0451 20 P 3152	0
		1457 43 N 4200 ²	K

Laser 150

6,2 107 105.6 PS	03.83-03.98	1457 43 N 4200 ²	K
------------------	-------------	-----------------------------	---

Vigneron

Vigneron 50

2,7 35 983 L	02.82-02.97	0451 10 P 3004	0
		1457 43 N 4201 ²	K

STEYR (STEYR-DAIMLER-PUCH AG)

Serie 8000

Serie 8000 8055

2,6 35 WD 311.46	09.86-09.01	0451 10 P 4065	0
		1457 42 S 9932	L
		1457 43 N 4105 ²	K

Serie 8000 8055/ 8065

2,6 35/41 WD 311.47; WD 311.85	09.86-09.01	0451 10 P 4065	0
		1457 42 S 9932	L

Serie 8000 8070/ 8075

3,5 47 WD 411.43, 44; WD 411.45, 46	01.84-10.99	0451 10 P 4065	0
		1457 43 N 4105 ²	K

Serie 8000 8080

3,5 53 WD 411.89, 90	06.84-06.99	0451 10 P 4065	0
----------------------	-------------	----------------	---

Serie 8000 8090

3,5 59 WD 411.87, 88	01.84-01.99	0451 10 P 4065	0
		1457 42 S 9941	L
		1457 43 N 4105 ²	K



Serie 8000 8130

5,2 81 WD 611.87, 88	07.84-07.99	0451 10 P 5067	0
----------------------	-------------	----------------	---

Serie 8000 8150

6,6 99 WD 612.87	12.82-12.97	0451 10 P 5067	0
------------------	-------------	----------------	---

VALMET

Serie 500

Serie 500 505

3,3 48 TD 33 DS 5(311 DS 5)	08.82-08.97	1457 43 N 4154 ²	K
-----------------------------	-------------	-----------------------------	---

Serie 600

Serie 600 605

3,3 53 TD 33 DS 6(311 DS 6)	08.82-08.97	1457 43 N 4154 ²	K
-----------------------------	-------------	-----------------------------	---

Serie 700

Serie 700 705

4,4 61 TD 44 DS 7(411 DS 7)	08.82-08.97	1457 43 N 4154 ²	K
-----------------------------	-------------	-----------------------------	---

Serie 800

Serie 800 805

4,4 70 TD 44 DS 8(411 DS 8)	08.82-08.97	1457 43 N 4154 ²	K
-----------------------------	-------------	-----------------------------	---

VOLVO BM

A

A 20

6,7 137 TD 71 G	08.86-08.01	1457 43 N 4154 ²	K
-----------------	-------------	-----------------------------	---

A 28/ 30

9,6 200 TD 102; TD 102 KF	04.87→	1457 43 N 4154 ²	K
---------------------------	--------	-----------------------------	---

L

L 50

4,5TD 45 B	11.91→	1457 42 S 9946	L
		1457 43 N 4154 ²	K

L 50/ 70

4,5 69/85 TD 45 B; TD 45 E	11.91→	1457 43 N 4154 ²	K
----------------------------	--------	-----------------------------	---





L 90

5,5 | 115 | TD 61 GB
 11.91→ 1 457 43 S 3611⁴ L

L 120

6,7 | 148 | TD 71 G-285
 01.87-01.02 0 451 40 P 3077 O
 1 457 42 S 9975 L
 1 457 43 N 4154² K

LM

LM 4200/ 4300/ 4500/ 622/ 642

147 | D 45 B; TD 45; TD 45 B; TD 45 B EM; TD 71 G; TJD 45 B
 03.85-01.01 1 457 43 N 4154² K

Serie 6000

Serie 6000 6300

4,5 | 84 | TD 45 E
 10.92→ 1 457 43 N 4154² K





CUMMINS

N/ NT/ NTA

14,0 144-368	01.88-12.03	XXX	1 457 43 N 4423 ²	K
--------------	-------------	-----	------------------------------	---

HATZ

Z

1,2 17	05.73→		0 451 20 P 3154	O
1,3 20/22	03.71→		0 451 20 P 3154	O

2 M

1,7 14,2	04.85→		0 451 10 P 4065	O
			1 457 43 S 3637	L

3 M

2,6 21,8	04.85→		0 451 10 P 4065	O
			1 457 43 S 3637	L

IVECO

8210

13,8 291	01.90-12.00		0 451 30 P 1156	O
----------	-------------	--	-----------------	---

8361

8,1 118	06.83-12.95		0 451 30 P 1156	O
---------	-------------	--	-----------------	---

KHD

F 4 L 912

3,8 51	10.89→		0 451 10 P 4066	O
			1 457 43 N 4154 ²	K

F 6 L 413

9,6 121	07.76→		0 451 10 P 5067	O
			1 457 43 N 4154 ²	K



F 6 L 912

5,7 76	10.89→		0 451 10 P 5067	O
			1 457 43 N 4154 ²	K

LOMBARDINI

8 LD

0,7 21	05.83→		0 451 10 P 3050	O
--------	--------	--	-----------------	---

MAN

D 0226

5,7 74	02.83-12.97	WW	1 457 43 N 4105 ²	K
--------	-------------	----	------------------------------	---

MERCEDES-BENZ

OM 603

3,0 105	10.88→		1 457 43 N 4123 ²	K
---------	--------	--	------------------------------	---

MMZ (MINSK MOTOREN WERK)

245

4,8 90/100/115/125	01.08→		0 451 20 P 3152	O
--------------------	--------	--	-----------------	---

MWM-DIESEL

D 226

2,1 16-30	01.72→		0 451 10 P 3062	O
			1 457 43 N 1159 ⁶	K
		TW	1 457 43 N 4051 ²	K

3,1|24-46

3,1 24-46	01.72→		0 451 10 P 3028	O
			1 457 43 N 1159 ⁶	K
		TW	1 457 43 N 4051 ²	K

D 327

1,9 27	01.72→		0 451 10 P 3062	O
			1 457 43 N 4154 ²	K

2,8 22-37	01.72→		0 451 10 P 3028	O
			1 457 43 N 4154 ²	K





3,8 30-54	01.72→	0 451 10 P 4065	O
		1 457 43 N 4154 ²	K

5,7 45-82	01.72→	0 451 10 P 4065	O
		1 457 43 N 4154 ²	K

PERKINS

A 4

08.85→	1 457 42 P 9559	O
	TW 0 451 10 P 4063	O
	1 457 43 N 4201 ²	K
	0 451 10 P 4063	O
	TW 0 451 20 P 3194	O
	1 457 43 N 4201 ²	K

AD 3

10.84→	1 457 43 N 4201 ²	K
--------	------------------------------	---

AD 4/ 4.203

08.85→	1 457 42 P 9117	O
	TW 1 457 42 P 9493	O
	1 457 43 N 4201 ²	K

4.270

08.85→	1 457 42 P 9559	O
	1 457 43 N 1158 ⁶	K
	1 457 43 N 1325 ⁷	K
	TW 1 457 43 N 4201 ²	K

4.300

08.85→	1 457 42 P 9559	O
	1 457 43 N 4201 ²	K

SCANIA

DC

11,7

01.99→	0 451 10 P 3343	O
	ASG 1 457 43 S 2188	L
	LSP 1 457 43 S 3904	L

DN

8,5 | 128

04.86-12.98	1 457 42 S 9975	L
	1 457 43 N 4154 ²	K
	WAS 1 457 43 N 4106 ²	K



11,0 158	04.86-06.91	1 457 43 N 4154 ²	K
		WAS 1 457 43 N 4106 ²	K

DS

8,5 | 136/187

06.88-12.98	1 457 43 N 4154 ²	K
-------------	------------------------------	---

11,0 | 202/232

08.71-12.98	0 451 10 P 3004	O
-------------	-----------------	---

14,2 | 257

01.71-12.98	0 451 10 P 3004	O
-------------	-----------------	---

14,2 | 294/318-334

06.84-12.98	0 451 10 P 3004	O
06.88-12.98	1 457 42 S 9975	L

SMART (MCC)

M 160

0,6 | 44

07.00→	1 457 42 P 9127	O
--------	-----------------	---

VOLVO BM

D/ TD

85

03.85→	1 457 43 N 4154 ²	K
--------	------------------------------	---

TD

4,5 | 82,5/84-92

04.85→	1 457 43 N 4154 ²	K
--------	------------------------------	---

TJD

243

06.87→	1 457 43 N 4154 ²	K
--------	------------------------------	---

VOLVO PENTA

TD

3,6 | 170

06.91→	1 457 43 N 4159 ²	K
--------	------------------------------	---

5,5 | 82/102/112/125/132/147

06.86→	1 457 43 N 4154 ²	K
--------	------------------------------	---

5,8 | 147

06.86→	1 457 43 N 4154 ²	K
--------	------------------------------	---

6,7 | 150/155/165/175

03.83→	1 457 43 N 4154 ²	K
--------	------------------------------	---





◀ TD

9,6 154/179/203	06.83→	1 457 43 N 4154 ²	K
12,0 192/199/256	01.84→	1 457 43 N 4154 ²	K

TID

5,5	01.86→	1 457 43 N 4154 ²	K
6,7 165/188	01.86→	1 457 43 N 4154 ²	K
12,0 250/253/295/302	01.86→	1 457 43 N 4154 ²	K

VW (VOLKSWAGEN) **

028

1,9 35	07.90-07.05	0 450 90 N 6172 ¹	K
		0 450 90 N 6267 ¹	K
1,9 55	05.93→	0 450 90 N 6174 ²	K

068.A/ 068.1/ 068.4/ 068.5

1,6 33/36/45,6/51	07.81-01.99	1 457 43 D 701 ²	K
---------------------	-------------	-----------------------------	---

075.1/ 075.2

2,4 55/75	04.83-04.98	1 457 43 D 701 ²	K
-------------	-------------	-----------------------------	---

YAMZ (YAROSLAWL MOTORENWERKE)

650/ 6501/ 6502

11,1 230/266/303	11.08→	0 451 10 P 4010	O
		1 457 43 N 4421 ²	K

ZMZ

2,2 73	01.09→	0 451 20 P 3194	O
----------	--------	-----------------	---





SCANIA

DN

11,0	07.89-12.99	1 457 42 S 9975	L
		1 457 43 N 4154 ²	K
	WAS	1 457 43 N 4106 ²	K

VOLVO PENTA

MD

2,4	04.86→	1 457 43 N 4296 ²	K
-----	--------	------------------------------	---

TAMD

2,4 96	06.85→	1 457 43 N 4296 ²	K
----------	--------	------------------------------	---

3,6 125/147	02.86→	XXX	1 457 43 N 4105 ²	K
---------------	--------	-----	------------------------------	---

5,5 184/220	05.83→	1 457 43 N 4154 ²	K
---------------	--------	------------------------------	---

6,7 220	04.86→	1 457 43 N 4154 ²	K
-----------	--------	------------------------------	---

12,0 270/280	09.83→	1 457 43 N 4154 ²	K
----------------	--------	------------------------------	---

TMD

2,4 74	06.85→	1 457 43 N 4296 ²	K
----------	--------	------------------------------	---

3,6 110	06.85→	XXX	1 457 43 N 4105 ²	K
-----------	--------	-----	------------------------------	---

6,7 134	06.82→	1 457 43 N 4154 ²	K
-----------	--------	------------------------------	---

9,6 177	09.85→	1 457 43 N 4154 ²	K
-----------	--------	------------------------------	---

1051

1 457 43 N 1158⁶ K

1052

1 457 43 N 1158⁶ K

1113

1 457 43 N 1158⁶ K

1 457 43 N 1325⁷ K



1114

1 457 43 N 1158⁶ K

1 457 43 N 1325⁷ K

2003

1,3 20,5/32	03.85→	1 457 43 N 4051 ²	K
---------------	--------	------------------------------	---



de

Gegenüberstellung

Benutzerhinweise

Im nachfolgenden Katalogteil sind Bestellnummern von Herstellern anderer Marken, für die es einbaugleiche Bosch-Erzeugnisse oder -Teile gibt, aufgeführt. Da die verschiedenartigsten Bezeichnungssysteme angewendet werden, konnten die fremden Bestellnummern nur in einer einheitlichen, alphanumerischen Sortierfolge geordnet werden. Sie weicht bei einigen Herstellern von der dort üblichen Sortierfolge ab.

„Werden Bosch-Teile mit Teilenummern versehen, sind aus wettbewerbsrechtlichen Gründen in jedem Fall die jeweiligen Bosch-Teilenummern zu verwenden und als solche kenntlich zu machen. Daneben können auch fremde Teilenummern verwendet werden, um die technische bzw. funktionale Gleichwertigkeit der jeweiligen Produkte zum Ausdruck zu bringen. Ggf. sollten nach Möglichkeit fremde Teilenummern sogleich mehrerer Hersteller aufgeführt werden.“

Eine fremde Teilenummer ist dabei eindeutig als solche eines anderen Herstellers kenntlich zu machen, wie insbesondere durch gleichzeitige Nennung des fremden Herstellers bzw. der fremden Marke sowie deren eindeutige Zuordnung zu der fremden Teilenummer.

Alle Angaben dürfen nur in Standard-Schrift erfolgen. Insbesondere dürfen keine Logos oder besondere Schriftzüge der fremden Hersteller verwendet und ihre Marken bzw. Namen auch sonst nicht besonders hervorgehoben werden. Vielmehr sollte die Nennung fremder Namen, Marken und Teilenummern generell möglichst unauffällig erfolgen.“

en

Cross-reference

Notes for users

The following catalog section lists part numbers of non-Bosch equipment for which there are interchangeable Bosch products or components available. Since a wide range of different designation systems are used, we were forced to arrange the non-Bosch part numbers in a uniform alphanumeric order. This differs from the customary order employed by some manufacturers.

“If part numbers are assigned to Bosch parts, the corresponding Bosch part numbers are always to be used and clearly identified as such to satisfy the law on competition. Use can additionally be made of non-Bosch part numbers to express the equivalent technical and functional properties of the products concerned.

If applicable, the non-Bosch part numbers of several manufacturers should be listed wherever possible. When doing so, a non-Bosch part number is to be clearly identified as that of another manufacturer, in particular by naming the other manufacturer or the non-Bosch make and clearly assigning this to the non-Bosch part number.

All such information must always be given in standard typeface. In particular, use is not to be made of any logos or special emblems of other manufacturers and their brands and names are not to be specially highlighted in any other way.

On the contrary, mention should only be made of non-Bosch names, makes and part numbers as inconspicuously as possible.”

fr

Table de correspondance

A l'attention de l'utilisateur

Cette section du catalogue reprend les références des fabricants d'autres marques pour lesquelles il existe des produits ou des composants Bosch de montage identique. De multiples systèmes de codage étant utilisés, les références des produits d'autres marques ne peuvent être reprises que suivant un classement alphanumérique uniforme. Pour certains fabricants, ce classement peut différer de celui qu'ils utilisent habituellement.

«Si des pièces Bosch sont munies de références, pour des raisons liées à la législation sur la concurrence, les références Bosch correspondantes doivent être utilisées dans tous les cas et être rendues identifiables comme telles. Parallèlement, des références étrangères peuvent également être utilisées pour exprimer l'équivalence technique ou fonctionnelle des produits considérés.

Le cas échéant, indiquer si possible conjointement les références étrangères de plusieurs fabricants.

Une référence étrangère doit être identifiée clairement comme étant celle d'un autre fabricant, notamment par l'indication simultanée de l'autre fabricant ou de l'autre marque, de même que par leur correspondance claire à la référence étrangère.

Toutes les indications doivent être effectuées dans la police standard. Aucun logo ou monogramme particulier des fabricants étrangers ne doit en particulier être utilisé et leurs marques ou noms ne doivent être mis en valeur d'aucune autre façon.

Au contraire, les noms, marques et références étrangers doivent, d'une manière générale, être cités de façon aussi discrète que possible.»

it

Comparazione

Avvertenze per la consultazione

Nella seguente parte del catalogo vengono riportati i numeri di ordinazione di costruttori di prodotti d'altra marca, per i quali sono disponibili prodotti o parti di prodotti Bosch di corrispondente applicazione. Dato che vengono utilizzati i più diversi sistemi di denominazione, si è potuto ordinare i numeri di ordinazione di altra marca solo in una sequenza di classificazione unitaria ed alfanumerica. Per alcune case costruttrici si differenzia perciò dalla sequenza di classificazione normalmente usata. In questo confronto le sigle Bosch vanno considerate come dati indicativi.

«Qualora componenti Bosch vengano coredati di codici, per motivi legati alle leggi che regolano la concorrenza si devono utilizzare in ogni caso i relativi codici Bosch evidenziandoli come tali. L'utilizzo di codici di altra marca è comunque possibile per esprimere una equivalenza tecnica o funzionale dei relativi prodotti.

Possibilmente è da prediligere l'indicazione contemporanea di codici di diversi costruttori.

Un codice che non sia Bosch va evidenziato in modo univoco in tal senso, in particolare nominando contestualmente il costruttore o la marca di appartenenza. Tutte le indicazioni devono essere riportate ricorrendo a caratteri standard. In particolare non si devono utilizzare loghi o scritte particolari usati dai costruttori di prodotti di altra marca né si devono mettere in risalto i relativi marchi o nomi.

Al contrario, l'indicazione di nomi, marche e codici diversi da Bosch dovrebbe essere in genere quanto più discreta possibile.»

es

Equivalencias

Indicaciones para el usuario

A continuación se han relacionado números de pedido de fabricantes de otras marcas para los que existen productos o piezas Bosch de iguales características. Dado que se utilizan los más diversos sistemas de designación, los números de pedido ajenos han podido relacionarse tan sólo en un orden unificado, alfanumérico. En el caso de algunos fabricantes, el orden de esta clasificación difiere del que utilizan habitualmente.

«Si piezas Bosch se dotan de números de pieza, por motivos de índole legal relativos a la competencia se deben utilizar en cualquier caso los respectivos números de pieza Bosch, identificándolos como tales debidamente. Paralelamente se pueden usar también números de pieza ajenos para poner de manifiesto la equivalencia técnica o funcional de los respectivos productos.

En su caso y en la medida de lo posible, se deberían citar al mismo tiempo números de pieza ajenos de varios fabricantes. Un número de pieza ajeno se debe identificar en estos casos claramente como perteneciente a otro fabricante, por ejemplo citando simultáneamente al fabricante ajeno o la marca ajena así como estableciendo la correspondencia de éstos con el número de pieza ajeno.

Todos los datos se deben escribir solo con letra estándar. En particular, no se permite utilizar logotipos o caracteres gráficos propios de los fabricantes ajenos, ni tampoco destacar sus marcas y nombres de manera especial.

Por el contrario, los nombres, las marcas y los números de piezas de empresas ajenas se deberían citar, en general, de la forma más discreta posible.»

nl

Opzoektabel

Aanwijzingen voor de gebruiker

In het hierna volgende deel van de catalogus vindt u bestelnummers van fabrikanten van andere merken, waarvoor identiek geconstrueerde Bosch-producten of -onderdelen bestaan. Aangezien de meest uiteenlopende nummeringssystemen in gebruik zijn, kunnen we de bestelnummers van andere fabrikanten slechts presenteren in één uniforme, alfanumerieke sorteervolgorde. Indien Bosch-onderdeelnummers van onderdeelnummers worden voorzien, moeten om redenen van het concurrentie-recht in elk geval de desbetreffende Bosch-onderdeelnummers worden gebruikt en als zodanig kenbaar worden gemaakt. Daarnaast kunnen ook externe onderdeelnummers worden gebruikt om de technische resp. functionele gelijkwaardigheid van de desbetreffende producten uit te drukken. Eventueel moeten, indien mogelijk, externe onderdeelnummers van meerdere fabrikanten worden vermeld.

Een extern onderdeelnummer moet daarbij duidelijk als onderdeel van een andere fabrikant kenbaar worden gemaakt, zoals in het bijzonder door gelijktijdig de externe fabrikant resp. het externe merk te vermelden en dit duidelijk toe te wijzen aan het externe onderdeelnummer. Alle gegevens mogen uitsluitend in een standaard lettertype plaatsvinden.

In het bijzonder mogen er geen logo's of bijzondere lettertypes van de externe fabrikant worden gebruikt en hun merk resp. naam mag ook niet bijzonder worden geaccentueerd.

Het noemen van namen, merken en onderdeelnummers moet over het algemeen zo opvallend als mogelijk gebeuren.”

sv

Jämförelse

Bruksanvisning

I efterföljande katalogdel ingår artikelnummer på de produkter av annan tillverkning, för vilka utbytbara Boschprodukter eller delar finns. Eftersom olika beteckningssystem används, har de främmande artikelnumren endast kunnat sorteras i en enhetlig, alfanumerisk följd, som avviker från sedvanlig sorteringsföljd när det gäller en del tillverkare.

»Om Bosch reservdelar förses med reservdelsnummer ska av konkurrensrättsliga skäl alltid respektive Bosch-reservdelsnummer användas och kännetecknas som sådant. Därutöver kan även främmande reservdelsnummer användas, för att markera att teknisk resp. funktionell likvärdighet består med respektive produkt. Om möjligt bör samtidigt främmande reservdelsnummer för flera tillverkare anges.

Därvid ska det entydigt framgå att det främmande reservdelsnumret härrör från en annan tillverkare, genom att framför allt den främmande tillverkaren eller det främmande märket samtidigt nämns samt dess entydiga allokering till det främmande reservdelsnumret.

Alla angivelser får bara göras med standardskrift. I synnerhet får inga logotyper eller speciella fonter från den främmande tillverkaren användas och inte heller dess märke eller namn speciellt framhållas. Tvärtom ska främmande namn, märken och reservdelsnummer generellt sett användas så diskret som möjligt.»

cs

Převod

Pokyny pro uživatele

V následující části katalogu jsou uvedena objednací čísla výrobků jiných značek, pro něž existují montážně shodné výrobky nebo díly Bosch. Protože se používají nejrůznější systémy označování, mohou být cizí objednací čísla uspořádána jen v jednotné, alfa-numerické posloupnosti třídění. U některých výrobců se mohou vyskytovat odchylky od zde používané běžné posloupnosti třídění.

„Jestliže jsou díly Bosch opatřeny číslem dílu, je z konkurenčně legálních důvodů v každém případě nutno používat čísla dílů Bosch a jako takové je označovat. Kromě toho mohou být používána také cizí čísla dílů, aby se vyjádřila technická popř. funkční ekvivalence příslušného produktu. Podle možnosti měla být případně uváděna cizí čísla dílů hned několika výrobců.

Cizí číslo dílu jiného výrobce je přitom jako takové třeba jednoznačně označit, zejména současným pojmenováním cizího výrobce popř. cizí značky a uvádět rovněž jejich jednoznačné přiřazení k cizímu dílu dílu. Všechny údaje smí být uváděny jen standardním písmem. Zejména se nesmí používat žádná loga nebo zvláštní nápisy cizích výrobců, a jejich značky popř. jména také nesmí jark zvlášť vyrazňovat. Spíše by měla být pojmenování cizími názvy, značkami a čísly dílů obecně pokud možno neupadnádná.“

pl

Zamienniki

Wskazówki dla użytkownika

W następniej części katalogu podane są numery katalogowe producentów innych marek, dla których istnieją zamienniki produkty lub części firmy Bosch. Ponieważ stosowane są bardzo różne systemy nazewnictwa, numery katalogowe innych firm podane są jedynie w jednolitej kolejności alfanumerycznej. W przypadku niektórych producentów odbiega ona od stosowanej przez nich kolejności sortowania.

„Jeśli części Bosch będą miały numery katalogowe, to ze względu na przepisy dotyczące konkurencji, w każdym przypadku należy użyć poszczególnych numerów katalogowych Bosch i wyrazić je tak oznaczyć. Ponadto można użyć obcych numerów katalogowych, aby zademonstrować techniczną lub funkcjonalną jednorodność z poszczególnymi produktami.

Eventualnie w razie możliwości można wymienić jednocześnie obce numery katalogowe kilku innych producentów. Obcy numer katalogowy musi zostać wyraźnie oznaczony jako dotyczący innego producenta, a w szczególności poprzez jednoczesne wymienienie innego producenta lub innej marki oraz ich jednoznaczne przyporządkowanie do obcego numeru katalogowego.

Wszystkie informacje muszą być sporządzone w standardowym sposobie zapisu. W szczególności nie można używać żadnych logotypów ani specjalnych napisów innych producentów, a ich marki lub nazwy nie mogą być wyróżnione w specjalny sposób.

Wymienienie obcych nazw, marek i numerów katalogowych powinno raczej zasadniczo nastąpić w sposób jak najmniej widoczny.”

ru

Сопоставления

Вниманию пользователей

В следующей части каталога приводятся номера каталогов производителей других марок, для которых имеются идентичные изделия или запчасти компании Bosch. Поскольку используются различные системы обозначений, номера заказов других производителей располагаются в едином алфавитно-цифровом порядке. Для некоторых производителей они отличаются от используемого у них порядка классификации.

«Если изделия Bosch имеют номера деталей, то по причинам законодательных положений в области конкуренции в любом случае необходимо использовать соответствующие номера Bosch и показывать их. Кроме того, можно использовать также номера деталей других производителей, чтобы показать техническую и функциональную равноценность соответствующих изделий.

В отдельных случаях необходимо по возможности указывать номера деталей нескольких производителей. Номер детали другого производителя явно показывать как таковой, например, одновременно называя другого производителя или другую марку, а также их однозначное отношение к номеру детали другого производителя. Все данные должны указываться стандартным шрифтом. В особенности, не разрешается использовать логотипы и специальные надписи других производителей и особым образом выделять их марки и названия.

Напротив, названия, марки и номера деталей других производителей всегда необходимо указывать по возможности неброско.»

AC DELCO

ACD 153	1 457 429 675	N 9675
ACD 157	1 457 429 230	N 9230
ACD 159	1 457 434 201	N 4201
ACD 173	1 457 434 201	N 4201
ACD182	1 457 431 159	N 1159
ACD185	1 457 431 158	N 1158
ACD205	1 457 431 713	N 1713
ACD 51	1 457 434 201	N 4201
ACD519	1 457 434 200	N 4200
ACD 52	1 457 431 159	N 1159
ACD53	1 457 431 270	N 1270
ACD 53	1 457 431 326	N 1326
ACD 54	1 457 431 158	N 1158
ACD55	1 457 431 261	N 1261
ACD 55	1 457 431 325	N 1325
ACD8002E	1 457 431 713	N 1713
ACD8003E	1 457 431 261	N 1261
ACD8004E	1 457 431 270	N 1270
ACD8011E	1 457 429 657	N 9657
ACD8017E	1 457 434 201	N 4201
ACD8018E	1 457 434 200	N 4200
ACD 8036 E	1 457 431 705	N 1705
ACD8038E	1 457 431 702	N 1702
ACD8057E	1 457 429 359	N 9359
ACD8058E	1 457 431 158	N 1158
ACD8065E	1 457 431 718	N 1718
ACD8070E	1 457 431 715	N 1715
AC 109	1 457 429 165	P 9165
AC156	1 457 429 740	P 9740
AC165	1 457 429 820	P 9820
AC179	1 457 429 735	P 9735
AC 20	1 457 429 117	P 9117
AC202	1 457 429 274	P 9274
AC209	1 457 429 157	P 9157
AC6017E	1 457 429 117	P 9117
AC6027E	1 457 429 251	P 9251
AC6040E	1 457 429 636	P 9636
AC6162E	1 457 429 416	P 9416
AC6187E	1 457 429 272	P 9272
AC6191E	1 457 429 194	P 9194
AC6200E	1 457 429 157	P 9157
AC6201E	1 457 429 119	P 9119
AC6209E	1 457 429 126	P 9126
AC6211E	1 457 429 185	P 9185
AC6212E	1 457 429 619	P 9619
AC6215E	1 457 429 118	P 9118
AC6217E	1 457 429 199	P 9199
AC6218E	1 457 429 152	P 9152
AC6221E	1 457 429 275	P 9275
AC6228E	1 457 429 647	P 9647
AC6242E	1 457 429 274	P 9274
AC6244E	1 457 429 267	P 9267
AC6246E	1 457 429 175	P 9175

AC6262E	1 457 429 239	P 9239
AC6279E	F 026 407 073	P 7073
AC6283E	F 026 407 075	P 7075
AC 87	1 457 429 175	P 9175
AF20042	1 457 433 546	S 3546
A1208C	1 457 433 056	S 3056
A1623C	1 457 433 008	S 3008
A 302 C	1 457 429 933	S 9933
A3081C	F 026 400 043	S 0043
A 425 C	1 457 429 800	S 9800
C115	1 457 429 175	P 9175
C23	1 457 429 175	P 9175
C26	1 457 429 175	P 9175
C 267	F 026 407 054	P 7054
C267X	F 026 407 054	P 7054
FS 1B	0 450 904 058	F 4058
FS 12	0 986 450 138	F 0138
FS 18	0 986 450 100	F 0100
FS 24	0 450 905 909	F 5909
FS 26	0 986 450 105	F 0105
FS 29	0 986 450 108	F 0108
FS 38	0 986 450 109	F 0109
FS 42	0 450 905 326	F 5326
FS 44	0 986 450 117	F 0117
FS 48	0 986 450 104	F 0104
FS 49	0 986 450 137	F 0137
FS9090E	0 450 904 060	F 4060
FS9094E	0 450 904 149	F 4149
FS9108E	0 450 904 159	F 4159
FS9119E	0 450 904 158	N 4158
FX20020	0 451 203 108	P 3108
GF461	0 450 904 149	F 4149
GF 466	0 986 450 138	F 0138
GF 466 B	0 986 450 138	F 0138
GF 481	0 986 450 119	F 0119
GF 516	0 450 905 280	F 5280
GF 539	0 986 450 039	F 0039
GF 540	0 986 450 117	F 0117
GF 584	0 986 450 102	F 0102
GF 589	0 450 902 162	F 2162
GF 590	0 986 450 109	F 0109
GF 600	0 450 905 326	F 5326
GF 604	0 986 450 100	F 0100
GF 613	0 986 450 124	F 0124
GF 615	0 986 450 110	F 0110
GF 618	0 450 905 273	F 5273
GF 621	0 986 450 119	F 0119
GF 626	0 986 450 119	F 0119
GF 629	0 986 450 115	F 0115
GF 656	0 450 905 912	F 5912
GF 657	0 986 450 604	F 0604
GF 660	0 986 450 111	F 0111
GF 663	0 986 450 114	F 0114
GF 666	0 986 450 137	F 0137
GF 675	0 986 450 123	F 0123

GF 697	0 986 450 104	F 0104
GF 708	0 450 905 929	F 5929
GF 735	0 450 905 916	F 5916
GF 745	0 986 450 113	F 0113
GF801	0 986 450 624	F 0624
GF 805	0 450 905 915	F 5915
GF 807	0 986 450 221	F 0221
GF 810	0 450 905 924	F 5924
GF 814	0 450 905 920	F 5920
GF 816	0 986 450 107	F 0107
MS-6130	1 987 431 175	M 1175
MS-6372	1 987 432 236	M 2236
PC100	1 457 433 652	S 3652
PC 108	1 457 429 900	S 9900
PC 120	1 457 429 053	S 9053
PC124	1 457 429 076	S 9076
PC 137 K	1 457 429 933	S 9933
PC163	1 457 429 080	S 9080
PC164	1 457 429 054	S 9054
PC 165	1 457 429 064	S 9064
PC 177	1 457 429 941	S 9941
PC 179	1 457 429 946	S 9946
PC 180	1 457 429 932	S 9932
PC 183	1 457 429 950	S 9950
PC 185	1 457 429 966	S 9966
PC 187	1 457 429 975	S 9975
PC2000E	1 457 433 008	S 3008
PC2001E	1 457 429 054	S 9054
PC2002E	1 457 429 895	S 9895
PC2002E	1 457 429 898	S 9898
PC2002E	1 457 433 087	S 3087
PC2005E	1 457 433 740	S 3740
PC2005E	1 457 433 799	S 3799
PC2006E	1 457 433 739	S 3739
PC2007E	1 457 433 084	S 3084
PC2008E	1 457 433 044	S 3044
PC2010E	1 457 433 069	S 3069
PC2013E	1 457 433 732	S 3732
PC2017E	1 457 429 839	S 9839
PC2019E	1 457 433 712	S 3712
PC2020E	1 457 433 538	S 3538
PC2024E	1 457 433 077	S 3077
PC2026E	1 457 433 275	S 3275
PC2030E	1 457 432 106	S 2106
PC2035E	1 457 433 715	S 3715
PC2040E	1 457 433 624	S 3624
PC2041E	1 987 429 401	S 9401
PC2045E	1 987 429 405	S 9405
PC2046E	1 457 433 576	S 3576
PC2062E	1 457 429 908	S 9908
PC2070E	1 457 433 588	S 3588
PC2072E	1 457 433 627	S 3627
PC2075E	1 457 433 589	S 3589
PC 2076 E	F 026 400 092	S 0092
PC2083E	1 457 429 900	S 9900



PC2084E	1 457 433 652	S 3652
PC2085E	1 457 433 791	S 3791
PC2087E	1 457 433 791	S 3791
PC2090E	1 457 433 233	S 3233
PC2101E	1 987 429 400	S 9400
PC2103E	1 457 429 795	S 9795
PC2105E	1 457 433 790	S 3790
PC2108E	1 457 432 154	S 2154
PC2112E	1 457 429 841	S 9841
PC2114E	1 457 433 590	S 3590
PC2120E	1 457 433 529	S 3529
PC2124E	1 457 433 078	S 3078
PC2127E	1 457 433 539	S 3539
PC2140E	1 457 433 617	S 3617
PC2142E	1 457 433 711	S 3711
PC2144E	1 457 429 842	S 9842
PC2147E	1 987 429 182	S 9182
PC2148E	F 026 400 010	S 0010
PC2167E	1 457 433 741	S 3741
PC2171E	1 457 433 785	S 3785
PC2177E	1 457 433 054	S 3054
PC2182E	1 457 433 743	S 3743
PC2184E	1 457 433 713	S 3713
PC2185E	1 457 433 532	S 3532
PC2187E	1 457 433 002	S 3002
PC2194E	1 457 433 956	S 3956
PC2195E	1 457 433 255	S 3255
PC2199E	1 457 432 204	S 2204
PC2203E	1 457 433 751	S 3751
PC2205E	1 457 433 075	S 3075
PC2206E	1 457 433 771	S 3771
PC2207E	1 457 433 045	S 3045
PC2208E	1 457 433 690	S 3690
PC2216E	1 457 432 108	S 2108
PC2219E	1 457 433 056	S 3056
PC2229E	1 457 433 265	S 3265
PC2230E	1 457 433 090	S 3090
PC2231E	1 987 429 402	S 9402
PC2235E	1 457 429 844	S 9844
PC2238E	1 457 433 550	S 3550
PC2239E	1 457 433 549	S 3549
PC2240E	1 987 429 406	S 9406
PC2246E	1 457 429 050	S 9050
PC2255E	1 457 432 134	S 2134
PC2269E	1 457 429 845	S 9845
PC2276E	1 457 429 964	S 9964
PC2278E	1 457 433 547	S 3547
PC2279E	1 457 433 659	S 3659
PC2281E	1 457 429 877	S 9877
PC2283E	1 457 429 870	S 9870
PC2285E	1 457 433 310	S 3310
PC2287E	1 457 433 772	S 3772
PC2295E	1 457 429 818	S 9818
PC2302E	1 457 433 541	S 3541
PC2308E	1 457 429 846	S 9846
PC2315E	1 457 433 311	S 3311
PC2318E	1 457 433 788	S 3788
PC2322E	1 457 433 555	S 3555
PC2323E	1 457 433 061	S 3061
PC2325E	1 457 433 571	S 3571
PC2326E	1 457 433 046	S 3046
PC2336E	1 457 433 533	S 3533
PC2338E	1 457 429 923	S 9923
PC2340E	1 457 433 736	S 3736
PC2342E	1 457 433 686	S 3686
PC2343E	1 457 433 792	S 3792
PC2344E	1 457 433 070	S 3070
PC2348E	1 457 433 537	S 3537
PC2351E	1 457 429 053	S 9053
PC2357E	1 457 433 540	S 3540
PC2358E	1 457 433 781	S 3781
PC2360E	1 457 433 067	S 3067
PC2362E	1 457 433 263	S 3263
PC2363E	1 457 433 577	S 3577
PC2369E	1 457 433 747	S 3747
PC2370E	1 457 429 949	S 9949
PC2382E	1 457 429 894	S 9894
PC2384E	1 457 433 268	S 3268
PC2389E	1 457 432 172	S 2172
PC2394E	1 457 433 300	S 3300
PC2395E	1 457 433 752	S 3752
PC2397E	1 457 429 819	S 9819
PC2398E	1 457 429 775	S 9775
PC2400E	1 457 433 623	S 3623
PC2404E	1 457 433 521	S 3521
PC2406E	1 987 429 403	S 9403
PC2411E	1 457 433 319	S 3319
PC2414E	1 457 433 797	S 3797
PC2416E	1 457 433 089	S 3089
PC2420E	1 457 433 546	S 3546
PC2421E	1 457 433 701	S 3701
PC2422E	1 457 429 777	S 9777
PC2425E	1 457 429 792	S 9792
PC2428E	1 457 433 581	S 3581
PC2429E	1 457 433 606	S 3606
PC2430E	1 457 432 150	S 2150
PC2431E	1 457 432 174	S 2174
PC2435E	1 457 429 778	S 9778
PC2436E	1 457 433 750	S 3750
PC2437E	1 457 433 543	S 3543
PC2438E	1 457 433 527	S 3527
PC2439E	1 457 433 060	S 3060
PC2441E	F 026 400 014	S 0014
PC2442E	1 457 433 523	S 3523
PC2443E	1 457 433 531	S 3531
PC2445E	1 457 433 088	S 3088
PC2447E	1 987 429 152	S 9152
PC2453E	1 457 432 200	S 2200
PC2455E	1 457 433 753	S 3753
PC2467E	1 457 429 994	S 9994
PC2477E	1 457 429 076	S 9076
PC2480E	1 457 433 524	S 3524
PC2483E	1 457 433 047	S 3047
PC2486E	1 457 433 276	S 3276
PC2488E	1 457 433 642	S 3642
PC2491E	1 457 433 535	S 3535
PC2492E	1 457 433 536	S 3536
PC2496E	1 457 433 574	S 3574
PC2497E	1 457 432 185	S 2185
PC2505E	1 457 429 983	S 9983
PC2509E	1 457 433 071	S 3071
PC2512E	1 457 433 058	S 3058
PC2514E	1 457 433 608	S 3608
PC2515E	1 457 433 714	S 3714
PC2517E	1 457 433 052	S 3052
PC2521E	1 457 433 065	S 3065
PC2529E	1 457 429 079	S 9079
PC2533E	1 457 433 609	S 3609
PC2534E	1 457 433 616	S 3616
PC2536E	1 457 429 786	S 9786
PC2539E	1 457 429 948	S 9948
PC2540E	1 457 429 970	S 9970
PC2546E	F 026 400 019	S 0019
PC2557E	1 457 429 988	S 9988
PC2558E	1 457 433 043	S 3043
PC2563E	1 457 429 793	S 9793
PC2575E	1 457 432 111	S 2111
PC2577E	1 457 429 080	S 9080
PC2578E	1 457 433 748	S 3748
PC2579E	1 457 433 703	S 3703
PC2581E	1 457 433 229	S 3229
PC2588E	1 457 429 944	S 9944
PC2599E	1 457 429 875	S 9875
PC2603E	1 457 429 085	S 9085
PC2610E	1 457 429 941	S 9941
PC268	1 457 432 111	S 2111
PC285	1 457 433 732	S 3732
PC 300	1 457 429 806	S 9806
PC 304	1 457 429 800	S 9800
PC 322	1 457 429 800	S 9800
PC345	1 457 429 908	S 9908
PC 350	1 457 429 064	S 9064
PC 358	1 457 429 085	S 9085
PC 380	1 457 429 061	S 9061
PC 390	1 457 429 944	S 9944
PC 409	1 457 429 079	S 9079
PC 450	1 457 429 920	S 9920
PC477	1 457 429 845	S 9845
PC484	1 457 429 875	S 9875
PC487	1 457 429 877	S 9877
PC 488	1 457 429 870	S 9870
PC507	1 457 429 080	S 9080
PC508	1 457 429 988	S 9988
PC511	1 457 429 964	S 9964
PC513	1 457 432 154	S 2154



◀ AC DELCO

PC 513	1 457 433 544	S 3544
PC514	1 457 433 652	S 3652
PC 515	1 457 429 894	S 9894
PC 518	1 457 429 898	S 9898
PC518	1 457 433 087	S 3087
PC520	1 457 432 172	S 2172
PC522	1 457 429 895	S 9895
PC523	1 457 429 895	S 9895
PC523	1 457 429 898	S 9898
PC528	1 457 432 185	S 2185
PC531	1 457 433 229	S 3229
PC537	1 457 432 200	S 2200
PC 542	1 457 429 844	S 9844
PC551	1 457 432 204	S 2204
PC553	1 457 429 923	S 9923
PC567	1 457 429 775	S 9775
PC568	1 457 429 819	S 9819
PC569	1 457 433 736	S 3736
PC571	1 457 429 778	S 9778
PC572	1 457 429 839	S 9839
PC574	1 457 433 713	S 3713
PC582	1 457 432 150	S 2150
PC586	1 457 429 842	S 9842
PC 587	1 457 433 571	S 3571
PC588	1 457 433 571	S 3571
PC589	1 457 433 571	S 3571
PC595	1 457 429 777	S 9777
PC597	1 457 433 233	S 3233
PC599	1 457 433 606	S 3606
PC601	1 457 433 008	S 3008
PC602	1 457 433 623	S 3623
PC603	1 457 433 609	S 3609
PC604	1 457 433 608	S 3608
PC 606	1 457 433 799	S 3799
PC607	1 457 433 740	S 3740
PC608	1 457 433 741	S 3741
PC609	1 457 433 771	S 3771
PC 610	1 457 433 273	S 3273
PC 612	1 457 433 950	S 3950
PC 618	1 457 433 264	S 3264
PC620	1 457 433 229	S 3229
PC 63	1 457 432 106	S 2106
PC631	1 457 433 624	S 3624
PC633	1 457 433 690	S 3690
PC636	1 457 429 793	S 9793
PC637	1 457 433 263	S 3263
PC 64	1 457 429 800	S 9800
PC640	1 457 433 229	S 3229
PC641	1 457 429 054	S 9054
PC647	1 457 433 255	S 3255
PC650	1 457 433 008	S 3008
PC651	1 457 433 659	S 3659
PC 658	1 457 433 275	S 3275
PC 660	1 457 433 544	S 3544
PC662	1 457 433 265	S 3265

PC663	1 457 433 268	S 3268
PC 68	1 457 432 108	S 2108
PC801	1 457 429 994	S 9994
PC803	1 457 432 174	S 2174
PC804	1 457 432 111	S 2111
PC809	1 457 432 134	S 2134
PC810	1 457 429 080	S 9080
PC 847	1 457 429 877	S 9877
PC85	1 457 433 732	S 3732
PC 86	1 457 429 801	S 9801
PC 87	1 457 429 050	S 9050
PF2207	0 451 105 067	P 5067
PF 25	0 451 104 064	P 4064
PF 28	0 451 104 005	P 4005
PF 38	0 451 104 015	P 4015
PF 38	0 451 105 067	P 5067
PF 857	0 451 403 077	P 3077
PF881	0 451 203 010	P 3010
PUK 1085 E	1 987 432 597	R 2597
PU10023E	1 987 432 060	M 2060
PU1009E	1 457 433 956	S 3956
PU1010E	1 987 432 105	M 2105
PU1013E	1 987 432 075	M 2075
PU1072E	1 987 432 042	M 2042
P115	1 457 429 175	P 9175
P 300	1 457 429 806	S 9806
P940	0 451 300 003	P 0003
SC655	1 457 429 175	P 9175
SC660	1 457 429 175	P 9175
SF	0 451 103 004	P 3004
SH	0 451 103 274	P 3274
SP-A	0 451 103 029	P 3029
SP646	1 457 429 175	P 9175
SP655	1 457 429 175	P 9175
SR	0 451 103 274	P 3274
S6	1 457 429 175	P 9175
S 75	F 026 407 054	P 7054
TP 570	1 457 431 159	N 1159
TP574	1 457 431 270	N 1270
TP 574	1 457 431 326	N 1326
TP 859	1 457 434 105	N 4105
XD 32	1 457 429 676	N 9676
XD33	1 457 429 681	N 9681
XD 67	1 457 434 105	N 4105
XD67	1 457 434 447	N 4447
XD 77	1 457 434 103	N 4103
XD79	1 457 434 453	N 4453
XD9001E	1 457 434 453	N 4453
XD9014E	1 457 434 291	N 4291
X101	0 451 203 005	P 3005
X 105	0 451 103 109	P 3109
X 105	0 451 203 108	P 3108
X 106	0 451 103 235	P 3235
X109	0 451 103 217	P 3217
X 11	0 451 104 065	P 4065

X 14	0 451 103 217	P 3217
X 14	0 451 203 005	P 3005
X149	0 451 203 201	P 3201
X154	0 451 103 252	P 3252
X 17	0 451 203 010	P 3010
X175	0 451 103 297	P 3297
X 18	0 451 103 274	P 3274
X 19	0 451 103 004	P 3004
X19	0 451 103 028	P 3028
X19	0 451 103 062	P 3062
X 2	0 451 104 066	P 4066
X 22	0 451 104 015	P 4015
X 22	0 451 105 067	P 5067
X 22	0 451 105 188	P 5188
X 28	0 451 103 232	P 3232
X35	0 451 103 004	P 3004
X35	0 451 103 062	P 3062
X 38	0 451 203 152	P 3152
X39	0 451 301 156	P 1156
X4011E	0 451 105 067	P 5067
X4018E	0 451 203 010	P 3010
X4026E	0 451 103 257	P 3257
X4028E	0 451 103 368	P 3368
X4036E	0 451 103 297	P 3297
X4057E	0 451 103 249	P 3249
X4070E	0 451 103 290	P 3290
X 4072 E	0 451 103 347	P 3347
X4083E	0 451 103 217	P 3217
X4089E	0 451 203 005	P 3005
X4094E	0 986 452 400	P 2400
X4097E	0 451 103 252	P 3252
X4098E	0 451 203 108	P 3108
X 41	0 451 104 015	P 4015
X 41	0 451 105 067	P 5067
X4101E	0 451 203 223	P 3223
X4110E	0 451 103 258	P 3258
X4119E	0 451 103 289	P 3289
X 4135 E	0 451 103 274	P 3274
X4189E	0 451 103 062	P 3062
X4193E	0 451 103 028	P 3028
X4245E	0 451 203 201	P 3201
X4257E	0 451 203 201	P 3201
X4313E	F 026 407 106	P 7106
X49	0 451 103 028	P 3028
X69	0 451 301 156	P 1156
X 7	0 451 103 141	P 3141
X 72	0 986 452 000	P 2000
06-267	F 026 407 054	P 7054
12115	1 457 429 175	P 9175
AL		
ALA 1100	1 987 429 135	S 9135
ALA 1101	1 457 433 952	S 3952
ALA 1102	1 987 429 151	S 9151



ALA 1103	1 457 433 957	S 3957
ALA1104	1 987 429 162	S 9162
ALA 1105	1 457 433 958	S 3958
ALA 1107	1 987 429 123	S 9123
ALA 1108	1 457 433 968	S 3968
ALA 1110	1 987 429 164	S 9164
ALA1111	1 987 429 137	S 9137
ALA 1112	1 457 433 784	S 3784
ALA1117	1 457 433 972	S 3972
ALA1118	1 987 429 163	S 9163
ALA 1119	1 457 433 971	S 3971
ALA-1120	F 026 400 162	S 0162
ALA 1121	1 987 429 187	S 9187
ALA-1125	F 026 400 158	S 0158
ALA 1126	1 987 429 177	S 9177
ALA-1127	1 987 429 183	S 9183
ALA-1135	F 026 400 154	S 0154
ALA 1200	1 987 429 146	S 9146
ALA 1201	1 457 433 959	S 3959
ALA1203	1 457 433 072	S 3072
ALA 1206	1 987 429 188	S 9188
ALA1207	1 987 429 188	S 9188
ALA-1208	F 026 400 165	S 0165
ALA 1211	1 987 429 184	S 9184
ALA 1300	1 457 433 950	S 3950
ALA 1300/1	1 457 433 950	S 3950
ALA 1300/2	1 457 433 950	S 3950
ALA 1301	1 457 433 951	S 3951
ALA 1301/1	1 457 433 951	S 3951
ALA 1302	1 987 429 136	S 9136
ALA 1302/1	1 987 429 136	S 9136
ALA 1304	1 457 433 970	S 3970
ALA 1310	1 457 433 955	S 3955
ALA 1313	1 987 429 176	S 9176
ALA 1317	1 987 429 192	S 9192
ALA1319	1 457 433 322	S 3322
ALA 1323/1	1 987 429 178	S 9178
ALA 1324	1 987 429 191	S 9191
ALA 1326	1 987 429 185	S 9185
ALA-1327	F 026 400 159	S 0159
ALA-1329	F 026 400 161	S 0161
ALA-1330	F 026 400 160	S 0160
ALA1500	1 457 433 037	S 3037
ALA 1502	1 457 433 953	S 3953
ALA 1503	1 457 433 956	S 3956
ALA 1506	1 987 429 175	S 9175
ALA15062	1 987 429 175	S 9175
ALA-1507	F 026 400 090	S 0090
ALA1510	F 026 400 001	S 0001
ALA 1600	1 457 433 961	S 3961
ALA 1602	1 987 429 174	S 9174
ALA-1603	1 987 429 180	S 9180
ALA 1700	1 457 433 954	S 3954
ALA 1701	1 457 433 969	S 3969
ALA 1703	1 457 433 965	S 3965

ALA 1800	1 987 429 051	S 9051
ALA 1800/2	1 987 429 051	S 9051
ALA 1900	1 457 433 962	S 3962
ALA 1901	1 457 433 963	S 3963
ALA 1903	1 987 429 166	S 9166
ALA1910	1 457 433 584	S 3584
ALA 8203	1 987 429 159	S 9159
ALA 8213	1 987 429 170	S 9170
ALA82152	1 457 433 273	S 3273
ALA8216	1 457 433 274	S 3274
ALA82182	1 987 429 125	S 9125
ALA8257	1 457 433 290	S 3290
ALA-8260	F 026 400 164	S 0164
ALA-8262/2	F 026 400 107	S 0107
ALA 8263	1 987 429 179	S 9179
ALA82632	1 987 429 179	S 9179
ALA8400	1 457 429 957	S 9957
ALA84032	1 457 433 298	S 3298
ALA8406	1 457 433 056	S 3056
ALA 8419/2	1 987 429 194	S 9194
ALA8423	F 026 400 004	S 0004
ALA8428	1 457 433 714	S 3714
ALA 8440	1 987 429 189	S 9189
ALA84402	1 987 429 189	S 9189
ALA8448	1 457 433 697	S 3697
ALA-8460	F 026 400 101	S 0101
ALA 8469	1 987 429 181	S 9181
ALA84692	1 987 429 181	S 9181
ALA8470	1 457 433 306	S 3306
ALA8493	1 457 433 046	S 3046
ALA84942	1 457 433 587	S 3587
ALA 8496/2	1 987 429 193	S 9193
ALA 8510	1 987 429 190	S 9190
ALA85102	1 987 429 190	S 9190
ALA851510	F 026 400 043	S 0043
ALA8520	1 457 433 067	S 3067
ALA85292	1 457 433 583	S 3583
ALA8802	1 457 433 533	S 3533
ALA88032	1 457 433 081	S 3081
ALA-8804	1 987 429 182	S 9182
ALA88042	1 987 429 182	S 9182
ALA88138	1 457 433 331	S 3331
ALA88142	F 026 400 013	S 0013
ALA88152	F 026 400 012	S 0012
ALA88182	1 457 433 090	S 3090
ALA88192	1 457 433 591	S 3591
ALA88368	1 457 433 065	S 3065
ALA-8848/2	F 026 400 102	S 0102
ALA-8865	F 026 400 153	S 0153
ALA8900	1 987 429 405	S 9405
ALA89001	1 457 433 576	S 3576
ALA8901	F 026 400 018	S 0018
ALA8905	1 457 433 538	S 3538
ALC 5216	1 987 432 088	M 2088
ALC 5221	1 987 432 084	M 2084

ALC 5222	1 987 432 084	M 2084
ALC-5255	1 987 432 200	M 2200
ALC5305	1 987 432 074	M 2074
ALC53051	1 987 432 074	M 2074
ALC5330	1 987 432 075	M 2075
ALC53301	1 987 432 075	M 2075
ALC5333	1 987 432 151	M 2151
ALC53331	1 987 432 151	M 2151
ALC5344	1 987 432 042	M 2042
ALC5355	1 987 432 150	M 2150
ALC-5366	1 987 431 166	M 1166
ALC5385	1 987 431 163	M 1163
ALC-5391	1 987 432 236	M 2236
ALC-5393	1 987 432 065	M 2065
ALC-5397	1 987 432 055	M 2055
ALC-5399	1 987 432 078	M 2078
ALC5407	1 987 432 058	M 2058
ALC-5412/15	1 987 432 086	M 2086
ALC-5701/13	1 987 432 122	M 2122
ALC-5703/14	1 987 432 077	M 2077
ALC-6324/1	1 987 432 320	R 2320
ALC-6449/1	1 987 431 458	R 1458
ALC-6459/1	1 987 432 488	R 2488
ALG 1/4 MP	0 450 904 058	F 4058
ALG 180	1 457 429 291	N 9291
ALG180	1 457 431 713	N 1713
ALG 182	1 457 429 621	N 9621
ALG183	1 457 431 702	N 1702
ALG 184	1 457 431 703	N 1703
ALG1841	1 457 431 703	N 1703
ALG 187	1 457 431 712	N 1712
ALG 193	0 450 906 460	N 6460
ALG198	1 457 431 720	N 1720
ALG 199	1 457 431 708	N 1708
ALG 201	1 457 429 657	N 9657
ALG 2010	0 450 905 087	F 5087
ALG 2010	0 450 905 104	F 5104
ALG 2010	0 450 905 401	F 5401
ALG 2011	0 450 905 145	F 5145
ALG 2011	0 450 905 200	F 5200
ALG 2011	0 450 905 601	F 5601
ALG 2011/8	0 450 905 964	F 5964
ALG 2013	0 450 905 030	F 5030
ALG 2013	0 450 905 095	F 5095
ALG 2015/3	0 450 905 203	F 5203
ALG 2015/4	0 450 905 203	F 5203
ALG 2016	0 450 905 143	F 5143
ALG 202	1 457 429 656	N 9656
ALG 2021	0 450 905 280	F 5280
ALG 2022	0 450 905 002	F 5002
ALG 2022	0 450 905 280	F 5280
ALG 2026	0 450 905 091	F 5091
ALG 2026	0 450 905 133	F 5133
ALG 2027	0 450 905 177	F 5177
ALG 2028	0 450 905 901	F 5901



◀ AL

ALG 203	1 457 431 705	N 1705
ALG 2031	0 450 905 195	F 5195
ALG 2031	0 450 905 216	F 5216
ALG 2035	0 450 905 030	F 5030
ALG 2035	0 450 905 095	F 5095

ALG 2035	0 450 905 275	F 5275
ALG 2035/1	0 450 905 275	F 5275
ALG 2036	0 450 905 264	F 5264
ALG 2036	0 450 905 318	F 5318
ALG 2036/1	0 450 905 318	F 5318

ALG 2040	0 450 915 003	F 5003
ALG 2040/1	0 450 915 003	F 5003
ALG 2041	0 450 915 001	F 5001
ALG2043	0 450 905 950	F 5950
ALG 2043/1	0 450 905 950	F 5950

ALG 2045/1	0 450 905 960	F 5960
ALG 2046	0 450 905 930	N 5930
ALG 2046/1	0 450 905 930	N 5930
ALG 2047	0 450 905 203	F 5203
ALG 2048	0 450 905 002	F 5002

ALG 2049	1 457 434 416	N 4416
ALG20498	1 457 434 416	N 4416
ALG 2050	1 457 434 329	N 4329
ALG 2051	1 457 434 105	N 4105
ALG 2051	1 457 434 106	N 4106

ALG 2053	1 457 434 105	N 4105
ALG 2054	1 457 434 103	N 4103
ALG 2056	1 457 434 184	N 4184
ALG 2056/1	1 457 434 184	N 4184
ALG 2058	1 457 434 324	N 4324

ALG 2058/1	1 457 434 324	N 4324
ALG 2059/8	1 457 434 187	N 4187
ALG 206	1 457 431 704	N 1704
ALG2060	1 457 434 453	N 4453
ALG 2061	1 457 434 435	N 4435

ALG 2062	1 457 434 438	N 4438
ALG 2063	0 986 450 508	N 0508
ALG 2068	0 450 905 903	F 5903
ALG 2070	0 450 905 030	F 5030
ALG 2070	0 450 905 095	F 5095

ALG 2074	0 450 905 195	F 5195
ALG 2074	0 450 905 216	F 5216
ALG 2074/1	0 450 905 908	F 5908
ALG 2075	F 026 402 017	N 2017
ALG208	1 457 431 713	N 1713

ALG-2087	F 026 402 000	N 2000
ALG-2092	F 026 402 063	N 2063
ALG 2129	0 450 905 942	N 5942
ALG 2131	0 450 905 927	F 5927
ALG214	1 457 431 715	N 1715

ALG-2146	F 026 402 003	N 2003
ALG-2150	F 026 403 000	F 3000
ALG 2156	1 457 434 198	N 4198
ALG2157	0 450 906 459	N 6459
ALG 2160	1 457 434 439	N 4439

ALG 2165	0 450 905 030	F 5030
ALG 2165	0 450 905 095	F 5095
ALG 2167	1 457 434 459	N 4459
ALG 2168	1 457 434 448	N 4448
ALG 2169	1 457 434 447	N 4447

ALG 2170	1 457 434 451	N 4451
ALG 2171	1 457 434 402	N 4402
ALG-2172	F 026 402 025	N 2025
ALG-2173	F 026 402 034	N 2034
ALG 2175	1 457 434 436	N 4436

ALG 2178	1 457 434 443	N 4443
ALG2179	F 026 402 013	N 2013
ALG 2229	0 450 906 450	N 6450
ALG2229	0 450 906 463	N 6463
ALG 2229/2	0 450 906 463	N 6463

ALG2244	0 450 905 959	F 5959
ALG 2245/1	1 457 434 437	N 4437
ALG22458	1 457 434 437	N 4437
ALG 2246/8	0 450 906 464	N 6464
ALG 2247	0 450 906 453	N 6453

ALG-2248	F 026 403 008	F 3008
ALG-2249	F 026 403 006	F 3006
ALG 2251	1 457 434 329	N 4329
ALG 2252	1 457 434 329	N 4329
ALG 2253	1 457 434 106	N 4106

ALG 2254	1 457 434 296	N 4296
ALG 2257	0 986 450 509	N 0509
ALG 2259	1 457 434 106	N 4106
ALG 2263	0 450 906 409	N 6409
ALG 2265	0 450 906 452	N 6452

ALG 2266	1 457 434 324	N 4324
ALG 2267	1 457 434 447	N 4447
ALG 2273	0 450 906 451	N 6451
ALG 2273/8	0 450 906 451	N 6451
ALG 2276	0 450 906 508	N 6508

ALG 2300	1 457 434 400	N 4400
ALG2343	F 026 403 003	F 3003
ALG2346	F 026 402 044	N 2044
ALG 2368	1 457 434 448	N 4448
ALG 2435	1 457 434 438	N 4438

ALG 2436	1 457 434 291	N 4291
ALG 2438	1 457 434 440	N 4440
ALG 2439/8	1 457 434 186	N 4186
ALG 2440	1 457 434 123	N 4123
ALG 2441	1 457 434 105	N 4105

ALG 2441	1 457 434 106	N 4106
ALG 2441	1 457 434 321	N 4321
ALG 2441/8	1 457 434 321	N 4321
ALG 300	0 450 904 058	F 4058
ALG 300	0 986 450 138	F 0138

ALG 306	0 450 904 058	F 4058
ALG 3062	0 450 905 924	F 5924
ALG 3062	0 986 450 103	F 0103
ALG 3070	0 450 905 988	F 5988
ALG 3071	0 450 905 953	F 5953

ALG 3073	0 450 905 990	F 5990
ALG-3076	F 026 403 001	F 3001
ALG 3077	0 450 905 904	F 5904
ALG 3077	0 450 905 974	F 5974
ALG 3079	0 450 905 951	F 5951

ALG 3081	0 450 905 978	F 5978
ALG 3083	0 450 905 958	F 5958
ALG 309 M	0 450 905 326	F 5326
ALG 3-1/2	0 450 904 058	F 4058
ALG 312	0 986 450 114	F 0114

ALG 317	0 986 450 114	F 0114
ALG 319	0 450 902 151	F 2151
ALG 3503	0 450 905 954	F 5954
ALG 4010	0 450 902 161	F 2161
ALG 4010	0 450 905 287	F 5287

ALG 4010 AR	0 450 902 161	F 2161
ALG 4010 AR	0 450 905 287	F 5287
ALG 4200	0 450 905 904	F 5904
ALG 4302/2	0 450 905 979	F 5979
ALG 4481 AR	0 986 450 119	F 0119

ALG 4481 Z	0 986 450 119	F 0119
ALG 4485 AR	0 986 450 124	F 0124
ALG4485Z	0 986 450 124	F 0124
ALG 4485 Z2	0 986 450 124	F 0124
ALG 4563 AR	0 450 905 911	F 5911

ALG 4564 AR	0 450 905 273	F 5273
ALG 4564 AR	0 450 905 316	F 5316
ALG 4564 Z2	0 450 905 273	F 5273
ALG 4564 Z2	0 450 905 316	F 5316
ALG 4566	0 450 905 911	F 5911

ALG4566Z2	0 450 905 911	F 5911
ALG-4567	F 026 403 009	F 3009
ALG4585	0 450 905 976	F 5976
ALG 4585/1	0 450 905 976	F 5976
ALG 4586	0 450 905 273	F 5273

ALG 4586	0 450 905 316	F 5316
ALG 4586	0 450 905 969	F 5969
ALG 498	0 450 904 077	N 4077
ALG 499	0 450 904 060	F 4060
ALG 5005	0 450 905 005	F 5005

ALG 5021	0 450 905 021	F 5021
ALG 5025	0 450 905 021	F 5021
ALG 5028	0 450 905 021	F 5021
ALG 5/16 G	0 450 904 058	F 4058
ALG 5/16 MP	0 450 904 058	F 4058

ALG 6031	0 450 905 955	F 5955
ALG 6042	0 450 905 912	F 5912
ALG 6044	0 986 450 110	F 0110
ALG 6045	0 450 905 963	F 5963
ALG 6053	0 986 450 123	F 0123

ALG 6059	0 450 905 924	F 5924
ALG 6059	0 986 450 103	F 0103
ALG 6059	0 986 450 107	F 0107
ALG 6059	0 986 450 111	F 0111
ALG 6059	0 986 450 113	F 0113

ALG 6061	0 986 450 604	F 0604
ALG 6063	0 986 450 110	F 0110
ALG 6063	0 986 450 115	F 0115
ALG 6065	0 986 450 221	F 0221
ALG 6066	0 450 905 981	F 5981

ALG 6-1/2	0 450 904 149	F 4149
ALG 6200	0 450 905 915	F 5915
ALG 630	0 986 450 018	F 0018
ALG6302	0 986 450 018	F 0018
ALG68	0 450 904 163	F 4163

ALG 680	0 986 450 039	F 0039
ALG 7061	0 986 450 104	F 0104
ALG 7065	0 450 905 909	F 5909
ALG 7065/2	0 450 905 909	F 5909
ALG 7070	0 986 450 100	F 0100

ALG 7095	0 450 902 162	F 2162
ALG 7200	0 450 905 916	F 5916
ALG 7296	0 450 905 920	F 5920
ALG7500	1 457 429 655	N 9655
ALG7501	1 457 431 723	N 1723

ALG7503	F 026 402 005	N 2005
ALG-7503 UD	F 026 402 005	N 2005
ALG7504	1 457 431 710	N 1710
ALG7511	F 026 402 006	N 2006
ALG-7514	F 026 402 028	N 2028

ALG7523	F 026 402 004	N 2004
ALG-7528	F 026 402 101	N 2101
ALG7535	F 026 402 062	N 2062
ALG 755	0 450 904 161	N 4161
ALG 757	0 986 450 137	F 0137

ALG 800	0 986 450 117	F 0117
ALG 8001	0 450 905 985	F 5985
ALG 882	0 450 905 982	F 5982
ALG 885	0 450 905 324	F 5324
ALG 885	0 450 905 966	F 5966

ALG 890	0 450 905 939	F 5939
ALG 891	1 457 434 329	N 4329
ALG 902	0 450 905 921	F 5921
ALG 9039	0 450 905 929	F 5929
ALG 9048	0 450 905 972	F 5972

ALG 9052	0 986 450 105	F 0105
ALG 9054	0 986 450 102	F 0102
ALG 9055	0 986 450 103	F 0103
ALG 9059	0 986 450 222	F 0222
ALG 9066	0 986 450 107	F 0107

ALG 9070	0 986 450 109	F 0109
ALG 9071	0 450 905 956	F 5956
ALG 9078	0 986 450 108	F 0108
ALG 9079	0 986 450 624	F 0624
ALG 9080	0 450 905 971	F 5971

ALG9083	0 450 905 914	F 5914
ALG 9083	0 450 905 924	F 5924
ALG 9083	0 986 450 113	F 0113
ALG 9083/2	0 450 905 914	F 5914
ALG 9086	0 450 905 924	F 5924

ALG 9086	0 986 450 107	F 0107
ALG 9086	0 986 450 113	F 0113
ALG 9088	0 450 905 929	F 5929
ALG 9090	0 986 450 106	F 0106
ALG 9092	0 450 905 924	F 5924

ALG 9092	0 986 450 113	F 0113
ALG 9097	0 450 905 962	F 5962
ALG 9103	0 450 905 989	F 5989
ALG 9107/2	0 450 905 924	F 5924
ALG 9107/2	0 986 450 103	F 0103

ALG 9107/2	0 986 450 107	F 0107
ALG 9107/2	0 986 450 111	F 0111
ALG 9107/2	0 986 450 113	F 0113
ALG 9109	0 450 905 977	F 5977
ALG 9112	0 450 905 924	F 5924

ALG 9113	0 450 905 983	F 5983
ALG 9119	0 450 905 967	F 5967
ALG 9120	0 450 905 973	F 5973
ALG 9122	0 986 450 225	F 0225
ALG 9123	0 450 905 986	F 5986

ALG 9124	0 450 905 957	F 5957
ALG 9136	0 450 905 987	F 5987
ALG 9139	0 450 905 980	F 5980
ALO8101	1 457 429 239	P 9239
ALO-8121	F 026 407 069	P 7069

ALO8124	F 026 407 026	P 7026
ALO8132	1 457 429 252	P 9252
ALO8138	1 457 429 302	P 9302
ALO8140	1 457 429 128	P 9128
ALO8142	1 457 429 152	P 9152

ALO8144	1 457 429 248	P 9248
ALO8146	1 457 429 199	P 9199
ALO8149	1 457 429 157	P 9157
ALO-8155	F 026 407 090	P 7090
ALO-8163	F 026 407 051	P 7051

ALO8164	1 457 429 198	P 9198
ALO-8172	F 026 407 070	P 7070
ALO8178	1 457 429 284	P 9284
ALO-8180	F 026 407 075	P 7075
ALO-8181	F 026 407 061	P 7061

ALO-8186	F 026 407 062	P 7062
ALO-8193	F 026 407 073	P 7073
ALO-8702	F 026 407 091	P 7091
ALO-8753/1	F 026 407 042	P 7042
AL 199	0 451 103 274	P 3274

AL 8138	1 457 429 302	P 9302
1131	F 026 400 114	S 0114
1133	F 026 400 143	S 0143
1212	F 026 400 129	S 0129
1322	F 026 400 054	S 0054

1333	F 026 400 132	S 0132
1513	F 026 400 125	S 0125
8312/10	F 026 400 137	S 0137
8826/2	F 026 400 121	S 0121
8839	F 026 400 130	S 0130

8856	F 026 400 126	S 0126
8859/2	F 026 400 140	S 0140
8870	F 026 400 135	S 0135

CAV (LUCAS)

BFA11	1 457 431 270	N 1270
BFA 11	1 457 431 326	N 1326
BFA5	1 457 431 261	N 1261

BFA 5	1 457 431 325	N 1325
HDF296	1 457 434 201	N 4201
HDF491	1 457 429 675	N 9675
HDF492	1 457 429 676	N 9676
HDF493	1 457 429 681	N 9681

HDF496	1 457 434 447	N 4447
HDF499	1 457 429 354	N 9354
HDF500	1 457 429 359	N 9359
HDF501	1 457 431 159	N 1159
HDF502	1 457 431 270	N 1270

HDF508	1 457 434 291	N 4291
HDF511	1 457 431 705	N 1705
HDF512	1 457 429 657	N 9657
HDF526	1 457 434 453	N 4453
HDF796	1 457 434 200	N 4200

HDF901	1 457 434 201	N 4201
HDF902	1 457 434 200	N 4200
HDF910	1 457 431 713	N 1713
HDF911	1 457 431 702	N 1702
HDF 912	1 457 429 621	N 9621

HDF916	1 457 431 702	N 1702
296	1 457 434 201	N 4201
491	1 457 429 675	N 9675
492	1 457 429 676	N 9676
493	1 457 429 681	N 9681

496	1 457 434 447	N 4447
7019 113	1 457 431 158	N 1158
7019122	1 457 431 270	N 1270
7019 122	1 457 431 326	N 1326
7019 221	1 457 431 158	N 1158

7031102	1 457 431 270	N 1270
7031 102	1 457 431 326	N 1326
7031 105	1 457 431 159	N 1159
7031 57	1 457 431 159	N 1159
70316	1 457 431 270	N 1270

7031 6	1 457 431 326	N 1326
7111113	1 457 431 261	N 1261
7111 113	1 457 431 325	N 1325
7111 296	1 457 434 201	N 4201
7111491	1 457 429 675	N 9675

7111492	1 457 429 676	N 9676
7111493	1 457 429 681	N 9681
7111496	1 457 434 447	N 4447
7111500	1 457 434 201	N 4201
7111 796	1 457 434 200	N 4200

◀ CAV

7176398	1 457 434 103	N 4103
7176491	1 457 429 675	N 9675
7176492	1 457 429 676	N 9676
7176493	1 457 429 681	N 9681
7176496	1 457 434 106	N 4106

7176499	1 457 429 354	N 9354
7176500	1 457 429 359	N 9359
7176501	1 457 431 159	N 1159
7176502	1 457 431 270	N 1270
7176521	1 457 434 438	N 4438

7176901	1 457 434 201	N 4201
7176902	1 457 434 200	N 4200
7176903	1 457 434 103	N 4103
7176906	1 457 434 321	N 4321
796	1 457 434 200	N 4200

9001910	1 457 431 713	N 1713
9001911	1 457 431 702	N 1702
910	1 457 431 713	N 1713
911	1 457 431 702	N 1702

CHAMPION

AP 148	1 457 433 781	S 3781
A 101	0 451 104 066	P 4066
A 270	0 986 452 046	P 2046

CAF 1704	1 987 432 052	M 2052
C 030	0 451 103 274	P 3274
C 102	0 451 103 028	P 3028
C 102	0 451 103 029	P 3029
C 102	0 451 103 062	P 3062

C 105	0 451 103 357	P 3357
C 105	0 451 203 194	P 3194
C 105	0 986 452 005	P 2005
C 107	0 451 103 274	P 3274
C 108	0 451 103 141	P 3141

C 109	0 986 452 023	P 2023
C 110	0 986 452 028	P 2028
C 114	0 986 452 000	P 2000
C 116	0 451 103 274	P 3274
C 122	0 451 103 290	P 3290

C 124	0 451 103 235	P 3235
C 125	0 451 103 289	P 3289
C 130	0 451 103 274	P 3274
C 131	0 986 452 035	P 2035
C 138	0 986 452 028	P 2028

C 141	0 986 452 060	P 2060
C 142	0 451 103 029	P 3029
C 143	0 451 203 194	P 3194
C 147	0 451 103 258	P 3258
C 152	0 451 203 223	P 3223

C 153	0 451 203 005	P 3005
C 154	0 451 103 217	P 3217
C 156	0 451 103 249	P 3249
C 158	0 451 103 141	P 3141
C 162	0 451 103 274	P 3274

C 163	0 451 103 276	P 3276
C 167	0 451 103 337	P 3337
C 170	0 986 452 019	P 2019
C 180	0 986 452 058	P 2058
C 209	0 986 452 024	P 2024

C 270	0 451 203 201	P 3201
C 303	0 986 452 019	P 2019
C 304	0 986 452 019	P 2019
E 101	0 986 452 015	P 2015
E 103	0 451 103 252	P 3252

E 105	F 026 407 053	P 7053
FN 23	0 986 450 138	F 0138
F 110	0 451 103 316	P 3316
F 111	0 986 452 016	P 2016
F 113	0 451 103 316	P 3316

F 115	0 451 203 108	P 3108
F 117	0 451 103 275	P 3275
F 119	0 451 103 316	P 3316
F 121	0 451 103 240	P 3240
F 123	0 451 103 316	P 3316

F 124	0 451 103 235	P 3235
F 125	0 451 203 108	P 3108
F 129	0 986 452 061	P 2061
F 131	0 451 103 109	P 3109
G 103	0 451 203 108	P 3108

G 105	0 451 103 232	P 3232
G 106	0 451 103 297	P 3297
K 270	0 986 452 042	P 2042
K 270	0 986 452 066	P 2066
K 271	0 986 452 064	P 2064

K 274	0 986 452 062	P 2062
K 275	0 986 452 030	P 2030
K 277	0 986 452 062	P 2062
K 282	0 451 103 368	P 3368
LFF 8101	F 026 402 035	N 2035

LFP 8982	F 026 407 049	P 7049
L 101	0 450 904 058	F 4058
L 102	0 986 450 138	F 0138
L 103	0 986 450 138	F 0138
L 104	0 450 904 058	F 4058

L 104	0 450 904 149	F 4149
L 105	0 450 904 077	N 4077
L 106	0 450 904 149	F 4149
L 111	1 457 434 103	N 4103
L 111	1 457 434 106	N 4106

L 112	1 457 434 106	N 4106
L 112	1 457 434 447	N 4447
L 113	1 457 434 103	N 4103
L 113	1 457 434 106	N 4106
L 115	1 457 434 291	N 4291

L 116	1 457 434 123	N 4123
L 117	1 457 434 184	N 4184
L 120	1 457 434 105	N 4105
L 120	1 457 434 321	N 4321
L 121	1 457 431 702	N 1702

L 122	1 457 429 621	N 9621
L 123	1 457 434 324	N 4324
L 124	1 457 434 187	N 4187
L 131	1 457 434 201	N 4201
L 132	1 457 434 200	N 4200

L 133	1 457 434 153	N 4153
L 135	1 457 429 289	N 9289
L 136	1 457 431 028	N 1028
L 137	1 457 434 201	N 4201
L 139	1 457 431 158	N 1158

L 140	1 457 431 159	N 1159
L 141	1 457 429 291	N 9291
L 141	1 457 431 713	N 1713
L 144	1 457 434 184	N 4184
L 145	1 457 434 281	N 4281

L 148	1 457 434 302	N 4302
L 150	1 457 434 186	N 4186
L 201	0 450 905 002	F 5002
L 201	0 450 905 280	F 5280
L 203	0 450 905 005	F 5005

L 203	0 450 905 021	F 5021
L 204	0 450 905 200	F 5200
L 204	0 450 905 601	F 5601
L 205	0 450 905 087	F 5087
L 205	0 450 905 104	F 5104

L 205	0 450 905 401	F 5401
L 206	0 450 905 030	F 5030
L 206	0 450 905 095	F 5095
L 206	0 450 905 264	F 5264
L 210	0 450 905 203	F 5203

L 211	0 450 905 924	F 5924
L 211	0 986 450 113	F 0113
L 212	0 450 905 177	F 5177
L 213	0 450 902 151	F 2151
L 214	0 986 450 100	F 0100

L 215	0 450 905 326	F 5326
L 217	0 450 905 091	F 5091
L 217	0 450 905 133	F 5133
L 218	0 450 905 324	F 5324
L 219	0 986 450 119	F 0119

L 220	0 450 905 326	F 5326
L 221	0 450 902 162	F 2162
L 222	0 450 905 909	F 5909
L 223	0 986 450 109	F 0109
L 224	0 450 905 904	F 5904

L 225	0 450 905 273	F 5273
L 225	0 450 905 316	F 5316
L 226	0 450 905 901	F 5901
L 227	0 986 450 108	F 0108
L 229	0 986 450 104	F 0104

L 230	0 450 905 903	F 5903
L 231	0 986 450 030	F 0030
L 235	0 986 450 108	F 0108
L 237	0 450 905 318	F 5318
L 242	0 450 905 275	F 5275

L246	0 450 905 939	F 5939	U 579	1 457 433 259	S 3259	U 665	1 987 429 051	S 9051
L252	1 457 429 657	N 9657	U 582	1 457 433 264	S 3264	U 667	1 457 429 957	S 9957
L 253	1 457 431 705	N 1705	U 583	1 457 433 023	S 3023	U 668	1 457 433 740	S 3740
L255	1 457 429 656	N 9656	U 585	1 457 433 253	S 3253	U 669	1 457 433 741	S 3741
L407	F 026 402 013	N 2013	U 586	1 457 433 008	S 3008	U 670	1 457 433 799	S 3799
L417	1 457 434 439	N 4439	U 587	1 457 433 659	S 3659	U 671	1 457 433 605	S 3605
U 501	1 457 429 076	S 9076	U 588	1 457 433 571	S 3571	U 672	1 457 433 700	S 3700
U 501	1 457 429 994	S 9994	U 590	1 457 429 814	S 9814	U 674	1 457 432 200	S 2200
U 502	1 457 429 076	S 9076	U 591	1 457 429 781	S 9781	U 675	1 457 433 965	S 3965
U 503	1 457 429 079	S 9079	U 592	0 451 104 015	P 4015	U 676	1 457 433 784	S 3784
U 504	1 457 429 928	S 9928	U 592	0 451 105 067	P 5067	U 677	1 457 433 958	S 3958
U 505	1 457 429 061	S 9061	U 595	1 457 433 571	S 3571	U 678	1 457 433 003	S 3003
U 506	1 457 429 957	S 9957	U 598	1 457 433 007	S 3007	U 680	1 457 433 265	S 3265
U 508	1 457 429 030	S 9030	U 601	1 457 433 571	S 3571	U 681	1 457 433 265	S 3265
U 516	1 457 429 875	S 9875	U 604	1 457 433 274	S 3274	U 682	1 457 433 963	S 3963
U 517	1 457 429 988	S 9988	U 605	1 987 429 123	S 9123	U 683	1 457 433 962	S 3962
U 520	1 457 432 173	S 2173	U 607	1 457 433 004	S 3004	U 684	1 457 433 303	S 3303
U 521	1 457 432 146	S 2146	U 610	1 457 433 952	S 3952	U 686	1 457 429 076	S 9076
U 523	1 457 432 172	S 2172	U 611	1 457 433 286	S 3286	U 687	1 457 433 697	S 3697
U 527	1 457 429 964	S 9964	U 612	1 457 429 791	S 9791	U 688	1 457 433 753	S 3753
U 528	1 457 429 983	S 9983	U 613	1 457 433 626	S 3626	U 690	1 457 433 547	S 3547
U 529	1 457 432 124	S 2124	U 615	1 457 433 606	S 3606	U 691	1 457 433 056	S 3056
U 531	1 457 429 085	S 9085	U 619	1 457 433 273	S 3273	U 692	1 457 433 703	S 3703
U 532	1 457 432 203	S 2203	U 623	1 457 433 072	S 3072	U 693	1 457 433 268	S 3268
U 533	1 457 432 180	S 2180	U 624	1 457 433 701	S 3701	U 694	1 457 433 742	S 3742
U 534	1 457 432 185	S 2185	U 625	1 457 433 002	S 3002	U 695	1 457 433 956	S 3956
U 535	1 457 432 183	S 2183	U 626	1 457 433 690	S 3690	U 697	1 457 433 686	S 3686
U 539	1 987 429 136	S 9136	U 627	1 457 433 954	S 3954	U 698	1 457 433 781	S 3781
U 543	1 457 432 200	S 2200	U 628	1 457 433 607	S 3607	U 699	1 457 433 543	S 3543
U 545	1 457 429 839	S 9839	U 631	1 457 433 736	S 3736	U 701	1 457 433 772	S 3772
U 547	1 457 429 987	S 9987	U 632	1 457 433 609	S 3609	U 702	1 457 433 743	S 3743
U 548	1 457 429 894	S 9894	U 633	1 457 429 792	S 9792	U 703	1 457 433 771	S 3771
U 548	1 987 429 051	S 9051	U 634	1 457 433 750	S 3750	U 706	1 457 433 555	S 3555
U 549	1 987 429 135	S 9135	U 637	1 987 429 135	S 9135	U 707	F 026 400 014	S 0014
U 550	1 457 433 266	S 3266	U 638	1 457 433 623	S 3623	U 708	F 026 400 010	S 0010
U 551	1 457 429 846	S 9846	U 639	1 457 433 541	S 3541	U 715	1 457 433 532	S 3532
U 553	1 457 432 150	S 2150	U 640	1 457 433 603	S 3603	U 716	1 457 433 571	S 3571
U 554	1 457 429 895	S 9895	U 641	1 457 433 713	S 3713	U 717	1 457 433 043	S 3043
U 554	1 457 429 896	S 9896	U 642	1 457 433 752	S 3752	U 720	1 457 433 078	S 3078
U 554	1 457 429 898	S 9898	U 643	1 457 433 603	S 3603	U 721	1 457 433 058	S 3058
U 554	1 457 433 087	S 3087	U 644	1 457 433 642	S 3642	U 722	1 457 433 070	S 3070
U 557	1 457 429 842	S 9842	U 645	1 987 429 123	S 9123	U 723	1 457 433 088	S 3088
U 558	1 457 429 844	S 9844	U 646	1 457 433 951	S 3951	U 724	1 457 433 529	S 3529
U 561	1 457 433 250	S 3250	U 647	1 457 433 255	S 3255	U 726	1 457 433 539	S 3539
U 562	1 457 433 714	S 3714	U 648	1 457 433 257	S 3257	U 729	1 457 433 090	S 3090
U 563	1 457 429 783	S 9783	U 649	1 457 433 256	S 3256	U 730	1 457 433 550	S 3550
U 564	1 457 433 265	S 3265	U 651	1 457 429 793	S 9793	U 733	1 457 433 747	S 3747
U 565	1 987 429 135	S 9135	U 652	1 457 433 253	S 3253	U 736	1 457 433 319	S 3319
U 567	1 457 429 870	S 9870	U 653	1 457 433 601	S 3601	U 737	1 457 433 531	S 3531
U 569	1 457 429 870	S 9870	U 654	1 457 433 608	S 3608	U 738	1 457 433 047	S 3047
U 570	1 457 429 877	S 9877	U 656	1 457 429 869	S 9869	U 741	1 457 433 075	S 3075
U 572	1 457 429 777	S 9777	U 658	1 457 433 950	S 3950	U 742	1 457 433 752	S 3752
U 573	1 457 433 605	S 3605	U 661	1 457 433 950	S 3950	U 751	1 457 433 574	S 3574
U 576	1 457 433 285	S 3285	U 663	1 457 433 711	S 3711	U 755	1 987 429 406	S 9406
U 577	1 457 433 269	S 3269	U 665	1 457 433 274	S 3274	U 756	1 457 433 577	S 3577



◀ CHAMPION

U758	1 457 433 573	S 3573
U761	F 026 400 113	S 0113
U762	F 026 400 141	S 0141
U764	F 026 400 107	S 0107
U769	F 026 400 166	S 0166

U774	1 457 433 067	S 3067
U775	1 457 433 585	S 3585
U776	1 987 429 402	S 9402
U778	1 457 433 788	S 3788
U780	1 457 433 581	S 3581

U781	1 457 433 523	S 3523
U785	1 457 433 071	S 3071
U787	1 457 433 065	S 3065
U789	1 457 433 594	S 3594
U795	F 026 400 013	S 0013

U800	F 026 400 020	S 0020
V401	1 457 429 908	S 9908
V405	1 457 432 124	S 2124
V408	1 457 433 791	S 3791
V414	1 457 433 234	S 3234

V417	1 987 429 042	S 9042/1
V423	1 457 429 839	S 9839
V424	1 457 433 646	S 3646
V429	1 457 433 233	S 3233
V431	1 457 432 138	S 2138

V432	1 457 433 624	S 3624
V433	1 457 433 229	S 3229
V434	F 026 400 011	S 0011
V436	1 987 429 127	S 9127
V438	1 457 433 227	S 3227

V439	1 457 433 791	S 3791
V440	1 457 433 538	S 3538
V441	1 457 433 715	S 3715
V442	1 457 433 077	S 3077
V446	1 457 433 069	S 3069

V457	F 026 400 061	S 0061
V460	1 457 433 589	S 3589
V464	1 987 429 401	S 9401
W 101	1 457 429 050	S 9050
W 101	1 457 429 959	S 9959

W 102	1 457 429 054	S 9054
W 102	1 457 429 915	S 9915
W 103	1 457 429 053	S 9053
W 105	1 457 429 800	S 9800
W 106	1 457 432 108	S 2108

W 108	1 457 429 801	S 9801
W 109	1 457 432 106	S 2106
W 110	1 457 429 064	S 9064
W 114	1 457 433 652	S 3652
W 115	1 457 432 124	S 2124

W 117	1 457 432 154	S 2154
W 120	1 457 429 806	S 9806
W 121	1 457 432 111	S 2111
W 123	1 987 429 115	S 9115
W 126	1 457 429 993	S 9993

W 132	1 457 433 231	S 3231
W 134	1 457 432 124	S 2124
W 136	1 457 429 953	S 9953
W 145	1 457 432 134	S 2134
W 147	1 457 429 795	S 9795

W 148	1 457 429 992	S 9992
W 149	1 457 429 080	S 9080
W 152	1 457 429 920	S 9920
W 153	1 457 429 920	S 9920
W 175	1 457 433 229	S 3229

W 184	1 457 429 845	S 9845
W 186	1 457 433 790	S 3790
W 187	1 457 433 954	S 3954
W 189	1 457 429 948	S 9948
W 190	1 457 429 923	S 9923

W 191	1 457 432 204	S 2204
W 196	1 457 429 949	S 9949
W 198	1 457 429 900	S 9900
W 200	1 457 433 732	S 3732
W 207	1 457 429 923	S 9923

W 209	1 457 433 534	S 3534
W 211	1 987 429 122	S 9122
W 212	1 457 429 841	S 9841
W 213	1 457 433 270	S 3270
W 220	1 457 433 037	S 3037

W 222	1 457 433 540	S 3540
W 225	1 457 429 819	S 9819
W 226	1 457 429 775	S 9775
W 227	1 457 433 652	S 3652
W 228	1 457 429 787	S 9787

W 229	1 457 429 970	S 9970
W 230	1 457 433 230	S 3230
W 231	1 987 429 133	S 9133
W 233	1 457 432 154	S 2154
W 237	1 457 433 955	S 3955

W 247	1 987 429 148	S 9148
W 249	1 457 433 785	S 3785
W 254	1 987 429 125	S 9125
W 259	1 457 433 785	S 3785
W 533	1 457 432 180	S 2180

W 706	1 457 429 944	S 9944
W 706	1 457 429 946	S 9946
W 708	1 457 433 275	S 3275
W 710	1 457 429 933	S 9933
W 711	1 457 429 941	S 9941

W 712	1 457 429 818	S 9818
W 713	1 457 433 521	S 3521
W 716	1 457 433 311	S 3311
XE 505	1 457 429 619	P 9619
XE 507	1 457 429 157	P 9157

XE 512	1 457 429 272	P 9272
XE 513	1 457 429 152	P 9152
XE 518	1 457 429 119	P 9119
XE 522	1 457 429 647	P 9647
XE 527	1 457 429 194	P 9194

XE 528	1 457 429 118	P 9118
XE 532	1 457 429 198	P 9198
XE 536	1 457 429 248	P 9248
XE 542	1 457 429 152	P 9152
XE 545	1 457 429 185	P 9185

XE 547	1 457 429 275	P 9275
XE 549	1 457 429 252	P 9252
XE 552	1 457 429 126	P 9126
XE 555	1 457 429 272	P 9272
X 103	1 457 429 274	P 9274

X 109	1 457 429 647	P 9647
X 114	1 457 429 636	P 9636
X 125	1 457 429 123	P 9123
X 129	1 457 429 251	P 9251

CLEAN FILTERS

CF 888	0 451 203 201	P 3201
DF 1888	F 026 407 106	P 7106
DF 1898	0 451 203 201	P 3201

DF 207	0 451 203 201	P 3201
DF 887	F 026 407 049	P 7049
DF 888	0 451 203 201	P 3201
DF 889	0 451 203 201	P 3201
DF 890	F 026 407 105	P 7105

DF 891	F 026 407 049	P 7049
DNW 1996	F 026 402 048	N 2048
DNW 1998	F 026 402 013	N 2013
DN 1904	0 450 905 930	N 5930
DN 1908	1 457 434 437	N 4437

DN 1910	0 450 906 452	N 6452
DN 1916	F 026 402 037	N 2037
DN 1921	F 026 402 044	N 2044
DN 1925	F 026 402 056	N 2056
DN 1926	1 457 434 421	N 4421

DN 1953	0 450 906 508	N 6508
DN 220	1 457 434 201	N 4201
DN 222	1 457 434 200	N 4200
DN 235	1 457 434 302	N 4302
DN 235	1 457 434 456	N 4456

DN 251A	1 457 434 453	N 4453
DN 253	1 457 434 123	N 4123
DN 253	1 457 434 331	N 4331
DN 256	1 457 434 154	N 4154
DN 256	1 457 434 165	N 4165

DN 256	1 457 434 296	N 4296
DN 256	1 457 434 432	N 4432
DN 258	1 457 429 681	N 9681
DN 260	1 457 434 051	N 4051
DN 287	1 457 434 438	N 4438

DN 297	1 457 429 676	N 9676
DN 299	1 457 429 681	N 9681
DN 301	1 457 434 105	N 4105
DN 306	1 457 429 675	N 9675
DN 323	1 457 434 106	N 4106



DN 334	1 457 434 103	N 4103
DN 876	1 457 434 402	N 4402
DN 877	1 457 434 324	N 4324
DN 898	1 457 434 435	N 4435
DN 916	1 457 434 432	N 4432
DN 919	1 457 434 105	N 4105
DN 919	1 457 434 321	N 4321
DN 938	1 457 434 291	N 4291
DN 947	1 457 434 186	N 4186
DN 996	1 457 434 187	N 4187
DN 997	1 457 434 294	N 4294
DN 998	1 457 434 105	N 4105
DN 998	1 457 434 321	N 4321
DOC 2211	F 026 407 059	P 7059
DOC 2212	F 026 407 058	P 7058
DOC 2213	F 026 407 060	P 7060
DO 1800	0 451 103 235	P 3235
DO1806	0 451 301 207	P 1207
DO 1810	F 026 407 048	P 7048
DO1814	0 451 103 297	P 3297
DO1817	0 451 103 289	P 3289
DO 1819	0 451 103 357	P 3357
DO 1820	F 026 407 053	P 7053
DO1832	F 026 407 027	P 7027
DO 1838	F 026 407 083	P 7083
DO 206	0 986 452 020	P 2020
DO 223	0 451 103 004	P 3004
DO 223	0 451 103 062	P 3062
DO 225	0 451 104 065	P 4065
DO 225/B	0 451 203 194	P 3194
DO225C	0 451 103 253	P 3253
DO 225/C	0 451 203 005	P 3005
DO 225/C	0 451 203 223	P 3223
DO 227	0 451 103 274	P 3274
DO 228	0 451 203 223	P 3223
DO 231	0 986 452 000	P 2000
DO 236	0 451 104 066	P 4066
DO 237	0 451 103 232	P 3232
DO 242	0 451 203 152	P 3152
DO 248	0 451 103 141	P 3141
DO 250	0 986 452 046	P 2046
DO 262/B	0 451 103 029	P 3029
DO 263	0 451 104 015	P 4015
DO 263	0 451 105 067	P 5067
DO 263	0 451 105 188	P 5188
DO263D	0 451 104 015	P 4015
DO263D	0 451 105 067	P 5067
DO 265	0 451 203 002	P 3002
DO 265	0 451 203 220	P 3220
DO 265	0 451 203 226	P 3226
DO 268	0 451 301 156	P 1156
DO 277	0 451 103 141	P 3141
DO 278	0 451 203 108	P 3108
DO 281	0 451 104 005	P 4005
DO 282	0 986 452 000	P 2000

DO 295	0 451 104 064	P 4064
DO 296	0 451 103 232	P 3232
DO 298	0 451 203 010	P 3010
DO 300	0 451 403 077	P 3077
DO 303	0 451 103 274	P 3274
DO 310	0 451 103 258	P 3258
DO 327	0 986 452 016	P 2016
DO 328	0 986 452 016	P 2016
DO 330	0 451 104 064	P 4064
DO 337	0 986 452 019	P 2019
DO 338	0 986 452 028	P 2028
DO 339	0 451 103 028	P 3028
DO 339	0 986 452 044	P 2044
DO 340	0 986 452 015	P 2015
DO 341	0 986 452 023	P 2023
DO 810	0 986 452 019	P 2019
DO 812	0 451 103 252	P 3252
DO 816	0 986 452 028	P 2028
DO 822	0 451 203 152	P 3152
DO 827	0 986 452 042	P 2042
DO 834	0 986 452 023	P 2023
DO 835	0 451 103 240	P 3240
DO 836	0 451 103 275	P 3275
DO 846	0 986 452 058	P 2058
DO 849	0 451 103 217	P 3217
DO 851	0 986 452 028	P 2028
DO 853	0 986 452 061	P 2061
DO 854	0 986 452 061	P 2061
DO 861	0 986 452 030	P 2030
DO 862	0 451 103 276	P 3276
DO 863	0 986 452 062	P 2062
DO 864	0 986 452 064	P 2064
DO 866	0 451 103 270	P 3270
DO 878	0 451 103 141	P 3141
DO 879	0 451 103 252	P 3252
DO 881	0 451 103 258	P 3258
DO 883	0 451 103 316	P 3316
DO 885	0 451 103 274	P 3274
DO 910	0 986 452 044	P 2044
DO 911	0 986 452 044	P 2044
DO 930	0 451 103 109	P 3109
DO 936	0 451 103 249	P 3249
DO 937	0 451 103 290	P 3290
DO 943	0 451 203 108	P 3108
DO 944	0 451 103 347	P 3347
DO 945	0 451 103 260	P 3260
DO 949	0 986 452 061	P 2061
MA 1000	1 457 433 008	S 3008
MA 1002	1 457 433 023	S 3023
MA 1003	1 457 433 642	S 3642
MA 1005	1 457 433 264	S 3264
MA 1006	1 457 429 792	S 9792
MA 1007	1 457 429 787	S 9787
MA 1008	1 457 429 791	S 9791
MA 1009	1 457 433 273	S 3273

MA 1011	1 457 433 605	S 3605
MA 1012	1 987 429 146	S 9146
MA 1013	1 457 429 793	S 9793
MA 1014	1 457 433 736	S 3736
MA 1016	1 457 433 623	S 3623
MA 1018	1 457 433 004	S 3004
MA 1019	1 457 433 606	S 3606
MA 1020	1 457 433 541	S 3541
MA 1027	1 457 433 255	S 3255
MA 1028	1 457 433 256	S 3256
MA 1029	1 457 433 257	S 3257
MA 1030	1 457 433 603	S 3603
MA 1031	1 457 433 713	S 3713
MA 1032	1 457 433 608	S 3608
MA 1033	1 457 433 608	S 3608
MA 1034	1 457 433 601	S 3601
MA 1036	1 457 433 790	S 3790
MA 1037	1 457 429 795	S 9795
MA 1038	1 457 433 234	S 3234
MA 1039	1 457 433 752	S 3752
MA 1040	1 987 429 159	S 9159
MA 1042	1 457 433 954	S 3954
MA 1044	1 457 433 791	S 3791
MA 1046	1 457 429 792	S 9792
MA 1047	1 457 433 286	S 3286
MA 1048	1 457 433 265	S 3265
MA 1049	1 457 433 626	S 3626
MA 1050	1 987 429 150	S 9150
MA 1051	1 457 433 951	S 3951
MA 1053	1 457 433 571	S 3571
MA 1054	1 457 433 571	S 3571
MA 1055	1 457 433 571	S 3571
MA 1056	1 457 433 266	S 3266
MA 1057	1 457 433 260	S 3260
MA 1058	1 457 433 699	S 3699
MA 1060	1 457 433 265	S 3265
MA 1061	1 457 433 714	S 3714
MA 1062	1 457 433 607	S 3607
MA 1063	1 457 433 282	S 3282
MA 1064	1 457 433 303	S 3303
MA 1065	1 457 433 716	S 3716
MA 1066	1 457 433 748	S 3748
MA 1067	1 457 433 753	S 3753
MA 1068	1 457 433 701	S 3701
MA 1069	1 457 433 052	S 3052
MA 107	1 457 429 992	S 9992
MA 1070	1 987 429 148	S 9148
MA 1071	1 987 429 127	S 9127
MA 1075	1 457 433 785	S 3785
MA 1077	1 457 433 544	S 3544
MA 1078	F 026 400 077	S 0077
MA 1079	1 457 433 743	S 3743
MA 1080	1 457 433 769	S 3769
MA 1081	1 457 433 791	S 3791
MA 1082	1 457 433 742	S 3742



◀ CLEAN FILTERS

MA 1083	1 457 433 268	S 3268
MA 1084	1 457 433 265	S 3265
MA 1086	1 457 433 272	S 3272
MA 1088	1 457 433 712	S 3712
MA 1089	1 457 433 711	S 3711

MA 1091	1 457 433 741	S 3741
MA 1092	1 457 433 697	S 3697
MA 1094	F 026 400 011	S 0011
MA 1095	1 457 433 521	S 3521
MA 1096	1 457 433 257	S 3257

MA 1097	1 457 433 791	S 3791
MA 1098	1 457 433 715	S 3715
MA 1099	1 457 433 281	S 3281
MA 1100	1 987 429 122	S 9122
MA 1102	1 457 433 784	S 3784

MA 1103	1 457 433 771	S 3771
MA 1104	1 457 433 781	S 3781
MA 1105	1 457 433 686	S 3686
MA 1106	1 457 433 773	S 3773
MA 1107	1 457 433 154	S 3154

MA 1110	1 457 433 624	S 3624
MA 1111	1 457 433 077	S 3077
MA 1112	1 457 433 161	S 3161
MA 1113	1 457 433 747	S 3747
MA 1114	1 457 433 553	S 3553

MA 1115	1 457 433 526	S 3526
MA 1116	1 457 433 280	S 3280
MA 1118	1 457 433 740	S 3740
MA1122	1 457 433 772	S 3772
MA 1127	1 457 433 152	S 3152

MA1128	1 457 433 588	S 3588
MA 113	1 457 433 253	S 3253
MA 1130	1 987 429 135	S 9135
MA1133	1 457 433 521	S 3521
MA 1136	1 457 433 155	S 3155

MA1136	1 457 433 543	S 3543
MA 1138	1 457 433 965	S 3965
MA1139	1 457 433 547	S 3547
MA 1142	1 457 433 311	S 3311
MA1144	1 457 433 531	S 3531

MA 1145	1 457 433 959	S 3959
MA1146	1 457 433 263	S 3263
MA 1149	1 987 429 151	S 9151
MA1152	1 457 433 616	S 3616
MA1153	1 457 433 229	S 3229

MA1155	1 457 433 752	S 3752
MA 1156	1 457 433 330	S 3330
MA1157	1 457 433 797	S 3797
MA1158	1 457 433 539	S 3539
MA1159	1 457 433 058	S 3058

MA1160	1 457 433 555	S 3555
MA 1161	1 457 433 958	S 3958
MA1162	1 457 433 529	S 3529
MA 1164	1 457 433 957	S 3957
MA 1165	1 987 429 171	S 9171

MA1166	1 457 433 527	S 3527
MA1168	1 457 433 061	S 3061
MA 1169	1 457 433 950	S 3950
MA1170	1 457 433 088	S 3088
MA1173	F 026 400 010	S 0010

MA 1173	1 457 433 769	S 3769
MA1174	1 457 433 538	S 3538
MA1176	1 457 433 532	S 3532
MA1178	1 457 433 047	S 3047
MA1179	1 457 433 536	S 3536

MA 118	1 457 432 138	S 2138
MA1181	1 457 433 070	S 3070
MA 1182	1 457 433 153	S 3153
MA 1186	1 457 433 274	S 3274
MA 1188	1 457 433 307	S 3307

MA1191	F 026 400 164	S 0164
MA1192	1 457 433 090	S 3090
MA 1194	1 457 433 150	S 3150
MA 1195	1 457 433 956	S 3956
MA 1198	1 457 433 953	S 3953

MA1199	1 457 433 078	S 3078
MA 124	1 457 429 080	S 9080
MA 125	1 457 432 173	S 2173
MA 126	1 457 432 172	S 2172
MA 129	1 457 432 108	S 2108

MA 130	1 457 429 993	S 9993
MA1300	1 457 433 642	S 3642
MA1302	1 457 433 075	S 3075
MA 1304	1 457 433 158	S 3158
MA 1306	1 457 433 325	S 3325

MA 131	1 457 429 819	S 9819
MA 1311	1 457 433 160	S 3160
MA1313	1 457 433 319	S 3319
MA1314	1 457 433 083	S 3083
MA 1316	1 457 433 971	S 3971

MA 1317	1 457 433 159	S 3159
MA 1318	1 457 433 083	S 3083
MA 1318	1 457 433 593	S 3593
MA1320	1 987 429 403	S 9403
MA1321	1 457 433 089	S 3089

MA 1324	1 457 433 324	S 3324
MA1326	1 457 433 521	S 3521
MA1329	1 457 433 060	S 3060
MA 133	1 457 429 953	S 9953
MA1332	1 457 433 091	S 3091

MA1334	1 457 433 792	S 3792
MA 1337	1 457 433 097	S 3097
MA 1339	1 457 433 326	S 3326
MA1342	1 457 433 043	S 3043
MA1343	1 457 433 523	S 3523

MA1344	1 457 433 751	S 3751
MA1346	1 457 433 056	S 3056
MA1348	1 987 429 406	S 9406
MA 1349	1 457 433 660	S 3660
MA1350	1 457 433 549	S 3549

MA1353	1 457 433 574	S 3574
MA1354	1 457 433 046	S 3046
MA1355	1 457 433 537	S 3537
MA1356	1 987 429 404	S 9404
MA1357	1 457 433 331	S 3331

MA1358	1 457 433 276	S 3276
MA1359	1 457 433 300	S 3300
MA 1360	F 026 400 023	S 0023
MA1362	1 457 433 739	S 3739
MA1364	1 457 433 069	S 3069

MA1365	F 026 400 002	S 0002
MA1366	1 457 433 703	S 3703
MA1367	F 026 400 059	S 0059
MA1368	1 457 433 573	S 3573
MA1369	1 987 429 182	S 9182

MA 1370	F 026 400 141	S 0141
MA1372	1 457 433 323	S 3323
MA1373	1 987 429 405	S 9405
MA1374	1 457 433 595	S 3595
MA1375	1 457 433 595	S 3595

MA1376	1 457 433 594	S 3594
MA1378	1 457 433 065	S 3065
MA1379	F 026 400 041	S 0041
MA1380	1 457 433 596	S 3596
MA1383	1 457 433 327	S 3327

MA1384	F 026 400 012	S 0012
MA1385	1 457 433 592	S 3592
MA1386	1 457 433 315	S 3315
MA1389	1 457 433 579	S 3579
MA 1392	F 026 400 166	S 0166

MA1395	F 026 400 044	S 0044
MA 1403	F 026 400 083	S 0083
MA 1404	F 026 400 086	S 0086
MA1412	1 457 433 332	S 3332
MA1414	F 026 400 014	S 0014

MA1418	1 457 433 042	S 3042
MA 1419	F 026 400 117	S 0117
MA 143	1 457 429 801	S 9801
MA1431	F 026 400 084	S 0084
MA 1433	F 026 400 069	S 0069

MA 1434	F 026 400 070	S 0070
MA 1439	F 026 400 078	S 0078
MA 1441	F 026 400 074	S 0074
MA 1442	F 026 400 075	S 0075
MA 1443	F 026 400 064	S 0064

MA 1448	F 026 400 067	S 0067
MA 1449	F 026 400 184	S 0184
MA1458	F 026 400 189	S 0189
MA 146	1 457 429 800	S 9800
MA 1476	F 026 400 080	S 0080

MA 148	1 457 429 953	S 9953
MA 1496	F 026 400 210	S 0210
MA 156	1 457 429 806	S 9806
MA 160	1 457 429 085	S 9085
MA 162	1 457 429 900	S 9900

MA 164	1 457 429 806	S 9806
MA 169	1 457 429 957	S 9957
MA 171	1 457 429 801	S 9801
MA 176	1 457 432 134	S 2134
MA 183	1 457 429 875	S 9875

MA 185	1 457 429 920	S 9920
MA 193	1 457 432 154	S 2154
MA 203	1 457 429 777	S 9777
MA3002	F 026 400 013	S 0013
MA3004	1 987 429 188	S 9188

MA3012	1 457 433 589	S 3589
MA3016	1 987 429 401	S 9401
MA 3019	F 026 400 107	S 0107
MA3028	1 457 433 071	S 3071
MA3030	1 987 429 152	S 9152

MA 309	1 457 432 106	S 2106
MA3110	1 987 429 176	S 9176
MA3124	F 026 400 201	S 0201
MA3141	1 987 429 178	S 9178
MA 347	1 457 429 869	S 9869

MA 348	1 457 429 844	S 9844
MA 354	1 457 433 233	S 3233
MA 355	1 457 429 781	S 9781
MA 356	1 457 432 111	S 2111
MA 361	1 457 429 050	S 9050

MA 362	1 457 429 053	S 9053
MA 363	1 457 429 895	S 9895
MA 363	1 457 429 898	S 9898
MA 371	1 457 429 948	S 9948
MA 373	1 457 429 839	S 9839

MA 374	1 457 429 778	S 9778
MA 378	1 457 429 842	S 9842
MA 381	1 457 429 076	S 9076
MA 390	1 457 429 054	S 9054
MA 390	1 457 429 915	S 9915

MA390A	1 457 429 054	S 9054
MA390A	1 457 433 540	S 3540
MA 391	1 457 429 064	S 9064
MA 401	1 457 432 124	S 2124
MA 409	1 457 429 908	S 9908

MA 420	1 457 429 975	S 9975
MA 430	1 457 429 794	S 9794
MA 434	1 457 432 174	S 2174
MA 435	1 457 429 061	S 9061
MA 436	1 457 429 778	S 9778

MA 439	1 457 429 064	S 9064
MA 440	1 457 433 227	S 3227
MA 444	1 457 429 030	S 9030
MA 446	1 457 429 076	S 9076
MA 447	1 457 432 146	S 2146

MA 448	1 457 429 994	S 9994
MA 449	1 457 429 050	S 9050
MA 449	1 457 429 959	S 9959
MA 460	1 457 429 079	S 9079
MA 465	1 457 429 987	S 9987

MA 510	1 457 429 932	S 9932
MA 514	1 457 429 817	S 9817
MA 514	1 457 429 942	S 9942
MA 519	1 457 433 901	S 3901
MA 523	1 457 432 192	S 2192

MA 526	1 457 429 950	S 9950
MA 531	1 457 429 966	S 9966
MA 535	1 457 429 946	S 9946
MA 539	1 457 429 941	S 9941
MA 544	1 457 429 933	S 9933

MA 545	1 457 433 201	S 3201
MA 567	1 457 429 969	S 9969
MA 576	1 457 433 627	S 3627
MA 578	F 026 400 179	S 0179
MA 581	1 457 433 728	S 3728

MA 585	1 457 433 729	S 3729
MA 588	1 457 433 200	S 3200
MA 590	1 987 429 121	S 9121
MA 593	1 457 429 775	S 9775
MA 597	1 457 429 923	S 9923

MA 598	1 457 429 846	S 9846
MA 599	1 987 429 125	S 9125
MA 600	1 987 429 042	S 9042/1
MA 604	1 457 433 534	S 3534
MA 606	1 457 429 894	S 9894

MA 607	1 457 429 814	S 9814
MA 608	1 457 433 690	S 3690
MA 609	1 457 433 269	S 3269
MA 612	1 457 433 229	S 3229
MA 614	1 457 433 231	S 3231

MA 617	1 457 429 841	S 9841
MA 619	1 457 433 274	S 3274
MA 620	1 987 429 117	S 9117
MA 623	1 457 433 646	S 3646
MA 626	1 457 429 890	S 9890

MA 631	1 457 433 230	S 3230
MA 632	1 457 432 204	S 2204
MA 634	1 457 432 180	S 2180
MA 635	1 457 432 185	S 2185
MA 638	1 457 432 183	S 2183

MA 639	1 457 429 983	S 9983
MA 640	1 457 429 928	S 9928
MA 642	1 457 432 200	S 2200
MA 644	1 457 429 783	S 9783
MA 645	1 457 429 777	S 9777

MA 646	1 987 429 051	S 9051
MA 648	1 987 429 172	S 9172
MA 649	1 457 429 959	S 9959
MA 656	1 457 429 987	S 9987
MA 657	1 457 429 964	S 9964

MA 658	1 457 432 150	S 2150
MA 660	1 457 429 970	S 9970
MA 661	1 457 429 988	S 9988
MA 662	1 457 433 308	S 3308
MA 663	1 457 433 259	S 3259

MA 664	1 457 433 285	S 3285
MA 669	1 457 429 845	S 9845
MA 670	1 457 433 652	S 3652
MA 678	1 457 429 896	S 9896
MA678	1 457 433 087	S 3087

MA 679	1 457 429 877	S 9877
MA 680	1 457 433 732	S 3732
MA 682	1 457 429 800	S 9800
MA 684	1 987 429 115	S 9115
MA 687	1 457 429 954	S 9954

MA 692	1 457 429 923	S 9923
MA 695	1 457 429 839	S 9839
MA 698	1 457 429 923	S 9923
MA699	1 457 429 870	S 9870
MA 699	1 457 429 877	S 9877

MA 699	1 987 429 162	S 9162
MA699A	1 457 429 870	S 9870
MA699A	1 457 429 877	S 9877
MA699A	1 457 433 310	S 3310
MA 710	1 457 429 841	S 9841

MA 712	1 457 429 795	S 9795
MA 712	1 457 429 944	S 9944
MA 727	1 457 433 795	S 3795
MA 733	1 457 432 188	S 2188
MA 735	1 457 433 734	S 3734

MA 747	1 457 433 903	S 3903
MA 749	F 026 400 197	S 0197
MA 755	F 026 400 207	S 0207
MA 778	1 457 429 899	S 9899
MA 779	1 457 433 270	S 3270

MA 785	1 457 429 854	S 9854
MA 793	1 457 433 005	S 3005
MA 794	1 457 433 904	S 3904
MA 800	1 457 433 651	S 3651
MA 802	F 026 400 082	S 0082

MA 809	1 457 433 735	S 3735
MBNA001	0 450 904 058	F 4058
MBNA006	0 450 904 058	F 4058
MBNA008	0 450 904 060	F 4060
MBNA018	0 450 904 149	F 4149

MBNA1514	F 026 403 009	F 3009
MBNA 1532	F 026 403 008	F 3008
MBNA 952	0 450 905 021	F 5021
MBNA959	0 450 905 906	F 5906
MBNA 967	0 450 905 287	F 5287

MBNA 969	0 450 905 318	F 5318
MBNA 979	0 986 450 109	F 0109
MB 001	0 450 904 058	F 4058
MB 002	0 986 450 138	F 0138
MB 004	0 986 450 018	F 0018

MB 005	0 986 450 018	F 0018
MB 006	0 450 904 058	F 4058
MB 007	0 450 904 077	N 4077
MB 008	0 450 904 077	N 4077
MB 015	0 986 450 117	F 0117



◀ CLEAN FILTERS

MB 018	0 450 904 149	F 4149
MB 022	0 450 902 151	F 2151
MB 1	0 450 904 058	F 4058
MB 18	0 450 904 149	F 4149
MB 6	0 450 904 058	F 4058

MB 7	0 450 904 077	N 4077
MB 8	0 450 904 060	F 4060
MB 950	0 450 905 002	F 5002
MB 950	0 450 905 280	F 5280
MB 952	0 450 905 021	F 5021

MB 953	0 450 905 200	F 5200
MB 953	0 450 905 601	F 5601
MB 954	0 450 905 021	F 5021
MB 955	0 450 905 005	F 5005
MB 956	0 450 905 203	F 5203

MB 957	0 450 905 030	F 5030
MB 957	0 450 905 095	F 5095
MB 958	0 450 905 203	F 5203
MB 959	0 450 905 104	F 5104
MB 962	0 450 905 091	F 5091

MB 963	0 450 905 177	F 5177
MB 964	0 450 905 002	F 5002
MB 964	0 450 905 280	F 5280
MB 965	0 450 905 324	F 5324
MB 966	0 450 905 903	F 5903

MB 967	0 450 902 161	F 2161
MB 970	0 450 905 326	F 5326
MB 975	0 986 450 100	F 0100
MB 979	0 986 450 109	F 0109
MB 981	0 450 905 901	F 5901

MB 983	0 450 905 195	F 5195
MB 983	0 450 905 216	F 5216
MB 984	0 986 450 119	F 0119
MB 985	0 450 905 273	F 5273
MB 985	0 450 905 316	F 5316

MB 987	0 450 905 904	F 5904
MC 1264	1 987 432 042	M 2042
MC 1266	1 987 432 052	M 2052
MGC1683	0 450 906 471	N 6471
MGC1685	0 450 906 460	N 6460

MG 007	1 457 431 261	N 1261
MG 007	1 457 431 325	N 1325
MG 038	1 457 431 028	N 1028
MG 043	1 457 429 289	N 9289
MG 053	1 457 431 270	N 1270

MG 053	1 457 431 326	N 1326
MG 083	1 457 431 712	N 1712
MG 086	1 457 431 270	N 1270
MG 086	1 457 431 326	N 1326
MG 088	1 457 429 359	N 9359

MG 089	1 457 429 354	N 9354
MG 089	1 457 431 159	N 1159
MG 094	1 457 431 158	N 1158
MG 095	1 457 429 291	N 9291
MG095	1 457 431 713	N 1713

MG096	1 457 431 702	N 1702
MG 097	1 457 429 621	N 9621
MG 098	1 457 429 657	N 9657
MG 099	1 457 431 705	N 1705
MG1600	1 457 429 656	N 9656

MG 1602	1 457 070 000	N 0000
MG 1604	1 457 431 724	N 1724
MG1607	0 450 906 462	N 6462
MG1610	1 457 431 715	N 1715
MG1612	1 457 431 723	N 1723

MG1617	F 026 402 008	N 2008
ML 030	1 457 429 619	P 9619
ML 032	1 457 429 175	P 9175
ML 044	1 457 429 154	P 9154
ML 045	1 457 429 157	P 9157

ML045A	1 457 429 157	P 9157
ML059	1 457 429 238	P 9238
ML059/A	1 457 429 238	P 9238
ML060	1 457 429 194	P 9194
ML068	1 457 429 239	P 9239

ML069	1 457 429 198	P 9198
ML072	1 457 429 199	P 9199
ML075	1 457 429 126	P 9126
ML075A	1 457 429 126	P 9126
ML 077	1 457 429 117	P 9117

ML 082	1 457 429 274	P 9274
ML1701	1 457 429 152	P 9152
ML1702	1 457 429 275	P 9275
ML1709	1 457 429 272	P 9272
ML1711	1 457 429 107	P 9107

ML1713	1 457 429 128	P 9128
ML1714	F 026 407 046	P 7046
ML 1715	F 026 407 026	P 7026
ML1718	1 457 429 118	P 9118
ML1723	1 457 429 185	P 9185

ML1727	F 026 407 021	P 7021
ML1728	1 457 429 248	P 9248
ML1740	F 026 407 069	P 7069
ML 26	1 457 429 820	P 9820
ML 32	1 457 429 175	P 9175

ML4522	F 026 407 073	P 7073
ML 457	1 457 429 267	P 9267
ML 461	1 457 429 735	P 9735
ML 462	1 457 429 740	P 9740
ML476	1 457 429 820	P 9820

ML 478	1 457 429 646	P 9646
ML 480	1 457 429 165	P 9165
ML 483	1 457 429 600	P 9600
ML489	1 457 429 636	P 9636
ML 492	1 457 429 413	P 9413

ML 492	1 457 429 647	P 9647
ML 495	1 457 429 646	P 9646
ML496	1 457 429 119	P 9119
ML496A	1 457 429 119	P 9119
ML 497	1 457 429 629	P 9629

ML 498	1 457 429 251	P 9251
ML 77	1 457 429 117	P 9117
ML 82	1 457 429 274	P 9274
NC2021	1 987 432 042	M 2042
NC2025	1 987 432 105	M 2105

NC2043	1 987 432 151	M 2151
NC2053	1 987 432 066	M 2066
NC2054	1 987 432 084	M 2084
NC2059	1 987 432 150	M 2150
NC2089	1 987 432 060	M 2060

NC2091	1 987 432 075	M 2075
NC2092	1 987 432 058	M 2058
NC2096CA	1 987 432 306	R 2306
NC2112	1 987 432 091	M 2091
NC2120	1 987 432 088	M 2088

NC2122	1 987 432 107	M 2107
NC2123	1 987 432 108	M 2108
NC2141	1 987 432 208	M 2208
NC2151	1 987 432 085	M 2085
NC2152	1 987 432 114	M 2114

NC2160	1 987 431 167	M 1167
NC2161	1 987 431 159	M 1159
NC 2162	1 987 431 175	M 1175
NC2164	1 987 431 165	M 1165
NC2165	1 987 431 163	M 1163

NC2200	1 987 432 092	M 2092
NC2205	1 987 432 203	M 2203
NC2207	1 987 432 074	M 2074

COOPERS

ACE 012	1 987 432 200	M 2200
ACE046	1 987 432 150	M 2150
ACE059	1 987 432 152	M 2152

ACE066	1 987 432 060	M 2060
ACE067	1 987 432 060	M 2060
ACE070	1 987 432 066	M 2066
ACE072	1 987 432 058	M 2058
ACE076	1 987 432 084	M 2084

ACE080	1 987 432 306	R 2306
ACE081	1 987 432 151	M 2151
ACE084	1 987 431 163	M 1163
ACE101	1 987 432 091	M 2091
ACE106	1 987 432 075	M 2075

ACE1132	1 987 432 074	M 2074
ACE118	1 987 432 092	M 2092
ACE120	1 987 432 085	M 2085
ACE124	1 987 432 114	M 2114
ACE130	1 987 432 088	M 2088

ACE146	1 987 431 166	M 1166
ACE 180	1 987 431 154	M 1154
ACE 181	1 987 431 451	R 1451
ACE 183	1 987 431 458	R 1458
ACE 195	1 987 432 406	R 2406



AEK 2044	1 457 429 933	S 9933
AEK 2128	1 457 433 201	S 3201
AEM 2108	1 457 432 192	S 2192
AEM 2112	1 457 433 534	S 3534
AEM 2146	1 457 429 854	S 9854
AEM 2484	1 457 432 188	S 2188
AEM 2546	1 457 433 005	S 3005
AEM 2556	1 457 433 735	S 3735
AEM 2616	F 026 400 207	S 0207
AEM 2632	1 457 433 651	S 3651
AEM 2644	1 457 433 627	S 3627
AEM 2656	1 457 433 270	S 3270
AEM 2665	1 457 433 901	S 3901
AEM 2690	F 026 400 077	S 0077
AEM2702	1 457 433 901	S 3901
AEM 2710	1 457 433 903	S 3903
AEM 2712	1 457 433 904	S 3904
AEM 2714	1 457 433 900	S 3900
AEM 2750	F 026 400 092	S 0092
AEM2752	F 026 400 084	S 0084
AEM 2796	F 026 400 070	S 0070
AEM 2800	F 026 400 069	S 0069
AEM 2818	1 457 433 728	S 3728
AEM2828	1 457 433 560	S 3560
AEM 2836	F 026 400 067	S 0067
AEM 2846	F 026 400 117	S 0117
AEM 2850	F 026 400 075	S 0075
AEM 2852	F 026 400 074	S 0074
AEM2858	F 026 400 068	S 0068
AEM2916	1 457 433 568	S 3568
AEM 2928	F 026 400 080	S 0080
AEM 2934	F 026 400 179	S 0179
AEM 2946	F 026 400 211	S 0211
AEM 2954	F 026 400 078	S 0078
AEP 3512	1 457 432 146	S 2146
AEP 3518	1 457 433 601	S 3601
AEP 3519	1 457 433 626	S 3626
AEP 3521	1 457 432 146	S 2146
AES 2559	F 026 400 065	S 0065
AES 2617	F 026 400 197	S 0197
AES 2955	F 026 400 022	S 0022
AG 1001	1 457 429 869	S 9869
AG 1002	1 457 429 777	S 9777
AG 1004	1 457 432 183	S 2183
AG 1005	1 457 432 185	S 2185
AG 1025	1 457 429 778	S 9778
AG 1025	1 457 433 750	S 3750
AG 1026	1 457 429 791	S 9791
AG 1029	1 457 429 844	S 9844
AG 1031	1 457 429 085	S 9085
AG 1033	1 457 432 203	S 2203
AG 1050	1 987 429 137	S 9137
AG 1053	1 987 429 148	S 9148
AG 1056	1 457 433 250	S 3250
AG 1057	1 457 429 841	S 9841
AG 1058	1 457 433 233	S 3233
AG 1059	1 457 429 923	S 9923
AG 1061	1 457 433 227	S 3227
AG 1063	1 457 433 229	S 3229
AG 1070	1 457 433 274	S 3274
AG 1080	1 987 429 127	S 9127
AG 1081	1 457 429 801	S 9801
AG 1084	1 987 429 127	S 9127
AG1086	F 026 400 038	S 0038
AG 1087	1 987 429 135	S 9135
AG 1089	1 457 433 605	S 3605
AG 1089ZZZ	1 457 433 605	S 3605
AG 1091	1 987 429 133	S 9133
AG 1093	1 987 429 146	S 9146
AG 1099	1 457 433 736	S 3736
AG 1100	1 457 433 950	S 3950
AG 1103	1 457 433 547	S 3547
AG 1105	1 457 433 007	S 3007
AG 1106	1 457 433 003	S 3003
AG 1107	1 457 433 008	S 3008
AG 1108	1 457 433 023	S 3023
AG 1112	1 457 433 275	S 3275
AG 1114	1 457 433 659	S 3659
AG 1115	1 457 433 789	S 3789
AG 1118	1 457 433 795	S 3795
AG 1122	1 987 429 159	S 9159
AG 1126	1 457 433 004	S 3004
AG 1127	1 457 429 814	S 9814
AG 1131	1 457 433 711	S 3711
AG 1132	1 457 433 958	S 3958
AG 1133	1 987 429 135	S 9135
AG 1134	1 457 433 273	S 3273
AG 1135	1 457 433 544	S 3544
AG 1136	1 457 429 795	S 9795
AG 1137	1 457 433 642	S 3642
AG 1140	1 457 433 951	S 3951
AG 1143	1 457 433 609	S 3609
AG 1146	1 457 433 603	S 3603
AG 1146	1 457 433 713	S 3713
AG 1147	1 457 433 713	S 3713
AG 1148	1 987 429 162	S 9162
AG 1150	1 457 433 954	S 3954
AG 1153	1 457 433 608	S 3608
AG 1161	1 457 433 784	S 3784
AG 1162	1 457 433 268	S 3268
AG 1163	1 457 429 777	S 9777
AG 1165	1 457 433 606	S 3606
AG 1169	1 457 429 787	S 9787
AG 1173	1 457 433 571	S 3571
AG 1174	1 457 433 571	S 3571
AG 1175	1 457 433 571	S 3571
AG 1181	1 457 433 274	S 3274
AG 1182	1 457 433 790	S 3790
AG 1184	1 457 433 624	S 3624
AG 1185	1 457 433 257	S 3257
AG 1186	1 457 433 256	S 3256
AG 1187	1 457 433 255	S 3255
AG 1188	1 457 433 263	S 3263
AG 1189	1 457 433 752	S 3752
AG 1192	1 457 433 968	S 3968
AG 1198	1 457 433 260	S 3260
AG1200	1 457 433 088	S 3088
AG1201	1 457 433 088	S 3088
AG 1204	1 457 433 781	S 3781
AG 1208	1 457 433 740	S 3740
AG 1208	1 457 433 799	S 3799
AG 1209	1 457 433 741	S 3741
AG 1210	1 457 433 617	S 3617
AG 1217	1 457 433 072	S 3072
AG 1220	1 457 429 923	S 9923
AG 1221	1 987 429 125	S 9125
AG 1222	1 987 429 152	S 9152
AG 1223	1 457 433 234	S 3234
AG 1225	1 457 433 265	S 3265
AG 1226	1 457 433 792	S 3792
AG 1227	1 457 433 742	S 3742
AG 1228	1 457 429 839	S 9839
AG 1234	1 457 433 697	S 3697
AG 1236	1 457 433 541	S 3541
AG 1237	1 457 433 743	S 3743
AG 1242	1 457 432 200	S 2200
AG 1243	1 457 433 276	S 3276
AG 1244	1 457 433 272	S 3272
AG 1245	1 457 433 230	S 3230
AG 1248	1 457 429 846	S 9846
AG 1252	1 457 429 993	S 9993
AG 1254	1 457 429 988	S 9988
AG 1255	1 457 433 686	S 3686
AG 1258	1 457 429 970	S 9970
AG 1259	1 457 429 890	S 9890
AG 1262	1 457 433 285	S 3285
AG 1264	1 457 433 266	S 3266
AG 1266	1 457 429 839	S 9839
AG 1267	1 457 433 952	S 3952
AG 1267/ZZZ	1 457 433 952	S 3952
AG 1269	1 457 433 769	S 3769
AG 1270	1 457 433 703	S 3703
AG 1273	1 457 429 792	S 9792
AG 1275	1 457 433 965	S 3965
AG 1279	1 457 433 771	S 3771
AG 1281	1 457 433 714	S 3714
AG 1283	1 987 429 042	S 9042/1
AG 1286	1 987 429 151	S 9151
AG 1287	1 457 433 264	S 3264
AG 1291	1 457 433 297	S 3297
AG 1292	1 457 433 290	S 3290
AG 1296	F 026 400 011	S 0011
AG 1298	1 457 433 549	S 3549
AG 1299	1 457 433 286	S 3286
AG 1300	1 457 433 259	S 3259



◀ COOPERS

AG 1301	1 457 429 793	S 9793
AG 1304	1 457 433 747	S 3747
AG 1310	1 457 433 253	S 3253
AG 1311	1 457 433 700	S 3700
AG 1313	1 457 433 616	S 3616

AG 1317	1 457 433 959	S 3959
AG 1320	1 457 433 712	S 3712
AG 1323	1 457 433 154	S 3154
AG 1324	1 457 433 060	S 3060
AG 1329	1 457 433 265	S 3265

AG 1331	1 457 433 073	S 3073
AG 1339	1 457 433 753	S 3753
AG 1343	1 457 433 970	S 3970
AG 1345	1 457 433 955	S 3955
AG 1349	1 457 433 281	S 3281

AG1350	1 457 433 070	S 3070
AG 1351	1 457 433 070	S 3070
AG 1354	1 457 433 282	S 3282
AG 1357	1 457 433 791	S 3791
AG 1358	1 457 433 716	S 3716

AG 1362	1 457 433 773	S 3773
AG 1364	1 457 433 526	S 3526
AG 1365	1 457 433 280	S 3280
AG 1366	1 457 433 590	S 3590
AG 1370	1 457 433 607	S 3607

AG 1375	1 457 433 269	S 3269
AG 1377	1 457 433 269	S 3269
AG 1380	1 457 429 781	S 9781
AG 1382	1 457 433 077	S 3077
AG 1386	F 026 400 014	S 0014

AG 1387	1 457 433 785	S 3785
AG 1391	F 026 400 011	S 0011
AG 1393	1 457 433 701	S 3701
AG 1395	1 457 433 748	S 3748
AG 1396	1 457 433 953	S 3953

AG 1398	1 457 433 535	S 3535
AG 1403	1 457 433 161	S 3161
AG 1404	1 457 433 056	S 3056
AG 1405	1 457 433 543	S 3543
AG 1406	1 457 433 529	S 3529

AG 1407	1 457 429 786	S 9786
AG 1410	1 457 433 089	S 3089
AG 1411	1 457 433 588	S 3588
AG 1418	1 457 433 536	S 3536
AG 1422	1 457 433 550	S 3550

AG 1423	1 457 433 153	S 3153
AG 1427	1 457 433 521	S 3521
AG 1428	1 457 433 265	S 3265
AG 1429	1 457 433 520	S 3520
AG 1430	1 457 433 553	S 3553

AG 1431	1 457 433 311	S 3311
AG 1432	1 457 433 047	S 3047
AG1439	1 457 429 948	S 9948
AG1442	1 457 433 090	S 3090
AG1446	1 457 433 083	S 3083

AG 1453	1 457 433 752	S 3752
AG 1481	1 457 433 593	S 3593
AG 1482	1 457 433 323	S 3323
AG 1486	1 457 433 555	S 3555
AG 1487/ZZZ	1 987 429 166	S 9166

AG 1489	1 457 433 533	S 3533
AG 1496	1 987 429 157	S 9157
AG 1497	1 457 433 046	S 3046
AG 1501	1 457 433 715	S 3715
AG 1502	1 457 433 069	S 3069

AG 1509	1 457 433 589	S 3589
AG 1512	1 457 433 797	S 3797
AG 1513	1 457 433 075	S 3075
AG 1514	1 457 433 320	S 3320
AG 1517	1 457 433 739	S 3739

AG 1520	F 026 400 061	S 0061
AG 1523	1 457 433 579	S 3579
AG 1524	1 457 433 578	S 3578
AG 1525	F 026 400 113	S 0113
AG 1526/ZZZ	1 987 429 175	S 9175

AG 1528	1 457 433 078	S 3078
AG 1535	1 457 433 306	S 3306
AG 1537	1 457 433 081	S 3081
AG1538	1 457 429 194	P 9194
AG 1539	1 987 429 403	S 9403

AG 1540	1 457 433 282	S 3282
AG1540	1 457 433 319	S 3319
AG1541	1 457 433 319	S 3319
AG1547	1 987 429 182	S 9182
AG1548	1 457 433 066	S 3066

AG 1550	F 026 400 096	S 0096
AG1551	1 987 429 406	S 9406
AG1554	1 457 433 331	S 3331
AG1557	1 457 433 002	S 3002
AG 156	1 457 429 800	S 9800

AG 156 M	1 457 429 800	S 9800
AG 1560	F 026 400 107	S 0107
AG1561	1 457 433 546	S 3546
AG1565	1 457 433 523	S 3523
AG1566	1 457 433 065	S 3065

AG1568	1 457 433 580	S 3580
AG1578	1 457 433 537	S 3537
AG1579	1 987 429 404	S 9404
AG1580	1 987 429 405	S 9405
AG1588	1 987 429 188	S 9188

AG1594	1 457 433 751	S 3751
AG1604	1 987 429 401	S 9401
AG1607	1 457 433 791	S 3791
AG1617	1 457 433 660	S 3660
AG1620	F 026 400 018	S 0018

AG1623	1 457 433 071	S 3071
AG1625	1 457 433 595	S 3595
AG1626	1 457 433 045	S 3045
AG1626	1 457 433 771	S 3771
AG1627	1 457 433 043	S 3043

AG1631	1 457 433 591	S 3591
AG1633	1 457 433 327	S 3327
AG1634	1 457 433 596	S 3596
AG1635	1 457 433 592	S 3592
AG 1644	F 026 400 166	S 0166

AG1651	1 457 433 655	S 3655
AG1652	1 457 433 587	S 3587
AG1665	1 457 433 315	S 3315
AG 1672	F 026 400 102	S 0102
AG1674	1 457 433 585	S 3585

AG1675	1 457 433 594	S 3594
AG1680	1 457 433 579	S 3579
AG1683	F 026 400 013	S 0013
AG1686	F 026 400 020	S 0020
AG1687	1 457 433 584	S 3584

AG1703	1 457 433 255	S 3255
AG 1704	F 026 400 110	S 0110
AG 1707	F 026 400 097	S 0097
AG1712	1 457 433 529	S 3529
AG1713	1 457 433 531	S 3531

AG1716	1 987 429 169	S 9169
AG 1724	F 026 400 090	S 0090
AG1733	1 457 433 573	S 3573
AG 1738	F 026 400 098	S 0098
AG1742	F 026 400 058	S 0058

AG 1754	F 026 400 109	S 0109
AG 1772	F 026 400 150	S 0150
AG1779	1 457 433 311	S 3311
AG1780	1 457 433 583	S 3583
AG 206	1 457 429 900	S 9900

AG 209	1 457 429 050	S 9050
AG 209	1 457 429 959	S 9959
AG 231	1 457 432 111	S 2111
AG 240	1 457 429 801	S 9801
AG 243	1 457 432 124	S 2124

AG 248	1 457 429 953	S 9953
AG 249	1 457 429 908	S 9908
AG 252	1 457 433 732	S 3732
AG 260	1 457 429 993	S 9993
AG 264	1 457 429 030	S 9030

AG 265	1 457 429 957	S 9957
AG 269	1 457 429 915	S 9915
AG 285	1 457 429 920	S 9920
AG 291	1 457 433 652	S 3652
AG 293	1 457 429 954	S 9954

AG 299	1 457 429 079	S 9079
AG 380	1 457 432 108	S 2108
AG 384	1 457 429 064	S 9064
AG 414	1 457 432 106	S 2106
AG 420	1 457 429 801	S 9801

AG 420 M	1 457 429 800	S 9800
AG 424	1 457 429 845	S 9845
AG 430	1 457 429 994	S 9994
AG 452	1 457 429 948	S 9948
AG 457	1 457 429 054	S 9054



AG 457	1 457 429 915	S 9915
AG 457	1 457 433 540	S 3540
AG 459	1 457 429 053	S 9053
AG 469	1 457 429 806	S 9806
AG 564	1 457 432 150	S 2150
AG 564	1 457 432 174	S 2174
AG 565	1 457 429 928	S 9928
AG 574	1 457 429 076	S 9076
AG574A	1 457 429 076	S 9076
AG575	1 457 429 076	S 9076
AG584	1 457 429 061	S 9061
AG622	1 457 429 080	S 9080
AG 637	1 457 433 534	S 3534
AG642	1 457 429 992	S 9992
AG 650	1 457 433 231	S 3231
AG658	1 457 432 154	S 2154
AG665	1 457 433 229	S 3229
AG677	1 987 429 121	S 9121
AG 777	1 457 433 690	S 3690
AG792	1 457 429 923	S 9923
AG797	1 457 429 819	S 9819
AG798	1 457 429 775	S 9775
AG808	1 987 429 122	S 9122
AG812	1 457 432 204	S 2204
AG854	1 457 433 711	S 3711
AG888	1 457 432 200	S 2200
AG889	1 457 429 964	S 9964
AG 896	1 457 429 117	P 9117
AG 896	1 987 429 117	S 9117
AG 897	1 987 429 135	S 9135
AG 901	1 457 432 180	S 2180
AG 906	1 457 432 138	S 2138
AG 908	1 457 429 842	S 9842
AG 914	1 457 429 778	S 9778
AG 922	1 987 429 051	S 9051
AG 927	1 457 429 875	S 9875
AG930	1 457 433 697	S 3697
AG 930	1 457 429 783	S 9783
AG 936	1 457 429 870	S 9870
AG 936	1 457 429 877	S 9877
AG 936	1 457 433 310	S 3310
AG 939	1 457 433 652	S 3652
AG 985	1 457 429 896	S 9896
AG 985	1 457 429 898	S 9898
AG985	1 457 433 087	S 3087
AG 987	1 457 433 734	S 3734
AG 990	1 457 432 172	S 2172
AG 993	1 987 429 123	S 9123
AZA 042	1 457 429 950	S 9950
AZA 101	1 457 429 946	S 9946
AZA 128	1 457 429 975	S 9975
AZA 128 T	1 457 429 975	S 9975
AZA 129	1 457 429 941	S 9941
AZA 132	1 457 429 966	S 9966
AZA 159	1 457 429 942	S 9942
AZA 174	1 457 432 192	S 2192
AZA 203	F 026 400 082	S 0082
AZA 204	1 457 429 944	S 9944
AZA 297	1 457 433 646	S 3646
AZA 301	1 457 429 933	S 9933
AZA 301 T	1 457 429 933	S 9933
AZA 319	1 457 429 794	S 9794
AZA 319 T	1 457 429 794	S 9794
AZA 332	1 457 429 794	S 9794
AZA 332 T	1 457 429 794	S 9794
AZA 337	1 457 433 200	S 3200
AZA 337 T	1 457 433 200	S 3200
AZA 340	1 457 429 794	S 9794
AZA 351	1 457 433 201	S 3201
AZA 431	1 987 429 042	S 9042/1
AZA 507	1 457 429 800	S 9800
AZA 633	1 457 429 932	S 9932
AZA 815	1 457 429 969	S 9969
AZA 852	1 457 432 188	S 2188
AZA 894	1 457 433 651	S 3651
AZA915	F 026 400 085	S 0085
AZF 003	1 457 434 154	N 4154
AZF 003	1 457 434 165	N 4165
AZF 003	1 457 434 432	N 4432
AZF 004	1 457 431 159	N 1159
AZF 008	1 457 431 158	N 1158
AZF 009	1 457 431 270	N 1270
AZF 009	1 457 431 326	N 1326
AZF 015	1 457 434 201	N 4201
AZF 019	1 457 429 681	N 9681
AZF 029	1 457 434 200	N 4200
AZF 034	1 457 429 676	N 9676
AZF 044	1 457 429 175	P 9175
AZF 048	0 450 904 058	F 4058
AZF 058	1 457 431 261	N 1261
AZF 068	1 457 431 270	N 1270
AZF 074	1 457 434 051	N 4051
AZF 075	1 457 429 681	N 9681
AZF 079	1 457 429 230	N 9230
AZF 084	1 457 431 028	N 1028
AZF 086	1 457 434 200	N 4200
AZF 090	1 457 434 105	N 4105
AZF 090	1 457 434 106	N 4106
AZF 091	1 457 434 051	N 4051
AZF 098	1 457 429 675	N 9675
AZF 099	1 457 429 681	N 9681
AZF 100	1 457 434 201	N 4201
AZF 101	1 457 434 201	N 4201
AZF 460	1 457 429 359	N 9359
AZF 460	1 457 431 158	N 1158
AZF 465	1 457 429 354	N 9354
AZF776	1 457 434 453	N 4453
AZF 785	1 457 434 105	N 4105
AZF 793	1 457 429 289	N 9289
AZF 830	1 457 434 154	N 4154
AZF 830	1 457 434 165	N 4165
AZF 830	1 457 434 432	N 4432
AZH 001	1 457 429 820	P 9820
AZH 002	1 457 429 165	P 9165
AZL 005	0 451 103 274	P 3274
AZL 006	0 451 103 004	P 3004
AZL 006	0 451 103 062	P 3062
AZL 008	0 451 203 010	P 3010
AZL009	0 451 203 002	P 3002
AZL 009	0 451 203 220	P 3220
AZL 012	1 457 429 117	P 9117
AZL 015	1 457 429 820	P 9820
AZL 025	1 457 429 274	P 9274
AZL 028	0 451 104 065	P 4065
AZL 029	0 451 104 005	P 4005
AZL 030	0 451 104 065	P 4065
AZL 032	0 451 104 015	P 4015
AZL 032	0 451 105 067	P 5067
AZL 032	0 451 105 188	P 5188
AZL 034	0 451 203 194	P 3194
AZL 047	0 451 103 029	P 3029
AZL 048	1 457 429 175	P 9175
AZL 055	0 451 104 066	P 4066
AZL 055 A	0 451 104 066	P 4066
AZL 075	F 026 407 054	P 7054
AZL 083	0 451 104 010	P 4010
AZL 083	0 451 403 077	P 3077
AZL 084	0 451 103 029	P 3029
AZL 092	1 457 429 413	P 9413
AZL 097	1 457 429 175	P 9175
AZL 098	1 457 429 740	P 9740
AZL 109	0 451 104 065	P 4065
AZL 109	0 451 203 194	P 3194
AZL 110	0 451 103 028	P 3028
AZL 120	0 451 301 156	P 1156
AZL 121	1 457 429 130	P 9130
AZL 126	0 451 203 152	P 3152
AZL 419	0 451 300 003	P 0003
AZL 432	1 457 429 735	P 9735
AZL 436	1 457 429 600	P 9600
AZL 458	1 457 429 646	P 9646
AZL 473	1 457 429 647	P 9647
AZL 474	1 457 429 740	P 9740
FA5912 ECO	F 026 402 078	N 2078
FEM 4102	1 457 429 291	N 9291
FEM4102	1 457 431 713	N 1713
FEM 4125	1 457 431 702	N 1702
FEM 4126	1 457 429 655	N 9655
FEM 4130	1 457 429 656	N 9656
FEM 4134	1 457 429 657	N 9657
FEM 4136	1 457 429 621	N 9621
FEM 4149	1 457 431 707	N 1707
FEM4180	1 457 431 710	N 1710
FEM4187	1 457 431 715	N 1715
FEM4195	1 457 431 723	N 1723



◀ COOPERS

FEM4198	F 026 402 033	N 2033
FEM4200	1 457 431 705	N 1705
FEM4229	1 457 431 705	N 1705
FEM4230	1 457 431 705	N 1705
FEM4233	F 026 402 004	N 2004

FEM4237	1 457 429 656	N 9656
FEM4251	F 026 402 047	N 2047
FEM4264	F 026 402 100	N 2100
FEM4292	F 026 402 008	N 2008
FIG 7000	0 450 905 200	F 5200

FIG 7000	0 450 905 601	F 5601
FIG 7001	0 450 905 021	F 5021
FIG 7002	0 450 905 030	F 5030
FIG 7002	0 450 905 095	F 5095
FIG 7004	0 450 905 002	F 5002

FIG 7004	0 450 905 280	F 5280
FIG 7008	0 450 905 087	F 5087
FIG 7008	0 450 905 104	F 5104
FIG 7008	0 450 905 401	F 5401
FIG 7010	0 986 450 119	F 0119

FIG 7010/ZZZ	0 986 450 119	F 0119
FIG 7011	0 986 450 115	F 0115
FIG 7011/ZZZ	0 986 450 115	F 0115
FIG 7012	0 450 905 203	F 5203
FIG 7013	0 450 905 177	F 5177

FIG 7014	0 450 905 909	F 5909
FIG 7014/ZZZ	0 450 905 909	F 5909
FIG 7015	0 450 905 195	F 5195
FIG 7015	0 450 905 216	F 5216
FIG 7016	0 450 905 324	F 5324

FIG 7017	0 450 905 326	F 5326
FIG 7017/ZZZ	0 450 905 326	F 5326
FIG 7018	0 450 905 901	F 5901
FIG 7019	0 450 905 005	F 5005
FIG 7020	0 986 450 103	F 0103

FIG 7021	0 450 905 273	F 5273
FIG 7021	0 450 905 316	F 5316
FIG 7022	0 450 905 903	F 5903
FIG 7022/ZZZ	0 450 905 903	F 5903
FIG7023/ZZZ	0 986 450 624	F 0624

FIG 7024	0 986 450 106	F 0106
FIG 7024/ZZZ	0 986 450 106	F 0106
FIG 7029	0 450 905 911	F 5911
FIG 7030	0 450 905 916	F 5916
FIG 7030/ZZZ	0 450 905 916	F 5916

FIG 7031	0 986 450 104	F 0104
FIG 7031/ZZZ	0 986 450 104	F 0104
FIG 7032	0 450 902 151	F 2151
FIG 7033	0 450 905 091	F 5091
FIG 7035	0 986 450 109	F 0109

FIG 7035/ZZZ	0 986 450 109	F 0109
FIG 7036	0 450 905 030	F 5030
FIG 7038	0 450 902 161	F 2161
FIG 7038	0 450 905 287	F 5287
FIG 7039	0 986 450 108	F 0108

FIG 7039/ZZZ	0 986 450 108	F 0108
FIG 7040/ZZZ	0 986 450 107	F 0107
FIG 7041	0 986 450 105	F 0105
FIG 7041/ZZZ	0 986 450 105	F 0105
FIG 7042	0 986 450 114	F 0114

FIG 7043	0 986 450 100	F 0100
FIG 7043/ZZZ	0 986 450 100	F 0100
FIG 7044	0 450 905 318	F 5318
FIG 7045	0 450 905 908	F 5908
FIG 7048	0 450 902 162	F 2162

FIG 7049	0 450 905 914	F 5914
FIG 7049/ZZZ	0 450 905 914	F 5914
FIG 7050	0 986 450 103	F 0103
FIG 7050/ZZZ	0 986 450 103	F 0103
FIG 7051	0 986 450 107	F 0107

FIG 7057	0 450 905 939	F 5939
FIG 7062	0 986 450 110	F 0110
FIG 7065	0 986 450 114	F 0114
FIG 7072	0 450 905 915	F 5915
FIG 7072/ZZZ	0 450 905 915	F 5915

FIG7073	0 986 450 123	F 0123
FIG 7075	0 450 905 911	F 5911
FIG 7076	0 450 905 924	F 5924
FIG 7076	0 986 450 111	F 0111
FIG 7078	0 450 905 904	F 5904

FIG7093	0 450 905 921	F 5921
FIG7097	F 026 403 009	F 3009
FIG 7107	F 026 403 008	F 3008
FIG 7108	F 026 403 006	F 3006
FIG7110	F 026 403 003	F 3003

FP5749	0 450 906 460	N 6460
FP5751	0 450 906 471	N 6471
FP5783	F 026 402 056	N 2056
FSM 4077	1 457 434 051	N 4051
FSM 4083	1 457 434 154	N 4154

FSM 4083	1 457 434 165	N 4165
FSM 4083	1 457 434 296	N 4296
FSM 4084	1 457 434 051	N 4051
FSM 4104	1 457 434 432	N 4432
FSM 4111	1 457 434 294	N 4294

FSM 4114	1 457 434 184	N 4184
FSM 4115	1 457 434 187	N 4187
FSM 4117	1 457 434 105	N 4105
FSM 4117	1 457 434 291	N 4291
FSM 4117	1 457 434 321	N 4321

FSM 4118	1 457 434 154	N 4154
FSM 4118	1 457 434 165	N 4165
FSM 4118	1 457 434 296	N 4296
FSM 4122	1 457 434 105	N 4105
FSM 4123	1 457 434 184	N 4184

FSM 4123	1 457 434 324	N 4324
FSM 4127	1 457 434 400	N 4400
FSM 4142	1 457 434 329	N 4329
FSM4166	F 026 402 030	N 2030
FSM 4167/ZZ	0 450 906 453	N 6453

FSM 4170	F 026 402 034	N 2034
FSM 4171	F 026 402 035	N 2035
FSM4178	1 457 434 421	N 4421
FSM4182	1 457 434 439	N 4439
FSM4185	0 450 906 462	N 6462

FSM4190	1 457 434 436	N 4436
FSM4208	F 026 402 025	N 2025
FSM 4239	F 026 402 037	N 2037
FSM 4252	F 026 402 056	N 2056
FSM4259	1 457 434 447	N 4447

FSM4261	F 026 402 017	N 2017
FSS4010	1 457 434 453	N 4453
FSW 4100	1 457 434 402	N 4402
FSW 4101	1 457 434 105	N 4105
FSW4169	1 457 434 447	N 4447

FSW4226	F 026 402 038	N 2038
GP39	1 457 429 175	P 9175
GP63	1 457 429 175	P 9175
G 1214	1 457 429 123	P 9123
G 1278	1 457 429 154	P 9154

G 1381	1 457 429 275	P 9275
G 1394	1 457 429 157	P 9157
G 1399	1 457 429 619	P 9619
G1409	1 457 429 239	P 9239
G 1412	1 457 429 152	P 9152

G 1413	1 457 429 119	P 9119
G 1454	1 457 429 199	P 9199
G1474	1 457 429 198	P 9198
G1505	1 457 429 118	P 9118
G 1506	1 457 429 185	P 9185

G1508	1 457 429 272	P 9272
G 153	1 457 431 159	N 1159
G 1538	1 457 429 194	P 9194
G1563	1 457 429 126	P 9126
G 1570	1 457 429 284	P 9284

G1640	1 457 429 271	P 9271
G1642	1 457 429 308	P 9308
G1668	1 457 429 272	P 9272
G 1669	F 026 407 014	P 7014
G 169	1 457 431 261	N 1261

G 169	1 457 431 325	N 1325
G 171	1 457 429 117	P 9117
G 1745	F 026 407 070	P 7070
G 1782	F 026 407 061	P 7061
G 263	1 457 431 158	N 1158

G 501	1 457 429 117	P 9117
G 536	1 457 431 270	N 1270
G 536	1 457 431 326	N 1326
G 536 F	1 457 431 159	N 1159
G 543	1 457 431 261	N 1261

G 543	1 457 431 325	N 1325
G 543 F	1 457 431 158	N 1158
G 562	1 457 429 117	P 9117
G 572	1 457 429 230	N 9230
G 582	1 457 431 270	N 1270

G 582	1 457 431 326	N 1326
G 589	1 457 429 413	P 9413
G 62	1 457 431 270	N 1270
G 62	1 457 431 326	N 1326
G 629	1 457 434 201	N 4201

G 643	1 457 429 165	P 9165
G 661	1 457 429 130	P 9130
G 671	1 457 431 028	N 1028
G 673	1 457 429 175	P 9175
G 76	F 026 407 054	P 7054

G 816	1 457 429 274	P 9274
G912	1 457 434 200	N 4200
G944	1 457 429 636	P 9636
HEM6176	1 457 429 820	P 9820
HEM6516	1 457 429 820	P 9820

HSM6197	0 451 103 330	P 3330
LEB5142	1 457 429 267	P 9267
LEB5151	1 457 429 175	P 9175
LEF51	1 457 429 277	P 9277
LEF51	1 457 429 646	P 9646

LEF5135	1 457 429 647	P 9647
LEF5142	1 457 429 267	P 9267
LEF5143	1 457 429 732	P 9732
LEF5156	1 457 429 277	P 9277
LEF5159	1 457 429 276	P 9276

LEF5168	1 457 429 128	P 9128
LEF5182	1 457 429 277	P 9277
LEF5183	1 457 429 646	P 9646
LEF5185	1 457 429 276	P 9276
LEF 5197	F 026 407 047	P 7047

LEF 5198	F 026 407 042	P 7042
LFS5026	0 451 403 208	P 3208
LSB5145	0 451 300 003	P 0003
LSB5164	0 451 300 003	P 0003
LSF 5001	0 451 104 065	P 4065

LSF 5014	0 451 203 201	P 3201
LSF5024	0 451 203 201	P 3201
LSF 5025	F 026 407 049	P 7049
LSF 5026	0 451 403 208	P 3208
LSF 5032	0 451 103 232	P 3232

LSF 5101	0 451 103 028	P 3028
LSF 5104	0 451 203 002	P 3002
LSF 5106	0 451 403 077	P 3077
LSF5140	0 451 403 077	P 3077
LSF5141	0 451 301 207	P 1207

LSF5146	0 451 203 002	P 3002
LSF5150	0 451 103 004	P 3004
LSF5157	F 026 407 105	P 7105
LSF5158	0 451 301 156	P 1156
LSF 5174	0 451 104 013	P 4013

LSF 5179	F 026 407 057	P 7057
LSF 5180	F 026 407 048	P 7048
LSF 5202	F 026 407 060	P 7060
LSF 5203	F 026 407 060	P 7060
RA794	1 457 429 899	S 9899

RA832	1 457 429 899	S 9899
RF536	1 457 429 354	N 9354
RF543	1 457 429 359	N 9359
RG1016	1 457 429 416	P 9416
RG589	1 457 429 647	P 9647

RG661	1 457 429 629	P 9629
RG971	1 457 429 646	P 9646
RG976	1 457 429 820	P 9820
RG980	1 457 429 600	P 9600
RG995A	1 457 429 740	P 9740

RG996	1 457 429 735	P 9735
R 51008/ZZZ	0 986 450 103	F 0103
R 51010/ZZZ	0 450 905 912	F 5912
R 51026/ZZZ	0 986 450 110	F 0110
R 51039/ZZZ	0 450 905 920	F 5920

R 51043/ZZZ	0 986 450 114	F 0114
R 51050/ZZZ	0 450 905 904	F 5904
R 51053/ZZZ	0 986 450 137	F 0137
Z 1012	0 451 203 223	P 3223
Z 1015	0 986 452 044	P 2044

Z 1022/ZZZ	0 986 450 039	F 0039
Z103	1 457 429 676	N 9676
Z 1037	0 451 103 217	P 3217
Z1038	0 986 452 058	P 2058
Z1039	0 986 452 061	P 2061

Z 1040	0 986 452 046	P 2046
Z1041	0 986 452 042	P 2042
Z1043	0 986 452 062	P 2062
Z 1042	0 451 103 276	P 3276
Z 1044	0 986 452 030	P 2030

Z1047	0 986 452 060	P 2060
Z 107	0 451 103 141	P 3141
Z 1094	0 451 103 275	P 3275
Z 11	0 451 103 274	P 3274
Z1138	0 451 103 240	P 3240

Z1139	0 986 452 064	P 2064
Z 1170	0 451 103 235	P 3235
Z1177	0 986 452 063	P 2063
Z1196	0 451 103 249	P 3249
Z1203	0 451 103 297	P 3297

Z1235	0 451 103 260	P 3260
Z1295	0 451 103 289	P 3289
Z 1302	0 451 103 341	P 3341
Z1309	0 451 103 258	P 3258
Z1315	0 451 103 290	P 3290

Z 1346/ZZZ	0 986 450 137	F 0137
Z135	0 451 103 253	P 3253
Z155	0 986 452 015	P 2015
Z 1575	F 026 407 053	P 7053
Z 1714	F 026 407 083	P 7083

Z1722	0 451 103 366	P 3366
Z180	1 457 434 453	N 4453
Z 197	0 986 452 023	P 2023
Z27A	0 986 452 003	P 2003
Z 27 A	0 451 103 029	P 3029

Z29	0 450 904 058	F 4058
Z29A	0 450 904 058	F 4058
Z 29/3	0 450 904 149	F 4149
Z294MHB	0 450 904 058	F 4058
Z 501	0 451 103 274	P 3274

Z507	0 450 904 058	F 4058
Z5072	0 450 904 058	F 4058
Z 508	0 451 103 274	P 3274
Z511	0 450 904 060	F 4060
Z 522	0 986 452 023	P 2023

Z528	0 451 203 108	P 3108
Z 652/ZZZ	0 986 450 117	F 0117
Z696	0 986 452 019	P 2019
Z 71	0 451 104 015	P 4015
Z 71	0 451 105 067	P 5067

Z78	1 457 429 681	N 9681
Z789	0 451 103 252	P 3252
Z789A	0 451 103 252	P 3252
Z 796	0 451 103 311	P 3311
Z803	0 451 103 274	P 3274

Z81	0 451 203 005	P 3005
Z 81	0 986 452 024	P 2024
Z 819	0 451 103 316	P 3316
Z82	1 457 429 681	N 9681
Z831	0 451 104 065	P 4065

Z 836	0 451 104 064	P 4064
Z 844	0 986 452 005	P 2005
Z850	0 986 452 044	P 2044
Z860	0 986 452 003	P 2003
Z903	0 451 203 201	P 3201

Z903A	0 451 203 201	P 3201
Z 91	0 451 103 316	P 3316
Z947	0 450 904 058	F 4058
Z 948	0 451 103 270	P 3270
Z 958	0 451 104 064	P 4064

Z954	1 457 434 438	N 4438
Z963	0 986 452 028	P 2028

CROSLAND

EC528	1 987 431 458	R 1458
E 315	1 987 432 060	M 2060
E 316	1 987 432 060	M 2060

E408	1 987 432 091	M 2091
E510	1 987 431 165	M 1165
E511	1 987 432 152	M 2152
E521	1 987 431 166	M 1166
1001	1 457 429 600	P 9600

1007	1 457 429 128	P 9128
1008	F 026 407 026	P 7026
1013	1 457 429 274	P 9274
1019	1 457 429 636	P 9636
102405	0 451 103 275	P 3275



◀ CROSLAND

1026	1 457 429 277	P 9277
1027	1 457 429 647	P 9647
1028	1 457 429 646	P 9646
1032	1 457 429 276	P 9276
1047	1 457 429 619	P 9619
1048	1 457 429 154	P 9154
105061	1 457 434 186	N 4186
105066	0 450 905 901	F 5901
1053	1 457 429 119	P 9119
1055	1 457 429 152	P 9152
1057	1 457 429 118	P 9118
106	1 457 431 158	N 1158
1060	1 457 429 277	P 9277
1061	1 457 429 137	P 9137
1062	1 457 429 647	P 9647
1063	1 457 429 646	P 9646
107	1 457 431 159	N 1159
1155	1 457 429 152	P 9152
1212	1 457 429 239	P 9239
168	1 457 431 261	N 1261
168	1 457 431 325	N 1325
180	1 457 431 270	N 1270
180	1 457 431 326	N 1326
190	1 457 431 270	N 1270
190	1 457 431 326	N 1326
191	1 457 431 270	N 1270
191	1 457 431 326	N 1326
2003	F 026 407 043	P 7043
2003	0 451 103 343	P 3343
2006	0 451 103 258	P 3258
2007	0 986 452 061	P 2061
2011	0 451 103 289	P 3289
2014	0 451 103 346	P 3346
2020	0 451 300 003	P 0003
2023	0 451 300 003	P 0003
2029	0 451 103 357	P 3357
2029	0 986 452 005	P 2005
2029	0 986 452 024	P 2024
2031	0 451 103 109	P 3109
2035	0 451 103 004	P 3004
2038	0 451 403 001	P 3001
2048	0 986 452 000	P 2000
2049	0 451 203 223	P 3223
2051	0 451 103 252	P 3252
2059	0 450 905 911	F 5911
2059	0 451 103 235	P 3235
2061	0 451 103 270	P 3270
2066	0 986 452 019	P 2019
2067	0 451 103 311	P 3311
2074	0 451 203 201	P 3201
2077	0 986 452 028	P 2028
2080	0 986 452 030	P 2030
2085	0 986 452 035	P 2035
2087	0 986 452 042	P 2042
2089	0 451 403 208	P 3208

2090	0 451 301 207	P 1207
2097	0 986 452 064	P 2064
2099	0 986 452 028	P 2028
2099	0 986 452 058	P 2058
2100	0 451 103 276	P 3276
2102	0 451 105 188	P 5188
2103	0 451 104 010	P 4010
2103	0 451 403 077	P 3077
2107	0 451 203 194	P 3194
2109	0 986 452 062	P 2062
2110	0 986 452 044	P 2044
2119	0 451 103 240	P 3240
2121	0 451 103 252	P 3252
2124	0 451 103 232	P 3232
2124	0 451 103 297	P 3297
2125	0 451 103 232	P 3232
2127	0 986 452 046	P 2046
2128	0 451 103 316	P 3316
2132	0 451 103 109	P 3109
2133	0 451 103 252	P 3252
2134	0 451 103 217	P 3217
2139	0 451 203 201	P 3201
2145	0 451 103 316	P 3316
2151	0 986 452 061	P 2061
2155	0 451 203 201	P 3201
2162	0 451 103 316	P 3316
2164	0 451 103 275	P 3275
2168	0 451 103 249	P 3249
2186	1 457 429 107	P 9107
2220	0 451 103 258	P 3258
2228	1 457 429 199	P 9199
2230	1 457 429 284	P 9284
2234	1 457 429 198	P 9198
2236	F 026 407 048	P 7048
2244	0 451 103 240	P 3240
2256	1 457 429 238	P 9238
2261	1 457 429 185	P 9185
2270	F 026 407 105	P 7105
2282	F 026 407 053	P 7053
2318	0 451 103 366	P 3366
2322	F 026 407 070	P 7070
2324	0 451 103 258	P 3258
2328	0 451 103 368	P 3368
2334	F 026 407 061	P 7061
303	1 457 434 105	N 4105
304	0 451 104 015	P 4015
304	0 451 105 067	P 5067
304	0 451 105 188	P 5188
308	0 451 203 010	P 3010
309	0 451 103 029	P 3029
310	0 986 452 016	P 2016
311	0 451 103 141	P 3141
339	0 451 104 065	P 4065
3512 4	1 457 433 276	S 3276
354	1 457 434 153	N 4153

355	0 451 103 274	P 3274
357	0 451 103 029	P 3029
358	1 457 434 201	N 4201
359	0 451 103 232	P 3232
366	0 986 452 019	P 2019
366	0 986 452 028	P 2028
368	0 986 452 016	P 2016
369	0 986 452 015	P 2015
375	0 451 203 108	P 3108
375	0 986 452 020	P 2020
4005	1 457 429 289	N 9289
4006	1 457 429 359	N 9359
4006	1 457 431 158	N 1158
4006 K	1 457 429 359	N 9359
4007	1 457 429 354	N 9354
4007	1 457 431 159	N 1159
4007 K	1 457 429 354	N 9354
4011	1 457 429 291	N 9291
4011	1 457 431 713	N 1713
4015	1 457 429 621	N 9621
4018	1 457 431 702	N 1702
4020	1 457 429 657	N 9657
4021	1 457 431 705	N 1705
4023	1 457 429 656	N 9656
4026	1 457 429 655	N 9655
4027	1 457 431 707	N 1707
4032	1 457 431 723	N 1723
4034	1 457 431 715	N 1715
4049	F 026 402 008	N 2008
417	1 457 431 028	N 1028
438	1 457 429 165	P 9165
439	0 451 203 194	P 3194
439	0 986 452 044	P 2044
453	1 457 431 270	N 1270
453	1 457 431 326	N 1326
4531	1 457 431 326	N 1326
457	1 457 431 261	N 1261
457	1 457 431 325	N 1325
463	1 457 429 130	P 9130
463	1 457 429 629	P 9629
475	1 457 429 175	P 9175
487	1 457 429 117	P 9117
5000	F 026 402 035	N 2035
5003	1 457 434 051	N 4051
5005	1 457 434 103	N 4103
5006	1 457 434 106	N 4106
5006	1 457 434 447	N 4447
5012	1 457 434 453	N 4453
5015	1 457 434 453	N 4453
5017	1 457 434 281	N 4281
5018	1 457 434 103	N 4103
5018	1 457 434 154	N 4154
5028	1 457 434 302	N 4302
5030	1 457 434 105	N 4105
5031	1 457 434 123	N 4123



5035	1 457 434 154	N 4154	659	0 451 103 141	P 3141	6731	0 450 905 216	F 5216
5035	1 457 434 165	N 4165	660	0 451 104 066	P 4066	6802	0 986 450 030	F 0030
5035	1 457 434 432	N 4432	683	0 986 452 003	P 2003	6804	0 450 905 901	F 5901
5036	1 457 434 123	N 4123	694	0 986 452 000	P 2000	6805	0 450 905 273	F 5273
5037	1 457 434 291	N 4291	6661	0 450 904 077	N 4077	6805	0 450 905 316	F 5316
5039	1 457 434 402	N 4402	6662	0 450 904 060	F 4060	6806	0 450 905 273	F 5273
5041	1 457 434 432	N 4432	6664	0 450 902 161	F 2161	6806	0 450 905 316	F 5316
5042	1 457 434 294	N 4294	6665	0 986 450 138	F 0138	6808	0 450 905 908	F 5908
5043	1 457 434 184	N 4184	6666	0 986 450 018	F 0018	6809	0 450 905 911	F 5911
5046	1 457 434 329	N 4329	6667	0 450 904 077	N 4077	6810	0 450 905 273	F 5273
5052	1 457 434 187	N 4187	6667	0 986 450 030	F 0030	6810	0 450 905 316	F 5316
507	1 457 429 413	P 9413	6671	0 986 450 039	F 0039	683	0 451 103 004	P 3004
5072	1 457 434 460	N 4460	6673	0 450 905 326	F 5326	683	0 451 103 062	P 3062
5074	1 457 434 421	N 4421	6675	0 986 450 018	F 0018	6850	F 026 403 006	F 3006
5083	F 026 402 037	N 2037	6681	0 986 450 108	F 0108	686	1 457 429 676	N 9676
5089	F 026 402 034	N 2034	6683	0 450 905 916	F 5916	687	1 457 429 675	N 9675
5097	0 450 906 460	N 6460	6684	0 986 450 137	F 0137	693	1 457 431 261	N 1261
5103	F 026 402 017	N 2017	6685	0 986 450 109	F 0109	693	1 457 431 325	N 1325
5129	F 026 402 056	N 2056	6687	0 986 450 117	F 0117	694	0 986 452 023	P 2023
5130	F 026 402 013	N 2013	6688	0 986 450 102	F 0102	697	1 457 429 820	P 9820
522	1 457 434 201	N 4201	6689	0 450 905 030	F 5030	699	1 457 431 261	N 1261
5222	F 026 402 028	N 2028	6689	0 450 905 095	F 5095	699	1 457 431 325	N 1325
529	0 451 103 029	P 3029	6690	0 450 905 002	F 5002	700	0 450 904 058	F 4058
529/1	0 451 103 029	P 3029	6690	0 450 905 280	F 5280	700 K	0 450 904 058	F 4058
529/1	0 986 452 003	P 2003	6690	0 450 905 326	F 5326	701	0 450 904 058	F 4058
531	0 986 452 044	P 2044	6691	0 450 905 104	F 5104	703	0 450 904 058	F 4058
532	0 451 203 194	P 3194	6691	0 450 905 200	F 5200	703 K	0 450 904 058	F 4058
533	1 457 434 201	N 4201	6691	0 450 905 601	F 5601	704 K	0 450 904 149	F 4149
542	0 451 104 064	P 4064	6697	0 986 450 105	F 0105	710	0 450 904 058	F 4058
543	0 451 104 064	P 4064	6698	0 450 905 203	F 5203	719	1 457 429 085	S 9085
544	1 457 434 201	N 4201	6699	0 450 905 021	F 5021	721	1 457 429 928	S 9928
547	0 451 103 274	P 3274	6700	0 450 905 091	F 5091	724	1 457 429 079	S 9079
550	1 457 429 175	P 9175	6700	0 450 905 133	F 5133	729	1 457 429 061	S 9061
551	1 457 429 175	P 9175	6701	0 450 905 195	F 5195	738	1 457 429 890	S 9890
566	1 457 434 201	N 4201	6701	0 450 905 216	F 5216	747	1 457 429 080	S 9080
591	0 451 103 274	P 3274	6702	0 450 905 005	F 5005	757	1 457 429 030	S 9030
591	0 986 452 044	P 2044	6703	0 450 905 005	F 5005	758	1 457 429 957	S 9957
6005	1 457 434 400	N 4400	6705	0 450 905 177	F 5177	764	1 457 429 908	S 9908
604	0 986 452 003	P 2003	6708	0 450 905 324	F 5324	769	1 457 432 124	S 2124
607	F 026 407 054	P 7054	6709	0 986 450 119	F 0119	774	1 457 429 900	S 9900
608	0 451 104 005	P 4005	6710	0 450 905 273	F 5273	777	1 457 432 111	S 2111
615	0 451 103 028	P 3028	6710	0 450 905 316	F 5316	780	1 457 429 076	S 9076
615	0 986 452 003	P 2003	6711	0 450 905 904	F 5904	792	1 457 429 800	S 9800
616	0 451 203 010	P 3010	6712	0 450 905 287	F 5287	8002	1 457 433 624	S 3624
619	0 451 203 002	P 3002	6713	0 450 905 903	F 5903	8003	1 457 433 606	S 3606
619	0 451 203 226	P 3226	6717	0 450 905 326	F 5326	8004	1 457 433 229	S 3229
620	1 457 434 200	N 4200	6719	0 450 902 151	F 2151	8005	1 457 429 795	S 9795
624	0 986 452 000	P 2000	672	0 451 103 316	P 3316	8006	1 457 432 154	S 2154
630	0 451 203 005	P 3005	672	0 986 452 061	P 2061	8006	1 457 433 544	S 3544
640	0 451 104 065	P 4065	6724	0 450 905 924	F 5924	8007	1 457 433 547	S 3547
655	0 451 104 065	P 4065	6724	0 986 450 113	F 0113	8009	1 457 433 571	S 3571
655	0 451 203 152	P 3152	6728	0 450 905 924	F 5924	8010	1 457 433 571	S 3571
658	1 457 434 154	N 4154	6728	0 986 450 113	F 0113	8013	1 457 433 951	S 3951
658	1 457 434 165	N 4165	6729	0 986 450 114	F 0114	8014	1 457 432 146	S 2146
658	1 457 434 296	N 4296	6731	0 450 905 195	F 5195	8016	1 457 433 260	S 3260



◀ CROSLAND

8017	1 457 429 869	S 9869
8018	1 457 433 004	S 3004
8023	1 457 429 970	S 9970
8024	1 457 429 993	S 9993
8025	1 457 433 616	S 3616
8027	1 457 433 741	S 3741
8029	1 457 433 642	S 3642
8030	1 457 433 740	S 3740
8031	1 457 433 273	S 3273
8032	1 457 433 274	S 3274
8036	1 987 429 146	S 9146
8038	1 457 433 784	S 3784
8039	1 457 433 968	S 3968
8040	1 987 429 169	S 9169
8041	1 457 433 712	S 3712
8042	1 457 433 234	S 3234
8043	1 457 433 750	S 3750
8044	1 457 433 282	S 3282
8045	1 457 433 266	S 3266
8047	1 457 433 002	S 3002
8048	1 457 433 607	S 3607
8049	1 457 429 846	S 9846
8050	1 457 433 286	S 3286
8051	1 457 433 752	S 3752
8052	1 457 429 814	S 9814
8053	1 457 433 701	S 3701
8054	1 457 433 700	S 3700
8055	1 457 429 792	S 9792
8058	1 457 433 703	S 3703
8059	1 457 433 285	S 3285
8060	1 457 433 743	S 3743
8062	1 457 433 265	S 3265
8064	1 457 433 571	S 3571
8065	1 457 433 742	S 3742
8066	1 457 433 008	S 3008
8068	1 457 433 257	S 3257
8070	1 457 429 870	S 9870
8071	1 457 433 790	S 3790
8073	1 457 433 623	S 3623
8077	1 457 429 793	S 9793
8078	1 457 432 172	S 2172
8080	1 457 429 949	S 9949
8081	1 457 433 748	S 3748
8082	1 457 433 268	S 3268
8083	1 457 433 535	S 3535
8084	1 457 433 795	S 3795
8087	1 457 433 952	S 3952
8089	1 987 429 123	S 9123
8091	1 457 433 275	S 3275
8095	1 457 433 954	S 3954
8097	1 457 433 958	S 3958
8100	1 457 433 965	S 3965
8103	1 457 433 255	S 3255
8104	1 457 433 256	S 3256
8107	1 457 433 769	S 3769

8108	1 457 433 590	S 3590
8109	F 026 400 010	S 0010
8110	1 457 433 627	S 3627
8112	1 457 433 531	S 3531
8114	1 457 433 259	S 3259
8116	1 457 433 081	S 3081
8116	1 457 433 714	S 3714
8117	F 026 400 011	S 0011
8118	1 457 433 056	S 3056
8119	1 457 433 543	S 3543
8120	1 457 433 060	S 3060
8123	1 457 433 771	S 3771
8125	1 457 433 642	S 3642
8126	1 457 433 270	S 3270
8127	1 457 433 697	S 3697
8128	1 457 433 272	S 3272
8131	1 457 433 303	S 3303
8133	1 457 433 791	S 3791
8134	1 457 433 642	S 3642
8135	1 457 429 814	S 9814
8137	1 457 429 890	S 9890
8138	1 457 433 269	S 3269
8139	1 457 433 555	S 3555
8140	1 457 433 281	S 3281
8143	1 457 433 088	S 3088
8145	F 026 400 011	S 0011
8146	1 457 433 773	S 3773
8147	F 026 400 014	S 0014
8152	1 457 433 791	S 3791
8153	1 457 429 957	S 9957
8154	1 457 433 715	S 3715
8157	1 987 429 152	S 9152
8159	1 457 433 077	S 3077
8160	1 457 432 124	S 2124
8162	1 457 433 529	S 3529
8165	1 457 433 256	S 3256
8168	1 457 433 716	S 3716
8170	1 457 433 955	S 3955
8171	1 457 433 526	S 3526
8172	1 457 433 280	S 3280
8173	1 457 433 544	S 3544
8175	1 457 433 747	S 3747
8178	1 457 433 520	S 3520
8180	1 457 433 553	S 3553
8182	1 457 433 550	S 3550
8183	1 457 433 276	S 3276
8184	1 457 433 753	S 3753
8186	1 457 433 752	S 3752
8187	1 457 433 231	S 3231
8189	1 457 433 588	S 3588
8191	1 457 433 772	S 3772
8193	1 457 433 686	S 3686
8194	1 457 433 536	S 3536
8197	1 987 429 166	S 9166
820	1 457 433 732	S 3732

8212	1 457 433 070	S 3070
8213	1 457 433 069	S 3069
8217	1 457 433 577	S 3577
8228	1 457 433 549	S 3549
8236	1 457 433 972	S 3972
8242	1 457 433 532	S 3532
8244	F 026 400 067	S 0067
8250	1 457 433 046	S 3046
8252	1 457 433 075	S 3075
8256	1 457 433 078	S 3078
8257	F 026 400 079	S 0079
8258	1 457 433 523	S 3523
8259	1 457 433 065	S 3065
8260	1 457 433 047	S 3047
8273	1 457 433 043	S 3043
8275	1 457 433 319	S 3319
8288	F 026 400 077	S 0077
8293	1 987 429 406	S 9406
8296	1 457 433 574	S 3574
8303	1 987 429 401	S 9401
8327	1 987 429 188	S 9188
8329	1 987 429 182	S 9182
8330	1 987 429 404	S 9404
8332	F 026 400 210	S 0210
8339	F 026 400 074	S 0074
8345	1 457 433 045	S 3045
8349	F 026 400 075	S 0075
8350	1 987 429 405	S 9405
8351	1 457 433 331	S 3331
8364	1 457 433 327	S 3327
8378	F 026 400 013	S 0013
8392	1 457 433 573	S 3573
8443	F 026 400 102	S 0102
8448	1 457 433 594	S 3594
8450	1 457 433 315	S 3315
8492	F 026 400 110	S 0110
8497	F 026 400 015	S 0015
8498	1 457 433 529	S 3529
8503	F 026 400 090	S 0090
8512	F 026 400 098	S 0098
8522	F 026 400 109	S 0109
8523	F 026 400 055	S 0055
8524	1 457 433 075	S 3075
8530	1 457 433 579	S 3579
8548	F 026 400 052	S 0052
8551	1 457 433 583	S 3583
880	1 457 432 108	S 2108
894	1 457 429 064	S 9064
896	1 457 429 923	S 9923
896	1 457 432 134	S 2134
9008	1 987 431 159	M 1159
901	1 457 434 201	N 4201
902	1 457 432 106	S 2106
9021	1 457 429 923	S 9923
9028	1 457 432 138	S 2138



9032	1 457 429 915	S 9915
9033	1 457 429 920	S 9920
9037	1 457 429 806	S 9806
9038	1 457 429 806	S 9806
9042	1 457 433 652	S 3652

9043	1 457 429 928	S 9928
9045	1 457 429 994	S 9994
9048	1 457 432 150	S 2150
9048	1 457 432 174	S 2174
9049	1 457 429 959	S 9959

9054	1 457 429 992	S 9992
9066	1 457 429 896	S 9896
9066	1 457 429 898	S 9898
9066	1 457 433 087	S 3087
9073	1 457 432 203	S 2203

9074	1 987 429 117	S 9117
9078	1 987 429 042	S 9042/1
9080	1 457 429 801	S 9801
9081	1 457 429 801	S 9801
9083	1 457 433 534	S 3534

9085	1 457 429 875	S 9875
9090	1 457 429 953	S 9953
9091	1 987 429 115	S 9115
9093	1 457 432 154	S 2154
9099	1 457 429 987	S 9987

9100	1 457 429 954	S 9954
9102	1 457 429 983	S 9983
9103	1 457 433 066	S 3066
9103	1 987 429 051	S 9051
9104	1 457 429 845	S 9845

9111	1 987 429 121	S 9121
9118	1 457 433 797	S 3797
9124	1 987 429 125	S 9125
9133	1 987 429 135	S 9135
9140	1 457 433 789	S 3789

9147	1 987 429 123	S 9123
9149	1 457 433 734	S 3734
9154	1 457 429 839	S 9839
9157	1 987 429 122	S 9122
9164	1 457 433 652	S 3652

9166	1 457 433 229	S 3229
9169	1 457 432 173	S 2173
9174	1 457 429 839	S 9839
9175	1 457 433 231	S 3231
9179	1 457 429 783	S 9783

9180	1 457 429 988	S 9988
9184	1 457 432 200	S 2200
9190	1 457 429 819	S 9819
9191	1 457 429 775	S 9775
9192	1 457 429 994	S 9994

9194	1 457 429 964	S 9964
9199	1 457 429 844	S 9844
920 K	1 457 434 201	N 4201
9205	1 987 429 136	S 9136
9212	1 987 429 127	S 9127

9214	1 987 429 133	S 9133
9216	1 457 429 842	S 9842
9217	1 457 429 778	S 9778
9218	1 457 433 250	S 3250
9223	1 457 432 204	S 2204

9224	1 457 429 777	S 9777
9226	1 457 433 601	S 3601
9229	F 026 400 179	S 0179
9234	1 457 433 729	S 3729
9235	1 457 429 895	S 9895

9235	1 457 429 896	S 9896
9235	1 457 433 087	S 3087
9239	1 987 429 148	S 9148
9245	1 457 433 605	S 3605
9247	1 457 429 870	S 9870

9247	1 457 429 877	S 9877
9248	1 457 433 003	S 3003
9255	1 457 429 791	S 9791
9256	1 457 433 233	S 3233
9257	1 457 432 183	S 2183

9258	1 457 432 180	S 2180
9259	1 457 432 185	S 2185
9264	1 457 433 626	S 3626
9265	1 457 433 736	S 3736
9267	1 457 429 777	S 9777

9269	1 457 429 841	S 9841
927	1 457 429 801	S 9801
9271	1 457 433 690	S 3690
9275	1 457 433 263	S 3263
9277	1 457 433 023	S 3023

9282	1 457 433 227	S 3227
9283	1 457 429 787	S 9787
9286	1 457 433 609	S 3609
9288	1 987 429 159	S 9159
9289	1 457 433 230	S 3230

929	1 457 429 915	S 9915
9290	1 987 429 135	S 9135
9291	1 457 433 950	S 3950
9292	1 457 433 711	S 3711
9294	1 457 429 778	S 9778

9294	1 457 433 750	S 3750
9295	1 457 433 781	S 3781
9296	1 457 433 605	S 3605
9297	1 457 433 713	S 3713
9298	1 457 433 603	S 3603

9299	1 457 433 608	S 3608
9304	0 451 301 156	P 1156
9307	1 457 429 681	N 9681
9308	1 457 429 740	P 9740
9309	0 451 403 077	P 3077

9310	1 457 429 735	P 9735
9322	1 457 429 175	P 9175
9325	0 451 104 015	P 4015
9325	0 451 105 067	P 5067
9326	1 457 429 740	P 9740

9326 K	1 457 429 740	P 9740
9327	1 457 429 735	P 9735
9327 K	1 457 429 735	P 9735
9329	0 451 203 220	P 3220
9330	0 451 203 220	P 3220

9361	0 451 403 077	P 3077
9362	0 451 203 194	P 3194
9365	1 457 429 646	P 9646
948	1 457 429 053	S 9053
9510	1 457 429 950	S 9950

9522	1 457 429 975	S 9975
9530	1 457 429 932	S 9932
955	1 457 429 806	S 9806
9551	1 457 429 946	S 9946
9556	1 457 429 966	S 9966

956	1 457 429 050	S 9050
956	1 457 429 959	S 9959
9561	1 457 429 941	S 9941
9563	1 457 432 192	S 2192
958 K	1 457 429 933	S 9933

9611 K	1 457 433 201	S 3201
962 K	1 457 433 200	S 3200
9620	1 457 429 817	S 9817
9620	1 457 429 942	S 9942
9647	1 457 429 969	S 9969

9649	F 026 400 082	S 0082
9659	1 457 429 944	S 9944
9660 K	1 457 433 646	S 3646
967	1 457 429 054	S 9054
9707	F 026 400 085	S 0085

9714	1 457 432 188	S 2188
9716	F 026 400 065	S 0065
9728	1 457 429 899	S 9899
9749	1 457 433 651	S 3651
9755	1 457 433 005	S 3005

9760	1 457 429 854	S 9854
9765	1 457 433 735	S 3735
9783	1 457 433 332	S 3332
9803	F 026 400 207	S 0207
9818	1 457 433 728	S 3728

9826	1 457 433 560	S 3560
9827	F 026 400 094	S 0094
9829	1 457 433 730	S 3730
9835	F 026 400 197	S 0197
997 K	1 457 429 794	S 9794

DELPHI

AF0012	1 457 432 106	S 2106
AF0013	1 457 432 108	S 2108
AF0018	1 457 429 050	S 9050

AF0021	1 457 433 652	S 3652
AF0028	1 457 429 053	S 9053
AF0031	1 457 429 080	S 9080
AF0032	1 457 429 054	S 9054
AF0045	1 457 432 111	S 2111



◀ DELPHI

AF0047	1 457 433 732	S 3732
AF0054	1 457 429 908	S 9908
AF0058	1 457 429 085	S 9085
AF0070	1 457 429 079	S 9079
AF0094	1 457 429 845	S 9845

AF0100	1 457 429 875	S 9875
AF0103	1 457 429 877	S 9877
AF0104	1 457 429 870	S 9870
AF0123	1 457 429 080	S 9080
AF0124	1 457 429 988	S 9988

AF0127	1 457 429 964	S 9964
AF0129	1 457 432 154	S 2154
AF0130	1 457 433 652	S 3652
AF0131	1 457 429 894	S 9894
AF0134	1 457 433 087	S 3087

AF0136	1 457 432 172	S 2172
AF0138	1 457 429 895	S 9895
AF0143	1 457 432 185	S 2185
AF0146	1 457 433 229	S 3229
AF0150	1 457 432 200	S 2200

AF0154	1 457 429 844	S 9844
AF0162	1 457 432 204	S 2204
AF0163	1 457 429 923	S 9923
AF0173	1 457 429 775	S 9775
AF0174	1 457 429 819	S 9819

AF0175	1 457 433 736	S 3736
AF0177	1 457 429 778	S 9778
AF0177	1 457 433 750	S 3750
AF0179	1 457 433 713	S 3713
AF0186	1 457 432 150	S 2150

AF0188	1 457 429 842	S 9842
AF0189	1 457 433 571	S 3571
AF0190	1 457 433 571	S 3571
AF0191	1 457 433 571	S 3571
AF0196	1 457 429 777	S 9777

AF0197	1 457 429 791	S 9791
AF0198	1 457 433 233	S 3233
AF0200	1 457 433 606	S 3606
AF0201	1 457 433 008	S 3008
AF0202	1 457 433 623	S 3623

AF0203	1 457 433 609	S 3609
AF0204	1 457 433 608	S 3608
AF0205	1 457 433 742	S 3742
AF0207	1 457 433 799	S 3799
AF0208	1 457 433 741	S 3741

AF0209	1 457 433 771	S 3771
AF0218	1 457 433 264	S 3264
AF0232	1 457 433 690	S 3690
AF0235	1 457 429 793	S 9793
AF0236	1 457 433 263	S 3263

AF0239	1 457 433 229	S 3229
AF0240	1 457 429 054	S 9054
AF0246	1 457 433 255	S 3255
AF0249	1 457 433 008	S 3008
AF0250	1 457 433 659	S 3659

AF0256	1 457 433 275	S 3275
AF0259	1 457 433 265	S 3265
AF0260	1 457 433 268	S 3268
AF0262	1 457 429 994	S 9994
AF0264	1 457 432 150	S 2150

AF0264	1 457 432 174	S 2174
AF0265	1 457 432 111	S 2111
AF0268	1 457 432 134	S 2134
AF0269	1 457 429 080	S 9080
AF0273	1 457 433 714	S 3714

AF0276	1 457 433 790	S 3790
AF0282	1 457 433 535	S 3535
AF0284	1 457 433 642	S 3642
AF0289	1 457 429 076	S 9076
AF0293	1 457 433 537	S 3537

AF0298	1 457 429 983	S 9983
AF0301	1 457 433 002	S 3002
AF0302	1 457 429 970	S 9970
AF0303	1 457 429 842	S 9842
AF0304	1 457 433 659	S 3659

AF0307	1 457 433 056	S 3056
AF0308	1 457 429 846	S 9846
AF0309	1 457 433 601	S 3601
AF0313	1 457 433 686	S 3686
AF0324	1 457 433 616	S 3616

AF0325	1 457 432 200	S 2200
AF0328	1 457 433 541	S 3541
AF0331	1 457 433 608	S 3608
AF 0339	1 457 433 326	S 3326
AF0347	1 457 433 752	S 3752

AF0349	1 457 433 052	S 3052
AF0358	1 457 432 134	S 2134
AF0362	F 026 400 038	S 0038
AF0364	1 457 433 617	S 3617
AF0365	1 457 433 711	S 3711

AF0367	1 457 433 748	S 3748
AF0368	1 457 433 748	S 3748
AF0369	1 457 433 747	S 3747
AF0370	1 457 433 753	S 3753
AF0374	1 987 429 152	S 9152

AF0375	1 457 433 536	S 3536
AF0385	1 457 433 956	S 3956
AF0389	1 457 433 314	S 3314
AF0392	1 457 433 060	S 3060
AF0393	1 457 429 792	S 9792

AF0394	1 457 433 772	S 3772
AF0395	1 457 433 276	S 3276
AF0401	1 987 429 152	S 9152
AF0404	1 457 433 521	S 3521
AF0411	1 457 429 795	S 9795

AF0412	1 457 433 712	S 3712
AF0419	1 457 429 818	S 9818
AF0436	1 457 433 790	S 3790
AF0445	1 457 429 949	S 9949
AF0455	1 457 433 785	S 3785

AF0467	1 457 433 791	S 3791
AF0468	1 457 433 791	S 3791
AF0471	1 457 429 969	S 9969
AF0472	1 457 433 627	S 3627
AF0479	1 457 429 944	S 9944

AF0490	1 987 429 169	S 9169
AF0492	F 026 400 014	S 0014
AF0493	1 457 433 781	S 3781
AF 189	1 457 433 571	S 3571
AF 20002	1 457 433 624	S 3624

AF 20010	1 457 433 280	S 3280
AF 20013	1 457 433 549	S 3549
AF 20014	1 457 429 948	S 9948
AF 20018	1 457 433 550	S 3550
AF20022	1 457 433 088	S 3088

AF 20023	1 457 433 742	S 3742
AF20024	1 457 433 590	S 3590
AF20025	1 457 433 739	S 3739
AF 20027	1 457 433 265	S 3265
AF 20028	1 457 433 769	S 3769

AF20029	1 457 433 543	S 3543
AF 20030	1 457 433 265	S 3265
AF 20031	1 457 433 547	S 3547
AF20032	1 457 433 589	S 3589
AF 20039	1 457 429 786	S 9786

AF20042	1 457 433 546	S 3546
AF 20043	1 457 433 523	S 3523
AF 20045	1 987 429 157	S 9157
AF20052	1 457 433 070	S 3070
AF20053	1 457 433 743	S 3743

AF20054	1 457 433 077	S 3077
AF20058	1 457 433 531	S 3531
AF20059	1 457 433 311	S 3311
AF20063	1 457 433 538	S 3538
AF20064	1 457 433 532	S 3532

AF20065	1 457 433 047	S 3047
AF20066	F 026 400 010	S 0010
AF20068	1 457 433 588	S 3588
AF20070	1 457 433 555	S 3555
AF20072	1 457 433 046	S 3046

AF20073	1 457 433 067	S 3067
AF20075	1 457 433 792	S 3792
AF20076	1 457 433 715	S 3715
AF20081	1 457 433 090	S 3090
AF20084	1 457 433 529	S 3529

AF20085	1 457 433 058	S 3058
AF20087	1 457 433 533	S 3533
AF20088	1 457 433 300	S 3300
AF20089	1 457 433 539	S 3539
AF20092	1 457 433 078	S 3078

AF20093	1 457 433 075	S 3075
AF20095	1 457 433 319	S 3319
AF20096	1 457 429 839	S 9839
AF20100	1 457 433 043	S 3043
AF20102	1 457 433 069	S 3069

AF20103	1 457 433 065	S 3065
AF20105	1 987 429 403	S 9403
AF20107	F 026 400 013	S 0013
AF20112	1 457 433 577	S 3577
AF 20113	1 457 433 593	S 3593

AF20119	1 457 433 578	S 3578
AF20120	1 457 433 579	S 3579
AF20122	1 457 433 797	S 3797
AF20125	1 987 429 404	S 9404
AF20129	1 457 433 574	S 3574

AF 207	1 457 433 799	S 3799
AF 210	1 457 433 273	S 3273
AF 218	1 457 433 264	S 3264
AF 256	1 457 433 275	S 3275
AF 258	1 457 433 544	S 3544

AF 275	1 457 433 274	S 3274
AF 282	1 457 433 535	S 3535
AF 293	1 457 433 537	S 3537
AF 316	1 457 433 526	S 3526
AF 328	1 457 433 541	S 3541

AF 349	1 457 433 052	S 3052
AF 352	1 457 433 274	S 3274
AF 375	1 457 433 536	S 3536
AF 404	1 457 433 521	S 3521
AF 468	1 457 433 791	S 3791

AF 470	1 457 433 534	S 3534
AF 492	F 026 400 014	S 0014
AF 493	1 457 433 781	S 3781
CAF43	1 987 432 107	M 2107
CAF45	1 987 432 052	M 2052

FF0001	1 457 434 201	N 4201
FF0002	1 457 431 158	N 1158
FF0006	1 457 431 713	N 1713
FF0007	1 457 434 200	N 4200
FF0009	0 450 904 058	F 4058

FF0010	0 450 904 058	F 4058
FF0010	0 450 904 149	F 4149
FF0012	0 450 904 058	F 4058
FF0014	0 450 904 058	F 4058
FF0015	0 450 904 058	F 4058

FF0019	0 450 904 058	F 4058
FF0053	1 457 429 676	N 9676
FF0057	1 457 434 453	N 4453
FF 0062	1 457 434 435	N 4435
FF0074	1 457 434 291	N 4291

FF0077	1 457 429 656	N 9656
FF 0088	1 457 431 702	N 1702
FF0091	1 457 431 261	N 1261
FF0092	1 457 429 657	N 9657
FF0094	0 450 904 060	F 4060

FF 0164	1 457 431 705	N 1705
FF 20001	0 450 905 939	F 5939
FF 20004	0 450 905 915	F 5915
FF 20005	0 986 450 222	F 0222
FF 20006	0 450 905 983	F 5983

FF 20012	0 450 905 920	F 5920
FF 20033	0 450 905 912	F 5912
FX0007	0 451 103 274	P 3274
FX0017	0 451 203 005	P 3005
FX0037	0 451 103 274	P 3274

FX0041	0 451 203 108	P 3108
FX0045	0 451 103 217	P 3217
FX0069	0 451 203 201	P 3201
FX0072	0 451 103 252	P 3252
FX0073	0 451 103 240	P 3240

FX0083	0 451 103 297	P 3297
FX0086	0 451 203 223	P 3223
FX0104	1 457 429 274	P 9274
FX0110	1 457 429 157	P 9157
FX0114	1 457 429 619	P 9619

FX0116	0 451 203 201	P 3201
FX0119	0 451 103 260	P 3260
FX0126	1 457 429 636	P 9636
FX0127	0 451 103 249	P 3249
FX0128	0 451 103 289	P 3289

FX0129	0 451 103 290	P 3290
FX0171	0 451 103 297	P 3297
FX0190	1 457 429 119	P 9119
FX0193	1 457 429 152	P 9152
FX 190	1 457 429 119	P 9119

FX 20003	0 451 103 311	P 3311
FX20006	0 451 103 347	P 3347
FX20011	0 451 103 257	P 3257
FX20020	0 451 203 108	P 3108
FX20023	1 457 429 239	P 9239

FX20027	1 457 429 118	P 9118
FX20030	0 451 103 260	P 3260
FX20033	1 457 429 126	P 9126
FX20034	1 457 429 272	P 9272
FX20037	1 457 429 194	P 9194

FX20040	1 457 429 185	P 9185
FX20042	1 457 429 199	P 9199
FX 20047	1 457 429 284	P 9284
HDF296	1 457 434 201	N 4201
HDF491	1 457 429 675	N 9675

HDF494	1 457 434 432	N 4432
HDF496	1 457 434 447	N 4447
HDF500	1 457 429 359	N 9359
HDF508	1 457 434 291	N 4291
HDF510	F 026 402 013	N 2013

HDF511	1 457 431 705	N 1705
HDF512	1 457 429 657	N 9657
HDF513	1 457 429 656	N 9656
HDF530	1 457 434 324	N 4324
HDF543	1 457 434 450	N 4450

HDF545	0 450 906 459	N 6459
HDF546	F 026 402 004	N 2004
HDF549	0 450 906 458	N 6458
HDF551	0 450 906 462	N 6462
HDF599	F 026 402 063	N 2063

HDF699	1 457 434 200	N 4200
HDF796	1 457 434 200	N 4200
HDF902	1 457 434 200	N 4200
HDF907	0 450 906 468	N 6468
HDF909	0 450 906 471	N 6471

HDF910	1 457 431 713	N 1713
HDF914	1 457 431 712	N 1712
HDF915	0 450 906 469	N 6469
HDF916	1 457 431 702	N 1702
HDF920	1 457 431 720	N 1720

HDF924	0 450 906 508	N 6508
HDF929	F 026 402 007	N 2007
HDF939	0 450 906 471	N 6471
HDF943	0 450 906 469	N 6469
HDF944	0 450 906 473	N 6473

HDF950	0 450 906 452	N 6452
TSP 0325042	1 987 432 042	M 2042
TSP0325043	1 987 432 107	M 2107
TSP0325046	1 987 431 165	M 1165
TSP0325052	1 987 432 105	M 2105

TSP0325059C	1 987 432 075	M 2075
TSP 0325060	1 987 432 060	M 2060
TSP0325072	1 987 432 058	M 2058
TSP0325072C	1 987 432 058	M 2058
TSP0325082	1 987 432 084	M 2084

TSP 0325098	1 987 432 052	M 2052
TSP0325102	1 987 432 066	M 2066
TSP0325108	1 987 432 075	M 2075
TSP0325120	1 987 431 154	M 1154
TSP0325130	1 987 431 159	M 1159

TSP0325141	1 987 432 074	M 2074
TSP0325141C	1 987 432 074	M 2074
TSP0325148	1 987 432 088	M 2088
TSP0325148C	1 987 432 088	M 2088
TSP0325149	1 987 432 084	M 2084

TSP0325162	1 987 432 091	M 2091
TSP0325173	1 987 432 084	M 2084
TSP0325173C	1 987 432 084	M 2084
TSP0325175	1 987 432 085	M 2085
TSP0325176C	1 987 432 092	M 2092

TSP0325231	1 987 432 236	M 2236
------------	---------------	---------------

FIAMM

FA5859 ECO	F 026 407 070	P 7070
FA5897ECO	F 026 407 061	P 7061
FA5903ECO	F 026 407 068	P 7068

FB 3329	F 026 407 054	P 7054
FL19004	F 026 400 065	S 0065
FL 19065	F 026 400 067	S 0067
FP5600HWS	1 457 434 310	N 4310
FP 5852	F 026 402 081	N 2081



◀ FIAMM

FT 4574	0 451 103 274	P 3274
FT 4626	0 451 103 274	P 3274
FT 4674	0 451 103 274	P 3274
FT 4775	0 451 103 274	P 3274
FT 4857	0 451 103 274	P 3274

FT 4883	0 451 103 274	P 3274
FT 5087	0 451 103 274	P 3274
FT 5103	0 451 103 274	P 3274
FT 5121	F 026 407 049	P 7049
FT 5527	F 026 402 035	N 2035

FT 5528	F 026 407 048	P 7048
FT 5599	F 026 402 034	N 2034
FT 5613	F 026 407 057	P 7057
FT 5657	F 026 407 048	P 7048
FT 5662	F 026 407 053	P 7053

FT 5855	0 450 905 959	F 5959
PA 7370	F 026 400 107	S 0107
PA 7407	F 026 400 094	S 0094
PA 7511	F 026 400 110	S 0110

FIAT

FA 5558 ECO	1 457 429 152	P 9152
FA5732 ECO	F 026 402 047	N 2047
FT5784	F 026 403 008	F 3008

PCK8193	1 987 432 406	R 2406
PC8154	1 987 432 208	M 2208

FILTRON

AE 250	1 457 429 775	S 9775
AE 251	1 457 429 819	S 9819
AE 277	1 457 429 818	S 9818

AE 311/1	1 457 433 769	S 3769
AE 320	1 987 429 150	S 9150
AE 326	1 457 429 949	S 9949
AE 328	1 457 429 993	S 9993
AE 335	1 457 433 234	S 3234

AK2181	1 987 429 401	S 9401
AK2182	1 457 433 333	S 3333
AK2183	1 457 433 334	S 3334
AK 246	1 457 429 908	S 9908
AK 284 S	1 457 432 204	S 2204

AK337	1 457 433 785	S 3785
AK 340	1 987 429 122	S 9122
AK 341	1 987 429 133	S 9133
AK 362	1 457 433 588	S 3588
AK 362/1	1 457 433 589	S 3589

AK3622	1 457 433 093	S 3093
AK3624	F 026 400 018	S 0018
AK370	1 987 429 405	S 9405
AK3701	1 457 433 576	S 3576
AK 435	1 457 433 005	S 3005

AM352/2	F 026 400 040	S 0040
AM401	1 457 429 899	S 9899
AM 401	1 457 429 969	S 9969
AM 401/1	1 457 429 899	S 9899
AM4011	1 457 429 969	S 9969

AM 405	1 457 429 966	S 9966
AM 406/1	1 457 429 941	S 9941
AM 406/2	1 457 433 270	S 3270
AM 407	1 457 433 627	S 3627
AM 409/1	1 457 433 735	S 3735

AM 412	1 987 429 117	S 9117
AM 413	1 457 429 932	S 9932
AM 414	1 457 429 946	S 9946
AM 414 W	F 026 400 082	S 0082
AM 416	1 457 432 188	S 2188

AM 416/1	1 457 433 903	S 3903
AM 416/2	1 457 433 904	S 3904
AM 416/3	1 457 433 042	S 3042
AM 418	1 457 429 854	S 9854
AM 420	1 457 429 950	S 9950

AM 422	1 457 429 795	S 9795
AM422	1 457 429 944	S 9944
AM 424/1	1 457 433 901	S 3901
AM 430	1 457 429 933	S 9933
AM 432	1 457 433 646	S 3646

AM 433	1 987 429 127	S 9127
AM 435	1 457 433 005	S 3005
AM 436/1	1 457 433 275	S 3275
AM 441/1	F 026 400 092	S 0092
AM 442/1	F 026 400 207	S 0207

AM 442/1 W	F 026 400 197	S 0197
AM442/2W	F 026 400 065	S 0065
AM 442/5	F 026 400 117	S 0117
AM 444/1	1 457 429 942	S 9942
AM 446	1 457 433 900	S 3900

AM 446/1	F 026 400 184	S 0184
AM446/2	F 026 400 067	S 0067
AM 446/3	F 026 400 068	S 0068
AM 446/3W	F 026 400 210	S 0210
AM 446/5	F 026 400 211	S 0211

AM 446/6	F 026 400 209	S 0209
AM447/2	F 026 400 084	S 0084
AM 447/7	F 026 400 069	S 0069
AM 453	1 457 433 795	S 3795
AM 455	1 457 433 651	S 3651

AM 455/2	F 026 400 074	S 0074
AM 455/3	F 026 400 075	S 0075
AM 457	F 026 400 077	S 0077
AM 458/1	F 026 400 078	S 0078
AM 465	1 457 433 730	S 3730

AM 465/1	1 457 433 729	S 3729
AM 465/2	1 457 433 728	S 3728
AM 465/2N	1 457 433 728	S 3728
AM 465/3	1 457 433 560	S 3560
AM4684	1 987 429 169	S 9169

AM 469	1 987 429 125	S 9125
AM471	F 026 400 083	S 0083
AM471/1	F 026 400 086	S 0086
AM 472	F 026 400 064	S 0064
AP 002	1 457 429 076	S 9076

AP 003	1 457 429 957	S 9957
AP 004	1 457 429 994	S 9994
AP 004/2	1 457 433 537	S 3537
AP 005	1 457 429 777	S 9777
AP 006	1 457 429 061	S 9061

AP 010	1 457 429 875	S 9875
AP 010/1	1 457 433 607	S 3607
AP 010/2	1 457 433 700	S 3700
AP 011	1 457 429 783	S 9783
AP 012	1 457 429 988	S 9988

AP 013	1 457 429 030	S 9030
AP 015	1 457 429 079	S 9079
AP 020	1 457 429 894	S 9894
AP0201	1 457 433 771	S 3771
AP 020/2	1 457 433 045	S 3045

AP 021	1 457 432 200	S 2200
AP 022	1 457 432 146	S 2146
AP 023	1 457 433 690	S 3690
AP 023/2	1 457 433 792	S 3792
AP 023/3	1 457 433 070	S 3070

AP024	1 457 432 150	S 2150
AP 024	1 457 432 174	S 2174
AP 024/1	1 457 433 086	S 3086
AP 025	1 457 429 928	S 9928
AP 026	1 457 429 964	S 9964

AP 028	1 457 433 004	S 3004
AP 029	1 457 429 983	S 9983
AP 031	1 457 429 814	S 9814
AP 032	1 457 429 869	S 9869
AP0321	1 457 433 067	S 3067

AP 034	1 457 433 002	S 3002
AP0341	1 457 433 585	S 3585
AP0342	1 457 433 594	S 3594
AP 035/1	1 457 433 524	S 3524
AP 035/2	1 457 433 043	S 3043

AP 038	1 457 432 172	S 2172
AP 039	1 457 432 185	S 2185
AP 040	1 457 432 173	S 2173
AP 041	1 457 433 253	S 3253
AP 042	1 457 432 180	S 2180

AP 043	1 457 433 285	S 3285
AP 045	1 457 429 842	S 9842
AP 046/1	1 457 433 659	S 3659
AP 051	1 457 433 281	S 3281
AP 051/1	1 457 433 055	S 3055

AP0513	F 026 400 013	S 0013
AP0514	F 026 400 013	S 0013
AP0515	F 026 400 020	S 0020
AP0516	F 026 400 012	S 0012
AP 052	1 457 429 844	S 9844

AP 056	1 457 429 870	S 9870
AP 057	1 457 429 896	S 9896
AP057	1 457 433 087	S 3087
AP 057/1	1 457 433 056	S 3056
AP 057/2	1 457 429 895	S 9895
AP 057/2	1 457 429 898	S 9898
AP 058	1 457 433 250	S 3250
AP0582	1 457 433 592	S 3592
AP 059	1 457 429 846	S 9846
AP 060	1 457 433 008	S 3008
AP 061	1 457 429 778	S 9778
AP 062	1 457 429 777	S 9777
AP 063	1 457 433 023	S 3023
AP0631	1 457 429 870	S 9870
AP 064	1 457 429 085	S 9085
AP 065	1 457 429 987	S 9987
AP 066	1 457 432 203	S 2203
AP 067	1 457 429 791	S 9791
AP 068	1 457 433 601	S 3601
AP 069	1 457 433 626	S 3626
AP 071	1 457 433 603	S 3603
AP0712	1 457 433 054	S 3054
AP 072	1 457 433 713	S 3713
AP 072/1	F 026 400 097	S 0097
AP 074	1 457 433 609	S 3609
AP 074/1	1 457 433 686	S 3686
AP 074/2	1 457 433 088	S 3088
AP 074/3	1 457 433 047	S 3047
AP0744	1 457 433 323	S 3323
AP0745	1 457 433 099	S 3099
AP0746	1 457 433 096	S 3096
AP 075	1 457 433 269	S 3269
AP 076	1 457 433 255	S 3255
AP 077	1 457 433 256	S 3256
AP 078	1 457 433 259	S 3259
AP 079	1 457 433 623	S 3623
AP 080	1 457 433 606	S 3606
AP 080/1	1 457 433 297	S 3297
AP08010	1 987 429 182	S 9182
AP 080/2	1 457 433 526	S 3526
AP 080/3	1 457 433 543	S 3543
AP 080/4	1 457 433 280	S 3280
AP0805	1 457 433 527	S 3527
AP0806	F 026 400 010	S 0010
AP 080/7	1 457 433 280	S 3280
AP 080/8	1 457 433 555	S 3555
AP 080/9	1 457 433 061	S 3061
AP 081	1 457 429 781	S 9781
AP 082	1 457 433 003	S 3003
AP 082/1	1 457 433 963	S 3963
AP0825	F 026 400 043	S 0043
AP 082/6	F 026 400 163	S 0163
AP 086	1 457 433 253	S 3253
AP 088	1 457 433 697	S 3697
AP 089	1 457 429 793	S 9793

AP 089/1	1 457 433 616	S 3616
AP 090	1 457 432 200	S 2200
AP0901	1 457 433 596	S 3596
AP 090/2	F 026 400 108	S 0108
AP0903	1 457 433 327	S 3327
AP0904	1 457 433 591	S 3591
AP 091	1 457 433 265	S 3265
AP 091/1	1 457 433 265	S 3265
AP 091/2	1 457 433 265	S 3265
AP 091/3	1 457 433 265	S 3265
AP 091/4	1 457 433 265	S 3265
AP 092	1 457 433 257	S 3257
AP 092/1	1 457 433 257	S 3257
AP 092/2	1 457 433 520	S 3520
AP092/8	F 026 400 041	S 0041
AP 093	1 457 433 286	S 3286
AP 095	1 457 433 541	S 3541
AP 098	1 457 433 253	S 3253
AP 098/1	1 457 433 289	S 3289
AP 099	1 457 433 608	S 3608
AP 102	1 457 433 950	S 3950
AP 102/1	1 457 433 970	S 3970
AP 103	1 987 429 136	S 9136
AP 104	1 457 433 951	S 3951
AP 104/1	1 457 433 955	S 3955
AP104/3	1 987 429 176	S 9176
AP104/4	1 987 429 178	S 9178
AP 108/1	1 457 433 290	S 3290
AP1084	1 457 433 097	S 3097
AP 111	1 987 429 146	S 9146
AP1111	1 457 433 066	S 3066
AP 112	1 457 433 605	S 3605
AP1131	1 987 429 188	S 9188
AP 118	1 457 433 752	S 3752
AP 118/1	1 457 433 699	S 3699
AP 118/2	1 457 433 052	S 3052
AP 118/3	1 457 433 071	S 3071
AP11832x	1 457 433 071	S 3071
AP 118/4	1 457 433 701	S 3701
AP 118/5	1 457 433 751	S 3751
AP 118/6	1 457 433 752	S 3752
AP 118/7	1 457 433 523	S 3523
AP1189	1 457 433 065	S 3065
AP 120	1 457 433 968	S 3968
AP 123	1 987 429 148	S 9148
AP 123/2	1 987 429 051	S 9051
AP 124	1 457 433 273	S 3273
AP 125	1 987 429 123	S 9123
AP 127	1 457 433 571	S 3571
AP 128	1 457 433 571	S 3571
AP 128/1	1 457 433 571	S 3571
AP 129	1 457 433 571	S 3571
AP 129/2	1 457 433 547	S 3547
AP 129/3	1 457 433 549	S 3549
AP 130/1	1 457 433 090	S 3090

AP 130/2	1 457 433 150	S 3150
AP130/4	F 026 400 023	S 0023
AP 132	1 457 433 260	S 3260
AP 133	1 457 433 743	S 3743
AP 133/2	1 457 433 078	S 3078
AP 134	1 457 433 266	S 3266
AP 134/1	1 457 433 282	S 3282
AP 134/2	1 457 433 531	S 3531
AP 134/4	1 457 433 163	S 3163
AP 134/5	1 457 433 577	S 3577
AP1347	1 457 433 595	S 3595
AP1348	1 457 433 660	S 3660
AP 135/2	1 457 433 075	S 3075
AP 137/1	F 026 400 014	S 0014
AP137/3	F 026 400 103	S 0103
AP 138	1 457 433 736	S 3736
AP1391	1 457 433 058	S 3058
AP1392	1 987 429 404	S 9404
AP140	1 457 433 264	S 3264
AP 143	1 987 429 151	S 9151
AP144	F 026 400 038	S 0038
AP 146	1 987 429 135	S 9135
AP 148	1 457 433 952	S 3952
AP 149	1 457 433 642	S 3642
AP 149/1	1 457 433 714	S 3714
AP 149/2-2X	1 457 433 539	S 3539
AP1494	1 457 433 319	S 3319
AP1496	1 987 429 403	S 9403
AP1497	1 457 433 315	S 3315
AP1498	1 457 433 102	S 3102
AP 150	1 457 433 617	S 3617
AP 150/1	F 026 400 110	S 0110
AP 151	1 457 433 605	S 3605
AP 151/1	1 457 433 711	S 3711
AP1513	1 457 433 083	S 3083
AP 152	1 457 433 740	S 3740
AP 152/1	1 457 433 578	S 3578
AP 152/2	1 457 433 579	S 3579
AP 153	1 457 433 741	S 3741
AP 154	1 457 433 274	S 3274
AP 154/1	1 987 429 051	S 9051
AP 155	1 457 433 003	S 3003
AP 155	1 457 433 303	S 3303
AP 156	1 457 433 268	S 3268
AP 156/1	F 026 400 096	S 0096
AP 157	1 457 433 748	S 3748
AP 157/1	1 457 433 703	S 3703
AP 157/2	1 457 433 747	S 3747
AP1574	1 457 433 331	S 3331
AP 158	1 457 433 753	S 3753
AP 159	1 457 433 742	S 3742
AP 160	1 457 429 869	S 9869
AP 165	1 457 433 272	S 3272
AP 165/1	1 457 433 536	S 3536
AP1652	1 457 433 300	S 3300



◀ FILTRON

AP1653	1 457 433 587	S 3587
AP1654	1 457 433 583	S 3583
AP 167	1 457 433 784	S 3784
AP 167/2	1 457 433 533	S 3533
AP 168	1 457 433 959	S 3959

AP 170	1 457 433 957	S 3957
AP 172	1 457 433 954	S 3954
AP 172/1	1 457 433 965	S 3965
AP 173/1	1 457 433 956	S 3956
AP 175	1 457 433 969	S 3969

AP 176	1 457 433 953	S 3953
AP1774	1 457 433 584	S 3584
AP1775	1 457 433 580	S 3580
AP 177/6	F 026 400 062	S 0062
AP 178	1 457 433 060	S 3060

AP 179	1 457 429 792	S 9792
AP1791	1 457 433 772	S 3772
AP1792	1 457 433 046	S 3046
AP 180	1 457 433 276	S 3276
AP 181	1 457 433 535	S 3535

AP 182	1 457 433 260	S 3260
AP 182/4	F 026 400 107	S 0107
AP 182/6	F 026 400 113	S 0113
AP1827	F 026 400 060	S 0060
AP 183	1 457 433 716	S 3716

AP1831	1 457 433 574	S 3574
AP1832	F 026 400 019	S 0019
AP 184	1 987 429 152	S 9152
AP 185	1 457 433 773	S 3773
AP 185/1	1 457 433 529	S 3529

AP1852	1 987 429 406	S 9406
AP1853	1 457 433 573	S 3573
AP 186	1 457 433 089	S 3089
AP 186	1 457 433 742	S 3742
AP 186/1	F 026 400 109	S 0109

AP 187/1	1 457 433 781	S 3781
AP 187/4	1 457 433 550	S 3550
AP 188	1 457 433 263	S 3263
AP 188/2	1 457 429 839	S 9839
AP1884	1 457 433 797	S 3797

AP1886	1 457 433 655	S 3655
AP 189	1 457 433 532	S 3532
AP191	F 026 400 094	S 0094
AP 192	1 457 433 593	S 3593
AP193	1 457 433 546	S 3546

AP1998	1 457 433 571	S 3571
AP 458/1	F 026 400 078	S 0078
AR 001	1 457 429 959	S 9959
AR 033	1 457 429 992	S 9992
AR 036	1 457 429 787	S 9787

AR 036/1	1 457 429 948	S 9948
AR 037	1 457 429 970	S 9970
AR1311	1 457 433 311	S 3311
AR1348	1 457 433 660	S 3660
AR 146	1 987 429 135	S 9135

AR2006	1 457 433 568	S 3568
AR 201	1 457 429 054	S 9054
AR 202	1 457 429 053	S 9053
AR 203	1 457 429 050	S 9050
AR 204	1 457 429 080	S 9080

AR 206	1 457 429 920	S 9920
AR 209	1 457 429 064	S 9064
AR 212	1 457 433 732	S 3732
AR 214	1 457 432 108	S 2108
AR 223	1 457 429 954	S 9954

AR 225	1 457 429 845	S 9845
AR 228	1 987 429 115	S 9115
AR 229	1 457 432 134	S 2134
AR 230	1 457 432 111	S 2111
AR 232	1 457 429 953	S 9953

AR 232/1	1 457 433 521	S 3521
AR 234/2	1 457 433 553	S 3553
AR 236	1 457 432 106	S 2106
AR 239	1 457 429 801	S 9801
AR 246/2	F 026 400 061	S 0061

AR 247	1 457 432 154	S 2154
AR252	1 457 432 106	S 2106
AR 255	1 457 429 064	S 9064
AR 257	1 457 433 231	S 3231
AR 257/1	1 457 433 624	S 3624

AR 257/3	1 457 433 161	S 3161
AR 263	1 457 432 138	S 2138
AR 265	1 457 429 795	S 9795
AR 265/1	1 457 433 712	S 3712
AR 266	1 457 429 890	S 9890

AR 266/1	1 457 429 890	S 9890
AR 274	1 457 429 841	S 9841
AR 275	1 457 432 124	S 2124
AR 276	1 457 429 923	S 9923
AR 282	1 457 433 233	S 3233

AR 284	1 457 432 204	S 2204
AR285	1 457 433 332	S 3332
AR286	1 457 433 652	S 3652
AR 291	1 457 429 800	S 9800
AR 304/1	1 457 433 154	S 3154

AR 305	1 457 433 230	S 3230
AR 307	1 457 433 734	S 3734
AR 308	1 457 433 544	S 3544
AR 311	1 457 433 227	S 3227
AR 314	1 457 433 229	S 3229

AR 314/1	1 457 433 077	S 3077
AR 316	1 457 433 790	S 3790
AR3181	1 457 433 791	S 3791
AR 327/1	1 457 433 715	S 3715
AR3272	1 457 433 069	S 3069

AR 329	1 987 429 121	S 9121
AR 330	1 987 429 159	S 9159
AR 347/2	1 457 433 785	S 3785
AR 348	1 457 433 791	S 3791
AR 348/1	1 457 433 791	S 3791

AR 349	F 026 400 011	S 0011
AR 352	1 457 433 534	S 3534
AR 353	1 987 429 042	S 9042/1
AR 364	1 457 433 739	S 3739
AR 366	1 457 429 839	S 9839

AR 366/1	1 457 429 900	S 9900
AR3662	1 457 433 590	S 3590
AR371	1 987 429 400	S 9400
FF5471	F 026 402 034	N 2034
K 1010 A	1 987 432 306	R 2306

K1011	1 987 432 105	M 2105
K1038	1 987 432 107	M 2107
K1041	1 987 432 151	M 2151
K 1042	1 987 432 150	M 2150
K 1044	1 987 432 052	M 2052

K10442x	1 987 432 052	M 2052
K 1056	1 987 432 042	M 2042
K1060	1 987 432 075	M 2075
K 1062	1 987 432 060	M 2060
K10622x	1 987 432 060	M 2060

K 1063	1 987 432 060	M 2060
K1083	1 987 432 084	M 2084
K1084	1 987 431 159	M 1159
K1090	1 987 432 066	M 2066
K1091	1 987 432 152	M 2152

K1096	1 987 432 058	M 2058
K1123	1 987 432 088	M 2088
K1128	1 987 432 091	M 2091
K1133	1 987 431 163	M 1163
K 1133A	1 987 431 458	R 1458

K1144	1 987 431 165	M 1165
K 1153	1 987 431 154	M 1154
K1155	1 987 432 114	M 2114
K1161A	1 987 432 092	M 2092
K1171	1 987 431 166	M 1166

K1176	1 987 432 108	M 2108
K1183	1 987 432 084	M 2084
K11982x	1 987 432 074	M 2074
K 1211 A	1 987 432 597	R 2597
K 1238A	1 987 432 406	R 2406

K 1248-2X	1 987 432 078	M 2078
K1264	1 987 432 236	M 2236
OC 601/1	1 457 429 267	P 9267
OC 602	1 457 429 274	P 9274
OC 604	1 457 429 175	P 9175

OE 640/1	1 457 429 619	P 9619
OE6406	1 457 429 272	P 9272
OE640/7	1 457 429 126	P 9126
OE 646	1 457 429 107	P 9107
OE 646/1	1 457 429 137	P 9137

OE 646/2	F 026 407 051	P 7051
OE 648/1	1 457 429 157	P 9157
OE 648/4	1 457 429 199	P 9199
OE6485	1 457 429 248	P 9248
OE648/8	F 026 407 073	P 7073

OE 649/2	1 457 429 119	P 9119
OE 649/5	1 457 429 118	P 9118
OE6497	1 457 429 185	P 9185
OE6498	1 457 429 252	P 9252
OE 650	1 457 429 152	P 9152

OE 651	1 457 429 128	P 9128
OE 651/1	F 026 407 040	P 7040
OE6512	F 026 407 026	P 7026
OE 651/3	F 026 407 042	P 7042
OE662/2	F 026 407 075	P 7075

OE6651	1 457 429 239	P 9239
OE6661	1 457 429 198	P 9198
OE667/1	1 457 429 238	P 9238
OE669	1 457 429 284	P 9284
OE6691	1 457 429 271	P 9271

OE 671	1 457 429 194	P 9194
OE6741	1 457 429 308	P 9308
OE 676/1	F 026 407 047	P 7047
OE 683	F 026 407 070	P 7070
OM 502	0 451 403 001	P 3001

OM507	1 457 429 175	P 9175
OM 507 T	1 457 429 175	P 9175
OM 512	1 457 429 820	P 9820
OM 513	1 457 429 646	P 9646
OM 513/1	1 457 429 732	P 9732

OM51312x	1 457 429 732	P 9732
OM 513/2	1 457 429 277	P 9277
OM 514	1 457 429 740	P 9740
OM 514/1	1 457 429 740	P 9740
OM 514/2	1 457 429 735	P 9735

OM 514/4	1 457 429 600	P 9600
OM 516	1 457 429 647	P 9647
OM 516/2	1 457 429 276	P 9276
OM 518	0 451 103 141	P 3141
OM521	1 457 429 636	P 9636

OM 522/1	1 457 429 251	P 9251
OM 522/2	1 457 429 275	P 9275
OM 523/1	1 457 429 123	P 9123
OM 523/2	1 457 429 154	P 9154
OM 529	1 457 429 130	P 9130

OM 529 T	1 457 429 130	P 9130
OM 529 T	1 457 429 629	P 9629
OM 584/1	0 451 105 188	P 5188
OM 611	1 457 429 165	P 9165
OM 611/1	1 457 429 174	P 9174

OP 520	0 451 103 274	P 3274
OP 520/1	0 451 103 274	P 3274
OP 525/1	0 451 103 249	P 3249
OP 525/2	0 451 103 289	P 3289
OP 525/3	0 451 103 290	P 3290

OP 525/4	0 451 103 347	P 3347
OP 525/5	0 451 103 257	P 3257
OP 531	0 451 203 005	P 3005
OP 533	0 451 103 029	P 3029
OP 536	0 986 452 016	P 2016

OP 539	0 986 452 019	P 2019
OP 541	0 451 103 232	P 3232
OP 542	0 451 203 108	P 3108
OP 543	0 451 103 252	P 3252
OP 550	0 451 103 028	P 3028

OP 555	0 986 452 020	P 2020
OP 562	0 986 452 003	P 2003
OP 563	0 451 203 194	P 3194
OP 563/1	0 451 203 194	P 3194
OP 564	0 986 452 058	P 2058

OP5661	0 451 103 274	P 3274
OP 567	0 986 452 024	P 2024
OP 567/1	0 986 452 024	P 2024
OP 569	0 451 203 223	P 3223
OP 569/1	0 451 103 260	P 3260

OP 571	0 986 452 015	P 2015
OP 572	0 986 452 028	P 2028
OP 574/1	0 451 203 010	P 3010
OP 574/2	0 451 103 368	P 3368
OP 576	0 451 103 004	P 3004

OP 577	0 451 203 226	P 3226
OP 580/2	0 451 103 311	P 3311
OP 581	0 986 452 000	P 2000
OP 581	0 986 452 023	P 2023
OP 583	0 451 103 276	P 3276

OP 583	0 986 452 028	P 2028
OP 584	0 451 403 077	P 3077
OP 584/1	0 451 105 188	P 5188
OP 586/2	0 451 103 235	P 3235
OP 587	0 986 452 042	P 2042

OP 588	0 986 452 046	P 2046
OP 588/1	0 451 103 357	P 3357
OP 589	0 451 103 270	P 3270
OP 592	0 451 105 067	P 5067
OP5921	F 026 407 049	P 7049

OP5923	0 451 301 156	P 1156
OP 592/5	F 026 407 053	P 7053
OP 592/6	F 026 407 048	P 7048
OP 594	0 451 203 201	P 3201
OP594/2	F 026 407 106	P 7106

OP 595	0 986 452 061	P 2061
OP 612	0 986 452 060	P 2060
OP 613	0 986 452 035	P 2035
OP 616/2	0 451 103 337	P 3337
OP 617	0 451 103 275	P 3275

OP 618	0 986 452 044	P 2044
OP 619	0 986 452 030	P 2030
OP 619/1	0 986 452 062	P 2062
OP 620	0 451 103 109	P 3109
OP 622	0 986 452 064	P 2064

OP 625	0 451 103 217	P 3217
OP 626	0 451 301 207	P 1207
OP 626/1	0 451 403 208	P 3208
OP 626/2	0 451 104 013	P 4013
OP 626/6	F 026 407 057	P 7057

OP 630	0 451 103 297	P 3297
OP631	0 451 300 003	P 0003
OP 631	0 451 403 001	P 3001
OP 632/2	0 451 103 270	P 3270
OP6324	0 451 103 366	P 3366

OP 632/7	F 026 407 084	P 7084
OP 637	0 986 452 061	P 2061
OP 642	0 986 452 061	P 2061
OP 643/1	0 451 103 240	P 3240
OP 644	0 451 103 258	P 3258

OP 647	0 451 104 066	P 4066
OP 647/3	0 451 104 005	P 4005
OP 668	0 451 103 330	P 3330
OR745	F 026 407 059	P 7059
OR7451	F 026 407 060	P 7060

OR7452	F 026 407 058	P 7058
PA7487	F 026 400 166	S 0166
PE 816/3	1 457 030 013	N 0013
PE8165	1 457 431 723	N 1723
PE823A	1 457 429 354	N 9354

PE 935	1 457 429 655	N 9655
PE 935/1	1 457 431 707	N 1707
PE 962	1 457 431 704	N 1704
PE973	1 457 431 715	N 1715
PE9732	F 026 402 008	N 2008

PE 9734	F 026 402 101	N 2101
PE 975	F 026 402 033	N 2033
PE977	1 457 431 710	N 1710
PE 977/1	F 026 402 028	N 2028
PM 801T	1 457 431 159	N 1159

PM 802T	1 457 431 270	N 1270
PM 802T	1 457 431 326	N 1326
PM 806	1 457 431 158	N 1158
PM 807	1 457 431 261	N 1261
PM 807	1 457 431 325	N 1325

PM808	1 457 431 270	N 1270
PM 808T	1 457 431 270	N 1270
PM 808T	1 457 431 326	N 1326
PM 809T	1 457 431 159	N 1159
PM 813/1	1 457 431 261	N 1261

PM 813/1	1 457 431 325	N 1325
PM 815	1 457 431 028	N 1028
PM 815/1	1 457 429 657	N 9657
PM 815/3	F 026 402 047	N 2047
PM 816	1 457 429 289	N 9289

PM 816/1	1 457 431 705	N 1705
PM 819	1 457 434 201	N 4201
PM 819/1	1 457 434 201	N 4201
PM 819/1T	1 457 434 201	N 4201
PM 844	1 457 434 200	N 4200

PM858	1 457 431 713	N 1713
PM8581	1 457 431 702	N 1702
PM8581A	1 457 431 702	N 1702
PM 858/2	1 457 429 621	N 9621
PM 936	1 457 429 656	N 9656



◀ FILTRON

PP 824	0 450 905 021	F 5021
PP 825	0 450 905 200	F 5200
PP 825	0 450 905 601	F 5601
PP 827	0 450 905 087	F 5087
PP 827	0 450 905 401	F 5401

PP827	0 450 905 906	F 5906
PP 829	0 450 905 005	F 5005
PP 830	0 450 902 151	F 2151
PP 831	0 450 905 002	F 5002
PP 831	0 450 905 280	F 5280

PP 831/1	0 450 905 287	F 5287
PP 832	0 450 905 901	F 5901
PP 833	0 450 905 021	F 5021
PP 834	0 450 905 177	F 5177
PP 835	0 450 905 203	F 5203

PP 836/1	0 450 905 318	F 5318
PP 836/3	F 026 403 008	F 3008
PP8363	0 450 905 925	F 5925
PP8365	F 026 403 003	F 3003
PP 837	1 457 434 106	N 4106

PP 837/1	1 457 434 447	N 4447
PP 840	1 457 434 153	N 4153
PP 841	1 457 434 123	N 4123
PP 841/1	0 450 905 930	N 5930
PP 841/7	F 026 402 056	N 2056

PP 843	1 457 434 103	N 4103
PP 845	1 457 434 154	N 4154
PP 845	1 457 434 165	N 4165
PP 845	1 457 434 296	N 4296
PP 845/1	1 457 434 447	N 4447

PP 845/2	1 457 434 154	N 4154
PP 845/2	1 457 434 432	N 4432
PP 848/1	1 457 434 400	N 4400
PP 849	0 450 905 091	F 5091
PP 849	0 450 905 133	F 5133

PP 850	1 457 434 184	N 4184
PP 850/2	1 457 434 329	N 4329
PP852	1 457 434 453	N 4453
PP 854/1	1 457 434 186	N 4186
PP 857	1 457 434 281	N 4281

PP8571	1 457 434 439	N 4439
PP 861	1 457 429 676	N 9676
PP 861/1	1 457 429 675	N 9675
PP 861/2	F 026 402 035	N 2035
PP8612	1 457 429 676	N 9676

PP8613	1 457 429 675	N 9675
PP 861/4	F 026 402 037	N 2037
PP 863	0 450 905 924	F 5924
PP 863	0 986 450 113	F 0113
PP 864	1 457 434 105	N 4105

PP 865	0 450 905 324	F 5324
PP 865/2	0 450 905 939	F 5939
PP 866	0 450 905 195	F 5195
PP 866	0 450 905 216	F 5216
PP 866/1	0 450 905 908	F 5908

PP 870	0 986 450 104	F 0104
PP 872	0 986 450 100	F 0100
PP 875/1	0 450 905 915	F 5915
PP 876/1	0 450 905 924	F 5924
PP 876/1	0 986 450 113	F 0113

PP 879	1 457 429 681	N 9681
PP 879/2	1 457 434 432	N 4432
PP 879/4	F 026 402 034	N 2034
PP 880	0 986 450 108	F 0108
PP 885	0 986 450 102	F 0102

PP 887	0 986 450 106	F 0106
PP 889	0 986 450 105	F 0105
PP 903	0 450 905 326	F 5326
PP 905	0 450 905 273	F 5273
PP 905	0 450 905 316	F 5316

PP 905/1	0 450 905 273	F 5273
PP 905/1	0 450 905 316	F 5316
PP 905/2	0 450 905 273	F 5273
PP 905/2	0 450 905 316	F 5316
PP 906	0 450 905 903	F 5903

PP 907	0 450 905 904	F 5904
PP 909	0 986 450 114	F 0114
PP 912/1	0 450 905 920	F 5920
PP 915	0 986 450 109	F 0109
PP 918	0 986 450 110	F 0110

PP 918/1	0 986 450 115	F 0115
PP 928/1	0 450 905 912	F 5912
PP 930	0 450 905 916	F 5916
PP932	1 457 434 291	N 4291
PP934	1 457 434 453	N 4453

PP 940	1 457 434 187	N 4187
PP 942	0 450 905 911	F 5911
PP 947	0 450 915 001	F 5001
PP 947/1	0 450 915 003	F 5003
PP 949	0 986 450 222	F 0222

PP 964	1 457 434 294	N 4294
PP 964/1	F 026 402 017	N 2017
PP966	0 450 906 452	N 6452
PP 966/2	F 026 402 049	N 2049
PP967	F 026 402 025	N 2025

PP9684	F 026 402 013	N 2013
PP971	1 457 434 421	N 4421
PP9761	0 450 906 462	N 6462
PP 987	F 026 402 043	N 2043
PS 820	0 450 904 077	N 4077

PS 821	0 450 904 060	F 4060
PS 822	0 450 904 149	F 4149
PS 842	0 450 904 058	F 4058
PS 862	0 986 450 018	F 0018
PS 883	0 986 450 117	F 0117

PS 901	0 986 450 138	F 0138
PS 913	0 986 450 030	F 0030
PS 914	0 986 450 137	F 0137
PS 916	0 986 450 018	F 0018
PS 917	0 986 450 039	F 0039

PS974	0 450 906 460	N 6460
PS 974/1	0 450 906 471	N 6471
PW 809	1 457 431 159	N 1159
PW 809T	1 457 431 159	N 1159
PW 813	1 457 431 158	N 1158

PW 813/1	1 457 431 261	N 1261
PW 813/1	1 457 431 325	N 1325
PW 814	1 457 429 359	N 9359
PW 823	1 457 429 354	N 9354
WF8214	0 986 450 123	F 0123

676/1N	F 026 407 047	P 7047
861/2N	F 026 402 035	N 2035
8613N	1 457 434 419	N 4419
984N	1 457 429 230	N 9230

FRAM

CAK253	1 457 429 933	S 9933
CAK256	1 457 433 200	S 3200
CAK1544	1 457 429 794	S 9794

CAK3193	1 457 433 646	S 3646
CAK3272	1 457 433 201	S 3201
CAK5722	1 987 429 169	S 9169
CAK5722	1 987 429 186	S 9186
CA10050	1 457 433 585	S 3585

CA10051	1 457 433 594	S 3594
CA10058	1 457 433 315	S 3315
CA10064	F 026 400 090	S 0090
CA10070	F 026 400 013	S 0013
CA10086	F 026 400 044	S 0044

CA10088	F 026 400 048	S 0048
CA10097	1 457 433 579	S 3579
CA10116	F 026 400 002	S 0002
CA10117	1 457 433 584	S 3584
CA10143	F 026 400 016	S 0016

CA10144	F 026 400 020	S 0020
CA10165	F 026 400 098	S 0098
CA10169	F 026 400 188	S 0188
CA10190	F 026 400 114	S 0114
CA10198	F 026 400 041	S 0041

CA10201	F 026 400 201	S 0201
CA10211	F 026 400 097	S 0097
CA 10212	F 026 400 049	S 0049
CA10213	F 026 400 110	S 0110
CA10224	F 026 400 121	S 0121

CA10233	F 026 400 054	S 0054
CA10249	1 457 433 529	S 3529
CA10250	1 457 433 163	S 3163
CA10251	1 457 433 531	S 3531
CA10252	F 026 400 015	S 0015

CA10286	F 026 400 125	S 0125
CA10290	F 026 400 106	S 0106
CA10296	F 026 400 143	S 0143
CA10306	F 026 400 102	S 0102
CA10314	F 026 400 051	S 0051

CA10327	F 026 400 058	S 0058	CA3565	1 457 432 106	S 2106	CA4801	1 457 433 553	S 3553
CA10330	F 026 400 055	S 0055	CA3688	1 457 433 734	S 3734	CA4813	1 457 432 138	S 2138
CA10356	F 026 400 109	S 0109	CA376	1 457 433 534	S 3534	CA4818	1 457 433 534	S 3534
CA10378	1 457 433 333	S 3333	CA3783	1 457 429 818	S 9818	CA4877	1 457 429 954	S 9954
CA10379	1 457 433 334	S 3334	CA3874	1 987 429 135	S 9135	CA4893	1 457 432 188	S 2188
CA10412	F 026 400 161	S 0161	CA3901	1 457 433 298	S 3298	CA4896	1 457 429 923	S 9923
CA10417	F 026 400 150	S 0150	CA3943	1 457 433 230	S 3230	CA4904	1 987 429 042	S 9042/1
CA10446	F 026 400 052	S 0052	CA3998	1 987 429 125	S 9125	CA4924	1 457 433 274	S 3274
CA10472	1 457 433 583	S 3583	CA4202	1 457 429 946	S 9946	CA4940	1 987 429 122	S 9122
CA10496	F 026 400 160	S 0160	CA4202SY	F 026 400 082	S 0082	CA4946	1 457 429 970	S 9970
CA10519	F 026 400 163	S 0163	CA4215	1 457 429 899	S 9899	CA4964	1 457 429 970	S 9970
CA10565	F 026 400 159	S 0159	CA4215	1 457 429 969	S 9969	CA4966	1 457 429 890	S 9890
CA10595	F 026 400 176	S 0176	CA4219	1 457 429 944	S 9944	CA4974	1 457 433 229	S 3229
CA10630	F 026 400 127	S 0127	CA4263	1 457 432 146	S 2146	CA4979	1 987 429 042	S 9042/1
CA10651	F 026 400 138	S 0138	CA4275	1 457 429 993	S 9993	CA5107	1 457 429 877	S 9877
CA10699	F 026 400 137	S 0137	CA4285	1 987 429 115	S 9115	CA5107	1 457 433 698	S 3698
CA10700	F 026 400 119	S 0119	CA4309	1 457 429 894	S 9894	CA5108	1 457 429 870	S 9870
CA1892	1 987 429 177	S 9177	CA4309	1 987 429 051	S 9051	CA5108	1 457 433 310	S 3310
CA2628	1 457 433 732	S 3732	CA4317	1 457 429 915	S 9915	CA5111	1 457 432 200	S 2200
CA2649	1 457 429 064	S 9064	CA4335	1 457 429 992	S 9992	CA5111B	1 457 432 200	S 2200
CA2663	1 457 432 106	S 2106	CA4354	1 457 432 134	S 2134	CA5111D	1 457 432 200	S 2200
CA2663A	1 457 432 106	S 2106	CA4365	1 457 429 085	S 9085	CA5111G	1 457 432 200	S 2200
CA2691	1 457 429 800	S 9800	CA4369	1 987 429 109	S 9109	CA5125	1 987 429 137	S 9137
CA2724	1 457 429 054	S 9054	CA4379	1 457 429 923	S 9923	CA5128	1 987 429 042	S 9042/1
CA2729	1 457 429 053	S 9053	CA4385	1 457 429 845	S 9845	CA5137	1 987 429 172	S 9172
CA2732	1 457 429 064	S 9064	CA4412	1 457 432 192	S 2192	CA5140	1 457 432 183	S 2183
CA2740	1 457 429 806	S 9806	CA4419	1 457 429 994	S 9994	CA5144	1 457 429 875	S 9875
CA3105	1 457 429 932	S 9932	CA4499	1 457 429 953	S 9953	CA5149	1 457 429 869	S 9869
CA3118	1 457 429 050	S 9050	CA4521	1 457 429 928	S 9928	CA5160	1 457 429 819	S 9819
CA3118	1 457 429 959	S 9959	CA4524	1 457 433 231	S 3231	CA5161	1 457 429 775	S 9775
CA3121	1 457 432 111	S 2111	CA4539	1 457 429 875	S 9875	CA5164	1 457 433 308	S 3308
CA3144	1 457 429 030	S 9030	CA4540	1 457 432 203	S 2203	CA5184	1 457 433 690	S 3690
CA3146	1 457 429 900	S 9900	CA4555	1 457 432 172	S 2172	CA5191	1 987 429 150	S 9150
CA3154	1 457 432 124	S 2124	CA4556	1 457 432 173	S 2173	CA5205	1 457 429 842	S 9842
CA3159	1 457 429 080	S 9080	CA4561	1 457 432 204	S 2204	CA5207	1 987 429 150	S 9150
CA3174	1 457 429 908	S 9908	CA4567	1 457 429 895	S 9895	CA5209	1 457 433 294	S 3294
CA3174A	1 457 429 908	S 9908	CA4567	1 457 429 898	S 9898	CA5222	1 457 433 627	S 3627
CA3174B	1 457 429 908	S 9908	CA4568	1 457 429 987	S 9987	CA5227	1 457 429 846	S 9846
CA3245	1 987 429 117	S 9117	CA4570	F 026 400 085	S 0085	CA5228	1 457 433 250	S 3250
CA3249	1 457 429 942	S 9942	CA4575	1 457 429 983	S 9983	CA5229	1 457 429 841	S 9841
CA3276	1 457 429 966	S 9966	CA4576	1 457 429 964	S 9964	CA5231	1 457 429 778	S 9778
CA3280	1 457 429 975	S 9975	CA4579	1 457 429 988	S 9988	CA5233	1 457 429 778	S 9778
CA3281	1 457 429 950	S 9950	CA4580	1 457 429 783	S 9783	CA5233	1 457 433 750	S 3750
CA3294	1 457 429 942	S 9942	CA4582	1 457 429 854	S 9854	CA5266	1 457 433 285	S 3285
CA3295	1 457 429 941	S 9941	CA4594	1 457 433 732	S 3732	CA5267	1 457 433 259	S 3259
CA3333	1 457 429 054	S 9054	CA4597	1 457 432 185	S 2185	CA5279	1 987 429 148	S 9148
CA3333	1 457 429 915	S 9915	CA4598	1 457 432 180	S 2180	CA5294	1 457 429 844	S 9844
CA3333	1 457 433 325	S 3325	CA4732	1 987 429 121	S 9121	CA530	1 457 429 777	S 9777
CA3333	1 457 433 540	S 3540	CA4739	1 457 429 920	S 9920	CA5301	1 457 429 777	S 9777
CA3373	1 457 429 076	S 9076	CA4744	1 457 433 652	S 3652	CA5304M	1 987 429 154	S 9154
CA3384	1 457 429 076	S 9076	CA4744A	1 457 433 652	S 3652	CA5308	1 457 433 233	S 3233
CA3399	1 457 429 061	S 9061	CA4760	1 457 432 154	S 2154	CA5309	1 457 429 923	S 9923
CA3441	1 457 429 957	S 9957	CA4760	1 457 433 544	S 3544	CA5329	1 457 433 227	S 3227
CA352	1 457 429 800	S 9800	CA4778	1 987 429 123	S 9123	CA5331	1 457 433 229	S 3229
CA353	1 457 429 801	S 9801	CA4790	1 457 429 983	S 9983	CA5345	1 457 433 795	S 3795



◀ FRAM

CA5349	1 457 429 781	S 9781
CA5350	1 457 433 004	S 3004
CA5351	1 457 429 814	S 9814
CA5352	1 457 433 269	S 3269
CA5357	1 457 429 791	S 9791

CA5358	1 457 433 736	S 3736
CA5367	1 457 429 795	S 9795
CA5368	1 457 433 735	S 3735
CA5369	1 457 433 275	S 3275
CA5370	1 457 433 023	S 3023

CA5371	1 457 433 003	S 3003
CA5376	1 457 433 253	S 3253
CA5377	1 457 433 264	S 3264
CA5378	1 457 433 008	S 3008
CA5383	1 457 429 941	S 9941

CA5393	1 987 429 170	S 9170
CA5397	1 457 429 896	S 9896
CA5397	1 457 433 087	S 3087
CA5400	1 457 433 007	S 3007
CA5409	1 457 433 659	S 3659

CA5417	1 457 429 787	S 9787
CA5422	1 457 433 275	S 3275
CA5432	F 026 403 002	F 3002
CA5432	1 457 433 005	S 3005
CA5435	1 457 433 601	S 3601

CA5436	1 457 433 642	S 3642
CA5437	1 457 429 817	S 9817
CA5445	1 457 433 072	S 3072
CA5451	1 457 433 651	S 3651
CA5454SY	F 026 400 065	S 0065

CA5456	1 457 432 154	S 2154
CA5456	1 457 433 544	S 3544
CA5461	1 457 433 624	S 3624
CA5463	1 457 433 623	S 3623
CA5466	1 457 433 958	S 3958

CA5467	1 987 429 135	S 9135
CA5468	1 457 433 273	S 3273
CA5488	1 457 433 606	S 3606
CA5489	1 457 433 701	S 3701
CA5492	1 457 433 608	S 3608

CA5494	1 457 433 609	S 3609
CA5495	1 457 433 541	S 3541
CA5496	1 457 433 309	S 3309
CA5496	1 457 433 603	S 3603
CA5501	1 457 433 713	S 3713

CA5517	1 457 433 257	S 3257
CA5517A	1 457 433 257	S 3257
CA5518	1 457 433 256	S 3256
CA5519	1 457 433 255	S 3255
CA5522	1 457 433 547	S 3547

CA5538	1 457 433 263	S 3263
CA5539	1 457 433 752	S 3752
CA5554	1 457 433 260	S 3260
CA5560	1 457 433 607	S 3607
CA5564	1 457 429 793	S 9793

CA5572	1 987 429 155	S 9155
CA5578	1 457 433 711	S 3711
CA5579	1 457 433 571	S 3571
CA5580	1 457 433 571	S 3571
CA5581	1 457 433 571	S 3571

CA5585	F 026 400 207	S 0207
CA5590	1 987 431 159	M 1159
CA 5595 USA	1 457 433 959	S 3959
CA5597	1 457 433 253	S 3253
CA5611	1 457 433 790	S 3790

CA5612	1 457 433 791	S 3791
CA5613	1 457 433 266	S 3266
CA5627	1 457 433 303	S 3303
CA5630	1 457 433 265	S 3265
CA5630A	1 457 433 265	S 3265

CA5636	1 457 433 626	S 3626
CA5641	1 457 433 697	S 3697
CA5646	1 457 433 326	S 3326
CA5657	1 457 433 781	S 3781
CA5658	1 457 433 268	S 3268

CA5668	1 457 433 270	S 3270
CA5673	1 457 433 743	S 3743
CA5677	1 457 433 286	S 3286
CA5678	1 457 433 234	S 3234
CA5680	1 457 433 740	S 3740

CA5680	1 457 433 799	S 3799
CA5681	1 457 433 741	S 3741
CA5682	1 457 433 605	S 3605
CA5684	1 457 433 617	S 3617
CA5687	1 457 433 953	S 3953

CA5688	1 457 433 265	S 3265
CA5695	1 987 429 152	S 9152
CA5699	F 026 400 077	S 0077
CA5699	1 457 433 292	S 3292
CA5708	1 457 433 901	S 3901

CA5709	1 457 433 742	S 3742
CA5715	1 457 432 200	S 2200
CA5716	1 457 433 616	S 3616
CA5718	1 457 433 265	S 3265
CA5736	1 457 433 712	S 3712

CA5739	1 457 433 276	S 3276
CA5741	1 457 433 332	S 3332
CA5748	1 457 433 274	S 3274
CA5761	1 457 433 900	S 3900
CA5776	1 457 433 769	S 3769

CA5777	1 457 433 703	S 3703
CA5780	1 457 433 272	S 3272
CA5781	1 457 433 747	S 3747
CA5782	1 457 433 699	S 3699
CA5788	1 987 429 171	S 9171

CA5799	1 457 429 792	S 9792
CA5821	1 457 433 791	S 3791
CA5826	1 457 433 753	S 3753
CA5827	1 457 433 714	S 3714
CA5829	1 457 433 060	S 3060

CA5830	1 457 429 793	S 9793
CA5854	1 457 433 771	S 3771
CA5857	1 457 433 748	S 3748
CA5860	1 457 433 792	S 3792
CA5871	F 026 400 092	S 0092

CA5875	1 457 433 748	S 3748
CA5880	1 457 433 699	S 3699
CA5881	1 457 433 314	S 3314
CA5891	1 457 433 549	S 3549
CA5894	1 457 433 282	S 3282

CA5898	1 457 433 716	S 3716
CA5899	1 457 433 535	S 3535
CA5904	1 457 433 264	S 3264
CA5929	1 457 433 686	S 3686
CA5930	1 457 433 154	S 3154

CA5941	1 457 433 773	S 3773
CA5945	1 457 433 962	S 3962
CA5948	1 457 433 752	S 3752
CA5962	1 457 429 783	S 9783
CA5967	1 987 429 157	S 9157

CA5970	1 457 433 281	S 3281
CA5988	1 457 433 521	S 3521
CA5994	1 457 433 590	S 3590
CA6306	1 457 429 923	S 9923
CA6333	1 987 429 136	S 9136

CA6362	1 987 429 127	S 9127
CA6375	1 457 429 053	S 9053
CA6376	1 457 433 785	S 3785
CA6388	1 457 429 949	S 9949
CA6393	1 457 429 839	S 9839

CA 6394	F 026 400 038	S 0038
CA6395	1 987 429 135	S 9135
CA6541	1 457 433 605	S 3605
CA6544	1 987 429 133	S 9133
CA6545	1 457 429 777	S 9777

CA660	1 457 432 108	S 2108
CA660PL	1 457 432 108	S 2108
CA6664	1 457 433 037	S 3037
CA6666	1 457 433 651	S 3651
CA6690	1 457 433 952	S 3952

CA6807	1 457 433 950	S 3950
CA6828	1 987 429 146	S 9146
CA6843	1 457 429 786	S 9786
CA6867	1 457 433 961	S 3961
CA6868	1 457 433 002	S 3002

CA6870	1 457 429 948	S 9948
CA697	1 457 429 800	S 9800
CA697	1 987 429 161	S 9161
CA 70 PL	1 457 433 732	S 3732
CA7167	1 457 433 957	S 3957

CA7174	1 457 433 951	S 3951
CA7245	1 457 429 787	S 9787
CA7246	1 457 429 814	S 9814
CA7336	1 457 433 700	S 3700
CA7337	1 457 433 524	S 3524



CA7344	1 457 433 968	S 3968
CA7351	1 987 429 151	S 9151
CA7417	1 987 429 162	S 9162
CA7420	1 457 433 970	S 3970
CA7440	F 026 400 004	S 0004
CA7597	1 457 433 056	S 3056
CA7620	1 457 433 071	S 3071
CA7623	1 457 433 701	S 3701
CA7630	1 457 433 954	S 3954
CA7697	F 026 400 085	S 0085
CA7737	1 457 433 088	S 3088
CA7738	1 457 433 609	S 3609
CA7764	1 457 433 955	S 3955
CA7775	1 457 433 290	S 3290
CA8014	1 457 433 642	S 3642
CA8069	1 457 433 956	S 3956
CA8070	1 457 433 052	S 3052
CA8099	1 457 433 263	S 3263
CA8162	1 457 433 073	S 3073
CA8169	1 457 433 747	S 3747
CA8194	1 457 433 537	S 3537
CA8208	1 457 433 969	S 3969
CA8220	1 457 433 067	S 3067
CA8548	1 987 429 179	S 9179
CA8602	1 457 433 714	S 3714
CA8674	1 457 433 526	S 3526
CA8675	1 457 433 280	S 3280
CA8676	1 457 433 297	S 3297
CA8713	1 457 433 536	S 3536
CA8715	1 457 433 642	S 3642
CA8720	1 457 433 546	S 3546
CA8733	1 457 433 571	S 3571
CA8734	1 987 429 167	S 9167
CA8748	1 457 433 077	S 3077
CA8761	1 457 432 200	S 2200
CA8766	F 026 400 164	S 0164
CA8768	1 457 433 071	S 3071
CA87682	1 457 433 071	S 3071
CA8774	F 026 400 011	S 0011
CA8775	1 457 433 229	S 3229
CA8779	1 457 433 797	S 3797
CA8786	1 457 433 161	S 3161
CA8789	1 457 433 715	S 3715
CA8797	1 987 429 166	S 9166
CA8812	1 457 433 265	S 3265
CA8821	F 026 400 014	S 0014
CA8824	1 457 433 289	S 3289
CA8854	1 457 432 200	S 2200
CA8855	1 457 432 200	S 2200
CA8856	1 457 432 200	S 2200
CA8857	1 457 432 200	S 2200
CA8886	1 457 433 087	S 3087
CA8887	1 457 433 772	S 3772
CA8888	1 457 433 276	S 3276
CA8889	1 457 433 751	S 3751
CA8899	1 457 433 520	S 3520
CA8900	1 457 433 553	S 3553
CA8919	1 457 433 070	S 3070
CA8922	1 987 429 188	S 9188
CA8926	1 457 433 307	S 3307
CA8934	1 457 433 588	S 3588
CA8937	1 457 433 739	S 3739
CA8939	1 457 433 330	S 3330
CA8957	1 457 433 077	S 3077
CA8963	1 457 433 543	S 3543
CA8964	1 457 433 529	S 3529
CA8972	1 457 433 971	S 3971
CA8979	1 457 433 536	S 3536
CA8980	1 457 429 152	P 9152
CA8985	1 457 433 589	S 3589
CA8987	1 457 433 061	S 3061
CA8987	1 457 433 555	S 3555
CA8995	1 457 433 058	S 3058
CA8997	1 457 433 095	S 3095
CA9007	1 457 433 085	S 3085
CA9015	1 457 433 059	S 3059
CA9021	F 026 400 165	S 0165
CA9022	1 457 433 089	S 3089
CA9040	1 457 433 729	S 3729
CA9041	1 457 433 065	S 3065
CA9073	1 457 433 300	S 3300
CA9074	1 457 433 311	S 3311
CA9075	1 457 433 788	S 3788
CA9078	F 026 400 015	S 0015
CA9079	1 987 429 162	S 9162
CA9080	1 457 433 150	S 3150
CA9081	1 457 433 150	S 3150
CA9082	1 457 433 090	S 3090
CA9093	1 457 433 086	S 3086
CA9095	1 457 433 533	S 3533
CA9096	1 457 433 539	S 3539
CA90962	1 457 433 539	S 3539
CA9098	1 457 433 531	S 3531
CA9099	F 026 400 010	S 0010
CA9102	1 457 433 550	S 3550
CA9120	F 026 400 040	S 0040
CA9126	1 457 433 047	S 3047
CA9230	1 457 433 791	S 3791
CA9277	F 026 400 107	S 0107
CA9284	1 457 433 320	S 3320
CA9295	1 457 433 972	S 3972
CA9313	1 457 433 158	S 3158
CA9315	1 457 433 159	S 3159
CA9327	1 457 433 155	S 3155
CA9328	1 457 433 152	S 3152
CA9329	1 457 433 317	S 3317
CA9339	1 457 433 322	S 3322
CA9354	F 026 400 084	S 0084
CA9359	1 987 429 163	S 9163
CA9388	1 457 433 560	S 3560
CA9391	1 457 433 055	S 3055
CA9409	1 457 433 046	S 3046
CA9410	1 457 433 532	S 3532
CA9411	1 457 433 078	S 3078
CA9415	1 457 433 083	S 3083
CA9423	1 457 433 043	S 3043
CA9426	1 457 433 523	S 3523
CA9428	1 457 433 324	S 3324
CA9429	1 457 433 739	S 3739
CA9435	1 457 433 306	S 3306
CA9438	1 457 433 069	S 3069
CA9441	F 026 400 123	S 0123
CA9446	F 026 400 019	S 0019
CA9469	1 457 433 577	S 3577
CA9473	1 457 433 045	S 3045
CA9477	1 457 433 075	S 3075
CA9482	F 026 400 017	S 0017
CA9487	F 026 400 001	S 0001
CA9489	1 987 429 185	S 9185
CA9493	F 026 400 061	S 0061
CA9494	1 457 433 593	S 3593
CA9500	1 457 433 590	S 3590
CA9505	F 026 400 067	S 0067
CA9525	1 987 429 180	S 9180
CA9542	1 457 433 339	S 3339
CA9551	F 026 400 046	S 0046
CA9564	1 987 429 192	S 9192
CA9568	F 026 400 094	S 0094
CA9570	F 026 400 075	S 0075
CA9571	F 026 400 074	S 0074
CA9573	1 987 429 403	S 9403
CA 9574	1 457 433 319	S 3319
CA9581	F 026 400 117	S 0117
CA9582	F 026 400 179	S 0179
CA9593	1 457 433 730	S 3730
CA9621	F 026 400 051	S 0051
CA9622	1 987 429 182	S 9182
CA9629	1 457 433 316	S 3316
CA9632	1 457 433 096	S 3096
CA9634	1 457 433 091	S 3091
CA9636	1 457 433 587	S 3587
CA9643	1 457 433 555	S 3555
CA9647	1 457 433 655	S 3655
CA9651	F 026 400 025	S 0025
CA9652	1 457 433 579	S 3579
CA9653	1 457 433 578	S 3578
CA9654	F 026 400 068	S 0068
CA9654SY	F 026 400 210	S 0210
CA9658	F 026 400 113	S 0113
CA9668	1 457 433 574	S 3574
CA9680	1 987 429 401	S 9401
CA9682	F 026 400 199	S 0199
CA9694	1 457 433 323	S 3323
CA9695	F 026 400 141	S 0141
CA9695	1 457 433 096	S 3096



◀ FRAM

CA9695	1 457 433 099	S 3099
CA9696	1 457 433 096	S 3096
CA9709	1 457 433 093	S 3093
CA9711	1 987 429 404	S 9404
CA9725	1 987 429 178	S 9178

CA9738	1 987 429 164	S 9164
CA9751	1 457 433 592	S 3592
CA9753	1 457 433 070	S 3070
CA9754	1 987 429 406	S 9406
CA9757	1 457 433 066	S 3066

CA9759	F 026 400 096	S 0096
CA9764	1 457 433 160	S 3160
CA9768	1 457 433 084	S 3084
CA9770	1 457 433 327	S 3327
CA9777	1 457 433 331	S 3331

CA9783	F 026 400 078	S 0078
CA9784	1 457 433 573	S 3573
CA9792	1 457 433 580	S 3580
CA9800	1 987 429 405	S 9405
CA9823	F 026 400 070	S 0070

CA9824	F 026 400 069	S 0069
CA9826	F 026 400 158	S 0158
CA9847	F 026 400 103	S 0103
CA9849	1 987 429 183	S 9183
CA9894	1 987 429 184	S 9184

CA9898	F 026 400 129	S 0129
CA 9902	F 026 400 043	S 0043
CA9923	1 457 433 596	S 3596
CA9924	1 457 433 591	S 3591
CA9932	1 457 433 595	S 3595

CA9937	1 457 433 660	S 3660
CA9945	1 987 429 191	S 9191
CA9951	F 026 400 018	S 0018
CA9991	F 026 400 166	S 0166
CFA10366	1 987 432 406	R 2406

CFA 10458	1 987 432 369	R 2369
CFA 10474-2	1 987 432 500	R 2500
CFA10657	1 987 432 327	R 2327
CFA9619	1 987 431 165	M 1165
CFA9623	1 987 432 306	R 2306

CFA9785	1 987 432 381	R 2381
CF10062	1 987 432 166	M 2166
CF10285	1 987 432 190	M 2190
CF10322	1 987 432 190	M 2190
CF10411	1 987 432 203	M 2203

CF10431	1 987 432 216	M 2216
CF10659	1 987 432 215	M 2215
CF5846	1 987 432 200	M 2200
CF8773	1 987 431 175	M 1175
CF8800	1 987 432 151	M 2151

CF8850	1 987 431 455	R 1455
CF8890	1 987 432 042	M 2042
CF8893	1 457 433 081	S 3081
CF8914	1 987 432 052	M 2052
CF8947	1 987 432 060	M 2060

CF8948	1 987 432 060	M 2060
CF8989	1 987 432 107	M 2107
CF9335	1 987 432 066	M 2066
CF9337	1 987 432 058	M 2058
CF9338	1 987 432 167	M 2167

CF9363	1 987 432 075	M 2075
CF9386	1 987 431 164	M 1164
CF9387	1 987 432 152	M 2152
CF9395	1 987 432 105	M 2105
CF9466	1 987 432 084	M 2084

CF9485	1 987 432 192	M 2192
CF9545	1 987 432 091	M 2091
CF9566	1 987 432 084	M 2084
CF9569	1 987 431 163	M 1163
CF9576	1 987 431 162	M 1162

CF9586	1 987 432 091	M 2091
CF9659	1 987 432 155	M 2155
CF9686	1 987 432 088	M 2088
CF9740	1 987 432 159	M 2159
CF98192	1 987 432 074	M 2074

CF9846	1 987 432 085	M 2085
CF9846	1 987 432 320	R 2320
CF9862	1 987 432 092	M 2092
CF9881	1 987 432 114	M 2114
CF9934	1 987 432 208	M 2208

CG 8953 ECO	1 457 030 013	N 0013
CH10035ECO	1 457 429 307	P 9307
CH10045ECO	1 457 429 248	P 9248
CH10052ECO	1 457 429 272	P 9272
CH 10076 ECO	F 026 407 014	P 7014

CH10158ECO	F 026 407 090	P 7090
CH10331 ECO	F 026 407 070	P 7070
CH10415ECO	F 026 407 075	P 7075
CH10434 ECO	F 026 407 068	P 7068
CH10473 ECO	F 026 407 061	P 7061

CH10636ECO	F 026 407 066	P 7066
CH10660ECO	F 026 407 072	P 7072
CH10876ECO	F 026 407 073	P 7073
CH2801	1 457 429 413	P 9413
CH28011	1 457 429 647	P 9647

CH28012	1 457 429 647	P 9647
CH2929	1 457 429 740	P 9740
CH2962	1 457 429 740	P 9740
CH2963	1 457 429 735	P 9735
CH4474	1 457 429 646	P 9646

CH4474A	1 457 429 646	P 9646
CH4474B	1 457 429 732	P 9732
CH4475	1 457 429 600	P 9600
CH4536	1 457 429 274	P 9274
CH457PL	1 457 429 165	P 9165

CH4802	1 457 429 636	P 9636
CH5212	1 457 429 732	P 9732
CH5221	1 457 429 251	P 9251
CH5412	1 457 429 267	P 9267
CH5413	1 457 429 732	P 9732

CH5565	1 457 429 123	P 9123
CH5576	1 457 429 820	P 9820
CH5643	1 457 429 277	P 9277
CH5644	1 457 429 275	P 9275
CH5714	1 457 429 276	P 9276

CH5853	1 457 429 277	P 9277
CH5855	1 457 429 154	P 9154
CH5912	1 457 429 107	P 9107
CH 5928 ECO	1 457 429 185	P 9185
CH5933	1 457 429 128	P 9128

CH5993	1 457 429 157	P 9157
CH 5993 ECO	1 457 429 157	P 9157
CH803APL	1 457 429 820	P 9820
CH813PL	1 457 429 117	P 9117
CH8530	1 457 429 619	P 9619

CH 8530 ECO	1 457 429 619	P 9619
CH8977	1 457 429 276	P 9276
CH8977ECO	1 457 429 276	P 9276
CH8978	1 457 429 272	P 9272
CH8978ECO	1 457 429 272	P 9272

CH8980	1 457 429 152	P 9152
CH 8980 ECO	1 457 429 152	P 9152
CH8982	1 457 429 277	P 9277
CH 8982 ECO	1 457 429 277	P 9277
CH8983	1 457 429 646	P 9646

CH8983ECO	1 457 429 646	P 9646
CH9011	1 457 429 119	P 9119
CH 9011 ECO	1 457 429 119	P 9119
CH9023	1 457 429 239	P 9239
CH 9023 ECO	1 457 429 239	P 9239

CH913PL	1 457 429 117	P 9117
CH9232	1 457 429 126	P 9126
CH 9232 ECO	1 457 429 126	P 9126
CH 9305 ECO	1 457 429 199	P 9199
CH 9348 ECO	1 457 429 118	P 9118

CH 9389 ECO	F 026 407 026	P 7026
CH9390ECO	1 457 429 137	P 9137
CH 9432 ECO	1 457 429 284	P 9284
CH 9462 ECO	1 457 429 198	P 9198
CH9528	1 457 429 185	P 9185

CH9528ECO	1 457 429 185	P 9185
CH 9530 ECO	1 457 429 194	P 9194
CH9540ECO	1 457 429 271	P 9271
CH956	1 457 429 130	P 9130
CH956PL	1 457 429 629	P 9629

CH957PL	1 457 429 165	P 9165
CH9657	1 457 429 238	P 9238
CH 9657 ECO	1 457 429 238	P 9238
CH 9685 ECO	F 026 407 069	P 7069
CH 9801 ECO	F 026 407 003	P 7003

CH 9919 ECO	1 457 429 308	P 9308
CH9994ECO	1 457 429 252	P 9252
CR121	0 450 904 058	F 4058
C10039ECO	1 457 429 656	N 9656
C10043ECO	F 026 402 004	N 2004



C10194	F 026 402 007	N 2007	C5932	1 457 429 655	N 9655	G5402	0 450 905 909	F 5909
C10308ECO	F 026 402 006	N 2006	C5940	1 457 429 657	N 9657	G5404	0 450 905 216	F 5216
C10448ECO	F 026 402 008	N 2008	C5946	1 457 429 621	N 9621	G5405	0 450 905 195	F 5195
C10571ECO	F 026 402 101	N 2101	C5953	1 457 429 174	P 9174	G5441	0 986 450 106	F 0106
C10586 ECO	F 026 402 078	N 2078	C5969	1 457 429 416	P 9416	G5477	0 986 450 604	F 0604
C11819PL	1 457 431 270	N 1270	C857	1 457 429 175	P 9175	G5540	0 450 905 273	F 5273
C11819PL	1 457 431 326	N 1326	C8820	1 457 431 705	N 1705	G5540	0 450 905 316	F 5316
C11832PL	1 457 431 261	N 1261	C8827	1 457 431 703	N 1703	G5561	0 450 905 904	F 5904
C11832PL	1 457 431 325	N 1325	C883	1 457 429 175	P 9175	G5561	0 450 905 974	F 5974
C11860	1 457 431 158	N 1158	C8837	1 457 431 712	N 1712	G5600	0 450 904 161	N 4161
C11860PL	1 457 431 261	N 1261	C8976	1 457 431 707	N 1707	G5603	0 986 450 624	F 0624
C11860PL	1 457 431 325	N 1325	C8981ECO	1 457 431 704	N 1704	G5607	0 450 905 903	F 5903
C11860P1	1 457 431 261	N 1261	C8990ECO	1 457 431 708	N 1708	G5690	0 450 905 920	F 5920
C 11860 P1	1 457 431 325	N 1325	C9670ECO	1 457 431 710	N 1710	G5857	0 450 902 161	F 2161
C11860Z	1 457 431 158	N 1158	C9679	1 457 431 705	N 1705	G5857	0 450 905 287	F 5287
C118601	1 457 431 158	N 1158	C9712ECO	1 457 070 000	N 0000	G5869	0 450 905 908	F 5908
C11861PL	1 457 431 270	N 1270	C9766ECO	1 457 431 715	N 1715	G5870	0 450 905 318	F 5318
C11861PL	1 457 431 326	N 1326	C9815ECO	1 457 431 723	N 1723	G5915	0 986 450 124	F 0124
C11861P1	1 457 431 270	N 1270	C9817ECO	1 457 431 724	N 1724	G5974	0 450 905 954	F 5954
C 11861 P1	1 457 431 326	N 1326	C9830ECO	F 026 402 033	N 2033	G5982	0 450 905 986	F 5986
C11861Z	1 457 431 159	N 1159	C989	1 457 429 175	P 9175	G6398	0 450 905 133	F 5133
C118611	1 457 431 159	N 1159	C9926ECO	F 026 402 005	N 2005	G6400	0 450 905 002	F 5002
C11863Z	1 457 429 354	N 9354	C9927ECO	F 026 402 047	N 2047	G6400	0 450 905 280	F 5280
C11864Z	1 457 429 359	N 9359	C9989	1 457 431 705	N 1705	G6458	0 986 450 117	F 0117
C11868PL	1 457 431 261	N 1261	C9989ECO	1 457 431 705	N 1705	G6459	0 986 450 137	F 0137
C11868PL	1 457 431 325	N 1325	C9990	1 457 431 705	N 1705	G6462	0 450 905 955	F 5955
C11909PL	1 457 431 028	N 1028	G10146	F 026 403 008	F 3008	G6462	0 986 450 103	F 0103
C1191	1 457 434 201	N 4201	G10147	F 026 403 006	F 3006	G6465	0 986 450 103	F 0103
C1191A	1 457 434 201	N 4201	G10214	F 026 403 003	F 3003	G6534	0 986 450 100	F 0100
C1191PL	1 457 434 201	N 4201	G10243	0 450 905 959	F 5959	G6536	0 986 450 102	F 0102
C11963	1 457 429 230	N 9230	G121	0 450 904 159	F 4159	G6537	0 986 450 105	F 0105
C11963PL	1 457 429 230	N 9230	G121	0 450 904 163	F 4163	G6553	0 986 450 103	F 0103
C175	F 026 407 054	P 7054	G20	0 450 904 058	F 4058	G6573	0 450 905 924	F 5924
C175A	F 026 407 054	P 7054	G3359	0 986 450 138	F 0138	G6573	0 450 905 963	F 5963
C175E	F 026 407 054	P 7054	G3641	0 450 905 985	F 5985	G6574	0 450 905 901	F 5901
C175T	F 026 407 054	P 7054	G3713	0 450 905 021	F 5021	G6674	0 986 450 110	F 0110
C21	1 457 429 175	P 9175	G3727	0 986 450 119	F 0119	G6677	0 450 902 162	F 2162
C21P	1 457 429 175	P 9175	G3736	0 450 905 203	F 5203	G6678	0 986 450 109	F 0109
C2933	1 457 429 735	P 9735	G3737	0 450 905 177	F 5177	G6679	0 986 450 222	F 0222
C4	1 457 429 274	P 9274	G3744	0 450 905 200	F 5200	G6680	0 450 905 912	F 5912
C4P	1 457 429 175	P 9175	G3744	0 450 905 601	F 5601	G6825	0 450 905 912	F 5912
C4PL	1 457 429 175	P 9175	G3744	0 450 905 964	F 5964	G6826	0 986 450 104	F 0104
C4107	1 457 429 676	N 9676	G3747	0 450 905 401	F 5401	G6859	0 986 450 123	F 0123
C4107L	1 457 429 676	N 9676	G3829	0 450 905 030	F 5030	G7099	0 450 905 324	F 5324
C4117	1 457 431 270	N 1270	G3829	0 450 905 095	F 5095	G7146	0 450 905 989	F 5989
C4155	1 457 434 201	N 4201	G3829	0 450 905 264	F 5264	G7146	0 986 450 108	F 0108
C4161	1 457 434 200	N 4200	G4164	0 450 904 058	F 4058	G7194	0 986 450 111	F 0111
C4454	1 457 431 158	N 1158	G4191	0 986 450 018	F 0018	G7355	0 450 905 914	F 5914
C4455	1 457 431 159	N 1159	G4378	0 986 450 030	F 0030	G7355	0 986 450 113	F 0113
C4459	1 457 429 230	N 9230	G4715	0 986 450 039	F 0039	G7367	0 986 450 114	F 0114
C4891	1 457 429 289	N 9289	G4775	0 986 450 117	F 0117	G7428	0 450 905 982	F 5982
C5363	1 457 431 713	N 1713	G4777	0 450 905 326	F 5326	G7599	0 450 905 916	F 5916
C5563	1 457 429 291	N 9291	G4953	0 450 904 149	F 4149	G7612	0 986 450 115	F 0115
C5783	1 457 431 702	N 1702	G5311	0 450 905 005	F 5005	G7647	0 450 905 924	F 5924
C5897	1 457 429 656	N 9656	G5312	0 450 902 151	F 2151	G7647	0 986 450 107	F 0107



◀ FRAM

G7766	0 986 450 604	F 0604
G7767	0 986 450 221	F 0221
G7770	0 450 905 924	F 5924
G8018	0 450 905 939	F 5939
G8122	0 450 905 920	F 5920

G8160	0 450 905 915	F 5915
G8864	0 986 450 225	F 0225
G9292	0 450 905 926	F 5926
G9334	0 450 905 960	F 5960
G9484	0 450 905 927	F 5927

G9552	0 450 905 921	F 5921
G9791	0 450 905 925	F 5925
G9809	F 026 403 001	F 3001
G9879	0 450 905 952	F 5952
PA4248	1 457 429 079	S 9079

PA4415	1 457 429 928	S 9928
PA4418	1 457 432 150	S 2150
PA4418	1 457 432 174	S 2174
PA4418A	1 457 432 150	S 2150
PA4419	1 457 429 994	S 9994

PA7286	1 457 433 963	S 3963
PA7336	1 457 433 152	S 3152
PA7376	1 457 433 153	S 3153
PH10127	0 451 103 366	P 3366
PH10267	F 026 407 083	P 7083

PH10268	F 026 407 024	P 7024
PH10401	0 451 103 368	P 3368
PH13	0 451 104 064	P 4064
PH16	0 451 103 274	P 3274
PH16	0 986 452 003	P 2003

PH20	0 451 104 005	P 4005
PH2801	0 451 105 067	P 5067
PH2801	0 451 105 188	P 5188
PH2811	0 451 103 004	P 3004
PH2811	0 451 103 062	P 3062

PH2811N	0 451 103 004	P 3004
PH2811N	0 451 103 029	P 3029
PH2811N	0 451 103 062	P 3062
PH2821	0 451 203 194	P 3194
PH2821A	0 451 104 067	P 4067

PH2826	0 451 203 152	P 3152
PH2829	0 451 203 002	P 3002
PH2829	0 451 203 226	P 3226
PH2834	0 451 103 274	P 3274
PH2838	0 451 103 028	P 3028

PH2840	0 451 103 253	P 3253
PH2842	0 451 104 066	P 4066
PH2850	0 451 103 357	P 3357
PH2850	0 986 452 005	P 2005
PH2854	0 451 103 274	P 3274

PH2854RN	0 451 103 274	P 3274
PH2855A	0 451 103 028	P 3028
PH2857A	0 451 103 029	P 3029
PH28631	0 451 103 274	P 3274
PH2871A	0 451 103 316	P 3316

PH2874	0 451 103 141	P 3141
PH2877	0 451 104 066	P 4066
PH2879	0 986 452 003	P 2003
PH2880	0 451 203 220	P 3220
PH2881	0 451 104 065	P 4065

PH2883	0 451 301 156	P 1156
PH2886	0 986 452 000	P 2000
PH2919	0 451 103 274	P 3274
PH2921	0 986 452 020	P 2020
PH2934	0 451 103 232	P 3232

PH2954	0 986 452 019	P 2019
PH2960	0 451 403 001	P 3001
PH2968	0 451 105 188	P 5188
PH2978	0 986 452 024	P 2024
PH2985	0 986 452 023	P 2023

PH2992	0 451 103 260	P 3260
PH30	0 451 104 064	P 4064
PH3403	0 451 104 015	P 4015
PH3403	0 451 105 067	P 5067
PH35	0 451 103 274	P 3274

PH3531	0 986 452 015	P 2015
PH3531B	0 986 452 015	P 2015
PH3562	0 986 452 016	P 2016
PH3569	0 451 103 253	P 3253
PH3569	0 451 103 346	P 3346

PH3569	0 451 104 065	P 4065
PH3614	0 451 103 337	P 3337
PH3614	0 986 452 044	P 2044
PH3639	0 986 452 023	P 2023
PH3682	0 986 452 023	P 2023

PH3776	0 451 105 067	P 5067
PH39	0 451 104 015	P 4015
PH39	0 451 105 067	P 5067
PH3950	0 451 103 316	P 3316
PH43	0 451 103 028	P 3028

PH4368	0 451 103 276	P 3276
PH4386	0 451 103 276	P 3276
PH4532	0 451 203 108	P 3108
PH4546	0 451 103 235	P 3235
PH4553	0 451 103 252	P 3252

PH4553A	0 451 103 252	P 3252
PH4738	0 986 452 024	P 2024
PH4743	0 451 203 194	P 3194
PH4746	0 986 452 035	P 2035
PH4825	0 451 203 005	P 3005

PH4832	0 986 452 000	P 2000
PH4847	0 451 203 201	P 3201
PH4847A	0 451 203 201	P 3201
PH4848	0 451 203 223	P 3223
PH4870	0 451 103 316	P 3316

PH49A	0 451 104 010	P 4010
PH49A	0 451 403 077	P 3077
PH4908	0 451 103 311	P 3311
PH4967	0 986 452 028	P 2028
PH4985	0 986 452 044	P 2044

PH4997	0 986 452 058	P 2058
PH4998	0 986 452 061	P 2061
PH 5	0 451 104 064	P 4064
PH5102	0 451 203 201	P 3201
PH5102	0 451 300 007	P 0007

PH5103	F 026 407 049	P 7049
PH5112	0 451 103 274	P 3274
PH5117	0 451 103 217	P 3217
PH5123	0 986 452 062	P 2062
PH5124	0 986 452 030	P 2030

PH5126	0 986 452 046	P 2046
PH5166	0 986 452 060	P 2060
PH5172	0 451 103 274	P 3274
PH5190	0 986 452 064	P 2064
PH5234	0 451 403 208	P 3208

PH5280	0 451 103 275	P 3275
PH5317	F 026 407 025	P 7025
PH5323	F 026 407 105	P 7105
PH5349	0 451 403 077	P 3077
PH5353	0 451 301 207	P 1207

PH5375	0 451 103 240	P 3240
PH5394	0 451 403 077	P 3077
PH5449	0 451 301 156	P 1156
PH5472	0 451 203 002	P 3002
PH5484	0 451 103 249	P 3249

PH5529	0 986 452 063	P 2063
PH5592	0 451 103 365	P 3365
PH5615	0 451 203 108	P 3108
PH5639	0 451 103 260	P 3260
PH5645	0 451 103 297	P 3297

PH5717	0 451 103 341	P 3341
PH5822	0 451 103 274	P 3274
PH5831	0 451 103 109	P 3109
PH5833	0 451 103 290	P 3290
PH5883	0 451 103 289	P 3289

PH5913	0 986 452 066	P 2066
PH5936	0 451 103 257	P 3257
PH6355	0 986 452 042	P 2042
PH6682	0 451 103 258	P 3258
PH6811	0 451 103 316	P 3316

PH7498	0 451 103 004	P 3004
PH8798	0 451 103 330	P 3330
PH8842	F 026 407 043	P 7043
PH8944	F 026 407 048	P 7048
PH9	0 451 103 004	P 3004

PH9B	0 451 103 004	P 3004
PH9B1	0 451 103 029	P 3029
PH9046	0 451 104 013	P 4013
PH927	0 451 103 274	P 3274
PH927PL	0 451 103 274	P 3274

PH9453	F 026 407 057	P 7057
PH9536	F 026 407 106	P 7106
PH9566	0 986 452 068	P 2068
PH9637	F 026 407 053	P 7053
PH9763	F 026 407 017	P 7017

PH977	0 451 203 010	P 3010
PH977A	0 451 203 010	P 3010
PS 10098EWS	F 026 402 013	N 2013
PS10397	F 026 402 081	N 2081
PS10486	F 026 402 068	N 2068

PS8745	1 457 434 198	N 4198
PS8752	1 457 434 192	N 4192
PS8784	1 457 434 440	N 4440
PS8950	0 450 906 409	N 6409
PS9043	0 450 906 452	N 6452

PS 9420 WST	1 457 434 310	N 4310
PS9451	0 450 906 508	N 6508
PS9472	1 457 434 329	N 4329
PS9537	0 450 906 461	N 6461
PS9638	1 457 434 439	N 4439

PS9638	1 457 434 451	N 4451
PS9664	1 457 434 198	N 4198
PS9789	1 457 434 436	N 4436
PS 9844 WST	1 457 434 460	N 4460
PS 9845 WST	1 457 434 455	N 4455

P10089	0 450 905 925	F 5925
P10089	0 450 906 457	N 6457
P10148	F 026 402 056	N 2056
P1129	1 457 434 105	N 4105
P3522	1 457 434 105	N 4105

P3555A	0 451 300 003	P 0003
P3726	1 457 434 452	N 4452
P3726	1 457 434 456	N 4456
P3828	0 451 103 270	P 3270
P4100A	1 457 429 675	N 9675

P4102	1 457 434 432	N 4432
P4102PL	1 457 434 154	N 4154
P4102PL	1 457 434 165	N 4165
P4102PL	1 457 434 432	N 4432
P4102RP	1 457 434 050	N 4050

P4105	1 457 429 681	N 9681
P4107	1 457 429 676	N 9676
P4140	1 457 429 681	N 9681
P4159	1 457 434 153	N 4153
P4173	0 450 904 077	N 4077

P4174	0 450 904 060	F 4060
P4183	1 457 434 106	N 4106
P4186	1 457 434 051	N 4051
P4473	1 457 434 154	N 4154
P4473	1 457 434 165	N 4165

P4506	1 457 434 051	N 4051
P4506PL	1 457 434 051	N 4051
P4516	1 457 434 051	N 4051
P4520	1 457 434 321	N 4321
P4532	0 451 203 108	P 3108

P4549A	1 457 434 123	N 4123
P4549A	1 457 434 331	N 4331
P4886	1 457 434 453	N 4453
P4922	1 457 434 438	N 4438
P5138	1 457 434 281	N 4281

P5138	1 457 434 439	N 4439
P5173	1 457 434 435	N 4435
P5457	1 457 434 105	N 4105
P5465	0 451 300 003	P 0003
P5498	1 457 434 174	N 4174

P5537	1 457 434 105	N 4105
P5614	1 457 434 402	N 4402
P5651	1 457 434 184	N 4184
P5652	1 457 434 184	N 4184
P5654	F 026 402 002	N 2002

P5654	1 457 434 187	N 4187
P5655	1 457 434 324	N 4324
P5672	1 457 434 291	N 4291
P5694	1 457 434 294	N 4294
P5753	1 457 434 186	N 4186

P5786	0 451 300 003	P 0003
P5877	1 457 434 447	N 4447
P5878	1 457 434 419	N 4419
P6446	0 450 904 060	F 4060
P7513	1 457 429 675	N 9675

P8833	1 457 434 450	N 4450
P8845	1 457 434 329	N 4329
P8916	0 986 450 509	N 0509
P8943	F 026 402 035	N 2035
P9384	1 457 434 416	N 4416

P9407	0 451 300 003	P 0003
P9421	F 026 402 034	N 2034
P9436	0 450 905 930	N 5930
P9444	F 026 402 002	N 2002
P9450	1 457 434 421	N 4421

P9486	1 457 434 448	N 4448
P9529	1 457 434 459	N 4459
P9626	F 026 402 017	N 2017
P9805	F 026 402 001	N 2001
P9811	0 450 906 460	N 6460

P9830ECO	F 026 402 033	N 2033
P9929	F 026 402 037	N 2037
P9947	0 450 906 471	N 6471
WK84215	1 457 434 455	N 4455

HENGST

D 06 E 133 24	1 457 429 647	P 9647
D 06 E 134 24	1 457 429 647	P 9647
D06E19624	1 457 429 646	P 9646

D 06 E 197 24	1 457 429 646	P 9646
D 09 E 196 57	1 457 429 629	P 9629
D 10 E 10 KFR	1 457 431 159	N 1159
D 10 E 10 KFR 2	1 457 429 354	N 9354
D 10 E 10 KFR 4	1 457 429 354	N 9354

D 10 E 10 KP	1 457 431 270	N 1270
D 11 E 174 14	1 457 429 735	P 9735
D 11 E 251 14	1 457 429 740	P 9740
D 12 E 5 KFR	1 457 431 158	N 1158
D 12 E 5 KFR 2	1 457 429 359	N 9359

D 12 E 5 KP	1 457 431 261	N 1261
D 13 E 243 14	1 457 429 600	P 9600
D15E170HN	1 457 429 274	P 9274
D 16 E 170 HN	1 457 429 274	P 9274
D 20 E 196 HN	1 457 429 267	P 9267

D23E160H01	F 026 407 040	P 7040
D 23 E 197 24	1 457 429 732	P 9732
D28E160H01EN	F 026 407 040	P 7040
D 28 E 161 H	1 457 429 107	P 9107
D28E161H01	F 026 407 026	P 7026

D28E161H01EN	F 026 407 026	P 7026
D 28 E 197 24	1 457 429 277	P 9277
D31E13424	1 457 429 276	P 9276
D 31 E 134 24	1 457 429 647	P 9647
D 31 E 197 24	1 457 429 277	P 9277

D 35 E 172 37	1 457 429 275	P 9275
D36E500KP	1 457 429 655	N 9655
D 36 500 KP	1 457 429 655	N 9655
D 37 E 500 H	1 457 429 128	P 9128
D40E182H	1 457 429 636	P 9636

D41E220H	1 457 429 251	P 9251
D44E350H	1 457 429 152	P 9152
D48E15326	1 457 429 619	P 9619
E 10 H 02	1 457 429 820	P 9820
E 10 K	1 457 431 270	N 1270

E 10 K	1 457 431 326	N 1326
E 10 KF	1 457 431 159	N 1159
E 10 KFR	1 457 431 159	N 1159
E10KFRD10	1 457 431 159	N 1159
E10KFR4	1 457 431 159	N 1159

E10KFR4D10	1 457 429 354	N 9354
E10KP	1 457 431 270	N 1270
E 10 KP	1 457 431 326	N 1326
E10KPD10	1 457 431 270	N 1270
E 10 KPF 1	1 457 431 159	N 1159

E100KP D182	F 026 402 078	N 2078
E1004L	F 026 400 119	S 0119
E1005L	1 987 429 164	S 9164
E1011L	F 026 400 111	S 0111
E1014L	F 026 400 133	S 0133

E 10 18 H	1 457 429 820	P 9820
E1018L	F 026 400 147	S 0147
E1019L	F 026 400 135	S 0135
E102HD156	1 457 429 307	P 9307
E1023L	F 026 400 138	S 0138

E1034L	F 026 400 205	S 0205
E106HD171	F 026 407 075	P 7075
E11HD117	F 026 407 070	P 7070
E 11 HD 26	1 457 429 119	P 9119
E 11 HD 52	1 457 429 157	P 9157

E 110 14	1 457 429 165	P 9165
E111H	1 457 429 165	P 9165
E112HD180	F 026 407 014	P 7014
E 112 L	1 457 429 932	S 9932
E113HD181	F 026 407 076	P 7076



◀ HENGST

E113L	1 457 429 941	S 9941
E114H	1 457 429 117	P 9117
E114L	1 457 429 946	S 9946
E114LS	F 026 400 082	S 0082
E114 205	1 457 429 117	P 9117

E115HD208	F 026 407 023	P 7023
E115L	1 457 429 950	S 9950
E116L	1 457 429 966	S 9966
E117L	1 457 429 975	S 9975
E118	1 457 429 969	S 9969

E118L	1 457 429 969	S 9969
E118L01	1 457 429 969	S 9969
E118L02	1 457 429 899	S 9899
E118L03	1 457 429 899	S 9899
E119L74	F 026 400 079	S 0079

E120L	1 457 429 944	S 9944
E120M	1 457 429 175	P 9175
E120MD04	1 457 429 175	P 9175
E12 14	1 457 429 175	P 9175
E12 14M	1 457 429 175	P 9175

E121499	1 457 429 175	P 9175
E122HD187	F 026 407 072	P 7072
E123HD194	F 026 407 100	P 7100
E124H	F 026 407 087	P 7087
E124HD202	F 026 407 087	P 7087

E13HD47	1 457 429 137	P 9137
E133L	1 457 429 854	S 9854
E133 24	1 457 429 413	P 9413
E13324	1 457 429 647	P 9647
E134HD04	1 457 429 413	P 9413

E134HD06	1 457 429 647	P 9647
E134HD31	1 457 429 276	P 9276
E134 24	1 457 429 647	P 9647
E140H	1 457 431 028	N 1028
E15HD59	1 457 429 118	P 9118

E152L	1 457 429 777	S 9777
E153L	1 457 429 987	S 9987
E15326	1 457 429 619	P 9619
E154H	1 457 429 619	P 9619
E154HD48	1 457 429 619	P 9619

E158HD24	1 457 429 123	P 9123
E16HD51	1 457 429 272	P 9272
E16H01D51	1 457 429 272	P 9272
E160	1 457 429 896	S 9896
E160	1 457 433 087	S 3087

E160H01	F 026 407 040	P 7040
E160H01D28	F 026 407 040	P 7040
E160L	1 457 429 895	S 9895
E160L	1 457 429 896	S 9896
E160L	1 457 429 898	S 9898

E161HD28	1 457 429 107	P 9107
E161H01	F 026 407 026	P 7026
E161H01D28	F 026 407 026	P 7026
E161L	1 457 429 877	S 9877
E161L	1 457 433 698	S 3698

E161L01	1 457 433 698	S 3698
E167L	1 457 433 524	S 3524
E169L	1 457 429 795	S 9795
E17HD50	1 457 429 126	P 9126
E17HD57	1 457 429 126	P 9126

E170HN	1 457 429 274	P 9274
E170HND16	1 457 429 274	P 9274
E171L	1 457 433 700	S 3700
E172L	1 457 429 787	S 9787
E173L	1 457 433 004	S 3004

E173L01	1 457 433 084	S 3084
E173L01	1 457 433 085	S 3085
E174HD11	1 457 429 735	P 9735
E175H	F 026 407 042	P 7042
E175HD129	F 026 407 042	P 7042

E175HD68	F 026 407 042	P 7042
E175L	1 457 433 023	S 3023
E18WDK03	F 026 402 037	N 2037
E182H	1 457 429 636	P 9636
E182HD40	1 457 429 636	P 9636

E184L	1 457 432 154	S 2154
E186L	1 457 429 050	S 9050
E187L	1 457 429 920	S 9920
E189L	1 457 429 053	S 9053
E190L	1 457 429 064	S 9064

E1905LI	1 987 431 159	M 1159
E1906LI	1 987 432 074	M 2074
E1908LI	1 987 431 166	M 1166
E1910LI	1 987 432 114	M 2114
E1925LC	1 987 432 400	R 2400

E1926LC	1 987 432 092	M 2092
E1926LI	1 987 432 092	M 2092
E1927LI	1 987 432 088	M 2088
E193L	0 450 905 087	F 5087
E1937LI	1 987 432 163	M 2163

E195L	1 457 432 111	S 2111
E1953LI	1 987 432 066	M 2066
E196HND20	1 457 429 267	P 9267
E196L	1 457 432 108	S 2108
E196L	1 457 432 134	S 2134

E1960LI	1 987 432 060	M 2060
E19624	1 457 429 646	P 9646
E1963LI	1 987 432 091	M 2091
E196 57	1 457 429 130	P 9130
E196 572	1 457 429 130	P 9130

E197HD06	1 457 429 646	P 9646
E197HD23	1 457 429 732	P 9732
E197HD28	1 457 429 277	P 9277
E197HD31	1 457 429 277	P 9277
E197L	1 457 429 949	S 9949

E197 24	1 457 429 277	P 9277
E19724	1 457 429 646	P 9646
E19724	1 457 429 732	P 9732
E1975LI	1 987 432 058	M 2058
E1976LI	1 987 432 164	M 2164

E198H	1 457 429 130	P 9130
E198HD09	1 457 429 629	P 9629
E1981LI	1 987 432 086	M 2086
E1987LI	1 987 432 058	M 2058
E199L	1 457 433 601	S 3601

E1998LC	1 987 432 426	R 2426
E20N01	1 457 433 255	S 3255
E200L	1 457 429 030	S 9030
E2000L	1 457 433 568	S 3568
E2020KLR	1 457 434 153	N 4153

E206L	1 457 429 870	S 9870
E206L	1 457 433 310	S 3310
E207L	1 457 433 002	S 3002
E209L	1 457 433 626	S 3626
E21K	1 457 429 230	N 9230

E21L	1 457 429 076	S 9076
E210L	1 457 432 192	S 2192
E214L	1 457 433 651	S 3651
E215L	1 457 429 814	S 9814
E216L	1 457 433 008	S 3008

E216L02	1 457 433 264	S 3264
E218L	1 457 432 188	S 2188
E219L	1 457 433 735	S 3735
E22HD190	F 026 407 073	P 7073
E22HD88	1 457 429 199	P 9199

E22L	1 457 429 061	S 9061
E220H	1 457 429 251	P 9251
E220HD41	1 457 429 251	P 9251
E221L	1 457 433 607	S 3607
E223L	1 457 433 752	S 3752

E224L	1 457 432 138	S 2138
E227L	1 457 433 701	S 3701
E23HD81	1 457 429 284	P 9284
E231L	1 457 429 844	S 9844
E235L	1 457 429 894	S 9894

E235L	1 987 429 051	S 9051
E236L01	1 457 433 007	S 3007
E237L	1 457 433 900	S 3900
E24HD80	F 026 407 003	P 7003
E240L	1 457 433 748	S 3748

E240L01	1 457 433 703	S 3703
E241L	1 457 429 869	S 9869
E242L	1 457 433 699	S 3699
E243HD13	1 457 429 600	P 9600
E243L	1 457 433 747	S 3747

E246L	1 457 433 571	S 3571
E247L	1 457 433 571	S 3571
E248L	1 457 433 741	S 3741
E249L	1 457 433 740	S 3740
E250L	1 457 433 309	S 3309

E250L	1 457 433 603	S 3603
E250L01	1 457 433 054	S 3054
E251HD11	1 457 429 740	P 9740
E251 14	1 457 429 740	P 9740
E253L	1 457 433 750	S 3750

E 256 L	1 457 429 786	S 9786
E 259 L	1 457 429 778	S 9778
E 26 H	1 457 429 416	P 9416
E 263 L	1 457 433 799	S 3799
E 270 L	F 026 400 077	S 0077
E 270 L	1 457 433 292	S 3292
E 272 L	1 457 433 901	S 3901
E 277 L	1 457 429 942	S 9942
E 277 L 01	1 457 429 817	S 9817
E 28 H 01 D 26	1 457 429 252	P 9252
E 285 L 01	1 457 433 627	S 3627
E 29 L	1 457 429 994	S 9994
E 290 L	1 457 433 904	S 3904
E2909LI	1 987 432 155	M 2155
E2915LC	1 987 432 320	R 2320
E2915LI	1 987 432 085	M 2085
E2918LI	1 987 432 203	M 2203
E2925LI	1 987 432 170	M 2170
E2930LI	1 987 432 084	M 2084
E2934LI	1 987 432 159	M 2159
E 295 L	1 457 433 005	S 3005
E2951LC	1 987 432 406	R 2406
E2951LI	1 987 432 206	M 2206
E 2952	1 457 433 005	S 3005
E2962LI	1 987 432 004	M 2004
E297L	1 457 433 729	S 3729
E 299 L	1 457 433 538	S 3538
E 299 L	1 457 433 712	S 3712
E 30 L	1 457 429 875	S 9875
E 30 L 01	1 457 429 987	S 9987
E 30 L 02	1 457 429 875	S 9875
E 301 L	1 457 433 714	S 3714
E301L01	1 457 433 081	S 3081
E 303 L	1 457 433 608	S 3608
E 304 L	1 457 433 609	S 3609
E 305 L	1 457 429 791	S 9791
E307L	F 026 400 067	S 0067
E 308 L	1 457 433 771	S 3771
E 309 L	1 457 429 793	S 9793
E 31 L	1 457 429 783	S 9783
E 31 L 02	1 457 429 783	S 9783
E 310 L	1 457 433 056	S 3056
E311L	1 457 433 753	S 3753
E 312 L	1 457 433 728	S 3728
E 314 L	1 457 433 730	S 3730
E315L	F 026 400 094	S 0094
E316L	F 026 400 207	S 0207
E317L	F 026 400 179	S 0179
E318L	1 457 433 751	S 3751
E 32 HD 21	F 026 407 021	P 7021
E 32 HD 26	1 457 429 185	P 9185
E 32 L	1 457 429 988	S 9988
E 32 L 02	1 457 429 988	S 9988
E 321 L	1 457 433 752	S 3752
E322L	1 457 433 716	S 3716
E 322 L01	F 026 400 019	S 0019
E323L	1 457 432 146	S 2146
E 324 L	1 457 429 792	S 9792
E 325 L	1 457 433 265	S 3265
E 327 L	1 457 433 713	S 3713
E 328 L	1 457 433 790	S 3790
E 329 L	1 457 429 775	S 9775
E33HD96	1 457 429 239	P 9239
E 33 L	1 457 429 957	S 9957
E332L	1 457 433 769	S 3769
E 333 L	1 457 433 234	S 3234
E 334 L	1 457 433 227	S 3227
E335L	1 457 429 842	S 9842
E336L	1 457 433 272	S 3272
E 337 L	1 457 429 818	S 9818
E 338 L	1 457 432 200	S 2200
E338L01	1 457 432 200	S 2200
E34HD97	F 026 407 046	P 7046
E 340 L	1 457 429 819	S 9819
E 341 L	1 457 433 250	S 3250
E342L	1 457 433 711	S 3711
E 343 L	1 457 433 535	S 3535
E 344 L	1 457 433 606	S 3606
E 345 L	1 457 429 923	S 9923
E 346 L	1 457 433 233	S 3233
E 347 L	1 457 429 841	S 9841
E 348 L	1 457 429 908	S 9908
E 349 L	1 457 433 229	S 3229
E350H	1 457 429 152	P 9152
E 350 HD 44	1 457 429 152	P 9152
E350L	1 457 433 069	S 3069
E350L02	1 457 433 069	S 3069
E 351 L	1 457 433 642	S 3642
E352L	1 457 433 281	S 3281
E 353 L	1 457 433 623	S 3623
E 354 L	1 457 433 260	S 3260
E 355 L	F 026 400 014	S 0014
E 356 L	1 457 433 697	S 3697
E 36 L	1 457 429 079	S 9079
E361L	1 457 433 560	S 3560
E366L	F 026 400 084	S 0084
E 368 L	1 457 433 052	S 3052
E 37 HD 84	1 457 429 194	P 9194
E 37 L	1 457 429 928	S 9928
E 37 L 01	1 457 429 928	S 9928
E 372 L	1 457 433 539	S 3539
E 373 L	1 457 433 043	S 3043
E 375 L	1 457 433 686	S 3686
E376L	1 457 433 589	S 3589
E377L	1 457 433 588	S 3588
E 378 L	1 457 433 742	S 3742
E 379 L	1 457 433 715	S 3715
E 380 L	1 457 433 772	S 3772
E 380 L	1 457 433 792	S 3792
E381L	1 457 433 537	S 3537
E382L	1 457 433 526	S 3526
E383L	1 457 433 280	S 3280
E38322	F 026 407 054	P 7054
E 384 L	1 457 433 616	S 3616
E 386 L	1 457 433 739	S 3739
E386L01	1 457 433 044	S 3044
E 387 L	1 457 433 624	S 3624
E 388 L	1 457 433 523	S 3523
E389L	1 457 429 983	S 9983
E 391 L	1 457 433 055	S 3055
E 391 L01	F 026 400 020	S 0020
E 392 L	1 457 433 521	S 3521
E 393 L	1 457 433 058	S 3058
E394L	1 457 433 268	S 3268
E 396 L	1 457 429 839	S 9839
E 397 L	1 457 433 065	S 3065
E397L01	1 457 433 065	S 3065
E398L	1 457 433 161	S 3161
E399L	1 457 433 046	S 3046
E 40 HD 105	1 457 429 238	P 9238
E 409 L	1 457 433 067	S 3067
E 41 H	1 457 429 174	P 9174
E 41 L	1 457 429 964	S 9964
E410L	F 026 400 010	S 0010
E410L01	F 026 400 010	S 0010
E411L	1 457 433 078	S 3078
E414L	1 457 433 083	S 3083
E414L	1 457 433 306	S 3306
E414L	1 457 433 593	S 3593
E 415 L	1 457 433 075	S 3075
E416L	1 457 433 520	S 3520
E417L	1 457 433 531	S 3531
E418L	1 457 433 300	S 3300
E420	F 026 400 034	S 0034
E420L	F 026 400 034	S 0034
E420LS	F 026 400 197	S 0197
E421L	1 457 433 333	S 3333
E422HD86	F 026 407 051	P 7051
E422KPD98	F 026 402 028	N 2028
E 422 L	1 987 429 403	S 9403
E423L	1 457 433 319	S 3319
E424L	1 457 433 042	S 3042
E426L	F 026 400 184	S 0184
E427L	1 457 433 532	S 3532
E428L	F 026 400 068	S 0068
E428LS	F 026 400 210	S 0210
E428L01	F 026 400 068	S 0068
E429L	1 457 433 791	S 3791
E43HD97	F 026 407 047	P 7047
E430L	1 457 432 124	S 2124
E431L	1 457 433 077	S 3077
E432L	F 026 400 011	S 0011
E433L	F 026 400 078	S 0078
E433LS	F 026 400 022	S 0022
E 434 L	1 457 433 332	S 3332



◀ HENGST

E436L	1 457 433 150	S 3150
E 451 L	1 457 433 903	S 3903
E452L	F 026 400 083	S 0083
E452L	F 026 400 145	S 0145
E452L01	F 026 400 145	S 0145

E454L	F 026 400 086	S 0086
E 455 L	1 457 433 071	S 3071
E 455 L 01	1 457 433 071	S 3071
E 456 L	1 457 433 522	S 3522
E 459 L	1 457 433 773	S 3773

E46HD126	1 457 429 248	P 9248
E460L	1 457 433 590	S 3590
E461L	1 457 433 529	S 3529
E461L01	1 457 433 529	S 3529
E 462 L	1 457 433 536	S 3536

E463L	1 457 433 797	S 3797
E464L	1 457 433 047	S 3047
E465L	1 457 433 571	S 3571
E466L	1 457 433 571	S 3571
E468L	1 457 433 059	S 3059

E469L	1 457 433 045	S 3045
E47HD112	1 457 429 275	P 9275
E470L	1 457 433 070	S 3070
E471L	1 457 433 153	S 3153
E472L	1 987 429 401	S 9401

E473L	1 457 433 061	S 3061
E473L	1 457 433 555	S 3555
E474L	1 457 433 163	S 3163
E475L	1 457 433 578	S 3578
E475L	1 457 433 579	S 3579

E478L	1 457 433 090	S 3090
E480L	1 457 433 553	S 3553
E482L	1 987 429 405	S 9405
E482L01	1 457 433 576	S 3576
E485L	1 457 433 325	S 3325

E485L01	1 457 433 159	S 3159
E 486 L	1 457 433 605	S 3605
E487L	1 457 433 574	S 3574
E488L	1 987 429 404	S 9404
E 489 L	1 457 433 093	S 3093

E490L	0 450 905 901	F 5901
E 490 L	1 987 429 182	S 9182
E493L	1 457 433 152	S 3152
E494L	1 457 433 089	S 3089
E495L	1 457 433 158	S 3158

E496L	F 026 400 117	S 0117
E496L01	F 026 400 117	S 0117
E497L	F 026 400 088	S 0088
E498L	F 026 400 069	S 0069
E498L01	F 026 400 069	S 0069

E 5 K	1 457 431 261	N 1261
E 5 K	1 457 431 325	N 1325
E 5K	1 457 429 413	P 9413
E 5 KF	1 457 431 158	N 1158
E 5 KFR	1 457 431 158	N 1158

E5KFRD12	1 457 431 158	N 1158
E5KFR2	1 457 429 359	N 9359
E5KFR2D12	1 457 429 359	N 9359
E 5 KFR2 OPTIMIER	1 457 429 359	N 9359
E 5 KP	1 457 431 261	N 1261

E 5 KP	1 457 431 325	N 1325
E5KPD12	1 457 431 261	N 1261
E500H	1 457 429 128	P 9128
E500HD129	1 457 429 128	P 9128
E 500 HD 37	1 457 429 128	P 9128

E500KP	1 457 429 655	N 9655
E500KPD36	1 457 429 655	N 9655
E500KP02D36	1 457 429 655	N 9655
E510L	1 457 433 587	S 3587
E511L	1 457 433 230	S 3230

E 52 KPD 36	1 457 431 707	N 1707
E53KP D61	1 457 431 704	N 1704
E542L01	F 026 400 072	S 0072
E 544 L	1 457 433 334	S 3334
E545L	1 987 429 127	S 9127

E546L	1 457 433 968	S 3968
E 547 L	1 457 433 255	S 3255
E 548 L	1 457 432 173	S 2173
E549L	1 987 429 122	S 9122
E 55 KPD 69	1 457 431 703	N 1703

E 550 L	1 987 429 135	S 9135
E551L	1 457 433 072	S 3072
E 552 L	1 987 429 137	S 9137
E553L	1 987 429 133	S 9133
E554L	1 457 433 527	S 3527

E554L	1 457 433 543	S 3543
E555L	1 457 433 274	S 3274
E 557 L	1 457 433 259	S 3259
E 558 L	1 987 429 152	S 9152
E559L	1 457 433 314	S 3314

E56KP D72	1 457 431 710	N 1710
E 560 L	1 987 429 171	S 9171
E561L	1 987 429 148	S 9148
E563L	1 457 429 933	S 9933
E 565 L	1 457 433 200	S 3200

E 567 L	1 457 429 794	S 9794
E572L	1 457 433 155	S 3155
E573L	1 457 433 084	S 3084
E575L	1 457 433 317	S 3317
E576L	1 457 433 079	S 3079

E577L	1 987 429 406	S 9406
E58KP	1 457 431 708	N 1708
E586L	1 457 433 270	S 3270
E587L	1 457 433 331	S 3331
E588L	1 457 433 323	S 3323

E 589 L	F 026 400 141	S 0141
E 589 L	1 457 433 099	S 3099
E 59 KPD 78	1 457 429 656	N 9656
E 590 L	1 457 433 096	S 3096
E595L	F 026 400 075	S 0075

E 597 L	1 987 429 181	S 9181
E598L	1 457 433 690	S 3690
E60KP	1 457 429 291	N 9291
E60KP	1 457 431 713	N 1713
E600L	F 026 400 096	S 0096

E 601 L	1 457 433 315	S 3315
E603L	F 026 400 064	S 0064
E 605 L	F 026 400 012	S 0012
E606L	1 457 433 573	S 3573
E607L	1 457 433 256	S 3256

E608L	1 457 433 091	S 3091
E609L	1 457 433 231	S 3231
E61KP D90	1 457 431 712	N 1712
E610L	1 457 433 591	S 3591
E611L	F 026 400 013	S 0013

E612L	1 457 433 585	S 3585
E613L	1 457 433 594	S 3594
E614L	F 026 400 103	S 0103
E 615 L	1 457 433 596	S 3596
E615L01	F 026 400 108	S 0108

E616L	1 457 433 327	S 3327
E617L	1 987 429 194	S 9194
E62HD128	F 026 407 054	P 7054
E62KP D91	1 457 030 013	N 0013
E 621 L	F 026 400 018	S 0018

E623L	1 457 433 959	S 3959
E624L	1 987 429 146	S 9146
E626L	F 026 400 189	S 0189
E628L	1 457 433 784	S 3784
E629L	1 457 429 781	S 9781

E63KP D78	1 457 431 705	N 1705
E633L	F 026 400 074	S 0074
E634L	1 457 433 316	S 3316
E635L	1 457 433 544	S 3544
E636L	1 457 433 263	S 3263

E637L	1 457 433 781	S 3781
E638L	1 457 433 971	S 3971
E639L	1 987 429 151	S 9151
E64H D96	1 457 429 198	P 9198
E 64 KPD 78	1 457 429 657	N 9657

E 64 L	1 457 429 948	S 9948
E640KP D185	F 026 402 062	N 2062
E 640 L	F 026 400 017	S 0017
E641L	1 457 433 972	S 3972
E648L	F 026 400 028	S 0028

E649L	1 457 433 066	S 3066
E 65KP D95	1 457 431 720	N 1720
E651L	1 457 433 788	S 3788
E652L	F 026 400 165	S 0165
E653L	1 457 433 276	S 3276

E656L	1 457 433 958	S 3958
E657L	1 457 433 095	S 3095
E658L	F 026 400 129	S 0129
E659L	1 987 429 188	S 9188
E66KP D36	F 026 402 033	N 2033

E660L	1 457 433 549	S 3549
E661L	F 026 400 209	S 0209
E 662 L	1 457 433 102	S 3102
E663L	1 457 433 970	S 3970
E664L	1 987 429 185	S 9185
E667L	1 987 429 184	S 9184
E669L	1 457 429 800	S 9800
E67KP	1 457 431 702	N 1702
E 677L	1 987 429 183	S 9183
E68KPD73	F 026 402 100	N 2100
E681L	F 026 400 080	S 0080
E682L	1 457 433 088	S 3088
E 684L	1 987 429 177	S 9177
E686L	1 457 433 289	S 3289
E686L	1 457 433 324	S 3324
E 687 L	F 026 400 060	S 0060
E689L	1 457 433 098	S 3098
-*E69HD81	1 457 429 271	P 9271
E69HD81	1 457 429 271	P 9271
E69KPD100	1 457 070 000	N 0000
E 69 L	1 457 429 948	S 9948
E691L	1 457 433 546	S 3546
E692L	1 457 433 736	S 3736
E693L	1 457 433 969	S 3969
E694L	1 457 433 273	S 3273
E695L	1 457 433 160	S 3160
E698L	1 457 433 307	S 3307
E701L01	1 457 433 660	S 3660
E703L	F 026 400 113	S 0113
E704L	F 026 400 002	S 0002
E705L	1 457 433 599	S 3599
E706L	F 026 400 211	S 0211
E708L	1 987 429 179	S 9179
E709L	F 026 400 107	S 0107
-*E71KPD104	1 457 429 621	N 9621
E718L	1 457 433 339	S 3339
E 72 KP D107	1 457 431 715	N 1715
E72KP01D107	1 457 431 715	N 1715
E720L	1 457 433 094	S 3094
E723L	1 987 429 400	S 9400
E727L	1 457 433 164	S 3164
E728L	1 457 433 101	S 3101
E729L	1 457 433 100	S 3100
E73HD134	F 026 407 002	P 7002
E73HD207	F 026 407 066	P 7066
E 73 L	1 457 429 970	S 9970
E732L	1 987 429 190	S 9190
E734L	1 457 433 049	S 3049
E747L	1 987 429 402	S 9402
E748L	F 026 400 163	S 0163
E 75 KD 42	1 457 434 201	N 4201
E 75 1 K	1 457 434 201	N 4201
E751L	1 987 429 163	S 9163
E756L	1 457 433 956	S 3956
E757L	F 026 400 123	S 0123
E758L	1 987 429 169	S 9169
E758L	1 987 429 186	S 9186
E76KD42	1 457 434 200	N 4200
E 76/1 K	1 457 434 200	N 4200
E762L	1 457 433 951	S 3951
E762L	1 457 433 955	S 3955
E763L	1 457 433 963	S 3963
E766L	1 457 433 253	S 3253
E768L	1 987 429 166	S 9166
E769L	1 457 433 595	S 3595
E770L	1 457 432 203	S 2203
E771L	1 457 433 950	S 3950
E772L	1 457 433 954	S 3954
E774L	F 026 400 015	S 0015
E776L	1 457 433 547	S 3547
E778L	1 457 429 890	S 9890
E779L	1 457 433 060	S 3060
E780L	1 457 433 266	S 3266
E784L	1 457 433 290	S 3290
E 79 KP D118	1 457 431 723	N 1723
E790L	1 457 433 953	S 3953
E791L	1 457 429 845	S 9845
E792L	1 457 433 298	S 3298
E796L	1 457 433 957	S 3957
E797L	1 987 429 172	S 9172
E798L	1 457 433 311	S 3311
E799L	1 987 429 115	S 9115
E8KFR	1 457 431 159	N 1159
E801L	1 457 432 180	S 2180
E 81 L	1 457 429 992	S 9992
E811H	F 026 407 069	P 7069
E811HD62	F 026 407 069	P 7069
E813L	F 026 400 061	S 0061
E814HD191	F 026 407 090	P 7090
E814L	1 457 433 073	S 3073
E815L	1 457 433 326	S 3326
E82KP D36	F 026 402 032	N 2032
E82KPD73	F 026 402 032	N 2032
E 82 L	1 457 429 993	S 9993
E820L	1 457 433 660	S 3660
E 821 L	F 026 400 055	S 0055
E822L	F 026 400 030	S 0030
E823L	1 457 433 785	S 3785
E826L	1 457 433 083	S 3083
E828L	1 457 433 743	S 3743
E83KPD140	1 457 070 001	N 0001
E830L	1 457 433 257	S 3257
E831L	1 457 433 154	S 3154
E832L	F 026 400 097	S 0097
E832L01	F 026 400 049	S 0049
E833L	F 026 400 016	S 0016
E834L	F 026 400 106	S 0106
E839L	F 026 400 059	S 0059
E84KPD148	F 026 402 015	N 2015
E842L	F 026 400 070	S 0070
E846L	1 457 433 550	S 3550
E 85 KP D146	F 026 402 006	N 2006
E850L	F 026 400 109	S 0109
E 853 L	F 026 400 058	S 0058
E87KPD150	F 026 402 008	N 2008
E 87 L	1 457 429 080	S 9080
E 87 L 01	1 457 429 080	S 9080
E88L	1 457 429 050	S 9050
E 88 L	1 457 429 959	S 9959
E883L	F 026 400 164	S 0164
E884L	1 457 433 583	S 3583
E89HD97	F 026 407 045	P 7045
E89KPD163	F 026 402 004	N 2004
E 89 L	1 457 429 054	S 9054
E 89 L	1 457 429 915	S 9915
E 89 L 01	1 457 429 054	S 9054
E 89 L 01	1 457 433 540	S 3540
E890L	1 457 433 593	S 3593
E891L	F 026 400 110	S 0110
E892L	F 026 400 035	S 0035
E895L	F 026 400 114	S 0114
E90KPD164	F 026 402 047	N 2047
E 906 LI	1 987 432 151	M 2151
E908LC	1 987 432 306	R 2306
E 909 LI	1 987 432 052	M 2052
E91KPD165	1 457 431 724	N 1724
E93KP	F 026 402 101	N 2101
E93KPD177	F 026 402 101	N 2101
E931LI	1 987 432 150	M 2150
E932LI01	1 987 431 175	M 1175
E933LC	1 987 431 456	R 1456
E938LI	1 987 431 165	M 1165
E 944 LI	1 987 432 152	M 2152
E947LC	1 987 431 451	R 1451
E947LI	1 987 431 167	M 1167
E 950 LI	1 987 432 107	M 2107
E951LI	1 987 432 200	M 2200
E 953 LI	1 987 432 042	M 2042
E954LC	1 987 431 458	R 1458
E954LI	1 987 431 163	M 1163
E 956 LI	1 987 432 153	M 2153
E975LI	1 987 432 075	M 2075
E98KP	1 457 429 289	N 9289
E980LI	1 987 431 168	M 1168
E982LI	1 987 431 154	M 1154
E99KPD172	F 026 402 005	N 2005
E991LI	1 987 432 157	M 2157
E998LC-R	1 987 432 597	R 2597
E998LC01	1 987 432 597	R 2597
HEGPS9845WST	1 457 434 455	N 4455
H 10 W	0 451 103 029	P 3029
H 10 W 01	0 451 103 029	P 3029
H 10 W 02	0 451 103 004	P 3004
H 10 W 03	0 451 103 062	P 3062
H 10 W 10	0 451 103 252	P 3252



◀ HENGST

H10W11	0 986 452 003	P 2003
H10 W 12	0 451 103 289	P 3289
H10 W 14	0 451 103 260	P 3260
H10W19	0 451 103 366	P 3366
H10W20	F 026 407 084	P 7084

H10W21	F 026 407 106	P 7106
H101 W	0 451 103 004	P 3004
H101 W	0 451 103 062	P 3062
H101WK	0 450 904 058	F 4058
H102WK	0 450 904 060	F 4060

H104WK	0 450 904 149	F 4149
H107 WK	0 450 905 287	F 5287
H109WK	0 450 905 901	F 5901
H11 W 01	0 451 103 141	P 3141
H110WK	0 450 905 316	F 5316

H111 WK	0 450 905 318	F 5318
H112 WK	0 450 902 161	F 2161
H113 WK	0 450 915 003	F 5003
H114WK	0 450 915 001	F 5001
H116 WK	1 457 434 186	N 4186

H117 WK	1 457 434 324	N 4324
H118 WK	1 457 434 187	N 4187
H119 WK	1 457 434 184	N 4184
H12W	0 451 103 274	P 3274
H12 W 01	0 451 103 274	P 3274

H12W07	0 451 103 341	P 3341
H12W08	F 026 407 024	P 7024
H121 WK	1 457 434 198	N 4198
H122WK	1 457 434 329	N 4329
H126WK	0 986 450 509	N 0509

H128 WK	1 457 434 416	N 4416
H13 W 01	0 451 103 316	P 3316
H13W03	0 451 103 275	P 3275
H13 1 WK	1 457 434 400	N 4400
H132WK	0 450 904 058	F 4058

H133WK	0 450 906 409	N 6409
H134WK	1 457 434 291	N 4291
H135 WK	0 450 905 195	F 5195
H135 WK	0 450 905 216	F 5216
H136WK	0 450 906 464	N 6464

H137WK	0 450 904 159	F 4159
H138WK	0 986 450 124	F 0124
H14 W 08	0 451 103 232	P 3232
H14 W 09	0 451 103 258	P 3258
H14 W 14	0 451 103 249	P 3249

H14W32	0 986 452 044	P 2044
H140 WK	1 457 434 437	N 4437
H140WK02	F 026 402 065	N 2065
H144 WK	0 450 906 452	N 6452
H146WK	0 450 905 908	F 5908

H147WK	0 450 906 453	N 6453
H148WK	0 450 905 906	F 5906
H149WK	0 450 905 104	F 5104
H15 W	0 451 104 005	P 4005
H15WK09	1 457 434 453	N 4453

H150 WK	0 450 906 451	N 6451
H152WK	F 026 402 034	N 2034
H153WK	0 450 902 151	F 2151
H154 WK	1 457 434 324	N 4324
H155WK	0 450 905 925	F 5925

H155WK01	F 026 403 008	F 3008
H155WK02	F 026 403 006	F 3006
H156WK	0 450 906 450	N 6450
H157 WK	0 450 905 952	F 5952
H16 W	0 451 104 064	P 4064

H16 W 02	0 986 452 000	P 2000
H16 W 02	0 986 452 023	P 2023
H16W03	0 986 452 035	P 2035
H161WK	F 026 402 013	N 2013
H164WK	0 450 905 904	F 5904

H165WK	0 986 450 018	F 0018
H166WK	0 986 450 117	F 0117
H17 W	0 451 104 065	P 4065
H17 WD 6	0 451 203 194	P 3194
H17 WD 8	0 451 203 005	P 3005

H17 WK 02	1 457 429 675	N 9675
H17WK03	1 457 434 419	N 4419
H17WK07	1 457 434 438	N 4438
H17WK08	1 457 434 281	N 4281
H17WK09	1 457 434 453	N 4453

H17 W 01	0 451 104 065	P 4065
H17 W 02	0 451 104 065	P 4065
H17 W 04	0 451 104 066	P 4066
H17 W 05	0 451 103 253	P 3253
H17 W 06	0 451 203 194	P 3194

H17 W 08	0 451 203 005	P 3005
H17 W 09	0 451 104 005	P 4005
H17W11	0 451 103 252	P 3252
H17W13	0 451 103 347	P 3347
H17 W 17	0 451 103 260	P 3260

H17 W 18	0 451 103 346	P 3346
H17 W 18	0 986 452 400	P 2400
H17W20	0 986 452 046	P 2046
H17W24	F 026 407 053	P 7053
H17W27	0 451 104 066	P 4066

H17W29	F 026 407 083	P 7083
H1701 W	0 451 104 066	P 4066
H18 W	0 451 104 015	P 4015
H18 W	0 451 105 067	P 5067
H18WDK01	F 026 402 035	N 2035

H18WDK02	1 457 434 421	N 4421
H18WDK03	F 026 402 037	N 2037
H18WDK04	F 026 402 035	N 2035
H18 WK 01	1 457 429 676	N 9676
H18WK03	1 457 434 294	N 4294

H18WK04	1 457 429 676	N 9676
H18 W 01	0 451 104 015	P 4015
H18 W 01	0 451 105 067	P 5067
H18 W 05	0 451 104 015	P 4015
H18 W 05	0 451 105 067	P 5067

H18 W 07	0 451 105 188	P 5188
H18/1 W	0 451 104 015	P 4015
H18/1 W	0 451 105 067	P 5067
H188WK	0 450 905 927	F 5927
H189WK	0 450 905 939	F 5939

H19 W	0 451 203 002	P 3002
H19 WD 01	0 451 203 226	P 3226
H19 WK 02	1 457 429 681	N 9681
H19 W 01	0 451 203 220	P 3220
H19 W 02	0 451 203 002	P 3002

H19 W 02	0 451 203 226	P 3226
H19 W 04	0 451 203 010	P 3010
H19 W 05	0 451 203 002	P 3002
H19 W 05	0 451 203 226	P 3226
H19 W 07	0 451 301 156	P 1156

H19W10	F 026 407 057	P 7057
H191WK	F 026 402 030	N 2030
H192 WK	0 450 906 508	N 6508
H193WK	1 457 434 436	N 4436
H20 W 03	0 986 452 016	P 2016

H20 W 05	0 986 452 020	P 2020
H20 W 06	0 451 103 290	P 3290
H20W12	0 451 103 240	P 3240
H200 W	0 451 403 001	P 3001
H200 WDK	F 026 402 017	N 2017

H200 WN	0 451 300 003	P 0003
H200 W 01	0 451 104 010	P 4010
H200 W 01	0 451 403 077	P 3077
H200 W 02	0 451 103 343	P 3343
H200W03	F 026 407 043	P 7043

H200W04	F 026 407 043	P 7043
H205 W 01	0 451 203 223	P 3223
H206W	0 986 452 062	P 2062
H206WK	0 450 906 459	N 6459
H207WK01	0 450 906 467	N 6467

H208 W 01	0 451 203 152	P 3152
H209W	0 986 452 042	P 2042
H210WN	0 451 203 201	P 3201
H210WN	0 451 300 007	P 0007
H210 W 01	0 451 301 207	P 1207

H211WK	1 457 434 443	N 4443
H212WK	1 457 434 310	N 4310
H214WK	0 450 906 406	N 6406
H215WK	F 026 402 036	N 2036
H216WK	F 026 402 003	N 2003

H219 WK	0 450 906 471	N 6471
H220 W	0 451 301 156	P 1156
H220WK	0 450 905 921	F 5921
H220WN	F 026 407 049	P 7049
H221 WK	0 450 905 983	F 5983

H223 WK	0 450 906 429	N 6429
H225 WK	F 026 403 003	F 3003
H227 WK	0 450 905 320	F 5320
H228 WK	0 450 905 989	F 5989
H228 WK	0 986 450 108	F 0108

H229WK	0 986 450 119	F 0119
H230W	F 026 407 048	P 7048
H232WK	1 457 434 440	N 4440
H237WK	1 457 434 459	N 4459
H239WK	0 450 904 158	N 4158

H 24 W 01	0 986 452 003	P 2003
H 24 W 01	0 451 103 028	P 3028
H24W02	0 451 103 217	P 3217
H24W05	0 451 103 330	P 3330
H24W06	0 986 452 064	P 2064

H 240 WK	1 457 434 439	N 4439
H 240 WK	1 457 434 451	N 4451
H240W01	0 451 300 003	P 0003
H241WK	0 986 450 508	N 0508
H241WK	1 457 434 453	N 4453

H247WK01	0 450 906 457	N 6457
H249WK	0 450 905 973	F 5973
H256WK	0 986 450 222	F 0222
H262WK	0 450 905 916	F 5916
H262WK	0 986 450 104	F 0104

H267WK	0 450 905 911	F 5911
H270WK	0 450 906 469	N 6469
H271WK	0 450 906 461	N 6461
-*H272WK	0 450 905 950	F 5950
H 273 WK	0 450 906 431	N 6431

H275WK	0 450 906 462	N 6462
H276WK	0 450 905 975	F 5975
H278WK	F 026 402 056	N 2056
H279WK	0 450 906 442	N 6442
H 280 WK	0 450 905 959	F 5959

H 281WK	F 026 402 000	N 2000
H 281 WK	0 450 906 500	N 6500
H282WK	0 450 906 437	N 6437
H284WK	0 450 906 426	N 6426
H285WK	0 986 450 114	F 0114

H297WK	0 450 905 903	F 5903
H298WK	0 450 905 942	N 5942
H 30 WK	1 457 434 051	N 4051
H 30 WK 01	1 457 434 051	N 4051
H 300 W 01	0 451 403 208	P 3208

H 300 W 02	0 451 104 013	P 4013
H 300W09	0 451 103 368	P 3368
H303WK	F 026 402 049	N 2049
H308W	F 026 407 105	P 7105
H 31 WK	1 457 434 153	N 4153

H 31 WK 01	1 457 434 153	N 4153
H322WK	F 026 402 059	N 2059
H323WK	F 026 402 046	N 2046
H 35 WK	1 457 434 123	N 4123
H 35 WK 01	1 457 434 123	N 4123

H35WK02	1 457 434 331	N 4331
H54WK	0 450 906 460	N 6460
H 60 WK	1 457 434 154	N 4154
H 60 WK	1 457 434 165	N 4165
H 60 WK	1 457 434 432	N 4432

H 60 WK 01	1 457 434 050	N 4050
H 60 WK 01	1 457 434 432	N 4432
H60WK03	1 457 434 296	N 4296
H70WDK06	1 457 434 447	N 4447
H70WDK13	1 457 434 447	N 4447

H70WDK14	1 457 434 447	N 4447
H 70 WK	1 457 434 105	N 4105
H 70 WK 02	1 457 434 106	N 4106
H 70 WK 02	1 457 434 174	N 4174
H 70 WK 06	1 457 434 447	N 4447

H70WK07	1 457 434 447	N 4447
H70WK09	1 457 434 402	N 4402
H 70 WK 11	0 450 905 930	N 5930
H70WK15	F 026 402 002	N 2002
H7020WK10	1 457 434 448	N 4448

H7052WK10	1 457 434 450	N 4450
H7090WK30	F 026 402 025	N 2025
H710WK	F 026 402 038	N 2038
H 8 W	0 451 103 029	P 3029
H 80 WK 01	0 450 905 030	F 5030

H 80 WK 01	0 450 905 095	F 5095
H 80 WK 01	0 450 905 275	F 5275
H 80 WK 02	0 450 905 401	F 5401
H 80 WK 04	0 450 905 203	F 5203
H 80 WK 05	0 450 905 177	F 5177

H 80 WK 07	0 450 905 030	F 5030
H 80 WK 07	0 450 905 264	F 5264
H 81 WK 01	1 457 434 103	N 4103
H 81 WK 01	1 457 434 321	N 4321
H 82 WK 01	0 450 905 002	F 5002

H 82 WK 01	0 450 905 273	F 5273
H 82 WK 01	0 450 905 280	F 5280
H 83 WK 01	0 450 905 021	F 5021
H 84 WK 01	0 450 905 200	F 5200
H 84 WK 01	0 450 905 601	F 5601

H 84 WK 02	0 450 905 143	F 5143
H 84 WK 02	0 450 905 324	F 5324
H 84 WK 03	0 450 905 091	F 5091
H 84 WK 03	0 450 905 133	F 5133
H 84 WK 03	0 450 905 145	F 5145

H 85 WK 01	0 450 905 005	F 5005
H90WK	1 457 429 675	N 9675
H 90 W 16	0 451 103 297	P 3297
H 90 W 24	0 451 103 337	P 3337
H90W27	0 986 452 068	P 2068

H90W32	F 026 407 017	P 7017
H96W	0 451 103 270	P 3270
H96W01	0 451 103 365	P 3365
H96W02	0 986 452 030	P 2030
H96W03	0 986 452 063	P 2063

H97W01	0 451 103 276	P 3276
H 97 W 03	0 986 452 061	P 2061
H 97 W 04	0 986 452 028	P 2028
H97W07	0 986 452 028	P 2028
H97W10	0 986 452 060	P 2060

H97W13	0 986 452 058	P 2058
Z10D64	F 026 407 059	P 7059
Z12D64	F 026 407 058	P 7058
Z13D94	F 026 407 060	P 7060
Z14	F 026 407 059	P 7059

01511	0 450 904 149	F 4149
122 279	0 450 905 326	F 5326
124193	0 986 450 624	F 0624
130 63 31	1 457 434 106	N 4106
2XD23E19724	1 457 429 732	P 9732

60 WK 01	1 457 434 165	N 4165
----------	---------------	---------------

KNECHT

AF121	1 457 429 820	P 9820
AF203D	1 457 429 740	P 9740
AF 21/2	1 457 429 735	P 9735

AF213D	1 457 429 735	P 9735
AF32	1 457 429 647	P 9647
AF32D	1 457 429 647	P 9647
AF34	1 457 429 646	P 9646
AF34D	1 457 429 646	P 9646

AF51D	1 457 429 600	P 9600
AF68	1 457 429 636	P 9636
AF78D	1 457 429 647	P 9647
AF79D	1 457 429 646	P 9646
AG108	1 457 429 957	S 9957

AG113	1 457 429 076	S 9076
AG116	1 457 432 111	S 2111
AG125	1 457 429 080	S 9080
AG129	1 457 429 928	S 9928
AG135	1 457 429 993	S 9993

AG137	1 457 433 200	S 3200
AG138	1 457 429 933	S 9933
AG15	1 457 432 106	S 2106
AG177	1 457 429 908	S 9908
AG180	1 457 429 079	S 9079

AG192	1 457 429 900	S 9900
AG194	1 457 429 994	S 9994
AG195	1 457 429 994	S 9994
AG219	1 457 429 085	S 9085
AG231	1 457 429 992	S 9992

AG232	1 457 429 050	S 9050
AG238	1 457 432 134	S 2134
AG239	1 457 429 854	S 9854
AG246	1 457 429 054	S 9054
AG255	1 457 429 076	S 9076

AG259	1 457 429 875	S 9875
AG261	1 457 429 988	S 9988
AG266	1 457 433 601	S 3601
AG267	1 457 429 777	S 9777
AG275	1 457 429 964	S 9964



◀ KNECHT

AG280	1 457 429 983	S 9983
AG29	1 457 429 959	S 9959
AG292	1 457 433 002	S 3002
AG295	1 457 429 869	S 9869
AG297	1 457 429 777	S 9777

AG298	1 457 429 777	S 9777
AG301	1 457 429 787	S 9787
AG302	1 457 429 787	S 9787
AG306	1 457 429 844	S 9844
AG3100	1 457 433 003	S 3003

AG32	1 457 429 053	S 9053
AG511	1 457 429 076	S 9076
AG551	1 457 429 061	S 9061
AG61	1 457 429 054	S 9054
AG73	1 457 429 932	S 9932

AG74	1 457 429 950	S 9950
AG87	1 457 429 941	S 9941
AG89	1 457 429 975	S 9975
AG90	1 457 429 969	S 9969
AG96	1 457 429 966	S 9966

AWK126	1 457 434 447	N 4447
AWK1261	1 457 434 447	N 4447
AWK27	1 457 429 675	N 9675
AWK 53	1 457 429 676	N 9676
AW1	0 451 103 274	P 3274

AW1	0 986 452 044	P 2044
AW165	0 451 301 207	P 1207
AW194	0 451 103 289	P 3289
AW2	0 451 103 062	P 3062
AW207	0 451 103 316	P 3316

AW27	1 457 429 675	N 9675
AW34	0 986 452 000	P 2000
AW38	0 451 104 064	P 4064
AW45	0 986 452 003	P 2003
AW51	0 451 203 010	P 3010

AW53	1 457 429 676	N 9676
AW 59	0 451 103 274	P 3274
AW6	0 986 452 003	P 2003
AW66	0 451 203 194	P 3194
AW78	0 451 203 005	P 3005

AW78	0 986 452 024	P 2024
AW91	0 451 301 156	P 1156
AW92	0 451 403 077	P 3077
B402	1 457 431 158	N 1158
B402C	1 457 431 158	N 1158

B402F	1 457 431 158	N 1158
B402100M1	1 457 431 158	N 1158
B404	1 457 431 159	N 1159
B404C	1 457 431 159	N 1159
B404C100M1	1 457 431 159	N 1159

B404F	1 457 431 159	N 1159
B404100M1	1 457 431 159	N 1159
CF1	1 457 429 165	P 9165
CF27	1 457 429 251	P 9251
DF21	1 457 434 200	N 4200

EH259	1 457 429 117	P 9117
EH2681	1 457 429 820	P 9820
EH302	1 457 429 130	P 9130
EH302	1 457 429 629	P 9629
EH302D	1 457 429 629	P 9629

EK402	1 457 431 261	N 1261
EK404	1 457 431 270	N 1270
EK414	1 457 429 230	N 9230
EK518	1 457 434 201	N 4201
EL447	1 457 432 108	S 2108

ENC305	1 457 429 175	P 9175
EN110M	1 457 429 175	P 9175
EN1100	1 457 429 175	P 9175
EN1103	1 457 429 175	P 9175
EN1104	1 457 429 175	P 9175

FB 619 1	0 450 904 149	F 4149
FB629S	0 450 904 149	F 4149
FB62915	0 450 904 149	F 4149
FB6294	0 450 904 149	F 4149
FB6295	0 450 904 149	F 4149

FB 683	0 450 905 030	F 5030
FB754	0 450 904 149	F 4149
FB793	0 450 904 149	F 4149
FB794	0 450 904 149	F 4149
FO37110	0 451 203 005	P 3005

FO37110	0 986 452 024	P 2024
FO3713	0 451 104 005	P 4005
FO373	0 451 103 004	P 3004
FO383	0 986 452 003	P 2003
FO385	0 451 103 028	P 3028

FO3851	0 451 103 028	P 3028
FP371	0 451 203 194	P 3194
FR4	1 457 429 354	N 9354
HX 15	1 457 429 820	P 9820
HX 44	1 457 429 416	P 9416

HX 5	1 457 429 165	P 9165
KC 100	1 457 434 440	N 4440
KC 102	1 457 434 154	N 4154
KC 102	1 457 434 447	N 4447
KC 103	1 457 434 198	N 4198

KC 104	1 457 434 436	N 4436
KC 109	1 457 434 400	N 4400
KC 111	1 457 434 443	N 4443
KC 112	1 457 434 103	N 4103
KC 112	1 457 434 106	N 4106

KC 117	1 457 434 419	N 4419
KC 135	1 457 434 438	N 4438
KC 140	1 457 434 460	N 4460
KC 17	1 457 434 105	N 4105
KC 18	1 457 434 106	N 4106

KC 18/1	1 457 434 106	N 4106
KC182	1 457 434 310	N 4310
KC 186	1 457 434 402	N 4402
KC 189	1 457 434 451	N 4451
KC 196	F 026 402 013	N 2013

KC 197	1 457 434 421	N 4421
KC 199	1 457 434 198	N 4198
KC 20	1 457 434 051	N 4051
KC 208	1 457 434 459	N 4459
KC219	1 457 434 450	N 4450

KC 22	1 457 434 153	N 4153
KC 24	1 457 434 154	N 4154
KC 24	1 457 434 165	N 4165
KC 244	F 026 402 043	N 2043
KC 256 D	F 026 402 063	N 2063

KC 33	1 457 434 186	N 4186
KC 34	1 457 434 184	N 4184
KC 38	1 457 434 106	N 4106
KC 4	1 457 429 681	N 9681
KC 43	1 457 434 106	N 4106

KC 46	1 457 434 453	N 4453
KC 47	1 457 434 187	N 4187
KC 51	1 457 434 105	N 4105
KC 51	1 457 434 321	N 4321
KC 56	1 457 434 302	N 4302

KC 56	1 457 434 456	N 4456
KC 6	1 457 434 050	N 4050
KC 6	1 457 434 432	N 4432
KC 62	1 457 434 324	N 4324
KC 631 D	1 457 434 123	N 4123

KC 65	1 457 434 324	N 4324
KC 66/1	1 457 434 154	N 4154
KC 67	1 457 434 281	N 4281
KC 67	1 457 434 439	N 4439
KC 68	1 457 434 105	N 4105

KC 68/D	1 457 434 105	N 4105
KC 69	1 457 434 184	N 4184
KC 7	1 457 429 676	N 9676
KC 71	1 457 434 324	N 4324
KC 74	1 457 434 154	N 4154

KC 75	1 457 434 294	N 4294
KC 76	1 457 434 291	N 4291
KC 8	1 457 429 675	N 9675
KC 80	1 457 434 329	N 4329
KC 82	1 457 434 435	N 4435

KC 83	1 457 434 438	N 4438
KC 85/1	F 026 402 002	N 2002
KC 93	0 450 902 162	F 2162
KC 98	1 457 434 324	N 4324
KLH 29/1	F 026 403 002	F 3002

KLH 44/25	F 026 402 061	N 2061
KL 100 2	0 450 905 930	N 5930
KL 103	0 450 906 409	N 6409
KL 104	0 450 905 950	F 5950
KL 108	0 986 450 104	F 0104

KL 109	0 986 450 104	F 0104
KL 111	0 986 450 624	F 0624
KL 112	0 450 905 929	F 5929
KL 114	0 986 450 106	F 0106
KL 115	0 450 905 989	F 5989



KL 115	0 986 450 108	F 0108
KL 116	0 986 450 117	F 0117
KL 117	0 986 450 102	F 0102
KL 118	0 986 450 105	F 0105
KL 121	0 986 450 106	F 0106
KL 123	0 450 905 929	F 5929
KL 126	0 986 450 604	F 0604
KL 128	0 450 905 914	F 5914
KL 129	0 986 450 103	F 0103
KL 13	0 450 904 058	F 4058
KL 13 OF	0 450 904 058	F 4058
KL 13 SB	0 450 904 058	F 4058
KL 130	0 450 905 924	F 5924
KL 130	0 986 450 113	F 0113
KL 131	0 450 905 914	F 5914
KL 132	0 986 450 604	F 0604
KL 133	0 986 450 138	F 0138
KL 134	0 986 450 114	F 0114
KL 135	0 450 905 971	F 5971
KL 136	0 450 905 920	F 5920
KL 137	0 986 450 117	F 0117
KL 138	0 986 450 039	F 0039
KL 139	0 986 450 110	F 0110
KL 14	0 450 905 280	F 5280
KL 140	0 986 450 115	F 0115
KL 141	0 986 450 117	F 0117
KL 142	0 986 450 018	F 0018
KL 144	0 986 450 111	F 0111
KL 146	0 450 905 974	F 5974
KL 147/1D	0 450 906 437	N 6437
KL 149	0 450 905 952	F 5952
KL 15	0 450 904 149	F 4149
KL 154	0 986 450 509	N 0509
KL 155 1	0 450 906 464	N 6464
KL 158	0 986 450 119	F 0119
KL 159	0 986 450 108	F 0108
KL 16	F 026 403 000	F 3000
KL 16	0 450 905 177	F 5177
KL 160 1	0 450 906 451	N 6451
KL 165	F 026 402 001	N 2001
KL 169	0 450 906 457	N 6457
KL 169 D	0 450 906 457	N 6457
KL 176/6 D	0 450 905 925	F 5925
KL 179	1 457 434 416	N 4416
KL 18	0 450 904 163	F 4163
KL 181	0 450 905 939	F 5939
KL 182	0 450 905 911	F 5911
KL 183	0 450 905 909	F 5909
KL 185	0 450 905 916	F 5916
KL 19	0 450 905 203	F 5203
KL 194	0 450 905 002	F 5002
KL 196	0 450 905 921	F 5921
KL 197	0 450 906 453	N 6453
KL 2	0 450 905 030	F 5030
KL 2	0 450 905 264	F 5264
KL 203	0 986 450 109	F 0109
KL 204	0 450 905 087	F 5087
KL 204	0 450 905 401	F 5401
KL 206	0 450 904 161	N 4161
KL 208	0 986 450 030	F 0030
KL 209	0 986 450 221	F 0221
KL 210	0 450 905 963	F 5963
KL 228	F 026 402 056	N 2056
KL 228 2	F 026 402 056	N 2056
KL 228/2 D	F 026 402 056	N 2056
KL 228 3	F 026 402 056	N 2056
KL 229 4	0 450 906 467	N 6467
KL 23	0 450 904 060	F 4060
KL 23 OF	0 450 904 060	F 4060
KL 231	0 986 450 107	F 0107
KL 24	0 450 905 002	F 5002
KL 24/1	0 450 905 002	F 5002
KL 245	0 450 905 987	F 5987
KL 246	0 450 905 978	F 5978
KL 247	0 450 905 951	F 5951
KL 28	0 450 905 133	F 5133
KL 29	0 450 905 143	F 5143
KL 30	0 450 905 200	F 5200
KL 30	0 450 905 601	F 5601
KL 30	0 450 905 964	F 5964
KL 313	1 457 434 437	N 4437
KL 33	0 450 904 077	N 4077
KL 33 OF	0 450 904 077	N 4077
KL 35	0 450 905 901	F 5901
KL 36	0 450 905 906	F 5906
KL 38	0 450 905 177	F 5177
KL 404/16	F 026 402 072	N 2072
KL 409	0 450 905 927	F 5927
KL 414	0 450 906 461	N 6461
KL 418	0 450 906 460	N 6460
KL 43	0 450 906 442	N 6442
KL 430	0 450 906 468	N 6468
KL 431	0 450 906 471	N 6471
KL 432	0 450 906 469	N 6469
KL 434	F 026 403 001	F 3001
KL 435	F 026 403 001	F 3001
KL 436	0 450 905 983	F 5983
KL 440 3	F 026 402 059	N 2059
KL 446	0 450 906 508	N 6508
KL 447	0 450 906 458	N 6458
KL 454	0 450 906 459	N 6459
KL 458	0 450 905 926	F 5926
KL 471	0 450 905 958	F 5958
KL 474	0 450 906 452	N 6452
KL 485/5D	F 026 402 067	N 2067
KL 5	0 450 905 021	F 5021
KL 51	0 450 905 906	F 5906
KL 559	F 026 403 009	F 3009
KL 566	F 026 402 049	N 2049
KL 568	F 026 402 051	N 2051
KL 569	F 026 402 046	N 2046
KL572	0 450 905 959	F 5959
KL 59	0 450 905 021	F 5021
KL 59	0 450 905 200	F 5200
KL 596	F 026 402 068	N 2068
KL 60	0 450 905 002	F 5002
KL 61	0 450 905 324	F 5324
KL 61	0 450 905 966	F 5966
KL 63	0 450 904 159	F 4159
KL 63 OF	0 450 904 058	F 4058
KL 630	F 026 402 054	N 2054
KL 65	0 450 905 275	F 5275
KL 658	F 026 402 066	N 2066
KL 658	F 026 402 068	N 2068
KL 705	F 026 403 014	F 3014
KL 71	0 450 905 908	F 5908
KL 72	0 450 902 161	F 2161
KL 72	0 450 905 287	F 5287
KL 78	0 450 905 942	N 5942
KL 79	0 450 905 318	F 5318
KL 82	0 450 915 003	F 5003
KL 82/2	0 450 905 968	F 5968
KL 83	0 450 905 273	F 5273
KL 83	0 450 905 316	F 5316
KL 84	0 450 905 273	F 5273
KL 84/2	0 450 905 975	F 5975
KL 85	0 450 905 216	F 5216
KL 86	0 450 902 151	F 2151
KL 87	0 450 915 001	F 5001
KL 88	0 450 905 145	F 5145
KL 9	0 450 905 030	F 5030
KL 93	0 986 450 104	F 0104
KL 94	0 450 905 005	F 5005
KL 95	0 450 905 903	F 5903
KL 96	0 450 905 960	F 5960
KNEKX201D	1 457 431 723	N 1723
KNELX1078	1 457 433 289	S 3289
KNELX113	1 457 429 053	S 9053
KNELX1595	1 457 433 712	S 3712
KNELX1617	1 457 433 327	S 3327
KNEOC106	0 451 103 029	P 3029
KX 13	1 457 431 028	N 1028
KX 178 DECO	1 457 431 715	N 1715
KX 183 D	1 457 431 720	N 1720
KX 200 S	1 457 431 718	N 1718
KX204D	1 457 431 724	N 1724
KX 206 D	1 457 431 705	N 1705
KX208DECO	1 457 070 001	N 0001
KX 211 D	F 026 402 004	N 2004
KX 218 D	F 026 402 047	N 2047
KX 218D DECO	F 026 402 047	N 2047
KX 226 D	F 026 402 005	N 2005
KX 23	1 457 434 201	N 4201
KX 24	1 457 434 200	N 4200
KX 26	1 457 431 159	N 1159



◀ KNECHT

KX 265 D	F 026 402 062	N 2062
KX 29	1 457 434 250	N 4250
KX 35	1 457 431 261	N 1261
KX 36	1 457 431 270	N 1270
KX 38	1 457 429 230	N 9230

KX 40	1 457 431 270	N 1270
KX 40	1 457 431 326	N 1326
KX 43	1 457 431 158	N 1158
KX 44	1 457 431 159	N 1159
KX 46	1 457 431 159	N 1159

KX 63	1 457 431 713	N 1713
KX 63/1	1 457 431 713	N 1713
KX 65 DECO	1 457 429 354	N 9354
KX 67/2 DECO	1 457 431 707	N 1707
KX 68 DECO	1 457 429 359	N 9359

KX 69 ECO	1 457 431 708	N 1708
KX 70 DECO	1 457 431 704	N 1704
KX 73/1 DECO	1 457 431 710	N 1710
KX 74	1 457 429 291	N 9291
KX 74	1 457 431 702	N 1702

KX 75 D	1 457 429 621	N 9621
KX 78 D	1 457 429 656	N 9656
KX 79 D	1 457 429 657	N 9657
KX 80 DECO	1 457 429 655	N 9655
KX 81 D	1 457 431 712	N 1712

KX 81 DECO	1 457 431 712	N 1712
KX 84 DECO	1 457 431 703	N 1703
KX 85 DECO	1 457 070 000	N 0000
KX 86/1 DECO	F 026 402 084	N 2084
KX 87 DECO	1 457 030 013	N 0013

KX 9	1 457 429 289	N 9289
KO13D	1 457 429 274	P 9274
LAG 113/S	1 987 432 117	M 2117
LAK 131	1 987 432 320	R 2320
LAK 156	1 987 432 381	R 2381

LAK 181/1	1 987 432 597	R 2597
LAK 182	1 987 432 114	M 2114
LAK 294	1 987 432 319	R 2319
LAK358	1 987 431 457	R 1457
LAK 373	1 987 432 488	R 2488

LAK 386	1 987 432 369	R 2369
LAK 410	1 987 432 406	R 2406
LAK 412	1 987 432 406	R 2406
LAK 426/S	1 987 432 500	R 2500
LAK43	1 987 431 454	R 1454

LAK 448	1 987 432 156	M 2156
LAK 463	1 987 432 415	R 2415
LAK 478	1 987 432 498	R 2498
LAK57	1 987 432 348	R 2348
LAK71	1 987 431 452	R 1452

LAK 77	1 987 432 306	R 2306
LAK85	1 987 431 456	R 1456
LA 109	1 987 432 084	M 2084
LA 118	1 987 432 192	M 2192
LA 119	1 987 432 075	M 2075

LA 122	1 987 432 074	M 2074
LA 123	1 987 432 042	M 2042
LA 130	1 987 432 058	M 2058
LA 131	1 987 432 085	M 2085
LA148	1 987 431 167	M 1167

LA 155	1 987 432 115	M 2115
LA 156 1	1 987 432 281	M 2281
LA 157	1 987 432 088	M 2088
LA 158	1 987 432 092	M 2092
LA 182	1 987 432 114	M 2114

LA 239	1 987 432 122	M 2122
LA279	1 987 431 162	M 1162
LA 289	1 987 432 194	M 2194
LA 296 S	1 987 432 086	M 2086
LA304	1 987 432 189	M 2189

LA 307	1 987 432 213	M 2213
LA 32/3	1 987 432 200	M 2200
LA 343	1 987 432 227	M 2227
LA344	1 987 432 203	M 2203
LA358	1 987 431 168	M 1168

LA 378	1 987 431 175	M 1175
LA382	1 987 432 208	M 2208
LA384	1 987 432 207	M 2207
LA 395	1 987 432 190	M 2190
LA 396	1 987 432 238	M 2238

LA 408	1 987 432 236	M 2236
LA410	1 987 432 206	M 2206
LA 411	1 987 432 065	M 2065
LA412	1 987 432 206	M 2206
LA 42	1 987 432 150	M 2150

LA424	1 987 432 216	M 2216
LA 441	1 987 432 055	M 2055
LA447	1 987 432 204	M 2204
LA449	1 987 432 214	M 2214
LA456	1 987 432 218	M 2218

LA 50	1 987 432 152	M 2152
LA 502	1 987 431 172	M 1172
LA55	1 987 431 164	M 1164
LA55/1	1 987 431 164	M 1164
LA 67	1 987 432 151	M 2151

LA71	1 987 431 169	M 1169
LA85	1 987 431 157	M 1157
LKK 165/S	1 987 432 512	R 2512
LKS 41	F 026 400 082	S 0082
LX 1	1 457 429 800	S 9800

LX 100 0	1 457 433 089	S 3089
LX 100 1	1 457 433 971	S 3971
LX 100 2	1 457 433 972	S 3972
LX 100 4	1 457 433 594	S 3594
LX 1006/1D	F 026 400 028	S 0028

LX 1008/1	F 026 400 006	S 0006
LX 1008/3	1 457 433 599	S 3599
LX 1020	F 026 400 024	S 0024
LX 1025	F 026 400 084	S 0084
LX 102 7	1 457 433 086	S 3086

LX 102 9	1 457 433 045	S 3045
LX 103 3	1 457 433 098	S 3098
LX 103 9	F 026 400 164	S 0164
LX 104 1	F 026 400 123	S 0123
LX 104 3	1 987 429 150	S 9150

LX 104 4	1 457 433 090	S 3090
LX 104 5	1 457 433 150	S 3150
LX 104 6	1 457 433 306	S 3306
LX 104 7	1 457 433 083	S 3083
LX 104 8	1 457 433 150	S 3150

LX 104 9	1 457 433 955	S 3955
LX 105	1 457 429 964	S 9964
LX 106	1 457 429 869	S 9869
LX 107 3	1 457 433 155	S 3155
LX 107 5	1 987 429 185	S 9185

LX 107 6	1 457 433 969	S 3969
LX 107 8	1 457 433 324	S 3324
LX 108	1 457 429 920	S 9920
LX 1080	1 457 433 319	S 3319
LX 108 3	1 457 433 797	S 3797

LX 109	1 457 429 983	S 9983
LX 112	1 457 429 846	S 9846
LX 1136	F 026 400 038	S 0038
LX 114	1 457 429 970	S 9970
LX 114 0	1 457 433 534	S 3534

LX 114 2	1 457 433 332	S 3332
LX 114 3	1 457 433 317	S 3317
LX 114 7	1 457 433 094	S 3094
LX 121 1	1 987 429 404	S 9404
LX 121 3	1 457 433 100	S 3100

LX 123	1 457 432 154	S 2154
LX123	1 457 433 544	S 3544
LX 1253	F 026 400 027	S 0027
LX 125 7	1 457 432 204	S 2204
LX 125 8	1 457 433 163	S 3163

LX 126 1	1 457 433 164	S 3164
LX 126 2	1 457 433 102	S 3102
LX 126 6	1 457 433 274	S 3274
LX 126 8	1 457 433 593	S 3593
LX 126 9	1 987 429 181	S 9181

LX 127 7	1 987 429 401	S 9401
LX 1281	F 026 400 034	S 0034
LX 128 6	F 026 400 017	S 0017
LX 128 7	1 457 433 159	S 3159
LX 129 4	1 457 433 578	S 3578

LX 129 4	1 457 433 579	S 3579
LX 129 6	1 457 432 200	S 2200
LX 129 8	1 457 433 274	S 3274
LX 130	1 457 432 106	S 2106
LX 14	1 457 433 200	S 3200

LX 144	1 987 429 115	S 9115
LX 145 1	1 457 433 325	S 3325
LX 145 2	1 457 433 160	S 3160
LX 145 5	1 987 429 403	S 9403
LX 145 6	1 457 433 095	S 3095



LX 1458	F 026 400 025	S 0025	LX 193 6	F 026 400 158	S 0158	LX 310	1 987 429 121	S 9121
LX 146 5	1 457 433 097	S 3097	LX 194 3	F 026 400 113	S 0113	LX 312	1 457 433 002	S 3002
LX 1466 S	1 457 433 581	S 3581	LX 194 8	F 026 400 159	S 0159	LX 314	1 457 429 795	S 9795
LX 146 7	1 987 429 193	S 9193	LX 194 9	F 026 400 054	S 0054	LX 316	1 457 433 003	S 3003
LX 147	1 457 433 231	S 3231	LX 196	1 457 429 942	S 9942	LX 317	1 457 429 923	S 9923
LX 147 4	F 026 400 096	S 0096	LX 196 8	F 026 400 097	S 0097	LX 32	1 457 433 201	S 3201
LX 147 5	1 457 433 574	S 3574	LX 198 3	F 026 400 126	S 0126	LX 329	1 457 433 233	S 3233
LX 1478	F 026 400 030	S 0030	LX 199	1 457 433 732	S 3732	LX 330	1 457 429 841	S 9841
LX 148	1 457 432 150	S 2150	LX 200	1 457 429 932	S 9932	LX 332	1 457 429 819	S 9819
LX 1497/1	F 026 400 150	S 0150	LX 202	1 457 429 064	S 9064	LX 333	1 457 433 250	S 3250
LX 151	1 457 432 204	S 2204	LX 2022	F 026 400 058	S 0058	LX 334	1 457 433 601	S 3601
LX 152	1 457 432 173	S 2173	LX 203	1 457 429 053	S 9053	LX 335	1 457 433 626	S 3626
LX 156 6	1 987 429 405	S 9405	LX 206 6	F 026 400 070	S 0070	LX 337	1 457 429 842	S 9842
LX 1568	1 987 429 182	S 9182	LX 206 7	F 026 400 147	S 0147	LX 339	1 457 429 792	S 9792
LX 156 9	F 026 400 004	S 0004	LX 208	1 457 429 054	S 9054	LX 343	1 457 433 004	S 3004
LX 157 0	1 457 433 099	S 3099	LX 208	1 457 429 915	S 9915	LX 345	1 457 433 651	S 3651
LX 157 1	1 457 433 096	S 3096	LX 209	1 457 429 959	S 9959	LX 347	1 457 429 844	S 9844
LX 157 2	1 457 433 323	S 3323	LX 212 2	1 987 429 164	S 9164	LX 348	1 457 433 700	S 3700
LX 158	1 457 432 108	S 2108	LX 212 3	F 026 400 098	S 0098	LX 35	1 457 429 079	S 9079
LX 158 3	F 026 400 103	S 0103	LX 218	1 457 429 076	S 9076	LX 350	1 987 429 146	S 9146
LX 158 7	F 026 400 117	S 0117	LX 220	1 457 429 061	S 9061	LX 354	1 987 429 121	S 9121
LX 159 5	1 457 433 538	S 3538	LX 227	1 457 429 966	S 9966	LX 36	1 457 429 928	S 9928
LX 1596	F 026 400 033	S 0033	LX 236	1 457 429 946	S 9946	LX 384	1 457 433 227	S 3227
LX 16	1 457 429 933	S 9933	LX 239	1 457 432 192	S 2192	LX 386	1 457 429 050	S 9050
LX 160	1 457 432 111	S 2111	LX 249	1 457 429 900	S 9900	LX 388	1 457 433 005	S 3005
LX 1601	1 457 433 316	S 3316	LX 259	1 457 429 957	S 9957	LX 389	1 457 433 007	S 3007
LX 160 4	F 026 400 102	S 0102	LX 261 2	F 026 400 125	S 0125	LX 395 5	1 457 433 590	S 3590
LX 160 9	1 457 433 320	S 3320	LX 261 7	F 026 400 160	S 0160	LX 405	1 457 433 023	S 3023
LX 161 1	1 987 429 163	S 9163	LX 261 8	F 026 400 161	S 0161	LX 408	1 457 429 814	S 9814
LX 161 2	1 987 429 187	S 9187	LX 263 3	F 026 400 135	S 0135	LX 414	1 457 429 895	S 9895
LX 161 3	F 026 400 162	S 0162	LX 263 6	F 026 400 140	S 0140	LX 417	1 457 433 008	S 3008
LX 161 9	1 457 433 591	S 3591	LX 263 8	F 026 400 093	S 0093	LX 418	1 457 433 264	S 3264
LX 162 1	1 457 433 591	S 3591	LX 264	1 457 429 080	S 9080	LX 422	1 457 433 698	S 3698
LX 162 5	F 026 400 107	S 0107	LX 264 9	F 026 400 127	S 0127	LX 425	1 457 433 230	S 3230
LX 163 1	F 026 400 101	S 0101	LX 265	1 457 429 950	S 9950	LX 430	1 457 429 896	S 9896
LX 164 0	F 026 400 119	S 0119	LX 266	1 457 429 030	S 9030	LX 435	1 457 429 791	S 9791
LX 164 3	1 457 433 315	S 3315	LX 267 9	F 026 400 163	S 0163	LX 436	1 457 429 899	S 9899
LX 165 1	F 026 400 018	S 0018	LX 268 1	F 026 400 188	S 0188	LX 438	1 457 433 701	S 3701
LX 165 6	F 026 400 166	S 0166	LX 271	1 457 429 975	S 9975	LX 439	1 457 433 752	S 3752
LX 165 9	F 026 400 108	S 0108	LX 273	1 457 429 969	S 9969	LX 439 1	1 457 433 752	S 3752
LX 1683	F 026 400 013	S 0013	LX 273 9	F 026 400 137	S 0137	LX 443	1 457 429 987	S 9987
LX 1686/1	F 026 400 133	S 0133	LX 275	1 457 429 941	S 9941	LX 444	1 457 429 781	S 9781
LX 168 8	F 026 400 129	S 0129	LX 275 1	F 026 400 154	S 0154	LX 446	1 987 429 125	S 9125
LX 178 5	F 026 400 044	S 0044	LX 276	1 457 429 993	S 9993	LX 448	1 457 429 877	S 9877
LX 179 2	1 457 433 084	S 3084	LX 279 2	F 026 400 114	S 0114	LX 448	1 457 433 310	S 3310
LX 18	1 457 429 794	S 9794	LX 290	1 457 432 124	S 2124	LX 452	1 457 433 266	S 3266
LX 1808	F 026 400 048	S 0048	LX 291	1 457 429 908	S 9908	LX 453	1 457 432 183	S 2183
LX 181 3	F 026 400 110	S 0110	LX 294	1 457 429 954	S 9954	LX 454	1 457 432 180	S 2180
LX 1826	F 026 400 013	S 0013	LX 295	1 457 429 777	S 9777	LX 460 1	1 457 432 172	S 2172
LX 183 7	F 026 400 121	S 0121	LX 296	1 457 429 777	S 9777	LX 463	1 457 432 185	S 2185
LX 1845	F 026 400 055	S 0055	LX 298	1 457 429 953	S 9953	LX 464	1 457 432 150	S 2150
LX1849	F 026 400 051	S 0051	LX 300	1 987 429 117	S 9117	LX 467	1 457 429 793	S 9793
LX 188 5	F 026 400 109	S 0109	LX 301	1 457 432 200	S 2200	LX 467 1	1 457 429 793	S 9793
LX 1915	F 026 400 043	S 0043	LX 307	1 457 429 894	S 9894	LX 469	1 457 433 537	S 3537
LX 192 6	F 026 400 012	S 0012	LX 307	1 987 429 051	S 9051	LX 469 1	1 457 433 537	S 3537



◀ KNECHT

LX 472	1 457 433 052	S 3052
LX 475	1 457 433 743	S 3743
LX477	1 457 433 282	S 3282
LX 478	1 457 432 138	S 2138
LX 478 1	1 457 432 138	S 2138

LX 480	1 457 433 259	S 3259
LX 485	1 457 433 037	S 3037
LX 486	1 457 432 154	S 2154
LX 486	1 457 433 544	S 3544
LX 487	1 457 432 204	S 2204

LX 488	1 457 433 606	S 3606
LX 492	1 457 429 778	S 9778
LX 492	1 457 433 750	S 3750
LX 494	1 457 433 067	S 3067
LX 495	1 457 433 285	S 3285

LX 496	1 457 433 627	S 3627
LX 498	1 457 429 817	S 9817
LX 499	F 026 400 011	S 0011
LX 500	1 457 433 697	S 3697
LX 501	1 457 429 964	S 9964

LX 502	1 457 433 229	S 3229
LX 503	1 457 433 272	S 3272
LX 504	1 457 433 276	S 3276
LX 506	1 457 433 728	S 3728
LX 507	1 457 433 729	S 3729

LX 509	1 457 433 623	S 3623
LX 511	1 457 433 748	S 3748
LX 511 1	1 457 433 748	S 3748
LX 513	1 457 433 703	S 3703
LX 513 1	1 457 433 703	S 3703

LX 514 1	1 457 433 535	S 3535
LX 516	1 457 429 845	S 9845
LX 517	1 457 433 699	S 3699
LX 519	1 457 433 624	S 3624
LX 521	1 457 433 608	S 3608

LX 522	1 457 433 609	S 3609
LX 523	1 457 433 309	S 3309
LX 523	1 457 433 603	S 3603
LX 524	1 457 433 713	S 3713
LX 525	1 457 433 309	S 3309

LX 526	1 457 433 607	S 3607
LX 527	1 457 429 775	S 9775
LX 531	1 457 432 188	S 2188
LX 532	1 457 432 146	S 2146
LX 534	1 457 433 959	S 3959

LX 537	1 457 433 747	S 3747
LX 538	1 457 433 747	S 3747
LX 539	1 457 433 751	S 3751
LX 54	1 457 429 994	S 9994
LX 541	1 457 433 260	S 3260

LX 542	1 457 433 072	S 3072
LX 544	1 457 433 785	S 3785
LX 547	1 457 433 605	S 3605
LX 548	1 457 433 571	S 3571
LX 549	1 457 433 571	S 3571

LX 550	1 457 433 571	S 3571
LX 551	1 457 433 085	S 3085
LX 552	1 987 429 172	S 9172
LX 558	1 457 429 949	S 9949
LX 561	1 457 433 642	S 3642

LX 562	1 457 433 735	S 3735
LX 568	1 457 433 540	S 3540
LX 569	1 457 433 616	S 3616
LX 570	1 987 429 123	S 9123
LX 571 1	1 457 433 716	S 3716

LX 572	1 457 432 200	S 2200
LX 577	1 457 433 298	S 3298
LX 579	1 457 433 659	S 3659
LX 58	1 457 429 992	S 9992
LX 580	1 457 433 255	S 3255

LX 581	1 457 433 256	S 3256
LX 583	1 457 433 750	S 3750
LX 588	1 457 429 894	S 9894
LX 589	1 457 433 541	S 3541
LX 59	1 457 429 085	S 9085

LX 591	1 457 433 968	S 3968
LX 592	1 457 433 257	S 3257
LX 593	1 457 433 772	S 3772
LX 593 1	1 457 433 772	S 3772
LX 595	1 457 433 066	S 3066

LX 597	1 457 433 234	S 3234
LX 598	1 457 433 741	S 3741
LX 604	1 457 433 042	S 3042
LX 604 1	1 457 433 042	S 3042
LX 606	1 457 433 734	S 3734

LX 61	1 457 429 787	S 9787
LX 610	1 457 433 270	S 3270
LX 611	1 457 433 790	S 3790
LX 612	1 457 433 900	S 3900
LX 613	1 457 433 740	S 3740

LX 613	1 457 433 799	S 3799
LX 614	1 457 433 740	S 3740
LX 615	1 457 433 690	S 3690
LX 617	1 457 433 524	S 3524
LX 618	1 457 433 265	S 3265

LX 622	1 457 429 870	S 9870
LX 624	1 457 433 711	S 3711
LX 625	1 457 433 253	S 3253
LX 626	1 457 433 292	S 3292
LX 632	1 457 433 736	S 3736

LX 637	1 457 433 536	S 3536
LX 638	1 457 429 948	S 9948
LX 642	1 457 433 280	S 3280
LX 643	1 457 433 526	S 3526
LX 644	F 026 400 010	S 0010

LX 644	1 457 433 769	S 3769
LX 645 1	F 026 400 010	S 0010
LX 646	F 026 400 011	S 0011
LX 646/1	F 026 400 011	S 0011
LX 660	1 457 433 161	S 3161

LX 662	1 457 433 276	S 3276
LX 667	1 457 433 950	S 3950
LX 67	1 457 429 801	S 9801
LX 670	1 987 429 127	S 9127
LX 673	1 987 429 169	S 9169

LX 673	1 987 429 186	S 9186
LX 674	1 457 433 901	S 3901
LX 675	1 457 433 961	S 3961
LX 676	1 987 429 179	S 9179
LX 678	1 457 433 753	S 3753

LX 684	1 457 433 714	S 3714
LX 685	1 457 433 712	S 3712
LX 686	1 457 433 642	S 3642
LX 687	1 457 433 605	S 3605
LX 688	1 457 433 742	S 3742

LX 689	1 457 433 286	S 3286
LX 69	1 457 429 050	S 9050
LX 691	1 457 433 771	S 3771
LX 692	1 457 433 268	S 3268
LX 694	1 457 433 555	S 3555

LX 699	1 457 433 294	S 3294
LX 700	1 457 433 300	S 3300
LX 704	1 457 433 531	S 3531
LX 704 1	1 457 433 531	S 3531
LX 706	1 457 433 652	S 3652

LX 712	1 457 433 904	S 3904
LX 713	F 026 400 083	S 0083
LX 714	1 457 433 903	S 3903
LX 715	1 457 433 769	S 3769
LX 716	1 457 429 818	S 9818

LX 717	1 457 432 203	S 2203
LX 719	1 457 433 781	S 3781
LX 720	1 457 429 890	S 9890
LX 722	1 457 433 056	S 3056
LX 724	1 987 429 148	S 9148

LX 725	1 457 433 273	S 3273
LX 726	1 457 433 642	S 3642
LX 729	1 987 429 122	S 9122
LX 731	1 457 433 061	S 3061
LX 733	1 987 429 133	S 9133

LX 735	1 457 433 281	S 3281
LX 737	1 457 433 153	S 3153
LX 738	1 457 433 577	S 3577
LX 739	1 457 433 730	S 3730
LX 742	1 457 433 075	S 3075

LX 744	1 457 433 543	S 3543
LX 745	1 457 433 290	S 3290
LX 746	1 457 433 314	S 3314
LX 752	1 457 433 065	S 3065
LX 756	1 987 429 152	S 9152

LX 759	1 457 433 093	S 3093
LX 764	F 026 400 085	S 0085
LX 773	1 457 433 529	S 3529
LX 774	F 026 400 086	S 0086
LX 776	1 457 433 560	S 3560



LX 778	1 457 433 091	S 3091	LX 882	1 457 433 795	S 3795	OC 132	0 451 104 067	P 4067
LX 786	1 457 433 331	S 3331	LX 886	1 457 433 549	S 3549	OC 138	0 986 452 020	P 2020
LX 788	1 457 433 078	S 3078	LX 887	1 457 433 303	S 3303	OC 139	0 986 452 035	P 2035
LX 79	1 987 429 042	S 9042/1	LX 888	1 457 433 546	S 3546	OC 140	0 986 452 024	P 2024
LX 790	1 457 433 073	S 3073	LX 889	1 457 433 550	S 3550	OC 145	0 451 103 289	P 3289
LX 791	1 457 433 069	S 3069	LX 890	1 987 429 159	S 9159	OC 15	0 451 203 152	P 3152
LX 792	1 987 429 190	S 9190	LX 913	1 457 433 791	S 3791	OC 171	0 451 104 015	P 4015
LX 794	1 457 433 715	S 3715	LX 914	1 457 433 791	S 3791	OC 171	0 451 105 067	P 5067
LX 795	F 026 400 023	S 0023	LX 916	1 457 433 269	S 3269	OC 182	0 986 452 019	P 2019
LX 798	1 457 433 686	S 3686	LX 918	1 457 433 538	S 3538	OC 195	0 986 452 061	P 2061
LX 799	1 457 433 088	S 3088	LX 92	1 457 429 854	S 9854	OC1955	0 986 452 061	P 2061
LX 8	1 457 429 806	S 9806	LX 920	1 457 433 326	S 3326	OC 199	0 451 103 240	P 3240
LX 800	1 457 433 617	S 3617	LX 923	1 457 433 957	S 3957	OC 206	0 451 301 207	P 1207
LX 801	1 457 429 839	S 9839	LX 925	1 457 433 539	S 3539	OC 214	0 451 103 257	P 3257
LX 802	1 457 433 263	S 3263	LX 925 S	1 457 433 539	S 3539	OC 214	0 451 203 223	P 3223
LX 803	1 457 433 154	S 3154	LX 927	1 457 433 523	S 3523	OC 215	0 986 452 058	P 2058
LX 804	1 457 433 071	S 3071	LX929	F 026 400 165	S 0165	OC 216	0 986 452 028	P 2028
LX 805	1 457 433 784	S 3784	LX 933	1 457 433 595	S 3595	OC 217	0 451 103 276	P 3276
LX 807	1 987 429 137	S 9137	LX 935	1 457 433 070	S 3070	OC 218	0 986 452 060	P 2060
LX 808	1 987 429 171	S 9171	LX 939	1 457 433 522	S 3522	OC 221	0 451 103 249	P 3249
LX 809	1 987 429 135	S 9135	LX 941	F 026 400 092	S 0092	OC 227	0 451 203 201	P 3201
LX 81	1 457 432 134	S 2134	LX 942	1 987 429 160	S 9160	OC 23	0 451 103 029	P 3029
LX 810	1 987 429 151	S 9151	LX 944	1 457 433 094	S 3094	OC 230	0 451 103 316	P 3316
LX 811	1 457 433 958	S 3958	LX 946	1 457 433 571	S 3571	OC 232	0 451 103 252	P 3252
LX 812	1 457 433 952	S 3952	LX 95	1 457 429 875	S 9875	OC 234	0 451 403 208	P 3208
LX 813	1 457 433 739	S 3739	LX 953	1 987 429 167	S 9167	OC 239	0 451 103 270	P 3270
LX 814/1	F 026 400 088	S 0088	LX 954	F 026 400 019	S 0019	OC 24	0 451 103 141	P 3141
LX 815/1	F 026 400 088	S 0088	LX 957 1	1 457 433 573	S 3573	OC 242	0 451 103 297	P 3297
LX 816 4	1 457 433 333	S 3333	LX 957 2	1 987 429 406	S 9406	OC 246	0 451 103 343	P 3343
LX 816 5	1 457 433 334	S 3334	LX 957 3	1 457 433 573	S 3573	OC 247	0 451 103 258	P 3258
LX 818	1 457 433 589	S 3589	LX 96	1 457 429 783	S 9783	OC 248	0 451 203 201	P 3201
LX 819	1 457 433 046	S 3046	LX 97	1 457 429 988	S 9988	OC 249	0 451 103 347	P 3347
LX 821	1 457 433 547	S 3547	LX 977 D	1 457 433 059	S 3059	OC 257	0 451 103 346	P 3346
LX 823	1 457 433 588	S 3588	LX 978	1 457 433 047	S 3047	OC 26	0 451 104 066	P 4066
LX 824	1 457 433 773	S 3773	LX 979	1 457 433 060	S 3060	OC 262	0 451 103 290	P 3290
LX 827	1 457 433 963	S 3963	LX 982	1 457 433 101	S 3101	OC 262	0 451 103 347	P 3347
LX 829	1 457 433 962	S 3962	LX 989	1 457 433 965	S 3965	OC 267	F 026 407 105	P 7105
LX 830	1 457 433 275	S 3275	LX 99	1 457 429 944	S 9944	OC 269	0 451 103 311	P 3311
LX 843	1 457 433 954	S 3954	LX 990	1 457 429 786	S 9786	OC 27	0 451 203 220	P 3220
LX 844	1 457 433 970	S 3970	LX 992	1 457 433 043	S 3043	OC 273	0 986 452 046	P 2046
LX 846	1 987 429 170	S 9170	LX 994	1 457 433 311	S 3311	OC 274	0 986 452 042	P 2042
LX 848	1 457 433 951	S 3951	LX 995	1 457 433 297	S 3297	OC 274	0 986 452 066	P 2066
LX 849	1 987 429 136	S 9136	LX 997	1 457 433 058	S 3058	OC 275	0 986 452 062	P 2062
LX 852	1 457 433 077	S 3077	LX 998	1 457 433 532	S 3532	OC 276	0 451 103 260	P 3260
LX 853	1 457 433 521	S 3521	LX 999	1 457 433 055	S 3055	OC 277	0 986 452 020	P 2020
LX 854	1 457 433 520	S 3520	OC 103	0 451 104 005	P 4005	OC 278	0 451 103 217	P 3217
LX 855	1 457 433 553	S 3553	OC 109	0 986 452 023	P 2023	OC 282	0 451 300 003	P 0003
LX 856	1 457 433 289	S 3289	OC 109 1	0 986 452 023	P 2023	OC 285	0 451 103 275	P 3275
LX 857	1 457 433 792	S 3792	OC 11	0 451 103 141	P 3141	OC 286	0 986 452 030	P 2030
LX 862	1 457 433 956	S 3956	OC 113	0 986 452 016	P 2016	OC 289	0 451 104 013	P 4013
LX 864	F 026 400 007	S 0007	OC 114	0 451 104 064	P 4064	OC 292	0 986 452 019	P 2019
LX 868	1 457 433 587	S 3587	OC 116	0 986 452 023	P 2023	OC 294	0 451 103 365	P 3365
LX 876	F 026 400 014	S 0014	OC 120	0 986 452 000	P 2000	OC 297	0 986 452 063	P 2063
LX 876 1	F 026 400 014	S 0014	OC 121	0 451 104 010	P 4010	OC 3	0 451 103 235	P 3235
LX 878	1 457 433 646	S 3646	OC 121	0 451 403 077	P 3077	OC 30	0 451 203 226	P 3226



◀ KNECHT

OC 312	0 451 103 341	P 3341
OC 313	0 451 103 260	P 3260
OC 314	0 451 103 337	P 3337
OC 32	0 451 104 015	P 4015
OC 32	0 451 105 067	P 5067

OC 326	0 986 452 064	P 2064
OC 33	0 451 103 357	P 3357
OC 33	0 986 452 005	P 2005
OC 35	0 451 301 156	P 1156
OC 36	0 986 452 003	P 2003

OC369	F 026 407 027	P 7027
OC 37	0 451 203 194	P 3194
OC 370	0 451 103 343	P 3343
OC 381	0 451 104 065	P 4065
OC 382	0 451 104 015	P 4015

OC 384	0 451 103 274	P 3274
OC 4	0 451 103 274	P 3274
OC 40	0 451 403 001	P 3001
OC 42	0 451 203 010	P 3010
OC 45	0 451 103 109	P 3109

OC 457	0 986 452 400	P 2400
OC 48	0 451 105 188	P 5188
OC 500	0 451 103 316	P 3316
OC 51	0 451 103 253	P 3253
OC 521	F 026 407 025	P 7025

OC 526	F 026 407 084	P 7084
OC 535	F 026 407 017	P 7017
OC 57	0 451 103 274	P 3274
OC570	F 026 407 024	P 7024
OC 59	0 451 104 065	P 4065

OC 60	0 451 104 015	P 4015
OC 60	0 451 105 067	P 5067
OC616	F 026 407 024	P 7024
OC 617	F 026 407 077	P 7077
OC 62	0 451 103 028	P 3028

OC 63	0 451 103 062	P 3062
OC 65	0 451 203 108	P 3108
OC 77	0 986 452 015	P 2015
OC 81	0 451 103 232	P 3232
OC 83	0 451 103 004	P 3004

OC 92	0 986 452 035	P 2035
OC 93	0 451 103 232	P 3232
OC 97	0 451 103 274	P 3274
OX 137 D	1 457 429 646	P 9646
OX 137D OEKO	1 457 429 646	P 9646

OX 137 D1	1 457 429 732	P 9732
OX 137D1 OEKO	1 457 429 732	P 9732
OX 137D2 OEKO	1 457 429 277	P 9277
OX 143 D	1 457 429 619	P 9619
OX 143D OEKO	1 457 429 619	P 9619

OX 146 D	1 457 429 137	P 9137
OX 146D OEKO	1 457 429 137	P 9137
OX 150D OEKO	1 457 429 647	P 9647
OX 150 D1	1 457 429 276	P 9276
OX 150 D1 OEKO	1 457 429 276	P 9276

OX 151 D	1 457 429 275	P 9275
OX 153	1 457 429 157	P 9157
OX 153D1 OEKO	1 457 429 157	P 9157
OX 153 D2	1 457 429 119	P 9119
OX 153 7	F 026 407 070	P 7070

OX 153/7 D	F 026 407 070	P 7070
OX 153/7 D ECO	F 026 407 070	P 7070
OX 153/7 D1	F 026 407 070	P 7070
OX 153/7 D1 ECO	F 026 407 070	P 7070
OX 155 D	1 457 429 107	P 9107

OX 155D OEKO	1 457 429 107	P 9107
OX 156 D	1 457 429 118	P 9118
OX 156D OEKO	1 457 429 118	P 9118
OX 159 D	1 457 429 154	P 9154
OX161D	F 026 407 040	P 7040

OX 163/1 D	1 457 429 199	P 9199
OX 163/1D OEKO	1 457 429 199	P 9199
OX 164 D	1 457 429 152	P 9152
OX 168 D	1 457 429 128	P 9128
OX 169 D	F 026 407 003	P 7003

OX 171/2D	1 457 429 238	P 9238
OX 171/2D OEKO	1 457 429 238	P 9238
OX 174 D ECO	F 026 407 026	P 7026
OX 177/3D OEKO	1 457 429 252	P 9252
OX 179 D	1 457 429 126	P 9126

OX 18	1 457 429 117	P 9117
OX 191 D	1 457 429 239	P 9239
OX196/1D	F 026 407 002	P 7002
OX 196/1 D ECO	F 026 407 002	P 7002
OX201D	1 457 429 272	P 9272

OX 201 D OEKO	1 457 429 272	P 9272
OX 205/2D	1 457 429 307	P 9307
OX 210 D	1 457 429 198	P 9198
OX 210D OEKO	1 457 429 198	P 9198
OX 347	F 026 407 068	P 7068

OX 347 D	F 026 407 068	P 7068
OX 347D ECO	F 026 407 068	P 7068
OX 359D	F 026 407 046	P 7046
OX 360 D	1 457 429 194	P 9194
OX 368D1	1 457 429 185	P 9185

OX 368D2 ECO	F 026 407 021	P 7021
OX 38D	1 457 429 274	P 9274
OX 39D	1 457 429 636	P 9636
OX 413D1	F 026 407 090	P 7090
OX 416D1	F 026 407 091	P 7091

OX 424 D	F 026 407 062	P 7062
OX 436	F 026 407 061	P 7061
OX 436 D	F 026 407 061	P 7061
OX 436 D ECO	F 026 407 061	P 7061
OX 44D	1 457 429 130	P 9130

OX 44D	1 457 429 629	P 9629
OX 559	F 026 407 087	P 7087
OX 559 D	F 026 407 087	P 7087
OX 559 D ECO	F 026 407 087	P 7087
OX 69D	1 457 429 740	P 9740

OX 71	1 457 429 735	P 9735
OX 72D	1 457 429 251	P 9251
OX 75D	1 457 429 600	P 9600
OX 85	1 457 429 175	P 9175
OX 96D	1 457 429 123	P 9123

OX 98D	1 457 429 267	P 9267
SE 080	F 026 400 082	S 0082
1311880	1 457 429 814	S 9814

KS KOLBENSCHMIDT

000-OS	0 451 104 015	P 4015
000-OS	0 451 105 067	P 5067
001-FS	1 457 434 105	N 4105

002-FS	1 457 434 154	N 4154
002-FS	1 457 434 165	N 4165
002-FS	1 457 434 432	N 4432
003-OS	0 451 103 029	P 3029
007-AR	1 457 429 992	S 9992

011-AR	1 457 429 993	S 9993
012-AR	1 457 429 970	S 9970
017-OS	0 451 301 156	P 1156
018-OS	0 451 103 357	P 3357
018-OS	0 986 452 005	P 2005

019-FS	1 457 429 681	N 9681
020-FC	1 457 429 354	N 9354
020-FC	1 457 431 159	N 1159
021-FC	1 457 431 270	N 1270
021-FC	1 457 431 326	N 1326

022-OC	1 457 429 735	P 9735
023-OC	1 457 429 600	P 9600
024-OC	1 457 429 740	P 9740
028-FC	1 457 429 359	N 9359
028-FC	1 457 431 158	N 1158

029-FC	1 457 431 261	N 1261
029-FC	1 457 431 325	N 1325
030FC	1 457 434 201	N 4201
031-FC	1 457 434 200	N 4200
032-FP	0 450 905 030	F 5030

032-FP	0 450 905 095	F 5095
032-FP	0 450 905 264	F 5264
033-FP	0 450 905 203	F 5203
034-AR	1 457 429 932	S 9932
035-AR	1 457 429 950	S 9950

036-AR	1 457 429 966	S 9966
037-AR	1 457 429 899	S 9899
037-AR	1 457 429 969	S 9969
038 AR	1 457 432 154	S 2154
038 AR	1 457 433 544	S 3544

040-AP	1 457 429 079	S 9079
042-OC	1 457 429 647	P 9647
043-OC	1 457 429 646	P 9646
044-OH	1 457 429 820	P 9820
045-OH	1 457 429 165	P 9165



046-OC	1 457 429 175	P 9175
050-OS	0 986 452 003	P 2003
053-OS	0 451 104 066	P 4066
055-OS	0 451 403 077	P 3077
057-OS	0 451 103 253	P 3253
059-AP	1 457 429 061	S 9061
060-AP	1 457 429 030	S 9030
061-OS	0 451 203 226	P 3226
064-AR	1 457 429 975	S 9975
066-AR	1 457 429 787	S 9787
067-FP	0 450 905 177	F 5177
070-AR	1 457 429 080	S 9080
074-FP	0 450 904 058	F 4058
075-FS	1 457 434 106	N 4106
077 AR	1 457 429 054	S 9054
077 AR	1 457 433 540	S 3540
078-AP	1 457 429 777	S 9777
079-FS	1 457 434 154	N 4154
079-FS	1 457 434 165	N 4165
079-FS	1 457 434 296	N 4296
080-FP	0 450 905 002	F 5002
080-FP	0 450 905 280	F 5280
082-AP	1 457 429 987	S 9987
083-AP	1 457 433 700	S 3700
084-AR	1 457 429 050	S 9050
085-AR	1 457 429 053	S 9053
087-AP	1 457 429 869	S 9869
089-AP	1 457 429 928	S 9928
090-AP	1 457 429 964	S 9964
092-AR	1 457 429 900	S 9900
093-AP	1 457 429 085	S 9085
094-OC	1 457 429 732	P 9732
098-OS	0 451 103 232	P 3232
104-OS	0 986 452 028	P 2028
105-OS	0 986 452 016	P 2016
106-OS	0 986 452 035	P 2035
107-OS	0 986 452 061	P 2061
110-OS	0 986 452 019	P 2019
119-AR	1 457 429 800	S 9800
121-AR	1 457 429 941	S 9941
122-AR	1 457 429 946	S 9946
124-AP	1 457 429 076	S 9076
125-AP	1 457 429 994	S 9994
126-AP	1 457 429 957	S 9957
127-FS	1 457 434 051	N 4051
128-AR	1 457 429 817	S 9817
128-AR	1 457 429 942	S 9942
131-AR	1 457 432 134	S 2134
133-AR	1 457 432 188	S 2188
136-OC	1 457 429 274	P 9274
138-OC	1 457 429 117	P 9117
141-AR	1 457 429 920	S 9920
142-AR	1 457 429 064	S 9064
147-OS	0 451 103 062	P 3062
149-OS	0 451 103 141	P 3141
150-OS	0 451 103 274	P 3274
154-OS	0 451 104 065	P 4065
155-OS	0 451 203 010	P 3010
157-OS	0 451 403 001	P 3001
158-FS	1 457 434 123	N 4123
159-FP	0 450 905 021	F 5021
160-AR	1 457 433 231	S 3231
162-OC	1 457 429 130	P 9130
162-OC	1 457 429 629	P 9629
165-AR	1 457 433 005	S 3005
168-AP	1 457 429 875	S 9875
169-AP	1 457 429 783	S 9783
171-FP	0 450 905 091	F 5091
171-FP	0 450 905 133	F 5133
171-FP	0 450 905 200	F 5200
171-FP	0 450 905 601	F 5601
172-OH	1 457 429 416	P 9416
173-AP	1 457 433 052	S 3052
174-FS	1 457 434 186	N 4186
176-AP	1 457 433 023	S 3023
177-AP	1 987 429 051	S 9051
178-AP	1 457 433 004	S 3004
179-AR	1 457 432 111	S 2111
180-AR	1 457 429 959	S 9959
183-AP	1 457 429 988	S 9988
184-FP	0 450 904 149	F 4149
185-FP	0 450 904 077	N 4077
189-FP	0 450 904 060	F 4060
190-AP	1 457 432 200	S 2200
191-FC	1 457 431 028	N 1028
192-AP	1 457 433 607	S 3607
193-FS	1 457 434 103	N 4103
197-AP	1 457 429 877	S 9877
199-OS	0 451 203 005	P 3005
201-AR	1 457 429 908	S 9908
203-AR	1 987 429 115	S 9115
205-AP	1 457 433 752	S 3752
206-AP	1 457 433 701	S 3701
210-AP	1 457 432 203	S 2203
211-AP	1 457 433 642	S 3642
215-OS	0 451 103 004	P 3004
220-AR	1 457 429 933	S 9933
222-AP	1 457 433 699	S 3699
224-FP	0 450 905 901	F 5901
229-AR	F 026 400 082	S 0082
231-AP	1 457 433 603	S 3603
234-AP	1 457 433 711	S 3711
238-AP	1 457 429 870	S 9870
238-AP	1 457 433 698	S 3698
240-AR	1 457 433 229	S 3229
241-AP	1 457 433 753	S 3753
243-AP	1 457 433 748	S 3748
248-OS	0 451 103 109	P 3109
249-OS	0 451 103 240	P 3240
250-AR	1 457 429 841	S 9841
251-AR	1 457 429 923	S 9923
258-AP	1 457 429 814	S 9814
261-OS	0 451 300 003	P 0003
262-FC	1 457 429 291	N 9291
262FC	1 457 431 713	N 1713
268-FP	0 450 905 273	F 5273
268-FP	0 450 905 316	F 5316
269-FC	1 457 429 621	N 9621
271-FP	0 450 905 195	F 5195
271-FP	0 450 905 216	F 5216
272-FS	1 457 434 291	N 4291
273-FP	0 450 905 087	F 5087
273-FP	0 450 905 104	F 5104
273-FP	0 450 905 401	F 5401
273-FP	0 450 905 906	F 5906
279-AP	1 457 429 792	S 9792
282-FC	1 457 429 289	N 9289
284-AR	1 457 433 233	S 3233
286-AP	1 457 433 747	S 3747
288-AR	1 457 433 790	S 3790
289-AP	1 457 433 623	S 3623
290-AP	1 457 433 740	S 3740
290-AP	1 457 433 799	S 3799
290-AP	1 457 433 799	S 3799
291-AP	1 457 433 697	S 3697
293-AR	1 457 429 795	S 9795
295-AR	F 026 400 065	S 0065
297-FS	1 457 434 447	N 4447
298-AP	1 457 433 606	S 3606
301-AR	1 457 433 234	S 3234
307-AP	1 457 429 791	S 9791
323-AP	1 457 433 690	S 3690
324-AP	1 457 429 793	S 9793
325-FP	0 450 905 275	F 5275
326-AP	1 457 433 713	S 3713
327-AP	1 457 429 895	S 9895
327-AP	1 457 429 896	S 9896
327-AP	1 457 429 898	S 9898
327AP	1 457 433 087	S 3087
333 AP	1 457 433 571	S 3571
334-AR	1 457 433 624	S 3624
335-AR	1 457 429 944	S 9944
338-AR	1 457 432 204	S 2204
342-AR	1 457 429 794	S 9794
345-OC	1 457 429 267	P 9267
347OC	1 457 429 636	P 9636
351FS	1 457 429 676	N 9676
353-FS	1 457 434 187	N 4187
355-OS	0 451 103 252	P 3252
359-OS	0 451 203 201	P 3201
362-OC	1 457 429 123	P 9123
363-AR	1 457 433 227	S 3227
364OX	1 457 429 194	P 9194
365-AP	1 457 433 659	S 3659
368-AR	1 457 432 124	S 2124



◀ KS KOLBENSCHMIDT

373-FP	0986 450 117	F 0117
375-FP	0986 450 018	F 0018
376-FP	0986 450 138	F 0138
377-AP	1 457 433 266	S 3266
379-AR	F 026 400 011	S 0011
382-FS	1 457 434 324	N 4324
383-AP	1 457 429 983	S 9983
385-AP	1 457 429 778	S 9778
385-AP	1 457 433 750	S 3750
388-AP	1 457 432 183	S 2183
392-AP	1 457 433 703	S 3703
393-AP	1 457 433 002	S 3002
394-OS	0 451 103 249	P 3249
398-OS	F 026 407 049	P 7049
400-AR	1 457 433 900	S 3900
4005FP	0 450 906 459	N 6459
4018FX	1 457 431 723	N 1723
4046FX	1 457 429 354	N 9354
4079-OS	F 026 407 083	P 7083
409-AR	1 457 433 627	S 3627
4147-OX	F 026 407 070	P 7070
415-AP	1 457 433 285	S 3285
416-AP	1 457 429 842	S 9842
417FS	1 457 429 675	N 9675
418-FS	1 457 434 184	N 4184
419-FP	0 450 905 318	F 5318
422-AP	1 457 433 523	S 3523
423-AP	1 457 433 071	S 3071
4232AP	1 457 433 071	S 3071
424-AP	1 457 433 537	S 3537
425-AP	1 457 433 526	S 3526
426-AP	1 457 433 751	S 3751
428-AP	1 457 433 265	S 3265
430-AP	1 457 433 716	S 3716
431-AP	1 457 433 529	S 3529
433-AP	1 457 433 543	S 3543
435-AP	1 457 433 065	S 3065
436-AP	1 457 433 255	S 3255
437-FC	1 457 429 657	N 9657
438-FP	0 450 915 003	F 5003
439-FP	0 450 915 001	F 5001
440-AP	1 457 433 626	S 3626
441-AP	1 457 433 772	S 3772
446-AP	1 457 433 046	S 3046
451-AR	1 457 433 712	S 3712
453-AR	1 457 429 854	S 9854
455-AP	1 457 433 773	S 3773
456AP	F 026 400 010	S 0010
458AR	1 457 429 839	S 9839
459-AR	1 457 433 651	S 3651
462-AR	1 457 433 735	S 3735
464-OS	0 451 203 152	P 3152
465-OS	0 451 301 207	P 1207
466-AR	1 457 433 901	S 3901
471-AR	F 026 400 077	S 0077

474-OS	0 451 203 220	P 3220
481-FS	1 457 434 294	N 4294
484OX	1 457 429 128	P 9128
489-OS	0 986 452 061	P 2061
490-AP	1 457 433 008	S 3008
490 AP	1 457 433 264	S 3264
500AP	1 457 433 315	S 3315
50013327	1 457 429 895	S 9895
50014015	0 450 906 460	N 6460
50014129	0 450 906 471	N 6471
502-AR	1 457 433 715	S 3715
503-AP	1 457 433 714	S 3714
506-OS	0 451 103 289	P 3289
510-OS	0 986 452 044	P 2044
513-OS	0 451 103 290	P 3290
515-OS	0 451 203 223	P 3223
518-AP	1 457 429 781	S 9781
519-AP	1 457 433 742	S 3742
520-AR	1 457 432 108	S 2108
521-AR	1 457 429 845	S 9845
523-FP	0 450 902 161	F 2161
523-FP	0 450 905 287	F 5287
524-FP	0 450 905 324	F 5324
526-OC	1 457 429 275	P 9275
527-OC	1 457 429 251	P 9251
528-OS	0 451 103 297	P 3297
530-AP	1 457 433 616	S 3616
539-AP	1 457 433 601	S 3601
543-AP	1 457 433 281	S 3281
544-AR	1 457 432 138	S 2138
595AP	1 457 433 539	S 3539
596AP	1 457 433 070	S 3070
597OX	1 457 429 239	P 9239
599AP	1 457 433 090	S 3090
600AR	1 457 433 729	S 3729
601AR	1 457 433 728	S 3728
602AR	1 457 433 730	S 3730
605AP	1 987 429 403	S 9403
606AP	1 457 433 089	S 3089
607AP	1 457 433 574	S 3574
608AP	1 987 429 404	S 9404
610FX	1 457 431 710	N 1710
616AR	1 457 433 560	S 3560
619OX	1 457 429 118	P 9118
621OX	1 457 429 199	P 9199
627FX	1 457 429 655	N 9655
628OX	1 457 429 185	P 9185
631OX	1 457 429 239	P 9239
633OX	1 457 429 198	P 9198
635-OZ	F 026 407 059	P 7059
636-OZ	F 026 407 060	P 7060
637-OZ	F 026 407 058	P 7058
650FS	F 026 402 017	N 2017
652OX	1 457 429 252	P 9252
657OS	0 451 103 330	P 3330

660OS	F 026 407 043	P 7043
663AP	1 457 433 536	S 3536
666-FS	F 026 402 037	N 2037
666-OS	F 026 407 043	P 7043
669AP	1 457 433 592	S 3592
670AR	F 026 400 084	S 0084
671OS	0 451 403 208	P 3208
673AR	F 026 400 086	S 0086
675OS	0 451 104 013	P 4013
681AP	1 457 433 331	S 3331
683FS	1 457 434 419	N 4419
689AR	F 026 400 067	S 0067
691OX	1 457 429 276	P 9276
697AP	1 457 433 585	S 3585
698AP	1 457 433 594	S 3594
699AP	1 457 433 592	S 3592
729AC	1 987 432 151	M 2151
732AC	1 987 432 150	M 2150
795AC	1 987 432 042	M 2042
801FS	1 457 434 453	N 4453
810AP	1 457 433 276	S 3276
815AP	1 987 429 152	S 9152
865OX	1 457 429 284	P 9284
867AP	1 457 433 956	S 3956
899AC	1 987 432 074	M 2074
900FC	1 457 431 715	N 1715
901AR	1 987 429 405	S 9405
905-FX	1 457 431 705	N 1705
907AP	1 457 433 532	S 3532
911AP	1 457 433 067	S 3067
913AR	1 457 433 588	S 3588
914AR	1 457 433 589	S 3589
918OS	0 451 203 108	P 3108
920AP	F 026 400 094	S 0094
930-FC	1 457 434 201	N 4201
933AC	1 987 432 075	M 2075
934AC	1 987 432 058	M 2058
975FP	F 026 403 003	F 3003
980AP	1 457 433 583	S 3583
MAN		
W 840/2	0 451 103 347	P 3347
MANN (MANN & HUMMEL)		
ALA1105	1 457 433 958	S 3958
ALA1911	F 026 400 016	S 0016
BFU 700 X	1 457 429 359	N 9359
BFU707	1 457 431 158	N 1158
BFU811	1 457 431 159	N 1159
BFU 900 X	1 457 429 354	N 9354
CA2679	1 457 433 073	S 3073
CF 1640	F 026 400 210	S 0210



CF 2000/1	F 026 400 197	S 0197	CU2326	1 987 432 066	M 2066	C1145/5	F 026 400 011	S 0011
CF 2100/1	F 026 400 022	S 0022	CU2327	1 987 432 074	M 2074	C 1145/6	F 026 400 011	S 0011
CF800	F 026 400 082	S 0082	CU2331	1 987 432 204	M 2204	C 1150	1 457 433 732	S 3732
CUK 18 000-2	1 987 432 512	R 2512	CU2336	1 987 432 170	M 2170	C 1184	1 457 433 229	S 3229
CUK 2140	1 987 431 451	R 1451	CU2337	1 987 432 105	M 2105	C 1188	1 457 433 200	S 3200
CUK 2141	1 987 432 416	R 2416	CU2344	1 987 432 107	M 2107	C 1189	1 457 433 307	S 3307
CUK 2226	1 987 432 320	R 2320	CU2345	1 987 432 075	M 2075	C12102	1 457 429 839	S 9839
CUK 2230	1 987 432 498	R 2498	CU2356	1 987 432 158	M 2158	C12104	1 457 433 553	S 3553
CUK 2231	1 987 432 426	R 2426	CU2358	1 987 432 166	M 2166	C12107	1 457 433 712	S 3712
CUK 2243	1 987 432 488	R 2488	CU 2362	1 987 432 227	M 2227	C 12 107/1	1 457 433 538	S 3538
CUK 2246	1 987 432 319	R 2319	CU 2418-2	1 987 432 078	M 2078	C12133	F 026 400 024	S 0024
CUK 2436	1 987 432 415	R 2415	CU2431	1 987 432 066	M 2066	C12178	1 457 433 334	S 3334
CUK2442	1 987 432 304	R 2304	CU2436	1 987 432 215	M 2215	C 12178/1	1 457 433 333	S 3333
CUK 2533-2	1 987 432 315	R 2315	CU2442	1 987 432 004	M 2004	C12178/2	F 026 400 205	S 0205
CUK2534	1 987 431 452	R 1452	CU2454	1 987 432 203	M 2203	C12861	1 457 433 077	S 3077
CUK2639	1 987 432 327	R 2327	CU2504	1 987 432 108	M 2108	C13103	1 987 429 117	S 9117
CUK 2722-2	1 987 432 438	R 2438	CU 2506-2	1 987 432 161	M 2161	C 13 103/1	1 457 433 275	S 3275
CUK 2723-2	1 987 432 500	R 2500	CU2513	1 987 432 221	M 2221	C13109	1 457 433 231	S 3231
CUK2939/1	1 987 432 597	R 2597	CU 2521-2	1 987 432 176	M 2176	C 13 114/4	1 457 429 932	S 9932
CUK 3172	1 987 432 381	R 2381	CU2530	1 987 432 058	M 2058	C 1361	F 026 400 018	S 0018
CUK 3448	1 987 432 348	R 2348	CU2534	1 987 431 169	M 1169	C 1362	1 457 432 106	S 2106
CUK 3554	1 987 432 306	R 2306	CU 2542-2	1 987 432 160	M 2160	C 1380	1 457 432 124	S 2124
CUK3823	1 987 431 454	R 1454	CU 2544	1 987 432 065	M 2065	C13801	1 987 429 042	S 9042/1
CUK3823	1 987 431 455	R 1455	CU 26 004	1 987 432 230	M 2230	C13803	1 457 433 062	S 3062
CUK 3840	1 987 432 400	R 2400	CU 2623	1 987 432 194	M 2194	C 1381	1 457 433 715	S 3715
CUK 3847	1 987 432 406	R 2406	CU 2630	1 987 432 077	M 2077	C 1387	1 457 433 161	S 3161
CUK4469	1 987 431 457	R 1457	CU 2631	1 987 432 055	M 2055	C13941	1 457 433 230	S 3230
CUK 4795	1 987 431 458	R 1458	CU2645	1 987 432 175	M 2175	C13992	1 457 433 624	S 3624
CUK5877	1 987 431 456	R 1456	CU2709	1 987 432 207	M 2207	C14114	1 987 429 401	S 9401
CU1526	1 987 432 218	M 2218	CU2785	1 987 431 159	M 1159	C14130	1 987 429 405	S 9405
CU1722	1 987 432 153	M 2153	CU2842	1 987 432 114	M 2114	C 14 130/1	1 457 433 576	S 3576
CU1823	1 987 432 167	M 2167	CU 3023-2	1 987 432 122	M 2122	C14176	1 457 433 154	S 3154
CU1827	1 987 432 173	M 2173	CU3132	1 987 432 152	M 2152	C14177	1 457 433 795	S 3795
CU1828	1 987 432 084	M 2084	CU 3172/1	1 987 432 281	M 2281	C14179	1 457 429 933	S 9933
CU 1830	1 987 432 034	M 2034	CU3360	1 987 432 200	M 2200	C14190	1 457 433 201	S 3201
CU1835	1 987 432 115	M 2115	CU3454	1 987 432 208	M 2208	C1430	F 026 400 061	S 0061
CU1900/03	1 987 432 060	M 2060	CU 3569	1 987 432 213	M 2213	C 1460	1 457 433 227	S 3227
CU1910	1 987 432 164	M 2164	CU 3649	1 987 432 192	M 2192	C 1468	1 457 429 908	S 9908
CU1915	1 987 432 157	M 2157	CU 37 001	1 987 431 172	M 1172	C14681	1 457 429 908	S 9908
CU 1919	1 987 432 190	M 2190	CU3847	1 987 432 206	M 2206	C 1472	1 457 433 769	S 3769
CU 1936	1 987 432 238	M 2238	CU3869	1 987 432 150	M 2150	C 1480	1 457 433 234	S 3234
CU2015	1 987 432 155	M 2155	CU 40 110	1 987 432 151	M 2151	C 15 105/1	1 457 433 588	S 3588
CU2028	1 987 432 214	M 2214	CU4179	1 987 432 091	M 2091	C 15 127/1	1 457 433 627	S 3627
CU 2033-2	1 987 432 117	M 2117	CU4228	1 987 431 164	M 1164	C 15 143/1	1 457 433 589	S 3589
CU2035	1 987 432 088	M 2088	CU4408	1 987 431 155	M 1155	C15163	F 026 400 092	S 0092
CU2043	1 987 432 092	M 2092	CU4442	1 987 432 042	M 2042	C 15 165/3	1 457 429 941	S 9941
CU2131	1 987 432 085	M 2085	CU4466	1 987 431 165	M 1165	C15200	1 457 433 005	S 3005
CU 2132	1 987 432 299	M 2299	CU4469	1 987 431 168	M 1168	C 1577	1 457 429 900	S 9900
CU 2138	1 987 432 236	M 2236	CU4795	1 987 431 163	M 1163	C15771	1 457 433 652	S 3652
CU2141	1 987 432 216	M 2216	CU5809	1 987 431 156	M 1156	C 1586	1 457 433 791	S 3791
CU2184	1 987 431 167	M 1167	CU5877	1 987 431 157	M 1157	C1589/3	1 457 433 791	S 3791
CU2200/12	1 987 432 163	M 2163	C10361	1 457 433 739	S 3739	C16113	1 457 433 233	S 3233
CU 2224-2	1 987 432 052	M 2052	C10362	1 457 433 084	S 3084	C16118	F 026 400 027	S 0027
CU 23 000-2	1 987 432 086	M 2086	C 1041	1 457 433 044	S 3044	C16148	1 987 429 169	S 9169
CU 2317	1 987 432 189	M 2189	C11120	1 457 433 069	S 3069	C16148	1 987 429 186	S 9186



◀ MANN

C1618	1 457 433 273	S 3273
C16181	1 457 433 646	S 3646
C16 247/1	1 457 433 270	S 3270
C16302	1 457 429 794	S 9794
C1652	1 987 429 400	S 9400

C1699	1 987 429 154	S 9154
C17129	1 457 432 138	S 2138
C17134	1 457 429 942	S 9942
C17137	F026 400 028	S 0028
C17160	1 457 429 817	S 9817

C17201	1 457 429 944	S 9944
C17 201/3	1 457 429 795	S 9795
C17 225/3	1 457 429 946	S 9946
C17 237	F026 400 059	S 0059
C17278	1 457 433 790	S 3790

C17337	1 457 433 332	S 3332
C1760	1 457 432 154	S 2154
C1760	1 457 433 544	S 3544
C1760/1	1 457 433 544	S 3544
C18108	1 457 429 841	S 9841

C18121	1 457 429 841	S 9841
C18143	1 457 433 590	S 3590
C18321	1 457 432 173	S 2173
C18581	1 457 433 529	S 3529
C18582	1 457 433 529	S 3529

C1869	F026 400 213	S 0213
C1880	F026 400 056	S 0056
C1882	1 457 433 093	S 3093
C1891	1 987 429 127	S 9127
C1922	1 987 429 164	S 9164

C1924	1 457 433 953	S 3953
C1932	1 457 433 078	S 3078
C19416	F026 400 189	S 0189
C19552	1 457 433 539	S 3539
C19620	F026 400 085	S 0085

C1980	1 987 429 125	S 9125
C1995	F026 400 023	S 0023
C1996	1 457 429 890	S 9890
C20 002	F026 400 135	S 0135
C20106	F026 400 097	S 0097

C20 106/1	F026 400 049	S 0049
C20189	1 457 433 734	S 3734
C2027	1 987 429 115	S 9115
C2029	F026 400 063	S 0063
C20 325/2	1 457 429 950	S 9950

C20356	1 457 429 854	S 9854
C2039	1 457 429 030	S 9030
C2050	F026 400 110	S 0110
C2053	1 457 433 617	S 3617
C2055	1 457 433 955	S 3955

C2056	1 457 433 711	S 3711
C2068	1 457 429 842	S 9842
C21104	1 987 429 182	S 9182
C21104/2	1 987 429 182	S 9182
C21 116/1	F026 400 010	S 0010

C2119	1 987 429 166	S 9166
C2129	1 457 433 961	S 3961
C2136	1 987 429 136	S 9136
C21361	1 457 433 969	S 3969
C21383	1 457 433 951	S 3951

C2150	1 457 433 326	S 3326
C2159	1 457 433 526	S 3526
C2192	1 457 433 280	S 3280
C22117	1 457 429 061	S 9061
C221171	1 457 429 061	S 9061

C22120	1 457 433 741	S 3741
C22212	1 457 433 534	S 3534
C2223	1 457 433 785	S 3785
C22267	1 987 429 157	S 9157
C2229	1 457 433 963	S 3963

C22311	1 987 429 172	S 9172
C22331	1 457 432 204	S 2204
C2237	1 457 433 306	S 3306
C2240	F026 400 098	S 0098
C2244	1 457 433 593	S 3593

C2245	1 457 433 100	S 3100
C22 478	F026 400 068	S 0068
C22 478	F026 400 069	S 0069
C22478/1	F026 400 069	S 0069
C2256	1 457 433 603	S 3603

C22561	1 457 433 603	S 3603
C22562	1 457 433 054	S 3054
C22562	1 457 433 309	S 3309
C22 580	F026 400 070	S 0070
C22 580/1	F026 400 070	S 0070

C2282	1 457 433 743	S 3743
C2287	1 457 433 585	S 3585
C2295	1 457 433 713	S 3713
C22952	1 457 433 532	S 3532
C23 004	F026 400 201	S 0201

C23148	1 457 433 002	S 3002
C2324	F026 400 043	S 0043
C2326	1 457 433 784	S 3784
C2329	1 457 433 274	S 3274
C2330	F026 400 125	S 0125

C2332	1 457 433 965	S 3965
C2335	1 457 433 954	S 3954
C2337	1 457 433 956	S 3956
C2339	1 457 429 801	S 9801
C2341	1 457 433 255	S 3255

C23 440/1	1 457 429 966	S 9966
C23 440/3	1 457 429 966	S 9966
C2345	1 457 432 146	S 2146
C23 513/1	F026 400 209	S 0209
C2356/5	1 457 432 204	S 2204

C23610	1 457 433 568	S 3568
C2368	1 987 429 123	S 9123
C24 005	F026 400 114	S 0114
C24 007	F026 400 176	S 0176
C24010	F026 400 127	S 0127

C24100	1 987 429 194	S 9194
C24106	1 457 433 751	S 3751
C24123	1 457 433 075	S 3075
C24123/1	1 457 433 075	S 3075
C24128	1 457 433 771	S 3771

C24 128/2	1 457 433 045	S 3045
C24130	1 457 433 690	S 3690
C24135	1 987 429 109	S 9109
C24 137/1	1 457 433 583	S 3583
C24196	F026 400 046	S 0046

C2420	F026 400 101	S 0101
C2421	1 457 433 584	S 3584
C2432	F026 400 090	S 0090
C2433/2	F026 400 126	S 0126
C2436	1 457 432 111	S 2111

C2438	1 457 433 968	S 3968
C24393	1 457 433 735	S 3735
C2440	1 457 429 959	S 9959
C24401	1 457 432 180	S 2180
C2443	1 457 432 108	S 2108

C24431	1 457 432 108	S 2108
C24461	1 457 429 801	S 9801
C2448	F026 400 037	S 0037
C24508	1 457 433 651	S 3651
C2452	1 457 433 056	S 3056

C24 650/1	1 457 429 975	S 9975
C2469	F026 400 164	S 0164
C24 745/2	F026 400 211	S 0211
C2485	1 457 433 595	S 3595
C2485/2	1 457 433 595	S 3595

C2493	1 457 433 697	S 3697
C2498	1 457 433 289	S 3289
C2498	1 457 433 324	S 3324
C25100	1 457 433 265	S 3265
C25101	1 457 433 090	S 3090

C25 101/1	1 457 433 090	S 3090
C25 109/1	F026 400 052	S 0052
C25 110- 2	1 987 429 402	S 9402
C25114	1 457 433 004	S 3004
C25 114/1	1 457 433 085	S 3085

C25 115	F026 400 138	S 0138
C25117	1 457 433 150	S 3150
C25118	1 457 429 844	S 9844
C2512	1 987 429 406	S 9406
C25126	1 457 433 150	S 3150

C25 128	F026 400 165	S 0165
C2513	1 457 433 972	S 3972
C25135	1 457 433 550	S 3550
C25136	1 457 433 098	S 3098
C25146	1 457 433 549	S 3549

C2517	1 457 433 972	S 3972
C2519	F026 400 016	S 0016
C2524	1 457 433 957	S 3957
C2524/1	F026 400 062	S 0062
C2534	1 457 429 920	S 9920



C 2535	1 457 433 952	S 3952
C25351	1 457 429 953	S 9953
C 2536	1 457 429 050	S 9050
C25371	1 457 433 962	S 3962
C25372	1 457 433 950	S 3950
C 2538	1 457 433 573	S 3573
C 2542	1 457 433 580	S 3580
C25522	1 987 429 146	S 9146
C25552	1 457 432 134	S 2134
C 2559	1 457 433 290	S 3290
C 2561	F 026 400 006	S 0006
C 2564	1 457 433 959	S 3959
C 25 660/1	F 026 400 074	S 0074
C 2567	1 457 433 327	S 3327
C 2568	1 987 429 137	S 9137
C25681	1 457 433 269	S 3269
C 2569	1 457 433 303	S 3303
C 2571	1 457 433 253	S 3253
C25711	1 457 432 183	S 2183
C 2573	1 457 433 605	S 3605
C 25 7301/1	F 026 400 067	S 0067
C 2579	1 457 433 153	S 3153
C 2582	1 457 429 845	S 9845
C 2584	1 457 433 599	S 3599
C 25 860/3	F 026 400 075	S 0075
C 25 978	F 026 400 184	S 0184
C 2598	1 457 433 003	S 3003
C 26 003	F 026 400 188	S 0188
C 2610	1 457 433 971	S 3971
C26100	1 457 433 095	S 3095
C 26 110/1	1 457 429 964	S 9964
C 26 110/2	1 457 433 053	S 3053
C26126	1 457 433 547	S 3547
C26133	1 457 433 659	S 3659
C 26 138/1	1 457 429 791	S 9791
C26144	1 457 429 877	S 9877
C26151	1 457 433 698	S 3698
C26168	1 457 429 870	S 9870
C 26 168/2	1 457 433 310	S 3310
C 2617	F 026 400 060	S 0060
C 2619	1 987 429 133	S 9133
C 261381KIT	1 457 429 791	S 9791
C 2620	F 026 400 017	S 0017
C26206	1 457 433 772	S 3772
C 26 206/1	1 457 433 772	S 3772
C2622	F 026 400 001	S 0001
C 2626	1 987 429 159	S 9159
C2628	F 026 400 093	S 0093
C 2631	F 026 400 044	S 0044
C2632/1	F 026 400 123	S 0123
C26381	1 457 429 818	S 9818
C 2645	1 987 429 121	S 9121
C26451	1 987 429 122	S 9122
C2653	F 026 400 045	S 0045
C 2656	1 987 429 179	S 9179
C 2657	1 457 433 541	S 3541
C2657/1	1 457 433 256	S 3256
C2658	F 026 400 107	S 0107
C26581	1 457 433 097	S 3097
C 2666	1 457 433 072	S 3072
C26671	1 457 433 605	S 3605
C26731	1 457 429 846	S 9846
C 2679	1 457 433 073	S 3073
C 2686	1 457 433 311	S 3311
C2687	F 026 400 096	S 0096
C 2695	1 457 433 080	S 3080
C26952	1 457 433 788	S 3788
C2697	1 457 433 037	S 3037
C27103	1 457 433 266	S 3266
C27105	F 026 400 141	S 0141
C27105	1 457 433 099	S 3099
C27114	F 026 400 030	S 0030
C27124	1 457 433 555	S 3555
C 27 124/1	1 457 433 061	S 3061
C 27 1250/1	F 026 400 068	S 0068
C 27 1320/1	F 026 400 064	S 0064
C 27 1320/3	F 026 400 064	S 0064
C 2714	1 987 429 167	S 9167
C27143	1 457 433 571	S 3571
C2715	1 987 429 177	S 9177
C 27 154/1	1 457 433 023	S 3023
C27161	F 026 400 106	S 0106
C27181	1 457 433 571	S 3571
C27192	1 457 433 571	S 3571
C 27 192/1	1 457 433 046	S 3046
C2726	1 987 429 185	S 9185
C27311	1 457 433 958	S 3958
C2735	F 026 400 091	S 0091
C 2748	1 457 433 083	S 3083
C 2749	1 457 429 064	S 9064
C 2751	1 457 429 064	S 9064
C27585	1 457 432 192	S 2192
C 27 585/3	1 457 432 192	S 2192
C27591	1 457 433 533	S 3533
C 2766	1 457 429 923	S 9923
C 2771	1 457 433 773	S 3773
C 2774	1 457 433 736	S 3736
C 2774/3	1 457 433 686	S 3686
C 27743KIT	1 457 433 686	S 3686
C 2775	F 026 400 048	S 0048
C 2788	1 457 433 792	S 3792
C 27 998/5	F 026 400 072	S 0072
C28100	1 457 433 070	S 3070
C28105	1 457 433 152	S 3152
C 28 105/1	F 026 400 041	S 0041
C28110	1 457 433 096	S 3096
C28122	1 457 433 323	S 3323
C28136	1 457 433 008	S 3008
C 28 136/1	1 457 433 264	S 3264
C28150	F 026 400 004	S 0004
C 28 160/1	F 026 400 150	S 0150
C 2821	1 987 429 148	S 9148
C 28 214/1	1 457 433 537	S 3537
C2841	F 026 400 129	S 0129
C 2846	1 457 429 053	S 9053
C2851	1 987 429 181	S 9181
C 2852	1 457 429 915	S 9915
C2852/2	1 457 429 054	S 9054
C28525	1 457 429 915	S 9915
C2853	1 457 429 806	S 9806
C 2860	1 457 429 957	S 9957
C28602	1 987 429 051	S 9051
C28612	1 457 433 049	S 3049
C 2868	1 457 429 800	S 9800
C 2872	1 457 433 316	S 3316
C 2873/1	1 457 433 540	S 3540
C 2874	1 457 433 781	S 3781
C 2892	1 457 433 155	S 3155
C29103/21	1 457 433 560	S 3560
C29105	1 457 433 067	S 3067
C29118	1 457 433 263	S 3263
C29121	1 457 433 577	S 3577
C29121/91	1 457 433 730	S 3730
C29122	1 457 429 987	S 9987
C 29 122/1	1 457 429 987	S 9987
C29124	1 457 433 086	S 3086
C 29 126/2	1 457 429 875	S 9875
C291366	F 026 400 084	S 0084
C291366/1	F 026 400 084	S 0084
C29144	1 457 433 607	S 3607
C29145	F 026 400 111	S 0111
C29198	1 457 433 747	S 3747
C29200	1 457 429 949	S 9949
C2938	1 987 429 117	S 9117
C 2943	1 987 429 150	S 9150
C29531	1 457 429 954	S 9954
C29631	1 457 429 806	S 9806
C 2964	1 987 429 051	S 9051
C 2966	1 457 433 066	S 3066
C 2974	1 457 429 894	S 9894
C 2975	1 987 429 189	S 9189
C 2981	1 457 433 286	S 3286
C 2982	1 457 433 268	S 3268
C 2982 KIT	1 457 433 268	S 3268
C2987	F 026 400 015	S 0015
C29911	1 457 429 895	S 9895
C29912	1 457 429 896	S 9896
C 2994	1 457 429 839	S 9839
C 2998/5 X	1 457 433 059	S 3059
C 2999	1 457 429 895	S 9895
C 2999	1 457 429 898	S 9898
C30122	1 457 429 080	S 9080
C 30 1240	1 457 433 903	S 3903
C30125	1 457 432 172	S 2172
C 30 125/1	1 457 433 055	S 3055



◀ MANN

C30 125/2	F 026 400 020	S 0020
C30126	1 457 433 079	S 3079
C30130	1 457 433 281	S 3281
C30 130/1	1 457 433 281	S 3281
C30 130/2	F 026 400 013	S 0013

C30 135	F 026 400 119	S 0119
C30 1353	1 457 433 900	S 3900
C30138	F 026 400 012	S 0012
C30139	1 457 433 094	S 3094
C30 1500	1 457 433 904	S 3904

C30 1537	1 457 429 899	S 9899
C30161	F 026 400 109	S 0109
C30163	F 026 400 103	S 0103
C30170	1 987 429 193	S 9193
C30 170/1	1 457 433 655	S 3655

C30189	1 457 433 300	S 3300
C30195	1 457 433 752	S 3752
C30 195/2	1 457 433 752	S 3752
C30271	1 457 433 970	S 3970
C3028	F 026 400 163	S 0163

C30321	1 457 429 819	S 9819
C3033	1 987 429 180	S 9180
C3034	1 457 429 775	S 9775
C30421	1 457 433 623	S 3623
C3065	F 026 400 113	S 0113

C30703	1 457 432 188	S 2188
C3073	1 457 433 259	S 3259
C3078	1 457 433 521	S 3521
C30825	1 457 433 330	S 3330
C3083	1 987 429 403	S 9403

C30831	1 457 433 315	S 3315
C30 850/2	1 457 429 969	S 9969
C3088	F 026 400 140	S 0140
C3093	1 457 433 282	S 3282
C3093/1	1 457 433 319	S 3319

C31 101/1	1 987 429 135	S 9135
C31104	1 457 433 797	S 3797
C31116	1 457 433 089	S 3089
C31 1254	1 457 433 042	S 3042
C31126	1 987 429 151	S 9151

C31130	1 457 433 546	S 3546
C31 1345	F 026 400 117	S 0117
C31 1410	F 026 400 145	S 0145
C31143	1 457 433 164	S 3164
C31144	1 457 433 701	S 3701

C31 145	F 026 400 121	S 0121
C31149	1 457 433 101	S 3101
C31152	1 457 429 777	S 9777
C31 152/1	1 457 429 777	S 9777
C3118	1 987 429 173	S 9173

C31195	1 457 429 792	S 9792
C3126	1 987 429 171	S 9171
C3127	F 026 400 143	S 0143
C3132	1 457 433 322	S 3322
C3136	F 026 400 038	S 0038

C3145	1 987 429 162	S 9162
C3166	1 457 433 285	S 3285
C3167/1	1 457 433 007	S 3007
C3170/1-2	1 457 433 581	S 3581
C3173	1 457 433 606	S 3606

C3177	1 457 432 150	S 2150
C3184	1 457 432 150	S 2150
C3184	1 457 432 174	S 2174
C32108	1 457 433 596	S 3596
C32119	1 457 433 297	S 3297

C32120	1 457 429 778	S 9778
C32 120/1	1 457 433 750	S 3750
C32123	1 457 433 543	S 3543
C32 123/1	1 457 433 527	S 3527
C32 140/1	1 457 433 060	S 3060

C32 1420/1	F 026 400 080	S 0080
C32 1420/2	F 026 400 080	S 0080
C321447	F 026 400 083	S 0083
C32 1500	F 026 400 207	S 0207
C32154	1 457 433 742	S 3742

C32 154/1	F 026 400 014	S 0014
C32164	1 457 433 523	S 3523
C321752	F 026 400 086	S 0086
C32191	1 457 433 331	S 3331
C32 191/1	F 026 400 007	S 0007

C3220	1 987 429 184	S 9184
C3230	1 987 429 183	S 9183
C3233	1 987 429 188	S 9188
C32338	1 457 433 748	S 3748
C32 338/1	1 457 433 703	S 3703

C3251	1 457 433 531	S 3531
C32511	1 457 433 531	S 3531
C3261	1 457 433 088	S 3088
C3270	1 987 429 160	S 9160
C3275	1 457 433 317	S 3317

C3282	1 457 433 160	S 3160
C3284/2	1 987 429 152	S 9152
C33102	1 457 433 700	S 3700
C33128	F 026 400 108	S 0108
C33130	1 457 429 814	S 9814

C33 1465/1	F 026 400 078	S 0078
C33156	1 457 432 200	S 2200
C33 156/1	1 457 432 200	S 2200
C33160/01	1 457 433 292	S 3292
C33 1600/2	F 026 400 077	S 0077

C3318	F 026 400 158	S 0158
C33 1840	1 457 433 901	S 3901
C33189	1 457 433 578	S 3578
C33 189/1	1 457 433 579	S 3579
C33194	1 457 433 587	S 3587

C33220	1 457 429 781	S 9781
C3324	1 987 429 191	S 9191
C33256	1 457 433 753	S 3753
C3347	1 987 429 178	S 9178
C3366	1 457 433 660	S 3660

C3377	1 457 433 260	S 3260
C3383/1	1 457 433 520	S 3520
C33 920/5	F 026 400 079	S 0079
C3394	1 457 429 928	S 9928
C33941	1 457 429 928	S 9928

C34100	1 987 429 179	S 9179
C34109	1 457 429 994	S 9994
C34116	1 457 433 799	S 3799
C34 116/1	1 457 433 740	S 3740
C34 1500	F 026 400 034	S 0034

C34175	1 457 433 699	S 3699
C34200	1 457 432 203	S 2203
C34651	1 457 433 308	S 3308
C3468	1 457 433 158	S 3158
C3474	1 457 429 076	S 9076

C34831	1 457 429 085	S 9085
C3484	1 457 433 524	S 3524
C3485	1 457 433 325	S 3325
C34851	1 457 433 159	S 3159
C3498	1 457 433 047	S 3047

C35003	F 026 400 133	S 0133
C35110	1 457 433 591	S 3591
C35124	1 457 433 276	S 3276
C35134	1 457 433 250	S 3250
C35148	1 457 433 642	S 3642

C35154	1 987 429 404	S 9404
C35156	1 457 433 535	S 3535
C35 160	F 026 400 058	S 0058
C35 160/1	F 026 400 058	S 0058
C35215	1 457 433 536	S 3536

C3575	1 457 433 574	S 3574
C3578	1 457 432 185	S 2185
C3594	1 457 433 272	S 3272
C35941	1 457 433 298	S 3298
C36 1820	F 026 400 179	S 0179

C36221	1 457 429 983	S 9983
C3671	1 457 433 592	S 3592
C36982	1 457 433 071	S 3071
C37107	1 457 429 992	S 9992
C37132	1 457 433 058	S 3058

C37148	1 457 433 608	S 3608
C37153	1 457 433 714	S 3714
C37 153/1	1 457 433 081	S 3081
C37157	1 457 433 052	S 3052
C3725	1 987 429 163	S 9163

C3766	1 457 433 339	S 3339
C38145	1 457 433 065	S 3065
C38 163/1	1 457 429 783	S 9783
C3873	1 457 433 257	S 3257
C3874	1 457 433 257	S 3257

C3875	1 457 433 163	S 3163
C3875/1	F 026 400 051	S 0051
C3877/1	F 026 400 002	S 0002
C39108	1 457 429 079	S 9079
C39161	1 457 429 869	S 9869



C39219	1 987 429 190	S 9190
C40107	1 457 433 609	S 3609
C40124	1 457 433 616	S 3616
C40163	1 457 433 594	S 3594
C40174	1 457 429 993	S 9993
C40193	1 457 429 786	S 9786
C41110	1 457 433 102	S 3102
C41121	1 457 429 787	S 9787
C41123	1 457 429 948	S 9948
C41173	1 457 429 970	S 9970
C 41 1776	F 026 400 088	S 0088
C 42 1404	1 457 433 729	S 3729
C 42 1729	1 457 433 728	S 3728
C 4287/1	F 026 400 019	S 0019
C42872	1 457 433 716	S 3716
C4287/2	1 457 433 716	S 3716
C 4312	F 026 400 055	S 0055
C 4312/1	F 026 400 055	S 0055
C 4692	F 026 400 102	S 0102
C47109	1 457 433 522	S 3522
C48183	1 457 429 988	S 9988
C52107	1 457 433 043	S 3043
C58185	1 457 429 793	S 9793
C 58 185/1	1 457 429 793	S 9793
C60230	1 457 433 601	S 3601
C60345	1 457 433 626	S 3626
C64 1500/1	F 026 400 094	S 0094
HU 1077 X	F 026 407 100	P 7100
HU 1077/1 X	F 026 407 100	P 7100
HU 12 100 X	F 026 407 042	P 7042
HU 12 103 X	F 026 407 045	P 7045
HU1214/0X	1 457 429 128	P 9128
HU1270X	F 026 407 046	P 7046
HU 1297 X	F 026 407 047	P 7047
HU 13 125 X	F 026 407 051	P 7051
HU 138/1 X	1 457 429 137	P 9137
HU615/2X	1 457 429 272	P 9272
HU 618 X	F 026 407 014	P 7014
HU 7004X	F 026 407 087	P 7087
HU 710 X	1 457 429 194	P 9194
HU 711/4 X	1 457 429 248	P 9248
HU 712/10 X	F 026 407 062	P 7062
HU 712/9 X	F 026 407 068	P 7068
HU714X	1 457 429 308	P 9308
HU 716/2X	1 457 429 238	P 9238
HU 718X	F 026 407 069	P 7069
HU 718/1 N	1 457 429 157	P 9157
HU 718/1 Z	1 457 429 119	P 9119
HU 718/6 X	F 026 407 070	P 7070
HU 719/8 Y	F 026 407 097	P 7097
HU 721/2 X	1 457 429 126	P 9126
HU 721/4 X	1 457 429 252	P 9252
HU721/5X	F 026 407 072	P 7072
HU72/2X	1 457 429 185	P 9185
HU 722 Y	F 026 407 021	P 7021
HU 726/1 X	1 457 429 619	P 9619
HU 726/2 X	1 457 429 619	P 9619
HU8001X	F 026 407 066	P 7066
HU81/8X	1 457 429 118	P 9118
HU 819/1 X	1 457 429 284	P 9284
HU820/X	1 457 429 199	P 9199
HU 820/1Y	F 026 407 073	P 7073
HU 822/5 X	F 026 407 061	P 7061
HU82/5X	1 457 429 271	P 9271
HU83/1X	F 026 407 002	P 7002
HU84/2X	1 457 429 152	P 9152
HU920X	1 457 429 239	P 9239
HU923X	1 457 429 198	P 9198
HU 924/2 X	1 457 429 275	P 9275
HU 925/4 Y	F 026 407 075	P 7075
HU926/5Y	F 026 407 076	P 7076
HU 931/5 X	F 026 407 040	P 7040
HU931/6X	F 026 407 040	P 7040
HU 932/4 N	1 457 429 276	P 9276
HU 932/4 X	1 457 429 647	P 9647
HU93/4X	F 026 407 003	P 7003
HU 934/1X	1 457 429 307	P 9307
HU 938/1 X	1 457 429 123	P 9123
HU 945/2 X	F 026 407 026	P 7026
HU 947/1 N	1 457 429 277	P 9277
HU 947/1 X	1 457 429 646	P 9646
HU947/1Z2	1 457 429 732	P 9732
HU 947/2 X	1 457 429 107	P 9107
H 1059/1 X	1 457 429 636	P 9636
H107/6X	1 457 429 600	P 9600
H12107	1 457 429 130	P 9130
H 12 107/1	1 457 429 130	P 9130
H12110/2X	1 457 429 740	P 9740
H 12 140 X	1 457 429 128	P 9128
H127/5X	1 457 429 735	P 9735
H1282	1 457 429 130	P 9130
H 1282	1 457 429 629	P 9629
H128/2X	1 457 429 629	P 9629
H138/1X	1 457 429 137	P 9137
H159/1X	1 457 429 636	P 9636
H 601/4	1 457 429 820	P 9820
H716/1X	1 457 429 154	P 9154
H820/3X	1 457 429 117	P 9117
H85	1 457 429 416	P 9416
H 929/3	1 457 429 174	P 9174
H9322	1 457 429 413	P 9413
H932/2T	1 457 429 413	P 9413
H9323x	1 457 429 413	P 9413
H932/3X	1 457 429 647	P 9647
H932/4X	1 457 429 647	P 9647
H938/1X	1 457 429 123	P 9123
H947/1N	1 457 429 277	P 9277
H947/1Z	1 457 429 732	P 9732
H 947/2	1 457 429 107	P 9107
H947/2X	1 457 429 107	P 9107
H 973 X	1 457 429 251	P 9251
LA 378	1 987 431 175	M 1175
MNC1184	1 457 433 077	S 3077
MNC121071	1 457 433 712	S 3712
MNC2256	1 457 433 309	S 3309
MNC25711	1 457 433 253	S 3253
MNC2580	1 457 433 314	S 3314
MNC26721	1 457 433 311	S 3311
MNC2982KIT	1 457 433 268	S 3268
MNC29912	1 457 433 087	S 3087
MNFIA1337724080	1 457 434 455	N 4455
MNP716	1 457 431 713	N 1713
MNW9207	0 451 103 029	P 3029
MW811	0 986 452 019	P 2019
PFU 19 326 X	F 026 407 054	P 7054
PF1050/1N	1 457 429 274	P 9274
PF1050/1X	1 457 429 274	P 9274
PF1055/1N	1 457 429 267	P 9267
PF1155	1 457 429 175	P 9175
PF 1155 N	1 457 429 175	P 9175
PL420X	F 026 402 038	N 2038
PU 1018 X	1 457 431 723	N 1723
PU 1021 X	1 457 431 703	N 1703
PU 1033 X	F 026 402 015	N 2015
PU 1040 X	1 457 431 729	N 1729
PU1046/1X	1 457 431 707	N 1707
PU 1059X	F 026 402 028	N 2028
PU723X	1 457 070 001	N 0001
PU742	1 457 431 708	N 1708
PU816X	F 026 402 101	N 2101
PU819/3X	F 026 402 084	N 2084
PU 821/X-2	1 457 431 718	N 1718
PU82/2X	1 457 431 712	N 1712
PU823X	F 026 402 005	N 2005
PU 825/X	F 026 402 006	N 2006
PU83/0X	1 457 070 000	N 0000
PU83/9X	1 457 431 704	N 1704
PU 850X	F 026 402 029	N 2029
PU85/5X	1 457 431 710	N 1710
PU 9001 X	F 026 402 062	N 2062
PU92/2X	0 450 905 987	F 5987
PU92/2X	1 457 030 013	N 0013
PU932X	F 026 402 078	N 2078
PU936X	1 457 070 007	N 0007
PU936X	1 457 431 715	N 1715
PU 936/1X	F 026 402 008	N 2008
PU936/2X	1 457 070 007	N 0007
PU93/7X	F 026 402 004	N 2004
PU941/1X	F 026 402 100	N 2100
PU 966/1X	F 026 402 032	N 2032
PU 966/2 X	F 026 402 031	N 2031
PU 999/1 X	1 457 429 655	N 9655
PU 999/2X	F 026 402 033	N 2033
P 609	1 457 429 230	N 9230
P 707	1 457 431 261	N 1261



◀ MANN

P707	1 457 431 325	N 1325
P707/2	1 457 431 261	N 1261
P716	1 457 429 291	N 9291
P716/1X	1 457 429 657	N 9657
P718X	F 026 402 047	N 2047

P725X	1 457 429 289	N 9289
P726X	1 457 431 724	N 1724
P732X	1 457 429 656	N 9656
P733/1X	1 457 431 705	N 1705
P735X	1 457 429 621	N 9621

P738X	1 457 431 702	N 1702
P78X	1 457 431 028	N 1028
P811	1 457 431 270	N 1270
P811	1 457 431 326	N 1326
P811/2	1 457 431 270	N 1270

P811/2K	1 457 431 270	N 1270
P917X	1 457 434 201	N 4201
P919/7	1 457 429 165	P 9165
P945X	1 457 434 200	N 4200
P999X	1 457 429 655	N 9655

WDK724	1 457 434 447	N 4447
WDK725	1 457 434 447	N 4447
WDK 925	F 026 402 037	N 2037
WDK 940/5	1 457 434 419	N 4419
WF9161	0 986 452 003	P 2003

WK 1060/3X	F 026 402 025	N 2025
WK 11 102/9	F 026 402 017	N 2017
WK112/3	1 457 434 186	N 4186
WK113/6	0 450 906 458	N 6458
WK 114271X	1 457 434 432	N 4432

WK 1149	F 026 402 034	N 2034
WK116/8	1 457 429 681	N 9681
WK312	0 450 904 058	F 4058
WK314	0 450 904 060	F 4060
WK315	0 450 904 077	N 4077

WK 32	0 450 904 149	F 4149
WK323	0 986 450 138	F 0138
WK324	0 450 904 058	F 4058
WK421/0	0 986 450 018	F 0018
WK421/2	0 986 450 138	F 0138

WK421/4	0 986 450 117	F 0117
WK422	0 450 904 159	F 4159
WK425	0 986 450 039	F 0039
WK428/1	0 986 450 030	F 0030
WK43/13	0 450 904 158	N 4158

WK438	0 450 904 163	F 4163
WK 45	0 986 450 137	F 0137
WK504	0 450 905 942	N 5942
WK511/1	0 450 905 975	F 5975
WK511/2	0 450 905 926	F 5926

WK512	0 450 905 273	F 5273
WK512	0 450 905 316	F 5316
WK512/1	0 450 905 939	F 5939
WK513/3	F 026 403 000	F 3000
WK516	0 450 905 901	F 5901

WK516/2	0 450 905 950	F 5950
WK521	0 450 906 450	N 6450
WK521	0 450 906 463	N 6463
WK521/3	0 450 906 463	N 6463
WK521/4	0 450 906 462	N 6462

WK523	0 450 906 457	N 6457
WK532	0 450 905 960	F 5960
WK532/1	0 450 905 952	F 5952
WK552	0 450 905 976	F 5976
WK55/3	0 450 905 969	F 5969

WK 57	0 450 905 979	F 5979
WK 59X	0 450 905 925	F 5925
WK590/19	F 026 402 036	N 2036
WK6001	F 026 402 066	N 2066
WK612	0 450 902 161	F 2161

WK612/1	0 450 905 287	F 5287
WK612/2	0 986 450 119	F 0119
WK612/3	0 450 905 911	F 5911
WK6124	0 450 905 914	F 5914
WK612/4	0 450 905 924	F 5924

WK612/4	0 450 905 963	F 5963
WK6124	0 986 450 107	F 0107
WK612/4	0 986 450 113	F 0113
WK6124	0 986 450 624	F 0624
WK612/5	0 986 450 124	F 0124

WK612/6	F 026 402 001	N 2001
WK613	0 450 905 002	F 5002
WK613	0 450 905 280	F 5280
WK613/1	0 450 902 151	F 2151
WK613/2	0 450 905 005	F 5005

WK614	0 450 905 956	F 5956
WK614/1	0 986 450 106	F 0106
WK 614/10	0 450 905 915	F 5915
WK 614/11	0 450 905 912	F 5912
WK 614/13	0 986 450 105	F 0105

WK 614/14	0 986 450 102	F 0102
WK 614/17	0 450 905 983	F 5983
WK 614/17	0 986 450 108	F 0108
WK6142	0 450 905 977	F 5977
WK61421	0 450 905 963	F 5963

WK 614/24	0 450 905 924	F 5924
WK 614/24	0 986 450 107	F 0107
WK 614/24	0 986 450 111	F 0111
WK61424x	0 986 450 221	F 0221
WK 614/26	0 986 450 123	F 0123

WK 614/27	0 450 905 955	F 5955
WK 614/27	0 986 450 103	F 0103
WK61429	0 450 905 962	F 5962
WK614/3	0 450 905 929	F 5929
WK 614/30	0 450 905 914	F 5914

WK 614/31	0 986 450 107	F 0107
WK 614/33	0 986 450 103	F 0103
WK 614/36	0 986 450 115	F 0115
WK 614/37	0 986 450 110	F 0110
WK 614/44	0 986 450 225	F 0225

WK61445	0 450 905 967	F 5967
WK614/46	F 026 403 009	F 3009
WK 614/47	0 450 905 986	F 5986
WK614/7	0 986 450 222	F 0222
WK614/8	0 986 450 109	F 0109

WK614/9	0 450 905 989	F 5989
WK614/9	0 986 450 108	F 0108
WK618	0 450 905 021	F 5021
WK618/1	0 450 905 903	F 5903
WK 66	0 450 905 326	F 5326

WK 67	0 450 905 909	F 5909
WK 68	0 450 905 904	F 5904
WK68	0 450 905 974	F 5974
WK681	0 450 905 916	F 5916
WK684	F 026 403 002	F 3002

WK688/2	0 450 905 988	F 5988
WK688/3	0 450 905 953	F 5953
WK 69	0 450 905 959	F 5959
WK 69/1	F 026 403 008	F 3008
WK69/2	F 026 403 006	F 3006

WK710	0 450 905 920	F 5920
WK710/1	0 450 905 954	F 5954
WK710/1	0 986 450 030	F 0030
WK711	0 986 450 114	F 0114
WK711/1	0 450 915 001	F 5001

WK712/2	1 457 434 051	N 4051
WK713	1 457 434 436	N 4436
WK716	1 457 434 153	N 4153
WK718/2	1 457 434 291	N 4291
WK720	0 450 915 003	F 5003

WK720/1	0 450 905 968	F 5968
WK 720/2 X	1 457 434 440	N 4440
WK720/3	F 026 403 003	F 3003
WK720/4	F 026 403 012	F 3012
WK723	1 457 434 154	N 4154

WK723	1 457 434 165	N 4165
WK723	1 457 434 296	N 4296
WK723/1	1 457 434 154	N 4154
WK723/1	1 457 434 165	N 4165
WK724	1 457 434 432	N 4432

WK725	0 450 905 906	F 5906
WK725/1	0 450 905 906	F 5906
WK727	1 457 434 154	N 4154
WK727	1 457 434 165	N 4165
WK728	F 026 402 086	N 2086

WK730/1	0 450 905 318	F 5318
WK730/2	1 457 434 329	N 4329
WK730/5	0 450 905 927	F 5927
WK731	1 457 434 154	N 4154
WK731	1 457 434 165	N 4165

WK731	1 457 434 432	N 4432
WK7341	0 450 905 964	F 5964
WK735/1	0 450 906 459	N 6459
WK 76	0 450 902 162	F 2162
WK761	0 450 905 909	F 5909

WK762	0 986 450 104	F 0104
WK763	0 986 450 100	F 0100
WK 79	0 450 905 324	F 5324
WK 79	0 450 905 966	F 5966
WK8021	0 450 906 503	N 6503
WK814/1	1 457 434 153	N 4153
WK815	1 457 434 435	N 4435
WK 817/3 X	1 457 434 123	N 4123
WK 817/3 X	1 457 434 331	N 4331
WK818/1	1 457 434 443	N 4443
WK820/1	1 457 434 437	N 4437
WK 820/2	F 026 402 065	N 2065
WK821	1 457 434 105	N 4105
WK821	1 457 434 321	N 4321
WK822/1	1 457 434 416	N 4416
WK822/2	0 450 905 921	F 5921
WK822/3	0 450 906 464	N 6464
WK822/4	1 457 434 454	N 4454
WK823/1	0 986 450 509	N 0509
WK823/2	F 026 402 000	N 2000
WK823/2	0 450 906 500	N 6500
WK828	1 457 434 438	N 4438
WK829	0 450 906 453	N 6453
WK 829/1X	0 450 906 437	N 6437
WK8292	0 450 906 452	N 6452
WK8292	0 450 906 453	N 6453
WK829/3	0 450 906 508	N 6508
WK830	0 450 905 030	F 5030
WK830	0 450 905 095	F 5095
WK830/3	0 450 905 203	F 5203
WK830/5	0 450 905 104	F 5104
WK830/6	0 450 905 087	F 5087
WK830/7	0 450 905 030	F 5030
WK830/7	0 450 905 264	F 5264
WK831	0 450 905 275	F 5275
WK832	1 457 434 103	N 4103
WK834/1	0 450 905 091	F 5091
WK834/1	0 450 905 133	F 5133
WK841/1	0 450 906 451	N 6451
WK842	1 457 434 105	N 4105
WK 842/10	1 457 434 192	N 4192
WK 842/11	1 457 434 329	N 4329
WK 842/13	0 450 905 930	N 5930
WK 842/15	1 457 434 455	N 4455
WK 842/17	0 450 905 930	N 5930
WK842/18	F 026 402 044	N 2044
WK842/2	1 457 434 106	N 4106
WK 842/20	F 026 402 003	N 2003
WK 842/21	0 450 906 429	N 6429
WK 842/23 X	F 026 402 056	N 2056
WK 842/24	F 026 402 043	N 2043
WK842/5	1 457 434 154	N 4154
WK842/5	1 457 434 165	N 4165
WK845	0 450 905 177	F 5177
WK845/1	1 457 434 184	N 4184
WK845/4	1 457 434 187	N 4187
WK845/5	1 457 434 324	N 4324
WK845/6	1 457 434 324	N 4324
WK845/7	1 457 434 324	N 4324
WK845/8	F 026 402 002	N 2002
WK849	0 450 905 195	F 5195
WK849	0 450 905 216	F 5216
WK850	0 450 905 908	F 5908
WK850/2	1 457 434 400	N 4400
WK853	0 450 905 200	F 5200
WK853	0 450 905 601	F 5601
WK853	0 450 905 964	F 5964
WK 853/14	1 457 434 198	N 4198
WK 853/17	0 450 906 431	N 6431
WK 853/20	F 026 402 049	N 2049
WK 853/23	F 026 402 051	N 2051
WK 853/24	F 026 402 054	N 2054
WK853/8	1 457 434 198	N 4198
WK 854/1	1 457 434 310	N 4310
WK854/3	1 457 434 460	N 4460
WK8544	F 026 402 013	N 2013
WK854/4	F 026 402 013	N 2013
WK854/5	F 026 402 048	N 2048
WK854/6	1 457 434 460	N 4460
WK857/1	0 450 906 467	N 6467
WK9008	F 026 402 072	N 2072
WK 9012 X	F 026 402 067	N 2067
WK918	1 457 434 302	N 4302
WK 9181	1 457 434 453	N 4453
WK920/1	0 986 450 508	N 0508
WK920/3	1 457 434 452	N 4452
WK920/3	1 457 434 456	N 4456
WK920/5	F 026 402 016	N 2016
WK921/1	1 457 434 456	N 4456
WK 924/1 X	1 457 434 448	N 4448
WK939	0 450 906 460	N 6460
WK939/1	0 450 906 461	N 6461
WK 939/13	F 026 402 046	N 2046
WK939/15	F 026 402 059	N 2059
WK939/2	0 450 906 471	N 6471
WK939/4	0 450 906 469	N 6469
WK939/6	0 450 906 468	N 6468
WK 940/11	1 457 434 453	N 4453
WK 940/16	1 457 434 453	N 4453
WK 940/18	1 457 434 421	N 4421
WK94020	1 457 434 421	N 4421
WK940/22	1 457 434 439	N 4439
WK 940/22	1 457 434 451	N 4451
WK940/5	1 457 429 675	N 9675
WK940/6	1 457 434 281	N 4281
WK950/21	F 026 402 030	N 2030
WK950/6	1 457 434 402	N 4402
WK 962/16	F 026 402 035	N 2035
WK962/4	1 457 429 676	N 9676
WK962/7	1 457 434 294	N 4294
WK1168	1 457 429 681	N 9681
WK4313	0 450 904 158	N 4158
WK7182	1 457 434 291	N 4291
WK7203	F 026 403 003	F 3003
WK94011	1 457 434 453	N 4453
WK9405	1 457 429 675	N 9675
WK9627	1 457 434 294	N 4294
WP1026	0 451 103 365	P 3365
WP1045	0 986 452 063	P 2063
WP 11 102	0 451 300 003	P 0003
WP1110/21	F 026 407 105	P 7105
WP 11 102/1 -2	F 026 407 105	P 7105
WP1144	0 451 203 201	P 3201
WP1168	0 451 300 007	P 0007
WP1169	F 026 407 049	P 7049
WP 914	F 026 407 106	P 7106
WP 914/80	0 986 452 030	P 2030
WP 920/80	0 986 452 064	P 2064
WP 928/80	0 986 452 062	P 2062
WP 928/81	0 986 452 042	P 2042
WP 928/82	0 986 452 046	P 2046
WP 928/83	0 986 452 066	P 2066
W111/02	0 451 403 001	P 3001
W11102/11	0 451 104 010	P 4010
W11102/14	0 451 103 343	P 3343
W11102/20	0 451 103 343	P 3343
W 11 102/27	F 026 407 043	P 7043
W 11 102/4	0 451 403 077	P 3077
W 1114/80	0 451 103 270	P 3270
W113/01	0 451 203 223	P 3223
W113/02	0 451 103 257	P 3257
W 1140	0 451 203 152	P 3152
W 1160	0 451 301 207	P 1207
W 1170	0 451 301 156	P 1156
W 1170/7	F 026 407 048	P 7048
W 13 145/3	0 451 403 208	P 3208
W 13145/6	0 451 104 013	P 4013
W 1323	0 451 103 368	P 3368
W 610/1	0 451 103 276	P 3276
W 610/4	0 986 452 060	P 2060
W 610/6	F 026 407 077	P 7077
W610/7	F 026 407 025	P 7025
W610/80	0 451 103 276	P 3276
W610/83	0 986 452 060	P 2060
W671	0 451 103 275	P 3275
W 67/1	0 986 452 061	P 2061
W 67/2	0 986 452 058	P 2058
W 67/80	0 986 452 061	P 2061
W 67/81	0 986 452 058	P 2058
W 68/1	0 986 452 028	P 2028
W 68/3	0 986 452 028	P 2028
W 68/80	0 986 452 028	P 2028
W 7 MULTI 3/4 - S	0 986 800 044	B7 TOP 3/4S
W711/80	0 986 452 044	P 2044
W71218	0 451 103 316	P 3316



◀ MANN

W71238	0986 452 003	P 2003
W712/41	0 451 103 297	P 3297
W712/54	0 451 103 337	P 3337
W712/73	0986 452 068	P 2068
W 712/82	F 026 407 017	P 7017

W 712/83	0986 452 044	P 2044
W 712/9	0 451 104 015	P 4015
W7131	0986 452 000	P 2000
W713/18	0 451 103 232	P 3232
W 713/35	F 026 407 027	P 7027

W7171	0986 452 044	P 2044
W719/14	0 451 103 258	P 3258
W 730/1	0 451 103 249	P 3249
W77	0 451 103 141	P 3141
W8004	0 451 203 194	P 3194

W811/80	0 451 103 316	P 3316
W811/81	0986 452 019	P 2019
W811/81	0986 452 035	P 2035
W811/83	0986 452 035	P 2035
W811/85	0 451 103 275	P 3275

W815/80	0986 452 016	P 2016
W815/81	0986 452 015	P 2015
W816/80	0986 452 020	P 2020
W8184	0986 452 000	P 2000
W818/81	0986 452 000	P 2000

W818/82	0986 452 023	P 2023
W 820	0 451 103 109	P 3109
W 830/1	0 451 103 290	P 3290
W 830/ 1	0 451 103 290	P 3290
W 830/3	F 026 407 018	P 7018

W85	0 451 103 235	P 3235
W 9009	F 026 407 083	P 7083
W91413	0986 452 016	P 2016
W91414	0986 452 015	P 2015
W914/2	0 451 103 274	P 3274

W 914/2	0 451 103 274	P 3274
W914/26	0 451 103 341	P 3341
W914/28	F 026 407 024	P 7024
W 920	0 451 103 062	P 3062
W92011	0 451 103 109	P 3109

W920/11	0 451 103 311	P 3311
W92014	0986 452 005	P 2005
W92014	0986 452 024	P 2024
W92026	0986 452 003	P 2003
W92031	0986 452 003	P 2003

W920/32	0 451 103 252	P 3252
W920/38	0 451 103 260	P 3260
W 920/4	0986 452 024	P 2024
W92048	0986 452 003	P 2003
W 920/7	0 451 103 004	P 3004

W9207	0986 452 003	P 2003
W 920/8	0 451 103 289	P 3289
W920/80	0986 452 003	P 2003
W920/81	0986 452 024	P 2024
W 930	0 451 103 028	P 3028

W930/11	0 451 203 108	P 3108
W930/12	0 451 103 217	P 3217
W930/14	0 451 103 330	P 3330
W930/26	0 451 103 366	P 3366
W 932	0 451 103 240	P 3240

W932/81	0 451 103 357	P 3357
W93281	0986 452 024	P 2024
W93281W9331	0 451 103 357	P 3357
W 933/1	0 451 103 357	P 3357
W 933/4	F 026 407 084	P 7084

W 936/4	0 451 104 005	P 4005
W 936/5	0 451 104 064	P 4064
W 940	0 451 104 065	P 4065
W940/13	0 451 103 253	P 3253
W940/18	0 451 104 066	P 4066

W940/21	0 451 203 005	P 3005
W94023	0986 452 024	P 2024
W940/24	0 451 203 194	P 3194
W94025	0 451 104 065	P 4065
W940/27	0 451 104 067	P 4067

W940/44	0 451 103 346	P 3346
W 940/5	0 451 104 066	P 4066
W940/50	0986 452 400	P 2400
W940/62	F 026 407 053	P 7053
W 940/69	F 026 407 083	P 7083

W9409	0 451 104 065	P 4065
W 950	0 451 203 220	P 3220
W 950/1	0 451 203 002	P 3002
W95013	0 451 203 002	P 3002
W950/13	0 451 203 226	P 3226

W950/39	F 026 407 057	P 7057
W 950/7	0 451 203 010	P 3010
W 962	0 451 104 015	P 4015
W 962	0 451 105 067	P 5067
W962/15	0 451 105 067	P 5067

W 962/2	0 451 105 188	P 5188
W 962/6	0 451 104 015	P 4015
W9634	0 451 104 005	P 4005
W9635	0 451 104 064	P 4064
XC1-1500	F 026 400 127	S 0127

XWK1-1211	F 026 402 063	N 2063
ZR 902 X	F 026 407 059	P 7059
ZR 904 X	F 026 407 060	P 7060
16 167	F 026 400 065	S 0065
21001/2	1 987 432 159	M 2159

22 002-2	1 987 432 156	M 2156
2450	1 987 432 369	R 2369
37230	1 987 431 162	M 1162
4594	1 987 431 166	M 1166
665035713	1 457 030 013	N 0013

MOTORCRAFT

AFD 157	1 457 434 201	N 4201
AFG 33	0986 450 117	F 0117
AFG 34	1 457 431 261	N 1261

AFG 34	1 457 431 325	N 1325
AFG 42 A	0986 450 117	F 0117
AFG 44	0986 450 102	F 0102
AFG 45	0986 450 105	F 0105
AFG 51	0 450 904 161	N 4161

AFG 52	0986 450 108	F 0108
AFG 56	0986 450 117	F 0117
AFG 57	0986 450 106	F 0106
AFL40	0986 452 023	P 2023
AFL50	0986 452 019	P 2019

AFL51	0986 452 015	P 2015
AFL61	0986 452 042	P 2042
AFL79A	0 451 103 316	P 3316
DFA 580	1 457 433 605	S 3605
EFA 009	1 457 433 750	S 3750

EFA 015	1 457 433 609	S 3609
EFA 018	1 457 429 791	S 9791
EFA 019	1 457 433 659	S 3659
EFA 022	1 457 433 608	S 3608
EFA 030	1 457 433 617	S 3617

EFA 040	1 457 429 064	S 9064
EFA 049	1 457 429 064	S 9064
EFA 057	1 457 429 915	S 9915
EFA 073	1 457 432 108	S 2108
EFA 080	1 457 432 106	S 2106

EFA 085	1 457 429 053	S 9053
EFA 086	1 457 429 064	S 9064
EFA 086 D	1 457 429 064	S 9064
EFA 106	1 457 429 800	S 9800
EFA 1066	1 457 433 605	S 3605

EFA 107	1 457 429 801	S 9801
EFA 109	1 457 429 050	S 9050
EFA 109	1 457 429 959	S 9959
EFA 109 D	1 457 429 050	S 9050
EFA 13	1 457 432 108	S 2108

EFA 146	1 457 429 054	S 9054
EFA 146 D	1 457 429 054	S 9054
EFA15	1 457 433 609	S 3609
EFA 153	1 457 432 106	S 2106
EFA 158	1 457 432 108	S 2108

EFA 160	1 457 429 076	S 9076
EFA 18	1 457 429 791	S 9791
EFA 180	1 457 432 111	S 2111
EFA 184	1 457 433 070	S 3070
EFA 188	1 457 429 900	S 9900

EFA19	1 457 433 659	S 3659
EFA 190	1 457 429 030	S 9030
EFA 204	1 457 429 806	S 9806
EFA 206	1 457 433 732	S 3732
EFA22	1 457 433 608	S 3608

EFA 224	1 457 429 920	S 9920
EFA 226	1 457 429 908	S 9908
EFA 227	1 457 432 124	S 2124
EFA 238	1 457 429 079	S 9079
EFA 243	1 457 429 061	S 9061

EFA 246	1 457 429 085	S 9085	EFA 498	1 457 429 993	S 9993	EFG 024	1 457 434 200	N 4200
EFA 250	1 457 429 994	S 9994	EFA 499	1 457 433 231	S 3231	EFG 025	1 457 434 154	N 4154
EFA 256	1 457 429 080	S 9080	EFA 500	1 457 429 777	S 9777	EFG 025	1 457 434 165	N 4165
EFA 261	1 457 429 957	S 9957	EFA 501	1 457 429 777	S 9777	EFG 025	1 457 434 296	N 4296
EFA 262	1 457 429 915	S 9915	EFA 511	1 457 432 180	S 2180	EFG 025	1 457 434 432	N 4432
EFA 269	1 457 429 932	S 9932	EFA 512	1 457 432 185	S 2185	EFG027	1 457 431 270	N 1270
EFA 272	1 457 429 806	S 9806	EFA 513	1 457 432 183	S 2183	EFG 027	1 457 431 326	N 1326
EFA 276	1 457 432 146	S 2146	EFA515	1 987 429 122	S 9122	EFG 028	1 457 431 261	N 1261
EFA 283	1 457 429 959	S 9959	EFA 516	1 457 429 896	S 9896	EFG 028	1 457 431 325	N 1325
EFA 287	1 457 429 992	S 9992	EFA516	1 457 433 087	S 3087	EFG 029	1 457 431 158	N 1158
EFA 296	1 457 429 953	S 9953	EFA 520	1 457 429 895	S 9895	EFG 030	1 457 431 159	N 1159
EFA 297	1 457 429 932	S 9932	EFA 522	1 457 429 787	S 9787	EFG 032	0 450 905 200	F 5200
EFA 299	1 457 429 954	S 9954	EFA 523	1 457 429 877	S 9877	EFG 032	0 450 905 601	F 5601
EFA300	1 457 433 617	S 3617	EFA 524	1 457 429 781	S 9781	EFG 033	1 457 434 153	N 4153
EFA 300	1 457 433 200	S 3200	EFA 530	1 457 432 150	S 2150	EFG 035	1 457 434 106	N 4106
EFA 302	1 457 429 933	S 9933	EFA 532	1 457 429 841	S 9841	EFG 038	0 450 904 077	N 4077
EFA 304	1 457 429 941	S 9941	EFA 535	1 987 429 051	S 9051	EFG 039	0 450 904 060	F 4060
EFA 306	1 457 429 794	S 9794	EFA 537	1 457 429 846	S 9846	EFG 041	0 450 905 203	F 5203
EFA 308	1 457 429 946	S 9946	EFA 542	1 457 433 259	S 3259	EFG 045	1 457 431 028	N 1028
EFA 311	1 457 429 950	S 9950	EFA 543	1 457 433 002	S 3002	EFG 048	1 457 434 106	N 4106
EFA 315	1 457 429 966	S 9966	EFA 546	1 987 429 051	S 9051	EFG 050	1 457 429 675	N 9675
EFA 319	1 457 429 975	S 9975	EFA 550	1 457 429 819	S 9819	EFG 051	0 450 905 002	F 5002
EFA 328	1 457 429 969	S 9969	EFA 551	1 457 429 814	S 9814	EFG 051	0 450 905 280	F 5280
EFA 353	1 457 429 928	S 9928	EFA 553	1 457 433 227	S 3227	EFG 055	0 450 905 021	F 5021
EFA 355	1 457 432 154	S 2154	EFA555	1 987 429 148	S 9148	EFG 057	1 457 434 106	N 4106
EFA 356	1 457 433 652	S 3652	EFA557	1 457 433 007	S 3007	EFG 062	1 457 429 681	N 9681
EFA 373	1 457 429 845	S 9845	EFA 559	1 457 429 923	S 9923	EFG 063	1 457 429 675	N 9675
EFA 376	1 457 429 054	S 9054	EFA 560	1 457 433 233	S 3233	EFG 066	1 457 429 354	N 9354
EFA 382	1 457 432 173	S 2173	EFA 562	1 457 433 023	S 3023	EFG 067	1 457 429 359	N 9359
EFA 388	1 457 432 203	S 2203	EFA 568	1 457 433 264	S 3264	EFG 077	1 457 434 200	N 4200
EFA 393	1 457 432 172	S 2172	EFA 569	1 457 433 008	S 3008	EFG079	1 457 429 676	N 9676
EFA 396	1 457 429 875	S 9875	EFA 571	1 457 433 606	S 3606	EFG 080	1 457 434 154	N 4154
EFA 401	1 457 432 174	S 2174	EFA 572	1 457 433 623	S 3623	EFG 080	1 457 434 165	N 4165
EFA 402	1 457 429 800	S 9800	EFA 577	1 457 433 711	S 3711	EFG 080	1 457 434 432	N 4432
EFA 417	1 457 432 154	S 2154	EFA 579	1 457 433 742	S 3742	EFG 088	1 457 434 201	N 4201
EFA 418	1 457 429 992	S 9992	EFA 581	1 457 433 792	S 3792	EFG 103	1 457 434 123	N 4123
EFA 429	1 457 433 231	S 3231	EFA 582	1 457 433 268	S 3268	EFG 104	1 457 429 289	N 9289
EFA 438	1 457 429 983	S 9983	EFA 583	1 457 433 047	S 3047	EFG 106	1 457 434 103	N 4103
EFA 440	1 457 429 992	S 9992	EFA584	1 457 433 083	S 3083	EFG 107	0 450 905 030	F 5030
EFA 445	1 457 429 964	S 9964	EFA586	1 457 433 096	S 3096	EFG 107	0 450 905 095	F 5095
EFA 449	1 457 429 875	S 9875	EFA587	1 457 433 099	S 3099	EFG 21	0 450 904 058	F 4058
EFA 478	1 457 429 870	S 9870	EFA 600	1 457 433 686	S 3686	EFG 22	0 450 905 021	F 5021
EFA 478	1 457 433 310	S 3310	EFA601	1 457 433 593	S 3593	EFG24	1 457 434 200	N 4200
EFA 481	1 987 429 042	S 9042/1	EFA730	1 457 433 605	S 3605	EFG 25	1 457 434 050	N 4050
EFA 482	1 987 429 117	S 9117	EFA732	1 987 429 148	S 9148	EFG 27	1 457 431 270	N 1270
EFA 484	1 457 429 842	S 9842	EFA 842	1 457 429 842	S 9842	EFG 296	1 457 434 201	N 4201
EFA 486	1 457 429 775	S 9775	EFG 003	1 457 434 201	N 4201	EFG3	1 457 434 201	N 4201
EFA 488	1 457 429 845	S 9845	EFG 005	1 457 434 201	N 4201	EFG 302	1 457 434 105	N 4105
EFA 489	1 457 429 819	S 9819	EFG 006	0 450 905 324	F 5324	EFG 309	1 457 434 438	N 4438
EFA 491	1 457 433 690	S 3690	EFG 008	1 457 434 051	N 4051	EFG 310	0 450 905 177	F 5177
EFA 492	1 457 429 869	S 9869	EFG 009	1 457 434 105	N 4105	EFG 313	0 450 905 901	F 5901
EFA 493	1 457 432 200	S 2200	EFG 014	0 450 905 195	F 5195	EFG 314	0 450 904 159	F 4159
EFA 495	1 457 429 783	S 9783	EFG 014	0 450 905 216	F 5216	EFG 315	1 457 434 201	N 4201
EFA 496	1 457 429 970	S 9970	EFG 021	0 450 904 058	F 4058	EFG 319	1 457 434 400	N 4400
EFA 497	1 457 429 988	S 9988	EFG 022	0 450 905 021	F 5021	EFG 79	1 457 429 676	N 9676



◀ MOTORCRAFT

EFL 001	0 451 104 065	P 4065
EFL 026	0 451 103 029	P 3029
EFL 037	0 451 103 029	P 3029
EFL 038	0 451 103 274	P 3274
EFL 039	0 451 103 029	P 3029

EFL 047	0 451 104 015	P 4015
EFL 049	0 451 103 141	P 3141
EFL 050	0 451 103 274	P 3274
EFL 050 D	0 451 103 274	P 3274
EFL 052	0 451 103 062	P 3062

EFL 053	0 451 103 004	P 3004
EFL 059	0 451 104 064	P 4064
EFL 060	0 451 104 065	P 4065
EFL 068	1 457 429 175	P 9175
EFL 074	0 451 203 194	P 3194

EFL 077	0 451 203 005	P 3005
EFL 090	0 451 103 029	P 3029
EFL 090 D	0 451 103 029	P 3029
EFL 090 S	0 451 103 029	P 3029
EFL 092	0 451 103 357	P 3357

EFL 092	0 986 452 005	P 2005
EFL 093	0 451 203 152	P 3152
EFL 098	0 451 103 141	P 3141
EFL 104	F 026 407 054	P 7054
EFL 112	0 451 104 015	P 4015

EFL 114	0 451 103 141	P 3141
EFL 115	0 451 103 274	P 3274
EFL 117	0 451 103 004	P 3004
EFL 118	0 451 103 029	P 3029
EFL 119	0 986 452 000	P 2000

EFL 130	0 451 103 316	P 3316
EFL 133	0 451 104 065	P 4065
EFL 136	0 451 203 010	P 3010
EFL 138	1 457 429 175	P 9175
EFL 143	0 451 103 232	P 3232

EFL 151	0 986 452 015	P 2015
EFL 152	0 451 203 010	P 3010
EFL 152	0 451 203 194	P 3194
EFL 158	0 451 103 029	P 3029
EFL 161	0 451 104 015	P 4015

EFL 161	0 451 105 067	P 5067
EFL 164	0 451 203 108	P 3108
EFL 167	0 986 452 016	P 2016
EFL 168	0 986 452 028	P 2028
EFL 170	0 451 403 077	P 3077

EFL 173	0 451 301 156	P 1156
EFL 175	0 451 203 220	P 3220
EFL 179	1 457 429 740	P 9740
EFL 180	1 457 429 735	P 9735
EFL 181	1 457 429 600	P 9600

EFL 206	1 457 429 130	P 9130
EFL 208	1 457 429 117	P 9117
EFL 211	1 457 429 413	P 9413
EFL 215	0 451 203 002	P 3002
EFL 222	0 451 104 015	P 4015

EFL 222	0 451 105 067	P 5067
EFL 223	0 451 103 004	P 3004
EFL 224	0 451 104 066	P 4066
EFL 253	0 451 103 274	P 3274
EFL 256	0 451 103 252	P 3252

EFL 260	0 451 103 232	P 3232
EFL 267	1 457 429 646	P 9646
EFL 270	1 457 429 629	P 9629
EFL 272	1 457 429 647	P 9647
EFL 279	0 986 452 023	P 2023

EFL 282	0 451 203 223	P 3223
EFL 284	0 986 452 016	P 2016
EFL 286	0 986 452 023	P 2023
EFL 288	0 986 452 019	P 2019
EFL 291	0 451 103 357	P 3357

EFL 291	0 986 452 005	P 2005
EFL 291	0 986 452 024	P 2024
EFL 292	0 986 452 028	P 2028
EFL 298	0 451 103 029	P 3029
EFL 298	0 451 103 274	P 3274

EFL 306	0 451 103 109	P 3109
EFL 307	1 457 429 636	P 9636
EFL 311	0 986 452 023	P 2023
EFL 313	0 451 103 029	P 3029
EFL 317	0 986 452 000	P 2000

EFL 318	0 451 103 357	P 3357
EFL 318	0 986 452 005	P 2005
EFL 322	1 457 429 274	P 9274
EFL 344	0 986 452 044	P 2044
EFL 346	0 451 103 109	P 3109

EFL 348	0 451 103 109	P 3109
EFL 357	1 457 429 636	P 9636
EFL 365	0 451 103 270	P 3270
EFL 366	0 451 203 194	P 3194
EFL 368	0 986 452 023	P 2023

EFL 378	0 451 203 010	P 3010
EFL 379	0 986 452 019	P 2019
EFL 385	0 986 452 035	P 2035
EFL 386	0 451 103 252	P 3252
EFL 391	0 986 452 028	P 2028

EFL 392	0 986 452 030	P 2030
EFL 395	1 457 429 251	P 9251
EFL 396	0 451 103 217	P 3217
EFL 397	0 451 103 276	P 3276
EFL 401	0 451 103 290	P 3290

EFL 401	0 451 103 347	P 3347
EFL 402	0 451 103 290	P 3290
EFL 484	1 457 429 239	P 9239
EFL 488	0 986 452 060	P 2060
EFL 490	0 451 103 240	P 3240

EFL 60	0 451 103 253	P 3253
EFL 903	0 451 103 252	P 3252
EFL 904	0 986 452 062	P 2062
EFL 910	0 986 452 068	P 2068
EFL 912	0 451 103 252	P 3252

EFL 914	1 457 429 239	P 9239
EFL 92	0 986 452 024	P 2024
EF 066	0 450 905 324	F 5324
FA 1066	1 457 433 605	S 3605
FA 1072	1 987 429 146	S 9146

FA1082	1 457 429 928	S 9928
FA1126	1 987 429 122	S 9122
FA 1613	1 457 433 088	S 3088
FA1696	1 457 433 095	S 3095
FA617	1 457 429 806	S 9806

FD157	1 457 434 201	N 4201
FG 803	0 986 450 117	F 0117
FG 817	0 986 450 039	F 0039
FG 851	0 986 450 119	F 0119
FG 864	0 986 450 102	F 0102

FG 866	0 986 450 105	F 0105
FG 885	0 986 450 103	F 0103
FG 986 B	0 450 905 939	F 5939
FL307	0 451 403 077	P 3077
FL332	0 986 452 003	P 2003

FL757	0 986 452 015	P 2015
FL805	0 986 452 042	P 2042
FL 816	0 986 452 061	P 2061
FL836	0 986 452 028	P 2028
FL839	0 986 452 023	P 2023

RFL 493	0 451 203 194	P 3194
MFA514	1 457 433 072	S 3072
MFA539	1 457 429 806	S 9806
MFA545	1 457 429 932	S 9932
MFA551	1 457 429 030	S 9030

MFA577	1 457 429 061	S 9061
MFA579	1 457 429 957	S 9957
MFA581	1 457 429 801	S 9801
MFA585	1 457 433 534	S 3534
MFA625	1 457 429 954	S 9954

MFA627	1 987 429 042	S 9042/1
MFA641	1 457 429 933	S 9933
MFA654	1 457 433 605	S 3605
MFA658	1 987 429 122	S 9122
MFA673	1 987 429 148	S 9148

MFA675	1 457 433 007	S 3007
MFA682	1 987 429 133	S 9133
MFA706	1 987 429 186	S 9186
MFG197	1 457 434 438	N 4438
MFL158	0 986 452 061	P 2061

MFL202	0 986 452 028	P 2028
MFL204	0 986 452 044	P 2044
MFL207	0 986 452 003	P 2003
MFL209	0 986 452 062	P 2062
MFL227	0 451 104 005	P 4005

MFL231	0 451 203 194	P 3194
MFL237	0 986 452 063	P 2063
MFL247	0 986 452 046	P 2046
MFL248	0 451 103 316	P 3316
MFL251	0 986 452 042	P 2042



MFL252	0 986 452 016	P 2016
MFL253	0 451 104 065	P 4065
MFL263	0 451 103 316	P 3316
MFL268	0 986 452 015	P 2015
MFL272	0 986 452 019	P 2019

MFL279	0 986 452 024	P 2024
MFL280	0 986 452 000	P 2000
MFL290	0 451 103 270	P 3270
MFL420	1 457 429 413	P 9413
MFL434	1 457 429 130	P 9130

MFL452	0 986 452 023	P 2023
MFL785A	0 451 103 270	P 3270

PURFLUX

AHC112	1 987 432 060	M 2060
AHC113	1 987 432 060	M 2060
AHC 122	1 987 432 306	R 2306

AHC211	1 987 432 381	R 2381
AHC 247	1 987 432 122	M 2122
AHC258	1 987 432 406	R 2406
AHC 264	1 987 432 500	R 2500
AHC 269	1 987 432 369	R 2369

AH102	1 987 432 200	M 2200
AH 112	1 987 432 060	M 2060
AH 113	1 987 432 060	M 2060
AH 151	1 987 432 159	M 2159
AH 157	1 987 432 052	M 2052

AH160	1 987 432 084	M 2084
AH 174	1 987 432 107	M 2107
AH175	1 987 432 066	M 2066
AH186	1 987 432 208	M 2208
AH189	1 987 432 088	M 2088

AH204	1 987 432 075	M 2075
AH205	1 987 432 091	M 2091
AH209	1 987 432 114	M 2114
AH210	1 987 432 085	M 2085
AH 220	1 987 432 074	M 2074

AH 221	1 987 432 166	M 2166
AH224	1 987 432 192	M 2192
AH225	1 987 432 058	M 2058
AH226	1 987 432 105	M 2105
AH231	1 987 432 042	M 2042

AH 256	1 987 432 190	M 2190
AH 259	1 987 432 190	M 2190
AH260	1 987 432 227	M 2227
AH262	1 987 432 216	M 2216
AH266	1 987 432 203	M 2203

AH273	1 987 432 078	M 2078
AH282	1 987 432 215	M 2215
A 1003	1 457 429 793	S 9793
A1004	1 987 429 152	S 9152
A 1005	1 987 429 171	S 9171

A 1006	1 457 433 950	S 3950
A 1008	F 026 400 014	S 0014
A1009	1 457 433 154	S 3154
A 1027	1 457 433 529	S 3529
A 1029	1 457 433 748	S 3748

A1031	1 457 433 269	S 3269
A 1033	1 457 433 161	S 3161
A 1034	1 457 433 544	S 3544
A 1035	1 457 433 077	S 3077
A 1036	1 457 433 526	S 3526

A 1037	1 457 433 280	S 3280
A 1040	1 457 432 124	S 2124
A 1040	1 457 433 062	S 3062
A 1041	1 457 429 841	S 9841
A 1043	1 457 433 281	S 3281

A 1045	1 457 433 716	S 3716
A 1046	1 457 433 659	S 3659
A 1048	1 457 433 297	S 3297
A 1049	1 457 433 752	S 3752
A 1050	1 457 433 747	S 3747

A 1052	1 457 433 588	S 3588
A1053	1 457 433 536	S 3536
A 1054	1 457 433 772	S 3772
A1055	1 457 433 044	S 3044
A 1055	1 457 433 739	S 3739

A 1056	1 457 433 686	S 3686
A 1057	1 457 433 061	S 3061
A1058	1 457 433 521	S 3521
A1059	1 457 433 553	S 3553
A 1060	1 987 429 166	S 9166

A 1062	1 457 429 890	S 9890
A 1067	1 457 433 531	S 3531
A 1068	1 457 433 311	S 3311
A1069	1 457 433 052	S 3052
A 1070	1 457 433 520	S 3520

A1071	1 457 433 791	S 3791
A1072	1 457 433 734	S 3734
A 1073	1 457 429 814	S 9814
A 1074	1 457 432 200	S 2200
A 1075	1 457 433 753	S 3753

A1076	1 457 433 276	S 3276
A 1077	1 457 433 550	S 3550
A 1078	1 457 433 589	S 3589
A1082	1 457 433 332	S 3332
A 1083	1 457 433 555	S 3555

A 1084	1 457 433 617	S 3617
A1085	F 026 400 010	S 0010
A1087	1 457 433 537	S 3537
A 1088	1 457 433 571	S 3571
A 1089	1 457 433 070	S 3070

A 1090	1 457 433 160	S 3160
A1093	1 457 433 069	S 3069
A 1094	1 457 433 058	S 3058
A1095	1 457 433 712	S 3712
A 1096	1 457 433 263	S 3263

A 1096	1 457 433 577	S 3577
A 1097	F 026 400 010	S 0010
A 1100	1 457 433 307	S 3307
A 1102	1 457 433 956	S 3956
A 1103	1 457 433 549	S 3549

A 1107	1 457 433 972	S 3972
A 1108	F 026 400 158	S 0158
A 1109	1 457 433 153	S 3153
A 1110	1 457 433 792	S 3792
A 1111	1 457 433 090	S 3090

A 1112	1 457 433 150	S 3150
A1113	1 457 433 532	S 3532
A 1114	1 457 433 539	S 3539
A 1115	1 457 433 317	S 3317
A 1116	1 457 433 155	S 3155

A 1117	1 457 433 152	S 3152
A 1118	F 026 400 038	S 0038
A 1119	1 457 433 046	S 3046
A 1120	1 457 433 324	S 3324
A 1121	1 457 433 075	S 3075

A 1122	1 457 433 163	S 3163
A 1123	1 457 433 078	S 3078
A 1124	1 457 433 523	S 3523
A 1125	1 457 433 065	S 3065
A 1126	1 457 433 047	S 3047

A1129	1 457 433 089	S 3089
A 1130	1 457 433 055	S 3055
A 1131	1 457 433 059	S 3059
A 1132	1 457 433 043	S 3043
A 1135	1 457 433 319	S 3319

A 1136	F 026 400 017	S 0017
A 1137	1 987 429 183	S 9183
A 1138	1 457 433 522	S 3522
A 1139	1 987 429 177	S 9177
A 1141	1 457 433 158	S 3158

A 1143	1 457 433 159	S 3159
A 1144	1 457 433 300	S 3300
A 1145	1 457 433 083	S 3083
A 1145	1 457 433 306	S 3306
A 1145	1 457 433 593	S 3593

A1149	1 457 433 579	S 3579
A1150	1 987 429 406	S 9406
A1151	F 026 400 025	S 0025
A 1152	1 987 429 403	S 9403
A 1153	1 457 433 574	S 3574

A1155	1 987 429 401	S 9401
A1156	1 457 433 083	S 3083
A 1157	1 987 429 188	S 9188
A 1159	1 987 429 182	S 9182
A 1160	1 987 429 404	S 9404

A1161	F 026 400 103	S 0103
A 1164	1 457 433 316	S 3316
A1165	1 457 433 045	S 3045
A1168	1 987 429 405	S 9405
A 1169	1 457 433 331	S 3331



◀ PURFLUX

A1170	F 026 400 141	S 0141
A1170	1 457 433 099	S 3099
A1171	1 457 433 096	S 3096
A1172	F 026 400 016	S 0016
A1173	F 026 400 123	S 0123

A1175	F 026 400 164	S 0164
A1176	1 457 433 584	S 3584
A1178	1 457 433 327	S 3327
A1179	1 457 433 596	S 3596
A1180	1 457 433 591	S 3591

A1183	F 026 400 051	S 0051
A1184	1 457 433 595	S 3595
A1185	1 457 433 660	S 3660
A1190	F 026 400 166	S 0166
A1191	F 026 400 013	S 0013

A1192	1 457 433 751	S 3751
A1195	1 987 429 406	S 9406
A1196	1 457 433 573	S 3573
A1197	1 987 429 191	S 9191
A1199	1 457 433 576	S 3576

A1201	F 026 400 018	S 0018
A1202	1 457 433 592	S 3592
A1207	1 457 433 071	S 3071
A1209	1 987 429 178	S 9178
A1213	1 457 433 585	S 3585

A1214	1 457 433 594	S 3594
A1216	1 457 433 315	S 3315
A1218	1 987 429 180	S 9180
A1219	1 457 433 093	S 3093
A1224	1 457 433 320	S 3320

A1227	F 026 400 002	S 0002
A1228	F 026 400 020	S 0020
A1230	F 026 400 015	S 0015
A1231	1 457 433 529	S 3529
A1232	1 457 433 531	S 3531

A1233	F 026 400 041	S 0041
A1235	F 026 400 044	S 0044
A1236	1 987 429 184	S 9184
A1237	F 026 400 129	S 0129
A1239	F 026 400 049	S 0049

A1241	F 026 400 201	S 0201
A1244	F 026 400 121	S 0121
A1245	F 026 400 125	S 0125
A1246	F 026 400 051	S 0051
A1248	1 457 433 333	S 3333

A1249	1 457 433 334	S 3334
A1251	F 026 400 143	S 0143
A1252	F 026 400 106	S 0106
A1257	F 026 400 058	S 0058
A1262	F 026 400 114	S 0114

A1263	1 987 429 192	S 9192
A1265	1 457 433 075	S 3075
A1266	F 026 400 055	S 0055
A1275	F 026 400 150	S 0150
A1278	1 457 433 311	S 3311

A1280	F 026 400 052	S 0052
A1284	1 457 433 282	S 3282
A1285	1 457 433 339	S 3339
A1287	1 457 433 583	S 3583
A1298	F 026 400 160	S 0160

A1300	F 026 400 159	S 0159
A1304	F 026 400 188	S 0188
A1305	F 026 400 176	S 0176
A1309	F 026 400 054	S 0054
A1314	F 026 400 138	S 0138

A1315	F 026 400 135	S 0135
A1318	1 987 429 163	S 9163
A1322	1 457 433 963	S 3963
A1325	F 026 400 140	S 0140
A1333	F 026 400 119	S 0119

A1343	F 026 400 137	S 0137
A1349	1 457 433 969	S 3969
A1351	1 987 429 162	S 9162
A1361	1 457 433 957	S 3957
A1363	1 987 429 164	S 9164

A197	1 457 432 106	S 2106
A200	1 457 429 899	S 9899
A201	1 457 429 787	S 9787
A203	1 457 429 819	S 9819
A204	1 457 429 898	S 9898

A205	1 457 429 854	S 9854
A208	1 457 433 601	S 3601
A2084	1 987 429 406	S 9406
A210	1 457 429 795	S 9795
A211	1 457 433 023	S 3023

A213	1 457 433 007	S 3007
A214	1 457 433 004	S 3004
A216	1 457 429 793	S 9793
A219	1 457 433 623	S 3623
A220	1 457 433 008	S 3008

A221	1 457 433 264	S 3264
A222	1 457 432 154	S 2154
A222	1 457 433 544	S 3544
A223	1 457 433 606	S 3606
A224	1 457 433 229	S 3229

A225	1 457 433 609	S 3609
A233	1 457 433 735	S 3735
A236	1 457 429 792	S 9792
A238	1 457 433 608	S 3608
A240	1 457 433 752	S 3752

A241	1 457 433 627	S 3627
A242	1 457 433 005	S 3005
A244	1 457 433 713	S 3713
A245	1 457 433 007	S 3007
A246	1 457 433 266	S 3266

A247	1 457 433 260	S 3260
A250	1 457 433 263	S 3263
A251	1 457 433 790	S 3790
A252	1 457 433 255	S 3255
A254	1 457 433 603	S 3603

A255	1 457 433 002	S 3002
A256	1 457 433 690	S 3690
A258	1 457 433 256	S 3256
A259	1 457 433 607	S 3607
A260	1 457 433 701	S 3701

A261	1 457 433 750	S 3750
A263	1 457 433 700	S 3700
A264	1 457 429 781	S 9781
A266	1 457 433 234	S 3234
A267	1 457 433 253	S 3253

A268	1 457 429 818	S 9818
A270	1 457 433 286	S 3286
A275	1 457 433 259	S 3259
A276	1 457 433 257	S 3257
A278	1 457 429 845	S 9845

A279	1 457 429 846	S 9846
A280	1 457 429 778	S 9778
A284	F 026 400 179	S 0179
A286	1 457 433 651	S 3651
A292	1 457 433 711	S 3711

A293	1 987 429 136	S 9136
A294	1 457 433 951	S 3951
A295	1 457 429 791	S 9791
A298	1 987 429 146	S 9146
A300	1 457 433 642	S 3642

A301	1 457 433 605	S 3605
A302	1 457 433 072	S 3072
A304	1 457 433 968	S 3968
A305	1 987 429 159	S 9159
A307	1 457 432 200	S 2200

A308	1 987 429 127	S 9127
A309	1 457 433 743	S 3743
A310	1 457 433 699	S 3699
A312	1 987 429 169	S 9169
A313	1 457 433 273	S 3273

A314	1 987 429 148	S 9148
A316	1 457 433 265	S 3265
A318	1 457 433 784	S 3784
A320	1 987 429 133	S 9133
A322	1 457 433 616	S 3616

A323	1 457 433 547	S 3547
A324	1 457 433 740	S 3740
A325	1 457 433 698	S 3698
A326	1 987 429 135	S 9135
A327	1 457 433 088	S 3088

A329	1 457 433 534	S 3534
A330	1 457 433 275	S 3275
A336	1 457 433 605	S 3605
A338	1 457 433 270	S 3270
A340	1 457 433 791	S 3791

A3401	1 457 433 791	S 3791
A341	1 457 433 741	S 3741
A342	1 457 433 703	S 3703
A342	1 457 433 748	S 3748
A344	1 457 433 742	S 3742



A 345	1 457 433 769	S 3769
A 346	1 457 433 712	S 3712
A 349	1 457 433 571	S 3571
A 350	1 457 433 571	S 3571
A 351	1 457 433 571	S 3571
A 352	1 987 429 125	S 9125
A 356	1 987 429 170	S 9170
A 360	1 457 433 571	S 3571
A 362	1 457 433 282	S 3282
A 363	F 026 400 011	S 0011
A 364	1 457 433 274	S 3274
A 367	1 457 433 272	S 3272
A 368	1 457 433 697	S 3697
A 369	F 026 400 011	S 0011
A 370	1 457 433 773	S 3773
A 371	1 457 433 265	S 3265
A 373	1 457 433 642	S 3642
A 374	1 457 433 642	S 3642
A 376	1 457 433 771	S 3771
A 377	1 457 433 056	S 3056
A 378	1 457 433 590	S 3590
A 379	1 457 433 714	S 3714
A 382	1 457 433 268	S 3268
A 383	1 457 433 303	S 3303
A 384	1 457 433 791	S 3791
A 388	1 457 433 736	S 3736
A 389	1 457 433 781	S 3781
A 391	1 457 433 535	S 3535
A 392	1 457 433 543	S 3543
A 393	1 457 433 715	S 3715
A 398	1 457 433 060	S 3060
A 402	1 457 432 134	S 2134
A 416	1 457 432 124	S 2124
A 421	1 457 429 908	S 9908
A 454	1 457 432 108	S 2108
A 455	1 457 432 111	S 2111
A 460	1 457 429 054	S 9054
A 460	1 457 433 540	S 3540
A 461	1 457 429 076	S 9076
A 463	1 457 429 064	S 9064
A 465	1 457 429 064	S 9064
A 485	1 457 429 801	S 9801
A 495	1 457 429 915	S 9915
A 495	1 457 433 325	S 3325
A 503	1 457 429 079	S 9079
A 507	1 457 429 030	S 9030
A 508	1 457 429 806	S 9806
A 515	1 457 429 061	S 9061
A 517	1 457 429 957	S 9957
A 518	1 457 429 908	S 9908
A 521	1 457 429 053	S 9053
A 535	1 457 429 933	S 9933
A 540	1 457 433 200	S 3200
A 545	1 457 433 201	S 3201
A 546	1 457 429 794	S 9794
A 575	1 457 432 134	S 2134
A 577	1 457 433 560	S 3560
A 586	1 457 429 953	S 9953
A 588	1 457 433 231	S 3231
A 590	1 457 432 154	S 2154
A 598	1 457 429 946	S 9946
A 599	1 457 429 950	S 9950
A 600	1 457 429 966	S 9966
A 602	1 457 429 975	S 9975
A 604	1 457 429 080	S 9080
A 624	1 457 429 923	S 9923
A 637	1 457 429 928	S 9928
A 640	1 457 429 992	S 9992
A 641	1 457 429 875	S 9875
A 647	1 457 429 993	S 9993
A 648	1 457 429 783	S 9783
A 649	1 457 429 920	S 9920
A 658	1 457 433 550	S 3550
A 698	1 457 429 050	S 9050
A 699	1 457 433 229	S 3229
A 751	1 457 432 204	S 2204
A 752	1 457 429 050	S 9050
A 753	1 457 432 200	S 2200
A 757	1 457 432 173	S 2173
A 760	1 457 432 150	S 2150
A 760	1 457 432 174	S 2174
A 761	1 457 429 970	S 9970
A 762	1 457 429 964	S 9964
A 763	1 457 429 085	S 9085
A 764	1 457 429 954	S 9954
A 768	1 457 429 983	S 9983
A 769	1 457 429 085	S 9085
A 770	1 457 433 003	S 3003
A 772	1 457 432 172	S 2172
A 774	1 457 429 949	S 9949
A 775	1 457 432 203	S 2203
A 781	1 457 429 994	S 9994
A 796	1 457 429 932	S 9932
A 801	1 457 429 941	S 9941
A 807	1 457 429 817	S 9817
A 813	1 457 429 969	S 9969
A 814	F 026 400 082	S 0082
A 818	1 457 432 138	S 2138
A 822	1 457 429 800	S 9800
A 823	1 987 429 117	S 9117
A 838	1 457 433 066	S 3066
A 838	1 987 429 051	S 9051
A 839	1 987 429 123	S 9123
A 840	1 987 429 122	S 9122
A 841	1 987 429 135	S 9135
A 844	1 457 429 841	S 9841
A 851	1 457 429 900	S 9900
A 853	1 457 429 839	S 9839
A 854	1 457 433 652	S 3652
A 855	1 457 429 987	S 9987
A 856	1 457 429 895	S 9895
A 856	1 457 429 896	S 9896
A 859	1 457 433 230	S 3230
A 863	1 987 429 042	S 9042/1
A 867	1 457 433 282	S 3282
A 879	1 457 429 944	S 9944
A 885	1 457 432 192	S 2192
A 886	1 457 432 188	S 2188
A 893	1 457 433 250	S 3250
A 925	1 457 432 146	S 2146
A 927	1 457 432 185	S 2185
A 928	1 457 432 180	S 2180
A 929	1 457 432 183	S 2183
A 935	1 457 433 233	S 3233
A 940	1 457 429 877	S 9877
A 941	1 457 429 870	S 9870
A 942	1 457 429 844	S 9844
A 943	1 457 429 894	S 9894
A 944	1 457 429 777	S 9777
A 945	1 457 429 842	S 9842
A 959	1 457 429 775	S 9775
A 972	1 457 433 624	S 3624
A 973	1 457 433 227	S 3227
CS157	1 457 434 201	N 4201
CS 157 A	1 457 434 201	N 4201
CS159	1 457 434 201	N 4201
CS162	1 457 429 675	N 9675
CS 162	1 457 434 154	N 4154
CS 162	1 457 434 165	N 4165
CS 162	1 457 434 432	N 4432
CS 164	1 457 429 676	N 9676
CS 170	1 457 434 153	N 4153
CS178	1 457 434 200	N 4200
CS 178 A	1 457 434 200	N 4200
CS 183	1 457 434 105	N 4105
CS 183	1 457 434 106	N 4106
CS 183	1 457 434 447	N 4447
CS 197 B	1 457 434 106	N 4106
CS 198	1 457 434 154	N 4154
CS 198	1 457 434 165	N 4165
CS198A	1 457 434 432	N 4432
CS 264	1 457 434 198	N 4198
CS 404 A	1 457 434 103	N 4103
CS 412 B	1 457 434 106	N 4106
CS412B	1 457 434 447	N 4447
CS 435 A	1 457 434 123	N 4123
CS 435 A	1 457 434 331	N 4331
CS 436	1 457 434 291	N 4291
CS 437	1 457 434 438	N 4438
CS 438	1 457 434 453	N 4453
CS 439	1 457 434 281	N 4281
CS 440	1 457 434 435	N 4435
CS441	1 457 434 453	N 4453
CS 445	1 457 429 681	N 9681
CS 448	1 457 434 187	N 4187



◀ PURFLUX

CS 449 A	1 457 434 321	N 4321
CS 451	1 457 434 402	N 4402
CS453	1 457 434 294	N 4294
CS 454	1 457 434 106	N 4106
CS 456	1 457 434 184	N 4184
CS 458	1 457 434 456	N 4456
CS 464	1 457 434 400	N 4400
CS 467	1 457 434 448	N 4448
CS 468	1 457 434 450	N 4450
CS 484	0 450 905 930	N 5930
CS 486	1 457 434 324	N 4324
CS 490	1 457 434 460	N 4460
CS 498	1 457 434 106	N 4106
CS 499	1 457 434 437	N 4437
CS 500	1 457 434 416	N 4416
CS 700	1 457 434 416	N 4416
CS 701	1 457 434 105	N 4105
CS 701	1 457 434 198	N 4198
CS 701	1 457 434 329	N 4329
CS 702	1 457 434 310	N 4310
CS 702	1 457 434 455	N 4455
CS713	1 457 434 439	N 4439
CS726	F 026 402 013	N 2013
CS736	F 026 402 056	N 2056
CS768	F 026 402 063	N 2063
C 106	1 457 431 270	N 1270
C 106	1 457 431 326	N 1326
C106A	1 457 431 159	N 1159
C106A	1 457 431 270	N 1270
C112	1 457 431 028	N 1028
C 116	1 457 431 158	N 1158
C 116	1 457 431 261	N 1261
C 116	1 457 431 325	N 1325
C161	1 457 429 230	N 9230
C180	1 457 429 289	N 9289
C 187	1 457 431 158	N 1158
C 188	1 457 429 354	N 9354
C188	1 457 431 159	N 1159
C 416	1 457 429 359	N 9359
C417	1 457 429 354	N 9354
C 422	1 457 429 291	N 9291
C 443	1 457 429 657	N 9657
C 446	1 457 431 703	N 1703
C 447	1 457 429 656	N 9656
C 457	1 457 429 621	N 9621
C 460	1 457 431 705	N 1705
C 480	1 457 429 291	N 9291
C 480	1 457 431 702	N 1702
C 481	1 457 431 712	N 1712
C 482	1 457 030 013	N 0013
C 483	1 457 431 708	N 1708
C 485	1 457 431 704	N 1704
C 489	1 457 431 723	N 1723
C 491	1 457 431 724	N 1724
C492	F 026 402 047	N 2047

C493	1 457 431 705	N 1705
C 493 E	1 457 431 705	N 1705
C494	1 457 431 705	N 1705
C 494E	1 457 431 705	N 1705
C 495	1 457 070 000	N 0000
C 496	1 457 431 720	N 1720
C505	1 457 431 715	N 1715
C509	F 026 402 005	N 2005
C512	F 026 402 004	N 2004
C515	F 026 402 006	N 2006
C516	F 026 402 005	N 2005
C518	F 026 402 008	N 2008
C523	F 026 402 078	N 2078
EP 100	0 450 905 324	F 5324
EP 103	0 450 904 058	F 4058
EP 111	0 450 905 904	F 5904
EP 111	0 450 905 974	F 5974
EP 139	0 450 902 151	F 2151
EP 139	0 450 905 002	F 5002
EP 139	0 450 905 273	F 5273
EP 139	0 450 905 280	F 5280
EP 144	0 450 905 287	F 5287
EP 145	0 450 902 161	F 2161
EP 150	0 450 905 901	F 5901
EP 151	0 450 905 203	F 5203
EP 152	0 450 905 177	F 5177
EP 153	0 450 905 145	F 5145
EP 153	0 450 905 200	F 5200
EP 153	0 450 905 601	F 5601
EP 154	0 450 905 143	F 5143
EP 155	0 450 905 316	F 5316
EP 161	0 450 905 324	F 5324
EP 161	0 450 905 966	F 5966
EP 178	0 450 904 161	N 4161
EP18	0 450 904 159	F 4159
EP 182	0 450 905 989	F 5989
EP 187	0 986 450 103	F 0103
EP188	0 986 450 123	F 0123
EP 189	0 450 905 275	F 5275
EP 189	0 450 915 003	F 5003
EP 191	0 450 905 030	F 5030
EP 191	0 450 905 264	F 5264
EP 192	0 450 905 318	F 5318
EP 193	0 450 905 216	F 5216
EP196	0 450 905 939	F 5939
EP 197	0 450 905 927	F 5927
EP20	0 450 904 058	F 4058
EP200	0 450 905 952	F 5952
EP203	F 026 403 008	F 3008
EP204	F 026 403 006	F 3006
EP205	F 026 403 003	F 3003
EP206	F 026 403 012	F 3012
EP207	0 450 905 959	F 5959
EP 57	0 450 904 058	F 4058
EP 58	0 450 904 058	F 4058

EP 90 C	0 450 905 021	F 5021
EP 90 C	0 450 905 030	F 5030
EP 90 C	0 450 905 095	F 5095
EP 91	0 450 905 021	F 5021
EP 91	0 450 905 087	F 5087
EP 91	0 450 905 104	F 5104
EP 91	0 450 905 401	F 5401
EP 92	0 450 905 903	F 5903
FCS 471	0 450 906 452	N 6452
FCS477	0 450 906 508	N 6508
FCS 704	0 450 906 460	N 6460
FCS709	0 450 906 467	N 6467
FCS 710	0 450 906 471	N 6471
FCS733	F 026 402 019	N 2019
FCS738	F 026 402 081	N 2081
FCS740	F 026 402 016	N 2016
FCS 748	0 450 906 468	N 6468
FCS749	F 026 402 072	N 2072
FCS750	F 026 402 061	N 2061
FCS753	F 026 402 059	N 2059
FCS754	F 026 402 068	N 2068
FC 500E	0 450 906 461	N 6461
FG 137	1 457 431 028	N 1028
FT5211	F 026 407 105	P 7105
GF12	0 450 904 058	F 4058
GF20	0 450 904 058	F 4058
LS144	0 451 103 274	P 3274
LS144A	0 451 103 274	P 3274
LS 144 B	0 451 103 274	P 3274
LS149	0 451 103 004	P 3004
LS 149	0 451 103 029	P 3029
LS 149	0 451 103 274	P 3274
LS 149	0 986 452 003	P 2003
LS154A	0 451 203 194	P 3194
LS161	0 451 103 274	P 3274
LS161	0 986 452 044	P 2044
LS164	0 986 452 044	P 2044
LS 168	0 451 104 005	P 4005
LS 169 B	0 451 103 141	P 3141
LS169B	0 451 103 235	P 3235
LS 186	0 451 103 028	P 3028
LS 186	0 451 104 065	P 4065
LS 214	0 451 103 290	P 3290
LS225	F 026 407 025	P 7025
LS 235	0 451 203 201	P 3201
LS 235	0 451 300 007	P 0007
LS 236	F 026 407 049	P 7049
LS 243	0 451 103 249	P 3249
LS 254	0 451 103 258	P 3258
LS 260	F 026 407 043	P 7043
LS 260	0 451 103 343	P 3343
LS 275	0 986 452 060	P 2060
LS 278	0 451 103 346	P 3346
LS 279	F 026 407 106	P 7106
LS 286	0 451 103 289	P 3289



LS 294	0 451 103 311	P 3311
LS 295	0 451 103 270	P 3270
LS 301	0 986 452 061	P 2061
LS 322	0 451 103 341	P 3341
LS 348	0 451 103 258	P 3258
LS350	F 026 407 077	P 7077
LS361	F 026 407 053	P 7053
LS384	F 026 407 017	P 7017
LS384	F 026 407 027	P 7027
LS386	F 026 407 024	P 7024
LS389	F 026 407 083	P 7083
LS 414	0 451 104 015	P 4015
LS 414	0 451 105 067	P 5067
LS 415	0 451 203 005	P 3005
LS 415	0 986 452 016	P 2016
LS 427	0 451 104 066	P 4066
LS 427 A	0 451 104 066	P 4066
LS 451	0 986 452 000	P 2000
LS 451 A	0 986 452 000	P 2000
LS 453	0 451 203 194	P 3194
LS453A	0 451 104 067	P 4067
LS 453 A	0 451 203 010	P 3010
LS 465	0 451 103 316	P 3316
LS 479	0 451 104 015	P 4015
LS 479	0 451 105 067	P 5067
LS479	0 451 105 188	P 5188
LS 479 A	0 451 104 015	P 4015
LS 479 A	0 451 105 067	P 5067
LS479A	0 451 105 188	P 5188
LS 479 B	0 451 105 188	P 5188
LS 479 C	0 451 105 188	P 5188
LS 482	0 451 203 108	P 3108
LS 483	0 451 103 109	P 3109
LS 489 A	0 451 103 316	P 3316
LS 489 A	0 986 452 061	P 2061
LS 491	0 986 452 000	P 2000
LS 492	0 986 452 000	P 2000
LS504	0 451 103 274	P 3274
LS506	0 451 103 274	P 3274
LS 530	0 451 103 232	P 3232
LS553B	0 451 203 223	P 3223
LS 553 C	0 451 103 253	P 3253
LS 553 C	0 451 103 347	P 3347
LS 553 C	0 451 203 223	P 3223
LS 581	0 451 104 066	P 4066
LS 582	0 451 104 065	P 4065
LS 582	0 451 203 005	P 3005
LS 582	0 451 203 152	P 3152
LS 582	1 457 432 108	S 2108
LS 583	0 451 203 002	P 3002
LS 590	0 451 103 235	P 3235
LS702	0 451 103 289	P 3289
LS 712	0 451 104 015	P 4015
LS 712	0 451 105 067	P 5067
LS712	0 451 301 156	P 1156
LS 712 C	0 451 104 015	P 4015
LS 712 C	0 451 105 067	P 5067
LS 712 C	0 451 301 156	P 1156
LS 713	0 986 452 023	P 2023
LS 716	0 986 452 024	P 2024
LS 717	0 451 103 357	P 3357
LS 717	0 986 452 005	P 2005
LS717	0 986 452 024	P 2024
LS 718	0 986 452 015	P 2015
LS720	0 451 103 028	P 3028
LS 731	0 986 452 028	P 2028
LS 738	0 451 203 201	P 3201
LS 740 A	0 986 452 042	P 2042
LS 743	0 986 452 028	P 2028
LS 753	0 451 103 346	P 3346
LS 760	0 451 103 240	P 3240
LS 760 A	0 451 103 240	P 3240
LS 760 D	0 451 103 240	P 3240
LS 767	0 451 104 066	P 4066
LS 774	0 451 104 066	P 4066
LS 778	0 451 403 077	P 3077
LS 783	0 451 403 001	P 3001
LS785	0 451 103 252	P 3252
LS 785 A	0 451 103 252	P 3252
LS801	0 986 452 044	P 2044
LS 805	0 451 104 064	P 4064
LS 812	0 451 103 004	P 3004
LS 820	0 986 452 020	P 2020
LS 830	0 986 452 023	P 2023
LS 833	0 451 103 232	P 3232
LS834	0 451 103 276	P 3276
LS 834	0 986 452 019	P 2019
LS 834	0 986 452 028	P 2028
LS 841	0 451 104 010	P 4010
LS 841	0 451 403 077	P 3077
LS 842	0 451 300 003	P 0003
LS 844	0 451 403 208	P 3208
LS 891	0 451 103 232	P 3232
LS 891	0 451 103 297	P 3297
LS892	0 986 452 061	P 2061
LS 893	0 986 452 030	P 2030
LS 894	0 986 452 064	P 2064
LS 895	0 986 452 062	P 2062
LS 896	0 986 452 058	P 2058
LS 897	0 986 452 046	P 2046
LS 900	0 451 103 029	P 3029
LS 901	0 986 452 035	P 2035
LS908	0 986 452 019	P 2019
LS911	0 986 452 063	P 2063
LS 922	0 451 103 337	P 3337
L 114	1 457 429 413	P 9413
L 121	1 457 429 820	P 9820
L 166	1 457 429 117	P 9117
L 221	1 457 429 646	P 9646
L 244	1 457 429 123	P 9123
L 270	1 457 429 198	P 9198
L 272	1 457 429 275	P 9275
L 276	1 457 429 732	P 9732
L 289	1 457 429 154	P 9154
L 291	1 457 429 619	P 9619
L 306	1 457 429 157	P 9157
L 307	1 457 429 119	P 9119
L 317	1 457 429 152	P 9152
L320	1 457 429 272	P 9272
L 321	1 457 429 118	P 9118
L 332	1 457 429 199	P 9199
L 333	1 457 429 284	P 9284
L 339	1 457 429 194	P 9194
L 343	1 457 429 238	P 9238
L343A	1 457 429 238	P 9238
L 347	1 457 429 185	P 9185
L352	F 026 407 069	P 7069
L 360	F 026 407 014	P 7014
L 364	1 457 429 271	P 9271
L365	1 457 429 308	P 9308
L369	1 457 429 252	P 9252
L371	1 457 429 307	P 9307
L373	1 457 429 248	P 9248
L382	F 026 407 002	P 7002
L385	F 026 407 090	P 7090
L393	F 026 407 070	P 7070
L396	F 026 407 061	P 7061
L397	F 026 407 068	P 7068
L403	F 026 407 066	P 7066
L407	F 026 407 072	P 7072
L419	F 026 407 091	P 7091
L 421	1 457 429 175	P 9175
L 424	1 457 433 255	S 3255
L 434	1 457 429 175	P 9175
L439	F 026 407 073	P 7073
L449	F 026 407 075	P 7075
L 558	1 457 429 636	P 9636
L 561	1 457 429 646	P 9646
L 562	1 457 429 647	P 9647
L563	1 457 429 629	P 9629
L 564	1 457 429 735	P 9735
L 565	1 457 429 740	P 9740
L 566	1 457 429 274	P 9274
L 769	1 457 429 629	P 9629
L 779	1 457 429 646	P 9646
L826	F 026 407 054	P 7054
L 856	1 457 429 251	P 9251
PA7178	1 457 433 326	S 3326
PA7255	1 457 433 297	S 3297
PA7335	1 457 433 317	S 3317
PRF	1 457 433 272	S 3272
PRFA1038	1 457 433 289	S 3289
PRFA1075	1 457 433 753	S 3753
PRFA1092	1 457 433 086	S 3086
PRFA1106	1 457 433 330	S 3330



◀ PURFLUX

PRFA1189	1 457 433 323	S 3323
PRFA1198	1 457 433 320	S 3320
PRFA202	1 457 433 285	S 3285
PRFA254	1 457 433 309	S 3309
PRFA306	1 987 429 109	S 9109
PRFA941	1 457 433 310	S 3310
PRFCS439	1 457 434 439	N 4439
PRFC422	1 457 431 713	N 1713
PRFC514	F 026 402 007	N 2007
PRFFA5024	1 457 429 636	P 9636
PRFFA5282	1 457 429 275	P 9275
PRFFA5591ECO	1 457 429 239	P 9239
PRFFA5619ECO	1 457 429 198	P 9198
PRFFA5710ECO	1 457 431 723	N 1723
PRFFA5773ECO	F 026 407 014	P 7014
PRFFA5787	F 026 402 007	N 2007
PRFFL6325	1 457 432 106	S 2106
PRFFL6338	1 457 429 053	S 9053
PRFFL6390	1 457 429 054	S 9054
PRFFL6397	1 457 429 050	S 9050
PRFFL6519	1 457 432 124	S 2124
PRFFL6640	1 457 433 231	S 3231
PRFFL6641	1 457 429 908	S 9908
PRFFL6658	1 457 432 138	S 2138
PRFFL6676	1 457 429 920	S 9920
PRFFL6744	1 987 429 109	S 9109
PRFFL6771	1 457 429 845	S 9845
PRFFL6787	1 457 433 230	S 3230
PRFFL6795	1 457 429 775	S 9775
PRFFL6798	1 457 433 233	S 3233
PRFFL6803	1 457 433 227	S 3227
PRFFL6805	1 457 433 229	S 3229
PRFFL6875	1 457 433 712	S 3712
PRFFL6917	1 457 433 330	S 3330
PRFFL6951	1 457 433 307	S 3307
PRFFL9002	1 457 433 077	S 3077
PRFFL9015	1 457 433 311	S 3311
PRFFP5145	1 457 434 439	N 4439
PRFFP5646	0 450 906 461	N 6461
PRFFP5716HWS	1 457 434 460	N 4460
PRFFP5717HWS	1 457 434 455	N 4455
PRFFT4777	0 451 203 226	P 3226
PRFFT4804	0 451 301 156	P 1156
PRFFT4826	0 451 103 029	P 3029
PRFFT5220	0 451 301 207	P 1207
PRFFT5263	1 457 431 713	N 1713
PRFFT5433	0 451 103 330	P 3330
PRFFT5631	0 450 905 926	F 5926
PRFL237	1 457 429 239	P 9239
PRFPA7026	1 457 432 146	S 2146
PRFPA7029	1 457 429 079	S 9079
PRFPA7054	1 457 432 203	S 2203
PRFPA7056	1 457 432 173	S 2173
PRFPA7068	1 457 429 987	S 9987
PRFPA7070	1 457 429 783	S 9783

PRFPA7077	1 457 432 180	S 2180
PRFPA7091	1 457 433 310	S 3310
PRFPA7095	1 457 432 183	S 2183
PRFPA7112	1 457 433 250	S 3250
PRFPA7113	1 457 433 259	S 3259
PRFPA7114	1 457 433 285	S 3285
PRFPA7118	1 457 429 781	S 9781
PRFPA7130	1 457 429 896	S 9896
PRFPA7136A	1 457 433 253	S 3253
PRFPA7137	1 457 433 023	S 3023
PRFPA7157	1 457 433 309	S 3309
PRFPA7161	1 457 433 256	S 3256
PRFPA7162A	1 457 433 257	S 3257
PRFPA7163	1 457 433 263	S 3263
PRFPA7165	1 457 433 260	S 3260
PRFPA7171	1 457 433 266	S 3266
PRFPA7199	1 457 433 272	S 3272
PRFPA7217	1 457 433 753	S 3753
PRFPA7221	1 457 433 268	S 3268
PRFPA7223	1 457 433 282	S 3282
PRFPA7248	1 457 433 281	S 3281
PRFPA7254	1 457 433 276	S 3276
PRFPA7256	1 457 433 526	S 3526
PRFPA7257	1 457 433 280	S 3280
PRFPA7278	1 457 433 289	S 3289
PRFPA7284	1 457 433 314	S 3314
PRFPA7294	1 457 433 087	S 3087
PRFPA7298	1 457 433 520	S 3520
PRFPA7321	1 457 433 070	S 3070
PRFPA7329	1 457 433 058	S 3058
PRFPA7334	1 457 433 085	S 3085
PRFPA7341	1 457 433 300	S 3300
PRFPA7350	1 457 433 086	S 3086
PRFPA7385	1 457 433 324	S 3324
PRFPA7391	1 457 433 549	S 3549
PRFPA7404	1 457 433 319	S 3319
PRFPA7418	1 457 433 316	S 3316
PRFPA7442	1 457 433 323	S 3323
PRFPA7467	1 457 433 327	S 3327
PRFPA7524	F 026 400 015	S 0015
661 041864 0	F 026 402 081	N 2081
AFP103	1 457 429 800	S 9800
AFP16	1 457 429 806	S 9806
AFP53	1 457 429 806	S 9806
AF110A	1 457 429 801	S 9801
AF1149	1 457 429 076	S 9076
AF2019K	1 457 433 200	S 3200
AF2028K	1 457 429 933	S 9933
AF2030K	1 457 429 933	S 9933

PURFLUX

AF2035	1 457 429 933	S 9933
AF2213K	1 457 429 933	S 9933
AF2909	1 457 433 201	S 3201
AF3035	1 457 429 933	S 9933
AF3085	1 457 429 079	S 9079
AF3087	1 457 429 928	S 9928
AF3100	F 026 400 082	S 0082
AF3127	1 457 429 994	S 9994
AF3141	1 457 429 992	S 9992
AF3146	1 457 429 085	S 9085
AF3210	1 457 429 801	S 9801
AF3349	1 457 429 875	S 9875
AF3420	1 457 432 134	S 2134
AF3436	1 457 429 085	S 9085
AF3488	1 457 429 854	S 9854
AF3499	1 457 429 875	S 9875
AF3501	1 457 429 988	S 9988
AF3534	1 457 429 076	S 9076
AF3537	1 457 429 944	S 9944
AF3538	1 987 429 121	S 9121
AF3558	1 457 429 964	S 9964
AF3559	1 457 429 869	S 9869
AF3561	1 457 429 920	S 9920
AF3564	1 457 429 983	S 9983
AF3568	1 457 429 994	S 9994
AF3569	1 457 429 846	S 9846
AF4278	1 987 429 051	S 9051
AF4295	1 457 432 106	S 2106
AF4349	1 457 429 076	S 9076
AF4349	1 457 429 994	S 9994
AF4353	1 457 429 970	S 9970
AF4418	1 457 432 172	S 2172
AF4467	1 987 429 122	S 9122
AF4490	1 457 433 605	S 3605
AF4600	1 987 429 133	S 9133
AF4876	1 457 429 923	S 9923
AF4885	1 457 432 174	S 2174
AF4980	1 457 432 172	S 2172
AG195	1 457 429 994	S 9994
A10122	1 457 429 076	S 9076
A1059	1 457 433 553	S 3553
A1068	1 457 433 311	S 3311
A11042	1 457 433 536	S 3536
A1105	F 026 400 092	S 0092
A11149	1 457 429 076	S 9076
A11149	1 457 429 994	S 9994
A1133	F 026 400 165	S 0165
A1205	F 026 400 108	S 0108
A1238	F 026 400 097	S 0097
A1240	F 026 400 110	S 0110
A1264	F 026 400 098	S 0098
A1268	F 026 400 109	S 0109
A14349	1 457 429 994	S 9994
A14622	1 987 429 404	S 9404
A15363	1 457 433 972	S 3972



A15445	1 457 433 522	S 3522	A24298	1 457 433 734	S 3734	A27319	1 457 433 608	S 3608
A17085	1 457 429 079	S 9079	A24341	1 457 429 818	S 9818	A27338	1 457 433 713	S 3713
A17111	1 457 433 732	S 3732	A24360	1 987 429 135	S 9135	A27353	1 457 429 970	S 9970
A17285	1 457 429 079	S 9079	A24372	1 457 433 298	S 3298	A27370	1 457 433 263	S 3263
A17305	1 457 433 652	S 3652	A24375	1 987 429 127	S 9127	A27399	1 457 433 642	S 3642
A17313	1 457 433 736	S 3736	A24409	1 457 429 777	S 9777	A27405	1 457 429 792	S 9792
A17328	1 457 433 255	S 3255	A24468	1 987 429 135	S 9135	A27406	1 457 433 273	S 3273
A17339	1 457 433 606	S 3606	A24490	1 457 433 605	S 3605	A27418	1 987 429 042	S 9042/1
A17340	1 457 433 623	S 3623	A24601	1 987 429 137	S 9137	A27499	1 457 429 875	S 9875
A17362	1 457 433 690	S 3690	A24635	1 457 429 898	S 9898	A27500	1 457 429 783	S 9783
A17392	1 457 433 541	S 3541	A24645	1 457 433 952	S 3952	A27501	1 457 429 988	S 9988
A17534	1 457 429 076	S 9076	A24648	1 987 429 146	S 9146	A27569	1 457 429 846	S 9846
A17559	1 457 429 869	S 9869	A24675	1 457 433 274	S 3274	A27623	1 457 433 616	S 3616
A17690	1 457 433 743	S 3743	A24680	1 457 433 950	S 3950	A27659	1 457 429 786	S 9786
A17696	1 457 433 711	S 3711	A24690	1 987 429 151	S 9151	A27660	1 457 433 701	S 3701
A17711	1 457 429 030	S 9030	A24720	1 457 433 968	S 3968	A27670	1 457 433 741	S 3741
A17773	1 457 432 154	S 2154	A24722	1 457 433 958	S 3958	A27683	1 457 433 265	S 3265
A17812	1 457 429 908	S 9908	A24858	1 457 433 609	S 3609	A27691	1 457 429 777	S 9777
A17872	1 457 432 154	S 2154	A24859	1 457 433 088	S 3088	A27697	1 457 432 200	S 2200
A17891	1 457 433 229	S 3229	A24869	1 457 433 088	S 3088	A27698	1 457 433 699	S 3699
A17892	1 457 432 146	S 2146	A24873	1 457 433 970	S 3970	A27736	1 457 429 793	S 9793
A17908	1 457 433 590	S 3590	A24880	1 457 433 056	S 3056	A27739	1 457 433 060	S 3060
A17943	1 457 433 781	S 3781	A25049	1 457 433 959	S 3959	A27746	1 457 433 268	S 3268
A17944	1 457 433 715	S 3715	A25051	1 457 433 961	S 3961	A27749	1 987 429 152	S 9152
A17961	1 457 432 180	S 2180	A25076	1 457 433 290	S 3290	A27757	1 457 433 265	S 3265
A17966	1 457 429 778	S 9778	A25107	1 457 429 814	S 9814	A27759	1 457 433 265	S 3265
A17974	1 457 432 173	S 2173	A25148	1 457 433 274	S 3274	A27763	1 457 429 993	S 9993
A18012	1 457 433 686	S 3686	A25156	1 457 433 700	S 3700	A27765	1 457 433 067	S 3067
A18054	1 457 433 752	S 3752	A25196	1 457 433 701	S 3701	A27766	1 457 433 714	S 3714
A18090	1 457 433 529	S 3529	A25210	1 457 433 263	S 3263	A27812	1 457 429 908	S 9908
A18091	F 026 400 014	S 0014	A25219	1 457 433 956	S 3956	A27813	1 457 433 642	S 3642
A18092	1 457 429 841	S 9841	A25220	1 457 433 953	S 3953	A27873	1 457 433 535	S 3535
A18096	1 457 433 537	S 3537	A25301	1 987 429 160	S 9160	A27875	1 457 429 814	S 9814
A18108	1 457 433 521	S 3521	A25304	1 457 433 072	S 3072	A27880	1 457 429 842	S 9842
A18109	F 026 400 113	S 0113	A25353	1 987 429 051	S 9051	A27882	1 457 429 844	S 9844
A18250	1 457 433 539	S 3539	A25358	1 457 433 590	S 3590	A27885	1 457 432 150	S 2150
A18252	1 457 433 531	S 3531	A25374	1 457 433 298	S 3298	A27885	1 457 432 174	S 2174
A18300	1 457 433 078	S 3078	A25395	1 457 433 605	S 3605	A27888	1 457 432 200	S 2200
A18306	1 457 433 090	S 3090	A25398	1 987 429 163	S 9163	A27889	1 457 432 154	S 2154
A18309	F 026 400 038	S 0038	A25458	1 457 433 523	S 3523	A27917	1 457 433 008	S 3008
A18315	1 457 433 075	S 3075	A25496	1 987 429 175	S 9175	A27917	1 457 433 264	S 3264
A18327	1 457 433 532	S 3532	A25503	1 987 429 192	S 9192	A27927	1 457 433 056	S 3056
A18346	1 987 429 404	S 9404	A25558	1 457 433 091	S 3091	A27941	1 457 433 543	S 3543
A18348	1 457 433 043	S 3043	A27001	1 457 433 004	S 3004	A27946	1 457 429 895	S 9895
A18918	1 457 433 058	S 3058	A27002	1 457 433 227	S 3227	A27946	1 457 429 896	S 9896
A21640	1 457 429 900	S 9900	A27003	1 457 433 008	S 3008	A27946	1 457 429 898	S 9898
A23087	1 457 429 928	S 9928	A27004	1 457 433 264	S 3264	A27946	1 457 433 087	S 3087
A23436	1 457 429 085	S 9085	A27028	1 457 432 150	S 2150	A27952	1 457 433 233	S 3233
A23456	1 457 429 957	S 9957	A27036	1 457 429 793	S 9793	A27954	1 457 429 841	S 9841
A23465	1 457 429 957	S 9957	A27049	1 457 433 601	S 3601	A27963	1 457 432 185	S 2185
A24278	1 457 429 894	S 9894	A27050	1 457 433 626	S 3626	A27969	1 457 432 183	S 2183
A24278	1 987 429 051	S 9051	A27063	1 457 429 791	S 9791	A27991	1 457 429 778	S 9778
A24282	1 987 429 117	S 9117	A27127	1 457 429 994	S 9994	A27994	1 457 433 250	S 3250
A24295	1 457 432 106	S 2106	A27273	1 457 433 652	S 3652	A28014	1 457 433 771	S 3771
A24297	1 987 429 123	S 9123	A27297	1 457 429 076	S 9076	A28019	1 457 433 265	S 3265



◀ PUROLATOR

A28254	1 457 433 070	S 3070
A28271	1 457 433 047	S 3047
A28273	1 457 433 792	S 3792
A28281	1 457 433 065	S 3065
A28291	1 457 433 533	S 3533
A28302	1 457 433 589	S 3589
A28303	1 457 433 739	S 3739
A28345	1 987 429 403	S 9403
A28349	1 457 433 319	S 3319
A28353	1 457 433 593	S 3593
A28914	F 026 400 010	S 0010
A28916	1 457 433 061	S 3061
A29095	1 457 433 573	S 3573
A29106	1 457 433 331	S 3331
A30017	1 457 429 801	S 9801
A30023	1 457 432 108	S 2108
A30110	1 457 429 800	S 9800
A30110	1 457 429 801	S 9801
A31153	1 457 429 061	S 9061
A33542	1 457 433 534	S 3534
A33582	1 457 433 971	S 3971
A33593	1 457 429 898	S 9898
A34269	1 457 429 953	S 9953
A34320	1 457 432 124	S 2124
A34361	1 457 432 111	S 2111
A34362	1 457 432 203	S 2203
A34473	1 987 429 125	S 9125
A34475	1 457 429 987	S 9987
A34487	1 987 429 136	S 9136
A34536	1 457 429 817	S 9817
A34536	1 457 429 942	S 9942
A34613	1 457 433 785	S 3785
A34623	1 457 429 890	S 9890
A34671	1 457 429 949	S 9949
A34715	1 457 433 965	S 3965
A34717	1 457 433 957	S 3957
A34721	1 987 429 162	S 9162
A347866	1 457 432 204	S 2204
A34799	1 457 433 951	S 3951
A34838	1 457 433 071	S 3071
A34839	1 457 433 954	S 3954
A34862	1 457 433 642	S 3642
A34868	1 987 429 193	S 9193
A34995	1 457 433 023	S 3023
A35050	1 457 433 965	S 3965
A35108	1 457 433 642	S 3642
A35150	1 457 433 955	S 3955
A35202	1 457 433 002	S 3002
A35207	1 457 433 073	S 3073
A35219	1 457 433 956	S 3956
A35244	1 457 433 969	S 3969
A35252	1 457 433 547	S 3547
A35267	1 457 433 081	S 3081
A35267	1 457 433 714	S 3714
A35323	1 457 433 095	S 3095

A35368	1 457 433 963	S 3963
A35369	1 457 433 962	S 3962
A35370	1 987 429 188	S 9188
A35371	1 457 433 052	S 3052
A35375	1 457 433 536	S 3536
A35396	1 987 429 194	S 9194
A35397	1 987 429 176	S 9176
A35406	1 457 433 751	S 3751
A35414	1 987 429 189	S 9189
A35432	1 987 429 187	S 9187
A35440	1 457 433 300	S 3300
A35442	1 457 433 085	S 3085
A35449	F 026 400 162	S 0162
A35452	1 457 433 788	S 3788
A35470	1 457 433 752	S 3752
A35517	1 987 429 180	S 9180
A35546	1 987 429 190	S 9190
A35629	1 987 429 400	S 9400
A35645	1 457 433 587	S 3587
A37005	1 457 429 795	S 9795
A37009	1 457 429 819	S 9819
A37010	1 457 433 007	S 3007
A37055	1 457 433 002	S 3002
A37082	1 457 429 870	S 9870
A37108	1 457 429 050	S 9050
A37113	1 987 429 115	S 9115
A37136	1 457 429 959	S 9959
A37153	1 457 429 061	S 9061
A37269	1 457 432 111	S 2111
A37272	1 457 429 845	S 9845
A37327	1 457 433 752	S 3752
A37349	1 457 429 050	S 9050
A37420	1 457 432 134	S 2134
A37478	1 457 432 204	S 2204
A37492	1 457 433 583	S 3583
A37564	1 457 429 983	S 9983
A37653	1 457 433 571	S 3571
A37654	1 457 433 571	S 3571
A37655	1 457 433 571	S 3571
A37656	1 457 433 627	S 3627
A37664	1 457 433 690	S 3690
A37669	1 457 433 740	S 3740
A37669	1 457 433 799	S 3799
A37682	1 457 433 742	S 3742
A37716	1 457 433 547	S 3547
A37859	1 457 433 747	S 3747
A37874	1 457 429 787	S 9787
A37881	1 457 433 003	S 3003
A37901	1 457 433 772	S 3772
A37930	1 457 433 791	S 3791
A37936	1 457 433 747	S 3747
A37980	1 457 432 172	S 2172
A37985	1 457 429 877	S 9877
A38020	1 457 433 077	S 3077
A38255	1 457 433 588	S 3588

A38299	1 457 433 797	S 3797
A38341	1 457 433 550	S 3550
A38350	1 457 433 578	S 3578
A38351	1 457 433 578	S 3578
A38915	1 457 433 555	S 3555
A39094	1 987 429 182	S 9182
A40016	1 457 429 806	S 9806
A40068	1 987 429 121	S 9121
A40068	1 987 429 127	S 9127
A40103	1 457 429 800	S 9800
A40103	1 457 429 801	S 9801
A41104	1 457 429 053	S 9053
A41133	1 457 429 054	S 9054
A41133	1 457 429 915	S 9915
A42019	1 457 433 200	S 3200
A42030	1 457 429 933	S 9933
A43463	1 457 432 134	S 2134
A43467	1 457 432 108	S 2108
A43558	1 457 429 964	S 9964
A43583	1 987 429 109	S 9109
A44326	1 987 429 121	S 9121
A44326	1 987 429 127	S 9127
A44328	1 457 429 923	S 9923
A44332	1 457 433 230	S 3230
A44467	1 987 429 122	S 9122
A44600	1 987 429 133	S 9133
A44626	1 457 429 801	S 9801
A44643	1 457 433 037	S 3037
A44647	1 457 429 839	S 9839
A44648	1 987 429 146	S 9146
A44681	1 457 429 970	S 9970
A44682	1 457 429 948	S 9948
A44727	F 026 400 004	S 0004
A45105	1 457 433 004	S 3004
A45211	1 457 429 787	S 9787
A45381	1 457 433 549	S 3549
A45443	1 457 433 049	S 3049
A45453	1 457 433 537	S 3537
A45457	1 457 433 046	S 3046
A47039	1 457 429 870	S 9870
A47039	1 457 433 698	S 3698
A47058	1 457 429 944	S 9944
A47103	1 457 429 064	S 9064
A47133	1 457 429 054	S 9054
A47282	1 457 429 845	S 9845
A47378	1 457 433 790	S 3790
A47457	1 457 433 735	S 3735
A47488	1 457 429 854	S 9854
A47561	1 457 429 920	S 9920
A47637	1 457 433 624	S 3624
A47687	1 457 429 923	S 9923
A47700	1 457 433 540	S 3540
A47701	1 457 433 703	S 3703
A47708	1 457 429 080	S 9080
A47718	1 457 433 791	S 3791



A47734	1 457 433 712	S 3712	C28187	1 987 432 066	M 2066	F43182	0 450 905 972	F 5972
A47752	1 457 433 753	S 3753	C35479	1 987 432 085	M 2085	F44662	0 986 450 103	F 0103
A47753	1 457 433 748	S 3748	C35516	1 987 432 085	M 2085	F44663	0 450 905 912	F 5912
A47866	1 457 432 204	S 2204	C35519	1 987 432 166	M 2166	F44703	0 986 450 103	F 0103
A47867	1 457 429 923	S 9923	C38161	1 987 432 107	M 2107	F44710	0 450 905 912	F 5912
A47879	1 457 429 954	S 9954	C38173	1 987 432 105	M 2105	F44781	0 986 450 113	F 0113
A47949	1 457 433 229	S 3229	C38186	1 987 432 075	M 2075	F44782	0 986 450 109	F 0109
A48105	1 457 433 791	S 3791	C38188	1 987 432 084	M 2084	F44788	0 986 450 123	F 0123
A48390	1 457 429 983	S 9983	C38236	1 987 432 088	M 2088	F44824	0 450 905 929	F 5929
A49121	F 026 400 166	S 0166	C45662	1 987 432 158	M 2158	F44829	0 986 450 604	F 0604
A51708	1 457 429 080	S 9080	EP145	0 450 902 161	F 2161	F44830	0 986 450 111	F 0111
A51712	1 457 429 966	S 9966	EP179	1 457 429 117	P 9117	F44861	0 450 905 963	F 5963
A53141	1 457 429 992	S 9992	EP204	F 026 403 006	F 3006	F44870	0 450 905 916	F 5916
A55380	1 457 433 546	S 3546	FA596	1 457 432 106	S 2106	F45057	0 450 905 914	F 5914
A55444	1 457 433 581	S 3581	FCA1153	1 457 429 061	S 9061	F45057	0 986 450 113	F 0113
A55539	1 457 433 703	S 3703	FCA16	1 457 429 806	S 9806	F45067	0 986 450 624	F 0624
A55539	1 457 433 748	S 3748	FCA1697	1 457 429 957	S 9957	F45068	0 986 450 221	F 0221
A57053	1 457 433 005	S 3005	FCA24	1 457 429 801	S 9801	F45069	0 450 905 924	F 5924
A57096	1 457 429 932	S 9932	FCO119	0 986 452 024	P 2024	F45071	0 986 450 103	F 0103
A57947	1 457 429 775	S 9775	FCO167	0 986 452 015	P 2015	F45071	0 986 450 107	F 0107
A57955	1 457 429 781	S 9781	FCO257	0 451 103 253	P 3253	F45071	0 986 450 113	F 0113
A58251	1 457 433 311	S 3311	FCO257	0 451 104 065	P 4065	F45191	0 986 450 221	F 0221
A61568	1 457 429 966	S 9966	FCO42	0 986 452 000	P 2000	F50086	1 457 434 105	N 4105
A61605	1 457 429 946	S 9946	FCS724	0 450 906 457	N 6457	F50086	1 457 434 106	N 4106
A63327	1 457 429 993	S 9993	FC101	0 451 103 274	P 3274	F50149	1 457 434 201	N 4201
A63393	1 457 429 794	S 9794	FC141	0 451 103 274	P 3274	F50153	0 450 904 077	N 4077
A63519	1 457 429 950	S 9950	FH21	0 451 103 274	P 3274	F50154	0 450 904 058	F 4058
A65224	1 457 429 786	S 9786	FPT750	F 026 407 054	P 7054	F50154	0 450 904 060	F 4060
A65295	1 457 433 332	S 3332	F20001M	0 450 904 058	F 4058	F50155	0 450 905 016	F 5016
A67065	1 457 432 188	S 2188	F20002	0 986 450 117	F 0117	F50155	0 450 905 021	F 5021
A67100	F 026 400 082	S 0082	F20005	0 450 904 058	F 4058	F50284	1 457 434 050	N 4050
A67373	1 457 429 949	S 9949	F20005	0 986 450 138	F 0138	F50284	1 457 434 051	N 4051
A67455	1 457 432 188	S 2188	F20005M	0 450 904 058	F 4058	F50284	1 457 434 296	N 4296
A67709	1 457 429 950	S 9950	F20005M	0 450 904 149	F 4149	F50284	1 457 434 432	N 4432
A67710	1 457 433 270	S 3270	F20005M	0 986 450 138	F 0138	F50305	1 457 434 456	N 4456
A67762	1 457 429 941	S 9941	F20117	0 450 904 058	F 4058	F50359	1 457 434 153	N 4153
A67842	1 457 433 903	S 3903	F20162	0 450 904 158	N 4158	F50453	1 457 429 359	N 9359
A73498	1 457 429 975	S 9975	F20265	0 986 450 039	F 0039	F50453	1 457 431 158	N 1158
A77051	1 457 429 899	S 9899	F21111	0 450 904 058	F 4058	F50453	1 457 431 261	N 1261
A77469	F 026 400 085	S 0085	F21111	0 450 904 149	F 4149	F50453	1 457 431 325	N 1325
A77742	F 026 400 077	S 0077	F21124	0 450 904 058	F 4058	F50454	1 457 431 270	N 1270
A77750	1 457 429 975	S 9975	F21124	0 450 904 149	F 4149	F50454	1 457 431 326	N 1326
A77760	1 457 429 969	S 9969	F23170	0 986 450 117	F 0117	F50456	1 457 429 230	N 9230
CS198	1 457 434 165	N 4165	F23175	0 450 905 005	F 5005	F53121	1 457 434 296	N 4296
CS439	1 457 434 439	N 4439	F24404	0 450 904 158	N 4158	F53125	1 457 434 154	N 4154
CS456	1 457 434 184	N 4184	F27332	0 450 904 058	F 4058	F53135	1 457 434 200	N 4200
C15439	1 987 432 074	M 2074	F27332	0 450 904 149	F 4149	F53191	0 450 905 087	F 5087
C18080	1 987 432 052	M 2052	F29157	0 986 450 018	F 0018	F53191	0 450 905 401	F 5401
C18128	1 987 432 058	M 2058	F29158	0 986 450 138	F 0138	F53191	0 450 905 906	F 5906
C18160	1 987 432 042	M 2042	F33142	0 986 450 117	F 0117	F54493	0 986 450 108	F 0108
C18323	1 987 432 091	M 2091	F33144	0 986 450 119	F 0119	F54498	0 986 450 137	F 0137
C18336	1 987 432 092	M 2092	F34713	0 450 905 911	F 5911	F54604	0 450 905 912	F 5912
C25246	1 987 432 052	M 2052	F40263	0 450 905 955	F 5955	F54638	0 986 450 100	F 0100
C27924	1 987 432 306	R 2306	F43178	0 450 905 326	F 5326	F54664	0 986 450 110	F 0110
C28181	1 987 432 108	M 2108	F43182	0 450 905 912	F 5912	F54664	0 986 450 115	F 0115



◀ PUROLATOR

F54665	0 450 902 162	F 2162
F54666	0 986 450 222	F 0222
F54667	0 986 450 105	F 0105
F54668	0 986 450 114	F 0114
F54689	0 986 450 104	F 0104

F54708	0 450 905 989	F 5989
F54708	0 986 450 108	F 0108
F54738	1 457 434 123	N 4123
F54738	1 457 434 153	N 4153
F54785	0 450 905 956	F 5956

F54794	0 450 905 326	F 5326
F54822	0 450 905 203	F 5203
F54828	0 986 450 104	F 0104
F54834	0 986 450 113	F 0113
F55085	0 450 905 195	F 5195

F55085	0 450 905 216	F 5216
F55365	0 450 905 986	F 5986
F55412	0 450 905 979	F 5979
F55580	F 026 402 003	N 2003
F57023	1 457 429 291	N 9291

F57023	1 457 431 713	N 1713
F57042	1 457 434 050	N 4050
F57048	1 457 429 675	N 9675
F57068	0 450 904 060	F 4060
F57145	1 457 429 354	N 9354

F57210	0 450 904 077	N 4077
F57213	1 457 429 359	N 9359
F57243	0 450 904 058	F 4058
F57243	0 450 904 149	F 4149
F57248	1 457 434 106	N 4106

F57248	1 457 434 447	N 4447
F57308	1 457 434 123	N 4123
F57308	1 457 434 331	N 4331
F57318	0 450 905 273	F 5273
F57322	1 457 434 153	N 4153

F57323	1 457 434 103	N 4103
F57453	1 457 429 359	N 9359
F57453	1 457 431 158	N 1158
F57454	1 457 431 159	N 1159
F57591	0 450 905 904	F 5904

F57608	0 450 904 058	F 4058
F57608	0 450 904 149	F 4149
F57629	1 457 434 201	N 4201
F57689	1 457 434 291	N 4291
F57721	1 457 434 106	N 4106

F57721	1 457 434 447	N 4447
F57769	1 457 431 713	N 1713
F57776	1 457 429 621	N 9621
F57777	1 457 431 702	N 1702
F57783	1 457 434 200	N 4200

F57800	1 457 429 289	N 9289
F57850	1 457 434 302	N 4302
F57851	1 457 434 453	N 4453
F58003	1 457 429 657	N 9657
F58062	0 450 905 915	F 5915

F58072	1 457 429 656	N 9656
F58094	1 457 431 705	N 1705
F58095	1 457 429 657	N 9657
F58137	1 457 431 028	N 1028
F58141	1 457 431 723	N 1723

F58151	F 026 402 047	N 2047
F58247	1 457 434 105	N 4105
F58280	0 450 905 930	N 5930
F58312	0 450 906 450	N 6450
F58356	1 457 434 439	N 4439

F58359	1 457 434 436	N 4436
F58361	F 026 402 084	N 2084
F59112	0 450 906 459	N 6459
F59113	0 450 905 952	F 5952
F59161	0 450 905 985	F 5985

F59453	1 457 429 359	N 9359
F60023	1 457 429 681	N 9681
F60023	1 457 434 154	N 4154
F60023	1 457 434 165	N 4165
F60134	1 457 431 159	N 1159

F60134	1 457 431 270	N 1270
F60134	1 457 431 325	N 1325
F60134	1 457 431 326	N 1326
F60146	0 450 905 030	F 5030
F60146	0 450 905 264	F 5264

F60146	0 450 905 275	F 5275
F60152	1 457 434 103	N 4103
F60152	1 457 434 105	N 4105
F60152	1 457 434 106	N 4106
F60217	1 457 434 105	N 4105

F60222	0 986 450 508	N 0508
F60222	1 457 434 453	N 4453
F60273	0 450 905 143	F 5143
F60454	1 457 429 354	N 9354
F60454	1 457 431 159	N 1159

F60454	1 457 431 270	N 1270
F60454	1 457 431 326	N 1326
F62870	0 450 906 508	N 6508
F63134	1 457 431 159	N 1159
F63177	0 450 905 091	F 5091

F63177	0 450 905 133	F 5133
F63177	0 450 905 601	F 5601
F63180	1 457 434 438	N 4438
F64492	0 986 450 102	F 0102
F64641	0 450 905 177	F 5177

F64795	0 450 905 982	F 5982
F64835	0 450 905 971	F 5971
F64857	0 450 905 145	F 5145
F64857	0 450 905 200	F 5200
F64857	0 450 905 601	F 5601

F64857	0 450 905 964	F 5964
F65217	0 450 905 273	F 5273
F65217	0 450 905 316	F 5316
F65277	0 450 905 939	F 5939
F65285	0 450 905 318	F 5318

F65364	1 457 434 329	N 4329
F65366	0 450 905 967	F 5967
F65377	0 450 905 908	F 5908
F65416	0 450 905 968	F 5968
F65416	0 450 915 003	F 5003

F65613	0 450 905 921	F 5921
F65615	0 450 905 939	F 5939
F67045	1 457 429 676	N 9676
F67144	0 450 905 021	F 5021
F67221	0 450 905 002	F 5002

F67221	0 450 905 280	F 5280
F67221	0 450 905 326	F 5326
F67260	0 450 905 177	F 5177
F67580	1 457 434 402	N 4402
F67617	0 450 905 903	F 5903

F67737	F 026 402 002	N 2002
F67756	0 450 905 318	F 5318
F67838	1 457 434 294	N 4294
F67902	0 986 450 509	N 0509
F68310	0 450 906 451	N 6451

F68311	0 450 906 453	N 6453
F68357	0 450 905 921	F 5921
F69092	1 457 431 715	N 1715
F69101	0 450 905 925	F 5925
F77128	1 457 434 187	N 4187

F77168	0 450 905 203	F 5203
F77804	0 450 905 901	F 5901
F79099	0 450 906 457	N 6457
F90006	F 026 402 049	N 2049
GF12	0 450 904 058	F 4058

GF1401	0 450 905 021	F 5021
GF144	0 450 905 021	F 5021
GF146	0 450 905 030	F 5030
GF20	0 450 904 058	F 4058
GF3144	0 986 450 119	F 0119

GF6	0 450 904 149	F 4149
GF68	0 450 904 058	F 4058
GF680F	0 450 904 058	F 4058
GF68S	0 450 904 058	F 4058
GF68S	0 450 904 149	F 4149

HOT40	0 451 104 064	P 4064
HOT49	0 451 104 064	P 4064
H17676	1 457 429 416	P 9416
H27122	1 457 429 820	P 9820
H57150	1 457 429 165	P 9165

LI3298	1 457 432 108	S 2108
LI3620	1 457 431 270	N 1270
LI3821	1 457 429 681	N 9681
LI3901	1 457 429 681	N 9681
LI3991	1 457 432 108	S 2108

LI4016	0 451 203 152	P 3152
LI4269	1 457 432 111	S 2111
LI4276	1 457 432 111	S 2111
LKS 41	F 026 400 082	S 0082
LS169B	0 450 905 133	F 5133



L10017	0 986 452 003	P 2003
L10018	0 451 103 004	P 3004
L10101	0 451 103 141	P 3141
L10109	0 986 452 061	P 2061
L10193	0 451 103 316	P 3316
L10193	0 986 452 016	P 2016
L10241	0 451 103 004	P 3004
L10241	0 451 103 141	P 3141
L10241	0 986 452 019	P 2019
L10241	0 986 452 028	P 2028
L10241	0 986 452 035	P 2035
L10241	0 986 452 044	P 2044
L10241	0 986 452 058	P 2058
L10241	0 986 452 062	P 2062
L10241	0 986 452 068	P 2068
L10291	0 986 452 015	P 2015
L10343	0 451 103 270	P 3270
L14459	F 026 407 077	P 7077
L14459	0 451 103 316	P 3316
L14459	0 986 452 016	P 2016
L14459	0 986 452 061	P 2061
L14460	0 451 103 275	P 3275
L14476	0 986 452 019	P 2019
L14476	0 986 452 028	P 2028
L14476	0 986 452 058	P 2058
L14477	0 451 103 276	P 3276
L14477	0 986 452 028	P 2028
L14477	0 986 452 044	P 2044
L14477	0 986 452 060	P 2060
L14610	0 986 452 061	P 2061
L14612	0 986 452 061	P 2061
L14622	0 451 103 316	P 3316
L14670	0 451 103 029	P 3029
L14670	0 451 103 062	P 3062
L14670	0 451 103 221	P 3221
L14670	0 986 452 003	P 2003
L17019	0 451 103 221	P 3221
L17320	0 451 103 311	P 3311
L17568	0 451 103 297	P 3297
L17603	0 451 103 141	P 3141
L17648	0 451 103 274	P 3274
L17825	0 451 103 235	P 3235
L17847	1 457 429 154	P 9154
L18237	1 457 429 118	P 9118
L18282	1 457 429 198	P 9198
L18296	1 457 429 199	P 9199
L18313	1 457 429 284	P 9284
L18340	1 457 429 194	P 9194
L20049	0 451 104 064	P 4064
L20051	1 457 429 175	P 9175
L20064	0 986 452 000	P 2000
L20064	0 986 452 023	P 2023
L20073	0 986 452 020	P 2020
L20073	0 986 452 061	P 2061
L20179	1 457 429 117	P 9117
L20252	0 986 452 023	P 2023
L20253	0 451 103 270	P 3270
L20253	0 986 452 020	P 2020
L20287	0 986 452 020	P 2020
L22167	0 986 452 024	P 2024
L22821	0 986 452 023	P 2023
L22821	0 986 452 028	P 2028
L24457	0 986 452 023	P 2023
L24457	0 986 452 035	P 2035
L24458	0 986 452 061	P 2061
L25230	0 451 103 258	P 3258
L25276	1 457 429 196	P 9196
L25277	1 457 429 196	P 9196
L27024	0 451 203 223	P 3223
L27122	1 457 429 820	P 9820
L27199	1 457 429 117	P 9117
L27218	0 451 103 062	P 3062
L27233	0 451 103 028	P 3028
L27264	0 451 103 232	P 3232
L27525	0 451 103 217	P 3217
L27545	0 451 103 258	P 3258
L27668	1 457 429 275	P 9275
L27826	0 451 203 108	P 3108
L27849	0 986 452 064	P 2064
L27904	1 457 429 157	P 9157
L28001	0 451 103 290	P 3290
L28139	1 457 429 272	P 9272
L28919	1 457 429 119	P 9119
L29093	1 457 429 238	P 9238
L30001	0 451 103 029	P 3029
L30001	0 451 104 065	P 4065
L30001	0 451 203 005	P 3005
L30001	0 451 203 194	P 3194
L30001	0 986 452 000	P 2000
L30001	0 986 452 005	P 2005
L30015	0 451 104 005	P 4005
L30022	0 451 103 062	P 3062
L30022	0 451 104 065	P 4065
L30034	1 457 429 175	P 9175
L30040	0 451 104 064	P 4064
L30042	0 986 452 000	P 2000
L30042	0 986 452 023	P 2023
L30054	0 451 104 066	P 4066
L30119	0 451 103 357	P 3357
L30119	0 451 203 005	P 3005
L30119	0 986 452 005	P 2005
L30137	0 451 203 194	P 3194
L30257	0 451 103 290	P 3290
L30257	0 451 103 346	P 3346
L30257	0 451 104 065	P 4065
L30257	0 451 203 223	P 3223
L30257	0 986 452 005	P 2005
L30341	0 451 104 065	P 4065
L34631	0 451 104 064	P 4064
L34750	0 986 452 042	P 2042
L34750	0 986 452 066	P 2066
L35132	0 451 104 064	P 4064
L35593	1 457 429 126	P 9126
L37026	1 457 429 413	P 9413
L37031	0 451 104 065	P 4065
L37031	0 451 203 005	P 3005
L37048	1 457 429 675	N 9675
L37169	0 451 103 257	P 3257
L37169	0 451 203 223	P 3223
L37196	0 451 203 223	P 3223
L37198	0 451 203 152	P 3152
L37202	0 451 104 066	P 4066
L37211	0 451 203 002	P 3002
L37225	0 451 203 005	P 3005
L37230	0 451 103 252	P 3252
L37247	0 451 203 010	P 3010
L37293	0 451 203 201	P 3201
L37359	0 451 103 249	P 3249
L37735	1 457 429 619	P 9619
L37755	0 451 103 346	P 3346
L37814	1 457 429 647	P 9647
L37821	0 451 103 109	P 3109
L38018	0 451 103 240	P 3240
L38240	1 457 429 126	P 9126
L38257	0 451 103 347	P 3347
L38257	0 451 203 005	P 3005
L38257	0 451 104 065	P 4065
L38258	0 451 203 005	P 3005
L38297	1 457 429 185	P 9185
L38365	F 026 407 053	P 7053
L39001	0 451 104 065	P 4065
L39001	0 451 203 005	P 3005
L40039	1 457 429 274	P 9274
L40048	0 451 203 002	P 3002
L40048	0 451 203 226	P 3226
L40050	1 457 429 175	P 9175
L40106	0 451 105 188	P 5188
L40107	0 451 203 010	P 3010
L40127	0 451 203 002	P 3002
L40127	0 451 203 226	P 3226
L40316	0 451 203 010	P 3010
L42168	0 451 105 067	P 5067
L45262	0 986 452 063	P 2063
L45308	1 457 429 619	P 9619
L47033	0 451 104 015	P 4015
L47033	0 451 105 067	P 5067
L47040	1 457 429 636	P 9636
L47045	1 457 429 676	N 9676
L47203	1 457 429 636	P 9636
L47226	1 457 429 267	P 9267
L47245	0 451 301 207	P 1207
L47304	1 457 429 130	P 9130
L47304	1 457 429 629	P 9629
L47430	1 457 429 735	P 9735
L47553	0 451 105 188	P 5188



◀ PUROLATOR

L47570	0 451 203 201	P 3201
L47811	1 457 429 251	P 9251
L47815	1 457 429 646	P 9646
L47905	1 457 429 152	P 9152
L48430	1 457 429 735	P 9735

L50068	0 451 104 010	P 4010
L50068	0 451 403 077	P 3077
L50250	0 451 300 003	P 0003
L57204	1 457 429 130	P 9130
L57204	1 457 429 600	P 9600

L57204	1 457 429 629	P 9629
L57232	0 451 301 156	P 1156
L57429	1 457 429 740	P 9740
L57447	1 457 429 600	P 9600
L57572	F 026 407 049	P 7049

L58244	0 451 403 001	P 3001
L58429	1 457 429 740	P 9740
L59068	0 451 103 343	P 3343
L60750	F 026 407 054	P 7054
L67224	1 457 429 277	P 9277

L67224	1 457 429 646	P 9646
L67224	1 457 429 732	P 9732
MFF 629 A	1 457 434 201	N 4201
MFF 783 A	1 457 434 200	N 4200
MF276A	1 457 429 117	P 9117

MF45800A	0 986 452 044	P 2044
MF67600A	0 451 203 002	P 3002
MF860K	1 457 429 794	S 9794
ML1681	0 986 452 019	P 2019
ML1681	0 986 452 061	P 2061

N51	1 457 429 175	P 9175
PC200	0 451 103 029	P 3029
PC202	0 451 104 066	P 4066
PC204	0 451 203 220	P 3220
PC211	0 451 203 002	P 3002

PC211	0 451 203 226	P 3226
PC224	0 451 104 015	P 4015
PC224	0 451 105 067	P 5067
PC225	0 451 203 005	P 3005
PC225	0 986 452 024	P 2024

PC23	0 986 452 003	P 2003
PC23	0 451 103 004	P 3004
PC232	0 451 301 156	P 1156
PC237	0 451 203 194	P 3194
PC238	0 986 452 000	P 2000

PC24	0 451 104 005	P 4005
PC244	0 451 403 001	P 3001
PC247	0 451 203 010	P 3010
PC257	0 451 104 065	P 4065
PC260	0 451 104 066	P 4066

PC27	0 451 103 274	P 3274
PC2710	0 451 103 274	P 3274
PC31	0 451 104 065	P 4065
PC33	0 451 104 015	P 4015
PC33	0 451 105 067	P 5067

PC 33 MIC 10	0 451 104 015	P 4015
PC 33 MIC 10	0 451 105 067	P 5067
PC 33 SM 10	0 451 104 015	P 4015
PC 33 SM 10	0 451 105 067	P 5067
PC37	0 451 103 028	P 3028

PC38	0 451 103 062	P 3062
PC42	1 457 434 050	N 4050
PC45	1 457 429 676	N 9676
PC48	1 457 429 675	N 9675
PC49	1 457 434 051	N 4051

PEA615	1 987 429 117	S 9117
PER11	0 451 104 064	P 4064
PER119	0 986 452 024	P 2024
PER137	0 451 203 194	P 3194
PER167	0 986 452 015	P 2015

PER17	0 986 452 044	P 2044
PER18	0 451 103 004	P 3004
PER193	0 986 452 016	P 2016
PER 2167	0 986 452 005	P 2005
PER2167	0 986 452 024	P 2024

PER 2176	0 986 452 024	P 2024
PER244	0 451 103 232	P 3232
PER 247 F	1 457 434 105	N 4105
PER 248 F	1 457 434 106	N 4106
PER248F	1 457 434 447	N 4447

PER263	0 986 452 019	P 2019
PER263	0 986 452 035	P 2035
PER264	0 451 103 232	P 3232
PER270	0 986 452 016	P 2016
PER 284 F	1 457 434 051	N 4051

PER291	0 986 452 015	P 2015
PER306	0 451 104 005	P 4005
PER 308 F	1 457 434 123	N 4123
PER 322 F	1 457 434 153	N 4153
PER 323 F	1 457 434 103	N 4103

PER 336 F	1 457 434 154	N 4154
PER 336 F	1 457 434 165	N 4165
PER40	0 451 104 064	P 4064
PER42	0 986 452 000	P 2000
PER 4457	0 986 452 023	P 2023

PER4670	0 451 103 062	P 3062
PER 4821	0 451 103 109	P 3109
PER 4825	0 451 103 235	P 3235
PER 4826	0 451 203 108	P 3108
PER51	0 451 104 005	P 4005

PER64	0 986 452 000	P 2000
PER67	0 451 403 001	P 3001
PER67	0 451 403 077	P 3077
PER68	0 451 403 077	P 3077
PFC1M	0 450 904 058	F 4058

PFC157	0 986 450 018	F 0018
PFC221	0 450 905 002	F 5002
PFC243	0 450 904 149	F 4149
PFC265	0 986 450 039	F 0039
PFC30	0 450 905 005	F 5005

PFC 3177	0 450 905 601	F 5601
PFC 4492	0 986 450 102	F 0102
PFC 4638	0 986 450 100	F 0100
PFC 4662	0 986 450 103	F 0103
PFC 4664	0 986 450 110	F 0110

PFC 4667	0 986 450 105	F 0105
PFC 4689	0 986 450 104	F 0104
PFC5	0 986 450 138	F 0138
PF3013D	1 457 429 359	N 9359
PF3145D	1 457 429 354	N 9354

PF3146	1 457 434 250	N 4250
PF3170	0 986 450 117	F 0117
PF453	1 457 431 158	N 1158
PF454	1 457 431 159	N 1159
PL14459	0 451 103 316	P 3316

PL14476	0 986 452 028	P 2028
PL34631	0 451 104 064	P 4064
PL39D	1 457 429 274	P 9274
PL40	1 457 429 636	P 9636
PL4814	1 457 429 647	P 9647

PL4815	1 457 429 646	P 9646
PM1073	1 457 429 942	S 9942
PM1095	1 457 433 732	S 3732
PM1096	1 457 429 932	S 9932
PM1103	1 457 429 064	S 9064

PM1104	1 457 429 053	S 9053
PM1133	1 457 429 054	S 9054
PM1133	1 457 429 915	S 9915
PM1136	1 457 429 959	S 9959
PM1149	1 457 429 076	S 9076

PM1153	1 457 429 061	S 9061
PM1556	1 457 429 800	S 9800
PM1568	1 457 429 966	S 9966
PM1597	1 457 429 928	S 9928
PM1605	1 457 429 946	S 9946

PM1620	1 457 432 192	S 2192
PM1640	1 457 429 900	S 9900
PM1697	1 457 429 957	S 9957
PM1708	1 457 429 080	S 9080
PM1709	1 457 429 950	S 9950

PM1711	1 457 429 030	S 9030
PM1750	1 457 429 975	S 9975
PM1760	1 457 429 969	S 9969
PM1762	1 457 429 941	S 9941
PM1763	1 457 429 993	S 9993

PM1812	1 457 429 908	S 9908
PM2026B	1 457 429 413	P 9413
PM204	1 457 429 130	P 9130
PM204	1 457 429 629	P 9629
PM204D	1 457 429 629	P 9629

PM2130	1 457 429 117	P 9117
PM2150	1 457 429 165	P 9165
PM2427	1 457 429 647	P 9647
PM2427D	1 457 429 647	P 9647
PM2429D	1 457 429 740	P 9740

ALFA ROMEO

10555 06 00300	0 986 452 003	P 2003
10555 06 00302	0 986 452 003	P 2003
10564 04 06001/02	1 457 434 201	N 4201

10564 06 0001	1 457 434 201	N 4201
10564 06 0002	1 457 434 201	N 4201
10564 06 06001	1 457 434 201	N 4201
10564 06 06002	1 457 434 201	N 4201
11354 32 06100	0 450 905 087	F 5087

11354 32 06100	0 450 905 401	F 5401
11609 06 03000	0 986 452 003	P 2003
11676 04 06000102	1 457 434 106	N 4106
11676 04 69601/00	1 457 434 106	N 4106
11676060	0 451 203 194	P 3194

11676 06 0300	0 451 203 194	P 3194
11911 32 04500	0 450 905 002	F 5002
11911 32 06104/00	0 450 905 030	F 5030
14060 04 06100	1 457 434 201	N 4201
16224 04 06100	0 450 905 002	F 5002

43230 62	0 450 904 058	F 4058
46403933	0 450 905 273	F 5273
46794403	1 457 433 086	S 3086
510313	0 986 452 003	P 2003
510889	0 986 452 003	P 2003

54677 70	0 450 905 005	F 5005
60507213	0 451 203 194	P 3194
60523432	0 450 905 030	F 5030
6053412	0 450 905 002	F 5002
60537455	0 450 905 005	F 5005

60538903	1 457 432 174	S 2174
60538903/1	1 457 432 174	S 2174
60538923	1 457 432 150	S 2150
60561931	1 457 433 253	S 3253
60570436	1 457 432 150	S 2150

60595381	1 457 433 253	S 3253
60809355	1 457 432 183	S 2183
60811342	1 457 433 791	S 3791
60811 34 21	1 457 433 791	S 3791
60811822	0 450 905 273	F 5273

60811900	1 457 433 265	S 3265
60811904	0 450 905 273	F 5273
60812738	0 450 905 273	F 5273
60813798	1 457 433 265	S 3265
60815000	1 457 433 265	S 3265

60816460	1 457 434 460	N 4460
701674	1 457 432 150	S 2150
701674	1 457 432 174	S 2174
705111	1 457 432 150	S 2150
705111	1 457 432 174	S 2174

71736100A	0 450 905 273	F 5273
71736130	1 457 432 150	S 2150
71736154	1 457 432 174	S 2174
72030 90 00000	1 457 432 150	S 2150
75853 48	0 450 902 151	F 2151

77362338	F 026 402 048	N 2048
7786225	1 457 433 791	S 3791
7786226	1 457 433 791	S 3791
7786626	1 457 433 791	S 3791
82416870	0 450 905 005	F 5005

99446 82	1 457 434 105	N 4105
99449 21	1 457 434 174	N 4174

AUSTIN

12H3274	0 986 452 044	P 2044
---------	---------------	---------------

BEDFORD

2754202	1 457 429 794	S 9794
637 1716	1 457 434 201	N 4201
737 1716	1 457 434 201	N 4201

796 5190	1 457 434 201	N 4201
796 5880	1 457 434 201	N 4201
798 4267	1 457 434 201	N 4201
798 4781	1 457 434 200	N 4200
798 8149	1 457 434 201	N 4201

901 66585	1 457 434 103	N 4103
-----------	---------------	---------------

CHEVROLET

13270887	F 026 400 020	S 0020
13271040	F 026 400 012	S 0012
13271041	F 026 400 013	S 0013

24437415	1 457 433 771	S 3771
24443113	F 026 400 013	S 0013
25 055 129	0 986 450 119	F 0119
25062032	1 457 429 845	S 9845
25062038	1 457 429 875	S 9875

25062055	1 457 433 310	S 3310
25062071	1 457 429 877	S 9877
25062072	1 457 433 310	S 3310
25062205	1 457 429 080	S 9080
25062206	1 457 429 988	S 9988

25062209	1 457 429 964	S 9964
25062211	1 457 432 154	S 2154
25062222	1 457 433 652	S 3652
25062227	1 457 433 087	S 3087
25062234	1 457 429 895	S 9895

25062235	1 457 429 895	S 9895
25062235	1 457 429 898	S 9898
25062244	1 457 429 908	S 9908
25062261	1 457 432 200	S 2200
25062266	1 457 429 844	S 9844

25062270	1 457 429 844	S 9844
25062272	1 457 429 053	S 9053
25062299	1 457 432 204	S 2204
25062406	1 457 429 877	S 9877
25062409	1 457 429 079	S 9079

25062418	1 457 433 087	S 3087
25062419	1 457 429 053	S 9053
25062500	1 457 432 150	S 2150
25067018	0 451 103 217	P 3217
25099149	1 457 433 056	S 3056

25750701	1 457 433 008	S 3008
30 025 009	1 457 433 956	S 3956
55355096	F 026 400 020	S 0020
55556465	F 026 400 013	S 0013
5570098	1 457 429 175	P 9175

5571792	1 457 429 175	P 9175
5572270	1 457 429 175	P 9175
5572288	1 457 429 175	P 9175
5573221	1 457 429 175	P 9175
5573898	F 026 407 054	P 7054

5576139	1 457 429 175	P 9175
5576148	F 026 407 054	P 7054
6435087	1 457 429 117	P 9117
6435109	1 457 434 201	N 4201
6435477	1 457 431 159	N 1159

6436629	1 457 434 201	N 4201
6437055	0 451 104 064	P 4064
6437553	F 026 407 054	P 7054
6438261	0 451 104 064	P 4064
6438384	0 451 104 064	P 4064

6439143	0 451 103 028	P 3028
6553450	F 026 400 163	S 0163
7961094	1 457 429 117	P 9117
7961161	1 457 434 201	N 4201
7965458	1 457 431 261	N 1261

7965460	1 457 431 158	N 1158
7984283	1 457 429 117	P 9117
7984288	1 457 434 201	N 4201
7984298	1 457 431 158	N 1158
7984299	1 457 431 261	N 1261

7984347	1 457 431 159	N 1159
7984348	1 457 431 270	N 1270
7984418	1 457 429 175	P 9175
7984655	0 451 203 005	P 3005
7984717	0 451 203 010	P 3010

7984781	1 457 434 200	N 4200
7984864	0 451 105 067	P 5067
7984864	0 451 105 188	P 5188
7984903	1 457 429 676	N 9676
7984943	1 457 429 740	P 9740

7987980	1 457 432 108	S 2108
7988016	1 457 432 106	S 2106
7988085	1 457 433 732	S 3732
7998336	1 457 429 050	S 9050
7998389	1 457 429 900	S 9900



7998710	1 457 429 053	S 9053
813231	1 457 429 050	S 9050
834292	1 457 429 895	S 9895
89703 90020	1 987 429 162	S 9162
90027967	1 457 429 079	S 9079

90118207	1 457 429 053	S 9053
90220955	1 457 429 877	S 9877
90220970	1 457 433 310	S 3310
9022896	F 026 407 054	P 7054
90284766	1 457 433 310	S 3310

90322261	1 457 433 087	S 3087
90322262	1 457 429 895	S 9895
90323083	1 457 429 844	S 9844
90325205	1 457 429 895	S 9895
90325205	1 457 429 898	S 9898

90421742	1 457 429 895	S 9895
90448737	1 457 433 571	S 3571
90448738	1 457 433 571	S 3571
90469336	1 457 433 713	S 3713
90469412	1 457 433 571	S 3571

9047626	F 026 407 054	P 7054
90486295	1 457 433 713	S 3713
90487526	1 457 429 898	S 9898
90499582	1 457 433 740	S 3740
90499589	1 457 433 799	S 3799

90499601	1 457 433 771	S 3771
90502200	1 457 433 741	S 3741
90510292	1 457 433 571	S 3571
90510293	1 457 433 571	S 3571
90510934	0 451 103 297	P 3297

90510935	0 451 103 297	P 3297
90512444	1 457 433 799	S 3799
90512446	1 457 433 740	S 3740
90512448	1 457 433 571	S 3571
90528818	1 457 433 571	S 3571

90540600	1 457 433 771	S 3771
90540602	1 457 433 771	S 3771
905406600	1 457 433 771	S 3771
90541322	1 457 433 054	S 3054
90543111	1 457 433 771	S 3771

90544191	1 457 429 157	P 9157
90570363	1 457 433 054	S 3054
9110614	1 457 433 531	S 3531
9110665	0 451 203 201	P 3201
91149684	1 457 433 571	S 3571

91159955	1 457 433 529	S 3529
9117321	1 457 429 157	P 9157
91181912	F 026 400 013	S 0013
9121071	F 026 400 166	S 0166
9161303	1 457 431 705	N 1705

9177267	1 457 433 579	S 3579
9201158	F 026 400 013	S 0013
9201435	1 457 429 198	P 9198
93152072	1 457 429 079	S 9079
93152793	1 457 429 079	S 9079

93152973	1 457 429 050	S 9050
93156291	0 451 103 252	P 3252
93156304	0 451 203 005	P 3005
93156390	0 451 203 005	P 3005
93156542	0 451 203 108	P 3108

93156575	0 451 103 217	P 3217
93156614	1 457 429 274	P 9274
93156634	1 457 434 453	N 4453
93156943	1 457 434 453	N 4453
93156952	0 451 203 005	P 3005

93160657	1 457 429 198	P 9198
93172272	1 457 429 118	P 9118
93172461	1 457 433 579	S 3579
93172463	1 457 433 578	S 3578
93180094	1 457 433 054	S 3054

93180258	1 457 429 271	P 9271
93181980	F 026 400 012	S 0012
93183040	1 457 433 056	S 3056
93183318	1 457 429 118	P 9118
93183412	1 457 429 248	P 9248

93184133	1 457 429 198	P 9198
93185381	1 457 431 705	N 1705
93187281	F 026 400 014	S 0014
93187335	1 457 433 531	S 3531
93 188 247	F 026 400 166	S 0166

93 188 725	F 026 400 097	S 0097
93190777	1 457 429 199	P 9199
93891826	1 457 429 994	S 9994
93892081	1 457 432 174	S 2174
93892086	1 457 432 134	S 2134

93892087	1 457 429 080	S 9080
94244456	1 457 434 453	N 4453
94248070	1 457 434 453	N 4453
94455838	1 457 429 894	S 9894
96055471	1 457 433 785	S 3785

96 314 494	1 987 429 166	S 9166
96 425 700	1 987 432 171	M 2171
96444649	0 450 905 969	F 5969
96 503 420	0 450 905 969	F 5969
96 536 696	F 026 400 043	S 0043

96 553 450	F 026 400 163	S 0163
96 565 412	0 986 452 058	P 2058
96 570 765	0 986 452 058	P 2058
96 816 473	1 457 070 001	N 0001
97049708	0 451 103 260	P 3260

97223218	1 457 429 199	P 9199
9949253	1 457 429 053	S 9053
9974113	1 457 429 054	S 9054
9974119	1 457 429 080	S 9080
9974133	1 457 429 941	S 9941

9974323	1 457 433 732	S 3732
9974336	1 457 429 076	S 9076
9974375	1 457 432 111	S 2111
9974620	1 457 433 652	S 3652
9974705	1 457 429 908	S 9908

9974791	1 457 429 085	S 9085
9975153	0 451 203 005	P 3005
9975157	1 457 434 201	N 4201
9975264	1 457 431 159	N 1159

CHRYSLER

J3232126	0 986 452 023	P 2023
MB504764	0 450 905 914	F 5914
MB504764	0 986 450 113	F 0113

MD084963	0 451 103 316	P 3316
MD084963	0 986 452 016	P 2016
MD353 795	0 451 103 029	P 3029
MD353 795	0 451 103 221	P 3221
MD353 795	0 986 452 003	P 2003

P4720 364	0 451 103 258	P 3258
T0544588	0 450 904 058	F 4058
T0544588	0 450 904 060	F 4060
T0680167	0 450 905 030	F 5030
T0680167	0 450 905 264	F 5264

T0680167	0 450 905 275	F 5275
T1348175	1 457 432 124	S 2124
T1349332	0 450 904 058	F 4058
T1349332	0 450 904 060	F 4060
01090 234	1 457 429 175	P 9175

01090 690	1 457 429 175	P 9175
01090 702	1 457 429 175	P 9175
01090 707	1 457 429 175	P 9175
01090 708	1 457 429 175	P 9175
01090 714	1 457 429 175	P 9175

01090 726	1 457 429 175	P 9175
01121 689	1 457 429 165	P 9165
01123 151	1 457 429 165	P 9165
01123 152	1 457 429 165	P 9165
01270 046	1 457 429 175	P 9175

01321 262	1 457 429 175	P 9175
01321 264	1 457 429 175	P 9175
01403 695	1 457 429 165	P 9165
01405 639	1 457 429 165	P 9165
01711 791	1 457 429 165	P 9165

01723 382	1 457 429 165	P 9165
01733 882	1 457 429 165	P 9165
01821 552	1 457 429 165	P 9165
02067 261	1 457 429 117	P 9117
02084 528	0 450 904 058	F 4058

02084 528	0 450 904 060	F 4060
02128 752	1 457 429 175	P 9175
02129 651	1 457 429 175	P 9175
02205 517	0 451 103 029	P 3029
02205 517	0 451 104 065	P 4065

02205 517	0 451 203 005	P 3005
02205 517	0 451 203 194	P 3194
02205 517	0 986 452 000	P 2000
02205 517	0 986 452 005	P 2005
03501 843	1 457 433 231	S 3231



◀ CHRYSLER

03549 232	0 451 103 029	P 3029
03549 232	0 451 104 065	P 4065
03549 232	0 451 203 005	P 3005
03549 232	0 451 203 194	P 3194
03549 232	0 986 452 000	P 2000
03549 232	0 986 452 005	P 2005
03838 011	0 451 103 316	P 3316
03838 011	0 986 452 016	P 2016
03838 011	0 986 452 020	P 2020
03838 011	0 986 452 061	P 2061
04026 486	0 451 103 316	P 3316
04026 486	0 986 452 016	P 2016
04041 252	1 987 429 121	S 9121
04041 252	1 987 429 127	S 9127
04105 409	0 986 452 044	P 2044
04105409AB	0 451 103 004	P 3004
04105409AB	0 451 103 141	P 3141
04105409AB	0 986 452 019	P 2019
04105409AB	0 986 452 028	P 2028
04105409AB	0 986 452 035	P 2035
04105409AB	0 986 452 044	P 2044
04105409AB	0 986 452 058	P 2058
04105409AB	0 986 452 062	P 2062
04105409AB	0 986 452 068	P 2068
04105409AC	0 451 103 004	P 3004
04105409AC	0 451 103 141	P 3141
04105409AC	0 986 452 019	P 2019
04105409AC	0 986 452 028	P 2028
04105409AC	0 986 452 035	P 2035
04105 409AC	0 986 452 044	P 2044
04105409AC	0 986 452 058	P 2058
04105409AC	0 986 452 062	P 2062
04105409AC	0 986 452 068	P 2068
04105409BB	0 451 103 004	P 3004
04105409BB	0 451 103 141	P 3141
04105409BB	0 986 452 019	P 2019
04105409BB	0 986 452 028	P 2028
04105409BB	0 986 452 035	P 2035
04105409BB	0 986 452 044	P 2044
04105409BB	0 986 452 058	P 2058
04105409BB	0 986 452 062	P 2062
04105409BB	0 986 452 068	P 2068
04179 647	1 987 429 121	S 9121
04179 647	1 987 429 127	S 9127
04186 165	0 451 103 316	P 3316
04186 165	0 986 452 016	P 2016
04186 167	1 457 429 800	S 9800
04186 167	1 457 429 801	S 9801
04213 583	1 457 429 957	S 9957
04241 042	1 457 429 957	S 9957
04243 445	0 451 103 316	P 3316
04243 445	0 986 452 016	P 2016
04243 693	0 451 103 316	P 3316
04243 693	0 986 452 016	P 2016
04243 805	0 451 103 316	P 3316

04243 805	0 986 452 016	P 2016
04273 810	0 451 103 004	P 3004
04273 810	0 451 103 141	P 3141
04273 810	0 986 452 019	P 2019
04273 810	0 986 452 028	P 2028
04273 810	0 986 452 035	P 2035
04273 810	0 986 452 044	P 2044
04273 810	0 986 452 058	P 2058
04273 810	0 986 452 062	P 2062
04273 810	0 986 452 068	P 2068
04342 800	1 457 429 957	S 9957
04417 559	0 986 452 003	P 2003
04494 477	0 451 103 316	P 3316
04494 477	0 986 452 016	P 2016
04720 364	0 451 103 258	P 3258
04723 905	1 457 434 448	N 4448
04778 838	0 451 103 258	P 3258
04798 166	1 457 434 450	N 4450
04861 041	1 457 429 957	S 9957
04861480AA	1 987 429 194	S 9194
05003 558AA	0 451 103 258	P 3258
05018777AA	1 987 429 189	S 9189
05018 777AB	1 987 429 189	S 9189
05038 883	1 457 429 117	P 9117
05039 546	1 457 429 117	P 9117
05041 315	0 451 103 029	P 3029
05057 957	0 451 103 029	P 3029
05057 957	0 986 452 044	P 2044
05069083 AA	F 026 407 069	P 7069
05069083 AD	F 026 407 069	P 7069
05069273AA	0 986 452 061	P 2061
05072720 AA	F 026 407 069	P 7069
05097052AA	0 450 905 968	F 5968
05097052AA	0 450 915 003	F 5003
05098424AA	1 457 433 049	S 3049
05098424AA	1 457 433 071	S 3071
05102905AA	1 457 429 196	P 9196
05102905AB	1 457 429 196	P 9196
05103554AA	1 457 433 703	S 3703
05103554AA	1 457 433 748	S 3748
05103554AB	1 457 433 703	S 3703
05103554AB	1 457 433 748	S 3748
05103555AA	1 457 433 703	S 3703
05103555AA	1 457 433 748	S 3748
05103577AA	F 026 402 003	N 2003
05117 492AA	F 026 402 056	N 2056
05135447AA	1 457 433 581	S 3581
05174 056AA	1 457 434 437	N 4437
05175 429AB	F 026 402 056	N 2056
05203 217	0 986 452 023	P 2023
05281 090	0 986 452 003	P 2003
05281090BA	0 451 103 029	P 3029
05281090BA	0 451 103 221	P 3221
05281090BA	0 986 452 003	P 2003
06598 492	1 457 429 933	S 9933

1090234	1 457 429 175	P 9175
1090690	1 457 429 175	P 9175
1090702	1 457 429 175	P 9175
1090707	1 457 429 175	P 9175
1090708	1 457 429 175	P 9175
1090714	1 457 429 175	P 9175
1090726	1 457 429 175	P 9175
1121689	1 457 429 165	P 9165
1123151	1 457 429 165	P 9165
1123152	1 457 429 165	P 9165
1270046	1 457 429 175	P 9175
1321262	1 457 429 175	P 9175
1321264	1 457 429 175	P 9175
1403695	1 457 429 165	P 9165
1405639	1 457 429 165	P 9165
1711791	1 457 429 165	P 9165
1723382	1 457 429 165	P 9165
1733882	1 457 429 165	P 9165
1821552	1 457 429 165	P 9165
2067261	1 457 429 117	P 9117
2084528	0 450 904 058	F 4058
2084528	0 450 904 060	F 4060
2128752	1 457 429 175	P 9175
2129651	1 457 429 175	P 9175
2205517	0 451 103 029	P 3029
2205517	0 451 104 065	P 4065
2205517	0 451 203 005	P 3005
2205517	0 451 203 194	P 3194
2205517	0 986 452 000	P 2000
2205517	0 986 452 005	P 2005
33000 076	0 450 905 985	F 5985
33001 795	1 457 429 818	S 9818
3501 843	1 457 433 231	S 3231
3549232	0 451 103 029	P 3029
3549232	0 451 104 065	P 4065
3549232	0 451 203 005	P 3005
3549232	0 451 203 194	P 3194
3549232	0 986 452 000	P 2000
3549232	0 986 452 005	P 2005
3838011	0 451 103 316	P 3316
3838011	0 986 452 016	P 2016
3838011	0 986 452 020	P 2020
3838011	0 986 452 061	P 2061
4026486	0 451 103 316	P 3316
4026486	0 986 452 016	P 2016
4041252	1 987 429 121	S 9121
4041252	1 987 429 127	S 9127
4105 409	0 986 452 044	P 2044
4105409AB	0 451 103 004	P 3004
4105409AB	0 451 103 141	P 3141
4105409AB	0 986 452 019	P 2019
4105409AB	0 986 452 028	P 2028
4105409AB	0 986 452 035	P 2035
4105409AB	0 986 452 044	P 2044
4105409AB	0 986 452 058	P 2058



4105409AB	0 986 452 062	P 2062
4105409AB	0 986 452 068	P 2068
4105409AC	0 451 103 004	P 3004
4105409AC	0 451 103 141	P 3141
4105409AC	0 986 452 019	P 2019
4105409AC	0 986 452 028	P 2028
4105409AC	0 986 452 035	P 2035
4105409AC	0 986 452 044	P 2044
4105409AC	0 986 452 058	P 2058
4105409AC	0 986 452 062	P 2062
4105409AC	0 986 452 068	P 2068
4105409BB	0 451 103 004	P 3004
4105409BB	0 451 103 141	P 3141
4105409BB	0 986 452 019	P 2019
4105409BB	0 986 452 028	P 2028
4105409BB	0 986 452 035	P 2035
4105409BB	0 986 452 044	P 2044
4105409BB	0 986 452 058	P 2058
4105409BB	0 986 452 062	P 2062
4105409BB	0 986 452 068	P 2068
4179647	1 987 429 121	S 9121
4179647	1 987 429 127	S 9127
4186165	0 451 103 316	P 3316
4186165	0 986 452 016	P 2016
4186167	1 457 429 800	S 9800
4186167	1 457 429 801	S 9801
4213 583	1 457 429 957	S 9957
4241042	1 457 429 957	S 9957
4243445	0 451 103 316	P 3316
4243445	0 986 452 016	P 2016
4243693	0 451 103 316	P 3316
4243693	0 986 452 016	P 2016
4243805	0 451 103 316	P 3316
4243805	0 986 452 016	P 2016
4273810	0 451 103 004	P 3004
4273810	0 451 103 141	P 3141
4273810	0 986 452 019	P 2019
4273810	0 986 452 028	P 2028
4273810	0 986 452 035	P 2035
4273810	0 986 452 044	P 2044
4273810	0 986 452 058	P 2058
4273810	0 986 452 062	P 2062
4273810	0 986 452 068	P 2068
4342 800	1 457 429 957	S 9957
4417559	0 986 452 003	P 2003
4494477	0 451 103 316	P 3316
4494477	0 986 452 016	P 2016
4720 364	0 451 103 258	P 3258
4723 905	1 457 434 448	N 4448
4778 838	0 451 103 258	P 3258
4798 166	1 457 434 450	N 4450
4861 041	1 457 429 957	S 9957
4861 480AA	1 987 429 194	S 9194
5003 558AA	0 451 103 258	P 3258
5018 777AA	1 987 429 189	S 9189

5018 777AB	1 987 429 189	S 9189
5038 883	1 457 429 117	P 9117
5039 546	1 457 429 117	P 9117
5041 315	0 451 103 029	P 3029
5057 957	0 451 103 029	P 3029
5057957	0 986 452 044	P 2044
5069 083AA	F 026 407 069	P 7069
5069 083AD	F 026 407 069	P 7069
5069 273AA	0 986 452 061	P 2061
5072 720AA	F 026 407 069	P 7069
5097 052AA	0 450 905 968	F 5968
5097 052AA	0 450 915 003	F 5003
5098 424AA	1 457 433 049	S 3049
5098 424AA	1 457 433 071	S 3071
5102 905AA	1 457 429 196	P 9196
5102 905AB	1 457 429 196	P 9196
5103 554AA	1 457 433 703	S 3703
5103 554AA	1 457 433 748	S 3748
5103 554AB	1 457 433 703	S 3703
5103 554AB	1 457 433 748	S 3748
5103 555AA	1 457 433 703	S 3703
5103 555AA	1 457 433 748	S 3748
5103 577AA	F 026 402 003	N 2003
5117 492AA	F 026 402 056	N 2056
5135 447AA	1 457 433 581	S 3581
5174 056AA	1 457 434 437	N 4437
5175 429AB	F 026 402 056	N 2056
5203217	0 986 452 023	P 2023
52129 237AA	1 457 434 310	N 4310
5281090	0 986 452 003	P 2003
5281090BA	0 451 103 029	P 3029
5281090BA	0 451 103 221	P 3221
5281090BA	0 986 452 003	P 2003
53002 184	1 457 429 076	S 9076
53004 383	1 457 433 298	S 3298
53006317	1 457 429 076	S 9076
53006317	1 457 429 994	S 9994
53007 386	F 026 400 004	S 0004
53030 688	F 026 400 004	S 0004
53040025	1 457 433 071	S 3071
6598492	1 457 429 933	S 9933
68012 876AA	1 987 432 213	M 2213
75061 411	0 451 103 029	P 3029
75065 702	0 451 203 010	P 3010
75221 405	0 451 103 029	P 3029
75221 481	0 451 103 029	P 3029
83501 843	1 457 433 231	S 3231
(89)05014664AA	1 457 429 076	S 9076
8953004383	1 457 433 298	S 3298
(89)53006317	1 457 429 076	S 9076
920257	1 457 429 175	P 9175

CITROEN

GX 0330 201 A	0 450 904 058	F 4058
GX 033 0202 A	0 450 904 058	F 4058
GX 033 0301 A	0 450 904 058	F 4058
GX 542 9192	0 450 904 058	F 4058
GX 542 9192 A	0 450 904 058	F 4058
KN41079	1 987 432 060	M 2060
MLS 000-144 A	0 451 103 274	P 3274
MLS 000 149	0 451 103 029	P 3029
MLS 000 169	0 451 103 141	P 3141
MLS 000 186	0 451 104 065	P 4065
MLS 000 451 A	0 986 452 000	P 2000
MLS 000 530	0 451 103 232	P 3232
ND 143 65	1 457 434 201	N 4201
ND 146 65	1 457 434 201	N 4201
PD 143 65	1 457 434 201	N 4201
PD 143 65 A	1 457 434 201	N 4201
SRV 000 503	0 450 904 058	F 4058
SVR 000 503	0 450 904 058	F 4058
10 033 346	1 457 432 154	S 2154
1051 98	1 457 429 175	P 9175
1109 AG	F 026 407 083	P 7083
1109 AT	F 026 407 083	P 7083
1109 AZ	0 986 452 028	P 2028
1109 A7	0 451 103 028	P 3028
1109 C0	0 451 103 029	P 3029
1109J3	0 451 203 201	P 3201
1109 Q0	0 451 203 201	P 3201
1109 Q1	0 451 203 201	P 3201
1109 T3	1 457 429 238	P 9238
1109 X8	1 457 429 307	P 9307
1109 Y2	1 457 429 238	P 9238
1109 Y4	0 986 452 028	P 2028
1109 Y6	F 026 407 053	P 7053
1109Y8	0 451 203 201	P 3201
1109 Z6	1 457 429 238	P 9238
1109 Z8	F 026 407 083	P 7083
1427 G4	1 457 433 555	S 3555
1427 G5	1 457 433 555	S 3555
1444 A0	1 457 433 790	S 3790
1444 A1	1 457 432 138	S 2138
1444 A4	1 457 432 200	S 2200
1444 A5	1 457 433 234	S 3234
1444 A7	1 457 433 227	S 3227
1444 A8	1 457 432 200	S 2200
1444 A9	1 457 432 200	S 2200
1444 CA	1 987 429 182	S 9182
1444 CC	1 987 429 182	S 9182
1444 CF	1 457 433 325	S 3325
1444 CJ	1 987 429 182	S 9182
1444 CK	1 987 429 182	S 9182
1444 CP	1 457 433 160	S 3160
1444 CV	1 457 433 591	S 3591
1444 CX	1 457 433 591	S 3591

◀ CITROEN

1444 CZ	1 457 433 158	S 3158
1444 EA	1 457 433 158	S 3158
1444 EC	1 457 433 325	S 3325
1444 EE	1 457 433 325	S 3325
1444 EH	1 457 433 596	S 3596

1444 EL	1 457 433 591	S 3591
1444 EQ	1 457 433 327	S 3327
1444 ER	1 457 433 327	S 3327
1444 ET	1 457 433 327	S 3327
1444 EV	1 457 433 596	S 3596

1444 EW	F 026 400 108	S 0108
1444 EZ	1 457 433 591	S 3591
1444 E5	1 457 433 769	S 3769
1444 E7	1 457 433 229	S 3229
1444 E8	1 457 433 297	S 3297

1444 E9	1 457 433 297	S 3297
1444 FC	1 457 433 592	S 3592
1444 FG	1 457 433 098	S 3098
1444 FH	1 457 433 090	S 3090
1444 F2	1 457 433 077	S 3077

1444 F2	1 457 433 229	S 3229
1444 F3	1 457 432 200	S 2200
1444 F4	1 457 432 200	S 2200
1444 F5	1 457 432 154	S 2154
1444 F5	1 457 433 544	S 3544

1444 F6	1 457 433 543	S 3543
1444 F7	1 457 433 543	S 3543
1444 F8	1 457 433 527	S 3527
1444 GH	1 457 433 158	S 3158
1444 G0	1 457 433 544	S 3544

1444 G1	1 457 433 544	S 3544
1444 G2	1 457 433 527	S 3527
1444 G9	1 457 433 526	S 3526
1444 H0	1 457 433 280	S 3280
1444 H1	1 457 433 077	S 3077

1444 H2	1 457 433 077	S 3077
1444 H3	F 026 400 010	S 0010
1444 H4	1 457 432 200	S 2200
1444 H5	1 457 432 200	S 2200
1444 H6	1 457 432 200	S 2200

1444 H7	1 457 432 200	S 2200
1444 H9	1 457 433 061	S 3061
1444 J0	1 457 433 061	S 3061
1444 J1	1 457 432 200	S 2200
1444 J2	1 457 432 200	S 2200

1444 J3	1 457 433 280	S 3280
1444 J4	F 026 400 010	S 0010
1444 J5	1 457 433 526	S 3526
1444 J7	1 457 433 229	S 3229
1444 J9	1 457 429 079	S 9079

1444 K1	1 457 433 233	S 3233
1444 K2	1 457 429 923	S 9923
1444 K3	1 457 432 134	S 2134
1444 K4	1 457 429 841	S 9841
1444 K5	1 457 432 204	S 2204

1444 K7	1 457 432 124	S 2124
1444 K8	1 457 429 994	S 9994
1444 L1	1 457 429 894	S 9894
1444 L3	1 457 429 053	S 9053
1444 L4	1 457 429 050	S 9050

1444 L5	1 457 429 920	S 9920
1444 L6	1 457 433 623	S 3623
1444 L7	1 457 429 842	S 9842
1444 L8	1 457 429 777	S 9777
1444 N0	1 457 429 791	S 9791

1444 N1	1 457 429 030	S 9030
1444 N3	1 457 432 111	S 2111
1444 N6	1 457 429 775	S 9775
1444 N7	1 457 433 624	S 3624
1444 N8	1 457 432 183	S 2183

1444 PW	1 457 433 971	S 3971
1444 P0	1 457 432 106	S 2106
1444 P1	1 457 433 606	S 3606
1444 P2	1 457 433 230	S 3230
1444 P3	1 457 429 076	S 9076

1444 P4	1 457 433 285	S 3285
1444 P6	1 457 433 008	S 3008
1444 P7	1 457 433 713	S 3713
1444 P8	1 457 433 255	S 3255
1444 P9	1 457 433 603	S 3603

1444 QE	F 026 400 010	S 0010
1444 QF	F 026 400 010	S 0010
1444 QP	F 026 400 150	S 0150
1444 QV	F 026 400 059	S 0059
1444 QW	F 026 400 058	S 0058

1444 QW	1 457 433 535	S 3535
1444 QX	F 026 400 058	S 0058
1444 QX	1 457 433 535	S 3535
1444 Q0	1 457 432 185	S 2185
1444 Q2	1 457 429 061	S 9061

1444 Q3	1 457 429 898	S 9898
1444 Q4	1 457 433 264	S 3264
1444 Q5	1 457 433 743	S 3743
1444 Q6	1 457 433 265	S 3265
1444 Q7	1 457 429 870	S 9870

1444 Q8	1 457 433 282	S 3282
1444 Q9	F 026 400 011	S 0011
1444 RG	1 457 433 971	S 3971
1444 RH	1 457 433 971	S 3971
1444 RP	F 026 400 150	S 0150

1444 R0	1 457 433 608	S 3608
1444 R1	F 026 400 010	S 0010
1444 R2	1 457 432 200	S 2200
1444 R3	F 026 400 010	S 0010
1444 R5	1 457 433 555	S 3555

1444 R6	1 457 433 555	S 3555
1444 R7	1 457 432 200	S 2200
1444 TE	F 026 400 150	S 0150
1444 T0	1 457 432 200	S 2200
1444 T1	1 457 432 200	S 2200

1444 T3	1 457 432 200	S 2200
1444 T4	1 457 432 200	S 2200
1444 T5	1 457 432 200	S 2200
1444 T6	1 457 432 200	S 2200
1444 T7	1 457 432 200	S 2200

1444 T8	1 457 432 200	S 2200
1444 T9	1 457 432 200	S 2200
1444 VH	1 457 433 325	S 3325
1444 VQ	1 987 429 182	S 9182
1444 VW	1 457 433 090	S 3090

1444 V0	F 026 400 025	S 0025
1444 V3	F 026 400 023	S 0023
1444 WN	F 026 400 058	S 0058
1444 W8	1 457 432 200	S 2200
1444 X0	1 457 433 158	S 3158

1444 X1	1 457 429 915	S 9915
1444 X1	1 457 433 325	S 3325
1444 X4	1 457 433 159	S 3159
1444 X5	1 457 433 160	S 3160
1444 02	1 457 429 908	S 9908

1444 08	1 457 432 200	S 2200
1444 09	1 457 432 138	S 2138
1444 84	1 457 433 544	S 3544
1444 88	1 457 432 200	S 2200
1444 99	1 457 433 790	S 3790

1445 08	1 457 432 200	S 2200
1445 26	1 457 433 229	S 3229
1445 74	1 457 432 154	S 2154
1445 90	1 457 432 154	S 2154
1445 96	1 457 433 229	S 3229

1567 A5	0 450 902 161	F 2161
1567 C6	0 450 905 287	F 5287
1567 10	0 450 905 401	F 5401
1567 13	0 450 905 030	F 5030
1567 17	0 450 905 087	F 5087

1567 17	0 450 905 401	F 5401
1567 17	0 450 905 906	F 5906
1567 28	0 450 905 002	F 5002
1567 74	0 450 905 016	F 5016
1567 74	0 450 905 021	F 5021

1567 79	0 450 905 002	F 5002
1567 81	0 450 902 161	F 2161
1567 85	0 450 902 161	F 2161
1567 87	0 450 902 161	F 2161
1567 89	0 450 905 273	F 5273

1567 93	0 450 902 161	F 2161
1567 94	0 450 902 161	F 2161
1901 66	0 450 906 460	N 6460
1901 67	0 450 906 471	N 6471
1901 68	0 450 906 460	N 6460

1901 70	0 450 906 460	N 6460
1901 73	0 450 906 460	N 6460
1901 75	0 450 906 460	N 6460
1901 76	F 026 402 004	N 2004
1901 78	0 450 906 471	N 6471

◀ COOPERS

AG1331	1 457 433 073	S 3073
AG565	1 457 429 928	S 9928
AG584	1 457 429 061	S 9061
AG642	1 457 429 992	S 9992
AG677	1 987 429 121	S 9121

AG808	1 987 429 122	S 9122
AG930	1 457 433 697	S 3697
AZL009	0 451 203 002	P 3002
FSM4166	F 026 402 030	N 2030
LSF5146	0 451 203 002	P 3002

Z1038	0 986 452 058	P 2058
Z1039	0 986 452 061	P 2061
Z1041	0 986 452 042	P 2042
Z1043	0 986 452 062	P 2062
Z1047	0 986 452 060	P 2060

Z1139	0 986 452 064	P 2064
Z1177	0 986 452 063	P 2063
Z155	0 986 452 015	P 2015
Z27A	0 986 452 003	P 2003
Z696	0 986 452 019	P 2019

Z831	0 451 104 065	P 4065
Z850	0 986 452 044	P 2044
Z860	0 986 452 003	P 2003
Z954	1 457 434 438	N 4438
Z963	0 986 452 028	P 2028

CROSLAND

366	0 986 452 019	P 2019
531	0 986 452 044	P 2044
591	0 986 452 044	P 2044

604	0 986 452 003	P 2003
615	0 986 452 003	P 2003
683	0 986 452 003	P 2003
694	0 986 452 000	P 2000

DAF

APUC43	F 026 400 069	S 0069
APUC944	F 026 400 070	S 0070
LBU5319	1 457 434 200	N 4200

0229348	1 457 429 820	P 9820
0241505	1 457 429 676	N 9676
0247138	1 457 429 676	N 9676
0267714	0 451 403 208	P 3208
0302043	1 457 429 165	P 9165

112243	1 457 434 105	N 4105
112294	1 457 429 966	S 9966
114786	0 451 104 015	P 4015
1296851	F 026 402 025	N 2025
1310891	F 026 407 058	P 7058

1310901	0 451 104 013	P 4013
13109011	0 451 104 013	P 4013
1318695	1 457 434 419	N 4419
1322255	1 987 432 152	M 2152
1322259	1 987 431 164	M 1164

1345335	F 026 402 037	N 2037
1347066	1 987 431 164	M 1164
1353115	F 026 400 084	S 0084
1362124	1 987 431 169	M 1169
1362168	1 987 431 452	R 1452

1363023	F 026 400 072	S 0072
1376481	F 026 407 058	P 7058
1391210	F 026 400 084	S 0084
1397764	F 026 407 046	P 7046
1397765	F 026 407 047	P 7047

1397766	F 026 402 033	N 2033
1399494	F 026 407 057	P 7057
1399760	F 026 402 030	N 2030
1433649	F 026 402 038	N 2038
1433690	F 026 400 069	S 0069

1433697	F 026 400 070	S 0070
1500069	1 457 429 933	S 9933
1500120	1 457 429 944	S 9944
1500137	1 457 429 969	S 9969
1500185	1 457 429 946	S 9946

1500187	1 457 429 975	S 9975
1500189	1 457 429 932	S 9932
1500199	1 457 429 941	S 9941
1500200	1 457 429 942	S 9942
1500299	1 457 429 950	S 9950

1500300	1 457 429 966	S 9966
1500302	1 457 433 005	S 3005
1500322	1 457 433 900	S 3900
1500404	1 457 433 750	S 3750
1500446	1 457 431 261	N 1261

1500446	1 457 431 325	N 1325
1500447	1 457 431 270	N 1270
1500447	1 457 431 326	N 1326
1500449	1 457 429 900	S 9900
1500450	1 457 434 201	N 4201

1500480	1 457 434 200	N 4200
1500483	1 457 431 158	N 1158
1500486	1 457 434 050	N 4050
1500486	1 457 434 154	N 4154
1500496	1 457 434 051	N 4051

1500500	1 457 431 028	N 1028
1500503	1 457 431 159	N 1159
1500508	0 450 904 058	F 4058
1500528	1 457 434 153	N 4153
1500537	1 457 434 105	N 4105

1500541	1 457 434 123	N 4123
1500662	1 457 429 165	P 9165
1500663	1 457 429 820	P 9820
1500830	1 457 429 117	P 9117
1500837	0 451 104 066	P 4066

1500842	0 451 104 005	P 4005
1500846	0 451 103 029	P 3029
1500851	0 451 203 010	P 3010
1500861	1 457 429 413	P 9413
1500867	0 986 452 000	P 2000

1500879	1 457 429 735	P 9735
1500880	0 451 403 077	P 3077
1500882	1 457 429 740	P 9740
1500887	0 986 452 016	P 2016
1500887	0 986 452 020	P 2020

1500888	0 986 452 019	P 2019
1500907	0 451 103 004	P 3004
1500908	0 451 103 062	P 3062
1500917	0 451 104 065	P 4065
1500928	0 986 452 003	P 2003

1500965	1 457 429 646	P 9646
1500977	1 457 429 647	P 9647
1501032	0 451 103 141	P 3141
1501056	0 451 203 002	P 3002
1501062	0 451 105 067	P 5067

1501062	0 451 105 188	P 5188
1501064	1 457 429 126	P 9126
1501067	1 457 429 130	P 9130
1501067	1 457 429 629	P 9629
1501068	0 451 403 001	P 3001

1616361	F 026 402 032	N 2032
1629393	F 026 407 045	P 7045
1638026	F 026 400 072	S 0072
1643070	F 026 407 045	P 7045
1643080	F 026 402 032	N 2032

1644641	F 026 400 070	S 0070
1644642	F 026 400 069	S 0069
1658991	1 987 432 152	M 2152
1659691	1 987 431 164	M 1164
1664524	F 026 400 084	S 0084

1664525	F 026 400 084	S 0084
1667999	F 026 400 069	S 0069
1668000	F 026 400 070	S 0070
1672463	F 026 400 069	S 0069
1672464	F 026 400 070	S 0070

1699168	F 026 402 032	N 2032
1726061	F 026 400 072	S 0072
1784782	F 026 402 033	N 2033
1789292	F 026 400 072	S 0072
1811391	F 026 402 031	N 2031

211340	1 457 429 413	P 9413
224785	1 457 432 106	S 2106
224788	0 451 103 274	P 3274
229348	1 457 429 820	P 9820
236481	1 457 429 413	P 9413

247138	1 457 429 676	N 9676
247139	1 457 429 675	N 9675
247139	1 457 434 419	N 4419
265045	1 457 429 950	S 9950
267714	0 451 403 208	P 3208

27060500	1 457 429 966	S 9966
289829	1 457 429 950	S 9950
302043	1 457 429 165	P 9165
393561	1 457 433 651	S 3651
494251	1 457 434 201	N 4201



548257	1 457 429 230	N 9230
548257	1 457 431 261	N 1261
548257	1 457 431 325	N 1325
607179	1 457 429 975	S 9975
611049	0 451 203 220	P 3220

661049	0 451 203 220	P 3220
661049	0 451 203 226	P 3226
667078	1 457 432 188	S 2188
690260	0 451 104 005	P 4005
690260	0 451 104 066	P 4066

694218	1 457 429 969	S 9969
695633	1 457 429 946	S 9946
893009	0 450 904 060	F 4060

DAIHATSU

1150100550	0 986 452 019	P 2019
11501 00550 000	0 986 452 019	P 2019
1150101610	0 986 452 028	P 2028

15600 25010 000	0 986 452 003	P 2003
15600 87104 000	0 986 452 003	P 2003
15600 87201 000	0 986 452 019	P 2019
15600 87307 000	0 986 452 003	P 2003
15601 13010	0 986 452 028	P 2028

15601 13010 000	0 986 452 028	P 2028
15601 13011	0 986 452 028	P 2028
15601 13011 000	0 986 452 028	P 2028
15601 33020 000	0 986 452 000	P 2000
1560187103	0 986 452 019	P 2019

15601 87103 000	0 986 452 019	P 2019
15601 87103 000	0 986 452 035	P 2035
15601 87104	0 986 452 028	P 2028
15601 87104 000	0 986 452 028	P 2028
15601 87105 000	0 986 452 000	P 2000

15601 87107 LOC	0 986 452 058	P 2058
15601 87107 000	0 986 452 058	P 2058
15601 87109	0 986 452 028	P 2028
15601 87110 000	0 451 103 276	P 3276
15601 87201 000	0 986 452 019	P 2019

15601 87203 000	0 986 452 019	P 2019
15601 87204 000	0 986 452 058	P 2058
15601 87305 000	0 986 452 020	P 2020
15601 87307 000	0 986 452 003	P 2003
1560187308	0 986 452 064	P 2064

15601 87309 000	0 986 452 020	P 2020
15601 87310 000	0 986 452 020	P 2020
15601 87700	0 986 452 058	P 2058
15601 87700 000	0 986 452 058	P 2058
1560187702	0 986 452 019	P 2019

15601 87702 000	0 986 452 019	P 2019
1560187703	0 986 452 058	P 2058
15601 87703 000	0 986 452 019	P 2019
15601 87703 000	0 986 452 058	P 2058
15601 87704	0 986 452 058	P 2058

15601 87704 000	0 986 452 058	P 2058
15601-87705	0 451 103 276	P 3276
15601-87705	0 986 452 044	P 2044
15601-87705	0 986 452 060	P 2060
15601 87705 000	0 986 452 044	P 2044

15601 87706 000	0 986 452 019	P 2019
15601-87716	1 987 429 123	S 9123
15601 97202	0 986 452 058	P 2058
15604 87704 000	0 986 452 058	P 2058
16501-87205-000	0 986 452 019	P 2019

16501-87205-000	0 986 452 028	P 2028
16501-87205-000	0 986 452 058	P 2058
17800 87801	1 987 429 164	S 9164
17801 72010 000	1 457 433 646	S 3646
17801-87104	1 987 429 123	S 9123

17801 87104 000	1 987 429 123	S 9123
1780187303	1 457 433 646	S 3646
17801 87303 000	1 457 433 646	S 3646
17801 87304 000	1 457 433 646	S 3646
1780187401	1 987 429 137	S 9137

1780187701	1 457 429 801	S 9801
17801 87701 000	1 457 429 801	S 9801
17801 87715 000	1 987 429 123	S 9123
17801-87716	1 987 429 123	S 9123
17801 87716 000	1 987 429 123	S 9123

17801 87718 000	1 987 429 123	S 9123
17801 97201	1 987 429 164	S 9164
17801 97201 000	1 987 429 164	S 9164
23300 15010 000	0 986 450 039	F 0039
23300-25020-000	0 986 450 117	F 0117

23300 87101 000	0 450 905 962	F 5962
2330087625	0 450 905 977	F 5977
23300 87625 000	0 450 905 977	F 5977
23300-87724	0 450 905 963	F 5963
23300 87724 000	0 450 905 963	F 5963

23300-87729	0 986 450 103	F 0103
23300 87729 000	0 986 450 103	F 0103
23300 87731 000	0 986 450 103	F 0103
23300-87733	0 986 450 103	F 0103
23300-87733	0 986 450 107	F 0107

23300-87733	0 986 450 113	F 0113
23300 87733 000	0 986 450 107	F 0107
23303-64010-000	1 457 434 438	N 4438
23303-87308	0 986 450 508	N 0508
23303-87308	1 457 434 453	N 4453

2330387309	0 986 450 508	N 0508
2330387309	1 457 434 453	N 4453
23303 87309 000	1 457 434 453	N 4453
40111834	0 986 452 003	P 2003
40111 8834	0 986 452 003	P 2003

FAUN

0746 293	1 457 431 159	N 1159
0746 369	1 457 429 950	S 9950
0746 383	1 457 429 946	S 9946

0746 389	1 457 429 969	S 9969
0746 444	1 457 429 966	S 9966
0746 555	1 457 429 794	S 9794
0746-839	F 026 400 082	S 0082
0746 920	1 457 429 675	N 9675

0746 928	1 457 429 969	S 9969
0794 693	1 457 431 326	N 1326
0796 293	1 457 431 159	N 1159
1146 4497	0 451 103 029	P 3029
1154 2957	0 451 103 029	P 3029

1170 781	1 457 429 975	S 9975
1190 514	1 457 429 165	P 9165
1470 294	1 457 434 432	N 4432
1470 654	0 451 403 001	P 3001
2165 039	1 457 429 941	S 9941

4134 217	0 451 105 067	P 5067
4134217	0 451 203 010	P 3010
4134 287	0 451 203 220	P 3220
4134 287	0 451 203 226	P 3226
4134 366	1 457 429 950	S 9950

4134 368	1 457 429 946	S 9946
4134-370	F 026 400 082	S 0082
4134 377	0 451 403 001	P 3001
4134 403	1 457 429 975	S 9975
4134 406	1 457 429 966	S 9966

4134 427	1 457 429 932	S 9932
4134 473	0 451 104 065	P 4065
4134 475	1 457 429 675	N 9675
4134 784	0 451 105 067	P 5067
4134784	0 451 203 010	P 3010

4198 280	F 026 407 054	P 7054
4702 26	1 457 431 159	N 1159
4790 226	1 457 431 159	N 1159
4795 772	1 457 434 050	N 4050
4795 772	1 457 434 432	N 4432

4795 837	0 451 105 067	P 5067
4795837	0 451 203 010	P 3010
4796 439	1 457 429 130	P 9130
746555	1 457 429 794	S 9794
9746 444	1 457 429 966	S 9966

FIAT

B31988	1 457 433 303	S 3303
FA 5558 ECO	1 457 429 152	P 9152
FA5732 ECO	F 026 402 047	N 2047

FT5784	F 026 403 008	F 3008
PC8193	1 987 432 406	R 2406
PC8154	1 987 432 208	M 2208
1186044	1 457 429 946	S 9946
1186046	1 457 429 950	S 9950

1310636080	1 457 433 790	S 3790
1312764080	1 987 432 042	M 2042
1312766080	1 987 432 042	M 2042
1337724080	1 457 434 455	N 4455
1337724080	1 457 434 460	N 4460



◀ FIAT

1349042080	F 026 400 059	S 0059
1354823	0 451 203 005	P 3005
1354828	0 451 104 065	P 4065
1400474780	F 026 400 058	S 0058
1400474780	1 457 433 535	S 3535

1475478080	1 987 432 060	M 2060
1475479080	1 987 432 060	M 2060
1484383080	1 987 432 091	M 2091
1497497080	1 987 432 206	M 2206
1497498080	1 987 432 406	R 2406

151849148	1 457 433 332	S 3332
1901602	0 451 203 152	P 3152
1901604	0 451 301 156	P 1156
1901605	1 457 429 681	N 9681
1901687	1 457 434 201	N 4201

1901779	1 457 429 975	S 9975
1902127	1 457 429 946	S 9946
1902457	1 457 432 138	S 2138
1909100	1 457 434 201	N 4201
1909102	0 451 203 152	P 3152

1909103	1 457 429 681	N 9681
1909108	1 457 429 230	N 9230
1909113	1 457 431 158	N 1158
1909119	1 457 429 681	N 9681
1909137	0 451 301 156	P 1156

1909139	1 457 429 933	S 9933
1909142	1 457 434 105	N 4105
1909957	1 457 429 794	S 9794
1930010	1 457 434 105	N 4105
1930213	0 451 203 201	P 3201

1930277	1 457 434 200	N 4200
1930327	0 451 103 028	P 3028
1930589	1 457 433 332	S 3332
1930820	1 457 434 432	N 4432
1930823	0 451 203 201	P 3201

1930906	F 026 407 049	P 7049
2165044	1 457 429 946	S 9946
2165049	1 457 429 950	S 9950
2165054	1 457 429 966	S 9966
2165059	1 457 429 975	S 9975

2348734	1 457 429 953	S 9953
2654392	0 451 203 152	P 3152
28482801	0 450 905 030	F 5030
2966261	1 457 429 820	P 9820
2992300	1 457 434 310	N 4310

35A1029	1 457 432 172	S 2172
4027979	0 451 203 152	P 3152
4059343	F 026 407 054	P 7054
4119015	0 451 203 005	P 3005
4119668	1 457 432 108	S 2108

4121392	0 451 203 005	P 3005
4122203	1 457 432 108	S 2108
4135600	0 451 203 152	P 3152
4146050	1 457 432 108	S 2108
4160703	0 986 452 044	P 2044

4170601	0 451 104 065	P 4065
4180565	1 457 432 108	S 2108
41805650	1 457 432 108	S 2108
4222406	0 451 203 152	P 3152
4234859	1 457 432 108	S 2108

4286051	0 451 103 029	P 3029
4313207	1 457 432 108	S 2108
4316238	0 451 103 029	P 3029
4321698	1 457 432 111	S 2111
4321699	1 457 432 111	S 2111

4323062	0 450 904 058	F 4058
4325601	0 450 904 058	F 4058
4335580	0 451 103 029	P 3029
4352637	0 450 904 058	F 4058
4361617	1 457 432 111	S 2111

4363009	1 457 432 108	S 2108
4363485	0 451 103 029	P 3029
4363560	1 457 432 111	S 2111
4370749	1 457 432 111	S 2111
4371572	1 457 432 111	S 2111

4371574	1 457 432 108	S 2108
4371580	0 451 103 029	P 3029
4389435	1 457 432 138	S 2138
4402070	1 457 429 953	S 9953
4406095	1 457 429 953	S 9953

4411578	1 457 432 108	S 2108
44115780	1 457 432 108	S 2108
4419493	1 457 429 076	S 9076
4434857	1 457 429 076	S 9076
4434858	1 457 432 146	S 2146

4434867	1 457 429 076	S 9076
4434868	1 457 432 146	S 2146
44348897	1 457 429 953	S 9953
4434951	1 457 429 953	S 9953
4434958	1 457 429 953	S 9953

4435104	0 450 905 030	F 5030
4435144	0 450 905 002	F 5002
4439265	1 457 432 146	S 2146
4439425	1 457 432 146	S 2146
4442559	0 450 905 030	F 5030

4446000	1 457 429 953	S 9953
4446001	1 457 429 953	S 9953
4446002	1 457 429 953	S 9953
4446003	1 457 429 953	S 9953
4446004	1 457 429 953	S 9953

4465121	1 457 434 106	N 4106
4506839	0 451 203 005	P 3005
4523873	0 451 203 005	P 3005
4561986	1 457 434 201	N 4201
4602186	0 451 203 152	P 3152

4607360	0 451 203 152	P 3152
4608186	0 451 203 152	P 3152
4612227	1 457 434 201	N 4201
4613310	1 457 429 681	N 9681
4618310	1 457 429 681	N 9681

4621540	1 457 434 201	N 4201
4621739	1 457 434 201	N 4201
4621740	1 457 434 201	N 4201
4625546	0 451 203 152	P 3152
4630787	0 451 203 152	P 3152

46402457	0 451 203 108	P 3108
46403932	0 450 905 273	F 5273
46403933	0 450 905 273	F 5273
46416684	0 986 450 220	F 0220
46420988	1 457 433 303	S 3303

46441236	0 450 905 273	F 5273
4644293	1 457 429 681	N 9681
46481588	1 457 433 265	S 3265
4651786	1 457 434 201	N 4201
46519049	1 457 433 289	S 3289

4651986	1 457 434 201	N 4201
46520658	1 457 433 265	S 3265
46523087	0 450 905 273	F 5273
46531688	0 450 906 452	N 6452
46536222	1 457 433 521	S 3521

46536382	1 457 433 255	S 3255
46536482	1 457 433 330	S 3330
46552772	1 457 433 553	S 3553
46552773	1 457 433 553	S 3553
46552777	1 457 433 520	S 3520

4667338	0 451 301 156	P 1156
4667339	0 451 301 156	P 1156
4667755	0 451 301 156	P 1156
4669550	1 457 434 201	N 4201
4669551	1 457 434 201	N 4201

4671001	1 457 429 681	N 9681
46737091	0 450 906 452	N 6452
46754989	1 457 433 307	S 3307
46783544	1 457 433 317	S 3317
46783546	1 457 433 152	S 3152

46786875	0 450 906 452	N 6452
46794403	1 457 433 086	S 3086
46795125	0 451 103 258	P 3258
46797378	1 457 434 460	N 4460
4680444	1 457 434 201	N 4201

46806576	1 457 433 324	S 3324
46807036	1 457 434 310	N 4310
46809151	1 457 433 155	S 3155
4694322	1 457 429 681	N 9681
4700487	1 457 429 681	N 9681

4730587	0 451 203 152	P 3152
4742848	1 457 429 681	N 9681
4764725	1 457 434 105	N 4105
4776902	1 457 429 950	S 9950
4787410	0 451 203 201	P 3201

4787733	F 026 407 049	P 7049
4788503	1 457 429 681	N 9681
4788592	1 457 432 188	S 2188
4795601	1 457 434 106	N 4106
4964322	1 457 429 681	N 9681



4980649	1 457 429 975	S 9975	60675978	0 450 905 320	F 5320	71711048	0 450 902 151	F 2151
4983958	1 457 434 201	N 4201	606 8113 42	1 457 433 791	S 3791	71713782	0 451 203 201	P 3201
504 0061 45	F 026 407 053	P 7053	60703776	1 457 434 106	N 4106	71714923	1 457 431 702	N 1702
504 0188 07	1 457 434 310	N 4310	60800097	0 450 905 002	F 5002	71718765	0 451 203 201	P 3201
510313	0 451 103 029	P 3029	60801638	0 450 905 005	F 5005	71731829	1 457 434 460	N 4460
510889	0 451 103 029	P 3029	60809275	1 457 433 253	S 3253	71732671	0 450 905 087	F 5087
51775324	F 026 400 002	S 0002	60809355	1 457 432 183	S 2183	71736100	0 450 905 273	F 5273
51775340	1 457 433 317	S 3317	60810503	0 450 905 087	F 5087	71736104	0 450 904 058	F 4058
51806865	1 457 433 317	S 3317	60811342	1 457 433 791	S 3791	71736105	0 450 904 159	F 4159
534372	0 451 103 029	P 3029	60811664	1 457 433 253	S 3253	71736112	0 450 904 058	F 4058
5414362	1 457 431 028	N 1028	608 1166 41	1 457 433 253	S 3253	71736117	0 450 906 452	N 6452
5414632	1 457 431 028	N 1028	60811822	0 450 905 273	F 5273	71736120	1 457 433 255	S 3255
5495251	0 451 103 109	P 3109	60811900	1 457 433 265	S 3265	71736123	1 457 433 791	S 3791
55183265	F 026 400 002	S 0002	60811904	0 450 905 273	F 5273	71736124	1 457 433 790	S 3790
55183269	1 457 433 316	S 3316	60815000	1 457 433 265	S 3265	71736136	1 457 432 172	S 2172
55183307	1 457 433 578	S 3578	60815415	1 457 433 791	S 3791	71736137	1 457 433 541	S 3541
55184943	F 026 400 041	S 0041	61142392	1 457 434 050	N 4050	71736141	1 457 432 185	S 2185
55189320	1 457 429 248	P 9248	61142392	1 457 434 432	N 4432	71736143	1 457 429 953	S 9953
55193849	F 026 400 002	S 0002	61142397	1 457 434 050	N 4050	71736149	1 457 432 174	S 2174
55198675	1 457 429 185	P 9185	61142397	1 457 434 432	N 4432	71736153	1 457 433 265	S 3265
572880	1 457 429 230	N 9230	61144392	1 457 434 050	N 4050	71736156	1 457 432 111	S 2111
582041	1 457 429 230	N 9230	61144392	1 457 434 432	N 4432	71737926	1 457 429 248	P 9248
59030255	0 986 452 044	P 2044	61584009	0 451 104 066	P 4066	71739634	0 451 203 201	P 3201
5926021	0 451 104 065	P 4065	61589105	1 457 429 681	N 9681	7174020	0 450 905 401	F 5401
5951661	1 457 434 106	N 4106	61589106	0 451 301 156	P 1156	71740470	F 026 407 021	P 7021
5951685	0 451 103 062	P 3062	61671160	0 451 105 067	P 5067	71740470	1 457 429 185	P 9185
5951865	0 451 103 004	P 3004	61671160	0 451 203 010	P 3010	71742069	F 026 400 201	S 0201
5951891	0 451 103 274	P 3274	61671600	0 451 105 067	P 5067	71742115	0 451 103 276	P 3276
5964796	0 451 103 004	P 3004	61671600	0 451 203 010	P 3010	71743821	1 987 432 173	M 2173
5964796	0 451 103 062	P 3062	61673585	0 451 105 067	P 5067	71743887	F 026 400 056	S 0056
5973689	1 457 432 173	S 2173	61673585	0 451 203 010	P 3010	71746761	0 451 103 276	P 3276
5980183	1 457 432 138	S 2138	61674455	1 457 434 050	N 4050	71747593	0 451 103 276	P 3276
5983298	1 457 434 201	N 4201	61674455	1 457 434 432	N 4432	71749828	F 026 407 083	P 7083
5983858	1 457 432 108	S 2108	62775368	1 457 434 201	N 4201	71753909	F 026 402 048	N 2048
5983859	1 457 432 174	S 2174	62775369	0 451 104 065	P 4065	71961003	0 451 203 152	P 3152
5983899	1 457 432 138	S 2138	62775371	1 457 429 681	N 9681	72053001	1 457 429 165	P 9165
5983900	0 451 203 201	P 3201	671160	0 451 105 067	P 5067	72370000	0 451 104 065	P 4065
5983958	1 457 434 201	N 4201	671160	0 451 203 010	P 3010	7301916	0 451 203 201	P 3201
5984018	1 457 434 200	N 4200	673588	0 451 105 067	P 5067	73038502	1 457 429 175	P 9175
5984020	1 457 432 172	S 2172	673588	0 451 203 010	P 3010	73067507	1 457 429 794	S 9794
5984093	0 450 905 002	F 5002	70112217	1 457 429 175	P 9175	73119795	1 457 429 794	S 9794
5998293	1 457 432 173	S 2173	701674	1 457 432 174	S 2174	73502069	1 457 433 579	S 3579
60506968	0 450 905 087	F 5087	70239518	1 457 433 200	S 3200	74027979	0 451 203 152	P 3152
60506969	0 450 905 087	F 5087	70243163	1 457 429 933	S 9933	74419493	1 457 429 076	S 9076
60507213	0 451 203 194	P 3194	70251397	1 457 434 201	N 4201	74434793	0 986 452 044	P 2044
60523432	0 450 905 030	F 5030	70257024	1 457 429 794	S 9794	74434794	0 986 452 044	P 2044
6053412	0 450 905 002	F 5002	7032389	0 451 103 274	P 3274	74446335	0 986 452 044	P 2044
60537455	0 450 905 005	F 5005	705111	1 457 432 174	S 2174	74502495	1 457 429 175	P 9175
60538903	1 457 432 174	S 2174	7053172	1 457 432 174	S 2174	74507257	1 457 429 175	P 9175
60538923	1 457 432 150	S 2150	7078711	1 987 432 107	M 2107	74511629	0 451 104 065	P 4065
60570436	1 457 432 150	S 2150	7079682	1 987 432 108	M 2108	74513411	0 451 203 152	P 3152
60585533	0 450 905 087	F 5087	7082301	1 987 432 183	M 2183	74630787	0 451 104 065	P 4065
60595381	1 457 432 183	S 2183	7110301	1 457 434 432	N 4432	74680444	1 457 434 201	N 4201
60595381	1 457 433 253	S 3253	71167808	1 457 429 933	S 9933	74907794	1 457 433 200	S 3200
60603977	1 457 433 791	S 3791	71455205	0 451 403 001	P 3001	74907795	1 457 429 933	S 9933



◀ FIAT

75208272	1 457 434 432	N 4432
7554755	1 457 432 180	S 2180
7564846	1 457 432 180	S 2180
7571569	0 451 203 201	P 3201
7574020	0 450 905 401	F 5401

7585348	0 450 902 151	F 2151
7604091	1 457 432 183	S 2183
7606404	0 450 902 151	F 2151
7612972	0 450 905 002	F 5002
7616156	1 457 432 185	S 2185

7628911	1 457 433 308	S 3308
7633139	1 457 433 259	S 3259
7634041	1 457 433 285	S 3285
7680997	0 450 905 002	F 5002
7683815	0 451 103 141	P 3141

7688498	1 457 433 286	S 3286
7688774	1 457 433 269	S 3269
7706339	1 457 432 146	S 2146
77110590	0 450 905 030	F 5030
7712505	1 457 433 541	S 3541

7719390	0 450 902 151	F 2151
7722936	1 457 433 253	S 3253
7729686	1 457 433 257	S 3257
77362258	F 026 402 013	N 2013
77362338	F 026 402 048	N 2048

77362340	1 457 070 001	N 0001
77363600	1 457 070 001	N 0001
77363804	F 026 402 049	N 2049
77364063	1 987 432 065	M 2065
77365864	1 457 070 001	N 0001

7759323	1 457 433 255	S 3255
7768720	1 457 433 265	S 3265
7782629	1 457 433 256	S 3256
7786042	1 457 433 253	S 3253
7786184	1 457 433 265	S 3265

7786225	1 457 433 791	S 3791
7786255	1 457 433 257	S 3257
7786434	1 457 433 265	S 3265
7786626	1 457 433 791	S 3791
7787063	0 450 902 151	F 2151

7787063	0 450 905 273	F 5273
79011386	1 457 429 794	S 9794
79026104	0 451 301 156	P 1156
79049791	1 457 433 201	S 3201
79083212	1 457 429 794	S 9794

7916156	1 457 432 185	S 2185
8093784	F 026 407 053	P 7053
8094864	F 026 407 083	P 7083
8094872	F 026 407 024	P 7024
8122408	1 457 432 188	S 2188

8123679	1 457 434 432	N 4432
82220425	0 451 104 065	P 4065
82232108	0 451 104 065	P 4065
82241613	0 451 104 065	P 4065
82282645	0 450 904 159	F 4159

82323784	0 450 904 058	F 4058
82342304	0 450 905 002	F 5002
82342881	0 451 103 029	P 3029
82345728	1 457 432 108	S 2108
82345730	1 457 432 108	S 2108

82367270	0 451 203 002	P 3002
82372779	1 457 432 174	S 2174
82380591	1 457 432 172	S 2172
82392325	0 450 905 005	F 5005
82392556	1 457 432 174	S 2174

82392557	1 457 432 174	S 2174
82398171	1 457 432 172	S 2172
82403555	0 450 905 021	F 5021
82403585	0 450 905 021	F 5021
82407227	0 451 103 028	P 3028

8241687	0 450 905 005	F 5005
82416870	0 450 905 005	F 5005
82425329	0 450 905 601	F 5601
82425490	0 450 904 058	F 4058
82425649	0 450 904 058	F 4058

82428006	0 450 904 058	F 4058
82429294	0 450 904 058	F 4058
82434499	0 450 905 021	F 5021
8245649	0 450 904 159	F 4159
8322383	1 457 432 138	S 2138

8322386	1 457 432 138	S 2138
8322986	1 457 429 969	S 9969
8322988	1 457 429 975	S 9975
8329989	1 457 429 975	S 9975
8508111	1 457 431 270	N 1270

8508111	1 457 431 326	N 1326
8821823	1 457 429 681	N 9681
9153580780	0 450 905 030	F 5030
9280124	1 457 434 201	N 4201
9293140	1 457 429 932	S 9932

9401901788	0 450 906 471	N 6471
9401906508	1 457 030 013	N 0013
9401906768	1 457 070 000	N 0000
9401906898	1 457 431 723	N 1723
9463381080	1 457 432 200	S 2200

9463624580	1 457 432 200	S 2200
9463624880	1 457 432 200	S 2200
9467565780	1 457 429 238	P 9238
9467616080	0 450 906 471	N 6471
9567494887	1 457 431 702	N 1702

9569762480	1 457 432 200	S 2200
9569762680	1 457 432 200	S 2200
9587494887	1 457 431 702	N 1702
9601099180	1 457 432 200	S 2200
9609896480	1 457 429 291	N 9291

9609896480	1 457 431 713	N 1713
9620823680	1 457 432 200	S 2200
9626759680	1 457 432 200	S 2200
96 288 906 80	1 457 431 703	N 1703
9647867780	0 450 905 287	F 5287

9651883380	1 457 433 327	S 3327
9819500	1 457 434 201	N 4201
9912650	1 457 429 165	P 9165
9918114	1 457 434 201	N 4201
9918144	1 457 434 201	N 4201

9918184	1 457 434 201	N 4201
9924318	1 457 434 201	N 4201
9927604	1 457 429 794	S 9794
9927846	1 457 429 941	S 9941
9936891	1 457 434 103	N 4103

9936891	1 457 434 106	N 4106
9939229	1 457 434 200	N 4200
9941058	1 457 434 105	N 4105
9942378	1 457 434 105	N 4105
9942378	1 457 434 321	N 4321

9944643	1 457 434 105	N 4105
9944643	1 457 434 321	N 4321
9944682	1 457 434 105	N 4105
9944682	1 457 434 321	N 4321
9944921	1 457 434 174	N 4174

9946972	1 457 434 192	N 4192
9947995	1 457 434 198	N 4198
9949267	1 457 434 310	N 4310
9950443	1 457 434 105	N 4105
9950451	1 457 434 174	N 4174

9951033	1 457 434 198	N 4198
9957615	1 457 429 933	S 9933
9983764	1 457 429 975	S 9975
9985779	1 457 429 941	S 9941
9987150	1 457 429 950	S 9950

FORD

AFA129	1 457 429 898	S 9898
AFA155	1 457 429 898	S 9898
AFG 27	0 450 905 030	F 5030

AFG 34	0 450 905 002	F 5002
AFG 57	0 986 450 106	F 0106
AGF 34	0 450 905 002	F 5002
A690X 6731 CA	0 451 103 029	P 3029
A700X 63714 DA	0 451 103 141	P 3141

A700X 6714 DA	0 451 103 141	P 3141
A700X 6714 EA	0 451 103 274	P 3274
A700X 6714 GA	0 451 103 062	P 3062
A700X 6714 HA	0 451 103 029	P 3029
A700X 6714 SA	0 451 104 065	P 4065

A700X 6714 SA	0 451 203 194	P 3194
A700X 9601 AGA	1 457 429 053	S 9053
A700X 9601 NA	1 457 432 108	S 2108
A710X 6714 CA	0 451 103 029	P 3029
A710X 6714 DA	0 451 103 029	P 3029

A710X 6714 EA	0 451 103 029	P 3029
A720X 6714 CA	0 451 203 005	P 3005
A720X 9601 AGA	1 457 429 053	S 9053
A720X 9601 AHA	1 457 429 050	S 9050
A720X 9601 HA	1 457 429 801	S 9801

A730X 6714 EPA	0 451 203 002	P 3002
A730X 6731 H3A	1 457 429 413	P 9413
A730X 6731 T1A	1 457 429 117	P 9117
A730X 6731 T3A	1 457 429 117	P 9117
A730X 6744 F3A	1 457 429 130	P 9130

A740X 6714 AA	0 986 452 005	P 2005
A740X 6714 BA	0 451 203 152	P 3152
A740X 6714 CA	0 451 103 141	P 3141
A740X 6714 FA	0 451 103 029	P 3029
A740X 9601 AA	1 457 429 054	S 9054

A740X 9601 ABA	1 457 432 106	S 2106
A760X 6714 LA	0 986 452 000	P 2000
A760X 9601 DA	1 457 432 106	S 2106
A760X 9601 JA	1 457 432 108	S 2108
A770X 6714 AAA	0 451 103 029	P 3029

A770X 6714 KA	0 451 103 029	P 3029
A770X 6714 LA	0 451 103 029	P 3029
A770X 6714 MA	0 451 103 029	P 3029
A770X 6714 RA	0 451 103 029	P 3029
A770X 6714 UA	0 451 103 029	P 3029

A770X 9601 AFA	1 457 429 900	S 9900
A770X 9601 BDA	1 457 429 806	S 9806
A770X 9601 BFA	1 457 433 732	S 3732
A770X 9601 CCA	1 457 429 064	S 9064
A770X 9601 CEA	1 457 429 064	S 9064

A770X 9601 SA	1 457 432 111	S 2111
A780X 9601 AA	1 457 429 908	S 9908
A780X 9601 BA	1 457 432 124	S 2124
A780X 9601 BGA	1 457 429 079	S 9079
A780X9601BGA	1 457 433 065	S 3065

A780X 9601 MA	1 457 429 900	S 9900
A780X 9601 TA	1 457 433 732	S 3732
A790X 9601 AA	1 457 429 061	S 9061
A790X 9601 AAA	1 457 429 080	S 9080
A790X 9601 EA	1 457 429 085	S 9085

A790X 9601 GA	1 457 429 050	S 9050
A790X 9601 JA	1 457 429 806	S 9806
A790X 9601 KA	1 457 429 994	S 9994
A800X 9601 EA	1 457 432 108	S 2108
A800X 9601 TA	1 457 432 106	S 2106

A810X-9150-CA	1 457 434 103	N 4103
A810X-9150-CA	1 457 434 105	N 4105
A810X-9150-CA	1 457 434 106	N 4106
A810X 9601 KA	1 457 429 080	S 9080
A810X 9601 NA	1 457 429 053	S 9053

A810X 9601 TA	1 457 429 908	S 9908
A820X 9601 GA	1 457 429 801	S 9801
A820X 9601 HA	1 457 429 992	S 9992
A820X 9601 KA	1 457 429 079	S 9079
A820X9601KA	1 457 433 065	S 3065

A820X 9601 RA	1 457 429 900	S 9900
A830X 9601 AEA	1 457 429 950	S 9950
A830X 9601 ANA	1 457 429 975	S 9975
A830X 9601 BEA	1 457 429 969	S 9969
A830X 9601 BRA	1 457 429 933	S 9933

A830X 9601 BSA	1 457 429 941	S 9941
A830X 9601 BUA	1 457 429 794	S 9794
A830X 9601 CCA	1 457 429 950	S 9950
A830X 9601 CLA	1 457 429 975	S 9975
A830X 9601 DBA	1 457 429 054	S 9054

A830X 9601 DEA	1 457 429 908	S 9908
A830X 9601 DFA	1 457 432 106	S 2106
A830X 9601 DHA	1 457 429 969	S 9969
A830X 9601 FA	1 457 429 953	S 9953
A830X 9601 NA	1 457 429 933	S 9933

A830X 9601 SA	1 457 429 941	S 9941
A830X 9601 UA	1 457 429 794	S 9794
A840X 9601 AAA	1 457 433 652	S 3652
A840X 9601 ARA	1 457 429 054	S 9054
A840X 9601 ATA	1 457 429 050	S 9050

A840X 9601 BEA	1 457 432 108	S 2108
A840X 9601 UA	1 457 432 154	S 2154
A850X 9601 DA	1 457 429 050	S 9050
A850X 9601 HA	1 457 432 106	S 2106
A850X 9601 LA	1 457 432 108	S 2108

A850X 9601 RA	1 457 432 111	S 2111
B359-20490	0 986 450 222	F 0222
B6M6-14-302	0 986 452 061	P 2061
C3AE 6714 A	0 451 104 065	P 4065
C3AE 6714 A	0 451 203 194	P 3194

C5NE 9176 C	1 457 434 201	N 4201
C6JZ 6714 A	0 986 452 003	P 2003
C7NN6714B	0 451 103 253	P 3253
C7NN 6714 B	0 451 104 065	P 4065
C7NN 6714 B	0 451 203 194	P 3194

C77NN 6714 B	0 451 203 194	P 3194
DONN 9N074 B	1 457 434 201	N 4201
DONN 9N07 4B	1 457 434 201	N 4201
D5NN 6714 A	0 451 103 062	P 3062
D7ZE 9601 A	1 457 429 806	S 9806

D7ZZ 9601 A	1 457 429 806	S 9806
D8NN F933 AC	0 451 203 002	P 3002
D8NN 6714 GA	0 451 203 194	P 3194
D8NN 6714 LA	0 451 203 194	P 3194
D8NN 9N074 AA	1 457 434 201	N 4201

D8NN 9176 AA	1 457 434 200	N 4200
EDL 6744 A2	1 457 434 201	N 4201
EDPN 9N074 AA	1 457 434 201	N 4201
EFA 224	1 457 429 920	S 9920
EFO1-13470	0 986 450 117	F 0117

EPN 6731 B	1 457 429 117	P 9117
E27Z 9155 A	0 986 450 117	F 0117
E3TZ 6731B	0 451 103 270	P 3270
E5HN 9N327 AA	1 457 434 050	N 4050
E5HN 9N327 AA	1 457 434 432	N 4432

E6HZ 9365 A	1 457 434 432	N 4432
E7HZ 6731 A	0 451 203 002	P 3002
E7NN 6714 AA	0 451 203 194	P 3194
E8BZ 9155 A	0 986 450 117	F 0117
E8NN 6714 BA	0 451 203 194	P 3194

E9BZ 9155 A	0 986 450 222	F 0222
E92Z 9155 A	0 986 450 102	F 0102
E92Z 9155 B	0 986 450 105	F 0105
FE0 513480	0 986 450 102	F 0102
FS1 113480	0 450 905 982	F 5982

F0NN 6714 AA	0 451 203 002	P 3002
F0NN 6714 AB	0 451 203 002	P 3002
F02Z 96 01A 1A	1 457 433 605	S 3605
F2NN 6714 AA	0 451 203 002	P 3002
F2NN 6714 AB	0 451 203 002	P 3002

F201 13Z00	1 457 433 605	S 3605
F32Z 9155 A	0 450 905 982	F 5982
F4BZ 9601 A	1 457 433 961	S 3961
F43X 9601 BB	1 457 433 088	S 3088
F5RZ 6731 A	0 986 452 003	P 2003

F5RZ 6731 B	0 986 452 003	P 2003
F505 13Z40	1 457 433 072	S 3072
F6NC 9B618 AA	1 457 429 946	S 9946
F63X 9601 BB	1 457 433 088	S 3088
F8B3 13Z409 A	1 457 433 605	S 3605

F87E 6714 AA	0 451 103 357	P 3357
F89E 9155 AA	0 450 905 939	F 5939
F89Z 9155 A	0 450 905 939	F 5939
F9BZ 9601	1 457 433 961	S 3961
G180522	1 457 429 791	S 9791

G29T 18689	1 457 429 175	P 9175
H75TM 9601 AA	1 457 429 076	S 9076
H77FG 9601 AA	1 457 429 928	S 9928
LS41 9155 AC	0 450 906 508	N 6508
M3307A01	1 457 433 070	S 3070

M8206A01	1 457 429 239	P 9239
N04039C155/A	F 026 400 135	S 0135
RFY 214302	0 451 103 316	P 3316
R20 723570	1 457 434 452	N 4452
VP3M5 U9601 AA	1 457 433 323	S 3323

V86HF 6714 AA	0 451 103 029	P 3029
V94DD 6714 AA	0 451 203 194	P 3194
W5051 45S442	0 451 103 029	P 3029
XL5E 9155 AB	1 457 434 329	N 4329
XM21 6744 AA	1 457 429 619	P 9619

XM219 A011 AB	0 450 906 318	N 6318
XM3J 6731 AA	0 986 452 062	P 2062
XM3J9150AA	1 457 434 438	N 4438
XM3J 9601 AA	F 026 400 165	S 0165
XM34 6731 AA	0 986 452 062	P 2062

XM34 9150 AA	1 457 434 438	N 4438
XM34 9159 EA	1 457 434 438	N 4438
XM349601AA	F 026 400 165	S 0165
XS4Q 6714 AB	0 451 103 252	P 3252
XS5X9601DA	F 026 400 096	S 0096

XS61 9155 AA	0 450 905 966	F 5966
XS7Q 6744 AA	1 457 429 239	P 9239
XS7Q6744A4	1 457 429 239	P 9239
XS71 9600 BB	1 457 433 608	S 3608
XS71 9600 EB	1 457 433 608	S 3608



◀ FORD

YC1H 19N619 AB	1 987 432 192	M 2192
YC1J-19N619 AB	1 987 432 192	M 2192
YC15 9601 BB	1 457 433 070	S 3070
YF1Z 9601 AA	1 457 433 095	S 3095
YL4J 6714 AA	0 986 452 023	P 2023
YL4J6714BA	0 986 452 046	P 2046
YL4J 6714 CA	0 451 103 357	P 3357
YL4J 9155 AA	0 450 905 326	F 5326
YL4J 9155 BA	1 457 434 281	N 4281
YL4J 9601 BA	1 457 433 275	S 3275
YL4J 9601 CA	1 457 433 154	S 3154
YL8U 9601 AA	1 457 433 095	S 3095
YL8Z 9601 AA	1 457 433 095	S 3095
YM2X 9601 AA	1 457 433 089	S 3089
YS61 9601 AA	1 457 433 083	S 3083
OHM 6716 BA	0 451 103 029	P 3029
0464 619	1 457 429 915	S 9915
1C15 9601 AB	1 457 433 070	S 3070
1C159601AC	1 457 433 070	S 3070
1C159601AD	1 457 433 070	S 3070
1E05-13490	0 450 905 966	F 5966
1S41 9155 AC	0 450 906 508	N 6508
1S6G6714DA	0 986 452 068	P 2068
1S7G6714DA	0 986 452 068	P 2068
1S71 9155 BA	0 450 905 927	F 5927
1S71 9601 AA	1 457 433 047	S 3047
1S719601AB	1 457 433 047	S 3047
1004509	1 457 433 605	S 3605
1015319	1 457 434 400	N 4400
1015734	1 457 434 400	N 4400
1017035	1 457 433 742	S 3742
1022150	0 450 905 324	F 5324
1022150	0 450 905 966	F 5966
1023134	1 457 433 792	S 3792
1030652	1 457 433 268	S 3268
1037150	0 451 103 290	P 3290
1050705	1 457 433 268	S 3268
1058022	1 457 433 686	S 3686
1059924	0 451 103 252	P 3252
1072246	1 457 433 686	S 3686
1085801	0 451 103 290	P 3290
1088179	1 457 429 239	P 9239
1089 896	F 026 400 096	S 0096
1097091	1 457 434 400	N 4400
1100696	1 457 429 619	P 9619
1102766	1 457 433 083	S 3083
1102785	1 457 433 742	S 3742
1110661	1 457 433 089	S 3089
1112650	0 986 452 023	P 2023
1112652	0 451 103 357	P 3357
1112653	0 450 905 326	F 5326
1112656	1 457 433 275	S 3275
1112657	1 457 433 154	S 3154
1120167	1 457 433 047	S 3047
1120475	1 987 432 306	R 2306

1129147	1 457 429 791	S 9791
1132631	0 450 906 508	N 6508
1136568	0 451 103 252	P 3252
1137026	0 450 906 508	N 6508
1140129	0 450 905 926	F 5926
11405640	0 451 103 029	P 3029
1140778	1 457 433 593	S 3593
11425472	0 451 103 029	P 3029
1142601	0 450 906 508	N 6508
11436936	0 451 103 029	P 3029
11436936	0 986 452 003	P 2003
11464231	0 451 103 029	P 3029
11464467	0 451 103 029	P 3029
11464497	0 451 103 029	P 3029
11464498	0 451 103 029	P 3029
11464498	0 986 452 003	P 2003
1146 4619	1 457 429 915	S 9915
1147685	1 457 429 238	P 9238
1148119	0 450 906 460	N 6460
1148703	0 451 103 252	P 3252
1152193	0 450 906 460	N 6460
11525472	0 451 103 029	P 3029
11525802	0 451 103 029	P 3029
11618024	1 457 429 117	P 9117
1207066	0 451 103 252	P 3252
1208300	1 457 434 400	N 4400
1212739	F 026 403 009	F 3009
1213438	0 986 452 062	P 2062
1213440	F 026 400 165	S 0165
1216907	1 457 433 047	S 3047
1230645	0 450 906 508	N 6508
1231233	0 451 103 252	P 3252
1232095	F 026 400 141	S 0141
1232095	1 457 433 099	S 3099
1232 325	0 450 906 471	N 6471
1232494	1 457 433 096	S 3096
1232496	1 457 433 323	S 3323
1250507	0 986 452 068	P 2068
1253789	0 450 906 406	N 6406
1254385	1 457 429 238	P 9238
1254391	0 450 906 471	N 6471
1318563	1 457 070 000	N 0000
1318563	1 457 431 723	N 1723
1318 701	0 451 103 347	P 3347
1322152	0 451 103 252	P 3252
132769	1 457 429 954	S 9954
1334772	0 450 906 460	N 6460
1335710	0 450 906 508	N 6508
1338 536	F 026 400 110	S 0110
1339125	F 026 407 017	P 7017
1340105	0 450 906 471	N 6471
1342601	0 450 906 508	N 6508
1349745	1 457 429 239	P 9239
1 351 227	0 450 906 508	N 6508
1352443	F 026 402 007	N 2007

1353 267	1 987 432 192	M 2192
1353270	1 987 432 306	R 2306
1355242	0 450 906 406	N 6406
1359941	1 457 429 238	P 9238
1373667	F 026 400 106	S 0106
1374652	0 450 905 927	F 5927
1383736	0 450 906 460	N 6460
1383737	0 450 906 460	N 6460
1386 037	F 026 402 046	N 2046
1418712	1 457 433 583	S 3583
1418 883	F 026 400 109	S 0109
1423477	1 457 434 201	N 4201
1432209	1 457 433 070	S 3070
1458065	0 450 906 471	N 6471
1459 009	1 987 432 192	M 2192
1465018	F 026 403 009	F 3009
1465170	F 026 400 109	S 0109
1471765	F 026 402 078	N 2078
1473773	0 451 103 029	P 3029
1476787	1 457 429 064	S 9064
1479059	F 026 400 109	S 0109
1480495	0 450 906 508	N 6508
1480561	0 450 906 508	N 6508
1480568	1 457 433 686	S 3686
1482151	0 451 103 029	P 3029
1486702	1 457 433 096	S 3096
1486703	F 026 400 141	S 0141
1486703	1 457 433 099	S 3099
1498017	0 451 103 141	P 3141
1498018	0 451 103 274	P 3274
1498020	0 451 103 062	P 3062
1498021	0 451 103 004	P 3004
1498027	0 451 104 064	P 4064
1498028	0 451 103 253	P 3253
1498028	0 451 104 065	P 4065
1498427	1 457 432 108	S 2108
1498434	1 457 432 106	S 2106
1498439	1 457 429 053	S 9053
1502254	1 457 434 051	N 4051
1502255	1 457 434 105	N 4105
1503832	1 457 429 064	S 9064
1506212	1 457 429 064	S 9064
1508831	0 451 103 029	P 3029
1515160	0 451 103 029	P 3029
1 516 725	F 026 400 135	S 0135
1516739	1 457 433 686	S 3686
1523494	0 451 203 005	P 3005
1523494	0 986 452 005	P 2005
1531787	1 457 429 117	P 9117
1541 456	1 987 432 215	M 2215
1542778	F 026 400 002	S 0002
1555451	0 451 103 029	P 3029
1556297	0 451 103 029	P 3029
1556564	F 026 407 054	P 7054
156212	1 457 429 064	S 9064

1564767	0 451 103 029	P 3029
1565204	0 451 203 010	P 3010
1565204	0 451 203 194	P 3194
1565486	0 451 103 029	P 3029
1566997	1 987 432 415	R 2415
1574618	1 457 429 076	S 9076
1582261	1 457 434 201	N 4201
1583371	1 457 434 200	N 4200
1594 615	1 987 432 215	M 2215
1612184	0 451 203 108	P 3108
1635103	1 457 434 201	N 4201
1641158	0 451 103 029	P 3029
1641158	0 451 103 274	P 3274
1641187	0 451 103 252	P 3252
165190	1 457 433 070	S 3070
1665410	1 457 433 609	S 3609
1665421	1 457 433 608	S 3608
1677302	0 450 906 460	N 6460
1698 684	F 026 400 109	S 0109
1706918	F 026 400 002	S 0002
1709787	0 450 906 508	N 6508
1718968	1 457 429 117	P 9117
1823491	1 457 434 201	N 4201
182590	0 451 203 002	P 3002
1952956	1 457 434 439	N 4439
1952999	1 457 433 275	S 3275
1960297	0 450 905 326	F 5326
1960332	1 457 433 154	S 3154
1960333	1 457 433 154	S 3154
1961451	0 986 452 023	P 2023
2M5C 9B072 AB	F 026 403 009	F 3009
2M5C9155AC	F 026 403 009	F 3009
2M5Q 6714 AB	0 451 103 252	P 3252
2M5Q 6714 AC	0 451 103 252	P 3252
2S419 B072 CB	0 450 906 406	N 6406
2S6Q 6714-AA	1 457 429 238	P 9238
2S6Q 6714-AB	1 457 429 238	P 9238
2S6Q 9155 AA	0 450 906 460	N 6460
2S6Q 9155 AB	0 450 906 460	N 6460
2S6Q 9155 AD	0 450 906 460	N 6460
2S6Q 9155-BA	0 450 906 460	N 6460
2S61 9155 AB	0 450 905 926	F 5926
2S61 9601 CA	1 457 433 593	S 3593
2T149B072BA	0 450 906 508	N 6508
2T14 9B072 BB	0 450 906 508	N 6508
2T14 9B072 BC	0 450 906 508	N 6508
2T149155BC	0 450 906 508	N 6508
2T149155BD	0 450 906 508	N 6508
2T14 9155 BE	0 450 906 508	N 6508
2U7J 6714 AA	0 451 103 252	P 3252
2000E 6228	1 457 433 200	S 3200
2506 2277	1 457 432 138	S 2138
2720E 6714 A	0 451 103 029	P 3029
2720E 9601 A	0 451 103 029	P 3029
2724E 6714 A	0 451 103 029	P 3029

2724E 6714 B	0 451 103 029	P 3029
2724E 6714 C	0 451 103 029	P 3029
2735E9601C	1 457 429 064	S 9064
2852007	1 457 431 159	N 1159
3M5Q 9155 BB	0 450 906 471	N 6471
3M5Q 9155 CA	0 450 906 471	N 6471
3M5Q9155CB	0 450 906 471	N 6471
3M5Q 9176 AA	1 457 070 000	N 0000
3M5Q 9176 AA	1 457 431 723	N 1723
3M51 -601-DA	F 026 400 141	S 0141
3M51 9601 AA	1 457 433 323	S 3323
3M51 9601-BA	1 457 433 096	S 3096
3M519601BA	1 457 433 607	S 3607
3M51 9601-DA	1 457 433 099	S 3099
3S71 9B072 AF	0 450 905 927	F 5927
3S71 9155-BA	0 450 906 508	N 6508
3S71 9155 B1B	0 450 906 508	N 6508
3U7J 6714 AA	0 451 103 347	P 3347
3U7J 6714 BA	0 451 103 347	P 3347
3051335111	0 450 905 030	F 5030
3252742	0 451 103 316	P 3316
3254957	0 451 103 270	P 3270
3255952	0 451 103 270	P 3270
3397051	0 450 905 982	F 5982
3397 078	1 457 433 072	S 3072
3598332	0 986 452 062	P 2062
3600772	F 026 400 165	S 0165
3707442	0 451 103 357	P 3357
3785586	1 457 433 088	S 3088
3885284	1 457 433 605	S 3605
3914074	1 457 434 201	N 4201
3917694	0 451 104 065	P 4065
3917694	0 451 203 194	P 3194
3947506	0 451 203 194	P 3194
3964918	F 026 403 009	F 3009
3964918	0 450 905 939	F 5939
4M5Q 6714-BA	0 451 103 252	P 3252
4M5Q6714CA	F 026 407 017	P 7017
4R8Q6744AA	1 457 429 307	P 9307
4X4Q9176AB	F 026 402 004	N 2004
4024213	1 457 434 438	N 4438
4041615	1 457 433 070	S 3070
4042 703	1 987 432 192	M 2192
4056773	1 457 433 095	S 3095
4103735	0 450 905 927	F 5927
4403318	1 457 434 438	N 4438
4486167	1 457 433 070	S 3070
464498	0 986 452 003	P 2003
5C1Q 6744 AA	1 457 429 239	P 9239
5M5Q 9155AA	F 026 402 046	N 2046
5M5Q 9176-AA	F 026 402 007	N 2007
5S61-9601-AA	F 026 400 110	S 0110
5000188	0 451 104 064	P 4064
5000189	0 451 104 065	P 4065
5000215	1 457 429 053	S 9053

5000261	1 457 429 800	S 9800
5000262	1 457 429 801	S 9801
5000263	1 457 429 050	S 9050
5000679	1 457 429 175	P 9175
5000831	1 457 429 117	P 9117
5000832	1 457 429 117	P 9117
5000833	1 457 429 117	P 9117
5000834	1 457 429 117	P 9117
5000847	1 457 429 130	P 9130
5000848	1 457 429 130	P 9130
5000856	0 451 203 002	P 3002
5000857	0 451 203 002	P 3002
5000858	0 451 203 002	P 3002
5000859	0 451 105 067	P 5067
5000859	0 451 203 010	P 3010
5000860	0 451 103 004	P 3004
5000861	0 451 104 005	P 4005
5000861	0 451 104 066	P 4066
5000862	0 451 104 065	P 4065
5000869	1 457 429 413	P 9413
5001025	0 451 203 194	P 3194
5001102	1 457 429 054	S 9054
5001123	0 986 452 005	P 2005
5001124	0 451 203 152	P 3152
5001156	0 451 103 141	P 3141
5001217	1 457 432 106	S 2106
5001248	0 451 103 029	P 3029
5002230	0 451 103 029	P 3029
5002463	1 457 432 106	S 2106
5002468	1 457 432 108	S 2108
5002535	0 986 452 000	P 2000
5003229	1 457 432 111	S 2111
5003237	1 457 429 900	S 9900
5003239	1 457 429 030	S 9030
5003559	0 451 103 029	P 3029
5003560	0 451 103 029	P 3029
5003561	0 451 103 029	P 3029
5003609	1 457 429 806	S 9806
5003611	1 457 433 732	S 3732
5003748	0 450 904 058	F 4058
5003932	0 451 103 029	P 3029
5003961	1 457 429 064	S 9064
5004262	1 457 429 908	S 9908
5004263	1 457 432 124	S 2124
5004359	1 457 429 064	S 9064
5004384	1 457 429 900	S 9900
5004470	1 457 433 732	S 3732
5004775	0 451 203 010	P 3010
5004777	1 457 429 175	P 9175
5004780	1 457 434 050	N 4050
5004780	1 457 434 432	N 4432
5004783	1 457 429 230	N 9230
5004783	1 457 431 261	N 1261
5004783	1 457 431 325	N 1325
5004784	1 457 431 158	N 1158



◀ FORD

5004785	1 457 431 159	N 1159
5004837	0 450 904 058	F 4058
5004838	1 457 431 270	N 1270
5004838	1 457 431 326	N 1326
5004884	1 457 429 050	S 9050

5004885	1 457 429 054	S 9054
5005097	0 451 103 274	P 3274
5005098	1 457 429 079	S 9079
5005098	1 457 433 065	S 3065
5005156	1 457 429 061	S 9061

5005532	1 457 429 085	S 9085
5005571	0 451 103 232	P 3232
5005804	0 451 103 232	P 3232
5005805	0 451 103 274	P 3274
5005820	1 457 429 050	S 9050

5005820	1 457 429 959	S 9959
5005822	1 457 429 806	S 9806
5005823	1 457 429 994	S 9994
5005831	1 457 429 080	S 9080
5006224	1 457 429 957	S 9957

5006573	1 457 432 108	S 2108
5006946	0 451 103 274	P 3274
5006950	1 457 432 106	S 2106
5006951	0 451 103 141	P 3141
5007222	0 986 452 015	P 2015

5007387	1 457 432 146	S 2146
5007417	1 457 429 959	S 9959
5007716	1 457 429 959	S 9959
5008677	0 451 103 029	P 3029
5008724	1 457 429 064	S 9064

5008885	1 457 431 028	N 1028
5009063	1 457 429 957	S 9957
5009064	1 457 429 080	S 9080
5009226	1 457 429 053	S 9053
5009229	1 457 429 908	S 9908

5009232	0 451 203 005	P 3005
5009417	1 457 429 959	S 9959
5009421	0 451 103 141	P 3141
5009781	1 457 429 801	S 9801
5010235	1 457 429 992	S 9992

5010292	0 986 452 028	P 2028
5010294	1 457 429 079	S 9079
5010294	1 457 433 065	S 3065
5010518	1 457 434 201	N 4201
5010664	0 451 105 067	P 5067

5010664	0 451 203 010	P 3010
5010665	0 451 103 004	P 3004
5010666	0 451 104 066	P 4066
5010669	1 457 429 900	S 9900
5010909	1 457 429 953	S 9953

5010910	1 457 429 932	S 9932
5010913	0 451 103 232	P 3232
5010965	0 986 452 015	P 2015
5010966	1 457 432 146	S 2146
5011310	1 457 433 200	S 3200

5011312	1 457 429 933	S 9933
5011314	1 457 429 941	S 9941
5011316	1 457 429 794	S 9794
5011321	1 457 429 950	S 9950
5011329	1 457 429 975	S 9975

5011338	1 457 429 969	S 9969
5011417	0 451 403 077	P 3077
5011426	1 457 429 740	P 9740
5011502	0 451 403 077	P 3077
5011546	1 457 429 933	S 9933

5011547	1 457 429 941	S 9941
5011549	1 457 429 794	S 9794
5011552	1 457 429 950	S 9950
5011560	1 457 429 975	S 9975
5011876	1 457 429 054	S 9054

5011879	1 457 429 908	S 9908
5011880	1 457 432 106	S 2106
5011882	1 457 429 969	S 9969
5012035	0 451 103 274	P 3274
5012037	0 451 103 141	P 3141

5012040	0 451 103 274	P 3274
5012045	1 457 431 028	N 1028
5012551	0 986 452 023	P 2023
5012553	1 457 429 820	P 9820
5012554	0 451 203 223	P 3223

5012561	1 457 429 928	S 9928
5012563	1 457 432 154	S 2154
5012564	1 457 433 652	S 3652
5012574	0 986 452 016	P 2016
5012575	0 986 452 023	P 2023

5012577	0 986 452 019	P 2019
5012580	0 986 452 005	P 2005
5012631	1 457 429 054	S 9054
5012633	1 457 429 050	S 9050
5012633	1 457 429 959	S 9959

5012634	1 457 429 030	S 9030
5012645	0 986 452 028	P 2028
5013135	1 457 432 108	S 2108
5013146	0 451 103 274	P 3274
5013148	0 451 203 005	P 3005

5013149	0 451 103 141	P 3141
5014053	1 457 434 432	N 4432
5014055	0 986 452 005	P 2005
5014055	0 986 452 024	P 2024
5014352	1 457 429 050	S 9050

5014352	1 457 429 959	S 9959
5014354	1 457 431 028	N 1028
5014768	1 457 432 106	S 2106
5014771	1 457 432 108	S 2108
5014774	1 457 432 111	S 2111

5015476	1 457 429 054	S 9054
5015543	0 450 904 058	F 4058
5015544	0 450 904 058	F 4058
5016787	1 457 429 061	S 9061
5016950	0 451 103 109	P 3109

5016955	0 986 452 023	P 2023
5016957	0 451 103 029	P 3029
5016961	0 986 452 000	P 2000
5016962	0 986 452 005	P 2005
5016966	1 457 429 274	P 9274

5016988	1 457 429 030	S 9030
5016989	1 457 432 173	S 2173
5016994	1 457 432 203	S 2203
5017002	1 457 429 875	S 9875
5017008	1 457 432 174	S 2174

5017016	1 457 429 908	S 9908
5017025	1 457 429 806	S 9806
5017026	1 457 429 801	S 9801
5017034	1 457 432 154	S 2154
5017035	1 457 429 992	S 9992

5017055	1 457 429 636	P 9636
5017457	1 457 432 154	S 2154
5017643	1 457 432 174	S 2174
5017808	0 451 103 109	P 3109
5017818	1 457 432 173	S 2173

5017832	1 457 429 289	N 9289
5017846	1 457 429 983	S 9983
5017848	1 457 429 992	S 9992
5017853	1 457 429 964	S 9964
5017855	1 457 429 636	P 9636

5018032	1 457 429 875	S 9875
5018351	0 451 203 194	P 3194
5018353	0 986 452 023	P 2023
5018498	1 457 432 106	S 2106
5018505	1 457 432 173	S 2173

5019408	1 457 429 870	S 9870
5019413	1 987 429 117	S 9117
5019415	1 457 429 932	S 9932
5019424	0 451 203 010	P 3010
5019425	0 451 203 010	P 3010

5019426	0 986 452 019	P 2019
5019924	0 451 203 194	P 3194
5020031	1 457 429 845	S 9845
5020286	1 457 434 200	N 4200
5020308	1 457 429 920	S 9920

5020405	0 450 905 964	F 5964
5020868	1 457 429 076	S 9076
5020944	1 457 429 079	S 9079
5020944	1 457 433 065	S 3065
5021023	0 451 103 316	P 3316

5022740	1 457 429 869	S 9869
5022741	1 457 432 200	S 2200
5022743	1 457 429 783	S 9783
5022744	1 457 429 970	S 9970
5022745	1 457 429 988	S 9988

5022746	1 457 429 993	S 9993
5022748	1 457 429 777	S 9777
5022749	1 457 429 777	S 9777
5022767	0 986 452 035	P 2035
5022796	0 986 452 000	P 2000



5022797	0 986 452 005	P 2005
5022799	0 986 452 023	P 2023
5022883	1 457 432 200	S 2200
5022955	0 451 103 252	P 3252
5023135	1 457 432 180	S 2180

5023136	1 457 432 185	S 2185
5023137	1 457 432 183	S 2183
5024 424	0 451 103 274	P 3274
5025058	1 457 429 787	S 9787
5025060	1 457 429 781	S 9781

5025066	1 457 432 150	S 2150
5025068	1 457 429 841	S 9841
5025 071	1 987 429 051	S 9051
5025073	1 457 429 846	S 9846
5025 082	1 987 429 051	S 9051

5025108	1 457 429 251	P 9251
5025133	0 451 103 217	P 3217
5025136	1 457 429 877	S 9877
5026836	1 457 434 200	N 4200
5027154	0 450 904 159	F 4159

5028225	1 987 432 058	M 2058
5028226	1 987 432 058	M 2058
5029459	1 457 434 201	N 4201
5029851	1 457 433 711	S 3711
5029854	0 451 203 108	P 3108

5029916	1 987 432 058	M 2058
5 101 917	0 450 905 016	F 5016
5 101 917	0 450 905 021	F 5021
6C119601CB	F 026 400 106	S 0106
6G9N9176-AB	F 026 402 078	N 2078

6G9T 14014-MBG	1 457 429 053	S 9053
6G91-9601-AA	F 026 400 109	S 0109
6G91 9601 AB	F 026 400 109	S 0109
6G91-9601-AC	F 026 400 109	S 0109
6M21 600D16-AD34D8	0 451 103 029	P 3029

6M5Y9601AA	1 457 433 583	S 3583
6058519	0 450 905 021	F 5021
6063340	0 451 103 274	P 3274
6080390	1 457 429 920	S 9920
6094614	0 451 103 252	P 3252

6103279	0 450 905 601	F 5601
6106753	1 457 434 050	N 4050
6106753	1 457 434 432	N 4432
6106841	0 451 105 067	P 5067
6106841	0 451 203 010	P 3010

6119196	0 451 103 252	P 3252
6124136	1 457 429 675	N 9675
6132769	1 457 429 954	S 9954
6135130	1 457 434 106	N 4106
6143136	1 457 429 845	S 9845

6149716	1 457 434 201	N 4201
6149717	1 457 434 201	N 4201
6153085	0 451 203 108	P 3108
6161789	1 457 434 201	N 4201
6162292	1 457 429 819	S 9819

6162293	1 457 429 842	S 9842
6162294	1 457 429 775	S 9775
6172024	1 457 433 690	S 3690
6176728	0 451 203 108	P 3108
6180522	1 457 429 791	S 9791

6184942	0 451 103 252	P 3252
6192187	0 450 905 195	F 5195
6194571	1 457 433 659	S 3659
6203126	0 451 103 252	P 3252
6497632	1 457 429 819	S 9819

6594603	0 450 905 324	F 5324
6594603	0 450 905 966	F 5966
6610580	1 457 433 750	S 3750
6688744	0 450 905 200	F 5200
6920749	1 457 433 711	S 3711

6925896	1 457 429 030	S 9030
6925896	1 457 433 617	S 3617
7G91 9601AA	F 026 400 109	S 0109
7M519601BA	1 457 433 096	S 3096
7M519601DA	1 457 433 099	S 3099

7N51-9155-AB	F 026 403 009	F 3009
7T169601AA	1 457 433 686	S 3686
7T169601AB	1 457 433 686	S 3686
70HH 6714 AB	0 451 103 029	P 3029
70HM 6714 AA	0 451 103 029	P 3029

70HM 6714 BB	0 451 103 029	P 3029
70HM 6716 BA	0 451 103 029	P 3029
7072637	0 451 203 194	P 3194
71HF 9601 BB	1 457 429 064	S 9064
711F9601EA	1 457 429 064	S 9064

715F 9150 AAA	1 457 434 051	N 4051
715F 9150 ABA	1 457 434 105	N 4105
7166160	1 457 433 088	S 3088
7212351	0 450 905 264	F 5264
7235770	1 457 434 201	N 4201

7236936	1 457 433 742	S 3742
74HM 6714 AA	0 451 103 029	P 3029
74HM 6714 BA	0 451 103 029	P 3029
74HM 6714 BA	0 451 203 194	P 3194
74HM 6714 BB	0 451 103 029	P 3029

74HM 6714 CA	0 451 103 029	P 3029
74HM6714CA	0 986 452 003	P 2003
74HM 6714 CB	0 451 103 029	P 3029
761F9601AA	1 457 429 933	S 9933
78GB 9150 AA	1 457 434 200	N 4200

78GB 9155 AB	0 450 905 021	F 5021
78GB 9155 BA	0 450 905 021	F 5021
79BF 9601 AA	1 457 429 920	S 9920
8V21 9601 AA	F 026 400 135	S 0135
8V5J 19G244-AA	1 987 432 415	R 2415

8V51 18D543-AA	1 987 432 215	M 2215
81879134	0 451 203 002	P 3002
82GB 9155 AA	0 450 905 601	F 5601
82GB 9155 BA	0 450 905 200	F 5200
82-20-044	1 457 429 933	S 9933

82429294	0 450 904 058	F 4058
82-48-012	1 457 429 933	S 9933
825F 9150 A2B	1 457 434 201	N 4201
8256032	1 457 433 200	S 3200
82-57-912	1 457 429 933	S 9933

8257914	1 457 433 200	S 3200
83EM 6714 BA	0 451 203 108	P 3108
84AB 9150 AA	1 457 434 106	N 4106
84HF 9600 AA	1 457 429 954	S 9954
84HF 9601 AA	1 457 429 954	S 9954

84HF 9601 HA	1 457 429 954	S 9954
844F 6714 AC	0 451 103 252	P 3252
844F 6714 A1A	0 451 103 252	P 3252
85EM 6714 AA	0 451 203 108	P 3108
86HF 9601 AA	1 457 429 845	S 9845

860X 9155 AA	0 450 904 058	F 4058
860X 9601 AA	1 457 429 054	S 9054
860X 9601 ABA	1 457 429 875	S 9875
860X9601AFA	1 457 429 030	S 9030
860X 9601 AGA	1 457 432 173	S 2173

860X 9601 BA	1 457 429 061	S 9061
860X 9601 BAA	1 457 429 908	S 9908
860X 9601 BFA	1 457 429 806	S 9806
860X 9601 BGA	1 457 429 801	S 9801
860X 9601 BHA	1 457 432 173	S 2173

860X 9601 BSA	1 457 432 154	S 2154
860X 9601 BTA	1 457 429 992	S 9992
860X 9601 CMA	1 457 432 154	S 2154
860X 9601 EA	1 457 432 173	S 2173
8616804	F 026 403 009	F 3009

87EM 6714 AA	0 451 203 108	P 3108
87HX 9601 AA	1 457 429 845	S 9845
870X 9601 AAA	1 457 429 875	S 9875
870X 9601 BCA	1 457 432 106	S 2106
870X 9601 CCA	1 457 429 870	S 9870

870X9601CGA	1 987 429 117	S 9117
870X 9601 CJA	1 457 429 932	S 9932
870X9601CMA	1 457 432 154	S 2154
870X 9601 GA	1 457 429 983	S 9983
870X 9601 JA	1 457 429 992	S 9992

870X 9601 OGA	1 987 429 117	S 9117
870X 9601 RA	1 457 429 964	S 9964
88GX 9155 BA	0 450 905 964	F 5964
88TX 9601 AA	1 457 429 076	S 9076
88VB 9601 AA	1 457 433 690	S 3690

88V890601AA	1 457 433 690	S 3690
880X 9601 CA	1 457 429 079	S 9079
880X9601CA	1 457 433 065	S 3065
89BF 9601 AA	1 457 429 819	S 9819
89BF 9601 BA	1 457 429 819	S 9819

89FF6714A1C	0 986 452 044	P 2044
89FF6714A2A	0 986 452 044	P 2044
89FF6714A2B	0 986 452 044	P 2044
89FF6714A2C	0 986 452 044	P 2044
89FF6714A2E	0 986 452 044	P 2044



◀ FORD

89FF 9601 AA	1 457 429 842	S 9842
89SF 9601 AA	1 457 429 775	S 9775
890X 9601 AA	1 457 429 869	S 9869
890X 9601 AGA	1 457 432 180	S 2180
890X 9601 BA	1 457 432 200	S 2200

890X 9601 DA	1 457 429 783	S 9783
890X 9601 EA	1 457 429 970	S 9970
890X 9601 FA	1 457 429 988	S 9988
890X 9601 GA	1 457 429 993	S 9993
890X 9601 JA	1 457 429 777	S 9777

890X 9601 KA	1 457 429 777	S 9777
9S519601BA	F 026 400 002	S 0002
900X 9601 TA	1 457 432 150	S 2150
9055171	1 457 429 928	S 9928
91AB 9155 AA	0 450 905 195	F 5195

91FF 9601 AA	1 457 429 791	S 9791
91FF9601AB	1 457 429 791	S 9791
914F 6714 A	0 451 103 252	P 3252
914F 6714 AA	0 451 103 252	P 3252
919F 9601 AA	1 457 433 659	S 3659

92FB 9155 AA	0 450 905 324	F 5324
92FB9155AA	0 450 905 966	F 5966
92FB 9155-AB	0 450 905 324	F 5324
92FB 9155-AB	0 450 905 966	F 5966
92VB 9601 HA	1 457 433 750	S 3750

93BB 9601 AB	1 457 433 609	S 3609
93BB 9601 BA	1 457 433 608	S 3608
93FF 9150 AA	1 457 434 201	N 4201
94FF 9601 AA	1 457 433 711	S 3711
94FX 9601 H2A	1 457 433 711	S 3711

94GX 6714 A2A	0 451 203 108	P 3108
94SF 9601 AA	1 457 429 030	S 9030
94SF 9601 AA	1 457 433 617	S 3617
940901788	0 450 906 471	N 6471
95VW 6714 BB	0 451 103 290	P 3290

95VW 9155 BA	0 450 905 264	F 5264
95VW 9601 BC	1 457 433 742	S 3742
95VW 9601 DA	1 457 433 742	S 3742
957E 6731 A	1 457 429 117	P 9117
96FJ 19G244-AA	1 987 432 306	R 2306

96FW 16N619 AB	1 987 432 306	R 2306
96FW 19G244-AA	1 987 432 306	R 2306
96MF 9601 AB	1 457 433 605	S 3605
9613320	0 451 103 316	P 3316
9613320	0 986 452 016	P 2016

9613320	0 986 452 061	P 2061
9613324	0 451 203 194	P 3194
9613330	0 451 103 029	P 3029
9613330	0 451 104 065	P 4065
9613330	0 451 203 005	P 3005

9613330	0 451 203 194	P 3194
9613330	0 986 452 000	P 2000
9613330	0 986 452 005	P 2005
9641789680	0 450 906 460	N 6460
9646231080	0 450 906 460	N 6460

97FF 9176 AA	1 457 434 400	N 4400
97FF 9176 AB	1 457 434 400	N 4400
97KB 9601 AB	1 457 433 268	S 3268
97KX 9601 AB	1 457 433 268	S 3268
97VB 9601 AA	1 457 433 792	S 3792

97VW 6714 AA	0 451 103 290	P 3290
98AB 9601 CB	1 457 433 686	S 3686
98AX 9601 AA	1 457 433 686	S 3686

FRAM

CAK1544	1 457 429 794	S 9794
CAK253	1 457 429 933	S 9933
CAK256	1 457 433 200	S 3200

CAK3272	1 457 433 201	S 3201
CAK5722	1 987 429 186	S 9186
CA2740	1 457 429 806	S 9806
CA3105	1 457 429 932	S 9932
CA3118	1 457 429 959	S 9959

CA3144	1 457 429 030	S 9030
CA3245	1 987 429 117	S 9117
CA3249	1 457 429 942	S 9942
CA3276	1 457 429 966	S 9966
CA3280	1 457 429 975	S 9975

CA3281	1 457 429 950	S 9950
CA3399	1 457 429 061	S 9061
CA3441	1 457 429 957	S 9957
CA3353	1 457 429 801	S 9801
CA3688	1 457 433 734	S 3734

CA376	1 457 433 534	S 3534
CA4202	1 457 429 946	S 9946
CA4275	1 457 429 993	S 9993
CA4335	1 457 429 992	S 9992
CA4521	1 457 429 928	S 9928

CA4732	1 987 429 121	S 9121
CA4877	1 457 429 954	S 9954
CA4904	1 987 429 042	S 9042/1
CA4940	1 987 429 122	S 9122
CA5149	1 457 429 869	S 9869

CA5207	1 987 429 150	S 9150
CA5279	1 987 429 148	S 9148
CA5345	1 457 433 795	S 3795
CA5371	1 457 433 003	S 3003
CA5400	1 457 433 007	S 3007

CA5417	1 457 429 787	S 9787
CA5445	1 457 433 072	S 3072
CA5451	1 457 433 651	S 3651
CA5496	1 457 433 603	S 3603
CA5560	1 457 433 607	S 3607

CA5627	1 457 433 303	S 3303
CA5641	1 457 433 697	S 3697
CA5748	1 457 433 274	S 3274
CA5761	1 457 433 900	S 3900
CA5880	1 457 433 699	S 3699

CA5967	1 987 429 157	S 9157
CA6541	1 457 433 605	S 3605
CA6544	1 987 429 133	S 9133
CA7246	1 457 429 814	S 9814
CA7417	1 987 429 162	S 9162

CA7440	F 026 400 004	S 0004
CA7775	1 457 433 290	S 3290
CA8162	1 457 433 073	S 3073
CA9015	1 457 433 059	S 3059
CA9391	1 457 433 055	S 3055

CH2801	1 457 429 413	P 9413
CH956	1 457 429 130	P 9130
G121	0 450 904 163	F 4163
PH13	0 451 104 064	P 4064
PH16	0 986 452 003	P 2003

PH20	0 451 104 005	P 4005
PH2821	0 451 203 194	P 3194
PH2871A	0 451 103 316	P 3316
PH2879	0 986 452 003	P 2003
PH2954	0 986 452 019	P 2019

PH3531B	0 986 452 015	P 2015
PH3562	0 986 452 016	P 2016
PH3569	0 451 104 065	P 4065
PH3682	0 986 452 023	P 2023
PH4386	0 451 103 276	P 3276

PH4738	0 986 452 024	P 2024
PH4832	0 986 452 000	P 2000
PH4967	0 986 452 028	P 2028
PH4985	0 986 452 044	P 2044
PH4997	0 986 452 058	P 2058

PH4998	0 986 452 061	P 2061
PH5123	0 986 452 062	P 2062
PH5124	0 986 452 030	P 2030
PH5126	0 986 452 046	P 2046
PH5166	0 986 452 060	P 2060

PH5190	0 986 452 064	P 2064
PH5472	0 451 203 002	P 3002
PH5529	0 986 452 063	P 2063
PH5717	0 451 103 341	P 3341
PH5913	0 986 452 066	P 2066

PH6355	0 986 452 042	P 2042
PH9566	0 986 452 068	P 2068
P3828	0 451 103 270	P 3270
P4922	1 457 434 438	N 4438

FREIGHTLINER

ABPN10GLF3393	0 451 301 156	P 1156
ABP/N10G-LF3675	F 026 407 043	P 7043
ABPN10GLF699	0 451 203 010	P 3010

**GMC
(GENERAL MOTORS CORP.)**

M39681	0 986 452 023	P 2023
VFF516	0 450 905 273	F 5273



07984544	0 450 904 058	F 4058	25010849	0 986 452 061	P 2061	25041167	1 457 429 900	S 9900
09200067	1 987 432 091	M 2091	25010850	0 986 452 061	P 2061	25041187	1 457 429 080	S 9080
09207486	1 987 432 066	M 2066	25011124	0 451 104 066	P 4066	25041231	1 457 429 085	S 9085
10318557	1 457 433 056	S 3056	25011131	0 451 203 194	P 3194	25041936	1 457 429 950	S 9950
10354942	1 457 433 056	S 3056	25011187	0 451 300 003	P 0003	25041956	1 457 429 950	S 9950
12337284	0 986 450 018	F 0018	25011188	0 451 300 003	P 0003	25043194	1 457 429 801	S 9801
12337452	1 987 429 125	S 9125	25011240	1 457 434 154	N 4154	25043775	1 987 429 051	S 9051
12337526	1 457 429 964	S 9964	25011243	0 451 103 290	P 3290	25055002	0 986 450 117	F 0117
12339993	0 451 103 276	P 3276	25011243	0 451 103 346	P 3346	25055073	0 986 450 117	F 0117
12339993	0 986 452 044	P 2044	25011243	0 451 104 065	P 4065	25055107	0 986 450 138	F 0138
12339993	0 986 452 060	P 2060	25011243	0 451 203 223	P 3223	25055121	0 450 905 016	F 5016
12339994	0 986 452 023	P 2023	25011243	0 986 452 005	P 2005	25055121	0 450 905 021	F 5021
12339994	0 986 452 035	P 2035	25011293	0 451 103 141	P 3141	25055182	0 450 904 058	F 4058
12339995	0 986 452 019	P 2019	25011296	0 986 452 015	P 2015	25055182	0 450 904 060	F 4060
12339995	0 986 452 028	P 2028	25011354	0 986 452 020	P 2020	25055184	0 450 904 077	N 4077
12339995	0 986 452 058	P 2058	25011354	0 986 452 061	P 2061	25055188	0 986 450 018	F 0018
12351012	0 986 450 102	F 0102	25011416	0 451 203 002	P 3002	25055223	0 450 904 058	F 4058
12482805	1 457 433 056	S 3056	25011416	0 451 203 226	P 3226	25055223	0 450 904 149	F 4149
12489487	1 987 432 052	M 2052	25011441	0 451 103 270	P 3270	25055280	0 450 904 158	N 4158
12565752	1 457 433 056	S 3056	25011441	0 986 452 020	P 2020	25055339	0 450 904 158	N 4158
12582255	0 986 452 061	P 2061	25011520	0 451 103 004	P 3004	25055360	0 450 904 058	F 4058
13230386	F 026 402 051	N 2051	25011520	0 451 103 141	P 3141	25055360	0 450 904 149	F 4149
13235540	F 026 402 054	N 2054	25011520	0 986 452 019	P 2019	25055364	1 457 429 230	N 9230
13240032	0 986 450 508	N 0508	25011520	0 986 452 028	P 2028	25055364	1 457 431 261	N 1261
13240032	1 457 434 453	N 4453	25011520	0 986 452 035	P 2035	25055419	0 450 905 985	F 5985
13271043	F 026 400 012	S 0012	25011520	0 986 452 044	P 2044	25055420	0 450 905 203	F 5203
13271190	1 987 432 004	M 2004	25011520	0 986 452 058	P 2058	25055421	0 450 905 177	F 5177
13271191	1 987 432 304	R 2304	25011520	0 986 452 062	P 2062	25055423	0 450 905 005	F 5005
1531787	1 457 429 117	P 9117	25011520	0 986 452 068	P 2068	25055425	0 450 905 145	F 5145
15587320	0 451 300 003	P 0003	25011623	0 986 452 000	P 2000	25055425	0 450 905 200	F 5200
1570158	1 457 429 175	P 9175	25011623	0 986 452 023	P 2023	25055425	0 450 905 601	F 5601
1595109	1 457 429 165	P 9165	25012352	0 451 103 270	P 3270	25055425	0 450 905 964	F 5964
1595131	1 457 429 165	P 9165	25012564	0 451 104 066	P 4066	25055427	0 450 905 143	F 5143
1595178	1 457 429 175	P 9175	25012645	0 451 203 002	P 3002	25055428	0 450 905 087	F 5087
1595222	1 457 429 175	P 9175	25012645	0 451 203 226	P 3226	25055428	0 450 905 401	F 5401
1595318	1 457 429 175	P 9175	25012645	1 457 431 270	N 1270	25055428	0 450 905 906	F 5906
1595394	1 457 429 175	P 9175	25012648	0 451 103 029	P 3029	25055479	0 986 450 117	F 0117
1595410	1 457 429 175	P 9175	25012648	0 451 103 221	P 3221	25055495	0 450 905 030	F 5030
1595500	1 457 429 175	P 9175	25012648	0 986 452 003	P 2003	25055495	0 450 905 264	F 5264
1595501	1 457 429 175	P 9175	25013032	0 451 103 316	P 3316	25055495	0 450 905 275	F 5275
1595505	1 457 429 175	P 9175	25013032	0 986 452 016	P 2016	25055660	0 986 450 117	F 0117
1595509	1 457 429 165	P 9165	25013075	0 986 452 024	P 2024	25055673	0 986 450 039	F 0039
1595898	1 457 429 175	P 9175	25013196	0 451 104 010	P 4010	25055857	0 450 905 955	F 5955
1595978	1 457 429 175	P 9175	25013196	0 451 403 077	P 3077	25055862	0 450 905 912	F 5912
1808602	1 987 432 091	M 2091	25013414	1 457 434 456	N 4456	25055862	0 450 905 972	F 5972
2054371	0 451 300 003	P 0003	25013451	0 451 103 316	P 3316	25055863	0 450 905 912	F 5912
2054377	0 451 300 003	P 0003	25013451	0 986 452 016	P 2016	25055863	0 450 905 972	F 5972
2244061	1 457 429 175	P 9175	25013451	0 986 452 061	P 2061	25062038	1 457 429 875	S 9875
23518672	0 451 300 003	P 0003	25014155	0 451 103 270	P 3270	25062071	1 457 429 877	S 9877
24437415	1 457 433 771	S 3771	25014155	0 986 452 020	P 2020	25062072	1 457 433 310	S 3310
25010441	0 451 104 065	P 4065	25014441	0 986 452 023	P 2023	25062204	1 457 429 992	S 9992
25010543	0 451 104 065	P 4065	25014441	0 986 452 028	P 2028	25062205	1 457 429 080	S 9080
25010638	0 451 203 002	P 3002	25041032	1 457 429 076	S 9076	25062206	1 457 429 988	S 9988
25010638	0 451 203 226	P 3226	25041032	1 457 429 994	S 9994	25062209	1 457 429 964	S 9964
25010638	1 457 431 270	N 1270	25041165	1 457 429 993	S 9993	25062211	1 457 432 154	S 2154



◀ GMC

25062222	1 457 433 652	S 3652
25062235	1 457 429 898	S 9898
25062266	1 457 429 844	S 9844
25062270	1 457 429 844	S 9844
25062299	1 457 432 204	S 2204

25062320	1 987 429 051	S 9051
25062398	1 457 433 003	S 3003
25062406	1 457 429 877	S 9877
25062409	1 457 433 065	S 3065
25062434	1 457 433 007	S 3007

25062467	1 457 433 007	S 3007
25062500	1 457 432 150	S 2150
25067018	0 451 103 217	P 3217
25067078	0 986 450 108	F 0108
25067130	0 450 904 058	F 4058

25067160	1 457 429 154	P 9154
25067293	0 986 452 064	P 2064
25067335	1 457 434 438	N 4438
25067344	0 986 450 117	F 0117
25069001	1 457 432 183	S 2183

25069012	1 457 433 603	S 3603
25095837	1 457 433 734	S 3734
25096099	1 457 429 957	S 9957
25096100	1 457 429 957	S 9957
25096105	1 457 429 080	S 9080

25096210	1 987 429 109	S 9109
25096891	1 987 429 123	S 9123
25097002	1 457 429 818	S 9818
25097184	1 987 429 117	S 9117
25097239	1 457 429 898	S 9898

25098522	1 987 429 135	S 9135
25099116	1 987 429 135	S 9135
25099149	1 457 433 056	S 3056
25099245	1 987 429 127	S 9127
25099249	1 457 433 785	S 3785

25099417	1 457 429 970	S 9970
25099421	1 457 429 777	S 9777
25121082	0 450 905 273	F 5273
25121082	0 450 905 316	F 5316
25121129	0 450 905 273	F 5273

25121129	0 450 905 316	F 5316
25121130	0 986 450 119	F 0119
25121141	0 450 905 911	F 5911
25121150	0 450 905 911	F 5911
25121160	0 450 905 911	F 5911

25121353	0 450 905 273	F 5273
25121353	0 450 905 316	F 5316
25121548	0 986 450 124	F 0124
25121585	0 450 902 162	F 2162
25121587	0 986 450 109	F 0109

25121600	0 450 905 326	F 5326
25121602	0 450 905 963	F 5963
25121604	0 986 450 100	F 0100
25121655	0 986 450 124	F 0124
25121673	0 986 450 119	F 0119

25121741	0 986 450 119	F 0119
25121757	0 986 450 110	F 0110
25121778	0 450 905 002	F 5002
25121778	0 450 905 280	F 5280
25121778	0 450 905 326	F 5326

25121792	0 986 450 119	F 0119
25121914	0 986 450 119	F 0119
25121915	0 986 450 119	F 0119
25121974	0 450 905 280	F 5280
25147112	1 457 433 950	S 3950

25147120	1 987 429 146	S 9146
25160729	0 450 905 273	F 5273
25161880	0 986 452 019	P 2019
25161880	0 986 452 028	P 2028
25161880	0 986 452 058	P 2058

25161891	0 986 450 018	F 0018
25161892	0 986 450 138	F 0138
25162815	0 451 103 029	P 3029
25162815	0 451 104 065	P 4065
25162815	0 451 203 005	P 3005

25162815	0 451 203 194	P 3194
25162815	0 986 452 000	P 2000
25162815	0 986 452 005	P 2005
25171109	0 986 450 119	F 0119
25171792	0 986 450 119	F 0119

25171959	0 986 452 019	P 2019
25171959	0 986 452 061	P 2061
25175337	1 457 429 786	S 9786
25175534	0 450 905 912	F 5912
25175535	0 986 450 604	F 0604

25175538	0 986 450 111	F 0111
25175539	0 986 450 108	F 0108
25175541	0 986 450 114	F 0114
25175544	0 986 450 137	F 0137
25175546	0 986 450 108	F 0108

25175553	0 986 450 123	F 0123
25175556	0 986 450 104	F 0104
25175574	0 450 905 912	F 5912
25175575	0 986 450 604	F 0604
25175582	0 986 450 123	F 0123

25176272	0 450 904 158	N 4158
25176275	0 986 450 104	F 0104
25176280	0 450 905 914	F 5914
25176280	0 986 450 113	F 0113
25176289	0 450 905 929	F 5929

25176294	0 450 905 326	F 5326
25176295	0 450 905 326	F 5326
25176297	0 450 905 912	F 5912
25176297	0 450 905 972	F 5972
25176298	0 450 905 002	F 5002

25176298	0 450 905 280	F 5280
25176298	0 450 905 326	F 5326
25176299	0 450 905 971	F 5971
25176322	0 450 905 195	F 5195
25176322	0 450 905 216	F 5216

25176324	0 450 905 916	F 5916
25177077	1 457 433 752	S 3752
25311968	1 457 433 274	S 3274
25311969	1 457 433 955	S 3955
25311970	1 457 433 956	S 3956

25313359	0 450 905 273	F 5273
25313795	1 457 433 073	S 3073
25313803	0 986 450 624	F 0624
25313807	0 450 905 915	F 5915
25313809	0 986 450 221	F 0221

25313811	0 986 450 221	F 0221
25313816	0 450 905 920	F 5920
25313818	0 986 450 107	F 0107
25313865	1 457 433 263	S 3263
25750701	1 457 433 008	S 3008

3694839	1 457 429 175	P 9175
3714215	1 457 429 175	P 9175
4301497	1 987 429 154	S 9154
4402614	1 457 433 531	S 3531
4411236	1 457 429 198	P 9198

4506039	1 457 429 198	P 9198
5181127	1 457 429 175	P 9175
52420930	1 987 432 304	R 2304
52425938	1 987 432 004	M 2004
5266845	0 451 300 003	P 0003

5372288	1 457 429 175	P 9175
5570092	1 457 429 175	P 9175
5570097	1 457 429 175	P 9175
5570098	1 457 429 175	P 9175
5570141	1 457 429 175	P 9175

5570142	1 457 429 175	P 9175
5570143	1 457 429 175	P 9175
5570151	1 457 429 175	P 9175
55702468	1 987 432 488	R 2488
5571343	1 457 429 175	P 9175

5571503	1 457 429 175	P 9175
5571504	1 457 429 175	P 9175
5571742	1 457 429 175	P 9175
5571792	1 457 429 175	P 9175
5572270	1 457 429 175	P 9175

5572288	1 457 429 175	P 9175
5572435	1 457 429 175	P 9175
5572472	1 457 429 175	P 9175
5572504	1 457 429 175	P 9175
5572509	1 457 429 165	P 9165

5572748	1 457 429 165	P 9165
5572941	1 457 429 175	P 9175
5573052	0 451 104 064	P 4064
5573136	1 457 429 175	P 9175
5573218	1 457 429 175	P 9175

5573221	1 457 429 175	P 9175
5573241	1 457 429 175	P 9175
5573332	1 457 429 175	P 9175
5573353	1 457 429 175	P 9175
5573607	1 457 429 175	P 9175



5573664	1 457 429 175	P 9175	7973411	0 450 904 058	F 4058	90027967	1 457 433 065	S 3065
5573898	F 026 407 054	P 7054	7984153	0 451 103 141	P 3141	90220955	1 457 429 877	S 9877
5574904	1 457 429 175	P 9175	7984225	0 451 103 274	P 3274	90220970	1 457 433 310	S 3310
5575412	1 457 429 175	P 9175	7984229	0 451 104 065	P 4065	9022896	F 026 407 054	P 7054
5575840	0 451 203 005	P 3005	7984283	1 457 429 117	P 9117	90284766	1 457 433 310	S 3310
5576138	1 457 429 175	P 9175	7984298	1 457 431 158	N 1158	90323083	1 457 429 844	S 9844
5576139	1 457 429 175	P 9175	7984299	1 457 429 230	N 9230	90325205	1 457 429 898	S 9898
5576148	F 026 407 054	P 7054	7984299	1 457 431 261	N 1261	90351529	1 457 433 007	S 3007
5576797	1 457 429 175	P 9175	7984299	1 457 431 325	N 1325	90351530	1 457 433 007	S 3007
5578052	0 451 104 064	P 4064	7984303	0 451 104 065	P 4065	90360171	1 987 432 091	M 2091
5578077	0 451 104 064	P 4064	7984326	0 986 452 023	P 2023	90360171	1 987 432 166	M 2166
5578085	0 451 104 064	P 4064	7984347	1 457 431 159	N 1159	90383627	1 987 432 091	M 2091
5578108	0 451 104 064	P 4064	7984348	1 457 431 270	N 1270	90411732	1 457 433 603	S 3603
5579164	0 451 103 274	P 3274	7984366	0 451 103 274	P 3274	90412779	1 457 433 603	S 3603
5579574	1 457 434 296	N 4296	7984418	1 457 429 175	P 9175	90443101	1 457 433 007	S 3007
5579920	0 451 103 062	P 3062	7984460	0 451 103 253	P 3253	90443102	1 457 433 007	S 3007
5579920	0 451 104 065	P 4065	7984460	0 451 104 065	P 4065	90448737	1 457 433 571	S 3571
5579970	0 451 104 065	P 4065	7984473	0 451 203 002	P 3002	90448738	1 457 433 571	S 3571
5650170	0 450 904 058	F 4058	7984543	0 450 904 058	F 4058	90469336	1 457 433 713	S 3713
5650718	0 450 904 058	F 4058	7984544	0 450 904 058	F 4058	90469412	1 457 433 571	S 3571
5650718	0 450 904 149	F 4149	7984550	0 451 103 141	P 3141	9047626	F 026 407 054	P 7054
5651290	0 450 904 058	F 4058	7984655	0 451 203 005	P 3005	90486282	1 987 432 091	M 2091
5651290	0 450 904 149	F 4149	7984717	0 451 203 010	P 3010	90486282	1 987 432 166	M 2166
5651673	0 450 904 058	F 4058	7984778	0 451 103 029	P 3029	90486295	1 457 433 713	S 3713
5651673	0 450 904 060	F 4060	7984778	0 986 452 000	P 2000	90486296	1 457 433 603	S 3603
5651676	0 450 904 058	F 4058	7984781	1 457 434 200	N 4200	90487526	1 457 429 898	S 9898
5651676	0 450 904 149	F 4149	7984844	0 451 103 253	P 3253	90499589	1 457 429 994	S 9994
5651765	0 450 904 058	F 4058	7984844	0 451 104 065	P 4065	90499601	1 457 433 771	S 3771
5651765	0 450 904 149	F 4149	7984864	0 451 105 067	P 5067	90502200	1 457 433 741	S 3741
5651767	0 450 904 058	F 4058	7984864	0 451 105 188	P 5188	90510292	1 457 433 571	S 3571
5651767	0 450 904 060	F 4060	7984864	0 451 203 010	P 3010	90510293	1 457 433 571	S 3571
5651775	0 986 450 138	F 0138	7984867	1 457 434 432	N 4432	90510934	0 451 103 297	P 3297
5651945	0 986 450 117	F 0117	7984871	1 457 429 413	P 9413	90510935	0 451 103 297	P 3297
6424688	1 457 433 200	S 3200	7984874	1 457 431 028	N 1028	90512444	1 457 429 994	S 9994
6435087	1 457 429 117	P 9117	7984903	1 457 429 676	N 9676	90512448	1 457 433 571	S 3571
6435477	1 457 431 159	N 1159	7984919	0 451 203 152	P 3152	90528818	1 457 433 571	S 3571
6435679	0 451 104 064	P 4064	7984937	0 451 103 232	P 3232	90540600	1 457 433 771	S 3771
6436383	0 451 104 005	P 4005	7984943	1 457 429 740	P 9740	90540602	1 457 433 771	S 3771
6437055	0 451 104 064	P 4064	7987980	1 457 432 108	S 2108	905406600	1 457 433 771	S 3771
6437553	F 026 407 054	P 7054	7988016	1 457 432 106	S 2106	90541322	1 457 433 054	S 3054
6437946	0 451 104 064	P 4064	7988085	1 457 433 732	S 3732	90542912	1 457 429 656	N 9656
6437968	0 451 104 005	P 4005	7998336	1 457 429 050	S 9050	90543111	1 457 433 771	S 3771
6438121	0 451 104 065	P 4065	7998336	1 457 429 959	S 9959	90544191	1 457 429 157	P 9157
6438261	0 451 104 064	P 4064	7998389	1 457 429 900	S 9900	90570363	1 457 433 054	S 3054
6438384	0 451 104 064	P 4064	7998710	1 457 429 053	S 9053	90590568	1 987 432 091	M 2091
6439143	0 451 103 028	P 3028	7998970	1 457 433 200	S 3200	9110614	1 457 433 531	S 3531
6439392	0 451 403 001	P 3001	813231	1 457 429 050	S 9050	9110665	0 451 203 201	P 3201
649011	0 451 103 316	P 3316	834581	1 457 433 603	S 3603	91149684	1 457 433 571	S 3571
6808600	1 987 432 166	M 2166	834619	1 457 433 054	S 3054	91159804	0 450 905 287	F 5287
7753221	1 457 429 175	P 9175	835614	1 457 433 799	S 3799	91159955	1 457 433 529	S 3529
7961094	1 457 429 117	P 9117	835621	1 457 433 056	S 3056	91160128	1 987 432 208	M 2208
7965458	1 457 429 230	N 9230	8994450	1 457 429 794	S 9794	91168237	F 026 400 103	S 0103
7965458	1 457 431 261	N 1261	8994643	1 457 429 794	S 9794	9117321	1 457 429 157	P 9157
7965458	1 457 431 325	N 1325	8994746	1 457 433 200	S 3200	91559804	0 450 905 287	F 5287
7965460	1 457 431 158	N 1158	90016800	1 457 434 106	N 4106	9161303	1 457 431 705	N 1705



◀ GMC

9177267	1 457 433 579	S 3579
9194405	F 026 400 012	S 0012
9194405	1 457 433 079	S 3079
9200067	1 987 432 091	M 2091
9200067	1 987 432 166	M 2166

9201435	1 457 429 198	P 9198
9202382	F 026 400 012	S 0012
9266281	0 450 906 451	N 6451
93152072	1 457 433 065	S 3065
93152793	1 457 433 065	S 3065

93156291	0 451 103 252	P 3252
93156304	0 451 203 005	P 3005
93156363	0 451 103 253	P 3253
93156390	0 451 203 005	P 3005
93156490	0 450 904 058	F 4058

93156542	0 451 203 108	P 3108
93156575	0 451 103 217	P 3217
93156614	1 457 429 274	P 9274
93156615	1 457 429 820	P 9820
93156634	1 457 434 453	N 4453

93156663	0 986 452 000	P 2000
93156668	0 986 452 023	P 2023
9315669	0 986 452 024	P 2024
93156770	0 986 452 035	P 2035
93156782	0 450 904 058	F 4058

93156943	1 457 434 453	N 4453
93156952	0 451 203 005	P 3005
93160660	F 026 400 103	S 0103
93160736	1 457 431 724	N 1724
93161121	F 026 402 047	N 2047

93161665	F 026 407 014	P 7014
93172272	1 457 429 118	P 9118
93172461	1 457 433 579	S 3579
93172463	1 457 433 578	S 3578
93180094	1 457 433 054	S 3054

93180258	1 457 429 271	P 9271
93182435	1 987 432 091	M 2091
93182435	1 987 432 166	M 2166
93183040	1 457 433 056	S 3056
93183412	1 457 429 248	P 9248

93185390	1 457 429 656	N 9656
93185604	1 457 429 656	N 9656
93187281	F 026 400 014	S 0014
93187335	1 457 433 531	S 3531
93189375	F 026 402 054	N 2054

93190777	1 457 429 199	P 9199
93190796	F 026 402 051	N 2051
93191747	F 026 407 087	P 7087
93193705	0 986 452 058	P 2058
93194847	1 987 432 214	M 2214

935824	1 457 433 079	S 3079
93856649	F 026 400 103	S 0103
93891826	1 457 429 994	S 9994
93892081	1 457 432 174	S 2174
93892086	1 457 432 134	S 2134

93892087	1 457 429 080	S 9080
93892092	1 457 429 928	S 9928
94107744	0 450 904 158	N 4158
94244456	1 457 434 453	N 4453
94248070	1 457 434 453	N 4453

94376353	1 457 433 952	S 3952
94382063	1 987 429 154	S 9154
94455838	1 457 429 894	S 9894
94847597	0 986 450 110	F 0110
94854916	0 986 450 115	F 0115

96055471	1 457 433 785	S 3785
96058022	0 986 450 109	F 0109
96565412	0 986 452 058	P 2058
96570765	0 986 452 058	P 2058
97021576	0 986 452 064	P 2064

97223218	1 457 429 199	P 9199
9974119	1 457 429 080	S 9080
9974133	1 457 429 941	S 9941
9974287	1 457 429 801	S 9801
9974323	1 457 433 732	S 3732

9974375	1 457 432 111	S 2111
9974620	1 457 433 652	S 3652
9974788	1 457 429 030	S 9030
9974791	1 457 429 085	S 9085
9974793	1 457 429 957	S 9957

9974851	1 457 432 124	S 2124
9975120	0 451 103 029	P 3029
9975153	0 451 203 005	P 3005
99752227	0 986 452 023	P 2023
9975227	0 986 452 024	P 2024

9975264	1 457 431 159	N 1159
---------	---------------	---------------

HOLDEN

M3 954 1	0 986 452 023	P 2023
M3 959 4	0 986 452 023	P 2023
M3 975 2	1 987 429 051	S 9051

15 601 030 10	0 986 452 028	P 2028
1651061A20	0 451 103 276	P 3276
16 546 180 00	1 457 429 801	S 9801
17 801 030 20	1 987 429 151	S 9151
17 801 150 60	1 987 429 133	S 9133

17 801 740 40	1 987 429 123	S 9123
23300-YA010	0 450 904 058	F 4058
23 300 793 05	0 986 450 604	F 0604
25 121 113	0 450 905 002	F 5002
25 161 249	0 450 905 002	F 5002

25 161 333	0 450 905 273	F 5273
25 170 650	0 450 905 002	F 5002
25 170 650	0 450 905 030	F 5030
25 313 359	0 450 905 273	F 5273
6438261	0 451 104 064	P 4064

82 505 536 40	0 450 905 002	F 5002
89 410 774 40	0 450 904 158	N 4158
90 016 571	0 450 905 030	F 5030
90 486 296	1 457 433 603	S 3603
90 512 446	1 457 433 740	S 3740

90 541 322	1 457 433 603	S 3603
90 541 474	1 457 433 087	S 3087
90 915 030 01	0 986 452 028	P 2028
90 915 100 01	0 986 452 028	P 2028
92 017 109	0 450 905 030	F 5030

92 019 306	0 450 905 002	F 5002
92 019 306	0 450 905 030	F 5030
92 035 349	0 450 905 030	F 5030
92 041 796	1 987 429 051	S 9051
92 059 409	0 450 905 273	F 5273

92 121 113	0 450 905 002	F 5002
------------	---------------	---------------

HYUNDAI

OK52A 23570A	0 450 906 508	N 6508
26300 02500	0 986 452 061	P 2061
26300 02501	0 986 452 061	P 2061

26300 02750	F 026 407 025	P 7025
26300 11100	0 986 452 016	P 2016
26300-11200	0 451 103 316	P 3316
26300-11200	0 986 452 016	P 2016
26300 21A00	0 451 103 316	P 3316

26300 21010	0 986 452 016	P 2016
26300 21020	0 451 103 316	P 3316
26300-21100	0 451 103 316	P 3316
26300-21100	0 986 452 016	P 2016
26300-21100	0 986 452 061	P 2061

2630035A00	0 451 103 316	P 3316
26300-35004	0 451 103 316	P 3316
26300-35004	0 986 452 016	P 2016
26300-35004	0 986 452 061	P 2061
26300 35054	0 451 103 316	P 3316

26300 35056	0 451 103 316	P 3316
26300 35500	0 451 103 316	P 3316
26300 35501	0 451 103 316	P 3316
26300 35502	0 451 103 316	P 3316
2630035503	0 451 103 316	P 3316

26300 42000	0 986 452 066	P 2066
26300 42010	0 986 452 066	P 2066
26300 42020	0 986 452 066	P 2066
2630042030	0 451 103 366	P 3366
26300 42040	0 451 103 366	P 3366

26300 42060	0 451 103 366	P 3366
26310 27000	F 026 407 069	P 7069
26310 27100	F 026 407 061	P 7061
26310 27200	F 026 407 018	P 7018
2631027200AR	F 026 407 018	P 7018



26310 27400	F 026 407 061	P 7061
26310-4A000	F 026 407 084	P 7084
26310-4A010	F 026 407 084	P 7084
26316 27000	F 026 407 069	P 7069
26320-2A000	F 026 407 062	P 7062

26320-2A001	F 026 407 062	P 7062
26320-2A002	F 026 407 062	P 7062
26320 27000	F 026 407 069	P 7069
26320 27100	1 457 429 308	P 9308
26320 27400	F 026 407 061	P 7061

26600 35500	0 451 103 316	P 3316
28113 H1915	1 457 433 580	S 3580
281130X000	F 026 400 127	S 0127
28113 02510	1 987 429 167	S 9167
28113 08000	F 026 400 044	S 0044

28113 1C000	1 457 433 097	S 3097
28113 1C500	F 026 400 016	S 0016
28113-1G100	F 026 400 093	S 0093
28113 1J000	F 026 400 137	S 0137
28113-11010	1 457 429 800	S 9800

28113-11010	1 457 429 801	S 9801
28113 17500	1 457 433 584	S 3584
281132B000	F 026 400 091	S 0091
281132H000	F 026 400 063	S 0063
28113-21330	1 987 429 121	S 9121

28113-21330	1 987 429 127	S 9127
28113 21340	1 987 429 121	S 9121
28113 21340	1 987 429 127	S 9127
28113 22051	1 457 433 290	S 3290
28113 22301	1 457 433 326	S 3326

28113 23001	1 457 433 073	S 3073
28113 24570	1 457 433 314	S 3314
28113 24570	1 987 429 146	S 9146
28113 24580	1 457 433 314	S 3314
28113 25500	F 026 400 062	S 0062

28113 26000	F 026 400 123	S 0123
28113-3K010	F 026 400 212	S 0212
28113 32510	1 987 429 127	S 9127
28113 37101	F 026 400 164	S 0164
281304A001	F 026 400 046	S 0046

2881323001	1 457 433 073	S 3073
31300 3E200	1 457 434 310	N 4310
31390 H1000	1 457 434 453	N 4453
31906 29001	1 457 431 713	N 1713
31910 11000	0 986 450 138	F 0138

31910 11100	0 986 450 138	F 0138
31910 11111	0 986 450 138	F 0138
31910 21100	0 986 450 138	F 0138
31910 21200	0 986 450 138	F 0138
31910 23500	0 986 450 624	F 0624

31910 28000	0 450 905 929	F 5929
31910 28300	0 986 450 111	F 0111
31911 02100	0 986 450 225	F 0225
31911 1A000	0 450 902 161	F 2161
31911 22000	0 986 450 624	F 0624

31911 28000	0 450 905 929	F 5929
31911 29000	0 450 905 915	F 5915
31911 3A000	0 450 905 974	F 5974
31911 3A500	0 450 905 958	F 5958
31911 34000	0 450 905 912	F 5912

31922 17400	1 457 434 443	N 4443
31922 26900	1 457 434 198	N 4198
31962 04010	1 457 434 453	N 4453
31970 26900	1 457 434 198	N 4198
31973 H1000	1 457 434 453	N 4453

31973 44000	1 457 434 453	N 4453
31973 44001	1 457 434 453	N 4453
31973 44100	1 457 434 453	N 4453
31973 44101	1 457 434 453	N 4453
31981 43000	1 457 434 453	N 4453

97133 07010	1 987 432 164	M 2164
971331E000	1 987 432 204	M 2204
971331E100	1 987 432 204	M 2204
97133 2D000	1 987 432 158	M 2158
971332D100	1 987 432 158	M 2158

97133 2E200	1 987 432 170	M 2170
971332G000	1 987 432 160	M 2160
97133-2L000	1 987 432 055	M 2055
971333K000	1 987 432 227	M 2227
97617 1C000	1 987 432 161	M 2161

976193D000	1 987 432 160	M 2160
976193D100	1 987 432 160	M 2160
976193D200	1 987 432 160	M 2160
9999Z07015	1 987 432 158	M 2158
9999Z07017	1 987 432 161	M 2161

ISUZU

0-28680-616-0	0 450 905 002	F 5002
0-28680-616-0	0 450 905 280	F 5280
0-28680-616-0	0 450 905 326	F 5326

1-13240-067-0	0 451 300 003	P 0003
1-14215-135-0	1 457 429 933	S 9933
13002B 181 0	1 457 429 950	S 9950
13240017	0 986 452 000	P 2000
13240 08 0	0 451 103 029	P 3029

14215 13 7	1 987 429 117	S 9117
2-94456-641-0	0 451 103 316	P 3316
2-94456-641-0	0 986 452 016	P 2016
2-94456-641-0	0 986 452 061	P 2061
2-97182-282-0	0 451 104 065	P 4065

5132400170	0 986 452 000	P 2000
5132400320	1 457 434 453	N 4453
5-13240-093-0	0 986 452 023	P 2023
5-13240-093-0	0 986 452 035	P 2035
5-14150-030-0	1 457 429 800	S 9800

5-14215-003-0	1 457 429 800	S 9800
5-14215-023-1	1 457 433 971	S 3971
5-14250-003-0	1 457 429 800	S 9800
5-14250-003-0	1 457 429 801	S 9801
5-15215-023-0	1 457 433 971	S 3971

5860001790	0 451 103 316	P 3316
5860001800	0 451 103 316	P 3316
5861024060	0 986 452 023	P 2023
5861024080	0 986 452 046	P 2046
5-86202-200-0	0 451 103 316	P 3316

5-86202-200-0	0 986 452 016	P 2016
5-86202-200-0	0 986 452 061	P 2061
5-86202-208-0	0 450 905 916	F 5916
6-11070-620-1	1 457 431 270	N 1270
6-11070-620-1	1 457 431 326	N 1326

6-11070-620-2	1 457 431 270	N 1270
6-11070-620-2	1 457 431 326	N 1326
6-11073-613-0	1 457 431 270	N 1270
6-11073-613-0	1 457 431 326	N 1326
8-25055-052-0	0 986 450 119	F 0119

8-25055-129-0	0 986 450 119	F 0119
8-25121-074-0	0 450 905 273	F 5273
8-25121-074-0	0 450 905 316	F 5316
8-25121-150-0	0 450 905 911	F 5911
8-25121-160-0	0 450 905 911	F 5911

8-25121-778-0	0 450 905 002	F 5002
8-25121-778-0	0 450 905 280	F 5280
8-25121-778-0	0 450 905 326	F 5326
8 4455 38	1 457 429 894	S 9894
8 8511 16 1	0 451 103 029	P 3029

8 8513 10 6	0 451 103 029	P 3029
8931566340	1 457 434 453	N 4453
8-93156-998-0	0 451 103 316	P 3316
8-93156-998-0	0 986 452 016	P 2016
8-93156-998-0	0 986 452 061	P 2061

8-94022-620-0	0 986 452 000	P 2000
8-94022-620-0	0 986 452 023	P 2023
8-94023-905-0	1 457 429 800	S 9800
8-94023-905-0	1 457 429 801	S 9801
8-94107-744-0	0 450 904 158	N 4158

8-94107-744-8	0 450 904 158	N 4158
8941110840	0 451 103 316	P 3316
8941214310	1 457 434 453	N 4453
8-94125-784-0	0 450 905 326	F 5326
8-94132-678-0	1 987 429 051	S 9051

8-94151-614-3	1 987 429 051	S 9051
8-94167-398-0	0 986 450 508	N 0508
8-94167-398-0	1 457 434 453	N 4453
8-94167-898-0	0 986 450 508	N 0508
8-94167-898-0	1 457 434 453	N 4453

8-94177-227-0	0 986 450 508	N 0508
8-94177-227-0	1 457 434 453	N 4453
8-94177-327-0	1 457 434 453	N 4453
8 9420 194 2	0 451 103 316	P 3316
8942019422	0 986 452 016	P 2016

8-94201-942-3	0 451 103 316	P 3316
8-94203-536-0	1 457 429 800	S 9800
8-94203-536-1	1 457 429 800	S 9800
8-94203-536-1	1 457 429 801	S 9801
8-94206-007-0	1 457 429 800	S 9800

◀ ISUZU

8-94207-736-0	0986 450 138	F 0138
8-94207-910-1	0986 450 138	F 0138
8-94215-172-0	1 457 429 800	S 9800
8-94215-172-0	1 457 429 801	S 9801
8942387570	1 457 434 453	N 4453

8-94242-502-0	0986 452 016	P 2016
8-94243-270-0	0986 452 016	P 2016
894243 502	0 451 103 316	P 3316
8-94243-502-0	0986 452 016	P 2016
8-94244-455-0	0986 450 508	N 0508

8-94244-455-0	1 457 434 453	N 4453
8-94244-456-0	0986 450 508	N 0508
8-94244-456-0	1 457 434 453	N 4453
8-94248-070-0	1 457 434 453	N 4453
8-94254-241-0	0986 450 508	N 0508

8-94254-241-0	1 457 434 453	N 4453
8-94340-259-0	0 451 103 270	P 3270
8-94340-697-0	0986 452 064	P 2064
8-94340-697-1	0986 452 064	P 2064
8943406980	0986 452 064	P 2064

8-94360-418-1	0986 452 015	P 2015
8-94360-427-0	0986 452 064	P 2064
8943604271	0986 452 064	P 2064
8943692991	1 457 434 453	N 4453
8-94376-353-0	1 457 433 952	S 3952

8-94382-063-0	1 987 429 154	S 9154
8-94389-299-0	0986 450 508	N 0508
8-94389-299-0	1 457 434 453	N 4453
8-94414-778-0	0 451 103 357	P 3357
8-94414-778-0	0986 452 005	P 2005

894430 411	0 451 103 316	P 3316
8-94430-411-1	0 451 103 316	P 3316
8-94430-411-2	0 451 103 316	P 3316
8-94430-411-2	0986 452 016	P 2016
8-94430-411-2	0986 452 061	P 2061

8-94455-838-0	1 457 429 894	S 9894
8-94463-715-0	0986 452 023	P 2023
8-94463-715-0	0986 452 028	P 2028
8-94463-715-1	0986 452 023	P 2023
8-94463-715-1	0986 452 028	P 2028

8944838500	1 457 434 453	N 4453
894511 100	0986 452 016	P 2016
8-97021-576-0	0986 452 064	P 2064
8970353030	1 987 429 162	S 9162
8-97039-002-0	1 987 429 162	S 9162

8970645580	1 987 429 162	S 9162
8-97182-282-0	0 451 104 065	P 4065
8-97223-187-0	1 457 429 199	P 9199
8-97310-472-0	1 457 429 302	P 9302
898018448Y	F 026 407 073	P 7073

9-13240-093-0	0986 452 000	P 2000
9 13240 804 0	0986 452 000	P 2000
9142151350	1 457 429 794	S 9794
9-14215-137-0	1 987 429 117	S 9117
9-14215-137-1	1 987 429 117	S 9117

9-14215-152-1	1 457 429 933	S 9933
9-14215-166-1	1 457 429 794	S 9794
9-14215-172-0	1 457 429 800	S 9800
9142151950	1 457 429 794	S 9794
9-14215-604-0	1 457 429 801	S 9801

93587 56 2	1 987 429 154	S 9154
93601464	1 987 429 162	S 9162
9 4201 942	0 451 103 316	P 3316
9 4203 536	1 457 429 800	S 9800
9 4206 007	1 457 429 800	S 9800

9 4215 007	1 457 429 800	S 9800
9 4360 418	0 451 103 270	P 3270
9-94152-386-0	0 451 103 270	P 3270
9-94152-386-0	0986 452 015	P 2015

IVECO

1160024	0 451 104 005	P 4005
1160024	0 451 104 066	P 4066
1160025	0 451 105 067	P 5067

1160025	0 451 203 010	P 3010
1160033	1 457 431 158	N 1158
1160034	1 457 431 159	N 1159
1160217	1 457 429 230	N 9230
1160217	1 457 431 261	N 1261

1160243	1 457 434 050	N 4050
1160243	1 457 434 432	N 4432
1161934	0 451 203 220	P 3220
1161934	0 451 203 226	P 3226
1164620	1 457 429 675	N 9675

1168407	1 457 431 159	N 1159
1168465	1 457 429 175	P 9175
1173430	0 451 105 067	P 5067
1173430	0 451 203 010	P 3010
1173481	0 451 104 005	P 4005

1173481	0 451 104 066	P 4066
1173765	0 451 403 001	P 3001
1174420	0 451 403 001	P 3001
1265504	1 457 429 946	S 9946
1267900	1 457 429 165	P 9165

1289048	1 457 431 159	N 1159
1289054	1 457 431 270	N 1270
1289054	1 457 431 326	N 1326
1900823	0 451 203 201	P 3201
1901133	1 457 434 432	N 4432

1901602	0 451 203 152	P 3152
1901604	0 451 301 156	P 1156
1901605	1 457 429 681	N 9681
1901629	1 457 434 201	N 4201
1901687	1 457 434 201	N 4201

1901779	1 457 429 975	S 9975
1901780	1 457 429 969	S 9969
1901919	0 451 105 067	P 5067
1901919	0 451 203 010	P 3010
1901925	1 457 429 975	S 9975

1901929	1 457 434 201	N 4201
1902047	0 451 203 201	P 3201
1902048	1 457 429 966	S 9966
1902076	0 451 203 201	P 3201
1902077	1 457 429 950	S 9950

1902101	1 457 429 941	S 9941
190 2102	F 026 407 049	P 7049
1902120	1 457 429 966	S 9966
1902127	1 457 429 946	S 9946
1902129	1 457 429 969	S 9969

1902130	F 026 400 082	S 0082
1902133	1 457 429 675	N 9675
1902134	1 457 434 050	N 4050
1902134	1 457 434 432	N 4432
1902135	0 451 104 005	P 4005

1902135	0 451 104 066	P 4066
1902136	0 451 203 226	P 3226
1902137	1 457 429 820	P 9820
1902138	1 457 434 105	N 4105
1902457	1 457 432 138	S 2138

1902465	1 457 429 966	S 9966
1903628	0 451 203 201	P 3201
190 3629	F 026 407 049	P 7049
1903630	F 026 407 105	P 7105
1903669	1 457 433 332	S 3332

190 3715	F 026 407 049	P 7049
1903785	0 451 203 201	P 3201
1903785	0 451 300 007	P 0007
1904640	1 457 434 432	N 4432
1905704	F 026 407 105	P 7105

1905983	1 457 433 735	S 3735
1907460	F 026 402 035	N 2035
1907539	1 457 434 402	N 4402
1907553	1 457 433 651	S 3651
1907567	0 451 203 152	P 3152

1907570	0 451 301 156	P 1156
1907571	F 026 407 105	P 7105
1907580	0 451 203 201	P 3201
1907581	F 026 407 049	P 7049
1907582	0 451 203 201	P 3201

1907583	0 451 203 201	P 3201
1907584	F 026 407 049	P 7049
1907640	1 457 434 432	N 4432
1907695	F 026 400 077	S 0077
1907695	1 457 433 292	S 3292

1907817	F 026 407 105	P 7105
1908312	1 457 434 154	N 4154
1908312	1 457 434 165	N 4165
1908312	1 457 434 432	N 4432
1908547	1 457 434 402	N 4402

1908868	1 457 433 270	S 3270
1909100	1 457 434 201	N 4201
1909103	1 457 429 681	N 9681
1909113	1 457 431 158	N 1158
1909119	1 457 429 681	N 9681

1909137	0 451 301 156	P 1156	41272515	F 026 400 077	S 0077	7301916	0 451 203 201	P 3201
1909139	1 457 429 933	S 9933	42015789	1 457 429 975	S 9975	7301939	0 451 203 201	P 3201
1909142	1 457 434 105	N 4105	42074972	1 457 434 050	N 4050	7571569	0 451 203 201	P 3201
1930010	1 457 434 105	N 4105	42074972	1 457 434 432	N 4432	7574020	0 450 905 401	F 5401
1930213	0 451 203 201	P 3201	4207829	1 457 429 950	S 9950	7585348	0 450 902 151	F 2151
1930277	1 457 434 200	N 4200	42471161	F 026 400 074	S 0074	7616156	1 457 432 185	S 2185
1930542	F 026 407 049	P 7049	42471166	F 026 400 075	S 0075	7984428	1 457 434 201	N 4201
1930729	1 457 433 201	S 3201	42488361	1 457 429 969	S 9969	8122353	1 457 434 296	N 4296
1930820	1 457 434 432	N 4432	42522761	1 457 429 230	N 9230	8122408	1 457 432 188	S 2188
1930823	0 451 203 201	P 3201	42522761	1 457 431 261	N 1261	8123679	1 457 434 432	N 4432
1930823	0 451 300 007	P 0007	42537127	0 451 104 010	P 4010	93162385	1 987 431 165	M 1165
1930906	F 026 407 049	P 7049	42538923	1 457 434 421	N 4421	98432648	0 451 203 201	P 3201
1930953	1 457 434 432	N 4432	42553256	F 026 400 074	S 0074	98432653	F 026 407 049	P 7049
1931100	F 026 402 035	N 2035	42553257	F 026 400 075	S 0075	98472349	0 451 203 201	P 3201
2133943	1 457 434 105	N 4105	4384509	0 450 904 058	F 4058	9912650	1 457 429 165	P 9165
216 5039	1 457 429 941	S 9941	4435144	0 450 905 002	F 5002	9918114	1 457 434 201	N 4201
2165044	1 457 429 946	S 9946	4442559	0 450 905 030	F 5030	9918144	1 457 434 201	N 4201
2165049	1 457 429 950	S 9950	4621740	1 457 434 201	N 4201	9918184	1 457 434 201	N 4201
2165054	1 457 429 966	S 9966	4667339	0 451 301 156	P 1156	9924318	1 457 434 201	N 4201
2165059	1 457 429 975	S 9975	4667755	0 451 301 156	P 1156	9927604	1 457 429 794	S 9794
2415950	F 026 400 082	S 0082	4694322	1 457 429 681	N 9681	9927846	1 457 429 941	S 9941
27146000	1 457 431 158	N 1158	4764693	1 457 434 154	N 4154	9930450	1 457 431 270	N 1270
2966261	1 457 429 820	P 9820	4764693	1 457 434 165	N 4165	9930450	1 457 431 326	N 1326
2991585	F 026 402 035	N 2035	4764693	1 457 434 432	N 4432	99445200	F 026 407 048	P 7048
299 1785	F 026 400 078	S 0078	4764725	1 457 434 106	N 4106	99478393	1 457 433 332	S 3332
2991785	1 457 433 901	S 3901	4787410	0 451 203 201	P 3201	99484067	F 026 402 035	N 2035
299 1793	F 026 400 079	S 0079	4787733	F 026 407 049	P 7049	9950443	1 457 434 105	N 4105
2992056	1 457 429 165	P 9165	4791113	0 451 203 201	P 3201	9950451	1 457 434 174	N 4174
2992188	F 026 407 053	P 7053	4792138	1 457 434 106	N 4106	9957615	1 457 429 933	S 9933
2992241	F 026 402 030	N 2030	4796458	0 451 203 201	P 3201	9983764	1 457 429 975	S 9975
2992300	1 457 434 310	N 4310	4796458	0 451 300 007	P 0007	9985779	1 457 429 941	S 9941
299 2374	F 026 400 078	S 0078	4799425	0 451 203 201	P 3201			
299 2544	F 026 407 048	P 7048	4799425	0 451 300 007	P 0007			
2992662	F 026 402 036	N 2036	4800107	F 026 407 105	P 7105			
2992677	1 457 433 332	S 3332	4980649	1 457 429 975	S 9975			
2994048	F 026 402 034	N 2034	5001019687	1 457 434 421	N 4421			
2994057	0 451 203 201	P 3201	5001021129	0 451 104 010	P 4010			
2995655	F 026 407 083	P 7083	5003 15480	F 026 402 034	N 2034			
2995811	F 026 407 024	P 7024	500387947	1 987 431 165	M 1165			
2995964	1 987 431 166	M 1166	503136115	0 451 105 188	P 5188			
2995966	1 987 431 165	M 1165	504000160	F 026 400 075	S 0075			
2996126	F 026 400 080	S 0080	504024890	1 987 431 166	M 1166			
2996127	F 026 400 077	S 0077	504026056	F 026 407 048	P 7048			
2996155	F 026 400 078	S 0078	504064501	1 457 433 332	S 3332			
2996156	F 026 400 079	S 0079	504091563	F 026 407 024	P 7024			
2996157	F 026 400 022	S 0022	5801 313604	F 026 400 080	S 0080			
2997050	1 457 433 332	S 3332	5983900	0 451 203 201	P 3201			
2997305	F 026 407 049	P 7049	61142392	1 457 434 050	N 4050			
3799020	1 987 431 165	M 1165	61142392	1 457 434 432	N 4432			
41214148	F 026 400 022	S 0022	61315398	F 026 407 049	P 7049			
41214149	F 026 400 022	S 0022	61315399	F 026 407 049	P 7049			
41270082	F 026 400 080	S 0080	6167116	0 451 105 067	P 5067			
41272124	F 026 400 080	S 0080	61671160	0 451 105 067	P 5067			
41272211	F 026 400 078	S 0078	61671160	0 451 203 010	P 3010			
41272212	F 026 400 079	S 0079	7110301	1 457 434 432	N 4432			
801 151 161	1 457 431 159	N 1159						
801 151 163	1 457 429 230	N 9230						
801 151 163	1 457 431 261	N 1261						
8 225 000 030	1 457 429 820	P 9820						
8 225 007 022	1 457 429 165	P 9165						
8 300 001 024	0 451 104 066	P 4066						
8 300 100 540	0 451 104 066	P 4066						
8 311 997 042 0	1 457 429 732	P 9732						
8 311 997 648 0	1 457 434 447	N 4447						
8 311 999 136	1 457 429 740	P 9740						
8 311 999 137	1 457 429 735	P 9735						
8 312 000 298	0 451 103 029	P 3029						
8 312 088 007 0	F 026 407 026	P 7026						
8 312 088 015 0	1 457 431 707	N 1707						
8 314 000 048	0 451 105 067	P 5067						

KAESSBOHRER

711 922 604 0 451 105 067 **P 5067**711 922 604 0 451 203 010 **P 3010**7 633 141 101 1 457 429 165 **P 9165**801 151 161 1 457 431 159 **N 1159**801 151 163 1 457 429 230 **N 9230**801 151 163 1 457 431 261 **N 1261**8 225 000 030 1 457 429 820 **P 9820**8 225 007 022 1 457 429 165 **P 9165**8 300 001 024 0 451 104 066 **P 4066**8 300 100 540 0 451 104 066 **P 4066**8 311 997 042 0 1 457 429 732 **P 9732**8 311 997 648 0 1 457 434 447 **N 4447**8 311 999 136 1 457 429 740 **P 9740**8 311 999 137 1 457 429 735 **P 9735**8 312 000 298 0 451 103 029 **P 3029**8 312 088 007 0 F 026 407 026 **P 7026**8 312 088 015 0 1 457 431 707 **N 1707**8 314 000 048 0 451 105 067 **P 5067**

◀ KAESSBOHRER

8 319 000 048	0 451 105 067	P 5067
8 319 000 104	1 457 431 325	N 1325
8 319 009 084	1 457 429 950	S 9950
8 319 085 102	1 457 429 966	S 9966
8 319 086 094	1 457 429 975	S 9975

8 319 095 116	1 457 429 969	S 9969
8 319 101 119 0	1 457 431 270	N 1270
8 319 121 610	1 457 434 447	N 4447
8 319 126 161 0	1 457 431 270	N 1270
8 319 128 161 0	1 457 434 447	N 4447

8 319 143 188 0	1 457 433 901	S 3901
8329000049	1 457 434 432	N 4432
9836141098	1 457 434 432	N 4432

KIA

BP012 0490A	0 986 450 108	F 0108
KB359 20490	0 986 450 222	F 0222
KK11C 13Z40	1 457 433 961	S 3961

K20113Z00	1 457 433 605	S 3605
K24020490	0 450 905 957	F 5957
K4672-357-0	1 457 434 453	N 4453
K5511 4302	0 451 103 366	P 3366
MB593 13Z40	1 457 433 961	S 3961

MZT42 20490	0 986 450 108	F 0108
OB63114302	0 986 452 061	P 2061
OFE3R-14-302	0 986 452 061	P 2061
OK05423570	1 457 434 454	N 4454
OK30C 13Z40A	F 026 400 107	S 0107

OK55114302	0 451 103 366	P 3366
PE11131160A	1 457 429 806	S 9806
RFY21 43029A	0 451 103 316	P 3316
OB631 14302	0 986 452 061	P 2061
OK03X 20490A	0 450 905 981	F 5981

OK054 23570	1 457 434 454	N 4454
OK2AA 20490	0 450 905 973	F 5973
OK2A5 13Z40A	1 987 429 179	S 9179
OK201 20490	0 450 905 957	F 5957
OK240 20490	0 450 905 957	F 5957

OK30C 13Z40A	F 026 400 107	S 0107
OK467 23570	0 986 450 508	N 0508
OK52Y 1333X	1 987 429 174	S 9174
OK551 14302	0 451 103 366	P 3366
OK55114302	0 986 452 042	P 2042

OK551 23570	1 457 434 435	N 4435
OK551 23570A	1 457 434 435	N 4435
OK552 23603A	F 026 400 113	S 0113
OK558 13Z40	1 987 429 174	S 9174
OK60C 23570	1 457 434 453	N 4453

OK71E 23570	1 457 434 435	N 4435
OK71E 23570A	1 457 434 435	N 4435
OK72B 13850B	1 457 434 435	N 4435
OK9A4 6152S	1 987 432 176	M 2176
OK9A4 6152X	1 987 432 176	M 2176

OK9A4 6152XA	1 987 432 176	M 2176
ORF03 23802	0 451 103 316	P 3316
ORF03 23802A	0 451 103 316	P 3316
ORF03 23802B	0 451 103 316	P 3316
26300 02500	0 986 452 061	P 2061

26300 02501	0 986 452 061	P 2061
26300 2Y500	0 986 452 061	P 2061
26300 35500	0 451 103 316	P 3316
26300 35501	0 451 103 316	P 3316
26300 35502	0 451 103 316	P 3316

26300 42040	0 451 103 366	P 3366
26310 27200	F 026 407 018	P 7018
26310 4A000	F 026 407 084	P 7084
26310 4A010	F 026 407 084	P 7084
26320 2A001	F 026 407 062	P 7062

26320 27000	F 026 407 069	P 7069
28113 07100	F 026 400 060	S 0060
2811307100	1 457 433 772	S 3772
28113 08000	F 026 400 044	S 0044
28113 1G000	F 026 400 048	S 0048

28113 1G100	F 026 400 093	S 0093
28113 1P000	F 026 400 137	S 0137
28113 2H000	F 026 400 063	S 0063
28113 2K000	F 026 400 137	S 0137
28113 3E000	1 987 429 180	S 9180

28113 37101	F 026 400 164	S 0164
31300 3E200	1 457 434 310	N 4310
31911 34000	0 450 905 912	F 5912
97133 0X900	1 987 432 164	M 2164
97133 07000	1 987 432 164	M 2164

97133 1H000	1 987 432 055	M 2055
97619 FD200	1 987 432 176	M 2176

LEYLAND

ABU 8532	0 451 203 226	P 3226
ABU 8533	0 451 203 226	P 3226
ABU 8534	0 451 203 226	P 3226

ABU 8535	0 451 203 226	P 3226
ABU 8555	1 457 434 200	N 4200
ABU 8558	1 457 434 201	N 4201
AEU 2147 L	1 457 434 106	N 4106
BBU5866	1 457 429 820	P 9820

12 H 3274	0 451 103 029	P 3029
17 H 2492	1 457 434 201	N 4201
17 H 9452	1 457 434 201	N 4201
235301	1 457 431 158	N 1158
27 H 8294	1 457 429 933	S 9933

30796305	1 457 429 117	P 9117
37 H 1581	1 457 434 201	N 4201
37 H 1881	1 457 434 201	N 4201
37 H 576	1 457 434 201	N 4201
37 H 7937	1 457 434 200	N 4200

5141403	1 457 434 201	N 4201
516920	1 457 434 201	N 4201
517711	1 457 434 201	N 4201
576920	1 457 434 201	N 4201
601980	1 457 434 201	N 4201

606168	0 450 904 058	F 4058
78747	1 457 434 201	N 4201
78881	1 457 434 201	N 4201
78891	1 457 434 201	N 4201
78981	1 457 434 201	N 4201

833544	1 457 434 201	N 4201
90517711	1 457 434 201	N 4201
9234125	1 457 431 325	N 1325
9234215	1 457 431 261	N 1261

MAN

A5000041045	0 451 103 028	P 3028
A5 00004 1045	0 451 104 065	P 4065
P302	1 457 429 130	P 9130

W 840/2	0 451 103 347	P 3347
00 00854 9757	1 457 431 028	N 1028
00 02415 1017	0 451 104 065	P 4065
00 02451 51017	0 451 104 065	P 4065
11 22504 2015	1 457 431 159	N 1159

245151017	0 451 104 065	P 4065
5000041045	0 451 103 028	P 3028
51 05501 0002	0 451 105 067	P 5067
51055010002	0 451 203 010	P 3010
51 05501 0003	0 451 105 067	P 5067

51055010003	0 451 203 010	P 3010
51 05501 7160	0 451 301 207	P 1207
51 05501 7161	0 451 301 207	P 1207
51 05501 7165	0 451 301 207	P 1207
51 05501 7166	0 451 301 207	P 1207

51 05501 7173	0 451 301 207	P 1207
51055017180	0 451 301 207	P 1207
51 05504 0007	1 457 429 165	P 9165
51 05504 0028	1 457 429 735	P 9735
51 05504 0044	1 457 429 740	P 9740

51 05504 0046	1 457 429 740	P 9740
51 05504 0047	1 457 429 740	P 9740
51 05504 0069	1 457 429 740	P 9740
51 05504 0070	1 457 429 740	P 9740
51 05504 0071	1 457 429 740	P 9740

51 05504 0087	1 457 429 740	P 9740
51 05504 0090	1 457 429 740	P 9740
51 05504 0091	1 457 429 735	P 9735
51 05504 0094	1 457 429 277	P 9277
51 05504 0096	1 457 429 107	P 9107

51 05504 0098	1 457 429 137	P 9137
51 05504 0107	F 026 407 051	P 7051
51 05504 0108	F 026 407 051	P 7051
51 12501 7260	F 026 402 038	N 2038
51 12501 7288	F 026 402 038	N 2038



51 12503 0004	1 457 434 154	N 4154
51 12503 0004	1 457 434 165	N 4165
51 12503 0004	1 457 434 447	N 4447
51 12503 0005	1 457 434 154	N 4154
51 12503 0005	1 457 434 165	N 4165
51 12503 0005	1 457 434 447	N 4447
51 12503 0009	1 457 434 106	N 4106
51 12503 0009	1 457 434 154	N 4154
51 12503 0009	1 457 434 165	N 4165
51 12503 0009	1 457 434 447	N 4447
51 12503 0010	1 457 434 154	N 4154
51 12503 0010	1 457 434 165	N 4165
51 12503 0010	1 457 434 447	N 4447
51 12503 0012	1 457 434 050	N 4050
51 12503 0012	1 457 434 154	N 4154
51 12503 0012	1 457 434 165	N 4165
51 12503 0012	1 457 434 432	N 4432
51 12503 0016	1 457 434 154	N 4154
51 12503 0016	1 457 434 165	N 4165
51 12503 0016	1 457 434 447	N 4447
51 12503 0018	1 457 434 154	N 4154
51 12503 0018	1 457 434 165	N 4165
51 12503 0018	1 457 434 447	N 4447
51 12503 0028	1 457 434 154	N 4154
51 12503 0028	1 457 434 165	N 4165
51 12503 0028	1 457 434 447	N 4447
51 12503 0029	1 457 434 154	N 4154
51 12503 0029	1 457 434 165	N 4165
51 12503 0029	1 457 434 447	N 4447
51 12503 0030	1 457 434 154	N 4154
51 12503 0030	1 457 434 165	N 4165
51 12503 0030	1 457 434 447	N 4447
51 12503 0031	1 457 434 447	N 4447
51 12503 0034	1 457 434 447	N 4447
51 12503 0035	1 457 434 432	N 4432
51 12503 0036	1 457 434 447	N 4447
51 12503 0037	1 457 431 710	N 1710
51 12503 0039	1 457 434 447	N 4447
51 12503 0040	1 457 434 447	N 4447
51 12503 0042	1 457 431 710	N 1710
51 12503 0048	F 026 402 029	N 2029
51 12503 0052	F 026 402 038	N 2038
51 12503 0053	F 026 402 017	N 2017
51 12503 0061	F 026 402 028	N 2028
51 12503 0063	F 026 402 028	N 2028
51 12503 0066	F 026 402 025	N 2025
76 33141 101	1 457 429 165	P 9165
81 00000 0238	1 457 429 740	P 9740
81 00000 0239	1 457 429 735	P 9735
81 00000 0244	1 457 429 230	N 9230
81 00000 0244	1 457 431 261	N 1261
81 00000 0245	1 457 431 159	N 1159
81 00000 0246	1 457 431 270	N 1270
81 00000 0246	1 457 431 326	N 1326
81 05501 7160	0 451 301 207	P 1207
81 05504 0007	1 457 429 165	P 9165
81 05504 0012	1 457 429 175	P 9175
81 05504 0025	1 457 429 130	P 9130
81 05504 0025	1 457 429 137	P 9137
81 05504 0027	1 457 429 130	P 9130
81 05504 0039	1 457 429 740	P 9740
81 05504 0041	1 457 429 740	P 9740
81 05504 0048	F 026 407 054	P 7054
81 05504 0049	F 026 407 054	P 7054
81 05504 0051	1 457 429 165	P 9165
81 05504 6001	1 457 429 165	P 9165
81 08205 0005	1 457 429 975	S 9975
81 08304 0015	F 026 400 067	S 0067
81 08304 0036	1 457 429 966	S 9966
81 08304 0038	1 457 429 969	S 9969
81 08304 0040	1 457 429 975	S 9975
81 08304 0041	1 457 429 975	S 9975
81 08304 0043	1 457 429 969	S 9969
81 08304 0044	1 457 429 969	S 9969
81 08304 0045	1 457 429 966	S 9966
81 08304 0048	1 457 429 975	S 9975
81 08304 0049	1 457 429 950	S 9950
81 08304 0053	1 457 429 946	S 9946
81 08304 0054	1 457 429 946	S 9946
81 08304 0055	1 457 429 950	S 9950
81 08304 0057	1 457 429 975	S 9975
81 08304 0060	1 457 429 975	S 9975
81 08304 0064	1 457 429 966	S 9966
81 08304 0076	1 457 433 651	S 3651
81 08304 0083	1 457 433 900	S 3900
81083040086	1 457 432 188	S 2188
81 08304 0087	F 026 400 067	S 0067
81 08304 0091	1 457 429 969	S 9969
81 08304 0093	F 026 400 184	S 0184
81 08304 0094	1 457 433 900	S 3900
81 08304 0097	1 457 433 900	S 3900
81 08401 6213	1 457 429 969	S 9969
81084050015	F 026 400 067	S 0067
81 08405 0016	F 026 400 068	S 0068
81 08405 0017	F 026 400 210	S 0210
81 08405 0020	F 026 400 068	S 0068
81 08405 0021	F 026 400 068	S 0068
81 08405 0022	F 026 400 211	S 0211
81 08405 0023	F 026 400 209	S 0209
81 12503 0001	1 457 429 230	N 9230
81 12503 0001	1 457 431 261	N 1261
81 12503 0001	1 457 431 325	N 1325
81 12503 0011	1 457 431 159	N 1159
81 12503 0013	1 457 431 158	N 1158
81 12503 0015	1 457 429 230	N 9230
81 12503 0015	1 457 431 261	N 1261
81 12503 0015	1 457 431 325	N 1325
81 12503 0016	1 457 429 230	N 9230
81 12503 0016	1 457 431 261	N 1261
81 12503 0016	1 457 431 325	N 1325
81 12503 0018	1 457 431 270	N 1270
81 12503 0018	1 457 431 326	N 1326
81 12503 0019	1 457 431 158	N 1158
81 12503 0020	1 457 429 230	N 9230
81 12503 0020	1 457 431 261	N 1261
81 12503 0020	1 457 431 325	N 1325
81 12503 0021	1 457 431 270	N 1270
81 12503 0021	1 457 431 326	N 1326
81 12503 0022	1 457 431 270	N 1270
81 12503 0022	1 457 431 326	N 1326
81 12503 0023	1 457 431 158	N 1158
81 12503 0024	1 457 431 159	N 1159
81 12503 0028	1 457 431 158	N 1158
81 12503 0032	1 457 431 158	N 1158
81 12503 0035	1 457 434 050	N 4050
81 12503 0035	1 457 434 432	N 4432
81 12503 0036	1 457 429 230	N 9230
81 12503 0036	1 457 431 261	N 1261
81 12503 0036	1 457 431 325	N 1325
81 12503 0037	1 457 431 158	N 1158
81 12503 0038	1 457 434 201	N 4201
81 12503 0039	1 457 429 230	N 9230
81 12503 0040	1 457 429 230	N 9230
81 12503 0040	1 457 431 261	N 1261
81 12503 0040	1 457 431 325	N 1325
81 12503 0041	1 457 429 230	N 9230
81 12503 0041	1 457 431 261	N 1261
81 12503 0041	1 457 431 325	N 1325
81 12503 0042	1 457 431 270	N 1270
81 12503 0042	1 457 431 326	N 1326
81 12503 0043	1 457 431 158	N 1158
81 12503 0044	1 457 431 159	N 1159
81 12503 0045	0 450 904 058	F 4058
81 12503 0046	1 457 431 159	N 1159
81 12503 0048	1 457 431 270	N 1270
81 12503 0048	1 457 431 326	N 1326
81 12503 0050	1 457 431 158	N 1158
81 12503 0051	1 457 429 230	N 9230
81 12503 0051	1 457 431 261	N 1261
81 12503 0051	1 457 431 325	N 1325
81 12503 0053	1 457 431 159	N 1159
81 12503 0054	1 457 431 270	N 1270
81 12503 0054	1 457 431 326	N 1326
81 12503 0056	0 450 904 058	F 4058
81 12503 0057	0 450 904 058	F 4058
81 12503 0058	0 450 904 058	F 4058
81 12503 0060	1 457 434 105	N 4105
81 12503 0062	1 457 431 159	N 1159
81 12503 0063	1 457 431 270	N 1270
81 12503 0063	1 457 431 326	N 1326
81 12503 0064	1 457 431 159	N 1159
81 12503 0066	1 457 431 159	N 1159
81 12503 0075	1 457 434 106	N 4106
81 12503 0075	1 457 434 447	N 4447
81 33118 0003	0 451 104 065	P 4065



◀ MAN

81 47301 6005	1 457 429 820	P 9820
81 47307 0001	1 457 429 165	P 9165
81 61910 0011	1 987 432 151	M 2151
81 61910 0018	1 987 431 163	M 1163
81 61910 0019	1 987 431 458	R 1458

84 08405 0022	F 026 400 211	S 0211
85 61950 0025	1 987 431 162	M 1162
86 05500 6005	0 451 203 010	P 3010
86 12000 6009	1 457 434 201	N 4201
86 77903 0378	0 451 203 010	P 3010

88 05501 6002	0 451 104 065	P 4065
90 80720 0756	1 457 429 165	P 9165

MERCEDES-BENZ

A 000 032 24 05	1 457 429 230	N 9230
A 000 032 24 05	1 457 431 261	N 1261
A 000 032 24 05	1 457 431 325	N 1325

A 000 090 11 51	1 457 429 359	N 9359
A 000 090 12 51	1 457 431 707	N 1707
A 000 090 14 51	1 457 429 354	N 9354
A 000 090 15 51	1 457 431 707	N 1707
A 000 090 26 51	F 026 400 055	S 0055

A 000 090 37 51	F 026 400 055	S 0055
A 000 092 15 05	1 457 431 158	N 1158
A 000 092 19 05	1 457 431 158	N 1158
A 000 092 23 05	1 457 429 230	N 9230
A 000 092 23 05	1 457 431 261	N 1261

A 000 092 23 05	1 457 431 325	N 1325
A 000 092 24 05	1 457 429 230	N 9230
A 000 092 24 05	1 457 431 261	N 1261
A 000 092 24 05	1 457 431 325	N 1325
A 000 092 27 83	1 457 434 154	N 4154

A 000 092 54 05	1 457 429 359	N 9359
A 000 092 83 01	1 457 429 675	N 9675
A 000 092 90 01	1 457 434 153	N 4153
A 000 094 00 04	1 457 429 165	P 9165
A 000 180 01 09	1 457 429 175	P 9175

A 000 180 16 09	F 026 407 040	P 7040
A 000 180 17 09	F 026 407 026	P 7026
A 000 180 18 09	F 026 407 054	P 7054
A 000 180 21 09	F 026 407 042	P 7042
A 000 180 24 09	1 457 429 820	P 9820

A 000 180 25 09	1 457 429 267	P 9267
A 000 180 29 09	F 026 407 042	P 7042
A 000 184 21 45	1 457 429 130	P 9130
A 000 184 21 45	1 457 429 629	P 9629
A 000 184 38 25	1 457 429 740	P 9740

A 000 184 40 25	1 457 429 130	P 9130
A 000 184 40 25	1 457 429 629	P 9629
A 000 184 41 25	1 457 429 130	P 9130
A 000 184 41 25	1 457 429 629	P 9629
A 000 184 58 25	1 457 429 175	P 9175

A 000 184 78 25	1 457 429 175	P 9175
A 000 184 94 25	1 457 429 130	P 9130
A 000 194 52 04	1 457 429 950	S 9950
A 000 466 00 04	1 457 429 165	P 9165
A 000 466 02 04	1 457 429 820	P 9820

A 000 466 06 04	1 457 429 820	P 9820
A 000 466 13 04	1 457 429 416	P 9416
A 000 466 16 03	1 457 429 416	P 9416
A 000 466 16 04	1 457 429 416	P 9416
A 000 466 21 04	1 457 429 416	P 9416

A 000 466 28 04	1 457 429 820	P 9820
A 000 470 01 92	1 457 431 158	N 1158
A 000 470 09 22	1 457 429 230	N 9230
A 000 470 09 22	1 457 431 261	N 1261
A 000 470 09 22	1 457 431 325	N 1325

A 000 477 08 15	1 457 429 230	N 9230
A 000 477 08 15	1 457 431 261	N 1261
A 000 477 08 15	1 457 431 325	N 1325
A 000 477 10 15	1 457 429 230	N 9230
A 000 477 10 15	1 457 431 261	N 1261

A 000 477 10 15	1 457 431 325	N 1325
A 000 477 31 15	1 457 431 159	N 1159
A 000 477 32 15	1 457 431 159	N 1159
A 000 477 35 15	1 457 431 270	N 1270
A 000 477 35 15	1 457 431 326	N 1326

A 000 477 35 80	1 457 429 359	N 9359
A 000 477 35 80	1 457 431 158	N 1158
A 000 477 35 80	1 457 431 261	N 1261
A 000 477 35 80	1 457 431 325	N 1325
A 000 477 38 15	1 457 431 158	N 1158

A 000 477 40 15	1 457 431 270	N 1270
A 000 477 40 15	1 457 431 326	N 1326
A 000 477 42 15	1 457 431 158	N 1158
A 000 477 45 15	1 457 431 270	N 1270
A 000 477 47 15	1 457 429 230	N 9230

A 000 477 47 15	1 457 431 261	N 1261
A 000 477 47 15	1 457 431 325	N 1325
A 000 477 54 15	1 457 431 158	N 1158
A 000 477 57 15	1 457 431 158	N 1158
A 000 477 59 01	1 457 431 159	N 1159

A 000 477 59 01	1 457 431 270	N 1270
A 000 477 59 01	1 457 431 325	N 1325
A 000 477 59 01	1 457 431 326	N 1326
A 000 477 64 15	1 457 429 230	N 9230
A 000 477 64 15	1 457 431 261	N 1261

A 000 477 68 15	1 457 431 158	N 1158
A 000 477 69 15	1 457 429 230	N 9230
A 000 477 69 15	1 457 431 261	N 1261
A 000 477 69 15	1 457 431 325	N 1325
A 000 477 70 01	1 457 429 359	N 9359

A 000 477 70 01	1 457 431 158	N 1158
A 000 477 70 01	1 457 431 261	N 1261
A 000 477 70 01	1 457 431 325	N 1325
A 000 477 72 15	1 457 431 326	N 1326
A 000 477 73 15	1 457 431 270	N 1270

A 000 477 75 15	1 457 431 159	N 1159
A 000 497 54 15	1 457 429 359	N 9359
A 000 497 54 15	1 457 431 158	N 1158
A 000 497 54 15	1 457 431 261	N 1261
A 000 497 54 15	1 457 431 325	N 1325

A 000 830 11 18	1 987 432 150	M 2150
A 000 830 12 18	1 987 431 154	M 1154
A 000 830 13 18	1 987 431 454	R 1454
A 000 830 15 18	1 987 431 455	R 1455
A 000 830 34 18	1 987 431 454	R 1454

A 000 835 26 47	1 457 429 230	N 9230
A 000 835 70 47	1 987 431 175	M 1175
A 001 092 04 01	1 457 434 153	N 4153
A 001 092 05 01	1 457 434 153	N 4153
A 001 092 22 01	1 457 434 123	N 4123

A 001 092 23 01	1 457 434 123	N 4123
A 001 092 23 02	1 457 434 123	N 4123
A 001 092 24 01	1 457 434 123	N 4123
A 001 092 24 01	1 457 434 153	N 4153
A 001 092 33 01	0 450 905 021	F 5021

A 001 092 90 01	1 457 434 123	N 4123
A 001 094 04 05	1 457 429 080	S 9080
A 001 094 42 04	1 457 429 950	S 9950
A 001 094 45 04	1 457 429 932	S 9932
A 001 094 46 04	1 457 429 946	S 9946

A 001 094 47 04	1 457 429 966	S 9966
A 001 094 52 04	1 457 429 950	S 9950
A 001 094 73 04	1 457 432 192	S 2192
A 001 094 78 04	1 457 429 993	S 9993
A 001 094 79 04	1 457 429 975	S 9975

A 001 094 82 04	1 457 429 941	S 9941
A 001 094 95 04	1 457 429 080	S 9080
A 001 184 02 25	1 457 429 735	P 9735
A 001 184 04 25	1 457 429 735	P 9735
A 001 184 05 25	1 457 429 735	P 9735

A 001 184 22 25	1 457 429 820	P 9820
A 001 184 38 25	1 457 429 740	P 9740
A 001 184 41 25	1 457 429 647	P 9647
A 001 184 42 25	1 457 429 646	P 9646
A 001 184 43 25	1 457 429 646	P 9646

A 001 184 44 25	1 457 429 647	P 9647
A 001 184 49 25	1 457 429 130	P 9130
A 001 184 49 25	1 457 429 629	P 9629
A 001 184 51 25	1 457 429 413	P 9413
A 001 184 51 25	1 457 429 647	P 9647

A 001 184 52 25	1 457 429 646	P 9646
A 001 184 54 25	1 457 429 647	P 9647
A 001 184 55 25	1 457 429 646	P 9646
A 001 184 56 25	1 457 429 600	P 9600
A 001 184 66 25	F 026 407 054	P 7054

A 001 184 67 25	1 457 429 130	P 9130
A 001 184 67 25	1 457 429 629	P 9629
A 001 184 72 25	1 457 429 130	P 9130
A 001 184 93 25	1 457 429 175	P 9175
A 001 184 96 01	0 451 105 067	P 5067



A 001 184 96 01	0 451 203 010	P 3010
A 001 477 03 01	0 450 905 203	F 5203
A 001 477 21 01	0 450 904 060	F 4060
A 001 477 33 01	0 450 904 060	F 4060
A 001 477 42 01	0 450 904 060	F 4060
A 001 477 56 01	0 450 904 060	F 4060
A 001 477 59 01	0 450 905 203	F 5203
A 001 477 63 01	0 450 904 077	N 4077
A 001 477 64 01	0 450 904 077	N 4077
A 001 477 66 01	0 450 904 077	N 4077
A 001 477 69 01	0 450 904 060	F 4060
A 001 477 79 01	0 450 904 077	N 4077
A 001 477 89 01	0 450 905 203	F 5203
A 001 835 44 47	1 457 434 447	N 4447
A 002 094 00 04	1 457 429 950	S 9950
A 002 094 30 04	1 457 429 992	S 9992
A 002 094 31 04	1 457 429 992	S 9992
A 002 094 34 04	1 457 429 941	S 9941
A 002 094 58 04	1 457 429 992	S 9992
A 002 094 60 04	1 457 429 946	S 9946
A 002 094 61 04	F 026 400 082	S 0082
A 002 094 73 04	1 457 429 854	S 9854
A 002 094 87 04	1 457 429 970	S 9970
A 002 094 88 04	1 457 429 948	S 9948
A 002 094 92 04	1 457 433 601	S 3601
A 002 094 93 04	1 457 433 626	S 3626
A 002 094 94 04	1 457 433 601	S 3601
A 002 184 04 25	F 026 407 054	P 7054
A 002 184 06 25	F 026 407 054	P 7054
A 002 184 40 01	0 451 104 065	P 4065
A 002 184 77 25	1 457 429 740	P 9740
A 002 477 00 01	0 450 904 163	F 4163
A 002 477 01 01	0 450 904 163	F 4163
A 002 477 04 01	0 450 905 203	F 5203
A 002 477 06 01	0 450 905 203	F 5203
A 002 477 07 01	0 450 905 203	F 5203
A 002 477 13 01	0 450 905 177	F 5177
A 002 477 17 01	0 450 905 177	F 5177
A 002 477 19 01	0 450 905 203	F 5203
A 002 477 26 01	0 450 905 030	F 5030
A 002 477 26 01	0 450 905 264	F 5264
A 002 477 26 01	0 450 905 275	F 5275
A 002 477 27 01	0 450 905 275	F 5275
A 002 477 28 01	0 450 905 275	F 5275
A 002 477 30 01	0 450 915 003	F 5003
A 002 477 31 01	0 450 915 003	F 5003
A 002 477 39 01	0 450 915 001	F 5001
A 002 477 44 01	0 450 905 177	F 5177
A 002 477 45 01	0 450 905 177	F 5177
A 002 477 53 01	0 450 905 968	F 5968
A 003 094 02 04	1 457 429 783	S 9783
A 003 094 15 04	1 457 429 899	S 9899
A 003 094 38 04	1 457 429 787	S 9787
A 003 094 39 04	1 457 433 627	S 3627
A 003 094 41 04	1 457 429 787	S 9787

A 003 094 50 04	1 457 429 969	S 9969
A 003 094 51 04	1 457 433 005	S 3005
A 003 094 53 04	1 457 429 786	S 9786
A 003 094 54 04	1 457 429 970	S 9970
A 003 094 58 04	1 457 429 787	S 9787
A 003 094 60 04	1 457 433 651	S 3651
A 003 094 61 04	1 457 433 700	S 3700
A 003 094 68 04	1 457 433 524	S 3524
A 003 094 70 04	1 457 433 901	S 3901
A 003 094 71 04	1 457 433 701	S 3701
A 003 094 72 04	1 457 433 052	S 3052
A 003 094 75 04	1 457 433 748	S 3748
A 003 094 82 04	1 457 433 703	S 3703
A 003 094 82 04	1 457 433 748	S 3748
A 003 094 83 04	1 457 433 703	S 3703
A 003 094 90 04	F 026 400 094	S 0094
A 003 094 91 04	1 457 433 728	S 3728
A 003 094 92 04	1 457 433 729	S 3729
A 003 094 95 04	1 457 433 560	S 3560
A 003 094 96 04	1 457 433 560	S 3560
A 004 094 02 04	1 457 433 730	S 3730
A 004 094 08 04	1 457 432 192	S 2192
A 004 094 09 04	1 457 429 966	S 9966
A 004 094 11 04	F 026 400 094	S 0094
A 004 094 13 04	1 457 433 752	S 3752
A 004 094 18 04	F 026 400 189	S 0189
A 004 094 24 04	F 026 400 088	S 0088
A 004 094 25 04	F 026 400 088	S 0088
A 004 094 26 04	1 457 433 748	S 3748
A 004 094 33 04	1 457 433 729	S 3729
A 004 094 35 04	F 026 400 064	S 0064
A 004 094 41 04	1 457 433 626	S 3626
A 004 094 66 04	F 026 400 094	S 0094
A 005 094 08 04	1 457 432 192	S 2192
A 012 094 85 02	1 457 432 192	S 2192
A 013 094 17 02	1 457 429 966	S 9966
A 013 094 18 02	1 457 429 950	S 9950
A 014 000 02 07	1 457 429 130	P 9130
A 023 000 02 07	1 457 429 950	S 9950
A 102 180 01 09	1 457 429 820	P 9820
A 102 184 03 25	1 457 429 820	P 9820
A 102 184 04 25	1 457 429 820	P 9820
A 104 094 02 04	1 457 433 701	S 3701
A 111 094 00 04	1 457 433 607	S 3607
A 111 094 02 04	1 457 433 522	S 3522
A 111 094 03 04	1 457 433 043	S 3043
A 112 094 00 04	1 457 433 071	S 3071
A 112 094 01 04	1 457 433 523	S 3523
A 112 094 02 04	1 457 433 523	S 3523
A 112 094 03 04	1 457 433 049	S 3049
A 112 094 04 04	1 457 433 581	S 3581
A 112 094 06 04	1 457 433 071	S 3071
A 135 090 05 01	1 457 433 599	S 3599
A 137 094 00 04	1 457 433 788	S 3788
A 137 094 01 04	1 457 433 788	S 3788

A 160 094 01 04	1 457 433 084	S 3084
A 166 094 00 04	1 457 433 715	S 3715
A 168 470 02 90	0 450 915 001	F 5001
A 211 830 00 18	1 987 432 381	R 2381
A 211 830 04 18	1 987 432 281	M 2281
A 211 830 08 18	1 987 432 512	R 2512
A 221 830 00 18	1 987 432 438	R 2438
A 221 830 03 18	1 987 432 438	R 2438
A 221 830 07 18	1 987 432 438	R 2438
A 266 094 00 04	1 457 433 585	S 3585
A 271 094 02 04	1 987 429 401	S 9401
A 275 094 01 04	1 987 429 402	S 9402
A 275 094 02 04	1 987 429 402	S 9402
A 314 180 01 09	1 457 429 647	P 9647
A 344 470 00 92	1 457 431 158	N 1158
A 344 477 72 15	1 457 431 158	N 1158
A 352 180 01 09	1 457 429 646	P 9646
A 352 180 02 09	1 457 429 130	P 9130
A 352 180 02 09	1 457 429 629	P 9629
A 352 470 00 92	1 457 429 359	N 9359
A 355 180 00 09	1 457 429 600	P 9600
A 355 180 01 09	1 457 429 600	P 9600
A 355 470 00 92	1 457 431 159	N 1159
A 355 470 01 92	1 457 431 270	N 1270
A 355 470 01 92	1 457 431 326	N 1326
A 362 180 01 10	1 457 429 735	P 9735
A 364 180 00 09	1 457 429 647	P 9647
A 364 180 01 09	1 457 429 647	P 9647
A 364 180 01 10	1 457 429 647	P 9647
A 364 180 03 09	1 457 429 647	P 9647
A 366 180 00 09	1 457 429 646	P 9646
A 366 180 03 09	1 457 429 646	P 9646
A 366 180 03 10	1 457 429 646	P 9646
A 366 180 06 09	1 457 429 276	P 9276
A 366 180 07 09	1 457 429 277	P 9277
A 366 180 08 09	1 457 429 646	P 9646
A 366 180 09 09	1 457 429 276	P 9276
A 366 180 10 09	1 457 429 277	P 9277
A 366 180 10 25	1 457 429 277	P 9277
A 366 180 13 09	1 457 429 277	P 9277
A 366 184 01 25	1 457 429 277	P 9277
A 366 184 01 25	1 457 429 646	P 9646
A 366 184 01 25	1 457 429 732	P 9732
A 366 184 02 25	1 457 429 276	P 9276
A 366 184 02 25	1 457 429 647	P 9647
A 366 184 05 25	1 457 429 732	P 9732
A 366 184 08 25	1 457 429 277	P 9277
A 366 184 08 25	1 457 429 646	P 9646
A 366 184 08 25	1 457 429 732	P 9732
A 366 184 09 25	1 457 429 277	P 9277
A 366 184 09 25	1 457 429 646	P 9646
A 366 184 10 25	1 457 429 277	P 9277
A 366 184 10 25	1 457 429 646	P 9646
A 366 184 10 25	1 457 429 732	P 9732
A 366 184 11 25	1 457 429 276	P 9276



◀ MERCEDES-BENZ

A 366 184 11 25	1 457 429 647	P 9647
A 366 184 12 25	1 457 429 647	P 9647
A 375 477 00 02	F 026 402 025	N 2025
A 388 094 70 04	1 457 429 969	S 9969
A 401 180 00 09	1 457 429 735	P 9735

A 401 184 00 25	1 457 429 735	P 9735
A 402 180 00 09	1 457 429 740	P 9740
A 403 184 00 25	1 457 429 740	P 9740
A 405 094 00 04	F 026 400 067	S 0067
A 416 094 99 04	1 457 429 794	S 9794

A 422 090 00 51	1 457 429 354	N 9354
A 422 092 00 05	1 457 429 354	N 9354
A 422 092 01 05	1 457 429 354	N 9354
A 422 092 02 05	1 457 429 354	N 9354
A 422 180 00 09	F 026 407 054	P 7054

A 422 180 02 10	1 457 429 740	P 9740
A 441 180 00 09	1 457 429 732	P 9732
A 441 180 01 09	1 457 429 732	P 9732
A 441 180 02 09	1 457 429 732	P 9732
A 441 180 03 09	1 457 429 732	P 9732

A 442 180 00 09	F 026 407 054	P 7054
A 451 835 02 47	1 987 432 299	M 2299
A 457 090 00 51	1 457 429 655	N 9655
A 457 184 00 25	1 457 429 128	P 9128
A 457 184 01 25	F 026 407 042	P 7042

A 476 094 00 04	F 026 400 064	S 0064
A 541 090 00 51	1 457 429 655	N 9655
A 541 090 01 51	1 457 429 655	N 9655
A 541 092 03 05	1 457 429 655	N 9655
A 541 092 04 05	1 457 429 655	N 9655

A 541 092 05 05	1 457 429 655	N 9655
A 541 092 06 05	1 457 429 655	N 9655
A 541 092 08 05	1 457 429 655	N 9655
A 541 092 09 05	1 457 429 655	N 9655
A 541 180 00 09	1 457 429 128	P 9128

A 541 180 00 83	F 026 407 059	P 7059
A 541 180 02 09	1 457 429 128	P 9128
A 541 184 02 25	1 457 429 128	P 9128
A 541 184 03 25	1 457 429 128	P 9128
A 589 452 07 00	1 457 431 159	N 1159

A 589 452 08 00	1 457 431 270	N 1270
A 598 452 07 00	1 457 431 159	N 1159
A 598 452 08 00	1 457 429 230	N 9230
A 598 452 08 00	1 457 431 261	N 1261
A 601 090 03 52	1 457 434 123	N 4123

A 601 090 03 52	1 457 434 153	N 4153
A 601 090 14 52	1 457 434 123	N 4123
A 601 090 16 52	1 457 434 123	N 4123
A 601 092 00 01	1 457 434 123	N 4123
A 601 092 01 01	1 457 434 123	N 4123

A 601 094 00 04	1 457 429 875	S 9875
A 601 094 01 04	1 457 429 875	S 9875
A 601 094 03 04	1 457 429 875	S 9875
A 601 094 04 04	1 457 429 875	S 9875
A 601 180 00 09	1 457 429 274	P 9274

A 601 180 01 09	1 457 429 274	P 9274
A 601 180 02 10	1 457 429 274	P 9274
A 601 184 00 25	1 457 429 274	P 9274
A 601 184 01 25	1 457 429 274	P 9274
A 602 094 01 04	1 457 429 783	S 9783

A 602 094 02 04	1 457 429 783	S 9783
A 602 094 04 04	1 457 433 002	S 3002
A 603 094 01 04	1 457 429 988	S 9988
A 603 094 02 04	1 457 429 949	S 9949
A 604 094 00 04	1 457 433 752	S 3752

A 604 094 01 04	1 457 433 752	S 3752
A 604 094 04 04	1 457 433 752	S 3752
A 604 094 05 04	1 457 433 699	S 3699
A 604 094 06 04	1 457 433 699	S 3699
A 604 094 09 04	1 457 433 751	S 3751

A 604 094 10 04	1 457 433 751	S 3751
A 604 094 13 04	1 457 433 752	S 3752
A 604 094 14 04	1 457 433 752	S 3752
A 606 180 00 09	F 026 407 003	P 7003
A 611 090 00 51	1 457 431 704	N 1704

A 611 090 01 52	1 457 431 704	N 1704
A 611 090 02 52	1 457 431 704	N 1704
A 611 090 05 52	1 457 431 704	N 1704
A 611 090 06 52	1 457 431 704	N 1704
A 611 090 08 52	0 450 905 930	N 5930

A 611 090 09 52	1 457 431 704	N 1704
A 611 090 12 52	1 457 434 416	N 4416
A 611 091 00 01	1 457 434 416	N 4416
A 611 092 00 01	1 457 434 416	N 4416
A 611 092 00 05	1 457 431 704	N 1704

A 611 092 01 01	F 026 402 044	N 2044
A 611 092 02 01	0 450 905 930	N 5930
A 611 092 06 01	0 450 905 930	N 5930
A 611 092 07 01	1 457 434 416	N 4416
A 611 094 00 04	1 457 433 065	S 3065

A 611 094 01 04	1 457 433 065	S 3065
A 611 094 02 04	1 457 433 333	S 3333
A 612 092 00 01	F 026 402 003	N 2003
A 613 094 00 04	1 457 433 065	S 3065
A 613 180 00 09	1 457 429 126	P 9126

A 613 184 00 25	1 457 429 126	P 9126
A 616 180 00 09	1 457 429 267	P 9267
A 616 180 05 10	1 457 429 267	P 9267
A 627 466 00 04	1 457 429 165	P 9165
A 628 092 01 01	0 450 906 464	N 6464

A 628 094 01 04	1 457 433 053	S 3053
A 628 180 00 09	F 026 407 003	P 7003
A 629 180 01 09	F 026 407 076	P 7076
A 638 090 00 51	1 457 433 753	S 3753
A 638 090 01 51	1 457 433 753	S 3753

A 639 090 05 01	F 026 400 006	S 0006
A 639 184 01 01	F 026 407 027	P 7027
A 639 477 00 01	0 450 905 975	F 5975
A 640 094 02 04	1 457 433 594	S 3594
A 640 180 00 09	1 457 429 272	P 9272

A 640 184 01 25	1 457 429 272	P 9272
A 642 090 16 52	F 026 402 065	N 2065
A 642 092 01 01	F 026 402 056	N 2056
A 642 092 02 01	F 026 402 065	N 2065
A 642 092 05 01	F 026 402 056	N 2056

A 642 092 07 01	F 026 402 056	N 2056
A 646 090 02 52	F 026 402 056	N 2056
A 646 092 00 01	1 457 434 437	N 4437
A 646 092 02 01	F 026 402 056	N 2056
A 646 092 03 01	1 457 434 437	N 4437

A 646 092 05 01	1 457 434 437	N 4437
A 646 092 06 01	F 026 402 056	N 2056
A 646 092 07 01	F 026 402 056	N 2056
A 646 094 00 04	F 026 400 024	S 0024
A 646 094 01 04	1 457 433 334	S 3334

A 646 094 03 04	F 026 400 205	S 0205
A 651 094 00 04	F 026 400 133	S 0133
A 661 092 30 55	1 457 434 123	N 4123
A 661 092 30 55	1 457 434 153	N 4153
A 668 094 00 04	1 457 433 069	S 3069

A 668 094 01 04	1 457 433 069	S 3069
A 668 094 02 04	1 457 433 069	S 3069
A 668 094 03 04	1 457 433 069	S 3069
A 668 180 00 09	1 457 429 272	P 9272
A 690 094 70 04	1 457 433 703	S 3703

A 822 500 00 30	1 457 429 820	P 9820
A 822 500 02 32	1 457 429 820	P 9820
A 822 500 70 22	1 457 429 165	P 9165
A 831 400 00 48	0 451 105 067	P 5067
A 831 400 00 48	0 451 203 010	P 3010

A 831 900 00 48	0 451 105 067	P 5067
A 831 900 00 48	0 451 203 010	P 3010
A 831 900 01 03	1 457 431 158	N 1158
A 831 900 01 04	1 457 429 230	N 9230
A 831 900 01 04	1 457 431 261	N 1261

A 831 900 01 10	1 457 429 735	P 9735
A 831 909 51 16	1 457 429 969	S 9969
A 831 910 11 90	1 457 431 159	N 1159
A 831 910 12 00	1 457 431 270	N 1270
A 831 912 16 10	1 457 434 447	N 4447

A 831 913 01 56	1 457 429 941	S 9941
A 831 914 31 88	1 457 433 901	S 3901
A 869 094 00 20	1 457 429 969	S 9969
A 904 180 00 09	F 026 407 040	P 7040
A 904 180 02 10	F 026 407 040	P 7040

A 906 090 00 51	1 457 431 707	N 1707
A 906 092 01 05	1 457 431 707	N 1707
A 906 092 02 05	1 457 431 707	N 1707
A 906 092 03 05	1 457 431 707	N 1707
A 906 092 05 05	1 457 431 707	N 1707

A 906 180 00 09	F 026 407 026	P 7026
A 906 830 02 18	1 987 432 213	M 2213
A 906 830 03 18	1 987 432 213	M 2213
A 940 835 00 47	1 987 431 168	M 1168
A 940 835 01 47	1 987 431 457	R 1457



A 940 835 02 47	1 987 431 155	M 1155
A 973 835 01 47	1 987 431 157	M 1157
A 973 835 02 47	1 987 431 156	M 1156
A 973 835 03 47	1 987 431 456	R 1456
B6 758 2411	1 987 431 456	R 1456
B6 758 2412	1 987 431 156	M 1156
B67582415	1 987 431 155	M 1155
000 032 24 05	1 457 429 230	N 9230
000 032 24 05	1 457 431 261	N 1261
000 032 24 05	1 457 431 325	N 1325
000 090 11 51	1 457 429 359	N 9359
000 090 12 51	1 457 431 707	N 1707
000 090 14 51	1 457 429 354	N 9354
000 090 15 51	1 457 431 707	N 1707
000 090 26 51	F 026 400 055	S 0055
000 090 37 51	F 026 400 055	S 0055
000 092 15 05	1 457 431 158	N 1158
000 092 19 05	1 457 431 158	N 1158
000 092 23 05	1 457 429 230	N 9230
000 092 23 05	1 457 431 261	N 1261
000 092 23 05	1 457 431 325	N 1325
000 092 24 05	1 457 429 230	N 9230
000 092 24 05	1 457 431 261	N 1261
000 092 24 05	1 457 431 325	N 1325
000 092 27 83	1 457 434 154	N 4154
000 092 54 05	1 457 429 359	N 9359
000 092 83 01	1 457 429 675	N 9675
000 092 90 01	1 457 434 153	N 4153
000 094 00 04	1 457 429 165	P 9165
000 180 01 09	1 457 429 175	P 9175
000 180 16 09	F 026 407 040	P 7040
000 180 17 09	F 026 407 026	P 7026
000 180 18 09	F 026 407 054	P 7054
000 180 21 09	F 026 407 042	P 7042
000 180 24 09	1 457 429 820	P 9820
000 180 25 09	1 457 429 267	P 9267
000 180 29 09	F 026 407 042	P 7042
000 184 21 45	1 457 429 130	P 9130
000 184 21 45	1 457 429 629	P 9629
000 184 38 25	1 457 429 740	P 9740
000 184 40 25	1 457 429 130	P 9130
000 184 40 25	1 457 429 629	P 9629
000 184 41 25	1 457 429 130	P 9130
000 184 41 25	1 457 429 629	P 9629
000 184 58 25	1 457 429 175	P 9175
000 184 78 25	1 457 429 175	P 9175
000 184 94 25	1 457 429 130	P 9130
000 194 52 04	1 457 429 950	S 9950
000 466 00 04	1 457 429 165	P 9165
000 466 02 04	1 457 429 820	P 9820
000 466 06 04	1 457 429 820	P 9820
000 466 13 04	1 457 429 416	P 9416
000 466 16 03	1 457 429 416	P 9416
000 466 16 04	1 457 429 416	P 9416
000 466 21 04	1 457 429 416	P 9416

000 466 28 04	1 457 429 820	P 9820
000 470 01 92	1 457 431 158	N 1158
000 470 09 22	1 457 429 230	N 9230
000 470 09 22	1 457 431 261	N 1261
000 470 09 22	1 457 431 325	N 1325
000 477 08 15	1 457 429 230	N 9230
000 477 08 15	1 457 431 261	N 1261
000 477 08 15	1 457 431 325	N 1325
000 477 10 15	1 457 429 230	N 9230
000 477 10 15	1 457 431 261	N 1261
000 477 10 15	1 457 431 325	N 1325
000 477 31 15	1 457 431 159	N 1159
000 477 32 15	1 457 431 159	N 1159
000 477 35 15	1 457 431 270	N 1270
000 477 35 15	1 457 431 326	N 1326
000 477 35 80	1 457 429 359	N 9359
000 477 35 80	1 457 431 158	N 1158
000 477 35 80	1 457 431 261	N 1261
000 477 35 80	1 457 431 325	N 1325
000 477 38 15	1 457 431 158	N 1158
000 477 40 15	1 457 431 270	N 1270
000 477 40 15	1 457 431 326	N 1326
000 477 42 15	1 457 431 158	N 1158
000 477 45 15	1 457 431 270	N 1270
000 477 47 15	1 457 429 230	N 9230
000 477 47 15	1 457 431 261	N 1261
000 477 47 15	1 457 431 325	N 1325
000 477 54 15	1 457 431 158	N 1158
000 477 57 15	1 457 431 158	N 1158
000 477 59 01	1 457 431 159	N 1159
000 477 59 01	1 457 431 270	N 1270
000 477 59 01	1 457 431 325	N 1325
000 477 59 01	1 457 431 326	N 1326
000 477 64 15	1 457 429 230	N 9230
000 477 64 15	1 457 431 261	N 1261
000 477 68 15	1 457 431 158	N 1158
000 477 69 15	1 457 429 230	N 9230
000 477 69 15	1 457 431 261	N 1261
000 477 69 15	1 457 431 325	N 1325
000 477 70 01	1 457 429 359	N 9359
000 477 70 01	1 457 431 158	N 1158
000 477 70 01	1 457 431 261	N 1261
000 477 70 01	1 457 431 325	N 1325
000 477 72 15	1 457 431 326	N 1326
000 477 73 15	1 457 431 270	N 1270
000 477 75 15	1 457 431 159	N 1159
000 497 54 15	1 457 429 359	N 9359
000 497 54 15	1 457 431 158	N 1158
000 497 54 15	1 457 431 261	N 1261
000 497 54 15	1 457 431 325	N 1325
000 830 11 18	1 987 432 150	M 2150
000 830 12 18	1 987 431 154	M 1154
000 830 13 18	1 987 431 454	R 1454
000 830 15 18	1 987 431 455	R 1455
000 830 34 18	1 987 431 454	R 1454

000 835 26 47	1 457 429 230	N 9230
000 835 70 47	1 987 431 175	M 1175
001 092 04 01	1 457 434 153	N 4153
001 092 05 01	1 457 434 153	N 4153
001 092 22 01	1 457 434 123	N 4123
001 092 23 01	1 457 434 123	N 4123
001 092 23 02	1 457 434 123	N 4123
001 092 24 01	1 457 434 123	N 4123
001 092 24 01	1 457 434 153	N 4153
001 092 33 01	0 450 905 021	F 5021
001 092 90 01	1 457 434 123	N 4123
001 094 04 05	1 457 429 080	S 9080
001 094 42 04	1 457 429 950	S 9950
001 094 45 04	1 457 429 932	S 9932
001 094 46 04	1 457 429 946	S 9946
001 094 47 04	1 457 429 966	S 9966
001 094 52 04	1 457 429 950	S 9950
001 094 73 04	1 457 432 192	S 2192
001 094 78 04	1 457 429 993	S 9993
001 094 79 04	1 457 429 975	S 9975
001 094 82 04	1 457 429 941	S 9941
001 094 95 04	1 457 429 080	S 9080
001 184 02 25	1 457 429 735	P 9735
001 184 04 25	1 457 429 735	P 9735
001 184 05 25	1 457 429 735	P 9735
001 184 22 25	1 457 429 820	P 9820
001 184 38 25	1 457 429 740	P 9740
001 184 41 25	1 457 429 647	P 9647
001 184 42 25	1 457 429 646	P 9646
001 184 43 25	1 457 429 646	P 9646
001 184 44 25	1 457 429 647	P 9647
001 184 49 25	1 457 429 130	P 9130
001 184 49 25	1 457 429 629	P 9629
001 184 51 25	1 457 429 413	P 9413
001 184 51 25	1 457 429 647	P 9647
001 184 52 25	1 457 429 646	P 9646
001 184 54 25	1 457 429 647	P 9647
001 184 55 25	1 457 429 646	P 9646
001 184 56 25	1 457 429 600	P 9600
001 184 66 25	F 026 407 054	P 7054
001 184 67 25	1 457 429 130	P 9130
001 184 67 25	1 457 429 629	P 9629
001 184 72 25	1 457 429 130	P 9130
001 184 93 25	1 457 429 175	P 9175
001 184 96 01	0 451 105 067	P 5067
001 184 96 01	0 451 203 010	P 3010
001 477 03 01	0 450 905 203	F 5203
001 477 21 01	0 450 904 060	F 4060
001 477 33 01	0 450 904 060	F 4060
001 477 42 01	0 450 904 060	F 4060
001 477 56 01	0 450 904 060	F 4060
001 477 59 01	0 450 905 203	F 5203
001 477 63 01	0 450 904 077	N 4077
001 477 64 01	0 450 904 077	N 4077
001 477 66 01	0 450 904 077	N 4077



◀ MERCEDES-BENZ

001 477 69 01	0 450 904 060	F 4060
001 477 79 01	0 450 904 077	N 4077
001 477 89 01	0 450 905 203	F 5203
001 835 44 47	1 457 434 447	N 4447
002 094 00 04	1 457 429 950	S 9950

002 094 30 04	1 457 429 992	S 9992
002 094 31 04	1 457 429 992	S 9992
002 094 34 04	1 457 429 941	S 9941
002 094 58 04	1 457 429 992	S 9992
002 094 60 04	1 457 429 946	S 9946

002 094 61 04	F 026 400 082	S 0082
002 094 73 04	1 457 429 854	S 9854
002 094 87 04	1 457 429 970	S 9970
002 094 88 04	1 457 429 948	S 9948
002 094 92 04	1 457 433 601	S 3601

002 094 93 04	1 457 433 626	S 3626
002 094 94 04	1 457 433 601	S 3601
002 184 04 25	F 026 407 054	P 7054
002 184 06 25	F 026 407 054	P 7054
002 184 40 01	0 451 104 065	P 4065

002 184 77 25	1 457 429 740	P 9740
002 477 00 01	0 450 904 163	F 4163
002 477 01 01	0 450 904 163	F 4163
002 477 04 01	0 450 905 203	F 5203
002 477 06 01	0 450 905 203	F 5203

002 477 07 01	0 450 905 203	F 5203
002 477 13 01	0 450 905 177	F 5177
002 477 17 01	0 450 905 177	F 5177
002 477 19 01	0 450 905 203	F 5203
002 477 26 01	0 450 905 030	F 5030

002 477 26 01	0 450 905 264	F 5264
002 477 26 01	0 450 905 275	F 5275
002 477 27 01	0 450 905 275	F 5275
002 477 28 01	0 450 905 275	F 5275
002 477 30 01	0 450 915 003	F 5003

002 477 31 01	0 450 915 003	F 5003
002 477 39 01	0 450 915 001	F 5001
002 477 44 01	0 450 905 177	F 5177
002 477 45 01	0 450 905 177	F 5177
002 477 53 01	0 450 905 968	F 5968

003 094 02 04	1 457 429 783	S 9783
003 094 15 04	1 457 429 899	S 9899
003 094 38 04	1 457 429 787	S 9787
003 094 39 04	1 457 433 627	S 3627
003 094 41 04	1 457 429 787	S 9787

003 094 50 04	1 457 429 969	S 9969
003 094 51 04	1 457 433 005	S 3005
003 094 53 04	1 457 429 786	S 9786
003 094 54 04	1 457 429 970	S 9970
003 094 58 04	1 457 429 787	S 9787

003 094 60 04	1 457 433 651	S 3651
003 094 61 04	1 457 433 700	S 3700
003 094 68 04	1 457 433 524	S 3524
003 094 70 04	1 457 433 901	S 3901
003 094 71 04	1 457 433 701	S 3701

003 094 72 04	1 457 433 052	S 3052
003 094 75 04	1 457 433 748	S 3748
003 094 82 04	1 457 433 703	S 3703
003 094 82 04	1 457 433 748	S 3748
003 094 83 04	1 457 433 703	S 3703

003 094 90 04	F 026 400 094	S 0094
003 094 91 04	1 457 433 728	S 3728
003 094 92 04	1 457 433 729	S 3729
003 094 95 04	1 457 433 560	S 3560
003 094 96 04	1 457 433 560	S 3560

004 094 02 04	1 457 433 730	S 3730
004 094 08 04	1 457 432 192	S 2192
004 094 09 04	1 457 429 966	S 9966
004 094 11 04	F 026 400 094	S 0094
004 094 13 04	1 457 433 752	S 3752

004 094 18 04	F 026 400 189	S 0189
004 094 24 04	F 026 400 088	S 0088
004 094 25 04	F 026 400 088	S 0088
004 094 26 04	1 457 433 748	S 3748
004 094 33 04	1 457 433 729	S 3729

004 094 35 04	F 026 400 064	S 0064
004 094 41 04	1 457 433 626	S 3626
004 094 66 04	F 026 400 094	S 0094
004 777 901	1 457 431 159	N 1159
004 778 901	1 457 429 359	N 9359

004 778 901	1 457 431 158	N 1158
004 778 901	1 457 431 261	N 1261
004 778 901	1 457 431 325	N 1325
005 094 08 04	1 457 432 192	S 2192
012 094 85 02	1 457 432 192	S 2192

013 094 17 02	1 457 429 966	S 9966
013 094 18 02	1 457 429 950	S 9950
014 000 02 07	1 457 429 130	P 9130
023 000 02 07	1 457 429 950	S 9950
102 180 01 09	1 457 429 820	P 9820

102 184 03 25	1 457 429 820	P 9820
102 184 04 25	1 457 429 820	P 9820
104 094 02 04	1 457 433 701	S 3701
10947804	1 457 429 993	S 9993
111 094 00 04	1 457 433 607	S 3607

111 094 02 04	1 457 433 522	S 3522
111 094 03 04	1 457 433 043	S 3043
112 094 00 04	1 457 433 071	S 3071
112 094 01 04	1 457 433 523	S 3523
112 094 02 04	1 457 433 523	S 3523

112 094 03 04	1 457 433 049	S 3049
112 094 04 04	1 457 433 581	S 3581
112 094 06 04	1 457 433 071	S 3071
135 090 05 01	1 457 433 599	S 3599
137 094 00 04	1 457 433 788	S 3788

137 094 01 04	1 457 433 788	S 3788
160 094 01 04	1 457 433 084	S 3084
162 048 2M1	0 451 103 062	P 3062
166 094 00 04	1 457 433 715	S 3715
168 470 02 90	0 450 915 001	F 5001

1801809	F 026 407 054	P 7054
211 830 00 18	1 987 432 381	R 2381
211 830 04 18	1 987 432 281	M 2281
211 830 08 18	1 987 432 512	R 2512
21844001	0 451 104 065	P 4065

221 830 00 18	1 987 432 438	R 2438
221 830 03 18	1 987 432 438	R 2438
221 830 07 18	1 987 432 438	R 2438
266 094 00 04	1 457 433 585	S 3585
271 094 02 04	1 987 429 401	S 9401

275 094 01 04	1 987 429 402	S 9402
275 094 02 04	1 987 429 402	S 9402
281 800 009	F 026 407 003	P 7003
309 438 04	1 457 429 787	S 9787
309 458 04	1 457 429 787	S 9787

309 461 04	1 457 433 700	S 3700
314 180 01 09	1 457 429 647	P 9647
344 470 00 92	1 457 431 158	N 1158
344 477 72 15	1 457 431 158	N 1158
352 180 01 09	1 457 429 646	P 9646

352 180 02 09	1 457 429 130	P 9130
352 180 02 09	1 457 429 629	P 9629
352 470 00 92	1 457 429 359	N 9359
355 180 00 09	1 457 429 600	P 9600
355 180 01 09	1 457 429 600	P 9600

355 470 00 92	1 457 431 159	N 1159
355 470 01 92	1 457 431 270	N 1270
355 470 01 92	1 457 431 326	N 1326
362 180 01 10	1 457 429 735	P 9735
364 180 00 09	1 457 429 647	P 9647

364 180 01 09	1 457 429 647	P 9647
364 180 01 10	1 457 429 647	P 9647
364 180 03 09	1 457 429 647	P 9647
366 180 00 09	1 457 429 646	P 9646
366 180 03 09	1 457 429 646	P 9646

366 180 03 10	1 457 429 646	P 9646
366 180 06 09	1 457 429 276	P 9276
366 180 07 09	1 457 429 277	P 9277
366 180 08 09	1 457 429 646	P 9646
366 180 09 09	1 457 429 276	P 9276

366 180 10 09	1 457 429 277	P 9277
366 180 10 25	1 457 429 277	P 9277
366 180 13 09	1 457 429 277	P 9277
366 184 01 25	1 457 429 277	P 9277
366 184 01 25	1 457 429 646	P 9646

366 184 01 25	1 457 429 732	P 9732
366 184 02 25	1 457 429 276	P 9276
366 184 02 25	1 457 429 647	P 9647
366 184 05 25	1 457 429 732	P 9732
366 184 08 25	1 457 429 277	P 9277

366 184 08 25	1 457 429 646	P 9646
366 184 08 25	1 457 429 732	P 9732
366 184 09 25	1 457 429 277	P 9277
366 184 09 25	1 457 429 646	P 9646
366 184 10 25	1 457 429 277	P 9277



366 184 10 25	1 457 429 646	P 9646
366 184 10 25	1 457 429 732	P 9732
366 184 11 25	1 457 429 276	P 9276
366 184 11 25	1 457 429 647	P 9647
366 184 12 25	1 457 429 647	P 9647
375 477 00 02	F 026 402 025	N 2025
388 094 70 04	1 457 429 969	S 9969
401 180 00 09	1 457 429 735	P 9735
401 184 00 25	1 457 429 735	P 9735
401 800 00 09	1 457 429 272	P 9272
401 800 10 09	1 457 429 272	P 9272
401 840 12 25	1 457 429 272	P 9272
402 180 00 09	1 457 429 740	P 9740
403 184 00 25	1 457 429 740	P 9740
405 094 00 04	F 026 400 067	S 0067
416 094 99 04	1 457 429 794	S 9794
422 090 00 51	1 457 429 354	N 9354
422 092 00 05	1 457 429 354	N 9354
422 092 01 05	1 457 429 354	N 9354
422 092 02 05	1 457 429 354	N 9354
422 180 00 09	F 026 407 054	P 7054
422 180 02 10	1 457 429 740	P 9740
441 180 00 09	1 457 429 732	P 9732
441 180 01 09	1 457 429 732	P 9732
441 180 02 09	1 457 429 732	P 9732
441 180 03 09	1 457 429 732	P 9732
442 180 00 09	F 026 407 054	P 7054
451 835 02 47	1 987 432 299	M 2299
457 090 00 51	1 457 429 655	N 9655
457 184 00 25	1 457 429 128	P 9128
457 184 01 25	F 026 407 042	P 7042
476 094 00 04	F 026 400 064	S 0064
541 090 00 51	1 457 429 655	N 9655
541 090 01 51	1 457 429 655	N 9655
541 092 03 05	1 457 429 655	N 9655
541 092 04 05	1 457 429 655	N 9655
541 092 05 05	1 457 429 655	N 9655
541 092 06 05	1 457 429 655	N 9655
541 092 08 05	1 457 429 655	N 9655
541 092 09 05	1 457 429 655	N 9655
541 180 00 09	1 457 429 128	P 9128
541 180 00 83	F 026 407 059	P 7059
541 180 02 09	1 457 429 128	P 9128
541 184 02 25	1 457 429 128	P 9128
541 184 03 25	1 457 429 128	P 9128
589 452 07 00	1 457 431 159	N 1159
589 452 08 00	1 457 431 270	N 1270
598 452 07 00	1 457 431 159	N 1159
598 452 08 00	1 457 429 230	N 9230
598 452 08 00	1 457 431 261	N 1261
601 090 03 52	1 457 434 123	N 4123
601 090 03 52	1 457 434 153	N 4153
601 090 14 52	1 457 434 123	N 4123
601 090 16 52	1 457 434 123	N 4123
601 092 00 01	1 457 434 123	N 4123

601 092 01 01	1 457 434 123	N 4123
601 094 00 04	1 457 429 875	S 9875
601 094 01 04	1 457 429 875	S 9875
601 094 03 04	1 457 429 875	S 9875
601 094 04 04	1 457 429 875	S 9875
601 180 00 09	1 457 429 274	P 9274
601 180 01 09	1 457 429 274	P 9274
601 180 02 10	1 457 429 274	P 9274
601 184 00 25	1 457 429 274	P 9274
601 184 01 25	1 457 429 274	P 9274
602 094 01 04	1 457 429 783	S 9783
602 094 02 04	1 457 429 783	S 9783
602 094 04 04	1 457 433 002	S 3002
602 094 20 101	1 457 434 123	N 4123
603 094 01 04	1 457 429 988	S 9988
603 094 02 04	1 457 429 949	S 9949
604 094 00 04	1 457 433 752	S 3752
604 094 01 04	1 457 433 752	S 3752
604 094 04 04	1 457 433 752	S 3752
604 094 05 04	1 457 433 699	S 3699
604 094 06 04	1 457 433 699	S 3699
604 094 09 04	1 457 433 751	S 3751
604 094 10 04	1 457 433 751	S 3751
604 094 13 04	1 457 433 752	S 3752
604 094 14 04	1 457 433 752	S 3752
606 180 00 09	F 026 407 003	P 7003
611 090 00 51	1 457 431 704	N 1704
611 090 01 52	1 457 431 704	N 1704
611 090 02 52	1 457 431 704	N 1704
611 090 05 52	1 457 431 704	N 1704
611 090 06 52	1 457 431 704	N 1704
611 090 08 52	0 450 905 930	N 5930
611 090 09 52	1 457 431 704	N 1704
611 090 12 52	1 457 434 416	N 4416
611 091 00 01	1 457 434 416	N 4416
611 092 00 01	1 457 434 416	N 4416
611 092 00 05	1 457 431 704	N 1704
611 092 01 01	F 026 402 044	N 2044
611 092 02 01	0 450 905 930	N 5930
611 092 06 01	0 450 905 930	N 5930
611 092 07 01	1 457 434 416	N 4416
611 094 00 04	1 457 433 065	S 3065
611 094 01 04	1 457 433 065	S 3065
611 094 02 04	1 457 433 333	S 3333
612 092 00 01	F 026 402 003	N 2003
613 094 00 04	1 457 433 065	S 3065
613 180 00 09	1 457 429 126	P 9126
613 184 00 25	1 457 429 126	P 9126
616 180 00 09	1 457 429 267	P 9267
616 180 05 10	1 457 429 267	P 9267
627 466 00 04	1 457 429 165	P 9165
628 092 01 01	0 450 906 464	N 6464
628 094 01 04	1 457 433 053	S 3053
628 180 00 09	F 026 407 003	P 7003
629 180 01 09	F 026 407 076	P 7076

638 090 00 51	1 457 433 753	S 3753
638 090 01 51	1 457 433 753	S 3753
639 090 05 01	F 026 400 006	S 0006
639 184 01 01	F 026 407 027	P 7027
639 477 00 01	0 450 905 975	F 5975
640 094 02 04	1 457 433 594	S 3594
640 180 00 09	1 457 429 272	P 9272
640 184 01 25	1 457 429 272	P 9272
642 090 16 52	F 026 402 065	N 2065
642 092 01 01	F 026 402 056	N 2056
642 092 02 01	F 026 402 065	N 2065
642 092 05 01	F 026 402 056	N 2056
642 092 07 01	F 026 402 056	N 2056
646 090 02 52	F 026 402 056	N 2056
646 092 00 01	1 457 434 437	N 4437
646 092 02 01	F 026 402 056	N 2056
646 092 03 01	1 457 434 437	N 4437
646 092 05 01	1 457 434 437	N 4437
646 092 06 01	F 026 402 056	N 2056
646 092 07 01	F 026 402 056	N 2056
646 094 00 04	F 026 400 024	S 0024
646 094 01 04	1 457 433 334	S 3334
646 094 03 04	F 026 400 205	S 0205
651 094 00 04	F 026 400 133	S 0133
661 092 30 55	1 457 434 123	N 4123
661 092 30 55	1 457 434 153	N 4153
668 094 00 04	1 457 433 069	S 3069
668 094 01 04	1 457 433 069	S 3069
668 094 02 04	1 457 433 069	S 3069
668 094 03 04	1 457 433 069	S 3069
668 180 00 09	1 457 429 272	P 9272
690 094 70 04	1 457 433 703	S 3703
822 500 00 30	1 457 429 820	P 9820
822 500 02 32	1 457 429 820	P 9820
822 500 70 22	1 457 429 165	P 9165
831 400 00 48	0 451 105 067	P 5067
831 400 00 48	0 451 203 010	P 3010
831 900 00 48	0 451 105 067	P 5067
831 900 00 48	0 451 203 010	P 3010
831 900 01 03	1 457 431 158	N 1158
831 900 01 04	1 457 429 230	N 9230
831 900 01 04	1 457 431 261	N 1261
831 900 01 10	1 457 429 735	P 9735
831 909 51 16	1 457 429 969	S 9969
831 910 11 90	1 457 431 159	N 1159
831 910 12 00	1 457 431 270	N 1270
831 912 16 10	1 457 434 447	N 4447
831 913 01 56	1 457 429 941	S 9941
831 914 31 88	1 457 433 901	S 3901
869 094 00 20	1 457 429 969	S 9969
904 180 00 09	F 026 407 040	P 7040
904 180 02 10	F 026 407 040	P 7040
906 090 00 51	1 457 431 707	N 1707
906 092 01 05	1 457 431 707	N 1707
906 092 02 05	1 457 431 707	N 1707



◀ MERCEDES-BENZ

906 092 03 05	1 457 431 707	N 1707
906 092 05 05	1 457 431 707	N 1707
906 180 00 09	F 026 407 026	P 7026
906 830 02 18	1 987 432 213	M 2213
906 830 03 18	1 987 432 213	M 2213

940 835 00 47	1 987 431 168	M 1168
940 835 01 47	1 987 431 457	R 1457
940 835 02 47	1 987 431 155	M 1155
973 835 01 47	1 987 431 157	M 1157
973 835 02 47	1 987 431 156	M 1156

973 835 03 47	1 987 431 456	R 1456
---------------	---------------	---------------

MITSUBISHI

AW311514	0 450 905 601	F 5601
J0927787	0 451 103 029	P 3029
J0927787	0 451 104 065	P 4065

J0927787	0 451 203 005	P 3005
J0927787	0 451 203 194	P 3194
J0927787	0 986 452 000	P 2000
J0927787	0 986 452 005	P 2005
J0936406	0 451 103 029	P 3029

J0936406	0 451 104 065	P 4065
J0936406	0 451 203 005	P 3005
J0936406	0 451 203 194	P 3194
J0936406	0 986 452 000	P 2000
J0936406	0 986 452 005	P 2005

J0938143	0 451 103 029	P 3029
J0938143	0 451 104 065	P 4065
J0938143	0 451 203 005	P 3005
J0938143	0 451 203 194	P 3194
J0938143	0 986 452 000	P 2000

J0938143	0 986 452 005	P 2005
J0990359	0 451 104 064	P 4064
K 4644110	1 457 429 800	S 9800
K466201	0 451 203 194	P 3194
K 4662010	0 986 452 016	P 2016

K 484403-0	1 457 429 800	S 9800
K 484403-0	1 457 429 801	S 9801
K 486201-1	0 451 103 316	P 3316
K 486201-1	0 986 452 016	P 2016
K 9665400	0 451 103 316	P 3316

MB025676	0 986 450 138	F 0138
MB134953	0 451 103 316	P 3316
MB134953	0 986 452 016	P 2016
MB134953	0 986 452 061	P 2061
MB220790	0 986 450 508	N 0508

MB220790	1 457 434 453	N 4453
MB220900	0 986 450 508	N 0508
MB220900	1 457 434 453	N 4453
MB348127	0 986 450 624	F 0624
MB400809	1 457 434 435	N 4435

MB433425	1 457 434 435	N 4435
MB433497	0 986 450 138	F 0138
MB504452	0 450 905 914	F 5914
MB504738	0 450 905 972	F 5972
MB504746	0 986 450 103	F 0103

MB504753	0 986 450 103	F 0103
MB504756	0 986 450 107	F 0107
MB504757	0 986 450 113	F 0113
MB504758	0 450 905 914	F 5914
MB504759	0 986 450 113	F 0113

MB504760	0 450 905 914	F 5914
MB504761	0 986 450 103	F 0103
MB504762	0 986 450 113	F 0113
MB504764	0 450 905 914	F 5914
MB504764	0 986 450 113	F 0113

MB554970	0 986 450 138	F 0138
MB620598	0 451 103 029	P 3029
MB620598	0 451 103 221	P 3221
MB620598	0 986 452 003	P 2003
MB658684	0 450 905 914	F 5914

MB658684	0 986 450 113	F 0113
MB658689	0 986 450 604	F 0604
MB868451	0 986 450 103	F 0103
MB868451	0 986 450 107	F 0107
MB868451	0 986 450 113	F 0113

MB868452	0 450 905 914	F 5914
MB868455	0 450 905 914	F 5914
MB868460	0 450 905 963	F 5963
MB906051	1 457 433 968	S 3968
MB906052	1 457 433 968	S 3968

MB957348	0 450 905 983	F 5983
MC031805	0 451 103 316	P 3316
MC031805	0 986 452 016	P 2016
MD001445	0 451 103 316	P 3316
MD005445	0 986 452 016	P 2016

MD007095	0 451 103 316	P 3316
MD007095	0 986 452 016	P 2016
MD007360	0 986 452 016	P 2016
MD013661	0 986 452 020	P 2020
MD017440	0 451 103 316	P 3316

MD030795	0 986 452 016	P 2016
MD031805	0 986 452 016	P 2016
MD052676	0 986 450 138	F 0138
MD061445	0 986 452 016	P 2016
MD064346	1 457 429 933	S 9933

MD069782	0 986 452 042	P 2042
MD069982	0 451 103 316	P 3316
MD071462	0 986 452 016	P 2016
MD084693	0 986 452 016	P 2016
MD084963	0 451 103 316	P 3316

MD084963	0 986 452 016	P 2016
MD097003	0 451 103 316	P 3316
MD108063	0 451 103 029	P 3029
MD108063	0 451 103 221	P 3221
MD108063	0 986 452 003	P 2003

MD129591	0 986 450 138	F 0138
MD129809	0 451 103 029	P 3029
MD129809	0 451 103 221	P 3221
MD129809	0 986 452 003	P 2003
MD134953	0 986 452 061	P 2061

MD136466	0 451 103 316	P 3316
MD136790	0 451 103 316	P 3316
MD162326	0 986 452 020	P 2020
MD17440	0 451 103 316	P 3316
MD184086	0 986 452 042	P 2042

MD228988	0 986 450 508	N 0508
MD228988	1 457 434 453	N 4453
MD308302	0 451 103 004	P 3004
MD308302	0 451 103 141	P 3141
MD308302	0 986 452 019	P 2019

MD308302	0 986 452 028	P 2028
MD308302	0 986 452 035	P 2035
MD308302	0 986 452 044	P 2044
MD308302	0 986 452 058	P 2058
MD308302	0 986 452 062	P 2062

MD308302	0 986 452 068	P 2068
MD320277	1 987 429 121	S 9121
MD320277	1 987 429 127	S 9127
MD322508	0 451 103 316	P 3316
MD326489	0 986 452 042	P 2042

MD336080	0 986 452 064	P 2064
MD352626	0 451 103 316	P 3316
MD353795	0 451 103 029	P 3029
MD353795	0 451 103 221	P 3221
MD353795	0 986 452 003	P 2003

MD356000	0 451 103 316	P 3316
MD409365	0 451 103 316	P 3316
MD409365	0 986 452 016	P 2016
MD409365	0 986 452 061	P 2061
MD571477	1 987 429 127	S 9127

MD603015	1 457 429 800	S 9800
MD603015	1 457 429 801	S 9801
MD603342	1 457 429 800	S 9800
MD603346	1 457 429 933	S 9933
MD603384	1 987 429 109	S 9109

MD603446	1 457 429 933	S 9933
MD603629	1 987 429 127	S 9127
MD603800	1 987 429 121	S 9121
MD603932	1 987 429 127	S 9127
MD620048	1 987 429 127	S 9127

MD620385	1 987 429 127	S 9127
MD620456	1 457 433 965	S 3965
MD620472	1 457 433 965	S 3965
MD620508	1 987 429 159	S 9159
MD620563	1 987 429 169	S 9169

MD620563	1 987 429 186	S 9186
MD620737	1 457 433 954	S 3954
MD620738	1 457 433 954	S 3954
MD623173	1 987 429 159	S 9159
MD 69782	0 986 452 042	P 2042



MD 84086	0 986 452 042	P 2042
ME013307	0 986 452 063	P 2063
ME013343	0 986 452 063	P 2063
ME013344	0 986 452 063	P 2063
ME013661	0 451 103 270	P 3270

ME013661	0 986 452 020	P 2020
ME017440	0 451 103 316	P 3316
ME034879	0 451 300 003	P 0003
ME132525	1 457 434 459	N 4459
ME201871	0 986 452 063	P 2063

ME202472	0 986 452 063	P 2063
ME215002	0 986 452 063	P 2063
MK666096	F 026 407 083	P 7083
MK667378	F 026 407 083	P 7083
MM409365	0 451 103 316	P 3316

MM409365	0 986 452 016	P 2016
MM409365	0 986 452 061	P 2061
MM510001	1 457 429 806	S 9806
MM510072	1 457 433 200	S 3200
MR127077	1 457 433 276	S 3276

MR127078	1 457 433 535	S 3535
MR188657	1 457 433 969	S 3969
MR212200	0 450 905 953	F 5953
MR227823	1 987 432 086	M 2086
MR239024	1 457 433 276	S 3276

MR239025	1 457 433 535	S 3535
MR239466	1 987 429 169	S 9169
MR239466	1 987 429 186	S 9186
MR258421	1 457 433 969	S 3969
MR262425	1 987 432 157	M 2157

MR266849	F 026 400 165	S 0165
MR315876	1 987 432 207	M 2207
MR323075	F 026 400 165	S 0165
MR323849	1 987 429 186	S 9186
MR323949	1 987 429 169	S 9169

MR323949	1 987 429 186	S 9186
MR355233	1 457 434 291	N 4291
MR355667	0 450 905 983	F 5983
MR398288	1 987 432 426	R 2426
MR404847	1 457 433 339	S 3339

MR460201	1 987 432 086	M 2086
MR500058	1 987 432 498	R 2498
MR529773	F 026 400 165	S 0165
MR552951	1 457 433 969	S 3969
MR571471	1 457 433 965	S 3965

MR571472	1 457 433 954	S 3954
MR571473	1 457 433 965	S 3965
MR571476	1 457 433 339	S 3339
MR571477	1 987 429 127	S 9127
MR597635	1 457 434 437	N 4437

MR911916	1 457 431 705	N 1705
MR958016	1 987 432 034	M 2034
MR993130	F 026 400 006	S 0006
MT126160	0 986 450 138	F 0138
MZ311784	1 457 433 954	S 3954

MZ311785	1 987 429 109	S 9109
MZ311786	1 987 429 169	S 9169
MZ311916	1 987 432 157	M 2157
MZ311917	1 987 432 086	M 2086
MZ312931	1 987 432 085	M 2085

MZ690071	0 986 452 042	P 2042
MZ690072	0 986 452 061	P 2061
MZ690116	0 451 103 316	P 3316
MZ690116	0 986 452 016	P 2016
MZ690116	0 986 452 061	P 2061

MZ690150	0 451 103 316	P 3316
PW510253	0 986 452 016	P 2016
XD 00145	0 451 103 316	P 3316
XD 00145	0 986 452 016	P 2016
XD620456	1 457 433 965	S 3965

XD620737	1 457 433 954	S 3954
XR127077	1 457 433 276	S 3276
XR188657	1 457 433 969	S 3969
XR266849	F 026 400 165	S 0165
XR 315876D	1 987 432 207	M 2207

XR323949	1 987 429 169	S 9169
XR398288	1 987 432 426	R 2426
XR398288D	1 987 432 426	R 2426
XR 500058D	1 987 432 498	R 2498
XR529773	F 026 400 165	S 0165

XZ311916	1 987 432 157	M 2157
XZ311917	1 987 432 086	M 2086
XZ 311917D	1 987 432 086	M 2086
1150101211	0 986 452 016	P 2016
1230A045	0 986 452 042	P 2042

1500A045	1 457 433 599	S 3599
1500A286	1 457 433 952	S 3952
156071480	0 986 452 042	P 2042
1770A024	F 026 402 086	N 2086
1770A053	1 457 434 438	N 4438

2220-2390	1 457 433 200	S 3200
2220-2392	1 457 433 200	S 3200
30A4000201	0 986 452 061	P 2061
3063056800	1 457 433 200	S 3200
3474000200	0 451 105 067	P 5067

3474000200	0 451 203 010	P 3010
4063396	0 451 103 316	P 3316
44001010	1 457 433 200	S 3200
7803A004	1 987 432 216	M 2216
7803A028	1 987 432 498	R 2498

7803A043	1 987 432 416	R 2416
7903A005	1 987 432 416	R 2416
9126100700	1 457 433 200	S 3200
9136101900	1 457 429 933	S 9933
9146111500	1 457 429 933	S 9933

MULTICAR

4011545	1 457 434 106	N 4106
---------	---------------	---------------

NISSAN

AY100HN022	0 451 103 316	P 3316
AY100KE001	0 986 452 061	P 2061
AY100NS005	0 451 103 276	P 3276

AY100 NS005	0 986 452 060	P 2060
AY100 NS007	0 986 452 023	P 2023
AY100NS011	0 986 452 046	P 2046
AY100NS026	0 986 452 023	P 2023
AY100NS027	0 986 452 064	P 2064

AY120 NS001	1 987 429 051	S 9051
AY120 NS006	1 987 429 170	S 9170
AY120 NS007	1 457 433 274	S 3274
AY120 NS023	1 457 433 677	S 3677
AY120 NS048	1 457 433 772	S 3772

A5208 H8903	0 986 452 023	P 2023
A5208 W1106	0 986 452 024	P 2024
A5208 01B01	0 986 452 035	P 2035
A5208 01B02	0 986 452 035	P 2035
A640C 59EMO	1 457 434 281	N 4281

A640C59EMOSA	1 457 434 281	N 4281
A640C59EMOSA	1 457 434 439	N 4439
A640M 41BMO SA	0 450 905 326	F 5326
NIS 16400 N9600	0 450 905 030	F 5030
13210-13211	0 986 452 023	P 2023

13210-13211	0 986 452 035	P 2035
13212-13213	0 986 452 023	P 2023
13212-13213	0 986 452 035	P 2035
15208AD20A	1 457 429 284	P 9284
15208 AD200	1 457 429 284	P 9284

15208 AD300	1 457 429 284	P 9284
15208AW001A	0 986 452 023	P 2023
15208AW001B	0 986 452 023	P 2023
15208 BN30A	0 986 452 003	P 2003
15208BN300	0 986 452 003	P 2003

15208 BN31A	1 457 429 284	P 9284
15208 BX00A	0 986 452 060	P 2060
15208 D9705	0 986 452 024	P 2024
15208 G3100	0 986 452 023	P 2023
15208 G9900	0 986 452 005	P 2005

15208HC010	0 986 452 061	P 2061
15208HC200	0 986 452 064	P 2064
15208HC253	0 986 452 064	P 2064
15208HC254	0 451 103 316	P 3316
15208HC300	0 451 103 316	P 3316

15208HC430	0 986 452 061	P 2061
15208HG001	0 986 452 000	P 2000
15208H1010	0 986 452 000	P 2000
15208 H1010	0 986 452 023	P 2023
15208 H1011	0 986 452 023	P 2023

15208H8900	0 986 452 023	P 2023
15208 H8903	0 986 452 023	P 2023
15208 H8904	0 986 452 023	P 2023
15208-H8909	0 986 452 023	P 2023
15208-H8909	0 986 452 035	P 2035



◀ NISSAN

15208-H8910	0986 452 023	P 2023
15208-H8910	0986 452 035	P 2035
15208-H8911	0986 452 023	P 2023
15208H8912	0986 452 023	P 2023
15208H8916	0986 452 000	P 2000
15208 H8916	0986 452 023	P 2023
15208 H8917	0986 452 023	P 2023
15208H8920	0986 452 000	P 2000
15208 H8920	0986 452 023	P 2023
15208-H8993	0986 452 023	P 2023
15208-H8993	0986 452 035	P 2035
15208H8994	0986 452 023	P 2023
15208J3100	0986 452 023	P 2023
15208-LA40A	F 026 407 057	P 7057
15208 M8903	0986 452 023	P 2023
15208-N8912	0986 452 023	P 2023
15208-N8912	0986 452 035	P 2035
15208 Q9100	0986 452 023	P 2023
15208 U3401	0451 103 357	P 3357
15208WG101	0986 452 024	P 2024
15208 W1103	0986 452 024	P 2024
15208 W1106	0986 452 024	P 2024
15208 W1111	0986 452 024	P 2024
15208 W1113	0986 452 024	P 2024
15208-W1115	0451 103 357	P 3357
15208-W1115	0986 452 005	P 2005
15208 W1116	0986 452 024	P 2024
15208 W1120	0986 452 005	P 2005
15208W1120	0986 452 024	P 2024
15208 W1123	0986 452 005	P 2005
15208W1123	0986 452 024	P 2024
15208 W3401	0451 103 357	P 3357
15208 W3401	0986 452 005	P 2005
15208 W3403	0451 103 357	P 3357
15208 W3403	0986 452 005	P 2005
15208 Y9701	0451 104 067	P 4067
15208 01B01	0986 452 035	P 2035
15208 01B10	0986 452 035	P 2035
15208 01B15	0986 452 035	P 2035
15208 01B25	0986 452 035	P 2035
15208 13201	0986 452 023	P 2023
1520813210	0986 452 000	P 2000
15208 13210	0986 452 023	P 2023
1520813211	0986 452 000	P 2000
15208 13211	0986 452 023	P 2023
1520813212	0986 452 000	P 2000
15208 13212	0986 452 023	P 2023
15208 20N00	0986 452 046	P 2046
15208 20N01	0986 452 046	P 2046
15208 20N02	0986 452 046	P 2046
1520-820N1A	0986 452 046	P 2046
15208 20N10	0986 452 046	P 2046
15208-4A00A	0986 452 058	P 2058
15208 40L00	0986 452 046	P 2046
15208 40L01	0986 452 046	P 2046

15208 40L02	0986 452 046	P 2046
15208 5M300	1 457 429 284	P 9284
15208 53J00	0986 452 060	P 2060
1520853J01	0451 103 276	P 3276
15208 53J01	0986 452 060	P 2060
15208 55Y00	0986 452 023	P 2023
15208 60U00	0986 452 023	P 2023
15208 65001	0451 103 357	P 3357
15208 65001	0986 452 005	P 2005
1520865001	0986 452 024	P 2024
15208 65002	0451 103 357	P 3357
15208 65002	0986 452 005	P 2005
1520865002	0986 452 024	P 2024
1520865004	0986 452 024	P 2024
15208 65005	0451 103 357	P 3357
15208 65010	0451 103 357	P 3357
15208 65010	0986 452 005	P 2005
1520865010	0986 452 024	P 2024
15208 65011	0986 452 005	P 2005
1520865011	0986 452 024	P 2024
15208 65012	0451 103 357	P 3357
1520865012	0451 104 065	P 4065
15208 65012	0986 452 005	P 2005
15208 65014	0986 452 005	P 2005
1520865014	0986 452 024	P 2024
15208 65016	0451 103 357	P 3357
15208 65016	0986 452 005	P 2005
1520865025	0986 452 024	P 2024
1520865077	0986 452 024	P 2024
15208 65210	0451 103 357	P 3357
15208 65210	0986 452 005	P 2005
15208-7B000	0986 452 061	P 2061
15208 7F400	0451 103 357	P 3357
15208 70J00	0986 452 060	P 2060
15208 70J01	0986 452 060	P 2060
1520871C00	0451 103 276	P 3276
15208 71J00	0986 452 023	P 2023
15208 80W00	0986 452 024	P 2024
1520889TA0	0986 452 064	P 2064
15208 9C600	0986 452 024	P 2024
15208-9E000	0986 452 061	P 2061
15208 9F600	0986 452 061	P 2061
152089X800	0451 203 010	P 3010
15209J1800	0986 452 000	P 2000
15209T9005	0451 203 010	P 3010
15209Y7500	0986 452 000	P 2000
15209Y7501	0986 452 000	P 2000
15209Y75012	0986 452 000	P 2000
15209Y7502	0986 452 000	P 2000
1520900QAA	1 457 429 198	P 9198
15209 00QAC	1 457 429 271	P 9271
1520900QQA	F 026 407 014	P 7014
1520910H00	0986 452 000	P 2000
15209 2W200	1 457 429 271	P 9271
15274-99186	0451 104 010	P 4010

15274-99186	0451 403 077	P 3077
15274-99626	0451 104 010	P 4010
15274-99626	0451 403 077	P 3077
1541073J00000	0450 906 471	N 6471
15467 6007	1987 429 117	S 9117
15546 22100	1 457 429 801	S 9801
16400-AH201	0450 905 326	F 5326
16400 A0600	0986 450 138	F 0138
16400BC40A	0450 906 468	N 6468
16400BN303	1 457 434 439	N 4439
16400 BN700	0450 906 468	N 6468
16400-C6400	0986 450 138	F 0138
16400 D0300	0450 905 326	F 5326
16400ES60A	F 026 402 059	N 2059
16400 E3000	0986 450 138	F 0138
16400 E3001	0450 904 058	F 4058
16400 E3001	0986 450 138	F 0138
16400 E3022	0986 450 138	F 0138
16400 E3025	0986 450 138	F 0138
16400 E5200	0986 450 138	F 0138
16400 E6600	0986 450 138	F 0138
16400 F3025	0986 450 138	F 0138
16400 F5100	0450 905 326	F 5326
16400 F5700	0450 905 326	F 5326
16400 H8500	0986 450 138	F 0138
16400 H8501	0450 904 058	F 4058
16400 H8501	0986 450 138	F 0138
16400 H8502	0986 450 138	F 0138
16400 H8594	0986 450 138	F 0138
16400-H8954	0450 904 058	F 4058
16400-H8954	0986 450 138	F 0138
16400 JD51A	0450 902 161	F 2161
16400 JD551A	0450 902 161	F 2161
16400-J7525	0450 905 030	F 5030
16400-J7525	0450 905 264	F 5264
16400-J7525	0450 905 275	F 5275
16400 J8000	0450 905 030	F 5030
16400 N1400	0450 904 159	F 4159
16400-N2700	0450 905 326	F 5326
16400-N6700	0450 905 326	F 5326
16400 N7600	0450 905 326	F 5326
16400 N7605	0450 905 326	F 5326
16400-N8100	0450 905 326	F 5326
16400 N8400	0450 904 159	F 4159
16400 VB201	1 457 434 281	N 4281
16400 V2700	0450 905 326	F 5326
16400 V2705	0450 905 326	F 5326
16400 W1100	0986 450 138	F 0138
16400 W1105	0986 450 138	F 0138
16400-0B000	0450 905 326	F 5326
16400-0B001	0450 905 326	F 5326
16400-0M200	0450 905 326	F 5326
16400-0M300	0450 905 326	F 5326
16400 0W000	0450 905 326	F 5326
16400 0W005	0450 905 326	F 5326



16400-0W01A	0 450 905 326	F 5326	16546 EB300	F 026 400 033	S 0033	16546 18001	1 457 429 801	S 9801
16400-0W010	0 450 905 326	F 5326	16546 ED000	F 026 400 101	S 0101	1654618007	1 457 429 801	S 9801
1640000Q0K	0 450 906 468	N 6468	16546 G9600	1 457 429 932	S 9932	1654618077	1 457 429 801	S 9801
16400 18010	0 986 450 138	F 0138	16546G9601	1 457 429 941	S 9941	1654618090	1 457 429 801	S 9801
16400-25900	0 986 450 138	F 0138	16546HL000	1 457 429 801	S 9801	16546 18094	1 457 429 801	S 9801
16400-3S500	0 450 905 326	F 5326	16546HL001	1 457 429 801	S 9801	1654621000	1 457 429 801	S 9801
16400 4M405	0 450 905 326	F 5326	16546 JD 20 A	F 026 400 126	S 0126	16546 22125	1 457 429 801	S 9801
16400 4U105	0 450 906 468	N 6468	16546-JG70A	F 026 400 126	S 0126	16546 23000	1 457 429 800	S 9800
16400 41B00	0 450 905 326	F 5326	16546-JK20A	F 026 400 130	S 0130	1654627610	1 457 429 950	S 9950
16400-41B01	0 450 905 326	F 5326	16546L110	1 987 429 117	S 9117	16546 3J400	1 987 429 051	S 9051
16400-41B02	0 450 905 326	F 5326	16546L1100	1 987 429 117	S 9117	16546 3J410	1 457 433 274	S 3274
16400 41B05	0 450 905 326	F 5326	16546 L3000	1 987 429 117	S 9117	16546-30P00	1 457 433 274	S 3274
16400-41B1A	0 450 905 326	F 5326	16546 R9000	1 987 429 117	S 9117	16546 41B00	1 457 433 273	S 3273
16400 41B25	0 450 905 326	F 5326	16546 S0100	1 457 429 800	S 9800	1654642K00	1 457 433 200	S 3200
16400 41B26	0 450 905 326	F 5326	16546 S0190	1 987 429 161	S 9161	16546 49500	1 987 429 117	S 9117
16400-7B000	0 450 905 326	F 5326	16546 VK501	F 026 400 199	S 0199	1654650100	1 457 429 800	S 9800
16400-7B010	0 450 905 326	F 5326	16546 V0100	1 987 429 051	S 9051	16546 6F900	1 457 433 234	S 3234
16400 70J00	0 450 905 264	F 5264	16546 V0110	1 987 429 051	S 9051	16546 6J400	1 987 429 051	S 9051
16400-76201	0 986 450 138	F 0138	16546 W2900	1 987 429 051	S 9051	16546 64J02	1 987 429 170	S 9170
16400 9F910	0 450 905 326	F 5326	16546 Y9500	1 987 429 117	S 9117	16546 7F000	1 457 433 154	S 3154
16400 9F927	0 450 905 326	F 5326	165460F000	1 457 433 275	S 3275	16546 7F000 B1	1 457 433 154	S 3154
16400 9F928	0 450 905 326	F 5326	16546 0U800	1 457 433 273	S 3273	16546 7F002	1 457 433 154	S 3154
16400-9F928-KE	0 450 905 326	F 5326	16546-0Z000	1 987 429 051	S 9051	16546 7S000	F 026 400 004	S 0004
1640100QAA	0 450 906 468	N 6468	16546-00H03	1 457 433 200	S 3200	16546-70J10	1 987 429 051	S 9051
16403 AW302	1 457 431 705	N 1705	16546 00QAA	1 457 433 529	S 3529	16546 73C00	1 457 433 274	S 3274
16403 G2400	1 457 434 281	N 4281	16546-00QAC	F 026 400 014	S 0014	16546 73C10	1 457 433 274	S 3274
16403 G2400	1 457 434 439	N 4439	16546-00QAD	F 026 400 166	S 0166	16546 73C11	1 457 433 274	S 3274
16403-G990A	1 457 434 281	N 4281	16546-00QAE	1 457 433 531	S 3531	16546 74S00	1 987 429 051	S 9051
16403 G9900	1 457 434 281	N 4281	1654600QAG	F 026 400 011	S 0011	16546 76000	1 987 429 117	S 9117
16403 G9900	1 457 434 439	N 4439	1654600QAK	1 457 433 163	S 3163	16546-76001	1 987 429 117	S 9117
16403 Y7525	1 457 429 800	S 9800	1654600QAL	1 457 433 078	S 3078	1654676007	1 987 429 117	S 9117
16403 05E01	1 457 434 439	N 4439	16546-00QAP	1 457 433 531	S 3531	16546 76015	1 987 429 117	S 9117
16403 4U105	1 457 434 281	N 4281	16546-00QAR	1 457 433 595	S 3595	16546 76016	1 987 429 117	S 9117
16403 59E00	1 457 434 281	N 4281	16546-00QAT	F 026 400 166	S 0166	16546 77A10	1 987 429 148	S 9148
16403 59E00	1 457 434 439	N 4439	16546-00QAU	1 457 433 529	S 3529	16546 80G00	1 457 433 275	S 3275
16403 6F900	1 457 434 321	N 4321	1654-600QOC	1 457 433 531	S 3531	16546 88A00	1 987 429 148	S 9148
164037F40A	1 457 434 439	N 4439	1654600QOH	F 026 400 103	S 0103	1654688A10	1 987 429 148	S 9148
164037F400	1 457 434 439	N 4439	16546 01B00	1 987 429 115	S 9115	16546-99205	1 457 429 933	S 9933
16403 7F400	1 457 434 451	N 4451	16546-01800	0 451 103 029	P 3029	26543 42	0 451 104 065	P 4065
164037F401	1 457 434 439	N 4439	16546-01800	1 457 429 800	S 9800	26543 43	0 451 104 065	P 4065
16403 7F401	1 457 434 451	N 4451	16546-01800	1 457 429 801	S 9801	27274 EA000	1 987 432 194	M 2194
16405 00QAA	1 457 431 720	N 1720	16546-02N00	1 457 429 933	S 9933	27275 1N625	1 987 432 179	M 2179
16405 00QAB	1 457 431 724	N 1724	16546 04N00	1 457 433 275	S 3275	27275 1N626	1 987 432 118	M 2118
16405-00QAC	F 026 402 047	N 2047	16546 08000	1 457 429 800	S 9800	27277 EN000	1 987 432 238	M 2238
16405 05E01	1 457 434 281	N 4281	16546 08001	1 457 429 800	S 9800	27277 EN025	1 987 432 238	M 2238
16405 05E01	1 457 434 439	N 4439	16546 10600	1 987 429 161	S 9161	27298-00QAA	1 987 432 208	M 2208
16405 05E02	1 457 434 439	N 4439	16546 10800	1 457 429 800	S 9800	27891 BM400	1 987 432 075	M 2075
16405 59E00	1 457 434 281	N 4281	16546 10801	1 457 429 800	S 9800	27891 BM401	1 987 432 075	M 2075
16405 59E00	1 457 434 439	N 4439	16546 14800	1 457 429 801	S 9801	27891BM401KE	1 987 432 075	M 2075
16456Y02S0	1 987 429 148	S 9148	16546-16300	0 451 103 029	P 3029	27891 BM410	1 987 432 075	M 2075
16545-L3010	1 987 429 117	S 9117	16546-16300	1 457 429 800	S 9800	278912F000	1 987 432 058	M 2058
16546 AX600	1 457 433 273	S 3273	16546-16300	1 457 429 801	S 9801	278932F900	1 987 432 058	M 2058
16546-BC40A	1 457 433 595	S 3595	16546 16800	1 457 429 800	S 9800	27893 6F600	1 987 432 119	M 2119
16546 BN700	1 457 433 163	S 3163	16546 16877	1 987 429 161	S 9161	27893 9F500	1 987 432 058	M 2058
16546 BN701	1 457 433 595	S 3595	16546 18000	1 457 429 801	S 9801	278939F500KE	1 987 432 058	M 2058



◀ NISSAN

31725-L1000	0986 452 023	P 2023
31725-L1000	0986 452 028	P 2028
3262290000	0986 452 000	P 2000
3262290002	0986 452 023	P 2023
77010 44595	F 026 400 014	S 0014

77600 000	0 450 904 158	N 4158

OPEL

VOF 109	0 451 103 217	P 3217
VOF 133	0 451 103 232	P 3232
VOF 14	0 451 203 005	P 3005

VOF 28	0 451 103 232	P 3232
VOF 28	0 451 103 297	P 3297
03469294	1 457 429 050	S 9050
04163853	0 450 905 200	F 5200
08130700	0 450 906 503	N 6503

10290491	0 450 905 979	F 5979
1097012	1 457 429 175	P 9175
13263262	F 026 402 062	N 2062
13270887	F 026 400 020	S 0020
13271040	F 026 400 012	S 0012

13271041	F 026 400 013	S 0013
1427938	1 457 429 175	P 9175
1650363	0 451 104 064	P 4064
1718962	1 987 432 052	M 2052
1808246	1 987 432 304	R 2304

1808524	1 987 432 004	M 2004
1808600	1 987 432 091	M 2091
1808602	1 987 432 091	M 2091
1808602	1 987 432 166	M 2166
1808609	1 987 432 052	M 2052

24438415	1 457 433 045	S 3045
24443113	F 026 400 013	S 0013
25055046	0986 450 119	F 0119
25055052	0986 450 119	F 0119
25055128	0986 450 119	F 0119

25055129	0986 450 119	F 0119
25055364	0 450 905 280	F 5280
25055480	0986 450 119	F 0119
25062010	1 457 429 954	S 9954
25062032	1 457 429 845	S 9845

25062038	1 457 429 875	S 9875
25062054	1 457 429 877	S 9877
25062055	1 457 433 310	S 3310
25062071	1 457 429 877	S 9877
25062072	1 457 429 079	S 9079

25062199	1 457 432 173	S 2173
25062203	1 457 429 783	S 9783
25062204	1 457 429 992	S 9992
25062205	1 457 429 080	S 9080
25062206	1 457 429 988	S 9988

25062209	1 457 429 964	S 9964
25062211	1 457 432 154	S 2154
25062212	1 457 429 894	S 9894
25062222	1 457 433 652	S 3652
25062227	1 457 429 896	S 9896

25062227	1 457 429 898	S 9898
25062234	1 457 429 895	S 9895
25062235	1 457 429 898	S 9898
25062242	1 457 432 180	S 2180
25062244	1 457 429 908	S 9908

25062261	1 457 432 200	S 2200
25062271	1 457 429 895	S 9895
25062272	1 457 429 896	S 9896
25062406	1 457 429 877	S 9877
25062413	1 457 429 050	S 9050

25062418	1 457 429 896	S 9896
25062419	1 457 429 053	S 9053
25062467	1 457 433 007	S 3007
25067018	0 451 103 217	P 3217
25067160	1 457 429 154	P 9154

25069015	1 457 429 894	S 9894
25099149	1 457 433 056	S 3056
25121113	0 450 905 002	F 5002
25121974	0 450 905 280	F 5280
25121974	0 450 905 326	F 5326

25161249	0 450 905 280	F 5280
25161333	0 450 905 273	F 5273
25164444	0 450 905 273	F 5273
25166009	1 457 434 201	N 4201
25313359	0 450 905 273	F 5273

25320277	0 450 905 273	F 5273
2908500	0 450 905 002	F 5002
3448661	0 451 104 064	P 4064
3448991	0 451 203 005	P 3005
3448992	0 451 203 005	P 3005

3469294	1 457 429 050	S 9050
4301497	1 987 429 154	S 9154
4402614	1 457 433 531	S 3531
4402665	0 451 203 201	P 3201
4402894	1 457 429 657	N 9657

4404191	1 457 431 720	N 1720
4405238	F 026 400 166	S 0166
4408101	0 450 905 287	F 5287
4408341	1 457 433 529	S 3529
4408840	1 987 432 208	M 2208

4411236	1 457 429 198	P 9198
4411279	F 026 400 103	S 0103
4411637	1 457 431 724	N 1724
4412830	F 026 402 047	N 2047
4414665	F 026 400 103	S 0103

4415218	1 457 429 271	P 9271
4415941	1 457 429 198	P 9198
4416392	F 026 400 014	S 0014
4416403	1 457 433 531	S 3531
4416481	F 026 400 166	S 0166

4417142	F 026 400 103	S 0103
4419683	1 987 432 078	M 2078
4431215	F 026 407 014	P 7014
4500935	F 026 400 014	S 0014
4501003	1 457 431 705	N 1705

4502627	1 457 431 705	N 1705
4506039	1 457 429 198	P 9198
4702969	1 457 433 153	S 3153
4705463	1 987 432 066	M 2066
4708106	1 987 432 066	M 2066

4708878	0986 452 058	P 2058
4710210	1 987 432 214	M 2214
5141522	1 457 429 933	S 9933
5198871	1 457 429 933	S 9933
5198872	1 457 429 933	S 9933

52470574	1 987 432 052	M 2052
5444682	1 457 429 302	P 9302
55355096	F 026 400 020	S 0020
55556465	F 026 400 013	S 0013
55557174	F 026 400 049	S 0049

55702468	1 987 432 488	R 2488
5575840	0986 452 005	P 2005
5650303	1 457 429 123	P 9123
5650304	0 451 103 316	P 3316
5650305	0 451 103 297	P 3297

5650307	1 457 429 139	P 9139
5650308	1 457 429 139	P 9139
5650314	F 026 407 018	P 7018
5650319	1 457 429 157	P 9157
5650334	1 457 429 118	P 9118

5650338	1 457 429 302	P 9302
5650353	1 457 429 118	P 9118
5650354	1 457 429 248	P 9248
5650375	F 026 407 073	P 7073
5650380	1 457 429 199	P 9199

5818085	F 026 402 062	N 2062
5818508	1 457 429 656	N 9656
5818509	1 457 429 656	N 9656
5834036	1 457 433 056	S 3056
5834040	F 026 400 012	S 0012

5834043	F 026 400 049	S 0049
5834252	1 457 433 045	S 3045
5834279	F 026 400 012	S 0012
5834281	F 026 400 013	S 0013
5835930	F 026 400 097	S 0097

6424691	1 457 429 933	S 9933
6435109	1 457 434 201	N 4201
6436629	1 457 434 201	N 4201
64 90 16	1 457 429 154	P 9154
650017	F 026 407 087	P 7087

650 300	1 457 429 199	P 9199
65 03 02	1 457 429 123	P 9123
65 03 03	1 457 429 123	P 9123
650306	0 451 103 316	P 3316
65 03 55	0 451 104 064	P 4064



65 03 62	0 451 203 005	P 3005
65 03 63	0 451 104 064	P 4064
65 03 72	0 451 203 005	P 3005
65 03 75	0 451 104 064	P 4064
65 03 82	0 451 103 232	P 3232

65 03 85	0 451 103 217	P 3217
65 03 88	0 451 103 232	P 3232
65 03 89	0 451 103 232	P 3232
65 03 91	0 986 452 064	P 2064
65 03 93	0 451 103 316	P 3316

6808600	1 987 432 091	M 2091
6808600	1 987 432 166	M 2166
6808610	1 987 432 091	M 2091
6808623	1 987 432 488	R 2488
7898968	1 457 429 933	S 9933

7961161	1 457 434 201	N 4201
7984288	1 457 434 201	N 4201
7984303	0 986 452 005	P 2005
7984326	0 986 452 023	P 2023
7984864	0 451 105 067	P 5067

7984937	0 451 103 232	P 3232
7998710	1 457 429 053	S 9053
7998968	1 457 429 933	S 9933
80 27 21	1 457 429 656	N 9656
81 30 30	0 450 906 451	N 6451

813058	F 026 402 054	N 2054
813059	F 026 402 051	N 2051
81 35 60	1 457 431 028	N 1028
813561	1 457 434 201	N 4201
81 35 62	1 457 434 201	N 4201

81 35 65	1 457 434 106	N 4106
81 35 66	1 457 434 103	N 4103
813569	1 457 070 001	N 0001
81 85 00	0 450 905 280	F 5280
81 85 01	0 450 905 280	F 5280

81 85 02	0 450 905 280	F 5280
81 85 08	0 450 905 273	F 5273
81 85 09	0 450 905 273	F 5273
818511	1 457 434 453	N 4453
81 85 12	0 450 905 280	F 5280

81 85 13	0 450 905 280	F 5280
81 85 14	0 450 905 273	F 5273
81 85 31	1 457 429 656	N 9656
81 85 41	0 450 905 002	F 5002
81 85 68	0 450 905 273	F 5273

834159	F 026 400 020	S 0020
83 42 31	1 457 429 050	S 9050
83 42 50	1 457 429 894	S 9894
834251	1 457 433 003	S 3003
83 42 57	1 457 429 053	S 9053

83 42 60	1 457 429 844	S 9844
83 42 62	1 457 429 895	S 9895
83 42 64	1 457 433 007	S 3007
834266	1 457 433 007	S 3007
83 42 70	1 457 429 053	S 9053

83 42 71	1 457 433 007	S 3007
83 42 73	1 457 429 050	S 9050
83 42 84	1 457 429 941	S 9941
83 42 85	1 457 429 870	S 9870
83 42 85	1 457 433 310	S 3310

83 42 86	1 457 429 877	S 9877
83 42 89	1 457 429 894	S 9894
83 42 91	1 457 433 003	S 3003
83 42 92	1 457 429 895	S 9895
83 42 93	1 457 429 896	S 9896

834293	1 457 433 087	S 3087
83 42 94	1 457 429 898	S 9898
83 42 95	1 457 429 844	S 9844
83 42 96	1 457 429 895	S 9895
83 42 97	1 457 429 896	S 9896

834297	1 457 433 087	S 3087
83 42 99	1 457 429 896	S 9896
834299	1 457 433 087	S 3087
83 43 16	1 457 433 771	S 3771
834322	1 457 433 741	S 3741

834323	1 457 433 771	S 3771
83 45 81	1 457 433 309	S 3309
83 45 81	1 457 433 603	S 3603
834583	1 457 433 309	S 3309
83 45 83	1 457 433 603	S 3603

83 45 85	1 457 433 713	S 3713
834617	1 457 433 045	S 3045
834618	1 457 433 741	S 3741
83 46 19	1 457 433 054	S 3054
83 46 19	1 457 433 309	S 3309

834621	1 457 433 054	S 3054
834647	F 026 400 111	S 0111
83 48 01	1 457 429 053	S 9053
83 48 03	1 457 429 050	S 9050
83 50 36	1 457 433 579	S 3579

83 56 05	1 457 433 007	S 3007
83 56 06	1 457 429 898	S 9898
83 56 07	1 457 433 571	S 3571
83 56 08	1 457 433 571	S 3571
83 56 09	1 457 433 571	S 3571

835614	1 457 429 994	S 9994
83 56 14	1 457 433 740	S 3740
83 56 14	1 457 433 799	S 3799
83 56 15	1 457 433 740	S 3740
83 56 16	1 457 433 741	S 3741

83 56 17	1 457 433 571	S 3571
83 56 20	1 457 433 087	S 3087
83 56 21	1 457 433 056	S 3056
83 56 22	1 457 433 281	S 3281
835624	F 026 400 012	S 0012

8 35 624	1 457 433 079	S 3079
835626	1 457 433 055	S 3055
83 56 30	1 457 433 578	S 3578
835631	1 457 433 579	S 3579
835632	F 026 400 013	S 0013

835633	F 026 400 020	S 0020
84 92 53	1 457 429 079	S 9079
849253	1 457 433 065	S 3065
8949253	1 457 429 079	S 9079
8949253	1 457 433 065	S 3065

8960570	1 457 429 053	S 9053
8983001	1 457 434 201	N 4201
8994750	1 457 429 933	S 9933
90016800	1 457 434 105	N 4105
90016800	1 457 434 106	N 4106

90027967	1 457 429 079	S 9079
90027967	1 457 433 065	S 3065
90118207	1 457 429 053	S 9053
90137364	1 457 429 941	S 9941
90166585	1 457 434 103	N 4103

90169150	0 450 905 002	F 5002
90183727	0 451 103 232	P 3232
90220955	1 457 429 877	S 9877
90322261	1 457 429 896	S 9896
90322261	1 457 433 087	S 3087

90322262	1 457 429 895	S 9895
90323083	1 457 429 844	S 9844
90325205	1 457 429 898	S 9898
90351529	1 457 433 007	S 3007
90360171	1 987 432 091	M 2091

90410651	1 457 433 007	S 3007
90411732	1 457 433 603	S 3603
90412779	1 457 433 603	S 3603
90421742	1 457 429 895	S 9895
90421982	0 451 103 232	P 3232

90442260	1 457 433 309	S 3309
90442434	0 451 103 232	P 3232
90443103	1 457 433 007	S 3007
90448738	1 457 433 571	S 3571
90469336	1 457 433 713	S 3713

90469412	1 457 433 571	S 3571
90485457	0 451 103 316	P 3316
90486293	1 457 433 713	S 3713
90486295	1 457 433 713	S 3713
90486296	1 457 433 603	S 3603

90486297	1 457 433 603	S 3603
90486299	1 457 433 603	S 3603
90486299	1 457 433 713	S 3713
90486883	1 457 433 007	S 3007
90487526	1 457 429 898	S 9898

90499145	0 451 103 232	P 3232
90499582	1 457 433 740	S 3740
90499589	1 457 429 994	S 9994
90499589	1 457 433 799	S 3799
90499601	1 457 433 771	S 3771

90502200	1 457 433 741	S 3741
90510290	1 457 433 571	S 3571
90510292	1 457 433 571	S 3571
90510934	0 451 103 297	P 3297
90510935	0 451 103 297	P 3297



◀ OPEL

90511738	1 457 429 123	P 9123
90512444	1 457 433 740	S 3740
90512444	1 457 433 799	S 3799
90512445	1 457 433 799	S 3799
90512446	1 457 433 740	S 3740

90512447	1 457 433 740	S 3740
90512448	1 457 433 741	S 3741
90512449	1 457 433 741	S 3741
90512851	1 457 433 571	S 3571
90531003	1 457 433 281	S 3281

90540460	1 457 429 157	P 9157
90540600	1 457 433 771	S 3771
90540660	1 457 433 771	S 3771
90541322	1 457 433 054	S 3054
90541474	1 457 433 087	S 3087

90541540	0 450 905 021	F 5021
90542212	1 457 429 656	N 9656
90542540	0 450 905 021	F 5021
90542604	1 457 429 139	P 9139
90542912	1 457 429 656	N 9656

90543111	1 457 433 771	S 3771
90570363	1 457 433 054	S 3054
90570368	1 457 429 157	P 9157
90575409	0 450 905 021	F 5021
90590568	1 987 432 091	M 2091

91066585	0 451 103 232	P 3232
9110614	1 457 433 531	S 3531
9110665	0 451 203 201	P 3201
91112038	1 987 429 042	S 9042/1
9112191	1 457 431 720	N 1720

91149684	1 457 433 571	S 3571
91155714	1 457 433 281	S 3281
91159955	1 457 433 529	S 3529
91167510	1 457 431 720	N 1720
9117321	1 457 429 157	P 9157

9117557	1 457 433 281	S 3281
91181912	F 026 400 013	S 0013
9121653	1 987 432 052	M 2052
9129747	1 457 433 055	S 3055
91 421 517 20	1 457 429 800	S 9800

9161235	F 026 400 014	S 0014
9161303	1 457 431 705	N 1705
9177260	1 457 433 579	S 3579
9194405	F 026 400 012	S 0012
9194405	1 457 433 079	S 3079

9195316	1 457 433 153	S 3153
9196120	1 457 433 055	S 3055
9196121	1 457 433 055	S 3055
9196805	1 987 432 066	M 2066
9201138	1 457 433 281	S 3281

9201158	F 026 400 013	S 0013
9201435	1 457 429 198	P 9198
9201929	1 457 433 045	S 3045
9201930	1 457 433 045	S 3045
9214143	1 987 429 173	S 9173

93152072	1 457 429 079	S 9079
93152533	1 457 429 920	S 9920
93152775	1 457 429 064	S 9064
93152793	1 457 429 079	S 9079
93152961	1 457 432 146	S 2146

93152971	1 457 429 053	S 9053
93152973	1 457 429 050	S 9050
93156093	0 451 103 316	P 3316
93156201	0 986 452 015	P 2015
93156291	0 451 103 252	P 3252

93156304	0 451 203 005	P 3005
93156305	0 451 103 232	P 3232
93156390	0 451 203 005	P 3005
93156542	0 451 103 109	P 3109
93156542	0 451 203 108	P 3108

93156575	0 451 103 217	P 3217
93156612	1 457 429 289	N 9289
93156612	1 457 434 200	N 4200
93156614	1 457 429 274	P 9274
93156662	0 986 452 019	P 2019

93156667	0 451 103 316	P 3316
93156668	0 986 452 023	P 2023
93156669	0 986 452 005	P 2005
93156669	0 986 452 024	P 2024
93156670	0 986 452 028	P 2028

93156770	0 986 452 023	P 2023
93156770	0 986 452 035	P 2035
93156782	0 450 904 058	F 4058
93156952	0 451 203 005	P 3005
93160657	1 457 429 198	P 9198

93160736	1 457 431 724	N 1724
93161665	F 026 407 014	P 7014
93171658	0 450 906 451	N 6451
93172272	1 457 429 118	P 9118
93172461	1 457 433 579	S 3579

93172462	1 457 433 579	S 3579
93172463	1 457 433 578	S 3578
93172464	1 457 433 578	S 3578
93177663	1 457 433 579	S 3579
93181377	1 457 070 001	N 0001

93181912	F 026 400 013	S 0013
93181955	F 026 400 020	S 0020
93181980	F 026 400 012	S 0012
93182007	1 457 429 061	S 9061
93183389	F 026 400 012	S 0012

93183412	1 457 429 248	P 9248
93185452	1 987 429 193	S 9193
93185604	1 457 429 656	N 9656
93187335	1 457 433 531	S 3531
93188572	1 987 432 066	M 2066

93188723	F 026 400 049	S 0049
93190334	1 457 431 720	N 1720
93192882	F 026 400 012	S 0012
93192884	F 026 400 013	S 0013
93193038	F 026 400 020	S 0020

93196533	0 450 906 503	N 6503
93 58 24	1 457 433 079	S 3079
93587562	1 987 429 154	S 9154
93891826	1 457 429 994	S 9994
93892079	1 457 429 953	S 9953

93892081	1 457 432 174	S 2174
93892087	1 457 429 080	S 9080
93892092	1 457 429 928	S 9928
94020442	1 457 429 800	S 9800
94201942	0 451 103 316	P 3316

94243502	0 451 103 316	P 3316
94360427	0 986 452 064	P 2064
94382063	1 987 429 154	S 9154
94419532	1 457 434 435	N 4435
94430411	0 451 103 316	P 3316

94455838	1 457 429 894	S 9894
94456741	0 451 103 316	P 3316
94840078	0 986 452 028	P 2028
97035303	1 987 429 162	S 9162
97111423	1 987 429 162	S 9162

97223218	1 457 429 199	P 9199
97310472	1 457 429 302	P 9302
98018448	F 026 407 073	P 7073
9949253	1 457 429 053	S 9053
9974113	1 457 429 054	S 9054

99 74 11301 AA	1 457 429 054	S 9054
9974117	1 457 429 064	S 9064
9974119	1 457 429 080	S 9080
9974133	1 457 429 941	S 9941
9974135	1 457 429 946	S 9946

9974136	1 457 429 932	S 9932
9974139	1 457 429 950	S 9950
9974143	1 457 429 975	S 9975
9974287	1 457 429 801	S 9801
9974323	1 457 433 732	S 3732

9974336	1 457 429 076	S 9076
9974337	1 457 429 806	S 9806
9974620	1 457 433 652	S 3652
9974705	1 457 429 908	S 9908
9974791	1 457 429 085	S 9085

9975120	0 451 103 004	P 3004
9975120	0 451 103 028	P 3028
9975120	0 451 103 029	P 3029
9975120	0 451 103 062	P 3062
9975153	0 451 203 005	P 3005

9975157	1 457 434 201	N 4201
99752227	0 986 452 023	P 2023
9975227	0 986 452 024	P 2024
9975227	0 986 452 028	P 2028

PEGASO

197785	1 457 434 200	N 4200
510185	1 457 434 201	N 4201
527563	1 457 434 201	N 4201

620751	0 451 103 062	P 3062
634479	1 457 429 941	S 9941
637 122	0 451 104 066	P 4066
740911	0 451 203 010	P 3010
770 286	0 451 103 274	P 3274

770915	1 457 434 200	N 4200
--------	---------------	---------------

PEUGEOT

0024 35	1 987 432 348	R 2348
1051 98	1 457 429 175	P 9175
1109 AF	F 026 407 083	P 7083

1109 AT	F 026 407 083	P 7083
1109 AZ	0 986 452 028	P 2028
1109 A0	0 451 103 274	P 3274
1109 A1	0 451 103 141	P 3141
1109 A7	0 451 103 028	P 3028

1109 A9	0 451 103 232	P 3232
1109 C0	0 451 103 029	P 3029
1109 C4	0 451 103 109	P 3109
1109 Q0	0 451 203 201	P 3201
1109 Q1	0 451 203 201	P 3201

1109 Q4	0 451 203 201	P 3201
1109 S5	1 457 429 238	P 9238
1109 X7	1 457 429 307	P 9307
1109 Y1	1 457 429 238	P 9238
1109 Y3	0 986 452 028	P 2028

1109 Y5	F 026 407 053	P 7053
1109 Y7	0 451 203 201	P 3201
1109 Z5	1 457 429 238	P 9238
1109 Z7	F 026 407 083	P 7083
1145 89	1 457 432 154	S 2154

1387 09	1 457 429 908	S 9908
1427 G4	1 457 433 555	S 3555
1427 G5	1 457 433 555	S 3555
1444 A0	1 457 433 790	S 3790
1444 A1	1 457 432 138	S 2138

1444 A4	1 457 432 200	S 2200
1444 A6	1 457 433 234	S 3234
1444 A8	1 457 432 200	S 2200
1444 A9	1 457 432 200	S 2200
1444 CA	1 987 429 182	S 9182

1444 CE	1 457 433 150	S 3150
1444 CF	1 457 433 325	S 3325
1444 CG	1 457 433 159	S 3159
1444 CJ	1 987 429 182	S 9182
1444 CP	1 457 433 160	S 3160

1444 CQ	1 457 433 592	S 3592
1444 CT	1 457 433 098	S 3098
1444 CV	1 457 433 591	S 3591
1444 CX	1 457 433 591	S 3591
1444 CZ	1 457 433 158	S 3158

1444 EA	1 457 433 158	S 3158
1444 EC	1 457 433 325	S 3325
1444 EE	1 457 433 325	S 3325
1444 EG	1 457 433 159	S 3159
1444 EH	1 457 433 596	S 3596

1444 EJ	F 026 400 108	S 0108
1444 EL	1 457 433 591	S 3591
1444 EQ	1 457 433 327	S 3327
1444 EV	1 457 433 596	S 3596
1444 EZ	1 457 433 591	S 3591

1444 E8	1 457 433 297	S 3297
1444 E9	1 457 433 297	S 3297
1444 F0	1 457 433 769	S 3769
1444 F1	1 457 433 229	S 3229
1444 F2	1 457 433 077	S 3077

1444 F3	1 457 432 200	S 2200
1444 F4	1 457 432 200	S 2200
1444 F5	1 457 433 544	S 3544
1444 F6	1 457 433 543	S 3543
1444 F7	1 457 433 543	S 3543

1444 F8	1 457 433 527	S 3527
1444 GH	1 457 433 158	S 3158
1444 G0	1 457 433 544	S 3544
1444 G1	1 457 433 544	S 3544
1444 G2	1 457 433 527	S 3527

1444 G9	1 457 433 526	S 3526
1444 H0	1 457 433 280	S 3280
1444 H1	1 457 433 077	S 3077
1444 H2	1 457 433 077	S 3077
1444 H3	F 026 400 010	S 0010

1444 H3	1 457 433 526	S 3526
1444 H4	1 457 432 200	S 2200
1444 H5	1 457 432 200	S 2200
1444 H6	1 457 432 200	S 2200
1444 H7	1 457 432 200	S 2200

1444 H9	1 457 433 061	S 3061
1444 J0	1 457 433 061	S 3061
1444 J1	1 457 432 200	S 2200
1444 J2	1 457 432 200	S 2200
1444 J3	1 457 433 280	S 3280

1444 J4	F 026 400 010	S 0010
1444 J5	1 457 433 526	S 3526
1444 J7	1 457 433 229	S 3229
1444 J9	1 457 429 079	S 9079
1444 K2	1 457 429 923	S 9923

1444 K3	1 457 432 134	S 2134
1444 K4	1 457 429 841	S 9841
1444 K5	1 457 432 204	S 2204
1444 K8	1 457 429 994	S 9994
1444 L1	1 457 429 894	S 9894

1444 L3	1 457 429 053	S 9053
1444 L4	1 457 429 050	S 9050
1444 L5	1 457 429 920	S 9920
1444 L6	1 457 433 623	S 3623
1444 L7	1 457 429 842	S 9842

1444 L8	1 457 429 777	S 9777
1444 N0	1 457 429 791	S 9791
1444 N3	1 457 432 111	S 2111
1444 N6	1 457 429 775	S 9775
1444 N7	1 457 433 624	S 3624

1444 N8	1 457 432 183	S 2183
1444 PV	1 457 433 971	S 3971
1444 P0	1 457 432 106	S 2106
1444 P2	1 457 433 230	S 3230
1444 P3	1 457 429 076	S 9076

1444 P4	1 457 433 285	S 3285
1444 P7	1 457 433 713	S 3713
1444 P9	1 457 433 603	S 3603
1444 QE	F 026 400 010	S 0010
1444 QF	F 026 400 010	S 0010

1444 QQ	F 026 400 150	S 0150
1444 QT	F 026 400 059	S 0059
1444 QW	F 026 400 058	S 0058
1444 QW	1 457 433 535	S 3535
1444 QX	F 026 400 058	S 0058

1444 QX	1 457 433 535	S 3535
1444 Q0	1 457 432 185	S 2185
1444 Q2	1 457 429 061	S 9061
1444 Q3	1 457 429 898	S 9898
1444 Q4	1 457 433 264	S 3264

1444 Q5	1 457 433 743	S 3743
1444 Q7	1 457 429 870	S 9870
1444 Q8	1 457 433 282	S 3282
1444 RG	1 457 433 971	S 3971
1444 RN	F 026 400 150	S 0150

1444 R0	1 457 433 608	S 3608
1444 R1	F 026 400 010	S 0010
1444 R2	1 457 432 200	S 2200
1444 R3	F 026 400 010	S 0010
1444 R5	1 457 433 555	S 3555

1444 R6	1 457 433 555	S 3555
1444 R7	1 457 432 200	S 2200
1444 TE	F 026 400 150	S 0150
1444 TJ	1 457 433 160	S 3160
1444 T0	1 457 432 200	S 2200

1444 T1	1 457 432 200	S 2200
1444 T3	1 457 432 200	S 2200
1444 T4	1 457 432 200	S 2200
1444 T5	1 457 432 200	S 2200
1444 T6	1 457 432 200	S 2200

1444 T7	1 457 432 200	S 2200
1444 T8	1 457 432 200	S 2200
1444 T9	1 457 432 200	S 2200
1444 VQ	1 987 429 182	S 9182
1444 VW	1 457 433 090	S 3090

1444 V1	F 026 400 025	S 0025
1444 V2	F 026 400 023	S 0023
1444 WN	F 026 400 058	S 0058
1444 W2	1 457 433 090	S 3090
1444 W3	1 457 433 090	S 3090



◀ PEUGEOT

1444 W5	1 457 433 150	S 3150
1444 W6	1 457 433 150	S 3150
1444 W8	1 457 432 200	S 2200
1444 X0	1 457 433 158	S 3158
1444 X1	1 457 433 325	S 3325

1444 X4	1 457 433 159	S 3159
1444 X5	1 457 433 160	S 3160
1444 02	1 457 429 908	S 9908
1444 08	1 457 432 200	S 2200
1444 09	1 457 432 138	S 2138

1444 10	1 457 433 250	S 3250
1444 11	1 457 433 229	S 3229
1444 84	1 457 432 154	S 2154
1444 84	1 457 433 544	S 3544
1444 85	1 457 433 227	S 3227

1444 86	1 457 433 606	S 3606
1444 88	1 457 432 200	S 2200
1444 99	1 457 433 790	S 3790
1445 08	1 457 432 200	S 2200
1445 26	1 457 433 229	S 3229

1445 53	1 457 432 154	S 2154
1445 74	1 457 432 154	S 2154
1445 84	1 457 432 154	S 2154
1445 89	1 457 432 154	S 2154
1445 90	1 457 432 154	S 2154

1445 96	1 457 433 229	S 3229
1567 A5	0 450 902 161	F 2161
1567 02	0 450 904 159	F 4159
1567 03	0 450 904 159	F 4159
1567 05	0 450 905 021	F 5021

1567 07	0 450 904 058	F 4058
1567 07	0 450 904 159	F 4159
1567 10	0 450 905 401	F 5401
1567 11	0 450 905 104	F 5104
1567 12	0 450 905 601	F 5601

1567 13	0 450 905 030	F 5030
1567 13	0 450 905 095	F 5095
1567 17	0 450 905 087	F 5087
1567 17	0 450 905 401	F 5401
1567 17	0 450 905 906	F 5906

1567 18	0 450 904 058	F 4058
1567 18	0 450 904 159	F 4159
1567 19	0 450 904 058	F 4058
1567 19	0 450 904 159	F 4159
1567 20	0 450 904 058	F 4058

1567 20	0 450 904 159	F 4159
1567 21	0 450 904 058	F 4058
1567 21	0 450 904 159	F 4159
1567 28	0 450 905 002	F 5002
1567 74	0 450 905 016	F 5016

1567 74	0 450 905 021	F 5021
1567 79	0 450 905 002	F 5002
1567 81	0 450 902 161	F 2161
1567 85	0 450 902 161	F 2161
1567 87	0 450 902 161	F 2161

1567 93	0 450 902 161	F 2161
1567 94	0 450 902 161	F 2161
1577 12	0 450 905 601	F 5601
1768 97	1 457 429 908	S 9908
1901 66	0 450 906 460	N 6460

1901 67	0 450 906 471	N 6471
1901 68	0 450 906 460	N 6460
1901 70	0 450 906 460	N 6460
1901 73	0 450 906 460	N 6460
1901 75	0 450 906 460	N 6460

1901 78	0 450 906 471	N 6471
1901 81	0 450 906 471	N 6471
1901 82	0 450 906 460	N 6460
1901 84	0 450 906 460	N 6460
1901 85	0 450 906 460	N 6460

1901 95	0 450 906 471	N 6471
1901 99	0 450 906 460	N 6460
1906 A1	1 457 030 013	N 0013
1906 A6	1 457 070 000	N 0000
1906 C4	1 457 070 001	N 0001

1906 C5	1 457 030 013	N 0013
1906 C6	1 457 434 105	N 4105
1906 01	1 457 429 289	N 9289
1906 02	1 457 431 028	N 1028
1906 04	1 457 431 158	N 1158

1906 04	1 457 431 261	N 1261
1906 05	1 457 431 261	N 1261
1906 05	1 457 431 325	N 1325
1906 07	1 457 431 325	N 1325
1906 08	1 457 434 201	N 4201

1906 11	1 457 429 289	N 9289
1906 12	1 457 434 200	N 4200
1906 13	1 457 434 201	N 4201
1906 14	1 457 434 200	N 4200
1906 23	1 457 434 103	N 4103

1906 23	1 457 434 321	N 4321
1906 24	1 457 434 103	N 4103
1906 24	1 457 434 321	N 4321
1906 29	1 457 429 291	N 9291
1906 29	1 457 431 713	N 1713

1906 29	1 457 431 713	N 1713
1906 32	1 457 434 201	N 4201
1906 33	1 457 429 291	N 9291
1906 33	1 457 431 713	N 1713
1906 34	1 457 429 291	N 9291

1906 34	1 457 431 702	N 1702
1906 35	1 457 431 702	N 1702
1906 38	1 457 429 291	N 9291
1906 38	1 457 431 713	N 1713
1906 39	1 457 434 103	N 4103

1906 39	1 457 434 321	N 4321
1906 40	1 457 434 103	N 4103
1906 40	1 457 434 321	N 4321
1906 41	1 457 434 103	N 4103
1906 41	1 457 434 321	N 4321

1906 42	1 457 434 103	N 4103
1906 42	1 457 434 321	N 4321
1906 43	1 457 429 291	N 9291
1906 43	1 457 431 713	N 1713
1906 48	1 457 431 703	N 1703

1906 49	1 457 431 703	N 1703
1906 50	1 457 030 013	N 0013
1906 51	1 457 030 013	N 0013
1906 52	1 457 431 705	N 1705
1906 53	1 457 431 705	N 1705

1906 54	1 457 431 702	N 1702
1906 55	1 457 431 702	N 1702
1906 56	1 457 429 657	N 9657
1906 60	1 457 434 105	N 4105
1906 61	1 457 434 105	N 4105

1906 64	1 457 429 291	N 9291
1906 64	1 457 431 713	N 1713
1906 76	1 457 070 000	N 0000
1906 84	1 457 434 439	N 4439
1906 87	1 457 434 106	N 4106

1906 88	1 457 434 106	N 4106
1906 89	1 457 431 723	N 1723
1906 90	1 457 431 723	N 1723
1906 93	F 026 402 013	N 2013
1906 95	F 026 402 004	N 2004

4496 4U	1 457 429 908	S 9908
54 143 62	1 457 431 028	N 1028
54 143 62 L	1 457 431 028	N 1028
54 705 30	0 450 905 002	F 5002
5947 34	1 457 434 200	N 4200

6447 H0	1 987 432 060	M 2060
6447 H1	1 987 432 060	M 2060
6447 JO	1 987 432 042	M 2042
6447 JO	1 987 432 042	M 2042
6447 LY	1 987 432 091	M 2091

6447 PE	1 987 432 348	R 2348
6447 P2	1 987 432 060	M 2060
6447 P3	1 987 432 060	M 2060
6447 SY	1 987 432 042	M 2042
6447 TT	1 987 432 189	M 2189

6447 YA	1 987 432 065	M 2065
6447 YJ	1 987 432 206	M 2206
6447 YL	1 987 432 406	R 2406
6447 ZX	1 987 432 216	M 2216
6479 C9	1 987 432 065	M 2065

6479 E9	1 987 432 416	R 2416
75 492 226	1 457 432 124	S 2124
90 002 276	0 450 905 401	F 5401
91 470 530	0 450 905 002	F 5002
91 505 306	0 450 905 021	F 5021

9150999180	0 450 905 145	F 5145
9150999180	0 450 905 200	F 5200
9150999180	0 450 905 601	F 5601
9150999180	0 450 905 964	F 5964
91 535 807	0 450 905 030	F 5030



9401 906 028	1 457 431 028	N 1028
9401 906 148	1 457 434 200	N 4200
95 470 530	0 450 905 002	F 5002
95 503 693	1 457 434 200	N 4200
95 583 693	1 457 434 200	N 4200

95 618 786	1 457 432 200	S 2200
95 650 878	1 457 434 321	N 4321
95 658 435	1 457 433 228	S 3228
95 685 435	1 457 433 228	S 3228
96 010 991	1 457 432 200	S 2200

96 019 991	1 457 432 200	S 2200
96 130 208	0 450 905 002	F 5002
96 131 549	0 450 905 002	F 5002
9636 783 780	1 987 432 077	M 2077
96 417 896 80	0 450 906 460	N 6460

96 453 975 80	1 457 433 159	S 3159
96 462 310 80	0 450 906 460	N 6460

RENAULT		
00 00 054 020	0 451 105 188	P 5188
00 00 122 440	1 457 429 175	P 9175
00 00 150 564	1 457 434 432	N 4432

00 00 504 020	0 451 105 188	P 5188
00 00 650 615	1 457 431 261	N 1261
00 00 870 159	1 457 431 261	N 1261
00 00 870 160	1 457 431 261	N 1261
00 01 225 001	1 457 431 261	N 1261

00 01 225 406	1 457 431 261	N 1261
00 01 229 148	1 457 431 261	N 1261
00 01 231 108	1 457 434 201	N 4201
00 01 231 545	1 457 429 117	P 9117
00 01 907 947	0 451 105 188	P 5188

00 02 656 621	1 457 434 201	N 4201
00 03 005 805	1 457 431 326	N 1326
00 03 005 806	1 457 431 326	N 1326
00 03 005 826	1 457 431 159	N 1159
00 03 052 535	1 457 434 200	N 4200

00 03 082 669	1 457 429 117	P 9117
00 03 082 671	0 986 452 000	P 2000
00 03 132 302	0 451 104 005	P 4005
00 03 141 914	0 451 104 065	P 4065
00 03 323 251	1 457 433 200	S 3200

00 03 563 021	1 457 429 969	S 9969
00 03 563 512	1 457 429 950	S 9950
00 03 563 565	1 457 429 946	S 9946
00 03 563 570	1 457 429 941	S 9941
00 03 563 577	1 457 429 932	S 9932

00 03 563 591	0 451 104 065	P 4065
00 03 563 595	1 457 429 966	S 9966
00 03 563 603	0 451 203 010	P 3010
00 03 563 604	1 457 429 165	P 9165
00 03 563 608	1 457 429 975	S 9975

00 03 564 024	1 457 433 200	S 3200
00 03 564 042	1 457 429 933	S 9933
00 03 564 105	1 457 429 794	S 9794
00 03 564 512	1 457 429 950	S 9950
00 04 205 627	0 451 105 188	P 5188

00 04 207 090	1 457 429 946	S 9946
00 04 212 747	1 457 429 950	S 9950
00 04 212 748	1 457 429 966	S 9966
00 04 214 189	1 457 429 966	S 9966
00 04 214 313	1 457 429 950	S 9950

00 04 214 314	1 457 429 966	S 9966
00 04 214 489	1 457 429 966	S 9966
00 04 309 015	1 457 429 946	S 9946
00 05 006 136	1 457 434 201	N 4201
00 05 006 163	1 457 434 201	N 4201

00 05 038 883	1 457 434 201	N 4201
00 05 150 017	0 451 104 065	P 4065
00 05 151 017	0 451 103 029	P 3029
00 05 151 017	0 451 104 065	P 4065
00 05 311 053	1 457 429 130	P 9130

00 05 490 862	0 450 904 058	F 4058
00 05 504 020	0 451 105 188	P 5188
00 08 503 375	1 457 429 175	P 9175
00 08 517 223	1 457 429 175	P 9175
00 08 548 759	1 457 431 261	N 1261

00 08 555 896	1 457 434 201	N 4201
00 08 704 657	1 457 431 261	N 1261
00 14 564 103	0 451 105 188	P 5188
00 22 004 800	1 457 429 966	S 9966
00 22 714 000	0 451 203 194	P 3194

00 22 852 200	1 457 434 154	N 4154
00 22 852 200	1 457 434 165	N 4165
00 22 852 800	1 457 434 432	N 4432
00 22 852 900	0 451 105 188	P 5188
00 22 860 400	1 457 429 975	S 9975

00 23 110 800	1 457 434 201	N 4201
00 24 151 017	0 451 104 065	P 4065
00 24 151 018	0 451 104 065	P 4065
00 24 151 119	1 457 431 326	N 1326
00 24 152 005	1 457 431 326	N 1326

00 24 164 103	0 451 105 067	P 5067
00 24 564 057	0 451 105 188	P 5188
00 24 564 058	0 451 105 188	P 5188
00 24 564 060	0 451 105 188	P 5188
00 24 564 103	0 451 105 188	P 5188

00 24 866 092	1 457 431 326	N 1326
00 60 377 200	1 457 429 950	S 9950
01 23 154 500	1 457 429 117	P 9117
01 858 000	F 026 407 059	P 7059
0850 337 500	1 457 429 175	P 9175

08 54 806 000	1 457 431 158	N 1158
08 54 975 700	1 457 431 028	N 1028
08 55 589 600	1 457 434 201	N 4201
08 55 590 600	1 457 434 201	N 4201
08 55 823 800	0 451 103 274	P 3274

08 55 891 099	0 451 103 141	P 3141
08 55 961 000	0 451 103 141	P 3141
08 55 961 100	0 451 103 141	P 3141
08 60 038 900	1 457 432 106	S 2106
08 70 017 560	1 457 434 154	N 4154

08 70 017 560	1 457 434 165	N 4165
08 70 017 560	1 457 434 432	N 4432
08 70 176 000	1 457 431 261	N 1261
08 70 176 000	1 457 431 325	N 1325
08 70 323 100	1 457 431 159	N 1159

08 70 465 700	1 457 431 261	N 1261
08 70 465 700	1 457 431 325	N 1325
09 20 049 500	0 450 905 287	F 5287
09 41 709 013	1 457 434 201	N 4201
09 44 700 122	1 457 429 175	P 9175

09 44 700 162	1 457 429 175	P 9175
09 80 465 700	1 457 431 261	N 1261
15 27 037 0579	0 450 902 161	F 2161
16546-JD20B	F 026 400 126	S 0126
20 70 945 9	F 026 407 043	P 7043

20 85 467 570	1 457 431 261	N 1261
20 85 480 470	1 457 431 261	N 1261
20 85 497 570	1 457 431 028	N 1028
20 85 558 9600	1 457 434 201	N 4201
20 87 046 570	1 457 431 261	N 1261

20 87 046 570	1 457 431 325	N 1325
22 85 290 0	0 451 105 188	P 5188
24151017	0 451 104 065	P 4065
24151018	0 451 104 065	P 4065
24 56 405 8	0 451 105 188	P 5188

24 56 406 0	0 451 105 188	P 5188
27 27 700 01R	1 987 432 500	R 2500
27 27 729 51R	1 987 432 500	R 2500
27 27 789 70R	1 987 432 327	R 2327
27 70 100 637	0 451 104 065	P 4065

27 70 100 6374	0 451 104 065	P 4065
27 70 100 8326	0 451 103 028	P 3028
27 70 100 8698	0 451 103 062	P 3062
3323251	1 457 433 200	S 3200
3564024	1 457 433 200	S 3200

3564042	1 457 429 933	S 9933
3564105	1 457 429 794	S 9794
40 33 156 710	1 457 434 432	N 4432
40 33 162 440	1 457 429 165	P 9165
40 55 020 005	0 450 905 030	F 5030

41 25 030 024	1 457 429 354	N 9354
41 25 030 024	1 457 431 159	N 1159
4212748	1 457 429 966	S 9966
4214189	1 457 429 966	S 9966
4214314	1 457 429 966	S 9966

4214489	1 457 429 966	S 9966
485 GB 3191	0 451 104 010	P 4010
485 GB 3191 A	0 451 104 010	P 4010
485 GB 3191 B	0 451 104 010	P 4010
50 00 031 068	1 457 429 354	N 9354



◀ RENAULT

50 00 031 168	0 450 904 058	F 4058
50 00 040 870	0 451 104 065	P 4065
50 00 044 059	0 451 104 065	P 4065
50 00 044 064	0 451 104 065	P 4065
50 00 044 064	0 451 203 194	P 3194

50 00 044 487	0 451 104 065	P 4065
50 00 044 959	0 451 104 065	P 4065
5000133555	0 451 104 010	P 4010
50 00 133 555	0 451 403 077	P 3077
50 00 241 250	1 457 431 028	N 1028

50 00 241 676	1 457 431 028	N 1028
50 00 241 677	1 457 431 261	N 1261
50 00 241 796	1 457 429 950	S 9950
50 00 242 503	1 457 429 966	S 9966
50 00 242 504	1 457 429 975	S 9975

50 00 243 097	1 457 434 201	N 4201
50 00 255 463	1 457 429 165	P 9165
50 00 255 643	1 457 429 165	P 9165
50 00 288 033	1 457 434 201	N 4201
50 00 504 020	0 451 105 188	P 5188

50 00 670 670	0 451 105 188	P 5188
50 00 670 699	0 451 104 010	P 4010
50 00 670 699	0 451 403 077	P 3077
50 00 670 700	0 451 104 010	P 4010
50 00 670 700	0 451 403 077	P 3077

50 00 670 735	F 026 407 059	P 7059
50 00 670 737	F 026 407 059	P 7059
50 00 686 589	1 457 434 154	N 4154
50 00 686 589	1 457 434 165	N 4165
50 00 686 589	1 457 434 432	N 4432

50 00 686 590	1 457 434 154	N 4154
50 00 686 590	1 457 434 165	N 4165
50 00 686 590	1 457 434 432	N 4432
50 00 783 932	1 457 429 966	S 9966
50 00 786 107	0 451 105 188	P 5188

5000790022	0 451 103 004	P 3004
50 00 790 570	1 457 434 154	N 4154
50 00 790 570	1 457 434 165	N 4165
50 00 790 570	1 457 434 432	N 4432
50 00 790 787	0 451 105 188	P 5188

50 00 790 788	0 451 105 188	P 5188
50 00 790 822	0 451 105 188	P 5188
50 00 790 823	0 451 105 188	P 5188
50 00 806 317	1 457 429 969	S 9969
50 00 806 336	1 457 434 050	N 4050

50 00 806 336	1 457 434 432	N 4432
50 00 806 377	1 457 429 969	S 9969
50 00 807 751	1 457 434 201	N 4201
50 00 812 484	0 451 300 003	P 0003
50 00 814 227	1 457 434 154	N 4154

50 00 814 227	1 457 434 165	N 4165
50 00 814 227	1 457 434 432	N 4432
50 00 814 407	1 457 429 820	P 9820
50 00 816 070	0 451 203 201	P 3201
50 00 820 895	1 457 429 820	P 9820

50 00 875 107	0 451 105 188	P 5188
50 00 876 107	0 451 105 188	P 5188
50 00 935 525	0 451 105 188	P 5188
50 00 935 712	0 451 105 188	P 5188
50 01 000 878	1 457 433 231	S 3231

50 01 008 878	1 457 433 231	S 3231
50 01 546 650	0 451 104 010	P 4010
50 01 834 750	1 457 429 966	S 9966
50 01 846 545	F 026 407 059	P 7059
50 01 846 546	F 026 407 059	P 7059

50 01 846 627	1 457 429 647	P 9647
5001846628	1 457 429 646	P 9646
50 01 846 629	1 457 429 732	P 9732
50 01 846 630	1 457 429 735	P 9735
50 01 846 631	1 457 429 740	P 9740

50 01 846 632	1 457 429 128	P 9128
50 01 846 633	1 457 429 274	P 9274
5001846635	0 451 103 004	P 3004
50 01 846 636	0 451 203 226	P 3226
50 01 846 637	0 451 104 066	P 4066

50 01 846 638	0 451 203 220	P 3220
50 01 846 639	0 451 104 015	P 4015
50 01 846 640	0 451 301 156	P 1156
50 01 846 641	F 026 407 043	P 7043
50 01 846 641	0 451 403 077	P 3077

50 01 846 642	F 026 407 043	P 7043
50 01 846 642	0 451 103 343	P 3343
50 01 846 644	0 451 403 208	P 3208
50 01 846 646	F 026 407 049	P 7049
50 01 846 647	0 451 300 003	P 0003

50 01 846 648	F 026 407 105	P 7105
50 01 846 993	1 457 429 107	P 9107
50 01 853 256	F 026 407 059	P 7059
50 01 853 860	1 457 434 421	N 4421
5001858000	F 026 407 059	P 7059

50 01 858 001	F 026 407 060	P 7060
50 01 858 099	F 026 407 048	P 7048
50 01 863 139	F 026 407 048	P 7048
50 01 865 723	F 026 400 145	S 0145
5001869773	1 457 429 271	P 9271

50 01 869 788	F 026 402 059	N 2059
50 10 140 505	1 457 429 946	S 9946
50 10 230 841	F 026 400 083	S 0083
50 10 230 916	F 026 400 086	S 0086
50 10 317 163	1 457 429 966	S 9966

50 10 412 350	1 457 434 421	N 4421
50 10 412 645	F 026 407 060	P 7060
50 10 437 143	F 026 407 060	P 7060
50 10 437 356	F 026 407 060	P 7060
50 10 450 824	1 457 434 421	N 4421

5010477855	1 457 434 421	N 4421
50 10 505 337	1 457 434 421	N 4421
5010550600	0 451 104 010	P 4010
5151017	0 451 104 065	P 4065
59 84 520 800	1 457 431 326	N 1326

60 00 141 020	0 451 104 065	P 4065
60 00 581 613	0 450 902 151	F 2151
60 00 591 768	0 450 902 161	F 2161
60 01 000 383	1 457 429 957	S 9957
60 01 000 471	0 450 905 021	F 5021

60 05 000 735	0 451 104 066	P 4066
60 05 000 788	1 457 434 050	N 4050
60 05 000 788	1 457 434 432	N 4432
60 05 000 894	1 457 434 201	N 4201
60 05 000 929	0 451 104 005	P 4005

60 05 000 929	0 451 104 066	P 4066
60 05 007 409	1 457 434 201	N 4201
60 05 012 109	0 451 104 005	P 4005
6005024443	0 451 104 066	P 4066
6005025477	0 451 104 015	P 4015

6005025477	0 451 105 067	P 5067
60 25 309 779	0 450 905 287	F 5287
60 25 404 659	1 457 433 080	S 3080
67 50 558 686	0 451 105 188	P 5188
71 00 544 588	0 450 904 058	F 4058

74 20 430 751	0 451 300 003	P 0003
74 20 541 379	0 451 300 003	P 0003
74 20 541 381	F 026 402 017	N 2017
74 20 709 459	F 026 407 043	P 7043
74 20 976 001	F 026 402 017	N 2017

74 85 116 340	1 457 431 724	N 1724
77 00 106 067	F 026 407 106	P 7106
77 00 109 402	1 457 429 198	P 9198
77 00 109 585	0 450 906 461	N 6461
77 00 111 834	1 457 433 075	S 3075

77 00 268 752	0 450 905 021	F 5021
77 00 271 011	0 450 904 159	F 4159
77 00 271 026	0 450 904 159	F 4159
77 00 274 216	1 457 433 311	S 3311
77 00 348 108	0 451 103 141	P 3141

77 00 403 481	1 457 429 079	S 9079
77 00 538 151	0 451 103 141	P 3141
77 00 538 153	0 451 103 274	P 3274
77 00 542 086	0 451 103 274	P 3274
77 00 542 285	0 451 103 141	P 3141

77 00 542 286	0 451 103 274	P 3274
77 00 542 523	0 451 103 141	P 3141
7700544588	0 450 904 058	F 4058
77 00 545 787	0 450 904 159	F 4159
77 00 545 868	0 451 103 274	P 3274

77 00 553 733	0 451 103 274	P 3274
77 00 565 729	1 457 432 106	S 2106
77 00 582 693	0 450 905 002	F 5002
77 00 629 215	0 451 103 141	P 3141
77 00 634 818	0 451 103 274	P 3274

77 00 638 670	0 451 103 274	P 3274
77 00 640 175	0 451 103 004	P 3004
77 00 646 761	0 451 103 274	P 3274
77 00 651 432	0 451 103 274	P 3274
77 00 668 711	1 457 434 103	N 4103



77 00 671 933	1 457 432 124	S 2124	77 01 010 100	1 457 434 201	N 4201	77 01 042 841	1 457 433 606	S 3606
77 00 673 219	0 451 103 274	P 3274	77 01 015 820	1 457 434 050	N 4050	77 01 043 620	1 457 429 657	N 9657
77 00 680 162	0 450 905 030	F 5030	77 01 015 820	1 457 434 154	N 4154	77 01 043 709	F 026 400 011	S 0011
77 00 680 162	0 450 905 264	F 5264	77 01 015 820	1 457 434 165	N 4165	77 01 044 101	1 457 433 773	S 3773
77 00 680 162	0 450 905 275	F 5275	77 01 015 820	1 457 434 432	N 4432	77 01 044 595	F 026 400 014	S 0014
77 00 680 167	0 450 905 030	F 5030	77 01 015 830	1 457 434 050	N 4050	77 01 044 645	1 457 433 062	S 3062
77 00 699 068	1 457 429 079	S 9079	77 01 015 830	1 457 434 432	N 4432	77 01 044 677	1 457 433 161	S 3161
7700699068	1 457 433 065	S 3065	77 01 016 181	1 457 434 201	N 4201	77 01 044 913	1 457 431 705	N 1705
77 00 700 092	1 457 434 103	N 4103	77 01 017 322	1 457 434 154	N 4154	77 01 045 724	1 457 433 529	S 3529
77 00 700 092	1 457 434 106	N 4106	77 01 017 322	1 457 434 165	N 4165	77 01 047 285	1 457 433 531	S 3531
77 00 703 481	1 457 429 079	S 9079	77 01 017 322	1 457 434 432	N 4432	77 01 047 417	F 026 400 015	S 0015
7700703481	1 457 433 065	S 3065	77 01 017 732	1 457 434 165	N 4165	77 01 047 478	1 457 433 577	S 3577
77 00 711 477	1 457 432 134	S 2134	77 01 019 017	1 457 429 946	S 9946	77 01 047 655	1 457 433 311	S 3311
77 00 715 536	1 457 433 230	S 3230	7701019018	F 026 400 082	S 0082	77 01 050 319	1 987 432 208	M 2208
77 00 720 987	1 457 432 124	S 2124	77 01 019 344	1 457 432 124	S 2124	77 01 052 082	1 457 433 320	S 3320
77 00 721 853	1 457 432 204	S 2204	77 01 020 783	1 457 432 124	S 2124	77 01 053 054	0 986 452 061	P 2061
77 00 721 968	1 457 432 134	S 2134	77 01 021 853	1 457 432 204	S 2204	77 01 056 390	1 987 432 400	R 2400
77 00 722 120	1 457 432 204	S 2204	77 01 022 800	0 451 104 065	P 4065	77 01 057 828	1 457 429 271	P 9271
77 00 722 482	0 451 103 235	P 3235	77 01 023 168	0 451 103 028	P 3028	77 01 059 409	1 457 433 660	S 3660
77 00 722 657	1 457 432 134	S 2134	7701023283	1 457 432 134	S 2134	77 01 064 439	1 457 433 660	S 3660
77 00 724 629	1 457 432 204	S 2204	77 01 023 306	1 457 432 124	S 2124	77 01 065 985	F 026 400 011	S 0011
77 00 724 743	0 450 904 159	F 4159	77 01 025 064	1 457 429 932	S 9932	77 01 066 680	F 026 402 019	N 2019
77 00 724 875	1 457 429 923	S 9923	77 01 026 651	1 457 432 124	S 2124	77 01 067 123	F 026 402 061	N 2061
77 00 726 615	1 457 432 134	S 2134	77 01 027 194	1 457 432 134	S 2134	77 01 068 107	0 450 902 161	F 2161
77 00 726 616	1 457 432 134	S 2134	77 01 027 195	1 457 432 134	S 2134	7701070525	1 457 433 311	S 3311
77 00 727 482	0 451 103 235	P 3235	77 01 028 157	1 457 432 134	S 2134	77 01 203 657	1 457 429 289	N 9289
77 00 728 143	0 450 904 159	F 4159	77 01 028 809	1 457 429 923	S 9923	77 01 204 497	1 457 429 621	N 9621
77 00 742 368	0 450 905 030	F 5030	77 01 029 278	0 451 103 062	P 3062	77 01 206 119	1 457 431 712	N 1712
77 00 742 386	0 450 905 030	F 5030	77 01 029 279	0 451 103 028	P 3028	77 01 206 928	1 457 431 720	N 1720
77 00 749 566	0 451 103 240	P 3240	77 01 029 280	0 451 104 065	P 4065	77 01 207 545	1 457 431 705	N 1705
77 00 820 375	0 450 905 904	F 5904	77 01 029 809	1 457 429 923	S 9923	77 01 207 667	1 457 431 724	N 1724
77 00 820 376	0 450 905 903	F 5903	77 01 030 195	1 457 434 103	N 4103	77 01 208 613	F 026 402 047	N 2047
7700834816	1 987 432 108	M 2108	77 01 030 195	1 457 434 105	N 4105	77 01 209 837	1 987 432 078	M 2078
77 00 838 890	0 450 905 030	F 5030	77 01 030 195	1 457 434 106	N 4106	77 01 218 107	0 451 103 141	P 3141
77 00 845 961	0 450 902 161	F 2161	77 01 030 196	1 457 433 230	S 3230	77 01 265 435	0 451 103 141	P 3141
77 00 845 961	0 450 905 287	F 5287	77 01 030 793	1 457 432 204	S 2204	77 01 348 018	0 451 103 141	P 3141
77 00 845 973	0 450 905 287	F 5287	77 01 031 111	0 451 103 274	P 3274	77 01 348 023	0 451 103 274	P 3274
77 00 850 394	0 451 103 240	P 3240	77 01 031 977	1 457 434 103	N 4103	77 01 348 028	0 451 103 141	P 3141
77 00 854 426	1 457 433 624	S 3624	77 01 033 176	1 457 431 028	N 1028	77 01 348 107	0 451 103 274	P 3274
77 00 857 336	1 457 433 624	S 3624	77 01 033 713	1 457 429 841	S 9841	77 01 348 108	0 451 103 141	P 3141
77 00 858 863	1 457 434 201	N 4201	77 01 033 837	0 451 103 141	P 3141	77 01 348 115	1 457 432 106	S 2106
77 00 860 823	0 451 203 201	P 3201	77 01 034 705	1 457 433 233	S 3233	77 01 348 175	1 457 432 124	S 2124
77 00 864 685	F 026 407 106	P 7106	77 01 034 872	1 457 429 923	S 9923	77 01 348 440	0 451 103 141	P 3141
77 00 865 981	0 451 103 240	P 3240	7701034934	1 457 433 230	S 3230	77 01 348 930	1 457 429 079	S 9079
7700957336	1 457 429 841	S 9841	77 01 035 650	0 451 203 201	P 3201	7701348930	1 457 433 065	S 3065
77 01 001 494	1 457 432 106	S 2106	77 01 035 650	0 451 300 007	P 0007	77 01 349 332	0 450 904 058	F 4058
77 01 001 499	1 457 432 106	S 2106	77 01 036 270	1 457 433 623	S 3623	77 01 349 332	0 450 904 159	F 4159
77 01 002 280	0 451 104 065	P 4065	77 01 037 111	1 457 433 260	S 3260	77 01 349 530	1 457 432 134	S 2134
77 01 005 514	1 457 432 106	S 2106	77 01 037 174	1 457 433 266	S 3266	77 01 365 435	0 451 103 141	P 3141
77 01 006 018	1 457 429 629	P 9629	77 01 038 857	F 026 400 011	S 0011	77 01 365 436	0 451 103 141	P 3141
77 01 006 020	1 457 429 629	P 9629	77 01 039 703	1 457 434 291	N 4291	77 01 365 661	0 451 103 274	P 3274
77 01 006 374	0 451 104 065	P 4065	77 01 039 857	F 026 400 011	S 0011	77 01 415 049	0 451 103 274	P 3274
77 01 008 326	0 451 103 028	P 3028	77 01 040 285	1 457 433 743	S 3743	77 01 415 051	0 451 104 065	P 4065
77 01 008 698	0 451 103 062	P 3062	77 01 040 780	1 457 432 124	S 2124	77 01 472 321	1 457 429 198	P 9198
77 01 009 924	1 457 429 130	P 9130	77 01 041 740	1 457 433 282	S 3282	77 01 474 004	1 457 429 302	P 9302



◀ RENAULT

77 01 475 229	F 026 402 047	N 2047
77 01 476 258	1 457 433 531	S 3531
77 01 476 463	1 457 431 705	N 1705
77 01 477 096	1 457 433 531	S 3531
77 01 477 208	1 457 433 163	S 3163

77 01 478 277	F 026 402 081	N 2081
77 01 478 821	F 026 402 067	N 2067
77 01 479 305	F 026 402 067	N 2067
77 01 638 670	0 451 103 274	P 3274
77 02 131 573	1 457 432 134	S 2134

77 02 134 953	1 457 432 134	S 2134
7702145581	1 457 432 134	S 2134
77 02 247 686	1 457 432 134	S 2134
77 11 064 163	0 450 905 401	F 5401
77 11 130 026	0 450 905 030	F 5030

77 70 418 696	0 450 905 287	F 5287
81 12 503 0011	1 457 431 270	N 1270
81 12 503 0016	1 457 431 261	N 1261
81 12 503 0018	1 457 431 270	N 1270
82 00 004 835	1 457 429 198	P 9198

82 00 023 480	1 457 433 163	S 3163
82 00 026 237	0 450 906 468	N 6468
82 00 065 768	1 457 433 531	S 3531
82 00 095 976	F 026 400 103	S 0103
82 00 104 272	1 457 433 078	S 3078

82 00 166 615	1 987 429 406	S 9406
82 00 186 217	0 450 906 469	N 6469
82 00 216 005	1 457 433 595	S 3595
82 00 259 359	F 026 400 166	S 0166
82 00 261 781	1 457 433 573	S 3573

82 00 275 382	1 457 433 660	S 3660
82 00 294 143	0 450 906 473	N 6473
82 00 298 074	F 026 400 051	S 0051
82 00 302 666	1 457 433 573	S 3573
82 00 358 714	0 450 904 159	F 4159

82 00 362 442	F 026 407 014	P 7014
8200371661	1 987 429 406	S 9406
82 00 371 663	1 457 433 573	S 3573
8200378889	1 987 429 406	S 9406
82 00 386 495	0 450 905 287	F 5287

82 00 399 214	1 457 433 595	S 3595
82 00 416 946	0 450 906 461	N 6461
8200421711	1 457 433 075	S 3075
82 00 431 051	1 457 433 529	S 3529
82 00 431 075	1 457 433 163	S 3163

82 00 431 081	F 026 400 051	S 0051
82 00 447 197	0 450 906 473	N 6473
82 00 457 286	1 457 433 531	S 3531
82 00 459 849	F 026 400 015	S 0015
82 00 490 109	F 026 400 103	S 0103

82 00 505 566	F 026 400 166	S 0166
82 00 602 361	F 026 400 052	S 0052
8200602361	1 457 433 090	S 3090
82 00 619 849	F 026 402 072	N 2072
82 00 671 525	F 026 402 067	N 2067

82 00 671 526	F 026 402 067	N 2067
82 00 697 875	F 026 402 016	N 2016
82 00 697 876	F 026 402 061	N 2061
8200792661	1 457 433 599	S 3599
82 00 799 782	1 457 433 075	S 3075

82 00 820 859	F 026 400 138	S 0138
82 00 926 014	0 450 906 473	N 6473
82 01 010 955	F 026 402 067	N 2067
82 01 010 956	F 026 402 067	N 2067
82 01 015 125	F 026 402 067	N 2067

82 01 015 126	F 026 402 067	N 2067
82 01 046 788	F 026 402 067	N 2067
85 48 060 000	1 457 431 158	N 1158
85 48 759 000	1 457 431 261	N 1261
8548979	0 986 452 044	P 2044

85 49 757 000	1 457 431 028	N 1028
8558238	0 986 452 044	P 2044
855823800	0 986 452 044	P 2044
8559611	0 986 452 044	P 2044
86 71 014 130	1 987 429 135	S 9135

87 01 760 000	1 457 429 230	N 9230
87 01 760 000	1 457 431 261	N 1261
87 01 760 000	1 457 431 325	N 1325
89 33 000 076	0 450 905 985	F 5985
89 33 001 395	1 457 429 818	S 9818

89 33 001 795	1 457 429 818	S 9818
89 63 500 079	1 457 432 134	S 2134
89 83 500 079	1 457 432 134	S 2134
89 83 501 000	0 451 103 141	P 3141
89 83 501 080	0 451 103 141	P 3141

SCANIA

1117285	0 451 103 343	P 3343
1117295	0 451 103 343	P 3343
12788338	1 457 433 655	S 3655

1301696	0 451 103 330	P 3330
1302756	1 457 434 201	N 4201
1329876	1 457 429 174	P 9174
1335678	1 457 433 904	S 3904
1335679	1 457 433 903	S 3903

1347726	0 451 103 343	P 3343
1379952	1 987 432 153	M 2153
1381235	1 457 429 174	P 9174
1387549	1 457 433 042	S 3042
1393640	F 026 402 025	N 2025

1401462	1 457 434 154	N 4154
1401462	1 457 434 165	N 4165
1401462	1 457 434 432	N 4432
1420197	1 987 432 153	M 2153
1421021	1 457 433 904	S 3904

1421022	1 457 433 903	S 3903
1459762	F 026 402 100	N 2100
1526087	1 457 433 042	S 3042
152875	1 457 431 270	N 1270
152875	1 457 431 326	N 1326

153468	1 457 429 820	P 9820
168185	1 457 429 165	P 9165
173171	0 451 103 004	P 3004
173171	0 451 103 029	P 3029
173171	0 986 452 003	P 2003

1742032	F 026 407 100	P 7100
1742037	F 026 407 100	P 7100
1801775	1 457 433 042	S 3042
181646	1 457 434 154	N 4154
181646	1 457 434 165	N 4165

181646	1 457 434 432	N 4432
1873016	F 026 402 100	N 2100
1913500	1 987 431 172	M 1172
210970	1 457 434 154	N 4154
210970	1 457 434 165	N 4165

210970	1 457 434 432	N 4432
211589	1 457 429 975	S 9975
217517	1 457 429 975	S 9975
218989	1 457 429 950	S 9950
219517	1 457 429 975	S 9975

219519	1 457 429 975	S 9975
2195196470	1 457 429 975	S 9975
235586	1 457 429 966	S 9966
24416213	1 457 429 656	N 9656
275588	1 457 429 969	S 9969

309439	1 457 431 158	N 1158
326065	1 457 434 154	N 4154
326065	1 457 434 165	N 4165
326065	1 457 434 432	N 4432
332441	1 457 434 051	N 4051

343144	1 457 434 106	N 4106
364624	1 457 434 154	N 4154
364624	1 457 434 165	N 4165
364624	1 457 434 432	N 4432
371307	1 457 432 188	S 2188

395773	1 457 432 188	S 2188
4163853	0 450 905 200	F 5200
4236030	1 457 433 263	S 3263
4236063	1 457 429 898	S 9898
4572491	1 457 433 590	S 3590

4772166	1 457 429 157	P 9157
4876199	1 457 433 797	S 3797
5173166	1 457 433 590	S 3590
5195516	1 457 429 656	N 9656
5464656	1 457 429 656	N 9656

55560911	1 457 433 590	S 3590
562810	0 451 103 343	P 3343

SEAT

ND1 042 020 1	1 457 434 201	N 4201
ND1 042 025 0	1 457 431 028	N 1028
SE 020 022 203 A	1 457 432 111	S 2111



SE 021 022 203 A	1 457 429 050	S 9050
SE 021 022 203 B	1 457 429 846	S 9846
SE 021 104 653 A	0 450 905 030	F 5030
SE0 212 020 0A	0 450 904 058	F 4058
SE 022 119 900 B	1 457 434 201	N 4201

XE 020 022 203 A	1 457 432 111	S 2111
XE 021 022 203 A	1 457 429 050	S 9050
XE 021 022 203 B	1 457 429 846	S 9846
000 389 799 1	0 451 103 029	P 3029
000 393 656 9	0 451 103 029	P 3029

000 393 687 0	0 451 103 029	P 3029
000 395 475 6	1 457 429 846	S 9846
000 446 512 1	1 457 434 106	N 4106
000 594 089 8	0 451 103 029	P 3029
000 993 689 1	1 457 434 106	N 4106

003 950 789	1 457 429 050	S 9050
021 104 653 A	0 450 905 030	F 5030
045 090 503 0	0 450 905 030	F 5030
1J0 201 511 A	0 450 905 318	F 5318
1L0 129 620	1 457 433 008	S 3008

1L0 129 620 A	1 457 433 264	S 3264
251 201 511 A	0 450 905 030	F 5030
6K0 127 401 G	0 450 906 409	N 6409
6K0 127 401 H	0 450 906 409	N 6409

SKODA

101940219	1 457 429 064	S 9064
115 946 200	1 457 429 064	S 9064
115 946 201	1 457 429 064	S 9064

115 946 202	1 457 429 054	S 9054
6U0 201 511 E	0 450 904 159	F 4159

SSANGYONG

224 010 50 40	0 450 905 281	F 5281
661 090 30 55	1 457 434 331	N 4331
661 180 30 09	1 457 429 274	P 9274

665 092 11 01	0 450 906 508	N 6508
665 092 12 01	0 450 906 508	N 6508
92060868	1 457 433 003	S 3003

STEYR**(STEYR-DAIMLER-PUCH AG)**

130100071001	0 451 103 028	P 3028
141185190010	1 457 429 941	S 9941

161100190020	F 026 400 082	S 0082
162000081001	1 457 434 200	N 4200
185 55 0065	1 457 431 159	N 1159
185 55 0066	1 457 431 326	N 1326
1855503	1 457 431 158	N 1158

1855504	1 457 429 230	N 9230
1855504	1 457 431 261	N 1261
209 07 0087	0 451 103 004	P 3004
209 07 0087	0 451 103 062	P 3062
209 0736	0 451 104 065	P 4065

209 0787	0 451 103 004	P 3004
2090787	0 451 103 062	P 3062
21785821	0 451 103 346	P 3346
295470705	1 457 429 165	P 9165
30100071001	0 451 103 028	P 3028

311 001 907 01	1 457 429 932	S 9932
380955163	1 457 431 158	N 1158
380955164	1 457 429 230	N 9230
380955164	1 457 431 261	N 1261
4060716	0 451 103 004	P 3004

4060718	0 451 104 065	P 4065
406 0757	0 451 104 065	P 4065
407 07 0030	0 451 104 065	P 4065
407 08 0076	1 457 434 105	N 4105
407080131	1 457 431 158	N 1158

407080132	1 457 429 230	N 9230
407080132	1 457 431 261	N 1261
409070036	0 451 104 065	P 4065
409 0736	0 451 104 065	P 4065
41185190010	1 457 429 941	S 9941

480 A4 70060	1 457 429 820	P 9820
480 A4 70748	1 457 429 820	P 9820
5402080B01	1 457 431 270	N 1270
5402080B02	1 457 431 159	N 1159
540208001B01	1 457 431 270	N 1270

540208001B02	1 457 431 159	N 1159
540 208 001 B0 1	1 457 431 326	N 1326
540 208 001 B0 2	1 457 431 159	N 1159
609 F 070 060	1 457 429 130	P 9130
609 G 070 028	1 457 429 130	P 9130

610 000 700 05	0 451 104 015	P 4015
61000070005	0 451 105 067	P 5067
61000070005	0 451 203 010	P 3010
611 00 19 0020	F 026 400 082	S 0082
612 001 900 37	1 457 429 950	S 9950

614 08 0739	1 457 431 270	N 1270
614080740	1 457 431 159	N 1159
614 09 0739	1 457 431 270	N 1270
615 000 800 43	1 457 434 105	N 4105
61500080135	1 457 429 676	N 9676

7002080492	0 450 904 058	F 4058
7101070332	0 451 104 066	P 4066
7121071142	0 451 104 065	P 4065
990 001 900 75	1 457 429 966	S 9966
990 001 907 02	1 457 429 966	S 9966

990 121 901 37	1 457 429 975	S 9975
990 121 907 01	1 457 429 966	S 9966
990 121 907 05	1 457 429 975	S 9975
990 141 900 33	1 457 429 969	S 9969

SUBARU

G3210-FC000	1 987 432 218	M 2218
13780 86G00	F 026 400 045	S 0045
13780 86G00 000	F 026 400 045	S 0045

13780 86000	1 457 433 785	S 3785
15208-AAU00	0 986 452 023	P 2023
15208-AAU00	0 986 452 035	P 2035
15208AA000	0 986 452 023	P 2023
15208 AA020	0 451 103 275	P 3275

15208AA020	0 451 103 316	P 3316
15208 AA021	0 451 103 275	P 3275
15208AA021	0 451 103 316	P 3316
15208 AA022	0 451 103 275	P 3275
15208AA022	0 451 103 316	P 3316

15208 AA023	0 451 103 275	P 3275
15208AA023	0 451 103 316	P 3316
15208 AA024	0 451 103 275	P 3275
15208 AA031	0 451 103 316	P 3316
15208 AA060	0 451 103 275	P 3275

15208AA080	0 986 452 061	P 2061
15208-AA09A	0 986 452 061	P 2061
15208 HA000	0 986 452 023	P 2023
15208 KA000	0 986 452 061	P 2061
15208 KA010	0 986 452 061	P 2061

16510 61A02	0 451 103 276	P 3276
16510 82703	0 986 452 058	P 2058
16546AA010	1 987 429 051	S 9051
16546 AA020	1 987 429 051	S 9051
16546 AA030	1 457 433 274	S 3274

16546 AA050	1 987 429 051	S 9051
16546-AA080	1 987 429 051	S 9051
16546-17B00	1 457 433 274	S 3274
16546-30P00	1 457 433 274	S 3274
16546-73C01	1 457 433 274	S 3274

281-454-110	0 451 103 029	P 3029
281-454-110	1 457 429 800	S 9800
281-454-110	1 457 429 801	S 9801
420335400	0 451 103 316	P 3316
42033 5400	0 986 452 061	P 2061

420335410	0 451 103 316	P 3316
42033 5410	0 986 452 061	P 2061
420335500	0 451 103 316	P 3316
42033 5500	0 986 452 061	P 2061
42033-7100	0 986 452 000	P 2000

42033-7100	0 986 452 023	P 2023
42033 7110	0 986 452 023	P 2023
42070-GA061	0 986 450 117	F 0117
42072 AA011	0 986 450 114	F 0114
42072 AA120	0 986 450 114	F 0114

42072 GA061	0 986 450 117	F 0117
42072 PA010	0 986 450 114	F 0114
42072 SA000	0 986 450 114	F 0114
42145 4110	1 457 429 801	S 9801
642010020	0 450 904 058	F 4058



◀ SUBARU

72880 AG000	1 987 432 085	M 2085
72880 AJ000	1 987 432 190	M 2190
74202 3000	0 450 904 158	N 4158
74202-3020	0 450 904 158	N 4158
74204-1140	0 986 450 117	F 0117

74204-2076	0 986 450 117	F 0117
74207 GA061	0 986 450 117	F 0117
74207 2170	0 450 904 158	N 4158
74207 2280	0 450 905 971	F 5971
74208-1080	0 450 904 158	N 4158

82145 4110	1 457 429 801	S 9801
87139 YZ03	1 987 432 320	R 2320
88084-4110	0 986 452 000	P 2000
88084-4110	0 986 452 023	P 2023
880872100	0 451 103 316	P 3316

88087 4100	0 986 452 023	P 2023
95860 78F10	1 987 432 066	M 2066

SUZUKI

13780-54G00	1 987 429 175	S 9175
13780 54G00 000	1 987 429 175	S 9175
13780-54G10	F 026 400 090	S 0090

13780 54G10 000	F 026 400 090	S 0090
13780-60B00	1 457 433 785	S 3785
13780 60B00 000	1 457 433 785	S 3785
13780-60G00	1 457 433 953	S 3953
13780 60G00 000	1 457 433 953	S 3953

13780 61AA0	1 457 433 037	S 3037
13780-61A00	1 457 433 037	S 3037
13780 61A00 000	1 457 433 037	S 3037
13780-62J00	F 026 400 037	S 0037
1378062J0000	F 026 400 037	S 0037

13780 62J00 000	F 026 400 037	S 0037
13780-65D10	1 457 433 956	S 3956
13780 65D10 000	1 457 433 956	S 3956
13780-65G50	1 457 433 953	S 3953
13780 65G50 000	1 457 433 953	S 3953

13780-65J00	F 026 400 125	S 0125
13780-73J00	1 457 433 160	S 3160
13780 73J00 000	1 457 433 160	S 3160
1378077EU0	1 457 433 956	S 3956
13780-77E00	1 457 433 956	S 3956

13780 77E00 000	1 457 433 956	S 3956
13780-79J00	F 026 400 201	S 0201
13780-79J50	F 026 400 056	S 0056
13780 79J50 000	F 026 400 056	S 0056
13780-79201	1 987 429 042	S 9042/1

13780-79210	1 987 429 042	S 9042/1
1378080GA0	F 026 400 001	S 0001
13780-83E00	1 457 433 153	S 3153
13780 83E00 000	1 457 433 153	S 3153
13780-83000	1 987 429 125	S 9125

13780-83010	1 987 429 125	S 9125
1378084CT0	F 026 400 015	S 0015
13780-84E50	1 987 429 173	S 9173
13780 84E50 000	1 987 429 173	S 9173
13780-86000	1 457 433 785	S 3785

15401-60B10	0 450 902 162	F 2162
15401 60B10 000	0 450 902 162	F 2162
15401-80E01	0 450 902 162	F 2162
15401 80E01 000	0 450 902 162	F 2162
15410-60B00	0 450 902 162	F 2162

15410 60B00 000	0 450 902 162	F 2162
15410-60B01	0 450 902 162	F 2162
15410 60B01 000	0 450 902 162	F 2162
15410-60G00	0 450 905 920	F 5920
15410 60G00 000	0 450 905 920	F 5920

15410-61A00	0 986 450 109	F 0109
15410 61A00 000	0 986 450 109	F 0109
15410-62G00	0 450 905 920	F 5920
15410 62G00 000	0 450 905 920	F 5920
15410-63400	0 986 450 030	F 0030

15410-63401	0 986 450 030	F 0030
15410-65D00	0 450 905 986	F 5986
15410 65D00 000	0 450 905 986	F 5986
15410-71500	0 986 450 030	F 0030
1541072F00	0 450 905 954	F 5954

15410 72F00 000	0 450 905 954	F 5954
15410-72F01	0 450 905 954	F 5954
15410 72F01 000	0 450 905 954	F 5954
15410-79100	0 986 450 030	F 0030
15410-80000	0 986 450 137	F 0137

15410-80200	0 986 450 030	F 0030
15410-84A00	0 450 906 468	N 6468
15410-84A51	F 026 402 072	N 2072
15410 84A51 000	F 026 402 072	N 2072
15410-85200	0 986 450 030	F 0030

15410-85500	0 986 450 030	F 0030
15410 86CA3	1 457 434 201	N 4201
15411-78E10	0 986 450 508	N 0508
15411 78E10 000	0 986 450 508	N 0508
15411-84E50	1 457 070 001	N 0001

15411 84E50 000	1 457 070 001	N 0001
15411-84E60	1 457 070 001	N 0001
15412-66G00	1 457 434 201	N 4201
15412 66G00 000	1 457 434 201	N 4201
1541284CT0	1 457 429 657	N 9657

15415 67JA0	1 457 431 705	N 1705
15601-76008	0 451 103 276	P 3276
15601-76008-71	0 451 103 276	P 3276
16510M68K00	0 986 452 058	P 2058
16510 M82703	0 986 452 058	P 2058

16510-05A00	0 986 452 019	P 2019
16510 05A00 000	0 986 452 019	P 2019
16510 3002	0 986 452 019	P 2019
16510-60B10	0 451 103 276	P 3276
16510 60B10 000	0 451 103 276	P 3276

16510-60B11	0 986 452 058	P 2058
16510 60B11 000	0 986 452 058	P 2058
16510-60M11	0 451 103 276	P 3276
16510 60M11 000	0 451 103 276	P 3276
1651061A00	0 451 103 276	P 3276

16510 61A00 000	0 451 103 276	P 3276
16510-61A01	0 451 103 276	P 3276
16510 61A01 000	0 451 103 276	P 3276
16510-61A02	0 451 103 276	P 3276
16510 61A02 000	0 451 103 276	P 3276

16510-61A20	0 451 103 276	P 3276
16510 61A20 MHL	0 451 103 276	P 3276
16510 61A20 000	0 451 103 276	P 3276
1651061A21	0 451 103 276	P 3276
16510 61A21 000	0 451 103 276	P 3276

16510-61A30	0 451 103 276	P 3276
16510 61A30 000	0 451 103 276	P 3276
16510-73J00	1 457 429 238	P 9238
16510 73J00 000	1 457 429 238	P 9238
16510-73J02	1 457 429 238	P 9238

16510 73J02 000	1 457 429 238	P 9238
165107300	0 986 452 019	P 2019
16510-73000	0 986 452 019	P 2019
16510-73001	0 986 452 019	P 2019
16510-73001-000	0 451 103 004	P 3004

16510-73001-000	0 451 103 141	P 3141
16510-73001-000	0 986 452 019	P 2019
16510-73001-000	0 986 452 028	P 2028
16510-73001-000	0 986 452 035	P 2035
16510-73001-000	0 986 452 044	P 2044

16510-73001-000	0 986 452 058	P 2058
16510-73001-000	0 986 452 062	P 2062
16510-73001-000	0 986 452 068	P 2068
16510-73002	0 986 452 019	P 2019
16510-73002-000	0 451 103 004	P 3004

16510-73002-000	0 451 103 141	P 3141
16510-73002-000	0 986 452 019	P 2019
16510-73002-000	0 986 452 028	P 2028
16510-73002-000	0 986 452 035	P 2035
16510-73002-000	0 986 452 044	P 2044

16510-73002-000	0 986 452 058	P 2058
16510-73002-000	0 986 452 062	P 2062
16510-73002-000	0 986 452 068	P 2068
16510-73010	0 986 452 019	P 2019
16510-73012	0 986 452 019	P 2019

16510-73013	0 986 452 019	P 2019
16510-78E00	0 986 452 064	P 2064
16510 78E00 000	0 986 452 064	P 2064
16510-79J50	1 457 429 248	P 9248
1651079J50000	1 457 429 248	P 9248

16510-81400	0 986 452 058	P 2058
1651081401	0 986 452 058	P 2058
1651081402	0 986 452 058	P 2058
16510-81403	0 986 452 058	P 2058
16510-81420	0 986 452 058	P 2058



16510-82001	0 451 103 004	P 3004
16510-82001	0 451 103 141	P 3141
16510-82001	0 986 452 019	P 2019
16510-82001	0 986 452 028	P 2028
16510-82001	0 986 452 035	P 2035
16510-82001	0 986 452 044	P 2044
16510-82001	0 986 452 058	P 2058
16510-82001	0 986 452 062	P 2062
16510-82001	0 986 452 068	P 2068
16510-82700	0 986 452 058	P 2058
16510-82701	0 986 452 058	P 2058
16510-82702	0 986 452 058	P 2058
16510-82703	0 986 452 058	P 2058
16510-83000	0 451 103 276	P 3276
16510 83000 000	0 451 103 276	P 3276
16510-83001	0 451 103 276	P 3276
16510 83001 000	0 451 103 276	P 3276
16510-83010	0 986 452 019	P 2019
16510-83012	0 451 103 276	P 3276
1651083012	0 986 452 019	P 2019
16510 83012 000	0 451 103 276	P 3276
16510-85C00	0 451 103 276	P 3276
16510 85C00 000	0 451 103 276	P 3276
16510-85FA0	0 451 103 276	P 3276
16510-85FA0-000	0 451 103 276	P 3276
1651087703	0 986 452 058	P 2058
16516-78E00	0 986 452 064	P 2064
16516 78E00 000	0 986 452 064	P 2064
18133-80400	0 986 452 019	P 2019
95860-51K00	1 987 432 214	M 2214
95860 51K00 000	1 987 432 214	M 2214
95860-62J00	1 987 432 173	M 2173
95860 62J00 000	1 987 432 173	M 2173
95860-63J10	1 987 432 173	M 2173
95860 63J10 000	1 987 432 173	M 2173
95860-78F00	1 987 432 066	M 2066
95860 78F 000	1 987 432 066	M 2066
95860 78F00 000	1 987 432 066	M 2066
95860-78F10	1 987 432 066	M 2066
95860 78F10 000	1 987 432 066	M 2066
95861-54G00	1 987 432 172	M 2172
95861 54G00 000	1 987 432 172	M 2172
95861-54J00	1 987 432 221	M 2221
95861 54J00 000	1 987 432 221	M 2221
95861-64J00	1 987 432 236	M 2236
95861 64J00 000	1 987 432 236	M 2236
95861-64J01	1 987 432 236	M 2236
95861 64J01 000	1 987 432 236	M 2236
95861-65D00	1 987 432 156	M 2156
95861 65D00 000	1 987 432 156	M 2156
99000990YJ003	1 457 433 785	S 3785

TALBOT

0005038883	1 457 434 201	N 4201
0005039456	1 457 429 117	P 9117
0005039546	1 457 429 117	P 9117
0013170900	0 450 904 058	F 4058
0013870900	1 457 429 908	S 9908
0017576700	1 457 429 908	S 9908
0017689700	1 457 429 908	S 9908
0043258500	1 457 429 908	S 9908
0075065702	0 451 203 010	P 3010
1051 98	1 457 429 175	P 9175
13 170 900	0 450 904 058	F 4058
1387 09	1 457 429 908	S 9908
17 576 700	1 457 429 908	S 9908
1768 97	1 457 429 908	S 9908
17 689 700	1 457 429 908	S 9908
38 840	0 450 904 058	F 4058
38 840 E	0 450 904 058	F 4058
43 258 500	1 457 429 908	S 9908
44964	1 457 429 908	S 9908
4496 4U	1 457 429 908	S 9908
50 388 83	1 457 434 201	N 4201
50 394 56	1 457 429 117	P 9117
50 395 46	1 457 429 117	P 9117
50 990 D	1 457 429 175	P 9175
5197828	1 457 429 933	S 9933
5501316450	0 451 105 067	P 5067
5501316450	0 451 203 010	P 3010
70 206	1 457 429 175	P 9175
75 065 702	0 451 203 010	P 3010
91 509 991	0 450 905 601	F 5601
91 517 815	0 450 905 104	F 5104
91 535 807	0 450 905 095	F 5095
92 117 8	1 457 429 175	P 9175
94 014 458 98	1 457 432 154	S 2154
94 019 060 28	1 457 431 028	N 1028
95 470 530	0 450 905 002	F 5002
99 093 7	0 451 104 065	P 4065
3500100468	1 457 431 703	N 1703
3500100696	0 450 906 460	N 6460
3500100775	0 450 906 460	N 6460
3500100794	0 450 906 460	N 6460
00120-00001	0 451 103 029	P 3029
00120-00001	0 451 104 065	P 4065
00120-00001	0 451 203 005	P 3005
00120-00001	0 451 203 194	P 3194
00120-00001	0 986 452 000	P 2000
00120-00001	0 986 452 005	P 2005
00120-00005	0 451 103 029	P 3029
00120-00005	0 451 103 221	P 3221
00120-00005	0 986 452 003	P 2003

TOYOTA

00120-00007	0 451 103 029	P 3029
00120-00007	0 451 103 221	P 3221
00120-00007	0 986 452 003	P 2003
00120-00009	0 451 103 004	P 3004
00120-00009	0 451 103 141	P 3141
00120-00009	0 986 452 019	P 2019
00120-00009	0 986 452 028	P 2028
00120-00009	0 986 452 035	P 2035
00120-00009	0 986 452 044	P 2044
00120-00009	0 986 452 058	P 2058
00120-00009	0 986 452 062	P 2062
00120-00009	0 986 452 068	P 2068
00120-00010	0 986 452 023	P 2023
00120-00010	0 986 452 028	P 2028
00120-00013	0 986 452 019	P 2019
00120-00013	0 986 452 028	P 2028
00120-00013	0 986 452 058	P 2058
00120-00014	0 451 103 004	P 3004
00120-00014	0 451 103 141	P 3141
00120-00014	0 986 452 019	P 2019
00120-00014	0 986 452 028	P 2028
00120-00014	0 986 452 035	P 2035
00120-00014	0 986 452 044	P 2044
00120-00014	0 986 452 058	P 2058
00120-00014	0 986 452 062	P 2062
00120-00014	0 986 452 068	P 2068
00120-00015	0 451 103 276	P 3276
00120-00015	0 986 452 044	P 2044
00120-00015	0 986 452 060	P 2060
04152-YZZA2	F 026 407 090	P 7090
041520R010	F 026 407 090	P 7090
04152 03002	0 986 452 044	P 2044
04152 03006	0 986 452 064	P 2064
04152 31060	F 026 407 090	P 7090
04152 37010	F 026 407 091	P 7091
04152 38010	F 026 407 090	P 7090
04152-64010	0 451 103 029	P 3029
04152-64010	0 451 103 221	P 3221
04152-64010	0 986 452 003	P 2003
0441631011	1 457 429 413	P 9413
08922-02001	0 451 103 276	P 3276
08922-02001	0 986 452 044	P 2044
08922-02001	0 986 452 060	P 2060
08922-02002	0 451 103 276	P 3276
08922-02002	0 986 452 044	P 2044
08922-02002	0 986 452 060	P 2060
08922 02003	0 986 452 028	P 2028
08922-02004	0 451 103 004	P 3004
08922-02004	0 451 103 141	P 3141
08922-02004	0 986 452 019	P 2019
08922-02004	0 986 452 028	P 2028
08922-02004	0 986 452 035	P 2035
08922-02004	0 986 452 044	P 2044
08922-02004	0 986 452 058	P 2058
08922-02004	0 986 452 062	P 2062



◀ TOYOTA

08922-02004	0986 452 068	P 2068
08922-02005	0986 452 028	P 2028
08922-02010	0451 103 004	P 3004
08922-02010	0451 103 141	P 3141
08922-02010	0986 452 019	P 2019
08922-02010	0986 452 028	P 2028
08922-02010	0986 452 035	P 2035
08922-02010	0986 452 044	P 2044
08922-02010	0986 452 058	P 2058
08922-02010	0986 452 062	P 2062
08922-02010	0986 452 068	P 2068
08922-02011	0451 103 004	P 3004
08922-02011	0451 103 141	P 3141
08922-02011	0986 452 019	P 2019
08922-02011	0986 452 028	P 2028
08922-02011	0986 452 035	P 2035
08922-02011	0986 452 044	P 2044
08922-02011	0986 452 058	P 2058
08922-02011	0986 452 062	P 2062
08922-02011	0986 452 068	P 2068
11501 00530	0986 452 023	P 2023
11501 00530	0986 452 028	P 2028
11501 00700	0986 452 023	P 2023
11501 00700	0986 452 028	P 2028
11501 01100	0986 452 023	P 2023
11501 01100	0986 452 028	P 2028
11501 01220	0986 452 023	P 2023
11501 01220	0986 452 028	P 2028
11501 01250	0986 452 023	P 2023
11501 01250	0986 452 028	P 2028
11501 01270	0986 452 023	P 2023
11501 01270	0986 452 028	P 2028
11501 01291	0986 452 028	P 2028
11501 01301	0986 452 044	P 2044
11501 01390	0451 103 276	P 3276
11501 077	0986 452 003	P 2003
11541 00161	0986 452 062	P 2062
136096001	0986 452 024	P 2024
15205 65F00	0986 452 061	P 2061
15205 65F01	0986 452 061	P 2061
15600-01020	0451 103 276	P 3276
15600-01020	0986 452 044	P 2044
15600-01020	0986 452 060	P 2060
1560005600	0986 452 003	P 2003
1560013050	0986 452 003	P 2003
15600 13051	0986 452 028	P 2028
15600-16010	0451 103 276	P 3276
15600-16010	0986 452 044	P 2044
15600-16010	0986 452 060	P 2060
15600-16020	0986 452 019	P 2019
15600-16020	0986 452 028	P 2028
15600-16020	0986 452 058	P 2058
15600 25010	0986 452 003	P 2003
1560025010B	0986 452 003	P 2003
15600 25010 SA	0986 452 003	P 2003

15600 25010 83	0986 452 003	P 2003
1560025070	0986 452 003	P 2003
15600 33010	0986 452 000	P 2000
15600-33020	0986 452 000	P 2000
15600-33020	0986 452 023	P 2023
15600-50010	0451 103 029	P 3029
15600-50010	0451 104 065	P 4065
15600-50010	0451 203 005	P 3005
15600-50010	0451 203 194	P 3194
15600-50010	0986 452 000	P 2000
15600-50010	0986 452 005	P 2005
15600-61030	0451 103 029	P 3029
15600-61030	0451 104 065	P 4065
15600-61030	0451 203 005	P 3005
15600-61030	0451 203 194	P 3194
15600-61030	0986 452 000	P 2000
15600-61030	0986 452 005	P 2005
1560087104	0986 452 003	P 2003
1560087307	0986 452 003	P 2003
15601-01010	0986 452 023	P 2023
15601-01010	0986 452 028	P 2028
15601 10004	0986 452 000	P 2000
15601 13010	0986 452 023	P 2023
15601 13010	0986 452 028	P 2028
15601 13011	0986 452 023	P 2023
15601 13011	0986 452 028	P 2028
1560113030	0986 452 000	P 2000
15601 13051	0986 452 028	P 2028
15601 22010	0986 452 000	P 2000
15601 25010	0986 452 003	P 2003
15601 33010	0986 452 000	P 2000
15601 33020	0986 452 000	P 2000
15601 33021	0986 452 000	P 2000
15601 41030	0986 452 000	P 2000
15601-44010-83	0451 103 029	P 3029
15601-44010-83	0451 104 065	P 4065
15601-44010-83	0451 203 005	P 3005
15601-44010-83	0451 203 194	P 3194
15601-44010-83	0986 452 000	P 2000
15601-44010-83	0986 452 005	P 2005
15601 76009	0986 452 044	P 2044
15601 76009 71	0986 452 044	P 2044
15601 78001	0986 452 003	P 2003
15601 78001 71	0986 452 003	P 2003
15601 78010	0986 452 042	P 2042
1560187202	0451 103 276	P 3276
1560187204	0986 452 058	P 2058
15601 87305	0986 452 020	P 2020
1560187307	0986 452 003	P 2003
1560187704	0986 452 058	P 2058
1560196001	0986 452 003	P 2003
15601 96006	0986 452 003	P 2003
15609 6001	0986 452 005	P 2005
15609 6001	0986 452 024	P 2024
15613-YZZA2	F 026 407 090	P 7090

15801-22010	0986 452 000	P 2000
15801-22010	0986 452 023	P 2023
16510 83011	0986 452 028	P 2028
17752-20540	1 457 429 933	S 9933
17791-11120-71	1 457 433 200	S 3200
1780087801	1 987 429 164	S 9164
17801-AD010	F 026 400 188	S 0188
17801 0B010	1 457 433 060	S 3060
17801 0B020	1 457 433 060	S 3060
17801 0D010	F 026 400 017	S 0017
17801-0D011	F 026 400 017	S 0017
17801 0D020	F 026 400 017	S 0017
17801-0D060	F 026 400 114	S 0114
17801 0G010	1 987 429 183	S 9183
17801 0H010	1 987 429 187	S 9187
17801-0J020	1 457 433 971	S 3971
178010N020	F 026 400 143	S 0143
17801-0N030	F 026 400 140	S 0140
17801-0N040	F 026 400 140	S 0140
17801-0N040-B	F 026 400 140	S 0140
17801-0R010	F 026 400 121	S 0121
17801-0T030	F 026 400 114	S 0114
178010W010	1 987 429 162	S 9162
17801 0Y010	1 457 433 972	S 3972
17801-01020	1 987 429 123	S 9123
17801 02020	1 987 429 135	S 9135
17801 02030	1 457 433 958	S 3958
17801 02040	1 987 429 152	S 9152
17801 02040 A	1 987 429 152	S 9152
17801 02040 00	1 987 429 152	S 9152
17801 02050	1 987 429 152	S 9152
17801 02080	1 457 433 533	S 3533
17801 03010	1 987 429 151	S 9151
17801-03030	1 987 429 123	S 9123
1780105500	1 457 429 933	S 9933
1780105610	1 457 429 932	S 9932
17801 08010	1 457 433 952	S 3952
1780108600	1 457 429 794	S 9794
17801 10030	1 987 429 122	S 9122
17801-10030-83	1 987 429 122	S 9122
17801 11050	1 457 433 784	S 3784
17801 11050	1 987 429 164	S 9164
17801 11060	1 987 429 171	S 9171
17801 11080	1 457 433 957	S 3957
17801 11090	1 457 433 784	S 3784
17801 11100	1 987 429 122	S 9122
17801 15060	1 987 429 133	S 9133
17801-15060-83	1 987 429 133	S 9133
17801 15070	1 457 433 958	S 3958
17801 16020	1 987 429 137	S 9137
17801 16020 83	1 987 429 137	S 9137
17801-16030	1 987 429 135	S 9135
17801-16040	1 987 429 137	S 9137
17801 20040	1 987 429 187	S 9187
17801 21030	1 457 433 972	S 3972



17801 21050	F 026 400 114	S 0114	17801 74060	1 987 429 151	S 9151	23300 22030	0 450 905 980	F 5980
17801 22020	F 026 400 017	S 0017	17801 75010	1 457 433 795	S 3795	23300 22040	0 450 905 978	F 5978
17801-23001-71	1 457 429 933	S 9933	17801 75020	F 026 400 092	S 0092	23300 22050	0 450 905 978	F 5978
17801 23030	1 457 433 971	S 3971	1780178010	1 987 429 157	S 9157	23300-24030	0 986 450 117	F 0117
17801 26010	F 026 400 176	S 0176	1780178011	1 987 429 157	S 9157	23300-24100	0 986 450 018	F 0018
17801 27010	1 987 429 135	S 9135	17801-87101	1 457 429 800	S 9800	23300-26030	0 986 450 117	F 0117
17801 27020	1 987 429 183	S 9183	17801-87101	1 457 429 801	S 9801	23300 28010	0 450 905 951	F 5951
17801 28010	1 987 429 163	S 9163	17801 87304	1 457 433 646	S 3646	23300 28020	0 450 905 987	F 5987
17801-31060	1 457 433 971	S 3971	23030 13020	0 450 905 955	F 5955	23300 29045	0 986 450 221	F 0221
17801 31120	F 026 400 188	S 0188	23030 41030	0 450 904 158	N 4158	23300-29049	0 450 905 924	F 5924
17801 33040	1 987 429 177	S 9177	23030 79025	0 450 905 955	F 5955	23300 34000	0 450 905 912	F 5912
17801-34040	1 457 429 800	S 9800	23030 79205	0 450 905 955	F 5955	23300 34100	0 986 450 018	F 0018
17801-34040	1 457 429 801	S 9801	23300 YA010	0 986 450 138	F 0138	23300-35020	0 450 905 912	F 5912
17801 35020	1 457 433 952	S 3952	23300 01010	0 986 450 039	F 0039	23300-35020	0 450 905 972	F 5972
17801-35020-83	1 457 433 952	S 3952	23300 11050	0 986 450 103	F 0103	23300 36020	0 986 450 117	F 0117
17801 37020	F 026 400 153	S 0153	23300 11100	0 986 450 115	F 0115	23300-36021	0 986 450 117	F 0117
17801 40040	F 026 400 154	S 0154	23300 11210	0 986 450 115	F 0115	23300 38010	0 986 450 117	F 0117
17801 41110	1 457 433 734	S 3734	2330013020	0 450 905 955	F 5955	23300-39025	0 450 905 912	F 5912
17801 46050	1 457 432 180	S 2180	23300 15010	0 986 450 039	F 0039	23300-39025	0 450 905 972	F 5972
17801 50060	F 026 400 162	S 0162	23300-15020	0 986 450 110	F 0110	23300 39035	0 450 905 912	F 5912
17801 54060	1 457 433 734	S 3734	23300-15020	0 986 450 115	F 0115	23300-39045	0 450 905 914	F 5914
17801 54100	1 457 433 795	S 3795	23300-16050	0 450 905 955	F 5955	23300-39045	0 986 450 113	F 0113
17801 54110	1 457 433 795	S 3795	23300 16080 A	0 986 450 138	F 0138	23300-41030	0 986 450 117	F 0117
17801 54140	F 026 400 092	S 0092	2330016170	0 986 450 111	F 0111	23300-41031	0 450 904 158	N 4158
17801-54140-8T	F 026 400 092	S 0092	23300 16210	0 986 450 115	F 0115	23300 58140	1 457 434 438	N 4438
17801 54140 83	F 026 400 092	S 0092	23300 16220	0 986 450 123	F 0123	23300 50020	0 450 905 912	F 5912
17801 54160	F 026 400 040	S 0040	23300 16240	0 986 450 123	F 0123	23300 50040	0 450 905 912	F 5912
17801 55010	1 987 429 123	S 9123	23300 16270	0 986 450 604	F 0604	23300 50050	0 450 905 912	F 5912
17801 55020	1 457 433 952	S 3952	23300 16280	0 986 450 123	F 0123	23300 61010	0 450 905 912	F 5912
17801 60040	1 457 433 534	S 3534	23300 16290	0 986 450 221	F 0221	23300 61020	0 450 905 912	F 5912
17801 61030	1 457 433 534	S 3534	23300 16330	F 026 403 001	F 3001	23300 62010	0 450 905 912	F 5912
17801 64010	1 987 429 135	S 9135	23300 19015	0 450 905 963	F 5963	23300 62020	0 450 905 912	F 5912
17801 64020	1 987 429 135	S 9135	23300 19025	0 986 450 107	F 0107	23300 62030	0 450 905 912	F 5912
17801 64020 83	1 987 429 135	S 9135	23300 19115	0 450 905 963	F 5963	23300 65010	0 450 905 912	F 5912
17801 64040	F 026 400 038	S 0038	23300 19145	0 986 450 110	F 0110	23300-74020	0 450 905 912	F 5912
1780164040	1 457 429 792	S 9792	23300-19155	0 450 905 963	F 5963	23300-74020	0 450 905 972	F 5972
17801 64050	F 026 400 038	S 0038	23300 19205	0 986 450 111	F 0111	23300 74040	0 986 450 111	F 0111
1780164050	1 457 429 792	S 9792	23300 19225	0 986 450 123	F 0123	23300 74050	0 986 450 111	F 0111
17801 64060	F 026 400 038	S 0038	23300 19235	0 986 450 103	F 0103	23300 74080	0 986 450 103	F 0103
1780164060	1 457 429 792	S 9792	23300 19245	0 986 450 107	F 0107	23300 74150	0 986 450 107	F 0107
17801 64070	1 987 429 135	S 9135	23300 19246	0 986 450 107	F 0107	23300 74160	0 986 450 107	F 0107
17801 66010	1 457 433 534	S 3534	23300 19265	0 986 450 111	F 0111	23300-74260	0 986 450 221	F 0221
17801 66020	1 457 433 534	S 3534	23300 19285	0 986 450 115	F 0115	23300 74290	0 986 450 221	F 0221
17801 66030	1 457 433 534	S 3534	23300 19295	0 986 450 115	F 0115	23300 74300	0 450 905 988	F 5988
17801 66040	1 457 433 534	S 3534	23300 19315	0 986 450 123	F 0123	23300 74310	0 450 905 988	F 5988
17801-67010	1 457 433 534	S 3534	23300 19325	0 986 450 123	F 0123	23300 74340	0 450 905 990	F 5990
17801 67030	1 987 429 157	S 9157	23300 19375	0 986 450 604	F 0604	23300 75080	0 986 450 109	F 0109
17801 67060	1 987 429 157	S 9157	23300 19385	0 450 905 924	F 5924	23300 79175	0 986 450 111	F 0111
17801 68020	1 457 433 534	S 3534	23300 19425	0 986 450 123	F 0123	23300 79185	0 986 450 111	F 0111
17801 68030	1 457 433 534	S 3534	23300 19465	0 986 450 221	F 0221	23300 79235	0 986 450 103	F 0103
17801 70050	F 026 400 158	S 0158	23300 19495	0 986 450 115	F 0115	23300 79305	0 986 450 604	F 0604
17801 72010	1 457 433 646	S 3646	23300 19515	0 986 450 115	F 0115	23300 79335	0 986 450 107	F 0107
17801 74010	1 987 429 123	S 9123	23300 19535	0 986 450 221	F 0221	23300 79355	0 986 450 107	F 0107
17801 74020	1 987 429 135	S 9135	23300-20020	0 986 450 221	F 0221	23300 79495	0 986 450 221	F 0221
17801-74020-83	1 987 429 135	S 9135	23300 22020	0 450 905 980	F 5980	23300 79525	0 986 450 109	F 0109



◀ TOYOTA

23300-79545	0986 450 221	F 0221
23300 79555	0 450 905 990	F 5990
23300 79575	0 450 905 990	F 5990
23300 87103	0 450 905 962	F 5962
23301-64020	1 457 434 438	N 4438
23303 56040	1 457 434 438	N 4438
23303 64010	1 457 434 438	N 4438
23303 64020	1 457 434 438	N 4438
23303 76002	1 457 434 438	N 4438
23303 76020	1 457 434 438	N 4438
2330376021	1 457 434 438	N 4438
23303-79025	0 450 905 955	F 5955
23307 79545	0986 450 221	F 0221
2339024480	1 457 434 438	N 4438
23390 30090	1 457 434 438	N 4438
23390 30150	1 457 434 438	N 4438
23390 30180	1 457 434 438	N 4438
23390 33010	1 457 434 440	N 4440
23390 33020	1 457 434 440	N 4440
23390 33060	1 457 434 440	N 4440
23390 64450	1 457 434 440	N 4440
23390 64480	1 457 434 438	N 4438
27801-34010	1 457 429 800	S 9800
27801-34010	1 457 429 801	S 9801
40150 30370 71	0986 452 003	P 2003
45267 53100	1987 429 157	S 9157
51421 50230	1 457 433 971	S 3971
80508 20130	1987 432 159	M 2159
87139 YZZ01	1987 432 319	R 2319
87139-YZZ02	1987 432 468	R 2468
87139YZZ03	1987 432 320	R 2320
87139 YZZ07	1987 432 088	M 2088
87139YZZ08	1987 432 190	M 2190
87139-0D010	1987 432 190	M 2190
87139 02020	1987 432 190	M 2190
87139-06030	1987 432 085	M 2085
87139-06040	1987 432 085	M 2085
87139 06080	1987 432 190	M 2190
87139 07010	1987 432 190	M 2190
87139-08030	1987 432 085	M 2085
87139 28010	1987 432 085	M 2085
87139 30040	1987 432 190	M 2190
87139 30070	1987 432 190	M 2190
87139 32010	1987 432 085	M 2085
87139 33010	1987 432 320	R 2320
87139 47010	1987 432 085	M 2085
87139 47010 83	1987 432 085	M 2085
87139 49010	1987 432 085	M 2085
87139 50010	1987 432 468	R 2468
87139 50030	1987 432 319	R 2319
87139 52010	1987 432 084	M 2084
87139 52020	1987 432 190	M 2190
88508 0H010	1987 432 189	M 2189
88508 12010	1987 432 155	M 2155
88508 12020	1987 432 155	M 2155

88508 12030	1987 432 155	M 2155
88508 20040	1987 432 159	M 2159
88508 20060	1987 432 159	M 2159
88508 20070	1987 432 159	M 2159
88508 20080	1987 432 159	M 2159
88508 20090	1987 432 159	M 2159
88508 20120	1987 432 085	M 2085
88508 20150	1987 432 159	M 2159
88568 02030	1987 432 088	M 2088
88568 52010	1987 432 084	M 2084
88568 52010 83	1987 432 084	M 2084
88880 20020	1987 432 159	M 2159
88880 20050	1987 432 159	M 2159
88880 20060	1987 432 159	M 2159
88880 20110	1987 432 159	M 2159
88880 44040	1987 432 159	M 2159
90080 91034	0986 452 019	P 2019
90080 91034	0986 452 028	P 2028
90080 91034	0986 452 058	P 2058
90080 91045	0986 452 028	P 2028
90080 91058	0986 452 028	P 2028
90080 91085	0986 452 028	P 2028
90080 91210	0 451 103 276	P 3276
90080 91210	0986 452 044	P 2044
90080 91210	0986 452 060	P 2060
90080 91220	0 451 103 276	P 3276
90461-12136	0986 450 117	F 0117
90915 TA001	0986 452 028	P 2028
90915TA002	0 451 103 276	P 3276
90915 TA003	0986 452 028	P 2028
90915 TB001	0986 452 044	P 2044
90915YZZA2	0986 452 028	P 2028
90915 YZZA3	0986 452 028	P 2028
90915YZZB3	0986 452 044	P 2044
90915YZZC4	0 451 103 276	P 3276
90915 YZZC7	0986 452 028	P 2028
90915YZZD4	0986 452 044	P 2044
90915-YZZE1	0986 452 028	P 2028
90915-YZZJ1	0986 452 028	P 2028
90915 YZZJ2	0 451 103 276	P 3276
90915YZZJ3	0986 452 044	P 2044
90915Y22D2	0986 452 044	P 2044
90915 03001	0986 452 028	P 2028
90915 03002	0986 452 044	P 2044
90915 03003	0986 452 030	P 2030
90915 03004	0 451 103 276	P 3276
90915 03005	0986 452 044	P 2044
90915 03006	0986 452 062	P 2062
9091505550	0986 452 062	P 2062
90915 10001	0986 452 028	P 2028
90915 10002	0 451 103 276	P 3276
90915 10003	0986 452 028	P 2028
90915 10004	0 451 103 276	P 3276
90915 20001	0986 452 044	P 2044
90915 20002	0986 452 044	P 2044

90915 20003	0986 452 044	P 2044
90915 20003	0986 452 062	P 2062
90915 20004	0986 452 044	P 2044
90915 203001	0986 452 035	P 2035
90915 30001	0986 452 030	P 2030
90915 30002	0986 452 062	P 2062
90915300028T	0986 452 062	P 2062
90915 30003	0 451 103 365	P 3365
90915 30003 8T	0 451 103 365	P 3365
90915 3002	0986 452 044	P 2044
90915 33021	0986 452 044	P 2044
90915 40001	0986 452 003	P 2003
90915 91058	0986 452 028	P 2028
VAUXHALL		
J90 915 100 02	0 451 103 276	P 3276
VAF522	1 457 429 895	S 9895
VAF540	1 457 433 003	S 3003
VOF109	0 451 103 217	P 3217
VOF14	0 451 203 005	P 3005
VOF28	0 451 103 297	P 3297
1808600	1987 432 091	M 2091
1808602	1987 432 091	M 2091
25062227	1 457 429 896	S 9896
25062235	1 457 429 898	S 9898
25067160	1 457 429 154	P 9154
25164435	0 450 905 002	F 5002
55560894	F 026 400 111	S 0111
55565960	F 026 407 087	P 7087
55702468	1987 432 488	R 2488
6808600	1987 432 091	M 2091
7984655	0 451 203 005	P 3005
7987982	1 457 429 050	S 9050
7998336	1 457 429 050	S 9050
7998710	1 457 429 053	S 9053
90027967	1 457 429 079	S 9079
90027967	1 457 433 065	S 3065
90220970	1 457 429 870	S 9870
90322261	1 457 429 896	S 9896
90322262	1 457 429 895	S 9895
90323083	1 457 429 844	S 9844
90411732	1 457 433 603	S 3603
90412779	1 457 433 603	S 3603
90469336	1 457 433 713	S 3713
90502200	1 457 433 741	S 3741
90510935	0 451 103 297	P 3297
90512445	1 457 429 994	S 9994
90512445	1 457 433 799	S 3799
90512447	1 457 433 740	S 3740
90512449	1 457 433 741	S 3741
9117321	1 457 429 157	P 9157
9194406	F 026 400 012	S 0012
93152793	1 457 429 079	S 9079



93152793	1 457 433 065	S 3065
93152971	1 457 429 053	S 9053
93152973	1 457 429 050	S 9050
93172462	1 457 433 579	S 3579
93177663	1 457 433 579	S 3579

93179530	1 457 433 741	S 3741
93181377	1 457 070 001	N 0001
93197779	1 987 432 078	M 2078
94201942	0 451 103 316	P 3316

VOLVO

11007388	1 987 431 159	M 1159
110073889	1 987 431 159	M 1159
110200	0 451 103 029	P 3029

110200	0 451 103 221	P 3221
110200	0 986 452 003	P 2003
11033128	1 457 429 969	S 9969
11033777	F 026 400 082	S 0082
11033777 6640	F 026 400 082	S 0082

11110148	F 026 400 082	S 0082
11110148-1	F 026 400 082	S 0082
11700375	0 451 104 066	P 4066
11883618	1 457 433 332	S 3332
11987489	1 457 431 158	N 1158

11993545	0 451 105 067	P 5067
11993545	0 451 105 188	P 5188
119935450	0 451 105 067	P 5067
119935450	0 451 203 010	P 3010
119962280	0 451 300 003	P 0003

1257201	1 457 434 106	N 4106
12572012	1 457 434 106	N 4106
1257305	1 457 429 061	S 9061
1257305-1	1 457 429 061	S 9061
1257460	1 457 432 203	S 2203

12574927	0 451 103 253	P 3253
1257546	1 457 432 203	S 2203
1257546-0	1 457 432 203	S 2203
1270529	1 457 434 184	N 4184
1276050	0 450 905 016	F 5016

1276050	0 450 905 021	F 5021
1276864	0 450 905 401	F 5401
1289562	0 450 905 145	F 5145
1289562	0 450 905 200	F 5200
1289562	0 450 905 601	F 5601

1289562	0 450 905 964	F 5964
1306530	0 450 905 601	F 5601
1306530-5	0 450 905 145	F 5145
1306530-5	0 450 905 200	F 5200
1306530-5	0 450 905 601	F 5601

1306530-5	0 450 905 964	F 5964
1306530-7	0 450 905 145	F 5145
1306530-7	0 450 905 200	F 5200
1306530-7	0 450 905 601	F 5601
1306530-7	0 450 905 964	F 5964

1326352	1 457 429 085	S 9085
1326352-0	1 457 429 085	S 9085
1326899	1 457 434 103	N 4103
1326899	1 457 434 105	N 4105
1326899	1 457 434 106	N 4106

1328047	1 457 429 061	S 9061
13280474	1 457 429 061	S 9061
1328126	0 451 104 065	P 4065
13281611	0 451 103 290	P 3290
13281611	0 451 103 346	P 3346

13281611	0 451 104 065	P 4065
13281611	0 451 203 223	P 3223
13281611	0 986 452 005	P 2005
1336397	1 457 429 987	S 9987
13363973	1 457 429 987	S 9987

1389450	0 450 905 601	F 5601
1389450-6	0 450 905 145	F 5145
1389450-6	0 450 905 200	F 5200
1389450-6	0 450 905 601	F 5601
1389450-6	0 450 905 964	F 5964

1389562	0 450 905 601	F 5601
1389562-8	0 450 905 145	F 5145
1389562-8	0 450 905 200	F 5200
1389562-8	0 450 905 601	F 5601
1389562-8	0 450 905 964	F 5964

1517575	F 026 407 054	P 7054
1584575	1 987 431 159	M 1159
15845753	1 987 431 159	M 1159
1665886	F 026 400 065	S 0065
16658866	F 026 400 065	S 0065

1665898	F 026 400 207	S 0207
1665908	F 026 400 179	S 0179
1665937	F 026 400 197	S 0197
16659377	F 026 400 197	S 0197
1674100	F 026 400 197	S 0197

203339	1 457 429 085	S 9085
20405160	F 026 402 017	N 2017
20405830	1 457 433 568	S 3568
20409908	1 987 431 451	R 1451
20430751	F 026 402 017	N 2017

20732726	F 026 400 145	S 0145
20815011	F 026 402 017	N 2017
20976003	F 026 402 017	N 2017
21041297	F 026 400 197	S 0197
233574	1 457 429 359	N 9359

233574	1 457 431 158	N 1158
233574	1 457 431 261	N 1261
233574	1 457 431 325	N 1325
233897	1 457 431 270	N 1270
233897	1 457 431 325	N 1325

233897	1 457 431 326	N 1326
2338978	1 457 431 270	N 1270
2338978	1 457 431 326	N 1326
233898	1 457 429 230	N 9230
233898	1 457 431 261	N 1261

233898	1 457 431 325	N 1325
2338986	1 457 429 230	N 9230
2338986	1 457 431 261	N 1261
2338986	1 457 431 325	N 1325
233988	1 457 429 230	N 9230

233988	1 457 431 261	N 1261
233988	1 457 431 325	N 1325
234464-5	1 457 434 103	N 4103
234464-5	1 457 434 105	N 4105
234464-5	1 457 434 106	N 4106

236481	1 457 429 413	P 9413
236628	1 457 434 201	N 4201
2366284	1 457 434 201	N 4201
238513	1 457 431 270	N 1270
241118	1 457 431 158	N 1158

241672	1 457 434 432	N 4432
2416725	1 457 434 154	N 4154
2416725	1 457 434 165	N 4165
2416725	1 457 434 432	N 4432
243004	1 457 434 432	N 4432

2430049	1 457 434 154	N 4154
2430049	1 457 434 165	N 4165
2430049	1 457 434 432	N 4432
243214	0 450 904 159	F 4159
2432144	0 450 904 159	F 4159

2434645	1 457 434 105	N 4105
243619	1 457 431 159	N 1159
2528215	1 457 431 159	N 1159
2528215	1 457 431 270	N 1270
2528215	1 457 431 325	N 1325

2528215	1 457 431 326	N 1326
25527	1 457 431 159	N 1159
284834	0 450 905 601	F 5601
30617334	1 457 431 705	N 1705
30620512	0 450 905 921	F 5921

30637444	1 457 433 583	S 3583
30639701	F 026 400 141	S 0141
30639701	1 457 433 099	S 3099
30671010	F 026 402 005	N 2005
30735878	1 457 429 238	P 9238

30740955	F 026 400 109	S 0109
30748268	1 457 433 099	S 3099
30750013	F 026 407 075	P 7075
30750085	0 450 906 471	N 6471
30750247	1 457 429 238	P 9238

3075715-5	1 457 433 583	S 3583
30783135	F 026 402 046	N 2046
30788490	F 026 407 097	P 7097
30792046	F 026 403 014	F 3014
30792514	F 026 402 005	N 2005

30792600	F 026 403 009	F 3009
30794824	F 026 402 078	N 2078
30812710	1 457 433 272	S 3272
30817997	0 450 905 908	F 5908
30862730	1 457 433 276	S 3276



◀ VOLVO

30871436	1 457 434 291	N 4291
30872785	1 457 433 535	S 3535
308727858	1 457 433 535	S 3535
30873414	1 457 433 276	S 3276
30887496	0 451 103 260	P 3260

3100127	1 457 432 106	S 2106
31001274	1 457 432 106	S 2106
31261044	F 026 403 014	F 3014
31261059	F 026 403 009	F 3009
31264940	F 026 403 014	F 3014

31274940	F 026 403 014	F 3014
31336192	F 026 402 078	N 2078
3162323	F 026 400 197	S 0197
3210209	1 457 434 200	N 4200
32102097	1 457 434 200	N 4200

323139	1 457 429 165	P 9165
3231396	1 457 429 165	P 9165
3343679	1 457 429 923	S 9923
33436791	1 457 429 923	S 9923
34139030	0 450 905 087	F 5087

3414709	1 457 429 778	S 9778
34147090	1 457 429 778	S 9778
3434495	1 457 429 778	S 9778
34344952	1 457 429 778	S 9778
3473308	0 450 905 087	F 5087

34736454	0 451 103 260	P 3260
3474010	1 457 434 291	N 4291
34740100	1 457 434 291	N 4291
3475706	1 457 433 750	S 3750
34757062	1 457 433 750	S 3750

349619	1 457 429 820	P 9820
3496191	1 457 429 820	P 9820
3496197	1 457 429 820	P 9820
3507416	0 450 905 216	F 5216
3507416-0	0 450 905 195	F 5195

3507416-0	0 450 905 216	F 5216
3528093	1 457 433 642	S 3642
3528093-2	1 457 433 642	S 3642
3 581 078	1 457 434 201	N 4201
35810787	1 457 434 201	N 4201

3713186	0 450 904 058	F 4058
3750085	0 450 906 471	N 6471
3815857	1 457 431 159	N 1159
3 825 133	1 457 434 154	N 4154
3825133	1 457 434 432	N 4432

3 825 133-6	1 457 434 154	N 4154
38251336	1 457 434 432	N 4432
3831236	0 451 105 067	P 5067
3831236	0 451 105 188	P 5188
3831236	0 451 203 010	P 3010

3976603	0 451 203 010	P 3010
39766035	0 451 203 010	P 3010
39766036	0 451 203 010	P 3010
405434	1 457 429 175	P 9175
414383	1 457 429 359	N 9359

414383	1 457 431 158	N 1158
414383	1 457 431 261	N 1261
414383	1 457 431 325	N 1325
414709	1 457 429 778	S 9778
418432	0 986 452 044	P 2044

418719	0 451 103 029	P 3029
418719	0 451 103 221	P 3221
418719	0 986 452 003	P 2003
419719	0 451 103 029	P 3029
419719	0 451 103 221	P 3221

419719	0 986 452 003	P 2003
420799	1 457 434 294	N 4294
4207999	1 457 434 294	N 4294
423135	0 451 203 002	P 3002
423135	0 451 203 226	P 3226

4231353	0 451 203 002	P 3002
4231353	0 451 203 226	P 3226
430143	0 451 104 065	P 4065
432135	0 451 203 002	P 3002
432135	0 451 203 226	P 3226

434061	1 457 434 105	N 4105
463505	1 457 429 085	S 9085
4635058	1 457 429 085	S 9085
463640	1 457 429 085	S 9085
464605	0 450 905 005	F 5005

466634	0 451 403 077	P 3077
466634-1	0 451 104 010	P 4010
466634-1	0 451 403 077	P 3077
4666343	0 451 403 077	P 3077
466987	1 457 434 154	N 4154

466987	1 457 434 165	N 4165
466987	1 457 434 432	N 4432
466987-3	1 457 434 154	N 4154
4669873	1 457 434 432	N 4432
4669875	1 457 434 154	N 4154

4669875	1 457 434 165	N 4165
4669875	1 457 434 432	N 4432
469954	0 451 203 002	P 3002
469954	0 451 203 226	P 3226
4699542	0 451 203 226	P 3226

471392	0 451 300 003	P 0003
4713921	0 451 300 003	P 0003
475861-0	1 457 429 946	S 9946
4771477	1 987 431 159	M 1159
477556	0 451 300 003	P 0003

4775565	0 451 300 003	P 0003
4780961	1 457 429 950	S 9950
478362	F 026 407 043	P 7043
4785391	1 457 434 200	N 4200
4785610	1 457 429 946	S 9946

47856109	1 457 429 946	S 9946
4785611	F 026 400 082	S 0082
4785612	1 457 429 946	S 9946
4785748	1 457 429 975	S 9975
47857487	1 457 429 975	S 9975

4785784	1 457 429 975	S 9975
4785971	0 451 203 226	P 3226
4785974	0 451 203 226	P 3226
47859749	0 451 203 226	P 3226
478736	F 026 407 043	P 7043

478736	0 451 103 343	P 3343
4787362	F 026 407 043	P 7043
4787362	0 451 103 343	P 3343
4795612	1 457 429 946	S 9946
4797362	0 451 103 343	P 3343

4804651	0 451 104 065	P 4065
4840740	0 451 203 194	P 3194
505434	1 457 429 175	P 9175
6G9N-9155-BC	F 026 403 014	F 3014
6211489	0 451 105 188	P 5188

62114897	0 451 105 188	P 5188
6211585	1 457 434 201	N 4201
6400373	1 457 429 076	S 9076
6400373	1 457 429 994	S 9994
6603091	1 457 431 159	N 1159

6603091	1 457 431 270	N 1270
6603091	1 457 431 325	N 1325
6603091	1 457 431 326	N 1326
6604948	1 457 431 159	N 1159
6604948	1 457 431 270	N 1270

6604948	1 457 431 325	N 1325
6604948	1 457 431 326	N 1326
6605860	1 457 429 230	N 9230
6605860	1 457 431 261	N 1261
6607576	1 457 431 270	N 1270

6607576	1 457 431 326	N 1326
6612069	1 457 429 117	P 9117
6613665	1 457 434 201	N 4201
66136656	1 457 434 201	N 4201
6640289	1 457 429 975	S 9975

6644839	1 457 429 946	S 9946
6644840	F 026 400 082	S 0082
6644990	1 457 429 966	S 9966
66449901	1 457 429 966	S 9966
66488453	1 457 434 201	N 4201

6774452	1 457 429 076	S 9076
6774452	1 457 429 994	S 9994
6776714	F 026 400 085	S 0085
6776715	F 026 400 085	S 0085
6792545	F 026 400 085	S 0085

6792554	F 026 400 085	S 0085
679568	1 457 429 076	S 9076
679568	1 457 429 994	S 9994
679658	1 457 429 076	S 9076
679658	1 457 429 994	S 9994

679658-5	0 451 103 029	P 3029
679658-5	0 451 103 221	P 3221
679658-5	0 986 452 003	P 2003
679658-6	1 457 429 076	S 9076
679658-6	1 457 429 994	S 9994

6842033	0 450 905 200	F 5200
6853668	1 457 431 723	N 1723
6895003	0 451 104 064	P 4064
7025282	1 457 429 359	N 9359
7083912	1 457 429 175	P 9175

7233574	1 457 429 230	N 9230
7233574	1 457 431 261	N 1261
7233574	1 457 431 325	N 1325
7233897	1 457 431 270	N 1270
7233897	1 457 431 326	N 1326

7236628	1 457 434 201	N 4201
7238513	1 457 431 159	N 1159
72430044	1 457 434 154	N 4154
72430044	1 457 434 165	N 4165
72430044	1 457 434 432	N 4432

72430049	1 457 434 154	N 4154
72430049	1 457 434 165	N 4165
72430049	1 457 434 432	N 4432
731094	0 451 104 065	P 4065
73194	0 451 104 065	P 4065

7362224	1 457 429 950	S 9950
73622243	1 457 429 950	S 9950
7362244	1 457 429 950	S 9950
7405434	1 457 429 175	P 9175
7423135	0 451 203 002	P 3002

7423135	0 451 203 226	P 3226
74406	1 457 431 270	N 1270
74406	1 457 431 326	N 1326
76648	1 457 431 159	N 1159
76649	1 457 431 270	N 1270

76649	1 457 431 326	N 1326
76653	1 457 431 261	N 1261
78288	1 457 431 270	N 1270
78288	1 457 431 326	N 1326
79055273	1 457 434 201	N 4201

79128732	1 457 434 154	N 4154
79159323	0 451 203 002	P 3002
79159323	0 451 203 226	P 3226
79178732	1 457 434 154	N 4154
795097	0 451 104 065	P 4065

8000250	1 457 434 154	N 4154
8000250	1 457 434 165	N 4165
8000250	1 457 434 432	N 4432
806012	0 450 904 159	F 4159
807180	0 451 103 029	P 3029

807180	0 451 103 221	P 3221
807180	0 986 452 003	P 2003
807200755	1 457 429 165	P 9165
8149064	F 026 400 117	S 0117
8149961	F 026 400 034	S 0034

8159975	F 026 402 025	N 2025
81599755	F 026 402 025	N 2025
817695	1 457 429 359	N 9359
817695	1 457 431 158	N 1158
817695	1 457 431 261	N 1261

817695	1 457 431 325	N 1325
8176950	1 457 429 359	N 9359
8176950	1 457 431 158	N 1158
8176950	1 457 431 261	N 1261
8176950	1 457 431 325	N 1325

8193841	1 457 434 294	N 4294
829913	1 457 434 051	N 4051
829913-3	1 457 434 154	N 4154
829993	1 457 434 296	N 4296
834337	0 451 103 141	P 3141

834337	0 986 452 044	P 2044
8343378	0 451 103 004	P 3004
8343378	0 451 103 141	P 3141
8343378	0 986 452 019	P 2019
8343378	0 986 452 028	P 2028

8343378	0 986 452 035	P 2035
8343378	0 986 452 044	P 2044
8343378	0 986 452 058	P 2058
8343378	0 986 452 062	P 2062
8343378	0 986 452 068	P 2068

835440	0 451 104 064	P 4064
8354409	0 451 104 064	P 4064
835 779	0 451 103 029	P 3029
835 779	0 451 104 065	P 4065
835 779	0 451 203 005	P 3005

835 779	0 451 203 194	P 3194
835 779	0 986 452 000	P 2000
835 779	0 986 452 005	P 2005
835 779-0	0 451 103 029	P 3029
835 779-0	0 451 104 065	P 4065

835 779-0	0 451 203 005	P 3005
835 779-0	0 451 203 194	P 3194
835 779-0	0 986 452 000	P 2000
835 779-0	0 986 452 005	P 2005
838593	1 457 434 105	N 4105

838593-2	1 457 434 105	N 4105
838593-2	1 457 434 106	N 4106
83912	1 457 429 175	P 9175
8414124	1 457 429 079	S 9079
84141241	1 457 429 079	S 9079

858201	1 457 434 201	N 4201
861476	0 451 103 311	P 3311
8616804	0 450 905 939	F 5939
8621645	F 026 402 078	N 2078
8621882	F 026 402 005	N 2005

8624522	1 457 434 436	N 4436
8638600	1 457 433 587	S 3587
8653668	1 457 431 723	N 1723
8683212	1 457 434 436	N 4436
8683560	1 457 433 096	S 3096

8683561	1 457 433 323	S 3323
883162	0 451 103 232	P 3232
9125224	0 451 203 223	P 3223
9141094	1 457 433 642	S 3642
91410944	1 457 433 642	S 3642

9141094-7	1 457 433 642	S 3642
9142648	0 450 905 195	F 5195
9142648	0 450 905 216	F 5216
9142658	0 450 905 216	F 5216
9142658-5	0 450 905 195	F 5195

9142658-5	0 450 905 216	F 5216
9155711	1 457 433 642	S 3642
91557116	1 457 433 642	S 3642
9161033	1 457 429 987	S 9987
9161033-7	1 457 429 987	S 9987

9180596	0 451 203 223	P 3223
91805960	0 451 203 223	P 3223
9186262	1 457 433 642	S 3642
91862623	1 457 433 642	S 3642
9186361	1 457 433 536	S 3536

91863613	1 457 433 536	S 3536
944577	1 457 433 642	S 3642
9445776	1 457 433 642	S 3642
9445776-9	1 457 433 642	S 3642
9454647	1 457 433 300	S 3300

9454647-0	1 457 433 300	S 3300
-----------	---------------	---------------

VW (VOLKSWAGEN)

BBW 115 561 B	0 451 104 065	P 4065
BCX129620	1 457 429 932	S 9932
C00 431 211 0	0 450 904 058	F 4058

H0127401A	0 450 906 467	N 6467
H0127401B	0 450 906 467	N 6467
H0129620A	F 026 400 007	S 0007
I90 915 030 06	0 986 452 062	P 2062
J15 600 250 10	0 986 452 003	P 2003

J15 601 330 21	0 986 452 000	P 2000
J17 801 350 20	1 457 433 952	S 3952
J17 801 540 60	1 457 433 734	S 3734
J90 915 030 06	0 986 452 062	P 2062
J90 915 200 01	0 986 452 044	P 2044

J90 915 300 02	0 986 452 062	P 2062
LP2038	1 457 433 732	S 3732
ND1 042 020 1	1 457 434 201	N 4201
Q 020 151 1	0 450 905 925	F 5925
SE020022203A	1 457 432 111	S 2111

SE021020200A	0 450 904 058	F 4058
SE 021 022 203 A	1 457 429 050	S 9050
SE021022203B	1 457 429 846	S 9846
WHT 002 257	F 026 402 015	N 2015
XE020022203A	1 457 432 111	S 2111

XE021020200A	0 450 904 058	F 4058
XE 021 022 203 A	1 457 429 050	S 9050
XE021022203B	1 457 429 846	S 9846
X 039 526 70	0 450 905 030	F 5030
000 091 511 A	0 986 452 000	P 2000



◀ VW

000 091 511 A	0986 452 023	P 2023
000 395 078 9	1 457 429 050	S 9050
000 395 267	0 450 905 030	F 5030
000 395 475 6	1 457 429 846	S 9846
003 950 789	1 457 429 050	S 9050

021 020 200 A	0 450 904 058	F 4058
021 022 203 A	1 457 429 050	S 9050
021 129 620	1 457 429 061	S 9061
021 129 620 D	1 457 429 061	S 9061
022 119 900 B	1 457 434 201	N 4201

025 129 620	1 457 429 890	S 9890
025 129 620 A	1 457 429 890	S 9890
026 133 837 A	1 457 429 994	S 9994
026 133 837 B	1 457 429 994	S 9994
027 133 843	1 457 429 957	S 9957

028 115 561	0 451 103 249	P 3249
028 115 561 B	0 451 103 290	P 3290
028 115 561 E	0 451 103 346	P 3346
028 115 561 G	0 986 452 400	P 2400
028 127 435	1 457 434 184	N 4184

028 127 435 A	1 457 434 184	N 4184
028 127 435 B	1 457 434 184	N 4184
03C 129 620	1 987 429 403	S 9403
03C 129 620 B	1 457 433 315	S 3315
03C 129 620 G	1 987 429 403	S 9403

03D 115 466 A	1 457 429 194	P 9194
03D 129 620	1 457 433 574	S 3574
03D 198 819	1 457 429 194	P 9194
03D 198 819 A	1 457 429 194	P 9194
03E 129 620	1 457 433 319	S 3319

03L 115 466	F 026 407 023	P 7023
03L 115 562	F 026 407 023	P 7023
030 115 561 C	0 451 103 289	P 3289
030 129 620 A	1 457 433 540	S 3540
030 129 620 C	1 457 433 539	S 3539

030 198 620	1 457 433 539	S 3539
032 129 620	1 457 429 054	S 9054
032 129 620	1 457 433 540	S 3540
032 129 620 C	1 457 433 716	S 3716
034 133 837	1 457 429 994	S 9994

034 911 279	0 450 902 161	F 2161
035 115 561 G	0 986 452 023	P 2023
035 133 843	1 457 429 994	S 9994
036 129 607 C	1 457 429 076	S 9076
036 129 607 C	1 457 429 959	S 9959

036 129 620	1 457 429 959	S 9959
036 129 620 C	1 457 433 716	S 3716
036 129 620 D	1 457 433 059	S 3059
036 129 620 F	1 457 433 716	S 3716
036 129 620 H	F 026 400 035	S 0035

036 198 620	1 457 433 059	S 3059
037 115 561 B	0 986 452 023	P 2023
038 115 466	1 457 429 619	P 9619
044 129 620	1 457 429 795	S 9795
044 129 620 A	1 457 429 944	S 9944

047 115 561 B	0 451 103 337	P 3337
047 115 561 G	0 451 103 337	P 3337
049 133 843	1 457 429 957	S 9957
052 126 620 A	1 457 429 054	S 9054
052 129 620 A	1 457 429 054	S 9054

055 129 620	1 457 429 076	S 9076
055 129 620 A	1 457 429 030	S 9030
056 129 620	1 457 429 054	S 9054
057 115 561 K	F 026 407 002	P 7002
057 115 561 L	F 026 407 002	P 7002

057 115 561 M	F 026 407 066	P 7066
057 127 401 A	0 986 450 509	N 0509
057 127 401 C	0 986 450 509	N 0509
057 127 435 C	0 450 906 458	N 6458
057 127 435 D	0 986 450 509	N 0509

057 127 435 E	0 450 906 458	N 6458
058 113 843	1 457 433 547	S 3547
058 133 843	1 457 429 870	S 9870
058 133 843 D	1 457 429 870	S 9870
058 133 843 M	1 457 429 870	S 9870

058 133 843 M	1 457 433 698	S 3698
059 115 561 A	1 457 429 152	P 9152
059 115 561 B	1 457 429 152	P 9152
059 115 562	1 457 429 152	P 9152
059 127 401 C	0 986 450 509	N 0509

059 127 401 E	0 986 450 509	N 0509
059 127 401 F	0 986 450 509	N 0509
059 133 843	1 457 433 772	S 3772
059 133 843 A	1 457 433 772	S 3772
059 133 843 B	F 026 400 028	S 0028

06C 133 843	1 457 433 046	S 3046
06E115466	1 457 429 185	P 9185
06E115562	1 457 429 185	P 9185
06E 115 562 A	1 457 429 185	P 9185
06F 133 843 A	1 457 433 102	S 3102

060 129 620	1 457 429 932	S 9932
061 115 561	0 451 203 010	P 3010
061 198 552	1 457 434 201	N 4201
062 115 561	0 451 103 368	P 3368
062 115 561 A	0 451 103 368	P 3368

068115561	0 451 104 065	P 4065
068 115 561 A	0 451 104 065	P 4065
068 115 561 B	0 451 104 065	P 4065
068 115 561 C	0 451 103 253	P 3253
068 115 561 E	0 451 103 347	P 3347

068 127 177	1 457 434 105	N 4105
068 127 177	1 457 434 106	N 4106
068 127 177 B	1 457 434 106	N 4106
068 127 177 EC	1 457 434 103	N 4103
068 127 177 EC	1 457 434 105	N 4105

068 127 177 EC	1 457 434 106	N 4106
069 115 561	0 451 203 223	P 3223
069 115 561 A	0 451 103 257	P 3257
074 115 562	1 457 429 619	P 9619
074 127 435	1 457 434 106	N 4106

074 129 620	1 457 433 747	S 3747
074 129 620 A	1 457 433 747	S 3747
075 129 620 A	1 457 429 946	S 9946
077 129 620 A	1 457 433 537	S 3537
077 129 620 B	1 457 433 537	S 3537

077 129 620 C	1 457 433 537	S 3537
077 129 620 D	1 457 433 537	S 3537
1F0 129 620	1 987 429 405	S 9405
1H0 129 620	1 457 433 023	S 3023
1H0 201 511	0 450 905 030	F 5030

1H0 201 511 A	0 450 905 264	F 5264
1J0129620	1 457 433 714	S 3714
1J0 129 620	1 457 433 714	S 3714
1J0 129 620 A	1 457 433 081	S 3081
1J0 201 511 A	0 450 905 318	F 5318

1K0 127 177 B	F 026 402 008	N 2008
1K0 127 177 B	F 026 402 008	N 2008
1K0127434	1 457 070 007	N 0007
1K0 127 434	1 457 431 715	N 1715
1K0 127 434 A	1 457 070 007	N 0007

1K0 127 434 B	F 026 402 008	N 2008
1K0 129 607 C	1 457 433 576	S 3576
1K0 129 620 C	1 457 433 576	S 3576
1K0 129 620 D	1 987 429 404	S 9404
1K0 129 620 F	1 987 429 404	S 9404

1K0 129 620 G	1 987 429 404	S 9404
1K0 201 051 B	0 450 905 959	F 5959
1K0 201 051 C	0 450 905 959	F 5959
1K0 201 051 F	F 026 403 013	F 3013
1K0 201 051 K	0 450 905 959	F 5959

1K2 819 653	1 987 432 597	R 2597
1K2 819 653 A	1 987 432 597	R 2597
1K2 819 653 B	1 987 432 597	R 2597
1L0 129 601 C	1 457 433 008	S 3008
1L0 129 601 D	1 457 433 008	S 3008

1L0 129 607 M	1 457 433 008	S 3008
1L0 129 607 N	1 457 433 008	S 3008
1L0129620	1 457 433 008	S 3008
1L0 129 601 C	1 457 433 264	S 3264
1L0 129 601 D	1 457 433 264	S 3264

1L0 129 607 M	1 457 433 264	S 3264
1L0 129 607 N	1 457 433 264	S 3264
1L0 129 607 Q	1 457 433 264	S 3264
1L0 129 620	1 457 433 008	S 3008
1L0 129 620 A	1 457 433 264	S 3264

1L0 129 620 C	1 457 433 008	S 3008
1M0 127 401	0 450 906 437	N 6437
101 917 045	1 457 433 732	S 3732
105 040 230	1 457 433 732	S 3732
110 946 200	1 457 433 732	S 3732

110 946 201	1 457 433 732	S 3732
110946202	1 457 433 732	S 3732
110 948 201	1 457 433 732	S 3732
113 129 620	1 457 429 076	S 9076
115 946 200	1 457 429 064	S 9064

115 946 201	1 457 429 064	S 9064	4E0 129 620 C	1 987 429 400	S 9400	6Q0 201 051 B	F 026 403 008	F 3008
115 946 201 S	1 457 429 064	S 9064	4F0 127 401 F	F 026 402 066	N 2066	6Q0 201 051 C	F 026 403 006	F 3006
115 946 202	1 457 429 054	S 9054	4F0 127 401 F	F 026 402 068	N 2068	6Q0 201 051 J	F 026 403 006	F 3006
115946204	1 457 429 054	S 9054	4F0 127 435	0 450 906 459	N 6459	6Q0 201 511	0 450 905 925	F 5925
115 946 204 S	1 457 429 054	S 9054	4F0 127 435 A	0 450 906 459	N 6459	6Q0 201 512	F 026 403 008	F 3008
115 946 205	1 457 433 540	S 3540	4F0 133 843 A	F 026 400 027	S 0027	6U0 129 620	1 457 433 008	S 3008
115 946 205 S	1 457 433 540	S 3540	4F0 201 511 B	F 026 403 003	F 3003	6U0 201 511 D	0 450 905 280	F 5280
121 261 275 A	0 450 904 149	F 4149	4F0 201 511 C	F 026 403 012	F 3012	6U0 201 511 E	0 450 904 159	F 4159
131 129 620	1 457 429 777	S 9777	4F0 201 511 D	F 026 403 003	F 3003	6X0 201 511 B	0 450 905 273	F 5273
131 261 275 A	0 450 904 149	F 4149	4F0 201 511 E	F 026 403 012	F 3012	6X0 201 511 B	0 450 905 316	F 5316
133 133 511	0 450 905 005	F 5005	411 133 511 D	0 450 905 087	F 5087	6Y0 129 620	1 457 433 532	S 3532
145 743 409 4	1 457 434 103	N 4103	411 133 511 D	0 450 905 401	F 5401	681 15 561 B	0 451 103 253	P 3253
145 743 409 4	1 457 434 105	N 4105	411 133 511 D	0 450 905 906	F 5906	681 155 61 C	0 451 103 253	P 3253
145 743 409 4	1 457 434 106	N 4106	412 015 11 C	0 450 905 906	F 5906	7H0 127 401 A	0 450 906 467	N 6467
17S129620	1 457 429 030	S 9030	431 133 511	0 450 905 021	F 5021	7H0 127 401 B	0 450 906 467	N 6467
178 015 406	1 457 433 734	S 3734	431 133 511 D	0 450 905 401	F 5401	7H0 129 620	1 457 433 331	S 3331
183129620	1 457 429 932	S 9932	441 201 511 B	0 450 905 087	F 5087	7H0 129 620 A	F 026 400 007	S 0007
191 129 620	1 457 429 777	S 9777	441 201 511 B	0 450 905 401	F 5401	7H0819631	1 987 432 114	M 2114
191 201 511 A	0 450 904 149	F 4149	441 201 511 B	0 450 905 906	F 5906	7L0 129 620	1 987 429 190	S 9190
191 291 511 A	0 450 904 149	F 4149	441 201 511 C	0 450 905 906	F 5906	7L6127177	1 457 431 718	N 1718
2D0129620	1 457 433 748	S 3748	443 133 511	0 450 905 145	F 5145	7L6 127 177 B	F 026 402 015	N 2015
2D0 129 620 A	1 457 433 703	S 3703	447 133 511	0 450 905 133	F 5133	7L6 127 177 C	F 026 402 015	N 2015
2D0 129 620 B	1 457 433 748	S 3748	481 209 261	0 450 904 058	F 4058	7L6 127 434	1 457 431 718	N 1718
2D0 129 620 C	1 457 433 748	S 3748	481 209 261	0 450 904 149	F 4149	7L6 127 434 A	1 457 431 729	N 1729
2D0 129 620 D	1 457 433 748	S 3748	49133843	1 457 429 957	S 9957	7L6 127 434 B	F 026 402 015	N 2015
2D0 201 051	0 450 905 275	F 5275	5Z0129620	1 457 433 532	S 3532	7L6 127 434 C	F 026 402 015	N 2015
2E0 127 159	F 026 402 101	N 2101	57115561K	F 026 407 002	P 7002	7M0 127 401 B	0 450 906 318	N 6318
2E0 127 177	F 026 402 101	N 2101	57115561L	F 026 407 002	P 7002	7M0 129 620 A	1 457 433 742	S 3742
2E0 129 620 B	F 026 400 055	S 0055	59115562	1 457 429 152	P 9152	7M0 129 620 BC	1 457 433 742	S 3742
2E0 129 620 D	F 026 400 055	S 0055	6F133843A	1 457 433 102	S 3102	7M3 129 620	1 457 433 089	S 3089
2E0 819 638	1 987 432 213	M 2213	6K0 129 601 E	1 457 433 008	S 3008	7M3129621	1 457 433 089	S 3089
200 129 620	1 457 433 748	S 3748	6K0 129 607 M	1 457 433 008	S 3008	741 155 62	1 457 429 619	P 9619
211 129 613 E	0 450 904 149	F 4149	6K0 129 607 R	1 457 433 008	S 3008	8A0 133 511	0 450 905 906	F 5906
251 201 511	0 450 904 149	F 4149	6K0 129 607 T	1 457 433 008	S 3008	8D0 127 435	1 457 434 329	N 4329
251 201 511 A	0 450 905 030	F 5030	6K0 127 401 G	0 450 906 409	N 6409	8E0 127 401	0 450 906 429	N 6429
251 201 511 C	0 450 904 149	F 4149	6K0 127 401 H	0 450 906 409	N 6409	8E0 127 401 B	0 450 906 431	N 6431
251 201 511 D	0 450 904 058	F 4058	6K0 129 601 E	1 457 433 264	S 3264	8E0 127 401 C	0 450 906 431	N 6431
251 201 511 D	0 450 904 149	F 4149	6K0 129 607 M	1 457 433 264	S 3264	8E0 127 435 A	0 450 906 429	N 6429
251 201 511 G	0 450 904 149	F 4149	6K0 129 607 R	1 457 433 264	S 3264	8K0 127 400	F 026 402 068	N 2068
251 201 511 H	0 450 905 030	F 5030	6K0 129 607 T	1 457 433 264	S 3264	8K0 127 400 A	F 026 402 068	N 2068
251 201 511 S	0 450 905 145	F 5145	6K0 129 620 B	1 457 433 058	S 3058	8T0 127 401 A	F 026 402 068	N 2068
251 201 511 S	0 450 905 200	F 5200	6K0 129 620 C	F 026 400 019	S 0019	8Z0 127 435	0 450 906 453	N 6453
251 201 511 S	0 450 905 601	F 5601	6N0129620	1 457 433 712	S 3712	8Z0 127 435 A	F 026 402 084	N 2084
251 201 511 S	0 450 905 964	F 5964	6N0129620	1 457 433 538	S 3538	8Z0 127 435 B	F 026 402 084	N 2084
3B0 819 817	1 457 434 329	N 4329	6N0 129 620	1 457 433 712	S 3712	8Z0 129 620	1 457 433 538	S 3538
3C0127177	F 026 402 006	N 2006	6N0 129 620 A	1 457 433 538	S 3538	8Z0 198 567	F 026 402 084	N 2084
3C0127434	F 026 402 006	N 2006	6N0 201 511	0 450 905 002	F 5002	803 201 151 C	0 450 904 058	F 4058
3C0 129 620	1 987 429 405	S 9405	6N0 201 511 A	0 450 905 002	F 5002	803 201 151 C	0 450 904 149	F 4149
317 801 540 60	1 457 433 734	S 3734	6Q0 127 400 F	0 450 906 500	N 6500	803 201 511 C	0 450 904 149	F 4149
330 298 511	0 450 904 149	F 4149	6Q0 127 400 H	0 450 906 426	N 6426	803 201 511 E	0 450 904 149	F 4149
36129620	1 457 429 959	S 9959	6Q0 127 400 J	0 450 906 426	N 6426	803 201 551 C	0 450 904 058	F 4058
3992043	1 457 429 846	S 9846	6Q0 127 401 F	F 026 402 000	N 2000	803 201 551 C	0 450 904 149	F 4149
4A0 129 620	1 457 429 792	S 9792	6Q0 127 401 F	0 450 906 500	N 6500	803 210 151 C	0 450 904 149	F 4149
4A0 133 511	0 450 905 133	F 5133	6Q0 201 051	F 026 403 008	F 3008	811 133 511	0 450 905 601	F 5601
4E0 129 620	1 987 429 400	S 9400	6Q0 201 051 A	F 026 403 006	F 3006	811 133 511 B	0 450 905 091	F 5091

253	Länge: 253 mm	EU6	Nicht für Fahrzeuge mit Abgasnorm Euro 6
2FE	Set, besteht aus 2 Filterelementen	EVG	Für Fahrzeuge mit elektronischem Vergaser
303	Durchmesser 303 mm	FBF	Für Baustellenfahrzeuge
327	Länge: 327 mm	FBF	Nicht für Baustellenfahrzeug
352	Durchmesser 352 mm	FEP	Für Einspritzpumpe
356	Durchmesser Brems Scheibe 356 mm	FG	Für Getriebe
35N	Länge: 350 mm	FHE	Für Heizung
3BA	3 bar	FIH	Kraftstofffilter beheizt
3FE	Set, besteht aus 3 Filterelementen	FIR	Filter rechteckig
3T5	Für Fahrzeuge mit 3,5 t zulässigem Gesamtgewicht	FIU	Kraftstofffilter unbeheizt
4BA	4 bar	FIZ	Filter zylindrisch
4T5	Für Fahrzeuge mit 4,5 t zulässigem Gesamtgewicht	FKO	Für Kompressor
6BA	6,4 bar	FKR	Für Fahrzeuge mit kurzem Radstand
AA	Allradantrieb	FL5	Nicht für Abgasnorm L5
ABM	Abmessungen beachten	FML	Für Fahrzeuge ohne Luftmassenmesser
ABS	Für Fahrzeuge mit ABS	FMV	Für Fahrzeuge mit Vorfilter
ABS	Für Fahrzeuge ohne ABS	FMV	Für Fahrzeuge ohne Vorfilter
AG	Für Fahrzeuge mit automatischem Getriebe	FOE	Für Ölkühlung
AGA	Für abgasentgiftetes Fahrzeug mit automatischem Getriebe	FPJ	Für Fahrzeugproduktion Japan
AGF	Für Fahrzeuge mit Abgasentgiftung	FRE	Für Retarder
AGF	Für Fahrzeuge ohne Abgasentgiftung	FVA	Für Filter-Verschmutzungsanzeige
AGR	Abgasrückführung	FVA	Ohne Filter-Verschmutzungsanzeige
AGR	Ohne Abgasrückführung	FW	Für Feuerwehrfahrzeuge
AHF	Ansauganlage hinter dem Fahrerhaus	FWG	Für Wandlergetriebe
ALD	Nur für Ölfiltergehäuse mit Aluminiumdeckel	FW	Nicht für Feuerwehrfahrzeug
ANV	Ansauganlage vorn	G10	Anschlussgewinde M10 x 1
ASG	Luftfilter ohne Sicherheitspatrone, Luftansaugung oben oder unten	GA	Gerade
ASO	Luftansaugung oben	GRF	Grundauführung
ASU	Luftansaugung unten	GS	Für Fahrzeuge mit Handschaltgetriebe
ATN	Nicht für Ausführung Trekking	H12	Höhe 120 mm
ATP	Für Fahrzeuge mit AMG Technik-Paket	H16	Höhe 116 mm
ATP	Für Fahrzeuge ohne AMG Technik-Paket	H25	Höhe 25 mm
AZY	Ansauganlage und Zyklonfilter hinten hochgezogen	H30	Höhe 30 mm
BAN	Nur für Blech-Luftfiltergehäuse	H42	Höhe 142 mm
BGB	Erzeugnis nicht für Gasbetrieb	H90	Höhe 90 mm
BHR	Einbaugleiches Bosch-Erzeugnis oder Teil für Behr	H96	Höhe 96 mm
BO	Bosch, nur als Ersatz für Bosch-Ausrüstung	HAU	Hauptstrom
BUS	Für Bus	HEI	Mit Heizung
CAV	Einbaugleiches Bosch-Erzeugnis oder Teil für CAV	HEI	Ohne Heizung
CSA	Erzeugnis auch online bestellbar "www.partbob.com"	HI	Hinten
DE	Drei erforderlich	HYP	Für Hydropumpe
DEL	Einbaugleiches Bosch-Erzeugnis oder Teil für Delco-Remy	I27	Innendurchmesser unten 27 mm
DHI	Einbaugleiches Bosch-Erzeugnis oder Teil für Delphi	I36	Innendurchmesser unten 36 mm
DIF	Für Differential	IF5	Für Abgasnorm IFL5
DOH	Zwei obenliegende Nockenwellen, DOHC	KAD	Nur für Kunststoff-Luftfiltergehäuse
DON	Luftfiltereinsatz für Donaldson-Luftfilter	KAT	Für Fahrzeuge mit Katalysator
DRR	Mit Druckregler	KAT	Für Fahrzeuge ohne Katalysator
DRR	Ohne Druckregler	KBF	Kombifilter als Vorfilter
DTV	Druckregler am Filter verbaut (Druckregler nicht im Lieferumfang)	KL	Für Fahrzeuge mit Klimaanlage
DTV	Druckregler nicht am Filter verbaut	KL	Für Fahrzeuge ohne Klimaanlage
E96	Für Abgasnorm EEC 96	KNE	Luftfiltereinsatz für Knecht-Luftfilter
EAB	Für Abgasnorm EEC A/B/D/E	KO	Für Kommunalfahrzeuge
ECC	Für Abgasnorm EEC C	KOB	Für Kombiwagen
ED1	Für Sondermodell Edition one	KSF	Nur für Ölfiltergehäuse mit Kunststoffdeckel
EDO	Hersteller Dongwoo	KTA	Für Fahrzeuge mit Kunststoff-Kraftstofftank
EFV	Auch Ersatz für Vorgänger	KUF	Kurzes Fahrerhaus
EHX	Für Fahrzeuge mit ELX-, HLX-Ausstattung	KW	Für Kastenwagen
ELH	Für Fahrzeuge ohne elektrisches Heizungssystem	KWI	Für verkürzten Wechselintervall
ERH	Für Fahrzeuge mit erhöhter Nutzlast	KZO	Kalte Zonen
EU2	Für Fahrzeuge mit Abgasnorm Euro 2	KZO	Nicht für kalte Zonen
EU3	Für Fahrzeuge mit Abgasnorm Euro 3	L11	Länge: 114 mm
EU3	Nicht für Fahrzeuge mit Abgasnorm Euro 3	L90	Länge: 900 mm
EU4	Für Fahrzeuge mit Abgasnorm Euro 4	LAB	Linksanbau
EU5	Für Fahrzeuge mit Abgasnorm Euro 5	LAF	Langes Fahrerhaus
EU5	Nicht für Fahrzeuge mit Abgasnorm Euro 5	LAT	Einbaugleiches Bosch-Erzeugnis oder Teil für Lautrette

LBE	Leichte Beanspruchung
LBF	Lange Bauform
LBF	Kurze Bauform
LHT	Luftansaugung unter dem Fahrerhausboden oder Luftansaugung hinten tief
LIM	Für Limousine
LSP	Für Luftfilter mit Sicherheitspatrone
LUB	Luftanschluss unter Fussboden
LUC	Einbaugleiches Bosch-Erzeugnis oder Teil für Lucas
LUD	Luftansaugöffnung Dach
LUM	Luftfiltereinsatz für Mann Luftfilter
LVH	Für Fahrzeuge mit Luftfederung vorne und hinten
LWG	Für Lieferwagen
MC1	Für Modell-Code 41, 45
MCY	Für Fahrzeuge mit Cyclonenfilter
MCY	Für Fahrzeuge ohne Cyclonenfilter
MES	Mit elektrischem Sensor
MG6	Für Fahrzeuge mit Handschaltgetriebe, 6 Gänge
MKG	Für Fahrzeuge ohne 380 V-Generator für Kühlaggregat
MHE	Für Fahrzeuge mit Zusatzheizung
MHE	Für Fahrzeuge ohne Zusatzheizung
MHF	Einbaugleiches Bosch-Erzeugnis oder Teil für Mann-Filter
MIH	Mit Halter
MIH	Ohne Halter
MKL	Für Fahrzeuge mit Klimaautomatik
MKL	Für Fahrzeuge ohne Klimaautomatik
MOK	Ölkühler eingebaut
MOO	Für Fahrzeuge mit und ohne Klimaanlage
MOR	Für Motor
MPR	Für Fahrzeuge mit Rußpartikelfilter
MPR	Für Fahrzeuge ohne Rußpartikelfilter
MRK	Für Fahrzeuge mit Kraftstoff-Rücklauf
MW1	Mit Wasserablaßschraube Gewinde M10
MW8	Mit Wasserablaßschraube Gewinde M8
MWA	Mit Wasserablaßschraube
MXF	Kraftstofffilter außerhalb vom Tank verbaut
N13	Für Abgasnorm Euro 96
N25	Für Abgasnorm Euro 2005, EC 2005
N25	Nicht für Abgasnorm Euro 2005, EC 2005
NAA	Nicht für Allradantrieb
ND	Einbaugleiches Bosch-Erzeugnis oder Teil für Denso
NEA	Für Nebenabtrieb
NEB	Nebenstromfilter
NFV	Für Fahrzeuge ohne Flexfuelbetrieb
NFV	Für Fahrzeuge mit Flexfuelbetrieb
NGB	Nicht für Fahrzeuge mit Gasbetrieb
NL4	Für Abgasnorm L4
NOR	Normale Ausführung
NW4	Für Abgasnorm W4
OES	Ölfilter stirnseitig angebaut
OMZ	Ölfilter mit Zentrifuge
OMZ	Ölfilter ohne Zentrifuge
ORK	Für Fahrzeuge ohne Kraftstoff-Rücklauf
PRF	Einbaugleiches Bosch-Erzeugnis oder Teil für Purflux
PRI	Primärkreis
RAB	Rechtsanbau
RAP	Nicht RME (Rapsölmethylester) fähig
RLE	Für Rechtslenker
RME	Riemenscheibe, mehrrollig
ROB	Für Rapsöl beständig
ROD	Einbaugleiches Bosch-Erzeugnis oder Teil für Roto-Diesel
RUL	Für Kraftstoffrücklaufleitung
SA	Sonderausrüstung
SAZ	Satz
SBE	Schwere Beanspruchung
SCJ	Für Fahrzeuge mit SCR (Selective Catalytic Reduction)

SGJ	Für Fahrzeuge ohne SCR (Selective Catalytic Reduction)
SFZ	Für Sonderfahrzeuge
SGA	Für abgasentgiftetes Fahrzeug mit Schaltgetriebe
SGP	Für Fahrzeuge mit Sigma Einspritzpumpe
SHL	Mit Schlauchschelle
SIE	Einbaugleiches Bosch-Erzeugnis oder Teil für Siemens
SIM	Für Siemens VDO Motorsteuerung
SIM	Nicht für Siemens VDO Motorsteuerung
SOH	Eine obenliegende Nockenwelle, SOHC
SSJ	Für Fahrzeuge ohne Start-Stopp-Funktion
SSZ	Für schlechten Straßenzustand
SSZ	Nicht für schlechten Straßenzustand
STH	Für Standheizung
STZ	Für staubige Zonen
STZ	Nicht für staubige Zonen
SVL	Mit Schnellverschluss
SWA	Mit Sensor im Wasserabscheider
SWA	Ohne Sensor im Wasserabscheider
TAF	Für Tankfahrzeuge
TEN	Einbaugleiches Bosch-Erzeugnis oder Teil für Tennex
TER	Für Fahrzeuge mit Thematic
TMT	Für Fahrzeuge mit Thermotronic
TMV	Trockenluftfilter mit Vorabscheider
TMV	Trockenluftfilter ohne Vorabscheider
TNK	Zur eindeutigen Identifikation der Bosch-Nummer muß die Datenkarte des Fahrzeuges vorliegen. Die beim Erzeugnis aufgeführten Komponenten müssen mit denen in der Datenkarte übereinstimmen.
TOR	Einbaugleiches Bosch-Erzeugnis oder Teil für Toyo Roki
TRQ	Nicht für Tropen
TW	Eingebautes Erzeugnis muss am Fahrzeug oder Motor ermittelt werden.
UFI	Einbaugleiches Bosch-Erzeugnis oder Teil für UFI
VFA	Abgasentgiftung/Katalysator vorbereitet
VKL	Für Fahrzeuge mit vollautomatischer Klimaanlage
VO	Vorne
VOW	Für Fahrzeuge mit Kraftstoffvorwärmung
VOW	Für Fahrzeuge ohne Kraftstoffvorwärmung
VWI	Für verlängerten Wechselintervall
W50	Mit 97,15 Prozent Effizienz
WAS	Mit Wasserabscheider
WAS	Ohne Wasserabscheider
WW	Wahlweise
XHI	Ohne integriertem Heizelement
XXX	Lieferung nur solange Vorrat
Y45	Nicht für heiße Zonen
Z34	Durchmesser 3/4 Zoll
ZE	Zwei erforderlich
ZNE	Für Fahrzeuge bei nachträglichem Einbau
ZUE	Zusätzlich eingebaut
*	Kraftstofffilter für alle Pkw-Modelle mit Vergasermotor 0 450 904 058
**	Kraftstofffilter für alle Pkw-Modelle mit Vergasermotor 0 450 904 149
1	Leitungsfilter
2	Filterbox
3	Für Lenkhilfpumpe
4	Sicherheitspatrone
6	Vorfilter
7	Feinfilter
8	Aktivkohle Innenraumfilter
A	Trockenmittelbox
C	Kühlwasserfilter
D	Denox Filter Service Set
H	Hydraulikfilter
I	Innenraumfilter
K	Kraftstofffilter
L	Luftfilter
O	Ölfilter















de

P Filter, Lenkhilfpumpe
S Ölabscheider

	Deckel DENOX-Filter		Filterelement
	Bestellnummer		Ausziehwerkzeug
	Pkw / Kleintransporter		Vorfilter
	Nkw / Kleintransporter		Ausgleichselement
	Bootsmotor		Ablassschraube
	Land- oder Baumaschine		Dichtungssatz
	Motortyp		Suchnummer
	Hubraum in l/ccm		Abbildung
	Motorleistung in kW		Werkstattverpackung
	Exportland		SB-Verpackung
	Datum / Einbauzeitraum		Einerpackung
	Sonderfälle		Stück pro Verpackung
	Kraftstofffilter		Volumen in l
	Luftfilter		Ausgang
	Ölfilter		Eingang
	Innenraumfilter		Öffnungsdruck Umgehungsventil
	Innenraumfilter mit Aktivkohle		Öffnungsdruck Rücklaufsperr
	Spezialfilter für Nkw		Höhe



de

 Durchmesser	 Durchlauferwärmer
 Gewindeanschluss	 Thermoschalter
 Schlauchanschluss	 Überstromventil
 Filtereinsätze	 Ablassschraube
 Kraftstofffilter-Aggregat	 Schutzkappe
 Deckel	 Dichtring



253	Length: 253 mm
2FE	Set, consists of 2 filter elements
303	Diameter 303 mm
327	Length: 327 mm
352	Diameter 352 mm
356	Brake disk diameter 356 mm
35N	Length: 350 mm
3BA	3 bar
3FE	Set comprising 3 filter elements
3T5	For vehicles with 3.5 t gross permissible weight
4BA	4 bar
4T5	For vehicles with 4.5 t gross permissible weight
6BA	6.4 bar
AA	All-wheel drive
ABM	Note dimensions
ABS	For vehicles with ABS
ABS	For vehicles without ABS
AG	For vehicles with automatic transmission
AGA	For vehicle with emission control and automatic transmission
AGF	For vehicles with emission control
AGF	For vehicles without emission control
AGR	Exhaust gas recirculation
AGR	Without exhaust gas recirculation
AHF	Intake system behind cab
ALD	Only for oil filter housing with aluminum cover
ANV	Intake system at front
ASG	Air filter without safety element, air intake at top or bottom
ASO	Air intake at top
ASU	Air intake at bottom
ATN	Not for Trekking version
ATP	For vehicles with AMG technology package
ATP	For vehicles without AMG technology package
AZY	Intake system and cyclone filter raised at rear
BAN	For sheet metal air cleaner housing only
BGB	Product not for vehicles running on gas
BHR	Interchangeable Bosch product or part for Behr
BO	Bosch, only as replacement for Bosch equipment
BUS	For bus
CAV	Interchangeable Bosch product or part for CAV
CSA	Product can also be ordered online "www.partbob.com"
DE	Three required
DEL	Interchangeable Bosch product or part for Delco-Remy
DHI	Interchangeable Bosch product or part for Delphi
DIF	For differential
DOH	Dual overhead camshafts, DOHC
DON	Donaldson air filter element
DRR	With pressure regulator
DRR	Without pressure regulator
DTV	Pressure regulator fitted at filter (pressure regulator not in scope of delivery)
DTV	Pressure regulator not fitted at filter
E96	For emission standard EEC 96
EAB	For emission standard EEC A/B/D/E
ECC	For emission standard EEC C
ED1	For Edition one special model
EDO	Manufacturer Dongwoo
EFV	Also replacement for predecessor
EHX	For vehicles with ELX, HLX equipment
ELH	For vehicles without electrical heating system
ERH	For vehicles with increased payload
EU2	For vehicles with emission standard Euro 2
EU3	For vehicles with emission standard Euro 3
EU3	Not for vehicles with emission standard Euro 3
EU4	For vehicles with emission standard Euro 4
EU5	For vehicles with emission standard Euro 5
EU5	Not for vehicles with emission standard Euro 5

EU6	Not for vehicles with emission standard Euro 6
EVG	For vehicles with electronic carburetor
FBF	For construction site vehicles
FBF	Not for construction site vehicles
FEP	For injection pump
FG	For transmission
FHE	For heater
FIH	Heated fuel filter
FIR	Filter rectangular
FIU	Non-heated fuel filter
FIZ	Filter cylindrical
FKO	For compressor
FKR	For vehicles with short wheelbase
FL5	Not for emission standard L5
FML	For vehicles without air mass meter
FMV	For vehicles with pre-filter
FMV	For vehicles without pre-filter
FOE	For oil cooling
FPJ	For vehicle production in Japan
FRE	For retarder
FVA	For filter contamination indicator
FVA	Without filter contamination indicator
FW	For fire service vehicles
FWG	For torque converter transmission
FW	Not for fire service vehicle
G10	Connecting thread M10 x 1
GA	Straight
GRF	Basic version
GS	For vehicles with manual transmission
H12	Height 120 mm
H16	Height 116 mm
H25	Height 25 mm
H30	Height 30 mm
H42	Height 142 mm
H90	Height 90 mm
H96	Height 96 mm
HAU	Primary current
HEI	With heater
HEI	Without heating
HI	Rear
HYP	For hydraulic pump
I27	Inside diameter at bottom 27 mm
I36	Inside diameter at bottom 36 mm
IF5	For emission standard IFL5
KAD	For plastic air cleaner housing only
KAT	For vehicles with catalytic converter
KAT	For vehicles without catalytic converter
KBF	Combination filter as pre-filter
KL	For vehicles with air conditioner
KL	For vehicles without air conditioner
KNE	Knecht air filter element
KO	For local authority vehicles
KOB	For station wagon
KSF	Only for oil filter housing with plastic cover
KTA	For vehicles with plastic fuel tank
KUF	Short cab
KW	For box-type van
KWI	For shorter replacement interval
KZO	Cold climates
KZO	Not for cold climates
L11	Length: 114 mm
L90	Length: 900 mm
LAB	Left side mounting
LAF	Long cab
LAT	Interchangeable Bosch product or part for Lautrette

LBE	Light duty
LBF	Long design
LBF	Short design
LHT	Air intake under cab floor or air intake at bottom rear
LIM	For limousine
LSP	For air filter with safety element
LUB	Air connection under floor
LUC	Interchangeable Bosch product or part for Lucas
LUD	Roof air intake opening
LUM	Air-filter element for Mann air filter
LVH	For vehicles with front and rear air suspension
LWG	For delivery van
MC1	For model code 41, 45
MCY	For vehicles with cyclone filter
MCY	For vehicles without cyclone filter
MES	With electrical sensor
MG6	For vehicles with 6-speed manual transmission
MGK	For vehicles without 380 V alternator for cooling unit
MHE	For vehicles with supplementary heater
MHE	For vehicles without supplementary heater
MHF	Interchangeable Bosch product or part for Mann Filter
MIH	With holder
MIH	Without holder
MKL	For vehicles with automatic air conditioner
MKL	For vehicles without automatic air conditioner
MOK	Oil cooler fitted
MOO	For vehicles with and without air conditioner
MOR	For engine
MPR	For vehicles with particulate filter
MPR	For vehicles without particulate filter
MRK	For vehicles with fuel return
MW1	With water drain plug, M10 thread
MW8	With water drain plug, M8 thread
MWA	With water drain plug
MXF	Fuel filter fitted outside tank
N13	For emission standard Euro 96
N25	For emission standard Euro 2005, EC 2005
N25	Not for emission standard Euro 2005, EC 2005
NAA	Not for all-wheel drive
ND	Interchangeable Bosch product or part for Denso
NEA	For power take-off
NEB	Bypass filter
NFV	For vehicles without flex fuel operation
NFV	For vehicles with flex fuel operation
NGB	Not for vehicles running on gas
NL4	For emission standard L4
NOR	Standard version
NW4	For emission standard W4
OES	Oil filter mounted on end face
OMZ	Oil filter with centrifuge
OMZ	Oil filter without centrifuge
ORK	For vehicles without fuel return
PRF	Interchangeable Bosch product or part for Purflux
PRI	Primary circuit
RAB	Right side mounting
RAP	Not suitable for RME (rapeseed oil methyl ester)
RLE	For RHD vehicles
RME	Multi-groove pulley
ROB	Resistant to rape seed oil
ROD	Interchangeable Bosch product or part for Roto-Diesel
RUL	For fuel return pipe
SA	Special equipment
SAZ	Set
SBE	Heavy duty
SCJ	For vehicles with SCR (Selective Catalytic Reduction)

SGJ	For vehicles without SCR (Selective Catalytic Reduction)
SFZ	For special-purpose vehicles
SGA	For vehicle with emission control with manual transmission
SGP	For vehicles with Sigma injection pump
SHL	With hose clamp
SIE	Interchangeable Bosch product or part for Siemens
SIM	For Siemens VDO engine management
SIM	Not for Siemens VDO engine management
SOH	Single overhead camshaft, SOHC
SSJ	For vehicles without Start-Stop function
SSZ	For rough roads
SSZ	Not for rough roads
STH	For auxiliary heater
STZ	For dusty zones
STZ	Not for dusty zones
SVL	With snap fastening
SWA	With sensor in water separator
SWA	Without sensor in water separator
TAF	For tank trucks
TEN	Interchangeable Bosch product or part for Tennex
TER	For vehicles with Thematic
TMT	For vehicles with Thermotronic
TMV	Dry-air cleaner with preliminary filter
TMV	Dry-air cleaner without preliminary filter
TNK	The vehicle data card is required for definite identification of the Bosch number. The components listed with the product must coincide with those on the data card.
TOR	Interchangeable Bosch product or part for Toyo Roki
TRQ	Not for tropics
TW	The product fitted must be identified on the vehicle or engine
UFI	Interchangeable Bosch product or part for UFI
VFA	Prepared for emission control/catalytic converter
VKL	For vehicles with fully automatic air conditioner
VO	Front
VOW	For vehicles with fuel preheating
VOW	For vehicles without fuel preheating
VWI	For extended replacement interval
W50	With 97.15 percent efficiency
WAS	With water separator
WAS	Without water separator
WW	Optional
XHI	without integrated heating
XXX	Available while stocks last
Y45	Not for hot climates
Z34	Diameter 3/4 inch
ZE	Two required
ZNE	For vehicles where retrofitted
ZUE	Additionally fitted
*	Fuel filter for all private vehicle models with carburetor motor 0 450 904 058
**	Fuel filter for all private vehicle models with carburetor motor 0 450 904 149
1	Fuel lead filter
2	Filter box
3	For power steering pump
4	Safety cartridge
6	Preliminary filter
7	Fine filter
8	Activated carbon interior filter
A	Desiccant box
C	Coolant filter
D	Denox filter Service set
H	Hydraulic filter
I	Filter for vehicle interior
K	Fuel filter
L	Air filter
O	Oil filter















en

P Filter, power steering pump
S Oil separator

	DENOX filter cover		Filter element
	Part number		Extraction tool
	Passenger cars/Small vans		Pre-filter
	Commercial vehicle / small transporter		Compensating element
	Marine engine		Drain plug
	Agricultural machine / construction machine		Set of seals
	Engine type		Search number
	Capacity in l/ccm		Illustration
	Engine power output in kW		Workshop pack
	Export market		Self-service pack
	Date/ Production period		Single pack
	Special case		Quantity per pack
	Fuel filter		Volume in l
	Air filter		Outlet
	Oil filter		Inlet
	Cabin filter		Bypass valve opening pressure
	Cabin filter with activated carbon		Non-return valve opening pressure
	Special filter for commercial vehicles		Height



en

	Diameter		Continuous flow heater
	Threaded connection		Thermostatic switch
	Hose connection		Overflow valve
	Filter elements		Drain plug
	Fuel filter assembly		Protective cap
	Cover		Sealing ring



253	Longueur : 253 mm
2FE	Jeu, comprenant 2 éléments filtrants
303	Diamètre 303 mm
327	Longueur : 327 mm
352	Diamètre 352 mm
356	Diamètre disque de frein 356 mm
35N	Longueur : 350 mm
3BA	3 bars
3FE	Jeu, comprenant 3 éléments filtrants
3T5	Pour les véhicules avec un PTAC de 3,5 t
4BA	4 bar
4T5	Pour les véhicules avec un PTAC de 4,5 t
6BA	6,4 bar
AA	Transmission intégrale
ABM	Tenir compte des dimensions
ABS	Pour véhicules avec ABS
ABS	Pour véhicules sans ABS
AG	Pour véhicules avec boîte automatique
AGA	Véhicule avec dépollution de l'échappement et boîte automatique
AGF	Pour véhicules av. dépollution de l'échap.
AGF	Pour véhicules ss dépollution de l'échap.
AGR	Recyclage des gaz d'échappement
AGR	Sans recyclage des gaz d'échappement
AHF	Système d'admission derrière la cabine
ALD	Uniquement pour corps de filtre à huile avec couvercle aluminium
ANV	Système d'admission avant
ASG	Filtre à air sans cartouche de sécurité, aspiration d'air en haut ou en bas
ASO	Aspiration d'air en haut
ASU	Aspiration d'air en bas
ATN	Pas pour version Trekking
ATP	Pour véhicules avec pack technique AMG
ATP	Pour véhicules sans pack technique AMG
AZY	Dispositif d'admission et filtre centrifuge remontés à l'arrière
BAN	Uniq. pr corps filtre à air en tête
BGB	Produit pas pour fonctionnement au GPL
BHR	Produit Bosch équivalent ou pièce pour Behr
BO	Bosch, uniquement comme remplacement pour équipement Bosch
BUS	Pour autobus
CAV	Produit Bosch équivalent ou pièce pour CAV
CSA	Produit disponible également en ligne "www.partbob.com"
DE	Trois sont nécessaires
DEL	Produit Bosch équivalent ou pièce pour Delco-Remy
DHI	Produit Bosch équivalent ou pièce pour Delphi
DIF	Pour différentiel
DOH	Deux arbres à cames en tête, DOHC
DON	Cartouche pour filtre à air Donaldson
DRR	Avec régulateur de pression
DRR	Sans régulateur de pression
DTV	Régulateur de pression monté sur le filtre (régulateur de pression pas compris dans la livraison)
DTV	Régulateur de pression pas monté sur filtre
E96	Pour norme antipollution CEE 96
EAB	Pour norme antipollution CEE A/B/D/E
ECC	Pour norme antipollution CEE C
ED1	Pour série spéciale Edition one
EDO	Fabricant Dongwoo
EFV	Remplacement aussi pour ancien modèle
EHX	Pour véhicules avec équipement ELX, HLX
ELH	Pour véhicules sans système de chauffage électrique
ERH	Pour véhicules à charge utile accrue
EU2	Pour véhicules avec norme antipollution Euro 2
EU3	Pour véhicules avec norme antipollution Euro 3
EU3	Pas pour les véhicules selon la norme antipollution Euro 3
EU4	Pour véhicules avec norme antipollution Euro 4
EU5	Pour véhicules avec norme antipollution Euro 5

EU5	Pas pour les véhicules selon la norme antipollution Euro 5
EU6	Pas pour les véhicules selon la norme antipollution Euro 6
EVG	Pour véhicules avec carburateur électronique
FBF	Pour engin de chantier
FBF	Pas pour engin de chantier
FEP	Pour pompe d'injection
FG	Pour boîte de vitesses
FHE	Pour chauffage
FIH	Filtre à carburant chauffé
FIR	Filtre rectangulaire
FIU	Filtre à carburant non chauffé
FIZ	Filtre cylindrique
FKO	Pour compresseur
FKR	Pour véhicules à empattement court
FL5	Pas pour norme antipollution L5
FML	Pour véhicules sans débitmètre massique d'air
FMV	Pour véhicules avec préfiltre
FMV	Pour véhicules sans préfiltre
FOE	Pour refroidissement de l'huile
FPJ	Pour production de véhicules au Japon
FRE	Pour ralentisseur
FVA	Pour témoin d'encrassement du filtre
FVA	Sans voyant d'encrassement du filtre
FW	Pour véhicules d'incendie
FWG	Pour boîte à convertisseur
FW	Pas pour véhicules de lutte anti-incendie
G10	Filetage M10 x 1
GA	Droit
GRF	Version de base
GS	Pour véhicules avec boîte manuelle
H12	Hauteur 120 mm
H16	Hauteur 116 mm
H25	Hauteur 25 mm
H30	Hauteur 30 mm
H42	Hauteur 142 mm
H90	Hauteur 90 mm
H96	Hauteur 96 mm
HAU	Courant principal
HEI	Avec chauffage
HEI	Ss chauffage
HI	Arrière
HYP	Pour pompe hydraulique
I27	Diamètre intérieur en bas 27 mm
I36	Diamètre intérieur en bas 36 mm
IF5	Pour norme antipollution IFL5
KAD	Uniq. pr corps filtre à air plastique
KAT	Pour véhicules avec catalyseur
KAT	Pour véhicules sans catalyseur
KBF	Filtre combiné en tant que préfiltre
KL	Pour véhicules avec climatiseur
KL	Pour véhicules sans climatiseur
KNE	Cartouche pour filtre à air Knecht
KO	Pour véhicules municipaux
KOB	Pour break
KSF	Uniquement pour corps de filtre à huile avec couvercle plastique
KTA	Pour véhicules avec réservoir de carburant en plastique
KUF	Cabine courte
KW	Pour fourgon
KWI	Pour fréquence de remplacement raccourcie
KZO	Zones froides
KZO	Pas pour zones froides
L11	Longueur : 114 mm
L90	Longueur : 900 mm
LAB	Montage à gauche
LAF	Cabine longue



















LAT	Produit Bosch équivalent ou pièce pour Lautrette
LBE	Sollicitation faible
LBF	Structure longue
LBF	Structure courte
LHT	Aspiration d'air sous le plancher de la cabine ou à l'arrière, en bas
LIM	Pour berline
LSP	Pour filtre à air avec cartouche de sécurité
LUB	Raccord d'air sous le plancher
LUC	Produit Bosch équivalent ou pièce pour Lucas
LUD	Ouverture d'aspiration d'air de toit
LUM	Cartouche pour filtre à air Mann
LVH	Pour véhicules avec suspension pneumatique avant et arrière
LWG	Pour fourgonnette
MC1	Pour code modèle 41, 45
MCY	Pour véhicules avec filtre cyclone
MGY	Pour véhicules sans filtre cyclone
MES	Avec capteur électrique
MG6	Pour véhicules avec boîte manuelle, 6 rapports
MGK	Pour véhicules sans alternateur 380V pour groupe frigorifique
MHE	Pour véhicules avec chauffage auxiliaire
MHE	Pour véhicules sans chauffage auxiliaire
MHF	Produit Bosch équivalent ou pièce pour filtre Mann
MIH	Avec support
MIH	Sans support
MKL	Pour véhicules avec climatiseur automatique
MKL	Pour véhicules sans climatiseur automatique
MOK	Avec radiateur d'huile
MOO	Pour véhicules avec ou sans climatiseur
MOR	Pour moteur
MPR	Pour véhicules avec filtre à particules
MPR	Pour véhicules sans filtre à particules
MRK	Pour véhicules avec retour du carburant
MW1	Avec vis d'écoulement d'eau filetage M10
MW8	Avec vis d'écoulement d'eau filetage M8
MWA	Avec vis de purge d'eau
MXF	Filtre à carb. monté hors du réservoir
N13	Pour norme antipollution Euro 96
N25	Pour norme antipollution Euro 2005, CE 2005
N25	Pas pour la norme antipollution Euro 2005, CE 2005
NAA	Pas pour transmission intégrale
ND	Produit Bosch équivalent ou pièce pour Denso
NEA	Pour entraînement auxiliaire
NEB	Filtre secondaire
NFV	Pour véhicules sans mode Flexfuel
NFV	Pour véhicules avec mode Flexfuel
NGB	Pas pour véhicules fonctionnant au GPL
NL4	Pour norme antipollution L4
NOR	Version standard
NW4	Pour norme antipollution W4
OES	Filtre à huile monté côté frontal
OMZ	Filtre à huile avec centrifugeuse
OMZ	Filtre à huile sans centrifugeuse
ORK	Pour véhicules sans retour du carburant
PRF	Produit Bosch équivalent ou pièce pour Purflux
PRI	Circuit primaire
RAB	Montage à droite
RAP	Non adapté RME (ester méthylique d'huile de colza)
RLE	Pour véhicules avec direction à droite
RME	Poulie multigorges
ROB	Supportant le diester de colza
ROD	Produit Bosch équivalent ou pièce pour Roto-Diesel
RUL	Pour conduite de retour de carburant
SA	Équipement spécial
SAZ	Jeu
SBE	Haute sollicitation



















SCJ	Pour véhicules avec SCR (Selective Catalytic Reduction)
SGJ	Pour véhicules sans SCR (Selective Catalytic Reduction)
SFZ	Pour véhicules spéciaux
SGA	Pour véhicule avec dépollution de l'échappement et boîte manuelle
SGP	Pour véhicules avec pompe d'injection Sigma
SHL	Avec collier pour tuyau souple
SIE	Produit Bosch équivalent ou pièce pour Siemens
SIM	Pour commande de moteur VDO Siemens
SIM	Pas pour commande de moteur VDO Siemens
SOH	Un arbre à cames en tête, SOHC
SSJ	Pour véhicules sans fonction démarrage-arrêt
SSZ	Pour routes en mauvais état
SSZ	Pas pour routes en mauvais état
STH	Pour chauffage auxiliaire
STZ	Pour zones poussiéreuses
STZ	Pas pour zones poussiéreuses
SVL	Avec fermeture instantanée
SWA	Avec sonde dans le séparateur d'eau
SWA	Sans sonde dans le séparateur d'eau
TAF	Pour camions-citernes
TEN	Produit Bosch équivalent ou pièce pour Tennex
TER	Pour véhicules avec Thematic
TMT	Pour véhicules avec Thermotronic
TMV	Filtre à air sec avec préséparateur
TMV	Filtre à air sec sans préséparateur
TNK	Vous devez disposer de la carte signalétique du véhicule pour l'identification exacte de la référence Bosch. Les composants énumérés pour le produit doivent correspondre à ceux de la carte signalétique.
TOR	Produit Bosch équivalent ou pièce pour Toyo Roki
TRQ	Pas pour climats tropicaux
TW	Le produit monté doit être déterminé sur le véhicule ou le moteur.
UFI	Produit Bosch équivalent ou pièce pour UFI
VFA	Dépollution de l'échappement/catalyseur prévu
VKL	Pour véhicules avec climatiseur entièrement automatique
VO	Avant
VOW	Pour véhicules avec préchauffage du carburant
VOW	Pour véhicules sans préchauffage du carburant
VWI	Pour fréquence de remplacement prolongée
W50	Avec 97,15 pour-cent d'efficacité
WAS	Avec séparateur d'eau
WAS	Sans séparateur d'eau
WW	Au choix
XHI	Sans élément chauffé intégré
XXX	Dans la limite des stocks disponibles
Y45	Pas pour zones chaudes
Z34	Diamètre 3/4 pouces
ZE	2 nécessaires
ZNE	Pour véhicules, pose ultérieure
ZUE	Monté en supplément
*	Filtre à carburant pour tous les modèles de véhicules de tourisme avec moteur à carburateur 0 450 904 058
**	Filtre à carburant pour tous les modèles de véhicule de tourisme avec moteur à carburateur 0 450 904 149
1	Filtre de conduite
2	Carter de filtre
3	Pour pompe d'assistance de direction
4	Cartouche de sécurité
6	Préfiltre
7	Filtre fin
8	Filtre au charbon actif habitacle
A	Cartouche de déshydratant
C	Filtre à liquide de refroidissement
D	Kit d'entretien filtre Denox
H	Filtre hydraulique
I	Filtre d'habitacle

fr

K	Filtre à carburant
L	Filtre à air
O	Filtre à huile













P	Filtre, pompe d'assistance de direction
S	Séparateur d'huile

	Couvercle filtre DENOX
	Référence
	Voiture particulière / véhicule utilitaire léger
	Véhicule utilitaire / Fourgonnette
	Moteur pour bateau
	Machine agricole ou machine de travaux publics
	Type de moteur
	Cylindrée en l/cm ³
	Puissance du moteur en kW
	Pays d'exportation
	Date/période de montage
	Cas spécial
	Filtre à carburant
	Filtre à air
	Filtre à huile
	Filtre d'habitacle
	Filtre d'habitacle à charbon actif
	Special Filtre spécial pour véhicules utilitaires

	Elément filtrant
	Extracteur
	Préfiltre
	Elément de compensation
	Vis de vidange
	Jeu de joints
	Code d'identification
	Fig. Illustration
	Emballage d'atelier
	Emballage libre-service
	Emballage unitaire
	Quantité par emballage
	Volume en l
	Sortie
	Entrée
	Pression d'ouverture soupape de dérivation
	Pression d'ouverture disp. antiretour
	Hauteur

! ?

fr

 Diamètre	 Chauffage instantané
 Raccord fileté	 Thermocontact
 Raccord de flexible	 Soupape de décharge
 Cartouches filtrantes	 Vis de vidange
 Unité filtre à carburant	 Capuchon de protection
 Couvercle	 Joint circulaire



253	Lunghezza: 253 mm
2FE	Kit comprendente 2 elementi filtranti
303	Diametro 303 mm
327	Lunghezza: 327 mm
352	Diametro 352 mm
356	Diam. disco freno 356 mm
35N	Lunghezza: 350 mm
3BA	3 bar
3FE	Kit comprendente 3 elementi filtranti
3T5	Per veicoli con peso massimo complessivo ammesso di 3,5 t
4BA	4 bar
4T5	Per veicoli con peso massimo complessivo ammesso di 4,5 t
6BA	6,4 bar
AA	Trazione integrale
ABM	Considerare le dimensioni esterne
ABS	Per veicoli con ABS
ABS	Per veicoli senza ABS
AG	Per veicoli con cambio automatico
AGA	Veicolo antinquinamento con cambio automatico
AGF	Per veicoli con depurazione dei gas di scarico
AGF	Per veicoli senza depurazione dei gas di scarico
AGR	Ricircolo gas di scarico
AGR	Senza ricircolo dei gas di scarico
AHF	Impianto di aspirazione dietro la cabina
ALD	Solo per alloggiamento filtro olio con coperchio in alluminio
ANV	Impianto di aspirazione anteriore
ASG	Filtro aria senza cartuccia di sicurezza, aspirazione aria in alto o in basso
ASO	Aspirazione aria in alto
ASU	Aspirazione aria in basso
ATN	Non per esecuzione Trekking
ATP	Per veicoli con pacchetto AMG Technik
ATP	Per veicoli senza pacchetto AMG Technik
AZY	Impianto di scarico e filtro centrifugo rialzati posteriormente
BAN	Solo per scatola filtro aria in lamiera
BGB	Prodotto non adeguato per funzionamento a gas
BHR	Prodotto Bosch equivalente o pezzo per Behr
BO	Solo come ricambio per l'equipaggiamento Bosch
BUS	Per autobus
CAV	Prodotto o parte Bosch di dimensioni identiche per CAV
CSA	Prodotto ordinabile anche online "www.partbob.com"
DE	Sono necessari tre pezzi
DEL	Prodotto Bosch identico o componente per Delco-Remy
DHI	Prodotto o parte Bosch di dimensioni identiche per Delphi
DIF	Per differenziale
DOH	Due alberi a camme in testa, DOHC
DON	Cartuccia filtro per filtro aria Donaldson
DRR	Con regolatore di pressione
DRR	Senza regolatore di pressione
DTV	Regolatore di pressione montato sul filtro (regolatore di pressione non compreso nella fornitura)
DTV	Regolatore di pressione non montato sul filtro
E96	Per norma sui gas di scarico EEC 96
EAB	Per norma sui gas di scarico EEC A/B/D/E
ECC	Per norma gas di scarico EEC C
ED1	Per modello speciale Edition one
EDO	Produttore Dongwoo
EFV	Ricambio anche per il modello precedente
EHX	Per veicoli con equipaggiamento ELX-, HLX
ELH	Per veicoli senza sistema di riscaldamento elettrico
ERH	Per veicoli con un carico utile superiore
EU2	Per veicoli con norma sui gas di scarico Euro 2
EU3	Per veicoli con norma sui gas di scarico Euro 3
EU3	Non per veicoli con norma gas di scarico Euro 3
EU4	Per veicoli con norma sui gas di scarico Euro 4
EU5	Per veicoli con norma sui gas di scarico Euro 5

EU5	Non per veicoli con norma gas di scarico Euro 5
EU6	Non per veicoli con norma gas di scarico Euro 6
EVG	Per veicoli con carburatore elettronico
FBF	Per veicoli da cantiere
FBF	Non per veicoli da cantiere
FEP	Per pompa di iniezione
FG	Per cambio
FHE	Per riscaldamento
FIH	Filtro carburante riscaldato
FIR	Filtro rettangolare
FIU	Filtro carburante non riscaldato
FIZ	Filtro cilindrico
FKO	Per compressore
FKR	Per veicoli a passo corto
FL5	Non per norma gas di scarico L5
FML	Per veicoli senza misuratore massa aria
FMV	Per veicoli con prefiltro
FMV	Per veicoli senza prefiltro
FOE	Per raffreddamento olio
FPJ	Per produzione veicoli Giappone
FRE	Per Retarder
FVA	Per indicazione filtro intasato
FVA	Senza indicazione filtro intasato
FW	Per autopompa antincendio
FWG	Per convertitore di coppia
FW	Non per autopompa antincendio
G10	Filettatura di raccordo M10 x 1
GA	Dritto
GRF	Versione base
GS	Per veicoli con cambio meccanico
H12	Altezza 120 mm
H16	Altezza 116 mm
H25	Altezza 25 mm
H30	Altezza 30 mm
H42	Altezza 142 mm
H90	Altezza 90 mm
H96	Altezza 96 mm
HAU	Corrente principale
HEI	Con riscaldamento
HEI	Senza riscaldamento
HI	Posteriore
HYP	Per pompa idraulica
I27	Diametro interno inferiore 27 mm
I36	Diametro interno inferiore 36 mm
IF5	Per norma gas di scarico IFL5
KAD	Solo per scatola filtro aria in plastica
KAT	Per veicoli con catalizzatore
KAT	Per veicoli senza catalizzatore
KBF	Filtro combinato con funzione di prefiltro
KL	Per veicoli con climatizzatore
KL	Per veicoli senza climatizzatore
KNE	Cartuccia filtro aria per filtro Knecht
KO	Per veicoli municipali
KOB	Per station wagon
KSF	Solo per alloggiamento filtro olio con coperchio in materiale sintetico
KTA	Per veicoli con serbatoio carburante in materiale sintetico
KUF	Cabina corta
KW	Per furgone
KWI	Con intervallo di sostituzione ridotto
KZO	Per zone fredde
KZO	Non per zone fredde
L11	Lunghezza 114 mm
L90	Lunghezza 900 mm
LAB	Montaggio a sinistra
LAF	Cabina lunga

LAT	Prodotto Bosch equivalente o pezzo per Lautrette
LBE	Sollecitazione leggera
LBF	Forma costruttiva lunga
LBF	Forma costruttiva corta
LHT	Aspirazione aria sotto il pavimento della cabina o nella parte posteriore in basso
LIM	Per berlina
LSP	Per filtro aria con cartuccia di sicurezza
LUB	Raccordo aria sotto il pavimento
LUC	Prodotto o parte Bosch di dimensioni identiche per Lucas
LUD	Apertura aspirazione aria da tetto
LUM	Cartuccia del filtro aria per filtri Mann
LVH	Per veicoli con sospensione pneumatica anteriore e posteriore
LWG	Per furgone per consegne
MC1	Per modello-codice 41, 45
MCY	Per veicoli con filtro ciclonico
MGY	Per veicoli senza filtro ciclonico
MES	Con sensore elettrico
MG6	Per veicoli con cambio meccanico a 6 marce
MGK	Per veicoli senza alternatore 380 V per gruppo refrigerante
MHE	Per veicoli con riscaldamento supplementare
MHE	Per veicoli senza riscaldamento supplementare
MHF	Prodotto Bosch identico o componente per Mann-Filter
MIH	Con supporto
MIH	Senza supporto
MKL	Per veicoli con climatizzatore automatico
MKL	Per veicoli senza climatizzatore automatico
MOK	Con raffreddamento olio
MOO	Per veicoli con e senza climatizzatore
MOR	Per motore
MPR	Per veicoli con filtro antiparticolato
MPR	Per veicoli senza filtro antiparticolato
MRK	Per veicoli con ritorno carburante
MW1	Con vite scarico acqua filettatura M10
MW8	Con vite scarico acqua filettatura M8
MWA	Con vite scarico acqua
MXF	Filtro carburante montato fuori dal serbatoio
N13	Per norma gas di scarico Euro 96
N25	Per norma gas di scarico Euro 2005, EC 2005
N25	Non per norma gas di scarico Euro 2005, EC 2005
NAA	Non per trazione integrale
ND	Prodotto Bosch identico o componente per Denso
NEA	Per presa di forza
NEB	Filtro a portata parziale
NFV	Per veicoli senza funzionamento Flexfuel
NFV	Per veicoli con funzionamento Flexfuel
NGB	Non per veicoli con funzionamento a gas
NL4	Per norma gas di scarico L4
NOR	Versione normale
NW4	Per norma gas di scarico W4
OES	Filtro olio con montaggio sul lato frontale
OMZ	Filtro olio con centrifuga
OMZ	Filtro olio senza centrifuga
ORK	Per veicoli senza ritorno carburante
PRF	Prodotto o parte Bosch di dimensioni identiche per Purflux
PRI	Circuito primario
RAB	Montaggio a destra
RAP	Non compatibile RME (estere metilico da olio di colza)
RLE	Per guida a destra
RME	Puleggia a più scanalature
ROB	Resistente all'olio di colza
ROD	Prodotto o parte Bosch di dimensioni identiche per Roto-Diesel
RUL	Per tubazione di ritorno carburante
SA	Equipaggiamento speciale
SAZ	Serie
SBE	Per forti sollecitazioni

SCJ	Per veicoli con SCR (Selective Catalytic Reduction)
SGJ	Per veicoli senza SCR (Selective Catalytic Reduction)
SFZ	Per veicoli speciali
SGA	Per veicolo antinquinamento con cambio meccanico
SGP	Per veicoli con pompa di iniezione Sigma
SHL	Con fascetta stringitubo
SIE	Prodotto Bosch equivalente o pezzo per Siemens
SIM	Per Siemens gestione motore VDO
SIH	Non per Siemens gestione motore VDO
SOH	Un albero a camme in testa, SOHC
SSJ	Per veicoli senza funzione di avviamento/arresto
SSZ	Per manto stradale in cattive condizioni
SSZ	Non per manto stradale in cattive condizioni
STH	Con riscaldamento autonomo
STZ	Per zone polverose
STZ	Non per zone polverose
SVL	Con chiusura rapida
SWA	Con sensore nel separatore acqua
SWA	Senza sensore nel separatore acqua
TAF	Per autocisterne
TEN	Prodotto Bosch identico o componente per Tennex
TER	Per veicoli con Thematic
TMT	Per veicoli con ThermoTronic
TMV	Filtro aria a secco con preseparatore
TMV	Filtro aria a secco senza preseparatore
TNK	Per un'identificazione sicura del numero Bosch deve essere disponibile la scheda dati del veicolo. I componenti riportati sul prodotto devono coincidere con quelli nella scheda dati.
TOR	Prodotto Bosch identico o componente per Toyo Roki
TRO	Non per climi tropicali
TW	Il prodotto montato deve essere rilevato sul veicolo o sul motore.
UFI	Prodotto Bosch identico o componente per UFI
VFA	Preparato per la depurazione dei gas di scarico/catalizzatore
VKL	Per veicoli con climatizzatore completamente automatico
VO	Anteriore
VOW	Per veicoli con preriscaldamento carburante
VOW	Per veicoli senza preriscaldamento carburante
VWI	Con intervallo di sostituzione prolungato
W50	Con efficienza del 97,15 percento
WAS	Con separatore acqua
WAS	Senza separatore acqua
WW	A scelta
XHI	Senza elemento termico integrato
XXX	Consegna solo fino ad esaurimento scorte
Y45	Non per zone molto calde
Z34	Diametro 3/4 pollici
ZE	Sono necessari due pezzi
ZNE	Per veicoli con montaggio successivo
ZUE	Montato in aggiunta
*	Filtro carburante per tutti i modelli di autoveicoli con motore a carburatore 0 450 904 058
**	Filtro carburante per tutti i modelli di autoveicoli con motore a carburatore 0 450 904 149
1	Filtro nella tubazione
2	Scatola filtro
3	Per pompa servosterzo
4	Cartuccia di sicurezza
6	Prefiltro
7	Filtro fine
8	Filtro abitacolo al carbone attivo
A	Box essiccante
C	Filtro liquido di raffreddamento
D	Kit di manutenzione filtro Denox
H	Filtro idraulico
I	Filtro per l'abitacolo



it

K	Filtro carburante
L	Filtro dell'aria
O	Filtro olio

P	Filtro, pompa servosterzo
S	Separatore d'olio

	Coperchio filtro DENOX
	Numero di ordinazione
	Autovettura / furgone
	Veicoli commerciali / camioncini
	Motore nautico
	Trattore o macchina per l'edilizia
	Tipo motore
	Cilindrata in l/ccm
	Potenza motore in kW
	Paese d'esportazione
	Data/Periodo di montaggio
	Caso specifico
	Filtro carburante
	Filtro aria
	Filtro olio
	Filtro abitacolo
	Filtro abitacolo con carboni attivi
	Special Filtro speciale per veicoli industriali

	Elemento filtrante
	Attrezzo di estrazione
	Prefiltro
	Elemento di compensazione
	Vite di scarico
	Kit guarnizioni
	Numero ricerca
	Fig. Illustrazione
	Confezione da officina
	Confezione self-service
	Confezione da 1 pezzo
	Unità per confezione
	Volume in l
	Uscita
	Entrata
	$p_{\frac{1}{2}}$ bar Pressione di apertura valvola by-pass
	$p_{\frac{1}{2}}$ bar Pressione di apertura bloccaggio antiritorno
	H mm Altezza



it



Diametro



Raccordo filettato



Raccordo per tubo flessibile



Inserti filtranti



Gruppo filtro carburante



Coperchio



Scaldacqua fluente



Interruttore termico



Valvola di troppo pieno



Vite di scarico



Cappuccio di protezione



Anello di tenuta



253	Longitud: 253 mm
2FE	Un juego esta integrado por 2 elementos filtradores
303	Diámetro de 303 mm
327	Longitud: 327 mm
352	Diámetro de 352 mm
356	Diámetro disco de freno 356 mm
35N	Longitud: 350 mm
3BA	3 bar
3FE	Un juego esta integrado por 3 elementos filtradores
3T5	Para vehículos con un peso total admisible de 3,5 t
4BA	4 bar
4T5	Para vehículos con un peso total admisible de 4,5 t
6BA	6,4 bar
AA	Tracción total
ABM	Observar las medidas
ABS	Para vehículos con ABS
ABS	Para vehículos sin ABS
AG	Para vehículos con cambio automático
AGA	Vehículo con desintoxicación de gases de escape y cambio automático
AGF	Para vehículos con desintoxicación de gases de escape
AGF	Para vehículos sin desintoxicación de gases de escape
AGR	Retroalimentación de gases de escape
AGR	Sin retroalimentación de gases de escape
AHF	Instalación de aspiración detrás de la cabina del conductor
ALD	Sólo para cuerpo de filtro de aceite con tapa de aluminio
ANV	Instalación de aspiración delante
ASG	Filtro de aire sin cartucho de seguridad, aspiración de aire arriba o abajo
ASO	Aspiración de aire arriba
ASU	Aspiración de aire abajo
ATN	No para la versión Trekking
ATP	Para vehículos con paquete de técnica AMG
ATP	Para vehículos sin paquete de técnica AMG
AZY	Sistema de aspiración y filtro ciclónico atrás levantado
BAN	No para carcasa del filtro del aire de chapa
BGB	Producto no para funcionamiento a gas
BHR	Producto Bosch de dimensiones idénticas para BEHR
BO	Bosch, sólo como producto de sustitución para el equipo Bosch
BUS	Para autobús
CAV	Producto Bosch de dimensiones idénticas para CAV
CSA	Producto también por pedido online "www.partbob.com"
DE	Se necesitan tres
DEL	Producto Bosch de igual montaje o pieza para Delco-Remy
DHI	Producto Bosch de dimensiones idénticas para Delphi
DIF	Para diferencial
DOH	Dos árboles de levas superiores, DOHC
DON	Cartucho de filtro de aire para filtro de aire Donaldson
DRR	Con regulador de presión
DRR	Sin regulador de presión
DTV	Regulador de presión montado en el filtro (regulador de presión no incluido en el volumen de suministro)
DTV	Regulador de presión no instalado en el filtro
E96	Para norma de gases de escape EEC 96
EAB	Para norma de gases de escape EEC A/B/D/E
ECC	Para norma de gases de escape EEC C
ED1	Para el modelo especial Edition one
EDO	Fabricante Dongwoo
EFV	También sustitución del anterior
EHX	Para vehículos con equipamiento ELX, HLX
ELH	Para vehículos sin sistema de calefacción eléctrico
ERH	Para vehículos con carga útil elevada
EU2	Para vehículos con norma de gases de escape EURO 2
EU3	Para vehículos con norma de gases de escape EURO 3
EU3	No para vehículos con norma de gases de escape Euro 3
EU4	Para vehículos con norma de gases de escape EURO 4
EU5	Para vehículos con norma de gases de escape EURO 5

EU5	No para vehículos con norma de gases de escape Euro 5
EU6	No para vehículos con norma de gases de escape Euro 6
EVG	Para vehículos con carburador electrónico
FBF	Para vehículos de obras
FBF	No para vehículo de obra
FEP	Para bomba de inyección
FG	Para caja de cambios
FHE	Para calefacción
FIH	Filtro de combustible calentado
FIR	Filtro rectangular
FIU	Filtro de combustible sin calentar
FIZ	Filtro cilíndrico
FKO	Para compresor
FKR	Para vehículos con corta distancia entre ejes
FL5	No para norma de gases de escape L5
FML	Para vehículos sin medidor de masa de aire
FMV	Para vehículos con filtro previo
FMV	Para vehículos sin filtro previo
FOE	Para refrigeración de aceite
FPJ	Para producción de vehículos Japón
FRE	Para retardador
FVA	Para indicación de ensuciamiento del filtro
FVA	Sin indicación de ensuciamiento del filtro
FW	Para vehículos de bomberos
FWG	Para variador hidráulico
FW	No para vehículos de bomberos
G10	Rosca de conexión M10 x 1
GA	Recto
GRF	Modelo básico
GS	Para vehículos con cambio manual
H12	Altura de 120 mm
H16	Altura 116 mm
H25	Altura 25 mm
H30	Altura 30 mm
H42	Altura 142 mm
H90	Altura de 90 mm
H96	Altura de 96 mm
HAU	Flujo principal
HEI	Con calefacción
HEI	Sin calefacción
HI	Trasero
HYP	Para bomba hidráulica
I27	Diámetro interior abajo 27 mm
I36	Diámetro interior abajo 36 mm
IF5	Para norma de gases de escape IFL5
KAD	No para carcasa del filtro del aire de plástico
KAT	Para vehículos con catalizador
KAT	Para vehículos sin catalizador
KBF	Filtro combinado como filtro previo
KL	Para vehículos con acondicionador de aire
KL	Para vehículos sin acondicionador de aire
KNE	Cartucho de filtro de aire para filtro de aire Knecht
KO	Para vehículos municipales
KOB	Para vehículos combinados
KSF	Sólo para cuerpo de filtro de aceite con tapa de plástico
KTA	Para vehículos con depósito de combustible de plástico
KUF	Cabina corta
KW	Para furgoneta
KWI	Para intervalo de cambio acortado
KZO	Para zonas frías
KZO	No para zonas frías
L11	Longitud: 114 mm
L90	Longitud: 900 mm
LAB	Montaje a la izquierda
LAF	Cabina del conductor larga

LAT	Producto o pieza Bosch de dimensiones idénticas para Lautrette
LBE	Esfuerzo limitada
LBF	Forma constructiva larga
LBF	Forma constructiva corta
LHT	Aspiración de aire por debajo del suelo de la cabina del conductor o aspiración de aire detrás profunda
LIM	Para berlina
LSP	Para filtro de aire con cartucho de seguridad
LUB	Conexión de aire debajo del suelo
LUC	Producto o pieza Bosch de dimensiones idénticas para Lucas
LUD	Orificio de aspiración de aire techo
LUM	Cartucho del filtro de aire de Mann
LVH	Para vehículos con suspensión neumática delantera y trasera
LWG	Para vehículos de reparto
MC1	Para el código de modelo 41, 45
MCY	Para vehículos con filtro ciclón
MCY	Para vehículos sin filtro ciclón
MES	Con sensor eléctrico
MG6	Para vehículos con cambio manual, 6 marchas
MGK	Para vehículos sin generador de 380 V para grupo refrigerador
MHE	Para vehículos con calefacción independiente
MHE	Para vehículos sin calefacción independiente
MHF	Producto Bosch de igual montaje o pieza para filtro Mann
MIH	Con soporte
MIH	Sin soporte
MKL	Para vehículos con climatizador automático
MKL	Para vehículos sin climatizador automático
MOK	Con refrigerante del aceite
MOO	Para vehículos con y sin acondicionador de aire
MOR	Para motor
MPR	Para vehículos con filtro de partículas de hollín
MPR	Para vehículos sin filtro de partículas de hollín
MRK	Para vehículos con retorno de combustible
MW1	Con tornillo de purga de agua rosca M10
MW8	Con tornillo de purga de agua rosca M8
MWA	Con tornillo de purga de agua
MXF	Filtro de combustible instalado fuera del depósito
N13	Para norma de gases de escape EURO 96
N25	Para norma de gases de escape Euro 2005, EC 2005
N25	No para norma de gases de escape Euro 2005, EC 2005
NAA	No para tracción total
ND	Producto Bosch de igual montaje o pieza para Denso
NEA	Para toma de fuerza auxiliar
NEB	Filtro secundario
NFV	Para vehículos sin servicio de combustible flexible
NFV	Para vehículos con servicio de combustible flexible
NGB	No para vehículos con funcionamiento con gas
NL4	Para norma de gases de escape L4
NOR	Versión normal
NW4	Para norma de gases de escape W4
OES	Filtro de aceite montado en el lado frontal
OMZ	Filtro de aceite con centrífuga
OMZ	Filtro de aceite sin centrífuga
ORK	Para vehículos sin retorno de combustible
PRF	Producto o pieza Bosch de dimensiones idénticas para Purflux
PRI	Circuito primario
RAB	montaje a la derecha
RAP	No apto RME (éster metílico aceite de colza)
RLE	Para vehículos de volante a la derecha
RME	Polea de correa multigargantas
ROB	Resistente al aceite de colza
ROD	Producto o pieza Bosch de dimensiones idénticas para Roto-Diesel
RUL	Para tubería de retorno de combustible
SA	Equipo especial
SAZ	Juego

SBE	Fuerte esfuerzo
SCJ	Para vehículos con SCR (Selective Catalytic Reduction)
SCJ	Para vehículos sin SCR (Selective Catalytic Reduction)
SFZ	Para vehículos especiales
SGA	Para vehículos con desintoxicación de gases de escape con cambio manual
SGP	Para vehículos con bomba de inyección Sigma
SHL	Con abrazadera de tubo flexible
SIE	Producto o pieza Bosch de dimensiones idénticas para Siemens
SIM	Para control del motor Siemens VDO
SIM	No para control del motor Siemens VDO
SOH	Un árbol de levas superior, SOHC
SSJ	Para vehículos sin función de arranque/parada
SSZ	Para calles en mal estado
SSZ	No para calles en mal estado
STH	Para calefacción independiente
STZ	Para zonas polvorrientas
STZ	No para zonas polvorrientas
SVL	Con enchufe rápido
SWA	Con sensor en el separador de agua
SWA	Sin sensor en el separador de agua
TAF	Para vehículos cisterna
TEN	Producto Bosch de igual montaje o pieza para Tennex
TER	Para vehículos con Thematic
TMT	Para vehículos con Thermotronic
TMV	Filtro de aire seco con separador previo
TMV	Filtro de aire seco sin separador previo
TNK	Para identificación inequívoca del número Bosch se debe tener a la vista la tarjeta de datos del vehículo. Los componentes enumerados en el producto deben coincidir con los de la tarjeta de datos.
TOR	Producto Bosch de igual montaje o pieza para Toyo Roki
TRO	No para los trópicos
TW	El producto montado se debe determinar en el vehículo o en el motor.
UFI	Producto Bosch de igual montaje o pieza para UFI
VFA	Preparado para la desintoxicación de gases de escape/catalizador
VKL	Para vehículos con acondicionador de aire totalmente automático
VO	Delante
VOW	Para vehículos con precalentamiento del combustible
VOW	Para vehículos sin precalentamiento del combustible
VWI	Para intervalo de cambio prolongado
W50	Con 97,15 por ciento de eficiencia
WAS	Con separador de agua
WAS	Sin separador de agua
WW	A elección
XHI	Sin elemento calefactor integrado
XXX	Suministro mientras duren las reservas
Y45	No para zonas cálidas
Z34	Diámetro de 3/4 pulgadas
ZE	2 necesarios
ZNE	Para vehículos en caso de montaje posterior
ZUE	Incorporado adicionalmente
*	Filtro de combustible para todos los modelos de automóviles con motor con carburador 0 450 904 058
**	Filtro de combustible para todos los modelos de automóviles con motor con carburador 0 450 904 149
1	Filtro de línea
2	Caja de filtro
3	Para la bomba de asistencia a la dirección
4	Cartucho de seguridad
6	Filtro previo
7	Filtro fino
8	Filtro carbón activo habitáculo interior
A	Caja de agente desecante
C	Filtro de agua de refrigeración
D	Set de servicio de filtro Denox
H	Filtro hidráulico





















es

I	Filtro de habitáculo interior
K	Filtro de combustible
L	Filtro de aire

O	Filtro de aceite
P	Filtro, dirección asistida
S	Separador de aceite

	Tapa filtro DENOX
	Número de referencia
	Turismo / furgoneta
	Vehículos industriales / de transporte pequeño
	Motor náutico
	Maquinaria agrícola o de construcción
	Tipo de motor
	Cilindrada en l/ccm
	Potencia del motor en kW
	País de exportación
	Fecha/periodo de fabricación
	Caso especial
	Filtro de combustible
	Filtro de aire
	Filtro de aceite
	Filtro para el habitáculo
	Filtro para el habitáculo con carbón activo
	Special Filtro especial para vehículos industriales

	Elemento filtrante
	Herramienta extractora
	Filtro previo
	Elemento de compensación
	tornillo de purga
	Juego de juntas
	Referencia comercial
	Fig. Ilustración
	Envase de taller
	Envase autoservicio
	Envase individual
	Piezas por embalaje
	Volumen en l
	Salida
	Entrada
	$\frac{p_{\frac{1}{2}}}{\text{bar}}$ presión de apertura válvula bypass
	$\frac{p_{\frac{1}{2}}}{\text{bar}}$ Presión apertura bloq retorno
	$\frac{H}{\text{mm}}$ Altura



es

	Diámetro		Calentador continuo
	Conexión de rosca		Termointerruptor
	empalme de tubo flexible		válvula de rebose
	Elementos del filtro		tornillo de purga
	Grupo filtro de combustible		tapa protectora
	Tapa		Anillo obturador



253	Lengte: 253 mm
2FE	Set, bestaand uit 2 filterelementen
303	Diameter 303 mm
327	Lengte: 327 mm
352	Diameter 352 mm
356	Diameter remschijf 356 mm
35N	Lengte: 350 mm
3BA	3 bar
3FE	Set, bestaand uit 3 filterelementen
3T5	Voor voertuigen met toegest. totaalgew. v. 3,5 t
4BA	4 bar
4T5	Voor voertuigen met toegest. totaalgew. v. 4,5 t
6BA	6,4 bar
AA	Vierwielaandrijving
ABM	Afmetingen controleren
ABS	Voor voertuigen met ABS
ABS	Voor voertuigen zonder ABS
AG	Voor voertuigen met automatische transmissie
AGA	Voertuigen met automatische transmissie en katalysator
AGF	Voor voertuigen met uitlaatgasreiniging
AGF	Voor voertuigen zonder uitlaatgasreiniging
AGR	Uitlaatgasrecirculatie
AGR	Zonder uitlaatgasrecirculatie
AHF	Aanzuiginstallatie achter cabine
ALD	Alleen voor oliefilterhuis met aluminium deksel
ANV	Aanzuiginstallatie voor
ASG	Luchtfilter onder veiligheidspatroon, luchtaanzuiging boven of onder
ASO	Luchtaanzuiging boven
ASU	Luchtaanzuiging onder
ATN	Niet voor uitvoering Trekking
ATP	Voor voertuigen met AMG Technik-pakket
ATP	Voor voertuigen zonder AMG-techniekpakket
AZY	Inlaatsysteem en cyclonfilter achter omhooggetrokken
BAN	Alleen voor blikken luchtfilterhuis
BGB	Product niet voor motoren op gas
BHR	Bosch-product met identieke inbouw of onderdeel voor Behr
BO	Bosch, alleen als vervangend product voor Bosch-uitrusting
BUS	Voor bus
CAV	Bosch-product met identieke inbouw of onderdeel voor CAV
CSA	Artikel ook online te bestellen "www.partbob.com"
DE	Drie zijn noodzakelijk
DEL	Bosch-product met identieke afmetingen of onderdeel voor Delco-Remy
DHI	Bosch-product met identieke inbouw of onderdeel voor Delphi
DIF	Voor differentiël
DOH	Twee bovenliggende nokkenassen, DOHC
DON	Luchtfilterpatroon voor Donaldson-luchtfilter
DRR	Met drukregelaar
DRR	Zonder drukregelaar
DTV	Drukregelaar op filter gemonteerd (drukregelaar maakt geen deel uit van de leveromvang)
DFV	Drukregelaar niet aan het filter bevestigd
E96	Voor uitlaatgasnorm EEC 96
EAB	Voor uitlaatgasnorm EEC A/B/D/E
ECC	Voor uitlaatgasnorm EEC C
ED1	Voor speciaal model Edition one
EDO	Fabrikant Dongwoo
EFV	Ook vervanging voor vorige versies
EHX	Voor voertuigen met ELX-, HLX-uitrusting
ELH	Voor voertuigen zonder elektrisch verwarmingssysteem
ERH	Voor voertuigen met verhoogd laadvermogen
EU2	Voor voertuigen met uitlaatgasemissienorm EURO 2
EU3	Voor voertuigen met uitlaatgasemissienorm EURO 3
EU3	Niet voor voertuigen met uitlaatgasnorm Euro 3
EU4	Voor voertuigen met uitlaatgasemissienorm EURO 4
EU5	Voor voertuigen met uitlaatgasemissienorm EURO 5

EU5	Niet voor voertuigen met uitlaatgasnorm Euro 5
EU6	Niet voor voertuigen met uitlaatgasnorm Euro 6
EVG	Voor voertuigen met een elektronische carburateur
FBF	Voor bouwplaatsvoertuigen
FBF	Niet voor bouwvoertuig
FEP	Voor inspuitpomp
FG	Voor transmissie
FHE	Voor verwarming
FIH	Brandstoffilter verwarmd
FIR	Filter rechthoekig
FIU	Brandstoffilter onverwarmd
FIZ	Filter cilindrisch
FKO	Voor compressor
FKR	Voor voertuigen met korte wielbasis
FL5	Niet voor uitlaatgasnorm L5
FML	Voor voertuigen zonder luchtmassameter
FMV	Voor voertuigen met voorfilter
FMV	Voor voertuigen zonder voorfilter
FOE	Voor oliekoeling
FPJ	Voor voertuigproductie Japan
FRE	Voor retarder
FVA	Voor verklikkerlampje van filtervervuiling
FVA	Zonder verklikkerlampje van filtervervuiling
FW	Voor brandweerauto's
FWG	Voor automatische transmissie met koppelvormer
FW	Niet voor brandweerauto's
G10	Aansluitschroefdraad M10 x 1
GA	Recht
GRF	Basismodel
GS	Voor voertuigen met handgeschakelde transmissie
H12	Hoogte 120 mm
H16	Hoogte 116 mm
H25	Hoogte 25 mm
H30	Hoogte 30 mm
H42	Hoogte 142 mm
H90	Hoogte 90 mm
H96	Hoogte 96 mm
HAU	Hoofdstroom
HEI	Met verwarming
HEI	Zonder verwarming
HI	Achter
HYP	Voor hydraulische pomp
I27	Binnendiameter onder 27 mm
I36	Binnendiameter onder 36 mm
IF5	Voor uitlaatgasnorm IFL5
KAD	Alleen voor kunststof-luchtfilterhuis
KAT	Voor voertuigen met katalysator
KAT	Voor voertuigen zonder katalysator
KBF	Combifilter als voorfilter
KL	Voor voertuigen met airconditioning
KL	Voor voertuigen zonder airconditioning
KNE	Luchtfilterpatroon voor Knecht-luchtfilter
KO	Voor gemeentevervoertuigen
KOB	Voor stationwagens
KSF	Alleen voor oliefilterhuis met kunststofdeksel
KTA	Voor voertuigen met een brandstoftank in kunststof
KUF	Korte cabine
KW	Voor bestelwagen
KWI	Voor korter vervangingsinterval
KZO	Voor koud klimaat
KZO	Niet voor koude klimaat
L11	Lengte 114 mm
L90	Lengte 900 mm
LAB	Montage links
LAF	Lange cabine















LAT	Bosch-product met identieke inbouw of onderdeel voor Lautrette
LBE	Lichte belasting
LBF	Lange bouwwijze
LBF	Korte bouwwijze
LHT	Luchtaanzuiging onder de cabinebodem of luchtaanzuiging achter laag
LIM	Voor sedan
LSP	Voor luchtfilters met veiligheidspatroon
LUB	Luchtaansluiting onder vloer
LUC	Bosch-product met identieke inbouw of onderdeel voor Lucas
LUD	Luchtaanzuigopening dak
LUM	Luchtfilterpatroon voor Mann-luchtfilter
LVH	Voor voertuigen met luchtvering voor en achter
LWG	Voor bestelwagens
MC1	Voor modelcode 41, 45
MCY	Voor voertuigen met cycloofilter
MGY	Voor voertuigen zonder wervelfilter
MES	Met elektronische sensor
MG6	Voor voertuigen met handgeschakelde transmissie, 6 versnellingen
MGK	Voor voertuigen zonder 380 V-dynamo voor koelaggregaat
MHE	Voor voertuigen met hulpverwarming
MHE	Voor voertuigen zonder hulpverwarming
MHF	Bosch-product met identieke afmetingen of onderdeel voor Mann-filter
MIH	Met houder
MIH	Zonder houder
MKL	Voor voertuigen met automatische airconditioning
MKL	Voor voertuigen zonder automatische airconditioning
MOK	Oliekoeler ingebouwd
MOO	Voor voertuigen met en zonder airconditioning
MOR	Voor motor
MPR	Voor voertuigen met roetdeeltjesfilter
MPR	Voor voertuigen zonder roetdeeltjesfilter
MRK	Voor voertuigen met brandstofterugloop
MW1	Met wateraftapplug met M10-draad
MW8	Met wateraftapplug met M8-draad
MWA	Met wateraftapplug
MXF	Brandstoffilter buiten tank ingebouwd
N13	Voor uitlaatgasemissienorm EURO 96
N25	Voor uitlaatgasemissienorm EURO 2005, CEE 2005
N25	Voor uitlaatgasemissienorm EURO 2005, EC 2005
NAA	Niet voor vierwielaandrijving
ND	Inbouwidentiek Bosch-certificaat of onderdeel voor Denso
NEA	Voor Power take-off
NEB	Nevenstroomfilter
NFV	Voor voertuigen zonder flexfuelwerking
NFV	Voor voertuigen met flexfuelwerking
NGB	Niet voor voertuigen met motoren op gas
NL4	Voor uitlaatgasnorm L4
NOR	Standaardversie
NW4	Voor uitlaatgasnorm W4
OES	Oliefilter aan de voorkant gemonteerd
OMZ	Oliefilter met centrifuge
OMZ	Oliefilter zonder centrifuge
ORK	Voor voertuigen zonder brandstofterugloop
PRF	Bosch-product met identieke inbouw of onderdeel voor Purflux
PRI	Primair circuit
RAB	Aanbouw rechts
RAP	Niet geschikt voor RME (raapolie methylester)
RLE	Voor voertuig met stuur rechts
RME	Riemschijf met meerdere loopgleuven
ROB	Bestand tegen raapolie
ROD	Bosch-product met identieke inbouw of onderdeel voor Roto-Diesel
RUL	Voor brandstofretourleiding
SA	Speciale uitrusting
SAZ	Set
SBE	Zware belasting

SCJ	Voor voertuigen met SCR (Selective Catalytic Reduction)
SGJ	Voor voertuigen zonder SCR (Selective Catalytic Reduction)
SFZ	Voor speciale voertuigen
SGA	Voor voertuigen met handgeschakelde versnellingsbak waarvan de uitlaatgassen ontgift zijn
SGP	Voor voertuigen met Sigma-inspuitpomp
SHL	Met slangkleem
SIE	Bosch-product met identieke inbouw of onderdeel voor Siemens
SIM	Voor Siemens, VDO-Motorsturing
SIM	Niet voor Siemens, VDO-Motorsturing
SOH	Een bovenliggende nokkenas, SOHC
SSJ	Voor voertuigen zonder start-stop-functie
SSZ	Voor slechte wegen
SSZ	Niet voor slechte wegen
STH	Voor standverwarming
STZ	Voor stoffige zones
STZ	Niet voor stoffige zones
SVL	Met snelsluiting
SWA	Met sensor in waterafscheider
SWA	Zonder sensor in waterafscheider
TAF	Voor tankwagens
TEN	Bosch-product met identieke afmetingen of onderdeel voor Tennex
TER	Voor voertuigen met Thematic
TMT	Voor voertuigen met Thermotronic
TMV	Droge-luchtfilter met voorafscheider
TMV	Droge-luchtfilter zonder voorafscheider
TNK	Voor de eenduidige identificatie van de Bosch-nummers moet de gegevenskaart van het voertuig aanwezig zijn. De bij de het product opgesomde componenten moeten met die op de gegevenskaart overeenstemmen.
TOR	Bosch-product met identieke afmetingen of onderdeel voor Toyo Roki
TRO	Niet voor de tropen
TW	Ingebouwd product moet aan het voertuig of de motor gedetecteerd worden.
UFI	Bosch-product met identieke afmetingen of onderdeel voor UFI
VFA	Voorzien voor katalysator/uitlaatgasreiniging
VKL	Voor voertuigen met een volautomatische airconditioning
VO	Voorzijde
VOW	Voor voertuigen met brandstofvoorverwarming
VOW	Voor voertuigen zonder brandstofvoorverwarming
VWI	Voor langer vervangingsinterval
W50	Met 97,15 procent efficiëntie
WAS	Met waterafscheider
WAS	Zonder waterafscheider
WW	In optie
XHI	Zonder geïntegreerd verwarmingselement
XXX	Leverbaar zo lang de voorraad strekt
Y45	Niet voor hete zones
Z34	Diameter 3/4 inch
ZE	Twee noodzakelijk
ZNE	Voor voertuigen met inbouw achteraf
ZUE	Als supplement ingebouwd
*	Brandstoffilter voor alle personenwagenmodellen met carburateurmotor 0 450 904 058
**	Brandstoffilter voor alle personenwagenmodellen met carburateurmotor 0 450 904 149
1	Leidingsfilter
2	Filterbox
3	Voor pomp van stuurbekrachtiging
4	Veiligheidspatroon
6	Voorfilter
7	Fijnfilter
8	Interieurfilter, actieve koolstof
A	Droogmiddelbox
C	Koelwaterfilter
D	Denox-filterserviceset
H	Hydraulisch filter

nl

I	Interieurfilter
K	Brandstoffilter
L	Luchtfilter













O	Oliefilter
P	Filter, stuurbe-krachtigingspomp
S	Olieafscheider

	Deksel DENOX-filter
	Artikelnummer
	Personenwagen / bestelbus
	Bedrijfswagen / kleine vrachtwagen
	Bootmotor
	Tractor of bouwvoertuig
	Motortype
	Cilinderinhoud in l/ccm
	Motorvermogen in kW
	Exportland
	Datum/ Ingebouwd van .. tot ..
	Speciaal geval
	Brandstoffilter
	Luchtfilter
	Oliefilter
	Interieurfilter
	Interieurfilter met actieve kool
	Speciaal filter voor bedrijfswagens

	Filterelement
	Uittrekgereedschap
	Voorfilter
	Compensatie-element
	Aftapschroef
	Pakkingset
	Zoeknummer
	Afbeelding
	Werkplaatsverpakking
	ZB-verpakking
	Losse verpakking
	Stuk per verpakking
	Volume in l
	Uitgang
	Ingang
	Openingsdruk bypassklep
	Openingsdruk terugloopblokering
	Hoogte



nl

 Diameter	 Boiler
 Schroefdraadaansluiting	 Thermoschakelaar
 Slangaansluiting	 Overloopklep
 Filterelementen	 Aftapschroef
 Aggregaat brandstoffilter	 Beschermkap
 Deksel	 Afdichtring



253	Längd: 253 mm
2FE	Setet består av 2 filterelement
303	Diameter 303 mm
327	Längd: 327 mm
352	Diameter 352 mm
356	Diameter bromsskiva 356 mm
35N	Längd: 350 mm
3BA	3 bar
3FE	Setet består av 3 filterelement
3T5	För fordon med 3,5 t högsta tillåtna totalvikt
4BA	4 bar
4T5	För fordon med 4,5 t högsta tillåtna totalvikt
6BA	6,4 bar
AA	Fyrhjulsdraft
ABM	Observera, måtten
ABS	För fordon med ABS
ABS	För fordon utan ABS
AG	För fordon med automatlåda
AGA	För avgasrenat fordon med automatlåda
AGF	För fordon med avgasrening
AGF	För fordon utan avgasrening
AGR	Avgasåterföring
AGR	Ej avgasåterföring
AHF	Insugningsanläggning bakom förarhytten
ALD	Endast för oljefilterhus med aluminiumlock
ANV	Insugningsanläggning fram
ASG	Luftfilter utan säkerhetspatron, luftinsugning uppe eller nere
ASO	Luftinsugning uppe
ASU	Luftinsugning nere
ATN	Inte för utförande Trekking
ATP	För fordon med AMG teknikpaket
ATP	För fordon utan AMG teknikpaket
AZY	Insugningsystem och cyklonrenare uppåtsvängd baktill
BAN	Endast för luftfilterhus av plåt
BGB	Produkt ej för gasdrift
BHR	Monteringslik Bosch-produkt eller del för Behr
BO	Bosch, endast som ersättning för Bosch-utrustning
BUS	För buss
CAV	Monteringslik Bosch-produkt eller del för CAV
CSA	Produkt kan beställas online "www.partbob.com"
DE	Tre erfordras
DEL	Bosch-produkt med lika monteringsvillkor eller del för Delco-Remy
DHI	Monteringslik Bosch-produkt eller del för Delphi
DIF	För differential
DOH	Två överliggande kamaxlar, DOHC
DON	Luftfilterinsats för Donaldson-luftfilter
DRR	Med tryckregulator
DRR	Utän tryckregulator
DTV	Tryckregulator monterad på filtret (tryckregulatorn ingår inte i leverans)
DTV	Tryckregulator ej monterad på filtret
E96	För avgasstandard EEC 96
EAB	För avgasstandard EEC A/B/D/E
ECC	För avgasstandard EEC C
ED1	För specialmodell Edition one
EDO	Tillverkare Dongwoo
EFV	Även ersättning för föregångare
EHX	För fordon med ELX-, HLX-utrustning
ELH	För fordon utan elvärmesystem
ERH	För bilar med utökad lastkapacitet
EU2	För bilar med avgasstandard Euro 2
EU3	För bilar med avgasstandard Euro 3
EU3	Inte för bilar med avgasstandard EURO 3
EU4	För bilar med avgasstandard Euro 4
EU5	För bilar med avgasstandard Euro 5
EU5	Inte för bilar med avgasstandard EURO 5

EU6	Inte för bilar med avgasstandard EURO 6
EVG	För fordon med elektronisk förgasare
FBF	För byggplatslastbilar
FBF	Inte för byggplatsfordon
FEP	För insprutningspump
FG	För växellåda
FHE	För värme
FIH	Bränslefilter uppvärmt
FIR	Rektangulärt filter
FIU	Bränslefilter ouppvärt
FIZ	Cylindriskt filter
FKO	För kompressor
FKR	För bil med kort hjulbas
FL5	Ej för avgasstandard L5
FML	För fordon utan luftmassamätare
FMV	För fordon med förfilter
FMV	För fordon utan förfilter
FOE	För oljekylning
FPJ	För bilproduktion Japan
FRE	För retarder
FVA	Till filterserviceindikator
FVA	Utän filterserviceindikator
FW	För brandbilar
FWG	För momentomvandlare
FW	Ej för brandbilar
G10	Anslutningsgånga M10 x 1
GA	Rak
GRF	Grundutförande
GS	För fordon med manuell växellåda
H12	Höjd 120 mm
H16	Höjd 116 mm
H25	Höjd 25 mm
H30	Höjd 30 mm
H42	Höjd 142 mm
H90	Höjd 90 mm
H96	Höjd 96 mm
HAU	Huvudström
HEI	Med värme
HEI	Utän värme
HI	Bak
HYP	För hydraulpump
I27	Innerdiameter nertill 27 mm
I36	Innerdiameter nertill 36 mm
IF5	För avgasstandard IFL5
KAD	Endast för luftfilterhus av plast
KAT	För katalysatorbilar
KAT	För bilar utan katalysator
KBF	Kombinationsfilter som förfilter
KL	För fordon med AC-anläggning
KL	För bilar utan AC-anläggning
KNE	Luftfilterinsats för Knecht luftfilter
KO	Kommunalfordon
KOB	För kombibil
KSF	Endast för oljefilterhus med plastlock
KTA	För fordon med bränsletank av plast
KUF	Kort förarhytt
KW	För skåpbil
KWI	För förkortade serviceintervall
KZO	Kalla zoner
KZO	Inte för kalla zoner
L11	Längd 114 mm
L90	Längd 900 mm
LAB	Vänstermontering
LAF	Lång förarhytt
LAT	Monteringslik Bosch-produkt eller del för Lautrette

LBE	Lätt belastning
LBF	Långt utförande
LBF	Kort utförande
LHT	Luftinsugning under hyttgolvet eller luftinsugning lågt bak
LIM	För limousine
LSP	Luftfilter med säkerhetspatron
LUB	Luftanslutning under golv
LUC	Monteringslik Bosch-produkt eller del för Lucas
LUD	Luftintagsöppning tak
LUM	Luftfilterinsats för Mann luftfilter
LVH	För fordon med luftfjädring fram och bak
LWG	För distributionsbil
MC1	För modellkod 41, 45
MCY	För fordon med cyklonfilter
MCY	För fordon utan cyklonfilter
MES	Med elektrisk sensor
MG6	För fordon med 6-växlad manuell växellåda
MGK	För fordon utan 380 V generator för kylaggregat
MHE	För fordon med extravärme
MHE	För fordon utan extravärme
MHF	Bosch-produkt med lika monteringsvillkor eller del för Mann-filter
MIH	Med hållare
MIH	Utan hållare
MKL	För fordon med automatisk klimatanläggning
MKL	För fordon utan automatisk klimatanläggning
MOK	Inbyggd oljekylare
MOO	För bilar med och utan AC-anläggning
MOR	För motor
MPR	För bilar med sotpartikelfilter
MPR	För bilar utan sotpartikelfilter
MRK	För bilar med bränslereturflöde
MW1	Med vattenavtappningsskruv gänga M10
MW8	Med vattenavtappningsskruv gänga M8
MWA	Med vattenavtappningsskruv
MXF	Bränslefilter monterat utanför tank
N13	För avgasstandard Euro 96
N25	För avgasnorm Euro 2005, EC 2005
N25	Ej för avgasnorm Euro 2005, EC 2005
NAA	Ej för fyrhjulsdrift
ND	Denso, monteringslik Bosch-produkt eller del
NEA	För kraftuttag
NEB	Biflödesfilter
NFV	För fordon utan Flexfuel-drift
NFV	För fordon med Flexfuel-drift
NGB	Inte för fordon med gasdrift
NL4	För avgasstandard L4
NOR	Normalt utförande
NW4	För avgasstandard W4
OES	Oljefiltret monterat på fronsidan
OMZ	Oljefilter med centrifug
OMZ	Oljefilter utan centrifug
ORR	För bilar utan bränslereturflöde
PRF	Monteringslik Bosch-produkt eller del för Purflux
PRI	Primärkrets
RAB	Högermontering
RAP	Ej RME-duglig (rapsoljeestylester)
RLE	För högerstyrda fordon
RME	Flerspårig remskiva
ROB	Beständig mot rapsolja
ROD	Monteringslik Bosch-produkt eller del för Roto-diesel
RUL	För bränslereturledning
SA	Specialutrustning
SAZ	Sats
SBE	Stor belastning
SCJ	För fordon med SCR (Selective Catalytic Reduction)

SCJ	För fordon utan SCR (Selective Catalytic Reduction)
SFZ	För specialfordon
SGA	För avgasrenad bil med manuell växellåda
SGP	För fordon med Sigma insprutningspump
SHL	Med slangklämma
SIE	Monteringslik Bosch-produkt eller del för Siemens
SIM	För Siemens VDO motorstyrning
SIM	Inte för Siemens VDO motorstyrning
SOH	En överliggande kamaxel, SOHC
SSJ	För bilar utan start-/stoppfunktion
SSZ	För dåliga vägförhållanden
SSZ	Ej för dåliga vägförhållanden
STH	För tillsatsvärmare
STZ	För dammiga zoner
STZ	Ej för dammiga zoner
SVL	Med snabbblås
SWA	Med sensor i vattenavskiljaren
SWA	Utan sensor i vattenavskiljaren
TAF	För tankbilar
TEN	Bosch-produkt med lika monteringsvillkor eller del för Tennex
TER	För bilar med Thematic
TMT	För bilar med Thermotronic
TMV	Torrluftfilter med föravskiljare
TMV	Torrluftfilter utan föravskiljare
TNK	För entydig identifiering av Bosch-numret måste bilens datakort föreligga. De vid produkten angivna komponenterna måste stämma överens med de på datakortet.
TOR	Bosch-produkt med lika monteringsvillkor eller del för Toyo Roki
TRQ	Ej för tropikerna
TW	Monterad produkt måste identifieras på bilen eller motorn.
UFI	Bosch-produkt med lika monteringsvillkor eller del för UFI
VFA	Förberedd för avgasrening/katalysator
VKL	För fordon med helautomatisk AC-anläggning
VO	Fram
VOW	För fordon med bränsleförvärmning
VOW	För fordon utan bränsleförvärmning
VWI	För förlängd serviceintervall
W50	Med 97,15 procent verkningsgrad
WAS	Med vattenavskiljare
WAS	Utan vattenavskiljare
WW	Valfritt
XHI	Utan integrerat värmeelement
XXX	Levereras endast så länge den finns i lager
Y45	Ej för varma zoner
Z34	Diameter 3/4 tum
ZE	2 erfodras
ZNE	För bilar vid montering i efterhand
ZUE	Extra monterad
*	Bränslefilter för alla personbilsmodeller med förgasarmotor 0 450 904 058
**	Bränslefilter för alla personbilsmodeller med förgasarmotor 0 450 904 149
1	Ledningsfilter
2	Filterbox
3	För styrservopump
4	Säkerhetspatron
6	Förfilter
7	Finfilter
8	Aktivtkol kupéfilter
A	Torkmedelsbox
C	Kylvätskefilter
D	Denox filter servicesats
H	Hydraulfilter
I	Kupéfilter
K	Bränslefilter
L	Luftfilter
O	Oljefilter



sv

P Filter, styrservopump
S Oljeavskiljare

	Lock DENOX-filter
	Artikelnummer
	Personbil/lätt lastbil
	Nyttofordon / pickup
	Båtmotor
	Jordbruks- eller entreprenadmaskin
	Motor typ
	Slagvolym i l/ccm
	Motoreffekt i kW
	Exportland
	Datum/monteringstidpunkt
	Speciellt fall
	Bränslefilter
	Luftfilter
	Oljefilter
	Kufilter
	Kufilter med aktivt kol
Special	Specialfilter för lastbilar

	Filterelement
	Urdragningsverktyg
	Förfilter
	Utjämningselement
	Avtappingskruv
	Packningssats
	Söknummer
Fig.	Bild
	Verkstadsförpackning
	Gör det själv-förpackning
	Enkelförpackning
	Antal per förpackning
	Volym i l
	Utlopp
	Inlopp
	Öppningstryck förbiledningsventil
	Öppningstryck returspär
	Höjd



	Diameter		Varmvattenberedare
	Gänganslutning		Termokontakt
	Slangkoppling		Överströmningsventil
	Filterinsatser		Avtappningskruv
	Bränslefilteraggregat		Skyddskåpa
	Lock		Tätningring



253	Délka: 253 mm
2FE	Sada, skládá ze 2 filtračních prvků
303	Průměr 303 mm
327	Délka: 327 mm
352	Průměr 352 mm
356	Průměr brzdového kotouče 356 mm
35N	Délka: 350 mm
3BA	3 bary
3FE	Sada, skládá ze 3 filtračních prvků
3T5	Pro vozidla s povolenou celkovou hmotností 3,5 t
4BA	4 bar
4T5	Pro vozidla s povolenou celkovou hmotností 4,5 t
6BA	6,4 bar
AA	Pohon všech kol
ABM	Dbejte na rozměry
ABS	Pro vozidla s ABS
ABS	Pro vozidla bez ABS
AG	Pro vozidla s automatickou převodovkou
AGA	Vozidlo s detoxikační výfukových plynů a automatickou převodovkou
AGF	Pro vozidla s detoxikací spalin
AGF	Pro vozidla bez detoxikace spalin
AGR	Recirkulace spalin
AGR	Bez recirkulace spalin
AHF	Sací systém za kabinou řidiče
ALD	Jen pro nádobu čističe oleje s hliníkovým víkem
ANV	Sací systém vpředu
ASG	Vzduchový filtr bez bezpečnostní patrony, nasávání vzduchu nahoře nebo dole
ASO	Nasávání vzduchu nahoře
ASU	Nasávání vzduchu dole
ATN	Ne pro provedení Trekking
ATP	Pro vozidla se soupravou AMG Technik-Paket
ATP	Pro vozidla bez soupravy AMG Technik-Paket
AZY	Sací systém a cyklónový filtr vzadu vytažený nahoru
BAN	Jen pro plechovou skříň čističe vzduchu
BGB	Výrobek nikoli pro plynový pohon
BHR	Montážně shodný výrobek Bosch nebo díl pro Behr
BO	Bosch, pouze jako náhrada za výbavu Bosch
BUS	Pro autobus
CAV	Výrobek nebo díl Bosch zaměnitelný za výrobek nebo díl CAV
CSA	Výrobek lze objednat také online na adrese "www.partbob.com"
DE	Jsou nutné tři
DEL	Montážně shodný výrobek Bosch nebo díl pro Delco Remy
DHI	Montážně shodný výrobek Bosch nebo díl pro Delphi
DIF	Pro diferenciál
DOH	Dva vačkové hřídele nahoře, DOHC
DON	Vložka čističe vzduchu Donaldson
DRR	S regulátorem tlaku
DRR	Bez regulátoru tlaku
DTV	Reg. tlaku zabud. na filtru (reg. tlaku není v rozsahu dodávky)
DTV	Regulátor tlaku nenamontován na filtru
E96	Pro emisní normu EEC 96
EAB	Pro emisní normu EEC A/B/D/E
ECC	Pro emisní normu EEC C
ED1	Pro speciální model Edition one
EDO	Výrobce Dongwoo
EFV	Také jako náhrada za předchozí typ
EHX	Pro vozidla s výbavou ELX, HLX
ELH	Pro vozidla bez elektrického systému vyhřívání
ERH	Pro vozidla se zvýšeným využitelným zatížením
EU2	Pro vozidla s emisní normou Euro 2
EU3	Pro vozidla s emisní normou Euro 3
EU3	Ne pro vozidla s emisní normou Euro 3
EU4	Pro vozidla s emisní normou Euro 4
EU5	Pro vozidla s emisní normou Euro 5
EU5	Ne pro vozidla s emisní normou Euro 5

EU6	Ne pro vozidla s emisní normou Euro 6
EVG	Pro vozidla s elektronickým karburátorem
FBF	Pro stavební vozidla
FBF	Ne pro stavební vozidla
FEP	Pro vstřikovací čerpadlo
FG	Pro převodovku
FHE	Pro topení
FIH	Čistič paliva vyhříváný
FIR	Hranatý filtr
FIU	Čistič paliva nevyhříváný
FIZ	Válcovitý filtr
FKO	Pro kompresor
FKR	Pro vozidla s malým rozchodem kol
FL5	Ne pro emisní normu L5
FML	Pro vozidla bez měřiče hmotnosti vzduchu
FMV	Pro vozidla s předřadným filtrem
FMV	Pro vozidla bez předřadného filtru
FOE	Pro chlazení oleje
FPJ	Pro vozidlo vyrobené v Japonsku
FRE	Pro retardér
FVA	Pro indikátor znečištění filtru
FVA	Bez ukazatele znečištění filtru
FW	Pro hasičská vozidla
FWG	Pro převodovku s měničem
FW	Ne pro hasičské vozidlo
G10	Spojovací závit M10 x 1
GA	Přímé
GRF	Základní provedení
GS	Pro vozidla s manuální převodovkou
H12	Výška 120 mm
H16	Výška 116 mm
H25	Výška 25 mm
H30	Výška 30 mm
H42	Výška 142 mm
H90	Výška 90 mm
H96	Výška 96 mm
HAU	Hlavní proud
HEI	S topením
HEI	Bez vyhřívání
HI	Vzadu
HYP	Pro hydraulické čerpadlo
I27	Vnitřní průměr pod 27 mm
I36	Vnitřní průměr pod 36 mm
IF5	Pro emisní normu IFL5
KAD	Jen pro plastovou skříň čističe vzduchu
KAT	Pro vozidla s katalyzátorem
KAT	Pro vozidla bez katalyzátoru
KBF	Kombinovaný filtr jako předřadný filtr
KL	Pro vozidla s klimatizací
KL	Pro vozidla bez klimatizace
KNE	Vložka čističe vzduchu Knecht
KO	Pro komunální vozidla
KOB	Pro vůz kombi
KSF	Jen pro nádobu čističe oleje s plastovým víkem
KTA	Pro vozidla s plastovou palivovou nádrží
KUF	Krátká kabina
KW	Pro skříňová vozidla
KWI	Pro zkrácený interval výměny
KZO	Chladné oblasti
KZO	Ne pro chladné oblasti
L11	Délka: 114 mm
L90	Délka: 900 mm
LAB	Montáž vlevo
LAF	Dlouhá kabina
LAT	Výrobek nebo díl Bosch zaměnitelný za výrobek nebo díl Lautrette

LBE	Malé namáhání
LBF	Dlouhé konstrukční provedení
LBF	Krátké konstrukční provedení
LHT	Nasávání vzduchu pod podlahou kabiny nebo nasávání vzduchu vzadu hluboko dole
LIM	Pro limuzínu
LSP	Pro vzduchový filtr s bezpečnostní vložkou
LUB	Přípojka vzduchu pod podlahou
LUC	Výrobek nebo díl Bosch zaměnitelný za výrobek nebo díl Lucas
LUD	Otvor pro nasávání vzduchu ve stropě
LUM	Nástavec čističe vzduchu pro vzduchový filtr Mann
LVH	Pro vozidla s vzduchovým pérováním vpředu a vzadu
LWG	Pro dodávkový vůz
MC1	Pro modely s kódem: 41, 45
MCY	Pro vozidla s cyklónovým filtrem
MGY	Pro vozidla bez cyklónového filtru
MES	S elektronickým snímačem
MG6	Pro vozidla s manuální převodovkou, 6 stupňů
MGK	Pro vozidla bez generátoru 380 V pro chladicí agregát
MHE	Pro vozidla s přídavným topením
MHE	Pro vozidla bez přídavného topení
MHF	Montážně shodný výrobek Bosch nebo díl pro filtry Mann
MIH	S držákem
MIH	Bez držáku
MKL	Pro vozidla s automatickou klimatizací
MKL	Pro vozidla bez automatické klimatizace
MOK	Vestavěný chladič oleje
MOO	Pro vozidla s klimatizací nebo bez klimatizace
MOR	Pro motor
MPR	Pro vozidla s filtrem částic sazí
MPR	Pro vozidla bez filtru sazí
MRK	Pro vozidla se zpětným vedením paliva
MW1	S výpustným šroubem, závit M10
MW8	S výpustným šroubem, závit M8
MWA	Se šroubem pro vypouštění vody
MXF	Palivový filtr zamontován vně nádrže
N13	Pro emisní normu Euro 96
N25	Pro emisní normu Euro 2005, EC 2005
N25	Ne pro emisní normu Euro 2005, EC 2005
NAA	Ne pro pohon všech kol
ND	Montážně shodný výrobek Bosch nebo díl pro Denso
NEA	Pro pomocný pohon
NEB	Obtokový filtr
NFV	Pro vozidla bez provozu Flexfuel
NFV	Pro vozidla s provozem Flexfuel
NGB	Ne pro vozidla s provozem na plyn
NL4	Pro emisní normu L4
NOR	Normální provedení
NW4	Pro emisní normu W4
OES	Olejový filtr je zamontován z čelní strany
OMZ	Olejový filtr s odstředivkou
OMZ	Olejový filtr bez odstředivky
ORK	Pro vozidla bez zpětného vedení paliva
PRF	Výrobek nebo díl Bosch zaměnitelný za výrobek nebo díl Purflux
PRI	Primární obvod
RAB	Montáž vpravo
RAP	Nevhodné pro MEŘO (metylester řepkového oleje)
RLE	Pro řízení na pravé straně
RME	Řemenice, s několika drážkami
ROB	Odolné řepkovému oleji:
ROD	Výrobek nebo díl Bosch zaměnitelný za výrobek nebo díl Roto-Diesel
RUL	Pro vratné palivové potrubí
SA	Speciální výbava
SAZ	Sada
SBE	Vysoké nároky
SCJ	Pro vozidla se SCR (Selective Catalytic Reduction)
SGJ	Pro vozidla bez SCR (Selective Catalytic Reduction)
SFZ	Pro speciální vozidla
SGA	Pro vozidla s neutralizací výfukových plynů s mech. převodovkou
SGP	Pro vozidla se vstříkovačím čerpadlem Sigma
SHL	S hadicovou sponou
SIE	Výrobek nebo díl Bosch zaměnitelný za výrobek nebo díl Siemens
SIM	Pro Siemens, řízení motoru VDO
SIM	Ne pro Siemens, řízení motoru VDO
SOH	Jeden vačkový hřídel v hlavě válců, SOHC
SSJ	Pro vozidla bez funkce Start-Stop
SSZ	Pro špatný stav silnic
SSZ	Ne pro špatný stav silnic
STH	Pro pomocné vytápění
STZ	Pro prašné oblasti
STZ	Ne pro prašné oblasti
SVL	S rychlouzávěrem
SWA	Se snímačem v odlučovací vodu
SWA	Bez snímače v odlučovací vodu
TAF	Pro cisternová vozidla
TEN	Mont. shod. výr. Bosch nebo díl pro Tennex
TER	Pro vozidla s jednotkou Thematic
TMT	Pro vozidla s jednotkou Thermotronic
TMV	Suchý čistič vzduchu s odlučovačem
TMV	Suchý čistič vzduchu bez odlučovače
TNK	Pro jednoznačnou identifikaci čísla Bosch je nutné předložit kartu s údaji vozidla. Komponenty uváděné u výrobku musí být shodné s těmi, které jsou uvedeny na kartě s údaji.
TOR	Montážně shodný výrobek Bosch nebo díl pro Toyo Roki
TRO	Ne pro tropy
TW	Namontovaný výrobek musí být uveden na vozidle nebo na motoru.
UFI	ontážně shodný výrobek Bosch nebo díl pro UFI
VFA	Připraveno pro detoxikaci výfukových plynů/katalyzátor
VKL	Pro vozidla se zcela automatickou klimatizací
VO	Vpředu
VOW	Předeřívání
VOW	Pro vozidla bez předeřívání paliva
VWI	Pro prodloužený interval výměny
W50	S účinností 97,15 procenta
WAS	S odlučovačem vody
WAS	bez odlučovače vody
WW	Volitelné
XHI	Bez integrovaného vyhřívacího elementu
XXX	Dodávky jen v rámci zásob
Y45	Ne pro horká pásma
Z34	Průměr 3/4 palce
ZE	Jsou nutné dva
ZNE	Pro vozidla při dodatečné montáži
ZUE	Navíc je vestavěno
*	Čistič paliva pro všechny modely osob. vozů s karbur. motorem 0 450 904 058
**	Čistič paliva pro všechny modely osob. vozů s karbur. motorem 0 450 904 149
1	Filtr ve vedení
2	Skříň filtru
3	Pro čerpadlo posilovače řízení
4	Pojistková patrona
6	Hrubý filtr
7	Jemný filtr
8	Vnitřní filtr s aktivním uhlím
A	Krabice s vysoušecím prostředkem
C	Filtr chladicí vody
D	Servisní sada filtru Denox
H	Hydraulický filtr
I	Filtr pro vnitřní prostor
K	Čistič paliva
L	Čistič vzduchu













cs

O	Čistič oleje
P	Filtr, čerpadlo posilovače řízení

	Víko filtru DENOX
	Objednací číslo
	Osobní vozidlo/malá dodávka
	Užitk. vozy / malé dodávky
	Lodní motor
	Zemědělský nebo stavební stroj
	Typ motoru
	Zdvih. objem v l/ccm
	Výkon motoru v kW
	Vyvážející země
	Datum/období montáže
	Zvláštní případ
	Čistič paliva
	Čistič vzduchu
	Olejový filtr
	Filtr pro vnitřní prostor
	Filtr pro vnitřní prostor s aktivním uhlím
Special	Speciální filtr pro užitková vozidla

S	Odlučovač oleje
---	-----------------

	Filtrační prvek
	Vytahovací nástroj
	Předřadný filtr
	Vyrovnávací prvek
	Vypouštěcí šroub
	Sada těsnění
	Vyhledávací číslo
Fig.	Obrázek
	Dílenské balení
	Samoobslužné balení
	Jednotkové balení
	Kusů na balení
	Objem v l
	Výstup
	Vstup
	Otev. tlak, obt. ventil
	Otev. tlak, blok. zpět. chodu
	Výška



cs

 Průměr	 Prût. ohříváč
 Závitová přípojka	 Tepl. spínač
 Hadic. přípojka	 Přepušt. ventil
 Fitr. vložky	 Vypušt. šroub
 Agr. pal. filtru	 Ochr. víčko
 Víko	 Těsn. kroužek



253	Długość: 253 mm
2FE	Zestaw składa się z 2 elementów filtra
303	Średnica 303 mm
327	Długość: 327 mm
352	Średnica 352 mm
356	Średnica tarczy hamulcowej 356 mm
35N	Długość: 350 mm
3BA	3 bar
3FE	Zestaw składa się z 3 elementów filtra
3T5	Dla pojazdów o dopuszczalnej masie całkowitej 3,5 t
4BA	4 bar
4T5	Dla pojazdów o dopuszczalnej masie całkowitej 4,5 t
6BA	6,4 bar
AA	Napęd na wszystkie koła
ABM	Zwrócić uwagę na wymiary
ABS	Do pojazdów z ABS
ABS	Dla pojazdów bez ABS
AG	Do pojazdów z automatyczną skrzynią biegów
AGA	Pojazd z układem oczyszczania spalin ze składników szkodliwych i przekładnią automatyczną
AGF	Dla pojazdów z oczyszczaniem spalin
AGF	Dla pojazdów bez oczyszczania spalin
AGR	Układ recyrkulacji spalin
AGR	Bez układu recyrkulacji spalin
AHF	Układ ssania za kabiną kierowcy
ALD	Tylko do obudowy filtra olejowego z pokrywą aluminiową
ANV	Układ ssania z przodu
ASG	Filter powietrza z nabojem bezpieczeństwa, zasysanie powietrza, góra lub dół
ASO	Zasysanie powietrza, góra
ASU	Zasysanie powietrza, dół
ATN	Nie dla wersji Trekking
ATP	Dla pojazdów z pakietem technicznym AMG
ATP	Dla pojazdów bez pakietu technicznego AMG
AZY	Układ ssania i filtr cyklonowy podniesiony do góry z tyłu
BAN	Tylko dla obudowy filtra powietrza z blachy
BGB	Produkt nie jest przeznaczony do pracy na gaz
BHR	Produkt firmy Bosch identyczny pod względem montażu lub część do Behr
BO	Bosch, jedynie jako część zamienna do wyposażenia Boscha
BUS	Do autobusu
CAV	Produkt firmy Bosch identyczny pod względem montażu lub część do CAV
CSA	Wyrób można zamówić również online na stronie "www.partbob.com"
DE	Wymagane trzy
DEL	Wyrób firmy Bosch identyczny montażowo lub część dla Delco-Remy
DHI	Produkt firmy Bosch identyczny pod względem montażu lub część do Delphi
DIF	do mechanizmu różnicowego
DOH	Dwa na górze usytuowane wały rozrządu, DOHC
DON	Wkład do filtra powietrza Donaldson
DRR	Z regulatorem ciśnienia
DRR	Bez regulatora ciśnienia
DTV	Regulator ciśnienia na filtrze (dostawa nie obejmuje regulatora ciśnienia)
DFV	Regulator ciśnienia niewbudowany w filtrze
E96	Dla normy emisji spalin EEC 96
EAB	Dla normy emisji spalin EEC A/B/D/E
ECC	Dla normy emisji spalin EEC C
ED1	Dla modelu specjalnego Edition one
EDO	Producent Dongwoo
EFV	Części zamienne również dla modelu poprzedniego
EHX	Dla pojazdów z wyposażeniem ELX, HLX
ELH	Dla pojazdów bez elektrycznego systemu ogrzewania
ERH	Dla pojazdów o podwyższonej ładowności
EU2	Dla pojazdów z normą emisji spalin Euro 2
EU3	Dla pojazdów z normą emisji spalin Euro 3
EU3	Nie dla pojazdów spełniających wymagania normy spalin EURO 3
EU4	Dla pojazdów z normą emisji spalin Euro 4
EU5	Dla pojazdów z normą emisji spalin Euro 5

EU5	Nie dla pojazdów spełniających wymagania normy spalin EURO 5
EU6	Nie dla pojazdów spełniających wymagania normy spalin EURO 6
EVG	Dla pojazdów z elektronicznym gaźnikiem
FBF	Do pojazdów budowlanych
FBF	Nie dotyczy pojazdu budowlanego
FEP	Do pompy wtryskowej
FG	Dla skrzyni biegów
FHE	Do ogrzewania
FIH	Filtr paliwa ogrzewany
FIR	Filtr prostokątny
FIU	Filtr paliwa nieogrzewany
FIZ	Filtr walcowy
FKO	Do kompresora
FKR	Dla pojazdów z krótkim rozstawem kół
FL5	Nie dla normy emisji spalin L5
FML	Dla pojazdów bez przepływomierza masowego powietrza
FMV	Dla pojazdów z filtrem wstępnym
FMV	Dla pojazdów bez filtra wstępnego
FOE	Do chłodzenia oleju
FPJ	Do pojazdów produkcji japońskiej
FRE	Dla pojazdów z retarderem
FVA	Do wskaźnika zabrudzenia filtra
FVA	Bez wskaźnika zabrudzenia filtru
FW	Dla pojazdów straży pożarnej
FWG	Do przekładni przetwornikowej
FW	Nie dotyczy pojazdów straży pożarnej
G10	Gwint przyłączeniowy M10 x 1
GA	Prosto
GRF	Wykonanie podstawowe
GS	Do pojazdów z ręczną skrzynią biegów
H12	Wysokość 120 mm
H16	Wysokość 116 mm
H25	Wysokość 25 mm
H30	Wysokość 30 mm
H42	Wysokość 142 mm
H90	Wysokość 90 mm
H96	Wysokość 96 mm
HAU	Prąd główny
HEI	Z ogrzewaniem
HEI	Bez ogrzewania
HI	Z tyłu
HYP	Do pompy hydraulicznej
I27	Średnica wewnętrzna na dole 27 mm
I36	Średnica wewnętrzna na dole 36 mm
IF5	Dla normy emisji spalin IFL5
KAD	Tylko dla obudowy filtra powietrza z tworzywa sztucznego
KAT	Dla pojazdów z katalizatorem
KAT	Dla pojazdów bez katalizatora
KBF	Filtr zespolony jako filtr wstępny
KL	Dla pojazdów z klimatyzacją
KL	Dla pojazdów bez klimatyzacji
KNE	Wkład do filtra powietrza Knecht
KO	Do pojazdów komunalnych
KOB	Do samochodów kombi
KSF	Tylko do obudowy filtra olejowego z pokrywą z tworzywa sztucznego
KTA	Dla pojazdów ze zbiornikiem paliwa z tworzywa sztucznego
KUF	Krótką kabiną kierowcy
KW	Dla furgonetki
KWI	Do skróconego odstępu między wymianami
KZO	Zimne strefy
KZO	Nie do zimnych stref klimatycznych
L11	Długość: 114 mm
L90	Długość: 900 mm
LAB	Montaż z lewej strony
LAF	Długa kabina kierowcy

LAT	Produkt firmy Bosch identyczny pod względem montażu lub część do Lautrette
LBE	Lekkie obciążenie
LBF	Długa konstrukcja
LBF	Krótką konstrukcja
LHT	Zasysanie powietrza pod podłogą kabiny kierowcy lub zasysanie powietrza położone nisko z tyłu
LIM	Dla limuzyny
LSP	Do filtra powietrza z nabojem układu bezpieczeństwa
LUB	Podłączenie powietrza pod podłogą
LUC	Produkt firmy Bosch identyczny pod względem montażu lub część do Lucasa
LUD	Otwór do zasysania powietrza w dachu
LUM	Wkład filtra powietrza do filtrów Mann
LVH	Dla pojazdów z zawieszeniem pneumatycznym z przodu i z tyłu
LWG	Dla samochodu dostawczego
MC1	Dla kodu modeli 41, 45
MCY	Dla pojazdów z filtrem cyklonowym
MCY	Dla pojazdów bez filtra cyklonowego
MES	Z czujnikiem elektrycznym
MG6	Do pojazdów z 6-cio biegową ręczną skrzynią biegów
MGK	Dla pojazdów bez generatora 380V dla agregatu chłodniczego
MHE	Do pojazdów z dodatkowym ogrzewaniem
MHE	Do pojazdów bez ogrzewania dodatkowego
MHF	Wyrób firmy Bosch identyczny montażowo lub część dla filtra firmy Mann
MIH	Z uchwytem
MIH	Bez uchwytu
MKL	Dla pojazdów z klimatyzacją automatyczną
MKL	Dla pojazdów bez automatycznej klimatyzacji
MOK	Wbudowana chłodnica oleju
MOO	Dla pojazdów z i bez klimatyzacji
MOR	Do silnika
MPR	Dla pojazdów z filtrem cząstek sadzy
MPR	Dla pojazdów bez filtra sadzy
MRK	Dla pojazdów z przewodem powrotnym paliwa
MW1	Ze śrubą spustową wody gwint M10
MW8	Ze śrubą spustową wody gwint M8
MWA	Ze śrubą spustową wody
MXF	Filtr paliwa zamontowany poza zbiornikiem paliwa
N13	Dla normy emisji spalin Euro 96
N25	Dla normy emisji spalin Euro 2005, EC 2005
N25	Nie dla normy spalin 2005, EC 2005
NAA	Nie do napędu na wszystkie koła
ND	Produkt firmy Bosch identyczny montażowo lub część dla Denso
NEA	Do napędu dodatkowego
NEB	Filtr bocznikowy
NFV	Dla pojazdów bez trybu mieszanki benzyny i etanolu
NFV	Dla pojazdów z trybem mieszanki benzyny i etanolu
NGB	Nie dotyczy pojazdów z silnikiem na gaz
NL4	Dla normy emisji spalin L4
NOR	Wykonanie normalne
NW4	Dla normy emisji spalin W4
OES	Filtr oleju zamontowany czołowo
OMZ	Filtr oleju z wirówką
OMZ	Filtr oleju bez wirówki
ORR	Dla pojazdów bez przewodu powrotnego paliwa
PRF	Produkt firmy Bosch identyczny pod względem montażu lub część do Purflux
PRI	Obwód pierwotny
RAB	Montaż z prawej strony
RAP	Nie przygotowany do jazdy na RME (ester metylowy oleju rzepakowego)
RLE	Dla pojazdów z kierownicą z prawej strony
RME	Koło pasowe, wielorolkowe
ROB	Tolerowanie oleju rzepakowego
ROD	Produkt firmy Bosch identyczny pod względem montażu lub część do Roto-Diesel
RUL	Do przewodu powrotu paliwa
SA	Wyposażenie specjalne

SAZ	Zestaw
SBE	Obciążenie ciężkie
SCJ	Do pojazdów z SCR (Selective Catalytic Reduction)
SCJ	Do pojazdów bez SCR (Selective Catalytic Reduction)
SFZ	Dla pojazdów specjalnych
SGA	Do pojazdu z układem oczyszczania spalin ze składników szkodliwych i z ręczną skrzynią biegów
SGP	Dla pojazdów z pompą wtryskową Sigma
SHL	Z opaską zaciskową
SIE	Produkt firmy Bosch identyczny pod względem montażu lub część do Siemens
SIM	Dla układu sterowania silnika Siemens VDO
SIM	Nie dla układu sterowania silnika Siemens VDO
SOH	Jeden z góry usytuowany wał rozrządu, SOHC
SSJ	Dla pojazdów bez funkcji start/stop
SSZ	Na drogi o złej nawierzchni
SSZ	Nie na drogi ze złą nawierzchnią
STH	Do ogrzewania stałego
STZ	Dla stref zapylonych
STZ	Nie dla stref zapylonych
SVL	Z szybkozłączem
SWA	Z czujnikiem w oddzielaczu wody
SWA	Bez czujnika w oddzielaczu wody
TAF	Dla cystern
TEN	Wyrób Boscha identyczny montażowo lub część dla Tennex
TER	Dla pojazdów z systemem Thematic
TMT	Dla pojazdów z systemem Thermotronic
TMV	Filtr suchego powietrza z separatorem wstępnym
TMV	Filtr suchego powietrza bez separatora wstępnego
TNK	W celu jednoznacznej identyfikacji numeru Boscha należy przedłożyć kartę danych pojazdu. Elementy towarzyszące wyrobowi muszą być zgodne z wymienionymi w karcie danych.
TOR	Wyrób firmy Bosch identyczny montażowo lub część dla firmy Toyo Roki
TRQ	Nie do klimatu tropikalnego
TW	Zamontowany wyrób musi być zidentyfikowany w pojeździe lub silniku.
UFI	Wyrób firmy Bosch identyczny montażowo lub część dla UFI
VFA	Oczyszczanie spalin/ katalizator przygotowany
VKL	Dla pojazdów z całkowicie automatyczną klimatyzacją
VO	Z przodu
VOW	Dla pojazdów z układem wstępnego podgrzania paliwa
VOW	Do pojazdów bez wstępnego podgrzewania paliwa
VWI	Do przedłużonego odstępu między wymianami
W50	Sprawność 97,15%
WAS	Z oddzielaczem wody
WAS	Bez oddzielacza wody
WW	Do wyboru
XHI	Bez zintegrowanego elementu grzewczego
XXX	Dostawa tylko do wyczerpania zapasu
Y45	Nie dla stref gorących
Z34	Średnica 3/4 cala
ZE	Konieczne dwa
ZNE	Do pojazdów, w których część nie jest montowana seryjnie
ZUE	Dodatkowo zamontowane
*	Filtr paliwa do wszystkich modeli samochodów osobowych z silnikiem gaźnikowym 0 450 904 058
**	Filtr paliwa do wszystkich modeli samochodów osobowych z silnikiem gaźnikowym 0 450 904 149
1	Filtr przewodu
2	Kaseta z filtrem
3	Dla pompy układu wspomagania kierownicy
4	Nabój bezpieczeństwa
6	Filtr wstępny
7	Filtr przeciwpłyowy
8	Filtr przeciwpłyowy z węglem aktywnym
A	Skrzynka osuszacza
C	Filtr wody chłodzącej



pl















D	Zestaw serwisowy filtra denox
H	Filtr ciecży hydraulicznej
I	Filtr wnętrza pojazdu
K	Filtr paliwa

L	Filtr powietrza
O	Filtr oleju
P	Filtr, pompa wspomagania kierownicy
S	odolejacz

	Pokrywa filtra DENOX
	Nr katalogowy
	Sam. osobowy / mała furgonetka
	Pojazd użytkowy / mała furgonetka
	Silniki do łodzi
	Maszyny rolnicze / budowlane
	Typ silnika
	Pojemność skokowa w l/ccm
	Moc silnika w kW
	Kraj eksportu
	Data produkcji
	Informacje dodatkowe
	Filtr paliwa
	Filtr powietrza
	Filtr oleju
	Filtr kabinowy
	Filtr kabinowy z węglem aktywnym

Special	Filtr specjalny do Nkw
	Element filtrujący
	Narzędzie do wyciągania
	Filtr wstępny
	Element wyrównawczy
	Śruba spustowa
	Zestaw uszczelek
	Nr referencyjny
Fig.	Ilustracja
	Opakowanie warsztatowe
	Opakowanie do sprzedaży samoobsługowej
	Opakowanie pojedyncze
	Ilość sztuk w opakowaniu
	Objętość w litrach
	Wyjście
	Wejście
	Ciśnienie otwarcia zaworu obejściowego



	Ciśnienie otwarcia blokady przepływu powrotnego		Pokrywa
	Wysokość		Ogrzewacz przepływowy
	Średnica		Wyłącznik termiczny
	Przyłącze gwintowane		Zawór przelewowy
	Przyłącze węża		Śruba spustowa
	Wkłady filtra		Kołpak ochronny
	Agregat filtra paliwa		Pierścień uszczelniający



253	Длина: 253 мм
2FE	Комплект состоит из 2 фильтрующих элементов
303	Диаметр 303 мм
327	Длина: 327 мм
352	Диаметр 352 мм
356	Диаметр тормозного диска 356 мм
35N	Длина: 350 мм
3BA	3 бар
3FE	Комплект состоит из 3 фильтрующих элементов
3T5	Для автомобилей с допустимой полной массой 3,5 т
4BA	4 бар
4T5	Для автомобилей с допустимой полной массой 4,5 т
6BA	6,4 бар
AA	Привод на все колеса
ABM	соблюдать размеры
ABS	для автомобилей с антиблокировочным устройством
ABS	для автомобилей без антиблокировочного устройства
AG	для автомобилей с автоматической коробкой скоростей
AGA	Автомобиль с пониженной токсичностью выхлопных газов и автоматической коробкой передач
AGF	Для автомобилей со сниженной токсичностью ОГ
AGF	Не для автомобилей со сниженным уровнем ОГ
AGR	Рециркуляция отработавших газов
AGR	без рециркуляции ОГ
AHF	Система впуска за кабиной водителя
ALD	только для корпуса масляного фильтра с алюминиевой крышкой
ANV	Система впуска впереди
ASG	Воздушный фильтр без предохранительного патрона, впуск воздуха вверх или вниз
ASO	Впуск воздуха вверх
ASU	Впуск воздуха вниз
ATN	Не для осуществления буксировки
ATP	Для автомобилей с техническим пакетом AMG
ATP	Для автомобилей без технического пакета AMG
AZY	Система впуска и циклонный фильтр, поднятый сзади
BAN	Только для корпуса воздушного фильтра из листовой стали
BGB	Изделие не для работы на газе
BHR	Монтируемое таким же образом изделие Bosch или деталь для Behr
BO	Bosch, только в качестве замены оснащения фирмы Bosch
BUS	для автобуса / магистрали
CAV	взаимозаменяемый продукт фирмы Bosch или деталь для фирмы CAV
CSA	Изделие можно также заказать он-лайн "www.partbob.com"
DE	Требуется три
DEL	Одинаковый монтаж изделий Bosch или деталей для Delco-Remy
DHI	Монтируемое таким же образом изделие Bosch или деталь для Delphi
DIF	Для дифференциала
DON	Два верхних распределительных вала, DONC
DON	Патрон воздушного фильтра для воздушного фильтра Donaldson
DRR	С регулятором давления
BRR	Без регулятора давления
DTV	Регулятор напора встроен в фильтр (Регулятор напора в поставку не входит)
DTV	Регулятор давления не на фильтре
E96	Для нормы токсичности ОГ ЕЕС 96
EAB	По норме токсичности ЕЕС А/В/Д/Е
ECC	По норме токсичности ЕЕС С
ED1	Для специальной модели Edition one
EDO	Изготовитель Dongwoo
EFV	Также замена для предшественника
EHX	Для автомобилей с оборудованием ELX, HLX
ELH	Для автомобилей без электрической системы обогрева
ERN	Для автомобилей с повышенной полезной нагрузкой
EU2	Для автомобилей с нормой токсичности ОГ Euro 2
EU3	Для автомобилей с нормой токсичности ОГ Euro 3
EU3	Не для автомобилей с нормой токсичности ОГ Euro 3
EU4	Для автомобилей с нормой токсичности ОГ Euro 4

EU5	Для автомобилей с нормой токсичности ОГ Euro 5
EU5	Не для автомобилей с нормой токсичности ОГ Euro 5
EU6	Не для автомобилей с нормой токсичности ОГ Euro 6
EVG	Для транспортных средств с электронным карбюратором
FBF	Для транспортных средств, используемых на стройке
FBF	Не для автомобиля для строительных работ
FEP	Для впрыскивающего топливного насоса
FG	для коробок передач
FHE	для отопления
FIH	Топливный фильтр с обогревом
FIR	Прямоугольный фильтр
FIU	Топливный фильтр без обогрева
FIZ	Цилиндрический фильтр
FKO	для компрессора
FKR	для автомобилей с короткой базой
FL5	Не для нормы токсичности ОГ L5
FML	Для автомобилей без датчика массового расхода воздуха
FMV	для автомобилей с фильтром грубой очистки
FMV	для автомобилей без фильтра грубой очистки
FOE	Для масляного охлаждения
FPJ	Для автомобилей производства Японии
FRE	Для тормоза-замедлителя
FVA	для фильтров с индикацией загрязнения
FVA	без указателя загрязнения фильтра
FW	для противопожарных автомобилей
FWG	для привода преобразователя
FW	Не для пожарных автомобилей
G10	Соединительная резьба М10 х 1
GA	прямо
GRF	базовое исполнение
GS	для автомобилей с коробкой передач с ручным управлением
H12	Высота 120 мм
H16	Высота 116 мм
H25	Высота 25 мм
H30	Высота 30 мм
H42	Высота 142 мм
H90	Высота 90 мм
H96	Высота 96 мм
HAU	ток якоря, главный ток; основной поток
HEI	с отоплением
HEI	Без подогрева
HI	сзади
HYP	для гидронасоса
I27	Внутренний диаметр менее 27 мм
I36	Внутренний диаметр менее 36 мм
IF5	Для нормы токсичности ОГ IFL5
KAD	Только для корпуса воздушного фильтра из пластмассы
KAT	для автомобилей с катализатором
KAT	для автомобилей без катализатора
KBF	Комбинированный фильтр как фильтр грубой очистки
KL	для автомобилей с кондиционером
KL	для автомобилей без кондиционера
KNE	Патрон воздушного фильтра для воздушного фильтра Knecht
KO	для автомобилей для нужд коммунального хозяйства
KOB	для автомобиля комби
KSF	только для корпуса масляного фильтра с крышкой из синтетического материала
KTA	для автомобилей с топливным баком из искусственных материалов
KUF	Короткая кабина
KW	для автомобилей-фургонов
KWI	для сокращенного интервала замены
KZO	Холодные зоны
KZO	Не для холодных зон
L11	Длина: 114 мм
L90	длина 900 мм



LAB	встроенная слева
LAF	Длинная кабина водителя
LAT	взаимозаменяемый продукт фирмы Bosch или деталь для фирмы Lautrette
LBE	легкая нагрузка
LBF	Длинное исполнение
LBF	краткое конструктивное исполнение
LHT	Впуск воздуха под днищем кабины или впуск воздуха сзади внизу
LIM	Для лимузинов
LSP	для воздушного фильтра с патроном безопасности
LUB	Подсоединение для воздуха под полом
LUC	взаимозаменяемый продукт фирмы Bosch или деталь для фирмы Lucas
LUD	Отверстие впуска воздуха, крыша
LUM	Сменный элемент для воздушного фильтра Mann
LVH	Для автомобилей с пневматической подвеской впереди и сзади
LWG	для автомобилей для перевозки мелкопартийных грузов
MC1	Для кода модели 41, 45
MCY	Для автомобилей с циклоном
MCY	Для автомобилей без циклона
MES	с электрическим датчиком
MG6	для автомобилей с коробкой передач с ручным управлением, 6-ти скоростной
MGK	Для автомобилей без генератора 380 В для холодильного агрегата
MHE	Для транспортных средств с дополнительными отоплением
MHE	Для транспортных средств без дополнительного отопления
MHF	Одинаковый монтаж изделий Bosch или детали для фильтра Mann
MIH	с держателем
MIH	без держателя
MKL	Для автомобилей с автоматическим кондиционером
MKL	Для автомобилей без автоматического кондиционера
MOK	масляный рабиатор встроенный
MOO	Для транспортных средств с и без климатической установки
MOR	Для двигателя
MPR	Для автомобилей с сажевым пылевым фильтром
MPR	Для автомобилей без сажевого пылевого фильтра
MRK	Для автомобилей с рециркуляцией топлива
MW1	С резьбовой пробкой водосливного отверстия, резьба M10
MW8	С резьбовой пробкой водосливного отверстия, резьба M8
MWA	с винтом для слива охлаждающей жидкости
MXF	Топливный фильтр не встроен в бак
N13	Для нормы токсичности ОГ Euro 96
N25	Для нормы токсичности ОГ Euro 2005, EC 2005
N25	Не для нормы токсичности ОГ Euro 2005, EC 2005
NAA	Не для привода на все колеса
ND	Идентичное изделие Bosch или деталь для Denso
NEA	Для вспомогательного привода
NEB	Масляный фильтр тонкой очистки
NFV	Для автомобилей без гибкого режима топлива
NFV	Для автомобилей с гибким режимом топлива
NGB	Не для автомобилей с работой на газе
NL4	Для нормы токсичности ОГ L4
NOR	Обычное исполнение
NW4	Для нормы токсичности ОГ W4
OES	Масляный фильтр установлен с лицевой стороны
OMZ	Масляный фильтр безцентрифуги
OMZ	Масляный фильтр с центрифугой
ORR	Для автомобилей без рециркуляции топлива
PRF	взаимозаменяемый продукт фирмы Bosch или деталь для фирмы Purflux
PRI	Первичная обмотка
RAB	встроенная справа
RAP	Без возможности работы на RME (сложный метиловый эфир рапсового масла)
RLE	для автомобилей с правосторонним расположением рулевого колеса
RME	шквив, многоканавочный
ROB	Для автомобилей, способных работать на рапсовом масле
ROD	взаимозаменяемый продукт фирмы Bosch или деталь для фирмы Roto-Diesel

RUL	Для линии стока топлива
SA	специальное оборудование
SAZ	комплект
SBE	большая нагрузка
SCJ	Для а/м с SCR (Selective Catalytic Reduction)
SCJ	Для а/м без SCR (Selective Catalytic Reduction)
SFZ	для специальных автомобилей
SGA	Для автомобилей со снижением токсичности ОГ, со ступенчатой коробкой передач
SGP	Для автомобилей с ТНВД Sigma
SHL	С хомутиком для шланга
SIE	взаимозаменяемый продукт фирмы Bosch или деталь для фирмы Siemens
SIM	Для Siemens, управление двигателем VDO
SIM	Не для Siemens, управление двигателем VDO
SOH	Один верхний распределительный вал, SOHC
SSJ	Для автомобилей без функции пуск-останов
SSZ	Для плохого состояния дорог
SSZ	Не для плохого состояния дорог
STH	для обогрева стнда
STZ	Для запыленных участков
STZ	Не для запыленных участков
SVL	С быстродействующим запором
SWA	С датчиком в водоотделителе
SWA	Без датчика в водоотделителе
TAF	Для автоцистерн
TEN	Одинаковые по монтажу изделия или части Bosch для Tennex
TER	Для автомобилей с Thematic
TMT	Для автомобилей с системой Thermotronic
TMV	Сухой воздухоочиститель с фильтром грубой очистки
TMV	Сухой воздухоочиститель без фильтра грубой очистки
TNK	Для однозначной идентификации № Bosch требуется карта данных автомобиля. Компоненты, установленные в изделии, должны совпадать с компонентами карты данных.
TOR	Одинаковый монтаж изделий Bosch или детали для Toyo Roki
TRO	Не для тропического климата
TW	Встроенное издание должно определяться в автомобиле или двигателе.
UFI	Одинаковый монтаж изделий Bosch или детали UFI
VFA	Снижение токсичности отработавших газов/катализатор подготавливает
VKL	Для транспортных средств с полностью автоматизированной климатической установкой
VO	спереди
VOW	предпусковой нагрев
VOW	Для автомобилей без подогрева топлива
VWI	для удлиненного интервала замены
W50	С эффективностью 97,15%
WAS	с водоотделителем
WAS	без водоотделителя
WW	на выбор
XHI	Без интегрированного нагревательного элемента
XXX	Поставка, пока есть на складе
Y45	Не для горячих зон
Z34	диаметр 3/4 дюймов
ZE	необходимо два
ZNE	Для автомобилей с более поздней установкой
ZUE	дополнительно монтируется
*	Топливный фильтр для всех моделей легковых автомобилей с карбюраторным ДВС O 450 904 058
**	Топливный фильтр для всех моделей легковых автомобилей с карбюраторным ДВС O 450 904 149
1	Прямоточный фильтр
2	Сменный фильтрующий элемент с арматурой
3	Для насоса сервопривода
4	Предохранительный патрон
6	Фильтр грубой очистки
7	Фильтр тонкой очистки

ru

8	Фильтр с активированным углем для салона
A	Коробка с сушильным агентом
C	Фильтр охлаждающей жидкости
D	Сервисный комплект для фильтров Denox
H	Гидравлический фильтр
I	Фильтр для салона











K	Топливный фильтр
L	Воздушный фильтр
O	Масляный фильтр
P	Фильтр, насос усилителя рулевого привода
S	Маслоотделитель

	Крышка фильтра DENOX
	Номер для заказа
	Легковой автомобиль / малый автомобиль-фургон
	Грузовик/автомобиль-фургон
	Лодочный мотор
	Сельскохозяйственная или строительная машина
	Тип двигателя
	Рабочий объем цилиндра в л/куб.см
	Мощность двигателя в кВт
	Страна-экспортер
	Дата / Период сборки
	Особый случай
	Топливный фильтр
	Воздушный фильтр
	Масляный фильтр
	Фильтр салона
	Фильтр салона с активированным углем

Special	Специальный фильтр для грузовых автомобилей
	Фильтрующий элемент
	Съемный инструмент
	Фильтр грубой очистки
	Компенсационный элемент
	Пробка сливного отверстия
	Комплект уплотнений
	Поисковый номер
Fig.	Чертеж
	Заводская упаковка
	Упаковка для магазинов самообслуживания
	Штучная упаковка
	Штук на упаковку
	Объем в л
	Выход
	Вход
	Давление открытия перепускного клапана



ru

	Давление открытия обратной блокировки		Крышка
	Высота		Проточный нагреватель
	Диаметр		Термовыключатель
	Резьбовое соединение		Перепускной клапан
	Подсоединение шланга		Резьбовая пробка выпускного отверстия
	Сменный элемент фильтра		Защитный колпачок
	Система топливного фильтра		Уплотнительное кольцо



Reliable diagnosis. Time saving repairs.
Bosch diagnostics and service parts

Everything from one single source.
Bosch has a complete program available
which increases efficiency and quality in the
workshop's daily work.
The service parts from the globally active
development expert and leading manufacturer
of automotive system technology are in
renowned Bosch OE quality.

Competence and quality:
Assuring your workshop's future success.



BOSCH

☎ 1 987 720 228/201203

AA/MKI – 03.2012 – Int

© 2012 Robert Bosch GmbH
Automotive Aftermarket
Postfach 41 09 60
76225 Karlsruhe

Token fee: € 10,00

www.bosch.de/aa

Editorial closing: 31.10.2011

Subject to change without notice.
Please direct questions and
comments to our Authorized
Representative in your country.
This edition supersedes all
previous editions.

