

# **EUROPROP ~ FEDERAL B.V.**

---

De Hoef 12, 5311 GH Gameren telefoon: +31(0)418 512666 Fax: +31(0)418 515455  
E-mail: [info@europrop.nl](mailto:info@europrop.nl) Web-site: [www.europrop.nl](http://www.europrop.nl)

REPLACEMENT SPARE PARTS FOR

**VOLVO PENTA**

**CATALOG + PRICELIST 2004**

Prijzen geldig vanaf 1 januari 2004  
Prijzen onder voorbehoud.



# Innehåll

<b>A</b>	
Avgasbälgsatser . . . . .	11.1
Avgaskrökar . . . . .	6.4
Avgasrör . . . . .	6.1
Avgasslangar för avgaskrök . . . . .	6.6
Avtappningskranar för kylvatten . . . . .	5.19
Avtappningsplugg för CAV filter . . . . .	7.4
Avtappningspropp för kylvatten . . . . .	5.20
Axiallager för vertikalaxel i underhus . . . . .	14.7
<b>B</b>	
Backhakefjädrar för drev . . . . .	11.8
Brickor för oljeavtappningsplugg . . . . .	4.6
Bricksatser för bränslesystem . . . . .	7.9
Brytarspetsar . . . . .	8.4
Brytpinnesats . . . . .	11.6
Bränslefilter . . . . .	7.1
Bränslepumpar . . . . .	7.5
Bult för CAV bränslefilter . . . . .	7.4
Bultsats för dubbellagerbox . . . . .	14.1
Bultsatser för avgasrör . . . . .	6.3
Bussningsats för upphängning av AQ-drev . . . . .	11.4
<b>C</b>	
CAV filter komplett . . . . .	7.2
Cirkulationspump för sötvattenkyllning . . . . .	5.23
Cylinderfodersatser (komplett med kolv och ringar) . . . . .	1.2
Cylinderfotspackningar . . . . .	1.7, 3.7
Cylinderlocksultsatser . . . . .	3.8
Cylinderlockspackningar . . . . .	3.1
Cylinderlocksmutter . . . . .	3.8
<b>D</b>	
Delar för Bosch tändfördelare . . . . .	8.7
Delar för V-6 och V-8 fördelare . . . . .	8.8
Distansbricka (plast) . . . . .	11.7
Distansbricka för bränslepump . . . . .	7.6
Distansbricka för propeller . . . . .	11.7
Drevdelar för underhus . . . . .	14.6
Drevdelar för överhus . . . . .	14.1
Drevsköldsdelar . . . . .	10.6
Drivknutkors . . . . .	14.1
Drivknutsbälgsatser . . . . .	11.1
Drivplatta för svänghjul . . . . .	10.2
Drivremmar . . . . .	8.10
Däckelpackning . . . . .	3.1
Dämpare för svänghjul . . . . .	10.2
<b>E</b>	
Elektrisk universal bränslepump . . . . .	7.6
Elpumpar för MARTEC sötvattenkyllning . . . . .	5.23
Expansionsbrickor (galvaniserade) . . . . .	1.8
Expansionsbrickor (rostfri) . . . . .	1.8
Expansionspluggar (galvaniserade) . . . . .	5.22
Expansionspluggar (rostfri) . . . . .	5.22
<b>F</b>	
Fisklinebricka . . . . .	11.5
Fjädersats för backhake . . . . .	11.8
Fördelarlock . . . . .	8.1
Förgasardelar . . . . .	7.5
Förgasarmembran . . . . .	7.6

# Content

<b>A</b>	
Adjusting shims cylinder - cylinder block . . . . .	3.7
Air filter inserts . . . . .	7.4
Axial bearing for vertical shaft in lower gear unit . . . . .	14.7
<b>B</b>	
Ball bearing for double bearing unit . . . . .	14.2
Ball bearing for vertical shaft in upper gear unit . . . . .	14.4
Bearing kit for interm. shaft . . . . .	2.3
Bolt for CAV fuel filter . . . . .	7.4
Bolt kits for double bearing unit . . . . .	14.1
Bolt kits for exhaust manifold . . . . .	6.3
Break pin kit . . . . .	11.6
Breaker points . . . . .	8.4
Bushing kits for hook up fork . . . . .	11.4
<b>C</b>	
Camshaft bearing kits . . . . .	2.2
Camshaft grease . . . . .	2.3
Camshaft kits . . . . .	2.2
Camshafts . . . . .	2.1
Carburettor diaphragm . . . . .	7.6
CAV fuel filter complete . . . . .	7.2
Con rod bearing kits . . . . .	1.5
Condensers . . . . .	8.5
Connecting plug for zinc anode . . . . .	5.20
Connecting rod bushings . . . . .	1.1
Connector kit for CAV filter . . . . .	7.3
Conversion gasket set . . . . .	9.5
Cotter pin for folding propeller lock nut . . . . .	11.6
Cover plate for exhaust manifold . . . . .	6.5
Crankcase filter . . . . .	4.3
Cross piece for water pump . . . . .	5.9
Cross reference for V-6 and V-8 distributors . . . . .	8.8
Cylinder head gaskets . . . . .	3.1
Cylinder head nut . . . . .	3.8
Cylinder head screw kits . . . . .	3.8
Cylinder liner kits (complete with piston and rings) . . . . .	1.2
<b>D</b>	
Damper (vibration damper) . . . . .	10.2
Decarb. gasket set . . . . .	9.1
Distributor caps . . . . .	8.1
Drain plug for CAV fuel filter . . . . .	7.4
Drain prop for cooling water . . . . .	5.20
Drain taps for cooling water . . . . .	5.19
Drive bellow kits . . . . .	11.1
Drive belts . . . . .	8.10
<b>E</b>	
Electric pumps for MARTEC fresh water cooling . . . . .	5.23
Electric universal fuel pump . . . . .	7.6
Exhaust bellow kits . . . . .	11.1
Exhaust bends . . . . .	6.4
Exhaust hoses for exhaust bend . . . . .	6.6
Exhaust manifolds . . . . .	6.1
Expansion plugs (galvanized) . . . . .	1.8
Expansion plugs (galvanized) . . . . .	5.22
Expansion plugs (stainless) . . . . .	1.8
Expansion plugs (stainless) . . . . .	5.22

<b>G</b>	
Gavellock för avgasrör	6.5
Glasskål för CAV bränslefilter	7.4
Glidtapp (växelförare)	14.5
Gummidämpare för ventiler	2.5
Gummikudde för motorupphängning	10.1
Gummikudde för propelleraxelkoppling	10.1
Gummipackning för ventilkåpsbultar	3.7
Gummiring för klämring i sköld	10.6

<b>H</b>	
Hydraulcylinderslangar för drev	10.9
Hållare för zinkanod	5.20

<b>I</b>	
Impelleravdragare	5.2
Impellerlocksskruvsatser	5.3
Impellersatser	5.1

<b>J</b>	
Justershims mellan cylinderfot och block	3.7

<b>K</b>	
Kamaxelbricka	2.1
Kamaxelfett	2.3
Kamaxellagersatser	2.2
Kamaxelremmar	2.4
Kamaxelsatser	2.2
Kamaxlar	2.1
Kamdrevsats (stål)	2.3
Kamlagersatser	2.2
Kamremmar	8.14
Kamremspännare	2.4
Klämringsbult i sköld	10.8
Knutbågssatser	11.1
Knutkors för drev	14.1
Kolvar (komplett med kolvbult och ringar)	1.1
Kolvringsatser	1.2
Kondensatorer	8.5
Korsstycke för vattenpump	5.9
Kullager för ingående axel i överhus	14.2
Kullager för vertikalaxel i överhus	14.4
Kylvattenkranar	5.19

<b>L</b>	
Laddningsregulator	8.14
Lager för underhus	14.6
Lagersats för svänghjulskåpa	10.3
Lagersats mellanaxel	2.3
Luftfilterinsatser	7.4
Låsbricka för propeller	11.7
Låsring för vertikalaxel	14.5
Låsskruv för propellerkona	11.7
Låsskruv för styrarm	10.9
Låsskruv och bricka för upphängningslagertapp	11.4
Låsskruvar för folding propellerblad	11.6

<b>M</b>	
Medbringare för svänghjul	10.2
Medbringare (korsstycke) för vattenpumpar	5.9
Monteringsklack för sjövattpump	5.8
Monteringsatser för avgaskrök	6.5
Motorkuddar	10.1
Motorpackningsatser	9.1

<b>F</b>	
Flange kit for crankshaft sealing (rear)	1.7
Fuel filters	7.1
Fuel pumps	7.5

<b>G</b>	
Gasket kit for cylinder liner	1.7
Gasket kits for connect. with turbo	6.7
Gasket kits for connecting fuel injector	7.9
Gasket kits for exhaust manifold	6.1
Gasket kits for sea water pumps	5.6
Gasket set for CAV fuel filter	7.3
Gasket set for cylinder liner	9.1
Gasket set for interm. housing - lower gear unit	13.4
Gasket set for upper gear unit - interm. housing	13.4
Gasket sets for after cooler	5.16
Gasket sets for carburettor	7.5
Gasket sets for complete AQ-drive units	13.1
Gasket sets for fuel pump	7.5
Gasket sets for gear mechanism	13.6
Gasket sets for heat exchanger	5.15
Gasket sets for inlet pipe	6.7
Gasket sets for lower gear unit	13.3
Gasket sets for oil cooler	5.17
Gasket sets for oil plugs	13.5
Gasket sets for propeller shaft	13.4
Gasket sets for universal joint	14.1
Gasket sets for upper gear unit	13.2
Gasket sets for vacuum valve	5.23
Gasket sets for water circulating pumps	5.18
Gasket sets for water pipe	5.12
Gaskets for exhaust bend	6.6
Gaskets for exhaust manifold	6.3
Glass bowl for CAV fuel filter	7.4

<b>H</b>	
Hose kit for hydraulic cylinder	10.9
Hose kits	11.2

<b>I</b>	
Ignition cable sets	8.2
Impeller kits	5.1
Impeller puller	5.2
Injector sleeve kit	3.8
Inner bearing for propeller shaft	14.8
Installation kits for exhaust bend	6.5

<b>L</b>	
Lock ring for vertical shaft	14.5
Lock screw for propeller cone	11.7
Lock screw for steering fork	10.9
Lock screws for folding propeller blades	11.6
Lower bearing for vertical shaft in lower gear unit	14.7

<b>M</b>	
Main bearing kits	1.4
Mounting clamp for sea water pump	5.8

<b>N</b>	
Needle bearing for hook up fork	14.6
Needle bearing for vertical shaft in upper gear unit	14.5
Nozzles	7.6

<b>N</b>	
Nedre lager för vertikalaxel i underhus	14.7
Nippelsats för CAV-filter	7.3
Nållager för upphängningsgaffel	14.6
Nållager för vertikalaxel i överhus	14.5
<b>O</b>	
Oljeavtappningsplugg	11.8
Oljeavtappningsplugg	4.6
Oljefilter	4.1
Oljepluggspackning för motor	4.6
Oljepumpar	4.4
Oljetryckskontakater	8.9
Oljetrågspackningar	4.4
Ombyggnadssats CAV-filter	7.3
Ombyggnadssats för bakre vevaxeltätning	1.7
<b>P</b>	
Packningar för avgaskrök	6.6
Packningar för avgasrör	6.3
Packningsklister	9.9
Packningssatser för bränslepump	7.5
Packningssatser för byte av knutkors	14.1
Packningssatser för CAV bränslefilter	7.3
Packningssatser för cylinderfoder	9.1
Packningssatser för propelleraxel	13.4
Packningssatser för vakuumventil	5.23
Packningssatser för växelmekanism	13.6
Packningssatser mellan mellanhus - underhus	13.4
Packningssatser mellan överhus - mellanhus	13.4
Packningssatser för avgaskrök - turbo	6.7
Packningssatser för avgasrör	6.1
Packningssatser för cirkulationspumpar	5.18
Packningssatser för cylinderfoder	1.7
Packningssatser för förgasare	7.5
Packningssatser för insugsrör	6.7
Packningssatser för kompletta AQ-drev	13.1
Packningssatser för mellankylare	5.16
Packningssatser för montering av spridare	7.9
Packningssatser för oljekylare	5.17
Packningssatser för oljepluggar	13.5
Packningssatser för sjövattpumpar	5.6
Packningssatser för underhus	13.3
Packningssatser för vattenrör	5.12
Packningssatser för värmeväxlare	5.15
Packningssatser för överhus	13.2
PINWING - skruvsatser för impellerlock	5.3
Propelleraxel	14.10
Propellerkona	11.6
<b>R</b>	
Ramlagersatser	1.4
Remmar	8.10
Reparationssats för svänghjulskåpa	10.3
Reparationssatser för sjövattpump	5.4
Rotorer	8.3
<b>S</b>	
Saxpinnar och bricka för reglage	11.4
Saxpinne för foldingpropellermutter	11.6
Sjövattpumpar komplett	5.8
Skruv till klämring	10.8
Skölddelar för AQ-drev	10.6
Slangfäste	11.3
Slangatsats för hydraulcylinder	10.9
<b>O</b>	
Oil drain plug	4.6
Oil drain plug	11.8
Oil filters	4.1
Oil pan gaskets	4.4
Oil pressure sensors	8.9
Oil pumps	4.4
Outer bearing for propeller shaft	14.9
<b>P</b>	
Parts for Bosch distributor	8.7
Pins and washer for control cable	11.4
PINWING - screw kits for impeller cover	5.3
Piston ring kits	1.2
Pistons (complete with piston pin and rings)	1.1
Propeller cone	11.6
Propeller shaft	14.10
Protecting cover for gearshift mechanism	11.5
<b>R</b>	
Rebuilding kit for CAV filter	7.3
Repair kits for flywheel casing	10.3
Repair kits for sea water pump	5.4
Rotors	8.3
Rubber block for engine suspension	10.1
Rubber block for propeller shaft coupling	10.1
Rubber ring (damper) for valves	2.5
Rubber rings for clamp ring in shield	10.6
Rubber seal for shield	10.8
Rubber seal for valve cover bolts	3.7
Rubber washer for camshaft	2.3
<b>S</b>	
Screw and washer for bearing pin	11.4
Screw for clamp ring in shield	10.8
Sea water pumps complete	5.8
Seal ring for steering fork	10.8
Sealing compound	9.9
Sealing washer kits for fuel system	7.9
Sealing washers for oil drain plug	4.6
Seals and bearings for sea water pump	5.6
Setting pin	11.5
Sliding pin	14.5
Spacer for fuel pump	7.6
Spacer washer (plastic)	11.7
Spacer washer for propeller cone	11.7
Spring sets for reverse tilt inhibitor	11.8
Support bearing in crankshaft	1.7
<b>T</b>	
Tab washer for propeller (stainless)	11.7
Thermostat kits	5.10
Thrust flange	2.1
Thrust washers (fishing line protectors)	11.5
Thrust washer kits for crankshaft	1.5
Timing belt tensioner	2.4
Timing belts	2.4
Timing belts	8.14
Timing gear kit (steel)	2.3
<b>U</b>	
Universal joint	14.1
Upper bearing for vertical shaft in lower gear unit	14.6

Slangsatser . . . . .	11.2
Slitbricka för dubbellagerbox . . . . .	14.2
Sotningssatser . . . . .	9.1
Spridarhylssats . . . . .	3.8
Spridarspets . . . . .	7.6
Spännrullar för kamrem . . . . .	2.4
Ställpinne . . . . .	11.5
Stödlager i vevaxel . . . . .	1.7
Svänghjulslager . . . . .	1.7
Svängningsdämpare . . . . .	10.2

## T

Termostatsatser . . . . .	5.10
Tilläggsatser . . . . .	9.5
Topplocksultssats . . . . .	3.8
Topplocksmuttrar . . . . .	3.8
Topplockspackningar . . . . .	3.1
Transmissionsdrevsats . . . . .	2.3
Tryckbrickssatser för vevaxel . . . . .	1.5
Täckkåpa för växelmekanism . . . . .	11.5
Tänddelar . . . . .	8.1
Tänddelar översiktstabell . . . . .	8.7
Tändkabelsats . . . . .	8.2
Tätbricka för kamaxel . . . . .	2.3
Tätlist för sköld . . . . .	10.8
Tätringar för styrarm . . . . .	10.8
Tätringar och lager för sjövattpump . . . . .	5.6
Tätringssats för svänghjulskåpa . . . . .	10.3

## U

Underdelspackningssatser . . . . .	9.5
Upphängningsbussningar för drev . . . . .	11.4

## V

Vattenfilter för sötvattenkyllning . . . . .	5.3
Vattenpumpsdelar . . . . .	5.1
Ventiler . . . . .	2.6
Ventilfjädrar . . . . .	2.8
Ventiljusterbrickor . . . . .	2.8
Ventilknaster . . . . .	2.6
Ventilkåpspackningar . . . . .	3.4
Ventillyftare . . . . .	2.2
Ventilstyrningar . . . . .	2.7
Ventiltryckare . . . . .	2.2
Ventiltätningar . . . . .	2.5
Vevaxeltätningssats . . . . .	1.7
Vevhusfilter . . . . .	4.3
Vevlagersatser . . . . .	1.5
Vevstaksbussningar . . . . .	1.1
Vibrationsdämpare svänghjul . . . . .	10.2
Växelmekanismkåpa för drev . . . . .	11.5

## Y

Yttre lager för propelleraxel . . . . .	14.9
---	------

## Z

Zinkanod för foldingpropeller . . . . .	12.3
Zinkanod för sköld . . . . .	12.1
Zinkanod för upphängningsgaffel . . . . .	12.2
Zinkanoder för kylsystem . . . . .	5.21
Zinkring för segelbåtsdrev . . . . .	12.2
Zinkringar för AQ-drev . . . . .	12.1

## Ö

Övre lager för vertikalaxel i underhus . . . . .	14.6
--	------

## V

Valve adjusting shims . . . . .	2.8
Valve cover gaskets . . . . .	3.4
Valve depressor . . . . .	2.2
Valve guides . . . . .	2.7
Valve keeper . . . . .	2.6
Valve lifters . . . . .	2.2
Valve springs . . . . .	2.8
Valve stem seals . . . . .	2.5
Valves . . . . .	2.6
Voltage regulator . . . . .	8.14





## W

Washer for oil sealer in double bearing unit . . . . .	14.2
Water filter for fresh water cooling . . . . .	5.3
Water hose connection . . . . .	11.3



## Z

Zinc anode for shield . . . . .	12.1
Zinc anode for suspension yoke . . . . .	12.2
Zinc anode kit for folding propeller . . . . .	12.3
Zinc anodes for cooling system . . . . .	5.21
Zinc ring kits for AQ drives . . . . .	12.1
Zinc ring kits for sailing boat drives . . . . .	12.2



## Kolvar (komplett med kolvbult och ringar) / Pistons (complete with piston pin and rings)

Motor typ Engine type	Ref.nr Ref. No.	Best.nr Part No.	
B18  Std .030" ö.d./o.s. .040" ö.d./o.s.	275193 275195	11 193 11 195 11 196	
MB 10A, B20, B30  Std .015" ö.d./o.s. .030" ö.d./o.s.  Kolvbult / Piston pin 22 mm	272002 272012 272004	11 202 11 203 11 200	
MB 10A, B20, B30  Std .015" ö.d./o.s. .030" ö.d./o.s.  Kolvbult / Piston pin 24 mm	272056 272058 272059	11 205 11 058 11 059	
AQ 120B, 125A, 140A BB 140A  Std 0.50 mm ö.d./o.s. 1.00 mm ö.d./o.s.  Ringbredd / Ring width 1.75x2.0x4.0 mm	272040 272042 272043	11 040 11 042 11 043	
MB 1B, 2B, 3B MD 11C,D, 17C,D  Std  MD 1B, 2B, 3B 0.50 mm ö.d./o.s.	875551  875579	11 551  11 579	





## Vevstaksbussningar / Connecting Rod Bushings

AQ 60, 90, 95, 100, 105, 110, 115, 120, 130, 165A, 170A,B BB100, 115A,B 165A, 170A,B MB10A, 20A  För 1 kolv / For 1 piston Kolvbult / Piston pin 22 mm	418295	11 295	
AQ115A,B, 120B, 125A, 130C,D, 140A, 145A, 170B,C BB 115B,C, 140A, 145A, 170B,C MB10A, 20B,C  För 1 kolv / For 1 piston Kolvbult / Piston pin 24 mm	463092	11 092	



## Cylinderfodersatser (komplett med kolv och ringar) / Cylinder Liner Kits (complete with piston and rings)

Motor typ Engine type	Ref.nr Ref. No.	Best.nr Part No.	
MD 11C,D MD 17C,D Packningssats för cylinderfoder ingår / Gasket set for cylinder liner included.  MD 11 = 2 st åtgår / 2 pcs required MD 17 = 3 st åtgår / 3 pcs required	875549	11 549	
MD 21 MO -3119179/XXXX MD 32  MD 21 = 4 st åtgår / 4 pcs required MD 32 = 6 st åtgår / 6 pcs required	829254	11 254	

## Kolvringsatser / Piston Ring Kits



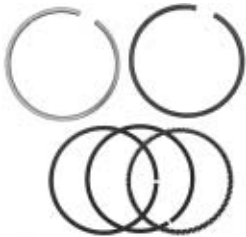

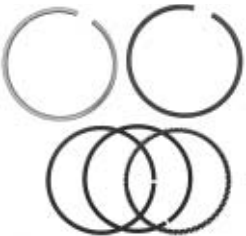
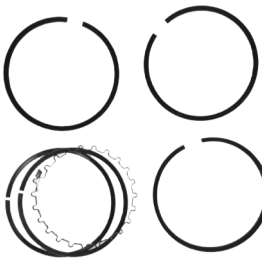
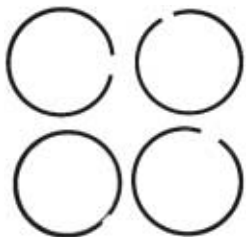

AQ 60, 90, 95, 100, 110, 120 (B 18)  Std ,020" ö.d./o.s.  Ringbredd / Ring width 2.0x2.0x4.0 mm	275282 275283	11 082 11 083	
MB 10A AQ 105, 115, 130, MB 20 (B 20) AQ 165A, 170A (B 30)  Std ,015" ö.d./o.s. ,030" ö.d./o.s.  Ringbredd / Ring width 1.75x2.0x4.7 mm	275334 275335 275336	11 534 11 535 11 536	
MB 10A AQ 115, 1300 (B 20) AQ 170B,C (B 30)  Std ,015" ö.d./o.s. ,030" ö.d./o.s.  Ringbredd / Ring width 1.75x2.0x4.0 mm	275344 275345 275346	11 344 11 345 11 346	
AQ 120B, 125A, 140A BB 140A  Std 0.50 mm ö.d./o.s. 1.00 mm ö.d./o.s.  Ringbredd / Ring width 1.75x2.0x4.0 mm	275340 275341 275342	11 340 11 341 11 342	

# Kolvringsatser (forts.) / Piston Ring Kits (cont.)



Motor typ Engine type	Ref.nr Ref. No.	Best.nr Part No.	
AQ 120B, 125A, 140A BB 140A  Std 0.50 mm ö.d./o.s. 1.00 mm ö.d./o.s.  Ringbredd / Ring width 2.0x2.0x4.0 mm	 275337 275338 275339	 11 337 11 338 11 339	
AQ 145A BB 145A  Std 0.30 mm ö.d./o.s. 1.00 mm ö.d./o.s.  Ringbredd / Ring width 1.75x2.0x4.0 mm	 275331 275332 275333	 11 531 11 533 11 532	
AQ 125B, 145B, 131A,B,C,D, 151A,B,C 171A,C, 230A, 250A, 251A  Std 0.30 mm ö.d./o.s. 0.60 mm ö.d./o.s.  Ringbredd / Ring width 1.75x1.75x3.5 mm	 275369 275370 275371	 11 369 11 370 11 371	
MD 1A, 2A  Std  MD1 = 1 st åtgång / 1 piece required MD2 = 2 st åtgång / 2 pcs required	 875271	 11 271	
MD 21 MD 32  Std  MD21 = 4 st åtgång / 4 pcs required MD32 = 6 st åtgång / 6 pcs required	 876161	 11 161	







# Ramlagersatser / Main Bearing Kits

Motor typ Engine type	Ref.nr Ref. No.	Best.nr Part No.	
AQ 60, 90, 95, 100, 105, 110, 115, 120A 120B, 125A, 130, 140A, 145A MB 18, 20, BB 30, 100  Std .010" u.d./u.s. .020" u.d./u.s.	271214 271215 271216	11 214 11 215 11 216	
AQ 165, 170 BB 165, 170  Std .010" u.d./u.s. .020" u.d./u.s.	271217 271218 271219	11 019 11 020 11 021	
AQ 125B, 131A,B, 145B, 151A,B, 171A  Std 0.25 mm u.d./u.s. 0.50 mm u.d./u.s.	271236 271237 271238	11 236 11 237 11 238	
AQ 131C,D, 151C, 171C 230A, 250A, 251A  Std 0.25 mm u.d./u.s. 0.50 mm u.d./u.s.	270906 270907 270908	11 906 11 907 11 908	
MD 21  Std 0.30 mm u.d./u.s. 0.50 mm u.d./u.s.	875306 875307 875308	11 306 11 307 11 308	
MD 29 MD 32  Std 0.30 mm u.d./u.s. 0.50 mm u.d./u.s.	875334 875335 875336	11 334 11 335 11 336	





## Tryckbrickssatser för vevaxel / Thust Washer Kits for Crankshaft

Motor typ Engine type	Ref.nr Ref. No.	Best.nr Part No.	
AQ 125B, 131A,B, 145B, 151A,B, 171A  Std	270471	11 471	
MD 21 MD 29 MD 32  Std	818262	11 262	



## Vevlagersatser / Con Rod Bearing Kits

MB 10A MO -2778  Std ,010" u.d./u.s. ,020" u.d./u.s.  Lagerbredd / Bearing width 27 mm	2 x 270015 2 x 875478 2 x 875479	11 477 11 478 11 479	
MB 10A MO 2779-  Std ,010" u.d./u.s. ,020" u.d./u.s.  Lagerbredd / Bearing width 24 mm	2 x 875538 2 x 875539 2 x 875540	11 538 11 539 11 540	
AQ 60, 90, 95, 100, 105, 110, 115A, 120A 130, BB 30, 100, 115A,B, MB 18, 20  Std ,010" u.d./u.s. ,020" u.d./u.s.  Lagerbredd / Bearing width 27 mm	271051 271052 271053	11 051 11 052 11 053	
AQ 105, 115A, B, 120B, 125A, 130 140A, 145A, BB 115B, C, 140A, 145A MB 20  Std ,010" u.d./u.s. ,020" u.d./u.s.  Lagerbredd / Bearing width 24 mm	271063 271064 271065	11 063 11 064 11 106	

## Vevlagersatser (forts.) / Con Rod Bearing Kits (cont.)

Motor typ Engine type	Ref.nr Ref. No.	Best.nr Part No.	
AQ 165, 170A AQ 170B MO -87712 BB 165A, 170A,B MO -89352  Std .010" u.d./u.s. .020" u.d./u.s.  Lagerbredd / Bearing width 27 mm	271054 271055 271056	11 022 11 023 11 024	
AQ 170B MO 87713- AQ 170C BB 170B,C MO 89353-  Std .010" u.d./u.s. .020" u.d./u.s.  Lagerbredd / Bearing width 24 mm	271066 271067 271068	11 025 11 026 11 027	
AQ 120B, 131, 145B, 151, 171 230A, 250A, 251A  Std 0.25 mm u.d./u.s. 0.50 mm u.d./u.s.	270136 270137 270138	11 136 11 137 11 138	
MD 21  Std 0.30 mm u.d./u.s. 0.50 mm u.d./u.s. 0.80 mm u.d./u.s.	875302 875303 875304 875305	11 302 11 303 11 304 11 305	
MD 29A MD 32  Std 0.30 mm u.d./u.s. 0.50 mm u.d./u.s. 0.80 mm u.d./u.s.	875330 875331 875332 875333	11 330 11 331 11 332 11 333	

## Packningssatser för cylinderfoder / Gasket Kit for Cylinder Liner

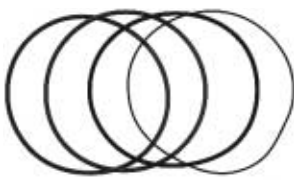
Motor typ Engine type	Ref.nr Ref. No.	Best.nr Part No.	
MD 5A,B, C	875560	11 560	
MD 11C,D MD 17C,D  MD 11 = 2 st åtgår / 2 pcs required MD 17 = 3 st åtgår / 3 pcs required	875550	11 550	
MD 30, 31 MD 40, 41, 42  MD30, 31 = 4 st åtgår / 4 pcs required MD40, 41, 42 = 6 st åtgår / 6 pcs required	275751 875651 (275595)	11 651	

## Stödlager i vevaxel / Support Bearing in Crankshaft

AQ 60, 90, 95, 100, 105, 110, 115, 120A 120B, 125, 130, 131, 140, 145, 151 165, 170, 171 230A, 250A, 251A MB 18, 20, BB 30, 100  Kapslat lager / Sealed bearing	181799	11 799	
---	--------	--------	---

## Ombyggnadssats för bakre vevaxeltätning / Flange Kit for Crankshaft Sealing (rear)

AQ 60, 90, 95, 100, 105, 110, 115, 120 130, MB 18, 20, BB 30, 100  Satsen innehåller / Contents: Bakre gavel / Rear flange 1218634 Packbox / Oil seal 430118 Packning / Gasket 430134		11 014	
---	--	--------	---





## Expansionsbrickor (galvaniserade) / Expansion Plugs (galvanized)

Motor typ Engine type	Ref.nr Ref. No.	Best.nr Part No.	
Diameter 35 mm	463903	<b>11 903</b>	
Diameter 42 mm	463902	<b>11 902</b>	
Diameter 40 mm	968955	<b>11 955</b>	
Diameter 45 mm	463904	<b>11 904</b>	
Diameter 52 mm	463905	<b>11 905</b>	

## Expansionsbrickor (rostfri) / Expansion Plugs (stainless)

B18, B20, MD30, 31, 40, 41 V-8 Diameter 26 mm	477026 (192426)	<b>11 031</b>	
B18, B20, B30, V-8, 2001, 2002 2003, MD 6, 7 Diameter 35 mm	477024 (192211)	<b>11 032</b>	
B18, B20, B30, MD21B, MD29 Diameter 45 mm	192212	<b>11 033</b>	



## Kamaxlar / Camshafts

Motor typ Engine type	Ref.nr Ref. No.	Best.nr Part No.	
AQ 60, 90, 95, 100, 105, 110, 115, 120A 130 BB 30, 100 MB 18, 20  Profil / Profile P	1218674 (418707)	12 003	
AQ 165A, 170A,B,C  Profil / Profile P	461511	12 004	
AQ 120B, 125A,B, 131A,B,C,D 230A  Märkt / Marked A	1336767 (1219706)	12 767	
AQ 140A AQ 151A,B,C 250A  Märkt / Marked V	1346442 (1219032)	12 442	

## Kamaxelbricka / Thrust Flange

AQ 60, 90, 95, 100, 105, 110, 115, 120A 130, 165, 170 BB 30, 100 MB 18, 20  Skruv ingår / Screw included		22 142	
---	--	--------	---

## Kamaxelsatser / Camshaft Kits

Motor typ Engine type	Ref.nr Ref. No.	Best.nr Part No.	
AQ 60, 95, 100, 105, 110, 115, 120A, 130 BB 30, 100, MB 18, 20  Innehåll / Contents: 1 Kamaxel / Camshaft 1218674 8 Lyftare / Lifters 1218630 1 Kamaxelfett / Camshaft grease		12 010	
AQ 165A, 170 BB 165, 170  Innehåll / Contents: 1 Kamaxel / Camshaft 461511 12 Lyftare / Lifters 1218630 1 Kamaxelfett / Camshaft grease		12 011	



## Ventillyftare / Valve Lifters

AQ 60, 90, 95, 100, 105, 110, 115, 120A 130, 165, 170 MB 18, 20 BB 30, 100, 165, 170	1218630 (418423)	12 513	
---	---------------------	--------	--

## Ventiltryckare / Valve Depressor

AQ 120B, 125A,B 131A,B,C,D 140A, 145A,B 151A,B,C 230A, 150A	463075	12 307	
---	--------	--------	---

## Kamaxellagersatser / Camshaft Bearing Kits

AQ 60, 90, 95, 100, 105, 110, 115, 120 130 MB 18, 20 BB 30, 100  Std		12 101	
AQ 165, 170 BB 165, 170  Std		12 102	

## Lagersats mellanaxel / Bearing Kit for Interm. Shaft

Motor typ Engine type	Ref.nr Ref. No.	Best.nr Part No.	
AQ 120B, 125, 131, 140, 145, 151, 171 230A, 250A, 251A  Std		12 100	

## Tätbricka för kamaxel / Rubber Washer for Camshaft

AQ 125B, 145B, 151A,B,C 230A, 250A  Std	1336763	12 006	
--	---------	--------	---

## Kamaxelfett / Camshaft Grease

Installationsfett av molybdendisulfidtyp / Installation and running -in paste on MoS base		12 311	
---	--	--------	---

## Kamdrevsats (stål) / Timing Gear Kit (steel)



AQ 60, 90, 95, 100, 105, 110, 115, 120A 130, 165, 170 MB 18, 20 BB 30, 100	271944 (270691) (875375) (418678)	12 944	
---	--	--------	---



## Kamaxelremmar / Timing Belts

Motor typ Engine type	Ref.nr Ref. No.	Best.nr Part No.	
AQ 120B, 125, 131, 140, 145, 151 230A, 250A BB 140A, 145A	463377	12 377	
AQ 171A,C 251A	855506	12 506	

## Spännrullar för kamrem / Timing Belt Tensioner

AQ 120B, 125, 131, 140, 145, 151 230A, 250A BB 140A, 145A  Rostfri och galvaniserad / Stainless and galvanized	831986	12 986	
AQ 171A, C 251A	855507	12 507	

## Ventiltätningar / Valve Stem Seals

2

Motor typ Engine type	Ref.nr Ref. No.	Best.nr Part No.	
AQ 105, 115, 120B, 125, 130, 131, 140 145, 151, 165, 170, 230A, 250A BB 115, 140, 145, 165, 170 MB 20 MD 1B, 2B, 3B, 5, 7, 11C,D, 17C,D 2001, 2002, 2003 MD30A MD 31A Tidigare utf. / Earlier version MD 40, 41A	1306630 (419702) (833347)	<b>12 630</b>	
AQ 171A,C 251A	3517893 (3517860)	<b>12 893</b>	
AQ 60, 90, 95,100, 110, 120A, BB 30, 100 MB 18 MD 6A,B	405357 415424	<b>12 357</b>	
2001 2002 2003  MD 31A Senare utf. / Late version MD 31B, 41B KAD/KAMD 42A, P-A	859171	<b>12 171</b>	

## Gummidämpare för ventiler / Rubber Ring (Damper) for Valves

AQ 120B, 125, 131, 140, 145, 151 230A, 250A BB 140A, 145A	3514432 (1219648)	<b>12 432</b>	
---	----------------------	---------------	---

## Ventiler / Valves

Motor typ Engine type	Ref.nr Ref. No.	Best.nr Part No.	
AQ 90, 95, 110 AQ 95A, 120A Endast avgas / Only outlet  Insugsventil / Inlet valve 40x8,6 mm  Avgasventil / Outlet valve 35x8,6 mm	419368 (418290) 419292 (415268)	<b>12 368</b>  <b>12 392</b>	
AQ 105A, 115, 130 AQ 165, 170 MB 20  Insugsventil / Inlet valve 42 mm  Avgasventil / Outlet valve 35 mm	419734  419735	<b>12 734</b>  <b>12 005</b>	
AQ 120B, 125, 131, 140, 145, 151 230A, 250 A  Insugsventil / Inlet valve  Avgasventil / Outlet valve	463395  463526	<b>12 395</b>  <b>12 526</b>	
AQ 171A,C, 251A  Insugsventil / Inlet valve  Avgasventil / Outlet valve	1317793  1317792	<b>12 793</b>  <b>12 792</b>	
MD 1B, 2B, 3B MD 11C,D, 17C,D  Insugsventil / Inlet valve 38 mm  Avgasventil / Outlet valve 34 mm	833188  829620	<b>12 188</b>  <b>12 020</b>	

## Ventilknaster / Valve Keeper



AQ 105, 115, 130, 165, 170, 120B 125, 131, 140, 145, 151 230A, 250A BB 115, 165, 170, 140A, 145A MB 10A, 20 MD 30, 40	419643	<b>12 643</b>	
--	--------	---------------	---

## Ventilstyrningar / Valve Guides

2

Motor typ Engine type	Ref.nr Ref. No.	Best.nr Part No.	
AQ 90, 95, 110 Insug och avgas / Inlet and outlet  AQ 95A, 120A Endast avgas / Only outlet  63,5x15,0x8,7 mm	415266 (418495)	<b>12 266</b>	
MB 10 A Insug och avgas / Inlet and outlet  AQ 105, 115, 130, 165, 170 Insug / Inlet std 52x13,5x8 mm  Avgas / Outlet std 59x13,5x8 mm	419652  419652  419653	<b>12 652</b>  <b>12 652</b>  <b>12 653</b>	
AQ 120B, 125, 131, 140, 145, 151 230A, 250A  Insug / Inlet 52x13,5x8 mm  Avgas / Outlet	419652  3582609 (3547603) (463771)	<b>12 652</b>  <b>12 603</b>	
AQ 171A,C 251A  Insug och avgas / Inlet and outlet	1378960	<b>12 960</b>	
MD 1B, 2B, 3B, 11C,D, 17C,D Insug / Inlet  ND 30, 31, 40, 41 KAD/KAMD 42P-A Insug och avgas / Inlet and outlet	419653	<b>12 653</b>	





## Ventilfjädrar / Valve Springs

Motor typ Engine type	Ref.nr Ref. No.	Best.nr Part No.	
MB 10A AQ 90, 95, 100, 105, 110, 115, 120A 130, 165, 170 MB 18, 20 BB 30, 100 MD 31A Tidigare utf. / Earlier version MD 41A	418737	12 737	
AQ 120B, 125, 131, 140, 145, 151 230A, 250A BB 140A, 145A	463739	12 739	



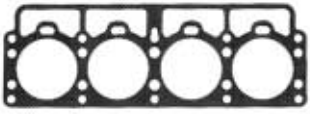

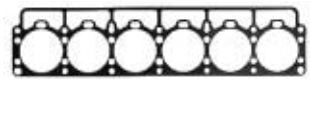
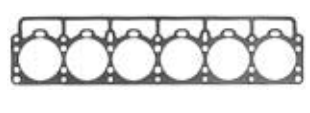

## Ventiljusterbrickor / Valve Adjusting Shims

AQ 120B, 125 131 140, 145 151 230A, 250A	3,30	436546	12 546	
	3,35	463547	12 547	
	3,40	463548	12 548	
	3,45	463549	12 549	
	3,50	463550	12 550	
	3,55	463551	12 551	
	3,60	463552	12 552	
	3,65	463553	12 553	
	3,70	463554	12 554	
	3,75	463555	12 555	
	3,80	463556	12 556	
	3,85	463557	12 557	
	3,90	463558	12 558	
	3,95	463559	12 559	
	4,00	463560	12 560	
	4,05	463561	12 561	
	4,10	463562	12 562	
	4,15	463563	12 563	
	4,20	463564	12 564	
	4,25	463565	12 565	
	4,30	463566	12 566	
	4,35	463567	12 567	
	4,40	463568	12 568	
	4,45	463569	12 569	
	4,50	463570	12 570	
	4,55		12 045	
	4,60		12 460	
	4,65		12 046	
4,70		12 470		
4,75		12 475		
4,80		12 480		
4,85		12 485		
4,90		12 490		
4,95		12 495		
5,00		12 500		

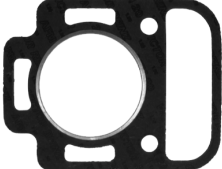

# Topplöckspackningar / Cylinder Head Gaskets

Motor typ Engine type	Ref.nr. Ref. No.	Best.nr. Part No.	
AQ 100, 110 B 18  Ej för fotogenmotor / Not for paraffin engine  Runda hål / Round holes Ingår i sotn.sats 21357/ Incl. in decarb. gasket set 21357	418990	13 990	
AQ 115A, 130A,C, MB 20B B20  Tjocklek 0,8 mm runda hål / Thickness 0,8 mm round holes Ingår i sotn. sats 21401 / Incl. in decarb. gasket set 21401	419310	13 009	
B 20  Tjocklek 0,8 mm ovala hål / Thickness 0,8 mm oval holes	419763	13 763	
AQ 115A, 130B, MB 20A, BB115A, B B 20  Tjocklek 2,0 mm runda hål / Thickness 2,0 mm round holes Ingår i sotn. sats 21418 / Incl. in decarb. gasket set 21418	(876783) (875543) (419628)	13 783	
AQ 115B, C, 130D, MB 20C, BB 115C B 20  Tjocklek 1,2 mm ovala hål / Thickness 1,2 mm oval holes Ingår i sotn. sats 21569 / Incl. in decarb. gasket set 21569	462623	13 623	
AQ 165, 170A, 170B BB 165A, 170A, 170B B 30  Tjocklek 0,8 mm ovala hål / Thickness 0,8 mm oval holes Ingår i sotn. sats 21335 / Incl. in decarb. gasket set 21335	9139284 (461056)	13 008	
AQ 170C BB 170C B 30 Tjocklek 1,2 mm ovala hål / Thickness 1,2 mm oval holes Ingår i sotn. sats 21359 / Incl. in decarb. gasket set 21359	3855409 (461618)	13 010	

## Topplockspackningar (forts.) / Cylinder Head Gaskets (cont.)

Motor typ Engine type	Ref.nr. Ref. No.	Best.nr. Part No.	
AQ 120B, 125A, 140A BB 140A	1378645 (463412)	13 645	
AQ 125B, 131, 145, 151, 171 230A, 250A, 251A BB 125A	1378646 (1326785) (1332644)	13 646	
MD 1A MD 2A  Ingår i sotn. sats 21422 / Incl. in decarb. gasket set 2142	833274	13 274	
MD 1B MD 2B MD 3B  Ingår i sotn. sats 21500, 21502, 21504 / Incl. in decarb. gasket set 21500, 21502, 21504	859151 (833070)	13 070	
MD 11C,D MD 17C,D  Ingår i sotn. sats 21553, 21572 / Incl. in decarb. gasket set 21553, 21572	859137 (833453)	13 453	
MD 5A,B,C  Ingår i sotn. sats 21561 / Incl. in decarb. gasket set 21561	859134 (838127)	13 127	
MD 6A,B  Ingår i sotn. sats 21379 / Incl. in decarb. gasket set 21379	859135 (3875376)	13 376	

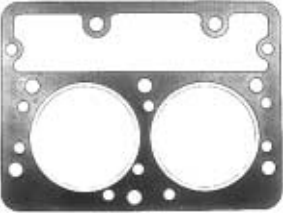
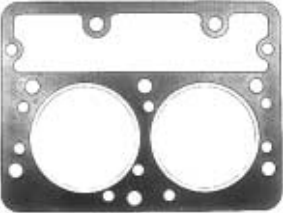
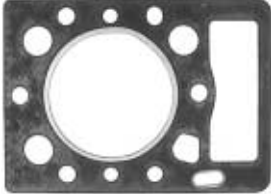
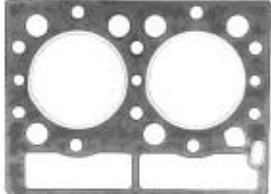
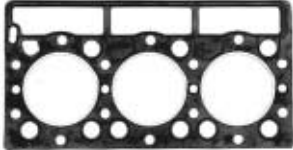
## Topplockspackningar (forts.) / Cylinder Head Gaskets (cont.)

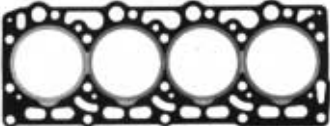



Motor typ Engine type	Ref.nr. Ref. No.	Best.nr. Part No.	
MD 7 MO -3544  Tjocklek 1,3 mm Thickness 1,3 mm  Ingår i sotn. sats 21430 Incl. in decarb. gasket set 21430	859136 (840270)	13 136	
MD 7 MO 3545-  Tjocklek 0,8 mm Thickness 0,8 mm  Ingår i sotn. sats 21431 Incl. in decarb. gasket set 21431	860749 (840910) (840270)	13 749	
2001, AG, B, BG  Ingår i sotn. sats 21307 Incl. in decarb. gasket set 21307	840569	13 569	
2002, AG, B, BG  Ingår i sotn. sats 21308 Incl. in decarb. gasket set 21308	859094 (840328)	13 094	
2003, AG, B, BG 2003T, TB  Ingår i sotn. sats 21309, 21310 Incl. in decarb. gasket set 21309, 21310	859093 (840405)	13 093	
MD 21A, B	859152 (829531) (829214)	13 531	
MD 30	859150	13 150	

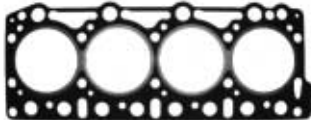
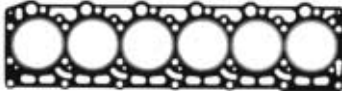
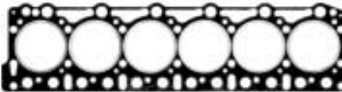







## Topplöckspackningar (forts.) / Cylinder Head Gaskets (cont.)

Motor typ Engine type	Ref.nr. Ref. No.	Best.nr. Part No.	
MD 31 MD 32 P-A	3582432 (858993)	13 993	
MD 40	859155	13 155	
MD 41 KAD/KAMD 42A,B TAMD 42B, P-A	3583786 (3582433) (3580742) (858992) (876853)	13 742	

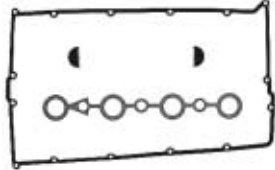



## Ventilkåpspackningar / Valve Cover Gaskets

AQ 60, 90, 95, 100, 105, 110, 115, 120A 130	419678	13 100	
AQ 165, 170	430039	13 039	
AQ 120B, 125A, 140, 145A	1378909	13 909	
AQ 125B, 131, 145B, 151	1378870 (1336753)	12 870	

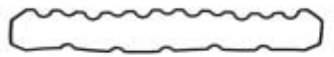

## Ventilkåpspackningar (forts.) / Valve Cover Gaskets (cont.)

Motor typ Engine type	Ref.nr. Ref. No.	Best.nr. Part No.	
AQ 171A, C  Innehåll / Contents: 1 Packning / Gasket 1378853 1 Packning / Gasket 1378851 2 Gummitätning / Rubber seal 463416		13 393	
AQ 120B, 125A, 140, 145A 171A,C, 251A  2 st utgår för 171A,C, 251A 2 pcs required for 171A,C, 251A Gummitätning för ventilkåpa / Rubber seal for valve cover	463416	11 416	
MD 1A, B MD 2A, B MD 3B MD 11C,D MD 17C,D	859120 (802399)	13 399	
MD 5A,B,C	838066	13 066	
MD 6A,B MD 7A  2 st åtgår / 2 pcs required  MD7B  1 st åtgår / 1 piece required	840115 (3875384)	13 115	
2001	859042 (840572)	13 042	
2002	859043 (840440)	13 043	



## Ventilkåpspackningar (forts.) / Valve Cover Gaskets (cont.)

Motor typ Engine type	Ref.nr. Ref. No.	Best.nr. Part No.	
2003	859044 (840461)	13 044	
30	1544119	13 119	
31	838652	13 652	
40	1542287	13 287	
41	838653	13 653	
31, 41 KAD/KAMD 42A, B, P-A 31 2 st åtgår / 2 pcs required 41 3 st åtgår / 3 pcs required 42 3 st åtgår / 3 pcs required	838654	13 654	

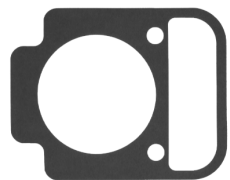

## Gummipackning för ventilkåpsbultar / Rubber Seal for Valve Cover Bolts

Motor typ Engine type	Ref.nr. Ref. No.	Best.nr. Part No.	
2001, 2002, 2003  2001 = 1 st åtgår / 1 piece required 2002 = 2 st åtgår / 2 pcs required 2003 = 3 st åtgår / 3 pcs required	840442	13 442	
30, 40  30 = 2 st åtgår / 2 pcs required 40 = 4 st åtgår / 4 pcs required	469846 (424342)	11 846	

## Justershims mellan cylinderfot och block / Adjusting Shims Cylinder - Cylinder Block

MD 1A, 2A	0,2 mm	859224 (807294)	13 024	
	0,3 mm	859225 (807298)	13 025	
MD 1B, 2B, 3B	0,2 mm	859138 (833497)	13 497	
	0,3 mm	859148 (833498)	13 498	
MD 11C,D, 17C,D	0,2 mm	833780	13 780	
	0,3 mm	833781	13 781	

## Cylinderlocksbulsets / Cylinder Head Screw Kits

Motor typ Engine type	Ref.nr. Ref. No.	Best.nr. Part No.	
AQ 120B, 125, 131, 140, 145, 151 230A, 250A  1 sats åtgår / 1 set required	10 x 1306341	<b>13 341</b>	
AQ 171A,C 251A  1 sats åtgår / 1 set required	3 x 1326239 7 x 1317761	<b>13 416</b>	



## Cylinderlocksmutter / Cylinder Head Nut

MD 1B 3 st åtgår / 3 pcs required MD 2B, 11C,D 6 st åtgår / 6 pcs required MD 3B, 17C,D 8 st åtgår / 8 pcs required  Packningar ingår / Gaskets included	943414	<b>13 414</b>	
---	--------	---------------	---

## Spridarhylssats / Injector Sleeve Kit

MD 31A,B MD 41A,B KAD/KAMD 42A,B TAMD 42B  Packningar ingår / Gaskets included	861255 (838609)	<b>11 609</b>	
---	--------------------	---------------	---

# Oljefilter / Oil Filters

Motor typ Engine type	Ref.nr Ref. No.	Best.nr Part No.	
MB 10A MD 1B, 2A,B, 3B MD 5A,B,C MD 6A,B, 7A,B MD 11C,D, 17C,D 2001, 2002, 2003	834337 (897321)	<b>14 337</b>	
MD 2010A,B	861473	<b>14 473</b>	
D2-55 MD 2020A,B MD 2030A,B MD 2040A,B	3581621 (861475) (861474) (3580228) (3580454)	<b>14 621</b>	
MD 22A MD 22L-A TMD 22A	861476	<b>14 476</b>	
AQ 60, 90, 95, 100, 105, 110, 115, 120, 125 130, 131, 140, 145, 151, 165, 170, 171 230A, 250A, 251A BB30A, 100, 140A, 145A MB 18, 20 MD 21A* MD 22I-B, 22P-B TMD 22B, TAMD 22P-B MD 30, 31 KAD 32A,P  * Tidigare utförande / Earlier version Upp till / Up to MO -103386	3517857 (1266286) (418432) (430143)	<b>14 057</b>	
AQ 175, 205, 430A,B, 431A,B, 432A, 434A 4,3 GL, GS	841750	<b>14 750</b>	

## Oljefilter (forts.) / Oil Filters (cont.)

Motor typ Engine type	Ref.nr Ref. No.	Best.nr Part No.	
V-8 5,0 GL, Gi 5,7 GS, GSi, GXi 7,4 GL, Gi, GSi BY, WT, EF 8,1 Gi, GSi 8,2 GL 8,2 GSi BY, WT, EF	3850559	14 559	
AQ 200, 211, 225, 231, 260A, 261, 271, 280A, 290A, 311 500A,B, 501A,B 570A, 571A, 572A 740A,B 3,0 GL, GS 5,7 GL, Gi 7,4 8,2	835440	14 440	
AQ 190, 240 5,0 FL, Fi 5,8 FL, Fi	835779	14 779	
MD 21A* MD 21B MD 32 61/71 by-pass 62/72, 73, 74 by-pass  * Senare utförande / Late version Från / From MO 103387-	3827069 (829390) (829161)	14 390	
AD 41A,B,D AQAD 40A,B AQAD 41A AQD 40A AQD 70BL, CL, D D 41A,B,D MD 40A TAMD 40A,B TAMD 41A,B,D,E THAMD 70B,C TMD 40A,B,C TMD 41A,B,D	471034	14 034	

## Oljefilter (forts.) / Oil Filters (cont.)





Motor typ Engine type	Ref.nr Ref. No.	Best.nr Part No.	
KAD/KAMD 42A,B,P-A 43, 44 TAMD 60A,B,C MD 70A,B,C TMD70A,AB,B,C AQD 70B,C,D,BL,CL TAMD 70B,C,D,E THAMD 70B,C TMD 100A,C MD 100B MD 120A TMD 120A,B,C, TAMD 120A,B TMD 121C	4785974 (423135)	<b>14 974</b>	
TAMD 61A TAMD 71A TAMD 102A,D TAMD 103A TAMD 120B,BCC TAMD 121C,D TAMD 122A,F,C TMD 100C TMD 102A,B TMD 120B TMD 121C TMD 122A	466634	<b>14 634</b>	

## Vevhusfilter / Crankcase Filter



30, 31, 40, 41, 60, 61,70, 71, 100, 120 121, 122  KAD 32	876069 (875850) (843736)	<b>14 069</b>	
---	--------------------------------	---------------	---







## Oljepumpar / Oil Pumps

Motor typ Engine type	Ref.nr Ref. No.	Best.nr Part No.	
AQ 60, 90, 95, 100, 105, 110, 115 120A, 130 MB 18, 20 BB 30, 100	1218706 (418280) (149542)	<b>14 706</b>	
AQ 165A AQ 170A,B,C	461677 (430190)	<b>14 677</b>	
AQ 120B Exkl / Excl USA MO -8586 1849/XXXX AQ 120B USA MO -8588 8754/XXXX BB 140A MO -8587 4154/XXXX AQ 145A MO -8589 1624/XXXX BB 145A	1219946	<b>14 946</b>	
AQ 120B Exkl / Excl USA MO -8586 850/XXXX AQ 120B USA MO -8588 5755/XXXX BB 140A MO -8587 4155/XXXX AQ 145A MO -8589 1625/XXXX  Aq 125, 131, 145B, 151, 171 230A, 250A, 251A	1346144 (1276336)	<b>14 144</b>	

## Oljetrågspackningar / Oil Pan Gaskets

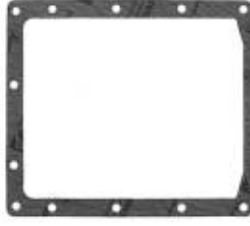
AQ 60, 90, 95, 100, 105, 110, 115 120A, 120B, 125, 130, 131, 140, 145, 151, 171, 230, 250, 251 MB 18, 20 BB 30, 100, 140, 145	1378864 (463587) (418262)	<b>14 864</b>	
AQ 165A AQ 170A,B,C	1378914 (461113)	<b>14 914</b>	

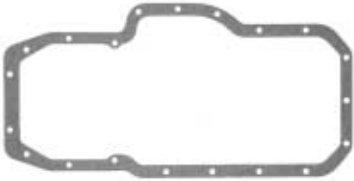
## Oljetrågspackningar (forts.) / Oil Pan Gaskets (cont.)

Motor typ Engine type	Ref.nr. Ref. No.	Best.nr. Part No.	
MD 5A,B,C	859031 (838235)	14 031	
MD 6A,B MD 7A,B	859036 (3875377)	14 036	
2001 2002 2003  Tätmassa i tub till oljetråg / Sealant for oil pan.	840879	14 879	
MD 21A,B	840648 (818035)	14 005	
MD 30 MD 31	861250 (860684) (1544124)	14 250	
MD 40, 41 KAD/KAMD 42A, P-A	861251 (860685) (1542247)	14 251	

## Oljeavtappningsplugg / Oil Drain Plug

Motor typ Engine type	Ref.nr. Ref. No.	Best.nr. Part No.	
AQ 60, 90, 95, 100, 105, 110, 115 120, 125, 130, 131, 140, 145, 151, 165, 170, 171 BB 30, 100, 140, 145 MB 18, 20 MD 30, 31, 40, 41 KAD/KAMD 42A	948187	14 001	





## Brickor för oljeavtappningsplugg / Sealing Washers for Oil Drain Plug

AQ 60, 90, 95, 100, 120A BB 30, 100 MB 18, 20  Fiber inner / Fiber inner 20.0 mm	191747	11 747	
AQ 105, 115, 120B, 125, 130, 131, 140, 145, 151, 165, 170, 171, 230, 250, 251 BB 115, 140, 145, 165, 170 MB 20 MD 30, 31, 40, 41 KAD/MAMD 42A  Koppar inner / Copper inner 19.3 mm	18818	14 818	

# Impellersatser / Impeller Kits

Motor typ Engine type	Ref.nr Ref. No.	Best.nr Part No.	
<p>AQD 2B MB 10A MD 1A,B, 2A,B MD 6A MD 2010A,B* MD 2020A,B*</p> <p>* Upp till / Up to MO. No -5101203007 Tidigare utförande med glidlager / Earlier version with plain bearing Impeller Ø 39 mm</p>	875807 (876689)	<b>15 807</b>	
<p>AQ 60, 80, 90, 95, 100, 105, 110, 115 120A, 130 B 16, BB 25, 30, 70, 100 MB 18, 20 MD 3B, 17C,D MD 2010B*, 2020B*, 2030B, 2040B</p> <p>* Från / From MO No. 5101203008- Impeller Ø 50 mm</p>	875808 (3580066) (897055) (804696) (876690)	<b>15 808</b>	
<p>MB 10A* MD 5, 6B, 7A,B, 11C,D 2001, 2002, 2003</p> <p>* För kullagrad pump / * For ball bearing pump Impeller Ø 39 mm</p>	875583	<b>15 583</b>	
<p>AQ 120B, 125, AQ 131, 140, 145 AQ 151, 165, 170, 171 230A, 250A, 251A BB 140, 145, 165, 170 MD 21A* MD 21B</p> <p>* Från / From MO 103387- Impeller Ø 57 mm med kilspår / With key groove</p>	875575 (831182)	<b>15 575</b>	
<p>AQ 150A,B, 175A, 200C,D,F, 211A, 230B 225C,D,F, 231A, 255A,B, 260A, 271A,C, 290A, 311A,B, 430A,B, 431A,B, 434 500A,B, 501A,B, 570A, 571A, 572A BB 225A,AV,B,C, 231A,B, 255AV 260A,AV,B, 261A MD 4 MD 22A MD 2003T, TB MD 21A*</p> <p>V8 - För pump monterad på vevaxel med fyra skruvar i impellerlocket / V8 - For pump mounted on the crankshaft with four screws in impeller cover ' Up to MO -103386 Impeller Ø 57 mm med splines / with splines</p>	3862281 3862567 (3858256) (875811) (829940) (876243) (3855546) (3856039) (3850107)	<b>15 811</b>	

## Impellersatser (forts.) / Impeller Kits (cont.)

Motor typ Engine type	Ref.nr Ref. No.	Best.nr Part No.	
AQ 200A,B,C, 225A,B,C, 255A US engines 1974- 5,7  För pump med remdrift / For pump with belt drive Impeller Ø 61 mm	3854286 (835512)	15 512	
AQ 190A, 240A  För pump med remdrift / For pump with belt drive Impeller Ø 64 mm	835874	15 874	
AQ 200C,D, 205A, 225C,D,E 231B, 255A,B, 260A,B, 271A,B,C,D 280A, 290A, 311A,B, 431A, 570A, 571A, 572A, 740B BB 225A,AV,B, 231A, 260A,AV,B, 261A  V8 - För pump monterad på vevaxel med sex skruvar i impellerlocket / V8 - For pump mounted on crankshaft with six screws in impeller cover Impeller Ø 57 mm med splines / With splines	876120 (834794)	15 120	
AQ 30, 31, 40, 41 AQD 19, 27, 29, 32 KAD/KAMD 42A,B,P MD 19, 27, 29, 32 TAMD 60A,B,C 70-engines  För pump med sex skruvar i locket / For pump with six screws in cover Impeller Ø 65 mm	877061 (875593) (807904)	15 593	
AQAD 40A,B, TAMD 40A,B TAMD 61-62A, 71-72A  För pump med fem skruvar i locket / For pump with five screws in cover Impeller Ø 95 mm	875736 (875660) (825942)	15 660	

## Impelleravdragare / Impeller Puller

Impuller  För alla utförande / For all versions		15 999	
---	--	--------	---

## Vattenfilter för sötvattenkyllning / Water Filter for Fresh Water Cooling

Motor typ Engine type	Ref.nr Ref. No.	Best.nr Part No.	
<p>Vattenfiltret monteras i motorns kylsystem för att eventuella rostflakor inte skall sätta igen slangar eller skada cirkulations-pumpen /</p> <p>Water filter to be mounted in connection with cooling system to avoid stops in pipes and hoses</p>		15 637	





## PINWING - skruvsatser för impellerlock / PINWING - Screw Kits for Impeller Cover

<p>Med sex skruvar i locket / With six screws in cover</p> <p>AQ 60, 90, 100, 105, 115, 120A, 130 MD 3B, 17C,D Ej för kullagrad pump / Not for ball bearing pump</p>		15 350	
<p>Med sex skruvar i locket / With six screws in cover</p> <p>MD 1A,B, 2A,B, 6A,B, 21A,B MD 22A, TMD22A, 2010A, 2020A, 2030A 2040A, MB10A AQ 165A, 170A,B,C AQ 200D, 225D, 255B, 260A, 280A, 290A BB 225A,AV, B, 260A,AV,B</p>			
<p>Med fyra skruvar i locket / With four screws in cover</p> <p>MD 5A,B,C, 7A,B, 11C,D 2001, 2002, 2003</p>		15 351	
<p>Med sex skruvar i locket / With six screws in cover För kullagrad pump / For ball bearing pump</p> <p>AQ 60, 90, 100, 105, 115, 120A, 130 MD 3B, 17C,D, 2003T</p>		15 932	
<p>Med två skruvar i locket / With two screws in cover</p> <p>AQ 120B, 125A,B, 131A,B,C,D, 140A 145A,B, 151A,B,C, 230A, 250A, 251A</p>		15 353	
<p>Med sex skruvar i locket / With six screws in cover</p> <p>MD 30, 31, 40, 41 KAD 42A, KAMD 42A</p>		15 934	





## PINWING - skruvsatser för impellerlock (forts.) / PINWING - Screw Kits for Impeller Cover (cont.)

Motor typ Engine type	Ref.nr. Ref. No.	Best.nr. Part No.	
Med fyra skruvar i locket / With four screws in cover  AQ 175A, 200D, 211A, 225D,F, 231A,B 430A,B, 431A,B, 500A,B, 501A 570A, 571A, 572A BB 225A,AV,B,C, 231B 260A,AV,B,C, 261B		15 935	
Med sex skruvar i locket / With six screws in cover  MD 27, 29, 32		15 356	
Med sex skruvar i locket / With six screws in cover  AQAD 40A,B TAMD 40A,B		15 357	

## Reparationssatser för sjövattpump / Repair Kits for Sea Water Pump



AQ 60, 90, 95, 100, 105, 110, 115, 120A 130 BB 30, 100, 115 MB 18, 20 MD 3B, 17C,D  För pump utan kullager / For pump without ball bearing		22 073	
AQ 60, 90, 95, 100, 105, 110, 115, 120A 130 BB 30, 100, 115, MB 18, 20 MD 3B, 17C,D  För kullagrad pump / For pump with ball bearing Kam ingår ej / Cam not included	(875698)	15 698	
AQ 165A, 170A,B,C MD 21A MO 103387- MD 21B  Kam ingår ej / Cam not included	(875383)	15 383	
AQ 120B, 125A,B, 131A,B,C,D 140A, 145A,B, 151A,B,C, 171C,D 230, 250, 251 BB 140, 145  Kam ingår ej / Cam not included	(876081) (875574)	15 574	

## Reparationssatser för sjövattpump (forts.) / Repair Kits for Sea Water Pump (cont.)

Motor typ Engine type	Ref.nr. Ref. No.	Best.nr. Part No.	
MB 10A MD 1B MD 2B MD 6A  Tidigare utförande med glidlager / Earlier version with plain bearing		22 076	
MD 5A,B,C MD 6B MD 7A,B MD 11C,D  Lock och kam ingår ej / Cover and cam not included	(875584)	15 584	
2001 2002 2003  Ej för turbo Lock och kam ingår ej / Not for turbo Cover and cam not included	(875756)	15 756	
AD 31B, 41B AQ 40, 41 AQAD 30A, 31A, 40A,B, 41A AQD 19, 27, 29, 32, 40A, 41A D 41B KAM 42A,B,P KAMD 42A,B,P MD 19, 27, 29, 32, 30A, 31A TAMD 30A, 31A, 40A,B, 41A,B, 60A,B,C TMD 30A, 31A,B, 40A,B,C, 41A,B 70-engines  För pump med sex skruvar i locket / For pump with six screws in cover Impeller Ø 65 mm	(876088) (876529) (875759)	22 136	
AD 40 MD 40A TMD 40A,B,C AQD 40A AQAD 40A,B TAMD 40A,B, 61-62A, 71-72A  För pump med fem skruvar i locket/ For pump with five screws in cover Impeller Ø 95 mm	(875769) (875712)	22 137	









## Tättringar och lager för sjövattpump / Seals and Bearings for Sea Water Pump

Motor typ Engine type	Ref.nr. Ref. No.	Best.nr. Part No.	
AQ 430A,B, 431A,B, 432A, 434A 500A,B, 501A,B, 570A, 571A, 572A  Tättring / Seal  Lager / Bearing  V8 - För pump med fyra skruvar i locket / V8 - For pump with four screws in cover	827247  183861	15 247  15 861	
AQ 175A, 200C,D,F, 211A, 225C,D,F 231A,B, 255A,B, 260A, 271A,C, 290A 311A,B 4430B, 431B, 500A,B, 501A,B, 570A 571A, 572 BB 225A,AV,B,C 231B, 255AV, 260A,AV,B  Låsring / lock ring  Tättring / Seal  2 st / pcs Lager / Bearing  För pump på vevaxeln med fyra skruvar i impellerlocket / For pump on crankshaft with four screws in impeller cover	809444  841642  183861	15 444  15 642  15 861	
AQ 200C,D, 205A, 225C,D,E, 231B, 255A,B 260A,B, 271A,B,C,D, 280A, 290A, 311A,B 431A, 570A, 571A, 572A, 740B BB 225A,AV,B, 260A,AV,B  Låsring / lock ring  Tättring / Seal  Lager / Bearing  För pump på vevaxeln med fyra skruvar i impellerlocket / For pump on crankshaft with four screws in impeller cover	809444  818684  181355 (806534)	15 444  15 864  15 355	

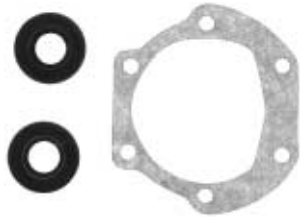

## Packningssatser för sjövattpumpar / Gasket Kits for Sea Water Pumps

AQ 60, 90, 95, 100, 105, 110, 115, 120A 130 MB 18, 20, BB 30, 100, 115 MD 3B, 17C,D  För pump utan kullager / For pump without ball bearing		22 042	
---	--	--------	---

## Packningssatser för sjövattpumpar (forts.) / Gasket Kits for Sea Water Pumps (cont.)

Motor typ Engine type	Ref.nr. Ref. No.	Best.nr. Part No.	
AQ 60, 90, 95, 100, 105, 110, 115, 120A 130 MB 18, 20, BB 30, 100, 115 MD 3B, 17C,D  För pump med kullager / For pump with ball bearing		22 009	
AQ 165A, 170A,B,C BB 165A, 170A,B,C MD 21A* MD 21B  * Från / From MO 103387-		22 047	
AQ 120B, 125, 131, 140, 145, 151, 171 230A, 250A, 251A BB 140A, 145A		22 072	
MB 10A MD 1B, 2A,B MD 6A  Tidigare utförande med glidlager / Earlier version with plain bearing		22 053	
MD 5A,B,C MD 6B MD 7A,B MD 11C,D 2001, 2002, 2003*  * Ej för turbo / Not for turbo		22 054	
2003 T 2003 TB  Endast för turbo / Only for turbo		22 040	

## Packningsatser för sjövattpumpar (forts.) / Gasket Kits for Sea Water Pumps (cont.)

Motor typ Engine type	Ref.nr. Ref. No.	Best.nr. Part No.	
AD 31B, 41B AQ 40, 41 AQAD 30A, 31A, 40A,B, 41A AQD 19, 27, 29, 32, 40A, 41A D 41B KAM 42A,B,P KAMD 42A,B,P MD 19, 27, 29, 32, 30A, 31A TAMD 30A, 31A, 40A,B, 41A,B, 60A,B,C TMD 30A, 31A,B, 40A,B,C, 41A,B 70-engines  För pump med sex skruvar i locket / For pump with six screws in cover Impeller Ø 65 mm		22 016	
AD 40 MD 40A TMD 40A,B,C AQD 40A AQAD 40A,B TAMD 40A,B, 61-62A, 71-72A  För pump med fem skruvar i locket / For pump with five screws in cover Impeller Ø 95 mm		22 089	





## Monteringsklack för sjövattpump / Mounting Clamp for Sea Water Pump

AQ 60, 80, 90, 95, 100, 105, 110, 115 120A, 130 B 16, BB 25, 30, 70, 100 MB 10A, 18, 20 MD 1A,B, 2A,B, 3B, 11C,D, 17C,D 5A,B,C, 6A,B, 7A,B AQD 2B  För kullagrad pump / For ball bearing pump.	833878	15 878	
---	--------	--------	---

## Sjövattpumpar komplett / Sea Water Pumps complete

AQD 2B MB 10A MD 1A,B, 2A,B MD 5A,B,C MD 6A,B, 7A,B MD 11C,D  Monteringsssats ingår. Kullagrad pump. Ersätter tidigare utförande med glidlager / Installation kit included. Ball bearing pump. Replacement for ealier version with plain bearing	833883 (833415) (833522) (858065) (840076)	15 883	
--	--	--------	---



## Sjövattenpumpar komplett (forts.) / Sea Water Pumps complete (cont.)

Motor typ Engine type	Ref.nr. Ref. No.	Best.nr. Part No.	
AQ 60, 80, 90, 95, 100, 105, 110, 115 120A, 130 B 16, BB 25, 30, 70, 100 MB 18, 20 MD 3B, 17C,D  Monteringssats ingår. Kullagrad pump. Ersätter tidigare utförande med glidlager / Installation kit included. Ball bearing pump. Replacement for earlier version with plain bearing	829895 (825816)	15 895	
AQ 120B, 125, 131, 140, 145 AQ 151, 165, 170, 171 230A, 250A, 251A BB 140, 145	855578 (828026)	15 578	
AQ 165, 170 BB 165, 170 MD 21A* MD 21B  * Från / From MO 103387-	831178	15 178	
AQ 150A,B, 175A, 200C,D,F, 211A, 230B 225C,D,F, 231A, 255A,B, 260A, 271A,C, 290A, 311A,B, 430A,B, 431A,B, 434 500A,B, 501A,B, 570A, 571A, 572A BB 225A,AV,B,C, 231A,B, 255AV 260A,AV,B, 261A  V8 - För pump monterad på vevaxel med fyra skruvar i impellerlocket / V8 - For pump mounted on the crankshaft with four screws in impeller cover High speed pump	856513 3860703	15 952	



## Medbringare (korsstycke) för vattenpumpar / Cross Piece for Water Pump

AQ 60, 80, 90, 95, 100, 105, 110, 115 120A,B, 125, 130, 131, 140, 145, 151, 165, 170, 171, 230A, 250A, 251A BB 30, 100, 140, 145, 165, 170 MB 18, 20 MD 3B, 17C,D, 21A*, 21B  * Från / From MO 103387-	831009 (806256)	15 109	
---	--------------------	--------	---







## Medbringare (korsstycke) för vattenpumpar (forts.) / Cross Piece for Water Pump (cont.)

Motor typ Engine type	Ref.nr. Ref. No.	Best.nr. Part No.	
30, 40  För pump med sex skruvar i locket / For pump with six screws in cover	829433	15 433	
31, 41 KAD/KAMD 42A  För pump med fem skruvar i locket / For pump with five screws in cover	858467	15 467	



## Termostatsatser / Thermostat Kits

MD 10A MD 6A,B, 7A,B	60C	875796 (833366)	15 796	
AQ 60, 90, 95, 100, 105, 110 115, 120A, 130 BB 30, 100 MB 20 För B18-B20 bensin / For B18-B20 gasoline  MD 2A,B, 3B MD 11C,D, 17C,D  Utan sjövattnenkylning / Without fresh-water cooling	60C	876097 876080 (875781) (875790) (824912) (829812)	15 097	
AQ 165A, 170A,B,C BB 165A, 170A,B,C	55C	875791 (831040)	15 791	





## Termostatsatser (forts.) / Thermostat Kits (cont.)

Motor typ Engine type	Ref.nr. Ref. No.	Best.nr. Part No.	
82C AQ 120B, 125A,B, 131A,B,C,D 140A, 145A,B, 151A,B,C, 171A,C 230A, 250A, 251A	875580	15 580	
62C AQ 175A, 205A, 430A,B, 431A,B 432A, 434A  För alla V6-V8 motorer upp till -1993 All V6-V8 engines up to -1993	876305 (875794) (424299) (835177)	15 305	
75C BB 30, MB 18F, 20B MD 1B MD 2, 3, 6, 7, 11, 17*  * Med Martec sötvattenkylning / * With Martec fresh-water cooling	875780	15 780	
74C MD 11C,D MD 17C,D  Med Volvo Penta sötvattenkylning / With Volvo Penta fresh-water cooling	877349 (875784) (838501)	15 784	
60C MD 5A,B,C	875783 (838286) (838011)	15 783	
60C 2001, 2002, 2003  Ej för Volvo Penta sötvattenkylning / Not for Volvo Penta fresh-water cooling	877355 (875779)	15 779	
71C AQD 19, 21A,B, 27, 29A, 32A MD 19, 21A,B, 27, 29A, 32A	875785 (833826)	15 785	







## Termostatsatser (forts.) / Thermostat Kits (cont.)

Motor typ Engine type	Ref.nr. Ref. No.	Best.nr. Part No.	
<p>76C</p> <p>MD 30A* MD 40A** TAMD 60, 70B,D</p> <p>* 2 st åtgår / 2 pcs required ** 1 st åtgår / 1 piece required</p>	<p>3831425 (875787) (824200) (1544297)</p>	<p>15 787</p>	
<p>70C</p> <p>MD 31A* MD 40A MD 41A** TAMD 60, 70B,D</p> <p>* Tidigare utförande / Earlier version ** Tidigare utförande 1 st åtgår / ** Earlier version 1 piece required</p>	<p>3831426 (875788) (824200) (1544389)</p>	<p>15 788</p>	

## Packningssatser för vattenrör / Gasket Sets for Water Pipe



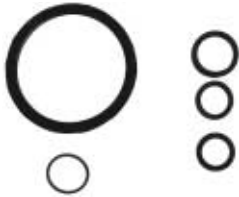

<p>MB 10A</p>		<p>22 036</p>	
<p>AQ 60, 90, 95, 100, 105, 110, 120A BB 30, 100 MB 18, 20</p>		<p>22 049</p>	
<p>AQ 115, 130 BB 115</p>		<p>22 061</p>	
<p>AQ 120B, 125A,B, 140A, 145A,B BB 140A, 145A</p>		<p>22 051</p>	
<p>AQ 131, 151, 171 230A, 250A, 251A</p>		<p>22 037</p>	

## Packningsseter för vattenrör (forts.) / Gasket Sets for Water Pipe (cont.)

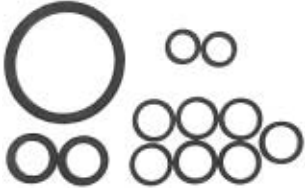

Motor typ Engine type	Ref.nr. Ref. No.	Best.nr. Part No.	
AQ 165A, 170A,B,C BB 165A, 170A,B,C		22 012	
MD 1B, 2B		22 035	
MD 5A,B,C		22 019	
MD 6A,B MD 7A,B		22 024	
MD 11C,D		22 021	
MD 11C,D, 17C,D  Med Volvo Penta sötvattenkyllning / With Volvo Penta fresh-water cooling		22 023	
MD 17C,D		22 025	



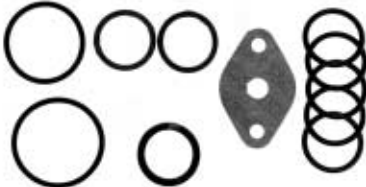
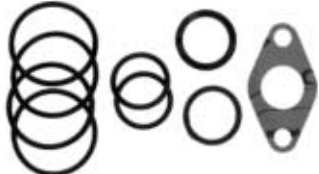

## Packningsatser för vattenrör (forts.) / Gasket Sets for Water Pipe (cont.)

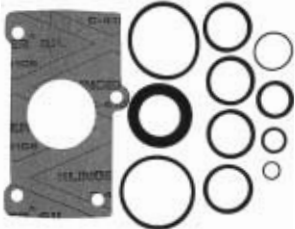
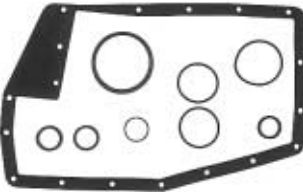
Motor typ Engine type	Ref.nr. Ref. No.	Best.nr. Part No.	
2001, 2002, 2003	876224	22 011	
2002, 2003  Med Volvo Penta sötvattenkyllning / With Volvo Penta fresh-water cooling		22 017	
2003T, TB  Med Volvo Penta sötvattenkyllning / With Volvo Penta fresh-water cooling		22 008	
MD 30 TMD 30		22 114	
AQAD 30A TAMD 30A		22 115	
MD 40 TMD 40		22 116	
MD 31 MD 41		22 113	

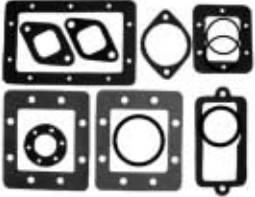
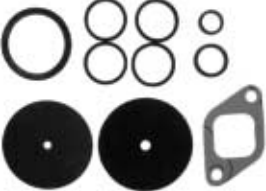
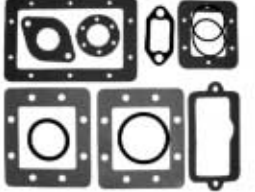
# Packningsseter för värmeväxlare / Gasket Sets for Heat Exchanger

Motor typ Engine type	Ref.nr. Ref. No.	Best.nr. Part No.	
AQ 120B, 125, 140, 145 BB 140A, 145A		22 103	
AQ 131, 151, 171 230A, 250A, 251A		22 015	
2002, 2003  För Volvo Penta sötvattenkyllning / For Volvo Penta fresh-water cooling		22 032	
2003T, 2003TB  För Volvo Penta sötvattenkyllning / For Volvo Penta fresh-water cooling		22 033	
MD 21A		22 122	
AQD 21A, MD 21B		22 123	
AQD 32A, MD 32A		22 124	

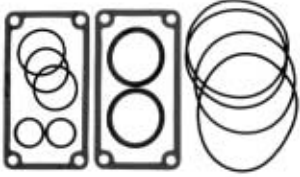
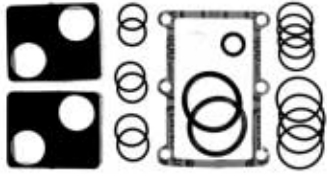
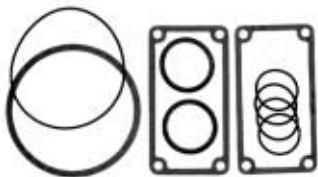
## Packningsatser för värmeväxlare (forts.) / Gasket Sets for Heat Exchanger (cont.)

Motor typ Engine type	Ref.nr. Ref. No.	Best.nr. Part No.	
MD 30A, TMD 30A		22 105	
MD 40A, TMD 40A, AQD 40A		22 106	
AQAD 40A,B AQD 40B TAMD 40A,B TMD 40B,C		22 107	
TMD 31B, 41B TAMD 31B, 41B AD 31B, 41B D 41B KAD/KAMD 42A		22 108	
TMD 31L-A, 41L-A TAMD 31P-A, L-A, M-A TAMD 41P-A, L-A, M-A, H-A AD 31P-A, L-A, 41 P-A, L-A D 41L-A		22 109	



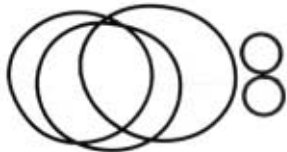
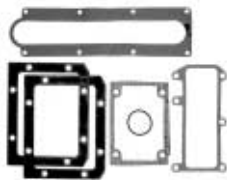



## Packningsatser för mellankylare / Gasket Sets for After Cooler

AQAD 30A TAMD 30A		22 110	
AQAD 40A,B TAMD 40A,B		22 111	

# Packningsseter för oljekylare / Gasket Sets for Oil Cooler

Motor typ Engine type	Ref.nr. Ref. No.	Best.nr. Part No.	
AQ 90, 95, 100, 110, 120A MB 18 BB 30, 100		22 068	
AQ 105, 115, 130, 140, 145, 151 165, 170, 171 230A, 250A, 251A BB 115, 140A, 145, 165, 170 MB 20 MD 21A, B		22 070	
2003T 2003TB  Med Volvo Penta sötvattenkylare / With Volvo Penta fresh-washer cooling		22 022	
MD 21A,B		22 127	
MD 32A		22 128	
30, 31, 40, 41- Motorer / Engines KAD 42P-A KAMD 42P-A TAMD 42WJ-A  För oljekylare med fyra skruvar / For oil cooler with four bolts		22 104	
KAD 32P-A, 42P-A, 43P-A, 44P-A KAMD 42P-A, 43P-A, 44P-A TAMD 42WJ-A  För oljekylare med tre skruvar / For oil cooler with three bolts		22 143	



## Packningsseter för cirkulationspumpar / Gasket Sets for Water Circulating Pumps

Motor typ Engine type	Ref.nr. Ref. No.	Best.nr. Part No.	
AQ 120B, 125A, 140A, 145A BB 140A, 145A		22 014	
AQ 125B, 145B		22 038	
AQ 131, 151, 171 230A, 250A, 251A		22 039	
AQ 165A, 170A,B,C BB 165A, 170A,B,C		22 013	
MD 21A,B		22 125	
MD 21B  Senare utförande med rörkylare / Late version with pipe cooler		22 126	

## Avtappningskranar för kylvatten / Drain Taps for Cooling Water

Motor typ Engine type	Ref.nr. Ref. No.	Best.nr. Part No.	
AQ 60, 90, 95, 100, 105, 110, 115, 120 130, 140, 145, 151, 165, 170, 171 230A, 250A, 251A BB 30, 100, 140, 145 MB 10A, 18, 20 MD 19, 21, 27, 29, 32  Gänga / Thread 1/8"	82744	15 744	
AQ 60, 90, 95, 100, 105, 110, 115, 120 130, 140, 145, 151, 165, 170, 171 230A, 250A, 251A BB 30, 100 MB 10A, 18, 20 MD 22A,L-A,L-B,P-B TMD 22P-B MD 19, 21, 27, 29, 32  Gänga / Thread 1/8"	966871	15 871	
AQ 90, 95, 100, 105, 110, 115, 120 125, 130, 131, 140, 145, 151, 171 BB 30, 100 MB 18, 20 AQD 40, AQAD 40, TMD 40  Gänga / Thread 1/4"	82745	15 745	
MD 1, 2, 3 MD 5A,B MD 6A, MD 6B*  * Earlier version Gänga / Thread 1/4"	807036	15 036	
MD 5C MD 11, 17	829592	15 592	
AQ 205A, 230A, 250A, 251A, 430, 431 500B, 501B, 570, 572, 740 MD 30, 31, 40, 41 KAD/KAMD 42A  Gänga / Thread 1/4"	949918	15 918	

## Avtappningskranar för kylvatten (forts.) / Drain Taps for Cooling Water (cont.)

Motor typ Engine type	Ref.nr. Ref. No.	Best.nr. Part No.	
AQ 90, 95, 100, 105, 110, 115, 120 125, 130, 131, 140, 145, 151, 171 BB 30, 100 MB 18, 20 MD 31A,B MD 40, 41B 2001, 2002, 2003  Gänga / Thread 1/4"	947893	15 893	
AQ 151, 171 230A, 250A, 251A  Gänga / Thread 3/8"	947894	15 894	

## Avtappningspropp för kylvatten / Drain Prop for Cooling Water

2002 V6 AQ 175A, 205A, 430A,B, 431A,B, 432A, 434A V-8 MD 30, 31, 40, 41 KAD/KAMD 42A  Gänga Thread 1/4"	861551 (192134)	15 134	
---	--------------------	--------	---

## Hållare för zinkanod / Connecting Plug for Zinc Anode

AQ 30, 31 AQ 40, 41 MD 19, 21, 27, 29, 32 2001, 2002, 2003  Gänga / Thread 1/2"	838728 (800475)	15 928	
--	--------------------	--------	---

## Zinkanoder för kylsystem / Zinc Anodes for Cooling System

Motortyp Engine type	Ref.nr. Ref. No.	Best.nr. Part No.	
AQ 30, 31, 40, 41 MD 19, 21, 27, 29, 32A 2001, 2002, 2003T KAD/KAMD 42A	838929 (804107) (800476) (858501)	<b>19 929</b>	
60, 70, 100, 120-motorer / engine  Zink anod / Zinc anode  Packning / Gasket	823661  836169	<b>15 661</b>  <b>15 169</b>	
AQ 120B, 125A,B, 140A, 145A,B 131A,B,C,D, 151A,B,C 230A, 250A  Endast för OSCO avgasrör / Only for OSCO exhaust manifold		<b>16 011</b>	
För MARTEC sötvattenkyllning For MARTEC fresh-water cooling MD 2A,B, 3B, 5A,B,C, 6A,B, 7A,B MD 11C,D, 17C,D 2001, 2002, 2003  1/4" x 15 mm	43957300	<b>15 300</b>	
För MARTEC sötvattenkyllning For MARTEC fresh-water cooling AQ 115, 130 (B 20) AQ 165, 170 (B 30)  1/4" x 27 mm	43957301	<b>15 301</b>	
För MARTEC sötvattenkyllning For MARTEC fresh-water cooling V-6, V-8  1/4" x 40 mm	43957302	<b>15 302</b>	
För Volvo Penta sötvattenkyllning For Volvo Penta fresh-water cooling V-6, V-8  3/8" x 36 mm	841063	<b>15 304</b>	



## Expansionsbrickor (rostfri) / Expansion Plugs (stainless)

Motor typ Engine type	Ref.nr. Ref. No.	Best.nr. Part No.	
B-18, B-20 V-8 MD 30, 31, 40, 41 KAD/KAMD 32A, 42A,B,P-A  Diameter 26 mm rostfri / stainless	477026 (192426)	11 031	
B-18, B-20, B-30, V-8 2001, 2002, 2003  Diameter 35 mm rostfri / stainless	477024 (192211)	11 032	
B-18, B-20, B-30 MD 21B, MD 29  Diameter 45 mm rostfri / stainless	192212	11 033	

## Expansionsbrickor (galvaniserade) / Expansion Plugs (galvanized)

Diameter 35 mm	463903	11 903	
B-18, B-20 Kamaxelbricka  Diameter 42 mm	463902 (955103)	11 902	
AQ 120B, 125A, 140A, 145A  Diameter 45 mm	463904	11 904	
KAD / KAMD 42A  Diameter 40 mm	968955 (1542263)	11 955	
AQ 131, 145, 151, 230, 250, 251 KAD /KAMD 42A  Diameter 52 mm	463905	11 905	

## Packningsatts för vakuumventil / Gasket Sets for Vacuum Valve

Motor typ Engine type	Ref.nr. Ref. No.	Best.nr. Part No.	
För alla motorer med vakuumventil / For all engines with vacuum valve	875738	15 738	

## Elpumpar för MARTEC sötvattenkyllning / Electric Pumps for MARTEC Fresh Water Cooling



MD 2A,B, 3B, 5A,B,C, 6A,B, 7A,B MD 11C,D, 17C,D 2001, 2002, 2003  16 mm anslutning / hose connection 14 liter / min. 12 volt	43213002	15 102	
MD 3, 17  19 mm anslutning / hose connection 23 liter / min. 12 volt	43213003	15 108	







## Avgasrör / Exhaust Manifolds

Motor typ Engine type	Ref.nr Ref. No.	Best.nr Part No.	
AQ 115A,B, 130A,B,C,D BB 115A,B,C  Passar ej / Not for: AQ 60F, BB 30, MB 18F, MB 20A,B,C	824532	16 532	
AQ 120B, 125A,B, 131A,B,C,D, 140A, 145A,B, 151A,B,C 230A,B, 250A,B	855387	16 387	
AQ 175A AQ 205A 430A,B, 431A,B, 432A, 434A	856894 (841676) (856137)	16 894	
AQ 200D,F, 211A, 225D,E,F, 231A,B, 255B, 280A, 260A,B, 271A,B,C,D, 290A, 311A,B 500A,B, 501A,B, 570A, 571A, 572A BB 225A,AV,C, 231A, 260A,AV,B,C, 261A	856883 (855926) (835804)	16 804	



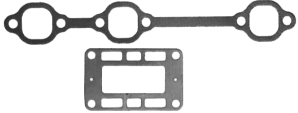

## Packningsatser för avgasrör / Gasket Kits for Exhaust Manifold

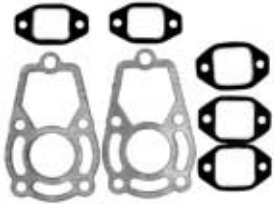
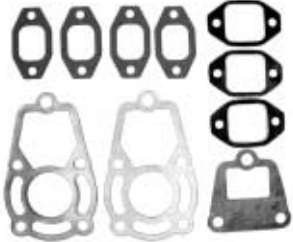
AQ 60, 90, 95, 100, 105, 110, 120A BB 30, 100 MB 18, 20A,B,C  För avgasrör 806333 / For exhaust manifold 806333		22 003	
AQ 115A,B,C, 130A,B,C,D BB 115A,B,C  För avgasrör 824532 / For exhaust manifold 824532		22 002	

## Packningsatser för avgasrör (forts.) / Gasket Kits for Exhaust Manifold (cont.)

Motor typ Engine type	Ref.nr Ref. No.	Best.nr Part No.	
AQ 120B, 125A,B, 131A,B,C,D 140A, 145A,B, 151A,B,C 230A, 250A BB 140A, 145A		22 004	
AQ 165A, 170A,B,C BB 165A, 170A,B,C		22 041	
AQ 175A AQ 205A 430A,B, 431A,B, 432A, 434A  P-sats för 1 sida / Gasket kits for one side 2 st åtgång / 2 pcs required		22 147	
AQ 200D,F, 211A, 225D,E,F, 231A,B, 255B, 280A, 260A,B, 271A,B,C,D, 290A, 311A,B 500A,B, 501A,B, 570A, 571A, 572A BB 225A,AV,C, 231A, 260A,AV,B,C, 261A  P-sats för 1 sida / Gasket kits for one side 2 st åtgång / 2 pcs required		22 001	
AQ 21A,B MD 21A,B		22 129	
AQD 32A MD 32A		22 130	





## Packningar för avgasrör / Gaskets for Exhaust Manifold

Motor typ Engine type	Ref.nr Ref. No.	Best.nr Part No.	
AQ 171A,C 251A	855513	16 513	
MD 1A,B MD 2A,B MD 3B MD 11C,D MD 17C,D  Mellan avgasrör och topplock / Exhaust manifold gasket	859145 (833598) (897322)	16 098	
MD 6A,B MD 7A,B  Mellan avgasrör och topplock / Exhaust manifold gasket	859194 (3875382)	16 194	
30, 40- Motorer / Engines  30 = 4 st åtgår / 4 pcs required 40 = 6 st åtgår / 6 pcs required	1542123	16 123	
31, 41- Motorer / Engines  31 = 4 st åtgår / 4 pcs required 41 = 6 st åtgår / 6 pcs required	838673 (876144)	16 673	

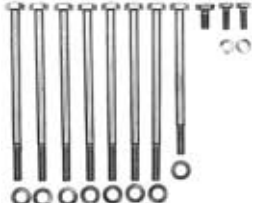

## Bultsatser för avgasrör / Bolt Kits for Exhaust Manifold

AQ 60, 90, 95, 100, 105A, 110 115A,B,C, 120A, 130A,B,C,D BB 30, 100, 115A,B,C MB 18, 20A,B,C  För avgasrör 806333, 824532 For exhaust manifold 806333, 824532		22 005	
---	--	--------	---

## Bultsatser för avgasrör (forts.) / Bolt Kits for Exhaust Manifold (cont.)

Motor typ Engine type	Ref.nr Ref. No.	Best.nr Part No.	
AQ 120B, 125A,B, 131A,B,C,D 140A, 145A,B, 151A,B,C 230A, 250A BB 140A, 145A		22 007	
AQ 165A AQ 170A,B,C		22 045	
430A,B, 431A,B, 432A, 434A AQ 175A AQ 205A  2 satser åtgår för komplett motor / 2 sets required for compl. engine		22 145	
AQ 200D,F, 211A, 225D,E,F, 231A,B, 255B, 280A, 260A,B, 271A,B,C,D, 290A, 311A,B 500A,B, 501A,B, 570A, 571A, 572A BB 225A,AV,C, 231A, 260A,AV,B,C, 261A  2 satser åtgår för komplett motor / 2 sets required for compl. engine		22 006	

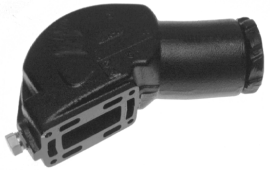

## Avgaskrökar / Exhaust Bends

BB 30, 100, 115A,B,C MB 18, 20A,B,C  För motorer med backslag / For engines with reverse gear	825600	16 600	
430A,B, 431A,B, 432A, 434A AQ 175A AQ 205A	857037 (841847) (855380) (856895)	16 037	
AQ 200D,F, 211A, 225D,E,F, 231A,B, 255B, 280A, 260A,B, 271A,B,C,D, 290A, 311A,B 500A,B, 501A,B, 570A, 571A, 572A BB 225A,AV,C, 231A, 260A,AV,B,C, 261A	856891 (855384)	16 384	

## Gavellock för avgasrör / Cover Plate for Exhaust Manifold

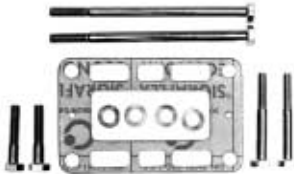

Motor typ Engine type	Ref.nr Ref. No.	Best.nr Part No.	
AQ 60, 90, 95, 100, 105, 110, 115, 120A, 130 BB 30, 100, 115 MB 18, 20  För alla B-18 och B-20 / For all B-18 and B-20	806341	16 341	

## Monteringskit för avgaskrök / Installation Kits for Exhaust Bend

AQ 60, 90, 95, 100, 105, 110, 115, 120A, 130 BB 30, 100, 115 MB 18, 20  För samtliga utföranden / For all version		16 001	
AQ 165, 170 BB 165, 170		22 102	
AQ 175A AQ 205A 430A,B, 431A,B, 432A, 434A  För avgaskrök 16037 / For exhaust bend 16037  2 satser åtgår för komplett motor / 2 sets required for compl. engine		22 146	
AQ 200D,F, 211A, 225D,E,F 231A,B, 255B, 280A, 260A,B 271A,B,C,D, 290A, 311A,B 500A,B, 501A,B, 570A, 571A, 572A  För avgaskrök 16384 / For exhaust bend 16384  2 satser åtgår för komplett motor / 2 sets required for compl. engine		16 008	





## Packningar för avgaskrök / Gaskets for Exhaust Bend

Motor typ Engine type	Ref.nr Ref. No.	Best.nr Part No.	
MD 6A,B MD 7A,B 2001 2002 2003	840902 (3875050)	16 902	
MB 10A MD 1A,B, 2A,B, 3B MD 11C,D, 17C,D MD 5A,B,C MD 6A,B, 7A,B	859015 (803374)	16 374	
AQD 19, 21A,B, 27, 29, 32A MD 19, 21A,B, 27, 29, 32A	859140 (819720)	16 140	

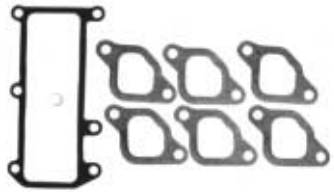

## Avgasslangar för avgaskrök / Exhaust Hoses for Exhaust Bend

AQ 60, 90, 95, 100, 105, 110, 115, 120A, 130 AQD 19, 21, 27, 29, 32A  Längd 200 mm. Innerdiameter $\varnothing$ 57 mm / Length 200 mm. Inside $\varnothing$ 57 mm		16 007	
AQ 165A, 170A,B,C  Längd 130 mm. Innerdiameter $\varnothing$ 75 mm / Length 130 mm. Inside $\varnothing$ 75 mm		16 010	
V-6 AQ 175A/280 AQ 430A, 431A Tid. utf. / Earl. version  V-8 För avgaskrök 16384 Längd 160 mm. Innerdiameter $\varnothing$ 95 mm 4 slangklammer 19012 åtgår / For exhaust bend 16384. Length 160 mm. Inside $\varnothing$ 95 mm 4 hose clamps 19012 required.	834751	16 751	

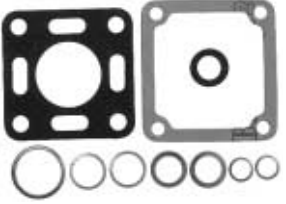

## Packningssatser för insugsrör / Gasket Sets for Inlet Pipe

Motor typ Engine type	Ref.nr. Ref. No.	Best.nr. Part No.	
AQAD 30A MD 30A TMD 30A TAMD 30A		22 119	
AQAD 40A,B MD 40A TAMD 40A,B		22 120	
AQD 40A TMD 40A		22 121	







## Packningssatser för avgaskrök - turbo / Gasket Kits for Connect. with Turbo

2003T 2003TB		22 034	
MD 30A MD 31A MD 40A		22 134	
AQAD 30A TAMD 30A TMD 30A	3582595 (876313) (875734)	22 135	





## Packningsatser för avgaskrök - turbo (forts.) / Gasket Kits for Connect. with Turbo (cont.)

Motor typ Engine type	Ref.nr. Ref. No.	Best.nr. Part No.	
AQAD 40A,B AQD 40A TAMD 40A,B TMD 40A,B,C	876398 (875646)	22 139	
31, 41, 42, 43, 44	3582563 (876312) (876108)	22 138	

# Bränslefilter / Fuel Filters

Motor typ Engine type	Ref.nr Ref. No.	Best.nr Part No.	
AQ 120B, 125, 131, 151, 171, 175A 200C,D, 225B,C,D,E,F, 230, 250 251, 255A,B, 260A,B, 280A, 290A BB 140A, 145A, 225A,AV,B 260A,AV,B,C  Packning ingår / Gasket included	841162 (835860)	17 162	
AQ 200F, 225F, 205A, 211A, 231A,B 271A,B,C,D, 311A,B 430A,B, 431A,B 500A,B, 501A,B, 570A, 571A, 572A 740A,B BB 225C, 231A, 261A  V-8 Senare utförande -93 V-8 Late version -93	855686	17 686	
MD 1A,B, 2A,B, 3B MD 5A,B, MO 19950, -20837, -22578 MD 11C,D MO -50883 MD 17C,D MO -16371  Packning ingår / Gasket included	876554 (870065)	17 065	
MD 5B,C, MO 19951-, 20838-, 22578- MD 7B MO 33080- MD 11C,D MO 50884- MD 17C,D MO 16372- 2001, 2002, 2003, 2003T	829913	17 913	
MD 2010 A,B MD 2020 A,B MD 2030 A,B MD 2040 A,B	861477	17 477	
AD 70C AQD 70B,D,BL,CL KAD 32A MD 7A,B MO -33079 MD 30A, 31A,B, 70B,C, 100B, 120A TAMD 60A,B,C, 70B,C,D,E, 120A,B,C THAMD 70B,C TMD 70B,C, 100A,C, 120A,B, 121C	3825133 (829993) (466987) (243004)	17 987	



## Bränslefilter (forts.) / Fuel Filters (cont.)

Motor typ Engine type	Ref.nr Ref. No.	Best.nr Part No.	
MD 6A,B MD 7A* MD 22A,L-B,P-B TMD 22B,L-A TAMD 22P-B MD 40A,B,C MD 41A,B KAD/KAMD 42A,B 43-44  * Tidigare utförande / Earlier version	860874 (838593) (243464)	17 874	
MD 21, 29, 32A  Kort filter för CAV vattenavskiljare (typ 296) / Short filters insert for CAV water separator (type 296)	3581078 (858201) (236628)	17 201	
Lång filterinsats för CAV filter / Long filter insert for CAV filter	858202 (858306)	17 306	
Filter insats för RACOR filter / Filter insert for RACOR filter  861143 and 861144  10 micron Packningar ingår / Rubber seals included	861014 (828897)	17 101	
Filter insats för RACOR filter / Filter insert for RACOR filter  3825020 and 3825021  10 micron Packningar ingår / Rubber seals included	3825027 (846734)	17 027	

## CAV filter komplett / CAV Fuel Filter complete

Med 1/2" x 20 UNF invändig gänga / With 1/2" x 20 UNF inner thread	1140639 (875542) (821094)	17 109	
---	---------------------------------	--------	---

## Nippelsats för CAV-filter / Connector Kit for CAV Filter

Motor typ Engine type	Ref.nr Ref. No.	Best.nr Part No.	
Slangfäste för 8 mm slang med 1/2" x 20 UNF gänga /  Hose connectors for 8 mm hose with 1/2" x 20 UNF thread  Sats om 2 st / Kit of 2 pcs		22 140	
Slangfäste för 8 mm slang / Hose connectors for 8 mm hose		17 004	
Slangfäste för 10 mm slang / Hose connectors for 10 mm hose		17 005	

## Ombyggnadssats CAV-filter / Rebuilding Kit for CAV Filter

		17 002	
--	--	--------	---

## Packningssats för CAV bränslefilter / Gasket Set for CAV Fuel Filter

Packningssats komplett för filter / Complete set of gasket for filter		22 046	
--	--	--------	---

## Glasskål för CAV bränslefilter / Glass Bowl for CAV Fuel Filter

Motor typ Engine type	Ref.nr. Ref. No.	Best.nr. Part No.	
Glasskål / Glass bowl	818407	17 407	



## Bult för CAV bränslefilter / Bolt for CAV Fuel Filter

Bult för ombyggnad av CAV vattenavskiljare till längre modell / Long centre bolt to convert CAV filter to longer type		17 307	
---	--	--------	---



## Avtappningsplugg för CAV filter / Drain Plug for CAV Fuel Filter

Packning 17249 ingår / Gasket 17249 included	862293 (826648)	17 648	
--	--------------------	--------	---



## Luftfilterinsatser / Air Filter Inserts

30, 32 40, 42, 43, 44 60 70	876185 (463505)	17 185	
31 41  Tidigare utförande / Earlier version	858488	17 488	

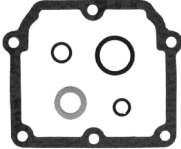

## Packningssats för bränslepump / Gasket Sets for Fuel Pump

Motor typ Engine type	Ref.nr. Ref. No.	Best.nr. Part No.	
MB 10A MD 1B, 2A,B, 3B MD 5A,B,C MD 6A,B, 7A,B MD 11C,D, 17C,D 2001, 2002, 2003		17 003	
30, 31 40, 41	273663	17 663	

## Packningssats för förgasare / Gasket Sets for Carburettor

AQ 120A, 130A,B,C, 165A  För Zenith/Stromberg förgasare CD 175 / For Zenith/Stromberg carburettor CD 175	271473 (275489)	22 141	
AQ 115, 125, 130, 131, 145, 151, 170, 171 230A, 250A, 251A BB 140A, 145A  För Solex förgasare / For Solex carburettor	856470 (824803)	17 803	

## Bränslepumpar / Fuel Pumps

AQ 120B, 140A senare utf. 125, 131, 145, 151, 171 230A, 250A, 251A BB 145A	841161	17 161	
MD 1B, 2A,B, 3B MD 5A,B,C MD 6A,B, 7A,B MD 11C,D, 17C,D 2001, 2002, 2003	833323	17 323	





## Elektrisk universal bränslepump / Electric Universal Fuel Pump

Motor typ Engine type	Ref.nr. Ref. No.	Best.nr. Part No.	
För bensen och dieselmotorer / For gasoline and diesel engines  12 volt / 132 liter/tim. sughöjd 300 mm med inbyggd övertrycksventil 0,3-0,5 kg  132 l / hour selfpriming 12 inches fuel lift. Built in pressure relief valve 6,5-7,5 psi		17 017	

## Distansbricka för bränslepump / Spacer for Fuel Pump

AQ 120B, 140A senare utf. 125, 131, 145, 151, 171 230A, 250A, 251A BB 145A	463391	17 391	
---	--------	--------	---

## Förgasarmembran / Carburettor Diaphragm

AQ 95, 105, 110 BB 100  För Zenith/Stromberg förgasare CD 150 For Zenith/Stromberg carburettor CD 150	825973 (820366)	17 973	
AQ 120A; 130A,B, 165A BB 115A, 165A  För Zenith/Stromberg förgasare CD 175 For Zenith/Stromberg carburettor CD 175	237666 (237299)	17 666	

## Spridarspets / Nozzles

MD 1B, MD 2B, MD 3B MD 11C MO -50988 MD 17C MO -16621	233179	17 179	
---	--------	--------	---

## Spridarspets (forts.) / Nozzles (cont.)

Motor typ Engine type	Ref.nr. Ref. No.	Best.nr. Part No.	
MD 5A,B,C MD 7A,B	838287	17 287	
MD 6A,B	3875400	17 400	
MD 11C MO 50989- MD 11D MD 17C MO 16622- MD 17D	829909	17 909	
2001 Prod. No. 868231 2002 Prod. No. 868232 2003 Prod. No. 868233	860340 (859461)	17 461	
2001, 2002, 2003	840597	17 597	
2001B, BG 2002B, BG 2003B, BG	860791	17 791	
2003 2003AG	860177	17 177	



## Spridarspets (forts.) / Nozzles (cont.)

Motor typ Engine type	Ref.nr. Ref. No.	Best.nr. Part No.	
2003T	858068	17 068	
2003TB	860557	17 557	
AQD 21A,B MD 21A,B	826574	17 574	
AQD 29A, 32A MD 29A, 32A	826578	17 578	
AQAD 30A, 40A,B AQD 40A MD 30A TAMD 30A, 40A,B TMD 30A, 40A,B,C	1542303	17 303	
MD 31A	858205	17 205	
AQAD 31A, 41A TAMD 31A, 41A TMD 31A, 41A	858358	17 358	



## Spridarspets (forts.) / Nozzles (cont.)

Motor typ Engine type	Ref.nr Ref. No.	Best.nr Part No.	
AD 31B, 41B D 41B TAMD 31B, 41B, 41P-A TMD 31B, 41B	859782	17 782	







## Packningssatser för montering av spridare / Gasket Kits for Connecting Fuel Injector

AQAD 30A MD 30A TAMD 30A TMD 30A		22 018	
AQAD 40A,B AQD 40A MD 40A TAMD 40A,B TMD 40A,B,C		22 010	



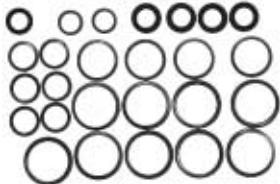



## Bricksatser för bränslesystem / Sealing Washer Kits for Fuel System

MD 1A,B MD 2A,B MD 11C		22 088	
MD 3B MD 17C		22 043	

# Bricksatser för bränslesystem (forts.) / Sealing Washer Kits for Fuel System (cont.)

Motor typ Engine type	Ref.nr Ref. No.	Best.nr Part No.	
MD 5A,B		22 048	
MD 5C		22 063	
MD 6A,B, MD 7A,B		22 044	
MD 11D		22 064	
MD 17D		22 065	
2001		22 029	





## Bricksatser för bränslesystem (forts.) / Sealing Washer Kits for Fuel System (cont.)

Motor typ Engine type	Ref.nr Ref. No.	Best.nr Part No.	
2002		22 030	
2003		22 031	
AQD 21A MD 21A		22 131	
AQD 21B MD 21B		22 132	
AQD 29, 32A MD 29, 32A		22 133	
MD 30A		22 020	

## Bricksatser för bränslesystem (forts.) / Sealing Washer Kits for Fuel System (cont.)



Motor typ Engine type	Ref.nr Ref. No.	Best.nr Part No.	
MD 31A		22 027	
MD 31B		22 026	
MD 31 L-A		22 117	
AQAD 40 AQD 40		22 052	
MD 41A	876227	22 069	
MD 41B KAD/KAMD 42A		22 028	
MD 41L-A		22 118	

# Fördelarlock / Distributor Caps





Motor typ Engine type	Ref.nr Ref. No.	Best.nr Part No.	
AQ 60, 90, 95, 100, 105, 110, 115 120A, 130 BB 30, 100, 115, MB 18, 20	879690 (870422) (239598) (233260) (243632)	<b>18 690</b>	
AQ 115, 120B, 130, 140A BB 115A,B MB 20B,C	243797	<b>18 797</b>	
AQ 165, 170 BB 165A  Diameter 73 mm	241669	<b>18 669</b>	
AQ 170B,C BB 170A,B,C  Diameter 90 mm	243658 (243803)	<b>18 658</b>	
AQ 120B, 125A,B, 131A,B,C,D, 140A 145A,B, 151A,B,C, 230A, 250A BB 140A, 145A  Lock med skruvfastsättning / Cap to be fitted with screws	841263	<b>18 263</b>	
AQ 175A, 205A, 430A,B, 431A,B	841926	<b>18 926</b>	
V-8  Platt lock / Flat cap	841244 (835310)	<b>18 244</b>	







## Fördelarlock (forts.)/ Distributor Caps (cont.)

Motor typ Engine type	Ref.nr Ref. No.	Best.nr Part No.	
V-8  Lock med skruvfastsättning / Cap to be fitted with screws	841070	18 070	
V-8  Lock med clipsfastsättning / Cap to be fitted with spring clips	835702	18 702	

## Tändkabelsats / Ignition Cable Sets

AQ 60, 90, 95, 100, 105, 110, 115 120A, 130 BB 30, 100, 115 MB 18, 20	875363	18 363	
AQ 120B, 125, 131, 140, 145, 151 230A, 250A BB 140A, 145A	875571	18 571	
AQ 165, 170 BB 165, 170	875404	18 404	
V-8  Värmetåliga silikonkablar / Heat resistant silicone cables	3651819	18 001	





# Rotorer / Rotors

Motor typ Engine type	Ref.nr Ref. No.	Best.nr Part No.	
B18 B 20	238258 (233678)	<b>18 258</b>	
MB 10A B 18 B 20 B 21 B 30*  * Tidigare utförande / Earlier version	243903 (240305) (243796)	<b>18 903</b>	
B 30  Senare utförande / Late version	243657	<b>18 657</b>	
V-8	841243	<b>18 243</b>	
V6, V8  5,0FL,GL,BY,WT,EF 5,7GL,GS 5,8FL 7,4GL 8,2GL 430A,B 431A,B 501A,B 570A 571A 572A/MS4A 740A,B AQ 175A AQ 200C,D,F AQ 205A AQ211A AQ 225B,D,E,F AQ 231A,B AQ 255B AQ 260A,B AQ 271A,B,C,D AQ 280A AQ 290A AQ 311A,B BB 225A,B,C BB 231A BB 260A,B,C BB 61A	3853801 (855845) (841907)	<b>18 845</b>	



## Rotorer (forts.) / Rotors (cont.)

Motor typ Engine type	Ref.nr. Ref. No.	Best.nr. Part No.	
V-8	834975	18 975	





## Brytarspetsar / Breaker Points

B 18 B 20	240149	18 149	
B 18 B 20	1306169	18 169	
MB 10A* B 18 B 20 B 21  * Fördelare / Distributor 0231 109 017	243799	18 799	
AQ 170B,C B 30*  * Tidigare utförande / Earlier version	241652	18 652	
B 30  Senare utförande / Late version	243801	18 801	





## Brytarspetsar (forts.) / Breaker Points (cont.)

Motor typ Engine type	Ref.nr. Ref. No.	Best.nr. Part No.	
V-8  För fördelare med platt lock / For distributor with flat cap	835304	<b>18 304</b>	
AQ 175A V-8	835705 (855846) (841287)	<b>18 705</b>	

## Kondensatorer / Condensers

B 18 B 20	233842	<b>18 842</b>	
MB 10A* B 18 B 20  * Fördelare / Distributor 0231 109 017	834545	<b>18 545</b>	
B 18 B 20	241710	<b>18 710</b>	
B 30  Tidigare utförande / Earlier version	243653	<b>18 653</b>	





## Kondensatorer (forts.) / Condensers (cont.)

Motor typ Engine type	Ref.nr. Ref. No.	Best.nr. Part No.	
B 30	834546	18 546	
B 21 B 23  Rund genomföring / Round hole	841262	18 262	
B 21 B 23  Fyrkantig genomföring / Square hole	834560	18 560	
V-8	835308	18 308	
V-8	835704	18 704	

# Delar för Bosch tändfördelare / Parts for Bosch Distributor

BOSCH beteckning på fördelarhus / BOSCH distributor Part No.	Äldre BOSCH beteckningar / Earlier BOSCH part No.	Fördelare Ref.nr./ Distributors Ref.No.	Lock Best.nr./ Cap Part No.	Rotor Best.nr./ Rotors Part No.	Brytare Best.nr./ Breaker p. Part No.	Kondens. Best.nr./ Condensor Part No.
0231 109 015		234240	--	18 903	--	--
0231 109 017		834695	--	18 903	18 799	18 545
0231 110 036	VJU 4 BR 30	238724	18 690	18 258	--	18 842
0231 110 038	VJ4 BL 32 (tmk)	238903	18 690	18 258	18 149	18 842
0231 110 043	VJ4 BL 37 t	239771	18 690	18 258	18 149	18 842
0231 112 007	VJU 4 BR 9	76853	18 690	18 258	--	--
0231 112 031	VJU 4 BR 20	233347	18 690	18 258	--	--
0231 116 054		241533	18 669	18 903	18 652	18 653
0231 116 060		241533	18 669	18 903	18 652	18 653
0231 121 008		831786	18 669	18 903	18 169	18 653
0231 153 003		240208	18 690	18 903	18 149	18 842
0231 153 007		241261	18 690	18 903	18 149	18 842
0231 153 010		--	18 690	18 903	18 169	18 710
0231 153 012		241531	18 690	18 903	18 169	18 710
0231 153 038		--	18 690	18 258	18 149	18 842
0231 178 005		831785	18 797	18 903	18 799	18 545
0231 178 010		831663	18 797	18 903	18 799	18 560
0231 178 011		834465	18 797	18 903	18 799	18 545
0231 178 016		834960	18 263	18 903	18 799	18 262
0231 178 017		834961	18 263	18 903	18 799	18 262
0231 178 018		841053	18 797	18 903	18 799	18 560
0231 178 019		855712	18 263	18 903	18 799	18 262
0231 311 002		834466	18 658	18 657	18 801	18 546

# Delar för V-6 och V-8 fördelare / Cross Reference for V-6 and V-8 Distributors

Lock typ / Cap type	Motor typ / Engine type	Fördelare Ref.nr./ Distributors Ref.No.	Lock Best.nr./ Caps Part No.	Rotor Best.nr./ Rotors Part No.	Brytare Best.nr./ Breaker p. Part No.	Kondens Best.nr./ Condensor Part No.
	AQ 175A	841760 855599	18 926	18 845	18 705	18 704
	AQ 205A 431A,B	856143	18 926	18 845	--	--
	430A,B	856846	18 926	18 845	--	--
Platt lock / Flat cap 	AQ 210A	835152	18 244	18 243	18 304	18 308
	AQ 200B 225A, B 255B	835309	18 244	18 243	18 304	18 308
	AQ 200C 225C 255A	826430	18 244	18 975	18 304	18 308
Lock med fjäderclips / Cap to be fitted with spring clips 	AQ 200D, 225D 255B, 260A, 280A	834855	18 702	18 975	18 705	18 704
	AQ 190A 240A	835689	18 702	18 975	18 705	18 704
	AQ 290A	841288	18 702	18 975	18 705	18 704
Lock med skruv / Cap to be fitted with screws 	AQ 200B, D 225B, C, D, E, F 255B, 260A, B BB 225A, AV, B, C 260A,B, AV, C 261A	841069	18 070	18 845	18 705	18 704

## Delar för V-6 och V-8 fördlare (forts.) / Cross Ref. for V-6 and V-8 Distributors (cont.)







Lock typ / (forts.) Cap type (cont.)	Motor typ / Engine type	Fördelare Ref.nr./ Distributors Ref.No.	Lock Best.nr./ Caps Part No.	Rotor Best.nr./ Rotors Part No.	Brytare Best.nr./ Breaker p. Part No.	Kondens Best.nr./ Condensor Part No.
	AQ 211A, 231A,B BB 231A	855929	18 070	18 845	1 8705	18 704
	AQ 290A	841729	18 070	18 845	18 705	18 704
	AQ271A,B, 311A	855705	18 070	18 845	--	--
	500A, 501A	856794	18 070	18 845	--	--
	500B	856840	18 070	18845	--	--
	501B	856975	18070	18 845	--	--
	271C,D, 311B 570A, 571A 740A,B	855932	18 070	18 845	--	--
	572A	857151	18 070	18 845	--	--

## Oljetryckskontakater / Oil Pressure Sensors







MB 10 B 18, B 20, B 30 Samtliga utförande / All versions  AQ 120B, 125A, 140A, 145A Exkl. USA AQ 200B, 210A, 225A,B AQD 21, 29, 32 MD 21, 29, 32 2001, 2002, 2003	1324750 (654874) (672910) (1266085) (1606877)	<b>18 750</b>	
MD 1, 2, 3 MD 5A,B MD 6A,B	807078	<b>18 078</b>	
MD 5C MD 7A,B MD 11C,D MD 17C,D	829587	<b>18 587</b>	









# Drivremmar / Drive Belts

Motor typ Engine type	Ref.nr. Ref. No.	Best.nr. Part No.	
AQ 60, 90, 95, 100, 105, 110, 115, 120A, 130 BB 30, 100, 115 MB 18, 20  Längd / Length 711 mm	966891	<b>18 805</b>	
MD 2A Upp till / Up to MO -6274  MD 30, 40 Med extra vx-generator / With additional alternator  Längd / Length 1000 mm	966914 (958310)	<b>18 310</b>	
MD 1B MD 2A Från / From MO 6275- MD 2B För vevaxelremskiva diam. 210 mm / For crankshaft pulley diam. 210 mm  Längd / Length 1025 mm	966916 (958311)	<b>18 311</b>	
MD 27, 29* V-8**  * Med vx-generator / With alternator ** För servopump / For servo pump  Längd / Length 1050 mm	966387	<b>18 387</b>	
MB 10A* * För Bosch startgenerator / * With Bosch dynamo 2 st åtgår / 2 pcs required  AQ 120B, 125A,B, 140A, 145A, 165A, 170A,B,C 230A,B, 250A,B, 251A BB 140, 165, 170  För 35 amp. generator / For 35 amps alternator  Längd / Length 1075 mm	966694 (834548)	<b>18 548</b>	
AQ 120B, 125A, 140A, 145A,B 131A,B,C,D, 151A,B,C 171A,C  För 50 amp. generator / For 50 amps alternator  Längd / Length 1092 mm	966382 (841821)	<b>18 382</b>	







## Drivremmar (forts.) / Drive Belts (cont.)

Motor typ Engine type	Ref.nr. Ref. No.	Best.nr. Part No.	
MD 30, 31 MD 40, 41 KAD/KAMD 42*  * Med extra generator / * With additional alternator  Sats om 2 remmar / Kit of 2 belts  Längd / Length 1100 mm	966978	<b>18 978</b>	
MD 6A Från / From MO 1235-  För startgenerator, sats om 2 remmar / For dynamo, kit of 2 belts  Längd / Length 1140 mm	966981	<b>18 981</b>	
MD 19, 21, 32  Med vx-geneator / With alternator  Längd / Length 1168 mm	829207	<b>18 207</b>	
MD 3B, 17C  Längd / Length 1175 mm	966383	<b>18 383</b>	
MD 6A Upp till / Up to MO -1234  För startgenerator, sats om 2 remmar / For dynamo, kit of 2 belts  Längd / Length 1175 mm	966700	<b>18 700</b>	
AQ 1175A, 200A,B,C,D,F, 205A, 210A, 225A,B,C,D,E,F 211A, 231A,B, 255A,B, 260A,B,C,D, 271A,B,C,D, 280A 290A, 311A,B 430A,B, 431A,B, 500A,B, 501A,B, 570A, 571A, 572A BB 225A,AV,B,C, 260A,B,C, 261A  Längd / Length 1200 mm	966857	<b>18 498</b>	



## Drivremmar (forts.) / Drive Belts (cont.)

Motor typ Engine type	Ref.nr. Ref. No.	Best.nr. Part No.	
MD 17D  Längd / Length 1250 mm	966385	<b>18 385</b>	
MD 1A Från / From MO 11132- MD 1B, 2A,B*  * För startgenerator sats om 2 remmar / * For dynamo. Kit of 2 belts  Längd / Length 1300 mm	966990	<b>18 990</b>	
MD 5 Upp till / Up to MO -30016 MD 11C  Längd / Length 1300 mm	966698	<b>18 698</b>	
MD 5 Från / From MO 30017-  Längd / Length 1325 mm	976492 (966843)	<b>18 843</b>	
MD 6A MD 11C  Längd / Length 1400 mm	966931	<b>18 931</b>	
MD 6B MD 7A  Längd / Length 1425 mm	966933 (958327)	<b>18 327</b>	
MD 7B  Längd / Length 1450 mm	966707	<b>18 707</b>	

## Drivremmar (forts.) / Drive Belts (cont.)

Motor typ Engine type	Ref.nr. Ref. No.	Best.nr. Part No.	
MD 17D  Längd / Length 1500 mm	966938	<b>18 330</b>	
MD 11C,D  Med V-P sötavattenkyllning / With V-P fresh water cooling  Längd / Length 1550 mm	966942	<b>18 942</b>	
2002 2003  Längd / Length 825 mm	966900	<b>18 900</b>	
2001  Längd / Length 863 mm	966903 (960281)	<b>18 003</b>	
MD 2B* MD 11C 2002** 2003 (T)**  * För vevaxelremskiva diam. 150 mm / * For crankshaft pulley diam. 150 mm ** Med V-P sötavattenkyllning / ** With V-P fresh water cooling  Längd / Length 900 mm	966906	<b>18 906</b>	
MD 11D  Längd / Length 913 mm	966907	<b>18 283</b>	



## Kamremmar / Timing Belts

Motor typ Engine type	Ref.nr. Ref. No.	Best.nr. Part No.	
AQ 120B, 125, 131, 140, 145, 151, 230, 250	463377	12 377	
AQ 171A,C 251A	855506	12 506	

## Laddningsregulator / Voltage Regulator

<p>För alla Volvo Penta marinmotorer med SEW-Marchal 35 amp generator. Komplett med långa kablar</p> <p>For all Volvo Penta marine engines with SEW-Marchal 35 amps alternator. Complete with long cables</p>	847605	18 605	
---	--------	--------	--

## Packningsatts för cylinderfoder / Gasket Set for Cylinder Liner

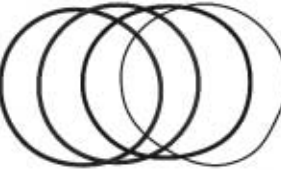
Motor typ Engine type	Ref.nr. Ref. No.	Best.nr. Part No.	
MD 11C,D, 17C,D  MD 11 = 2 st åtgår / 2 pcs required MD 17 = 3 st åtgår / 3 pcs required	875550	11 550	
MD 5A,B,C  1 st åtgår / 1 piece required	875560	11 560	
30, 31 40, 41 KAD/KAMD 42  30, 31 = 4 st åtgår / 4 pcs required 40, 41 = 6 st åtgår / 6 pcs required	275751 875651 (275595)	11 651	

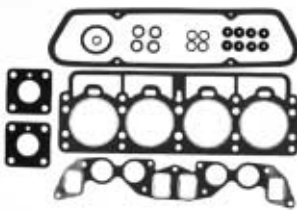
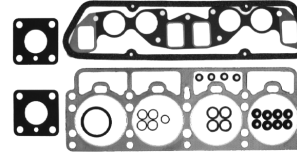
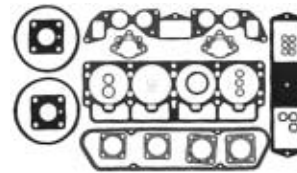

## Sotningsatser / Decarb. Gasket Set

AQ 95, 110 BB 100, MB 18	876357	21 357	
AQ 95, 110 BB 100, MB 18  För motorer med B-20 block / For engines with B-20 block		21 358	
AQ 115A, 130A,C MB 20B	876356 (875401)	21 401	

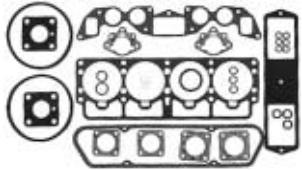
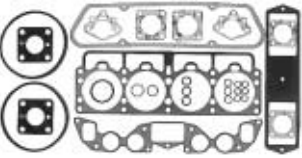
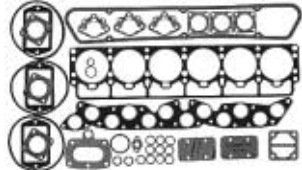
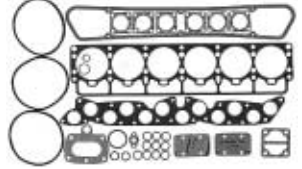
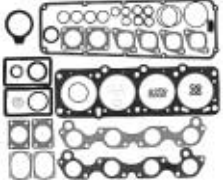
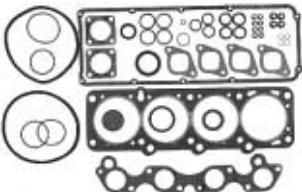
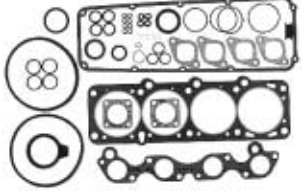
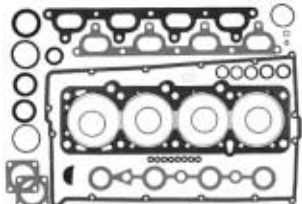
## Sotningsatser (forts.) / Decarb. Gasket Set (cont.)

Motor typ Engine type	Ref.nr. Ref. No.	Best.nr. Part No.	
AQ 130B BB 115A,B MB 20A	876348 (875418)	21 418	
AQ 115B,C, 130D MB 20C	876358 (875569)	21 569	
AQ 165A 170A, B BB 165A 170A,B	876335 876337 (875402) (8755335)	21 335	
AQ 170C BB 170C	876359 (875570)	21 359	
AQ 120B, 125A, 140A BB 140A	876300 (875587)	21 300	
AQ 125B, 131A,B,C,D, 145B, 151A,B,C 230A,B, 250A,B	876302 (876022)	21 302	
AQ 145A BB 145A	876301 (875678)	21 301	
AQ 171A,C 251A	876303 (876071)	21 303	

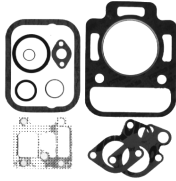
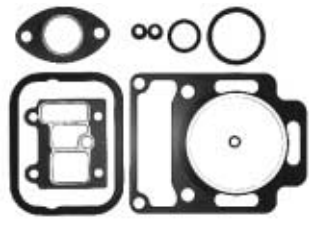
## Sotningsatser (forts.) / Decarb. Gasket Set (cont.)

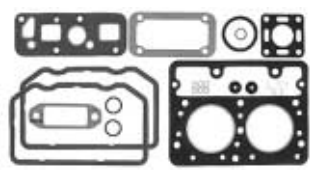
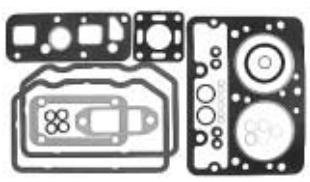
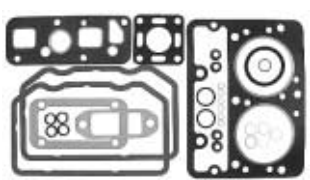
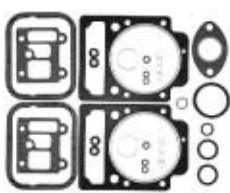
Motor typ Engine type	Ref.nr. Ref. No.	Best.nr. Part No.	
MD 1A, 2A  Kolv / Piston Ø 79 mm  MD 1A = 1 st åtgång / 1 piece required MD 2A = 2 st åtgång / 2 pcs required	875422 (876415)	21 422	
MD 1B  Kolv / Piston Ø 89 mm  MD 1B = 1 st åtgång / 1 piece required MD 2B = 2 st åtgång / 2 pcs required MD 3B = 3 st åtgång / 3 pcs required	876377 (875500) 876374 (875502) 876375 (875504)	21 500	
MD 5A,B,C	876341 (875561)	21 561	
MD 6A,B	876379 (875508)	21 379	
MD 7  Upp till / Up to MO -35144	876430 (875613)	21 430	
MD 7  Från / From MO 35145-	876431 (875613)	21 431	
MD 11C,D  Foderpackningssats 11550 ingår ej i denna packningssats / Cylinder liner gasket kit 11550 not included. 2 st 11550 åtgång / 2 pcs 11550 required	876376 (875553)	21 553	

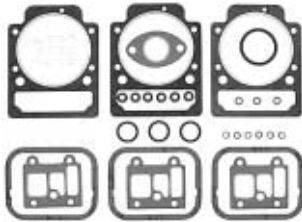
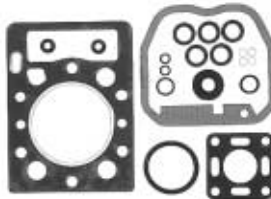
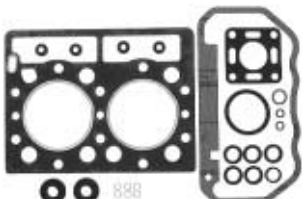
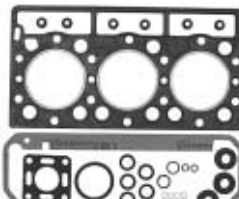
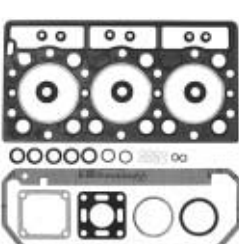
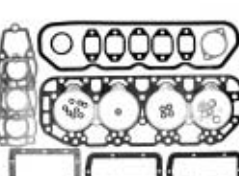
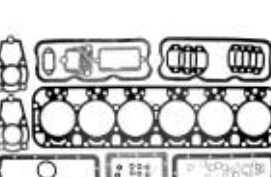

## Sotningsatser (forts.) / Decarb. Gasket Set (cont.)

Motor typ Engine type	Ref.nr. Ref. No.	Best.nr. Part No.	
MD 17C,D  Foderpackningssats 11550 ingår ej i denna packningssats / Cylinder liner gasket kit 11550 not included. 3 st 11550 åtgår / 3 pcs 11550 required	876380 (875572)	21 572	
2001 2001AG 2001B 2001BG	876307	21 307	
2002 2002AG 2002B 2002BG	876308	21 308	
2003 2003AG 2003B 2003BG	876309	21 309	
2003T 2003TB	876310	21 310	
AQD 21A,B MD 21A,B	876417 (875388) (875567)	21 417	
AQD 32A MD 32A	876416 (875438)	21 416	



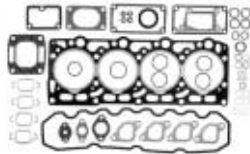
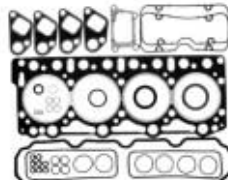
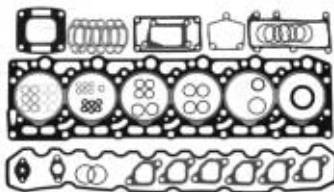
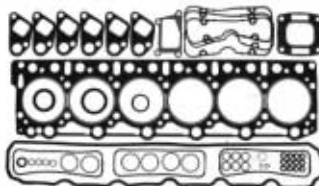

## Sotningsatser (forts.) / Decarb. Gasket Set (cont.)

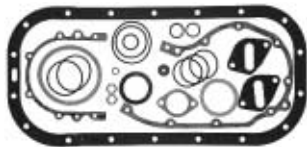
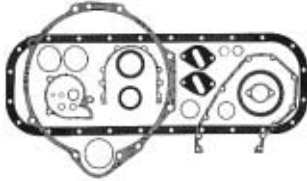
Motor typ Engine type	Ref.nr. Ref. No.	Best.nr. Part No.	
AQAD 30A MD 30A TAMD 30A TMD 30A	3582597 (876453) (875031)	21 453	
AD 31B,P-A,L-A AQAD 31A KAD 32P-A MD 31A TAMD 31A,B,P-A,L-A,M-A TMD 31A,L-A	876103	21 103	
AQAD 40A,B AQD 40A MD 40A TAMD 40A,B TMD 40A,B,C	3582596 (876395) (875633) (875662)	21 395	
AD 41B,L-A AQAD 41A AQD 41A D 41B,L-A KAD 42A KAD43P-A KAMD 42A KAMD 43P-A TAMD 41A,B,P-A,L-A,M-A,HA TAMD 42WJ-A TMD41A,B,L-A	3583787 (876104) (876530)	21 104	

## Tilläggsatser / Conversion Gasket Set

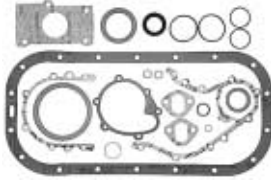
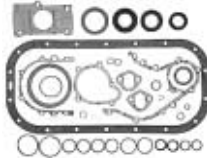
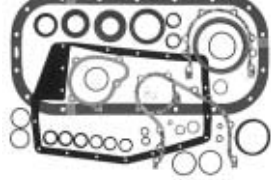
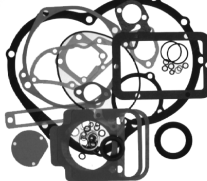
AQ 60, 90, 95, 100, 105, 110, 115 120A, 130 BB 30, 100, 115 MB 18, 20  Satsen är kompletterad att passa både B-18 och B-20 motorer / Gaskets added to fit both B18 and B20 engines	876342 (875400)	21 400	
AQ 165A, 170A,B,C BB 165A, 170A,B,C	876306 (875403)	21 306	

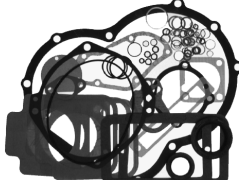
## Tilläggsatser (forts.) / Conversion Gasket Set (cont.)

Motor typ Engine type	Ref.nr. Ref. No.	Best.nr. Part No.	
AQ 120B, 125A, 140A, 145A BB 140A, 145A	876433 (875588)	21 433	
AQ 125B, 145B	876448 (876023)	21 023	
AQ 131A,B,C,D, AQ 151A,B,C 171A,C 230A,B, 250A,B, 251A	876304	21 304	
MD 1A	875423	21 423	
MD 1B	876378 (875501)	21 378	
MD 2A	876394 (875424)	21 394	
MD 2B	876389 (875503)	21 389	

## Tilläggsatser (forts.) / Conversion Gasket Set (cont.)

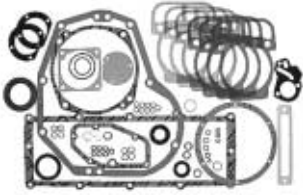
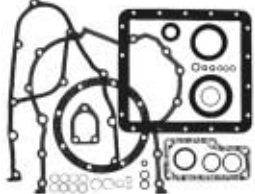
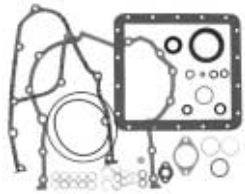
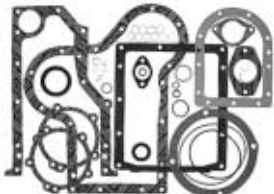
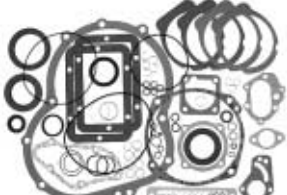
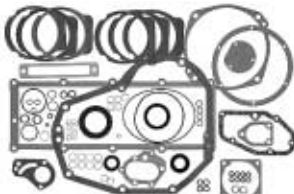
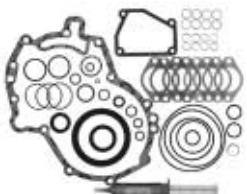
Motor typ Engine type	Ref.nr. Ref. No.	Best.nr. Part No.	
MD 3B	876388 (875505)	21 388	
MD 5A,B  Foderpackningssats 11560 ingår ej i denna packningssats / Cylinder liner gasket kit 11560 not included. 1 st 11560 åtgår / 1 piece 11560 required.	876381 (875562)	21 381	
MD 5C  Foderpackningssats 11560 ingår ej i denna packningssats / Cylinder liner gasket kit 11560 not included. 1 st 11560 åtgår / 1 piece 11560 required.	876382 (875715)	21 382	
MD 6A,B MD 7A,B	876314 (875509)	21 314	
MD 11C,D  Foderpackningssats 11550 ingår ej i denna packningssats / Cylinder liner gasket kit 11550 not included. 2 st 11550 åtgår / 2 pcs 11550 required.	876384 (875554)	21 384	
MD 17C,D  Foderpackningssats 11550 ingår ej i denna packningssats / Cylinder liner gasket kit 11550 not included. 2 st 11550 åtgår / 2 pcs 11550 required.	876383 (875573)	21 383	
2001AG, B, BG 2002AG, B, BG 2003AG, B, BG	875757	21 757	



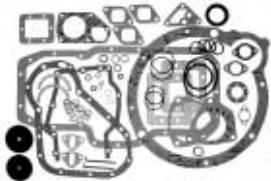
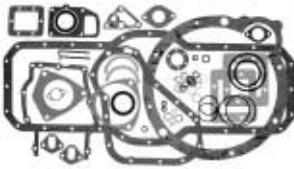
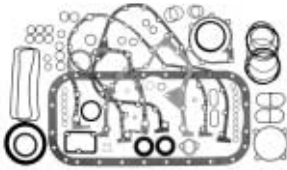
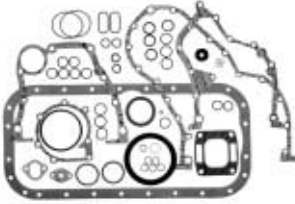
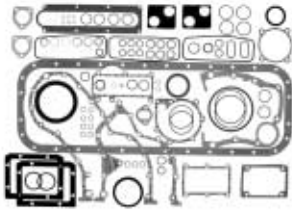

## Tilläggsatser (forts.) / Conversion Gasket Set (cont.)

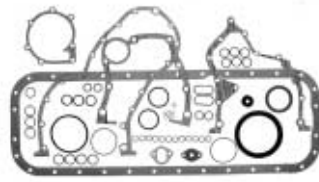
Motor typ Engine type	Ref.nr. Ref. No.	Best.nr. Part No.	
2003T 2003TB	876054	21 054	
MD 21A,B	875387	21 387	
MD 32A	875439	21 439	
AQAD 30A MD 30A TAMD 30A TMD 30A  Foderpackningssats 11651 ingår ej i denna packningssats / Cylinder liner gasket kit 11651 not included. 4 st 11651 åtgår / 4 pcs 11651 required	876427 (876032)	21 427	
AQ 31B,P-A,L-A AQAD 31A MD 31A KAD 32P-A TAMD 31A,B,P-A,L-A,M-A TMD 31A,L-A  Foderpackningssats 11651 ingår ej i denna packningssats / Cylinder liner gasket kit 11651 not included. 4 st 11651 åtgår / 4 pcs 11651 required.	876361 (876105)	21 361	
AQAD 40A,B AQD 40A MD 40A TAMD 40A,B TMD 40A,B,C  Foderpackningssats 11651 ingår ej i denna packningssats / Cylinder liner gasket kit 11651 not included. 6 st 11651 åtgår / 6 pcs 11651 required	876349 (875634)	21 349	

## Tilläggsatser (forts.) / Conversion Gasket Set (cont.)





Motor typ Engine type	Ref.nr. Ref. No.	Best.nr. Part No.	
AD 41B,L-A AQAD 41A AQD 41A D 41B,L-A KAD 42A,B,P-A KAD 43P-A KAD 44P-A KAMD 42A,B,P-A KAMD 43P-A KAMD 44P-A TAMD 41A,B,P-A,L-A,M-A,HA TAMD 42WJ-A TMD 41A,B,L-A, 42B  Foderpackningssats 11651 ingår ej i denna packningssats / Cylinder liner gasket kit 11651 not included. 6 st 11651 åtgår / 6 pcs 11651 required.	876774 (876362) (876106) (876531)	21 362	

## Packningsklister / Sealing Compound

Silicone  Form A Gasket No. 6 BR  Permatex 40 ml		13 750	
Packningsspray / Gasket spray  Loctite 3020  För topplockspackningar mm. For cylinder head gasket etc.  400 ml		13 751	
Packningsklister / Sealing compound  Loctite 5972  För höga temperaturer / For high temperature -40°→315°C  200 ml		13 752	
Universalpackning / Universal gasket  Loctite 574  25 g	840879	14 879	



## Gummikudde för motorupphängning / Rubber Block for Engine Suspension



Motor typ Engine type	Ref.nr. Ref. No.	Best.nr. Part No.	
AQ 60, 90, 95, 100, 105, 110, 115A,B, 120A 130A,B,C  För motorer med främre stödbalk / For engine with forward support	653190	19 106	
AQ 165A, 170A,B  För främre stödbalk / For forward support	682694	19 107	
MD 10A MD 11C,D, 17C,D MD 5A,B,C MD 6A,B MD 7A,B  1 st muttrar 18950 ingår / 1 nuts 19850 included	833950	22 050	
MB 10A MD 1A*, 2A* MD 1B, 2B, 3B MD 6A,B MD 7A,B MD 11C,D  * Bakre fäste / Rear rubber block  2 st muttrar 19850 ingår / 2 nuts 19850 included	849170 (833315) (833625) (807464) (833720)	22 144	

## Gummikudde för propelleraxelkoppling / Rubber Block for Propeller Shaft Coupling



BB 30, 100, 115, 165, 170 MB 10A MB 18, 20 MD 1A,B, 2A,B, 3B MD 5A,B,C MD 6A,B MD 7A,B MD 11C,D, 17C,D MD 21, 27, 29, 32 2001, 2002, 2003  4 eller 6 st åtgår / 4 or 6 pcs required 2 st muttrar ingår / 2 nuts included	803762	22 062	
--	--------	--------	---

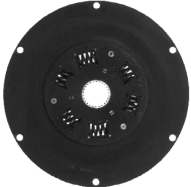



# Svängningsdämpare / Damper (Vibration Damper)

Motor typ Engine type	AQ-drev - Backslags typ Sterndrive type	Ref.nr. Ref. No.	Best.nr. Part No.	
AQ 125A AQD 21A AQD 21B MD 21A MD 21B	270 250 250 RB RB	841891 (829476)	19 092	
AQD 21A AQD 21B MD 21A MD 21B MD 29 MD 29A MD 32A	110S 110S Borg Warner Borg Warner, MS3 Borg Warner Borg Warner Borg Warner	841894 (829132) (818405)	19 189	
230A,B 250A,B 251A AD 31A,B AD 31D AD 31XD AQ 115A,B AQ 120B AQ 125A,B AQ 130A,B,C,D AQ 140A AQ 145A,B AQ 151A,B,C AQ 171A,C AQAD 30A AQAD 31A AQAD 40B AQD 40A BB 115A,B,C BB 140A BB 145A KAD 32P MB 20A,B,C MD 30A MD 31A MD 40A TAMD 30A,B TAMD 31A,B,D TAMD 40A,B TMD 30A TMD 31A,B,D TMD 40A,B,C	MS4  MS4  MS4, MS4B	855389 (831778) (841895)	19 389	

## Svängningsdämpare (forts.) / Damper (Vibration Damper) (cont.)





Motor typ Engine type	AQ-drev - Backslags typ Sterndrive type	Ref.nr. Ref. No.	Best.nr. Part No.	
AQ 110 AQ 115A,B AQ 120 AQ 130A,B,C,D AQ 60F AQ 90 AQ 95 AQ 95A AQD 29 AQD 29A AQD 32A BB 100 BB 115A,B,C BB 30 MB 18 MB 20A,B,C MD 29 MD 29A	250       RB RB	841896 (806270) (831777)	<b>19 896</b>	
AD 41A,B,D AQAD 41A D 41A,B,D KAD 42A,B,D KAD 42A,B,P KAD 43P KAD 44PEDC KAMD 42A TAMD 41A,B TMD 41A,B		855617	<b>19 617</b>	

## Reparationssats för svänghjulskåpa / Repair Kits for Flywheel Casing

432A 434A 500B 501B 570A 572A 740B	SP-C1, DP-C1 SP-C1, DP-C1 SP-C1, DP-C1, DP-D1 SP-C1, DP-C1, DP-D1 SP-C1, DP-C1, DP-D1 SP-C1, DP-C1, DP-D1 SP-C1, DP-C1, DP-D1	958859 958860 856917 11013	<b>22 055</b>	
B 16 AQ 60 AQ 80S AQ 90 AQ 95 AQ 100 AQ 105A AQ 110 AQ 115 AQ 130 AQD 19	80 100 80 100 100 100 100 100 100 100 100	958973 11012	<b>22 057</b>	

10

## Reparationssats för svänghjulskåpa (forts.) / Repair Kits for Flywheel Casing (cont.)

Motor typ Engine type	AQ-drev - Backslags typ Sterndrive type	Ref.nr. Ref. No.	Best.nr. Part No.	
AQ 115A,B	100B	958859 958866 181105	22 058	
AQ 110 AQ 115A,B,C AQ 120A AQ 130 AQD 21A AQD 27 AQD 29 AQD 32A	200 250 200 250 250 200 200, 250 250	958973 946242 11012	22 059	
AQ 165A AQ 170	250 270	2 x 946242 19058	22 060	
AQ 120B AQ 125A,B AQ 130 AQ 131A,B,C,D AQ 140A AQ 145A,B AQ 151A,B,C AQ 165A AQ 170 AQ 171A,C 230 250' 251 AQD 21A,B AQD 32A	270 270, 275A 270, 270T, 280 275, 290, SP-A 280, 280PT 280, 280PT, 290 290, 290A, SP-A 250 250, 270, 270T, 280, 280T 290A, SP-A 275, SP-A, SP-A1 SP-A, SP-A1 SP-A, SP-A1 270, 280 270, 280	946242 958860 11013	22 074	

# Reparationssats för svänghjulskåpa (forts.) / Repair Kits for Flywheel Casing (cont.)

Motor typ Engine type	AQ-drev - Backslags typ Sterndrive type	Ref.nr. Ref. No.	Best.nr. Part No.	
AQ 175	280,PT, 290			
AQ 200B,C,D	280,PT, 290			
AQ 205A	SP-A, DP-A			
AQ 211A	290A,DP, SP-A, DP-A			
AQ 225A,B,C,D,E,F	275, 280,PT, 280L, 290A,DP			
AQ 231A,B	275, 285, 290A,DP			
AQ 225A,B	280			
AQ 260A	280PT, 290			
AQ 271A,B,C,D	275, 290A			
AQ 290A	280PT, 290			
AQ 311A,B	290A, SP-A			
430	SP-A, DP-A			
430A	SP-A1, SP-A2, SP-C, DP-A, DP-A1	2 x 958860	<b>22 075</b>	
430A	DP-A2, DP-C	181105		
430B	SP-C, DP-C	11013		
431A	SP-A, SP-A1, SP-A2, SP-C, DP-A			
431A	DP-A1, DP-A2, DP-C			
431B	SP-C, DP-C			
500B	SP-A1, SP-A2, SP-C, DP-A1			
500B	DP-A2, DP-C			
501B	SP-A2, SP-C, DP-A2, DP-C			
570A	SP-A, SP-A1, SP-A2, SP-C			
570A	DP-A, DP-A1, DP-A2			
572A	SP-C, DP-C			
740A	DP-B, DP-B1, DP-C			
AQAD 30A	Cardan shaft 2 pcs required			
AQAD 30A	280DP,PT, 290A,DP			
AD 30A	290A,DP			
AD 31A,B	290A,DP, SP-C, DP-C, DP-D			
AQAD 31A	290A,DP			
TAMD 31B	SP-A2, DP-A2			
AQD 40A	280DP,PT			
AQAD 40A,B	280DP,PT, 290DP			
AQAD 40B	Cardan shaft 2 pcs required			
AD 40B	280DP, 290DP			
AD 41A	290DP			
AQAD 41A	290A,DP			
AQD 41A	290A,DP			
AD 41B	SP-A2, SP-C, DP-C, DP-D, DP-B1			
D 41B	SP-A2, DP-A2			
TAMD 41B	SP-A2, SP-C, DP-B1, DP-D			
KAD 42	SP-D			

# Gummiring för klämring i sköld / Rubber Rings for Clamp Ring in Shield

Motor typ Engine type	Ref.nr. Ref. No.	Best.nr. Part No.	
<p>Hård / Hard</p> <p>Ytter / Outer 200 mm 2 st åtgår / 2 pcs required</p> <p>230A / SP-A/MT 250A / SP-A/MT 500A 501A 571A 740A AQ 100* AQ 105* AQ 110* AQ 115A*,B* AQ 120A* AQ 120B AQ 125A,B AQ 130A*,B* AQ 131A,D AQ 175A AQ 190A AQ 200A,C,D,F AQ 210A AQ 211A AQ 225A,B,C,D,E,F AQ 231A,B AQ 240A AQ 255A,B AQ 260A,B AQ 271A,B,C,D AQ 280A AQ 290A AQ 311A,B AQ 60F* AQ 80* AQ 90* AQ 95* AQD 19* AQD 29A AQD 32A</p> <p>* Utan främre motorbalk / * Without forward support</p>	<p>804190</p>	<p>19 190</p>	



# Gummiring för klämring i sköld (forts.) / Rubber Rings for Clamp Ring in Shield (cont.)

Motor typ Engine type	Ref.nr. Ref. No.	Best.nr. Part No.	
<p>Mjuk / Soft</p> <p>Ytter / Outer 200 mm 2 st åtgång / 2 pcs required</p> <p>230A / SP-A, SP-A1 230B 250A,B 251A 430A,B 431A,B 432A 434A 500B 501B 570A 572A 740B AD 31A,B,D,XD AD 40B AD 41A,B,D AQ 100* AQ 105* AQ 110* AQ 115A*,B* AQ 130A*,B* AQ 131B,C AQ 140A AQ 145A,B AQ 151A,B,C AQ 171A,C AQ 205A AQ 60F* AQ 90* AQ 95* AQAD 30A AQAD 31A AQAD 40A,B AQAD 41A AQD 19* AQD 21A,B AQD 40A D 41A,B,D KAD 32 KAD 42A,B,P KAD 43P KAD 44P KAMD 42A TAMD 41A</p> <p>* Med främre motorbalk / * For forward support</p>	<p>813967</p>	<p>19 967</p>	



## Skruv till klämring / Screw for Clamp Ring in Shield

Aq-drev typ Sterndrive type	Ref.nr. Ref. No.	Best.nr. Part No.	
För alla modeller / For all versions  6 st åtgår / 6 pcs required	191844	19 844	

## Tätlist för sköld / Rubber Seal for Shield

AQ 200, 250, 270T, 275A 280T,DP SP-A/MT	897726	19 726	
AQ 290A,DP SP-A, SP-A1, SP-A2, SP-C DP-A1, DP-A2, DP-B1, DP-C, DP-C1 DP-D, DP-D1 DPX	852868	19 015	

## Tätningar för styrarm / Seal Ring for Steering Fork

V-ring  Inre Ø 28 mm tidigare utförande / Inner Ø 28 mm earlier version	814359	19 359	
V-ring see catalogue  Inre Ø 36 mm senare utförande / Inner Ø 36 mm late version	839195	19 195	
SP-C DP-C, DP-C1 DP-D, DP-D1 DPX  Packbox inner Ø 40 mm / Seal ring inner Ø 40 mm	977313	19 313	

## Låsskruv för styrarm / Lock Screw for Steering Fork

Aq-drev typ Sterndrive type	Ref.nr. Ref. No.	Best.nr. Part No.	
SP-C, SP-C1 DP-C, DP-C1 DP-D1  Rostfri / Stainless	947904	19 904	

## Slangsats för hydraulcylinder / Hose Kit for Hydraulic Cylinder

290, 290A, 290DP SP-A, SP-A1, SP-A2 DP-A, DP-A2, DP-B, DP-B1 Från / From SN 110 159 2794-  Rostfri slang / Stainless hose Satsen ersätter slangar / Kit replace hoses: 852847, 852848, 853708, 853709, 854710, 854711  2 O-ringar 13053 ingår / 2 O-rings 13053 included	857624 (854752)	19 052	
---	--------------------	--------	---









## Knutbälgsatser / Drive Bellow Kits

Aq-drev typ Sterndrive type	Ref.nr. Ref. No.	Best.nr. Part No.	
AQ 80, 100, 100B AQ 100S*  * Segelbåtsdrev / Sailing boat drive  Slangklammor ingår / Hose clamps included	875827 (804186) (875512)	<b>19 827</b>	
AQ 200, 250, 270, 270T, 275, 275A 280, 280T, 280PT, 280DP, 280L, 285A 290, 290A, 290DP SP-A, SP-A/MT, SP-A1, SP-A2 SP-C, SP-C1 DP-A, DP-A1, DP-A2 DP-B, DP-B1 DP-C, DP-C1 DP-D, DP-D1 DPX  Slangklammor ingår / Hose clamps included	876294 (875826) (897889)	<b>19 294</b>	
SX-drev  Slangklamma ingår ej / Hose clamp not included	3854127	<b>19 127</b>	
Slangklamma för knutbälg 19127 / Hose clamp for drive bellow 19127		<b>19 012</b>	



## Avgasbälgsatser / Exhaust Bellow Kits

AQ 200, 250, 270, 275, 280, 280DP 290, 290DP SP-A, SP-A/MT, SP-A1, SP-A2 SP-C DP-A, DP-A1, SP-A2 DP-B, DP-B1 DP-C, DP-C1 DP-D, DP-D1 DPX  Utan klaffar / Without flaps  Slangklammor ingår / Hose clamps included	876631 (875848)	<b>19 848</b>	
--	--------------------	---------------	---





## Avgasbälgsatser (forts.) / Exhaust Bellow Kits (cont.)

Aq-drev typ Sterndrive type	Ref.nr. Ref. No.	Best.nr. Part No.	
<p>AQ 280, 280T, 280PT, 280DP 290A, DP SP-A, SP-A/MT, SP-A1, SP-A2 SP-C DP-A, DP-A1, SP-A2 DP-B, DP-B1 DP-C, DP-C1 DP-D, DP-D1 DPX</p> <p>För V-8 och 40 motorer / For V-8 and type 40-engines</p> <p>Med klaffar / With flaps</p> <p>Slangklammor ingår / Hose clamps included</p>	<p>876633 (875828) (875829) (850004)</p>	<b>19 828</b>	
SX-drev / SX-Drive	3850426	<b>19 069</b>	
<p>Slangklamma för knutbälg 19069 / Hose clamp for drive bellow 19069</p> <p>1 st åtgår / 1 piece required</p>	3852603	<b>19 603</b>	



## Slangsatser / Hose Kits

<p>AQ 200, 250, 270, 275, 280, 280DP 280PT, 285, 285A, 290DP SP-A/MT</p> <p>Slangklammor ingår / Hose clamps included</p>	<p>875822 (897599)</p>	<b>19 822</b>	
<p>AQ 290, 290A, 290DP SP-A, SP-A1, SP-A2, SP-C, SP-C1 DP-A, DP-A1, DP-A2 DP-B, DP-B1 DP-C, DP-C1, DP-D, DP-D1 DPX</p> <p>Slangklamma och O-ring ingår / Hose clamp and O-ring included</p>	<p>876632 (875847) (854555)</p>	<b>19 630 (19 847)</b>	<p><b>NEW VERSION</b></p> 

## Slangsatser (forts.) / Hose Kits (cont.)

Aq-drev typ Sterndrive type	Ref.nr. Ref. No.	Best.nr. Part No.	
AQ 270T, 280T  Slangklammor ingår / Hose clamps included	832831	19 831	
SX, DP-S  Slangklammor ingår ej / Hose clamps not included	3852352	19 097	
SX, DP-S  Slanglammer för 19097 / Clamps for 19097  Klamma motorsida / Clamp engine side	3852602	19 548	
Bandklamma drevsida / Plastic stripe sterndrive side	948616	19 616	

## Slangfäste / Water Hose Connection

AQ 200, 250, 270, 275, 280, 280DP, 285A, 290, 290A, 290DP SP-A, SP-A/MT, SP-A1, SP-A2 SP-C, SP-C1 DP-A, DP-A1, DP-A2 DP-B, DP-B1 DP-C DP-D  Packning 19356 ingår / Gasket 19356 included	854031 (851766) (897600)	19 766	
AQ 270T, 280T, 280PT  Packning 19356 ingår / Gasket 19356 included	832846	19 846	



## Bussningssett för upphängning av AQ-drev / Bushing Kits for Hook up Fork

Aq-drev typ Sterndrive type	Ref.nr. Ref. No.	Best.nr. Part No.	
AQ 80, 100, 100B, 200, 250, 270, 275A 280, 280L, 280DP, 280PT, 285A SP-A/MT  Satas om 2 bussningar / Set of 2 bushings	876278 (826341)	19 278	
290, 290A, 290DP SP-A, SP-A1, SP-A2 DP-A, DP-A1, DP-A2 DP-B, DP-B1  Sats om 2 bussningar / Set of 2 bushings	876279 (853223)	19 279	
AQ 270T, 280T  Sats om 2 bussningar / Set of 2 bushings	(2 x 832820)	22 080	



## Saxpinnar och bricka för reglage / Pins and Washer for Control Cable Cube

För länkar och växelmechanism / For control rod gear shift mechanism	17253	19 053	
För reglagetärning / For control cable cube	17276	19 276	
Rostfri bricka för reglagetärning / Stainless washer for control cable cube	940191	19 091	

## Låsskruv och bricka för upphängningslagertapp / Screw and Washer for Bearing Pin

200, 250, 270, 275, 280, 285 SP-A, SP-A/MT  Gänga / Thread 5/16" UNC	2 x 941873 2 x 941670	22 092	
290, 290A, 290DP SP-A, SP-A1, SP-A2 SP-C, SP-C1 DP-A, DP-A1, P-A2 DP-B, DP-B1 DP-C, DP-C1 DP-D, DP-D1 DPX Gänga / Thread M 8	2 x 963699 2 x 941670	22 093	



## Täckåpa för växelmekanism / Protecting Cover for Gearshift Mechanism

Aq-drev typ Sterndrive type	Ref.nr. Ref. No.	Best.nr. Part No.	
AQ 200, 250, 270T, 275A 280L,T,DP, 285A, 290A,DP  Övre och undre skruvar ingår / Lower and upper screw included	832570	19 570	
AQ 200, 250, 270T, 275A 280L,T,DP, 285A, 290A,DP  Nedre skruv i täckåpa / Lower screw for protecting cover	941816	19 816	

## Ställpinne / Setting Pin

AQ 200, 250, 270T, 275A 280L,T,DP, 285A, 290A,DP  2 rostfria muttrar och brickor ingår / 2 stainless nuts and washers included	814301	19 301	
--	--------	--------	--



## Fisklinebricka / Thrust Washers (Fishing Line Protectors)

AQ 110S, 200	832965	19 965	
AQ 250, 270, 275	839534	19 534	
AQ 280, 285, 290  Ej för DP-drev / Not for DP drive	839423	19 423	

## Brytpinnesats / Break Pin Kit

Aq-drev typ Sterndrive type	Ref.nr. Ref. No.	Best.nr. Part No.	
AQ 100, 100B, 100S	1 x 806661 1 x 907886 (17268)	22 094	

## Låsskruvar för folding propellerblad / Lock Screws for Folding Propeller Blades

For 14" and 15" propellers  Rostfri / Stainless Längd / Length 20 mm	947903	19 904	
For 16" and 17" propellers  Rostfri / Stainless Längd / Length 12 mm	946847	19 047	

## Saxpinne för foldingpropellermutter / Cotter Pin for Folding Propeller Lock Nut

För alla propellrar utom 100S For all propellers except 100S  Rostfri / Stainless	949807	19 007	
--	--------	--------	---

## Propellerkona / Propeller Cone

AQ 200, 250, 270, 275, 280, 285 290, SP-A, SP-A/MT, SP-A1, SP-A2 SP-C, SP-C1  Ej för DP-drev / Not for DP drive  För propeller med kort nav behövs distansbricka 19261 / For propeller with short hub spacer washer 19261 is required	854045 (850785)	19 785	
--	--------------------	--------	---

## Distansbricka för propeller / Spacer Washer for Propeller Cone

Aq-drev typ Sterndrive type	Ref.nr. Ref. No.	Best.nr. Part No.	
AQ 200, 250, 270, 275, 280, 285, 290 SP-A, SP-A/MT, SP-A1, SP-A2 SP-C, SP-C1  Ej för DP-drev. För drev med kort nav / Not for DP-gear. Required for propeller with short hub	854047 (851261)	<b>19 261</b>	

## Distansbricka (plast) / Spacer Washer (plastic)

AQ 200, 250, 270, 275, 280, 285 290, SP-A, SP-A/MT, SP-A1, SP-A2 SP-C, SP-C1  För propellerkona med låsskruv / For propeller cone with lock screw	850888	<b>19 888</b>	
--	--------	---------------	---

## Låsbricka för propeller / Tab Washer for Propeller (stainless)

AQ 200, 250, 270, 275, 280, 285 290, SP-A, SP-A/MT, SP-A1, SP-A2 SP-C, SP-C1  För propellerkona utan låsskruv / For propeller cone without lock screw	897367	<b>19 367</b>	
--	--------	---------------	---

## Låsskruv för propellerkona / Lock Screw for Propeller Cone

AQ 200, 250, 270, 275, 280, 285 290, SP-A, SP-A/MT, SP-A1, SP-A2 SP-C, SP-C1  För propellerkona med låsskruv / For propeller cone with lock screw	850889	<b>19 889</b>	
--	--------	---------------	---





## Fjädersats för backhake / Spring Sets for Reverse Tilt Inhibitor

Aq-drev typ Sterndrive type	Ref.nr. Ref. No.	Best.nr. Part No.	
AQ 250, 270, 275A, 280DP,L 285A, 290A,DP SP-A, SP-A/MT, SP-A1, SP-A2 DP-A, DP-A1, DP-A2 DP-B, DP-B1		22 056	



## Oljeavtappningsplugg / Oil Drain Plug

80 100, 100B, 100S 110S 120S, 120S-B 200, 250, 270*  * Tidigare version / Earlier version	804262	19 062	
---	--------	--------	---



## Zinkanod för sköld / Zinc Anode for Shield

Aq-drev typ Sterndrive type	Ref.nr. Ref. No.	Best.nr. Part No.	
200 250*  För sköld / For shield * Tidigare utförande / Earlier version	838929	19 929	
250* 270, 275, 280, 280DP, 280PT, 285 SP-A/MT Cardan shaft  * Senare utförande / Later version Passar ej 270T, 280T-drev Not for 270T, 280T drive	832598	19 598	
290, 290A, 290DP SP-A, SP-A1, SP-A2 SP-C, SP-C1 DP-A, DP-A1, SP-A2 DP-B, DP-B1 DP-C, DP-C1 DP-D, DP-D1	832835	19 835	

## Zinkringar för AQ-drev / Zinc Ring Kits for AQ Drives

80, 100, 100B  Skruvar ingår / Screws included	875810	19 810	
200  Skruvar ingår / Screws included	875809	19 809	
250, 270, 270T, 275, 275A SP-A/MT SP-A1, SP-A2, SP-C  Skruvar ingår / Screws included	875805	19 805	



## Zinkringar för AQ-drev (forts.) / Zinc Ring Kits for AQ Drives (cont.)

Aq-drev typ Sterndrive type	Ref.nr. Ref. No.	Best.nr. Part No.	
280, 280L, 280T, 280PT, 285A 290, 290A SP-ASP-A/MT, SP-A1, SP-A2 SP-C, SP-C1  Skrubar ingår / Screws included	875815	19 815	
280DP, 290DP DP-A, DP-A1, DP-A2 DP-B, DP-B1 DP-C, DP-C1 DP-D, DP-D1  Skrubar ingår / Screws included	875821	19 821	

## Zinkanod för upphängningsgaffel / Zinc Anode for Suspension Yoke

För SP och DP-drev For SP and D-drive  1 eller 2 åtgår / 1 or 2 required  Installationsanvisning och skruv ingår / Installation instructions and screw included	872793	19 793	
---	--------	--------	--







## Zinkring för segelbåtsdrev / Zinc Ring Kits for Sailing Boat Drives

100S  Ej för 100S med foldingpropeller / Not for 100S with folding propeller  Skrubar ingår / Screws included	875810	19 810	
100S  Skrubar och O-ring ingår / Screws and O-ring included	875812	19 812	
120S, 120SB, 120S-D S120C  Skrubar ingår / Screws included	876286 (851983)	19 983	

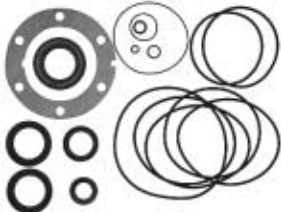

## Zinkanod för foldingpropeller / Zinc Anode Kit for Folding Propeller

Aq-drev typ Sterndrive type	Ref.nr. Ref. No.	Best.nr. Part No.	
110S 120S, 120SB, 120S-D S120C  För 2-bladig folding tidigare utförande / For 2-blade folding earlier version  Skruvar ingår / Screws included	852018	<b>19 018</b>	 A photograph showing the components of the zinc anode kit: two curved metal anodes with circular holes, and two screws with washers.





# Packningsatser för kompletta AQ-drev / Gasket Sets for complete AQ-Drive Units

Aq-drev typ Sterndrive type	Ref.nr. Ref. No.	Best.nr. Part No.	
100	876399 (875129)	19 399	
100B  Segelbåtsdrev / Sailing boat drive	876392 (875389)	19 392	
100S  Segelbåtsdrev / Sailing boat drive	876397 (875591)	19 591	
120S 120S-B 120S-D S120C  Segelbåtsdrev / Sailing boat drive	876391 (875720)	19 720	
200, 250, 270, 275, 280, 285, 290 SP-A, SP-A/MT, SP-A1, SP-A2 SP-C  Passar alla drevtyper utom DP-drev / Fits all types except DP-drive		19 037	
250, 270, 275, 280, 285, 290 För drev med DP-underhus / For drive units with DP lower housing  DP-A, DP-A1, D-A2 D-B, DP-B1 DP-C DP-D	875741 (876266) (876267)	19 741	
DP-C1 DP-D1		19 035	

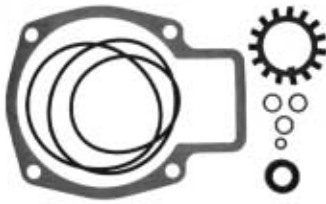

## Packningsatser för kompletta AQ-drev (forts.) / Gasket Sets for complete AQ-drive Units (cont.)

Aq-drev typ Sterndrive type	Ref.nr. Ref. No.	Best.nr. Part No.	
285, 290A SP-A, SP-A/MT  Passar alla drevtyper utom DP-drev / Fits all types except DP-drive		19 031	
SP-A1, SP-A2 SP-C, SP-C1		19 033	

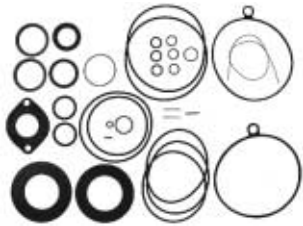

## Packningsatser för överhus / Gasket Sets for Upper Gear Unit

100		22 090	
100B, 100S		22 091	
110S		22 096	
120S, 120S-B, 120S-D, S120C		22 097	

## Packningssatser för överhus (forts.) / Gasket Sets for Upper Gear Unit (cont.)

Aq-drev typ Sterndrive type	Ref.nr. Ref. No.	Best.nr. Part No.	
200, 250, 270, 275, 280, 285, 290 SP-A, SP-A/MT, SP-A1, SP-A2 SP-C DP-A, DP-A1, DP-A2 DP-B1 DP-C, DP-C1 DP-D, DP-D1	876266	19 036	
280DP 285A 290A, 290DP SP-A, SP-A/MT, SP-A1, SP-A2 SP-C, SP-C1 DP-A, DP-A1, DP-A2 DP-B, DP-B1 DP-C, DP-C1 DP-D, DP-D1 DPX		19 029	

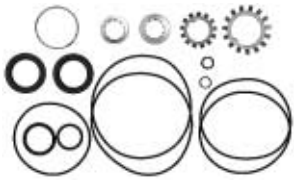
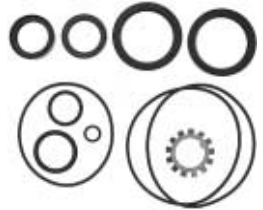
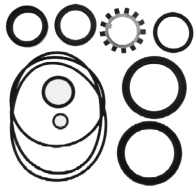
## Packningssatser för underhus / Gasket Sets for Lower Gear Unit

200, 250, 270, 280, 285, 290 SP-A, SP-A/MT  Passar alla drevtyper utom DP-drev / Fits all types except DP-drive	876268	19 010	
SP-A1, SP-A2 SP-C, SP-C1  För alla drev med DP-underhus / For all drive units with DP lower housing		19 011	
280DP 290DP DP-A, DP-A1, DP-A2 DP-B, DP-B1, DP-C, DP-D  För alla drev med DP-underhus / For all drive units with DP lower housing	876267	19 267	
DP-C1 DP-D1		19 026	



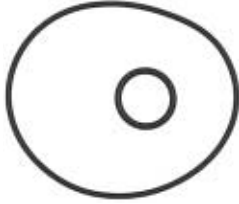

## Packningssats mellan överhus - mellanhus / Gasket Set for Upper Gear Unit - Interm. Housing

Aq-drev typ Sterndrive type	Ref.nr. Ref. No.	Best.nr. Part No.	
200, 250, 270, 275, 280, 285, 290 SP-A, SP-A/MT, SP-A1, SP-A2 SP-C, SP-C1 DP-A, DP-A1, DP-A2, DP-B, DP-B1 DP-C, DP-C1, DP-D, DP-D1 DPX		22 079	

## Packningssats mellan mellanhus - underhus / Gasket Set for Interm. Housing - Lower Gear Unit

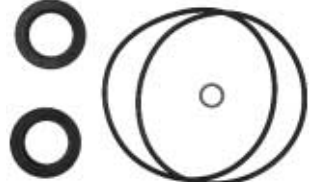

200, 250, 270, 275, 280, 285, 290 SP-A, SP-A/MT, SP-A1, SP-A2 SP-C, SP-C1 DP-A, DP-A1, DP-A2 DP-B, DP-B1 DP-C, DP-C1, DP-D, DP-D1		22 081	
---	--	--------	---

## Packningssats för propelleraxel / Gasket Sets for Propeller Shaft



100, 100B, 100S		22 082	
110S		22 083	
120S 120S-B 120S-D S120C		22 085	
200		22 084	





## Packningsatts för propelleraxel (forts.) / Gasket Sets for Propeller Shaft (cont.)

Aq-drev typ Sterndrive type	Ref.nr. Ref. No.	Best.nr. Part No.	
250, 270T, 275A, 280L,T 285A, 290A SP-A, SP-A/MT, SP-A1, SP-A2 SP-C, SP-C1  Ej för DP-drev / Not for DP-drive		22 086	
280DP, 290DP DP-A, DP-A1, DP-A2 DP-B, DP-B1 DP-C, DP-C1 DP-D, DP-D1  För alla med DP-drev / For all with DP-drive		22 087	

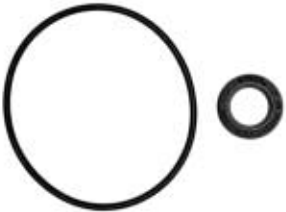

## Packningsatser för oljepluggar / Gasket Sets for Oil Plugs

80, 100, 100B, 100S, 110S		22 066	
120S 120S-B 120S-D S120C		22 071	
200, 250, 270, 275, 280, 285, 290 SP-A, SP-A/MT, SP-A1, SP-A2 SP-C, SP-C1 DP-A, DP-A1, DP-A2 DP-B, DP-B1 DP-C, DP-C1 DP-D, DP-D1 DPX		22 067	

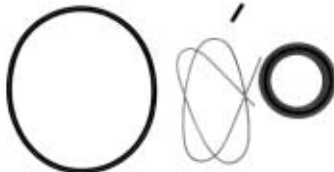
# Packningsatts för växelmekanism / Gasket Sets for Gear Mechanism

Aq-drev typ Sterndrive type	Ref.nr. Ref. No.	Best.nr. Part No.	
100, 100B, 100S		22 095	
110S, 120S-B, 120S-D, S120C 200, 250, 270, 275  Packbox med enkel tätyta / Oil seal with single sealing lips		22 098	
275, 280, 285, 290 SP-A, SP-A/MT, SP-A1, SP-A2 SP-C, SP-C1 DP-A, DP-A1, DP-A2 DP-B, DP-B1 DP-C, DP-C1 DP-D, DP-D1 DPX  Packbox med dubbla tätytor / Oil seal with double sealing lips		22 101	



## Drivknutkors / Universal Joint

Aq-drev typ Sterndrive type	Ref.nr. Ref. No.	Best.nr. Part No.	
AQ 200, 250, 270T, 275A 280DP,L,T 285A 290A,DP SP-A, SP-A/MT DP-A DP-B	853255 (897707)	19 255	
SP-A1, SP-A2 SP-C, SP-C1 P-A1, DP-A2 DP-B1 DP-C, DP-C1 DP-D, DP-D1 DPX	3860232 (854619)	19 619	

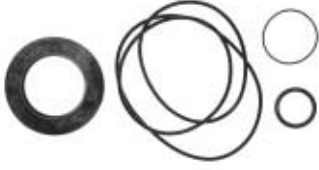
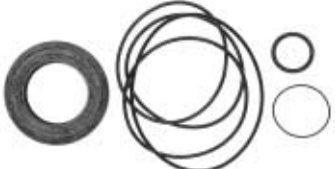

## Packningsatts för byte av knutkors / Gasket Sets for Universal Joint

200, 250		22 150	
270T, 275A, 280, 285, 290 SP-A, SP-A/MT, SP-A1, SP-A2 SP-C, SP-C1 DP-A, DP-A1, DP-A2 DP-B, DP-B1 DP-C, DP-C1 DP-D, DP-D1 DPX		22 151	



## Bultsats för dubbellagerbox / Bolt Kits for Double Bearing Unit

AQ 200, 250, 270T, 280DP,L,T 290A,DP  Samtliga utföranden / All versions Längd / Length 63 mm	4 x 956590 4 x 942598	22 099	
AQ 275A, 285A, 290A,DP SP-A, SP-A/MT, SP-A1, SP-A2 SP-C, SP-C1 DP-A, DP-A1, DP-A2 DP-B, DP-B1 DP-C, DP-C1 DP-D, DP-D1 DPX  Samtliga utföranden / All versions Längd / Length 70 mm	4 x 956591 4 x 942598	22 100	



## Slitbricka för dubbellagerbox / Washer for Oil Sealer in Double Bearing Unit

Aq-drev typ Sterndrive type	Ref.nr. Ref. No.	Best.nr. Part No.	
200, 250  Alla versioner / All versions	897315	19 315	
270, 275, 280, 285, 290 SP-A, SP-A/MT, SP-A1, SP-A2 SP-C, SP-C1 DP-A, DP-A1, DP-A2 DP-B, DP-B1 DP-C, DP-C1 DP-D, DP-D1 DPX  Alla versioner / All versions	832675	19 075	





## Kullager för ingående axel i överhus / Ball Bearing for Double Bearing Unit

100 100S  2 st åtgår / 2 pcs required	181290	19 290	
120S 120S-B 120S-D S120C  Koniskt rullager / Roller bearing Yttering / Outer ring  Yttre lager i dubbellagerbox / Outer bearing for double bearing unit	183752 183750	19 700	
120S 120S-B 120S-D S120C  Koniskt rullager / Roller bearing  Yttering / Outer ring  Inre lager i dubbellagerbox / Inner bearing for double bearing unit	181301  181302	19 006  19 302	





## Kullager för ingående axel i överhus (forts.) / Ball Bearing for Double Bearing Unit (cont.)

Aq-drev typ Sterndrive type	Ref.nr. Ref. No.	Best.nr. Part No.	
200, 250, 270, 275 280, 280T, 280L, 280PT, 280DP 285A 290, 290A, 290DP SP-A, SP-A/MT, SP-A1, SP-A2 SP-C, SP-C1 DP-A, DP-A1, DP-A2 DP-B, DP-B1 DP-C, DP-C1 DP-D, DP-D1 DPX  Yttre lager i dubbellagerbox / Outer bearing for double bearing unit	183247	19 247	
200, 250, 270, 275 280, 280T, 280L, 280PT, 280DP 285A 290, 290A, 290DP SP-A, SP-A/MT, SP-A1, SP-A2 SP-C, SP-C1 DP-A, DP-A1, DP-A2 DP-B, DP-B1 DP-C, DP-C1 DP-D, DP-D1 DPX  Inre lager i dubbellagerbox / Inner bearing for double bearing unit	3850852 (853949) (183247) (183668)	19 949	

## Kullager för vertikalaxel i överhus / Ball Bearing for Vertical Shaft in Upper Gear Unit

Aq-drev typ Sterndrive type	Ref.nr. Ref. No.	Best.nr. Part No.	
100, 100B, 100S, 110S  2 st åtgår / 2 pcs required	181287	19 087	
120S, 120S-B, 120S-D, S120C  2 st åtgår / 2 pcs required	851756	19 756	
200, 250  2 st åtgår / 2 pcs required	183458	19 458	
270, 275 280, 280T, 280L, 280PT, 280DP 285A 290, 290A, 290DP SP-A, SP-A/MT DP-A DP-B  2 st åtgår / 2 pcs required	853542	19 542	
SP-A1, SP-A2 SP-C, SP-C1 DP-A1, DP-A2 DP-B1 DP-C, DP-C1 DP-D, DP-D1 DPX  2 st åtgår / 2 pcs required	3857176 (854670) (3522389)	19 019	

## Nållager för vertikalaxel i överhus / Needle Bearing for Vertical Shaft in Upper Gear Unit

Aq-drev typ Sterndrive type	Ref.nr. Ref. No.	Best.nr. Part No.	
100, 100B, 100S, 110S  4 st åtgår / 4 pcs required	181288	19 068	
120C, 120C-B, 120S-D S120C  2 st åtgår / 2 pcs required	851757	19 757	
200, 250, 270, 275 280, 280T, 280L, 280PT, 280DP  4 st åtgår / 4 pcs required	181359	19 059	
285A 290, 290A, 290DP SP-A, SP-A/MT, SP-A1, SP-A2 SP-C, SP-C1 DP-A, DP-A1, DP-A2 DP-B, DP-B1 DP-C, DP-C1 DP-D, DP-D1 DPX  2 st åtgår / 2 pcs required	3852390 (853819)	19 819	



## Låsring för vertikalaxel / Lock Ring for Vertical Shaft

100, 100B, 100S  2 st åtgår / 2 pcs required	814030	19 030	
--	--------	--------	---

## Glidtapp (växelförare) / Sliding Pin

100, 100B, 100S	813934	19 934	
-----------------	--------	--------	---

## Nållager för upphängningsgaffel / Needle Bearing for Hook up Fork

Aq-drev typ Sterndrive type	Ref.nr. Ref. No.	Best.nr. Part No.	
80, 100, 100B  2 st åtgår / 2 pcs required	181289	19 289	
200, 250, 270, 275, 280, 285, 290 SP-A, SP-A/MT, SP-A1, SP-A2 SP-C DP-A, DP-A1, DP-A2 DP-B, DP-B1 DP-C DP-D	183391	19 391	

## Övre lager för vertikalaxel i underhus / Upper Bearing for Vertical Shaft in Lower Gear Unit

80, 100, 100B, 110S	18559	19 559	
120S, 120S-B, 120S-D, S120C  Koniskt rulllager / Roller bearing Ytterring / Outer ring  Lagersats / Bearing kit	183752 183750	19 700	
200, 250, 270, 275 280, 285 290 SP-A, SP-A/MT, SP-A1, SP-A2 SP-C, SP-C1 DP-A, DP-A1, DP-A2 DP-B, DP-B1 DP-C, DP-C1 DP-D, DP-D1 DPX  Koniskt lager / Roller bearing	11072	19 072	
200, 250  Kullager under koniska lagret / Ball bearing under roller bearing	181522	19 522	



## Övre lager för vertikalaxel i underhus (forts.) / Upper Bearing for Vertical Shaft in Lower Gear Unit (cont.)

Aq-drev typ Sterndrive type	Ref.nr. Ref. No.	Best.nr. Part No.	
270, 275 280, 285 290 SP-A, SP-A/MT, SP-A1, SP-A2 SP-C, SP-C1 DP-A, DP-A1, DP-A2 DP-B, DP-B1 DP-C, DP-C1 DP-D, DP-D1 DPX  Kullager under koniska lagret / Ball bearing under roller bearing	183374	19 374	

## Axiallager för vertikalaxel i underhus Axial Bearing for Vertical Shaft in Lower Gear Unit

80, 100, 100B, 110S	806620	19 004	
---------------------	--------	--------	--

## Nedre lager för vertikalaxel i underhus Lower Bearing for Vertical Shaft in Lower Gear Unit

80, 100, 100B, 110S	181288	19 288	
120S, 120S-B, 120S-D S120C	852508	19 508	
200	181621	19 621	

## Nedre lager för vertikalaxel i underhus (forts.) Lower Bearing for Vertical Shaft in Lower Gear Unit (cont.)

Aq-drev typ Sterndrive type	Ref.nr. Ref. No.	Best.nr. Part No.	
DP280, DP290 DP-A, DP-A1, DP-A2 DP-B, DP-B1 DP-C, DP-C1 DP-D, DP-D1 DPX			
Nållager / Needle bearing	184654	<b>19 654</b>	
Innerring / Inner ring	184682	<b>19 008</b>	

## Inre lager för propelleraxel / Inner Bearing for Propeller Shaft

100, 100B, 100S  110S*  * För utväxling 1,66:1 / * Ratio 1,66:1	181413	<b>19 413</b>	
110S  För utväxling 2,15:1 / Ratio 2,15:1	183390	<b>19 390</b>	
120S, 120S-B, 120S-D S120C  Koniskt rullager / Roller bearing Yttering / Outer ring  Lagersats / Bearing kit	181588  181587	<b>19 500</b>	
200, 250, 270, 275 280 285 290 SP-A, SP-A/MT, SP-A1, SP-A2 SP-C, SP-C1	1183390	<b>19 390</b>	
280DP 290DP DP-A, DP-A1, DP-A2 DP-B, DP-B1 DP-C, DP-C1 DP-D, DP-D1 DPX  Inre lager på inre propelleraxel / Inner bearing on inner propeller shaft	11044	<b>19 044</b>	



## Inre lager för propelleraxel (forts.) / Inner Bearing for Propeller Shaft (cont.)

Aq-drev typ Sterndrive type	Ref.nr. Ref. No.	Best.nr. Part No.	
280DP 290DP DP-A, DP-A1, DP-A2 DP-B, DP-B1 DP-C, DP-C1 DP-D, DP-D1 DPX  Inre lager på yttre propelleraxel / Inner bearing on outer propeller shaft Röraxel / Pipe shaft	184691	19 691	

## Yttre lager för propelleraxel / Outer Bearing for Propeller Shaft

100, 100B, 100S 110S*  * För utväxling 1,66:1 / * Ratio 1,66:1	181286	19 286	
110S* 200, 250  * För utväxling 2,15:1 / * Ratio 2,15:1	181287	19 087	
120S, 120S-B, 120S-D S120C  Koniskt rulllager / Roller bearing Yttering / Outer ring  Lagersats / Bearing kit	181588  181587	19 500	
270, 275 280, 285 290 SP-A, SP-A/MT, SP-A1, SP-A2 SP-C, SP-C1	854541 (181366)	19 541	
280DP 290DP DP-A, DP-A1, DP-A2 DP-B, DP-B1 DP-C, DP-C1 DP-D, DP-D1 DPX  Yttre nållager på inre propelleraxel / Outer bearing on inner propeller shaft	183272	19 272	

## Yttre lager för propelleraxel (forts.) / Outer Bearing for Propeller Shaft (cont.)

Aq-drev typ Sterndrive type	Ref.nr. Ref. No.	Best.nr. Part No.	
280DP 290DP DP-A, DP-A1, DP-A2 DP-B, DP-B1 DP-C, DP-C1 DP-D, DP-D1 DPX  Koniskt lager / Roller bearing	174765 (184690)	19 765	
280DP 290DP DP-A, DP-A1, DP-A2 DP-B, DP-B1 DP-C, DP-C1 DP-D, DP-D1 DPX  Nållager / Needle bearing  Innerring / Inner ring  Yttre lager på yttre propelleraxel / Outer bearing on outer propeller shaft	183859  184683	19 859  18 683	

## Propelleraxel / Propeller Shaft

100, 100B, 100S  Inre nållager ingår / Inner needle bearing included	875177	19 177	
---	--------	--------	---



# OBT Part No. - Ref. No.

Best. nr. Part No.	Ref. nr. Ref. No.	Sida Page
11005	859115	
11014		1.7
11019	271217	1.4
11020	271218	1.4
11021	271219	1.4
11022	271054	1.6
11023	271055	1.6
11024	271056	1.6
11025	271066	1.6
11026	271067	1.6
11027	271068	1.6
11031	477026	1.8, 5.22
11032	477024	1.8, 5.22
11033	192212	1.8, 5.22
11038	860921	
11039	859039	
11040	272040	1.1
11042	272042	1.1
11043	272043	1.1
11051	271051	1.5
11052	1542052	1.5
11053	271053	1.5
11058	272058	1.1
11059	272059	1.1
11063	271063	1.5
11064	271064	1.5
11065	925065	
11075	840075	
11082	275282	1.2
11083	275283	1.2
11088	859088	
11092	463092	1.1
11096	1275379	
11105	271052	
11106	271065	1.5
11134	430134	
11136	270136	1.6
11137	270137	1.6
11138	270138	1.6
11159	859159	
11160	6842160	
11161	876161	1.3
11177	943177	
11181	944181	
11183	957183	
11193	275193	1.1
11195	275195	1.1
11196	275196	1.1
11200	272004	1.1
11202	272002	1.1
11203	272012	1.1
11205	272056	1.1
11214	271214	1.4
11215	271215	1.4
11216	271216	1.4
11236	271236	1.4
11237	271237	1.4
11238	271238	1.4

Best. nr. Part No.	Ref. nr. Ref. No.	Sida Page
11254	829254	1.2
11262	818262	1.5
11271	875271	1.3
11282	946282	
11295	418295	1.1
11302	875302	1.6
11303	875303	1.6
11304	875304	1.6
11305	875305	1.6
11306	875306	1.4
11307	875307	1.4
11308	875308	1.4
11318	1542318	
11329	949329	
11330	875330	1.6
11331	875331	1.6
11332	875332	1.6
11333	875333	1.6
11334	875334	1.4
11335	875335	1.4
11336	875336	1.4
11337	275337	1.3
11338	275338	1.3
11339	275339	1.3
11340	275340	1.2
11341	275341	1.2
11342	275342	1.2
11344	275344	1.2
11345	275345	1.2
11346	275346	1.2
11356	803356	
11359	803359	
11369	275369	1.3
11370	275370	1.3
11371	275371	1.3
11385	471956	
11385	980936	
11416	463416	3.5
11471	270471	1.5
11472	864723	
11477	270015	1.5
11478	875478	1.5
11479	875479	1.5
11487	829487	
11492	1378492	
11531	275331	1.3
11532	275333	1.3
11533	275332	1.3
11534	275334	1.2
11535	275335	1.2
11536	275336	1.2
11538	875538	1.5
11539	875539	1.5
11540	875540	1.5
11549	875549	1.2
11550	875550	1.7, 9.1
11551	875551	1.1
11560	875560	1.7, 9.1

# OBT Part No. - Ref. No.

Best. nr. Part No.	Ref. nr. Ref. No.	Sida Page
11579	875579	1.1
11590	967590	
11592	967592	
11609		3.8
11621	418621	
11622	418622	
11646	948646	
11651	275751	1.7, 9.1
11651	875651	1.7, 9.1
11677	18677	
11742	946742	
11742	955982	
11743	946743	
11747	191747	4.6
11789	947789	
11799	11009	1.7
11799	181799	1.7
11821	943821	
11846	469846	3.7
11882	948882	
11902	463902	1.8, 5.22
11903	463903	1.8, 5.22
11904	463904	1.8, 5.22
11905	463905	1.8, 5.22
11906	270906	1.4
11907	270907	1.4
11908	270908	1.4
11919	861211	
11955	968955	1.8, 5.22
11971	3852851	
11980	955980	
11998	11998	
12002	838062	
12003	1218674	2.1
12004	461511	2.1
12005	419735	2.6
12006	1336763	2.3
12009	859089	
12010		2.2
12011		2.2
12020	829620	2.6
12044	833044	
12045		2.8
12046		2.8
12048	859048	
12053	859053	
12059	838059	
12062	859062	
12066	859066	
12067	859067	
12075	3877075	
12084	947084	
12090	955990	
12100		2.3
12101		2.2
12102		2.2
12122	856122	
12141	859141	

Best. nr. Part No.	Ref. nr. Ref. No.	Sida Page
12171	859171	2.5
12173	960173	
12181	859181	
12186	859186	
12187	859187	
12188	833188	2.6
12198	969198	
12252	190252	
12266	415266	2.7
12273	6842273	
12278	859147	
12292	419292	2.6
12307	463075	2.2
12311		2.3
12327	897327	
12357	405357	2.5
12360	803360	
12368	419368	2.6
12371	803371	
12377	463377	2.4, 8.14
12395	463395	2.6
12425	1276425	
12432	3514432	2.5
12441	944441	
12442	1346442	2.1
12446	840446	
12455	943455	
12460		2.8
12465	3853159	
12470		2.8
12475		2.8
12480		2.8
12485		2.8
12490		2.8
12493	1378493	
12495		2.8
12500		2.8
12506	855506	2.4, 8.14
12507	855507	2.4
12513	1218630	2.2
12526	463526	2.6
12546	463546	2.8
12547	463547	2.8
12548	463548	2.8
12549	463549	2.8
12550	463550	2.8
12551	463551	2.8
12552	463552	2.8
12553	463553	2.8
12554	463554	2.8
12555	463555	2.8
12556	463556	2.8
12557	463557	2.8
12558	463558	2.8
12559	463559	2.8
12560	463560	2.8
12561	463561	2.8
12562	463562	2.8

# OBT Part No. - Ref. No.

Best. nr. Part No.	Ref. nr. Ref. No.	Sida Page
12563	463563	2.8
12564	463564	2.8
12565	463565	2.8
12566	463566	2.8
12567	463567	2.8
12568	463568	2.8
12569	463569	2.8
12570	463570	2.8
12603	3582609	2.7
12630	1306630	2.5
12643	419643	2.6
12652	419652	2.7
12653	419653	2.7
12734	419734	2.6
12737	418737	2.8
12739	463739	2.8
12759	833759	
12760	833760	
12767	1336767	2.1
12792	1317792	2.6
12793	1317793	2.6
12870	1378870	3.4
12893	3517893	2.5
12944	271944	2.3
12960	1378960	2.7
12979	1378979	
12986	831986	2.4
13008	9139284	3.1
13009	419310	3.1
13010	3855409	3.1
13024	807294	3.7
13025	859225	3.7
13039	430039	3.4
13042	859042	3.5
13043	859043	3.5
13044	859044	3.6
13051	1378851	
13052	1378853	
13053	925053	
13066	838066	3.5
13068	803068	
13070	859151	3.2
13090	859090	
13093	859093	3.3
13094	859094	3.3
13100	419678	3.4
13115	840115	3.5
13119	1544119	3.6
13127	859134	3.2
13136	859136	3.3
13150	859150	3.3
13155	859155	3.4
13181	957181	
13191	957191	
13221	945221	
13274	833274	3.2
13287	1542287	3.6
13296	3514296	

Best. nr. Part No.	Ref. nr. Ref. No.	Sida Page
13341	1306341	3.8
13376	859135	3.2
13393		3.5
13399	859120	3.5
13414	943414	3.8
13416	1317761	3.8
13416	1326239	3.8
13442	840442	3.7
13453	859137	3.2
13497	859138	3.7
13498	859148	3.7
13531	859152	3.3
13569	840569	3.3
13623	9139282	3.1
13645	1378645	3.2
13646	1378646	3.2
13652	838652	3.6
13653	838653	3.6
13654	838654	3.6
13742	3583786	3.4
13749	860749	3.3
13750		9.9
13751		9.9
13752		9.9
13763	419763	3.1
13780	833780	3.7
13781	833781	3.7
13783	876783	3.1
13909	1378909	3.4
13986	955986	
13990	418990	3.1
13993	3582432	3.4
14001	948187	4.6
14005	840648	4.5
14031	859031	4.5
14034	471034	4.2
14035	859035	
14036	859036	4.5
14057	3517857	4.1
14061	947061	
14069	876069	4.3
14074	838074	
14086	859086	
14087	949187	
14114	947114	
14132	907132	
14144	1346144	4.4
14157	859157	
14158	421158	
14184	957184	
14189	859189	
14193	957193	
14222	3848222	
14250	861250	4.5
14251	861251	4.5
14337	834337	4.1
14360	829714	
14390	3827069	4.2



# OBT Part No. - Ref. No.

Best. nr. Part No.	Ref. nr. Ref. No.	Sida Page
14440	835440	4.2
14473	861473	4.1
14476	861476	4.1
14482	469482	
14483	469483	
14559	3850559	4.2
14568	833568	
14570	858570	
14591	967591	
14621	3581621	4.1
14626	907135	
14626	947626	
14627	947627	
14634	466634	4.3
14641	420641	
14653	945653	
14677	461677	4.4
14706	1218706	4.4
14711	862711	
14730	859081	
14731	859082	
14750	841750	4.1
14779	835779	4.2
14805	419805	
14806	18806	
14807	838807	
14811	18811	
14818	18818	4.6
14840	18840	
14840	947624	
14855	833855	
14864	1378864	4.4
14879	840879	4.5, 9.9
14914	1378914	4.4
14946	1219946	4.4
14974	4785974	4.3
14975	955975	
14977	955977	
14992	11992	
15001	833991	
15003	826013	
15004	856004	
15005	18669	
15006	835417	
15007	808007	
15007	835511	
15009	826241	
15010	11010	
15013	838013	
15014	827014	
15017	430017	
15018	430018	
15020	430020	
15027	859027	
15028	855728	
15033	416033	
15036	807036	5.19
15037	856037	

Best. nr. Part No.	Ref. nr. Ref. No.	Sida Page
15044	955244	
15045	1378491	
15047	859047	
15055	859104	
15057	925057	
15059	951959	
15061	859061	
15066	949722	
15067	968927	
15068	925068	
15069	925069	
15091	975672	
15092	925092	
15093	841693	
15094	812994	
15095	842695	
15096	925096	
15097	876097	5.10
15102	43213002	5.23
15106	964106	
15108	43213003	5.23
15109	831009	5.9
15111	846111	
15120	876120	5.2
15127	860127	
15130	422130	
15131	859131	
15133	838942	
15134	861551	5.20
15149	841149	
15168	411168	
15169	836169	5.21
15172	430172	
15178	831178	5.9
15179	859216	
15181	831181	
15183	960183	
15189	1526189	
15196	859196	
15198	1542198	
15215	806215	
15227	958227	
15244	826244	
15247	827247	5.6
15250	827250	
15255	925255	
15275	808275	
15282	947282	
15300	43957300	5.21
15301	43957301	5.21
15302	43957302	5.21
15304	841063	5.21
15305	876305	5.11
15330	969330	
15331	969331	
15350		5.3
15351		5.3
15352	859103	

# OBT Part No. - Ref. No.

Best. nr. Part No.	Ref. nr. Ref. No.	Sida Page
15353		5.3
15354	845354	
15355	181355	5.6
15356		5.4
15357		5.4
15383	875383	5.4
15385	840385	
15387	840387	
15405	855405	
15408	859105	
15411	418411	
15412	418412	
15417	833417	
15423	855423	
15424	828424	
15433	829433	5.10
15444	809444	5.6
15445	418445	
15446	914446	
15467	858467	5.10
15476	834476	
15502	925027	
15508	835508	
15508	3854293	
15512	3854286	5.2
15551	802551	
15554	963554	
15555	968555	
15574	875574	5.4
15574	876081	5.4
15575	875575	5.1
15578	855578	5.9
15580	875580	5.11
15581	835581	
15582	855582	
15583	875583	5.1
15584	875584	5.5
15590	859010	
15592	829592	5.19
15593	877061	5.2
15597	842597	
15601	826601	
15608	946608	
15610	841610	
15615	845615	
15617	831617	
15622	831622	
15625	1336255	
15629	817629	
15637		5.3
15642	841642	5.6
15656	949656	
15657	949657	
15658	949658	
15659	949659	
15660	875736	5.2
15661	823661	5.21
15689	859084	

Best. nr. Part No.	Ref. nr. Ref. No.	Sida Page
15693	804693	
15693	840785	
15695	804695	
15697	804697	
15698	875698	5.4
15699	330699	
15714	829714	
15717	181717	
15721	949721	
15728	825728	
15730	803730	
15738	875738	5.23
15744	82744	5.19
15745	82745	5.19
15756	875756	5.5
15766	838766	
15769	875769	
15771	418771	
15773	840773	
15779	877355	5.11
15780	875780	5.11
15783	875783	5.11
15785	875785	5.11
15787	3831425	5.12
15788	3831426	5.12
15791	875791	5.10
15795	840795	
15796	875796	5.10
15804	859119	
15807	875807	5.1
15808	875808	5.1
15811	3862281	5.1
15811	3862567	5.1
15825	817825	
15836	18836	
15855	838855	
15861	183861	5.6
15864	818684	5.6
15871	966871	5.19
15874	835874	5.2
15878	833878	5.8
15880	859215	
15883	858065	5.8
15891	831891	
15892	831892	
15893	947893	5.20
15894	947894	5.20
15895	829895	5.9
15901	855901	
15906	1378906	
15912	804912	
15913	842913	
15918	949918	5.19
15928	838928	5.20
15932		5.3
15934		5.3
15935		5.4
15938	817938	

# OBT Part No. - Ref. No.

Best. nr. Part No.	Ref. nr. Ref. No.	Sida Page
15952	856513	5.9
15952	3860703	5.9
15957	951957	
15959	819959	
15960	831960	
15971	968971	
15972	829972	
15974	829974	
15976	955976	
15979	838979	
15981	948981	
15983	955983	
15986	858986	
15989	829989	
15994	833994	
15995	955995	
15996	833996	
15997	840384	
15998	955998	
15999		5.2
16001		6.5
16007		6.6
16008		6.5
16010		6.6
16011		5.21
16027	859114	
16028	856028	
16034	856034	
16036	856036	
16037	857037	6.4
16039	857618	
16041	856041	
16042	856042	
16046	950046	
16047	942547	
16086	842986	
16091	859091	
16098	859145	6.3
16105	860105	
16107	859107	
16111	3582676	
16112	859112	
16116	940116	
16123	1542123	6.3
16140	859140	6.6
16186	940186	
16194	859194	6.3
16268	942268	
16271	955271	
16281	947281	
16293	955293	
16308	973080	
16310	955310	
16336	942336	
16341	806341	6.5
16374	859015	6.6
16384	856891	6.4
16387	855387	6.1

Best. nr. Part No.	Ref. nr. Ref. No.	Sida Page
16513	855513	6.3
16532	824532	6.1
16535	955535	
16542	947542	
16547	955547	
16600	825600	6.4
16622	947622	
16633	856044	
16673	876144	6.3
16679	967944	
16690	859085	
16751	834751	6.6
16793	959793	
16794	959794	
16804	856883	6.1
16826	955826	
16844	859144	
16854	1378854	
16864	838864	
16879	1378879	
16894	856894	6.1
16900	859002	
16901	859011	
16902	840902	6.6
16906	941906	
16907	941907	
16911	1378911	
16913	1378913	
16943	859004	
16944	840944	
16967	855967	
16980	952980	
16986	952986	
17000	1695000	
17001	1695001	
17002		7.3
17003		7.5
17004		7.3
17005		7.3
17017		7.6
17020	828020	
17027	3825027	7.2
17034	859034	
17040	856040	
17045	859045	
17052	925052	
17056	925056	
17065	876554	7.1
17068	858068	7.8
17101	861014	7.2
17109	1140639	7.2
17129	831129	
17130	859130	
17138	978961	
17139	859139	
17142	859142	
17143	859143	
17146	859146	

# OBT Part No. - Ref. No.

Best. nr. Part No.	Ref. nr. Ref. No.	Sida Page
17149	859149	
17157	1542157	
17158	1542158	
17159	1542159	
17161	841161	7.5
17162	855952	7.1
17170	957170	
17171	957171	
17173	834452	
17173	957173	
17175	957175	
17176	957177	
17177	860177	7.7
17178	957178	
17179	233179	7.6
17182	859182	
17185	876185	7.4
17187	1542187	
17201	3581078	7.2
17205	858205	7.8
17239	831239	
17249	6643249	
17255	861255	3.8
17287	838287	7.7
17303	1542303	7.8
17306	858202	7.2
17307		7.4
17323	833323	7.5
17353	942353	
17358	858358	7.8
17374	1357374	
17384	860384	
17391	463391	7.6
17400	3875400	7.7
17407	818407	7.4
17477	861477	7.1
17488	858488	7.4
17521	15521	
17530	3501530	
17534	25534	
17557	860557	7.8
17570	236570	
17574	826574	7.8
17578	826578	7.8
17588	48588	
17590	824590	
17597	840597	7.7
17620	947620	
17629	236629	
17648	862293	7.4
17656	76656	
17663	273663	7.5
17665	18665	
17666	237666	7.6
17677	824677	
17686	855686	7.1
17717	957179	
17754	418754	

Best. nr. Part No.	Ref. nr. Ref. No.	Sida Page
17781	946781	
17782	859782	7.9
17791	860791	7.7
17803	856470	7.5
17813	18813	
17817	18817	
17821	838821	
17832	824832	
17838	969011	
17839	18839	
17874	860874	7.2
17893	955893	
17896	838896	
17899	817899	
17902	831902	
17905	1378905	
17906	859065	
17909	829909	7.7
17913	829913	7.1
17948	418948	
17973	825973	7.6
17979	955979	
17981	955981	
17984	955984	
17987	3825133	7.1
17990	190990	
17991	11991	
17994	11994	
18001	3851819	8.2
18003	966903	8.13
18060	925060	
18070	3853815	8.2
18078	807078	8.9
18149	240149	8.4
18169	1306169	8.4
18207	829207	8.11
18243	841243	8.3
18244	841244	8.1
18258	238258	8.3
18262	841262	8.6
18263	841263	8.1
18265	418265	
18283	966907	8.13
18304	835304	8.5
18308	835308	8.6
18310	966914	8.10
18311	966916	8.10
18327	966933	8.12
18330	966938	8.13
18363	875363	8.2
18382	966382	8.10
18383	966383	8.11
18385	966385	8.12
18387	966387	8.10
18404	875404	8.2
18498	966857	8.11
18545	834545	8.5
18546	834546	8.6

# OBT Part No. - Ref. No.

Best. nr. Part No.	Ref. nr. Ref. No.	Sida Page
18548	966694	8.10
18560	834560	8.6
18571	875571	8.2
18587	829587	8.9
18605	847605	8.14
18652	241652	8.4
18653	243653	8.5
18657	243657	8.3
18658	243658	8.1
18669	241669	8.1
18690	870690	8.1
18698	966698	8.12
18700	966700	8.11
18702	835702	8.2
18704	835704	8.6
18705	855846	8.5
18707	966707	8.12
18710	241710	8.5
18750	1324750	8.9
18797	243797	8.1
18799	243799	8.4
18801	243801	8.4
18805	966891	8.10
18842	233842	8.5
18843	976492	8.12
18845	3853801	8.3
18900	966900	8.13
18903	243903	8.3
18906	966906	8.13
18926	841926	8.1
18931	966931	8.12
18942	966942	8.13
18975	834975	8.4
18978	966978	8.11
18981	966981	8.11
18990	966990	8.12
19000	956000	
19004	806620	14.7
19005	948883	
19006	181301	14.2
19007	949807	11.6
19008	184682	14.8
19009	941809	
19010	876268	13.3
19011		13.3
19012	853012	11.1
19013	853013	
19014	958859	
19015	852868	10.8
19017	125017	
19018	852018	12.3
19019	3857176	14.4
19020	941820	
19021	956591	
19022	969073	
19023	907023	
19024	907024	
19025	907025	

Best. nr. Part No.	Ref. nr. Ref. No.	Sida Page
19026		13.3
19029		13.3
19030	814030	14.5
19031		13.2
19033		13.2
19034	832534	
19035		13.1
19036	876266	13.3
19037		13.1
19044	11044	14.8
19047	946847	11.6
19052	857624	10.9
19053	17253	11.4
19054	925054	
19055	925055	
19058	19258	
19061	804261	
19062	804262	11.8
19063	925063	
19065	826765	
19068	181268	14.5
19069	3850426	11.2
19071	969071	
19072	11072	14.6
19073	941873	
19075	832675	14.2
19087	181287	14.4, 14.9
19090	979254	
19091	940191	11.4
19092	841892	10.2
19093	925093	
19094	925094	
19095	925095	
19096	872755	
19097	3852352	11.3
19098	942598	
19101	11013	
19105	181105	
19106	653190	10.1
19107	682694	10.1
19112	11012	
19127	3854127	11.1
19165	814165	
19168	814168	
19175	831075	
19177	875177	14.10
19188	948188	
19189	841894	10.2
19190	804190	10.6
19191	832191	
19195	839195	10.8
19195	872290	10.8
19201	925261	
19203	940203	
19209	804209	
19211	834211	
19218	943218	
19238	960238	

# OBT Part No. - Ref. No.

Best. nr. Part No.	Ref. nr. Ref. No.	Sida Page
19242	946242	
19247	183247	14.3
19253	839253	
19253	853670	
19254	1664473	
19255	853255	14.1
19256	925256	
19257	925257	
19258	925258	
19259	925259	
19260	925260	
19261	854047	11.7
19262	925262	
19263	925263	
19266	876266	
19267	876267	13.3
19268	907881	
19272	183272	14.9
19276	17276	11.4
19278	876278	11.4
19286	181286	14.9
19287	851287	
19288	181288	14.7
19289	181289	14.6
19290	181290	14.2
19294	876294	11.1
19300	854300	
19301	814301	11.5
19302	181302	14.2
19313	977313	10.8
19315	897315	14.2
19332	814332	
19338	941338	
19344	804344	
19352	945352	
19356	814356	
19359	814359	10.8
19374	183374	14.7
19389	855389	10.2
19390	183390	14.8
19391	183391	14.6
19392	875129	13.1
19392	876392	13.1
19396	814396	
19399	876392	13.1
19407	851407	
19413	181413	14.8
19419	814419	
19423	839423	11.5
19426	897426	
19458	183458	14.4
19483	830483	
19500	181587	14.8, 14.9
19500	181588	14.8, 14.9
19508	852508	14.7
19522	181522	14.6
19534	839534	11.5
19541	854541	14.9

Best. nr. Part No.	Ref. nr. Ref. No.	Sida Page
19542	853542	14.4
19548	853548	11.3
19548	3852602	11.3
19559	18559	14.6
19570	832570	11.5
19573	191573	
19590	956590	
19591	876397	13.1
19598	832598	12.1
19603	3852603	11.2
19615	942615	
19616	948616	11.3
19617	855617	10.3
19619	3860232	14.1
19620	181620	
19621	181621	14.7
19632	852632	
19654	184654	14.8
19661	806661	
19669	832669	
19670	941670	
19673	961673	
19675	872531	
19677	963677	
19682	897682	
19683	184683	14.10
19691	184691	14.9
19695	963695	
19699	963699	
19700	183750	14.6
19700	183752	14.2
19720	876391	13.1
19726	897726	10.8
19741	875741	13.1
19755	873094	
19756	851756	14.4
19757	851757	14.5
19765	184765	14.10
19766	854031	11.3
19785	854045	11.6
19805	875805	12.1
19807	958807	
19808	966808	
19809	875809	12.1
19810	875810	12.1, 12.2
19812	875812	12.2
19815	875815	12.2
19816	941816	11.5
19819	3852390	14.5
19821	875821	12.2
19822	875822	11.2
19823	949823	
19827	875827	11.1
19828	876633	11.2
19831	832831	11.3
19835	852835	12.1
19838	958838	
19844	191844	10.8

# OBT Part No. - Ref. No.

Best. nr. Part No.	Ref. nr. Ref. No.	Sida Page
19846	832846	11.3
19848	897631	11.1
19850	955850	
19856	958856	
19859	183859	14.10
19860	958860	
19866	958866	
19868	853868	
19871	853871	
19873	897873	
19885	853885	
19886	853886	
19888	850888	11.7
19889	850889	11.7
19892	3856834	
19894	853894	
19896	841896	10.3
19898	853898	
19904	947904	10.9, 11.6
19917	3860697	
19929	838929	5.21, 12.1
19934	813934	14.5
19941	853941	
19945	853945	
19949	3850852	14.3
19962	949962	
19965	832965	11.5
19967	813967	10.7
19973	958973	
19974	955974	
19979	873108	
19983	876286	12.2
19989	955989	
20935	853935	
21023	876448	9.6
21054	876054	9.8
21103	876103	9.5
21104	3583787	9.5
21300	876300	9.2
21301	876301	9.2
21302	876302	9.2
21303	876303	9.2
21304	876304	9.6
21306	876306	9.5
21307	876307	9.4
21308	876308	9.4
21309	876309	9.4
21310	876310	9.4
21314	876314	9.7
21335	876335	9.2
21349	876349	9.8
21357	876357	9.1
21358		9.1
21359	876359	9.2
21361	876361	9.8
21362	876774	9.9
21378	876378	9.6
21379	876379	9.3

Best. nr. Part No.	Ref. nr. Ref. No.	Sida Page
21381	876381	9.7
21382	876382	9.7
21383	876383	9.7
21384	876384	9.7
21387	875387	9.8
21388	876388	9.7
21389	876389	9.6
21394	876394	9.6
21395	3582596	9.5
21400	876342	9.5
21401	876356	9.1
21416	876416	9.4
21417	876417	9.4
21418	876348	9.2
21422	875422	9.3
21423	875423	9.6
21427	876427	9.8
21430	876430	9.3
21431	876431	9.3
21433	876433	9.6
21439	875439	9.8
21453	3582587	9.5
21500	876377	9.3
21553	876376	9.3
21561	876341	9.3
21569	876358	9.2
21572	876380	9.4
21757	875757	9.7
22001		6.2
22002		6.1
22003		6.1
22004		6.2
22005		6.3
22006		6.4
22007		6.4
22008		5.14
22009		5.7
22010		7.9
22011	876224	5.14
22012		5.13
22013		5.18
22014		5.18
22015		5.15
22016		5.8
22017		5.14
22018		7.9
22019		5.13
22020		7.11
22021		5.13
22022		5.17
22023		5.13
22024		5.13
22025		5.13
22026		7.12
22027		7.12
22028		7.12
22029		7.10
22030		7.11

# OBT Part No. - Ref. No.

Best. nr. Part No.	Ref. nr. Ref. No.	Sida Page
22031		7.11
22032		5.15
22033		5.15
22034		6.7
22035		5.13
22036		5.12
22037		5.12
22038		5.18
22039		5.18
22040		5.7
22041		6.2
22042		5.6
22043		7.9
22044		7.10
22045		6.4
22046		7.3
22047		5.7
22048		7.10
22049		5.12
22050	833950	10.1
22051		5.12
22052		7.12
22053		5.7
22054		5.7
22055		10.3
22056		11.8
22057		10.3
22058		10.4
22059		10.4
22060		10.4
22061		5.12
22062	803762	10.1
22063		7.10
22064		7.10
22065		7.10
22066		13.5
22067		13.5
22068		5.17
22069	876227	7.12
22070		5.17
22071		13.5
22072		5.7
22073		5.4
22074		10.4
22075		10.5
22076		5.5
22079		13.4
22080	832820	11.4
22081		13.4
22082		13.4
22083		13.4
22084		13.4
22085		13.4
22086		13.5
22087		13.5
22088		7.9
22089		5.8
22090		13.2

Best. nr. Part No.	Ref. nr. Ref. No.	Sida Page
22091		13.2
22094		11.6
22095		13.6
22096		13.2
22097		13.2
22098		13.6
22099		14.1
22100		14.1
22101		13.6
22102		6.5
22103		5.15
22104		5.17
22105		5.16
22106		5.16
22107		5.16
22108		5.16
22109		5.16
22110		5.16
22111		5.16
22113		5.14
22114		5.14
22115		5.14
22116		5.14
22117		7.12
22118		7.12
22119		6.7
22120		6.7
22121		6.7
22122		5.15
22123		5.15
22124		5.15
22125		5.18
22126		5.18
22127		5.17
22128		5.17
22129		6.2
22130		6.2
22131		7.11
22132		7.11
22133		7.11
22134		6.7
22135	3582595	6.7
22136	875759	5.5
22137	875769	5.5
22138	3582563	6.8
22139	876398	6.8
22140		7.3
22141	271473	7.5
22142		2.1
22143		5.17
22144	849170	10.1
22145		6.4
22146		6.5
22147		6.2
22150		14.1
22151		14.1



# Ref. No. - OBT Part No.

Ref. nr. Ref. No.	Best. nr. Part No.	Sida Page
11009	11799	1.7
11010	15010	
11012	19112	
11013	19101	
11044	19044	14.8
11072	19072	14.6
11991	17991	
11992	14992	
11994	17994	
11998	11998	
15301	11998	
15521	17521	
17253	19053	11.4
17268	19268	
17276	19276	11.4
18559	19559	14.6
18665	17665	
18669	15005	
18671	17838	
18677	11677	
18806	14806	
18811	14811	
18813	17813	
18817	17817	
18818	14818	4.6
18820	14626	
18836	15836	
18838	17838	
18839	17839	
18840	14840	
19258	19058	
25534	17534	
48588	17588	
61830	17905	
76656	17656	
82744	15744	5.19
82745	15745	5.19
125017	19017	
181105	19105	
181268	19068	14.5
181286	19286	14.9
181287	19087	14.4, 14.9
181288	19288	14.7
181289	19289	14.6
181290	19290	14.2
181301	19006	14.2
181302	19302	14.2
181355	15355	5.6
181359	19059	14.5
181366	19541	14.9
181413	19413	14.8
181522	19522	14.6
181587	19500	14.8, 14.9
181588	19500	14.8, 14.9
181619	19391	14.6
181620	19620	
181621	19621	14.7
181624	19390	14.8

Ref. nr. Ref. No.	Best. nr. Part No.	Sida Page
181648	15189	
181717	15717	
181799	11799	1.7
183247	19247	14.3
183272	19272	14.9
183374	19374	14.7
183390	19390	14.8
183391	19391	14.6
183457	19542	14.4
183458	19458	14.4
183668	19949	14.3
183729	19542	14.4
183750	19700	14.6
183752	19700	14.2
183859	19859	14.10
183861	15861	5.6
184654	19654	14.8
184682	19008	14.8
184683	19683	14.10
184689	19765	14.10
184690	19765	14.10
184691	19691	14.9
184765	19765	14.10
190252	12252	
190803	19458	14.4
190935	16793	
190990	17990	
191573	19573	
191698	15745	5.19
191747	11747	4.6
191844	19844	10.8
192134	15134	5.20
192211	11032	1.8, 5.22
192212	11033	1.8, 5.22
192426	11031	1.8, 5.22
233179	17179	7.6
233260	18690	8.1
233678	18258	8.3
233842	18842	8.5
236570	17570	
236628	17201	7.2
236629	17629	
237299	17666	7.6
237666	17666	7.6
238258	18258	8.3
239598	18690	8.1
240149	18149	8.4
240305	18903	8.3
241652	18652	8.4
241669	18669	8.1
241710	18710	8.5
243004	17987	7.1
243464	17874	7.2
243632	18690	8.1
243653	18653	8.5
243657	18657	8.3
243658	18658	8.1
243796	18903	8.3

## Ref. No. - OBT Part No.

Ref. nr. Ref. No.	Best. nr. Part No.	Sida Page
243797	18797	8.1
243799	18799	8.4
243801	18801	8.4
243803	18658	8.1
243903	18903	8.3
270015	11477	1.5
270136	11136	1.6
270137	11137	1.6
270138	11138	1.6
270471	11471	1.5
270691	12944	2.3
270906	11906	1.4
270907	11907	1.4
270908	11908	1.4
271051	11051	1.5
271052	11105	
271053	11053	1.5
271054	11022	1.6
271055	11023	1.6
271056	11024	1.6
271063	11063	1.5
271064	11064	1.5
271065	11106	1.5
271066	11025	1.6
271067	11026	1.6
271068	11027	1.6
271214	11214	1.4
271215	11215	1.4
271216	11216	1.4
271217	11019	1.4
271218	11020	1.4
271219	11021	1.4
271236	11236	1.4
271237	11237	1.4
271238	11238	1.4
271473	22141	7.5
271944	12944	2.3
272002	11202	1.1
272004	11200	1.1
272010	11059	1.1
272012	11203	1.1
272040	11040	1.1
272042	11042	1.1
272043	11043	1.1
272056	11205	1.1
272058	11058	1.1
272059	11059	1.1
273663	17663	7.5
275193	11193	1.1
275195	11195	1.1
275196	11196	1.1
275282	11082	1.2
275283	11083	1.2
275331	11531	1.3
275332	11533	1.3
275333	11532	1.3
275334	11534	1.2
275335	11535	1.2

Ref. nr. Ref. No.	Best. nr. Part No.	Sida Page
275336	11536	1.2
275337	11337	1.3
275338	11338	1.3
275339	11339	1.3
275340	11340	1.2
275341	11341	1.2
275342	11342	1.2
275344	11344	1.2
275345	11345	1.2
275346	11346	1.2
275369	11369	1.3
275370	11370	1.3
275371	11371	1.3
275489	22141	7.5
275595	11651	1.7, 9.1
275751	11651	1.7, 9.1
276275	12944	2.3
276662	11051	1.5
276663	11105	
276664	11053	1.5
276698	11214	1.4
276699	11215	1.4
276700	11216	1.4
330699	15699	
382005	19005	
405357	12357	2.5
411168	15168	
415266	12266	2.7
415268	12292	2.6
415424	12357	2.5
416033	15033	
418256	13100	3.4
418262	14864	4.4
418265	18265	
418280	14706	4.4
418290	12368	2.6
418295	11295	1.1
418360	14360	
418361	15033	
418411	15411	
418412	15412	
418415	13990	3.1
418423	12513	2.2
418432	14057	4.1
418445	15445	
418495	12266	2.7
418620	12122	
418621	11621	
418622	11622	
418678	12944	2.3
418707	12003	2.1
418737	12737	2.8
418754	17754	
418771	15771	
418870	16911	
418948	17948	
418990	13990	3.1
419292	12292	2.6

# Ref. No. - OBT Part No.

Ref. nr. Ref. No.	Best. nr. Part No.	Sida Page
419310	13009	3.1
419368	12368	2.6
419542	14706	4.4
419628	13783	3.1
419643	12643	2.6
419652	12652	2.7
419653	12653	2.7
419678	13100	3.4
419702	12630	2.5
419734	12734	2.6
419735	12005	2.6
419763	13763	3.1
419805	14805	
420641	14641	
421158	14158	
422130	15130	
422581	14483	
423135	14974	4.3
424299	15305	5.11
424342	11846	3.7
424346	14482	
430017	15017	
430018	15018	
430020	15020	
430039	13039	3.4
430107	13008	3.1
430118	11160	
430133	12979	
430134	11134	
430143	14057	4.1
430172	15172	
430190	14677	4.4
431092	16913	
461056	13008	3.1
461113	14914	4.4
461511	12004	2.1
461618	13010	3.1
461677	14677	4.4
462623	13623	3.1
463075	12307	2.2
463092	11092	1.1
463225	16225	
463377	12377	2.4, 8.14
463391	17391	7.6
463392	17530	
463395	12395	2.6
463412	13645	3.2
463416	11416	3.5
463430	15625	
463431	15906	
463505	17185	7.4
463526	12526	2.6
463546	12546	2.8
463547	12547	2.8
463548	12548	2.8
463549	12549	2.8
463550	12550	2.8
463551	12551	2.8

Ref. nr. Ref. No.	Best. nr. Part No.	Sida Page
463552	12552	2.8
463553	12553	2.8
463554	12554	2.8
463555	12555	2.8
463556	12556	2.8
463557	12557	2.8
463558	12558	2.8
463559	12559	2.8
463560	12560	2.8
463561	12561	2.8
463562	12562	2.8
463563	12563	2.8
463564	12564	2.8
463565	12565	2.8
463566	12566	2.8
463567	12567	2.8
463568	12568	2.8
463569	12569	2.8
463570	12570	2.8
463587	14864	4.4
463739	12739	2.8
463771	12603	2.7
463829	11492	
463902	11902	1.8, 5.22
463903	11903	1.8, 5.22
463904	11904	1.8, 5.22
463905	11905	1.8, 5.22
463999	13909	3.4
466393	14641	
466634	14634	4.3
466987	17987	7.1
469482	14482	
469483	14483	
469846	11846	3.7
471034	14034	4.2
471956	11385	
477024	11032	1.8, 5.22
477026	11031	1.8, 5.22
653190	19106	10.1
653874	18750	8.9
672910	18750	8.9
677608	17374	
680642	17374	
682694	19107	10.1
800326	16107	
800475	15928	5.20
800476	19929	5.21, 12.1
802399	13399	3.5
802551	15551	
802910	16028	
803068	13068	
803227	20935	
803356	11356	
803359	11359	
803360	12360	
803361	12141	
803371	12371	
803374	16374	6.6

## Ref. No. - OBT Part No.

Ref. nr. Ref. No.	Best. nr. Part No.	Sida Page
803520	17146	
803723	15693	
803730	15730	
803762	22062	10.1
804107	19929	5.21, 12.1
804186	19827	11.1
804190	19190	10.6
804207	19973	
804209	19209	
804218	19278	11.4
804227	19278	11.4
804257	19844	10.8
804261	19061	
804262	19062	11.8
804266	19886	
804267	19898	
804270	19885	
804344	19344	
804417	19810	12.1, 12.2
804693	15693	
804695	15695	
804696	15808	5.1
804697	15697	
804912	15912	
806215	15215	
806256	15109	5.9
806270	19896	10.3
806328	16028	
806340	15097	5.10
806341	16341	6.5
806534	15355	5.6
806620	19004	14.7
806661	19661	
806890	15890	
807036	15036	5.19
807078	18078	8.9
807276	12187	
807278	12278	
807294	13024	3.7
807298	13025	3.7
807363	14193	
807464	22144	10.1
807474	14568	
807475	14035	
807904	15593	5.2
808007	15007	
808275	15275	
809444	15444	5.6
812994	15094	
813912	19912	
813934	19934	14.5
813959	19013	
813967	19967	10.7
814030	19030	14.5
814165	19165	
814168	19168	
814217	19356	
814275	19570	11.5

Ref. nr. Ref. No.	Best. nr. Part No.	Sida Page
814301	19301	11.5
814332	19332	
814356	19356	
814357	19357	
814359	19359	10.8
814396	19396	
814419	19419	
814597	19294	11.1
814953	16980	
815844	16844	
817629	15629	
817730	14730	
817731	14731	
817825	15825	
817880	15880	
817894	15804	
817899	17899	
817918	15179	
817938	15938	
818035	14005	4.5
818262	11262	1.5
818352	15352	
818355	15055	
818405	19189	10.2
818407	17407	7.4
818408	15408	
818684	15864	5.6
819025	18605	8.14
819689	15689	
819690	16690	
819720	16140	6.5
819727	16140	6.6
819959	15959	
820271	16027	
820366	17973	7.6
821094	17109	7.2
823661	15661	5.21
824200	15787	5.12
824200	15788	5.12
824532	16532	6.1
824590	17590	
824633	16633	
824677	17677	
824803	17803	7.5
824832	17832	
824912	15097	5.10
825558	16028	
825600	16600	6.4
825728	15728	
825916	15895	5.9
825940	15811	5.1
825941	15593	5.2
825942	15660	5.2
825973	17973	7.6
826013	15003	
826241	15009	
826244	15244	
826341	19278	11.4

# Ref. No. - OBT Part No.

Ref. nr. Ref. No.	Best. nr. Part No.	Sida Page
826574	17574	7.8
826578	17578	7.8
826601	15601	
826648	17648	7.4
826765	19065	
827014	15014	
827247	15247	5.6
827250	15250	
828020	17020	
828021	17040	
828026	15578	5.9
828424	15424	
828897	17101	7.2
829132	19189	10.2
829161	14390	4.2
829189	18387	8.10
829207	18207	8.11
829214	13531	3.3
829254	11254	1.2
829390	14390	4.2
829433	15433	5.10
829476	19092	10.2
829487	11487	
829531	13531	3.3
829587	18587	8.9
829592	15592	5.19
829620	12020	2.6
829714	14360	
829714	15714	
829812	15097	5.10
829812	15796	5.10
829813	15780	5.11
829895	15895	5.9
829909	17909	7.7
829913	17913	7.1
829972	15972	
829974	15974	
829989	15989	
829993	17987	7.1
830483	19483	
831009	15109	5.9
831040	15791	5.10
831073	16036	
831075	19175	
831129	17129	
831178	15178	5.9
831181	15181	
831182	15575	5.1
831239	17239	
831330	16042	
831480	16042	
831518	16041	
831617	15617	
831622	15622	
831777	19896	10.3
831778	19389	10.2
831891	15891	
831892	15892	

Ref. nr. Ref. No.	Best. nr. Part No.	Sida Page
831893	15037	
831902	17902	
831960	15960	
831986	12986	2.4
832191	19191	
832524	19805	12.1
832534	19034	
832570	19570	11.5
832598	19598	12.1
832669	19669	
832675	19075	14.2
832820	22080	11.4
832831	19831	11.3
832846	19846	11.3
832952	19945	
832965	19965	11.5
833044	12044	
833047	14189	
833048	17142	
833070	13070	3.2
833174	12066	
833188	12188	2.6
833274	13274	3.2
833315	22144	10.1
833323	17323	7.5
833347	12630	2.5
833366	15796	5.10
833411	15780	5.11
833415	15883	5.8
833417	15417	
833453	13453	3.2
833497	13497	3.7
833498	13498	3.7
833522	15883	5.8
833550	15807	5.1
833568	14568	
833598	16098	6.3
833625	22144	10.1
833720	22144	10.1
833759	12759	
833760	12760	
833780	13780	3.7
833781	13781	3.7
833792	11159	
833826	15785	5.11
833855	14855	
833856	14157	
833878	15878	5.8
833883	15883	5.8
833950	22050	10.1
833991	15001	
833994	15994	
833995	15583	5.1
833996	15996	
833997	15997	
834211	19211	
834337	14337	4.1
834452	17173	

## Ref. No. - OBT Part No.

Ref. nr. Ref. No.	Best. nr. Part No.	Sida Page
834476	15476	
834523	15901	
834545	18545	8.5
834546	18546	8.6
834548	18548	8.10
834560	18560	8.6
834751	16751	6.6
834794	15120	5.2
834975	18975	8.4
835177	15305	5.11
835180	15004	
835304	18304	8.5
835308	18308	8.6
835310	18244	8.1
835417	15006	
835440	14440	4.2
835465	12465	
835476	18001	8.2
835477	18001	8.2
835478	18001	8.2
835479	18001	8.2
835480	18001	8.2
835481	18001	8.2
835508	15508	
835511	15007	
835512	15512	5.2
835581	15581	
835702	18702	8.2
835704	18704	8.6
835705	18705	8.5
835779	14779	4.2
835804	16804	6.1
835860	17162	7.1
835874	15874	5.2
835908	16039	
835966	16034	
836169	15169	5.21
838011	15783	5.11
838013	15013	
838055	11005	
838058	19941	
838059	12059	
838062	12002	
838066	13066	3.5
838074	14074	
838127	13127	3.2
838235	14031	4.5
838286	15783	5.11
838287	17287	7.7
838377	17139	
838400	17149	
838501	15784	5.11
838593	17874	7.2
838609	11609	3.8
838628	13993	3.4
838652	13652	3.6
838653	13653	3.6
838654	13654	3.6

Ref. nr. Ref. No.	Best. nr. Part No.	Sida Page
838673	16673	6.3
838766	15766	
838807	14807	
838821	17821	
838855	15855	
838864	16864	
838896	17896	
838928	15928	5.20
838929	19929	5.21, 12.1
838942	15133	
838979	15979	
839195	19195	10.8
839218	19894	
839253	19253	
839388	19815	12.2
839423	19423	11.5
839534	19534	11.5
840075	11075	
840076	15883	5.8
840115	13115	3.5
840270	13136	3.3
840270	13749	3.3
840328	13094	3.3
840376	16091	
840384	15997	
840385	15385	
840387	15387	
840405	13093	3.3
840440	13043	3.5
840442	13442	3.7
840446	12446	
840461	13044	3.6
840486	12053	
840569	13569	3.3
840572	13042	3.5
840578	12048	
840597	17597	7.7
840648	14005	4.5
840773	15773	
840785	15693	
840795	15795	
840879	14879	4.5, 9.9
840902	16902	6.6
840910	13749	3.3
840919	11919	
840932	16112	
840944	16944	
841063	15304	5.21
841070	18070	8.2
841149	15149	
841161	17161	7.5
841162	17162	7.1
841224	18001	8.2
841225	18001	8.2
841226	18001	8.2
841227	18001	8.2
841228	18001	8.2
841243	18243	8.3

# Ref. No. - OBT Part No.

Ref. nr. Ref. No.	Best. nr. Part No.	Sida Page
841244	18244	8.1
841262	18262	8.6
841263	18263	8.1
841287	18705	8.5
841610	15610	
841642	15642	5.6
841676	16894	6.1
841693	15093	
841750	14750	4.1
841821	18382	8.10
841847	16037	6.4
841892	19092	10.2
841894	19189	10.2
841895	19389	10.2
841896	19896	10.3
841907	18845	8.3
841926	18926	8.1
842586	14086	
842597	15597	
842645	17906	
842669	15061	
842695	15095	
842744	15986	
842913	15913	
842928	14711	
842943	16943	
842986	16086	
842990	11038	
843009	16111	
843042	16900	
843547	18605	8.13
843736	14069	4.3
844084	15131	
845109	17109	7.2
845291	17045	
845310	15590	
845334	15979	
845353	15196	
845354	15354	
845527	16901	
845585	15047	
845615	15615	
846074	17130	
846111	15111	
846734	17027	7.2
847605	18605	8.14
849170	22144	10.1
850004	19828	11.2
850073	19812	12.2
850443	19828	11.2
850785	19785	11.6
850888	19888	11.7
850889	19889	11.7
851261	19261	11.7
851287	19287	
851406	19871	
851407	19407	
851755	19755	

Ref. nr. Ref. No.	Best. nr. Part No.	Sida Page
851756	19756	14.4
851757	19757	14.5
851766	19766	11.3
851979	19979	
851983	19983	12.2
851996	19892	
852018	19018	12.3
852508	19508	14.7
852632	19632	
852768	19630	
852835	19835	12.1
852868	19015	10.8
853012	19012	11.1
853013	19013	
853223	19279	11.4
853255	19255	14.1
853542	19542	14.4
853548	19548	11.3
853670	19253	
853819	19819	14.5
853868	19868	
853871	19871	
853885	19885	
853886	19886	
853892	19892	
853894	19894	
853898	19898	
853935	20935	
853941	19941	
853945	19945	
853949	19949	14.3
854031	19766	11.3
854045	19785	11.6
854047	19261	11.7
854300	19300	
854541	19541	14.9
854555	19630	11.2
854619	19619	14.1
854670	19019	14.4
854752	19052	10.9
855380	16037	6.4
855383	16967	
855384	16384	6.4
855387	16387	6.1
855389	19389	10.2
855405	15405	
855423	15423	
855506	12506	2.4, 8.14
855507	12507	2.4
855513	16513	6.3
855578	15578	5.9
855582	15582	
855617	19617	10.3
855674	18001	8.2
855675	18001	8.2
855676	18001	8.2
855677	18001	8.2
855678	18001	8.2

## Ref. No. - OBT Part No.

Ref. nr. Ref. No.	Best. nr. Part No.	Sida Page
855686	17686	7.1
855728	15028	
855845	18845	8.3
855846	18705	8.5
855901	15901	
855926	16804	6.1
855952	17162	7.1
855967	16967	
856004	15004	
856028	16028	
856034	16034	
856036	16036	
856037	15037	
856039	16039	
856040	17040	
856041	16041	
856042	16042	
856044	16633	
856045	16042	
856122	12122	
856137	16894	6.1
856272	18001	8.2
856470	17803	7.5
856513	15952	5.9
856883	16804	6.1
856891	16384	6.4
856894	16894	6.1
856895	16037	6.4
856917	19917	
857037	16037	6.4
857618	16039	
857624	19052	10.9
858065	15883	5.8
858068	17068	7.8
858133	15133	
858201	17201	7.2
858202	17306	7.2
858205	17205	7.8
858306	17306	7.2
858358	17358	7.8
858467	15467	5.10
858488	17488	7.4
858501	19929	5.21, 12.1
858503	13155	3.4
858570	14570	
858986	15986	
858992	13742	3.4
858993	13993	3.4
859002	16900	
859004	16943	
859010	15590	
859011	16901	
859015	16374	6.6
859027	15027	
859031	14031	4.5
859034	17034	
859035	14035	
859036	14036	4.5

Ref. nr. Ref. No.	Best. nr. Part No.	Sida Page
859038	11038	
859039	11039	
859042	13042	3.5
859043	13043	3.5
859044	13044	3.6
859045	17045	
859047	15047	
859048	12048	
859053	12053	
859061	15061	
859062	12062	
859065	17906	
859066	12066	
859067	12067	
859081	14730	
859082	14731	
859084	15689	
859085	16690	
859086	14086	
859088	11088	
859089	12009	
859090	13090	
859091	16091	
859093	13093	3.3
859094	13094	3.3
859103	15352	
859104	15055	
859105	15408	
859107	16107	
859111	16111	
859112	16112	
859114	16027	
859115	11005	
859119	15804	
859120	13399	3.5
859130	17130	
859131	15131	
859134	13127	3.2
859135	13376	3.2
859136	13136	3.3
859137	13453	3.2
859138	13497	3.7
859139	17139	
859140	16140	6.6
859141	12141	
859142	17142	
859143	17143	
859144	16844	
859145	16098	6.3
859146	17146	
859147	12278	
859148	13498	3.7
859149	17149	
859150	13150	3.3
859151	13070	3.2
859152	13531	3.3
859155	13155	3.4
859157	14157	



# Ref. No. - OBT Part No.

Ref. nr. Ref. No.	Best. nr. Part No.	Sida Page
859159	11159	
859171	12171	2.5
859172	16091	
859181	12181	
859182	17182	
859186	12186	
859187	12187	
859189	14189	
859194	16194	6.3
859196	15196	
859215	15880	
859216	15179	
859224	13024	3.7
859225	13025	3.7
859461	17461	7.7
859782	17782	7.9
860008	17874	7.2
860105	16105	
860127	15127	
860177	17177	7.7
860340	17461	7.7
860384	17384	
860431	11971	
860557	17557	7.8
860684	14250	4.5
860685	14251	4.5
860749	13749	3.3
860791	17791	7.7
860874	17874	7.2
860921	11038	
860971	11971	
861014	17101	7.2
861211	11919	
861250	14250	4.5
861251	14251	4.5
861255	17255	3.8
861473	14473	4.1
861474	14621	4.1
861475	14621	4.1
861476	14476	4.1
861477	17477	7.1
861551	15134	5.20
862293	17648	7.4
862711	14711	
864723	11472	
870065	17065	7.1
870422	18690	8.1
870690	18690	8.1
872281	19294	11.1
872290	19195	10.8
872531	19675	
872675	19575	
872755	19096	
872793	19793	12.2
873094	19755	
873108	19979	
873291	19868	
875031	21453	9.5

Ref. nr. Ref. No.	Best. nr. Part No.	Sida Page
875129	19392	13.1
875129	19399	13.1
875177	19177	14.10
875192	19192	
875256	19294	11.1
875271	11271	1.3
875302	11302	1.6
875303	11303	1.6
875304	11304	1.6
875305	11305	1.6
875306	11306	1.4
875307	11307	1.4
875308	11308	1.4
875330	11330	1.6
875331	11331	1.6
875332	11332	1.6
875333	11333	1.6
875334	11334	1.4
875335	11335	1.4
875336	11336	1.4
875363	18363	8.2
875375	12944	2.3
875377	11161	1.3
875383	15383	5.4
875387	21387	9.8
875388	21417	9.4
875389	19392	13.1
875400	21400	9.5
875401	21401	9.1
875402	21335	9.2
875403	21306	9.5
875404	18404	8.2
875418	21418	9.2
875422	21422	9.3
875423	21423	9.6
875424	21394	9.6
875438	21416	9.4
875439	21439	9.8
875478	11478	1.5
875479	11479	1.5
875500	21500	9.3
875501	21378	9.6
875502	21500	9.3
875503	21389	9.6
875504	21500	9.3
875505	21388	9.7
875508	21379	9.3
875509	21314	9.7
875512	19827	11.1
875533	21335	9.2
875538	11538	1.5
875539	11539	1.5
875540	11540	1.5
875542	17109	7.2
875543	13783	3.1
875549	11549	1.2
875550	11550	1.7, 9.1
875551	11551	1.1

## Ref. No. - OBT Part No.

Ref. nr. Ref. No.	Best. nr. Part No.	Sida Page
875553	21553	9.3
875554	21384	9.7
875560	11560	1.7, 9.1
875561	21561	9.3
875562	21381	9.7
875567	21417	9.4
875569	21569	9.2
875570	21359	9.2
875571	18571	8.2
875572	21572	9.4
875573	21383	9.7
875574	15574	5.4
875575	15575	5.1
875579	11579	1.1
875580	15580	5.11
875583	15583	5.1
875584	15584	5.5
875587	21300	9.2
875588	21433	9.6
875591	19591	13.1
875593	15593	5.2
875613	21430	9.3
875613	21431	9.3
875633	21395	9.5
875634	21349	9.8
875646	22139	6.8
875651	11651	1.7, 9.1
875660	15660	5.2
875662	21395	9.5
875678	21301	9.2
875698	15698	5.4
875712	15769	
875712	22137	5.5
875715	21382	9.7
875720	19720	13.1
875734	22135	6.7
875736	15660	5.2
875738	15738	5.23
875741	19741	13.1
875756	15756	5.5
875757	21757	9.7
875759	22136	5.5
875769	15769	
875769	22137	5.5
875779	15779	5.11
875780	15780	5.11
875781	15097	5.10
875783	15783	5.11
875784	15784	5.11
875785	15785	5.11
875787	15787	5.12
875788	15788	5.12
875790	15097	5.10
875791	15791	5.10
875794	15305	5.11
875796	15796	5.10
875805	19805	12.1
875807	15807	5.1

Ref. nr. Ref. No.	Best. nr. Part No.	Sida Page
875808	15808	5.1
875809	19809	12.1
875810	19810	12.1, 12.2
875811	15811	5.1
875812	19812	12.2
875815	19815	12.2
875821	19821	12.2
875822	19822	11.2
875826	19294	11.1
875827	19827	11.1
875828	19828	11.2
875829	19828	11.2
875830	19848	11.1
875847	19630	11.2
875848	19848	11.1
875850	14069	4.3
876022	21302	9.2
876023	21023	9.6
876032	21427	9.8
876054	21054	9.8
876069	14069	4.3
876071	21303	9.2
876080	15097	5.10
876081	15574	5.4
876088	22136	5.5
876097	15097	5.10
876103	21103	9.5
876104	21104	9.5
876105	21361	9.8
876106	21362	9.9
876108	22138	6.8
876120	15120	5.2
876144	16673	6.3
876161	11161	1.3
876185	17185	7.4
876224	22011	5.14
876227	22069	7.12
876243	15811	5.1
876266	19266	
876267	19267	13.3
876268	19010	13.3
876278	19278	11.4
876279	19279	11.4
876286	19983	12.2
876294	19294	11.1
876300	21300	9.2
876301	21301	9.2
876302	21302	9.2
876303	21303	9.2
876304	21304	9.6
876305	15305	5.11
876306	21306	9.5
876307	21307	9.4
876308	21308	9.4
876309	21309	9.4
876310	21310	9.4
876312	22138	6.8
876313	22135	6.7

# Ref. No. - OBT Part No.

Ref. nr. Ref. No.	Best. nr. Part No.	Sida Page
876314	21314	9.7
876335	21335	9.2
876337	21335	9.2
876341	21561	9.3
876342	21400	9.5
876348	21418	9.2
876349	21349	9.8
876356	21401	9.1
876357	21357	9.1
876358	21569	9.2
876359	21359	9.2
876361	21361	9.8
876362	21362	9.9
876374	21500	9.3
876375	21500	9.3
876376	21553	9.3
876377	21500	9.3
876378	21378	9.6
876379	21379	9.3
876380	21572	9.4
876381	21381	9.7
876382	21382	9.7
876383	21383	9.7
876384	21384	9.7
876388	21388	9.7
876389	21389	9.6
876391	19720	13.1
876392	19392	13.1
876392	19399	13.1
876394	21394	9.6
876395	21395	9.5
876397	19591	13.1
876398	22139	6.8
876399	19399	13.1
876415	21422	9.3
876416	21416	9.4
876417	21417	9.4
876427	21427	9.8
876430	21430	9.3
876431	21431	9.3
876433	21433	9.6
876448	21023	9.6
876453	21453	9.5
876529	22136	5.5
876530	21104	9.5
876531	21362	9.9
876554	17065	7.1
876631	19848	11.1
876632	19630	11.2
876633	19828	11.2
876689	15807	5.1
876690	15808	5.1
876691	15779	5.11
876774	21362	9.9
876783	13783	3.1
876853	13742	3.4
877061	15593	5.2
877349	15784	5.11

Ref. nr. Ref. No.	Best. nr. Part No.	Sida Page
877355	15779	5.11
897055	15808	5.1
897255	12181	
897315	19315	14.2
897321	14337	4.1
897322	16098	6.3
897327	12327	
897339	19809	12.1
897365	19785	11.6
897367	19367	11.7
897375	19570	11.5
897392	17143	
897426	19426	
897453	19012	11.1
897599	19822	11.2
897600	19766	11.3
897631	19848	11.1
897682	19682	
897707	19255	14.1
897723	19301	11.5
897726	19726	10.8
897729	19675	
897756	19965	11.5
897873	19873	
897889	19294	11.1
907023	19023	
907024	19024	
907025	19025	
907132	14132	
907135	14626	
907881	19268	
914446	15446	
921803	12455	
925027	15502	
925052	17052	
925053	13053	
925054	19054	
925055	19055	
925056	17056	
925057	15057	
925059	15656	
925060	18060	
925061	15658	
925062	15721	
925063	19063	
925065	11065	
925066	15066	
925067	15067	
925068	15068	
925069	15069	
925091	15091	
925092	15092	
925093	19093	
925094	19094	
925095	19095	
925096	15096	
925254	19254	
925255	15255	

## Ref. No. - OBT Part No.

Ref. nr. Ref. No.	Best. nr. Part No.	Sida Page
925256	19256	
925257	19257	
925258	19258	
925259	19259	
925260	19260	
925261	19201	
925262	19262	
925263	19263	
940096	11096	
940116	16116	
940186	16186	
940191	19091	11.4
940203	19203	
941338	19338	
941670	19670	
941809	19009	
941816	19816	11.5
941818	19242	
941820	19020	
941866	19838	
941873	19073	
941906	16906	
941907	16907	
942268	16268	
942336	16336	
942353	17353	
942547	16047	
942598	19098	
942615	19615	
942770	11743	
943177	11177	
943218	19218	
943414	13414	3.8
943455	12455	
943658	17176	
943821	11821	
944181	11181	
944441	12441	
945221	13221	
945352	19352	
945522	16005	
945653	14653	
946242	19242	
946282	11282	
946608	15608	
946742	11742	
946743	11743	
946781	17781	
946847	19047	11.6
947061	14061	
947084	12084	
947114	14114	
947281	16281	
947282	15282	
947542	16542	
947620	17620	
947621	17838	
947622	16622	

Ref. nr. Ref. No.	Best. nr. Part No.	Sida Page
947624	14840	
947626	14626	
947627	14627	
947789	11789	
947893	15893	5.20
947894	15894	5.20
947904	19904	10.9, 11.6
948187	14001	4.6
948188	19188	
948209	19338	
948610	15067	
948616	19616	11.3
948646	11646	
948828	16141	
948882	11882	
948883	19005	
948981	15981	
949187	14087	
949329	11329	
949656	15656	
949657	15657	
949658	15658	
949659	15659	
949721	15721	
949722	15066	
949807	19007	11.6
949823	19823	
949918	15918	5.19
949962	19962	
950046	16046	
950805	18805	8.10
951924	19924	
951957	15957	
951959	15059	
952980	16980	
952986	16986	
955103	11902	1.8, 5.22
955244	15044	
955271	16271	
955293	16293	
955308	16308	
955310	16310	
955535	16535	
955547	16547	
955826	16826	
955850	19850	
955893	17893	
955972	14087	
955974	19974	
955975	14975	
955976	15976	
955977	14977	
955979	17979	
955980	11980	
955981	17981	
955982	11742	
955983	15983	
955984	17984	

# Ref. No. - OBT Part No.

Ref. nr. Ref. No.	Best. nr. Part No.	Sida Page
955986	13986	
955989	19989	
955990	12090	
955995	15995	
955998	15998	
956000	19000	
956590	19590	
956591	19021	
957170	17170	
957171	17171	
957173	17173	
957174	17175	
957175	17175	
957176	17176	
957177	17176	
957178	17178	
957179	17717	
957181	13181	
957183	11183	
957184	14184	
957191	13191	
957193	14193	
958227	15227	
958303	18900	8.13
958306	18906	8.13
958310	18310	8.10
958311	18311	8.10
958317	18383	8.11
958322	18698	8.12
958327	18327	8.12
958328	18707	8.12
958330	18330	8.13
958332	18942	8.13
958359	18978	8.11
958362	18700	8.11
958367	18990	8.12
958368	18843	8.12
958498	18498	8.11
958807	19807	
958838	19838	
958856	19856	
958859	19014	
958860	19860	
958866	19866	
958973	19973	
959793	16793	
959794	16794	
960173	12173	
960183	15183	
960238	19238	
960281	18003	8.13
960283	18283	8.13
960336	18981	8.11
961668	19548	11.3
961673	19673	
961675	19675	
961676	19012	11.1
961677	19013	

Ref. nr. Ref. No.	Best. nr. Part No.	Sida Page
963554	15554	
963677	19677	
963695	19695	
963699	19699	
964106	15106	
966382	18382	8.10
966383	18383	8.11
966385	18385	8.12
966387	18387	8.10
966694	18548	8.10
966698	18698	8.12
966700	18700	8.11
966707	18707	8.12
966808	19808	
966843	18843	8.12
966857	18498	8.11
966871	15871	5.19
966891	18805	8.10
966900	18900	8.13
966903	18003	8.13
966906	18906	8.13
966907	18283	8.13
966914	18310	8.10
966916	18311	8.10
966931	18931	8.12
966933	18327	8.12
966938	18330	8.13
966942	18942	8.13
966978	18978	8.11
966981	18981	8.11
966990	18990	8.12
967590	11590	
967591	14591	
967592	11592	
967643	12198	
967944	16679	
968555	15555	
968927	15067	
968955	11955	1.8, 5.22
968971	15971	
969011	17838	
969071	19071	
969073	19022	
969198	12198	
969330	15330	
969331	15331	
973080	16308	
975138	17138	
975672	15091	
976492	18843	8.12
977313	19313	10.8
978961	17138	
979254	19090	
980936	11385	
1140639	17109	7.2
1218630	12513	2.2
1218674	12003	2.1
1218706	14706	4.4

## Ref. No. - OBT Part No.

Ref. nr. Ref. No.	Best. nr. Part No.	Sida Page
1219032	12442	2.1
1219648	12432	2.5
1219706	12767	2.1
1219946	14946	4.4
1246817	12493	
1266085	18750	8.9
1266286	14057	4.1
1266796	16879	
1275379	11096	
1276336	14144	4.4
1276424	12425	
1276425	12425	
1306169	18169	8.4
1306333	12773	
1306341	13341	3.8
1306630	12630	2.5
1317466	15033	
1317761	13416	3.8
1317792	12792	2.6
1317793	12793	2.6
1324750	18750	8.9
1326239	13416	3.8
1326344	15491	
1326785	13646	3.2
1332644	13646	3.2
1336255	15625	
1336753	12870	3.4
1336763	12006	2.3
1336767	12767	2.1
1346144	14144	4.4
1346442	12442	2.1
1357374	17374	
1378491	15045	
1378492	11492	
1378493	12493	
1378645	13645	3.2
1378646	13646	3.2
1378851	13051	
1378853	13052	
1378854	16854	
1378864	14864	4.4
1378870	12870	3.4
1378879	16879	
1378905	17905	
1378906	15906	
1378909	13909	3.4
1378911	16911	
1378913	16913	
1378914	14914	4.4
1378960	12960	2.7
1378979	12979	
1526189	15189	
1542052	11052	1.5
1542123	16123	6.3
1542157	17157	
1542158	17158	
1542159	17159	
1542177	16123	6.3

Ref. nr. Ref. No.	Best. nr. Part No.	Sida Page
1542187	17187	
1542198	15198	
1542204	11971	
1542219	11039	
1542229	15027	
1542247	14251	4.5
1542263	11955	1.8, 5.22
1542287	13287	3.6
1542289	17034	
1542303	17303	7.8
1542318	11318	
1542385	11385	
1544109	13150	3.3
1544119	13119	3.6
1544124	14250	4.5
1544297	15787	5.12
1544389	15788	5.12
1606877	18750	8.9
1664473	19254	
1695000	17000	
1695001	17001	
3501530	17530	
3514296	13296	
3514432	12432	2.5
3517857	14057	4.1
3517860	12893	2.5
3517893	12893	2.5
3547603	12603	2.7
3547991	15625	
3580066	15808	5.1
3580067	15959	
3580228	14621	4.1
3580454	14621	4.1
3580742	13742	3.4
3581078	17201	7.2
3581621	14621	4.1
3582432	13993	3.4
3582433	13742	3.4
3582435	21103	9.5
3582436	21104	9.5
3582563	22138	6.8
3582587	21453	9.5
3582595	22135	6.7
3582596	21395	9.5
3582609	12603	2.7
3582676	16111	
3583786	13742	3.4
3583787	21104	9.5
3825027	17027	7.2
3825133	17987	7.1
3827069	14390	4.2
3831425	15787	5.12
3831426	15788	5.12
3848222	14222	
3850426	19069	11.2
3850559	14559	4.2
3850852	19949	14.3
3851819	18001	8.2

## Ref. No. - OBT Part No.

Ref. nr. Ref. No.	Best. nr. Part No.	Sida Page
3852352	19097	11.3
3852389	19019	14.4
3852390	19819	14.5
3852602	19548	11.3
3852603	19603	11.2
3852851	11971	
3853159	12465	
3853801	18845	8.3
3853815	18070	8.2
3854127	19127	11.1
3854286	15512	5.2
3854293	15508	
3855409	13010	3.1
3855546	15811	5.1
3856039	15811	5.1
3856834	19892	
3857176	19019	14.4
3858256	15811	5.1
3860232	19619	14.1
3860697	19917	
3860703	15952	5.9
3862281	15811	5.1
3862567	15811	5.1
3875050	16902	6.6
3875376	13376	3.2
3875377	14036	4.5
3875378	12062	
3875379	12186	
3875380	11088	
3875381	16091	
3875382	16194	6.3
3875384	13115	3.5
3875385	13090	
3875386	12067	
3875387	17182	
3875388	12009	
3875400	17400	7.7
3877075	12075	
3877076	11075	
4785974	14974	4.3
6611452	15244	
6643249	17249	
6842160	11160	
6842273	12273	
9139282	13623	3.1
9139284	13008	3.1
43213002	15102	5.23
43213003	15108	5.23
43957300	15300	5.21
43957301	15301	5.21
43957302	15302	5.21

Ref. nr. Ref. No.	Best. nr. Part No.	Sida Page
----------------------	-----------------------	--------------



**Prijslijst Infomar**

Art. No.	Omschrijving	Prijs € Excl BTW	Prijs € Incl BTW	Code	Art. No.	Omschrijving	Prijs € Excl BTW	Prijs € Incl BTW	Code
11014	SEAL RING KIT	56,85	67,65	D	11340	RING KIT / 1 PISTON	45,00	53,55	D
11019	MAIN BEARING KIT	177,00	210,63	D	11341	RING KIT / 1 PISTON	45,00	53,55	D
11020	MAIN BEARING KIT	195,00	232,05	D	11342	RING KIT / 1 PISTON	45,00	53,55	D
11021	MAIN BEARING KIT	183,00	217,77	D	11344	RING KIT / 1 PISTON	45,00	53,55	D
11022	CON ROD BEARING KIT	75,75	90,14	D	11345	RING KIT / 1 PISTON	45,00	53,55	D
11023	CON ROD BEARING KIT	92,70	110,31	D	11345	RING KIT / 1 PISTON	45,00	53,55	D
11024	CON ROD BEARING KIT	92,70	110,31	D	11345	RING KIT / 1 PISTON	45,00	53,55	D
11025	CON ROD BEARING KIT	85,05	101,21	D	11346	RING KIT / 1 PISTON	35,10	41,77	D
11026	CON ROD BEARING KIT	87,90	104,60	D	11369	RING KIT / 1 PISTON	48,00	57,12	D
11027	CON ROD BEARING KIT	87,90	104,60	D	11370	RING KIT / 1 PISTON	45,00	53,55	D
11031	EXPANSION PLUG	1,50	1,79	D	11371	RING KIT / 1 PISTON	48,00	57,12	D
11032	EXPANSION PLUG	2,85	3,39	D	11416	RUBBER SEAL	0,90	1,07	D
11033	EXPANSION PLUG	2,85	3,39	D	11471	THRUST WASHER KIT	14,40	17,14	D
11038	GASKET	15,30	18,21	D	11477	CON ROD BEARING KIT	24,90	29,63	D
11039	GASKET	11,55	13,74	D	11478	CON ROD BEARING KIT	34,35	40,88	D
11040	PISTON	147,00	174,93	D	11479	CON ROD BEARING KIT	34,35	40,88	D
11042	PISTON	106,50	126,74	D	11487	GASKET	2,85	3,39	D
11043	PISTON	147,00	174,93	D	11498	RING KIT / 1 PISTON	90,90	108,17	D
11051	CON ROD BEARING KIT	48,00	57,12	D	11499	RING KIT / 1 PISTON	132,75	157,97	D
11053	CON ROD BEARING KIT	66,00	78,54	D	11531	RING KIT / 1 PISTON	28,65	34,09	D
11058	PISTON	93,75	111,56	D	11532	RING KIT / 1 PISTON	42,00	49,98	D
11059	PISTON	132,00	157,08	D	11533	RING KIT / 1 PISTON	40,65	48,37	D
11063	CON ROD BEARING KIT	45,00	53,55	D	11534	RING KIT / 1 PISTON	21,60	25,70	D
11064	CON ROD BEARING KIT	66,00	78,54	D	11535	RING KIT / 1 PISTON	36,00	42,84	D
11082	RING KIT / 1 PISTON	33,00	39,27	D	11536	RING KIT / 1 PISTON	21,60	25,70	D
11083	RING KIT / 1 PISTON	33,00	39,27	D	11538	CON ROD BEARING KIT	24,15	28,74	D
11090	DISCONTINUED	-	-	D	11539	CON ROD BEARING KIT	34,35	40,88	D
11092	CONNECTING ROD BUSH.	6,15	7,32	D	11540	CON ROD BEARING KIT	34,35	40,88	D
11100	DISCONTINUED	-	-	D	11549	CYLINDER LINER KIT	526,35	626,36	D
11105	CON ROD BEARING KIT	72,00	85,68	D	11550	SEAL RING KIT	39,90	47,48	D
11106	CON ROD BEARING KIT	72,00	85,68	D	11551	PISTON	316,20	376,28	D
11119	PISTON 0,50	390,15	464,28	D	11560	CYLINDER GASKET KIT	52,95	63,01	D
11136	CON ROD BEARING KIT	54,15	64,44	D	11579	PISTON	397,65	473,20	D
11137	CON ROD BEARING KIT	57,75	68,72	D	11609	INJECTOR SLEEVE KIT	21,00	24,99	D
11138	CON ROD BEARING KIT	57,75	68,72	D	11651	SEAL RING KIT	36,30	43,20	D
11159	GASKET	5,85	6,96	D	11747	WASHER	0,60	0,71	D
11161	RING KIT / 1 PISTON	105,90	126,02	D	11799	BALL BEARING	9,75	11,60	D
11193	PISTON	110,10	131,02	D	11846	SEAL RING	2,25	2,68	D
11194	PISTON	132,00	157,08	D	11902	EXPANSION PLUG	1,80	2,14	D
11195	PISTON	132,00	157,08	D	11903	EXPANSION PLUG	0,90	1,07	D
11196	PISTON	132,00	157,08	D	11904	EXPANSION PLUG	0,90	1,07	D
11200	PISTON	132,00	157,08	D	11905	EXPANSION PLUG	2,25	2,68	D
11202	PISTON	132,00	157,08	D	11906	MAIN BEARING KIT	115,35	137,27	D
11203	PISTON	132,00	157,08	D	11907	MAIN BEARING KIT	155,10	184,57	D
11205	PISTON	132,00	157,08	D	11908	MAIN BEARING KIT	155,10	184,57	D
11214	MAIN BEARING KIT	93,00	110,67	D	11955	EXPANSION PLUG	1,50	1,79	D
11215	MAIN BEARING KIT	108,00	128,52	D	11971	SEAL RING	37,95	45,16	D
11216	MAIN BEARING KIT	108,00	128,52	D	12003	CAMSHAFT	328,05	390,38	D
11233	DISCONTINUED	-	-	D	12004	CAMSHAFT	343,95	409,30	D
11236	MAIN BEARING KIT	108,00	128,52	D	12005	EXHAUST VALVE	38,85	46,23	D
11237	MAIN BEARING KIT	108,00	128,52	D	12006	RUBBER WASHER	3,30	3,93	D
11238	MAIN BEARING KIT	108,00	128,52	D	12010	CAMSHAFT KIT	366,90	436,61	D
11254	CYLINDER LINER KIT	416,55	495,69	D	12011	CAMSHAFT KIT B-30	519,00	617,61	D
11262	THRUST WASHER KIT	28,50	33,92	D	12020	EXHAUST VALVE	66,30	78,90	D
11271	PISTON RING KIT	27,00	32,13	D	12045	VALVE SHIMS	2,25	2,68	D
11295	CONNECTING ROD BUSH.	18,00	21,42	D	12046	VALVE SHIMS	2,25	2,68	D
11296	CON ROD BOLT	14,70	17,49	D	12100	BEARING KIT	48,30	57,48	D
11302	CON ROD BEARING KIT	117,60	139,94	D	12101	CAMSHAFT BEARING KIT	55,20	65,69	D
11303	CON ROD BEARING KIT	132,60	157,79	D	12102	CAMSHAFT BEARING KIT	123,00	146,37	D
11304	CON ROD BEARING KIT	132,60	157,79	D	12107	CAMSHAFT	151,35	180,11	D
11305	CON ROD BEARING KIT	208,35	247,94	D	12171	VALVE STEM SEAL	8,10	9,64	D
11306	MAIN BEARING KIT	187,50	223,13	D	12188	INTAKE VALVE	55,20	65,69	D
11307	MAIN BEARING KIT	238,80	284,17	D	12266	VALVE GUIDES	4,35	5,18	D
11308	MAIN BEARING KIT	246,30	293,10	D	12292	EXHAUST VALVE	20,85	24,81	D
11318	SEAL RING	28,05	33,38	D	12307	VALVE DEPRESSOR	33,00	39,27	D
11330	CON ROD BEARING KIT	156,45	186,18	D	12311	CAMSHAFT GREASE	2,85	3,39	D
11331	CON ROD BEARING KIT	164,70	195,99	D	12357	VALVE SEAL	1,50	1,79	D
11332	CON ROD BEARING KIT	164,70	195,99	D	12368	INTAKE VALVE	15,90	18,92	D
11333	CON ROD BEARING KIT	257,40	306,31	D	12377	TIMING BELT	16,50	19,64	D
11334	MAIN BEARING KIT	234,60	279,17	D	12395	INTAKE VALVE	13,35	15,89	D
11335	MAIN BEARING KIT	297,45	353,97	D	12432	RUBBER RING (DAMPER)	0,60	0,71	D
11336	MAIN BEARING KIT	306,90	365,21	D	12442	CAMSHAFT	186,75	222,23	D
11337	RING KIT / 1 PISTON	45,00	53,55	D	12460	VALVE SHIMS	2,25	2,68	D
11338	RING KIT / 1 PISTON	36,00	42,84	D	12465	CAMSHAFT	208,35	247,94	D
11339	RING KIT / 1 PISTON	45,00	53,55	D	12470	VALVE SHIMS	2,25	2,68	D





**Prijslijst Infomar**

Art. No.	Omschrijving	Prijs € Excl BTW	Prijs € Incl BTW	Code	Art. No.	Omschrijving	Prijs € Excl BTW	Prijs € Incl BTW	Code
12475	VALVE SHIMS	2,25	2,68	D	13376	CYLINDER HEAD GASKET	29,10	34,63	D
12480	VALVE SHIMS	2,25	2,68	D	13393	VALVE COVER GASKET	27,60	32,84	D
12485	VALVE SHIMS	2,25	2,68	D	13399	VALVE COVER GASKET	3,30	3,93	D
12490	VALVE SHIMS	2,25	2,68	D	13414	CYLINDER HEAD NUT	8,55	10,17	D
12495	VALVE SHIMS	2,25	2,68	D	13416	CYL. HEAD SCREW KIT	32,10	38,20	D
12500	VALVE SHIMS	2,25	2,68	D	13442	GASKET	11,55	13,74	D
12506	TIMING BELT	102,30	121,74	D	13453	CYLINDER HEAD GASKET	28,50	33,92	D
12507	TIMING BELT TENSION.	292,80	348,43	D	13497	SHIMS 0,2	8,70	10,35	D
12513	VALVE LIFTER	9,75	11,60	D	13498	SHIMS 0,3	7,50	8,93	D
12526	EXHAUST VALVE	34,50	41,06	D	13531	CYLINDER HEAD GASKET	97,35	115,85	D
12546	VALVE SHIMS	2,25	2,68	D	13569	CYLINDER HEAD GASKET	24,15	28,74	D
12547	VALVE SHIMS	2,25	2,68	D	13623	CYLINDER HEAD GASKET	16,35	19,46	D
12548	VALVE SHIMS	2,25	2,68	D	13645	CYLINDER HEAD GASKET	16,95	20,17	D
12549	VALVE SHIMS	2,25	2,68	D	13646	CYLINDER HEAD GASKET	15,45	18,39	D
12550	VALVE SHIMS	2,25	2,68	D	13652	VALVE COVER GASKET	94,80	112,81	D
12551	VALVE SHIMS	2,25	2,68	D	13653	VALVE COVER GASKET	66,30	78,90	D
12552	VALVE SHIMS	2,25	2,68	D	13654	VALVE COVER GASKET	11,55	13,74	D
12553	VALVE SHIMS	2,25	2,68	D	13742	CYLINDER HEAD GASKET	89,10	106,03	D
12554	VALVE SHIMS	2,25	2,68	D	13749	CYLINDER HEAD GASKET	28,50	33,92	D
12555	VALVE SHIMS	2,25	2,68	D	13750	SILICONE 40 ML	19,35	23,03	D
12556	VALVE SHIMS	2,25	2,68	D	13751	HIGH TACK SPRAY 99	34,50	41,06	D
12557	VALVE SHIMS	2,25	2,68	D	13752	GASKET	25,50	30,35	D
12558	VALVE SHIMS	2,25	2,68	D	13763	CYLINDER HEAD GASKET	32,10	38,20	D
12559	VALVE SHIMS	2,25	2,68	D	13780	ADJUSTING SHIMS 0,2	11,55	13,74	D
12560	VALVE SHIMS	2,25	2,68	D	13781	ADJUSTING SHIMS 0,3	11,10	13,21	D
12561	VALVE SHIMS	2,25	2,68	D	13783	CYL. HEAD GASK. 2 MM	23,55	28,02	D
12562	VALVE SHIMS	2,25	2,68	D	13909	VALVE COVER GASKET	8,25	9,82	D
12563	VALVE SHIMS	2,25	2,68	D	13990	CYLINDER HEAD GASKET	21,30	25,35	D
12564	VALVE SHIMS	2,25	2,68	D	13993	CYLINDER HEAD GASKET	72,15	85,86	D
12565	VALVE SHIMS	2,25	2,68	D	14001	OIL DRAIN PLUG	3,60	4,28	D
12566	VALVE SHIMS	2,25	2,68	D	14005	OIL PAN GASKET	58,50	69,62	D
12567	VALVE SHIMS	2,25	2,68	D	14031	OIL PAN GASKET	13,35	15,89	D
12568	VALVE SHIMS	2,25	2,68	D	14034	OIL FILTER	19,05	22,67	D
12569	VALVE SHIMS	2,25	2,68	D	14036	OIL PAN GASKET	17,40	20,71	D
12570	VALVE SHIMS	2,25	2,68	D	14057	OIL FILTER	7,20	8,57	D
12603	VALVE GUIDES	7,20	8,57	D	14069	CRANKCASE FILTER	55,50	66,05	D
12630	VALVE SEAL	1,50	1,79	D	14087	O-RING	0,90	1,07	D
12643	VALVE KEEPER	0,90	1,07	D	14144	OIL PUMP	255,00	303,45	D
12652	VALVE GUIDES	3,90	4,64	D	14161	OIL FILTER = 14390	-	-	D
12653	VALVE GUIDES	3,90	4,64	D	14250	OIL PAN GASKET	49,35	58,73	D
12734	INLET VALVE	23,10	27,49	D	14251	OIL PAN GASKET	51,30	61,05	D
12737	VALVE SPRING	7,20	8,57	D	14337	OIL FILTER	11,10	13,21	D
12739	VALVE SPRING	6,15	7,32	D	14390	OIL FILTER	16,50	19,64	D
12767	CAMSHAFT	186,75	222,23	D	14440	OIL FILTER	16,95	20,17	D
12792	EXHAUST VALVE	42,90	51,05	D	14473	OIL FILTER	19,50	23,21	D
12793	INTAKE VALVE	41,10	48,91	D	14476	OILFILTER	19,50	23,21	D
12870	VALVE COVER GASKET	8,25	9,82	D	14559	OIL FILTER	19,50	23,21	D
12893	VALVE SEAL	2,85	3,39	D	14621	OIL FILTER	19,50	23,21	D
12944	TIMING GEAR KIT	336,00	399,84	D	14634	OIL FILTER	23,70	28,20	D
12960	VALVE GUIDES	8,25	9,82	D	14677	OIL PUMP	330,00	392,70	D
12986	TIMING BELT TENSION.	131,70	156,72	D	14706	OIL PUMP	148,50	176,72	D
13008	CYLINDER HEAD GASKET	45,45	54,09	D	14750	OIL FILTER	17,25	20,53	D
13009	CYLINDER HEAD GASKET	32,85	39,09	D	14779	OIL FILTER	20,85	24,81	D
13010	CYLINDER HEAD GASKET	41,85	49,80	D	14818	WASHER	0,60	0,71	D
13024	CYLINDER SHIMS 0,2MM	6,00	7,14	D	14864	OIL PAN GASKET	13,50	16,07	D
13025	CYLINDER SHIMS 0,3MM	6,00	7,14	D	14879	SEALING COMPOUND	59,85	71,22	D
13039	VALVE COVER GASKET	19,50	23,21	D	14914	GASKET	26,85	31,95	D
13042	VALVE COVER GASKET	4,35	5,18	D	14946	OIL PUMP	151,35	180,11	D
13043	VALVE COVER GASKET	7,50	8,93	D	14974	OIL FILTER	20,25	24,10	D
13044	VALVE COVER GASKET	10,80	12,85	D	15028	SCREW	6,90	8,21	D
13066	VALVE COVER GASKET	2,55	3,03	D	15033	GASKET	0,90	1,07	D
13070	CYLINDER HEAD GASKET	33,00	39,27	D	15036	DRAIN TAPS	14,40	17,14	D
13093	CYLINDER HEAD GASKET	44,40	52,84	D	15044	SCREW	0,60	0,71	D
13094	CYLINDER HEAD GASKET	36,30	43,20	D	15066	O-RING	1,50	1,79	D
13100	VALVE COVER GASKET	7,65	9,10	D	15093	SCREW	1,50	1,79	D
13107	CYLINDER HEAD GASKET	34,35	40,88	D	15097	THERMOSTAT KIT	34,35	40,88	D
13115	VALVE COVER GASKET	3,30	3,93	D	15101	FRESH WATER COOLING	1.207,80	1.437,28	D
13119	VALVE COVER GASKET	56,25	66,94	D	15102	EL-PUMP	191,25	227,59	D
13127	CYLINDER HEAD GASKET	25,20	29,99	D	15103	FRESH WATER COOLING	1.232,10	1.466,20	D
13136	CYLINDER HEAD GASKET	32,40	38,56	D	15104	FRESH WATER COOLING	1.192,65	1.419,25	D
13150	CYLINDER HEAD GASKET	87,30	103,89	D	15105	FRESH WATER COOLING	1.192,50	1.419,08	D
13155	CYLINDER HEAD GASKET	108,15	128,70	D	15107	FRESH WATER COOLING	1.192,50	1.419,08	D
13274	CYLINDER HEAD GASKET	72,15	85,86	D	15108	EL-PUMP	234,60	279,17	D
13287	VALVE COVER GASKET	47,70	56,76	D	15109	CROSS PIECES	7,50	8,93	D
13341	CYLINDER HEAD SCREW	47,70	56,76	D	15110	FRESH WATER COOLING	1.192,50	1.419,08	D



**Prijslijst Infomar**

Art. No.	Omschrijving	Prijs € Excl BTW	Prijs € Incl BTW	Code	Art. No.	Omschrijving	Prijs € Excl BTW	Prijs € Incl BTW	Code
15111	GASKET	2,25	2,68	D	15864	SEAL RING	45,45	54,09	D
15112	FRESH WATER COOLING	1.271,85	1.513,50	D	15871	DRAIN TAPS	21,60	25,70	D
15113	FRESH WATER COOLING	1.330,65	1.583,47	D	15874	IMPELLER KIT	53,40	63,55	D
15115	FRESH WATER COOLING	1.887,30	2.245,89	D	15878	MOUNTING CLAMP	18,90	22,49	D
15116	FRESH WATER COOLING	2.146,50	2.554,34	D	15883	WATER PUMP	422,10	502,30	D
15117	GASKET KIT	159,15	189,39	D	15893	DRAIN TAPS	14,40	17,14	D
15118	GASKET KIT	694,65	826,63	D	15894	DRAIN TAPS	18,00	21,42	D
15120	IMPELLER KIT	41,85	49,80	D	15895	WATER PUMP	432,00	514,08	D
15121	FRESH WATER COOLING	1.272,00	1.513,68	D	15901	GASKET	2,25	2,68	D
15122	FRESH WATER COOLING	1.152,90	1.371,95	D	15918	DRAIN TAPS	14,40	17,14	D
15134	DRAIN PLUG 1/4"	4,35	5,18	D	15928	PLUG FOR ZINC ANODE	4,65	5,53	D
15169	GASKET FOR ZINK ANODE	1,95	2,32	D	15932	SCREW KIT	36,00	42,84	D
15178	WATER PUMP	676,05	804,50	D	15934	SCREW KIT	36,00	42,84	D
15215	WATER PIPE	41,85	49,80	D	15935	SCREW KIT	32,10	38,20	D
15244	GASKET	0,90	1,07	D	15952	WATER PUMP	675,00	803,25	D
15247	SEAL RING	3,60	4,28	D	15959	GASKET	1,50	1,79	D
15250	GASKET	0,90	1,07	D	15994	GASKET	0,90	1,07	D
15275	GASKET	2,25	2,68	D	15996	SEAL RING	3,60	4,28	D
15300	ZINC ANODE	16,35	19,46	D	15997	SCREW	0,60	0,71	D
15301	ZINC ANODE	17,70	21,06	D	15999	IMPULLER	127,35	151,55	D
15302	ZINC ANODE	19,50	23,21	D	16001	INSTALLATION KIT	7,50	8,93	D
15304	ZINK ANODE V8	21,60	25,70	D	16007	HOSE KIT	22,50	26,78	D
15305	THERMOSTAT KIT	36,00	42,84	D	16008	INSTALLATION KIT	9,75	11,60	D
15350	SCREW KIT	36,00	42,84	D	16010	EXHAUST HOSE	22,50	26,78	D
15351	SCREW KIT	32,10	38,20	D	16011	ZINC ANODE	35,85	42,66	D
15353	SCREW KIT	17,70	21,06	D	16037	EXHAUST BEND	315,00	374,85	D
15355	BALL BEARING	58,80	69,97	D	16091	GASKET	2,25	2,68	D
15356	SCREW KIT	36,00	42,84	D	16095	EXHAUST MANIFOLD	4.542,60	5.405,69	D
15357	SCREW KIT	36,00	42,84	D	16098	EXHAUST GASKET	8,25	9,82	D
15383	REPAIR KIT	87,30	103,89	D	16107	GASKET	0,90	1,07	D
15385	GASKET	1,95	2,32	D	16112	EXHAUST GASKET	6,45	7,68	D
15412	SEAL RING	0,90	1,07	D	16123	EXHAUST GASKET	3,90	4,64	D
15417	GASKET	0,90	1,07	D	16140	EXHAUST GASKET	10,80	12,85	D
15433	CROSS PIECES	75,45	89,79	D	16172	GASKET	1,95	2,32	D
15444	LOCK RING	14,10	16,78	D	16194	EXHAUST GASKET	17,25	20,53	D
15467	CROSS PIECES	9,15	10,89	D	16333	EXHAUST MANIFOLD	1.050,15	1.249,68	D
15508	O-RING	3,60	4,28	D	16341	COVER PLATE	9,75	11,60	D
15512	IMPELLER KIT	40,50	48,20	D	16374	EXHAUST GASKET	2,55	3,03	D
15574	REPAIR KIT	90,90	108,17	D	16384	EXHAUST BEND	297,00	353,43	D
15575	IMPELLER KIT	22,80	27,13	D	16387	EXHAUST MANIFOLD	843,00	1.003,17	D
15578	WATER PUMP	435,45	518,19	D	16513	EXHAUST GASKET	27,00	32,13	D
15580	THERMOSTAT KIT	38,85	46,23	D	16532	EXHAUST MANIFOLD	1.050,00	1.249,50	D
15583	IMPELLER KIT	15,15	18,03	D	16600	EXHAUST BEND	117,00	139,23	D
15584	REPAIR KIT	73,95	88,00	D	16633	EXHAUST GASKET	17,25	20,53	D
15592	DRAIN TAPS	14,40	17,14	D	16673	EXHAUST GASKET	11,55	13,74	D
15593	IMPELLER KIT	34,50	41,06	D	16751	ECHAUST HOSE	20,85	24,81	D
15610	GASKET	1,50	1,79	D	16804	EXHAUST MANIFOLD	522,00	621,18	D
15617	SEAL RING	1,95	2,32	D	16854	GASKET	7,95	9,46	D
15637	WATER FILTER	71,85	85,50	D	16879	GASKET	4,35	5,18	D
15642	SEAL RING	82,50	98,18	D	16894	EXHAUST MANIFOLD	498,00	592,62	D
15660	IMPELLER KIT	52,95	63,01	D	16902	EXHAUST GASKET	5,55	6,60	D
15661	ZINK ANODE	11,40	13,57	D	16913	EXHAUST GASKET	18,00	21,42	D
15693	SCREW	0,90	1,07	D	16944	GASKET	3,30	3,93	D
15695	SEAL RING	6,60	7,85	D	17002	CAV FILTER KIT	49,50	58,91	D
15698	REPAIR KIT	96,60	114,95	D	17003	GASKET SET	2,85	3,39	D
15728	GASKET	1,95	2,32	D	17004	HOSE CONNECTOR 8 MM	5,85	6,96	D
15738	GASKET SET	4,65	5,53	D	17005	HOSE CONNECTOR 10 MM	7,50	8,93	D
15744	DRAIN TAPS	14,40	17,14	D	17017	ELECTRIC FUELPUMP	116,70	138,87	D
15745	DRAIN TAPS	14,40	17,14	D	17027	FUEL FILTER	39,00	46,41	D
15756	REPAIR KIT	100,65	119,77	D	17065	FUEL FILTER	21,90	26,06	D
15779	THERMOSTAT KIT	40,50	48,20	D	17068	NOZZLE	159,00	189,21	D
15780	THERMOSTAT KIT	61,80	73,54	D	17101	FUEL FILTER	31,50	37,49	D
15783	THERMOSTAT KIT	75,00	89,25	D	17109	CAV FUEL FILTER	104,85	124,77	D
15784	THERMOSTAT KIT	39,90	47,48	D	17139	GASKET	6,45	7,68	D
15785	THERMOSTAT KIT	56,85	67,65	D	17142	GASKET	6,90	8,21	D
15787	THERMOSTAT KIT	36,00	42,84	D	17143	GASKET	4,65	5,53	D
15788	THERMOSTAT KIT	34,35	40,88	D	17146	GASKET	7,20	8,57	D
15791	THERMOSTAT KIT	40,50	48,20	D	17149	SHIMS 0,3	8,55	10,17	D
15795	GASKET	1,95	2,32	D	17161	FUEL PUMP	352,35	419,30	D
15796	THERMOSTAT KIT	37,95	45,16	D	17162	FUEL FILTER	19,05	22,67	D
15807	IMPELLER KIT	13,05	15,53	D	17179	NOZZLE	111,75	132,98	D
15808	IMPELLER KIT	15,15	18,03	D	17182	GASKET	1,95	2,32	D
15811	IMPELLER KIT	32,85	39,09	D	17185	AIR FILTER	10,95	13,03	D
15825	SCREW	0,90	1,07	D	17201	"CAV" FUEL FILTER	7,80	9,28	D
15861	BALL BEARING	10,50	12,50	D	17205	NOZZLE	113,70	135,30	D



**Prijslijst Infomar**

Art. No.	Omschrijving	Prijs € Excl BTW	Prijs € Incl BTW	Code	Art. No.	Omschrijving	Prijs € Excl BTW	Prijs € Incl BTW	Code
17249	GASKET	0,60	0,71	D	18704	CONDENSER	12,30	14,64	D
17255	INJECTOR SLEEVE	19,05	22,67	D	18705	BREAKER POINTS	11,55	13,74	D
17287	NOZZLE	133,50	158,87	D	18707	BELT	17,70	21,06	D
17303	NOZZLE	93,00	110,67	D	18710	CONDENSER	29,85	35,52	D
17306	FUEL FILTER	19,50	23,21	D	18750	OIL PRESSURE	11,10	13,21	D
17307	BOLT CAV	3,90	4,64	D	18797	CAP	15,45	18,39	D
17323	FUEL PUMP	255,00	303,45	D	18799	BREAKER POINTS	10,80	12,85	D
17358	NOZZLE	130,95	155,83	D	18801	BREAKER POINTS	16,65	19,81	D
17391	SPACER FOR FUEL PUMP	10,50	12,50	D	18805	BELT	9,45	11,25	D
17400	NOZZLE	147,00	174,93	D	18842	CONDENSER	28,50	33,92	D
17407	GLASS BOWL	16,50	19,64	D	18843	BELT KIT	22,80	27,13	D
17461	NOZZLE	178,05	211,88	D	18845	ROTOR	13,35	15,89	D
17477	FUEL FILTER	21,60	25,70	D	18900	BELT	9,75	11,60	D
17488	AIR FILTER	22,80	27,13	D	18903	ROTOR	10,05	11,96	D
17530	GASKET	0,90	1,07	D	18906	BELT	9,45	11,25	D
17557	NOZZLE	168,00	199,92	D	18926	CAP	31,35	37,31	D
17574	NOZZLE	216,00	257,04	D	18931	BELT	14,10	16,78	D
17578	NOZZLE	216,00	257,04	D	18942	BELT	16,50	19,64	D
17597	NOZZLE	138,45	164,76	D	18975	ROTOR	11,55	13,74	D
17648	DRAIN PLUG "CAV"	3,30	3,93	D	18978	BELT KIT	20,85	24,81	D
17663	GASKET SET	11,55	13,74	D	18981	BELT KIT	20,85	24,81	D
17666	DIAPHRAGM	1,50	1,79	D	18990	BELT KIT	22,35	26,60	D
17678	SPACER FOR FUEL PUMP	9,15	10,89	D	19004	BEARING	85,50	101,75	D
17686	FUEL FILTER	19,05	22,67	D	19006	BEARING RING	37,20	44,27	D
17782	NOZZLE	138,45	164,76	D	19007	COTTER PIN	0,60	0,71	D
17791	NOZZLE	128,70	153,15	D	19008	INNER RING	13,35	15,89	D
17803	GASKET SET	20,85	24,81	D	19010	GASKET SET	43,65	51,94	D
17874	FUEL FILTER	32,85	39,09	D	19011	GASKET SET	52,95	63,01	D
17905	GASKET	0,90	1,07	D	19012	CLAMP RING SMO	10,50	12,50	D
17909	NOZZLE	141,00	167,79	D	19015	SEALING STRIP	32,40	38,56	D
17913	FUEL FILTER	17,25	20,53	D	19018	ZINC ANODE KIT	9,75	11,60	D
17973	DIAPHRAGM	1,50	1,79	D	19019	BALL BEARING	138,45	164,76	D
17987	FUEL FILTER	14,40	17,14	D	19022	LOCK NUT	22,80	27,13	D
18001	IGNITION CABLE SET	79,65	94,78	D	19024	LOCK WASHER	1,95	2,32	D
18003	BELT	9,75	11,60	D	19026	GASKET SET	64,65	76,93	D
18070	CAP	32,40	38,56	D	19029	GASKET SET	60,45	71,94	D
18078	OIL PRESSURE	10,80	12,85	D	19030	LOCK RING	6,15	7,32	D
18149	BREAKER POINTS	10,50	12,50	D	19031	GASKET SET	102,00	121,38	D
18169	BREAKER POINTS	10,80	12,85	D	19033	GASKET SET	113,70	135,30	D
18207	BELT	13,20	15,71	D	19034	SPRING	4,35	5,18	D
18243	ROTOR	13,35	15,89	D	19035	GASKET SET	121,20	144,23	D
18244	CAP	66,30	78,90	D	19036	GASKET SET	56,85	67,65	D
18258	ROTOR	14,40	17,14	D	19037	GASKET SET	90,90	108,17	D
18262	CONDENSER	17,25	20,53	D	19044	BEARING	55,20	65,69	D
18263	CAP	88,50	105,32	D	19047	LOCK SCREW	3,60	4,28	D
18283	BELT	9,75	11,60	D	19052	HOSE KIT	302,85	360,39	D
18304	BREAKER POINTS	18,75	22,31	D	19053	COTTER PIN	0,60	0,71	D
18308	CONDENSER	13,35	15,89	D	19054	O-RING	0,60	0,71	D
18310	BELT	10,50	12,50	D	19055	O-RING	0,60	0,71	D
18311	BELT	10,50	12,50	D	19059	NEEDLE BEARING	17,25	20,53	D
18327	BELT	14,10	16,78	D	19062	DRAIN PLUG	3,60	4,28	D
18330	BELT	18,00	21,42	D	19068	NEEDLE BEARING	9,15	10,89	D
18363	IGNITION CABLE SET	60,45	71,94	D	19069	EXHAUST BELLOW	41,85	49,80	D
18382	BELT	10,80	12,85	D	19071	LOCK NUT	11,10	13,21	D
18383	BELT	10,80	12,85	D	19072	BEARING	60,45	71,94	D
18385	BELT	13,50	16,07	D	19075	WASHER	40,50	48,20	D
18387	BELT	15,00	17,85	D	19087	BEARING	62,70	74,61	D
18404	IGNITION CABLE SET	104,25	124,06	D	19091	WASHER	0,60	0,71	D
18498	BELT	15,15	18,03	D	19092	VIBRATION DAMPER	252,00	299,88	D
18545	CONDENSER	59,85	71,22	D	19097	WATER HOSE KIT	15,75	18,74	D
18546	CONDENSER	36,00	42,84	D	19106	RUBBER BLOCK	17,25	20,53	D
18548	BELT	10,80	12,85	D	19107	RUBBER BLOCK	28,50	33,92	D
18560	CONDENSER	19,05	22,67	D	19127	DRIVE BELLOW	38,85	46,23	D
18571	IGNITION CABLE SET	94,80	112,81	D	19177	PROPELLER SHAFT	397,65	473,20	D
18587	OIL PRESSURE	11,10	13,21	D	19189	VIBRATION DAMPER	288,00	342,72	D
18605	VOLTAGE REGULATOR	102,30	121,74	D	19190	RUBBER RING	20,85	24,81	D
18652	BREAKER POINTS	11,55	13,74	D	19195	V-RING	4,65	5,53	D
18653	CONDENSER	44,40	52,84	D	19209	SEAL RING	6,90	8,21	D
18657	ROTOR	13,35	15,89	D	19212	NUT	22,80	27,13	D
18658	CAP	21,60	25,70	D	19247	BALL BEARING	37,95	45,16	D
18669	CAP	41,40	49,27	D	19255	UNIVERSAL JOINT	41,85	49,80	D
18690	CAP	25,95	30,88	D	19256	O-RING	0,90	1,07	D
18698	BELT	12,75	15,17	D	19260	O-RING	1,50	1,79	D
18700	BELT KIT	20,85	24,81	D	19261	SPACER WASHER	11,55	13,74	D
18702	CAP	43,50	51,77	D	19263	O-RING	1,50	1,79	D



**Prijslijst Infomar**

Art. No.	Omschrijving	Prijs € Excl BTW	Prijs € Incl BTW	Code	Art. No.	Omschrijving	Prijs € Excl BTW	Prijs € Incl BTW	Code
19267	GASKET SET	66,30	78,90	D	19844	SCREW	9,75	11,60	D
19272	BEARING	10,50	12,50	D	19846	WATER HOSE CONNECT.	58,80	69,97	D
19276	COTTER PIN	0,60	0,71	D	19847	HOSE KIT	26,70	31,77	D
19278	BUSHING KIT	4,35	5,18	D	19848	EXHAUST BELLOW	41,85	49,80	D
19279	BUSHING KIT	5,55	6,60	D	19859	NEEDLE BEARING	21,90	26,06	D
19286	BEARING	66,30	78,90	D	19868	SEAL RING	25,20	29,99	D
19288	BALL BEARING	58,80	69,97	D	19885	GASKET	0,90	1,07	D
19289	BEARING	32,70	38,91	D	19886	GASKET	3,60	4,28	D
19290	BEARING	68,25	81,22	D	19888	SPACER WASHER	3,90	4,64	D
19294	DRIVE BELLOW KIT	39,90	47,48	D	19889	LOCK SCREW	4,35	5,18	D
19295	BELLOW KIT 19294 SMO	45,45	54,09	D	19894	GASKET	3,90	4,64	D
19300	NUT	8,55	10,17	D	19896	VIBRATION DAMPER	240,00	285,60	D
19301	SETTING PIN	39,90	47,48	D	19898	GASKET	3,30	3,93	D
19302	OUTER RING	27,75	33,02	D	19904	LOCK SCREW	8,55	10,17	D
19313	SEAL RING	8,25	9,82	D	19929	ZINC ANODE	4,65	5,53	D
19315	WASHER	45,45	54,09	D	19934	SLIDING PIN	108,15	128,70	D
19332	SPRING	6,15	7,32	D	19949	BALL BEARING	114,60	136,37	D
19359	V-RING	3,60	4,28	D	19965	THRUST WASHER	24,90	29,63	D
19367	LOCK WASHER	6,90	8,21	D	19967	RUBBER RING	20,85	24,81	D
19374	NEEDLE BEARING	41,85	49,80	D	19983	ZINC RING	17,25	20,53	D
19389	VIBRATION DAMPER	219,00	260,61	D	21023	GASKET KIT	90,90	108,17	D
19390	NEEDLE BEARING	25,20	29,99	D	21054	GASKET KIT	195,00	232,05	D
19391	NEEDLE BEARING	12,30	14,64	D	21103	GASKET SET	312,60	371,99	D
19392	GASKET SET	87,30	103,89	D	21104	GASKET SET	354,15	421,44	D
19396	SPRING	4,35	5,18	D	21300	GASKET SET	102,30	121,74	D
19399	GASKET SET	60,45	71,94	D	21301	GASKET SET	102,30	121,74	D
19413	BEARING	37,95	45,16	D	21302	GASKET SET	102,30	121,74	D
19419	SHAFT	26,70	31,77	D	21303	GASKET SET	163,05	194,03	D
19423	THRUST WASHER	31,50	37,49	D	21304	GASKET KIT	121,20	144,23	D
19458	BALL BEARING	105,90	126,02	D	21306	GASKET KIT	73,95	88,00	D
19500	BEARING	60,45	71,94	D	21307	GASKET SET	77,85	92,64	D
19508	DISCONTINUED	-	-	D	21308	GASKET SET	87,30	103,89	D
19522	BALL BEARING	18,00	21,42	D	21309	GASKET SET	102,30	121,74	D
19534	THRUST WASHER	28,50	33,92	D	21310	GASKET SET	143,85	171,18	D
19541	BEARING	132,60	157,79	D	21314	GASKET KIT	113,70	135,30	D
19542	BALL BEARING	130,95	155,83	D	21335	GASKET SET	140,25	166,90	D
19548	CLAMP RING A4 38MM	4,95	5,89	D	21337	GASKET SET = 21335	-	-	D
19559	BALL BEARING	15,15	18,03	D	21349	GASKET KIT	330,00	392,70	D
19570	PROTECTING COVER	94,80	112,81	D	21357	GASKET SET	64,65	76,93	D
19573	LOCK WASHER	1,95	2,32	D	21358	GASKET SET	94,35	112,28	D
19591	GASKET SET	51,30	61,05	D	21359	GASKET SET	138,45	164,76	D
19598	ZINC ANODE	18,00	21,42	D	21361	GASKET KIT	246,30	293,10	D
19603	CLAMP RING A4 65-89MM	5,70	6,78	D	21362	GASKET KIT	299,25	356,11	D
19616	PLASTIC STRIPE	2,70	3,21	D	21378	GASKET KIT	98,40	117,10	D
19617	VIBRATION DAMPER	252,00	299,88	D	21379	GASKET SET	75,75	90,14	D
19619	UNIVERSAL JOINT	90,90	108,17	D	21381	GASKET KIT	110,10	131,02	D
19620	SEAL RING	6,45	7,68	D	21382	GASKET KIT	87,30	103,89	D
19621	NEEDLE BEARING	26,70	31,77	D	21383	GASKET KIT	163,05	194,03	D
19630	HOSE KIT	32,70	38,91	D	21384	GASKET KIT	121,20	144,23	D
19654	NEEDLE BEARING	13,35	15,89	D	21387	GASKET KIT	187,50	223,13	D
19683	INNER RING	21,75	25,88	D	21388	GASKET KIT	149,70	178,14	D
19691	BALL BEARING	106,50	126,74	D	21389	GASKET KIT	123,30	146,73	D
19700	BEARING KIT	26,40	31,42	D	21394	GASKET KIT	191,85	228,30	D
19720	GASKET SET	47,70	56,76	D	21395	GASKET SET	274,80	327,01	D
19726	SEALING STRIP	32,10	38,20	D	21400	GASKET KIT	49,35	58,73	D
19741	GASKET SET	110,10	131,02	D	21401	GASKET SET	90,90	108,17	D
19756	BEARING	96,60	114,95	D	21416	GASKET SET	429,75	511,40	D
19757	NEEDLE BEARING	14,70	17,49	D	21417	GASKET SET	219,45	261,15	D
19765	BEARING	208,80	248,47	D	21418	GASKET SET	90,90	108,17	D
19766	WATER HOSE CONNECT.	37,95	45,16	D	21422	GASKET SET	79,65	94,78	D
19785	PROPELLER CONE	21,30	25,35	D	21423	GASKET KIT	136,20	162,08	D
19793	ZINC ANODE KIT	12,75	15,17	D	21427	GASKET KIT	284,10	338,08	D
19805	ZINC RING KIT	9,75	11,60	D	21430	GASKET SET	93,00	110,67	D
19809	ZINC RING KIT	9,45	11,25	D	21431	GASKET SET	94,80	112,81	D
19810	ZINC RING KIT	7,50	8,93	D	21433	GASKET KIT	56,85	67,65	D
19812	ZINC RING KIT	18,30	21,78	D	21439	GASKET KIT	255,00	303,45	D
19815	ZINC RING KIT	18,30	21,78	D	21453	GASKET SET	216,00	257,04	D
19816	SCREW	8,40	10,00	D	21500	GASKET SET	60,45	71,94	D
19819	BEARING	43,50	51,77	D	21502	GASKET SET	105,90	126,02	D
19821	ZINC RING KIT	20,70	24,63	D	21504	GASKET SET	155,40	184,93	D
19822	HOSE KIT	24,45	29,10	D	21553	GASKET SET	102,30	121,74	D
19827	DRIVE BELLOW KIT	37,95	45,16	D	21561	GASKET SET	56,85	67,65	D
19828	EXHAUST BELLOW	75,45	89,79	D	21569	GASKET SET	87,30	103,89	D
19831	HOSE KIT	36,00	42,84	D	21572	GASKET SET	146,10	173,86	D
19835	ZINC ANODE	18,30	21,78	D	21757	GASKET KIT	147,75	175,82	D



**Prijslijst Infomar**

Art. No.	Omschrijving	Prijs € Excl BTW	Prijs € Incl BTW	Code	Art. No.	Omschrijving	Prijs € Excl BTW	Prijs € Incl BTW	Code
22001	GASKET SET	19,05	22,67	D	22076	REPAIR KIT	37,95	45,16	D
22002	GASKET SET	24,90	29,63	D	22079	GASKET KIT	3,30	3,93	D
22003	GASKET SET	21,30	25,35	D	22080	BUSHING KIT	3,90	4,64	D
22004	GASKET SET	17,70	21,06	D	22081	GASKET KIT	4,05	4,82	D
22005	BOLT KIT	9,30	11,07	D	22082	GASKET SET	9,45	11,25	D
22006	BOLT KIT	13,35	15,89	D	22083	GASKET SET	20,25	24,10	D
22007	BOLT KIT	21,60	25,70	D	22084	GASKET SET	20,25	24,10	D
22008	GASKET SET	34,95	41,59	D	22085	GASKET SET	10,05	11,96	D
22009	GASKET SET	8,85	10,53	D	22086	GASKET SET	20,25	24,10	D
22010	GASKET SET	22,80	27,13	D	22087	GASKET SET	47,70	56,76	D
22011	GASKET KIT	11,55	13,74	D	22088	SEALING WASHER KIT	3,60	4,28	D
22012	GASKET SET	14,70	17,49	D	22089	GASKET KIT	124,50	148,16	D
22013	GASKET SET	6,75	8,03	D	22090	GASKET SET	15,15	18,03	D
22014	GASKET SET	4,95	5,89	D	22091	GASKET SET	20,85	24,81	D
22015	GASKET SET	59,85	71,22	D	22092	BOLT KIT	17,25	20,53	D
22016	GASKET SET	9,90	11,78	D	22093	BOLT KIT	7,50	8,93	D
22017	GASKET SET	6,15	7,32	D	22094	BREAK PIN KIT	3,90	4,64	D
22018	GASKET KIT	15,15	18,03	D	22095	GASKET SET	9,45	11,25	D
22019	GASKET SET	7,50	8,93	D	22096	GASKET SET	22,80	27,13	D
22020	SEALING WASHER KIT	5,85	6,96	D	22097	GASKET SET	30,30	36,06	D
22021	GASKET SET	3,90	4,64	D	22098	GASKET SET	12,75	15,17	D
22022	GASKET SET	5,55	6,60	D	22099	BOLT KIT	13,35	15,89	D
22023	GASKET SET	6,15	7,32	D	22100	BOLT KIT	10,05	11,96	D
22024	GASKET SET	4,65	5,53	D	22101	GASKET SET	19,05	22,67	D
22025	GASKET SET	3,60	4,28	D	22102	INSTALLATION KIT	13,65	16,24	D
22026	SEALING WASHER KIT	5,85	6,96	D	22103	GASKET SET	9,45	11,25	D
22027	SEALING WASHER KIT	6,15	7,32	D	22104	GASKET SET	49,35	58,73	D
22028	SEALING WASHER KIT	6,45	7,68	D	22105	GASKET SET	25,80	30,70	D
22029	SEALING WASHER KIT	3,90	4,64	D	22106	GASKET SET	83,25	99,07	D
22030	SEALING WASHER KIT	4,65	5,53	D	22107	GASKET SET	20,25	24,10	D
22031	SEALING WASHER KIT	5,85	6,96	D	22108	GASKET SET	16,65	19,81	D
22032	GASKET SET	17,25	20,53	D	22109	GASKET SET	12,60	14,99	D
22033	GASKET SET	17,25	20,53	D	22110	GASKET SET	16,95	20,17	D
22034	GASKET SET	19,20	22,85	D	22111	GASKET SET	34,50	41,06	D
22035	GASKET SET	3,75	4,46	D	22113	GASKET SET	26,70	31,77	D
22036	GASKET SET	4,35	5,18	D	22114	GASKET SET	19,05	22,67	D
22037	GASKET SET	5,85	6,96	D	22115	GASKET SET	39,00	46,41	D
22038	GASKET SET	4,65	5,53	D	22116	GASKET SET	29,25	34,81	D
22039	GASKET SET	5,10	6,07	D	22117	SEALING WASHER KIT	9,45	11,25	D
22040	GASKET SET	10,35	12,32	D	22118	SEALING WASHER KIT	13,65	16,24	D
22041	GASKET SET	34,35	40,88	D	22119	GASKET SET	20,85	24,81	D
22042	GASKET SET	16,50	19,64	D	22120	GASKET SET	24,90	29,63	D
22043	SEALING WASHER KIT	4,20	5,00	D	22121	GASKET SET	24,90	29,63	D
22044	SEALING WASHER KIT	5,40	6,43	D	22122	GASKET SET	25,95	30,88	D
22045	BOLT KIT	15,15	18,03	D	22123	GASKET SET	19,95	23,74	D
22046	GASKET SET	2,85	3,39	D	22124	GASKET SET	29,40	34,99	D
22047	GASKET SET	10,50	12,50	D	22125	GASKET SET	31,50	37,49	D
22048	SEALING WASHER KIT	4,35	5,18	D	22126	GASKET SET	26,70	31,77	D
22049	GASKET SET	5,55	6,60	D	22127	GASKET SET	12,30	14,64	D
22050	RUBBER BLOCK KIT	41,85	49,80	D	22128	GASKET SET	7,50	8,93	D
22051	GASKET SET	6,90	8,21	D	22129	GASKET SET	66,00	78,54	D
22052	SEALING WASHER KIT	5,40	6,43	D	22130	GASKET SET	69,00	82,11	D
22053	GASKET SET	16,50	19,64	D	22131	SEALING WASHER KIT	15,15	18,03	D
22054	GASKET SET	8,70	10,35	D	22132	SEALING WASHER KIT	15,15	18,03	D
22055	REPAIR KIT	49,35	58,73	D	22133	SEALING WASHER KIT	20,85	24,81	D
22056	SPRING SET	20,25	24,10	D	22134	GASKET SET	32,40	38,56	D
22057	REPAIR KIT	19,05	22,67	D	22135	GASKET KIT	39,90	47,48	D
22058	REPAIR KIT	32,40	38,56	D	22136	REPAIR KIT	47,70	56,76	D
22059	REPAIR KIT	26,70	31,77	D	22137	REPAIR KIT	195,00	232,05	D
22060	REPAIR KIT	26,40	31,42	D	22138	GASKET SET	75,00	89,25	D
22061	GASKET SET	7,20	8,57	D	22139	GASKET SET	52,95	63,01	D
22062	RUBBER BLOCK KIT	26,70	31,77	D	22140	CONNECTORS KIT CAV	15,45	18,39	D
22063	SEALING WASHER KIT	3,90	4,64	D	22141	GASKET SET CARB.CD175	10,50	12,50	D
22064	SEALING WASHER KIT	3,30	3,93	D	22142	THRUST FLANGE	30,00	35,70	D
22065	SEALING WASHER KIT	4,05	4,82	D	22143	GASKET SET OIL COOLER	21,00	24,99	D
22066	GASKET SET	1,95	2,32	D	22144	ENGINE MOUNT.	19,50	23,21	D
22067	GASKET SET	2,55	3,03	D	22145	BOLT KIT EXH.MAN. V6	9,60	11,42	D
22068	GASKET SET	4,95	5,89	D	22146	MOUNT.KIT EXH.BEND V6	16,50	19,64	D
22069	SEALING WASHER KIT	9,75	11,60	D	22147	GASKET SET	19,50	23,21	D
22070	GASKET SET	3,90	4,64	D	22150	GASKET SET	12,75	15,17	D
22071	GASKET SET	3,30	3,93	D	22151	GASKET SET	13,35	15,89	D
22072	GASKET SET	6,00	7,14	D					
22073	REPAIR KIT	37,95	45,16	D					
22074	REPAIR KIT	24,90	29,63	D					
22075	REPAIR KIT	49,35	58,73	D					

**Bestellingen**

Europrop-Federal bv ontvangt bestellingen bij voorkeur per fax of e-mail.

**Publicaties**

Voor druk- en zetfouten in haar publicaties kan Europrop-Federal bv geen verantwoordelijkheid nemen. Model en uitvoeringswijzigingen voorbehouden.

**Leveringen**

Aansprakelijkheid wegens het niet of te laat leveren, kunnen wij niet aanvaarden. Bestellingen met een waarde boven de Euro 500,-- (netto, excl. BTW) franco adres in Nederland. Bij volumineuze artikelen geldt franco levering bij een netto orderbedrag van Euro 1000,--. Orders beneden een waarde van Euro 115,-- netto, excl. BTW worden belast met Euro 5,-- orderkosten. Naleveringen zijn franco.

**Verzendingen**

Indien de goederen door Europrop-Federal B.V. verzonden dienen te worden, zal dit gebeuren door een door Europrop-Federal B.V. aangewezen vervoerder. Transport geschiedt voor risico van de opdrachtgever/afnemer, ongeacht of de zending franco of niet franco geleverd wordt.

**Ontvangst goederen**

De door u ontvangen zendingen dienen te worden gecontroleerd op compleetheid en juistheid. Reclames ten gevolge van transportschade of vermissing dienen bij aflevering op de vrachtbrief te worden gemeld. Tevens dient u van de vervoerder een afschrift te eisen. Reclames dienen binnen 5 werkdagen, uitsluitend schriftelijk aan ons te worden gemeld.

**Retourzendingen**

Goederen die door ons geleverd zijn kunnen uitsluitend aan ons geretourneerd worden na schriftelijke toestemming van Europrop-Federal bv. De zending dient franco aangeleverd te worden. Alle retourzendingen geschieden voor risico van de koper. Artikelen die niet in deze catalogus staan en/of waar een klantspecifieke bewerking op is uitgevoerd, kunnen niet geretourneerd worden. Europrop-Federal bv behoudt zich het recht voor, voor de afhandeling van retourzendingen 10% van de netto goederenwaarde te berekenen.

**Reclames**

Reclames dienen binnen 5 dagen na ontvangst van de goederen in ons bezit te zijn. Over een eventuele toekenning van een garantieclaim wordt uitsluitend door ons beslist, na advies ingewonnen te hebben van de fabrikant of importeur. Wij zijn op generlei wijze aansprakelijk voor schade, voortvloeiend uit een defect of door niet of niet voldoende functioneren van een door ons geleverd product. Reclames ontheffen u niet van uw betalingsverplichting.

**Betalingen**

Al onze leveringen zijn gebaseerd op een betalingconditie van contant, tenzij anders overeengekomen. Bij overschrijding van de betalingstermijn zijn wij gerechtigd 1% rente te berekenen per maand of een gedeelte daarvan. Indien geleverd wordt tegen netto(actie) prijzen, is er geen enkele betalingskorting mogelijk. Niet of niet volledig betaalde goederen blijven eigendom van Europrop-Federal bv.

**Garantie**

Bij garantiegevallen zijn de garantiebepalingen van de fabrikant van toepassing.

**Prijzen**

Prijzen en leveringen zijn per stuk, of per hoeveelheid zoals vermeld. Prijzen en aanbiedingen zijn immer vrijblijvend. Prijzen kunnen als gevolg van valutaschommelingen zonder bericht vooraf gewijzigd worden.

**Leveringen**, voorzover niet vallend onder de boven beschreven voorwaarden, geschieden overeenkomstig de METAALUNIE VOORWAARDEN.

**Metaalunie voorwaarden.**

Op al onze offertes, op alle opdrachten aan ons en op alle met ons gesloten overeenkomsten zijn toepasselijk de metaalunie voorwaarden gedeponneerd ter griffie van de Rechtbank te Rotterdam zoals deze luiden volgens de laatstelijk aldaar neergelegde tekst, alsmede de bovenstaand weergegeven leveringsvoorwaarden van Europrop-Federal bv. Deze voorwaarden worden op verzoek toegezonden.

Onze producten zijn onderhevig aan voortdurende verbetering zodat wij het recht voorbehouden technische specificaties te wijzigen zonder voorafgaande kennisgeving.



# europrop

De Hoef 12  
5311 GH Gameren  
Tel. 0418 - 512666  
Fax. 0418 - 515455  
email : verkoop@europrop.nl



**FLEX-O-FOLD  
PROPELLERS**

**MAX-PROP**  
AUTOMATIC FEATHERING PROPELLERS



**VORTEX™  
XHS™**  
PERFORMANCE PROPELLERS

**RAPTURE**

**BALLISTIC™**  
STAINLESS STEEL PROPS

**Michigan  
propellers**



Uw Dealer:

Februari 1, 2004  
©2004 Europrop~Federal b.v.  
All Rights reserved.  
Printed in the Netherlands  
Part No. 200301  
Euro 5,50