

RUS

2009–2010



NGK | **NTK**
SPARK PLUGS | TECHNICAL CERAMICS

NTK – Ведущий производитель кислородных датчиков в мире

Информация

- R** управляющий зонд
- D** диагностический зонд
-  Установка слева
-  Установка справа
-  Механическая коробка передач
-  Автоматическая коробка передач
-  Система впрыскивания фирмы Bosch
-  Работа на газе
-  Автомобиль с правосторонним расположением рулевого управления
-  Автомобиль с левосторонним расположением рулевого управления
-  без каталитического нейтрализатора
- OE** Обратите внимание на номер оригинальной запчасти
- 2** Установка 2 сенсоров

Лямбда-датчик с элементом из диоксида циркония

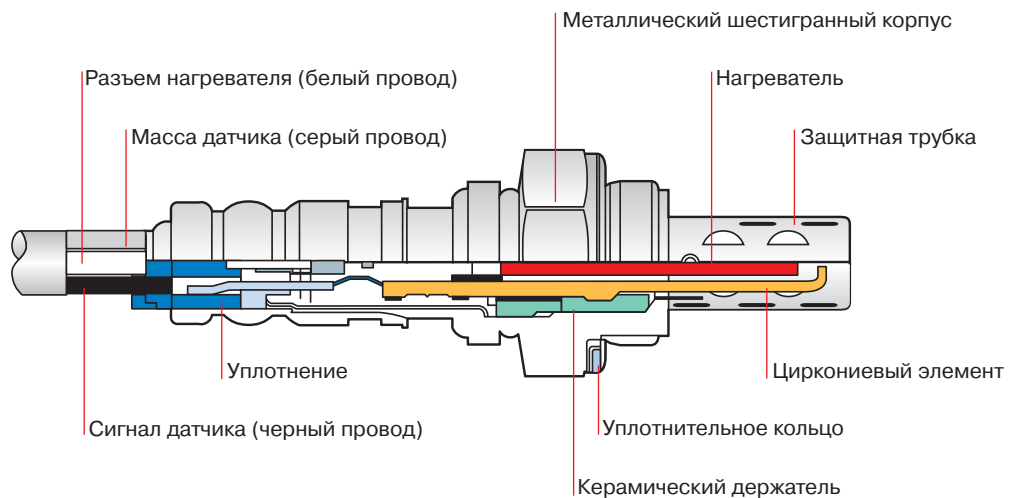

Лямбда-датчик с элементом из диоксида титана

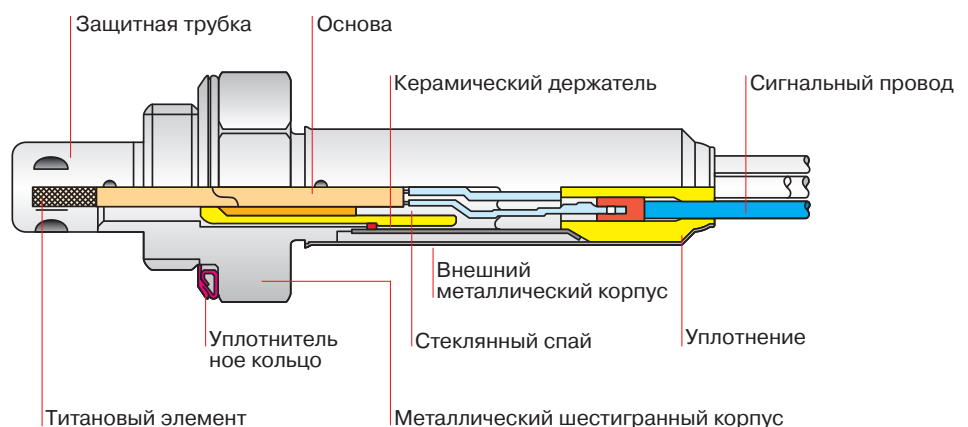

Следующие производители автомобилей доверяют в их производстве кислородным датчикам фирмы NTK: Aston Martin · Audi · BMW · Citroen · Daewoo · Daihatsu · Chrysler · Fiat · Ford · General Motors · Honda · Hyundai · Isuzu · Jaguar · Kia · Lancia · Mazda · Mitsubishi · Nissan · Opel · Peugeot · Renault · Rover · Seat · Skoda · Subaru · Suzuki · Toyota · Volvo · VW

Содержание

Информация о продукте

Кислородные датчики для оптимального понижения уровня отработавших газов (ОГ)	II
Принцип действия и техника	II
Испытание функционирования	III
Визуальный контроль	IV
Кислородные датчики фирмы NTK	
Надежность благодаря качеству	IV

Перечень производителей автомобилей, которые применяют кислородные датчики NTK (Автомобили)

Alfa Romeo	1
Aston Martin	5
Audi	5
Autobianchi	11
BMW	12
Chevrolet	19
Chrysler	20
Citroen	22
Dacia	30
Daewoo	31
Daihatsu	31
Daimler	32

Dodge	32	Rover	103
Ferrari	33	Saab	106
Fiat	33	Seat	107
Ford	40	Skoda	111
Gm-Vaz	46	Smart	113
Honda	46	SsangYong	114
Hyundai	49	Steyr-Daimler-Puch	115
Innocenti	51	Subaru	115
Jaguar	51	Suzuki	116
Jeep	52	Toyota	116
Kia	53	TVR	118
Lada (Avtovaz)	53	Volvo	118
Lamborghini	54	VW	122
Lancia	55	Zastava	133
Land Rover	58		
Lexus	58	Таблица применимости (Мотоциклы)	134
Mazda	59	Техническая информация	
Mercedes Benz	60	Датчик - Производитель	140
MG	69	Рекомендационный перечень	146
Mini	70	NTK → NTK	175
Mitsubishi	71	Информация о датчиках	176
Nissan	72	Вид штекера	183
Opel	75	л.с. ↔ квт.	223
Peugeot	83	Принцип установки	223
Pontiac	93		
Renault	93		

Примечания:

1. Данный перечень служит только для выбора типов.
2. После публикации этого издания все предыдущие перечни становятся недействительными.
3. Данное содержание не обуславливает правового притязания.



Кислотные датчики для оптимального понижения уровня отработавших газов.

Законные предписания в области отработавших газов обязывают автомобильную промышленность к понижению эмиссии отработавших газов. По этой причине сегодня все автомобили с двигателями внутреннего сгорания оснащаются трехкомпонентным каталитическим нейтрализатором. Нейтрализатор преобразует вредные отработавшие газы в газы с безвредным воздействием на экологию. Для эффективной работы нейтрализатора необходимо четко согласовать соотношение топлива и воздуха. Кислородный датчик постоянно проверяет состав отработавших газов. Кислородный датчик находится в передней части системы отработавших газов перед нейтрализатором. Датчик измеряет содержание остаточного количества кислорода в отработавших газах. С помощью выходного сигнала

он регулирует систему управления двигателем, которая в свою очередь с помощью карбюратора производит четкую настройку топливоздушную смеси (см. рис. I). Данный, так называемый замкнутый контур регулирования обеспечивает оптимальное соотношение составных компонентов смеси. Благодаря этому одновременно обеспечивается оптимальный уровень преобразующего

действия нейтрализатора, а также оптимальная мощность двигателя. С помощью второго кислородного датчика, находящегося за нейтрализатором, осуществляется постоянный контроль безупречного функционирования нейтрализатора и датчика, расположенного перед ним. В случае погрешности на панели приборов немедленно появляется оптический сигнал.

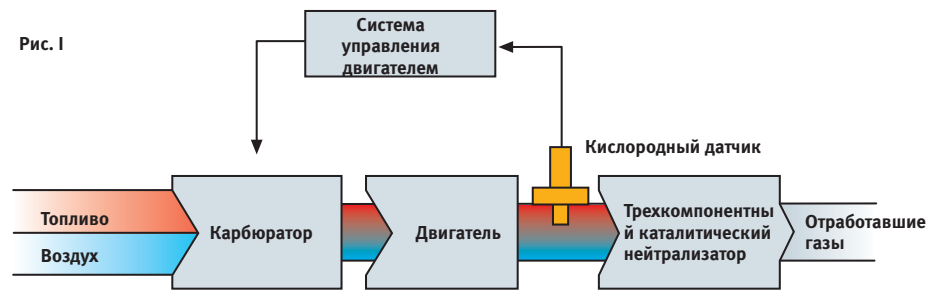

Функция и техника

Существуют различные типы кислородных датчиков. Их различие заключается в керамических элементах, с помощью которых производится измерение составных частей отработавших газов. Датчики окиси циркония: внешняя сторона элемента окиси циркония находится в непосредственном контакте с отработавшими газами. Внутренняя сторона имеет контакт с воздухом. На обеих сторонах элемента нанесено тонкое платиновое покрытие. Ионы кислорода проходят через элемент и оставляют на платиновом покрытии электрический заряд. При этом платиновое покрытие представляет собой электроды; сигнал датчика передается дальше от элемента к соединительному проводу датчика (см. рис. II). При температуре 300°C элемент окиси циркония

достигает проводящую способность для ионов кислорода. Если на обеих сторонах элемента окиси циркония концентрация кислорода различна, то по причине особых свойств элемента образуется напряжение. При обедненном соотношении топлива и воздуха возникает невысокое напряжение. Если же данное соотношение насыщено, то напряжение высокое. Типичный скачок

напряжения происходит при соотношении топлива и воздуха приблизительно на уровне 1:14,7 (см. рис. III). Данное соотношение можно также охарактеризовать коэффициентом избытка воздуха ($\lambda = 1$ соответствует соотношению топлива и воздуха в размере 1:14,7; т.е. при этом происходит полное сгорание).

Рис. II



Рис. III



С помощью карбюратора либо электронного впрыскового механизма система управления двигателем регулирует соотношение топлива и воздуха. Необходимую для этого информацию система управления получает от кислородного датчика. Датчик создает напряжение только при достижении рабочей температуры свыше 300°C. По этой причине после старта двигателя элемент должен поработать определенное время для того, чтобы он нагрелся.

Сегодня почти все датчики оснащены внутренним керамическим нагревательным приспособлением, которое сокращает интервал времени до момента начала работы датчика. Датчики с нагревательными приспособлениями фирмы NTK являются примером многолетнего опыта в области толстопленочной и многослойной технологии. Благодаря им обеспечиваются высокое качество и надежность. Датчики окиси титана: элемент окиси титана не создает напряжение, как это происходит у элемента окиси циркония. Вместо этого производится изменение электрического сопротивления элемента окиси титана

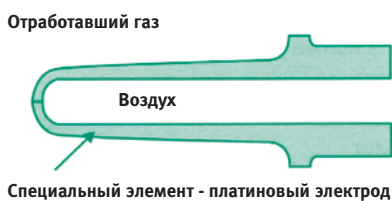
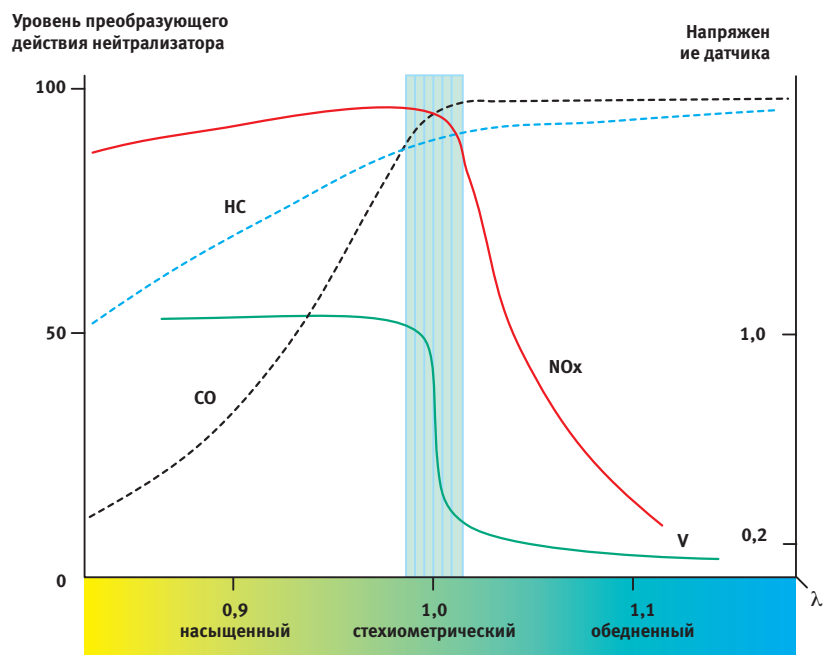
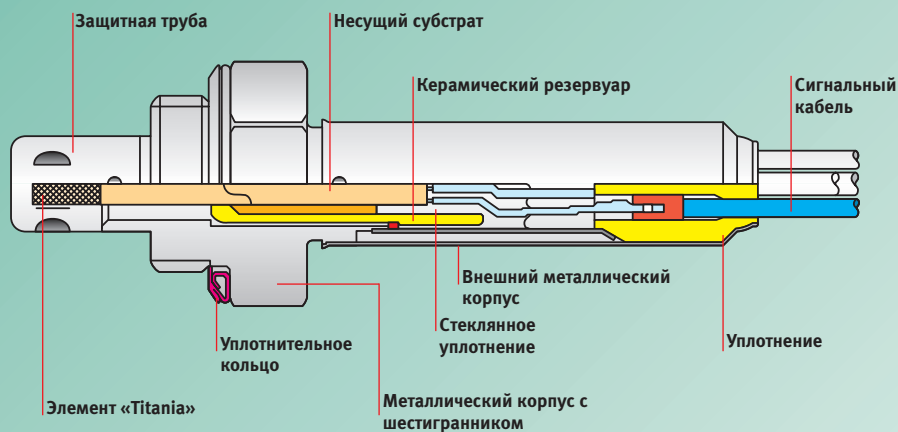

в зависимости от концентрации кислорода в отработавших газах. При величине Лямбда 1,0 сопротивление сильно изменяется. При подаче напряжения к элементу изменяется выходное напряжение в соответствии с концентрацией кислорода в отработавших газах. Датчик окиси титана в отличие от датчика окиси циркония не нуждается в исходном воздухе по причине другой конструкции его функционального механизма. В связи с этим датчик окиси титана имеет небольшие габариты. Элемент датчика, его платиновые электроды и нагревательный элемент устанавливаются на базе толстопленочной и многослойной технологии фирмы NTK на керамическом субстрате. Датчики на

основе окиси титана нельзя заменить датчиками на основе окиси циркония, и, наоборот, по причине их различных габаритов и стратегических видов управления, которые используются для анализа сигналов от датчиков.

Испытание функционирования

Кислородные датчики, вышедшие из строя или с дефектами, обуславливают проблемы, как, например, высокий расход топлива, выход из строя и повреждение каталитического нейтрализатора, плохие динамические свойства или отрицательная оценка при прохождении теста отработавших газов. Испытание кислородных датчиков производится с помощью осциллоскопа. Перед выполнением испытания необходимо обеспечить условие, при котором двигатель должен быть настроен согласно данным производителя. После этого двигатель должен поработать определенное время, и достигнуть рабочей температуры, так как кислородный датчик функционирует только при правильной температуре.

С помощью соответствующего соединительного устройства выход датчика подключается к осциллоскопу. Датчик нельзя отсоединять от системы управления двигателем. Число оборотов двигателя должно находиться приблизительно на уровне 2.000 об./мин. В случае правильного функционирования кислородного датчика величина скачка напряжения находится приблизительно в диапазоне от 0,2 до 0,8 Вольт. Время, необходимое для повышения от 0,1 Вольт до 0,9 Вольт (время реакции «обедненное состояние - насыщенное состояние», должно составлять около 300 миллисекунд. Время реакции «обедненное состояние - насыщенное состояние» находится также в пределах этого диапазона. Если значение выхода датчика остается

постоянным или время реакции проходит медленно, то в данном случае замедленный датчик должен быть заменен.

Функционирование кислородного датчика необходимо проверять в рамках каждого технического осмотра и каждого контроля токсичности отработавших газов.

Медленно действующий датчик повышает расход топлива и в связи с этим такой датчик должен быть заменен.

Визуальный контроль

Для определения работоспособности кислородного датчика не достаточно выполнять визуальный контроль. Необходимо производить контроль соединительных линий и штекера, а также корпуса датчика, так как отклонения на этих участках обуславливают также искажение сигнала датчика. Повреждения на корпусе датчика говорят о механических ударах. Также состояние защитной трубы датчика может предоставить сведения о возможном неправильном функционировании.

Высокий уровень осаждения сажи приводит к закупорке датчика и отражается на времени реакции. Соотношение топлива и воздуха может быть чрезмерно насыщенным или же вышло из строя сенсорное нагревательное приспособление датчика. В любом случае такой датчик необходимо заменить.

Сажа



Высокий уровень осаждения белого или серого цвета указывает на использование присадок к топливу или на сгорание масла в двигателе. Определенные составные части в присадках к топливу и в масле загрязняют элемент датчика. Необходимо устранить причину загрязнения и заменить датчик.

Масло



Блестящие виды осаждения указывают на содержание свинца в топливе. Свинец производит разрушающее действие на платину, которая находится на элементе датчика и на каталитическом нейтрализаторе. При этом датчик должен быть заменен. После выполнения замены необходимо обратить внимание на то, чтобы использовалось исключительно только топливо без содержания свинца.

Свинец



Кислородные датчики фирмы NTK Надежность благодаря качеству

Результат многолетнего опыта: фирма NTK является ведущим производителем кислородных датчиков в мире. Благодаря многолетнему опыту в области разработок и изготовления кислородных датчиков фирма NTK в состоянии предложить соответствующий датчик почти для каждого автомобиля. Все составные

части, типы элементов, нагревательные сопротивления и соединительные штекера соответствуют оригинальным запчастям производителей, и предоставляют возможность для удобной установки без всяких проблем.

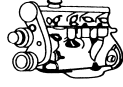

ℓ kW

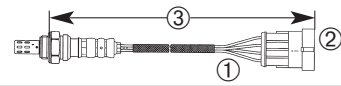

ORDER No. STOCK No. TYPE No. UNIVERSAL No. DIMENSIONAL No.

ALFA ROMEO

33

1.4i.e.	907 A	AR30.755	1.4	64	09.91-12.91		R	3	19	1665	OZA446-E49	0291	S3	0412
1.4i.e. SW	907 B	AR30.755	1.4	64	09.91-12.91		R	3	19	1665	OZA446-E49	0291	S3	0412
1.4i.e.	907 A	AR30.732	1.4	65	02.94-10.94		R	3	51	1700	OTA5F-3C1	1921	---	---
1.4i.e SW	907 B	AR30.732	1.4	65	02.94-10.94		R	3	51	1700	OTA5F-3C1	1921	---	---
1.5i.e.	907 A	AR30.751	1.5	70-72	06.90-03.92		R	3	19	1665	OZA446-E49	0291	S3	0412
1.5i.e. SW	907 B	AR30.751	1.5	70-72	06.90-03.92		R	3	19	1665	OZA446-E49	0291	S3	0412
1.5i.e. SW 4x4	907 B	AR30.751	1.5	70-72	06.90-03.92		R	3	19	1665	OZA446-E49	0291	S3	0412
1.7i.e. SW	905 A	AR30.558	1.7	77	09.88-12.89		R	3	19	1665	OZA446-E49	0291	S3	0412
1.7i.e. SW 4x4	905 A	AR30.558	1.7	77	09.88-12.89		R	3	19	1665	OZA446-E49	0291	S3	0412
1.7i.e.	907 A	AR30.558	1.7	77	10.87-12.89		R	3	19	1665	OZA446-E49	0291	S3	0412
1.7i.e. 4x4	907 A	AR30.737	1.7	79	07.90-03.92		R	3	19	1665	OZA446-E49	0291	S3	0412
1.7i.e.	907 A	AR30.737	1.7	79	01.90-03.92		R	3	19	1665	OZA446-E49	0291	S3	0412
1.7i.e. SW	907 B	AR30.737	1.7	79	07.90-03.92		R	3	19	1665	OZA446-E49	0291	S3	0412
1.7i.e. SW 4x4	907 B	AR30.737	1.7	79	07.90-03.92		R	3	19	1665	OZA446-E49	0291	S3	0412
1.7i.e. 16V	907 A	AR30.747	1.7	95	01.90-10.94		R	3	19	1665	OZA446-E49	0291	S3	0412
1.7i.e. 16V 4x4	907 A	AR30.747	1.7	95	01.90-10.94		R	3	19	1665	OZA446-E49	0291	S3	0412
1.7i.e. 16V SW 4x4	907 B	AR30.747	1.7	95	06.90-10.94		R	3	19	1665	OZA446-E49	0291	S3	0412
1.7i.e. 16V 4x4	907 A	AR30.747	1.7	97	06.90-09.94		R	3	19	1665	OZA446-E49	0291	S3	0412

75

1.6i.e.	611.01		1.6	77-79	08.89-02.92		R	3	19	895	OZA446-E4	1877	S3	0412
1.8i.e.	612.01		1.8	88	08.89-02.92		R	3	19	895	OZA446-E4	1877	S3	0412
2.0 T.S.	061.66		2.0	106	09.87-05.90		R	3	19	1100	OZA446-E5	1838	S3	0412
3.0 V6	061.24		3.0	133	02.87-01.90		R	3	19	895	OZA446-E4	1877	S3	0412
3.0 V6	061.503		3.0	139-141	02.90-02.92		R	3	19	895	OZA446-E4	1877	S3	0412
3.0 ES Coupe Zagato	615.01		3.0	152	03.89-02.92		R	3	19	895	OZA446-E4	1877	S3	0412

145

1.4i.e.	AR33.501		1.4	66	08.94-02.97		R	3	51	1000	OTA6F-3A1	1928	---	---
1.4 i.e. 16V T.S. [G97]	AR33.503		1.4	76	11.96-02.99	VET 016 5088 ->	R	4	40	1170	OZA659-EE30	1612	---	---
1.4 i.e. 16V T.S. [G97]	AR33.503		1.4	76	11.96-02.99	-> VET 012 9332	R	4	40	972	OZA527-E7	0213	S4CG	1919
1.4 i.e. 16V T.S. [G99]	AR33.503		1.4	76	02.99-12.00		R	4	40	1170	OZA659-EE30	1612	---	---
1.6i.e	AR33.201		1.6	78	04.94-12.94		R	4	40	972	OZA527-E7	0213	S4CG	1919
1.6i.e. 16V T.S. [G97]	AR67.601		1.6	88	11.96-02.99	VET 317 4687 ->	R	4	40	1170	OZA659-EE30	1612	---	---
1.6i.e. 16V T.S. [G99]	AR32.102		1.6	88	02.99-12.00		R	4	40	1170	OZA659-EE30	1612	---	---
1.6i.e. 16V T.S. [G99]	AR67.601		1.6	88	02.99-12.00		R	4	40	1170	OZA659-EE30	1612	---	---
1.7i.e 16V	AR33.401		1.7	96	04.94-11.96		R	4	40	972	OZA527-E7	0213	S4CG	1919
1.8i.e. 16V T.S. [G97]	AR32.201		1.8	103	11.96-05.98		R	4	40	972	OZA527-E7	0213	S4CG	1919
1.8i.e. 16V T.S. [G97]	AR32.201		1.8	103	05.98-01.99		R	4	40	1170	OZA659-EE30	1612	---	---
1.8i.e. 16V T.S. [G99]	AR32.201		1.8	103	02.99-12.00		R	4	40	1170	OZA659-EE30	1612	---	---
1.8i.e. 16V T.S.	AR67.106		1.8	103	11.96-04.98		R	4	40	972	OZA527-E7	0213	S4CG	1919
1.8i.e. 16V T.S. [G97]	AR67.106		1.8	103	11.96-05.98		R	4	40	972	OZA527-E7	0213	S4CG	1919
2.0i.e. 16V T.S. [G97]	AR32.301		2.0	110	05.98-02.99		R	4	40	1170	OZA659-EE30	1612	---	---
2.0ti 16V T.S. [G99]	AR32.301		2.0	110	02.99-12.00		R	4	40	1170	OZA659-EE30	1612	---	---
2.0i.e. 16V T.S.	AR67.204		2.0	110	10.95-04.98		R	4	40	972	OZA527-E7	0213	S4CG	1919

146

1.4i.e.	AR33.501		1.4	66	08.94-02.97		R	3	51	1000	OTA6F-3A1	1928	---	---
1.4i.e. 16V T.S. [G97]	AR33.503		1.4	76	11.96-02.99	VET 016 5088 ->	R	4	40	1170	OZA659-EE30	1612	---	---
1.4i.e. 16V T.S. [G97]	AR33.503		1.4	76	11.96-05.98	-> VET 012 9332	R	4	40	972	OZA527-E7	0213	S4CG	1919
1.4i.e. 16V T.S. [G99]	AR33.503		1.4	76	02.99-12.00		R	4	40	1170	OZA659-EE30	1612	---	---

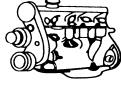

ℓ kW

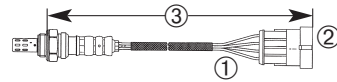

STOCK No. TYPE No. UNIVERSAL No. MOTOR No.

ALFA ROMEO

146

1.6i.e.	AR33.201	1.6	78	04.94-12.94		R	4	40	972	OZA527-E7	0213	S4CG	1919
1.6i.e. 16V T.S. [G97]	AR67.601	1.6	88	11.96-02.99		R	4	40	1170	OZA659-EE30	1612	---	---
1.6i.e. 16V T.S. [G99]	AR67.601	1.6	88	02.99-12.00		R	4	40	1170	OZA659-EE30	1612	---	---
1.6i.e. 16V T.S. [G99]	AR32.102	1.6	88	02.99-12.00		R	4	40	1170	OZA659-EE30	1612	---	---
1.7i.e. 16V	AR33.401	1.7	96	12.94-11.96		R	4	40	972	OZA527-E7	0213	S4CG	1919
1.8i.e. 16V T.S.	AR67.106	1.8	103	11.96-04.98		R	4	40	972	OZA527-E7	0213	S4CG	1919
1.8i.e. 16V T.S. [G97]	AR32.201	1.8	103	05.98-02.99		R	4	40	1170	OZA659-EE30	1612	---	---
1.8i.e. 16V T.S. [G99]	AR32.201	1.8	103	02.99-12.00		R	4	40	1170	OZA659-EE30	1612	---	---
2.0ti 16V T.S. [G97]	AR32.301	2.0	110	05.98-02.99		R	4	40	1170	OZA659-EE30	1612	---	---
2.0ti 16V T.S. [G99]	AR32.301	2.0	110	02.99-12.00		R	4	40	1170	OZA659-EE30	1612	---	---
2.0ti 16V T.S.	AR67.204	2.0	110	10.95-04.98		R	4	40	972	OZA527-E7	0213	S4CG	1919

147

1.6i 16V T.S. Eco	AR37.203	1.6	77	11.00-		R	4	40	300	OZA675-EE1	7978	---	---
1.6i 16V T.S. Eco	AR37.203	1.6	77	11.00-		D	4	40	600	OZA659-EE56	7863	---	---
1.6i 16V T.S.	AR32.104	1.6	88	11.00-		R	4	40	400	OZA659-EE49	5753	---	---
1.6i 16V T.S.	AR32.104	1.6	88	11.00-		D	4	40	2020	OZA659-EE57	7864	---	---
2.0i 16V T.S.	AR32.310	2.0	110	11.00-		R	4	40	400	OZA659-EE49	5753	---	---
2.0i 16V T.S.	AR32.310	2.0	110	11.00-		D	4	40	2020	OZA659-EE57	7864	---	---
3.2i GTA	932A000	3.2	184	01.03-		R	4	40	300	OZA659-EE3	0377	---	---
3.2i GTA	932A000	3.2	184	01.03-		R	4	40	820	OZA659-EE58	7903	---	---
3.2i GTA	932A000	3.2	184	01.03-		D	4	40	2000	OZA659-EE60	7905	---	---
3.2i GTA	932A000	3.2	184	01.03-		D	4	40	2315	OZA659-EE59	7904	---	---

155

1.6i 16V T.S.	AR67.601	1.6	85	05.96-10.97		R	4	40	972	OZA527-E7	0213	S4CG	1919
1.7i T.S.	AR67.105	1.7	85	04.93-04.96		R	4	38	1130	OZA527-E5	0253	S4CG	1919
1.7i T.S.	AR67.103	1.7	95	02.92-04.93		R	4	38	1130	OZA527-E5	0253	S4CG	1919
1.8i T.S.	AR67.101 / 102	1.8	93	02.92-04.96		R	4	38	1130	OZA527-E5	0253	S4CG	1919
1.8i 16V T.S.	AR67.106	1.8	100	05.96-10.97		R	4	40	972	OZA527-E7	0213	S4CG	1919
2.0i T.S.	AR67.202	2.0	104	04.93-02.95		R	4	38	1130	OZA527-E5	0253	S4CG	1919
2.0i 16V T.S.	AR67.204	2.0	110	03.95-10.97		R	4	40	972	OZA527-E7	0213	S4CG	1919
2.5i V6	AR67.301	2.5	120	02.92-04.96		R	4	38	1130	OZA527-E5	0253	S4CG	1919
2.5i V6	AR67.303	2.5	121	05.96-10.97		R	4	38	880	OZA527-E4	0218	S4CG	1919

156

1.6i 16V T.S.	AR67.601	1.6	88	10.99-09.00	->VET 001 2328	R	3	22	890	OZA446-E18	1887	S3	0412
1.6i 16V T.S.	AR32.102	1.6	88	10.97-09.00	VET 002 3373 ->	R	4	40	1170	OZA659-EE30	1612	---	---
1.6i 16V T.S.	AR67.601	1.6	88	10.99-09.00	VET 002 3373 ->	R	4	40	1175	OZA527-E24	0287	S4CG	1919
1.6i 16V T.S.	AR32.103	1.6	88	09.00-12.01		R	4	40	400	OZA659-EE49	5753	---	---
1.6i 16V T.S.	AR32.103	1.6	88	09.00-12.01		D	4	40	2020	OZA659-EE57	7864	---	---
1.6i 16V T.S.	AR32.104	1.6	88	09.00-12.01		R	4	40	400	OZA659-EE49	5753	---	---
1.6i 16V T.S.	AR32.104	1.6	88	09.00-10.05		D	4	40	2020	OZA659-EE57	7864	---	---
1.6i 16V T.S. Sport Wagon	AR67.601	1.6	88	06.00-09.00		R	4	40	1170	OZA659-EE30	1612	---	---
1.6i 16V T.S. Sport Wagon	AR32.104	1.6	88	09.00-12.01		R	4	40	400	OZA659-EE49	5753	---	---
1.6i 16V T.S. Sport Wagon	AR32.104	1.6	88	09.00-12.05		D	4	40	2020	OZA659-EE57	7864	---	---
1.8i 16V T.S.	AR32.201	1.8	106	12.97-09.00		R	4	40	1170	OZA659-EE30	1612	---	---
1.8i 16V T.S.	AR32.205	1.8	106	09.00-12.01		R	4	40	400	OZA659-EE49	5753	---	---
1.8i 16V T.S.	AR32.205	1.8	106	09.00-10.05		D	4	40	2020	OZA659-EE57	7864	---	---
1.8i 16V T.S. Sport Wagon	AR32.201	1.8	106	06.00-09.00		R	4	40	1170	OZA659-EE30	1612	---	---
1.8i 16V T.S. Sport Wagon	AR32.205	1.8	106	09.00-12.01		R	4	40	400	OZA659-EE49	5753	---	---
1.8i 16V T.S. Sport Wagon	AR32.205	1.8	106	09.00-12.05		D	4	40	2020	OZA659-EE57	7864	---	---

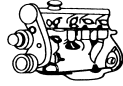

ℓ kW

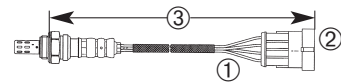

STOCK No. TYPE No. UNIVERSAL No. ORDER No.

ALFA ROMEO

156

2.0i 16V T.S.	AR32.301	2.0	114	12.97-12.01		R	4	40	1170	OZA659-EE30	1612	---	---
2.0i 16V T.S.	AR32.310	2.0	114	09.00-12.01		R	4	40	400	OZA659-EE49	5753	---	---
2.0i 16V T.S.	AR32.310	2.0	114	09.00-12.01		D	4	40	2020	OZA659-EE57	7864	---	---
2.0i 16V T.S. Sport Wagon	AR32.301	2.0	114	06.00-09.00		R	4	40	1170	OZA659-EE30	1612	---	---
2.0i 16V T.S. Sport Wagon	AR32.310	2.0	114	09.00-12.01		R	4	40	400	OZA659-EE49	5753	---	---
2.0i 16V T.S. Sport Wagon	AR32.310	2.0	114	09.00-12.01		D	4	40	2020	OZA659-EE57	7864	---	---
2.0 JTS	937A1.000	2.0	121	01.02-10.05		D	4	40	600	OZA659-EE31	1613	---	---
2.0 JTS Sport Wagon	937A1.000	2.0	121	01.02-12.05		D	4	40	600	OZA659-EE31	1613	---	---
2.0i 16V T.S.	AR32.310	2.0	121	01.02-10.05		R	4	40	400	OZA659-EE49	5753	---	---
2.0i 16V T.S.	AR32.310	2.0	121	01.02-10.05		D	4	40	2020	OZA659-EE57	7864	---	---
2.0i 16V T.S. Sport Wagon	AR32.310	2.0	121	01.02-10.05		R	4	40	400	OZA659-EE49	5753	---	---
2.0i 16V T.S. Sport Wagon	AR32.310	2.0	121	01.02-10.05		D	4	40	2020	OZA659-EE57	7864	---	---
2.5i 24V	AR32.401	2.5	140	10.97-12.01		R	4	40	1170	OZA659-EE30	1612	---	---
2.5i 24V	AR32.402	2.5	140	10.97-12.01		R	4	40	1170	OZA659-EE30	1612	---	---
2.5i 24V	AR32.405	2.5	140	09.00-12.01	↑	R	4	40	400	OZA659-EE49	5753	---	---
2.5i 24V	AR32.405	2.5	140	09.00-12.01	↑	R	4	40	820	OZA659-EE58	7903	---	---
2.5i 24V	AR32.405	2.5	140	09.00-12.01	↑	D	4	40	2000	OZA659-EE60	7905	---	---
2.5i 24V	AR32.405	2.5	140	09.00-12.01	↑	D	4	40	2315	OZA659-EE59	7904	---	---
2.5i 24V Sport Wagon	AR32.401	2.5	140	06.00-09.00		R	4	40	1170	OZA659-EE30	1612	---	---
2.5i 24V Sport Wagon	AR32.405	2.5	140	09.00-12.01	↑	R	4	40	400	OZA659-EE49	5753	---	---
2.5i 24V Sport Wagon	AR32.405	2.5	140	09.00-12.01	↑	R	4	40	820	OZA659-EE58	7903	---	---
2.5i 24V Sport Wagon	AR32.405	2.5	140	09.00-12.01	↑	D	4	40	2000	OZA659-EE60	7905	---	---
2.5i 24V Sport Wagon	AR32.405	2.5	140	09.00-12.01	↑	D	4	40	2315	OZA659-EE59	7904	---	---
2.5i 24V	AR32.405	2.5	141	01.02-10.05		R	4	40	820	OZA659-EE58	7903	---	---
2.5i 24V	AR32.405	2.5	141	01.02-10.05	↑	D	4	40	2000	OZA659-EE60	7905	---	---
2.5i 24V	AR32.405	2.5	141	01.02-10.05	↑	D	4	40	2315	OZA659-EE59	7904	---	---
2.5i 24V Sport Wagon	AR32.405	2.5	141	01.02-10.05		R	4	40	820	OZA659-EE58	7903	---	---
2.5i 24V Sport Wagon	AR32.405	2.5	141	01.02-10.05	↑	D	4	40	2000	OZA659-EE60	7905	---	---
2.5i 24V Sport Wagon	AR32.405	2.5	141	01.02-10.05	↑	D	4	40	2315	OZA659-EE59	7904	---	---
3.2 GTA	932A000	3.2	184	03.02-10.05		R	4	40	820	OZA659-EE58	7903	---	---
3.2 GTA	932A000	3.2	184	03.02-10.05	↑	D	4	40	2000	OZA659-EE60	7905	---	---
3.2 GTA	932A000	3.2	184	03.02-10.05	↑	D	4	40	2315	OZA659-EE59	7904	---	---
3.2 GTA Sport Wagon	932A000	3.2	184	03.02-10.05		R	4	40	820	OZA659-EE58	7903	---	---
3.2 GTA Sport Wagon	932A000	3.2	184	03.02-10.05	↑	D	4	40	2000	OZA659-EE60	7905	---	---
3.2 GTA Sport Wagon	932A000	3.2	184	03.02-10.05	↑	D	4	40	2315	OZA659-EE59	7904	---	---

159

1.8i 16V	939A4.000	1.8	103	07.05-		R	4	74	471	OZA334-SZ5	1705	---	---
1.8i 16V Station Wagon	939A4.000	1.8	103	03.06-		R	4	74	471	OZA334-SZ5	1705	---	---

164

2.0 T.S.	064.16	2.0	102	01.88-09.92		R	3	19	895	OZA446-E4	1877	S3	0412
2.0 T.S.	64.103	2.0	106	12.93-10.98		R	4	38	880	OZA527-E4	0218	S4CG	1919
2.0i.e V6 Turbo	64.102	2.0	148	03.91-09.92		R	3	19	1100	OZA446-E5	1838	S3	0412
2.0i.e V6 Turbo	64.102	2.0	148	09.92-10.98		R	3	19	1100	OZA446-E5	1838	S3	0412
3.0i.e.	064.12	3.0	132	04.88-05.91		R	3	19	895	OZA446-E4	1877	S3	0412
3.0i.e.	064.12	3.0	132	06.91-09.92		R	3	19	1100	OZA446-E5	1838	S3	0412
3.0i.e. QV	064.30	3.0	147	09.90-05.91		R	3	19	895	OZA446-E4	1877	S3	0412
3.0i.e. QV	064.30	3.0	147	06.91-09.92		R	3	19	1100	OZA446-E5	1838	S3	0412
3.0i.e. Q4 4x4	64.307 / 66.304	3.0	171	12.93-10.98		R	4	38	880	OZA527-E4	0218	S4CG	1919

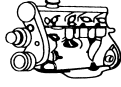

ℓ kW

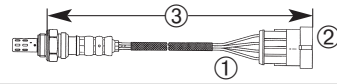

STOCK No. TYPE No. UNIVERSAL No. MOTOR No.

ALFA ROMEO

166

2.0i 16V T.S.	AR34.103	2.0	114	10.98-05.00		R	4	40	1170	OZA659-EE30	1612	---	---
2.0i 16V T.S.	AR36.301	2.0	114	09.00-		D	4	40	600	OZA659-EE56	7863	---	---
2.0 Turbo V6	AR34.102	2.0	151	10.98-12.04		R	4	40	1170	OZA659-EE30	1612	---	---
2.5 24V V6	AR36.201	2.5	140	09.00-		R	4	40	300	OZA659-EE3	0377	---	---
2.5 24V V6	AR36.201	2.5	140	09.00-	Y	D	4	40	2315	OZA659-EE59	7904	---	---
2.5 24V V6	AR36.201	2.5	140	09.00-	Y	D	4	40	2000	OZA659-EE60	7905	---	---
2.5 24V V6	AR34.201	2.5	140	10.98-09.00		R	4	40	1170	OZA659-EE30	1612	---	---
3.0 24V V6	AR34.301	3.0	166	10.98-09.00		R	4	40	1170	OZA659-EE30	1612	---	---
3.0 24V V6	AR34.302	3.0	166	10.98-09.00		R	4	40	1170	OZA659-EE30	1612	---	---
3.0 24V V6	AR36.101	3.0	166	09.00-	Y	R	4	40	820	OZA659-EE58	7903	---	---
3.0 24V V6	AR36.101	3.0	166	09.00-	Y	R	4	40	300	OZA659-EE3	0377	---	---
3.0 24V V6	AR36.101	3.0	166	09.00-	Y	D	4	40	2315	OZA659-EE59	7904	---	---
3.0 24V V6	AR36.101	3.0	166	09.00-	Y	D	4	40	2000	OZA659-EE60	7905	---	---
3.0 24V V6	936A000	3.2	166	06.03-	Y	R	4	40	820	OZA659-EE58	7903	---	---
3.2 24V V6	936A000	3.2	166	06.03-	Y	R	4	40	300	OZA659-EE3	0377	---	---
3.2 24V V6	936A000	3.2	166	06.03-	Y	D	4	40	2315	OZA659-EE59	7904	---	---
3.2 24V V6	936A000	3.2	166	06.03-	Y	D	4	40	2000	OZA659-EE60	7905	---	---

GT

1.8 T.S.	AR32.205	1.8	106	10.03-		R	4	40	400	OZA659-EE49	5753	---	---
1.8 T.S.	AR32.205	1.8	106	10.03-		D	4	40	2020	OZA659-EE57	7864	---	---
2.0 JTS	932A2.000	2.0	120	10.03-		D	4	40	600	OZA659-EE31	1613	---	---
3.2 V6	936A000	3.2	176	10.03-	Y	R	4	40	2315	OZA659-EE59	7904	---	---
3.2 V6	936A000	3.2	176	10.03-	Y	R	4	40	300	OZA659-EE3	0377	---	---
3.2 V6	936A000	3.2	176	10.03-	Y	D	4	40	820	OZA659-EE58	7903	---	---
3.2 V6	936A000	3.2	176	10.03-	Y	D	4	40	2000	OZA659-EE60	7905	---	---

GTV

1.8 16V T.S.	AR32.201	1.8	106	03.98-12.00		R	4	40	1170	OZA659-EE30	1612	---	---
2.0 16V T.S.	AR16.201	2.0	110	04.95-03.98		R	3	22	890	OZA446-E18	1887	S3	0412
2.0 16V T.S.	AR16.201	2.0	110	04.98-09.00		R	4	40	1170	OZA659-EE30	1612	---	---
2.0 16V T.S.	AR32.310	2.0	110	06.00-12.05		D	4	40	400	OZA659-EE49	5753	---	---
2.0 JTS	937A1.000	2.0	121	06.03-12.05		D	4	40	600	OZA659-EE56	7863	---	---
3.0 24V V6	AR16.102	3.0	162	11.96-03.98		R	3	22	890	OZA446-E18	1887	S3	0412
3.0 24V V6	AR16.102	3.0	162	03.98-10.99		R	4	40	600	OZA659-EE31	1613	---	---
3.0 24V V6	AR16.102	3.0	162	11.99-09.00		R	4	40	1170	OZA659-EE30	1612	---	---
3.0 24V V6	AR16.105	3.0	162	06.00-12.05	Y	R	4	40	300	OZA659-EE3	0377	---	---
3.0 24V V6	AR16.105	3.0	162	06.00-12.05	Y	R	4	40	820	OZA659-EE58	7903	---	---
3.0 24V V6	AR16.105	3.0	162	06.00-12.05	Y	D	4	40	2000	OZA659-EE60	7905	---	---
3.0 24V V6	AR16.105	3.0	162	06.00-12.05	Y	D	4	40	2315	OZA659-EE59	7904	---	---
3.2 24V V6	936A6.000	3.2	176	06.03-12.05	Y	R	4	40	300	OZA659-EE3	0377	---	---
3.0 24V V6	936A6.000	3.2	176	06.03-12.05	Y	R	4	40	820	OZA659-EE58	7903	---	---
3.0 24V V6	936A6.000	3.2	176	06.03-12.05	Y	D	4	40	2000	OZA659-EE60	7905	---	---
3.0 24V V6	936A6.000	3.2	176	06.03-12.05	Y	D	4	40	2315	OZA659-EE59	7904	---	---

SPIDER

1.8 16V T.S.	AR32.201	1.8	106	03.98-12.00		R	4	40	1170	OZA659-EE30	1612	---	---
2.0i.e.	AR015.88	2.0	88	01.90-12.94		R	3	19	895	OZA446-E4	1877	S3	0412
2.0 16V T.S.	AR16.201	2.0	110	04.95-03.98		R	3	22	890	OZA446-E18	1887	S3	0412
2.0 16V T.S.	AR16.201 / 32.301	2.0	110	04.98-11.99		R	4	40	1175	OZA527-E24	0287	S4CG	1919
2.0 16V T.S.	AR32.310	2.0	110	09.00-02.06		D	4	40	400	OZA659-EE49	5753	---	---
2.0 JTS	937A1.000	2.0	121	06.03-02.06		D	4	40	600	OZA659-EE56	7863	---	---

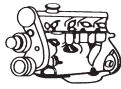
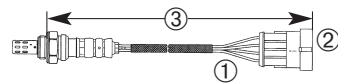

ℓ kW



STOCK
No. **TYPE**
No. **UNIVERSAL**
No. **REVISION**
No.

ALFA ROMEO

SPIDER

3.0 12V V6	AR16.101	3.0	141	04.95-11.99		R	3	22	890	OZA446-E18	1887	S3	0412
3.0 12V V6	AR16.101	3.0	141	06.00-09.00		R	4	40	1170	OZA659-EE30	1612	---	---
3.0 24V V6	AR16.105	3.0	162	09.00-02.06		R	4	40	1170	OZA659-EE30	1612	---	---
3.2 24V V6	936A6.000	3.2	176	06.03-02.06	↑	R	4	40	300	OZA659-EE3	0377	---	---
3.2 24V V6	936A6.000	3.2	176	06.03-02.06	↑	R	4	40	820	OZA659-EE58	7903	---	---
3.2 24V V6	936A6.000	3.2	176	06.03-02.06	↑	D	4	40	2000	OZA659-EE60	7905	---	---
3.2 24V V6	936A6.000	3.2	176	06.03-02.06	↑	D	4	40	2315	OZA659-EE59	7904	---	---

SPRINT

1.7i.e.	305.58	1.7	77	10.87-12.89		R	3	19	1665	OZA446-E49	0291	S3	0412
---------	--------	-----	----	-------------	--	---	---	----	------	------------	------	----	------

ASTON MARTIN

DB7

3.2		3.2	250	01.96-01.99		R	4	32	393	OZA201-AM1	0168	S4	1952
3.2		3.2	250	01.96-01.99		D	4	32	393	OZA201-AM2	0179	S4	1952
3.2		3.2	250	01.96-01.99		R	4	32	393	OZA201-AM1	0168	S4	1952
3.2		3.2	250	01.96-01.99		D	4	32	393	OZA201-AM2	0179	S4	1952
5.9		5.9	309	07.99-		D	4	32	393	OZA381-D3	0462	---	---

VANTAGE

3.4		3.4		06.05-	2↑	R	4	32	493	OZA488-AM1	0042	---	---
3.4		3.4		06.05-	2↑	D	4	32	650	OZA381-AM1	1707	---	---

VIRAGE

5.3		5.3		01.89-12.00	Webber System	R	3	103	876	OTD5F-3E1	0023	---	---
-----	--	-----	--	-------------	---------------	---	---	-----	-----	-----------	------	-----	-----

AUDI

80

1.6	PP	1.6	51	08.87-09.91		R	1	3	472	OZA401-E2	1802	S1	1951
1.6	ABM	1.6	51	01.92-01.96		R	3	19	710	OZA446-E50	0204	S3	0412
1.6	ADA	1.6	75	06.93-01.96		R	3	19	975	OZA446-E2	1855	S3	0412
1.8	PM	1.8	66	03.88-08.91		R	1	3	472	OZA401-E2	1802	S1	1951
1.8	JN	1.8	68	08.83-08.86		R	1	3	472	OZA401-E2	1802	S1	1951
1.8	JN	1.8	68	08.85-08.86		R	3	19	975	OZA446-E2	1855	S3	0412
1.8	PV	1.8	81	08.85-08.86		R	3	19	975	OZA446-E2	1855	S3	0412
1.8	DZ	1.8	82	10.84-08.86	Universal	R	1	---	---	OZA624-E1	1951	S1	1951
1.9	SD	1.9	83	09.87-07.88		R	3	19	975	OZA446-E2	1855	S3	0412
2.0	ABT	2.0	66	09.91-01.96		R	3	19	365	OZA446-E12	1805	S3	0412
2.0	ABT	2.0	66	09.91-01.96	☒	R	3	19	710	OZA446-E50	0204	S3	0412
2.0	3A	2.0	83	08.88-10.90		R	3	19	975	OZA446-E2	1855	S3	0412
2.0	AAD	2.0	83	10.90-08.91		R	3	19	975	OZA446-E2	1855	S3	0412
2.0	ABK	2.0	85	09.91-01.96	☒	R	3	19	975	OZA445-E7	0269	S3	0412
2.0	ABK	2.0	85	09.91-01.96		R	3	19	1215	OZA446-E16	1859	S3	0412
2.0	6A	2.0	101	03.90-07.92		R	3	19	975	OZA446-E2	1855	S3	0412
2.0	ACE	2.0	103	08.92-01.96		R	3	19	975	OZA446-E2	1855	S3	0412
2.1	WE	2.1	85	10.80-08.83		R	1	3	472	OZA401-E2	1802	S1	1951
2.2 S2	ABY	2.2	169	02.93-01.96		R	3	19	975	OZA446-E2	1855	S3	0412
2.2 RS2	ADU	2.2	232	03.94-05.95		R	3	19	975	OZA446-E2	1855	S3	0412

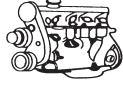

ℓ kW

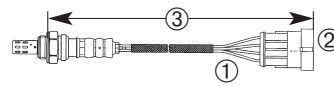
STOCK
REVERSE
NO.
UNIVERSAL
TYPE
NO.
CUMMINS
AL
NO.

AUDI

80

2.3	NG	2.3	98	09.91-01.96		R	3	19	1215	OZA446-E16	1859	S3	0412
2.6	ABC	2.6	110	07.92-01.96		R	3	19	490	OZA446-E11	1898	S3	0412
2.6	ABC	2.6	110	07.92-01.96		R	3	19	710	OZA446-E50	0204	S3	0412
2.8	AAH	2.8	128	08.92-01.96		R	3	19	710	OZA446-E50	0204	S3	0412

90

2.0	SK	2.0	83	02.86-03.87		R	1	3	472	OZA401-E2	1802	S1	1951
2.0	PS	2.0	85	04.87-07.91		R	3	19	975	OZA445-E7	0269	S3	0412
2.2	KX	2.2	85	01.85-03.87		R	1	3	472	OZA401-E2	1802	S1	1951
2.2	JT	2.2	88	10.84-03.87		R	3	19	975	OZA446-E2	1855	S3	0412
2.3	NG	2.3	100	04.87-09.91		R	3	19	1215	OZA446-E16	1859	S3	0412
2.3	7A	2.3	125	08.88-09.91		R	3	19	975	OZA446-E2	1855	S3	0412

100

1.8	4B	1.8	66	01.88-10.89		R	1	3	472	OZA401-E2	1802	S1	1951
1.8	PH	1.8	66	04.85-07.88		R	1	3	472	OZA401-E2	1802	S1	1951
2.0	AAE	2.0	74	12.90-07.94		R	3	19	975	OZA445-E7	0269	S3	0412
2.0	AAE	2.0	74	12.90-07.93		R	3	19	490	OZA446-E11	1898	S3	0412
2.0	RT	2.0	83	01.88-11.90		R	3	19	975	OZA446-E2	1855	S3	0412
2.0	AAD	2.0	85	12.90-07.92		R	3	19	975	OZA445-E7	0269	S3	0412
2.0	AAD	2.0	85	01.91-12.92		R	3	19	975	OZA445-E7	0269	S3	0412
2.0	AAD	2.0	85	01.91-12.92		R	3	19	975	OZA446-E2	1855	S3	0412
2.0	ABK	2.0	85	01.93-07.94		R	3	19	975	OZA446-E2	1855	S3	0412
2.0	ACE	2.0	101-103	01.92-07.94		R	3	19	975	OZA446-E2	1855	S3	0412
2.2	KZ	2.2	85-88	10.84-09.86		R	1	3	472	OZA401-E2	1802	S1	1951
2.2	PX	2.2	88	08.85-07.86		R	3	19	975	OZA446-E2	1855	S3	0412
2.2	MC	2.2	121	11.88-11.90	K..038 262 ->	R	3	19	1215	OZA446-E16	1859	S3	0412
2.2	MC	2.2	121	03.86-11.88	-> K..038 261	R	3	19	975	OZA446-E2	1855	S3	0412
2.2 S4	AAN	2.2	169	08.91-07.94		R	3	19	975	OZA445-E7	0269	S3	0412
2.2 S4	AAN	2.2	169	08.91-07.94		R	3	19	975	OZA446-E2	1855	S3	0412
2.3	AAR	2.3	98	12.90-07.94		R	3	19	1215	OZA446-E16	1859	S3	0412
2.3	NF	2.3	100	07.89-11.90	44.L..000 001 ->	R	3	19	1215	OZA446-E16	1859	S3	0412
2.6	ABC	2.6	110	04.92-07.94		R	3	19	490	OZA446-E11	1898	S3	0412
2.8	AAH	2.8	128	12.90-09.92	-> 4A..P..022 306	R	3	19	490	OZA446-E11	1898	S3	0412
2.8	AAH	2.8	128	09.92-07.94	4A..P..022 307 ->	R	3	19	710	OZA446-E50	0204	S3	0412
4.2 S4	ABH	4.2	206	10.92-07.94		R	3	19	975	OZA445-E7	0269	S3	0412

200

2.2	MC	2.2	118-121	08.85-12.91		R	3	19	975	OZA446-E2	1855	S3	0412
2.2	MC	2.2	118-121	01.85-11.88	-> 44..K..038 261	R	3	19	975	OZA446-E2	1855	S3	0412
2.2	MC	2.2	118-121	11.88-12.90	44..K..038 262 ->	R	3	19	1215	OZA446-E16	1859	S3	0412
2.2	3B	2.2	162	03.89-12.90		R	3	19	975	OZA446-E2	1855	S3	0412
2.3	NF	2.3	100	11.86-07.89		R	3	19	1665	OZA446-E49	0291	S3	0412

A2

1.4	AUA	1.4	55	02.00-08.05		R	5	92	250	LZA11-V1	1825	---	---
1.4	AUA	1.4	55	02.00-08.05		D	4	65	620	OZA510-AU1	1782	---	---
1.4	BBY	1.4	55	02.00-08.05		R	5	92	250	LZA11-V1	1825	---	---
1.4	BBY	1.4	55	02.00-08.05		D	4	65	620	OZA510-AU1	1782	---	---

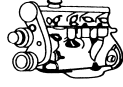

ℓ kW



ORDER No. STOCK No. TYPE No. UNIVERSAL No. DIMENSIONS No.

AUDI

A3

1.6	AEH	1.6	74	04.97-07.98	8L..V..095 001 -> 8L..W..150 000	R	4	64	470	OZA447-E17	0270	S4	1952
1.6	AEH	1.6	74	08.98-06.01	8L..X..000 001 ->	R	4	64	1135	OZA659-EE25	0399	---	---
1.6	AKL	1.6	74	08.97-07.98	8L..V..095 001 -> 8L..W..150 000	R	4	64	470	OZA447-E17	0270	S4	1952
1.6	AKL	1.6	74	08.98-06.01	8L..X..000 001 ->	R	4	64	1135	OZA659-EE25	0399	---	---
1.6	APF	1.6	74	08.98-08.00		D	4	65	700	OZA659-EE33	1617	---	---
1.6	AVU	1.6	75	05.00-06.03		D	4	65	560	OZA659-EE14	0388	---	---
1.6	BFQ	1.6	75	05.00-06.03		D	4	65	560	OZA659-EE14	0388	---	---
1.6	BGU	1.6	75	05.03-		R	5	92	750	LZA07-V1	1851	---	---
1.6	BGU	1.6	75	05.03-		D	4	85	471	OZA510-V11	1884	---	---
1.6	BSE	1.6	75	01.04-		R	5	92	750	LZA07-V1	1851	---	---
1.6	BSE	1.6	75	01.04-		D	4	85	471	OZA510-V11	1884	---	---
1.6	BSF	1.6	75	01.04-		R	5	92	750	LZA07-V1	1851	---	---
1.6	BSF	1.6	75	01.04-		D	4	85	471	OZA510-V11	1884	---	---
1.8	AGN	1.8	92	09.96-07.97		R	4	64	700	OZA447-E32	0471	S4	1952
1.8	AGN	1.8	92	07.99-11.00		R	4	64	620	OZA447-E18	0281	S4	1952
1.8	APG	1.8	92	08.98-04.03		D	4	65	560	OZA659-EE14	0388	---	---
1.8	AGU	1.8	110	12.96-07.97	8L..V..050 001 -> 8L..V..150 000	R	4	66	1140	OZA447-E25	0494	S4	1952
1.8	AGU	1.8	110	12.96-11.00	-> 8L..V..050 000	R	4	48	985	OZA447-E30	0449	S4	1952
1.8	AGU	1.8	110	12.96-11.00	8L..W..000 001 ->	R	4	64	700	OZA447-E32	0471	S4	1952
1.8	ARZ	1.8	110	07.99-04.00		D	4	65	560	OZA659-EE14	0388	---	---
1.8	APP	1.8	132	08.98-05.00		D	4	65	560	OZA659-EE14	0388	---	---
1.8	ARY	1.8	132	09.00-06.01		D	4	64	975	OZA659-EE1	0375	---	---

A4

1.6	ANA	1.6	74	07.99-07.00		R	4	64	1055	OZA516-AU1	0452	---	---
1.6	ANA	1.6	74	06.99-07.00		D	4	65	700	OZA334-AU1	0474	---	---
1.6	ANA	1.6	74	07.99-11.00		D	4	65	780	OZA334-AU2	1789	---	---
1.6	ADP	1.6	74	11.94-10.96		R	4	48	967	OZA447-E14	0129	S4	1952
1.6	ADP	1.6	74	11.96-07.99		R	4	48	985	OZA447-E30	0449	S4	1952
1.6	AHL	1.6	74	01.95-07.99		R	4	48	985	OZA447-E30	0449	S4	1952
1.6	ARM	1.6	74	01.95-07.99		R	4	48	985	OZA447-E30	0449	S4	1952
1.6	ALZ	1.6	75	07.99-11.00		R	4	64	1055	OZA516-AU1	0452	---	---
1.6	ALZ	1.6	75	06.99-11.00		D	4	65	780	OZA334-AU2	1789	---	---
1.8	AFY	1.8	85	07.95-12.98		R	4	48	985	OZA447-E30	0449	S4	1952
1.8	AFY	1.8	85	01.99-10.01	8D..X..200 001 ->	R	4	64	1175	OZA659-EE17	0391	---	---
1.8	ADR	1.8	92	11.94-11.00		R	4	48	967	OZA447-E14	0129	S4	1952
1.8	APT	1.8	92	02.99-09.01		R	4	64	1175	OZA659-EE17	0391	---	---
1.8	ARG	1.8	92	07.97-10.00		R	4	64	1175	OZA659-EE17	0391	---	---
1.8	AEB	1.8	110	07.96-07.97		R	4	66	1140	OZA447-E25	0494	S4	1952
1.8	AEB	1.8	110	08.97-07.98		R	4	66	1350	OZA447-E35	0493	S4	1952
1.8	ANB	1.8	110	05.99-06.00		R	4	64	1175	OZA659-EE17	0391	---	---
1.8	ANB	1.8	110	05.99-06.00		D	4	65	690	OZA659-EE64	7949	---	---
1.8	APU	1.8	110	08.98-11.00		R	4	66	1350	OZA447-E35	0493	S4	1952
1.8	ARK	1.8	110	07.97-10.00		R	4	64	1175	OZA659-EE17	0391	---	---
1.8	AVJ	1.8	110	12.00-12.04		D	4	65	690	OZA659-EE64	7949	---	---
1.8	AWT	1.8	110	06.00-10.00		D	4	65	690	OZA659-EE64	7949	---	---
1.8	BFB	1.8	120	11.04-		D	4	65	690	OZA659-EE64	7949	---	---
1.8	BKB	1.8	120	04.03-		D	4	65	690	OZA659-EE64	7949	---	---

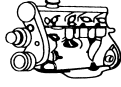

ℓ kW

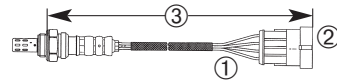

STOCK No. TYPE No. UNIVERSAL No. MOTOR No.

AUDI

A4

1.8	BEX	1.8	140	12.00-12.04		D	4	65	690	OZA659-EE64	7949	---	---
1.8	AJL	1.8	132	08.97-11.00		R	4	66	1350	OZA447-E35	0493	S4	1952
2.0	ALT	2.0	96	12.00-		D	4	65	690	OZA659-EE64	7949	---	---
2.0	AWA	2.0	110	12.00-12.04		D	4	65	690	OZA659-EE64	7949	---	---
2.4	AMM	2.4	120	06.00-12.05		R	4	64	535	OZA659-EE40	1627	---	---
2.4	APZ	2.4	120	08.97-06.00		R	4	48	615	OZA659-EE36	1620	---	---
2.4	AML	2.4	121	08.98-11.00		R	4	48	615	OZA659-EE36	1620	---	---
2.4	AML	2.4	121	08.98-11.00	Y / Bank 1	D	4	48	1435	OZA659-EE46	5748	---	---
2.4	AML	2.4	121	08.98-11.00	Y / Bank 2	D	4	66	1440	OZA659-EE47	5750	---	---
2.4	APS	2.4	121	08.98-09.01		R	4	48	615	OZA659-EE36	1620	---	---
2.4	APS	2.4	121	08.98-09.01	Y / Bank 1	D	4	48	1435	OZA659-EE46	5748	---	---
2.4	APS	2.4	121	08.98-09.01	Y / Bank 2	D	4	66	1440	OZA659-EE47	5750	---	---
2.4	ARJ	2.4	121	08.98-09.01		R	4	48	615	OZA659-EE36	1620	---	---
2.4	ARJ	2.4	121	08.98-09.01	Y / Bank 1	D	4	48	1435	OZA659-EE46	5748	---	---
2.4	ARJ	2.4	121	08.98-09.01	Y / Bank 2	D	4	66	1440	OZA659-EE47	5750	---	---
2.4	BDV	2.4	125	04.03-		R	4	64	535	OZA659-EE40	1627	---	---
2.6	ABC	2.6	110	11.94-11.00		R	3	26	410	OZA446-E43	0194	S3	0412
2.7	AGB	2.7	195	02.99-10.00		R	4	48	615	OZA659-EE36	1620	---	---
2.7	AGB	2.7	195	02.99-10.00	Y / Bank 1	D	4	48	1435	OZA659-EE46	5748	---	---
2.7	AGB	2.7	195	08.98-09.01	Y / Bank 2	D	4	66	1440	OZA659-EE47	5750	---	---
2.8	AAH	2.8	128	11.94-11.00		R	3	26	410	OZA446-E43	0194	S3	0412
2.8	AMX	2.8	142	08.98-09.01		R	4	48	615	OZA659-EE36	1620	---	---
2.8	AMX	2.8	142	08.98-09.01	Y / Bank 1	D	4	48	1435	OZA659-EE46	5748	---	---
2.8	AMX	2.8	142	08.98-09.01	Y / Bank 2	D	4	66	1440	OZA659-EE47	5750	---	---
2.8	APR	2.8	142	08.98-09.01		R	4	48	615	OZA659-EE36	1620	---	---
2.8	AQD	2.8	142	08.98-11.00		R	4	48	615	OZA659-EE36	1620	---	---
2.8	ATQ	2.8	142	08.98-11.00		R	4	48	615	OZA659-EE36	1620	---	---
3.2 FSI	AUK	3.2	188	01.05-	Y / Bank 1	D	4	84	591	OZA510-AU6	0049	---	---
3.2 FSI	AUK	3.2	188	01.05-	Y / Bank 2	D	4	85	721	OZA510-AU7	0050	---	---

A6

1.8	AFY	1.8	85	10.98-05.00	4B..X..036 901 ->	R	4	64	1175	OZA659-EE17	0391	---	---
1.8	ADR	1.8	92	06.94-10.97		R	4	48	550	OZA447-E16	0259	S4	1952
1.8	AJP	1.8	92	10.98-07.99	4B..X..036 901 ->	R	4	64	1175	OZA659-EE17	0391	---	---
1.8	AQE	1.8	92	01.99-04.01		R	4	64	1175	OZA659-EE17	0391	---	---
1.8	ARH	1.8	92	01.99-04.01		R	4	64	1175	OZA659-EE17	0391	---	---
1.8	AEB	1.8	110	04.97-01.99		R	4	66	1350	OZA447-E35	0493	S4	1952
1.8	APU	1.8	110	01.99-04.01		R	4	64	1175	OZA659-EE17	0391	---	---
1.8	ANB	1.8	110	01.99-09.00		R	4	64	1175	OZA659-EE17	0391	---	---
1.8	ANB	1.8	110	01.99-09.00		D	4	65	690	OZA659-EE64	7949	---	---
1.8	ARK	1.8	110	01.99-04.01		R	4	64	1175	OZA659-EE17	0391	---	---
1.8	AWL	1.8	110	07.00-11.05		D	4	65	690	OZA659-EE64	7949	---	---
1.8	AWT	1.8	110	05.00-05.04		D	4	65	690	OZA659-EE64	7949	---	---
1.8	AJL	1.8	132	07.98-01.05		R	4	66	1350	OZA447-E35	0493	S4	1952
2.0	AAE	2.0	74	06.94-08.96		R	3	19	975	OZA445-E7	0269	S3	0412
2.0	ALT	2.0	96	06.01-05.04		D	4	65	690	OZA659-EE64	7949	---	---
2.0	ACE	2.0	103	06.94-02.97		R	3	19	975	OZA446-E2	1855	S3	0412
2.3	AAR	2.3	98	06.94-02.97		R	3	19	1215	OZA446-E16	1859	S3	0412
2.4	ALW	2.4	100	12.98-01.99		R	4	48	615	OZA659-EE36	1620	---	---
2.4	ARN	2.4	100	02.99-05.00		R	4	48	615	OZA659-EE36	1620	---	---
2.4	ASM	2.4	120	06.01-05.04		R	4	64	535	OZA659-EE40	1627	---	---

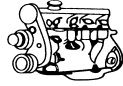

ℓ kW

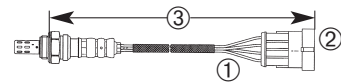
STOCK
ORDER
No.
UNIVERSAL
TYPE
No.
UNIVERSAL
TYPE
No.

AUDI

A6

2.4	APC	2.4	115	12.98-05.01	4B..X..068 801 ->	R	4	48	615	OZA659-EE36	1620	---	---
2.4	ALF	2.4	120	06.97-12.98		R	4	48	520	OZA448-E31	0151	S4	1952
2.4	ALF	2.4	120	12.98-01.99		R	4	48	615	OZA659-EE36	1620	---	---
2.4	AJG	2.4	120	04.97-01.05		R	4	48	520	OZA448-E31	0151	S4	1952
2.4	APZ	2.4	120	12.98-05.01	4B..X..068 801 ->	R	4	48	615	OZA659-EE36	1620	---	---
2.4	AGA	2.4	121	04.97-01.05		R	4	48	520	OZA448-E31	0151	S4	1952
2.4	AGA	2.4	121	12.98-01.99		R	4	48	615	OZA659-EE36	1620	---	---
2.4	AML	2.4	121	06.00-05.01		R	4	64	535	OZA659-EE40	1627	---	---
2.4	AML	2.4	121	06.00-05.01	↑ / Bank 1	D	4	48	1435	OZA659-EE46	5748	---	---
2.4	AML	2.4	121	06.00-05.01	↑ / Bank 2	D	4	66	1440	OZA659-EE47	5750	---	---
2.4	APS	2.4	121	09.99-09.05		R	4	48	615	OZA659-EE36	1620	---	---
2.4	ARJ	2.4	120	12.98-05.01	4B..X..068 801 ->	R	4	48	615	OZA659-EE36	1620	---	---
2.4	BDV	2.4	125	06.01-05.04		R	4	64	535	OZA659-EE40	1627	---	---
2.4	BDW	2.4	130	05.04-	2↑	R	5	91	600	LZA07-AU1	1772	---	---
2.4	BDW	2.4	130	05.04-	↑ / Bank 2	D	4	84	971	OZA510-AU2	1783	---	---
2.4	BDW	2.4	130	05.04-	↑ / Bank 1	D	4	85	971	OZA510-AU3	1784	---	---
2.6	ABC	2.6	110	06.94-10.97		R	3	19	710	OZA446-E50	0204	S3	0412
2.7 Biturbo	AJK	2.7	169	02.99-05.01		R	4	48	615	OZA659-EE36	1620	---	---
2.8	AEJ	2.8	120	06.94-10.97		R	3	19	710	OZA446-E50	0204	S3	0412
2.8	AAH	2.8	128	06.94-10.97		R	3	19	710	OZA446-E50	0204	S3	0412
2.8	AGE	2.8	132	12.98-05.00	4B..X..068 801 ->	R	4	48	615	OZA659-EE36	1620	---	---
2.8	ATX	2.8	140	09.99-09.05		R	4	48	615	OZA659-EE36	1620	---	---
2.8	ACK	2.8	142	04.97-01.05		R	4	48	520	OZA448-E31	0151	S4	1952
2.8	ALG	2.8	142	06.97-12.98		R	4	48	520	OZA448-E31	0151	S4	1952
2.8	ALG	2.8	142	12.98-05.01	4B..X..068 801 ->	R	4	48	615	OZA659-EE36	1620	---	---
2.8	APR	2.8	142	12.98-05.01		R	4	48	615	OZA659-EE36	1620	---	---
2.8	AMX	2.8	142	06.00-05.01		R	4	48	615	OZA659-EE36	1620	---	---
2.8	AMX	2.8	142	06.00-05.01	↑ / Bank 1	D	4	48	1435	OZA659-EE46	5748	---	---
2.8	AMX	2.8	142	06.00-05.01	↑ / Bank 2	D	4	66	1440	OZA659-EE47	5750	---	---
2.8	AQD	2.8	142	06.00-05.01	4B..X..068 801 ->	R	4	48	615	OZA659-EE36	1620	---	---
3.0	ASN	3.0	162	06.01-01.05		R	4	64	535	OZA659-EE40	1627	---	---
3.0	BBJ	3.0	162	06.01-01.05		R	4	64	535	OZA659-EE40	1627	---	---
3.2 FSI	AUK	3.2	188	05.04-	2↑	R	5	91	600	LZA07-AU1	1772	---	---
3.2 FSI	AUK	3.2	188	05.04-	↑ / Bank 2	D	4	84	971	OZA510-AU2	1783	---	---
3.2 FSI	AUK	3.2	188	05.04-	↑ / Bank 1	D	4	85	971	OZA510-AU3	1784	---	---
4.2	ARS	4.2	220	04.99-05.01		R	4	48	615	OZA659-EE36	1620	---	---
4.2	ASG	4.2	220	04.99-05.01		R	4	48	615	OZA659-EE36	1620	---	---

ALLROAD

2.7	ARE	2.7	184	05.00-06.01	-> 4B..1..200 000	R	4	48	615	OZA659-EE36	1620	---	---
2.7	ARE	2.7	184	07.01-06.02	4B..2..000 001 ->	R	4	64	535	OZA659-EE40	1627	---	---
2.7	ARE	2.7	184	05.00-06.01	-> 4B..1..200 000	D	4	48	1435	OZA659-EE46	5748	---	---
					↑ / Bank 1								
2.7	ARE	2.7	184	05.00-06.01	-> 4B..1..200 000	D	4	66	1440	OZA659-EE47	5750	---	---
					↑ / Bank 2								
2.7	BES	2.7	184	07.02-08.05		R	4	64	535	OZA659-EE40	1627	---	---

A8

2.8	AAH	2.8	128	06.94-03.96		R	3	19	710	OZA446-E50	0204	S3	0412
2.8	ACK	2.8	142	10.98-12.98		R	4	48	615	OZA659-EE36	1620	---	---
2.8	ALG	2.8	142	10.98-12.98		R	4	48	615	OZA659-EE36	1620	---	---
2.8	AMX	2.8	142	01.99-09.02		R	4	48	615	OZA659-EE36	1620	---	---

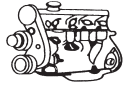

ℓ kW

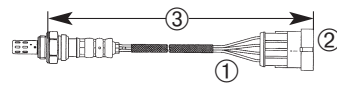
STOCK
REVERSE
UNIVERSAL
TYPE
INVERSION
NO.
NO.
NO.
NO.

AUDI

A8

2.8	APR	2.8	142	01.99-09.02		R	4	48	615	OZA659-EE36	1620	---	---
2.8	AQD	2.8	142	01.99-09.02		R	4	48	615	OZA659-EE36	1620	---	---
3.2 FSI	BPK	3.2	191	06.05-	⚡ / Bank 1	R	5	98	830	LZA07-AU2	0026	---	---
3.2 FSI	BPK	3.2	191	06.05-	⚡ / Bank 2	R	5	91	830	LZA07-AU3	0027	---	---
3.2 FSI	BPK	3.2	191	06.05-	⚡ / Bank 1	D	4	84	591	OZA510-AU4	0047	---	---
3.2 FSI	BPK	3.2	191	06.05-	⚡ / Bank 2	D	4	85	541	OZA510-AU5	0048	---	---
3.7	AGW	3.7	169	07.95-11.98		R	4	48	720	OZA447-E31	0460	S4	1952
4.2	AEM	4.2	180	03.94-07.96		R	4	48	720	OZA447-E31	0460	S4	1952
4.2	ABZ	4.2	220	03.94-11.98		R	4	48	720	OZA447-E31	0460	S4	1952

CABRIO

2.0	ABK	2.0	85	01.93-07.98	⚡	R	3	19	975	OZA445-E7	0269	S3	0412
2.0	ABK	2.0	85	01.93-07.98		R	3	19	975	OZA446-E2	1855	S3	0412
2.0	ACE	2.0	103	05.95-07.96		R	3	19	975	OZA446-E2	1855	S3	0412
2.3	NG	2.3	98-100	05.91-07.94		R	3	19	1215	OZA446-E16	1859	S3	0412
2.6	ABC	2.6	110	01.94-08.00		R	3	19	490	OZA446-E11	1898	S3	0412
2.8	AAH	2.8	128	11.92-08.00		R	3	19	710	OZA446-E50	0204	S3	0412

COUPE

1.8	JN	1.8	66-68	01.85-10.88		R	1	3	472	OZA401-E2	1802	S1	1951
1.8	PV	1.8	79	08.86-10.88		R	3	19	975	OZA446-E2	1855	S3	0412
2.0	3A	2.0	83-85	05.89-07.90	o. Kat	R	3	19	975	OZA445-E7	0269	S3	0412
2.0	3A	2.0	83-85	05.89-07.90		R	3	19	1215	OZA446-E16	1859	S3	0412
2.0	AAD	2.0	83-85	08.90-07.91		R	3	19	975	OZA446-E2	1855	S3	0412
2.0	ABK	2.0	85	09.91-12.95		R	3	19	1215	OZA446-E16	1859	S3	0412
2.0	ABK	2.0	85	09.91-12.95	o. Kat	R	3	19	975	OZA445-E7	0269	S3	0412
2.0	ACE	2.0	103	08.92-07.94		R	3	19	975	OZA446-E2	1855	S3	0412
2.2	KX	2.2	85	01.84-10.88		R	1	3	472	OZA401-E2	1802	S1	1951
2.2	JT	2.2	89	12.84-10.88		R	3	19	975	OZA446-E2	1855	S3	0412
2.2 S2	ABY	2.2	169	10.92-07.95		R	3	19	975	OZA445-E7	0269	S3	0412
2.3	NG	2.3	98-100	08.89-07.94		R	3	19	1215	OZA446-E16	1859	S3	0412
2.3	7A	2.3	125	08.89-07.91		R	3	19	1215	OZA446-E16	1859	S3	0412
2.6	ABC	2.6	110	08.92-08.94		R	3	19	710	OZA446-E50	0204	S3	0412
2.8	AAH	2.8	128	01.93-05.95		R	3	19	710	OZA446-E50	0204	S3	0412
2.2 Quattro	RR	2.2	162	08.89-07.90		R	3	19	1215	OZA446-E16	1859	S3	0412
2.2 Quattro	RR	2.2	162	08.90-07.91		R	3	19	975	OZA446-E2	1855	S3	0412

RS4

2.7 Avant	ASJ	2.7	280	05.00-09.01		R	4	48	615	OZA659-EE36	1620	---	---
2.7 Avant	ASJ	2.7	280	05.00-09.01	⚡ / Bank 1	D	4	48	1435	OZA659-EE46	5748	---	---
2.7 Avant	ASJ	2.7	280	05.00-09.01	⚡ / Bank 2	D	4	66	1440	OZA659-EE47	5750	---	---
2.7 Avant	AZR	2.7	280	05.00-09.01		R	4	48	615	OZA659-EE36	1620	---	---
2.7 Avant	AZR	2.7	280	05.00-09.01	⚡ / Bank 1	D	4	48	1435	OZA659-EE46	5748	---	---
2.7 Avant	AZR	2.7	280	05.00-09.01	⚡ / Bank 2	D	4	66	1440	OZA659-EE47	5750	---	---

RS6

4.2	BCY	4.2	331	07.02-04.04	⚡ / Bank 1	D	4	48	1435	OZA659-EE46	5748	---	---
4.2	BCY	4.2	331	07.02-04.04	⚡ / Bank 2	D	4	66	1440	OZA659-EE47	5750	---	---
4.2 Avant	BCY	4.2	331	05.02-09.04	⚡ / Bank 1	D	4	48	1435	OZA659-EE46	5748	---	---
4.2 Avant	BCY	4.2	331	05.02-09.04	⚡ / Bank 2	D	4	66	1440	OZA659-EE47	5750	---	---
4.2 Avant	BRV	4.2	331	05.02-09.04	⚡ / Bank 1	D	4	48	1435	OZA659-EE46	5748	---	---
4.2 Avant	BRV	4.2	331	05.02-09.04	⚡ / Bank 2	D	4	66	1440	OZA659-EE47	5750	---	---

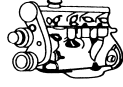

ℓ kW



SUMMER No.
UNIVERSAL No.
TYPE No.
STOCK No.

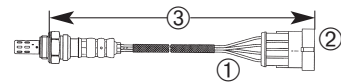

AUDI

S3

1.8	APY	1.8	154	08.98-08.00		D	4	65	560	OZA659-EE14	0388	---	---
1.8	AUL	1.8	154	08.98-08.00		D	4	65	560	OZA659-EE14	0388	---	---

S4

2.7	APB	2.7	187	10.97-12.98	/ Bank 1	D	4	48	1435	OZA659-EE46	5748	---	---
2.7	APB	2.7	187	10.97-12.98	/ Bank 2	D	4	66	1440	OZA659-EE47	5750	---	---
2.7	AGB	2.7	195	10.97-09.01		R	4	48	615	OZA659-EE36	1620	---	---
2.7	AGB	2.7	195	10.97-09.01	/ Bank 1	D	4	48	1435	OZA659-EE46	5748	---	---
2.7	AGB	2.7	195	10.97-09.01	/ Bank 2	D	4	66	1440	OZA659-EE47	5750	---	---
2.7	AZB	2.7	195	11.00-09.01		R	4	48	615	OZA659-EE36	1620	---	---
2.7	AZB	2.7	195	11.00-09.01	/ Bank 1	D	4	48	1435	OZA659-EE46	5748	---	---
2.7	AZB	2.7	195	11.00-09.01	/ Bank 2	D	4	66	1440	OZA659-EE47	5750	---	---

S6

2.2	AAN	2.2	169	06.94-07.97		R	3	19	975	OZA445-E7	0269	S3	0412
2.2	AAN	2.2	169	06.94-07.97		R	3	19	1215	OZA446-E16	1859	S3	0412
4.2	AHK	4.2	240	06.96-10.97		R	4	48	1430	OZA447-E36	1950	S4	1952
4.2	ANK	4.2	250	06.01-05.04		R	4	48	615	OZA659-EE36	1620	---	---
4.2	AQJ	4.2	250	09.99-05.01		R	4	48	615	OZA659-EE36	1620	---	---

S8

4.2	AHC	4.2	250	07.96-06.99		R	4	48	720	OZA447-E31	0460	S4	1952
4.2	AKH	4.2	250	07.96-06.99		R	4	48	720	OZA447-E31	0460	S4	1952

V8

3.6	PT	3.6	184	10.88-11.93		R	3	19	975	OZA445-E7	0269	S3	0412
3.6	PT	3.6	184	10.88-11.93		R	3	19	975	OZA446-E2	1855	S3	0412
3.6	PT	3.6	184	08.91-11.93		R	3	19	975	OZA446-E2	1855	S3	0412
4.2	ABH	4.2	206	10.91-11.93		R	3	19	975	OZA445-E7	0269	S3	0412
4.2	ABH	4.2	206	10.91-11.93		R	3	19	975	OZA446-E2	1855	S3	0412

TT COUPE

1.8	AUM	1.8	110	09.02-06.06		D	4	64	975	OZA659-EE1	0375	---	---
1.8	APP	1.8	132	11.99-09.00		D	4	65	560	OZA659-EE14	0388	---	---
1.8	AUQ	1.8	132	09.02-06.06		D	4	64	975	OZA659-EE1	0375	---	---
1.8	APX	1.8	165	07.98-08.01		D	4	65	490	OZA659-EE18	0392	---	---

TT ROADSTER

1.8	AUM	1.8	110	09.02-		D	4	64	975	OZA659-EE1	0375	---	---
1.8	APP	1.8	132	09.99-10.01		D	4	65	560	OZA659-EE14	0388	---	---
1.8	AUQ	1.8	132	09.02-		D	4	64	975	OZA659-EE1	0375	---	---
1.8	APX	1.8	165	03.99-08.01		D	4	65	490	OZA659-EE18	0392	---	---

AUTOBIANCHI

Y 10

1.0	156A2.146	1.0	33	10.87-07.89		R	3	19	670	OZA446-E1	1833	S3	0412
1.0	156A2.256	1.0	33	07.89-09.92		R	3	19	670	OZA446-E1	1833	S3	0412
1.1	156C046	1.1	37	07.89-09.92		R	3	19	895	OZA446-E4	1877	S3	0412
1.1	156C046	1.1	37	09.92-01.95		R	4	38	880	OZA527-E4	0218	S4CG	1919
1.1i.e. ECVT	176B2.000	1.1	40	02.95-12.95		R	4	40	972	OZA527-E7	0213	S4CG	1919
1.1i.e.	176B2.000	1.1	43	02.95-12.95		R	4	40	972	OZA527-E7	0213	S4CG	1919

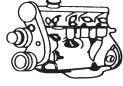

ℓ kW

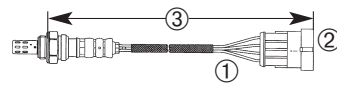
STOCK
REVERSE
UNIVERSAL
TYPE
INVERTER
NO.
NO.
NO.
NO.

AUTOBIANCHI

Y 10

1.3	146A5.046	1.3	53	02.89-09.92		R	3	19	895	OZA446-E4	1877	S3	0412
1.3	146A5.046 MPI	1.3	53	09.92-12.95		R	3	19	895	OZA446-E4	1877	S3	0412
1.3	146A5.046	1.3	54	11.87-06.89		R	3	19	895	OZA446-E4	1877	S3	0412

BMW

1 (E87)

116i	E87	N45B16	1.6	85	09.04-		R	4	54	591	OZA600-BM2	1845	---	---
116i	E87	N45B16	1.6	85	09.04-		D	4	54	431	OZA600-BM5	1846	---	---
118i	E87	N42B20B OL	2.0	95	09.04-		D	4	54	431	OZA600-BM5	1846	---	---
120i	E87	N46B20 OL	2.0	110	06.04-	Cyl. 1+4	D	4	54	431	OZA600-BM5	1846	---	---
120i	E87	N46B20 OL	2.0	110	06.04-10.04	Cyl. 2+3	D	4	54	241	OZA600-BM7	1847	---	---
120i	E87	N46B20 OL	2.0	110	11.04-	Cyl. 2+3	D	4	68	281	OZA600-BM8	0069	---	---

3 (E30)

316i Touring	E30	M40B16	1.6	73	09.91-04.94		R	4	35	910	OZA572-E12	0273	S4CG	1919
316i	E30	M40B16	1.6	73	09.88-04.94		R	4	35	910	OZA572-E12	0273	S4CG	1919
318i	E30	M40B18	1.8	83-85	04.89-04.94		R	4	35	910	OZA572-E12	0273	S4CG	1919
318iS	E30	M42B18	1.8	100	09.89-08.90		R	4	35	730	OZA572-E3	0264	S4CG	1919
320i	E30	M20B20	2.0	90-95	10.87-03.93		R	4	35	510	OZA572-E2	0252	S4CG	1919
325i	E30	M20B25	2.5	125	10.87-10.93		R	4	35	510	OZA572-E2	0252	S4CG	1919
325e	E30	M20B27	2.7	90-95	10.87-09.90		R	4	35	540	OZA572-E8	0209	S4CG	1919

3 (E36)

316i	E36	M40B16	1.6	73	09.90-09.93	Siemens	R	4	54	968	OTA7N-5D3	1991	---	---
316i Touring	E36	M43B16	1.6	75	01.96-09.99	Siemens	R	4	54	968	OTA7N-5D3	1991	---	---
316i Compact	E36	M40B16	1.6	75	03.94-08.00	Siemens	R	4	54	968	OTA7N-5D3	1991	---	---
316i	E36	M43B16	1.6	75	07.93-02.98	Siemens	R	4	54	968	OTA7N-5D3	1991	---	---
316i	E36		1.6	75	09.90-10.93	Siemens	R	4	54	968	OTA7N-5D3	1991	---	---
316i Coupe	E36	M43B16	1.6	75	09.93-04.99	Siemens	R	4	54	968	OTA7N-5D3	1991	---	---
316g Compact	E36		1.6	75	12.95-08.00	Siemens	R	4	54	968	OTA7N-5D3	1991	---	---
316g Compact	E36	M43B16	1.6	65-75	02.96-08.00		R	4	47	350	OZA572-E6	1777	S4CG	1919
316g Compact	E36	M43B16	1.6	65-75	11.95-09.00		R	4	47	570	OZA572-E14	0408	S4CG	1919
316i	E36	M40B16	1.6	73-75	12.90-02.94		R	4	35	540	OZA572-E8	0209	S4CG	1919
316i Compact	E36	M43B16	1.6	75	03.94-09.95		R	4	35	540	OZA572-E8	0209	S4CG	1919
316i	E36	M43B16	1.6	75	09.93-09.95		R	4	35	540	OZA572-E8	0209	S4CG	1919
316i	E36	M43B16	1.6	75	09.93-12.98		R	4	47	570	OZA572-E14	0408	S4CG	1919
316i Coupe	E36	M43B16	1.6	75	09.93-12.99		R	4	47	570	OZA572-E14	0408	S4CG	1919
316i Compact	E36	M43B16	1.6	75	10.95-09.00		R	4	47	570	OZA572-E14	0408	S4CG	1919
316i Compact	E36	M43B18	1.6	77	01.99-09.00		R	4	68	340	OZA447-E28	0427	S4	1952
318i	E36	M40B18 (Kat.)	1.8	83	12.90-10.93	Siemens	R	4	54	968	OTA7N-5D3	1991	---	---
318i Cabrio	E36	M43B18	1.8	85	01.94-04.99	Siemens	R	4	54	968	OTA7N-5D3	1991	---	---
318i Touring	E36	M43B18	1.8	85	07.95-10.99	Siemens	R	4	54	968	OTA7N-5D3	1991	---	---
318i	E36	M43B18	1.8	85	10.93-02.98	Siemens	R	4	54	968	OTA7N-5D3	1991	---	---
318i	E36	M40B18	1.8	85	12.90-02.94		R	4	35	540	OZA572-E8	0209	S4CG	1919
318i Cabrio	E36	M43B18	1.8	85	01.94-12.99		R	4	47	570	OZA572-E14	0408	S4CG	1919
318i Touring	E36	M43B18	1.8	85	07.95-12.99		R	4	47	570	OZA572-E14	0408	S4CG	1919
318i	E36	M43B18	1.8	85	09.93-09.95		R	4	35	540	OZA572-E8	0209	S4CG	1919
318i	E36	M43B18	1.8	85	10.95-12.98		R	4	47	570	OZA572-E14	0408	S4CG	1919
318iS Coupe	E36	M42B18	1.8	103	03.92-10.95	Siemens	R	4	54	968	OTA7N-5D3	1991	---	---

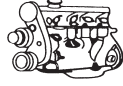

ℓ kW

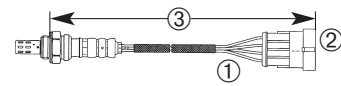

STOCK No. TYPE No. UNIVERSAL No. PART No. ORDER No.

BMW

3 (E36)

318iS	E36	M42B18	1.8	103	03.93-09.97	Siemens	R	4	54	968	OTA7N-5D3	1991	---	---
318ti Compact	E36	M42B18	1.8	103	11.94-08.95	Siemens	R	4	54	968	OTA7N-5D3	1991	---	---
318iS	E36	M42B18	1.8	103	09.93-12.98		R	4	35	540	OZA572-E8	0209	S4CG	1919
318iS Coupe	E36	M42B18	1.8	103	03.92-12.98		R	4	35	540	OZA572-E8	0209	S4CG	1919
318ti Compact	E36	M42B18	1.8	103	10.94-11.95		R	4	35	540	OZA572-E8	0209	S4CG	1919
316i Compact	E36	M43B18	1.9	77	12.98-08.00	Siemens	R	4	54	968	OTA7N-5D3	1991	---	---
316i Compact	E36	M43B18	1.9	77	12.98-08.00		D	4	69	730	OZA660-EE5	5662	S4	1952
318ti Compact	E36	M44B19	1.9	103	07.95-08.00	Siemens	R	4	54	968	OTA7N-5D3	1991	---	---
318iS Coupe	E36	M44B19	1.9	103	09.95-04.99	Siemens	R	4	54	968	OTA7N-5D3	1991	---	---
318iS	E36	M44B19	1.9	103	09.95-02.98	Siemens	R	4	54	968	OTA7N-5D3	1991	---	---
318iS	E36	M44B19	1.9	103	09.94-12.98		R	4	68	340	OZA447-E28	0427	S4	1952
318iS Coupe	E36	M44B19	1.9	103	12.95-04.99		D	4	69	730	OZA660-EE5	5662	S4	1952
318ti Compact	E36	M44B19	1.9	103	12.95-08.00		D	4	69	730	OZA660-EE5	5662	S4	1952
318ti Compact	E36	M44B19	1.9	103	12.95-09.00		R	4	68	340	OZA447-E28	0427	S4	1952
318iS Coupe	E36	M44B19	1.9	103	12.95-12.99		R	4	68	340	OZA447-E28	0427	S4	1952
320i	E36	M50B (20 6 S2) Vanos	2.0	110	09.90-02.98	Siemens	R	4	54	968	OTA7N-5D3	1991	---	---
320i	E36	M50B20	2.0	110	09.90-08.92		R	4	35	400	OZA572-E5	0242	S4CG	1919
320i	E36	M50B20	2.0	110	09.90-08.92		R	4	35	540	OZA572-E8	0209	S4CG	1919
320i	E36	M52B20	2.0	110	09.92-08.94	/ Siemens	R	4	52	398	OTA7H-3A2	1943	---	---
320i	E36	M50B20	2.0	110	09.92-12.95	/ Siemens	R	4	52	238	OTA7N-5B1	1973	---	---
320i	E36	M52B20	2.0	110	09.94-09.95	2 ↑ / Siemens	R	4	47	968	OTA7N-5C1	1963	---	---
320i	E36	M52B20	2.0	110	09.95-09.99	Siemens	R	4	54	968	OTA7H-5A1	0486	---	---
320i Cabrio	E36	M52B20	2.0	110	09.94-09.95	2 ↑ / Siemens	R	4	47	968	OTA7N-5C1	1963	---	---
320i Cabrio	E36	M52B (20 6 S3) Vanos	2.0	110	12.93-04.99	Siemens	R	4	54	968	OTA7N-5D3	1991	---	---
320i Cabrio	E36	M50B20	2.0	110	12.93-12.95	/ Siemens	R	4	52	238	OTA7N-5B1	1973	---	---
320i Coupe	E36	M50B (20 6 S2) Vanos	2.0	110	03.92-04.99	Siemens	R	4	54	968	OTA7N-5D3	1991	---	---
320i Coupe	E36	M50B20	2.0	110	09.92-12.95	/ Siemens	R	4	52	238	OTA7N-5B1	1973	---	---
320i Coupe	E36	M52B20	2.0	110	09.94-09.95	2 ↑ / Siemens	R	4	47	968	OTA7N-5C1	1963	---	---
320i Touring	E36	M52B (20 6 S3) Vanos	2.0	110	01.95-10.99	Siemens	R	4	54	968	OTA7N-5D3	1991	---	---
320i Touring	E36	20 6 S3	2.0	110	01.95-09.95	2 ↑ / Siemens	R	4	47	968	OTA7N-5C1	1963	---	---
323i	E36	M52B25 (Vanos)	2.5	125	03.95-02.98	Siemens	R	4	54	968	OTA7N-5D3	1991	---	---
323i Cabrio	E36	M52B25 (Vanos)	2.5	125	06.95-04.99	Siemens	R	4	54	968	OTA7N-5D3	1991	---	---
323i Coupe	E36	M52B25 (Vanos)	2.5	125	03.95-04.99	Siemens	R	4	54	968	OTA7N-5D3	1991	---	---
323i Touring	E36	M52B25 (Vanos)	2.5	125	09.95-10.99	Siemens	R	4	54	968	OTA7N-5D3	1991	---	---
323i Cabrio	E36	M52B25	2.5	125	06.95-09.95	2 ↑ / Siemens	R	4	47	968	OTA7N-5C1	1963	---	---
323i Coupe	E36	M52B25	2.5	125	06.95-09.95	2 ↑ / Siemens	R	4	47	968	OTA7N-5C1	1963	---	---
323i	E36	M52B25	2.5	125	06.95-09.99	Siemens	R	4	54	968	OTA7H-5A1	0486	---	---
323i	E36	M52B25	2.5	125	06.95-09.95	2 ↑ / Siemens	R	4	47	968	OTA7N-5C1	1963	---	---
323ti Compact	E36	M52B25 (Vanos)	2.5	125	08.97-08.00	Siemens	R	4	54	968	OTA7N-5D3	1991	---	---
323ti Compact	E36	M52B25	2.5	125	01.99-08.00	Siemens	R	4	54	388	OTA7N-5D1	1974	---	---
325i	E36	M52B25 (Vanos)	2.5	141	09.90-09.98	Siemens	R	4	54	968	OTA7N-5D3	1991	---	---
325i	E36	M50B25	2.5	141	09.90-09.98		R	4	35	400	OZA572-E5	0242	S4CG	1919
325i	E36	M50B25	2.5	141	09.90-09.98		R	4	35	540	OZA572-E8	0209	S4CG	1919
325i Cabrio	E36	M52B25 (Vanos)	2.5	141	03.93-03.95	Siemens	R	4	54	968	OTA7N-5D3	1991	---	---
325i Coupe	E36	M52B25 (Vanos)	2.5	141	03.92-04.99	Siemens	R	4	54	968	OTA7N-5D3	1991	---	---
328i	E36	M52B28	2.8	142	01.95-09.99	2 ↑ / Siemens / OE	R	4	54	968	OTA7N-5D3	1991	---	---
328i	E36	M52B28	2.8	142	01.95-09.99	2 ↑ / Siemens / OE	R	4	54	968	OTA7H-5A1	0486	---	---
328i Cabrio	E36	M52B28	2.8	142	03.95-09.95	2 ↑ / Siemens / OE	R	4	54	968	OTA7N-5D3	1991	---	---
328i Cabrio	E36	M52B28	2.8	142	03.95-09.95	2 ↑ / Siemens / OE	R	4	47	968	OTA7N-5C1	1963	---	---
328i Coupe	E36	M52B28	2.8	142	01.95-09.95	2 ↑ / Siemens / OE	R	4	54	968	OTA7N-5D3	1991	---	---

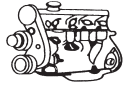

ℓ kW

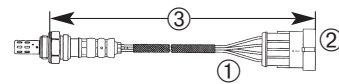
STOCK
REVERSE
TYPE
UNIVERSAL
INVERSE
NO.
NO.
NO.
NO.

BMW

3 (E36)

328i Coupe	E36	M52B28	2.8	142	01.95-09.95	2 ↑ / Siemens / OE	R	4	47	968	OTA7N-5C1	1963	---	---
328i Touring	E36	M52B28	2.8	142	01.95-09.95	2 ↑ / Siemens / OE	R	4	54	968	OTA7N-5D3	1991	---	---
328i Touring	E36	M52B28	2.8	142	01.95-09.95	2 ↑ / Siemens / OE	R	4	47	968	OTA7N-5C1	1963	---	---

3 (E46)

316i	E46	M43B16	1.6	75	04.98-02.05		R	4	68	340	OZA447-E28	0427	S4	1952
316i	E46	M43B18	1.6	77	04.98-02.05		R	4	68	340	OZA447-E28	0427	S4	1952
316i	E46	M43B16 (16 4 E3)	1.6	77	04.98-09.02		D	4	69	730	OZA660-EE5	5662	S4	1952
316 Ci Coupe	E46	M43B16	1.6	75	10.99-		R	4	68	340	OZA447-E28	0427	S4	1952
316 Ci Coupe	E46	M43B16 (16 4 E3)	1.6	77	04.00-09.02		D	4	69	730	OZA660-EE5	5662	S4	1952
316i	E46	M43B18 (19 4 E1)	1.9	77	09.98-09.02		D	4	69	730	OZA660-EE5	5662	S4	1952
318i	E46	M43B19	1.9	87	04.98-09.01		D	4	69	730	OZA660-EE5	5662	S4	1952
318i	E46	M43B18	1.9	87	04.98-09.01		R	4	68	340	OZA447-E28	0427	S4	1952
318i Touring	E46	M43B19	1.9	87	10.99-09.01		D	4	69	730	OZA660-EE5	5662	S4	1952
318i Touring	E46	M43B18	1.9	87	10.99-		R	4	68	340	OZA447-E28	0427	S4	1952
318 Ci Coupe	E46	M43B19	1.9	87	11.99-09.01		D	4	69	730	OZA660-EE5	5662	S4	1952
318 Ci Coupe	E46	M43B18	1.9	87	04.99-09.01		R	4	68	340	OZA447-E28	0427	S4	1952
320i	E46	M52B20	2.0	110	03.98-09.00		R	4	68	290	OZA447-E27	0416	S4	1952
320i	E46	M52B20	2.0	110	03.98-09.00		D	4	69	975	OZA447-E29	0438	S4	1952
320 Ci Coupe	E46	M52B20	2.0	110	08.99-09.00		R	4	68	290	OZA447-E27	0416	S4	1952
320 Ci Coupe	E46	M52B20	2.0	110	08.99-09.00		D	4	69	975	OZA447-E29	0438	S4	1952
320i Touring	E46	M52B20	2.0	110	10.99-09.00		R	4	68	290	OZA447-E27	0416	S4	1952
320i Touring	E46	M52B20	2.0	110	10.99-09.00		D	4	69	975	OZA447-E29	0438	S4	1952
320i	E46	M54	2.2	125	09.00-02.05		R	4	68	290	OZA447-E27	0416	S4	1952
320i	E46	M54	2.2	125	09.00-02.05		D	4	69	975	OZA447-E29	0438	S4	1952
320 Ci Cabrio	E46	M54	2.2	125	09.00-		R	4	68	290	OZA447-E27	0416	S4	1952
320 Ci Cabrio	E46	M54	2.2	125	09.00-		D	4	69	975	OZA447-E29	0438	S4	1952
320 Ci Coupe	E46	M54	2.2	125	09.00-09.06		R	4	68	290	OZA447-E27	0416	S4	1952
320 Ci Coupe	E46	M54	2.2	125	09.00-09.06		D	4	69	975	OZA447-E29	0438	S4	1952
320i Touring	E46	M54	2.2	125	09.00-09.05		D	4	69	975	OZA447-E29	0438	S4	1952
320i Touring	E46	M54	2.2	125	09.00-09.05		R	4	68	290	OZA447-E27	0416	S4	1952
323i	E46	M52B25	2.5	125	03.98-09.00		R	4	68	290	OZA447-E27	0416	S4	1952
323i	E46	M52B25	2.5	125	04.98-09.00		D	4	69	975	OZA447-E29	0438	S4	1952
323 Ci Cabrio	E46	M52B25	2.5	125	03.00-09.00		D	4	69	975	OZA447-E29	0438	S4	1952
323 Ci Cabrio	E46	M52B25	2.5	125	03.00-09.00		R	4	68	290	OZA447-E27	0416	S4	1952
323 Ci Coupe	E46	M52B25	2.5	125	04.99-09.00		R	4	68	290	OZA447-E27	0416	S4	1952
323 Ci Coupe	E46	M52B25	2.5	125	04.99-09.00		D	4	69	975	OZA447-E29	0438	S4	1952
323i Touring	E46	M52B25	2.5	125	08.98-09.00		R	4	68	290	OZA447-E27	0416	S4	1952
325i	E46	25 6 S5	2.5	141	09.00-02.05		R	4	68	290	OZA447-E27	0416	S4	1952
325i	E46	25 6 S5	2.5	141	09.00-02.05		D	4	69	975	OZA447-E29	0438	S4	1952
325 Xi	E46	25 6 S5	2.5	141	09.00-02.05		R	4	68	290	OZA447-E27	0416	S4	1952
325 Xi	E46	25 6 S5	2.5	141	09.00-02.05		D	4	69	975	OZA447-E29	0438	S4	1952
325i Touring	E46	25 6 S5	2.5	141	09.00-09.05		R	4	68	290	OZA447-E27	0416	S4	1952
325i Touring	E46	25 6 S5	2.5	141	09.00-09.05		D	4	69	975	OZA447-E29	0438	S4	1952
325 Xi Touring	E46	25 6 S5	2.5	141	09.00-09.05		R	4	68	290	OZA447-E27	0416	S4	1952
325 Xi Touring	E46	25 6 S5	2.5	141	09.00-09.05		D	4	69	975	OZA447-E29	0438	S4	1952
325 B668Ci Coupe	E46	25 6 S5	2.5	141	09.00-09.06		R	4	68	290	OZA447-E27	0416	S4	1952
325 Ci Coupe	E46	25 6 S5	2.5	141	09.00-09.06		D	4	69	975	OZA447-E29	0438	S4	1952
325ti Compact	E46	M54256S5	2.5	141	06.01-12.04		R	4	68	290	OZA447-E27	0416	S4	1952
325 Ci Cabrio	E46	25 6 S5	2.5	141	09.00-		R	4	68	290	OZA447-E27	0416	S4	1952
325 Ci Cabrio	E46	25 6 S5	2.5	141	09.00-		D	4	69	975	OZA447-E29	0438	S4	1952

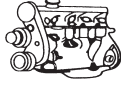

ℓ kW

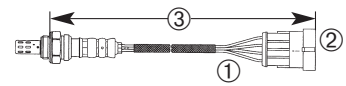
STOCK
REVERSE
TYPE
UNIVERSAL
NO.
NO.
NO.

BMW

3 (E46)

328i	E46	M52B28	2.8	142	04.98-09.00		R	4	68	290	OZA447-E27	0416	S4	1952
328i	E46	M52B28	2.8	142	04.98-09.00		D	4	69	975	OZA447-E29	0438	S4	1952
328 Ci Coupe	E46	M52B28	2.8	142	04.99-06.00		R	4	68	290	OZA447-E27	0416	S4	1952
328 Ci Coupe	E46	M52B28	2.8	142	04.99-06.00		D	4	69	975	OZA447-E29	0438	S4	1952
328i Touring	E46	M52B28	2.8	142	10.99-06.00		R	4	68	290	OZA447-E27	0416	S4	1952
328i Touring	E46	M52B28	2.8	142	10.99-06.00		D	4	69	975	OZA447-E29	0438	S4	1952
330i	E46	30 6 S3	3.0	170	05.00-02.05		R	4	68	290	OZA447-E27	0416	S4	1952
330i	E46	30 6 S3	3.0	170	05.00-02.05		D	4	69	975	OZA447-E29	0438	S4	1952
330 Xi	E46	30 6 S3	3.0	170	07.00-02.05		R	4	68	290	OZA447-E27	0416	S4	1952
330 Xi	E46	30 6 S3	3.0	170	07.00-02.05		D	4	69	975	OZA447-E29	0438	S4	1952
330 Ci Cabrio	E46	30 6 S3	3.0	170	05.00-		R	4	68	290	OZA447-E27	0416	S4	1952
330 Ci Cabrio	E46	30 6 S3	3.0	170	05.00-		D	4	69	975	OZA447-E29	0438	S4	1952
330 Ci Coupe	E46	30 6 S3	3.0	170	05.00-09.06		R	4	68	290	OZA447-E27	0416	S4	1952
330 Ci Coupe	E46	30 6 S3	3.0	170	05.00-09.06		D	4	69	975	OZA447-E29	0438	S4	1952
330i Touring	E46	30 6 S3	3.0	170	05.00-09.05		R	4	68	290	OZA447-E27	0416	S4	1952
330i Touring	E46	30 6 S3	3.0	170	05.00-09.05		D	4	69	975	OZA447-E29	0438	S4	1952
330 Xi Touring	E46	30 6 S3	3.0	170	07.00-09.05		R	4	68	290	OZA447-E27	0416	S4	1952
330 Xi Touring	E46	30 6 S3	3.0	170	07.00-09.05		D	4	69	975	OZA447-E29	0438	S4	1952

3 (E90)

318i	E90	N46B20B UL	2.0	95	09.05-		D	4	54	431	OZA600-BM5	1846	---	---
320i	E90	N46B20A OL	2.0	110	01.05-	Cyl. 1+4	D	4	54	431	OZA600-BM5	1846	---	---
320i	E90	N46B20A OL	2.0	110	01.05-	Cyl. 2+3	D	4	68	281	OZA600-BM8	0069	---	---
320i	E90	N46B20C OL	2.0	110	01.05-	Cyl. 1+4	D	4	54	431	OZA600-BM5	1846	---	---
320i	E90	N46B20C OL	2.0	110	01.05-	Cyl. 2+3	D	4	68	281	OZA600-BM8	0069	---	---
320si	E90	N45B20	2.0	127	05.06-	Cyl. 1+4	D	4	54	431	OZA600-BM5	1846	---	---
320si	E90	N45B20	2.0	127	05.06-	Cyl. 2+3	D	4	68	281	OZA600-BM8	0069	---	---

3 TOURING (E91)

318i	E91	N46B20B UL	2.0	95	01.06-		D	4	54	431	OZA600-BM5	1846	---	---
320i	E91	N46B20A OL	2.0	110	01.05-	Cyl. 1+4	D	4	54	431	OZA600-BM5	1846	---	---
320i	E91	N46B20A OL	2.0	110	01.05-	Cyl. 2+3	D	4	68	281	OZA600-BM8	0069	---	---
320i	E91	N46B20C OL	2.0	110	01.05-	Cyl. 1+4	D	4	54	431	OZA600-BM5	1846	---	---
320i	E91	N46B20C OL	2.0	110	01.05-	Cyl. 2+3	D	4	68	281	OZA600-BM8	0069	---	---

5 (E34)

518g Touring	E34	M43B18	1.8	75-85	11.95-06.96		R	4	35	910	OZA572-E12	0273	S4CG	1919
518i	E34	M40B18	1.8	83-85	09.89-12.95		R	4	35	910	OZA572-E12	0273	S4CG	1919
518i	E34	M40B18	1.8	83-85	09.91-12.95		R	4	35	910	OZA572-E12	0273	S4CG	1919
518i Touring	E34	M40B18	1.8	83-85	03.93-12.95		R	4	35	910	OZA572-E12	0273	S4CG	1919
518i Touring	E34	M43B18	1.8	85	12.93-12.95		R	4	35	910	OZA572-E12	0273	S4CG	1919
518i	E34	M43B18	1.8	85	12.93-12.95		R	4	35	910	OZA572-E12	0273	S4CG	1919
520i	E34	M20B20	2.0	95	01.88-08.91		R	4	59	675	OZA572-E7	0419	S4CG	1919
520i	E34	M50B20	2.0	110	09.92-08.95	Siemens	R	4	52	1408	OTA7H-3A1	1932	---	---
520i	E34	M50B20	2.0	110	09.89-09.95	Bosch	R	4	35	1445	OZA660-EE14	5707	S4	1952
520i Touring	E34	M50B20	2.0	110	11.91-12.96	Bosch	R	4	35	1445	OZA660-EE14	5707	S4	1952
525i	E34	M50B25	2.5	125	01.88-08.91		R	4	59	675	OZA572-E7	0419	S4CG	1919
525i	E34	M50B25	2.5	141	09.89-09.95		R	4	35	1420	OZA572-E4	0295	S4CG	1919
525i Touring	E34	M50B25	2.5	141	11.91-12.96		R	4	35	1420	OZA572-E4	0295	S4CG	1919
525iX	E34	M50B25	2.5	141	10.91-09.95		R	4	35	1420	OZA572-E4	0295	S4CG	1919
525iX Touring	E34	M50B25	2.5	141	02.92-12.96		R	4	35	1420	OZA572-E4	0295	S4CG	1919
530i	E34	M30B30	3.0	138	01.88-02.90		R	4	35	1490	OZA527-E27	0466	S4CG	1919

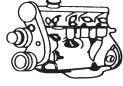

ℓ kW

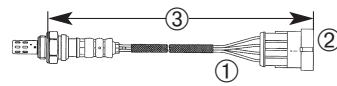
STOCK
NO.
UNIVERSAL
TYPE
NO.
UNIVERSAL
NO.

BMW

5 (E34)

530i	E34	M60B30	3.0	160	09.92-06.94		R	4	35	540	OZA572-E8	0209	S4CG	1919
530i	E34	M60B30	3.0	160	09.92-06.94		R	4	35	540	OZA572-E8	0209	S4CG	1919
535i	E34	M30B35	3.4	155	01.88-12.93		R	4	35	1490	OZA527-E27	0466	S4CG	1919
540i	E34	M60B40	4.0	210	09.92-07.93		R	4	35	540	OZA572-E8	0209	S4CG	1919
540i	E34	M60B40	4.0	210	09.92-06.94		R	4	35	540	OZA572-E8	0209	S4CG	1919

5 (E39)

520i	E39	M52B20	2.0	110	02.96-09.98	Siemens	R	4	54	968	OTA7H-5A1	0486	---	---
520i	E39	M52B20	2.0	110	10.98-09.00		R	4	68	290	OZA447-E27	0416	S4	1952
520i	E39	M52B20	2.0	110	10.98-09.00		D	4	69	975	OZA447-E29	0438	S4	1952
520i Touring	E39	M52B20	2.0	110	02.96-09.98	Siemens	R	4	54	968	OTA7H-5A1	0486	---	---
520i Touring	E39	M52B20	2.0	110	10.98-09.00		R	4	68	290	OZA447-E27	0416	S4	1952
520i Touring	E39	M52B20	2.0	110	10.98-09.00		D	4	69	975	OZA447-E29	0438	S4	1952
520i	E39	M54	2.2	125	09.00-06.03		R	4	68	290	OZA447-E27	0416	S4	1952
520i	E39	M54	2.2	125	09.00-06.03		D	4	69	975	OZA447-E29	0438	S4	1952
520i Touring	E39	M54	2.2	125	09.00-05.04		R	4	68	290	OZA447-E27	0416	S4	1952
520i Touring	E39	M54	2.2	125	09.00-05.04		D	4	69	975	OZA447-E29	0438	S4	1952
523i	E39	M52B25	2.5	125	09.95-09.98	Siemens	R	4	54	968	OTA7H-5A1	0486	---	---
523i	E39	M52B25	2.5	125	10.98-09.00		R	4	68	290	OZA447-E27	0416	S4	1952
523i	E39	M52B25	2.5	125	10.98-09.00		D	4	69	975	OZA447-E29	0438	S4	1952
523i Touring	E39	M52B25	2.5	125	10.98-09.00		R	4	68	290	OZA447-E27	0416	S4	1952
523i Touring	E39	M52B25	2.5	125	10.98-09.00		D	4	69	975	OZA447-E29	0438	S4	1952
525i	E39	25 6 S5	2.5	141	09.00-06.03		R	4	68	290	OZA447-E27	0416	S4	1952
525i	E39	25 6 S5	2.5	141	09.00-06.03		D	4	69	975	OZA447-E29	0438	S4	1952
525i Touring	E39	25 6 S5	2.5	141	09.00-05.04		R	4	68	290	OZA447-E27	0416	S4	1952
525i Touring	E39	25 6 S5	2.5	141	09.00-05.04		D	4	69	975	OZA447-E29	0438	S4	1952
528i	E39	M52B28	2.8	142	09.95-09.98	Siemens	R	4	54	968	OTA7H-5A1	0486	---	---
528i	E39	M52B28	2.8	142	10.98-09.00		R	4	68	290	OZA447-E27	0416	S4	1952
528i	E39	M52B28	2.8	142	10.98-09.00		D	4	69	975	OZA447-E29	0438	S4	1952
528i Touring	E39	M52B28	2.8	142	10.98-09.00		R	4	68	290	OZA447-E27	0416	S4	1952
528i Touring	E39	M52B28	2.8	142	10.98-09.00		D	4	69	975	OZA447-E29	0438	S4	1952
530i	E39	30 6 S3	3.0	170	09.00-06.03		R	4	68	290	OZA447-E27	0416	S4	1952
530i	E39	30 6 S3	3.0	170	09.00-06.03		D	4	69	975	OZA447-E29	0438	S4	1952
530i Touring	E39	30 6 S3	3.0	170	09.00-05.04		R	4	68	290	OZA447-E27	0416	S4	1952
530i Touring	E39	30 6 S3	3.0	170	09.00-05.04		D	4	69	975	OZA447-E29	0438	S4	1952
535i	E39	M62B35	3.5	173	10.98-03.99		R	4	68	340	OZA447-E28	0427	S4	1952
535i	E39	M62B35	3.5	180	04.99-06.03		R	4	68	340	OZA447-E28	0427	S4	1952
540i	E39	M62B44	4.4	210	01.96-09.98		R	4	68	290	OZA447-E27	0416	S4	1952
540i	E39	M62B44	4.4	210	10.98-06.03		R	4	68	340	OZA447-E28	0427	S4	1952
540i Touring	E39	M62B44	4.4	210	10.98-05.04		R	4	68	290	OZA447-E27	0416	S4	1952
540i Touring	E39	M62B44	4.4	210	10.98-05.04		R	4	68	340	OZA447-E28	0427	S4	1952

5 (E60)

520i	E60	M54226S1	2.2	125	07.03-03.05		R	4	68	290	OZA447-E27	0416	S4	1952
525i	E60	M54256S5	2.5	141	09.03-03.05		R	4	68	290	OZA447-E27	0416	S4	1952
525i Touring	E60	M54256S5	2.5	141	05.04-03.05		R	4	68	290	OZA447-E27	0416	S4	1952
530i	E60	M54306S3	3.0	170	07.03-03.05		R	4	68	290	OZA447-E27	0416	S4	1952

6 (E24)

635 CSi	E24	M30B35	3.4	136	01.85-05.89		R	4	35	1490	OZA527-E27	0466	S4CG	1919
635 CSi	E24	M30B35	3.4	141	04.85-09.90		R	4	35	1490	OZA527-E27	0466	S4CG	1919

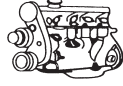

ℓ kW

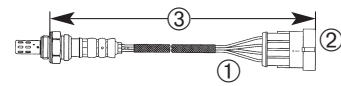
STOCK
NO.
UNIVERSAL
NO.
TYPE
NO.
REVISION
NO.

BMW

6 (E24)

635 CSI	E24	M30B35	3.4	155	08.87-05.89		R	4	35	1490	OZA527-E27	0466	S4CG	1919
---------	-----	--------	-----	-----	-------------	--	---	---	----	------	------------	------	------	------

7 (E32)

730i,iL	E32	M30B30	3.0	138	10.87-09.94		R	4	35	1490	OZA527-E27	0466	S4CG	1919
730i,iL	E32	M30B30	3.0	145	10.87-09.94		R	4	35	1490	OZA527-E27	0466	S4CG	1919
730i	E32	M60B30	3.0	160	04.92-10.94		R	4	35	540	OZA572-E8	0209	S4CG	1919
730i	E32	M60B30	3.0	160	04.92-10.94		R	4	35	540	OZA572-E8	0209	S4CG	1919
735i,iL	E32	M30B35	3.4	155	10.87-09.92		R	4	35	1490	OZA527-E27	0466	S4CG	1919
735i,iL	E32	M30B35	3.4	162	09.86-12.87		R	4	35	1490	OZA527-E27	0466	S4CG	1919
740i	E32	M60B40	4.0	210	04.92-10.94		R	4	35	540	OZA572-E8	0209	S4CG	1919
750i	E32	M70B50	5.0	220	09.87-10.94		R	4	35	540	OZA572-E8	0209	S4CG	1919

7 (E38)

728i	E38	M52B28	2.8	141	09.95-09.98	Siemens	R	4	54	968	0TA7H-5A1	0486	---	---
728i, iL	E38	M52B28	2.8	142	10.98-11.01		R	4	68	290	OZA447-E27	0416	S4	1952
728i, iL	E38	M52B28	2.8	142	10.98-11.01		D	4	69	975	OZA447-E29	0438	S4	1952
730i,iL	E38	M60B30	3.0	155	06.94-12.96		R	4	47	570	OZA572-E14	0408	S4CG	1919
730i,iL	E38	M60B30	3.0	160	06.94-12.96		R	4	47	570	OZA572-E14	0408	S4CG	1919
735i,iL	E38	M62B35	3.5	173	10.98-11.01		R	4	68	340	OZA447-E28	0427	S4	1952
735i,iL	E38	M62B35	3.5	175	10.98-11.01		R	4	68	290	OZA447-E27	0416	S4	1952
740i,iL	E38	M60B40	4.0	210	10.94-12.95		R	4	47	570	OZA572-E14	0408	S4CG	1919
740i,iL	E38	M62B44	4.4	210	10.98-11.01		R	4	68	290	OZA447-E27	0416	S4	1952
740i,iL	E38	M62B44	4.4	210	01.96-09.98		R	4	68	340	OZA447-E28	0427	S4	1952
750i,iL	E38	M73B54	5.4	240	12.94-11.01		R	4	68	290	OZA447-E27	0416	S4	1952
750i,iL	E38	M73B54	5.4	240	10.98-11.01		D	4	69	730	OZA660-EE5	5662	S4	1952

7 (E65/E66)

730i,Li	E65/E66	M54306S3	3.0	170	03.03-03.05		R	4	68	290	OZA447-E27	0416	S4	1952
---------	---------	----------	-----	-----	-------------	--	---	---	----	-----	------------	------	----	------

8 (E31)

840 Ci	E31	M60B40	4.0	210	04.93-09.93		R	4	47	350	OZA572-E6	1777	S4CG	1919
840 Ci	E31	M60B40	4.0	210	04.93-		R	4	35	540	OZA572-E8	0209	S4CG	1919
840 Ci	E31	M62B44	4.4	210	09.94-12.99		R	4	68	340	OZA447-E28	0427	S4	1952
850 Ci	E31	M70B50	5.0	220	04.90-12.94		R	4	35	540	OZA572-E8	0209	S4CG	1919
850 CSi	E31	M70B56	5.6	280	08.92-10.96		R	4	35	910	OZA572-E12	0273	S4CG	1919
850 Ci	E31	M73B54	5.4	240	03.94-12.99		R	4	68	290	OZA447-E27	0416	S4	1952

M POWER

M3	E36	S50B30	3.0	210	01.94-12.95		R	4	35	540	OZA572-E8	0209	S4CG	1919
M3 Coupe	E36	S 50 B 30	3.0	210	10.92-	Siemens	R	4	54	968	0TA7N-5D3	1991	---	---
M3 Cabriolet	E36	S 50 B 30	3.0	210	01.94-	Siemens	R	4	54	968	0TA7N-5D3	1991	---	---
M3	E36	S 50 B 30	3.0	210	08.94-	Siemens	R	4	54	968	0TA7N-5D3	1991	---	---
M3 Coupe	E36	S 50 B 30	3.0	217	01.95-	Siemens	R	4	54	968	0TA7N-5D3	1991	---	---
M3	E36	S 50 B 32	3.2	236	09.95-	Siemens	R	4	54	968	0TA7N-5D3	1991	---	---
M3 Cabriolet	E36	S 50 B 32	3.2	236	10.95-	Siemens	R	4	54	968	0TA7N-5D3	1991	---	---
M3 Coupe	E36	S 50 B 32	3.2	236	10.95-	Siemens	R	4	54	968	0TA7N-5D3	1991	---	---
M5	E34	S38 B36	3.5	232	10.88-12.92		R	4	35	1490	OZA527-E27	0466	S4CG	1919
M5	E34	S38 B36	3.8	250	03.92-12.95		R	4	35	1490	OZA527-E27	0466	S4CG	1919
M5 Touring	E34	S38 B36	3.8	250	04.92-12.95		R	4	35	1490	OZA527-E27	0466	S4CG	1919
M5	E39	50 8 S1	5.0	294	10.98-06.03		R	4	68	290	OZA447-E27	0416	S4	1952

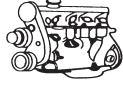

ℓ kW

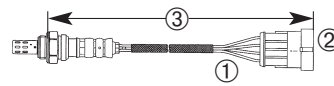
STOCK
NO.
UNIVERSAL
TYPE
NO.
UNIVERSAL
NO.

BMW

X3 (E83)

X3 2.0i	E83	N46B20A OL	2.0	110	07.05-		D	4	54	431	OZA600-BM5	1846	---	---
X3 2.5i	E83	M54256S5	2.5	141	01.04-09.06	Cyl 1-3	R	4	68	290	OZA447-E27	0416	S4	1952
X3 2.5i	E83	M54256S5	2.5	141	01.04-09.06	Cyl 1-3	D	4	69	975	OZA447-E29	0438	S4	1952
X3 3.0i	E83	M54306S3	3.0	170	01.04-09.06	Cyl 1-3	R	4	68	290	OZA447-E27	0416	S4	1952
X3 3.0i	E83	M54306S3	3.0	170	01.04-09.06	Cyl 1-3	D	4	69	975	OZA447-E29	0438	S4	1952

X5 (E53)

X5 3.0i	E53	30 6 S8	3.0	163	05.00-10.06		R	4	68	290	OZA447-E27	0416	S4	1952
X5 3.0i	E53	30 6 S3	3.0	163	05.00-10.06		D	4	69	975	OZA447-E29	0438	S4	1952
X5 3.0i	E53	30 6 S8	3.0	170	05.00-10.06		R	4	68	290	OZA447-E27	0416	S4	1952
X5 3.0i	E53	30 6 S3	3.0	170	05.00-10.06		D	4	69	975	OZA447-E29	0438	S4	1952
X5 4.4i	E53	44 8 S2	4.4	210	05.00-09.03		R	4	68	290	OZA447-E27	0416	S4	1952
X5 4.4i	E53	44 8 S2	4.4	210	05.00-09.03		D	4	69	730	OZA660-EE5	5662	S4	1952
X5 4.6iS	E53	46 8 S1	4.6	255	02.02-09.03		R	4	68	290	OZA447-E27	0416	S4	1952
X5 4.6iS	E53	46 8 S1	4.6	255	02.02-09.03		D	4	69	730	OZA660-EE5	5662	S4	1952

Z1 (Z/B)

Z1	Z/B	M20B25	2.5	125	11.88-06.91		R	4	35	510	OZA572-E2	0252	S4CG	1919
----	-----	--------	-----	-----	-------------	--	---	---	----	-----	-----------	-------------	------	-------------

Z3 (E36/7)

Z3	E36/7	M43B18	1.8	85	10.95-		R	4	47	570	OZA572-E14	0408	S4CG	1919
Z3	E36/7	M44B19	1.9	103	09.95-12.99		R	4	68	340	OZA447-E28	0427	S4	1952
Z3	E36/7	M43B19	1.9	87	09.98-		R	4	68	340	OZA447-E28	0427	S4	1952
Z3	E36/7	M52B25	2.0	110	04.99-12.00		R	4	68	290	OZA447-E27	0416	S4	1952
Z3	E36/7	M52B25	2.0	110	04.99-12.00		D	4	69	975	OZA447-E29	0438	S4	1952
Z3	E36/7	M54	2.2	125	08.00-12.02		R	4	68	290	OZA447-E27	0416	S4	1952
Z3	E36/7	M54	2.2	125	08.00-12.02		D	4	69	975	OZA447-E29	0438	S4	1952
Z3	E36/7	M52B28	2.8	141	04.97-09.98	Siemens	R	4	54	388	OTA7N-5D1	1974	---	---
Z3	E36/7	M52B28	2.8	141	10.98-06.00		R	4	68	290	OZA447-E27	0416	S4	1952
Z3	E36/7	M52B28	2.8	141	10.98-06.00		D	4	69	975	OZA447-E29	0438	S4	1952
Z3 Coupe	E36/7	M52B28	2.8	141	07.97-09.98	Siemens	R	4	54	388	OTA7N-5D1	1974	---	---
Z3 Coupe	E36/7	M52B28	2.8	141	10.98-06.00		R	4	68	290	OZA447-E27	0416	S4	1952
Z3 Coupe	E36/7	M52B28	2.8	141	10.98-06.00		D	4	69	975	OZA447-E29	0438	S4	1952
Z3	E36/7	M52B28	2.8	142	11.96-09.00		R	4	68	290	OZA447-E27	0416	S4	1952
Z3	E36/7	M52B28	2.8	142	11.96-09.00		D	4	69	975	OZA447-E29	0438	S4	1952
Z3 Coupe	E36/7	M52B28	2.8	142	09.97-09.00		R	4	68	290	OZA447-E27	0416	S4	1952
Z3 Coupe	E36/7	M52B28	2.8	142	09.97-09.00		D	4	69	975	OZA447-E29	0438	S4	1952
Z3	E36/7	30 6 S3	3.0	170	05.00-12.02		R	4	68	290	OZA447-E27	0416	S4	1952
Z3	E36/7	30 6 S3	3.0	170	05.00-12.02		D	4	69	975	OZA447-E29	0438	S4	1952
Z3 Coupe	E36/7	30 6 S3	3.0	170	05.00-12.02		R	4	68	290	OZA447-E27	0416	S4	1952
Z3 Coupe	E36/7	30 6 S3	3.0	170	05.00-12.02		D	4	69	975	OZA447-E29	0438	S4	1952
Z3 M Coupe	E36/7	S52 (M3)	3.2	236	02.98-06.01		R	4	68	745	OZA660-EE22	5720	S4	1952
Z3 M Cabriolet	E36/7	S52 (M3)	3.2	236	03.97-06.01		R	4	68	745	OZA660-EE22	5720	S4	1952
Z3 M Coupe	E36/7	S52 (M3)	3.2	236	02.98-06.01	Siemens	R	4	54	638	OTA7N-5D2	1975	---	---
Z3 M Cabriolet	E36/7	S52 (M3)	3.2	236	03.97-06.01	Siemens	R	4	54	638	OTA7N-5D2	1975	---	---
Z3 M Coupe	E36/7	S52 (M3)	3.3	239	06.01-	Siemens	R	4	54	638	OTA7N-5D2	1975	---	---
Z3 M Cabriolet	E36/7	S52 (M3)	3.3	239	06.01-	Siemens	R	4	54	638	OTA7N-5D2	1975	---	---

Z4 (E85)

Z4	E85	N46B20A OL	2.0	110	04.05-		D	4	54	736	OZA600-BM1	0068	---	---
Z4	E85	M54226S1	2.2	125	10.03-01.06	Cyl 1-3	R	4	68	290	OZA447-E27	0416	S4	1952
Z4	E85	M54226S1	2.2	125	10.03-01.06	Cyl 1-3	D	4	69	975	OZA447-E29	0438	S4	1952
Z4	E85	M54256S5	2.5	141	02.03-01.06	Cyl 1-3	R	4	68	290	OZA447-E27	0416	S4	1952

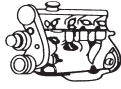

ℓ kW

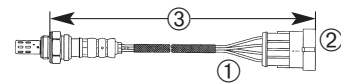
STOCK
NO.
TYPE
NO.
UNIVERSAL
NO.
UNIVERSAL
NO.

BMW

Z4 (E85)

Z4	E85	M54256S5	2.5	141	02.03-01.06	Cyl 1-3	D	4	69	975	OZA447-E29	0438	S4	1952
Z4	E85	M54306S3	3.0	170	02.03-01.06	Cyl 1-3	R	4	68	290	OZA447-E27	0416	S4	1952
Z4	E85	M54306S3	3.0	170	02.03-01.06	Cyl 1-3	D	4	69	975	OZA447-E29	0438	S4	1952

Z8 (E52)

Z8	E52	50 8 S1	5.0	294	06.00-06.03		R	4	68	290	OZA447-E27	0416	S4	1952
----	-----	---------	-----	-----	-------------	--	----------	---	----	-----	------------	-------------	----	-------------

CHEVROLET

AVEO

1.4i 16V			1.4	69	03.05-		R	4	31	400	OZA629-W2	0017	---	---
----------	--	--	-----	----	--------	--	----------	---	----	-----	-----------	-------------	-----	-----

BERETTA

2.2i	LN2 (4)		2.2	87	10.91-09.96		R	1	6	387	OZA19-E12	6379	S1	1951
2.3i	LG0 (A)		2.3	130	09.90-10.94		R	1	6	387	OZA19-E12	6379	S1	1951
3.1i	LH0 (M)		3.1	103	10.92-09.93		R	1	6	387	OZA19-E12	6379	S1	1951

CAMARO

3.1i	LH0 (T)		3.1	103	10.89-09.92		R	1	6	387	OZA19-E12	6379	S1	1951
3.4i	(S)		3.4	119	10.92-10.95		R	1	6	387	OZA19-E12	6379	S1	1951
5.0i	LG4 (7)		5.0	112-137	12.81-12.92		R	1	6	387	OZA19-E12	6379	S1	1951
5.7i	LT1 (P)		5.7	205	12.92-09.93		R	1	6	387	OZA19-E12	6379	S1	1951

CAPRICE

5.0i	LG4 (E)		5.0	112-137	10.89-09.92		R	1	6	387	OZA19-E12	6379	S1	1951
5.7i	L98 (6)		5.7	168	10.84-10.93		R	1	6	387	OZA19-E12	6379	S1	1951

CAVALIER

2.0i	Z20 LSY L850		2.0				R	4	86	247	OZA531-GM7	1870	---	---
2.2i	LN2 (4)		2.2	90	10.91-09.96		R	1	6	387	OZA19-E12	6379	S1	1951

CORVETTE

5.7i	8 TPI		5.7	179-183	08.88-08.91		R	3	14	375	OZA446-E8	1827	S3	0412
5.7i	L98 (8)		5.7	179-207	10.89-10.93		R	1	6	387	OZA19-E12	6379	S1	1951
5.7i Convertible	P TPI		5.7	225	09.91-08.93		R	3	14	375	OZA446-E8	1827	S3	0412
5.7i ZR-1	LT5 MFI		5.7	279	06.89-08.91		R	3	14	375	OZA446-E8	1827	S3	0412
5.7i ZR-1	LT5 J SFI		5.7	279-302	09.91-08.93		R	3	14	375	OZA446-E8	1827	S3	0412

KALOS

1.4i 16V			1.4	69	03.05-		R	4	42	310	OZA341-W2	0440	---	---
1.4i 16V			1.4	69	03.05-		D	4	42	310	OZA341-W2	0440	---	---

LACETTI

1.4i 16V			1.4	70	03.05-		R	4	31	400	OZA629-W2	0017	---	---
----------	--	--	-----	----	--------	--	----------	---	----	-----	-----------	-------------	-----	-----

LUMINA

2.5i	(R)		2.5	82	10.89-09.93		R	1	6	387	OZA19-E12	6379	S1	1951
3.1i	LH0 (T)		3.1	103	10.89-09.94		R	1	6	387	OZA19-E12	6379	S1	1951
3.4i	(X)		3.4	149	10.89-09.94		R	1	6	387	OZA19-E12	6379	S1	1951

MATIZ

0.8i	F8CV		0.8	38	09.98-12.03	Euro II	R	4	42	310	OZA341-W2	0440	---	---
0.8i	F8CV		0.8	38	01.04-	Euro IV	R	4	31	310	OZA629-W6	0019	---	---
0.8i	F8CV		0.8	38	01.04-	Euro IV	D	4	102	380	OZA610-W2	0014	---	---
1.0i			1.0	47	01.03-12.03	Euro II	R	4	31	510	OZA629-W5	0018	---	---

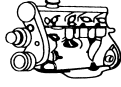

ℓ kW

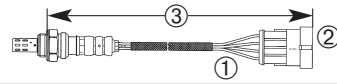

NUMERO IN STOCK
UNIVERSAL
TYPE No.
NUMERO P. IN STOCK

CHEVROLET

MATIZ

1.0i		1.0	47	01.04-	Euro IV	R	4	31	510	OZA629-W5	0018	---	---
1.0i		1.0	47	01.04-	Euro IV	D	4	102	350	OZA610-W5	0015	---	---

REZZO

1.6i	A16DMS	1.6	77	03.05-		D	4	113	220	OZA341-W1	6408	---	---
1.6i	A16DMS	1.6	79	08.05-		D	4	113	220	OZA341-W1	6408	---	---

CHRYSLER

300

2.7i	FX	2.7	142	01.05-	Y	R	4	89	425	OZA571-C2	6384	---	---
2.7i	FX	2.7	142	01.05-	Y	R	4	89	425	OZA571-C2	6384	---	---
2.7i	FX	2.7	142	01.05-	Y	D	4	89	425	OZA571-C2	6384	---	---
2.7i	FX	2.7	142	01.05-	Y	D	4	89	425	OZA571-C2	6384	---	---

300 C

5.7i	FX	5.7	250	01.05-	Y	R	4	118	300	OZA623-C1	6397	---	---
5.7i	FX	5.7	250	01.05-	Y	R	4	118	300	OZA623-C1	6397	---	---
5.7i	FX	5.7	250	01.05-	Y	D	4	89	425	OZA571-C2	6384	---	---
5.7i	FX	5.7	250	01.05-	Y	D	4	89	425	OZA571-C2	6384	---	---
6.1i	FX	6.1	317	01.05-	Y	R	4	118	300	OZA623-C1	6397	---	---
6.1i	FX	6.1	317	01.05-	Y	R	4	118	300	OZA623-C1	6397	---	---
6.1i	FX	6.1	317	01.05-	Y	D	4	89	425	OZA571-C2	6384	---	---
6.1i	FX	6.1	317	01.05-	Y	D	4	89	425	OZA571-C2	6384	---	---

300 M

3.5i	EGG	3.5	185	01.01-12.01	Y	R	4	115	380	OZA521-C8	6383	---	---
3.5i	EGG	3.5	185	01.01-12.01	Y	R	4	115	380	OZA521-C8	6383	---	---
3.5i	EGG	3.5	185	01.02-12.04	Y	R	4	116	300	OZA571-C4	6385	---	---
3.5i	EGG	3.5	185	01.02-12.04	Y	R	4	116	300	OZA571-C4	6385	---	---
3.5i	EGG	3.5	185	01.01-12.04	Y	D	4	115	380	OZA521-C8	6383	---	---
3.5i	EGG	3.5	185	01.01-12.04	Y	D	4	115	380	OZA521-C8	6383	---	---

CIRRUS

2.5i 24V	EEB	2.5	118	09.96-12.00		R	3	19	490	OZA446-E11	1898	S3	0412
2.5i 24V	EEO	2.5	118	09.96-12.00		R	3	19	490	OZA446-E11	1898	S3	0412

CONCORDE

2.7i	EER	2.7	149	01.01-12.01	Y	R	4	115	380	OZA521-C8	6383	---	---
2.7i	EER	2.7	149	01.01-12.01	Y	R	4	115	380	OZA521-C8	6383	---	---
2.7i	EER	2.7	149	01.02-12.04	Y	R	4	116	300	OZA571-C4	6385	---	---
2.7i	EER	2.7	149	01.02-12.04	Y	R	4	116	300	OZA571-C4	6385	---	---
2.7i	EER	2.7	149	01.01-12.04	Y	D	4	115	380	OZA521-C8	6383	---	---
2.7i	EER	2.7	149	01.01-12.04	Y	D	4	115	380	OZA521-C8	6383	---	---
3.2i	EGW	3.2	174	01.01-12.01	Y	R	4	115	380	OZA521-C8	6383	---	---
3.2i	EGW	3.2	174	01.01-12.01	Y	R	4	115	380	OZA521-C8	6383	---	---
3.2i	EGW	3.2	174	01.01-12.01	Y	D	4	115	380	OZA521-C8	6383	---	---
3.2i	EGW	3.2	174	01.01-12.01	Y	D	4	115	380	OZA521-C8	6383	---	---
3.5i		3.5	186	01.03-12.04	Y	R	4	116	300	OZA571-C4	6385	---	---
3.5i		3.5	186	01.03-12.04	Y	R	4	116	300	OZA571-C4	6385	---	---

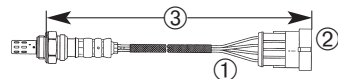

ORDER No.
STOCK No.
UNIVERSAL No.
TYPE No.
CHASSIS No.
ENGINE No.



ℓ kW



CHRYSLER

CONCORDE

3.5i		3.5	186	01.03-12.04		D	4	115	380	OZA521-C8	6383	---	---
3.5i		3.5	186	01.03-12.04		D	4	115	380	OZA521-C8	6383	---	---

CONVERTIBLE

2.5i 24V	EEB	2.5	118	01.98-12.00			R	3	19	490	OZA446-E11	1898	S3	0412
2.5i 24V	EEO	2.5	118	01.98-12.00			R	3	19	490	OZA446-E11	1898	S3	0412

CROSSFIRE

3.2i	EGX	3.2	160	03.02-		D	4	47	240	OZA659-EE15	0389	---	---
3.2i	EGX	3.2	160	03.02-		D	4	47	320	OZA659-EE22	0396	---	---
3.2i SRT-6	EGZ	3.2	247	03.02-		D	4	47	240	OZA659-EE15	0389	---	---
3.2i SRT-6	EGZ	3.2	247	03.02-		D	4	47	320	OZA659-EE22	0396	---	---

INTEPID

2.7i		2.7	149	01.03-12.04			R	4	116	300	OZA571-C4	6385	---	---
2.7i		2.7	149	01.03-12.04			R	4	116	300	OZA571-C4	6385	---	---
3.5i		3.5	186	01.03-12.04			R	4	116	300	OZA571-C4	6385	---	---
3.5i		3.5	186	01.03-12.04			R	4	116	300	OZA571-C4	6385	---	---

PACIFICA

3.8i		3.8		01.05-		D	4	117	457	OZA571-C7	6396	---	---
3.8i		3.8		01.05-		D	4	117	457	OZA571-C7	6396	---	---

PT CRUISER

2.4i	EDZ	2.4	105	01.05-			R	4	117	457	OZA571-C7	6396	---	---
2.4i	EDZ	2.4	105	01.05-			R	4	117	457	OZA571-C7	6396	---	---
2.4i	EDZ	2.4	105	01.05-		D	4	89	425	OZA571-C2	6384	---	---	
2.4i	EDZ	2.4	105	01.05-		D	4	89	425	OZA571-C2	6384	---	---	

NEON

2.0i		2.0	89	01.04-			R	4	117	457	OZA571-C7	6396	---	---
2.4i	SRT-4	2.4		01.04-			R	4	89	425	OZA571-C2	6384	---	---

SEBRING

2.0i	ECF	2.0	104	03.95-10.96			R	4	114	590	OZA28-C3	6380	S4	1952
2.4i	EDZ	2.4	105	12.04-			R	4	117	457	OZA571-C7	6396	---	---
2.4i	EDZ	2.4	112	01.01-12.04			D	4	115	380	OZA521-C8	6383	---	---
2.5i V6	EEB	2.5	120	03.95-10.99			R	4	114	590	OZA28-C3	6380	S4	1952
2.5i V6	EEB	2.5	120	03.95-10.99			R	4	114	590	OZA28-C3	6380	S4	1952
2.5i 24V Cabrio	EEB	2.5	122	01.00-12.00			R	3	19	490	OZA446-E11	1898	S3	0412
2.5i 24V Cabrio	EEO	2.5	122	01.00-12.00			R	3	19	490	OZA446-E11	1898	S3	0412
2.5i 24V Cabrio	EER	2.5	122	01.00-12.00			R	3	19	490	OZA446-E11	1898	S3	0412
2.7i	EES	2.7	149	01.01-12.04			R	4	115	380	OZA521-C8	6383	---	---
2.7i	EES	2.7	149	01.01-12.04			R	4	115	380	OZA521-C8	6383	---	---
2.7i	EES	2.7	149	01.01-12.04		D	4	115	380	OZA521-C8	6383	---	---	
2.7i	EES	2.7	149	01.01-12.04		D	4	115	380	OZA521-C8	6383	---	---	
2.7i	EES	2.7	149	01.05-			R	4	89	425	OZA571-C2	6384	---	---
2.7i	EES	2.7	149	01.05-			R	4	89	425	OZA571-C2	6384	---	---
2.7i	EES	2.7	149	01.05-		D	4	89	425	OZA571-C2	6384	---	---	
2.7i	EES	2.7	149	01.05-		D	4	89	425	OZA571-C2	6384	---	---	

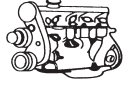

ℓ kW

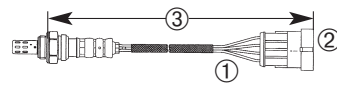
STOCK
No.
UNIVERSAL
No.
TYPE
No.
UNIVERSAL
No.

CHRYSLER

STRATUS

2.4i	EDZ	2.4	112	01.04-12.05		R	4	117	457	OZA571-C7	6396	---	---
2.4i	EDZ	2.4	112	01.06-		R	4	89	425	OZA571-C2	6384	---	---
2.4i	EDZ	2.4	112	01.06-		D	4	89	425	OZA571-C2	6384	---	---
2.5i 24V	EEB	2.5	118	01.98-12.99		R	3	19	490	OZA446-E11	1898	S3	0412
2.5i 24V	EEO	2.5	118	01.98-12.99		R	3	19	490	OZA446-E11	1898	S3	0412
2.5i V6	HOO	2.5	120	01.98-12.99		R	3	19	490	OZA446-E11	1898	S3	0412
2.5i 24V Cabrio	EEB	2.5	120	01.98-12.99		R	3	19	490	OZA446-E11	1898	S3	0412
2.5i 24V Cabrio	EEO	2.5	120	01.98-12.99		R	3	19	490	OZA446-E11	1898	S3	0412
2.5i Cabrio	625H	2.5	120	01.98-12.99		R	3	19	490	OZA446-E11	1898	S3	0412
2.5i V6		2.5	125	01.98-12.99		R	3	19	490	OZA446-E11	1898	S3	0412
2.7i	EES	2.7	149	01.05-	⌋	R	4	89	425	OZA571-C2	6384	---	---
2.7i	EES	2.7	149	01.05-	⌋	R	4	89	425	OZA571-C2	6384	---	---
2.7i	EES	2.7	149	01.05-	⌋	D	4	89	425	OZA571-C2	6384	---	---
2.7i	EES	2.7	149	01.05-	⌋	D	4	89	425	OZA571-C2	6384	---	---

VIPER

8.0i	EWB	8.0		03.92-02.95		R	4	114	590	OZA28-C3	6380	S4	1952
8.0i	EWB	8.0		03.95-10.98	⌋	D	4	115	457	OZA248-C1	6381	S4	1952
8.0i	EWB	8.0		03.95-10.98	⌋	D	4	115	457	OZA248-C1	6381	S4	1952

CITROEN

AX

1.0i	CDY <TU9M>	1.0	31-33	02.95-12.98	Org. N. 6630 ->	R	4	49	1220	OZA527-E17	0445	S4CG	1919
1.0i	CDY <TU9M>	1.0	31-33	07.92-01.95	Org. N. ->6629	R	4	58	1470	OZA527-E3	0201	S4CG	1919
1.0i	CDZ <TU9M>	1.0	37	02.95-12.98	Org. N. 6630 ->	R	4	49	1220	OZA527-E17	0445	S4CG	1919
1.0i	CDZ <TU9M>	1.0	37	07.92-01.95	Org. N. ->6629	R	4	58	1470	OZA527-E3	0201	S4CG	1919
1.1i	HAZ <TU1CP>	1.1	40	12.86-12.89		R	4	37	1210	OZA527-E22	0274	S4CG	1919
1.1i	HDZ <TU1M>	1.1	40-44	06.91-04.92	Org. N. 5293->6629	R	4	58	1470	OZA527-E3	0201	S4CG	1919
1.1i	HDZ <TU1M>	1.1	40-44	10.89-05.91	Org. N. ->5292	R	4	37	1210	OZA527-E22	0274	S4CG	1919
1.1i	HDY <TU1M>	1.1	44	02.95-06.98	Org. N. 6630 ->	R	4	49	1220	OZA527-E17	0445	S4CG	1919
1.1i	HDY <TU1M>	1.1	44	05.92-01.95	Org. N. 5293->6629	R	4	58	1470	OZA527-E3	0201	S4CG	1919
1.4i	KDX <TU3FM>	1.4	55	01.93-01.95	Org. N. 5293->6629	R	4	58	1470	OZA527-E3	0201	S4CG	1919
1.4i	KDX <TU3FM>	1.4	55	02.95-12.96	Org. N. 6630 ->	R	4	49	1220	OZA527-E17	0445	S4CG	1919
1.4i	KDX <TU3M/Z>	1.4	55	02.95-12.96	Org. N. 6630 ->	R	4	111	1230	OZA660-EE24	5739	S4	1952
1.4i 4x4	KDX <TU3M/Z>	1.4	55	02.95-12.96	Org. N. 6630 ->	R	4	111	1230	OZA660-EE24	5739	S4	1952
1.4i	KDY <TU3FM>	1.4	55-58	02.95-12.96	Org. N. 6630 ->	R	4	49	1220	OZA527-E17	0445	S4CG	1919
1.4i	KDY <TU3FM>	1.4	55-58	10.89-05.91	Org. N. ->5292	R	4	37	1210	OZA527-E22	0274	S4CG	1919
1.4i	KDY <TU3FM>	1.4	55-58	06.91-01.95	Org. N. 5293->6629	R	4	58	1470	OZA527-E3	0201	S4CG	1919
1.4i 4x4	KDY <TU3FM>	1.4	55	02.95-12.96	Org. N. 6630 ->	R	4	111	1230	OZA660-EE24	5739	S4	1952
1.4i	KDY <TU3M>	1.4	55-58	02.95-12.96	Org. N. 6630->	R	4	49	1220	OZA527-E17	0445	S4CG	1919
1.4i	KDY <TU3M>	1.4	55-58	06.90-05.91	Org. N. ->5292	R	4	37	1210	OZA527-E22	0274	S4CG	1919
1.4i	KDY <TU3M>	1.4	55-58	06.91-01.95	Org. N. 5293->6629	R	4	58	1470	OZA527-E3	0201	S4CG	1919
1.4i 4x4	KDY <TU3M>	1.4	55	02.95-12.96	Org. N. 6630 ->	R	4	111	1230	OZA660-EE24	5739	S4	1952
1.4i	KDZ <TU3M/Z>	1.4	55	02.95-12.96	Org. N. 6630 ->	R	4	111	1230	OZA660-EE24	5739	S4	1952
1.4i	KDZ <TU3M>	1.4	58	06.88-05.90	Org. N. ->5292	R	4	37	1210	OZA527-E22	0274	S4CG	1919
1.4i	K6B <TU3FJ2>	1.4	66	05.91-01.95	Org. N. ->6629	R	4	58	450	OZA527-E12	0220	S4CG	1919
1.4i	KFY <TU3FJ>	1.4	66	02.95-12.96	Org. N. 6630 ->	R	4	49	1220	OZA527-E17	0445	S4CG	1919
1.4 GTi	KFY <TU3FJ2>	1.4	66	02.95-12.96	Org. N. 6630 ->	R	4	111	1230	OZA660-EE24	5739	S4	1952

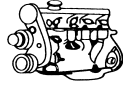

e kW



ORDER No.
STOCK No.
UNIVERSAL No.
TYPE No.
NUMBER No.

CITROEN

AX

1.4i	KFY <TU3FJ>	1.4	66	05.91-01.95	Org. N. ->6629	R	4	58	450	OZA527-E12	0220	S4CG	1919
1.4 GTi	KFZ <TU3FJ2>	1.4	69	02.95-12.96	Org. N. 6630 ->	R	4	111	1230	OZA660-EE24	5739	S4	1952
1.4i	KFZ <TU3FJ>	1.4	70	02.95-12.96	Org. N. 6630 ->	R	4	49	1220	OZA527-E17	0445	S4CG	1919
1.4i	KFZ <TU3FJ>	1.4	70	05.91-01.95	Org. N. ->6629	R	4	58	450	OZA527-E12	0220	S4CG	1919
1.4i	K6B <TU3FJ>	1.4	74	02.95-12.96	Org. N. 6630 ->	R	4	49	1220	OZA527-E17	0445	S4CG	1919
1.4i	K6B <TU3FJ>	1.4	74	05.91-01.95	Org. N. ->6629	R	4	58	450	OZA527-E12	0220	S4CG	1919

BERLINGO

1.1i	HDZ	1.1	44	12.98-11.02		R	3	19	975	OZA446-E2	1855	---	---
1.1i	HDY	1.1	44	12.98-11.02		R	3	19	975	OZA446-E2	1855	---	---
1.1i	HDY <TU1M+>	1.1	44	07.96-11.98		R	4	49	380	OZA448-E57	0492	S4	1952
1.1i	HDY	1.1	44	07.96-11.98		R	4	49	375	OZA527-E15	0298	S4CG	1919
1.1i	HDZ	1.1	44	07.96-11.98		R	4	49	375	OZA527-E15	0298	S4CG	1919
1.1i	HFX <TU1JP>	1.1	44	06.00-		R	4	83	540	OZA659-EE4	0378	---	---
1.1i	HFX <TU1JP>	1.1	44	06.00-		D	4	82	565	OZA659-EE10	0384	---	---
1.1i	HFZ <TU1JP+>	1.1	44	06.00-	Euro 2000	R	4	82	536	OZA341-PG5	1813	---	---
1.1i	HFZ <TU1JP+>	1.1	44	06.00-	Euro 2000	D	4	82	536	OZA341-PG5	1813	---	---
1.4 8V	TU3A	1.4	54	01.00-		R	4	83	381	OZA608-U2	0070	---	---
1.4 8V	TU3A	1.4	54	01.00-		D	4	82	536	OZA341-PG5	1813	---	---
1.4i	KFW <TU3JP>	1.4	55	09.96-12.00		R	4	87	380	OZA676-EE1	7979	---	---
1.4i	KFX <TU3JP>	1.4	55	07.96-06.98		R	4	49	380	OZA448-E57	0492	S4	1952
1.4i	KFX <TU3JP>	1.4	55	07.98-11.02		R	4	83	380	OZA659-EE12	0386	---	---
1.4i	KFX <TU3JP>	1.4	55	07.98-11.02		D	4	83	1230	OZA659-EE8	0382	---	---
1.4i	KFX <TU3JP+>	1.4	55	12.02-		R	4	83	536	OZA495-PG2	1852	---	---
1.4i	KFX <TU3JP+>	1.4	55	12.02-		D	4	82	536	OZA341-PG5	1813	---	---
1.6i 16V	NFU <TU5JP4>	1.6	80	06.00-		R	4	83	540	OZA659-EE4	0378	---	---
1.6i 16V	NFU <TU5JP4>	1.6	80	06.00-		D	4	82	565	OZA659-EE10	0384	---	---

BX

14i	KDZ <TU3M/Z>	1.4	55	09.88-07.90		R	4	37	1210	OZA527-E22	0274	S4CG	1919
14i	KDY <TU3M/Z>	1.4	55	04.90-09.93		R	4	37	1210	OZA527-E22	0274	S4CG	1919
16i	BDZ <XU5MZ>	1.6	65	05.89-10.91		R	4	37	1210	OZA527-E22	0274	S4CG	1919
16i	BDY <XU5M>	1.6	65	07.91-12.94		R	4	37	1210	OZA527-E22	0274	S4CG	1919
19i	DFZ <XU9J1/Z>	1.9	75-77	03.86-06.86		R	3	19	490	OZA446-E11	1898	S3	0412
19i	DFZ <XU9J1/Z>	1.9	75-77	07.86-12.94		R	4	37	1210	OZA527-E22	0274	S4CG	1919
19i	DDZ <XU9M/Z>	1.9	80	06.88-12.94		R	4	37	1210	OZA527-E22	0274	S4CG	1919
19i 4x4	DDZ <XU9M>	1.9	80	10.90-05.91		R	4	37	1210	OZA527-E22	0274	S4CG	1919
19i	DKZ <XU9JA/Z>	1.9	88	06.88-03.94		R	4	37	1210	OZA527-E22	0274	S4CG	1919
19i 16S	DFW <XU9J4/Z>	1.9	108	03.88-12.94		R	4	37	1210	OZA527-E22	0274	S4CG	1919

C1

1.0i	1KR-FE	1.0	50	06.05-		R	4	123	275	OZA659-EE62	7916	---	---
1.0i	1KR-FE	1.0	50	06.05-		D	4	34	290	OZA659-EE63	7948	---	---

C2

1.1i	HFX <TU1JP>	1.1	44	09.03-		R	4	83	540	OZA659-EE4	0378	---	---
1.1i	HFX <TU1JP>	1.1	44	09.03-		D	4	82	536	OZA341-PG5	1813	---	---
1.1i	TU1A	1.1	45	09.05-		R	4	83	381	OZA608-U2	0070	---	---
1.1i	TU1A	1.1	45	09.05-		D	4	82	536	OZA341-PG5	1813	---	---
1.4i 8V	TU3A	1.4	54	09.05-		R	4	83	381	OZA608-U2	0070	---	---
1.4i 8V	TU3A	1.4	54	09.05-		D	4	82	536	OZA341-PG5	1813	---	---

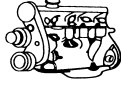

ℓ kW

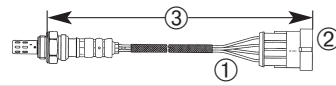
NUMEROUS P. No.
UNIVERSAL No.
TYPE No.
STOCK No.
ORDER No.

CITROEN

C2

1.4i 16V	TU3JP+	1.4	66	09.05-		R	4	83	536	OZA495-PG2	1852	---	---
1.4i 16V	TU3JP+	1.4	66	09.05-		D	4	82	536	OZA341-PG5	1813	---	---
1.6i	NFU <TU5JP4>	1.6	80	09.03-		R	4	83	540	OZA659-EE4	0378	---	---
1.6i	NFU <TU5JP4>	1.6	80	09.03-		D	4	82	565	OZA659-EE10	0384	---	---
1.6i VTS	NFS <TU5JP4S>	1.6	90	01.05-		R	4	83	540	OZA659-EE4	0378	---	---
1.6i VTS	NFS <TU5JP4S>	1.6	90	01.05-		D	4	82	565	OZA659-EE10	0384	---	---

C3

1.1i	HFX <TU1JP>	1.1	44	01.02-08.05		R	4	83	540	OZA659-EE4	0378	---	---
1.1i	HFX <TU1JP>	1.1	44	01.02-08.05		D	4	82	536	OZA341-PG5	1813	---	---
1.1i	TU1A	1.1	45	09.05-		R	4	83	381	OZA608-U2	0070	---	---
1.1i	TU1A	1.1	45	09.05-		D	4	82	536	OZA341-PG5	1813	---	---
1.4i	TU3A	1.4	54	09.05-		R	4	83	381	OZA608-U2	0070	---	---
1.4i	TU3A	1.4	54	09.05-		D	4	82	536	OZA341-PG5	1813	---	---
1.4i	KFV <TU3JP>	1.4	55	01.02-08.05		R	4	83	381	OZA608-U2	0070	---	---
1.4i	KFV <TU3JP>	1.4	55	01.02-08.05		D	4	82	536	OZA341-PG5	1813	---	---
1.4i 16V	KFU <ET3J4>	1.4	65	12.03-		R	4	83	380	OZA659-EE12	0386	---	---
1.4i 16V	TU3JP+	1.4	66	09.05-		R	4	83	536	OZA495-PG2	1852	---	---
1.4i 16V	TU3JP+	1.4	66	09.05-		D	4	82	536	OZA341-PG5	1813	---	---
1.6i	NFU <TU5JP4>	1.6	80	01.02-		R	4	83	540	OZA659-EE4	0378	---	---
1.6i	NFU <TU5JP4>	1.6	80	01.02-		D	4	82	565	OZA659-EE10	0384	---	---
1.6i 16V	TU5JP4	1.6	81	05.03-09.05		R	4	83	540	OZA659-EE4	0378	---	---

C3 PLURIEL

1.4i 8V	TU3A	1.4	54	09.05-		R	4	83	381	OZA608-U2	0070	---	---
1.4i 8V	TU3A	1.4	54	09.05-		D	4	82	536	OZA341-PG5	1813	---	---
1.4i 16V	TU3JP+	1.4	66	09.05-		R	4	83	536	OZA495-PG2	1852	---	---
1.4i 16V	TU3JP+	1.4	66	09.05-		D	4	82	536	OZA341-PG5	1813	---	---
1.6i 16V	NFU <TU5JP4>	1.6	80	05.03-		R	4	83	540	OZA659-EE4	0378	---	---
1.6i 16V	NFU <TU5JP4>	1.6	80	05.03-		D	4	82	565	OZA659-EE10	0384	---	---

C4

1.4i 16V	KFU <ET3J4>	1.4	65	11.04-		R	4	83	380	OZA659-EE12	0386	---	---
1.6i	NFU <TU5JP4>	1.6	80	11.04-		R	4	83	540	OZA659-EE4	0378	---	---
1.6i	NFU <TU5JP4>	1.6	80	11.04-		D	4	82	565	OZA659-EE10	0384	---	---
2.0i	RFN <EW10J4>	2.0	100	11.04-		R	4	83	540	OZA659-EE4	0378	---	---
2.0i	RFN <EW10J4>	2.0	100	11.04-		D	4	82	1490	OZA659-EE21	0395	---	---

C4 PICASSO

1.6i Vti 120	EP6	1.6	88	07.08-		D	4	82	446	OZA628-U1	0016	---	---
1.6i THP 150	EP6DT	1.6	110	11.08-		D	4	82	446	OZA628-U1	0016	---	---
1.8i 16V	6FZ <EW7J4	1.8	93	02.07-07.08		R	4	83	540	OZA659-EE4	0378	---	---
1.8i 16V	6FZ <EW7J4	1.8	93	02.07-07.08		D	4	82	1850	OZA659-EE61	7915	---	---
2.0i 16V	RFN <EW10J4>	2.0	105	02.07-11.08		R	4	83	540	OZA659-EE4	0378	---	---
2.0i 16V	RFN <EW10J4>	2.0	105	02.07-11.08		D	4	82	1850	OZA659-EE61	7915	---	---

C4 GRAND PICASSO

1.6i Vti 120	EP6	1.6	88	07.08-		D	4	82	446	OZA628-U1	0016	---	---
1.6i THP 150	EP6DT	1.6	110	11.08-		D	4	82	446	OZA628-U1	0016	---	---
1.8i 16V	6FZ <EW7J4	1.8	93	09.06-07.08		R	4	83	540	OZA659-EE4	0378	---	---
1.8i 16V	6FZ <EW7J4	1.8	93	09.06-07.08		D	4	82	1850	OZA659-EE61	7915	---	---

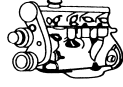

ℓ kW



ORDER No. STOCK No. TYPE No. UNIVERSAL No. PART No. DIMENSIONS No.

CITROEN

C4 GRAND PICASSO

2.0i 16V	RFN <EW10J4>	2.0	105	09.06-07.08		R	4	83	540	OZA659-EE4	0378	---	---
2.0i 16V	RFN <EW10J4>	2.0	105	09.06-07.08		D	4	82	1850	OZA659-EE61	7915	---	---

C5

1.8i 16V	6FZ <EW7J4>	1.8	85	01.01-09.04	Euro 2000	R	4	83	536	OZA495-PG2	1852	---	---
1.8i 16V	6FZ <EW7J4>	1.8	85	01.01-02.01	Euro 2000	D	4	82	1236	OZA341-PG6	1814	---	---
1.8i 16V	6FZ <EW7J4>	1.8	85	02.01-09.04	Euro 2000	D	4	82	1836	OZA341-PG8	1816	---	---
1.8i 16V	6FZ <EW7J4>	1.8	85	10.04-		R	4	83	540	OZA659-EE4	0378	---	---
1.8i 16V	6FZ <EW7J4>	1.8	85	10.04-		D	4	82	1850	OZA659-EE61	7915	---	---
2.0i 16V	RFN <EW10J4>	2.0	100	03.01-09.04		R	4	83	540	OZA659-EE4	0378	---	---
2.0i 16V	RFN <EW10J4>	2.0	100	03.01-09.04		D	4	82	1850	OZA659-EE61	7915	---	---
2.0 Hpi 16V	RLZ <EW10D>	2.0	105	07.01-		R	5	93	375	LZA06-U1	1840	---	---
2.0 Hpi 16V	RLZ <EW10D>	2.0	105	07.01-09.01	Euro 2000	D	4	82	1236	OZA538-PG1	1818	---	---
2.0 Hpi 16V	RLZ <EW10D>	2.0	105	09.01-	Euro 2000	D	4	82	1836	OZA538-PG2	1819	---	---
3.0i	XFX <ES9J4S>	3.0	150	03.01-09.04		R	4	83	540	OZA659-EE4	0378	---	---
3.0i	XFX <ES9J4S>	3.0	150	03.01-09.04		D	4	82	565	OZA659-EE10	0384	---	---
3.0i	XFU <ES9A>	3.0	155	10.04-		R	4	83	540	OZA659-EE4	0378	---	---
3.0i	XFU <ES9A>	3.0	155	10.04-	front	D	4	82	565	OZA659-EE10	0384	---	---
3.0i	XFU <ES9A>	3.0	155	10.04-	rear	D	4	82	1230	OZA659-EE52	1996	---	---

C6

3.0i	XFV <ES9A>	3.0	155	11.05-		R	4	83	540	OZA659-EE4	0378	---	---
3.0i	XFV <ES9A>	3.0	155	11.05-		D	4	82	565	OZA659-EE10	0384	---	---

C8

2.0i 16V	RFN <EW10J4>	2.0	100	06.02-		R	4	83	380	OZA659-EE12	0386	---	---
2.0i 16V	RFN <EW10J4>	2.0	100	06.02-		D	4	83	380	OZA659-EE12	0386	---	---
2.2i 16V	3FZ <EW12J4>	2.2	116	06.02-		R	4	83	380	OZA659-EE12	0386	---	---
2.2i 16V	3FZ <EW12J4>	2.2	116	06.02-		D	4	83	380	OZA659-EE12	0386	---	---
3.0i	XFW <ES9J4S>	2.9	150	10.02-		R	4	83	540	OZA659-EE4	0378	---	---
3.0i	XFW <ES9J4S>	2.9	150	10.02-		D	4	83	380	OZA659-EE12	0386	---	---

C15

1.1i	HDZ <TUIM>	1.1	44	06.89-04.92	Org. N. ->5656	R	4	37	1210	OZA527-E22	0274	S4CG	1919
1.1i	HDZ	1.1	44	04.92-12.96	Org. N. 5657 ->	R	4	58	1470	OZA527-E3	0201	S4CG	1919
1.4i	K1G <TU3A>	1.4	51	07.87-12.96		R	4	37	1210	OZA527-E22	0274	S4CG	1919
1.4i	KDY <TU3FM>	1.4	55-58	04.92-12.96	Org. N. 5657 ->	R	4	58	1470	OZA527-E3	0201	S4CG	1919
1.4i	KDY <TU3FM>	1.4	55-58	01.92-04.92		R	4	37	1210	OZA527-E22	0274	S4CG	1919

C25

2.0	XN1T <170A/B>	2.0	89-98	09.81-03.94		R	4	37	1210	OZA527-E22	0274	S4CG	1919
-----	---------------	-----	-------	-------------	--	---	---	----	------	------------	------	------	------

CX

25 Injection	M25-668 <EN5L>	2.5	89-98	05.86-12.92		R	4	37	1210	OZA527-E22	0274	S4CG	1919
25 i	M25-663	2.5		07.85-05.86		R	4	37	1210	OZA527-E22	0274	S4CG	1919

EVASION

1.8i	LFW <XU7JP>	1.8	73	09.96-07.02		R	4	49	1480	OZA448-E56	0481	S4	1952
2.0i	RFU <XU10J2>	2.0	89	06.94-07.02		R	4	49	1480	OZA448-E56	0481	S4	1952
2.0i 16V	RFV <XU10J4R>	2.0	99	05.98-04.00		R	4	83	1230	OZA659-EE8	0382	---	---
2.0i 16V	RFV <XU10J4R>	2.0	99	05.98-04.00		D	4	82	1490	OZA659-EE21	0395	---	---
2.0i 16V	RFN <EW10J4>	2.0	100	04.00-07.02		R	4	83	380	OZA659-EE12	0386	---	---
2.0i 16V	RFN <EW10J4>	2.0	100	04.00-07.02		D	4	83	380	OZA659-EE12	0386	---	---

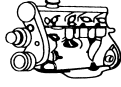

ℓ kW

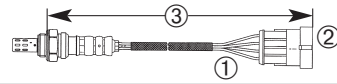
STOCK
ORDER
No.
TYPE
UNIVERSAL
No.
UNIVERSAL
No.
UNIVERSAL
No.

CITROEN

EVASION

2.0i Turbo	RGX <XU10J2TE>	2.0	108	06.94-07.02		R	4	49	1480	OZA448-E56	0481	S4	1952
------------	----------------	-----	-----	-------------	--	---	---	----	------	------------	------	----	------

JUMPER

2.0i	RFW <XU10J2U>	2.0	80	02.94-02.02	Fg.Nr. 15267331 ->	R	4	49	1480	OZA448-E56	0481	S4	1952
2.0i	RFW	2.0	80	02.94-02.02	Fg.Nr. -> 15267330	R	4	58	1470	OZA527-E3	0201	S4CG	1919
2.0i	RFL <XU10J2>	2.0	80	02.02-		R	4	83	540	OZA659-EE4	0378	---	---
2.0i	RFL <XU10J2>	2.0	80	02.02-		D	4	82	1230	OZA659-EE52	1996	---	---

JUMPY

1.6i	220 A2.000	1.6	58	10.95-09.97		R	4	49	1480	OZA448-E56	0481	S4	1952
2.0i	RFN <EW10J4>	2.0	100	04.00-		R	4	83	380	OZA659-EE12	0386	---	---
2.0i	RFN <EW10J4>	2.0	100	04.00-		D	4	83	380	OZA659-EE12	0386	---	---

NEMO

1.4i	TU3A	1.4	54	09.08-		R	4	83	381	OZA608-U2	0070	---	---
1.4i	TU3A	1.4	54	09.08-		D	4	82	536	OZA341-PG5	1813	---	---

SAXO

1.0i	CDZ <TU9M>	1.0	33	10.98-09.03	Euro 93	R	3	19	975	OZA446-E2	1855	S3	0412
1.0i	CDY <TU9M>	1.0	33	02.96-09.03		R	4	49	380	OZA448-E57	0492	S4	1952
1.0i	CDZ <TU9M>	1.0	33	02.96-09.03		R	4	49	375	OZA527-E15	0298	S4CG	1919
1.0i	CDY <TU9M>	1.0	37	10.98-09.03	Euro 93	R	3	19	975	OZA446-E2	1855	S3	0412
1.0i	CDZ <TU9M>	1.0	37	02.96-09.03		R	4	49	380	OZA448-E57	0492	S4	1952
1.0i	CDY <TU9M>	1.0	37	02.96-09.03		R	4	49	375	OZA527-E15	0298	S4CG	1919
1.1i	HDZ	1.1	40	10.98-09.03	Euro 93	R	3	19	975	OZA446-E2	1855	S3	0412
1.1i	HDY <TU1M+>	1.1	40	02.96-09.03	Euro 96	R	4	49	380	OZA448-E57	0492	S4	1952
1.1i	HDY <TU1M+>	1.1	40	02.96-09.03		R	4	73	370	OZA527-E29	0488	S4CG	1919
1.1i	HDZ	1.1	40	02.96-09.98		R	4	49	375	OZA527-E15	0298	S4CG	1919
1.1i	HDZ <TU1M+>	1.1	44	02.96-09.03		R	4	73	370	OZA527-E29	0488	S4CG	1919
1.1i	HDZ <TU1M+>	1.1	44	02.96-09.03	Euro 96	R	4	49	380	OZA448-E57	0492	S4	1952
1.1i	HDY	1.1	44	02.96-09.03		R	4	49	375	OZA527-E15	0298	S4CG	1919
1.1i	HDY	1.1	44	10.98-09.03	Euro 93	R	3	19	975	OZA446-E2	1855	S3	0412
1.1i	HFX <TU1JP>	1.1	44	03.00-09.03		R	4	83	540	OZA659-EE4	0378	---	---
1.1i	HFX <TU1JP>	1.1	44	03.00-09.03		D	4	82	565	OZA659-EE10	0384	---	---
1.1i	HFZ <TU1JP+>	1.1	44	06.00-09.03	Euro 2000	R	4	82	536	OZA341-PG5	1813	---	---
1.1i	HFZ <TU1JP+>	1.1	44	06.00-09.03	Euro 2000	D	4	82	536	OZA341-PG5	1813	---	---
1.4i	KFW <TU3JP/L4>	1.4	55	06.00-09.03		R	4	83	540	OZA659-EE4	0378	---	---
1.4i	KFW <TU3JP/L4>	1.4	55	06.00-09.03		D	4	82	535	OZA659-EE10	0384	---	---
1.4i	KFX	1.4	55	10.98-09.03	Euro 96	R	3	19	975	OZA446-E2	1855	S3	0412
1.4i	KFX <TU3JP>	1.4	55	02.96-09.03	Euro 96	R	4	49	380	OZA448-E57	0492	S4	1952
1.4i	KFX	1.4	55	02.96-09.03		R	4	49	375	OZA527-E15	0298	S4CG	1919
1.4i	KFX <TU3JP>	1.4	55	02.96-09.03		R	4	73	370	OZA527-E29	0488	S4CG	1919
1.4i	KFX <TU3JP+>	1.4	55	09.99-09.03	/ Euro 2000 Depol L4	D	4	82	536	OZA341-PG5	1813	---	---
1.4i	KFX <TU3JP+>	1.4	55	09.99-09.03	/ Euro 2000 Depol L4	R	4	83	536	OZA495-PG2	1852	---	---
1.4i	KFX <TU3JP>	1.4	55	02.96-09.03	Euro 2000 / CEE 2000	R	4	83	380	OZA659-EE12	0386	---	---
1.4i	KFX <TU3JP>	1.4	55	02.96-09.03	Euro 2000 / CEE 2000	D	4	83	380	OZA659-EE12	0386	---	---
1.6i	NFZ	1.6	66	10.98-09.03	Euro 96	R	3	19	975	OZA446-E2	1855	S3	0412
1.6i	NFZ	1.6	65	02.96-09.03		R	4	49	375	OZA527-E15	0298	S4CG	1919
1.6i	NFZ <TU5JP>	1.6	66	05.96-01.98	Org. N. -> 7727	R	4	49	380	OZA448-E57	0492	S4	1952
1.6i	NFZ <TU5JP>	1.6	66	02.98-09.03	Org. N. 7728 ->	R	4	83	380	OZA659-EE12	0386	---	---
1.6i	NFZ <TU5JP>	1.6	66	02.96-09.03		R	4	73	370	OZA527-E29	0488	S4CG	1919
1.6i	NFT <TU5JP/L4>	1.6	74	06.00-09.03		R	4	83	540	OZA659-EE4	0378	---	---

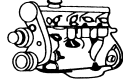

e kW



STOCK
ORDER No.

UNIVERSAL
TYPE No.

UNIVERSAL
NUMBER No.

CITROEN

SAXO

1.6i	NFT <TU5JP/L4>	1.6	74	06.00-09.03		D	4	82	535	OZA659-EE10	0384	---	---
1.6i	NFX <TU5J4>	1.6	87	07.96-09.03		R	4	49	630	OZA527-E16	0434	S4CG	1919
1.6i 16V VTS	NFX <TU5JP4>	1.6	87	07.96-09.99	Org. N. -> 8364	R	4	111	535	OZA660-EE23	5737	S4	1952
1.6i 16V VTS	NFX <TU5J4>	1.6	88	06.97-08.99	Euro 96	D	4	49	536	OZA334-PG1	1790	---	---
1.6i 16V VTS	NFX <TU5J4>	1.6	88	09.99-01.01	Euro 96	D	4	49	536	OZA334-PG1	1790	---	---
1.6i 16V VTS	NFX <TU5JP L4>	1.6	88	01.01-09.03	Euro 2000	R	4	82	536	OZA341-PG5	1813	---	---
1.6i 16V VTS	NFX <TU5JP L4>	1.6	88	01.01-09.03	Euro 2000	D	4	82	536	OZA341-PG5	1813	---	---
1.6i 16V VTS (New Morning)	NFX <TU5JP L4>	1.6	88	03.01-12.01	Euro 2000	R	4	82	536	OZA341-PG5	1813	---	---
1.6i 16V VTS (New Morning)	NFX <TU5JP L4>	1.6	88	03.01-12.01	Euro 2000	D	4	82	536	OZA341-PG5	1813	---	---

XANTIA

1.6i	BFZ <XU5JP>	1.6	65	06.95-01.98	Org. N. 6780 ->	R	4	111	535	OZA660-EE23	5737	S4	1952
1.6i	BFZ <XU5JP/Z,L3>	1.6	66	03.93-05.95	Org. N. -> 6779	R	4	58	450	OZA527-E12	0220	S4CG	1919
1.6i	BFZ <XU5JP/Z,L3>	1.6	66	06.95-01.98	Org. N. 6780 ->	R	4	49	630	OZA527-E16	0434	S4CG	1919
1.8i	L6A <XU7JP/K>	1.8	71	03.93-05.95	Org. N. -> 6779	R	4	58	450	OZA527-E12	0220	S4CG	1919
1.8i	L6A <XU7JP/K>	1.8	71	06.95-01.98	Org. N. 6780 ->	R	4	49	630	OZA527-E16	0434	S4CG	1919
1.8i	LFZ <XU7JP>	1.8	74	06.95-01.98	Org. N. 6780 ->	R	4	111	535	OZA660-EE23	5737	S4	1952
1.8i Break	LFZ <XU7JP>	1.8	74	09.95-01.98	Org. N. -> 6780	R	4	111	535	OZA660-EE23	5737	S4	1952
1.8i	LFZ <XU7JP/K>	1.8	76	03.93-05.95	Org. N. ->6779	R	4	58	450	OZA527-E12	0220	S4CG	1919
1.8i	LFZ <XU7JP/K>	1.8	76	06.95-01.98	Org. N. 6780 ->	R	4	49	630	OZA527-E16	0434	S4CG	1919
1.8i 16V	LFY <XU7JP4/L3>	1.8	81	05.95-10.96	Org. N. ->7250	R	4	49	630	OZA527-E16	0434	S4CG	1919
1.8i 16V	LFY <XU7JP4>	1.8	81	06.95-10.96	Org. N. -> 7250	R	4	111	535	OZA660-EE23	5737	S4	1952
1.8i 16V	LFY <XU7JP4>	1.8	81	12.97-12.01		R	4	83	380	OZA659-EE12	0386	---	---
1.8i 16V	LFY <XU7JP4>	1.8	81	12.97-12.01		D	4	82	1490	OZA659-EE21	0395	---	---
2.0i	RFX <XU10J2C>	2.0	89	06.95-01.98	Org. N. 6780 ->	R	4	111	535	OZA660-EE23	5737	S4	1952
2.0i	RFX <XU10J2C>	2.0	89	01.98-12.01		R	4	111	535	OZA660-EE23	5737	S4	1952
2.0i Break	RFX <XU10J2C>	2.0	89	09.95-01.98	Org. N. -> 6780	R	4	111	535	OZA660-EE23	5737	S4	1952
2.0i	RFX <XU10J2C/Z,L3>	2.0	90	03.93-05.95	Org. N. -> 6779	R	4	58	450	OZA527-E12	0220	S4CG	1919
2.0i	RFX <XU10J2C/Z,L3>	2.0	90	06.95-01.98	Org. N. 6780 ->	R	4	49	630	OZA527-E16	0434	S4CG	1919
2.0i	R6D <XU10J2C/K>	2.0	92	03.93-05.95	Org. N. -> 6779	R	4	58	450	OZA527-E12	0220	S4CG	1919
2.0i	R6D <XU10J2C/K>	2.0	92	06.95-01.98	Org. N. 6780 ->	R	4	49	630	OZA527-E16	0434	S4CG	1919
2.0i 16V	RFV <XU10J4R>	2.0	97	12.94-01.98		R	4	49	1480	OZA448-E56	0481	S4	1952
2.0i 16V	N05, W10 RFV <XU10J4R>	2.0	97	12.97-12.01		R	4	49	1480	OZA448-E56	0481	S4	1952
2.0i Turbo	RGX <XU10J2TE>	2.0	108	06.95-12.01		R	4	111	535	OZA660-EE23	5737	S4	1952
2.0i Turbo Break	RGX <XU10J2TE>	2.0	108	09.95-12.01		R	4	111	535	OZA660-EE23	5737	S4	1952
2.0i 16V	RFT, RFY <XU10J4/Z,L3>	2.0	110	03.93-12.98		R	4	58	1470	OZA527-E3	0201	S4CG	1919
2.0i Turbo	RGX <XU10J2CTE>	2.0	110	05.95-01.98		R	4	49	630	OZA527-E16	0434	S4CG	1919
2.0i 16V	RFT	2.0	114	03.93-12.96		R	4	58	1470	OZA527-E3	0201	S4CG	1919
2.0i 16V	RFY	2.0	114	03.93-12.96		R	4	58	1470	OZA527-E3	0201	S4CG	1919
2.1i Turbo	N01, W16 RFV <XU10J4R>	2.1	97	12.97-12.02		R	4	73	1460	OZA527-E33	1980	S4CG	1919

XM

2.0i	RDZ <XU10MZ>	2.0	79-81	05.91-06.94	Org. N. 5337 ->	R	4	58	1470	OZA527-E3	0201	S4CG	1919
2.0i	RFZ <XU10J2Z>	2.0	89-90	05.91-06.94	Org. N. 5337 ->	R	4	58	1470	OZA527-E3	0201	S4CG	1919
2.0i	R6A <XU10J2K>	2.0	90-96	05.91-06.94	Org. N. 5337 ->	R	4	58	1470	OZA527-E3	0201	S4CG	1919
2.0i 16V	RFV <XU10J4R>	2.0	97-99	07.94-10.00		R	4	58	1470	OZA527-E3	0201	S4CG	1919
2.0i 16V	RFV <XU10J4R>	2.0	99	07.94-10.00		R	4	49	1480	OZA448-E56	0481	S4	1952
2.0i Turbo	RGY <XU10J2TE/Z>	2.0	104-107	09.92-06.94		R	4	58	1470	OZA527-E3	0201	S4CG	1919
2.0i Turbo	RGX <XU10J2TE>	2.0	108	07.94-10.00		R	4	49	1480	OZA448-E56	0481	S4	1952

XSARA

1.4i	KFX <TU3JP+>	1.4	55	08.00-	Euro 2000	D	4	82	536	OZA341-PG5	1813	---	---
1.4i	KFX <TU3JP+>	1.4	55	08.00-	Euro 2000	R	4	83	536	OZA495-PG2	1852	---	---

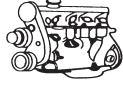

ℓ kW

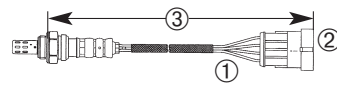
STOCK
NO.
UNIVERSAL
TYPE
NO.
INVERSIONE
ALN.
NO.

CITROEN

XSARA

1.4i	KFX <TU3JP>	1.4	55	07.97-12.97	Org. N. -> 7706	R	4	49	380	OZA448-E57	0492	S4	1952
1.4i	KFX <TU3JP>	1.4	55	07.97-08.00	Org. N. 7706 ->	R	4	73	370	OZA527-E29	0488	---	---
1.4i	KFX <TU3JP>	1.4	55	06.98-08.00	Euro 2000 / CEE 2000	R	4	83	380	OZA659-EE12	0386	---	---
1.4i	KFX <TU3JP>	1.4	55	06.98-08.00	Euro 2000 / CEE 2000	D	4	83	1230	OZA659-EE8	0382	---	---
1.4i Coupe	KFX <TU3JP>	1.4	55	07.97-08.00		R	4	49	380	OZA448-E57	0492	S4	1952
1.4i Coupe	KFX <TU3JP>	1.4	55	03.98-03.05	Org. N. -> 7729	R	4	73	370	OZA527-E29	0488	S4CG	1919
1.4i Coupe	KFX <TU3JP>	1.4	55	06.98-08.00	Euro 2000 / CEE 2000	R	4	83	380	OZA659-EE12	0386	---	---
1.4i Coupe	KFX <TU3JP>	1.4	55	06.98-08.00	Euro 2000 / CEE 2000	D	4	83	1230	OZA659-EE8	0382	---	---
1.4i Break	KFX <TU3JP>	1.4	55	04.98-08.00		R	4	73	370	OZA527-E29	0488	S4CG	1919
1.4i Break	KFX <TU3JP>	1.4	55	06.98-08.00	Euro 2000 / CEE 2000	R	4	83	380	OZA659-EE12	0386	---	---
1.4i Break	KFX <TU3JP>	1.4	55	06.98-08.00	Euro 2000 / CEE 2000	D	4	83	1230	OZA659-EE8	0382	---	---
1.6i	NFZ <TU5JP>	1.6	66	07.97-12.97	Org. N. -> 7706	R	4	49	380	OZA448-E57	0492	S4	1952
1.6i	NFZ <TU5JP>	1.6	66	01.98-08.00	Org. N. 7707 ->	R	4	83	380	OZA659-EE12	0386	---	---
1.6i	NFZ <TU5JP>	1.6	66	07.97-12.97	Org. N. 7729 ->	R	4	73	370	OZA527-E29	0488	S4CG	1919
1.6i Break	NFZ <TU5JP>	1.6	66	10.97-08.00	Org. N. 7729 ->	R	4	73	370	OZA527-E29	0488	S4CG	1919
1.6i Break	NFZ <TU5JP>	1.6	66	10.97-12.97	Org. N. -> 7706	R	4	49	380	OZA448-E57	0492	S4	1952
1.6i Break	NFZ <TU5JP>	1.6	66	01.98-08.00	Org. N. 7707 ->	R	4	83	380	OZA659-EE12	0386	---	---
1.8i	LFZ <XU7JP>	1.8	74	07.97-08.00	Euro 96, CEE 95, L3	R	4	111	1230	OZA660-EE24	5739	S4	1952
1.8i Break	LFZ <XU7JP>	1.8	74	04.98-08.00	Euro 96, CEE 95, L3	R	4	111	1230	OZA660-EE24	5739	S4	1952
1.8i Coupe	LFZ <XU7JP>	1.8	74	07.97-08.00	Euro 96, CEE 95, L3	R	4	111	1230	OZA660-EE24	5739	S4	1952
1.8i	L6A, LFZ <XU7JP>	1.8	75	07.97-09.98		R	4	73	530	OZA527-E34	1981	S4CG	1919
1.8i	L6A, LFZ <XU7JP>	1.8	75	10.98-08.00		R	4	73	1220	OZA527-E35	1982	S4CG	1919
1.8i Break	L6A, LFZ <XU7JP>	1.8	75	10.98-08.00		R	4	73	1220	OZA527-E35	1982	S4CG	1919
1.8i Coupe	L6A, LFZ <XU7JP>	1.8	75	07.97-09.98		R	4	73	530	OZA527-E34	1981	S4CG	1919
2.0i 16V	RFV <XU10J4R>	2.0	97	07.98-08.00		R	4	111	535	OZA660-EE23	5737	S4	1952
2.0i 16V	RFS <XU10J4RS>	2.0	120	07.97-08.00		R	4	111	1230	OZA660-EE24	5739	S4	1952
2.0i 16V Coupe	RFS <XU10J4RS>	2.0	120	02.98-08.00		R	4	111	1230	OZA660-EE24	5739	S4	1952

XSARA 2

1.6i 16V	NFU <TU5JP4>	1.6	80	09.00-		R	4	83	540	OZA659-EE4	0378	---	---
1.6i 16V	NFU <TU5JP4>	1.6	80	09.00-		D	4	82	535	OZA659-EE10	0384	---	---
1.8i 16V	6FZ <EW7J4>	1.8	85	09.00-	Euro 2000 (F)	R	4	83	536	OZA495-PG2	1852	---	---
1.8i 16V	6FZ <EW7J4>	1.8	85	09.00-	Euro 2000 (F)	D	4	82	1486	OZA341-PG7	1815	---	---
2.0i 16V	RFN <EW10J4>	2.0	100	09.00-		R	4	83	540	OZA659-EE4	0378	---	---
2.0i 16V	RFN <EW10J4>	2.0	100	09.00-		D	4	82	1490	OZA659-EE21	0395	---	---
2.0i 16V Coupe	RFS <XU10J4RS>	2.0	120	09.00-		R	4	83	1230	OZA659-EE8	0382	---	---
2.0i 16V Coupe	RFS <XU10J4RS>	2.0	120	09.00-		D	4	82	1490	OZA659-EE21	0395	---	---

XSARA PICASSO

1.6i	NFZ <TU5JP/L3>	1.6	66	01.00-		R	4	83	380	OZA659-EE12	0386	---	---
1.6i	<TU5JP>	1.6	67	06.02-		R	4	83	540	OZA659-EE4	0378	---	---
1.6i	<TU5JP>	1.6	67	06.02-		D	4	83	380	OZA659-EE12	0386	---	---
1.6i	NFV <TU5JP/L4>	1.6	74	01.00-		R	4	83	540	OZA659-EE4	0378	---	---
1.6i	NFV <TU5JP/L4>	1.6	74	01.00-		D	4	83	380	OZA659-EE12	0386	---	---
1.8i 16V	6FZ <EW7J4>	1.8	85	12.99-	Euro 2000	R	4	83	536	OZA495-PG2	1852	---	---
1.8i 16V	6FZ <EW7J4>	1.8	85	12.99-	Euro 2000	D	4	82	1486	OZA341-PG7	1815	---	---
2.0i 16V	RFN <EW10J4>	2.0	100	03.01-		R	4	83	540	OZA659-EE4	0378	---	---
2.0i 16V	RFN <EW10J4>	2.0	100	03.01-		D	4	82	1490	OZA659-EE21	0395	---	---
2.0i 16V	RFM <EW10J4>	2.0	100	03.01-		R	4	83	540	OZA659-EE4	0378	---	---
2.0i 16V	RFM <EW10J4>	2.0	100	03.01-		D	4	82	1490	OZA659-EE21	0395	---	---

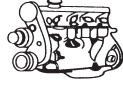

ℓ kW

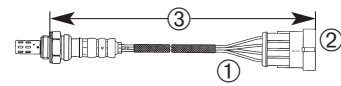
STOCK
NO.
UNIVERSAL
NO.
TYPE
NO.
INVENTORY
NO.

CITROEN

ZX

1.1i	HDY <TU1M>	1.1	44	07.95-08.96	Org. N. 6809 ->	R	4	49	1220	OZA527-E17	0445	S4CG	1919
1.1i	HDY <TU1M>	1.1	44	04.94-06.95	Org. N. ->6808	R	4	58	1470	OZA527-E3	0201	S4CG	1919
1.1i	HDY <TU1M+>	1.1	44	09.96-06.97		R	4	49	380	OZA448-E57	0492	S4	1952
1.1i	HDZ <TU1M+>	1.1	44	09.96-06.97	Euro 96	R	3	19	975	OZA446-E2	1855	S3	0412
1.1i	HDZ <TU1M>	1.1	44	10.91-03.94	Org. N. ->6808	R	4	58	1470	OZA527-E3	0201	S4CG	1919
1.1i	HDZ <TU1M+>	1.1	44	09.96-06.97		R	4	49	380	OZA448-E57	0492	S4	1952
1.4i	KFX <TU3JP>	1.4	55	05.96-10.97		R	4	73	370	OZA527-E29	0488	S4CG	1919
1.4i	KDX	1.4	55	09.94-06.95		R	4	58	450	OZA527-E12	0220	S4CG	1919
1.4i	KDX <TU3MC/Z>	1.4	55	07.95-08.96		R	4	49	375	OZA527-E15	0298	S4CG	1919
1.4i	KDX <TU3MC/Z>	1.4	55	07.95-08.96	Org. N. 6809 ->	R	4	49	1220	OZA527-E17	0445	S4CG	1919
1.4i	KDX <TU3MC/Z>	1.4	55	08.92-08.94	Org. N. 5538->6505	R	4	58	1470	OZA527-E3	0201	S4CG	1919
1.4i	KDX <TU3MC/Z>	1.4	55	09.94-06.95	Org. N. 6506->6808	R	4	58	1470	OZA527-E3	0201	S4CG	1919
1.4i	KDX <TU3MC/Z>	1.4	55	07.95-08.96	Org. N. 6809 ->	R	4	111	1230	OZA660-EE24	5739	S4	1952
					ABS / KLIMA								
1.4i Break	KDY <TU3M>	1.4	55	07.95-08.96	Org. N. 6809 ->	R	4	111	1230	OZA660-EE24	5739	S4	1952
					ABS / KLIMA								
1.4i	KFX <TU3JP>	1.4	55	05.96-10.97		R	4	49	380	OZA448-E57	0492	S4	1952
1.4i	KDY, HDY <TU3M/Z>	1.4	55	01.92-08.92	Org. N. 5538 ->	R	4	58	1470	OZA527-E3	0201	S4CG	1919
1.4i	KFX	1.4	55	06.96-10.97	Euro 96	R	3	19	975	OZA446-E2	1855	S3	0412
1.4i Break	KFX <TU3JP>	1.4	55	07.95-08.96	Org. N. 6809 ->	R	4	111	1230	OZA660-EE24	5739	S4	1952
					ABS / KLIMA								
1.6i	PRC <TU5JP>	1.6	63	10.96-06.97		R	4	73	370	OZA527-E29	0488	S4CG	1919
1.6i	B4A <XU5M/4K>	1.6	65	01.92-06.97	Org. N. 5538 ->	R	4	58	1470	OZA527-E3	0201	S4CG	1919
1.6i	BDY <XU5M/4Z>	1.6	65	01.92-12.94	Org. N. 5538 ->	R	4	58	1470	OZA527-E3	0201	S4CG	1919
1.6i Break	BDY <XU5M>	1.6	65	05.95-08.96	Org. N. 6749 - 7244	R	4	111	1230	OZA660-EE24	5739	S4	1952
1.6i Break	BDY <XU5M>	1.6	65	09.96-10.97	Org. N. 7245 ->	R	4	111	1230	OZA660-EE24	5739	S4	1952
1.6i	BFZ <XU5JP>	1.6	65	07.93-04.95	Org. N. ->6748	R	4	58	1470	OZA527-E3	0201	S4CG	1919
1.6i	BFZ <XU5JP>	1.6	65	05.95-06.97	Org. N. 6749 ->	R	4	49	1220	OZA527-E17	0445	S4CG	1919
1.6i Break	BFZ <XU5JP>	1.6	65	05.95-08.96	Org. N. 6749 - 7244	R	4	111	1230	OZA660-EE24	5739	S4	1952
1.6i Break	BFZ <XU5JP>	1.6	65	09.96-10.97	Org. N. 7245 ->	R	4	111	1230	OZA660-EE24	5739	S4	1952
1.6i	NFZ <TU5JP>	1.6	66	02.96-10.97		R	4	73	370	OZA527-E29	0488	S4CG	1919
1.8i	LFZ <XU7JP>	1.8	74	05.95-10.97	Org. N. 6749 ->	R	4	49	1220	OZA527-E17	0445	S4CG	1919
1.8i	LFZ <XU7JP>	1.8	74	07.92-04.95	Org. N. ->6748	R	4	58	1470	OZA527-E3	0201	S4CG	1919
1.8i	LFZ <XU7JP>	1.8	74	05.95-08.96	Org. N. 6749 -> 7244	R	4	111	1230	OZA660-EE24	5739	S4	1952
1.8i	LFZ <XU7JP>	1.8	74	09.96-06.97	Org. N. 7245 ->	R	4	111	1230	OZA660-EE24	5739	S4	1952
1.8i Break	LFZ <XU7JP>	1.8	74	05.95-08.96	Org. N. 6749 - 7244	R	4	111	1230	OZA660-EE24	5739	S4	1952
1.8i Break	LFZ <XU7JP>	1.8	74	09.96-10.97	Org. N. 7245 ->	R	4	111	1230	OZA660-EE24	5739	S4	1952
1.8i	L6A <XU7JP>	1.8	76	05.95-10.97	Org. N. 6749 ->	R	4	49	1220	OZA527-E17	0445	S4CG	1919
1.8i	L6A <XU7JP>	1.8	76	07.93-04.95	Org. N. ->6748	R	4	58	1470	OZA527-E3	0201	S4CG	1919
1.8i 16V	LFY <XU7JP4>	1.8	81	09.96-06.97		R	4	111	1230	OZA660-EE24	5739	S4	1952
1.8i 16V Break	LFY <XU7JP4>	1.8	81	09.96-02.98		R	4	111	1230	OZA660-EE24	5739	S4	1952
1.9i	DKZ <XU9JA>	1.9	88	05.95-08.96	Org. N. 6749 - 7244	R	4	111	1230	OZA660-EE24	5739	S4	1952
1.9i	DKZ <XU9JA>	1.9	88	03.91-06.97	Org. N. 7245 ->	R	4	111	1230	OZA660-EE24	5739	S4	1952
1.9i	DFY <XU9JAZ>	1.9	90	03.91-04.95	Org. N. ->6748	R	4	58	1470	OZA527-E3	0201	S4CG	1919
1.9i	DFY <XU9JAZ>	1.9	90	05.95-10.97	Org. N. 6749 ->	R	4	49	1220	OZA527-E17	0445	S4CG	1919
1.9i	DKZ <XU9JAZ>	1.9	90	03.91-04.95	Org. N. ->6748	R	4	58	1470	OZA527-E3	0201	S4CG	1919
1.9i	DKZ <XU9JAZ>	1.9	90	05.95-10.97	Org. N. 6749 ->	R	4	49	1220	OZA527-E17	0445	S4CG	1919
1.9i	D6E <XU9JA/K>	1.9	96	03.91-04.95	Org. N. ->6748	R	4	58	1470	OZA527-E3	0201	S4CG	1919
1.9i	D6E <XU9JA/K>	1.9	96	05.95-10.97	Org. N. 6749 ->	R	4	49	1220	OZA527-E17	0445	S4CG	1919
2.0i	RFX <XU10J2CZ>	2.0	89	05.95-10.97	Org. N. 6749 ->	R	4	49	1220	OZA527-E17	0445	S4CG	1919

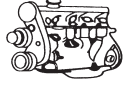

ℓ kW

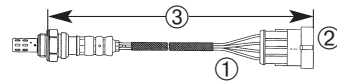

STOCK No.
UNIVERSAL No.
TYPE No.
CUMMINS No.

CITROEN

ZX

2.0i	RFX <XU10J2CZ>	2.0	89	07.92-04.95	Org. N. ->6748	R	4	58	1470	OZA527-E3	0201	S4CG	1919
2.0i	RFX <XU10J2C>	2.0	89	05.95-08.96	Org. N. 6749 - 7244	R	4	111	1230	OZA660-EE24	5739	S4	1952
2.0i	RFX <XU10J2C>	2.0	89	09.96-06.97	Org. N. 7245 ->	R	4	111	1230	OZA660-EE24	5739	S4	1952
2.0i	R6D <XU10J2>	2.0	90	07.93-04.95	Org. N. ->6748	R	4	58	1470	OZA527-E3	0201	S4CG	1919
2.0i	R6D <XU10J2>	2.0	90	05.95-10.97	Org. N. 6749 ->	R	4	49	1220	OZA527-E17	0445	S4CG	1919
2.0i 16V	RFT <XU10J4Z>	2.0	110	05.95-08.96	Org. N. 6749 - 7244	R	4	111	1230	OZA660-EE24	5739	S4	1952
2.0i 16V	RFT <XU10J4Z>	2.0	110	09.96-06.97	Org. N. 7245 ->	R	4	111	1230	OZA660-EE24	5739	S4	1952
2.0i 16V	RFT <XU10J4Z>	2.0	114	07.92-04.95	Org. N. ->6748	R	4	58	1470	OZA527-E3	0201	S4CG	1919
2.0i 16V	RFT <XU10J4Z>	2.0	114	05.95-06.97	Org. N. 6749 ->	R	4	49	1220	OZA527-E17	0445	S4CG	1919
2.0i 16V	RFY <XU10J4Z>	2.0	114	07.92-04.95	Org. N. ->6748	R	4	58	1470	OZA527-E3	0201	S4CG	1919
2.0i 16V	RFY <XU10J4Z>	2.0	114	05.95-06.97	Org. N. 6749 ->	R	4	49	1220	OZA527-E17	0445	S4CG	1919
2.0i 16V	RFS <XU10J4RS>	2.0	120	09.96-06.97		R	4	111	1230	OZA660-EE24	5739	S4	1952

DACIA

LOGAN

1.4 Mpi	K7J710	1.4	55	06.05-11.06		R	4	67	445	OZA507-R2	0480	---	---
1.4 Mpi	K7J710	1.4	55	06.05-11.06		D	4	67	260	OZA277-R1	1704	---	---
1.4 Mpi	K7J710	1.4	55	12.06-		D	4	101	239	OZA277-R3	6514	---	---
1.6 Mpi	K7M710	1.6	66	06.05-11.06		R	4	67	445	OZA507-R2	0480	---	---
1.6 Mpi	K7M710	1.6	66	06.05-11.06		D	4	67	260	OZA277-R1	1704	---	---
1.6 Mpi	K7M710	1.6	66	12.06-		D	4	101	239	OZA277-R3	6514	---	---
1.6 Mpi	K7M716	1.6	66	06.05-		R	4	101	424	OZA507-R5	6517	---	---
1.6 Mpi	K7M716	1.6	66	06.05-		D	4	101	239	OZA277-R3	6514	---	---
1.6i 16V	K4M690	1.6	78	02.06-		R	4	101	424	OZA507-R5	6517	---	---
1.6i 16V	K4M690	1.6	78	02.06-		D	4	101	239	OZA277-R3	6514	---	---
1.6i 16V	K4M697	1.6	78	02.06-		R	4	101	424	OZA507-R5	6517	---	---
1.6i 16V	K4M697	1.6	78	02.06-		D	4	101	239	OZA277-R3	6514	---	---

SANDERO

1.4 Mpi	K7J710	1.4	55	06.08-		R	4	67	445	OZA507-R2	0480	---	---
1.4 Mpi	K7J710	1.4	55	06.08-		D	4	67	260	OZA277-R1	1704	---	---
1.6 Mpi	K7M	1.6	66	06.08-		R	4	67	445	OZA507-R2	0480	---	---
1.6 Mpi	K7M	1.6	66	06.08-		D	4	67	260	OZA277-R1	1704	---	---

SOLENZIA

1.4i	E7J 260	1.4	55	04.03-		R	4	67	210	OZA507-R1	6515	---	---
1.4i	E7J 260	1.4	55	04.03-		D	4	67	260	OZA277-R1	1704	---	---
1.4i	E7J 262	1.4	55	04.03-		R	4	67	210	OZA507-R1	6515	---	---
1.4i	E7J 262	1.4	55	04.03-		D	4	67	260	OZA277-R1	1704	---	---

SUPERNOVA

1.4i	E7J 260	1.4	55	04.03-		R	4	67	210	OZA507-R1	6515	---	---
1.4i	E7J 260	1.4	55	04.03-		D	4	67	260	OZA277-R1	1704	---	---
1.4i	E7J 262	1.4	55	04.03-		R	4	67	210	OZA507-R1	6515	---	---
1.4i	E7J 262	1.4	55	04.03-		D	4	67	260	OZA277-R1	1704	---	---

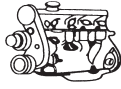

ℓ kW

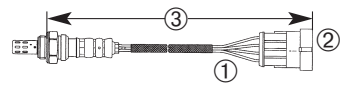
STOCK
REVERSE
TYPE
UNIVERSAL
NO.
NO.
NO.

DAEWOO

ESPERO

1.5i 16V	A15MF	1.5	66	02.95-06.97		R	1	6	320	OZA401-E6	1882	S1	1951
1.8i	C18LE	1.8	66	02.95-06.97		R	1	6	320	OZA401-E6	1882	S1	1951
2.0i	C20LE	2.0	77	02.95-06.97		R	1	6	320	OZA401-E6	1882	S1	1951

KALOS

1.4i 16V		1.4	69	04.03-02.05		R	4	42	310	OZA341-W2	0440	---	---
1.4i 16V		1.4	69	04.03-02.05		D	4	42	310	OZA341-W2	0440	---	---

LACETTI

1.4i 16V		1.4	70	02.04-		R	4	31	400	OZA629-W2	0017	---	---
----------	--	-----	----	--------	--	---	---	----	-----	-----------	------	-----	-----

LANOS

1.5	A15SMS	1.5	63	05.97-		R	1	6	320	OZA401-E6	1882	S1	1951
-----	--------	-----	----	--------	--	---	---	---	-----	-----------	------	----	------

LEGANZA

2.2i	T22SED	2.2	100	04.99-12.02		R	4	42	310	OZA341-W2	0440	---	---
------	--------	-----	-----	-------------	--	---	---	----	-----	-----------	------	-----	-----

MATIZ

0.8i	F8CV	0.8	38	09.98-12.03	Euro II	R	4	42	310	OZA341-W2	0440	---	---
0.8i	F8CV	0.8	38	01.04-	Euro IV	R	4	31	310	OZA629-W6	0019	---	---
0.8i	F8CV	0.8	38	01.04-	Euro IV	D	4	102	380	OZA610-W2	0014	---	---
1.0i		1.0	47	01.03-12.03	Euro II	R	4	31	510	OZA629-W5	0018	---	---
1.0i		1.0	47	01.04-	Euro IV	R	4	31	510	OZA629-W5	0018	---	---
1.0i		1.0	47	01.04-	Euro IV	D	4	102	350	OZA610-W5	0015	---	---

NEXIA

1.5	G15MF	1.5	55	02.95-08.97		R	1	6	320	OZA401-E6	1882	S1	1951
1.5i 16V	A15MF	1.5	66	02.95-08.97		R	1	6	320	OZA401-E6	1882	S1	1951

NUBIRA

1.6i	A16DMS	1.6	76	07.00-		D	4	113	220	OZA341-W1	6408	---	---
------	--------	-----	----	--------	--	---	---	-----	-----	-----------	------	-----	-----

REZZO

1.6i	A16DMS	1.6	77	09.00-		D	4	113	220	OZA341-W1	6408	---	---
1.8i	F18D2	1.8	67	09.00-		D	4	113	220	OZA341-W1	6408	---	---
1.8i	A18DMS	1.8	72	09.00-		D	4	113	220	OZA341-W1	6408	---	---
1.8i		1.8	74	09.00-		D	4	113	220	OZA341-W1	6408	---	---

ROYAL

2.0i Salon	H20MR	2.0	94	01.88-12.89		R	3	19	490	OZA446-E11	1898	S3	0412
------------	-------	-----	----	-------------	--	---	---	----	-----	------------	------	----	------

DAIHATSU

APPLAUSE I

1.6 16V	HD-E	1.6	77	06.89-07.97	Universal	R	1	---	---	OZA624-E1	1951	S1	1951
1.6 16V 4WD	HD-E	1.6	77	06.89-07.97	Universal	R	1	---	---	OZA624-E1	1951	S1	1951

CHARADE III

1.0	CB 90	1.0	40	11.90-12.92	Universal	R	1	---	---	OZA624-E1	1951	S1	1951
1.3i	HCE	1.3	66	06.88-12.92	Universal	R	1	---	---	OZA624-E1	1951	S1	1951
1.3i 4WD	HCE	1.3	66	06.88-12.92	Universal	R	1	---	---	OZA624-E1	1951	S1	1951

CUORE II

0.8	ED 10	0.8	29	12.89-12.90	Universal	R	1	---	---	OZA624-E1	1951	S1	1951
0.8	ED 10	0.8	32	09.88-06.90	Universal	R	1	---	---	OZA624-E1	1951	S1	1951

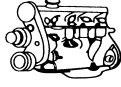

ℓ kW

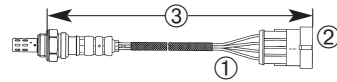

ORDER No.
STOCK No.
UNIVERSAL No.
TYPE No.
UNIVERSAL No.
SUPPLIER No.

DAIHATSU

CUORE II

0.8 4WD	ED 10	0.8	32	09.88-06.90	Universal	R	1	---	---	OZA624-E1	1951	S1	1951
---------	-------	-----	----	-------------	-----------	---	---	-----	-----	-----------	------	----	------

CUORE IV

0.8	ED 20	0.8	32	01.95-11.96	Universal	R	1	---	---	OZA624-E1	1951	S1	1951
-----	-------	-----	----	-------------	-----------	---	---	-----	-----	-----------	------	----	------

CUORE V

0.8	EF-EL	0.8	31	11.96-10.98	Universal	R	1	---	---	OZA624-E1	1951	S1	1951
-----	-------	-----	----	-------------	-----------	---	---	-----	-----	-----------	------	----	------

FEROZA

1.6i 16V Hard Top	HD-E	1.6	70	01.89-12.95	Universal	R	1	---	---	OZA624-E1	1951	S1	1951
-------------------	------	-----	----	-------------	-----------	---	---	-----	-----	-----------	------	----	------

1.6i 16V Soft Top	HD-E	1.6	70	01.89-12.95	Universal	R	1	---	---	OZA624-E1	1951	S1	1951
-------------------	------	-----	----	-------------	-----------	---	---	-----	-----	-----------	------	----	------

MOVE

0.8	ED 20	0.8	31	10.96-01.98	Universal	R	1	---	---	OZA624-E1	1951	S1	1951
-----	-------	-----	----	-------------	-----------	---	---	-----	-----	-----------	------	----	------

SIRION

1.0i 4WD	EJ-DE	1.0	41	04.99-09.00		D	4	34	275	OZA502-E31	0250	S4	1952
----------	-------	-----	----	-------------	--	---	---	----	-----	------------	------	----	------

1.0i 12V	1KR-FE	1.0	51	01.05-		R	4	123	275	OZA659-EE62	7916	---	---
----------	--------	-----	----	--------	--	---	---	-----	-----	-------------	------	-----	-----

1.0i 12V	1KR-FE	1.0	51	01.05-		D	4	34	290	OZA659-EE63	7948	---	---
----------	--------	-----	----	--------	--	---	---	----	-----	-------------	------	-----	-----

YRV

1.3i	K3-VE	1.3	64	02.01-		R	4	34	275	OZA502-E31	0250	S4	1952
------	-------	-----	----	--------	--	---	---	----	-----	------------	------	----	------

1.3i 4WD	K3-VE	1.3	64	02.01-		R	4	34	275	OZA502-E31	0250	S4	1952
----------	-------	-----	----	--------	--	---	---	----	-----	------------	------	----	------

DAIMLER

SOVEREIGN

3.2	AJ6	3.2		94- 98		D	4	56	730	OTD3J-5B1	0464	---	---
-----	-----	-----	--	--------	--	---	---	----	-----	-----------	------	-----	-----

4.0	AJ6	4.0		94- 98		D	4	56	730	OTD3J-5B1	0464	---	---
-----	-----	-----	--	--------	--	---	---	----	-----	-----------	------	-----	-----

DODGE

CARAVAN

2.4i	EDZ	2.4	111	01.04-		R	4	89	425	OZA571-C2	6384	---	---
------	-----	-----	-----	--------	--	---	---	----	-----	-----------	------	-----	-----

2.4i	EDZ	2.4	111	01.04-		D	4	117	457	OZA571-C7	6396	---	---
------	-----	-----	-----	--------	--	---	---	-----	-----	-----------	------	-----	-----

3.3i		3.3	147	01.04-		D	4	117	457	OZA571-C7	6396	---	---
------	--	-----	-----	--------	--	---	---	-----	-----	-----------	------	-----	-----

GRAND CARAVAN

3.3i		3.3	147	01.04-		D	4	117	457	OZA571-C7	6396	---	---
------	--	-----	-----	--------	--	---	---	-----	-----	-----------	------	-----	-----

3.8i		3.8	169	01.04-		D	4	117	457	OZA571-C7	6396	---	---
------	--	-----	-----	--------	--	---	---	-----	-----	-----------	------	-----	-----

INTEPID

2.7i		2.7	149	01.03-12.04	Y	R	4	116	300	OZA571-C4	6385	---	---
------	--	-----	-----	-------------	---	---	---	-----	-----	-----------	------	-----	-----

2.7i		2.7	149	01.03-12.04	Y	R	4	116	300	OZA571-C4	6385	---	---
------	--	-----	-----	-------------	---	---	---	-----	-----	-----------	------	-----	-----

3.5i		3.5	186	01.03-12.04	Y	R	4	116	300	OZA571-C4	6385	---	---
------	--	-----	-----	-------------	---	---	---	-----	-----	-----------	------	-----	-----

3.5i		3.5	186	01.03-12.04	Y	R	4	116	300	OZA571-C4	6385	---	---
------	--	-----	-----	-------------	---	---	---	-----	-----	-----------	------	-----	-----

NEON

2.0i		2.0	89	01.04-		R	4	117	457	OZA571-C7	6396	---	---
------	--	-----	----	--------	--	---	---	-----	-----	-----------	------	-----	-----

2.4i	SRT-4	2.4		01.04-		R	4	89	425	OZA571-C2	6384	---	---
------	-------	-----	--	--------	--	---	---	----	-----	-----------	------	-----	-----

STRATUS

2.4i	EDZ	2.4	112	01.01-12.04		D	4	115	380	OZA521-C8	6383	---	---
------	-----	-----	-----	-------------	--	---	---	-----	-----	-----------	------	-----	-----

2.4i	EDZ	2.4	112	01.06-		R	4	89	425	OZA571-C2	6384	---	---
------	-----	-----	-----	--------	--	---	---	----	-----	-----------	------	-----	-----

2.4i	EDZ	2.4	112	01.06-		D	4	89	425	OZA571-C2	6384	---	---
------	-----	-----	-----	--------	--	---	---	----	-----	-----------	------	-----	-----

2.5i V6		2.5	125	01.98-12.99		R	3	19	490	OZA446-E11	1898	S3	0412
---------	--	-----	-----	-------------	--	---	---	----	-----	------------	------	----	------

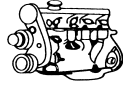

ℓ kW



STOCK
ORDER
No.
UNIVERSAL
TYPE
No.
UNIVERSAL
TYPE
No.

DODGE

STRATUS

2.7i		2.7	149	01.01-12.04	Y	R	4	115	380	OZA521-C8	6383	---	---
2.7i		2.7	149	01.01-12.04	Y	R	4	115	380	OZA521-C8	6383	---	---
2.7i		2.7	149	01.01-12.04	Y	D	4	115	380	OZA521-C8	6383	---	---
2.7i		2.7	149	01.01-12.04	Y	D	4	115	380	OZA521-C8	6383	---	---
2.7i	EES	2.7	149	01.05-	Y	R	4	89	425	OZA571-C2	6384	---	---
2.7i	EES	2.7	149	01.05-	Y	R	4	89	425	OZA571-C2	6384	---	---
2.7i	EES	2.7	149	01.05-	Y	D	4	89	425	OZA571-C2	6384	---	---
2.7i	EES	2.7	149	01.05-	Y	D	4	89	425	OZA571-C2	6384	---	---

FERRARI

348

TB Coupe	F119F000	3.4	217-221	02.90-04.94		R	4	38	880	OZA527-E4	0218	S4CG	1919
TS Spider	F119F000	3.4	217-221	08.90-04.94		R	4	38	880	OZA527-E4	0218	S4CG	1919

512

TR	F113D00 / 40	5.0	315	01.92-10.94		R	4	38	880	OZA527-E4	0218	S4CG	1919
----	--------------	-----	-----	-------------	--	---	---	----	-----	-----------	------	------	------

MONDIAL

3.2 Quattrovalvole	F105C..	3.2	191	01.86-12.87		R	3	19	670	OZA446-E1	1833	S3	0412
--------------------	---------	-----	-----	-------------	--	---	---	----	-----	-----------	------	----	------

TESTAROSSA

4.9	F113B..	4.9	272	08.86-10.91		R	3	19	670	OZA446-E1	1833	S3	0412
-----	---------	-----	-----	-------------	--	---	---	----	-----	-----------	------	----	------

FIAT

500

1.2i.e.	169A4.000	1.2	51	07.07-		R	4	104	310	OZA641-A1	1726	---	---
1.2i.e.	169A4.000	1.2	51	07.07-		D	4	104	310	OZA641-A1	1726	---	---
1.3 MJTD	169A1.000	1.3	55	07.07-		R	5	91	610	LZA15-A5	1727	---	---
1.4i.e.	169A3.000	1.4	74	07.07-		R	4	40	300	OZA659-EE3	0377	---	---
1.4i.e.	169A3.000	1.4	74	07.07-		D	4	40	300	OZA659-EE3	0377	---	---

ALBEA

1.2i 8V	188A4.000	1.2	44	01.02-		R	4	40	300	OZA659-EE3	0377	---	---
1.2i 8V	188A4.000	1.2	44	01.02-		D	4	40	300	OZA659-EE3	0377	---	---
1.2i 16V	188A5.000	1.2	59	01.02-		R	4	40	300	OZA675-EE1	7978	---	---
1.2i 16V	188A5.000	1.2	59	01.02-		D	4	40	300	OZA675-EE1	7978	---	---
1.4i 8V	350A1.000	1.4	57	07.06-		R	4	40	300	OZA659-EE3	0377	---	---
1.4i 8V	350A1.000	1.4	57	07.06-		D	4	40	300	OZA659-EE3	0377	---	---

BARCETTA

1.8i 16V	183A1.000	1.8	96	04.95-05.98		R	4	31	300	OZA112-A2	0225	S4	1952
1.8i 16V	183A1.000	1.8	96	06.98-10.00		R	4	40	310	OZA334-A3	0245	---	---
1.8i 16V	188A6.000	1.8	96	10.00-12.05	2↑	R	4	40	260	OZA532-A3	0409	---	---
1.8i 16V	188A6.000	1.8	96	10.00-12.05		D	4	40	260	OZA532-A3	0409	---	---

BRAVA

1.2i 16V	182B2.000	1.2	60	11.98-09.01		R	4	40	300	OZA675-EE1	7978	---	---
1.2i 16V	188A5.000	1.2	60	08.00-09.01		R	4	40	300	OZA675-EE1	7978	---	---
1.2i 16V	188A5.000	1.2	60	08.00-09.01		D	4	40	600	OZA659-EE31	1613	---	---
1.4i 12V	182A5.000	1.4	55	10.95-10.98	4029960->	R	4	40	378	OZA527-E19	0296	S4CG	1919

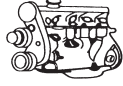

ℓ kW

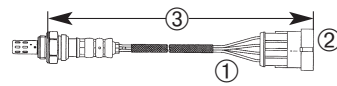
STOCK
NO.
UNIVERSAL
TYPE
NO.
UNIVERSAL
NO.

FIAT

500

1.4i 12V	182A3.000	1.4	59	10.95-02.98	4029960->	R	4	40	378	OZA527-E19	0296	S4CG	1919
1.6i 16V	182A4.000	1.6	74	10.95-04.98		R	4	31	850	OZA112-A1	0146	S4	1952
100 16V	182A4.000	1.6	74	12.98-10.00		R	4	40	610	OZA334-A1	0223	---	---
1.6i 16V	182A4.000	1.6	74	05.98-11.98		R	4	40	610	OZA334-A1	0223	---	---
1.8i 16V	182A2.000	1.8	84	10.95-06.99		R	4	31	600	OZA112-A3	0157	S4	1952
1.8i 16V- 115 CV	182A2.000	1.8	85	07.99-06.00	Phase 2	R	4	40	310	OZA341-A1	1798	---	---

BRAVO

1.2i 16V	182B2.000	1.2	60	11.98-09.01		R	4	40	300	OZA675-EE1	7978	---	---
1.2i 16V	188A5.000	1.2	60	08.00-09.01		R	4	40	300	OZA675-EE1	7978	---	---
1.2i 16V	188A5.000	1.2	60	08.00-09.01		D	4	40	600	OZA659-EE31	1613	---	---
1.4 12V	182A5.000	1.4	55	10.95-10.98		R	4	40	378	OZA527-E19	0296	S4CG	1919
1.4 12V	182A3.000	1.4	59	10.95-02.98		R	4	40	378	OZA527-E19	0296	S4CG	1919
1.4 T-Jet		1.4	110	09.07-		R	4	40	300	OZA659-EE3	0377	---	---
1.4 T-Jet		1.4	110	09.07-		D	4	40	600	OZA659-EE56	7863	---	---
1.6 16V	182A4.000	1.6	74	10.95-04.98		R	4	31	850	OZA112-A1	0146	S4	1952
100 16V	182A4.000	1.6	74	12.98-10.00		R	4	40	610	OZA334-A1	0223	---	---
1.6i 16V	182A4.000	1.6	74	05.98-11.98		R	4	40	610	OZA334-A1	0223	---	---
1.8 16V GT	182A2.000	1.8	84	10.95-06.99		R	4	31	600	OZA112-A3	0157	S4	1952
1.8 16V- 115 CV	182A2.000	1.8	85	07.99-06.00	Phase 2	R	4	40	310	OZA341-A1	1798	---	---
2.0i 20V	182A1.000	2.0	108	10.95-10.98		R	4	40	972	OZA527-E7	0213	S4CG	1919
2.0i 20V	182B7.000	2.0	113	11.98-09.01		R	4	40	600	OZA659-EE31	1613	---	---

CINQUECENTO

700i	170 A.000	0.7	23	07.94-09.98		R	1	2	650	OZA65-A2	1889	S1	1951
900i	170A1.046 /-->9147274	0.9	30	10.91-03.95		R	4	38	880	OZA527-E4	0218	S4CG	1919
900i	170A1.046 /9147275-->	0.9	30	03.95-07.98		R	4	40	972	OZA527-E7	0213	S4CG	1919
1100i Sporting	176B2.000	1.1	40	10.94-07.98		R	4	40	378	OZA527-E19	0296	S4CG	1919

COUPÉ

1.8i 16V	183A1.000	1.8	96	02.96-05.98		R	4	31	600	OZA112-A3	0157	S4	1952
1.8i 16V	183A1.000	1.8	96	06.98-12-00		R	4	40	980	OZA334-A2	0234	---	---
2.0i 16V	836A3.000 / M1	2.0	104	05.95-09.96		R	3	22	890	OZA446-E18	1887	S3	0412
2.0i 16V	836A3.000 / M1	2.0	104	04.94-05.95		R	3	19	895	OZA446-E4	1877	S3	0412
2.0i 16V	836A3.011 / M3	2.0	104	04.94-09.96		R	4	40	972	OZA527-E7	0213	S4CG	1919
2.0i 20V	182A1.000 / M2	2.0	108	09.96-02.00		R	4	40	972	OZA527-E7	0213	S4CG	1919
2.0i 20V	182A1.000	2.0	108	10.96-02.00		R	4	40	972	OZA527-E7	0213	S4CG	1919
2.0i 20V	182B3.000	2.0	113	04.98-09.00		R	4	40	600	OZA659-EE31	1613	---	---
2.0i 20V Turbo	175A3.000/M3	2.0	162	09.96-02.00		R	4	40	972	OZA527-E7	0213	S4CG	1919
2.0i	175A1.000/M2	2.0	143	04.94-09.96		R	3	19	975	OZA446-E2	1855	S3	0412

CROMA

2.0i.e.	834B048	2.0	83-85	03.86-09.90		R	3	19	670	OZA446-E1	1833	S3	0412
2.0i.e.	834B146	2.0	85	11.92-12.96		R	3	19	670	OZA446-E1	1833	S3	0412
2.0i.e.16V	154E1.000	2.0	101	11.92-12.96		R	4	38	880	OZA527-E4	0218	S4CG	1919
2.0i.e.Turbo	154C4.046	2.0	110	10.90-12.96		R	3	19	670	OZA446-E1	1833	S3	0412
2.0i.e.Turbo	834C146	2.0	110-114	07.86-09.90		R	3	19	670	OZA446-E1	1833	S3	0412
2.5i.e.	834G.000	2.5	117	06.93-12.96		R	4	38	1130	OZA527-E5	0253	S4CG	1919

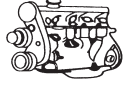

ℓ kW

ORDINE
STOCK
 No.
UNIVERSAL
 No.
TYPE
PER
NUMERO
ORDINE
 No.

FIAT

CROMA (MY05)

1.8i 16V	939A4.000	1.8	103	06.05-		R	4	74	471	OZA334-SZ5	1705	---	---
2.2i	194A1.000	2.2	108	05.05-		D	4	74	1485	OZA531-GM24	0055	---	---

DOBLÒ

1.2i.e. 8V	223A5.000	1.2	48	07.00-09.05		R	4	40	300	OZA659-EE3	0377	---	---
1.2i.e. 8V	223A5.000	1.2	48	07.00-01.04		D	4	40	1170	OZA659-EE30	1612	---	---
1.2i.e. 8V	223A5.000	1.2	48	02.04-09.05		D	4	40	300	OZA659-EE3	0377	---	---
1.4i.e.	350A1.000	1.4	55	10.05-		R	4	40	300	OZA659-EE3	0377	---	---
1.4i.e.	350A1.000	1.4	55	10.05-		D	4	40	300	OZA659-EE3	0377	---	---
1.6i.e. 16V	182B6.000	1.6	76	10.01-09.05		R	4	40	400	OZA659-EE49	5753	---	---
1.6i.e. 16V	182B6.000	1.6	76	10.01-01.04		D	4	40	1170	OZA659-EE30	1612	---	---
1.6i.e. 16V	182B6.000	1.6	76	02.04-09.05		D	4	40	400	OZA659-EE49	5753	---	---
1.6i.e. 16V Bipower	182B6.000	1.6	76	01.03-01.04		D	4	40	1170	OZA659-EE30	1612	---	---
1.6i 16V CNG	182B6.000	1.6	76	11.02-		R	4	40	410	OZA534-A2	1764	---	---
1.6i 16V CNG	182B6.000	1.6	76	11.02-		D	4	40	410	OZA534-A2	1764	---	---

DUCATO

2.0i.e.	RFW	2.0	80	03.94-		R	4	49	1480	OZA448-E56	0481	S4	1952
2.0i.e. 4x4	RFW	2.0	80	03.94-		R	4	49	1480	OZA448-E56	0481	S4	1952
14 (94)	RFW	2.0	80	03.94-12.02		R	4	58	1470	OZA527-E3	0201	S4CG	1919
10 (94)	RFW	2.0	80	03.94-12.02		R	4	58	1470	OZA527-E3	0201	S4CG	1919
18 (94)	RFW	2.0	80	03.94-12.02		R	4	58	1470	OZA527-E3	0201	S4CG	1919
2.0 Panorama	170D	2.0	62	09.88-06.90		R	3	45	510	OZA446-E48	0280	S3	0412
2.0 Panorama	170D	2.0	62	07.90-02.94		R	3	45	510	OZA446-E48	0280	S3	0412

FIORINO

1.4 i.e.	146D5.000	1.4	49	06.95-12.00		R	4	40	972	OZA527-E7	0213	S4CG	1919
1.4i.e.	146D5.000	1.4	51	06.95-12.00		R	4	40	972	OZA527-E7	0213	S4CG	1919
1.4i.e.	146C5.000	1.4	52	09.93-06.95		R	3	19	895	OZA446-E4	1877	S3	0412
1.5i.e.	149C1.000	1.5	55	01.88-08.93		R	3	19	895	OZA446-E4	1877	S3	0412
1.6i.e.	146C6.000	1.6	59	09.93-06.95		R	3	19	895	OZA446-E4	1877	S3	0412
1.6 i.e.	146D6.000	1.6	59	06.95-12.00		R	4	40	972	OZA527-E7	0213	S4CG	1919

IDEA

1.2i.e. 16V	188A5.000	1.2	59	01.04-		R	4	40	300	OZA675-EE1	7978	---	---
1.2i.e. 16V	188A5.000	1.2	59	01.04-		D	4	40	300	OZA675-EE1	7978	---	---
1.3 MJT	199A2.000	1.3	51	09.05-		R	5	91	318	LZA15-A3	0031	---	---
1.3 MJT	199A3.000	1.3	66	09.05-		R	5	91	318	LZA15-A3	0031	---	---
1.4i.e. 8V	350A1.000	1.4	57	10.05-		R	4	40	300	OZA659-EE3	0377	---	---
1.4i.e. 8V	350A1.000	1.4	57	10.05-		D	4	40	300	OZA659-EE3	0377	---	---
1.4i.e. 16V	192B2.000	1.4	66	10.04-		R	4	40	300	OZA675-EE1	7978	---	---
1.4i.e. 16V	192B2.000	1.4	66	10.04-		D	4	40	300	OZA675-EE1	7978	---	---
1.4i.e. 16V	843A1.000	1.4	70	10.04-		R	4	40	300	OZA675-EE1	7978	---	---
1.4i.e. 16V	843A1.000	1.4	70	10.04-		D	4	40	300	OZA675-EE1	7978	---	---

LINEA

1.3 JTD	199A3.000	1.3	66	04.07-		R	5	91	610	LZA15-A5	1727	---	---
1.4 T-Jet		1.4	88	09.07-		R	4	40	300	OZA659-EE3	0377	---	---
1.4 T-Jet		1.4	88	09.07-		D	4	40	600	OZA659-EE56	7863	---	---

MAREA

1.2i.e. 16V	182B2.000	1.2	60	03.99-09.02		R	4	40	300	OZA675-EE1	7978	---	---
1.4i 12V / Weekend	182A3.000	1.4	59	10.96-02.98	SPI-Bosch	R	4	40	378	OZA527-E19	0296	S4CG	1919

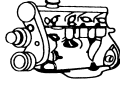

ℓ kW

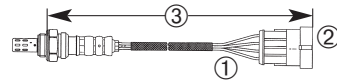

STOCK No. TYPE No. UNIVERSAL No. SPORES No.

FIAT

MAREA

1.6i 16V Weekend	182A4.000	1.6	74	09.96-11.98		R	4	31	850	OZA112-A1	0146	S4	1952
1.6i 16V Weekend	182A4.000	1.6	74	09.96-04.98		R	4	31	850	OZA112-A1	0146	S4	1952
1.6i 16V Bi -Power	185A3.000	1.6	74	11.97-11.98		R	4	31	850	OZA112-A1	0146	S4	1952
1.6i 16V	182A4.000	1.6	74	09.96-04.98		R	4	31	850	OZA112-A1	0146	S4	1952
100 16V Bi - Power	185A3.000	1.6	74	12.98-10.00		R	4	40	610	OZA334-A1	0223	---	---
1.6i 16V Weekend	182A4.000	1.6	74	05.98-11.98		R	4	40	610	OZA334-A1	0223	---	---
100 16V Weekend	182A4.000	1.6	74	12.98-06.00		R	4	40	610	OZA334-A1	0223	---	---
1.6i 16V	182A4.000	1.6	74	05.98-11.98		R	4	40	610	OZA334-A1	0223	---	---
100 16V	182A4.000	1.6	74	12.98-06.00		R	4	40	610	OZA334-A1	0223	---	---
1.6i 16V	182A4.000	1.6	75	11.00-12.02		D	4	40	980	OZA532-A1	0478	---	---
1.6i 16V	182B6.000	1.6	75	11.00-12.02		R	4	40	610	OZA534-A1	1762	---	---
1.8i 16V Weekend	182A2.000	1.8	84	09.96-06.99		R	4	31	600	OZA112-A3	0157	S4	1952
1.8i 16V	182A2.000	1.8	84	09.96-06.99		R	4	31	600	OZA112-A3	0157	S4	1952
1.8 16V	182A4.000	1.8	85	07.99-10.00	Phase 2	R	4	40	310	OZA341-A1	1798	---	---
2.0i 20V	182A1.000	2.0	108	10.96-06.99		R	4	40	972	OZA527-E7	0213	S4CG	1919
2.0i 20V Weekend	182A1.000	2.0	108	10.96-02.99		R	4	40	972	OZA527-E7	0213	S4CG	1919
2.0i 20V	185A8.000	2.0	110	08.00-12.02		R	4	40	300	OZA659-EE3	0377	---	---
2.0i 20V	185A8.000	2.0	110	08.00-12.02		D	4	40	300	OZA659-EE3	0377	---	---
2.0i 20V	182B7.000	2.0	113	03.99-12.02		R	4	40	600	OZA659-EE31	1613	---	---

MULTIPLA

1.6i 16V	182A4.000	1.6	75	01.99-09.00		R	4	40	980	OZA334-A2	0234	---	---
1.6i 16V Blu-Power	182A3.000	1.6	75	01.99-09.00		R	4	40	980	OZA334-A2	0234	---	---
1.6i 16V Bi-Power	182A4.000	1.6	75	01.99-12.00		R	4	40	980	OZA334-A2	0234	---	---
1.6i 16V	182B6.000	1.6	75	10.00-		R	4	40	610	OZA534-A1	1762	---	---
1.6i 16V	182B6.000	1.6	75	10.00-		D	4	40	980	OZA532-A1	0478	---	---
1.6i 16V Bi-Power	182B6.000	1.6	75	10.00-		R	4	40	610	OZA534-A1	1762	---	---
1.6i 16V Bi-Power	182B6.000	1.6	75	10.00-		D	4	40	980	OZA532-A1	0478	---	---
1.6i 16V Blu-Power	182B6.000	1.6	75	10.00-		R	4	40	610	OZA534-A1	1762	---	---
1.6i 16V Blu-Power	182B6.000	1.6	75	10.00-		D	4	40	980	OZA532-A1	0478	---	---
1.6i 16V ELX	182B6.000	1.6	75	10.00-		R	4	40	610	OZA534-A1	1762	---	---
1.6i 16V ELX	182B6.000	1.6	75	10.00-		D	4	40	980	OZA532-A1	0478	---	---
1.6i 16V SX	182B6.000	1.6	75	10.00-		R	4	40	610	OZA534-A1	1762	---	---
1.6i 16V SX	182B6.000	1.6	75	10.00-		D	4	40	980	OZA532-A1	0478	---	---

PALIO

1.0i 16V	178D8.011	1.0	52	08.00-02.03		R	4	40	400	OZA659-EE49	5753	---	---
1.0i 16V Weekend	178D8.011	1.0	52	09.00-02.03		R	4	40	400	OZA659-EE49	5753	---	---
1.2i 8V	188A4.000	1.2	44	01.01-		R	4	40	300	OZA659-EE3	0377	---	---
1.2i 8V	188A4.000	1.2	44	01.01-		D	4	40	300	OZA659-EE3	0377	---	---
1.2i 8V Weekend	188A4.000	1.2	44	10.01-		R	4	40	300	OZA659-EE3	0377	---	---
1.2i 8V Weekend	188A4.000	1.2	44	10.01-		D	4	40	300	OZA659-EE3	0377	---	---
1.2i 8V	178B5.000	1.2	44	01.01-09.01		D	4	40	300	OZA659-EE3	0377	---	---
1.2i.e.	178B5.000	1.2	54	10.97-12.00		R	4	40	400	OZA112-A6	1759	S4	1952
1.2i.e. Weekend	188A4.000	1.2	54	08.00-09.01		R	4	40	300	OZA659-EE3	0377	---	---
1.2i.e. Weekend	188A4.000	1.2	54	10.01-09.04		R	4	40	300	OZA659-EE3	0377	---	---
1.2i.e. Weekend	188A4.000	1.2	54	10.01-09.04		D	4	40	300	OZA659-EE3	0377	---	---
1.2i 16V	188A5.000	1.2	59	10.01-		R	4	40	300	OZA675-EE1	7978	---	---
1.2i 16V	188A5.000	1.2	59	10.01-		D	4	40	300	OZA675-EE1	7978	---	---
1.2i 16V Weekend	188A5.000	1.2	59	10.01-		R	4	40	300	OZA675-EE1	7978	---	---
1.2i 16V Weekend	188A5.000	1.2	59	10.01-		D	4	40	300	OZA675-EE1	7978	---	---
1.3i 16V	178D6.011	1.3	59	03.00-		R	4	40	400	OZA659-EE49	5753	---	---

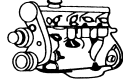

e kW



UNIVERSAL
TYPE No.
STOCK
ORDER No.
S4C
1952

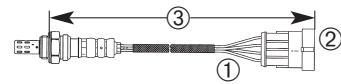

FIAT

PALIO

1.3i 16V Weekend	178D6.011	1.3	59	03.00-		R	4	40	400	OZA659-EE49	5753	---	---
1.4i.e.	350A1.000	1.4	57	07.03-		R	4	40	300	OZA659-EE3	0377	---	---
1.4i.e.	350A1.000	1.4	57	07.03-		D	4	40	300	OZA659-EE3	0377	---	---
1.4i (Siena)	178B2.000	1.4	59	10.97-09.01	Phase 2 (I) (PL) (TR)	R	4	40	700	OZA112-A7	1760	S4	1952
1.6i 16V	178B3.000	1.6	74	11.97-09.99		R	4	40	800	OZA112-A4	0236	S4	1952
1.6i 16V	178B3.000	1.6	74	10.99-09.00		R	4	40	980	OZA334-A2	0234	---	---
1.6 RST	182B6.000	1.6	75	10.00-12.04		R	4	40	410	OZA534-A2	1764	---	---
1.6 RST	182B6.000	1.6	75	10.00-12.04		D	4	40	810	OZA532-A9	1793	---	---

PANDA

900i.e.	1170A1.046	0.9	29	1991-03.92	base gamma 94, inieź Weber (I)	R	4	38	880	OZA527-E4	0218	S4CG	1919
900i.e.	1170A1.046	0.9	29	02.95-12.00	No 1146723 SPI USA 84 (I)	R	4	40	972	OZA527-E7	0213	S4CG	1919
1000i.e. 4x4	156A2.146	1.0	33	10.87-05.91		R	3	19	670	OZA446-E1	1833	S3	0412
1000i.e.	156A2.146	1.0	33	10.87-05.91		R	3	19	670	OZA446-E1	1833	S3	0412
1000i.e.	156A2.246	1.0	33	01.86-04.92	(I)	R	3	19	975	OZA446-E2	1855	S3	0412
1000i.e. 4x4	156A2.246	1.0	33	01.86-06.90	(I)	R	3	19	975	OZA446-E2	1855	S3	0412
1000i.e.	141C2.000	1.0	33	01.95-11.00		R	4	40	972	OZA527-E7	0213	S4CG	1919
1100i.e. Selecta	156C.046	1.1	37	07.90-12.92	(I)	R	3	19	975	OZA446-E2	1855	S3	0412
1100i.e. 4x4	156C.046	1.1	37	03.92-12.92	(I)	R	3	19	975	OZA446-E2	1855	S3	0412
1100i.e.	156C.046	1.1	37	03.92-12.92		R	3	19	895	OZA446-E4	1877	S3	0412
1100i.e. Selecta	176B2.000	1.1	37	01.95-11.00	(I)	R	4	40	972	OZA527-E7	0213	S4CG	1919
1100i.e. Selecta	176B2.000	1.1	40	01.95-11.00	SPI-Weber	R	4	40	972	OZA527-E7	0213	S4CG	1919
1100 i.e.	176B2.000	1.1	40	01.95-11.00		R	4	40	972	OZA527-E7	0213	S4CG	1919
1100i.e.	176B2.000	1.1	40	01.95-11.00	SPI-Weber	R	4	40	972	OZA527-E7	0213	S4CG	1919
1.1i 8V	187A1.001	1.1	40	10.00-06.04		R	4	40	260	OZA532-A3	0409	---	---
1.1i 8V	187A1.001	1.1	40	10.00-06.04		D	4	40	260	OZA532-A3	0409	---	---

PANDA (MY03)

1.1i	169	187A1.000	1.1	40	09.03-09.05		R	4	40	310	OZA532-A10	1794	---	---
1.1i	169	187A1.000	1.1	40	09.03-09.05		D	4	40	310	OZA532-A10	1794	---	---
1.1i	169	187A1.000	1.1	40	10.05-		R	4	104	310	OZA532-A12	0056	---	---
1.1i	169	187A1.000	1.1	40	10.05-		D	4	104	310	OZA532-A12	0056	---	---
1.2i 8V	169	188A4.000	1.2	44	09.03-09.05		R	4	40	310	OZA532-A10	1794	---	---
1.2i 8V	169	188A4.000	1.2	44	09.03-09.05		D	4	40	310	OZA532-A10	1794	---	---
1.2i 8V	169	188A4.000	1.2	44	10.05-		R	4	104	310	OZA532-A12	0056	---	---
1.2i 8V	169	188A4.000	1.2	44	10.05-		D	4	104	310	OZA532-A12	0056	---	---

PUNTO

1.1i.e. 55	176A6.000	1.1	40	08.93-12.94	SPI-Weber	R	4	38	880	OZA527-E4	0218	S4CG	1919
1.1i.e. 55	176B2.000	1.1	40	01.95-09.99	SPI-Weber	R	4	40	972	OZA527-E7	0213	S4CG	1919
1.2i.e. 60	176A7.000	1.2	43	08.93-05.94	SPI-Weber	R	4	38	880	OZA527-E4	0218	S4CG	1919
1.2i.e. 60 Cabrio	176A7.000	1.2	43	08.93-05.94	SPI-Weber	R	4	38	880	OZA527-E4	0218	S4CG	1919
1.2i.e. 60 Selecta	176B1.000	1.2	43	01.95-05.95	SPI-Weber	R	4	40	972	OZA527-E7	0213	S4CG	1919
1.2i.e. 60	176B4.000	1.2	43	01.95-09.99	SPI-Weber	R	4	40	972	OZA527-E7	0213	S4CG	1919
1.2i.e. 60 Cabrio	176B4.000	1.2	43	06.95-09.99	SPI-Weber	R	4	40	972	OZA527-E7	0213	S4CG	1919
1.2i 8V	188A4.000	1.2	44	07.99-		R	4	40	300	OZA659-EE3	0377	---	---
1.2i 8V	188A4.000	1.2	44	10.00-		D	4	40	300	OZA659-EE3	0377	---	---
1.2i 8V Natural Power	188A4.000	1.2	44	09.03-		R	4	40	300	OZA659-EE3	0377	---	---

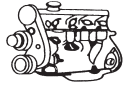

ℓ kW

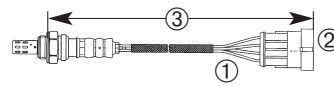
STOCK
REVERSE
UNIVERSAL
TYPE
NO.
UNIVERSAL
NO.

FIAT

PUNTO

1.2i 8V Natural Power	188A4.000	1.2	44	09.03-		D	4	40	300	OZA659-EE3	0377	---	---
1.2i.e. 75	176A8.000	1.2	54	01.95-09.99	MPI-Weber	R	4	40	972	OZA527-E7	0213	S4CG	1919
1.2i.e. 75	176A8.000	1.2	54	08.93-12.94	MPI-Weber	R	4	38	880	OZA527-E4	0218	S4CG	1919
1.2i 16V	188A5.000	1.2	59	07.99-06.03		R	4	40	300	OZA675-EE1	7978	---	---
1.2i 16V	188A5.000	1.2	59	03.01-06.03		D	4	40	300	OZA675-EE1	7978	---	---
1.2i.e. 16V	188A5.000	1.2	59	06.03-		R	4	40	300	OZA675-EE1	7978	---	---
1.2i.e. 16V	188A5.000	1.2	59	06.03-		D	4	40	300	OZA675-EE1	7978	---	---
1.4i.e. 16V	834A1.000	1.4	70	07.03-		R	4	40	300	OZA675-EE1	7978	---	---
1.4i.e. 16V	834A1.000	1.4	70	07.03-		D	4	40	300	OZA675-EE1	7978	---	---
1.4i.e. GT Turbo	176A4.000 / 176B6.000	1.4	98	08.93-12.94		R	4	38	880	OZA527-E4	0218	S4CG	1919
1.4i.e. GT Turbo	176A4.000 / 176B6.000	1.4	98	01.95-09.99		R	4	40	972	OZA527-E7	0213	S4CG	1919
GT 1.4 i.e. Turbo	176A4.000 / 176B6.000	1.4	98	08.93-08.99	Mot.Nr. 9240633 ->	R	4	40	972	OZA527-E7	0213	S4CG	1919
1.6 90 / Sporting	176A9.000	1.6	65	08.93-05.97		R	4	42	820	OZA527-E11	1787	S4CG	1919
1.8i 16V HGT	183A1.000	1.8	96	09.99-10.00		R	4	40	610	OZA334-A1	0223	---	---
1.8i 16V HGT	188A6.000	1.8	96	09.00-12.05		R	4	40	980	OZA532-A7	1796	---	---
1.8i 16V HGT	188A6.000	1.8	96	09.00-12.05		R	4	40	260	OZA532-A3	0409	---	---
1.8i 16V HGT	188A6.000	1.8	96	09.00-12.05		D	4	40	1370	OZA532-A4	1786	---	---

GRANDE PUNTO

1.2i.e.	199A4.000	1.2	48	10.05-		R	4	40	300	OZA659-EE3	0377	---	---
1.2i.e.	199A4.000	1.2	48	10.05-		D	4	40	300	OZA659-EE3	0377	---	---
1.3 MJT	199A2.000	1.3	55	06.05-		R	5	91	660	LZA15-A1	0029	---	---
1.3 MJT	199A3.000	1.3	66	06.05-		R	5	91	660	LZA15-A1	0029	---	---
1.4i.e. 8V	199A6.000	1.4	57	10.05-		R	4	40	300	OZA659-EE3	0377	---	---
1.4i.e. 8V	199A6.000	1.4	57	10.05-		D	4	40	300	OZA659-EE3	0377	---	---
1.4i.e. 16V	350A1.000	1.4	70	10.05-		R	4	40	300	OZA675-EE1	7978	---	---
1.4i.e. 16V	350A1.000	1.4	70	10.05-		D	4	40	300	OZA675-EE1	7978	---	---
1.4 T-Jet		1.4	88	09.07-		R	4	40	300	OZA659-EE3	0377	---	---
1.4 T-Jet		1.4	88	09.07-		D	4	40	600	OZA659-EE56	7863	---	---
1.4 Abarth		1.4	114	12.07-		R	4	40	300	OZA659-EE3	0377	---	---
1.4 Abarth		1.4	114	12.07-		D	4	40	600	OZA659-EE56	7863	---	---

REGATA

75i.e.	138C2..	1.5	55	10.85-04.87		R	1	3	472	OZA401-E2	1802	S1	1951
75i.e.	149C1.000	1.5	55	05.87-06.90		R	3	19	895	OZA446-E4	1877	S3	0412
90i.e.	149C2.000	1.6	66	01.87-07.89	Universal	R	1	---	---	OZA624-E1	1951	S1	1951

RITMO

75i.e.	138C2.048	1.5	55	10.85-10.87		R	1	3	472	OZA401-E2	1802	S1	1951
75i.e.	149C1..	1.5	55	05.87-12.88		R	3	19	895	OZA446-E4	1877	S3	0412
90i.e.	149C2.000	1.6	66	05.87-12.87		R	3	19	895	OZA446-E4	1877	S3	0412

SCUDO

1.6i	220A2.000	1.6	58	10.95-05.00		R	4	49	1480	OZA448-E56	0481	S4	1952
2.0i.e. 16V	RFN	2.0	100	06.00-		R	4	83	380	OZA659-EE12	0386	---	---
2.0i.e. 16V	RFN	2.0	100	06.00-		D	4	83	380	OZA659-EE12	0386	---	---

SEICENTO

1100i	176 B2.000	1.1	40	03.98-06.00		R	4	40	378	OZA527-E19	0296	S4CG	1919
1.1i 8V	187A1.000	1.1	40	10.00-		R	4	40	260	OZA532-A3	0409	---	---
1.1i 8V	187A1.000	1.1	40	10.00-		D	4	40	260	OZA532-A3	0409	---	---

STILO

1.2i.e. 16V	188A5.000	1.2	59	10.01-12.03		R	4	40	300	OZA675-EE1	7978	---	---
1.2i.e. 16V	188A5.000	1.2	59	10.01-12.03		D	4	40	300	OZA675-EE1	7978	---	---

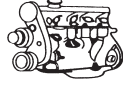

ℓ kW

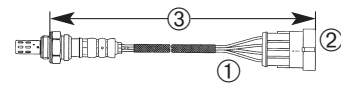
STOCK
NO.
UNIVERSAL
NO.
TYPE
NO.
INVENTORY
NO.

FIAT

STILO

1.4i.e. 16V	192B2.000	1.4	66	01.04-12.06		R	4	40	300	OZA675-EE1	7978	---	---
1.4i.e. 16V	192B2.000	1.4	66	01.04-12.06		D	4	40	300	OZA675-EE1	7978	---	---
1.4i.e. 16V	843A1.000	1.4	70	01.04-		R	4	40	300	OZA675-EE1	7978	---	---
1.4i.e. 16V	843A1.000	1.4	70	01.04-		D	4	40	300	OZA675-EE1	7978	---	---
1.6i 16V	182B6.000	1.6	76	10.01-12.06		R	4	40	400	OZA659-EE49	5753	---	---
1.6i 16V	182B6.000	1.6	76	10.01-12.06		D	4	40	600	OZA659-EE31	1613	---	---
1.6i 16V Multi Wagon	182B6.000	1.6	76	10.02-		R	4	40	400	OZA659-EE49	5753	---	---
1.6i 16V Multi Wagon	182B6.000	1.6	76	10.02-		D	4	40	600	OZA659-EE31	1613	---	---
1.8i 16V	192A4.000	1.8	96	10.01-12.06	2↑	R	4	40	260	OZA532-A3	0409	---	---
1.8i 16V	192A4.000	1.8	96	10.01-12.06		D	4	40	610	OZA532-A2	0489	---	---
2.4i 20V	192A7.011	2.4	123	06.02-12.06		R	4	40	300	OZA659-EE3	0377	---	---
2.4i 20V	192A2.000	2.4	125	10.01-12.06		R	4	40	300	OZA659-EE3	0377	---	---
2.4i 20V	192A2.000	2.4	125	10.01-12.06		D	4	40	300	OZA659-EE3	0377	---	---

STRADA

1.2i. 8V	188A4.000	1.2	54	05.01-06.05		R	4	40	300	OZA659-EE3	0377	---	---
1.2i. 8V	188A4.000	1.2	54	05.01-06.05		D	4	40	300	OZA659-EE3	0377	---	---

TEMPRA

1.4i.e.	160A1.046	1.4	51	03.92-03.95	SPI-Bosch	R	3	19	895	OZA446-E4	1877	S3	0412
1.4i.e. SW	160A1.046	1.4	51	03.92-03.95	SPI-Bosch	R	3	19	895	OZA446-E4	1877	S3	0412
1.4 i.e.	836A4.000	1.4	51	03.95-12.96		R	4	40	972	OZA527-E7	0213	S4CG	1919
1.4i.e.	836A4.000	1.4	51	03.95-12.96	SPI-Bosch	R	4	40	972	OZA527-E7	0213	S4CG	1919
1.4i.e. SW	836A4.000	1.4	51	03.95-12.96	SPI-Bosch	R	4	40	972	OZA527-E7	0213	S4CG	1919
1.6i.e. SW	159A3.046	1.6	52	01.91-07.92	SPI-Bosch	R	3	19	895	OZA446-E4	1877	S3	0412
1.6i.e. SW	835C1.000	1.6	55	04.93-12.96	SPI-Bosch	R	4	40	972	OZA527-E7	0213	S4CG	1919
1.6i.e.	835C1.000	1.6	55	04.93-12.96	SPI-Bosch	R	4	40	972	OZA527-E7	0213	S4CG	1919
1.6i.e.	835C1.000	1.6	55	01.95-12.96		R	4	40	972	OZA527-E7	0213	S4CG	1919
1.6i.e. Selecta	159A3.046	1.6	57	06.90-07.92	SPI-Bosch	R	3	19	895	OZA446-E4	1877	S3	0412
1.6i.e.	159A3.046	1.6	59	06.90-07.92	SPI-Bosch	R	3	19	895	OZA446-E4	1877	S3	0412
1.6i.e.	159B9.000	1.6	66	04.94-10.96		R	4	42	820	OZA527-E11	1787	S4CG	1919
1.8i.e.	835C4.000	1.8	66	04.93-12.96	MPI-Weber	R	4	38	880	OZA527-E4	0218	S4CG	1919
1.8i.e.	159A4.046	1.8	76	04.93-12.96	MPI-Weber	R	4	38	880	OZA527-E4	0218	S4CG	1919
1.8i.e.	159A4.046	1.8	76	04.93-12.96	MPI-Weber	R	4	38	880	OZA527-E4	0218	S4CG	1919
1.8i.e.	159A5.046	1.8	77	03.92-03.93	MPI-Weber	R	3	19	670	OZA446-E1	1833	S3	0412
1.8i.e.	159A5.046	1.8	77	03.92-03.93	MPI-Weber	R	3	19	670	OZA446-E1	1833	S3	0412
1.8i.e.	159A4.000	1.8	80	02.90-09.92	MPI-Weber	R	3	19	670	OZA446-E1	1833	S3	0412
1.8i.e.	159A4.000	1.8	80	12.90-09.92	MPI-Weber	R	3	19	670	OZA446-E1	1833	S3	0412
2.0i.e. SW 4x4	159A6.046	2.0	83	03.92-12.96	MPI-Weber	R	3	19	670	OZA446-E1	1833	S3	0412
2.0i.e.	159AC6.046	2.0	85	02.90-12.96	MPI-Weber	R	3	19	670	OZA446-E1	1833	S3	0412

TIPO

1.4i.e.	160A1.046	1.4	51	05.89-03.93	SPI-Bosch	R	3	19	895	OZA446-E4	1877	S3	0412
1.4i.e.	160A1.046	1.4	52	03.93-10.95		R	3	19	895	OZA446-E4	1877	S3	0412
1.6i.e. Selecta	159A3.048	1.6	56	03.93-10.95		R	3	19	895	OZA446-E4	1877	S3	0412
1.6i.e.	835C1.000	1.6	56	03.93-10.95		R	4	38	880	OZA527-E4	0218	S4CG	1919
1.6i.e.	159A3.046	1.6	57	01.92-03.93	SPI-Bosch	R	3	19	895	OZA446-E4	1877	S3	0412
1.6i.e.	159A3.046	1.6	57	03.90-03.93	SPI-Bosch	R	3	19	895	OZA446-E4	1877	S3	0412
1.8i.e.	835C2.000	1.8	77	03.93-10.95		R	3	19	895	OZA446-E4	1877	S3	0412
1.8i.e. GT	159A4.046	1.8	77	03.92-03.93	MPI-Weber	R	3	19	895	OZA446-E4	1877	S3	0412
2.0i.e.	159A6.046	2.0	83	03.90-03.92	MPI-Weber	R	3	19	895	OZA446-E4	1877	S3	0412
2.0i.e.	159A6.046	2.0	85	03.93-10.95		R	3	19	895	OZA446-E4	1877	S3	0412

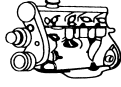

ℓ kW

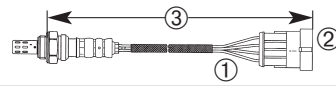
**NUMERO
ORDRE**
STOCK
UNIVERSAL
TYPE
UNIVERSAL
NUMERO

FIAT

TIPO

2.0i.e.	159A6.046	2.0	85	03.93-10.95		R	3	19	895	OZA446-E4	1877	S3	0412
2.0i.e. 16V	836A3.000	2.0	104	03.93-10.95		R	3	19	895	OZA446-E4	1877	S3	0412

ULYSSE

1.8i	LFW	1.8	75	05.96-05.00		R	4	49	1480	OZA448-E56	0481	S4	1952
2.0i.e.	RFU	2.0	90	09.94-05.00		R	4	49	1480	OZA448-E56	0481	S4	1952
2.0i.e. 16V	RFV	2.0	97	05.98-05.00		R	4	83	1230	OZA659-EE8	0382	---	---
2.0i.e. 16V	RFV	2.0	97	05.98-05.00		D	4	82	1490	OZA659-EE21	0395	---	---
2.0i.e. 16V	RFN	2.0	100	03.00-10.05		R	4	83	380	OZA659-EE12	0386	---	---
2.0i.e. 16V	RFN	2.0	100	03.00-10.05		D	4	83	380	OZA659-EE12	0386	---	---
2.0i.e. Turbo	RGX	2.0	110	09.94-05.00		R	4	49	1480	OZA448-E56	0481	S4	1952
3.0i. 24V	XFW	3.0	150	01.03-10.05		R	4	83	380	OZA659-EE12	0386	---	---
3.0i. 24V	XFW	3.0	150	01.03-10.05		D	4	83	380	OZA659-EE12	0386	---	---

UNO

45i.e. Fire	156A2..	1.0	33	10.87-08.89	SPI-Bosch	R	1	3	472	OZA401-E2	1802	S1	1951
45i.e. Van	156A2.246	1.0	33	09.92-03.94		R	3	19	670	OZA446-E1	1833	S3	0412
45i.e.	156A2.246	1.0	33	06.92-03.94		R	3	19	895	OZA446-E4	1877	S3	0412
1.0i.e.	146C7.000	1.0	35	07.94-06.97		R	4	31	290	OZA114-A1	1856	S4	1952
1.1i.e.	146C3.000	1.1	36	09.89-03.94		R	3	19	975	OZA446-E2	1855	S3	0412
1.1i.e.	156C.046	1.1	37	06.92-03.94		R	3	19	895	OZA446-E4	1877	S3	0412
1.3i.e. Turbo	146A2..	1.3	73	10.87-08.89		R	3	19	895	OZA446-E4	1877	S3	0412
1.3i.e. Turbo	146A2.146	1.3	74	09.89-03.91		R	3	19	895	OZA446-E4	1877	S3	0412
Uno 70 i.e.	146C1.000	1.4	52	09.89-09.92		R	3	19	885	OZA445-E6	0258	S3	0412
70i.e.	160A1.046	1.4	51	09.89-03.94		R	3	19	895	OZA446-E4	1877	S3	0412
75i.e.	138C2..Kat.	1.5	55	10.85-08.87		R	1	3	472	OZA401-E2	1802	S1	1951
75i.e.	149C1.000	1.5	55	09.87-08.89	SPI-Bosch	R	3	19	895	OZA446-E4	1877	S3	0412
75i.e. Selecta	149C1.000	1.5	55	05.92-03.94		R	3	19	895	OZA446-E4	1877	S3	0412
75i.e.	149C1.000	1.5	55	09.89-03.94		R	3	19	895	OZA446-E4	1877	S3	0412

FORD

COUGAR

2.0i 16V	ED - Zetec-E SEFI	2.0	96	10.98-12.01		R	4	32	372	OZA519-D1	0244	---	---
2.5i V6	LCBA - Duratec-VE SEFI	2.5	125	10.98-12.01		R	4	32	372	OZA519-D1	0244	---	---
2.5i V6	LCBB - Duratec-VE SEFI	2.5	125	10.98-12.01		R	4	32	372	OZA519-D1	0244	---	---
2.5i V6	LCBC - Duratec-VE SEFI	2.5	125	10.98-12.01		R	4	32	372	OZA519-D1	0244	---	---
2.5i V6	LCBE - Duratec-VE SEFI	2.5	125	10.98-12.01		R	4	32	372	OZA519-D1	0244	---	---
2.5i V6 ST200	MABB - Duratec-VE SEFI	2.5	151	01.00-12.01		R	4	32	372	OZA519-D1	0244	---	---

ESCORT

1.3i	J6A	1.3	44	05.91-12.91		R	4	27	270	OZA448-E12	1865	S4	1952
1.3i (95)	J6A	1.3	44	01.95-10.98		R	4	27	375	OZA448-E44	0293	S4	1952
1.3i	J6A	1.3	44	10.92-12.94		R	4	27	375	OZA448-E44	0293	S4	1952
1.3 Turnier	J4B / J6A	1.3	44	01.92-09.92		R	4	27	270	OZA660-EE15	5708	S4	1952
1.3i Express (91)	JBD	1.3	46	01.92-09.92		R	4	27	270	OZA660-EE15	5708	S4	1952
1.4i (95)	F4B	1.4	52	01.95-10.98		R	4	27	375	OZA448-E44	0293	S4	1952
1.4i	F6F / F6G	1.4	52	05.91-12.91		R	4	27	270	OZA448-E12	1865	S4	1952
1.4i	F6F / F6G	1.4	52	10.92-12.94		R	4	27	375	OZA448-E44	0293	S4	1952
1.4i Express (91)	F6F / F6G	1.4	52	01.92-09.92		R	4	27	270	OZA660-EE15	5708	S4	1952
1.4	F6F / F6G	1.4	52	01.92-09.92		R	4	27	270	OZA660-EE15	5708	S4	1952

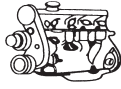

ℓ kW

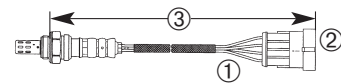

STOCK
No.

UNIVERSAL
No.

TYPE
No.

CUINVENIEN
No.

FORD

ESCORT

1.4 Cabrio	F6F / F6G	1.4	52	01.92-09.92		R	4	27	270	OZA660-EE15	5708	S4	1952
1.4 Turnier	F6F / F6G	1.4	52	01.92-09.92		R	4	27	270	OZA660-EE15	5708	S4	1952
1.4	F6F / F6G	1.4	52	01.92-09.92		R	4	27	270	OZA660-EE15	5708	S4	1952
1.4 Turnier	F6F / F6G	1.4	52	01.92-09.92		R	4	27	270	OZA660-EE15	5708	S4	1952
1.4i Express	F6	1.4	54	01.86-07.90		R	3	25	550	OZA446-E62	1729	S3	0412
1.4i Express 55 (95)	F4B	1.4	54	01.95-10.98		R	4	27	375	OZA448-E44	0293	S4	1952
1.4i Express 75 (95)	F4B	1.4	54	01.95-10.98		R	4	27	375	OZA448-E44	0293	S4	1952
1.4i Turnier	F4B	1.4	54	02.94-12.94		R	4	27	375	OZA448-E44	0293	S4	1952
1.4i	F6B / F6D	1.4	54	01.87-07.90		R	3	25	550	OZA446-E62	1729	S3	0412
1.4i Turnier	F6	1.4	54	01.87-07.90		R	3	25	550	OZA446-E62	1729	S3	0412
1.4i	F6B / F6D	1.4	54	09.89-07.90		R	4	27	270	OZA448-E12	1865	S4	1952
1.4i Cabrio	F6B / F6D	1.4	54	01.87-07.90	OE	R	4	63	270	OZA527-E21	1817	S4CG	1919
1.4i	F6B / F6D	1.4	54	01.87-07.90	OE	R	4	63	270	OZA527-E21	1817	S4CG	1919
1.4i Turnier	F6B / F6D	1.4	54	01.87-07.90	OE	R	4	63	270	OZA527-E21	1817	S4CG	1919
1.6i 16V (95)	L1H	1.6	65	01.95-02.99		R	4	27	610	OZA448-E48	0239	S4	1952
1.6i 16V	L1E	1.6	66	09.96-02.99	III	R	4	27	600	OZA33-D8	1867	S4	1952
1.6i 16V	L1E	1.6	66	09.92-09.95		R	4	27	600	OZA33-D8	1867	S4	1952
1.6i 16V	L1E	1.6	66	01.93-12.94		R	4	27	610	OZA448-E48	0239	S4	1952
1.6i 16V 4x4 (95)	L1E	1.6	66	01.95-02.99		R	4	27	610	OZA448-E48	0239	S4	1952
1.6i 16V	L1K	1.6	66	09.96-02.99	III	R	4	27	600	OZA33-D8	1867	S4	1952
1.6i 16V (95)	L1K	1.6	66	01.95-02.99		R	4	27	610	OZA448-E48	0239	S4	1952
1.6i	L4B	1.6	66	08.85-12.85		R	3	25	550	OZA446-E62	1729	S3	0412
1.6i 16V	L4B	1.6	66	01.86-07.90		R	3	25	271	OZA446-E46	0139	S3	0412
1.6i XR3i	L4B	1.6	66	01.86-07.90		R	3	25	271	OZA446-E46	0139	S3	0412
1.6i 16V	L1K / L1E - Zetec	1.6	66	08.95-07.00		R	4	27	360	OZA89-D2	0135	S4	1952
1.6i XR3i	LJA	1.6	75	08.89-07.90		R	3	25	550	OZA446-E62	1729	S3	0412
1.6i XR3i	LJB	1.6	75	08.89-07.90		R	3	25	271	OZA446-E46	0139	S3	0412
1.6i XR3i	LJB	1.6	75	09.89-07.90		R	4	27	270	OZA448-E12	1865	S4	1952
1.6	LJF	1.6	77	01.92-09.92		R	4	27	270	OZA660-EE15	5708	S4	1952
1.6 Cabrio	LJF	1.6	77	01.92-09.92		R	4	27	270	OZA660-EE15	5708	S4	1952
1.6i Cabrio	LJE	1.6	77-79	05.91-12.91		R	4	27	270	OZA448-E12	1865	S4	1952
1.6i	LJF	1.6	77-79	05.91-12.91		R	4	27	270	OZA448-E12	1865	S4	1952
1.6i XR3i	LJA	1.6	79	09.89-07.90		R	4	27	270	OZA448-E12	1865	S4	1952
1.8i 16V	RDA	1.8	77	10.96-01.99		R	4	27	600	OZA33-D8	1867	S4	1952
1.8i 16V (95)	RDA	1.8	77	01.95-01.99		R	4	27	610	OZA448-E48	0239	S4	1952
1.8i 16V XR3i	RDA	1.8	77	01.93-12.94		R	4	27	610	OZA448-E48	0239	S4	1952
1.8i 16V	RDA - Zetec SEFI	1.8	77	01.92-09.95		R	4	27	600	OZA33-D8	1867	S4	1952
1.8i 16V	RDA - Zetec	1.8	85	08.95-01.99		R	4	27	360	OZA89-D2	0135	S4	1952
1.8i 16V (95)	RKC	1.8	85	01.95-02.99		R	4	27	610	OZA448-E48	0239	S4	1952
1.8i 16V	RQB	1.8	96	10.96-02.99		R	4	27	600	OZA33-D8	1867	S4	1952
1.8i 16V	RQB	1.8	96	04.93-03.96		R	4	27	600	OZA33-D8	1867	S4	1952
1.8i 16V XR 3i Cabrio (95)	RQB	1.8	96	01.95-05.96		R	4	27	610	OZA448-E48	0239	S4	1952
1.8i 16V XR3i	RQB	1.8	96	01.93-12.94		R	4	27	610	OZA448-E48	0239	S4	1952
2.0 Cosworth	N5F	2.0	162	12.91-07.93	Webber System	R	3	103	876	OTD5F-3E1	0023	---	---
2.0i RS	N7A	2.0	110	09.91-12.94	I	R	4	27	610	OZA448-E48	0239	S4	1952
2.0i 16V RS 2000 (95)	N7A	2.0	110	01.95-10.98	I	R	4	27	610	OZA448-E48	0239	S4	1952
RS 2000	N7A	2.0	110	05.91-12.92		R	4	27	720	OZA448-E55	0470	S4	1952
RS 2000 4x4	N7A	2.0	110	08.93-01.95		R	4	27	720	OZA448-E55	0470	S4	1952

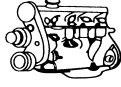

ℓ kW

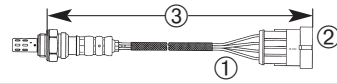

ORDER NO. STOCK No. TYPE UNIVERSAL No. SUPPLIER No.

FORD

FIESTA

1.1i	G6A	1.1	36-37	03.89-12.92		R	4	27	270	OZA448-E12	1865	S4	1952
1.1i	G6A	1.1	36-37	01.93-12.96		R	4	27	375	OZA448-E44	0293	S4	1952
1.3i	J6B	1.3	43-44	06.91-12.92		R	4	27	270	OZA448-E12	1865	S4	1952
1.3i	J6B	1.3	43-44	01.93-12.96		R	4	27	375	OZA448-E44	0293	S4	1952
1.4i	F6A / F6C	1.4	52	10.86-02.89		R	3	25	271	OZA446-E46	0139	S3	0412
1.4i	F6E	1.4	52	03.89-12.92		R	4	27	270	OZA448-E12	1865	S4	1952
1.4i	F6E	1.4	52	01.93-12.96		R	4	27	375	OZA448-E44	0293	S4	1952
1.6i	LUH	1.6	66	02.94-09.95		R	4	27	600	OZA33-D8	1867	S4	1952
1.6i XR2i	LJD	1.6	76	03.89-12.92		R	4	27	270	OZA448-E12	1865	S4	1952
1.6 XR2i	LJC / LJD	1.6	76-81	01.93-12.96		R	4	27	375	OZA448-E44	0293	S4	1952
1.6i XR2i	LJC	1.6	81	03.89-12.92		R	4	27	270	OZA448-E12	1865	S4	1952
1.8	RDB - Zetec	1.8	77	01.93-01.94		R	4	27	300	OZA33-D5	0199	S4	1952
1.8	RQC - Zetec	1.8	96	01.93-10.95		R	4	27	300	OZA33-D5	0199	S4	1952

FIESTA IV

1.25i 16V	DHA / DHB - Zetec SE	1.25	55	11.95-09.98		R	4	27	370	OZA659-EE44	1638	---	---
1.25i 16V	DHC / DHD - Zetec SE	1.25	55	11.95-09.98		R	4	27	370	OZA659-EE44	1638	---	---
1.25i 16V	DH - Zetec SEFI	1.25	55	10.98-12.02		R	4	32	372	OZA519-D1	0244	---	---
1.25i 16V	DH - Zetec SEFI	1.25	55	10.98-12.02		R	4	27	370	OZA659-EE44	1638	---	---
1.3i	JJA / JJC	1.3	37	10.95-01.02		R	4	27	375	OZA448-E44	0293	S4	1952
1.3i (96)	J4..	1.3	44	10.95-09.98		R	4	27	375	OZA448-E44	0293	S4	1952
1.3i	J4..	1.3	44	10.98-01.02		R	4	32	372	OZA519-D1	0244	---	---
1.4i 16V	FHC - Zetec-SE	1.4	66	04.96-08.99		R	4	27	370	OZA659-EE44	1638	---	---
1.4i 16V	FHA / FHE - Zetec-SE	1.4	66	01.96-12.00		R	4	27	370	OZA659-EE44	1638	---	---
1.4i 16V	FHA / FHE - Zetec-SEFI	1.4	66	01.96-12.00		R	4	27	370	OZA659-EE44	1638	---	---
1.6i 16V	L1 - Zetec SEFI	1.6	76	02.00-01.02		R	4	32	372	OZA519-D1	0244	---	---

FIESTA V

1.25i 16V	FUJA / FUJB	1.25	55	03.03-		R	4	32	335	OZA519-SZ2	0052	---	---
1.25i 16V	FUJA / FUJB	1.25	55	03.03-		D	4	32	300	OZA341-SZ3	0039	---	---
1.3i 8V	A9JA / A9JB	1.3	51	04.02-03.03		R	4	32	372	OZA488-SZ1	1766	---	---
1.3i 8V	A9JA / A9JB	1.3	51	04.02-03.03		D	4	32	300	OZA341-SZ3	0039	---	---
1.4	FXJA / FXJB	1.4	59	04.02-		R	4	32	335	OZA519-SZ2	0052	---	---
1.4	FXJA / FXJB	1.4	59	04.02-		D	4	32	300	OZA341-SZ3	0039	---	---
1.6	FYJA / FYJB	1.6	74	04.02-		R	4	32	335	OZA519-SZ2	0052	---	---
1.6	FYJA / FYJB	1.6	74	04.02-		D	4	32	300	OZA341-SZ3	0039	---	---
1.6	FYJA / FYJB	1.6	74	04.02-		D	4	32	800	OZA341-SZ2	0038	---	---

FOCUS

1.4i 16V	FX - Zetec-SE SFI	1.4	55	08.98-07.00		R	4	32	375	OZA659-EE9	0383	---	---
1.4i 16V	FX - Zetec-SE SFI	1.4	55	08.00-11.04		R	4	32	372	OZA519-D1	0244	---	---
1.4i 16V	FX - Zetec-SE SFI	1.4	55	08.00-11.04		D	4	32	372	OZA381-D1	1820	---	---
1.6i 16V	FY - Zetec-SE SFI	1.6	74	08.99-07.00		R	4	32	375	OZA659-EE9	0383	---	---
1.6i 16V	FY - Zetec-SE SFI	1.6	74	08.99-07.00		D	4	32	390	OZA659-EE43	1630	---	---
1.6i 16V	FY - Zetec-SE SFI	1.6	74	07.00-11.04		R	4	32	372	OZA519-D1	0244	---	---
1.6i 16V	FY - Zetec-SE SFI	1.6	74	07.00-11.04		D	4	32	372	OZA381-D1	1820	---	---
1.8i 16V	EY - Zetec-E SFI	1.8	85	10.98-11.04		R	4	32	372	OZA519-D1	0244	---	---
1.8i 16V	EY - Zetec-E SFI	1.8	85	07.00-11.04		D	4	32	372	OZA381-D1	1820	---	---
2.0i 16V	ED - Zetec-E SFI	2.0	96	10.99-11.04		R	4	32	372	OZA519-D1	0244	---	---
2.0i 16V	ED - Zetec-E SFI	2.0	96	07.00-11.04		D	4	32	372	OZA381-D1	1820	---	---
2.0i 16V ST170	Duratec ST	2.0	127	03.02-11.04		R	4	32	393	OZA488-D2	1757	---	---

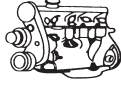

ℓ kW

STOCK
NO.
UNIVERSAL
NO.
TYPE
NO.
ACCESORIES
NO.

FORD

FUSION

1.4	FXJA / FXJB	1.4	59	08.02-		R	4	32	335	OZA519-SZ2	0052	---	---
1.4	FXJA / FXJB	1.4	59	08.02-		D	4	32	300	OZA341-SZ3	0039	---	---
1.6	FYJA / FYJB	1.6	74	08.02-		R	4	32	335	OZA519-SZ2	0052	---	---
1.6	FYJA / FYJB	1.6	74	08.02-		D	4	32	300	OZA341-SZ3	0039	---	---

GALAXY

2.0i	NSE - DL20 SEFI	2.0	85	02.95-03.00		R	4	27	370	OZA659-EE44	1638	---	---
2.0i	ZVSA - DL20 SEFI	2.0	85	01.01-02.06		R	4	32	375	OZA659-EE9	0383	---	---
2.3i 16V	Y5B - DH23 SEFI	2.3	107	01.97-03.00		R	4	27	370	OZA659-EE44	1638	---	---
2.3i 16V	E5SA - DH23 SEFI	2.3	107	04.00-07.02		R	4	32	375	OZA659-EE9	0383	---	---
2.8i V6	AAA	2.8	128	01.96-10.97		R	4	48	720	OZA447-E31	0460	S4	1952
2.8i V6 4x4	AAA	2.8	128	04.96-04.00		R	4	48	720	OZA447-E31	0460	S4	1952
2.8i V6	AAA	2.8	128	11.95-12.95		R	4	48	1430	OZA447-E36	1950	S4	1952

GRANADA

2.0i		2.0	85	11.92-09.94		R	3	25	550	OZA446-E62	1729	S3	0412
------	--	-----	----	-------------	--	---	---	----	-----	------------	------	----	------

KA

1.3i	JJB	1.3	37	09.96-01.99		R	4	27	375	OZA448-E44	0293	S4	1952
1.3i	J4K	1.3	44	09.96-07.98		R	4	27	375	OZA448-E44	0293	S4	1952
1.3i	J4D	1.3	44	09.96-07.98		R	4	27	375	OZA448-E44	0293	S4	1952
1.3i	J4 - Endura	1.3	44	08.98-01.09		R	4	32	372	OZA519-D1	0244	---	---
1.3i	A9A / A9B / BAA /RoCam	1.3	51	11.02-01.09		R	4	32	372	OZA488-SZ1	1766	---	---
1.3i	A9A / A9B / BAA /RoCam	1.3	51	11.02-01.09		D	4	32	300	OZA341-SZ3	0039	---	---
1.6i	RoCam	1.6	70	07.03-01.09		R	4	32	372	OZA488-SZ1	1766	---	---
1.2i	Duratec	1.2	51	02.09-		R	4	104	310	OZA641-A1	1726	---	---
1.2i	Duratec	1.2	51	02.09-		D	4	104	310	OZA641-A1	1726	---	---
1.3 TDCi	Duratorq	1.3	55	02.09-		R	5	91	610	LZA15-A5	1727	---	---

MERKUR

2.9i		2.9	107	11.86-08.89		R	3	25	550	OZA446-E62	1729	S3	0412
------	--	-----	-----	-------------	--	---	---	----	-----	------------	------	----	------

MONDEO I

1.6i 16V	L1J - Zetec	1.6	65	09.96-07.98		R	4	27	360	OZA216-D2	0190	S4	1952
1.6i 16V	L1J - Zetec	1.6	65	02.93-07.96		R	4	27	375	OZA448-E44	0293	S4	1952
1.6i	L1F	1.6	66	08.96-07.98		R	4	27	360	OZA216-D2	0190	S4	1952
1.6i	L1F - Zetec-E SEFI	1.6	66	02.93-07.96		R	4	27	300	OZA89-D1	1890	S4	1952
1.6i 16V	L1F DOHC	1.6	66	02.93-07.96		R	4	27	375	OZA448-E44	0293	S4	1952
1.8i 16V	Zetec	1.8	85	08.98-10.00		D	4	32	372	OZA381-D1	1820	---	---
1.8i	RKB - Zetec	1.8	82	08.96-07.98		R	4	27	360	OZA216-D2	0190	S4	1952
1.8i 16V	RKB DOHC	1.8	82	02.93-07.96		R	4	27	375	OZA448-E44	0293	S4	1952
1.8i	RKA	1.8	85	08.96-07.98		R	4	27	360	OZA216-D2	0190	S4	1952
1.8i	RKA	1.8	85	02.93-07.96		R	4	27	300	OZA89-D1	1890	S4	1952
1.8i 16V	RKA DOHC	1.8	85	02.93-07.96		R	4	27	375	OZA448-E44	0293	S4	1952
2.0i	NGA - Zetec-E SEFI	2.0	96	08.96-07.98		R	4	27	710	OZA216-D3	0125	S4	1952
2.0i 16V	Zetec	2.0	96	08.98-10.00		D	4	32	372	OZA381-D1	1820	---	---
2.0i	Zetec-E SEFI	2.0	100	08.96-07.98		R	4	27	710	OZA216-D3	0125	S4	1952
2.0i	NGA - Zetec-E SEFI	2.0	100	02.93-07.96		R	4	27	300	OZA89-D1	1890	S4	1952
2.0i 16V	NGA DOHC	2.0	100	02.93-07.96		R	4	27	375	OZA448-E44	0293	S4	1952
2.0i 16V 4x4	NGA DOHC	2.0	100	07.93-07.96		R	4	27	375	OZA448-E44	0293	S4	1952
2.5i	SEA V6	2.5	125	08.96-08.98	2 ↑	R	4	27	360	OZA216-D2	0190	S4	1952
2.5i	SEA V6	2.5	125	10.94-07.96	2 ↑	R	4	27	360	OZA89-D2	0135	S4	1952

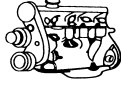

ℓ kW

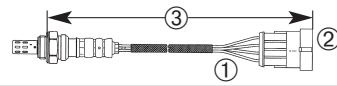
ORDER NO.
STOCK No.
UNIVERSAL No.
TYPE No.
MANUFACTURER No.

FORD

MONDEO II

1.6i 16V	L1J - Zetec-E SEFI	1.6	66	08.98-11.00		R	4	32	372	OZA519-D1	0244	---	---
1.6i 16V Turnier	L1J - Zetec-E SEFI	1.6	66	08.98-11.00		R	4	32	372	OZA519-D1	0244	---	---
2.0i 16V	NGA	2.0	96	10.00-11.00		R	4	32	372	OZA519-D1	0244	---	---
2.0i 16V Turnier	NGA	2.0	96	10.00-11.00		R	4	32	372	OZA519-D1	0244	---	---
2.5i	V6 SEFI	2.5	125	09.98-11.00		R	4	32	393	OZA488-D2	1757	---	---
2.5i	V6 SEFI	2.5	125	06.99-11.00		D	4	32	372	OZA381-D1	1820	---	---

MONDEO III

1.8i 16V	CGBA / CGBB	1.8	81	10.00-		R	4	32	330	OZA504-D2	1708	---	---
1.8i 16V	CGBA / CGBB	1.8	81	10.00-		D	4	32	915	OZA555-D2	0057	---	---
1.8i 16V Turnier	CGBA / CGBB	1.8	81	10.00-		R	4	32	330	OZA504-D2	1708	---	---
1.8i 16V Turnier	CGBA / CGBB	1.8	81	10.00-		D	4	32	915	OZA555-D2	0057	---	---
1.8i 16V	RK	1.8	82	10.00-		R	4	32	372	OZA519-D1	0244	---	---
1.8i 16V Turnier	RK	1.8	82	10.00-		R	4	32	372	OZA519-D1	0244	---	---
1.8i 16V	CHBA / CHBB	1.8	92	10.00-		R	4	32	330	OZA504-D2	1708	---	---
1.8i 16V	CHBA / CHBB	1.8	92	10.00-		D	4	32	915	OZA555-D2	0057	---	---
1.8i 16V Turnier	CHBA / CHBB	1.8	92	10.00-		R	4	32	330	OZA504-D2	1708	---	---
1.8i 16V Turnier	CHBA / CHBB	1.8	92	10.00-		D	4	32	915	OZA555-D2	0057	---	---
1.8 SCi	CFBA	1.8	96	06.03-		R	4	32	390	OZA659-EE43	1630	---	---
1.8 Sci Turnier	CFBA	1.8	96	06.03-		R	4	32	390	OZA659-EE43	1630	---	---
2.0i 16V	CJBA / CJBB	2.0	107	10.00-		R	4	32	330	OZA504-D2	1708	---	---
2.0i 16V	CJBA / CJBB	2.0	107	10.00-		D	4	32	915	OZA555-D2	0057	---	---
2.0i 16V Turnier	CJBA / CJBB	2.0	107	10.00-		R	4	32	330	OZA504-D2	1708	---	---
2.0i 16V Turnier	CJBA / CJBB	2.0	107	10.00-		D	4	32	915	OZA555-D2	0057	---	---
2.5i	LCBD	2.5	125	10.00-		R	4	32	330	OZA504-D2	1708	---	---
2.5i	LCBD	2.5	125	10.00-		D	4	32	915	OZA555-D2	0057	---	---
2.5i Turnier	LCBD	2.5	125	10.00-		R	4	32	330	OZA504-D2	1708	---	---
2.5i Turnier	LCBD	2.5	125	10.00-		D	4	32	915	OZA555-D2	0057	---	---
ST 220	MEBA	3.0	166	06.03-		R	4	32	330	OZA504-D2	1708	---	---
ST 220	MEBA	3.0	166	06.03-		D	4	32	372	OZA555-D3	0058	---	---
ST 220 Turnier	MEBA	3.0	166	06.03-		R	4	32	330	OZA504-D2	1708	---	---
ST 220 Turnier	MEBA	3.0	166	06.03-		D	4	32	372	OZA555-D3	0058	---	---

ORION

1.3i	J6A	1.3	44	05.91-12.91		R	4	27	270	OZA448-E12	1865	S4	1952
1.4i	F6F / F6G	1.4	52	05.91-12.91		R	4	27	270	OZA448-E12	1865	S4	1952
1.4	F6F / F6G	1.4	52	12.91-12.93		R	4	27	270	OZA660-EE15	5708	S4	1952
1.4i	F6B / F6D	1.4	54	10.87-07.90		R	3	25	271	OZA446-E46	0139	S3	0412
1.6i	L1E	1.6	66	09.92-08.93		R	4	27	600	OZA33-D8	1867	S4	1952
1.6i	L4B	1.6	66	09.85-12.85		R	3	25	550	OZA446-E62	1729	S3	0412
1.6i	L4B	1.6	66	01.86-07.90		R	3	25	271	OZA446-E46	0139	S3	0412
1.6i	LJB	1.6	75	08.89-07.90		R	3	25	550	OZA446-E62	1729	S3	0412
1.6i	LJF	1.6	77	05.91-12.91		R	4	27	270	OZA448-E12	1865	S4	1952
1.6i	LJF	1.6	77	12.91-09.92		R	4	27	270	OZA660-EE15	5708	S4	1952
1.6i	LJE	1.6	79	05.91-12.91		R	4	27	270	OZA448-E12	1865	S4	1952
1.8i	RDA	1.8	77	01.92-08.93		R	4	27	600	OZA33-D8	1867	S4	1952
1.8i	RQB	1.8	96	02.92-08.93		R	4	27	600	OZA33-D8	1867	S4	1952

PROBE

2.5i 24V		2.5	121	07.91-06.97		R	4	31	480	OZA74-F1	0401	S4	1952
----------	--	-----	-----	-------------	--	---	---	----	-----	----------	------	----	------

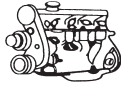

ℓ kW

STOCK
UNIVERSAL
TYPE
NO.
NO.
NO.

FORD

PUMA

1.4i	FHD / FHF - Zetec-SE	1.4	66	01.98-11.00		R	4	27	370	OZA659-EE44	1638	---	---
1.4i	FHD / FHF - Zetec-SE	1.4	66	01.98-11.00		D	4	27	370	OZA659-EE44	1638	---	---
1.4i	FHD / FHF - Zetec-SEFI	1.4	66	01.98-11.00		R	4	27	370	OZA659-EE44	1638	---	---
1.4i	FHD / FHF - Zetec-SEFI	1.4	66	01.98-11.00		D	4	27	370	OZA659-EE44	1638	---	---
1.6i 16V	L1W - Tetec-SE SFI	1.6	76	10.00-06.02		R	4	32	372	OZA519-D1	0244	---	---
1.6i 16V	L1W - Tetec-SE SFI	1.6	76	10.00-06.02		D	4	32	372	OZA519-D1	0244	---	---
1.7i	MHA / MHB - Zetec-S VCT	1.7	92	06.97-12.01		R	4	27	370	OZA659-EE44	1638	---	---
1.7i	MHA / MHB - Zetec-S VCT	1.7	92	06.97-12.01		D	4	27	370	OZA659-EE44	1638	---	---

SCORPIO I

2.0	NER / NE4	2.0	74	10.87-08.89		R	4	63	270	OZA527-E21	1817	S4CG	1919
2.0	NRC	2.0	74	10.85-12.90	OE	R	4	63	270	OZA527-E21	1817	S4CG	1919
2.0i	NRC	2.0	74	10.85-05.89		R	3	25	271	OZA446-E46	0139	S3	0412
2.0	NEL	2.0	77	04.85-08.89		R	4	63	270	OZA527-E21	1817	S4CG	1919
2.0	N8B / N8D	2.0	77-82	05.89-02.92		R	4	63	270	OZA527-E21	1817	S4CG	1919
2.0i	N9F	2.0	85	02.92-09.94		R	4	27	720	OZA448-E55	0470	S4	1952
2.0i Turnier	N9F	2.0	85	09.91-09.94		R	4	27	720	OZA448-E55	0470	S4	1952
2.0	NRA EFI OHC	2.0	85	04.85-02.92		R	4	63	270	OZA527-E21	1817	S4CG	1919
2.0	N9D	2.0	88	05.89-08.89		R	4	63	270	OZA527-E21	1817	S4CG	1919
2.0i	N9D	2.0	88	09.89-02.92		R	4	27	270	OZA448-E12	1865	S4	1952
2.0	N9B	2.0	93	05.89-08.89		R	4	63	270	OZA527-E21	1817	S4CG	1919
2.0i	N9B	2.0	93	09.89-02.92		R	4	27	270	OZA448-E12	1865	S4	1952
2.4i	ARD	2.4	92	10.88-04.89		R	3	25	550	OZA446-E62	1729	S3	0412
2.4i (92)	ARD	2.4	92	02.92-12.94		R	4	27	555	OZA448-E42	0271	S4	1952
2.9i 4x4	BRE	2.9	107	09.86-07.89		R	3	25	550	OZA446-E62	1729	S3	0412
2.9i 4x4	BRF	2.9	107	09.86-07.89		R	3	25	550	OZA446-E62	1729	S3	0412
2.9i 4x4 (92)	BRE	2.9	107	02.92-12.94	↑	R	4	27	555	OZA448-E42	0271	S4	1952
2.9i 4x4 (92)	BRE	2.9	107	02.92-12.94	↑	R	4	27	375	OZA448-E44	0293	S4	1952
2.9i (92)	BRF	2.9	107	02.92-12.94	↑	R	4	27	555	OZA448-E42	0271	S4	1952
2.9i (92)	BRF	2.9	107	02.92-12.94	↑	R	4	27	375	OZA448-E44	0293	S4	1952
2.9i 24V (92)	BOA	2.9	143	02.92-12.94	↑	R	4	27	555	OZA448-E42	0271	S4	1952
2.9i 24V (92)	BOA	2.9	143	02.92-12.94	↑	R	4	27	375	OZA448-E44	0293	S4	1952

SCORPIO II

2.0i	NSD - DL20 SEFI	2.0	85	10.94-12.98		R	4	27	370	OZA659-EE44	1638	---	---
2.0i	N3A - DH20 SEFI	2.0	100	10.94-04.96		R	4	27	370	OZA659-EE44	1638	---	---
2.0i	N3A - DH20 SEFI	2.0	100	10.94-04.96		D	4	27	370	OZA659-EE44	1638	---	---
2.3i 16V	Y5A - DH23 SEFI	2.3	108	05.96-12.98		R	4	27	370	OZA659-EE44	1638	---	---
2.9i (95)	BRG	2.9	110	01.95-12.98		R	4	27	555	OZA448-E42	0271	S4	1952
2.9i 24V (95)	BOB	2.9	152	01.95-12.98		R	4	27	375	OZA448-E44	0293	S4	1952

SIERRA

1.6i	L6B	1.6	59	01.90-02.93		R	4	27	270	OZA448-E12	1865	S4	1952
1.6i	L6B	1.6	59	10.89-01.90		R	4	63	270	OZA527-E21	1817	S4CG	1919
1.6i Turnier	L6B	1.6	59	10.89-01.90		R	4	63	270	OZA527-E21	1817	S4CG	1919
1.8	CVH	1.8	63-66	01.87-12.92		R	4	27	600	OZA33-D8	1867	S4	1952
2.0i	N4B	2.0	74	01.87-11.91		R	3	25	271	OZA446-E46	0139	S3	0412
2.0i	N4B	2.0	74	11.91-02.93		R	4	27	270	OZA448-E12	1865	S4	1952
2.0i Turnier	N4B	2.0	74	01.87-02.93		R	4	63	270	OZA527-E21	1817	S4CG	1919
2.0i	NRD	2.0	74	10.85-12.86		R	3	25	271	OZA446-E46	0139	S3	0412

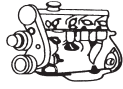

ℓ kW

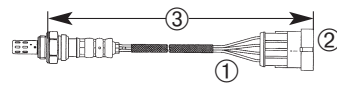
STOCK
UNIVERSAL
TYPE
UNIVERSAL
NO.
NO.
NO.
NO.

FORD

SIERRA

2.0i	N4A	2.0	85	01.87-11.91		R	3	25	271	OZA446-E46	0139	S3	0412
2.0i	N4A	2.0	85	11.91-02.93		R	4	27	270	OZA448-E12	1865	S4	1952
2.0i	N4I	2.0	85	01.87-10.89		R	3	25	271	OZA446-E46	0139	S3	0412
2.0i	NR2	2.0	85	10.85-12.86		R	3	25	550	OZA446-E62	1729	S3	0412
2.0 4x4	N9C	2.0	88	01.90-02.93		R	4	27	720	OZA448-E55	0470	S4	1952
2.0 4x4 Turnier	N9C	2.0	88	02.90-02.93		R	4	27	720	OZA448-E55	0470	S4	1952
2.0 XR4i	N9C	2.0	88	01.90-02.93		R	4	63	720	OZA527-E28	0477	S4CG	1919
2.0i	N9C	2.0	88	06.89-02.93		R	4	27	600	OZA33-D8	1867	S4	1952
2.0i HB	N9C	2.0	88	06.89-02.93		R	4	63	720	OZA527-E28	0477	S4CG	1919
2.0i Turnier	N9C	2.0	88	05.89-02.93		R	4	63	720	OZA527-E28	0477	S4CG	1919
2.0 Cosworth	N5D / N5C	2.0	162	12.91-07.93	Webber System	R	3	103	876	OTD5F-3E1	0023	---	---
2.0 Cosworth 4x4	N5D / N5C	2.0	162	12.91-07.93	Webber System	R	3	103	876	OTD5F-3E1	0023	---	---
2.9i XR4i	B4A	2.9	107	08.88-11.89		R	3	25	550	OZA446-E62	1729	S3	0412
2.9i XR4i	B4A	2.9	110	08.88-11.89		R	3	25	550	OZA446-E62	1729	S3	0412

SPORT KA

1.6i	CDRA / CDRB	1.6	70	07.03-07.05		R	4	32	372	OZA488-SZ1	1766	---	---
1.6i	CDRA / CDRB	1.6	70	05.03-07.05		D	4	32	300	OZA341-SZ3	0039	---	---

STREET KA

1.6i	CDRA / CDRB	1.6	70	02.03-07.05		R	4	32	372	OZA488-SZ1	1766	---	---
1.6i	CDRA / CDRB	1.6	70	02.03-07.05		D	4	32	300	OZA341-SZ3	0039	---	---

TRANSIT

2.0i	N6T	2.0	57	10.88-09.91		R	3	25	550	OZA446-E62	1729	S3	0412
2.0i SWB 80-150	NCA	2.0	72	04.93-10.94		R	4	27	570	OZA448-E41	0260	S4	1952
2.0i LWB 100-190	NCA	2.0	72	04.93-10.94		R	4	27	570	OZA448-E41	0260	S4	1952
FT080	NSF / NSG SEFI	2.0	84	08.94-07.00		R	4	27	370	OZA659-EE44	1638	---	---
FT100	NSF / NSG SEFI	2.0	84	08.94-07.00		R	4	27	370	OZA659-EE44	1638	---	---
FT120	NSF / NSG SEFI	2.0	84	08.94-07.00		R	4	27	370	OZA659-EE44	1638	---	---
FT150	NSF / NSG SEFI	2.0	84	08.94-07.00		R	4	27	370	OZA659-EE44	1638	---	---
FT190	NSF / NSG SEFI	2.0	84	08.94-07.00		R	4	27	370	OZA659-EE44	1638	---	---

GM-VAZ

GM-NIVA

Chevrolet-Niva 1.7 8V	21214	1.7	60	01.04-		R	4	107	415	OZA659-EE41	1628	---	---
-----------------------	-------	-----	----	--------	--	---	---	-----	-----	-------------	------	-----	-----

HONDA

ACCORD III

2.0i EX	CA5	A20A1	2.0	75	11.85-12.89	Universal	R	1	---	OZA624-E1	1951	S1	1951
2.0i EX	CA5	A20A2	2.0	78	11.85-05.89	Universal	R	1	---	OZA624-E1	1951	S1	1951

ACCORD IV

2.0i 16V Coupe	CC1	F20A7	2.0	98	01.92-09.93		R	4	17	583	OZA446-E42	0150	S4	1952
2.0i 16V Coupe	CC1	F20A7	2.0	98	01.92-09.93		R	4	43	350	OZA660-EE18	5714	S4	1952
2.2i 16V Aerodeck	CB8	F22A8	2.2	108	01.91-12.93		R	4	17	583	OZA446-E42	0150	S4	1952
2.2i 16V Aerodeck	CB8	F22A8	2.2	108	01.91-12.93		R	4	43	350	OZA660-EE18	5714	S4	1952

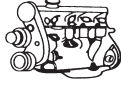

ℓ kW

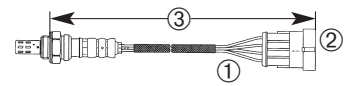
STOCK
NO.
UNIVERSAL
NO.
TYPE
NO.
LINE
NO.

HONDA

ACCORD IV

2.2i 16V Aerodeck	CB8	F22A7	2.2	110	01.91-12.93		R	4	17	583	OZA446-E42	0150	S4	1952
2.2i 16V Aerodeck	CB8	F22A7	2.2	110	01.91-12.93		R	4	43	350	OZA660-EE18	5714	S4	1952

ACCORD V

2.0i 16V	CC7	F20Z2	2.0	85	03.93-09.95		R	4	17	583	OZA446-E42	0150	S4	1952
2.0i 16V S	CC7	F20Z1	2.0	96	03.93-09.95		R	4	17	583	OZA446-E42	0150	S4	1952

ACCORD VI

1.8i 16V	CE7	F18A3	1.8	85	09.94-		R	4	43	240	OZA569-H1	0499	S4	1952
1.8i 16V	CE7	F18A3	1.8	85	09.94-		D	4	44	450	OZA501-H23	0469	S4	1952
1.8i 16V	CE7	F18A	1.8	85	02.96-10.98		R	4	44	410	OZA245-H1	0169	S4	1952
2.0i 16V	CE8	F20Z / F20B	2.0	96	02.96-10.98		R	4	44	410	OZA245-H1	0169	S4	1952
2.0i 16V	CE8	F20B / F20Z	2.0	100	02.96-10.98		R	4	44	410	OZA245-H1	0169	S4	1952
2.0i 16V	CE2	F20B3	2.0	100	09.94-		R	4	43	240	OZA569-H1	0499	S4	1952
2.0i 16V	CE2	F20B3	2.0	100	09.94-		D	4	44	450	OZA501-H23	0469	S4	1952
2.2i 16V	CE9	F22Z	2.2	110	02.96-10.98		R	4	43	225	OZA245-H2	0180	S4	1952
2.2i 16V	CD7	F22B5	2.2	110	09.94-		R	4	43	240	OZA569-H1	0499	S4	1952
2.2i 16V	CD7	F22B5	2.2	110	09.94-		D	4	44	450	OZA501-H23	0469	S4	1952

ACCORD VII

1.8i	CG	F18B	1.8	100	10.98-		R	4	43	240	OZA421-H1	0255	---	---
1.8i	CG	F18B	1.8	100	10.98-		R	4	43	240	OZA501-H17	0266	S4	1952
1.8i	CG	F18B	1.8	100	10.98-		D	4	44	450	OZA333-H19	0277	---	---
2.2i Type-R	CG	F22Z	2.2	156	02.99-		R	4	43	240	OZA421-H1	0255	---	---
2.2i Type-R	CG	F22Z	2.2	156	02.99-		D	4	44	450	OZA333-H19	0277	---	---
3.0 V6 24V Coupe	CG	J30A1	3.0	147	02.98-		R	3	14	1220	OZA446-E3	1866	S3	0412

CIVIC II

1.5i GTI	EW4		1.5	66	03.86-10.87		R	1	7	470	OZA401-E52	0164	S1	1951
1.6i 16V Shuttle 4WD	EE4	D16A6	1.6	80	01.88-12.89		R	1	5	370	OZA401-E57	0153	S1	1951
1.6i 16V Shuttle 4WD	EE4	D16A6	1.6	81	01.88-02.95		R	1	5	370	OZA401-E57	0153	S1	1951

CIVIC III

1.3i 16V HB	EC8	D13B2	1.3	55	09.89-09.91		R	1	5	370	OZA401-E57	0153	S1	1951
1.5i 16V HB	ED8	D15B2	1.5	69	10.88-09.91		R	1	5	370	OZA401-E57	0153	S1	1951
1.5i 16V Sedan	ED3	D15B2	1.5	69	12.89-09.91		R	1	5	370	OZA401-E57	0153	S1	1951
1.6i 16V HB	ED7	D16A6	1.6	80	10.87-09.91		R	1	5	370	OZA401-E57	0153	S1	1951
1.6i 16V Sedan	ED4	D16A6	1.6	80	10.89-09.91		R	1	5	370	OZA401-E57	0153	S1	1951
1.6i 16V HB	ED7	D16Z2	1.6	81	10.87-09.91		R	1	5	370	OZA401-E57	0153	S1	1951
1.6i 16V Sedan	ED4	D16Z2	1.6	81	10.87-09.91		R	1	5	370	OZA401-E57	0153	S1	1951

CIVIC IV

1.3i 16V	EG3	D13B2	1.3	55	10.91-11.95	Universal	R	1	---	---	OZA624-E1	1951	S1	1951
1.4i Fastback	MA8	D14A2	1.4	66	09.94-01.97		R	4	43	350	OZA660-EE18	5714	S4	1952
1.5i Vtec-E	MA9	D15Z3	1.5	66	09.94-01.97		R	5	100	410	LZA09-E1	0025	---	---
1.5i 16V HB	EG4	D15Z1	1.5	69	01.93-01.94		R	4	43	410	OZA444-E1	0439	---	---
1.5i 16V	EG4	D15Z1	1.5	69	10.91-11.95		R	5	100	410	LZA09-E1	0025	---	---
1.5i 16V	EG8	D15Z1	1.5	69	10.91-11.95		R	4	43	410	OZA444-E1	0439	---	---
1.5i LS Coupe	EJ2	D15B7	1.5	74	01.94-11.95		R	4	43	350	OZA660-EE18	5714	S4	1952
1.6i Fastback	MB1	D16Y3	1.6	83	09.94-01.97		R	4	43	350	OZA660-EE18	5714	S4	1952
1.6i 16V Sedan	MB1	D16Z7	1.6	88	10.91-09.95		R	4	43	410	OZA502-E28	0425	S4	1952
1.6i 16V Sedan	MB1	D16Z6	1.6	92	10.91-09.95		R	4	43	410	OZA502-E28	0425	S4	1952

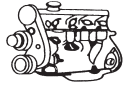

ℓ kW

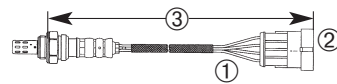
STOCK
UNIVERSAL
TYPE
INVERSE
NO.
NO.
NO.
NO.

HONDA

CIVIC IV

1.6i HB	EH9	D16Z6	1.6	92	10.91-09.95		R	4	43	410	OZA502-E28	0425	S4	1952
1.6i 16V Vtec	EH9	D16Z6	1.6	92	10.91-11.95		R	4	43	410	OZA444-E1	0439	---	---
1.6i 16V Vtec HB	EG5	D16Z6	1.6	92	10.91-12.93		R	4	43	410	OZA444-E1	0439	---	---
1.6i 16V Vtec Coupe	EJ1	D16Z6	1.6	92	01.94-03.96		R	4	43	410	OZA444-E1	0439	---	---
1.6i 16V Vtec FB	MB1	D16Y2	1.6	92	09.94-01.97		R	4	43	410	OZA444-E1	0439	---	---

CIVIC V

1.4 16V Fastback	MB2	D14A7	1.4	55	01.97-02.01		R	4	43	350	OZA660-EE18	5714	S4	1952
1.4i 16V	EJ9	D14A3	1.4	55	11.95-12.96		R	1	125	335	OZA218-H2	6455	S1	1951
1.4i 16V	EJ9	D14Z1	1.4	55	11.95-02.01		R	1	125	335	OZA218-H2	6455	S1	1951
1.4i 16V	EJ9	D14A3	1.4	55	01.97-02.01		R	4	43	320	OZA333-H4	0137	---	---
1.4i S	EJ9	D14A4	1.4	66	11.95-02.01		R	1	125	335	OZA218-H2	6455	S1	1951
1.4i 16V	MB8	D14A	1.4	66	02.99-02.01		R	4	43	320	OZA333-H26	0299	---	---
1.4i 16V	MB8	D14A	1.4	66	02.99-02.01		D	4	43	245	OZA333-H25	0288	---	---
1.4 16V Aerodeck	MB8	D14A8	1.4	66	04.98-02.01		R	4	43	350	OZA660-EE18	5714	S4	1952
1.4 16V Fastback	MB2	D14A8	1.4	66	01.97-02.01		R	4	43	350	OZA660-EE18	5714	S4	1952
1.5i 16V	MB9	D15Z	1.5	84	02.99-02.01		R	4	43	410	OZA333-H27	0212	---	---
1.5i	EK3	D15Z	1.5	84	01.97-02.01		R	4	43	410	OZA333-H5	0148	---	---
1.5i 16V Aerodeck	MB9	D15Z8	1.5	84	01.97-02.01		R	4	43	410	OZA444-E1	0439	---	---
1.6i	EJ6	D16Y7	1.6	77	03.96-03.00		R	4	43	410	OZA444-E1	0439	---	---
1.6i HB	EK1	D16Y5	1.6	84	11.95-02.01		R	4	43	410	OZA444-E1	0439	---	---
1.6i	EK1	D16Y	1.6	84	02.99-02.01		R	4	43	320	OZA333-H26	0299	---	---
1.6i	EK1	D16Y	1.6	84	01.97-01.99		R	4	43	320	OZA333-H4	0137	---	---
1.6i	EK1	D16Y	1.6	84	02.99-02.01		D	4	43	245	OZA333-H25	0288	---	---
1.6 16V Aerodeck	MC1	D16B2	1.6	85	04.98-02.01		R	4	43	350	OZA660-EE18	5714	S4	1952
1.6 16V Fastback	MB4	D16B2	1.6	85	01.97-02.01		R	4	43	350	OZA660-EE18	5714	S4	1952
1.6i Vtec	EJ9	D16Y8	1.6	92	11.95-12.00		R	4	43	410	OZA444-E1	0439	---	---
1.8i 16V	MC2	B18C	1.8	124	02.99-02.01		R	4	43	240	OZA501-H17	0266	S4	1952
1.8i	MB6	B18C4	1.8	124	01.97-02.01		R	4	43	235	OZA333-H6	0159	---	---

CIVIC VI

1.3i IMA	LDA1		1.3	61	01.04-09.05		D	4	44	535	OZA668-EE12	7951	---	---
1.4i	D14Z5		1.4	66	02.01-09.05	UK	R	4	44	535	OZA508-H4	0046	---	---
1.4i	D14Z5		1.4	66	02.01-09.05	UK	D	4	44	595	OZA501-H20	0045	---	---
1.6i	D16V1		1.6	81	02.01-09.05	UK	R	4	44	535	OZA508-H4	0046	---	---
1.6i	D16V1		1.6	81	02.01-09.05	UK	D	4	44	595	OZA501-H20	0045	---	---
1.6i	D16W7		1.6	81	02.01-09.05		D	4	44	535	OZA668-EE12	7951	---	---
1.7i Coupe	D17A8		1.7	88	05.01-12.05		D	4	44	595	OZA669-EE11	7971	---	---
1.7i Vtec Coupe	D17A9		1.7	92	05.01-01.03		D	4	44	535	OZA668-EE12	7951	---	---
1.7i Vtec Coupe	D17A9		1.7	92	02.03-12.05		D	4	44	595	OZA669-EE11	7971	---	---
2.0i Type R	K20A2		2.0	147	07.01-09.05		R	4	43	340	OZA563-H5	0061	---	---
2.0i Type R	K20A2		2.0	147	07.01-09.05		D	4	44	740	OZA562-H7	0059	---	---
2.0i Type R	K20A3		2.0	147	10.02-05.04		D	4	44	690	OZA563-H8	0063	---	---
2.0i Type R	K20A3		2.0	147	05.04-09.05	EURO IV	D	4	44	500	OZA614-H3	0071	---	---

CIVIC VII

1.4i	L13A7		1.4	66	09.05-		D	4	105	335	OZA635-H4	0076	---	---
1.8i	R18A2		1.8	100	09.05-		D	4	105	275	OZA635-H1	0075	---	---

CONVERTO

1.5i 16V	HW	D15B2	1.5	66	08.89-12.92		R	1	5	370	OZA401-E57	0153	S1	1951
1.6i 16V	HW	D16A8	1.6	90	08.89-03.95	Universal	R	1	---	---	OZA624-E1	1951	S1	1951

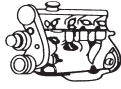

ℓ kW



STOCK
No.

UNIVERSAL
No.

TYPE
No.

LINE
No.

MEMBER
No.

HONDA

CONVERTO

1.6i 16V	HW	D16Z2	1.6	82	08.89-12.92		R	1	5	370	OZA401-E57	0153	S1	1951
----------	----	-------	-----	----	-------------	--	---	---	---	-----	------------	------	----	------

CR-V II

2.0	RD	K20A4	2.0	110	02.02-11.04		R	4	43	300	OZA563-H6	0062	---	---
2.0	RD	K20A4	2.0	110	02.02-11.04		D	4	44	455	OZA562-H9	0060	---	---

CRX II

1.6i 16V	ED9	D16Z5	1.6	91	10.87-02.92		R	1	5	370	OZA401-E57	0153	S1	1951
1.6i 16V	ED9	D16A9	1.6	96	10.87-12.89	Universal	R	1	---	---	OZA624-E1	1951	S1	1951

CRX III

1.6i 16V	EH6	D16Z6	1.6	92	03.92-12.98		R	4	43	410	OZA502-E28	0425	S4	1952
1.6i ESi	EH6	D16Y8	1.6	92	03.92-12.98		R	4	43	410	OZA502-E28	0425	S4	1952
1.6i ESi	EH6	D16Z6	1.6	92	03.92-12.98		R	4	43	410	OZA444-E1	0439	---	---

FR-V

1.7i		D17A2	1.7	92	02.05-01.07		D	4	44	595	OZA669-EE11	7971	---	---
------	--	-------	-----	----	-------------	--	---	---	----	-----	-------------	------	-----	-----

LEGEND I

2.5i	HS	C25A1	2.5	110	01.86-12.87	Universal	R	1	---	---	OZA624-E1	1951	S1	1951
2.7i 24V	KA4	C27A1	2.7	124	01.88-12.90	Universal	R	1	---	---	OZA624-E1	1951	S1	1951

LOGO

1.3i	GA3	D13B7	1.3	48	03.99-03.02		R	4	43	410	OZA444-E1	0439	---	---
------	-----	-------	-----	----	-------------	--	---	---	----	-----	-----------	------	-----	-----

PRELUDE

1.8i EX	AB	ET4	1.8	74	11.85-04.87		R	1	5	380	OZA401-E56	0154	S1	1951
2.0i EX	BA4	B20A3	2.0	80	04.87-01.92		R	1	5	370	OZA401-E57	0153	S1	1951
2.0i 16V	BB3	F20A4	2.0	98	02.92-09.96	Universal	R	1	---	---	OZA624-E1	1951	S1	1951
2.0i EX 16V	BA2	B20A1	2.0	101	04.86-12.87	Universal	R	1	---	---	OZA624-E1	1951	S1	1951
2.0i EX 16V	BA4	B20A5	2.0	101	04.87-01.92	Universal	R	1	---	---	OZA624-E1	1951	S1	1951
2.2i 16V	BB	H22A5	2.2	136	10.96-10.00		R	4	44	535	OZA668-EE12	7951	---	---
2.2i 16V	BB	H22A5	2.2	136	10.96-10.00		R	4	44	595	OZA669-EE11	7971	---	---
2.2i 16V	BB	H22A5	2.2	147	10.96-09.98		R	4	44	595	OZA669-EE11	7971	---	---

STREAM

1.7i 16V	RN	D17A2	1.7	92	05.01-		D	4	44	595	OZA669-EE11	7971	---	---
----------	----	-------	-----	----	--------	--	---	---	----	-----	-------------	------	-----	-----

HYUNDAI

ACCENT

1.3i	X-3	G4EH	1.3	44	07.94-07.99		R	3	79	265	OZA446-E56	0461	S3	0412
1.3i	X-3	G4EH	1.3	55	07.94-07.99		R	3	79	265	OZA446-E56	0461	S3	0412
1.3i	LC	G4E-A	1.3	55	01.00-		R	4	30	317	OZA107-KH2	6407	---	---
1.3i	X-3	G4EH	1.3	62	07.94-07.99		R	3	79	265	OZA446-E56	0461	S3	0412
1.3i	LC		1.3	62	08.02-		R	4	30	317	OZA107-KH2	6407	---	---
1.5i	X-3	G4EK	1.5	63-68	07.94-07.99		R	3	79	265	OZA446-E56	0461	S3	0412
1.3i	LC	G4E-A	1.3	63	01.00-		R	4	30	317	OZA107-KH2	6407	---	---
1.4i	MC	G4EE	1.4	71	11.05-		R	4	30	317	OZA107-KH2	6407	---	---
1.5i	LC	G4EB	1.5	66	01.00-		R	4	30	317	OZA107-KH2	6407	---	---
1.5i	X-3	G4EK	1.5	70-71	04.94-07.99		R	3	79	265	OZA446-E56	0461	S3	0412
1.5i	LC	G4EC-A	1.5	75	09.00-		R	4	30	317	OZA107-KH2	6407	---	---
1.6i	LC	G4ED-G	1.6	77	12.02-		R	4	30	317	OZA107-KH2	6407	---	---

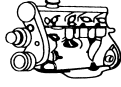

ℓ kW

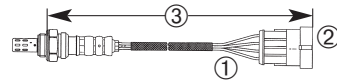

ORDER No.
STOCK No.
UNIVERSAL No.
TYPE No.
UNIVERSAL No.
SPECIAL No.

HYUNDAI

ACCENT

1.6i GLS	MC	G4ED	1.6	82	11.05-		R	4	30	317	OZA107-KH2	6407	---	---
----------	----	------	-----	----	--------	--	---	---	----	-----	------------	------	-----	-----

COUPE

1.6i 16V	GK	G4ED-G	1.6	77	04.02-		R	4	30	317	OZA107-KH2	6407	---	---
1.6i 16V	GK	G4ED-G	1.6	79	04.02-		R	4	30	317	OZA107-KH2	6407	---	---
1.6i 16V	RD	4G61	1.6	84	06.00-04.02		R	4	30	317	OZA107-KH2	6407	---	---
1.6i 16V	RD	G4GR	1.6	85	06.00-04.02		R	4	30	317	OZA107-KH2	6407	---	---

ELANTRA

1.5i		New Orion	1.5	63	10.90-04.95		R	1	8	550	OZA25-KH3	1969	S1	1951
1.6i	XD	G4ED-G	1.6	77	05.03-		R	4	30	317	OZA107-KH2	6407	---	---
1.6i	XD	G4ED-G	1.6	79	06.00-		R	4	30	317	OZA107-KH2	6407	---	---

EXCEL

1.3 Ecotronic		New Orion	1.3	43	04.89-07.94		R	1	8	550	OZA25-KH3	1969	S1	1951
1.3i		G4EH	1.3	55	07.94-07.99		R	3	79	265	OZA446-E56	0461	S3	0412
1.5i Ecotronic		New Orion	1.5	53	04.89-07.94		R	1	8	550	OZA25-KH3	1969	S1	1951
1.5i		New Orion	1.5	61	04.89-07.94		R	1	8	550	OZA25-KH3	1969	S1	1951

GETZ

1.3i	TB	G4E-A	1.3	60	09.03-		R	4	30	317	OZA107-KH2	6407	---	---
1.3i	TB	G4E-A	1.3	63	09.03-		R	4	30	317	OZA107-KH2	6407	---	---
1.4i	TB	G4EE	1.4	71	08.05-		R	4	30	317	OZA107-KH2	6407	---	---
1.6i	TB	G4ED-G	1.6	77	09.02-		R	4	30	317	OZA107-KH2	6407	---	---

H 100

2.4i		G4CS	2.4	84	01.97-03.00	Universal	R	1	---	---	OZA624-E1	1951	S1	1951
2.4i		New Sirius	2.4	90	07.93-03.00		R	1	8	550	OZA25-KH3	1969	S1	1951

LANTRA

1.5i		New Orion	1.5	63	10.90-04.95		R	1	8	550	OZA25-KH3	1969	S1	1951
------	--	-----------	-----	----	-------------	--	---	---	---	-----	-----------	------	----	------

MATRIX

1.6i	FC	G4ED-G	1.6	76	06.01-		R	4	30	317	OZA107-KH2	6407	---	---
1.8i	FC	G4GB-G	1.8	90	06.01-		D	4	30	317	OZA107-KH2	6407	---	---

PONY

1.3		New Orion	1.3	45-49	04.89-07.94		R	1	8	550	OZA25-KH3	1969	S1	1951
1.3i		G4EH	1.3	62	07.94-07.99		R	3	79	265	OZA446-E56	0461	S3	0412
1.5i Ecotronic		New Orion	1.5	53	04.89-07.94		R	1	8	550	OZA25-KH3	1969	S1	1951
1.5i		New Orion	1.5	61	04.89-07.94		R	1	8	550	OZA25-KH3	1969	S1	1951

S-COUPE

1.5i		G4EK	1.5	65	08.92-12.94		R	3	79	265	OZA446-E56	0461	S3	0412
1.5i		Alpha G4EK	1.5	65-68	07.92-06.93		R	3	19	975	OZA446-E2	1855	S3	0412
1.5i		4G62	1.5	70	06.88-06.93		R	1	8	550	OZA25-KH3	1969	S1	1951
1.5i GT Turbo		Alpha G4EK-TC	1.5	84-85	04.91-06.93		R	3	19	975	OZA446-E2	1855	S3	0412

SONATA

1.8i		4G62	1.8	70	06.88-06.93		R	1	8	650	OZA25-KH1	1940	S1	1951
2.0i		4G63	2.0	72-74	06.88-06.93		R	1	8	650	OZA25-KH1	1940	S1	1951
2.4i		4G64	2.4	80-82	01.89-10.93		R	1	8	650	OZA25-KH1	1940	S1	1951

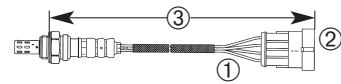

SUBORDINAT. No.
UNIVERSAL No.
TYPE No.
STOCK No.
ORDER No.



ℓ kW



HYUNDAI

TRAJET

2.0i	FO	G4GC-G	2.0	103	01.04-		D	4	30	317	OZA107-KH2	6407	---	---
------	----	--------	-----	-----	--------	--	----------	---	----	-----	------------	-------------	-----	-----

TUCSON

2.0i	JM	G4GC	2.0	104	08.04-		D	4	30	317	OZA107-KH2	6407	---	---
------	----	------	-----	-----	--------	--	----------	---	----	-----	------------	-------------	-----	-----

INNOCENTI

ELBA

1.4i.e.		146C5.000	1.4	49	09.93-06.95		R	3	19	895	OZA446-E4	1877	S3	0412
1.4i.e.		146D5.000	1.4	49	06.95-06.97		R	4	38	880	OZA527-E4	0218	S4CG	1919
1.6i.e.		146C6.000 Jetronic	1.6	55	09.93-03.96		R	3	19	895	OZA446-E4	1877	S3	0412
1.6i.e.		146C6.000 Motronic	1.6	55	03.96-06.97		R	4	38	880	OZA527-E4	0218	S4CG	1919

MILLE

1.0i 8V		146C7.000	1.0	35	09.95-06.97		R	4	31	290	OZA114-A1	1856	S4	1952
---------	--	-----------	-----	----	-------------	--	---	---	----	-----	-----------	-------------	----	-------------

JAGUAR

DAIMLER

3.6i		AJ6.4 DOHC	3.6	136	10.86-08.89		R	3	19	975	OZA446-E2	1855	S3	0412
------	--	------------	-----	-----	-------------	--	---	---	----	-----	-----------	-------------	----	-------------

SOVEREIGN

2.9i		AJ6	2.9	104	10.86-08.90		R	3	19	975	OZA446-E2	1855	S3	0412
3.2i 24V		AJ6 OHC	3.2	149	09.90-		R	3	19	975	OZA446-E2	1855	S3	0412
3.6i		AJ6 DOHC	3.6	135	10.86-08.89	ⓓ	R	3	19	975	OZA446-E2	1855	S3	0412
6.0 XJ 81		OHC	6.0	234	03.93-		R	3	19	975	OZA446-E2	1855	S3	0412

S-TYPE

3.0i		AJ-V6	3.0	175	09.98-		R	4	32	271	OZA488-D1	0403	---	---
3.0i		AJ-V6	3.0	175	10.98-	L86902 -> M45254	R	4	32	296	OZA381-D12	0041	---	---
3.0i		AJ-V6	3.0	175	10.98-09.00		D	4	32	271	OZA381-D2	0451	---	---
3.0i		AJ-V6	3.0	175	09.98-		D	4	32	393	OZA381-D3	0462	---	---
4.0i		AJ-V8	4.0	205	09.98-		R	4	32	271	OZA488-D1	0403	---	---
4.0i		AJ-V8	4.0	205	09.98-		D	4	32	393	OZA381-D3	0462	---	---

XJ6

2.9i		AJ6	2.9	108-117	10.86-12.88		R	3	19	975	OZA446-E2	1855	S3	0412
3.2i 24V		AJ6 OHC	3.2	146	10.90-09.94		R	3	19	975	OZA446-E2	1855	S3	0412
3.2i		AJ6	3.2		10.94-		R	4	56	730	OTD3J-5B1	0464	---	---
3.2i		AJ6	3.2		10.94-		D	4	56	730	OTD3J-5B1	0464	---	---
3.6i		AJ6.4 DOHC	3.6	136	10.86-08.89		R	3	19	975	OZA446-E2	1855	S3	0412
4.0i		AJ6 DOHC	4.0	163	09.89-09.94		R	3	19	895	OZA446-E4	1877	S3	0412
4.0i		AJ6	4.0		10.94-		D	4	56	730	OTD3J-5B1	0464	---	---
4.2i			4.2	147	03.79-10.86		R	3	19	975	OZA446-E2	1855	S3	0412

XJS

3.6i		AJ3.6 DOHC	3.6	165	10.86-12.88		R	3	19	975	OZA446-E2	1855	S3	0412
3.6i SC Cabriolet		AJ3.6 DOHC	3.6	165	10.86-12.88		R	3	19	975	OZA446-E2	1855	S3	0412
4.0i		AJ6 DOHC	4.0	163-166	05.91-09.94		R	3	19	975	OZA446-E2	1855	S3	0412
4.0i		AJ6	4.0		09.94-		D	4	56	730	OTD3J-5B1	0464	---	---

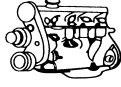

ℓ kW

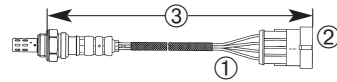

STOCK
UNIVERSAL
TYPE
UNIVERSAL
NO.

JAGUAR

XJS

5.3i	HE V12	5.3	183	07.81-12.87		R	3	19	975	OZA446-E2	1855	S3	0412
6.0i V12	DOHC	6.0	222-227	05.92-		R	3	19	975	OZA446-E2	1855	S3	0412

XJR

4.0i	AJ6	4.0		09.94-		D	4	56	730	OTD3J-5B1	0464	---	---
------	-----	-----	--	--------	--	---	---	----	-----	-----------	------	-----	-----

XJ12

5.3i	V12HE	5.3	194	07.81-09.94		R	3	19	975	OZA446-E2	1855	S3	0412
------	-------	-----	-----	-------------	--	---	---	----	-----	-----------	------	----	------

JEEP

CHEROKEE

2.5i		2.5	89	03.91-12.96		R	4	114	590	OZA28-C3	6380	S4	1952
2.5i		2.5	89	01.96-12.96		D	4	115	457	OZA248-C1	6381	S4	1952
2.8i	<W>	2.8	81	10.83-09.86		R	1	6	387	OZA19-E12	6379	S1	1951
4.0i		4.0	135	03.91-12.94		R	4	114	590	OZA28-C3	6380	S4	1952
4.0i		4.0	131	01.95-12.97		D	4	36	1075	OZA527-E36	1993	S4CG	1919
4.0i		4.0	131	01.95-12.97		D	4	115	457	OZA248-C1	6381	S4	1952

COMMANDER

3.7i		3.7	157	01.05-	Y	R	4	118	300	OZA623-C1	6397	---	---
3.7i		3.7	157	01.05-	Y	R	4	118	300	OZA623-C1	6397	---	---
3.7i		3.7	157	01.06-	Y	D	4	89	425	OZA571-C2	6384	---	---
3.7i		3.7	157	01.06-	Y	D	4	89	425	OZA571-C2	6384	---	---
5.7i		5.7	240	01.06-	Y	R	4	118	300	OZA623-C1	6397	---	---
5.7i		5.7	240	01.06-	Y	R	4	118	300	OZA623-C1	6397	---	---
5.7i		5.7	240	01.06-	Y	D	4	89	425	OZA571-C2	6384	---	---
5.7i		5.7	240	01.06-	Y	D	4	89	425	OZA571-C2	6384	---	---

GRAND CHEROKEE

3.7i		3.7	157	06.05-	Y	R	4	118	300	OZA623-C1	6397	---	---
3.7i		3.7	157	06.05-	Y	R	4	118	300	OZA623-C1	6397	---	---
3.7i		3.7	157	06.05-	Y	D	4	89	425	OZA571-C2	6384	---	---
3.7i		3.7	157	06.05-	Y	D	4	89	425	OZA571-C2	6384	---	---
4.0i	S01	4.0	130	10.95-01.97		D	4	36	1075	OZA527-E36	1993	S4CG	1919
4.0i		4.0	132	09.92-01.97		D	4	36	1075	OZA527-E36	1993	S4CG	1919
4.0i	MX	4.0	135	09.92-01.97		D	4	36	1075	OZA527-E36	1993	S4CG	1919
5.2i		5.2	155	03.93-12.95		R	4	114	590	OZA28-C3	6380	S4	1952
5.2i		5.2	155	03.93-12.95		D	4	114	590	OZA28-C3	6380	S4	1952
5.2i	Y01	5.2	156	10.95-01.97		D	4	36	1075	OZA527-E36	1993	S4CG	1919
5.2i	Y	5.2	158	09.92-01.97		D	4	36	1075	OZA527-E36	1993	S4CG	1919
5.7i		5.7	240	06.05-	Y	R	4	118	300	OZA623-C1	6397	---	---
5.7i		5.7	240	06.05-	Y	R	4	118	300	OZA623-C1	6397	---	---
5.7i		5.7	240	06.05-	Y	D	4	89	425	OZA571-C2	6384	---	---
5.7i		5.7	240	06.05-	Y	D	4	89	425	OZA571-C2	6384	---	---

LIBERTY

2.4i		2.4	105	06.04-		R	4	89	425	OZA571-C2	6384	---	---
2.4i		2.4	105	06.04-		D	4	89	425	OZA571-C2	6384	---	---
3.7i		3.7	157	06.05-	Y	R	4	118	300	OZA623-C1	6397	---	---
3.7i		3.7	157	06.05-	Y	R	4	118	300	OZA623-C1	6397	---	---

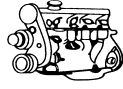
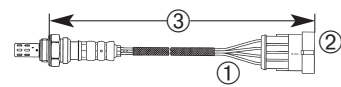

ℓ kW



ORDER No.
STOCK No.
UNIVERSAL No.
TYPE No.
SPECIAL No.
SUSPENSION No.

JEEP

LIBERTY

3.7i		3.7	157	06.05-	↑	D	4	89	425	OZA571-C2	6384	---	---
3.7i		3.7	157	06.05-	↑	D	4	89	425	OZA571-C2	6384	---	---

WAGONEER

2.8i	<W>	2.8	81	10.84-09.86			R	1	6	387	OZA19-E12	6379	S1	1951
4.0i	<M>	4.0	127	01.87-12.87			R	1	6	387	OZA19-E12	6379	S1	1951

WRANGLER

2.4i		2.4	105	06.05-			R	4	89	425	OZA571-C2	6384	---	---
2.4i		2.4	105	06.05-			D	4	89	425	OZA571-C2	6384	---	---
2.5i		2.5	89	03.91-12.95			R	4	114	590	OZA28-C3	6380	S4	1952
4.0i		4.0	124	06.05-12.05			R	4	89	425	OZA571-C2	6384	---	---
4.0i		4.0	124	01.06-	↑		R	4	119	457	OZA623-C2	6400	---	---
4.0i		4.0	124	01.06-	↑		R	4	118	300	OZA623-C1	6397	---	---
4.0i		4.0	124	06.05-			D	4	89	425	OZA571-C2	6384	---	---
4.0i		4.0	135	03.91-12.95			R	4	114	590	OZA28-C3	6380	S4	1952
4.2i	<C>	4.2	81	01.87-09.90			R	1	6	387	OZA19-E12	6379	S1	1951

KIA

CARENS II

2.0 CWT	FJ		2.0	102	08.04-05.06			R	4	30	317	OZA107-KH2	6407	---	---
---------	----	--	-----	-----	-------------	--	--	---	---	----	-----	------------	------	-----	-----

CERATO

1.6i	G4ED		1.6	77	07.04-			R	4	30	317	OZA107-KH2	6407	---	---
2.0i	G4GC		2.0	105	04.04-			D	4	30	317	OZA107-KH2	6407	---	---

RIO II

1.4i 16V	G4EE		1.4	71	03.05-			R	4	30	317	OZA107-KH2	6407	---	---
1.4i 16V	G4EE		1.4	71	03.05-			D	4	30	317	OZA107-KH2	6407	---	---
1.6i 16V	G4ED		1.6	82	03.05-			R	4	30	317	OZA107-KH2	6407	---	---
1.6i 16V	G4ED		1.6	82	03.05-			D	4	30	317	OZA107-KH2	6407	---	---

SEPHIA

1.6i	FA	B6	1.6	59	01.95-12.97	Universal		R	1	---	---	OZA624-E1	1951	S1	1951
------	----	----	-----	----	-------------	-----------	--	---	---	-----	-----	-----------	------	----	------

SPORTAGE

2.0i 16V	JE	G4GC	2.0	104	09.04-			D	4	30	317	OZA107-KH2	6407	---	---
----------	----	------	-----	-----	--------	--	--	---	---	----	-----	------------	------	-----	-----

LADA (AVTOVAZ)

110

1.5 8V	2111		1.5	56	01.96-	Bosch MP7.0 HFM		R	4	107	400	OZA660-EE1	5653	S4	1952
1.5 8V	2111		1.5	56	01.96-	Bosch MP7.0 HFM		D	4	28	395	OZA660-EE2	5654	S4	1952
1.5 16V	2112		1.5	67	06.99-	Bosch MP7.0 HFM		R	4	107	400	OZA660-EE1	5653	S4	1952
1.5 16V	2112		1.5	67	06.99-	Bosch MP7.0 HFM		D	4	28	395	OZA660-EE2	5654	S4	1952
1.6 8V	21114		1.6	59	01.02-	Bosch MP7.0 HFM		R	4	107	400	OZA660-EE1	5653	S4	1952
1.6 8V	21114		1.6	59	01.02-	Bosch MP7.0 HFM		D	4	28	395	OZA660-EE2	5654	S4	1952
1.6 16V	21124		1.6	66	01.02-	Bosch MP7.0 HFM		R	4	107	400	OZA660-EE1	5653	S4	1952
1.6 16V	21124		1.6	66	01.02-	Bosch MP7.0 HFM		D	4	28	395	OZA660-EE2	5654	S4	1952

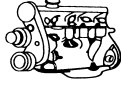

ℓ kW

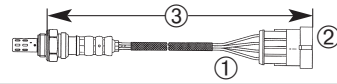
ORDER No.
UNIVERSAL No.
TYPE No.
UNIVERSAL No.
ORDER No.

LADA (AVTOVAZ)

111

1.5 8V	2111	1.5	56	01.96-	Bosch MP7.0 HFM	R	4	107	400	OZA660-EE1	5653	S4	1952
1.5 8V	2111	1.5	56	01.96-	Bosch MP7.0 HFM	D	4	28	395	OZA660-EE2	5654	S4	1952
1.5 16V	2112	1.5	67	06.99-	Bosch MP7.0 HFM	R	4	107	400	OZA660-EE1	5653	S4	1952
1.5 16V	2112	1.5	67	06.99-	Bosch MP7.0 HFM	D	4	28	395	OZA660-EE2	5654	S4	1952
1.6 8V	21114	1.6	59	01.02-	Bosch MP7.0 HFM	R	4	107	400	OZA660-EE1	5653	S4	1952
1.6 8V	21114	1.6	59	01.02-	Bosch MP7.0 HFM	D	4	28	395	OZA660-EE2	5654	S4	1952
1.6 16V	21124	1.6	66	01.02-	Bosch MP7.0 HFM	R	4	107	400	OZA660-EE1	5653	S4	1952
1.6 16V	21124	1.6	66	01.02-	Bosch MP7.0 HFM	D	4	28	395	OZA660-EE2	5654	S4	1952

112

1.5 8V	2111	1.5	56	01.96-	Bosch MP7.0 HFM	R	4	107	400	OZA660-EE1	5653	S4	1952
1.5 8V	2111	1.5	56	01.96-	Bosch MP7.0 HFM	D	4	28	395	OZA660-EE2	5654	S4	1952
1.5 16V	2112	1.5	67	06.99-	Bosch MP7.0 HFM	R	4	107	400	OZA660-EE1	5653	S4	1952
1.5 16V	2112	1.5	67	06.99-	Bosch MP7.0 HFM	D	4	28	395	OZA660-EE2	5654	S4	1952
1.6 8V	21114	1.6	59	01.02-	Bosch MP7.0 HFM	R	4	107	400	OZA660-EE1	5653	S4	1952
1.6 8V	21114	1.6	59	01.02-	Bosch MP7.0 HFM	D	4	28	395	OZA660-EE2	5654	S4	1952
1.6 16V	21124	1.6	66	01.02-	Bosch MP7.0 HFM	R	4	107	400	OZA660-EE1	5653	S4	1952
1.6 16V	21124	1.6	66	01.02-	Bosch MP7.0 HFM	D	4	28	395	OZA660-EE2	5654	S4	1952

KALINA

1117	21114	1.6	59	10.04-	OE	R	4	107	415	OZA659-EE41	1628	---	---
1117	21114	1.6	59	10.04-	OE	D	4	107	415	OZA659-EE41	1628	---	---
1118	21114	1.6	59	10.04-	OE	R	4	107	415	OZA659-EE41	1628	---	---
1118	21114	1.6	59	10.04-	OE	D	4	107	415	OZA659-EE41	1628	---	---
1119	21114	1.6	59	10.04-	OE	R	4	107	415	OZA659-EE41	1628	---	---
1119	21114	1.6	59	10.04-	OE	D	4	107	415	OZA659-EE41	1628	---	---
1117	21124	1.6	66	10.04-	OE	R	4	107	415	OZA659-EE41	1628	---	---
1117	21124	1.6	66	10.04-	OE	D	4	107	415	OZA659-EE41	1628	---	---
1118	21124	1.6	66	10.04-	OE	R	4	107	415	OZA659-EE41	1628	---	---
1118	21124	1.6	66	10.04-	OE	D	4	107	415	OZA659-EE41	1628	---	---
1119	21124	1.6	66	10.04-	OE	R	4	107	415	OZA659-EE41	1628	---	---
1119	21124	1.6	66	10.04-	OE	D	4	107	415	OZA659-EE41	1628	---	---

NIVA

1.7	VAZ	1.7	60	07.99-12.00		R	4	107	400	OZA660-EE1	5653	S4	1952
1.7	VAZ-2121.3	1.7	62	07.99-12.00		R	4	107	400	OZA660-EE1	5653	S4	1952

SAMARA

1.3i	BA3 21115	1.3	50	02.96-		R	4	107	400	OZA660-EE1	5653	S4	1952
1.5 8V	2111	1.5	56	01.96-		R	4	107	400	OZA660-EE1	5653	S4	1952
1.5 16V	2112	1.5	67	06.99-		R	4	107	400	OZA660-EE1	5653	S4	1952

LAMBORGHINI

GALLARDO

		5.0	368	08.03-	2↑	R	5	92	810	LZA11-V4	1842	---	---
--	--	-----	-----	--------	----	---	---	----	-----	----------	------	-----	-----

MURCIELAGO

		6.2	426	11.01-	2↑	R	5	92	810	LZA11-V4	1842	---	---
--	--	-----	-----	--------	----	---	---	----	-----	----------	------	-----	-----

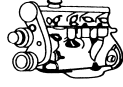

ℓ kW

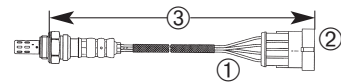

NUMERO IN
UNIVERSAL
TYPE No.
STOCK
ORDER No.

LANCIA

DEDRA

1.6i	835C1.000	1.6	55	04.93-10.94	SPI-Bosch ①	R	4	38	880	OZA527-E4	0218	S4CG	1919
1.6i	835A1.046	1.6	57	08.89-03.93	■ ①	R	3	19	895	OZA446-E4	1877	S3	0412
1.6i.e 16V	182A4.000	1.6	74	01.98-01.00		R	4	40	610	OZA334-A1	0223	---	---
1.6i.e 16V S.W.	182A4.000	1.6	74	01.98-01.00		R	4	40	610	OZA334-A1	0223	---	---
1.8i	836A5.000	1.8	74	10.94-12.95	MPI-Weber	R	4	40	972	OZA527-E7	0213	S4CG	1919
1.8i	836A5.000	1.8	74	10.94-12.95	MPI-Weber	R	4	40	972	OZA527-E7	0213	S4CG	1919
1.8i SW	836A5.000	1.8	74	10.94-12.95	MPI-Weber	R	4	40	972	OZA527-E7	0213	S4CG	1919
1.8i SW	836A5.000	1.8	74	10.94-12.95	MPI-Weber	R	4	40	972	OZA527-E7	0213	S4CG	1919
1.8i	835A2046	1.8	77	09.89-10.94	MPI-Weber	R	3	19	895	OZA446-E4	1877	S3	0412
1.8i 16V	182A2.000	1.8	83	01.96-01.00	MPI-Hit.	R	4	40	972	OZA527-E7	0213	S4CG	1919
1.8i 16V SW	182A2.000	1.8	83	01.96-01.00	MPI-Hit.	R	4	40	972	OZA527-E7	0213	S4CG	1919
1.8i 16V	182A2.000	1.8	84	06.96-12.97		R	4	31	600	OZA112-A3	0157	S4	1952
1.8i 16V S.W.	182A2.000	1.8	84	06.96-12.97		R	4	31	600	OZA112-A3	0157	S4	1952
1.8i 16V	182A1.000	1.8	96	06.96-12.97		R	4	31	600	OZA112-A3	0157	S4	1952
1.8i 16V S.W.	182A1.000	1.8	96	06.96-12.97		R	4	31	600	OZA112-A3	0157	S4	1952
1.8i.e 16V	182A2.000	1.8	96	01.98-09.99		R	4	40	980	OZA334-A2	0234	---	---
1.8i.e 16V S.W.	182A2.000	1.8	96	01.98-09.99		R	4	40	980	OZA334-A2	0234	---	---
2.0i	835A5.046	2.0	83	01.89-09.94	MPI-Weber	R	3	19	895	OZA446-E4	1877	S3	0412
2.0i 16V	836A3.000	2.0	102	10.94-08.96	MPI-Weber	R	3	22	890	OZA446-E18	1887	S3	0412
2.0i 16V 4x4 SW	836A3.000	2.0	102	10.94-08.96	MPI-Weber	R	3	22	890	OZA446-E18	1887	S3	0412
2.0i 16V SW	836A3.000	2.0	102	10.94-08.96	MPI-Weber	R	3	22	890	OZA446-E18	1887	S3	0412
2.0i Turbo	835A8.046	2.0	119	11.90-10.94	MPI-Weber	R	3	19	670	OZA446-E1	1833	S3	0412
2.0i Turbo	835A8.046	2.0	119	11.90-10.94	MPI-Weber	R	3	19	670	OZA446-E1	1833	S3	0412
2.0i Turbo 4x4	835A7.046	2.0	124	04.91-10.94	MPI-Weber	R	3	19	670	OZA446-E1	1833	S3	0412
2.0i Turbo 4x4	835A7.046	2.0	124	04.91-10.94	MPI-Weber	R	3	19	670	OZA446-E1	1833	S3	0412

DELTA

1.4i.e.	160A1.046	1.4	51	01.93-04.94	SPI-Bosch	R	3	19	895	OZA446-E4	1877	S3	0412
1.4i.e.	160A1.046	1.4	51	05.94-01.00	SPI-Bosch	R	4	38	880	OZA527-E4	0218	S4CG	1919
1.4 i.e.	836A4.000	1.4	51	04.94-01.00		R	4	40	972	OZA527-E7	0213	S4CG	1919
1.5i.e.	138C..	1.5	55	12.85-10.87		R	1	3	472	OZA401-E2	1802	S1	1951
1.6 i.e.	835C1.000	1.6	55	01.93-03.98		R	4	40	972	OZA527-E7	0213	S4CG	1919
1.6i.e.	835C1.000	1.6	55	01.93-12.95	SPI-Bosch	R	4	38	880	OZA527-E4	0218	S4CG	1919
1.6 16V	182A4.000	1.6	74	06.96-03.98		R	4	31	850	OZA112-A1	0146	S4	1952
1.6i.e 16V HPE	182A4.000	1.6	74	04.98-01.00		R	4	40	610	OZA334-A1	0223	---	---
1.8i.e.	835C4.000	1.8	66	01.93-01.00	MPI-Weber	R	4	40	972	OZA527-E7	0213	S4CG	1919
1.8i.e.	835C5.000	1.8	71	01.93-12.94	MPI-Weber	R	4	38	880	OZA527-E4	0218	S4CG	1919
1.8i.e.	836A5.000 / A6.000	1.8	71	01.93-12.94		R	4	40	972	OZA527-E7	0213	S4CG	1919
1.8 i.e.	836A5.000 / 836A6.000	1.8	74	01.95-05.98		R	4	40	972	OZA527-E7	0213	S4CG	1919
1.8i.e.	835C2.000	1.8	76	01.93-12.94	MPI-Weber	R	4	38	880	OZA527-E4	0218	S4CG	1919
1.8 16V	182A2.000	1.8	84	06.96-05.98		R	4	31	600	OZA112-A3	0157	S4	1952
1.8 16V	182A1.000	1.8	96	06.96-05.98		R	4	31	600	OZA112-A3	0157	S4	1952
1.8i.e 16V HPE	182A2.000	1.8	96	06.98-01.00		R	4	40	980	OZA334-A2	0234	---	---
2.0i.e. 16V	836A3.000	2.0	102	01.95-12.95	MPI-Weber	R	3	22	890	OZA446-E18	1887	S3	0412
2.0i.e. 16V	836A3.000	2.0	102	01.93-12.94	MPI-Weber	R	3	19	895	OZA446-E4	1877	S3	0412
2.0i.e. 16V Turbo HPE	836A2.000	2.0	137	01.93-09.96	MPI-Weber	R	3	19	975	OZA446-E2	1855	S3	0412
2.0i.e. 16V Turbo HPE	175A4.000	2.0	137	09.96-01.00	MPI-Weber	R	3	19	975	OZA446-E2	1855	S3	0412

KAPPA

2.0i 20V	838A1.000	2.0	110	11.94-06.98	■	R	4	40	972	OZA527-E7	0213	S4CG	1919
2.0i 20V	838A1.000	2.0	110	11.94-06.96	■	R	4	40	972	OZA527-E7	0213	S4CG	1919

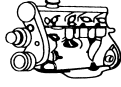

ℓ kW

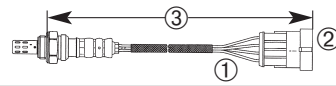
ORDER No.
STOCK No.
UNIVERSAL No.
TYPE No.
NUMBERS PL.
SUPPLEMENT No.

LANCIA

KAPPA

2.0i 20V	838A6.000	2.0	114	06.96-06.98		R	4	40	972	OZA527-E7	0213	S4CG	1919
2.0i 20V	838A6.000	2.0	114	07.98-12.00		R	4	40	600	OZA659-EE31	1613	---	---
2.0i 20V S.W.	838A6.000	2.0	114	06.96-06.98		R	4	40	972	OZA527-E7	0213	S4CG	1919
2.0i 20V S.W.	838A6.000	2.0	114	07.98-12.00		R	4	40	600	OZA659-EE31	1613	---	---
2.0i 16V Turbo Coupe	838A4.000	2.0	151	01.97-12.01		R	4	40	971	OZA527-E7	0213	S4CG	1919
2.0i 16V Turbo S.W.	838A4.000	2.0	151	11.94-06.98		R	4	40	972	OZA527-E7	0213	S4CG	1919
2.4i 20V	838A2.000	2.4	129	11.94-06.98		R	4	40	972	OZA527-E7	0213	S4CG	1919
2.4i 20V	838B2.000	2.4	129	07.98-12.00		R	4	40	600	OZA659-EE31	1613	---	---
2.4i 20V S.W.	838A2.000	2.4	129	11.94-06.98		R	4	40	972	OZA527-E7	0213	S4CG	1919
2.4i 20V S.W.	838B2.000	2.4	129	07.98-12.00		R	4	40	600	OZA659-EE31	1613	---	---
2.4i 20V Coupe	838A2.000	2.4	129	01.97-06.98		R	4	40	972	OZA527-E7	0213	S4CG	1919
3.0 V6 24V	838B.000	3.0	150	11.94-04.99		R	4	40	1175	OZA527-E24	0287	S4CG	1919
3.0 V6 24V	838B.000	3.0	150	05.99-12.00		R	4	40	1170	OZA659-EE30	1612	---	---
3.0 V6 24V Coupe	838B.000	3.0	150	01.97-04.99		R	3	22	890	OZA446-E18	1887	S3	0412
3.0 V6 24V Coupe	838B.000	3.0	150	05.99-06.00		R	4	40	1170	OZA659-EE30	1612	---	---
3.0 V6 24V S.W.	838B.000	3.0	150	11.94-04.99		R	3	22	890	OZA446-E18	1887	S3	0412
3.0 V6 24V S.W.	838B.000	3.0	150	05.99-12.00		R	4	40	1170	OZA659-EE30	1612	---	---

LYBRA

1.6i 16V	182A4.000	1.6	74	09.99-09.00		R	4	40	610	OZA334-A1	0223	---	---
1.6i 16V	182B6.000	1.6	75	10.00-06.06		R	4	40	410	OZA534-A2	1764	---	---
1.6i 16V	182B6.000	1.6	75	10.00-06.06		D	4	40	980	OZA534-A3	1800	---	---
1.8i 16V	182A2.000	1.8	96	09.99-09.00		R	4	40	980	OZA334-A2	0234	---	---
1.8i 16V	839A7.000	1.8	96	10.00-06.06		R	4	40	610	OZA532-A2	0489	---	---
1.8i 16V	839A7.000	1.8	96	10.00-06.06		R	4	40	260	OZA532-A3	0409	---	---
1.8i 16V	839A7.000	1.8	96	10.00-06.06	EU3	D	4	40	1810	OZA532-A5	1792	---	---
2.0i 20V	185A8.000	2.0	110	10.00-12.06		R	4	40	300	OZA659-EE3	0377	---	---
2.0i 20V	185A8.000	2.0	110	10.00-12.06		D	4	40	400	OZA659-EE49	5753	---	---
2.0i 20V	182B7.000	2.0	113	10.99-09.00		R	4	40	600	OZA659-EE31	1613	---	---

MUSA

1.3 MJT	199A2.000	1.3	51	09.05-		R	5	91	318	LZA15-A3	0031	---	---
1.3 MJT	199A3.000	1.3	66	09.05-		R	5	91	318	LZA15-A3	0031	---	---
1.4i	350A1.000	1.4	57	10.04-		R	4	40	300	OZA659-EE3	0377	---	---
1.4i 16V	192B2.000	1.4	66	03.05-		R	4	40	300	OZA675-EE1	7978	---	---
1.4i 16V	843A1.000	1.4	70	10.04-		R	4	40	300	OZA675-EE1	7978	---	---

PHEDRA

2.0i 16V	RFN	2.0	100	09.02-		R	4	83	380	OZA659-EE12	0386	---	---
2.0i 16V	RFN	2.0	100	09.02-		D	4	83	380	OZA659-EE12	0386	---	---
3.0i 24V	XFW	3.0	150	09.02-		R	4	83	380	OZA659-EE12	0386	---	---
3.0i 24V	XFW	3.0	150	09.02-		D	4	83	380	OZA659-EE12	0386	---	---

PRISMA

1.5i.e.	138C..	1.5	55	12.85-12.86		R	1	3	472	OZA401-E2	1802	S1	1951
1.6i.e.	831B..	1.6	66	05.87-12.89	SPI-Weber	R	1	3	472	OZA401-E2	1802	S1	1951
1.6i.e. Super	149C2.000	1.6	66	05.87-12.89	Universal	R	1	---	---	OZA624-E1	1951	S1	1951
1.6i.e.	831B7.000	1.6	80	05.86-12.89	Universal	R	1	---	---	OZA624-E1	1951	S1	1951

THEMA

2.0i.e.	834B0..	2.0	83-85	03.86-09.88		R	3	19	670	OZA446-E1	1833	S3	0412
2.0i.e.	834B146	2.0	84	05.92-11.94		R	3	19	670	OZA446-E1	1833	S3	0412

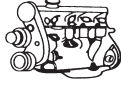

ℓ kW

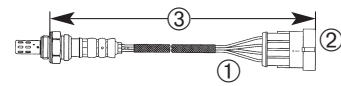
STOCK
NO.
UNIVERSAL
NO.
TYPE
NO.
CONFIRMATION
NO.

LANCIA

THEMA

2.0i.e. 16V	834B2.000	2.0	107	02.89-05.92		R	3	19	895	OZA446-E4	1877	S3	0412
2.0i.e. Turbo	834C146	2.0	110	07.86-05.90		R	3	19	670	OZA446-E1	1833	S3	0412
2.0i.e. 16V	834F1.000	2.0	112	05.92-11.94		R	4	38	880	OZA527-E4	0218	S4CG	1919
2.0i.e. Turbo 16V	834C1.246	2.0	132	04.89-05.92		R	3	19	895	OZA446-E4	1877	S3	0412
2.9i V6	PRV834E146	2.9	108	06.88-09.91		R	3	19	1215	OZA446-E16	1859	S3	0412
8.32	Ferrari F105L..	2.9	150	12.87-12.90		R	3	19	1215	OZA446-E16	1859	S3	0412
3.0i.e.	834F.000	3.0	126	05.92-11.94		R	4	38	1130	OZA527-E5	0253	S4CG	1919

THESIS

2.0i Turbo	841E.000	2.0	136	04.02-		R	4	40	300	OZA659-EE3	0377	---	---
2.4i 20V	841D.000	2.4	125	04.02-		R	4	40	400	OZA659-EE49	5753	---	---
3.0i V6	841A.000	3.0	158	04.02-	Zylinder 1,2,3	R	4	40	820	OZA659-EE58	7903	---	---
3.0i V6	841A.000	3.0	158	04.02-	Zylinder 4,5,6	R	4	40	300	OZA659-EE3	0377	---	---
3.2i V6 24V	841A.000	3.2	169	06.03-	Zylinder 1,2,3	R	4	40	820	OZA659-EE58	7903	---	---
3.2i V6 24V	841A.000	3.2	169	06.03-	Zylinder 4,5,6	R	4	40	300	OZA659-EE3	0377	---	---

Y10

1.0i.e. Fire 4WD	156A2.146	1.0	33	10.87-07.89		R	3	19	670	OZA446-E1	1833	S3	0412
1.0i.e. Fire	156A2.146	1.0	33	10.87-07.89		R	3	19	670	OZA446-E1	1833	S3	0412
1.0i.e. Fire	156A2.256	1.0	33	01.89-12.90		R	3	19	895	OZA446-E4	1877	S3	0412
1.0i.e. Fire	156A2.256	1.0	33	01.89-02.92		R	3	19	895	OZA446-E4	1877	S3	0412
1.1i.e. Fire	156C046	1.1	37	07.89-09.92		R	3	19	895	OZA446-E4	1877	S3	0412
1.1 i.e. Selectronic	156C046	1.1	37	09.92-12.95		R	4	38	880	OZA527-E4	0218	S4CG	1919
1.1i.e.	156C046	1.1	37	09.92-12.95		R	4	38	880	OZA527-E4	0218	S4CG	1919
1.1i.e. 4WD	156C046	1.1	37	09.92-12.95		R	4	38	880	OZA527-E4	0218	S4CG	1919
1.3 i.e.	146A5.046	1.3	53	09.92-12.95		R	3	19	895	OZA446-E4	1877	S3	0412
1.3i.e.Fire	146A5.046	1.3	53	02.89-09.92		R	3	19	895	OZA446-E4	1877	S3	0412
1.3i.e.Fire	146A5.046	1.3	54	11.87-06.89		R	3	19	610	OZA446-E44	0162	S3	0412

Y

1.2 i.e.	840A3.000	1.2	44	01.96-10.96	SPI-Weber	R	4	40	972	OZA527-E7	0213	S4CG	1919
1.2 i.e.	840A3.000	1.2	44	10.96-06.00		R	4	40	885	OZA527-E20	1797	S4CG	1919
1.2i	188A4.000	1.2	44	06.00-06.03		R	4	40	300	OZA659-EE3	0377	---	---
1.4i.e. 12V	840A4.000	1.4	55	01.96-12.98	Ⓛ	R	4	40	972	OZA527-E7	0213	S4CG	1919
1.4i.e. 12V	840A2.000	1.4	55-59	01.96-12.98		R	4	40	972	OZA527-E7	0213	S4CG	1919
1.2i 16V	188A5.000	1.2	63	06.00-06.03		R	4	40	300	OZA675-EE1	7978	---	---

YPSILON

1.2i	188A4.000	1.2	44	06.03-		R	4	40	300	OZA659-EE3	0377	---	---
1.2i	188A4.000	1.2	44	06.03-		D	4	40	300	OZA659-EE3	0377	---	---
1.2i 16V	188A5.000	1.2	59	06.03-		R	4	40	300	OZA675-EE1	7978	---	---
1.2i 16V	188A5.000	1.2	59	06.03-		D	4	40	300	OZA675-EE1	7978	---	---
1.3 MJT	199A2.000	1.3	55	10.06-		R	5	91	318	LZA15-A3	0031	---	---
1.3 MJT	199A3.000	1.3	66	10.06-		R	5	91	318	LZA15-A3	0031	---	---
1.4i 16V	843A1.000	1.4	70	06.03-		R	4	40	300	OZA675-EE1	7978	---	---
1.4i 16V	843A1.000	1.4	70	06.03-		D	4	40	300	OZA675-EE1	7978	---	---

ZETA

2.0i.e. 16V	RFV	2.0	97	06.99-09.99		R	4	83	380	OZA659-EE12	0386	---	---
2.0i.e. 16V	RFV	2.0	97	10.99-10.00		R	4	83	1230	OZA659-EE8	0382	---	---
2.0i.e. 16V	RFV	2.0	97	06.99-10.00		D	4	82	1490	OZA659-EE21	0395	---	---
2.0i.e. 16V	RFN	2.0	97	10.00-06.02		R	4	83	380	OZA659-EE12	0386	---	---

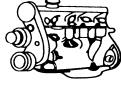

ℓ kW

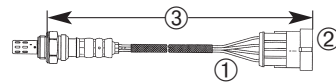

NUMERO P.L.
UNIVERSAL
STOCK
ORDER
No.

LANCIA

ZETA

2.0i.e. Turbo	RGX	2.0	110	09.94-04.98		R	4	49	1480	OZA448-E56	0481	S4	1952
2.0i.e. Turbo	RGX	2.0	110	09.94-04.98		R	4	58	1470	OZA527-E3	0201	S4CG	1919
2.0i.e. Turbo	RGX	2.0	110	05.98-06.99		R	4	82	1490	OZA659-EE21	0395	---	---

LAND ROVER

DEFENDER

3.5i	V8 EFI	3.5	107-115	09.88-12.98		R	3	55	521	OTD3G-3A1	0453	---	---
------	--------	-----	---------	-------------	--	---	---	----	-----	-----------	------	-----	-----

DISCOVERY

3.5i	V8 EFI	3.5	107-113	09.88-12.98		R	3	55	521	OTD3G-3A1	0453	---	---
3.9i	V8 EFI	3.9	136	10.93-12.98		R	3	55	521	OTD3G-3A1	0453	---	---
3.9i	35D / 36D	3.9	134	01.96-12.97		R	4	56	460	OTD3J-5A3	0024	---	---
3.9i	35D / 36D	3.9	134	01.96-12.97		D	3	55	521	OTD3G-3A1	0453	---	---

FREELANDER

1.8i 16V	MK I	18K4F	1.8	86	11.00-	1A 000 001 ->	R	4	106	540	OZA659-EE2	0376	---	---
1.8i 16V	MK I	18K4F	1.8	86	11.00-	1A 000 001 ->	D	4	109	510	OZA659-EE50	5754	---	---
1.8i 16V	MK I	18K4F	1.8	88	02.98-	1A 000 001 ->	R	4	106	540	OZA659-EE2	0376	---	---
1.8i 16V	MK I	18K4F	1.8	88	02.98-	1A 000 001 ->	D	4	109	510	OZA659-EE50	5754	---	---
2.5i	MK I	KV6	2.5	130	09.00-09.03		R	4	75	428	OZA495-RV2	0044	---	---
2.5i	MK I	KV6	2.5	130	09.00-09.03		D	4	109	510	OZA659-EE50	5754	---	---
2.5i	MK II	KV6	2.5	130	09.00-06.05		R	4	75	428	OZA495-RV2	0044	---	---
2.5i	MK II	KV6	2.5	130	09.00-06.05		D	4	109	510	OZA659-EE50	5754	---	---

RANGE ROVER I

3.5i	V8 EFI	3.5	110	01.88-08.90		R	3	55	521	OTD3G-3A1	0453	---	---
3.9i	37D	3.9	127	01.89-01.95		R	3	55	521	OTD3G-3A1	0453	---	---
3.9i	38D	3.9	127	01.89-01.95		R	3	55	521	OTD3G-3A1	0453	---	---
4.3i	40D	4.3	149	09.92-07.94		R	3	55	521	OTD3G-3A1	0453	---	---

RANGE ROVER II

4.0i	42D	4.0	136-140	09.94-09.95		R	3	55	521	OTD3G-3A1	0453	---	---
4.0i	42D	4.0	136-140	10.95-09.02		R	4	43	521	OTD3J-5C1	0475	---	---
4.2i	46D	4.2		01.95-12.97	--> VA350101	R	4	56	460	OTD3J-5A3	0024	---	---
4.6i	46D	4.6	160-166	10.95-09.02		R	4	43	521	OTD3J-5C1	0475	---	---

RANGE ROVER III

4.4i	BMW	4.4	210	03.02-		R	4	68	290	OZA447-E27	0416	S4	1952
4.4i	BMW	4.4	210	03.02-		D	4	69	975	OZA447-E29	0438	S4	1952
4.4i	BMW	4.4	225	03.02-		R	4	68	290	OZA447-E27	0416	S4	1952
4.4i	BMW	4.4	225	03.02-		D	4	69	975	OZA447-E29	0438	S4	1952

LEXUS

GS 300

3.0i	2JZ-GE	3.0	156	08.95-08.97		D	4	34	330	OZA669-EE12	7973	---	---
------	--------	-----	-----	-------------	--	---	---	----	-----	-------------	------	-----	-----

IS 200

2.0i	1G-FE	2.0	114	04.99-		R	4	34	275	OZA502-E31	0250	S4	1952
------	-------	-----	-----	--------	--	---	---	----	-----	------------	------	----	------

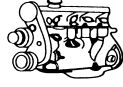

ℓ kW



MAZDA
UNIVERSAL
TYPE
NO.
ORDER
NO.
STOCK
NO.
SUB
NO.

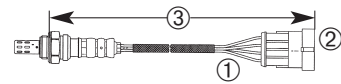

MAZDA

121

1.3i 16V	DB	D3	1.3	53	01.91-03.96		R	3	15	350	OZA73-F1	0177	S3	0412
----------	----	----	-----	----	-------------	--	---	---	----	-----	----------	------	----	------

323 III

1.6 GT	BF	B6	1.6	63	09.87-10.89	Universal	R	1	---	---	OZA624-E1	1951	S1	1951
1.6 GT Turbo	BF	B6	1.6	103	10.85-11.91	Universal	R	1	---	---	OZA624-E1	1951	S1	1951

323 IV

1.3i HB	BG	B3E	1.3	49	09.89-07.94		R	1	9	450	OZA401-E55	0143	S1	1951
1.3i Sedan	BG	B3	1.3	49	09.89-06.91		R	1	9	450	OZA401-E55	0143	S1	1951
1.3i 16V HB	BG	B3	1.3	54	08.91-07.94		R	1	9	450	OZA401-E55	0143	S1	1951
1.3i 16V Sedan	BG	B3	1.3	54	04.91-07.94		R	1	9	450	OZA401-E55	0143	S1	1951
1.6i	BG	B6E	1.6	62	09.89-06.91		R	1	9	450	OZA401-E55	0143	S1	1951
1.6i Sedan	BG	B6E	1.6	62	09.89-06.91		R	1	9	450	OZA401-E55	0143	S1	1951
1.6i 16V Sedan	BG	B6	1.6	65	03.91-10.94		R	1	9	450	OZA401-E55	0143	S1	1951
1.6i 16V	BG	B6	1.6	65	03.91-10.94		R	1	9	450	OZA401-E55	0143	S1	1951
1.8i 16V 4WD	BG	BP	1.8	76	11.91-12.93	Universal	R	1	---	---	OZA624-E1	1951	S1	1951
1.8i 16V	BG	BP	1.8	76	08.89-07.94	Universal	R	1	---	---	OZA624-E1	1951	S1	1951
1.8i 16V GT	BG	BP	1.8	94	08.89-07.94	Universal	R	1	---	---	OZA624-E1	1951	S1	1951
1.9i 16V	BG	B5	1.9	94	09.89-03.93		R	1	9	450	OZA401-E55	0143	S1	1951

323 V

1.5i	BA	Z5	1.5	65	07.94-09.98	-> 194 444	R	3	16	380	OZA186-F5	0188	S3	0412
------	----	----	-----	----	-------------	------------	---	---	----	-----	-----------	------	----	------

626 II

2.0i	GC	FE	2.0	74	03.83-09.87	700 001 ->	R	1	1	550	OZA25-F1	0187	S1	1951
------	----	----	-----	----	-------------	------------	---	---	---	-----	----------	------	----	------

626 III

2.0i	GV	FE	2.0	66	10.88-10.92	200 001 ->	R	1	2	550	OZA25-F12	0198	S1	1951
2.0i	GD	FE	2.0	66	09.87-10.90	500 001 ->	R	1	2	550	OZA25-F12	0198	S1	1951
2.0i	GD	FE	2.0	66	09.87-10.90	-> 500 000	R	1	1	550	OZA25-F3	0176	S1	1951
2.0i	GV	FE	2.0	66	10.88-10.92	-> 200 000	R	1	1	550	OZA25-F3	0176	S1	1951
2.2i 12V	GV	F2	2.2	85	03.89-11.96	Universal	R	1	---	---	OZA624-E1	1951	S1	1951

626 IV

1.8i 16V HB	GE	FP	1.8	66	07.95-03.97		R	4	31	280	OZA74-F2	0433	S4	1952
1.8i 16V	GE	FP	1.8	66	07.95-03.97		R	4	31	280	OZA74-F2	0433	S4	1952
1.8i 16V	GE	FP	1.8	66	06.94-06.95		R	4	31	250	OZA74-F3	0446	S4	1952
1.8i 16V HB	GE	FP	1.8	66	06.94-06.95		R	4	31	250	OZA74-F3	0446	S4	1952
1.8i 16V	GE	FP	1.8	77	08.91-03.97		R	4	31	480	OZA74-F1	0401	S4	1952
2.0i 16V	GE	FS	2.0	85	08.91-03.97		R	4	31	480	OZA74-F1	0401	S4	1952
2.0i	GE	FS	2.0	85	08.91-04.97		R	4	31	250	OZA253-F6	0122	S4	1952
2.0i 16V 4WD	GE	FS	2.0	85	09.91-03.97		R	4	31	480	OZA74-F1	0401	S4	1952
2.5i 24V	GE	KL	2.5	121	09.91-03.97		R	4	31	480	OZA74-F1	0401	S4	1952

929

2.0i	HC	FE	2.0	85	06.87-12.88		R	1	1	550	OZA25-F3	0176	S1	1951
2.2i 12V	HC	F21 / F2E / F2	2.2	85	01.88-04.89	Universal	R	1	---	---	OZA624-E1	1951	S1	1951
3.0i 18V	HC	JE1	3.0	123	10.87-06.89		R	3	78	420	OZA21-F3	0256	S3	0412
3.0i 18V	HC	JE01	3.0	140	12.86-06.89		R	3	78	420	OZA21-F3	0256	S3	0412

MX-3

1.6i	EC	B69	1.6	65	07.91-		R	1	9	450	OZA401-E55	0143	S1	1951
------	----	-----	-----	----	--------	--	---	---	---	-----	------------	------	----	------

MX-5

1.6i	NA	B64F	1.6	85	05.90-01.94		R	1	9	450	OZA401-E55	0143	S1	1951
------	----	------	-----	----	-------------	--	---	---	---	-----	------------	------	----	------

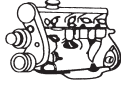

ℓ kW

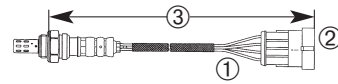

STOCK No. TYPE UNIVERSAL No. SERIAL No.

MAZDA

MX-6

2.0i	GE	FS	2.0	85	91- 97		R	4	31	250	OZA253-F6	0122	S4	1952
2.5i 24V	GE	KL	2.5	121	07.91-06.97		R	4	31	480	OZA74-F1	0401	S4	1952

XEDOS 6

2.0i 24V	CA	KF1	2.0	105	01.92-03.94		R	4	31	480	OZA74-F1	0401	S4	1952
----------	----	-----	-----	-----	-------------	--	---	---	----	-----	----------	------	----	------

XEDOS 9

2.3i 24V	TA	KJ-ZEM Miller-Cycle	2.3	155	06.96-07.98		R	3	15	450	OZA186-F7	0457	S3	0412
2.3i 24V	TA	KJ-ZEM Miller-Cycle	2.3	155-162	12.94-05.96		R	3	15	450	OZA186-F7	0457	S3	0412
2.3i Kompressor	TA	KJ	2.3	155	06.96-07.98		R	4	47	485	OZA673-EE1	7974	---	---
2.3i Kompressor	TA	KJ	2.3	155-162	12.94-05.96		R	4	47	485	OZA673-EE1	7974	---	---

MERCEDES BENZ

190 (W201)

190E 1.7	W201	M102.919	1.7	77	05.92-08.93	P	R	3	20	510	OZA446-E7	1872	S3	0412
190E 1.8	W201	M102.910	1.8	80	04.90-08.93		R	3	20	510	OZA446-E7	1872	S3	0412
190E 1.9	W201	M102.924	1.9	75-77	01.86-12.89		R	3	21	315	OZA446-E13	1826	S3	0412
190E 2.0	W201	M102.962 / 236839 -->	2.0	87-90	09.89-08.93		R	3	20	510	OZA446-E7	1872	S3	0412
190E 2.0	W201	M102.962 / 122336 -->	2.0	87-90	09.89-08.93		R	3	20	510	OZA446-E7	1872	S3	0412
190E 2.0	W201	M102.962 / -> A528957	2.0	87-90	09.85-09.89		R	3	20	510	OZA446-E7	1872	S3	0412
190E 2.3	W201	M102.985 / -> A528957	2.3	97-100	09.86-09.89		R	3	20	760	OZA446-E14	1837	S3	0412
190E 2.3	W201	M102.985 / 033730 -->	2.3	97-100	09.89-08.93		R	3	20	510	OZA446-E7	1872	S3	0412
190E 2.3	W201	M102.985 / 080065 -->	2.3	97-100	09.89-08.93		R	3	20	510	OZA446-E7	1872	S3	0412
190E 2.3-16V	W201	M102.983	2.3	125-130	09.85-08.88		R	3	20	760	OZA446-E14	1837	S3	0412
190E 2.5-16V Evolution I	W201	M102.991	2.5	143	03.89-04.90		R	3	21	315	OZA446-E13	1826	S3	0412
190E 2.5-16V	W201	M102.990	2.5	143-150	09.88-08.93		R	3	21	315	OZA446-E13	1826	S3	0412
190E 2.5-16V Evolution II	W201	M102.992	2.5	173	05.90-08.93		R	3	21	315	OZA446-E13	1826	S3	0412
190E 2.6	W201	M103.942	2.6	118-122	09.86-08.93		R	3	21	315	OZA446-E13	1826	S3	0412

A (W168)

A 140	W168	M166.940	1.4	60	10.97-08.04	--> J 853957	R	4	47	240	OZA659-EE15	0389	---	---
A 160	W168	M166.960	1.6	75	10.97-08.04	--> J 853957	R	4	47	240	OZA659-EE15	0389	---	---
A 190	W168	M166.990	1.9	92	03.99-08.04	--> J 853957	R	4	47	240	OZA659-EE15	0389	---	---
A 210 Evolution	W168	M166.995	2.1	103	03.02-08.04	--> J 853957	R	4	47	240	OZA659-EE15	0389	---	---

A (C / W169)

A 150	C169	M266.920	1.5	70	09.04-04.05	--> A ...151310	R	4	89	300	OZA571-C10	1836	---	---
A 150	C169	M266.920	1.5	70	09.04-04.05	--> A ...151310	D	4	89	300	OZA571-C10	1836	---	---
A 150	W169	M266.920	1.5	70	09.04-04.05	--> A ...151310	R	4	89	300	OZA571-C10	1836	---	---
A 150	W169	M266.920	1.5	70	09.04-04.05	--> A ...151310	D	4	89	300	OZA571-C10	1836	---	---
A 170	C169	M266.940	1.7	85	09.04-04.05	--> A ...151310	R	4	89	300	OZA571-C10	1836	---	---
A 170	C169	M266.940	1.7	85	09.04-04.05	--> A ...151310	D	4	89	300	OZA571-C10	1836	---	---
A 170	W169	M266.940	1.7	85	09.04-04.05	--> A ...151310	R	4	89	300	OZA571-C10	1836	---	---
A 170	W169	M266.940	1.7	85	09.04-04.05	--> A ...151310	D	4	89	300	OZA571-C10	1836	---	---
A 200	C169	M266.960	2.0	110	09.04-04.05	--> A ...151310	R	4	89	300	OZA571-C10	1836	---	---
A 200	C169	M266.960	2.0	110	09.04-04.05	--> A ...151310	D	4	89	300	OZA571-C10	1836	---	---
A 200	W169	M266.960	2.0	110	09.04-04.05	--> A ...151310	R	4	89	300	OZA571-C10	1836	---	---
A 200	W169	M266.960	2.0	110	09.04-04.05	--> A ...151310	D	4	89	300	OZA571-C10	1836	---	---

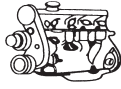

ℓ kW

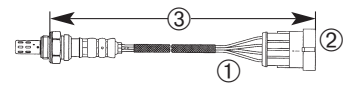

STOCK No. TYPE No. UNIVERSAL No. CUTTING No.

MERCEDES BENZ

C (W202)

C 180	W202	M111.920 / --> xx050883	1.8	90	03.93-04.00		R	4	39	875	OZA527-E6	0463	S4CG	1919
C 180	W202	M111.920 / --> xx117655	1.8	90	03.93-04.00		R	4	39	875	OZA527-E6	0463	S4CG	1919
C 180	W202	M111.920 / xx050884 -->	1.8	90	03.93-04.00		R	4	47	830	OZA527-E13	0285	S4CG	1919
C 180	W202	M111.920 / xx117656 -->	1.8	90	03.93-04.00		R	4	47	830	OZA527-E13	0285	S4CG	1919
C 200	W202	M111.941 / --> xx014845	2.0	100	01.94-04.00		R	4	39	875	OZA527-E6	0463	S4CG	1919
C 200	W202	M111.941 / --> xx015981	2.0	100	01.94-04.00		R	4	39	875	OZA527-E6	0463	S4CG	1919
C 200	W202	M111.941, M111.945 -->	2.0	100	01.94-04.00		R	4	47	985	OZA448-E45	0206	S4	1952
C 200	W202	M111.941... -->	2.0	100	01.94-04.00		R	4	47	830	OZA527-E13	0285	S4CG	1919
C 200	W202	M111.941 / xx014846 -->	2.0	100	01.94-04.00		R	4	47	830	OZA527-E13	0285	S4CG	1919
C 200 Kompressor	W202	M111.944	2.0	132-141	09.95-04.00		R	4	47	985	OZA448-E45	0206	S4	1952
C 220	W202	M111.961 / -->017341	2.2	110	03.93-09.96		R	4	39	875	OZA527-E6	0463	S4CG	1919
C 220	W202	M111.961 / -->050895	2.2	110	03.93-09.96		R	4	39	875	OZA527-E6	0463	S4CG	1919
C 200	W202	M111.961 / 017342 -->	2.2	110	03.93-09.96		R	4	47	830	OZA527-E13	0285	S4CG	1919
C 200	W202	M111.961 / 050896 -->	2.2	110	03.93-09.96		R	4	47	830	OZA527-E13	0285	S4CG	1919
C 230	W202	M111.974	2.3	110	09.96-05.97		R	4	47	985	OZA448-E45	0206	S4	1952
C 230 Kompressor	W202	M111.975	2.3	142	09.95-04.00		R	4	47	985	OZA448-E45	0206	S4	1952
C 240	W202	M112.910	2.4	125	06.97-02.01		R	4	47	815	OZA447-E34	0482	S4	1952
C 240	W202	M112.910	2.4	125	06.97-02.01		R	4	68	655	OZA660-EE9	5694	S4	1952
C 280	W202	M112.920	2.8	145	06.97-02.01		R	4	47	815	OZA447-E34	0482	S4	1952
C 280	W202	M112.920	2.8	145	06.97-02.01		R	4	68	655	OZA660-EE9	5694	S4	1952
C 43 AMG	W202	M113.944	4.3	225	11.97-04.00		R	4	47	815	OZA447-E34	0482	S4	1952
C 43 AMG	W202	M113.944	4.3	225	11.97-04.00		R	4	68	655	OZA660-EE9	5694	S4	1952

C T-MODEL (S202)

C 180 T	S202	M111.920 / --> xx050883	1.8	90	05.96-02.01		R	4	39	875	OZA527-E6	0463	S4CG	1919
C 180 T	S202	M111.920 / --> xx117655	1.8	90	05.96-02.01		R	4	39	875	OZA527-E6	0463	S4CG	1919
C 180 T	S202	M111.920 --> xx007268	1.8	90	05.96-02.01		R	4	47	985	OZA448-E45	0206	S4	1952
C 180 T	S202	M111.920 --> xx004126	1.8	90	05.96-02.01		R	4	47	985	OZA448-E45	0206	S4	1952
C 180 T	S202	M111.920 / xx050884-->	1.8	90	05.96-02.01		R	4	47	830	OZA527-E13	0285	S4CG	1919
C 180 T	S202	M111.920 / xx117656-->	1.8	90	05.96-02.01		R	4	47	830	OZA527-E13	0285	S4CG	1919
C 180 T	S202	M111.921 / xx004127-->	1.8	90	05.96-02.01		R	4	47	1145	OZA448-E29	0182	S4	1952
C 180 T	S202	M111.921 / xx007269-->	1.8	90	05.96-02.01		R	4	47	1145	OZA448-E29	0182	S4	1952
C 180 T	S202	M111.952	2.0	95	05.96-02.01		D	4	47	380	OZA659-EE27	1609	---	---
C 200 T	S202	M111.941 / --> xx014845	2.0	100	05.96-02.01		R	4	39	875	OZA527-E6	0463	S4CG	1919
C 200 T	S202	M111.941 / --> xx015981	2.0	100	05.96-02.01		R	4	39	875	OZA527-E6	0463	S4CG	1919
C 200 T	S202	M111.941, -->M111.945	2.0	100	05.96-02.01		R	4	47	985	OZA448-E45	0206	S4	1952
C 200 T	S202	xx001912												
C 200 T	S202	M111.941, M111.945	2.0	100	05.96-02.01		R	4	47	985	OZA448-E45	0206	S4	1952
C 200 T	S202	xx003752												
C 200 T	S202	M111.941 / xx014846-->	2.0	100	05.96-02.01		R	4	47	830	OZA527-E13	0285	S4CG	1919
C 200 T	S202	M111.945 / xx001913-->	2.0	100	05.96-02.01		R	4	47	1145	OZA448-E29	0182	S4	1952
C 200 T	S202	M111.945 / xx003753-->	2.0	100	05.96-02.01		R	4	47	1145	OZA448-E29	0182	S4	1952
C 200 T	S202	M111.945 / xx015982-->	2.0	100	05.96-02.01		R	4	47	830	OZA527-E13	0285	S4CG	1919
C 200 T Kompressor	S202	M111.956	2.0	120	04.00-02.01		D	4	47	380	OZA659-EE27	1609	---	---
C 200 T Kompressor	S202	M111.944 / 003873-->	2.0	141	06.97-08.02		R	4	47	1145	OZA448-E29	0182	S4	1952
C 200 T Kompressor	S202	M111.944 / 000055-->	2.0	141	06.97-08.02		R	4	47	1145	OZA448-E29	0182	S4	1952
C 200 T Kompressor	S202	M111.944 / 000055-->	2.0	141	06.97-08.02		R	4	47	1145	OZA448-E29	0182	S4	1952
C 200 T Kompressor	S202	M111.944 / 000055-->	2.0	141	06.97-08.02		R	4	47	1145	OZA448-E29	0182	S4	1952
C 200 T Kompressor	S202	M111.944 / 000055-->	2.0	141	06.97-08.02		R	4	47	1145	OZA448-E29	0182	S4	1952
C 200 T Kompressor	S202	M111.944 / 003873-->	2.0	141	06.97-08.02		R	4	47	1145	OZA448-E29	0182	S4	1952

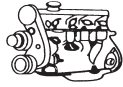

ℓ kW

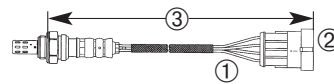
STOCK
UNIVERSAL
TYPE
UNIVERSAL
NO.
NO.
NO.
NO.

MERCEDES BENZ

C T-MODEL (S202)

C 200 T Kompressor	S202	M111.944 / 003873-->	2.0	141	06.97-08.02		R	4	47	1145	OZA448-E29	0182	S4	1952
C 200 T Kompressor	S202	M111.944 / 003873-->	2.0	141	06.97-08.02		R	4	47	1145	OZA448-E29	0182	S4	1952
C 230 T	S202	M111.974 / -->001871	2.3	110	05.96-05.97		R	4	47	985	OZA448-E45	0206	S4	1952
C 230 T	S202	M111.974 / -->004991	2.3	110	05.96-05.97		R	4	47	985	OZA448-E45	0206	S4	1952
C 230 T	S202	M111.974 / 001872-->	2.3	110	05.96-05.97		R	4	47	1145	OZA448-E29	0182	S4	1952
C 230 T	S202	M111.974 / 004992-->	2.3	110	05.96-05.97		R	4	47	1145	OZA448-E29	0182	S4	1952
C 230 T Kompressor	S202	M111.975 / -->000555	2.3	142	06.97-08.02		R	4	47	985	OZA448-E45	0206	S4	1952
C 230 T Kompressor	S202	M111.975 / -->005799	2.3	142	06.97-08.02		R	4	47	985	OZA448-E45	0206	S4	1952
C 230 T Kompressor	S202	M111.975 / 000556-->	2.3	142	06.97-08.02		R	4	47	1145	OZA448-E29	0182	S4	1952
C 230 T Kompressor	S202	M111.975 / 005800-->	2.3	142	06.97-08.02		R	4	47	1145	OZA448-E29	0182	S4	1952
C 240 T	S202	M112.910	2.4	125	06.97-02.01		R	4	47	815	OZA447-E34	0482	S4	1952
C 240 T	S202	M112.910	2.4	125	06.97-02.01		R	4	68	655	OZA660-EE9	5694	S4	1952
C 280 T	S202	M112.920	2.8	145	06.97-03.01		R	4	47	815	OZA447-E34	0482	S4	1952
C 280 T	S202	M112.920	2.8	145	06.97-03.01		R	4	68	655	OZA660-EE9	5694	S4	1952
C 43 T AMG	S202	M113.944	4.3	225	10.97-02.01		R	4	47	815	OZA447-E34	0482	S4	1952
C 43 T AMG	S202	M113.944	4.3	225	10.97-02.01		R	4	68	655	OZA660-EE9	5694	S4	1952

C (W203)

C 180	W203	M111.951	2.0	95	10.00-08.02	Euro 3	R	4	47	480	OZA659-EE29	1611	---	---
C 180	W203	M111.951	2.0	95	10.00-08.02	Euro 3	D	4	47	585	OZA659-EE34	1618	---	---
C 180	W203	M111.951	2.0	95	10.00-08.02	Euro 4	R	4	108	600	OZA659-EE48	5752	---	---
C 180	W203	M111.951	2.0	95	10.00-08.02	Euro 4	D	4	47	240	OZA659-EE15	0389	---	---
C 200 Kompressor	W203	M111.955	2.0	120	05.00-08.02		R	4	47	400	OZA659-EE24	0398	---	---
C 200 Kompressor	W203	M111.955	2.0	120	05.00-08.02		D	4	47	585	OZA659-EE34	1618	---	---
C 240	W203	M112.912	2.6	125	05.00-05.05		R	4	47	435	OZA659-EE26	0400	---	---
C 320	W203	M112.946	3.2	160	05.00-05.05		R	4	47	435	OZA659-EE26	0400	---	---
C 32 AMG Kompressor	W203	M112.961	3.2	260	01.01-01.04		R	4	47	435	OZA659-EE26	0400	---	---

C T-MODEL (S203)

C 180 T	S203	M111.951	2.0	95	01.01-08.02	Euro 3	R	4	47	480	OZA659-EE29	1611	---	---
C 180 T	S203	M111.951	2.0	95	01.01-08.02	Euro 3	D	4	47	585	OZA659-EE34	1618	---	---
C 180 T	S203	M111.951	2.0	95	01.01-08.02	Euro 4	R	4	108	600	OZA659-EE48	5752	---	---
C 180 T	S203	M111.951	2.0	95	01.01-08.02	Euro 4	D	4	47	240	OZA659-EE15	0389	---	---
C 200 T Kompressor	S203	M111.955	2.0	120	01.01-08.02		R	4	47	400	OZA659-EE24	0398	---	---
C 200 T Kompressor	S203	M111.955	2.0	120	01.01-08.02		D	4	47	585	OZA659-EE34	1618	---	---
C 240 T	S203	M112.912	2.6	125	05.00-05.05		R	4	47	435	OZA659-EE26	0400	---	---
C 320 T	S203	M112.946	3.2	160	05.00-05.05		R	4	47	435	OZA659-EE26	0400	---	---
C 32 AMG T Kompressor	S203	M112.961	3.2	260	01.01-01.04		R	4	47	435	OZA659-EE26	0400	---	---
C 55 AMG T Kompressor	S203	M113.988	5.4	270	02.04-		R	4	47	435	OZA659-EE26	0400	---	---

C COUPE (CL203)

C 180 Coupe	CL203	M111.951	2.0	95	10.00-08.02	Euro 3	R	4	47	480	OZA659-EE29	1611	---	---
C 180 Coupe	CL203	M111.951	2.0	95	10.00-08.02	Euro 3	D	4	47	585	OZA659-EE34	1618	---	---
C 180 Coupe	CL203	M111.951	2.0	95	10.00-08.02	Euro 4	R	4	108	600	OZA659-EE48	5752	---	---
C 180 Coupe	CL203	M111.951	2.0	95	10.00-08.02	Euro 4	D	4	47	240	OZA659-EE15	0389	---	---
C 200 Coupe Kompressor	CL203	M111.955	2.0	120	05.00-08.02		R	4	47	400	OZA659-EE24	0398	---	---
C 200 Coupe Kompressor	CL203	M111.955	2.0	120	05.00-08.02		D	4	47	585	OZA659-EE34	1618	---	---
C 230 Coupe Kompressor	CL203	M111.981	2.3	145	01.01-01.04		R	4	47	400	OZA659-EE24	0398	---	---
C 230 Coupe Kompressor	CL203	M111.981	2.3	145	01.01-01.04		D	4	47	585	OZA659-EE34	1618	---	---

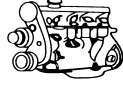

ℓ kW



STOCK No. ORDER No. TYPE No. UNIVERSAL No. MANUFACTURER No.

MERCEDES BENZ

CLK CABRIO (A208)

CLK 200 Kompressor	A208	M111.956	2.0	120	06.00-01.03		R	4	47	435	OZA659-EE26	0400	---	---
CLK 200 Kompressor	A208	M111.956	2.0	120	06.00-01.03		D	4	47	380	OZA659-EE27	1609	---	---
CLK 230 Kompressor	A208	M111.982	2.3	145	06.00-01.03		D	4	47	380	OZA659-EE27	1609	---	---
CLK 320	A208	M112.940	3.2	160	06.98-01.03		R	4	47	815	OZA447-E34	0482	S4	1952
CLK 320	A208	M112.940	3.2	160	06.98-01.03		R	4	68	655	OZA660-EE9	5694	S4	1952
CLK 320	A208	M112.940	3.2	160	06.98-01.03		D	4	108	600	OZA659-EE48	5752	---	---
CLK 430	A208	M113.943	3.2	160	09.98-01.03		R	4	47	815	OZA447-E34	0482	S4	1952
CLK 430	A208	M113.943	4.3	205	09.98-01.03		R	4	68	655	OZA660-EE9	5694	S4	1952
CLK 430	A208	M113.943	4.3	205	09.98-01.03		D	4	108	600	OZA659-EE48	5752	---	---
CLK 55 AMG	A208	M113.984	5.4	255	09.00-04.02		D	4	108	600	OZA659-EE48	5752	---	---

CLK CABRIO (A209)

CLK 240	A209	M112.912	2.6	125	05.02-		R	4	47	435	OZA659-EE26	0400	---	---
CLK 320	A209	M112.955	3.2	160	05.02-		R	4	47	435	OZA659-EE26	0400	---	---
CLK 500	A209	M113.968	5.0	225	05.02-		R	4	47	435	OZA659-EE26	0400	---	---
CLK 55 AMG	A209	M113.987	5.4	270	09.02-		R	4	47	435	OZA659-EE26	0400	---	---

CLK COUPE (C208)

CLK 200	C208	M111.945 / -->001912	2.0	100	06.97-		R	4	47	985	OZA448-E45	0206	S4	1952
CLK 200	C208	M111.945 / -->003752	2.0	100	06.97-		R	4	47	985	OZA448-E45	0206	S4	1952
CLK 200	C208	M111.945 / 001913-->	2.0	100	06.97-		R	4	47	1145	OZA448-E29	0182	S4	1952
CLK 200	C208	M111.945 / 003753-->	2.0	100	06.97-		R	4	47	1145	OZA448-E29	0182	S4	1952
CLK 200 Kompressor	C208	M111.956	2.0	120	06.00-01.03		R	4	47	435	OZA659-EE26	0400	---	---
CLK 200 Kompressor	C208	M111.956	2.0	120	06.00-01.03		D	4	47	380	OZA659-EE27	1609	---	---
CLK 230 Kompressor	C208	M111.982	2.3	145	06.00-01.03		D	4	47	380	OZA659-EE27	1609	---	---
CLK 200 Kompressor	C208	M111.944 / -->000054	2.0	141	09.97-	I GR P	R	4	47	985	OZA448-E45	0206	S4	1952
CLK 200 Kompressor	C208	M111.944 / -->003872	2.0	141	09.97-	I GR P	R	4	47	985	OZA448-E45	0206	S4	1952
CLK 200 Kompressor	C208	M111.944 / 000055-->	2.0	141	09.97-		R	4	47	1145	OZA448-E29	0182	S4	1952
CLK 200 Kompressor	C208	M111.944 / 003873-->	2.0	141	09.97-		R	4	47	1145	OZA448-E29	0182	S4	1952
CLK 230 Kompressor	C208	M111.975 / -->000555	2.3	142	06.97-		R	4	47	985	OZA448-E45	0206	S4	1952
CLK 230 Kompressor	C208	M111.975 / -->005799	2.3	142	06.97-		R	4	47	985	OZA448-E45	0206	S4	1952
CLK 230 Kompressor	C208	M111.975 / 000556-->	2.3	142	06.97-		R	4	47	1145	OZA448-E29	0182	S4	1952
CLK 230 Kompressor	C208	M111.975 / 005800-->	2.3	142	06.97-		R	4	47	1145	OZA448-E29	0182	S4	1952
CLK 320	C208	M112.940	3.2	160	06.97-06.02		R	4	47	815	OZA447-E34	0482	S4	1952
CLK 320	C208	M112.940	3.2	160	06.97-06.02		R	4	68	655	OZA660-EE9	5694	S4	1952
CLK 320	C208	M112.940	3.2	160	06.97-06.02		D	4	108	600	OZA659-EE48	5752	---	---
CLK 430	C208	M113.943	3.2	160	07.98-06.02		R	4	47	815	OZA447-E34	0482	S4	1952
CLK 430	C208	M113.943	4.3	205	07.98-06.02		R	4	68	655	OZA660-EE9	5694	S4	1952
CLK 430	C208	M113.943	4.3	205	07.98-06.02		D	4	108	600	OZA659-EE48	5752	---	---
CLK 55 AMG	C208	M113.984	3.2	160	07.99-06.02		R	4	47	815	OZA447-E34	0482	S4	1952
CLK 55 AMG	C208	M113.984	5.5	255	08.99-06.02		R	4	68	655	OZA660-EE9	5694	S4	1952

CLK COUPE (C209)

CLK 240	C209	M112.912	2.6	125	05.02-		R	4	47	435	OZA659-EE26	0400	---	---
CLK 320	C209	M112.955	3.2	160	05.02-		R	4	47	435	OZA659-EE26	0400	---	---
CLK 500	C209	M113.968	5.0	225	05.02-		R	4	47	435	OZA659-EE26	0400	---	---
CLK 55 AMG	C209	M113.987	5.4	270	09.02-		R	4	47	435	OZA659-EE26	0400	---	---

CL (C215)

CL 500	C215	M113.960	5.0	225	03.99-05.06	--> A 008782	R	4	47	465	OZA674-EE1	7975	---	---
CL 500	C215	M113.960	5.0	225	03.99-05.06	A 008783 -->	R	4	47	460	OZA659-EE35	1619	---	---

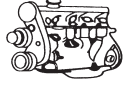

l kW

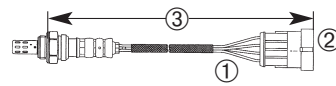

STOCK No. UNIVERSAL No. TYPE No. INVENTORY No.

MERCEDES BENZ

CL (C215)

CL 500	C215	M113.960	5.0	225	03.99-05.06	A 008783 ->	D	4	47	320	OZA659-EE22	0396	---	---
CL 55 AMG	C215	M113.986	5.4	265	10.99-08.02		R	4	47	460	OZA659-EE35	1619	---	---
CL 55 AMG	C215	M113.986	5.4	265	10.99-08.02		D	4	47	320	OZA659-EE22	0396	---	---
CL 55 AMG Kompressor	C215	M113.991	5.4	368	09.02-08.06		R	4	47	460	OZA659-EE35	1619	---	---
CL 55 AMG Kompressor	C215	M113.991	5.4	368	09.02-08.06		D	4	47	320	OZA659-EE22	0396	---	---
CL 600	C215	M137.970	5.8	270	09.99-08.02	4 ↑	R	4	47	435	OZA659-EE26	0400	---	---
CL 600	C215	M137.970	5.8	270	09.99-08.02	4 ↑	D	4	47	380	OZA659-EE27	1609	---	---

CLS (C219)

CLS 500	C219	M113.967	5.0	225	06.04-	2 ↑	R	4	47	400	OZA659-EE24	0398	---	---
CLS 500	C219	M113.967	5.0	225	06.04-	2 ↑	D	4	68	430	OZA659-EE55	7860	---	---
CLS 55 AMG	C219	M113.990	5.4	350	01.05-03.06	2 ↑	R	4	47	400	OZA659-EE24	0398	---	---
CLS 55 AMG	C219	M113.990	5.4	350	01.05-03.06	2 ↑	D	4	68	430	OZA659-EE55	7860	---	---

E (W124)

200 E	W124	M102.922	2.0	80	01.86-08.89		R	3	20	760	OZA446-E14	1837	S3	0412
200 E	W124	M102.963	2.0	87-90	09.88-09.89		R	3	20	760	OZA446-E14	1837	S3	0412
200 E	W124	M102.963	2.0	87-90	10.89-08.92		R	3	20	510	OZA446-E7	1872	S3	0412
200 E	W124	M102.963 / 036266-->	2.0	87-90	09.89-08.92	↑	R	3	20	510	OZA446-E7	1872	S3	0412
200 E	W124	M102.963 / 009690-->	2.0	87-90	09.89-08.92	↑	R	3	20	510	OZA446-E7	1872	S3	0412
200 E	W124	M111.940	2.0	100	07.93-06.95		R	4	41	770	OZA527-E10	0263	S4CG	1919
200 E	W124	M111.940	2.0	100	09.92-06.93		R	4	41	770	OZA527-E10	0263	S4CG	1919
220 E	W124	M111.960	2.2	110	07.93-06.96		R	4	41	770	OZA527-E10	0263	S4CG	1919
220 E	W124	M111.960	2.2	110	09.92-06.93		R	4	41	770	OZA527-E10	0263	S4CG	1919
230 E	W124	M102.982	2.3	97-100	05.85-09.89		R	3	20	760	OZA446-E14	1837	S3	0412
230 E	W124	M102.982 / 146597-->	2.3	97-100	09.89-08.92	↑	R	3	20	510	OZA446-E7	1872	S3	0412
230 E	W124	M102.982 / 147102-->	2.3	97-100	09.89-08.92	↑	R	3	20	510	OZA446-E7	1872	S3	0412
260 E	W124	M103.940	2.6	118-122	09.85-08.92		R	3	20	760	OZA446-E14	1837	S3	0412
280 E	W124	M104.942	2.8	145	06.93-06.95		R	4	41	750	OZA527-E25	0444	S4CG	1919
280 E	W124	M104.942	2.8	145	10.92-06.93		R	4	41	750	OZA527-E25	0444	S4CG	1919
300 E	W124	M103.983	3.0	132-138	09.85-08.92		R	3	20	760	OZA446-E14	1837	S3	0412
300 E	W124	M104.980	3.0	162	09.89-08.92		R	3	20	760	OZA446-E14	1837	S3	0412
320 E	W124	M104.992	3.2	162	06.93-06.95		R	4	41	750	OZA527-E25	0444	S4CG	1919

E T-MODEL (S124)

200 TE	S124	M111.940	2.0	100	07.93-05.96		R	4	41	770	OZA527-E10	0263	S4CG	1919
200 TE	S124	M102.963	2.0	87	09.88-08.92		R	3	20	510	OZA446-E7	1872	S3	0412
200 TE	S124	M102.962	2.0	90	09.88-12.89		R	3	20	510	OZA446-E7	1872	S3	0412
220 TE	S124	M111.960	2.2	110	07.93-05.96		R	4	41	770	OZA527-E10	0263	S4CG	1919
230 TE	S124	M102.982	2.3	100	09.88-08.92		R	3	20	510	OZA446-E7	1872	S3	0412
300 TE 4MATIC	S124	M103.985	3.0	138	09.86-06.93		R	3	20	760	OZA446-E14	1837	S3	0412
300 TE	S124	M103.983	3.0	138	01.86-08.92		R	3	20	760	OZA446-E14	1837	S3	0412
300 TE	S124	M104.980	3.0	162	09.89-08.92		R	3	20	760	OZA446-E14	1837	S3	0412

E CABRIO (A124)

200 E Cabrio	A124	M111.940	2.0	100	07.93-		R	4	41	770	OZA527-E10	0263	S4CG	1919
220 E Cabrio	A124	M111.960	2.2	110	07.93-		R	4	41	770	OZA527-E10	0263	S4CG	1919
300 CE Cabrio	A124	M104.980	3.0	162	04.92-06.93		R	3	20	760	OZA446-E14	1837	S3	0412

E COUPE (C124)

200 E Coupe	C124	M111.940	2.0	100	07.93-06.96		R	4	41	770	OZA527-E10	0263	S4CG	1919
220 E Coupe	C124	M111.960	2.2	110	07.93-06.96		R	4	41	770	OZA527-E10	0263	S4CG	1919

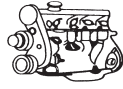

ℓ kW



STOCK No. TYPE No. UNIVERSAL No. COUNTRY No.

MERCEDES BENZ

E COUPE (C124)

230 CE Coupe	C124	M102.982	2.3	100	03.87-08.88		R	3	20	760	OZA446-E14	1837	S3	0412
230 CE Coupe	C124	M102.982	2.3	100	09.88-08.92		R	3	20	510	OZA446-E7	1872	S3	0412
300 CE Coupe	C124	M103.983	3.0	138	03.87-08.92	CH DK N S	R	3	20	760	OZA446-E14	1837	S3	0412
300 CE Coupe	C124	M103.983	3.0	138	03.87-08.92		R	3	20	760	OZA446-E14	1837	S3	0412
300 CE Coupe	C124	M104.980	3.0	162	09.89-08.92		R	3	20	760	OZA446-E14	1837	S3	0412

E (W210)

E 200	W210	M111.942	2.0	100	06.95-08.00		R	4	47	465	OZA447-E44	1976	S4	1952
E 200 Kompressor	W210	M111.957	2.0	120	09.00-03.02		D	4	47	435	OZA659-EE26	0400	---	---
E 200 Kompressor	W210	M111.947	2.0	137	09.97-08.00		R	4	47	465	OZA447-E44	1976	S4	1952
E 230	W210	M111.970	2.3	110	06.95-08.97		R	4	47	485	OZA673-EE1	7974	---	---
E 240	W210	M112.911	2.4	125	09.97-06.99	Y	R	4	47	625	OZA447-E22	0227	S4	1952
E 240	W210	M112.911	2.4	125	09.97-06.99	Y	R	4	47	325	OZA660-EE8	5682	S4	1952
E 240	W210	M112.911	2.4	125	09.97-06.99	2↑	D	4	47	325	OZA660-EE8	5682	S4	1952
E 240	W210	M112.914	2.6	125	09.00-03.02	B 173368 -> Y	R	4	47	460	OZA659-EE35	1619	---	---
E 240	W210	M112.914	2.6	125	09.00-03.02	B 173368 -> Y	R	4	47	565	OZA659-EE37	1624	---	---
E 240	W210	M112.914	2.6	125	09.00-03.02		D	4	47	320	OZA659-EE22	0396	---	---
E 280	W210	M112.921	2.8	150	12.96-03.02	Y	R	4	47	625	OZA447-E22	0227	S4	1952
E 280	W210	M112.921	2.8	150	12.96-06.00	Y	R	4	47	325	OZA660-EE8	5682	S4	1952
E 280	W210	M112.921	2.8	150	12.96-06.00	2↑	D	4	47	325	OZA660-EE8	5682	S4	1952
E 280	W210	M112.921	2.8	150	03.97-06.99	Y	R	4	47	625	OZA447-E22	0227	S4	1952
E 280	W210	M112.921	2.8	150	03.97-06.99	Y	R	4	47	465	OZA674-EE1	7975	---	---
E 280 4MATIC	W210	M112.921	2.8	150	03.97-06.99	2↑	D	4	47	325	OZA660-EE8	5682	S4	1952
E 280 4MATIC	W210	M112.921	2.8	150	07.99-01.03	B 173368 -> Y	R	4	47	460	OZA659-EE35	1619	---	---
E 280 4MATIC	W210	M112.921	2.8	150	07.99-01.03	B 173368 -> Front right	R	4	47	565	OZA659-EE37	1624	---	---
E 280	W210	M112.921	2.8	150	07.99-01.03	2↑	D	4	47	320	OZA659-EE22	0396	---	---
E 320	W210	M112.941	3.2	165	03.97-06.99	Y	R	4	47	465	OZA674-EE1	7975	---	---
E 320	W210	M112.941	3.2	165	03.97-06.99	Y	R	4	47	625	OZA447-E22	0227	S4	1952
E 320	W210	M112.941	3.2	165	07.99-03.02	B 173368 -> Y	R	4	47	460	OZA659-EE35	1619	---	---
E 320	W210	M112.941	3.2	165	07.99-03.02	B 173368 -> Y	R	4	47	565	OZA659-EE37	1624	---	---
E 320	W210	M112.941	3.2	165	06.97-06.99	2↑	D	4	47	325	OZA660-EE8	5682	S4	1952
E 320	W210	M112.941	3.2	165	07.99-03.02	2↑	D	4	47	325	OZA660-EE8	5682	S4	1952
E 320 4MATIC	W210	M112.941	3.2	165	03.97-06.99	Y	R	4	47	465	OZA674-EE1	7975	---	---
E 320 4MATIC	W210	M112.941	3.2	165	06.97-06.99	Y	R	4	47	625	OZA447-E22	0227	S4	1952
E 320 4MATIC	W210	M112.941	3.2	165	07.99-03.02	B 173368 -> Y	R	4	47	460	OZA659-EE35	1619	---	---
E 320 4MATIC	W210	M112.941	3.2	165	07.99-03.02	B 173368 -> Y	R	4	47	565	OZA659-EE37	1624	---	---
E 320 4MATIC	W210	M112.941	3.2	165	06.97-06.99	2↑	D	4	47	325	OZA660-EE8	5682	S4	1952
E 320 4MATIC	W210	M112.941	3.2	165	07.99-03.02	2↑	D	4	47	325	OZA660-EE8	5682	S4	1952
E 420	W210	M119.985	4.2	205	01.96-08.97	Y	R	4	47	565	OZA447-E21	0216	S4	1952
E 420	W210	M119.985	4.2	205	01.96-08.97	Y	R	4	47	625	OZA447-E22	0227	S4	1952
E 430	W210	M113.940	4.3	205	09.97-06.99	Y	R	4	47	625	OZA447-E22	0227	S4	1952
E 430	W210	M113.940	4.3	205	09.97-06.99	Y	R	4	47	565	OZA447-E21	0216	S4	1952
E 430	W210	M113.940	4.3	205	07.99-03.02	B 173368 -> Y	R	4	47	460	OZA659-EE35	1619	---	---
E 430	W210	M113.940	4.3	205	07.99-03.02	B 173368 -> Y	R	4	47	565	OZA659-EE37	1624	---	---
E 430	W210	M113.940	4.3	205	07.99-03.02	2↑	D	4	47	325	OZA660-EE8	5682	S4	1952
E 430 4MATIC	W210	M113.940	4.3	205	09.97-06.99	Y	R	4	47	625	OZA447-E22	0227	S4	1952
E 430 4MATIC	W210	M113.940	4.3	205	09.97-06.99	Y	R	4	47	565	OZA447-E21	0216	S4	1952
E 430 4MATIC	W210	M113.940	4.3	205	06.99-03.02	B 173368 -> Y	R	4	47	460	OZA659-EE35	1619	---	---
E 430 4MATIC	W210	M113.940	4.3	205	06.99-03.02	B 173368 -> Y	R	4	47	565	OZA659-EE37	1624	---	---
E 430 4MATIC	W210	M113.940	4.3	205	07.99-03.02	2↑	D	4	47	325	OZA660-EE8	5682	S4	1952
E 55 AMG	W210	M113.980	5.5	260	06.99-03.02	Y	R	4	47	565	OZA447-E21	0216	S4	1952

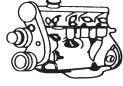

ℓ kW

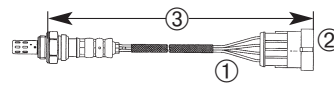
STOCK
NO.
UNIVERSAL
TYPE
NO.
INVENTORY
NO.

MERCEDES BENZ

E (W210)

E 55 AMG	W210	M113.980	5.5	260	06.99-03.02	↑	R	4	47	625	OZA447-E22	0227	S4	1952
----------	------	----------	-----	-----	-------------	---	---	---	----	-----	------------	------	----	------

E T-MODEL (S210)

E 200 T	S210	M111.942	2.0	100	06.96-08.00		R	4	47	465	OZA447-E44	1976	S4	1952	
E 200 T Kompressor	S210	M111.957	2.0	120	09.00-01.03		D	4	47	435	OZA659-EE26	0400	---	---	
E 200 T Kompressor	S210	M111.947	2.0	137	09.00-03.03		R	4	47	465	OZA447-E44	1976	---	---	
E 200 T Kompressor	S210	M111.947	2.0	137	07.99-01.03		D	4	47	435	OZA659-EE26	0400	---	---	
E 230 T	S210	M111.970	2.3	110	05.96-08.97		R	4	47	485	OZA673-EE1	7974	---	---	
E 230 T	S210	M112.911	2.4	125	07.99-01.03	-> B 173367	R	4	47	465	OZA674-EE1	7975	---	---	
E 240 T	S210	M112.911	2.4	125	07.99-01.03	B 173368 ->	↑	R	4	47	460	OZA659-EE35	1619	---	---
E 240 T	S210	M112.911	2.4	125	07.99-01.03	B 173368 ->	↑	R	4	47	565	OZA659-EE37	1624	---	---
E 240 T	S210	M112.911	2.4	125	01.98-03.03	2↑	D	4	47	325	OZA660-EE8	5682	S4	1952	
E 280 T	S210	M112.921	2.8	150	07.96-01.03		R	4	47	460	OZA659-EE35	1619	---	---	
E 280 T	S210	M112.921	2.8	150	01.98-01.03	2↑	D	4	47	325	OZA660-EE8	5682	S4	1952	
E 280 T 4MATIC	S210	M112.921	2.8	150	07.99-03.03	B 173368 ->	↑	R	4	47	460	OZA659-EE35	1619	---	---
E 280 T 4MATIC	S210	M112.921	2.8	150	07.99-03.03	B 173368 ->	↑	R	4	47	565	OZA659-EE37	1624	---	---
E 280 T 4MATIC	S210	M112.921	2.8	150	07.99-03.03	2↑	D	4	47	325	OZA660-EE8	5682	S4	1952	
E 320 T	S210	M112.941	3.2	165	03.97-06.99		R	4	47	625	OZA447-E22	0227	S4	1952	
E 320 T	S210	M112.941	3.2	165	07.99-01.03	B 173368 ->	↑	R	4	47	460	OZA659-EE35	1619	---	---
E 320 T	S210	M112.941	3.2	165	07.99-01.03	B 173368 ->	↑	R	4	47	565	OZA659-EE37	1624	---	---
E 320 T	S210	M112.941	3.2	165	01.98-03.03	2↑	D	4	47	325	OZA660-EE8	5682	S4	1952	
E 320 T 4MATIC	S210	M112.941	3.2	165	06.97-06.99		R	4	47	625	OZA447-E22	0227	S4	1952	
E 320 T 4MATIC	S210	M112.941	3.2	165	07.99-01.03	B 173368 ->	↑	R	4	47	460	OZA659-EE35	1619	---	---
E 320 T 4MATIC	S210	M112.941	3.2	165	07.99-01.03	B 173368 ->	↑	R	4	47	565	OZA659-EE37	1624	---	---
E 320 T 4MATIC	S210	M112.941	3.2	165	01.98-02.01	2↑	D	4	47	325	OZA660-EE8	5682	S4	1952	
E 420 T	S210	M119.985	4.2	205	05.96-08.97	->B 132401	R	4	47	565	OZA447-E21	0216	S4	1952	
E 420 T	S210	M119.985	4.2	205	05.96-08.97	B 132402->	R	4	47	625	OZA447-E22	0227	S4	1952	
E 430 T	S210	M113.940	4.3	205	09.97-03.03	↑	R	4	47	625	OZA447-E22	0227	S4	1952	
E 430 T	S210	M113.940	4.3	205	09.97-03.03	↑	R	4	47	565	OZA447-E21	0216	S4	1952	
E 430 T	S210	M113.940	4.3	205	07.99-01.03	B 173368 ->	↑	R	4	47	460	OZA659-EE35	1619	---	---
E 430 T	S210	M113.940	4.3	205	07.99-01.03	B 173368 ->	↑	R	4	47	565	OZA659-EE37	1624	---	---
E 430 T	S210	M113.940	4.3	205	01.98-03.03	2↑	D	4	47	325	OZA660-EE8	5682	S4	1952	
E 430 T 4MATIC	S210	M113.940	4.3	205	09.97-03.03	↑	R	4	47	625	OZA447-E22	0227	S4	1952	
E 430 T 4MATIC	S210	M113.940	4.3	205	09.97-03.03	↑	R	4	47	565	OZA447-E21	0216	S4	1952	
E 430 T 4MATIC	S210	M113.940	4.3	205	06.97-01.03	B 173368 ->	↑	R	4	47	460	OZA659-EE35	1619	---	---
E 430 T 4MATIC	S210	M113.940	4.3	205	06.97-01.03	B 173368 ->	↑	R	4	47	565	OZA659-EE37	1624	---	---
E 430 T 4MATIC	S210	M113.940	4.3	205	05.99-03.03	2↑	D	4	47	325	OZA660-EE8	5682	S4	1952	
E 55 T AMG	S210	M113.980	5.5	260	03.98-06.99	↑	R	4	47	625	OZA447-E22	0227	S4	1952	
E 55 T AMG	S210	M113.980	5.5	260	03.98-06.99	↑	R	4	47	565	OZA447-E21	0216	S4	1952	
E 55 T AMG	S210	M113.980	5.5	260	07.99-01.03	B 173368 ->	↑	R	4	47	460	OZA659-EE35	1619	---	---
E 55 T AMG	S210	M113.980	5.5	260	07.99-01.03	B 173368 ->	↑	R	4	47	565	OZA659-EE37	1624	---	---
E 55 T AMG	S210	M113.980	5.5	260	07.99-01.03	2↑	D	4	47	325	OZA660-EE8	5682	S4	1952	

E (W211)

E 240	W211	M112.913	2.6	130	03.02-03.05	2↑	R	4	47	400	OZA659-EE24	0398	---	---
E 240	W211	M112.913	2.6	130	03.02-03.05	2↑	D	4	68	430	OZA659-EE55	7860	---	---
E 240 4MATIC	W211	M112.917	2.6	130	09.03-	2↑	R	4	47	400	OZA659-EE24	0398	---	---
E 240 4MATIC	W211	M112.917	2.6	130	09.03-	2↑	D	4	68	430	OZA659-EE55	7860	---	---
E 320	W211	M112.949	3.2	165	03.02-03.05	2↑	R	4	47	400	OZA659-EE24	0398	---	---
E 320	W211	M112.949	3.2	165	03.02-03.05	2↑	D	4	68	430	OZA659-EE55	7860	---	---
E 320 4MATIC	W211	M112.954	3.2	165	09.03-03.05	2↑	R	4	47	400	OZA659-EE24	0398	---	---
E 320 4MATIC	W211	M112.954	3.2	165	09.03-03.05	2↑	D	4	68	430	OZA659-EE55	7860	---	---

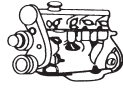

ℓ kW

STOCK
NO.
UNIVERSAL
NO.
TYPE
NO.
REVISION
NO.

MERCEDES BENZ

E (W211)

E 500	W211	M113.967	5.0	225	03.02-03.06	2↑		R	4	47	400	OZA659-EE24	0398	---	---
E 500	W211	M113.967	5.0	225	03.02-03.06	2↑		D	4	68	430	OZA659-EE55	7860	---	---
E 500 4MATIC	W211	M113.969	5.0	225	03.02-08.06	2↑		R	4	47	400	OZA659-EE24	0398	---	---
E 500 4MATIC	W211	M113.969	5.0	225	03.02-08.06	2↑		D	4	68	430	OZA659-EE55	7860	---	---
E 55 AMG Kompressor	W211	M113.990	5.4	350	10.02-03.06	2↑		R	4	47	400	OZA659-EE24	0398	---	---
E 55 AMG Kompressor	W211	M113.990	5.4	350	10.02-03.06	2↑		D	4	68	430	OZA659-EE55	7860	---	---

E T-MODEL (S211)

E 240	S211	M112.913	2.6	130	02.03-03.05	2↑		R	4	47	400	OZA659-EE24	0398	---	---
E 240	S211	M112.913	2.6	130	02.03-03.05	2↑		D	4	68	430	OZA659-EE55	7860	---	---
E 240 4MATIC	S211	M112.917	2.6	130	09.03-	2↑		R	4	47	400	OZA659-EE24	0398	---	---
E 240 4MATIC	S211	M112.917	2.6	130	09.03-	2↑		D	4	68	430	OZA659-EE55	7860	---	---
E 320	S211	M112.949	3.2	165	02.03-03.05	2↑		R	4	47	400	OZA659-EE24	0398	---	---
E 320	S211	M112.949	3.2	165	02.03-03.05	2↑		D	4	68	430	OZA659-EE55	7860	---	---
E 320 4MATIC	S211	M112.954	3.2	165	09.03-03.05	2↑		R	4	47	400	OZA659-EE24	0398	---	---
E 320 4MATIC	S211	M112.954	3.2	165	09.03-03.05	2↑		D	4	68	430	OZA659-EE55	7860	---	---
E 500	S211	M113.967	5.0	225	09.03-03.06	2↑		R	4	47	400	OZA659-EE24	0398	---	---
E 500	S211	M113.967	5.0	225	09.03-03.06	2↑		D	4	68	430	OZA659-EE55	7860	---	---
E 500 4MATIC	S211	M113.969	5.0	225	03.02-08.06	2↑		R	4	47	400	OZA659-EE24	0398	---	---
E 500 4MATIC	S211	M113.969	5.0	225	03.02-08.06	2↑		D	4	68	430	OZA659-EE55	7860	---	---
E 55 AMG Kompressor	S211	M113.990	5.4	350	09.03-03.06	2↑		R	4	47	400	OZA659-EE24	0398	---	---
E 55 AMG Kompressor	S211	M113.990	5.4	350	09.03-03.06	2↑		D	4	68	430	OZA659-EE55	7860	---	---

S (W126)

420	W126	M116.965	4.2	150	10.85-06.91			R	3	20	965	OZA446-E63	1730	S3	0412
420	W126	M116.965	4.2	160	10.85-12.87			R	3	20	965	OZA446-E63	1730	S3	0412
420	W126	M116.965	4.2	165	10.85-06.91			R	3	20	965	OZA446-E63	1730	S3	0412
420	W126	M116.965	4.2	170	10.85-12.87			R	3	20	965	OZA446-E63	1730	S3	0412
500	W126	M117.965	5.0	164	08.85-06.91			R	3	20	965	OZA446-E63	1730	S3	0412
500	W126	M117.965	5.0	180	09.85-06.91			R	3	20	965	OZA446-E63	1730	S3	0412
500	W126	M117.965	5.0	185	09.87-06.91			R	3	20	965	OZA446-E63	1730	S3	0412
500	W126	M117.965	5.0	195	09.87-06.91			R	3	20	965	OZA446-E63	1730	S3	0412
560	W126	M117.968	5.6	178	10.85-06.91			R	3	20	965	OZA446-E63	1730	S3	0412

S (W140)

420 Coupe	W140	M119.971	4.2	205	06.96-08.99	--> A 290167		R	4	47	465	OZA674-EE1	7975	---	---
420 Coupe	W140	M119.981	4.2	205	06.96-08.99	--> A 290167		R	4	47	465	OZA674-EE1	7975	---	---

S (W220)

S 280	W220	M112.922	2.8	150	01.99-08.02	--> A 138350		R	4	47	465	OZA674-EE1	7975	---	---
S 280	W220	M112.922	2.8	150	01.99-08.02	--> A 138350	2↑	D	4	47	325	OZA660-EE8	5682	S4	1952
S 280	W220	M112.922	2.8	150	01.99-08.05	A 138351 -->	2↑	R	4	47	460	OZA659-EE35	1619	---	---
S 280	W220	M112.922	2.8	150	01.99-08.05	A 138351 -->	2↑	D	4	47	320	OZA659-EE22	0396	---	---
S 320	W220	M112.944	3.2	165	10.98-08.02	--> A 138350		R	4	47	465	OZA674-EE1	7975	---	---
S 320	W220	M112.944	3.2	165	10.98-08.02	--> A 138350	2↑	D	4	47	325	OZA660-EE8	5682	S4	1952
S 320	W220	M112.944	3.2	165	10.98-08.02	A 138351 -->	2↑	R	4	47	460	OZA659-EE35	1619	---	---
S 320	W220	M112.944	3.2	165	10.98-08.02	A 138351 -->	2↑	D	4	47	320	OZA659-EE22	0396	---	---
S 350	W220	M112.972	3.7	180	09.02-08.05		2↑	R	4	47	460	OZA659-EE35	1619	---	---
S 350	W220	M112.972	3.7	180	09.02-08.05		2↑	D	4	47	320	OZA659-EE22	0396	---	---
S 350 4MATIC	W220	M112.975	3.7	180	09.02-08.05		2↑	R	4	47	460	OZA659-EE35	1619	---	---
S 350 4MATIC	W220	M112.975	3.7	180	09.02-08.05		2↑	D	4	47	320	OZA659-EE22	0396	---	---

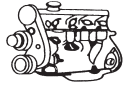

ℓ kW

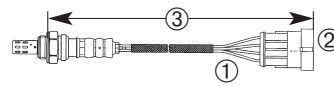
STOCK
NO.
UNIVERSAL
TYPE
NO.
INVENTORY
NO.

MERCEDES BENZ

S (W220)

S 430	W220	M113.941	4.3	205	10.98-08.05	--> A 138350	R	4	47	465	OZA674-EE1	7975	---	---
S 430	W220	M113.941	4.3	205	10.98-08.05	--> A 138350 2↑	D	4	47	325	OZA660-EE8	5682	S4	1952
S 430	W220	M113.941	4.3	205	10.98-08.05	A 138351 --> 2↑	R	4	47	460	OZA659-EE35	1619	---	---
S 430	W220	M113.941	4.3	205	10.98-08.05	A 138351 --> 2↑	D	4	47	320	OZA659-EE22	0396	---	---
S 430 4MATIC	W220	M113.948	4.3	205	09.02-08.05	2↑	R	4	47	460	OZA659-EE35	1619	---	---
S 430 4MATIC	W220	M113.948	4.3	205	09.02-08.05	2↑	D	4	47	320	OZA659-EE22	0396	---	---
S 500	W220	M113.960	5.0	225	10.98-08.05	--> A 138350	R	4	47	465	OZA674-EE1	7975	---	---
S 500	W220	M113.960	5.0	225	10.98-08.05	--> A 138350 2↑	D	4	47	325	OZA660-EE8	5682	S4	1952
S 500	W220	M113.960	5.0	225	10.98-08.05	A 138351 --> 2↑	R	4	47	460	OZA659-EE35	1619	---	---
S 500	W220	M113.960	5.0	225	10.98-08.05	A 138351 --> 2↑	D	4	47	320	OZA659-EE22	0396	---	---
S 500 4MATIC	W220	M113.966	5.0	225	09.02-08.05	2↑	R	4	47	460	OZA659-EE35	1619	---	---
S 500 4MATIC	W220	M113.966	5.0	225	09.02-08.05	2↑	D	4	47	320	OZA659-EE22	0396	---	---
S 55 AMG	W220	M113.986	5.4	265	08.00-08.05	2↑	R	4	47	460	OZA659-EE35	1619	---	---
S 55 AMG	W220	M113.986	5.4	265	08.00-08.05	2↑	D	4	47	320	OZA659-EE22	0396	---	---
S 55 AMG Kompressor	W220	M113.991	5.4	368	08.00-08.05	2↑	R	4	47	460	OZA659-EE35	1619	---	---
S 55 AMG Kompressor	W220	M113.991	5.4	368	08.00-08.05	2↑	D	4	47	320	OZA659-EE22	0396	---	---
S 600	W220	M137.970	5.8	270	08.99-08.05	4↑	R	4	47	435	OZA659-EE26	0400	---	---
S 600	W220	M137.970	5.8	270	08.99-08.05	4↑	D	4	47	380	OZA659-EE27	1609	---	---

SL (W107)

300 SL	W107	M103.982	3.0	132-138	09.85-08.89		R	3	20	760	OZA446-E14	1837	S3	0412
--------	------	----------	-----	---------	-------------	--	---	---	----	-----	------------	------	----	------

SL (R129)

SL 280	R129	M112.923	2.8	150	06.98-	OE	R	4	47	625	OZA447-E22	0227	S4	1952
SL 320	R129	M112.943	3.2	165	06.98-	OE	R	4	47	625	OZA447-E22	0227	S4	1952
SL 500	R129	M113.961	5.0	225	06.98-		R	4	47	625	OZA447-E22	0227	S4	1952

SL (R230)

SL 350	R230	M112.973	3.5	180	03.03-12.05	2↑	R	4	47	460	OZA659-EE35	1619	---	---
SL 500	R230	M113.963	5.0	225	10.01-12.05	2↑	R	4	47	435	OZA659-EE26	0400	---	---
SL 500	R230	M113.963	5.0	225	10.01-12.05	2↑	D	4	68	430	OZA659-EE55	7860	---	---
SL 55 AMG	R230	M113.992	5.4	368	10.01-12.05	2↑	R	4	47	435	OZA659-EE26	0400	---	---
SL 55 AMG	R230	M113.992	5.4	368	10.01-12.05	2↑	D	4	68	430	OZA659-EE55	7860	---	---

SLK (R170)

SLK 200	R170	M111.946	2.0	100	09.96-03.00		R	4	47	280	OZA448-E54	0459	S4	1952
SLK 200 Kompressor	R170	M111.958	2.0	120	02.00-03.04		R	4	47	320	OZA659-EE22	0396	---	---
SLK 200 Kompressor	R170	M111.958	2.0	120	02.00-03.04		D	4	47	380	OZA659-EE27	1609	---	---
SLK 200 Kompressor	R170	M111.943	2.0	135	10.96-03.00		R	4	47	280	OZA448-E54	0459	S4	1952
SLK 230 Kompressor	R170	M111.973	2.3	142	09.96-03.00		R	4	47	280	OZA448-E54	0459	S4	1952
SLK 230 Kompressor	R170	M111.983	2.3	145	02.00-03.04		R	4	47	320	OZA659-EE22	0396	---	---
SLK 230 Kompressor	R170	M111.983	2.3	145	02.00-03.04		R	4	47	480	OZA659-EE29	1611	---	---
SLK 320	R170	M112.947	3.2	160	06.99-03.04		R	4	47	435	OZA659-EE26	0400	---	---
SLK 320	R170	M112.947	3.2	160	06.99-03.04	4↑	D	4	47	240	OZA659-EE15	0389	---	---
SLK 320	R170	M112.947	3.2	160	06.99-03.04	4↑	D	4	47	320	OZA659-EE22	0396	---	---
SLK 32 AMG Kompressor	R170	M112.960	3.2	260	06.99-03.04		R	4	47	435	OZA659-EE26	0400	---	---
SLK 32 AMG Kompressor	R170	M112.960	3.2	260	06.99-03.04	4↑	D	4	47	240	OZA659-EE15	0389	---	---
SLK 32 AMG Kompressor	R170	M112.960	3.2	260	06.99-03.04	4↑	D	4	47	320	OZA659-EE22	0396	---	---

SLK (R171)

SLK 55 AMG	R171	M113.989	5.4	265	04.04-	4↑	R	4	47	585	OZA659-EE34	1618	---	---
------------	------	----------	-----	-----	--------	-----------	---	---	----	-----	-------------	------	-----	-----

M (W163)

ML 320	W163	M112.942	3.2	160	02.98-08.02	2↑	R	4	47	325	OZA660-EE8	5682	S4	1952
ML 320	W163	M112.942	3.2	160	02.98-08.02	--> A 051463 2↑	D	4	47	325	OZA660-EE8	5682	S4	1952

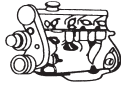

ℓ kW



STOCK No. TYPE No. UNITS AVAILABLE

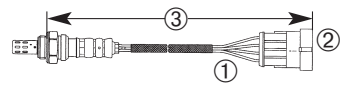

MERCEDES BENZ

M (W163)

ML 350	W163	M112.970	3.7	173	08.02-06.05		R	4	47	320	OZA659-EE22	0396	---	---
ML 350	W163	M112.970	3.7	173	08.02-06.05		D	4	47	240	OZA659-EE15	0389	---	---
ML 350	W163	M112.970	3.7	180	08.02-06.05		D	4	47	240	OZA659-EE15	0389	---	---
ML 430	W163	M113.942	4.3	200	06.98-07.02		R	4	47	320	OZA659-EE22	0396	---	---
ML 430	W163	M113.942	4.3	200	06.98-07.02		D	4	47	240	OZA659-EE15	0389	---	---
ML 500	W163	M113.965	5.0	215	09.01-06.05		R	4	47	320	OZA659-EE22	0396	---	---
ML 500	W163	M113.965	5.0	215	09.01-06.05		D	4	47	240	OZA659-EE15	0389	---	---
ML 55 AMG	W163	M113.981	5.5	255	02.00-	2↑	R	4	47	325	OZA660-EE8	5682	S4	1952

M (W164)

ML 500	W164	M113.964	5.0	225	07.05-	↑	R	4	47	585	OZA659-EE34	1618	---	---
ML 500	W164	M113.964	5.0	225	07.05-	↑	D	4	68	430	OZA659-EE55	7860	---	---

R (W251)

R 500	W251	M113.971	5.0	225	02.06-	↑	R	4	47	585	OZA659-EE34	1618	---	---
R 500	W251	M113.971	5.0	225	02.06-	↑	D	4	68	430	OZA659-EE55	7860	---	---

VANEO

Vaneo 1.6	414	M166.961	1.6	60	02.02-08.05		R	4	47	240	OZA659-EE15	0389	---	---
Vaneo 1.6	414	M166.961	1.6	60	02.02-08.05		D	4	47	380	OZA659-EE27	1609	---	---
Vaneo 1.6	414	M166.961	1.6	75	02.02-08.05		R	4	47	240	OZA659-EE15	0389	---	---
Vaneo 1.6	414	M166.961	1.6	75	02.02-08.05		D	4	47	380	OZA659-EE27	1609	---	---
Vaneo 1.9	414	M166.991	1.9	92	02.02-08.05		R	4	47	240	OZA659-EE15	0389	---	---
Vaneo 1.9	414	M166.991	1.9	92	02.02-08.05		D	4	47	380	OZA659-EE27	1609	---	---

V

V 200	638/2	M111.948	2.0	95	02.97-		R	4	47	985	OZA448-E45	0206	S4	1952
V 230	638/2	M111.978	2.3	105	10.96-		R	4	47	985	OZA448-E45	0206	S4	1952

SPRINTER

Sprinter 214 2.3i		M111.984	2.3	95	04.00-		R	4	47	815	OZA447-E34	0482	S4	1952
Sprinter 214 2.3i		M111.984	2.3	95	04.00-		D	4	47	465	OZA674-EE1	7975	---	---
Sprinter 314 2.3i		M111.984	2.3	95	04.00-		R	4	47	815	OZA447-E34	0482	S4	1952
Sprinter 314 2.3i		M111.984	2.3	95	04.00-		D	4	47	465	OZA674-EE1	7975	---	---
Sprinter 214 2.3i		M111.979	2.3	105	02.95-03.00		R	4	47	815	OZA447-E34	0482	S4	1952
Sprinter 214 2.3i		M111.984	2.3	105	04.00-		R	4	47	815	OZA447-E34	0482	S4	1952
Sprinter 214 2.3i		M111.984	2.3	105	04.00-		D	4	47	465	OZA674-EE1	7975	---	---
Sprinter 314 2.3i		M111.979	2.3	105	02.95-08.02		R	4	47	815	OZA447-E34	0482	S4	1952
Sprinter 314 2.3i		M111.984	2.3	105	04.00-		R	4	47	815	OZA447-E34	0482	S4	1952
Sprinter 314 2.3i		M111.984	2.3	105	04.00-		D	4	47	465	OZA674-EE1	7975	---	---
Sprinter 414 2.3i		M111.979	2.3	105	02.95-03.00		R	4	47	815	OZA447-E34	0482	S4	1952
Sprinter 414 2.3i		M111.984	2.3	105	04.00-		R	4	47	815	OZA447-E34	0482	S4	1952
Sprinter 414 2.3i		M111.984	2.3	105	04.00-		D	4	47	465	OZA674-EE1	7975	---	---

MG

MGF

1.6i 16V	16K4F	1.6	82	10.01-03.02	-> YD 522 572		R	4	33	590	OZA527-E9	0498	S4CG	1919
1.6i 16V	16K4F	1.6	82	10.01-03.02	YD 522 573 ->		R	4	106	540	OZA659-EE2	0376	---	---

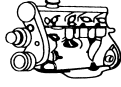

ℓ kW

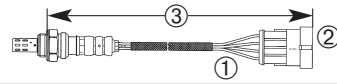
ORDER No.
STOCK No.
UNIVERSAL No.
TYPE No.
SUBVERSAL No.
SUPPLEMENT No.

MG

MGF

1.8i 16V	18K4F	1.8	88	10.95-03.02	-> YD 522 572	R	4	33	590	OZA527-E9	0498	S4CG	1919
1.8i 16V	18K4F	1.8	88	10.95-03.02	YD 522 573 ->	R	4	106	540	OZA659-EE2	0376	---	---
1.8i 16V WVC	18K4K	1.8	107	10.95-03.02	-> YD 522 572	R	4	33	590	OZA527-E9	0498	S4CG	1919
1.8i 16V WVC	18K4K	1.8	107	10.95-03.02	YD 522 573 ->	R	4	106	540	OZA659-EE2	0376	---	---
1.8i 16V WVC	18K4K	1.8	118	10.95-03.02	-> YD 522 572	R	4	33	590	OZA527-E9	0498	S4CG	1919
1.8i 16V WVC	18K4K	1.8	118	10.95-03.02	YD 522 573 ->	R	4	106	540	OZA659-EE2	0376	---	---

MGTF

1.8i 16V	18K4F	1.8	88	03.02-05.05	-> YD 522 572	R	4	33	590	OZA527-E9	0498	S4CG	1919
1.8i 16V	18K4F	1.8	88	03.02-05.05	YD 522 573 ->	R	4	106	540	OZA659-EE2	0376	---	---
1.8i 16V	18K4F	1.8	88	03.02-05.05		D	4	106	540	OZA659-EE2	0376	---	---
1.8i 16V	18K4F	1.8	100	03.02-05.05	-> YD 522 572	R	4	33	590	OZA527-E9	0498	S4CG	1919
1.8i 16V	18K4F	1.8	100	03.02-05.05	YD 522 573 ->	R	4	106	540	OZA659-EE2	0376	---	---
1.8i 16V	18K4F	1.8	100	03.02-05.05		D	4	106	540	OZA659-EE2	0376	---	---
1.8i 16V WVC	18K4F	1.8	118	03.02-05.05	-> YD 522 572	R	4	33	590	OZA527-E9	0498	S4CG	1919
1.8i 16V WVC	18K4F	1.8	118	03.02-05.05	YD 522 573 ->	R	4	106	540	OZA659-EE2	0376	---	---
1.8i 16V WVC	18K4F	1.8	118	03.02-05.05		D	4	106	540	OZA659-EE2	0376	---	---

MGR

3.9i	V8	3.9	140	09.92-12.95		R	3	55	521	OTD3G-3A1	0453	---	---
------	----	-----	-----	-------------	--	---	---	----	-----	-----------	------	-----	-----

ZR

1.4i 16V	K-Serie	1.4	76	10.01-05.05		R	4	112	745	OZA659-EE45	5747	---	---
1.8i 16V	18K4F	1.8	86	10.01-05.05	YD 522 573 ->	R	4	106	540	OZA659-EE2	0376	---	---

ZS

1.6i 16V	K-Serie	1.6	80	07.03-05.05	-> YD 471 063	R	4	33	590	OZA527-E9	0498	S4CG	1919
1.6i 16V	K-Serie	1.6	80	07.03-05.05	YD 471 064->	R	4	106	540	OZA659-EE2	0376	---	---
1.6i 16V	K-Serie	1.6	80	07.03-05.05	YD 471 064->	D	4	112	745	OZA659-EE45	5747	---	---
1.8i 16V	18K4F	1.8	86	10.01-05.05		R	4	106	540	OZA659-EE2	0376	---	---
1.8i 16V	18K4F	1.8	86	10.01-05.05		D	4	106	540	OZA659-EE2	0376	---	---

ZT

1.8i	K-Serie	1.8	88	07.03-		R	4	75	620	OZA341-RV2	0429	---	---
1.8i	K-Serie	1.8	88	07.03-		D	4	75	620	OZA341-RV2	0429	---	---
1.8i Turbo	K-Serie	1.8	118	10.02-		R	4	75	620	OZA341-RV2	0429	---	---
1.8i Turbo	K-Serie	1.8	118	10.02-		D	4	75	620	OZA341-RV2	0429	---	---
2.5i	KV6 25K4F	2.5	118	06.01-		R	4	75	620	OZA341-RV2	0429	---	---
2.5i	KV6 25K4F	2.5	118	06.01-		D	4	75	620	OZA341-RV2	0429	---	---
2.5i	KV6 25K4F	2.5	140	06.01-		R	4	75	620	OZA341-RV2	0429	---	---
2.5i	KV6 25K4F	2.5	140	06.01-		D	4	75	620	OZA341-RV2	0429	---	---

MINI

ONE

1.6	R50		1.6	66	04.01-		R	4	75	620	OZA495-RV1	0043	---	---
1.6	R50		1.6	66	04.01-		D	4	75	620	OZA495-RV1	0043	---	---

COOPER

1.6	R50		1.6	85	04.01-12.06		R	4	75	620	OZA495-RV1	0043	---	---
1.6	R50		1.6	85	04.01-12.06		D	4	75	620	OZA495-RV1	0043	---	---
1.6	R56		1.6	88	01.07-		D	4	82	446	OZA628-U1	0016	---	---

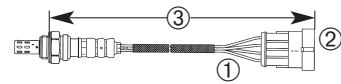

MINI
UNIVERSAL
TYPE
No.
STOCK
ORDER
No.



ℓ kW



MINI

COOPER S

1.6	R53		1.6	125	05.02-12.06		R	4	75	620	OZA495-RV1	0043	---	---
1.6	R53		1.6	125	05.02-12.06		D	4	75	620	OZA495-RV1	0043	---	---
1.6	R56		1.6	128	01.07-		D	4	82	446	OZA628-U1	0016	---	---

MITSUBISHI

CARISMA

1.6i 16V	4G92	1.6	66	05.95-02.99		R	4	71	340	OZA448-E52	0437	S4	1952
1.6i 16V	4G92	1.6	73	05.97-		R	4	71	340	OZA448-E52	0437	S4	1952
1.8i 16V	4G93	1.8	85	05.96-02.99		R	4	71	340	OZA448-E52	0437	S4	1952
1.8i 16V GDI	4G93	1.8	92	05.97-02.99		R	4	76	400	OZA448-E53	0448	S4	1952
1.8i 16V	4G93	1.8	103	05.95-04.97		R	4	71	340	OZA448-E52	0437	S4	1952

COLT II

1.3 GL	4G13	1.3	44	04.88-12.90	Universal	R	1	---	---	OZA624-E1	1951	S1	1951
1.3	G13B	1.3	49	06.86-06.88		R	1	8	700	OZA401-E68	0428	S1	1951
1.5	G15B	1.5	51	06.86-05.87		R	1	8	700	OZA401-E68	0428	S1	1951
1.5 GLXi	4G15	1.5	62	04.88-05.92	Universal	R	1	---	---	OZA624-E1	1951	S1	1951
1.6i Turbo	4G32	1.6	77	07.86-04.88		R	1	8	700	OZA401-E68	0428	S1	1951

COLT III

1.3	4G13	1.3	44-55	04.88-05.92		R	1	8	700	OZA401-E68	0428	S1	1951
1.5i	4G15	1.5	62	04.88-05.92		R	1	8	700	OZA401-E68	0428	S1	1951
1.5 GLXi	4G15	1.5	66	04.88-04.89		R	1	8	550	OZA401-E63	0207	S1	1951
1.5i 8V	4G15	1.5	66	05.89-05.90		R	2	11	630	OZA428-E3	0121	S2	1918
1.5i 12V	4G13	1.5	66	06.90-05.92		R	2	11	630	OZA428-E3	0121	S2	1918

COLT IV

1.3i 12V	4G13	1.3	55	04.92-04.96		R	4	30	290	OZA85-M1	0165	S4	1952
1.6i	4G92	1.6	66	12.91-12.96		R	4	30	320	OZA502-E34	0436	S4	1952
1.6i 16V	4G92 SOHC	1.6	83	12.91-11.95		R	4	30	320	OZA502-E34	0436	S4	1952
1.8i 16V	4G93 DOHC	1.8	103	12.91-11.95		R	4	30	320	OZA502-E34	0436	S4	1952

CORDIA

1.8i Turbo	G62B	1.8	100	10.86-12.89		R	1	8	500	OZA401-E66	0406	S1	1951
------------	------	-----	-----	-------------	--	---	---	---	-----	------------	------	----	------

ECLIPSE

2.0i	4G63	2.0	107	08.95-09.99		R	4	30	285	OZA502-E36	0458	S4	1952
------	------	-----	-----	-------------	--	---	---	----	-----	------------	------	----	------

GALANT

1.8i	4G37	1.8	62	11.87-05.90		R	1	8	650	OZA401-E67	0417	S1	1951
1.8i Sedan	4G37	1.8	66	11.87-10.92		R	2	12	580	OZA428-E2	0197	S2	1918
1.8i HB	4G37	1.8	66	11.88-10.92		R	2	12	580	OZA428-E2	0197	S2	1918
1.8i 16V	4G93	1.8	85	11.92-05.96		R	4	30	265	OZA502-E35	0447	S4	1952
1.8i 16V	4G93	1.8	93	12.93-05.96		R	4	30	265	OZA502-E35	0447	S4	1952
2.0i	G63B	2.0	66	06.86-12.87		R	1	8	655	OZA401-E53	0175	S1	1951
2.0i	4G63	2.0	75	06.84-12.87		R	1	8	655	OZA401-E53	0175	S1	1951
2.0i HB	4G63	2.0	80	11.88-05.91		R	1	8	445	OZA401-E54	0186	S1	1951
2.0i HB	4G63	2.0	80	06.91-10.92		R	2	12	460	OZA428-E4	0132	S2	1918
2.0i Sedan	4G63	2.0	80	11.88-05.91		R	1	8	445	OZA401-E54	0186	S1	1951
2.0i Sedan	4G63	2.0	80	06.91-10.92		R	2	12	460	OZA428-E4	0132	S2	1918
2.0i 16V	4G63	2.0	101	11.92-05.96		R	4	30	285	OZA502-E36	0458	S4	1952
2.0i	4G63T	2.0	107-110	06.84-11.87		R	1	8	650	OZA401-E67	0417	S1	1951
2.4i	G64B	2.4	82	07.85-11.87		R	1	8	650	OZA401-E67	0417	S1	1951

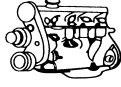

ℓ kW

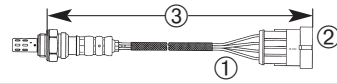
ORDER No.
STOCK No.
UNIVERSAL No.
TYPE No.
UNIVERSAL No.
SUPPLIER No.

MITSUBISHI

L300

2.0	G63B	2.0	64	11.86-06.95	Universal	R	1	---	---	OZA624-E1	1951	S1	1951
2.0i	4G63	2.0	66	11.86-06.95		R	1	8	655	OZA401-E53	0175	S1	1951
2.4 4WD	G64B	2.4	80	11.86-12.90	Universal	R	1	---	---	OZA624-E1	1951	S1	1951
2.4 4WD	4G64	2.4	82	11.90-12.95	Universal	R	1	---	---	OZA624-E1	1951	S1	1951

LANCER

1.3	4G13	1.3	55	01.92-12.96		R	4	30	290	OZA85-M1	0165	S4	1952
1.5	4G15	1.5	66	04.88-04.89		R	1	8	550	OZA401-E63	0207	S1	1951
1.5 SW	4G15	1.5	66	04.88-04.89		R	1	8	550	OZA401-E63	0207	S1	1951
1.5 8V	4G15	1.5	66	05.89-05.90		R	2	11	630	OZA428-E3	0121	S2	1918
1.5 8V SW	4G15	1.5	66	09.88-12.91		R	2	11	630	OZA428-E3	0121	S2	1918
1.5 12V HB	4G15	1.5	66	06.90-05.92		R	2	11	630	OZA428-E3	0121	S2	1918
1.5 8V HB	4G15	1.5	66	05.89-05.90		R	2	11	630	OZA428-E3	0121	S2	1918
1.5 12V	4G15	1.5	66	06.90-05.92		R	2	11	630	OZA428-E3	0121	S2	1918
1.5	4G15	1.5	66	01.92-12.96		R	4	30	290	OZA85-M1	0165	S4	1952
1.6i 16V 4WD	4G92 SOHC	1.6	83	06.92-07.95		R	4	30	320	OZA502-E34	0436	S4	1952
1.6i 16V HB	4G92 SOHC	1.6	83	06.92-07.95		R	4	30	320	OZA502-E34	0436	S4	1952
1.6i 16V	4G92 SOHC	1.6	83	01.93-12.96		R	4	30	320	OZA502-E34	0436	S4	1952
1.6i 16V 4WD	4G92	1.6	83	05.92-11.93		R	4	30	265	OZA502-E35	0447	S4	1952
1.6i SW	4G92	1.6	83	06.92-		R	4	30	285	OZA502-E36	0458	S4	1952
1.8i 16V	4G93 DOHC	1.8	100-103	05.92-11.95		R	4	30	320	OZA502-E34	0436	S4	1952
1.8i 16V HB	4G93 DOHC	1.8	103	06.92-07.95		R	4	30	320	OZA502-E34	0436	S4	1952

SPACE RUNNER

1.8i	4G93	1.8	85	06.96-08.99		R	4	30	285	OZA502-E36	0458	S4	1952
1.8i	4G93	1.8	90	10.91-08.99		R	4	30	285	OZA502-E36	0458	S4	1952

SPACE WAGON

2.0 GLX	G63B	2.0	62	06.86-05.88	Universal	R	1	---	---	OZA624-E1	1951	S1	1951
2.0 GLXi	4G63	2.0	74	06.88-04.91	Universal	R	1	---	---	OZA624-E1	1951	S1	1951
2.0i 16V	4G63 SOHC	2.0	98	10.92-10.98		R	4	30	320	OZA502-E34	0436	S4	1952

TREDIA

2.0i 4WD	G63B	2.0	75	09.86-12.89		R	1	8	500	OZA401-E66	0406	S1	1951
----------	------	-----	----	-------------	--	---	---	---	-----	------------	------	----	------

NISSAN

100 NX

1.6	B13	GA16DS	1.6	66	03.90-10.94	Universal	R	1	---	---	OZA624-E1	1951	S1	1951
1.6i 16V	B13	GA16DE	1.6	75-81	10.92-10.94		R	3	23	380	OZA446-E45	0155	S3	0412

350 Z

3.5i V6 24V	VQ35DE	3.5	180	10.03-		R	4	70	371	OZA544-N8	1804	---	---
3.5i V6 24V	VQ35DE	3.5	180	10.03-		D	4	88	500	OZA544-R1	1857	---	---

ALMERA II

1.5i	N16	QG15DE	1.5	66	03.00-10.00		R	3	110	325	OZA660-EE6	5680	S3	0412
1.5i	N16	QG15DE	1.5	66	11.00-07.02		R	3	129	330	OZA446-E64	1737	---	---
1.5i	N16	QG15DE	1.5	66	08.02-		R	4	70	401	OZA544-N14	6513	---	---
1.5i	N16	QG15DE	1.5	72	10.02-		R	4	70	401	OZA544-N14	6513	---	---

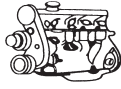

ℓ kW

STOCK
UNIVERSAL
TYPE
LINE
NO.
No.
No.
No.

NISSAN

ALMERA II

1.8i	N16	QG18DE	1.8	84	03.00-10.00		R	3	110	325	OZA660-EE6	5680	S3	0412
1.8i	N16	QG18DE	1.8	84	11.00-07.02		R	3	129	330	OZA446-E64	1737	---	---
1.8i	N16	QG18DE	1.8	84	08.02-		R	4	70	401	OZA544-N14	6513	---	---
1.8i	N16	QG18DE	1.8	85	10.02-		R	4	70	401	OZA544-N14	6513	---	---
1.8i	N16	GA18DE	1.8	88	12.00-		R	3	129	330	OZA446-E64	1737	---	---

ALMERA TINO

1.8i	V10	QG18DE	1.8	84	05.00-10.00		R	3	110	325	OZA660-EE6	5680	S3	0412
1.8i	V10	QG18DE	1.8	84	11.00-02.03		R	3	129	330	OZA446-E64	1737	---	---

BLUEBIRD

1.8	T72	CA18D	1.8	95	02.89-12.90		R	1	3	200	OZA401-E51	0142	S1	1951
1.8	T12	CA18D	1.8	99	11.88-12.90		R	1	3	200	OZA401-E51	0142	S1	1951
2.0	U11	CA20E	2.0	72	04.86-01.88		R	1	3	170	OZA401-E50	0131	S1	1951
2.0	T72	CA20E	2.0	72	09.88-12.90		R	1	3	170	OZA401-E50	0131	S1	1951
2.0	T12	CA20E	2.0	72	03.86-12.90		R	1	3	170	OZA401-E50	0131	S1	1951
2.0i	U11	CA20E	2.0	77	04.84-01.88	Universal	R	1	---	---	OZA624-E1	1951	S1	1951

KUBISTAR

1.2i			1.2	44	08.03-		R	4	67	455	OZA659-EE6	0380	---	---
1.6i 16V			1.6	70	08.03-	2↑	R	4	67	455	OZA659-EE6	0380	---	---

MAXIMA

3.0i	J30	VG30E	3.0	125	10.88-06.94		R	3	60	810	OTD2F-3K1	1907	---	---
------	-----	-------	-----	-----	-------------	--	---	---	----	-----	-----------	------	-----	-----

MICRA (K10)

1.0	K10	MA10S	1.0	37	12.82-12.89		R	1	3	170	OZA401-E50	0131	S1	1951
1.0	K10	MA10S	1.0	40	05.82-12.89		R	1	3	170	OZA401-E50	0131	S1	1951
1.2	K10	MA12S	1.2	40	07.86-07.92		R	1	3	170	OZA401-E50	0131	S1	1951

MICRA (K11)

1.0i 16V	K11	CG10DE	1.0	40	08.92-08.00		R	3	23	380	OZA446-E45	0155	S3	0412
1.0i 16V	K11	CG10DE	1.0	40	09.00-11.00		R	4	122	350	OZA447-E42	1971	S4	1952
1.0i 16V	K11	CG10DE	1.0	44	08.00-11.00		R	4	122	350	OZA447-E42	1971	S4	1952
1.0i 16V	K11	CG10DE	1.0	44	12.00-		R	4	70	350	OZA448-E58	1909	S4	1952
1.3i 16V	K11	CG13DE	1.3	55	08.92-07.00		R	3	23	380	OZA446-E45	0155	S3	0412
1.0i 16V	K11	CGA3DE	1.4	60	07.00-11.00		R	4	122	350	OZA447-E42	1971	S4	1952
1.4i 16V	K11	CGA3DE	1.4	60	12.00-02.03		R	4	70	350	OZA448-E58	1909	S4	1952

MICRA (K12)

1.0i 16V	K12		1.0	48	01.03-10.04		R	4	70	401	OZA544-N14	6513	---	---
1.0i 16V	K12		1.0	48	01.03-10.04		D	4	70	401	OZA544-N14	6513	---	---
1.2i 16V	K12	CR12DE	1.2	48	01.03-05.05		R	4	70	401	OZA544-N14	6513	---	---
1.2i 16V	K12	CR12DE	1.2	48	01.03-05.05		D	4	70	401	OZA544-N14	6513	---	---
1.2i 16V	K12	CR12DE	1.2	48	06.05-		R	4	31	271	OZA603-N2	0012	---	---
1.2i 16V	K12	CR12DE	1.2	48	06.05-		D	4	31	271	OZA603-N2	0012	---	---
1.2i 16V	K12	CR12DE	1.2	59	01.03-05.05		R	4	70	401	OZA544-N14	6513	---	---
1.2i 16V	K12	CR12DE	1.2	59	01.03-05.05		D	4	70	401	OZA544-N14	6513	---	---
1.2i 16V	K12	CR12DE	1.2	59	06.05-		R	4	31	271	OZA603-N2	0012	---	---
1.2i 16V	K12	CR12DE	1.2	59	06.05-		D	4	31	271	OZA603-N2	0012	---	---
1.4i 16V	K12		1.4	65	01.03-05.05		R	4	70	401	OZA544-N14	6513	---	---
1.4i 16V	K12		1.4	65	01.03-05.05		D	4	70	401	OZA544-N14	6513	---	---
160 SR	K12	HR16DE	1.6	81	06.05-		R	4	31	271	OZA603-N2	0012	---	---
160 SR	K12	HR16DE	1.6	81	06.05-		D	4	31	271	OZA603-N2	0012	---	---

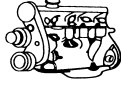

ℓ kW

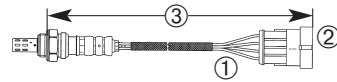
ORDER No.
STOCK No.
UNIVERSAL No.
TYPE No.
UNIVERSAL No.
SUPPLIER No.

NISSAN

NOTE

1.6i	E11	HR16DE	1.6	81	03.06-		R	4	31	271	OZA603-N2	0012	---	---
------	-----	--------	-----	----	--------	--	---	---	----	-----	-----------	------	-----	-----

PATHFINDER

2.4	D21	Z24i	2.4	74	10.88-04.92		R	1	3	200	OZA401-E51	0142	S1	1951
2.4	D21	KA24E	2.4	93	04.92-02.98		R	1	3	170	OZA401-E50	0131	S1	1951

PICK UP

2.4	D21	Z24i	2.4	74	10.88-04.92		R	1	3	200	OZA401-E51	0142	S1	1951
2.4	D21	KA24E	2.4	93	04.92-02.98		R	1	3	170	OZA401-E50	0131	S1	1951

PRARIE

2.0i	M11	CA20E	2.0	72	10.88-04.92		R	1	3	170	OZA401-E50	0131	S1	1951
2.4i	M11	KA24E	2.4	98	04.92-07.94	Universal	R	1	---	---	OZA624-E1	1951	S1	1951

PRIMASTAR

2.0i		F4R 720	2.0	88	03.01-		R	4	67	455	OZA659-EE6	0380	---	---
2.0i		F4R 722	2.0	88	03.01-		R	4	67	455	OZA659-EE6	0380	---	---

PRIMERA

1.6i	W10	GA16DS	1.6	66	07.90-04.93		R	1	3	200	OZA401-E51	0142	S1	1951
1.6i 16V	W10	GA16DE	1.6	75	04.93-12.97		R	3	23	380	OZA446-E45	0155	S3	0412
1.6i	P11	QG16DE	1.6	78	09.00-12.01		R	3	129	330	OZA446-E64	1737	---	---
1.6i 16V	P12	QG16DE	1.6	78	01.02-		R	4	70	401	OZA544-N14	6513	---	---
1.6i	P12	QG16DE	1.6	80	04.06-		R	4	70	401	OZA544-N14	6513	---	---
1.8i 16V	P11	QG18DE	1.8	84	08.99-09.00		R	3	110	325	OZA660-EE6	5680	S3	0412
1.8i	P11	QG18DE	1.8	84	10.00-12.01		R	3	129	330	OZA446-E64	1737	---	---
1.8i 16V	P12	QG18DE	1.8	85	04.06-		R	4	70	401	OZA544-N14	6513	---	---
2.0i 16V	P10	SR20DI	2.0	85	06.90-01.96		R	3	60	810	OTD2F-3K1	1907	---	---
2.0i 16V	P11	SR20DI	2.0	85	09.96-10.97		R	3	23	380	OZA446-E45	0155	S3	0412
2.0i 16V	P11	SR20DE	2.0	96	09.96-10.97		R	3	23	380	OZA446-E45	0155	S3	0412
2.0i 16V	P11	SR20DEL	2.0	96	10.97-06.99		R	3	23	380	OZA446-E45	0155	S3	0412
2.0i 16V	P11	SR20DE	2.0	96	09.96-10.97		R	3	23	380	OZA446-E45	0155	S3	0412
2.0i 16V	P11	SR20DEL	2.0	96	10.97-06.99		R	3	23	380	OZA446-E45	0155	S3	0412
2.0i	P11	SR20DE	2.0	103	02.01-12.01		R	3	129	330	OZA446-E64	1737	---	---
2.0i	P12	QR20DE	2.0	103	03.02-		R	4	70	271	OZA544-N7	6497	---	---
2.0i GT	P10	SR20DE	2.0	110	06.90-01.96		R	3	60	810	OTD2F-3K1	1907	---	---

SANTANA

1.8i		JN SOHC	1.8	67	01.84-		R	1	3	472	OZA401-E2	1802	S1	1951
2.0i			2.0	77	01.84-01.87		R	1	3	472	OZA401-E2	1802	S1	1951

SUNNY

1.4i 16V	N14	GA14DS	1.4	55	10.90-05.95		R	1	3	200	OZA401-E51	0142	S1	1951
1.4i 16V	N14	GA14DE	1.4	55	10.92-05.95		R	3	23	380	OZA446-E45	0155	S3	0412
1.4i 16V	N14	GA14DE	1.4	60-64	10.92-05.95		R	3	23	380	OZA446-E45	0155	S3	0412
1.6i	B12	E16i	1.6	54	06.86-10.88		R	3	60	196	OTD2F-1P2	0022	---	---
1.6i	N13	E16i	1.6	54	06.86-08.90		R	3	60	196	OTD2F-1P2	0022	---	---
1.6i	B13	GA16DS	1.6	66	10.90-10.92		R	1	3	200	OZA401-E51	0142	S1	1951
1.6i	N14	GA16DS	1.6	66	10.90-10.92		R	1	3	200	OZA401-E51	0142	S1	1951
1.6i	Y10	GA16DS	1.6	66	05.92-10.92		R	1	3	200	OZA401-E51	0142	S1	1951
1.6i 16V	N14	GA16DE	1.6	75-81	10.92-05.95		R	3	23	380	OZA446-E45	0155	S3	0412
1.6i 16V	B12	CA16D	1.6	81	02.87-10.88		R	1	3	200	OZA401-E51	0142	S1	1951

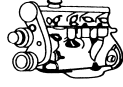

e kW



ORDER No.
UNIVERSAL No.
TYPE No.
SUNNY No.

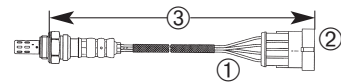

NISSAN

SUNNY

1.8i	B12	CA18D	1.8	92	10.88-		R	1	3	200	OZA401-E51	0142	S1	1951
2.0i		SR20DE	2.0	105	07.93-		R	3	60	810	OTD2F-3K1	1907	---	---

TERRANO I

2.4i	WD21	Z24i	2.4	77	08.87-07.92		R	1	3	200	OZA401-E51	0142	S1	1951
------	------	------	-----	----	-------------	--	---	---	---	-----	------------	------	----	------

TIIDA

1.6i	SZC11	HR16DE	1.6	81	09.07-		R	4	31	271	OZA603-N2	0012	---	---
------	-------	--------	-----	----	--------	--	---	---	----	-----	-----------	------	-----	-----

VANETTE

2.4i	GC22	Z24i	2.4	77	09.86-09.87		R	1	3	170	OZA401-E50	0131	S1	1951
2.4i	GC22	Z24i	2.4	77	09.87-		R	1	3	200	OZA401-E51	0142	S1	1951

X-TRAIL

2.0i	T30	QR20DE	2.0	103	07.01-		R	4	70	271	OZA544-N7	6497	---	---
2.5i	T30	QR25DE	2.5	121	01.03-		R	4	70	271	OZA544-N7	6497	---	---

OPEL

AGILA

1.0i		Z10XE	1.0	43	09.99-08.03		R	4	74	520	OZA659-EE28	1610	---	---
1.0i		Z10XE	1.0	43	09.99-08.03		D	4	74	295	OZA659-EE5	0379	---	---
1.2i		Z12XE	1.2	55	09.99-06.04		R	4	74	600	OZA659-EE51	1995	---	---
1.2i		Z12XE	1.2	55	09.99-06.04		D	4	74	295	OZA659-EE5	0379	---	---

ASCONA

1.6i	C	E16NZ	1.6	55	09.87-08.88		R	1	6	320	OZA401-E6	1882	S1	1951
1.6i	C	„C16NZ ; C16LZ“	1.6	55	09.86-08.88		R	1	6	320	OZA401-E6	1882	S1	1951
1.6i	C	E16NZ	1.6	55	09.87-08.88		R	1	6	320	OZA401-E6	1882	S1	1951
1.8E	C	C18NE	1.8	74	01.85-08.86		R	3	14	885	OZA446-E6	1861	S3	0412
2.0i	C	Z0NE	2.0	85	09.86-08.88		R	3	14	885	OZA446-E6	1861	S3	0412

ASTRA F

1.4i	F	C14NZ OHC	1.4	44	09.91-09.98	->T2576507, T5076960	R	1	6	320	OZA401-E6	1882	S1	1951
1.4i	F	C14NZ OHC	1.4	44	09.91-09.98	T2576508, T5076961->	R	1	6	320	OZA401-E6	1882	S1	1951
1.4i Van	F	C14NZ OHC	1.4	44	03.93-02.98		R	1	6	320	OZA401-E6	1882	S1	1951
1.4i	F	14SE, C14SE OHC	1.4	60	03.92-03.96	->T2576507, T5076960	R	1	6	320	OZA401-E6	1882	S1	1951
1.4i	F	14SE, C14SE OHC	1.4	60	03.92-03.96	T2576508, T5076961->	R	1	6	320	OZA401-E6	1882	S1	1951
1.4i 16V	F	X14XE DOHC	1.4	66	04.96-09.98		R	1	6	320	OZA401-E6	1882	S1	1951
1.6i Van	F	X16SZ OHC	1.6	52	02.93-07.96		R	1	6	320	OZA401-E6	1882	S1	1951
1.6i	F	X16SZ OHC	1.6	52	09.92-03.96	T2576508, T5076961->	R	1	6	320	OZA401-E6	1882	S1	1951
1.6i	F	X16SZ OHC	1.6	52	09.92-03.96	->T2576507, T5076960	R	1	6	320	OZA401-E6	1882	S1	1951
1.6i	F	X16SZR OHC	1.6	55	04.96-09.98	->T2576507, T5076960	R	1	6	320	OZA401-E6	1882	S1	1951
1.6i	F	X16SZR OHC	1.6	55	04.96-09.98	T2576508, T5076961->	R	1	6	320	OZA401-E6	1882	S1	1951
1.6i Van	F	C16NZ	1.6	55	03.93-02.98		R	1	6	320	OZA401-E6	1882	S1	1951
1.6i	F	C16NZ, E16NZ OHC	1.6	60	09.91-09.98	->T2576507, T5076960	R	1	6	320	OZA401-E6	1882	S1	1951
1.6i	F	C16NT, E16NZ OHC	1.6	60	09.91-09.98	T2576508, T5076961->	R	1	6	320	OZA401-E6	1882	S1	1951
1.6i	F	X16XEL DOHC	1.6	74	09.95-09.98	->W1285446; W5276825; W7154258	R	1	6	320	OZA401-E6	1882	S1	1951
1.6i	F	C16SE OHC	1.6	74	03.92-09.98	T2576508, T5076961->	R	1	6	320	OZA401-E6	1882	S1	1951
1.6i	F	C16SE OHC	1.6	74	03.92-09.98	->T2576507, T5076960	R	1	6	320	OZA401-E6	1882	S1	1951
1.8i	F	C18NZ OHC	1.8	66	09.91-09.98	->T2576507, T5076960	R	1	6	320	OZA401-E6	1882	S1	1951
1.8i	F	C18NZ OHC	1.8	66	09.91-09.98	T2576508, T5076961->	R	1	6	320	OZA401-E6	1882	S1	1951

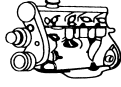

ℓ kW

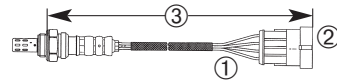

ORDER No. STOCK No. TYPE No. UNIVERSAL No. SUPPLEMENT No.

OPEL

ASTRA F

1.8i 16V	F	C18XEL	1.8	85	09.94-01.98		R	4	53	708	OTA7L-3C3	0442	---	---
1.8i 16V	F	X18XE	1.8	85	09.94-01.98		R	4	53	708	OTA7L-3C3	0442	---	---
1.8i 16V	F	C18XE, XEV	1.8	92	09.92-08.95		R	4	53	828	OTA7H-3C1	1954	---	---
1.8i 16V	F	C18XE, XEV	1.8	92	09.95-09.98		R	4	53	708	OTA7L-3C3	0442	---	---
2.0i 16V	F	X20XEV	2.0	100	01.95-07.95		R	4	53	828	OTA7H-3C1	1954	---	---
2.0i 16V	F	X20XEV	2.0	100	08.95-09.98		R	4	53	708	OTA7L-3C3	0442	---	---
2.0i 16V	F	C20XE	2.0	110	09.91-01.98		R	3	14	885	OZA446-E6	1861	S3	0412
2.0i 16V Caravan	F	C20XE	2.0	110	03.93-01.98		R	3	14	885	OZA446-E6	1861	S3	0412
2.0i	F	C20NE	2.0	85	03.92-09.98		R	3	14	885	OZA446-E6	1861	S3	0412
2.0i Cabrio	F	C20NE	2.0	85	03.93-10.94		R	3	14	885	OZA446-E6	1861	S3	0412
2.0i Caravan	F	C20NE	2.0	85	09.91-07.94		R	3	14	885	OZA446-E6	1861	S3	0412
2.0i CC	F	C20NE	2.0	85	09.91-01.98		R	3	14	885	OZA446-E6	1861	S3	0412

ASTRA G

1.2i 16V	G	X12XE	1.2	48	09.98-09.00		R	4	72	510	OZA447-E26	0405	S4	1952
1.2i 16V Caravan	G	X12XE	1.2	48	02.98-09.00		R	4	72	510	OZA447-E26	0405	S4	1952
1.2i	G	Z12XE	1.2	55	09.00-09.03		R	4	74	520	OZA659-EE28	1610	---	---
1.2i	G	Z12XE	1.2	55	09.00-09.03		D	4	74	295	OZA659-EE5	0379	---	---
1.2i Caravan	G	Z12XE	1.2	55	09.00-09.03		R	4	74	520	OZA659-EE28	1610	---	---
1.2i Caravan	G	Z12XE	1.2	55	09.00-09.03		D	4	74	295	OZA659-EE5	0379	---	---
1.4i 16V	G	X14XE	1.4	66	03.98-09.03		R	4	42	320	OZA448-E49	0404	S4	1952
1.4i 16V	G	Z14XE	1.4	66	09.00-01.04		R	4	72	515	OZA660-EE7	5681	S4	1952
1.4i 16V	G	Z14XE	1.4	66	09.00-01.04		D	4	74	290	OZA660-EE3	5656	S4	1952
1.4i 16V Caravan	G	Z14XE	1.4	66	09.00-06.04		R	4	72	515	OZA660-EE7	5681	S4	1952
1.4i 16V Caravan	G	Z14XE	1.4	66	09.00-06.04		D	4	74	290	OZA660-EE3	5656	S4	1952
1.4i 16V CC	G	Z14XE	1.4	66	09.00-01.04		R	4	72	515	OZA660-EE7	5681	S4	1952
1.4i 16V CC	G	Z14XE	1.4	66	09.00-01.04		D	4	74	290	OZA660-EE3	5656	S4	1952
1.6i	G	X16SZR	1.6	55	09.98-09.00		R	1	6	320	OZA401-E6	1882	S1	1951
1.6i Caravan	G	X16SZR	1.6	55	02.98-09.00		R	1	6	320	OZA401-E6	1882	S1	1951
1.6i Van	G	X16SZR	1.6	55	01.99-09.00		R	1	6	320	OZA401-E6	1882	S1	1951
1.6i CC	G	X16SZR	1.6	55	02.98-09.00		R	1	6	320	OZA401-E6	1882	S1	1951
1.6i	G	Z16SE	1.6	62	09.00-01.04		R	4	74	285	OZA660-EE13	5706	S4	1952
1.6i	G	Z16SE	1.6	62	09.00-01.04	22 000 001 ->, 28 000 001 ->	D	4	74	290	OZA660-EE3	5656	S4	1952
1.6i	G	Z16SE	1.6	62	09.00-01.04	-> 12 999 999, -> 18 999 999	D	4	74	285	OZA660-EE13	5706	S4	1952
1.6i Caravan	G	Z16SE	1.6	62	09.00-06.04		R	4	74	285	OZA660-EE13	5706	S4	1952
1.6i Caravan	G	Z16SE	1.6	62	09.00-06.04		D	4	74	290	OZA660-EE3	5656	S4	1952
1.6i CC	G	Z16SE	1.6	62	09.00-01.04		R	4	74	285	OZA660-EE13	5706	S4	1952
1.6i CC	G	Z16SE	1.6	62	09.00-01.04		D	4	74	290	OZA660-EE3	5656	S4	1952
1.6i Kasten	G	Z16SE	1.6	62	09.00-06.04		R	4	74	285	OZA660-EE13	5706	S4	1952
1.6i Kasten	G	Z16SE	1.6	62	09.00-06.04		D	4	74	290	OZA660-EE3	5656	S4	1952
1.6 CNG Caravan	G	Z16YNG	1.6	71	03.03-06.04		R	4	72	515	OZA660-EE7	5681	S4	1952
1.6 CNG Caravan	G	Z16YNG	1.6	71	03.03-06.04	-> 12 999 999, -> 1H 999 999	D	4	72	655	OZA660-EE10	5695	S4	1952
1.6 CNG Caravan	G	Z16YNG	1.6	71	09.02-06.04	22 000 002 ->, 2H 000 001 ->	D	4	74	290	OZA660-EE3	5656	S4	1952
1.6i 16V Cabrio	G	Z16XE	1.6	74	03.01-08.05		R	4	72	515	OZA660-EE7	5681	S4	1952
1.6i 16V Cabrio	G	Z16XE	1.6	74	03.01-10.05	-> 12 999 999, -> 18 999 999	D	4	72	655	OZA660-EE10	5695	S4	1952

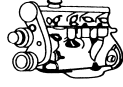

ℓ kW

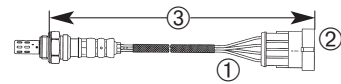

ORDER No. STOCK No. TYPE No. UNIVERSAL No. DRAWING No.

OPEL

ASTRA G

1.6i 16V Cabrio	G	Z16XE	1.6	74	03.01-10.05	22 000 001 -> 28 000 001 ->	D	4	74	290	OZA660-EE3	5656	S4	1952
1.6i 16V	G	X16XEL	1.6	74	03.98-01.05		R	4	42	320	OZA448-E49	0404	S4	1952
1.6i 16V	G	X16XEL	1.6	74	03.98-01.05		D	4	74	285	OZA660-EE13	5706	S4	1952
1.6i 16V	G	Z16XE	1.6	74	03.98-01.05		R	4	42	320	OZA448-E49	0404	S4	1952
1.6i 16V	G	Z16XE	1.6	74	03.98-01.05		D	4	74	285	OZA660-EE13	5706	S4	1952
1.8i 16V	G	X18XE	1.8	85	03.99-09.00		R	4	53	770	OTA7N-5A2	1938	---	---
1.8i 16V	G	X18XE1	1.8	85	02.98-09.00		R	4	53	770	OTA7N-5A2	1938	---	---
1.8i 16V Caravan	G	X18XE1	1.8	85	02.98-09.00		R	4	53	770	OTA7N-5A2	1938	---	---
1.8i 16V Coupe	G	X18XE1	1.8	85	03.00-10.00		R	4	53	770	OTA7N-5A2	1938	---	---
1.8i 16V	G	Z18XE	1.8	92	01.00-02.04		R	4	74	741	OZA334-SZ1	0485	---	---
1.8i 16V	G	Z18XE	1.8	92	01.00-02.04		R	4	74	571	OZA334-SZ2	0496	---	---
1.8i 16V	G	Z18XE	1.8	92	01.00-02.04		D	4	74	401	OZA334-SZ3	0407	---	---
1.8i 16V Caravan	G	Z18XE	1.8	92	09.00-07.04		R	4	74	741	OZA334-SZ1	0485	---	---
1.8i 16V Caravan	G	Z18XE	1.8	92	09.00-07.04		R	4	74	571	OZA334-SZ2	0496	---	---
1.8i 16V Caravan	G	Z18XE	1.8	92	09.00-07.04		D	4	74	401	OZA334-SZ3	0407	---	---
1.8i 16V Cabrio	G	Z18XE	1.8	92	03.01-08.05		R	4	74	741	OZA334-SZ1	0485	---	---
1.8i 16V Cabrio	G	Z18XE	1.8	92	03.01-08.05		D	4	74	271	OZA334-SZ4	0418	---	---
2.0i 16V	G	X20XEV	2.0	100	03.99-02.04		R	4	53	620	OTA7N-5A1	1920	---	---
2.0i 16V OPC CC	G	X20XER	2.0	118	11.99-09.02		R	4	53	770	OTA7N-5A2	1938	---	---
2.0i OPC	G	Z20LET	2.0	141	09.02-01.04		R	4	74	520	OZA659-EE28	1610	---	---
2.0i Turbo	G	Z20LET	2.0	141	03.02-08.05		R	4	74	520	OZA659-EE28	1610	---	---
2.0i Turbo Caravan	G	Z20LET	2.0	141	09.01-06.04		R	4	74	520	OZA659-EE28	1610	---	---
2.0i Turbo Coupe	G	Z20LET	2.0	141	09.00-02.05		R	4	74	520	OZA659-EE28	1610	---	---
2.0i OPC	G	Z20LET	2.0	147	09.02-01.04		R	4	74	520	OZA659-EE28	1610	---	---
2.0i Turbo	G	Z20LET	2.0	147	03.02-08.05		R	4	74	520	OZA659-EE28	1610	---	---
2.0i Turbo Caravan	G	Z20LET	2.0	147	09.01-06.04		R	4	74	520	OZA659-EE28	1610	---	---
2.0i Turbo Coupe	G	Z20LET	2.0	147	09.00-02.05		R	4	74	520	OZA659-EE28	1610	---	---
2.2i 16V	G	Z22SE	2.2	108	05.99-12.99		R	4	86	660	OZA531-GM1	1862	---	---
2.2i 16V	G	Z22SE	2.2	108	01.00-02.05		R	4	86	607	OZA531-GM6	1869	---	---
2.2i 16V	G	Z22SE	2.2	108	05.01-02.05		D	4	74	1245	OZA531-GM2	1863	---	---
2.2i 16V	G	Z22SE	2.2	108	05.01-02.05		D	4	74	1115	OZA531-GM3	1864	---	---

ASTRA H

1.3 CDTI	H	Z13DTH	1.3	66	04.05-		R	5	91	990	LZA15-GM1	0032	---	---
1.8i	H	Z18XE	1.8	92	03.04-		R	4	74	741	OZA334-SZ1	0485	---	---
1.8i	H	Z18XE	1.8	92	03.04-		D	4	74	271	OZA334-SZ4	0418	---	---
1.8i Caravan	H	Z18XE	1.8	92	08.04-		R	4	74	741	OZA334-SZ1	0485	---	---
1.8i Caravan	H	Z18XE	1.8	92	08.04-		D	4	74	271	OZA334-SZ4	0418	---	---
1.8i GTC	H	Z18XE	1.8	92	03.05-		R	4	74	741	OZA334-SZ1	0485	---	---
1.8i GTC	H	Z18XE	1.8	92	03.05-		D	4	74	271	OZA334-SZ4	0418	---	---
1.8i Twin Top	H	Z18XE	1.8	92	09.05-		R	4	74	741	OZA334-SZ1	0485	---	---
1.8i Twin Top	H	Z18XE	1.8	92	09.05-		D	4	74	271	OZA334-SZ4	0418	---	---
1.8i 16V	H	Z18XER	1.8	103	01.06-		R	4	74	471	OZA334-SZ5	1705	---	---
1.8i 16V	H	Z18XER	1.8	103	01.06-		D	4	74	471	OZA334-SZ6	1706	---	---
1.8i 16V Twin Top	H	Z18XER	1.8	103	09.05-		R	4	74	471	OZA334-SZ5	1705	---	---
1.8i 16V Twin Top	H	Z18XER	1.8	103	09.05-		D	4	74	471	OZA334-SZ6	1706	---	---
1.8i 16V GTC	H	Z18XER	1.8	103	01.06-		R	4	74	471	OZA334-SZ5	1705	---	---
1.8i 16V GTC	H	Z18XER	1.8	103	01.06-		D	4	74	471	OZA334-SZ6	1706	---	---
2.0i Turbo	H	Z20LEL	2.0	125	03.04-		R	4	74	520	OZA659-EE28	1610	---	---

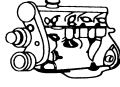

ℓ kW

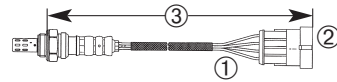
ORDER No.
STOCK No.
UNIVERSAL No.
TYPE No.
UNIVERSAL No.
SUPPLIER No.

OPEL

ASTRA H

2.0i Turbo Caravan	H	Z20LEL	2.0	125	09.04-		R	4	74	520	OZA659-EE28	1610	---	---
2.0i Turbo TwinTop	H	Z20LEL	2.0	125	09.05-		R	4	74	520	OZA659-EE28	1610	---	---
2.0i Turbo GTC	H	Z20LEL	2.0	125	03.05-		R	4	74	520	OZA659-EE28	1610	---	---
2.0i Turbo	H	Z20LER	2.0	147	03.04-		R	4	74	520	OZA659-EE28	1610	---	---
2.0i Turbo Caravan	H	Z20LER	2.0	147	09.04-		R	4	74	520	OZA659-EE28	1610	---	---
2.0i Turbo TwinTop	H	Z20LER	2.0	147	09.05-		R	4	74	520	OZA659-EE28	1610	---	---
2.0i Turbo GTC	H	Z20LER	2.0	147	03.05-		R	4	74	520	OZA659-EE28	1610	---	---
2.0i Turbo	H	Z20LEH	2.0	177	03.04-		R	4	74	520	OZA659-EE28	1610	---	---
2.0i Turbo Caravan	H	Z20LEH	2.0	177	09.04-		R	4	74	520	OZA659-EE28	1610	---	---
2.0i Turbo GTC	H	Z20LEH	2.0	177	03.05-		R	4	74	520	OZA659-EE28	1610	---	---

CALIBRA

2.0i	A	C20NE	2.0	85	06.90-07.97		R	3	14	885	OZA446-E6	1861	S3	0412
2.0i 4x4	A	C20NE	2.0	85	06.90-07.97		R	3	14	885	OZA446-E6	1861	S3	0412
2.0i 16V	A	X20XEV	2.0	100	03.94-12.95		R	4	53	828	OTA7H-3C1	1954	---	---
2.0i 16V	A	X20XEV	2.0	100	01.96-04.97		R	4	53	708	OTA7L-3C3	0442	---	---
2.0i 16V	A	C20XE	2.0	110	06.90-02.94	->P1000345, N9999999	R	3	14	885	OZA446-E6	1861	S3	0412
2.0i 16V 4x4	A	C20XE	2.0	110	06.90-02.94	->P1000345, N9999999	R	3	14	885	OZA446-E6	1861	S3	0412
2.0i 16V Turbo	A	C20LET	2.0	150	03.92-03.97		R	3	14	1220	OZA446-E3	1866	S3	0412
2.5i V6	A	C25XE, X25XE	2.5	125	04.93-07.97		R	3	14	885	OZA446-E6	1861	S3	0412

COMBO

1.2i		12NZ, C12NZ OHC	1.2	33	07.94-10.01		R	1	6	320	OZA401-E6	1882	S1	1951
1.2i		X12SZ OHC	1.2	33	03.94-10.01		R	1	6	320	OZA401-E6	1882	S1	1951
1.4i		X14SZ	1.4	44	04.96-10.01		R	1	6	320	OZA401-E6	1882	S1	1951
1.4i		C14NZ OHC	1.4	44	07.94-03.96		R	1	6	320	OZA401-E6	1882	S1	1951
1.4i		C14SE OHC	1.4	60	07.94-10.01		R	1	6	320	OZA401-E6	1882	S1	1951
1.6i			1.6	64	10.01-08.04		R	4	74	290	OZA660-EE3	5656	S4	1952
1.6i			1.6	64	10.01-08.04		D	4	74	290	OZA660-EE3	5656	S4	1952
1.6i Tour			1.6	64	10.01-08.04		R	4	74	290	OZA660-EE3	5656	S4	1952
1.6i Tour			1.6	64	10.01-08.04		D	4	74	290	OZA660-EE3	5656	S4	1952

CORSA A

1.2i	A	C12NZ OHC	1.2	33	09.90-03.93		R	1	6	320	OZA401-E6	1882	S1	1951
1.3i	A	C13N	1.3	44	09.85-03.93		R	1	6	320	OZA401-E6	1882	S1	1951
1.4i	A	C14NZ	1.4	40-44	01.90-03.93		R	1	6	320	OZA401-E6	1882	S1	1951
1.6i	A	C16NZ, E16NZ	1.6	55	04.89-03.93		R	1	6	320	OZA401-E6	1882	S1	1951
1.6 GSi	A	C16SEi	1.6	72	09.89-03.93		R	3	14	885	OZA446-E6	1861	S3	0412
1.6 GSi	A	E16SE	1.6	74	05.88-03.92		R	3	14	885	OZA446-E6	1861	S3	0412
1.6 GSi	A	C16SEi	1.6	74	02.92-03.93		R	3	14	885	OZA446-E6	1861	S3	0412

CORSA B

1.0i 12V	B	X10XE	1.0	40	03.97-09.00		R	4	72	510	OZA447-E26	0405	S4	1952
1.2i	B	X12SZ OHC	1.2	33	03.94-09.00		R	1	6	320	OZA401-E6	1882	S1	1951
1.2i	B	12NZ, C12NZ OHC	1.2	33	03.93-09.00		R	1	6	320	OZA401-E6	1882	S1	1951
1.2i 16V	B	X12XE	1.2	48	09.97-09.00		R	4	72	510	OZA447-E26	0405	S4	1952
1.4i	B	X14SZ	1.4	40-44	04.96-09.00		R	1	6	320	OZA401-E6	1882	S1	1951
1.4i Van	B	X14SZ	1.4	44	08.99-09.00		R	1	6	320	OZA401-E6	1882	S1	1951
1.4i	B	C14NZ	1.4	44	03.93-03.96		R	1	6	320	OZA401-E6	1882	S1	1951
1.4i	B	C14SE	1.4	60	03.93-09.00		R	1	6	320	OZA401-E6	1882	S1	1951
1.4i 16V	B	X14XE DOHC	1.4	66	09.94-09.00	S3000001->	R	1	6	320	OZA401-E6	1882	S1	1951
1.4i 16V	B	X14XE DOHC	1.4	66	09.94-09.00	T4124376, T6060014->	R	1	6	320	OZA401-E6	1882	S1	1951

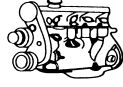

ℓ kW

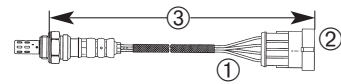

STOCK
ORDER
No.
UNIVERSAL
TYPE
No.
UNIVERSAL
TYPE
No.

OPEL

CORSA B

1.4i 16V	B	X14XE DOHC	1.4	66	09.94-09.00	S4000001, S6000001 ->T4124375, T606001	R	1	6	320	OZA401-E6	1882	S1	1951
1.6i 16V	B	X16XE DOHC	1.6	78	09.94-09.00	S3000001->	R	1	6	320	OZA401-E6	1882	S1	1951
1.6i 16V	B	X16XE DOHC	1.6	78	09.94-09.00	T4124376, T6060014->	R	1	6	320	OZA401-E6	1882	S1	1951
1.6i 16V	B	X16XE DOHC	1.6	78	09.94-09.00	S4000001, S6000001 ->T4124375, T606001	R	1	6	320	OZA401-E6	1882	S1	1951
1.6i	B	C16XE DOHC	1.6	80	03.93-09.00	S3000001->	R	1	6	320	OZA401-E6	1882	S1	1951
1.6i	B	C16XE DOHC	1.6	80	03.93-09.00	T4124376, T6060014->	R	1	6	320	OZA401-E6	1882	S1	1951
1.6i	B	C16XE DOHC	1.6	80	03.93-09.00	S4000001, S6000001 ->T4124375, T606001	R	1	6	320	OZA401-E6	1882	S1	1951

CORSA C

1.0i 12V	C	Z10XE	1.0	43	09.00-08.03		R	4	74	420	OZA659-EE7	0381	---	---
1.0i 12V	C	Z10XE	1.0	43	09.00-08.03		D	4	74	295	OZA659-EE5	0379	---	---
1.0i	C	Z10XEP	1.0	44	09.03-09.06		R	4	74	420	OZA659-EE7	0381	---	---
1.2i 16V	C	Z12XE	1.2	55	09.00-06.04		R	4	74	520	OZA659-EE28	1610	---	---
1.2i 16V	C	Z12XE	1.2	55	09.00-06.04	-> 1302 5250, -> 1417 7496, -> 1607 9019	D	4	74	295	OZA659-EE5	0379	---	---
1.2i 16V	C	Z12XE	1.2	55	09.00-06.04	1302 5251 ->, 1417 7497 ->, 1607 9020 ->	D	4	74	270	OZA659-EE39	1626	---	---
1.3 CDTI	C	Z13DTH	1.3	66	04.06-01.07		R	5	91	860	LZA15-GM3	1728	---	---
1.4i	C	Z14XE	1.4	66	09.00-08.03		R	4	72	515	OZA660-EE7	5681	S4	1952
1.4i	C	Z14XE	1.4	66	09.00-08.03		D	4	72	655	OZA660-EE10	5695	S4	1952
1.4i	C	Z14XE	1.4	66	09.00-08.03	2300 0001 ->	D	4	74	290	OZA660-EE3	5656	S4	1952
1.8i 16V	C	Z18XE	1.8	92	09.00-08.05		R	4	74	741	OZA334-SZ1	0485	---	---
1.8i 16V	C	Z18XE	1.8	92	09.00-08.05		D	4	74	271	OZA334-SZ4	0418	---	---

CORSA D

1.3 CDTI	D	Z13DTH	1.3	66	02.07-		R	5	91	860	LZA15-GM3	1728	---	---
----------	---	--------	-----	----	--------	--	---	---	----	-----	-----------	------	-----	-----

FRONTERA

2.0i	A	C20NE	2.0	85	09.91-10.98		R	3	14	1220	OZA446-E3	1866	S3	0412
2.0i	A	X20SE OHC	2.0	85	02.95-10.98		R	3	14	422	OZA446-E40	0193	S3	0412
2.2i 16V	A	X22XE DOHC	2.2	100	02.95-10.98		R	3	14	422	OZA446-E40	0193	S3	0412

KADETT E

1.3N Van	E	13N, 13NB	1.3	44	09.84-07.89		R	1	6	320	OZA401-E6	1882	S1	1951
1.3N Combo	E	C13N	1.3	44	01.86-12.89		R	1	6	320	OZA401-E6	1882	S1	1951
1.3i	E	C13N	1.3	44	09.85-08.91		R	1	6	320	OZA401-E6	1882	S1	1951
1.4i	E	C14NZ	1.4	44	01.90-08.91		R	1	6	320	OZA401-E6	1882	S1	1951
1.6i Combo	E	C16NZ	1.6	55	08.91-07.94		R	1	6	320	OZA401-E6	1882	S1	1951
1.6i	E	C16LZ, C16NZ	1.6	55	09.86-08.91		R	1	6	320	OZA401-E6	1882	S1	1951
1.6i Van	E	C16NZ	1.6	55	08.89-09.93		R	1	6	320	OZA401-E6	1882	S1	1951
1.6i	E	E16NZ OHC I	1.6	55	09.87-08.91		R	1	6	320	OZA401-E6	1882	S1	1951
1.8i	E	C18NZ OHC II	1.8	66	09.90-08.91		R	1	6	320	OZA401-E6	1882	S1	1951
1.8i Van	E	C18NT	1.8	66	08.84-09.92		R	1	6	320	OZA401-E6	1882	S1	1951
1.8i Van	E	C18NT	1.8	66	08.84-09.92		R	3	14	885	OZA446-E6	1861	S3	0412
1.8i	E	C18NT, C18NZ	1.8	66	06.85-09.85		R	3	14	885	OZA446-E6	1861	S3	0412
1.8i	E	C18NE	1.8	74	10.85-08.86		R	3	14	885	OZA446-E6	1861	S3	0412
2.0i Caravan	E	C20NE	2.0	85	09.87-08.91		R	3	14	885	OZA446-E6	1861	S3	0412

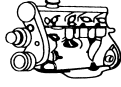

ℓ kW

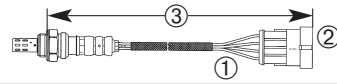
STOCK
ORDER
No.
UNIVERSAL
No.
UNIVERSAL
No.
UNIVERSAL
No.

OPEL

KADETT E

2.0i	E	20NE	2.0	85	03.87-08.91		R	3	14	885	OZA446-E6	1861	S3	0412
2.0i Cabrio	E	C20NE	2.0	85	10.86-02.93		R	3	14	885	OZA446-E6	1861	S3	0412
2.0i	E	C20NE	2.0	85	03.87-08.91		R	3	14	885	OZA446-E6	1861	S3	0412
2.0i GSi	E	20NE	2.0	85	09.86-08.91		R	3	14	885	OZA446-E6	1861	S3	0412
2.0i Caravan	E	20NE	2.0	85	09.87-08.91		R	3	14	885	OZA446-E6	1861	S3	0412
2.0i Cabrio	E	20NE	2.0	85	10.86-02.93		R	3	14	885	OZA446-E6	1861	S3	0412
2.0i GSi	E	C20NE	2.0	85	09.86-08.91		R	3	14	885	OZA446-E6	1861	S3	0412
2.0i 16V GSi	E	C20XE, 20XEJ	2.0	110	03.88-08.91		R	3	14	885	OZA446-E6	1861	S3	0412
2.0i 16V GSi	E	20XE	2.0	115	03.88-08.91		R	3	14	885	OZA446-E6	1861	S3	0412

MERIVA

1.6i		Z16SE	1.6	64	03.03-09.05		R	4	74	290	OZA660-EE3	5656	S4	1952
1.6i		Z16SE	1.6	64	03.03-09.05		D	4	74	290	OZA660-EE3	5656	S4	1952
1.6i 16V		Z16XE	1.6	74	05.03-01.06		R	4	72	515	OZA660-EE7	5681	S4	1952
1.6i 16V		Z16XE	1.6	74	05.03-01.06		D	4	74	290	OZA660-EE3	5656	S4	1952
1.8i 16V		Z18XE	1.8	92	05.03-		R	4	74	741	OZA334-SZ1	0485	---	---
1.8i 16V		Z18XE	1.8	92	05.03-		D	4	74	271	OZA334-SZ4	0418	---	---

MONZA

3.0 GSE	A	C30LE	3.0	115	09.85-08.86		R	3	14	885	OZA446-E6	1861	S3	0412
---------	---	-------	-----	-----	-------------	--	---	---	----	-----	-----------	------	----	------

OMEGA A

2.0i	A	C20NEF	2.0	74	09.90-03.94		R	3	14	1220	OZA446-E3	1866	S3	0412
2.0i	A	20NE, C20NE OHC	2.0	85	09.86-03.94		R	3	14	1220	OZA446-E3	1866	S3	0412
2.6i	A	C26NE	2.6	110	09.90-03.94		R	3	14	885	OZA446-E6	1861	S3	0412
3.0i	A	C30LE	3.0	115	03.87-12.87		R	3	14	885	OZA446-E6	1861	S3	0412
3.0i	A	C30NE	3.0	130	01.88-03.94		R	3	14	885	OZA446-E6	1861	S3	0412
3000	A	C30NE	3.0	130	03.88-03.94		R	3	14	885	OZA446-E6	1861	S3	0412
3000 24V	A	C30SEJ	3.0	147	09.89-03.94		R	3	14	885	OZA446-E6	1861	S3	0412
3000 24V	A	C30SE	3.0	150	09.89-03.94		R	3	14	885	OZA446-E6	1861	S3	0412

OMEGA B

2.0i	B	X20SE OHC	2.0	85	01.94-07.03		R	3	14	422	OZA446-E40	0193	S3	0412
2.0i	B	20SE OHC	2.0	85	01.94-07.03		R	3	14	225	OZA446-E41	0128	S3	0412
2.0i 16V	B	X20XEV	2.0	100	01.94-02.95		R	4	53	338	OTA7H-3C2	0420	---	---
2.0i 16V	B	X20XEV	2.0	100	02.95-02.99		R	4	53	338	OTA7L-3C4	0431	---	---
2.0i 16V	B	X20XEV	2.0	100	03.99-07.03		R	4	53	620	OTA7N-5A1	1920	---	---
2.2i 16V	B	Y22XE	2.2	106	09.99-07.03		R	4	74	741	OZA334-SZ1	0485	---	---
2.2i 16V	B	Y22XE	2.2	106	09.99-07.03		D	4	74	401	OZA334-SZ3	0407	---	---
2.5i 24V	B	X25XE DOHC V6	2.5	125	01.94-08.94		R	3	14	422	OZA446-E40	0193	S3	0412
2.6i	B	Y26SE	2.6	132	09.00-09.03		R	4	74	270	OZA659-EE39	1626	---	---
2.6i	B	Y26SE	2.6	132	09.00-09.03		D	4	74	270	OZA659-EE39	1626	---	---
2.6i	B	Y26SE	2.6	132	09.00-09.03		R	4	74	600	OZA659-EE51	1995	---	---
3.0i 24V	B	X30XE DOHC V6	3.0	155	01.94-08.94		R	3	14	422	OZA446-E40	0193	S3	0412
3.0i 24V	B	X30XE DOHC V6	3.0	155	01.94-07.03		R	3	14	422	OZA446-E40	0193	S3	0412
3.2i	B	Y32SE	3.2	160	09.00-09.03		R	4	74	270	OZA659-EE39	1626	---	---
3.2i	B	Y32SE	3.2	160	09.00-09.03		R	4	74	600	OZA659-EE51	1995	---	---

REKORD

1.8i	E	C18NV OHC	1.8	74	05.85-08.86		R	3	14	1220	OZA446-E3	1866	S3	0412
------	---	-----------	-----	----	-------------	--	---	---	----	------	-----------	------	----	------

SENATOR

2.6i	B	C26NE	2.6	110	09.90-09.93		R	3	14	885	OZA446-E6	1861	S3	0412
3.0i	B	C30LE	3.0	115	09.87-09.93	->M100 0000	R	3	14	885	OZA446-E6	1861	S3	0412

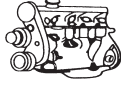

ℓ kW

STOCK
REVERSE
TYPE
LINE
NO.
No.
No.
No.

OPEL

SENATOR

3.0i	A	C30LE	3.0	115	09.85-08.87		R	3	14	885	OZA446-E6	1861	S3	0412
3.0i	B	C30NE	3.0	130	01.88-09.93		R	3	14	885	OZA446-E6	1861	S3	0412
3.0i 24V	B	C30SE	3.0	150	09.89-09.93	->M100 0000	R	3	14	885	OZA446-E6	1861	S3	0412
3.6i	B	C3.6NE Irmischer	3.6	145	08.89-09.93		R	3	14	885	OZA446-E6	1861	S3	0412

SIGNUM

1.8i		Z18XE	1.8	90	05.03-		R	4	74	741	OZA334-SZ1	0485	---	---
1.8i		Z18XE	1.8	90	05.03-		D	4	74	271	OZA334-SZ4	0418	---	---
1.8i 16V		Z18XER	1.8	103	09.05-		R	4	74	471	OZA334-SZ5	1705	---	---
1.8i 16V		Z18XER	1.8	103	09.05-		D	4	74	471	OZA334-SZ6	1706	---	---
2.0i 16V Turbo		Z20NET	2.0	129	05.03-		R	4	49	355	OZA575-GM2	1896	---	---
2.0i 16V Turbo		Z20NET	2.0	129	05.03-		D	4	87	1465	OZA531-GM16	1891	---	---
3.2i V6		Z32SE	3.2	155	05.03-09.05		R	4	74	270	OZA659-EE39	1626	---	---
3.2i V6		Z32SE	3.2	155	05.03-09.05		D	4	74	270	OZA659-EE39	1626	---	---

SINTRA

2.2i 16V		X22XE	2.2	141	11.96-04.99		R	3	14	885	OZA446-E6	1861	S3	0412
3.0i 24V		X30XE DOHC V6	3.0	148	09.96-04.99		R	3	14	422	OZA446-E40	0193	S3	0412

SPEEDSTER

2.0i Turbo		Z20LET	2.0	147	04.03-09.06		R	4	74	520	OZA659-EE28	1610	---	---
2.2i 16V		Z22SE	2.2	108	05.99-12.99		R	4	86	660	OZA531-GM1	1862	---	---
2.2i 16V		Z22SE	2.2	108	01.00-		R	4	86	607	OZA531-GM6	1869	---	---
2.2i 16V		Z22SE	2.2	108	05.01-		D	4	74	1245	OZA531-GM2	1863	---	---
2.2i 16V		Z22SE	2.2	108	05.01-		D	4	74	1115	OZA531-GM3	1864	---	---

TIGRA

1.4i 16V		X14XE DOHC	1.4	66	09.94-12.00	T4124376, T6060014 ->	R	1	6	320	OZA401-E6	1882	S1	1951
1.4i 16V		X14XE DOHC	1.4	66	09.94-12.00	S4000001, S6000001 ->T4124375, T606001	R	1	6	320	OZA401-E6	1882	S1	1951
1.4i 16V		X14XE DOHC	1.4	66	09.94-12.00	S3000001->	R	1	6	320	OZA401-E6	1882	S1	1951
1.6i 16V		X16XE DOHC	1.6	78	09.94-08.98	S3000001->	R	1	6	320	OZA401-E6	1882	S1	1951
1.6i 16V		X16XE DOHC	1.6	78	09.94-08.98	S4000001, S6000001 ->T4124375, T606001	R	1	6	320	OZA401-E6	1882	S1	1951
1.6i 16V		X16XE DOHC	1.6	78	09.94-08.98	T4124376, T6060014->	R	1	6	320	OZA401-E6	1882	S1	1951

TIGRA TWINTOP

1.8i		Z18XE	1.8	92	06.04-		R	4	74	741	OZA334-SZ1	0485	---	---
1.8i		Z18XE	1.8	92	06.04-		D	4	74	271	OZA334-SZ4	0418	---	---

VECTRA A

1.6i	A	X16SZ OHC	1.6	52	09.93-08.95		R	1	6	320	OZA401-E6	1882	S1	1951
1.6i	A	C16NZ, E16NZ OHC	1.6	55	09.88-08.95		R	1	6	320	OZA401-E6	1882	S1	1951
1.8i	A	C18NZ OHC	1.8	66	03.90-08.95		R	1	6	320	OZA401-E6	1882	S1	1951
1.8i 16V	A	X18XE1	1.8	85	09.95-12.95		R	4	53	828	OTA7H-3C1	1954	---	---
2.0i 16V	A	X20XE	2.0	100	03.93-12.95		R	4	53	828	OTA7H-3C1	1954	---	---
2.0i 16V 4x4	A	C20XE	2.0	110	02.90-08.92		R	3	14	885	OZA446-E6	1861	S3	0412
2.0i 16V 4x4	A	20XEJ	2.0	110	09.89-10.90		R	3	14	885	OZA446-E6	1861	S3	0412
2.0i 16V	A	20XEJ	2.0	110	09.89-06.94		R	3	14	885	OZA446-E6	1861	S3	0412
2.0i 16V	A	C20XE	2.0	110	02.90-08.95		R	3	14	885	OZA446-E6	1861	S3	0412
2.0i 4x4	A	C20NE	2.0	85	01.89-08.95		R	3	14	885	OZA446-E6	1861	S3	0412

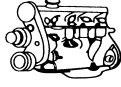

ℓ kW

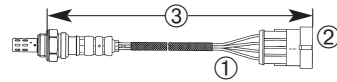

ORDER No. STOCK No. TYPE No. UNIVERSAL No. SUPPLEMENT No.

OPEL

VECTRA A

2.0i 4x4	A	20NE	2.0	85	01.89-10.90		R	3	14	885	OZA446-E6	1861	S3	0412
2.0i	A	C20NE	2.0	85	09.88-08.95		R	3	14	885	OZA446-E6	1861	S3	0412
2.0i	A	20NE	2.0	85	09.88-10.90		R	3	14	885	OZA446-E6	1861	S3	0412

VECTRA B

1.6i	B	X16SZR OHC	1.6	55	09.95-04.02		R	1	6	320	OZA401-E6	1882	S1	1951
1.6i 16V	B	X16XEL DOHC	1.6	74	09.95-04.02		R	1	6	320	OZA401-E6	1882	S1	1951
1.6i 16V	B	X16XEL DOHC	1.6	74	09.95-08.00		R	4	42	320	OZA448-E49	0404	S4	1952
1.6i 16V	B	Y16XE	1.6	74	09.99-04.02		R	4	72	770	OZA660-EE4	5658	S4	1952
1.6i 16V	B	Y16XE	1.6	74	09.99-04.02		D	4	72	655	OZA660-EE10	5695	S4	1952
1.6i 16V	B	Z16XE	1.6	74	09.99-04.02		R	4	72	770	OZA660-EE4	5658	S4	1952
1.6i 16V	B	Z16XE	1.6	74	09.99-04.02		D	4	72	655	OZA660-EE10	5695	S4	1952
1.6i 16V Caravan	B	Y16XE	1.6	74	09.99-09.02		R	4	72	770	OZA660-EE4	5658	S4	1952
1.6i 16V Caravan	B	Y16XE	1.6	74	09.99-09.02		D	4	72	655	OZA660-EE10	5695	S4	1952
1.6i 16V Caravan	B	Z16XE	1.6	74	09.99-09.02		R	4	72	770	OZA660-EE4	5658	S4	1952
1.6i 16V Caravan	B	Z16XE	1.6	74	09.99-09.02		D	4	72	655	OZA660-EE10	5695	S4	1952
1.6i 16V CC	B	Y16XE	1.6	74	09.99-09.02		R	4	72	770	OZA660-EE4	5658	S4	1952
1.6i 16V CC	B	Y16XE	1.6	74	09.99-09.02		D	4	72	655	OZA660-EE10	5695	S4	1952
1.6i 16V CC	B	Z16XE	1.6	74	09.99-09.02		R	4	72	770	OZA660-EE4	5658	S4	1952
1.6i 16V CC	B	Z16XE	1.6	74	09.99-09.02		D	4	72	655	OZA660-EE10	5695	S4	1952
1.8i 16V	B	X18XE1	1.8	85	01.96-09.00		R	4	53	708	OTA7L-3C3	0442	---	---
1.8i 16V	B	X18XE	1.8	85	10.95-09.00		R	4	53	770	OTA7N-5A2	1938	---	---
1.8i 16V	B	Z18XE	1.8	92	01.00-07.03		R	4	74	741	OZA334-SZ1	0485	---	---
1.8i 16V	B	Z18XE	1.8	92	01.00-07.03		R	4	74	571	OZA334-SZ2	0496	---	---
1.8i 16V	B	Z18XE	1.8	92	01.00-07.03		D	4	74	401	OZA334-SZ3	0407	---	---
2.0i 16V	B	X20XE1	2.0	100	01.96-02.99		R	4	53	708	OTA7L-3C3	0442	---	---
2.0i 16V	B	X20XE1	2.0	100	03.99-07.03		R	4	53	620	OTA7N-5A1	1920	---	---
2.5i V6	B	X25XE	2.5	125	10.95-09.00		R	3	14	885	OZA446-E6	1861	S3	0412
2.5i V6	B	X25XE	2.5	125	10.95-09.00		D	3	14	422	OZA446-E40	0193	S3	0412
2.5i V6 Caravan	B	X25XE	2.5	125	11.96-09.00		R	3	14	885	OZA446-E6	1861	S3	0412
2.5i V6 Caravan	B	X25XE	2.5	125	11.96-09.00		D	3	14	422	OZA446-E40	0193	S3	0412

VECTRA C

1.6 16V	C	Z16XE	1.6	74	09.01-07.05		R	4	72	515	OZA660-EE7	5681	S4	1952
1.6 16V	C	Z16XE	1.6	74	09.01-07.05		D	4	74	290	OZA660-EE3	5656	S4	1952
1.8i	C	Z18XE	1.8	90	04.02-		R	4	74	741	OZA334-SZ1	0485	---	---
1.8i	C	Z18XE	1.8	90	04.02-		D	4	74	271	OZA334-SZ4	0418	---	---
1.8i Caravan	C	Z18XE	1.8	90	10.03-		R	4	74	741	OZA334-SZ1	0485	---	---
1.8i Caravan	C	Z18XE	1.8	90	10.03-		D	4	74	271	OZA334-SZ4	0418	---	---
1.8i GTS	C	Z18XE	1.8	90	08.02-		R	4	74	741	OZA334-SZ1	0485	---	---
1.8i GTS	C	Z18XE	1.8	90	08.02-		D	4	74	271	OZA334-SZ4	0418	---	---
1.8i 16V	C	Z18XER	1.8	103	01.06-		R	4	74	471	OZA334-SZ5	1705	---	---
1.8i 16V	C	Z18XER	1.8	103	01.06-		D	4	74	471	OZA334-SZ6	1706	---	---
1.8i 16V Caravan	C	Z18XER	1.8	103	01.06-		R	4	74	471	OZA334-SZ5	1705	---	---
1.8i 16V Caravan	C	Z18XER	1.8	103	01.06-		D	4	74	471	OZA334-SZ6	1706	---	---
1.8i 16V GTC	C	Z18XER	1.8	103	01.06-		R	4	74	471	OZA334-SZ5	1705	---	---
1.8i 16V GTC	C	Z18XER	1.8	103	01.06-		D	4	74	471	OZA334-SZ6	1706	---	---
2.0i 16V Turbo	C	Z20NET	2.0	129	01.03-		R	4	49	355	OZA575-GM2	1896	---	---
2.0i 16V Turbo	C	Z20NET	2.0	129	10.03-		D	4	87	1465	OZA531-GM16	1891	---	---
2.2i 16V	C	Z22SE	2.2	108	04.02-		R	4	86	312	OZA583-GM1	1753	---	---
2.2i 16V	C	Z22SE	2.2	108	04.02-08.04		D	4	74	1465	OZA531-GM22	1892	---	---

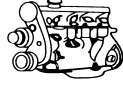

ℓ kW



STOCK
ORDER
No.
UNIVERSAL
No.
TYPE
No.
NUMBERS
No.
NUMBER
No.

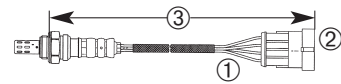

OPEL

VECTRA C

2.2i 16V	C	Z22SE	2.2	108	09.04-		D	4	74	1485	OZA531-GM24	0055	---	---
3.2i V6	C	Z32SE	3.2	155	08.02-09.05		R	4	74	270	OZA659-EE39	1626	---	---
3.2i V6	C	Z32SE	3.2	155	08.02-09.05		D	4	74	270	OZA659-EE39	1626	---	---
3.2i V6 Caravan	C	Z32SE	3.2	155	09.03-09.05		R	4	74	270	OZA659-EE39	1626	---	---
3.2i V6 Caravan	C	Z32SE	3.2	155	09.03-09.05		D	4	74	270	OZA659-EE39	1626	---	---

ZAFIRA A

1.6 CNG		Z16YNG	1.6	71	09.01-07.05		R	4	72	515	OZA660-EE7	5681	S4	1952
1.6 CNG		Z16YNG	1.6	71	09.01-07.05	-> 12 999 999, ->1H 999 999	D	4	72	655	OZA660-EE10	5695	S4	1952
1.6 CNG		Z16YNG	1.6	71	09.01-07.05	22 000 001 ->, 2H 000 001 ->	D	4	74	290	OZA660-EE3	5656	S4	1952
1.6i 16V		Z16XE	1.6	74	09.99-07.05		R	4	72	515	OZA660-EE7	5681	S4	1952
1.6i 16V		Z16XE	1.6	74	09.99-07.05	-> 12 999 999, ->1H 999 999	D	4	72	655	OZA660-EE10	5695	S4	1952
1.6i 16V		Z16XE	1.6	74	09.99-07.05	22 000 001 ->, 2H 000 001 ->	D	4	74	290	OZA660-EE3	5656	S4	1952
1.6i 16V		X16XEL	1.6	74	03.99-06.05	-> 12 999 999, ->18 999 999	R	4	42	320	OZA448-E49	0404	S4	1952
1.6i 16V		X16XEL	1.6	74	04.99-08.99	22 000 001 ->, 2H 000 001 ->	R	4	74	290	OZA660-EE3	5656	S4	1952
1.8i 16V		X18XE1	1.8	85	03.99-09.00		R	4	53	770	OTA7N-5A2	1938	---	---
1.8i 16V		Z18XE	1.8	92	10.00-06.05		R	4	74	741	OZA334-SZ1	0485	---	---
1.8i 16V		Z18XE	1.8	92	10.00-06.05		R	4	74	571	OZA334-SZ2	0496	---	---
1.8i 16V		Z18XE	1.8	92	10.00-06.05		D	4	74	401	OZA334-SZ3	0407	---	---
2.0i Turbo		Z20LET	2.0	141	09.01-07.05		R	4	74	520	OZA659-EE28	1610	---	---
2.0i Turbo		Z20LET	2.0	147	09.01-07.05		R	4	74	520	OZA659-EE28	1610	---	---
2.2i 16V		Z22SE	2.2	108	05.99-12.99		R	4	86	660	OZA531-GM1	1862	---	---
2.2i 16V		Z22SE	2.2	108	01.00-06.05		R	4	86	607	OZA531-GM6	1869	---	---
2.2i 16V		Z22SE	2.2	108	01.01-06.05		D	4	74	1245	OZA531-GM2	1863	---	---
2.2i 16V		Z22SE	2.2	108	01.01-06.05		D	4	74	1115	OZA531-GM3	1864	---	---

ZAFIRA B

1.8i 16V		Z18XER	1.8	103	07.05-		R	4	74	471	OZA334-SZ5	1705	---	---
1.8i 16V		Z18XER	1.8	103	07.05-		D	4	74	471	OZA334-SZ6	1706	---	---
2.0i Turbo		Z20LER	2.0	147	07.05-		R	4	74	520	OZA659-EE28	1610	---	---
2.0i Turbo		Z20LEH	2.0	177	07.05-		R	4	74	520	OZA659-EE28	1610	---	---

VIVARO

2.0i 16V		F4R 720	2.0	88	08.01-		R	4	67	455	OZA659-EE6	0380	---	---
----------	--	---------	-----	----	--------	--	---	---	----	-----	------------	-------------	-----	-----

PEUGEOT

106

1.0i		TU9M <CDY>	1.0	33	05.96-07.03		R	4	49	380	OZA448-E57	0492	S4	1952
1.0i		TU9M <CDY>	1.0	33	07.92-04.96		R	4	49	380	OZA448-E57	0492	S4	1952
1.0i		TU9M <CDY>	1.0	33	07.92-04.96		R	4	73	370	OZA527-E29	0488	S4CG	1919
1.0i		TU9M	1.0	33	07.92-06.95		R	4	58	450	OZA527-E12	0220	S4CG	1919
1.0i		TU9M	1.0	33	07.95-07.03		R	4	49	375	OZA527-E15	0298	S4CG	1919
1.0i		TU9M <CDZ>	1.0	37	07.92-04.96		R	4	73	370	OZA527-E29	0488	S4CG	1919

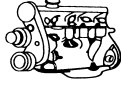

ℓ kW

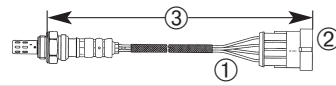
STOCK
ORDER
No.
TYPE
UNIVERSAL
No.
UNIVERSAL
No.
UNIVERSAL
No.

PEUGEOT

106

1.0i	TU9M <CDZ>	1.0	37	07.92-04.96		R	4	49	380	OZA448-E57	0492	S4	1952
1.0i	TU9M <CDZ>	1.0	37	05.96-07.03		R	4	49	380	OZA448-E57	0492	S4	1952
1.0i	TU9M	1.0	37	07.92-06.95		R	4	58	450	OZA527-E12	0220	S4CG	1919
1.0i	TU9M	1.0	37	07.95-04.96		R	4	49	375	OZA527-E15	0298	S4CG	1919
1.1i	TU1M+ <HDY>	1.1	40	05.96-07.03		R	4	49	380	OZA448-E57	0492	S4	1952
1.1i	TU1M <HDY>	1.1	40	08.92-04.96	ECE R15.04	R	4	49	380	OZA448-E57	0492	S4	1952
1.1i	TU1M+	1.1	40	08.92-06.95		R	4	58	450	OZA527-E12	0220	S4CG	1919
1.1i	TU1M+	1.1	40	07.95-04.96		R	4	49	375	OZA527-E15	0298	S4CG	1919
1.1i	TU1M	1.1	40	05.96-07.03		R	4	49	375	OZA527-E15	0298	S4CG	1919
1.1i	TU1M <HDY>	1.1	40	08.92-04.96	ECE R15.04	R	4	73	370	OZA527-E29	0488	S4CG	1919
1.1i	TU1M+ <HDZ>	1.1	44	05.96-07.03		R	4	49	380	OZA448-E57	0492	S4	1952
1.1i	TU1M	1.1	44	09.91-12.93		R	4	58	450	OZA527-E12	0220	S4CG	1919
1.1i	TU1JP <HFX>	1.1	44	03.00-05.05		R	4	83	540	OZA659-EE4	0378	---	---
1.1i	TU1JP <HFX>	1.1	44	03.00-05.05		D	4	82	535	OZA659-EE10	0384	---	---
1.3i	TU2J2	1.3	74	10.93-06.95		R	4	58	450	OZA527-E12	0220	S4CG	1919
1.3i	TU2J2	1.3	74	07.95-04.96		R	4	49	375	OZA527-E15	0298	S4CG	1919
1.3i	TU2J2 <MFZ>	1.3	74	10.93-04.96	ECE R15.04	R	4	73	370	OZA527-E29	0488	S4CG	1919
1.3i	TU2J2 <MFZ>	1.3	77	10.93-04.96	ECE R15.04	R	4	49	380	OZA448-E57	0492	S4	1952
1.4i	TU3JP+ <KFX>	1.4	55	01.00-07.03	Euro 2000	D	4	82	536	OZA341-PG5	1813	---	---
1.4i	TU3JP+ <KFX>	1.4	55	01.00-07.03	Euro 2000	R	4	83	536	OZA495-PG2	1852	---	---
1.4i	TU3FMC <KDX>	1.4	55	12.92-04.96		R	4	49	380	OZA448-E57	0492	S4	1952
1.4i	TU3MC <KDX>	1.4	55	04.93-04.96		R	4	49	380	OZA448-E57	0492	S4	1952
1.4i	TU3JP <KFW>	1.4	55	04.96-09.03		R	4	87	380	OZA676-EE1	7979	---	---
1.4i	TU3JP <KFX>	1.4	55	05.96-07.03		R	4	49	380	OZA448-E57	0492	S4	1952
1.4i	TU3M	1.4	55	09.91-02.94		R	4	58	450	OZA527-E12	0220	S4CG	1919
1.4i	TU3MC	1.4	55	04.93-06.95		R	4	58	450	OZA527-E12	0220	S4CG	1919
1.4i	TU3FMC	1.4	55	12.92-06.95		R	4	58	450	OZA527-E12	0220	S4CG	1919
1.4i	TU3MC	1.4	55	07.95-04.96		R	4	49	375	OZA527-E15	0298	S4CG	1919
1.4i	TU3FMC	1.4	55	07.95-04.96		R	4	49	375	OZA527-E15	0298	S4CG	1919
1.4i	TU3JP	1.4	55	05.96-07.03		R	4	49	375	OZA527-E15	0298	S4CG	1919
1.4i	TU3FMC <KDX>	1.4	55	12.93-04.96		R	4	73	370	OZA527-E29	0488	S4CG	1919
1.4i	TU3MC <KDX>	1.4	55	04.93-04.96		R	4	73	370	OZA527-E29	0488	S4CG	1919
1.4i	TU3JP <KFX>	1.4	55	05.96-05.05	Euro 2000 / CEE 2000	R	4	83	380	OZA659-EE12	0386	---	---
1.4i	TU3JP <KFX>	1.4	55	05.96-05.05	Euro 2000 / CEE 2000	D	4	83	380	OZA659-EE12	0386	---	---
1.4i	TU3FJ <KFZ>	1.4	69	09.91-04.96		R	4	49	380	OZA448-E57	0492	S4	1952
1.4i	TU3FJ	1.4	69	09.91-06.95		R	4	58	450	OZA527-E12	0220	S4CG	1919
1.4i	TU3FJ	1.4	69	07.95-04.96		R	4	49	375	OZA527-E15	0298	S4CG	1919
1.4i	TU3FJ <KFZ>	1.4	69	09.91-04.96		R	4	73	370	OZA527-E29	0488	S4CG	1919
1.4i	TU3FJ <K6B>	1.4	72	09.91-04.96	ECE R15.04	R	4	49	380	OZA448-E57	0492	S4	1952
1.4i	TU3FJ	1.4	72	09.91-06.95		R	4	58	450	OZA527-E12	0220	S4CG	1919
1.4i	TU3FJ	1.4	72	07.95-04.96		R	4	49	375	OZA527-E15	0298	S4CG	1919
1.4i	TU3FJ <K6B>	1.4	72	09.91-04.96	ECE R15.04	R	4	73	370	OZA527-E29	0488	S4CG	1919
1.6i	TU5JP	1.6	65	06.93-06.95		R	4	58	450	OZA527-E12	0220	S4CG	1919
1.6i	TU5JP	1.6	65	05.96-07.03		R	4	49	375	OZA527-E15	0298	S4CG	1919
1.6i	TU5JP	1.6	65	07.95-04.96		R	4	49	375	OZA527-E15	0298	S4CG	1919
1.6i	ZU5JP <NFZ>	1.6	66	06.93-04.96		R	4	49	380	OZA448-E57	0492	S4	1952
1.6i	TU5JP <NFZ>	1.6	66	05.96-07.03		R	4	49	380	OZA448-E57	0492	S4	1952
1.6i	TU5JP <NFZ>	1.6	66	06.93-04.96		R	4	73	370	OZA527-E29	0488	S4CG	1919
1.6i	TU5J2 <NFY>	1.6	74	05.96-07.03		R	4	49	380	OZA448-E57	0492	S4	1952
1.6i	TU5J2 <NFW>	1.6	74	05.96-07.03		R	4	49	380	OZA448-E57	0492	S4	1952

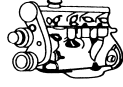

ℓ kW

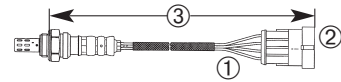

STOCK No. TYPE No. UNIVERSAL No. DIMENSIONS No.

PEUGEOT

106

1.6i	TU5J2	1.6	74	05.96-07.03		R	4	49	375	OZA527-E15	0298	S4CG	1919
1.6i	TU5J2	1.6	77	06.93-06.95		R	4	58	450	OZA527-E12	0220	S4CG	1919
1.6i	TU5J2	1.6	77	07.95-04.96		R	4	49	375	OZA527-E15	0298	S4CG	1919
1.6i	TU5J2 <NFY>	1.6	77	06.93-04.96	ECE R15.04	R	4	49	380	OZA448-E57	0492	S4	1952
1.6i	TU5J2 <NFY>	1.6	77	06.93-04.96	ECE R15.04	R	4	73	370	OZA527-E29	0488	S4CG	1919
1.6 S16	TU5J4 <NFX>	1.6	87	05.96-04.98	Euro96-CEE95, L3, Euro93-CEE19.5	R	4	111	535	OZA660-EE23	5737	S4	1952
1.6 S16	TU5J4 <NFX>	1.6	87	05.98-10.99	Org.N. -> 8364 Euro93-CEE19.5	R	4	111	535	OZA660-EE23	5737	S4	1952
1.6 S16	TU5J4 <NFX>	1.6	87	05.96-05.05	ECE R15.04	R	4	73	530	OZA527-E34	1981	S4CG	1919
1.6 16V S16, GTi	TU5JP L4 <NFX>	1.6	88	01.00-07.03	Euro 2000	R	4	82	536	OZA341-PG5	1813	---	---
1.6 16V S16, GTi	TU5JP L4 <NFX>	1.6	88	01.00-07.03	Euro 2000	D	4	82	536	OZA341-PG5	1813	---	---
1.6i	TU5J4	1.6	88	05.96-07.03		R	4	49	630	OZA527-E16	0434	S4CG	1919
1.6 16V S16, GTI	TU5J4 <NFX>	1.6	88	06.96-01.00	Engine No. -> 0365 Euro 96	R	4	49	536	OZA334-PG1	1790	---	---
1.6 16V S16, GTI	TU5J4 <NFX>	1.6	88	01.00-07.03	Engine No. -> 0365 Euro 96 / D3	R	4	49	536	OZA334-PG1	1790	---	---

107

1.0i	1KR <384F>	1.0	50	06.05-		R	4	123	275	OZA659-EE62	7916	---	---
1.0i	1KR <384F>	1.0	50	06.05-		D	4	34	290	OZA659-EE63	7948	---	---

205

1.0i	TU9M	1.0	37	07.92-09.98		R	4	37	510	OZA527-E2	0265	S4CG	1919
1.1 CJ	TU1M <HDZ>	1.1	44	10.89-12.94		R	4	37	510	OZA527-E2	0265	S4CG	1919
1.1	TU1M <HDZ>	1.1	44	07.89-09.98		R	4	37	510	OZA527-E2	0265	S4CG	1919
1.1	TU1M <HDY>	1.1	44	07.89-09.98		R	4	37	510	OZA527-E2	0265	S4CG	1919
1.4	TU3CP	1.4	41	10.87-10.90		R	3	45	510	OZA446-E48	0280	S3	0412
1.4	XY7CP	1.4	41	02.83-10.87		R	3	45	510	OZA446-E48	0280	S3	0412
1.4	TU3CP <KAY>	1.4	44	01.89-10.90		R	3	45	510	OZA446-E48	0280	S3	0412
1.4i	TU3MC	1.4	55	09.92-09.98		R	4	37	510	OZA527-E2	0265	S4CG	1919
1.4i	TU3FM <KDY>	1.4	55	06.91-12.94		R	4	37	510	OZA527-E2	0265	S4CG	1919
1.4i	TU3M <KDY>	1.4	58	07.88-09.98		R	4	37	510	OZA527-E2	0265	S4CG	1919
1.4i	TU3M <KDZ>	1.4	58	07.88-10.90		R	4	37	510	OZA527-E2	0265	S4CG	1919
1.6	XU5CP	1.6	58	02.83-10.87		R	3	45	510	OZA446-E48	0280	S3	0412
1.6i	XU5M <BDY>	1.6	65	05.90-09.98		R	4	37	510	OZA527-E2	0265	S4CG	1919
1.9	XU9J1	1.9	75	10.86-10.87		R	3	45	510	OZA446-E48	0280	S3	0412
1.9 GTI	XU92C <D2A>	1.9	75	10.87-05.89		R	3	45	510	OZA446-E48	0280	S3	0412
1.9 CTI Cabrio	XU9J1 <DFZ>	1.9	75	10.87-10.94		R	3	45	510	OZA446-E48	0280	S3	0412
1.9	XU9JAZ <DFY>	1.9	88	07.88-10.94		R	4	37	510	OZA527-E2	0265	S4CG	1919
1.9	XU9JAZ <DKZ>	1.9	88	07.88-10.94		R	4	37	510	OZA527-E2	0265	S4CG	1919

206

1.1i	TU1JP+ <HFZ>	1.1	44	09.98-12.99		R	4	87	380	OZA676-EE1	7979	---	---
1.1i	TU1JP+ <HFZ>	1.1	44	01.00-10.05	Euro 2000	R	4	82	536	OZA341-PG5	1813	---	---
1.1i	TU1JP+ <HFZ>	1.1	44	01.00-10.05	Euro 2000	D	4	82	536	OZA341-PG5	1813	---	---
1.1i	TU1JP+ <HFY>	1.1	44	01.00-10.05	Euro 2000	R	4	82	536	OZA341-PG5	1813	---	---
1.1i	TU1JP+ <HFY>	1.1	44	01.00-10.05	Euro 2000	D	4	82	536	OZA341-PG5	1813	---	---
1.1i	TU1JP/L3 <HFY>	1.1	44	06.98-10.05		R	4	83	380	OZA659-EE12	0386	---	---
1.1i	TU1A	1.1	44	11.05-		R	4	83	381	OZA608-U2	0070	---	---
1.1i	TU1A	1.1	44	11.05-		D	4	82	536	OZA341-PG5	1813	---	---

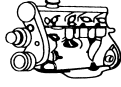

ℓ kW

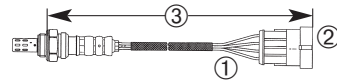

ORDER No. STOCK No. TYPE No. UNIVERSAL No. PEUGEOT No.

PEUGEOT

206

1.4i	TU3A	1.1	54	11.05-		R	4	83	381	OZA608-U2	0070	---	---
1.4i	TU3A	1.1	54	11.05-		D	4	82	536	OZA341-PG5	1813	---	---
1.4i	TU3JP <K6C>	1.4	55	06.98-05.02		R	4	73	370	OZA527-E29	0488	S4CG	1919
1.4i	TU3JP+ <KFX>	1.4	55	09.98-05.02	Euro 2000	R	4	83	536	OZA495-PG2	1852	---	---
1.4i	TU3JP+ <KFX>	1.4	55	09.98-05.02	Euro 2000	D	4	82	536	OZA341-PG5	1813	---	---
1.4i	TU3JP	1.4	55	02.04-12.05		R	4	83	540	OZA659-EE4	0378	---	---
1.4i 16V	ET3J4 <KFU>	1.4	65	03.04-		R	4	83	380	OZA659-EE12	0386	---	---
1.6i	NFZ	1.6	65	10.99-12.00		R	4	83	380	OZA659-EE12	0386	---	---
1.6i	TU5JP <NFZ>	1.6	66	06.98-		R	4	83	380	OZA659-EE12	0386	---	---
1.6i	TU5JP <NFZ>	1.6	66	06.98-		D	4	82	1490	OZA659-EE21	0395	---	---
1.6i 16V	TU5JP4	1.6	79	06.01-04.05		R	4	83	540	OZA659-EE4	0378	---	---
1.6i 16V Break	N6A	1.6	79	03.04-04.05		R	4	83	540	OZA659-EE4	0378	---	---
1.6i 16V	TU5JP4 <NFU>	1.6	80	03.00-	OE	R	4	83	540	OZA659-EE4	0378	---	---
1.6i 16V	TU5JP4 <NFU>	1.6	80	03.00-	OE	R	4	83	380	OZA659-EE12	0386	---	---
1.6i 16V	TU5JP4 <NFU>	1.6	80	03.00-		D	4	82	535	OZA659-EE10	0384	---	---
1.6i 16V Break	TU5JP4 <NFU>	1.6	80	03.02-	OE	R	4	83	540	OZA659-EE4	0378	---	---
1.6i 16V Break	TU5JP4 <NFU>	1.6	80	03.02-	OE	R	4	83	380	OZA659-EE12	0386	---	---
1.6i 16V Break	TU5JP4 <NFU>	1.6	80	03.02-		D	4	82	535	OZA659-EE10	0384	---	---
1.6i 16V CC	TU5JP4 <NFU>	1.6	80	09.00-	OE	R	4	83	540	OZA659-EE4	0378	---	---
1.6i 16V CC	TU5JP4 <NFU>	1.6	80	09.00-	OE	R	4	83	380	OZA659-EE12	0386	---	---
1.6i 16V CC	TU5JP4 <NFU>	1.6	80	09.00-		D	4	82	535	OZA659-EE10	0384	---	---
1.6i 16V	TU5JP L4 <NFU>	1.6	81	03.01-	Euro 2000	R	4	82	536	OZA341-PG5	1813	---	---
1.6i 16V	TU5JP L4 <NFU>	1.6	81	03.01-	Euro 2000	D	4	82	536	OZA341-PG5	1813	---	---
2.0i S16	DEW10J4 <RFR>	2.0	99	01.99-10.00		R	4	83	540	OZA659-EE4	0378	---	---
2.0i S16	DEW10J4 <RFR>	2.0	99	01.99-10.00		D	4	82	1230	OZA659-EE52	1996	---	---
2.0i S16	EW10J4 <RFN>	2.0	100	01.99-		R	4	83	540	OZA659-EE4	0378	---	---
2.0i S16	EW10J4 <RFN>	2.0	100	01.99-		D	4	82	1230	OZA659-EE52	1996	---	---
2.0i S16 Break	EW10J4 <RFN>	2.0	100	03.02-		R	4	83	540	OZA659-EE4	0378	---	---
2.0i S16 Break	EW10J4 <RFN>	2.0	100	03.02-		D	4	82	1230	OZA659-EE52	1996	---	---
2.0i S16 CC	EW10J4 <RFN>	2.0	100	09.00-	OE	R	4	83	540	OZA659-EE4	0378	---	---
2.0i S16 CC	EW10J4 <RFN>	2.0	100	09.00-		D	4	82	1230	OZA659-EE52	1996	---	---
2.0i RC	EW10J4S <RFK>	2.0	130	03.03-		R	4	83	1230	OZA659-EE8	0382	---	---
2.0i RC	EW10J4S <RFK>	2.0	130	03.03-		D	4	82	1230	OZA659-EE52	1996	---	---

207

1.4 8V	TU3A	1.4	54	04.06-		R	4	83	381	OZA608-U2	0070	---	---
1.4 8V	TU3A	1.4	54	04.06-		D	4	82	536	OZA341-PG5	1813	---	---
1.4	EP3	1.4	55	04.06-		D	4	82	446	OZA628-U1	0016	---	---
1.4i 16V	ET3J4 <KFU>	1.4	65	04.06-		R	4	83	380	OZA659-EE12	0386	---	---
1.6i	TU5JP4 <NFU>	1.6	80	05.06-		R	4	83	380	OZA659-EE12	0386	---	---
1.6i	TU5JP4 <NFU>	1.6	80	05.06-		D	4	82	535	OZA659-EE10	0384	---	---
1.6 16V	EP6	1.6	85	04.06-		D	4	82	446	OZA628-U1	0016	---	---
1.6 16V	EP6DT	1.6	105	04.06-		D	4	82	446	OZA628-U1	0016	---	---
1.6 16V	EP6DTS	1.6	125	12.06-		D	4	82	446	OZA628-U1	0016	---	---

305

1.6	XU5CP	1.6	54	10.82-07.90		R	3	45	510	OZA446-E48	0280	S3	0412
1.6 Break	XU5CP	1.6	54	11.86-12.88		R	3	45	510	OZA446-E48	0280	S3	0412
1.9	XU9J1 <DFZ>	1.9	72	11.86-12.88		R	3	45	510	OZA446-E48	0280	S3	0412
1.9	XU9J1 <DFZ>	1.9	72	10.82-07.90		R	3	45	510	OZA446-E48	0280	S3	0412

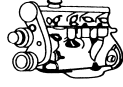

ℓ kW

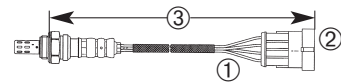

ORDER No. STOCK No. TYPE No. UNIVERSAL No. PEUGEOT No.

PEUGEOT

306

1.1i	TU1M <HDY>	1.1	40	01.93-12.95		R	4	49	380	OZA448-E57	0492	S4	1952
1.1i	TU1M+ <HDY>	1.1	40	01.96-04.97		R	4	49	380	OZA448-E57	0492	S4	1952
1.1i	TU1M	1.1	40	01.93-02.95		R	4	58	450	OZA527-E12	0220	S4CG	1919
1.1i	TU1M	1.1	40	03.95-12.95		R	4	49	375	OZA527-E15	0298	S4CG	1919
1.1i	TU1M+	1.1	40	01.96-04.97		R	4	49	375	OZA527-E15	0298	S4CG	1919
1.1	TU1M	1.1	44	01.93-02.95		R	4	58	450	OZA527-E12	0220	S4CG	1919
1.1	TU1M	1.1	44	03.95-12.95		R	4	49	375	OZA527-E15	0298	S4CG	1919
1.1	TU1M+	1.1	44	01.96-04.97		R	4	49	375	OZA527-E15	0298	S4CG	1919
1.1i	TU1M+ <HDZ>	1.1	44	01.96-04.97		R	4	49	380	OZA448-E57	0492	S4	1952
1.1i	TU1M <HDZ>	1.1	44	01.93-12.95		R	4	49	380	OZA448-E57	0492	S4	1952
1.4i	TU3JP+ <KFX>	1.4	55	01.00-10.03	Euro 2000	R	4	83	536	OZA495-PG2	1852	---	---
1.4i	TU3JP+ <KFX>	1.4	55	01.00-10.03	Euro 2000	D	4	82	536	OZA341-PG5	1813	---	---
1.4i	TU3JP <K6C>	1.4	55	05.97-10.03		R	4	73	530	OZA527-E34	1981	S4CG	1919
1.4i	TU3MC <KDY>	1.4	55	01.93-04.97		R	4	49	380	OZA448-E57	0492	S4	1952
1.4i	TU3JP <KFX>	1.4	55	09.96-04.97		R	4	49	380	OZA448-E57	0492	S4	1952
1.4i	TU3JP <KFX>	1.4	55	05.97-12.99		R	4	49	380	OZA448-E57	0492	S4	1952
1.4i	TU3JP <KFX>	1.4	55	05.97-10.03	Euro 2000 / CEE 2000	R	4	83	380	OZA659-EE12	0386	---	---
1.4i	TU3JP <KFX>	1.4	55	05.97-10.03	Euro 2000 / CEE 2000	D	4	83	1230	OZA659-EE8	0382	---	---
1.4i Break	TU3JP <KFX>	1.4	55	05.97-03.02	Euro 2000 / CEE 2000	R	4	83	380	OZA659-EE12	0386	---	---
1.4i Break	TU3JP <KFX>	1.4	55	05.97-03.02	Euro 2000 / CEE 2000	D	4	83	1230	OZA659-EE8	0382	---	---
1.4i Break	TU3JP <K6C>	1.4	55	05.97-10.03		R	4	73	530	OZA527-E34	1981	S4CG	1919
1.4i	TU3MC	1.4	55	01.93-02.95		R	4	58	450	OZA527-E12	0220	S4CG	1919
1.4i	TU3JP	1.4	55	09.96-04.97		R	4	49	375	OZA527-E15	0298	S4CG	1919
1.4i	TU3MC	1.4	55	03.95-04.97		R	4	49	375	OZA527-E15	0298	S4CG	1919
1.6i	TU5JP	1.6	65	01.93-02.95		R	4	58	450	OZA527-E12	0220	S4CG	1919
1.6i	TU5JP	1.6	65	03.95-04.97		R	4	49	375	OZA527-E15	0298	S4CG	1919
1.6i	TU5JP <NFZ>	1.6	66	05.97-10.03		R	4	49	380	OZA448-E57	0492	S4	1952
1.6i	TU5JP <NFZ>	1.6	66	01.93-04.97		R	4	49	380	OZA448-E57	0492	S4	1952
1.6i	TU5JP <NFZ>	1.6	66	05.97-10.03	Euro 2000 / CEE 2000	R	4	83	380	OZA659-EE12	0386	---	---
1.6i	TU5JP <NFZ>	1.6	66	05.97-10.03	Euro 2000 / CEE 2000	D	4	83	1230	OZA659-EE8	0382	---	---
1.6i Break	TU5JP <NFZ>	1.6	66	05.97-10.00		R	4	49	380	OZA448-E57	0492	S4	1952
1.6i Break	TU5JP <NFZ>	1.6	66	05.97-10.00	Euro 2000 / CEE 2000	R	4	83	380	OZA659-EE12	0386	---	---
1.6i Break	TU5JP <NFZ>	1.6	66	05.97-10.00	Euro 2000 / CEE 2000	D	4	83	1230	OZA659-EE8	0382	---	---
1.6i Cabrio	TU5JP <NFZ>	1.6	66	05.97-10.03	Euro 2000 / CEE 2000	R	4	83	380	OZA659-EE12	0386	---	---
1.6i Cabrio	TU5JP <NFZ>	1.6	66	05.97-10.03	Euro 2000 / CEE 2000	D	4	83	1230	OZA659-EE8	0382	---	---
1.6i	TU5JP4/L4 <NFT>	1.6	74	10.00-10.03		R	4	83	540	OZA659-EE4	0378	---	---
1.6i	TU5JP4/L4 <NFT>	1.6	74	10.00-10.03		D	4	82	535	OZA659-EE10	0384	---	---
1.6i Break	TU5JP4/L4 <NFT>	1.6	74	10.00-03.02		R	4	83	540	OZA659-EE4	0378	---	---
1.6i Break	TU5JP4/L4 <NFT>	1.6	74	10.00-03.02		D	4	82	535	OZA659-EE10	0384	---	---
1.6i Cabrio	TU5JP4/L4 <NFT>	1.6	74	10.00-10.03		R	4	83	540	OZA659-EE4	0378	---	---
1.6i Cabrio	TU5JP4/L4 <NFT>	1.6	74	10.00-10.03		D	4	82	535	OZA659-EE10	0384	---	---
1.8i	XU7JP <LFZ>	1.8	74	03.95-04.97		R	4	111	535	OZA660-EE23	5737	S4	1952
1.8i	XU7JP <L6A>	1.8	74	05.97-10.03		R	4	73	530	OZA527-E34	1981	S4CG	1919
1.8i ST	XU7JP <LFZ>	1.8	74	03.95-04.97		R	4	111	535	OZA660-EE23	5737	S4	1952
1.8i Break	XU7JP <LFZ>	1.8	74	06.97-03.02		R	4	111	535	OZA660-EE23	5737	---	---
1.8i Break	XU7JP <L6A>	1.8	74	05.97-03.02		R	4	73	530	OZA527-E34	1981	S4CG	1919
1.8i Cabrio	XU7JP <LFZ>	1.8	74	03.95-04.97		R	4	111	535	OZA660-EE23	5737	S4	1952
1.8i	XU7JP	1.8	76	03.95-04.97		R	4	49	630	OZA527-E16	0434	S4CG	1919
1.8i	XU7JP	1.8	76	01.93-02.95		R	4	58	1470	OZA527-E3	0201	S4CG	1919
1.8i	XU7JP <L6A>	1.8	76	05.97-10.03		R	4	73	530	OZA527-E34	1981	S4CG	1919

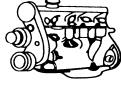

ℓ kW

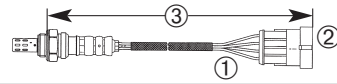
STOCK
ORDER
No.
TYPE
UNIVERSAL
No.
NUMBER
PLATE
No.

PEUGEOT

306

1.8i Break	XU7JP <L6A>	1.8	76	05.97-03.02		R	4	73	530	OZA527-E34	1981	S4CG	1919
1.8i 16V	XU7JP4 <LFY>	1.8	81	05.97-10.03		R	4	83	540	OZA659-EE4	0378	---	---
1.8i 16V	XU7JP4 <LFY>	1.8	81	05.97-10.03		D	4	82	1230	OZA659-EE52	1996	---	---
1.8i 16V Break	XU7JP4 <LFY>	1.8	81	05.98-03.02		R	4	83	540	OZA659-EE4	0378	---	---
1.8i 16V Break	XU7JP4 <LFY>	1.8	81	05.98-03.02		D	4	82	1230	OZA659-EE52	1996	---	---
1.8i 16V Cabrio	XU7JP4 <LFY>	1.8	81	05.98-10.03		R	4	83	540	OZA659-EE4	0378	---	---
1.8i 16V Cabrio	XU7JP4 <LFY>	1.8	81	05.98-10.03		D	4	82	1230	OZA659-EE52	1996	---	---
2.0i ST	XU10J2 <RFX>	2.0	89	03.95-04.97		R	4	111	535	OZA660-EE23	5737	S4	1952
2.0i Cabrio	XU10J2 <RFX>	2.0	89	03.95-04.97		R	4	111	535	OZA660-EE23	5737	S4	1952
2.0 XSi	XU10J2 <RFX>	2.0	89	03.95-04.97		R	4	111	535	OZA660-EE23	5737	S4	1952
2.0i	XU10J2	2.0	90	03.95-04.97		R	4	49	630	OZA527-E16	0434	S4CG	1919
2.0i	XU10J2	2.0	90	08.93-02.95		R	4	58	1470	OZA527-E3	0201	S4CG	1919
2.0i 16V	XU10J4R <RFV>	2.0	97	05.97-10.03		R	4	111	535	OZA660-EE23	5737	---	---
2.0i 16V Break	XU10J4R <RFV>	2.0	97	05.98-03.02		R	4	111	535	OZA660-EE23	5737	---	---
2.0i 16V Cabrio	XU10J4R <RFV>	2.0	97	05.97-10.03		R	4	111	535	OZA660-EE23	5737	---	---
2.0 S16	XU10J4 <RFT>	2.0	110	03.95-04.97		R	4	111	535	OZA660-EE23	5737	S4	1952
2.0 S16	XU10J4Z <RFY>	2.0	112	03.95-04.97		R	4	111	535	OZA660-EE23	5737	S4	1952
2.0i 16V	XU10J4	2.0	114	03.95-04.97		R	4	49	630	OZA527-E16	0434	S4CG	1919
2.0i 16V	XU10J4	2.0	114	08.93-02.95		R	4	58	1470	OZA527-E3	0201	S4CG	1919
2.0i 16V S16	XU10J4RS <RFS>	2.0	120	07.96-04.97		R	4	111	1230	OZA660-EE24	5739	S4	1952
2.0i 16V	XU10J4RS8	2.0	120	07.96-04.97		R	4	49	1220	OZA527-E17	0445	S4CG	1919

307

1.4i	TU3JP+ <KFX>	1.4	55	04.01-	Euro 2000 (F)	R	4	83	536	OZA495-PG2	1852	---	---
1.4i	TU3JP+ <KFX>	1.4	55	04.01-	Euro 2000 (F)	D	4	82	536	OZA341-PG5	1813	---	---
1.4i 16V	ET3J4 <KFU>	1.4	65	11.03-		R	4	83	380	OZA659-EE12	0386	---	---
1.6i 16V	TU5JP4 <NFU>	1.6	78	06.04-		R	4	83	540	OZA659-EE4	0378	---	---
1.6i 16V	TU5JP4 <NFU>	1.6	78	06.04-		D	4	82	535	OZA659-EE10	0384	---	---
1.6i	TU5JP4 <NFU>	1.6	80	08.00-11.04	Org.N. -> 10228	R	4	83	540	OZA659-EE4	0378	---	---
1.6i	TU5JP4 <NFU>	1.6	80	12.04-05.05	Org.N. 10229->	R	4	83	380	OZA659-EE12	0386	---	---
					Euro 2000 / CEE 2000								
1.6i	TU5JP4 <NFU>	1.6	80	08.00-05.05		D	4	82	535	OZA659-EE10	0384	---	---
1.6i	TU5JP4 <NFU>	1.6	80	05.05-		R	4	83	380	OZA659-EE12	0386	---	---
1.6i	TU5JP4 <NFU>	1.6	80	05.05-		D	4	82	535	OZA659-EE10	0384	---	---
1.6i Break	TU5JP4 <NFU>	1.6	80	03.02-11.04	Org.N. -> 10228	R	4	83	540	OZA659-EE4	0378	---	---
1.6i Break	TU5JP4 <NFU>	1.6	80	12.04-05.05	Org.N. 10229->	R	4	83	380	OZA659-EE12	0386	---	---
					Euro 2000 / CEE 2000								
1.6i Break	TU5JP4 <NFU>	1.6	80	03.02-05.05		D	4	82	535	OZA659-EE10	0384	---	---
1.6i Break	TU5JP4 <NFU>	1.6	80	05.05-		R	4	83	380	OZA659-EE12	0386	---	---
1.6i Break	TU5JP4 <NFU>	1.6	80	05.05-		D	4	82	535	OZA659-EE10	0384	---	---
1.8 16V	EW7J4	1.8	85	04.01-		R	4	83	536	OZA495-PG2	1852	---	---
1.8 16V	EW7J4	1.8	85	04.01-		D	4	82	1486	OZA341-PG7	1815	---	---
2.0i 16V	EW10J4 <RFN>	2.0	100	08.00-		R	4	83	1230	OZA659-EE8	0382	---	---
2.0i 16V	EW10J4 <RFN>	2.0	100	08.00-		D	4	82	1490	OZA659-EE21	0395	---	---
2.0i 16V Break	EW10J4 <RFN>	2.0	100	03.02-05.05		R	4	83	1230	OZA659-EE8	0382	---	---
2.0i 16V Break	EW10J4 <RFN>	2.0	100	03.02-05.05		D	4	82	1490	OZA659-EE21	0395	---	---
2.0i	EW10J4S <RFK>	2.0	130	06.05-		R	4	83	1230	OZA659-EE8	0382	---	---
2.0i	EW10J4S <RFK>	2.0	130	06.05-		D	4	82	1490	OZA659-EE21	0395	---	---

307 CC

1.6i	TU5JP4 <NFU>	1.6	80	06.05-		R	4	83	380	OZA659-EE12	0386	---	---
1.6i	TU5JP4 <NFU>	1.6	80	06.05-		D	4	82	535	OZA659-EE10	0384	---	---

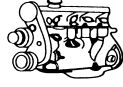

ℓ kW

STOCK
ORDER
NO.
TYPE
UNIVERSAL
NO.
NUMBER
NO.

PEUGEOT

307 CC

2.0i Sport	EW10J4 <RFN>	2.0	100	10.03-05.05		R	4	83	1230	OZA659-EE8	0382	---	---
2.0i Sport	EW10J4 <RFN>	2.0	100	10.03-05.05		D	4	82	1490	OZA659-EE21	0395	---	---
2.0i Sport	EW10J4S <RFK>	2.0	130	06.05-		R	4	83	1230	OZA659-EE8	0382	---	---
2.0i Sport	EW10J4S <RFK>	2.0	130	06.05-		D	4	82	1490	OZA659-EE21	0395	---	---

308

1.4 Vti 16V	EP3	1.4	70	09.07-	(F)	D	4	82	446	OZA628-U1	0016	---	---
1.6 Vti 16V	EP6	1.6	88	09.07-	(F)	D	4	82	446	OZA628-U1	0016	---	---
1.6 THP 16V	EP6DT	1.6	103	09.07-		D	4	82	446	OZA628-U1	0016	---	---
1.6 THP 16V	EP6DT	1.6	110	09.07-		D	4	82	446	OZA628-U1	0016	---	---
1.6 THP 16V RC	EP6DTS	1.6	128	03.08-		D	4	82	446	OZA628-U1	0016	---	---

309

1.1i	TU1MZ <HDZ>	1.1	44	10.90-12.93		R	4	37	510	OZA527-E2	0265	S4CG	1919
1.1i	TU1MZ <HDY>	1.1	44	10.90-12.93		R	4	37	510	OZA527-E2	0265	S4CG	1919
1.4	TU3M <KDY>	1.4	55	03.89-07.89		R	4	37	510	OZA527-E2	0265	S4CG	1919
1.4	TU3M <KDZ>	1.4	55	03.89-07.89		R	4	37	510	OZA527-E2	0265	S4CG	1919
1.4i	TU3FM <KDY>	1.4	58	06.91-12.93		R	4	37	510	OZA527-E2	0265	S4CG	1919
1.4i	TU3M <KDZ>	1.4	58	10.88-10.90		R	4	37	510	OZA527-E2	0265	S4CG	1919
1.6	XU5CP	1.6	54	06.86-06.88		R	3	45	510	OZA446-E48	0280	S3	0412
1.6i	XU5M <BDZ>	1.6	65	07.89-03.91		R	4	37	510	OZA527-E2	0265	S4CG	1919
1.6i	XU5M <BDY>	1.6	65	01.91-12.93		R	4	37	510	OZA527-E2	0265	S4CG	1919
1.9	XU9J1 <DFZ>	1.9	72	03.86-12.93		R	3	45	510	OZA446-E48	0280	S3	0412
1.9i	XU9M <DDZ>	1.9	80	07.88-12.93		R	4	37	510	OZA527-E2	0265	S4CG	1919
1.9i GTI	XU9JAZ <DKZ>	1.9	88	07.88-07.89		R	4	37	510	OZA527-E2	0265	S4CG	1919
1.9i	XU9JAZ <DKZ>	1.9	90	07.88-12.93		R	4	37	510	OZA527-E2	0265	S4CG	1919
1.9i	XU9JAZ <DFY>	1.9	90	07.88-12.93		R	4	37	510	OZA527-E2	0265	S4CG	1919
1.9i 16V	XU9J4/Z	1.9	108	08.90-12.93		R	4	37	510	OZA527-E2	0265	S4CG	1919

405

1.4i	TU3MC <KDX>	1.4	55	06.92-04.97		R	4	58	1470	OZA527-E3	0201	S4CG	1919
1.6i	XU5JP <BFZ>	1.6	65	07.95-04.97		R	4	49	1220	OZA527-E17	0445	S4CG	1919
1.6i	XU5M <BDY>	1.6	65	07.95-04.97		R	4	49	1220	OZA527-E17	0445	S4CG	1919
1.6i	XU5M <BDY>	1.6	65	09.90-12.92		R	4	37	1210	OZA527-E22	0274	S4CG	1919
1.6i	XU5M <BDZ>	1.6	65	07.89-09.90		R	4	37	1210	OZA527-E22	0274	S4CG	1919
1.6i	XU5M <BDY>	1.6	65	06.92-06.95		R	4	58	1470	OZA527-E3	0201	S4CG	1919
1.6i	XU5JP <BFZ>	1.6	65	09.94-06.95		R	4	58	1470	OZA527-E3	0201	S4CG	1919
1.6i	XU5M2Z <BDY>	1.6	65	07.95-10.95		R	4	111	1230	OZA660-EE24	5739	S4	1952
1.6i	XU5M3Z <BDY>	1.6	65	07.95-10.95		R	4	111	1230	OZA660-EE24	5739	S4	1952
1.6i	XU5M <BDZ>	1.6	65	07.95-10.95		R	4	111	1230	OZA660-EE24	5739	S4	1952
1.6i	XU5JP <BFZ>	1.6	65	07.95-10.95		R	4	111	1230	OZA660-EE24	5739	S4	1952
1.8i	XU7JP <L6A>	1.8	74	06.92-04.97		R	4	49	380	OZA448-E57	0492	S4	1952
1.8i	XU7JP <LFZ>	1.8	74	06.92-04.97		R	4	49	380	OZA448-E57	0492	S4	1952
1.8i	XU7JP	1.8	74	07.95-04.97		R	4	49	1220	OZA527-E17	0445	S4CG	1919
1.8i	XU7JP	1.8	74	06.92-06.95		R	4	58	1470	OZA527-E3	0201	S4CG	1919
1.8i	XU7JP <LFZ>	1.8	74	07.95-10.95		R	4	111	1230	OZA660-EE24	5739	S4	1952
1.9	XU9J1 <DFZ>	1.9	77	07.87-12.92		R	3	45	510	OZA446-E48	0280	S3	0412
1.9i	XU9M <DDZ>	1.9	80	07.88-01.89		R	4	37	510	OZA527-E2	0265	S4CG	1919
1.9i	XU9M <DDZ>	1.9	80	07.88-12.92		R	4	37	1210	OZA527-E22	0274	S4CG	1919
1.9i	XU9J2 <DFV>	1.9	82	07.87-01.89		R	4	37	510	OZA527-E2	0265	S4CG	1919
1.9i	XU9J2 <DDZ>	1.9	82	01.89-12.92		R	4	37	1210	OZA527-E22	0274	S4CG	1919
1.9i	XU9JAZ <DFY>	1.9	88	07.88-01.89		R	4	37	510	OZA527-E2	0265	S4CG	1919

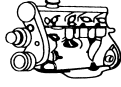

ℓ kW

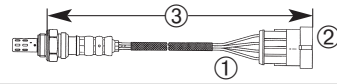
STOCK
ORDER
No.
UNIVERSAL
TYPE
No.
UNIVERSAL
NUMBER
No.

PEUGEOT

405

1.9i	XU9JAZ <DKZ>	1.9	88	07.88-01.89		R	4	37	510	OZA527-E2	0265	S4CG	1919
1.9i	XU9JAZ <DFY>	1.9	88	01.89-12.92		R	4	37	1210	OZA527-E22	0274	S4CG	1919
1.9i	XU9JAZ <DKZ>	1.9	88	01.89-12.92		R	4	37	1210	OZA527-E22	0274	S4CG	1919
1.9i	XU9J2 <D6D>	1.9	89	07.95-04.97		R	4	49	1220	OZA527-E17	0445	S4CG	1919
1.9i	XU9J2 <D6D>	1.9	89	06.92-06.95		R	4	58	1470	OZA527-E3	0201	S4CG	1919
1.9i 16V	XU9J4Z <DFW>	1.9	108	04.88-01.89		R	4	37	510	OZA527-E2	0265	S4CG	1919
1.9i 16V	XU9J4Z <DFW>	1.9	108	01.89-12.92		R	4	37	1210	OZA527-E22	0274	S4CG	1919
2.0i	XU10J2 <RFX>	2.0	89	07.95-04.97		R	4	49	1220	OZA527-E17	0445	S4CG	1919
2.0i	XU10J2 <R6D>	2.0	89	07.95-04.97		R	4	49	1220	OZA527-E17	0445	S4CG	1919
2.0i	XU10J2 <RFX>	2.0	89	06.92-06.95		R	4	58	1470	OZA527-E3	0201	S4CG	1919
2.0i	XU10J2 <R6D>	2.0	89	06.92-06.95		R	4	58	1470	OZA527-E3	0201	S4CG	1919
2.0i	XU10J2 <RFX>	2.0	89	07.95-10.95		R	4	111	1230	OZA660-EE24	5739	S4	1952
2.0i X4	XU10J2 <RFX>	2.0	89	07.95-10.95		R	4	111	1230	OZA660-EE24	5739	S4	1952
2.0i Mi16	XU10J4 <RFT>	2.0	110	01.93-06.95		R	4	58	1470	OZA527-E3	0201	S4CG	1919
2.0i 16V	XU10J4 <RFT>	2.0	110	07.95-10.95		R	4	111	1230	OZA660-EE24	5739	S4	1952
2.0i Mi16	XU10J4 <RFT>	2.0	110	07.95-06.95		R	4	49	1220	OZA527-E17	0445	S4CG	1919
2.0i Mi16	XU10J4 <RFY>	2.0	110	01.93-06.95		R	4	58	1470	OZA527-E3	0201	S4CG	1919
2.0i Mi16	XU10J4 <RFY>	2.0	110	07.95-04.97		R	4	49	1220	OZA527-E17	0445	S4CG	1919
2.0 MI-16	XU10J4Z <RFY>	2.0	112	07.95-10.95		R	4	111	1230	OZA660-EE24	5739	S4	1952
2.0 T 16 X4	XU10J4TE/Z <RGZ>	2.0	144	07.95-10.95		R	4	111	1230	OZA660-EE24	5739	S4	1952
2.0i T16	XU10J4TE <RGZ>	2.0	159	09.92-06.95		R	4	58	1470	OZA527-E3	0201	S4CG	1919
2.0i T16	XU10J4TE <RGZ>	2.0	159	07.95-04.97		R	4	49	1220	OZA527-E17	0445	S4CG	1919
2.0i T16 4x4	XU10J4TE <RGZ>	2.0	159	09.92-04.97		R	4	49	380	OZA448-E57	0492	S4	1952

406

1.6i	XU5JP <BFZ>	1.6	65	11.95-03.96	Org.N. -> 7083	R	4	111	535	OZA660-EE23	5737	S4	1952	
1.6i	XU5JP <BFZ>	1.6	65	04.99-05.04		R	4	49	380	OZA448-E57	0492	S4	1952	
1.6i	XU5JP <BFZ>	1.6	65	10.95-03.99		R	4	49	380	OZA448-E57	0492	S4	1952	
1.6i	XU5JP	1.6	65	04.96-05.04	Org.N. 7084->	R	4	49	375	OZA527-E15	0298	S4CG	1919	
1.6i	XU5JP	1.6	65	10.95-03.96	Org.N. -> 7083	R	4	49	630	OZA527-E16	0434	S4CG	1919	
1.8i	XU7JB <LFX>	1.8	66	07.97-12.00		R	4	87	380	OZA676-EE1	7979	---	---	
1.8i 16V	XU7JP4	1.8	81	04.96-12.96	Org.N. 7084 ->7329	R	4	49	375	OZA527-E15	0298	S4CG	1919	
1.8i 16V	XU7JP4	1.8	81	10.95-03.96	Org.N. -> 7083	R	4	49	630	OZA527-E16	0434	S4CG	1919	
1.8i 16V	XU7JP4 <LFY>	1.8	81	11.95-03.96	Org.N. -> 7083	R	4	111	535	OZA660-EE23	5737	S4	1952	
1.8i 16V	XU7JP4 <LFY>	1.8	81	10.95-12.00		R	4	87	380	OZA676-EE1	7979	---	---	
1.8i 16V	XU7JP4 <LFY>	1.8	82	10.95-03.96		R	4	49	380	OZA448-E57	0492	S4	1952	
1.8i 16V	XU7JP4 <LFY>	1.8	82	04.99-06.04	Euro 2000 / CEE 2000	R	4	83	380	OZA659-EE12	0386	---	---	
1.8i 16V	XU7JP4 <LFY>	1.8	82	04.99-06.04	Euro 2000 / CEE 2000	D	4	82	1490	OZA659-EE21	0395	---	---	
2.0i 16V	XU10J4R <RFV>	2.0	97	11.95-03.99		R	4	111	1230	OZA660-EE24	5739	S4	1952	
2.0i 16V	XU10J4R <R6E>	2.0	97	12.95-03.99		R	4	73	1220	OZA527-E35	1982	S4CG	1919	
2.0i 16V	XU10J4R <RFV>	2.0	97	04.99-05.04		R	4	73	1220	OZA527-E35	1982	---	---	
2.0i 16V	EW10J4 <RFR>	2.0	99	04.99-10.00		R	4	83	540	OZA659-EE4	0378	---	---	
2.0i 16V	EW10J4 <RFN>	2.0	100	08.00-02.05		R	4	83	1230	OZA659-EE8	0382	---	---	
2.0i 16V	EW10J4 <RFN>	2.0	100	08.00-02.05	Euro 2000 / CEE 2000	D	4	82	1490	OZA659-EE21	0395	---	---	
2.0i Turbo	XU10J2TE <RGX>	2.0	108	04.96-03.99		R	4	111	535	OZA660-EE23	5737	S4	1952	
2.0i Turbo	XU10J2TE	2.0	110	04.96-03.99		R	4	49	630	OZA527-E16	0434	S4CG	1919	
2.2i 16V	EW12J4 <3FZ>	2.2	116	04.99-02.05		R	4	83	1230	OZA659-EE8	0382	---	---	
2.2i 16V	EW12J4 <3FZ>	2.2	116	04.99-02.05		D	4	82	1230	OZA659-EE52	1996	---	---	
3.0i	ES9J4S <XFX>	3.0	152	12.99-12.00	Org.N. -> 8819	OE	R	4	83	540	OZA659-EE4	0378	---	---
3.0i	ES9J4S <XFX>	3.0	152	12.99-12.00	Org.N. -> 8819	OE	R	4	83	380	OZA659-EE12	0386	---	---
3.0i	ES9J4S <XFX>	3.0	152	01.01-02.05	Org.N. 8820 ->	R	4	83	540	OZA659-EE4	0378	---	---	

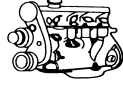

ℓ kW



ORDER
NO.
UNIVERSAL
TYPE
NO.
NUMBER
NO.

PEUGEOT

406

3.0i	ES9J4S <XFX>	3.0	152	12.99-12.00		D	4	82	535	OZA659-EE10	0384	---	---
------	--------------	-----	-----	-------------	--	----------	---	----	-----	-------------	-------------	-----	-----

406 PHASE 2

1.8i 16V	EW7J4 <6FZ>	1.8	85	09.00-06.04	Euro 2000		R	4	83	536	OZA495-PG2	1852	---	---
1.8i 16V	EW7J4 <6FZ>	1.8	85	09.00-06.04	Euro 2000	D	4	82	1236	OZA341-PG6	1814	---	---	
2.0 Hpi 16V	EW10D <RLZ>	2.0	105	04.01-	Euro 2000		R	5	93	375	LZA06-U1	1840	---	---
2.0 Hpi 16V	EW10D <RLZ>	2.0	105	04.01-06.01	Euro 2000	D	4	82	1236	OZA538-PG1	1818	---	---	
2.0 Hpi 16V	EW10D <RLZ>	2.0	105	06.01-	Euro 2000	D	4	82	1836	OZA538-PG2	1819	---	---	

407

1.8i 16V	EW7J4 <6FZ>	1.8	85	04.04-			R	4	83	1236	OZA495-PG3	1853	---	---
1.8 16V	EW7J4 <6FZ>	1.8	85	04.04-		D	4	82	1836	OZA341-PG8	1816	---	---	
2.0i	EW10J4 <RFN>	2.0	100	05.04-			R	4	83	1230	OZA659-EE8	0382	---	---
2.0i	EW10J4 <RFN>	2.0	100	05.04-		D	4	82	1850	OZA659-EE61	7915	---	---	
2.2i	EW12J4 <3FZ>	2.2	116	05.04-			R	4	83	1230	OZA659-EE8	0382	---	---
2.2i	EW12J4 <3FZ>	2.2	116	05.04-		D	4	82	1850	OZA659-EE61	7915	---	---	
3.0i	ES9A <XFV>	3.0	155	05.04-			R	4	83	540	OZA659-EE4	0378	---	---
3.0i	ES9A <XFV>	3.0	155	05.04-		D	4	82	535	OZA659-EE10	0384	---	---	
3.0i Coupe	ES9A <XFV>	3.0	155	10.05-			R	4	83	540	OZA659-EE4	0378	---	---
3.0i Coupe	ES9A <XFV>	3.0	155	10.05-		D	4	82	535	OZA659-EE10	0384	---	---	

505

2.0i	XN6	2.0	71	05.85-06.86			R	3	19	490	OZA446-E11	1898	S3	0412
2.0	XN6	2.0	71	01.80-06.87			R	3	45	510	OZA446-E48	0280	S3	0412
2.2	ZDJL <851X>	2.2	84	03.86-12.93			R	3	45	510	OZA446-E48	0280	S3	0412
2.2i Turbo	N9T	2.2	105-106	03.84-06.86			R	3	19	490	OZA446-E11	1898	S3	0412
2.2 Turbo	N9T	2.2	105-116	03.84-10.88			R	3	45	510	OZA446-E48	0280	S3	0412
2.2 Turbo Injektion	N9TEA <176W>	2.2	128	06.87-12.88			R	3	45	510	OZA446-E48	0280	S3	0412
2.8i V6	ZN3J <154X>	2.8	105	06.86-12.93			R	3	45	510	OZA446-E48	0280	S3	0412

605

2.0	XU10M <LRDZY>	2.0	79	03.91-06.94			R	4	58	1470	OZA527-E3	0201	S4CG	1919
2.0i	XU10J2 <RFZ>	2.0	89-90	03.91-06.94			R	4	58	1470	OZA527-E3	0201	S4CG	1919
2.0i 16V	XU10J4R <R6E>	2.0	97	07.94-05.99			R	4	73	1460	OZA527-E33	1980	S4CG	1919
2.0i Turbo	XU10J2TE <RGY>	2.0	104	07.92-06.94			R	4	58	1470	OZA527-E3	0201	S4CG	1919
2.0i Turbo	XU10J2TE <RGX>	2.0	104-110	07.94-05.99			R	4	49	1480	OZA448-E56	0481	S4	1952

607

2.0i	EW10J4 <RFN>	2.0	100	03.00-11.04			R	4	83	1230	OZA659-EE8	0382	---	---
2.0i	EW10J4 <RFN>	2.0	100	03.00-11.04		D	4	82	1490	OZA659-EE21	0395	---	---	
2.2i	EW12J4 <3FZ>	2.2	116	03.00-			R	4	83	1230	OZA659-EE8	0382	---	---
2.2i	EW12J4 <3FZ>	2.2	116	03.00-		D	4	82	1490	OZA659-EE21	0395	---	---	
2.9i	ES9J4S <XFX>	2.9	152	03.00-12.00	Org.N. -> 8819front		R	4	83	540	OZA659-EE4	0378	---	---
2.9i	ES9J4S <XFX>	2.9	152	03.00-12.00	Org.N. -> 8819rear		R	4	83	380	OZA659-EE12	0386	---	---
2.9i	ES9J4S <XFX>	2.9	152	01.01-11.04	Org.N. 8820 ->		R	4	83	540	OZA659-EE4	0378	---	---
2.9i	ES9J4S <XFX>	2.9	152	01.01-11.04		D	4	82	535	OZA659-EE10	0384	---	---	
3.0i	ES9A <XFV>	3.0	155	12.04-	front		R	4	83	540	OZA659-EE4	0378	---	---
3.0i	ES9A <XFV>	3.0	155	12.04-	rear		R	4	83	380	OZA659-EE12	0386	---	---
3.0i	ES9A <XFV>	3.0	155	12.04-		D	4	82	535	OZA659-EE10	0384	---	---	

806

1.8i	XU7JP <LFW>	1.8	73	07.95-08.02			R	4	49	1480	OZA448-E56	0481	S4	1952
1.8i	XU7JP <LFW>	1.8	73	07.95-08.02	ECE R15.04		R	4	73	1460	OZA527-E33	1980	S4CG	1919
2.0i	XU10J2 <RFU>	2.0	89	06.94-08.02			R	4	49	1480	OZA448-E56	0481	S4	1952
2.0i	XU10J2 <RFU>	2.0	89	06.94-08.02	ECE R15.04		R	4	73	1460	OZA527-E33	1980	S4CG	1919

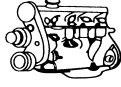

ℓ kW

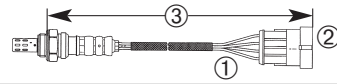
STOCK
ORDER
No.
UNIVERSAL
TYPE
No.
NUMBER
PLATE
No.

PEUGEOT

806

2.0i 16V	XU10J4R <RFV>	2.0	97	05.98-09.00		R	4	49	1480	OZA448-E56	0481	---	---
2.0i 16V	XU10J4R <RFV>	2.0	99	05.98-09.00	Euro 2000 / CEE 2000	R	4	83	1230	OZA659-EE8	0382	---	---
2.0i 16V	XU10J4R <RFV>	2.0	99	05.98-09.00	Euro 2000 / CEE 2000	D	4	82	1490	OZA659-EE21	0395	---	---
2.0i 16V	EW10J4 <RFN>	2.0	100	09.00-08.02	Euro 2000 / CEE 2000	R	4	83	380	OZA659-EE12	0386	---	---
2.0i Turbo	XU10J2TE <RGX>	2.0	108	06.94-08.02		R	4	49	1480	OZA448-E56	0481	S4	1952

807

2.0i 16V	EW10J4 <RFN>	2.0	100	06.02-		R	4	83	380	OZA659-EE12	0386	---	---
2.0i 16V	EW10J4 <RFN>	2.0	100	06.02-		D	4	83	380	OZA659-EE12	0386	---	---
2.2i 16V	EW12J4 <3FZ>	2.2	116	06.02-		R	4	83	380	OZA659-EE12	0386	---	---
2.2i 16V	EW12J4 <3FZ>	2.2	116	06.02-		D	4	83	380	OZA659-EE12	0386	---	---
2.9i	ES9J4S <XFW>	2.9	152	06.02-		R	4	83	540	OZA659-EE4	0378	---	---
2.9i	ES9J4S <XFW>	2.9	152	06.02-	OE	D	4	83	380	OZA659-EE12	0386	---	---
2.9i	ES9J4S <XFW>	2.9	152	06.02-	OE	D	4	82	535	OZA659-EE10	0384	---	---

1007

1.4 8V	TU3A	1.4	54	04.05-		R	4	83	381	OZA608-U2	0070		
1.4 8V	TU3A	1.4	54	04.05-		D	4	82	536	OZA341-PG5	1813	---	---
1.6i	TU5JP4 <NFU>	1.6	80	04.05-		R	4	83	380	OZA659-EE12	0386	---	---
1.6i	TU5JP4 <NFU>	1.6	80	04.05-		D	4	82	535	OZA659-EE10	0384	---	---

BIPPER

1.4i	TU3A	1.4	54	09.08-		R	4	83	381	OZA608-U2	0070		
1.4i	TU3A	1.4	54	09.08-		D	4	82	536	OZA341-PG5	1813	---	---

BOXER

2.0i	XU10J2 <RFW>	2.0	80	02.94-09.00		R	4	49	1480	OZA448-E56	0481	S4	1952
2.0i	XU10J2	2.0	80	02.94-12.95		R	4	58	1470	OZA527-E3	0201	S4CG	1919
2.0i	XU10J2 <RFL>	2.0	80	02.02-		R	4	83	540	OZA659-EE4	0378	---	---
2.0i	XU10J2 <RFL>	2.0	80	02.02-		D	4	82	1230	OZA659-EE52	1996	---	---

EXPERT

1.6i	222 A2	1.6	58	09.95-		R	4	49	1480	OZA448-E56	0481	S4	1952
1.8i	XU7JP <L6B>	1.8	74	10.96-09.00		R	4	73	1460	OZA527-E33	1980	S4CG	1919
2.0i 16V	EW10J4 <RFN>	2.0	100	03.00-		R	4	83	380	OZA659-EE12	0386	---	---
2.0i 16V	EW10J4 <RFN>	2.0	100	03.00-		D	4	83	380	OZA659-EE12	0386	---	---

J5

J5	XN1TACP	2.0	62	07.87-12.93		R	3	45	510	OZA446-E48	0280	S3	0412
----	---------	-----	----	-------------	--	---	---	----	-----	------------	------	----	------

PARTNER

1.1i	TU1M+ <HDY>	1.1	44	07.96-08.02		R	4	49	380	OZA448-E57	0492	S4	1952
1.1i	TU1M+ <HDZ>	1.1	44	07.96-08.02		R	4	49	380	OZA448-E57	0492	S4	1952
1.1i	TU1M+	1.1	44	07.96-08.02		R	4	49	375	OZA527-E15	0298	S4CG	1919
1.1i	TU1JP <HFX>	1.1	44	09.02-		R	4	83	540	OZA659-EE4	0378	---	---
1.4 8V	TU3A	1.4	54	10.05-		R	4	83	381	OZA608-U2	0070	---	---
1.4 8V	TU3A	1.4	54	10.05-		D	4	82	536	OZA341-PG5	1813	---	---
1.4i	TU3JP <KFX>	1.4	55	07.96-08.02		R	4	49	380	OZA448-E57	0492	S4	1952
1.4i	TU3JP	1.4	55	07.96-08.02		R	4	49	375	OZA527-E15	0298	S4CG	1919
1.4i	TU3JP <KFX>	1.4	55	07.96-08.02	Euro 2000 / CEE 2000	R	4	83	380	OZA659-EE12	0386	---	---
1.4i	TU3JP <KFX>	1.4	55	07.96-08.02	Euro 2000 / CEE 2000	D	4	83	1230	OZA659-EE8	0382	---	---
1.4i	TU3JP+ <KFX>	1.4	55	01.00-	Euro 2000	R	4	83	536	OZA495-PG2	1852	---	---
1.4i	TU3JP+ <KFX>	1.4	55	01.00-	Euro 2000	D	4	82	536	OZA341-PG5	1813	---	---

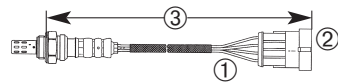

ORDER No.
STOCK No.
UNIVERSAL No.
TYPE No.
SUMMER No.

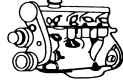

ℓ kW



PEUGEOT

PARTNER

1.6i	TU5JP4 <NFU>	1.6	80	09.00-08.02		R	4	83	540	OZA659-EE4	0378	---	---
1.6i	TU5JP4 <NFU>	1.6	80	09.00-08.02		D	4	82	535	OZA659-EE10	0384	---	---
1.6i 16V	TU5JP4 <NFU>	1.6	80	09.02-		R	4	83	540	OZA659-EE4	0378	---	---
1.6i 16V	TU5JP4 <NFU>	1.6	80	09.02-		D	4	82	535	OZA659-EE10	0384	---	---

RANCH

1.4i	TU3JP <KFX>	1.4	55	07.97-07.98		R	4	49	380	OZA448-E57	0492	S4	1952
1.4i	TU3JP <KFX>	1.4	55	07.97-	Euro 2000 / CEE 2000	R	4	83	380	OZA659-EE12	0386	---	---
1.4i	TU3JP <KFX>	1.4	55	07.97-	Euro 2000 / CEE 2000	D	4	83	1230	OZA659-EE8	0382	---	---

PONTIAC

BONNEVILLE

3.8i	<A>	3.8	122-149	10.82-09.93		R	1	6	387	OZA19-E12	6379	S1	1951
------	-----	-----	---------	-------------	--	---	---	---	-----	-----------	------	----	------

FIREBIRD

5.0i	<F>	5.0	112-127	10.82-09.92		R	1	6	387	OZA19-E12	6379	S1	1951
------	-----	-----	---------	-------------	--	---	---	---	-----	-----------	------	----	------

PHOENIX

2.8i	<Z>	2.8	85	10.82-09.84		R	1	6	387	OZA19-E12	6379	S1	1951
------	-----	-----	----	-------------	--	---	---	---	-----	-----------	------	----	------

SUNBIRD

2.0i	<H>	2.0		10.92-09.94		R	1	6	387	OZA19-E12	6379	S1	1951
3.1i	<T>	3.1		10.91-09.94		R	1	6	387	OZA19-E12	6379	S1	1951

SUNFIRE

2.0i	Z20 LSY L850	2.0		08.04-	USA	R	4	86	247	OZA531-GM7	1870	---	---
------	--------------	-----	--	--------	-----	---	---	----	-----	------------	------	-----	-----

TRANS SPORT

3.1i	<D>	3.1	98-104	10.90-09.95		R	1	6	387	OZA19-E12	6379	S1	1951
3.8i	<L>	3.8	112-127	01.92-12.92		R	1	6	387	OZA19-E12	6379	S1	1951

RENAULT

R5

1.4i	C3J 700 / 702 / 760	1.4	44	10.84-12.96	Y0000236-> Y0059550	R	3	19	490	OZA446-E11	1898	S3	0412
1.4i	C3J 700 / 702 / 760	1.4	44	07.89-03.95	-> Y.047 117	R	1	3	472	OZA401-E2	1802	S1	1951
1.7i	F3N 716 / 718 / 717	1.7	55	10.86-12.96	-> Y.047 117	R	1	3	472	OZA401-E2	1802	S1	1951
1.7i	F3N 702/ 722	1.7	69	10.86-12.96	F..0000 4823 ->	R	3	19	490	OZA446-E11	1898	S3	0412
1.7i	F3N 702/ 722	1.7	69	10.86-12.96	F..0000 4691 ->	R	3	14	375	OZA446-E8	1827	S3	0412
					F..0000 4822								

R9

1.7i	F3N 718	1.7	54	12.88-03.91		R	3	14	375	OZA446-E8	1827	S3	0412
1.7i	F3N 708/ 722	1.7	69	12.88-03.91		R	3	14	375	OZA446-E8	1827	S3	0412

R11

1.7i	F3N 718	1.7	55	12.88-03.91		R	3	14	375	OZA446-E8	1827	S3	0412
1.7	F3N 708	1.7	69	12.88-03.91		R	3	14	375	OZA446-E8	1827	S3	0412
1.7	F3N 722	1.7	69	12.88-03.91		R	3	14	375	OZA446-E8	1827	S3	0412

R18

2.2i	J7T 718/ 719	2.2	76-77	10.83-02.86	D..02451(C532)->	R	1	3	472	OZA401-E2	1802	S1	1951
------	--------------	-----	-------	-------------	------------------	---	---	---	-----	-----------	------	----	------

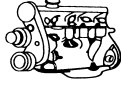

ℓ kW

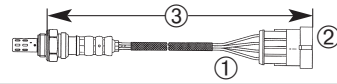
STOCK
ORDER
No.
UNIVERSAL
TYPE
No.
UNIVERSAL
TYPE
No.

RENAULT

R19

1.2i	E7F 730	1.2	46	05.92-12.01		R	3	14	375	OZA446-E8	1827	S3	0412
1.4i	C3J 710/ 760	1.4	40-44	08.93-12.01	D..02451(C532)->	R	1	3	472	OZA401-E2	1802	S1	1951
1.4i	C3J 710/ 760	1.4	40-44	08.93-12.95	D..036147 (L532)->	R	3	14	375	OZA446-E8	1827	S3	0412
1.4i	E7J 745	1.4	55-59	07.92-12.95		R	3	14	375	OZA446-E8	1827	---	---
1.4i	E7J 700	1.4	55-59	05.90-11.93		R	3	14	375	OZA446-E8	1827	S3	0412
1.4	E7J 742	1.4	55	11.94-11.95		R	3	13	180	OZA55-R3	0134	S3	0412
1.7i	F3N 740/ 741/ 718	1.7	54	07.92-12.95	Mot.Nr. I010849->	R	1	3	472	OZA401-E2	1802	S1	1951
1.7i	F3N 740/ 741/ 718	1.7	54	07.92-12.95	Mot.Nr. I137628->	R	1	3	472	OZA401-E2	1802	S1	1951
1.7i	F3N 742/ 743	1.7	66-70	09.88-12.95		R	3	14	375	OZA446-E8	1827	S3	0412
1.8i	F3P 760	1.8	65	10.94-12.95		R	3	14	375	OZA446-E8	1827	S3	0412
1.8i	F3P 708 / 760	1.8	65	02.93-12.95		R	3	14	375	OZA446-E8	1827	S3	0412
1.8i	F3P 704 / 705 / 706 / 707	1.8	65	05.92-12.95		R	3	14	375	OZA446-E8	1827	S3	0412
1.8i	F3P 706	1.8	65-66	09.94-12.95		R	3	14	375	OZA446-E8	1827	S3	0412
1.8i	F3P 682/ 765	1.8	79	09.94-12.95		R	3	14	375	OZA446-E8	1827	S3	0412
1.8i	F3P 764/ 765	1.8	79	10.94-12.95		R	3	14	375	OZA446-E8	1827	S3	0412
1.8i	F3P 682 / 700	1.8	79-83	05.92-12.95		R	3	14	375	OZA446-E8	1827	S3	0412
1.8i 16V	F7P 704	1.8	99-101	06.89-12.95		R	3	14	375	OZA446-E8	1827	S3	0412

R21

1.7i	F3N 726/ 740/ 718	1.7	54	03.86-12.94	H..7251, S..1723 ->	R	1	3	472	OZA401-E2	1802	S1	1951
1.7i Nevada	F3N 726/ 718/ 740	1.7	54	06.86-12.95	H..0000 4301 ->	R	1	3	472	OZA401-E2	1802	S1	1951
1.7i HB	F3N 726/ 718/ 740	1.7	54	09.89-12.93	S..0000 7201 ->	R	1	3	472	OZA401-E2	1802	S1	1951
1.7i Nevada	F3N 722/ 723	1.7	66-70	06.86-12.95	H..0000 7401 ->	R	3	14	375	OZA446-E8	1827	S3	0412
1.7i HB	F3N 722/ 723	1.7	66-70	09.89-12.93		R	3	14	375	OZA446-E8	1827	S3	0412
1.7i	F3N 722/ 723	1.7	66-70	03.86-12.94	H..9001, S..1241 ->	R	3	14	375	OZA446-E8	1827	S3	0412
2.0i	J7R 746/ 747	2.0	75	06.90-12.94		R	3	14	375	OZA446-E8	1827	S3	0412
2.0i Nevada	J7R 746/ 747	2.0	88	06.90-12.95		R	3	14	375	OZA446-E8	1827	S3	0412
2.0i HB	J7R 746/ 747	2.0	99	06.90-12.93		R	3	14	375	OZA446-E8	1827	S3	0412
2.0i HB	J7R 740	2.0	100	09.89-12.93		R	3	14	375	OZA446-E8	1827	S3	0412
2.0i Turbo	J7R 756	2.0	119-121	05.89-03.93		R	3	14	375	OZA446-E8	1827	S3	0412
2.2i Nevada	J7T 754/ 755	2.2	79-81	02.90-12.95	S..0000 9742 ->	R	1	3	472	OZA401-E2	1802	S1	1951
2.2i	J7T 754/ 755	2.2	79-81	02.90-12.94	S..0000 5773 ->	R	1	3	472	OZA401-E2	1802	S1	1951
2.2i HB	J7T 754/ 755	2.2	79-81	09.89-12.93	S..0000 6710 ->	R	1	3	472	OZA401-E2	1802	S1	1951
2.2i	J7T 754/ 755	2.2	79-81	07.86-02.90	-> S..0000 5772	R	3	14	375	OZA446-E8	1827	S3	0412
2.2i HB	J7T 754/ 755	2.2	79-81	09.89-12.93	-> S..0000 6709	R	3	14	375	OZA446-E8	1827	S3	0412
2.2i Nevada	J7T 754/ 755	2.2	79-81	10.86-01.90	-> S..0000 9741	R	3	14	375	OZA446-E8	1827	S3	0412
2.2i Nevada	J7T 756	2.2	79-81	04.93-12.95		R	3	14	375	OZA446-E8	1827	S3	0412

R25

2.0i	JR 726	2.0	99-100	06.89-12.92		R	3	14	375	OZA446-E8	1827	S3	0412
2.2i	J7T 732/ 733	2.2	79-81	02.90-12.92		R	1	3	472	OZA401-E2	1802	S1	1951
2.5i Turbo	Z7U 700	2.5	147-151	05.89-12.92		R	3	14	375	OZA446-E8	1827	S3	0412
2.8i V6	Z7W 706/ 707	2.9	110	04.90-12.92		R	3	19	490	OZA446-E11	1898	S3	0412

ALPINE

2.5i Turbo	Z7U 734	2.5	136	06.87-12.92		R	3	19	490	OZA446-E11	1898	S3	0412
3.0i Turbo	Z7X 744	3.0	184	03.91-12.95		R	3	14	375	OZA446-E8	1827	S3	0412

AVANTIME

2.0i 16V Turbo	F4R 760	2.0	120	09.01-12.03		R	4	67	330	OZA659-EE13	0387	---	---
2.0i 16V Turbo	F4R 760	2.0	120	09.01-12.03		D	4	67	330	OZA659-EE13	0387	---	---

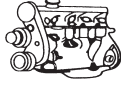

ℓ kW

STOCK
REVERSE
TYPE
NUMBER
NO.
NO.
NO.

RENAULT

AVANTIME

2.0i 16V Turbo	F4R 761	2.0	120	09.01-12.03		R	4	67	330	OZA659-EE13	0387	---	---
2.0i 16V Turbo	F4R 761	2.0	120	09.01-12.03		D	4	67	330	OZA659-EE13	0387	---	---
3.0i 24V	L7X 720	3.0	152	09.01-05.03		R	4	83	540	OZA659-EE4	0378	---	---
3.0i 24V	L7X 720	3.0	152	09.01-05.03		D	4	83	540	OZA659-EE4	0378	---	---
3.0i 24V	L7X 721	3.0	152	09.01-05.03		R	4	83	540	OZA659-EE4	0378	---	---
3.0i 24V	L7X 721	3.0	152	09.01-05.03		D	4	83	540	OZA659-EE4	0378	---	---

CLIO I

1.2i	D7F 730	1.2	40	04.96-02.98		R	3	13	685	OZA660-EE16	5709	S3	0412
1.2i	C3G 720	1.2	40	03.96-12.96		R	2	10	370	OZA428-E1	1807	S2	1918
1.2i	E7F 706	1.2	41	06.90-02.98		R	3	14	375	OZA446-E8	1827	S3	0412
1.2i	D7F 730	1.2	43	04.96-04.98		R	3	13	385	OZA446-E57	0472	S3	0412
1.2i	E7F 708	1.2	44	10.93-02.98		R	3	13	180	OZA55-R3	0134	S3	0412
1.2i	E7F 750	1.2	44	02.94-03.96		R	3	13	180	OZA55-R3	0134	S3	0412
1.2i	E7F 700	1.2	44	06.90-03.96		R	3	14	375	OZA446-E8	1827	S3	0412
1.4i	E7J 718/ 719	1.4	57	06.90-03.96		R	3	14	375	OZA446-E8	1827	S3	0412
1.4i	E7J 710/ 711	1.4	58	06.90-02.98		R	3	14	375	OZA446-E8	1827	S3	0412
1.4i	E7J 601	1.4	58	06.90-02.98		R	3	14	375	OZA446-E8	1827	S3	0412
1.4i	E7J 757	1.4	59	09.96-02.98		R	3	14	288	OZA236-R1	0147	S3	0412
1.4i	E7J 756	1.4	59	09.96-02.98		R	3	13	180	OZA236-R2	0158	S3	0412
1.4i	E7J 754	1.4	59	05.94-06.96		R	3	13	180	OZA55-R3	0134	S3	0412
1.8i	F3P 714	1.8	65	06.90-03.96		R	3	14	375	OZA446-E8	1827	S3	0412
1.8i	F3P 710	1.8	65	06.90-02.98		R	3	14	375	OZA446-E8	1827	S3	0412
1.8i	F3P 744/ 745	1.8	66	09.96-02.98		R	3	14	375	OZA446-E8	1827	S3	0412
1.8i	F3P 754/ 755	1.8	66	09.96-02.98		R	3	14	375	OZA446-E8	1827	S3	0412
1.8i	F3P 745	1.8	66	09.96-02.98		R	3	14	375	OZA446-E8	1827	S3	0412
1.8i	F3P 754/ 755	1.8	66	01.94-02.98		R	3	14	375	OZA446-E8	1827	S3	0412
1.8i	F3P 755	1.8	66	01.94-03.96		R	3	14	375	OZA446-E8	1827	S3	0412
1.8i	F3P 748	1.8	79	09.96-02.98		R	3	14	375	OZA446-E8	1827	S3	0412
1.8i	F3P 758	1.8	79	09.96-02.98		R	3	14	375	OZA446-E8	1827	S3	0412
1.8i	F3P 758	1.8	80	01.94-03.96		R	3	14	375	OZA446-E8	1827	S3	0412
1.8i 16V	F7P 722	1.8	99	03.91-03.96		R	3	14	375	OZA446-E8	1827	S3	0412
2.0i Williams	F7R 700	2.0	108	07.92-03.96		R	3	14	375	OZA446-E8	1827	S3	0412

CLIO II

1.0i	D7D 760	1.0	43	03.99-		R	3	13	385	OZA446-E57	0472	S3	0412
1.1i Kasten	D7F 720 / D7F722	1.1	43	09.98-		R	3	13	685	OZA660-EE16	5709	S3	0412
1.2i 8V	D7F 726	1.2	43	02.99-		R	4	67	445	OZA277-R2	0468	---	---
1.2i 8V	D7F 726	1.2	43	02.99-		D	4	67	445	OZA277-R2	0468	---	---
1.2i 8V	D7F 726	1.2	43	10.99-	Bosch	R	4	67	455	OZA659-EE6	0380	---	---
1.2i 8V	D7F 710	1.2	43	09.98-		R	3	13	685	OZA660-EE16	5709	S3	0412
1.2i 8V	D7F 720	1.2	43	03.98-		R	3	13	385	OZA446-E57	0472	S3	0412
1.2i 8V	D7F 722	1.2	43	10.99-		R	3	13	385	OZA446-E57	0472	S3	0412
1.2i 16V	D4F 712 / 714	1.2	55	10.00-07.06		R	4	67	445	OZA507-R2	0480	---	---
1.2i 16V	D4F 712 / 714	1.2	55	10.00-07.06		D	4	67	445	OZA507-R2	0480	---	---
1.4i	E7J 780	1.4	55	04.98-06.00		R	3	24	257	OZA311-R2	0126	S3	0412
1.4i	E7J 781	1.4	55	04.98-06.00		R	3	24	257	OZA311-R2	0126	S3	0412
1.4i	E7J 634	1.4	55	03.99-		R	4	67	210	OZA507-R1	6515	---	---
1.4i	K7J 700	1.4	55	07.00-07.03		R	4	67	210	OZA507-R1	6515	---	---
1.4i	K7J 700	1.4	55	07.00-07.03		D	4	67	260	OZA277-R1	1704	---	---
1.4i 16V	K4J 712 / 713	1.4	70	10.99-08.00		R	4	67	380	OZA448-E50	0415	---	---

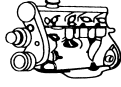

ℓ kW

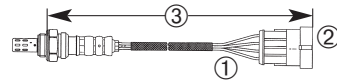
STOCK
ORDER No.
TYPE
UNIVERSAL No.
NUMBER P. No.
RENO No.

RENAULT

CLIO II

1.4i 16V	K4J 712 / 713	1.4	70	10.99-08.00		D	4	67	380	OZA659-EE53	7858	---	---
1.4i 16V	K4J 710 / 711 / 712 / 713	1.4	72	08.00-		R	4	67	455	OZA659-EE6	0380	---	---
1.4i 16V	K4J 710 / 711 / 712 / 713	1.4	72	08.00-		D	4	67	380	OZA659-EE53	7858	---	---
1.6i	K7M 744 / 745	1.6	66	04.98-12.00		R	3	24	257	OZA311-R2	0126	S3	0412
1.6i	K4M 734 / 742 / 743	1.6	66	11.01-		R	4	67	455	OZA659-EE6	0380	---	---
1.6i	K4M 734 / 742 / 743	1.6	66	11.01-		D	4	67	380	OZA659-EE53	7858	---	---
1.6i	K4M 745	1.6	66	01.01-		R	4	67	455	OZA659-EE6	0380	---	---
1.6i	K4M 745	1.6	66	01.01-		D	4	67	380	OZA659-EE53	7858	---	---
1.6i 16V	K4M 708	1.6	79	08.00-		R	4	67	455	OZA659-EE6	0380	---	---
1.6i 16V	K4M 708	1.6	79	08.00-		D	4	67	330	OZA659-EE13	0387	---	---
1.6i 16V	K4M 748	1.6	79	06.98-		R	4	67	380	OZA448-E50	0415	S4	1952
1.6i 16V	K4M 748	1.6	79	06.98-		D	4	67	380	OZA659-EE53	7858	---	---
2.0i 16V Sport	F4R 730 / 732 / 736 / 738	2.0	124	03.99-		R	4	67	455	OZA659-EE6	0380	---	---
2.0i 16V Sport	F4R 730 / 732 / 736 / 738	2.0	124	03.99-		D	4	67	380	OZA659-EE53	7858	---	---
3.0i 24V Sport	L7X 760	3.0	166	11.00-12.02		R	4	83	540	OZA659-EE4	0378	---	---
3.0i 24V Sport	L7X 760	3.0	166	11.00-12.02		D	4	83	540	OZA659-EE4	0378	---	---
3.0i 24V Sport	L7X 762	3.0	187	12.02-		R	4	83	540	OZA659-EE4	0378	---	---
3.0i 24V Sport	L7X 762	3.0	187	12.02-		D	4	83	540	OZA659-EE4	0378	---	---

CLIO III

1.2i 16V	D4F 764	1.2	55	07.05-05.07		R	4	67	445	OZA636-R1	0020	---	---
1.2i 16V	D4F 764	1.2	55	07.05-05.07		D	4	67	445	OZA636-R1	0020	---	---
1.2i 16V	D4F 764	1.2	55	06.07-		R	4	121	424	OZA636-R3	6519	---	---
1.2i 16V	D4F 764	1.2	55	06.07-		D	4	121	424	OZA636-R3	6519	---	---
1.6i 16V	K4M 804	1.6	65	06.05-		R	4	67	455	OZA659-EE6	0380	---	---
1.6i 16V	K4M 804	1.6	65	06.05-		D	4	67	455	OZA659-EE6	0380	---	---
1.6i 16V	K4M 800 / 801	1.6	82	06.05-		R	4	67	455	OZA659-EE6	0380	---	---
1.6i 16V	K4M 800 / 801	1.6	82	06.05-		D	4	67	455	OZA659-EE6	0380	---	---
2.0i 16V Sport	F4R 830	2.0	145	12.05-		R	4	67	455	OZA659-EE6	0380	---	---
2.0i 16V Sport	F4R 830	2.0	145	12.05-		D	4	67	380	OZA659-EE53	7858	---	---
2.0i 16V	M4R	2.0	147	05.06-		R	4	101	434	OZA603-R2	0013	---	---

ESPACE I

2.2i	J7T 770	2.2	79	07.86-12.90		R	1	3	472	OZA401-E2	1802	S1	1951
2.2i Quadra	J7T 770	2.2	79	01.88-12.90		R	1	3	472	OZA401-E2	1802	S1	1951

ESPACE II

2.0i	J7R 768	2.0	76	01.91-02.93	-> T..12551	R	3	19	490	OZA446-E11	1898	S3	0412
2.0i	J7R 768	2.0	77	03.93-09.96	T..12552->	R	3	14	375	OZA446-E8	1827	S3	0412
2.2i	J7T 772/ 773	2.2	79	01.91-09.96		R	3	14	375	OZA446-E8	1827	S3	0412
2.2i	J7T 772/ 773	2.2	79	05.91-09.96		R	3	14	375	OZA446-E8	1827	S3	0412
2.2i	J7T 776	2.2	79-81	05.93-09.96		R	3	14	375	OZA446-E8	1827	S3	0412
2.9i	Z7W 712/ 713	2.9	110	01.91-07.94	-> T..18370	R	3	19	490	OZA446-E11	1898	S3	0412
2.9i	Z7W 712/ 713	2.9	110-113	04.94-09.96		R	3	14	375	OZA446-E8	1827	S3	0412

ESPACE III

2.0i	F3R 768 / 769	2.0	84	10.96-10.02		R	4	28	255	OZA448-E43	0282	S4	1952
2.0i	F3R 728 / 729	2.0	84	10.96-10.02		R	4	28	255	OZA448-E43	0282	S4	1952
2.0i 16V	F4R 700 / 701	2.0	103	10.98-10.02		R	4	67	455	OZA659-EE6	0380	S4	1952
2.0i 16V	F4R 700 / 701	2.0	103	10.98-10.02		D	4	67	380	OZA659-EE53	7858	---	---
3.0	Z7X 775	3.0	123	10.96-09.98		R	4	28	368	OZA83-R3	0178	S4	1952
3.0i 24V	L7X 727	3.0	140	10.98-10.02		R	4	73	415	OZA660-EE20	5717	S4	1952

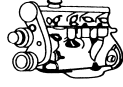

e kW



STOCK
ORDER
No.
UNIVERSAL
TYPE
No.
NUMBER
No.

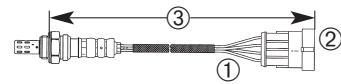

RENAULT

ESPACE IV

2.0i 16V	F4R 790 / 791	2.0	100	11.02-		R	4	67	455	OZA659-EE6	0380	---	---
2.0i 16V	F4R 790 / 791	2.0	100	11.02-		D	4	67	330	OZA659-EE13	0387	---	---
2.0i 16V Turbo	F4R 794 / 795	2.0	120	11.02-		R	4	67	330	OZA659-EE13	0387	---	---
2.0i 16V Turbo	F4R 794 / 795	2.0	120	11.02-		D	4	67	330	OZA659-EE13	0387	---	---
2.0i	F4R 796 / 797	2.0	125	11.02-		R	4	67	330	OZA659-EE13	0387	---	---
2.0i	F4R 796 / 797	2.0	125	11.02-		D	4	67	330	OZA659-EE13	0387	---	---
2.0i	F4R 896 / 897	2.0	125	11.02-		R	4	67	330	OZA659-EE13	0387	---	---
2.0i	F4R 896 / 897	2.0	125	11.02-		D	4	67	330	OZA659-EE13	0387	---	---
3.5i V6 24V	V4Y 711	3.5	180	10.02-	2↑	R	4	70	371	OZA544-N8	1804	---	---
3.5i V6 24V	V4Y 711	3.5	180	10.02-		D	4	88	500	OZA544-R1	1857	---	---

EXPRESS

1.2	C3G 510	1.2	40	09.91-10.97		R	2	10	370	OZA428-E1	1807	S2	1918
1.2	C3G 710	1.2	40	09.93-06.95		R	2	10	370	OZA428-E1	1807	S2	1918
1.2	C3G 712	1.2	40	10.96-03.98		R	3	14	228	OZA55-R4	0145	S3	0412
1.4	E7J 770	1.4	55	10.96-03.98		R	3	14	288	OZA236-R1	0147	S3	0412
1.4	E7J 771	1.4	55	11.96-03.98		R	3	13	180	OZA236-R2	0158	S3	0412
1.4	E7J 728	1.4	55	05.94-07.96		R	3	13	180	OZA55-R3	0134	S3	0412
1.4i	C3J 762	1.4	44	09.91-05.95		R	1	3	472	OZA401-E2	1802	S1	1951
1.4i	C3J 760	1.4	44	06.87-08.91	-> U..034 749	R	1	3	472	OZA401-E2	1802	S1	1951
1.4i	C3J 700	1.4	44	03.86-05.87	-> U..034 749	R	1	3	472	OZA401-E2	1802	S1	1951
1.4i	C3J 702	1.4	44	06.87-08.91		R	1	3	472	OZA401-E2	1802	S1	1951
1.4i	C3J 762	1.4	44	06.95-03.97	-> U..034 750	R	3	14	375	OZA446-E8	1827	S3	0412
1.4i	E7J 720	1.4	55-59	09.91-10.97		R	3	14	375	OZA446-E8	1827	S3	0412
1.4i	E7J 724/ 710	1.4	55-59	09.91-10.97		R	3	14	375	OZA446-E8	1827	S3	0412
1.4i	E7J 728/ 754	1.4	55-59	03.94-10.97		R	3	14	375	OZA446-E8	1827	S3	0412
1.4i	E7J 773/ 710	1.4	55-59	03.94-10.97		R	3	14	375	OZA446-E8	1827	S3	0412

FUEGO

1.6i Turbo	W50	A7L 723	1.6	81	02.83-08.83		R	1	3	472	OZA401-E2	1802	S1	1951
2.2i	W50	J7T 718 /719	2.2	75-76	10.83-10.85		R	1	3	472	OZA401-E2	1802	S1	1951

GRAND ESPACE

3.5i V6 24V	V4Y 711	3.5	180	10.02-	2↑	R	4	70	371	OZA544-N8	1804	---	---
3.5i V6 24V	V4Y 711	3.5	180	10.02-		D	4	88	500	OZA544-R1	1857	---	---

KANGOO

1.0i	D7D 700	1.0	43	09.98-		R	3	13	385	OZA446-E57	0472	S3	0412
1.2i 8V	D7F 726	1.2	43	07.98-		R	4	67	445	OZA277-R2	0468	---	---
1.2i 8V	D7F 726	1.2	43	07.98-		D	4	67	445	OZA277-R2	0468	---	---
1.2i 8V	D7F 744	1.2	43	09.98-		R	4	67	455	OZA659-EE6	0380	S4	1952
1.2i	D7F 710 / 720 / 722	1.2	43	03.98-		R	3	13	685	OZA660-EE16	5709	S3	0412
1.2i	D7F 764 / 766	1.2	43	03.02-		R	4	67	455	OZA659-EE6	0380	---	---
1.2i	D7F 720	1.2	44	03.98-		R	3	13	385	OZA446-E57	0472	S3	0412
1.2i	D7F 726	1.2	44	09.98-		R	3	13	385	OZA446-E57	0472	S3	0412
1.2i GPL	D7F 722	1.2	44	10.97-		R	3	13	385	OZA446-E57	0472	S3	0412
1.2i 16V	D4F	1.2	55	10.00-		R	4	67	445	OZA507-R2	0480	---	---
1.2i 16V	D4F	1.2	55	10.00-		D	4	67	445	OZA507-R2	0480	---	---
1.4i	E7J 780	1.4	54	10.97-04.98		R	3	13	255	OZA311-R1	0191	S3	0412
1.4i	E7J 780	1.4	54	05.98-		R	3	24	257	OZA311-R2	0126	S3	0412
1.4i	E7J 634	1.4	55	03.99-		R	4	67	210	OZA507-R1	6515	---	---

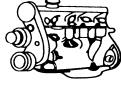

ℓ kW

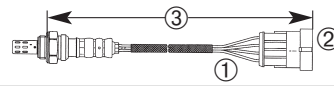
ORDER No.
STOCK No.
UNIVERSAL No.
TYPE No.
UNIVERSAL No.
SUPPLIER No.

RENAULT

KANGOO

1.4i	E7J 634	1.4	55	03.99-		D	4	67	260	OZA277-R1	1704	---	---
1.4i	K7J 700 / 701	1.4	55	07.00-		R	4	67	210	OZA507-R1	6515	---	---
1.4i	K7J 700 / 701	1.4	55	07.00-		D	4	67	260	OZA277-R1	1704	---	---
1.6i 16V	K4M 708	1.6	70	06.01-		R	4	67	455	OZA659-EE6	0380	---	---
1.6i 16V	K4M 708	1.6	70	06.01-		D	4	67	330	OZA659-EE13	0387	---	---
1.6i 16V 4x4	K4M 708	1.6	70	06.01-		R	4	67	455	OZA659-EE6	0380	---	---
1.6i 16V 4x4	K4M 708	1.6	70	06.01-		D	4	67	330	OZA659-EE13	0387	---	---
1.6i 16V	K4M 750 / 752 / 753	1.6	70	06.01-		R	4	67	455	OZA659-EE6	0380	---	---
1.6i 16V	K4M 750 / 752 / 753	1.6	70	06.01-		D	4	67	455	OZA659-EE6	0380	---	---
1.6i 16V 4x4	K4M 750 / 752 / 753	1.6	70	10.01-		R	4	67	455	OZA659-EE6	0380	---	---
1.6i 16V 4x4	K4M 750 / 752 / 753	1.6	70	10.01-		R	4	67	455	OZA659-EE6	0380	---	---

LAGUNA I

1.6i 16V	K4M 720 / 724	1.6	75-79	05.98-02.01		R	4	67	455	OZA659-EE6	0380	S4	1952
1.6i 16V	K4M 720 / 724	1.6	75-79	05.98-02.01		D	4	67	350	OZA660-EE12	5698	S4	1952
1.6i 16V Grandtour	K4M 720 / 724	1.6	75-79	05.98-02.01		R	4	67	455	OZA659-EE6	0380	S4	1952
1.6i 16V Grandtour	K4M 720 / 724	1.6	75-79	05.98-02.01		D	4	67	350	OZA660-EE12	5698	S4	1952
1.8i	F3P 678	1.8	66	11.93-03.95		R	3	14	288	OZA55-R1	1878	S3	0412
1.8i	F3P 670 / 674	1.8	66-70	09.95-02.01		R	4	28	255	OZA448-E43	0282	S4	1952
1.8i Grandtour	F3P 670 / 674	1.8	66-70	09.95-02.01		R	4	28	255	OZA448-E43	0282	S4	1952
1.8i 16V	F4P 760	1.8	88	05.98-10.98		R	4	67	350	OZA660-EE12	5698	S4	1952
1.8i 16V	F4P 760	1.8	88	11.98-02.01		R	4	67	455	OZA659-EE6	0380	S4	1952
1.8i 16V Grandtour	F4P 760	1.8	88	05.98-10.98		R	4	67	350	OZA660-EE12	5698	S4	1952
1.8i 16V Grandtour	F4P 760	1.8	88	11.98-02.01		R	4	67	455	OZA659-EE6	0380	S4	1952
1.9i	N7Q 700	1.9	103	03.95-03.01		R	4	28	478	OZA83-R1	0156	S4	1952
1.9i	N7Q 704	1.9	103	06.95-03.01		R	4	28	478	OZA83-R1	0156	S4	1952
2.0i	F3R 722 / 723	2.0	83	01.94-02.01		R	3	14	288	OZA55-R1	1878	S3	0412
2.0i	F3R 768 / 769	2.0	83-85	09.95-03.01		R	4	28	255	OZA448-E43	0282	S4	1952
2.0i	F3R 728 / 729	2.0	83-85	09.95-03.01		R	4	28	255	OZA448-E43	0282	S4	1952
2.0i Grantour	F3R 728 / 729	2.0	83-85	09.95-03.01		R	4	28	255	OZA448-E43	0282	S4	1952
2.0i Grantour	F3R 768 / 769	2.0	83-85	09.95-03.01		R	4	28	255	OZA448-E43	0282	S4	1952
2.0i	F3R 611	2.0	88	05.98-02.01		R	4	28	255	OZA448-E43	0282	S4	1952
2.0i Grandtour	F3R 611	2.0	88	05.98-02.01		R	4	28	255	OZA448-E43	0282	S4	1952
2.0i 16V	F4R 780	2.0	100	09.99-02.01		R	4	67	455	OZA659-EE6	0380	---	---
2.0i 16V Grandtour	F4R 780	2.0	100	09.99-02.01		R	4	67	455	OZA659-EE6	0380	---	---
2.0i	N7Q 700 / 704	2.0	102	09.95-03.01		R	4	28	478	OZA83-R1	0156	S4	1952
2.0i Grantour	N7Q 700 / 704	2.0	102	09.95-03.01		R	4	28	478	OZA83-R1	0156	S4	1952
2.0i	F4R 780	2.0	103	09.99-02.01		R	4	67	350	OZA660-EE12	5698	---	---
3.0i	Z7X 765	3.0	125	11.93-11.96		R	3	14	368	OZA55-R2	0123	S3	0412
3.0i	Z7X 760	3.0	125	11.93-11.96		R	3	14	368	OZA55-R2	0123	S3	0412
3.0i	Z7X 767	3.0	125	10.96-03.01		R	4	28	368	OZA83-R3	0178	S4	1952
3.0i 24V	L7X 700 / 701	3.0	140	03.97-03.01		R	4	73	415	OZA660-EE20	5717	S4	1952
3.0i 24V Grandtour	L7X 700 / 701	3.0	140	03.97-03.01		R	4	73	415	OZA660-EE20	5717	S4	1952

LAGUNA II

1.6i 16V	K4M 710 / 711	1.6	79	03.01-		R	4	67	455	OZA659-EE6	0380	---	---
1.6i 16V	K4M 710 / 711	1.6	79	03.01-		D	4	67	330	OZA659-EE13	0387	---	---
1.6i 16V Grandtour	K4M 710 / 711	1.6	79	03.01-		R	4	67	455	OZA659-EE6	0380	---	---
1.6i 16V Grandtour	K4M 710 / 711	1.6	79	03.01-		D	4	67	330	OZA659-EE13	0387	---	---
1.6i 16V		1.6	82	02.05-		R	4	67	455	OZA659-EE6	0380	---	---
1.6i 16V		1.6	82	02.05-		D	4	67	330	OZA659-EE13	0387	---	---

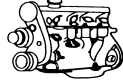

ℓ kW



ORDER No.
STOCK No.
UNIVERSAL No.
TYPE No.
CUMMINS No.
SUNBELT No.

RENAULT

LAGUNA II

1.6i 16V Grandtour		1.6	82	02.05-		R	4	67	455	OZA659-EE6	0380	---	---
1.6i 16V Grandtour		1.6	82	02.05-		D	4	67	330	OZA659-EE13	0387	---	---
1.8i 16V	F4P 770 / 771 / 774 / 775	1.8	85	03.01-		R	4	67	455	OZA659-EE6	0380	---	---
1.8i 16V	F4P 770 / 771 / 774 / 775	1.8	85	03.01-		D	4	67	330	OZA659-EE13	0387	---	---
1.8i 16V Grandtour	F4P 771 / 773 / 774	1.8	85	03.01-		R	4	67	455	OZA659-EE6	0380	---	---
1.8i 16V Grandtour	F4P 771 / 773 / 774	1.8	85	03.01-		D	4	67	330	OZA659-EE13	0387	---	---
1.8i 16V	F4P 770 / 773	1.8	88	03.01-		R	4	67	455	OZA659-EE6	0380	---	---
1.8i 16V	F4P 770 / 773	1.8	88	03.01-		D	4	67	330	OZA659-EE13	0387	---	---
1.8i 16V	F4P 770 / 774	1.8	89	03.01-		R	4	67	455	OZA659-EE6	0380	---	---
1.8i 16V	F4P 770 / 774	1.8	89	03.01-		D	4	67	330	OZA659-EE13	0387	---	---
1.8i 16V Grandtour	F4P 770 / 774	1.8	89	03.01-		R	4	67	455	OZA659-EE6	0380	---	---
1.8i 16V Grandtour	F4P 770 / 774	1.8	89	03.01-		D	4	67	330	OZA659-EE13	0387	---	---
2.0i 16V	F4R 712 / 713 / 714 / 715	2.0	99	08.02-		R	4	67	455	OZA659-EE6	0380	---	---
2.0i 16V	F4R 712 / 713 / 714 / 715	2.0	99	08.02-		D	4	67	330	OZA659-EE13	0387	---	---
2.0i 16V Grandtour	F4R 712 / 713 / 714 / 715	2.0	99	08.02-		R	4	67	455	OZA659-EE6	0380	---	---
2.0i 16V Grandtour	F4R 712 / 713 / 714 / 715	2.0	99	08.02-		D	4	67	330	OZA659-EE13	0387	---	---
2.0i 16V IDE	F5R 700	2.0	103	03.01-		R	4	67	330	OZA659-EE13	0387	---	---
2.0i 16V IDE	F5R 700	2.0	103	03.01-		D	4	67	330	OZA659-EE13	0387	---	---
2.0i 16V IDE Grandtour	F5R 700	2.0	103	03.01-		R	4	67	330	OZA659-EE13	0387	---	---
2.0i 16V IDE Grandtour	F5R 700	2.0	103	03.01-		D	4	67	330	OZA659-EE13	0387	---	---
2.0i 16V Turbo	F4R 764 / 765 / 786 / 787	2.0	120	03.01-		R	4	67	330	OZA659-EE13	0387	---	---
2.0i 16V Turbo	F4R 764 / 765 / 786 / 787	2.0	120	03.01-		D	4	67	330	OZA659-EE13	0387	---	---
2.0i 16V Turbo Grandtour	F4R 764 / 765 / 786 / 787	2.0	120	03.01-		R	4	67	330	OZA659-EE13	0387	---	---
2.0i 16V Turbo Grandtour	F4R 764 / 765 / 786 / 787	2.0	120	03.01-		D	4	67	330	OZA659-EE13	0387	---	---
2.0i 16V	M4R	2.0	150	01.05-		R	4	101	434	OZA603-R2	0013	---	---
3.0i 24V	L7X 731	3.0	152	03.01-		R	4	83	540	OZA659-EE4	0378	---	---
3.0i 24V	L7X 731	3.0	152	03.01-		D	4	83	540	OZA659-EE4	0378	---	---
3.0i 24V	L7X 733	3.0	152	03.01-		R	4	83	540	OZA659-EE4	0378	---	---
3.0i 24V	L7X 733	3.0	152	03.01-		D	4	83	540	OZA659-EE4	0378	---	---
3.0i 24V Grandtour	L7X 731	3.0	152	03.01-		R	4	83	540	OZA659-EE4	0378	---	---
3.0i 24V Grandtour	L7X 731	3.0	152	03.01-		D	4	83	540	OZA659-EE4	0378	---	---
3.0i 24V Grandtour	L7X 733	3.0	152	03.01-		R	4	83	540	OZA659-EE4	0378	---	---
3.0i 24V Grandtour	L7X 733	3.0	152	03.01-		D	4	83	540	OZA659-EE4	0378	---	---

LAGUNA III

2.0i 16V	M4R704	2.0	103	10.07-		R	4	101	434	OZA603-R2	0013	---	---
2.0i 16V	M4R704	2.0	103	10.07-		D	4	120	400	OZA603-R3	6518	---	---

MASTER

T 28-35	J7T 782	2.2	67	09.80-09.97		R	1	3	472	OZA401-E2	1802	S1	1951
2.2 R.E.	J7T 788	2.2		07.94-07.98		R	3	14	368	OZA55-R2	0123	S3	0412

MEGANE

1.4i	E7J 624	1.4	51	02.96-02.99		R	3	14	288	OZA236-R1	0147	S3	0412
1.4i	E7J 764	1.4	55	04.95-02.99		R	3	14	288	OZA236-R1	0147	S3	0412
1.4i	E7J 626	1.4	55	03.99-		R	4	67	210	OZA507-R1	6515	---	---
1.4i	E7J 626	1.4	55	03.99-		D	4	67	260	OZA277-R1	1704	---	---
1.4i 16V	K4J 714 / 750	1.4	70	03.99-10.02		R	4	67	455	OZA659-EE6	0380	---	---
1.4i 16V	K4J 714 / 750	1.4	70	03.99-10.02		D	4	67	330	OZA659-EE13	0387	---	---
1.6i	K7M 702 / 703 / 720	1.6	66	06.95-02.99		R	3	14	288	OZA236-R1	0147	S3	0412
1.6i 16V	K4M 700 / 701 / 704 / 708	1.6	79	03.99-10.02		R	4	67	455	OZA659-EE6	0380	---	---

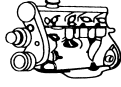

ℓ kW

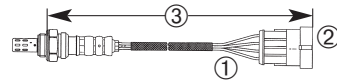
STOCK
ORDER
NO.
UNIVERSAL
TYPE
NO.
MANUFACTURE
NO.

RENAULT

MEGANE

1.6i 16V	K4M 700 / 701 / 704 / 708	1.6	79	03.99-10.02		D	4	67	330	OZA659-EE13	0387	---	---
1.6i 16V	K4M 700	1.6	84	04.99-10.02		R	4	67	445	OZA277-R2	0468	---	---
1.8i 16V	F4P 720 / 722	1.8	85	01.01-10.02		R	4	67	455	OZA659-EE6	0380	---	---
1.8i 16V	F4P 720 / 722	1.8	85	01.01-10.02		D	4	67	330	OZA659-EE13	0387	---	---
2.0i	F3R 750 / 751	2.0	83-84	01.96-10.02		R	4	28	255	OZA448-E43	0282	S4	1952
2.0i	F3R 791	2.0	84	03.97-10.02		R	4	28	255	OZA448-E43	0282	S4	1952
2.0i	F3R 796 / 797 / 798	2.0	84	01.97-10.02		R	4	28	255	OZA448-E43	0282	S4	1952
2.0i 16V	F4R 746	2.0	103	05.00-10.02		R	4	67	455	OZA659-EE6	0380	---	---
2.0i 16V	F4R 746	2.0	103	05.00-10.02		D	4	67	330	OZA659-EE13	0387	---	---
2.0i 16V	F7R 710 / 714	2.0	108-110	01.96-10.02		R	4	28	255	OZA448-E43	0282	S4	1952

MEGANE GRANDTOUR

1.4i	E7J 626	1.4	55	03.99-		R	4	67	210	OZA507-R1	6515	---	---
1.4i	E7J 626	1.4	55	03.99-		D	4	67	260	OZA277-R1	1704	---	---
1.4i 16V	K4J 714 / 750	1.4	70	03.99-09.03		R	4	67	455	OZA659-EE6	0380	---	---
1.4i 16V	K4J 714 / 750	1.4	70	03.99-09.03		D	4	67	330	OZA659-EE13	0387	---	---
1.6i 16V	K4M 700 / 701 / 704 / 708	1.6	79	03.99-09.03		R	4	67	455	OZA659-EE6	0380	---	---
1.6i 16V	K4M 700 / 701 / 704 / 708	1.6	79	03.99-09.03		D	4	67	330	OZA659-EE13	0387	---	---
1.8i 16V	F4P 720 / 722	1.8	85	10.00-09.03		R	4	67	455	OZA659-EE6	0380	---	---
1.8i 16V	F4P 720 / 722	1.8	85	10.00-09.03		D	4	67	330	OZA659-EE13	0387	---	---

MEGANE CLASSIC

1.4i	E7J 764	1.4	55	04.95-02.99		R	3	14	288	OZA236-R1	0147	---	---
1.4i	E7J 626	1.4	55	03.99-		R	4	67	210	OZA507-R1	6515	---	---
1.4i	E7J 626	1.4	55	03.99-		D	4	67	260	OZA277-R1	1704	---	---
1.4i 16V	K4J 714 / 750	1.4	70	03.99-09.03		R	4	67	455	OZA659-EE6	0380	---	---
1.4i 16V	K4J 714 / 750	1.4	70	03.99-09.03		D	4	67	330	OZA659-EE13	0387	---	---
1.6i 16V	K4M 700 / 701	1.6	79	08.98-09.03		R	4	67	455	OZA659-EE6	0380	---	---
1.6i 16V	K4M 700 / 701	1.6	79	08.98-09.03		D	4	67	330	OZA659-EE13	0387	---	---
1.6i 16V	K4M 706	1.6	79	03.02-09.03		R	4	67	455	OZA659-EE6	0380	---	---
1.6i 16V	K4M 708 / 709	1.6	79	05.00-09.03		R	4	67	455	OZA659-EE6	0380	---	---
1.6i 16V	K4M 708 / 709	1.6	79	05.00-09.03		D	4	67	330	OZA659-EE13	0387	---	---
1.8i 16V	F4P 720 / 722	1.8	85	05.00-09.03		R	4	67	455	OZA659-EE6	0380	---	---
1.8i 16V	F4P 720 / 722	1.8	85	05.00-09.03		D	4	67	330	OZA659-EE13	0387	---	---
2.0i	F3R 750 / 751 / 752	2.0	83-84	09.96-09.03		R	4	28	255	OZA448-E43	0282	S4	1952
2.0i	F3R 796 / 797 / 798	2.0	84	09.96-09.03		R	4	28	255	OZA448-E43	0282	S4	1952
2.0i	F4R 740 / 741	2.0	101	11.00-09.03		R	4	67	455	OZA659-EE6	0380	---	---
2.0i	F4R 740 / 741	2.0	101	11.00-09.03		D	4	67	330	OZA659-EE13	0387	---	---
2.0i	F4R 746	2.0	102	03.01-09.03		R	4	67	455	OZA659-EE6	0380	---	---
2.0i	F4R 746	2.0	102	03.01-09.03		D	4	67	330	OZA659-EE13	0387	---	---

MEGANE CABRIO

1.4i 16V	K4J 714 / 750	1.4	70	03.99-09.03		R	4	67	455	OZA659-EE6	0380	---	---
1.4i 16V	K4J 714 / 750	1.4	70	03.99-09.03		D	4	67	330	OZA659-EE13	0387	---	---
1.6i 16V	K4M 700 / 701 / 708	1.6	79	03.99-09.03		R	4	67	455	OZA659-EE6	0380	---	---
1.6i 16V	K4M 700 / 701 / 708	1.6	79	03.99-09.03		D	4	67	330	OZA659-EE13	0387	---	---
2.0i	F3R 791 / 796	2.0	83	09.96-09.03		R	4	28	255	OZA448-E43	0282	S4	1952
2.0i 16V	F4R 746	2.0	102	01.01-09.03		R	4	67	455	OZA659-EE6	0380	---	---
2.0i 16V	F4R 746	2.0	102	01.01-09.03		D	4	67	330	OZA659-EE13	0387	---	---
2.0i 16V	F5R 740	2.0	103	03.99-09.03		R	4	67	545	OZA659-EE54	7859	---	---

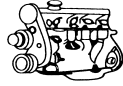

ℓ kW

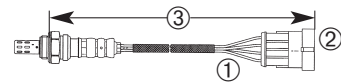

ORDER No.
STOCK No.
UNIVERSAL No.
TYPE No.
REPAIR No.
SUMMARY No.

RENAULT

MEGANE CABRIO

2.0i 16V	F7R 710 / 714	2.0	108	09.96-09.03		R	4	28	255	OZA448-E43	0282	S4	1952
----------	---------------	-----	-----	-------------	--	---	---	----	-----	------------	------	----	------

MEGANE COUPE

1.4i 16V	K4J 714 / 750	1.4	70	03.99-10.02		R	4	67	455	OZA659-EE6	0380	---	---
1.4i 16V	K4J 714 / 750	1.4	70	03.99-10.02		D	4	67	330	OZA659-EE13	0387	---	---
1.6i 16V	K4M 700 / 701 / 708	1.6	79	03.99-10.02		R	4	67	455	OZA659-EE6	0380	---	---
1.6i 16V	K4M 700 / 701 / 708	1.6	79	03.99-10.02		D	4	67	330	OZA659-EE13	0387	---	---
2.0i	F3R 750	2.0	83	01.96-10.02		R	4	28	255	OZA448-E43	0282	S4	1952
2.0i 16V	F4R 746	2.0	102	01.02-10.02		R	4	67	455	OZA659-EE6	0380	---	---
2.0i 16V	F4R 746	2.0	102	01.02-10.02		D	4	67	330	OZA659-EE13	0387	---	---
2.0i 16V	F5R 740	2.0	103	03.99-10.02		R	4	67	545	OZA659-EE54	7859	---	---
2.0i 16V	F7R 710	2.0	108	01.96-10.02		R	4	28	255	OZA448-E43	0282	S4	1952

MEGANE II

1.4i 16V	K4J 730 / 732 / 740	1.4	72	11.02-		R	4	67	455	OZA659-EE6	0380	---	---
1.4i 16V	K4J 730 / 732 / 740	1.4	72	11.02-		D	4	67	455	OZA659-EE6	0380	---	---
1.6i 16V	K4M 760 / 761 / 764	1.6	83	11.02-		R	4	67	455	OZA659-EE6	0380	---	---
1.6i 16V	K4M 760 / 761 / 764	1.6	83	11.02-		D	4	67	455	OZA659-EE6	0380	---	---
2.0i 16V	F4R 770 / 771	2.0	99	09.02-		R	4	67	455	OZA659-EE6	0380	---	---
2.0i 16V	F4R 770 / 771	2.0	99	09.02-		D	4	67	455	OZA659-EE6	0380	---	---
2.0i 16V	F4R 776	2.0	120	03.03-		R	4	67	330	OZA659-EE13	0387	---	---
2.0i 16V	F4R 776	2.0	120	03.03-		D	4	67	330	OZA659-EE13	0387	---	---
2.0i 16V Sport	F4R 774	2.0	165	03.03-		R	4	67	330	OZA659-EE13	0387	---	---
2.0i 16V Sport	F4R 774	2.0	165	03.03-		D	4	67	330	OZA659-EE13	0387	---	---

MEGANE II GRANDTOUR

1.4i 16V	K4J 730 / 740	1.4	72	10.03-		R	4	67	455	OZA659-EE6	0380	---	---
1.4i 16V	K4J 730 / 740	1.4	72	10.03-		D	4	67	455	OZA659-EE6	0380	---	---
1.6i 16V	K4M 760 / 761 / 764	1.6	83	10.03-		R	4	67	455	OZA659-EE6	0380	---	---
1.6i 16V	K4M 760 / 761 / 764	1.6	83	10.03-		D	4	67	455	OZA659-EE6	0380	---	---
2.0i 16V	F4R 770 / 771	2.0	99	10.03-		R	4	67	455	OZA659-EE6	0380	---	---
2.0i 16V	F4R 770 / 771	2.0	99	10.03-		D	4	67	455	OZA659-EE6	0380	---	---

MEGANE II CC

1.6i 16V	K4M 760 / 761	1.6	83	10.03-		R	4	67	455	OZA659-EE6	0380	---	---
1.6i 16V	K4M 760 / 761	1.6	83	10.03-		D	4	67	455	OZA659-EE6	0380	---	---
2.0i 16V	F4R 770 / 771	2.0	99	10.03-		R	4	67	455	OZA659-EE6	0380	---	---
2.0i 16V	F4R 770 / 771	2.0	99	10.03-		D	4	67	455	OZA659-EE6	0380	---	---
2.0i 16V	F4R 776	2.0	120	10.03-		R	4	67	330	OZA659-EE13	0387	---	---
2.0i 16V	F4R 776	2.0	120	10.03-		D	4	67	330	OZA659-EE13	0387	---	---

MODUS

1.2i 16V	D4F 740	1.2	55	12.04-		R	4	67	445	OZA636-R1	0020	---	---
1.2i 16V	D4F 740	1.2	55	12.04-		D	4	67	445	OZA636-R1	0020	---	---
1.2i 16V	D4F 764	1.2	55	12.04-05.07		R	4	67	445	OZA636-R1	0020	---	---
1.2i 16V	D4F 764	1.2	55	12.04-05.07		D	4	67	445	OZA636-R1	0020	---	---
1.2i 16V	D4F 764	1.2	55	06.07-		R	4	121	424	OZA636-R3	6519	---	---
1.2i 16V	D4F 764	1.2	55	06.07-		D	4	121	424	OZA636-R3	6519	---	---
1.6i		1.6	65	12.04-		R	4	67	455	OZA659-EE6	0380	---	---
1.6i		1.6	65	12.04-		D	4	67	455	OZA659-EE6	0380	---	---
1.6i	K4M 790 / 791	1.6	82	12.04-		R	4	67	455	OZA659-EE6	0380	---	---
1.6i	K4M 790 / 791	1.6	82	12.04-		D	4	67	455	OZA659-EE6	0380	---	---

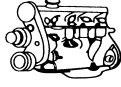

ℓ kW

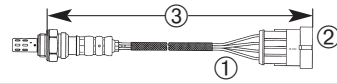
ORDER No.
STOCK No.
UNIVERSAL No.
TYPE No.
UNIVERSAL No.
SUPPLIER No.

RENAULT

SAFRANE

1.8	N7Q 710 / 711	1.8	100	10.96-12.00		R	4	28	318	OZA83-R2	0167	S4	1952
2.0	J7R 732 / 733	2.0	79	04.92-10.96		R	3	14	288	OZA55-R1	1878	S3	0412
2.0	J7R 734 / 735 12V	2.0	97	04.92-10.96		R	3	14	288	OZA55-R1	1878	S3	0412
2.2	J7T 762 / 763 / 766 / 767	2.2		04.92-10.96		R	3	14	288	OZA55-R1	1878	S3	0412
2.2	J7T 760 / 761 12V	2.2	101	04.92-10.96		R	3	14	288	OZA55-R1	1878	S3	0412
3.0	Z7X 722 / 723 / 753	3.0	123	04.95-10.96		R	3	14	288	OZA55-R1	1878	S3	0412
3.0	Z7X 755	3.0	125	10.96-12.00		R	4	28	253	OZA83-R4	0189	S4	1952
3.0i 24V	L7X 713	3.0	140	03.99-12.00		R	4	73	415	OZA660-EE20	5717	---	---

SCENIC

1.4i	E7J 764	1.4	55	04.95-09.99		R	3	14	288	OZA236-R1	0147	S3	0412
1.4i 16V	K4J 714 / 750	1.4	70	08.98-		R	4	67	455	OZA659-EE6	0380	S4	1952
1.4i 16V	K4J 714 / 750	1.4	70	08.98-		D	4	67	330	OZA659-EE13	0387	---	---
1.6i	K7M 702 / 703 / 720	1.6	66	06.95-09.99		R	3	14	288	OZA236-R1	0147	S3	0412
1.6i 16V	K4M 700 / 701 / 704 / 706	1.6	79	08.98-		R	4	67	455	OZA659-EE6	0380	S4	1952
1.6i 16V	K4M 700 / 701 / 704 / 706	1.6	79	08.98-		D	4	67	330	OZA659-EE13	0387	---	---
1.6i 16V	K4M 708 / 709 / 712	1.6	79	03.99-		R	4	67	455	OZA659-EE6	0380	---	---
1.6i 16V	K4M 708 / 709 / 712	1.6	79	03.99-		D	4	67	330	OZA659-EE13	0387	---	---
1.8i 16V	F4P 720 / 722	1.8	85	09.00-		R	4	67	455	OZA659-EE6	0380	---	---
1.8i 16V	F4P 720 / 722	1.8	85	09.00-		D	4	67	330	OZA659-EE13	0387	---	---
1.8i 16V	F4P 720	1.8	88	02.01-		R	4	67	455	OZA659-EE6	0380	---	---
1.8i 16V	F4P 720	1.8	88	02.01-		D	4	67	330	OZA659-EE13	0387	---	---
2.0i	F3R 750 / 751	2.0	84	11.96-09.99		R	4	28	255	OZA448-E43	0282	S4	1952
2.0i	F3R 791 / 796 / 797 / 798	2.0	84	11.96-09.99		R	4	28	255	OZA448-E43	0282	S4	1952
2.0i 16V	F4R 740	2.0	102	07.00-		R	4	67	350	OZA660-EE12	5698	---	---
2.0i 16V	F4R 740	2.0	102	07.00-		D	4	67	330	OZA659-EE13	0387	---	---
2.0i 16V	F4R 741	2.0	102	03.99-		R	4	67	455	OZA659-EE6	0380	---	---
2.0i 16V	F4R 741	2.0	102	03.99-		D	4	67	330	OZA659-EE13	0387	---	---
2.0i 16V RX4	F4R 744	2.0	102	06.00-		R	4	67	350	OZA660-EE12	5698	---	---
2.0i 16V RX4	F4R 744	2.0	102	06.00-		D	4	67	455	OZA659-EE6	0380	---	---

SCENIC II

1.4i 16V	K4J 730 / 740	1.4	72	06.03-		R	4	67	455	OZA659-EE6	0380	---	---
1.4i 16V	K4J 730 / 740	1.4	72	06.03-		D	4	67	455	OZA659-EE6	0380	---	---
1.6i 16V	K4M 760 / 761 / 764	1.6	83	06.03-		R	4	67	455	OZA659-EE6	0380	---	---
1.6i 16V	K4M 760 / 761 / 764	1.6	83	06.03-		D	4	67	455	OZA659-EE6	0380	---	---
1.6i 16V	K4M 812 / 813	1.6	83	06.03-		R	4	67	455	OZA659-EE6	0380	---	---
1.6i 16V	K4M 812 / 813	1.6	83	06.03-		D	4	67	455	OZA659-EE6	0380	---	---
2.0i 16V	F4R 770 / 771	2.0	99	06.03-		R	4	67	455	OZA659-EE6	0380	---	---
2.0i 16V	F4R 770 / 771	2.0	99	06.03-		D	4	67	455	OZA659-EE6	0380	---	---
2.0i 16V Turbo	F4R 776	2.0	120	06.03-		R	4	67	330	OZA659-EE13	0387	---	---
2.0i 16V Turbo	F4R 776	2.0	120	06.03-		D	4	67	330	OZA659-EE13	0387	---	---

GRAND SCENIC

1.6i 16V	K4M	1.6	83	04.04-		R	4	67	455	OZA659-EE6	0380	---	---
1.6i 16V	K4M	1.6	83	04.04-		D	4	67	455	OZA659-EE6	0380	---	---
2.0i 16V	F4R	2.0	99	04.04-		R	4	67	455	OZA659-EE6	0380	---	---
2.0i 16V	F4R	2.0	99	04.04-		D	4	67	455	OZA659-EE6	0380	---	---
2.0i 16V Turbo	F4R 776	2.0	120	04.04-		R	4	67	330	OZA659-EE13	0387	---	---
2.0i 16V Turbo	F4R 776	2.0	120	04.04-		D	4	67	330	OZA659-EE13	0387	---	---

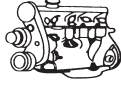

ℓ kW

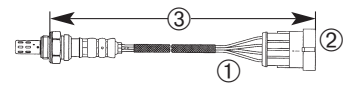
STOCK
REVERSE
TYPE
LINE
NO.
No.
No.
No.

RENAULT

SPORT SPIDER

2.0i	F7R 710 / 712 / 720	2.0	108	05.96-10.99		R	4	28	255	OZA448-E43	0282	S4	1952
------	---------------------	-----	-----	-------------	--	---	---	----	-----	------------	------	----	------

THALIA II

1.4i 16V	K4J 712	1.4	72	06.01-		R	4	67	455	OZA659-EE6	0380	---	---
1.4i 16V	K4J 712	1.4	72	06.01-		D	4	67	380	OZA659-EE53	7858	---	---
1.6i 16V	K4M 734	1.6	66	11.01-		R	4	67	455	OZA659-EE6	0380	---	---
1.6i 16V	K4M 734	1.6	66	11.01-		D	4	67	380	OZA659-EE53	7858	---	---

TRAFIC

2.0i	F4R 720	2.0	88	06.01-		R	4	67	455	OZA659-EE6	0380	---	---
2.0i	F4R 720	2.0	88	06.01-		D	4	67	455	OZA659-EE6	0380	---	---
2.0i 16V	F4R 722	2.0	88	08.01-	2↑	R	4	67	455	OZA659-EE6	0380	---	---
2.0i 16V	F4R 722	2.0	88	06.01-		D	4	67	455	OZA659-EE6	0380	---	---
2.2i	J7T 780	2.2	69	03.96-03.01		R	1	3	472	OZA401-E2	1802	S1	1951
2.2	J7T 600	2.2	70	07.94-03.01		R	3	14	288	OZA55-R1	1878	S3	0412
2.2	J7T 600	2.2	70	07.94-03.01		R	3	14	288	OZA55-R1	1878	S3	0412
2.2	J7T 600	2.2	70	07.94-03.01		R	3	14	288	OZA55-R1	1878	S3	0412
2.2	J7T 600	2.2	70	07.94-03.01		R	3	14	288	OZA55-R1	1878	S3	0412

TWINGO

1.0i	D7D 740	1.0	43	01.00-		R	3	13	385	OZA446-E57	0472	S3	0412
1.2i	C3G 700	1.2	40	03.93-08.96		R	2	10	370	OZA428-E1	1807	S2	1918
1.2i	C3G 702	1.2	40	03.93-08.97		R	3	14	228	OZA55-R4	0145	S3	0412
1.2i	D7F 700	1.2	40-44	09.96-11.99		R	3	13	385	OZA446-E57	0472	S3	0412
1.2i	D7F 701	1.2	40-44	09.96-11.99		R	3	13	385	OZA446-E57	0472	S3	0412
1.2i	D7F 700	1.2	40-44	12.99-		R	4	67	380	OZA448-E50	0415	---	---
1.2i	D7F 701	1.2	40-44	12.99-		R	4	67	380	OZA448-E50	0415	---	---
1.2i	D7F 700 / 701	1.2	43	09.96-11.99		R	3	13	685	OZA660-EE16	5709	S3	0412
1.2i	D7F 706	1.2	43	09.98-11.99		R	3	13	385	OZA446-E57	0472	S3	0412
1.2i	D7F 706	1.2	43	12.99-		R	4	67	380	OZA448-E50	0415	---	---
1.2i 8V	D7F 702	1.2	44	07.98-11.00		R	4	67	445	OZA277-R2	0468	---	---
1.2i 8V	D7F 702	1.2	44	07.98-11.00		D	4	67	445	OZA277-R2	0468	---	---
1.2i 8V	D7F 703	1.2	44	07.98-11.00		D	4	67	445	OZA277-R2	0468	---	---
1.2i 8V	D7F 703	1.2	44	07.98-11.00		R	4	67	445	OZA277-R2	0468	---	---
1.2i 16V	D4F 702	1.2	55	10.00-		R	4	67	445	OZA507-R2	0480	---	---
1.2i 16V	D4F 702	1.2	55	10.00-		D	4	67	445	OZA507-R2	0480	---	---
1.2i 16V	D4F 703	1.2	55	10.00-		R	4	67	445	OZA507-R2	0480	---	---
1.2i 16V	D4F 703	1.2	55	10.00-		D	4	67	445	OZA507-R2	0480	---	---

VEL SATIS

2.0i 16V Turbo	F4R 762 / 763	2.0	120	04.02-		R	4	67	330	OZA659-EE13	0387	---	---
2.0i 16V Turbo	F4R 762 / 763	2.0	120	04.02-		D	4	67	330	OZA659-EE13	0387	---	---
2.0i 16V Turbo		2.0	125	04.02-		R	4	67	330	OZA659-EE13	0387	---	---
2.0i 16V Turbo		2.0	125	04.02-		D	4	67	330	OZA659-EE13	0387	---	---
3.5i V6 24V	V4Y 701	3.5	180	10.02-	2↑	R	4	70	371	OZA544-N8	1804	---	---
3.5i V6 24V	V4Y 701	3.5	180	10.02-		D	4	88	500	OZA544-R1	1857	---	---

ROVER

25

1.1i 16V	K4F	1.1	55	02.03-05.05	-> YD 471 564	R	4	33	590	OZA527-E9	0498	S4CG	1919
1.1i 16V	K4F	1.1	55	02.03-05.05	YD 471 565 ->	R	4	106	540	OZA659-EE2	0376	---	---

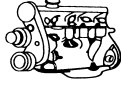

ℓ kW

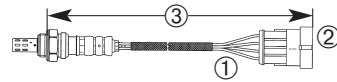
STOCK
ORDER
No.
UNIVERSAL
TYPE
No.
NUMBERS
PL
No.
NUMBERS
PL
No.

ROVER

25

1.1i 16V	K4F	1.1	55	02.03-05.05		D	4	112	745	OZA659-EE45	5747	---	---
1.4i 16V	K14	1.4	62	02.00-05.05	-> YD 471 564	R	4	33	590	OZA527-E9	0498	S4CG	1919
1.4i 16V	K14	1.4	62	02.00-05.05	YD 471 565 ->	R	4	106	540	OZA659-EE2	0376	---	---
1.4i 16V	K14	1.4	62	02.00-05.05		D	4	112	745	OZA659-EE45	5747	---	---
1.4i 16V	K14	1.4	76	02.00-05.05	-> YD 471 564	R	4	33	590	OZA527-E9	0498	S4CG	1919
1.4i 16V	K14	1.4	76	02.00-05.05	YD 471 565 ->	R	4	106	540	OZA659-EE2	0376	---	---
1.4i 16V	K14	1.4	76	02.00-05.05		D	4	112	745	OZA659-EE45	5747	---	---
1.6i 16V	K16	1.6	80	02.00-05.05	-> YD 471 564	R	4	33	590	OZA527-E9	0498	S4CG	1919
1.6i 16V	K16	1.6	80	02.00-05.05	YD 471 565 ->	R	4	106	540	OZA659-EE2	0376	---	---
1.6i 16V	K16	1.6	80	02.00-05.05		D	4	112	745	OZA659-EE45	5747	---	---
1.8i 16V	K18	1.8	86	02.00-05.05	-> YD 471 564	R	4	33	590	OZA527-E9	0498	S4CG	1919
1.8i 16V	K18	1.8	86	02.00-05.05	YD 471 565 ->	R	4	106	540	OZA659-EE2	0376	---	---
1.8i 16V	K18	1.8	107	02.00-05.05	-> YD 471 564	R	4	33	590	OZA527-E9	0498	S4CG	1919
1.8i 16V	K18	1.8	107	02.00-05.05	YD 471 565 ->	R	4	106	540	OZA659-EE2	0376	---	---

45

1.4i 16V	K14	1.4	76	02.00-05.05	-> YD 471 063	R	4	33	590	OZA527-E9	0498	S4CG	1919
1.4i 16V	K14	1.4	76	02.00-05.05	YD 471 064 ->	R	4	106	540	OZA659-EE2	0376	---	---
1.4i 16V	K14	1.4	76	02.00-05.05	YD 471 064 ->	D	4	112	745	OZA659-EE45	5747	---	---
1.6i 16V	K16	1.6	80	02.00-05.05	-> YD 471 063	R	4	33	590	OZA527-E9	0498	S4CG	1919
1.6i 16V	K16	1.6	80	02.00-05.05	YD 471 064 ->	R	4	106	540	OZA659-EE2	0376	---	---
1.6i 16V	K16	1.6	80	02.00-05.05	YD 471 064 ->	D	4	112	745	OZA659-EE45	5747	---	---
1.8i 16V	K18	1.8	86	02.00-05.05		R	4	106	540	OZA659-EE2	0376	---	---
1.8i 16V	K18	1.8	86	02.00-05.05		D	4	112	745	OZA659-EE45	5747	---	---
2.0i V6	KV6	2.0	110	02.00-05.05		R	4	33	545	OZA527-E18	0430	S4CG	1919
2.0i V6	KV6	2.0	110	02.00-05.05		D	4	112	745	OZA659-EE45	5747	---	---

75

1.8i	K4	1.8	88	05.98-		R	4	75	620	OZA341-RV2	0429	---	---
1.8i	K4	1.8	88	05.98-		D	4	75	620	OZA341-RV2	0429	---	---
2.0i	KV6	2.0	110	05.98-		R	4	75	620	OZA341-RV2	0429	---	---
2.0i	KV6	2.0	110	05.98-		D	4	75	620	OZA341-RV2	0429	---	---
2.5i	KV6	2.5	130	05.98-		R	4	75	620	OZA341-RV2	0429	---	---
2.5i	KV6	2.5	130	05.98-		D	4	75	620	OZA341-RV2	0429	---	---

100 METRO

1.1i	11K2D	1.1	44	09.90-12.97		R	4	33	390	OZA527-E8	0284	S4CG	1919
1.4i	K-Serie	1.4	55	09.90-03.98		R	4	33	390	OZA527-E8	0284	S4CG	1919
1.4i 16V	14K4C	1.4	66-70	05.90-12.92		R	4	33	390	OZA527-E8	0284	S4CG	1919
1.4i 16V	14K4C	1.4	66-70	05.90-12.92		D	4	112	745	OZA659-EE45	5747	---	---
1.4i 16V	14K4D	1.4	66-70	05.90-12.92		R	4	33	390	OZA527-E8	0284	S4CG	1919
1.4i 16V	14K4D	1.4	66-70	05.90-12.92		D	4	112	745	OZA659-EE45	5747	---	---
1.4i 16V Cabrio	K-Serie	1.4	75	04.97-10.98		R	4	33	390	OZA527-E8	0284	S4CG	1919
1.4i 16V GTI	14K4F	1.4	76	05.90-10.95		R	4	33	390	OZA527-E8	0284	S4CG	1919

200

1.1i	K-Serie	1.1	44	11.95-03.00	-> YD 471 564	R	4	33	590	OZA527-E9	0498	S4CG	1919
1.1i	K-Serie	1.1	44	11.95-03.00	YD 471 565 ->	R	4	106	540	OZA659-EE2	0376	---	---
1.4i	14K2A	1.4	55	01.93-02.96		R	4	33	390	OZA527-E8	0284	S4CG	1919
1.4i	14K2F	1.4	55	10.95-03.00	-> YD 471 564	R	4	33	590	OZA527-E9	0498	S4CG	1919

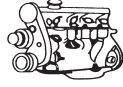

ℓ kW

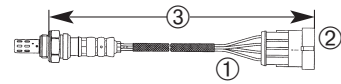

ORDER No.
STOCK No.
UNIVERSAL No.
TYPE No.
UNIVERSAL No.
ENGINE No.

ROVER

200

1.4i	14K2F	1.4	55	10.95-03.00	YD 471 565 ->	R	4	106	540	OZA659-EE2	0376	---	---
1.4i 16V	K16 DOHC	1.4	66	10.89-09.93		R	4	33	390	OZA527-E8	0284	S4CG	1919
1.4i 16V	K16 DOHC	1.4	76	10.92-02.96		R	4	33	390	OZA527-E8	0284	S4CG	1919
1.4i 16V	14KAF	1.4	76	10.95-03.00	-> YD 471 564	R	4	33	590	OZA527-E9	0498	S4CG	1919
1.4i 16V	14KAF	1.4	76	10.95-03.00	YD 471 565 ->	R	4	106	540	OZA659-EE2	0376	---	---
1.6i 16V	16K4F	1.6	82	10.95-03.00	-> YD 471 564	R	4	33	590	OZA527-E9	0498	S4CG	1919
1.6i 16V	16K4F	1.6	82	10.95-03.00	YD 471 565 ->	R	4	106	540	OZA659-EE2	0376	---	---
1.6i 16V Cabrio	16K4F	1.6	82	03.96-03.00		R	4	33	590	OZA527-E9	0498	S4CG	1919
1.6i 16V Coupe	16K4F	1.6	82	03.96-03.00		R	4	33	590	OZA527-E9	0498	S4CG	1919
1.8i 16V	K-Serie	1.8	88	10.95-03.00	-> YD 471 564	R	4	33	590	OZA527-E9	0498	S4CG	1919
1.8i 16V	K-Serie	1.8	88	10.95-03.00	YD 471 565->	R	4	106	540	OZA659-EE2	0376	---	---
1.8i 16V	18K4K	1.8	107	10.95-03.00	-> YD 471 564	R	4	33	590	OZA527-E9	0498	S4CG	1919
1.8i 16V Coupe	K-Serie	1.8	107	03.96-03.00		R	4	33	590	OZA527-E9	0498	S4CG	1919
2.0 Turbo	20T4G	2.0	147	01.93-06.96		R	4	33	390	OZA527-E8	0284	S4CG	1919
2.0 GTi	T16 DOHC	2.0	100	10.92-06.96		R	4	33	590	OZA527-E9	0498	S4CG	1919
2.0 GSi	T16 DOHC	2.0	100	10.92-06.96		R	4	33	590	OZA527-E9	0498	S4CG	1919
2.0 GTi	T16 DOHC	2.0	103	09.91-06.96		R	4	33	590	OZA527-E9	0498	S4CG	1919

400

1.4i 16V GSi	K16 DOHC	1.4	70	04.90-10.92		R	4	33	390	OZA527-E8	0284	S4CG	1919
1.4i 16V GSi	K14K4F	1.4	76	01.93-02.96		R	4	33	390	OZA527-E8	0284	S4CG	1919
1.4i 16V	K-Serie	1.6	76	05.95-03.00	YD 471 064->	R	4	106	540	OZA659-EE2	0376	---	---
1.4i 16V	K-Serie	1.6	76	05.95-03.00	YD 471 064->	D	4	112	745	OZA659-EE45	5747	---	---
1.4i 16V Tourer	K-Serie	1.6	76	05.95-03.00	YD 471 064->	R	4	106	540	OZA659-EE2	0376	---	---
1.4i 16V Tourer	K-Serie	1.6	76	05.95-03.00	YD 471 064->	D	4	112	745	OZA659-EE45	5747	---	---
1.6i 16V	K16	1.6	82	05.95-03.00		R	4	33	590	OZA527-E9	0498	S4CG	1919
1.6i 16V	K16	1.6	82	05.95-03.00	YD 471 064->	R	4	106	540	OZA659-EE2	0376	---	---
1.6i 16V	K16	1.6	82	05.95-03.00	YD 471 064->	D	4	112	745	OZA659-EE45	5747	---	---
1.6i 16V Tourer	D16 B2	1.6	82	02.96-03.00		R	4	33	590	OZA527-E9	0498	S4CG	1919
1.8i 16V Tourer	VVC DOHC	1.8	107	03.96-12.98		R	4	33	590	OZA527-E9	0498	S4CG	1919
2.0i 16V GTi	20T4H	2.0	100	10.95-03.00		R	4	33	545	OZA527-E18	0430	S4CG	1919
2.0i 16V GTi	T16 DOHC	2.0	103	02.92-02.96		R	4	33	590	OZA527-E9	0498	S4CG	1919
2.0i 16V Turbo	20T4G	2.0	147	01.93-02.96		R	4	33	390	OZA527-E8	0284	S4CG	1919

600

1.8i	F18A3	1.8	85	03.96-02.99		R	4	44	410	OZA245-H1	0169	S4	1952
2.0i	F20Z2	2.0	85	08.93-06.96		R	4	44	410	OZA245-H1	0169	S4	1952
2.0i	F20Z1	2.0	96	08.93-02.99		R	4	44	410	OZA245-H1	0169	S4	1952
2.0i 16V Turbo	T16 Turbo	2.0	147	04.93-12.98		R	4	33	390	OZA527-E8	0284	S4CG	1919
2.3i	H23A3	2.3	116	01.96-02.99		R	4	43	225	OZA245-H2	0180	S4	1952

800

2.0i	20HDM16	2.0	98	10.88-12.91		R	3	55	521	OTD3G-3A1	0453	---	---
2.0i	20T4H	2.0	100	01.92-01.96		R	4	33	590	OZA527-E9	0498	S4CG	1919
2.0i 16V Turbo	T16	2.0	132-147	01.92-01.99		R	4	33	390	OZA527-E8	0284	S4CG	1919
2.5 V6	25K4F	2.5	129	04.96-02.99		R	4	33	540	OZA222-RV1	0136	S4	1952

MINI

1.3	SPI	1.3	39-46	02.91-09.00		R	4	33	390	OZA527-E8	0284	S4CG	1919
1.3 Cooper	SPI	1.3	39-46	02.91-09.00		R	4	33	390	OZA527-E8	0284	S4CG	1919

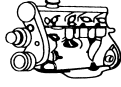

ℓ kW

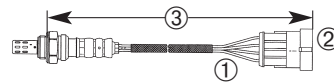

STOCK No. TYPE No. UNIVERSAL No. UNIVERSAL No.

SAAB

900 I

2.0i 8V	B201I	2.0	81	09.87-08.90		R	3	19	1215	OZA446-E16	1859	S3	0412
2.0i 16V	B202I	2.0	92-93	09.85-08.92		R	3	19	1215	OZA446-E16	1859	S3	0412
2.0i 16V	B202I	2.0	92-98	09.89-08.92		R	3	19	1215	OZA446-E16	1859	S3	0412
2.0i 16V Cabrio	B202I	2.0	92-99	09.89-08.93		R	3	19	1215	OZA446-E16	1859	S3	0412
2.0i 8V Turbo	B201S	2.0	103	09.88-09.90		R	3	19	1215	OZA446-E16	1859	S3	0412
2.0i 16V Turbo	B202L	2.0	118	08.84-08.85		R	1	3	472	OZA401-E2	1802	S1	1951
2.0i 16V Turbo	B202L	2.0	118	09.85-08.89		R	3	19	1215	OZA446-E16	1859	S3	0412
2.1i 16V	B212I	2.1	100-103	09.90-08.93		R	3	19	1215	OZA446-E16	1859	S3	0412
2.1i 16V Cabrio	B212I	2.1	103	09.91-08.93		R	3	19	1215	OZA446-E16	1859	S3	0412

900 II

S 2.0i	B204I	2.0	96	09.94-08.98		R	3	77	1095	OZA446-E58	0483	S3	0412
S 2.0i Coupe	B204I	2.0	96	09.94-08.98		R	3	77	1095	OZA446-E58	0483	S3	0412
2.0i 16V	B206I	2.0	98	09.93-08.98		R	3	77	1095	OZA446-E58	0483	S3	0412
2.0i 16V Coupe	B206I	2.0	98	03.94-08.98		R	3	77	1095	OZA446-E58	0483	S3	0412
2.0i 16V Cabrio	B206I	2.0	98	09.93-08.98		R	3	77	1095	OZA446-E58	0483	S3	0412
2.0i 16V Turbo	B204L	2.0	136	09.93-08.98		R	3	77	1095	OZA446-E58	0483	S3	0412
2.0i 16V Turbo Cabrio	B204L	2.0	136	09.93-08.98		R	3	77	1095	OZA446-E58	0483	S3	0412
2.0i 16V Turbo Coupe	B204L	2.0	136	03.94-08.98		R	3	77	1095	OZA446-E58	0483	S3	0412
2.3i 16V Coupe	B234I	2.3	110	03.94-08.98		R	3	77	1095	OZA446-E58	0483	S3	0412
2.3i 16V Cabrio	B234I	2.3	110	09.93-08.98		R	3	77	1095	OZA446-E58	0483	S3	0412
2.3i 16V	B234I	2.3	110	09.93-08.98		R	3	77	1095	OZA446-E58	0483	S3	0412

9000

2.0i 16V	B202I	2.0	90	09.86-08.91		R	3	19	670	OZA446-E1	1833	S3	0412
2.0i 16V	B202I	2.0	90	08.86-08.86		R	3	19	1215	OZA446-E16	1859	S3	0412
2.0i 16V	B202I	2.0	94	09.91-08.93		R	3	77	1095	OZA446-E58	0483	S3	0412
2.0i 16V CD	B202I	2.0	96	09.89-08.91		R	3	19	1215	OZA446-E16	1859	S3	0412
2.0i 16V Turbo CD	B202S	2.0	108	09.92-12.98		R	3	77	1095	OZA446-E58	0483	S3	0412
2.0i 16V Turbo	B202L	2.0	118	09.84-08.88		R	3	19	1215	OZA446-E16	1859	S3	0412
2.0i 16V Turbo	B202XL	2.0	118	09.91-08.93		R	3	77	1095	OZA446-E58	0483	S3	0412
2.0i Turbo CD	B202L	2.0	120	05.88-08.91		R	3	19	1215	OZA446-E16	1859	S3	0412
2.0i 16V Turbo CD	B202XL	2.0	120	09.91-08.93		R	3	77	1095	OZA446-E58	0483	S3	0412
2.0i 16V Turbo	B202L	2.0	121	01.90-08-93		R	3	19	1215	OZA446-E16	1859	S3	0412
2.3i 16V CD	B234L	2.3	107	09.89-08.91		R	3	19	1215	OZA446-E16	1859	S3	0412
2.3i 16V CS	B234I	2.3	107	09.91-08.93		R	3	77	1095	OZA446-E58	0483	S3	0412
2.3i 16V	B234I	2.3	114	09.89-08.91		R	3	19	1215	OZA446-E16	1859	S3	0412
2.3i 16V CDE Eco-Power	B234E	2.3	125	09.93-12.98		R	3	77	1095	OZA446-E58	0483	S3	0412
2.3i 16V CS Eco Power	B234E	2.3	125	09.93-08.95		R	3	77	1095	OZA446-E58	0483	S3	0412
2.3 Turbo CD	B234L	2.3	143	09.91-08.93		R	3	19	1215	OZA446-E16	1859	S3	0412
2.3 Turbo S CD	B234L	2.3	143	09.90-08.91		R	3	19	1215	OZA446-E16	1859	S3	0412
2.3i 16V Turbo	B234	2.3	143	09.90-06.91		R	3	19	1215	OZA446-E16	1859	S3	0412
2.3i 16V CDE Turbo	B234L	2.3	147	09.93-09.95		R	3	77	1095	OZA446-E58	0483	S3	0412
2.3i 16V Turbo CSE	B234L	2.3	147	09.93-09.95		R	3	77	1095	OZA446-E58	0483	S3	0412
2.3i 16V Turbo Aero CS	B234R	2.3	162	02.93-08.95		R	3	77	1095	OZA446-E58	0483	S3	0412
2.3i 16V Turbo Aero CS	B234R	2.3	165	09.92-08.95		R	3	77	1095	OZA446-E58	0483	S3	0412

9-3

1.8i	Z18XE	1.8	90	05.03-		R	4	74	741	OZA334-SZ1	0485	---	---
1.8i	Z18XE	1.8	90	05.03-		D	4	74	271	OZA334-SZ4	0418	---	---
2.0i 16V	B204I	2.0	96	03.98-		R	3	77	1095	OZA446-E58	0483	S3	0412
2.0 16V Turbo Eco-Power	B205L	2.0	110	01.99-		R	3	77	1095	OZA446-E58	0483	S3	0412

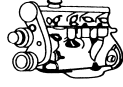

ℓ kW



ORDER No. STOCK No. TYPE No. UNIVERSAL No. SAAB No.

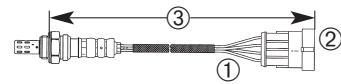

SAAB

9-3

2.0 16V Turbo	B204L	2.0	113	09.98-		R	3	77	1095	OZA446-E58	0483	S3	0412
2.0 16V Turbo	B204E	2.0	113	01.98-		R	3	77	1095	OZA446-E58	0483	S3	0412
2.0T Cabrio		2.0	129	08.03-		R	4	49	425	OZA575-GM1	1895	---	---
2.0T Cabrio		2.0	129	08.03-		D	4	87	725	OZA583-GM2	1754	---	---
2.0 16V Turbo	B204L	2.0	136	03.98-		R	3	77	1095	OZA446-E58	0483	S3	0412
2.0 16V Turbo	B205R	2.0	140	01.99-		R	3	77	1095	OZA446-E58	0483	S3	0412
2.0 16V Turbo	B204R	2.0	147	01.98-		R	3	77	1095	OZA446-E58	0483	S3	0412
2.0 16V Turbo	B204L	2.0	147	09.98-		R	3	77	1095	OZA446-E58	0483	S3	0412
2.0 16V Turbo	B204L	2.0	151	09.99-		R	3	77	1095	OZA446-E58	0483	S3	0412
2.0T Cabrio		2.0	154	08.03-		R	4	49	425	OZA575-GM1	1895	---	---
2.0T Cabrio		2.0	154	08.03-		D	4	87	725	OZA583-GM2	1754	---	---
2.3i 16V	B234I	2.3	110	03.98-		R	3	77	1095	OZA446-E58	0483	S3	0412
2.3i 16V Turbo	B235R	2.3	125	01.99-		R	3	77	1095	OZA446-E58	0483	S3	0412
2.3i 16V Turbo	B234I	2.3	165	09.99-		R	3	77	1095	OZA446-E58	0483	S3	0412

SEAT

ALHAMBRA

1.8 T 20V	AWC	1.8	110	06.00-		D	4	64	975	OZA659-EE1	0375	---	---
2.0	ADY	2.0	85	03.96-		R	4	48	1430	OZA572-E10	0275	S4CG	1919
2.0	ATM	2.0	85	06.00-		D	4	64	975	OZA659-EE1	0375	---	---

ALTEA

1.4i 16V	BXW	1.4	63	05.06-		R	4	84	511	OZA629-V3	1720	---	---
1.4i 16V	BXW	1.4	63	05.06-		D	4	64	526	OZA510-V5	0435	---	---
1.6	BGU	1.6	75	06.04-		R	5	92	750	LZA07-V1	1851	---	---
1.6	BGU	1.6	75	06.04-		D	4	85	471	OZA510-V11	1884	---	---
1.6	BSE	1.6	75	06.04-		R	5	92	750	LZA07-V1	1851	---	---
1.6	BSE	1.6	75	06.04-		D	4	85	471	OZA510-V11	1884	---	---
1.6	BSF	1.6	75	06.04-		R	5	92	750	LZA07-V1	1851	---	---
1.6	BSF	1.6	75	06.04-		D	4	85	471	OZA510-V11	1884	---	---

AROSA

1.0i	ALD	1.0	37	01.99-07.00		R	4	64	535	OZA659-EE40	1627	---	---
1.0i	ANV	1.0	37	01.99-07.00		D	4	64	1670	OZA659-EE16	0390	---	---
1.0i	AUC	1.0	37	05.00-08.02	-> 6H..3..009 600	D	4	64	1670	OZA659-EE16	0390	---	---
1.0i	ALL	1.0	37	10.97-05.99		R	4	64	700	OZA447-E32	0471	S4	1952
1.0i	AER	1.0	37	02.97-05.00		R	4	64	475	OZA448-E51	0426	S4	1952
1.4i	AEX	1.4	44	02.97-09.99		R	4	64	700	OZA447-E32	0471	S4	1952
1.4i	AKK	1.4	44	01.99-10.00		R	4	64	535	OZA659-EE40	1627	---	---
1.4i	AKV	1.4	44	05.97-09.99		R	4	64	700	OZA447-E32	0471	S4	1952
1.4i	APQ	1.4	44	12.97-09.99		R	4	64	700	OZA447-E32	0471	S4	1952
1.4i	ANW	1.4	44	01.99-10.00		D	4	64	1670	OZA659-EE16	0390	---	---
1.4i	AUD	1.4	44	01.99-05.02	-> 6H..3..002 400	D	4	64	1670	OZA659-EE16	0390	---	---
1.4i	AUD	1.4	44	01.99-06.04		D	4	64	1590	OZA659-EE20	0394	---	---
1.4i 16V	AUA	1.4	55	05.99-10.00		D	4	64	1686	OZA510-V1	0491	---	---
1.4i 16V	AUA	1.4	55	05.99-10.00		D	4	64	1576	OZA510-V2	0402	---	---
1.4i 16V	AUB	1.4	74	05.99-06.04		D	4	64	1686	OZA510-V1	0491	---	---
1.4i 16V	AUB	1.4	74	05.99-06.04		D	4	64	1576	OZA510-V2	0402	---	---

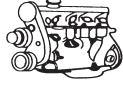

l kW

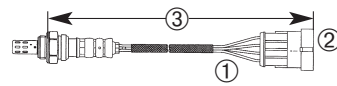
STOCK
NO.
UNIVERSAL
TYPE
NO.
UNIVERSAL
NO.

SEAT

CORDOBA

1.0i	ALD	1.0	37	05.99-12.02		R	4	65	480	OZA659-EE32	1614	---	---
1.0i	AER	1.0	37	09.96-04.97		R	4	48	290	OZA114-V4	1769	---	---
1.0i	AER	1.0	37	05.97-06.99		R	4	48	520	OZA448-E31	0151	S4	1952
1.2i	BMD	1.2	40	11.04-		R	4	64	611	OZA534-V1	1778	---	---
1.2i	AZQ	1.2	47	10.02-		R	4	85	481	OZA532-V3	1776	---	---
1.2i	AZQ	1.2	47	10.02-		D	4	64	251	OZA510-V6	1885	---	---
1.4i	ABD	1.4	44	06.94-12.94	-> 6K..ZR..700 000	R	4	36	1075	OZA527-E36	1993	S4CG	1919
1.4i	ABD	1.4	44	09.93-12.95	-> 6K..ZR..000 000	R	4	36	550	OZA572-E1	0283	S4CG	1919
1.4i	AKK	1.4	44	05.99-12.02		R	4	65	480	OZA659-EE32	1614	---	---
1.4i Vario	AKK	1.4	44	08.99-08.02		R	4	65	480	OZA659-EE32	1614	---	---
1.4i Vario	AUD	1.4	44	11.00-12.02	6K..1..148 501 ->	D	4	65	480	OZA659-EE32	1614	---	---
1.4i	AEX	1.4	44	09.95-12.97		R	4	48	520	OZA448-E31	0151	S4	1952
1.4i	AUA	1.4	55	05.00-10.02		R	5	92	465	LZA11-V3	1829	---	---
1.4i	AUA	1.4	55	05.00-10.02		D	4	65	1326	OZA510-V3	0413	---	---
1.4i	APE	1.4	55	05.00-10.02		R	5	92	465	LZA11-V3	1829	---	---
1.4i	APE	1.4	55	05.00-10.02		D	4	65	1326	OZA510-V3	0413	---	---
1.4i	BKY	1.4	55	06.04-		R	5	91	330	LZA07-V3	1880	---	---
1.4i	BKY	1.4	55	06.04-		D	4	64	526	OZA510-V5	0435	---	---
1.4i 16V	BBY	1.4	55	10.02-		R	5	92	535	LZA11-V2	1774	---	---
1.4i 16V	BBY	1.4	55	10.02-		D	4	64	1596	OZA510-V10	1883	---	---
1.4i 16V	BBY	1.4	55	10.02-		D	4	64	1706	OZA510-V7	1886	---	---
1.4i 16V	BXW	1.4	63	05.06-		R	4	84	511	OZA629-V3	1720	---	---
1.4i 16V	BXW	1.4	63	05.06-		D	4	64	526	OZA510-V5	0435	---	---
1.4i 16V	AFH	1.4	74	09.96-06.99		R	4	48	290	OZA114-V4	1769	---	---
1.6i	ALM	1.6	55	03.97-06.99		R	4	48	550	OZA447-E16	0259	S4	1952
1.6i	AEE	1.6	55	03.97-12.98		R	4	48	550	OZA447-E16	0259	S4	1952
1.6i	1F	1.6	55	09.94-10.95		R	4	48	520	OZA448-E31	0151	S4	1952
1.6i	1F	1.6	55	11.95-06.99		R	4	48	290	OZA114-V4	1769	---	---
1.6i	ABU	1.6	55	03.93-07.94		R	4	36	550	OZA572-E1	0283	S4CG	1919
1.6i	AFT	1.6	74	09.95-05.98		R	4	36	585	OZA572-E13	0254	S4CG	1919
1.6i	AKL	1.6	74	10.99-12.02		R	4	65	480	OZA659-EE32	1614	---	---
1.6i	AEH	1.6	74	05.99-12.02		R	4	65	480	OZA659-EE32	1614	---	---
1.6i	BAH	1.6	74	04.03-		D	4	65	545	OZA659-EE19	0393	---	---
1.6i 16V	BTS	1.6	77	11.06-		R	4	84	511	OZA629-V3	1720	---	---
1.6i 16V	BTS	1.6	77	11.06-		D	4	85	526	OZA629-V4	1721	---	---
1.8i	ABS	1.8	66	09.93-07.94		R	2	4	480	OZA401-E4	1822	S2	1918
1.8i	ABS	1.8	66	09.93-07.94		R	4	17	583	OZA446-E42	0150	S4	1952
1.8i	ADZ	1.8	66	07.94-		R	4	48	520	OZA448-E31	0151	S4	1952
1.8i Monotronic	ABS	1.8	66	02.93-09.94		R	4	48	520	OZA448-E31	0151	S4	1952
1.8i 16V	ADL	1.8	95	09.93-06.96	6K..ZR..564 367 ->	R	4	36	585	OZA572-E13	0254	S4CG	1919
2.0i	2E	2.0	85	09.93-04.96		R	4	36	1075	OZA527-E36	1993	S4CG	1919
2.0	2E	2.0	85	09.93-04.96		R	4	36	585	OZA572-E13	0254	S4CG	1919
2.0 Digifant	2E	2.0	85	02.93-06.96		R	4	36	585	OZA572-E13	0254	S4CG	1919
2.0i	BBX	2.0	85	04.03-		R	4	65	545	OZA659-EE19	0393	---	---
2.0i	AZL	2.0	85	09.02-04.05		D	4	65	545	OZA659-EE19	0393	---	---
2.0i 16V	ABF	2.0	110	08.96-06.99		R	4	48	720	OZA447-E31	0460	S4	1952

IBIZA I

1.2	021A00	1.2	51	12.89-05.93		R	3	19	975	OZA446-E2	1855	S3	0412
1.3	AAV	1.3	40	03.93-07.94		R	4	36	550	OZA572-E1	0283	S4CG	1919

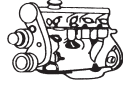

ℓ kW

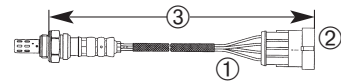
ORDER
STOCK
No.
UNIVERSAL
No.
TYPE
No.
UNIVERSAL
No.

SEAT

IBIZA I

1.5i	021 A2000	1.5	66	10.86-05.93		R	3	19	975	OZA446-E2	1855	S3	0412
1.5i	021 A2000	1.5	70	11.89-05.93		R	3	19	975	OZA446-E2	1855	S3	0412
1.7i	021 B3000	1.7	76	01.91-05.93		R	3	19	975	OZA446-E2	1855	S3	0412

IBIZA II

1.0i	AAU	1.0	33	03.93-06.96		R	4	36	1075	OZA527-E36	1993	S4CG	1919
1.0i	AAU	1.0	33	03.93-09.96		R	4	36	550	OZA572-E1	0283	S4CG	1919
1.0i	AER	1.0	37	09.96-08.99		R	4	48	520	OZA448-E31	0151	S4	1952
1.4	ABD	1.4	40-44	09.93-12.95	-> 6K..ZR..155 000	R	4	36	550	OZA572-E1	0283	S4CG	1919
1.4	ABD	1.4	40-44	09.93-12.95	-> 6K..ZR..700 000	R	4	36	550	OZA572-E1	0283	S4CG	1919
1.4i	AEX	1.4	44	09.95-12.97		R	4	48	520	OZA448-E31	0151	S4	1952
1.4i 16V	AFH	1.4	74	07.96-08.99		R	4	48	550	OZA447-E16	0259	S4	1952
1.6i	1F	1.6	55	05.94-09.97		R	2	4	480	OZA401-E4	1822	S2	1918
1.6i	AEE	1.6	55	03.97-12.98		R	4	48	550	OZA447-E16	0259	S4	1952
1.6i	ALM	1.6	55	05.97-12.98		R	4	48	550	OZA447-E16	0259	S4	1952
1.6i	1F	1.6	55	09.94-09.97		R	4	48	520	OZA448-E31	0151	S4	1952
1.6i	ABU	1.6	55	03.93-07.94		R	4	36	550	OZA572-E1	0283	S4CG	1919
1.6i	AFT	1.6	74	09.95-05.98		R	4	36	585	OZA572-E13	0254	S4CG	1919
1.8	ABS	1.8	66	03.93-07.94		R	4	17	583	OZA446-E42	0150	S4	1952
1.8i Monotronic	ABS	1.8	66	02.93-09.94		R	4	48	520	OZA448-E31	0151	S4	1952
1.8i	ADZ	1.8	66	07.94-08.99		R	4	48	520	OZA448-E31	0151	S4	1952
1.8 16 V	ADL	1.8	95	09.93-06.96		R	4	36	585	OZA572-E13	0254	S4CG	1919
2.0i	2E	2.0	85	03.93-04.96		R	4	36	1075	OZA527-E36	1993	S4CG	1919
2.0	2E	2.0	85	03.93-04.96		R	4	36	585	OZA572-E13	0254	S4CG	1919
2.0 Digifant	2E	2.0	85	02.93-06.96		R	4	36	585	OZA572-E13	0254	S4CG	1919
2.0i 16V	ABF	2.0	110	08.96-08.99		R	4	48	720	OZA447-E31	0460	S4	1952

IBIZA III

1.0i	ALD	1.0	37	05.99-05.02		R	4	65	480	OZA659-EE32	1614	---	---
1.4i	AKK	1.4	44	05.99-05.02		R	4	65	480	OZA659-EE32	1614	---	---
1.4i	AUD	1.4	44	11.00-05.02		D	4	65	480	OZA659-EE32	1614	---	---
1.4i 16V	AUA	1.4	55	05.00-01.02		R	5	92	465	LZA11-V3	1829	---	---
1.4i 16V	AUA	1.4	55	05.00-01.02		D	4	65	1326	OZA510-V3	0413	---	---
1.4i 16V	APE	1.4	55	05.00-01.02		R	5	92	465	LZA11-V3	1829	---	---
1.4i 16V	APE	1.4	55	05.00-01.02		D	4	65	1326	OZA510-V3	0413	---	---
1.4i 16V	BBY	1.4	55	05.99-01.02		R	5	92	535	LZA11-V2	1774	---	---
1.4i 16V	BBY	1.4	55	05.99-01.02		D	4	65	1326	OZA510-V3	0413	---	---
1.4i 16V	BBZ	1.4	74	05.99-05.02		D	4	65	1326	OZA510-V3	0413	---	---
1.6i	AEH	1.6	74	05.99-05.02		R	4	65	480	OZA659-EE32	1614	---	---
1.6i	AKL	1.6	76	10.99-05.02		R	4	65	480	OZA659-EE32	1614	---	---

IBIZA IV

1.2	BMD	1.2	40	11.04-		R	4	64	611	OZA534-V1	1778	---	---
1.2	AZQ	1.2	47	02.02-		R	4	85	481	OZA532-V3	1776	---	---
1.2	AZQ	1.2	47	02.02-		D	4	64	251	OZA510-V6	1885	---	---
1.4i 16V	BKY	1.4	55	06.04-		R	5	91	330	LZA07-V3	1880	---	---
1.4i 16V	BKY	1.4	55	06.04-		D	4	64	526	OZA510-V5	0435	---	---
1.4i 16V	BBY	1.4	55	02.02-		R	5	92	535	LZA11-V2	1774	---	---
1.4i 16V	BBY	1.4	55	02.02-		D	4	64	1706	OZA510-V7	1886	---	---
1.4i 16V	BBY	1.4	55	02.02-		D	4	64	1596	OZA510-V10	1883	---	---
1.4i 16V	BXW	1.4	63	05.06-		R	4	84	511	OZA629-V3	1720	---	---
1.4i 16V	BXW	1.4	63	05.06-		D	4	64	526	OZA510-V5	0435	---	---

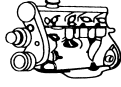

ℓ kW

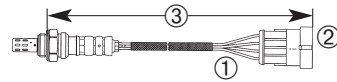
STOCK
REF. No.
UNIVERSAL
TYPE No.
SEAT
REGISTRATION No.

SEAT

IBIZA IV

1.6i	BAH	1.6	74	04.03-		D	4	65	545	OZA659-EE19	0393	---	---
1.6i 16V	BTS	1.6	77	11.06-		R	4	84	511	OZA629-V3	1720	---	---
1.6i 16V	BTS	1.6	77	11.06-		D	4	85	526	OZA629-V4	1721	---	---
1.8 T FR	BJX	1.8	110	12.03-		D	4	64	975	OZA659-EE1	0375	---	---
1.8 T FR	BKV	1.8	110	12.03-		D	4	64	975	OZA659-EE1	0375	---	---
1.8 T Cupra R	BBU	1.8	132	01.04-		D	4	64	975	OZA659-EE1	0375	---	---
2.0i	BBX	2.0	85	04.03-		R	4	65	545	OZA659-EE19	0393	---	---

IBIZA V

1.4i 16V	BXW	1.4	63	05.08-		R	4	84	511	OZA629-V3	1720	---	---
1.4i 16V	BXW	1.4	63	05.08-		D	4	64	526	OZA510-V5	0435	---	---
1.4i 16V Sportcoupe	BXW	1.4	63	07.08-		R	4	84	511	OZA629-V3	1720	---	---
1.4i 16V Sportcoupe	BXW	1.4	63	07.08-		D	4	64	526	OZA510-V5	0435	---	---

LEON

1.4i	APE	1.4	55	12.99-05.00		D	4	65	545	OZA659-EE19	0393	---	---
1.4i 16V	AXP	1.4	55	06.00-02.02		D	4	65	545	OZA659-EE19	0393	---	---
1.4i 16V	BCA	1.4	55	02.02-04.04		D	4	65	575	OZA659-EE23	0397	---	---
1.4i 16V	BXW	1.4	63	06.06-		R	4	84	511	OZA629-V3	1720	---	---
1.4i 16V	BXW	1.4	63	06.06-		D	4	64	526	OZA510-V5	0435	---	---
1.6i 16V	AEH	1.6	74	04.99-07.04		R	4	64	1135	OZA659-EE25	0399	---	---
1.6i 16V	AKL	1.6	74	04.99-07.04		R	4	64	1135	OZA659-EE25	0399	---	---
1.6i	BFQ	1.6	75	10.05-		D	4	65	560	OZA659-EE14	0388	---	---
1.6i	BSE	1.6	75	06.04-		R	5	92	750	LZA07-V1	1851	---	---
1.6i	BSE	1.6	75	06.04-		D	4	85	471	OZA510-V11	1884	---	---
1.6i	BSF	1.6	75	06.04-		R	5	92	750	LZA07-V1	1851	---	---
1.6i	BSF	1.6	75	06.04-		D	4	85	471	OZA510-V11	1884	---	---
1.6i 16V	AUS	1.6	77	09.00-10.02		R	5	92	810	LZA11-V4	1842	---	---
1.6i 16V	AUS	1.6	77	11.02-		R	5	92	810	LZA11-V4	1842	---	---
1.6i 16V	AUS	1.6	77	09.00-		D	4	65	541	OZA510-V4	0424	---	---
1.6i 16V	AZD	1.6	77	09.00-10.02		R	5	92	810	LZA11-V4	1842	---	---
1.6i 16V	AZD	1.6	77	11.02-		R	5	92	810	LZA11-V4	1842	---	---
1.6i 16V	AZD	1.6	77	02.00-		D	4	65	541	OZA510-V4	0424	---	---
1.6i 16V	BCB	1.6	77	09.00-10.02		R	5	92	810	LZA11-V4	1842	---	---
1.6i 16V	BCB	1.6	77	11.02-		R	5	92	810	LZA11-V4	1842	---	---
1.6i 16V	BCB	1.6	77	09.00-		D	4	65	541	OZA510-V4	0424	---	---
1.8i 20V	APG	1.8	92	12.99-07.04		D	4	65	560	OZA659-EE14	0388	---	---
1.8 T	APP	1.8	132	12.99-12.00		R	4	64	975	OZA659-EE1	0375	---	---
1.8 T	APP	1.8	132	12.99-12.00		D	4	65	560	OZA659-EE14	0388	---	---
1.8 T	AUQ	1.8	132	09.00-04.04		D	4	64	975	OZA659-EE1	0375	---	---

MALAGA

1.2i	021 C1000	1.2	52	12.89-12.93		R	3	19	975	OZA446-E2	1855	S3	0412
1.5i	021 A2000	1.5	66	10.86-12.93		R	3	19	975	OZA446-E2	1855	S3	0412
1.5i	021 B2000	1.5	74	11.89-12.93		R	3	19	975	OZA446-E2	1855	S3	0412
1.7i		1.7	77	01.91-12.93		R	3	19	975	OZA446-E2	1855	S3	0412

MARBELLA

0.9	09NCB	0.9	30	01.92-05.98		R	3	19	490	OZA446-E11	1898	S3	0412
-----	-------	-----	----	-------------	--	---	---	----	-----	------------	-------------	----	-------------

TOLEDO I

1.6i	1F	1.6	55	05.91-11.93	-> 1L..ZD..308 450	R	1	3	472	OZA401-E2	1802	S1	1951
1.6i	1F	1.6	55	11.93-08.95	1L..ZD..308 451 ->	R	2	4	480	OZA401-E4	1822	S2	1918

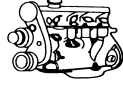

ℓ kW

STOCK
ORDER
No.
UNIVERSAL
No.
TYPE
No.
NUMBER
No.

SEAT

TOLEDO I

1.6i	AKL	1.6	74	10.98-03.99		R	4	64	470	OZA447-E17	0270	S4	1952
1.6i	AEH	1.6	74	10.98-03.99		R	4	64	470	OZA447-E17	0270	S4	1952
1.8i	RP	1.8	66	05.91-11.93	-> 1L..ZD..308 450	R	1	3	472	OZA401-E2	1802	S1	1951
1.8i	ABS	1.8	66	11.93-07.94	1L..ZD..308 451 ->	R	2	4	480	OZA401-E4	1822	S2	1918
1.8i 16V	PL	1.8	95	05.91-11.93	-> L..ZD..308 450	R	3	19	975	OZA446-E2	1855	S3	0412
2.0i	2E	2.0	85	03.94-06.96		R	4	36	1075	OZA527-E36	1993	S4CG	1919
2.0i	2E	2.0	85	05.91-03.94	-> 1L..ZD..320 000	R	4	17	583	OZA446-E42	0150	S4	1952
2.0i	2E	2.0	85	03.94-01.95	1L..ZD..320 001 ->	R	4	36	585	OZA572-E13	0254	S4CG	1919
					1L..ZR..020 000								
2.0i 16V	ABF	2.0	110	03.94-01.95	1L..ZD..320 001 ->	R	4	36	585	OZA572-E13	0254	S4CG	1919
					1L..ZR..020 000								
2.0i 16V	ABF	2.0	110	01.95-03.99	1L..ZR..023 558 ->	R	4	48	720	OZA447-E31	0460	S4	1952

TOLEDO II

1.4i 16V	AXP	1.4	55	06.00-02.02		D	4	65	575	OZA659-EE23	0397	---	---
1.6i 16V	AEH	1.6	74	04.99-05.02		R	4	64	1135	OZA659-EE25	0399	---	---
1.6i 16V	AKL	1.6	74	04.99-05.02		R	4	64	1135	OZA659-EE25	0399	---	---
1.6i 16V	AUS	1.6	77	09.00-10.02		R	5	92	810	LZA11-V4	1842	---	---
1.6i 16V	AUS	1.6	77	11.02-		R	5	92	810	LZA11-V4	1842	---	---
1.6i 16V	AUS	1.6	77	02.00-		D	4	65	541	OZA510-V4	0424	---	---
1.6i 16V	AZD	1.6	77	09.00-10.02		R	5	92	810	LZA11-V4	1842	---	---
1.6i 16V	AZD	1.6	77	11.02-		R	5	92	810	LZA11-V4	1842	---	---
1.6i 16V	AZD	1.6	77	02.00-		D	4	65	541	OZA510-V4	0424	---	---
1.8i 20V	APG	1.8	92	05.99-05.02		D	4	65	560	OZA659-EE14	0388	---	---
1.8 T	AUQ	1.8	132	09.00-05.02		D	4	64	975	OZA659-EE1	0375	---	---

TOLEDO III

1.6	BGU	1.6	75	06.04-		R	5	92	750	LZA07-V1	1851	---	---
1.6	BGU	1.6	75	06.04-		D	4	85	471	OZA510-V11	1884	---	---
1.6	BSE	1.6	75	06.04-		R	5	92	750	LZA07-V1	1851	---	---
1.6	BSE	1.6	75	06.04-		D	4	85	471	OZA510-V11	1884	---	---
1.6	BSF	1.6	75	06.04-		R	5	92	750	LZA07-V1	1851	---	---
1.6	BSF	1.6	75	06.04-		D	4	85	471	OZA510-V11	1884	---	---

SKODA

FABIA

1.0i	AQV	1.0	37	09.99-08.02		D	4	65	7	OZA659-EE14	0388	---	---
1.2i 12V	AWY	1.2	40	08.02-		R	4	64	601	OZA585-I1	1809	---	---
1.2i 12V	AWY	1.2	40	08.02-		D	4	65	231	OZA510-I1	1808	---	---
1.2i	BMD	1.2	40	11.04-		R	4	64	611	OZA534-V1	1778	---	---
1.2i	AZQ	1.2	47	01.03-		R	4	85	481	OZA532-V3	1776	---	---
1.2i	AZQ	1.2	47	01.03-		D	4	64	251	OZA510-V6	1885	---	---
1.4i	AZF	1.4	44	12.99-03.03		D	4	65	560	OZA659-EE14	0388	---	---
1.4i	AQW	1.4	50	12.99-05.03		D	4	65	560	OZA659-EE14	0388	---	---
1.4i	ATZ	1.4	50	12.99-05.03		D	4	65	560	OZA659-EE14	0388	---	---
1.4i 16V	AUA	1.4	55	09.99-		R	5	92	535	LZA11-V2	1774	---	---
1.4i 16V	AUA	1.4	55	09.99-		D	4	64	526	OZA510-V5	0435	---	---
1.4i 16V	BBY	1.4	55	09.99-		R	5	92	535	LZA11-V2	1774	---	---
1.4i 16V	BBY	1.4	55	09.99-		D	4	64	526	OZA510-V5	0435	---	---
1.4i	BKY	1.4	55	06.04-		R	5	91	330	LZA07-V3	1880	---	---

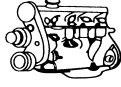

ℓ kW

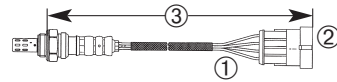
STOCK
ORDER
No.
UNIVERSAL
TYPE
No.
NUMBER
PL
NO.

SKODA

FABIA

1.4i	BKY	1.4	55	06.04-		D	4	64	526	OZA510-V5	0435	---	---
1.4i 16V	BXW	1.4	63	03.07-		R	4	84	511	OZA629-V3	1720	---	---
1.4i 16V	BXW	1.4	63	03.07-		D	4	64	526	OZA510-V5	0435	---	---
1.4i 16V	AUB	1.4	74	09.98-05.01		R	5	92	465	LZA11-V3	1829	---	---
1.4i 16V	AUB	1.4	74	09.98-05.01		D	4	64	1686	OZA510-V1	0491	---	---
1.4i 16V	AUB	1.4	74	09.98-05.01		D	4	64	1576	OZA510-V2	0402	---	---
1.4i 16V	BBZ	1.4	74	11.01-		R	5	92	535	LZA11-V2	1774	---	---
1.4i 16V	BBZ	1.4	74	11.01-		D	4	64	526	OZA510-V5	0435	---	---
1.6i 16V	BTS	1.6	77	04.07-		R	4	84	511	OZA629-V3	1720	---	---
1.6i 16V	BTS	1.6	77	04.07-		D	4	85	526	OZA629-V4	1721	---	---
2.0i	AZL	2.0	85	07.00-		D	4	65	545	OZA659-EE19	0393	---	---

FAVORIT

135	OHV	1.3	40	05.89-09.94		R	3	19	610	OZA446-E44	0162	S3	0412
135E	781.135E	1.3	40	12.92-06.95		R	4	36	550	OZA572-E1	0283	S4CG	1919

FELICIA

135	MPI	1.3	40	08.96-		R	4	36	517	OZA447-E13	0183	S4	1952
1.3i	AMG	1.3	40	01.99-		D	4	36	516	OZA457-I1	0414	---	---
136	MPI	1.3	50	08.96-		R	4	36	517	OZA447-E13	0183	S4	1952
1.3i	AMH	1.3	50	01.99-		D	4	36	516	OZA457-I1	0414	---	---
1.4i 16V	MN.7	1.4	55	09.99-		D	4	64	526	OZA510-V5	0435	---	---
1.4i 16V	MN.7	1.4	74	09.99-		D	4	64	526	OZA510-V5	0435	---	---
1.6	MPI	1.6	55	09.95-		R	4	36	517	OZA447-E13	0183	S4	1952

OCTAVIA

1.4i 16V	AXP	1.4	55	08.00-09.04		D	4	65	575	OZA659-EE23	0397	---	---
1.4i 16V	BCA	1.4	55	08.00-09.04		D	4	65	575	OZA659-EE23	0397	---	---
1.4i 16V	BUD	1.4	59	05.06-		R	4	84	511	OZA629-V3	1720	---	---
1.4i 16V	BUD	1.4	59	05.06-		D	4	64	526	OZA510-V5	0435	---	---
1.6i	AEH	1.6	74	11.96-07.98		R	4	64	470	OZA447-E17	0270	S4	1952
1.6i	AEH	1.6	74	08.98-09.04		R	4	64	1135	OZA659-EE25	0399	---	---
1.6i	AKL	1.6	74	08.00-09.04		R	4	64	1135	OZA659-EE25	0399	---	---
1.6i	AVU	1.6	75	08.00-09.04		D	4	65	560	OZA659-EE14	0388	---	---
1.6i	BFQ	1.6	75	08.00-09.04		D	4	65	560	OZA659-EE14	0388	---	---
1.6i	BGU	1.6	75	06.04-		R	5	92	750	LZA07-V1	1851	---	---
1.6i	BGU	1.6	75	06.04-		D	4	85	471	OZA510-V11	1884	---	---
1.6i	BSE	1.6	75	06.04-		R	5	92	750	LZA07-V1	1851	---	---
1.6i	BSE	1.6	75	06.04-		D	4	85	471	OZA510-V11	1884	---	---
1.6i	BSF	1.6	75	06.04-		R	5	92	750	LZA07-V1	1851	---	---
1.6i	BSF	1.6	75	06.04-		D	4	85	471	OZA510-V11	1884	---	---
1.8i T	ARZ	1.8	110	01.00-07.00		D	4	65	560	OZA659-EE14	0388	---	---
1.8i T	AUM	1.8	110	08.00-09.04		D	4	64	975	OZA659-EE1	0375	---	---
1.8i T	ARX	1.8	110	08.00-09.04		D	4	64	975	OZA659-EE1	0375	---	---
1.8i T RS	AUQ	1.8	132	08.00-09.04		D	4	64	975	OZA659-EE1	0375	---	---
2.0i	AEG	2.0	85	08.00-10.02		R	4	64	975	OZA659-EE1	0375	---	---
2.0i	AEG	2.0	85	11.02-01.05		R	4	64	1135	OZA659-EE25	0399	---	---
2.0i	APK	2.0	85	06.99-09.04		R	4	64	975	OZA659-EE1	0375	---	---
2.0i	APK	2.0	85	06.99-09.04		D	4	65	490	OZA659-EE18	0392	---	---
2.0i	AQY	2.0	85	06.99-09.04		R	4	64	975	OZA659-EE1	0375	---	---
2.0i	AQY	2.0	85	06.99-09.04		D	4	65	490	OZA659-EE18	0392	---	---
2.0i	AZH	2.0	85	08.00-09.04		D	4	65	560	OZA659-EE14	0388	---	---

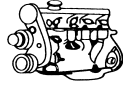

ℓ kW



ORDER No.
STOCK No.
UNIVERSAL No.
TYPE No.
NUMBER No.

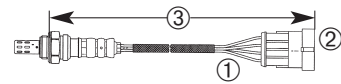

SKODA

OCTAVIA

2.0i 4x4	AZJ	2.0	85	03.02-09.04		D	4	65	740	OZA659-EE11	0385	---	---
----------	-----	-----	----	-------------	--	----------	---	----	-----	-------------	-------------	-----	-----

PRAKTIK

1.4i 16V	BXW	1.4	63	06.07-		R	4	84	511	OZA629-V3	1720	---	---
1.4i 16V	BXW	1.4	63	06.07-		D	4	64	526	OZA510-V5	0435	---	---

ROOMSTER

1.4i 16V	BXW	1.4	63	09.06-		R	4	84	511	OZA629-V3	1720	---	---
1.4i 16V	BXW	1.4	63	09.06-		D	4	64	526	OZA510-V5	0435	---	---
1.6i 16V	BTS	1.6	77	05.06-		R	4	84	511	OZA629-V3	1720	---	---
1.6i 16V	BTS	1.6	77	05.06-		D	4	85	526	OZA629-V4	1721	---	---

SUPERB

1.8i T	AWT	1.8	110	12.01-		D	4	65	690	OZA659-EE64	7949	---	---
2.8i V6	AMX	2.8	140	12.01-		R	4	48	615	OZA659-EE36	1620	---	---
2.8i V6	AMX	2.8	140	12.01-	↑ / Bank 1	D	4	48	1435	OZA659-EE46	5748	---	---
2.8i V6	AMX	2.8	140	12.01-	↑ / Bank 2	D	4	66	1440	OZA659-EE47	5750	---	---
2.8i V6	BBG	2.8	142	12.01-		R	4	48	615	OZA659-EE36	1620	---	---
2.8i V6	BBG	2.8	142	12.01-	↑ / Bank 1	D	4	48	1435	OZA659-EE46	5748	---	---
2.8i V6	BBG	2.8	142	12.01-	↑ / Bank 2	D	4	66	1440	OZA659-EE47	5750	---	---

PICK UP

135	MPI	1.3	40	08.96-		R	4	36	517	OZA447-E13	0183	S4	1952
136	MPI	1.3	50	08.96-		R	4	36	517	OZA447-E13	0183	S4	1952
1.6	AEE MPI	1.6	55	10.95-		R	4	36	517	OZA447-E13	0183	S4	1952

SMART

FORTWO COUPE

0.6i		0.6	37	02.04-		R	4	47	295	OZA659-EE42	1629	---	---
0.6i		0.6	37	02.04-		D	4	47	295	OZA659-EE42	1629	---	---
0.6i		0.6	45	02.04-		R	4	47	295	OZA659-EE42	1629	---	---
0.6i		0.6	45	02.04-		D	4	47	295	OZA659-EE42	1629	---	---
0.7i Brabus		0.7	55	02.04-		R	4	47	295	OZA659-EE42	1629	---	---
0.7i Brabus		0.7	55	02.04-		D	4	47	295	OZA659-EE42	1629	---	---
1.0i		1.0	45	03.07-		R	4	89	300	OZA571-GB1	1709	---	---
1.0i		1.0	45	03.07-		D	4	89	300	OZA571-GB1	1709	---	---
1.0i		1.0	52	03.07-		R	4	89	300	OZA571-GB1	1709	---	---
1.0i		1.0	52	03.07-		D	4	89	300	OZA571-GB1	1709	---	---
1.0i		1.0	62	03.07-		R	4	89	300	OZA571-GB1	1709	---	---
1.0i		1.0	62	03.07-		D	4	89	300	OZA571-GB1	1709	---	---
1.0i Brabus		1.0	72	03.07-		R	4	89	300	OZA571-GB1	1709	---	---
1.0i Brabus		1.0	72	03.07-		D	4	89	300	OZA571-GB1	1709	---	---

FORTWO CABRIO

0.7i		0.7	45	02.04-		R	4	47	295	OZA659-EE42	1629	---	---
0.7i		0.7	45	02.04-		D	4	47	295	OZA659-EE42	1629	---	---
0.7i Brabus		0.7	55	02.04-		R	4	47	295	OZA659-EE42	1629	---	---
0.7i Brabus		0.7	55	02.04-		D	4	47	295	OZA659-EE42	1629	---	---
1.0i		1.0	52	03.07-		R	4	89	300	OZA571-GB1	1709	---	---
1.0i		1.0	52	03.07-		D	4	89	300	OZA571-GB1	1709	---	---

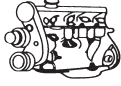

ℓ kW

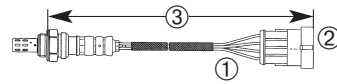

STOCK No. TYPE No. UNITS AVAILABLE INVENTORY No.

SMART

FORTWO COUPE

1.0i		1.0	62	03.07-		R	4	89	300	OZA571-GB1	1709	---	---
1.0i		1.0	62	03.07-		D	4	89	300	OZA571-GB1	1709	---	---
1.0i Brabus		1.0	72	03.07-		R	4	89	300	OZA571-GB1	1709	---	---
1.0i Brabus		1.0	72	03.07-		D	4	89	300	OZA571-GB1	1709	---	---

ROADSTER

0.7i	160.921	0.7	45	04.03-11.05		R	4	47	295	OZA659-EE42	1629	---	---
0.7i	160.922	0.7	60	04.03-11.05		R	4	47	295	OZA659-EE42	1629	---	---
0.7i Brabus	160.923	0.7	74	12.03-11.05		R	4	47	295	OZA659-EE42	1629	---	---

ROADSTER COUPE

0.7i	160.921	0.7	45	04.03-11.05		R	4	47	295	OZA659-EE42	1629	---	---
0.7i	160.922	0.7	60	04.03-11.05		R	4	47	295	OZA659-EE42	1629	---	---
0.7i Brabus	160.923	0.7	74	12.03-11.05		R	4	47	295	OZA659-EE42	1629	---	---

SMART CITY-COUPE

0.6i		0.6	33	07.98-01.04		R	4	47	295	OZA659-EE42	1629	---	---
0.6i		0.6	33	07.98-01.04		D	4	47	295	OZA659-EE42	1629	---	---
0.6i		0.6	37	01.03-01.04		R	4	47	295	OZA659-EE42	1629	---	---
0.6i		0.6	37	01.03-01.04		D	4	47	295	OZA659-EE42	1629	---	---
0.6i		0.6	40	07.98-01.04		R	4	47	295	OZA659-EE42	1629	---	---
0.6i		0.6	40	07.98-01.04		D	4	47	295	OZA659-EE42	1629	---	---
0.6i		0.6	45	01.01-01.04		R	4	47	295	OZA659-EE42	1629	---	---
0.6i		0.6	45	01.01-01.04		D	4	47	295	OZA659-EE42	1629	---	---
0.6i		0.6	52	01.01-01.04		R	4	47	295	OZA659-EE42	1629	---	---
0.6i		0.6	52	01.01-01.04		D	4	47	295	OZA659-EE42	1629	---	---
0.7i		0.7	45	01.03-01.04		R	4	47	295	OZA659-EE42	1629	---	---
0.7i		0.7	45	01.03-01.04		D	4	47	295	OZA659-EE42	1629	---	---
0.7i Brabus		0.7	55	01.03-01.04		R	4	47	295	OZA659-EE42	1629	---	---
0.7i Brabus		0.7	55	01.03-01.04		D	4	47	295	OZA659-EE42	1629	---	---

SMART CABRIO

0.6i		0.6	40	03.00-01.04		R	4	47	295	OZA659-EE42	1629	---	---
0.6i		0.6	40	03.00-01.04		D	4	47	295	OZA659-EE42	1629	---	---
0.6i		0.6	45	03.00-01.04		R	4	47	295	OZA659-EE42	1629	---	---
0.6i		0.6	45	03.00-01.04		D	4	47	295	OZA659-EE42	1629	---	---
0.6i		0.6	52	03.00-01.04		R	4	47	295	OZA659-EE42	1629	---	---
0.6i		0.6	52	03.00-01.04		D	4	47	295	OZA659-EE42	1629	---	---
0.7i		0.7	45	01.03-01.04		R	4	47	295	OZA659-EE42	1629	---	---
0.7i		0.7	45	01.03-01.04		D	4	47	295	OZA659-EE42	1629	---	---
0.7i Brabus		0.7	55	01.03-01.04		R	4	47	295	OZA659-EE42	1629	---	---
0.7i Brabus		0.7	55	01.03-01.04		D	4	47	295	OZA659-EE42	1629	---	---

SSANGYONG

MUSSO

3.2i 24V	162.990	3.2	162	01.96-		R	4	41	750	OZA527-E25	0444	S4CG	1919

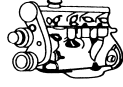

ℓ kW

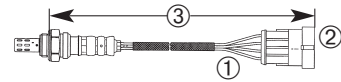

STOCK
ORDER
No.
UNIVERSAL
TYPE
No.
UNIVERSAL
TYPE
No.

STEYR-DAIMLER-PUCH

G-MODELL

	M112.945	3.2	158	01.98-		R	4	47	565	OZA447-E21	0216	S4	1952
	M113.962	5.0	218	01.98-		R	4	47	565	OZA447-E21	0216	S4	1952

SUBARU

IMPREZA

1.6i	EJ16E / EJ16J	1.6	66	01.93-07.98		R	3	80	440	OZA395-E9	0495	S3	0412
1.6i 4WD	EJ16E / EJ16J	1.6	66	01.93-07.98		R	3	80	440	OZA395-E9	0495	S3	0412
1.6i Coupe	EJ16E	1.6	66	10.93-09.00		R	3	80	440	OZA395-E9	0495	S3	0412
1.6i Kombi	EJ16E / EJ16J	1.6	66	01.93-07.98		R	3	80	440	OZA395-E9	0495	S3	0412
1.6i Kombi 4WD	EJ16E / EJ16J	1.6	66	01.93-07.98		R	3	80	440	OZA395-E9	0495	S3	0412
1.8i	EJ18E	1.8	76	01.93-06.97		R	3	80	440	OZA395-E9	0495	S3	0412
1.8i 4WD	EJ18E	1.8	76	01.93-06.97		R	3	80	440	OZA395-E9	0495	S3	0412
1.8i Kombi	EJ18E	1.8	76	01.93-06.97		R	3	80	440	OZA395-E9	0495	S3	0412
1.8i Kombi 4WD	EJ18E	1.8	76	01.93-06.97		R	3	80	440	OZA395-E9	0495	S3	0412
2.0i	EJ20E	2.0	85	08.95-07.98		R	3	80	440	OZA395-E9	0495	S3	0412
2.0i 4WD	EJ20E	2.0	85	08.95-07.98		R	3	80	440	OZA395-E9	0495	S3	0412
2.0i Kombi	EJ20E	2.0	85	08.95-07.98		R	3	80	440	OZA395-E9	0495	S3	0412
2.0i Kombi 4WD	EJ20E	2.0	85	08.95-07.98		R	3	80	440	OZA395-E9	0495	S3	0412

JUSTY I

1000	EF10	1.0	37	05.87-10.95	Universal	R	1	---	---	OZA624-E1	1951	S1	1951
1000 4WD	EF10	1.0	37	05.87-11.94	Universal	R	1	---	---	OZA624-E1	1951	S1	1951
1200	EF12	1.2	49	05.87-10.95	Universal	R	1	---	---	OZA624-E1	1951	S1	1951
1200 4WD	EF12	1.2	49	05.87-05.91	Universal	R	1	---	---	OZA624-E1	1951	S1	1951

JUSTY II

1.3 GX 4x4	EF13	1.3	50	10.95-		R	1	6	320	OZA401-E6	1882	S1	1951
------------	------	-----	----	--------	--	---	---	---	-----	-----------	------	----	------

LEGACY I

1.8i	EJ18A / EJ18S	1.8	76	01.89-12.93		R	3	80	440	OZA395-E9	0495	S3	0412
1.8i 4WD	EJ18A / EJ18S	1.8	76	01.89-12.93		R	3	80	440	OZA395-E9	0495	S3	0412
2.0i 16V	EJ20E	2.0	85	05.92-12.93		R	3	80	440	OZA446-E55	0450	S3	0412
2.0i 16V 4WD	EJ20E	2.0	85	05.92-12.93		R	3	80	440	OZA446-E55	0450	S3	0412
2.2i	EJ22	2.2	100	01.89-11.89		R	3	80	440	OZA395-E9	0495	S3	0412
2.2i 4WD	EJ22	2.2	100	01.89-11.89		R	3	80	440	OZA395-E9	0495	S3	0412

LEGACY II

1.8i	EJ18E	1.8	76	07.95-11.98		R	3	80	440	OZA395-E9	0495	S3	0412
2.0i 16V	EJ20E	2.0	85	01.94-11.98		R	3	80	440	OZA446-E55	0450	S3	0412
2.0i 16V 4WD	EJ20E	2.0	85	01.94-11.98		R	3	80	440	OZA446-E55	0450	S3	0412
2.0i Kombi	EJ20E	2.0	85	01.94-08.98		R	3	80	440	OZA395-E9	0495	S3	0412
2.0i Kombi 4WD	EJ20E	2.0	85	01.94-08.98		R	3	80	440	OZA395-E9	0495	S3	0412
2.2i	EJ22E	2.2	96	01.94-05.97		R	3	80	440	OZA395-E9	0495	S3	0412
2.2i 4WD	EJ22E	2.2	96	01.94-05.97		R	3	80	440	OZA395-E9	0495	S3	0412
2.2i Kombi	EJ22E	2.2	96	01.94-05.97		R	3	80	440	OZA395-E9	0495	S3	0412
2.2i Kombi 4WD	EJ22E	2.2	96	01.94-05.97		R	3	80	440	OZA395-E9	0495	S3	0412

LEONE II

1800 4WD	EA82	1.8	88	01.88-12.90	Universal	R	1	---	---	OZA624-E1	1951	S1	1951
----------	------	-----	----	-------------	-----------	---	---	-----	-----	-----------	------	----	------

SVX

3.3i	EG33	3.3	176	09.92-12.96		R	3	80	440	OZA395-E9	0495	S3	0412
------	------	-----	-----	-------------	--	---	---	----	-----	-----------	------	----	------

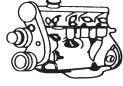

ℓ kW

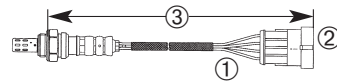
STOCK
UNIVERSAL
TYPE
UNIVERSAL
INVENTORY
NO.
NO.
NO.
NO.

SUZUKI

BALENO

1.3i 16V	G13B	1.3	63	07.95-04.05	Universal	R	1	---	---	OZA624-E1	1951	S1	1951
1.6i 16V	G16B	1.6	72	07.95-04.05	Universal	R	1	---	---	OZA624-E1	1951	S1	1951
1.6i 16V SW	G16B	1.6	72	08.96-	Universal	R	1	---	---	OZA624-E1	1951	S1	1951

JIMNY

1.3 16V	M13A	1.3	60	02.01-		R	4	96	245	OZA668-EE13	7952	---	---
---------	------	-----	----	--------	--	---	---	----	-----	-------------	------	-----	-----

SAMURAI

1.3	G13BA	1.3	51	01.90-		R	1	5	380	OZA401-E56	0154	S1	1951
-----	-------	-----	----	--------	--	---	---	---	-----	------------	------	----	------

SWIFT

1.0	G10A	1.0	39	10.91-08.96		R	1	6	320	OZA401-E6	1882	S1	1951
1.0	G10A	1.0	40	12.89-09.91		R	1	6	320	OZA401-E6	1882	S1	1951
1.3	G13A	1.3	50	08.94-05.01		R	1	6	320	OZA401-E6	1882	S1	1951
1.3	G13BA	1.3	50	10.91-07.94		R	1	6	320	OZA401-E6	1882	S1	1951
1.3	G13BA	1.3	52	12.89-09.91		R	1	6	320	OZA401-E6	1882	S1	1951
1.3	G13B	1.3	74	10.86-09.91		R	1	6	445	OZA401-E58	0166	S1	1951
1.6i	G16B	1.6	68	01.90-05.01		R	1	6	320	OZA401-E6	1882	S1	1951
1.6i 4x4	G16B	1.6	68	01.90-05.01		R	1	6	320	OZA401-E6	1882	S1	1951

VITARA

1.6 Soft Top	G16A	1.6	60	07.88-12.91		R	1	5	380	OZA401-E56	0154	S1	1951
1.6 SW	G16A	1.6	60	07.88-12.91		R	1	5	380	OZA401-E56	0154	S1	1951
1.6	G16A	1.6	60	08.88-08.91		R	1	5	380	OZA401-E56	0154	S1	1951

TOYOTA

AYGO

1.0i	1KR-FE	1.0	50	02.05-		R	4	123	275	OZA659-EE62	7916	---	---
1.0i	1KR-FE	1.0	50	02.05-		D	4	34	290	OZA659-EE63	7948	---	---

AVENSIS

1.6i 16V	T22	4A-FE	1.6	74	09.97-10.00		R	4	34	310	OZA448-E47	0228	S4	1952
1.6i 16V	T22	4A-FE	1.6	81	09.97-10.00		R	4	34	310	OZA448-E47	0228	S4	1952
1.8i	T22	1ZZ-FE	1.8	95	07.00-02.03		R	4	123	365	OZA669-EE9	7954	---	---
2.0i	T22	3S-FE	2.0	94	10.97-06.00		R	4	34	330	OZA669-EE12	7973	---	---
2.0i VVT-i	T22	1AF-SE	2.0	110	07.00-01.03	↑	R	4	34	330	OZA669-EE12	7973	---	---
2.0i VVT-i	T22	1AF-SE	2.0	110	07.00-01.03	↑	R	4	123	365	OZA669-EE9	7954	---	---
2.0i	T22	1AZF-SE	2.0	110	07.00-01.03	↑	R	4	34	330	OZA669-EE12	7973	---	---
2.0i	T22	1AZF-SE	2.0	110	07.00-01.03	↑	R	4	123	365	OZA669-EE9	7954	---	---

CAMRY

2.2i 16V SW	V10	5S-FE	2.2	100	03.92-07.96		R	4	34	300	OZA384-E39	0473	---	---
2.2i 16V	V1	5S-FE	2.2	100	06.91-08.96		R	4	34	300	OZA384-E39	0473	---	---
3.0i	V20	1MZ-FE	3.0	137	08.01-12.05		D	4	123	315	OZA669-EE10	7970	---	---
3.0i	V20	1MZ-FE	3.0	140	08.96-08.99	↑	R	4	34	330	OZA669-EE12	7973	---	---
3.0i	V20	1MZ-FE	3.0	140	08.99-07.01		D	4	34	640	OZA669-EE8	7953	---	---

CARINA E

1.6	AT190	4A-FE	1.6	72-79	04.92-		R	---	---	---	---	---	---	
2.0i 16V	T19	3S-FE	2.0	93	05.95-10.97		R	4	34	300	OZA384-E39	0473	---	---
2.0i 16V	T19	3S-FE	2.0	98	11.92-01.96		R	4	34	300	OZA384-E39	0473	---	---
2.0 GTi	T19	3S-GE	2.0	116	04.92-01.96		R	4	34	338	OZA384-E40	0484	S4	1952

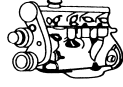

ℓ kW



ORDER No.
UNIVERSAL No.
TYPE No.
SUNBELT No.

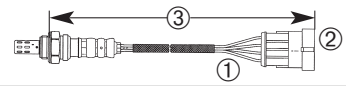

TOYOTA

CELICA

1.6 STI	T18	4A-FE	1.6	77	09.91-10.93		R	4	34	338	OZA384-E40	0484	S4	1952
2.0i	T20	3S-GER	2.0	125	06.96-08.99		R	4	34	330	OZA669-EE12	7973	---	---
2.0i	T20	3S-GER	2.0	129	06.96-07.99		R	4	34	330	OZA669-EE12	7973	---	---

COROLLA

1.3 LB	EE90	2E	1.3	55	08.87-04.92		R	1	7	340	OZA401-E49	0120	---	---
1.3 Sedan	EE90	2E	1.3	55	08.87-04.92		R	1	7	340	OZA401-E49	0120	---	---
1.3 SW	EE90	2E	1.3	55	08.87-04.92		R	1	7	340	OZA401-E49	0120	---	---
1.3 Compact	EE90	2E	1.3	55	08.87-04.92		R	1	7	340	OZA401-E49	0120	---	---
1.3	E10	4E-FE	1.3	65	08.92-09.95	OE 89465-19575	R	4	34	200	OZA448-E16	1839	---	---
1.4i 16V HB	E11	4ZZ-FE	1.4	71	10.99-07.01		R	4	34	525	OZA447-E41	1739	S4	1952
1.4i 16V LB	E11	4ZZ-FE	1.4	71	10.99-09.01		R	4	34	525	OZA447-E41	1739	S4	1952
1.4i 16V Sedan	E11	4ZZ-FE	1.4	71	10.99-09.01		R	4	34	525	OZA447-E41	1739	S4	1952
1.4i 16V SW	E11	4ZZ-FE	1.4	71	10.99-09.01		R	4	34	525	OZA447-E41	1739	S4	1952
1.6 Gti	E9	4A-GE	1.6	85	08.87-04.92		R	4	48	985	OZA447-E30	0449	S4	1952

HIACE

2.4 4WD	H1	2R-ZE	2.4	88	08.89-07.95		R	4	34	338	OZA384-E40	0484	S4	1952
2.4	H1	2R-ZE	2.4	88	08.89-08.95		R	4	34	338	OZA384-E40	0484	S4	1952

LAND CRUISER

3.4i 24V	J9	5VZ-FE	3.4	131	04.96-		R	4	34	392	OZA384-E32	0133	S4	1952
----------	----	--------	-----	-----	--------	--	---	---	----	-----	------------	------	----	------

MR 2

1.8i 16V VT-i	W3	1ZZ-FE	1.8	103	12.99-		R	4	34	330	OZA669-EE12	7973	---	---
1.8i 16V VT-i	W3	1ZZ-FE	1.8	103	12.99-		D	4	34	640	OZA669-EE8	7953	---	---
2.0i 16V	W2	3S-GE	2.0	115	11.93-06.96		R	4	34	392	OZA384-E32	0133	S4	1952
2.0i 16V	W2	3S-GE	2.0	125	11.93-06.96		R	4	34	392	OZA384-E32	0133	S4	1952
2.0i 16V	W2	3S-GE	2.0	129	11.93-06.96		R	4	34	392	OZA384-E32	0133	S4	1952

PASEO

1.5i	EL54	5E-FE	1.5	66	08.95-08.96		R	4	34	330	OZA669-EE12	7973	---	---
1.5i	EL54	5E-FE	1.5	66	04.97-03.99		R	4	34	330	OZA669-EE12	7973	---	---

PICNIC

2.0i	XM10	3S-FE	2.0	94	09.96-05.00		R	4	34	330	OZA669-EE12	7973	---	---
------	------	-------	-----	----	-------------	--	---	---	----	-----	-------------	------	-----	-----

PREVIA

2.4	CR	2TZ-FE	2.4	97	10.90-		R	4	34	392	OZA384-E32	0133	---	---
-----	----	--------	-----	----	--------	--	---	---	----	-----	------------	------	-----	-----

PRIUS

1.5i	NHW11	1NZ-FXE	1.5	53	05.00-07.03		R	4	34	330	OZA669-EE12	7973	---	---
------	-------	---------	-----	----	-------------	--	---	---	----	-----	-------------	------	-----	-----

RAV 4

2.0i	SXA1	3S-FE	2.0	94	12.97-04.00		R	4	34	330	OZA669-EE12	7973	---	---
2.0i	SXA1	3S-FE	2.0	95	08.96-07.00		R	4	34	330	OZA669-EE12	7973	---	---

STARLET

1.3i 16V	EP91	4E-FE	1.3	55	01.96-07.99		R	4	34	330	OZA669-EE12	7973	---	---
1.3i 16V	EP91	4E-FE	1.3	55	01.96-		R	4	34	275	OZA502-E31	0250	S4	1952

YARIS

1.0i		1SZ-FE	1.0	50	01.99-12.02		R	4	34	640	OZA669-EE8	7953	---	---
1.0i		1SZ-FE	1.0	50	01.99-12.02		D	4	34	330	OZA669-EE12	7973	---	---
1.0i VVT-i		1KR-FE	1.0	50	01.06-		R	4	123	275	OZA659-EE62	7916	---	---
1.0i VVT-i		1KR-FE	1.0	50	01.06-		D	4	34	290	OZA659-EE63	7948	---	---

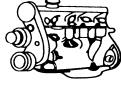

ℓ kW

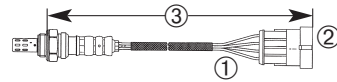

ORDER No.
STOCK No.
UNIVERSAL No.
TYPE No.
SUBVERSAL No.
SUSPENSION No.

TOYOTA

YARIS

1.3i	2NZ-FE	1.3	63	08.99-12.02		R	4	34	330	OZA669-EE12	7973	---	---
1.5i	1NZ-FE	1.5	78	01.01-12.02		R	4	34	330	OZA669-EE12	7973	---	---

YARIS VERSO

1.3i	2NZ-FE	1.3	63	08.99-11.02		R	4	34	330	OZA669-EE12	7973	---	---
1.5i	1NZ-FE	1.5	78	03.00-11.02		R	4	34	330	OZA669-EE12	7973	---	---

4-RUNNER

2.7i	3RZ-FE	2.7	112	11.95-		R	4	34	275	OZA502-E31	0250	S4	1952
3.4i	5VZ-FE	3.4	136	11.95-		R	4	34	392	OZA384-E32	0133	S4	1952

TVR

CERBERA

		4.2		01.96-01.01		R	3	55	521	OTD3G-3A1	0453	---	---
--	--	-----	--	-------------	--	---	---	----	-----	-----------	------	-----	-----

CHIMAERA

		4.0		01.93-01.01		R	3	55	521	OTD3G-3A1	0453	---	---
--	--	-----	--	-------------	--	---	---	----	-----	-----------	------	-----	-----

GRIFFITH

		4.0		01.92-01.01		R	3	55	521	OTD3G-3A1	0453	---	---
--	--	-----	--	-------------	--	---	---	----	-----	-----------	------	-----	-----

T 350

		3.6	257	01.06-		R	4	33	738	OZA341-NB1	0037	---	---
--	--	-----	-----	--------	--	---	---	----	-----	------------	------	-----	-----

TAMORA

		3.6	257	01.06-		R	4	33	738	OZA341-NB1	0037	---	---
--	--	-----	-----	--------	--	---	---	----	-----	------------	------	-----	-----

TUSCAN

		4.0	268	01.06-		R	4	33	738	OZA341-NB1	0037	---	---
--	--	-----	-----	--------	--	---	---	----	-----	------------	------	-----	-----

VOLVO

200

2.3 Injection SW	B230FD	2.3		08.92-08.93	-> 808 999	R	3	19	975	OZA446-E2	1855	S3	0412
2.3 Injection	B230FD	2.3		08.92-08.93	-> 334 099	R	3	19	975	OZA446-E2	1855	S3	0412
2.3 Injection	B230F	2.3	84	08.84-07.88	-> 334 099	R	3	19	975	OZA446-E2	1855	S3	0412
2.3 Injection SW	B230F	2.3	84	08.84-07.88	-> 808 999	R	3	19	975	OZA446-E2	1855	S3	0412

400

1.6i	B16F	1.6	61	09.93-08.97		R	3	19	1665	OZA446-E49	0291	S3	0412
1.7 Injection	B18F	1.7	70	09.88-08.91		R	3	19	1665	OZA446-E49	0291	S3	0412
1.7 GL	B18FP	1.7	75	09.89-08.91		R	3	19	1665	OZA446-E49	0291	S3	0412
1.7 Turbo	B18FT	1.7	88	09.88-08.91		R	3	19	1665	OZA446-E49	0291	S3	0412
1.7 Turbo	B18FT	1.7	90	01.91-07.96		R	3	19	1665	OZA446-E49	0291	S3	0412
1.8 Injection	B18U	1.8	66	09.91-08.97		R	3	19	1665	OZA446-E49	0291	S3	0412
2.0i	B20F	2.0	80	09.92-12.96		R	3	19	1665	OZA446-E49	0291	S3	0412
1.6 Injection	B16F	1.6	61	09.93-08.97		R	3	19	1665	OZA446-E49	0291	S3	0412
1.8 Injection	B18U	1.8	66	09.91-08.97		R	3	19	1665	OZA446-E49	0291	S3	0412
1.7 GLE	B18FP	1.7	75	03.90-08.91		R	3	19	975	OZA446-E2	1855	S3	0412
1.7 GLE	B18FP	1.7	75	09.91-08.93	-> 603 473	R	3	19	1665	OZA446-E49	0291	S3	0412
2.0 Injection	B20F	2.0	80	09.92-12.96		R	3	19	1665	OZA446-E49	0291	S3	0412
1.7 Turbo	B18FT	1.7	88	03.90-08.91		R	3	19	975	OZA446-E2	1855	S3	0412
1.7 Turbo	B18FT	1.7	88	09.91-09.96	-> 603 473	R	3	19	1665	OZA446-E49	0291	S3	0412

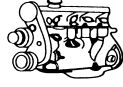

ℓ kW



ORDER NO. STOCK No. TYPE UNIVERSAL No. NUMBER No.

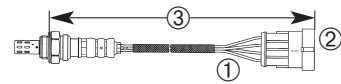

VOLVO

400

1.7 ES	B18F	1.7	70-75	05.87-08.89		R	3	19	1665	OZA446-E49	0291	S3	0412
1.7 Turbo	B18FT	1.7	88-90	08.88-08.95		R	3	19	1665	OZA446-E49	0291	S3	0412
2.0 Injection	B20F	2.0	81	09.92-12.96		R	3	19	1665	OZA446-E49	0291	S3	0412

700

2.0 Injection	B200F	2.0	82	08.89-07.93	-> 294 099	R	3	19	670	OZA446-E1	1833	S3	0412
2.0 Injection	B200F	2.0	82	08.89-07.93	294 100 ->	R	3	19	975	OZA446-E2	1855	S3	0412
2.0 Injection SW	B200F	2.0	82	08.89-07.93	-> 176 799	R	3	19	670	OZA446-E1	1833	S3	0412
2.0 Injection SW	B200F	2.0	82	08.89-07.93	176 800 ->	R	3	19	975	OZA446-E2	1855	S3	0412
2.0 Injection Turbo	B200FT	2.0	114	08.90-07.92		R	3	19	975	OZA446-E2	1855	S3	0412
2.0i 16V Turbo Intercooler	B204GT	2.0	136	08.89-07-90	ⓘ	R	3	19	885	OZA445-E6	0258	S3	0412
2.0 Injection 16V Turbo Intercooler	B204FT	2.0	140	01.90-07.90	ⓘ	R	3	19	975	OZA446-E2	1855	S3	0412
2.3 Injection	B230F	2.3	85	08.88-08.94	-> 294 099 🇪🇺	R	3	19	975	OZA446-E2	1855	S3	0412
2.3 Injection SW	B230F	2.3	85	08.88-08.94	->176 700 🇪🇺	R	3	19	975	OZA446-E2	1855	S3	0412
2.3i	B230F	2.3	85	08.87-07.92		R	3	57	1700	OTA4F-3B1	1763	---	---
2.3 Injection Turbo Intercooler	B230FT	2.3	114-119	08.89-07.91		R	3	19	975	OZA446-E2	1855	S3	0412
2.3i Turbo Intercooler	B230GT	2.3	120	08.89-07-90		R	3	19	885	OZA445-E6	0258	S3	0412
2.3i Turbo	B230GT	2.3	120	08.89-07-90		R	3	19	885	OZA445-E6	0258	S3	0412
2.3 Injection Turbo	B230FT	2.3	114-119	08.84-07.89		R	3	19	975	OZA446-E2	1855	S3	0412
2.3 Injection Turbo	B230FT	2.3	114-119	08.89-07.92		R	3	19	975	OZA446-E2	1855	S3	0412
2.8 Injection	B280F	2.8	105	05.86-10.86		R	3	19	1665	OZA446-E49	0291	S3	0412
2.0i 16V Turbo Intercooler	B204GT	2.0	136	08.89-07-90		R	3	19	885	OZA445-E6	0258	S3	0412

800

2.0	N2H20	2.0	93	05.94-12.96		R	4	50	530	OTA4N-5B1	1765	---	---
2.0	B5204F	2.0	105	09.91-12.96	-> 70018 🇪🇺	R	4	38	880	OZA527-E4	0218	S4CG	1919
2.0 SW	B5204F	2.0	105	09.91-08.96	-> 821 🇪🇺	R	4	38	880	OZA527-E4	0218	S4CG	1919
2.0 Turbo	B5204FT	2.0	155	01.95-12.96		R	4	73	740	OZA660-EE11	5697	S4	1952
2.0 Turbo SW	B5204FT	2.0	155	01.95-12.96		R	4	73	740	OZA660-EE11	5697	S4	1952
2.0 Turbo SW	B5204T	2.0	155	01.95-12.96		R	4	73	740	OZA660-EE11	5697	S4	1952
2.3 T5	B5234FT	2.3	166	08.93-07.96		R	4	73	740	OZA660-EE11	5697	S4	1952
2.3 T5 SW	B5234FT	2.3	166	09.93-07.96		R	4	73	740	OZA660-EE11	5697	S4	1952
2.3 T5-R	B5234T4	2.3	184	08.95-12.96		R	4	73	740	OZA660-EE11	5697	S4	1952
2.3 T5-R SW	B5234T4	2.3	184	08.95-12.96		R	4	73	740	OZA660-EE11	5697	S4	1952
2.5 Bi-Fuel	N2H25	2.5	103	08.97-04.99		R	4	81	570	OZA324-L1	1779	---	---
2.5	N2H25	2.5	106	02.93-12.96		R	4	50	530	OTA4N-5B1	1765	---	---
2.5	B5252	2.5	103	06.91-07.94		R	4	50	530	OTA4N-5B1	1765	---	---
2.5	B5252FS	2.5	103	06.91-07.94		R	4	50	530	OTA4N-5B1	1765	---	---
2.5i	N2H25	2.5	106	04.91-02.93		R	4	94	530	OTA4N-5A1	1755	---	---
2.5	B5254S	2.5	125	08.96-12.96		R	4	73	740	OZA660-EE11	5697	S4	1952
2.5 SW	B5254S	2.5	125	08.96-12.96		R	4	73	740	OZA660-EE11	5697	S4	1952
2.5 GLT	B5254F	2.5	125	09.91-12.96	-> 70018 🇪🇺	R	4	38	880	OZA527-E4	0218	S4CG	1919
2.5 GLT SW	B5254F	2.5	125	09.91-12.96	-> 821 🇪🇺	R	4	38	880	OZA527-E4	0218	S4CG	1919
2.5 AWD	B5254T	2.5	142	09.96-12.96		R	4	73	740	OZA660-EE11	5697	S4	1952
2.5 AWD SW	B5254T	2.5	142	09.96-12.96		R	4	73	740	OZA660-EE11	5697	S4	1952

900

2.0 Turbo Intercooler	B200FT	2.0	114	09.91-08.93		R	3	19	975	OZA446-E2	1855	S3	0412
2.3 Turbo Intercooler	B230FT	2.3	121	09.90-08.93	🇪🇺	R	3	19	975	OZA446-E2	1855	S3	0412
2.3i	B230F	2.3	85	08.92-07.94		R	3	57	1700	OTA4F-3B1	1763	---	---
2.3i	B230F Regina	2.3	85	08.92-07.94		R	3	95	1900	OTA4F-3C1	1773	---	---
2.3 Turbo	B230FT	2.3	121	09.93-07.94		R	3	77	1095	OZA446-E58	0483	S3	0412
2.0 Turbo SW	B200FT	2.0	114	09.93-07.95		R	3	77	1095	OZA446-E58	0483	S3	0412

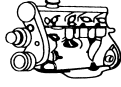

ℓ kW

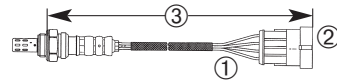

ORDER No. STOCK No. TYPE No. UNIVERSAL No. SUPPLEMENT No.

VOLVO

900

2.3 Turbo SW	B230FT	2.3	121	09.93-07.94		R	3	77	1095	OZA446-E58	0483	S3	0412
2.0 Turbo Intercooler	B200FT	2.0	105	09.92-08.93		R	3	19	975	OZA446-E2	1855	S3	0412
2.0i 16V Turbo Intercooler	B204FT	2.0	140	09.91-08.93		R	3	19	975	OZA446-E2	1855	S3	0412

900 II

2.0 Turbo	B200FT	2.0	114	04.96-08.96		R	3	77	1095	OZA446-E58	0483	S3	0412
2.3ti	B230FK	2.3	99	01.95-08.96		R	3	77	1095	OZA446-E58	0483	S3	0412
2.3 Turbo	B230FT	2.3	121	08.94-08.96		R	3	77	1095	OZA446-E58	0483	S3	0412
2.0 Turbo SW	B200FT	2.0	114	04.96-08.96		R	3	77	1095	OZA446-E58	0483	S3	0412
2.3ti SW	B230FK	2.3	99	01.95-08.96		R	3	77	1095	OZA446-E58	0483	S3	0412
2.3 Turbo SW	B230FT	2.3	121	08.94-08.96		R	3	77	1095	OZA446-E58	0483	S3	0412

C70

2.0 Cabrio	B5204T2	2.0	132	03.98-07.98		R	4	73	740	OZA660-EE11	5697	S4	1952
2.0 Coupe	B5204T2	2.0	132	03.97-07.98		R	4	73	740	OZA660-EE11	5697	S4	1952
2.0 T Coupe	B5204T3	2.0	166	03.97-07.98		R	4	73	740	OZA660-EE11	5697	S4	1952
2.3 T-5 Coupe	B5234T3	2.3	176	09.97-07.98		R	4	73	740	OZA660-EE11	5697	S4	1952
2.5 T Coupe	B5244T / B5254T	2.5	142	01.98-07.98		R	4	73	740	OZA660-EE11	5697	S4	1952

S40

1.6i	B4164S	1.6	77	05.99-08.01		R	4	61	663	OTA4F-5F1	1908	---	---
1.6i	B4164S	1.6	77	05.99-05.01		D	4	61	750	OTA4F-5G2	1927	---	---
1.6i	B4164S	1.6	77	01.96-04.99		R	4	29	1038	OZA83-VN1	0124	S4	1952
1.6i	B4164S2	1.6	80	08.00-		R	4	61	343	OTA4N-5F1	1795	---	---
1.6i	B4164S2	1.6	80	04.99-01.00		D	4	61	750	OTA4N-5G1	1758	---	---
1.6i	B4164S2	1.6	80	05.01-		D	4	61	750	OTA4N-5H1	1768	---	---
1.6i	B4164 S2	1.6	80	03.99-	Siemens	R	4	54	638	OTA7N-5D2	1975	---	---
1.8i	B4184S	1.8	85	05.99-08.01		R	4	61	663	OTA4F-5F1	1908	---	---
1.8i	B4184S	1.8	85	05.99-05.01		D	4	61	750	OTA4F-5G2	1927	---	---
1.8i	B4184S	1.8	85	01.96-04.99		R	4	29	1038	OZA83-VN1	0124	S4	1952
1.8i		1.8	90	03.99-	Siemens	R	4	54	638	OTA7N-5D2	1975	---	---
1.8i		1.8	90	08.00-		R	4	61	343	OTA4N-5F1	1795	---	---
1.8i		1.8	90	04.99-01.00		D	4	61	750	OTA4N-5G1	1758	---	---
1.8i		1.8	90	05.01-		D	4	61	750	OTA4N-5H1	1768	---	---
1.8i	B4184SM	1.8	92	09.97-07.00		R	4	76	400	OZA448-E53	0448	S4	1952
1.9i	N1P19T	1.9	118	03.97-10.99		D	4	90	1362	OTA4N-5D1	1785	---	---
T4	B4194T	1.9	147	03.97-04.00		R	4	62	1039	OTA4F-5C2	1948	---	---
T4	B4194T	1.9	147	09.97-04.00		D	4	61	870	OTA4F-5E1	1942	---	---
1.9i	N1P20LT	1.9	147	03.97-10.99		D	4	90	1362	OTA4N-5D1	1785	---	---
2.0i	B4204S	2.0	100	07.95-07.00	Siemens	R	4	54	638	OTA7N-5D2	1975	---	---
2.0i	B4204S	2.0	100	08.00-		R	4	61	343	OTA4N-5F1	1795	---	---
2.0i	B4204S	2.0	100	04.99-01.00		D	4	61	750	OTA4N-5G1	1758	---	---
2.0i	B4204S	2.0	100	05.01-		D	4	61	750	OTA4N-5H1	1768	---	---
2.0i	B4204S	2.0	102	01.96-04.99		R	4	29	1038	OZA83-VN1	0124	S4	1952
2.0i	B4204S	2.0	103	05.99-08.01		R	4	61	663	OTA4F-5F1	1908	---	---
2.0i	B4204S	2.0	103	05.99-05.01		D	4	61	750	OTA4F-5G2	1927	---	---
2.0i	B4204S	2.0	103	07.95-04.99	Siemens	R	4	54	638	OTA7N-5D2	1975	---	---
2.0i T	B4204T	2.0	118	10.97-	Siemens	R	4	54	638	OTA7N-5D2	1975	---	---
2.0i T	B4204T	2.0	118	03.97-04.00		R	4	62	1039	OTA4F-5C2	1948	---	---
2.0i T	B4204T	2.0	118	09.97-04.00		D	4	61	870	OTA4F-5E1	1942	---	---
2.0i		2.0	120	06.01-	Siemens	R	4	54	638	OTA7N-5D2	1975	---	---
2.0i		2.0	121	07.00-	Siemens	R	4	54	638	OTA7N-5D2	1975	---	---

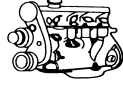

ℓ kW



STOCK
ORDER
No.
UNIVERSAL
TYPE
No.
MANUFACTURER
No.

VOLVO

S40

2.0i		2.0	147	07.00-	Siemens	R	4	54	638	OTA7N-5D2	1975	---	---
2.5 Bi-Fuel	N2H25	2.5	103	09.01-	USA	R	4	61	1356	OZA324-L2	1780	---	---
2.5 Bi-Fuel	B4184	2.5	103	09.96-08.01	USA	R	4	61	1356	OZA324-L2	1780	---	---

S70

2.0	B5204S	2.0	105	01.97-07.98		R	4	73	740	OZA660-EE11	5697	S4	1952
2.0	B5204T2	2.0	132	01.97-07.98		R	4	73	740	OZA660-EE11	5697	S4	1952
2.0 Turbo	B5204T	2.0	155	01.97-07.98		R	4	73	740	OZA660-EE11	5697	S4	1952
2.3 T-5	B5234T3	2.3	176	01.97-07.98		R	4	73	740	OZA660-EE11	5697	S4	1952
2.3 Turbo	B5234FT+	2.3	184	01.97-07.98		R	4	73	740	OZA660-EE11	5697	S4	1952
2.4	B5254S	2.4	125	01.97-07.98		R	4	73	740	OZA660-EE11	5697	S4	1952
2.4 Turbo	B5244T / B5254T	2.4	142	01.97-07.98		R	4	73	740	OZA660-EE11	5697	S4	1952
2.5i	B5252S	2.5	106	01.97-11.00		R	4	50	530	OTA4N-5B1	1765	---	---
2.5		2.5	121	06.98-07.98		R	4	73	740	OZA660-EE11	5697	S4	1952

S80

T6	B 6284 T	2.8	200	05.98-		R	4	87	725	OZA583-GM2	1754	---	---
T6	B 6294 S	3.0	200	06.01-		R	4	87	725	OZA583-GM2	1754	---	---

V40

1.6	B4164S	1.6	77	05.99-08.01		R	4	61	663	OTA4F-5F1	1908	---	---
1.6	B4164S	1.6	77	05.99-05.01		D	4	61	750	OTA4F-5G2	1927	---	---
1.6	B4164S	1.6	77	01.96-04.99		R	4	29	1038	OZA83-VN1	0124	S4	1952
1.6i	B4164S2	1.6	80	08.00-		R	4	61	343	OTA4N-5F1	1795	---	---
1.6i	B4164S2	1.6	80	04.99-01.00		D	4	61	750	OTA4N-5G1	1758	---	---
1.6i	B4164S2	1.6	80	05.01-		D	4	61	750	OTA4N-5H1	1768	---	---
1.6i	B4164S2	1.6	80	03.99-	Siemens	R	4	54	638	OTA7N-5D2	1975	---	---
1.8i	B4184S	1.8	85	05.99-08.01		R	4	61	663	OTA4F-5F1	1908	---	---
1.8i	B4184S	1.8	85	05.99-05.01		D	4	61	750	OTA4F-5G2	1927	---	---
1.8i	B4184S	1.8	85	01.96-04.99		R	4	29	1038	OZA83-VN1	0124	S4	1952
1.8i		1.8	90	03.99-07.00	Siemens	R	4	54	638	OTA7N-5D2	1975	---	---
1.8i		1.8	90	08.00-		R	4	61	343	OTA4N-5F1	1795	---	---
1.8i		1.8	90	04.99-01.00		D	4	61	750	OTA4N-5G1	1758	---	---
1.8i		1.8	90	05.01-		D	4	61	750	OTA4N-5H1	1768	---	---
1.8i	B4184SM	1.8	92	09.97-07.00		R	4	76	400	OZA448-E53	0448	S4	1952
1.9i	N1P19T	1.9	118	03.97-10.99		D	4	90	1362	OTA4N-5D1	1785	---	---
T4	B4194T	1.9	147	03.97-04.00		R	4	62	1039	OTA4F-5C2	1948	---	---
T4	B4194T	1.9	147	09.97-04.00		D	4	61	870	OTA4F-5E1	1942	---	---
1.9i	N1P20LT	1.9	147	03.97-10.99		D	4	90	1362	OTA4N-5D1	1785	---	---
2.0i	B4204S	2.0	100	08.00-		R	4	61	343	OTA4N-5F1	1795	---	---
2.0i	B4204S	2.0	100	04.99-01.00		D	4	61	750	OTA4N-5G1	1758	---	---
2.0i	B4204S	2.0	100	05.01-		D	4	61	750	OTA4N-5H1	1768	---	---
2.0	B4204S	2.0	100	07.95-07.00	Siemens	R	4	54	638	OTA7N-5D2	1975	---	---
2.0	B4204S	2.0	102	01.96-04.99		R	4	29	1038	OZA83-VN1	0124	S4	1952
2.0	B4204S	2.0	103	05.99-08.01		R	4	61	663	OTA4F-5F1	1908	---	---
2.0	B4204S	2.0	103	05.99-05.01		D	4	61	750	OTA4F-5G2	1927	---	---
2.0	B4204S	2.0	103	07.95-04.99	Siemens	R	4	54	638	OTA7N-5D2	1975	---	---
2.0	B4204T	2.0	118	10.97-	Siemens	R	4	54	638	OTA7N-5D2	1975	---	---
2.0 T	B4204T	2.0	118	03.97-04.00		R	4	62	1039	OTA4F-5C2	1948	---	---
2.0 T	B4204T	2.0	118	09.97-04.00		D	4	61	870	OTA4F-5E1	1942	---	---
2.0		2.0	120	06.01-	Siemens	R	4	54	638	OTA7N-5D2	1975	---	---
2.0		2.0	121	07.00-	Siemens	R	4	54	638	OTA7N-5D2	1975	---	---

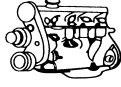

ℓ kW

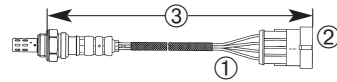

ORDER No. STOCK No. TYPE No. UNIVERSAL No. NUMBER No.

VOLVO

V40

2.0		2.0	147	07.00-	Siemens	R	4	54	638	0TA7N-5D2	1975	---	---
2.5 Bi-Fuel	N2H25	2.5	103	09.01-	USA	R	4	61	1356	OZA324-L2	1780	---	---
2.5 Bi-Fuel	B4184	2.5	103	09.96-08.01	USA	R	4	61	1356	OZA324-L2	1780	---	---

V70

2.0	B5204T2	2.0	132	01.97-07.98		R	4	73	740	OZA660-EE11	5697	S4	1952
2.0 Turbo	B5204T	2.0	155	01.97-07.98		R	4	73	740	OZA660-EE11	5697	S4	1952
2.0 Turbo	B5204T3	2.0	166	01.97-07.98		R	4	73	740	OZA660-EE11	5697	S4	1952
2.0 Turbo AWD	B5204T3	2.0	166	01.97-07.98		R	4	73	740	OZA660-EE11	5697	S4	1952
2.3 T-5	B5234T3	2.3	176	01.97-07.98		R	4	73	740	OZA660-EE11	5697	S4	1952
2.3 T-5 AWD	B5234T3	2.3	176	01.97-07.98		R	4	73	740	OZA660-EE11	5697	S4	1952
2.3 T AWD	B5234FT+	2.3	184	08.97-07.98		R	4	73	740	OZA660-EE11	5697	S4	1952
2.3 Turbo	B5234FT+	2.3	184	01.97-07.98		R	4	73	740	OZA660-EE11	5697	S4	1952
2.4 Turbo	B5244T / B5254T	2.4	142	01.97-07.98		R	4	73	740	OZA660-EE11	5697	S4	1952
2.5i	B5252S	2.5	106	01.97-11.00	OE	R	4	50	530	0TA4N-5B1	1765	---	---
2.5 Bi-Fuel	B5252S	2.5	106	10.98-		R	4	81	570	OZA324-L1	1779	---	---
2.5		2.5	121	06.98-07.98		R	4	73	740	OZA660-EE11	5697	S4	1952
2.5 Turbo AWD	B 5244 T/B 5254 T	2.5	142	01.97-07.98		R	4	73	740	OZA660-EE11	5697	S4	1952

XC90

T6	B6294S	3.0	200	10.02-		R	4	87	725	OZA583-GM2	1754	---	---
----	--------	-----	-----	--------	--	---	---	----	-----	------------	------	-----	-----

VW

BORA

1.4i	APE	1.4	55	01.99-10.01		R	5	92	465	LZA11-V3	1829	---	---
1.4i	APE	1.4	55	01.99-10.01		D	4	65	545	OZA659-EE19	0393	---	---
1.4i	AXP	1.4	55	01.99-10.01		D	4	65	545	OZA659-EE19	0393	---	---
1.4i Variant	AXP	1.4	55	05.00-10.01		D	4	65	545	OZA659-EE19	0393	---	---
1.4i 16V	BCA	1.4	55	10.01-05.05		D	4	65	575	OZA659-EE23	0397	---	---
1.4i 16V Variant	BCA	1.4	55	10.01-05.05		D	4	65	575	OZA659-EE23	0397	---	---
1.6i 16V	AEH	1.6	74	10.98-05.05		R	4	64	1135	OZA659-EE25	0399	---	---
1.6i 16V Variant	AEH	1.6	74	05.99-05.05		R	4	64	1135	OZA659-EE25	0399	---	---
1.6i 16V	AKL	1.6	74	10.98-05.05		R	4	64	1135	OZA659-EE25	0399	---	---
1.6i 16V Variant	AKL	1.6	74	05.99-05.05		R	4	64	1135	OZA659-EE25	0399	---	---
1.6i	APF	1.6	74	05.99-09.00		D	4	65	700	OZA659-EE33	1617	---	---
1.6i Variant	APF	1.6	74	05.99-09.00		D	4	65	700	OZA659-EE33	1617	---	---
1.6i	AVU	1.6	75	09.00-05.05		D	4	65	560	OZA659-EE14	0388	---	---
1.6i Variant	AVU	1.6	75	09.00-05.05		D	4	65	560	OZA659-EE14	0388	---	---
1.6i	BFQ	1.6	75	05.02-05.03		D	4	65	560	OZA659-EE14	0388	---	---
1.6i Variant	BFQ	1.6	75	05.02-05.03		D	4	65	560	OZA659-EE14	0388	---	---
1.6i 16V	ATN	1.6	77	02.00-05.05		R	5	92	810	LZA11-V4	1842	---	---
1.6i 16V	ATN	1.6	77	02.00-05.05		D	4	65	541	OZA510-V4	0424	---	---
1.6i 16V Variant	ATN	1.6	77	02.00-05.05		R	5	92	810	LZA11-V4	1842	---	---
1.6i 16V Variant	ATN	1.6	77	02.00-05.05		D	4	65	541	OZA510-V4	0424	---	---
1.6i 16V	AUS	1.6	77	02.00-05.05		R	5	92	810	LZA11-V4	1842	---	---
1.6i 16V	AUS	1.6	77	02.00-05.05		D	4	65	541	OZA510-V4	0424	---	---
1.6i 16V Variant	AUS	1.6	77	02.00-05.05		R	5	92	810	LZA11-V4	1842	---	---
1.6i 16V Variant	AUS	1.6	77	02.00-05.05		D	4	65	541	OZA510-V4	0424	---	---
1.6i 16V	AZD	1.6	77	02.00-05.05		R	5	92	810	LZA11-V4	1842	---	---
1.6i 16V	AZD	1.6	77	02.00-05.05		D	4	65	541	OZA510-V4	0424	---	---

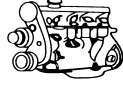

ℓ kW

STOCK
ORDER
No.
UNIVERSAL
TYPE
No.
NUMBER
No.
VW**BORA**

1.6i 16V Variant	AZD	1.6	77	02.00-05.05		R	5	92	810	LZA11-V4	1842	---	---
1.6i 16V Variant	AZD	1.6	77	02.00-05.05		D	4	65	541	OZA510-V4	0424	---	---
1.6i 16V	BCB	1.6	77	02.00-05.05		R	5	92	810	LZA11-V4	1842	---	---
1.6i 16V	BCB	1.6	77	02.00-05.05		D	4	65	541	OZA510-V4	0424	---	---
1.6i 16V Variant	BCB	1.6	77	02.00-05.05		R	5	92	810	LZA11-V4	1842	---	---
1.6i 16V Variant	BCB	1.6	77	02.00-05.05		D	4	65	541	OZA510-V4	0424	---	---
1.8i 20V	BAF	1.8	92	08.01-		D	4	65	545	OZA659-EE19	0393	---	---
2.0i	APK	2.0	85	09.98-05.05		R	4	64	975	OZA659-EE1	0375	---	---
2.0i	APK	2.0	85	09.98-05.05		D	4	65	490	OZA659-EE18	0392	---	---
2.0i Variant	APK	2.0	85	05.99-05.05		R	4	64	975	OZA659-EE1	0375	---	---
2.0i Variant	APK	2.0	85	05.99-05.05		D	4	65	490	OZA659-EE18	0392	---	---
2.0i	AQY	2.0	85	09.98-05.05		R	4	64	975	OZA659-EE1	0375	---	---
2.0i	AQY	2.0	85	09.98-05.05		D	4	65	490	OZA659-EE18	0392	---	---
2.0i Variant	AQY	2.0	85	05.99-05.05		R	4	64	975	OZA659-EE1	0375	---	---
2.0i Variant	AQY	2.0	85	05.99-05.05		D	4	65	490	OZA659-EE18	0392	---	---
2.0i	AZJ	2.0	85	05.01-05.05		D	4	65	505	OZA659-EE38	1625	---	---
2.0i 4Motion	AZJ	2.0	85	05.01-05.05		D	4	65	740	OZA659-EE11	0385	---	---
2.0i Variant	AZJ	2.0	85	05.01-05.05		D	4	65	505	OZA659-EE38	1625	---	---
2.0i Variant 4Motion	AZJ	2.0	85	05.01-05.05		D	4	65	740	OZA659-EE11	0385	---	---
2.0i Variant	AZG	2.0	85	05.01-05.05		D	4	65	505	OZA659-EE38	1625	---	---

BUS

2.1	SR	2.1	64	08.86-07.92	CH	R	3	19	975	OZA446-E2	1855	S3	0412
2.1	SS	2.1	68	08.89-07.92		R	3	19	975	OZA446-E2	1855	S3	0412
2.1	MV	2.1	70	08.85-07.92		R	3	19	975	OZA446-E2	1855	S3	0412

CADDY

1.4i	AUD	1.4	44	11.00-05.02		D	4	65	480	OZA659-EE32	1614	---	---
1.4i 16V	BUD	1.4	59	05.06-		R	4	84	511	OZA629-V3	1720	---	---
1.4i 16V	BUD	1.4	59	05.06-		D	4	64	526	OZA510-V5	0435	---	---
1.6i	AEE	1.6	55	06.96-12.97		R	4	36	517	OZA447-E13	0183	S4	1952
1.6i	AEE	1.6	55	06.97-12.97		R	4	48	550	OZA447-E16	0259	S4	1952
1.8i	JH	1.8	70	08.85-07.92		R	1	3	472	OZA401-E2	1802	S1	1951
1.4i	AEX	1.4	44	11.95-05.97		R	4	48	720	OZA447-E31	0460	S4	1952
1.6i	BGU	1.6	75	06.04-		R	5	92	680	LZA07-V2	1868	---	---
1.6i	BGU	1.6	75	06.04-		D	4	85	471	OZA510-V11	1884	---	---
1.6i	BSE	1.6	75	06.04-		R	5	92	680	LZA07-V2	1868	---	---
1.6i	BSE	1.6	75	06.04-		D	4	85	471	OZA510-V11	1884	---	---
1.6i	BSF	1.6	75	06.04-		R	5	92	680	LZA07-V2	1868	---	---
1.6i	BSF	1.6	75	06.04-		D	4	85	471	OZA510-V11	1884	---	---

CALIFORNIA

2.0	AAC	2.0	62-64	01.96-06.03	T..200 001 ->	R	3	14	1220	OZA446-E3	1866	S3	0412
2.0	AAC	2.0	62-64	09.90-12.95	-> T..200 000	R	3	46	545	OZA446-E51	0215	S3	0412
2.5 Syncro	AAF	2.5	80-81	11.92-12.93	-> T..200 000	R	3	46	335	OZA446-E53	0237	S3	0412
2.5	AAF	2.5	80-81	11.90-12.93	-> T..200 000	R	3	46	335	OZA446-E53	0237	S3	0412
2.5	ACU	2.5	81	07.94-10.96	-> T..200 000	R	3	46	335	OZA446-E53	0237	S3	0412

CARAVELLE

2.0	AAC	2.0	62-64	09.90-12.95	-> T..200 000	R	3	46	545	OZA446-E51	0215	S3	0412
2.5	AAF	2.5	80-81	11.90-12.93	-> T..200 000	R	3	46	335	OZA446-E53	0237	S3	0412
2.5	ACU	2.5	81	07.94-10.96	-> T..200 000	R	3	46	335	OZA446-E53	0237	S3	0412
2.5 Syncro	ACU	2.5	81	07.94-12.95	-> T..200 000	R	3	46	335	OZA446-E53	0237	S3	0412

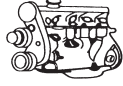

ℓ kW

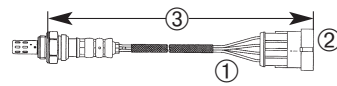
STOCK
NO.
UNIVERSAL
TYPE
NO.
UNIVERSAL
NO.
VW**CORRADO**

1.8 G60	PG	1.8	118	09.88-06.89	-> 50..K..015 000	R	3	18	970	OZA446-E15	1848	S3	0412
1.8 G60	PG	1.8	118	09.88-06.89	-> 50..K..011 579	R	3	18	970	OZA446-E15	1848	S3	0412
1.8 G60	PG	1.8	118	09.88-09.93		R	3	46	430	OZA446-E52	0226	S3	0412
2.0	9A	2.0	100	08.91-07.95		R	3	46	430	OZA446-E52	0226	S3	0412
2.0	2E	2.0	85	04.93-09.94	-> 50..S..000 719	R	4	36	585	OZA572-E13	0254	S4CG	1919
2.0	ADY	2.0	85	09.94-10.94	-> 50..S..000 719	R	4	36	585	OZA572-E13	0254	S4CG	1919
2.9i VR6	ABV	2.9	140	08.91-07.95		R	4	36	1075	OZA527-E36	1993	S4CG	1919
2.9i VR6	ABV	2.9	140	08.91-10.94	-> 50..S..000 719	R	4	36	585	OZA572-E13	0254	S4CG	1919

EUROVAN

2.5	ACU	2.5	81	01.96-05.96	T..200 001 ->	R	3	14	1220	OZA446-E3	1866	S3	0412
-----	-----	-----	----	-------------	---------------	---	---	----	------	-----------	------	----	------

FOX

1.2	BMD	1.2	40	04.05-		R	4	64	600	OZA532-V4	0006	---	---
1.2	BMD	1.2	40	04.05-		D	4	65	231	OZA510-I1	1808	---	---

GOLF CABRIO

1.8	AAM	1.8	55	09.93-11.94	-> 1E..S..012 000	R	2	4	480	OZA401-E4	1822	S2	1918
1.8	AAM	1.8	55	09.93-04.98		R	4	17	583	OZA446-E42	0150	S4	1952
1.8	AAM	1.8	55	03.95-07.95	1E..S..024 274 ->	R	4	48	520	OZA448-E31	0151	S4	1952
1.8	ABS	1.8	66	09.93-11.94	-> 1E..S..012 000	R	2	4	480	OZA401-E4	1822	S2	1918
1.8	ABS	1.8	66	09.93-07.95		R	4	17	583	OZA446-E42	0150	S4	1952
1.8	ADZ	1.8	66	03.95-07.95	1E..S..024 274 ->	R	4	48	520	OZA448-E31	0151	S4	1952
1.8	ABS	1.8	66	03.95-07.95	1E..S..024 274 ->	R	4	48	520	OZA448-E31	0151	S4	1952
1.8	JH	1.8	70	08.83-08.93		R	1	3	472	OZA401-E2	1802	S1	1951
1.8	2H	1.8	74	08.89-08.93		R	4	17	583	OZA446-E42	0150	S4	1952
2.0	2E	2.0	85	09.93-09.94		R	4	36	585	OZA572-E13	0254	S4CG	1919

GOLF II

1.3	NZ	1.3	40	08.87-07.90	19..J..000 001 -> 1G..L..990 000	R	3	18	960	OZA445-E3	1860	S3	0412
1.3	NZ	1.3	40	02.87-07.87	19..H..000 001 -> 19..H..990 000	R	3	18	970	OZA446-E15	1848	S3	0412
1.3	NZ	1.3	40	08.90-07.92	1G..M..000 001 ->	R	4	17	920	OZA445-E4	1850	S4	1952
1.6	PN	1.6	51	08.87-07.92		R	1	3	472	OZA401-E2	1802	S1	1951
1.8	GX	1.8	66	01.84-05.88		R	1	3	472	OZA401-E2	1802	S1	1951
1.8 Syncro	GX	1.8	66	02.86-07.88		R	3	19	975	OZA446-E2	1855	S3	0412
1.8	RP	1.8	66	11.87-10.91		R	1	3	472	OZA401-E2	1802	S1	1951
1.8 Syncro	1P	1.8	72	08.88-07.91		R	3	18	970	OZA446-E15	1848	S3	0412
1.8	PF	1.8	79	01.87-10.91		R	3	18	970	OZA446-E15	1848	S3	0412
1.8	RD	1.8	79	08.85-10.87		R	3	19	975	OZA446-E2	1855	S3	0412
1.8	PB	1.8	82	01.87-10.91		R	1	3	472	OZA401-E2	1802	S1	1951
1.8 16V	PL	1.8	95	02.86-10.91		R	3	19	975	OZA446-E2	1855	S3	0412
1.8 16V	KR	1.8	102	02.86-10.91		R	1	3	472	OZA401-E2	1802	S1	1951
1.8 Rallye	1H	1.8	118	04.89-12.89		R	3	18	970	OZA446-E15	1848	S3	0412
1.8 G60	PG	1.8	118	04.90-07.91		R	4	17	583	OZA446-E42	0150	S4	1952

GOLF III

1.4 Variant		1.4	40	07.93-09.94	-> S..120 000	R	4	36	1075	OZA527-E36	1993	S4CG	1919
1.4 Variant	ABD	1.4	40-44	10.94-07.95	S..120 001 ->	R	4	48	550	OZA447-E16	0259	S4	1952
1.4	ABD	1.4	40-44	09.94-07.95	1H..S..120 001 ->	R	4	48	550	OZA447-E16	0259	S4	1952
1.4	ABD	1.4	40-44	11.91-09.94	-> 1H..S..120 000	R	4	36	550	OZA572-E1	0283	S4CG	1919

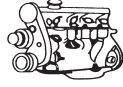

ℓ kW

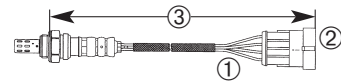

STOCK No. TYPE No. UNIVERSAL No. REFERENCE No.

VW

GOLF III

1.4	ABD	1.4	44	11.91-12.94	-> 1H..S..120 000	R	4	36	1075	OZA527-E36	1993	S4CG	1919
1.6	ABU	1.6	55	09.92-09.94	-> 1H..S..120 000	R	4	36	550	OZA572-E1	0283	S4CG	1919
1.6	AEA	1.6	55	10.94-12.97	1H..S..120 001 ->	R	4	48	550	OZA447-E16	0259	S4	1952
1.6	AEE	1.6	55	10.94-12.97	1H..S..120 001 ->	R	4	48	550	OZA447-E16	0259	S4	1952
1.8	AAM	1.8	55	11.91-09.94	-> 1H..S..120 000	R	2	4	480	OZA401-E4	1822	S2	1918
1.8	AAM	1.8	55	11.91-09.94	-> 1H..S..120 000	R	4	17	583	OZA446-E42	0150	S4	1952
1.8	AAM	1.8	55	10.94-08.97		R	4	48	520	OZA448-E31	0151	S4	1952
1.8	ABS	1.8	66	11.91-09.94	-> 1H..S..120 000	R	2	4	480	OZA401-E4	1822	S2	1918
1.8	ABS	1.8	66	11.91-09.94	-> 1H..S..120 000	R	4	17	583	OZA446-E42	0150	S4	1952
1.8	ADZ	1.8	66	10.94-12.97		R	4	48	520	OZA448-E31	0151	S4	1952
2.0	2E	2.0	85	11.91-09.94		R	4	36	1075	OZA527-E36	1993	S4CG	1919
2.0 Variant	2E	2.0	85	07.93-09.94		R	4	36	1075	OZA527-E36	1993	S4CG	1919
2.0	2E	2.0	85	11.91-09.94		R	4	36	585	OZA572-E13	0254	S4CG	1919
2.0 Variant	2E	2.0	85	07.93-09.94		R	4	36	585	OZA572-E13	0254	S4CG	1919
2.0 Variant Syncro	AGG	2.0	85	07.95-04.97	-> 1H..V..800 000	R	4	48	780	OZA572-E11	0251	S4CG	1919
2.0 Variant Syncro	AGG	2.0	85	05.97-02.99	1H..W..000 001 ->	R	4	48	780	OZA572-E11	0251	S4CG	1919
2.0 Syncro	AGG	2.0	85	07.95-12.97		R	4	48	780	OZA572-E11	0251	S4CG	1919
2.0 GTI 16V	ABF	2.0	110	08.92-08.97		R	4	36	1075	OZA527-E36	1993	S4CG	1919
2.0i GTI 16V	ABF	2.0	110	01.95-08.97	1H..S 120 001 ->	R	4	48	720	OZA447-E31	0460	S4	1952
2.8 VR6	AAA	2.8	128	01.92-12.94	-> 1H..S..120 000	R	4	36	1075	OZA527-E36	1993	S4CG	1919
2.8 VR 6	AAA	2.8	128	01.92-08.94		R	4	36	550	OZA572-E1	0283	S4CG	1919
2.8 VR 6	AAA	2.8	128	09.94-06.95		R	4	48	620	OZA572-E9	0423	S4CG	1919
2.8 VR 6	AAA	2.8	128	07.95-12.97		R	4	48	720	OZA447-E31	0460	S4	1952
2.9 VR6 Syncro	ABV	2.9	140	10.94-07.95	1H..S..120 001 ->	R	4	36	585	OZA572-E13	0254	S4CG	1919
					1H..S..990 000								
2.9 VR6 Syncro	ABV	2.9	140	07.95-12.97		R	4	48	1430	OZA447-E36	1950	S4	1952

GOLF IV

1.4i	AKQ	1.4	55	10.97-05.04		R	4	64	620	OZA447-E18	0281	S4	1952
1.4i Variant	AKQ	1.4	55	05.99-05.04		R	4	64	620	OZA447-E18	0281	S4	1952
1.4i	APE	1.4	55	05.99-05.00		R	5	92	465	LZA11-V3	1829	---	---
1.4i	APE	1.4	55	05.99-05.00		D	4	65	545	OZA659-EE19	0393	---	---
1.4i	AXP	1.4	55	05.00-04.01		D	4	65	545	OZA659-EE19	0393	---	---
1.4i	AXP	1.4	55	05.01-10.01		D	4	65	575	OZA659-EE23	0397	---	---
1.4i Variant	AXP	1.4	55	05.00-04.01		D	4	65	545	OZA659-EE19	0393	---	---
1.4i Variant	AXP	1.4	55	05.01-10.01		D	4	65	575	OZA659-EE23	0397	---	---
1.4i 16V	BCA	1.4	55	10.01-05.04		D	4	65	575	OZA659-EE23	0397	---	---
1.4i 16V Variant	BCA	1.4	55	10.01-06.06		D	4	65	575	OZA659-EE23	0397	---	---
1.6i	AEH	1.6	74	01.98-10.98	-> 1J..X..260 000	R	4	64	470	OZA447-E17	0270	S4	1952
1.6i	AKL	1.6	74	10.97-10.98	-> 1J..X..260 000	R	4	64	470	OZA447-E17	0270	S4	1952
1.6i	AKL	1.6	74	10.98-04.02		R	4	64	1135	OZA659-EE25	0399	---	---
1.6i Variant	AKL	1.6	74	05.99-04.02		R	4	64	1135	OZA659-EE25	0399	---	---
1.6i	APF	1.6	74	05.00-08.00		D	4	65	700	OZA659-EE33	1617	---	---
1.6i	AVU	1.6	75	09.00-05.04		D	4	65	560	OZA659-EE14	0388	---	---
1.6i Variant	AVU	1.6	75	09.00-06.06		D	4	65	560	OZA659-EE14	0388	---	---
1.6i	BFQ	1.6	75	05.02-05.04		D	4	65	560	OZA659-EE14	0388	---	---
1.6i Variant	BFQ	1.6	75	05.02-06.06		D	4	65	560	OZA659-EE14	0388	---	---
1.6i 16V	ATN	1.6	77	02.00-06.05		R	5	92	810	LZA11-V4	1842	---	---
1.6i 16V	ATN	1.6	77	02.00-06.05		D	4	65	541	OZA510-V4	0424	---	---
1.6i 16V Variant	ATN	1.6	77	02.00-06.05		R	5	92	810	LZA11-V4	1842	---	---

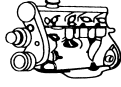

ℓ kW

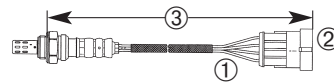

ORDER No. STOCK No. TYPE No. UNIVERSAL No. SUSPENSION No. CHASSIS No.

VW

GOLF IV

1.6i 16V Variant	ATN	1.6	77	02.00-06.05		D	4	65	541	OZA510-V4	0424	---	---
1.6i 16V	AUS	1.6	77	02.00-06.05		R	5	92	810	LZA11-V4	1842	---	---
1.6i 16V	AUS	1.6	77	02.00-06.05		D	4	65	541	OZA510-V4	0424	---	---
1.6i 16V Variant	AUS	1.6	77	02.00-06.05		R	5	92	810	LZA11-V4	1842	---	---
1.6i 16V Variant	AUS	1.6	77	02.00-06.05		D	4	65	541	OZA510-V4	0424	---	---
1.6i 16V	AZD	1.6	77	02.00-06.05		R	5	92	810	LZA11-V4	1842	---	---
1.6i 16V	AZD	1.6	77	02.00-06.05		D	4	65	541	OZA510-V4	0424	---	---
1.6i 16V Variant	AZD	1.6	77	02.00-06.05		R	5	92	810	LZA11-V4	1842	---	---
1.6i 16V Variant	AZD	1.6	77	02.00-06.05		D	4	65	541	OZA510-V4	0424	---	---
1.6i 16V	BCB	1.6	77	02.00-06.05		R	5	92	810	LZA11-V4	1842	---	---
1.6i 16V	BCB	1.6	77	02.00-06.05		D	4	65	541	OZA510-V4	0424	---	---
1.6i 16V Variant	BCB	1.6	77	02.00-06.05		R	5	92	810	LZA11-V4	1842	---	---
1.6i 16V Variant	BCB	1.6	77	02.00-06.05		D	4	65	541	OZA510-V4	0424	---	---
1.8i	BAF	1.8	92	07.03-		D	4	65	545	OZA659-EE19	0393	---	---
1.8i 20V	AGU	1.8	110	10.97-06.05		R	4	64	620	OZA447-E18	0281	S4	1952
1.8i 20V	AGU	1.8	110	10.97-06.05		R	4	64	700	OZA447-E32	0471	S4	1952
1.8T	ARZ	1.8	110	05.99-09.00		D	4	65	560	OZA659-EE14	0388	---	---
1.8T Variant	ARZ	1.8	110	05.99-09.00		D	4	65	560	OZA659-EE14	0388	---	---
1.8T GTi	AUQ	1.8	132	05.03-		D	4	64	975	OZA659-EE1	0375	---	---
2.0i	APK	2.0	85	08.98-05.04		R	4	64	975	OZA659-EE1	0375	---	---
2.0i	APK	2.0	85	08.98-05.04		D	4	65	490	OZA659-EE18	0392	---	---
2.0i Variant	APK	2.0	85	05.99-06.06		R	4	64	975	OZA659-EE1	0375	---	---
2.0i Variant	APK	2.0	85	05.99-06.06		D	4	65	490	OZA659-EE18	0392	---	---
2.0i	AQY	2.0	85	08.98-05.04		R	4	64	975	OZA659-EE1	0375	---	---
2.0i	AQY	2.0	85	08.98-05.04		D	4	65	490	OZA659-EE18	0392	---	---
2.0i Variant	AQY	2.0	85	05.99-06.06		R	4	64	975	OZA659-EE1	0375	---	---
2.0i Variant	AQY	2.0	85	05.99-06.06		D	4	65	490	OZA659-EE18	0392	---	---
2.0i Cabrio	ATU	2.0	85	06.99-06.02		R	4	64	1135	OZA659-EE25	0399	---	---
2.0i Cabrio	AWF	2.0	85	06.99-06.02		R	4	64	1135	OZA659-EE25	0399	---	---
2.0i Cabrio	AWG	2.0	85	06.99-06.02		R	4	64	1135	OZA659-EE25	0399	---	---
2.0i	AZG	2.0	85	05.01-04.02		D	4	65	505	OZA659-EE38	1625	---	---
2.0i	AZJ	2.0	85	05.01-05.04		D	4	65	505	OZA659-EE38	1625	---	---
2.0i 4Motion	AZJ	2.0	85	05.01-06.05		D	4	65	740	OZA659-EE11	0385	---	---
2.0i Variant	AZJ	2.0	85	05.01-06.06		D	4	65	505	OZA659-EE38	1625	---	---
2.0i Variant 4Motion	AZJ	2.0	85	05.01-06.06		D	4	65	740	OZA659-EE11	0385	---	---
2.0i	BEH	2.0	85	05.02-05.03		D	4	65	505	OZA659-EE38	1625	---	---
2.0i Variant	BEH	2.0	85	05.02-06.06		D	4	65	505	OZA659-EE38	1625	---	---
2.3 VR5	AGZ	2.3	110	10.97-06.05		R	4	64	700	OZA447-E32	0471	S4	1952
2.3 VR5 4motion	AGZ	2.3	110	11.98-06.05		R	4	64	700	OZA447-E32	0471	S4	1952
2.3 VR5 Variant	AGZ	2.3	110	05.99-06.05		R	4	64	700	OZA447-E32	0471	S4	1952

GOLF V

1.4i 16V	BUD	1.4	59	05.06-		R	4	84	511	OZA629-V3	1720	---	---
1.4i 16V	BUD	1.4	59	05.06-		D	4	64	526	OZA510-V5	0435	---	---
1.4i TSI	BMY	1.4	103	05.06-		R	4	84	521	OZA629-V5	1722	---	---
1.4i TSI	BMY	1.4	103	05.06-		D	4	85	601	OZA629-V7	1725	---	---
1.4i TSI	BMY	1.4	103	05.06-		D	4	85	651	OZA629-V6	1723	---	---
1.4i TSI	BLG	1.4	125	05.06-		R	4	84	521	OZA629-V5	1722	---	---
1.4i TSI	BLG	1.4	125	05.06-		D	4	85	601	OZA629-V7	1725	---	---
1.4i TSI	BLG	1.4	125	05.06-		D	4	85	651	OZA629-V6	1723	---	---

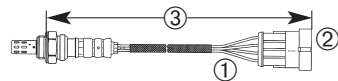

STOCK
ORDER
No.
UNIVERSAL
TYPE
No.
NUMBER
No.



ℓ kW
 21



VW

GOLF V

1.6i 16V	BGU	1.6	75	01.04-		R	5	92	750	LZA07-V1	1851	---	---
1.6i 16V	BGU	1.6	75	01.04-		D	4	85	471	OZA510-V11	1884	---	---
1.6i 16V	BSE	1.6	75	01.04-		R	5	92	750	LZA07-V1	1851	---	---
1.6i 16V	BSE	1.6	75	01.04-		D	4	85	471	OZA510-V11	1884	---	---
1.6i 16V	BSF	1.6	75	01.04-		R	5	92	750	LZA07-V1	1851	---	---
1.6i 16V	BSF	1.6	75	01.04-		D	4	85	471	OZA510-V11	1884	---	---

GOLF V PLUS

1.4i 16V	BUD	1.4	59	01.05-		R	4	84	511	OZA629-V3	1720	---	---
1.4i 16V	BUD	1.4	59	01.05-		D	4	64	526	OZA510-V5	0435	---	---
1.4i TSI	BMV	1.4	103	05.06-		R	4	84	521	OZA629-V5	1722	---	---
1.4i TSI	BMV	1.4	103	05.06-		D	4	85	601	OZA629-V7	1725	---	---
1.4i TSI	BMV	1.4	103	05.06-		D	4	85	651	OZA629-V6	1723	---	---
1.4i TSI	BLG	1.4	125	05.06-		R	4	84	521	OZA629-V5	1722	---	---
1.4i TSI	BLG	1.4	125	05.06-		D	4	85	601	OZA629-V7	1725	---	---
1.4i TSI	BLG	1.4	125	05.06-		D	4	85	651	OZA629-V6	1723	---	---
1.6i 16V	BGU	1.6	75	05.05-		R	5	92	750	LZA07-V1	1851	---	---
1.6i 16V	BGU	1.6	75	05.05-		D	4	85	471	OZA510-V11	1884	---	---
1.6i 16V	BSE	1.6	75	05.05-		R	5	92	750	LZA07-V1	1851	---	---
1.6i 16V	BSE	1.6	75	05.05-		D	4	85	471	OZA510-V11	1884	---	---
1.6i 16V	BSF	1.6	75	05.05-		R	5	92	750	LZA07-V1	1851	---	---
1.6i 16V	BSF	1.6	75	05.05-		D	4	85	471	OZA510-V11	1884	---	---

JETTA

1.3	NZ	1.3	40	08.87-07.90		R	3	18	960	OZA445-E3	1860	S3	0412
1.3	NZ	1.3	40	02.87-07.87		R	3	18	970	OZA446-E15	1848	S3	0412
1.3	NZ	1.3	40	08.90-07.92		R	4	17	920	OZA445-E4	1850	S4	1952
1.6	PN	1.6	51	10.86-07.92		R	1	3	472	OZA401-E2	1802	S1	1951
1.8	GX	1.8	66	08.84-10.87		R	1	3	472	OZA401-E2	1802	S1	1951
1.8	RP	1.8	66	11.87-10.91		R	1	3	472	OZA401-E2	1802	S1	1951
1.8	RP	1.8	66	10.87-10.91		R	3	19	975	OZA445-E7	0269	S3	0412
1.8 Syncro	GX	1.8	66	08.87-07.88		R	3	19	975	OZA446-E2	1855	S3	0412
1.8 Syncro	1P	1.8	66-72	08.88-07.92		R	3	18	970	OZA446-E15	1848	S3	0412
1.8	PF	1.8	79	02.87-07.92		R	3	18	970	OZA446-E15	1848	S3	0412
1.8	RD	1.8	79	08.85-10.87		R	3	19	975	OZA446-E2	1855	S3	0412
1.8	PB	1.8	82	02.87-10.91		R	1	3	472	OZA401-E2	1802	S1	1951
1.8i 16V	PL	1.8	95	08.86-10.91		R	3	19	975	OZA446-E2	1855	S3	0412
1.8 16V	KR	1.8	102	08.86-10.91		R	1	3	472	OZA401-E2	1802	S1	1951

JETTA III

1.4i TSI	BMV	1.4	103	07.06-		R	4	84	521	OZA629-V5	1722	---	---
1.4i TSI	BMV	1.4	103	07.06-		D	4	85	601	OZA629-V7	1725	---	---
1.4i TSI	BMV	1.4	103	07.06-		D	4	85	651	OZA629-V6	1723	---	---
1.4i TSI	BLG	1.4	125	07.06-		R	4	84	521	OZA629-V5	1722	---	---
1.4i TSI	BLG	1.4	125	07.06-		D	4	85	601	OZA629-V7	1725	---	---
1.4i TSI	BLG	1.4	125	07.06-		D	4	85	651	OZA629-V6	1723	---	---
1.6	BSE	1.6	75	10.05-		R	5	91	725	LZA07-V4	0028	---	---
1.6	BSE	1.6	75	10.05-		D	4	85	511	OZA510-V12	0051	---	---
1.6	BSF	1.6	75	10.05-		R	5	91	725	LZA07-V4	0028	---	---
1.6	BSF	1.6	75	10.05-		D	4	85	511	OZA510-V12	0051	---	---

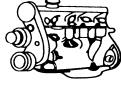

ℓ kW

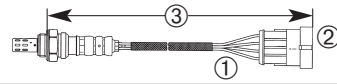

STOCK No. TYPE No. UNIVERSAL No. SUPPLEMENT No.

VW

JETTA III

2.0 TFSI	BWA	2.0	147	10.05-		R	4	64	1135	OZA659-EE25	0399	---	---
----------	-----	-----	-----	--------	--	---	---	----	------	-------------	------	-----	-----

KÄFER

1600	ACD	1.6	34	10.92-09.95	-> S..999 000	R	3	18	970	OZA446-E15	1848	S3	0412
1600	ACD	1.6	34	10.95-07.03	-> V..000 001	R	4	36	550	OZA572-E1	0283	S4CG	1919

LT

2.4	1E	2.4	70	10.88-04.96		R	3	18	970	OZA446-E15	1848	S3	0412
2.4	1E	2.4	70	10.88-04.96		R	3	18	970	OZA446-E15	1848	S3	0412
2.4	1E	2.4	70	10.88-04.96		R	3	18	970	OZA446-E15	1848	S3	0412
2.3	AGL	2.3	105	05.96-11.01		R	4	47	985	OZA448-E45	0206	S4	1952

LUPO

1.0i	AER	1.0	37	10.98-07.05		R	4	64	475	OZA448-E51	0426	S4	1952
1.0i	ALD	1.0	37	10.98-07.05		R	4	64	535	OZA659-EE40	1627	---	---
1.0i	ALD	1.0	37	10.98-07.05		D	4	64	1670	OZA659-EE16	0390	---	---
1.0i	ALL	1.0	37	10.98-07.05		R	4	64	700	OZA447-E32	0471	S4	1952
1.0i	ANV	1.0	37	10.98-05.00		D	4	64	1670	OZA659-EE16	0390	---	---
1.0i	AUC	1.0	37	05.00-05.04	-> 6X..4..060 000	D	4	64	1670	OZA659-EE16	0390	---	---
1.4i	AUD	1.4	44	09.00-04.02	-> 6E..2..010 000	D	4	64	1670	OZA659-EE16	0390	---	---
1.4i	AUD	1.4	44	09.00-07.05		D	4	64	1590	OZA659-EE20	0394	---	---
1.4i 16V	AUA	1.4	55	09.98-05.01		R	5	92	465	LZA11-V3	1829	---	---
1.4i 16V	AUA	1.4	55	09.98-05.01		D	4	64	1686	OZA510-V1	0491	---	---
1.4i 16V	AUA	1.4	55	09.98-05.01		D	4	64	1576	OZA510-V2	0402	---	---
1.4i 16V	APE	1.4	55	09.98-05.01		R	5	92	465	LZA11-V3	1829	---	---
1.4i 16V	APE	1.4	55	09.98-05.01		D	4	64	1686	OZA510-V1	0491	---	---
1.4i 16V	APE	1.4	55	09.98-05.01		D	4	64	1576	OZA510-V2	0402	---	---
1.4i 16V	BBY	1.4	55	11.01-07.05		R	5	92	535	LZA11-V2	1774	---	---
1.4i 16V	BBY	1.4	55	11.01-07.05		D	4	64	1596	OZA510-V10	1883	---	---
1.4i 16V	BBY	1.4	55	11.01-07.05		D	4	64	1706	OZA510-V7	1886	---	---
1.4i 16V	AHW	1.4	55	09.98-05.01		R	4	64	700	OZA447-E32	0471	S4	1952
1.4i 16V	ANM	1.4	74	09.98-05.01		R	5	92	465	LZA11-V3	1829	---	---
1.4i 16V	ANM	1.4	74	09.98-05.01		D	4	64	1686	OZA510-V1	0491	---	---
1.4i 16V	ANM	1.4	74	09.98-05.01		D	4	64	1576	OZA510-V2	0402	---	---
1.4i 16V	AQQ	1.4	74	09.98-05.01		R	5	92	465	LZA11-V3	1829	---	---
1.4i 16V	AQQ	1.4	74	09.98-05.01		D	4	64	1686	OZA510-V1	0491	---	---
1.4i 16V	AQQ	1.4	74	09.98-05.01		D	4	64	1576	OZA510-V2	0402	---	---
1.4i 16V	AUB	1.4	74	09.98-05.01		R	5	92	465	LZA11-V3	1829	---	---
1.4i 16V	AUB	1.4	74	09.98-05.01		D	4	64	1686	OZA510-V1	0491	---	---
1.4i 16V	AUB	1.4	74	09.98-05.01		D	4	64	1576	OZA510-V2	0402	---	---
1.4i 16V	AFK	1.4	74	09.98-05.01		R	4	64	700	OZA447-E32	0471	S4	1952

MULTIVAN

2.0	AAC	2.0	62-64	01.96-03.97	T..200 001 ->	R	3	14	1220	OZA446-E3	1866	S3	0412
2.0	AAC	2.0	62-64	09.90-12.95	-> T..200 000	R	3	46	545	OZA446-E51	0215	S3	0412
2.5 Syncro	AAF	2.5	80-81	11.92-12.93	-> T..200 000	R	3	46	335	OZA446-E53	0237	S3	0412
2.5	AAF	2.5	80-81	11.90-12.93	-> T..200 000	R	3	46	335	OZA446-E53	0237	S3	0412
2.5	ACU	2.5	81	01.96-03.97	T..200 001 ->	R	3	14	1220	OZA446-E3	1866	S3	0412
2.5 Syncro	ACU	2.5	81	07.94-10.96	-> T..200 000	R	3	46	335	OZA446-E53	0237	S3	0412
2.5	ACU	2.5	81	07.94-10.96	-> T..200 000	R	3	46	335	OZA446-E53	0237	S3	0412

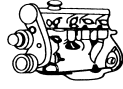
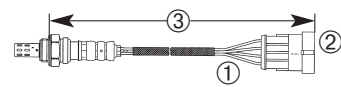

ℓ kW



ORDER No. STOCK No. TYPE No. UNIVERSAL No. PARTS No. DRAWING No.

VW

NEW BEETLE

1.4i 16V	BCA	1.4	55	11.01-		D	4	65	575	OZA659-EE23	0397	---	---
1.6i	AWH	1.6	74	10.99-10.00		D	4	65	700	OZA659-EE33	1617	---	---
1.6i	AYD	1.6	75	06.00-06.05		D	4	65	560	OZA659-EE14	0388	---	---
1.6i	BFS	1.6	75	06.02-	OE	D	4	65	560	OZA659-EE14	0388	---	---
1.8 T	APH	1.8	110	10.98-05.01		D	4	65	545	OZA659-EE19	0393	---	---
1.8 T	AVC	1.8	110	10.98-05.01		D	4	65	545	OZA659-EE19	0393	---	---
2.0i	AEG	2.0	85	01.98-10.01		R	4	64	975	OZA659-EE1	0375	---	---
2.0i	AEG	2.0	85	05.99-10.01	1C..X..460 001 ->	D	4	65	490	OZA659-EE18	0392	---	---
2.0i	AEG	2.0	85	05.99-10.01	9C..X..645 561 ->	D	4	65	490	OZA659-EE18	0392	---	---
2.0i	APK	2.0	85	11.98-06.05		R	4	64	975	OZA659-EE1	0375	---	---
2.0i	APK	2.0	85	11.98-06.05		D	4	65	490	OZA659-EE18	0392	---	---
2.0i	AQY	2.0	85	11.98-06.05		R	4	64	975	OZA659-EE1	0375	---	---
2.0i	AQY	2.0	85	11.98-06.05		D	4	65	490	OZA659-EE18	0392	---	---
2.0i	AZG	2.0	85	08.00-		D	4	65	505	OZA659-EE38	1625	---	---

NEW BEETLE CABRIO

1.4i 16V	BCA	1.4	55	01.03-		D	4	65	575	OZA659-EE23	0397	---	---
1.6i	BFS	1.6	75	01.03-		D	4	65	560	OZA659-EE14	0388	---	---
1.8 T	AWU	1.8	110	01.03-		D	4	64	975	OZA659-EE1	0375	---	---
1.8 T	AWV	1.8	110	01.03-		D	4	64	975	OZA659-EE1	0375	---	---
2.0i	AZJ	2.0	85	01.03-		D	4	65	505	OZA659-EE38	1625	---	---

PASSAT

1.6	1F	1.6	51	08.88-04.90	-> 31..L..300 00	R	1	3	472	OZA401-E2	1802	S1	1951
1.6	1F	1.6	53	04.90-07.90	31..L..300 01 ->	R	3	19	490	OZA446-E11	1898	S3	0412
1.6	ADP	1.6	74	10.96-12.98		R	4	48	967	OZA447-E14	0129	S4	1952
1.6	ADP	1.6	74	01.99-11.00		R	4	64	1175	OZA659-EE17	0391	---	---
1.6	AEK	1.6	74	10.94-12.95		R	4	48	780	OZA572-E11	0251	S4CG	1919
1.6	AFT	1.6	74	10.94-12.95		R	4	48	780	OZA572-E11	0251	S4CG	1919
1.6	AHL	1.6	74	10.96-11.00		R	4	48	967	OZA447-E14	0129	S4	1952
1.6i	ANA	1.6	74	07.99-09.00		R	4	64	1055	OZA516-AU1	0452	---	---
1.6i	ANA	1.6	74	07.99-09.00		D	4	65	700	OZA334-AU1	0474	---	---
1.6i	ALZ	1.6	75	10.00-05.05		R	4	64	1055	OZA516-AU1	0452	---	---
1.6i	ALZ	1.6	75	10.00-05.05		D	4	65	700	OZA334-AU1	0474	---	---
1.6i	BGU	1.6	75	06.05-		R	5	92	750	LZA07-V1	1851	---	---
1.6i	BGU	1.6	75	06.05-		D	4	85	471	OZA510-V11	1884	---	---
1.6	BSE	1.6	75	06.05-		R	5	91	725	LZA07-V4	0028	---	---
1.6	BSE	1.6	75	06.05-		D	4	85	511	OZA510-V12	0051	---	---
1.6	BSF	1.6	75	06.05-		R	5	91	725	LZA07-V4	0028	---	---
1.6	BSF	1.6	75	06.05-		D	4	85	511	OZA510-V12	0051	---	---
1.8	AAM	1.8	55	08.90-03.97		R	4	17	583	OZA446-E42	0150	S4	1952
1.8	AAM	1.8	55	07.95-03.97	3A..T..000 001 ->	R	4	48	520	OZA448-E31	0151	S4	1952
1.8	ABS	1.8	66	08.91-09.94	-> 3A..S..075 00	R	2	4	480	OZA401-E4	1822	S2	1918
1.8	ABS	1.8	66	08.91-09.94		R	4	17	583	OZA446-E42	0150	S4	1952
1.8	ADS	1.8	66	07.95-03.97	3A..T..000 001 ->	R	4	48	520	OZA448-E31	0151	S4	1952
1.8	ADZ	1.8	66	10.94-12.96		R	4	48	520	OZA448-E31	0151	S4	1952
1.8	RP	1.8	66	04.88-04.90	-> 31..L..300 000	R	1	3	472	OZA401-E2	1802	S1	1951
1.8	RP	1.8	66	04.90-07.91	31..L..300 001->	R	3	19	490	OZA446-E11	1898	S3	0412
1.8	JN	1.8	68	08.84-03.88		R	1	3	472	OZA401-E2	1802	S1	1951
1.8 Syncro	JN	1.8	68	01.86-03.88		R	3	19	975	OZA446-E2	1855	S3	0412
1.8	PF	1.8	79	04.88-07.90		R	3	18	970	OZA446-E15	1848	S3	0412

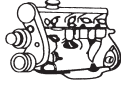

ℓ kW

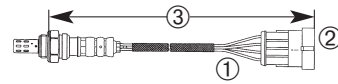

STOCK No. TYPE No. UNIVERSAL No. SERIAL No.

VW

PASSAT

1.8	AFY	1.8	85	01.99-11.00		R	4	64	1175	OZA659-EE17	0391	---	---
1.8	ADR	1.8	92	10.96-12.98		R	4	48	967	OZA447-E14	0129	S4	1952
1.8	ADR	1.8	92	01.99-11.00		R	4	64	1175	OZA659-EE17	0391	---	---
1.8 Syncro	ADR	1.8	92	06.97-11.00		R	4	64	1175	OZA659-EE17	0391	---	---
1.8	APT	1.8	92	01.99-11.00		R	4	64	1175	OZA659-EE17	0391	---	---
1.8	ARG	1.8	92	01.99-11.00		R	4	64	1175	OZA659-EE17	0391	---	---
1.8 T	AEB	1.8	110	10.96-12.98		R	4	66	1140	OZA447-E25	0494	S4	1952
1.8 T	AEB	1.8	110	01.99-11.00		R	4	64	1175	OZA659-EE17	0391	---	---
1.8 T	ANB	1.8	110	08.98-11.00		R	4	64	1175	OZA659-EE17	0391	---	---
1.8 T	ANB	1.8	110	08.98-11.00		D	4	65	690	OZA659-EE64	7949	---	---
1.8 T	APU	1.8	110	01.99-11.00		R	4	64	1175	OZA659-EE17	0391	---	---
1.8 T	AWL	1.8	110	10.01-		D	4	65	690	OZA659-EE64	7949	---	---
1.8 T	AWT	1.8	110	10.00-05.05		D	4	65	690	OZA659-EE64	7949	---	---
1.8 T	AWM	1.8	125	10.00-05.05		D	4	65	690	OZA659-EE64	7949	---	---
2.0	2E	2.0	85	08.90-07.94	-> 3A..R..300 000	R	4	17	583	OZA446-E42	0150	S4	1952
2.0	2E	2.0	85	07.94-09.94	3A..R..300 001 ->	R	4	36	622	OZA527-E14	0455	S4CG	1919
2.0	ADY	2.0	85	10.94-12.95		R	4	48	620	OZA572-E9	0423	S4CG	1919
2.0 Syncro	ADY	2.0	85	10.94-12.95		R	4	48	780	OZA572-E11	0251	S4CG	1919
2.0 Syncro	AGG	2.0	85	07.95-03.97		R	4	48	780	OZA572-E11	0251	S4CG	1919
2.0i	AZM	2.0	85	11.00-		R	4	64	1055	OZA516-AU1	0452	---	---
2.0i	AZM	2.0	85	11.00-		D	4	65	700	OZA334-AU1	0474	---	---
2.0i	BFF	2.0	85	03.03-		D	4	65	690	OZA659-EE64	7949	---	---
2.0i	ASU	2.0	88	10.99-10.00		R	4	64	1055	OZA516-AU1	0452	---	---
2.0i	ASU	2.0	88	11.99-10.00		D	4	65	700	OZA334-AU1	0474	---	---
2.0i	ALT	2.0	96	11.01-05.05		D	4	65	690	OZA659-EE64	7949	---	---
2.0i 16V	9A	2.0	100	08.88-07.90		R	3	19	975	OZA446-E2	1855	S3	0412
2.0i 16V	9A	2.0	100	08.90-09.93	-> 3A..R..300 000	R	4	17	583	OZA446-E42	0150	S4	1952
2.0i 16V	ABF	2.0	110	09.94-05.97	3A..S..075 001->	R	4	48	720	OZA447-E31	0460	S4	1952
2.0 TDI	BMR	2.0	125	08.05-		R	5	91	680	LZA17-VW1	0033	---	---
2.2	KX	2.2	85	08.85-03.88		R	1	3	472	OZA401-E2	1802	S1	1951
2.2 Syncro	JT	2.2	88	08.85-03.88		R	3	19	975	OZA446-E2	1855	S3	0412
2.3 Syncro	AGZ	2.3	110	10.97-11.00		R	4	66	1350	OZA447-E35	0493	S4	1952
2.8 VR6	AAA	2.8	128	06.91-07.94	-> 3A..R..400 000	R	4	36	585	OZA572-E13	0254	S4CG	1919
2.8 VR6	AAA	2.8	128	07.94-07.95	3A..S..000 001 ->	R	4	48	620	OZA572-E9	0423	S4CG	1919
					3A..T..000 209								
2.8 VR6	AAA	2.8	128	08.95-		R	4	48	720	OZA447-E31	0460	S4	1952
2.8i V6	BBG	2.8	140	10.00-05.05		R	4	48	615	OZA659-EE36	1620	---	---
2.8i V6	BBG	2.8	140	10.00-05.05	↑ / Bank 1	D	4	48	1435	OZA659-EE46	5748	---	---
2.8i V6	BBG	2.8	140	10.00-05.05	↑ / Bank 2	D	4	66	1440	OZA659-EE47	5750	---	---
2.8i V6	AMX	2.8	142	10.00-05.05		R	4	48	615	OZA659-EE36	1620	---	---
2.8i V6	AMX	2.8	140	10.00-05.05	↑ / Bank 1	D	4	48	1435	OZA659-EE46	5748	---	---
2.8i V6	AMX	2.8	140	10.00-05.05	↑ / Bank 2	D	4	66	1440	OZA659-EE47	5750	---	---
2.8i V6	ATQ	2.8	142	10.00-05.05		R	4	48	615	OZA659-EE36	1620	---	---
2.8i V6	ATQ	2.8	140	10.00-05.05	↑ / Bank 1	D	4	48	1435	OZA659-EE46	5748	---	---
2.8i V6	ATQ	2.8	140	10.00-05.05	↑ / Bank 2	D	4	66	1440	OZA659-EE47	5750	---	---
2.8i V6 Syncro	APR	2.8	142	01.99-11.00		R	4	48	615	OZA659-EE36	1620	---	---
2.8i V6 Syncro	AQD	2.8	142	01.99-11.00		R	4	48	615	OZA659-EE36	1620	---	---

POLO

1.05	AAU	1.0	33	10.90-09.94		R	4	17	920	OZA445-E4	1850	S4	1952
1.05 Van	AAU	1.0	33	04.93-09.94		R	4	17	920	OZA445-E4	1850	S4	1952

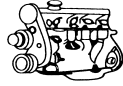

ℓ kW

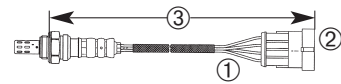

STOCK No. ORDER No. TYPE No. UNITS No. SERIAL No.

VW

POLO

1.0i	AER	1.0	37	03.96-04.97		R	4	64	475	OZA448-E51	0426	S4	1952
1.0i	ALD	1.0	37	07.98-09.01		R	4	64	535	OZA659-EE40	1627	---	---
1.0i	AUC	1.0	37	10.99-09.01		D	4	64	1670	OZA659-EE16	0390	---	---
1.05	AEV	1.05	33	10.94-12.99		R	4	48	985	OZA447-E30	0449	S4	1952
1.2	AWY	1.2	40	01.02-		R	4	64	601	OZA585-I1	1809	---	---
1.2	AWY	1.2	40	01.02-		D	4	65	231	OZA510-I1	1808	---	---
1.2	BMD	1.2	40	11.04-		R	4	64	611	OZA534-V1	1778	---	---
1.2	BME	1.2	47	10.01-		R	4	85	481	OZA532-V3	1776	---	---
1.2	BME	1.2	47	10.01-		D	4	64	251	OZA510-V6	1885	---	---
1.2	AZQ	1.2	47	10.01-		D	4	64	251	OZA510-V6	1885	---	---
1.3	AAV	1.3	40	08.91-09.94		R	4	17	450	OZA445-E2	1810	S4	1952
1.3	AAV	1.3	40	01.91-07.91		R	4	17	920	OZA445-E4	1850	S4	1952
1.3	ADX	1.3	40	10.94-07.95		R	4	48	985	OZA447-E30	0449	S4	1952
1.3	NZ	1.3	40	10.87-08.90	80..J..600 001 ->	R	3	18	960	OZA445-E3	1860	S3	0412
1.3	NZ	1.3	40	12.86-09.87	-> 80..J..060 000	R	3	18	970	OZA446-E15	1848	S3	0412
1.3	NZ	1.3	40	10.90-12.92		R	4	17	920	OZA445-E4	1850	S4	1952
1.3	3F	1.3	56-59	10.89-08.90		R	3	18	970	OZA446-E15	1848	S3	0412
1.3	3F	1.3	56-59	10.90-09.94		R	4	17	920	OZA445-E4	1850	S4	1952
1.3 G40	PY	1.3	82-85	10.90-09.94		R	4	17	920	OZA445-E4	1850	S4	1952
1.4i	AEX	1.4	44	07.95-12.99		R	4	48	985	OZA447-E30	0449	S4	1952
1.4i	AEX	1.4	44	07.95-10.99		R	4	48	720	OZA447-E31	0460	S4	1952
1.4i Classic	AEX	1.4	44	05.97-11.97		R	4	48	720	OZA447-E31	0460	S4	1952
1.4i Classic	AEX	1.4	44	05.97-11.97	6K..X..541 001->	R	4	64	700	OZA447-E32	0471	S4	1952
1.4i	AEX	1.4	44	05.97-11.97	6N..W 000 001->	R	4	64	700	OZA447-E32	0471	S4	1952
1.4i Van	AEX	1.4	44	05.98-12.99	6N..W 000 001->	R	4	64	700	OZA447-E32	0471	S4	1952
1.4 Variant	AEX	1.4	44	03.97-04.97		R	4	48	520	OZA448-E31	0151	S4	1952
1.4i Classic	AKV	1.4	44	05.97-11.97	6K..X..541 001->	R	4	64	700	OZA447-E32	0471	S4	1952
1.4i	AKK	1.4	44	09.98-09.01		R	4	64	535	OZA659-EE40	1627	---	---
1.4i Classic	AKK	1.4	44	10.99-09.01		R	4	65	480	OZA659-EE32	1614	---	---
1.4i Variant	AKK	1.4	44	10.99-09.01		R	4	65	480	OZA659-EE32	1614	---	---
1.4i Van	APQ	1.4	44	05.98-12.99	6N..W 000 001->	R	4	64	700	OZA447-E32	0471	S4	1952
1.4i	APQ	1.4	44	05.97-12.99	6N..W 000 001->	R	4	64	700	OZA447-E32	0471	S4	1952
1.4i	AUD	1.4	44	10.99-09.01		D	4	64	1670	OZA659-EE16	0390	---	---
1.4i	AUD	1.4	44	10.99-09.01		D	4	64	1590	OZA659-EE20	0394	---	---
1.4i Classic	AUD	1.4	44	11.00-09.01	6K..1..526 501->	D	4	65	480	OZA659-EE32	1614	---	---
1.4i	ANW	1.4	44	09.98-09.01		D	4	64	1670	OZA659-EE16	0390	---	---
1.4i	ANW	1.4	44	09.98-09.01		D	4	64	1590	OZA659-EE20	0394	---	---
1.4i 16V	APE	1.4	55	07.99-04.02		R	5	92	465	LZA11-V3	1829	---	---
1.4i 16V	APE	1.4	55	07.99-10.01		D	4	64	1686	OZA510-V1	0491	---	---
1.4i 16V	APE	1.4	55	07.99-10.01		D	4	64	1576	OZA510-V2	0402	---	---
1.4i 16V	APE	1.4	55	11.01-04.02		D	4	64	526	OZA510-V5	0435	---	---
1.4i 16V	AUA	1.4	55	10.99-09.01		R	5	92	465	LZA11-V3	1829	---	---
1.4i 16V	AUA	1.4	55	10.01-04.02		R	5	92	535	LZA11-V2	1774	---	---
1.4i 16V	BKY	1.4	55	06.04-		R	5	91	330	LZA07-V3	1880	---	---
1.4i 16V	BKY	1.4	55	06.04-		D	4	64	526	OZA510-V5	0435	---	---
1.4i 16V	BBY	1.4	55	11.01-		R	5	92	465	LZA11-V3	1829	---	---
1.4i 16V	BUD	1.4	59	05.06-		R	4	84	511	OZA629-V3	1720	---	---
1.4i 16V	BUD	1.4	59	05.06-		D	4	64	526	OZA510-V5	0435	---	---
1.4i 16V	AFH	1.4	74	04.96-12.99		R	4	48	985	OZA447-E30	0449	S4	1952
1.4i 16V	AFH	1.4	74	05.97-04.98	-> 6N..X..068 038	R	4	64	995	OZA447-E40	1738	S4	1952

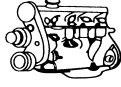

ℓ kW

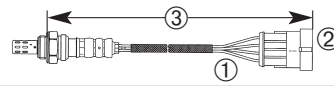
STOCK
REORDER
No.
UNIVERSAL
TYPE
No.
SUPPLIER
REF. No.
VW**POLO**

1.4i 16V	AFH	1.4	74	05.98-09.01	6N..X..068 039->		R	4	64	700	OZA447-E32	0471	S4	1952
1.4i 16V	AUA	1.4	74	11.01-			R	5	92	535	LZA11-V2	1774	---	---
1.4i 16V	AUA	1.4	74	11.01-			D	4	64	526	OZA510-V5	0435	---	---
1.4i 16V	AUB	1.4	74	10.99-09.01			R	5	92	465	LZA11-V3	1829	---	---
1.4i 16V	AUB	1.4	74	10.99-09.01			D	4	64	1686	OZA510-V1	0491	---	---
1.4i 16V	BBZ	1.4	74	07.99-11.01			D	4	64	1686	OZA510-V1	0491	---	---
1.4i 16V	BBZ	1.4	74	07.99-11.01			D	4	64	1576	OZA510-V2	0402	---	---
1.4i 16V	BBZ	1.4	74	11.01-			R	5	92	535	LZA11-V2	1774	---	---
1.4i 16V	BBZ	1.4	74	11.01-			D	4	64	526	OZA510-V5	0435	---	---
1.6	AEA	1.6	55	10.94-07.95			R	4	48	985	OZA447-E30	0449	S4	1952
1.6	AEE	1.6	55	07.95-12.99			R	4	64	995	OZA447-E40	1738	S4	1952
1.6	AEE	1.6	55	07.95-01.96			R	4	48	985	OZA447-E30	0449	S4	1952
1.6	AEE	1.6	55	02.96-12.99			R	4	64	995	OZA447-E40	1738	S4	1952
1.6 Variant	AEE	1.6	55	04.97-12.98			R	4	48	550	OZA447-E16	0259	S4	1952
1.6 Classic	AEE	1.6	55	04.97-12.98			R	4	48	550	OZA447-E16	0259	S4	1952
1.6	AHS	1.6	55	03.96-12.99			R	4	64	995	OZA447-E40	1738	S4	1952
1.6i Classic	AEH	1.6	74	10.99-09.01			R	4	65	480	OZA659-EE32	1614	---	---
1.6i Variant	AEH	1.6	74	10.99-09.01			R	4	65	480	OZA659-EE32	1614	---	---
1.6i Classic	AKL	1.6	74	10.99-09.01			R	4	65	480	OZA659-EE32	1614	---	---
1.6i Variant	AKL	1.6	74	10.99-09.01			R	4	65	480	OZA659-EE32	1614	---	---
1.6i 16V	BTS	1.6	77	05.06-			R	4	84	511	OZA629-V3	1720	---	---
1.6i 16V	BTS	1.6	77	05.06-			D	4	85	526	OZA629-V4	1721	---	---
1.6i 16V GTI	AJV	1.6	88	09.98-10.99			R	4	64	700	OZA447-E32	0471	S4	1952
1.6i 16V GTI	ARC	1.6	92	11.99-09.01			D	4	64	1670	OZA659-EE16	0390	---	---
1.6i 16V GTI	AVY	1.6	92	11.99-09.01			D	4	64	1670	OZA659-EE16	0390	---	---

SANTANA

1.8	JN	1.8	68	08.84-12.84			R	1	3	472	OZA401-E2	1802	S1	1951
-----	----	-----	----	-------------	--	--	---	---	---	-----	-----------	------	----	------

SCIROCCO

1.8	JH	1.8	68-70	05.83-07.92			R	1	3	472	OZA401-E2	1802	S1	1951
1.8i 16V	PL	1.8	92-95	02.86-07.92			R	3	19	975	OZA446-E2	1855	S3	0412

SHARAN

1.8 T	AWC	1.8	110	05.00-			D	4	64	975	OZA659-EE1	0375	---	---
2.0i	ADY	2.0	85	09.95-03.96	-> 7M..T..036 895		R	4	48	1430	OZA572-E10	0275	S4CG	1919
2.0i	ATM	2.0	85	05.00-			D	4	64	975	OZA659-EE1	0375	---	---
2.8i VR6 Syncro	AAA	2.8	128	11.96-01.98			R	4	48	720	OZA447-E31	0460	S4	1952
2.8i VR6	AAA	2.8	128	09.95-01-98			R	4	48	720	OZA447-E31	0460	S4	1952
2.8i VR6	AAA	2.8	128	02.98-04.00			R	4	48	1430	OZA447-E36	1950	S4	1952

TOURAN

1.4i TSI	BMY	1.4	103	07.06-			R	4	84	521	OZA629-V5	1722	---	---
1.4i TSI	BMY	1.4	103	07.06-			D	4	85	601	OZA629-V7	1725	---	---
1.4i TSI	BMY	1.4	103	07.06-			D	4	85	651	OZA629-V6	1723	---	---
1.6i	BGU	1.6	75	07.03-			R	5	92	680	LZA07-V2	1868	---	---
1.6i	BGU	1.6	75	07.03-			D	4	85	471	OZA510-V11	1884	---	---
1.6i	BSE	1.6	75	07.03-			R	5	92	680	LZA07-V2	1868	---	---
1.6i	BSE	1.6	75	07.03-			D	4	85	471	OZA510-V11	1884	---	---
1.6i	BSF	1.6	75	07.03-			R	5	92	680	LZA07-V2	1868	---	---
1.6i	BSF	1.6	75	07.03-			D	4	85	471	OZA510-V11	1884	---	---

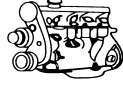

ℓ kW

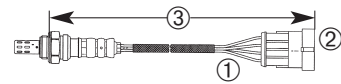
STOCK
ORDER
No.
TYPE
UNIVERSAL
No.
NUMBER
No.
VW**TRANSPORTER**

2.0	AAC	2.0	64	09.90-12.95	-> T..200 000	R	3	46	545	OZA446-E51	0215	S3	0412
2.0	AAC	2.0	64	01.96-06.03	T..200 001 ->	R	3	14	1220	OZA446-E3	1866	S3	0412
2.1	SR	2.1	64	10.86-07.92	ⓄH	R	3	19	975	OZA446-E2	1855	S3	0412
2.1	SS	2.1	68	08.89-07.92		R	3	19	975	OZA446-E2	1855	S3	0412
2.1	MV	2.1	70	08.85-07.92		R	3	19	975	OZA446-E2	1855	S3	0412
2.1 Syncro	MV	2.1	70	08.85-07.92		R	3	19	975	OZA446-E2	1855	S3	0412
2.5	AAF	2.5	80	11.92-12.93	-> T..200 000	R	3	46	335	OZA446-E53	0237	S3	0412
2.5 Syncro	AAF	2.5	80	11.90-12.93	-> T..200 000	R	3	46	335	OZA446-E53	0237	S3	0412
2.5	ACU	2.5	81	01.94-10.96	-> T..200 000	R	3	46	335	OZA446-E53	0237	S3	0412
2.5	ACU	2.5	81	01.96-08.96	T..200 001 ->	R	3	14	1220	OZA446-E3	1866	S3	0412
2.5 Syncro	ACU	2.5	81	01.94-10.96	-> T..200 000	R	3	46	335	OZA446-E53	0237	S3	0412
2.8 VR6	AES	2.8	103	01.96-10.97		R	4	48	720	OZA447-E31	0460	S4	1952

VENTO

1.4	ABD	1.4	40-44	09.94-07.95	1H..S..120 001 ->	R	4	48	550	OZA447-E16	0259	S4	1952	
1.4	ABD	1.4	40-44	11.91-09.94	-> 1H..S..120 000	R	4	36	550	OZA572-E1	0283	S4CG	1919	
1.4	ABD	1.4	44	11.91-09.94	-> 1H..S..120 000		R	4	36	1075	OZA527-E36	1993	S4CG	1919
1.6	ABU	1.6	55	09.92-09.94	-> 1H..S..120 000	R	4	36	550	OZA572-E1	0283	S4CG	1919	
1.6	AEA	1.6	55	10.94-12.97	1H..S..120 001 ->	R	4	48	550	OZA447-E16	0259	S4	1952	
1.6	AEE	1.6	55	10.94-12.97	1H..S..120 001 ->	R	4	48	550	OZA447-E16	0259	S4	1952	
1.8	AAM	1.8	55	11.91-09.94	-> 1H..S..120 000		R	2	4	480	OZA401-E4	1822	S2	1918
1.8	AAM	1.8	55	11.91-09.94	-> 1H..S..120 000		R	4	17	583	OZA446-E42	0150	S4	1952
1.8	ABS	1.8	66	11.91-09.94	-> 1H..S..120 000		R	2	4	480	OZA401-E4	1822	S2	1918
1.8	ABS	1.8	66	11.91-09.94	-> 1H..S..120 000		R	4	17	583	OZA446-E42	0150	S4	1952
1.8	ADZ	1.8	66	10.94-07.95		R	4	48	520	OZA448-E31	0151	S4	1952	
2.0	2E	2.0	85	11.91-09.94		R	4	36	1075	OZA527-E36	1993	S4CG	1919	
2.0	2E	2.0	85	11.91-09.94		R	4	36	585	OZA572-E13	0254	S4CG	1919	
2.0	ADY	2.0	85	10.94-05-96		R	4	48	620	OZA572-E9	0423	S4CG	1919	
2.0	AGG	2.0	85	07.95-12.97		R	4	48	620	OZA572-E9	0423	S4CG	1919	
2.8 VR6	AAA	2.8	128	01.92-12.97		R	4	36	1075	OZA527-E36	1993	S4CG	1919	
2.8 VR6	AAA	2.8	128	09.94-07.95		R	4	48	620	OZA572-E9	0423	S4CG	1919	

ZASTAVA**FLORIDA**

1.3	OHC-M5	1.3	50	07.89-12.90		R	1	3	472	OZA401-E2	1802	S1	1951
1.3	OHC-M5	1.3	50	01.91-12.93		R	3	19	490	OZA446-E11	1898	S3	0412

YUGO

60 i.e.	OHC-M4	1.1	44	07.89-05.90		R	1	3	472	OZA401-E2	1802	S1	1951
65 i.e.	OHC-M5	1.3	47	07.89-05.90		R	1	3	472	OZA401-E2	1802	S1	1951
1.3i.e. Cabrio	OHC-M5	1.3	48	07.89-05.90		R	1	3	472	OZA401-E2	1802	S1	1951
65 i.e.	OHC.M5	1.3	47	06.90-12.93		R	3	19	490	OZA446-E11	1898	S3	0412
1.3 i.e.Cabrio	OHC-M5	1.3	48	06.90-12.93		R	3	19	490	OZA446-E11	1898	S3	0412

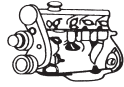

ccm kW

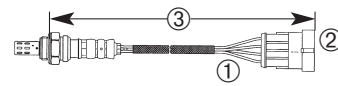

① ② ③

ORDER
No.No.

APRILIA

RSV 1000 R	Rotax V2	998	102	04.04-		4	31	590	OZA591-SZ1	1767
RSV 1000 R Factory	Rotax V2	998	102	10.03-		4	31	590	OZA591-SZ1	1767
Tuono 1000 R	Rotax V2	998	102	03.06-		4	31	590	OZA591-SZ1	1767
Tuono 1000 R Factory	Rotax V2	998	102	03.06-		4	31	590	OZA591-SZ1	1767

BMW

F 650 CS		652	25	11.01-12.03		4	68	340	OZA447-E28	0427
F 650 CS		652	25	11.01-12.03		4	68	340	OZA447-E28	0427
F 650 GS		652	37	09.99-12.03		4	68	340	OZA447-E28	0427
F 650 GS Dakar		652	37	09.99-12.03		4	68	340	OZA447-E28	0427
F 650 CS	K14/02	652	25	01.04-12.05		4	68	341	OZA630-BM3	0074
F 650 CS	K14/02	652	37	01.04-12.05		4	68	341	OZA630-BM3	0074
F 650 GS	R13Mü	652	25	12.03-		4	68	341	OZA630-BM3	0074
F 650 GS	R13Mü	652	37	12.03-		4	68	341	OZA630-BM3	0074
G 650 Xchallenge	K15	650	39	03.07-		4	99	231	OZA630-BM1	0072
G 650 Xmoto	K15	650	39	03.07-		4	99	231	OZA630-BM1	0072
G 650 Xcountry	K15	650	39	03.07-		4	99	231	OZA630-BM1	0072
F 800 S	K71	799	25	12.05-		4	99	521	OZA630-BM2	0073
F 800 S	K71	799	60	12.05-		4	99	521	OZA630-BM2	0073
F 800 ST	K71	798	25	09.06-		4	99	521	OZA630-BM2	0073
F 800 ST	K71	798	62	09.06-		4	99	521	OZA630-BM2	0073
F 800 R	K73	799	25	12.06-		4	99	521	OZA630-BM2	0073
F 800 R	K73	799	60	12.06-		4	99	521	OZA630-BM2	0073
R 850 R	R28	848	25	07.02-08.05		4	69	922	OZA522-BM1	0053
R 850 R	R28	848	52	07.02-08.05		4	69	922	OZA522-BM1	0053
R 850 RT	R22	848	52	03.01-12.04		4	69	922	OZA522-BM1	0053
R 1100 S	259S	1085	72	01.03-12.03		4	69	922	OZA522-BM1	0053
R 1150 GS	R21	1130	63	11.01-12.03		4	69	922	OZA522-BM1	0053
R 1150 GS Adventure	R21	1130	63	11.01-09.06		4	69	922	OZA522-BM1	0053
R 1150 R	R28	1130	63	10.02-08.05		4	69	922	OZA522-BM1	0053
R 1150 RS	R22	1130	70	05.01-09.04		4	69	922	OZA522-BM1	0053
R 1150 RT	R22	1130	70	03.01-12.04		4	69	922	OZA522-BM1	0053
K 1200 GT	K41GT	1171	72	11.02-08.05		4	69	922	OZA522-BM1	0053
K 1200 GT	K41GT	1171	96	11.02-08.05		4	69	922	OZA522-BM1	0053
K 1200 GT	K44	1157	112	12.05-		4	99	521	OZA630-BM2	0073
K 1200 LT	K589	1171	85	01.04-		4	69	554	OZA522-BM2	0054
K 1200 RS	K41	1171	72	01.01-12.04		4	69	922	OZA522-BM1	0053
K 1200 RS	K41	1171	96	01.01-12.04		4	69	922	OZA522-BM1	0053
K 1200 R	K43	1157	120	03.05-		4	99	521	OZA630-BM2	0073
K 1200 S	K40	1157	123	06.04-		4	99	521	OZA630-BM2	0073
R 1200 C	259C	1170	45	06.03-12.04		4	69	922	OZA522-BM1	0053
R 1200 CL	K30	1170	45	02.02-12.04		4	69	922	OZA522-BM1	0053
R 1200 GS	K25	1170	72	11.03-		4	99	231	OZA630-BM1	0072
R 1200 R	K27	1170	81	12.06-		4	99	231	OZA630-BM1	0072
R 1200 RT	K26	1170	81	10.04-		4	99	231	OZA630-BM1	0072
R 1200 S	K29	1170	81	10.05-		4	99	231	OZA630-BM1	0072
R 1200 ST	K28	1170	81	12.04-		4	99	231	OZA630-BM1	0072
HP2	K25HP	1170	77	12.05-		4	99	231	OZA630-BM1	0072

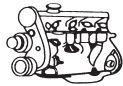

ccm kW

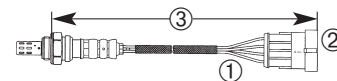

① ② ③

O
R
D
E
R
C
O
D
E
N
o.
No.**DUCATI**

Monster 695		695	54	06.04-		4	40	880	OZA591-BB3	0066
Monster 696		696	59	08.08-	2x	4	31	320	OZA591-BA1	6496
Monster S2R		803	57	04.06-		4	40	880	OZA591-BB3	0066
848		849	99	09.07-		4	40	880	OZA591-BB3	0066
848 S		849	99	09.07-		4	40	880	OZA591-BB3	0066
GT 1000		992	68	01.06-		4	40	880	OZA591-BB3	0066
Monster S2R 1000		992	70	01.06-		4	40	880	OZA591-BB3	0066
Monster S4RS		992	96	06.04-		4	40	880	OZA591-BB3	0066
Paul Smart 1000		992	68	01.06-		4	40	880	OZA591-BB3	0066
ST3		992	79	01.04-		4	40	880	OZA591-BB3	0066
ST3 S		992	79	01.04-		4	40	880	OZA591-BB3	0066
Sport 1000		992	68	01.06-		4	40	880	OZA591-BB3	0066
Desmosedici RR		989	147	07.07-		4	40	880	OZA591-BB3	0066
Hypermotard		1078	70	08.07-		4	40	880	OZA591-BB3	0066
Hypermotard S		1078	70	08.07-		4	40	880	OZA591-BB3	0066
Multistrada 1100		1078	70	06.06-		4	40	880	OZA591-BB3	0066
Multistrada 1100 S		1078	70	06.06-		4	40	880	OZA591-BB3	0066
1098		1098	119	11.06-		4	40	880	OZA591-BB3	0066
1098 S		1098	119	11.06-		4	40	880	OZA591-BB3	0066

HONDA

Zoomer 50		50	3	01.05-		4	96	225	OZA577-H13	6475
Pantheon 125i		125	10	01.05-		4	96	280	OZA577-H6	0065
PS 125i		125	10	01.06-		4	96	210	OZA577-H15	0064
SH 125i		125	10	01.05-		4	96	210	OZA577-H15	0064
S-Wing 125		125	10	01.06-		4	96	210	OZA577-H15	0064
PS 150i		150	11	01.06-		4	96	210	OZA577-H15	0064
Pantheon 150i		150	12	01.05-		4	96	280	OZA577-H6	0065
SH 150i		150	11	01.05-		4	96	210	OZA577-H15	0064
S-Wing 150		150	11	01.06-		4	96	210	OZA577-H15	0064
S-Wing 150 ABS		150	11	01.06-		4	96	210	OZA577-H15	0064
SH 300		279	28	04.07-		1	127	285	ZSJ0002-HG002	6538
SH 300 ABS		279	28	04.07-		1	127	285	ZSJ0002-HG002	6538
Silver Wing 600		582	37	02.07-		4	96	440	OZA577-H22	6483
Hornet 600		599	75	02.07-		4	80	500	OZA656-H3	6493
CBR 600 RR		599	88	01.07-		4	80	675	OZA577-H24	6484
XL 680 Transalp		680	44	07.08-		4	80	305	OZA656-H1	6491
VT 750		745	34	01.07-	Sensor I	4	96	225	OZA577-H19	6476
VT 750		745	34	01.07-	Sensor II	4	96	405	OZA577-H20	6477
VT 750 Shadow		745	34	01.07-	Sensor I	4	96	225	OZA577-H19	6476
VT 750 Shadow		745	34	01.07-	Sensor II	4	96	405	OZA577-H20	6477
VT 750 Shadow Spirit		745	34	01.07-	Sensor I	4	96	225	OZA577-H19	6476
VT 750 Shadow Spirit		745	34	01.07-	Sensor II	4	96	405	OZA577-H20	6477
VFR 800		782	80	01.99-12.99		4	96	510	OZA333-H16	6456
VFR 800		782	80	01.00-12.00		4	96	510	OZA333-H29	6459
VFR 800		782	80	01.01-	Sensor I	4	96	340	OZA333-H30	6460
VFR 800		782	80	01.01-	Sensor II	4	96	300	OZA333-H31	6462
XL 1000 Varadeiro		996	69	01.03-12.06		4	96	840	OZA577-H7	6471
XL 1000 Varadeiro		996	69	01.07-		4	96	880	OZA656-H2	6492
CBF 1000		998	72	01.06-		4	80	990	OZA577-H17	0007

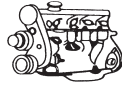

ccm kW

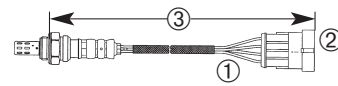

① ② ③

ORDER
No.No.

HONDA

CBF 1000 ABS		998	72	01.06-		4	80	990	OZA577-H17	0007
CBR 1000 RR Fireblade		998	126	02.04-12.05		4	80	970	OZA577-H12	6473
CBR 1000 RR Fireblade		998	126	01.06-12.07		4	80	865	OZA577-H21	6479
CBR 1000 RR Fireblade		1000	131	01.08-		4	105	930	AZD0102-HG009	6576
CBR 1100 XX Super Blackbird		1137	112	01.03-12.07		4	96	640	AZD0101-HG004	6543
Pan European		1261	93	01.06-08.07	Sensor I	4	96	530	OZA577-H4	6463
Pan European		1261	93	01.06-08.07	Sensor II	4	96	530	OZA577-H5	6469
Pan European		1261	93	09.07-	Sensor I	4	96	530	OZA656-H5	6494
Pan European		1261	93	09.07-	Sensor II	4	96	530	OZA656-H6	6495
CB 1300		1284	85	03.08-	Sensor I	4	80	930	AZD0102-HG003	7664
CB 1300		1284	85	03.08-	Sensor II	4	80	590	AZD0102-HG004	7665
CB 1300 S		1284	85	03.08-	Sensor I	4	80	930	AZD0102-HG003	7664
CB 1300 S		1284	85	03.08-	Sensor II	4	80	590	AZD0102-HG004	7665
VTX 1800		1795	71	01.03-12.05		4	96	450	AZD0101-HG003	6541
GL 1800 Gold Wing		1832	87	01.07-	Sensor I	4	96	700	AZD0101-HG001	6539
GL 1800 Gold Wing		1832	87	01.07-	Sensor II	4	96	750	AZD0101-HG002	6540

HUSQVARNA

TE 450		449	21	09.07-		4	97	410	OZA591-WB1	0010
SM 450 R		449	14	09.07-		4	97	410	OZA591-WB1	0010
SM 510 R		501	14	09.07-		4	97	410	OZA591-WB1	0010
SM 610		576	39	10.06-		4	97	410	OZA591-WB1	0010

HYOSUNG

GT 650i		647	25	01.07-		4	97	410	OZA591-WB1	0010
GT 650i		647	60	01.07-		4	97	410	OZA591-WB1	0010
GV 650i		647	24	01.07-		4	97	410	OZA591-WB1	0010
GV 650i		647	59	01.07-		4	97	410	OZA591-WB1	0010

KAWASAKI

ZX-6R Ninja		599	25	01.07-	Sensor I	4	34	235	AZD0101-KJ002	6552
ZX-6R Ninja		599	25	01.07-	Sensor II	4	34	235	AZD0101-KJ006	6559
ZX-6R Ninja		599	72	01.07-	Sensor I	4	34	235	AZD0101-KJ002	6552
ZX-6R Ninja		599	72	01.07-	Sensor II	4	34	235	AZD0101-KJ006	6559
ZX-6R Ninja		599	92	01.07-	Sensor I	4	34	235	AZD0101-KJ002	6552
ZX-6R Ninja		599	92	01.07-	Sensor II	4	34	235	AZD0101-KJ006	6559
ZX-10R		998	128	11.05-05.06		4	80	345	AZD0101-KJ001	6551
ZX-10R		998	129	06.06-12.07	Sensor I	4	34	345	AZD0101-KJ004	6556
ZX-10R		998	129	06.06-12.07	Sensor II	4	80	500	AZD0101-KJ005	6558
ZX-10R		998	129	01.08-	Sensor I	4	34	660	AZD0102-KJ003	6568
ZX-10R		998	129	01.08-	Sensor II	4	34	760	AZD0102-KJ004	6574
ZZR 1400		1352	72	01.07-12.07	Sensor I	4	34	345	AZD0101-KJ004	6556
ZZR 1400		1352	72	01.07-12.07	Sensor II	4	34	275	AZD0101-KJ008	6561
ZZR 1400		1352	140	01.07-12.07	Sensor I	4	34	345	AZD0101-KJ004	6556
ZZR 1400		1352	140	01.07-12.07	Sensor II	4	34	275	AZD0101-KJ008	6561

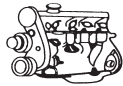

ccm kW

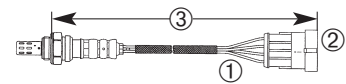

① ② ③

O
R
E
B
E
C
K
N
o.
N
o.**KAWASAKI**

ZZR 1400		1352	142	01.08-		4	34	235	AZD0102-KJ001	6567
----------	--	------	-----	--------	--	---	----	-----	---------------	-------------

KTM

690 Enduro		654	45	03.08-		4	80	500	AZD0101-VB002	7673
690 Supermoto		654	47	03.07-		4	80	500	AZD0101-VB002	7673
690 Supermoto R		654	46	03.08-		4	80	500	AZD0101-VB002	7673
690 SMC		654	45	03.08-		4	80	500	AZD0101-VB002	7673
690 Duke		654	48	03.08-		4	80	500	AZD0101-VB002	7673
990 Adventure		999	25	01.06-		4	97	500	OZA591-VB2	0009
990 Adventure		999	72	01.06-		4	97	500	OZA591-VB2	0009
990 Adventure S		999	72	01.06-		4	97	500	OZA591-VB2	0009
990 Superduke		999	88	01.06-		4	97	500	OZA591-VB2	0009
990 Superduke R		999	88	01.06-		4	97	500	OZA591-VB2	0009
990 Supermoto		999	85	03.08-		4	97	500	OZA591-VB2	0009

KYMCO

People S 200i		163	8	01.07-		4	80	500	AZD0101-BA001	7667
People S 250i		251	15	01.07-		4	80	500	AZD0101-BA001	7667
Yager GT 200i		176	11	06.06-		4	31	590	OZA591-YB1	0011
Venox 250 AFI		249	21	06.06-		4	31	590	OZA591-YB1	0011
Xciting 250i		251	16	06.06-		4	31	590	OZA591-YB1	0011

MV AGUSTA

F4 Brutale 910		910	100	10.06-		4	40	880	OZA591-BB3	0066
F4 1000R		998	128	10.06-		4	40	880	OZA591-BB3	0066
F4 1000CC		1078	141	07.07-		4	40	880	OZA591-BB3	0066

MOTO GUZZI

Breva V 750 i.e.		744	25	01.03-12.05		4	40	310	OZA341-BB1	0036
Breva V 750 i.e.		744	36	01.03-12.05		4	40	310	OZA341-BB1	0036
Breva V 750 i.e.		744	36	01.06-		4	40	310	OZA591-BB2	1710
Nevada V 750 i.e.		744	36	01.06-		4	40	310	OZA591-BB2	1710
Breva V 850 i.e.		877	53	01.06-		4	40	310	OZA591-BB2	1710
Griso V 850 i.e.		877	56	01.06-		4	40	310	OZA591-BB2	1710
Norge V 850 i.e.		877	53	01.06-		4	40	310	OZA591-BB2	1710
Breva V 1100		1064	62	03.04-12.05		4	40	310	OZA341-BB1	0036
Breva V 1100 i.e.		1064	63	01.06-		4	40	310	OZA591-BB2	1710
California EV		1064	55	03.04-12.05		4	40	310	OZA341-BB1	0036
California EV Touring		1064	55	03.04-12.05		4	40	310	OZA341-BB1	0036
California Classic		1064	55	01.06-12.05		4	40	310	OZA341-BB1	0036
California Classic		1064	54	01.06-		4	40	310	OZA591-BB2	1710
California Touring		1064	55	01.06-12.05		4	40	310	OZA341-BB1	0036
California Vintage		1064	55	01.06-12.05		4	40	310	OZA341-BB1	0036
California Vintage		1064	54	01.06-		4	40	310	OZA591-BB2	1710
Griso V 1100 i.e.		1064	65	01.06-		4	40	310	OZA591-BB2	1710
V11 Cafè Sport		1064	67	03.04-12.04		4	40	310	OZA341-BB1	0036
V11 Coppa Italia		1064	67	03.04-12.05		4	40	310	OZA341-BB1	0036

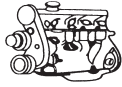

ccm kW

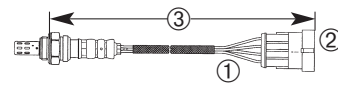

① ② ③

ORDER
No.No.

MOTO GUZZI

V11 Le Mans		1064	67	03.04-12.05		4	40	310	OZA341-BB1	0036
V11 Le Mans Nero		1064	67	03.04-12.05		4	40	310	OZA341-BB1	0036
V11 Le Mans Rosso Corsa		1064	67	03.04-12.05		4	40	310	OZA341-BB1	0036
V11 Scura R		1064	67	01.05-12.05		4	40	310	OZA341-BB1	0036
V11 Sport Ballabio		1064	67	03.04-12.05		4	40	310	OZA341-BB1	0036
Norge V 1200 i.e.		1151	66	01.06-		4	40	310	OZA591-BB2	1710
Sport V 1200 i.e.		1151	70	01.06-		4	40	310	OZA591-BB2	1710

MOTO MORINI

Corsaro 1200		1187	103	01.05-		4	40	310	OZA341-BB1	0036
9 1/2		1187	86	01.05-		4	40	310	OZA341-BB1	0036

PEUGEOT

Geopolis 125		125	11	03.06-		4	31	590	OZA591-SZ1	1767
Satelis 125		125	11	03.06-		4	31	590	OZA591-SZ1	1767
Satelis 125 K15 Compressor		125	11	03.06-		4	31	590	OZA591-SZ1	1767
Satelis 125 K20 Compressor		125	15	03.06-		4	31	590	OZA591-SZ1	1767

SUZUKI

RV 125 VanVan		125	9	01.07-		4	128	460	AZD0101-SU002	6547
GSX-R 600		599	91	03.06-12.07		4	80	690	OZA448-J4	0003
GSX-R 600		599	91	01.08-		4	128	710	AZD0101-SU005	7671
DL 650 V-Strom		645	25	03.06-		4	80	365	OZA591-J2	6454
DL 650 V-Strom		645	49	03.06-		4	80	365	OZA591-J2	6454
SV 650		645	25	01.07-		4	128	710	AZD0101-SU005	7671
SV 650 S		645	25	02.07-		4	128	710	AZD0101-SU005	7671
SV 650		645	53	01.07-		4	128	710	AZD0101-SU005	7671
SV 650 S		645	53	02.07-		4	128	710	AZD0101-SU005	7671
GSX-R 750		750	110	03.06-12.07		4	80	690	OZA448-J4	0003
GSX-R 750		750	110	01.08-		4	128	710	AZD0101-SU005	7671
VL 800 Intruder		805	39	05.04-		4	128	610	AZD0101-SU001	6545
DL 1000 V-Strom		996	72	05.02-12.06		4	124	480	OZA448-J2	6414
TL 1000		996	92	05.07-12.00		4	80	630	OZA448-J3	6415
GSX-R 1000		999	136	01.07-		4	128	235	AZD0101-SU004	7668
Bandit 1200		1157	72	11.06-12.07		4	128	710	AZD0101-SU005	7671
Bandit 1200 S		1157	72	11.06-12.07		4	128	710	AZD0101-SU005	7671
GSX-R 1300 Hayabusa		1299	129	05.02-12.06		4	80	420	OZA448-J1	6413
GSX-R 1300 Hayabusa		1299	129	05.07-		4	128	235	AZD0101-SU004	7668
VL 1500 Intruder		1462	49	01.06-		4	128	460	AZD0101-SU002	6547
M 1800 R		1783	92	04.06-12.07		4	80	370	OZA448-J5	0004
VZR 1800 Intruder		1783	92	01.08-		2	126	370	OZA582-J3	6446
VZR 1800 Intruder		1783	92	01.08-		2	126	203	OZA582-J4	6447

TRIUMPH

Daytona 600		599	25	01.03-12.05		4	97	640	OZA591-UB1	0067
-------------	--	-----	----	-------------	--	---	----	-----	------------	------



0003	OZA448-J4	SUZUKI	
0004	OZA448-J5	SUZUKI	
0006	OZA532-V4	VW	
0007	OZA577-H17	HONDA	
0008	OZA591-UB2	TRIUMPH	
0009	OZA591-VB2	KTM	
0010	OZA591-WB1	HUSQVARNA / HYOSUNG	
0011	OZA591-YB1	KYMCO	
0012	OZA603-N2	NISSAN	
0013	OZA603-R2	RENAULT	
0014	OZA610-W2	CHEVROLET / DAEWOO	
0015	OZA610-W5	CHEVROLET / DAEWOO	
0016	OZA628-U1	MINI / PEUGEOT	
0017	OZA629-W2	CHEVROLET / DAEWOO	
0018	OZA629-W5	CHEVROLET / DAEWOO	
0019	OZA629-W6	CHEVROLET / DAEWOO	
0020	OZA636-R1	RENAULT	
0022	OTD2F-1P2	NISSAN	
0023	OTD5F-3E1	ASTON MARTIN / FORD	
0024	OTD3J-5A3	LAND ROVER	
0025	LZA09-E1	HONDA	
0026	LZA07-AU2	AUDI	
0027	LZA07-AU3	AUDI	
0028	LZA07-V4	VW	
0029	LZA15-A1	FIAT	
0031	LZA15-A3	FIAT / LANCIA	
0032	LZA15-GM1	OPEL	
0033	LZA17-VW1	VW	
0036	OZA341-BB1	MOTO GUZZI	
0037	OZA341-NB1	TVR	
0038	OZA341-SZ2	FORD	
0039	OZA341-SZ3	FORD	
0041	OZA381-D12	JAGUAR	
0042	OZA488-AM1	ASTON MARTIN	
0043	OZA495-RV1	MINI	
0044	OZA495-RV2	LAND ROVER	
0045	OZA501-H20	HONDA	
0046	OZA508-H4	HONDA	
0047	OZA510-AU4	AUDI	
0048	OZA510-AU5	AUDI	
0049	OZA510-AU6	AUDI	
0050	OZA510-AU7	AUDI	
0051	OZA510-V12	VW	
0052	OZA519-SZ2	FORD	
0053	OZA522-BM1	BMW	
0054	OZA522-BM2	BMW	
0055	OZA531-GM24	FIAT	
0056	OZA532-A12	FIAT	
0057	OZA555-D2	FORD	
0058	OZA555-D3	FORD	
0059	OZA562-H7	HONDA	
0060	OZA562-H9	HONDA	
0061	OZA563-H5	HONDA	

0062	OZA563-H6	HONDA	
0063	OZA563-H8	HONDA	
0064	OZA577-H15	HONDA	
0065	OZA577-H6	HONDA	
0066	OZA591-BB3	DUCATI / MV AGUSTA	
0067	OZA591-UB1	TRIUMPH	
0068	OZA600-BM1	BMW	
0069	OZA600-BM8	BMW	
0070	OZA608-U2	CITROEN / PEUGEOT	
0071	OZA614-H3	HONDA	
0072	OZA630-BM1	BMW	
0073	OZA630-BM2	BMW	
0074	OZA630-BM3	BMW	
0075	OZA635-H1	HONDA	
0076	OZA635-H4	HONDA	
0120	OZA401-E49	TOYOTA	
0121	OZA428-E3	MITSUBISHI	
0122	OZA253-F6	MAZDA	
0123	OZA55-R2	RENAULT	
0124	OZA83-VN1	VOLVO	
0125	OZA216-D3	FORD	
0126	OZA311-R2	RENAULT	
0128	OZA446-E41	OPEL	
0129	OZA447-E14	AUDI / VW	
0131	OZA401-E50	NISSAN	
0132	OZA428-E4	MITSUBISHI	
0133	OZA384-E32	TOYOTA	
0134	OZA55-R3	RENAULT	
0135	OZA89-D2	FORD	
0136	OZA222-RV1	ROVER	
0137	OZA333-H4	HONDA	
0139	OZA446-E46	FORD	
0142	OZA401-E51	NISSAN	
0143	OZA401-E55	MAZDA	
0145	OZA55-R4	RENAULT	
0146	OZA112-A1	FIAT / LANCIA	
0147	OZA236-R1	RENAULT	
0148	OZA333-H5	HONDA	
0150	OZA446-E42	HONDA / SEAT / VW	
0151	OZA448-E31	AUDI / SEAT / VW	
0153	OZA401-E57	HONDA	
0154	OZA401-E56	HONDA / SUZUKI	
0155	OZA446-E45	NISSAN	
0156	OZA83-R1	RENAULT	
0157	OZA112-A3	FIAT / LANCIA	
0158	OZA236-R2	RENAULT	
0159	OZA333-H6	HONDA	
0162	OZA446-E44	LANCIA / SKODA	
0164	OZA401-E52	HONDA	
0165	OZA85-M1	MITSUBISHI	
0166	OZA401-E58	SUZUKI	
0167	OZA83-R2	RENAULT	
0168	OZA201-AM1	ASTON MARTIN	





0169	OZA245-H1	HONDA / ROVER	0259	OZA447-E16	AUDI / SEAT / VW
0175	OZA401-E53	MITSUBISHI	0260	OZA448-E41	FORD
0176	OZA25-F3	MAZDA	0263	OZA527-E10	MERCEDES
0177	OZA73-F1	MAZDA	0264	OZA572-E3	BMW
0178	OZA83-R3	RENAULT	0265	OZA527-E2	PEUGEOT
0179	OZA201-AM2	ASTON MARTIN	0266	OZA501-H17	HONDA
0180	OZA245-H2	HONDA / ROVER	0269	OZA445-E7	AUDI / VW
0182	OZA448-E29	MERCEDES	0270	OZA447-E17	AUDI / SEAT / SKODA / VW
0183	OZA447-E13	SKODA / VW	0271	OZA448-E42	FORD
0186	OZA401-E54	MITSUBISHI	0273	OZA572-E12	BMW
0187	OZA25-F1	MAZDA	0274	OZA527-E22	CITROEN / PEUGEOT
0188	OZA186-F5	MAZDA	0275	OZA572-E10	SEAT / VW
0189	OZA83-R4	RENAULT	0277	OZA333-H19	HONDA
0190	OZA216-D2	FORD	0280	OZA446-E48	FIAT / PEUGEOT
0191	OZA311-R1	RENAULT	0281	OZA447-E18	AUDI / SEAT / SKODA / VW
0193	OZA446-E40	OPEL	0282	OZA448-E43	RENAULT
0194	OZA446-E43	AUDI	0283	OZA572-E1	SEAT / VW
0197	OZA428-E2	MITSUBISHI	0284	OZA527-E8	ROVER
0198	OZA25-F12	MAZDA	0285	OZA527-E13	MERCEDES
0199	OZA33-D5	FORD	0287	OZA527-E24	ALFA ROMEO / LANCIA
0201	OZA527-E3	CITROEN / FIAT / LANCIA / PEUGEOT	0288	OZA333-H25	HONDA
0204	OZA446-E50	AUDI	0291	OZA446-E49	ALFA ROMEO / AUDI / HONDA / VOLVO
0206	OZA448-E45	MERCEDES	0293	OZA448-E44	FORD
0207	OZA401-E63	MITSUBISHI	0295	OZA572-E4	BMW
0209	OZA572-E8	BMW	0296	OZA527-E19	FIAT
0212	OZA333-H27	HONDA	0298	OZA527-E15	CITROEN / PEUGEOT
0213	OZA527-E7	ALFA ROMEO / AUTOBIANCHI / FIAT / LANCIA	0299	OZA333-H26	HONDA
0215	OZA446-E51	VW	0375	OZA659-EE1	AUDI / SEAT / SKODA / VW
0216	OZA447-E21	MERCEDES / STEYR-DAIMLER-PUCH	0376	OZA659-EE2	LAND ROVER / MG / ROVER
0218	OZA527-E4	ALFA ROMEO / AUTOBIANCHI / FERRARI / FIAT / INNOCENTI / LANCIA / VOLVO	0377	OZA659-EE3	ALFA ROMEO / FIAT / LANCIA
0220	OZA527-E12	CITROEN / PEUGEOT	0378	OZA659-EE4	CITROEN / PEUGEOT / RENAULT
0223	OZA334-A1	FIAT / LANCIA	0379	OZA659-EE5	OPEL
0225	OZA112-A2	FIAT	0380	OZA659-EE6	NISSAN / OPEL / RENAULT
0226	OZA446-E52	VW	0381	OZA659-EE7	OPEL
0227	OZA447-E22	MERCEDES	0382	OZA659-EE8	CITROEN / FIAT / LANCIA / PEUGEOT
0228	OZA448-E47	TOYOTA	0383	OZA659-EE9	FORD
0234	OZA334-A2	FIAT / LANCIA	0384	OZA659-EE10	CITROEN / PEUGEOT
0236	OZA112-A4	FIAT	0385	OZA659-EE11	SKODA / VW
0237	OZA446-E53	VW	0386	OZA659-EE12	CITROEN / FIAT / LANCIA / PEUGEOT
0239	OZA448-E48	FORD	0387	OZA659-EE13	RENAULT
0242	OZA572-E5	BMW	0388	OZA659-EE14	AUDI / SEAT / SKODA / VW
0244	OZA519-D1	FORD	0389	OZA659-EE15	CHRYSLER / MERCEDES
0245	OZA334-A3	FIAT	0390	OZA659-EE16	SEAT / VW
0250	OZA502-E31	TOYOTA	0391	OZA659-EE17	AUDI / VW
0251	OZA572-E11	VW	0392	OZA659-EE18	AUDI / SKODA / VW
0252	OZA572-E2	BMW	0393	OZA659-EE19	SEAT / SKODA / VW
0253	OZA527-E5	ALFA ROMEO / FIAT / LANCIA	0394	OZA659-EE20	SEAT / VW
0254	OZA572-E13	SEAT / VW	0395	OZA659-EE21	CITROEN / FIAT / LANCIA / PEUGEOT
0255	OZA421-H1	HONDA	0396	OZA659-EE22	CHRYSLER / MERCEDES
0256	OZA21-F3	MAZDA	0397	OZA659-EE23	SEAT / SKODA / VW
0258	OZA445-E6	FIAT / VOLVO	0398	OZA659-EE24	MERCEDES
			0399	OZA659-EE25	AUDI / SEAT / SKODA / VW
			0400	OZA659-EE26	MERCEDES



0401	OZA74-F1	FORD / MAZDA
0402	OZA510-V2	SEAT / VW
0403	OZA488-D1	JAGUAR
0404	OZA448-E49	OPEL
0405	OZA447-E26	OPEL
0406	OZA401-E66	MITSUBISHI
0407	OZA334-SZ3	OPEL
0408	OZA572-E14	BMW
0409	OZA532-A3	FIAT / LANCIA
0413	OZA510-V3	SEAT
0414	OZA457-I1	SKODA
0415	OZA448-E50	RENAULT
0416	OZA447-E27	BMW / LAND ROVER
0417	OZA401-E67	MITSUBISHI
0418	OZA334-SZ4	OPEL
0419	OZA572-E7	BMW
0420	OTA7H-3C2	OPEL
0423	OZA572-E9	VW
0424	OZA510-V4	VW
0425	OZA502-E28	HONDA
0426	OZA448-E51	SEAT / VW
0427	OZA447-E28	BMW
0428	OZA401-E68	MITSUBISHI
0429	OZA341-RV2	ROVER
0430	OZA527-E18	ROVER
0431	OTA7L-3C4	OPEL
0433	OZA74-F2	MAZDA
0434	OZA527-E16	CITROEN / PEUGEOT
0435	OZA510-V5	SKODA / VW
0436	OZA502-E34	MITSUBISHI
0437	OZA448-E52	MITSUBISHI
0438	OZA447-E29	BMW / LAND ROVER
0439	OZA444-E1	HONDA
0440	OZA341-W2	DAEWOO
0442	OTA7L-3C3	OPEL
0444	OZA527-E25	MERCEDES / SSANGYONG
0445	OZA527-E17	CITROEN / PEUGEOT
0446	OZA74-F3	MAZDA
0447	OZA502-E35	MITSUBISHI
0448	OZA448-E53	MITSUBISHI, VOLVO
0449	OZA447-E30	AUDI / TOYOTA / VW
0450	OZA446-E55	SUBARU
0451	OZA381-D2	JAGUAR
0452	OZA516-AU1	AUDI / VW
0453	OTD3G-3A1	LAND ROVER / MG / ROVER
0455	OZA527-E14	VW
0457	OZA186-F7	MAZDA
0458	OZA502-E36	MITSUBISHI
0459	OZA448-E54	MERCEDES
0460	OZA447-E31	AUDI / FORD / VW
0461	OZA446-E56	HYUNDAI
0462	OZA381-D3	ASTON MARTIN / JAGUAR
0463	OZA527-E6	MERCEDES















0464	OTD3J-5B1	DAIMLER / JAGUAR
0466	OZA527-E27	BMW
0468	OZA277-R2	RENAULT
0469	OZA501-H23	HONDA
0470	OZA448-E55	FORD
0471	OZA447-E32	AUDI / SEAT / SKODA / VW
0472	OZA446-E57	RENAULT
0473	OZA384-E39	TOYOTA
0474	OZA334-AU1	AUDI / VW
0475	OTD3J-5C1	LAND ROVER
0477	OZA527-E28	FORD
0478	OZA532-A1	FIAT
0480	OZA507-R2	DACIA / RENAULT
0481	OZA448-E56	CITROEN / FIAT / LANCIA / PEUGEOT
0482	OZA447-E34	MERCEDES
0483	OZA446-E58	SAAB
0484	OZA384-E40	TOYOTA
0485	OZA334-SZ1	OPEL
0486	OTA7H-5A1	BMW
0488	OZA527-E29	CITROEN / PEUGEOT
0489	OZA532-A2	FIAT / LANCIA
0491	OZA510-V1	SEAT / VW
0492	OZA448-E57	CITROEN / PEUGEOT
0493	OZA447-E35	AUDI
0494	OZA447-E25	AUDI / VW
0495	OZA395-E9	SUBARU
0496	OZA334-SZ2	OPEL
0498	OZA527-E9	MG / ROVER
0499	OZA569-H1	HONDA
1609	OZA659-EE27	MERCEDES
1610	OZA659-EE28	OPEL
1611	OZA659-EE29	MERCEDES
1612	OZA659-EE30	ALFA ROMEO / FIAT / LANCIA
1613	OZA659-EE31	ALFA ROMEO / FIAT / LANCIA
1614	OZA659-EE32	SEAT / VW
1617	OZA659-EE33	AUDI / VW
1618	OZA659-EE34	MERCEDES
1619	OZA659-EE35	MERCEDES
1620	OZA659-EE36	AUDI / SKODA / VW
1624	OZA659-EE37	MERCEDES
1625	OZA659-EE38	VW
1626	OZA659-EE39	OPEL
1627	OZA659-EE40	AUDI / SEAT / VW
1628	OZA659-EE41	LADA
1629	OZA659-EE42	SMART
1630	OZA659-EE43	FORD
1638	OZA659-EE44	FORD
1704	OZA277-R1	DACIA
1705	OZA334-SZ5	ALFA ROMEO / FIAT / OPEL
1706	OZA334-SZ6	OPEL
1707	OZA381-AM1	ASTON MARTIN
1708	OZA504-D2	FORD
1709	OZA571-GB1	SMART



1710	OZA591-BB2	MOTO GUZZI		1802	OZA401-E2	AUDI / FIAT / LANCIA / NISSAN / RENAULT / SAAB / SEAT / VW / ZASTAVA
1720	OZA629-V3	SEAT / SKODA / VW		1804	OZA544-N8	NISSAN / RENAULT
1721	OZA629-V4	SEAT / SKODA / VW		1805	OZA446-E12	AUDI
1722	OZA629-V5	VW		1807	OZA428-E1	RENAULT
1723	OZA629-V6	VW		1808	OZA510-I1	SKODA / VW
1725	OZA629-V7	VW		1809	OZA585-I1	SKODA / VW
1726	OZA641-A1	FIAT		1810	OZA445-E2	VW
1727	LZA15-A5	FIAT		1813	OZA341-PG5	CITROEN / PEUGEOT
1728	LZA15-GM3	OPEL		1814	OZA341-PG6	CITROEN / PEUGEOT
1729	OZA446-E62	FORD		1815	OZA341-PG7	CITROEN
1730	OZA446-E63	MERCEDES		1816	OZA341-PG8	CITROEN
1737	OZA446-E64	NISSAN		1817	OZA527-E21	FORD
1738	OZA447-E40	VW		1818	OZA538-PG1	CITROEN / PEUGEOT
1739	OZA447-E41	TOYOTA		1819	OZA538-PG2	CITROEN / PEUGEOT
1753	OZA583-GM1	OPEL		1820	OZA381-D1	FORD
1754	OZA583-GM2	SAAB / VOLVO		1822	OZA401-E4	SEAT / VW
1755	OTA4N-5A1	VOLVO		1825	LZA11-V1	AUDI
1757	OZA488-D2	FORD		1826	OZA446-E13	MERCEDES
1758	OTA4N-5G1	VOLVO		1827	OZA446-E8	RENAULT
1759	OZA112-A6	FIAT		1828	OZA401-E5	ROVER
1760	OZA112-A7	FIAT		1829	LZA11-V3	VW
1762	OZA534-A1	FIAT		1833	OZA446-E1	AUTOBIANCHI / FERRARI / FIAT / LANCIA / SAAB / VOLVO
1763	OTA4F-3B1	VOLVO		1836	OZA571-C10	MERCEDES
1764	OZA534-A2	FIAT / LANCIA		1837	OZA446-E14	MERCEDES
1765	OTA4N-5B1	VOLVO		1838	OZA446-E5	ALFA ROMEO
1766	OZA488-SZ1	FORD		1839	OZA448-E16	TOYOTA
1767	OZA591-SZ1	APRILIA		1840	LZA06-U1	CITROEN / PEUGEOT
1768	OTA4N-5H1	VOLVO		1842	LZA11-V4	LAMBORGHINI / SEAT / VW
1769	OZA114-V4	SEAT		1845	OZA600-BM2	BMW
1772	LZA07-AU1	AUDI		1846	OZA600-BM5	BMW
1773	OTA4F-3C1	VOLVO		1847	OZA600-BM7	BMW
1774	LZA11-V2	SEAT / VW		1848	OZA446-E15	VW
1776	OZA532-V3	SEAT / SKODA / VW		1850	OZA445-E4	VW
1777	OZA572-E6	BMW		1851	LZA07-V1	AUDI / SEAT / SKODA / VW
1778	OZA534-V1	SEAT / SKODA / VW		1852	OZA495-PG2	CITROEN / PEUGEOT
1779	OZA324-L1	VOLVO		1853	OZA495-PG3	PEUGEOT
1780	OZA324-L2	VOLVO		1855	OZA446-E2	AUDI / CITROEN / FIAT / HYUNDAI / JAGUAR / LANCIA / SEAT / VOLVO / VW
1782	OZA510-AU1	AUDI		1856	OZA114-A1	FIAT / INNOCENTI
1783	OZA510-AU2	AUDI		1857	OZA544-R1	NISSAN / RENAULT
1784	OZA510-AU3	AUDI		1859	OZA446-E16	AUDI / LANCIA / SAAB
1785	OTA4N-5D1	VOLVO		1860	OZA445-E3	VW
1786	OZA532-A4	FIAT		1861	OZA446-E6	OPEL
1787	OZA527-E11	FIAT		1862	OZA531-GM1	OPEL
1789	OZA334-AU2	AUDI		1863	OZA531-GM2	OPEL
1790	OZA334-PG1	CITROEN / PEUGEOT		1864	OZA531-GM3	OPEL
1792	OZA532-A5	LANCIA		1865	OZA448-E12	FORD
1793	OZA532-A9	FIAT		1866	OZA446-E3	HONDA / OPEL / VW
1794	OZA532-A10	FIAT		1867	OZA33-D8	FORD
1795	OTA4N-5F1	VOLVO		1868	LZA07-V2	VW
1796	OZA532-A7	FIAT		1869	OZA531-GM6	OPEL
1797	OZA527-E20	LANCIA				
1798	OZA341-A1	FIAT				
1800	OZA534-A3	LANCIA				



1870	OZA531-GM7	CHEVROLET / PONTIAC
1872	OZA446-E7	MERCEDES
1877	OZA446-E4	ALFA ROMEO / AUTOBIANCHI / FIAT / INNOCENTI / JAGUAR / LANCIA
1878	OZA55-R1	RENAULT
1880	LZA07-V3	SEAT / SKODA / VW
1882	OZA401-E6	DAEWOO / OPEL / SUBARU / SUZUKI
1883	OZA510-V10	SEAT / VW
1884	OZA510-V11	AUDI / SEAT / SKODA / VW
1885	OZA510-V6	SEAT / SKODA / VW
1886	OZA510-V7	SEAT / VW
1887	OZA446-E18	ALFA ROMEO / FIAT / LANCIA
1889	OZA65-A2	FIAT
1890	OZA89-D1	FORD
1891	OZA531-GM16	OPEL
1892	OZA531-GM22	OPEL
1895	OZA575-GM1	SAAB
1896	OZA575-GM2	OPEL
1898	OZA446-E11	AUDI / CITROEN / PEUGEOT / RENAULT / SEAT / ZASTAVA
1907	OTD2F-3K1	NISSAN
1908	OTA4F-5F1	VOLVO
1909	OZA448-E58	NISSAN
1920	OTA7N-5A1	OPEL
1921	OTA5F-3C1	ALFA ROMEO
1927	OTA4F-5G2	VOLVO
1928	OTA6F-3A1	ALFA ROMEO
1932	OTA7H-3A1	BMW
1938	OTA7N-5A2	OPEL
1940	OZA25-KH1	HYUNDAI
1942	OTA4F-5E1	VOLVO
1943	OTA7H-3A2	BMW
1948	OTA4F-5C2	VOLVO
1950	OZA447-E36	FORD / VW
1954	OTA7H-3C1	OPEL
1963	OTA7N-5C1	BMW
1969	OZA25-KH3	HYUNDAI
1971	OZA447-E42	NISSAN
1973	OTA7N-5B1	BMW
1974	OTA7N-5D1	BMW
1975	OTA7N-5D2	BMW / VOLVO
1976	OZA447-E44	MERCEDES
1980	OZA527-E33	CITROEN / PEUGEOT
1981	OZA527-E34	CITROEN / PEUGEOT
1982	OZA527-E35	CITROEN / PEUGEOT
1991	OTA7N-5D3	BMW
1993	OZA527-E36	JEEP / SEAT / VW
1995	OZA659-EE51	OPEL
1996	OZA659-EE52	CITROEN / PEUGEOT
5653	OZA660-EE1	LADA
5654	OZA660-EE2	LADA
5656	OZA660-EE3	OPEL
5658	OZA660-EE4	OPEL

5662	OZA660-EE5	BMW
5680	OZA660-EE6	NISSAN
5681	OZA660-EE7	OPEL
5682	OZA660-EE8	MERCEDES
5694	OZA660-EE9	MERCEDES
5695	OZA660-EE10	OPEL
5697	OZA660-EE11	VOLVO
5698	OZA660-EE12	RENAULT
5706	OZA660-EE13	OPEL
5707	OZA660-EE14	BMW
5708	OZA660-EE15	FORD
5709	OZA660-EE16	RENAULT
5713	OZA660-EE17	BMW
5714	OZA660-EE18	HONDA
5716	OZA660-EE19	BMW
5717	OZA660-EE20	RENAULT
5719	OZA660-EE21	RENAULT
5720	OZA660-EE22	BMW
5737	OZA660-EE23	CITROEN / PEUGEOT
5739	OZA660-EE24	CITROEN / PEUGEOT
5747	OZA659-EE45	MG / ROVER
5748	OZA659-EE46	AUDI / SKODA / VW
5750	OZA659-EE47	AUDI / SKODA / VW
5752	OZA659-EE48	MERCEDES
5753	OZA659-EE49	ALFA ROMEO / FIAT / LANCIA
5754	OZA659-EE50	LAND ROVER
6379	OZA19-E12	CHEVROLET / JEEP / PONTIAC
6380	OZA28-C3	CHRYSLER / JEEP
6381	OZA248-C1	CHRYSLER / JEEP
6383	OZA521-C8	CHRYSLER / DODGE
6384	OZA571-C2	CHRYSLER / DODGE / JEEP
6385	OZA571-C4	CHRYSLER / DODGE
6396	OZA571-C7	CHRYSLER / DODGE
6397	OZA623-C1	CHRYSLER / JEEP
6400	OZA623-C2	JEEP
6407	OZA107-KH2	HYUNDAI / KIA
6408	OZA341-W1	DAEWOO / CHEVROLET
6413	OZA448-J1	SUZUKI 
6414	OZA448-J2	SUZUKI 
6415	OZA448-J3	SUZUKI 
6446	OZA582-J3	SUZUKI 
6447	OZA582-J4	SUZUKI 
6454	OZA591-J2	SUZUKI 
6455	OZA218-H2	HONDA
6456	OZA333-H16	HONDA 
6459	OZA333-H29	HONDA 
6460	OZA333-H30	HONDA 
6462	OZA333-H31	HONDA 
6463	OZA577-H4	HONDA 
6469	OZA577-H5	HONDA 
6471	OZA577-H7	HONDA 
6473	OZA577-H12	HONDA 
6475	OZA577-H13	HONDA 



6476	OZA577-H19	HONDA		7948	OZA659-EE63	CITROEN / DAIHATSU / PEUGEOT / TOYOTA
6477	OZA577-H20	HONDA		7949	OZA659-EE64	AUDI / SKODA / VW
6479	OZA577-H21	HONDA		7951	OZA668-EE12	HONDA
6483	OZA577-H22	HONDA		7952	OZA668-EE13	SUZUKI
6484	OZA577-H24	HONDA		7953	OZA669-EE8	TOYOTA
6491	OZA656-H1	HONDA		7954	OZA669-EE9	TOYOTA
6492	OZA656-H2	HONDA		7970	OZA669-EE10	TOYOTA
6493	OZA656-H3	HONDA		7971	OZA669-EE11	HONDA
6494	OZA656-H5	HONDA		7973	OZA669-EE12	TOYOTA
6495	OZA656-H6	HONDA		7974	OZA673-EE1	MAZDA / MERCEDES
6496	OZA591-BA1	DUCATI		7975	OZA674-EE1	MERCEDES
6497	OZA544-N7	NISSAN		7978	OZA675-EE1	ALFA ROMEO / FIAT / LANCIA
6513	OZA544-N14	NISSAN		7979	OZA676-EE1	CITROEN / PEUGEOT
6514	OZA277-R3	DACIA				
6515	OZA507-R1	DACIA / RENAULT				
6517	OZA507-R5	DACIA				
6518	OZA603-R3	RENAULT				
6519	OZA636-R3	RENAULT				
6538	ZSJ0002-HG002	HONDA				
6539	AZD0101-HG001	HONDA				
6540	AZD0101-HG002	HONDA				
6541	AZD0101-HG003	HONDA				
6543	AZD0101-HG004	HONDA				
6545	AZD0101-SU001	SUZUKI				
6547	AZD0101-SU002	SUZUKI				
6551	AZD0101-KJ001	KAWASAKI				
6552	AZD0101-KJ002	KAWASAKI				
6556	AZD0101-KJ004	KAWASAKI				
6558	AZD0101-KJ005	KAWASAKI				
6559	AZD0101-KJ006	KAWASAKI				
6561	AZD0101-KJ008	KAWASAKI				
6567	AZD0102-KJ001	KAWASAKI				
6568	AZS0102-KJ003	KAWASAKI				
6574	AZS0102-KJ004	KAWASAKI				
6576	AZD0102-HG009	HONDA				
7664	AZD0102-HG003	HONDA				
7665	AZD0102-HG004	HONDA				
7667	AZD0101-BA001	KYMCO				
7668	AZD0101-SU004	SUZUKI				
7671	AZD0101-SU005	SUZUKI				
7673	AZD0101-VB002	KTM / TRIUMPH				
7689	AZD0101-VB003	TRIUMPH				
7690	AZD0101-VB004	TRIUMPH				
7858	OZA659-EE53	RENAULT				
7859	OZA659-EE54	RENAULT				
7860	OZA659-EE55	MERCEDES				
7863	OZA659-EE56	ALFA ROMEO / FIAT				
7864	OZA659-EE57	ALFA ROMEO				
7903	OZA659-EE58	ALFA ROMEO / LANCIA				
7904	OZA659-EE59	ALFA ROMEO				
7905	OZA659-EE60	ALFA ROMEO				
7915	OZA659-EE61	CITROEN / PEUGEOT				
7916	OZA659-EE62	CITROEN / DAIHATSU / PEUGEOT / TOYOTA				

REFERENZLISTE
CROSS REFERENCE GUIDE
Рекомендационный перечень
REFERANS LISTESI

TABLE DE CORRESPONDANCE
TABELLE COMPARATIVE
Συστάσεις

GUIA EQUIVALENCIAS
LISTA PORÓWNAWCZA
REFERENTIELIJST

GENUINE	NTK	ORDER
ALFA ROMEO		
161 241 101 601	OZA446-E4	1877
46 44 42 84	OZA527-E7	0213
46 46 20 06	OZA527-E24	0287
46 75 02 41	OZA659-EE30	1612
46 75 02 43	OZA659-EE31	1613
46 75 02 46	OZA659-EE30	1612
46 75 10 82	OZA675-EE1	7978
46 76 08 63	OZA659-EE57	7864
46 76 21 82	OZA659-EE49	5753
46 76 26 53	OZA659-EE56	7863
46 76 26 530	OZA659-EE56	7863
46 76 42 07	OZA659-EE58	7903
46 77 62 86	OZA659-EE59	7904
46 80 57 49	OZA659-EE60	7905
46 80 57 50	OZA659-EE59	7904
55 35 38 11	OZA334-SZ5	1705
59 63 51 60	OZA401-E2	1802
60 50 76 900	OZA446-E4	1877
60 53 76 500	OZA446-E49	0291
60 56 77 59	OZA446-E5	1838
60 57 65 30	OTA5F-3C1	1921
60 57 65 300	OTA5F-3C1	1921
60 60 53 74	OTA6F-3A1	1928
60 80 90 12	OZA446-E1	1833
76 19 30 300	OZA446-E4	1877
ASTON MARTIN		
SPD 5551	OZA201-AM1	0168
SPD 5552	OZA201-AM2	0179
XR3F 9G444 BA	OZA381-D3	0462
6G33 9F472 AA	OZA488-AM1	0042
6G33 9G444 AA	OZA381-AM1	1707
AUDI		
030 906 262 D	OZA659-EE40	1627
030 906 262 E	OZA659-EE40	1627
030 906 262 L	OZA659-EE40	1627
030 906 265 AD	OZA447-E16	0259
034 906 265 E	OZA446-E11	1898
048 906 265	OZA446-E11	1898
048 906 265 A	OZA446-E12	1805
048 906 265 B	OZA446-E50	0204
051 906 265 D	OZA445-E7	0269
053 906 265	OZA445-E7	0269
058 906 265 B	OZA659-EE17	0391
058 906 265 C	OZA659-EE64	7949
058 906 265 V	OZA659-EE64	7949
06A 906 262 AC	OZA659-EE25	0399
06A 906 262 AJ	OZA659-EE14	0388
06A 906 262 AK	OZA659-EE25	0399
06A 906 262 AM	OZA659-EE33	1617

GENUINE	NTK	ORDER
AUDI		
06A 906 262 F	OZA659-EE18	0392
06A 906 262 Q	OZA659-EE1	0375
06A 906 262 R	OZA659-EE14	0388
06A 906 265 E	OZA447-E17	0270
06A 906 265 H	OZA447-E18	0281
06B 906 265 A	OZA334-AU1	0474
06B 906 265 B	OZA516-AU1	0452
06E 906 265 J	OZA510-AU4	0047
06E 906 265 K	OZA510-AU5	0048
06E 906 265 L	LZA07-AU2	0026
06E 906 265 M	LZA07-AU3	0027
06E 906 265 N	OZA510-AU6	0049
06E 906 265 P	OZA510-AU7	0050
077 906 265	OZA446-E4	1877
077 906 265 B	OZA445-E7	0269
078 906 265 B	OZA446-E50	0204
078 906 265 M	OZA659-EE36	1620
078 906 265 N	OZA659-EE46	5748
078 906 265 P	OZA659-EE47	5750
BERU		
0 824 010 003	OZA527-E27	0466
0 824 010 004	OZA446-E49	0291
0 824 010 005	OZA572-E7	0419
0 824 010 006	OZA527-E22	0274
0 824 010 008	OZA446-E13	1826
0 824 010 009	OZA445-E4	1850
0 824 010 010	OZA446-E42	0150
0 824 010 011	OZA446-E51	0215
0 824 010 012	OZA446-E45	0155
0 824 010 013	OZA445-E2	1810
0 824 010 014	OZA448-E12	1865
0 824 010 015	OZA216-D3	0125
0 824 010 017	OZA527-E25	0444
0 824 010 018	OZA446-E50	0204
0 824 010 020	OZA446-E40	0193
0 824 010 021	OZA448-E42	0271
0 824 010 022	OZA527-E13	0285
0 824 010 023	OZA572-E11	0251
0 824 010 024	OZA572-E14	0408
0 824 010 026	OZA448-E45	0206
0 824 010 027	OZA446-E14	1837
0 824 010 028	OZA445-E6	0258
0 824 010 030	OZA446-E3	1866
0 824 010 031	OZA527-E2	0265
0 824 010 032	OZA572-E4	0295
0 824 010 033	OZA445-E4	1850
0 824 010 034	OZA446-E7	1872
0 824 010 035	OZA446-E8	1827
0 824 010 036	OZA527-E3	0201
0 824 010 037	OZA527-E4	0218

REFERENZLISTE
CROSS REFERENCE GUIDE
 Рекомендационный перечень
REFERANS LĪSTESĪ

TABLE DE CORRESPONDANCE
TABELLE COMPARATIVE
 Συστάσεις

GUIA EQUIVALENCIAS
LISTA PORÓWNAWCZA
REFERENTIELIJST

GENUINE	NTK	ORDER
BERU		
0 824 010 038	OZA572-E8	0209
0 824 010 038	OZA572-E2	0252
0 824 010 039	OZA446-E2	1855
0 824 010 040	OZA527-E12	0220
0 824 010 041	OZA572-E12	0273
0 824 010 042	OZA446-E6	1861
0 824 010 043	OZA527-E10	0263
0 824 010 044	OZA527-E6	0463
0 824 010 045	OZA572-E1	0283
0 824 010 046	OZA446-E11	1898
0 824 010 047	OZA448-E44	0293
0 824 010 048	OZA446-E16	1859
0 824 010 049	OZA446-E15	1848
0 824 010 050	OZA445-E3	1860
0 824 010 051	OZA114-A1	1856
0 824 010 052	OZA33-D8	1867
0 824 010 053	OZA401-E4	1822
0 824 010 054	OZA401-E57	0153
0 824 010 055	OZA401-E6	1882
0 824 010 056	OZA446-E13	1826
0 824 010 057	OZA446-E18	1887
0 824 010 058	OZA527-E9	0498
0 824 010 059	OZA527-E11	1787
0 824 010 060	OZA527-E5	0253
0 824 010 061	OZA527-E7	0213
0 824 010 062	OZA527-E8	0284
0 824 010 063	OZA236-R1	0147
0 824 010 063	OZA55-R1	1878
0 824 010 064	OZA65-A2	1889
0 824 010 065	OZA33-D5	0199
0 824 010 065	OZA89-D1	1890
0 824 010 068	OZA527-E4	0218
0 824 010 070	OZA527-E19	0296
0 824 010 072	OZA446-E48	0280
0 824 010 075	OZA447-E14	0129
0 824 010 076	OZA447-E16	0259
0 824 010 077	OZA448-E31	0151
0 824 010 080	OZA527-E15	0298
0 824 010 081	OZA527-E28	0477
0 824 010 084	OZA253-F6	0122
0 824 010 089	OZA527-E17	0445
0 824 010 090	OZA401-E50	0131
0 824 010 094	OZA401-E2	1802
0 824 010 096	OZA401-E55	0143
0 824 010 098	OZA55-R4	0145
0 824 010 099	OZA112-A1	0146
0 824 010 102	OZA448-E31	0151
0 824 010 104	OZA401-E56	0154
0 824 010 105	OZA83-R1	0156
0 824 010 106	OZA112-A3	0157
0 824 010 107	OZA236-R2	0158

GENUINE	NTK	ORDER
BERU		
0 824 010 111	OZA401-E58	0166
0 824 010 112	OZA83-R2	0167
0 824 010 114	OZA527-E18	0430
0 824 010 117	OZA73-F1	0177
0 824 010 118	OZA83-R3	0178
0 824 010 120	OZA448-E29	0182
0 824 010 121	OZA447-E13	0183
0 824 010 124	OZA186-F5	0188
0 824 010 125	OZA83-R4	0189
0 824 010 127	OZA311-R1	0191
0 824 010 128	OZA446-E43	0194
0 824 010 129	OZA527-E16	0434
0 824 010 131	OZA25-F12	0198
0 824 010 133	OZA401-E51	0142
0 824 010 139	OZA446-E57	0472
0 824 010 143	OZA428-E1	1807
0 824 010 144	OZA660-EE3	5656
0 824 010 145	OZA447-E26	0405
0 824 010 146	OZA660-EE4	5658
0 824 010 147	OZA334-SZ1	0485
0 824 010 148	OZA334-SZ2	0496
0 824 010 152	OZA334-A1	0223
0 824 010 154	OZA245-H1	0169
0 824 010 155	OZA245-H2	0180
0 824 010 156	OZA333-H5	0148
0 824 010 157	OZA333-H26	0299
0 824 010 158	OZA447-E22	0227
0 824 010 159	OZA311-R2	0126
0 824 010 161	OZA447-E17	0270
0 824 010 162	OZA447-E18	0281
0 824 010 164	OZA83-VN1	0124
0 824 010 165	OZA446-E52	0226
0 824 010 172	OZA527-E20	1797
0 824 010 176	OZA446-E63	1730
0 824 010 177	OZA660-EE8	5682
0 824 010 179	OZA447-E44	1976
0 824 010 180	OZA448-E45	0206
0 824 010 182	OZA448-E49	0404
0 824 010 185	OZA447-E31	0460
0 824 010 191	OZA446-E58	0483
0 824 010 194	OZA660-EE16	5709
0 824 010 197	OZA74-F1	0401
0 824 010 202	OZA447-E29	0438
0 824 010 203	OZA448-E51	0426
0 824 010 207	OZA447-E28	0427
0 824 010 211	OZA447-E32	0471
0 824 010 212	OZA516-AU1	0452
0 824 010 213	OZA510-V2	0402
0 824 010 216	OZA510-V4	0424
0 824 010 218	OZA448-E50	0415
0 824 010 224	OZA334-AU1	0474

REFERENZLISTE
CROSS REFERENCE GUIDE
Рекомендационный перечень
REFERANS LISTESI

TABLE DE CORRESPONDANCE
TABELLE COMPARATIVE
Συστάσεις

GUIA EQUIVALENCIAS
LISTA PORÓWNAWCZA
REFERENTIELIJST

GENUINE	NTK	ORDER
BERU		
0 824 010 234	OZA673-EE1	7974
0 824 010 239	OZA527-E34	1981
0 824 010 240	OZA527-E35	1982
0 824 010 249	OZA447-E40	1738
0 824 010 259	OZA446-E64	1737
OZH 002	OZA527-E27	0466
OZH 003	OZA446-E49	0291
OZH 004	OZA572-E7	0419
OZH 005	OZA527-E22	0274
OZH 007	OZA446-E13	1826
OZH 008	OZA445-E4	1850
OZH 009	OZA446-E42	0150
OZH 010	OZA446-E51	0215
OZH 011	OZA446-E45	0155
OZH 012	OZA445-E2	1810
OZH 013	OZA448-E12	1865
OZH 014	OZA216-D3	0125
OZH 016	OZA527-E25	0444
OZH 017	OZA446-E50	0204
OZH 019	OZA446-E40	0193
OZH 020	OZA448-E42	0271
OZH 021	OZA527-E13	0285
OZH 022	OZA572-E11	0251
OZH 023	OZA572-E14	0408
OZH 025	OZA448-E45	0206
OZH 026	OZA446-E14	1837
OZH 027	OZA445-E6	0258
OZH 028	OZA446-E3	1866
OZH 029	OZA527-E2	0265
OZH 030	OZA572-E4	0295
OZH 031	OZA445-E4	1850
OZH 032	OZA446-E7	1872
OZH 033	OZA446-E8	1827
OZH 034	OZA527-E3	0201
OZH 035	OZA527-E4	0218
OZH 036	OZA572-E8	0209
OZH 036	OZA572-E2	0252
OZH 037	OZA446-E2	1855
OZH 038	OZA527-E12	0220
OZH 039	OZA572-E12	0273
OZH 040	OZA446-E6	1861
OZH 041	OZA527-E10	0263
OZH 042	OZA527-E6	0463
OZH 043	OZA572-E1	0283
OZH 044	OZA446-E11	1898
OZH 045	OZA448-E44	0293
OZH 046	OZA446-E16	1859
OZH 047	OZA446-E15	1848
OZH 048	OZA445-E3	1860
OZH 049	OZA114-A1	1856
OZH 050	OZA33-D8	1867

GENUINE	NTK	ORDER
BERU		
OZH 051	OZA446-E13	1826
OZH 052	OZA446-E18	1887
OZH 053	OZA527-E9	0498
OZH 054	OZA527-E11	1787
OZH 055	OZA527-E5	0253
OZH 056	OZA527-E7	0213
OZH 057	OZA527-E8	0284
OZH 058	OZA236-R1	0147
OZH 058	OZA55-R1	1878
OZH 059	OZA33-D5	0199
OZH 059	OZA89-D1	1890
OZH 062	OZA527-E4	0218
OZH 064	OZA527-E19	0296
OZH 066	OZA446-E48	0280
OZH 069	OZA447-E14	0129
OZH 070	OZA447-E16	0259
OZH 071	OZA448-E31	0151
OZH 074	OZA527-E15	0298
OZH 075	OZA527-E28	0477
OZH 076	OZA253-F6	0122
OZH 079	OZA527-E17	0445
OZH 083	OZA55-R4	0145
OZH 084	OZA112-A1	0146
OZH 086	OZA448-E31	0151
OZH 087	OZA83-R1	0156
OZH 088	OZA112-A3	0157
OZH 092	OZA83-R2	0167
OZH 094	OZA527-E18	0430
OZH 095	OZA73-F1	0177
OZH 096	OZA83-R3	0178
OZH 098	OZA448-E29	0182
OZH 099	OZA447-E13	0183
OZH 100	OZA186-F5	0188
OZH 101	OZA83-R4	0189
OZH 103	OZA446-E43	0194
OZH 104	OZA527-E16	0434
OZH 107	OZA446-E57	0472
OZH 108	OZA236-R2	0158
OZH 109	OZA311-R1	0191
OZH 110	OZA660-EE3	5656
OZH 111	OZA447-E26	0405
OZH 112	OZA660-EE4	5658
OZH 113	OZA334-SZ1	0485
OZH 114	OZA334-SZ2	0496
OZH 118	OZA334-A1	0223
OZH 120	OZA245-H1	0169
OZH 121	OZA245-H2	0180
OZH 122	OZA333-H5	0148
OZH 123	OZA333-H26	0299
OZH 124	OZA447-E22	0227
OZH 125	OZA311-R2	0126

REFERENZLISTE
CROSS REFERENCE GUIDE
 Рекомендационный перечень
REFERANS LÍSTESĪ

TABLE DE CORRESPONDANCE
TABELLE COMPARATIVE
 Συστάσεις

GUIA EQUIVALENCIAS
LISTA PORÓWNAWCZA
REFERENTIELIJST

GENUINE	NTK	ORDER
BERU		
OZH 127	OZA447-E17	0270
OZH 128	OZA447-E18	0281
OZH 130	OZA83-VN1	0124
OZH 131	OZA446-E52	0226
OZH 138	OZA527-E20	1797
OZH 142	OZA446-E63	1730
OZH 143	OZA660-EE8	5682
OZH 145	OZA447-E44	1976
OZH 146	OZA448-E45	0206
OZH 148	OZA448-E49	0404
OZH 151	OZA447-E31	0460
OZH 157	OZA446-E58	0483
OZH 160	OZA660-EE16	5709
OZH 163	OZA74-F1	0401
OZH 168	OZA447-E29	0438
OZH 169	OZA448-E51	0426
OZH 173	OZA447-E28	0427
OZH 177	OZA447-E32	0471
OZH 178	OZA516-AU1	0452
OZH 179	OZA510-V2	0402
OZH 182	OZA510-V4	0424
OZH 184	OZA448-E50	0415
OZH 190	OZA334-AU1	0474
OZH 200	OZA673-EE1	7974
OZH 205	OZA527-E34	1981
OZH 206	OZA527-E35	1982
OZH 215	OZA447-E40	1738
OZH 225	OZA446-E64	1737
OZU 003	OZA401-E4	1822
OZU 004	OZA401-E57	0153
OZU 005	OZA401-E6	1882
OZU 006	OZA65-A2	1889
OZU 010	OZA401-E50	0131
OZU 012	OZA401-E55	0143
OZU 014	OZA401-E56	0154
OZU 015	OZA401-E58	0166
OZU 021	OZA25-F12	0198
OZU 022	OZA401-E2	1802
OZU 024	OZA401-E51	0142
OZU 025	OZA428-E1	1807
BMW		
11781 247 406	OZA447-E28	0427
11781 247 475	OZA572-E6	1777
11781 405 325	OZA660-EE22	5720
11781 406 981	OTA7N-5D2	1975
11781 427 884	OTA7H-5A1	0486
11781 433 071	OTA7N-5D1	1974
11781 433 159	OZA572-E14	0408
11781 433 940	OZA447-E29	0438
11781 437 586	OZA660-EE17	5713

GENUINE	NTK	ORDER
BMW		
11781 437 943	OTA7N-5D3	1991
11781 704 259	OZA572-E14	0408
11781 720 536	OZA572-E2	0252
11781 720 537	OZA527-E27	0466
11781 721 125	OZA572-E3	0264
11781 730 005	OZA572-E2	0252
11781 730 007	OZA572-E7	0419
11781 730 025	OTA7H-3A1	1932
11781 734 393	OZA572-E8	0209
11781 734 796	OZA572-E12	0273
11781 735 132	OTA7N-5B1	1973
11781 735 499	OZA572-E5	0242
11781 735 710	OZA572-E4	0295
11781 738 282	OTA7H-3A2	1943
11781 739 845	OZA660-EE5	5662
11781 741 317	OZA572-E14	0408
11781 742 023	OZA572-E14	0408
11781 742 050	OZA447-E27	0416
11781 748 762	OTA7N-5C1	1963
11787 503 441	OZA660-EE19	5716
11787 530 285	OZA600-BM5	1846
11787 530 287	OZA600-BM2	1845
11787 530 318	OZA600-BM1	0068
11787 537 995	OZA600-BM7	1847
11787 547 313	OZA600-BM8	0069
11787 548 961	OZA628-U1	0016
11787 671 756	OZA522-BM1	0053
11787 671 757	OZA522-BM2	0054
11787 672 785	OZA630-BM2	0073
11787 674 452	OZA630-BM1	0072
11787 685 320	OZA630-BM3	0074
BOSCH		
0258 001 025	OZA401-E2	1802
0258 001 026	OZA401-E2	1802
0258 001 027	OZA401-E2	1802
0258 001 035	OZA401-E50	0131
0258 001 043	OZA401-E2	1802
0258 001 051	OZA401-E2	1802
0258 001 052	OZA401-E2	1802
0258 002 014	OZA401-E6	1882
0258 002 035	OZA401-E2	1802
0258 002 040	OZA401-E2	1802
0258 002 041	OZA401-E2	1802
0258 002 053	OZA401-E68	0428
0258 002 058	OZA428-E1	1807
0258 003 004	OZA446-E11	1898
0258 003 006	OZA446-E2	1855
0258 003 009	OZA446-E1	1833
0258 003 014	OZA446-E2	1855
0258 003 015	OZA446-E13	1826

REFERENZLISTE
CROSS REFERENCE GUIDE
 Рекомендационный перечень
REFERANS LISTESI

TABLE DE CORRESPONDANCE
TABELLE COMPARATIVE
 Συστάσεις

GUIA EQUIVALENCIAS
LISTA PORÓWNAWCZA
REFERENTIELIJST

GENUINE	NTK	ORDER
BOSCH		
0258 003 017	OZA446-E6	1861
0258 003 019	OZA446-E2	1855
0258 003 021	OZA446-E3	1866
0258 003 027	OZA446-E49	0291
0258 003 028	OZA446-E5	1838
0258 003 032	OZA446-E2	1855
0258 003 034	OZA446-E49	0291
0258 003 035	OZA446-E62	1729
0258 003 036	OZA446-E15	1848
0258 003 040	OZA445-E6	0258
0258 003 046	OZA446-E48	0280
0258 003 051	OZA527-E21	1817
0258 003 052	OZA527-E27	0466
0258 003 057	OZA446-E16	1859
0258 003 060	OZA446-E49	0291
0258 003 061	OZA446-E4	1877
0258 003 063	OZA446-E11	1898
0258 003 064	OZA572-E2	0252
0258 003 068	OZA572-E7	0419
0258 003 069	OZA572-E3	0264
0258 003 074	OZA527-E2	0265
0258 003 075	OZA446-E44	0162
0258 003 078	OZA527-E22	0274
0258 003 082	OZA446-E6	1861
0258 003 083	OZA445-E6	0258
0258 003 085	OZA445-E6	0258
0258 003 086	OZA446-E8	1827
0258 003 090	OZA446-E2	1855
0258 003 094	OZA446-E4	1877
0258 003 095	OZA445-E7	0269
0258 003 096	OZA446-E46	0139
0258 003 097	OZA446-E62	1729
0258 003 101	OZA446-E5	1838
0258 003 103	OZA527-E4	0218
0258 003 108	OZA572-E4	0295
0258 003 112	OZA445-E4	1850
0258 003 114	OZA445-E4	1850
0258 003 115	OZA572-E4	0295
0258 003 118	OZA527-E28	0477
0258 003 119	OZA446-E49	0291
0258 003 120	OZA527-E4	0218
0258 003 121	OZA216-D3	0125
0258 003 122	OZA448-E12	1865
0258 003 123	OZA448-E48	0239
0258 003 130	OZA446-E14	1837
0258 003 132	OZA446-E14	1837
0258 003 134	OZA446-E13	1826
0258 003 139	OZA446-E6	1861
0258 003 141	OZA446-E3	1866
0258 003 144	OZA446-E14	1837
0258 003 146	OZA446-E14	1837

GENUINE	NTK	ORDER
BOSCH		
0258 003 156	OZA446-E7	1872
0258 003 157	OZA446-E7	1872
0258 003 158	OZA446-E11	1898
0258 003 164	OZA446-E11	1898
0258 003 165	OZA446-E42	0150
0258 003 166	OZA446-E42	0150
0258 003 167	OZA446-E42	0150
0258 003 168	OZA446-E42	0150
0258 003 175	OZA446-E2	1855
0258 003 181	OZA446-E42	0150
0258 003 189	OZA446-E8	1827
0258 003 193	OZA527-E8	0284
0258 003 194	OZA446-E11	1898
0258 003 203	OZA527-E3	0201
0258 003 207	OZA446-E52	0226
0258 003 208	OZA446-E52	0226
0258 003 211	OZA446-E51	0215
0258 003 213	OZA446-E53	0237
0258 003 215	OZA572-E8	0209
0258 003 219	OZA572-E5	0242
0258 003 220	OZA572-E8	0209
0258 003 222	OZA527-E4	0218
0258 003 229	OZA527-E9	0498
0258 003 231	OZA572-E8	0209
0258 003 234	OZA446-E2	1855
0258 003 235	OZA446-E2	1855
0258 003 239	OZA527-E12	0220
0258 003 240	OZA527-E4	0218
0258 003 241	OZA445-E7	0269
0258 003 244	OZA572-E8	0209
0258 003 246	OZA446-E49	0291
0258 003 247	OZA445-E2	1810
0258 003 248	OZA445-E2	1810
0258 003 250	OZA446-E55	0450
0258 003 253	OZA448-E21	0260
0258 003 254	OZA445-E7	0269
0258 003 256	OZA446-E45	0155
0258 003 259	OZA448-E12	1865
0258 003 261	OZA572-E12	0273
0258 003 262	OZA527-E4	0218
0258 003 265	OZA572-E1	0283
0258 003 266	OZA572-E1	0283
0258 003 267	OZA572-E13	0254
0258 003 268	OZA572-E13	0254
0258 003 269	OZA527-E36	1993
0258 003 271	OZA527-E36	1993
0258 003 276	OZA446-E45	0155
0258 003 279	OZA446-E12	1805
0258 003 280	OZA446-E12	1805
0258 003 281	OZA446-E50	0204
0258 003 282	OZA446-E50	0204

REFERENZLISTE
CROSS REFERENCE GUIDE
 Рекомендационный перечень
REFERANS LÍSTESİ

TABLE DE CORRESPONDANCE
TABELLE COMPARATIVE
 Συστάσεις

GUIA EQUIVALENCIAS
LISTA PORÓWNAWCZA
REFERENTIELIJST

GENUINE	NTK	ORDER
BOSCH		
0258 003 291	OZA448-E12	1865
0258 003 292	OZA216-D3	0125
0258 003 295	OZA446-E50	0204
0258 003 300	OZA446-E6	1861
0258 003 301	OZA527-E5	0253
0258 003 302	OZA527-E4	0218
0258 003 303	OZA527-E14	0455
0258 003 307	OZA660-EE15	5708
0258 003 310	OZA572-E8	0209
0258 003 311	OZA446-E45	0155
0258 003 312	OZA446-E45	0155
0258 003 313	OZA446-E2	1855
0258 003 314	OZA527-E25	0444
0258 003 320	OZA527-E10	0263
0258 003 321	OZA527-E10	0263
0258 003 324	OZA527-E6	0463
0258 003 325	OZA527-E6	0463
0258 003 331	OZA446-E42	0150
0258 003 333	OZA527-E18	0430
0258 003 334	OZA572-E1	0283
0258 003 336	OZA660-EE11	5697
0258 003 339	OZA448-E12	1865
0258 003 340	OZA448-E41	0260
0258 003 342	OZA448-E12	1865
0258 003 343	OZA448-E42	0271
0258 003 344	OZA446-E50	0204
0258 003 357	OZA572-E8	0209
0258 003 360	OZA448-E56	0481
0258 003 381	OZA446-E58	0483
0258 003 383	OZA502-E36	0458
0258 003 396	OZA446-E50	0204
0258 003 420	OZA446-E45	0155
0258 003 423	OZA448-E55	0470
0258 003 426	OZA572-E8	0209
0258 003 437	OZA527-E14	0455
0258 003 439	OZA572-E1	0283
0258 003 446	OZA446-E41	0128
0258 003 447	OZA446-E40	0193
0258 003 448	OZA446-E40	0193
0258 003 454	OZA447-E31	0460
0258 003 455	OZA447-E31	0460
0258 003 456	OZA448-E12	1865
0258 003 457	OZA448-E12	1865
0258 003 461	OZA186-F7	0457
0258 003 464	OZA527-E33	1980
0258 003 466	OZA527-E7	0213
0258 003 477	OZA447-E27	0416
0258 003 478	OZA447-E30	0449
0258 003 479	OZA447-E30	0449
0258 003 484	OZA448-E12	1865
0258 003 485	OZA448-E48	0239

GENUINE	NTK	ORDER
BOSCH		
0258 003 486	OZA448-E44	0293
0258 003 508	OZA446-E11	1898
0258 003 510	OZA446-E12	1805
0258 003 511	OZA446-E12	1805
0258 003 513	OZA527-E13	0285
0258 003 515	OZA448-E45	0206
0258 003 518	OZA447-E14	0129
0258 003 519	OZA447-E14	0129
0258 003 522	OZA572-E6	1777
0258 003 523	OZA572-E14	0408
0258 003 524	OZA446-E43	0194
0258 003 542	OZA447-E16	0259
0258 003 543	OZA447-E16	0259
0258 003 544	OZA448-E31	0151
0258 003 545	OZA448-E31	0151
0258 003 546	OZA572-E9	0423
0258 003 547	OZA572-E9	0423
0258 003 548	OZA572-E11	0251
0258 003 556	OZA448-E52	0437
0258 003 559	OZA447-E28	0427
0258 003 561	OZA660-EE5	5662
0258 003 569	OZA446-E18	1887
0258 003 570	OZA446-E18	1887
0258 003 571	OZA673-EE1	7974
0258 003 572	OZA673-EE1	7974
0258 003 575	OZA572-E11	0251
0258 003 576	OZA572-E11	0251
0258 003 578	OZA527-E4	0218
0258 003 579	OZA527-E7	0213
0258 003 584	OZA447-E31	0460
0258 003 586	OZA572-E11	0251
0258 003 587	OZA572-E11	0251
0258 003 593	OZA660-EE11	5697
0258 003 597	OZA572-E14	0408
0258 003 604	OZA572-E11	0251
0258 003 605	OZA572-E9	0423
0258 003 611	OZA447-E36	1950
0258 003 612	OZA447-E36	1950
0258 003 613	OZA447-E31	0460
0258 003 624	OZA446-E45	0155
0258 003 627	OZA527-E19	0296
0258 003 630	OZA447-E36	1950
0258 003 631	OZA447-E36	1950
0258 003 632	OZA572-E10	0275
0258 003 638	OZA527-E25	0444
0258 003 642	OZA674-EE1	7975
0258 003 644	OZA448-E43	0282
0258 003 646	OZA447-E31	0460
0258 003 667	OZA527-E15	0298
0258 003 668	OZA527-E16	0434
0258 003 669	OZA527-E17	0445

REFERENZLISTE
CROSS REFERENCE GUIDE
 Рекомендационный перечень
REFERANS LISTESI

TABLE DE CORRESPONDANCE
TABELLE COMPARATIVE
 Συστάσεις

GUIA EQUIVALENCIAS
LISTA PORÓWNAWCZA
REFERENTIELIJST

GENUINE	NTK	ORDER
BOSCH		
0258 003 670	OZA448-E56	0481
0258 003 671	OZA527-E29	0488
0258 003 672	OZA527-E34	1981
0258 003 673	OZA527-E35	1982
0258 003 694	OZA447-E31	0460
0258 003 696	OZA447-E31	0460
0258 003 703	OZA73-F1	0177
0258 003 713	OZA89-D1	1890
0258 003 714	OZA448-E44	0293
0258 003 715	OZA446-E57	0472
0258 003 716	OZA448-E57	0492
0258 003 717	OZA660-EE23	5737
0258 003 718	OZA660-EE24	5739
0258 003 719	OZA448-E56	0481
0258 003 734	OZA447-E31	0460
0258 003 738	OZA447-E31	0460
0258 003 740	OZA447-E25	0494
0258 003 741	OZA447-E25	0494
0258 003 745	OZA447-E13	0183
0258 003 755	OZA447-E30	0449
0258 003 756	OZA447-E30	0449
0258 003 757	OZA447-E35	0493
0258 003 759	OZA448-E31	0151
0258 003 760	OZA448-E31	0151
0258 003 770	OZA527-E20	1797
0258 003 772	OZA527-E7	0213
0258 003 779	OZA33-D8	1867
0258 003 782	OZA660-EE8	5682
0258 003 783	OZA660-EE8	5682
0258 003 798	OZA447-E21	0216
0258 003 802	OZA447-E27	0416
0258 003 805	OZA527-E19	0296
0258 003 810	OZA572-E14	0408
0258 003 811	OZA447-E35	0493
0258 003 829	OZA527-E36	1993
0258 003 830	OZA527-E36	1993
0258 003 842	OZA447-E31	0460
0258 003 843	OZA447-E31	0460
0258 003 846	OZA447-E32	0471
0258 003 847	OZA447-E32	0471
0258 003 855	OZA448-E54	0459
0258 003 856	OZA448-E54	0459
0258 003 857	OZA447-E30	0449
0258 003 858	OZA447-E30	0449
0258 003 862	OZA447-E22	0227
0258 003 866	OZA572-E11	0251
0258 003 870	OZA448-E45	0206
0258 003 892	OZA660-EE16	5709
0258 003 893	OZA447-E44	1976
0258 003 894	OZA447-E44	1976
0258 003 895	OZA660-EE22	5720

GENUINE	NTK	ORDER
BOSCH		
0258 003 913	OZA446-E46	0139
0258 003 915	OZA446-E13	1826
0258 003 925	OZA446-E14	1837
0258 003 926	OZA446-E63	1730
0258 003 931	OZA446-E2	1855
0258 003 936	OZA446-E15	1848
0258 003 957	OZA446-E16	1859
0258 003 965	OZA445-E7	0269
0258 003 973	OZA446-E15	1848
0258 003 979	OZA445-E3	1860
0258 003 995	OZA445-E7	0269
0258 005 001	OZA448-E29	0182
0258 005 002	OZA448-E29	0182
0258 005 007	OZA447-E26	0405
0258 005 026	OZA447-E35	0493
0258 005 030	OZA660-EE20	5717
0258 005 049	OZA447-E31	0460
0258 005 055	OZA448-E49	0404
0258 005 066	OZA447-E31	0460
0258 005 068	OZA447-E31	0460
0258 005 070	OZA448-E47	0228
0258 005 075	OZA447-E31	0460
0258 005 079	OZA447-E17	0270
0258 005 083	OZA448-E29	0182
0258 005 088	OZA447-E34	0482
0258 005 089	OZA447-E34	0482
0258 005 090	OZA660-EE9	5694
0258 005 091	OZA660-EE9	5694
0258 005 096	OZA112-A4	0236
0258 005 097	OZA660-EE11	5697
0258 005 100	OZA447-E32	0471
0258 005 109	OZA447-E29	0438
0258 005 110	OZA448-E53	0448
0258 005 113	OZA447-E18	0281
0258 005 115	OZA448-E51	0426
0258 005 116	OZA448-E51	0426
0258 005 117	OZA447-E32	0471
0258 005 119	OZA447-E32	0471
0258 005 121	OZA447-E40	1738
0258 005 123	OZA447-E40	1738
0258 005 133	OZA660-EE1	5653
0258 005 134	OZA660-EE12	5698
0258 005 135	OZA448-E50	0415
0258 005 136	OZA660-EE21	5719
0258 005 158	OZA447-E31	0460
0258 005 160	OZA447-E35	0493
0258 005 177	OZA660-EE17	5713
0258 005 178	OZA447-E32	0471
0258 005 187	OZA447-E32	0471
0258 005 211	OZA660-EE6	5680
0258 005 212	OZA660-EE6	5680

REFERENZLISTE
CROSS REFERENCE GUIDE
Рекомендационный перечень
REFERANS LÍSTESİ

TABLE DE CORRESPONDANCE
TABELLE COMPARATIVE
Συστάσεις

GUIA EQUIVALENCIAS
LISTA PORÓWNAWCZA
REFERENTIELIJST

GENUINE	NTK	ORDER
BOSCH		
0258 005 225	OZA660-EE13	5706
0258 005 234	OZA660-EE4	5658
0258 005 235	OZA660-EE10	5695
0258 005 240	OZA447-E41	1739
0258 005 241	OZA447-E41	1739
0258 005 247	OZA660-EE2	5654
0258 005 249	OZA112-A3	0157
0258 005 251	OZA660-EE18	5714
0258 005 253	OZA253-F6	0122
0258 005 254	OZA502-E34	0436
0258 005 255	OZA85-M1	0165
0258 005 256	OZA660-EE7	5681
0258 005 259	OZA660-EE19	5716
0258 005 263	OZA447-E42	1971
0258 005 264	OZA447-E42	1971
0258 005 274	OZA446-E64	1737
0258 005 275	OZA446-E64	1737
0258 005 291	OZA660-EE3	5656
0258 005 293	OZA448-E58	1909
0258 005 294	OZA448-E58	1909
0258 005 318	OZA572-E8	0209
0258 005 322	OZA660-EE14	5707
0258 005 324	OZA572-E8	0209
0258 005 325	OZA572-E12	0273
0258 005 658	OZA112-A4	0236
0258 005 708	OZA74-F1	0401
0258 005 710	OZA660-EE18	5714
0258 006 018	OZA659-EE15	0389
0258 006 021	OZA659-EE30	1612
0258 006 022	OZA659-EE44	1638
0258 006 023	OZA659-EE36	1620
0258 006 026	OZA659-EE8	0382
0258 006 027	OZA659-EE4	0378
0258 006 028	OZA659-EE12	0386
0258 006 029	OZA659-EE21	0395
0258 006 046	OZA659-EE6	0380
0258 006 053	OZA659-EE9	0383
0258 006 055	OZA659-EE43	1630
0258 006 057	OZA659-EE1	0375
0258 006 067	OZA659-EE46	5748
0258 006 069	OZA659-EE47	5750
0258 006 072	OZA659-EE31	1613
0258 006 079	OZA659-EE16	0390
0258 006 081	OZA659-EE20	0394
0258 006 089	OZA659-EE17	0391
0258 006 101	OZA659-EE32	1614
0258 006 109	OZA659-EE18	0392
0258 006 121	OZA659-EE1	0375
0258 006 123	OZA659-EE15	0389
0258 006 124	OZA659-EE15	0389
0258 006 125	OZA659-EE27	1609

GENUINE	NTK	ORDER
BOSCH		
0258 006 126	OZA659-EE27	1609
0258 006 127	OZA659-EE2	0376
0258 006 139	OZA659-EE19	0393
0258 006 141	OZA659-EE14	0388
0258 006 147	OZA659-EE25	0399
0258 006 151	OZA659-EE25	0399
0258 006 153	OZA659-EE33	1617
0258 006 155	OZA659-EE9	0383
0258 006 163	OZA659-EE25	0399
0258 006 167	OZA659-EE26	0400
0258 006 168	OZA659-EE26	0400
0258 006 170	OZA659-EE7	0381
0258 006 171	OZA659-EE28	1610
0258 006 172	OZA659-EE5	0379
0258 006 176	OZA659-EE51	1995
0258 006 181	OZA659-EE29	1611
0258 006 185	OZA659-EE10	0384
0258 006 186	OZA659-EE52	1996
0258 006 190	OZA659-EE30	1612
0258 006 191	OZA659-EE30	1612
0258 006 192	OZA659-EE3	0377
0258 006 193	OZA659-EE31	1613
0258 006 194	OZA659-EE42	1629
0258 006 206	OZA675-EE1	7978
0258 006 217	OZA659-EE40	1627
0258 006 219	OZA659-EE16	0390
0258 006 220	OZA659-EE16	0390
0258 006 221	OZA659-EE20	0394
0258 006 222	OZA659-EE20	0394
0258 006 223	OZA659-EE40	1627
0258 006 229	OZA659-EE32	1614
0258 006 230	OZA659-EE32	1614
0258 006 237	OZA659-EE18	0392
0258 006 238	OZA659-EE18	0392
0258 006 245	OZA659-EE1	0375
0258 006 246	OZA659-EE1	0375
0258 006 255	OZA659-EE19	0393
0258 006 256	OZA659-EE19	0393
0258 006 257	OZA659-EE14	0388
0258 006 258	OZA659-EE14	0388
0258 006 261	OZA659-EE25	0399
0258 006 263	OZA659-EE33	1617
0258 006 264	OZA659-EE33	1617
0258 006 268	OZA659-EE34	1618
0258 006 269	OZA659-EE34	1618
0258 006 272	OZA659-EE24	0398
0258 006 273	OZA659-EE24	0398
0258 006 274	OZA659-EE35	1619
0258 006 275	OZA659-EE35	1619
0258 006 276	OZA659-EE22	0396
0258 006 277	OZA659-EE22	0396

REFERENZLISTE
CROSS REFERENCE GUIDE
Рекомендационный перечень
REFERANS LISTESI

TABLE DE CORRESPONDANCE
TABELLE COMPARATIVE
Συστάσεις

GUIA EQUIVALENCIAS
LISTA PORÓWNAWCZA
REFERENTIELIJST

GENUINE	NTK	ORDER
BOSCH		
0258 006 287	OZA659-EE36	1620
0258 006 288	OZA659-EE36	1620
0258 006 290	OZA659-EE45	5747
0258 006 294	OZA659-EE53	7858
0258 006 295	OZA659-EE13	0387
0258 006 305	OZA659-EE64	7949
0258 006 307	OZA659-EE17	0391
0258 006 308	OZA659-EE17	0391
0258 006 309	OZA659-EE54	7859
0258 006 311	OZA659-EE13	0387
0258 006 312	OZA659-EE46	5748
0258 006 313	OZA659-EE46	5748
0258 006 314	OZA659-EE47	5750
0258 006 315	OZA659-EE47	5750
0258 006 324	OZA659-EE48	5752
0258 006 325	OZA659-EE48	5752
0258 006 328	OZA659-EE55	7860
0258 006 329	OZA659-EE55	7860
0258 006 353	OZA659-EE37	1624
0258 006 354	OZA659-EE37	1624
0258 006 373	OZA659-EE38	1625
0258 006 374	OZA659-EE38	1625
0258 006 375	OZA659-EE56	7863
0258 006 376	OZA659-EE49	5753
0258 006 386	OZA659-EE39	1626
0258 006 388	OZA659-EE57	7864
0258 006 389	OZA659-EE58	7903
0258 006 391	OZA659-EE59	7904
0258 006 398	OZA659-EE23	0397
0258 006 399	OZA659-EE23	0397
0258 006 422	OZA659-EE40	1627
0258 006 423	OZA659-EE40	1627
0258 006 424	OZA659-EE60	7905
0258 006 431	OZA659-EE61	7915
0258 006 432	OZA659-EE50	5754
0258 006 440	OZA659-EE11	0385
0258 006 441	OZA659-EE11	0385
0258 006 450	OZA659-EE43	1630
0258 006 537	OZA659-EE41	1628
0258 006 563	OZA659-EE42	1629
0258 006 564	OZA659-EE42	1629
0258 006 720	OZA659-EE62	7916
0258 006 721	OZA659-EE63	7948
0258 986 605	OZA444-E1	0439
0986 258 002	OTD2F-1P2	0022
0986 258 009	OZA446-E56	0461
F00 E261 264	OTA7N-5D3	1991
F00 HL00 018	OZA446-E45	0155
F00 HL00 053	OZA395-E9	0495

GENUINE	NTK	ORDER
CHEVROLET		
25 162 600	OZA19-E12	6379
25 162 693	OZA19-E12	6379
25 166 816	OZA19-E12	6379
96 253 547	OZA341-W1	6408
96 415 635	OZA629-W6	0019
96 415 639	OZA629-W5	0018
96 415 640	OZA610-W2	0014
96 418 965	OZA629-W2	0017
96 419 320	OZA610-W5	0015
CHRYSLER		
4606 091	OZA28-C3	6380
4606 133 AD	OZA521-C8	6383
4606 555 AC	OZA571-C4	6385
5099 817 AA	OZA659-EE15	0389
5099 821 AA	OZA659-EE22	0396
5602 8994 AB	OZA623-C1	6397
5602 9049 AA	OZA571-C2	6384
5602 9050 AA	OZA571-C7	6396
5604 1004	OZA248-C1	6381
5604 1005	OZA248-C1	6381
MD 119 210	OZA401-E63	0207
MD 128 262	OZA401-E54	0186
MD 148 738	OZA428-E3	0121
MD 150 609	OZA428-E2	0197
MD 183 145	OZA502-E34	0436
MD 183 399	OZA502-E35	0447
CITROEN		
1618 72	OZA495-PG3	1853
1618 K9	OZA659-EE63	7948
1618 Q5	OZA659-EE62	7916
1618 R0	OZA608-U2	0070
1628 3W	OZA527-E12	0220
1628 6R	OZA527-E15	0298
1628 6S	OZA527-E16	0434
1628 6W	OZA527-E17	0445
1628 7R	OZA676-EE1	7979
1628 7S	OZA527-E29	0488
1628 7Z	OZA527-E33	1980
1628 83	OZA446-E11	1898
1628 8C	OZA527-E35	1982
1628 9A	OZA527-E34	1981
1628 9S	OZA660-EE24	5739
1628 9T	OZA448-E56	0481
1628 9V	OZA660-EE23	5737
1628 9W	OZA448-E57	0492
1628 A4	OZA446-E48	0280
1628 CW	OZA659-EE12	0386
1628 CX	OZA659-EE21	0395
1628 EC	OZA659-EE8	0382

REFERENZLISTE
CROSS REFERENCE GUIDE
Рекомендационный перечень
REFERANS LISTESI

TABLE DE CORRESPONDANCE
TABELLE COMPARATIVE
Συστάσεις

GUIA EQUIVALENCIAS
LISTA PORÓWNAWCZA
REFERENTIELIJST

GENUINE	NTK	ORDER
CITROEN		
1628 HN	OZA659-EE4	0378
1628 HQ	OZA659-EE8	0382
1628 HR	OZA659-EE12	0386
1628 HT	OZA660-EE23	5737
1628 HV	OZA659-EE21	0395
1628 J4	OZA527-E2	0265
1628 KN	OZA495-PG2	1852
1628 KP	OZA341-PG7	1815
1628 KY	OZA659-EE10	0384
1628 L4	OZA527-E22	0274
1628 LP	OZA334-PG1	1790
1628 NY	OZA341-PG5	1813
1628 PL	OZA659-EE52	1996
1628 PW	LZA06-U1	1840
1628 PX	OZA538-PG1	1818
1628 QY	OZA341-PG6	1814
1628 T2	OZA527-E3	0201
1628 TG	OZA538-PG2	1819
1628 TH	OZA341-PG8	1816
1628 VN	OZA659-EE61	7915
1628 V4	OZA527-E12	0220
91 518 193	OZA446-E11	1898
91 535 718	OZA446-E11	1898
96 027 244	OZA527-E2	0265
96 036 827	OZA527-E22	0274
96 121 278 17	OZA527-E12	0220
96 127 346	OZA527-E12	0220
96 138 608	OZA527-E3	0201
96 229 969	OZA527-E15	0298
96 230 002	OZA527-E29	0488
96 284 479	OZA448-E57	0492
96 284 479 80	OZA448-E57	0492
96 284 482	OZA448-E56	0481
96 366 522 80	OZA334-PG1	1790
96 368 766	OZA659-EE52	1996
96 369 209 80	LZA06-U1	1840
96 369 683 80	OZA341-PG5	1813
96 369 684 80	OZA341-PG6	1814
96 369 685 80	OZA341-PG7	1815
96 369 687 80	OZA495-PG2	1852
96 369 688 80	OZA495-PG3	1853
96 393 054 80	OZA538-PG1	1818
96 424 706	OZA659-EE61	7915
96 424 707 80	OZA538-PG2	1819
96 424 708 80	OZA341-PG8	1816
96 576 329 80	OZA608-U2	0070
DACIA		
7700 274 190	OZA507-R1	6515
7700 875 342	OZA277-R1	1704
8200 052 062	OZA507-R2	0480

GENUINE	NTK	ORDER
DACIA		
8200 663 806	OZA507-R5	6517
8200 668 947	OZA277-R3	6514
DAEWOO		
25 106 073	OZA401-E6	1882
96 253 547	OZA341-W1	6408
96 415 635	OZA629-W6	0019
96 415 639	OZA629-W5	0018
96 415 640	OZA610-W2	0014
96 418 965	OZA629-W2	0017
96 419 320	OZA610-W5	0015
96 507 986	OZA341-W2	0440
DELPHI		
ES10226-12B1	OZA401-E49	0120
ES10242-12B1	OZA446-E16	1859
ES10254-12B1	OZA572-E8	0209
ES10258-12B1	OZA446-E13	1826
ES10262-12B1	OZA446-E15	1848
ES10276-12B1	OZA527-E10	0263
ES10403-12B1	OZA447-E25	0494
ES10456-12B1	OZA446-E45	0155
ES10568-12B1	OZA447-E31	0460
ES10671-12B1	OZA401-E2	1802
ES10760-12B1	OZA624-E1	1951
ES10761-12B1	OZA624-E2	1918
ES10762-12B1	OZA624-E3	0412
ES10763-12B1	OZA624-E5	1919
ES10857-12B1	OZA447-E29	0438
ES10899-12B1	OZA447-E28	0427
ES10957-12B1	OZA446-E49	0291
ES10966-12B1	OZA401-E6	1882
ES10967-12B1	OZA572-E11	0251
ES10968-12B1	OZA55-R2	0123
ES10971-12B1	OZA311-R2	0126
ES10976-12B1	OZA447-E13	0183
ES10977-12B1	OZA447-E36	1950
ES10978-12B1	OZA447-E17	0270
ES10979-12B1	OZA447-E16	0259
ES10982-12B1	OZA447-E26	0405
ES10983-12B1	OZA447-E27	0416
ES10987-12B1	OZA447-E35	0493
ES10989-12B1	OZA428-E1	1807
ES10991-12B1	OZA446-E40	0193
ES10992-12B1	OZA446-E57	0472
ES10994-12B1	OZA446-E48	0280
ES10996-12B1	OZA446-E6	1861
ES10998-12B1	OZA401-E4	1822
ES20037-12B1	OZA74-F1	0401
ES20080-12B1	OZA448-E53	0448

REFERENZLISTE
CROSS REFERENCE GUIDE
Рекомендационный перечень
REFERANS LISTESI

TABLE DE CORRESPONDANCE
TABELLE COMPARATIVE
Συστάσεις

GUIA EQUIVALENCIAS
LISTA PORÓWNAWCZA
REFERENTIELIJST

GENUINE	NTK	ORDER
DELPHI		
ES20135-12B1	OZA448-E49	0404
ES20185-12B1	OZA527-E13	0285
ES20220-12B1	OZA448-E58	1909
ES20229-12B1	OZA527-E12	0220
ES20230-12B1	OZA527-E29	0488
ES20231-12B1	OZA527-E7	0213
ES20232-12B1	OZA527-E4	0218
ES20233-12B1	OZA527-E3	0201
ES20234-12B1	OZA527-E16	0434
ES20235-12B1	OZA527-E8	0284
ES20236-12B1	OZA527-E19	0296
ES20237-12B1	OZA527-E22	0274
ES20238-12B1	OZA527-E24	0287
ES20239-12B1	OZA527-E9	0498
ES20240-12B1	OZA527-E5	0253
ES20241-12B1	OZA527-E17	0445
ES20242-12B1	OZA527-E15	0298
ES20243-12B1	OZA527-E18	0430
ES20244-12B1	OZA527-E2	0265
ES20252-12B1	OZA448-E55	0470
ES20255-12B1	OZA334-PG1	1790
ES20256-12B1	OZA448-E31	0151
ES20259-12B1	OZA448-E52	0437
ES20261-12B1	OZA448-E39	0210
ES20262-12B1	OZA532-A5	1792
ES20263-12B1	OZA532-A4	1786
ES20266-12B1	OZA83-VN1	0124
ES20268-12B1	OZA448-E47	0228
ES20271-12B1	OZA510-V6	1885
ES20274-12B1	OZA448-E45	0206
ES20281-12B1	OZA334-SZ1	0485
ES20282-12B1	OZA334-SZ2	0496
ES20283-12B1	OZA334-SZ3	0407
ES20284-12B1	OZA334-SZ4	0418
ES20285-12B1	OZA516-AU1	0452
ES20288-12B1	OZA448-E54	0459
ES20293-12B1	OZA448-E56	0481
ES20299-12B1	OZA341-W2	0440
ES20309-12B0	OZA659-EE8	0382
ES20310-12B1	OZA659-EE13	0387
DENSO		
DOX-0204	OZA669-EE12	7973
DOX-0206	OZA669-EE8	7953
DOX-0238	OZA669-EE9	7954
0922	OZA669-EE10	7970
5135	OZA669-EE12	7973
6015	OZA669-EE8	7953
6363	OZA669-EE9	7954
7004	OZA668-EE12	7951
7014	OZA669-EE11	7971

GENUINE	NTK	ORDER
DENSO		
9033	OZA668-EE13	7952
DODGE		
4606 133 AD	OZA521-C8	6383
4606 555 AC	OZA571-C4	6385
5602 9049 AA	OZA571-C2	6384
5602 9050 AA	OZA571-C7	6396
DUCATI		
CA.0083 476	OZA591-BB3	0066
466 031	OZA591-BA1	6496
55 21 11 11A	OZA591-BB3	0066
FACET		
1 997 020	OZA527-E20	1797
1 997 021	OZA527-E19	0296
1 997 022	OZA527-E7	0213
1 997 024	OZA448-E56	0481
1 997 025	OZA446-E50	0204
1 997 026	OZA446-E2	1855
1 997 027	OZA446-E2	1855
1 997 028	OZA446-E5	1838
1 997 030	OZA446-E49	0291
1 997 031	OZA446-E12	1805
1 997 032	OZA572-E3	0264
1 997 033	OZA572-E1	0283
1 997 034	OZA527-E14	0455
1 997 035	OZA527-E36	1993
1 997 036	OZA527-E12	0220
1 997 037	OZA527-E5	0253
1 997 040	OZA527-E4	0218
1 997 041	OZA527-E5	0253
1 997 042	OZA446-E42	0150
1 997 043	OZA445-E2	1810
1 997 044	OZA445-E4	1850
1 997 045	OZA446-E15	1848
1 997 046	OZA65-A2	1889
1 997 047	OZA401-E2	1802
1 997 048	OZA446-E18	1887
1 997 049	OZA572-E9	0423
1 997 051	OZA446-E16	1859
1 997 052	OZA572-E9	0423
1 997 054	OZA334-A3	0245
1 997 055	OZA186-F7	0457
1 997 056	OZA572-E13	0254
1 997 057	OZA527-E9	0498
1 997 059	OZA324-L1	1779
1 997 062	OZA446-E57	0472
1 997 063	OZA527-E16	0434
1 997 064	OZA527-E3	0201
1 997 065	OZA527-E34	1981

REFERENZLISTE
CROSS REFERENCE GUIDE
Рекомендационный перечень
REFERANS LÍSTESİ

TABLE DE CORRESPONDANCE
TABELLE COMPARATIVE
Συστάσεις

GUIA EQUIVALENCIAS
LISTA PORÓWNAWCZA
REFERENTIELIJST

GENUINE	NTK	ORDER
FACET		
1 997 066	OZA527-E33	1980
1 997 068	OZA527-E35	1982
1 997 069	OZA527-E29	0488
1 997 070	OZA527-E11	1787
1 997 072	OZA401-E6	1882
1 997 073	OZA527-E24	0287
1 997 074	OZA428-E1	1807
1 997 075	OZA334-A3	0245
1 997 076	OZA446-E3	1866
1 997 077	OZA446-E6	1861
1 997 079	OZA446-E48	0280
1 997 080	OZA527-E20	1797
1 997 081	OZA676-EE1	7979
1 997 085	OZA447-E32	0471
1 997 087	OZA447-E36	1950
1 997 089	OZA447-E26	0405
1 997 090	OZA510-V4	0424
1 997 093	OZA659-EE28	1610
1 997 096	OZA334-A2	0234
1 997 097	OZA448-E50	0415
1 997 114	OZA334-SZ3	0407
1 997 116	OZA531-GM2	1863
1 997 119	OZA401-E58	0166
1 997 136	OZA334-SZ4	0418
1 997 144	OZA447-E31	0460
1 997 145	OZA572-E10	0275
1 997 148	OZA447-E14	0129
1 997 149	OZA448-E31	0151
1 997 157	OZA659-EE5	0379
1 997 159	OZA531-GM2	1863
1 997 162	OZA659-EE1	0375
1 997 163	OZA447-E32	0471
1 997 164	OZA659-EE20	0394
1 997 165	OZA510-V1	0491
1 997 167	OZA659-EE25	0399
1 997 168	OZA659-EE16	0390
1 997 169	OZA447-E18	0281
1 997 171	OZA447-E17	0270
1 997 178	OZA510-AU1	1782
1 997 179	OZA659-EE19	0393
1 997 180	OZA510-V3	0413
1 997 181	OZA659-EE32	1614
1 997 184	OZA572-E4	0295
1 997 188	OZA572-E5	0242
1 997 197	OZA74-F1	0401
1 997 199	OZA74-F2	0433
1 997 203	OZA74-F1	0401
1 997 205	OZA112-A3	0157
1 997 211	OZA112-A4	0236
1 997 212	OZA659-EE31	1613
1 997 213	OZA341-A1	1798

GENUINE	NTK	ORDER
FACET		
1 997 214	OZA334-A1	0223
1 997 215	OZA675-EE1	7978
1 997 217	OZA659-EE8	0382
1 997 223	OZA659-EE21	0395
1 997 241	OZA25-F12	0198
1 997 247	OZA25-KH1	1940
1 997 263	OZA73-F1	0177
1 997 264	OZA236-R1	0147
1 997 265	OZA446-E6	1861
1 997 268	OZA83-R1	0156
1 997 269	OZA448-E43	0282
1 997 280	OZA277-R2	0468
1 997 282	OZA277-R2	0468
1 997 283	OZA659-EE6	0380
1 997 290	OZA107-KH2	6407
1 997 296	OZA89-D1	1890
1 997 300	OZA446-E43	0194
1 997 301	OZA448-E31	0151
1 997 304	OZA447-E25	0494
1 997 305	OZA659-EE18	0392
1 997 306	OZA516-AU1	0452
1 997 307	OZA112-A2	0225
1 997 311	OZA74-F3	0446
1 997 313	OZA673-EE1	7974
1 997 318	OZA488-D2	1757
1 997 320	OZA519-D1	0244
1 997 322	OZA381-D1	1820
1 997 327	OZA446-E45	0155
1 997 328	OZA446-E45	0155
1 997 336	OZA448-E49	0404
1 997 337	OZA532-A5	1792
1 997 338	OZA659-EE49	5753
1 997 341	OZA334-SZ2	0496
1 997 342	OZA334-SZ1	0485
1 997 343	OZA334-SZ3	0407
1 997 345	OZA446-E40	0193
1 997 346	OZA446-E40	0193
1 997 348	OZA445-E4	1850
1 997 352	OZA447-E31	0460
1 997 355	OZA510-V3	0413
1 997 356	OZA516-AU1	0452
1 997 357	OZA510-V2	0402
1 997 361	OZA447-E40	1738
1 997 362	OZA334-AU1	0474
1 997 364	OZA85-M1	0165
1 997 366	OZA401-E63	0207
1 997 367	OZA401-E68	0428
1 997 377	OZA384-E32	0133
1 997 378	OZA384-E32	0133
1 997 383	OZA401-E51	0142
1 997 389	OZA448-E53	0448

REFERENZLISTE
CROSS REFERENCE GUIDE
Рекомендационный перечень
REFERANS LISTESI

TABLE DE CORRESPONDANCE
TABELLE COMPARATIVE
Συστάσεις

GUIA EQUIVALENCIAS
LISTA PORÓWNAWCZA
REFERENTIELIJST

GENUINE	NTK	ORDER
FACET		
1 997 394	OZA660-EE18	5714
1 997 396	OZA446-E45	0155
1 997 403	OZA448-E57	0492
1 997 404	OZA659-EE12	0386
1 997 405	OZA659-EE30	1612
1 997 411	OZA448-E45	0206
1 997 413	OZA448-E54	0459
1 997 414	OZA659-EE22	0396
1 997 420	OZA659-EE48	5752
1 997 422	OZA447-E44	1976
1 997 423	OZA447-E22	0227
1 997 425	OZA659-EE15	0389
1 997 428	OZA447-E35	0493
1 997 441	OZA112-A1	0146
1 997 495	OZA245-H1	0169
1 997 572	OZA333-H27	0212
1 997 576	OZA444-E1	0439
1 997 584	OZA334-SZ2	0496
1 997 588	OZA659-EE10	0384
1 997 588	OZA341-PG5	1813
1 997 589	OZA446-E44	0162
1 997 591	OZA341-PG6	1814
1 997 597	OZA495-PG2	1852
1 997 598	OZA447-E17	0270
1 997 600	OZA510-V5	0435
1 997 601	OZA659-EE4	0378
1 997 611	OZA659-EE9	0383
1 997 612	OZA659-EE44	1638
1 997 621	OZA516-AU1	0452
1 997 625	OZA74-F2	0433
1 997 627	OZA74-F1	0401
1 997 660	OZA502-E31	0250
1 997 670	OZA112-A6	1759
1 997 671	OZA112-A7	1760
1 997 673	OZA659-EE36	1620
1 997 682	OZA659-EE43	1630
1 997 685	OZA488-D2	1757
1 997 692	OZA583-GM2	1754
1 997 697	OZA575-GM1	1895
1 997 702	OZA448-E21	0260
1 997 714	OZA448-E50	0415
1 997 725	OZA333-H4	0137
1 997 726	OZA502-E28	0425
1 997 727	OZA333-H26	0299
1 997 732	OZA333-H27	0212
1 997 740	OZA333-H19	0277
1 997 742	OZA668-EE12	7951
1 997 747	OZA245-H1	0169
1 997 749	OZA659-EE2	0376
1 997 779	OZA659-EE24	0398
1 997 781	OZA659-EE26	0400

GENUINE	NTK	ORDER
FACET		
1 997 785	OZA446-E55	0450
1 997 788	OZA447-E31	0460
1 997 848	OZA447-E41	1739
1 997 890	OZA446-E58	0483
1 997 898	OZA573-E1	0286
1 997 907	OZA532-A7	1796
1 997 917	OZA516-AU1	0452
1 997 921	OZA659-EE25	0399
1 997 927	OZA572-E14	0408
1 997 928	OZA659-EE37	1624
1 997 936	OZA510-V10	1883
1 997 943	OZA532-A4	1786
1 997 945	OZA534-A2	1764
1 997 946	OZA532-A5	1792
1 997 966	OZA629-V3	1720
1 998 077	OZA341-W1	6408
10.7020	OZA527-E20	1797
10.7021	OZA527-E19	0296
10.7022	OZA527-E7	0213
10.7024	OZA448-E56	0481
10.7025	OZA446-E50	0204
10.7026	OZA446-E2	1855
10.7027	OZA446-E2	1855
10.7028	OZA446-E5	1838
10.7030	OZA446-E49	0291
10.7031	OZA446-E12	1805
10.7032	OZA572-E3	0264
10.7033	OZA572-E1	0283
10.7034	OZA527-E14	0455
10.7035	OZA527-E36	1993
10.7036	OZA527-E12	0220
10.7037	OZA527-E5	0253
10.7040	OZA527-E4	0218
10.7041	OZA527-E5	0253
10.7042	OZA446-E42	0150
10.7043	OZA445-E2	1810
10.7044	OZA445-E4	1850
10.7045	OZA446-E15	1848
10.7046	OZA65-A2	1889
10.7047	OZA401-E2	1802
10.7048	OZA446-E18	1887
10.7049	OZA572-E9	0423
10.7051	OZA446-E16	1859
10.7052	OZA572-E9	0423
10.7054	OZA334-A3	0245
10.7055	OZA186-F7	0457
10.7056	OZA572-E13	0254
10.7057	OZA527-E9	0498
10.7059	OZA324-L1	1779
10.7062	OZA446-E57	0472
10.7063	OZA527-E16	0434

REFERENZLISTE
CROSS REFERENCE GUIDE
Рекомендационный перечень
REFERANS LĪSTESĪ

TABLE DE CORRESPONDANCE
TABELLE COMPARATIVE
Συστάσεις

GUIA EQUIVALENCIAS
LISTA PORÓWNAWCZA
REFERENTIELIJST

GENUINE	NTK	ORDER
FACET		
10.7064	OZA527-E3	0201
10.7065	OZA527-E34	1981
10.7066	OZA527-E33	1980
10.7068	OZA527-E35	1982
10.7069	OZA527-E29	0488
10.7070	OZA527-E11	1787
10.7072	OZA401-E6	1882
10.7073	OZA527-E24	0287
10.7074	OZA428-E1	1807
10.7075	OZA334-A3	0245
10.7076	OZA446-E3	1866
10.7077	OZA446-E6	1861
10.7078	OZA446-E6	1861
10.7079	OZA446-E48	0280
10.7080	OZA527-E20	1797
10.7081	OZA676-EE1	7979
10.7085	OZA447-E32	0471
10.7087	OZA447-E36	1950
10.7088	OZA447-E31	0460
10.7089	OZA447-E26	0405
10.7090	OZA510-V4	0424
10.7093	OZA659-EE28	1610
10.7096	OZA334-A2	0234
10.7097	OZA448-E50	0415
10.7114	OZA334-SZ3	0407
10.7116	OZA531-GM2	1863
10.7119	OZA401-E58	0166
10.7136	OZA334-SZ4	0418
10.7144	OZA447-E31	0460
10.7145	OZA572-E10	0275
10.7148	OZA447-E14	0129
10.7149	OZA448-E31	0151
10.7157	OZA659-EE5	0379
10.7159	OZA531-GM2	1863
10.7162	OZA659-EE1	0375
10.7163	OZA447-E32	0471
10.7164	OZA659-EE20	0394
10.7165	OZA510-V1	0491
10.7167	OZA659-EE25	0399
10.7168	OZA659-EE16	0390
10.7169	OZA447-E18	0281
10.7171	OZA447-E17	0270
10.7178	OZA510-AU1	1782
10.7179	OZA659-EE19	0393
10.7180	OZA510-V3	0413
10.7181	OZA659-EE32	1614
10.7184	OZA572-E4	0295
10.7188	OZA572-E5	0242
10.7197	OZA74-F1	0401
10.7199	OZA74-F2	0433
10.7203	OZA74-F1	0401

GENUINE	NTK	ORDER
FACET		
10.7205	OZA112-A3	0157
10.7211	OZA112-A4	0236
10.7212	OZA659-EE31	1613
10.7213	OZA341-A1	1798
10.7214	OZA334-A1	0223
10.7215	OZA675-EE1	7978
10.7217	OZA659-EE8	0382
10.7223	OZA659-EE21	0395
10.7241	OZA25-F12	0198
10.7247	OZA25-KH1	1940
10.7263	OZA73-F1	0177
10.7264	OZA236-R1	0147
10.7265	OZA446-E6	1861
10.7268	OZA83-R1	0156
10.7269	OZA448-E43	0282
10.7279	OZA55-R3	0134
10.7280	OZA277-R2	0468
10.7282	OZA277-R2	0468
10.7283	OZA659-EE6	0380
10.7284	OZA311-R2	0126
10.7290	OZA107-KH2	6407
10.7296	OZA89-D1	1890
10.7300	OZA446-E43	0194
10.7301	OZA448-E31	0151
10.7304	OZA447-E25	0494
10.7305	OZA659-EE18	0392
10.7306	OZA516-AU1	0452
10.7307	OZA112-A2	0225
10.7311	OZA74-F3	0446
10.7313	OZA673-EE1	7974
10.7318	OZA488-D2	1757
10.7320	OZA519-D1	0244
10.7322	OZA381-D1	1820
10.7327	OZA446-E45	0155
10.7328	OZA446-E45	0155
10.7336	OZA448-E49	0404
10.7337	OZA532-A5	1792
10.7338	OZA659-EE49	5753
10.7341	OZA334-SZ2	0496
10.7342	OZA334-SZ1	0485
10.7343	OZA334-SZ3	0407
10.7345	OZA446-E40	0193
10.7346	OZA446-E40	0193
10.7348	OZA445-E4	1850
10.7352	OZA447-E31	0460
10.7355	OZA510-V3	0413
10.7356	OZA516-AU1	0452
10.7357	OZA510-V2	0402
10.7361	OZA447-E40	1738
10.7362	OZA334-AU1	0474
10.7364	OZA85-M1	0165

REFERENZLISTE
CROSS REFERENCE GUIDE
Рекомендационный перечень
REFERANS LISTESI

TABLE DE CORRESPONDANCE
TABELLE COMPARATIVE
Συστάσεις

GUIA EQUIVALENCIAS
LISTA PORÓWNAWCZA
REFERENTIELIJST

GENUINE	NTK	ORDER
FACET		
10.7366	OZA401-E63	0207
10.7367	OZA401-E68	0428
10.7377	OZA384-E32	0133
10.7378	OZA384-E32	0133
10.7383	OZA401-E51	0142
10.7389	OZA448-E53	0448
10.7394	OZA660-EE18	5714
10.7396	OZA446-E45	0155
10.7403	OZA448-E57	0492
10.7404	OZA659-EE12	0386
10.7405	OZA659-EE30	1612
10.7405	OZA527-E24	0287
10.7411	OZA448-E45	0206
10.7413	OZA448-E54	0459
10.7414	OZA659-EE22	0396
10.7420	OZA659-EE48	5752
10.7422	OZA447-E44	1976
10.7423	OZA447-E22	0227
10.7425	OZA659-EE15	0389
10.7428	OZA447-E35	0493
10.7441	OZA112-A1	0146
10.7495	OZA245-H1	0169
10.7572	OZA333-H27	0212
10.7575	OZA333-H4	0137
10.7576	OZA444-E1	0439
10.7584	OZA334-SZ2	0496
10.7588	OZA659-EE10	0384
10.7589	OZA446-E44	0162
10.7591	OZA341-PG6	1814
10.7597	OZA495-PG2	1852
10.7598	OZA447-E17	0270
10.7600	OZA510-V5	0435
10.7601	OZA659-EE4	0378
10.7611	OZA659-EE9	0383
10.7612	OZA659-EE44	1638
10.7621	OZA516-AU1	0452
10.7625	OZA74-F2	0433
10.7627	OZA74-F1	0401
10.7660	OZA502-E31	0250
10.7670	OZA112-A6	1759
10.7671	OZA112-A7	1760
10.7673	OZA659-EE36	1620
10.7682	OZA659-EE43	1630
10.7685	OZA488-D2	1757
10.7692	OZA583-GM2	1754
10.7697	OZA575-GM1	1895
10.7702	OZA448-E21	0260
10.7714	OZA448-E50	0415
10.7725	OZA333-H4	0137
10.7726	OZA502-E28	0425
10.7727	OZA333-H26	0299

GENUINE	NTK	ORDER
FACET		
10.7732	OZA333-H27	0212
10.7740	OZA333-H19	0277
10.7742	OZA668-EE12	7951
10.7747	OZA245-H1	0169
10.7749	OZA659-EE2	0376
10.7760	OZA186-F5	0188
10.7779	OZA659-EE24	0398
10.7781	OZA659-EE26	0400
10.7785	OZA446-E55	0450
10.7848	OZA447-E41	1739
10.7890	OZA446-E58	0483
10.7898	OZA573-E1	0286
10.7907	OZA532-A7	1796
10.7917	OZA516-AU1	0452
10.7921	OZA659-EE25	0399
10.7927	OZA572-E14	0408
10.7928	OZA659-EE37	1624
10.7936	OZA510-V10	1883
10.7943	OZA532-A4	1786
10.7945	OZA534-A2	1764
10.7946	OZA532-A5	1792
10.7966	OZA629-V3	1720
10.8077	OZA341-W1	6408
FERRARI		
12 15 15	OZA446-E1	1833
14 25 14	OZA527-E4	0218
FIAT		
00 55 19 11 27	LZA15-A1	0029
00 55 20 16 10	OZA532-A12	0056
00 55 20 23 69	LZA15-A3	0031
46 40 73 16	OZA112-A2	0225
46 40 84 49	OZA446-E18	1887
46 41 79 69	OZA527-E7	0213
46 41 85 68	OZA527-E19	0296
46 41 88 13	OZA112-A3	0157
46 41 92 22	OZA114-A1	1856
46 42 06 12	OZA527-E5	0253
46 42 26 49	OZA527-E11	1787
46 42 37 98	OZA527-E5	0253
46 42 47 23	OZA527-E7	0213
46 43 45 52	OZA527-E24	0287
46 44 78 41	OZA112-A4	0236
46 44 94 01	OZA527-E19	0296
46 46 20 06	OZA527-E24	0287
46 48 14 57	OZA112-A6	1759
46 48 14 58	OZA112-A7	1760
46 52 11 70	OZA334-A1	0223
46 52 31 29	OZA334-A2	0234
46 52 93 85	OZA334-A3	0245

REFERENZLISTE
CROSS REFERENCE GUIDE
Рекомендационный перечень
REFERANS LĪSTESĪ

TABLE DE CORRESPONDANCE
TABELLE COMPARATIVE
Συστάσεις

GUIA EQUIVALENCIAS
LISTA PORÓWNAWCZA
REFERENTIELIJST

GENUINE	NTK	ORDER
FIAT		
46 54 54 32	OZA341-A1	1798
46 55 23 13	OZA532-A1	0478
46 75 02 41	OZA659-EE30	1612
46 75 02 43	OZA659-EE31	1613
46 75 02 45	OZA675-EE1	7978
46 75 02 46	OZA659-EE30	1612
46 75 02 49	OZA532-A2	0489
46 75 10 82	OZA675-EE1	7978
46 76 08 63	OZA659-EE57	7864
46 76 08 67	OZA532-A3	0409
46 76 21 82	OZA659-EE49	5753
46 76 26 53	OZA659-EE56	7863
46 76 26 530	OZA659-EE56	7863
46 76 42 07	OZA659-EE58	7903
46 77 45 31	OZA534-A1	1762
46 77 45 34	OZA534-A3	1800
46 77 62 86	OZA659-EE59	7904
46 78 60 46	OZA534-A2	1764
46 78 60 47	OZA532-A5	1792
46 80 74 54	OZA532-A7	1796
46 80 57 49	OZA659-EE60	7905
46 80 57 50	OZA659-EE59	7904
46 81 13 13	OZA532-A4	1786
46 82 38 80	OZA532-A9	1793
51 80 12 78	LZA15-A5	1727
51 80 12 780	LZA15-A5	1727
51 77 44 22	OZA641-A1	1726
51 77 44 220	OZA641-A1	1726
55 18 45 45	OZA532-A10	1794
55 19 11 270	LZA15-A1	0029
55 20 11 610	OZA532-A12	0056
55 20 23 690	LZA15-A3	0031
55 35 38 11	OZA334-SZ5	1705
55 55 68 180	OZA531-GM24	0055
60 50 76 90	OZA446-E4	1877
60 53 76 50	OZA446-E49	0291
60 56 25 36	OZA527-E4	0218
60 56 77 59	OZA446-E5	1838
60 57 87 68	OZA527-E5	0253
60 80 54 28	OZA446-E4	1877
60 80 84 57	OZA446-E5	1838
60 80 90 12	OZA446-E1	1833
60 81 08 14	OZA527-E7	0213
60 81 56 49	OZA659-EE30	1612
76 19 303	OZA446-E4	1877
76 54 221	OZA446-E5	1838
76 68 286	OZA527-E5	0253
76 74 048	OZA445-E6	0258
77 06 754	OZA65-A2	1889
77 51 308	OZA112-A1	0146
77 85 973	OZA446-E18	1887

GENUINE	NTK	ORDER
FIAT		
96 22 99 76 80	OZA659-EE8	0382
96 28 44 82	OZA448-E56	0481
96 28 44 82 80	OZA448-E56	0481
96 35 97 89 80	OZA659-EE8	0382
96 36 14 88 80	OZA659-EE21	0395
FORD		
1001 702	OZA216-D2	0190
1010 006	OZA659-EE44	1638
1010 620	OZA448-E44	0293
1013 764	OZA89-D1	1890
1025 958	OZA216-D3	0125
1035 595	OZA381-D1	1820
1053 108	OZA519-D1	0244
1067 580	OZA659-EE9	0383
1088 851	OZA659-EE9	0383
1108 640	OZA659-EE43	1630
1108 795	OZA659-EE44	1638
1113 382	OZA488-SZ1	1766
1133 441	OZA341-SZ2	0038
1143 514	OZA519-SZ2	0052
1148 070	OZA341-SZ3	0039
1123 897	OZA504-D2	1708
1208 560	OZA555-D3	0058
1300 544	OZA659-EE43	1630
1640 552	OZA446-E46	0139
1647 993	OZA446-E62	1729
3000 923	OZA488-D2	1757
3010 660	OZA488-D1	0403
3017 524	OZA381-D2	0451
3721 930	OZA381-D3	0462
6164 926	OZA446-E62	1729
6169 693	OZA527-E21	1817
6196 227	OZA446-E62	1729
6199 647	OZA527-E28	0477
6789 246	OZA660-EE15	5708
6847 908	OZA33-D8	1867
6847 910	OZA33-D5	0199
6847 911	OZA89-D1	1890
6847 912	OZA448-E12	1865
6847 914	OZA448-E42	0271
6847 916	OZA448-E41	0260
6909 240	OTD5F-3E1	0023
7011 190	OZA448-E55	0470
7089 574	OZA89-D2	0135
7126 155	OZA448-E48	0239
7126 156	OZA448-E44	0293
7325 143	OZA447-E36	1950
196A 9G444 BA	OZA341-SZ2	0038
1R83 9G444 AA	OZA381-D12	0041
1S6A 9G444 BA	OZA341-SZ2	0038

REFERENZLISTE
CROSS REFERENCE GUIDE
Рекомендационный перечень
REFERANS LISTESI

TABLE DE CORRESPONDANCE
TABELLE COMPARATIVE
Συστάσεις

GUIA EQUIVALENCIAS
LISTA PORÓWNAWCZA
REFERENTIELIJST

GENUINE	NTK	ORDER
FORD		
1S7F 9F472 AB	OZA504-D2	1708
1S7F 9G444 BB	OZA555-D2	0057
2S7A 6G444 BA	OZA555-D3	0058
2S6A 9F472 BB	OZA519-SZ2	0052
2S6A 9G444 BA	OZA341-SZ3	0039
256A 9F472 BB	OZA519-SZ2	0052
256A 9G444 BA	OZA341-SZ3	0039
2S7A 9G444 BA	OZA555-D3	0058
3S7A 9G444 CA	OZA659-EE43	1630
87AB 9F472 AA	OZA527-E21	1817
87GB 9F472 AA	OZA446-E62	1729
89BB 9F472 AA	OZA527-E28	0477
89FB 9F472 AC	OZA448-E12	1865
89GB 9F472 AA	OZA446-E62	1729
89GB 9F472 BA	OZA446-E62	1729
90BB 9F472 AB	OZA216-D3	0125
93AB 9F472 AA	OZA33-D8	1867
93AB 9F472 CA	OZA33-D5	0199
93BB 9F472 AA	OZA89-D1	1890
93FB 9F472 AA	OZA448-E12	1865
93GB 9F472 AA	OZA448-E12	1865
93GB 9F472 BA	OZA448-E42	0271
93GB 9F472 DA	OZA448-E55	0470
93VB 9F472 AA	OZA448-E41	0260
94BB 9F472 BB	OZA89-D2	0135
95FB 9F472 CB	OZA448-E48	0239
95FB 9F472 DB	OZA448-E44	0293
95VW 9F472 CB	OZA447-E36	1950
95VW 9F472 FA	OZA447-E31	0460
96BB 9F472 BA	OZA216-D2	0190
96FB 9F472 DA	OZA448-E44	0293
96VB 9F472 DA	OZA659-EE44	1638
96VB 9F472 DB	OZA659-EE44	1638
97BB 9F472 AA	OZA216-D3	0125
97VW 9F472 AA	OZA447-E31	0460
98AB 9F472 BB	OZA519-D1	0244
98AB 9G444 BB	OZA381-D1	1820
98FB 9F472 BB	OZA659-EE9	0383
98FB 9F472 CA	OZA659-EE9	0383
E4ZF 9F472 AA	OZA446-E62	1729
E59F 9F472 A1A	OZA446-E62	1729
E67F 9F472 AA	OZA446-E62	1729
S1087 480 04A	OZA341-SZ2	0038
S1087 748 105A	OZA519-SZ2	0052
S1087 748 106A	OZA341-SZ3	0039
V92HF 9F472 AA	OTD5F-3E1	0023
XC2F 9F472 AA	OZA488-D1	0403
XC2F 9F472 BA	OZA488-D2	1757
XR3F 9G444 AA	OZA381-D2	0451
XR3F 9G444 BA	OZA381-D3	0462
XS6A 9F472 AC	OZA488-SZ1	1766

GENUINE	NTK	ORDER
HELLA		
6PA 009 165-001	OZA401-E6	1882
6PA 009 165-011	OZA448-E44	0293
6PA 009 165-021	OZA446-E49	0291
6PA 009 165-041	OZA527-E15	0298
6PA 009 165-051	OZA527-E7	0213
6PA 009 165-061	OZA446-E8	1827
6PA 009 165-071	OZA401-E2	1802
6PA 009 165-081	OZA527-E4	0218
6PA 009 165-091	OZA33-D8	1867
6PA 009 165-101	OZA572-E8	0209
6PA 009 165-111	OZA236-R1	0147
6PA 009 165-131	OZA445-E4	1850
6PA 009 165-141	OZA527-E8	0284
6PA 009 165-151	OZA572-E1	0283
6PA 009 165-161	OZA447-E30	0449
6PA 009 165-171	OZA527-E2	0265
6PA 009 165-181	OZA446-E45	0155
6PA 009 165-191	OZA446-E42	0150
6PA 009 165-201	OZA446-E6	1861
6PA 009 165-211	OZA527-E12	0220
6PA 009 165-221	OZA447-E14	0129
6PA 009 165-231	OZA527-E3	0201
6PA 009 165-241	OZA446-E15	1848
6PA 009 165-251	OZA446-E57	0472
6PA 009 165-261	OZA527-E13	0285
6PA 009 165-271	OZA446-E49	0291
6PA 009 165-301	OZA401-E50	0131
6PA 009 165-311	OZA446-E7	1872
6PA 009 165-321	OZA448-E31	0151
6PA 009 165-331	OZA401-E4	1822
6PA 009 165-341	OZA527-E17	0445
6PA 009 165-351	OZA446-E40	0193
6PA 009 165-361	OZA445-E3	1860
6PA 009 165-371	OZA447-E16	0259
6PA 009 165-381	OZA445-E6	0258
6PA 009 165-391	OZA401-E55	0143
6PA 009 165-401	OZA446-E14	1837
6PA 009 165-411	OZA527-E16	0434
6PA 009 165-421	OZA446-E16	1859
6PA 009 165-431	OZA446-E3	1866
6PA 009 165-441	OZA527-E19	0296
6PA 009 165-451	OZA572-E6	1777
6PA 009 165-461	OZA112-A1	0146
6PA 009 165-471	OZA55-R4	0145
6PA 009 165-481	OZA428-E1	1807
6PA 009 165-491	OZA572-E12	0273
6PA 009 165-511	OZA446-E11	1898
6PA 009 165-521	OZA83-R4	0189
6PA 009 165-531	OZA445-E2	1810
6PA 009 165-541	OZA527-E22	0274
6PA 009 165-551	OZA572-E11	0251

REFERENZLISTE
CROSS REFERENCE GUIDE
Рекомендационный перечень
REFERANS LÍSTESİ

TABLE DE CORRESPONDANCE
TABELLE COMPARATIVE
Συστάσεις

GUIA EQUIVALENCIAS
LISTA PORÓWNAWCZA
REFERENTIELIJST

GENUINE	NTK	ORDER
HELLA		
6PA 009 165-561	OZA89-D1	1890
6PA 009 165-571	OZA216-D3	0125
6PA 009 165-581	OZA446-E13	1826
6PA 009 165-591	OZA572-E4	0295
6PA 009 165-601	OZA401-E51	0142
6PA 009 165-621	OZA446-E50	0204
6PA 009 165-631	OZA401-E57	0153
6PA 009 165-641	OZA447-E13	0183
6PA 009 165-651	OZA527-E9	0498
6PA 009 165-671	OZA236-R2	0158
6PA 009 166-001	OZA186-F5	0188
6PA 009 166-011	OZA527-E10	0263
6PA 009 166-031	OZA448-E31	0151
6PA 009 166-051	OZA572-E7	0419
6PA 009 166-061	OZA527-E27	0466
6PA 009 166-071	OZA25-F12	0198
6PA 009 166-081	OZA446-E48	0280
6PA 009 166-091	OZA527-E28	0477
6PA 009 166-101	OZA65-A2	1889
6PA 009 166-111	OZA527-E5	0253
6PA 009 166-121	OZA446-E51	0215
6PA 009 166-141	OZA448-E29	0182
6PA 009 166-151	OZA112-A3	0157
6PA 009 166-161	OZA401-E56	0154
6PA 009 166-171	OZA446-E18	1887
6PA 009 166-191	OZA253-F6	0122
6PA 009 166-201	OZA73-F1	0177
6PA 009 166-211	OZA527-E18	0430
6PA 009 166-221	OZA448-E45	0206
6PA 009 166-231	OZA527-E25	0444
6PA 009 166-241	OZA311-R1	0191
6PA 009 166-251	OZA527-E11	1787
6PA 009 166-261	OZA83-R1	0156
6PA 009 166-271	OZA446-E43	0194
6PA 009 166-281	OZA401-E58	0166
6PA 009 166-311	OZA448-E48	0239
6PA 009 166-321	OZA83-R2	0167
6PA 009 166-331	OZA83-R3	0178
6PA 009 166-421	OTA7H-3A1	1932
6PA 009 166-441	OTA7H-3A2	1943
6PA 009 166-451	OTA7N-5C1	1963
6PA 009 166-461	OTA7H-5A1	0486
6PA 009 166-471	OTA7L-3C3	0442
6PA 009 166-481	OTA7L-3C4	0431
6PA 009 166-491	OTA7H-3C1	1954
6PA 009 166-511	OZA334-SZ4	0418
6PA 009 166-521	OTA7N-5A1	1920
6PA 009 166-531	OTA7N-5A2	1938
6PA 009 166-541	OTA7N-5D1	1974
6PA 009 166-551	OTA7H-3C2	0420
6PA 009 166-561	OZA334-SZ3	0407

GENUINE	NTK	ORDER
HELLA		
6PA 009 166-571	OZA334-SZ2	0496
6PA 009 166-621	OZA334-SZ3	0407
6PA 009 166-631	OZA527-E35	1982
6PA 009 166-651	OZA527-E34	1981
6PA 009 166-661	OZA674-EE1	7975
HLS 001	OZA401-E6	1882
HLS 002	OZA448-E44	0293
HLS 003	OZA446-E49	0291
HLS 005	OZA527-E15	0298
HLS 006	OZA527-E7	0213
HLS 007	OZA446-E8	1827
HLS 008	OZA401-E2	1802
HLS 009	OZA527-E4	0218
HLS 010	OZA33-D8	1867
HLS 011	OZA572-E8	0209
HLS 012	OZA236-R1	0147
HLS 013	OZA445-E4	1850
HLS 014	OZA527-E8	0284
HLS 015	OZA572-E1	0283
HLS 016	OZA447-E30	0449
HLS 017	OZA527-E2	0265
HLS 018	OZA446-E45	0155
HLS 019	OZA446-E42	0150
HLS 020	OZA446-E6	1861
HLS 021	OZA527-E12	0220
HLS 022	OZA447-E14	0129
HLS 023	OZA527-E3	0201
HLS 024	OZA446-E15	1848
HLS 025	OZA446-E57	0472
HLS 026	OZA527-E13	0285
HLS 027	OZA446-E49	0291
HLS 030	OZA401-E50	0131
HLS 031	OZA446-E7	1872
HLS 032	OZA448-E31	0151
HLS 033	OZA401-E4	1822
HLS 034	OZA527-E17	0445
HLS 035	OZA446-E40	0193
HLS 036	OZA445-E3	1860
HLS 037	OZA447-E16	0259
HLS 038	OZA445-E6	0258
HLS 039	OZA401-E55	0143
HLS 040	OZA446-E14	1837
HLS 041	OZA527-E16	0434
HLS 042	OZA446-E16	1859
HLS 043	OZA446-E3	1866
HLS 044	OZA527-E19	0296
HLS 045	OZA572-E6	1777
HLS 046	OZA112-A1	0146
HLS 047	OZA55-R4	0145
HLS 048	OZA428-E1	1807
HLS 049	OZA572-E12	0273

REFERENZLISTE
CROSS REFERENCE GUIDE
 Рекомендационный перечень
REFERANS LISTESI

TABLE DE CORRESPONDANCE
TABELLE COMPARATIVE
 Συστάσεις

GUIA EQUIVALENCIAS
LISTA PORÓWNAWCZA
REFERENTIELIJST

GENUINE	NTK	ORDER
HELLA		
HLS 051	OZA446-E11	1898
HLS 052	OZA83-R4	0189
HLS 053	OZA445-E2	1810
HLS 054	OZA527-E22	0274
HLS 055	OZA572-E11	0251
HLS 056	OZA89-D1	1890
HLS 057	OZA216-D3	0125
HLS 058	OZA446-E13	1826
HLS 059	OZA572-E4	0295
HLS 060	OZA401-E51	0142
HLS 062	OZA446-E50	0204
HLS 063	OZA401-E57	0153
HLS 064	OZA447-E13	0183
HLS 065	OZA527-E9	0498
HLS 067	OZA236-R2	0158
HLS 068	OZA186-F5	0188
HLS 069	OZA527-E10	0263
HLS 071	OZA448-E31	0151
HLS 073	OZA572-E7	0419
HLS 074	OZA527-E27	0466
HLS 075	OZA25-F12	0198
HLS 076	OZA446-E48	0280
HLS 077	OZA527-E28	0477
HLS 078	OZA65-A2	1889
HLS 079	OZA527-E5	0253
HLS 080	OZA446-E51	0215
HLS 082	OZA448-E29	0182
HLS 083	OZA112-A3	0157
HLS 084	OZA401-E56	0154
HLS 085	OZA446-E18	1887
HLS 087	OZA253-F6	0122
HLS 088	OZA73-F1	0177
HLS 089	OZA527-E18	0430
HLS 090	OZA448-E45	0206
HLS 091	OZA527-E25	0444
HLS 092	OZA311-R1	0191
HLS 093	OZA527-E11	1787
HLS 094	OZA83-R1	0156
HLS 095	OZA446-E43	0194
HLS 096	OZA401-E58	0166
HLS 099	OZA448-E48	0239
HLS 100	OZA83-R2	0167
HLS 101	OZA83-R3	0178
HLS 107	OTA7H-3A1	1932
HLS 109	OTA7H-3A2	1943
HLS 111	OTA7H-5A1	0486
HLS 112	OTA7L-3C3	0442
HLS 113	OTA7L-3C4	0431
HLS 114	OTA7H-3C1	1954
HLS 116	OZA334-SZ4	0418
HLS 117	OTA7N-5A1	1920

GENUINE	NTK	ORDER
HELLA		
HLS 118	OTA7N-5A2	1938
HLS 120	OTA7H-3C2	0420
HLS 121	OZA334-SZ3	0407
HLS 122	OZA334-SZ2	0496
HJS		
9201 7721	OZA445-E7	0269
9201 7759	OZA448-E43	0282
9201 7766	OTA7N-5D1	1974
9201 7768	OZA447-E26	0405
9201 7769	OZA448-E43	0282
9201 7774	OZA527-E7	0213
9201 7775	OZA527-E19	0296
9201 7782	OZA446-E40	0193
9201 7788	OZA448-E45	0206
9201 7789	OZA527-E4	0218
9201 7790	OZA572-E12	0273
9201 7793	OZA572-E10	0275
9201 7794	OZA446-E45	0155
9201 7795	OZA447-E35	0493
9201 7797	OZA447-E18	0281
9201 7799	OZA448-E51	0426
9201 7800	OZA446-E15	1848
9201 7801	OZA445-E3	1860
9201 7802	OZA448-E31	0151
9201 7803	OZA445-E4	1850
9201 7804	OZA446-E42	0150
9201 7805	OZA446-E11	1898
9201 7806	OZA446-E16	1859
9201 7807	OZA401-E2	1802
9201 7810	OZA572-E9	0423
9201 7812	OZA446-E12	1805
9201 7813	OZA446-E6	1861
9201 7814	OZA446-E3	1866
9201 7816	OZA401-E6	1882
9201 7818	OZA401-E4	1822
9201 7820	OZA572-E13	0254
9201 7821	OZA572-E1	0283
9201 7822	OZA446-E53	0237
9201 7823	OZA445-E2	1810
9201 7826	OZA401-E2	1802
9201 7827	OZA446-E8	1827
9201 7829	OZA446-E8	1827
9201 7830	OZA572-E9	0423
9201 7831	OZA401-E2	1802
9201 7832	OZA446-E11	1898
9201 7833	OZA446-E48	0280
9201 7834	OZA527-E2	0265
9201 7835	OZA527-E22	0274
9201 7836	OZA527-E22	0274
9201 7838	OZA401-E55	0143

REFERENZLISTE
CROSS REFERENCE GUIDE
 Рекомендационный перечень
REFERANS LÍSTESI

TABLE DE CORRESPONDANCE
TABELLE COMPARATIVE
 Συστάσεις

GUIA EQUIVALENCIAS
LISTA PORÓWNAWCZA
REFERENTIELIJST

GENUINE	NTK	ORDER
HJS		
9201 7840	OZA25-F3	0176
9201 7841	OZA25-F12	0198
9201 7844	OZA446-E42	0150
9201 7846	OZA401-E63	0207
9201 7856	OZA401-E54	0186
9201 7859	OZA447-E30	0449
9201 7861	OZA401-E2	1802
9201 7868	OZA401-E49	0120
9201 7872	OZA446-E4	1877
9201 7874	OZA384-E39	0473
9201 7876	OZA527-E27	0466
9201 7880	OZA572-E3	0264
9201 7881	OZA572-E3	0264
9201 7882	OZA572-E2	0252
9201 7883	OZA572-E7	0419
9201 7884	OTA7H-3A1	1932
9201 7885	OZA572-E8	0209
9201 7886	OZA572-E5	0242
9201 7890	OZA527-E3	0201
9201 7890	OZA527-E17	0445
9201 7891	OZA401-E57	0153
9201 7894	OZA401-E56	0154
9201 7901	OZA401-E2	1802
9201 7908	OZA401-E6	1882
9201 7909	OZA401-E56	0154
9201 7910	OZA401-E58	0166
9201 7911	OZA446-E14	1837
9201 7912	OZA446-E13	1826
9201 7915	OZA446-E14	1837
9201 7918	OZA448-E12	1865
9201 7920	OZA527-E21	1817
9201 7923	OZA527-E28	0477
9201 7925	OZA448-E55	0470
9201 7932	OZA401-E50	0131
9201 7935	OTD2F-3K1	1907
9201 7936	OZA401-E51	0142
9201 7941	OZA446-E1	1833
9201 7942	OZA446-E4	1877
9201 7943	OZA446-E7	1872
9201 7946	OZA448-E12	1865
9201 7947	OZA448-E12	1865
9201 7948	OZA448-E42	0271
9201 7955	OZA446-E2	1855
9201 7956	OZA446-E49	0291
9201 7957	OZA446-E1	1833
9201 7960	OZA572-E8	0209
9201 7961	OZA527-E25	0444
9201 7962	OZA527-E10	0263
9201 7963	OZA527-E13	0285
9201 7963	OZA527-E6	0463
9201 7964	OZA384-E40	0484

GENUINE	NTK	ORDER
HJS		
9201 7965	OZA446-E3	1866
9201 7966	OZA401-E6	1882
9201 7968	OZA428-E1	1807
9201 7970	OZA527-E12	0220
9201 7971	OZA527-E3	0201
9201 7972	OTA7H-3A2	1943
9201 7974	OZA572-E6	1777
9201 7975	OZA527-E17	0445
9201 7981	OZA447-E17	0270
9201 7982	OTA7N-5C1	1963
9201 7984	OZA448-E44	0293
9201 7985	OTA7H-5A1	0486
9201 7986	OZA447-E28	0427
9201 7987	OZA447-E17	0270
9201 7993	OZA527-E14	0455
9201 7994	OZA447-E16	0259
9201 7995	OZA448-E31	0151
9201 7998	OZA447-E14	0129
9201 9929	OZA446-E49	0291
9201 9930	OZA446-E2	1855
9201 9931	OZA446-E2	1855
9207 0016	OZA401-E6	1882
HONDA		
36531-GEZ-6410-M1	OZA577-H13	6475
36531-KRJ-901	OZA577-H6	0065
36531-KRJ-9010-M1	OZA577-H6	0065
36531-KTF-641	OZA577-H15	0064
36531-KTF-6410-M1	OZA577-H15	0064
36531-KTW-9010-M1	ZSJ0002-HG002	6538
36531-MAT-G220-M1	AZD0101-HG004	6543
36531-MBG-0010	OZA333-H29	6459
36531-MBG-6310-M1	OZA333-H16	6456
36531-MBT-C410-M1	OZA656-H2	6492
36531-MBT-D210-M1	OZA577-H7	6471
36531-MCA-0231	AZD0101-HG001	6539
36531-MCS-D910-M1	OZA656-H5	6494
36531-MCS-G010-M1	OZA577-H4	6463
36531-MCW-D010-M1	OZA333-H30	6460
36531-MFE-6410-M1	OZA577-H19	6476
36531-MEFJ-D010-M1	OZA577-H22	6483
36531-MEL-6110-M1	OZA577-H12	6473
36531-MEL-D210-M1	OZA577-H21	6479
36531-MFAA-D011-M1	OZA577-H17	0007
36531-MFF-D011-M1	OZA656-H1	6491
36531-MFG-D010-M1	OZA656-H3	6493
36531-MFJ-D011-M1	OZA577-H24	6484
36531-MFJA-D012-M1	OZA577-H24	6484
36531-MFL-6410-M1	AZD0102-HG009	6576
36531-MFPA-D010-M1	AZD0102-HG003	7664
36531-P06-A11	OZA660-EE18	5714

REFERENZLISTE
CROSS REFERENCE GUIDE
Рекомендационный перечень
REFERANS LISTESI

TABLE DE CORRESPONDANCE
TABELLE COMPARATIVE
Συστάσεις

GUIA EQUIVALENCIAS
LISTA PORÓWNAWCZA
REFERENTIELIJST

GENUINE	NTK	ORDER
HONDA		
36531-P06-A12	OZA660-EE18	5714
36531-P07-003	LZA09-E1	0025
36531-P07-L02	OZA444-E1	0439
36531-P0G-A01	OZA444-E1	0439
36531-P1H-E01	OZA444-E1	0439
36531-P1K-E01	OZA660-EE18	5714
36531-P1K-E02	OZA333-H4	0137
36531-P1K-E03	OZA333-H26	0299
36531-P28-A01	OZA444-E1	0439
36531-P28-A02	OZA444-E1	0439
36531-P2E-A01	OZA444-E1	0439
36531-P3Y-G02	OZA218-H2	6455
36531-P45-G012	OZA245-H1	0169
36531-P45-G02	OZA245-H1	0169
36531-P5S-G012	OZA245-H2	0180
36531-P7A-G01	OZA444-E1	0439
36531-P7A-G02	OZA444-E1	0439
36531-P9K-E01	OZA333-H6	0159
36531-P9K-E011	OZA333-H6	0159
36531-P9L-E011	OZA333-H5	0148
36531-P9L-E02	OZA333-H27	0212
36531-PDA-E02	OZA501-H17	0266
36531-PDE-E01	OZA421-H1	0255
36531-PDE-E02	OZA569-H1	0499
36531-PE7-662	OZA401-E52	0164
36531-PK3-A05	OZA660-EE18	5714
36531-PLD-013	OZA668-EE12	7951
36531-PLR-A01	OZA508-H4	0046
36531-PLR-A012-M2	OZA508-H4	0046
36531-PM8-305	OZA401-E57	0153
36531-PM8-A03	OZA401-E57	0153
36531-PNB-G01	OZA563-H6	0062
36531-PNB-G010-M201	OZA563-H6	0062
36531-PRA-G01	OZA563-H5	0061
36531-PRA-G010-M201	OZA563-H5	0061
36531-PT2-J04	OZA660-EE18	5714
36531-PT2-J05	OZA660-EE18	5714
36531-PT6-A02	OZA660-EE18	5714
36532-MCA-0231	AZD0101-HG002	6540
36532-MCS-D910-M1	OZA656-H6	6495
36532-MCS-G010-M1	OZA577-H5	6469
36532-MCV-7720-M1	AZD0101-HG003	6541
36532-MCW-D010-M1	OZA333-H31	6462
36532-MFE-6410-M1	OZA577-H20	6477
36532-MFPA-D010-M1	AZD0102-HG004	7665
36532-P1J-E01	OZA333-H25	0288
36532-P1J-E010-M2	OZA333-H25	0288
36532-PDE-E01	OZA333-H19	0277
36532-PDE-E010-M2	OZA333-H19	0277
36532-PDE-E020 M2	OZA501-H23	0469
36532-PLA-G01	OZA501-H20	0045

GENUINE	NTK	ORDER
HONDA		
36532-PLA-G012-M2	OZA501-H20	0045
36532-PLD-013	OZA669-EE11	7971
36532-PLR-A01	OZA508-H4	0046
36532-PLR-A012-M2	OZA508-H4	0046
36532-PNB-G02	OZA562-H9	0060
36532-PNB-G020-M2	OZA562-H9	0060
36532-PNE-004	OZA614-H3	0071
36532-PNE-0041	OZA614-H3	0071
36532-PNF-E01	OZA563-H8	0063
36532-PNF-E010-M2	OZA563-H8	0063
36532-PRC-004	OZA562-H7	0059
36532-PRC-0042	OZA562-H7	0059
36532-RNA-A01	OZA635-H1	0075
36532-RNA-A010-M2	OZA635-H1	0075
36532-RSH-E01	OZA635-H4	0076
36532-RSH-E010-M2	OZA635-H4	0076
HUSQVARNA		
E 252 201	OZA591-WB1	0010
HYUNDAI		
39210 22015	OZA446-E56	0461
39210 22610	OZA107-KH2	6407
39210 24520	OZA25-KH3	1969
39210 32520	OZA25-KH1	1940
MD 076 706	OZA401-E66	0406
MD 078 791	OZA401-E67	0417
MD 088 616	OZA401-E68	0428
MD 107 793	OZA401-E68	0428
JAGUAR		
4LS D3J	OTD3J-5B1	0464
70412 A	OTD3J-5B1	0464
DBC 6907	OZA446-E4	1877
LHE 1682 AA	OTD3J-5B1	0464
XC2F 9F472 AA	OZA488-D1	0403
XR3F 9G444 AA	OZA381-D2	0451
XR3F 9G444 BA	OZA381-D3	0462
XR8 22998	OZA381-D12	0041
JEEP		
501 47 80AA	OZA19-E12	6379
530 00 886	OZA19-E12	6379
560 28 200	OZA28-C3	6380
560 28 301	OZA28-C3	6380
560 28 994 AB	OZA623-C1	6397
560 28 995 AB	OZA623-C2	6400
560 29 049 AA	OZA571-C2	6384
560 41 004	OZA248-C1	6381
560 41 005	OZA248-C1	6381
560 41 056	OZA527-E36	1993

REFERENZLISTE
CROSS REFERENCE GUIDE
Рекомендационный перечень
REFERANS LİSTESİ

TABLE DE CORRESPONDANCE
TABELLE COMPARATIVE
Συστάσεις

GUIA EQUIVALENCIAS
LISTA PORÓWNAWCZA
REFERENTIELIJST

GENUINE	NTK	ORDER
KAWASAKI		
21176-0015	AZS0102-KJ004	6574
21176-0043	AZD0101-KJ001	6551
21176-0073	AZD0101-KJ002	6552
21176-0077	AZD0101-KJ004	6556
21176-0081	AZD0101-KJ005	6558
21176-0086	AZD0101-KJ006	6559
21176-0089	AZD0101-KJ008	6561
21176-0097D	AZD0102-KJ001	6567
21176-0114	AZS0102-KJ003	6568
KIA		
BP03 18861 B	OZA401-E55	0143
39210 22610	OZA107-KH2	6407
KTM		
161 488 300 00	OZA591-VB2	0009
161 490 200 00	AZD0101-VB002	7673
610 041 090 000	OZA591-VB2	0009
KYMCO		
1614-897-000	AZD0101-BA001	7667
3160-0361	OZA591-YB1	0011
39450-LEA6-800	OZA591-YB1	0011
LADA		
100 961 29	OZA660-EE1	5653
2112 385 00 10 20	OZA660-EE1	5653
LAMBORGHINI		
036 906 262 J	LZA11-V4	1842
LANCIA		
00 55 20 23 69	LZA15-A3	0031
46 45 25 98	OZA527-E20	1797
46 46 20 06	OZA527-E24	0287
46 52 11 70	OZA334-A1	0223
46 52 31 29	OZA334-A2	0234
46 75 02 41	OZA659-EE30	1612
46 75 02 43	OZA659-EE31	1613
46 75 10 52	OZA675-EE1	7978
46 75 10 82	OZA675-EE1	7978
46 76 21 82	OZA659-EE49	5753
46 76 42 07	OZA659-EE58	7903
55 20 23 690	LZA15-A3	0031
60 81 27 17	OZA527-E7	0213
96 22 99 76 80	OZA659-EE8	0382
96 28 44 82	OZA448-E56	0481
96 28 44 82 80	OZA448-E56	0481
96 35 97 82	OZA659-EE12	0386

GENUINE	NTK	ORDER
MARELLI		
CA.0013 382.A	OZA334-BB1	0035
CA.0019 265	OZA341-BB1	0036
CA.0083 477 A	OZA591-BB2	1710
CA.0083 476	OZA591-BB3	0066
MAZDA		
B3C7 18861 A	OZA73-F1	0177
B64N 18861	OZA25-F12	0198
B6DC 18861 A	OZA186-F5	0188
BP03 18861 B	OZA401-E55	0143
F201 18861 A	OZA25-F3	0176
FEH1 18861	OZA25-F1	0187
JE08 18861 B	OZA21-F3	0256
JE49 18861 A	OZA74-F2	0433
JE50 18861	OZA74-F3	0446
JE50 18861 A	OZA253-F6	0122
K802 18861 C	OZA74-F1	0401
KJ01 18861	OZA186-F7	0457
MERCEDES		
000 540 3817	OZA527-E25	0444
000 540 3917	OZA527-E10	0263
000 540 4017	OZA527-E6	0463
000 540 5717	OZA673-EE1	7974
000 540 5917	OZA572-E14	0408
000 540 6117	OZA448-E54	0459
000 540 6217	OZA447-E44	1976
000 540 6417	OZA527-E13	0285
000 540 6517	OZA448-E45	0206
000 540 7617	OZA674-EE1	7975
000 540 8117	OZA660-EE8	5682
000 540 8517	OZA447-E21	0216
000 540 9017	OZA447-E22	0227
000 540 9217	OZA448-E45	0206
001 540 0417	OZA448-E29	0182
001 540 0517	OZA659-EE24	0398
001 540 0617	OZA659-EE29	1611
001 540 0817	OZA447-E34	0482
001 540 1017	OZA660-EE9	5694
001 540 3717	OZA659-EE15	0389
001 540 3817	OZA659-EE27	1609
001 540 4717	OZA659-EE34	1618
001 540 5017	OZA659-EE26	0400
001 540 5117	OZA659-EE35	1619
001 540 6017	OZA659-EE22	0396
001 540 7317	OZA659-EE48	5752
001 540 7617	OZA659-EE55	7860
001 540 8517	OZA659-EE37	1624
003 542 8118	OZA571-C10	1836
004 542 5318	OZA571-GB1	1709
006 542 9617	OZA446-E13	1826

REFERENZLISTE
CROSS REFERENCE GUIDE
Рекомендационный перечень
REFERANS LISTESİ

TABLE DE CORRESPONDANCE
TABELLE COMPARATIVE
Συστάσεις

GUIA EQUIVALENCIAS
LISTA PORÓWNAWCZA
REFERENTIELIJST

GENUINE	NTK	ORDER
MERCEDES		
007 542 3217	OZA446-E63	1730
008 542 9117	OZA446-E14	1837
009 542 3917	OZA446-E14	1837
009 542 4117	OZA446-E13	1826
009 542 8717	OZA446-E7	1872
009 542 9017	OZA446-E14	1837
A 003 542 8118	OZA571-C10	1836
A 004 542 5318	OZA571-GB1	1709
MINI		
0872674	OZA495-RV1	0043
0872674.01	OZA495-RV1	0043
7548961	OZA628-U1	0016
MITSUBISHI		
MD 076 706	OZA401-E66	0406
MD 078 791	OZA401-E67	0417
MD 088 616	OZA401-E68	0428
MD 109 613	OZA401-E53	0175
MD 119 210	OZA401-E63	0207
MD 128 262	OZA401-E54	0186
MD 148 738	OZA428-E3	0121
MD 150 609	OZA428-E2	0197
MD 160 578	OZA428-E4	0132
MD 182 691	OZA85-M1	0165
MD 183 145	OZA502-E34	0436
MD 183 399	OZA502-E35	0447
MD 197 852	OZA448-E52	0437
MD 198 529	OZA502-E36	0458
MD 300 080	OZA502-E36	0458
MD 340 904	OZA448-E53	0448
MD 351 752	OZA448-E53	0448
MOTO GUZZI		
CA.0019 265	OZA341-BB1	0036
CA.0083 477 A	OZA591-BB2	1710
32 727 010	OZA341-BB1	0036
MV AGUSTA		
CA.0083 476.A	OZA591-BB3	0066
NISSAN		
22690 00QAA	OZA659-EE6	0380
22690 06F00	OZA401-E50	0131
22690 07G00	OZA401-E51	0142
22690 17B00	OZA401-E50	0131
22690 19B10	OZA401-E50	0131
22690 1F700	OZA447-E42	1971
22690 1F701	OZA448-E58	1909
22690 2A000	OZA544-N8	1804
22690 3J400	OZA446-E45	0155

GENUINE	NTK	ORDER
NISSAN		
22690 3J410	OZA446-E45	0155
22690 61A00	OTD2F-1P2	0022
22690 64J01	OTD2F-3K1	1907
22690 73C00	OZA446-E45	0155
22690 76J00	OZA446-E45	0155
22690 8J001	OZA544-N7	6497
22690 81N00	OZA401-E51	0142
22690 99B00	OZA446-E45	0155
22690 9F600	OZA660-EE6	5680
22690 9F601	OZA446-E64	1737
22690 AX000	OZA544-N14	6513
22690 ED000	OZA603-N2	0012
22691 2A000	OZA544-N8	1804
OPEL		
02 336 121	OZA446-E3	1866
09 118 698	OZA448-E49	0404
09 158 718	OZA334-SZ4	0418
09 202 575	OZA334-SZ1	0485
09 202 576	OZA334-SZ2	0496
09 202 577	OZA334-SZ3	0407
12 565 428	OZA531-GM1	1862
12 567 680	OZA531-GM3	1864
12 567 681	OZA531-GM2	1863
12 568 234	OZA531-GM7	1870
12 569 391	OZA531-GM6	1869
12 573 936	OZA583-GM1	1753
12 574 574	OZA531-GM22	1892
24 403 182	OZA659-EE51	1995
24 403 192	OZA659-EE51	1995
25 164 596	OZA401-E6	1882
25 177 596	OZA448-E49	0404
25 321 313	OZA660-EE10	5695
25 323 632	OZA660-EE13	5706
25 324 206	OZA660-EE4	5658
25 327 304	OZA660-EE7	5681
25 335 280	OZA660-EE3	5656
44 089 54	OZA659-EE6	0380
55 191 128	LZA15-GM1	0032
55 351 836	OZA575-GM2	1896
55 353 269	OZA531-GM16	1891
55 353 811	OZA334-SZ5	1705
55 353 812	OZA334-SZ6	1706
55 354 595	OZA531-GM22	1892
55 562 290	LZA15-GM3	1728
55 556 818	OZA531-GM24	0055
5WK9 1000	OZA334-SZ3	0407
5WK9 1701	OZA334-SZ1	0485
5WK9 1702	OZA334-SZ2	0496
5WK9 1709	OZA334-SZ4	0418
5WK9 3207	OTA7N-5A2	1938

REFERENZLISTE
CROSS REFERENCE GUIDE
Рекомендационный перечень
REFERANS LĪSTESĪ

TABLE DE CORRESPONDANCE
TABELLE COMPARATIVE
Συστάσεις

GUIA EQUIVALENCIAS
LISTA PORÓWNAWCZA
REFERENTIELIJST

GENUINE	NTK	ORDER
OPEL		
855 300	OZA446-E6	1861
855 302	OZA446-E3	1866
855 305	OZA401-E6	1882
855 306	OZA446-E6	1861
855 307	OZA446-E3	1866
855 313	OTA7H-3C1	1954
855 315	OZA401-E6	1882
855 322	OZA446-E40	0193
855 323	OZA446-E41	0128
855 324	OTA7H-3C2	0420
855 330	OTA7L-3C3	0442
855 331	OTA7L-3C4	0431
855 333	OZA401-E6	1882
855 341	OZA447-E26	0405
855 342	OTA7N-5A1	1920
855 343	OTA7N-5A2	1938
855 345	OZA448-E49	0404
855 351	OZA659-EE5	0379
855 353	OZA660-EE10	5695
855 355	OZA659-EE28	1610
855 356	OZA334-SZ1	0485
855 357	OZA334-SZ2	0496
855 358	OZA334-SZ3	0407
855 359	OZA659-EE7	0381
855 360	OZA660-EE4	5658
855 362	OZA659-EE51	1995
855 366	OZA660-EE13	5706
855 390	OZA334-SZ3	0407
855 372	OZA531-GM2	1863
855 375	OZA660-EE7	5681
855 382	OZA531-GM6	1869
855 386	OZA659-EE39	1626
855 389	OZA334-SZ4	0418
855 390	OZA660-EE3	5656
855 391	OZA583-GM1	1753
855 395	OZA531-GM22	1892
855 397	OZA575-GM2	1896
855 400	OZA531-GM16	1891
855 419	LZA15-GM1	0032
855 507	OZA531-GM22	1892
855 523	OZA660-EE7	5681
855 524	OZA660-EE3	5656
90 009 053	OZA446-E6	1861
90 010 999	OZA446-E3	1866
90 019 999	OZA446-E3	1866
90 397 523	OZA446-E6	1861
90 397 524	OZA446-E3	1866
90 409 385	OZA446-E6	1861
90 411 959	OTA7H-3C1	1954
90 448 458	OZA446-E6	1861
90 499 264	OTA7H-3C2	0420

GENUINE	NTK	ORDER
OPEL		
90 509 169	OZA446-E40	0193
90 510 147	OZA446-E6	1861
90 528 253	OTA7L-3C3	0442
90 528 640	OTA7L-3C4	0431
90 530 068	OZA447-E26	0405
90 530 586	OTA7N-5A1	1920
90 536 393	OTA7N-5A2	1938
90 543 281	OZA447-E26	0405
91 160 174	OZA659-EE6	0380
91 587 18	OZA334-SZ4	0418
91 929 22	OZA659-EE5	0379
91 931 48	OZA659-EE28	1610
91 936 54	OZA659-EE7	0381
91 956 06	OZA659-EE51	1995
91 994 70	OZA659-EE39	1626
92 025 75	OZA334-SZ1	0485
92 025 76	OZA334-SZ2	0496
92 025 77	OZA334-SZ3	0407
93 185 159	LZA15-GM1	0032
93 189 974	OZA660-EE7	5681
93 189 975	OZA660-EE3	5656
PEUGEOT		
1618 72	OZA495-PG3	1853
1618 K9	OZA659-EE63	7948
1618 Q5	OZA659-EE62	7916
1618 R0	OZA608-U2	0070
1618 V3	OZA628-U1	0016
1628 3W	OZA527-E12	0220
1628 6R	OZA527-E15	0298
1628 6S	OZA527-E16	0434
1628 6W	OZA527-E17	0445
1628 7R	OZA676-EE1	7979
1628 7S	OZA527-E29	0488
1628 7Z	OZA527-E33	1980
1628 83	OZA446-E11	1898
1628 8C	OZA527-E35	1982
1628 9A	OZA527-E34	1981
1628 9S	OZA660-EE24	5739
1628 9T	OZA448-E56	0481
1628 9V	OZA660-EE23	5737
1628 9W	OZA448-E57	0492
1628 A4	OZA446-E46	0280
1628 CW	OZA659-EE12	0386
1628 CX	OZA659-EE21	0395
1628 EC	OZA659-EE8	0382
1628 HN	OZA659-EE4	0378
1628 HQ	OZA659-EE8	0382
1628 HR	OZA659-EE12	0386
1628 HT	OZA660-EE23	5737
1628 HV	OZA659-EE21	0395

REFERENZLISTE
CROSS REFERENCE GUIDE
Рекомендационный перечень
REFERANS LISTESI

TABLE DE CORRESPONDANCE
TABELLE COMPARATIVE
Συστάσεις

GUIA EQUIVALENCIAS
LISTA PORÓWNAWCZA
REFERENTIELIJST

GENUINE	NTK	ORDER
PEUGEOT		
1628 KN	OZA495-PG2	1852
1628 KP	OZA341-PG7	1815
1628 KY	OZA659-EE10	0384
1628 L4	OZA527-E22	0274
1628 LP	OZA334-PG1	1790
1628 NY	OZA341-PG5	1813
1628 PL	OZA659-EE52	1996
1628 PW	LZA06-U1	1840
1628 PX	OZA538-PG1	1818
1628 QY	OZA341-PG6	1814
1628 TG	OZA538-PG2	1819
1628 TH	OZA341-PG8	1816
1628 VN	OZA659-EE61	7915
1628 V4	OZA527-E12	0220
46 603 00A	OZA591-SZ1	1767
75 489 618 0	OZA628-U1	0016
91 518 193	OZA446-E11	1898
91 535 718	OZA446-E11	1898
96 027 244	OZA527-E2	0265
96 121 278 17	OZA527-E12	0220
96 127 346	OZA527-E12	0220
96 138 608	OZA527-E3	0201
96 229 969	OZA527-E15	0298
96 229 997	OZA659-EE12	0386
96 230 002	OZA527-E29	0488
96 284 479	OZA448-E57	0492
96 284 479 80	OZA448-E57	0492
96 284 482	OZA448-E56	0481
96 368 766	OZA659-EE52	1996
96 368 766 80	OZA659-EE52	1996
96 369 209 80	LZA06-U1	1840
96 369 688 80	OZA495-PG3	1853
96 393 054 80	OZA538-PG1	1818
96 424 706	OZA659-EE61	7915
96 424 706 80	OZA659-EE61	7915
96 424 707 80	OZA538-PG2	1819
96 576 329 80	OZA608-U2	0070
PONTIAC		
25 162 600	OZA19-E12	6379
25 162 693	OZA19-E12	6379
25 166 816	OZA19-E12	6379
PROTON		
MD 182 691	OZA85-M1	0165
MD 183 145	OZA502-E34	0436
RENAULT		
22690 2A000	OZA544-N8	1804
6001 009 534	OZA446-E11	1898
7700 100 713	OZA83-R4	0189

GENUINE	NTK	ORDER
RENAULT		
7700 101 345	OZA660-EE16	5709
7700 105 557	OZA660-EE20	5717
7700 107 433	OZA660-EE21	5719
7700 107 434	OZA448-E50	0415
7700 107 438	OZA660-EE12	5698
7700 108 027	OZA277-R2	0468
7700 260 909	OZA446-E11	1898
7700 266 922	OZA446-E11	1898
7700 273 273	OZA236-R2	0158
7700 273 715	OZA311-R2	0126
7700 274 190	OZA507-R1	6515
7700 854 148	OZA446-E8	1827
7700 854 506	OZA55-R1	1878
7700 856 629	OZA55-R1	1878
7700 860 246	OZA428-E1	1807
7700 862 426	OZA55-R2	0123
7700 864 987	OZA55-R3	0134
7700 867 295	OZA55-R4	0145
7700 867 408	OZA83-R1	0156
7700 870 318	OZA236-R1	0147
7700 871 544	OZA448-E43	0282
7700 872 820	OZA311-R1	0191
7700 872 878	OZA446-E57	0472
7700 874 327	OZA83-R2	0167
7700 874 600	OZA83-R3	0178
7700 875 342	OZA277-R1	1704
8200 033 864	OZA659-EE54	7859
8200 034 961	OZA659-EE54	7859
8200 034 964	OZA659-EE54	7859
8200 035 997	OZA659-EE53	7858
8200 036 542	OZA659-EE13	0387
8200 036 544	OZA659-EE53	7858
8200 036 545	OZA659-EE13	0387
8200 052 062	OZA507-R2	0480
8200 145 714	OZA544-R1	1857
8200 461 432	OZA603-R2	0013
8200 485 076	OZA636-R1	0020
8200 551 743	OZA659-EE6	0380
8200 556 133	OZA636-R3	6519
8200 663 806	OZA507-R5	6517
8200 668 947	OZA277-R3	6514
8200 761 588	OZA603-R3	6518
9635 978 580	OZA659-EE4	0378
ROLLSROYCE		
PB 20364	OZA447-E27	0416
ROVER		
AMR 6244	OTD3J-5C1	0475
ERR 1834	OTD3J-5A3	0024
ERR 6729	OTD3G-3A1	0453

REFERENZLISTE
CROSS REFERENCE GUIDE
Рекомендационный перечень
REFERANS LÍSTESI

TABLE DE CORRESPONDANCE
TABELLE COMPARATIVE
Συστάσεις

GUIA EQUIVALENCIAS
LISTA PORÓWNAWCZA
REFERENTIELIJST

GENUINE	NTK	ORDER
ROVER		
MHK 000 070	OZA495-RV2	0044
MHK 000 210	OZA447-E27	0416
MHK 100 04	OZA527-E8	0284
MHK 100 06	OZA527-E9	0498
MHK 100 21	OZA527-E18	0430
MHK 100 23	OZA401-E5	1828
MHK 100 300	OZA222-RV1	0136
MHK 100 722	OZA341-RV2	0429
MHK 100 840	OZA659-EE2	0376
MHK 101 086	OZA659-EE45	5747
SAAB		
127 881 29	OZA575-GM1	1895
127 991 69	OZA583-GM2	1754
423 958 8	OZA446-E58	0483
753 014 0	OZA401-E2	1802
913 2564	OZA446-E58	0483
913 6284	OZA446-E58	0483
914 6937	OZA446-E58	0483
SEAT		
021 906 265 A	OZA572-E13	0254
021 906 265 AC	OZA447-E36	1950
021 906 265 AK	OZA447-E31	0460
030 906 262	OZA659-EE16	0390
030 906 262 A	OZA659-EE20	0394
030 906 262 C	OZA510-V1	0491
030 906 262 D	OZA659-EE40	1627
030 906 262 E	OZA659-EE40	1627
030 906 262 K	LZA11-V3	1829
030 906 262 L	OZA659-EE40	1627
030 906 265	OZA446-E15	1848
030 906 265 AC	OZA527-E36	1993
030 906 265 AD	OZA447-E16	0259
030 906 265 AP	OZA572-E9	0423
030 906 265 C	OZA445-E3	1860
030 906 265 CB	OZA448-E51	0426
030 906 265 E	OZA401-E4	1822
030 906 265 J	OZA445-E4	1850
030 906 265 T	OZA572-E1	0283
032 906 265	OZA447-E30	0449
034 906 265 C	OZA446-E2	1855
034 906 265 F	OZA446-E16	1859
035 906 265 B	OZA401-E2	1802
036 906 262 AA	OZA629-V3	1720
036 906 262 D	OZA510-V5	0435
036 906 262 F	OZA510-V4	0424
036 906 262 G	LZA11-V2	1774
036 906 262 H	OZA659-EE23	0397
036 906 262 J	LZA11-V4	1842
036 906 262 J	LZA11-V4	1842

GENUINE	NTK	ORDER
SEAT		
036 906 262 T	LZA07-V3	1880
037 906 265 AD	OZA572-E10	0275
037 906 265 J	OZA527-E36	1993
03C 906 262	OZA510-V6	1885
03C 906 262 M	OZA629-V4	1721
03D 906 265	OZA585-I1	1809
03D 906 265 A	OZA510-I1	1808
051 906 265 E	OZA401-E2	1802
06A 906 262 AC	OZA659-EE25	0399
06A 906 262 AH	OZA659-EE19	0393
06A 906 262 AJ	OZA659-EE14	0388
06A 906 262 AK	OZA659-EE25	0399
06A 906 262 AR	OZA659-EE32	1614
06A 906 262 BR	LZA07-V1	1851
06A 906 262 BS	OZA510-V11	1884
06A 906 262 CF	LZA07-V2	1868
06A 906 262 N	OZA659-EE19	0393
06A 906 262 Q	OZA659-EE1	0375
06A 906 262 R	OZA659-EE14	0388
06A 906 265 E	OZA447-E17	0270
06A 906 265 H	OZA447-E18	0281
330 906 265	OZA527-E36	1993
6KE 906 265 A	OZA114-V4	1769
6K0 906 262 A	OZA510-V3	0413
SIEMENS		
5WK9 0131	OTA7N-5B1	1973
5WK9 0171	OTA7N-5C1	1963
5WK9 3341	OTA7N-5D1	1974
5WK9 0041	OTA7H-3A1	1932
5WK9 0132	OTA7N-5D2	1975
5WK9 0255	OTA7N-5D3	1991
5WK9 1000	OZA334-SZ3	0407
5WK9 1701	OZA334-SZ1	0485
5WK9 1702	OZA334-SZ2	0496
5WK9 1709	OZA334-SZ4	0418
5WK9 3207	OTA7N-5A2	1938
5WK9 3980	OZA334-SZ5	1705
5WK9 3990	OZA334-SZ6	1706
A2 C 53025886	OZA591-SZ1	1767
S1087 480 01A	OZA488-SZ1	1766
S1087 480 04A	OZA341-SZ2	0038
S1087 748 105A	OZA519-SZ2	0052
S1087 748 106A	OZA341-SZ3	0039
SKODA		
004 165 009	OZA446-E44	0162
030 906 262 K	LZA11-V3	1829
036 906 262 AA	OZA629-V3	1720
036 906 262 D	OZA510-V5	0435
036 906 262 G	LZA11-V2	1774

REFERENZLISTE
CROSS REFERENCE GUIDE
Рекомендационный перечень
REFERANS LISTESI

TABLE DE CORRESPONDANCE
TABELLE COMPARATIVE
Συστάσεις

GUIA EQUIVALENCIAS
LISTA PORÓWNAWCZA
REFERENTIELIJST

GENUINE	NTK	ORDER
SKODA		
036 906 262 H	OZA659-EE23	0397
03C 906 262	OZA510-V6	1885
03C 906 262 M	OZA629-V4	1721
03D 906 265	OZA585-I1	1809
03D 906 265 A	OZA510-I1	1808
058 906 265 C	OZA659-EE64	7949
058 906 265 V	OZA659-EE64	7949
06A 906 262 AC	OZA659-EE25	0399
06A 906 262 AH	OZA659-EE19	0393
06A 906 262 AJ	OZA659-EE14	0388
06A 906 262 AK	OZA659-EE25	0399
06A 906 262 BL	OZA659-EE11	0385
06A 906 262 F	OZA659-EE18	0392
06A 906 262 N	OZA659-EE19	0393
06A 906 262 Q	OZA659-EE1	0375
06A 906 262 R	OZA659-EE14	0388
06A 906 265 E	OZA447-E17	0270
06A 906 265 H	OZA447-E18	0281
06B 906 265 A	OZA334-AU1	0474
06B 906 265 B	OZA516-AU1	0452
078 906 265 M	OZA659-EE36	1620
078 906 265 N	OZA659-EE46	5748
078 906 265 P	OZA659-EE47	5750
6KE 906 265 A	OZA114-V4	1769
6U0 906 265 E	OZA457-I1	0414
SMART		
002 5402 317	OZA659-EE42	1629
004 5425 318	OZA571-GB1	1709
000 3122 V005	OZA659-EE42	1629
STEYR		
000 540 8517	OZA447-E21	0216
001 540 5017	OZA659-EE26	0400
SUBARU		
18213 60B00	OZA401-E6	1882
22690 AA090	OZA395-E9	0495
22690 AA150	OZA446-E55	0450
22690 AA170	OZA395-E9	0495
22690 AA180	OZA395-E9	0495
22690 AA190	OZA395-E9	0495
22690 AA270	OZA395-E9	0495
22690 AA310	OZA395-E9	0495
22690 AA330	OZA395-E9	0495
22690 AA740	OZA395-E9	0495
SUZUKI		
18213-01H00	OZA448-J4	0003
18213-06G00	OZA448-J2	6414
18213-10F00	AZD0101-SU001	6545

GENUINE	NTK	ORDER
SUZUKI		
18213-15H00	AZD0101-SU004	7668
18213-16G00	OZA448-J3	6415
18213-18H00	AZD0101-SU005	7671
18213-22H00	OZA582-J4	6447
18213-24FA0	OZA448-J1	6413
18213-27G00	OZA591-J2	6454
18213-41F00	AZD0101-SU002	6547
18213-48G00	OZA448-J5	0004
18213-48G10	OZA582-J3	6446
18213-57B10	OZA401-E56	0154
18213-60B00	OZA401-E6	1882
18213-61A10	OZA401-E56	0154
18213-64B00	OZA401-E6	1882
18113-65D32	OZA668-EE13	7952
19213-64B00	OZA401-E58	0166
TOYOTA		
89465-0H010	OZA659-EE62	7916
89465-0H020	OZA659-EE63	7948
89465-02040	OZA447-E41	1739
89465-05020	OZA448-E47	0228
89465-10070	OZA502-E31	0250
89465-19275	OZA401-E49	0120
89465-19295	OZA447-E30	0449
89465-19575	OZA448-E16	1839
89465-20300	OZA573-E1	0286
89465-20430	OZA669-EE12	7973
89465-20660	OZA669-EE9	7954
89465-20790	OZA669-EE10	7970
89465-29316	OZA401-E49	0120
89465-29495	OZA384-E32	0133
89465-29545	OZA384-E40	0484
89465-39435	OZA384-E39	0473
89465-39445	OZA384-E40	0484
89465-52020	OZA669-EE8	7953
TRIUMPH		
002H 528 1500	AZD0101-VB003	7689
1614 007 0000	AZD0101-VB004	7690
2201 347	OZA591-UB1	0067
2201 247	OZA591-UB2	0008
2206 500	AZD0101-VB004	7690
2201 671	AZD0101-VB002	7673
2201 671	AZD0101-VB003	7689
TVR		
M1444	OZA341-NB1	0037
VOLVO		
1271 939	OZA660-EE11	5697
1326 578	OZA446-E11	1898

REFERENZLISTE
CROSS REFERENCE GUIDE
Рекомендационный перечень
REFERANS LĪSTESĪ

TABLE DE CORRESPONDANCE
TABELLE COMPARATIVE
Συστάσεις

GUIA EQUIVALENCIAS
LISTA PORÓWNAWCZA
REFERENTIELIJST

GENUINE	NTK	ORDER
VOLVO		
3061 1232	OTA4F-5C2	1948
3061 1233	OTA4N-5D1	1785
3061 1510	OTA4F-5F1	1908
3061 1511	OTA4N-5G1	1758
3061 7337	OTA4F-5C2	1948
3061 8049	OTA4F-5G2	1927
3063 0130	OTA4N-5F1	1795
3063 0132	OTA4N-5H1	1768
3063 7837	OZA583-GM2	1754
3081 4907	OZA83-VN1	0124
3086 4308	OTA4F-5E1	1942
3087 3634	OZA448-E53	0448
3110 4892	OZA324-L2	1780
3474 457	OZA446-E49	0291
3517 394	OTA4F-3B1	1763
3517 778	OZA445-E6	0258
3531 251	OZA446-E49	0291
3547 001	OTA4N-5A1	1755
3547 445	OTA4F-3C1	1773
6842 522	OZA660-EE11	5697
9125 580	OZA660-EE11	5697
9135 329	OTA4N-5B1	1765
9135 794	OZA446-E58	0483
9202 719	OZA660-EE11	5697
9207 998	OTA4N-5A1	1755
9207 999	OTA4N-5B1	1765
9445 464	OZA324-L1	1779
VW		
021 906 265 A	OZA572-E13	0254
021 906 265 AC	OZA447-E36	1950
021 906 265 AE	OZA447-E35	0493
021 906 265 AG	OZA447-E25	0494
021 906 265 AH	OZA447-E35	0493
021 906 265 AK	OZA447-E31	0460
021 906 265 AQ	OZA447-E35	0493
021 906 265 K	OZA447-E31	0460
021 906 265 M	OZA527-E14	0455
030 906 262	OZA659-EE16	0390
030 906 262 A	OZA659-EE20	0394
030 906 262 B	LZA11-V3	1829
030 906 262 C	OZA510-V1	0491
030 906 262 D	OZA659-EE40	1627
030 906 262 E	OZA659-EE40	1627
030 906 262 F	OZA510-V2	0402
030 906 262 K	LZA11-V3	1829
030 906 262 L	OZA659-EE40	1627
030 906 265	OZA446-E15	1848
030 906 265 AC	OZA527-E36	1993
030 906 265 AD	OZA447-E16	0259
030 906 265 AE	OZA448-E31	0151

GENUINE	NTK	ORDER
VW		
030 906 265 AP	OZA572-E9	0423
030 906 265 BD	OZA572-E11	0251
030 906 265 BH	OZA448-E31	0151
030 906 265 C	OZA445-E3	1860
030 906 265 CB	OZA448-E51	0426
030 906 265 E	OZA401-E4	1822
030 906 265 G	OZA446-E53	0237
030 906 265 J	OZA445-E4	1850
030 906 265 K	OZA446-E42	0150
030 906 265 Q	OZA445-E2	1810
030 906 265 T	OZA572-E1	0283
032 906 265	OZA447-E30	0449
032 906 265 C	OZA447-E40	1738
032 906 265 D	OZA447-E40	1738
034 906 265 C	OZA446-E2	1855
034 906 265 E	OZA446-E11	1898
034 906 265 F	OZA446-E16	1859
035 906 265 B	OZA401-E2	1802
036 906 262 AA	OZA629-V3	1720
036 906 262 D	OZA510-V5	0435
036 906 262 E	LZA11-V4	1842
036 906 262 F	OZA510-V4	0424
036 906 262 G	LZA11-V2	1774
036 906 262 H	OZA659-EE23	0397
036 906 262 J	LZA11-V4	1842
036 906 262 M	OZA510-V7	1886
036 906 262 Q	OZA510-V10	1883
036 906 262 T	LZA07-V3	1880
036 906 265 H	OZA510-AU1	1782
036 906 265 J	LZA11-V1	1825
037 906 265 AD	OZA572-E10	0275
037 906 265 B	OZA446-E42	0150
037 906 265 E	OZA446-E52	0226
037 906 265 G	OZA446-E51	0215
037 906 265 J	OZA527-E36	1993
037 906 265 S	OZA447-E31	0460
03C 906 262	OZA510-V6	1885
03C 906 262 M	OZA629-V4	1721
03C 906 262 P	OZA629-V6	1723
03C 906 262 Q	OZA629-V5	1722
03C 906 262 R	OZA629-V7	1725
03D 906 265	OZA585-I1	1809
03D 906 265 A	OZA510-I1	1808
03D 906 265 B	OZA534-V1	1778
03D 906 265 C	OZA532-V4	0006
03E 906 262 B	OZA532-V3	1776
03G 906 262 B	LZA17-VW1	0033
048 906 265	OZA446-E11	1898
048 906 265 A	OZA446-E12	1805
051 906 265 D	OZA445-E7	0269
051 906 265 E	OZA401-E2	1802

REFERENZLISTE
CROSS REFERENCE GUIDE
 Рекомендационный перечень
REFERANS LISTESI

TABLE DE CORRESPONDANCE
TABELLE COMPARATIVE
 Συστάσεις

GUIA EQUIVALENCIAS
LISTA PORÓWNAWCZA
REFERENTIELIJST

GENUINE	NTK	ORDER
VW		
058 906 265 A	OZA447-E14	0129
058 906 265 B	OZA659-EE17	0391
058 906 265 C	OZA659-EE64	7949
058 906 265 V	OZA659-EE64	7949
06A 906 262 AC	OZA659-EE25	0399
06A 906 262 AH	OZA659-EE19	0393
06A 906 262 AJ	OZA659-EE14	0388
06A 906 262 AK	OZA659-EE25	0399
06A 906 262 AM	OZA659-EE33	1617
06A 906 262 AR	OZA659-EE32	1614
06A 906 262 BG	OZA659-EE38	1625
06A 906 262 BL	OZA659-EE11	0385
06A 906 262 BR	LZA07-V1	1851
06A 906 262 BS	OZA510-V11	1884
06A 906 262 CF	LZA07-V2	1868
06A 906 262 CR	LZA07-V4	0028
06A 906 262 CS	OZA510-V12	0051
06A 906 262 F	OZA659-EE18	0392
06A 906 262 N	OZA659-EE19	0393
06A 906 262 Q	OZA659-EE1	0375
06A 906 262 R	OZA659-EE14	0388
06A 906 265 E	OZA447-E17	0270
06A 906 265 F	OZA447-E32	0471
06A 906 265 H	OZA447-E18	0281
06B 906 265 A	OZA334-AU1	0474
06B 906 265 B	OZA516-AU1	0452
06B 906 265 E	OZA334-AU2	1789
06E 906 265 D	OZA510-AU2	1783
06E 906 265 E	OZA510-AU3	1784
06E 906 265 F	LZA07-AU1	1772
06E 906 265 J	OZA510-AU4	0047
06E 906 265 K	OZA510-AU5	0048
06E 906 265 L	LZA07-AU2	0026
06E 906 265 M	LZA07-AU3	0027
06E 906 265 N	OZA510-AU6	0049
06E 906 265 P	OZA510-AU7	0050
077 906 265	OZA446-E4	1877
078 906 265 D	OZA446-E43	0194
078 906 265 M	OZA659-EE36	1620
078 906 265 N	OZA659-EE46	5748
078 906 265 P	OZA659-EE47	5750
2D0 906 265	OZA448-E45	0206
330 906 265	OZA527-E36	1993
6KE 906 265 A	OZA114-V4	1769
6K0 906 262 A	OZA510-V3	0413
6U0 906 265 C	OZA447-E13	0183
6U0 906 265 E	OZA457-I1	0414

Sonden-Info
Sensor Information
Информация о датчиках
SENSÖR ENFORMASYONU

Informations des Sondes
Caratteristiche delle sonde lambda
Πληροφορίες αισθητήρων

Información sobre el sensor
Informacje dotyczące sondy
Sonden-info

Order	NTK	No. of wires	Connector No.	Length
0003	OZA448-J4	4	80	690
0004	OZA448-J5	4	80	370
0006	OZA532-V4	4	64	600
0007	OZA577-H17	4	80	990
0008	OZA591-UB2	4	97	535
0009	OZA591-VB2	4	97	500
0010	OZA591-WB1	4	97	410
0011	OZA591-YB1	4	31	590
0012	OZA603-N2	4	31	271
0013	OZA603-R2	4	101	434
0014	OZA610-W2	4	102	380
0015	OZA610-W5	4	102	350
0016	OZA628-U1	4	82	446
0017	OZA629-W2	4	31	400
0018	OZA629-W5	4	31	510
0019	OZA629-W6	4	31	310
0020	OZA636-R1	4	67	445
0022	OTD2F-1P2	3	60	196
0023	OTD5F-3E1	3	103	876
0024	OTD3J-5A3	4	56	460
0025	LZA09-E1	5	100	410
0026	LZA07-AU2	5	98	830
0027	LZA07-AU3	5	91	830
0028	LZA07-V4	5	91	725
0029	LZA15-A1	5	91	660
0031	LZA15-A3	5	91	318
0032	LZA15-GM1	5	91	990
0033	LZA17-VW1	5	91	680
0036	OZA341-BB1	4	40	310
0037	OZA341-BN1	4	33	738
0038	OZA341-SZ2	4	32	800
0039	OZA341-SZ3	4	32	300
0041	OZA381-D12	4	32	296
0042	OZA488-AM1	4	32	493
0043	OZA495-RV1	4	75	620
0044	OZA495-RV2	4	75	428
0045	OZA501-H20	4	44	595
0046	OZA508-H4	4	44	535
0047	OZA510-AU4	4	84	591
0048	OZA510-AU5	4	85	541
0049	OZA510-AU6	4	84	591
0050	OZA510-AU7	4	85	721
0051	OZA510-V12	4	85	511
0052	OZA519-SZ2	4	32	335
0053	OZA522-BM1	4	69	922
0054	OZA522-BM2	4	69	554
0055	OZA531-GM24	4	74	1485
0056	OZA532-A12	4	104	310
0057	OZA555-D2	4	32	915
0058	OZA555-D3	4	32	372
0059	OZA562-H7	4	44	740

Order	NTK	No. of wires	Connector No.	Length
0060	OZA562-H9	4	44	455
0061	OZA563-H5	4	43	340
0062	OZA563-H6	4	43	300
0063	OZA563-H8	4	44	690
0064	OZA577-H15	4	96	210
0065	OZA577-H6	4	96	280
0066	OZA591-BB3	4	40	880
0067	OZA591-UB1	4	97	640
0068	OZA600-BM1	4	54	736
0069	OZA600-BM8	4	68	281
0070	OZA608-U2	4	83	381
0071	OZA614-H3	4	44	500
0072	OZA630-BM1	4	99	231
0073	OZA630-BM2	4	99	521
0074	OZA630-BM3	4	68	341
0075	OZA635-H1	4	105	275
0076	OZA635-H4	4	105	335
0120	OZA401-E49	1	7	340
0121	OZA428-E3	2	11	630
0122	OZA253-F6	4	31	250
0123	OZA55-R2	3	14	368
0124	OZA83-VN1	4	29	1038
0125	OZA216-D3	4	27	710
0126	OZA311-R2	3	24	257
0128	OZA446-E41	3	14	225
0129	OZA447-E14	4	48	967
0131	OZA401-E50	1	3	170
0132	OZA428-E4	2	12	460
0133	OZA384-E32	4	34	392
0134	OZA55-R3	3	13	180
0135	OZA89-D2	4	27	360
0136	OZA222-RV1	4	33	540
0137	OZA333-H4	4	43	320
0139	OZA446-E46	3	25	271
0142	OZA401-E51	1	3	200
0143	OZA401-E55	1	9	450
0145	OZA55-R4	3	14	228
0146	OZA112-A1	4	31	850
0147	OZA236-R1	3	14	288
0148	OZA333-H5	4	43	410
0150	OZA446-E42	4	17	583
0151	OZA448-E31	4	48	520
0153	OZA401-E57	1	5	370
0154	OZA401-E56	1	5	380
0155	OZA446-E45	3	23	380
0156	OZA83-R1	4	28	478
0157	OZA112-A3	4	31	600
0158	OZA236-R2	3	13	180
0159	OZA333-H6	4	43	235
0162	OZA446-E44	3	19	610
0164	OZA401-E52	1	7	470

Sonden-Info
Sensor Information
Информация о датчиках
SENSÖR ENFORMASYONU

Informations des Sondes
Caratteristiche delle sonde lambda
Πληροφορίες αισθητήρων

Información sobre el sensor
Informacje dotyczące sondy
Sonden-info

Order	NTK	No. of wires	Connector No.	Length
0165	OZA85-M1	4	30	290
0166	OZA401-E58	1	6	445
0167	OZA83-R2	4	28	318
0168	OZA201-AM1	4	32	393
0169	OZA245-H1	4	44	410
0175	OZA401-E53	1	8	655
0176	OZA25-F3	1	1	550
0177	OZA73-F1	3	15	350
0178	OZA83-R3	4	28	368
0179	OZA201-AM2	4	32	393
0180	OZA245-H2	4	43	225
0182	OZA448-E29	4	47	1145
0183	OZA447-E13	4	36	517
0186	OZA401-E54	1	8	445
0187	OZA25-F1	1	1	550
0188	OZA186-F5	3	16	380
0189	OZA83-R4	4	28	253
0190	OZA216-D2	4	27	360
0191	OZA311-R1	3	13	255
0193	OZA446-E40	3	14	422
0194	OZA446-E43	3	26	410
0197	OZA428-E2	2	12	580
0198	OZA25-F12	1	2	550
0199	OZA33-D5	4	27	300
0201	OZA527-E3	4	58	1470
0204	OZA446-E50	3	19	710
0206	OZA448-E45	4	47	985
0207	OZA401-E63	1	8	550
0209	OZA572-E8	4	35	540
0212	OZA333-H27	4	43	410
0213	OZA527-E7	4	40	972
0215	OZA446-E51	3	46	545
0216	OZA447-E21	4	47	565
0218	OZA527-E4	4	38	880
0220	OZA527-E12	4	58	450
0223	OZA334-A1	4	40	610
0225	OZA112-A2	4	31	300
0226	OZA446-E52	3	46	430
0227	OZA447-E22	4	47	625
0228	OZA448-E47	4	34	310
0234	OZA334-A2	4	40	980
0236	OZA112-A4	4	40	800
0237	OZA446-E53	3	46	335
0239	OZA448-E48	4	27	610
0242	OZA572-E5	4	35	400
0244	OZA519-D1	4	32	372
0245	OZA334-A3	4	40	310
0250	OZA502-E31	4	34	275
0251	OZA572-E11	4	48	780
0252	OZA572-E2	4	35	510
0253	OZA527-E5	4	38	1130

Order	NTK	No. of wires	Connector No.	Length
0254	OZA572-E13	4	36	585
0255	OZA421-H1	4	43	240
0256	OZA21-F3	3	78	420
0258	OZA445-E6	3	19	885
0259	OZA447-E16	4	48	550
0260	OZA448-E41	4	27	570
0263	OZA527-E10	4	41	770
0264	OZA572-E3	4	35	730
0265	OZA527-E2	4	37	510
0266	OZA501-H17	4	43	240
0269	OZA445-E7	3	19	975
0270	OZA447-E17	4	64	470
0271	OZA448-E42	4	27	555
0273	OZA572-E12	4	35	910
0274	OZA527-E22	4	37	1210
0275	OZA572-E10	4	48	1430
0277	OZA333-H19	4	44	450
0280	OZA446-E48	3	45	510
0281	OZA447-E18	4	64	620
0282	OZA448-E43	4	28	255
0283	OZA572-E1	4	36	550
0284	OZA527-E8	4	33	390
0285	OZA527-E13	4	47	830
0287	OZA527-E24	4	40	1175
0288	OZA333-H25	4	43	245
0291	OZA446-E49	3	19	1665
0293	OZA448-E44	4	27	375
0295	OZA572-E4	4	35	1420
0296	OZA527-E19	4	40	378
0298	OZA527-E15	4	49	375
0299	OZA333-H26	4	43	320
0375	OZA659-EE1	4	64	975
0376	OZA659-EE2	4	106	540
0377	OZA659-EE3	4	40	300
0378	OZA659-EE4	4	83	540
0379	OZA659-EE5	4	74	295
0380	OZA659-EE6	4	67	455
0381	OZA659-EE7	4	74	420
0382	OZA659-EE8	4	83	1230
0383	OZA659-EE9	4	32	375
0384	OZA659-EE10	4	82	535
0385	OZA659-EE11	4	65	740
0386	OZA659-EE12	4	83	380
0387	OZA659-EE13	4	67	330
0388	OZA659-EE14	4	65	560
0389	OZA659-EE15	4	47	240
0390	OZA659-EE16	4	64	1670
0391	OZA659-EE17	4	64	1175
0392	OZA659-EE18	4	65	490
0393	OZA659-EE19	4	65	545
0394	OZA659-EE20	4	64	1590

Sonden-Info
Sensor Information
Информация о датчиках
SENSÖR ENFORMASYONU

Informations des Sondes
Caratteristiche delle sonde lambda
Πληροφορίες αισθητήρων

Información sobre el sensor
Informacje dotyczące sondy
Sonden-info

Order	NTK	No. of wires	Connector No.	Length
0395	OZA659-EE21	4	82	1490
0396	OZA659-EE22	4	47	320
0397	OZA659-EE23	4	65	575
0398	OZA659-EE24	4	47	400
0399	OZA659-EE25	4	64	1135
0400	OZA659-EE26	4	47	435
0401	OZA74-F1	4	31	480
0402	OZA510-V2	4	64	1576
0403	OZA488-D1	4	32	271
0404	OZA448-E49	4	42	320
0405	OZA447-E26	4	72	510
0406	OZA401-E66	1	8	500
0407	OZA334-SZ3	4	74	401
0408	OZA572-E14	4	47	570
0409	OZA532-A3	4	40	260
0413	OZA510-V3	4	65	1326
0414	OZA457-I1	4	36	516
0415	OZA448-E50	4	67	380
0416	OZA447-E27	4	68	290
0417	OZA401-E67	1	8	650
0418	OZA334-SZ4	4	74	271
0419	OZA572-E7	4	59	675
0420	OTA7H-3C2	4	53	338
0423	OZA572-E9	4	48	620
0424	OZA510-V4	4	65	541
0425	OZA502-E28	4	43	410
0426	OZA448-E51	4	64	475
0427	OZA447-E28	4	68	340
0428	OZA401-E68	1	8	700
0429	OZA341-RV2	4	75	620
0430	OZA527-E18	4	33	545
0431	OTA7L-3C4	4	53	338
0433	OZA74-F2	4	31	280
0434	OZA527-E16	4	49	630
0435	OZA510-V5	4	64	526
0436	OZA502-E34	4	30	320
0437	OZA448-E52	4	71	340
0438	OZA447-E29	4	69	975
0439	OZA444-E1	4	43	410
0440	OZA341-W2	4	42	310
0442	OTA7L-3C3	4	53	708
0444	OZA527-E25	4	41	750
0445	OZA527-E17	4	49	1220
0446	OZA74-F3	4	31	250
0447	OZA502-E35	4	30	265
0448	OZA448-E53	4	76	400
0449	OZA447-E30	4	48	985
0450	OZA446-E55	3	80	440
0451	OZA381-D2	4	32	271
0452	OZA516-AU1	4	64	1055
0453	OTD3G-3A1	3	55	521

Order	NTK	No. of wires	Connector No.	Length
0455	OZA527-E14	4	36	622
0457	OZA186-F7	3	15	450
0458	OZA502-E36	4	30	285
0459	OZA448-E54	4	47	280
0460	OZA447-E31	4	48	720
0461	OZA446-E56	3	79	265
0462	OZA381-D3	4	32	393
0463	OZA527-E6	4	39	875
0464	OTD3J-5B1	4	56	730
0466	OZA527-E27	4	35	1490
0468	OZA277-R2	4	67	445
0469	OZA501-H23	4	44	450
0470	OZA448-E55	4	27	720
0471	OZA447-E32	4	64	700
0472	OZA446-E57	3	13	385
0473	OZA384-E39	4	34	300
0474	OZA334-AU1	4	65	700
0475	OTD3J-5C1	4	43	521
0477	OZA527-E28	4	63	720
0478	OZA532-A1	4	40	980
0480	OZA507-R2	4	67	445
0481	OZA448-E56	4	49	1480
0482	OZA447-E34	4	47	815
0483	OZA446-E58	3	77	1095
0484	OZA384-E40	4	34	338
0485	OZA334-SZ1	4	74	741
0486	OTA7H-5A1	4	54	968
0488	OZA527-E29	4	73	370
0489	OZA532-A2	4	40	610
0491	OZA510-V1	4	64	1686
0492	OZA448-E57	4	49	380
0493	OZA447-E35	4	66	1350
0494	OZA447-E25	4	66	1140
0495	OZA395-E9	3	80	440
0496	OZA334-SZ2	4	74	571
0498	OZA527-E9	4	33	590
0499	OZA569-H1	4	43	240
1609	OZA659-EE27	4	47	380
1610	OZA659-EE28	4	74	520
1611	OZA659-EE29	4	47	480
1612	OZA659-EE30	4	40	1170
1613	OZA659-EE31	4	40	600
1614	OZA659-EE32	4	65	480
1617	OZA659-EE33	4	65	700
1618	OZA659-EE34	4	47	585
1619	OZA659-EE35	4	47	460
1620	OZA659-EE36	4	48	615
1624	OZA659-EE37	4	47	565
1625	OZA659-EE38	4	65	505
1626	OZA659-EE39	4	74	270
1627	OZA659-EE40	4	64	535

Sonden-Info
Sensor Information
Информация о датчиках
SENSÖR ENFORMASYONU

Informations des Sondes
Caratteristiche delle sonde lambda
Πληροφορίες αισθητήρων

Información sobre el sensor
Informacje dotyczące sondy
Sonden-info

Order	NTK	No. of wires	Connector No.	Length
1628	OZA659-EE41	4	107	415
1629	OZA659-EE42	4	47	295
1630	OZA659-EE43	4	32	390
1638	OZA659-EE44	4	27	370
1704	OZA277-R1	4	67	260
1705	OZA334-SZ5	4	74	471
1706	OZA334-SZ6	4	74	471
1707	OZA381-AM1	4	32	650
1708	OZA504-D2	4	32	330
1709	OZA571-GB1	4	89	300
1710	OZA591-BB2	4	40	310
1720	OZA629-V3	4	84	511
1721	OZA629-V4	4	85	526
1722	OZA629-V5	4	84	521
1723	OZA629-V6	4	85	651
1725	OZA629-V7	4	85	601
1726	OZA641-A1	4	104	310
1727	LZA15-A5	5	91	610
1728	LZA15-GM3	5	91	860
1729	OZA446-E62	3	25	550
1730	OZA446-E63	3	20	965
1737	OZA446-E64	3	129	330
1738	OZA447-E40	4	64	995
1739	OZA447-E41	4	34	525
1753	OZA583-GM1	4	86	312
1754	OZA583-GM2	4	87	725
1755	OTA4N-5A1	4	94	530
1757	OZA488-D2	4	32	393
1758	OTA4N-5G1	4	61	750
1759	OZA112-A6	4	40	400
1760	OZA112-A7	4	40	700
1762	OZA534-A1	4	40	610
1763	OTA4F-3B1	3	57	1700
1764	OZA534-A2	4	40	410
1765	OTA4N-5B1	4	50	530
1766	OZA488-SZ1	4	32	372
1767	OZA591-SZ1	4	31	590
1768	OTA4N-5H1	4	61	750
1769	OZA114-V4	4	48	290
1772	LZA07-AU1	5	91	600
1773	OTA4F-3C1	3	95	1900
1774	LZA11-V2	5	92	535
1776	OZA532-V3	4	85	481
1777	OZA572-E6	4	47	350
1778	OZA534-V1	4	64	611
1779	OZA324-L1	4	81	570
1780	OZA324-L2	4	61	1356
1782	OZA510-AU1	4	65	620
1783	OZA510-AU2	4	84	971
1784	OZA510-AU3	4	85	971
1785	OTA4N-5D1	4	90	1362

Order	NTK	No. of wires	Connector No.	Length
1786	OZA532-A4	4	40	1370
1787	OZA527-E11	4	42	820
1789	OZA334-AU2	4	65	780
1790	OZA334-PG1	4	49	536
1792	OZA532-A5	4	40	1810
1793	OZA532-A9	4	40	810
1794	OZA532-A10	4	40	310
1795	OTA4N-5F1	4	61	343
1796	OZA532-A7	4	40	980
1797	OZA527-E20	4	40	885
1798	OZA341-A1	4	40	310
1800	OZA534-A3	4	40	980
1802	OZA401-E2	1	3	472
1804	OZA544-N8	4	70	371
1805	OZA446-E12	3	19	365
1807	OZA428-E1	2	10	370
1808	OZA510-I1	4	65	231
1809	OZA585-I1	4	64	601
1810	OZA445-E2	4	17	450
1813	OZA341-PG5	4	82	536
1814	OZA341-PG6	4	82	1236
1815	OZA341-PG7	4	82	1486
1816	OZA341-PG8	4	82	1836
1817	OZA527-E21	4	63	270
1818	OZA538-PG1	4	82	1236
1819	OZA538-PG2	4	82	1836
1820	OZA381-D1	4	32	372
1822	OZA401-E4	2	4	480
1825	LZA11-V1	5	92	250
1826	OZA446-E13	3	21	315
1827	OZA446-E8	3	14	375
1828	OZA401-E5	1	5	370
1829	LZA11-V3	5	92	465
1833	OZA446-E1	3	19	670
1836	OZA571-C10	4	89	300
1837	OZA446-E14	3	20	760
1838	OZA446-E5	3	19	1100
1839	OZA448-E16	4	34	200
1840	LZA06-U1	5	93	375
1842	LZA11-V4	5	92	810
1845	OZA600-BM2	4	54	591
1846	OZA600-BM5	4	54	431
1847	OZA600-BM7	4	54	241
1848	OZA446-E15	3	18	970
1850	OZA445-E4	4	17	920
1851	LZA07-V1	5	92	750
1852	OZA495-PG2	4	83	536
1853	OZA495-PG3	4	83	1236
1855	OZA446-E2	3	19	975
1856	OZA114-A1	4	31	290
1857	OZA544-R1	4	88	500

Sonden-Info
Sensor Information
Информация о датчиках
SENSÖR ENFORMASYONU

Informations des Sondes
Caratteristiche delle sonde lambda
Πληροφορίες αισθητήρων

Información sobre el sensor
Informacje dotyczące sondy
Sonden-info



Order	NTK	No. of wires	Connector No.	Length
1859	OZA446-E16	3	19	1215
1860	OZA445-E3	3	18	960
1861	OZA446-E6	3	14	885
1862	OZA531-GM1	4	86	660
1863	OZA531-GM2	4	74	1245
1864	OZA531-GM3	4	74	1115
1865	OZA448-E12	4	27	270
1866	OZA446-E3	3	14	1220
1867	OZA33-D8	4	27	600
1868	LZA07-V2	5	92	680
1869	OZA531-GM6	4	86	607
1870	OZA531-GM7	4	86	247
1872	OZA446-E7	3	20	510
1877	OZA446-E4	3	19	895
1878	OZA55-R1	3	14	288
1880	LZA07-V3	5	91	330
1882	OZA401-E6	1	6	320
1883	OZA510-V10	4	64	1596
1884	OZA510-V11	4	85	471
1885	OZA510-V6	4	64	251
1886	OZA510-V7	4	64	1706
1887	OZA446-E18	3	22	890
1889	OZA65-A2	1	2	650
1890	OZA89-D1	4	27	300
1891	OZA531-GM16	4	87	1465
1892	OZA531-GM22	4	74	1465
1895	OZA575-GM1	4	49	425
1896	OZA575-GM2	4	49	355
1898	OZA446-E11	3	19	490
1907	OTD2F-3K1	3	60	810
1908	OTA4F-5F1	4	61	663
1909	OZA448-E58	4	70	350
1920	OTA7N-5A1	4	53	620
1921	OTA5F-3C1	3	51	1700
1927	OTA4F-5G2	4	61	750
1928	OTA6F-3A1	3	51	1000
1932	OTA7H-3A1	4	52	1408
1938	OTA7N-5A2	4	53	770
1940	OZA25-KH1	1	8	650
1942	OTA4F-5E1	4	61	870
1943	OTA7H-3A2	4	52	398
1948	OTA4F-5C2	4	62	1039
1950	OZA447-E36	4	48	1430
1954	OTA7H-3C1	4	53	828
1963	OTA7N-5C1	4	47	968
1969	OZA25-KH3	1	8	550
1971	OZA447-E42	4	122	350
1973	OTA7N-5B1	4	52	238
1974	OTA7N-5D1	4	54	388
1975	OTA7N-5D2	4	54	638
1976	OZA447-E44	4	47	465

Order	NTK	No. of wires	Connector No.	Length
1980	OZA527-E33	4	73	1460
1981	OZA527-E34	4	73	530
1982	OZA527-E35	4	73	1220
1991	OTA7N-5D3	4	54	968
1993	OZA527-E36	4	36	1075
1995	OZA659-EE51	4	74	600
1996	OZA659-EE52	4	82	1230
5653	OZA660-EE1	4	107	400
5654	OZA660-EE2	4	28	395
5656	OZA660-EE3	4	74	290
5658	OZA660-EE4	4	72	770
5662	OZA660-EE5	4	69	730
5680	OZA660-EE6	3	110	325
5681	OZA660-EE7	4	72	515
5682	OZA660-EE8	4	47	325
5694	OZA660-EE9	4	68	655
5695	OZA660-EE10	4	72	655
5697	OZA660-EE11	4	73	740
5698	OZA660-EE12	4	67	350
5706	OZA660-EE13	4	74	285
5707	OZA660-EE14	4	35	1445
5708	OZA660-EE15	4	27	270
5709	OZA660-EE16	3	13	685
5713	OZA660-EE17	4	68	970
5714	OZA660-EE18	4	43	350
5716	OZA660-EE19	4	68	550
5717	OZA660-EE20	4	73	415
5719	OZA660-EE21	4	67	450
5720	OZA660-EE22	4	68	745
5737	OZA660-EE23	4	111	535
5739	OZA660-EE24	4	111	1230
5747	OZA659-EE45	4	112	745
5748	OZA659-EE46	4	48	1435
5750	OZA659-EE47	4	66	1440
5752	OZA659-EE48	4	108	600
5753	OZA659-EE49	4	40	400
5754	OZA659-EE50	4	109	510
6379	OZA19-E12	1	6	387
6380	OZA28-C3	4	114	590
6381	OZA248-C1	4	115	457
6383	OZA521-C8	4	115	380
6384	OZA571-C2	4	89	425
6385	OZA571-C4	4	116	300
6396	OZA571-C7	4	117	457
6397	OZA623-C1	4	118	300
6400	OZA623-C2	4	119	457
6407	OZA107-KH2	4	30	317
6408	OZA341-W1	4	113	220
6413	OZA448-J1	4	80	420
6414	OZA448-J2	4	124	480
6415	OZA448-J3	4	80	630

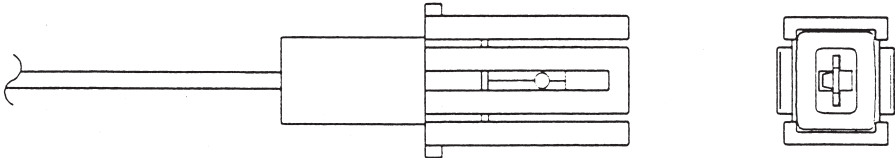
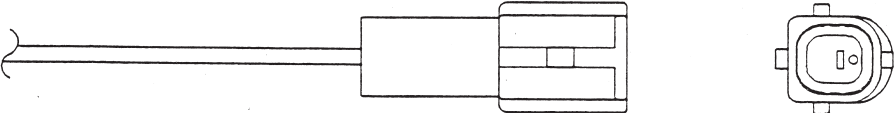
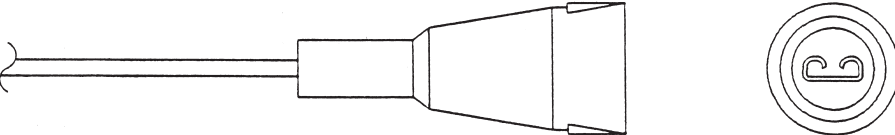
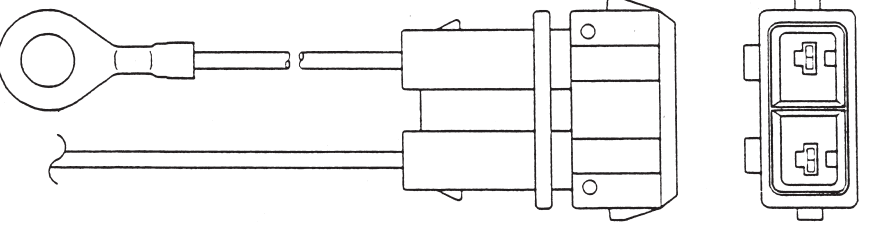

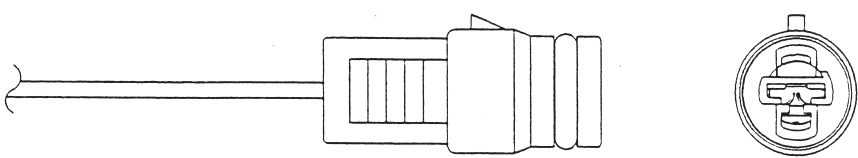
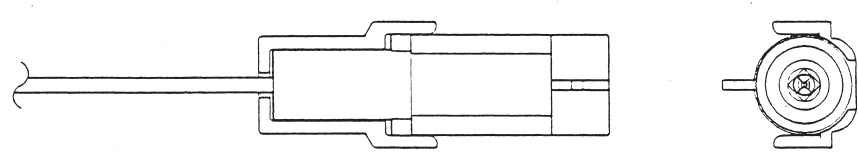
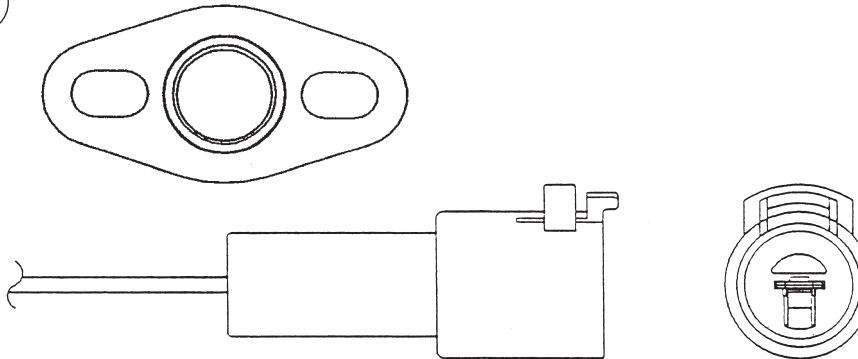
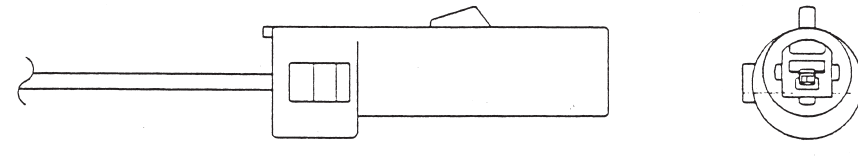
STECKERABBILDUNG CONNECTORS Вид штекера BAĞLANTI RESMİ	CONNECTEURS CONNETTORI Εικόνα φικς	CONECTORES KOŃCÓWKI PRZYŁĄCZENIOWE STEKKEAFBEELDING	NTK	ORDER STOCK	mm
<div style="text-align: center;"> 1 </div> 	OZA25-F1	0187	550		
	OZA25-F3	0176	550		
<div style="text-align: center;"> 2 </div> 	OZA25-F12	0198	550		
	OZA65-A2	1889	650		
<div style="text-align: center;"> 3 </div> 	OZA401-E2	1802	472		
	OZA401-E50	0131	170		
	OZA401-E51	0142	200		
<div style="text-align: center;"> 4 </div> 	OZA401-E4	1822	480		

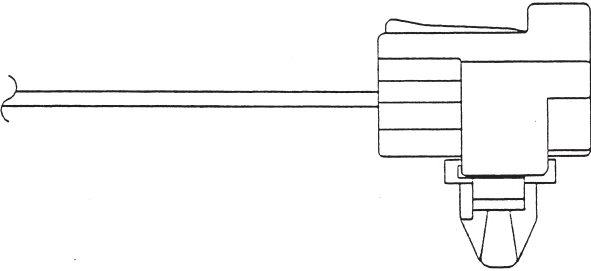
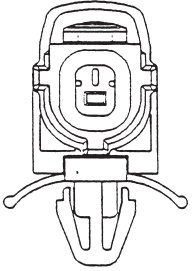
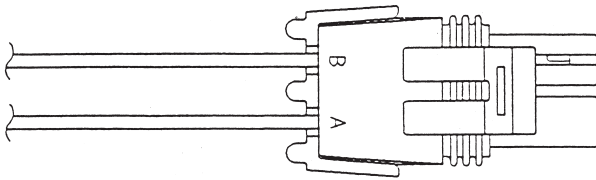
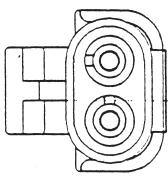
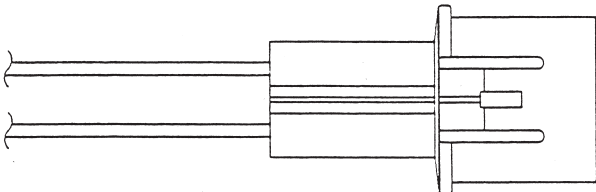
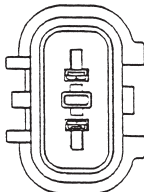
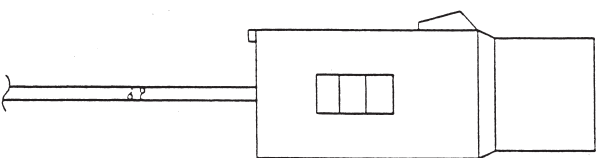
STECKERABBILDUNG CONNECTORS Вид штекера BAĞLANTI RESMİ	CONNECTEURS CONNETTORI Εικόνα φις	CONECTORES KOŃCÓWKI PRZYŁĄCZENIOWE STEKKERAFBEELDING	NTK	ORDER STOCK	mm
5 	OZA401-E5	1828	370		
	OZA401-E56	0154	380		
	OZA401-E57	0153	370		
6 	OZA19-E12	6379	387		
	OZA401-E6	1882	320		
	OZA401-E58	0166	445		
7 * 	*OZA401-E49	0120	340		
	OZA401-E52	0164	470		
8 	OZA25-KH1	1940	650		
	OZA25-KH3	1969	550		
	OZA401-E53	0175	655		
	OZA401-E54	0186	445		
	OZA401-E63	0207	550		
	OZA401-E66	0406	500		
	OZA401-E67	0417	650		
	OZA401-E68	0428	700		

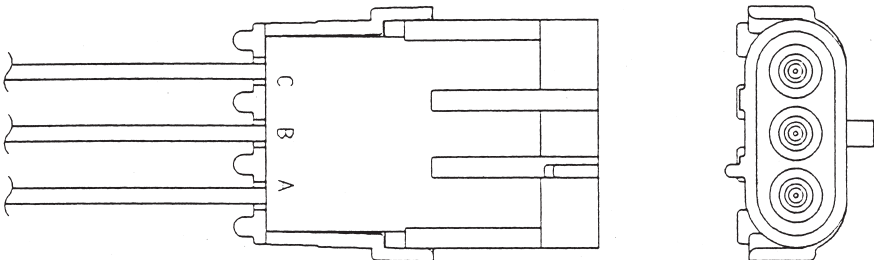
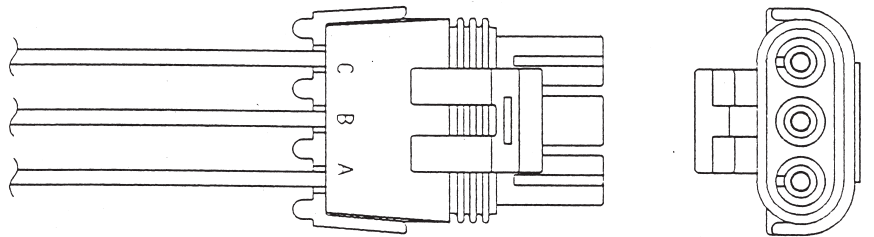
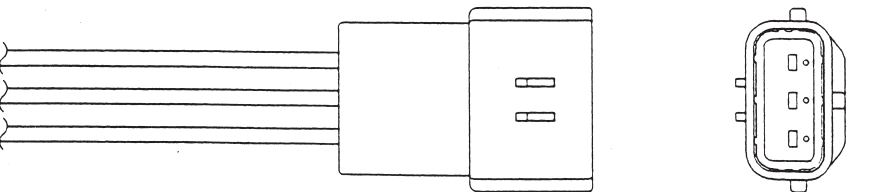

STECKERABBILDUNG CONNECTORS Вид штекера BAĞLANTI RESMİ	CONNECTEURS CONNETTORI Εικόνα φις	CONECTORES KOŃCÓWKI PRZYŁĄCZENIOWE STEKKEAFBEELDING	NTK	ORDER STOCK	mm
9 			OZA401-E55	0143	450
10 			OZA428-E1	1807	370
11 			OZA428-E3	0121	630
12 			OZA428-E2	0197	580
			OZA428-E4	0132	460

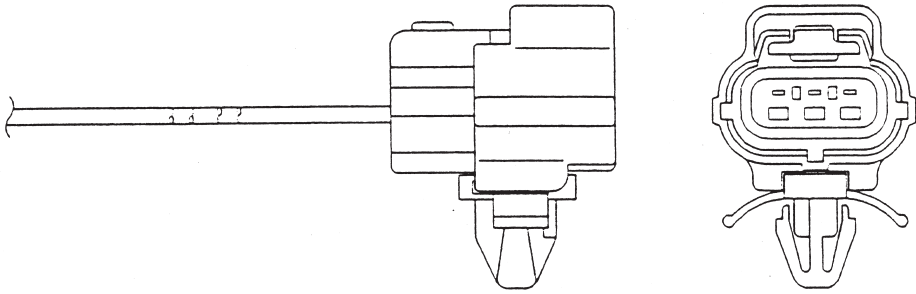
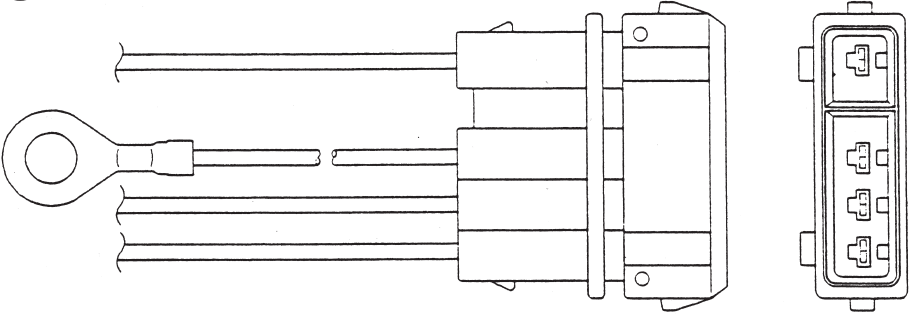
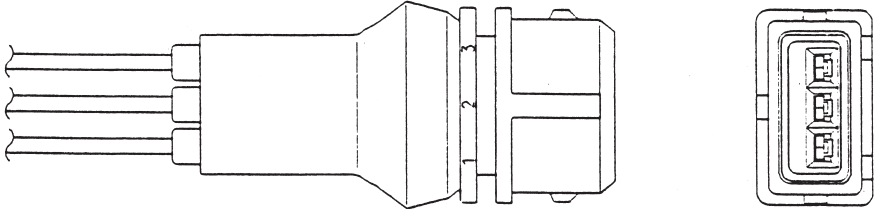
STECKERABBILDUNG CONNECTORS Вид штекера BAĞLANTI RESMİ	CONNECTEURS CONNETTORI Εικόνα φις	CONECTORES KOŃCÓWKI PRZYŁĄCZENIOWE STEKKERAFBEELDING	NTK	ORDER STOCK	mm
13 			OZA55-R3	0134	180
			OZA236-R2	0158	180
			OZA311-R1	0191	255
			OZA446-E57	0472	385
			OZA660-EE16	5709	685
14 			OZA55-R1	1878	288
			OZA55-R2	0123	368
			OZA55-R4	0145	228
			OZA236-R1	0147	288
			OZA446-E3	1866	1220
			OZA446-E6	1861	885
			OZA446-E8	1827	375
			OZA446-E40	0193	422
OZA446-E41	0128	225			
15 			OZA73-F1	0177	350
			OZA186-F7	0457	450

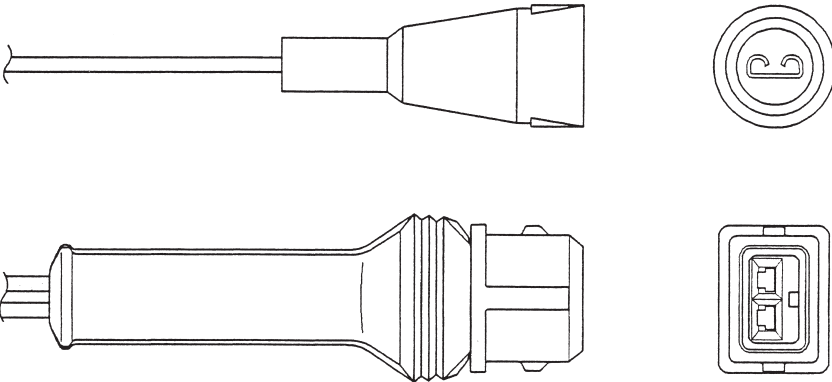
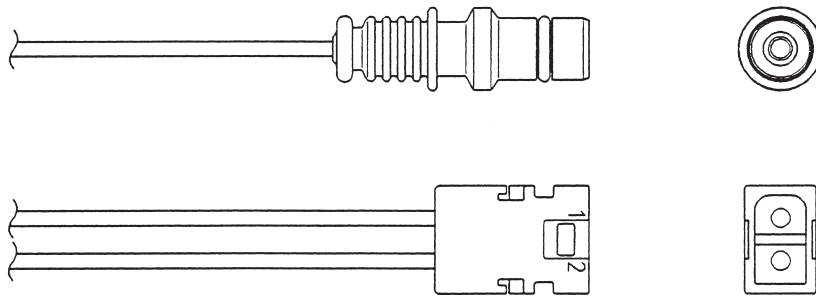
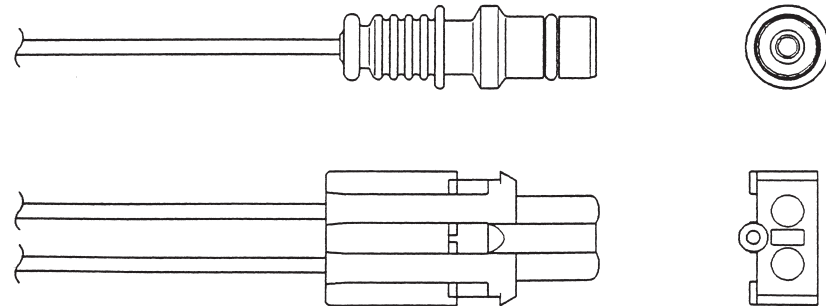
STECKERABBILDUNG CONNECTORS Вид штекера BAĞLANTI RESMİ	CONNECTEURS CONNETTORI Εικόνα φικς	CONECTORES KOŃCÓWKI PRZYŁĄCZENIOWE STEKKEAFBEELDING	NTK	ORDER STOCK	mm
<div data-bbox="165 277 229 338" style="border: 1px solid black; border-radius: 50%; width: 30px; height: 30px; display: flex; align-items: center; justify-content: center; margin-bottom: 10px;">16</div> 	OZA186-F5	0188	380		
<div data-bbox="165 741 229 801" style="border: 1px solid black; border-radius: 50%; width: 30px; height: 30px; display: flex; align-items: center; justify-content: center; margin-bottom: 10px;">17</div> 	OZA445-E2	1810	450		
	OZA445-E4	1850	920		
	OZA446-E42	0150	583		
<div data-bbox="165 1205 229 1265" style="border: 1px solid black; border-radius: 50%; width: 30px; height: 30px; display: flex; align-items: center; justify-content: center; margin-bottom: 10px;">18</div> 	OZA445-E3	1860	960		
	OZA446-E15	1848	970		

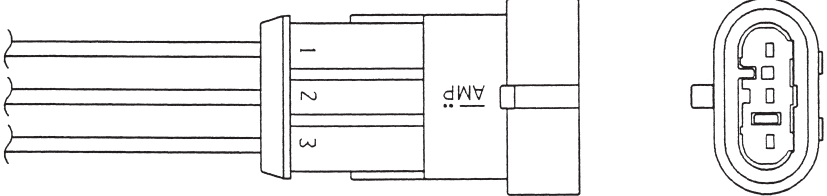
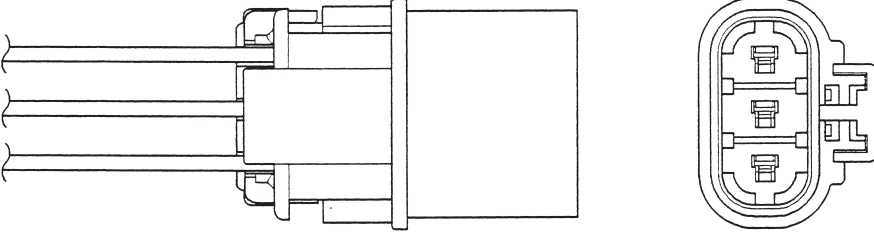
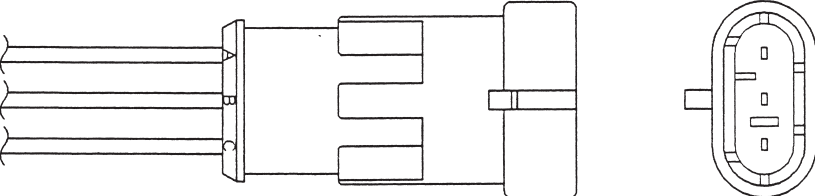
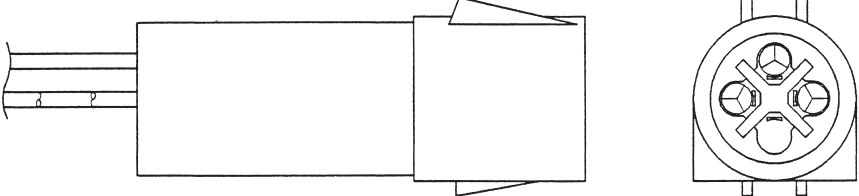
STECKERABBILDUNG CONNECTORS Вид штекера BAĞLANTI RESMİ	CONNECTEURS CONNETTORI Εικόνα φικς	CONECTORES KOŃCÓWKI PRZYŁĄCZENIOWE STEKKERAFBEELDING	NTK	ORDER STOCK	mm
19 			OZA445-E6	0258	885
			OZA445-E7	0269	975
			OZA446-E1	1833	670
			OZA446-E2	1855	975
			OZA446-E4	1877	895
			OZA446-E5	1838	1100
			OZA446-E11	1898	490
			OZA446-E12	1805	365
			OZA446-E16	1859	1215
			OZA446-E44	0162	610
			OZA446-E49	0291	1665
			OZA446-E50	0204	710
20 		OZA446-E14	1837	760	
			OZA446-E63	1730	965
			OZA446-E7	1872	510
21 			OZA446-E13	1826	315

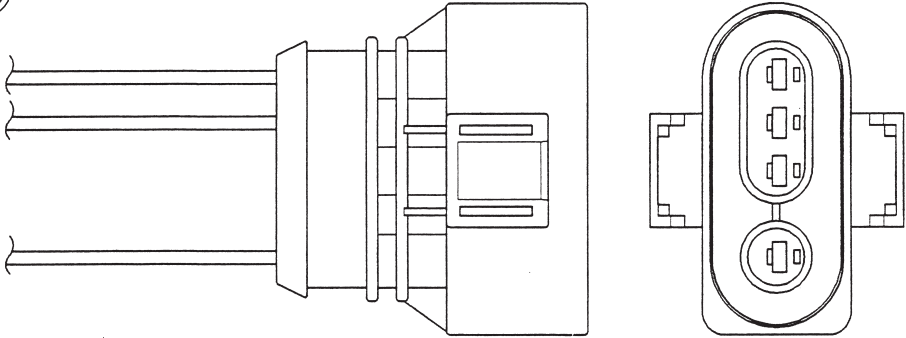
STECKERABBILDUNG CONNECTORS Вид штекера BAĞLANTI RESMİ	CONNECTEURS CONNETTORI Εικόνα φικς	CONECTORES KOŃCÓWKI PRZYŁĄCZENIOWE STEKKEAFBEELDING	NTK	ORDER STOCK	mm
<div style="display: flex; align-items: center;"> <div style="margin-right: 20px;"> <p style="font-size: 24px; border: 1px solid black; border-radius: 50%; padding: 5px; display: inline-block;">22</p> </div>  </div>	OZA446-E18	1887	890		
<div style="display: flex; align-items: center;"> <div style="margin-right: 20px;"> <p style="font-size: 24px; border: 1px solid black; border-radius: 50%; padding: 5px; display: inline-block;">23</p> </div>  </div>	OZA446-E45	0155	380		
<div style="display: flex; align-items: center;"> <div style="margin-right: 20px;"> <p style="font-size: 24px; border: 1px solid black; border-radius: 50%; padding: 5px; display: inline-block;">24</p> </div>  </div>	OZA311-R2	0126	257		
<div style="display: flex; align-items: center;"> <div style="margin-right: 20px;"> <p style="font-size: 24px; border: 1px solid black; border-radius: 50%; padding: 5px; display: inline-block;">25</p> </div>  </div>	OZA446-E46	0139	271		
	OZA446-E62	1729	550		

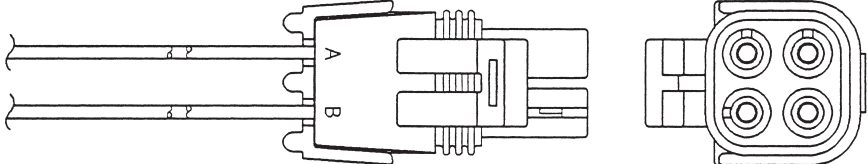
STECKERABBILDUNG CONNECTORS Вид штекера BAĞLANTI RESMİ	CONNECTEURS CONNETTORI Εικόνα φις	CONECTORES KOŃCÓWKI PRZYŁĄCZENIOWE STEKKERAFBEELDING	NTK	ORDER STOCK	mm
26 			OZA446-E43	0194	410
27 			OZA33-D5	0199	300
			OZA33-D8	1867	600
			OZA89-D1	1890	300
			OZA89-D2	0135	360
			OZA216-D2	0190	360
			OZA216-D3	0125	710
			OZA448-E12	1865	270
			OZA448-E41	0260	570
			OZA448-E42	0271	555
			OZA448-E44	0293	375
			OZA448-E48	0239	610
			OZA448-E55	0470	720
			OZA659-EE44	1638	370
			OZA660-EE15	5708	270
28 			OZA83-R1	0156	478
			OZA83-R2	0167	318
			OZA83-R3	0178	368
			OZA83-R4	0189	253
			OZA448-E43	0282	255
			OZA660-EE2	5654	395

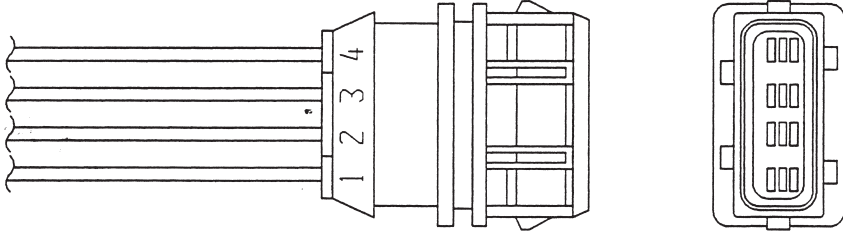
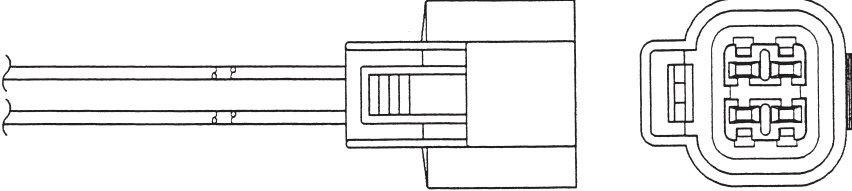
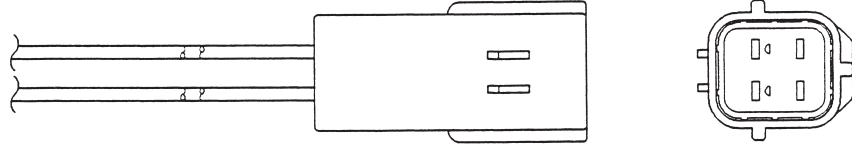

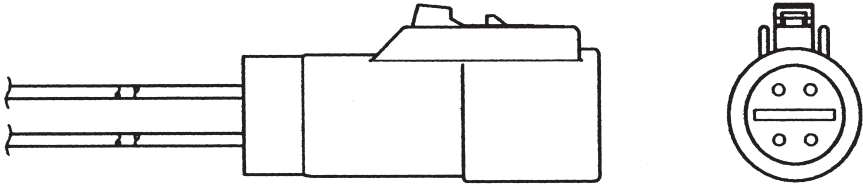
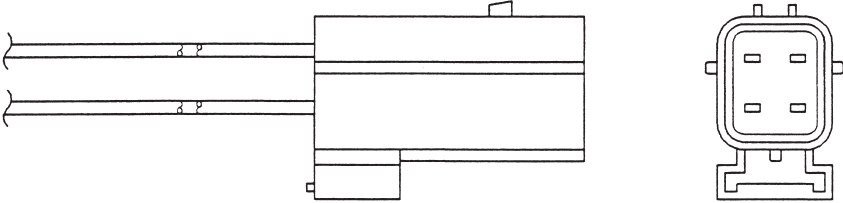
STECKERABBILDUNG CONNECTORS Вид штекера BAĞLANTI RESMİ	CONNECTEURS CONNETTORI Εικόνα φικς	CONECTORES KOŃCÓWKI PRZYŁĄCZENIOWE STEKKEAFBEELDING	NTK	ORDER STOCK	mm
29 			OZA83-VN1	0124	1038
30 			OZA85-M1	0165	290
			OZA107-KH2	6407	317
			OZA502-E34	0436	320
			OZA502-E35	0447	265
			OZA502-E36	0458	285
31 			OZA74-F1	0401	480
			OZA74-F2	0433	280
			OZA74-F3	0446	250
			OZA112-A1	0146	850
			OZA112-A2	0225	300
			OZA112-A3	0157	600
			OZA114-A1	1856	290
			OZA253-F6	0122	250
			OZA591-BA1	6496	320
			OZA591-SZ1	1767	590
			OZA591-YB1	0011	590
			OZA603-N2	0012	271
			OZA629-W2	0017	400
			OZA629-W5	0018	510
		OZA629-W6	0019	310	

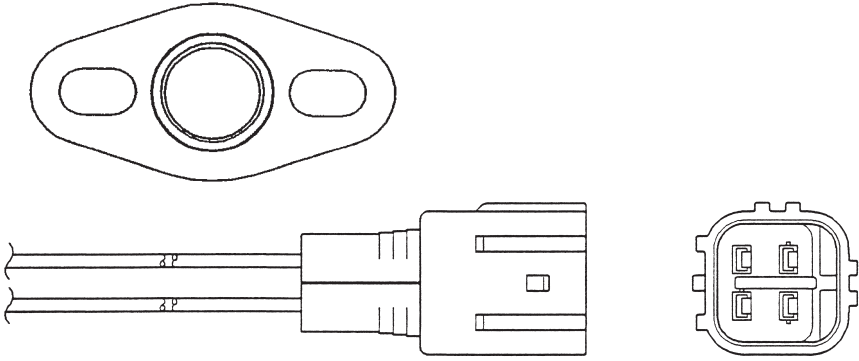
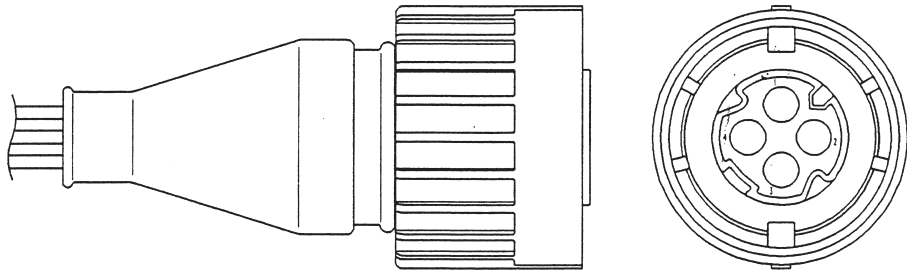
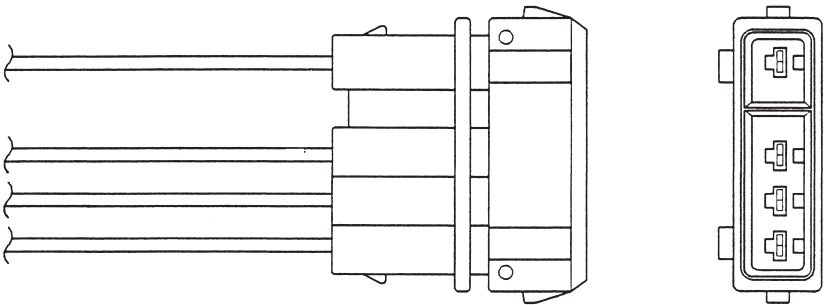
STECKERABBILDUNG CONNECTORS Вид штекера BAĞLANTI RESMİ	CONNECTEURS CONNETTORI Εικόνα φις	CONECTORES KOŃCÓWKI PRZYŁĄCZENIOWE STEKKERAFBEELDING	NTK	ORDER STOCK	mm
32 			OZA201-AM1	0168	393
			OZA201-AM2	0179	393
			OZA341-SZ2	0038	800
			OZA341-SZ3	0039	300
			OZA381-AM1	1707	650
			OZA381-D1	1820	372
			OZA381-D2	0451	271
			OZA381-D3	0462	393
			OZA381-D12	0041	296
			OZA488-AM1	0042	493
			OZA488-D1	0403	271
			OZA488-D2	1757	393
			OZA488-SZ1	1766	372
			OZA504-D2	1708	330
			OZA519-D1	0244	372
			OZA519-SZ2	0052	335
			OZA555-D2	0057	915
			OZA555-D3	0058	372
			OZA659-EE9	0383	375
			OZA659-EE43	1630	390
33 			OZA222-RV1	0136	540
			OZA341-BN1	0037	738
			OZA527-E8	0284	390
			OZA527-E9	0498	590
			OZA527-E18	0430	545

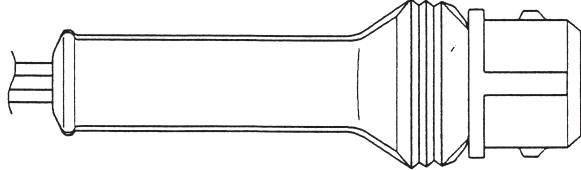
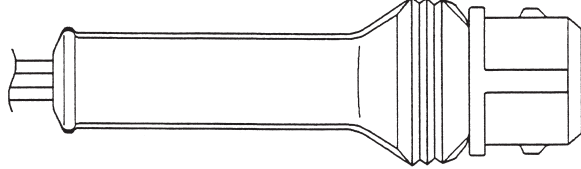
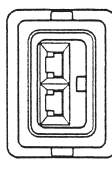
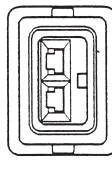
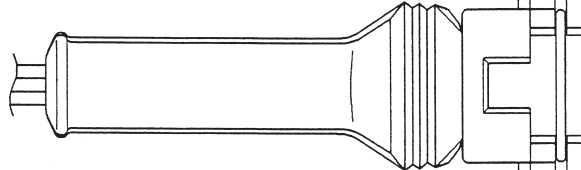
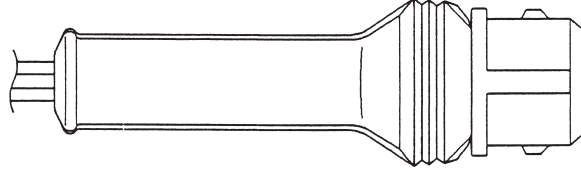
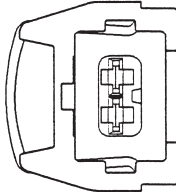
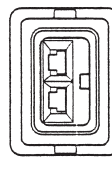
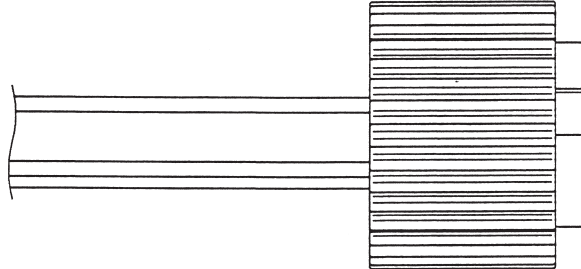
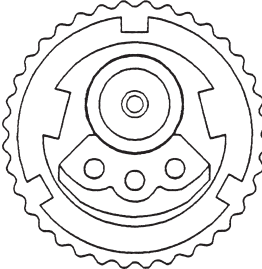
STECKERABBILDUNG CONNECTORS Вид штекера BAĞLANTI RESMİ	CONNECTEURS CONNETTORI Εικόνα φικς	CONECTORES KOŃCÓWKI PRZYŁĄCZENIOWE STEKKERAFBEELDING	NTK	ORDER STOCK	mm
34 * 	AZD0101-KJ002	6552	235		
	AZD0101-KJ004	6556	345		
	AZD0101-KJ006	6559	235		
	AZD0101-KJ008	6561	275		
	AZD0102-KJ001	6567	235		
	AZS0102-KJ003	6568	660		
	AZS0102-KJ004	6574	760		
	*OZA384-E32	0133	392		
	*OZA384-E39	0473	300		
	*OZA384-E40	0484	338		
	*OZA447-E41	1739	525		
	*OZA448-E16	1839	200		
	OZA448-E47	0228	310		
	OZA502-E31	0250	275		
	OZA659-EE63	7948	290		
	OZA669-EE8	7953	640		
OZA669-EE12	7973	330			
35 	OZA527-E27	0466	1490		
	OZA572-E2	0252	510		
	OZA572-E3	0264	730		
	OZA572-E4	0295	1420		
	OZA572-E5	0242	400		
	OZA572-E8	0209	540		
	OZA572-E12	0273	910		
	OZA660-EE14	5707	1445		
36 	OZA447-E13	0183	517		
	OZA457-I1	0414	516		
	OZA527-E14	0455	622		
	OZA527-E36	1993	1075		
	OZA572-E1	0283	550		
	OZA572-E13	0254	585		

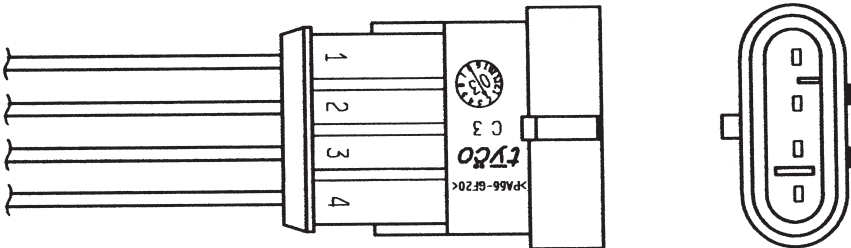
STECKERABBILDUNG CONNECTORS Вид штекера BAĞLANTI RESMİ	CONNECTEURS CONNETTORI Εικόνα φις	CONECTORES KOŃCÓWKI PRZYŁĄCZENIOWE STEKKERAFBEELDING	NTK	ORDER STOCK	mm
37 		 	OZA527-E2	0265	510
			OZA527-E22	0274	1210
38 		 	OZA527-E4	0218	880
			OZA527-E5	0253	1130
39 			OZA527-E6	0463	875

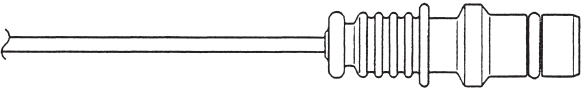
STECKERABBILDUNG CONNECTORS Вид штекера BAĞLANTI RESMİ	CONNECTEURS CONNITORI Εικόνα φης	CONECTORES KOŃCÓWKI PRZYŁĄCZENIOWE STEKKERAFBEELDING	NTK	ORDER STOCK	mm													
<div style="border: 1px solid black; border-radius: 50%; width: 30px; height: 30px; display: flex; align-items: center; justify-content: center; margin-bottom: 10px;">40</div>  <table border="1" style="margin-left: auto; margin-right: auto; border-collapse: collapse;"> <thead> <tr> <th>NTK</th> <th>ORDER STOCK</th> <th>mm</th> </tr> </thead> <tbody> <tr> <td>OZA112-A4</td> <td>0236</td> <td>800</td> </tr> <tr> <td>OZA112-A6</td> <td>1759</td> <td>400</td> </tr> <tr> <td>OZA112-A7</td> <td>1760</td> <td>700</td> </tr> <tr> <td></td> <td></td> <td></td> </tr> </tbody> </table>	NTK	ORDER STOCK	mm	OZA112-A4	0236	800	OZA112-A6	1759	400	OZA112-A7	1760	700				OZA334-A1	0223	610
	NTK	ORDER STOCK	mm															
	OZA112-A4	0236	800															
	OZA112-A6	1759	400															
	OZA112-A7	1760	700															
	OZA334-A2	0234	980															
	OZA334-A3	0245	310															
	OZA341-A1	1798	310															
	OZA341-BB1	0036	310															
	OZA527-E7	0213	972															
	OZA527-E19	0296	378															
	OZA527-E20	1797	885															
	OZA527-E24	0287	1175															
	OZA532-A1	0478	980															
	OZA532-A2	0489	610															
	OZA532-A3	0409	260															
	OZA532-A4	1786	1370															
	OZA532-A5	1792	1810															
	OZA532-A7	1796	980															
	OZA532-A9	1793	810															
	OZA532-A10	1794	310															
	OZA534-A1	1762	610															
	OZA534-A2	1764	410															
	OZA534-A3	1800	980															
	OZA591-BB2	1710	310															
	OZA591-BB3	0066	880															
	OZA659-EE3	0377	300															
	OZA659-EE30	1612	1170															
	OZA659-EE31	1613	600															
	OZA659-EE49	5753	400															
	OZA659-EE56	7863	600															
OZA659-EE57	7864	2020																
OZA659-EE58	7903	820																
OZA659-EE59	7904	2315																
OZA659-EE60	7905	2000																
OZA675-EE1	7978	300																

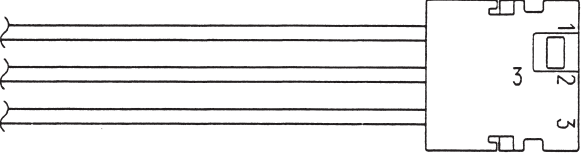
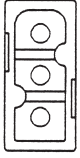
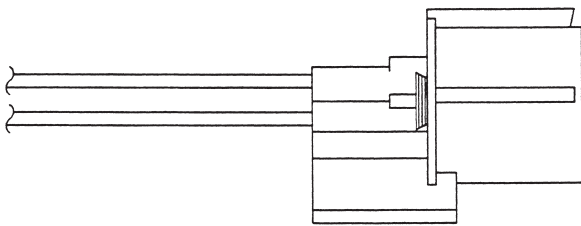
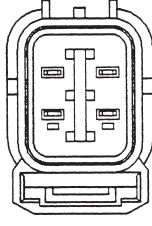
STECKERABBILDUNG CONNECTORS Вид штекера BAĞLANTI RESMİ	CONNECTEURS CONNETTORI Εικόνα φις	CONECTORES KOŃCÓWKI PRZYŁĄCZENIOWE STEKKERAFBEELDING	NTK	ORDER STOCK	mm
41			OZA527-E10	0263	770
			OZA527-E25	0444	750
42			OZA341-W2	0440	310
			OZA448-E49	0404	320
43			OZA527-E11	1787	820
			OTD3J-5C1	0475	521
			OZA245-H2	0180	225
			OZA333-H4	0137	320
			OZA333-H5	0148	410
			OZA333-H6	0159	235
			OZA333-H25	0288	245
			OZA333-H26	0299	320
			OZA333-H27	0212	410
			OZA421-H1	0255	240
			OZA444-E1	0439	410
			OZA501-H17	0266	240
			OZA502-E28	0425	410
OZA563-H5	0061	340			
OZA563-H6	0062	300			
OZA569-H1	0499	240			
OZA660-EE18	5714	350			

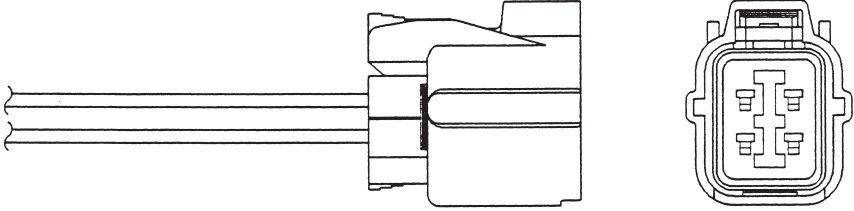
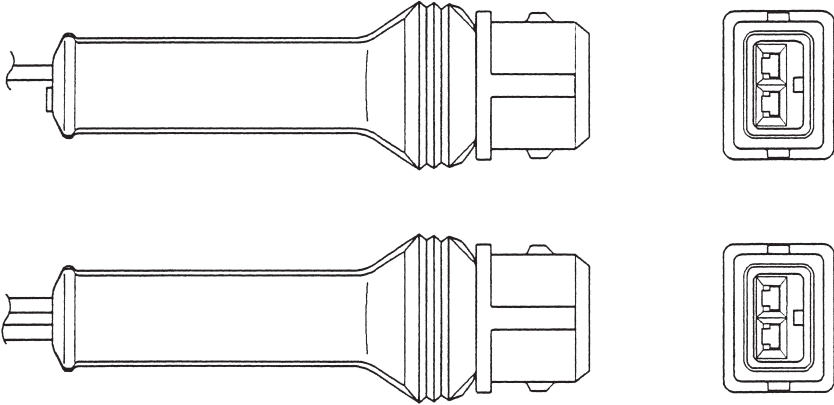
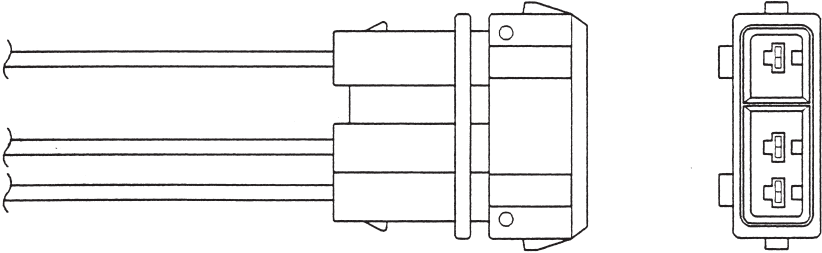
STECKERABBILDUNG CONNECTORS Вид штекера BAĞLANTI RESMİ	CONNECTEURS CONNITORI Εικόνα φικς	CONECTORES KOŃCÓWKI PRZYŁĄCZENIOWE STEKKEAFBEELDING	NTK	ORDER STOCK	mm
<p>44</p> 			OZA245-H1	0169	410
			OZA333-H19	0277	450
			OZA501-H20	0045	595
			OZA501-H23	0469	450
			OZA508-H4	0046	535
			OZA562-H7	0059	740
			OZA562-H9	0060	455
			OZA563-H8	0063	690
			OZA614-H3	0071	500
			OZA668-EE12	7951	535
			OZA669-EE11	7971	595
<p>45</p> 			OZA446-E48	0280	510
<p>46</p> 			OZA446-E51	0215	545
			OZA446-E52	0226	430
			OZA446-E53	0237	335

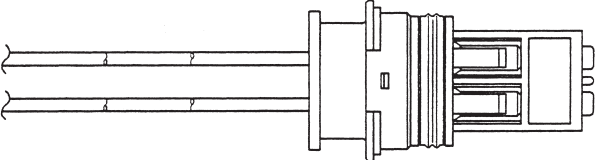
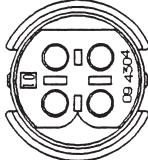
STECKERABBILDUNG CONNECTORS Вид штекера BAĞLANTI RESMİ	CONNECTEURS CONNETTORI Εικόνα φις	CONECTORES KOŃCÓWKI PRZYŁĄCZENIOWE STEKKERAFBEELDING	NTK	ORDER STOCK	mm
<div data-bbox="92 277 150 331" style="border: 1px solid black; border-radius: 50%; width: 36px; height: 24px; display: flex; align-items: center; justify-content: center; margin-bottom: 10px;">47</div> <div style="display: flex; justify-content: space-around; align-items: center;">   </div>	OTA7N-5C1	1963	968		
	OZA447-E21	0216	565		
	OZA447-E22	0227	625		
	OZA447-E34	0482	815		
	OZA447-E44	1976	465		
	OZA448-E29	0182	1145		
	OZA448-E45	0206	985		
	OZA448-E54	0459	280		
	OZA527-E13	0285	830		
	OZA572-E6	1777	350		
	OZA572-E14	0408	570		
	OZA659-EE15	0389	240		
	OZA659-EE22	0396	320		
	OZA659-EE24	0398	400		
	OZA659-EE26	0400	435		
	OZA659-EE27	1609	380		
	OZA659-EE29	1611	480		
	OZA659-EE34	1618	585		
	OZA659-EE35	1619	460		
	OZA659-EE37	1624	565		
	OZA659-EE42	1629	295		
	OZA660-EE8	5682	325		
	OZA673-EE1	7974	485		
	OZA674-EE1	7975	465		

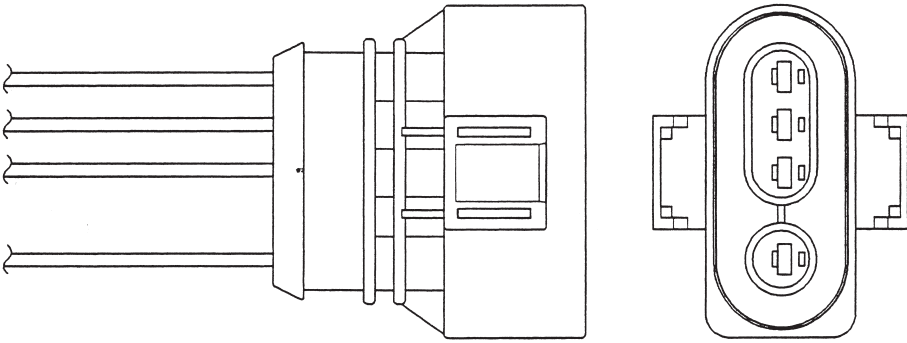
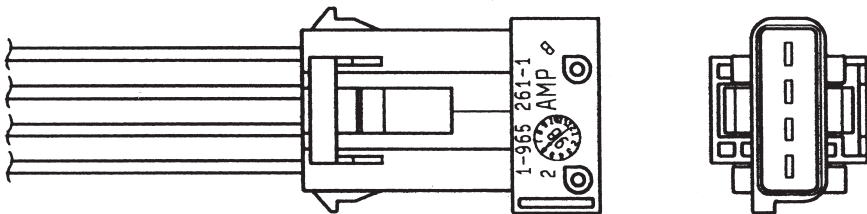
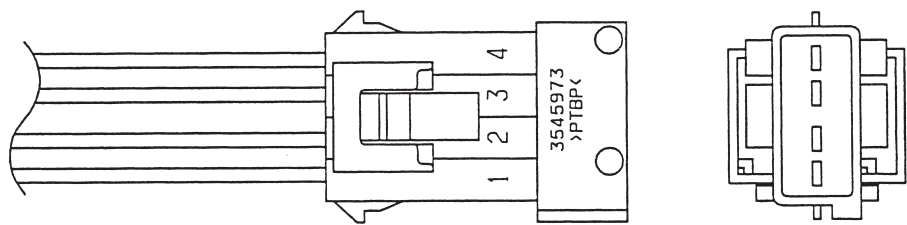
STECKERABBILDUNG CONNECTORS Вид штекера BAĞLANTI RESMİ	CONNECTEURS CONNETTORI Εικόνα φικς	CONECTORES KOŃCÓWKI PRZYŁĄCZENIOWE STEKKERAFBEELDING	NTK	ORDER STOCK	mm
48 			OZA114-V4	1769	290
			OZA447-E14	0129	967
			OZA447-E16	0259	550
			OZA447-E30	0449	985
			OZA447-E31	0460	720
			OZA447-E36	1950	1430
			OZA448-E31	0151	520
			OZA572-E9	0423	620
			OZA572-E10	0275	1430
			OZA572-E11	0251	780
			OZA659-EE36	1620	615
			OZA659-EE46	5748	1435
49 			OZA334-PG1	1790	536
			OZA448-E56	0481	1480
			OZA448-E57	0492	380
			OZA527-E15	0298	375
			OZA527-E16	0434	630
			OZA527-E17	0445	1220
			OZA575-GM1	1895	425
			OZA575-GM2	1896	355
50 			OTA4N-5B1	1765	530

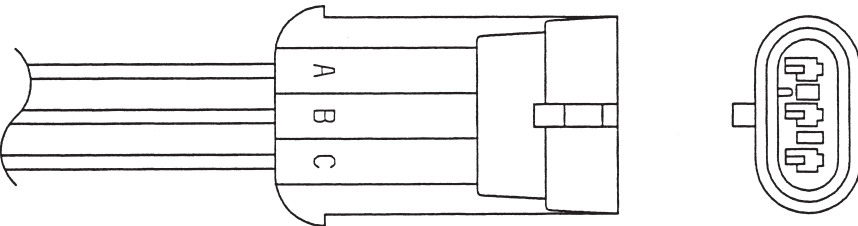
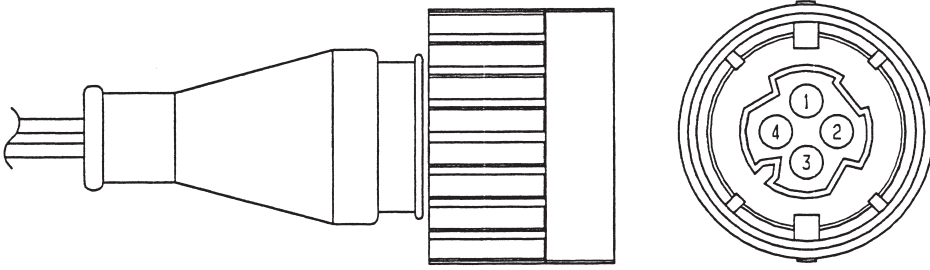
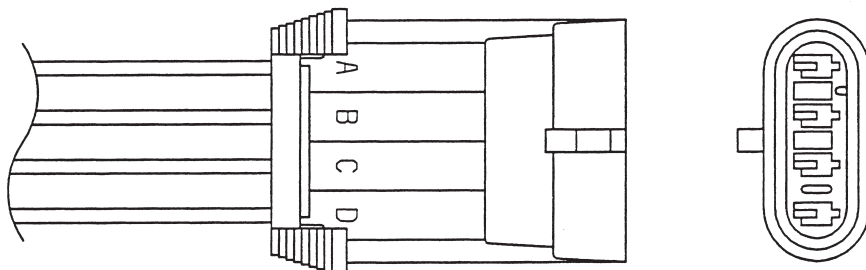
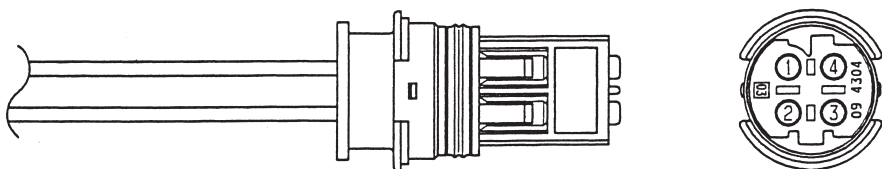

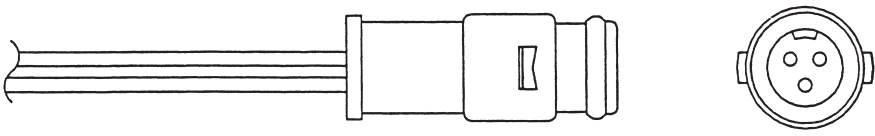
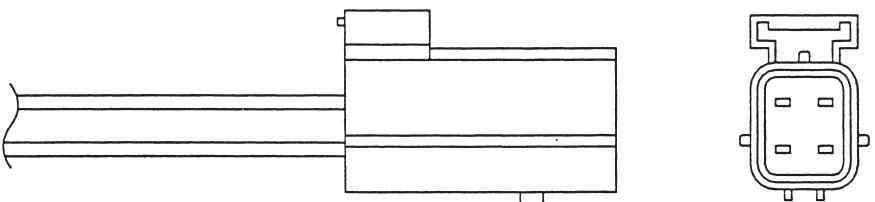
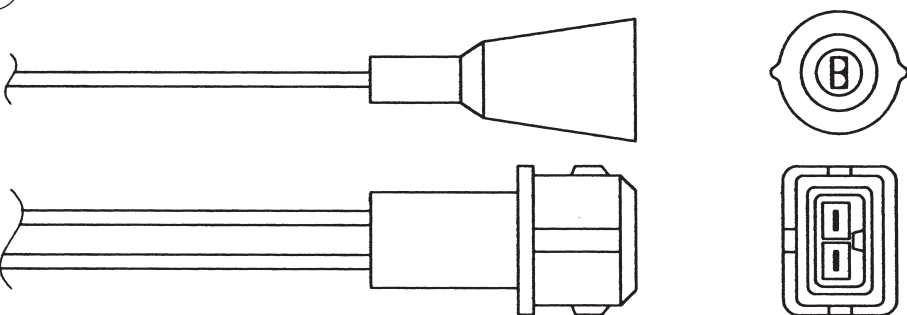
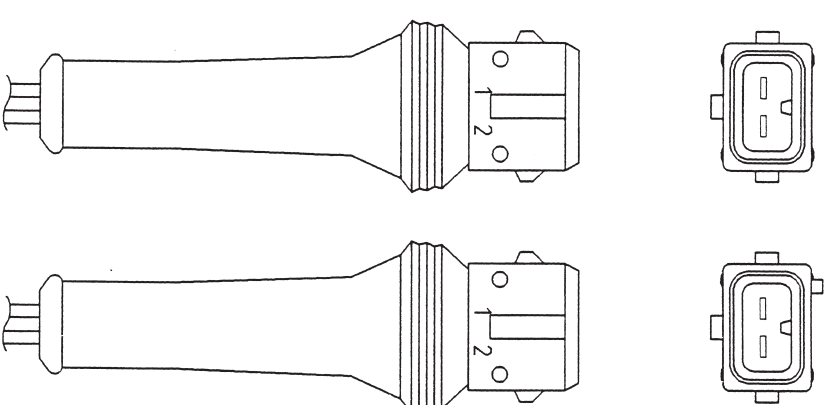
STECKERABBILDUNG CONNECTORS Вид штекера BAĞLANTI RESMİ	CONNECTEURS CONNETTORI Εικόνα φις	CONECTORES KOŃCÓWKI PRZYŁĄCZENIOWE STEKKERAFBEELDING	NTK	ORDER STOCK	mm	
51 	OTA5F-3C1	1921	1700			
	OTA6F-3A1	1928	1000			
52 	OTA7H-3A1	1932	1408			
	OTA7H-3A2	1943	398			
	OTA7N-5B1	1973	238			
53 	OTA7H-3C1	1954	828			
	OTA7H-3C2	0420	338			
	OTA7L-3C3	0442	708			
	OTA7L-3C4	0431	338			
	OTA7N-5A1	1920	620			
	OTA7N-5A2	1938	770			
54 	OTA7H-5A1	0486	968			
	OTA7N-5D1	1974	388			
	OTA7N-5D2	1975	638			
	OTA7N-5D3	1991	968			
	OZA600-BM1	0068	736			
	OZA600-BM2	1845	591			
	OZA600-BM5	1846	431			
	OZA600-BM7	1847	241			

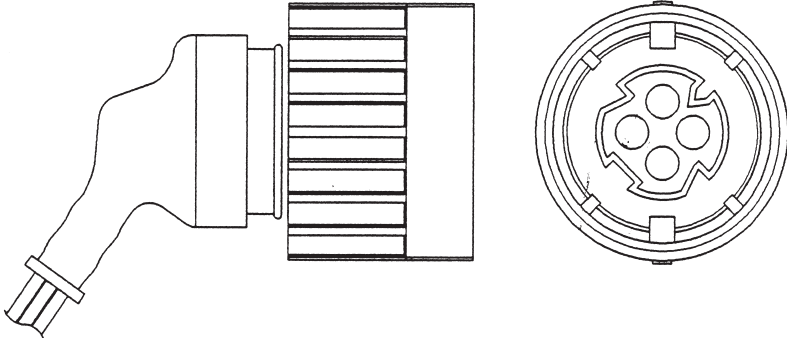
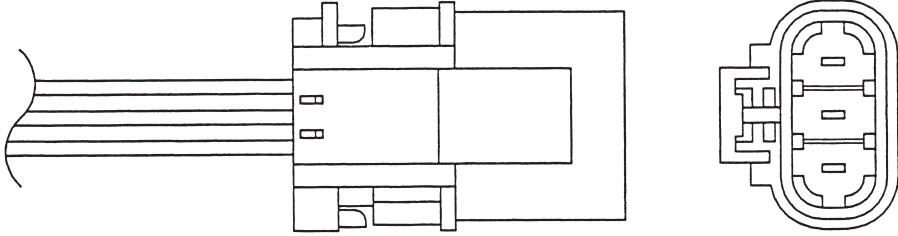
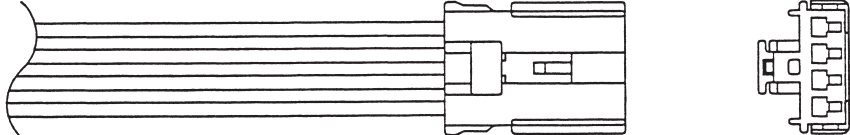
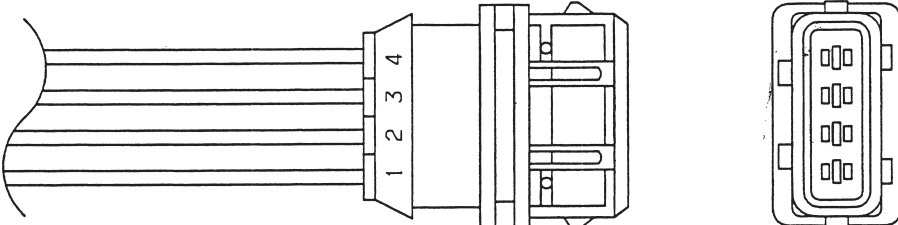
STECKERABBILDUNG CONNECTORS Вид штекера BAĞLANTI RESMİ	CONNECTEURS CONNETTORI Εικόνα φικς	CONECTORES KOŃCÓWKI PRZYŁĄCZENIOWE STEKKERAFBEELDING	NTK	ORDER STOCK	mm
55 			OTD3G-3A1	0453	521
56 			OTD3J-5A3	0024	460
			OTD3J-5B1	0464	730
57 			OTA4F-3B1	1763	1700
58 			OZA527-E3	0201	1470
			OZA527-E12	0220	450

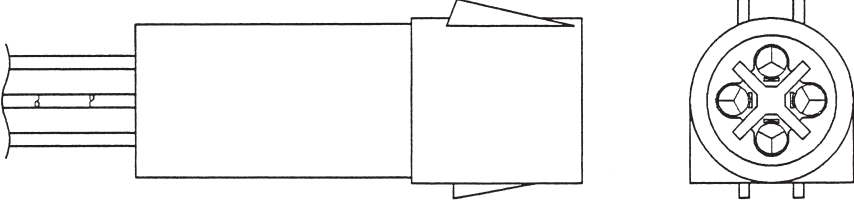
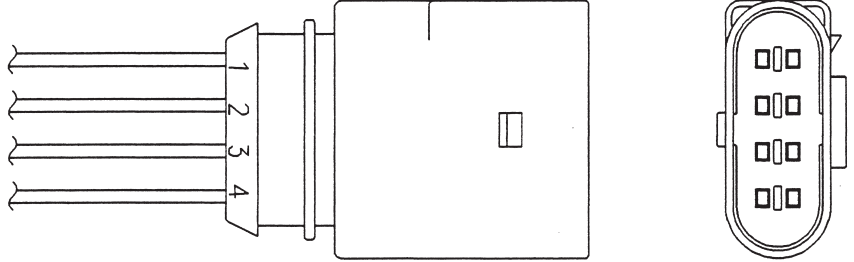
STECKERABBILDUNG CONNECTORS Вид штекера BAĞLANTI RESMİ	CONNECTEURS CONNETTORI Εικόνα φις	CONECTORES KOŃCÓWKI PRZYŁĄCZENIOWE STEKKERAFBEELDING	NTK	ORDER STOCK	mm
<div style="text-align: center;"> 59 </div> 			OZA572-E7	0419	675
<div style="text-align: center;"> 60 </div> 			OTD2F-1P2	0022	196
			OTD2F-3K1	1907	810
<div style="text-align: center;"> 61 </div> 			OTA4F-5E1	1942	870
			OTA4F-5F1	1908	663
			OTA4F-5G2	1927	750
			OTA4N-5F1	1795	343
			OTA4N-5G1	1758	750
			OTA4N-5H1	1768	750
			OZA324-L2	1780	1356
<div style="text-align: center;"> 62 </div> 			OTA4F-5C2	1948	1039

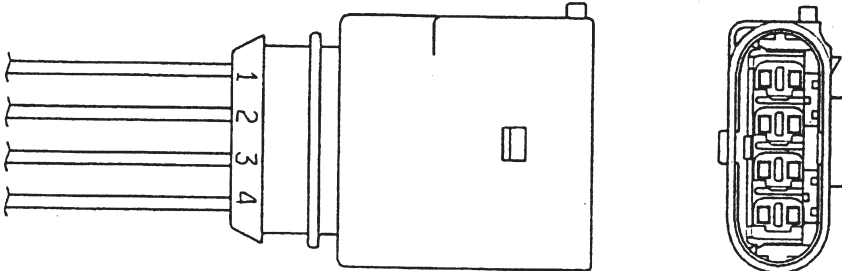
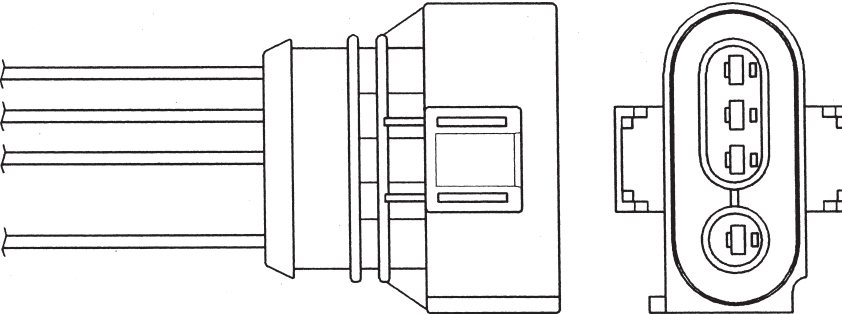
STECKERABBILDUNG CONNECTORS Вид штекера BAĞLANTI RESMİ	CONNECTEURS CONNETTORI Εικόνα φικς	CONECTORES KOŃCÓWKI PRZYŁĄCZENIOWE STEKKEAFBEELDING	NTK	ORDER STOCK	mm
63 			OZA527-E21	1817	270
			OZA527-E28	0477	720
64 			OZA447-E17	0270	470
			OZA447-E18	0281	620
			OZA447-E32	0471	700
			OZA447-E40	1738	995
			OZA448-E51	0426	475
			OZA510-V1	0491	1686
			OZA510-V2	0402	1576
			OZA510-V5	0435	526
			OZA510-V6	1885	251
			OZA510-V7	1886	1706
			OZA510-V10	1883	1596
			OZA516-AU1	0452	1055
			OZA532-V4	0006	600
			OZA534-V1	1778	611
			OZA585-I1	1809	601
			OZA659-EE1	0375	975
			OZA659-EE16	0390	1670
			OZA659-EE17	0391	1175
			OZA659-EE20	0394	1590
			OZA659-EE25	0399	1135
		OZA659-EE40	1627	535	

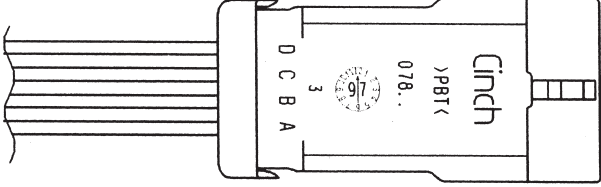
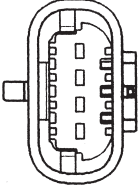
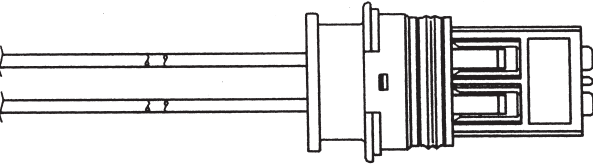
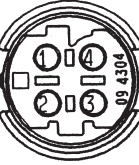
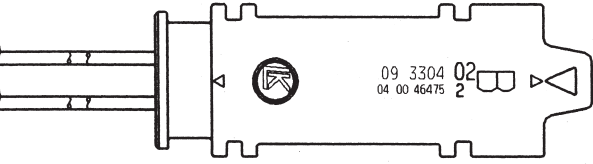
STECKERABBILDUNG CONNECTORS Вид штекера BAĞLANTI RESMİ	CONNECTEURS CONNETTORI Εικόνα φις	CONECTORES KOŃCÓWKI PRZYŁĄCZENIOWE STEKKERAFBEELDING	NTK	ORDER STOCK	mm
<div style="display: flex; align-items: center;"> <div style="margin-right: 20px;"> <p>65</p>  </div> </div>			OZA334-AU1	0474	700
			OZA334-AU2	1789	780
			OZA510-AU1	1782	620
			OZA510-I1	1808	231
			OZA510-V3	0413	1326
			OZA510-V4	0424	541
			OZA659-EE11	0385	740
			OZA659-EE14	0388	560
			OZA659-EE18	0392	490
			OZA659-EE19	0393	545
			OZA659-EE23	0397	575
			OZA659-EE32	1614	480
			OZA659-EE33	1617	700
			OZA659-EE38	1625	505
			OZA659-EE64	7949	690
<div style="display: flex; align-items: center;"> <div style="margin-right: 20px;"> <p>66</p>  </div> </div>			OZA447-E25	0494	1140
			OZA447-E35	0493	1350
			OZA659-EE47	5750	1440

STECKERABBILDUNG CONNECTORS Вид штекера BAĞLANTI RESMİ	CONNECTEURS CONNETTORI Εικόνα φικς	CONECTORES KOŃCÓWKI PRZYŁĄCZENIOWE STEKKERAFBEELDING	NTK	ORDER STOCK	mm
<div style="display: flex; align-items: center;"> <div style="margin-right: 20px;"> <p>67</p>  </div> <div>  </div> </div>	OZA277-R1	1704	260		
	OZA277-R2	0468	445		
	OZA448-E50	0415	380		
	OZA507-R1	6515	210		
	OZA507-R2	0480	445		
	OZA636-R1	0020	445		
	OZA659-EE6	0380	455		
	OZA659-EE13	0387	330		
	OZA659-EE53	7858	380		
	OZA659-EE54	7859	545		
	OZA660-EE12	5698	350		
	OZA660-EE21	5719	450		
	<div style="display: flex; align-items: center;"> <div style="margin-right: 20px;"> <p>68</p>  </div> <div>  </div> </div>	OZA447-E27	0416	290	
OZA447-E28	0427	340			
OZA600-BM8	0069	281			
OZA630-BM3	0074	341			
OZA659-EE55	7860	430			
OZA660-EE9	5694	655			
OZA660-EE17	5713	970			
OZA660-EE19	5716	550			
OZA660-EE22	5720	745			
<div style="display: flex; align-items: center;"> <div style="margin-right: 20px;"> <p>69</p>  </div> <div>  </div> </div>	OZA447-E29	0438	975		
OZA522-BM1	0053	922			
OZA522-BM2	0054	554			
OZA660-EE5	5662	730			

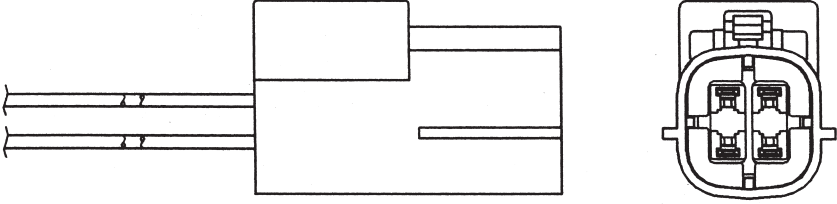
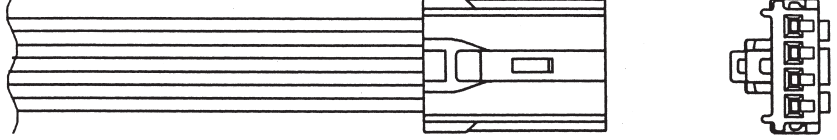
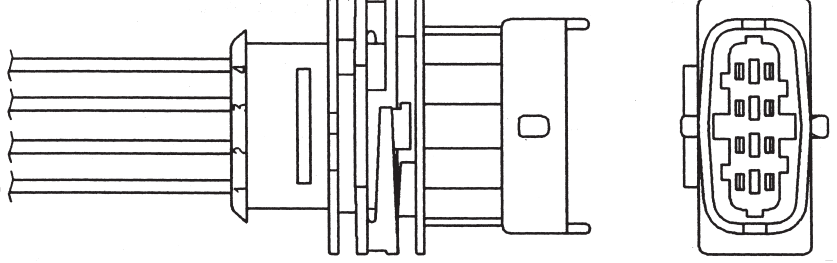
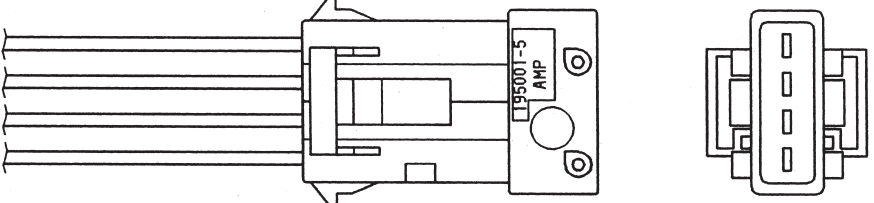
STECKERABBILDUNG CONNECTORS Вид штекера BAĞLANTI RESMİ	CONNECTEURS CONNETTORI Εικόνα φις	CONECTORES KOŃCÓWKI PRZYŁĄCZENIOWE STEKKERAFBEELDING	NTK	ORDER STOCK	mm
70 			OZA448-E58	1909	350
			OZA544-N7	6497	271
			OZA544-N8	1804	371
			OZA544-N14	6513	401
71 			OZA448-E52	0437	340
72 			OZA447-E26	0405	510
			OZA660-EE4	5658	770
			OZA660-EE7	5681	515
			OZA660-EE10	5695	655
73 			OZA527-E29	0488	370
			OZA527-E33	1980	1460
			OZA527-E34	1981	530
			OZA527-E35	1982	1220
			OZA660-EE11	5697	740
			OZA660-EE20	5717	415

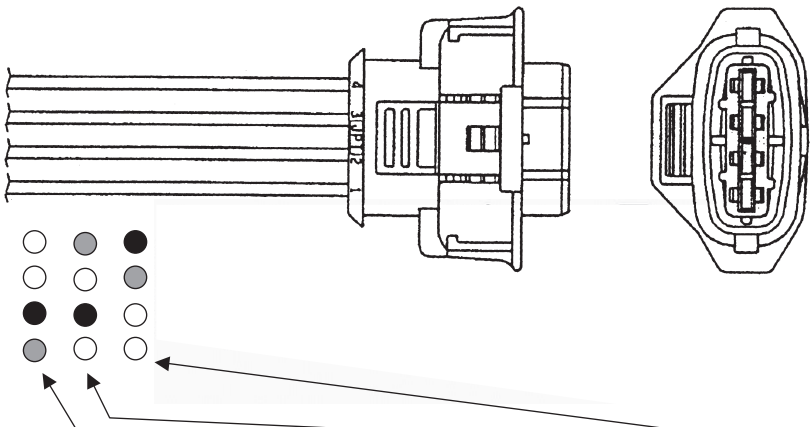
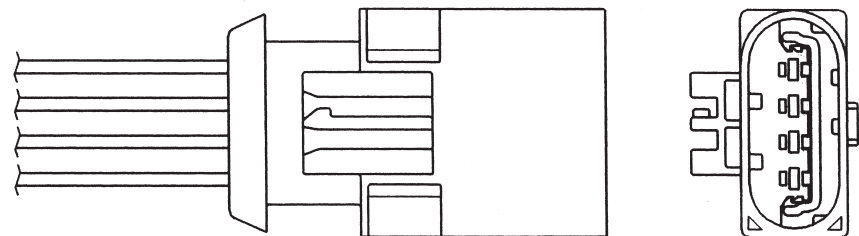
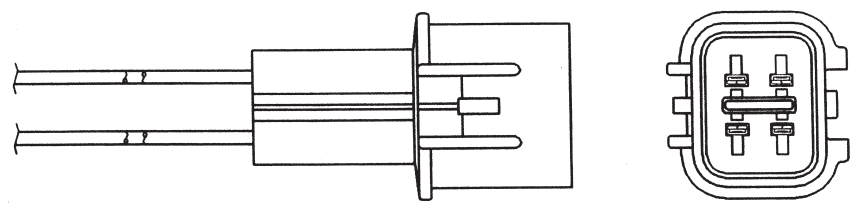
STECKERABBILDUNG CONNECTORS Вид штекера BAĞLANTI RESMİ	CONNECTEURS CONNETTORI Εικόνα φις	CONECTORES KOŃCÓWKI PRZYŁĄCZENIOWE STEKKERAFBEELDING	NTK	ORDER STOCK	mm
<p>74</p>  <p> White ○ White ○ Black ● Grey ● </p> <p> Grey ● White ○ Black ● White ○ </p> <p> Black ● Grey ● White ○ White ○ </p> <p> OZA531-GM2 (1863) OZA531-GM3 (1864) OZA531-GM22 (1892) OZA531-GM24 (0055) </p> <p> OZA334-SZ1 (0485) OZA334-SZ2 (0496) OZA334-SZ3 (0407) OZA334-SZ4 (0418) OZA334-SZ5 (1705) OZA334-SZ6 (1706) </p> <p> OZA659-EE5 (0379) OZA659-EE7 (0381) OZA659-EE28 (1610) OZA659-EE39 (1626) OZA659-EE51 (1995) OZA660-EE3 (5656) OZA660-EE13 (5706) </p>	OZA334-SZ1	0485	741		
	OZA334-SZ2	0496	571		
	OZA334-SZ3	0407	401		
	OZA334-SZ4	0418	271		
	OZA334-SZ5	1705	471		
	OZA334-SZ6	1706	471		
	OZA531-GM2	1863	1245		
	OZA531-GM22	1892	1465		
	OZA531-GM24	0055	1485		
	OZA531-GM3	1864	1115		
	OZA659-EE28	1610	520		
	OZA659-EE39	1626	270		
	OZA659-EE5	0379	295		
	OZA659-EE51	1995	600		
OZA659-EE7	0381	420			
OZA660-EE13	5706	285			
<p>75</p> 	OZA341-RV2	0429	620		
	OZA495-RV1	0043	620		
	OZA495-RV2	0044	428		
<p>76</p> 	OZA448-E53	0448	400		

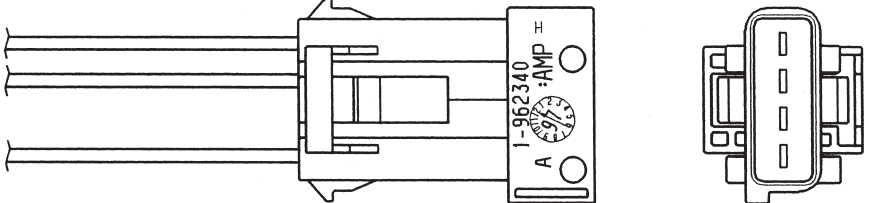
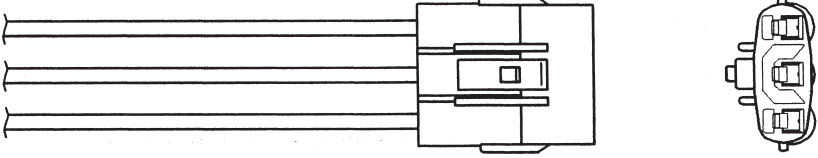
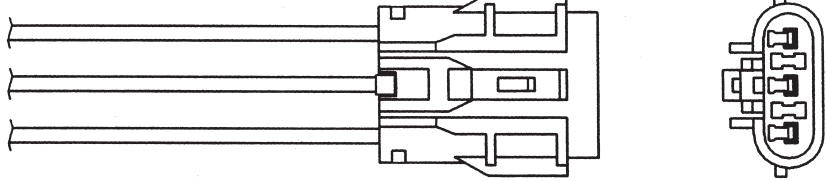
STECKERABBILDUNG CONNECTORS Вид штекера BAĞLANTI RESMİ	CONNECTEURS CONNETTORI Εικόνα φικς	CONECTORES KOŃCÓWKI PRZYŁĄCZENIOWE STEKKERAFBEELDING	NTK	ORDER STOCK	mm
<p>77</p> 			OZA446-E58	0483	1095
<p>78</p> 			OZA21-F3	0256	420
<p>79</p> 			OZA446-E56	0461	265

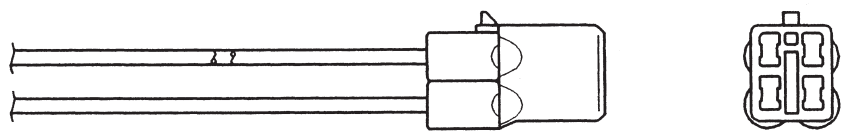
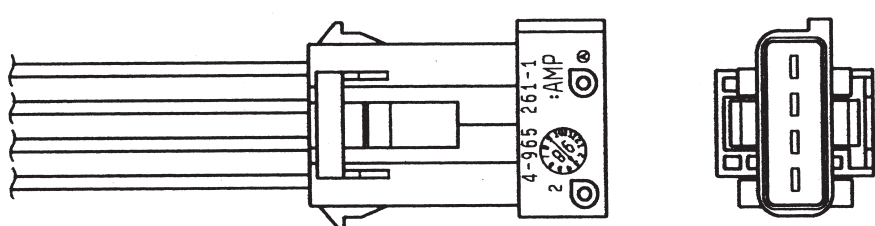
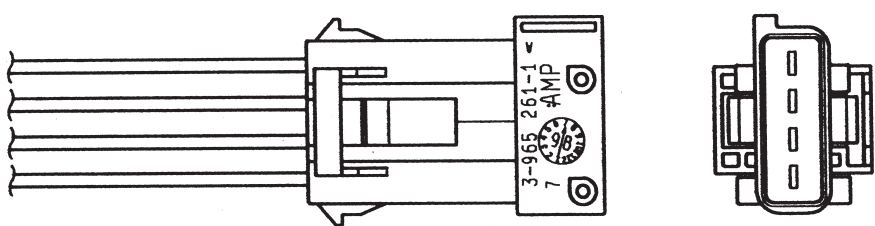
STECKERABBILDUNG CONNECTORS Вид штекера BAĞLANTI RESMİ	CONNECTEURS CONNITORI Εικόνα φικς	CONECTORES KOŃCÓWKI PRZYŁĄCZENIOWE STEKERAFBEELDING	NTK	ORDER STOCK	mm
80 			AZD0102-HG004	7665	590
			OZA395-E9	0495	440
			OZA446-E55	0450	440
			OZA448-J1	6413	420
			OZA448-J3	6415	630
			OZA448-J4	0003	690
			OZA448-J5	0004	370
			OZA577-H12	6473	970
			OZA577-H17	0007	990
			OZA577-H21	6479	865
OZA577-H24	6484	675			
OZA591-J2	6454	365			
OZA656-H1	6491	305			
OZA656-H3	6493	500			
81 			OZA324-L1	1779	570
82 			OZA341-PG5	1813	536
			OZA341-PG6	1814	1236
			OZA341-PG7	1815	1486
			OZA341-PG8	1816	1836
			OZA538-PG1	1818	1236
			OZA538-PG2	1819	1836
			OZA628-U1	0016	446
			OZA659-EE10	0384	535
			OZA659-EE21	0395	1490
			OZA659-EE52	1996	1230
OZA659-EE61	7915	1850			

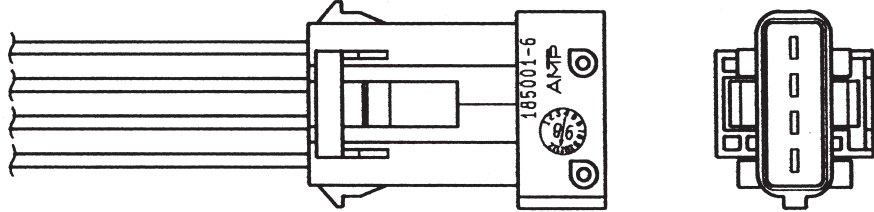
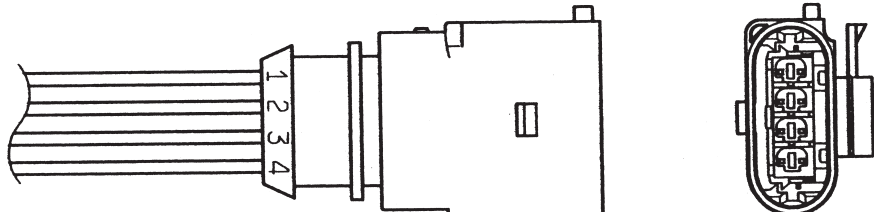
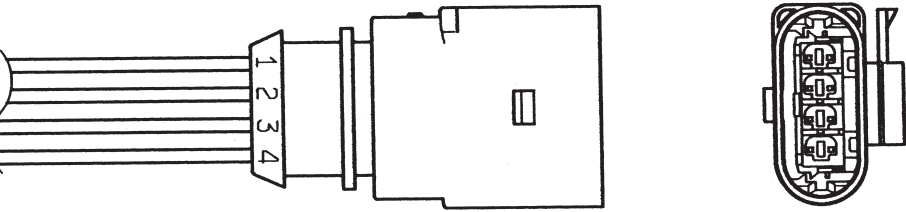
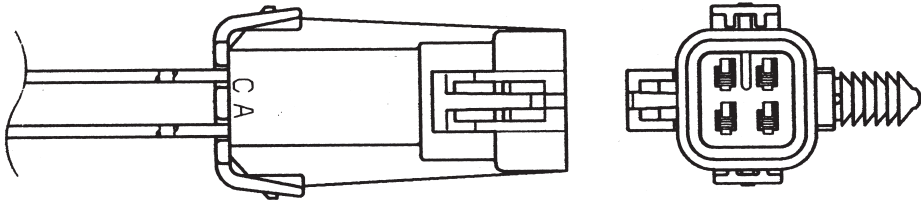
STECKERABBILDUNG CONNECTORS Вид штекера BAĞLANTI RESMİ	CONNECTEURS CONNETTORI Εικόνα φις	CONECTORES KOŃCÓWKI PRZYŁĄCZENIOWE STEKKERAFBEELDING	NTK	ORDER STOCK	mm
83 	OZA495-PG2	1852	536		
	OZA495-PG3	1853	1236		
	OZA608-U2	0070	381		
	OZA659-EE4	0378	540		
	OZA659-EE8	0382	1230		
	OZA659-EE12	0386	380		
84 	OZA510-AU2	1783	971		
	OZA510-AU4	0047	591		
	OZA510-AU6	0049	591		
	OZA629-V3	1720	511		
	OZA629-V5	1722	521		
85 	OZA510-AU3	1784	971		
	OZA510-AU5	0048	541		
	OZA510-AU7	0050	721		
	OZA510-V11	1884	471		
	OZA510-V12	0051	511		
	OZA532-V3	1776	481		
	OZA629-V4	1721	526		
	OZA629-V6	1723	651		
	OZA629-V7	1725	601		
86 	OZA531-GM1	1862	660		
	OZA531-GM6	1869	607		
	OZA531-GM7	1870	247		
	OZA583-GM1	1753	312		

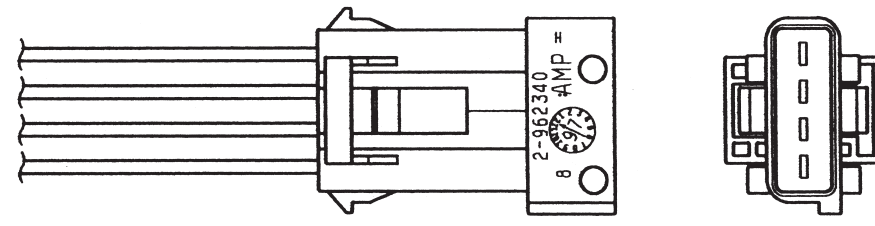
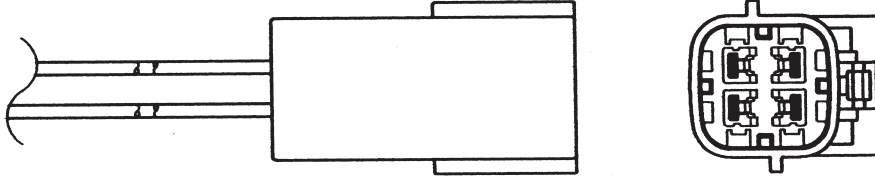
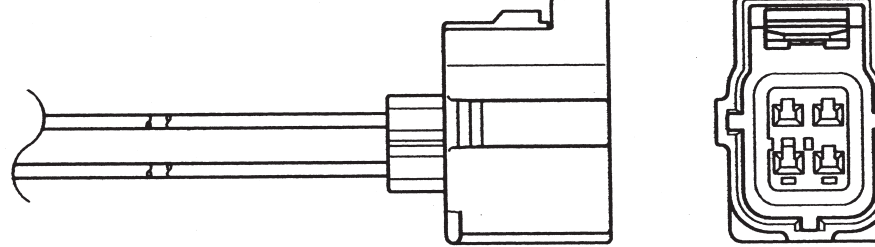
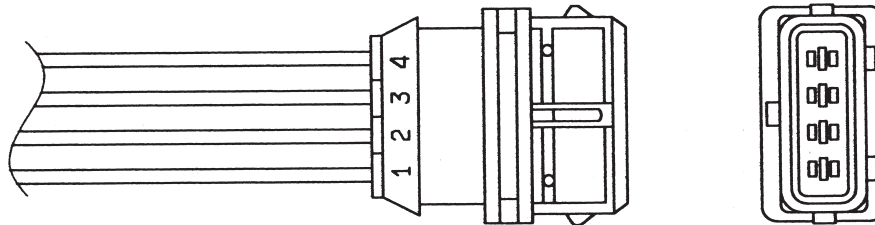
STECKERABBILDUNG CONNECTORS Вид штекера BAĞLANTI RESMİ	CONNECTEURS CONNETTORI Εικόνα φικς	CONECTORES KOŃCÓWKI PRZYŁĄCZENIOWE STEKKEAFBEELDING	NTK	ORDER STOCK	mm
<div style="display: flex; align-items: center;"> <div style="margin-right: 20px;"> 87 </div>  </div>	OZA531-GM16	1891	1465		
	OZA583-GM2	1754	725		
	OZA676-EE1	7979	380		
	Empty cells for this row				
<div style="display: flex; align-items: center;"> <div style="margin-right: 20px;"> 88 </div>  </div>	OZA544-R1	1857	500		
	Empty cells for this row				
	<div style="display: flex; align-items: center;"> <div style="margin-right: 20px;"> 89 </div>  </div>	OZA571-C2	6384	425	
		OZA571-C10	1836	300	
OZA571-GB1		1709	300		
Empty cells for this row					
<div style="display: flex; align-items: center;"> <div style="margin-right: 20px;"> 90 </div>  </div>	OTA4N-5D1	1785	1362		
	Empty cells for this row				
	Empty cells for this row				
	Empty cells for this row				

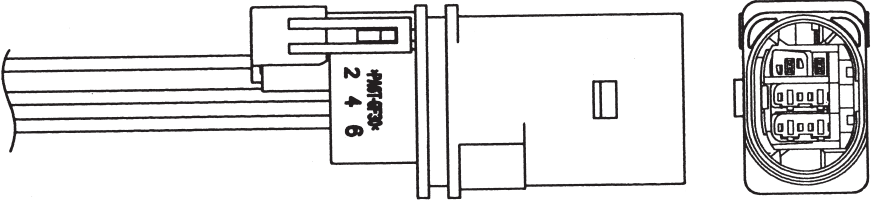
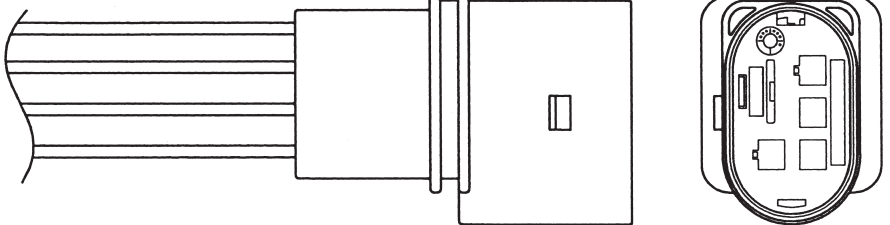
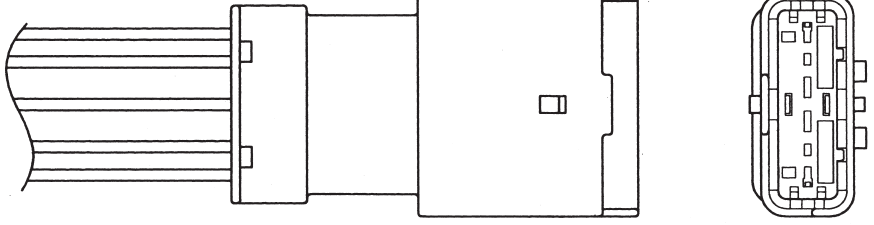
STECKERABBILDUNG CONNECTORS Вид штекера BAĞLANTI RESMİ	CONNECTEURS CONNETTORI Εικόνα φις	CONECTORES KOŃCÓWKI PRZYŁĄCZENIOWE STEKKERAFBEELDING	NTK	ORDER STOCK	mm
91 	LZA07-AU1	1772	600		
	LZA07-AU3	0027	830		
	LZA07-V3	1880	330		
	LZA07-V4	0028	725		
	LZA15-A1	0029	660		
	LZA15-A3	0031	318		
	LZA15-A5	1727	610		
	LZA15-GM1	0032	990		
	LZA15-GM3	1728	860		
	LZA17-VW1	0033	680		
92 	LZA07-V1	1851	750		
	LZA07-V2	1868	680		
	LZA11-V1	1825	250		
	LZA11-V2	1774	535		
	LZA11-V3	1829	465		
	LZA11-V4	1842	810		
93 	LZA06-U1	1840	375		

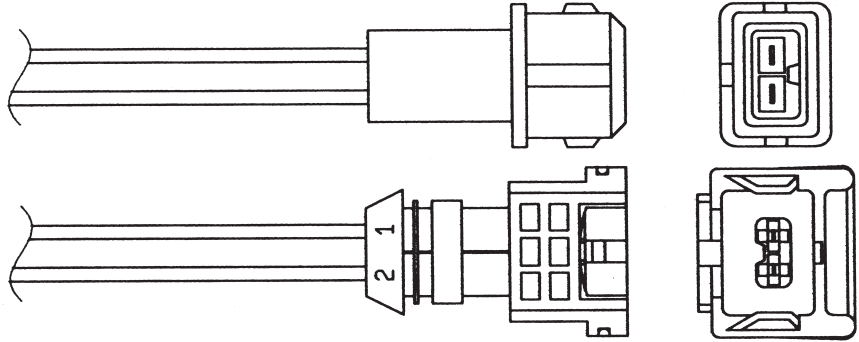
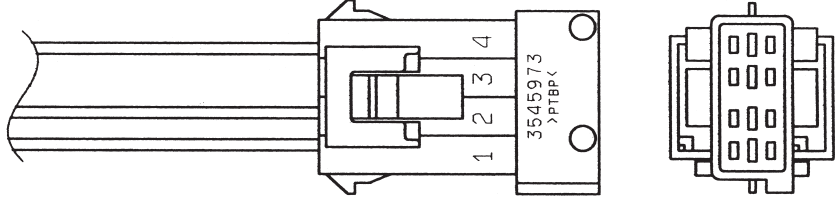
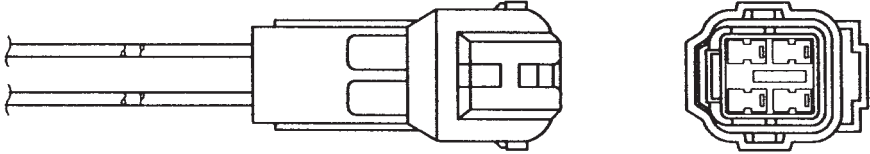
STECKERABBILDUNG CONNECTORS Вид штекера BAĞLANTI RESMİ	CONNECTEURS CONNETTORI Εικόνα φικς	CONECTORES KOŃCÓWKI PRZYŁĄCZENIOWE STEKKERAFBEELDING	NTK	ORDER STOCK	mm
94 			OTA4N-5A1	1755	530
95 			OTA4F-3C1	1773	1900
96 			OZA333-H29	6459	510
			OZA333-H30	6460	340
			OZA333-H31	6462	300
			OZA577-H4	6463	530
			OZA577-H5	6469	530
			OZA577-H6	0065	280
			OZA577-H7	6471	840
			OZA577-H13	6475	225
			OZA577-H15	0064	210
			OZA577-H19	6476	225
			OZA577-H20	6477	405
			OZA577-H22	6483	440
			OZA656-H2	6492	880
			OZA656-H5	6494	530
		OZA656-H6	6495	530	
		OZA668-EE13	7952	245	

NTK	ORDER STOCK	mm
AZD0101-HG001	6539	700
AZD0101-HG002	6540	750
AZD0101-HG003	6541	450
AZD0101-HG004	6543	640
OZA333-H16	6456	510

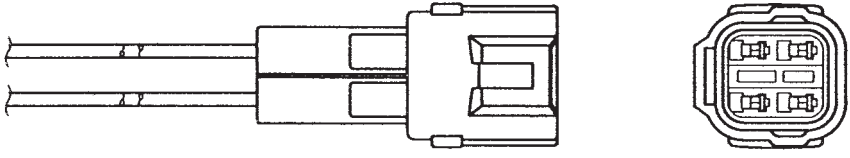
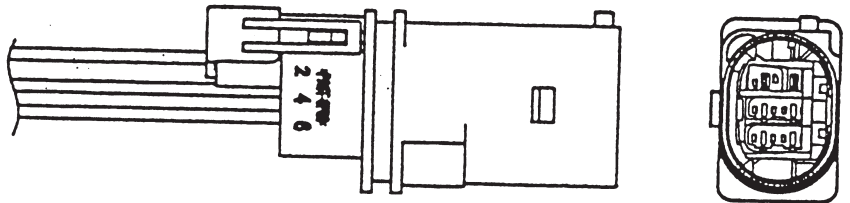
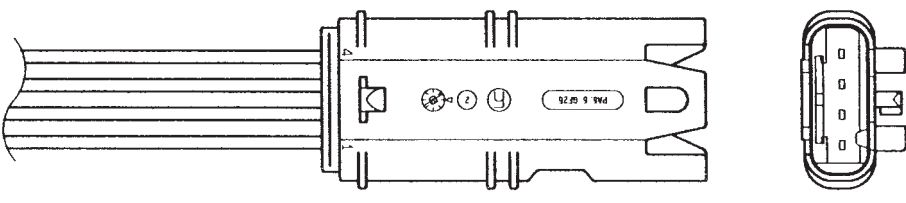
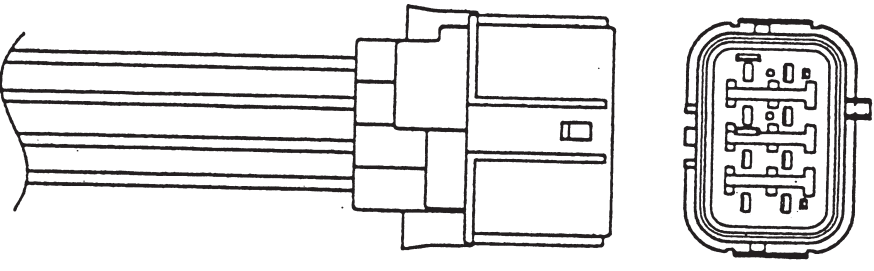
STECKERABBILDUNG CONNECTORS Вид штекера BAĞLANTI RESMİ	CONNECTEURS CONNETTORI Εικόνα φίς	CONECTORES KOŃCÓWKI PRZYŁĄCZENIOWE STEKKERAFBEELDING	NTK	ORDER STOCK	mm
<div style="text-align: center;"> 97 </div> 			OZA591-UB1	0067	640
			OZA591-UB2	0008	535
			OZA591-VB2	0009	500
			OZA591-WB1	0010	410
<div style="text-align: center;"> 98 </div> 			LZA07-AU2	0026	830
<div style="text-align: center;"> 99 </div> 			OZA630-BM1	0072	231
			OZA630-BM2	0073	521
<div style="text-align: center;"> 100 </div> 			LZA09-E1	0025	410

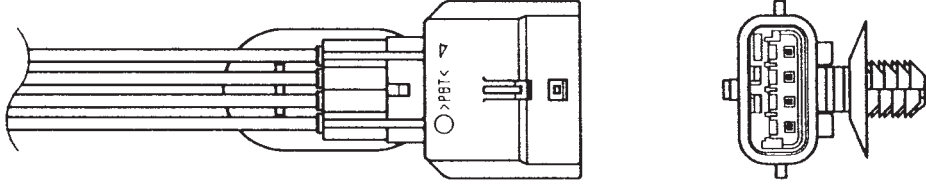
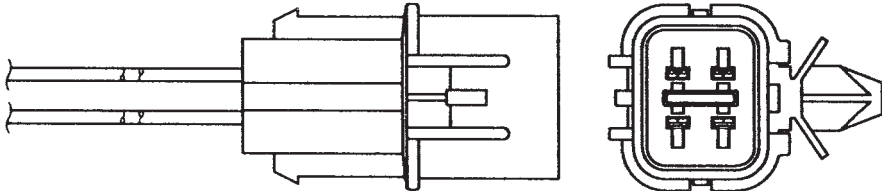
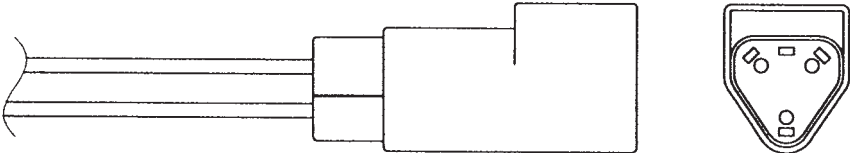
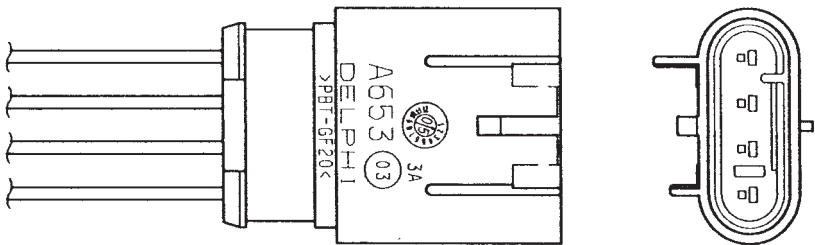
STECKERABBILDUNG CONNECTORS Вид штекера BAĞLANTI RESMİ	CONNECTEURS CONNETTORI Εικόνα φικς	CONECTORES KOŃCÓWKI PRZYŁĄCZENIOWE STEKKERAFBEELDING	NTK	ORDER STOCK	mm
<p>101</p> 	OZA277-R3	6514	239		
	OZA507-R5	6517	424		
	OZA603-R2	0013	434		
<p>102</p> 	OZA610-W2	0014	380		
	OZA610-W5	0015	350		
<p>103</p> 	OTD5F-3E1	0023	876		
<p>104</p> 	OZA532-A12	0056	310		
	OZA641-A1	1726	310		

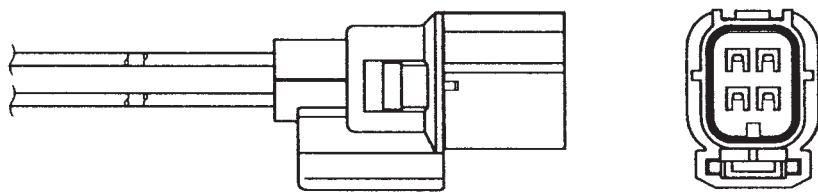
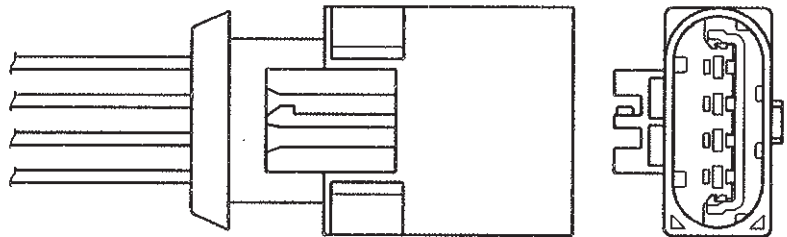
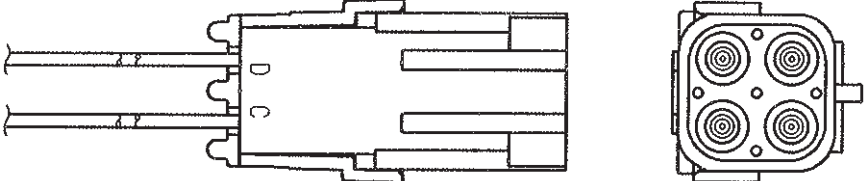
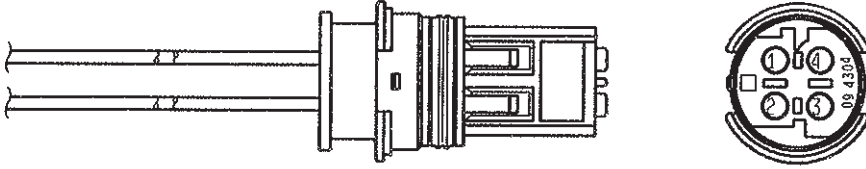
STECKERABBILDUNG CONNECTORS Вид штекера BAĞLANTI RESMİ	CONNECTEURS CONNETTORI Εικόνα φις	CONECTORES KOŃCÓWKI PRZYŁĄCZENIOWE STEKKERAFBEELDING	NTK	ORDER STOCK	mm
105 			AZD0102-HG009	6576	930
			OZA635-H1	0075	275
			OZA635-H4	0076	335
106 			OZA659-EE2	0376	540
107 			OZA659-EE41	1628	415
			OZA660-EE1	5653	400
108 			OZA659-EE48	5752	600

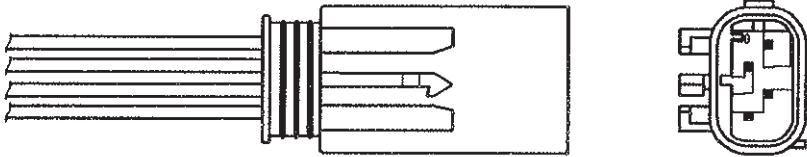
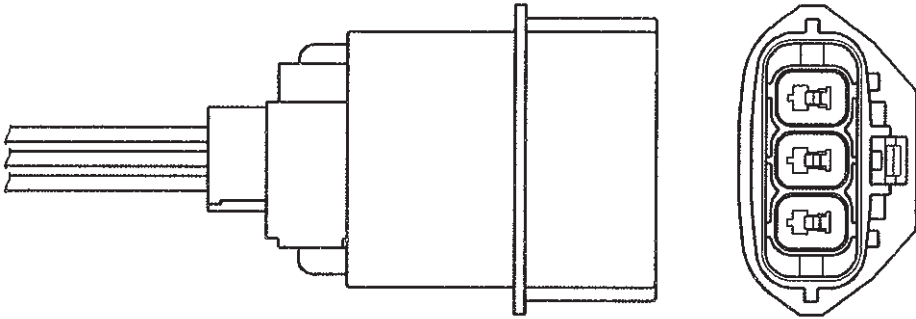
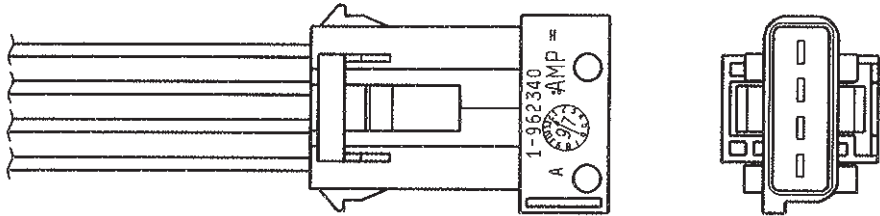
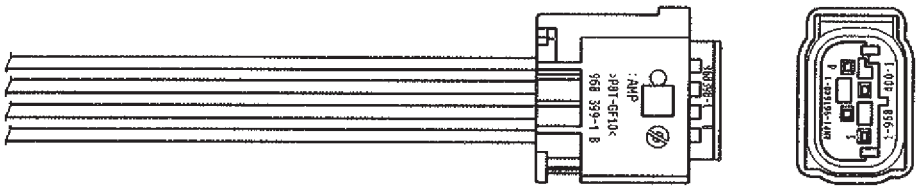
STECKERABBILDUNG CONNECTORS Вид штекера BAĞLANTI RESMİ	CONNECTEURS CONNETTORI Εικόνα φικς	CONECTORES KOŃCÓWKI PRZYŁĄCZENIOWE STEKKERAFBEELDING	NTK	ORDER STOCK	mm
<p>109</p> 			OZA659-EE50	5754	510
<p>110</p> 			OZA660-EE6	5680	325
<p>111</p> 			OZA660-EE23	5737	535
			OZA660-EE24	5739	1230
<p>112</p> 			OZA659-EE45	5747	745

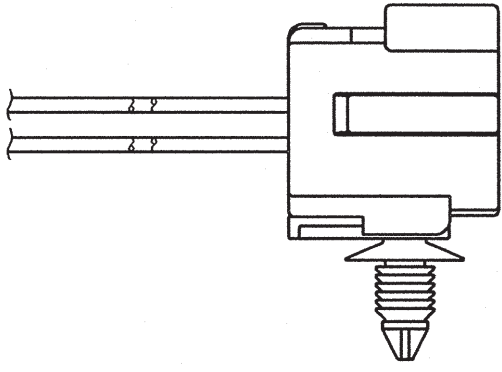
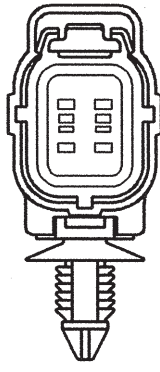
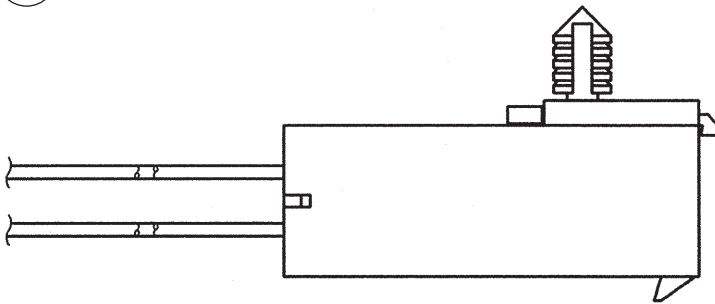
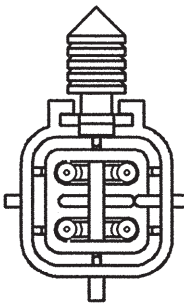
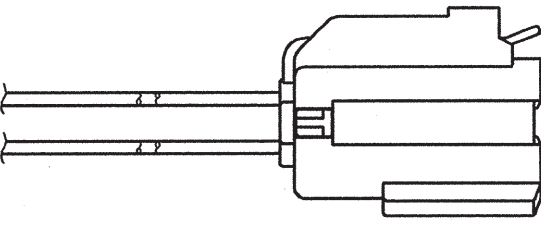
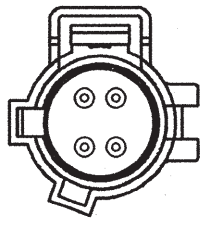
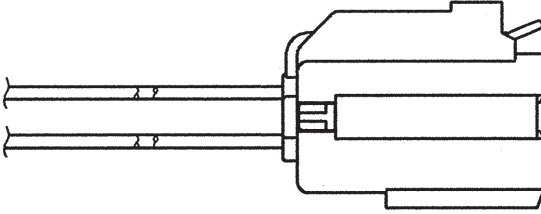
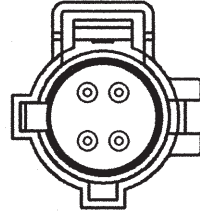
STECKERABBILDUNG CONNECTORS Вид штекера BAĞLANTI RESMİ	CONNECTEURS CONNETTORI Εικόνα φικς	CONECTORES KOŃCÓWKI PRZYŁĄCZENIOWE STEKKERAFBEELDING	NTK	ORDER STOCK	mm
113 			OZA341-W1	6408	220
114 			OZA28-C3	6380	590
115 			OZA248-C1	6381	457
			OZA521-C8	6383	380
116 			OZA571-C4	6385	300

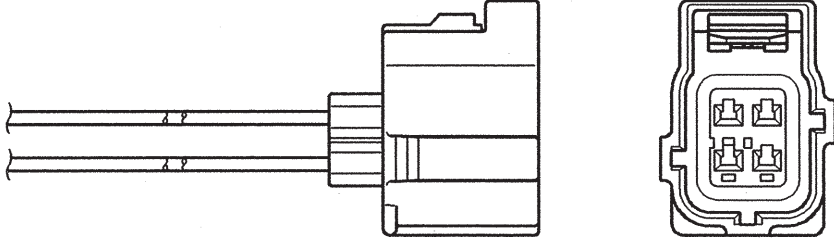
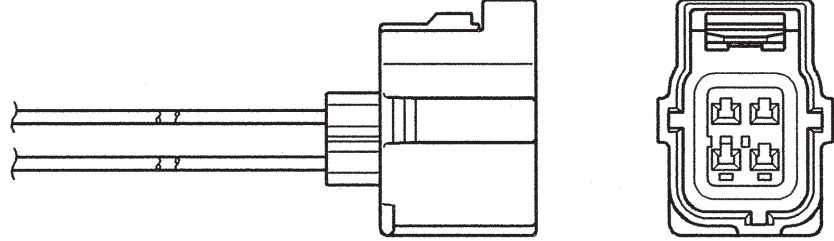
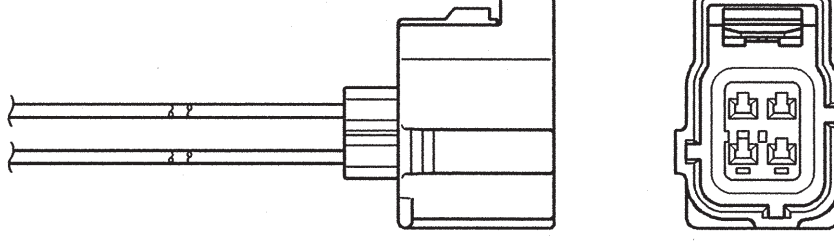
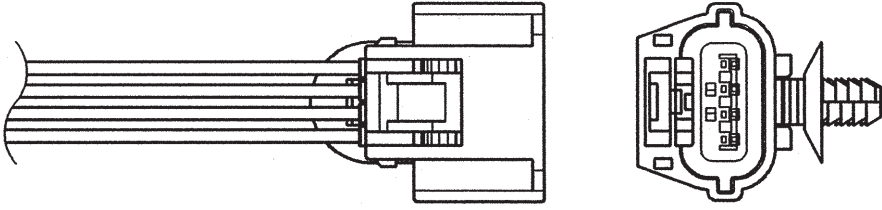
STECKERABBILDUNG CONNECTORS Вид штекера BAĞLANTI RESMİ	CONNECTEURS CONNETTORI Εικόνα φικς	CONECTORES KOŃCÓWKI PRZYŁĄCZENIOWE STEKKEAFBEELDING	NTK	ORDER STOCK	mm
<p>117</p> 			OZA571-C7	6396	457
<p>118</p> 			OZA623-C1	6397	300
<p>119</p> 			OZA623-C2	6400	457
<p>120</p> 			OZA603-R3	6518	400

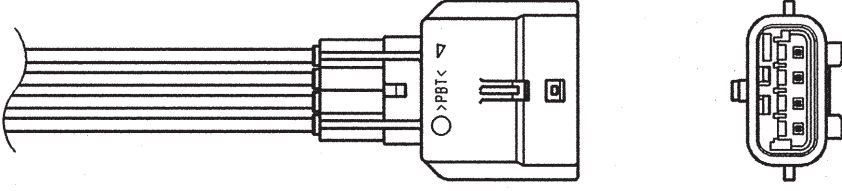
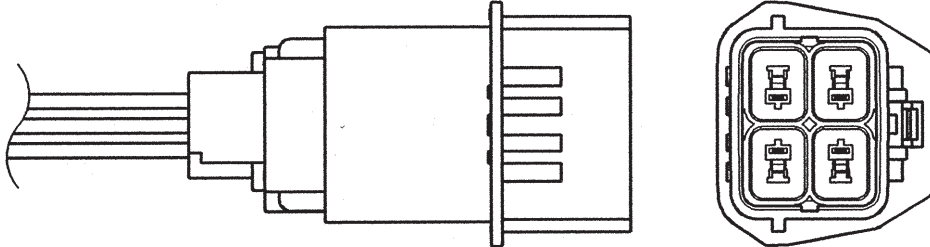
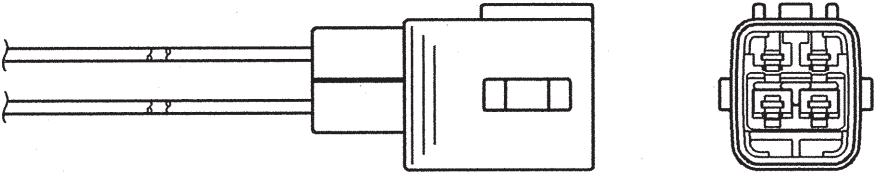
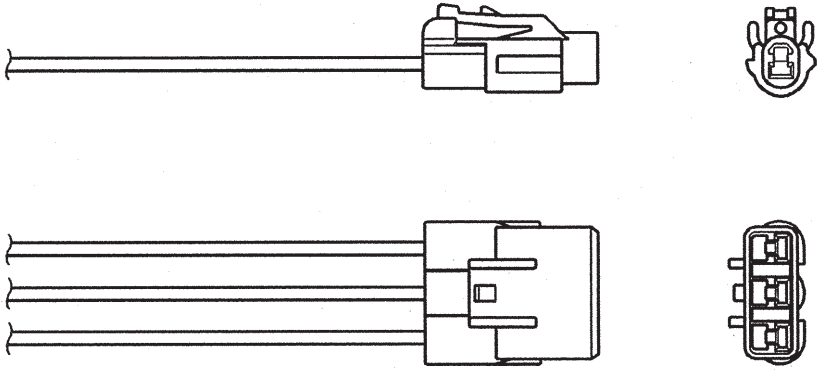
STECKERABBILDUNG CONNECTORS Вид штекера BAĞLANTI RESMİ	CONNECTEURS CONNETTORI Εικόνα φις	CONECTORES KOŃCÓWKI PRZYŁĄCZENIOWE STEKKERAFBEELDING	NTK	ORDER STOCK	mm
<div style="display: flex; justify-content: space-between;"> <div style="width: 15%; text-align: center;"> <p>121</p> </div> <div style="width: 85%;">  </div> </div>	OZA636-R3	6519	424		
<div style="display: flex; justify-content: space-between;"> <div style="width: 15%; text-align: center;"> <p>122</p> </div> <div style="width: 85%;">  </div> </div>	OZA447-E42	1971	350		
<div style="display: flex; justify-content: space-between;"> <div style="width: 15%; text-align: center;"> <p>123</p> </div> <div style="width: 85%;">  </div> </div>	OZA659-EE62	7916	275		
	OZA669-EE9	7954	365		
	OZA669-EE10	7970	315		
<div style="display: flex; justify-content: space-between;"> <div style="width: 15%; text-align: center;"> <p>124</p> </div> <div style="width: 85%;">  </div> </div>	OZA448-J2	6414	480		

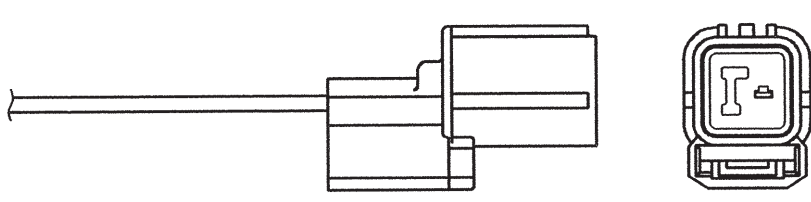
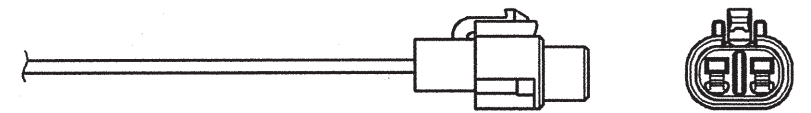
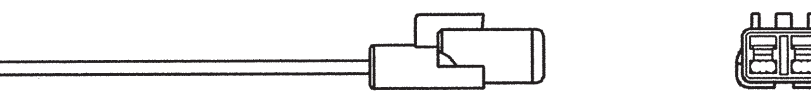
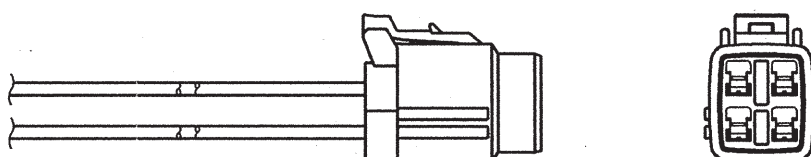
STECKERABBILDUNG CONNECTORS Вид штекера BAĞLANTI RESMİ	CONNECTEURS CONNITORI Εικόνα φικς	CONECTORES KOŃCÓWKI PRZYŁĄCZENIOWE STEKKEAFBEELDING	NTK	ORDER STOCK	mm
<p>125</p> 			OZA218-H2	6455	335
<p>126</p> 			OZA582-J3	6446	370
			OZA582-J4	6447	203
<p>127</p> 			ZSJ0002-HG002	6538	285
<p>128</p> 			AZD0101-SU001	6545	610
			AZD0101-SU002	6547	460
			AZD0101-SU004	7668	235
			AZD0101-SU005	7671	710

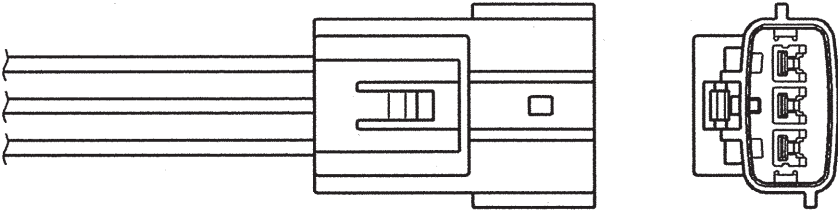
STECKERABBILDUNG CONNECTORS Вид штекера BAĞLANTI RESMİ	CONNECTEURS CONNETTORI Εικόνα φις	CONECTORES KOŃCÓWKI PRZYŁĄCZENIOWE STEKKERAFBEELDING	NTK	ORDER STOCK	mm
129			OZA446-E64	1737	330

PS <---> kW

PS	kW	kW	PS
1	0,736	1	1,360
30	22,065	20	27,192
35	25,742	25	33,991
40	29,420	30	40,789
45	33,097	35	47,587
50	36,775	40	54,385
55	40,452	45	61,183
60	44,130	50	67,981
65	47,807	55	74,779
70	51,485	60	81,577
75	55,162	65	88,375
80	58,840	70	95,173
85	62,517	75	101,972
90	66,195	80	108,770
95	69,872	85	115,568
100	73,550	90	122,366
105	77,227	95	129,162
110	80,905	100	135,962
115	84,582	105	142,760
120	88,260	110	149,558
125	91,937	115	156,356
130	95,615	120	163,154
135	99,292	125	169,953
140	102,970	130	176,751
145	106,647	135	183,549
150	110,325	140	190,347
155	114,002	145	197,145
160	117,680	150	203,943
165	121,357	155	210,741
170	125,035	160	217,539
175	128,712	165	224,337
180	132,390	170	231,135
185	136,067	175	237,934
190	139,745	180	244,732
195	143,422	185	251,530
200	147,100	190	258,328
205	150,777	195	265,126
210	154,455	200	271,924
215	158,132	205	278,722
220	161,810	210	285,520
225	165,487	215	292,318
230	169,165	220	299,116
235	172,842	225	305,915
240	176,520	230	312,713
245	180,197	235	319,511
250	183,875	240	326,309
255	187,552	245	333,107
260	191,230	250	339,905
265	194,907	255	346,703
270	198,585	260	353,501
275	202,263	265	360,299

HANDLING INSTRUCTIONS

- Read enclosed instructions before installation.
- Do not use sensor if it has been dropped.
- Do not store under high temperature and/or high humidity conditions.

INSTALLATION INSTRUCTIONS

- This sensor is designed for the use in automobiles only.
- Use the correct part number as listed in the application catalogue.
- Do not use sensor if it has been dropped.
- Remove protection cap just prior to installation.
- Firstly install sensor body ensuring lead wire is not twisted or bent.
- Do not use impact wrench or socket type wrench to install sensor.

- **M18 sensors** - install finger tight then 1/2 - 3/4 turn with a wrench (35 ~ 45 Nm).

- **M12 sensors** - install finger tight then 3/4 - 1 turn with a wrench (18 ~ 23 Nm).

- Then connect and route lead wire as originally installed.
- Do not allow lead wire to touch exhaust manifold or any other hot component.
- Do not expose this product to water, oil, windshield cleaner, anti-corrosion oil, grease, terminal cleaner etc.
- Do not use leaded fuels, silicone or metal based additives.

Notes





Notes





Notes



NGK SPARK PLUG EUROPE GMBH
Harkortstr. 41
40880 Ratingen
Germany
Tel. +49(0)2102/974-000
Fax +49(0)2102/974-149
www.ngk-europe.com

Сивцев Вражек пер., 25/9 стр.1
119002 Москва
Россия
Тел. +7 (495) 617-02-83
Факс +7 (495) 617-02-85
www.ngk.ru



A 831

Order No. A831

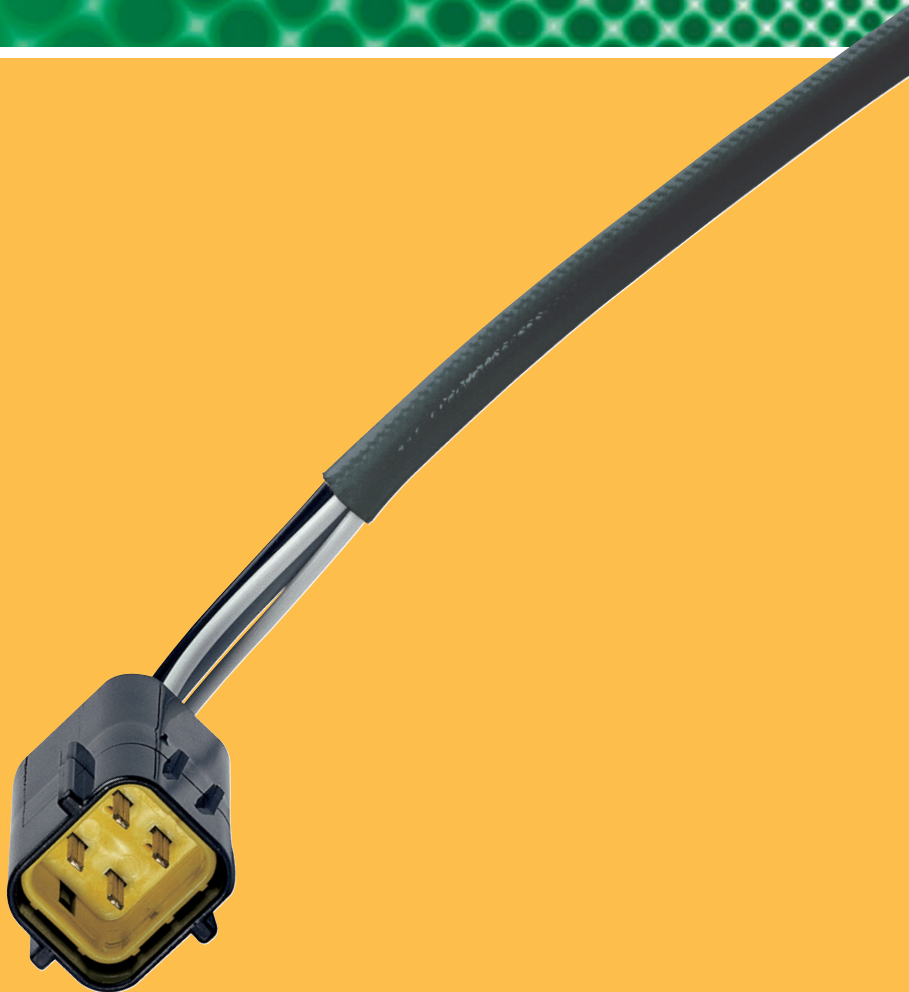

NGK | **NTK**
SPARK PLUGS | TECHNICAL CERAMICS

